

SE079M NEUTRON ACER TENDL-2021 LIBRARY; T=293.6K
Principal cross sections

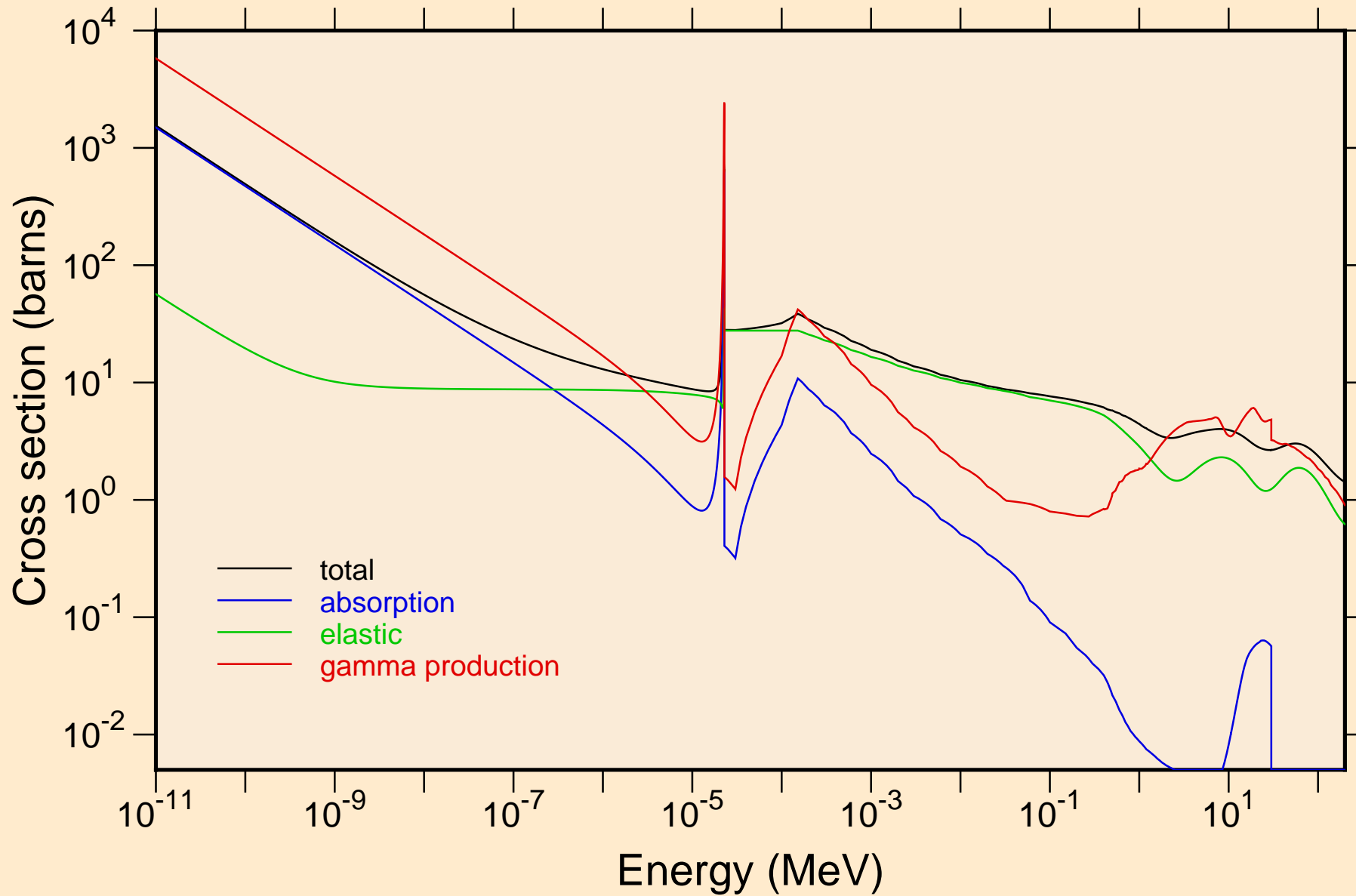

SE079M NEUTRON ACER TENDL-2021 LIBRARY; T=293.6K
Heating

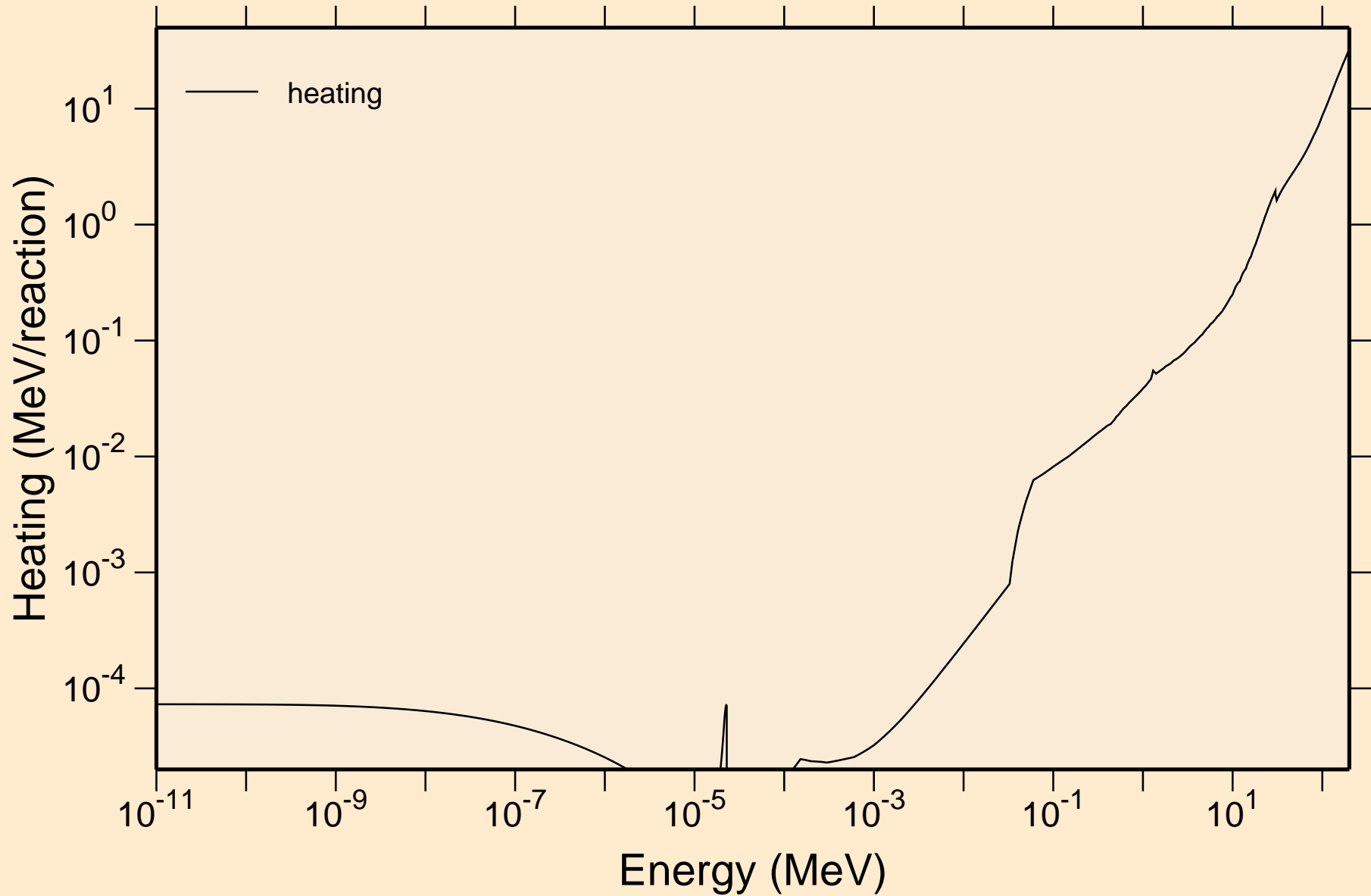

SE079M NEUTRON ACER TENDL-2021 LIBRARY; T=293.6K Damage

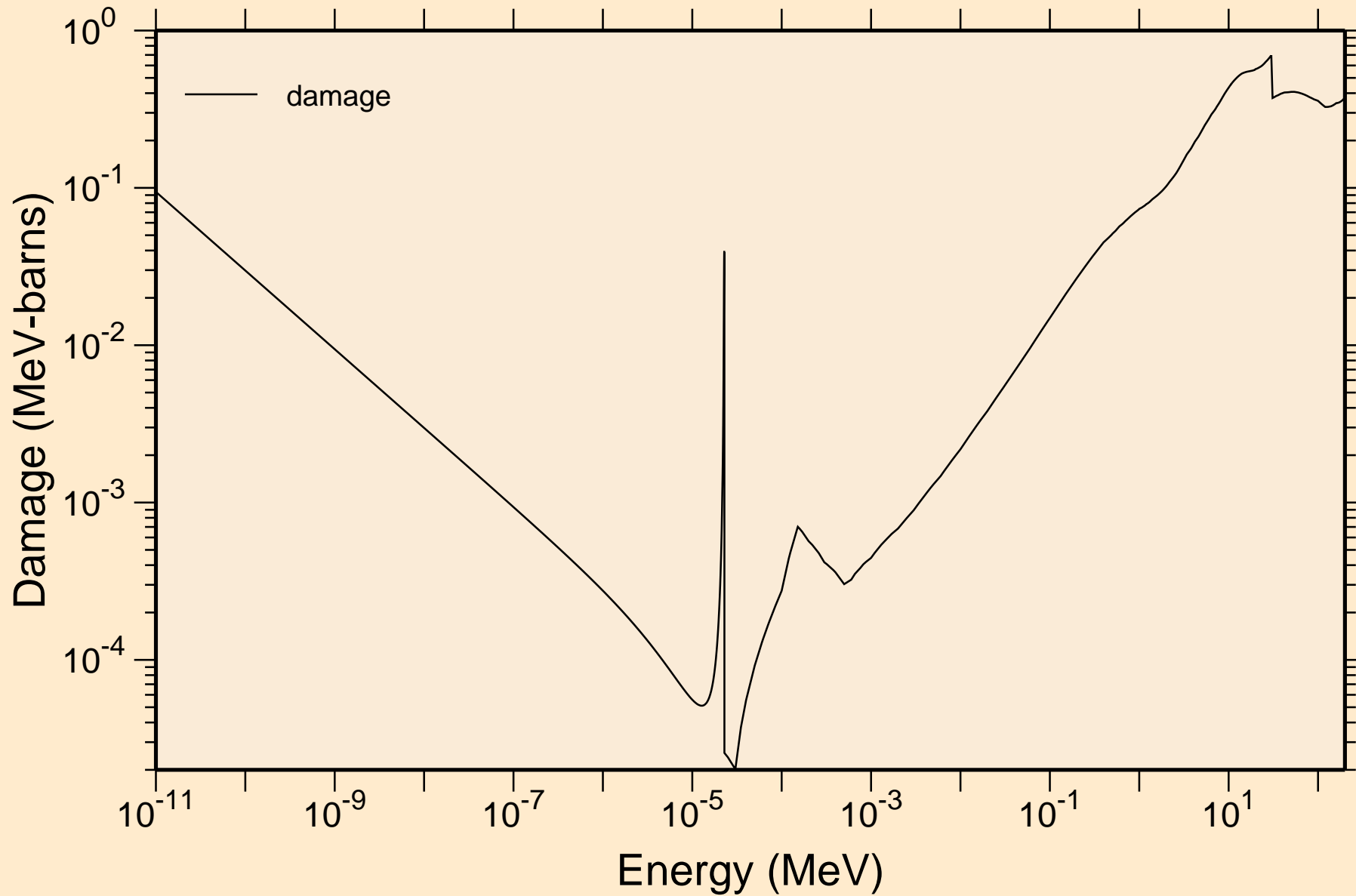

SE079M NEUTRON ACER TENDL-2021 LIBRARY; T=293.6K
Non-threshold reactions

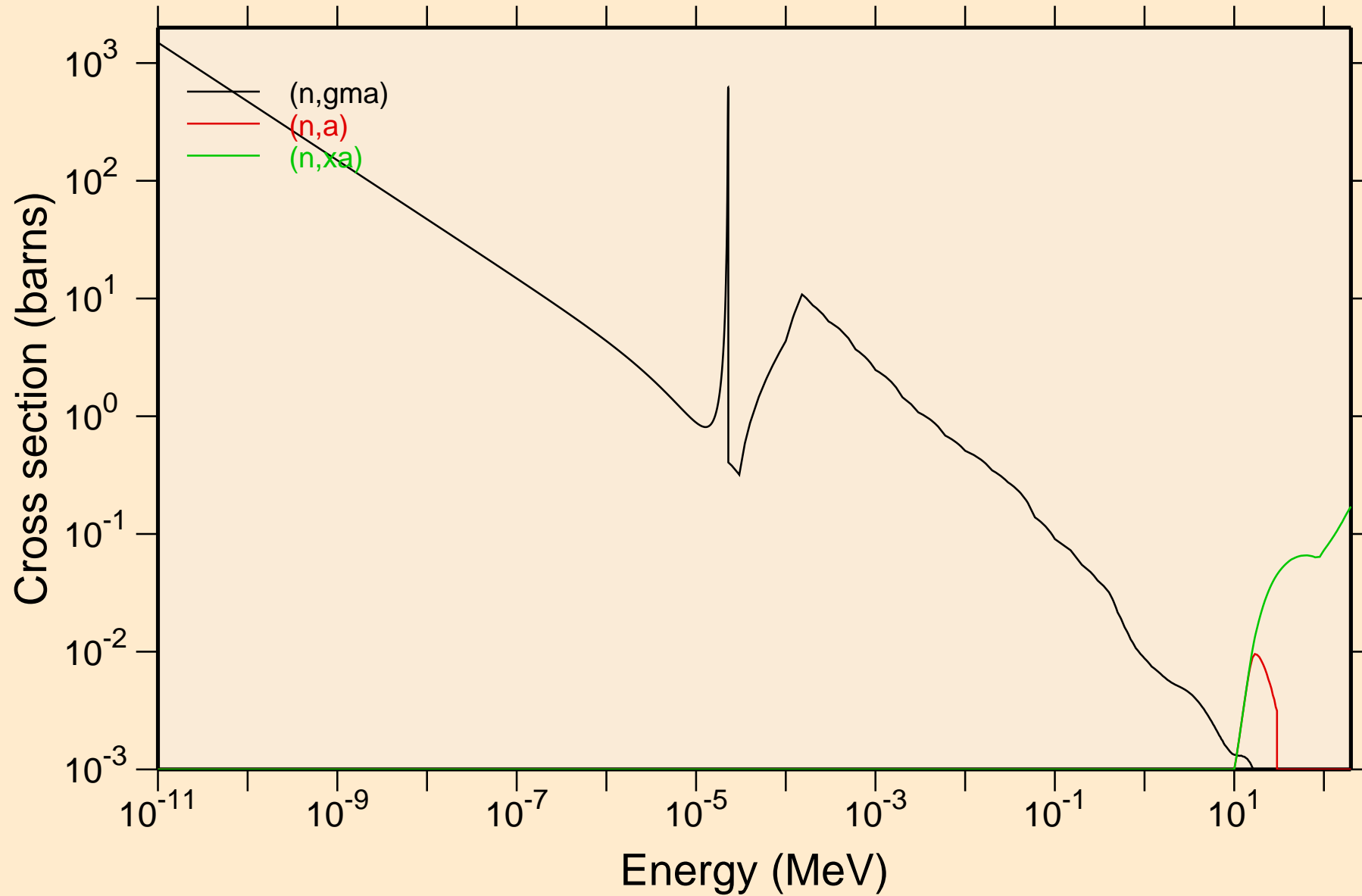

SE079M NEUTRON ACER TENDL-2021 LIBRARY; T=293.6K
Principal cross sections

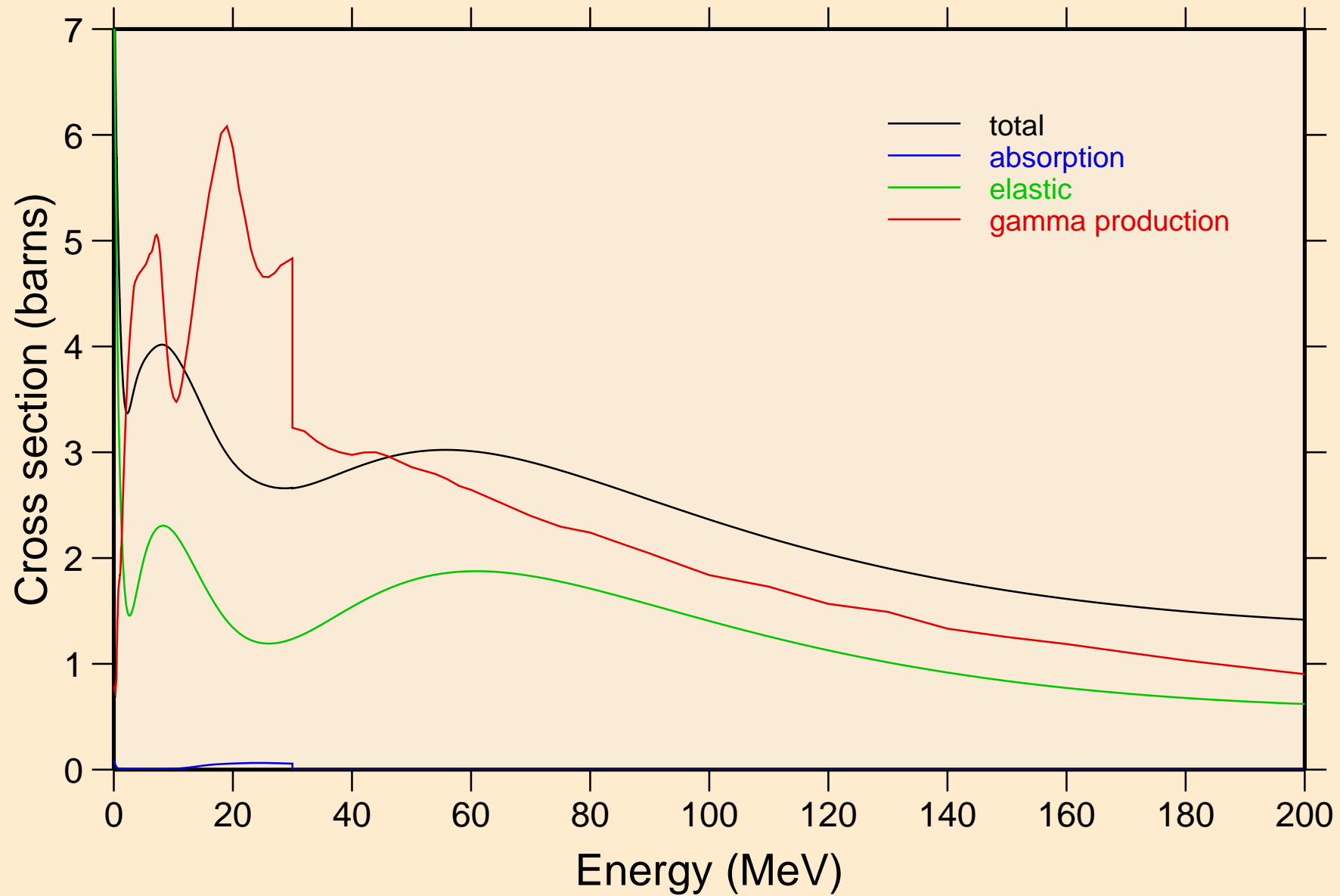

SE079M NEUTRON ACER TENDL-2021 LIBRARY; T=293.6K
Heating

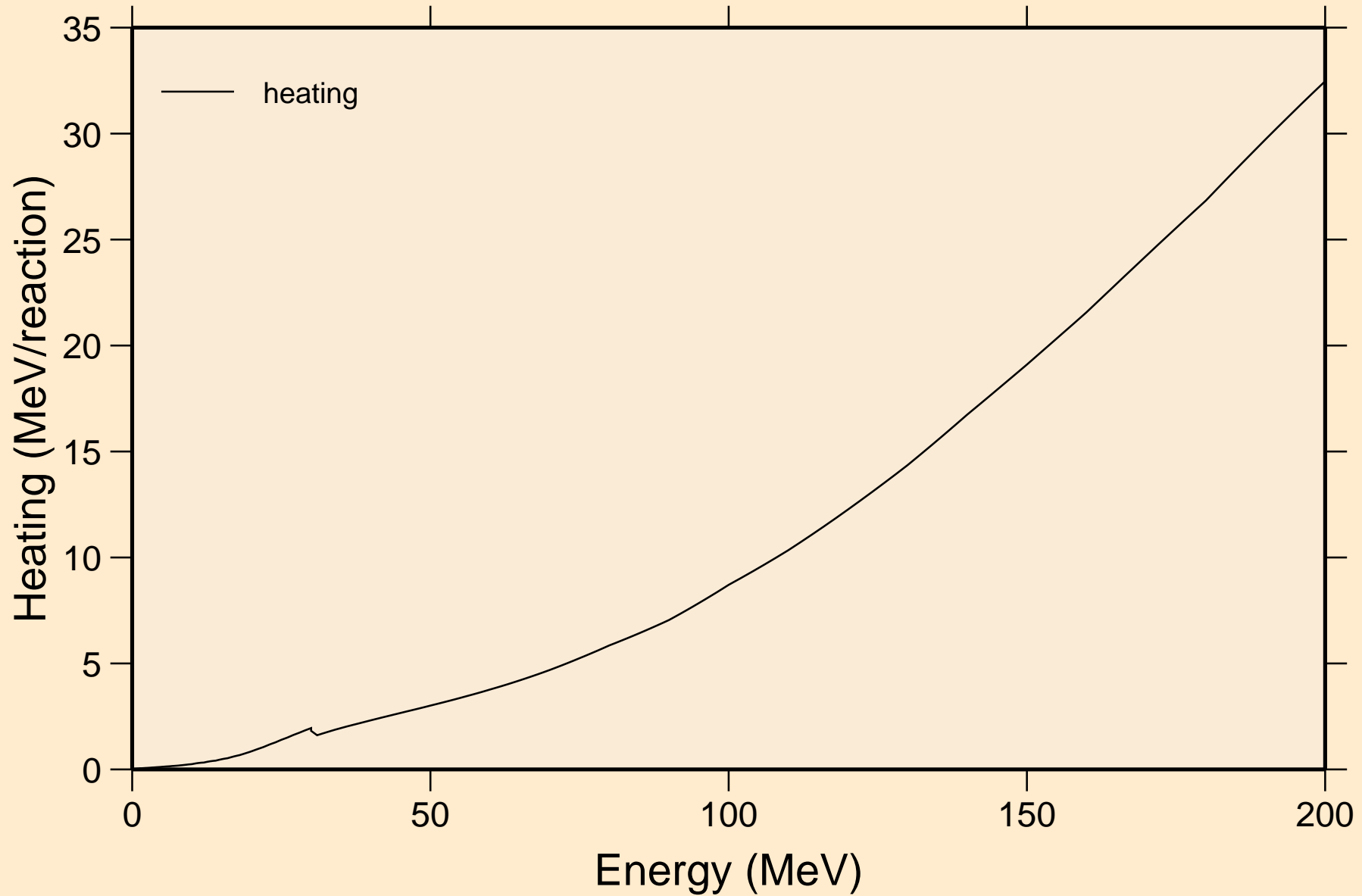

SE079M NEUTRON ACER TENDL-2021 LIBRARY; T=293.6K
Damage

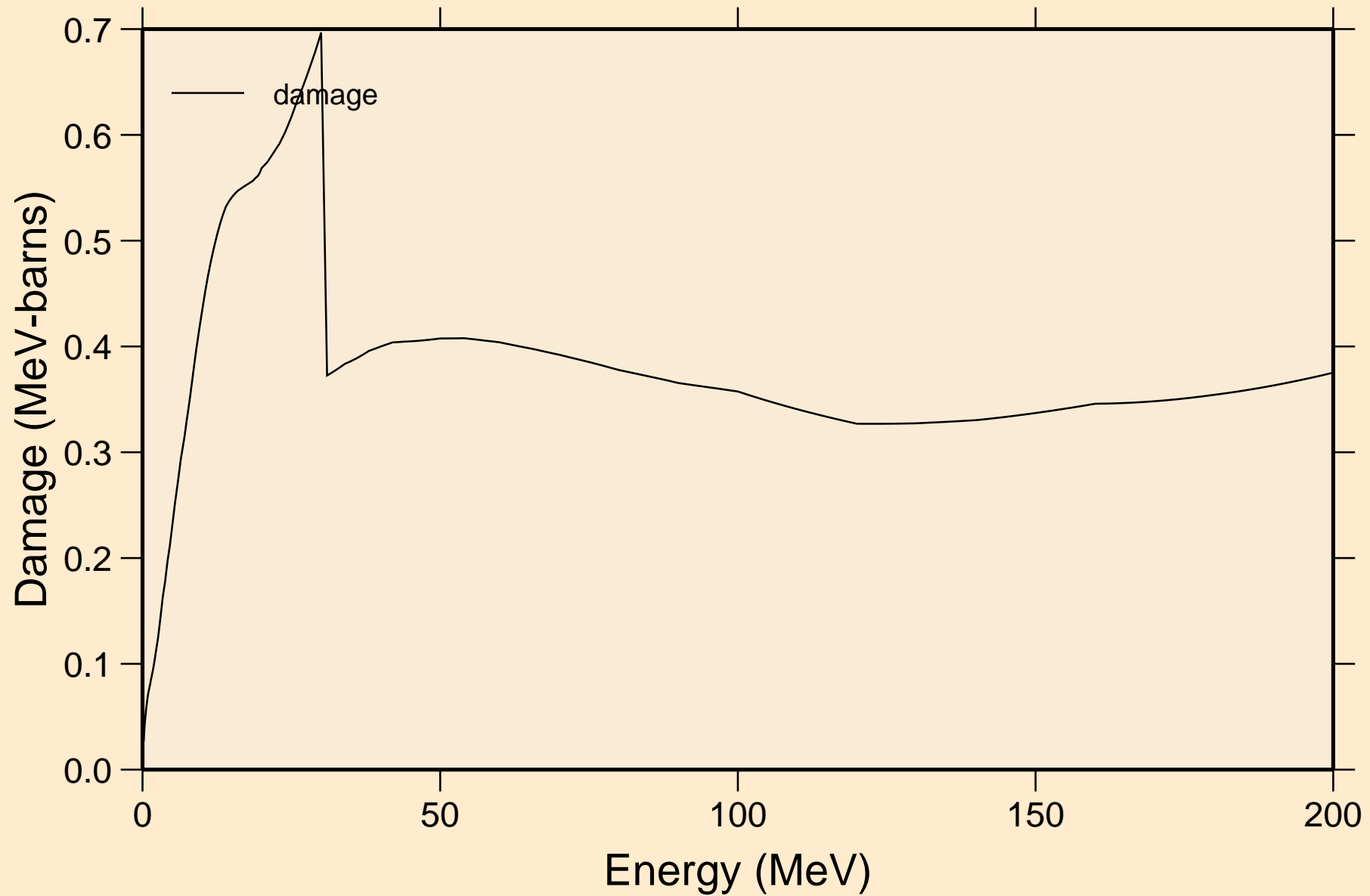

SE079M NEUTRON ACER TENDL-2021 LIBRARY; T=293.6K
Non-threshold reactions

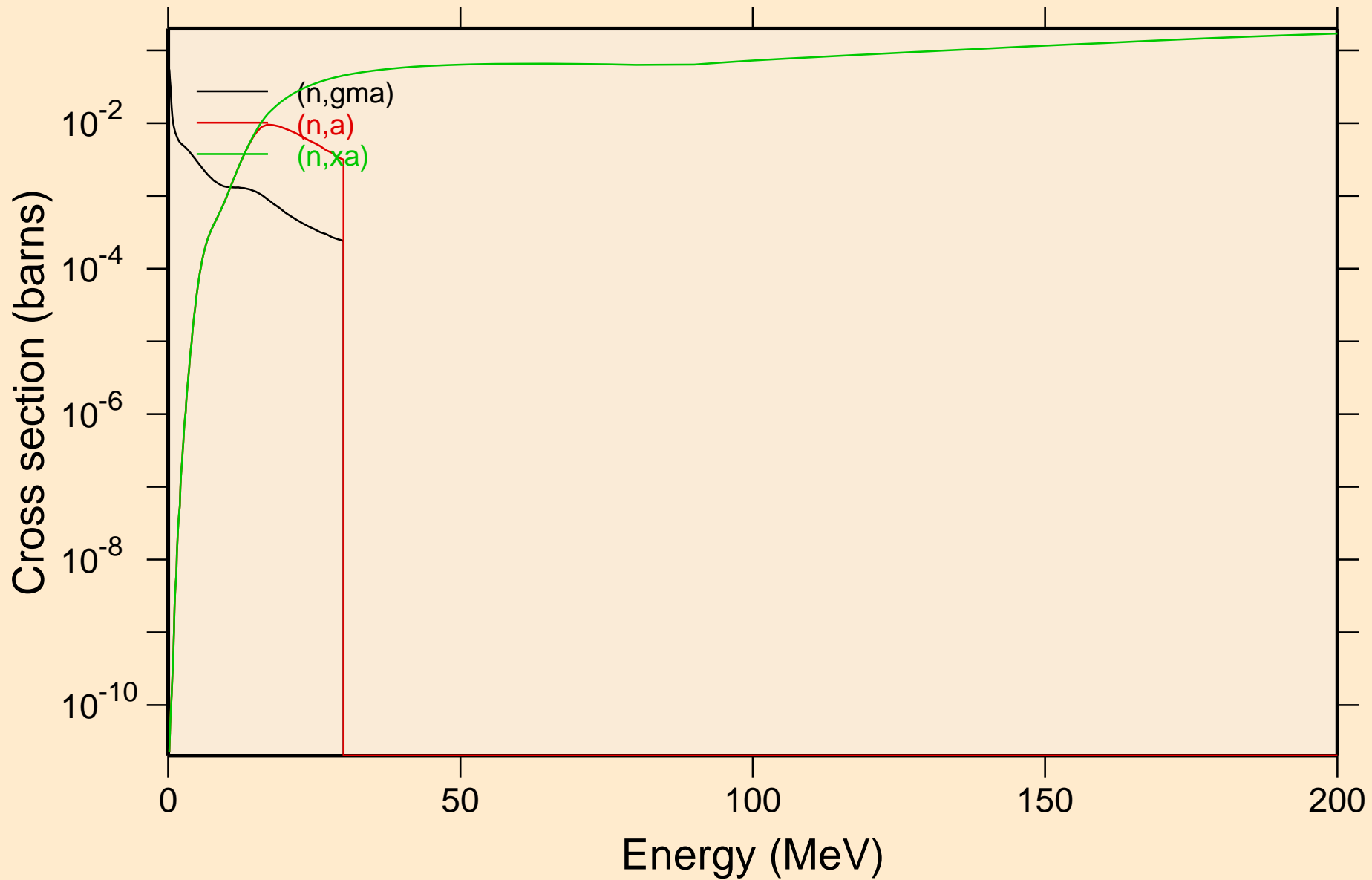

SE079M NEUTRON ACER TENDL-2021 LIBRARY; T=293.6K
Inelastic levels

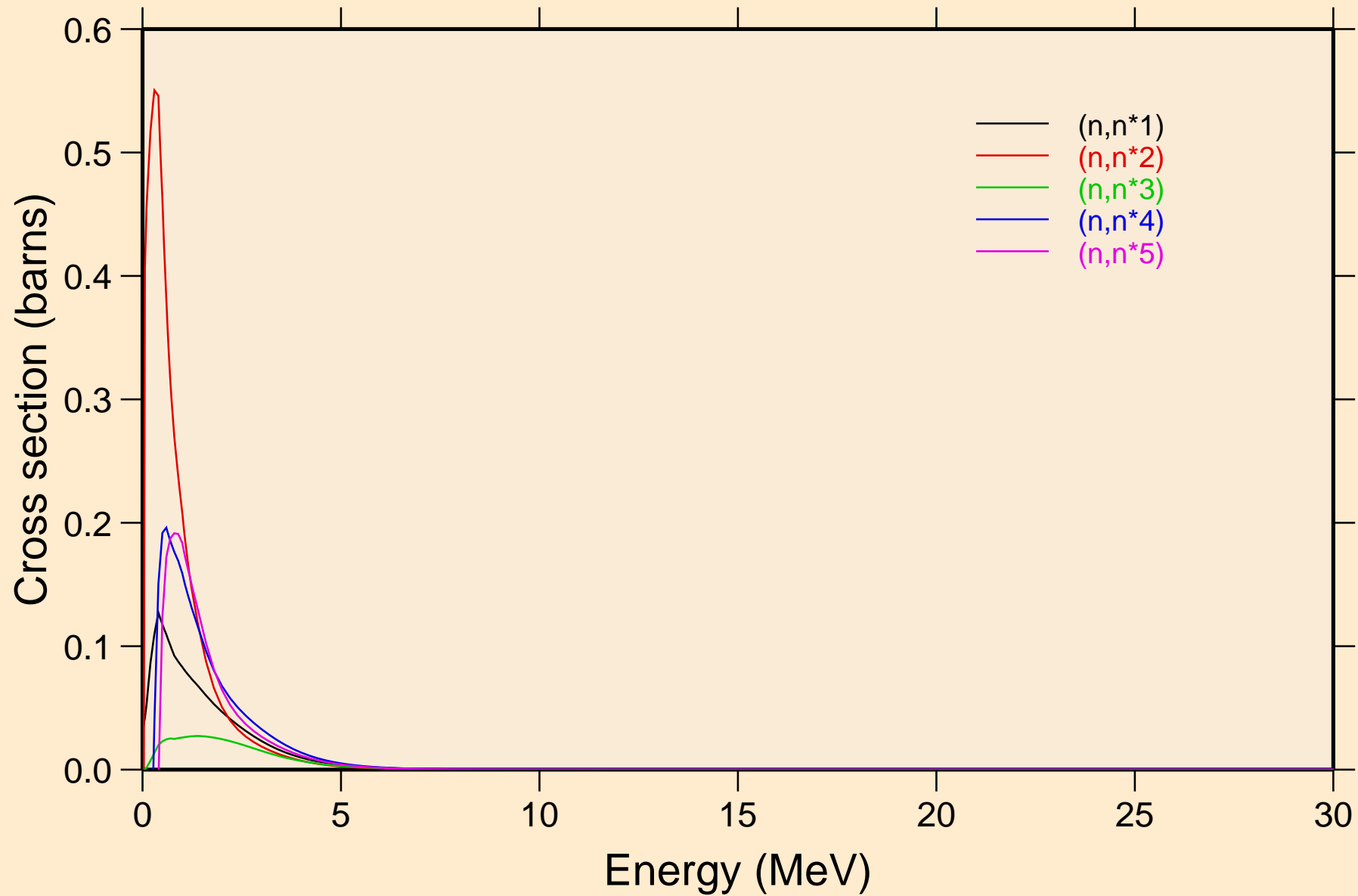

SE079M NEUTRON ACER TENDL-2021 LIBRARY; T=293.6K
Inelastic levels

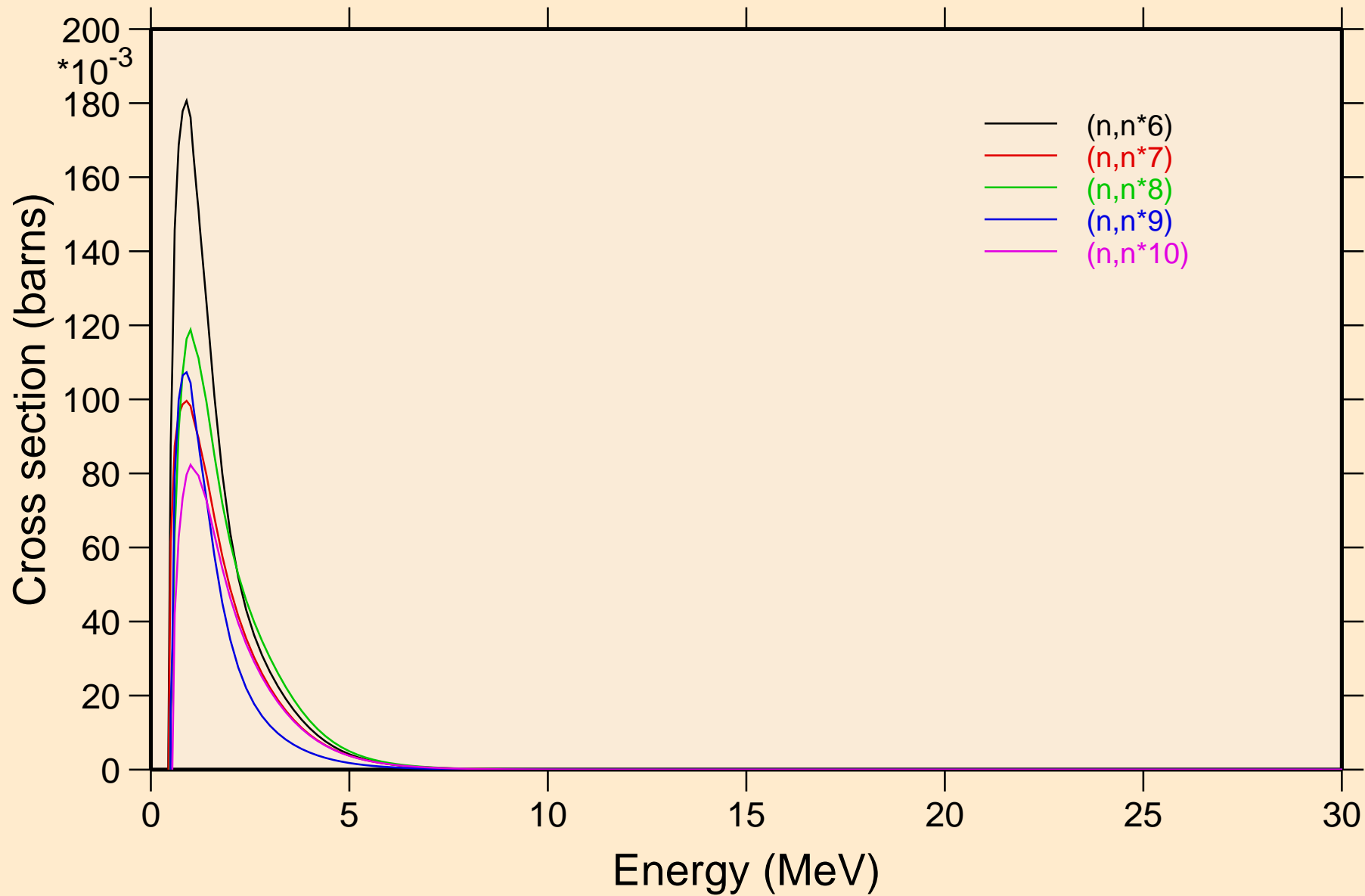

SE079M NEUTRON ACER TENDL-2021 LIBRARY; T=293.6K
Inelastic levels

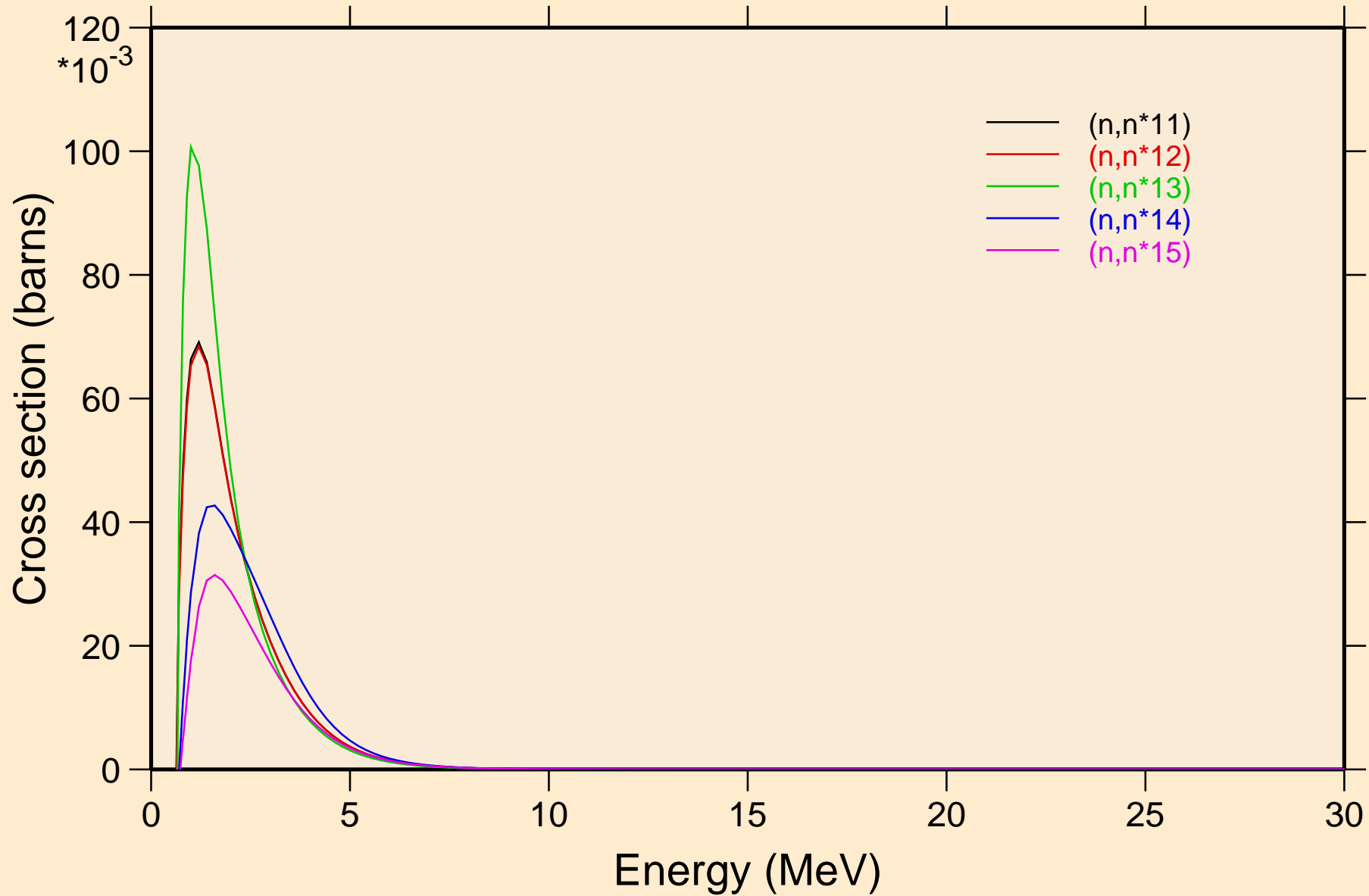

SE079M NEUTRON ACER TENDL-2021 LIBRARY; T=293.6K
Inelastic levels

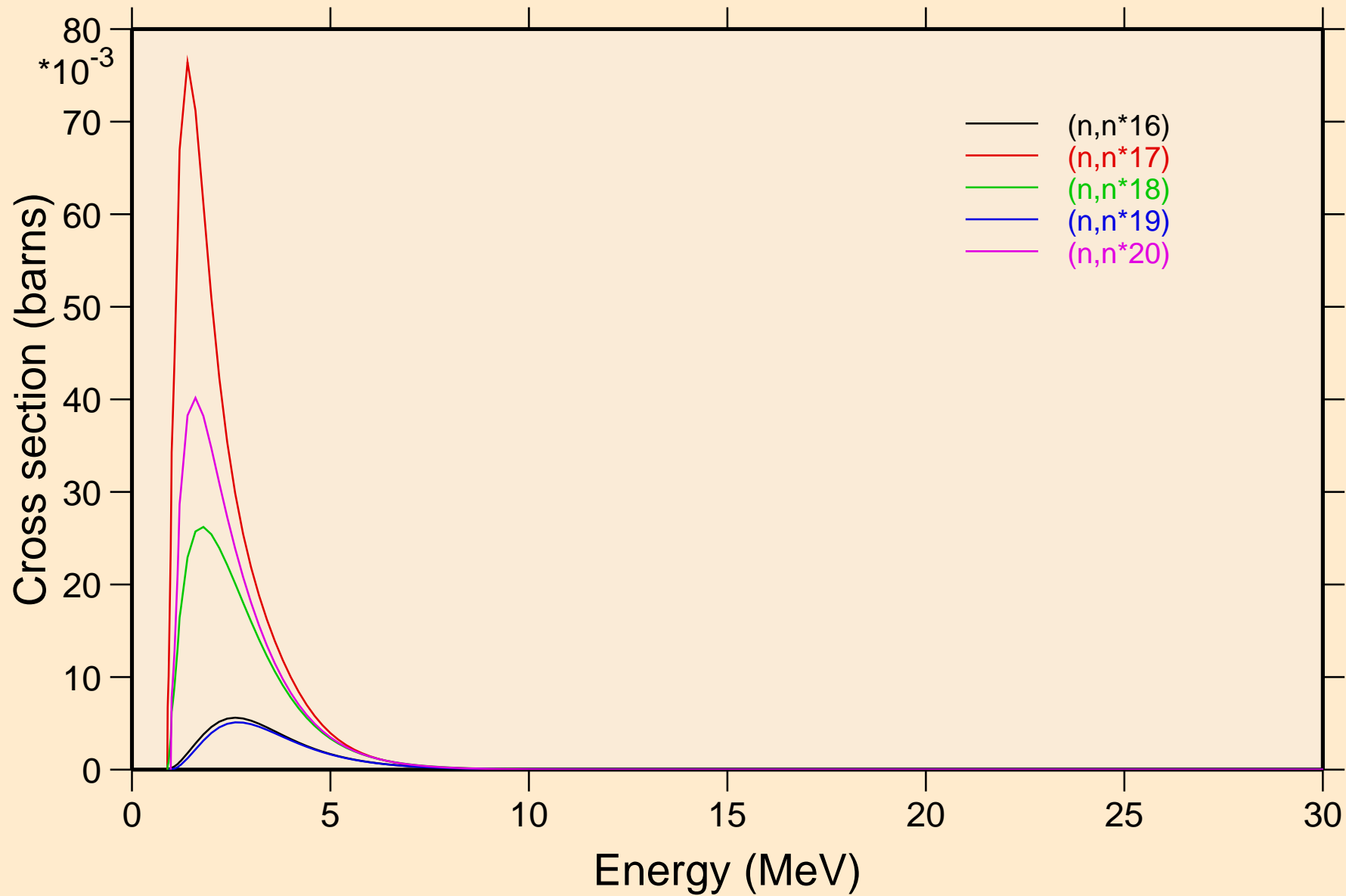

SE079M NEUTRON ACER TENDL-2021 LIBRARY; T=293.6K
Inelastic levels

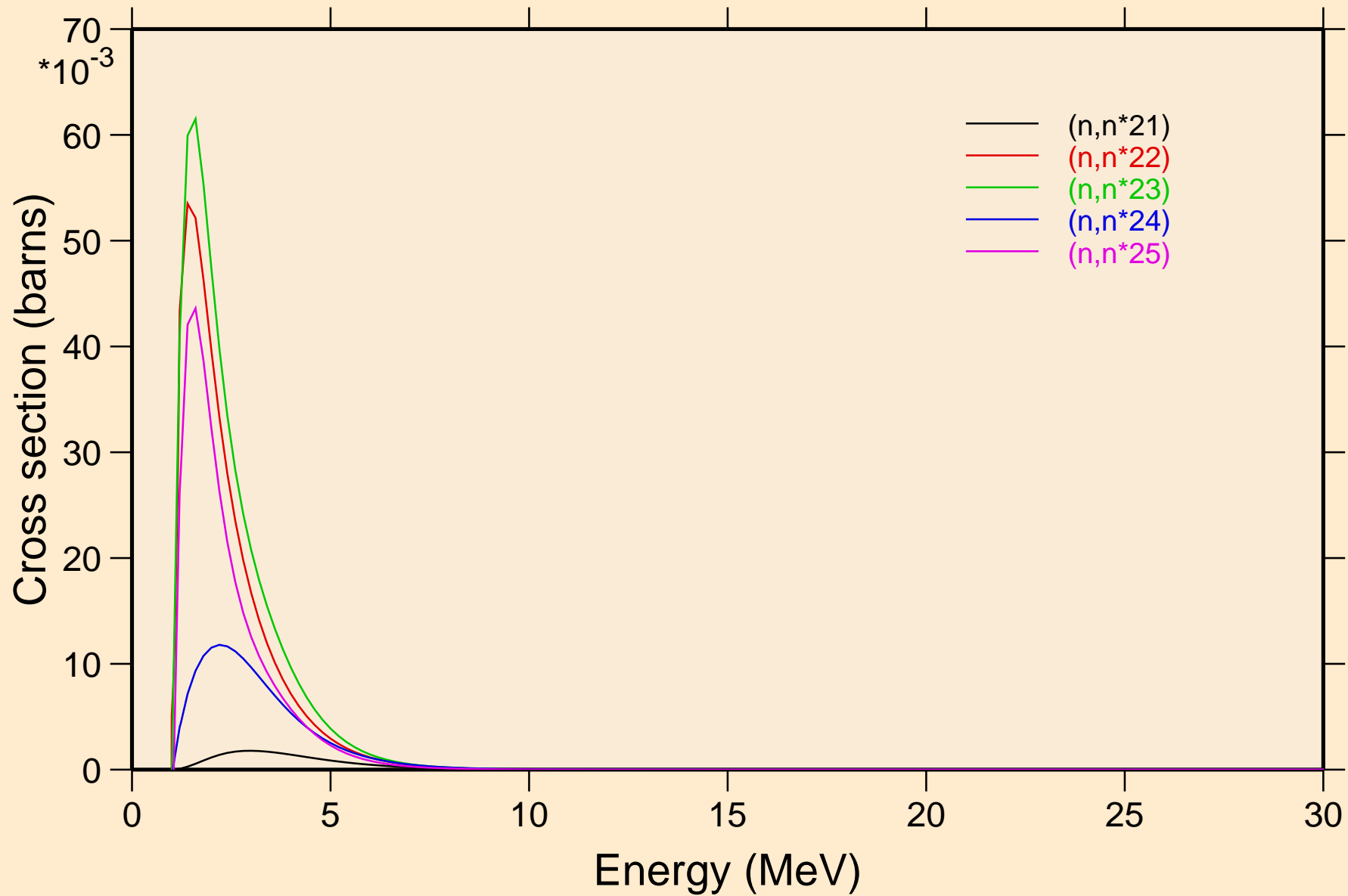

SE079M NEUTRON ACER TENDL-2021 LIBRARY; T=293.6K
Inelastic levels

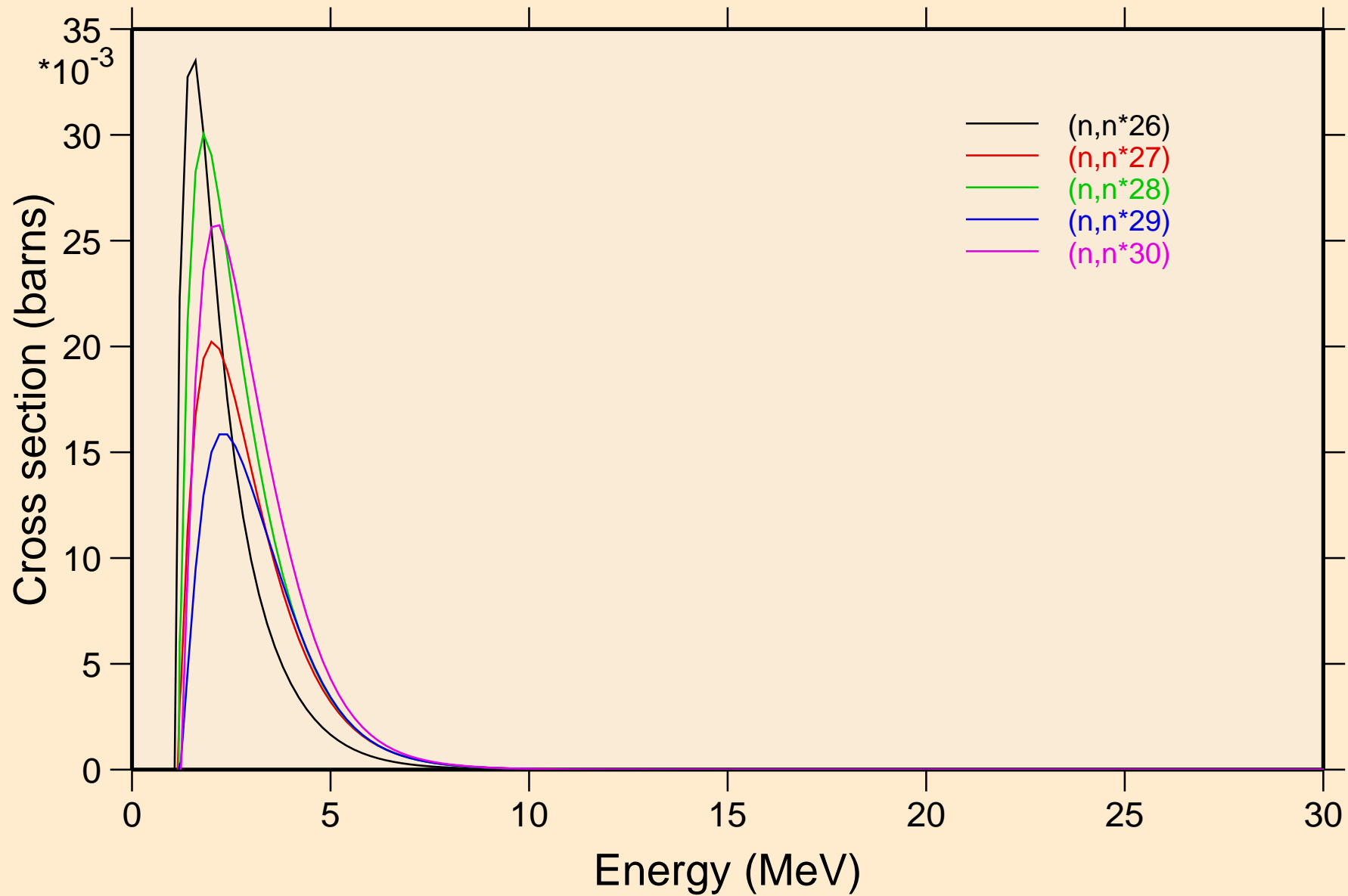

SE079M NEUTRON ACER TENDL-2021 LIBRARY; T=293.6K
Threshold reactions

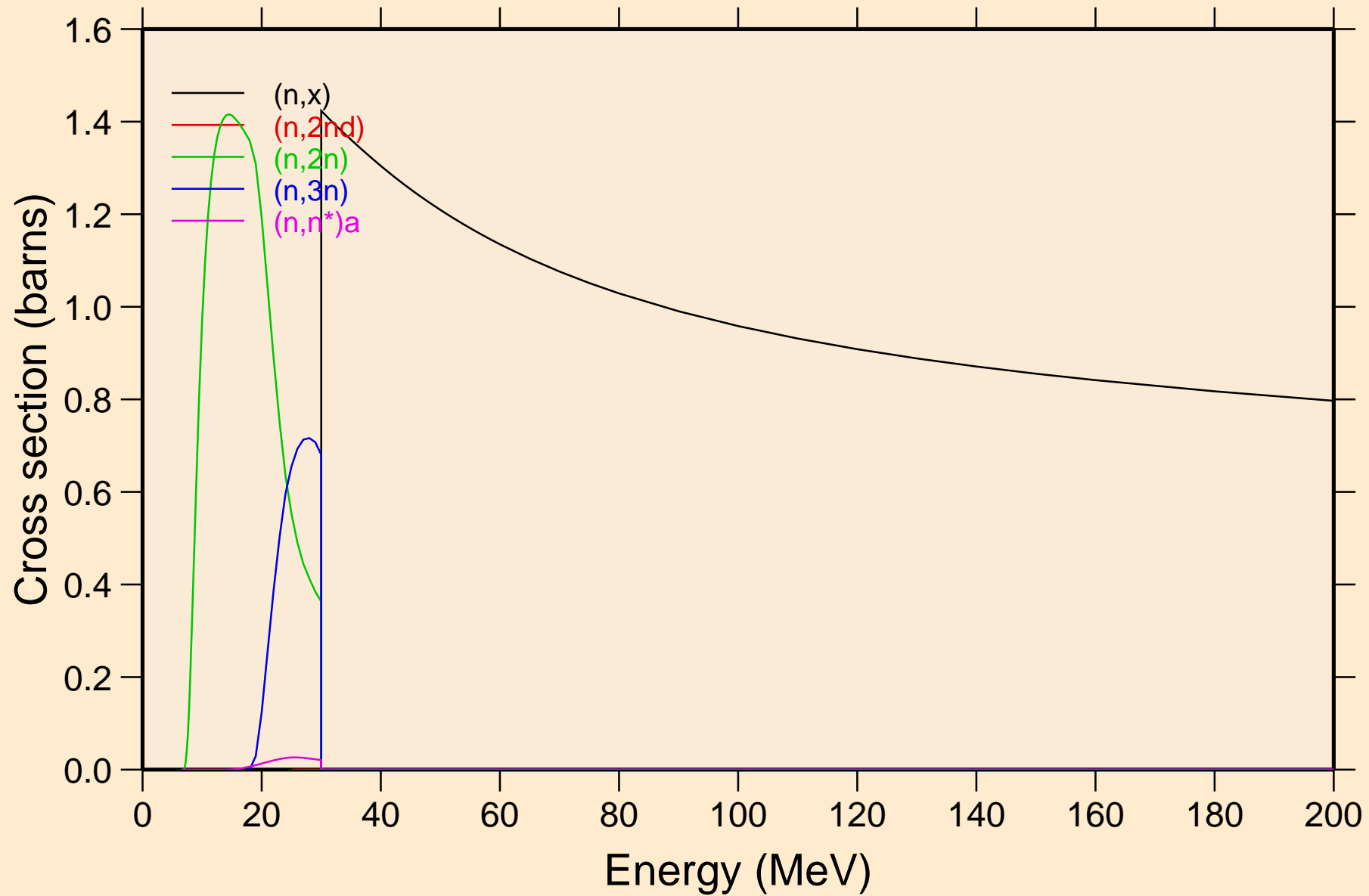

SE079M NEUTRON ACER TENDL-2021 LIBRARY; T=293.6K
Threshold reactions

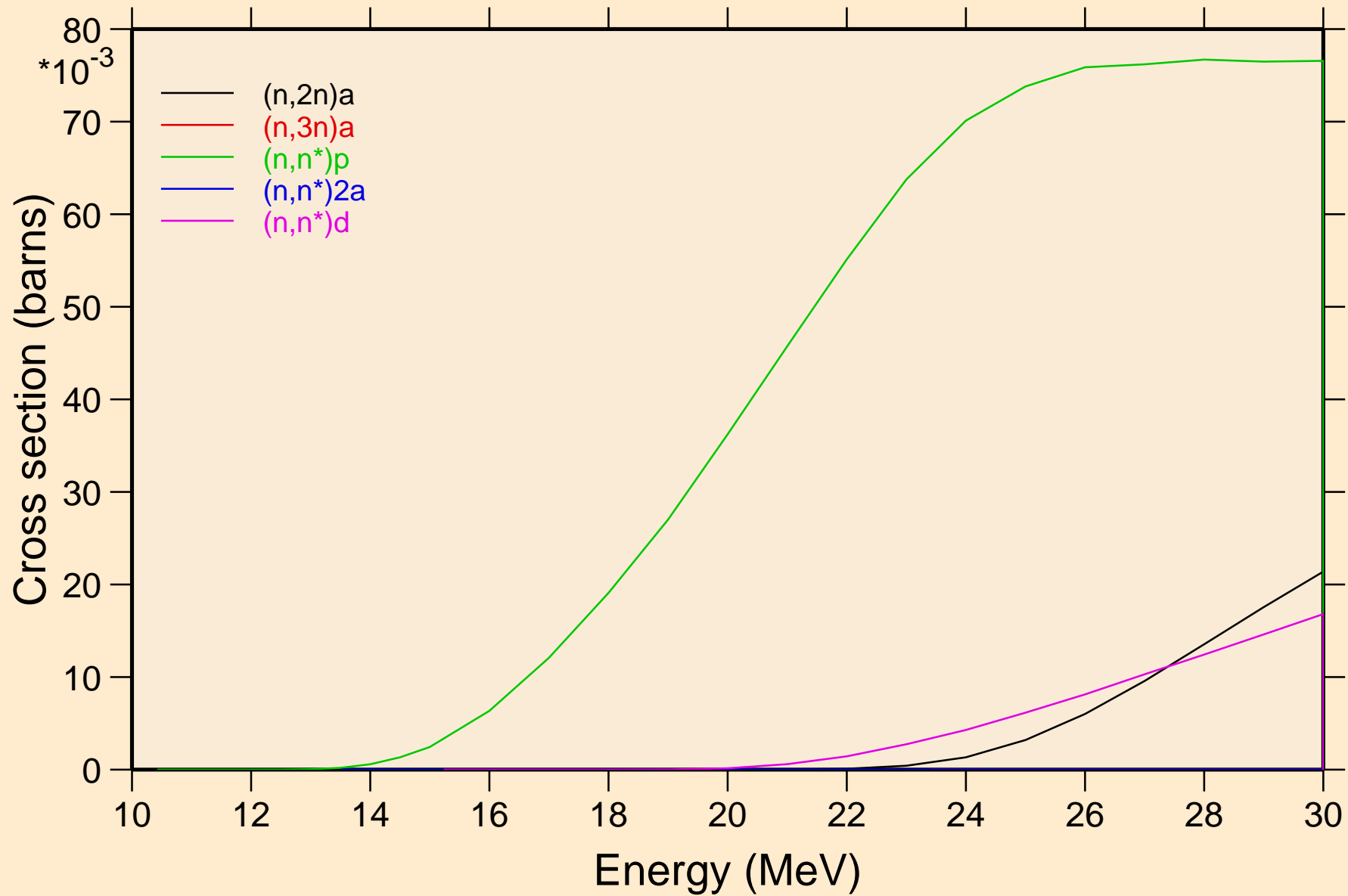

SE079M NEUTRON ACER TENDL-2021 LIBRARY; T=293.6K
Threshold reactions

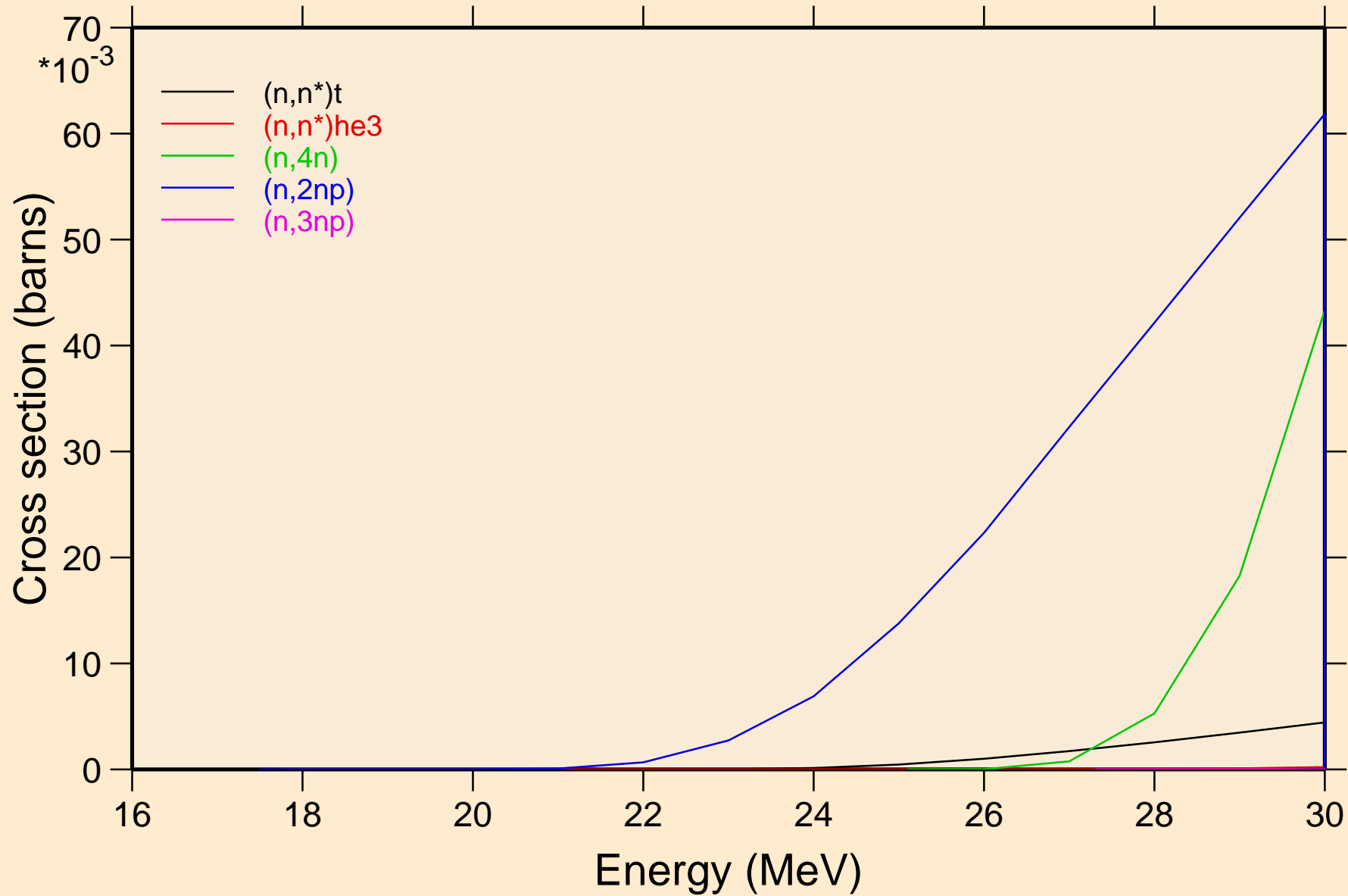

SE079M NEUTRON ACER TENDL-2021 LIBRARY; T=293.6K
Threshold reactions

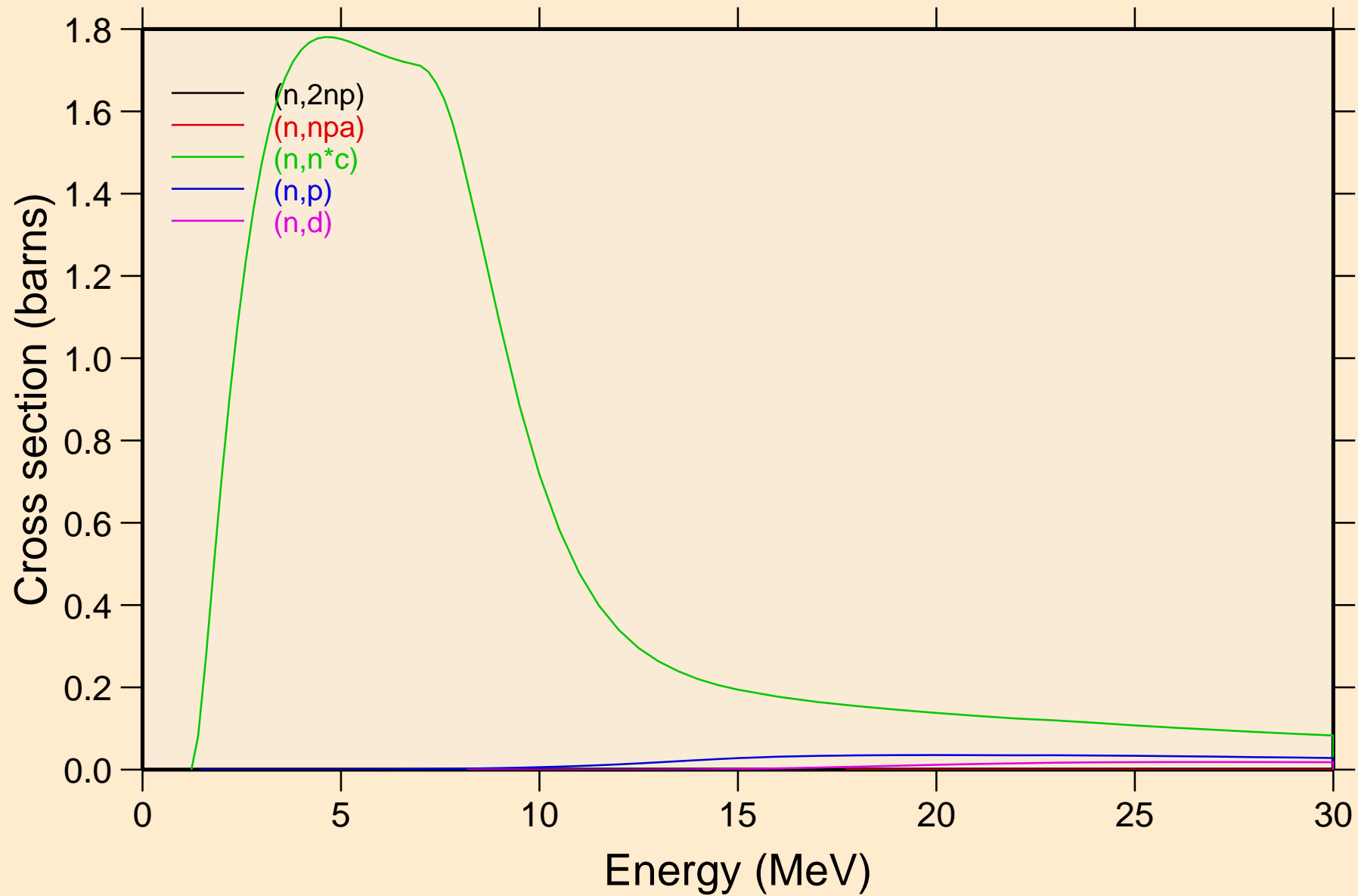

SE079M NEUTRON ACER TENDL-2021 LIBRARY; T=293.6K
Threshold reactions

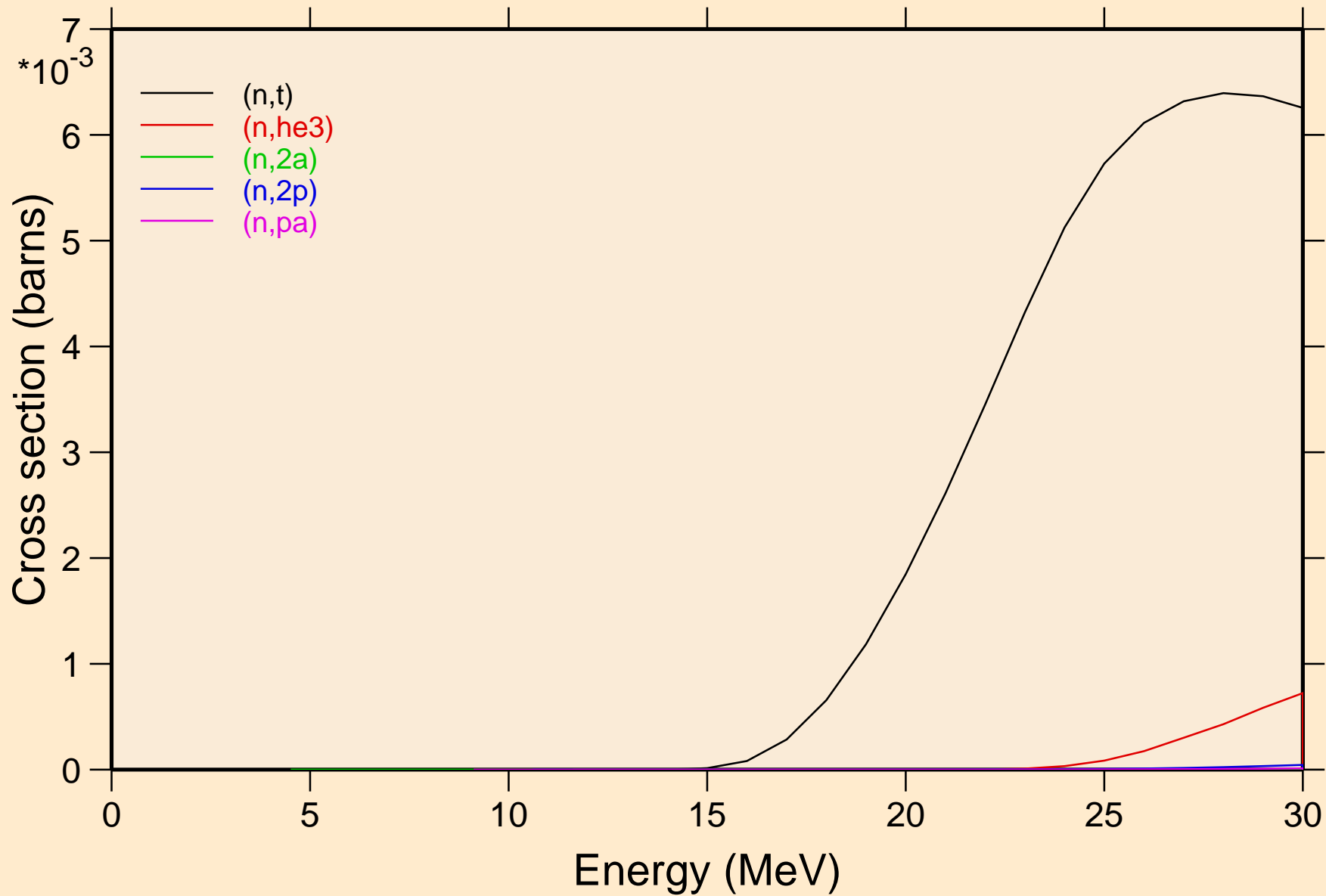

SE079M NEUTRON ACER TENDL-2021 LIBRARY; T=293.6K
Threshold reactions

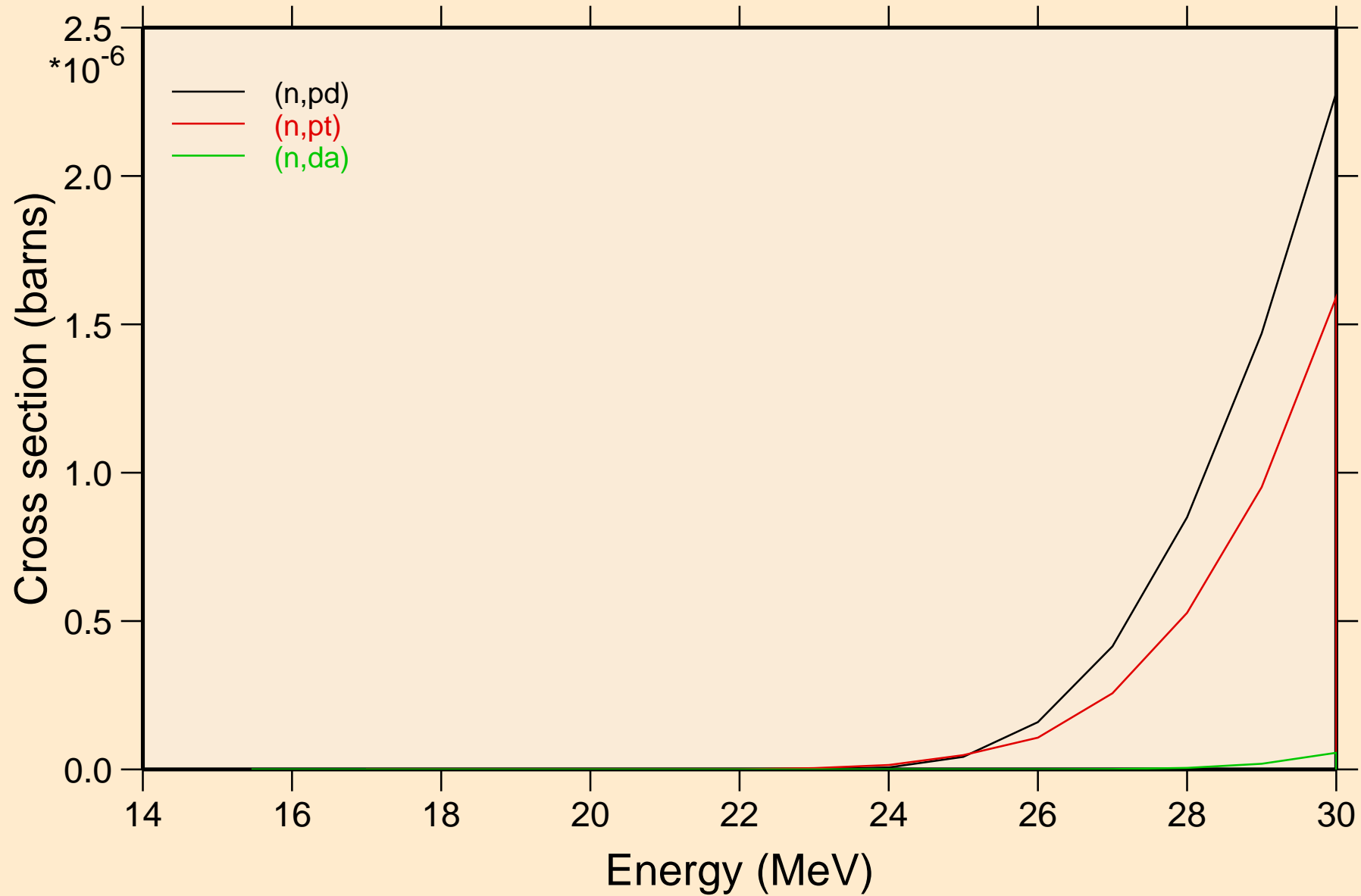

SE079M NEUTRON ACER TENDL-2021 LIBRARY; T=293.6K
Threshold reactions

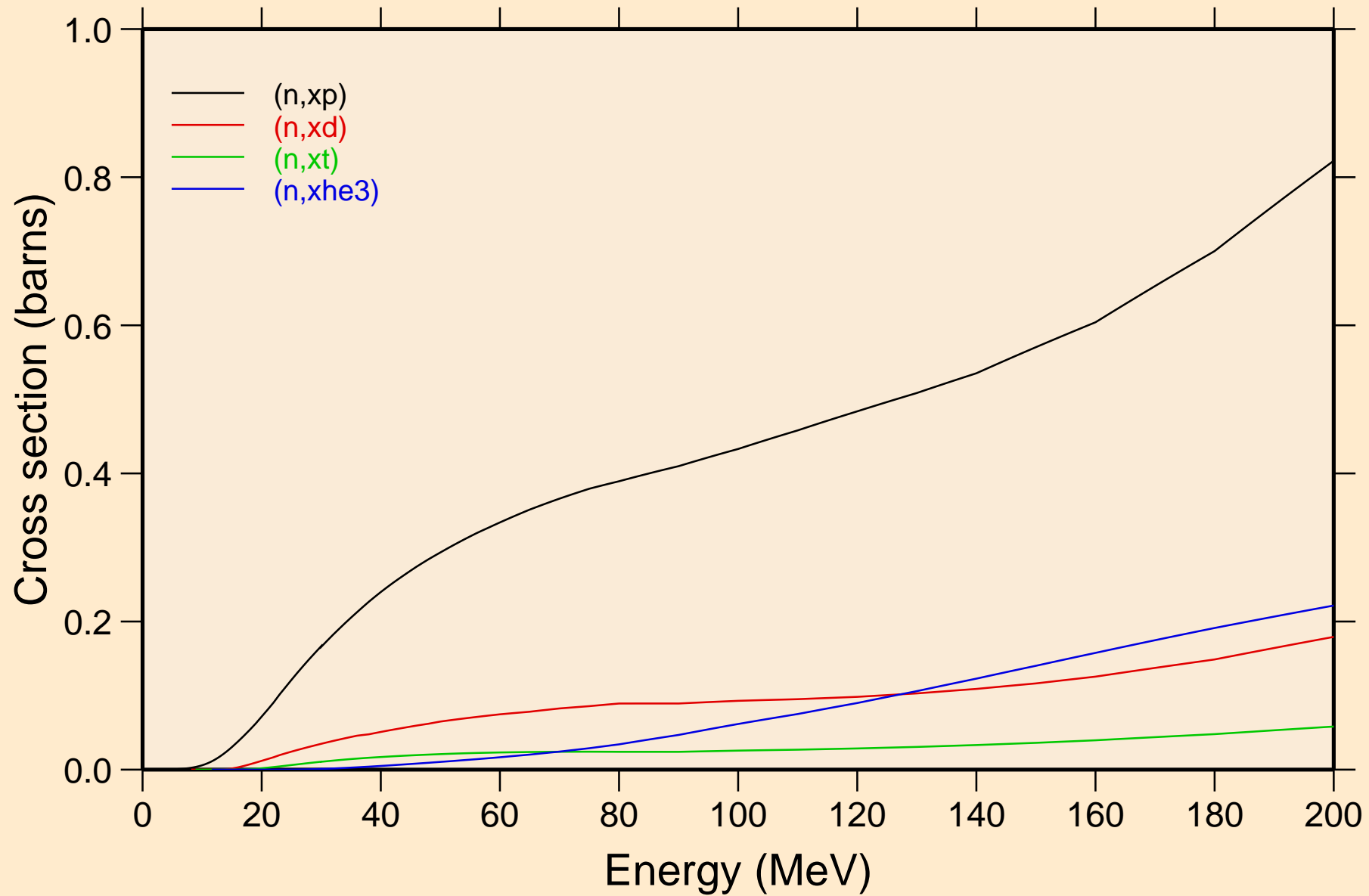

SE079M NEUTRON ACER TENDL-2021 LIBRARY; T=293.6K
angular distribution for elastic

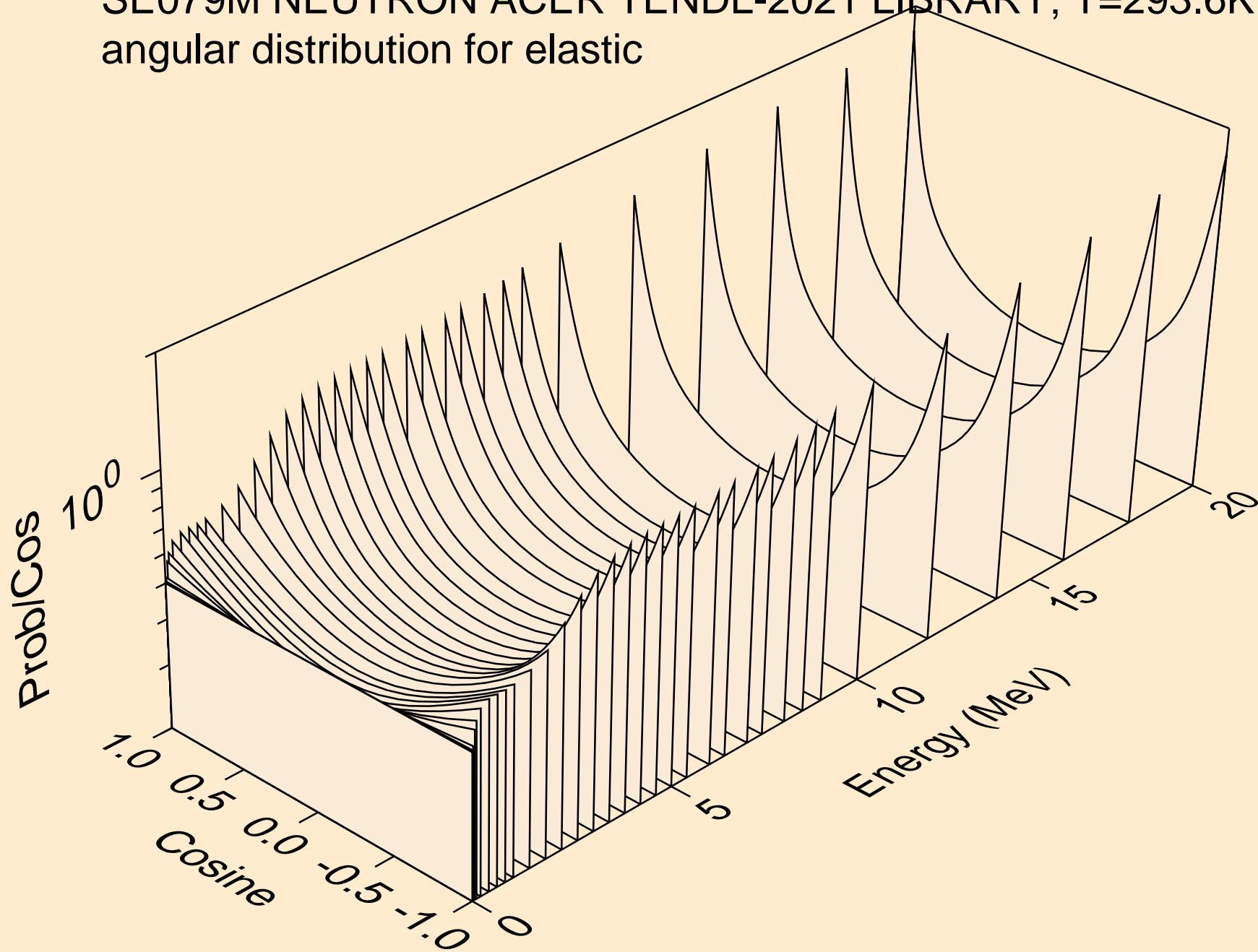

SE079M NEUTRON ACER TENDL-2021 LIBRARY; T=293.6K
angular distribution for elastic

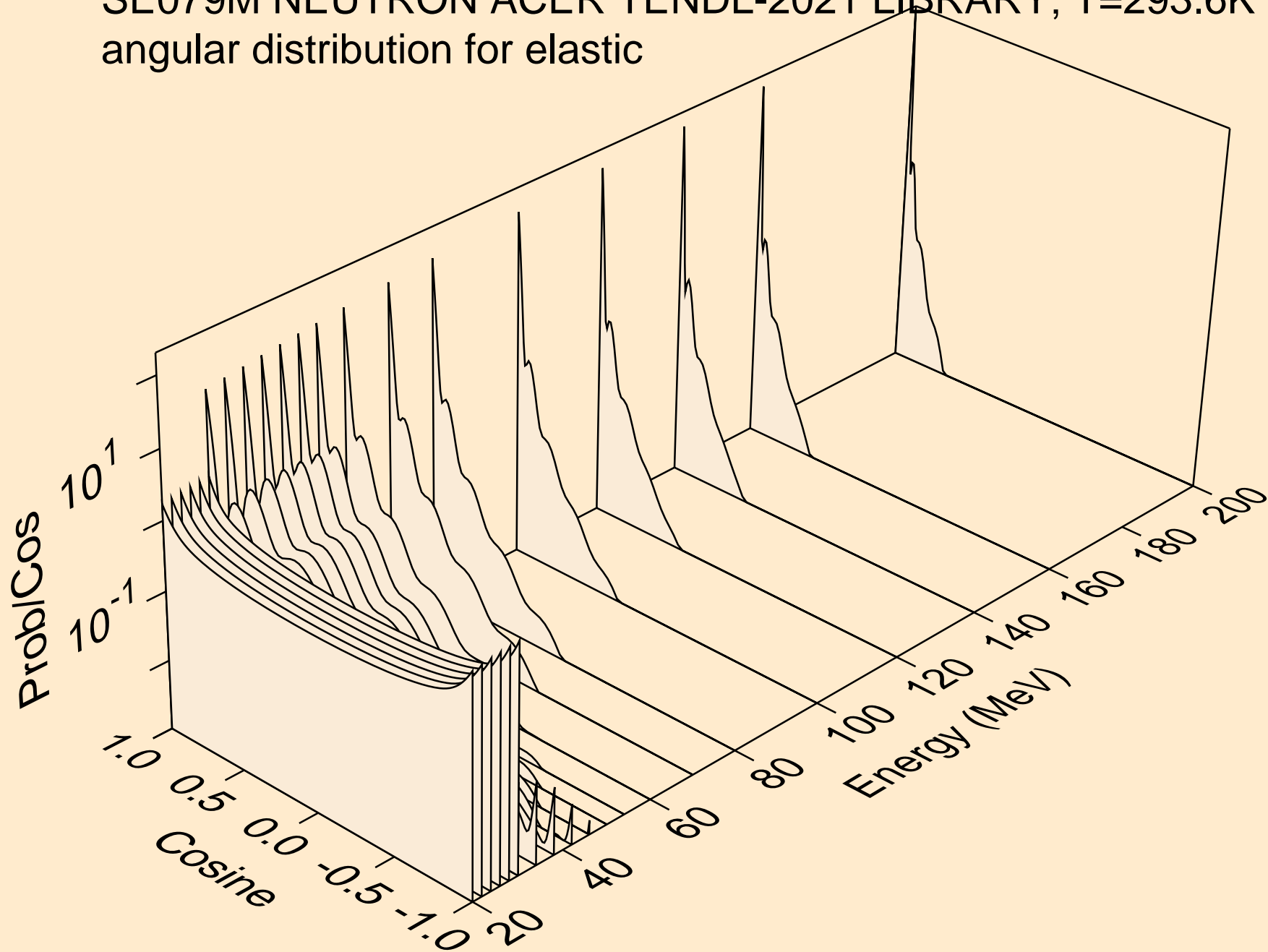

SE079M NEUTRON ACER TENDL-2021 LIBRARY; T=293.6K
angular distribution for (n,n*1)

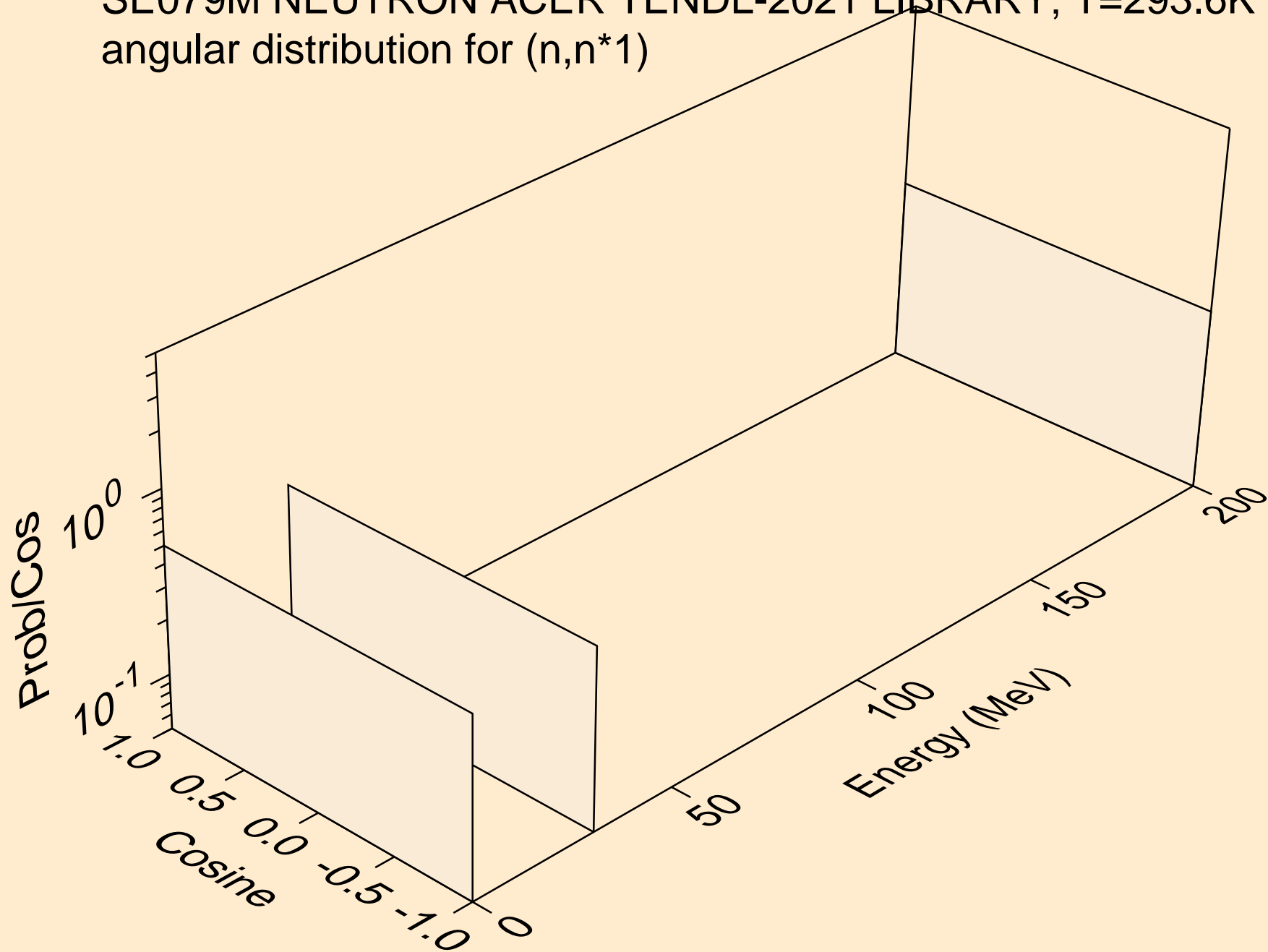

SE079M NEUTRON ACER TENDL-2021 LIBRARY; T=293.6K
angular distribution for (n,n*2)

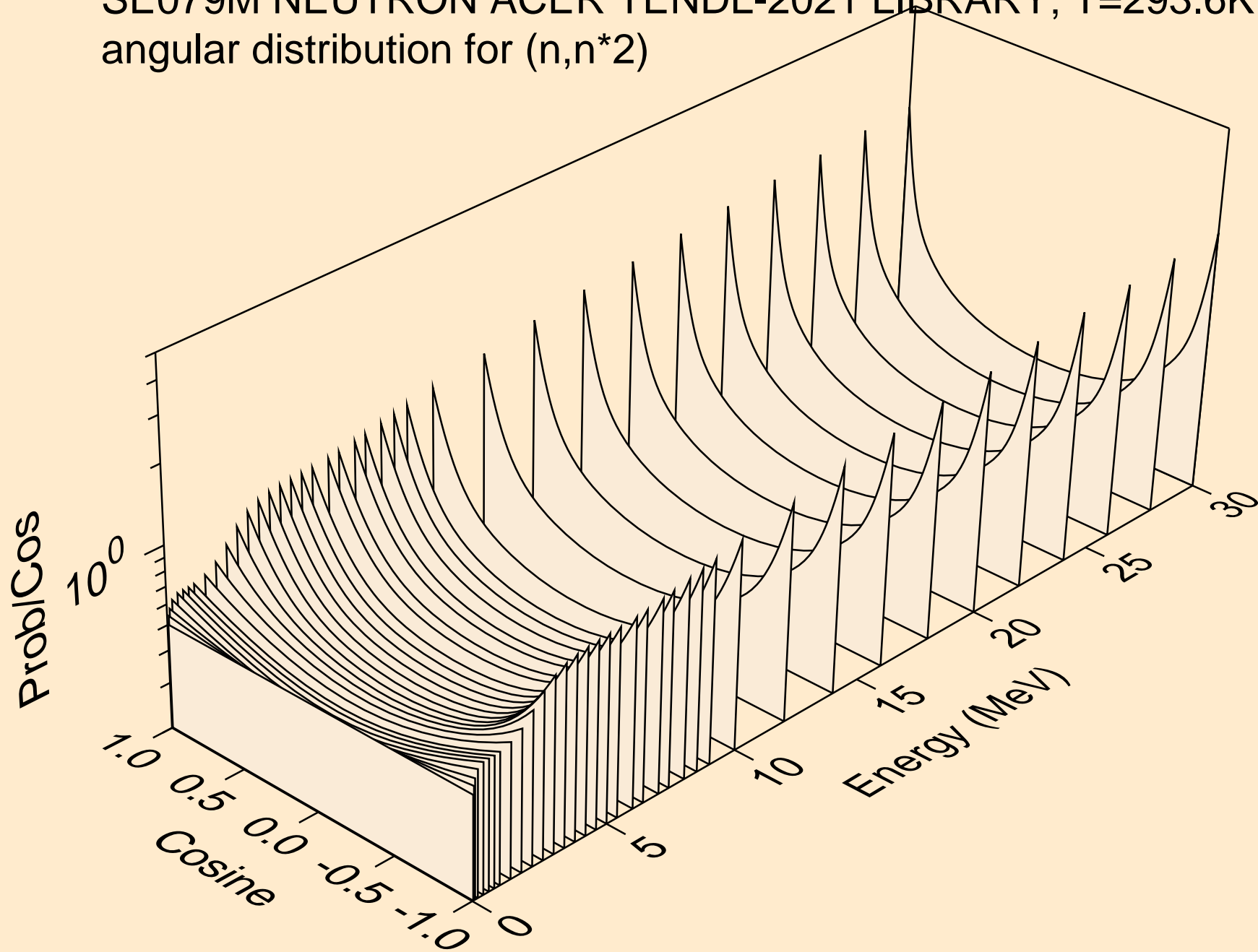

SE079M NEUTRON ACER TENDL-2021 LIBRARY; T=293.6K
angular distribution for (n,n*3)

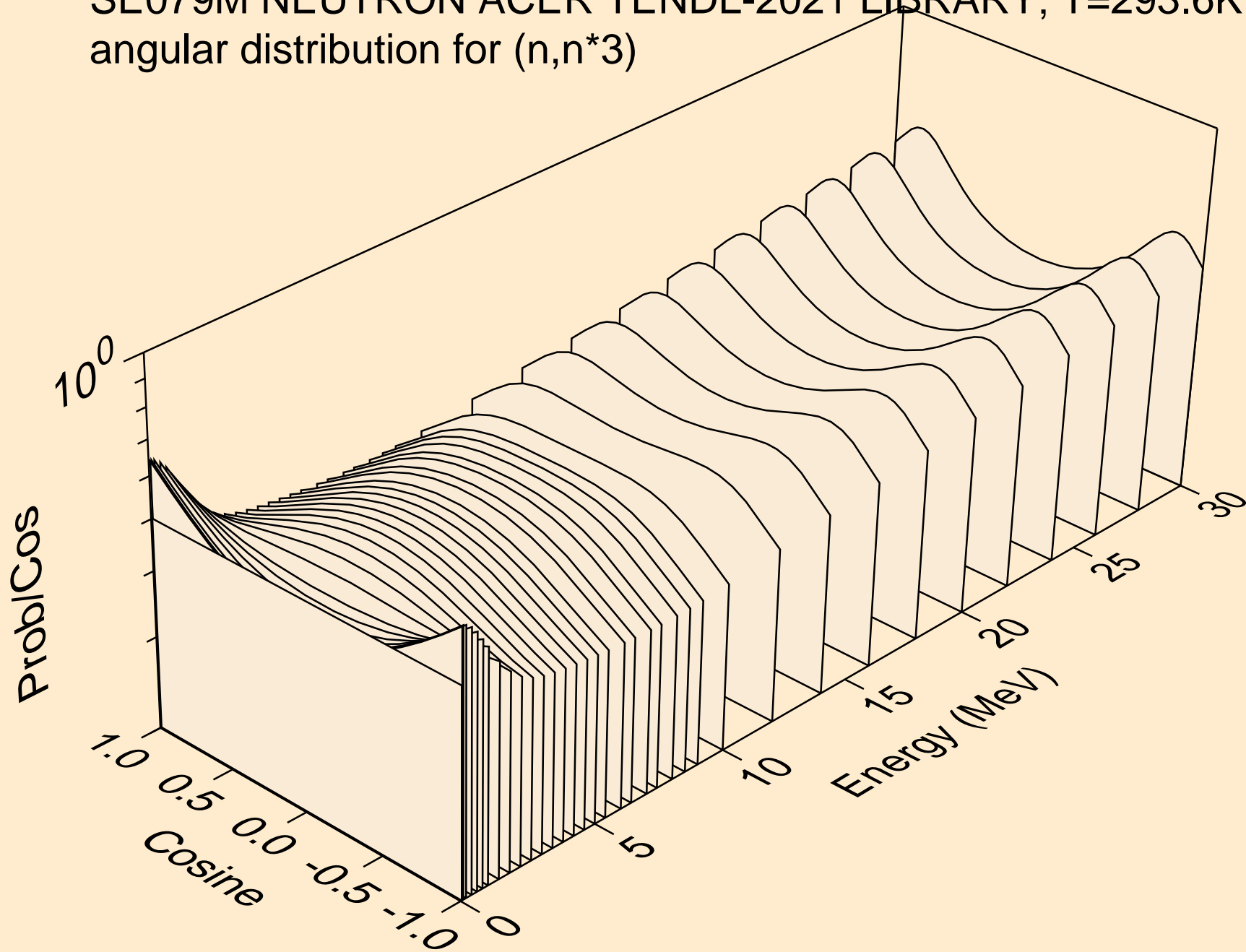

SE079M NEUTRON ACER TENDL-2021 LIBRARY; T=293.6K
angular distribution for (n,n*4)

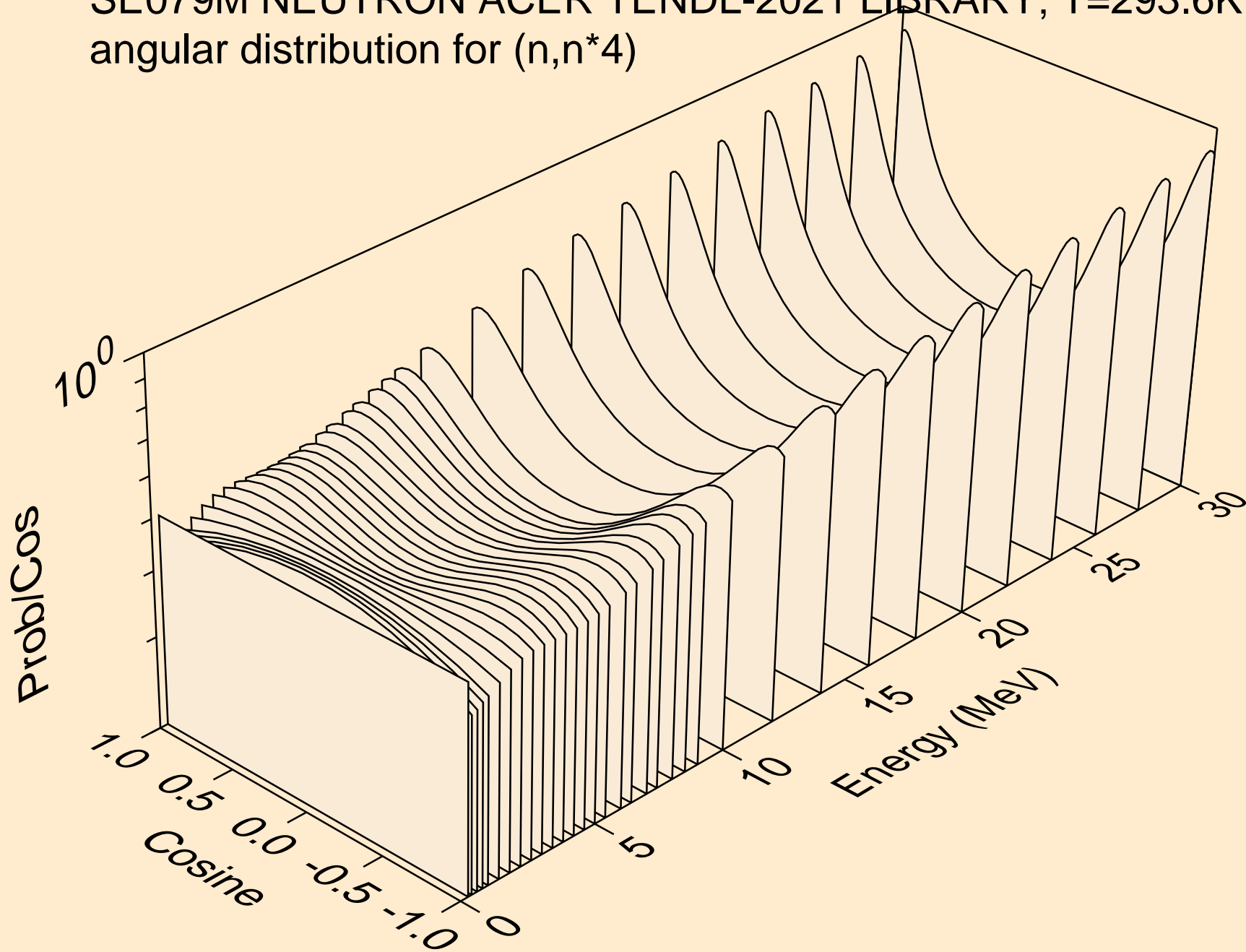

SE079M NEUTRON ACER TENDL-2021 LIBRARY; T=293.6K
angular distribution for (n,n*5)

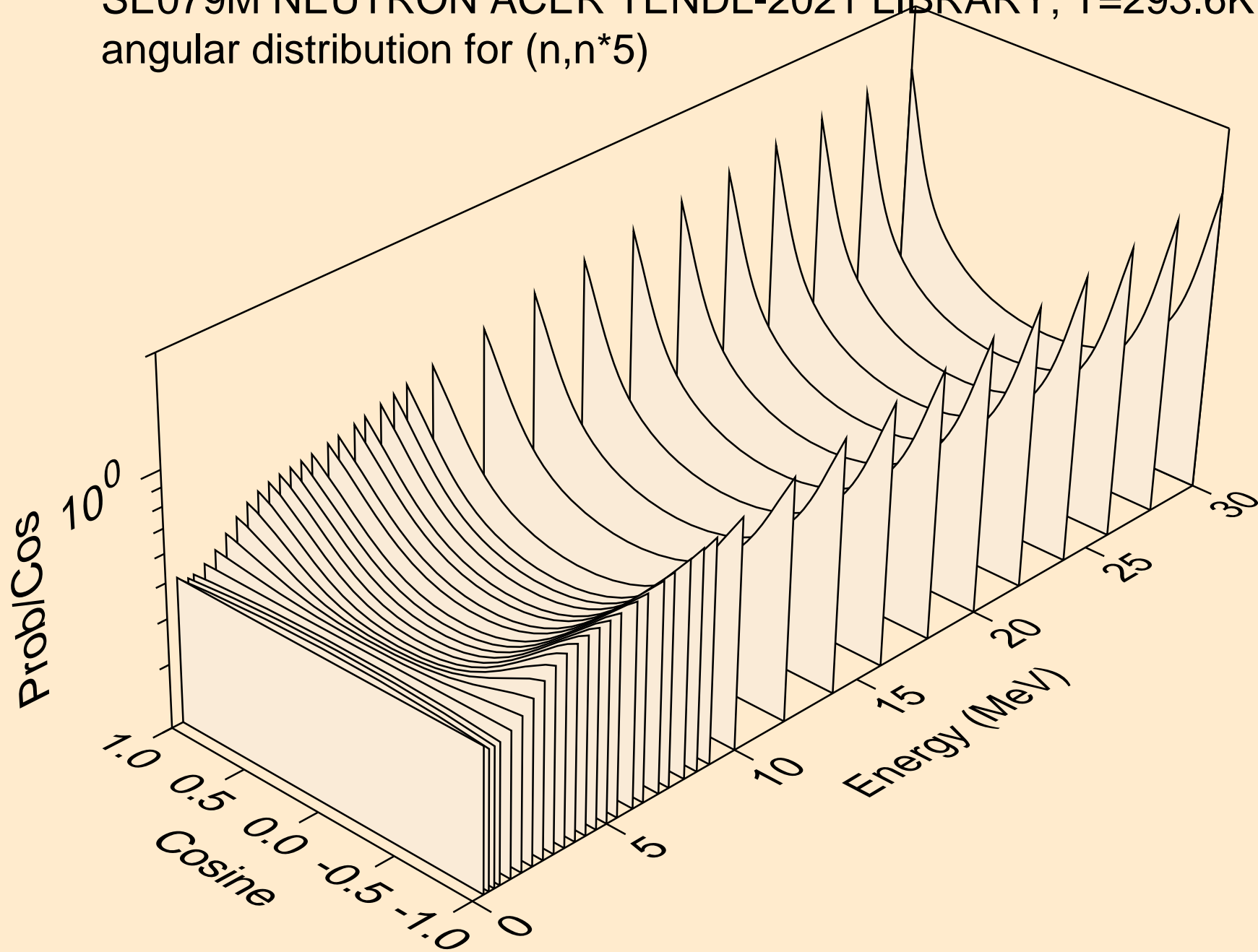

SE079M NEUTRON ACER TENDL-2021 LIBRARY; T=293.6K
angular distribution for (n,n*6)

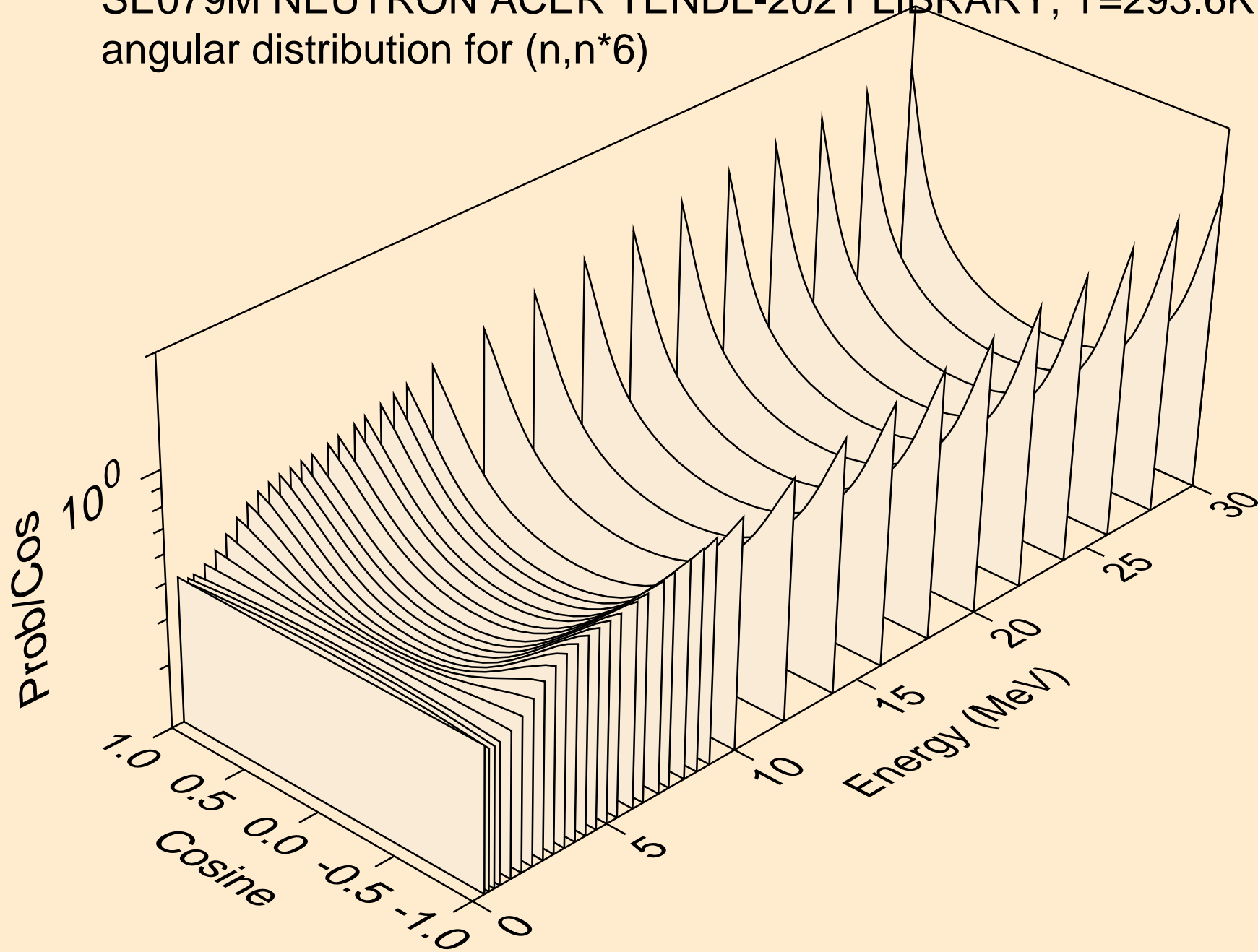

SE079M NEUTRON ACER TENDL-2021 LIBRARY; T=293.6K
angular distribution for (n,n*7)

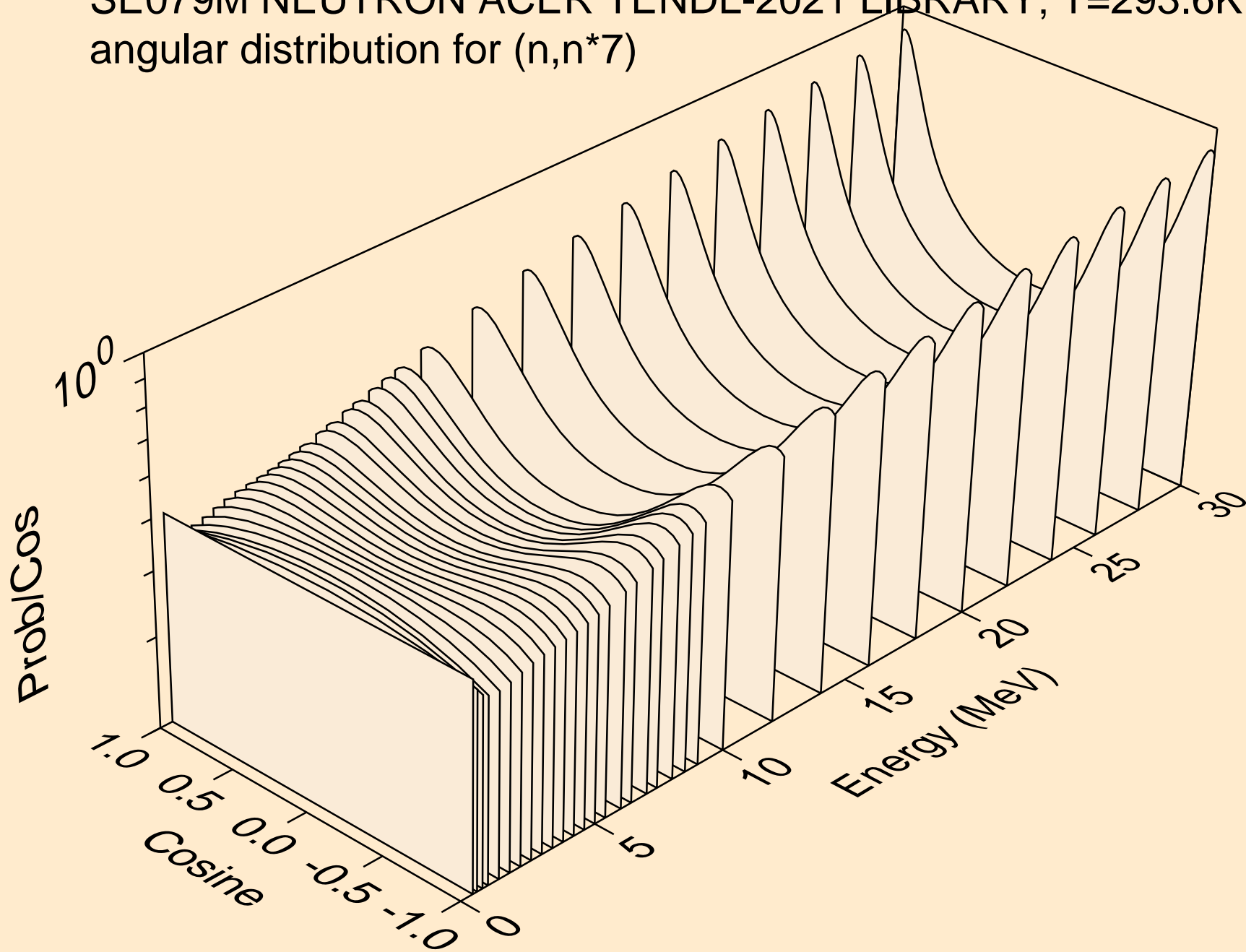

SE079M NEUTRON ACER TENDL-2021 LIBRARY; T=293.6K
angular distribution for (n,n*8)

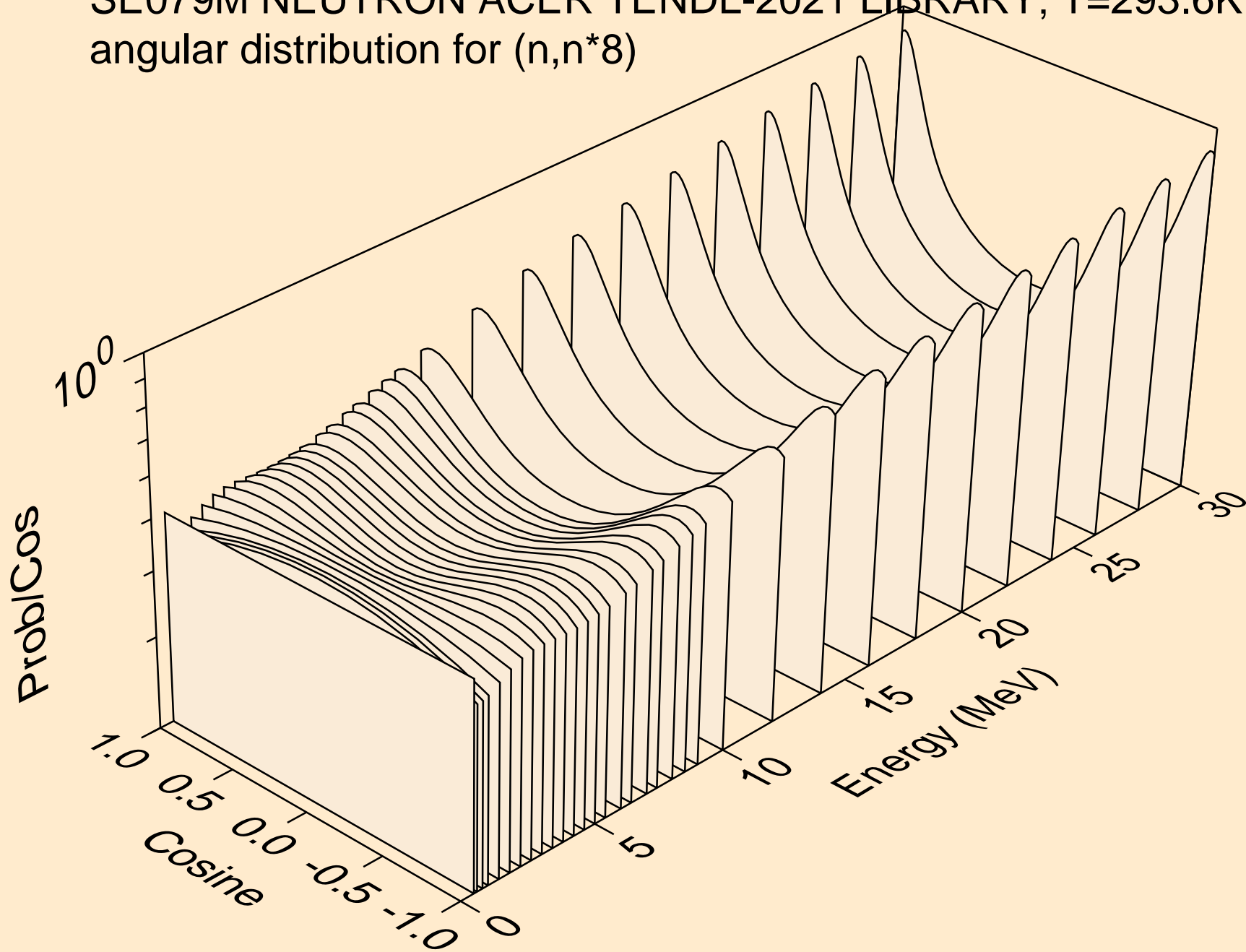

SE079M NEUTRON ACER TENDL-2021 LIBRARY; T=293.6K
angular distribution for (n,n*9)

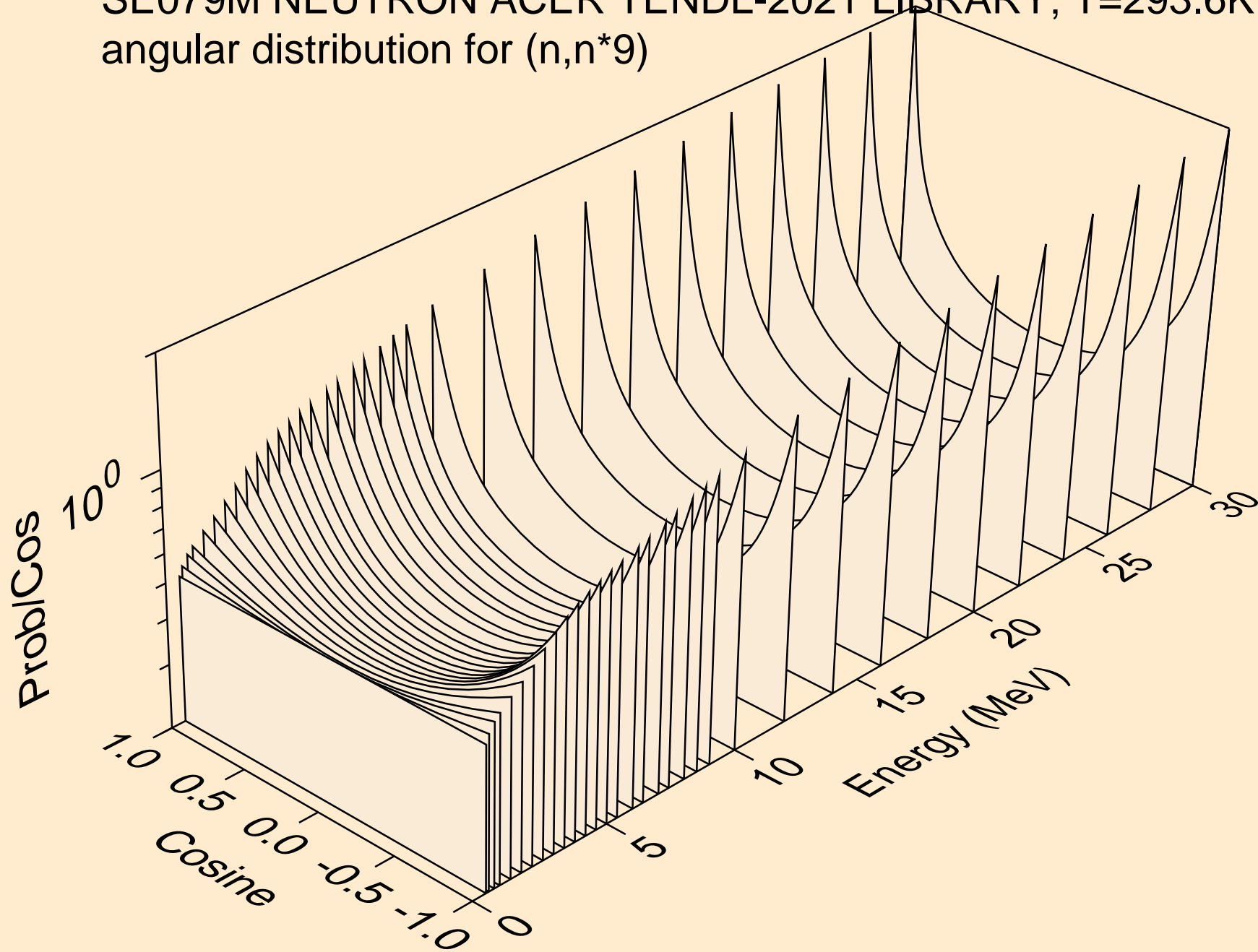

SE079M NEUTRON ACER TENDL-2021 LIBRARY; T=293.6K
angular distribution for (n,n*10)

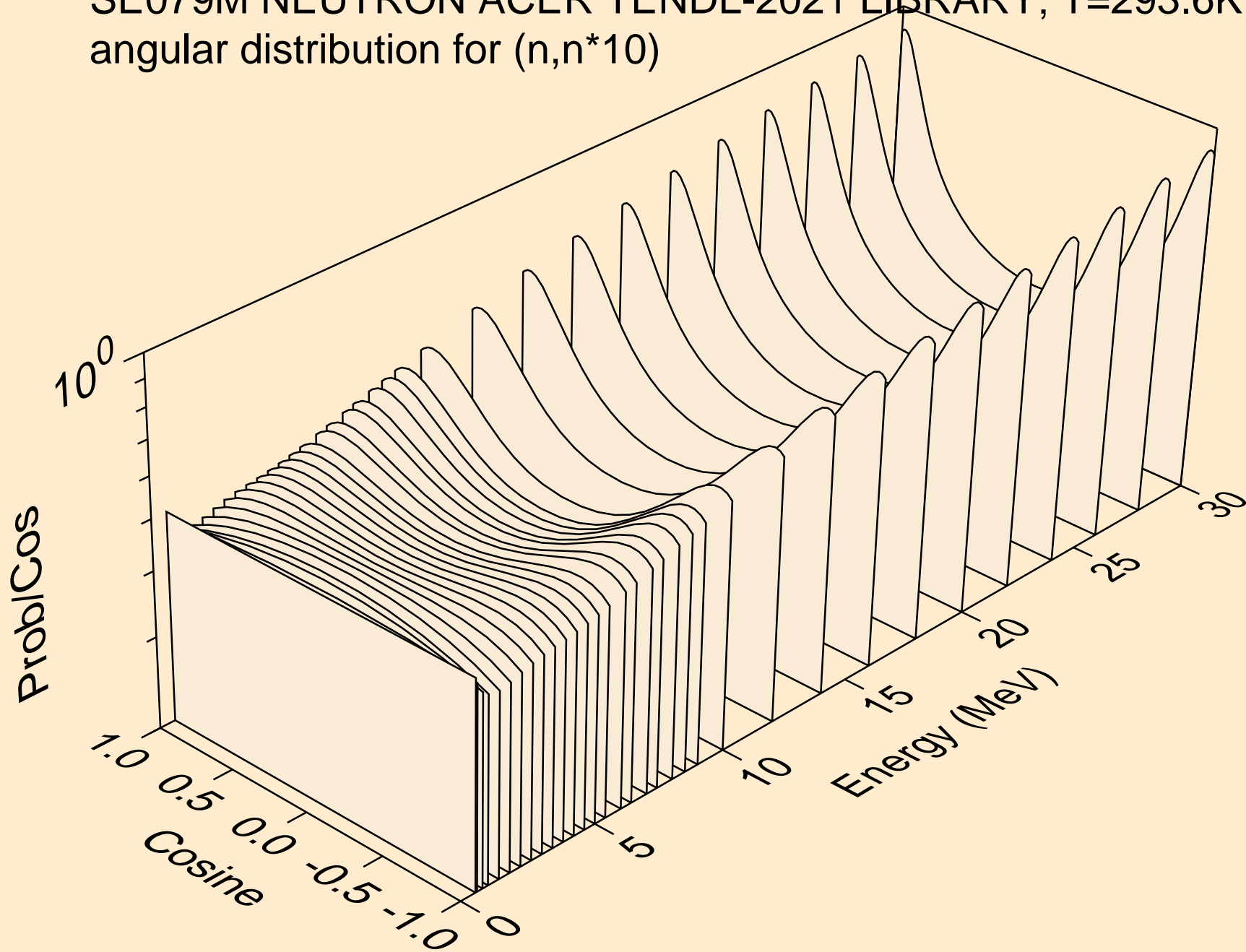

SE079M NEUTRON ACER TENDL-2021 LIBRARY; T=293.6K
angular distribution for (n,n*11)

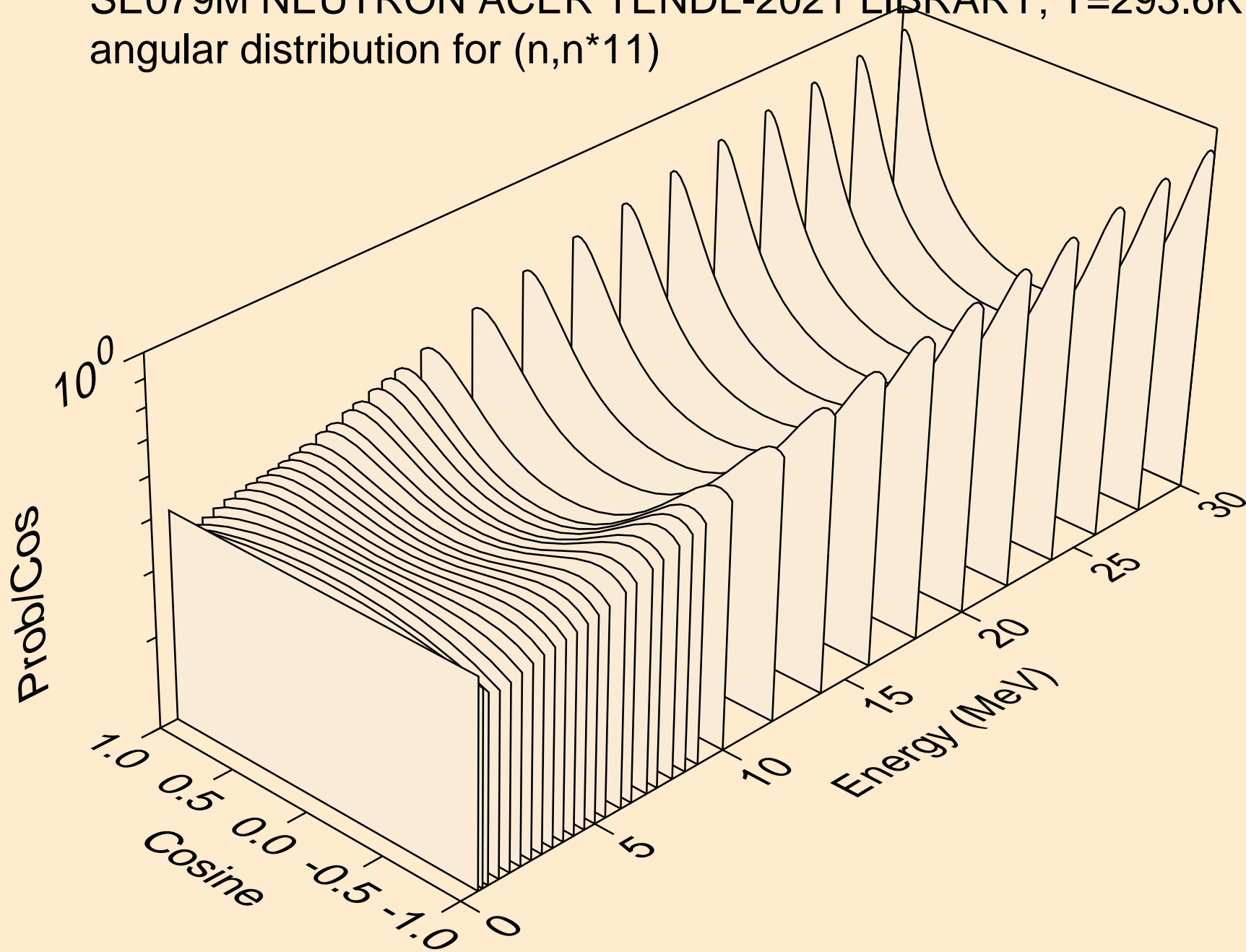

SE079M NEUTRON ACER TENDL-2021 LIBRARY; T=293.6K
angular distribution for (n,n*12)

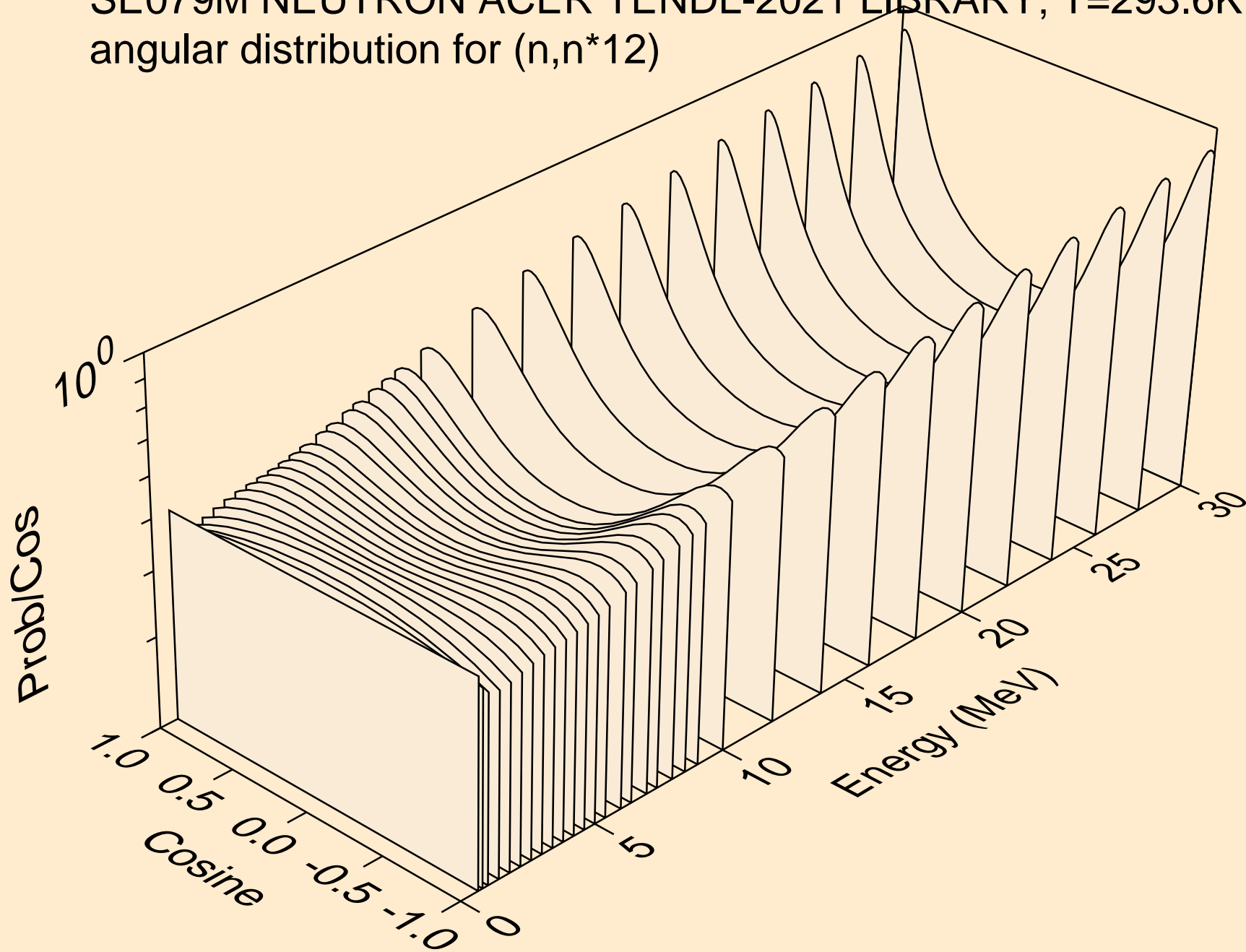

SE079M NEUTRON ACER TENDL-2021 LIBRARY; T=293.6K
angular distribution for (n,n*13)

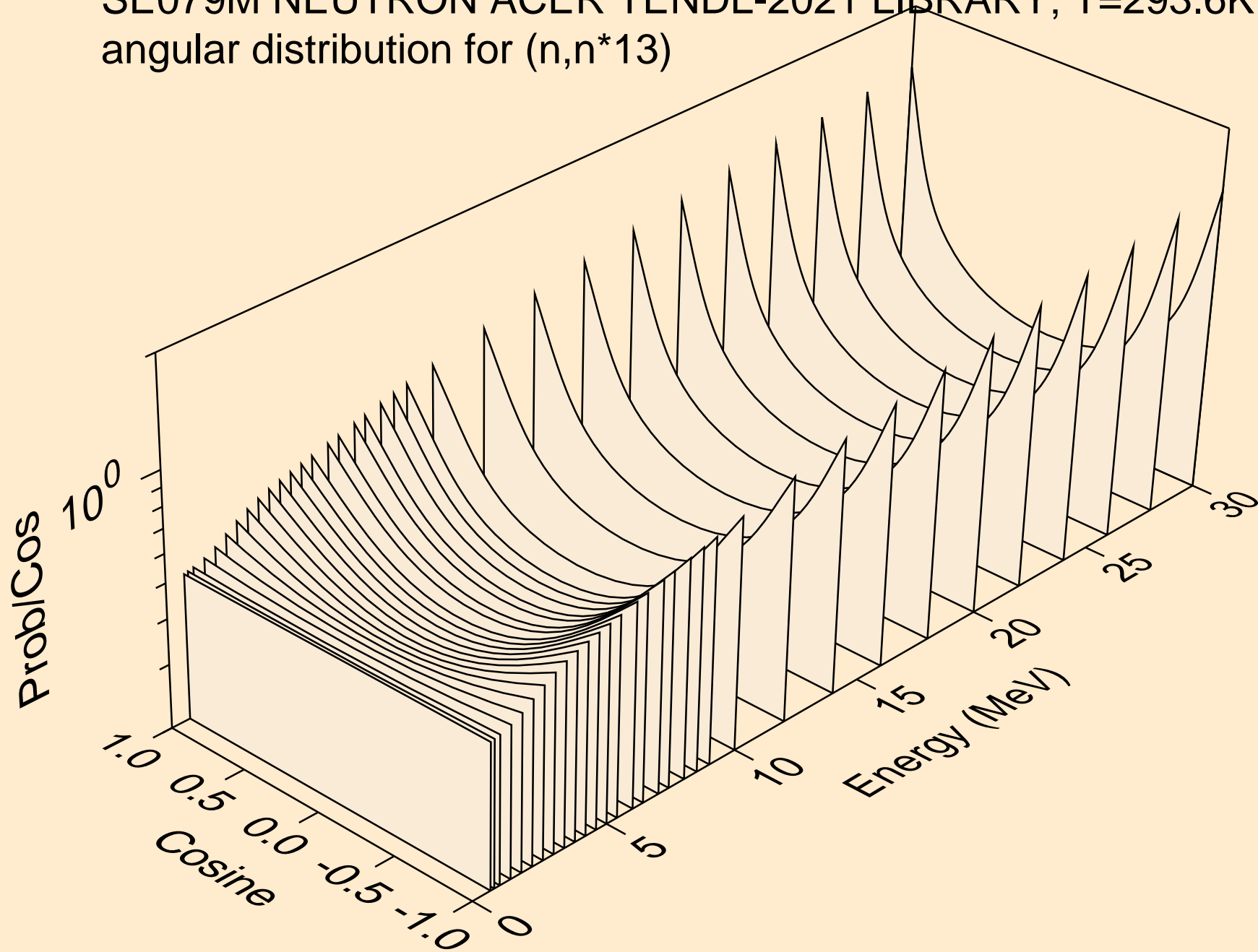

SE079M NEUTRON ACER TENDL-2021 LIBRARY; T=293.6K
angular distribution for (n,n*14)

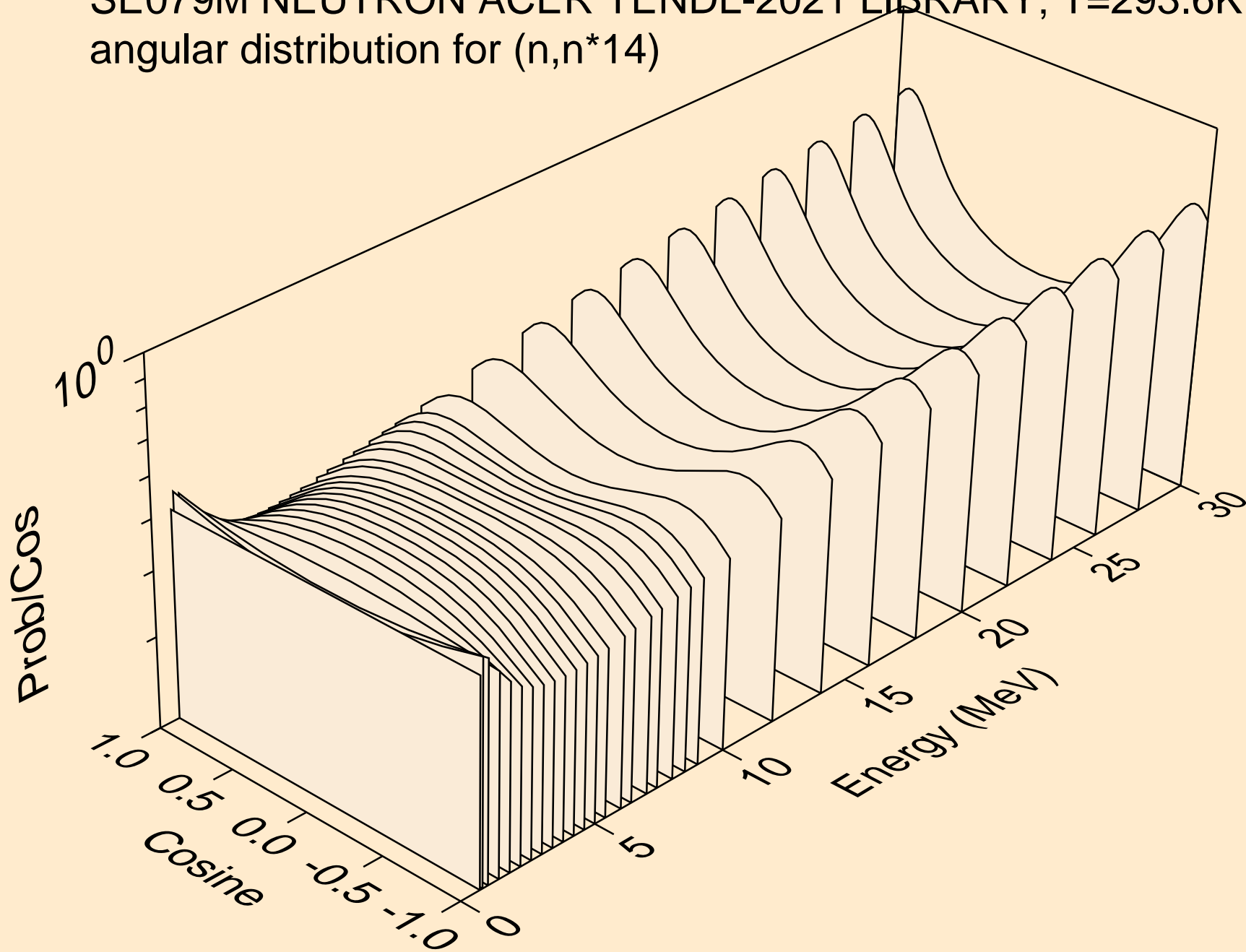

SE079M NEUTRON ACER TENDL-2021 LIBRARY; T=293.6K
angular distribution for (n,n*15)

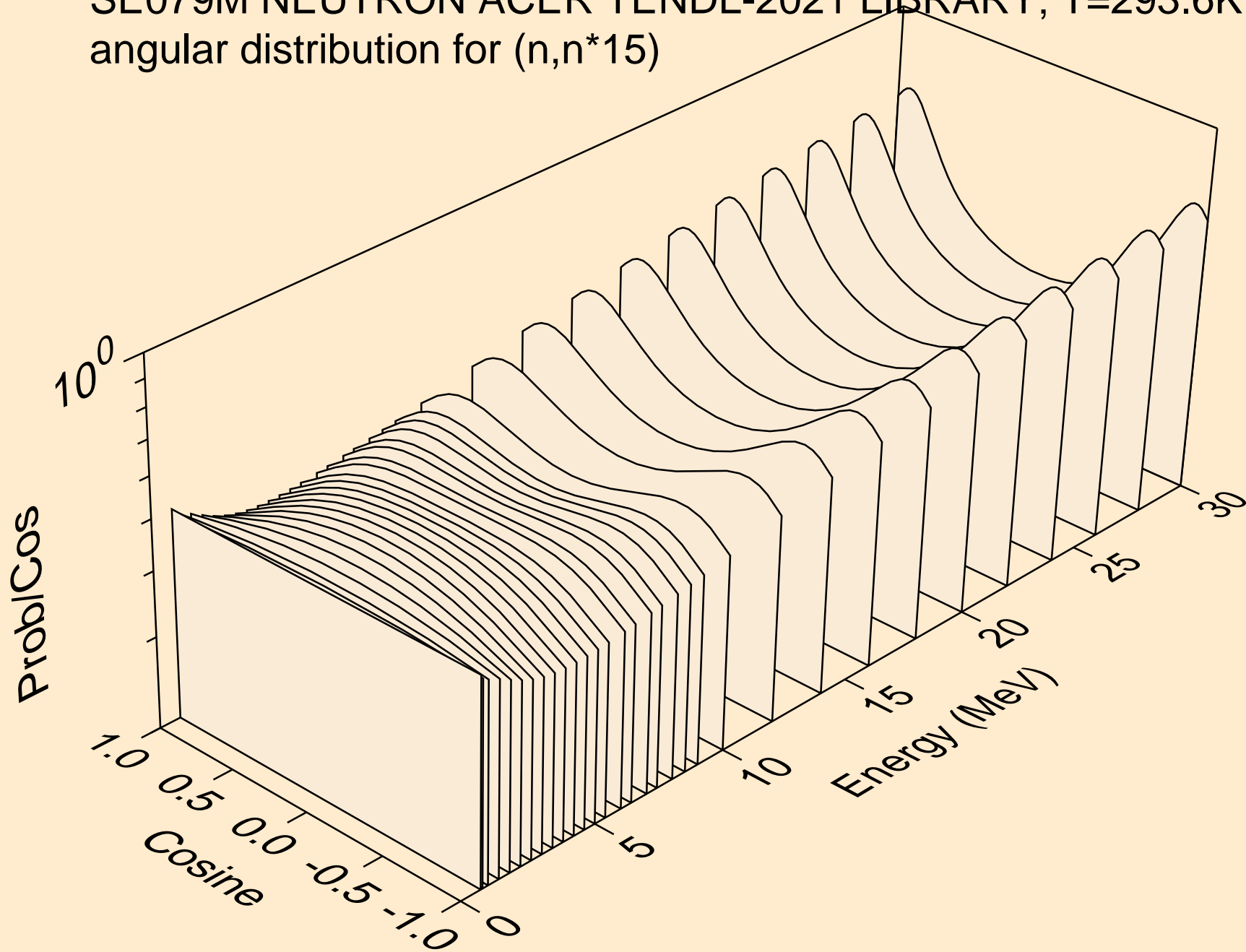

SE079M NEUTRON ACER TENDL-2021 LIBRARY; T=293.6K
angular distribution for (n,n*16)

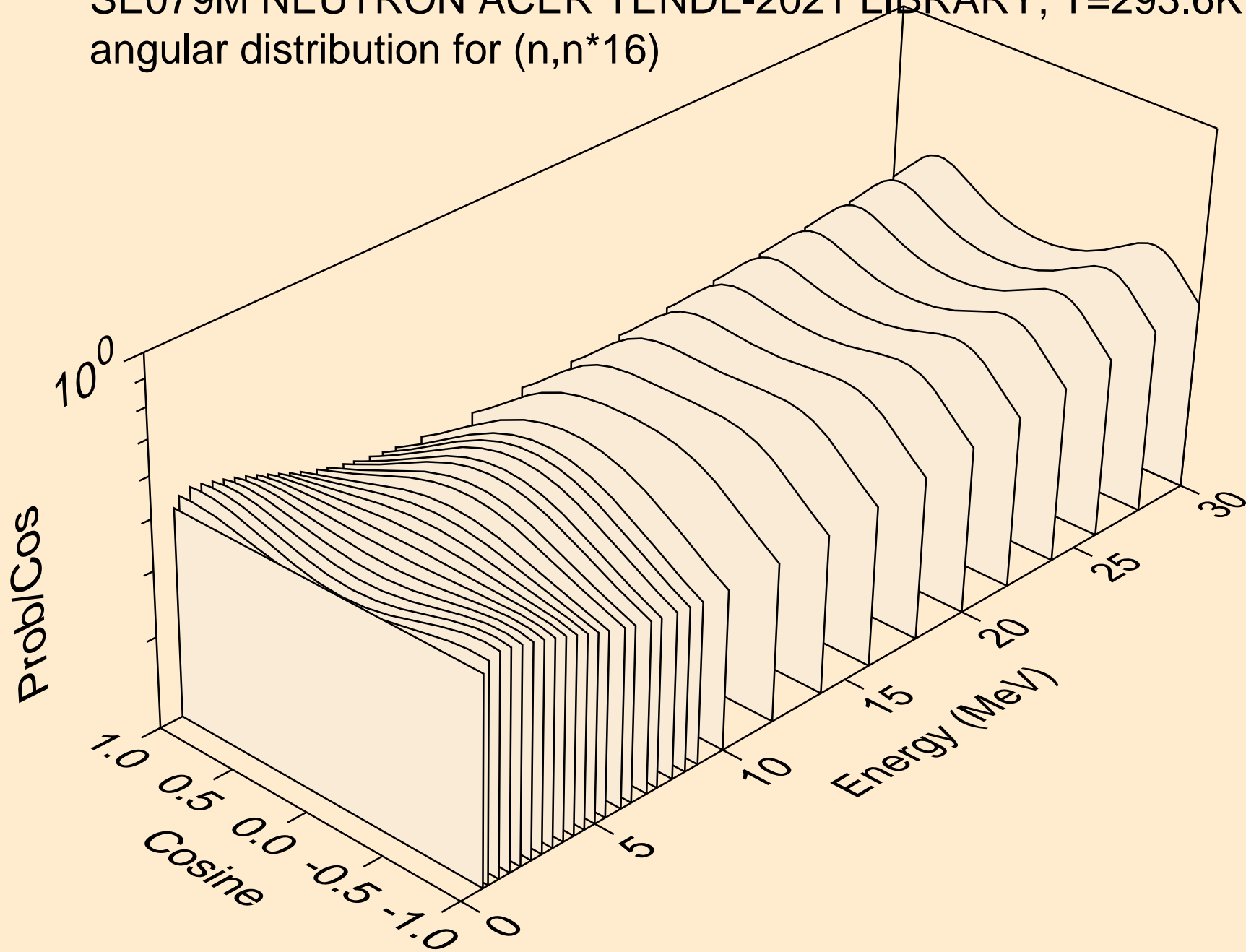

SE079M NEUTRON ACER TENDL-2021 LIBRARY; T=293.6K
angular distribution for (n,n*17)

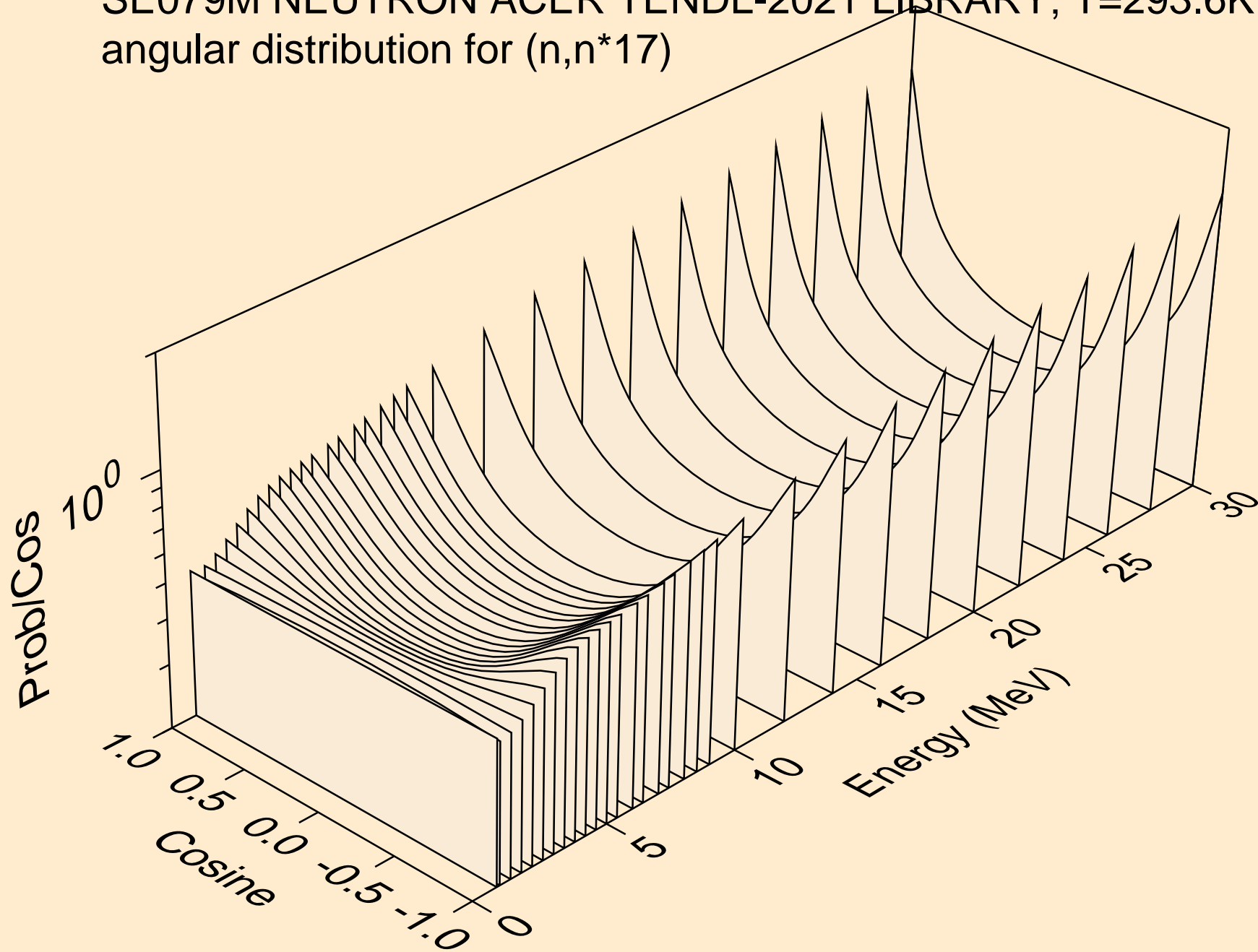

SE079M NEUTRON ACER TENDL-2021 LIBRARY; T=293.6K
angular distribution for (n,n*18)

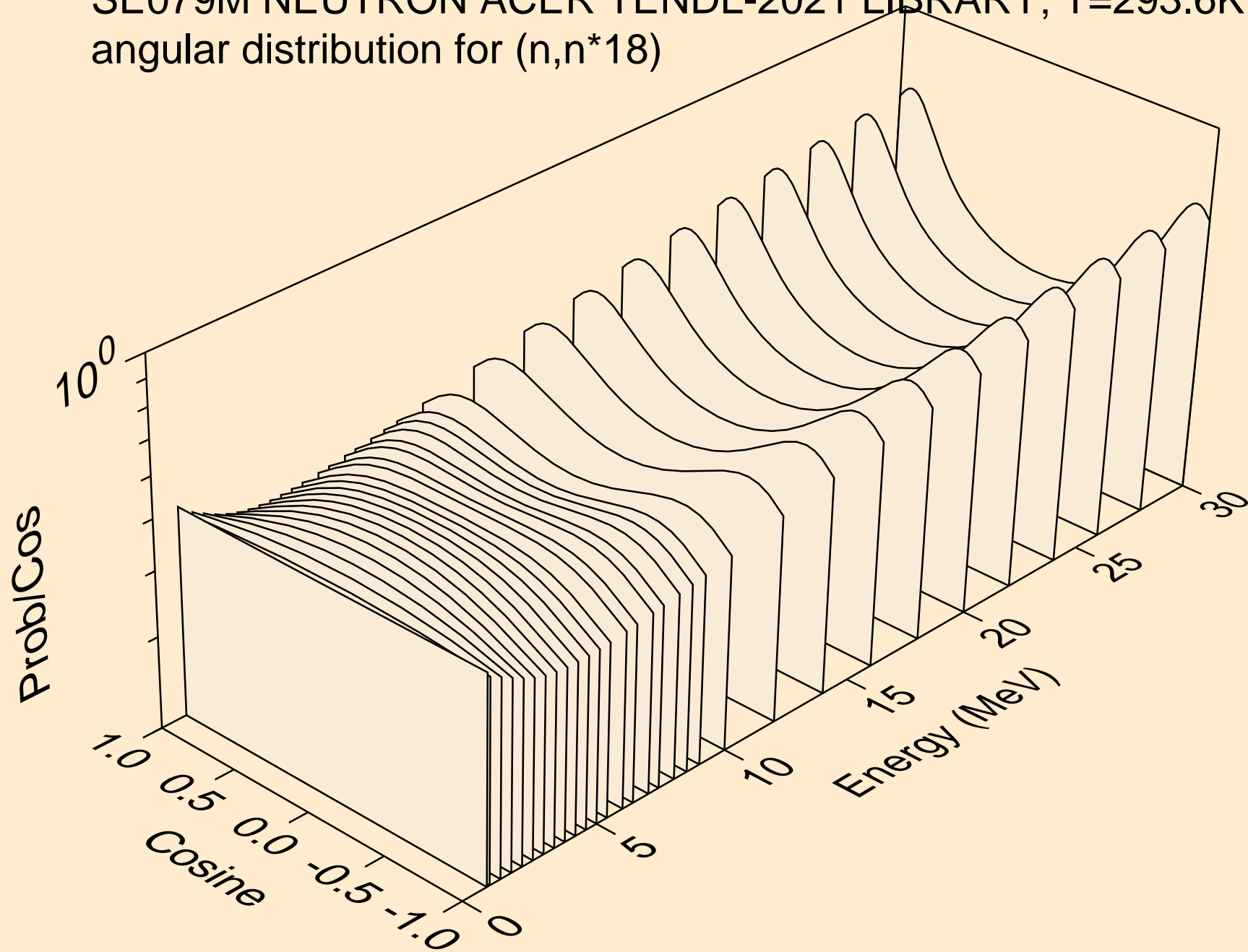

SE079M NEUTRON ACER TENDL-2021 LIBRARY; T=293.6K
angular distribution for (n,n*19)

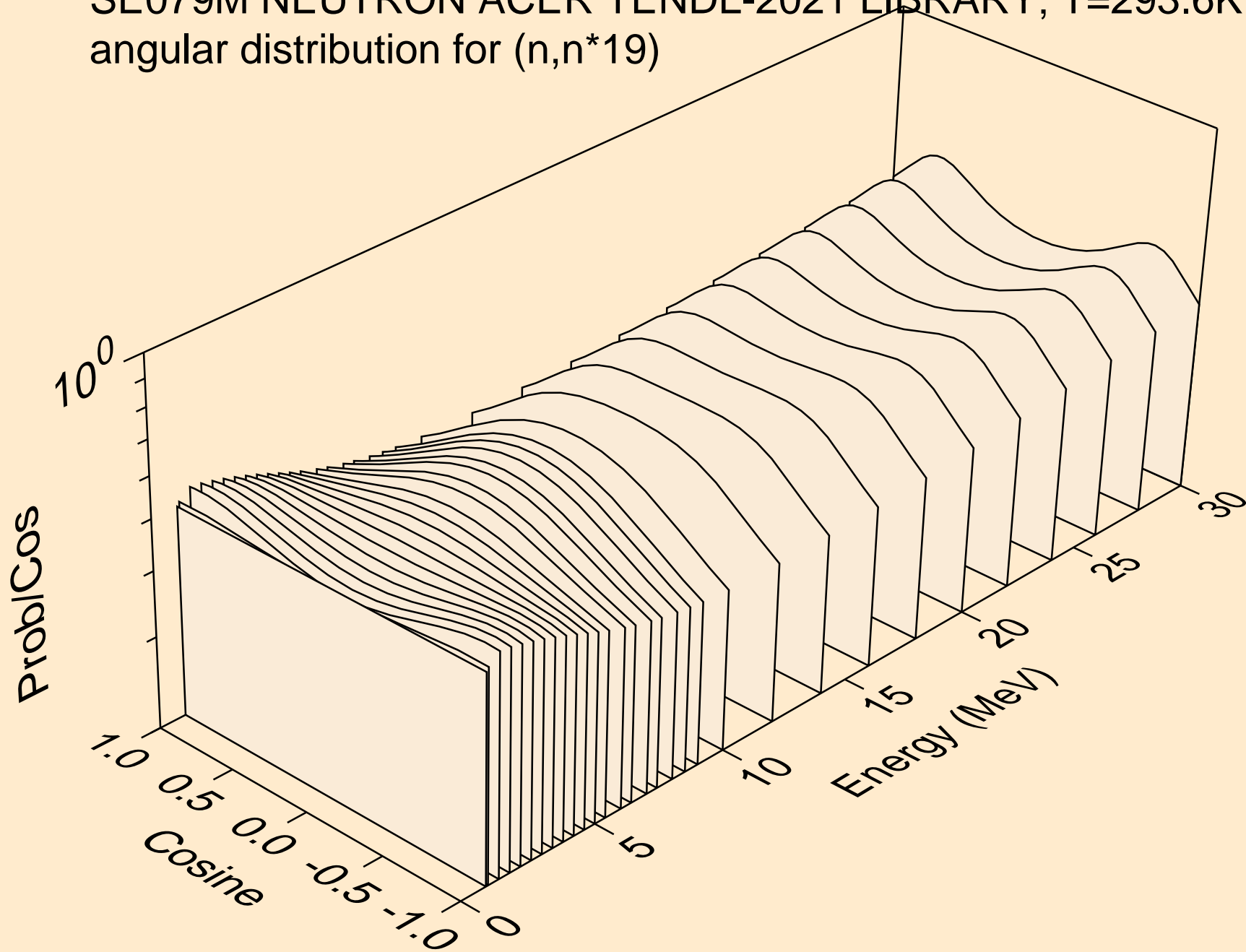

SE079M NEUTRON ACER TENDL-2021 LIBRARY; T=293.6K
angular distribution for (n,n*20)

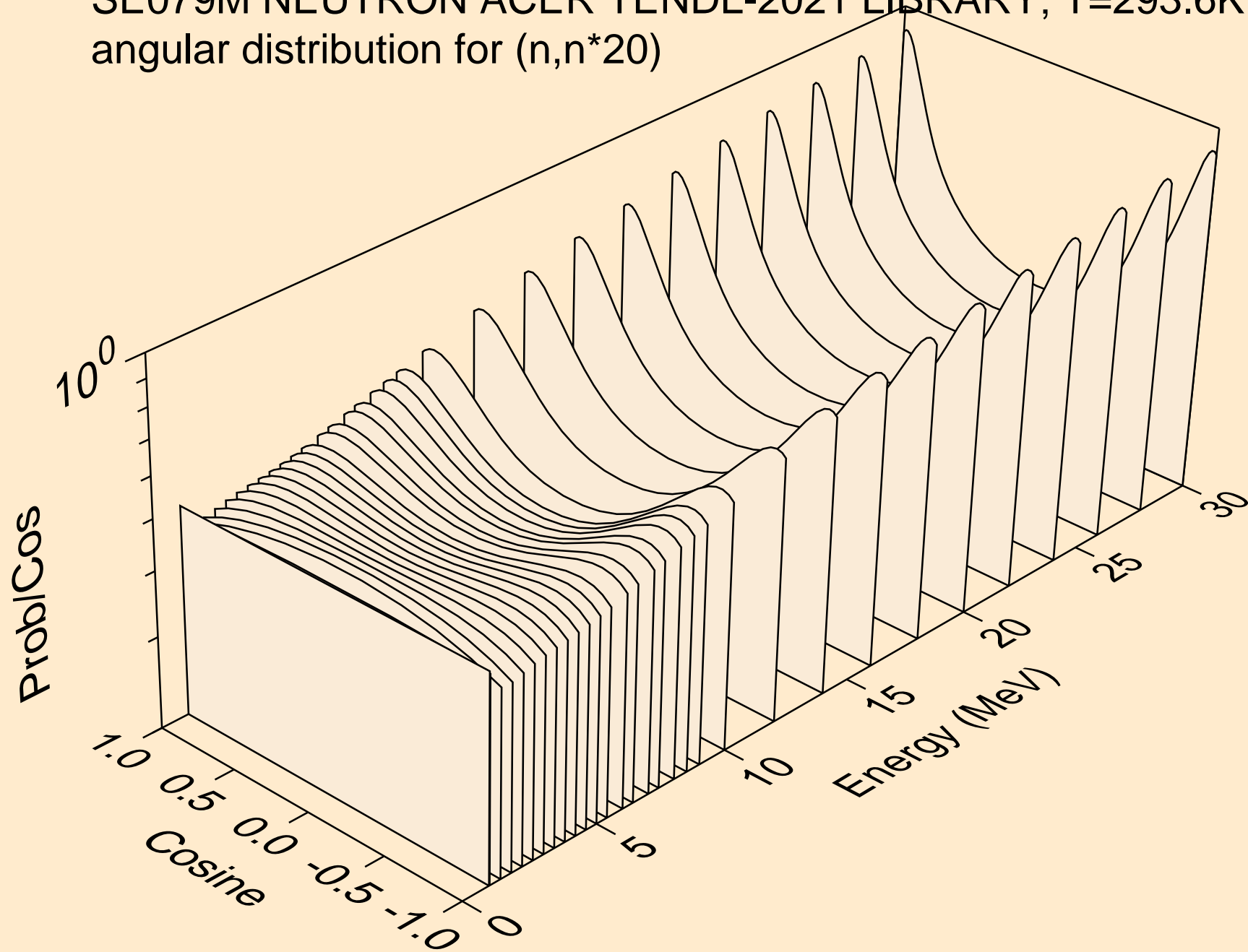

SE079M NEUTRON ACER TENDL-2021 LIBRARY; T=293.6K
angular distribution for (n,n*21)

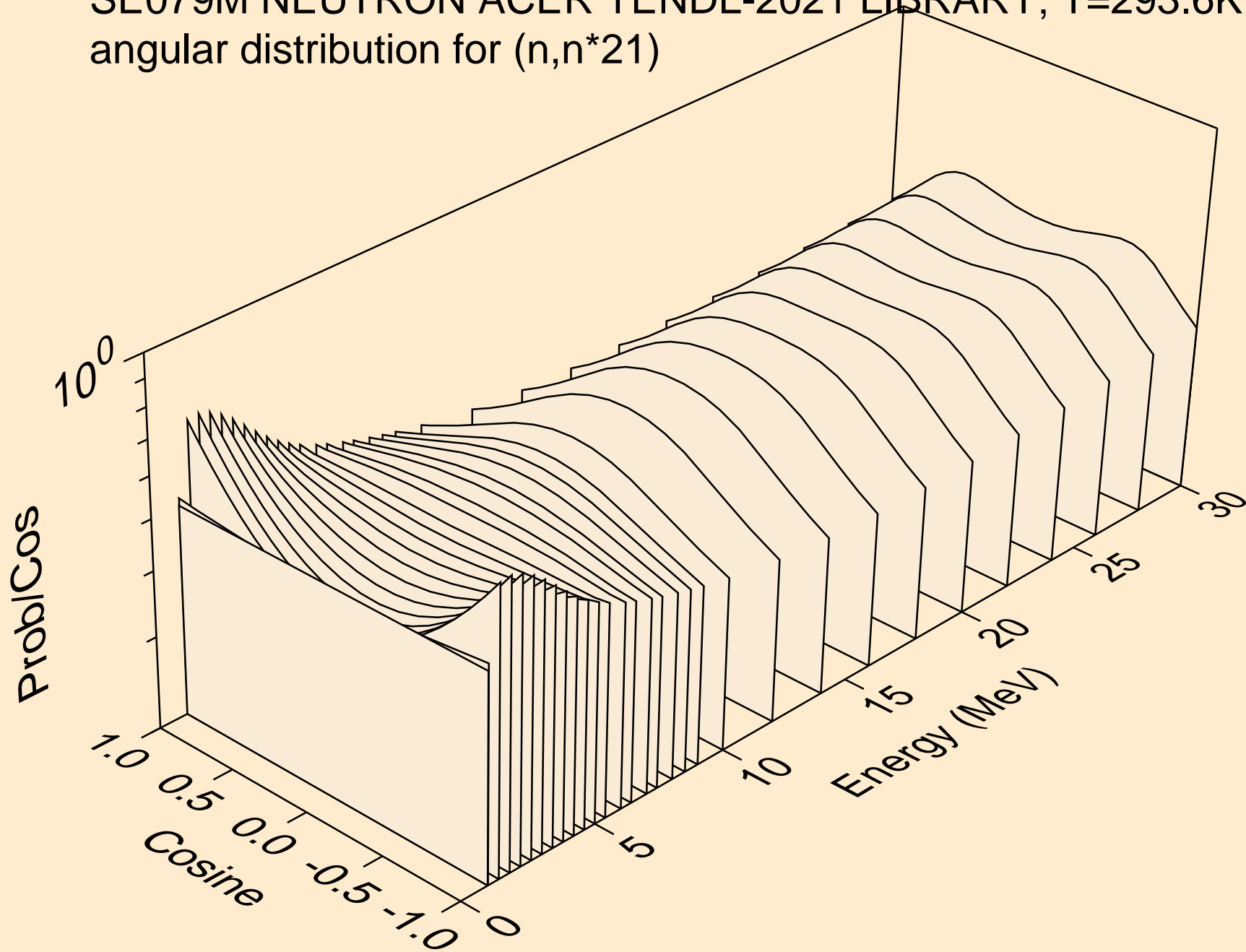

SE079M NEUTRON ACER TENDL-2021 LIBRARY; T=293.6K
angular distribution for (n,n*22)

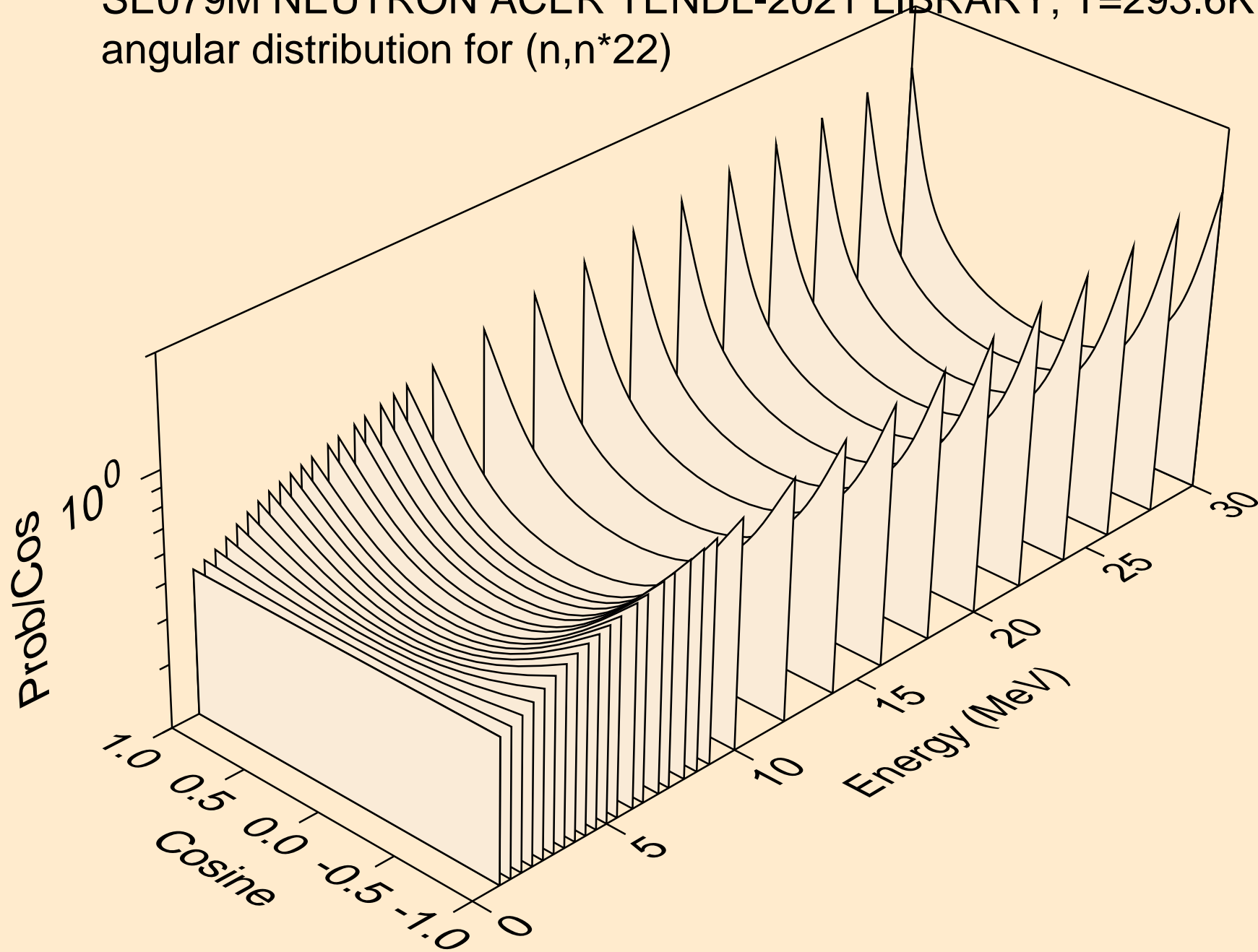

SE079M NEUTRON ACER TENDL-2021 LIBRARY; T=293.6K
angular distribution for (n,n*23)

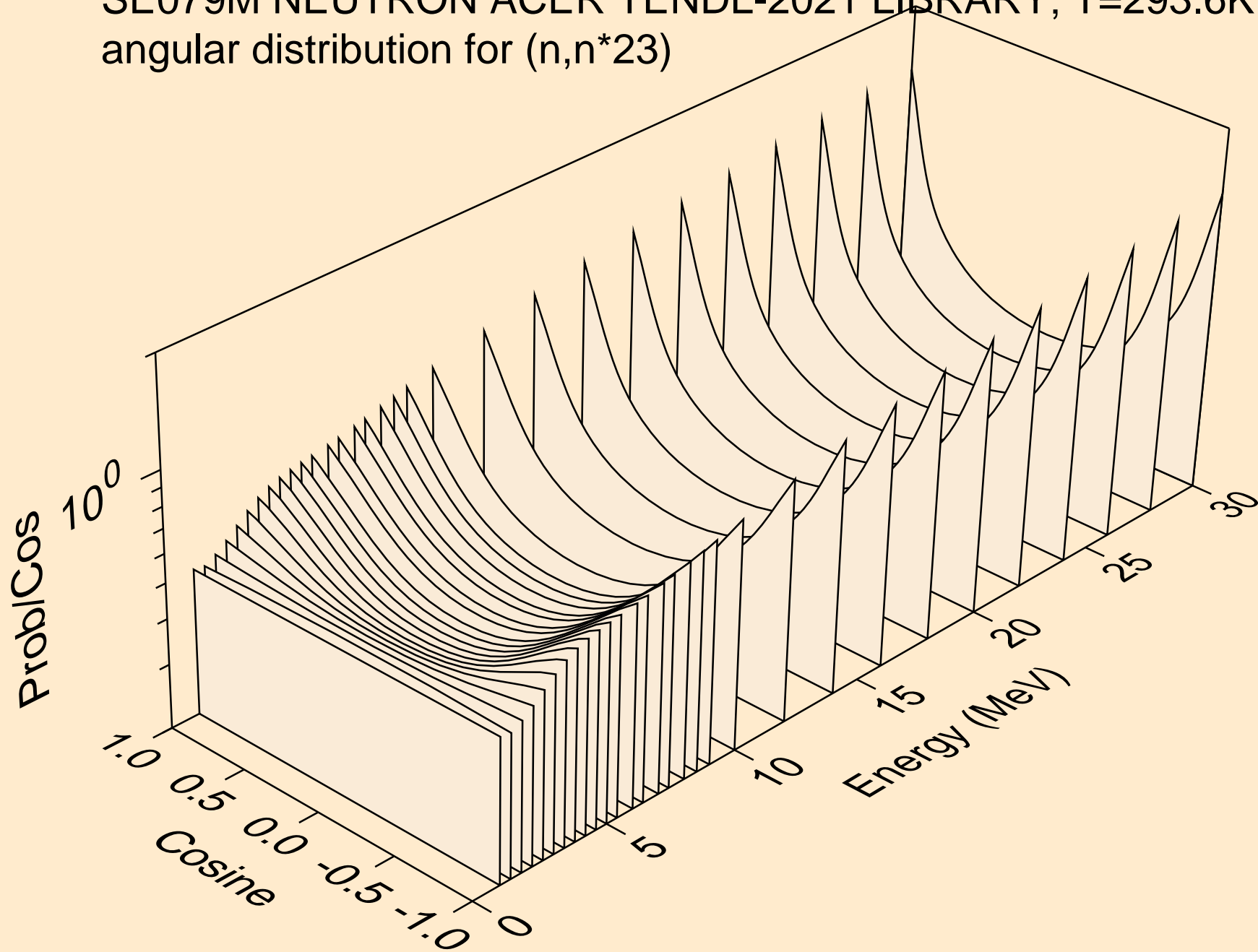

SE079M NEUTRON ACER TENDL-2021 LIBRARY; T=293.6K
angular distribution for (n,n*24)

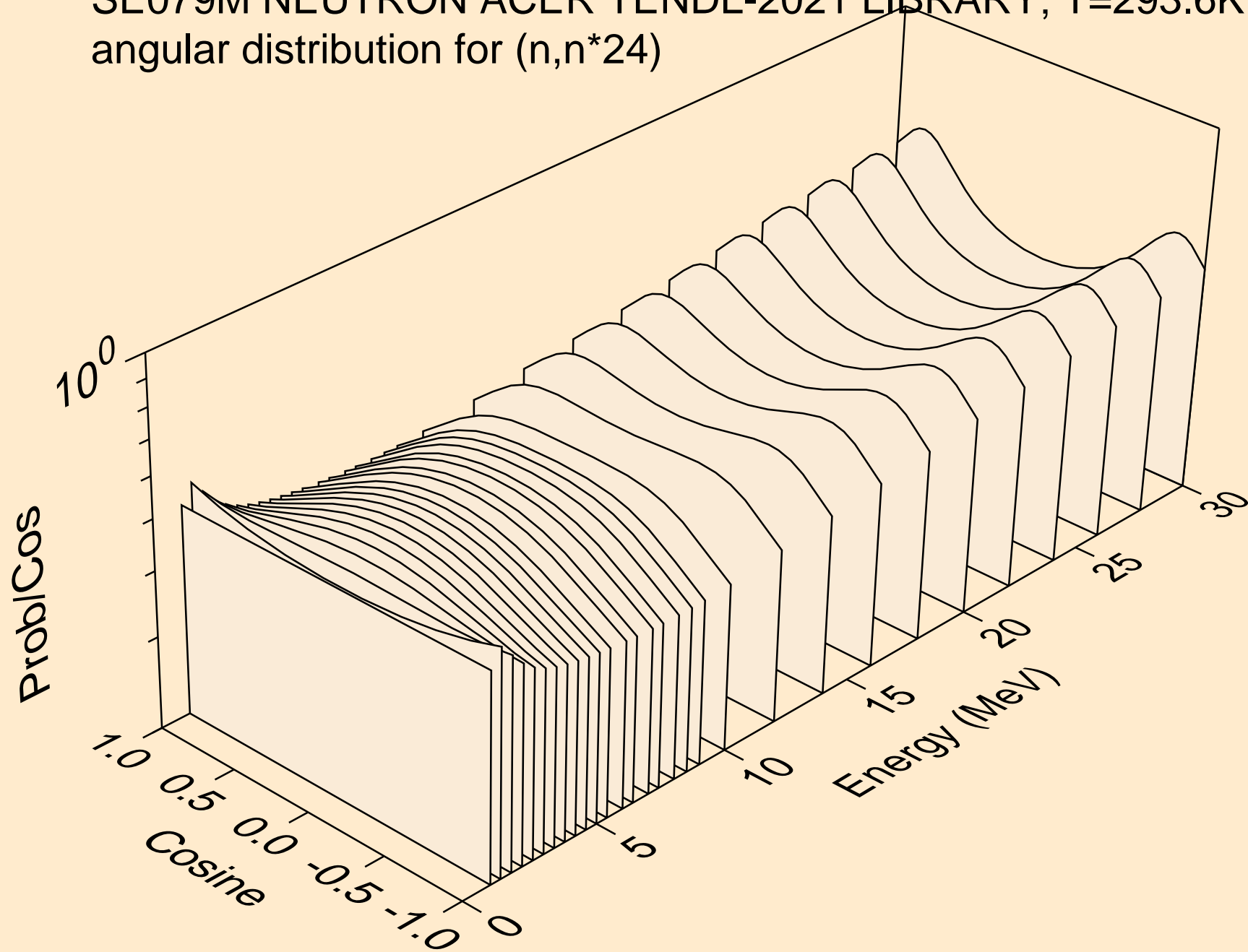

SE079M NEUTRON ACER TENDL-2021 LIBRARY; T=293.6K
angular distribution for (n,n*25)

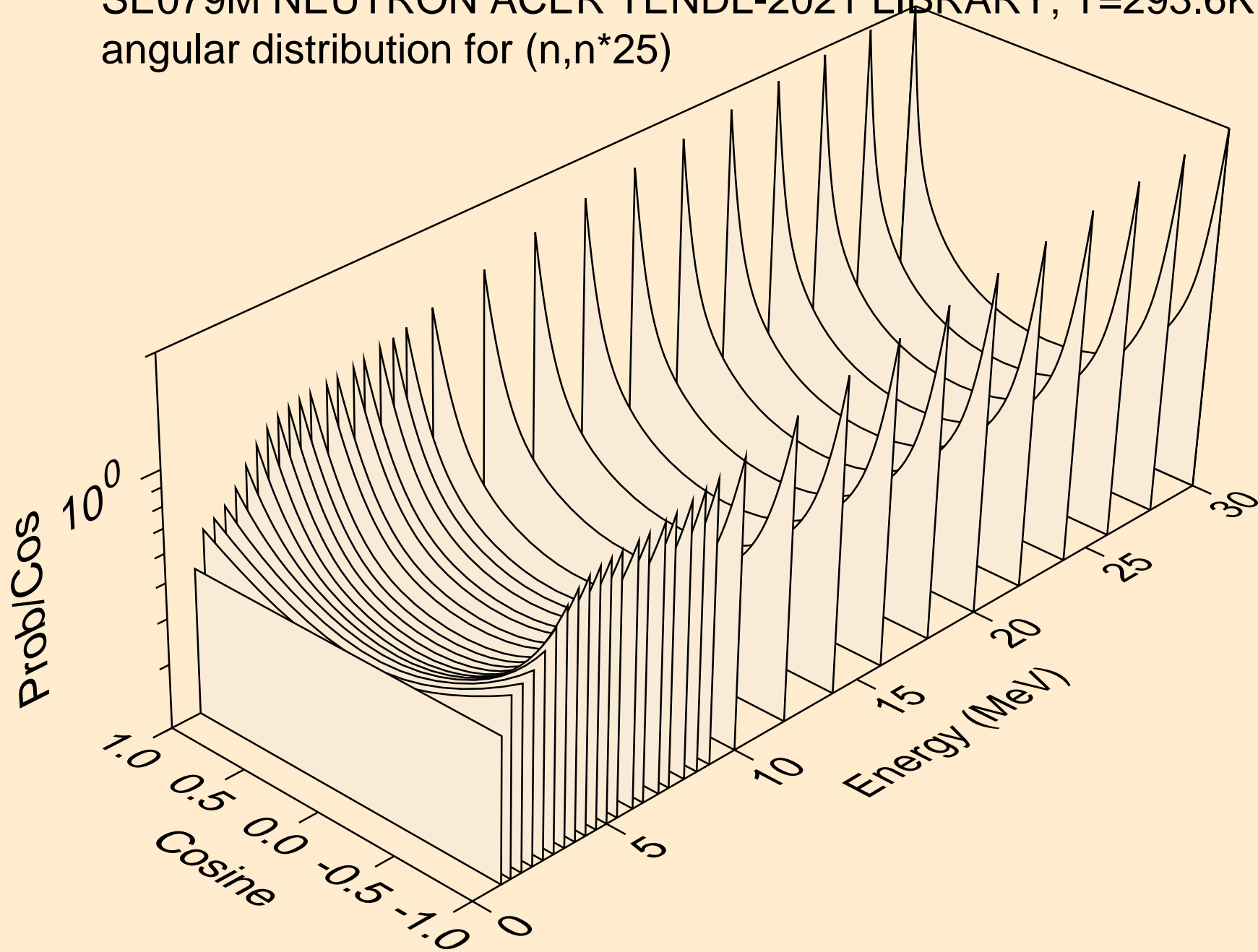

SE079M NEUTRON ACER TENDL-2021 LIBRARY; T=293.6K
angular distribution for (n,n*26)

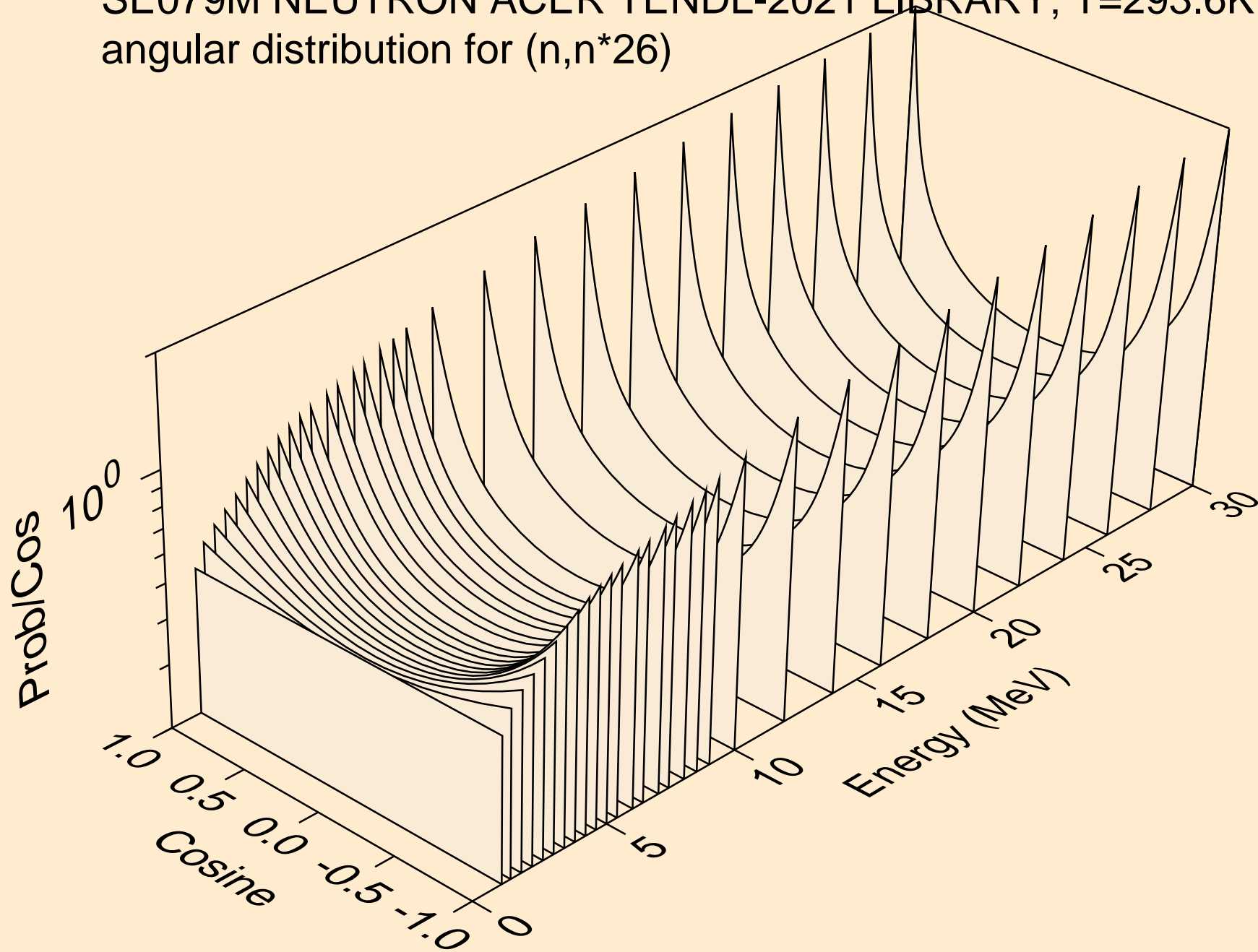

SE079M NEUTRON ACER TENDL-2021 LIBRARY; T=293.6K
angular distribution for (n,n*27)

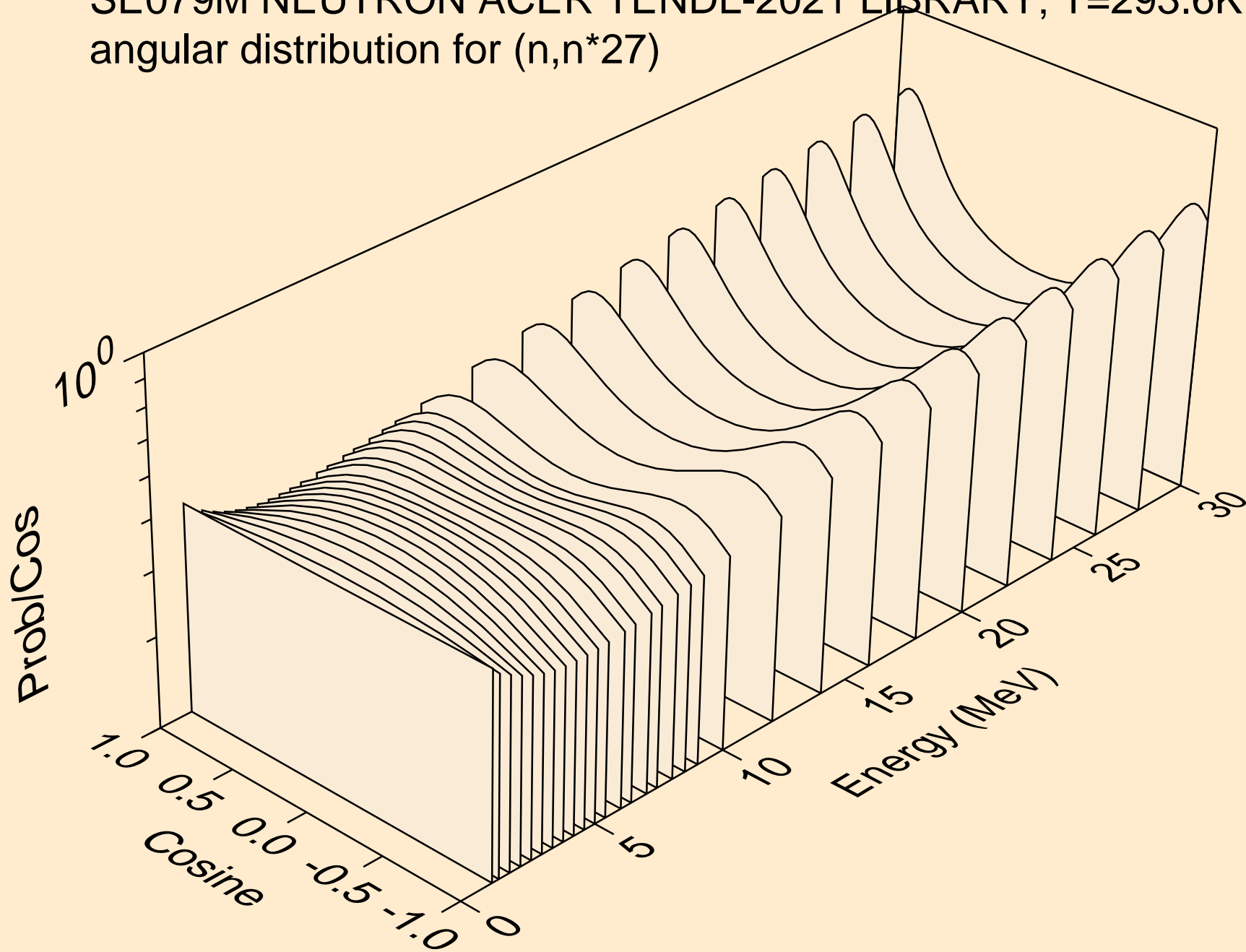

SE079M NEUTRON ACER TENDL-2021 LIBRARY; T=293.6K
angular distribution for (n,n*28)

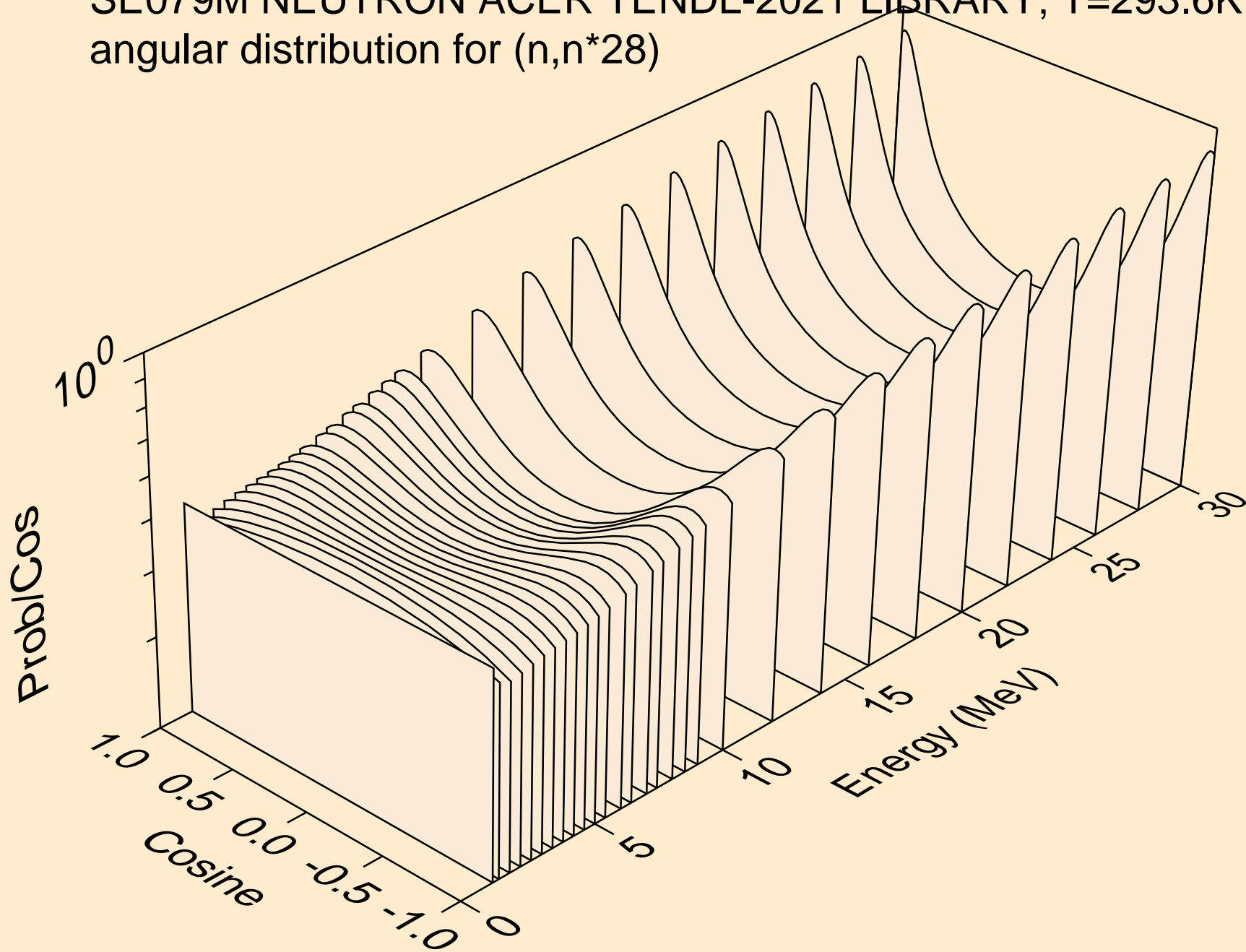

SE079M NEUTRON ACER TENDL-2021 LIBRARY; T=293.6K
angular distribution for (n,n*29)

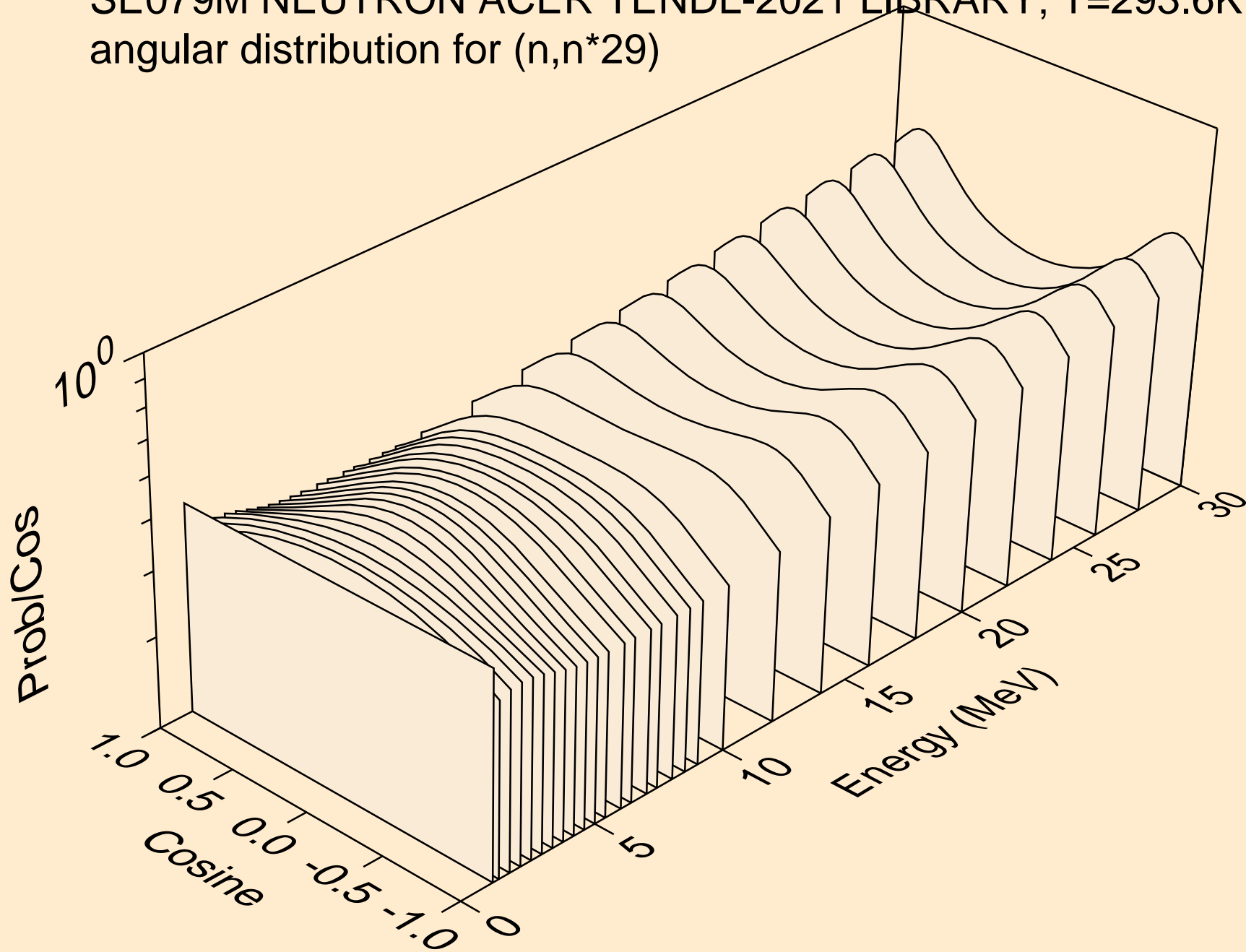

SE079M NEUTRON ACER TENDL-2021 LIBRARY; T=293.6K
angular distribution for (n,n*30)

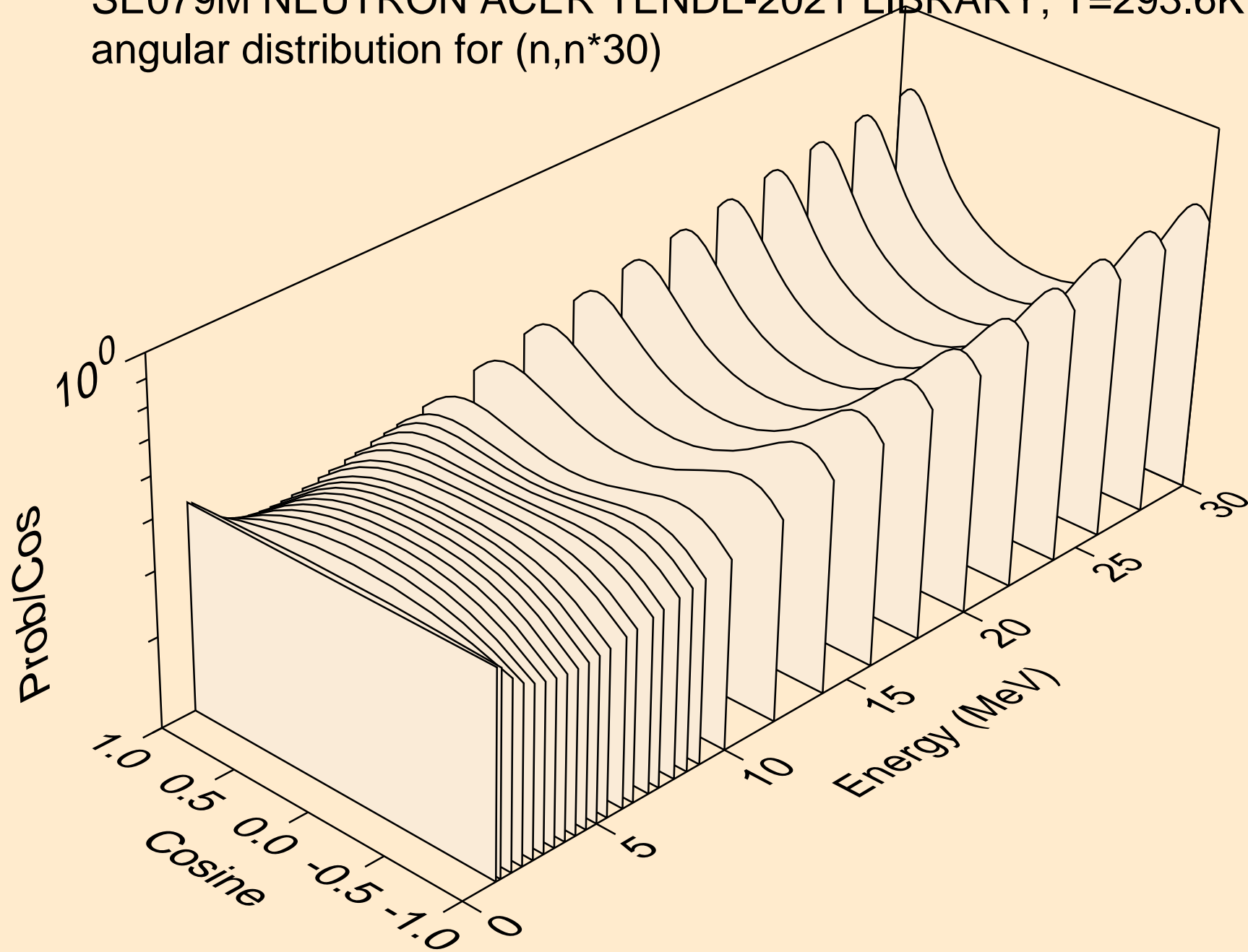

SE079M NEUTRON ACER TENDL-2021 LIBRARY; T=293.6K
Neutron emission for (n,x)

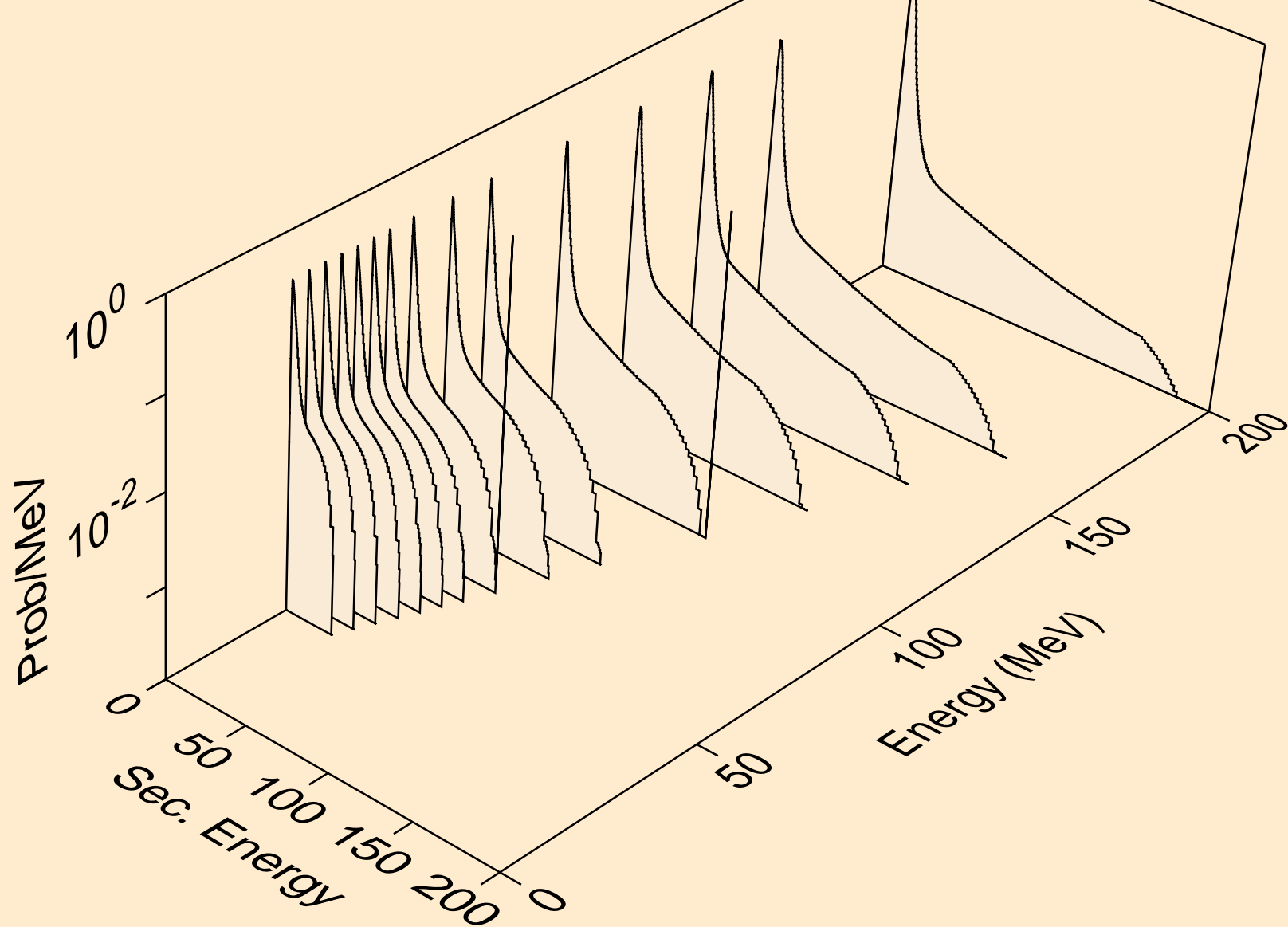

SE079M NEUTRON ACER TENDL-2021 LIBRARY; T=293.6K
Neutron emission for (n,2nd)

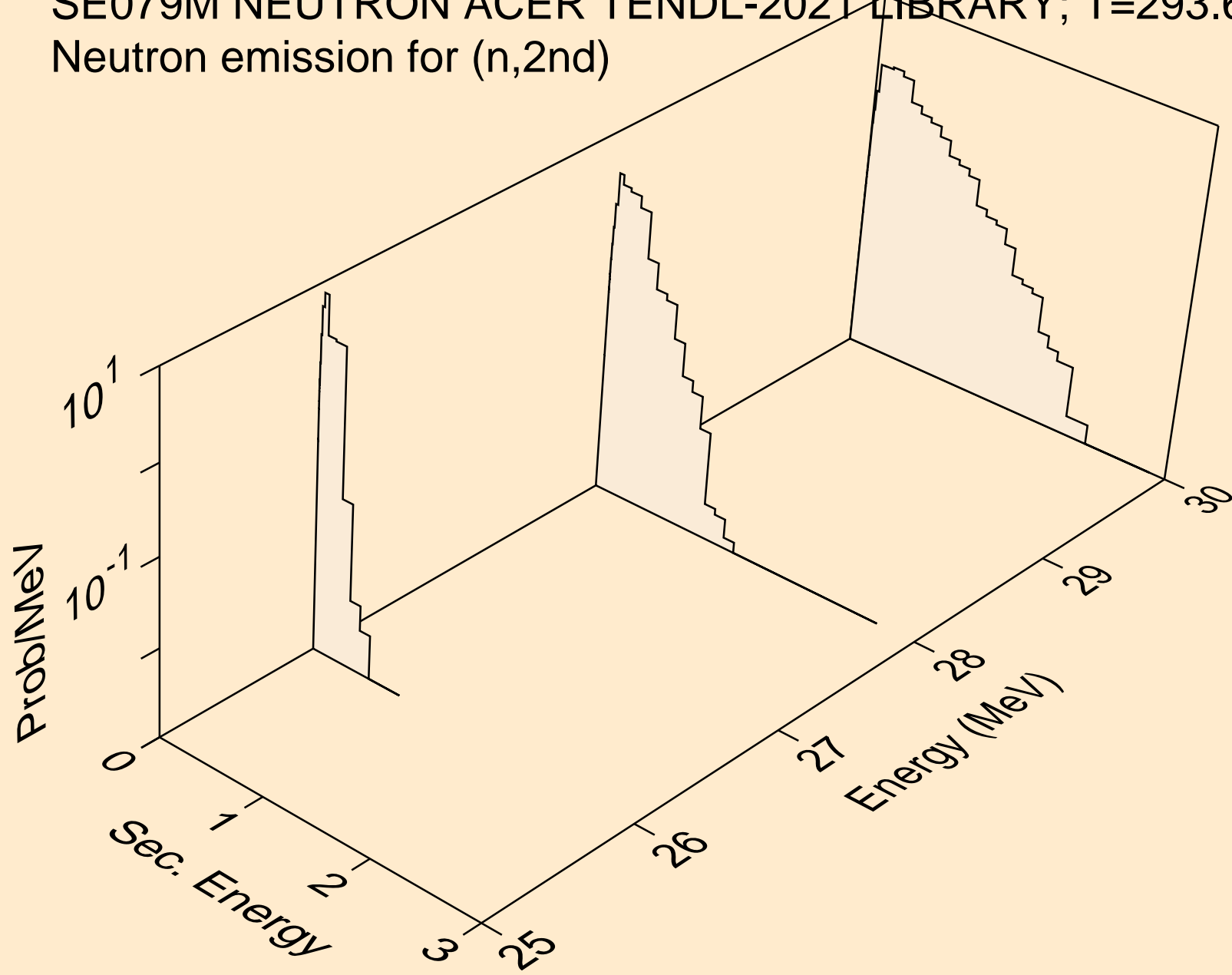

SE079M NEUTRON ACER TENDL-2021 LIBRARY; T=293.6K
Neutron emission for (n,2n)

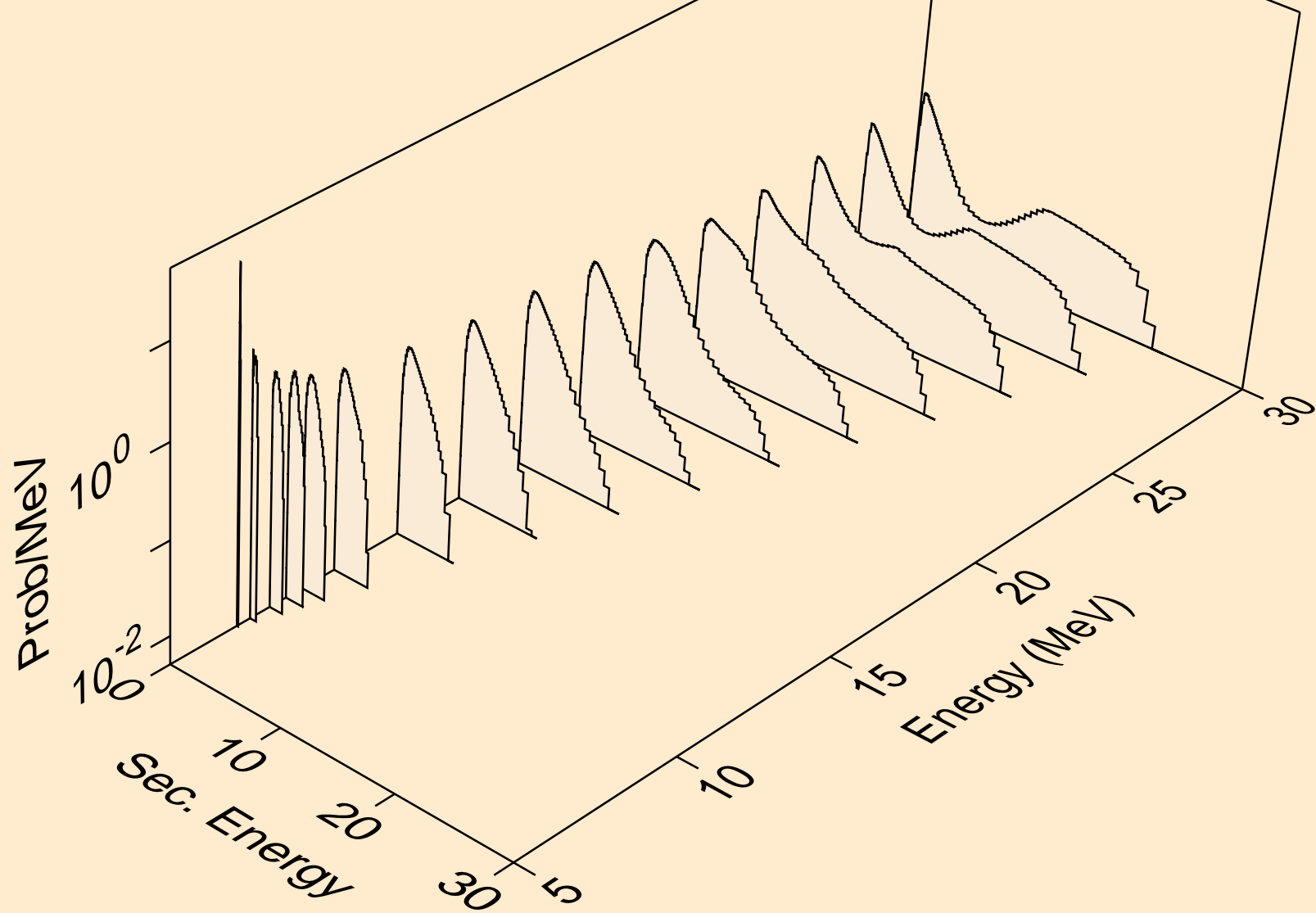

SE079M NEUTRON ACER TENDL-2021 LIBRARY; T=293.6K
Neutron emission for (n,3n)

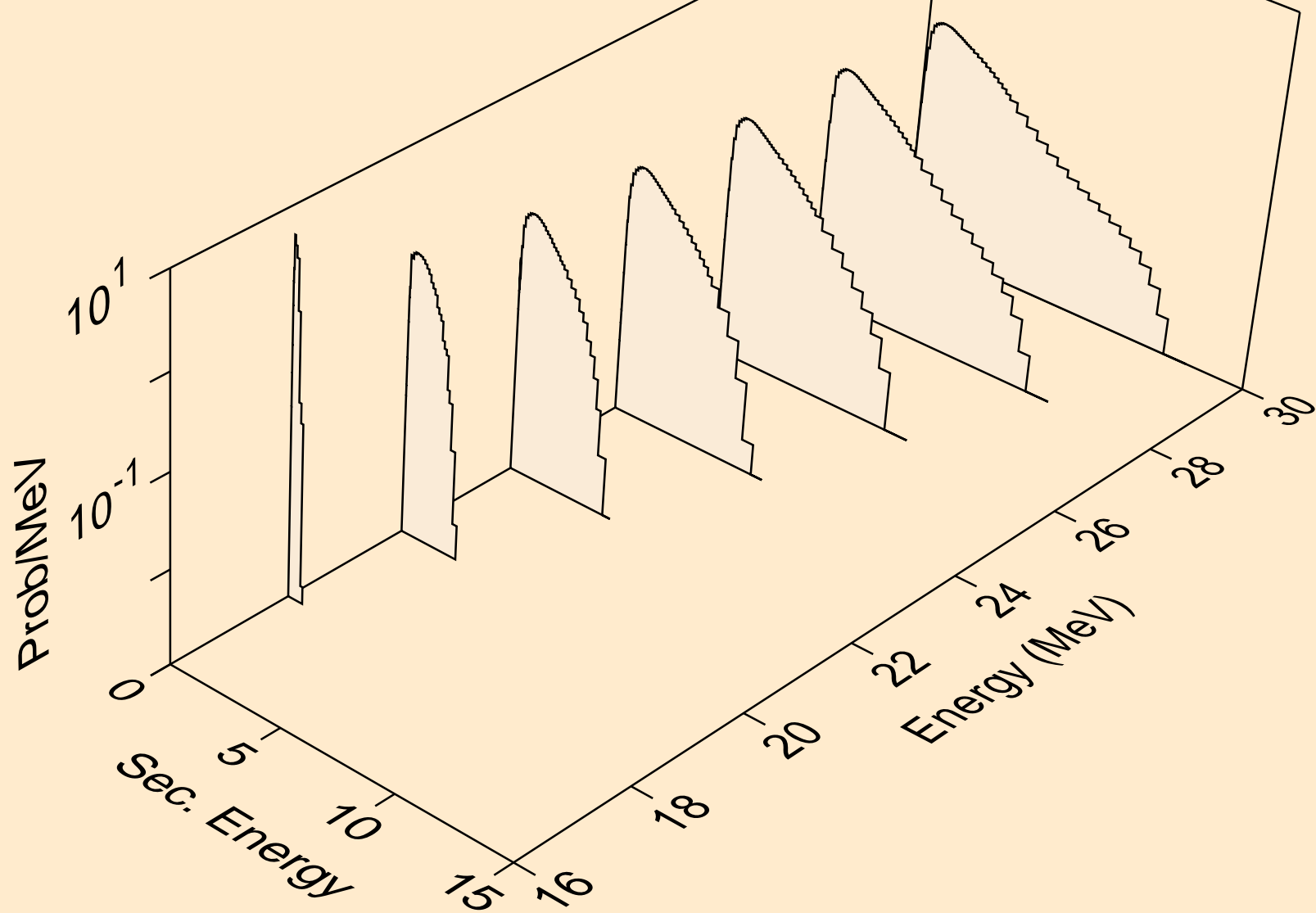

SE079M NEUTRON ACER TENDL-2021 LIBRARY; T=293.6K
Neutron emission for (n,n*)a

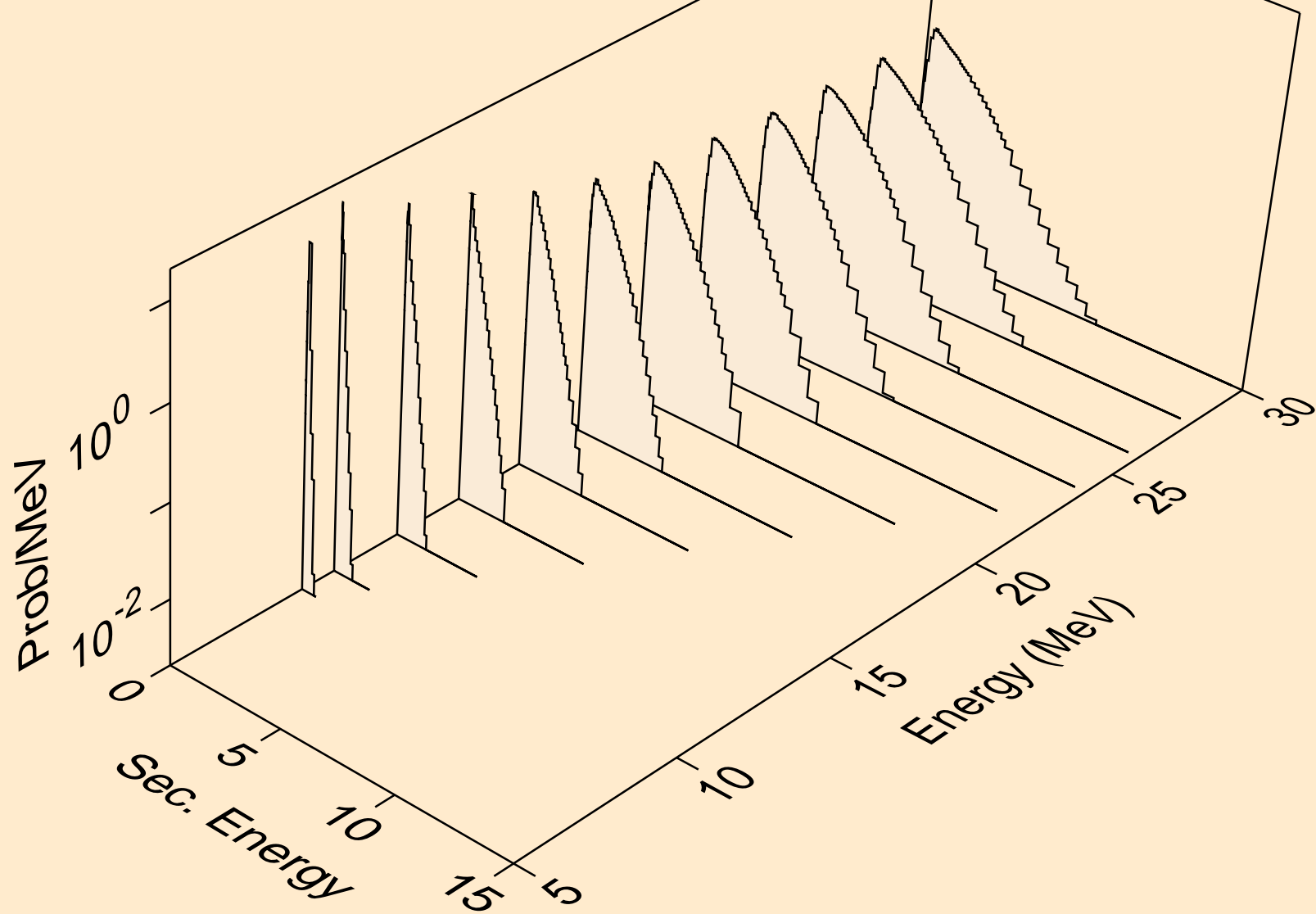

SE079M NEUTRON ACER TENDL-2021 LIBRARY; T=293.6K
Neutron emission for (n,2n)a

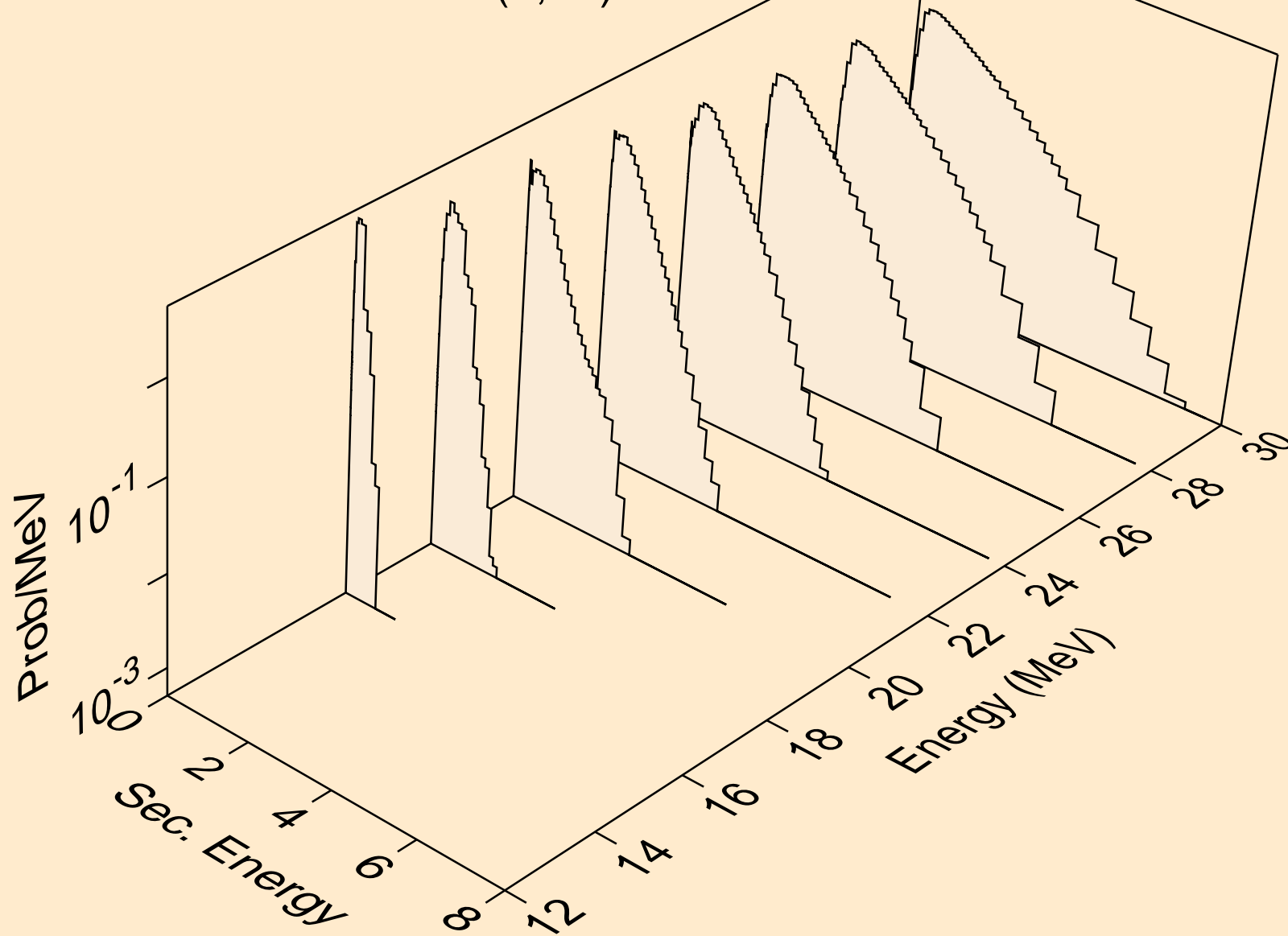

SE079M NEUTRON ACER TENDL-2021 LIBRARY; T=293.6K
Neutron emission for (n,3n)a

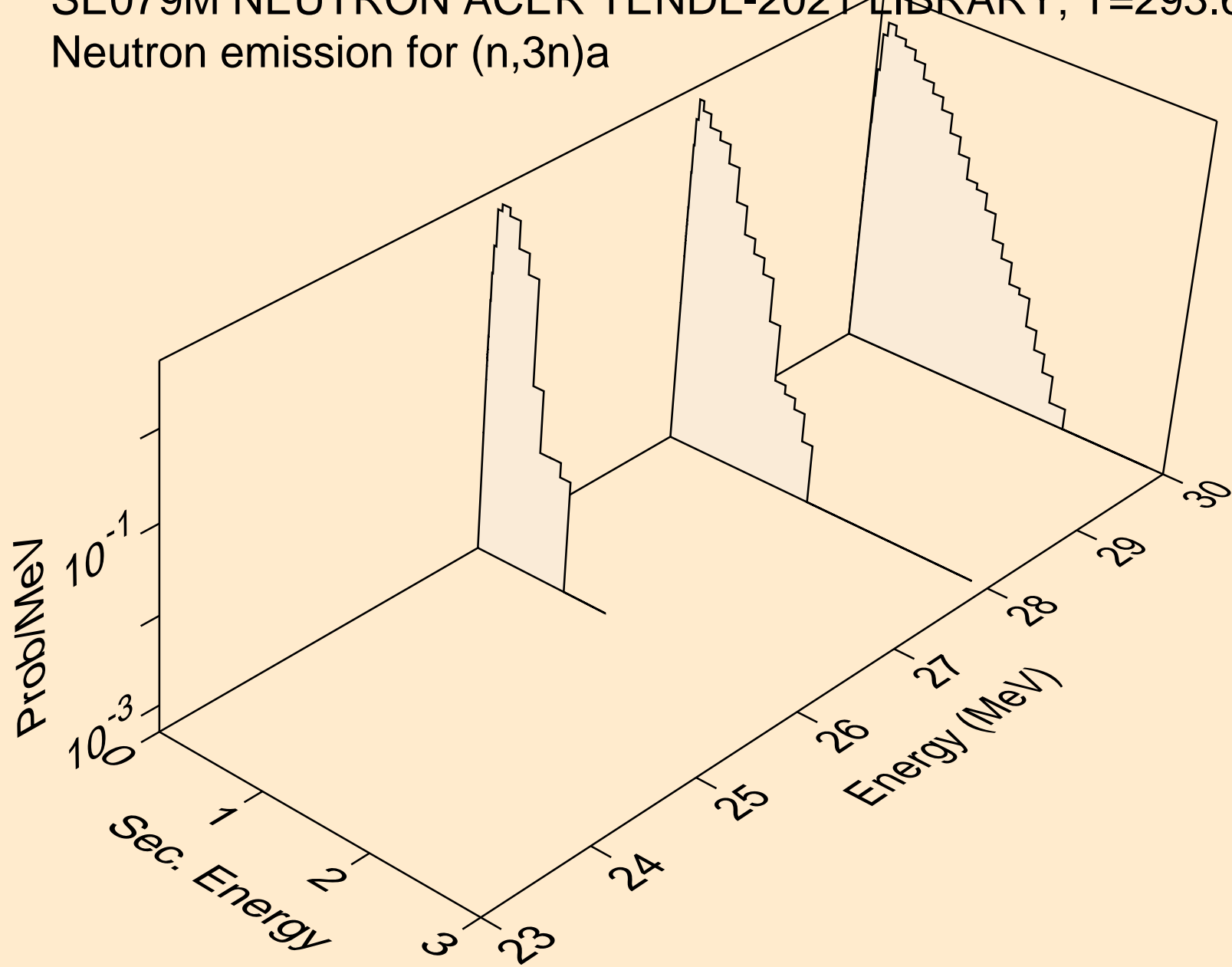

SE079M NEUTRON ACER TENDL-2021 LIBRARY; T=293.6K
Neutron emission for (n,n*)p

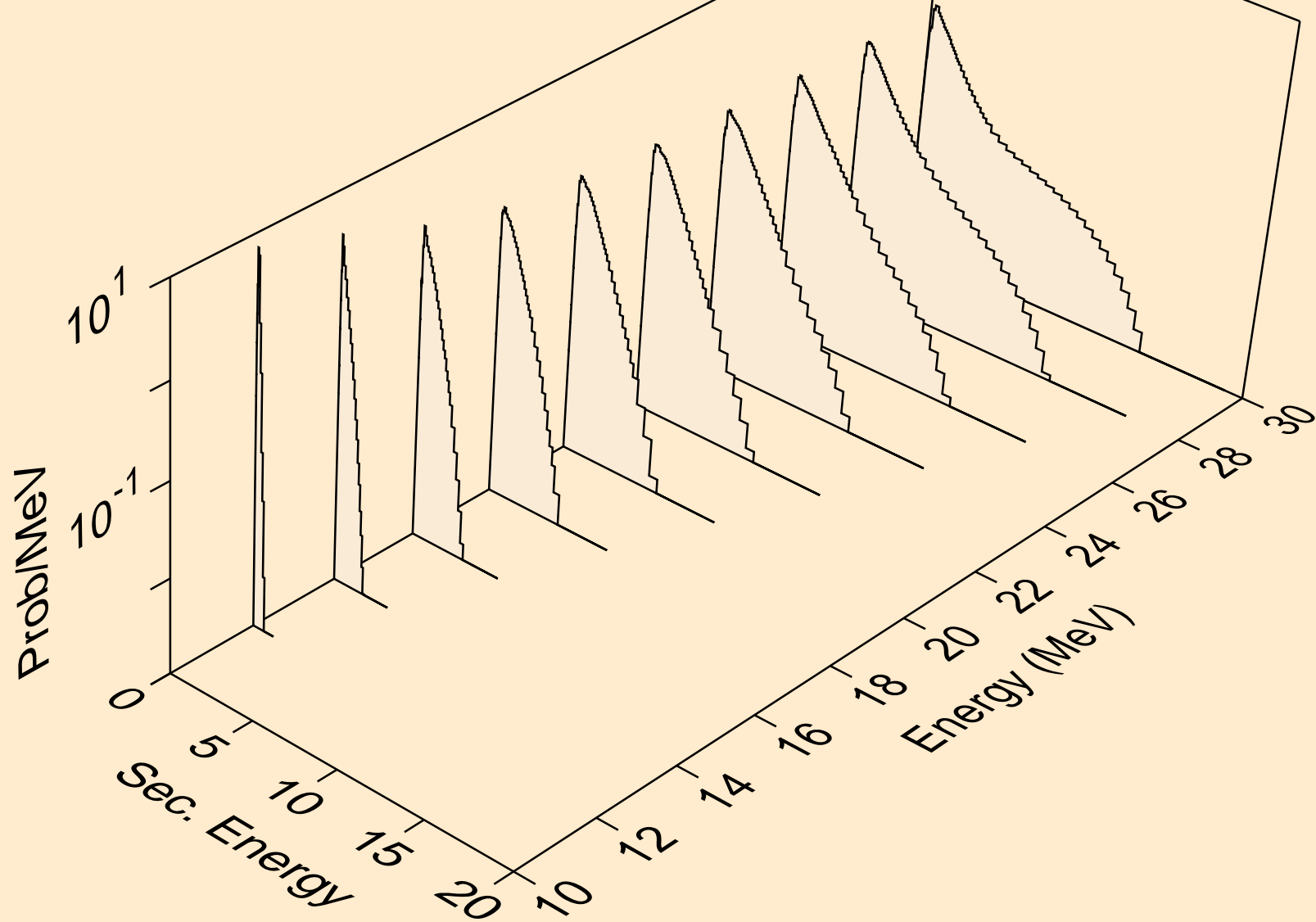

SE079M NEUTRON ACER TENDL-2021 LIBRARY; T=293.6K
Neutron emission for (n,n*)2a

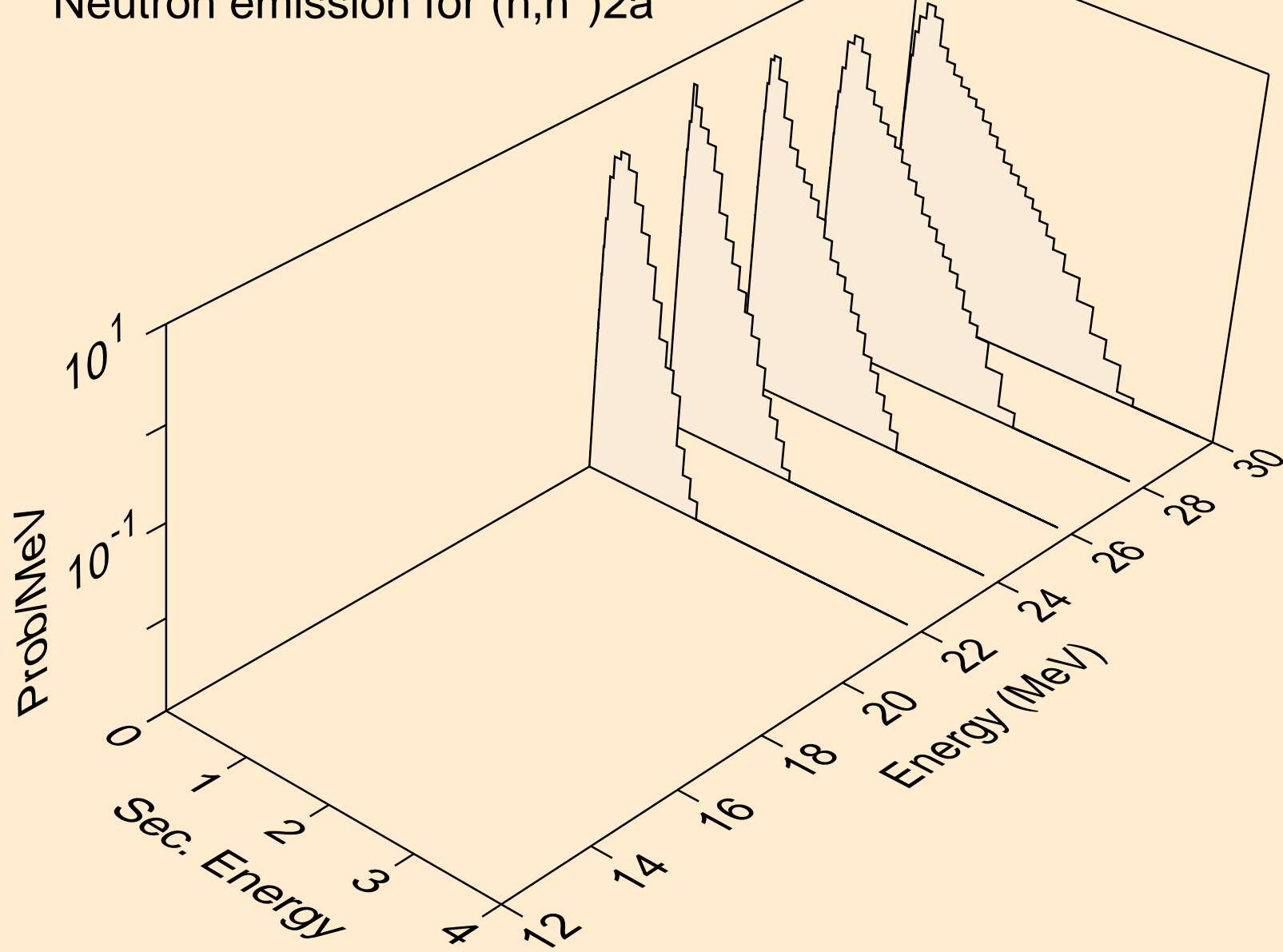

SE079M NEUTRON ACER TENDL-2021 LIBRARY; T=293.6K
Neutron emission for (n,n*)d

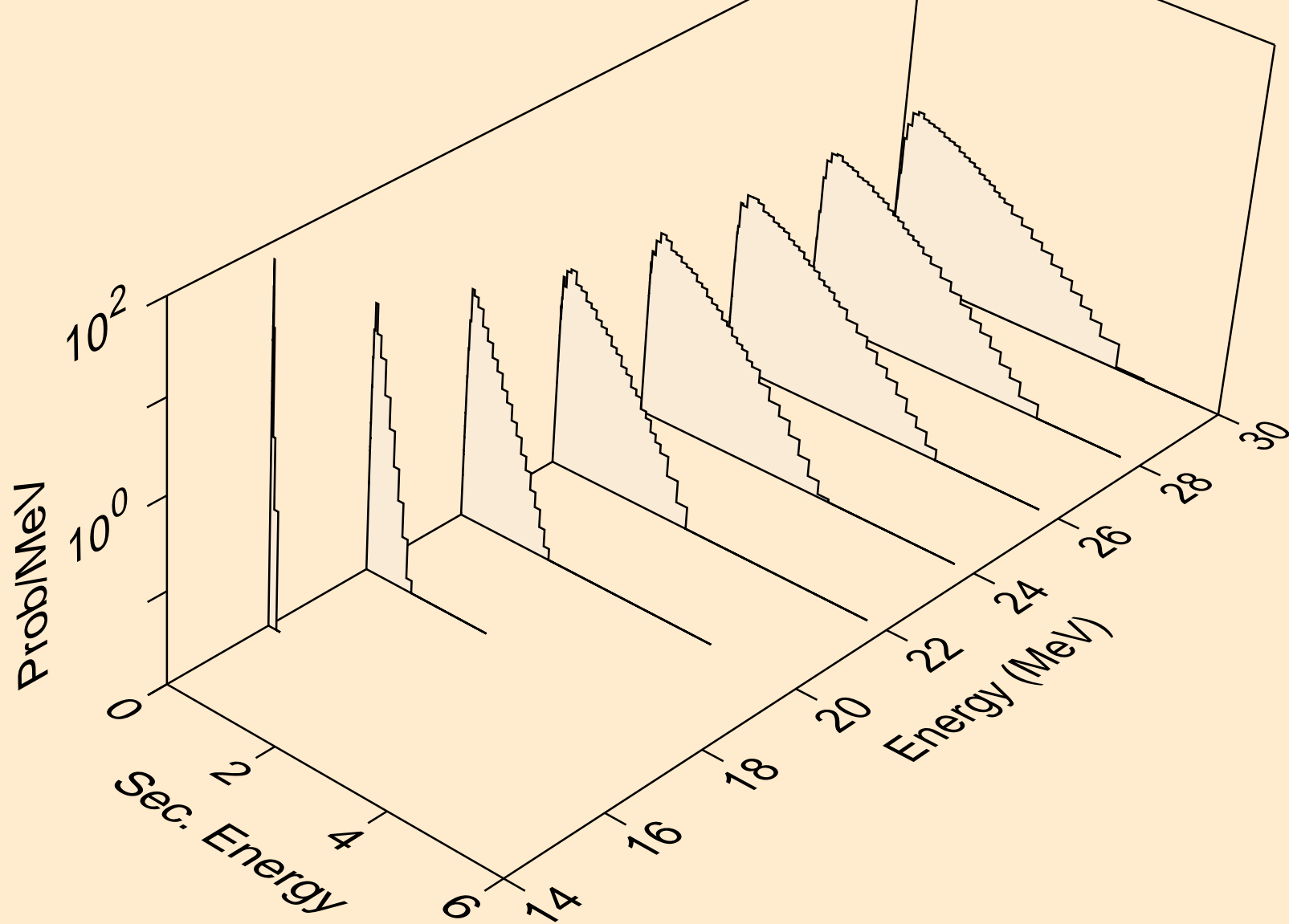

SE079M NEUTRON ACER TENDL-2021 LIBRARY; T=293.6K
Neutron emission for (n,n*)t

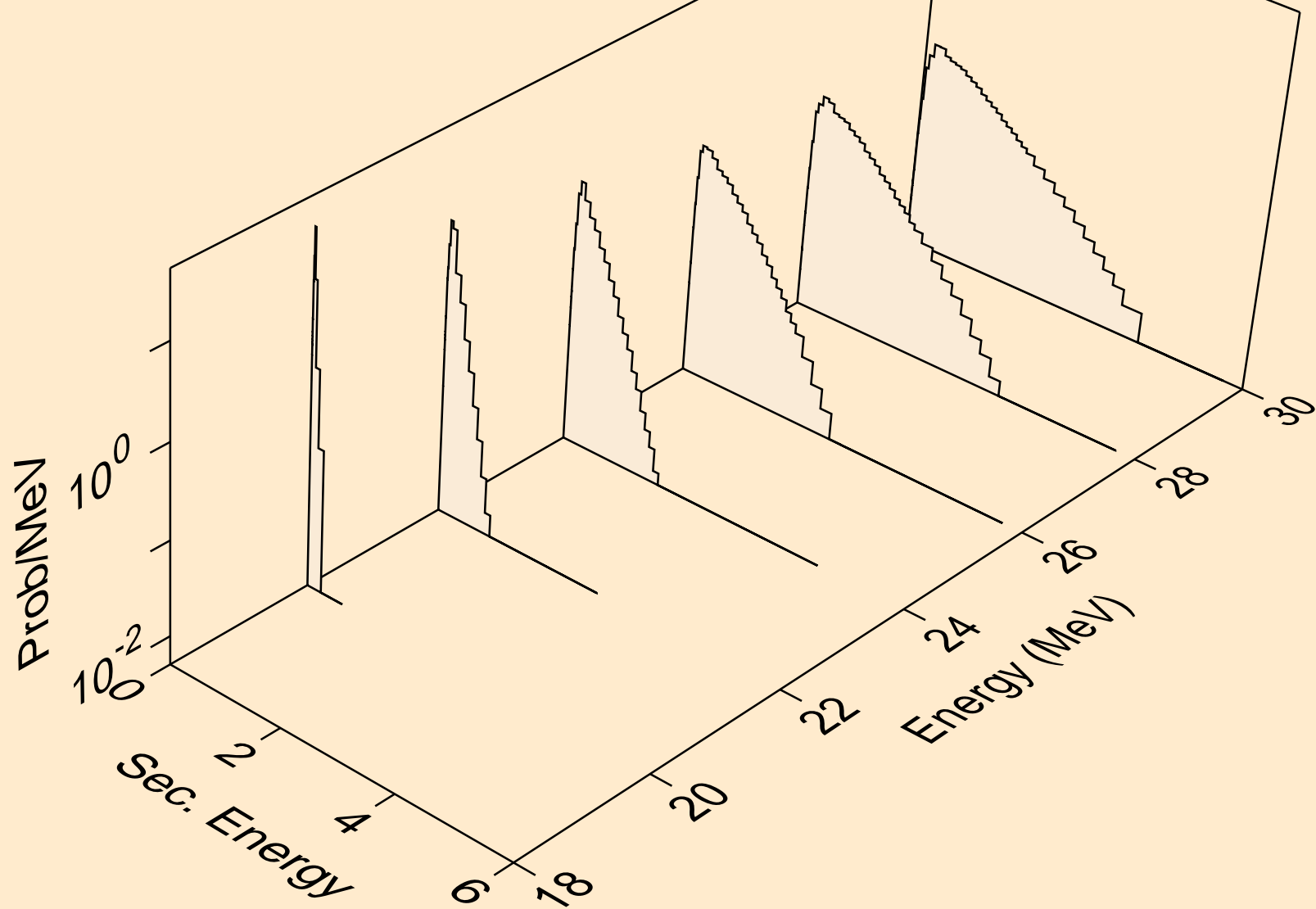

SE079M NEUTRON ACER TENDL-2021 LIBRARY; T=293.6K
Neutron emission for (n,n*)he3

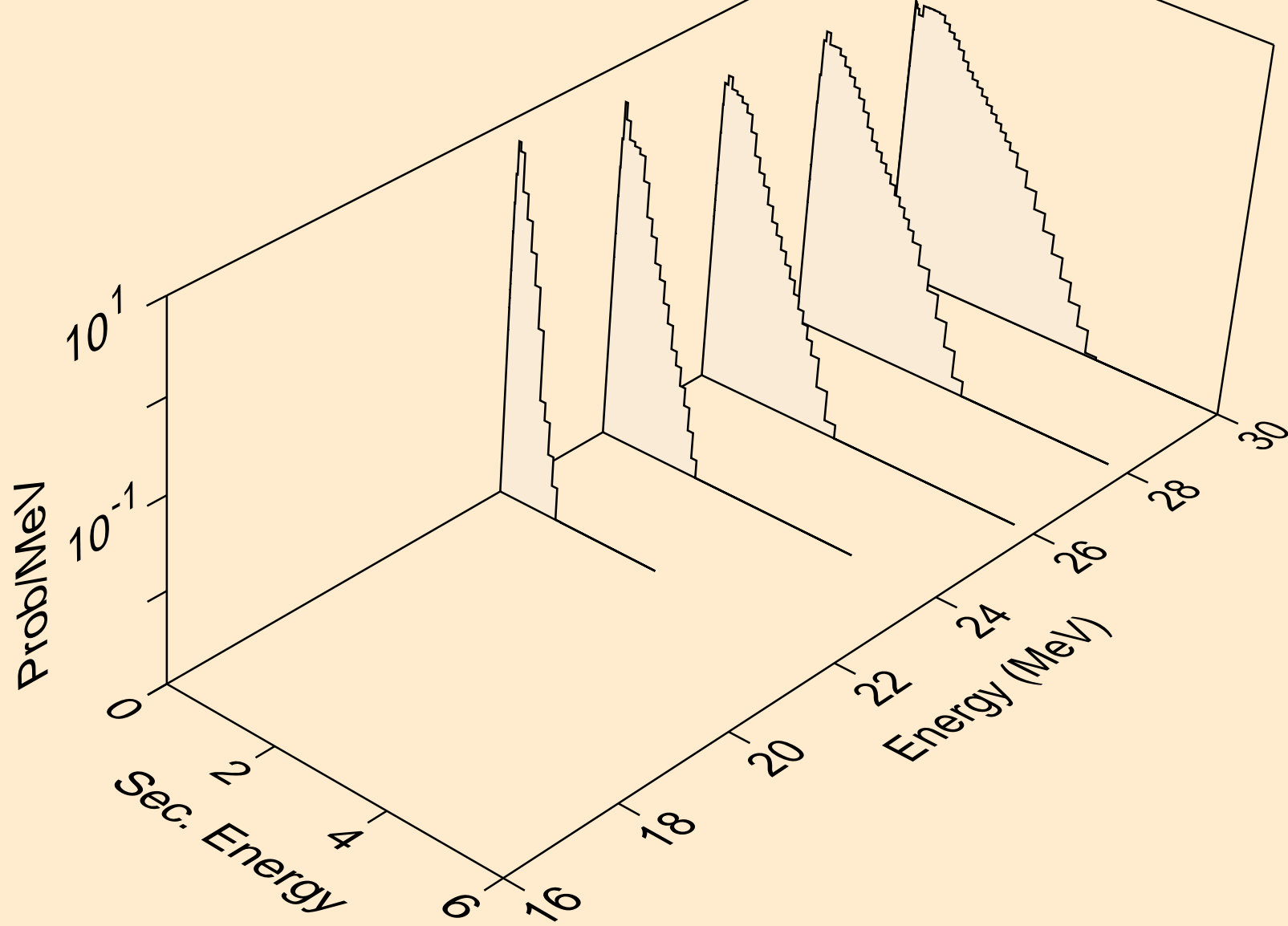

SE079M NEUTRON ACER TENDL-2021 LIBRARY; T=293.6K
Neutron emission for (n,4n)

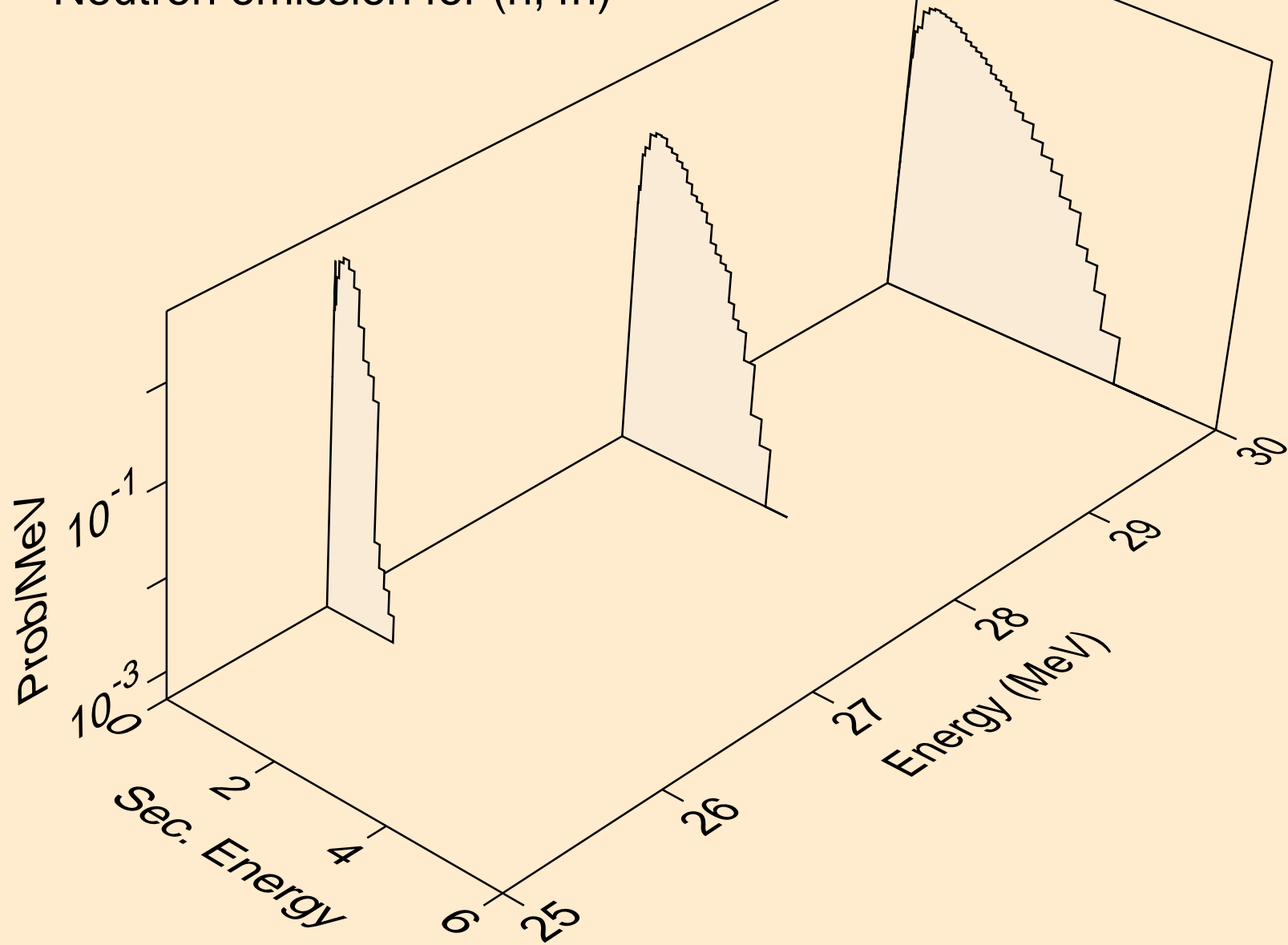

SE079M NEUTRON ACER TENDL-2021 LIBRARY; T=293.6K
Neutron emission for (n,2np)

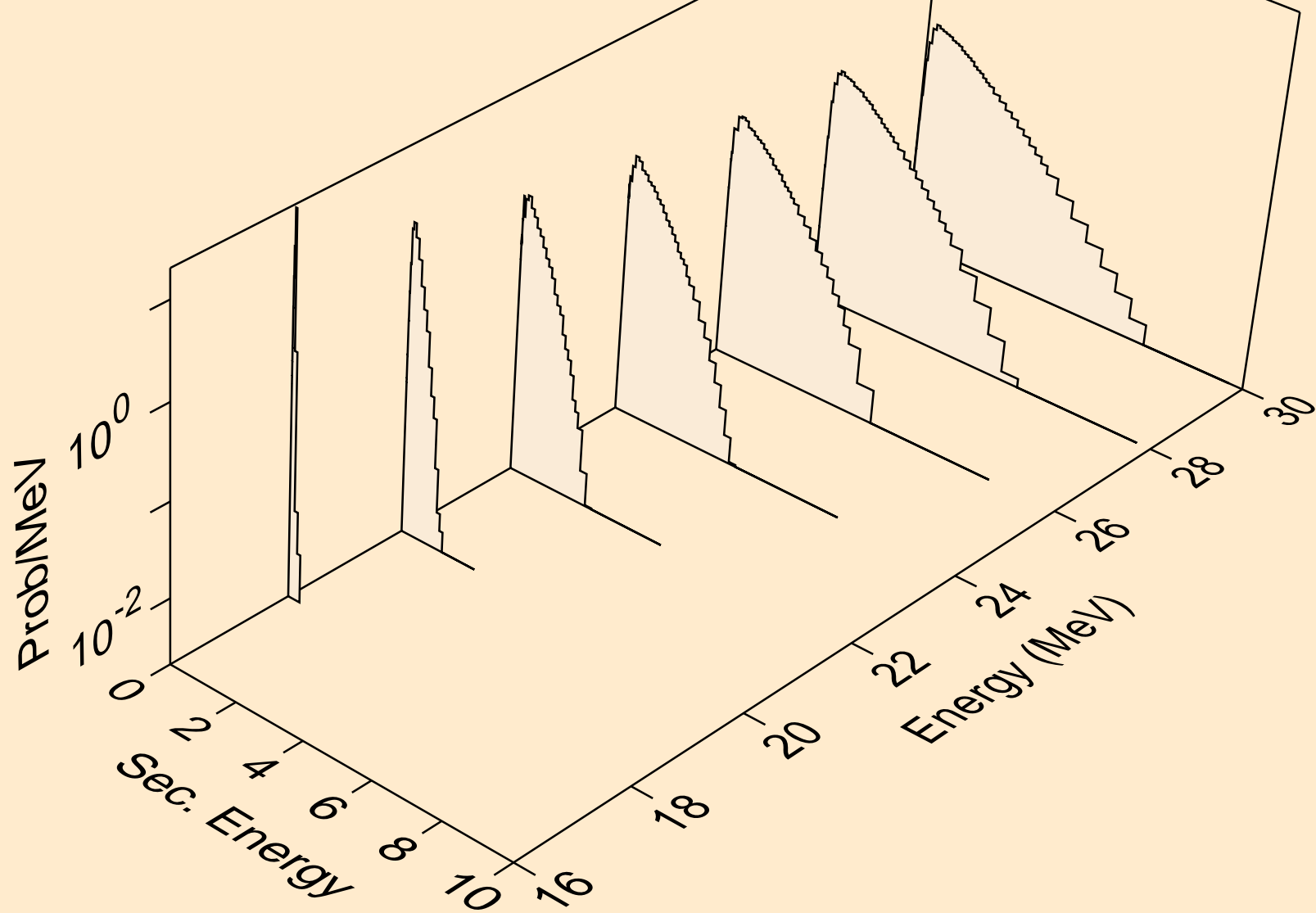

SE079M NEUTRON ACER TENDL-2021 LIBRARY; T=293.6K
Neutron emission for (n,3np)

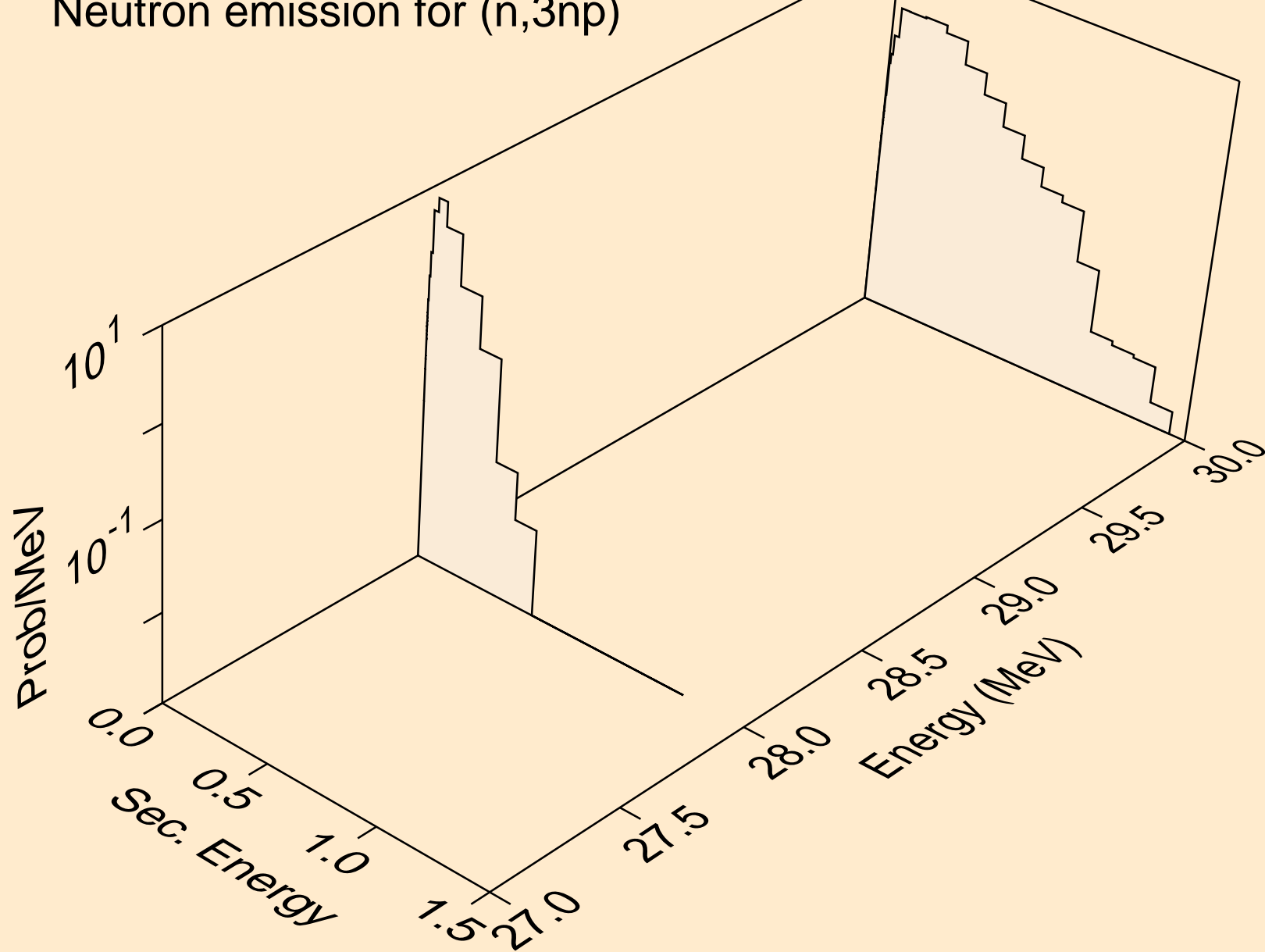

SE079M NEUTRON ACER TENDL-2021 LIBRARY; T=293.6K
Neutron emission for (n,2np)

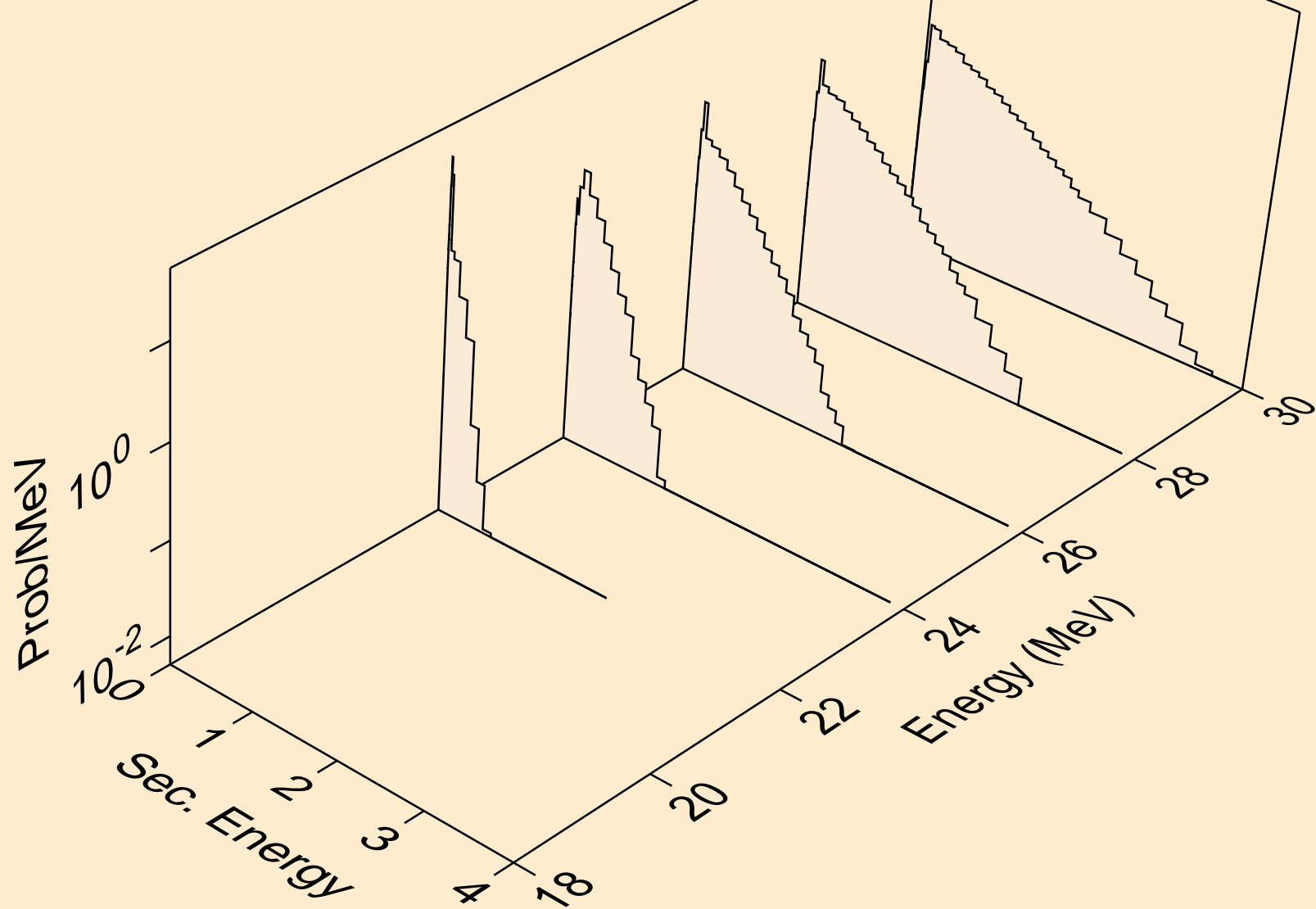

SE079M NEUTRON ACER TENDL-2021 LIBRARY; T=293.6K
Neutron emission for (n,npa)

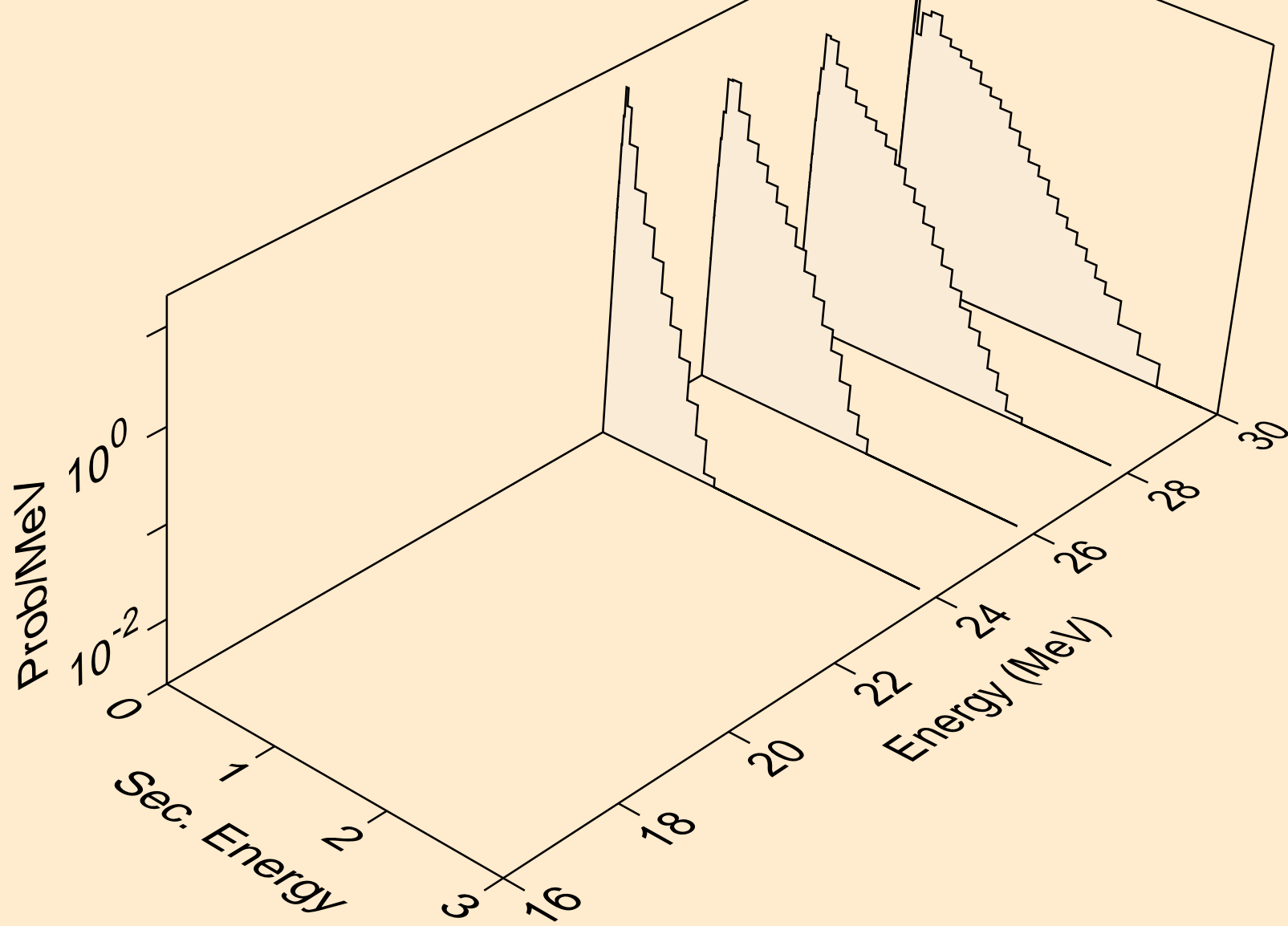

SE079M NEUTRON ACER TENDL-2021 LIBRARY; T=293.6K
Neutron emission for (n,n*c)

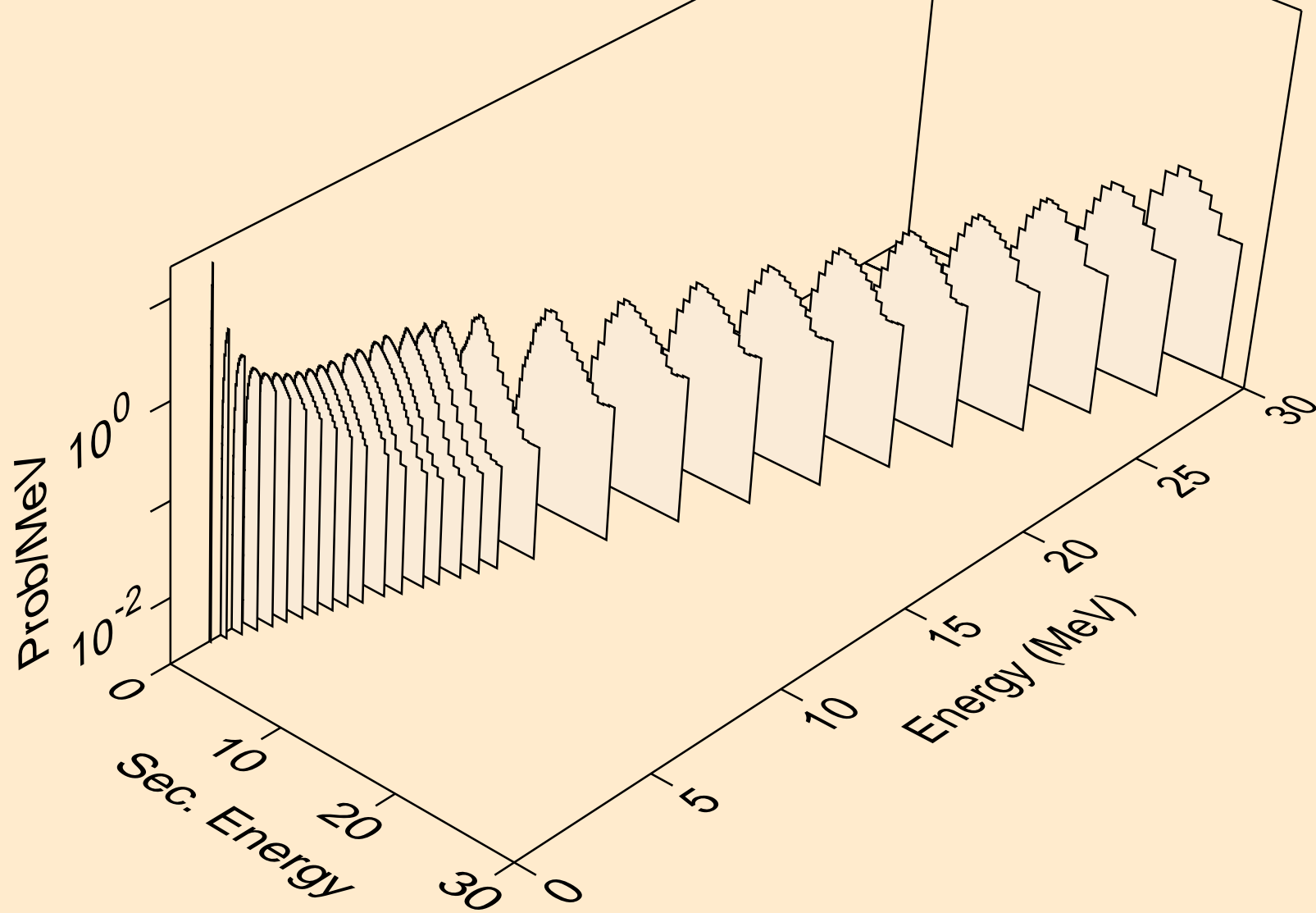

SE079M NEUTRON ACER TENDL-2021 LIBRARY; T=293.6K
Photon emission for (n,x)

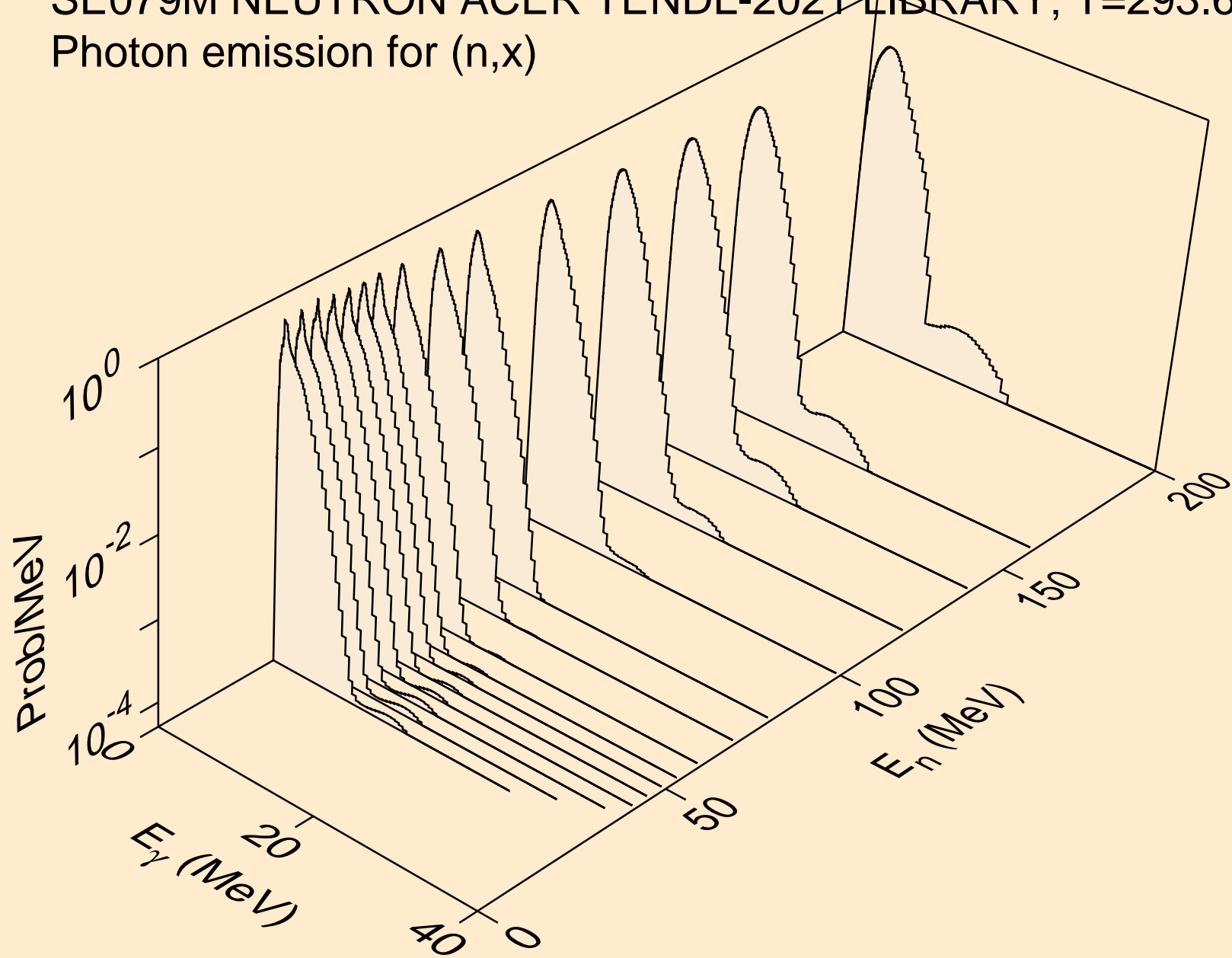

SE079M NEUTRON ACER TENDL-2021 LIBRARY; T=293.6K
Photon emission for (n,2nd)

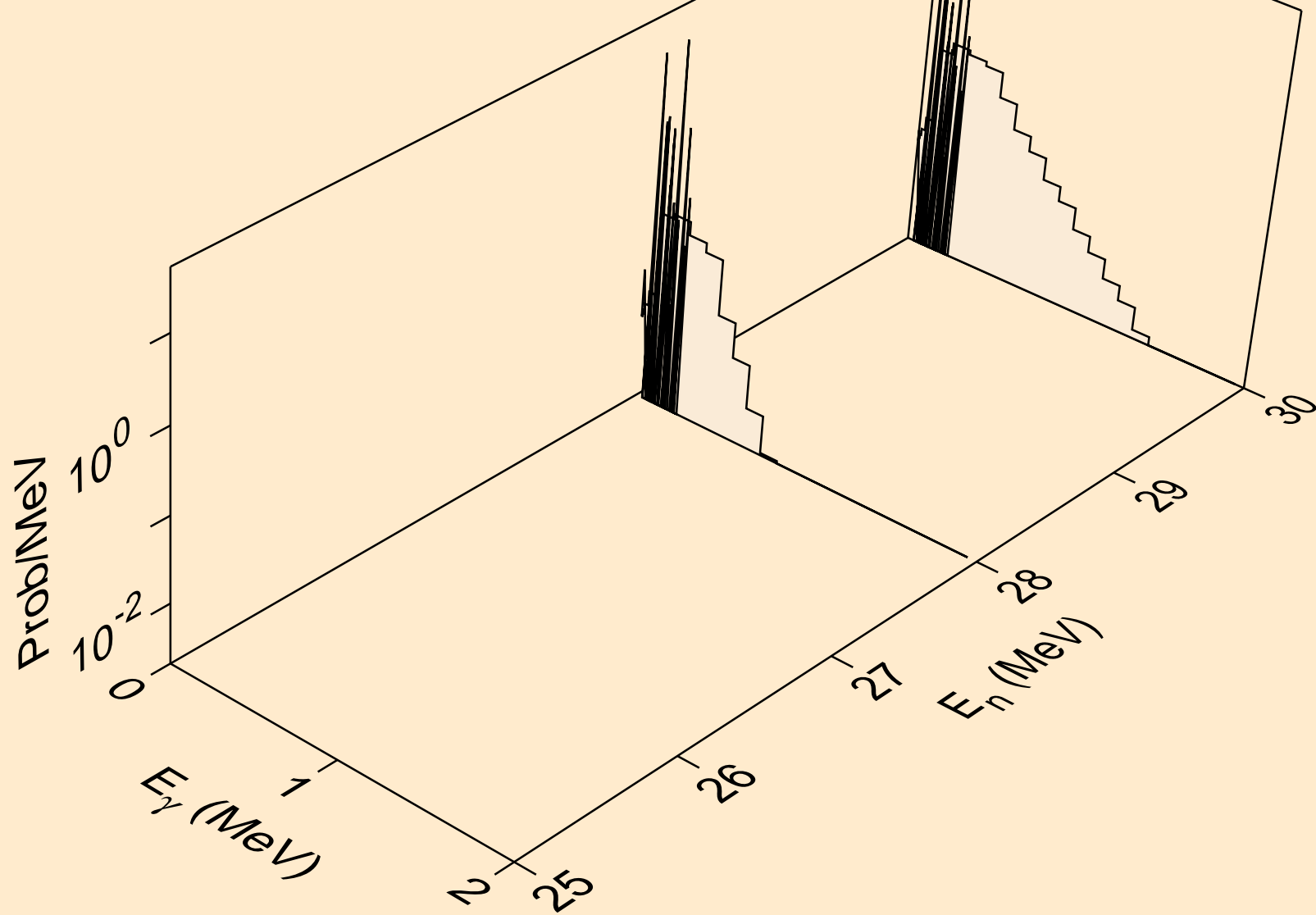

SE079M NEUTRON ACER TENDL-2021 LIBRARY; T=293.6K
Photon emission for (n,2n)

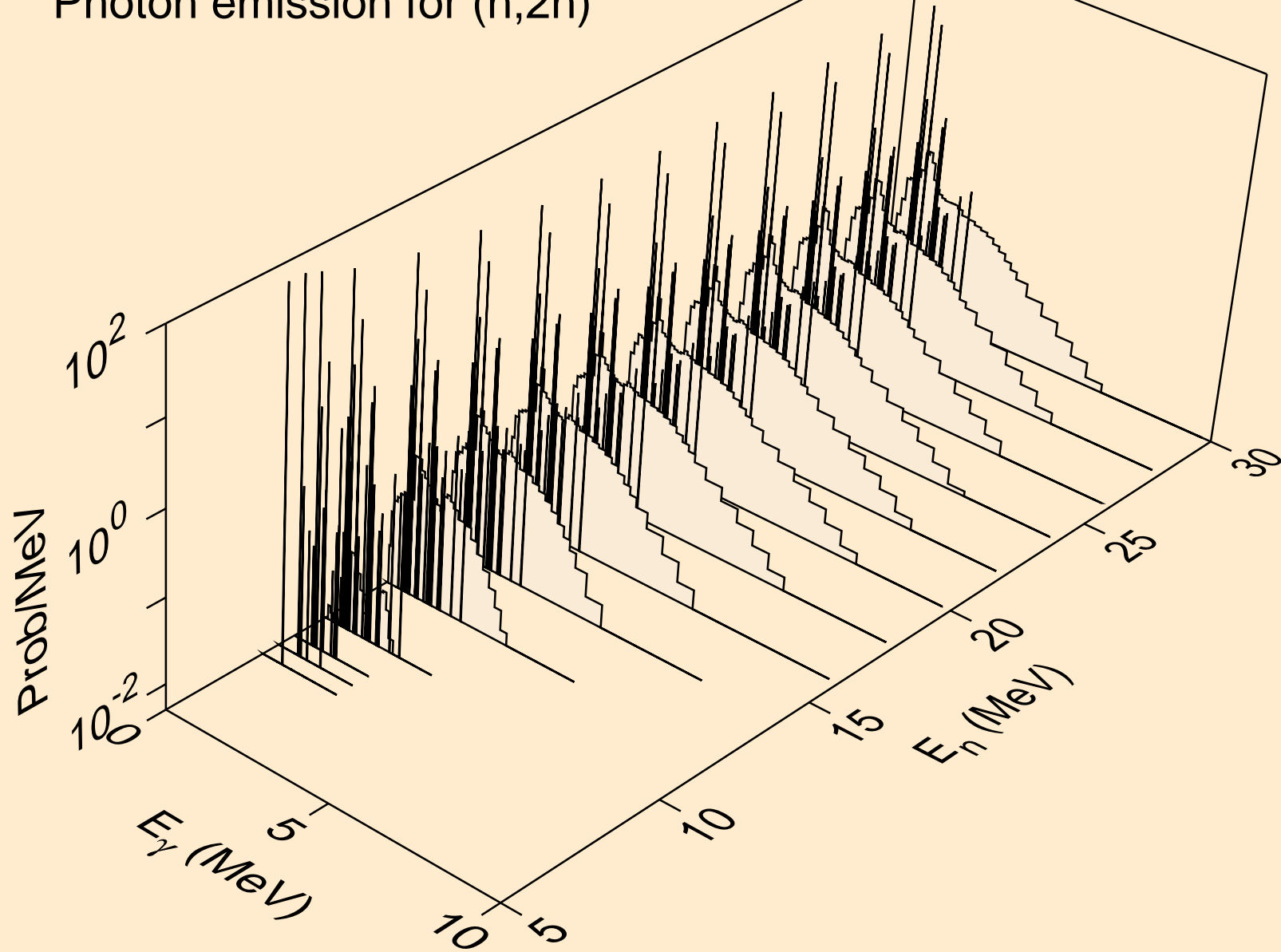

SE079M NEUTRON ACER TENDL-2021 LIBRARY; T=293.6K
Photon emission for (n,3n)

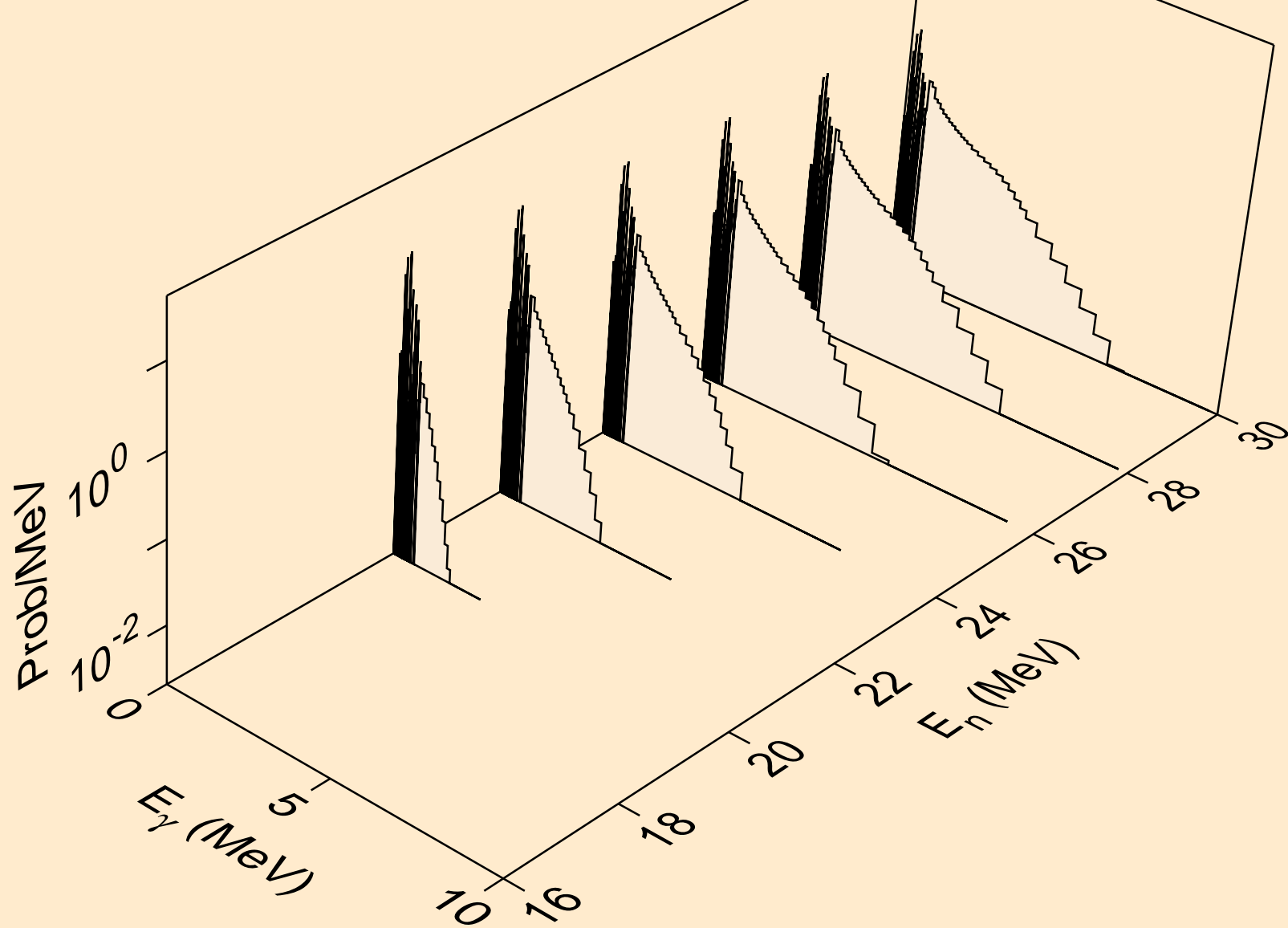

SE079M NEUTRON ACER TENDL-2021 LIBRARY; T=293.6K
Photon emission for (n,n*)a

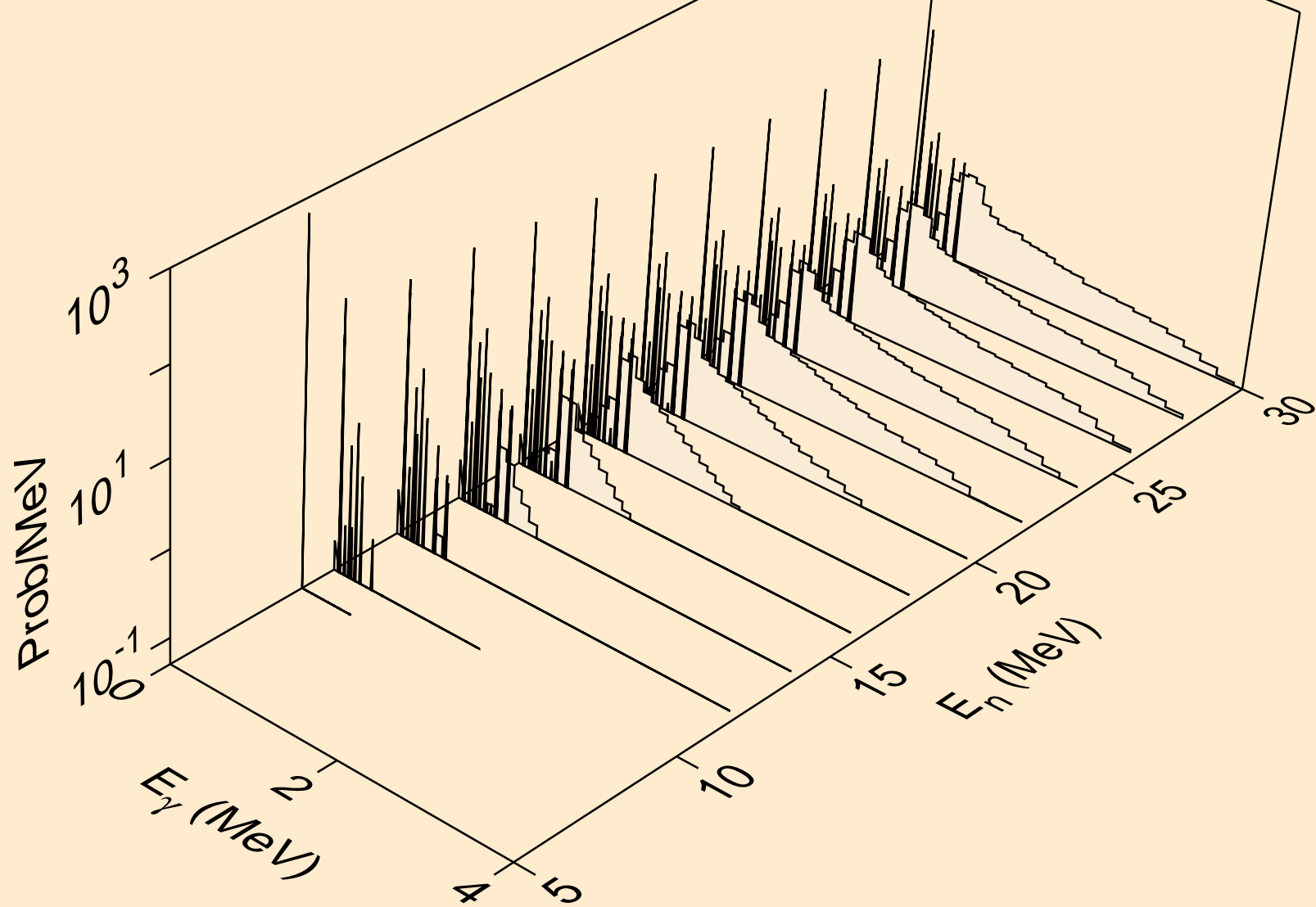

SE079M NEUTRON ACER TENDL-2021 LIBRARY; T=293.6K
Photon emission for (n,2n)a

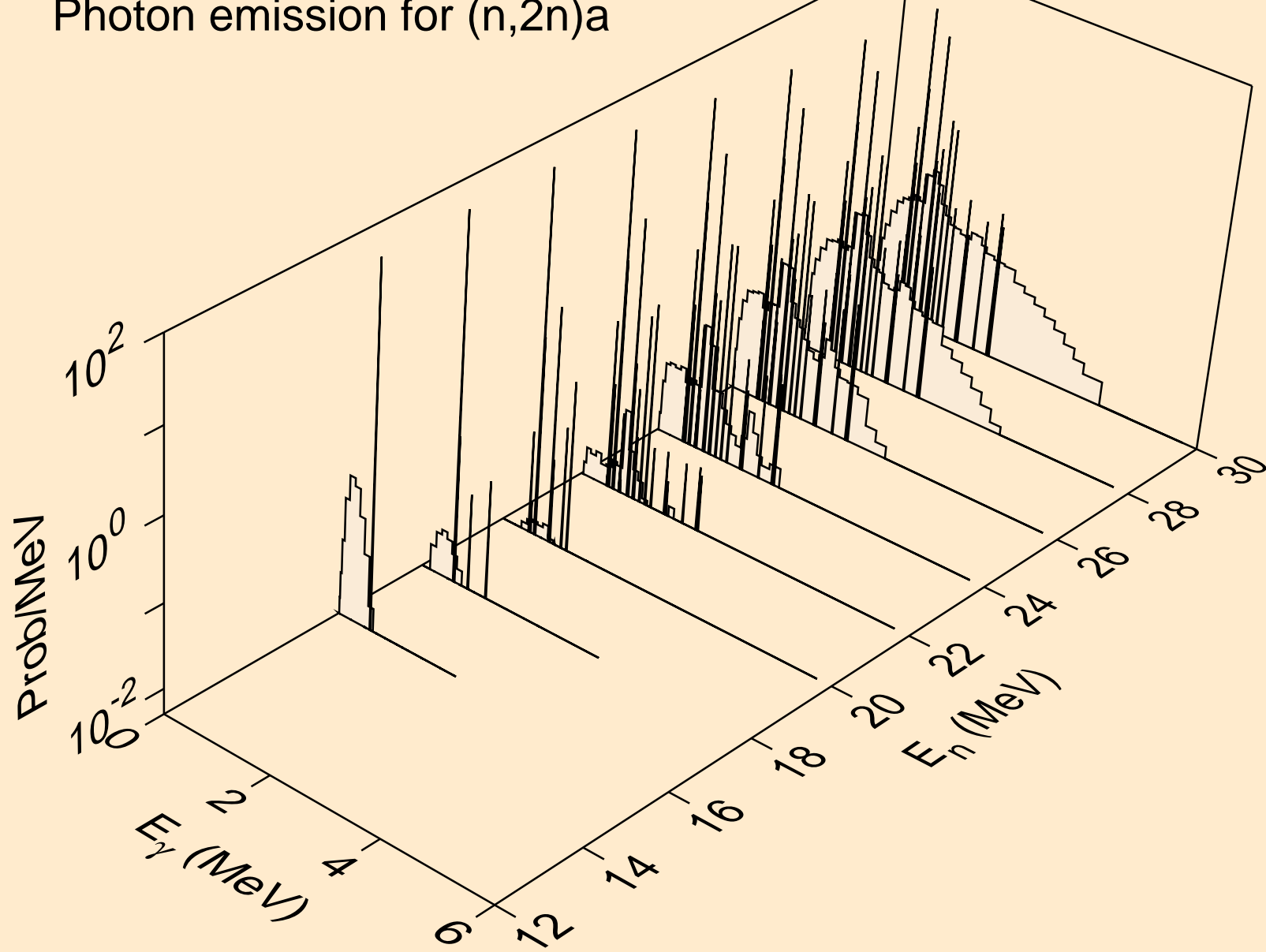

SE079M NEUTRON ACER TENDL-2021 LIBRARY; T=293.6K
Photon emission for (n,3n)a

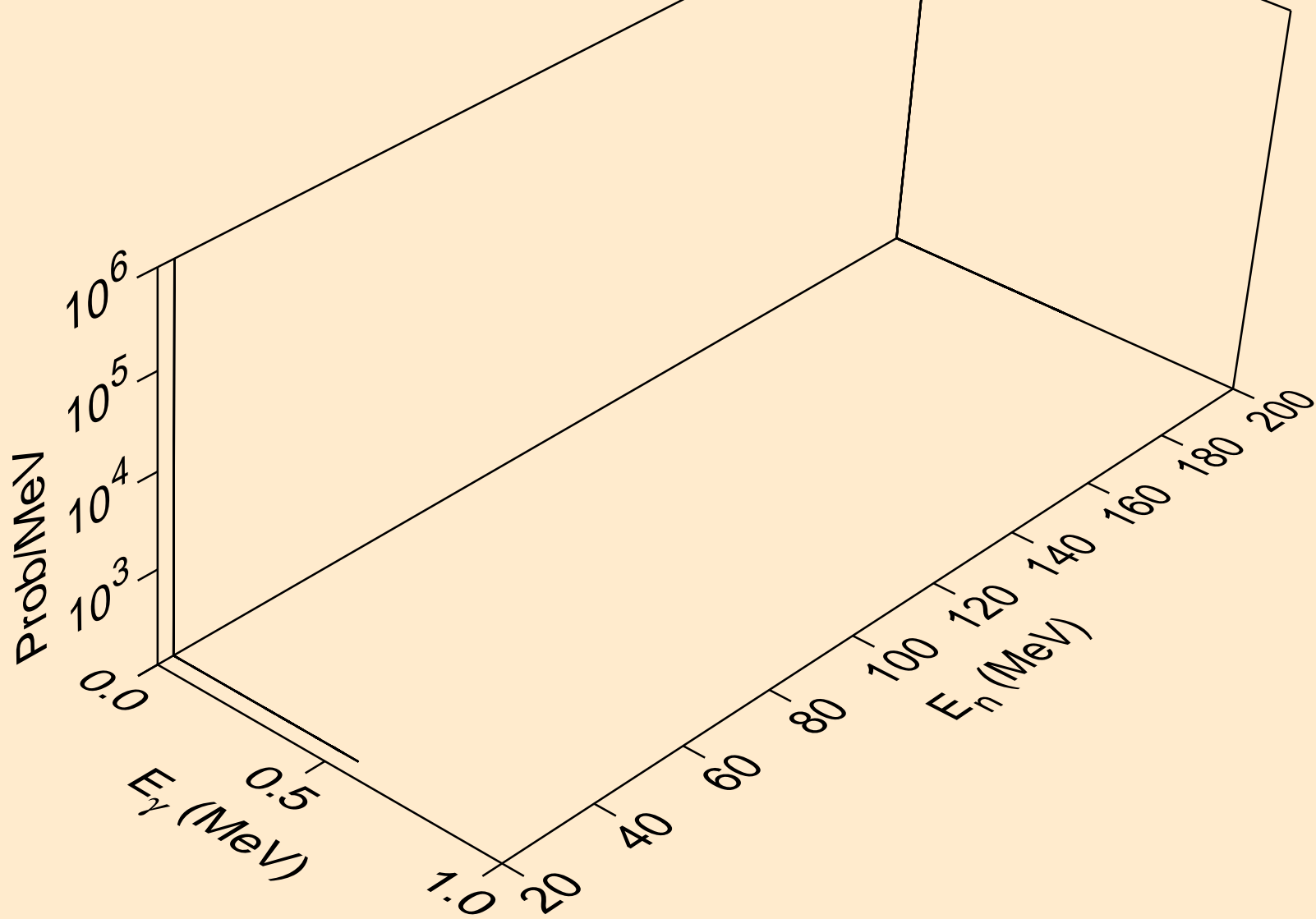

SE079M NEUTRON ACER TENDL-2021 LIBRARY; T=293.6K
Photon emission for (n,n*)p

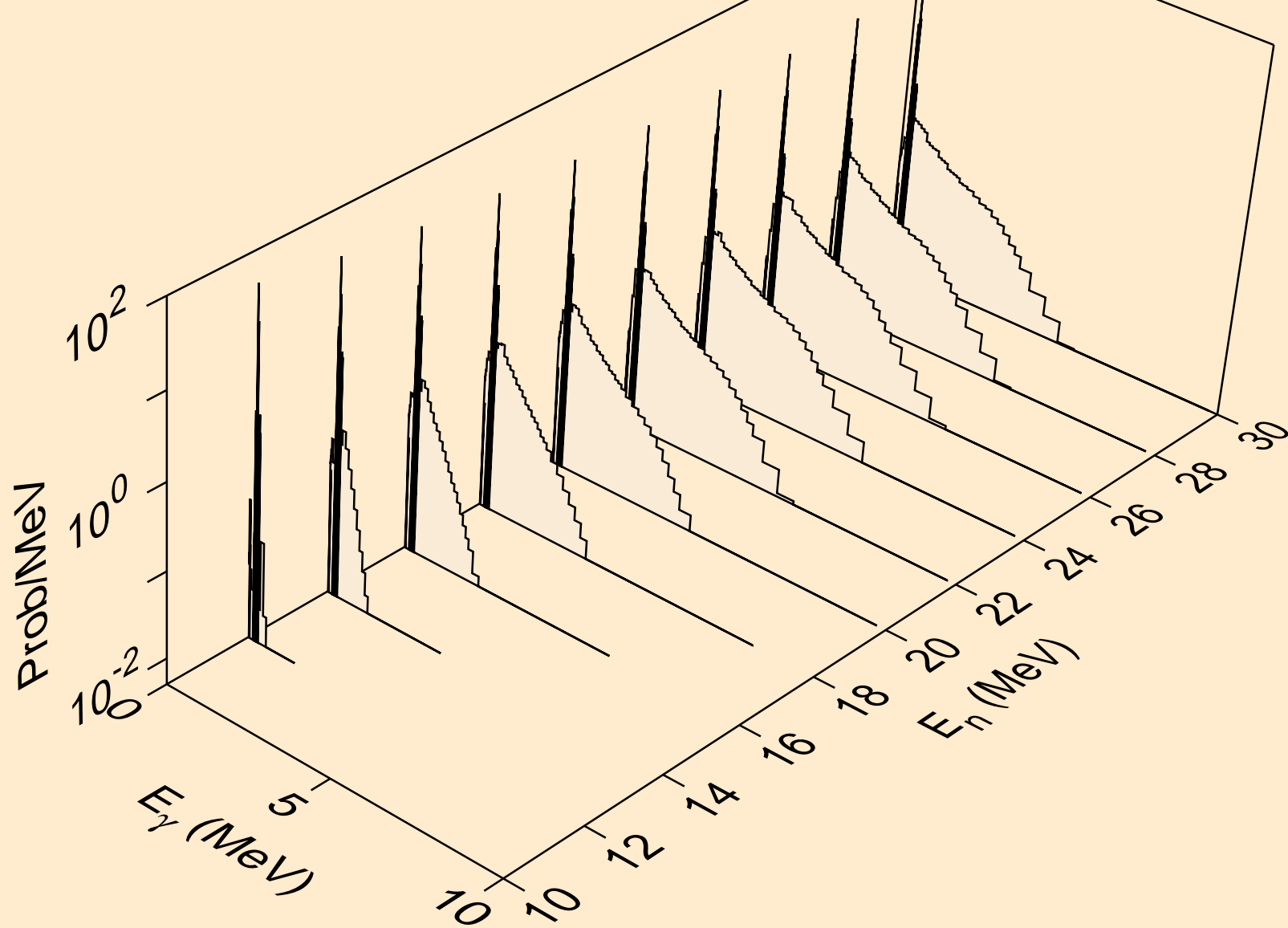

SE079M NEUTRON ACER TENDL-2021 LIBRARY; T=293.6K
Photon emission for (n,n*)2a

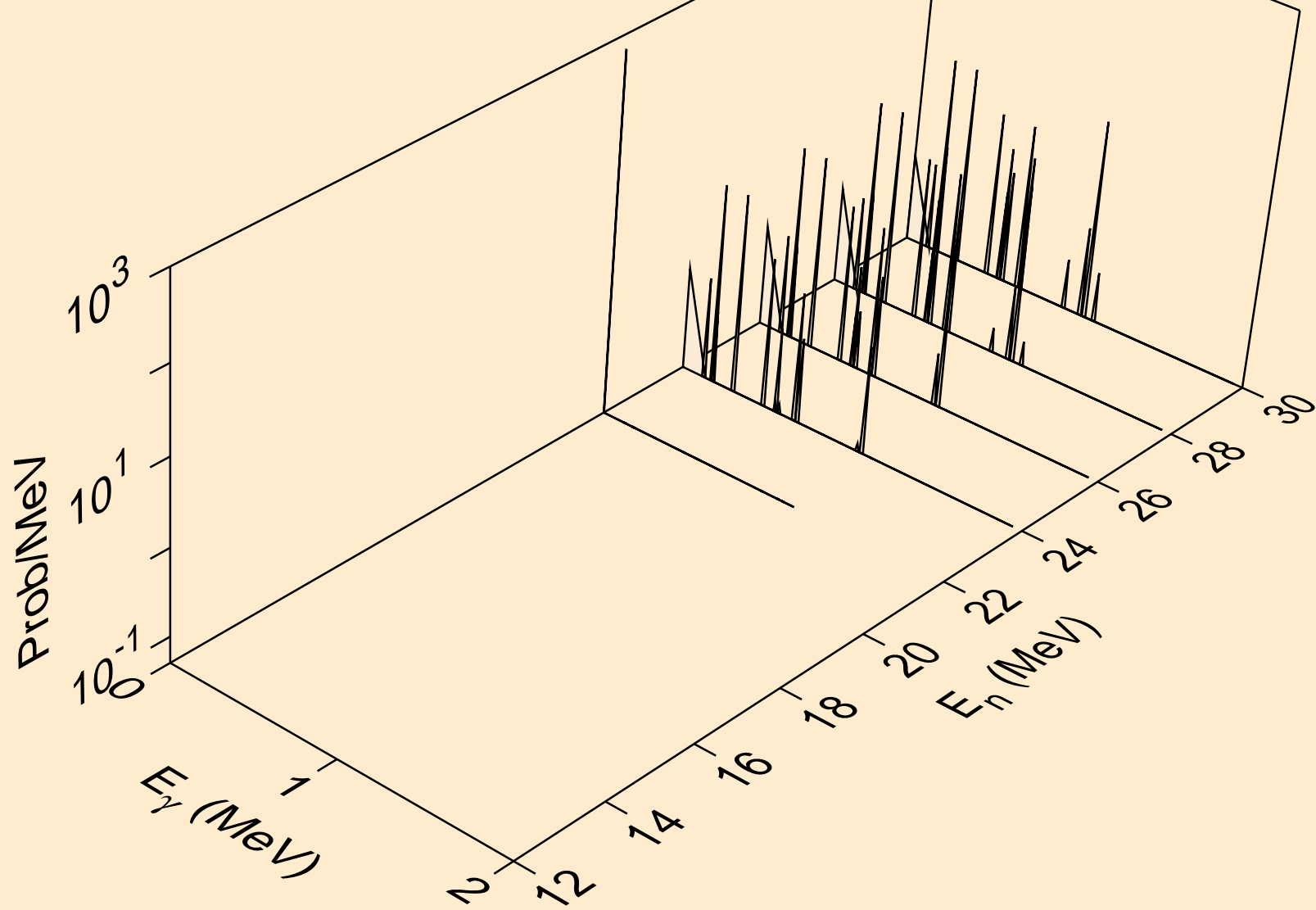

SE079M NEUTRON ACER TENDL-2021 LIBRARY; T=293.6K
Photon emission for (n,n*)d

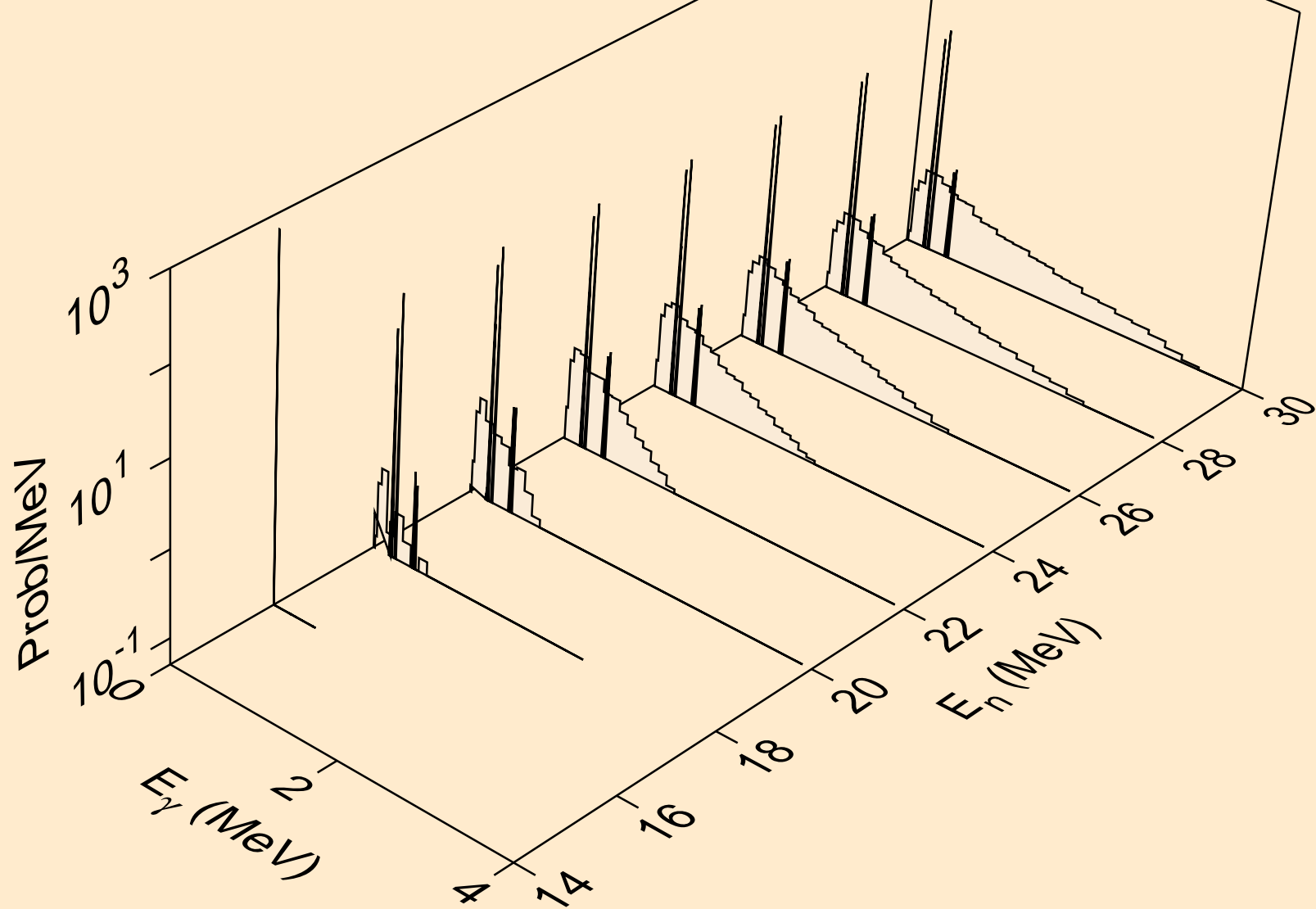

SE079M NEUTRON ACER TENDL-2021 LIBRARY; T=293.6K
Photon emission for (n,n*)t

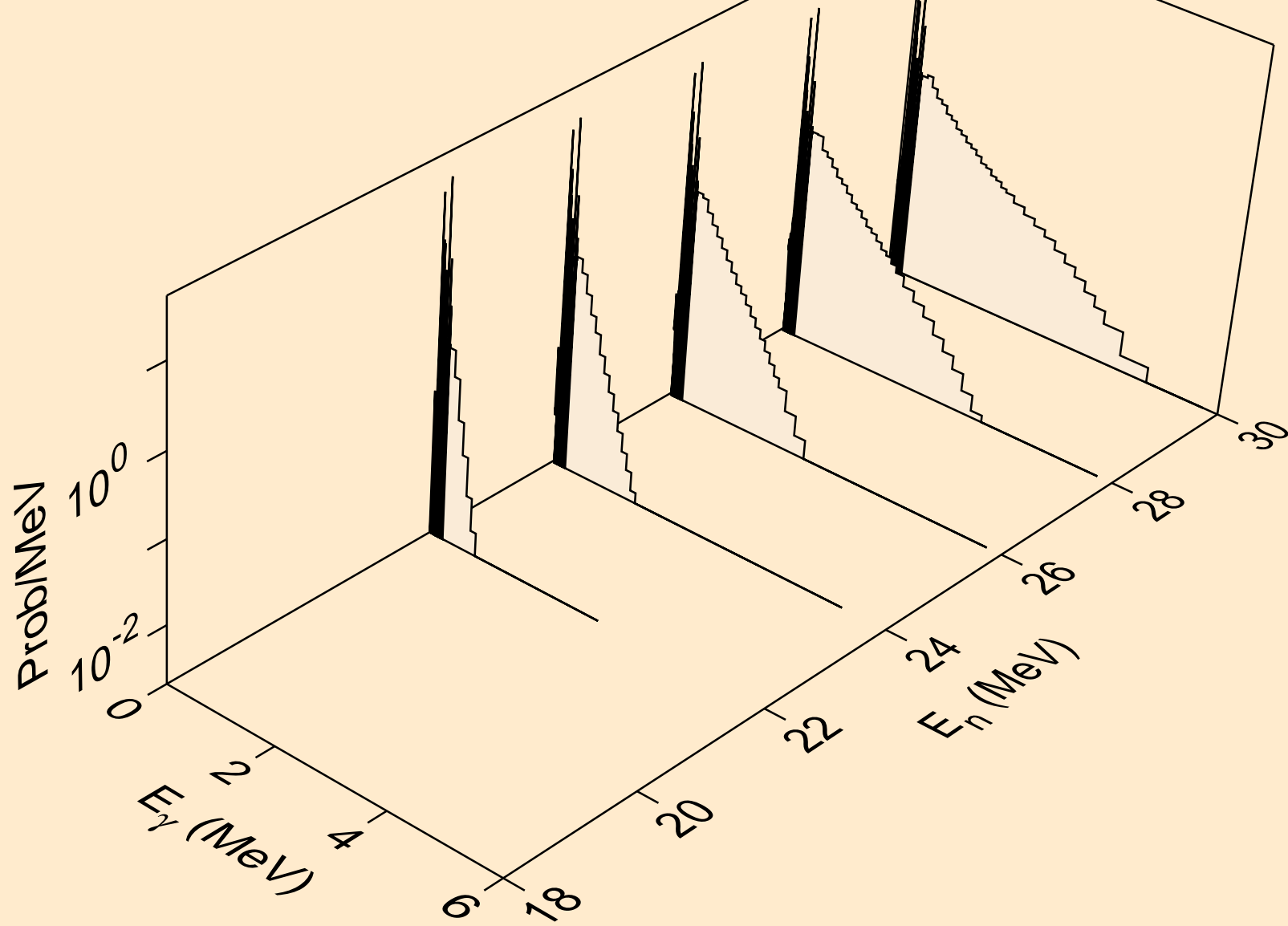

SE079M NEUTRON ACER TENDL-2021 LIBRARY; T=293.6K
Photon emission for (n,n*)he3

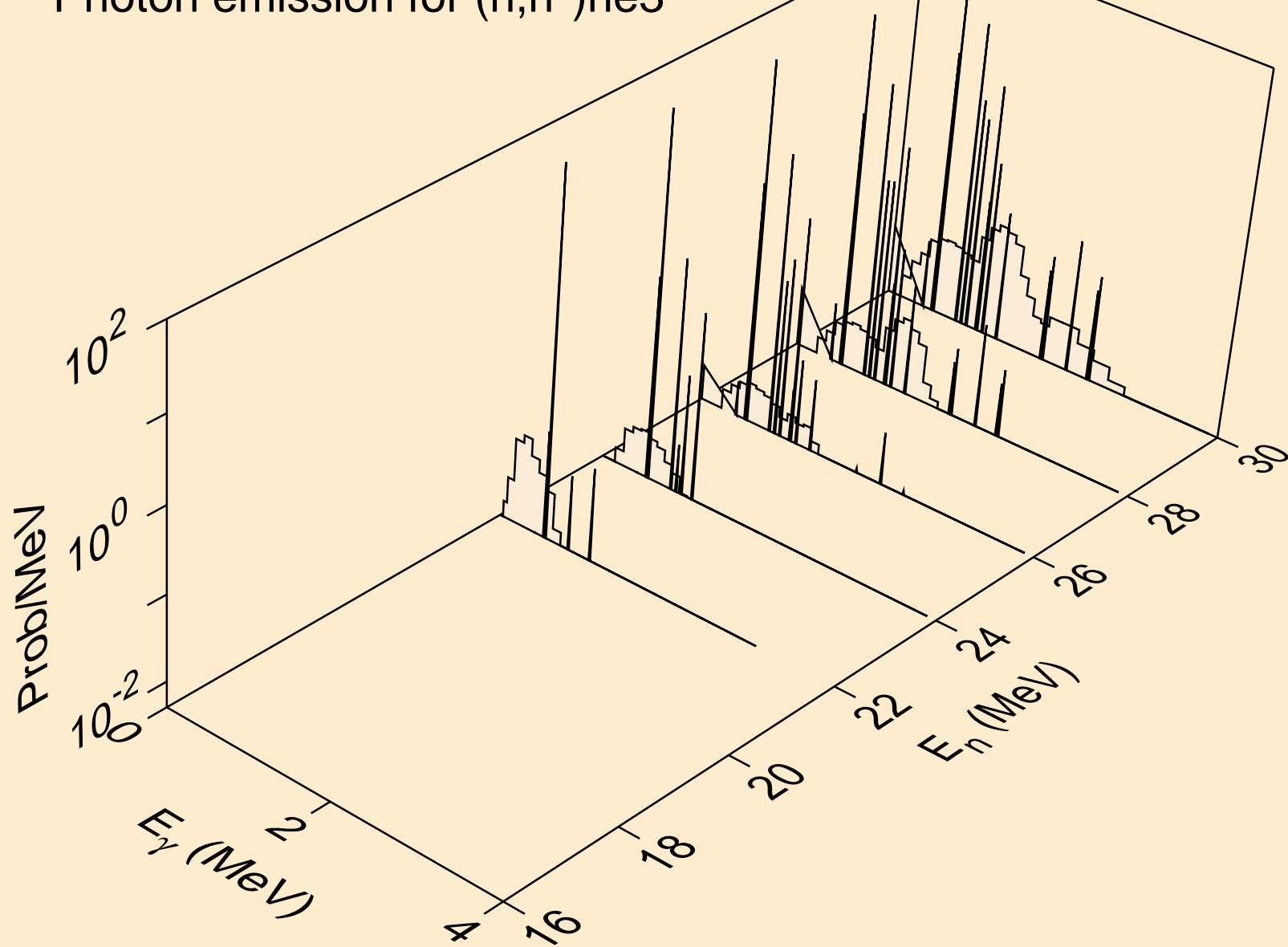

SE079M NEUTRON ACER TENDL-2021 LIBRARY; T=293.6K
Photon emission for (n,4n)

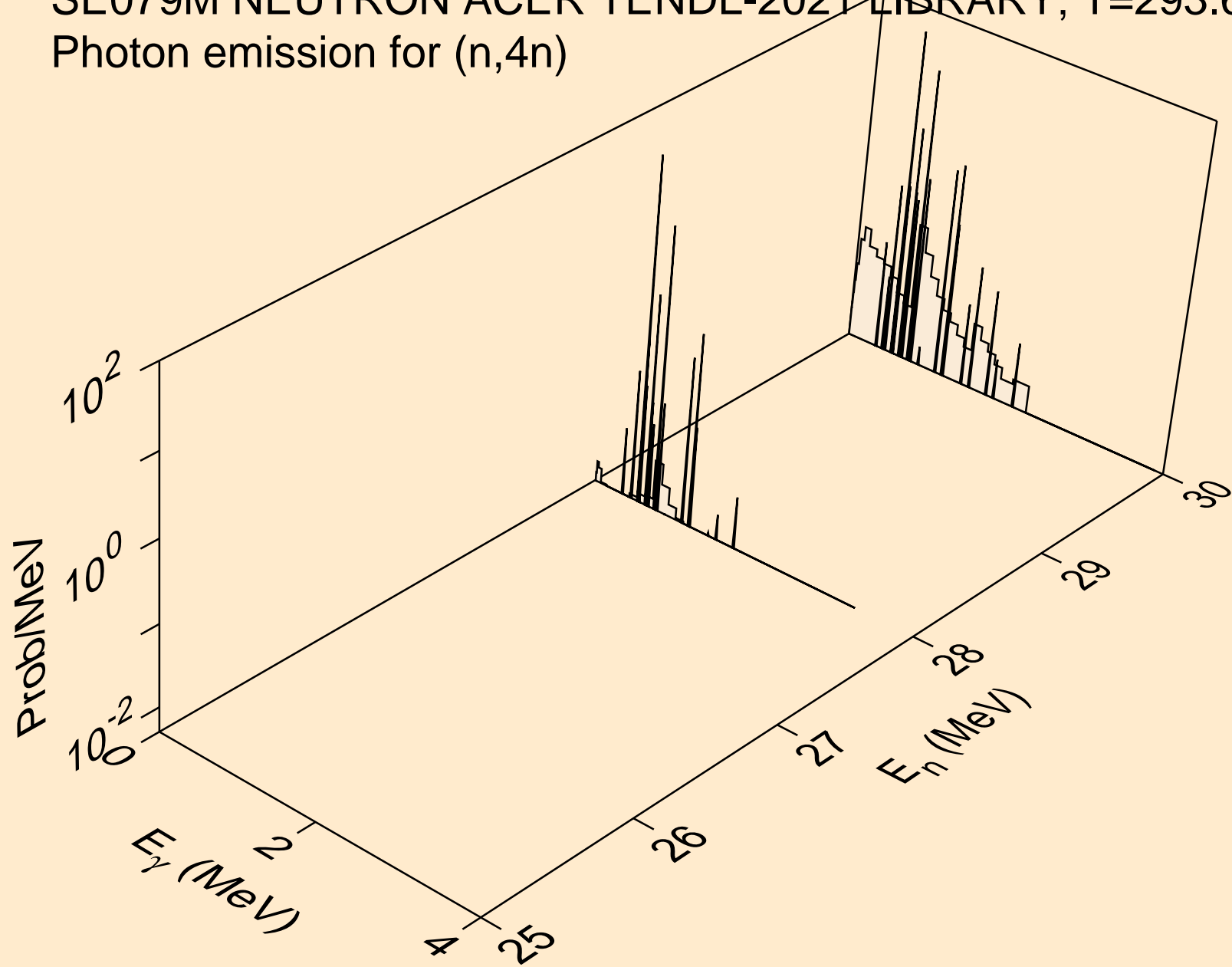

SE079M NEUTRON ACER TENDL-2021 LIBRARY; T=293.6K
Photon emission for (n,2np)

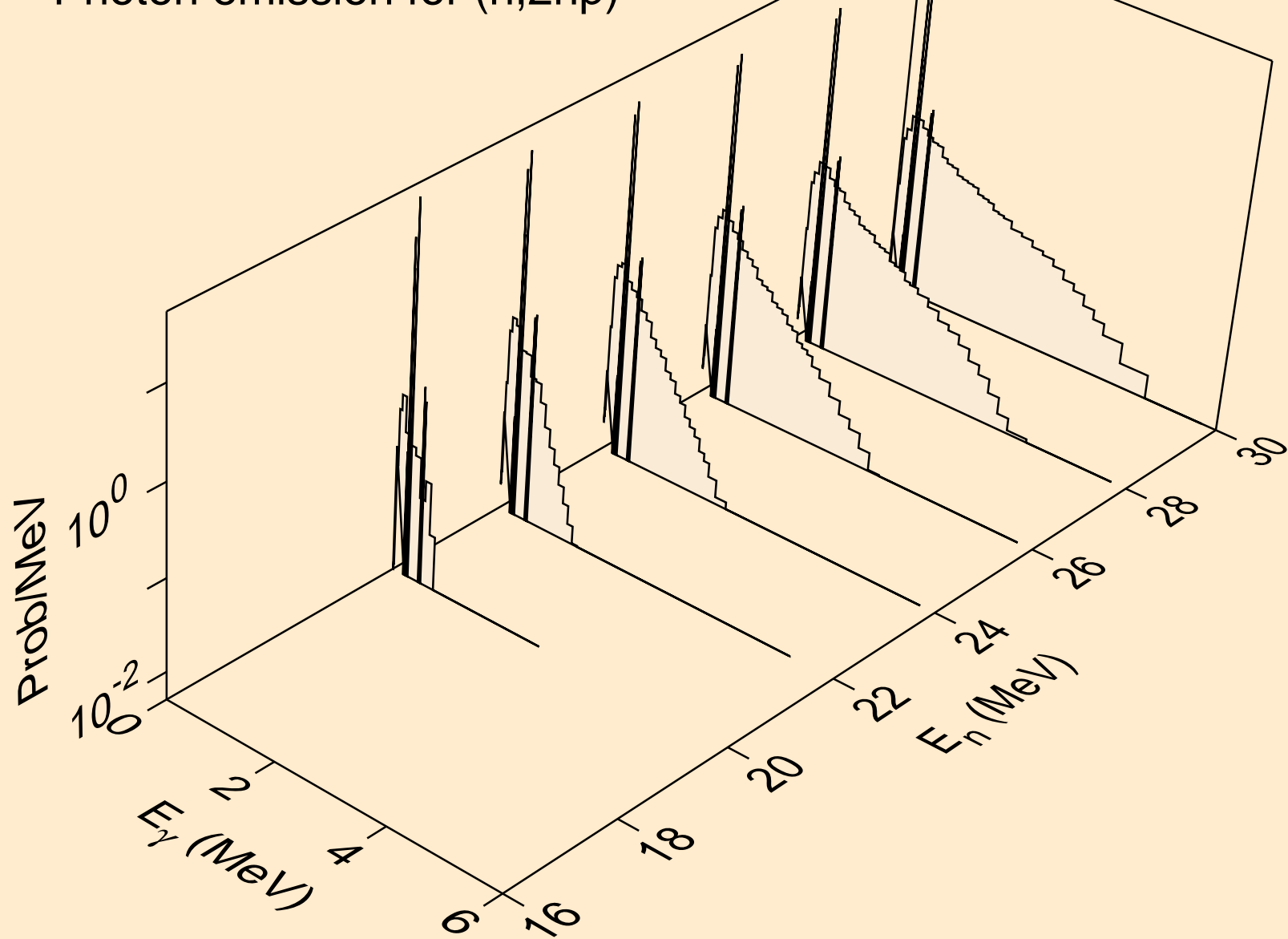

SE079M NEUTRON ACER TENDL-2021 LIBRARY; T=293.6K
Photon emission for (n,3np)

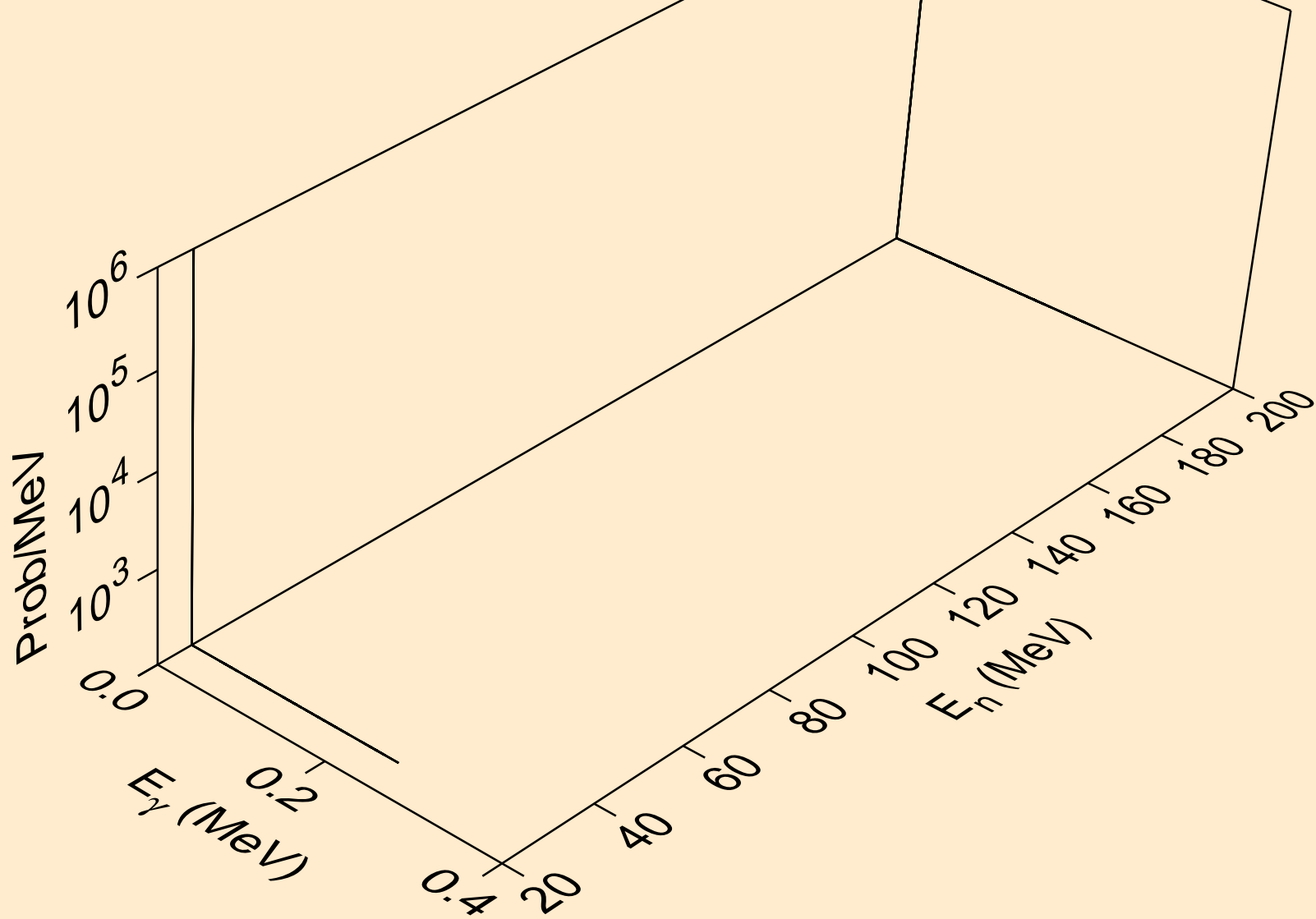

SE079M NEUTRON ACER TENDL-2021 LIBRARY; T=293.6K
Photon emission for (n,2np)

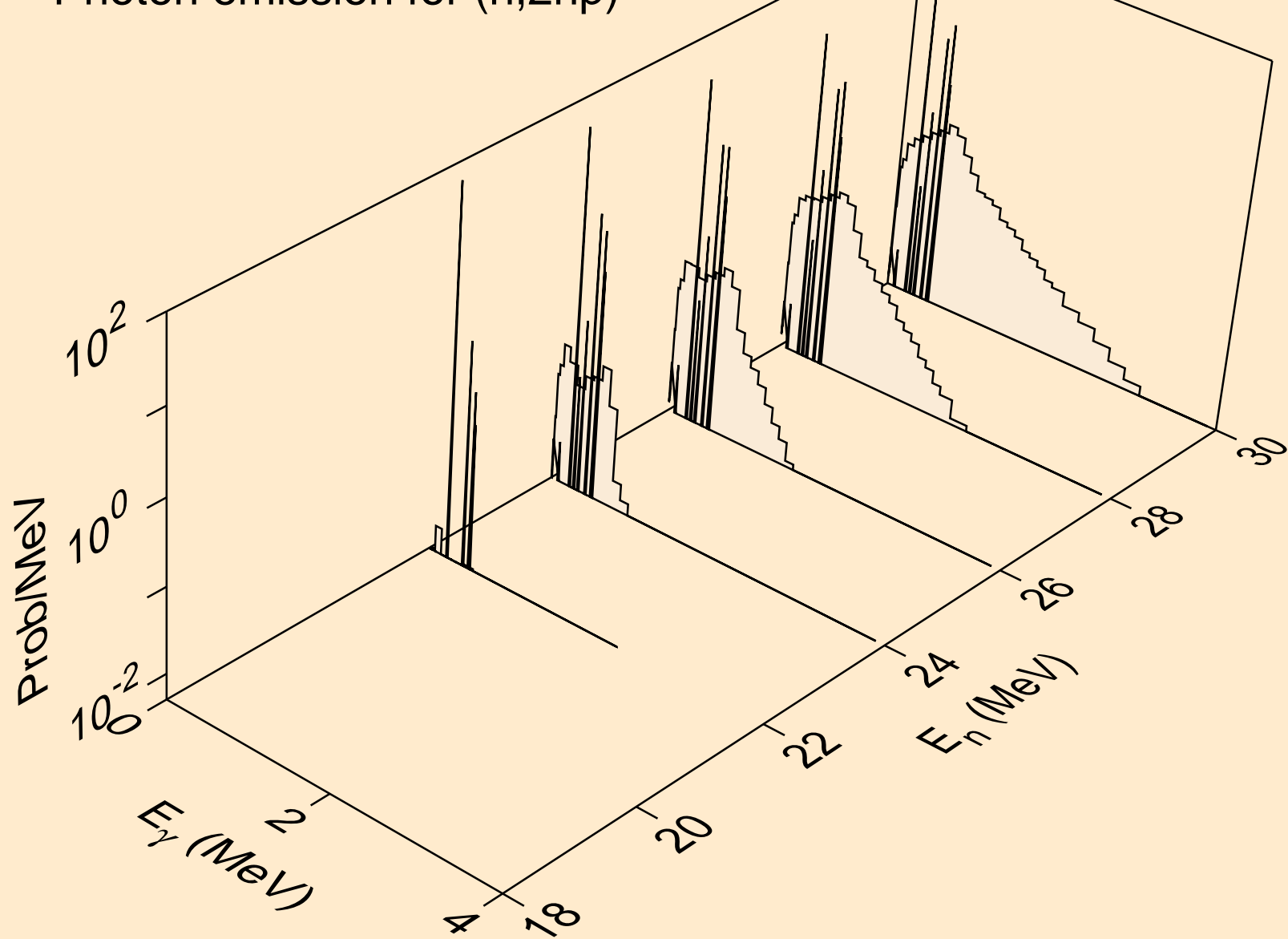

SE079M NEUTRON ACER TENDL-2021 LIBRARY; T=293.6K
Photon emission for (n,npa)

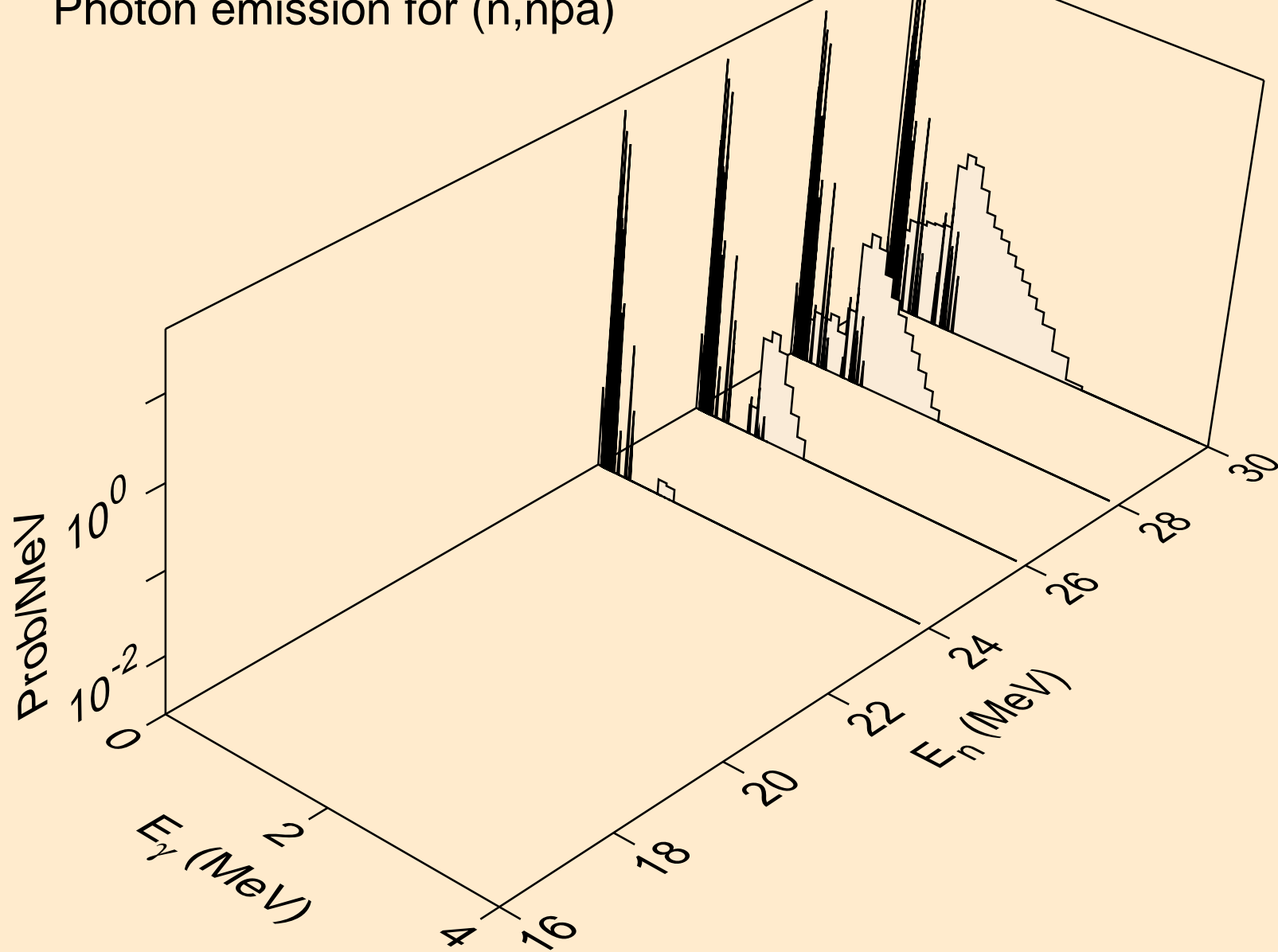

SE079M NEUTRON ACER TENDL-2021 LIBRARY; T=293.6K
Photon emission for (n,n*2)

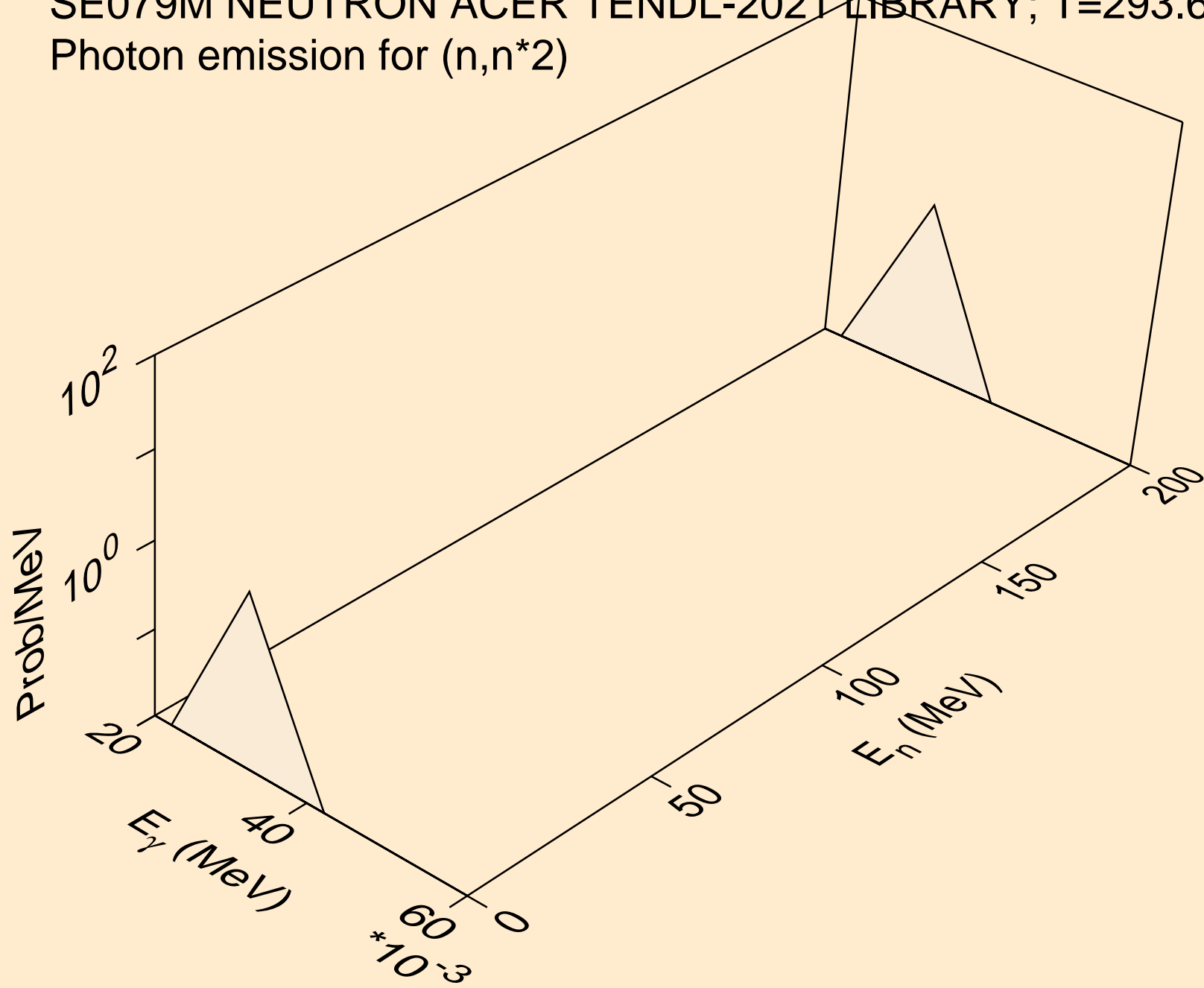

SE079M NEUTRON ACER TENDL-2021 LIBRARY; T=293.6K
Photon emission for (n,n*3)

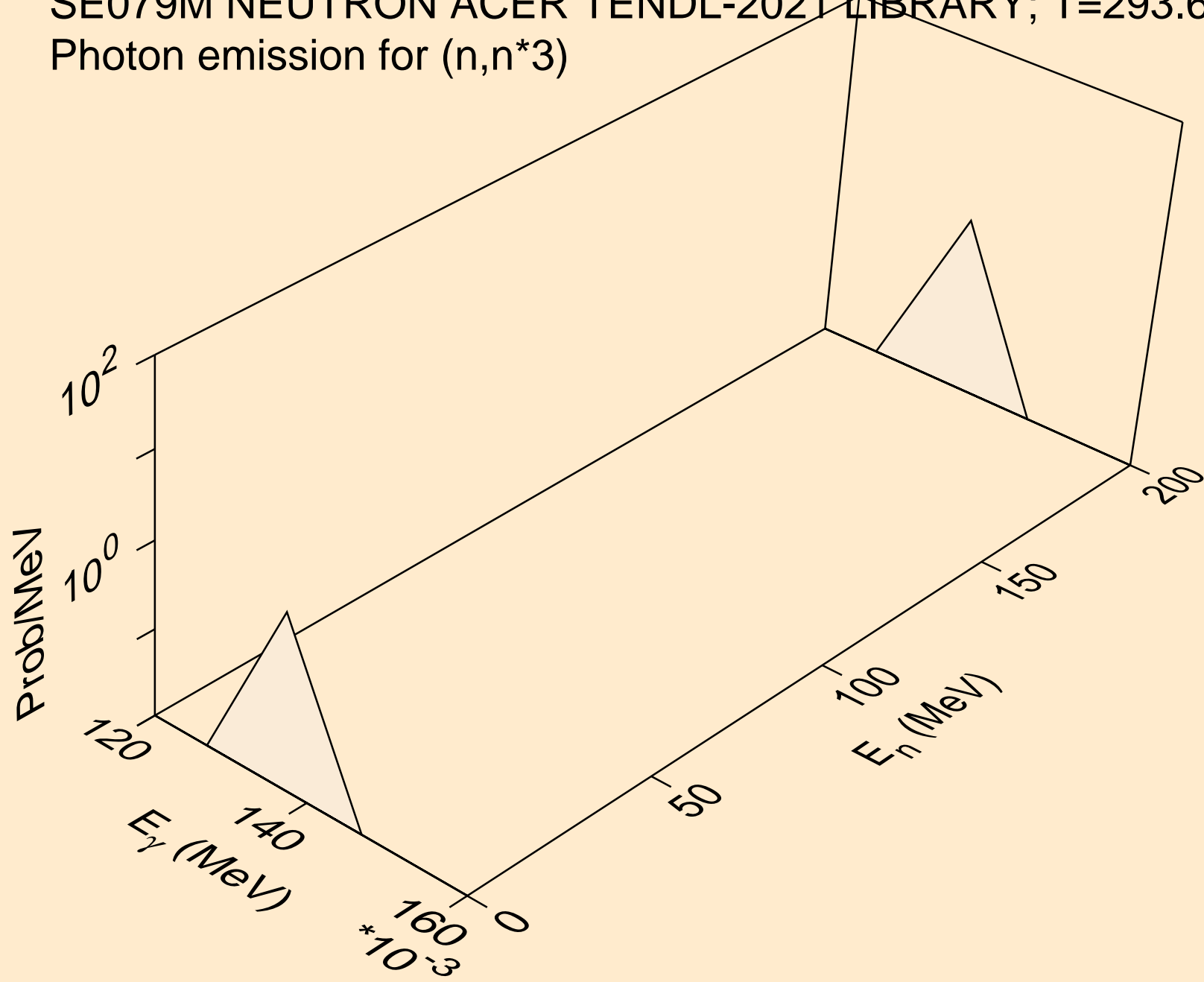

SE079M NEUTRON ACER TENDL-2021 LIBRARY; T=293.6K
Photon emission for (n,n*4)

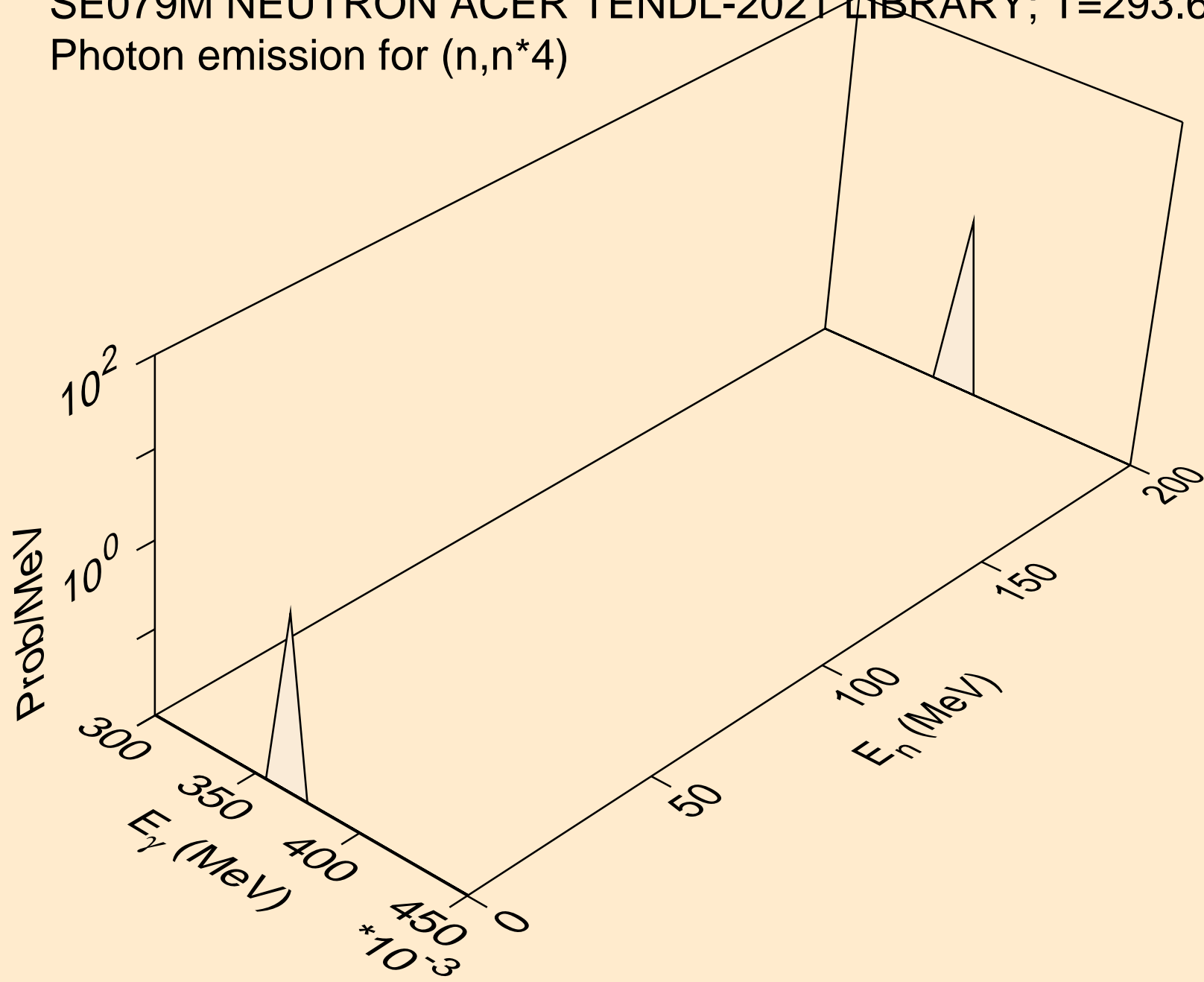

SE079M NEUTRON ACER TENDL-2021 LIBRARY; T=293.6K
Photon emission for (n,n*5)

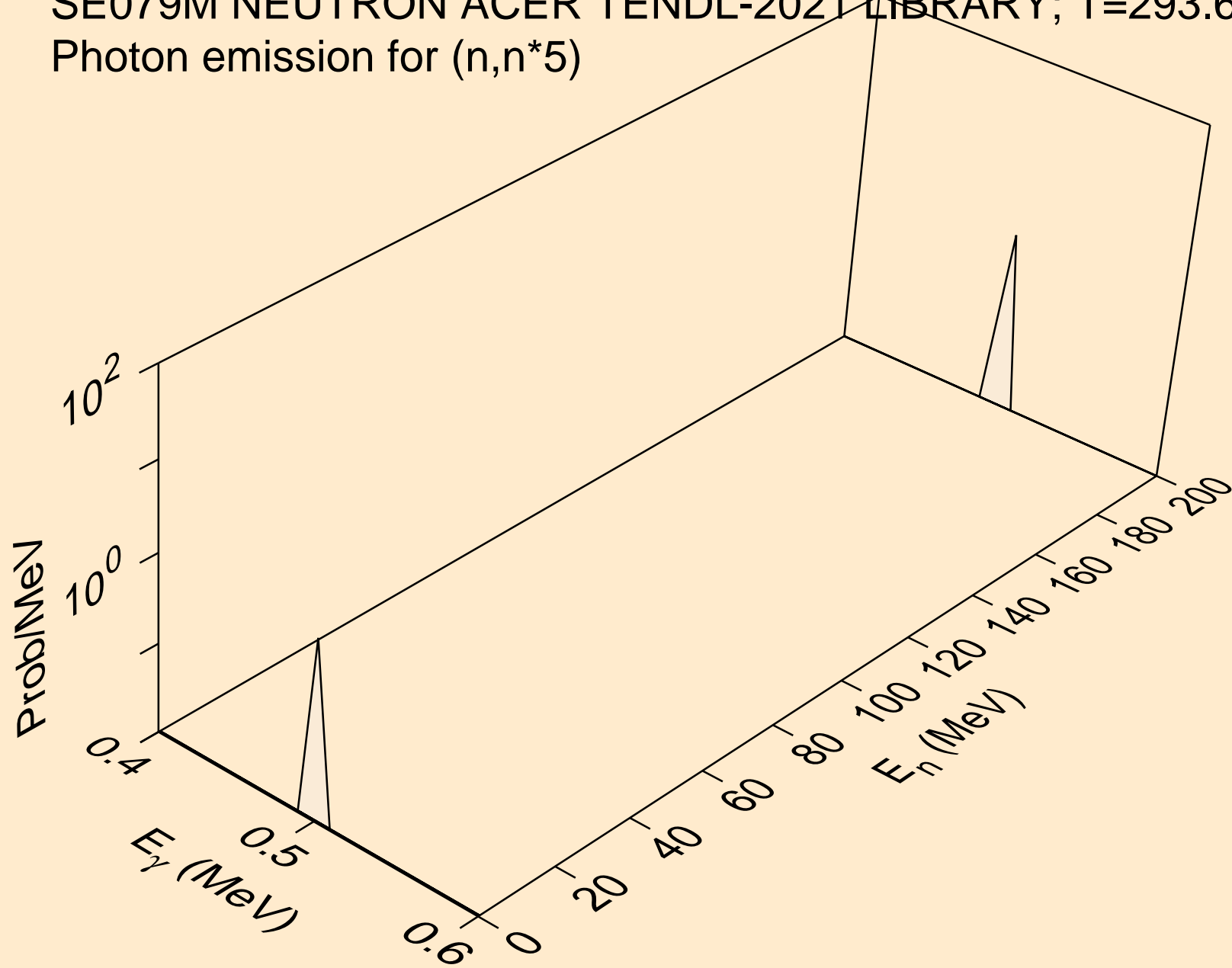

SE079M NEUTRON ACER TENDL-2021 LIBRARY; T=293.6K
Photon emission for (n,n*6)

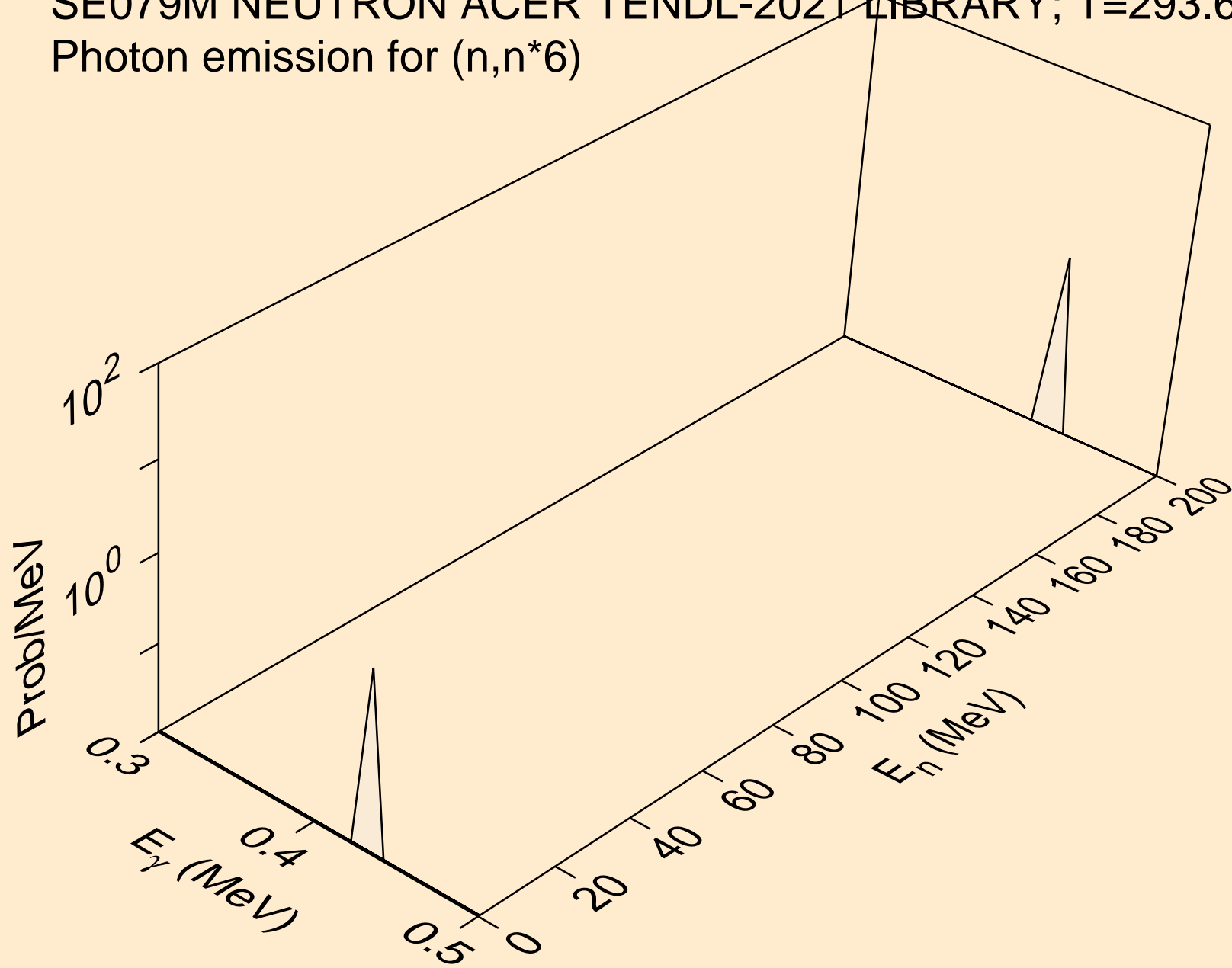

SE079M NEUTRON ACER TENDL-2021 LIBRARY; T=293.6K
Photon emission for (n,n*7)

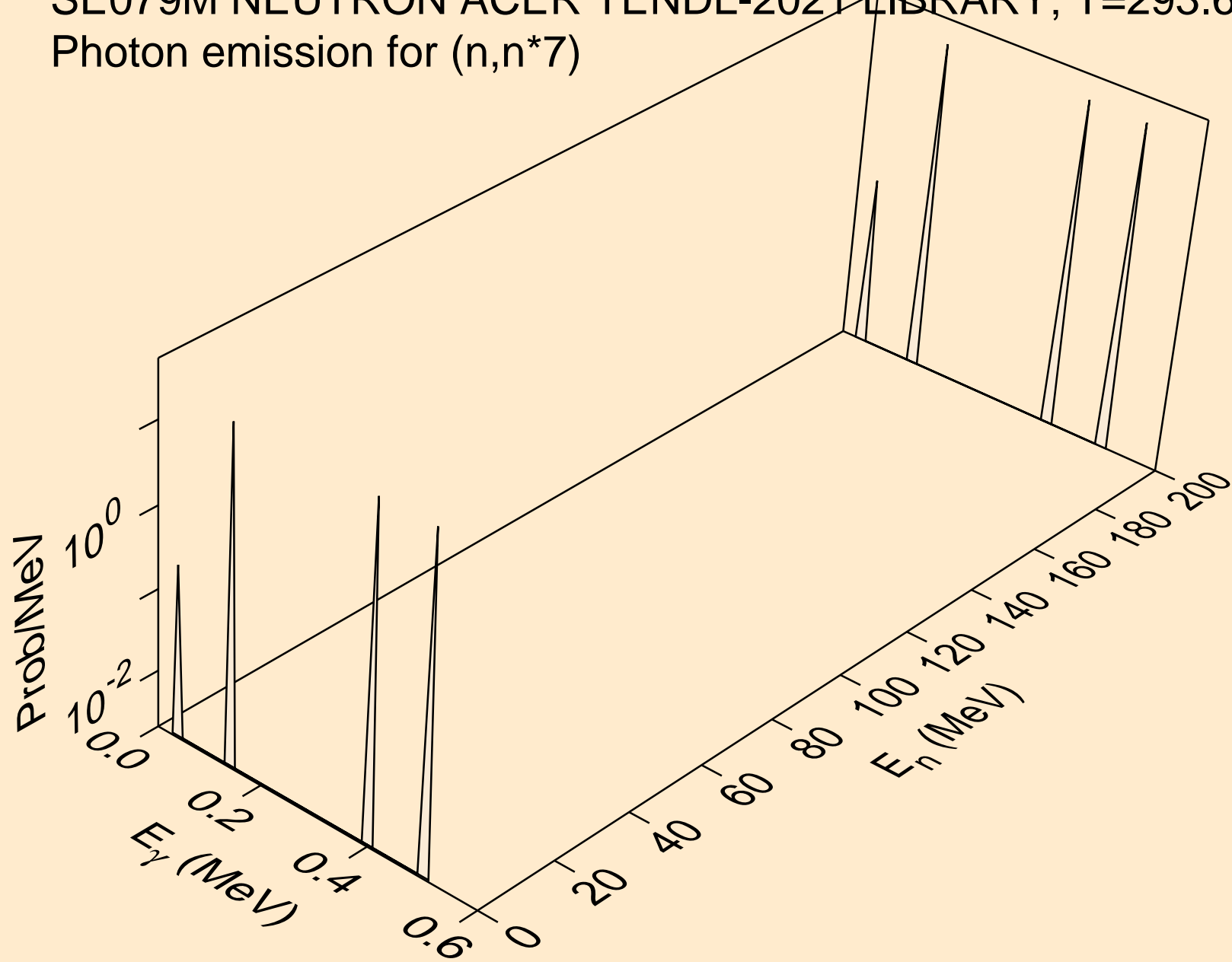

SE079M NEUTRON ACER TENDL-2021 LIBRARY; T=293.6K
Photon emission for (n,n*8)

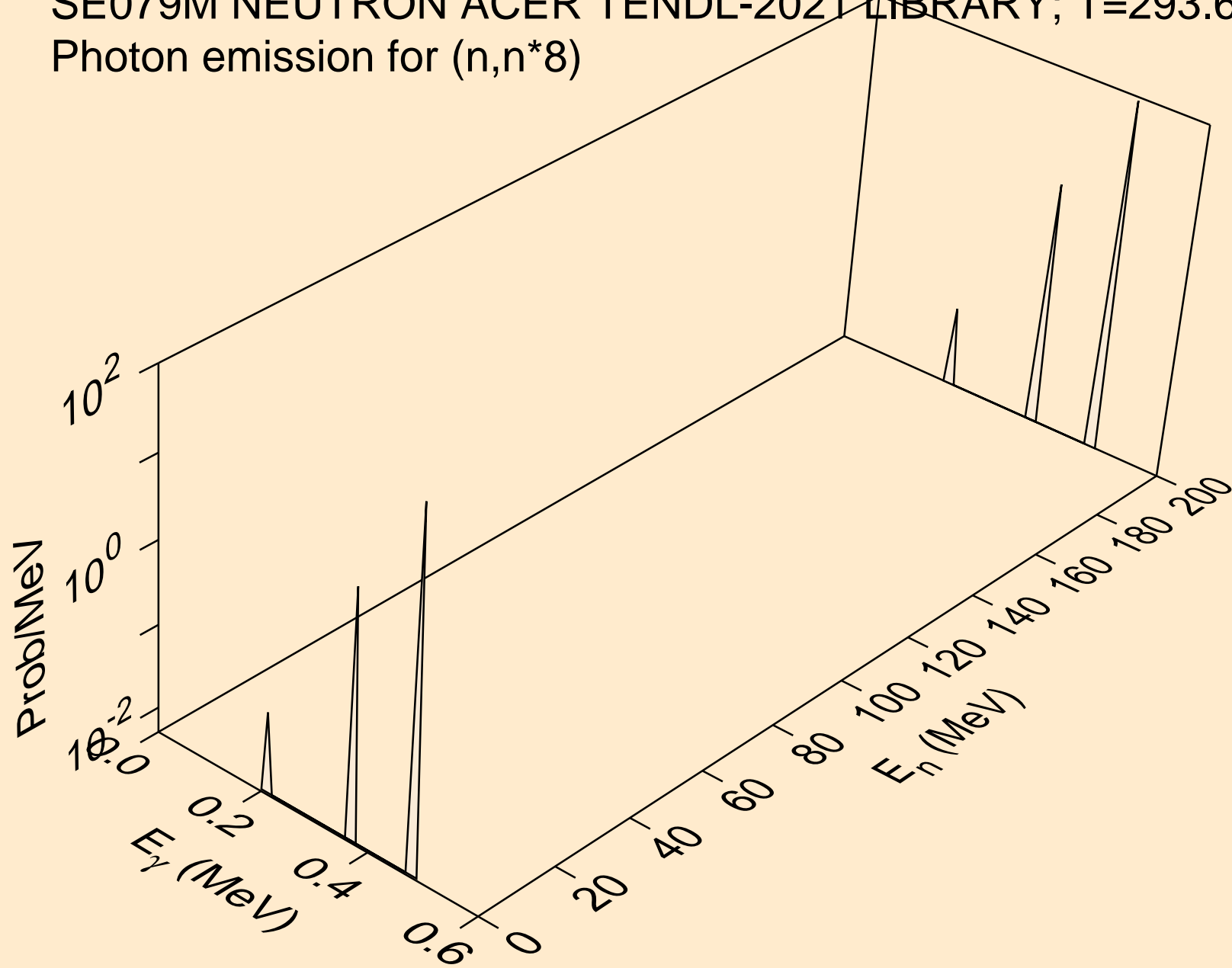

SE079M NEUTRON ACER TENDL-2021 LIBRARY; T=293.6K
Photon emission for (n,n*9)

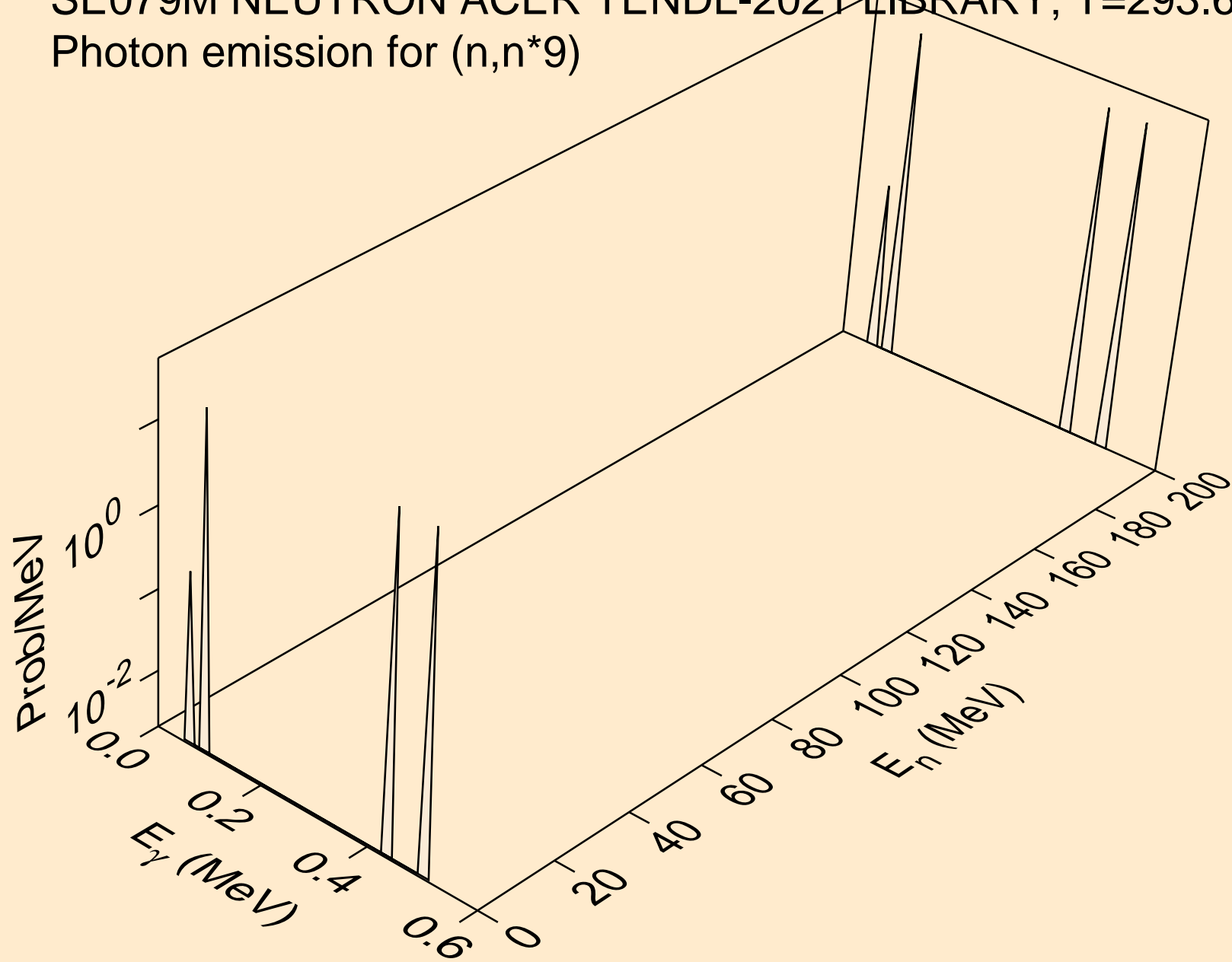

SE079M NEUTRON ACER TENDL-2021 LIBRARY; T=293.6K
Photon emission for (n,n*11)

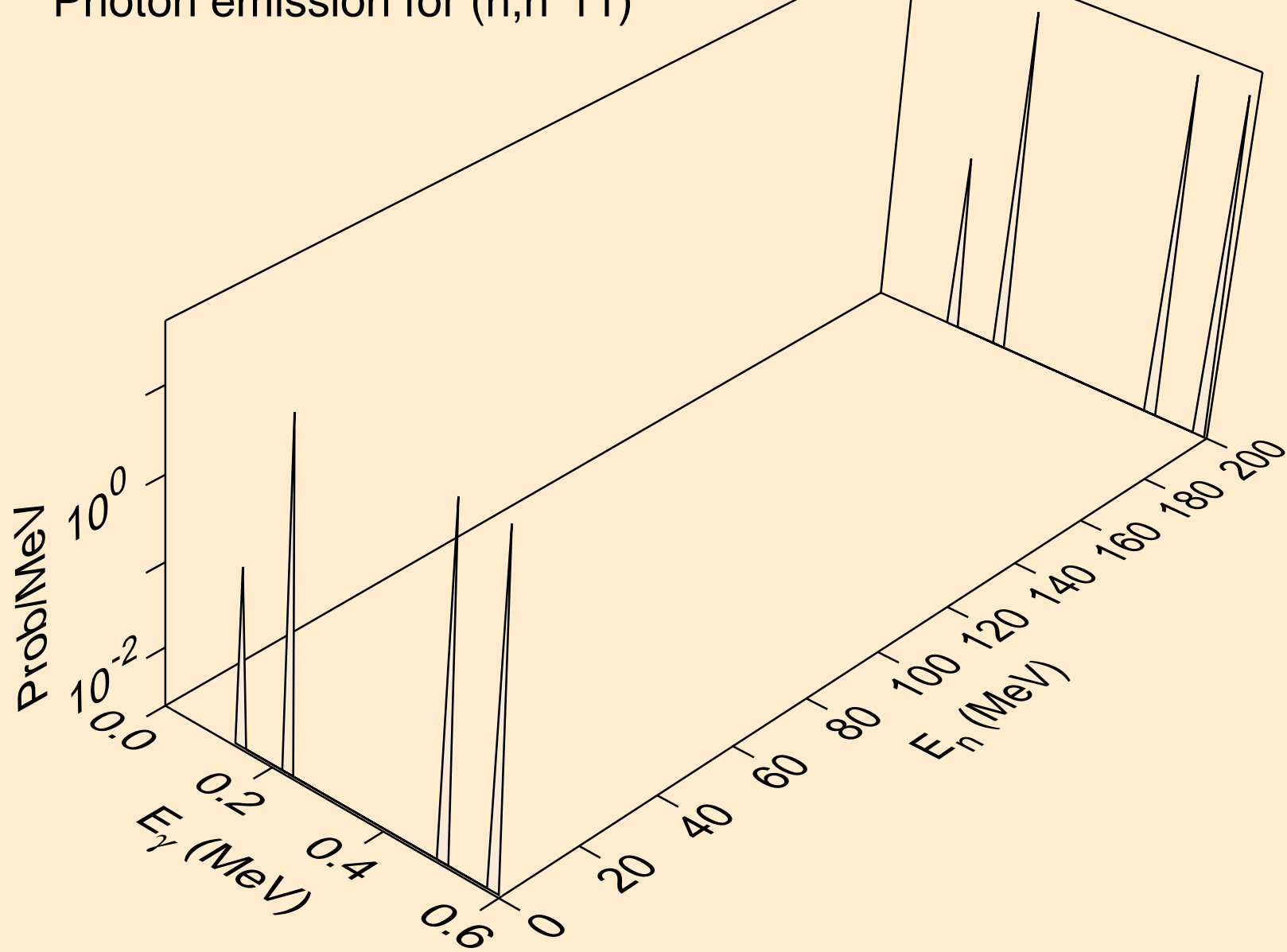

SE079M NEUTRON ACER TENDL-2021 LIBRARY; T=293.6K
Photon emission for (n,n*12)

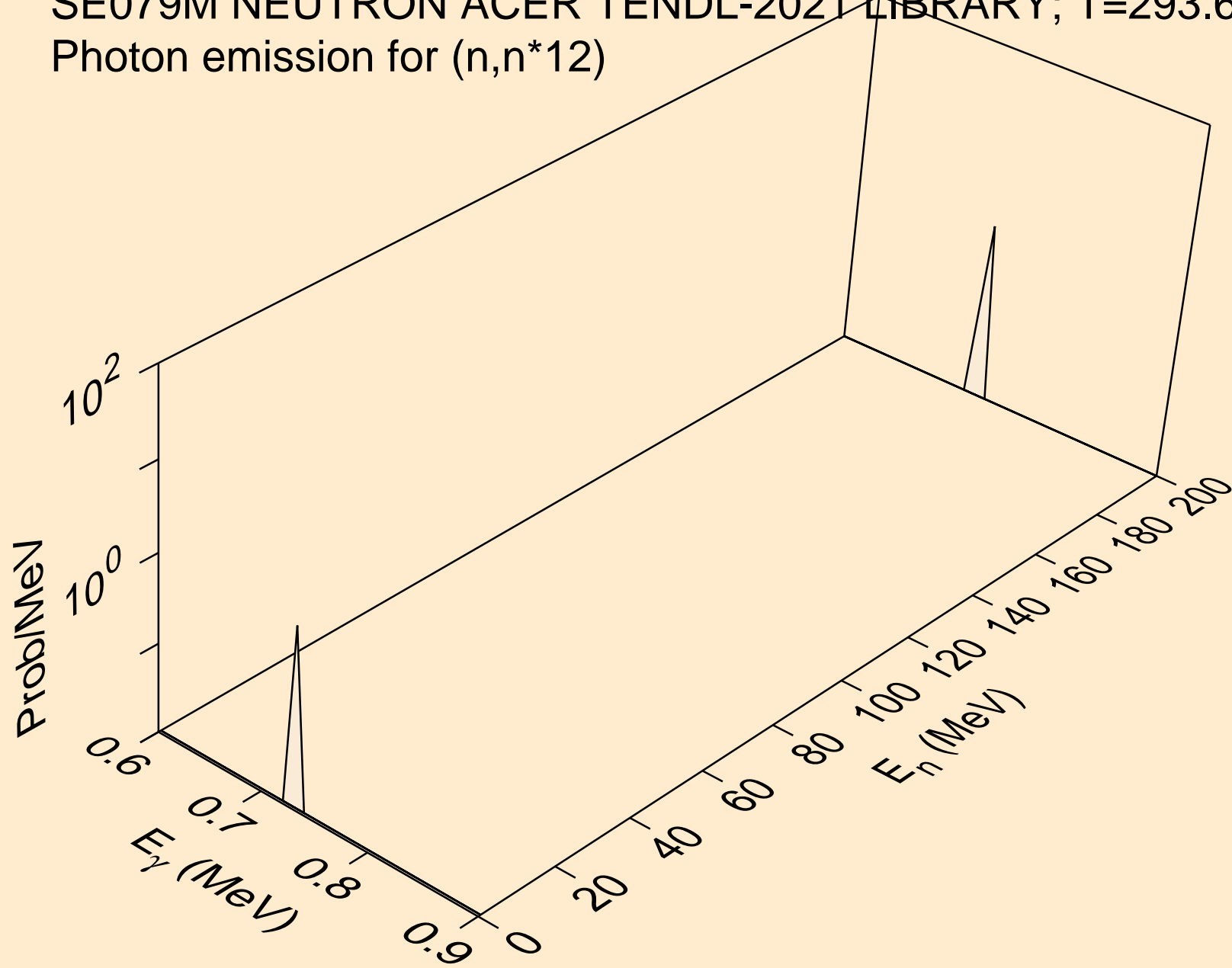

SE079M NEUTRON ACER TENDL-2021 LIBRARY; T=293.6K
Photon emission for (n,n*13)

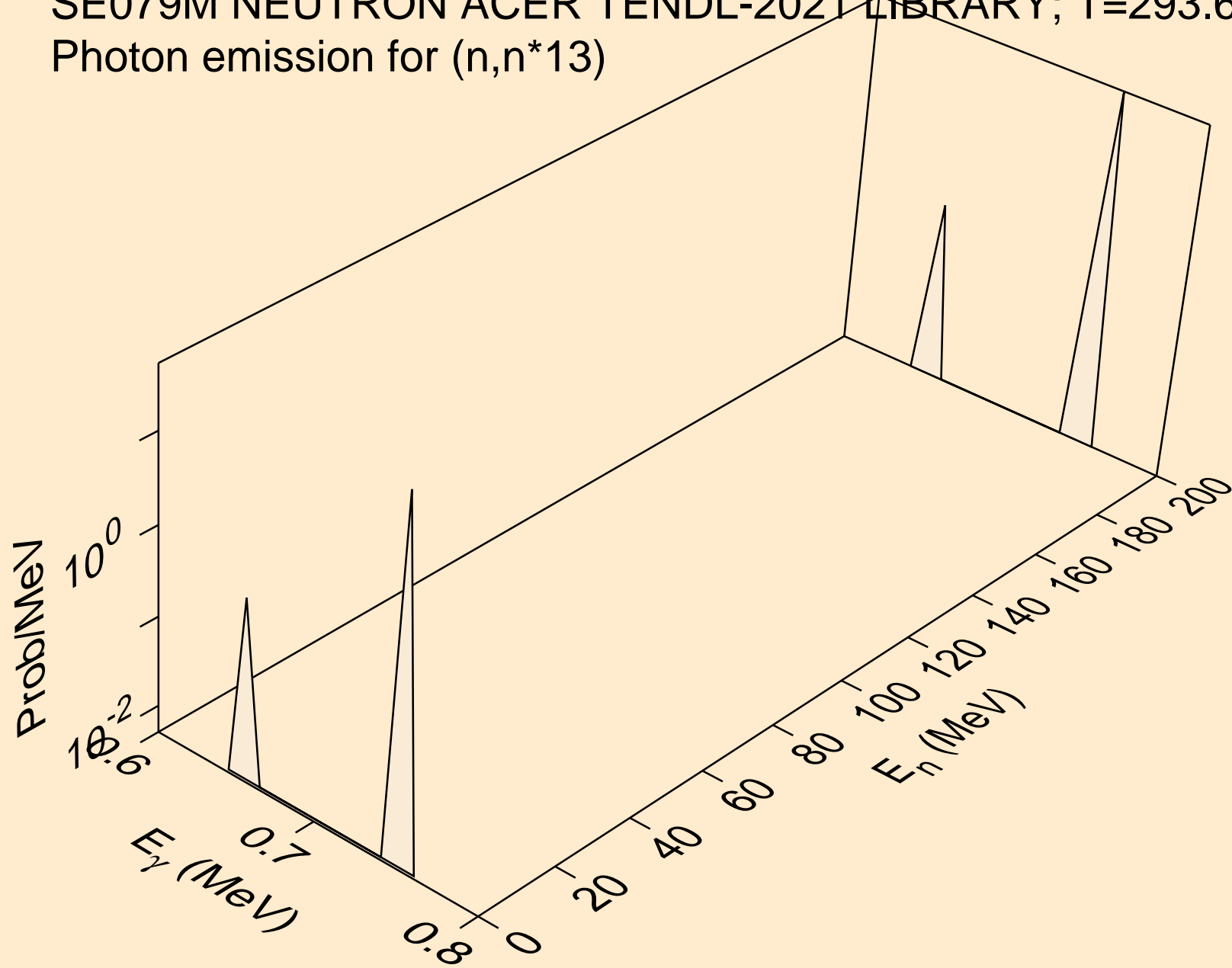

SE079M NEUTRON ACER TENDL-2021 LIBRARY; T=293.6K
Photon emission for (n,n*14)

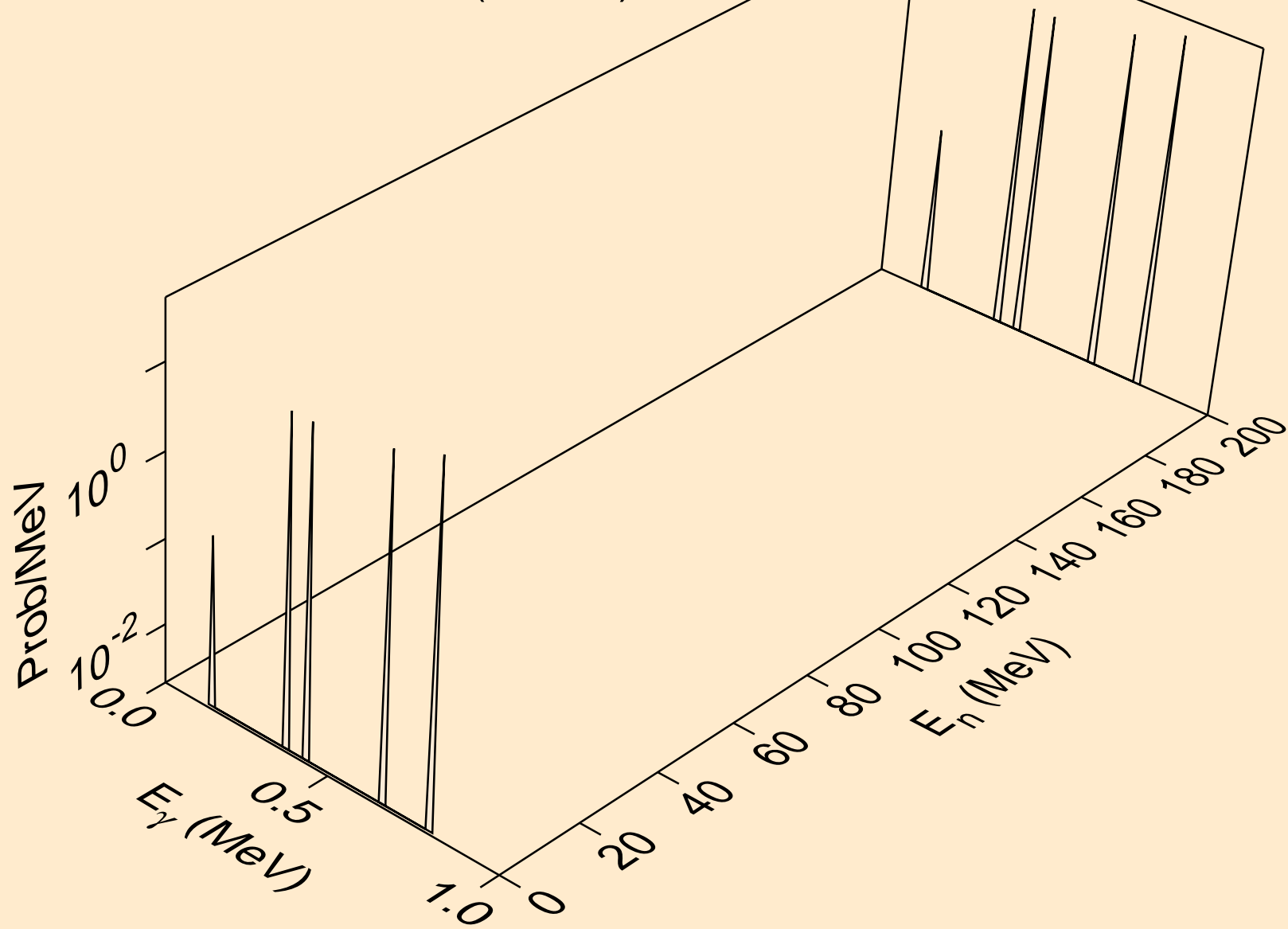

SE079M NEUTRON ACER TENDL-2021 LIBRARY; T=293.6K
Photon emission for (n,n*15)

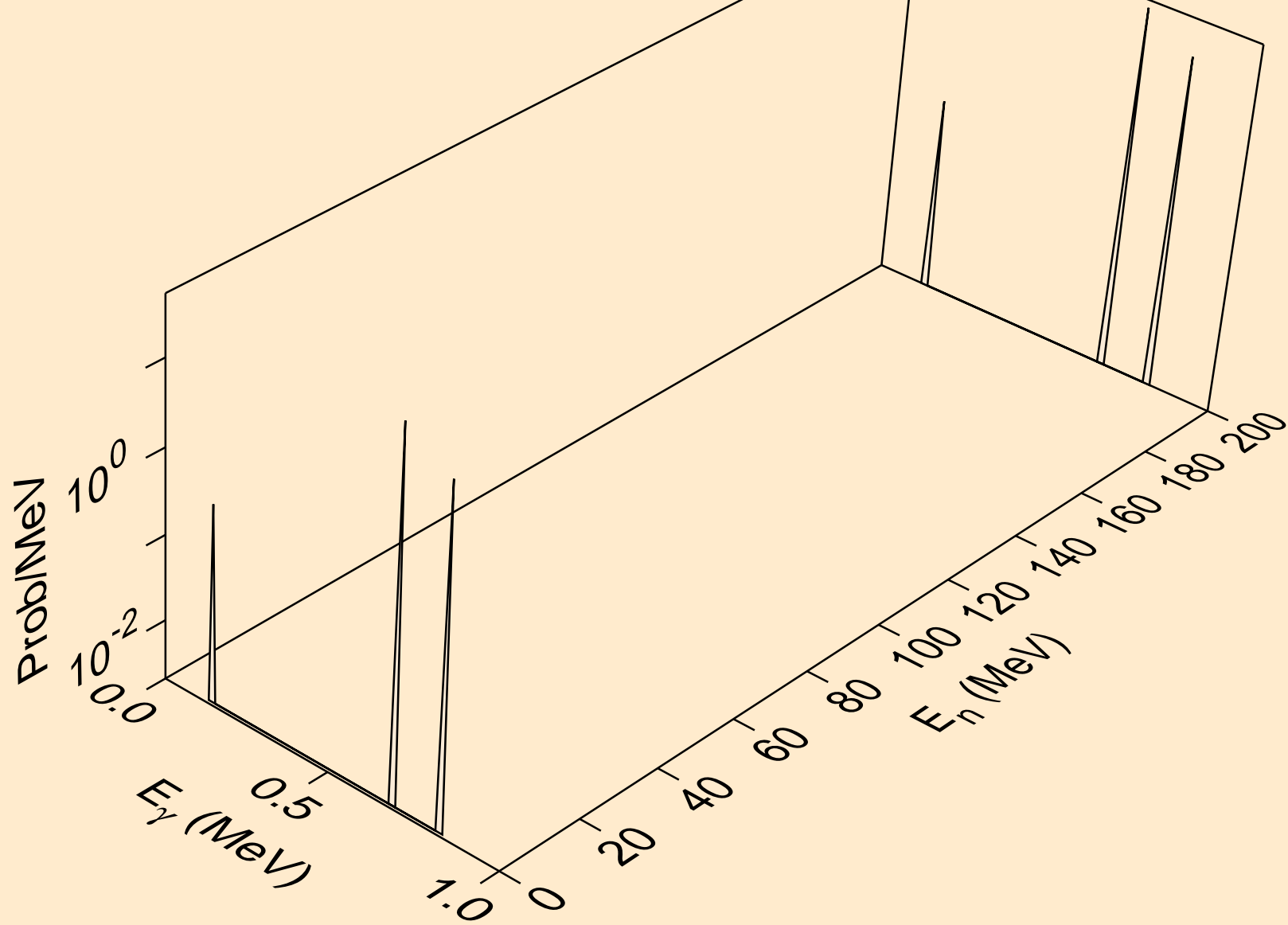

SE079M NEUTRON ACER TENDL-2021 LIBRARY; T=293.6K
Photon emission for (n,n*16)

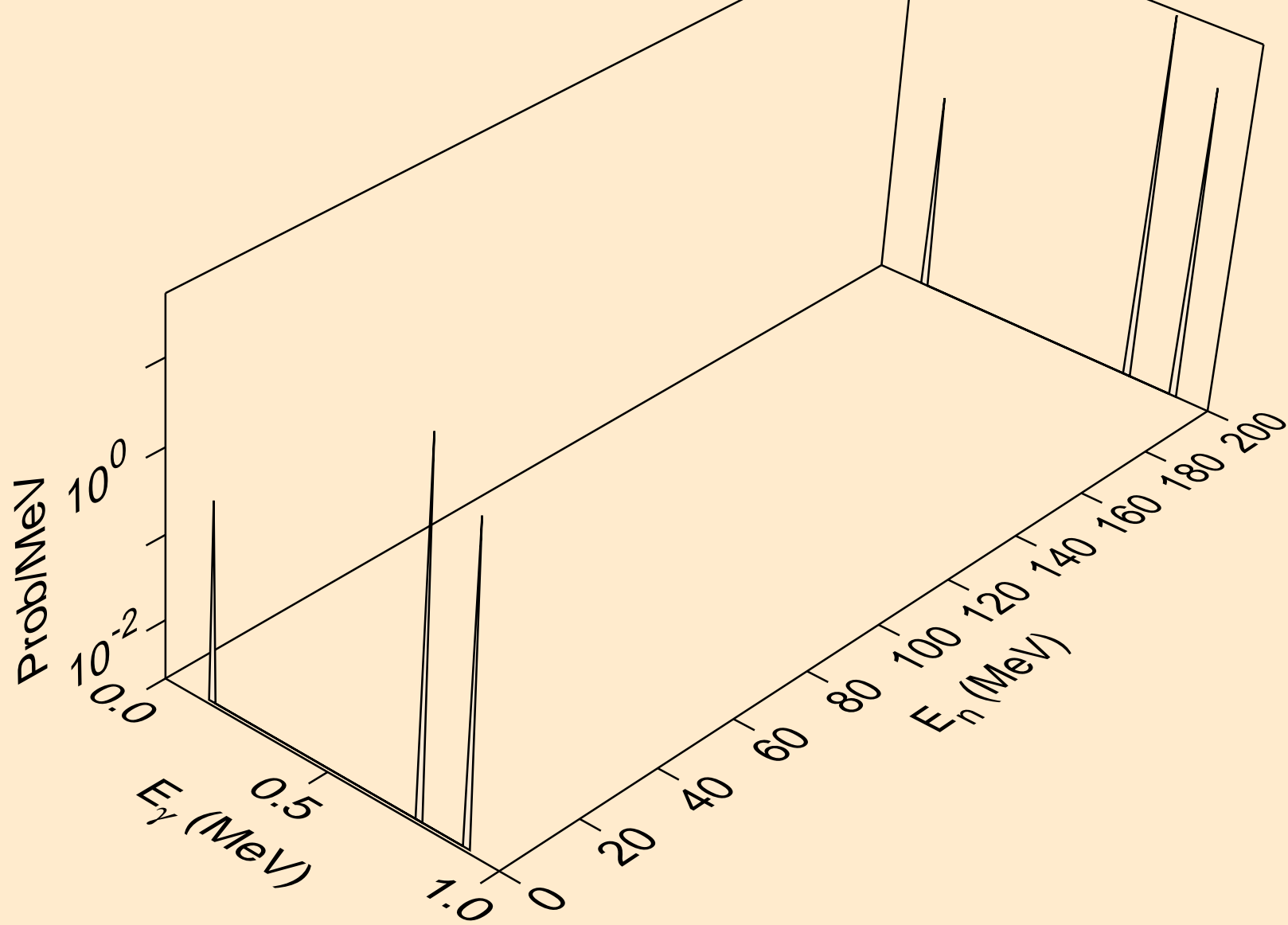

SE079M NEUTRON ACER TENDL-2021 LIBRARY; T=293.6K
Photon emission for (n,n*17)

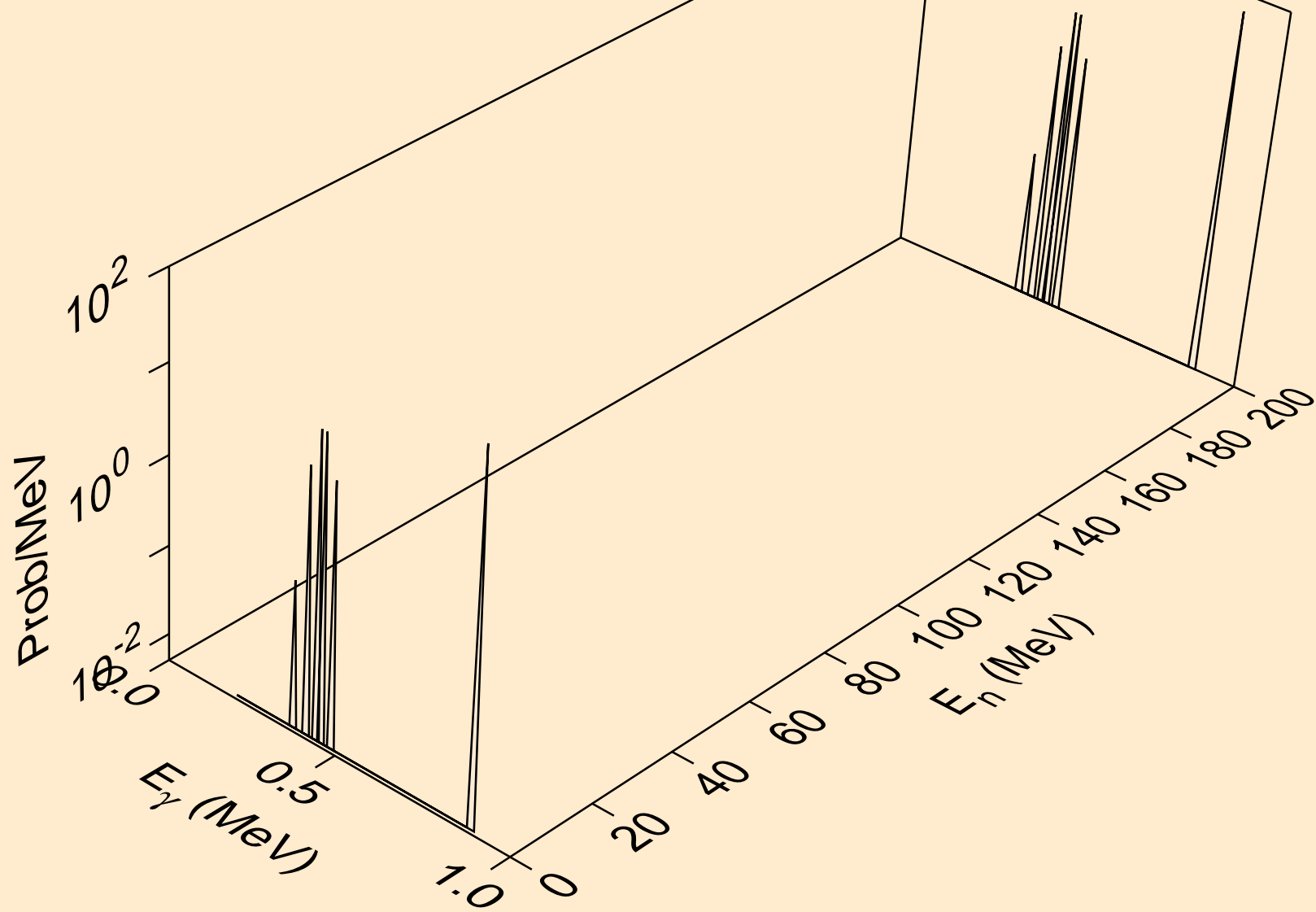

SE079M NEUTRON ACER TENDL-2021 LIBRARY; T=293.6K
Photon emission for (n,n*18)

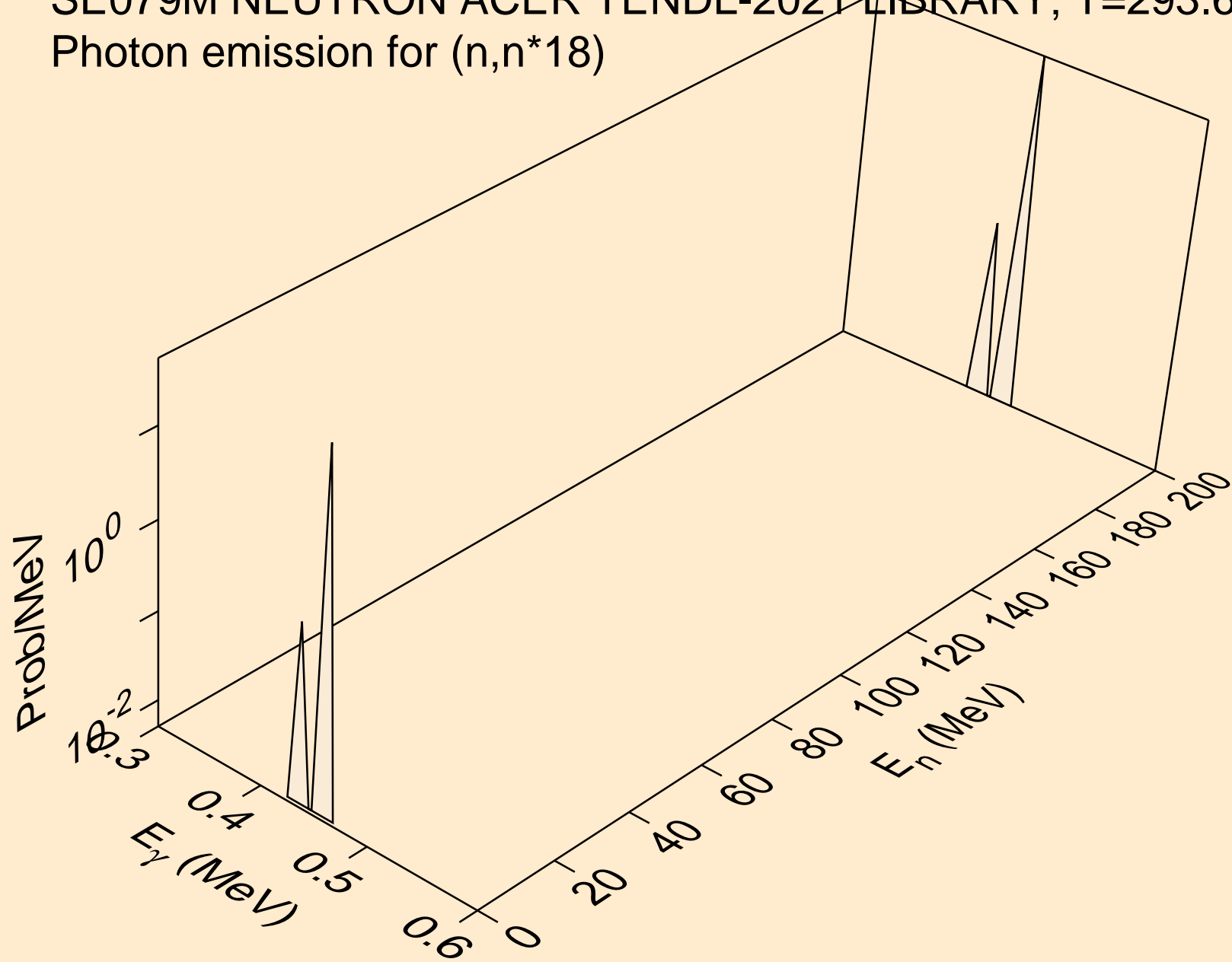

SE079M NEUTRON ACER TENDL-2021 LIBRARY; T=293.6K
Photon emission for (n,n*19)

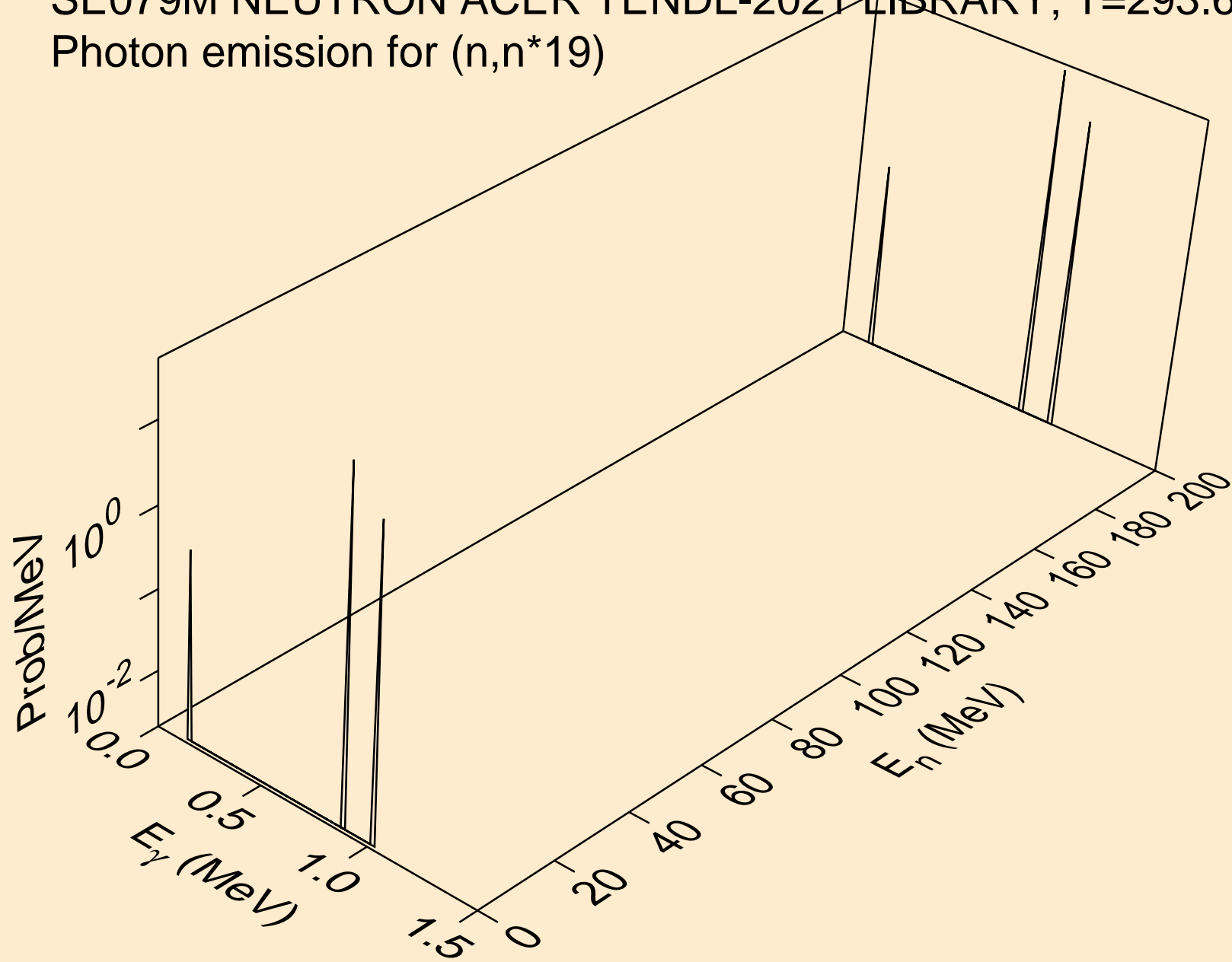

SE079M NEUTRON ACER TENDL-2021 LIBRARY; T=293.6K
Photon emission for (n,n*20)

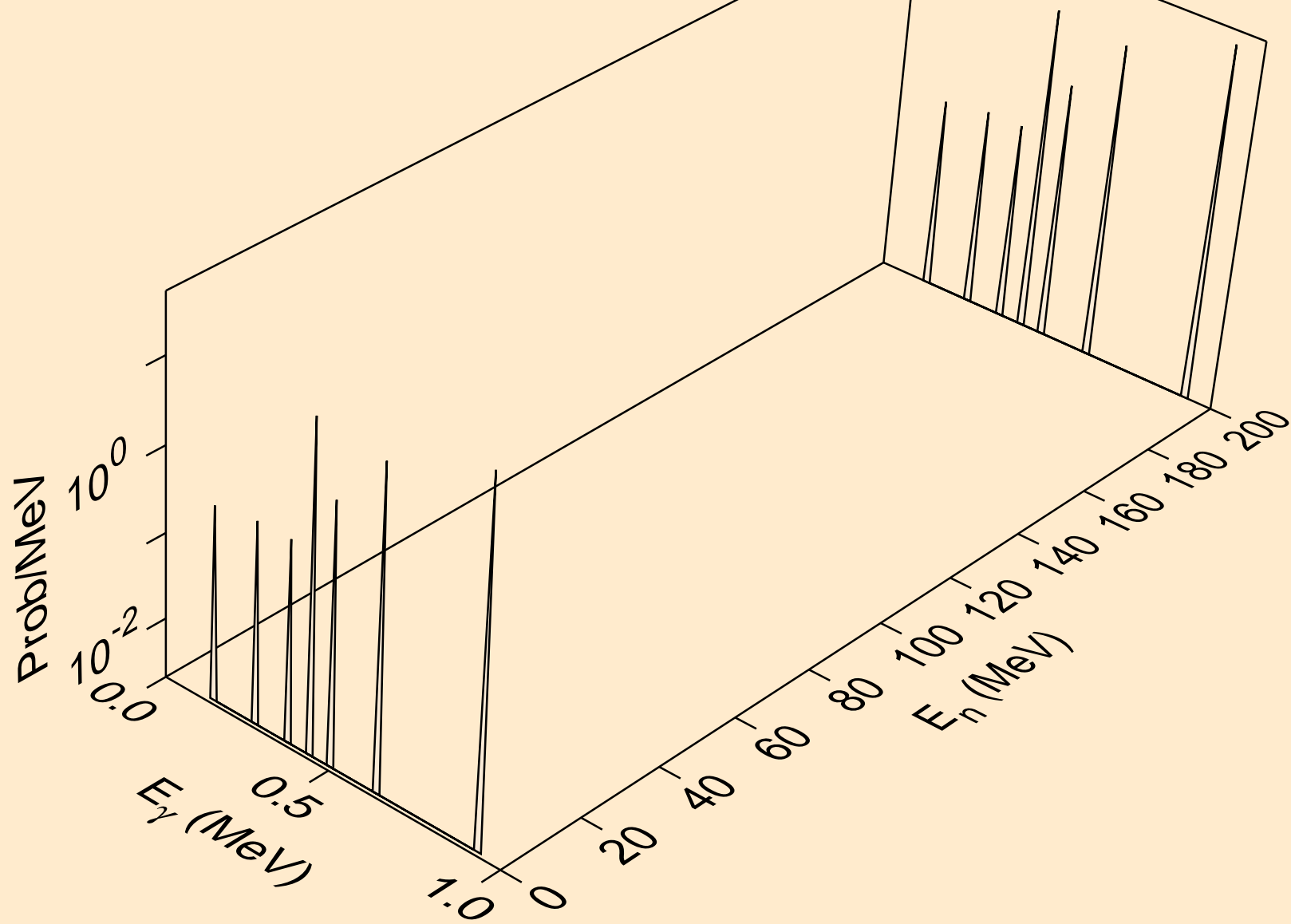

SE079M NEUTRON ACER TENDL-2021 LIBRARY; T=293.6K
Photon emission for (n,n*21)

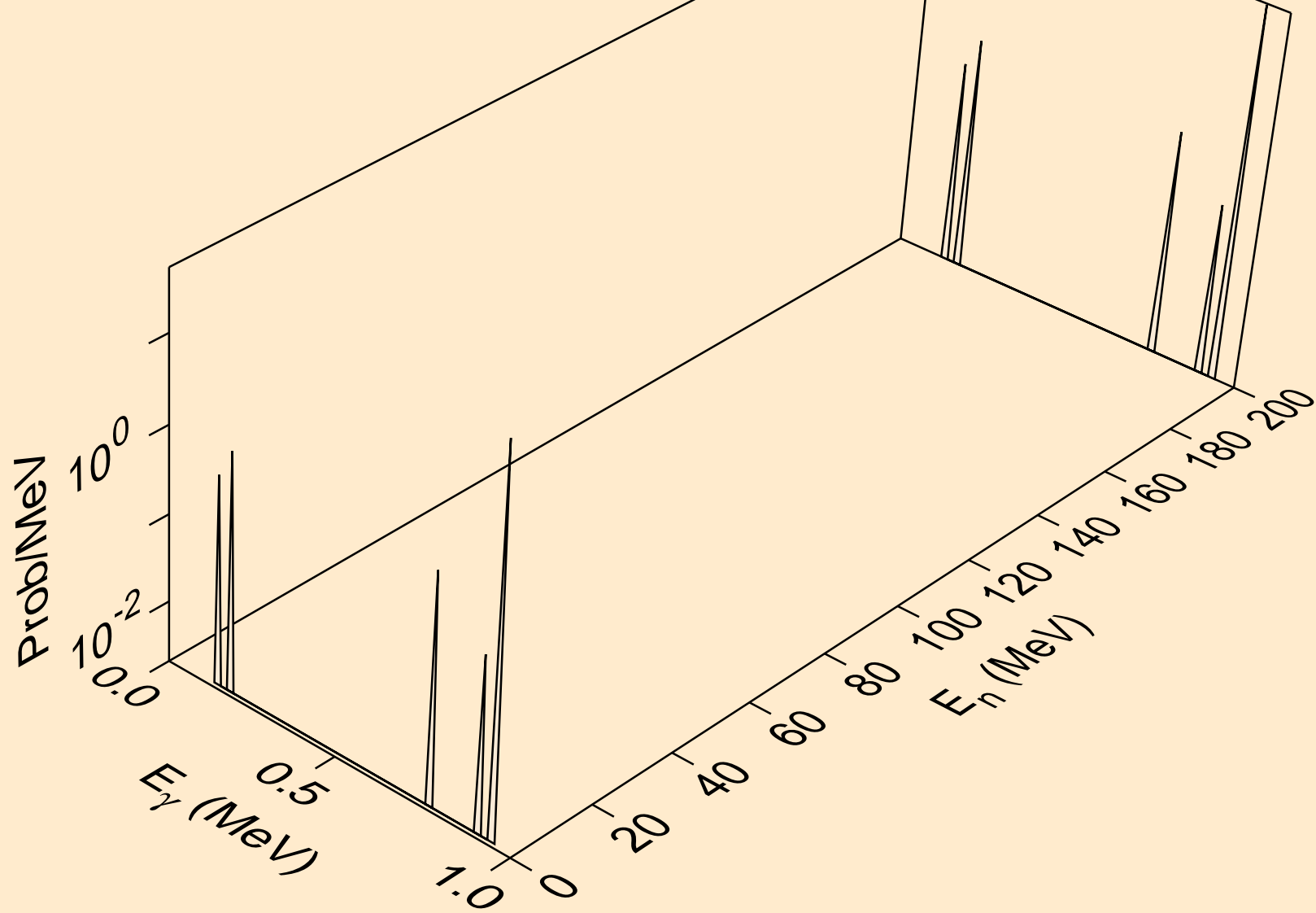

SE079M NEUTRON ACER TENDL-2021 LIBRARY; T=293.6K
Photon emission for (n,n*22)

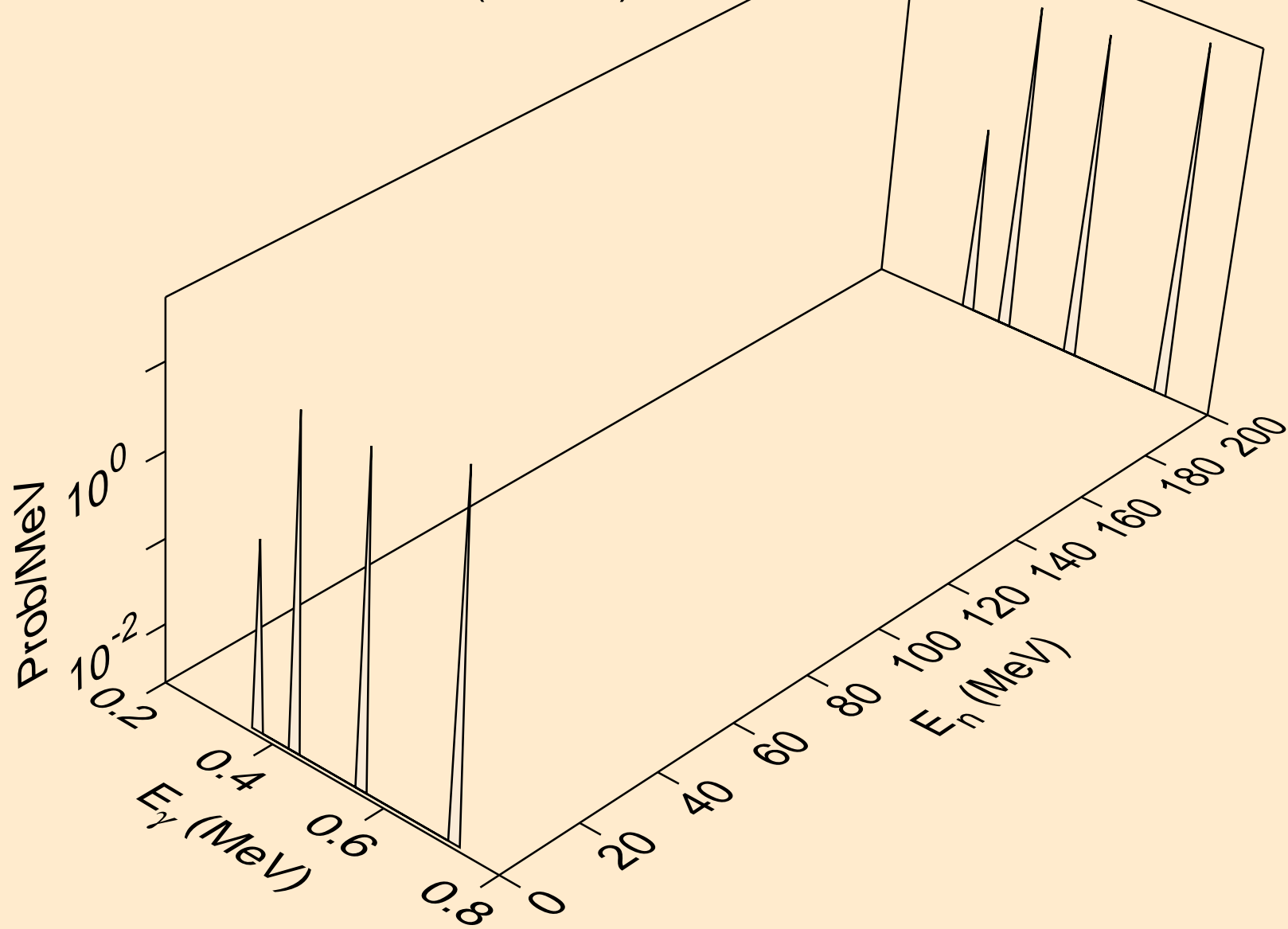

SE079M NEUTRON ACER TENDL-2021 LIBRARY; T=293.6K
Photon emission for (n,n*23)

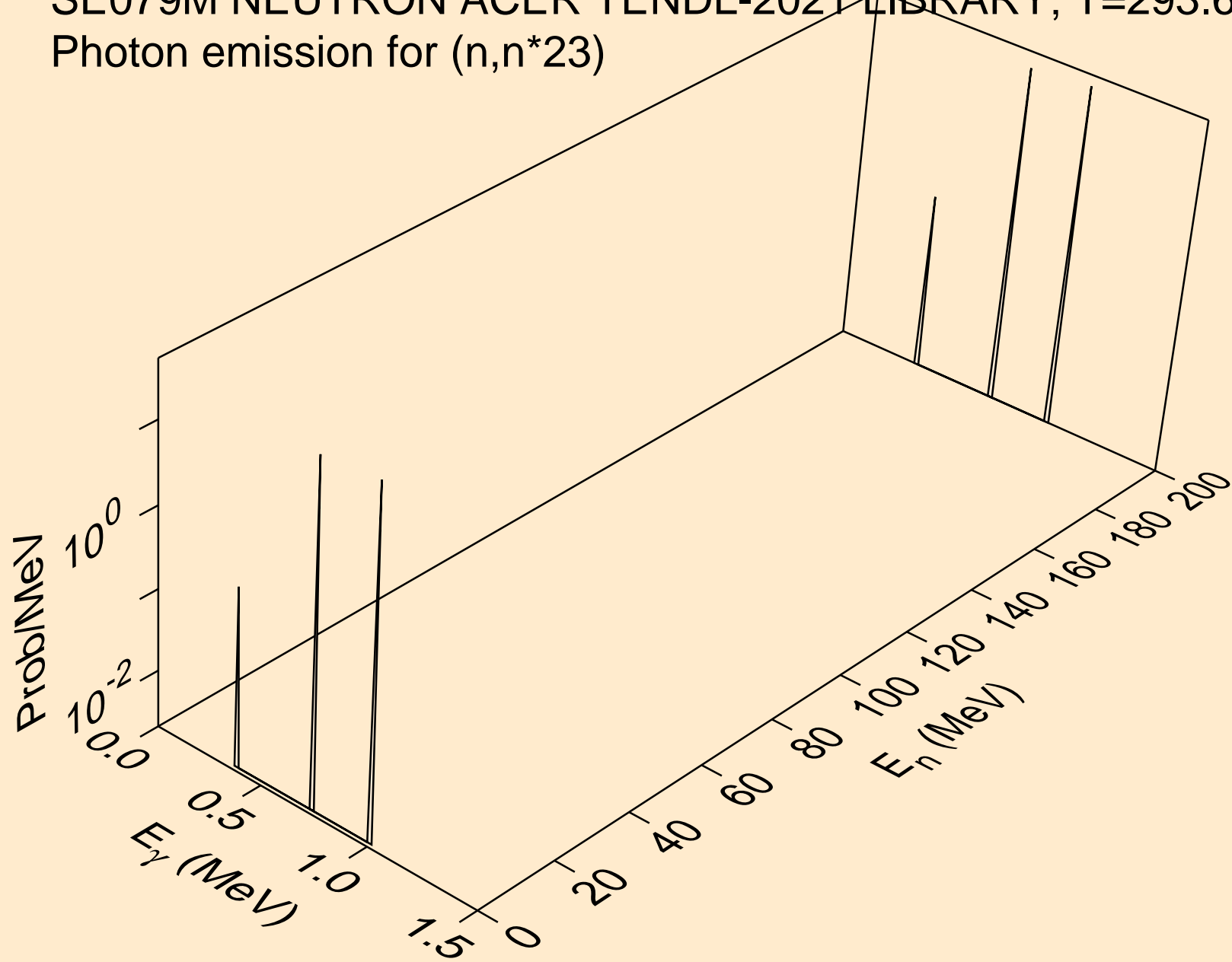

SE079M NEUTRON ACER TENDL-2021 LIBRARY; T=293.6K
Photon emission for (n,n*24)

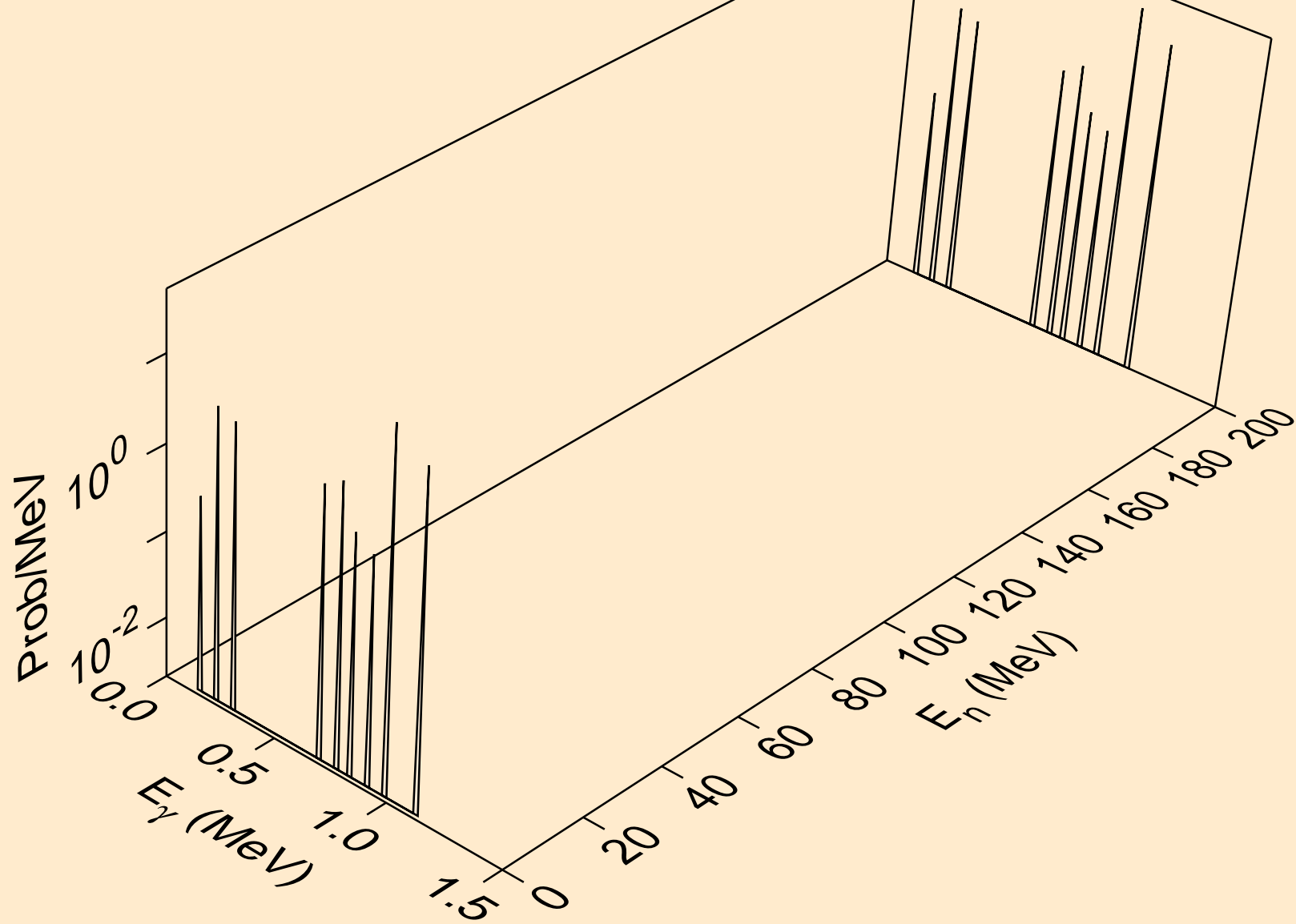

SE079M NEUTRON ACER TENDL-2021 LIBRARY; T=293.6K
Photon emission for (n,n*25)

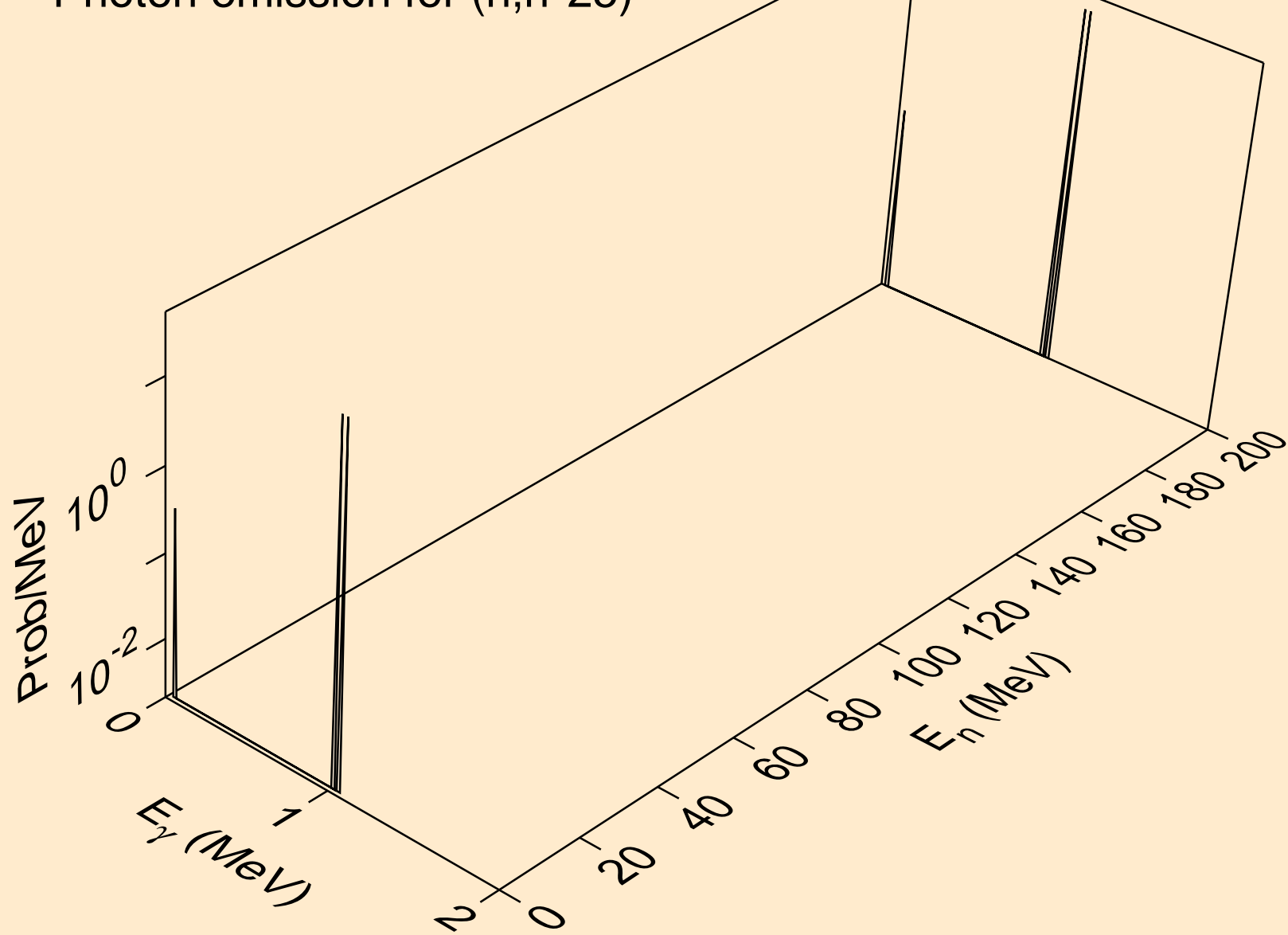

SE079M NEUTRON ACER TENDL-2021 LIBRARY; T=293.6K
Photon emission for (n,n*26)

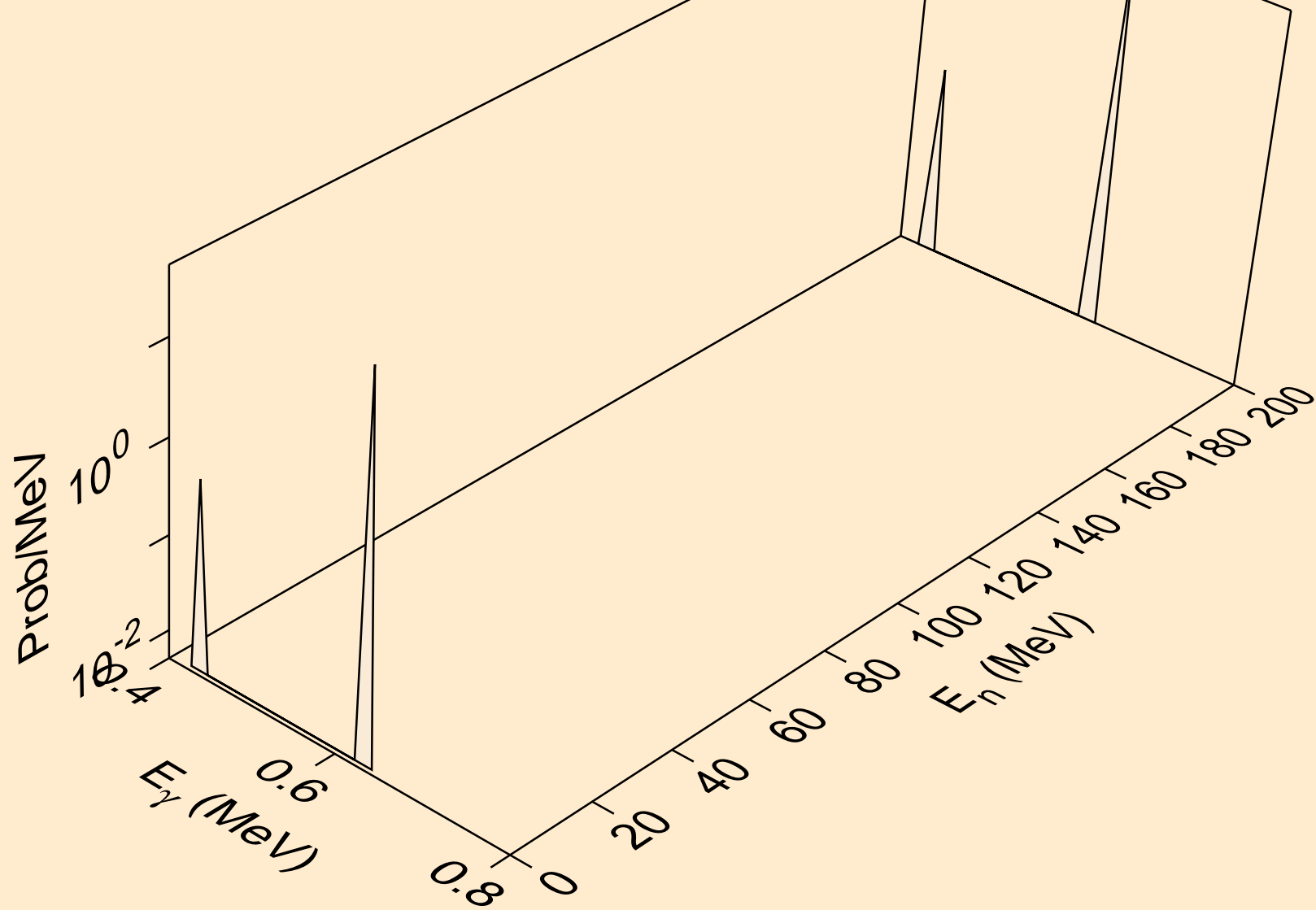

SE079M NEUTRON ACER TENDL-2021 LIBRARY; T=293.6K
Photon emission for (n,n*27)

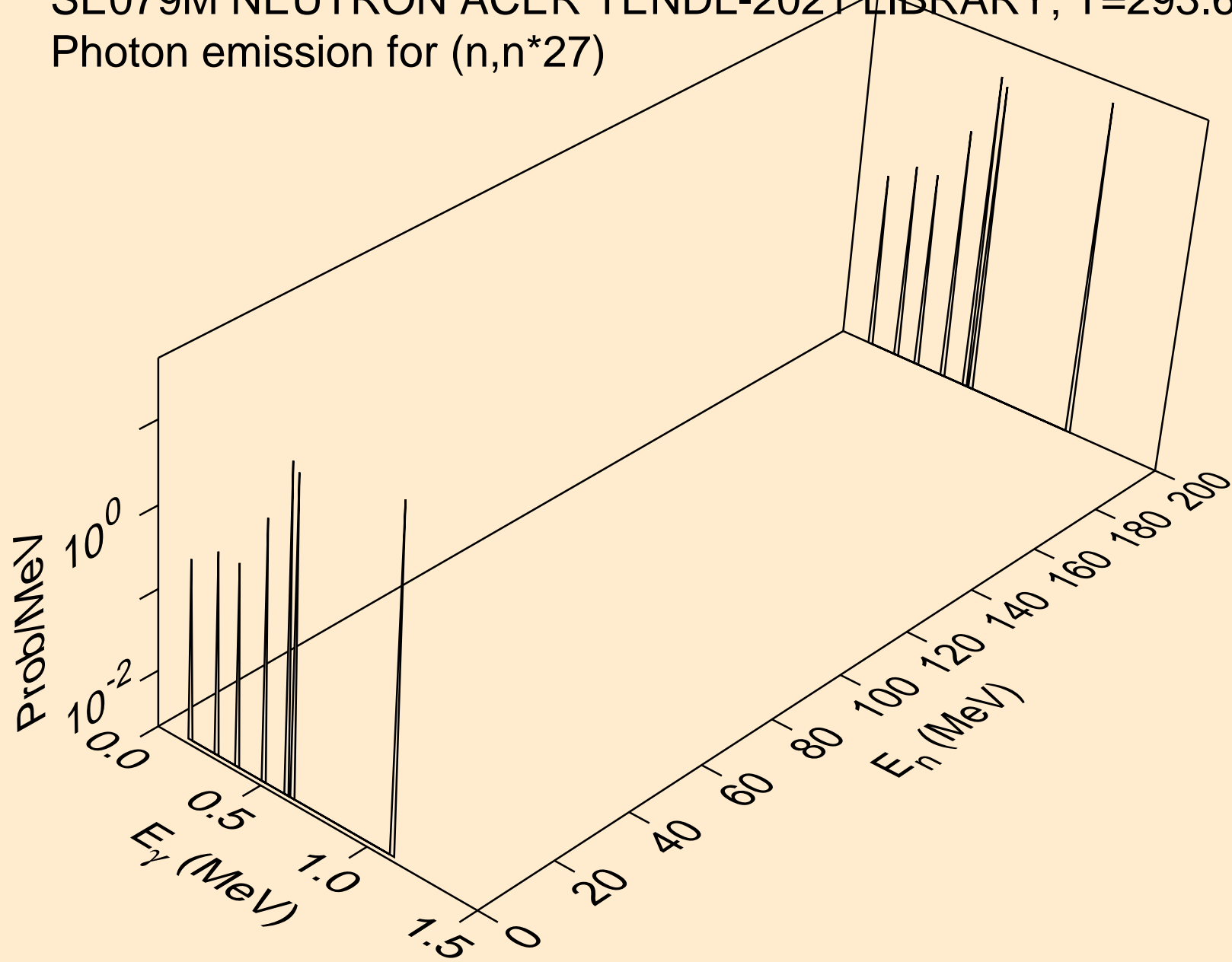

SE079M NEUTRON ACER TENDL-2021 LIBRARY; T=293.6K
Photon emission for (n,n*28)

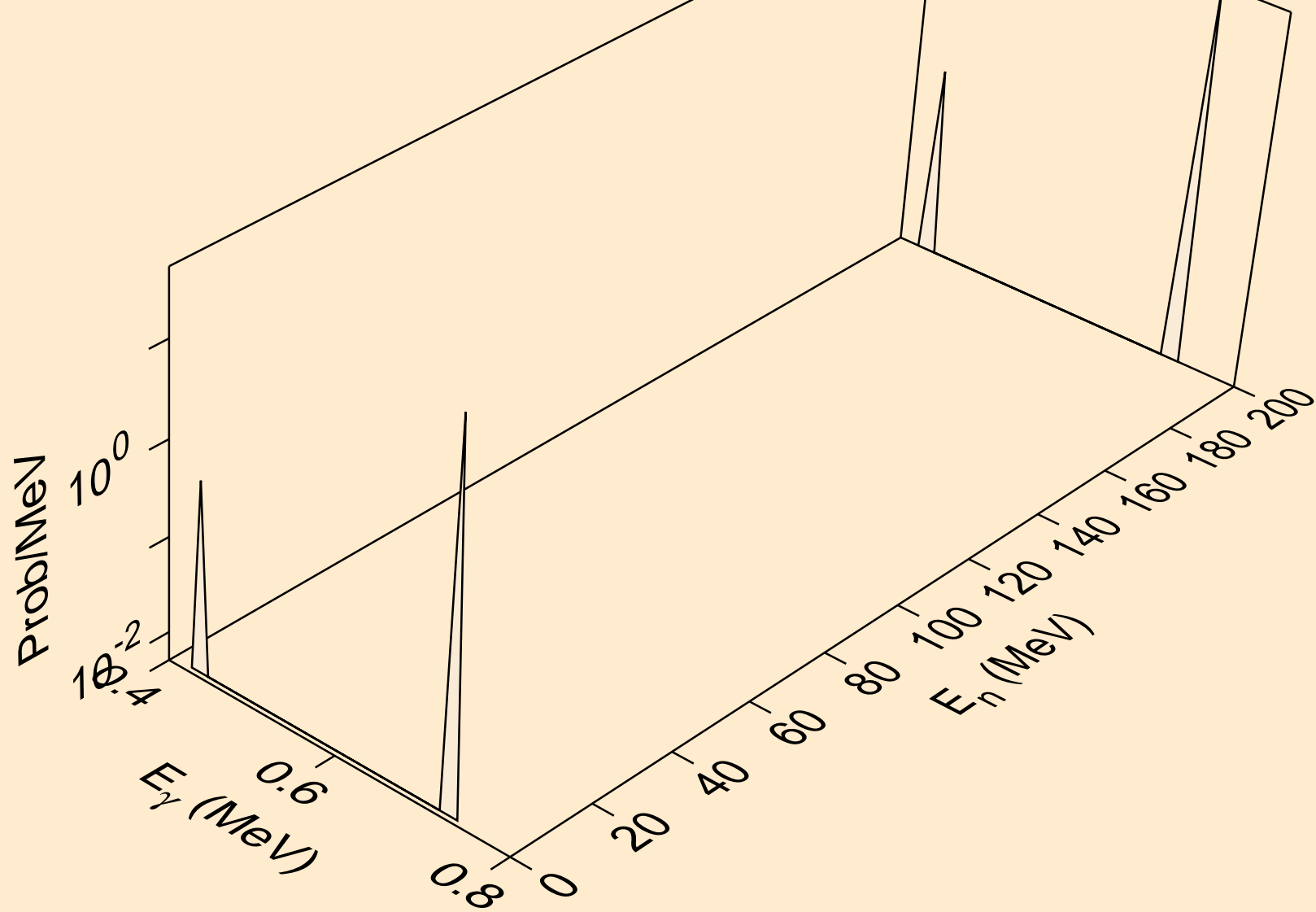

SE079M NEUTRON ACER TENDL-2021 LIBRARY; T=293.6K
Photon emission for (n,n*29)

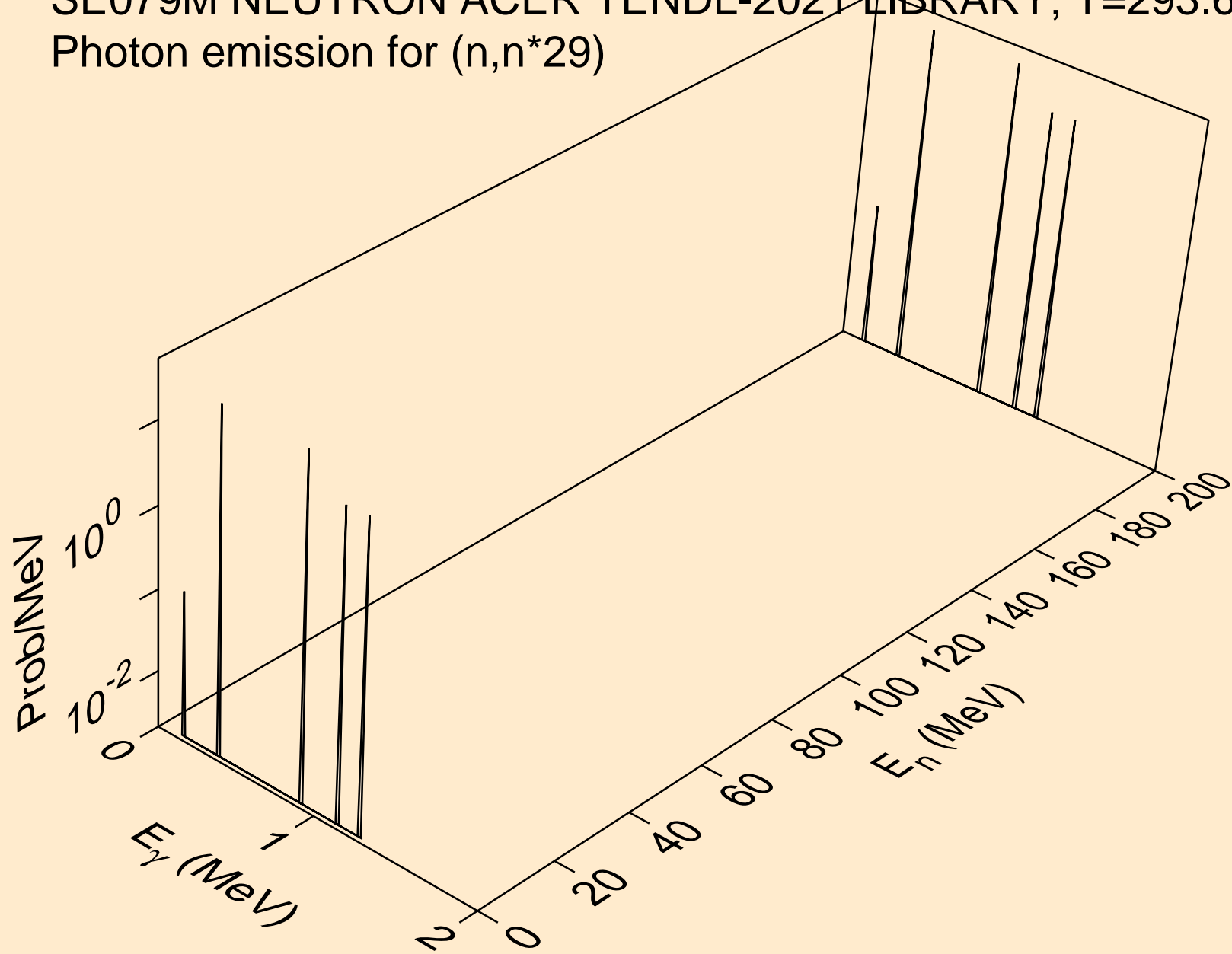

SE079M NEUTRON ACER TENDL-2021 LIBRARY; T=293.6K
Photon emission for (n,n*30)

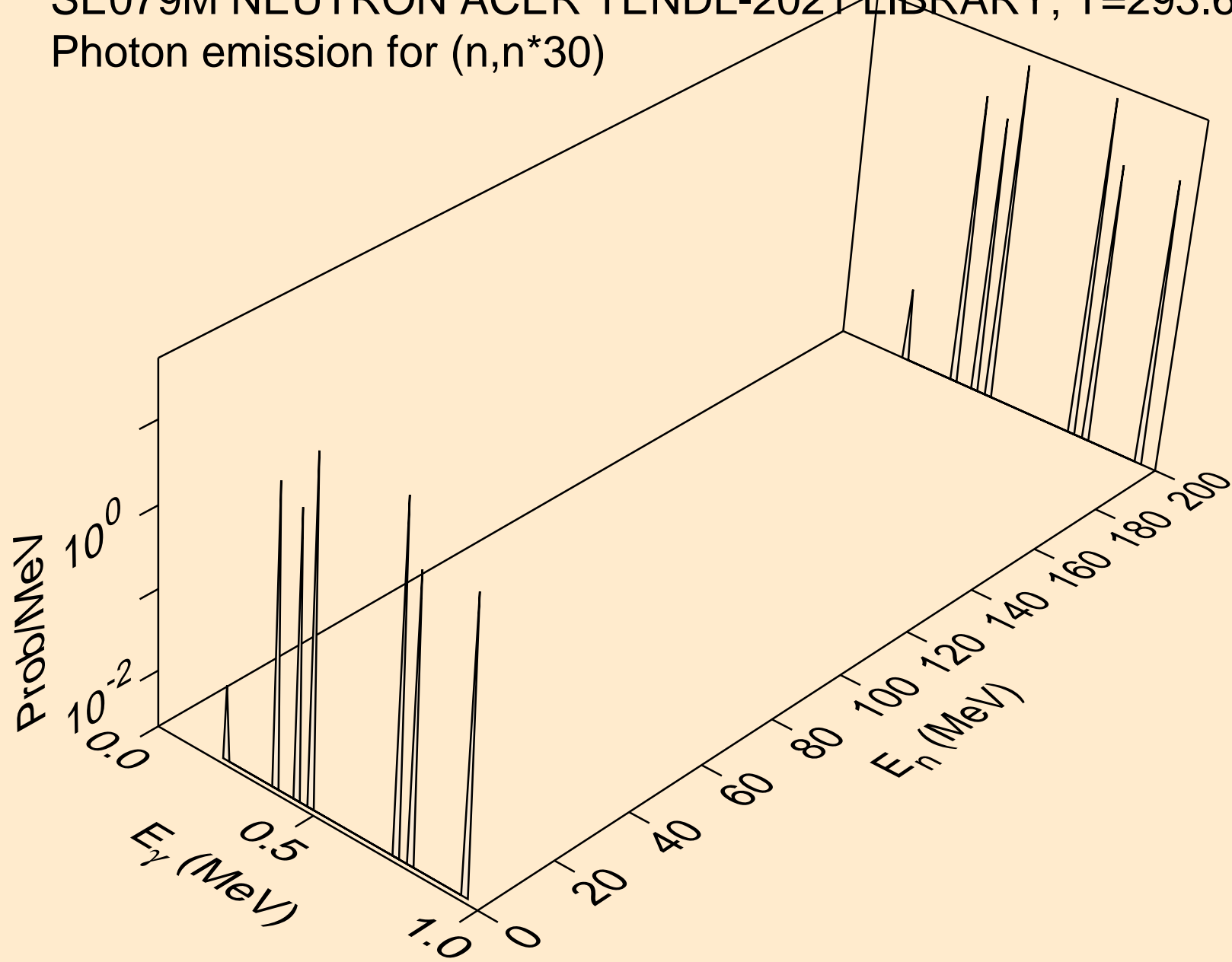

SE079M NEUTRON ACER TENDL-2021 LIBRARY; T=293.6K
Photon emission for (n,n*c)

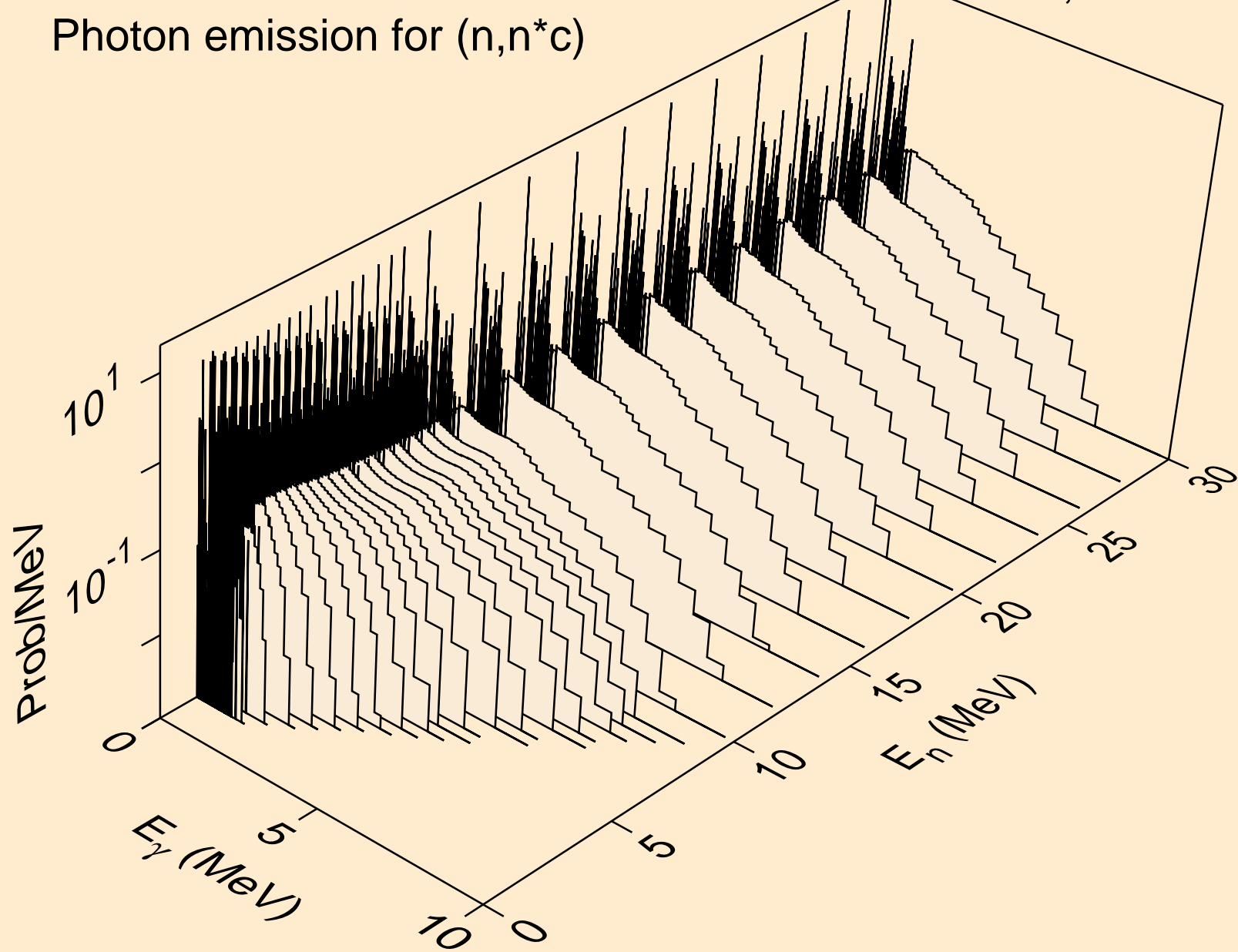

SE079M NEUTRON ACER TENDL-2021 LIBRARY; T=293.6K
Photon emission for (n,gma)

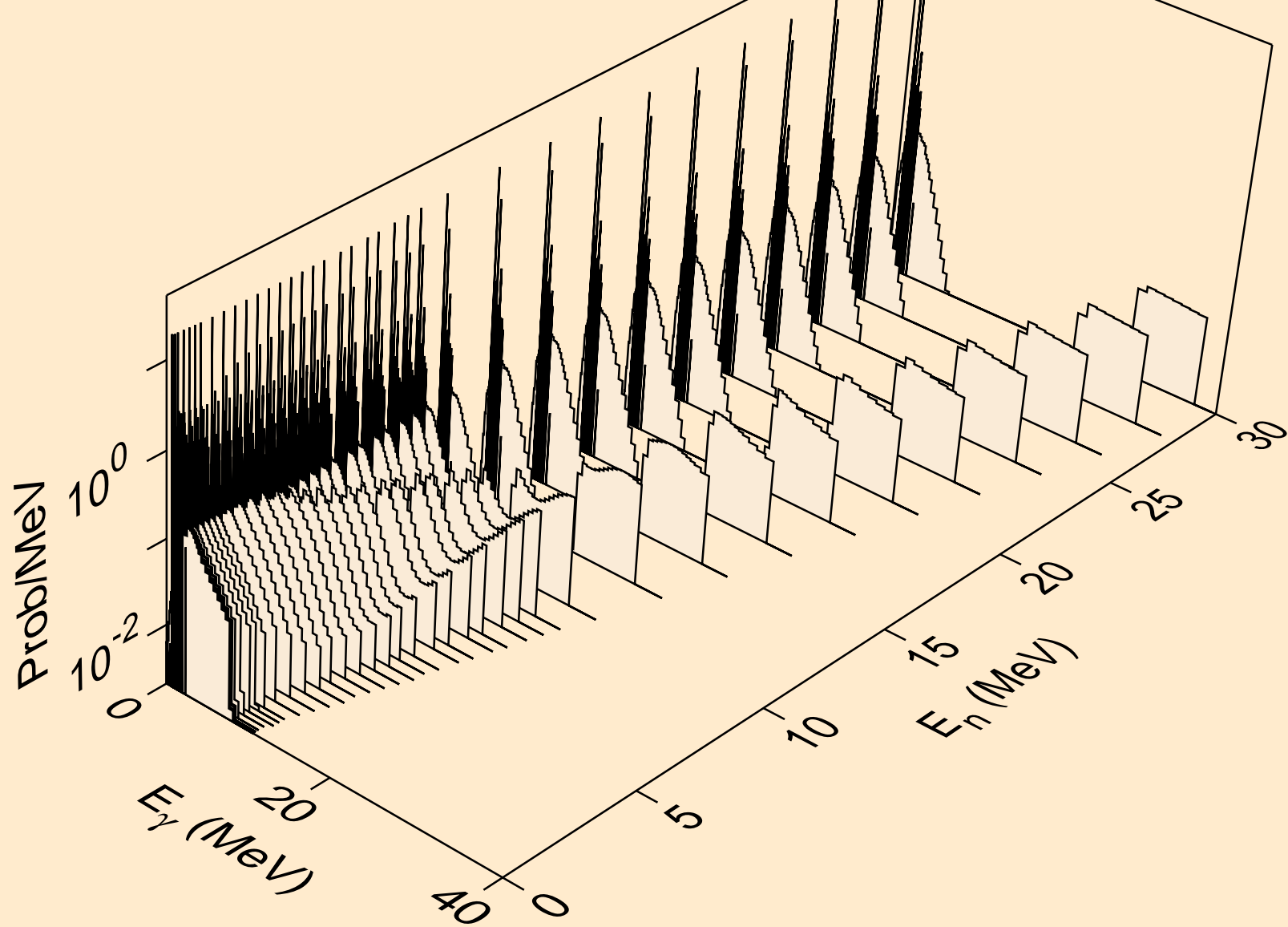

SE079M NEUTRON ACER TENDL-2021 LIBRARY; T=293.6K
Photon emission for (n,p)

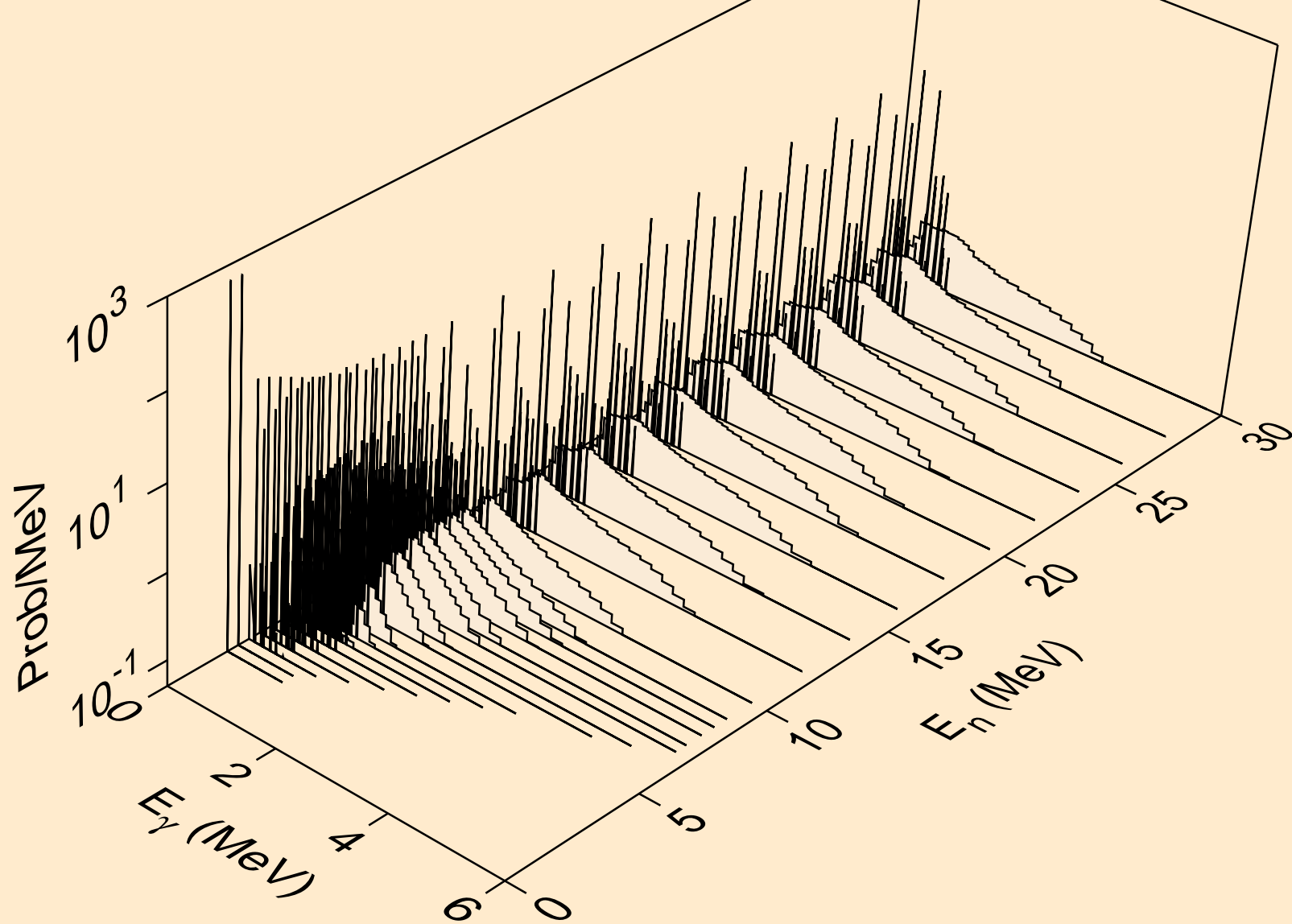

SE079M NEUTRON ACER TENDL-2021 LIBRARY; T=293.6K
Photon emission for (n,d)

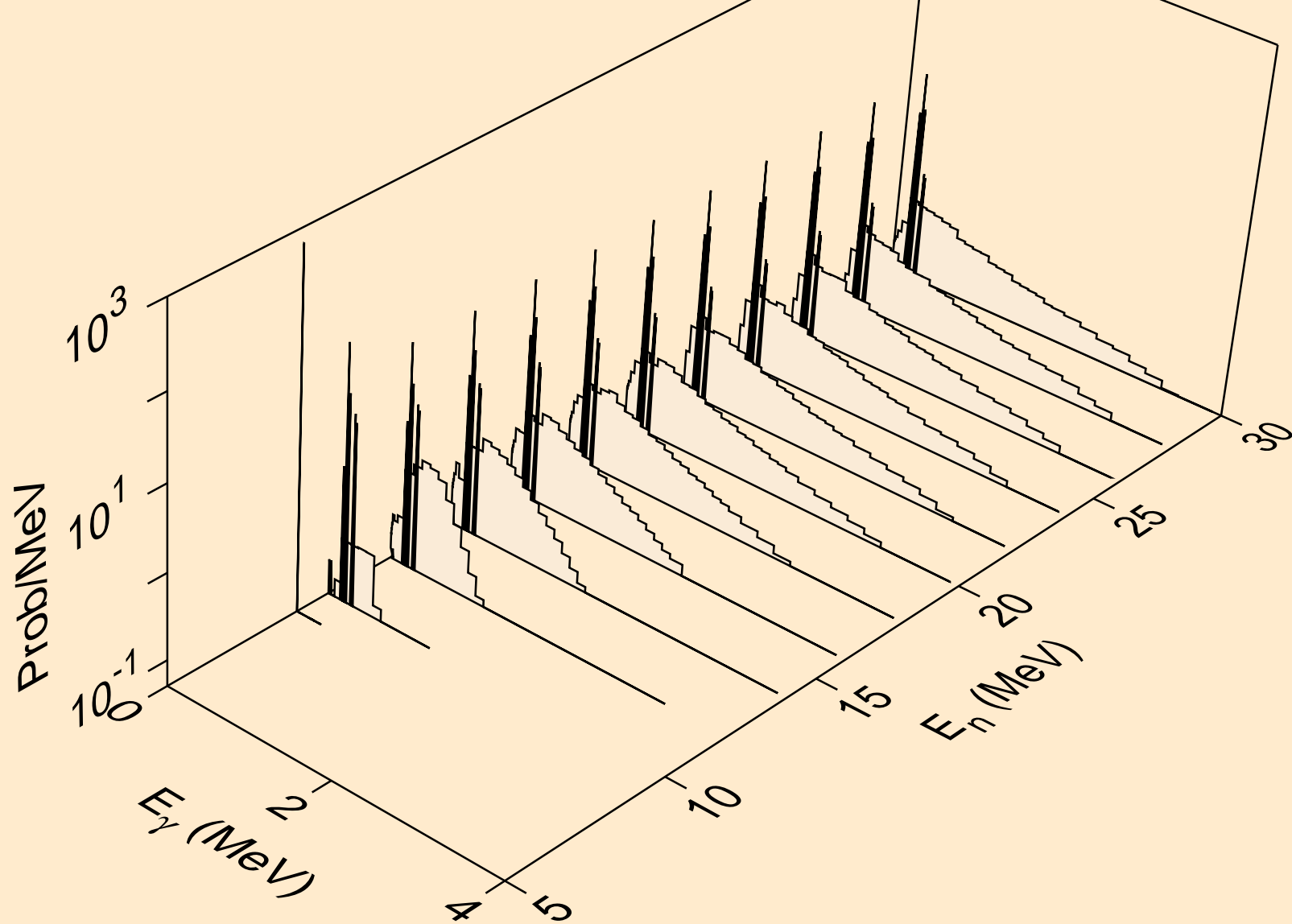

SE079M NEUTRON ACER TENDL-2021 LIBRARY; T=293.6K
Photon emission for (n,t)

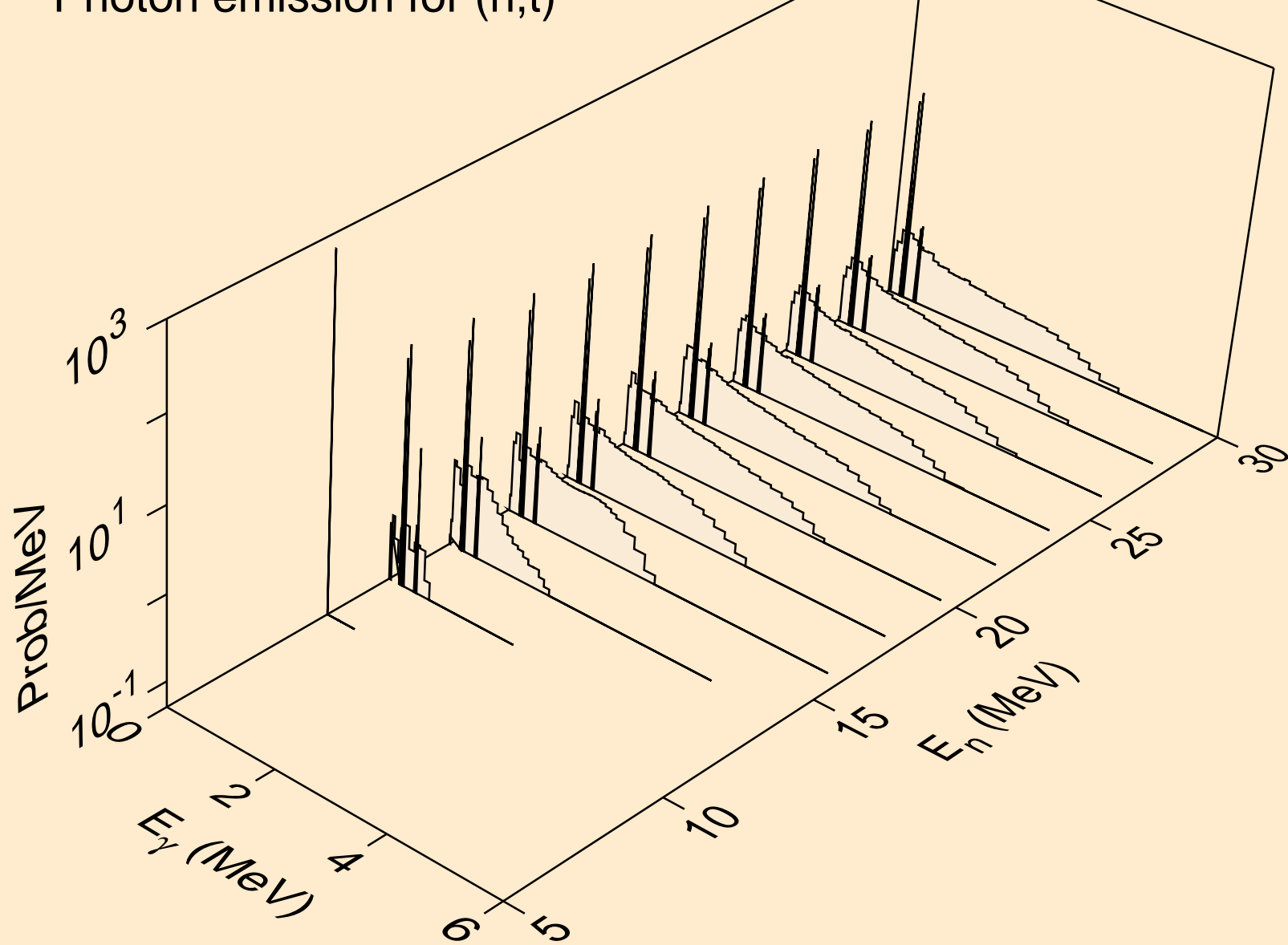

SE079M NEUTRON ACER TENDL-2021 LIBRARY; T=293.6K
Photon emission for (n,he3)

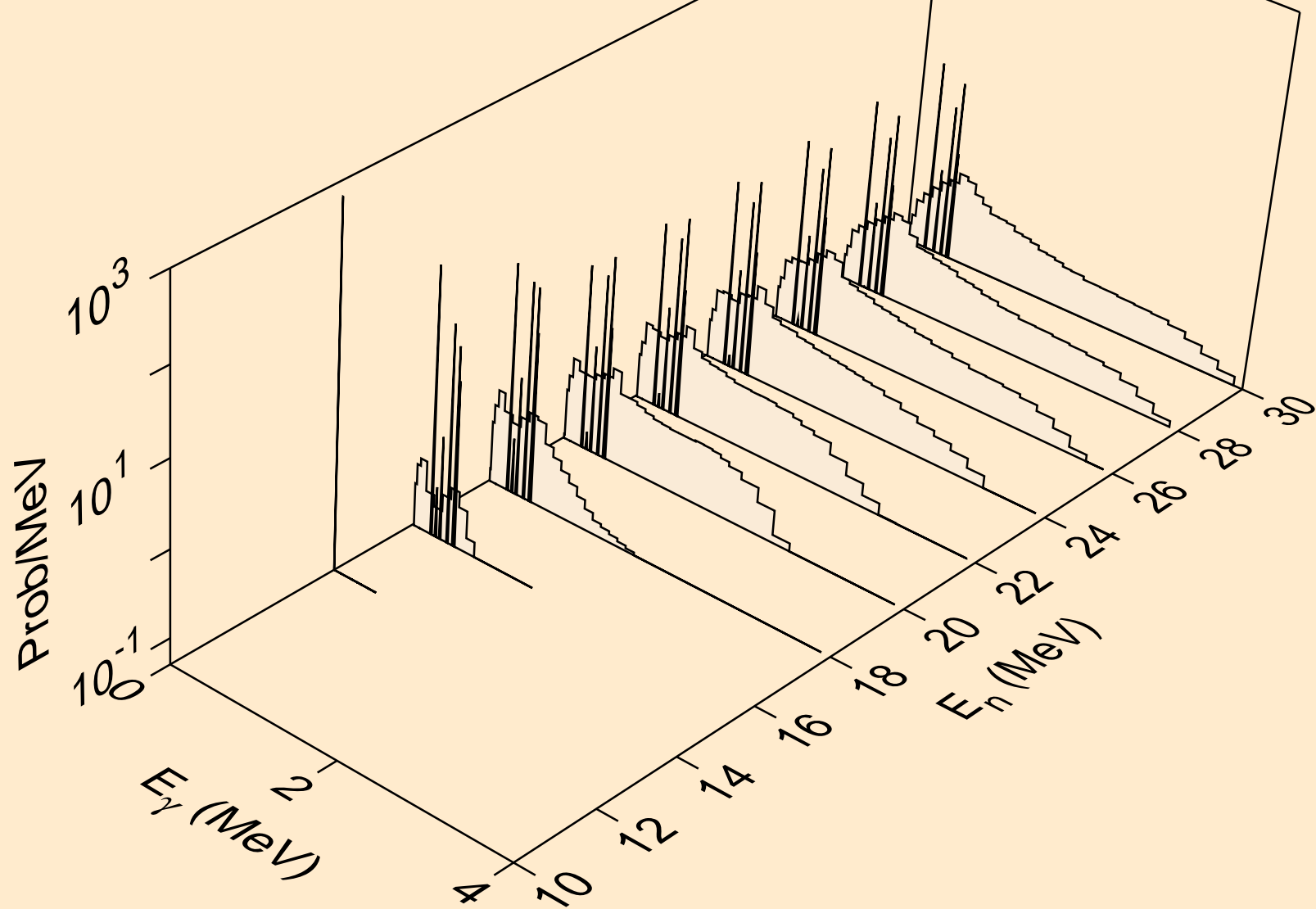

SE079M NEUTRON ACER TENDL-2021 LIBRARY; T=293.6K
Photon emission for (n,a)

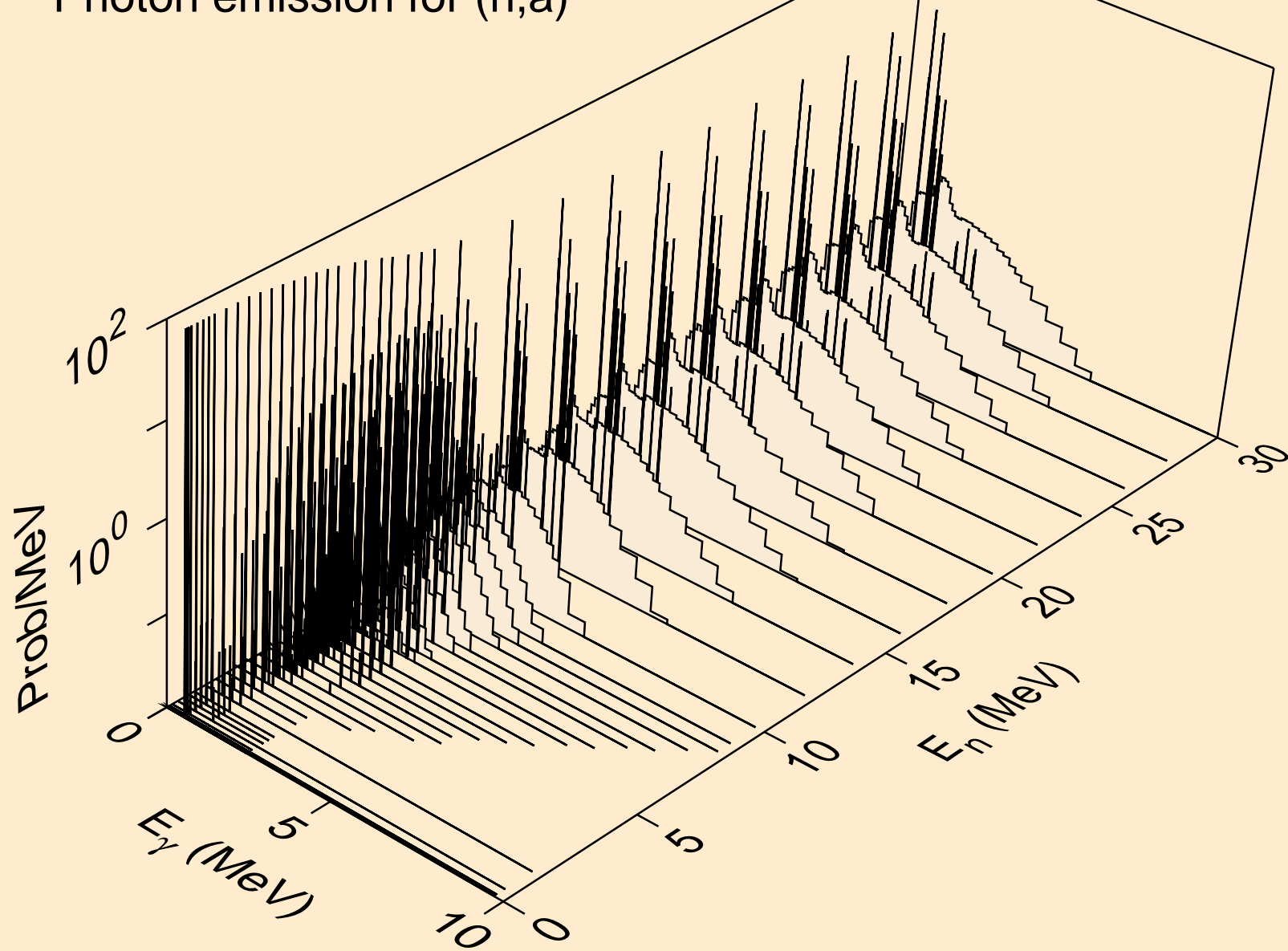

SE079M NEUTRON ACER TENDL-2021 LIBRARY; T=293.6K
Photon emission for (n,2a)

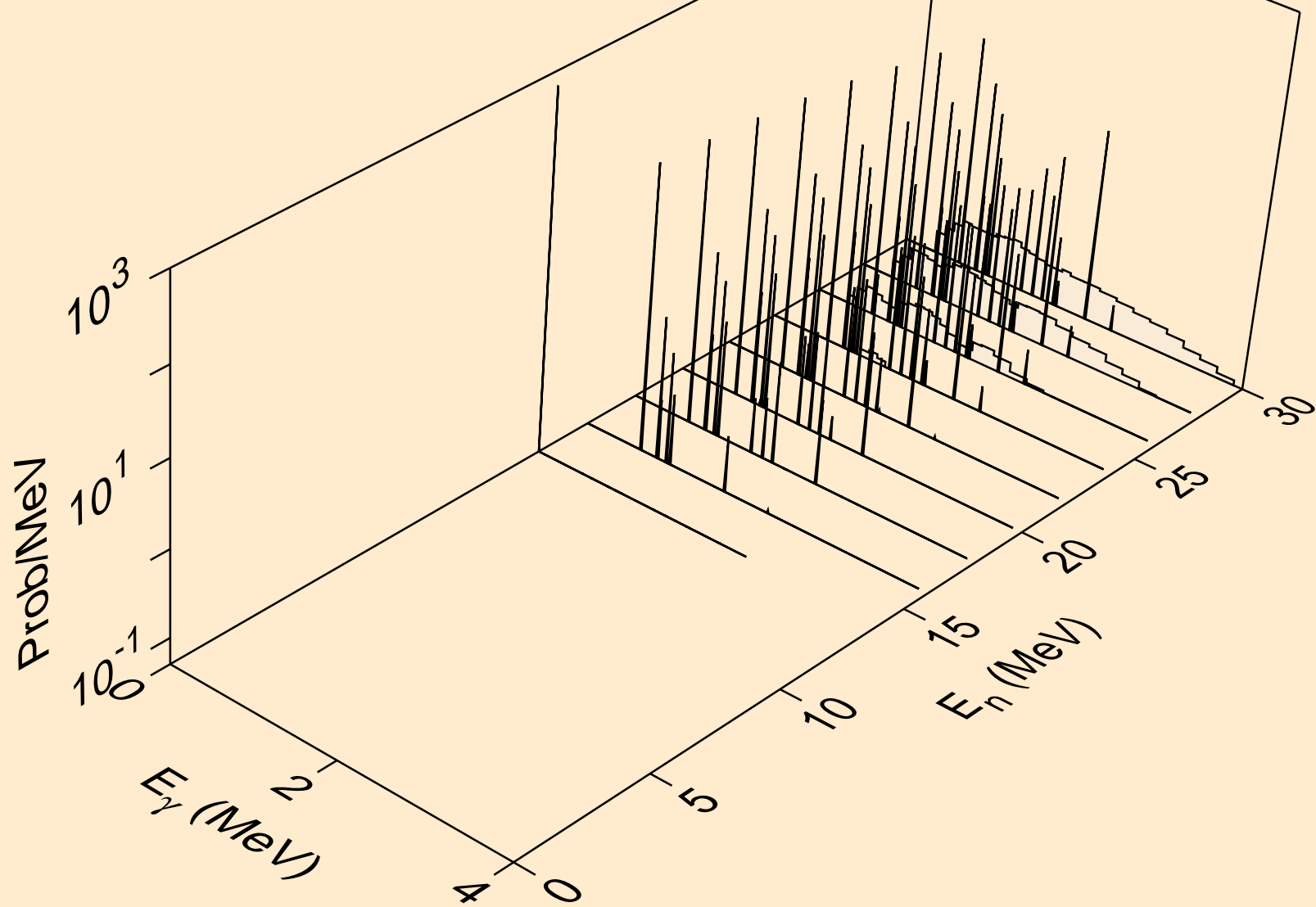

SE079M NEUTRON ACER TENDL-2021 LIBRARY; T=293.6K
Photon emission for (n,2p)

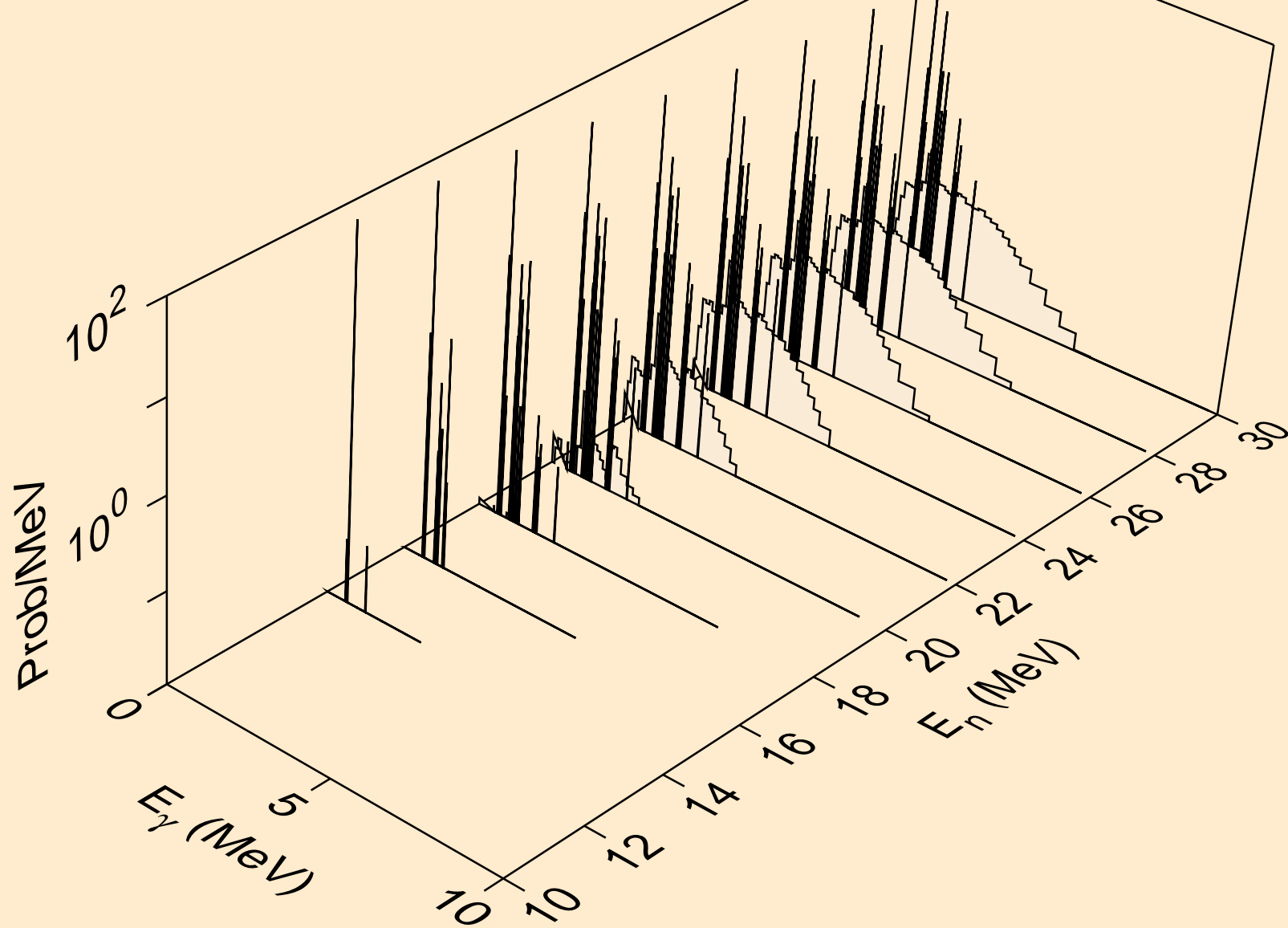

SE079M NEUTRON ACER TENDL-2021 LIBRARY; T=293.6K
Photon emission for (n,p)

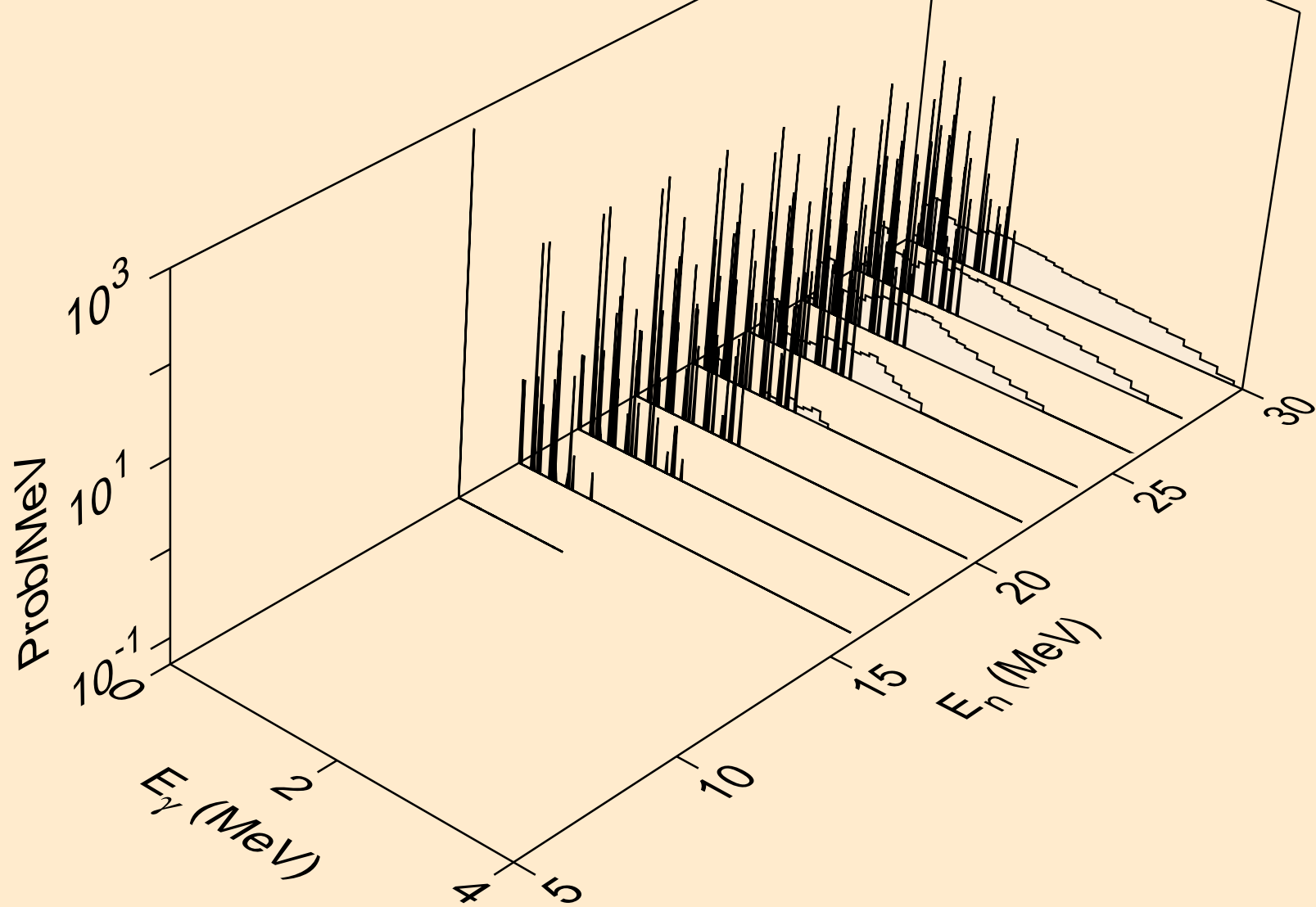

SE079M NEUTRON ACER TENDL-2021 LIBRARY; T=293.6K
Photon emission for (n,pd)

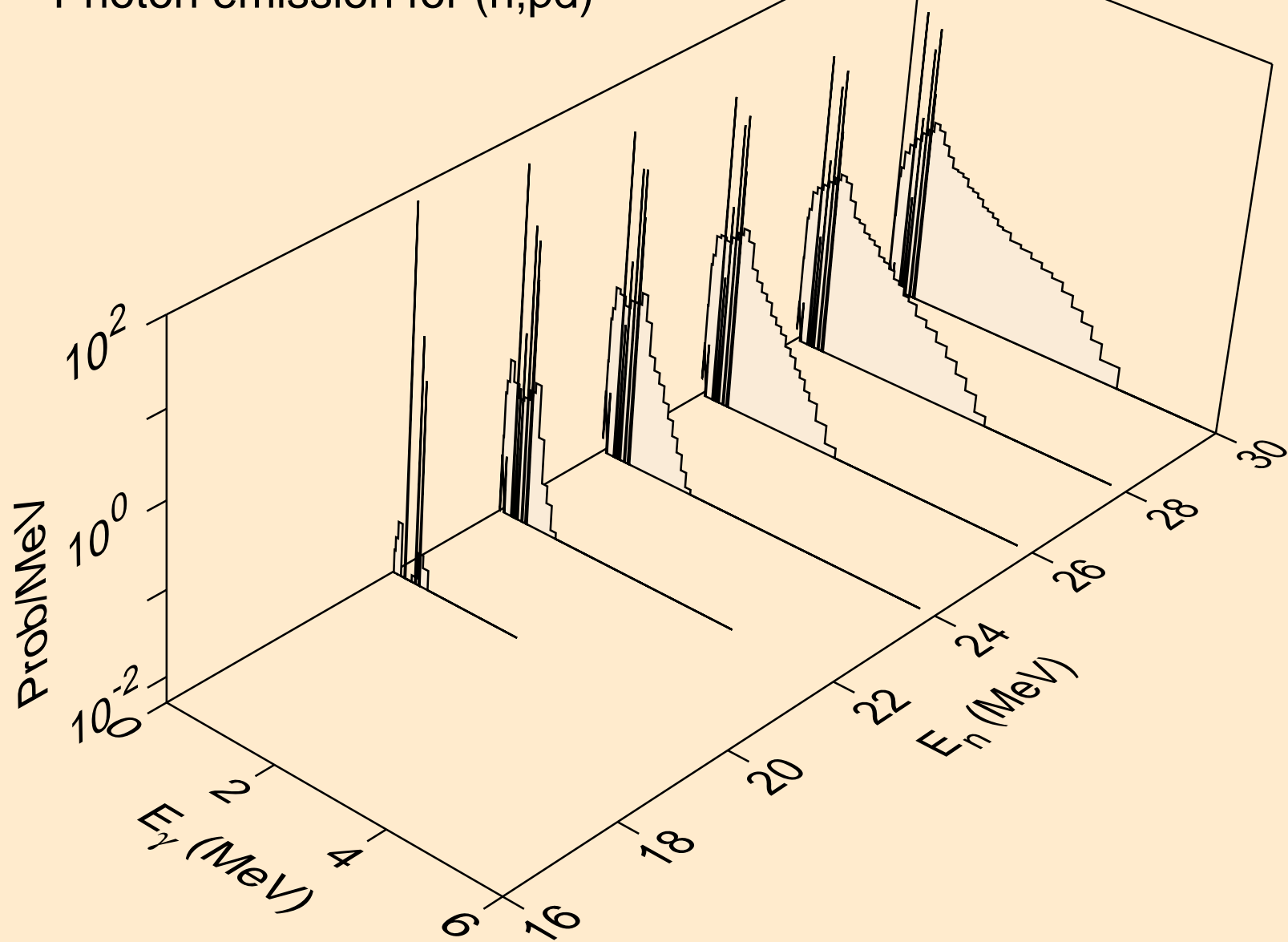

SE079M NEUTRON ACER TENDL-2021 LIBRARY; T=293.6K
Photon emission for (n,pt)

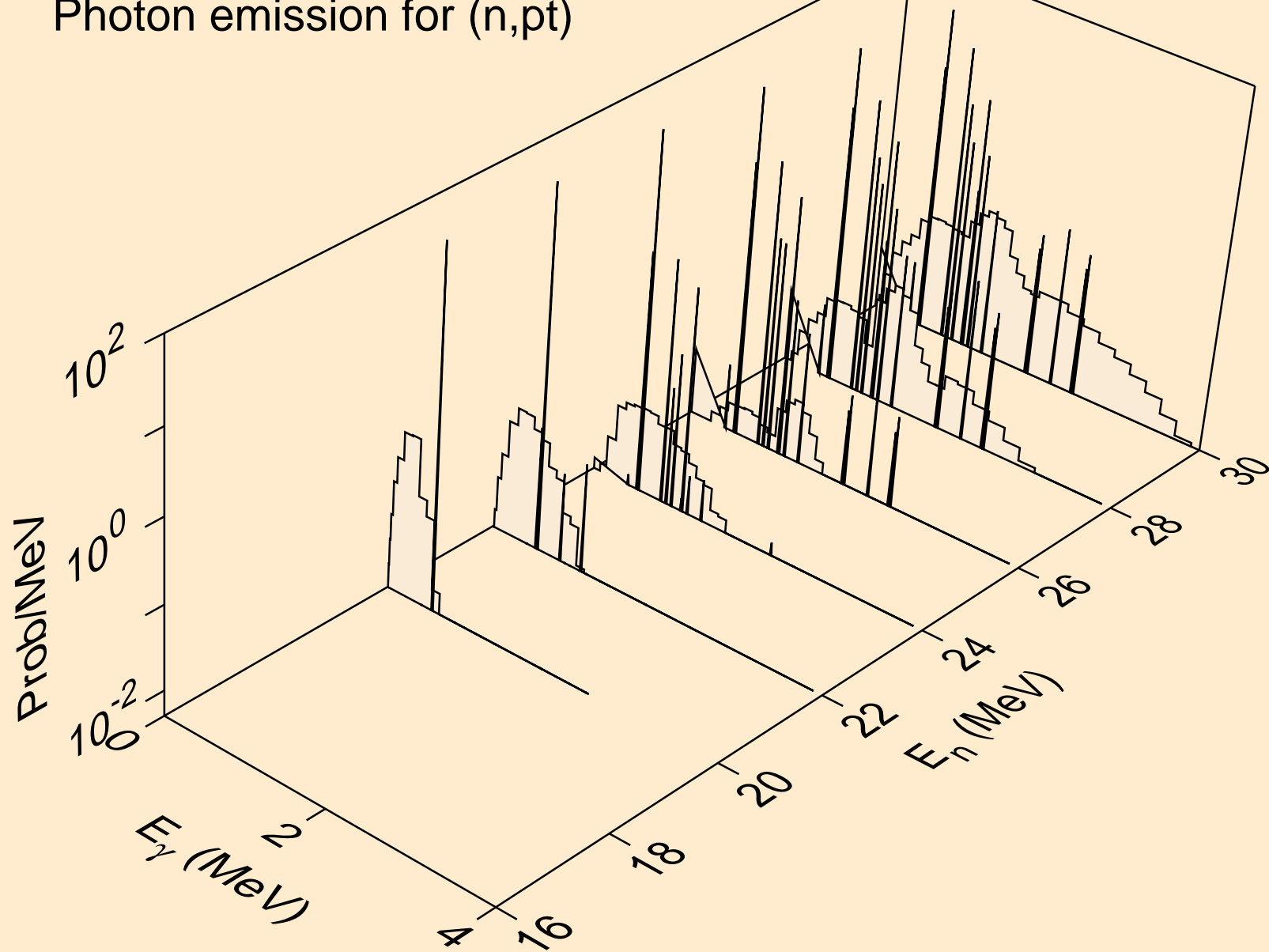

SE079M NEUTRON ACER TENDL-2021 LIBRARY; T=293.6K
Photon emission for (n,da)

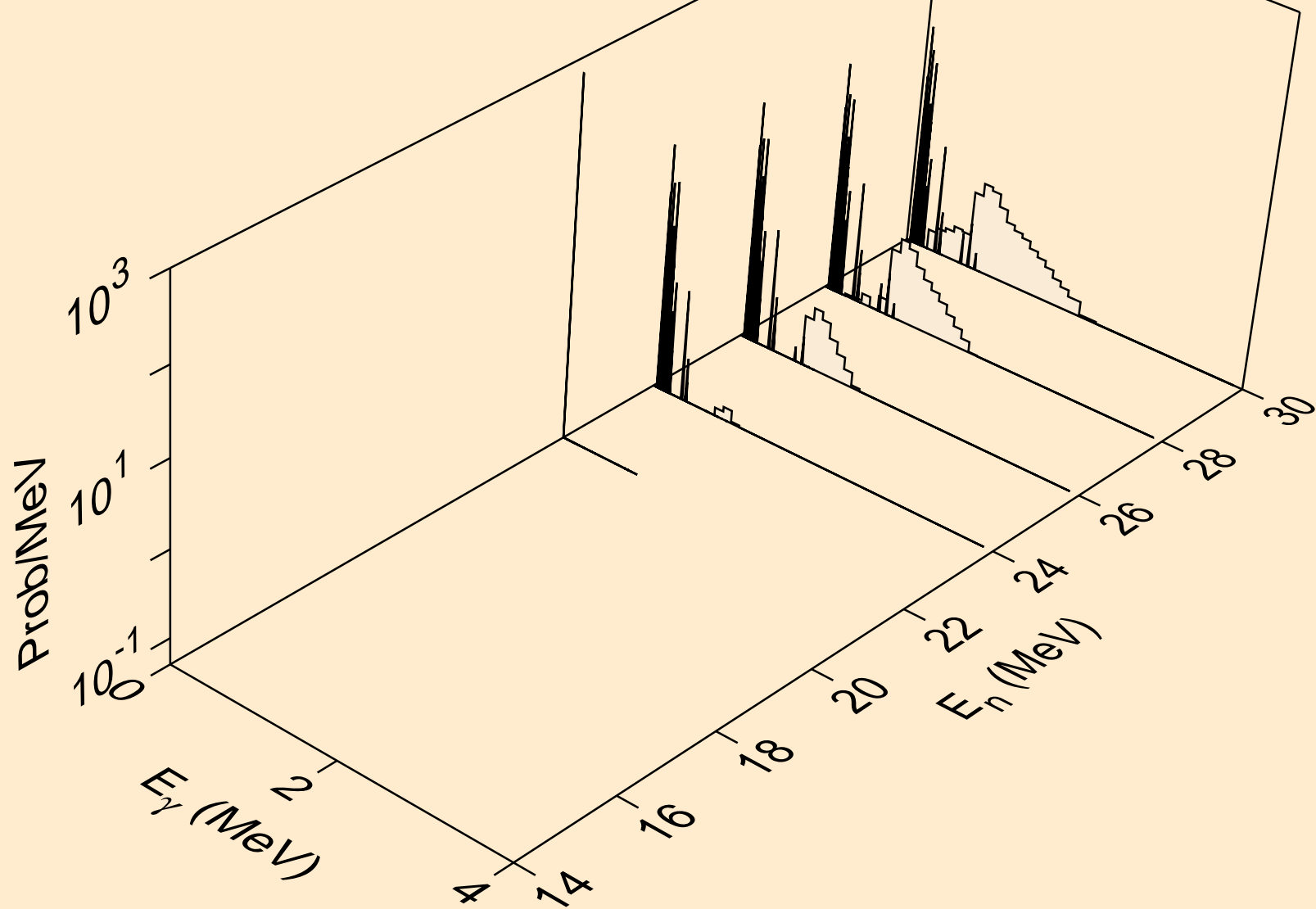

SE079M NEUTRON ACER TENDL-2021 LIBRARY; T=293.6K
thermal capture photon spectrum

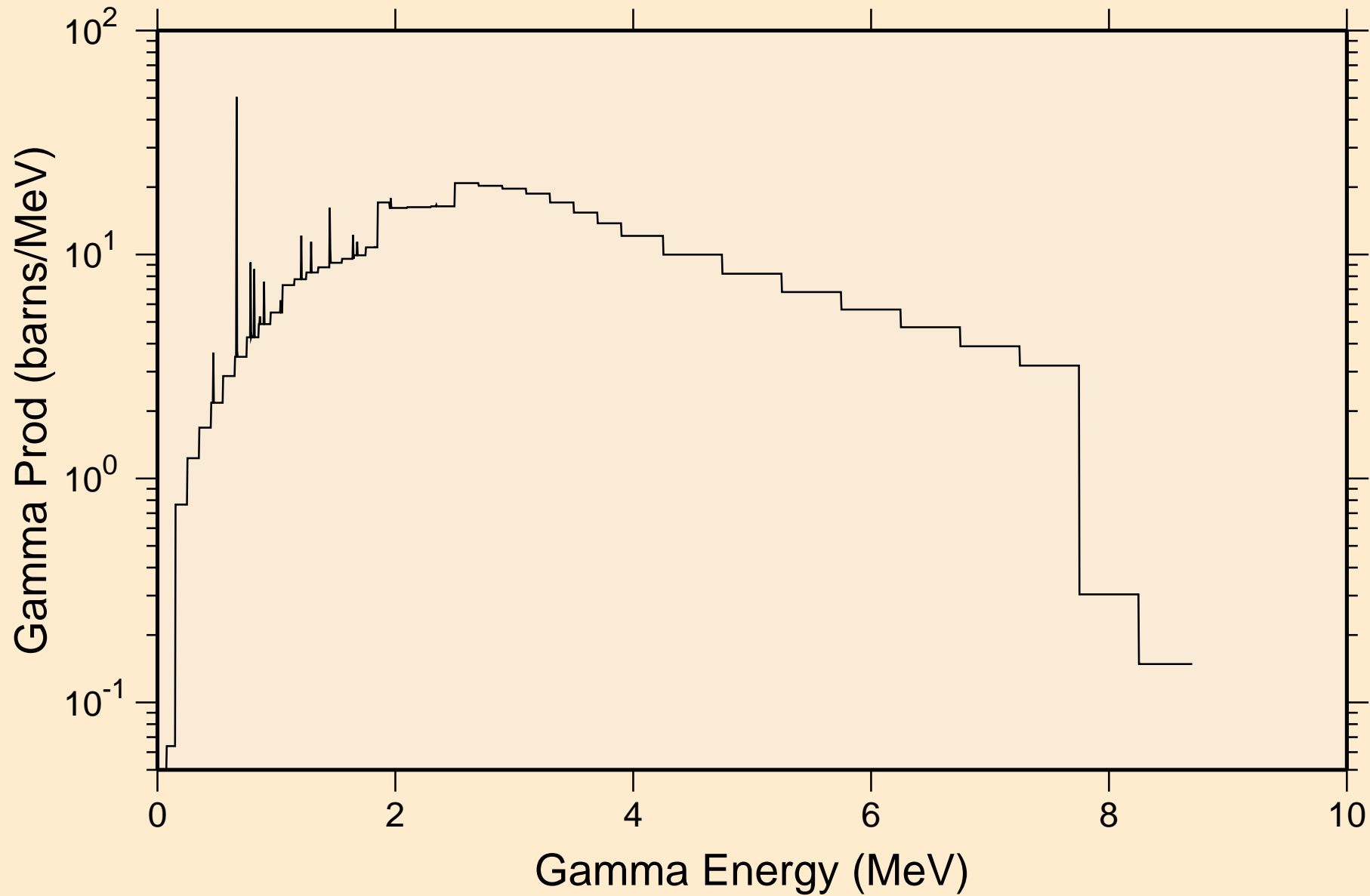

SE079M NEUTRON ACER TENDL-2021 LIBRARY; T=293.6K
14 MeV photon spectrum

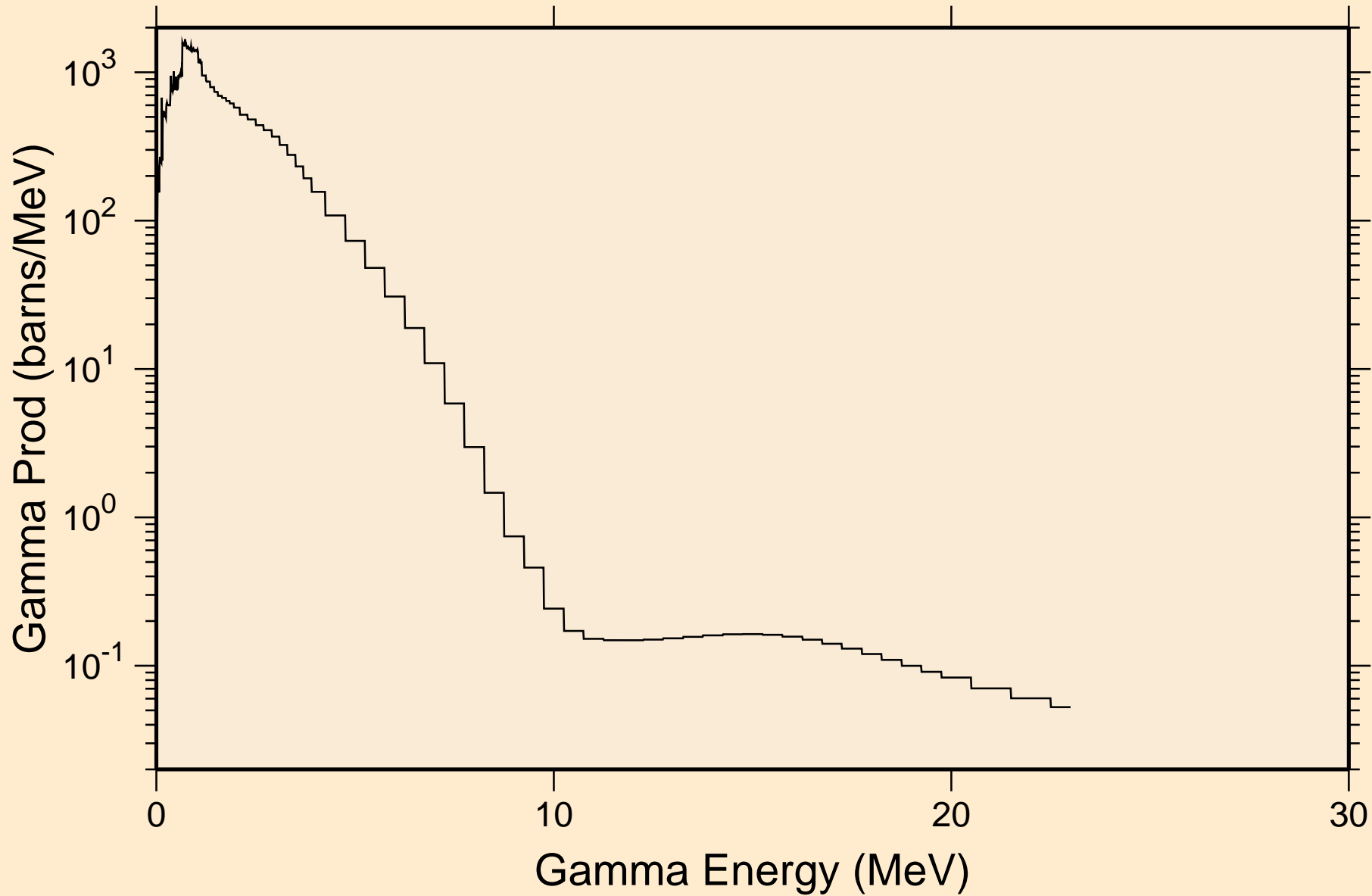

SE079M NEUTRON ACER TENDL-2021 LIBRARY; T=293.6K
Particle heating contributions

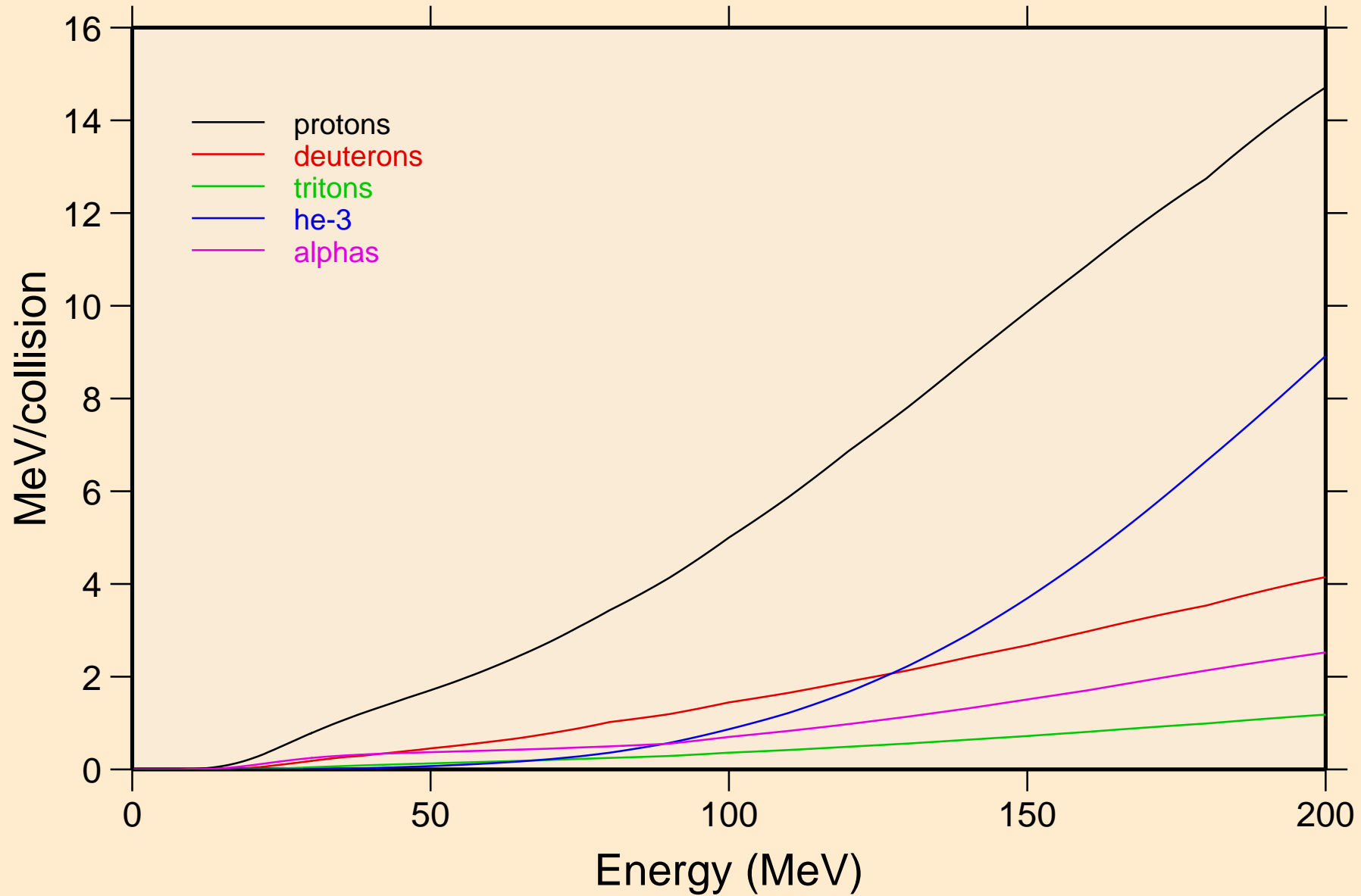

SE079M NEUTRON ACER TENDL-2021 LIBRARY; T=293.6K
Recoil Heating

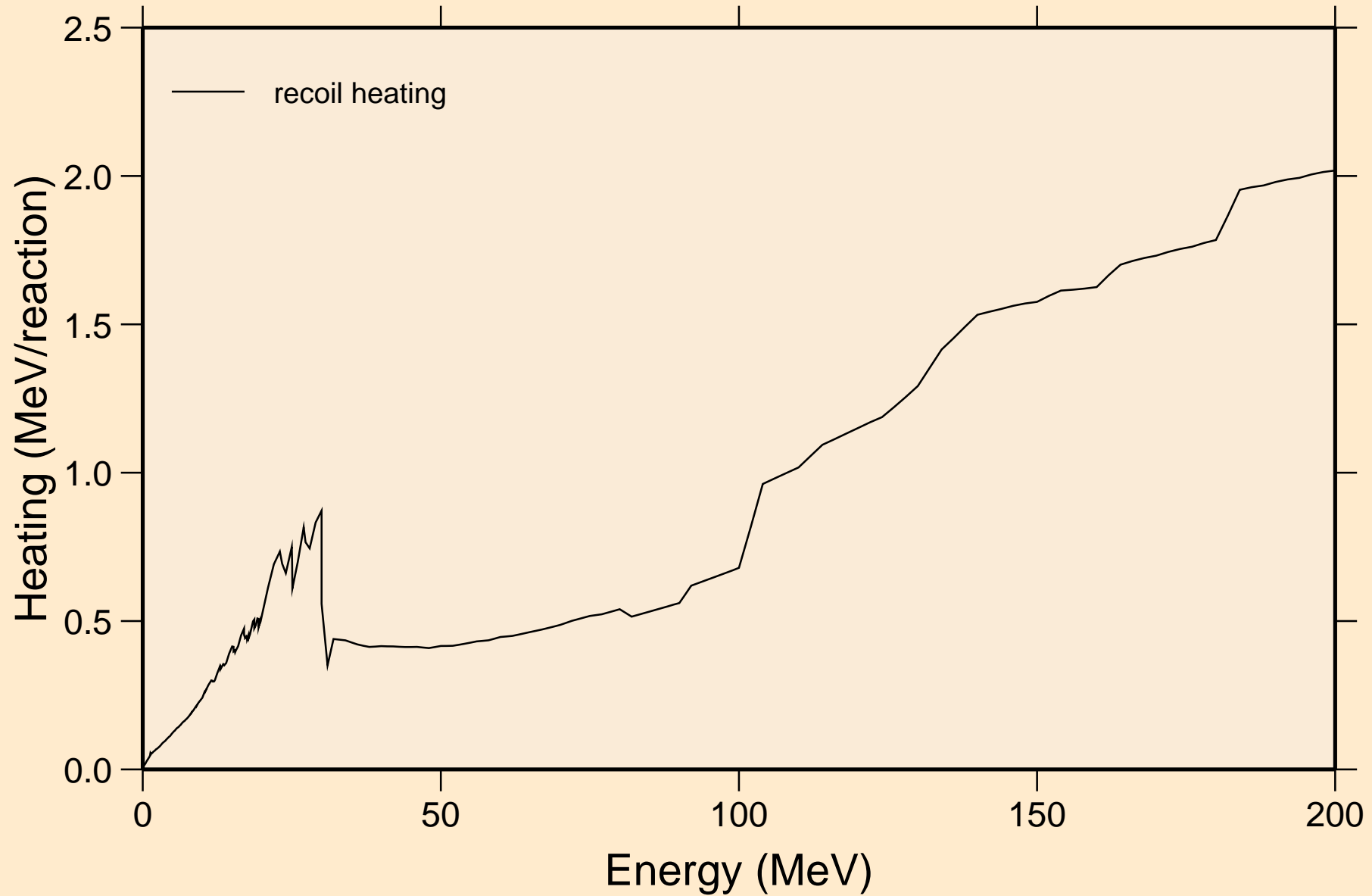

SE079M NEUTRON ACER TENDL-2021 LIBRARY; T=293.6K
Particle production cross sections

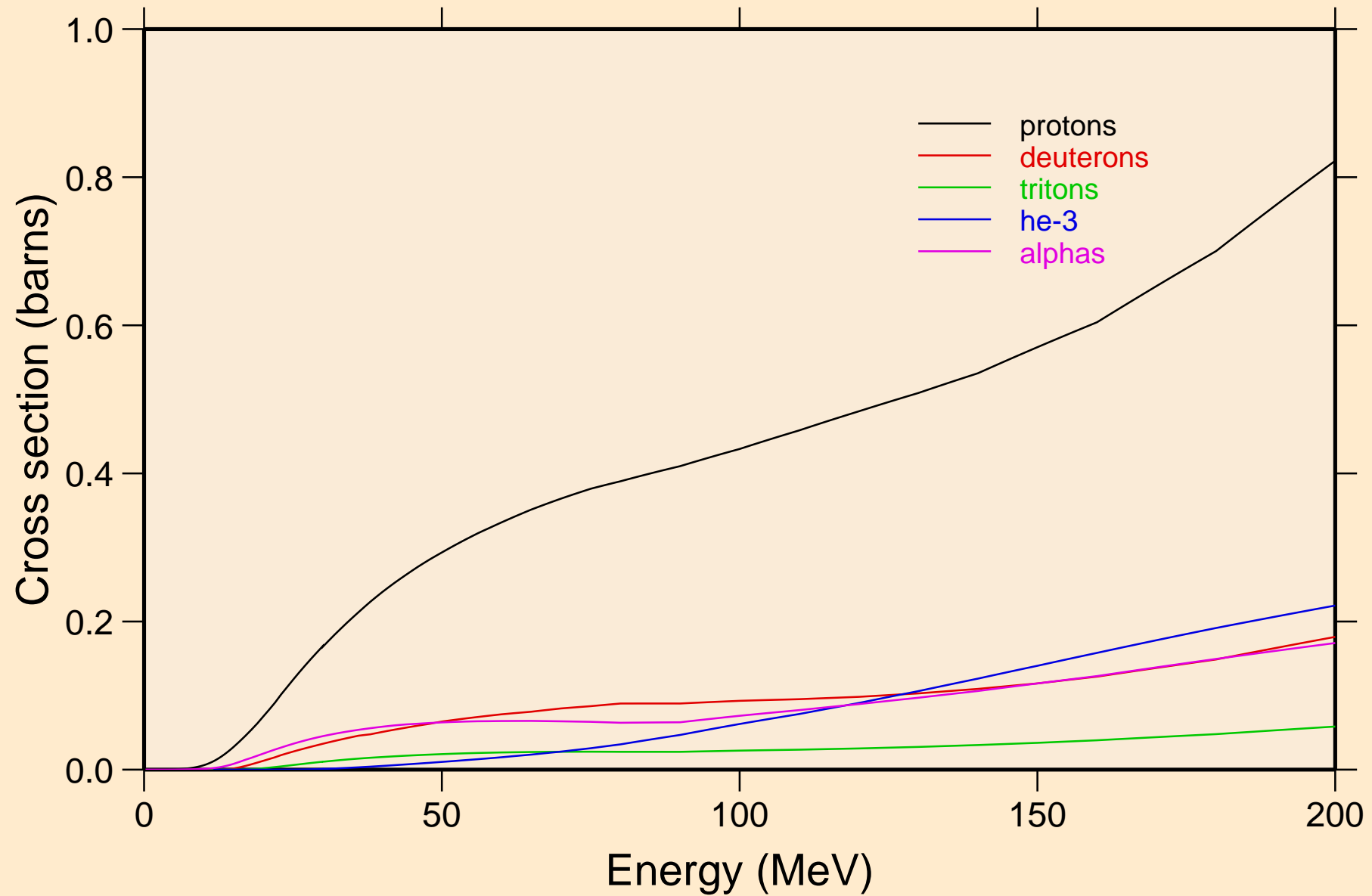

SE079M NEUTRON ACER TENDL-2021 LIBRARY; T=293.6K
protons from (n,x)

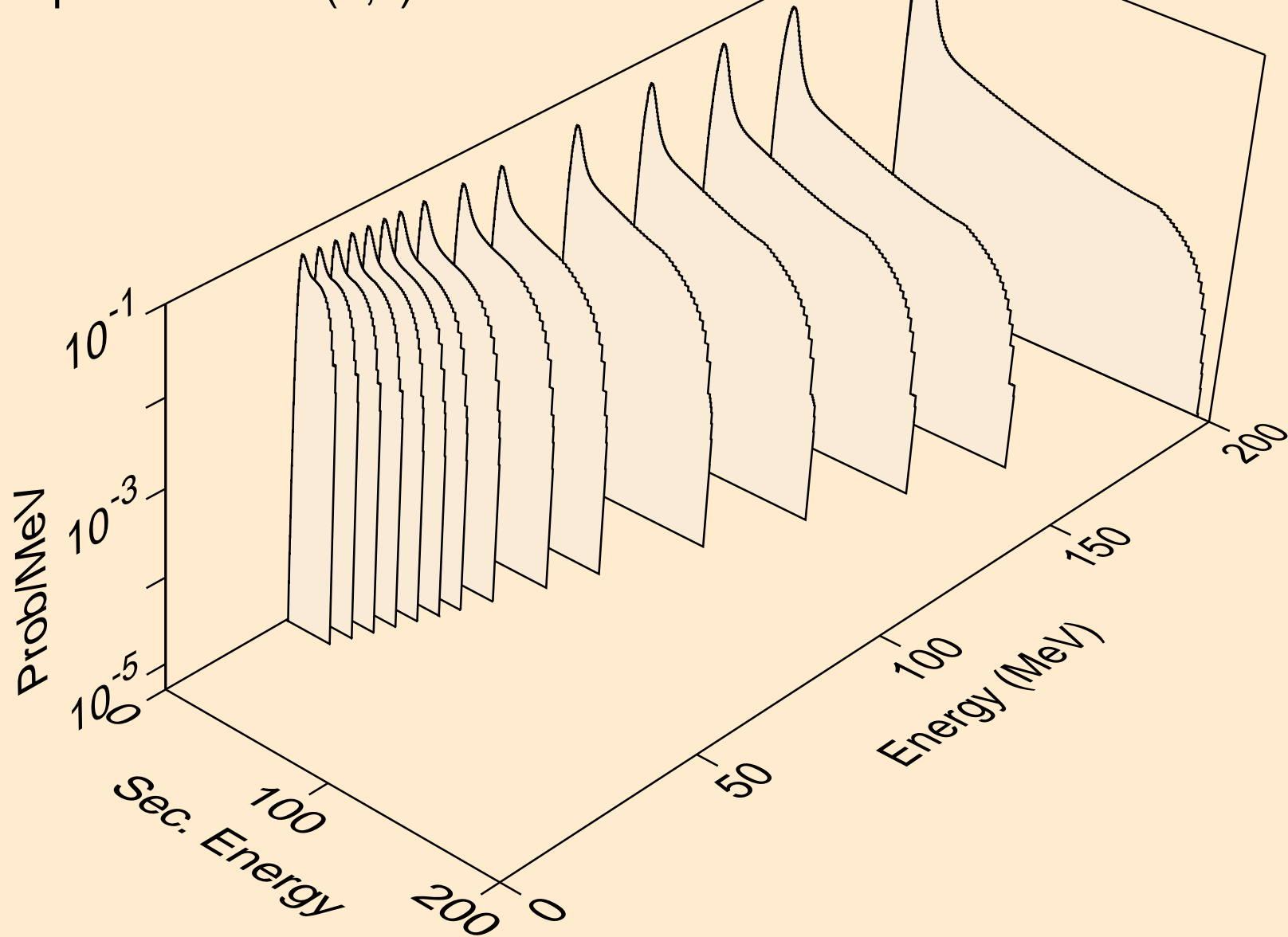

SE079M NEUTRON ACER TENDL-2021 LIBRARY; T=293.6K
protons from (n,n*)p

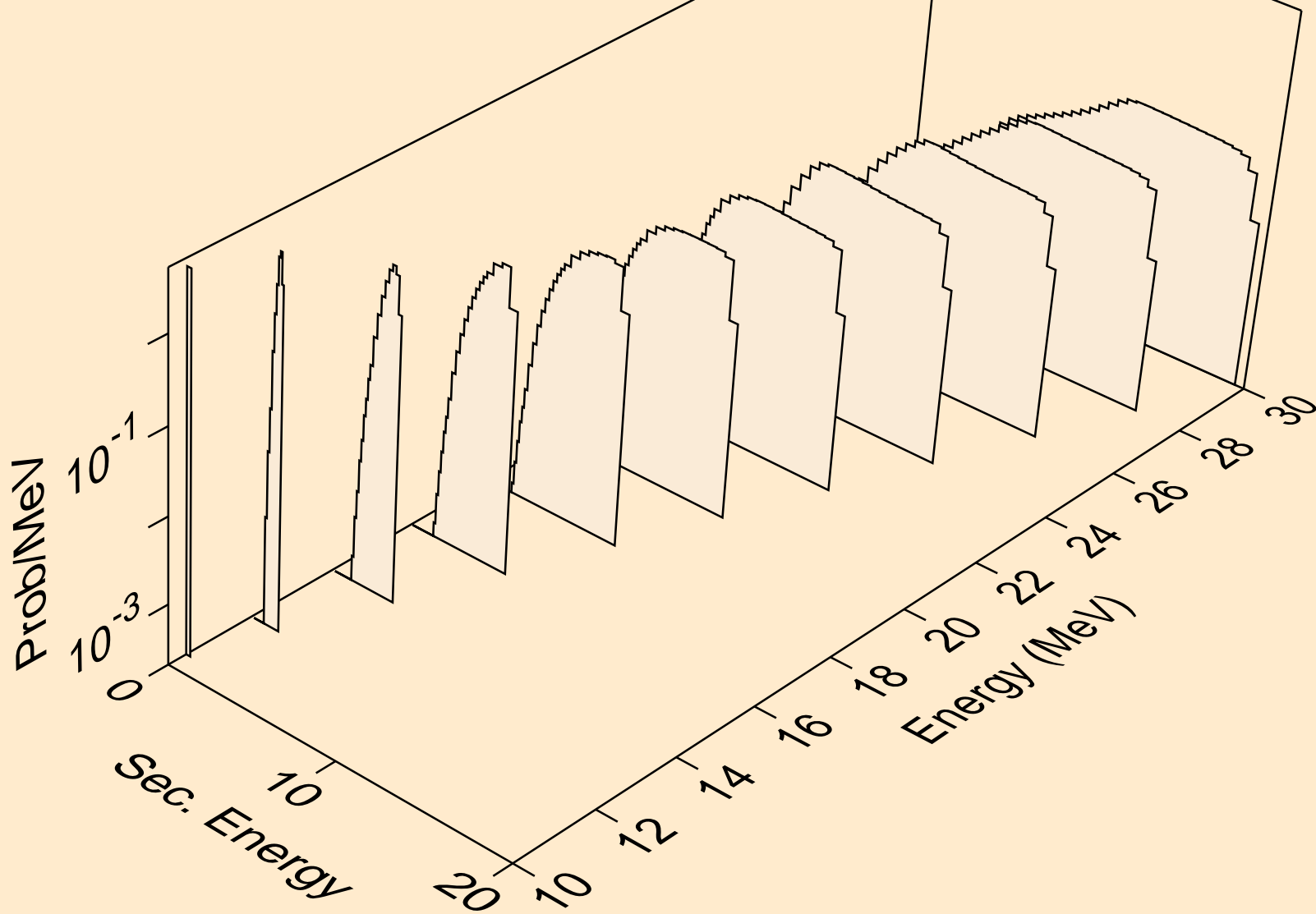

SE079M NEUTRON ACER TENDL-2021 LIBRARY; T=293.6K
protons from (n,2np)

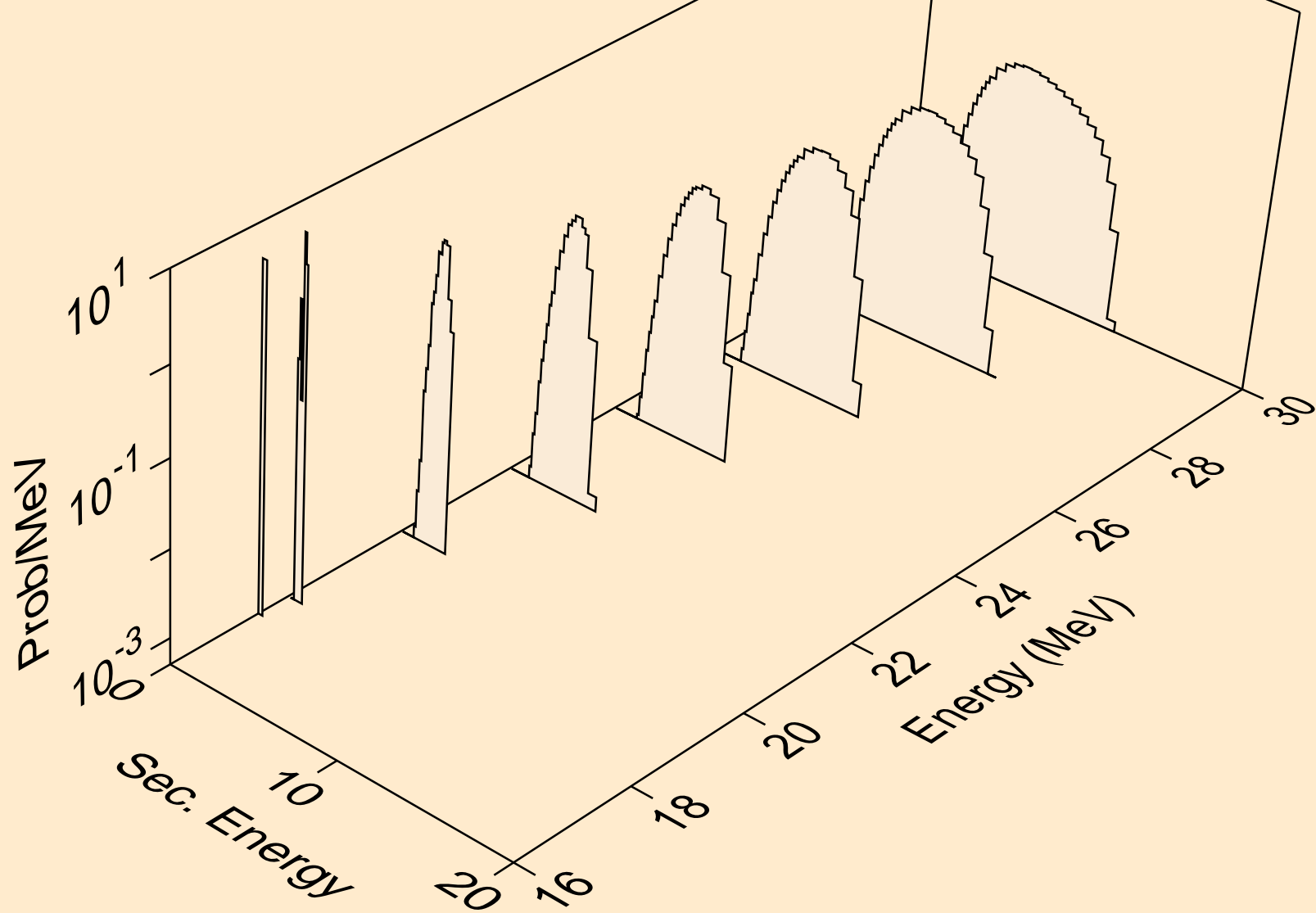

SE079M NEUTRON ACER TENDL-2021 LIBRARY; T=293.6K
protons from (n,3np)

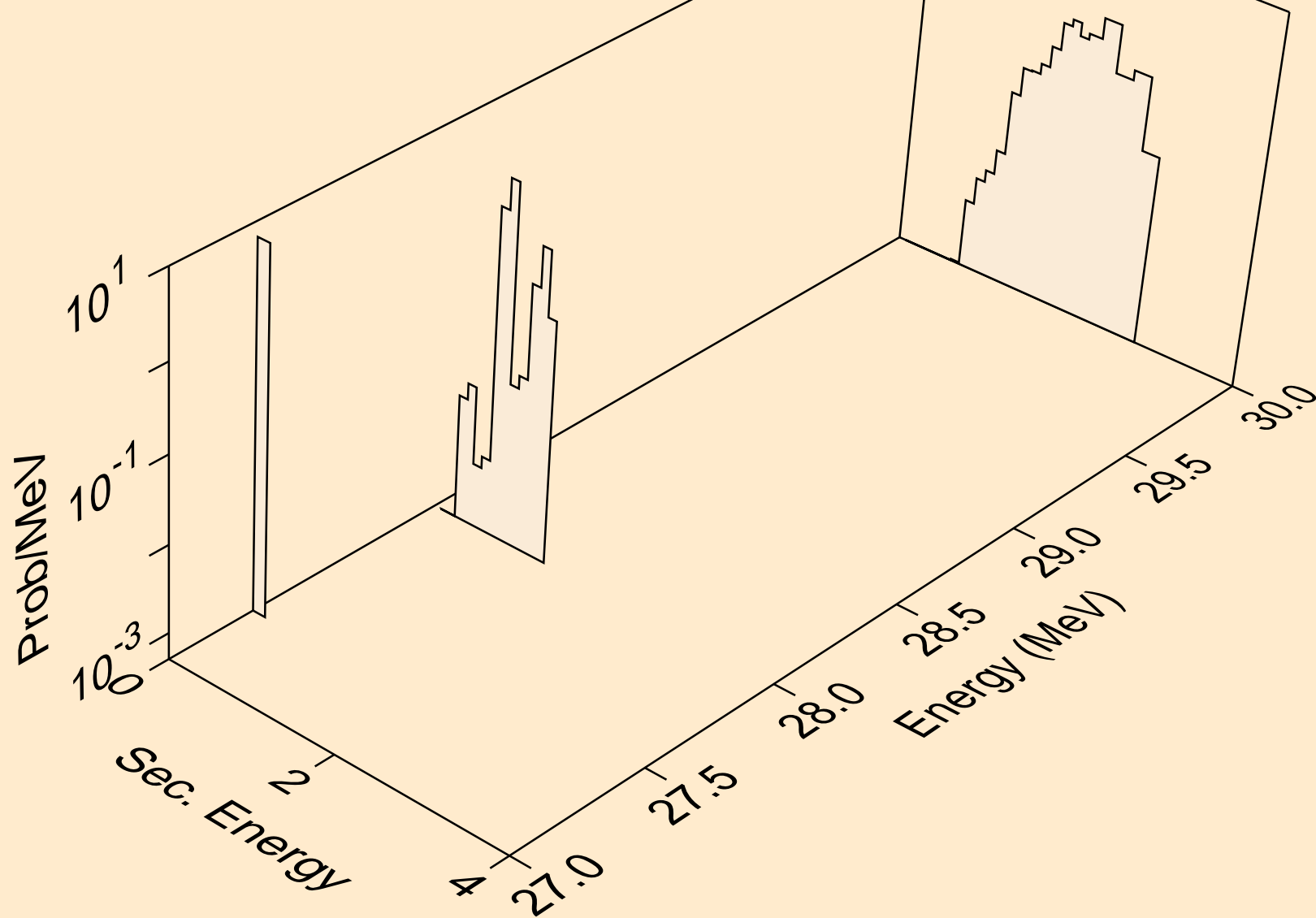

SE079M NEUTRON ACER TENDL-2021 LIBRARY; T=293.6K
protons from (n,2np)

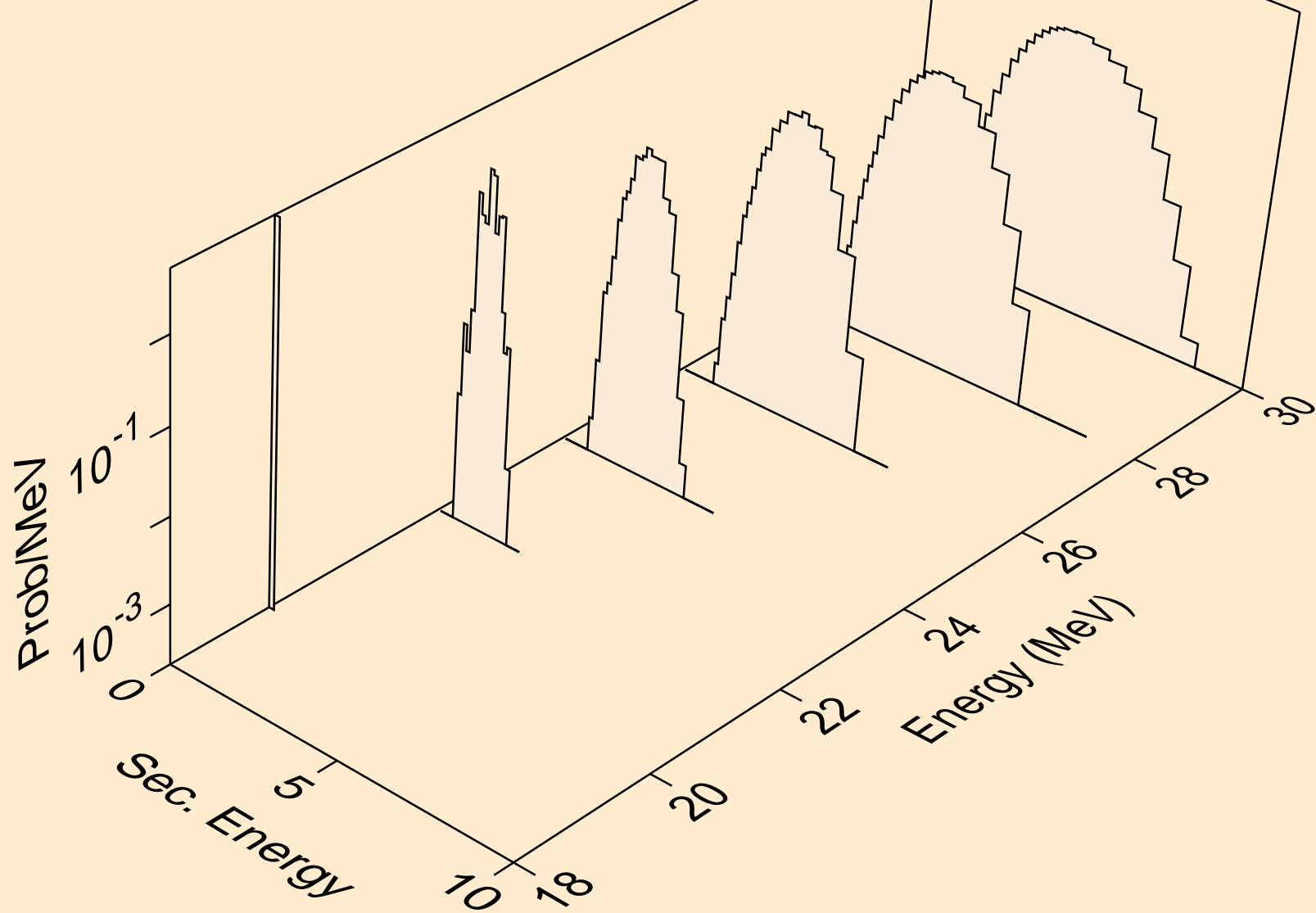

SE079M NEUTRON ACER TENDL-2021 LIBRARY; T=293.6K
protons from (n,npa)

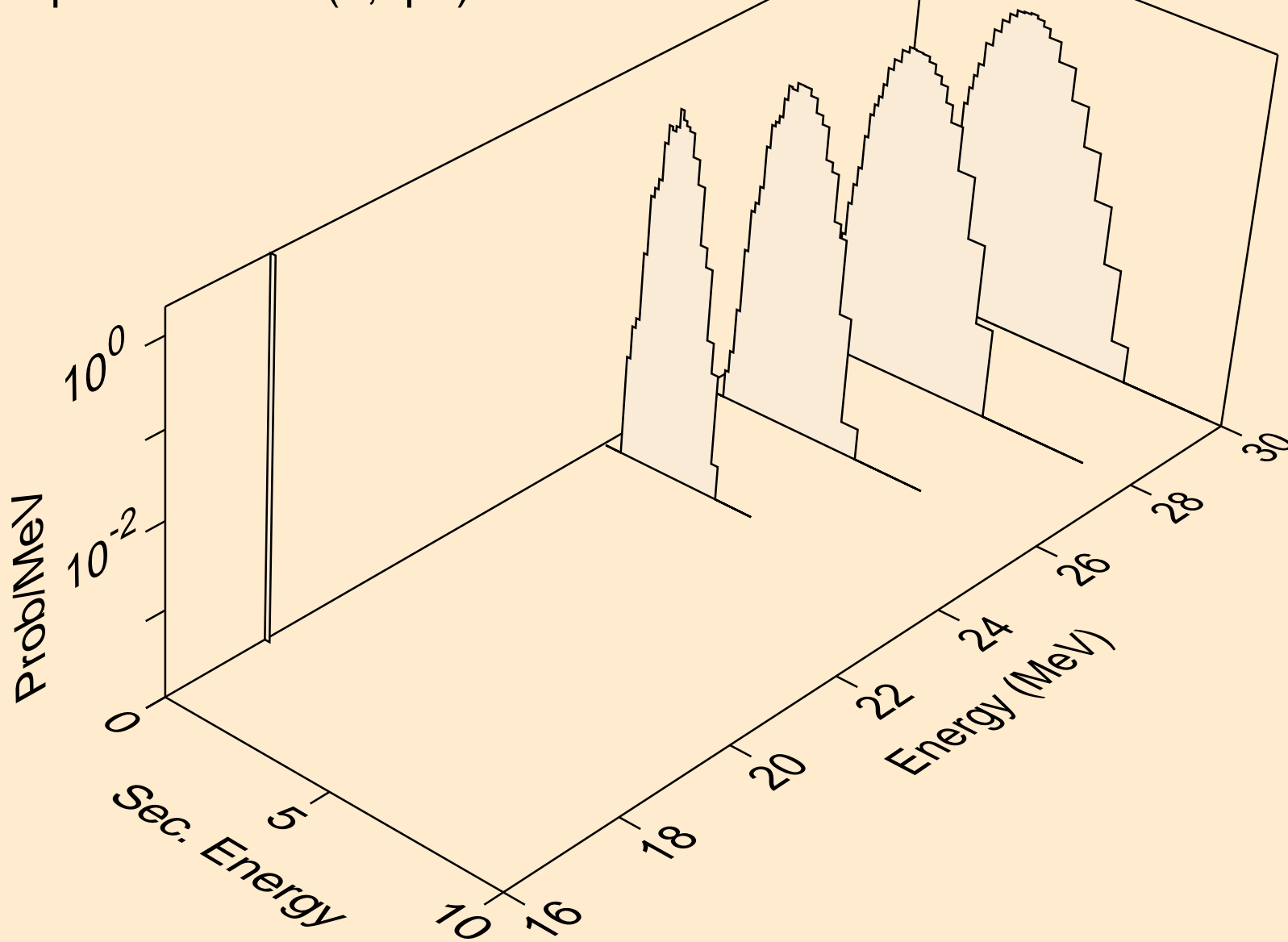

SE079M NEUTRON ACER TENDL-2021 LIBRARY; T=293.6K
protons from (n,p)

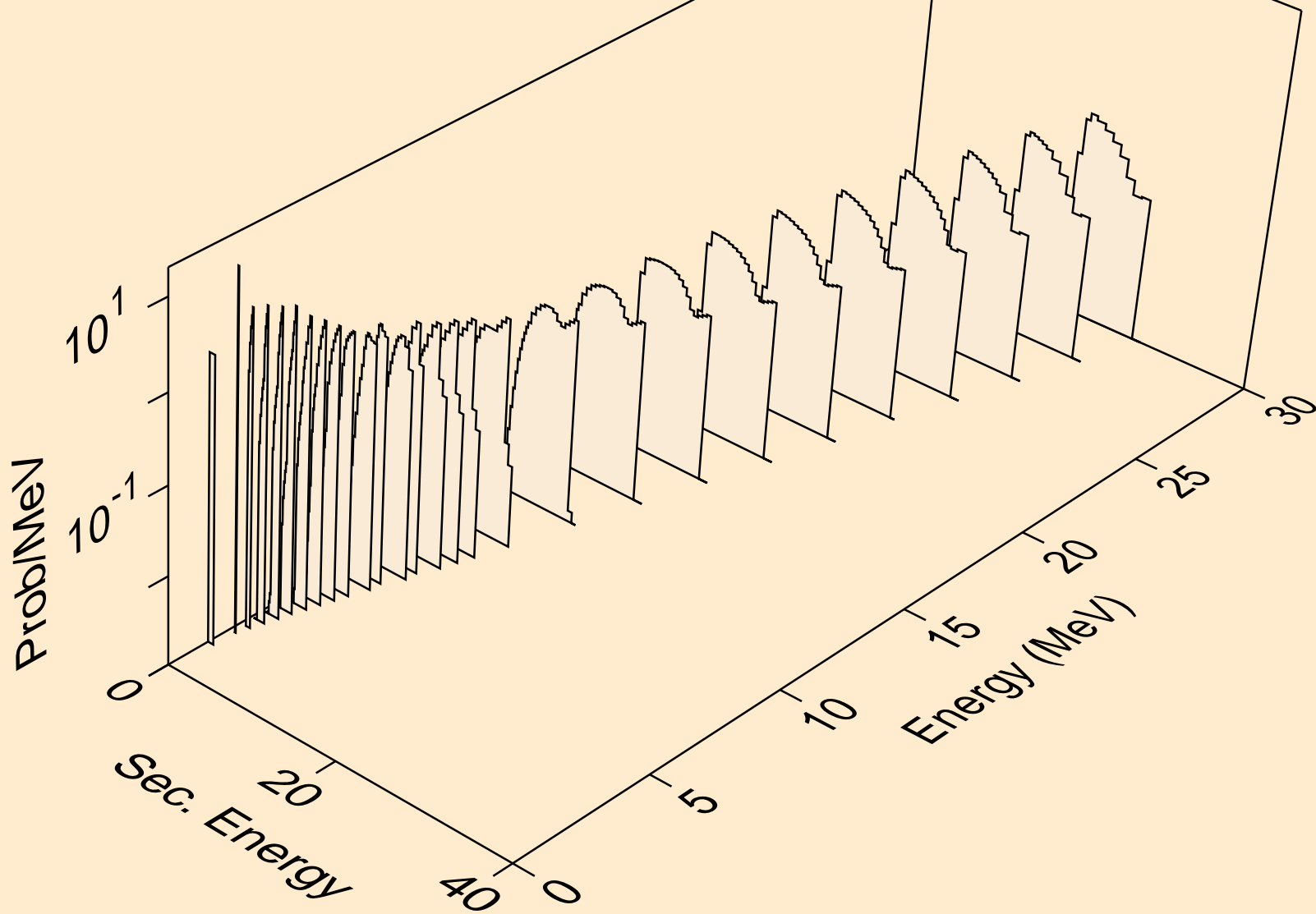

SE079M NEUTRON ACER TENDL-2021 LIBRARY; T=293.6K
protons from (n,2p)

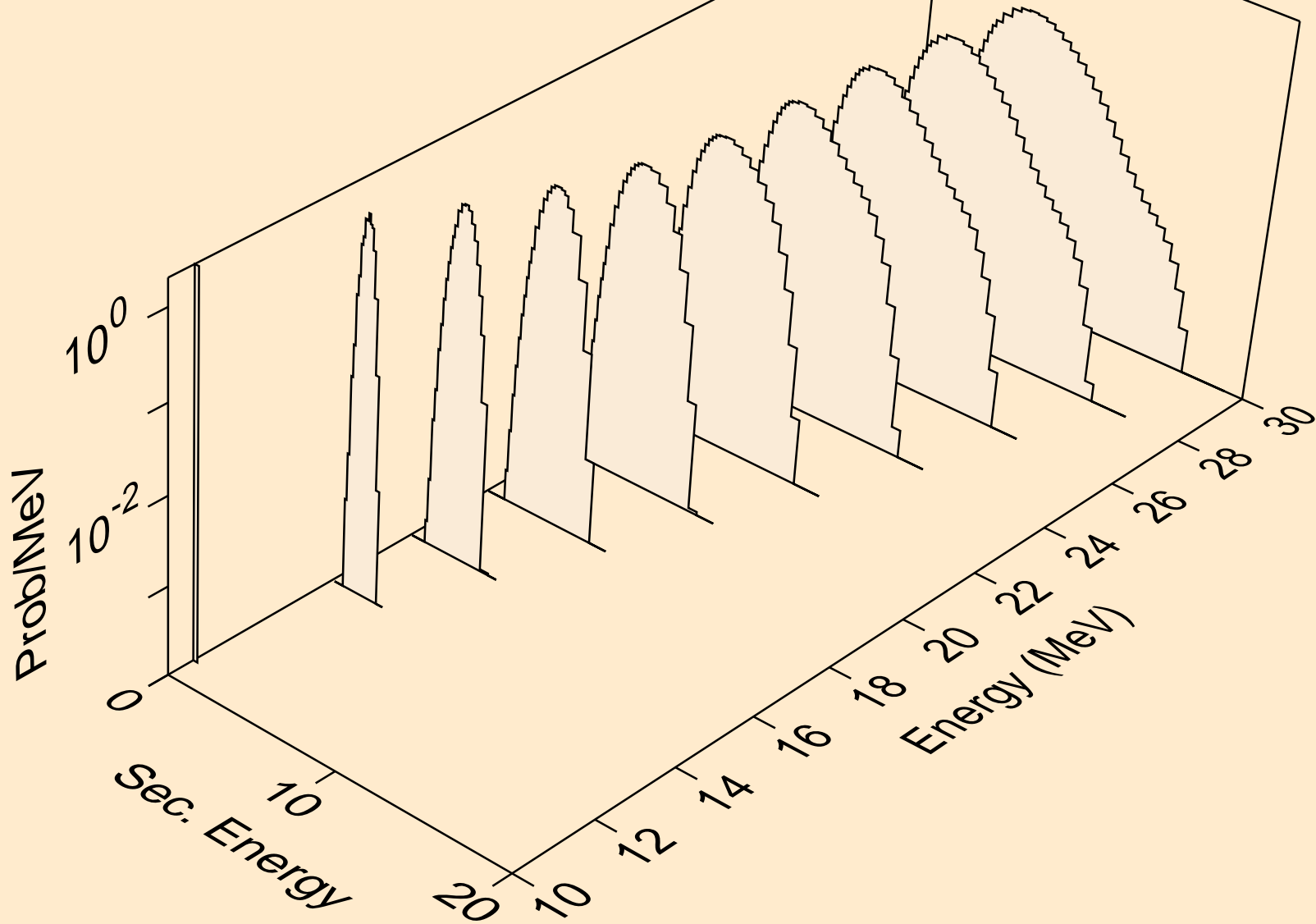

SE079M NEUTRON ACER TENDL-2021 LIBRARY; T=293.6K
protons from (n,p)

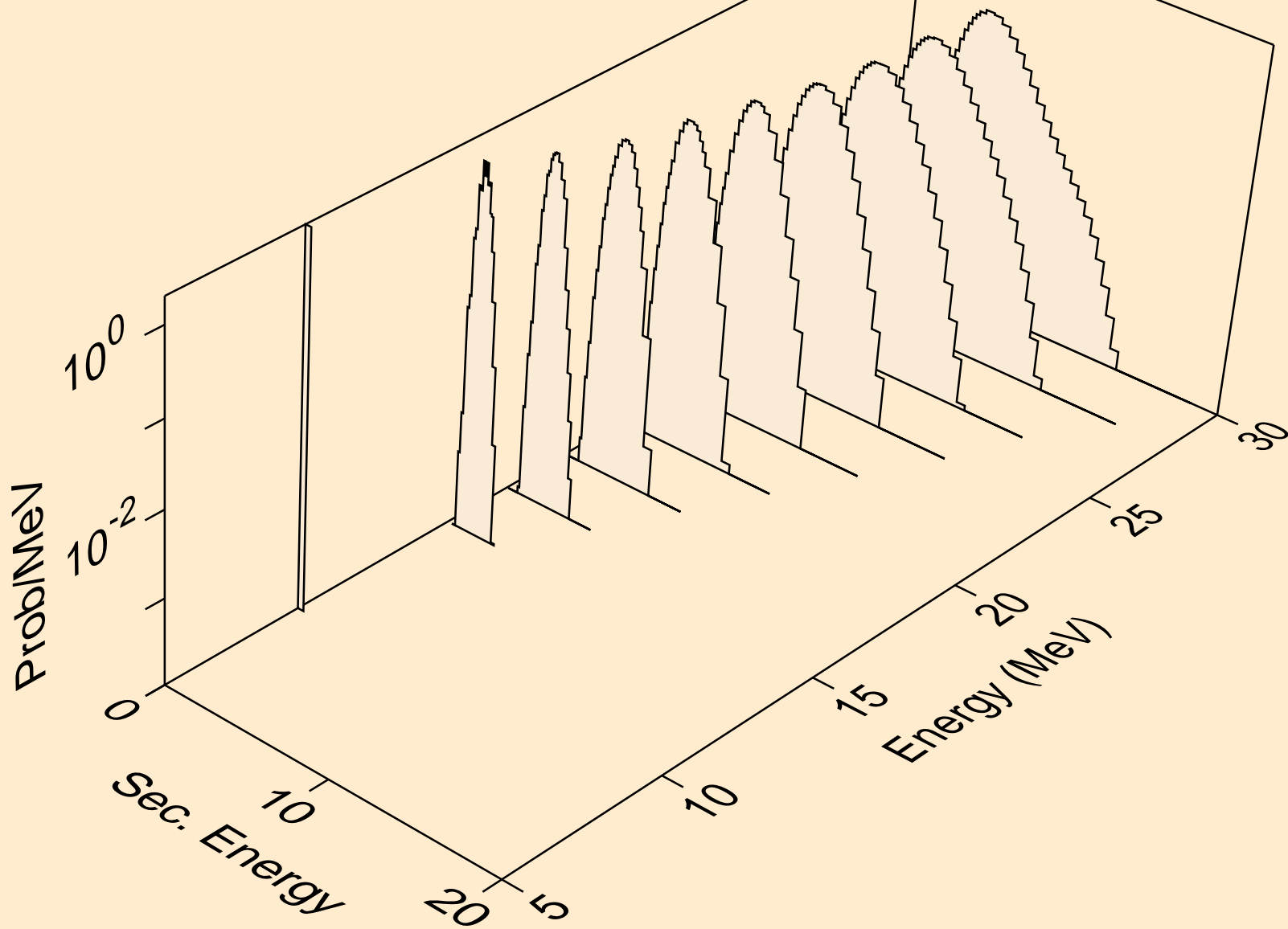

SE079M NEUTRON ACER TENDL-2021 LIBRARY; T=293.6K
protons from (n,pd)

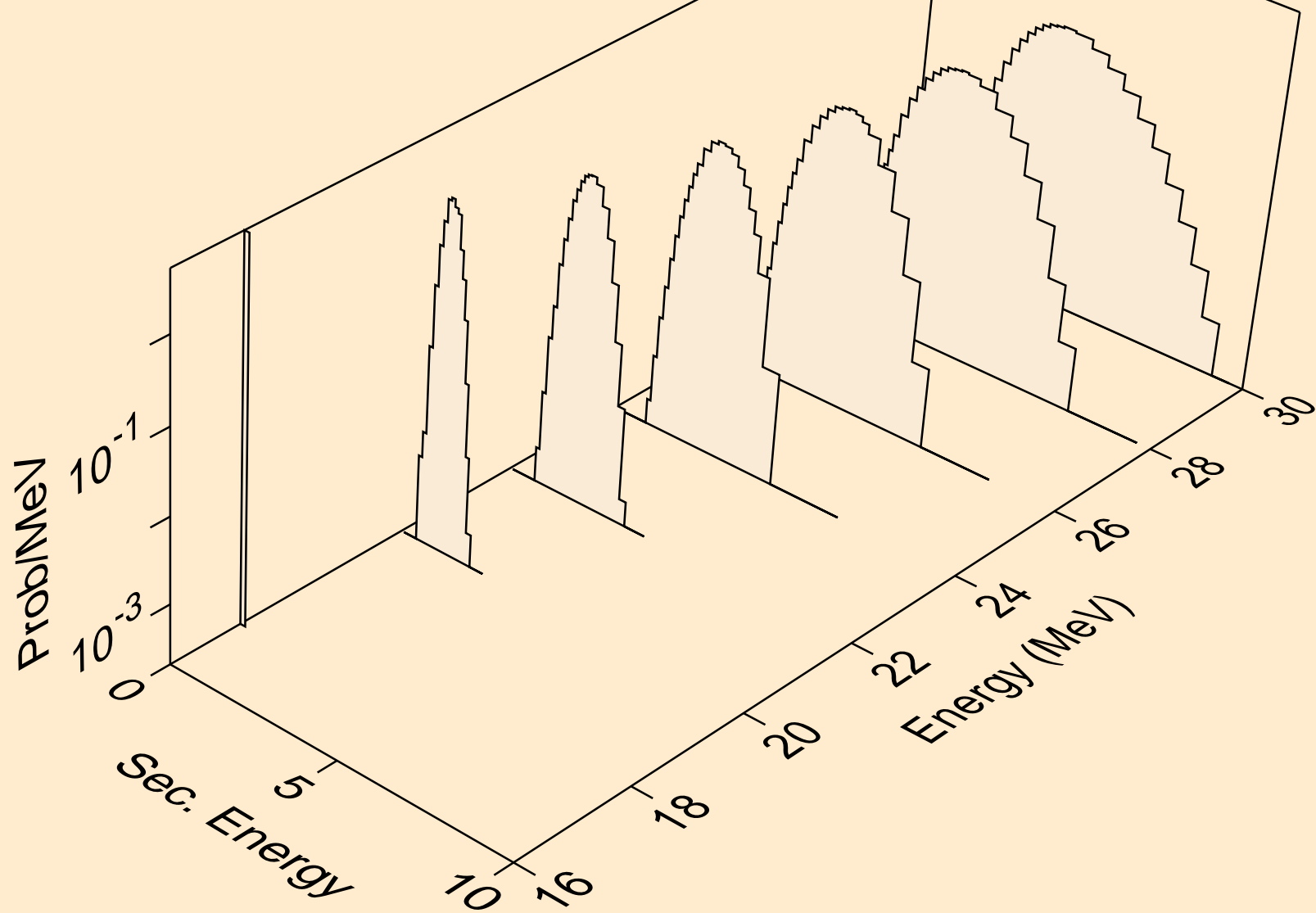

SE079M NEUTRON ACER TENDL-2021 LIBRARY; T=293.6K
protons from (n,pt)

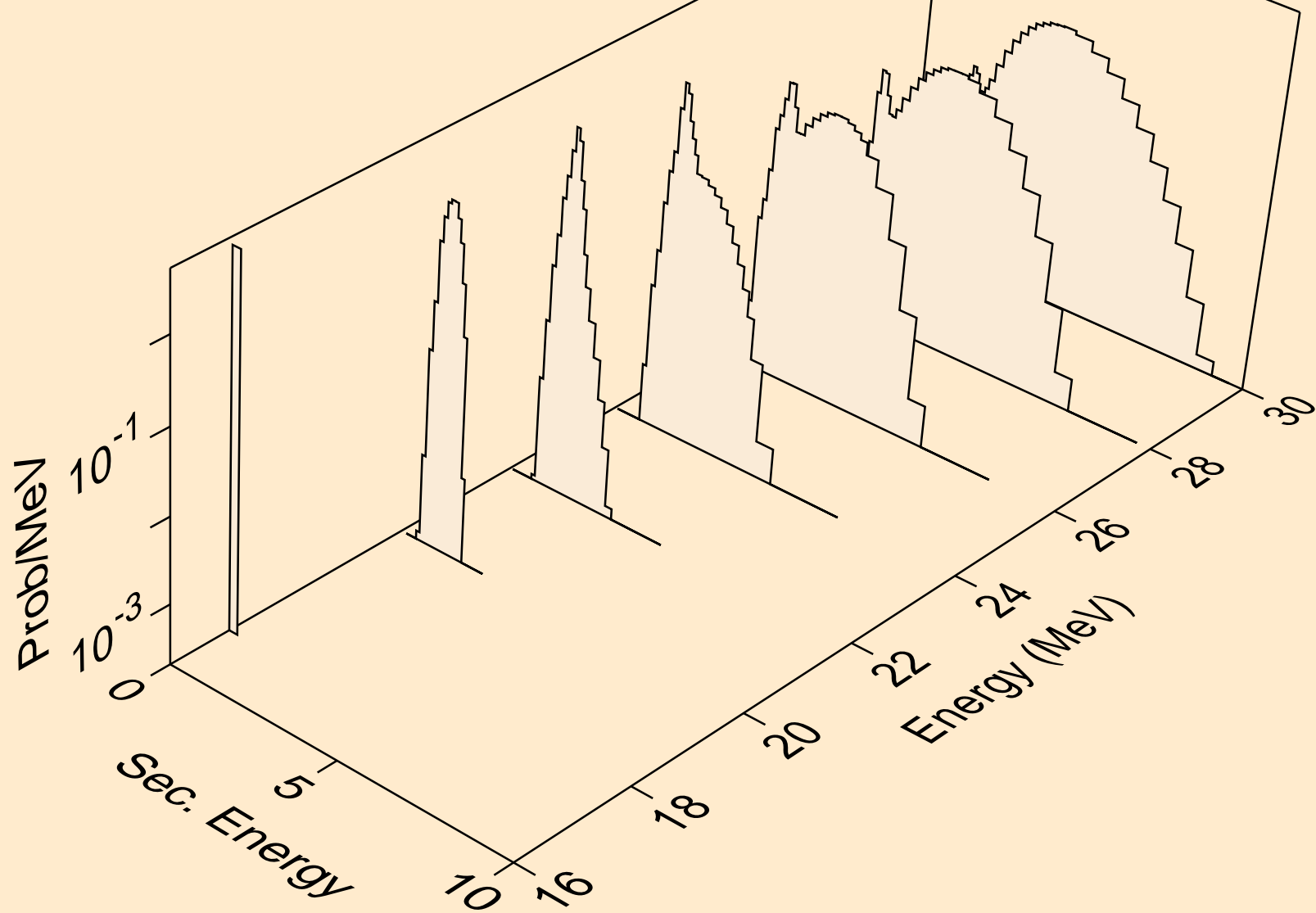

SE079M NEUTRON ACER TENDL-2021 LIBRARY; T=293.6K
deuterons from (n,x)

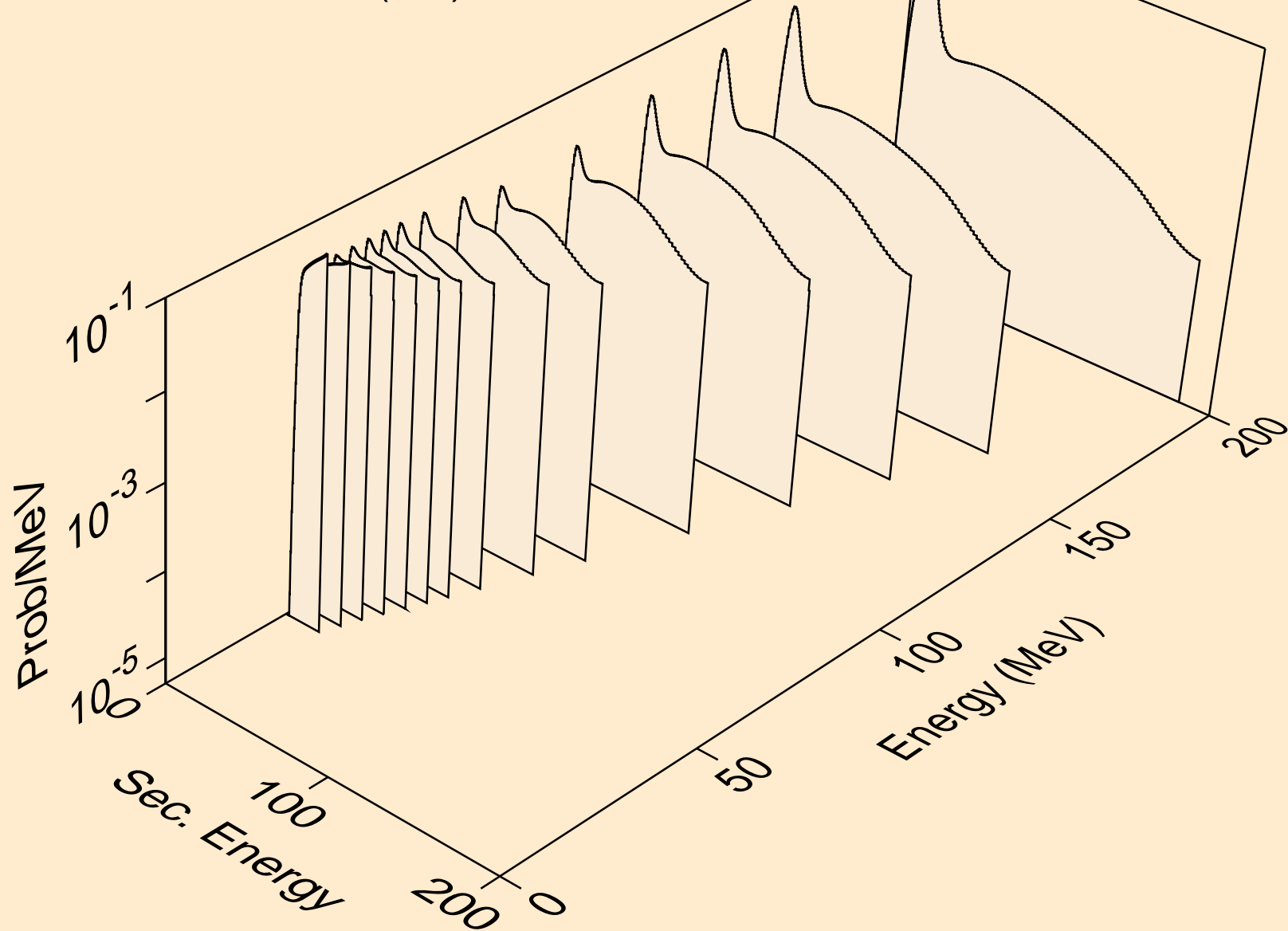

SE079M NEUTRON ACER TENDL-2021 LIBRARY; T=293.6K
deuterons from (n,2nd)

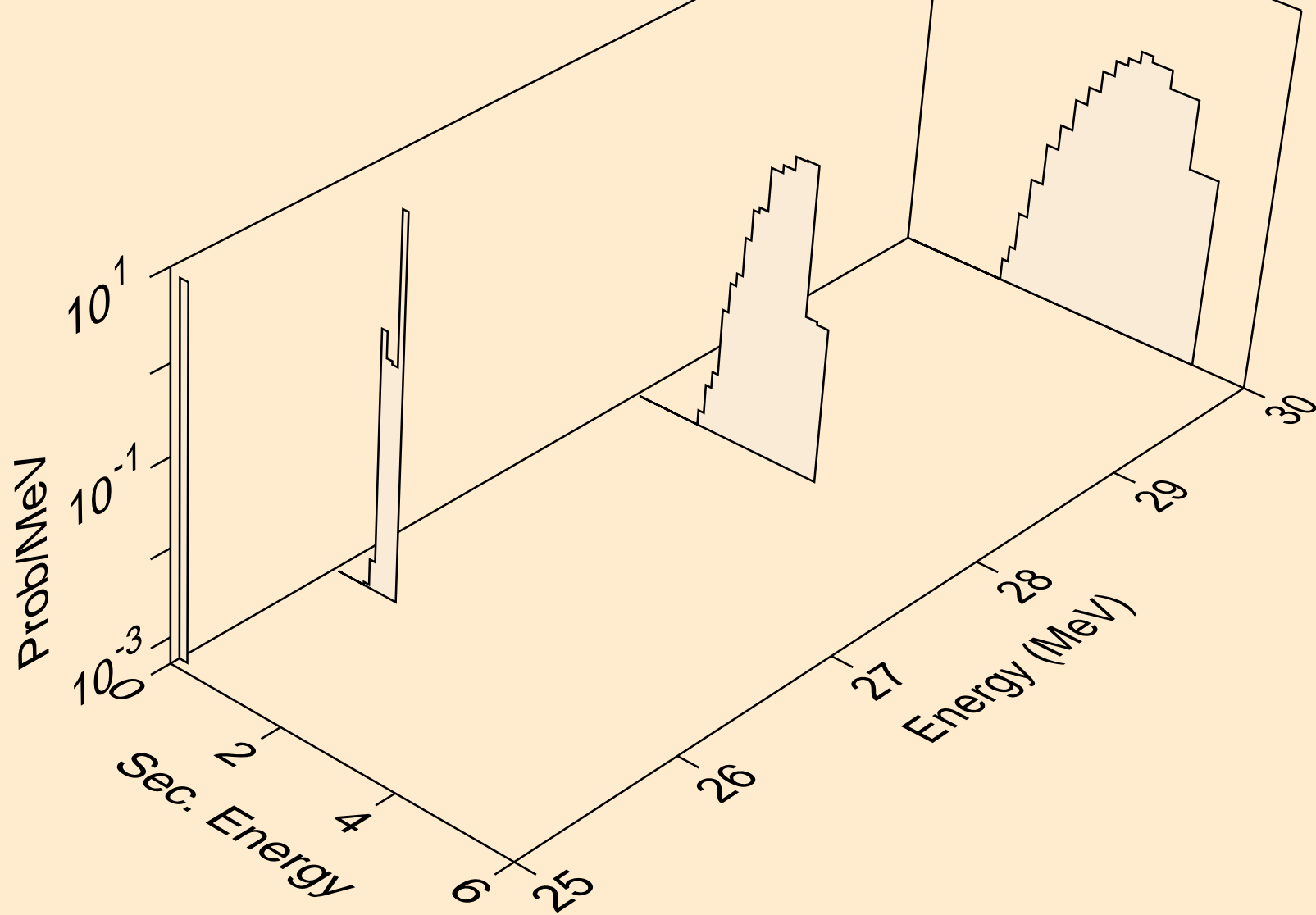

SE079M NEUTRON ACER TENDL-2021 LIBRARY; T=293.6K
deuterons from (n,n*)d

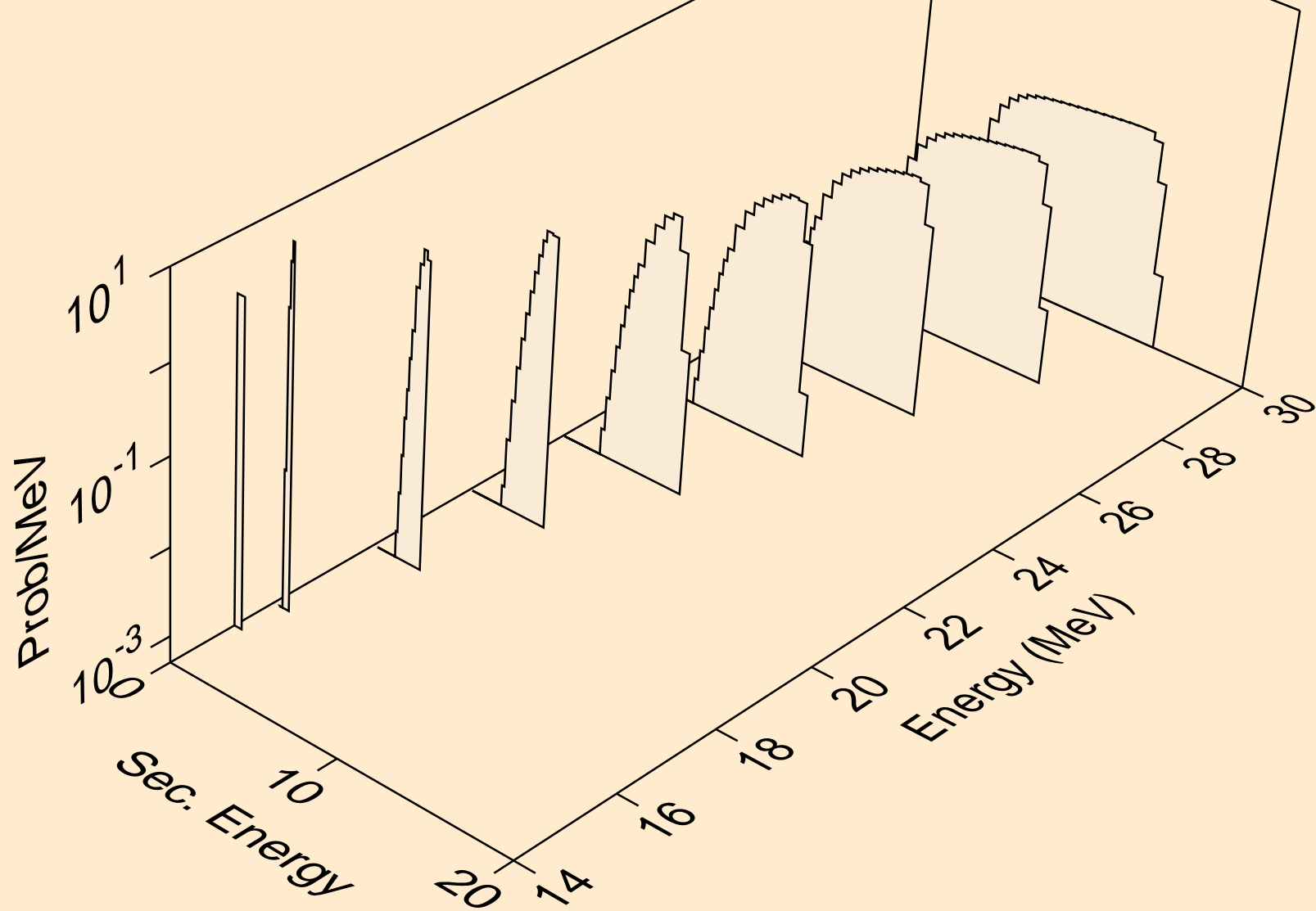

SE079M NEUTRON ACER TENDL-2021 LIBRARY; T=293.6K
deuterons from (n,d)

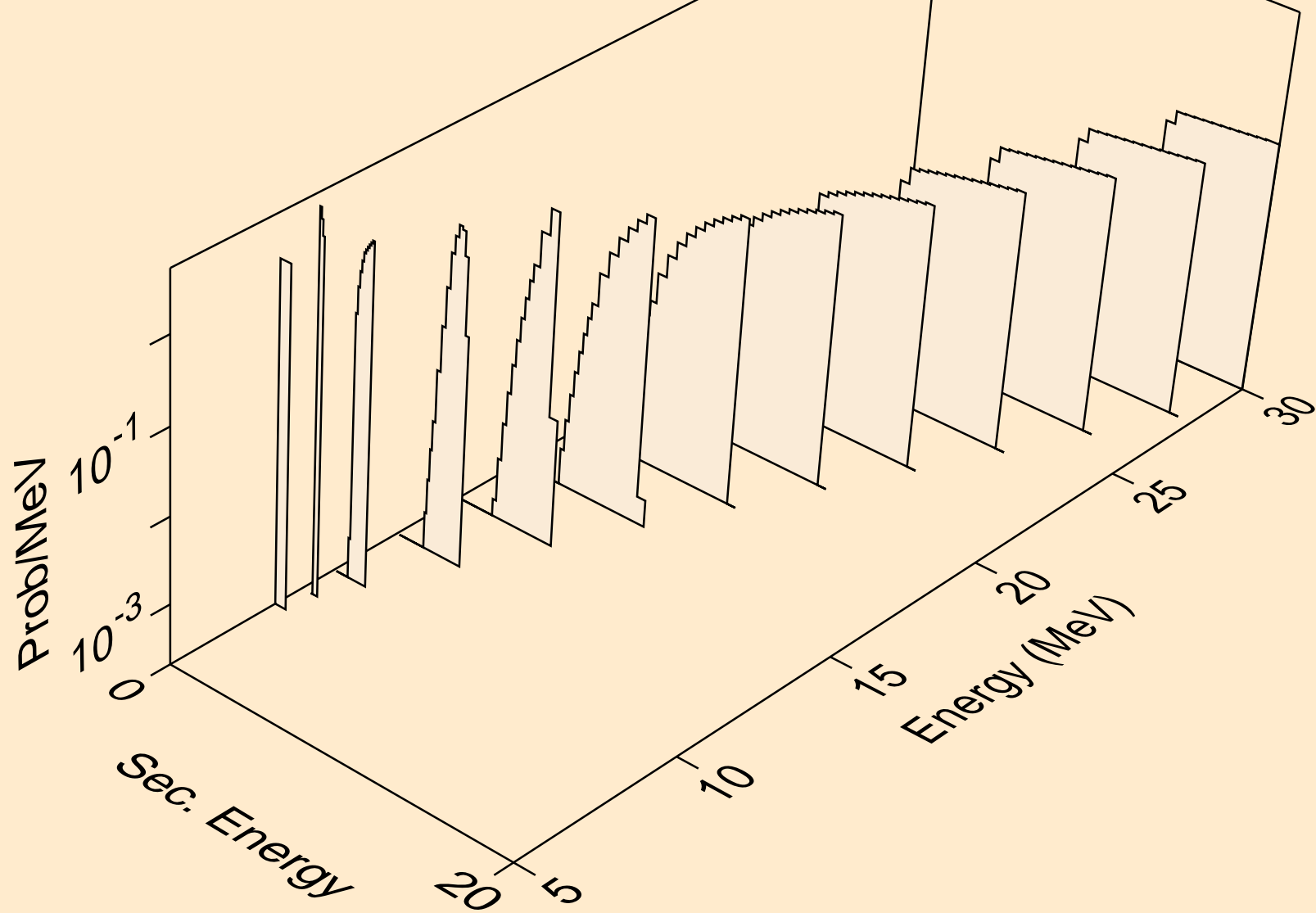

SE079M NEUTRON ACER TENDL-2021 LIBRARY; T=293.6K
deuterons from (n,pd)

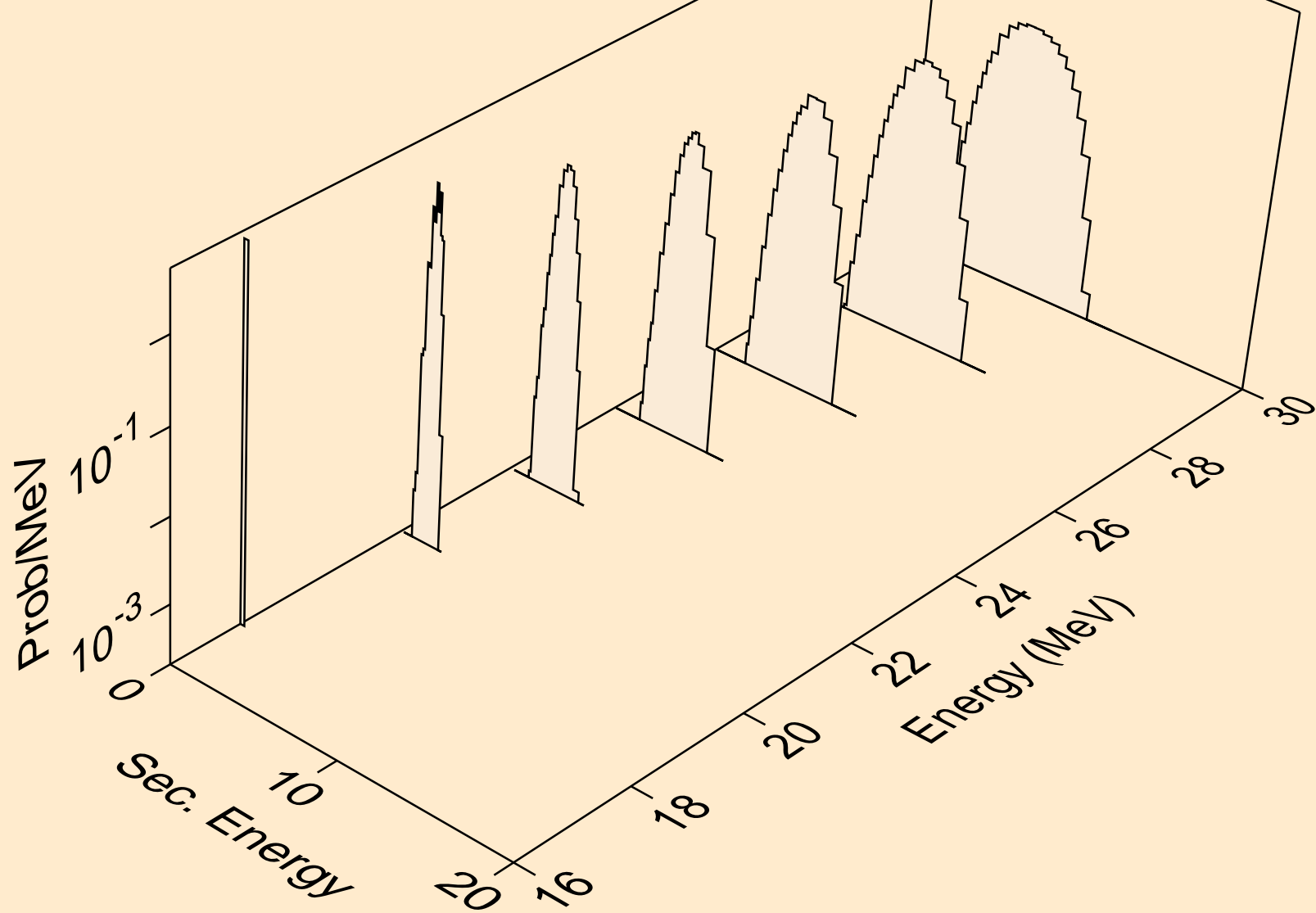

SE079M NEUTRON ACER TENDL-2021 LIBRARY; T=293.6K
deuterons from (n,da)

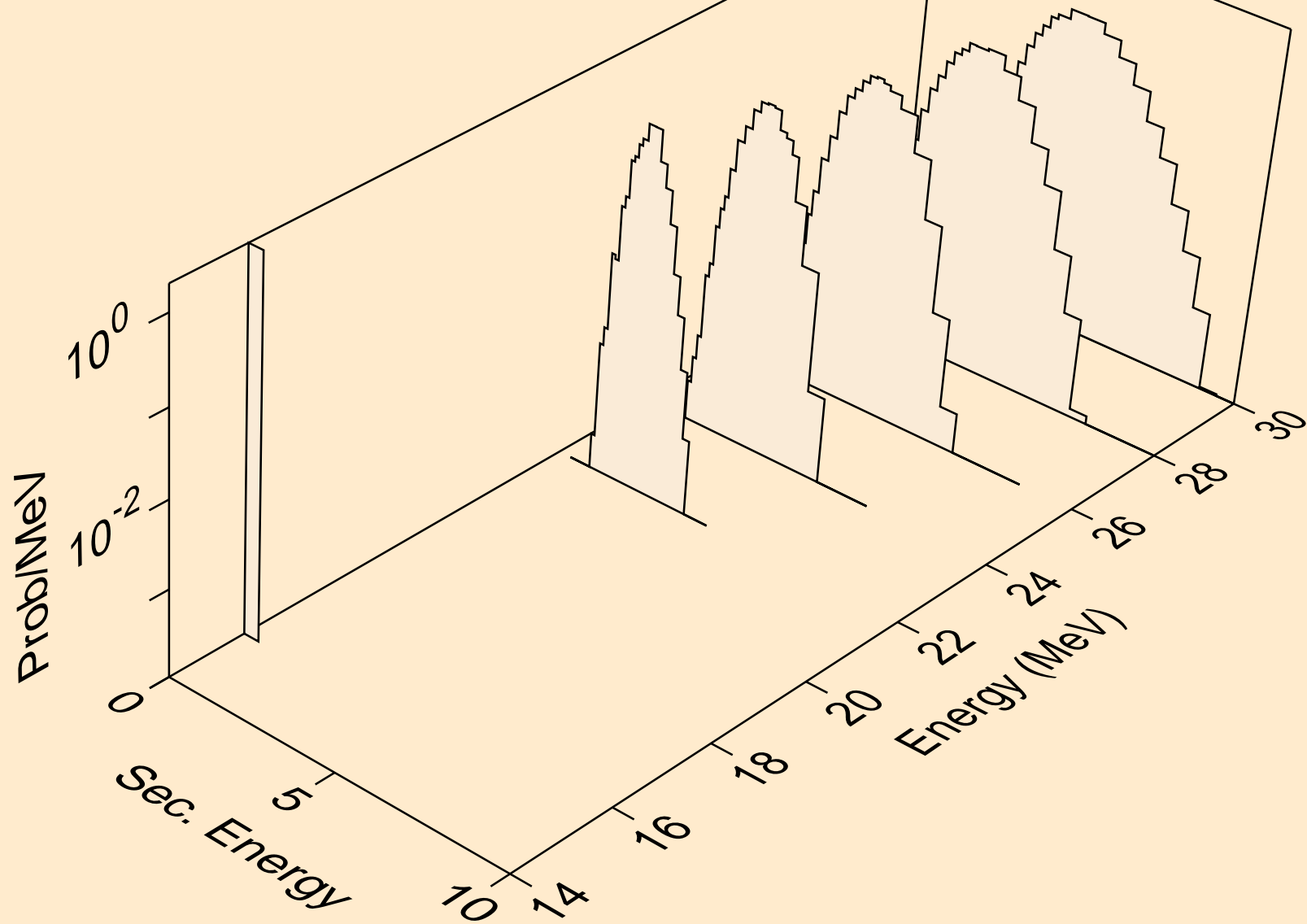

SE079M NEUTRON ACER TENDL-2021 LIBRARY; T=293.6K
tritons from (n,x)

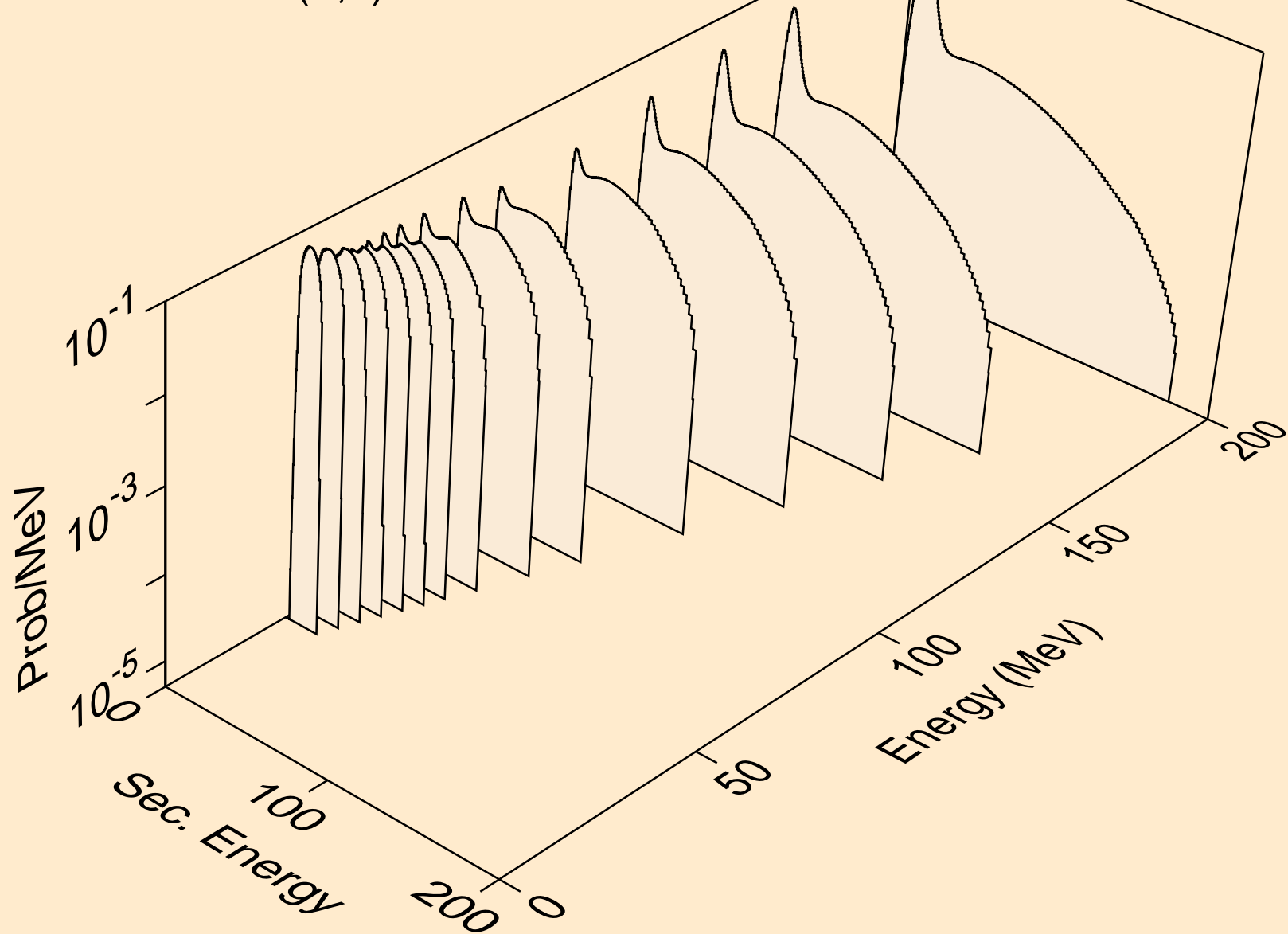

SE079M NEUTRON ACER TENDL-2021 LIBRARY; T=293.6K
tritons from (n,n*)t

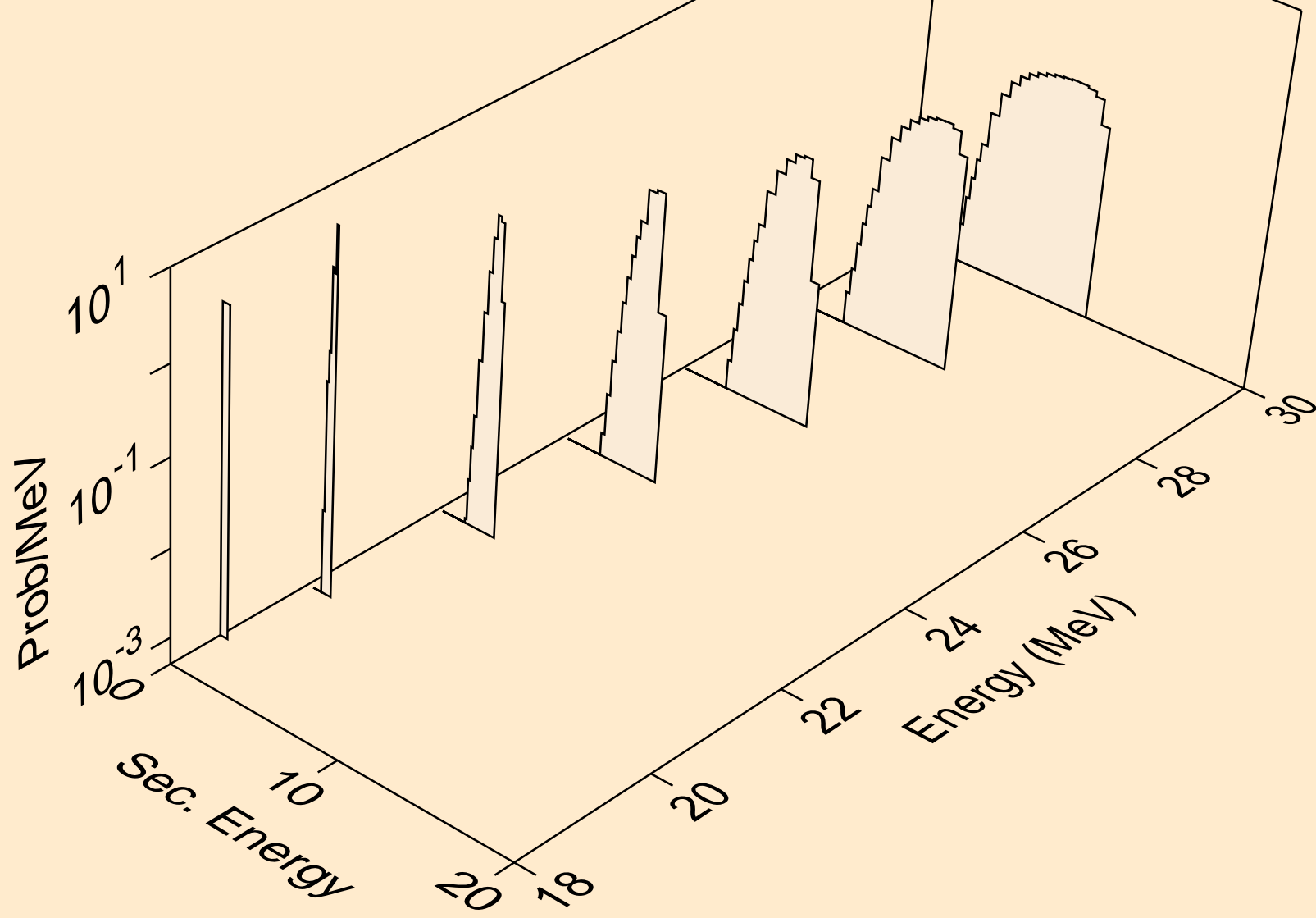

SE079M NEUTRON ACER TENDL-2021 LIBRARY; T=293.6K
tritons from (n,t)

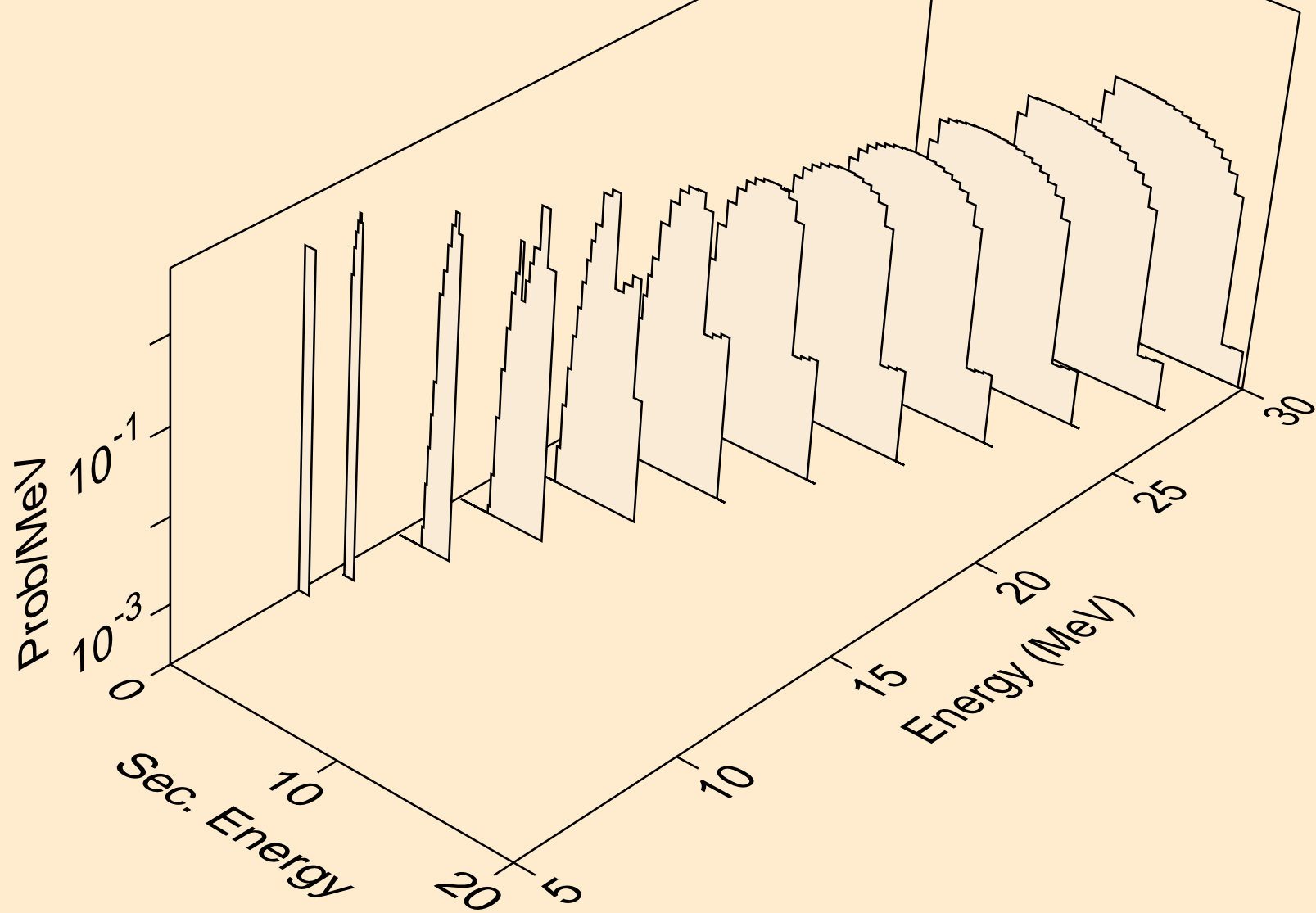

SE079M NEUTRON ACER TENDL-2021 LIBRARY; T=293.6K
tritons from (n,pt)

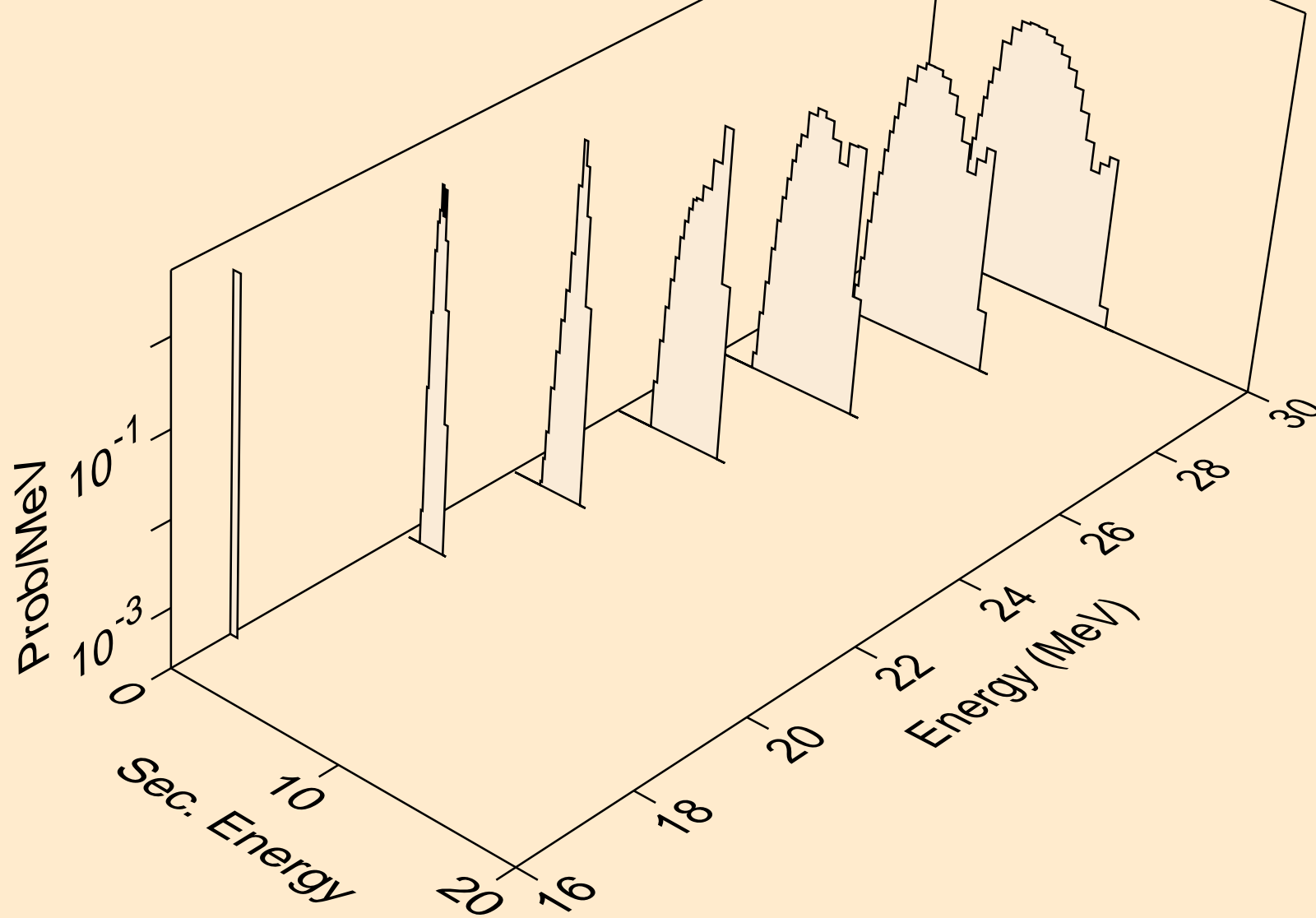

SE079M NEUTRON ACER TENDL-2021 LIBRARY; T=293.6K
he3s from (n,x)

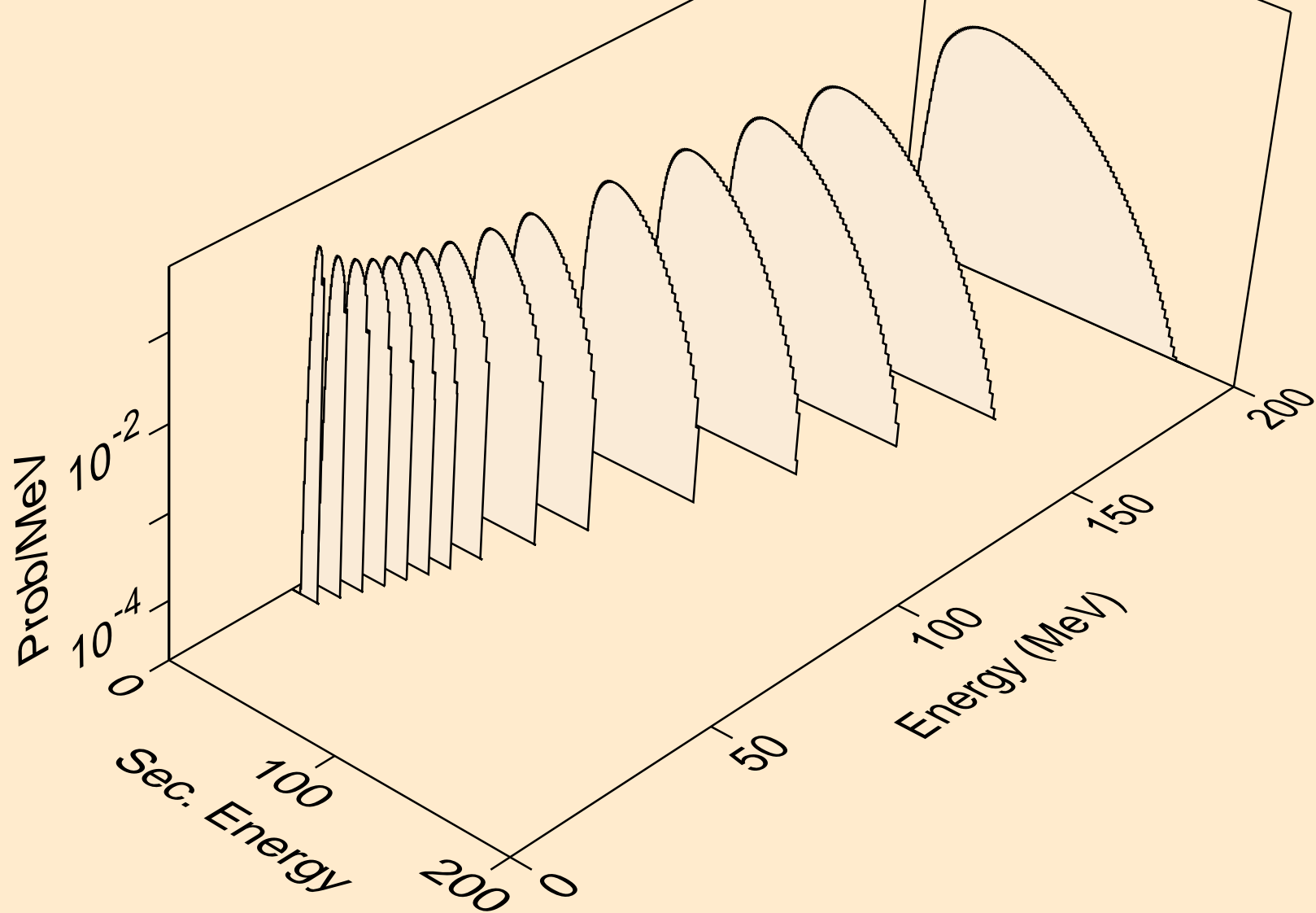

SE079M NEUTRON ACER TENDL-2021 LIBRARY; T=293.6K
he3s from (n,n*)he3

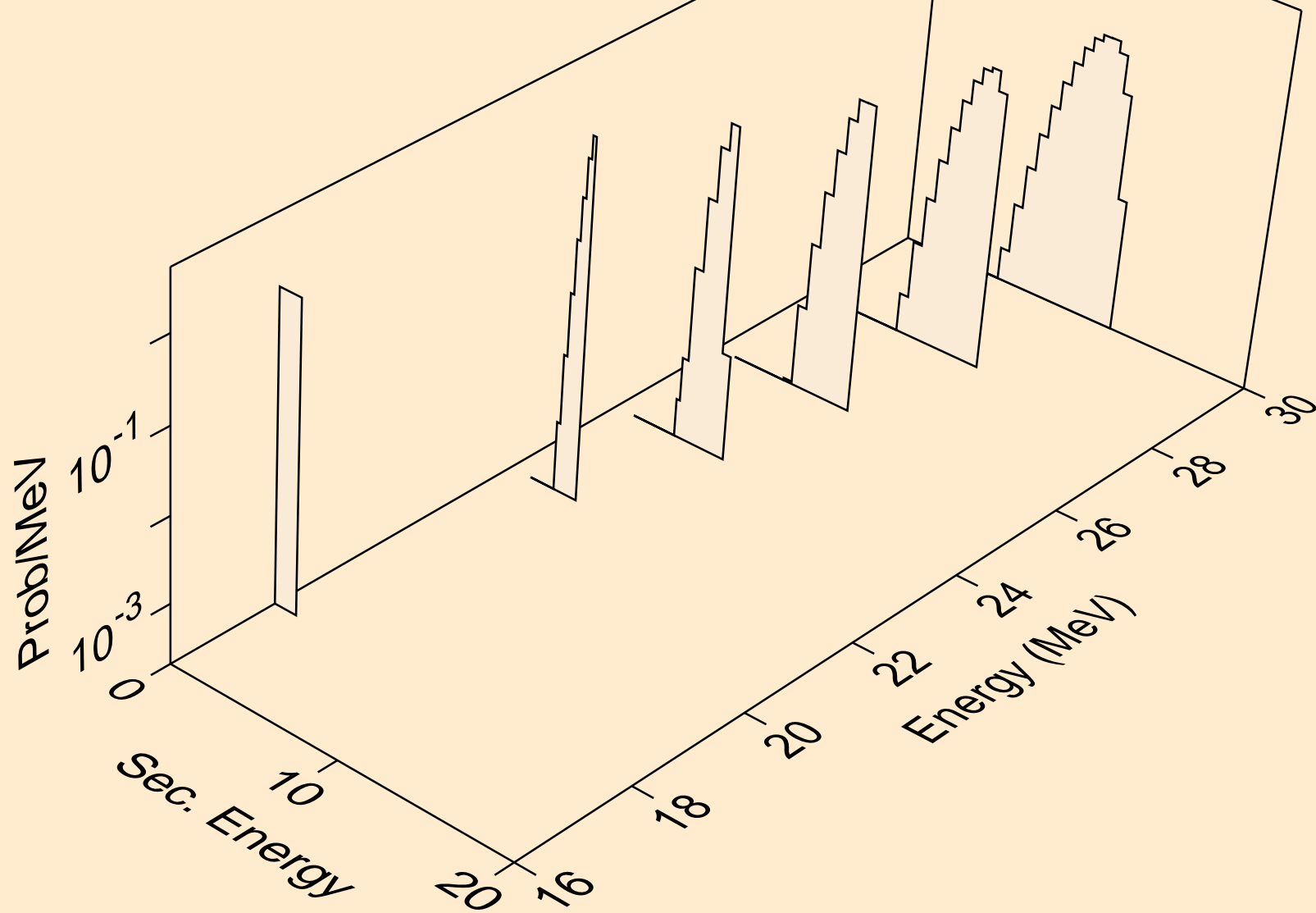

SE079M NEUTRON ACER TENDL-2021 LIBRARY; T=293.6K
he3s from (n,he3)

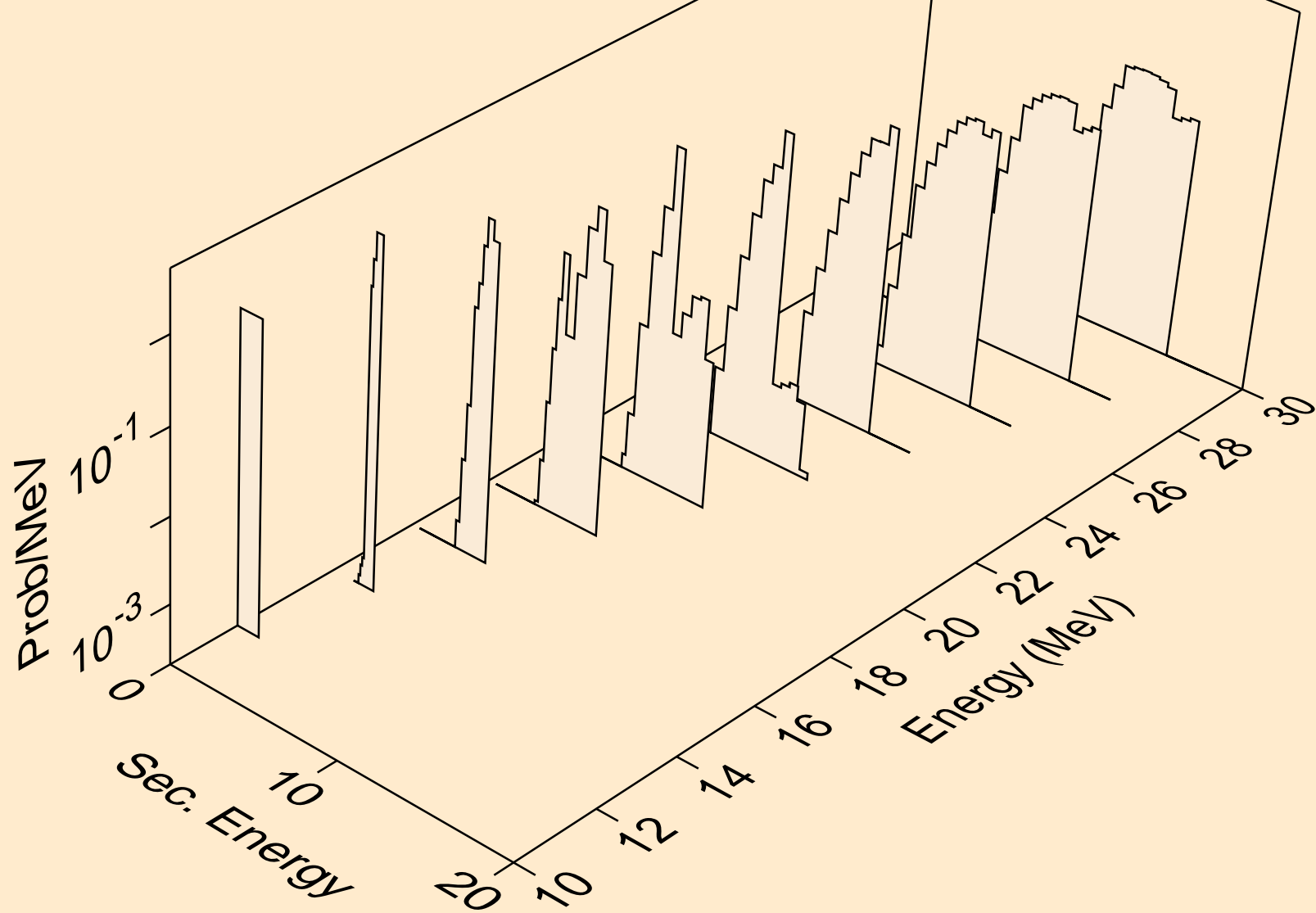

SE079M NEUTRON ACER TENDL-2021 LIBRARY; T=293.6K
alphas from (n,x)

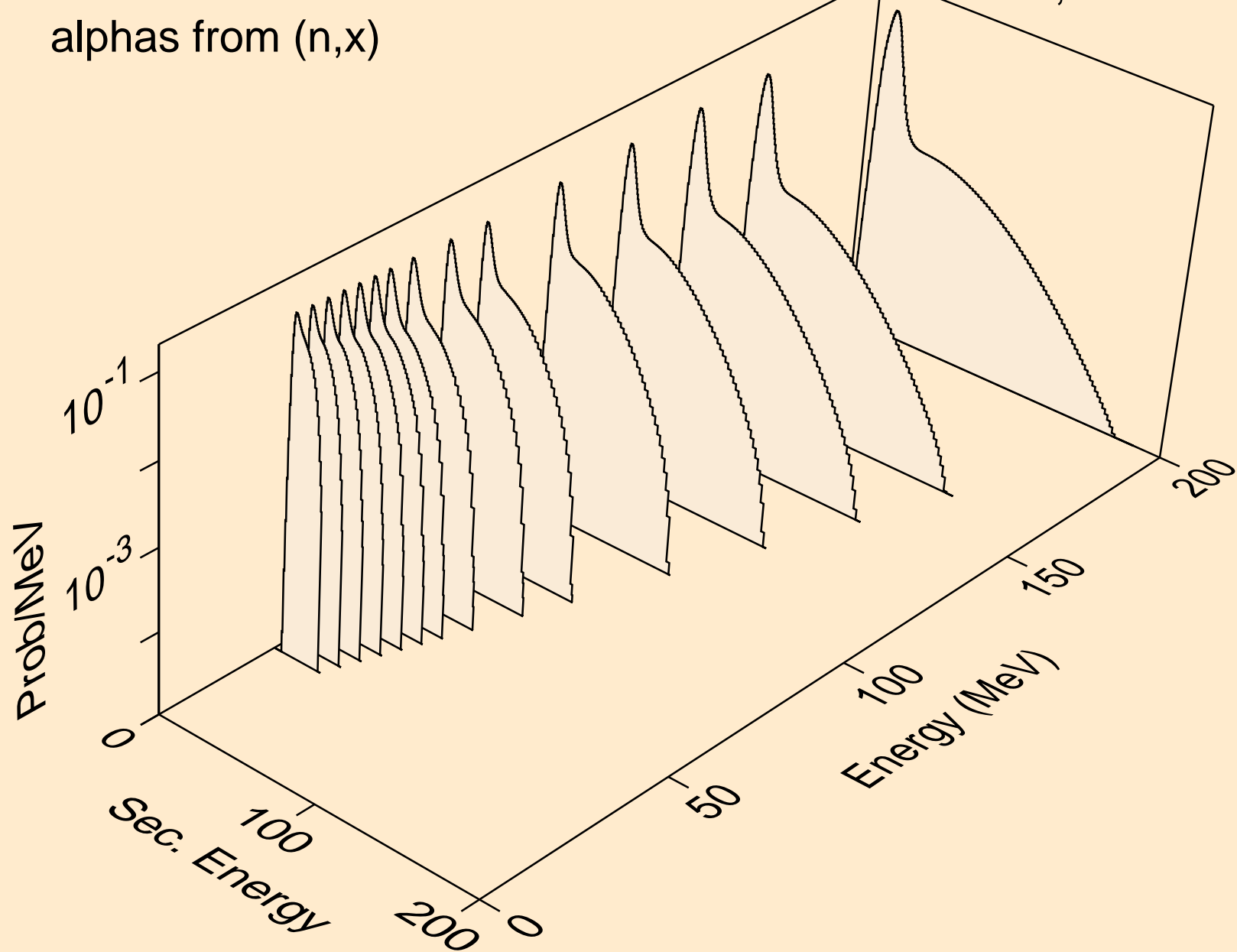

SE079M NEUTRON ACER TENDL-2021 LIBRARY; T=293.6K
alphas from (n,n*)a

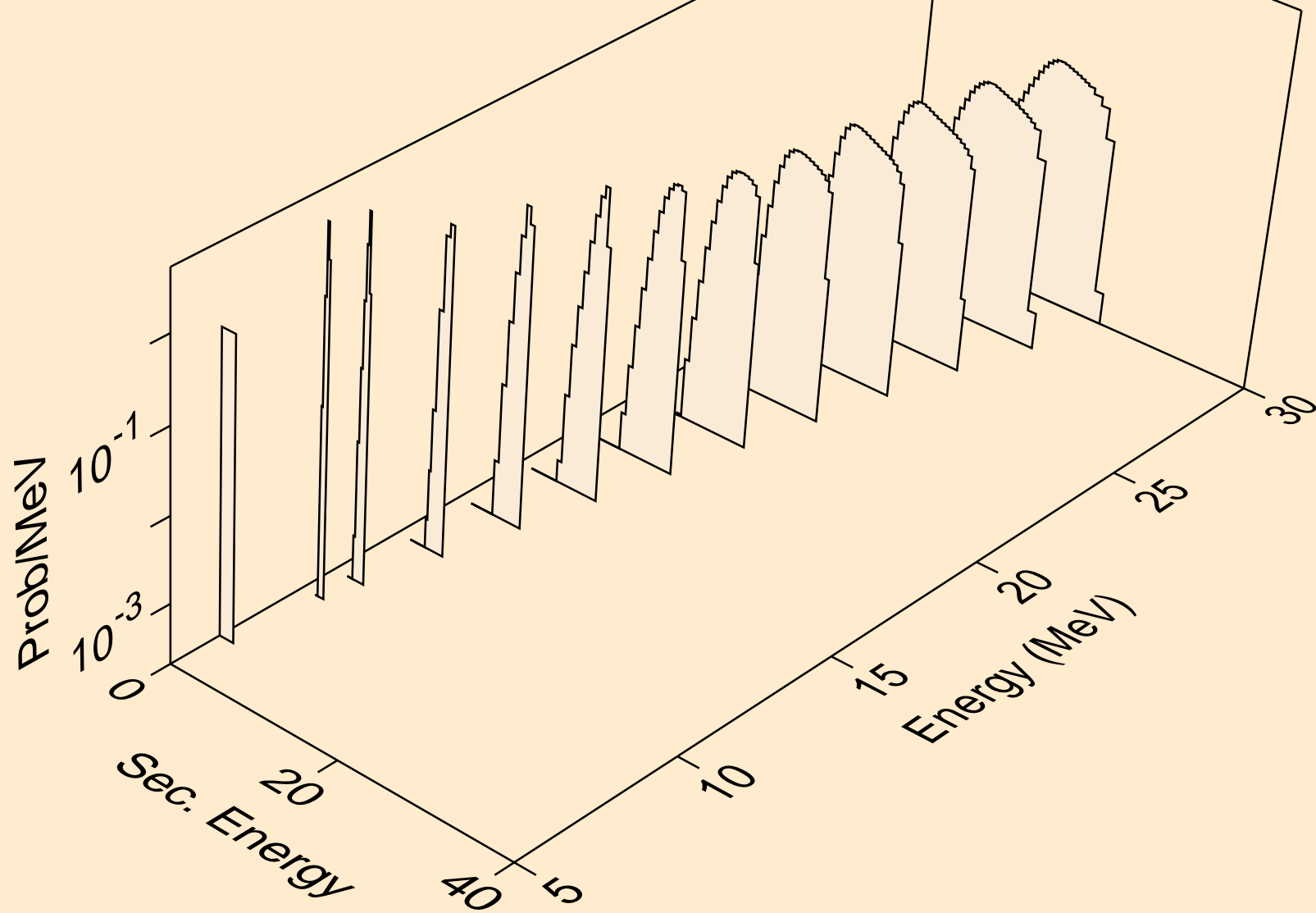

SE079M NEUTRON ACER TENDL-2021 LIBRARY; T=293.6K
alphas from (n,2n)a

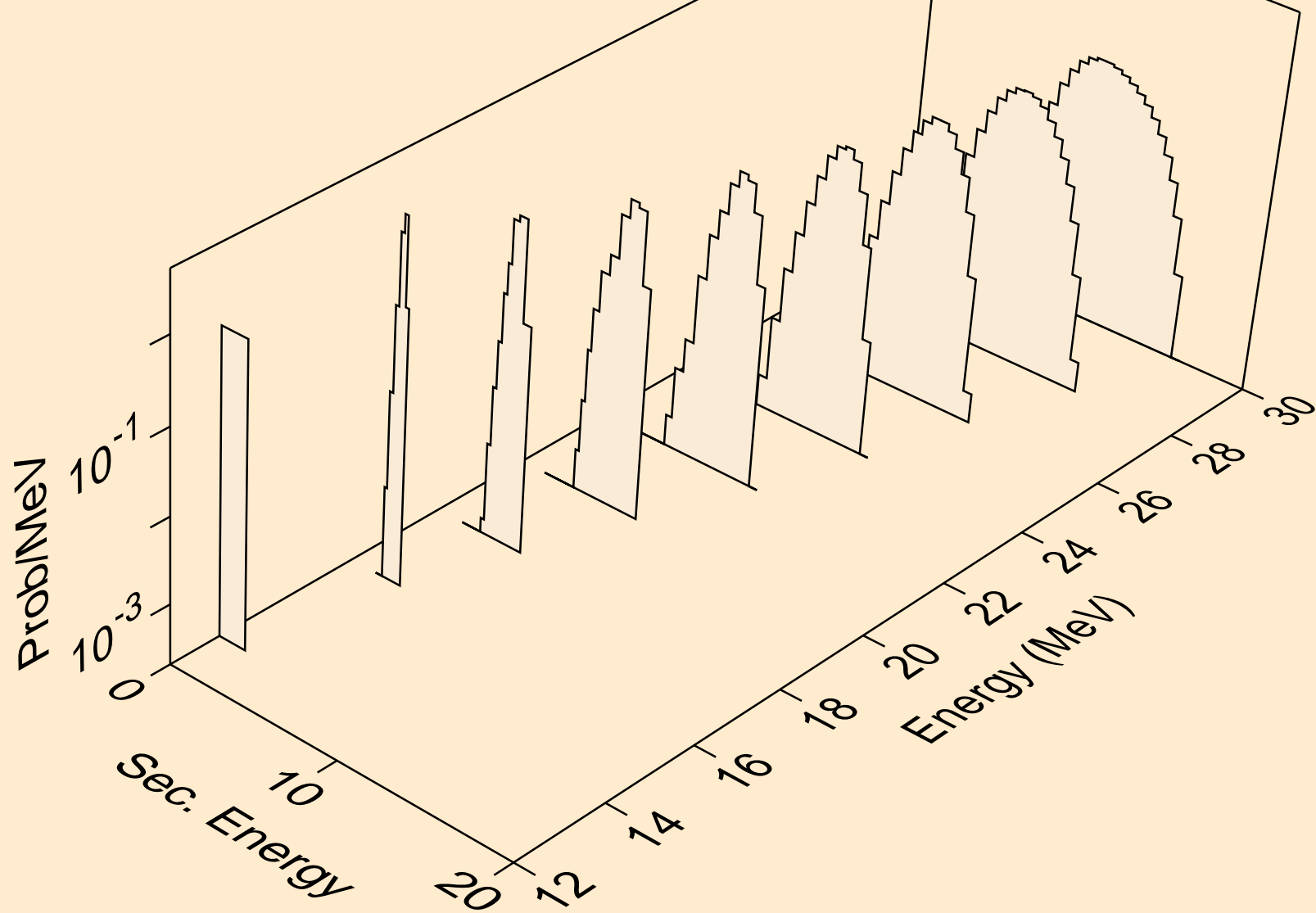

SE079M NEUTRON ACER TENDL-2021 LIBRARY; T=293.6K
alphas from (n,3n)a

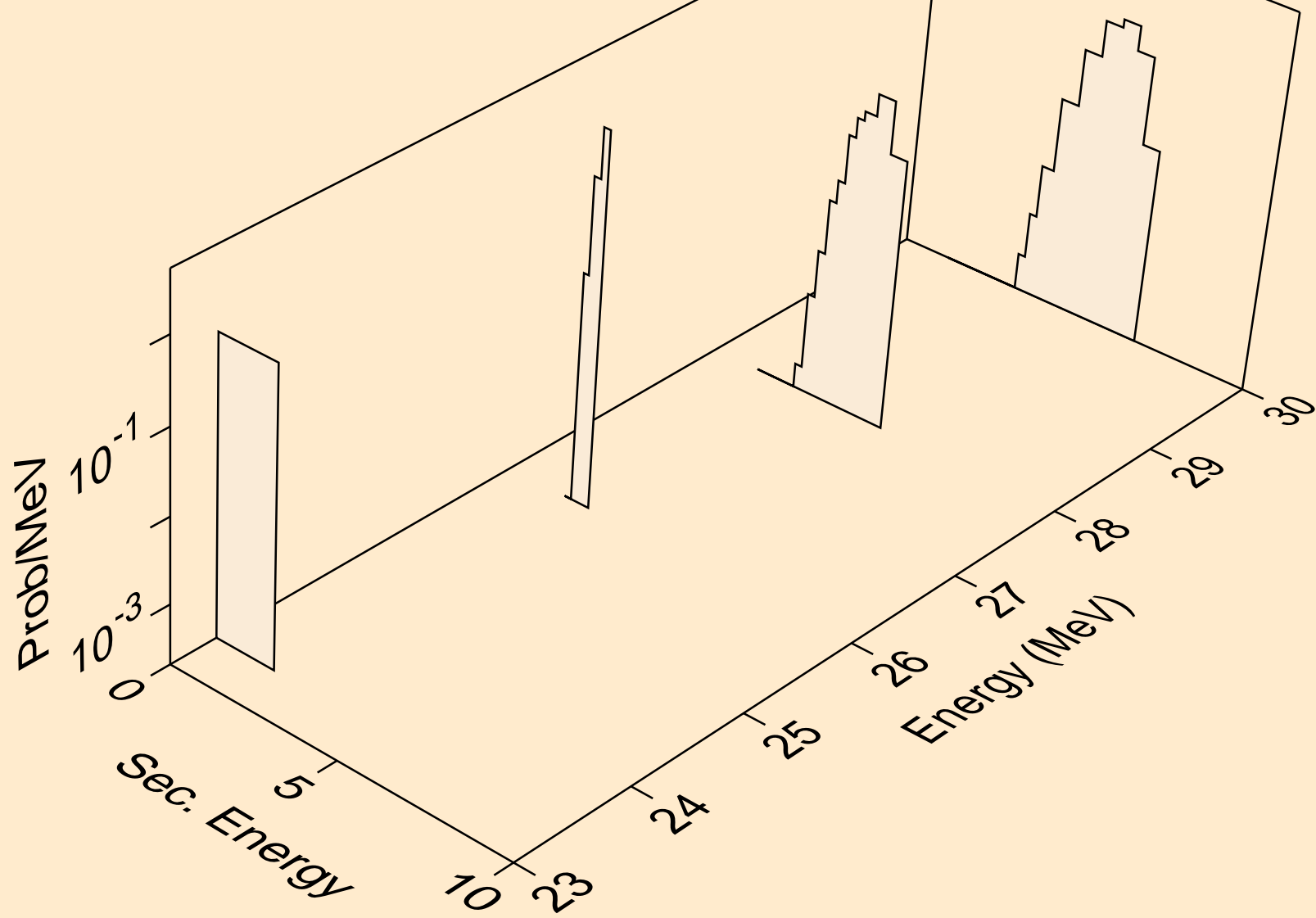

SE079M NEUTRON ACER TENDL-2021 LIBRARY; T=293.6K
alphas from (n,n*)2a

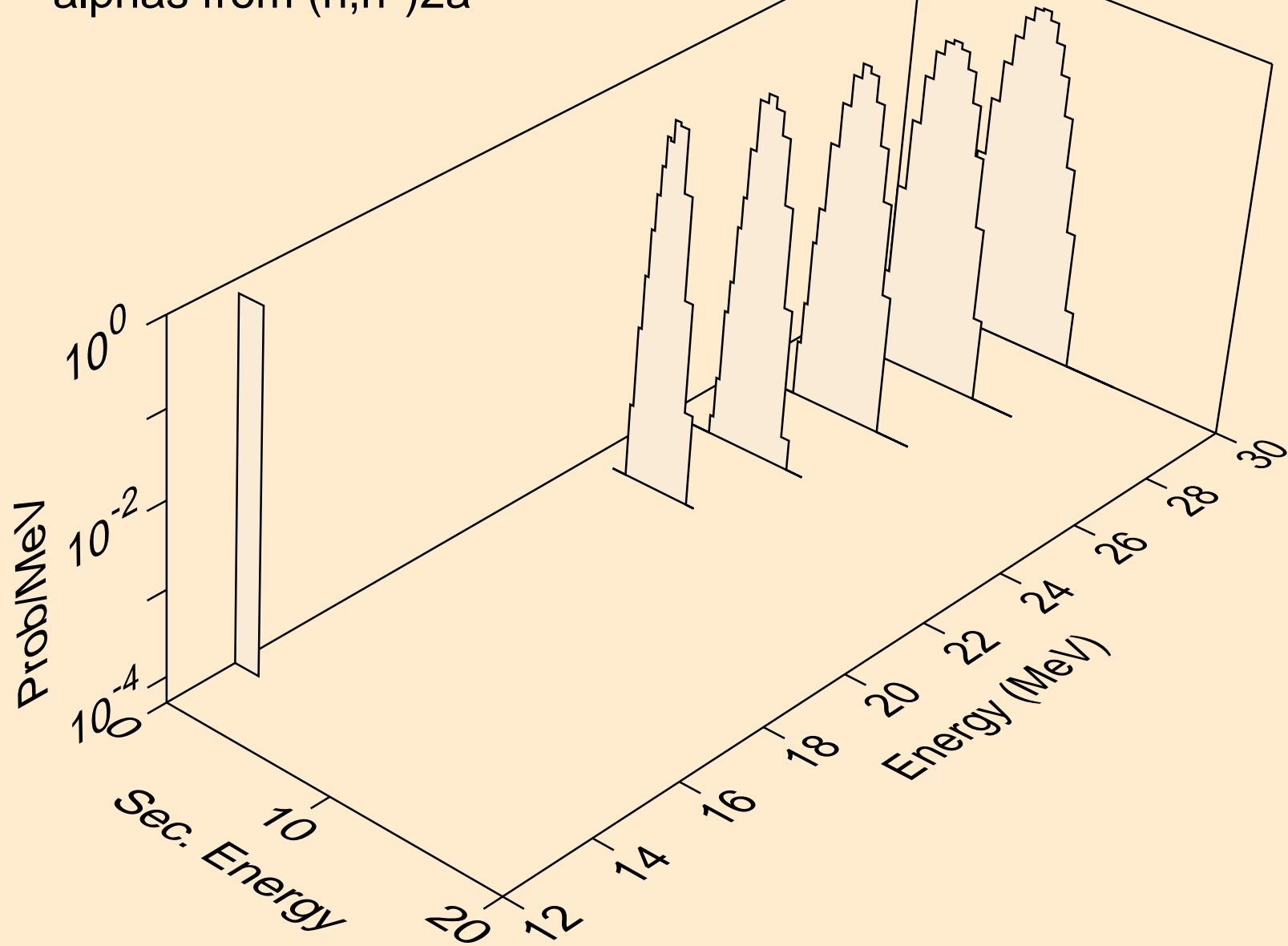

SE079M NEUTRON ACER TENDL-2021 LIBRARY; T=293.6K
alphas from (n,npa)

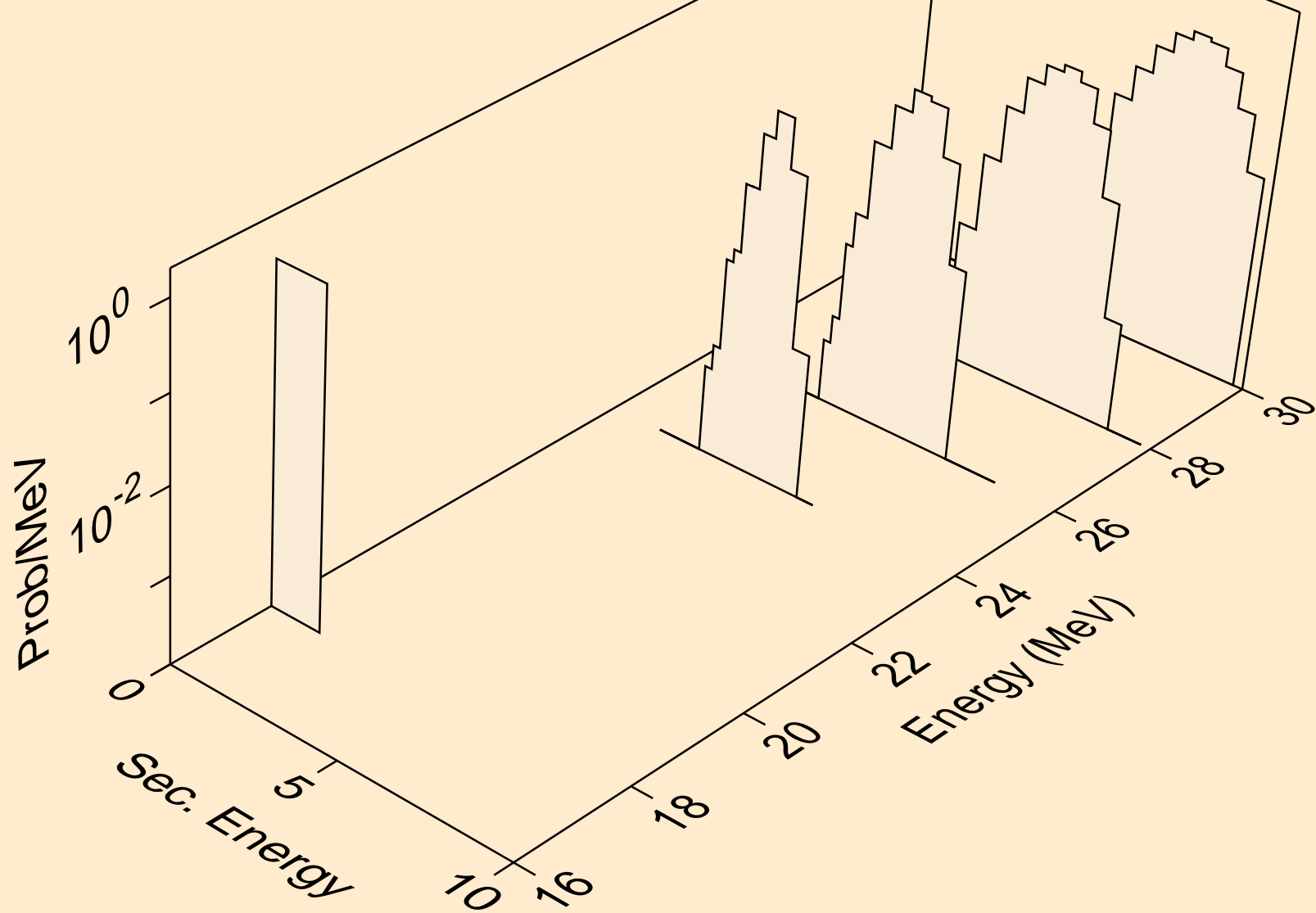

SE079M NEUTRON ACER TENDL-2021 LIBRARY; T=293.6K
alphas from (n,a)

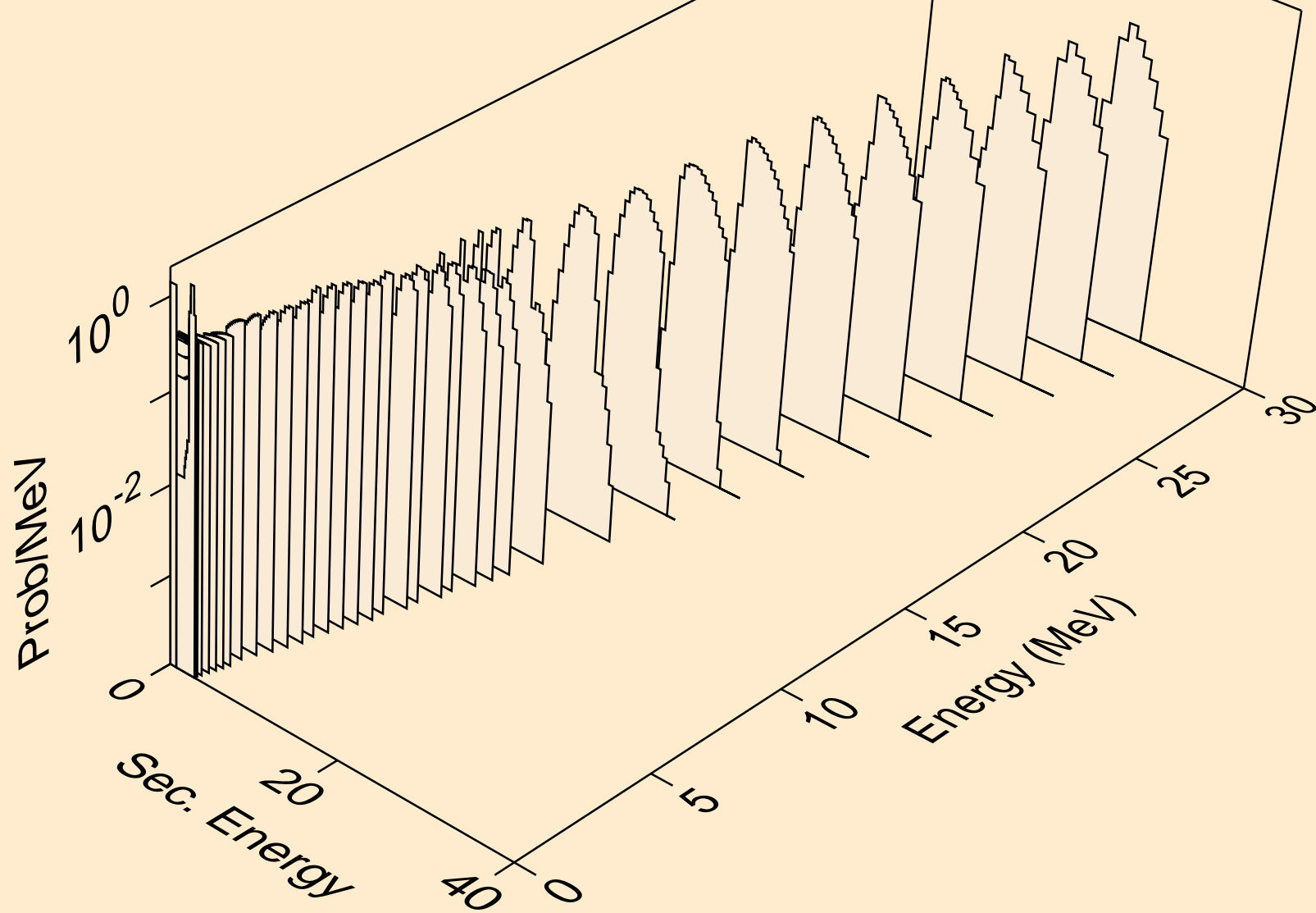

SE079M NEUTRON ACER TENDL-2021 LIBRARY; T=293.6K
alphas from (n,2a)

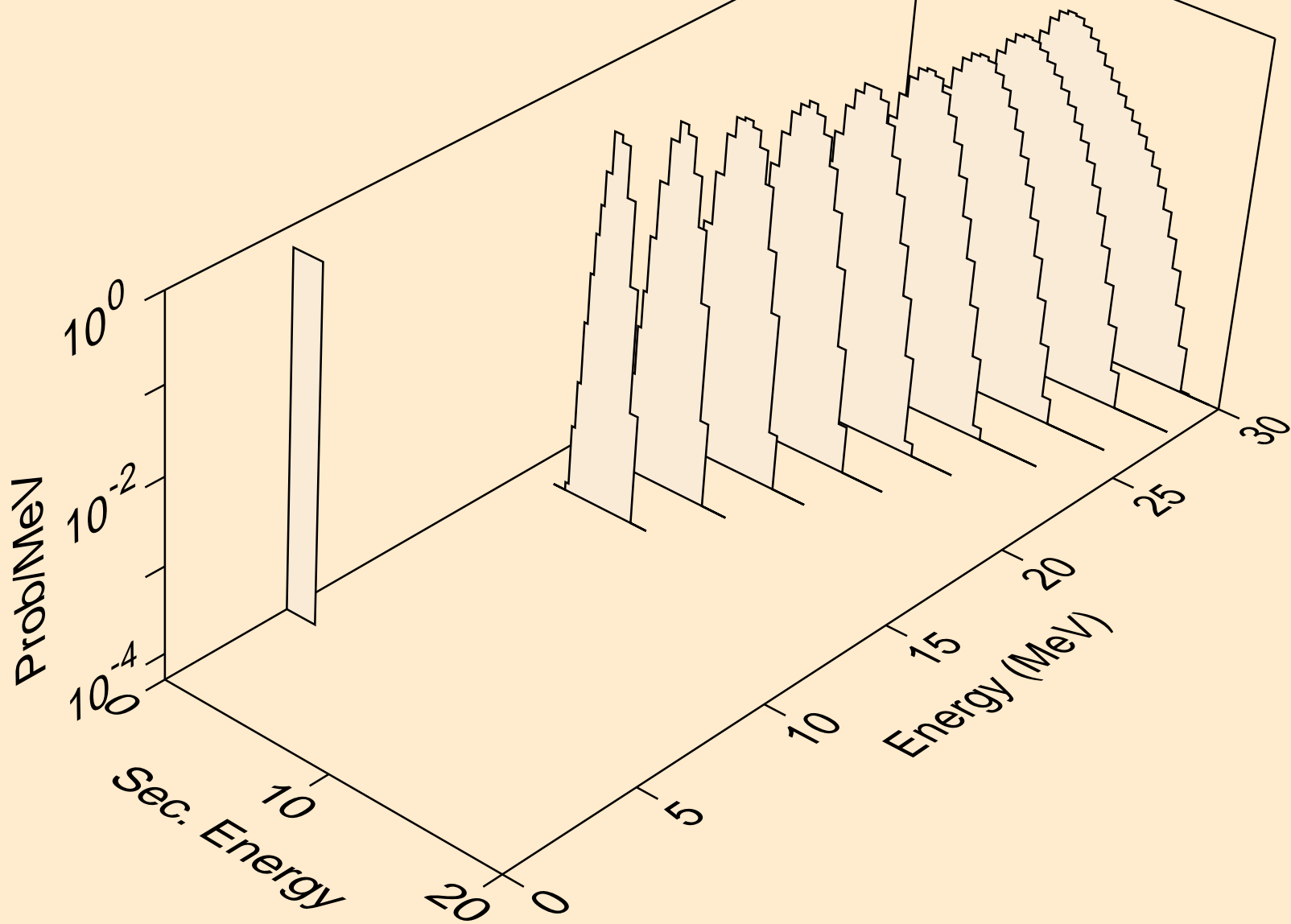

SE079M NEUTRON ACER TENDL-2021 LIBRARY; T=293.6K
alphas from (n,pa)

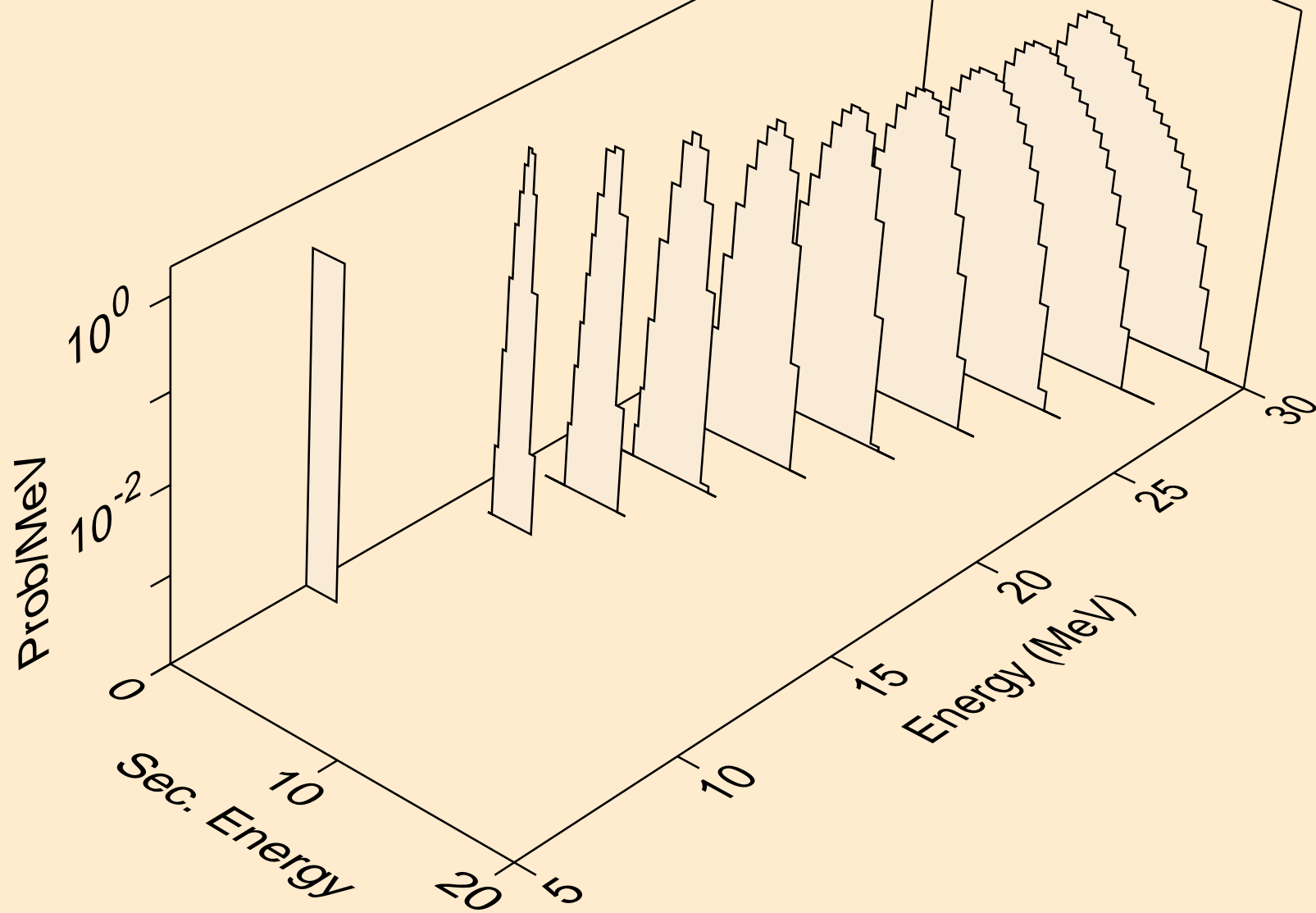

SE079M NEUTRON ACER TENDL-2021 LIBRARY; T=293.6K
alphas from (n,da)

