

SG267 NEUTRON ACER TENDL-2021 LIBRARY; T=293.6K

Principal cross sections

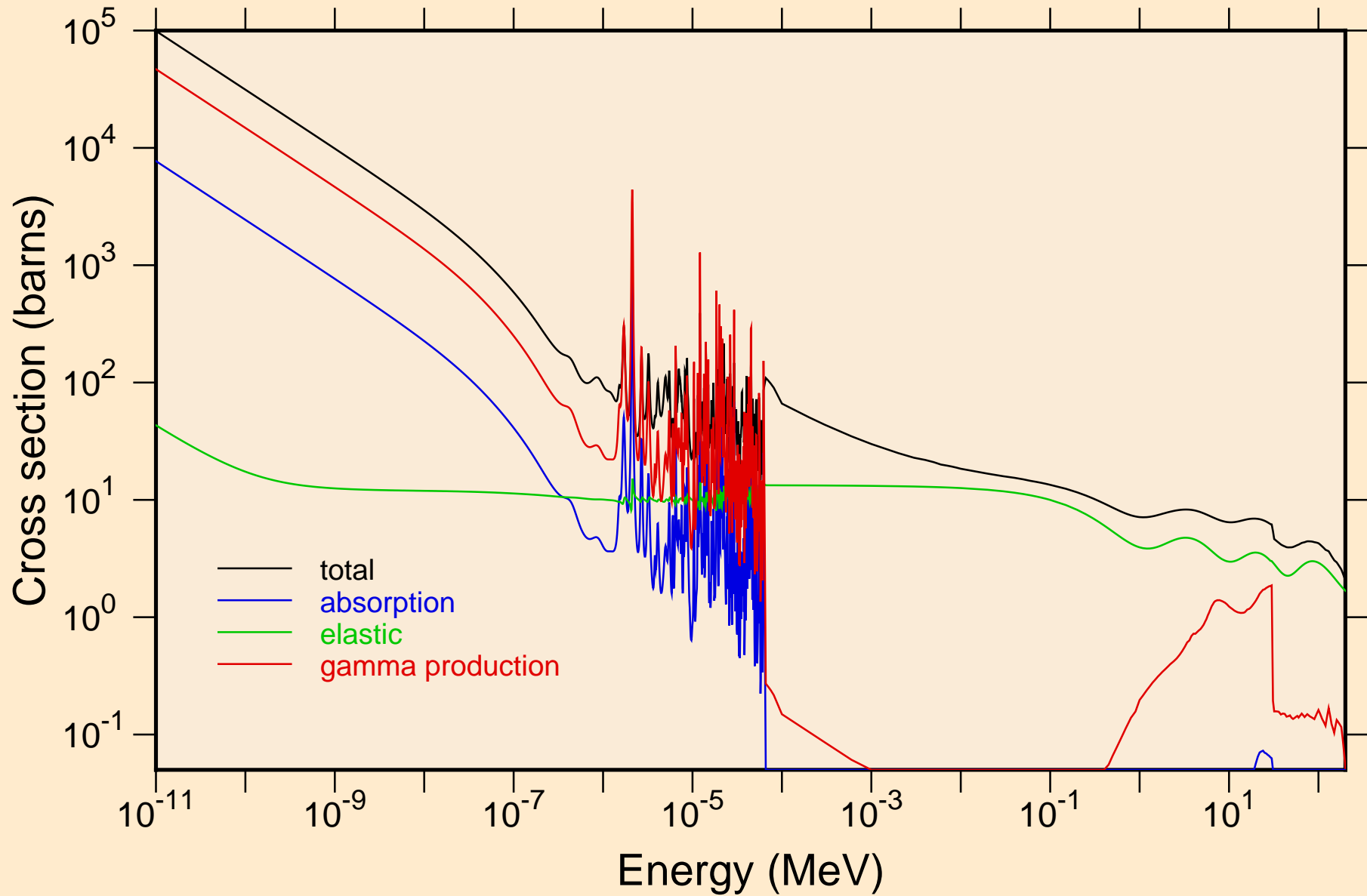

SG267 NEUTRON ACER TENDL-2021 LIBRARY; T=293.6K
resonance total cross section

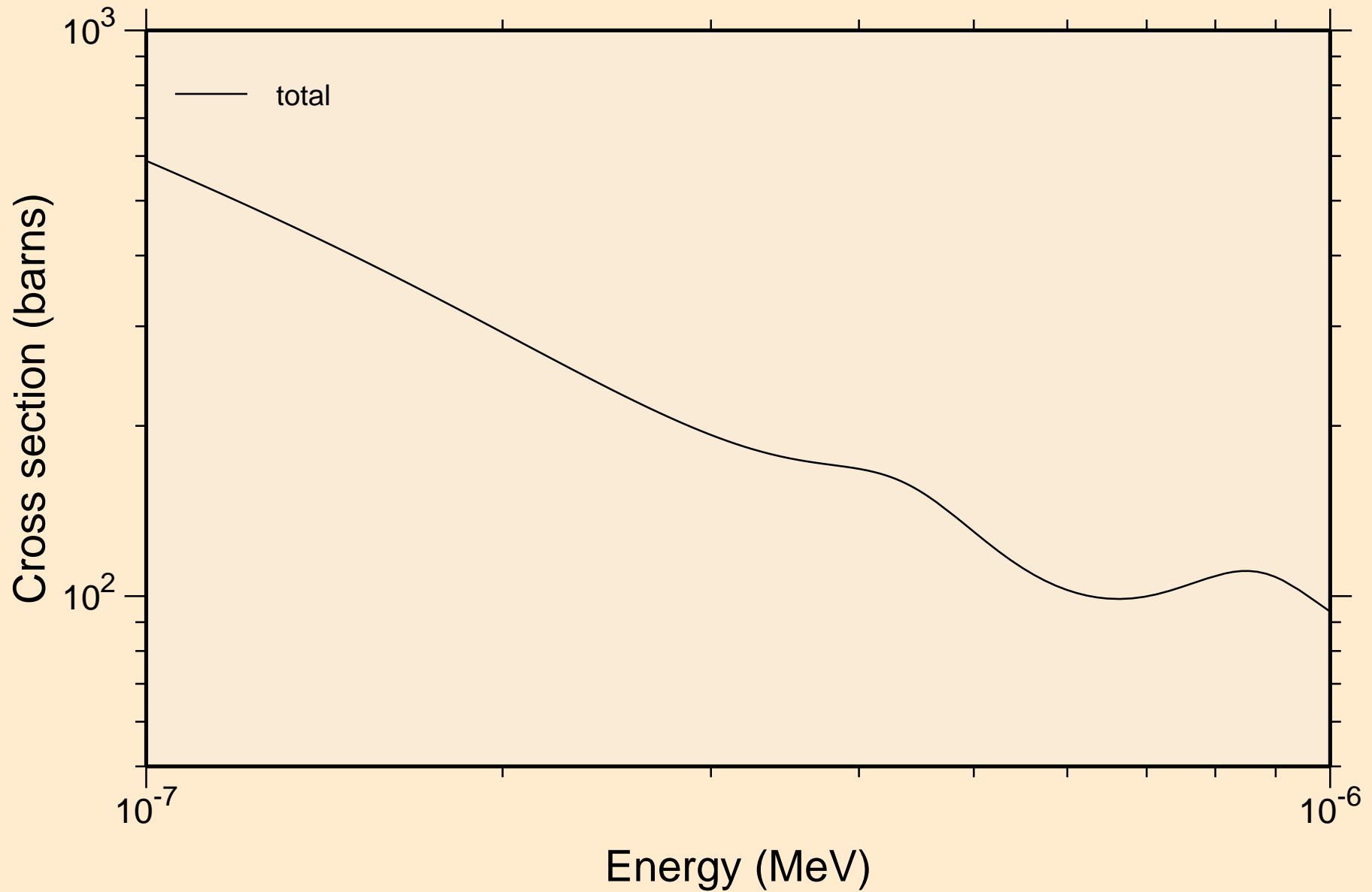

SG267 NEUTRON ACER TENDL-2021 LIBRARY; T=293.6K
resonance total cross section

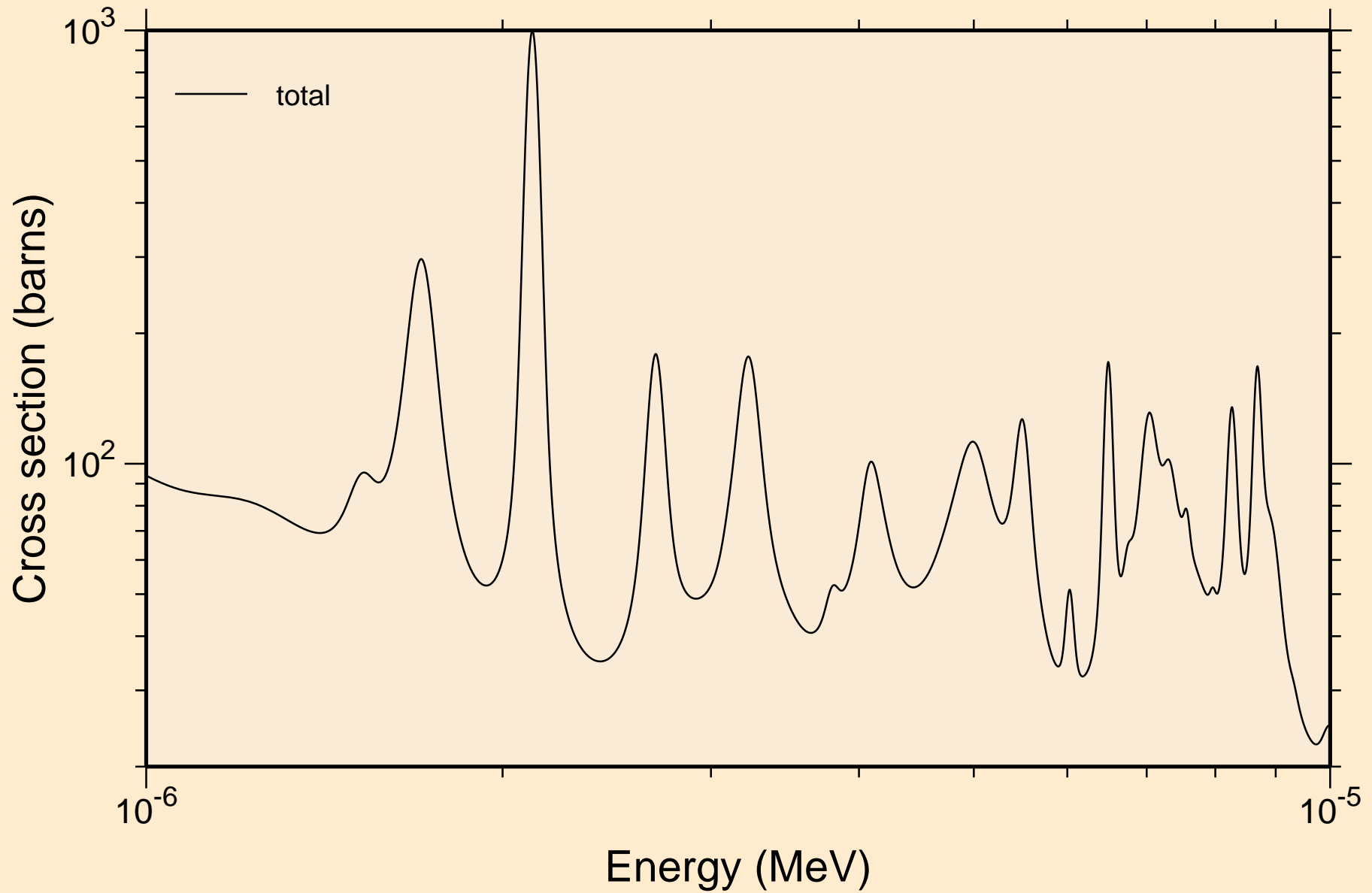

SG267 NEUTRON ACER TENDL-2021 LIBRARY; T=293.6K
resonance total cross section

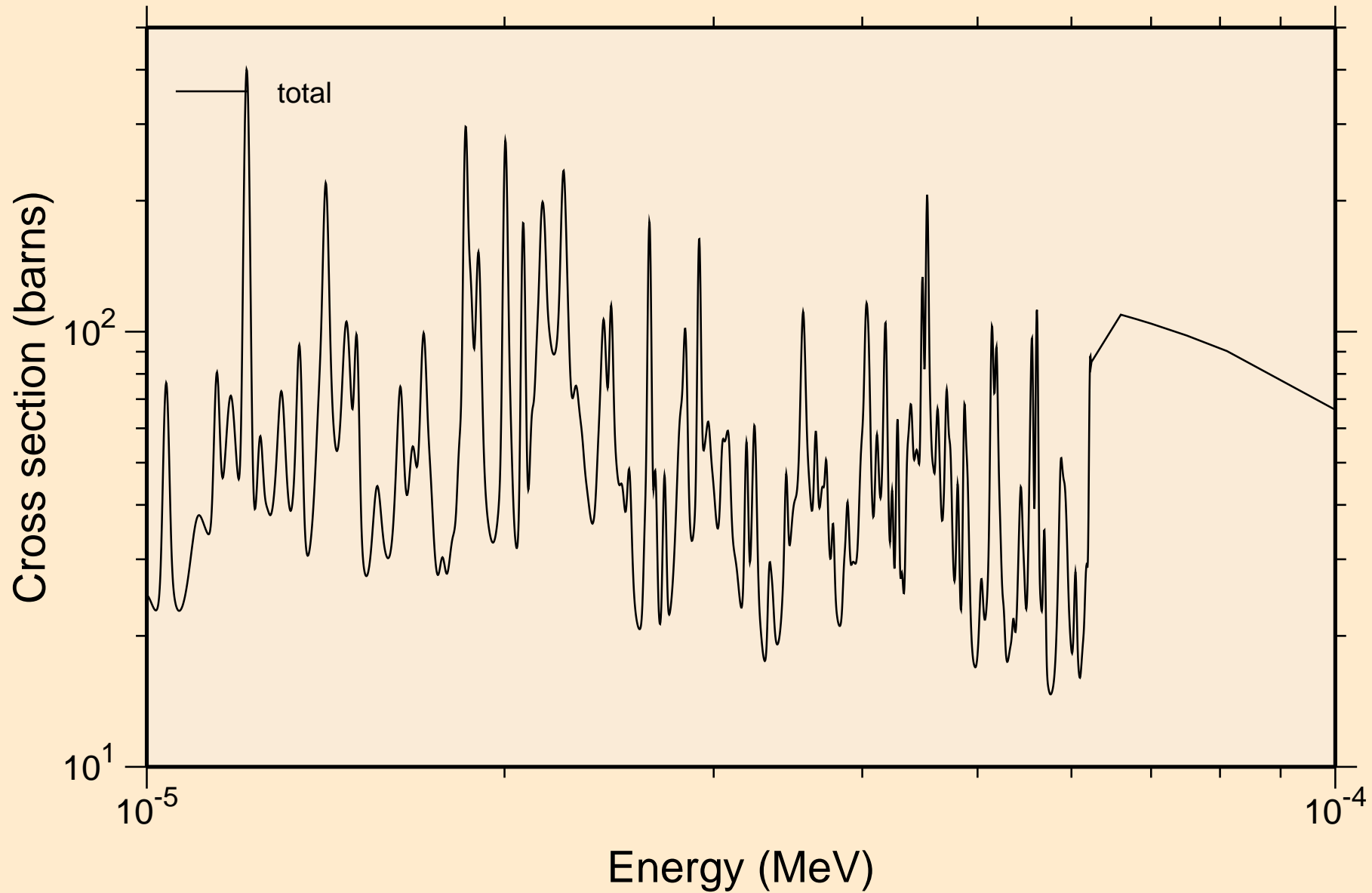

SG267 NEUTRON ACER TENDL-2021 LIBRARY; T=293.6K
resonance total cross section

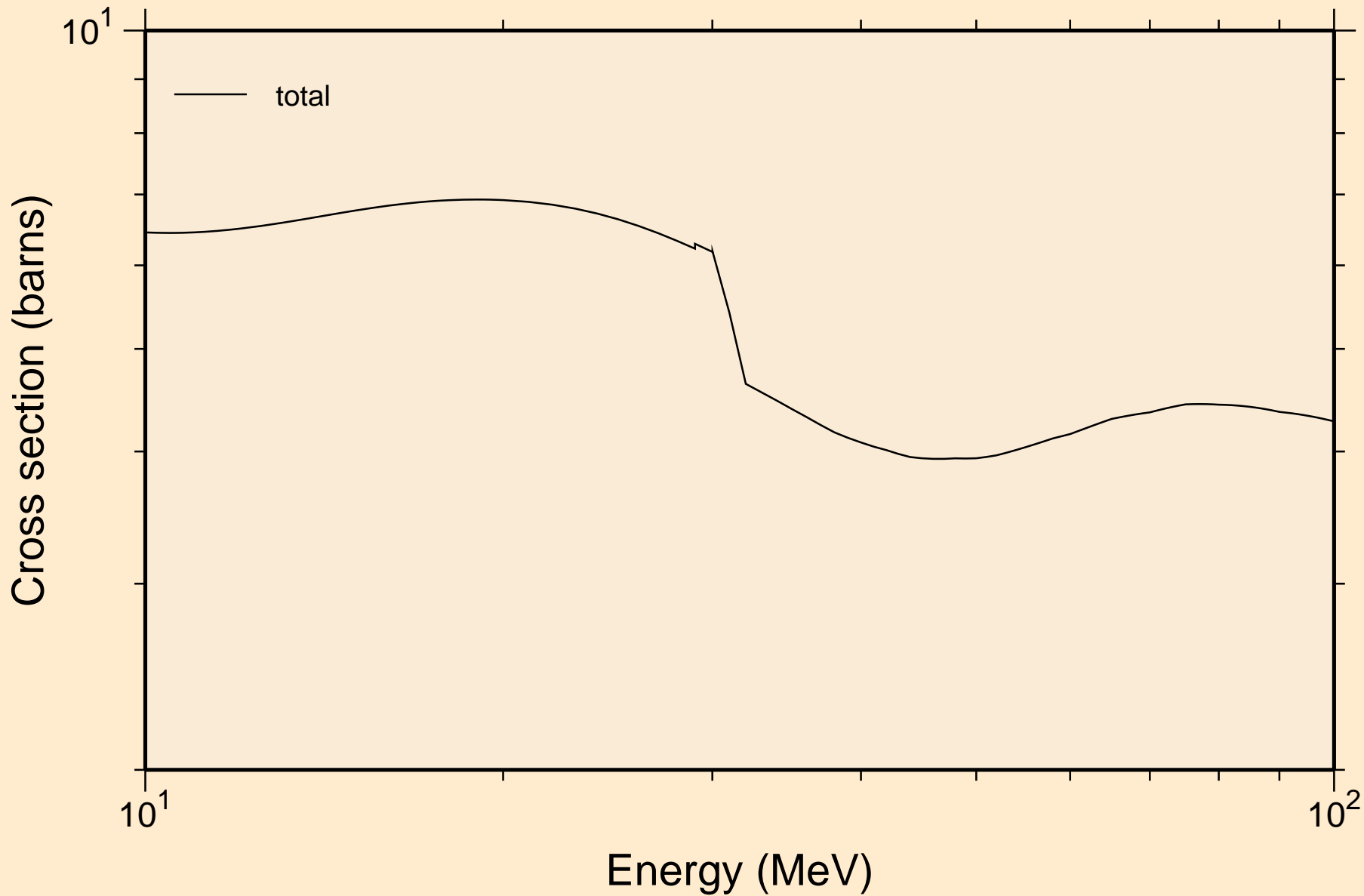

SG267 NEUTRON ACER TENDL-2021 LIBRARY; T=293.6K
resonance absorption cross sections

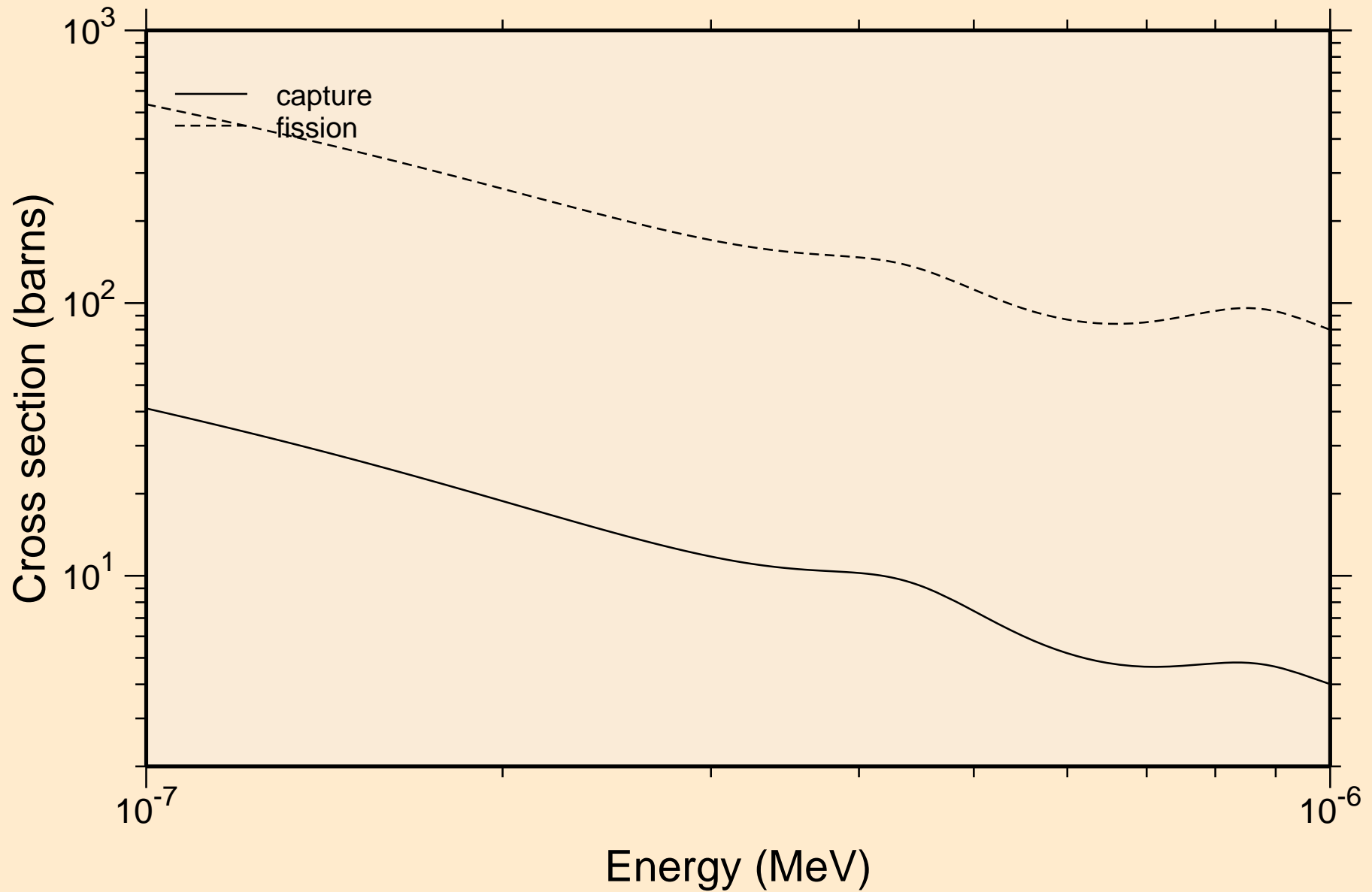

SG267 NEUTRON ACER TENDL-2021 LIBRARY; T=293.6K
resonance absorption cross sections

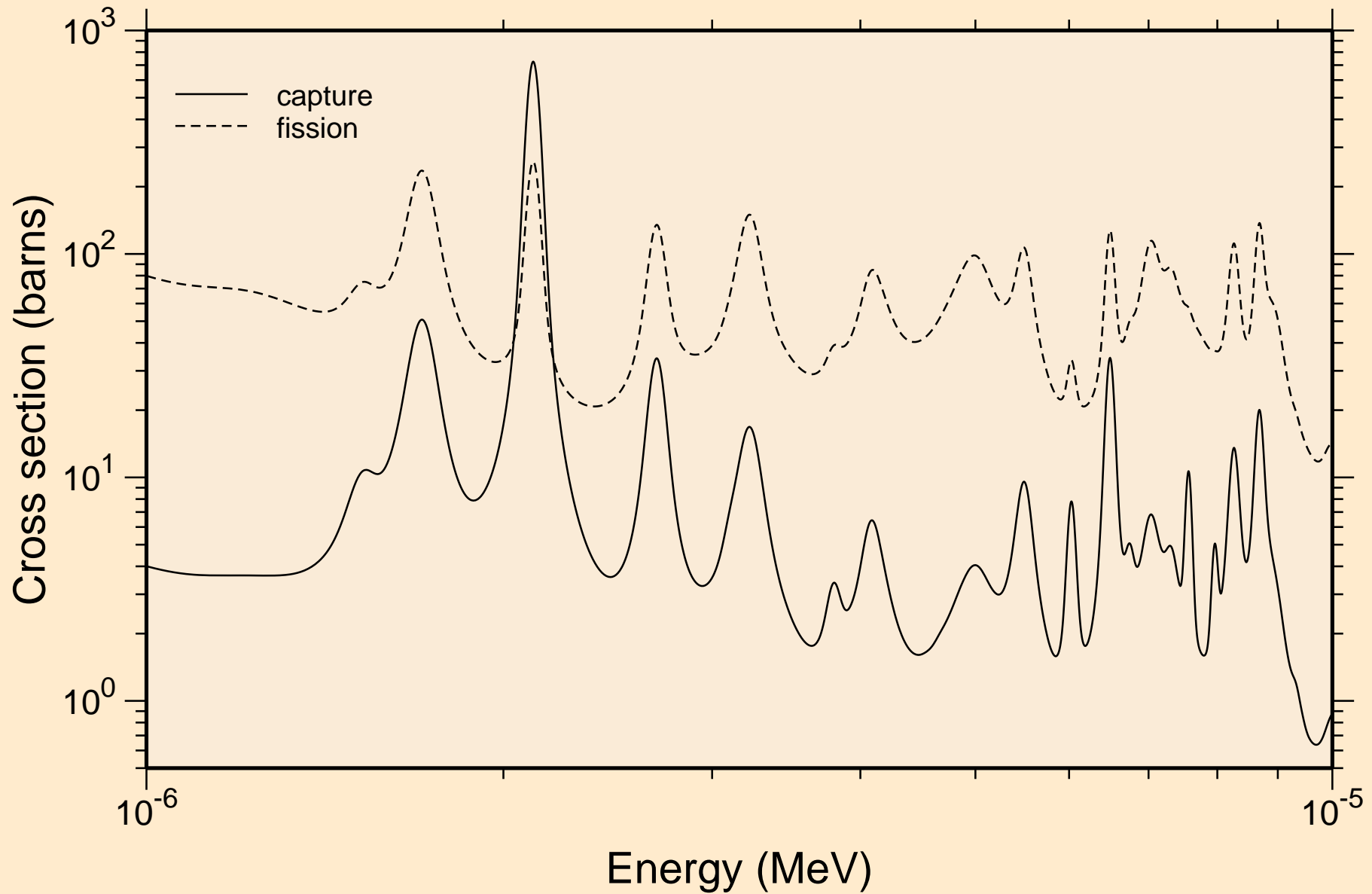

SG267 NEUTRON ACER TENDL-2021 LIBRARY; T=293.6K
resonance absorption cross sections

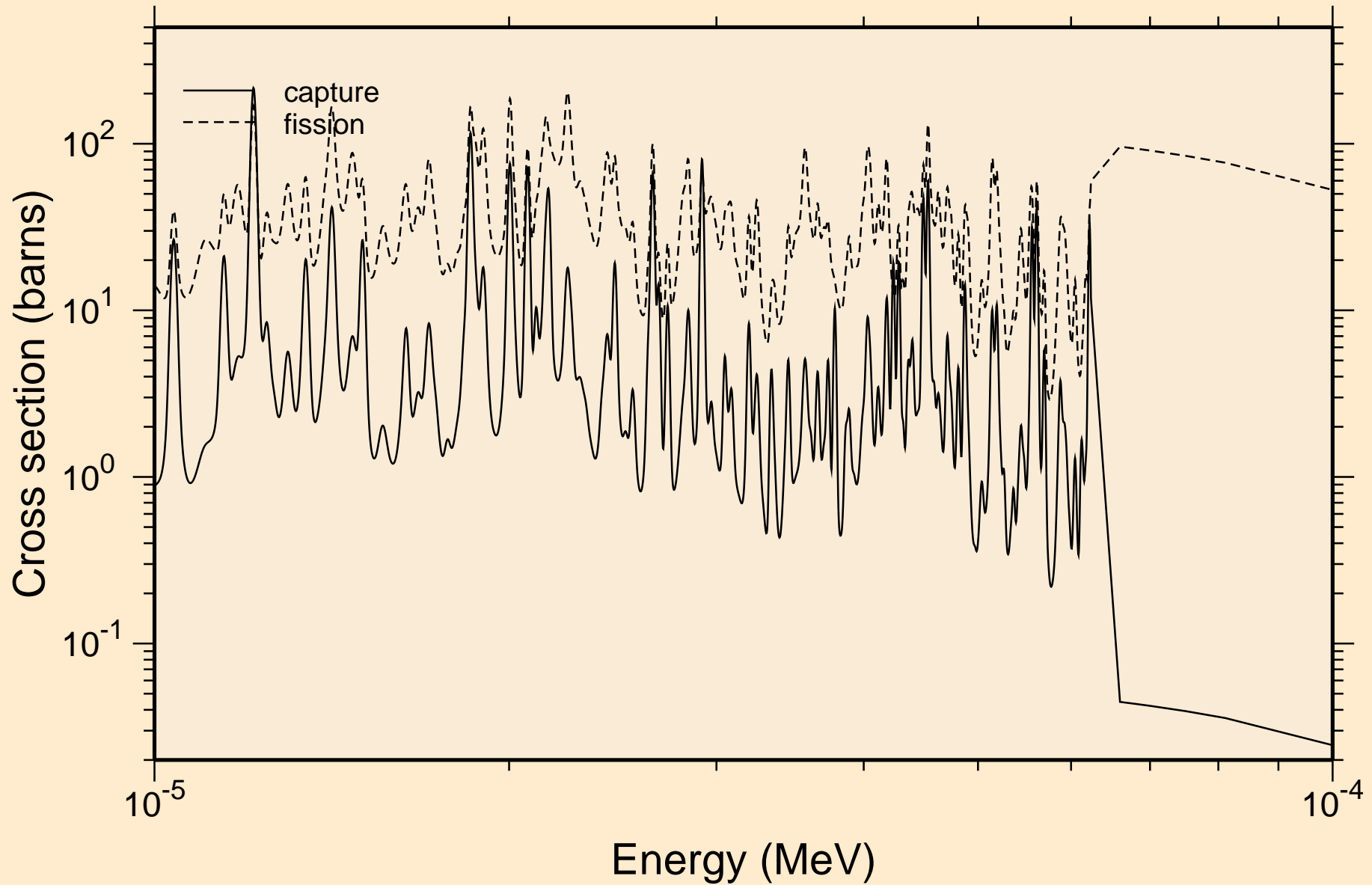

SG267 NEUTRON ACER TENDL-2021 LIBRARY; T=293.6K
resonance absorption cross sections

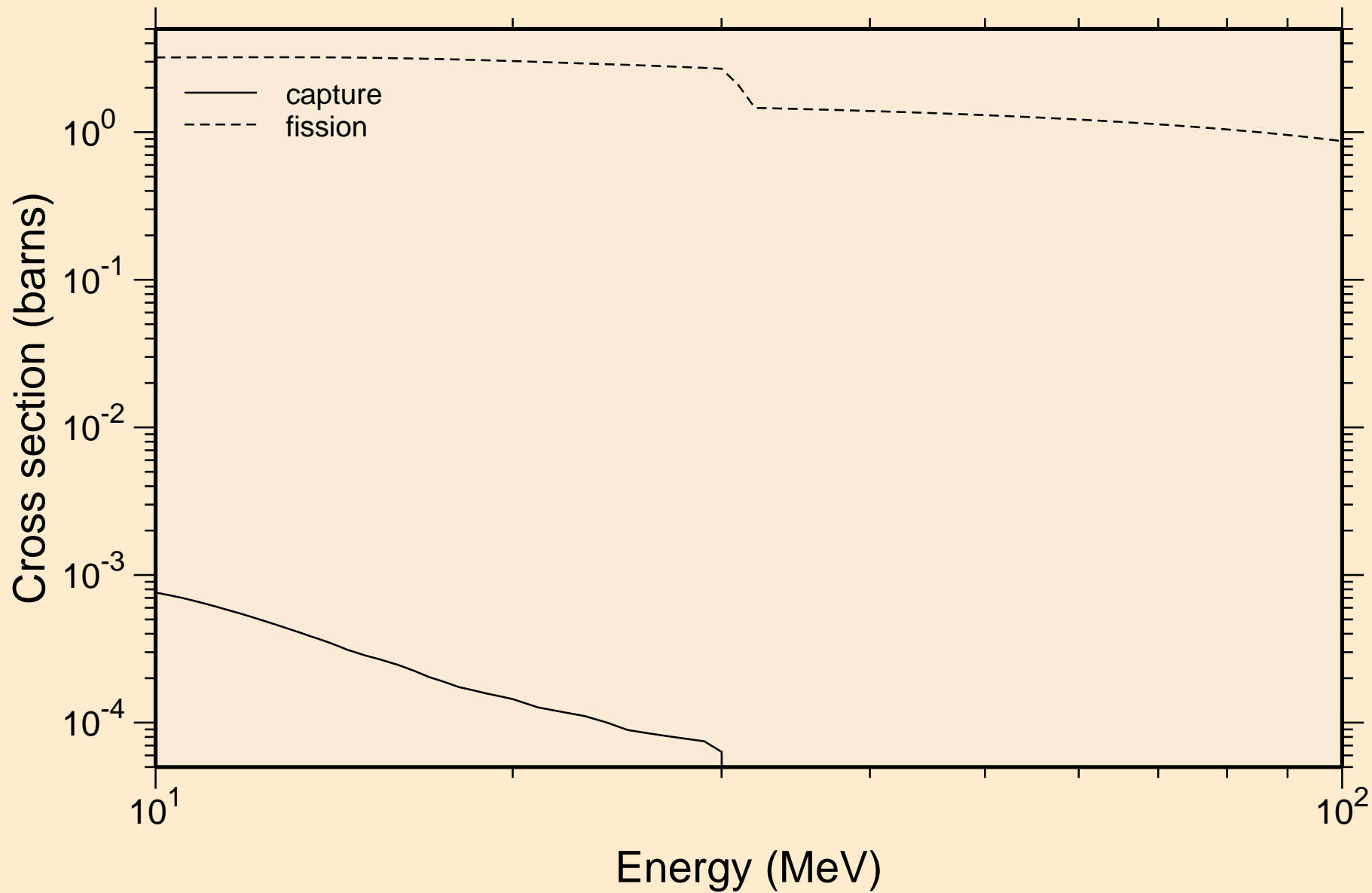

SG267 NEUTRON ACER TENDL-2021 LIBRARY; T=293.6K
Heating

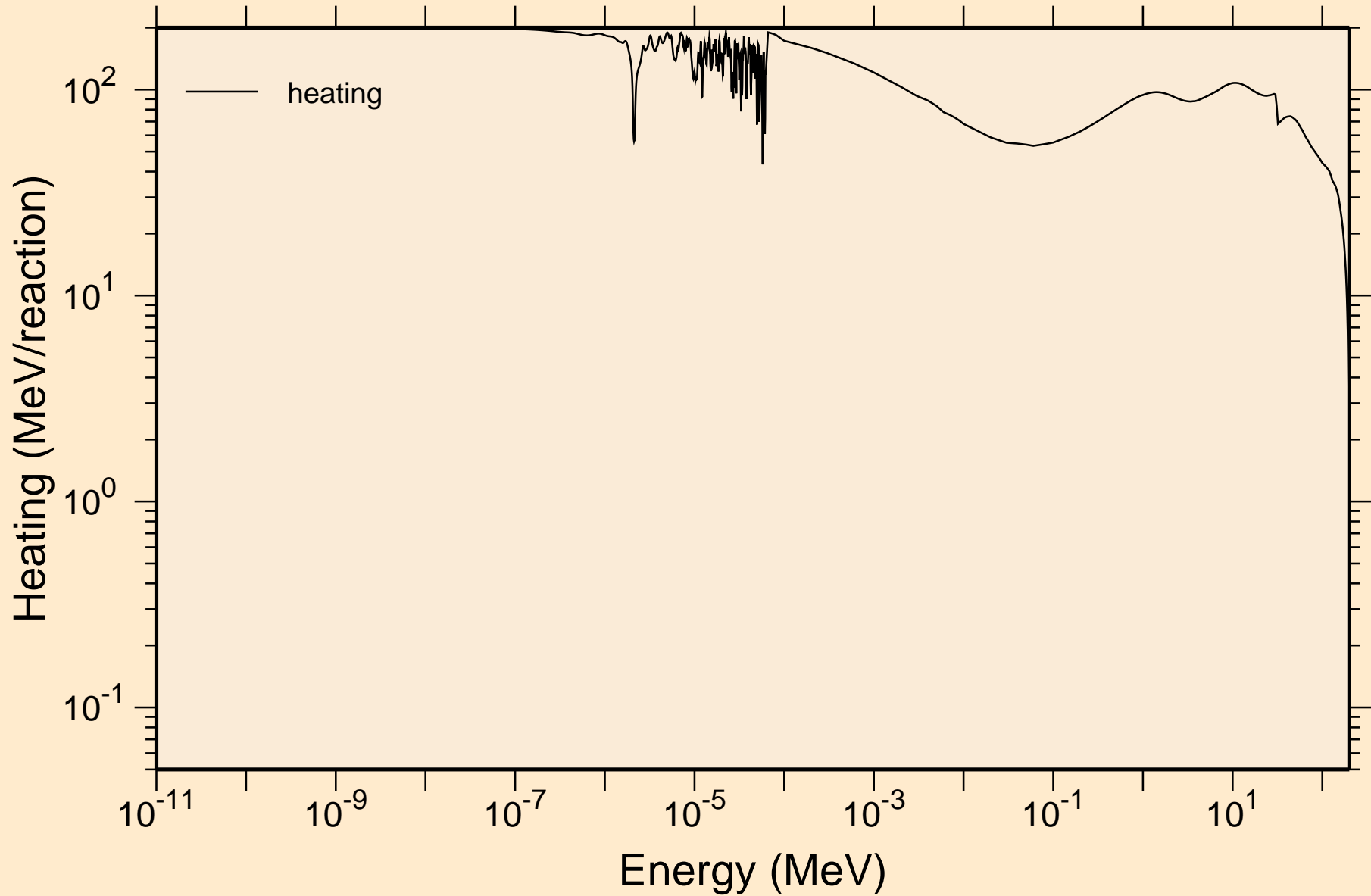

SG267 NEUTRON ACER TENDL-2021 LIBRARY; T=293.6K
Damage

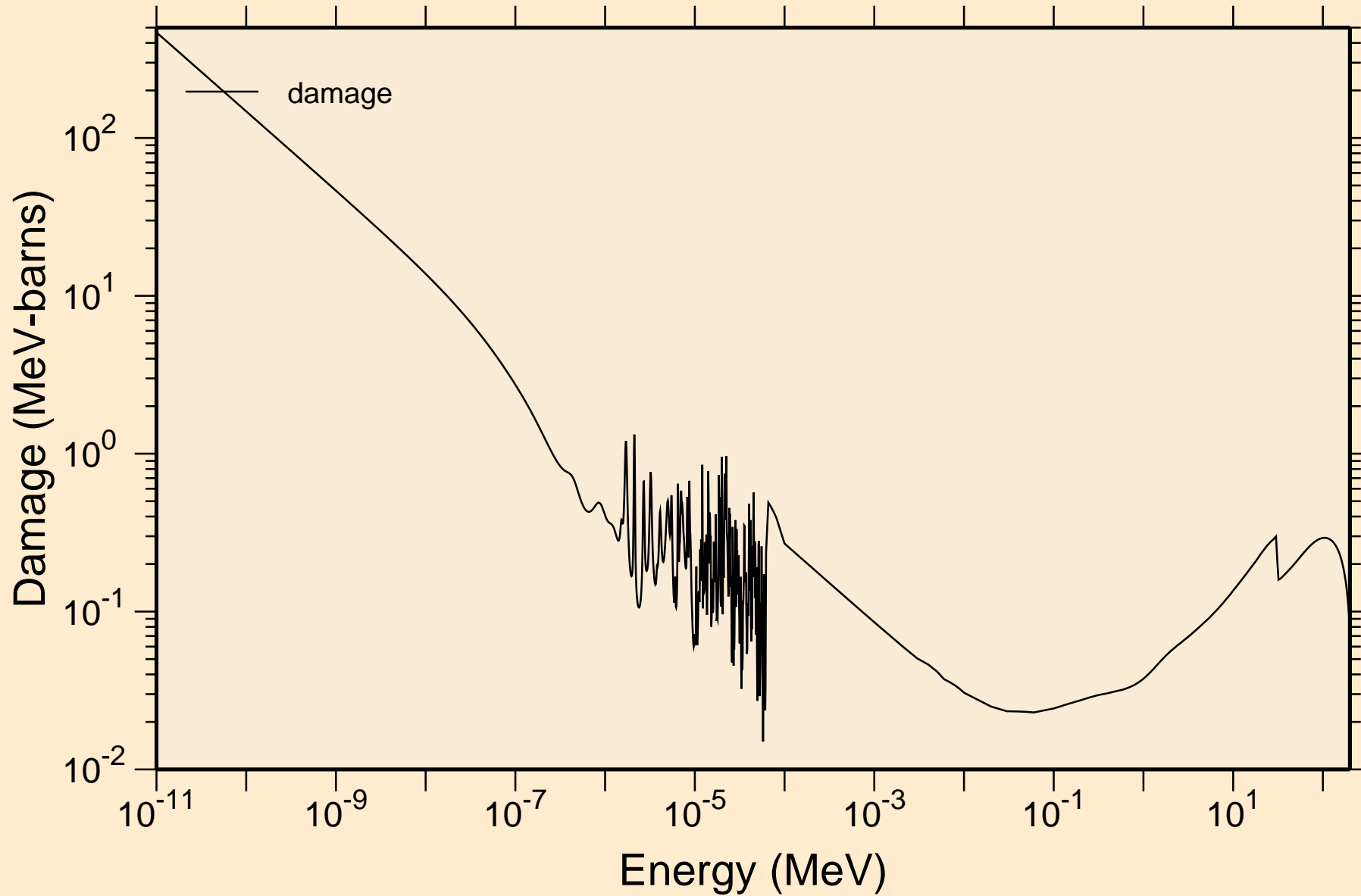

SG267 NEUTRON ACER TENDL-2021 LIBRARY; T=293.6K

Non-threshold reactions

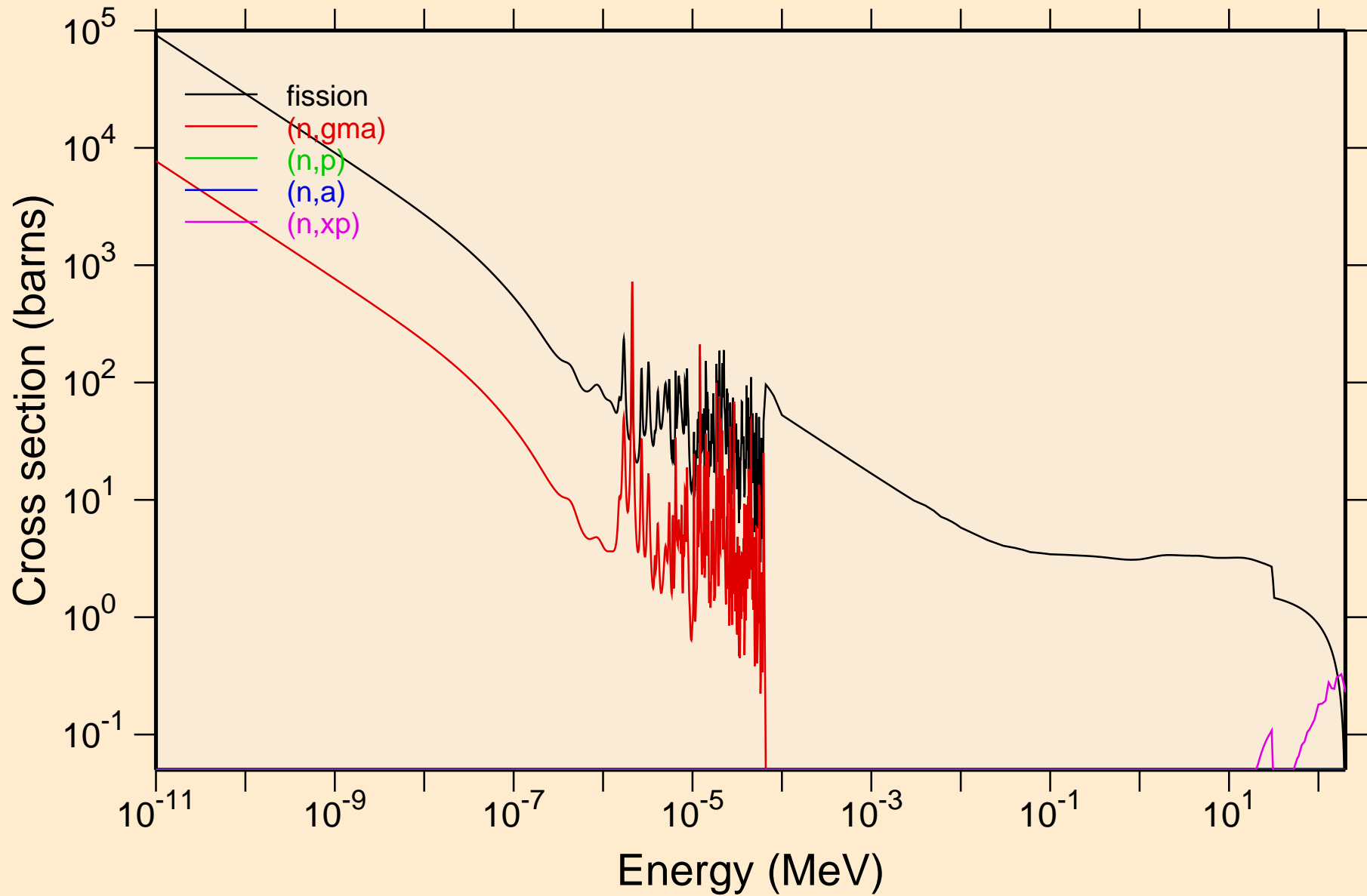

SG267 NEUTRON ACER TENDL-2021 LIBRARY; T=293.6K
Non-threshold reactions

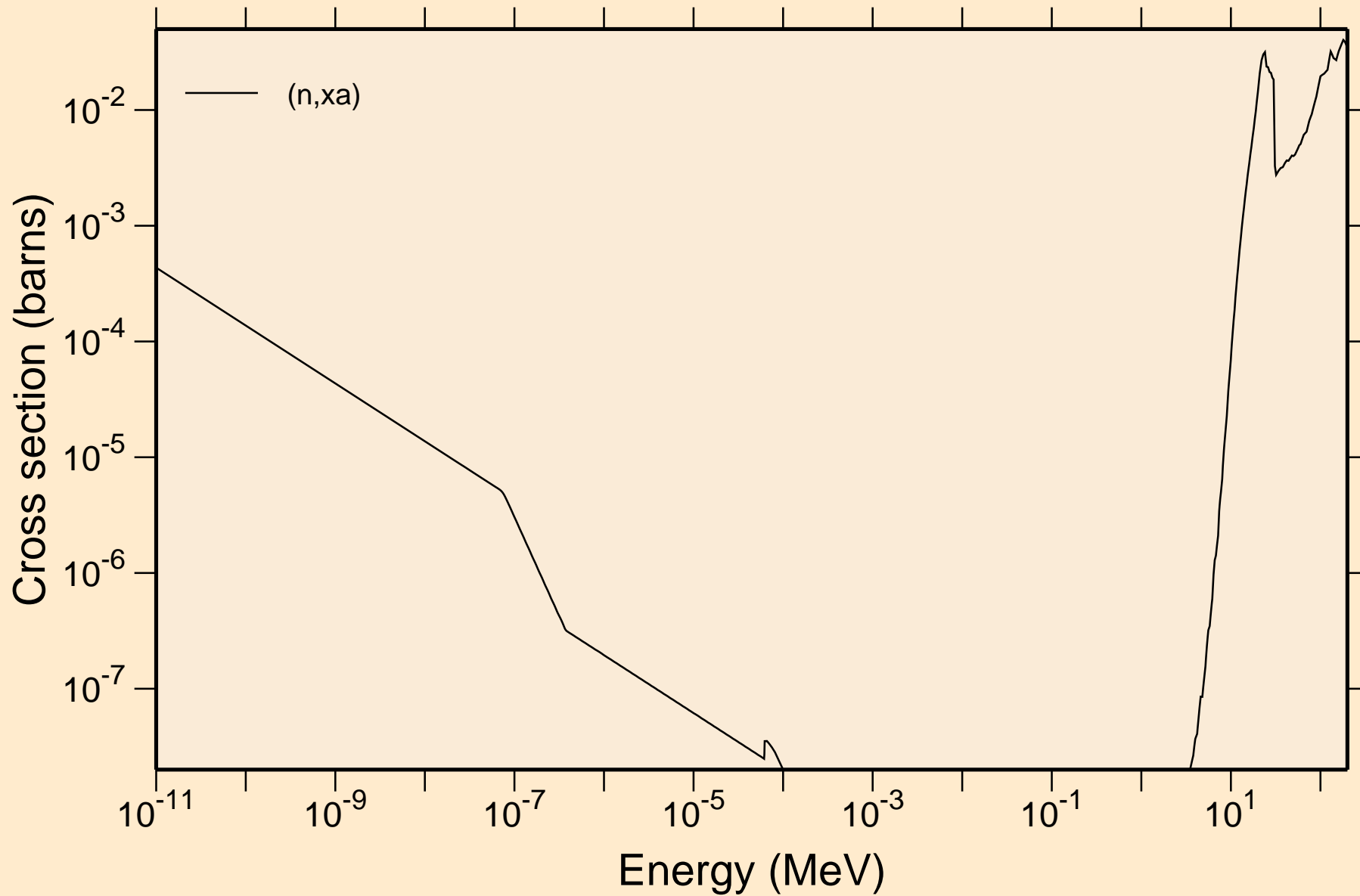

SG267 NEUTRON ACER TENDL-2021 LIBRARY; T=293.6K
Principal cross sections

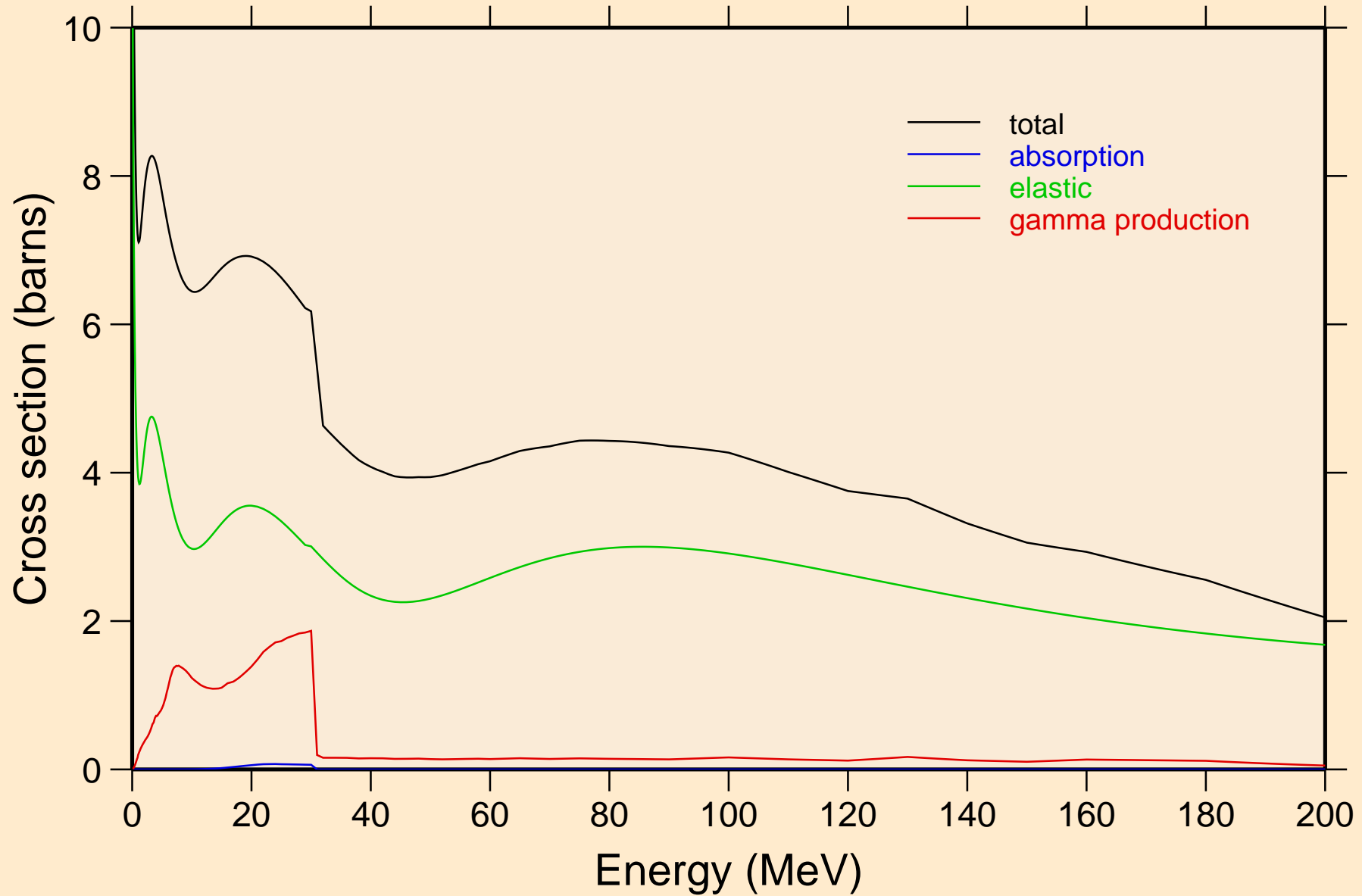

SG267 NEUTRON ACER TENDL-2021 LIBRARY; T=293.6K
Heating

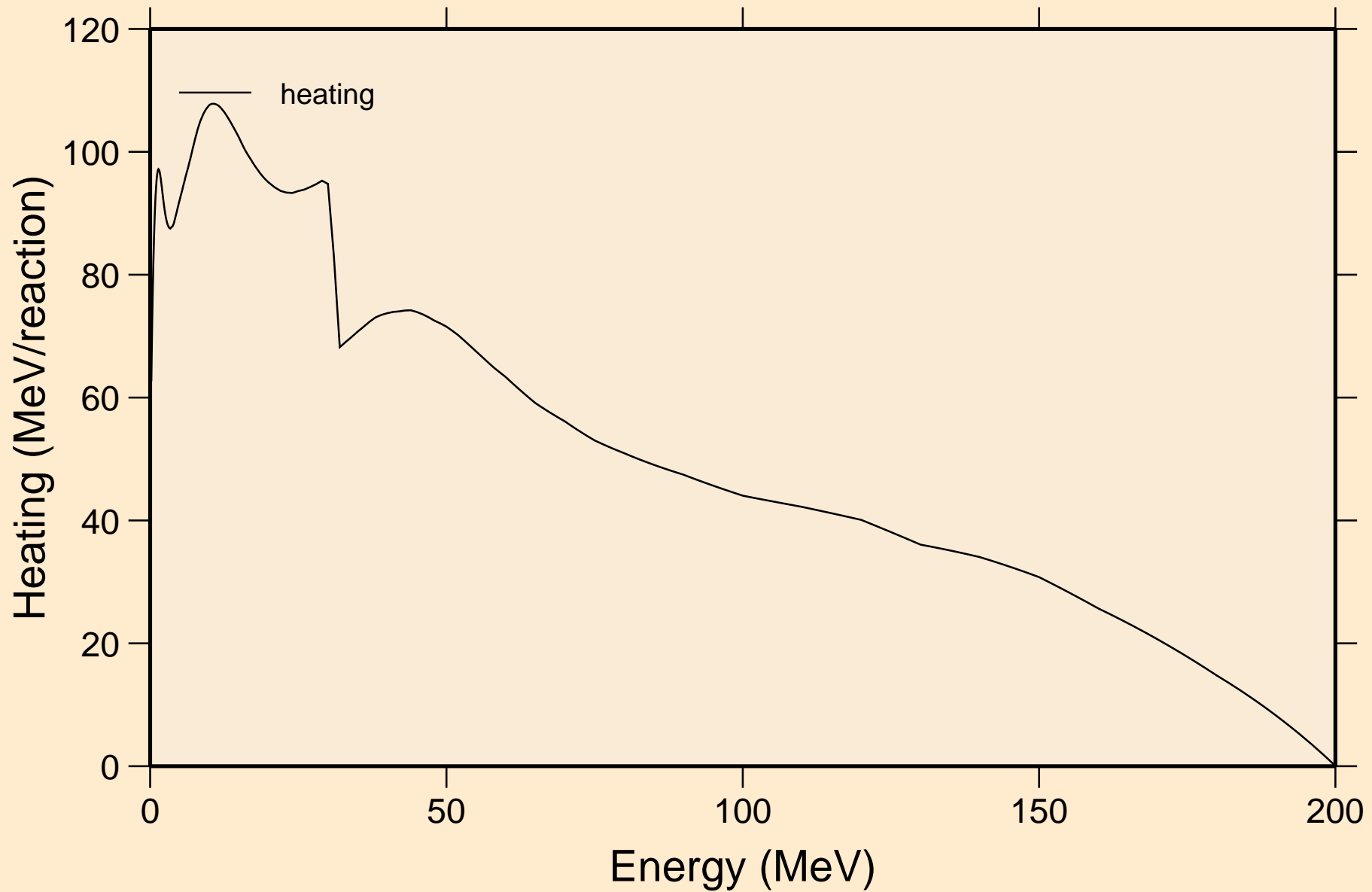

SG267 NEUTRON ACER TENDL-2021 LIBRARY; T=293.6K
Damage

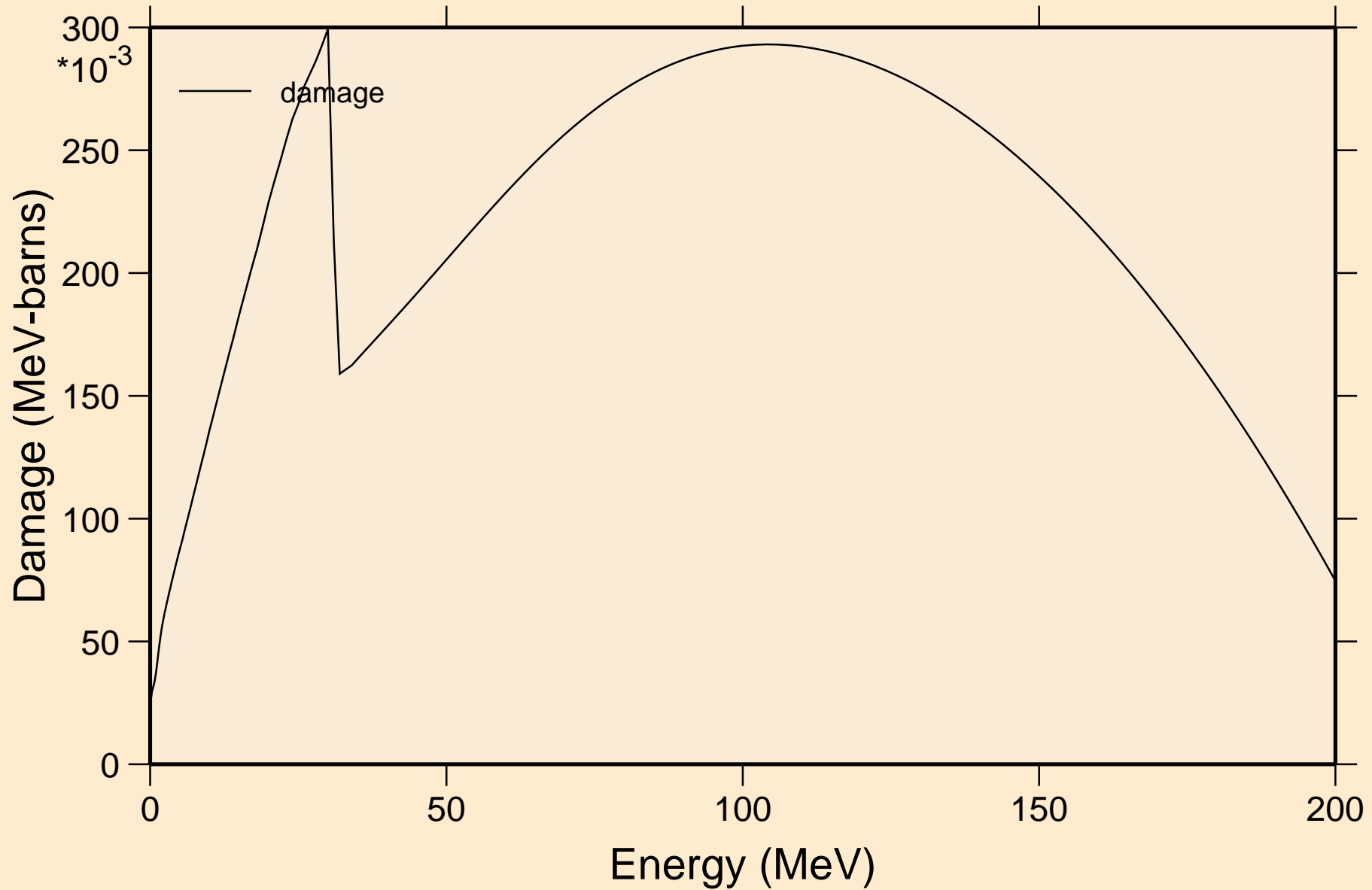

SG267 NEUTRON ACER TENDL-2021 LIBRARY; T=293.6K
Non-threshold reactions

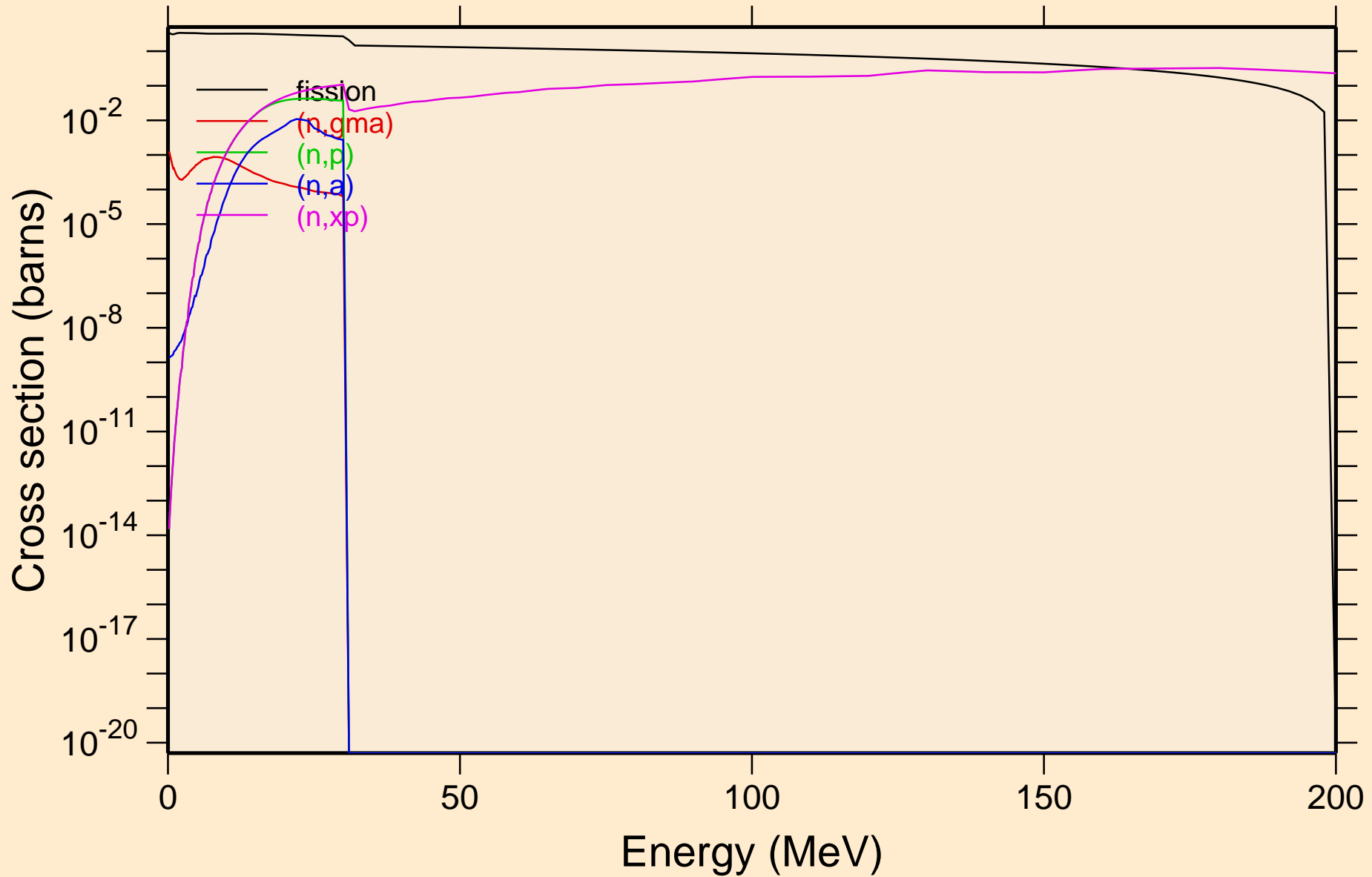

SG267 NEUTRON ACER TENDL-2021 LIBRARY; T=293.6K
Non-threshold reactions

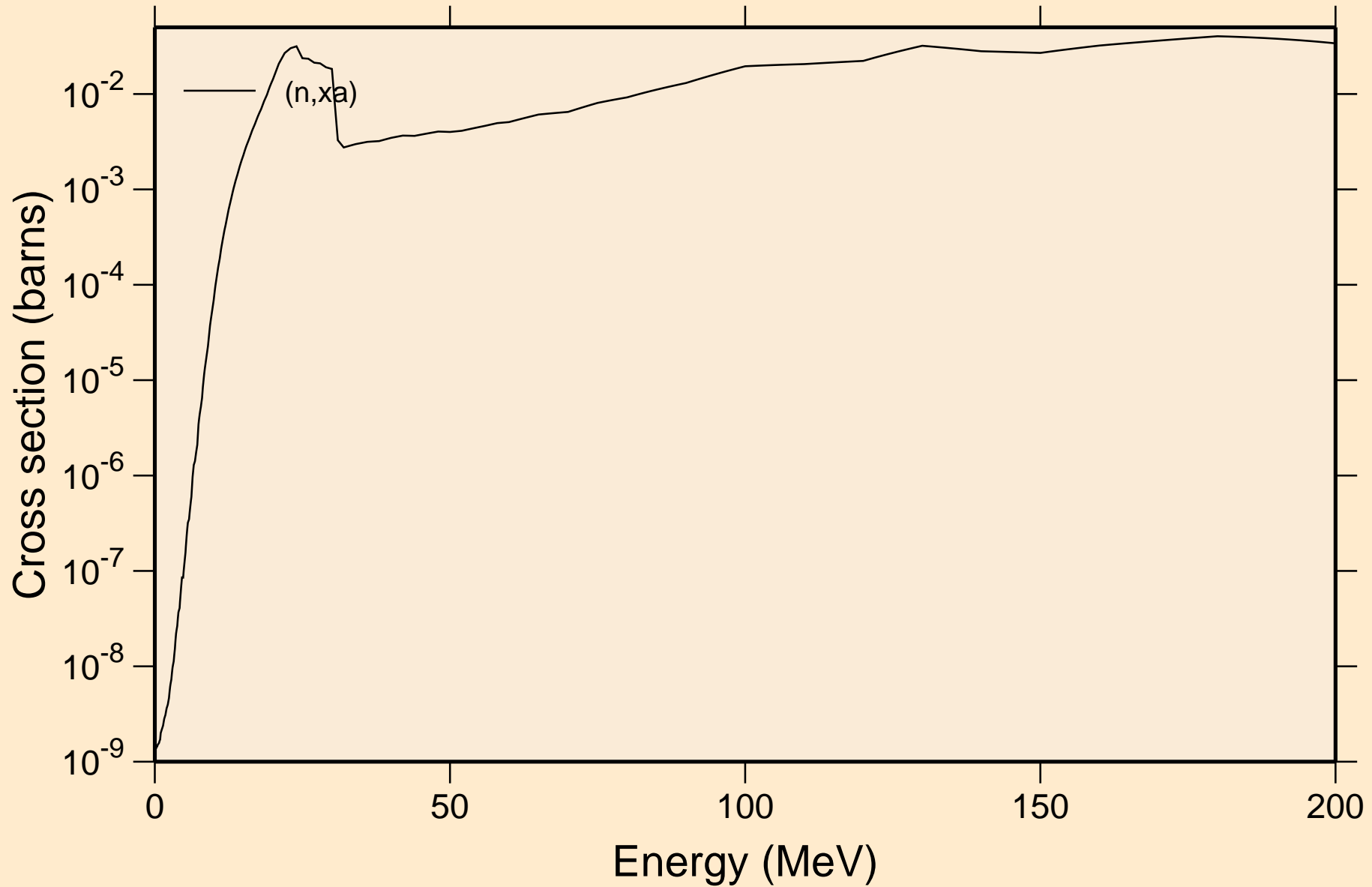

SG267 NEUTRON ACER TENDL-2021 LIBRARY; T=293.6K
Inelastic levels

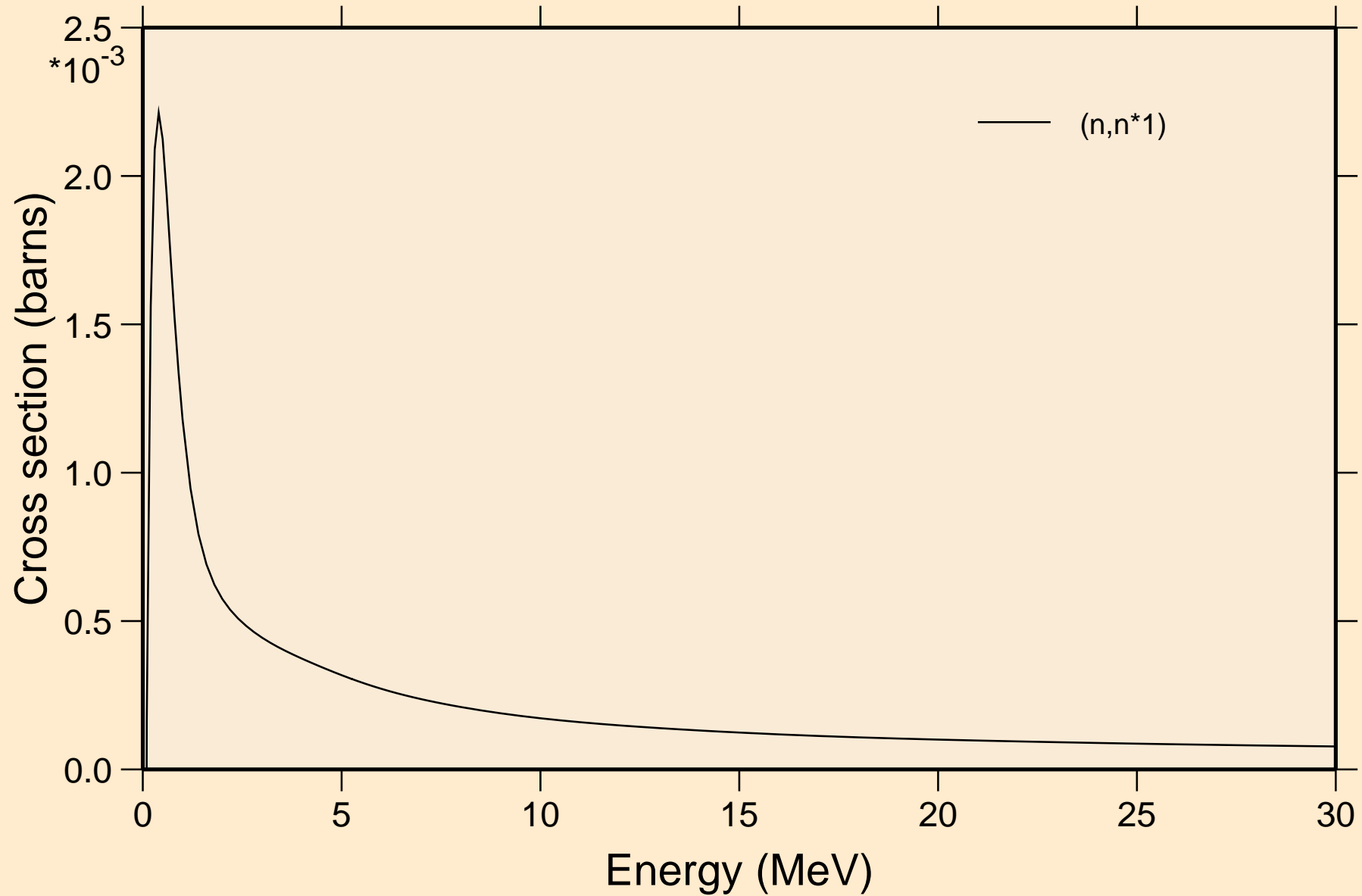

SG267 NEUTRON ACER TENDL-2021 LIBRARY; T=293.6K

Threshold reactions

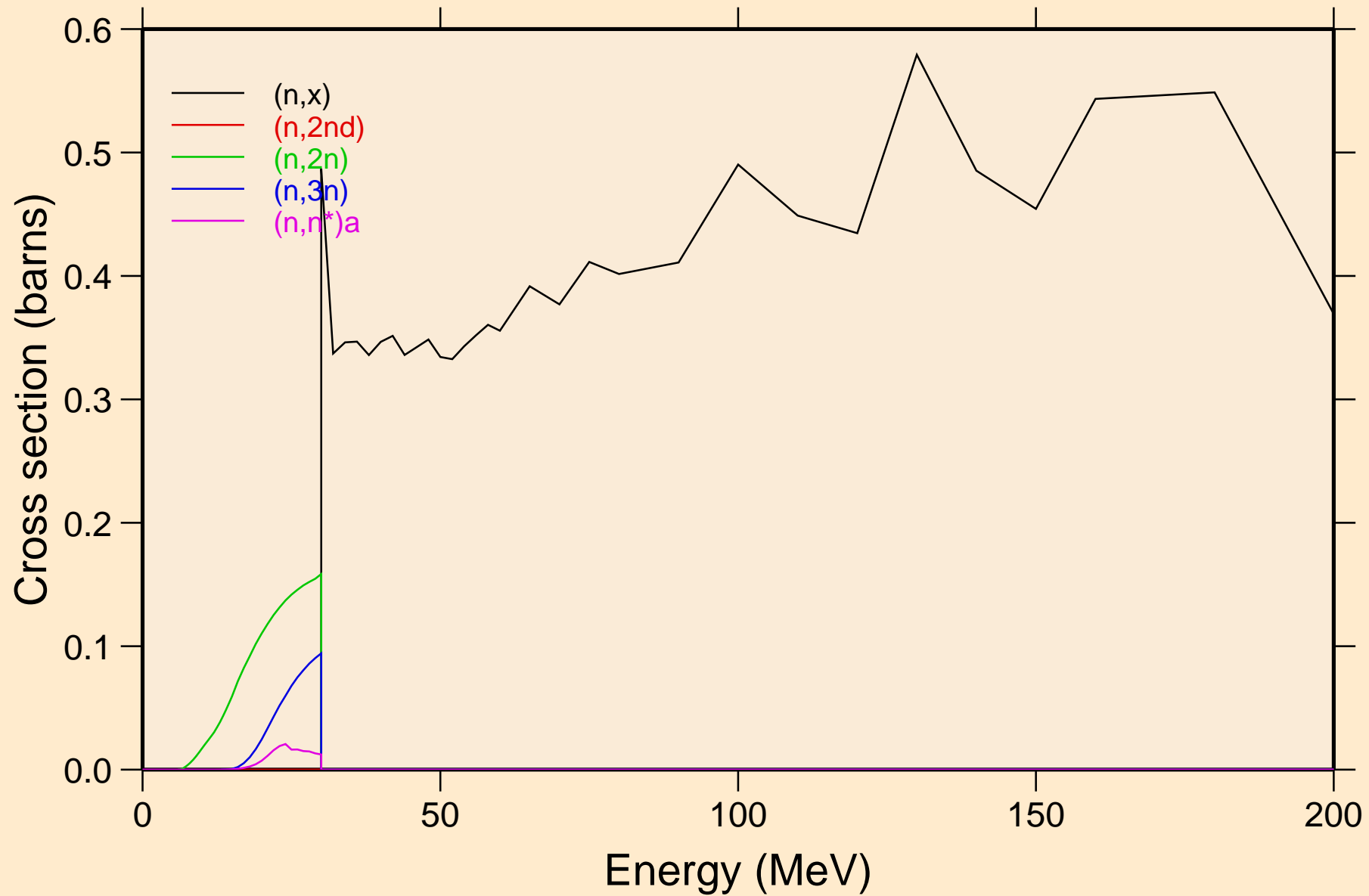

SG267 NEUTRON ACER TENDL-2021 LIBRARY; T=293.6K

Threshold reactions

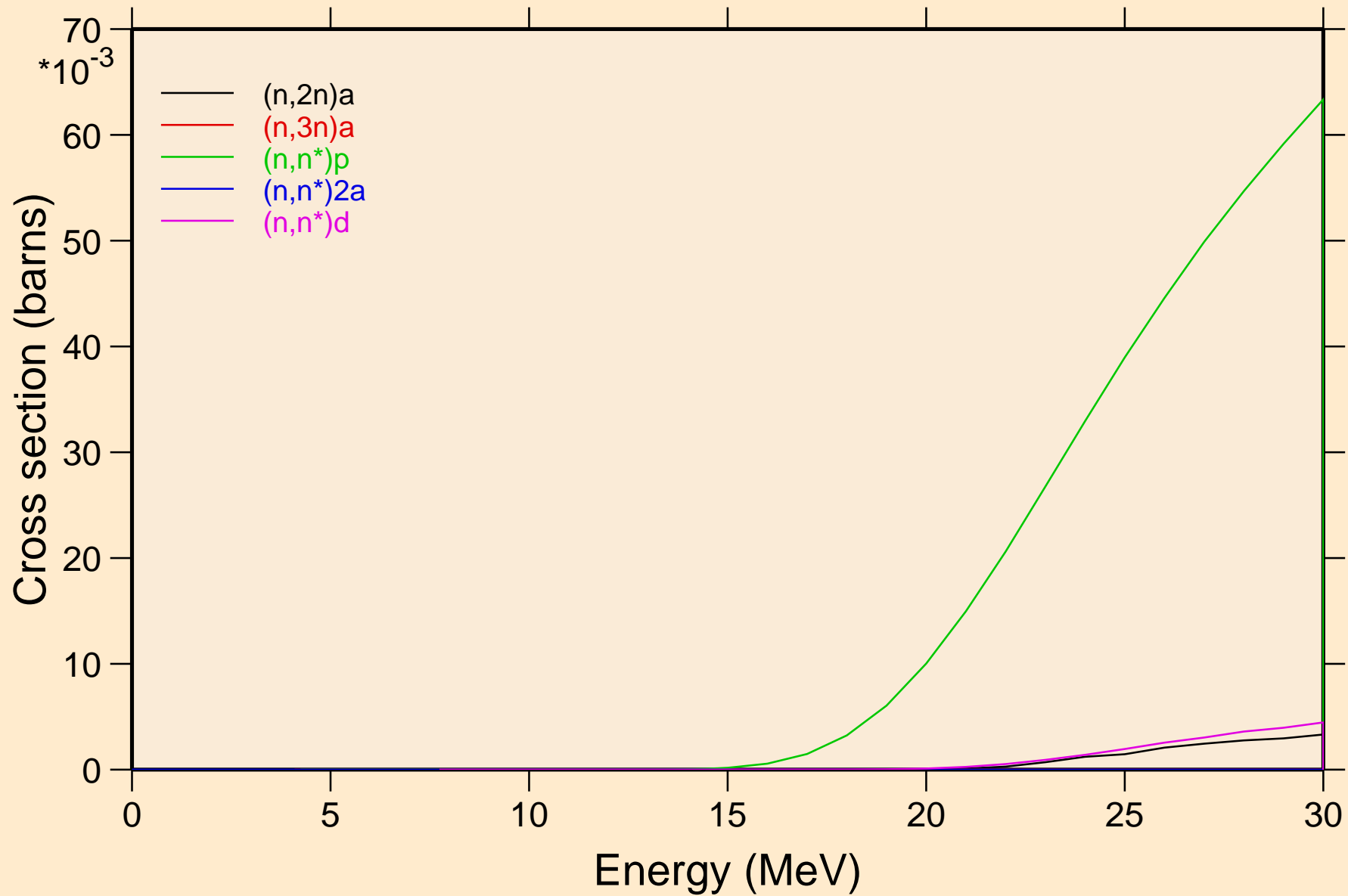

SG267 NEUTRON ACER TENDL-2021 LIBRARY; T=293.6K
Threshold reactions

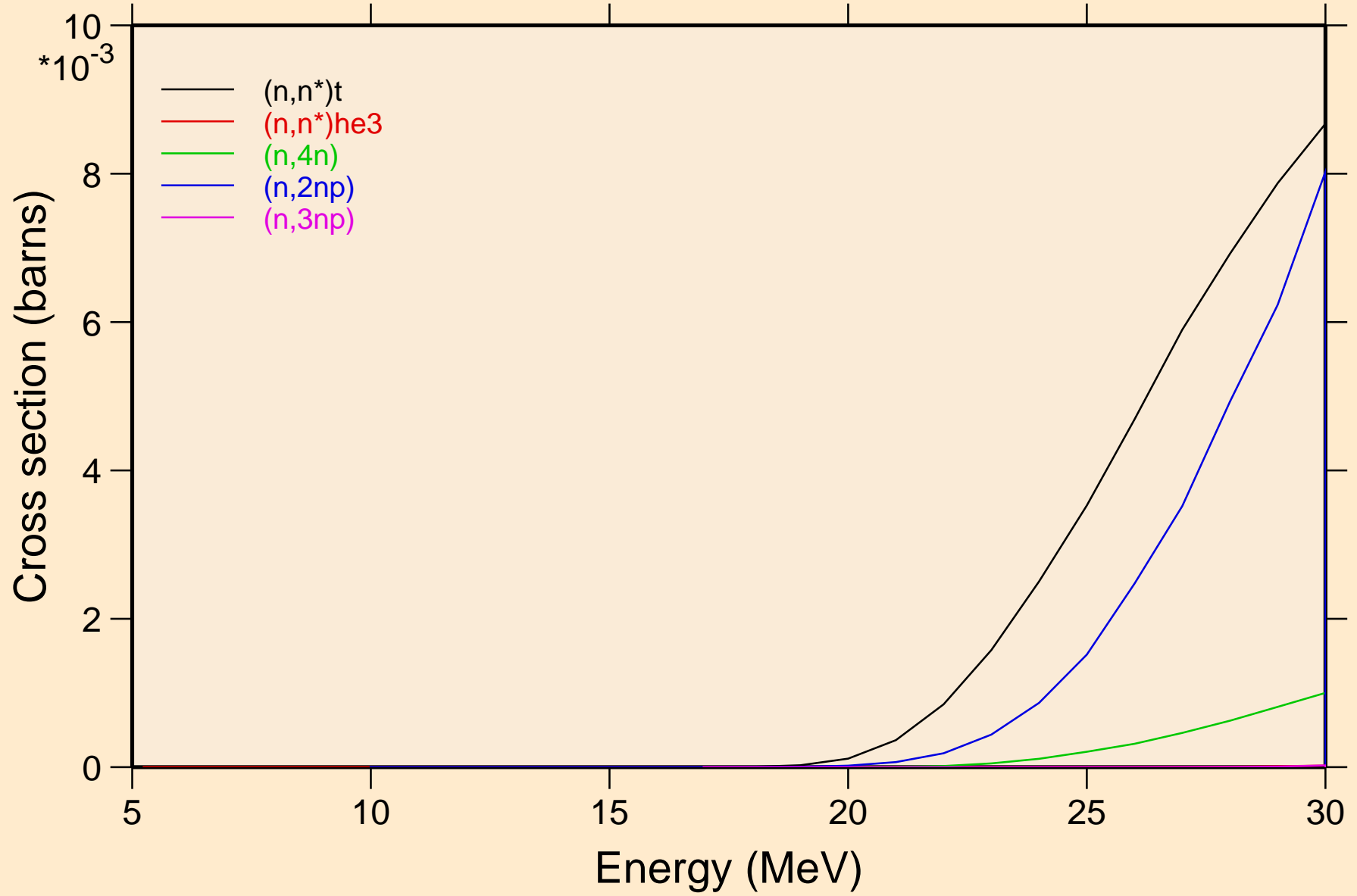

SG267 NEUTRON ACER TENDL-2021 LIBRARY; T=293.6K

Threshold reactions

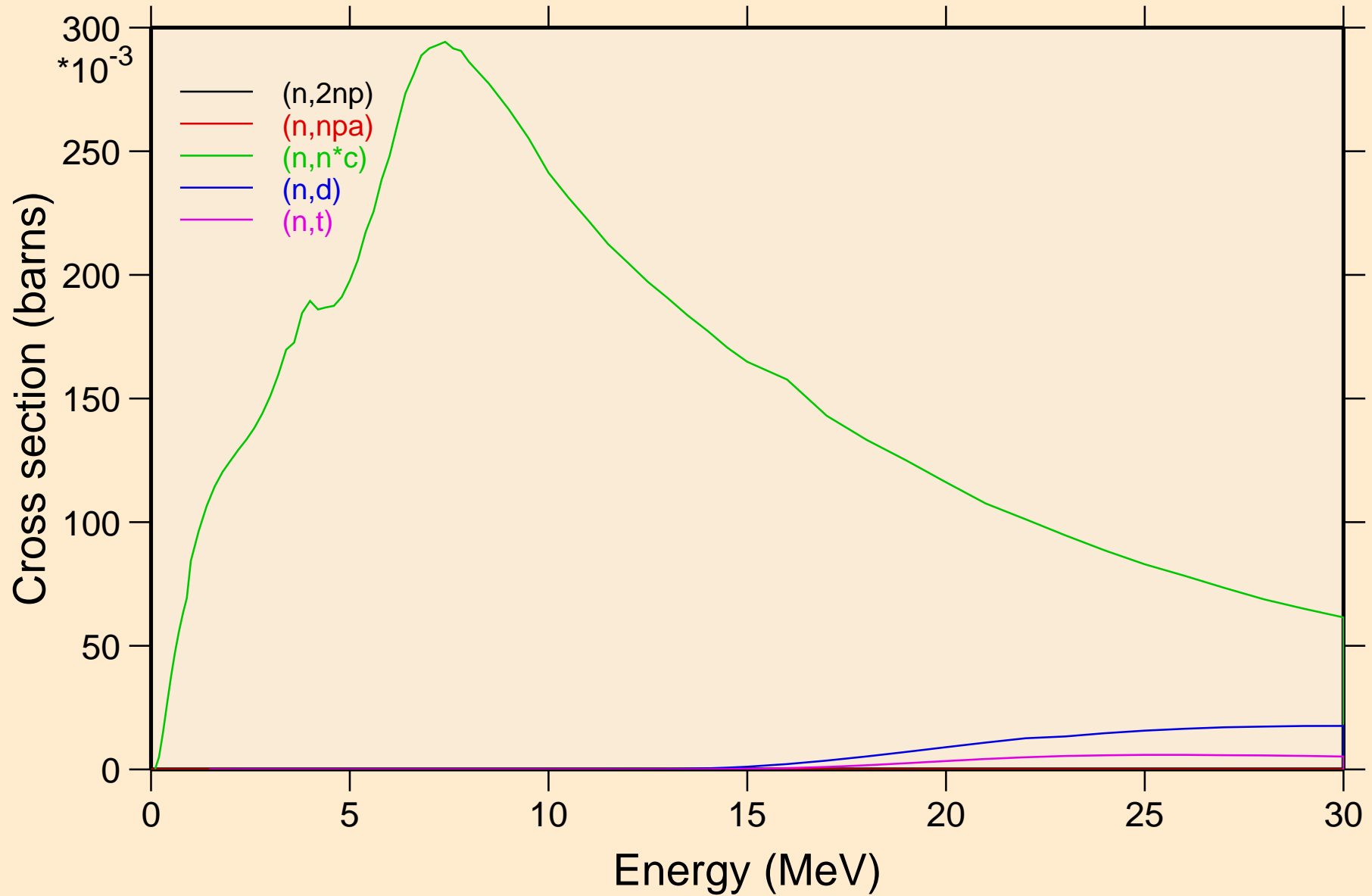

SG267 NEUTRON ACER TENDL-2021 LIBRARY; T=293.6K
Threshold reactions

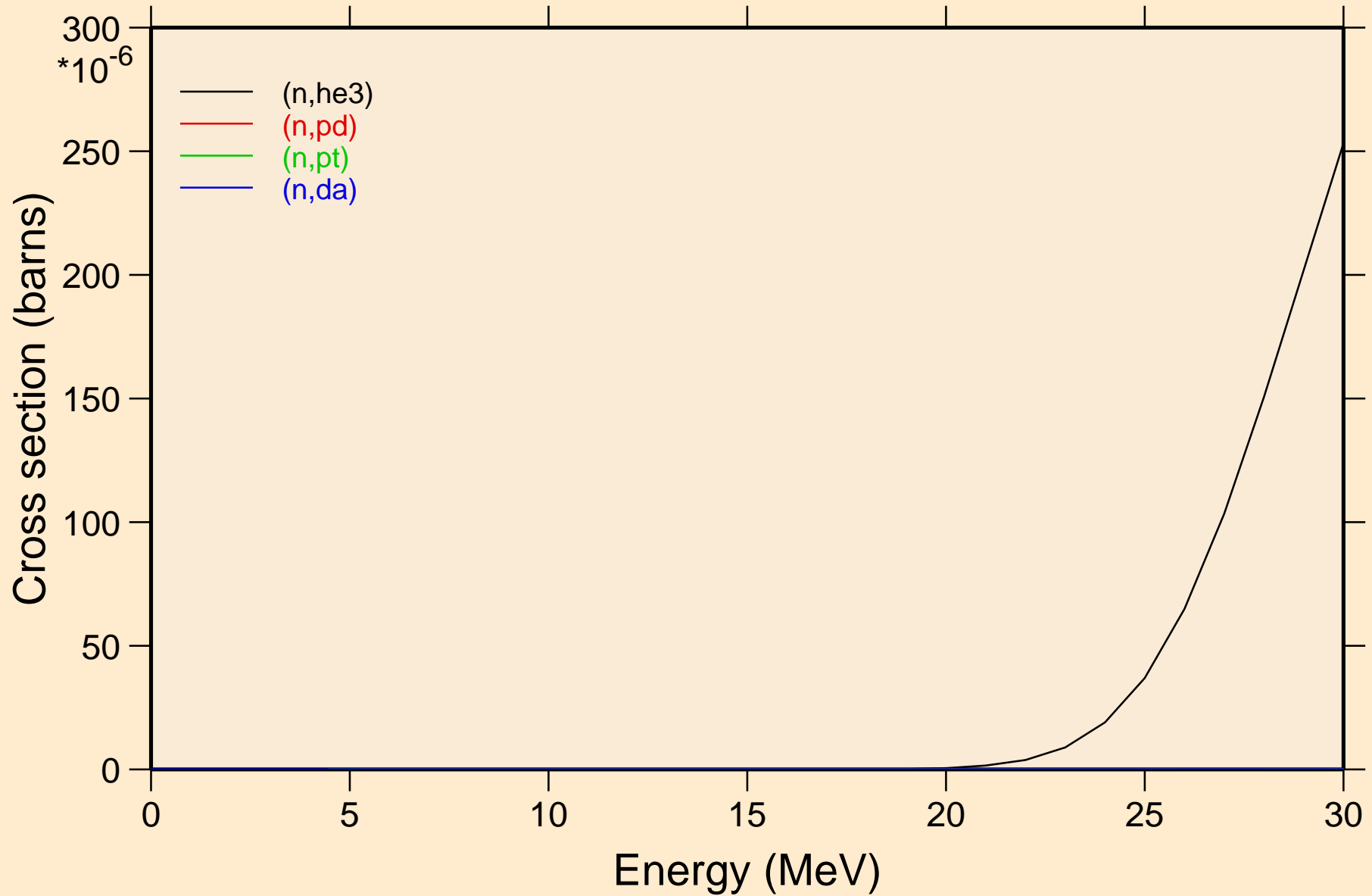

SG267 NEUTRON ACER TENDL-2021 LIBRARY; T=293.6K

Threshold reactions

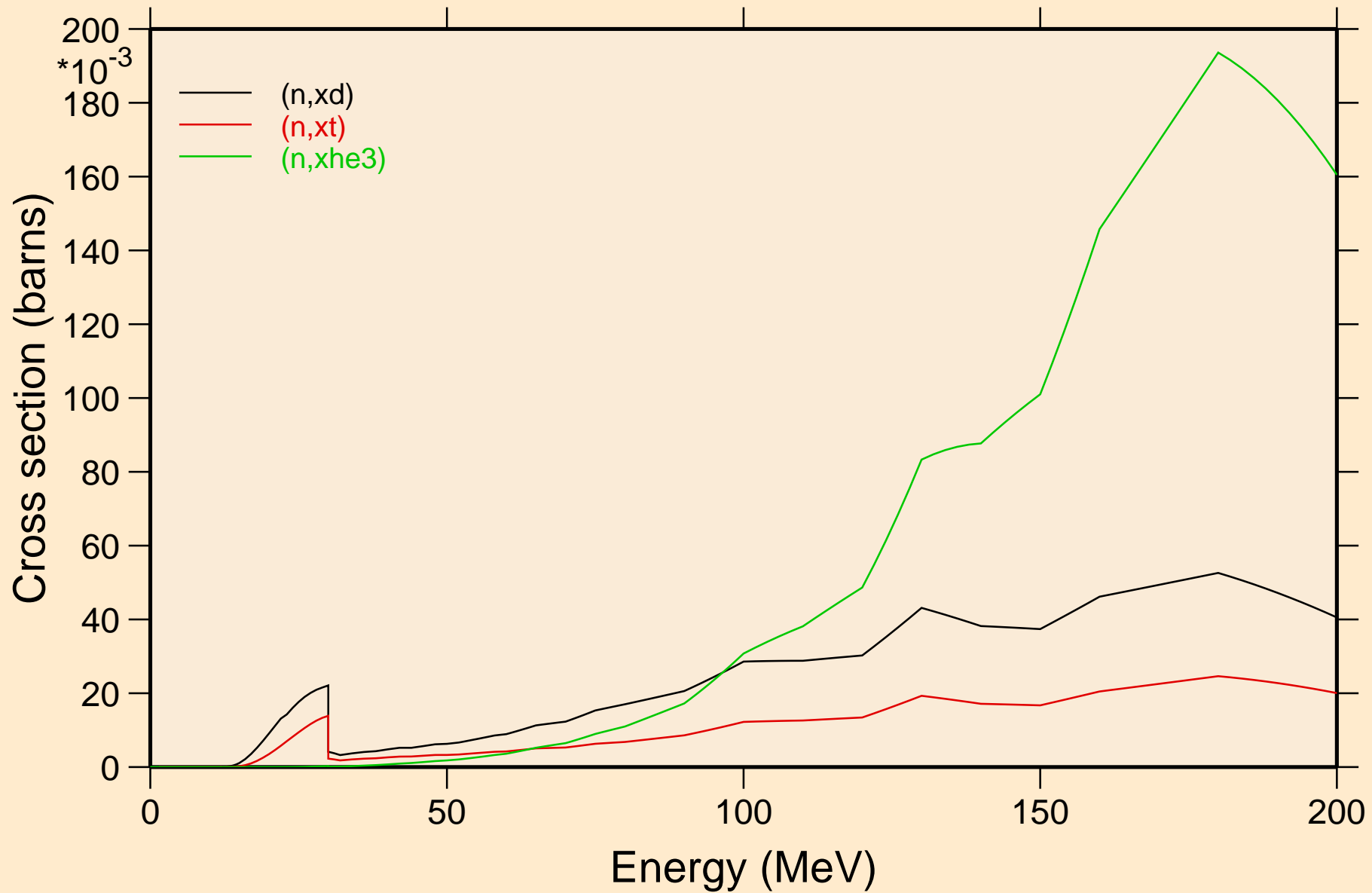

SG267 NEUTRON ACER TENDL-2021 LIBRARY; T=293.6K
angular distribution for elastic

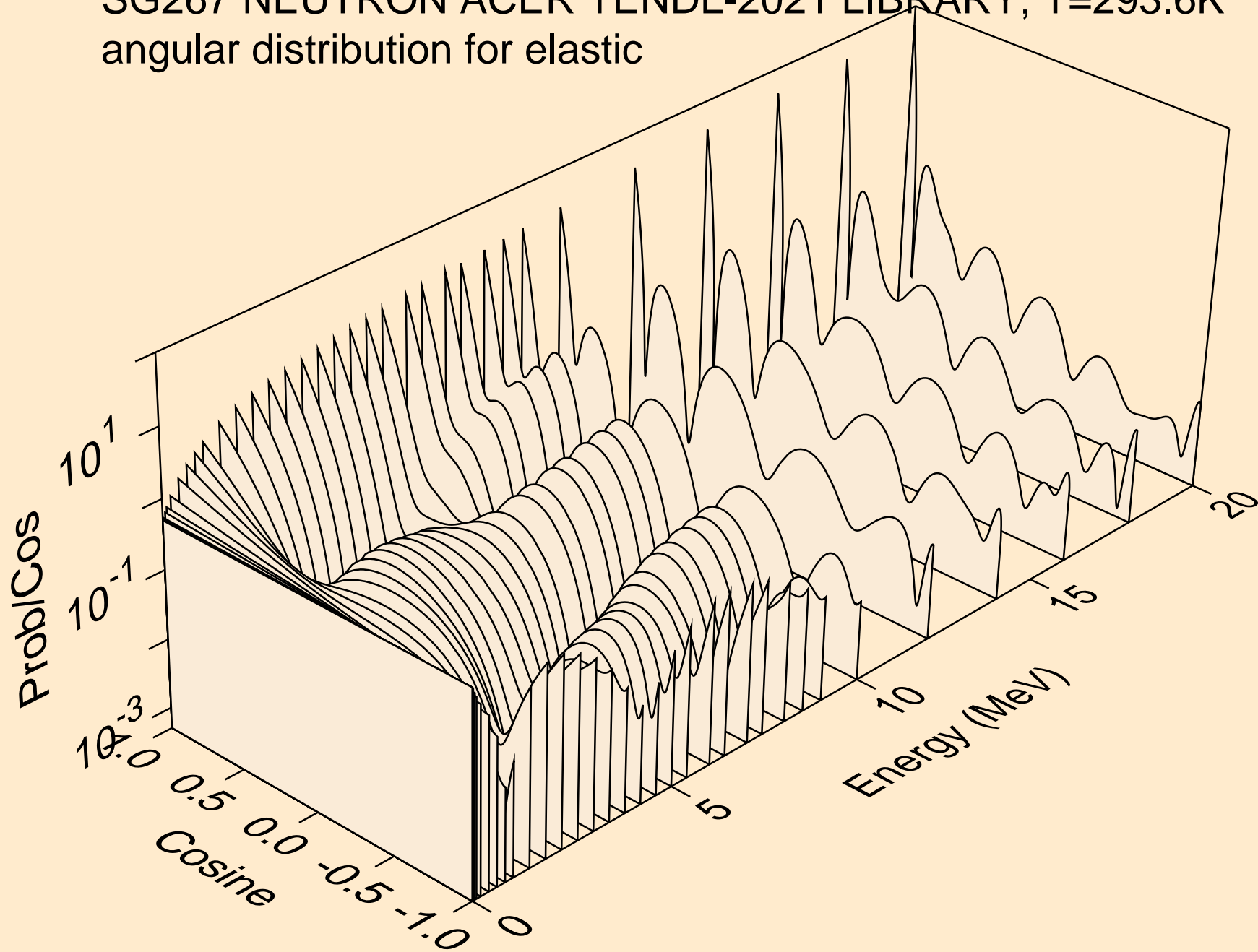

SG267 NEUTRON ACER TENDL-2021 LIBRARY; T=293.6K
angular distribution for elastic

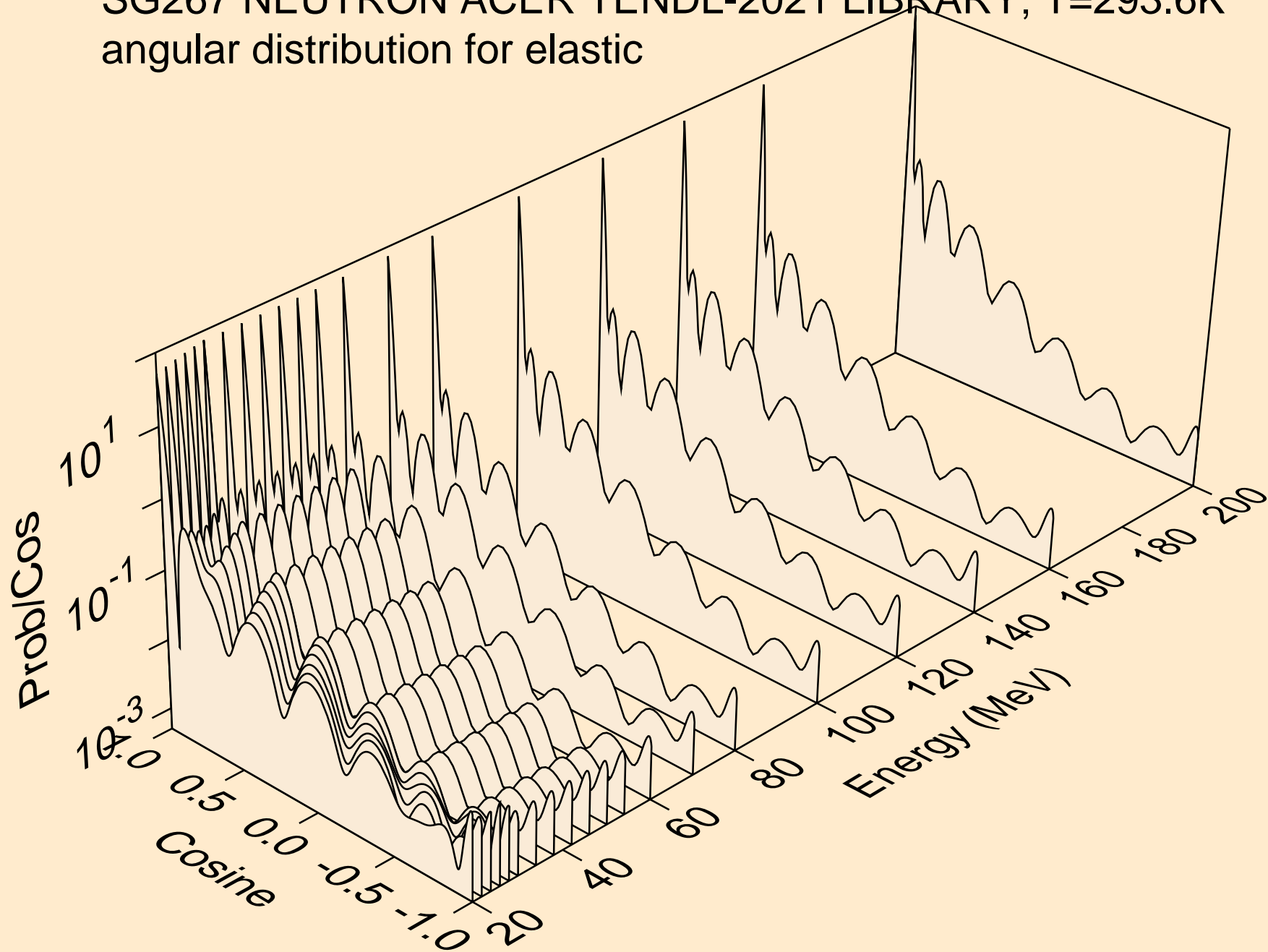

SG267 NEUTRON ACER TENDL-2021 LIBRARY; T=293.6K
angular distribution for (n,n*1)

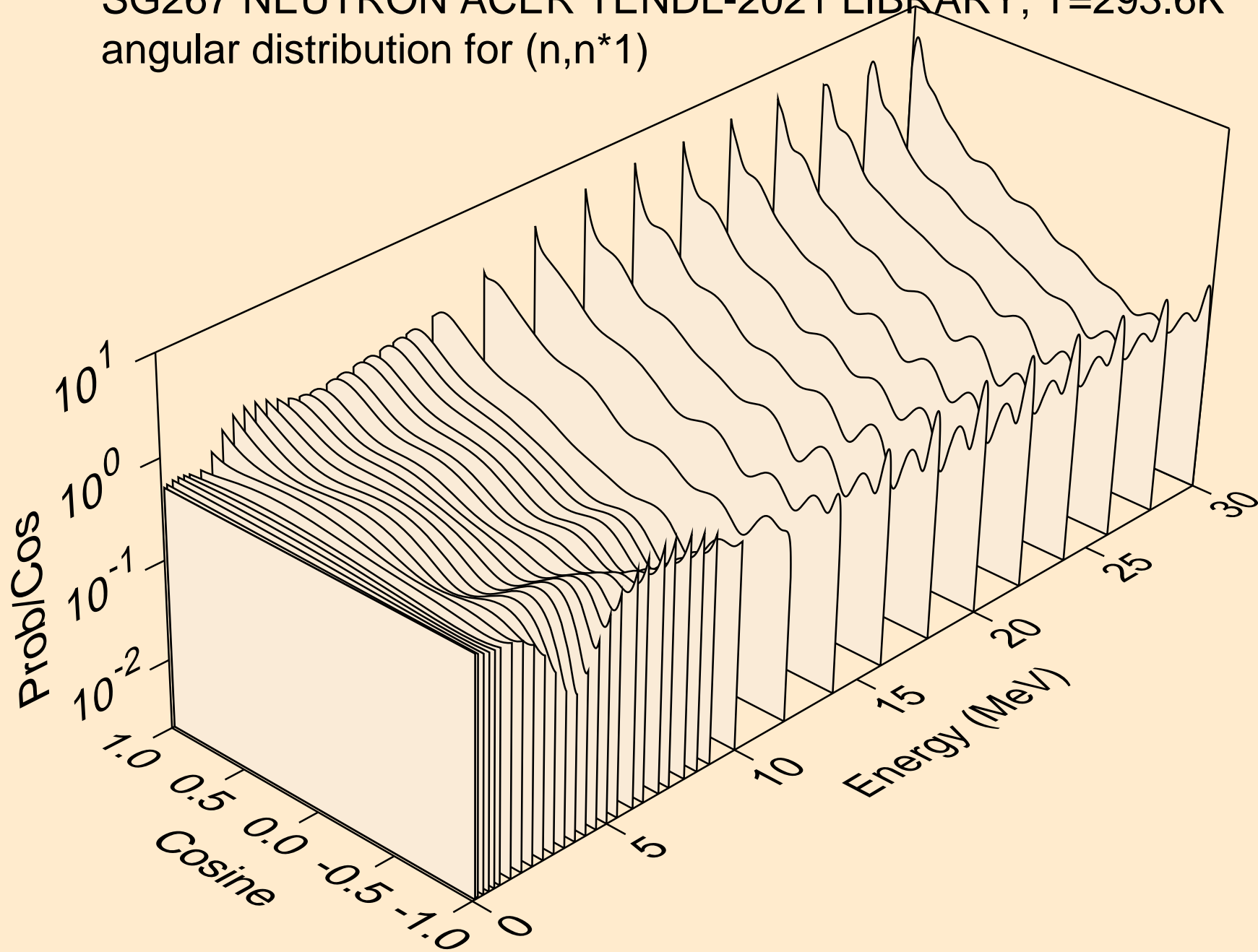

SG267 NEUTRON ACER TENDL-2021 LIBRARY; T=293.6K
Total fission nubar

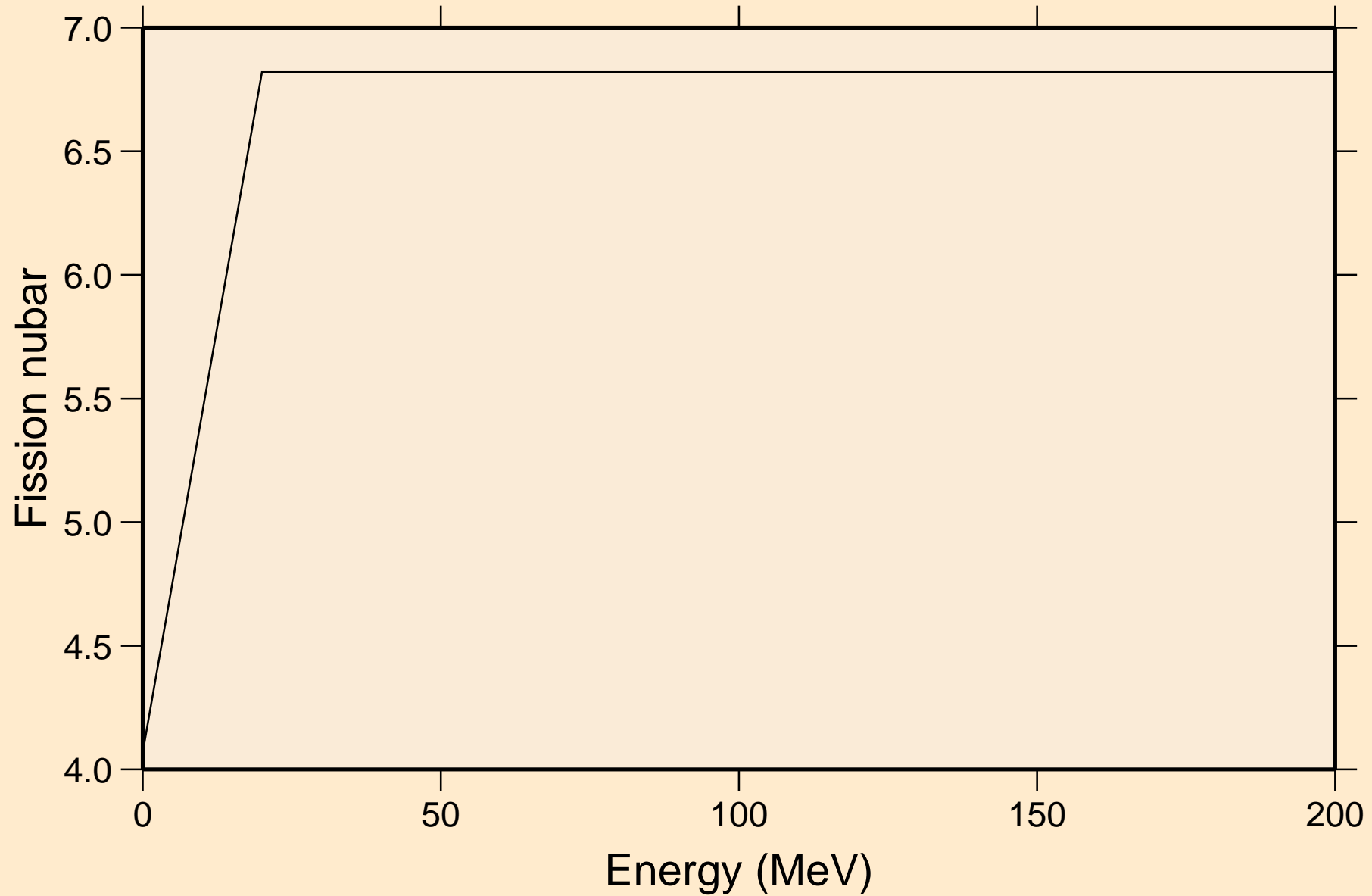

SG267 NEUTRON ACER TENDL-2021 LIBRARY; T=293.6K
Neutron emission for (n,x)

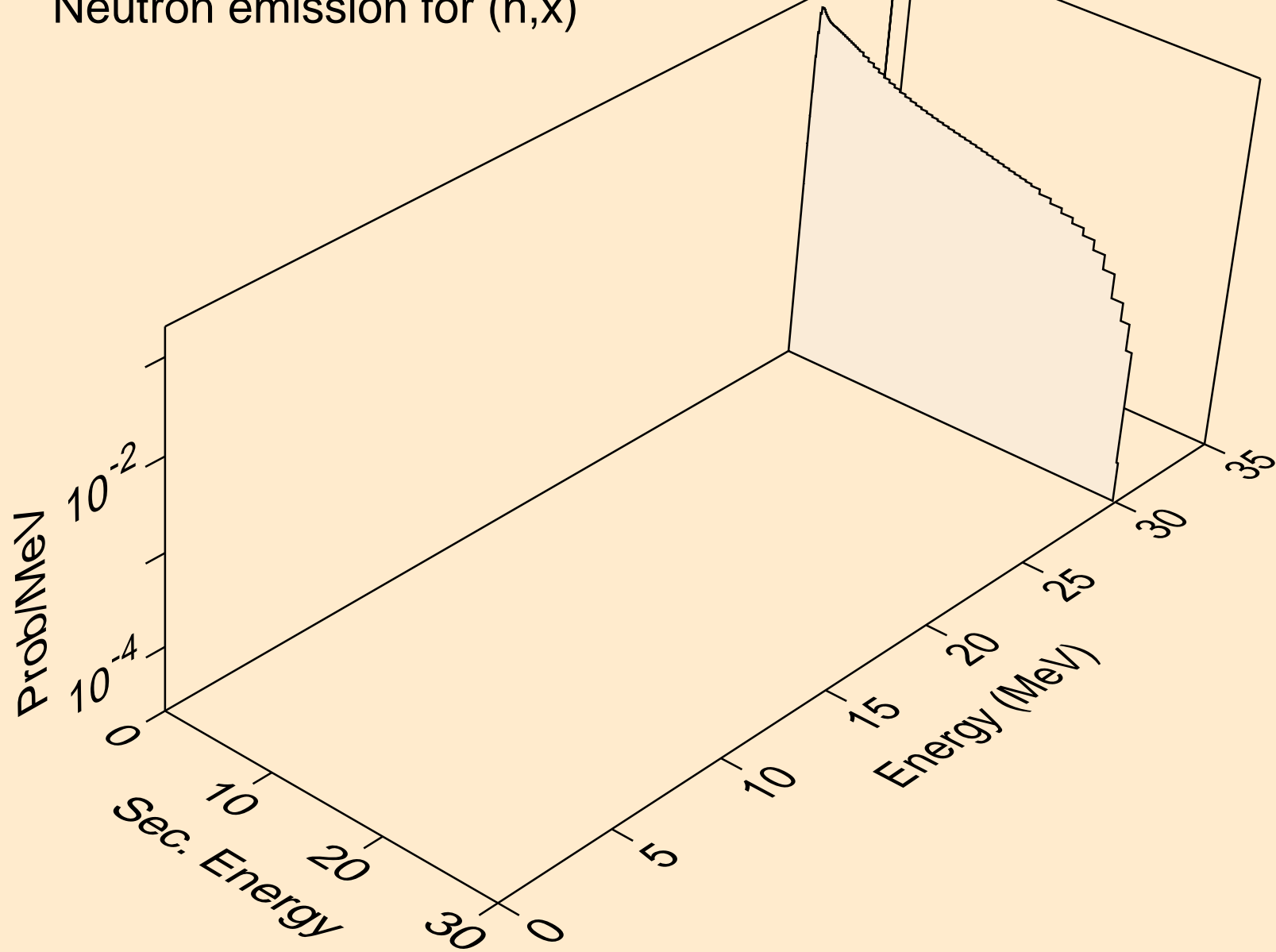

SG267 NEUTRON ACER TENDL-2021 LIBRARY; T=293.6K
Neutron emission for (n,2nd)

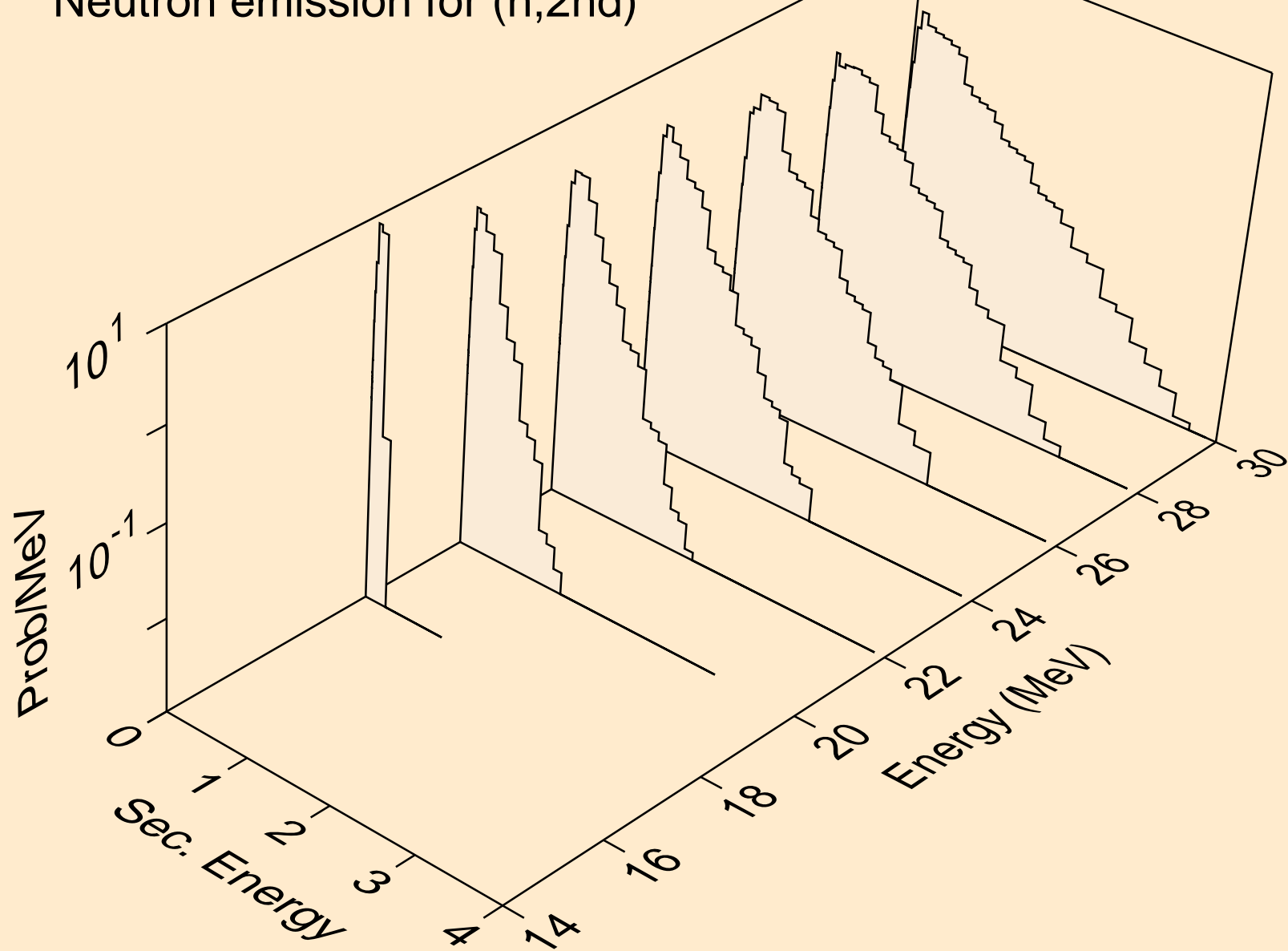

SG267 NEUTRON ACER TENDL-2021 LIBRARY; T=293.6K
Neutron emission for (n,2n)

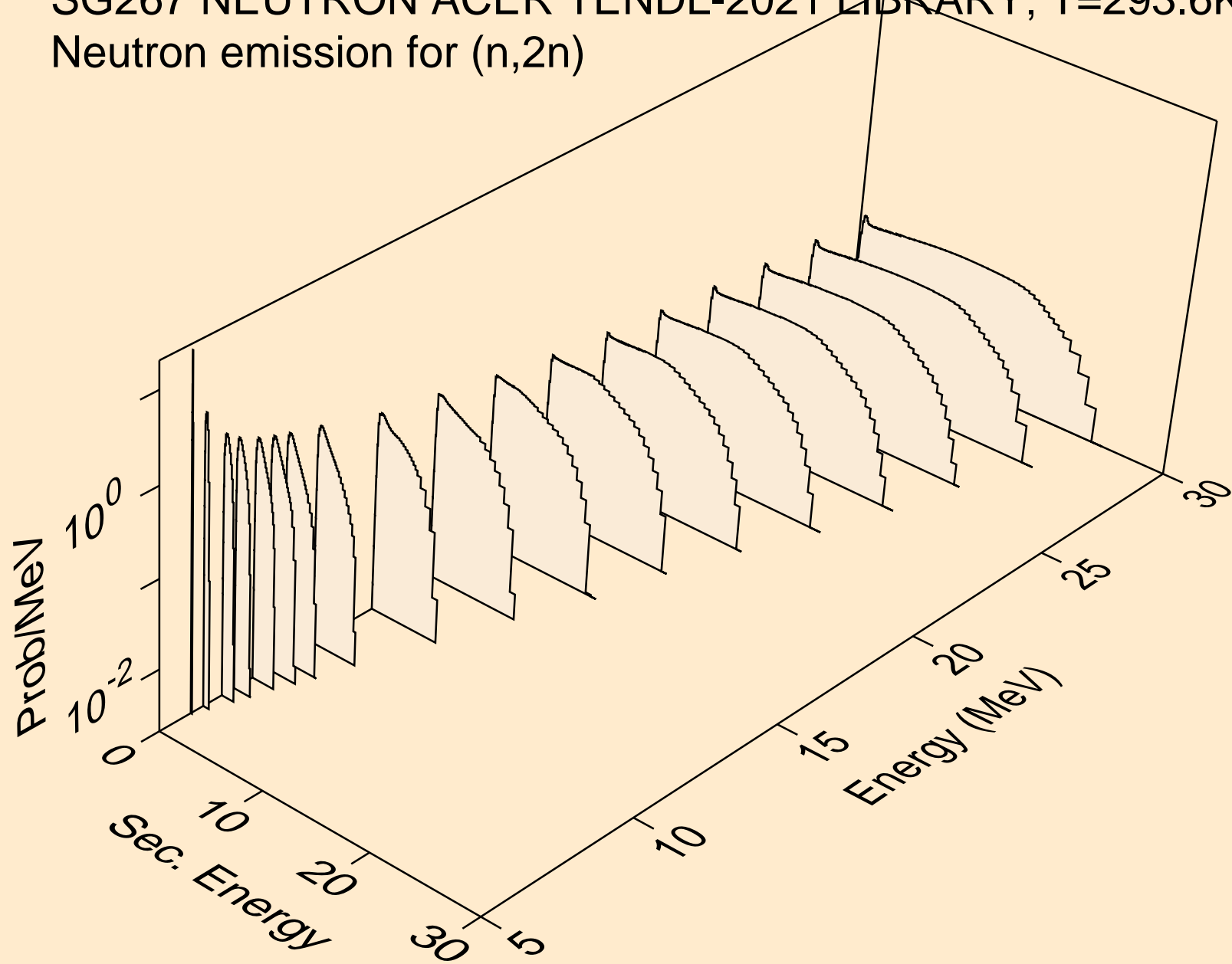

SG267 NEUTRON ACER TENDL-2021 LIBRARY; T=293.6K
Neutron emission for (n,3n)

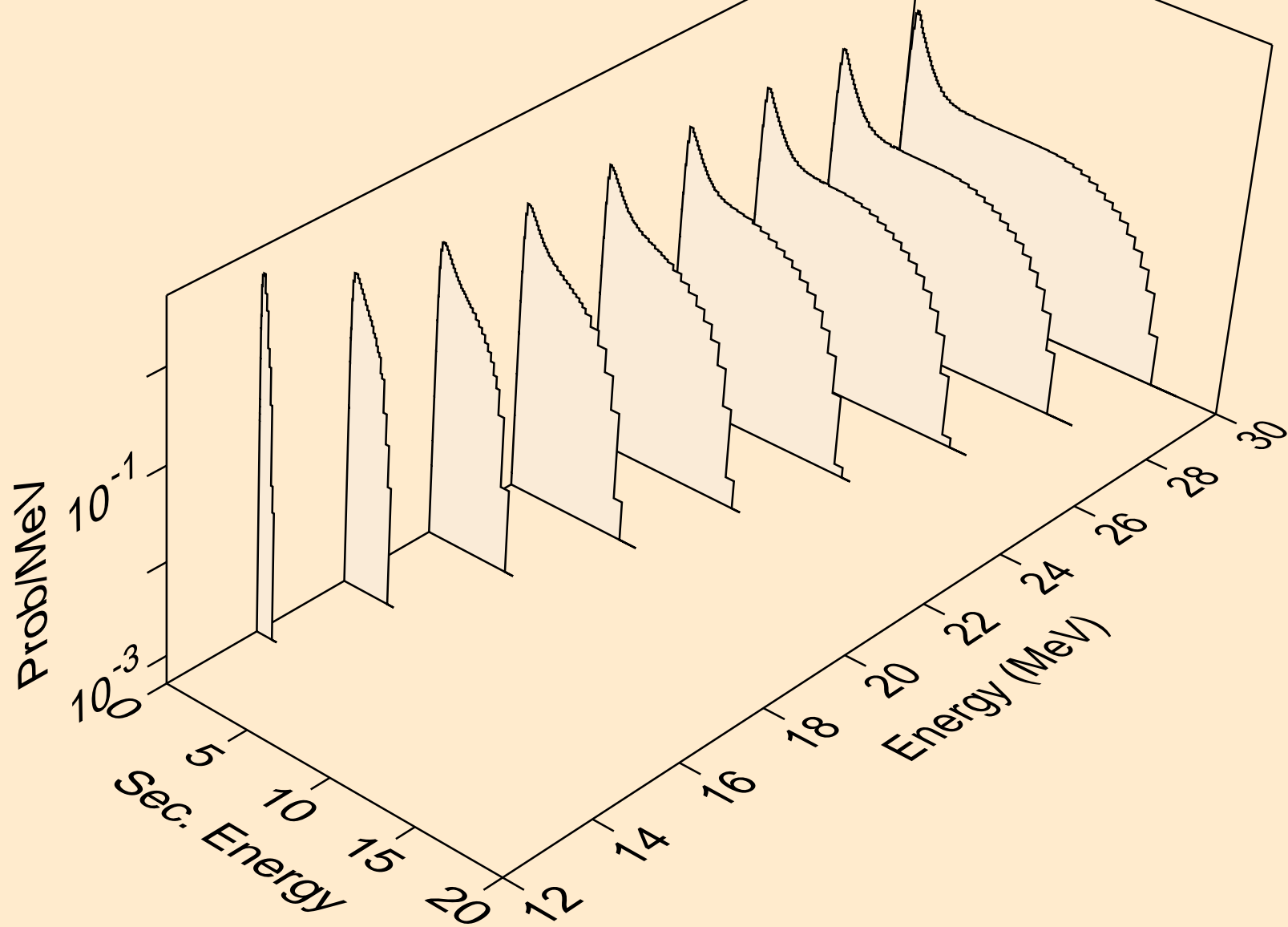

SG267 NEUTRON ACER TENDL-2021 LIBRARY; T=293.6K
Neutron emission for fission

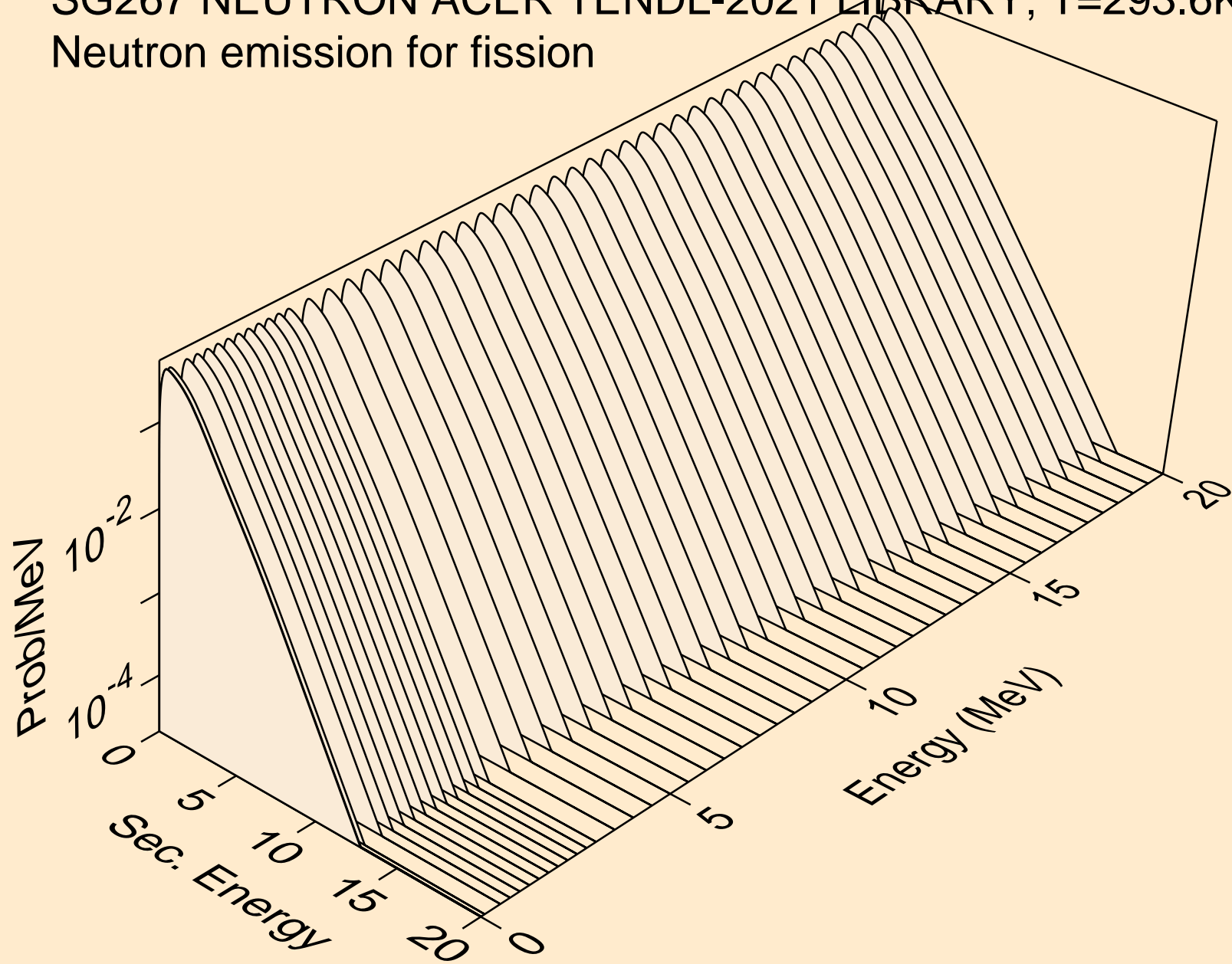

SG267 NEUTRON ACER TENDL-2021 LIBRARY; T=293.6K
Neutron emission for (n,n*)a

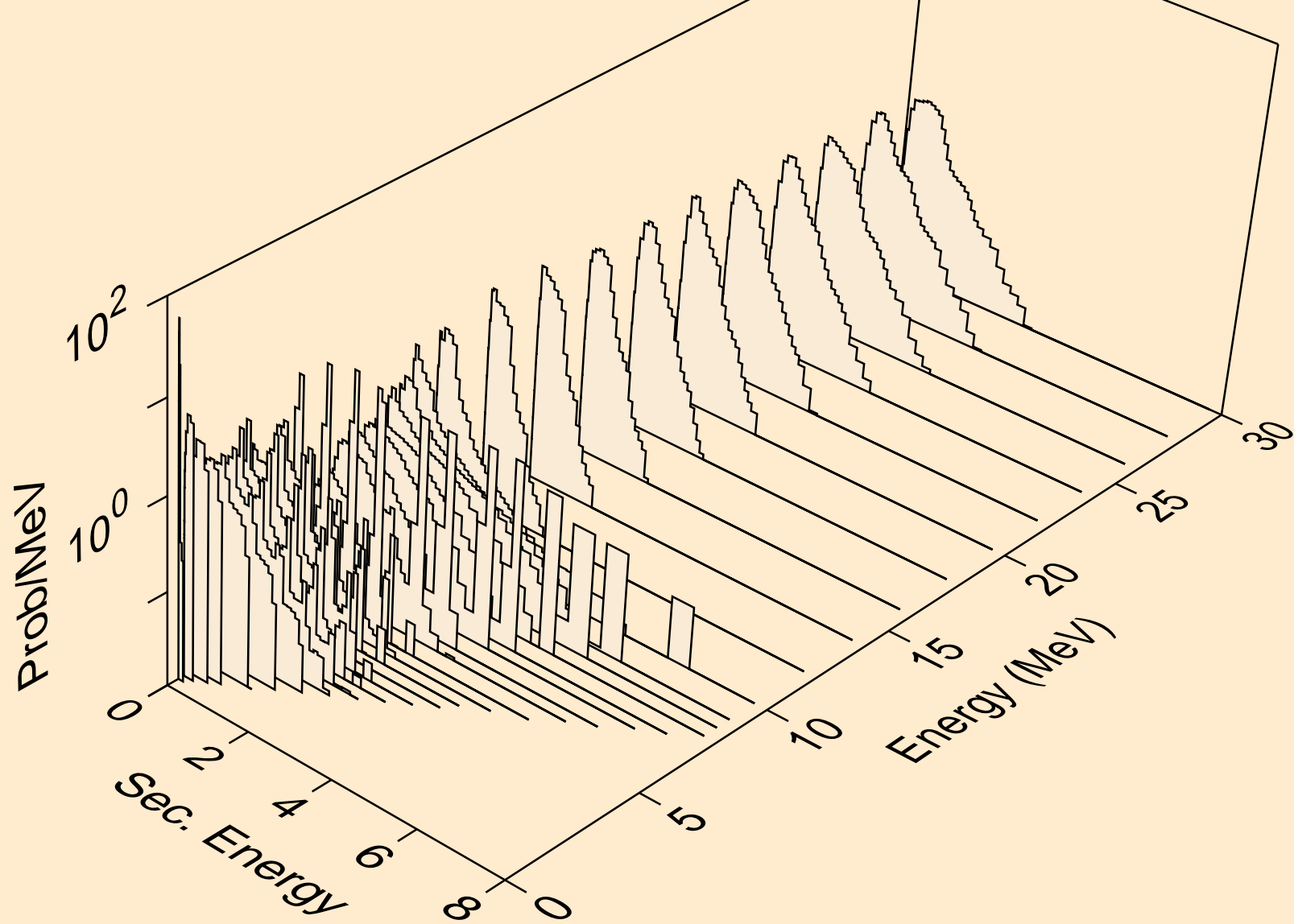

SG267 NEUTRON ACER TENDL-2021 LIBRARY; T=293.6K
Neutron emission for (n,2n)_a

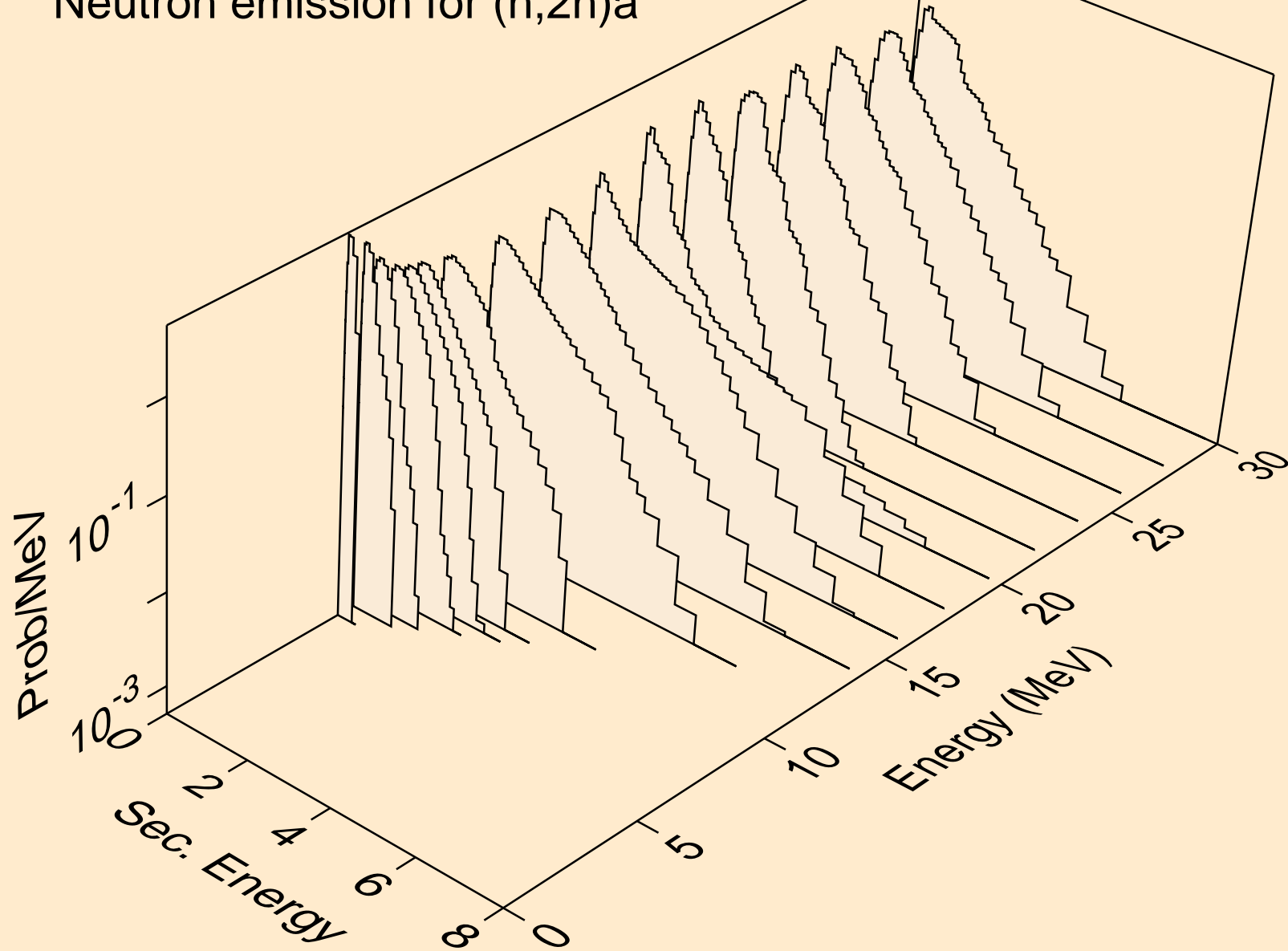

SG267 NEUTRON ACER TENDL-2021 LIBRARY; T=293.6K
Neutron emission for (n,3n)a

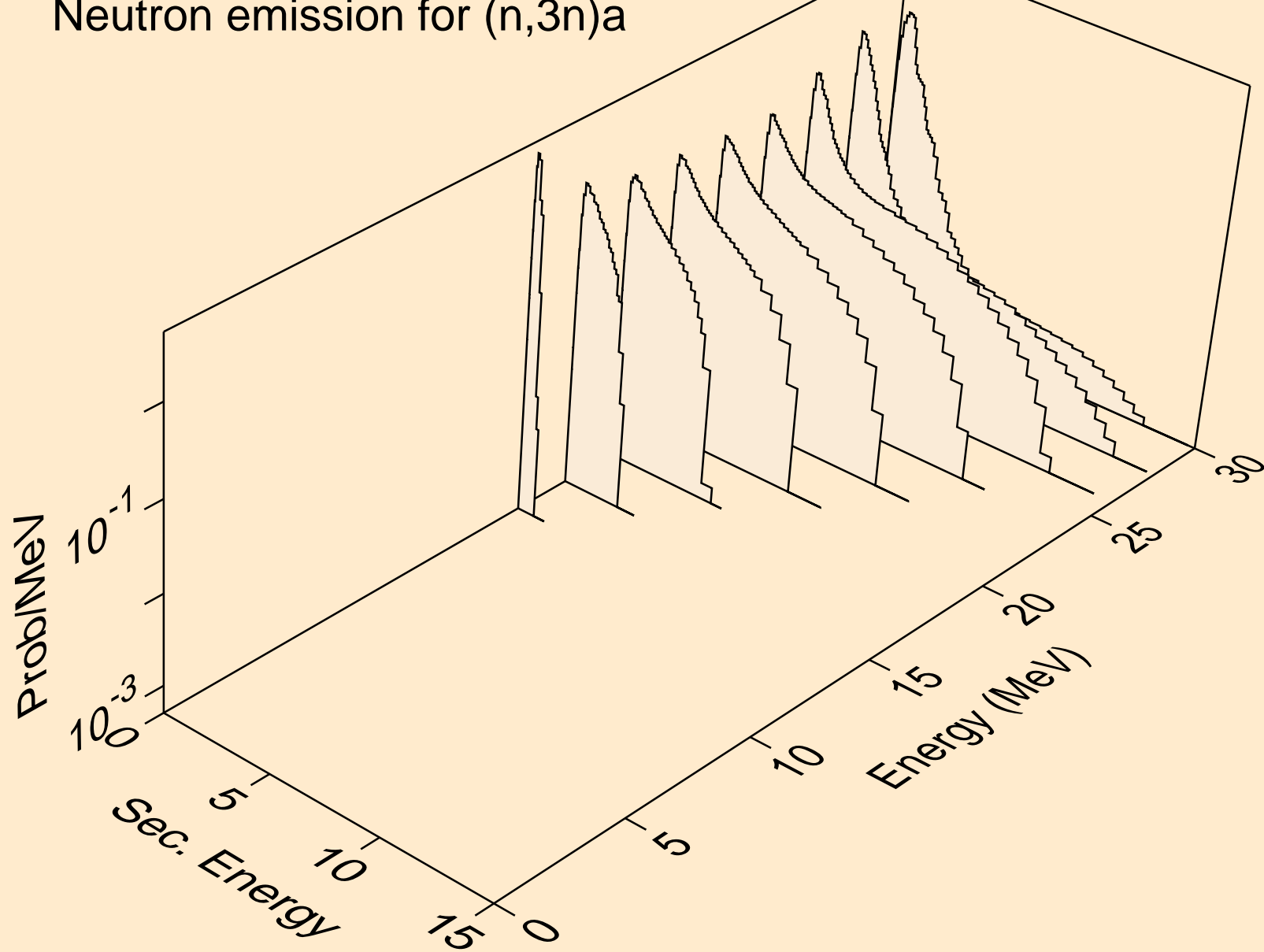

SG267 NEUTRON ACER TENDL-2021 LIBRARY; T=293.6K
Neutron emission for (n,n*)p

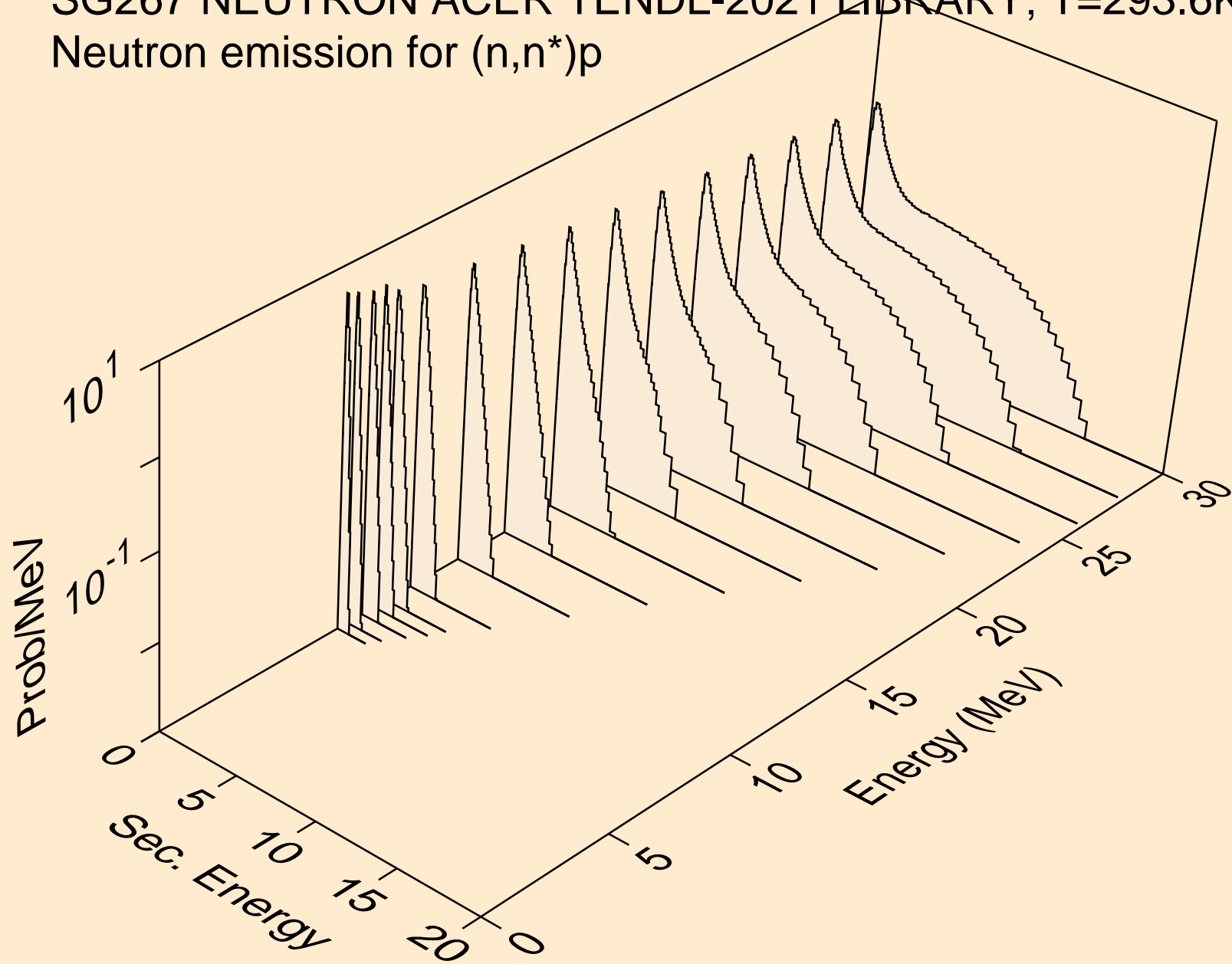

SG267 NEUTRON ACER TENDL-2021 LIBRARY; T=293.6K
Neutron emission for (n,n*)2a

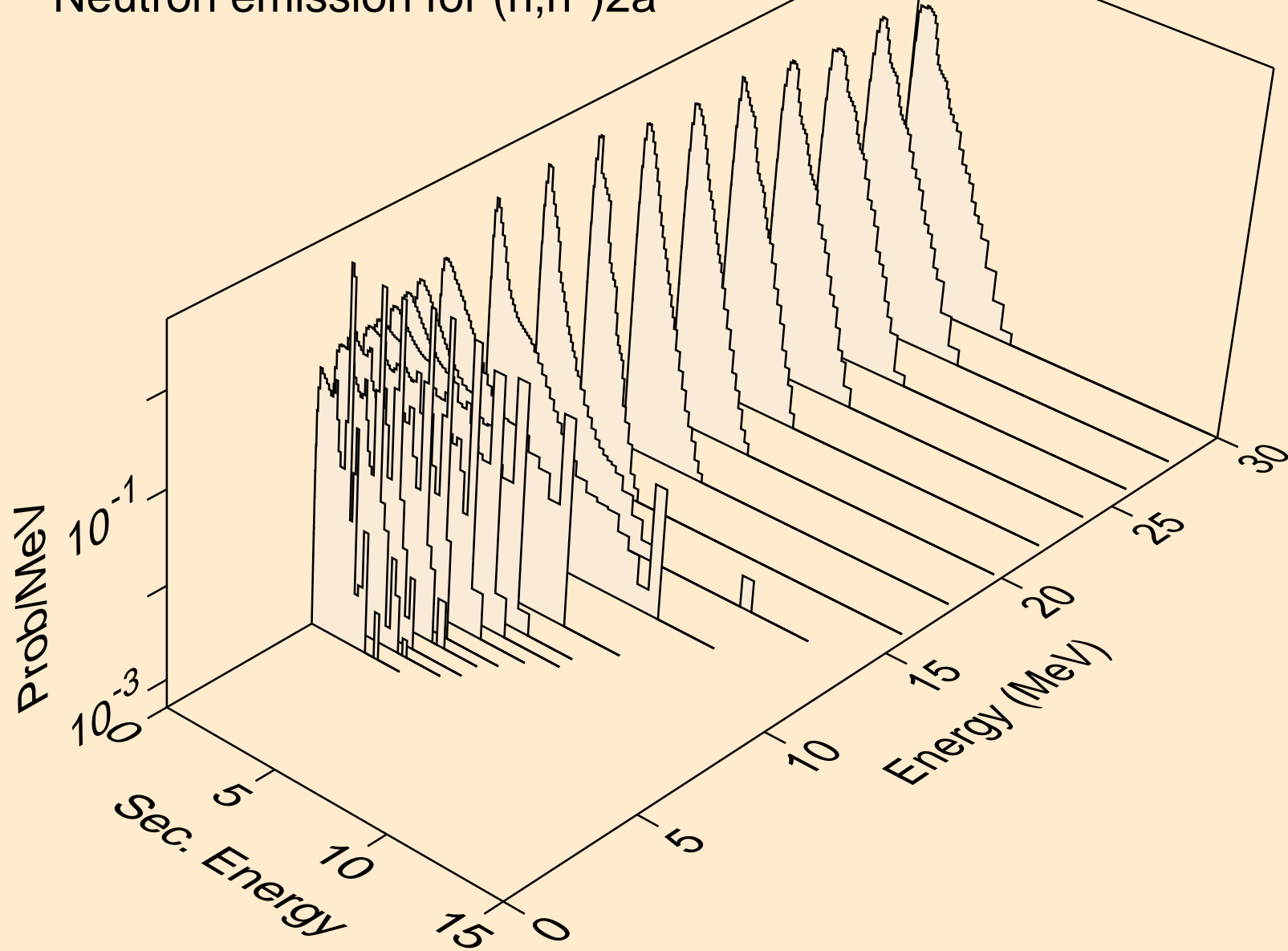

SG267 NEUTRON ACER TENDL-2021 LIBRARY; T=293.6K
Neutron emission for (n,n*)d

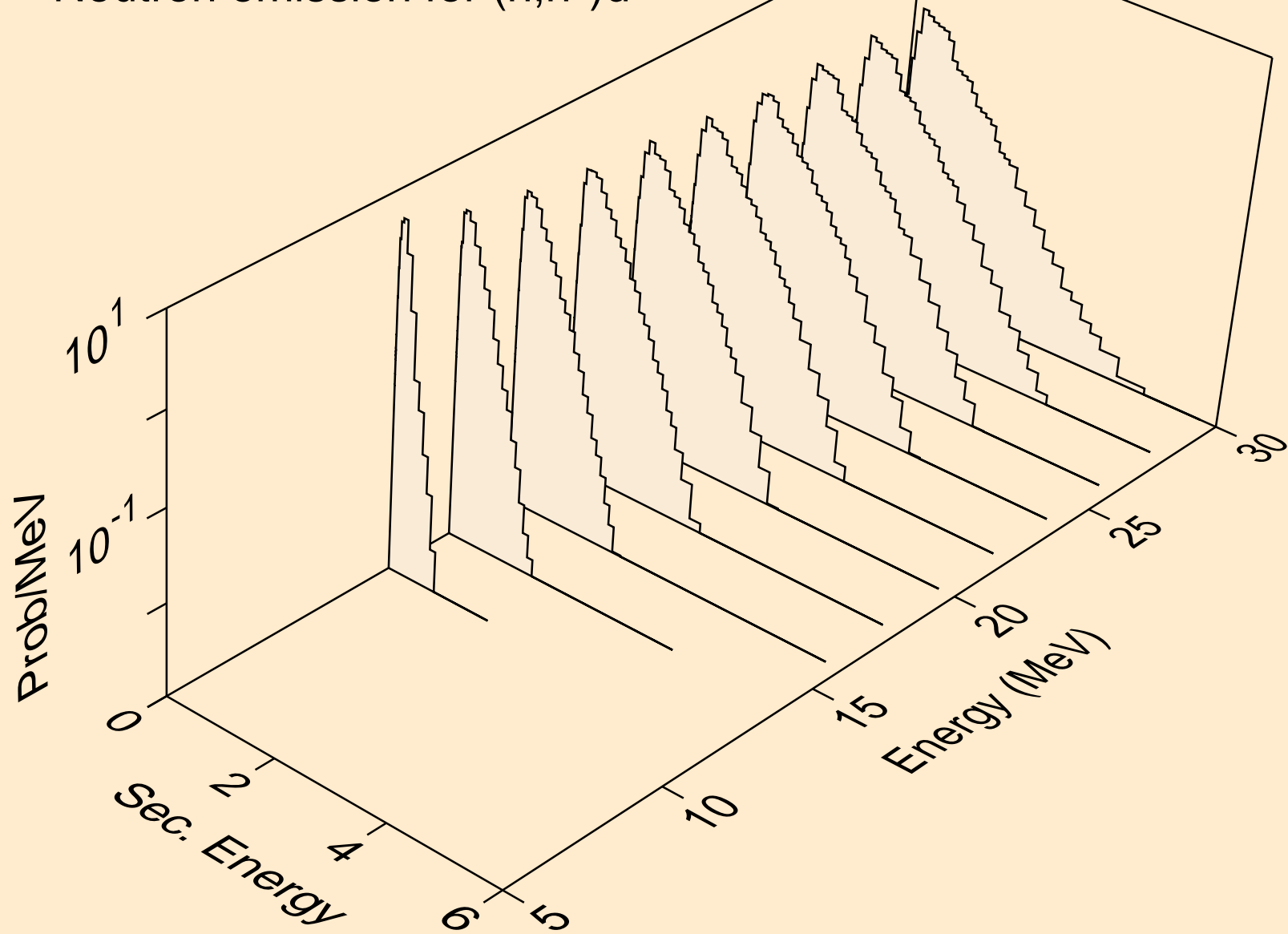

SG267 NEUTRON ACER TENDL-2021 LIBRARY; T=293.6K
Neutron emission for (n,n*)t

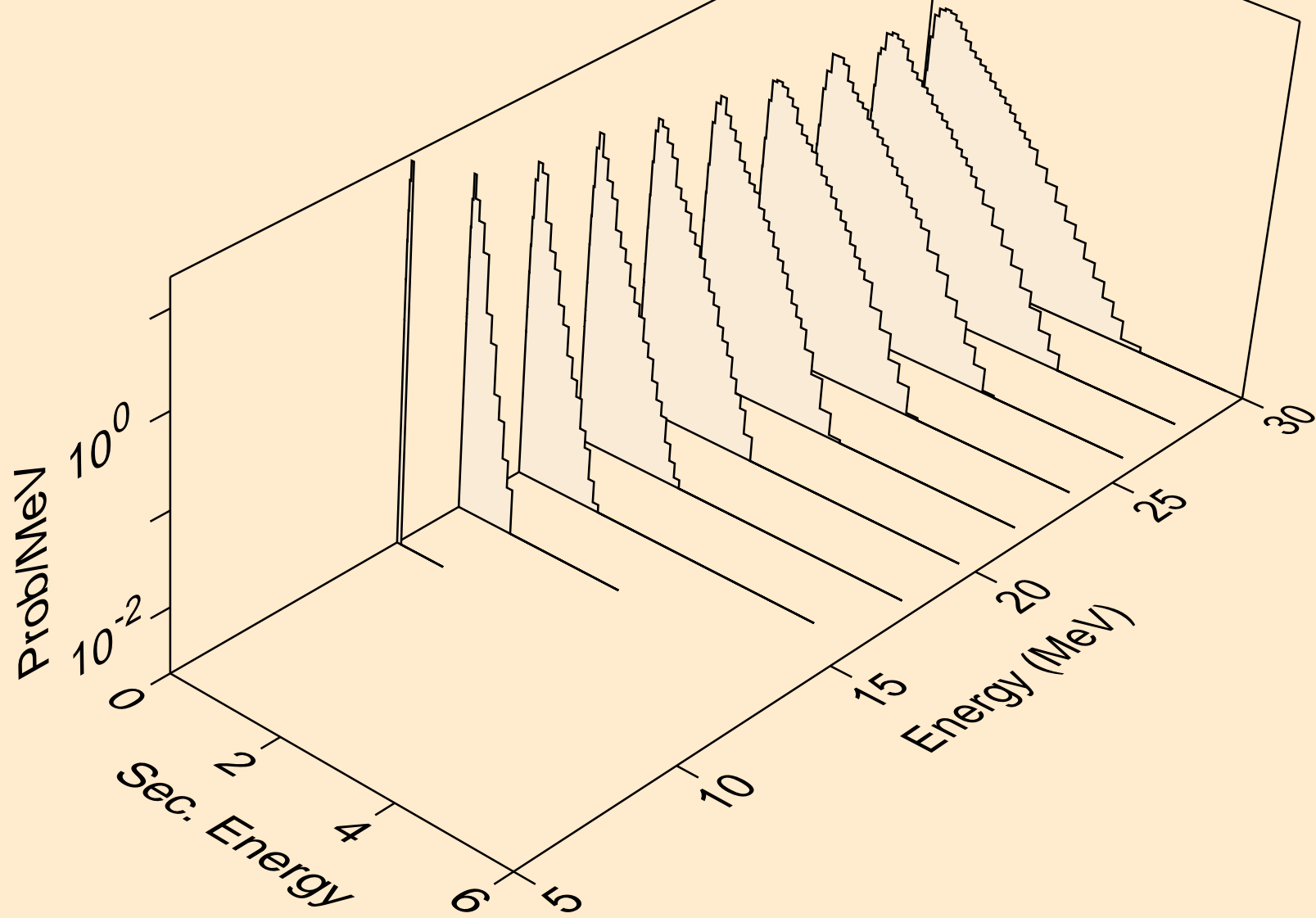

SG267 NEUTRON ACER TENDL-2021 LIBRARY; T=293.6K
Neutron emission for (n,n*)he3

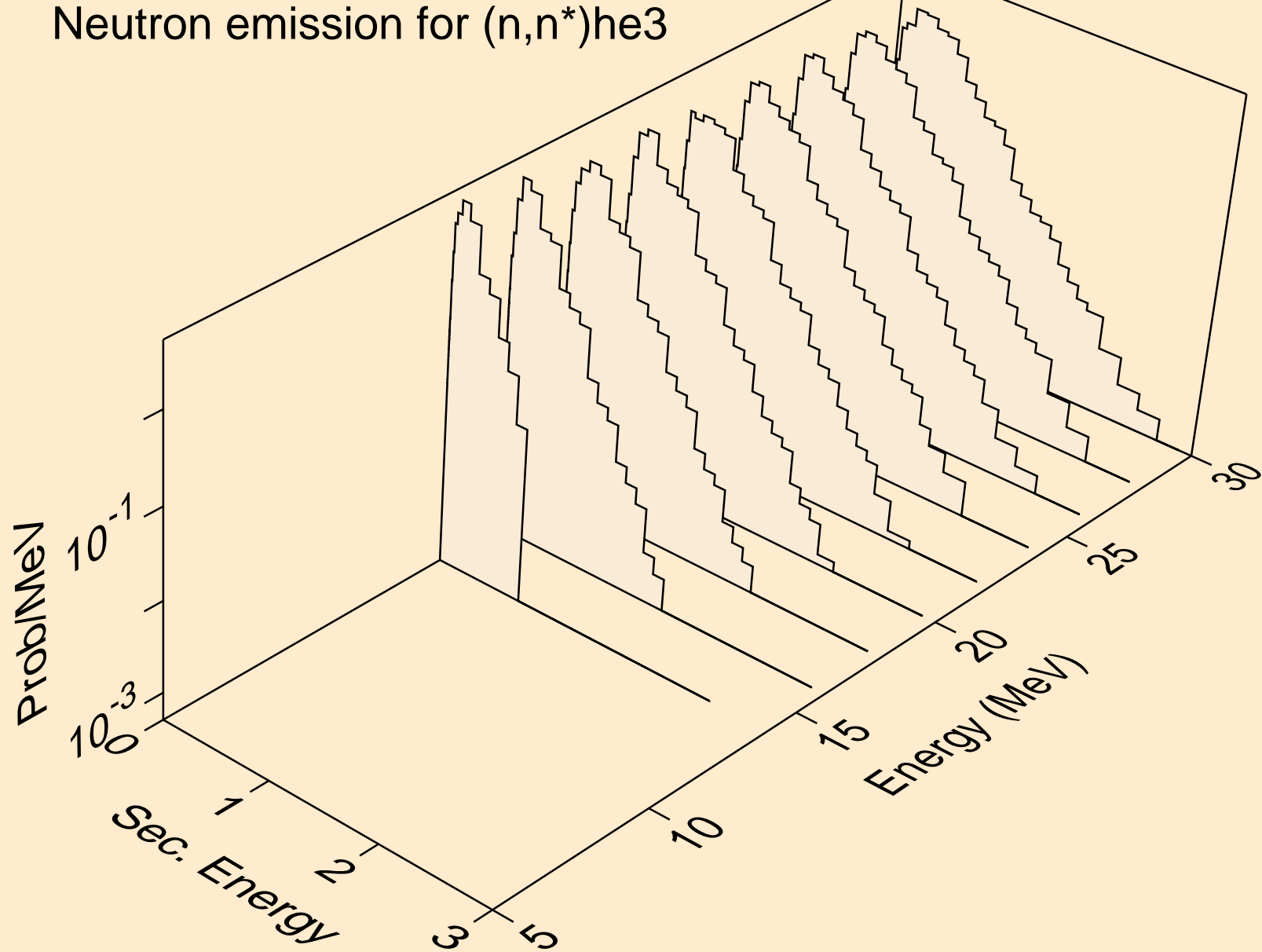

SG267 NEUTRON ACER TENDL-2021 LIBRARY; T=293.6K
Neutron emission for (n,4n)

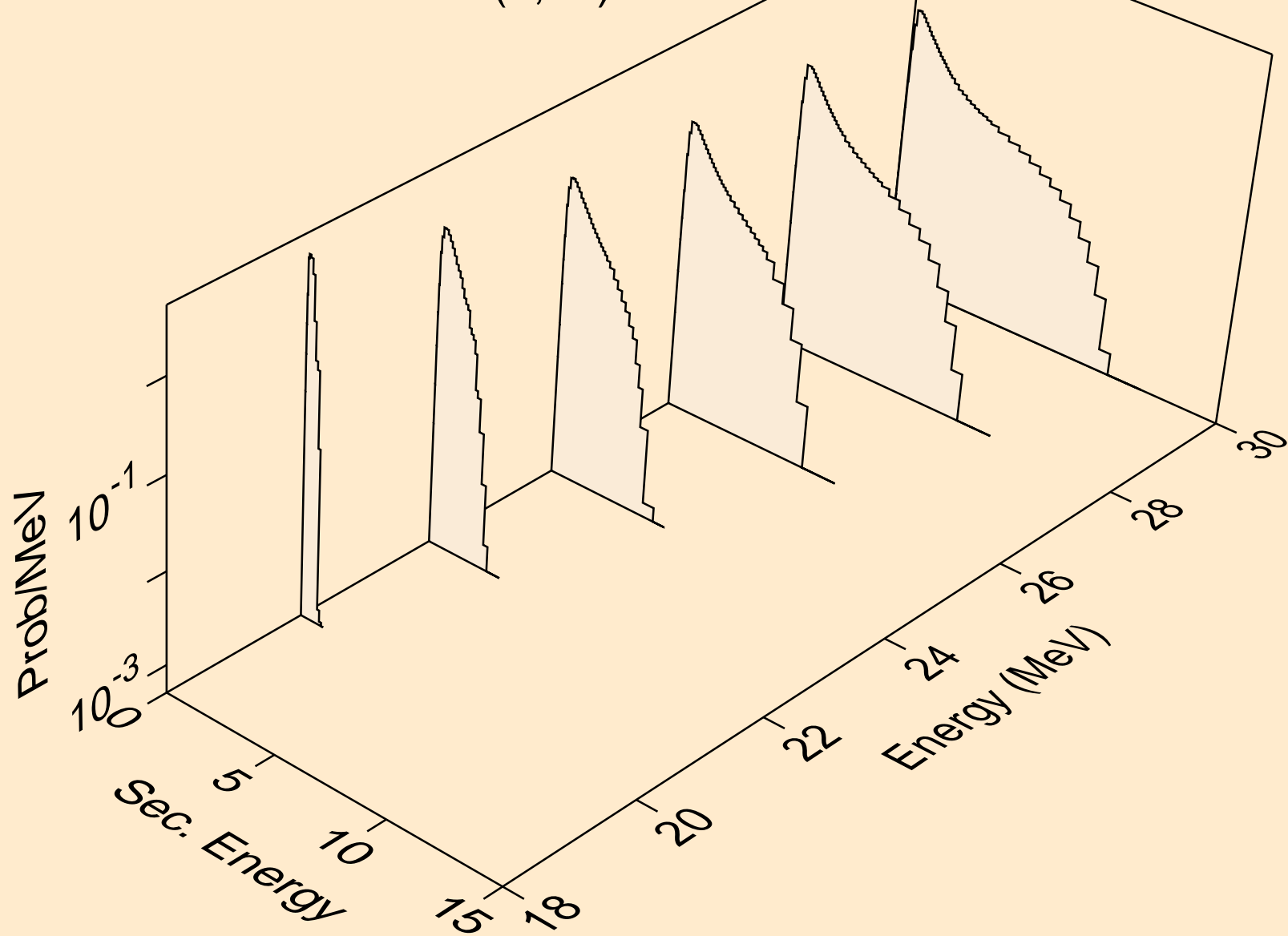

SG267 NEUTRON ACER TENDL-2021 LIBRARY; T=293.6K
Neutron emission for (n,2np)

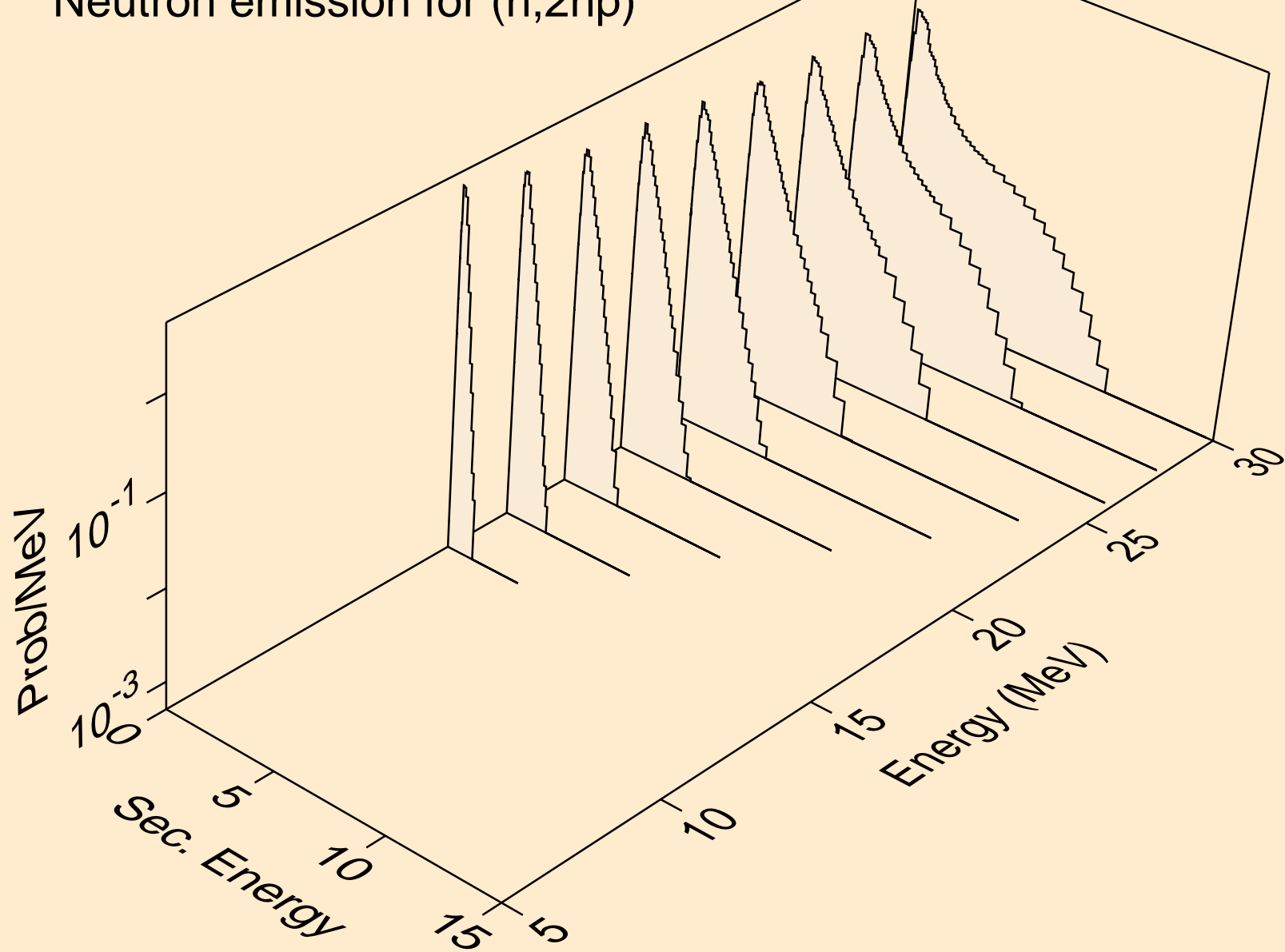

SG267 NEUTRON ACER TENDL-2021 LIBRARY; T=293.6K
Neutron emission for (n,3np)

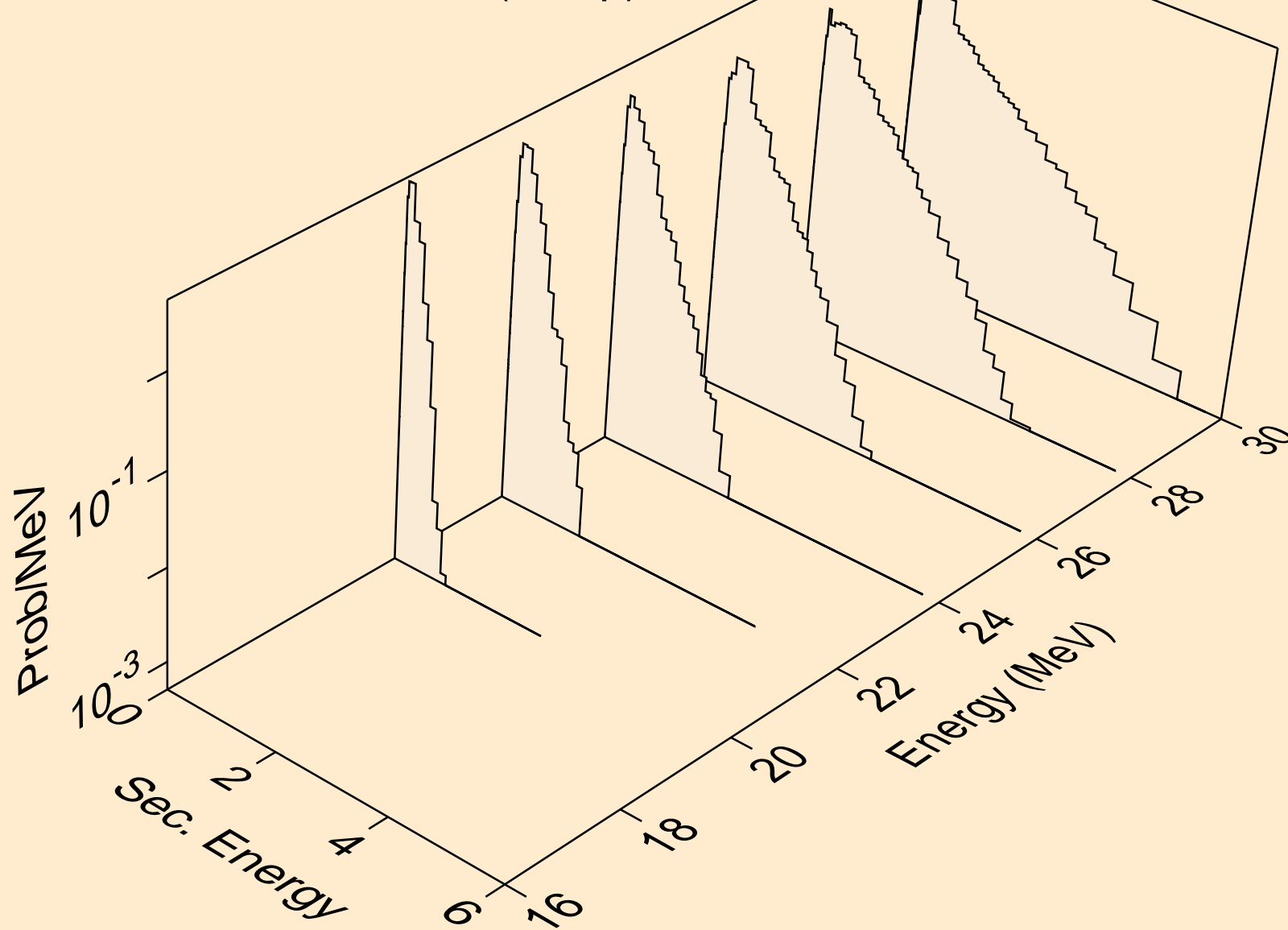

SG267 NEUTRON ACER TENDL-2021 LIBRARY; T=293.6K
Neutron emission for (n,2np)

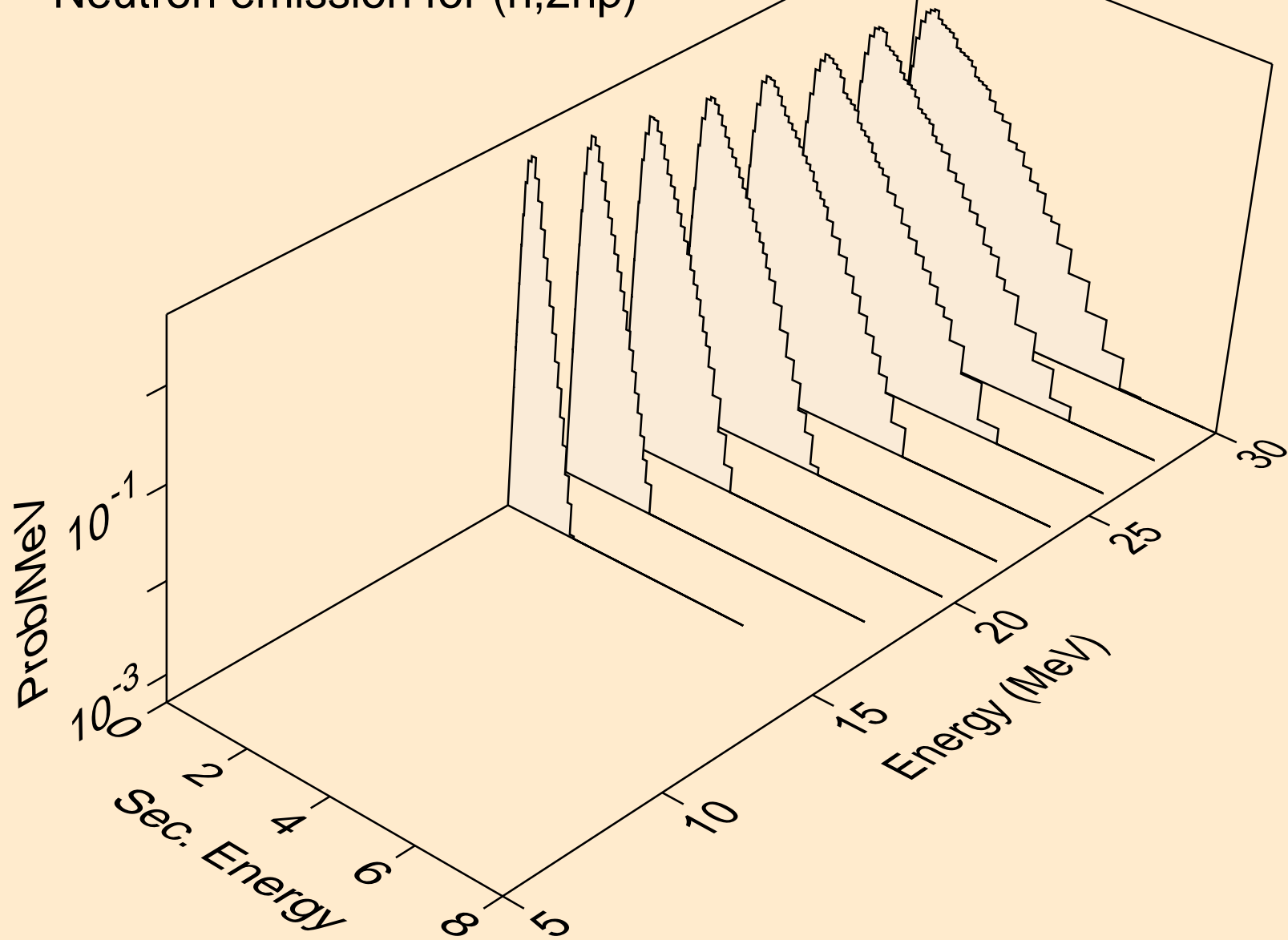

SG267 NEUTRON ACER TENDL-2021 LIBRARY; T=293.6K
Neutron emission for (n,npa)

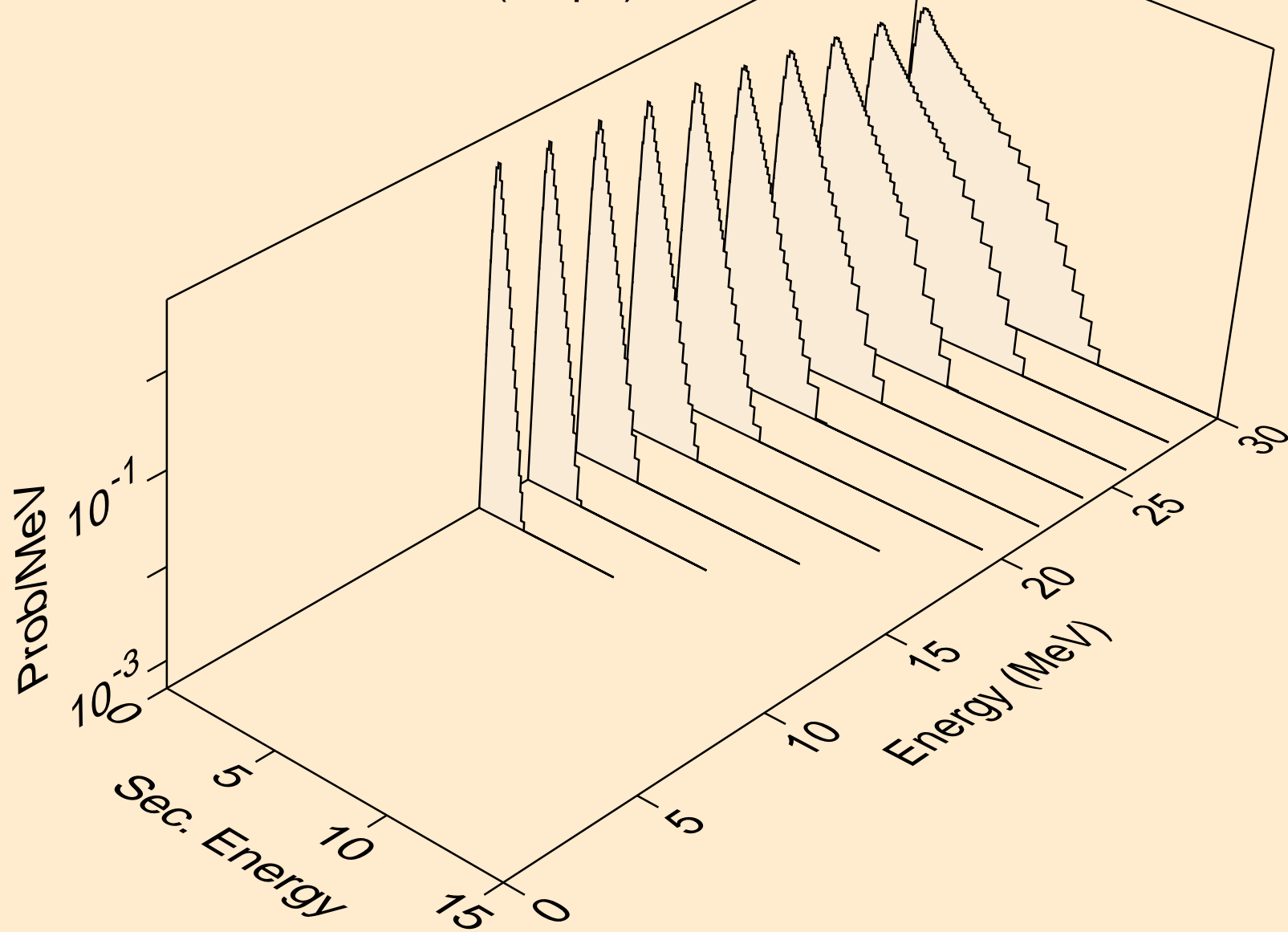

SG267 NEUTRON ACER TENDL-2021 LIBRARY; T=293.6K
Neutron emission for (n,n*c)

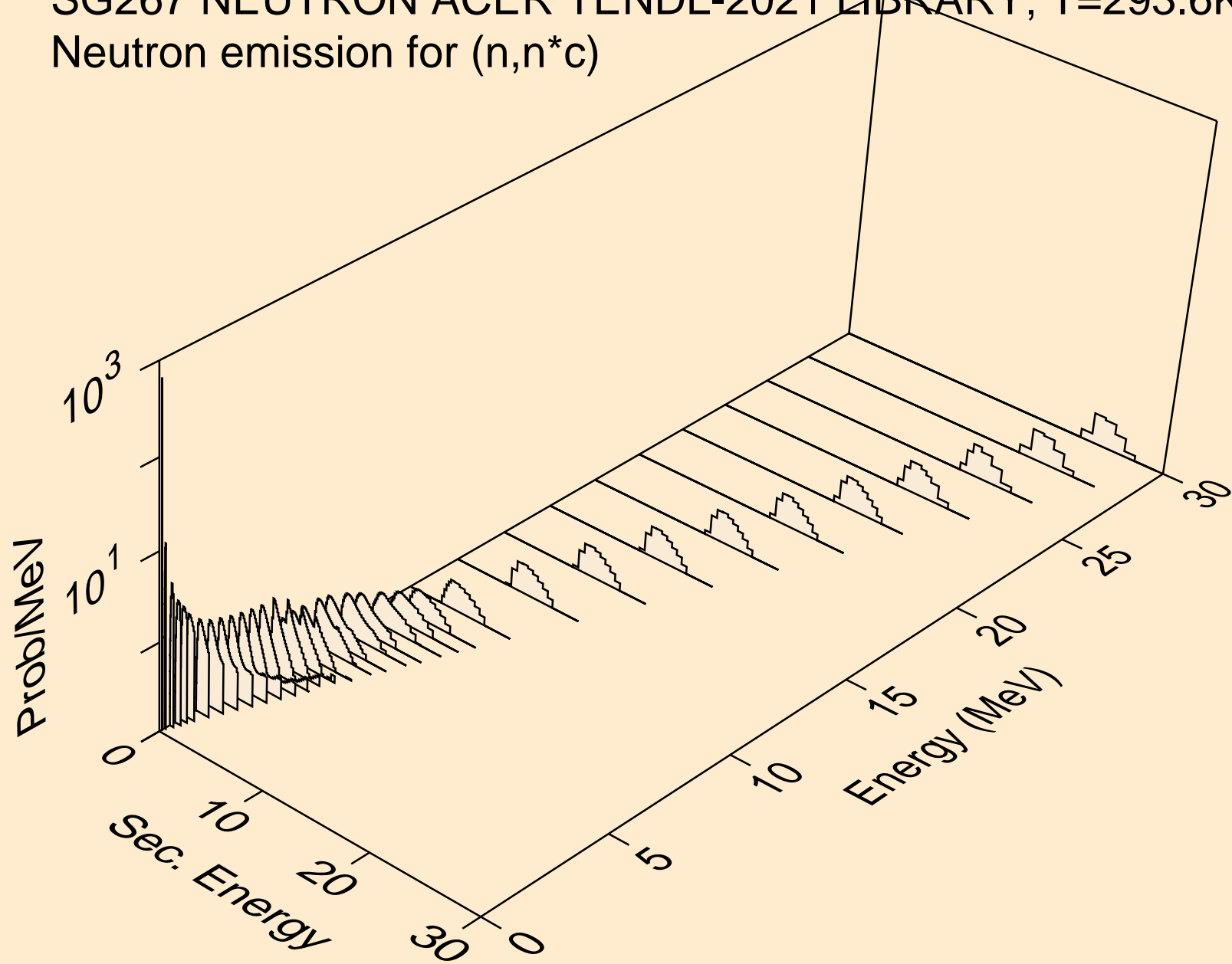

SG267 NEUTRON ACER TENDL-2021 LIBRARY; T=293.6K
Delayed nubar

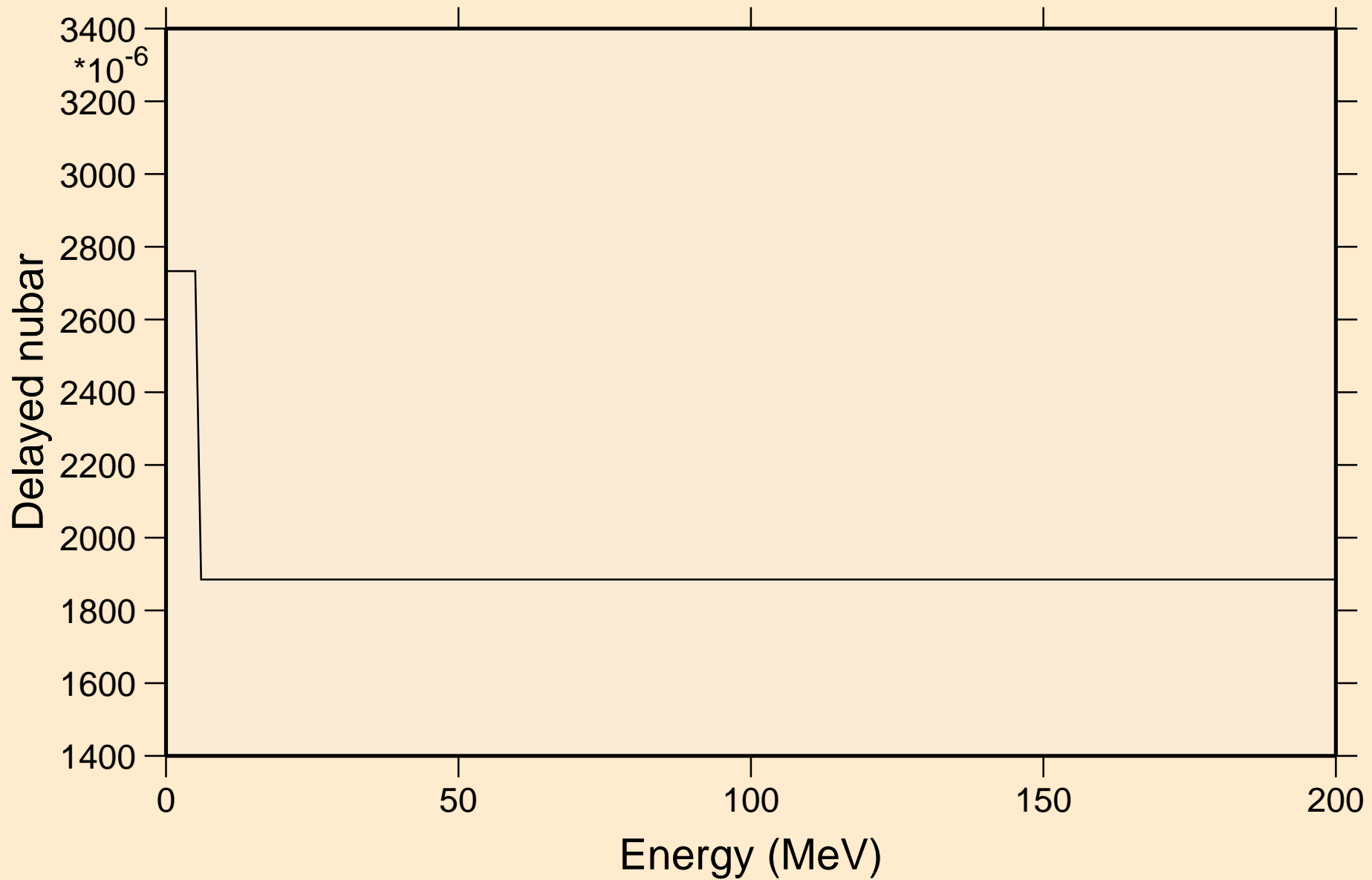

SG267 NEUTRON ACER TENDL-2021 LIBRARY; T=293.6K

Delayed neutron spectra

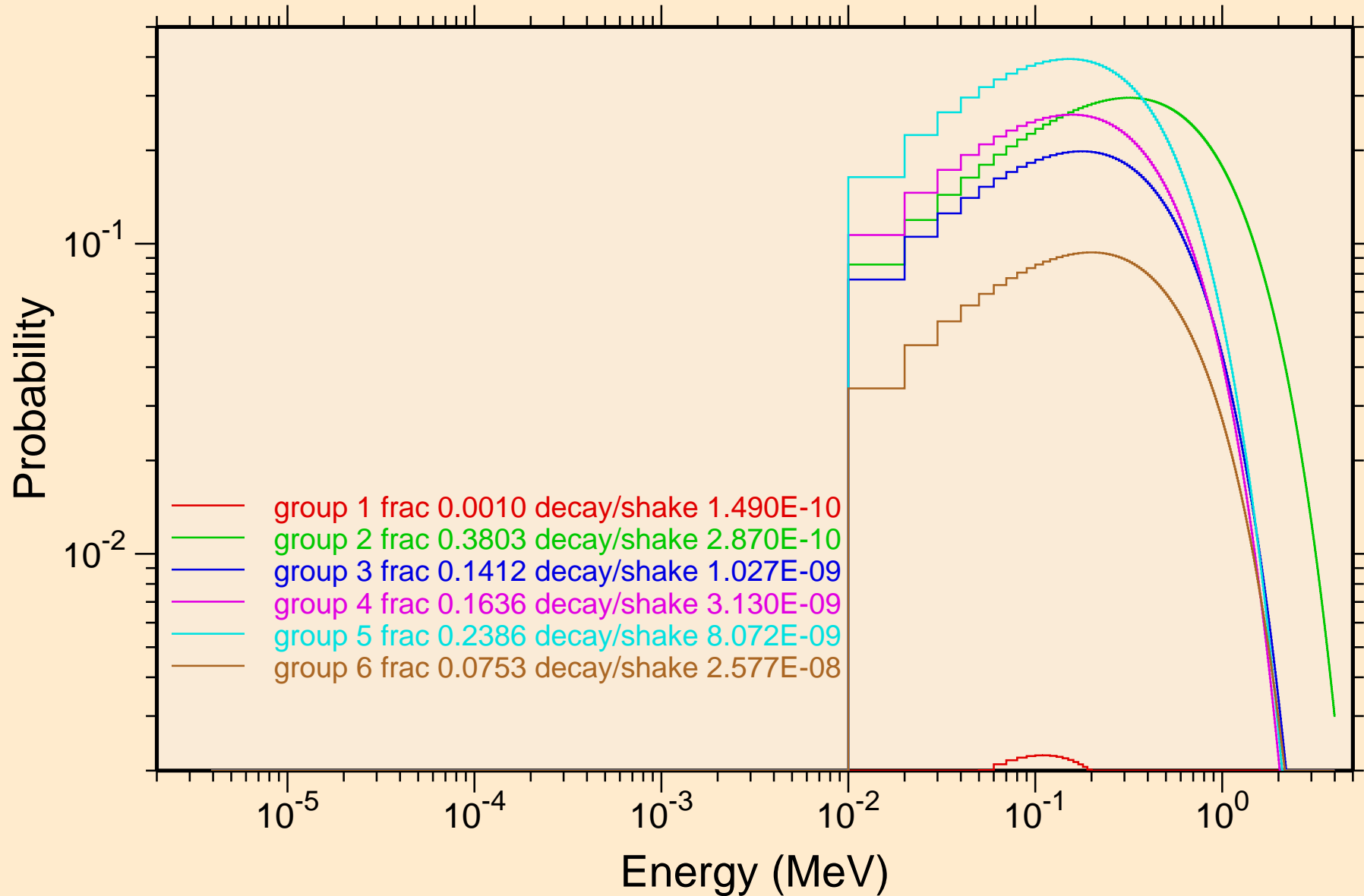

SG267 NEUTRON ACER TENDL-2021 LIBRARY; T=293.6K
Photon emission for (n,x)

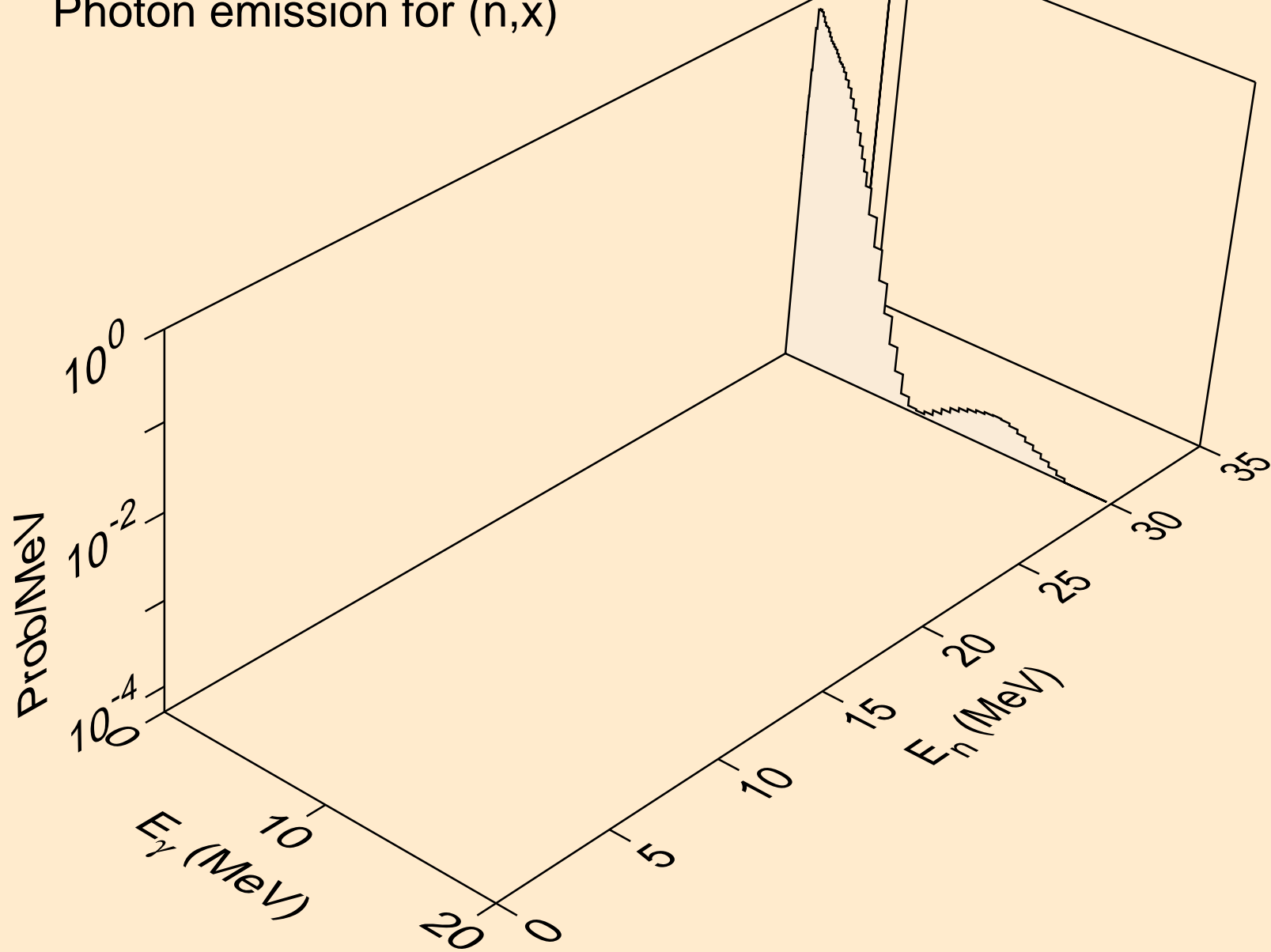

SG267 NEUTRON ACER TENDL-2021 LIBRARY; T=293.6K
Photon emission for (n,2nd)

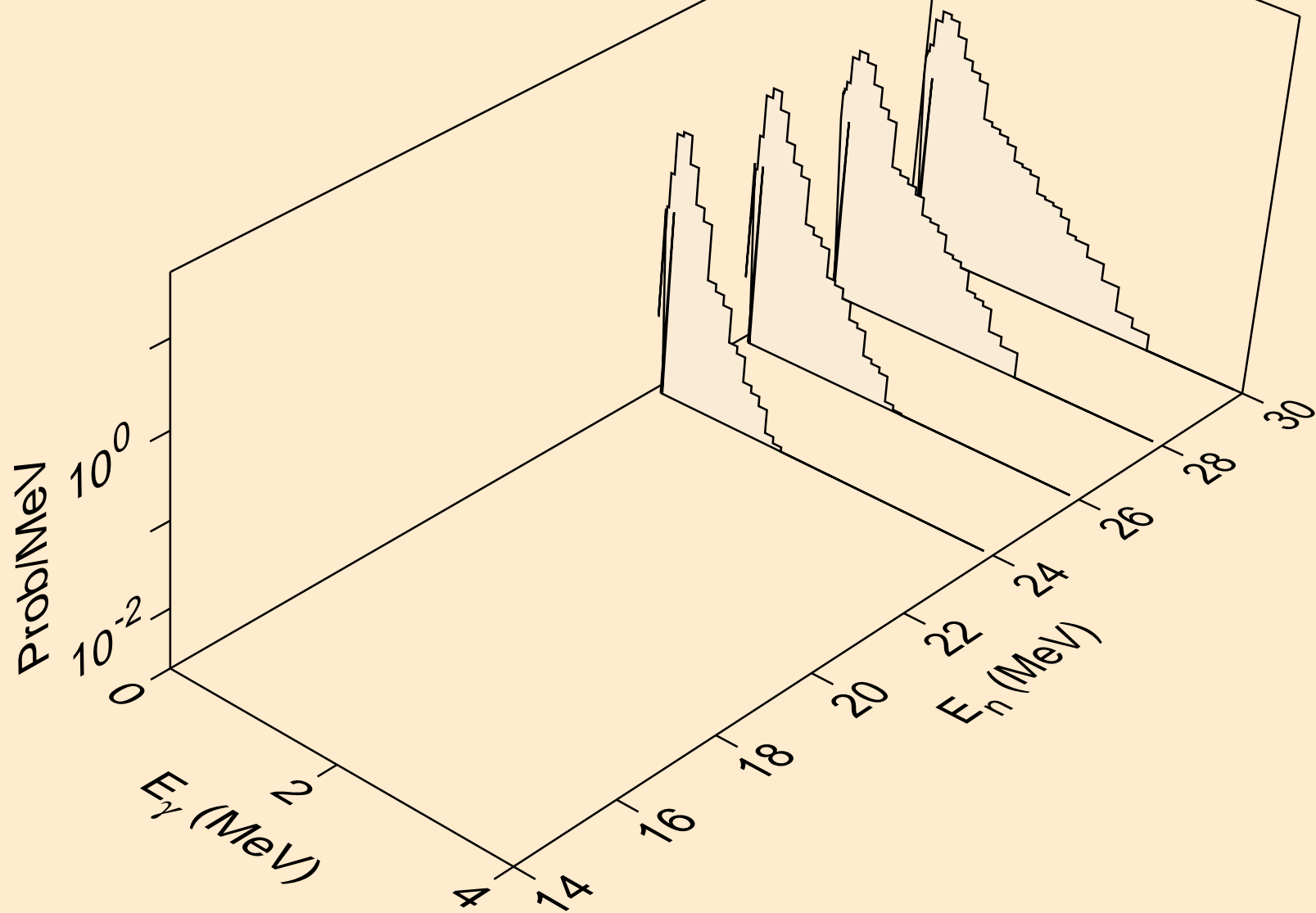

SG267 NEUTRON ACER TENDL-2021 LIBRARY; T=293.6K
Photon emission for (n,2n)

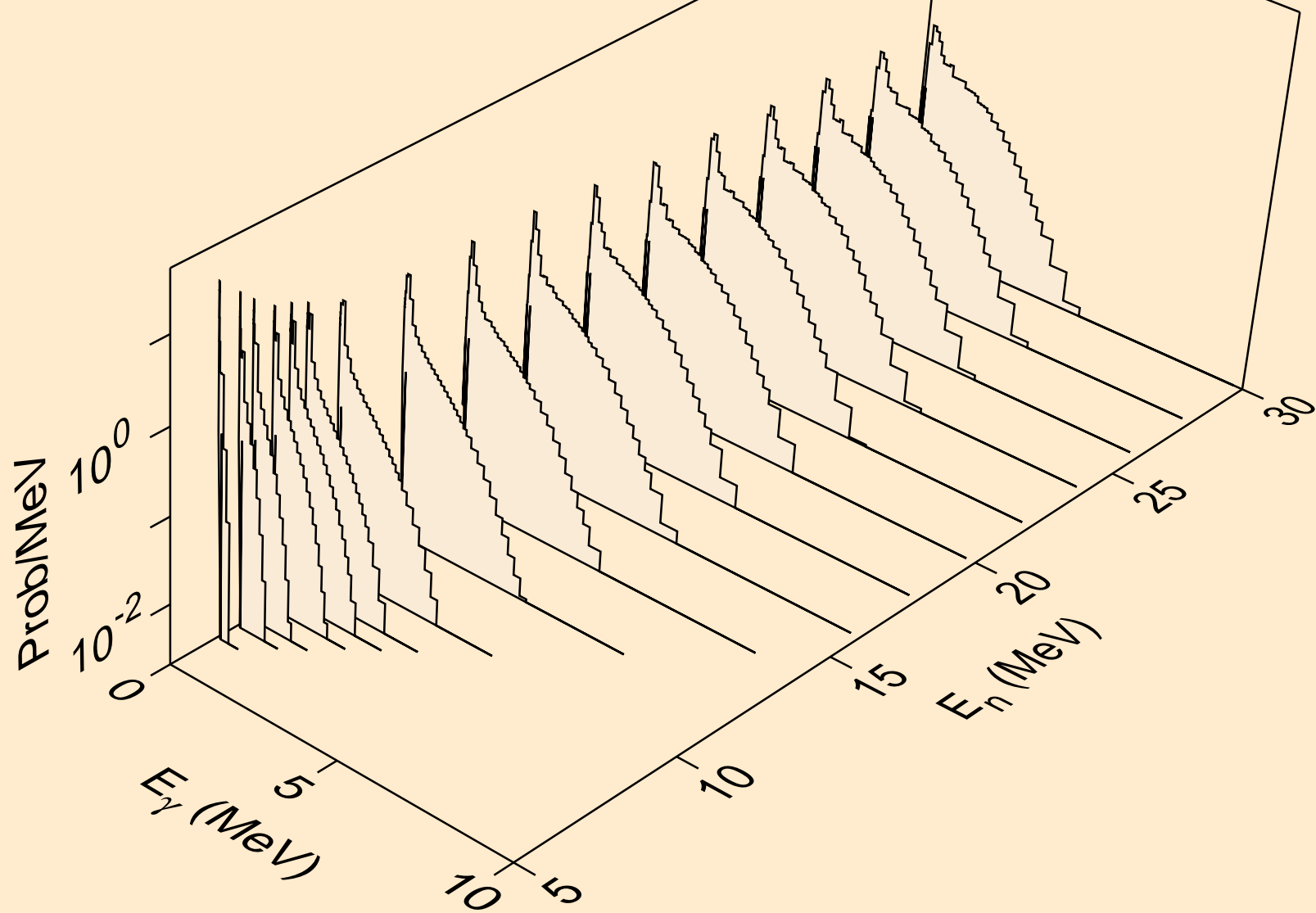

SG267 NEUTRON ACER TENDL-2021 LIBRARY; T=293.6K
Photon emission for (n,3n)

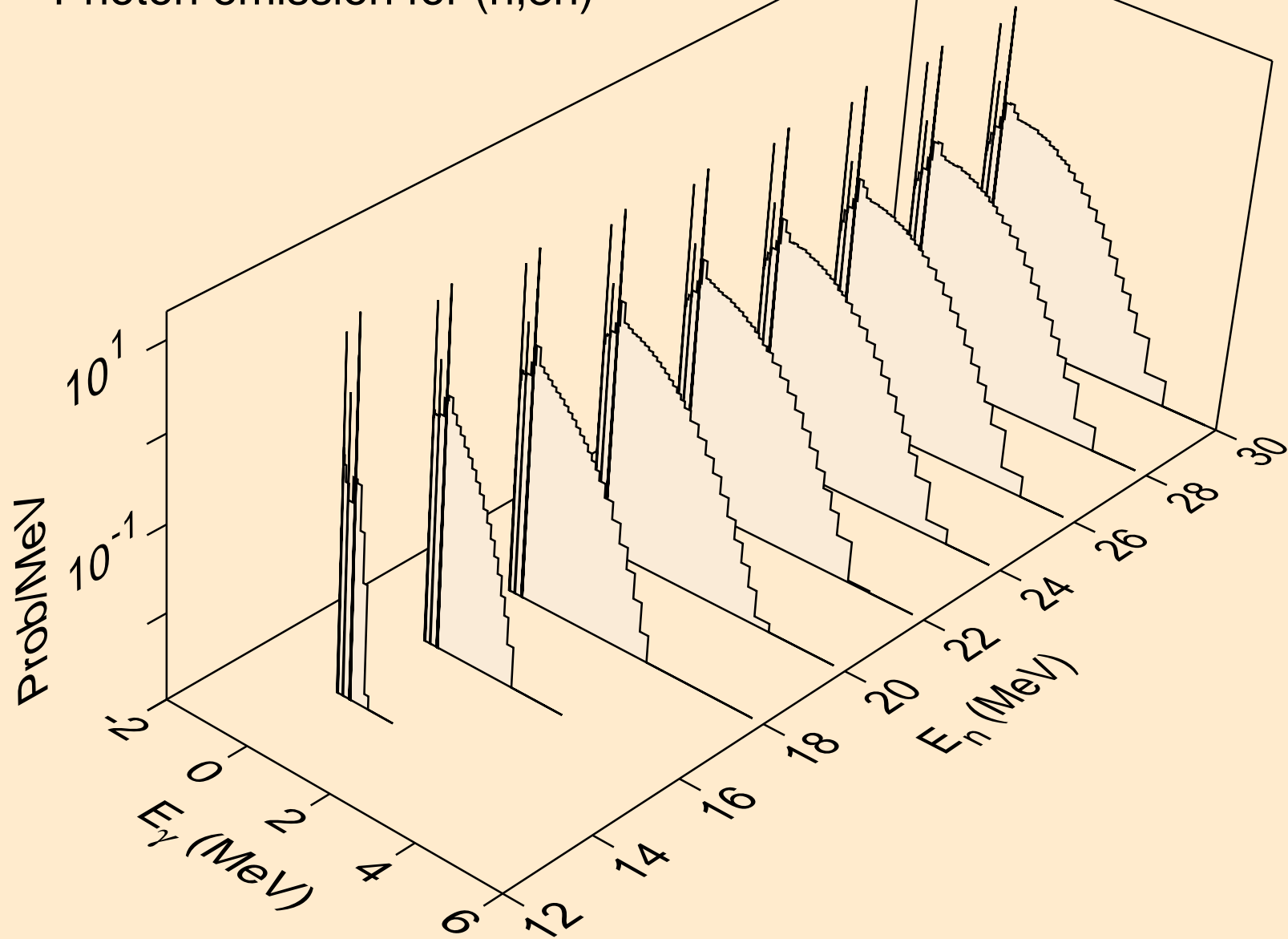

SG267 NEUTRON ACER TENDL-2021 LIBRARY; T=293.6K
Photon emission for (n,n*)a

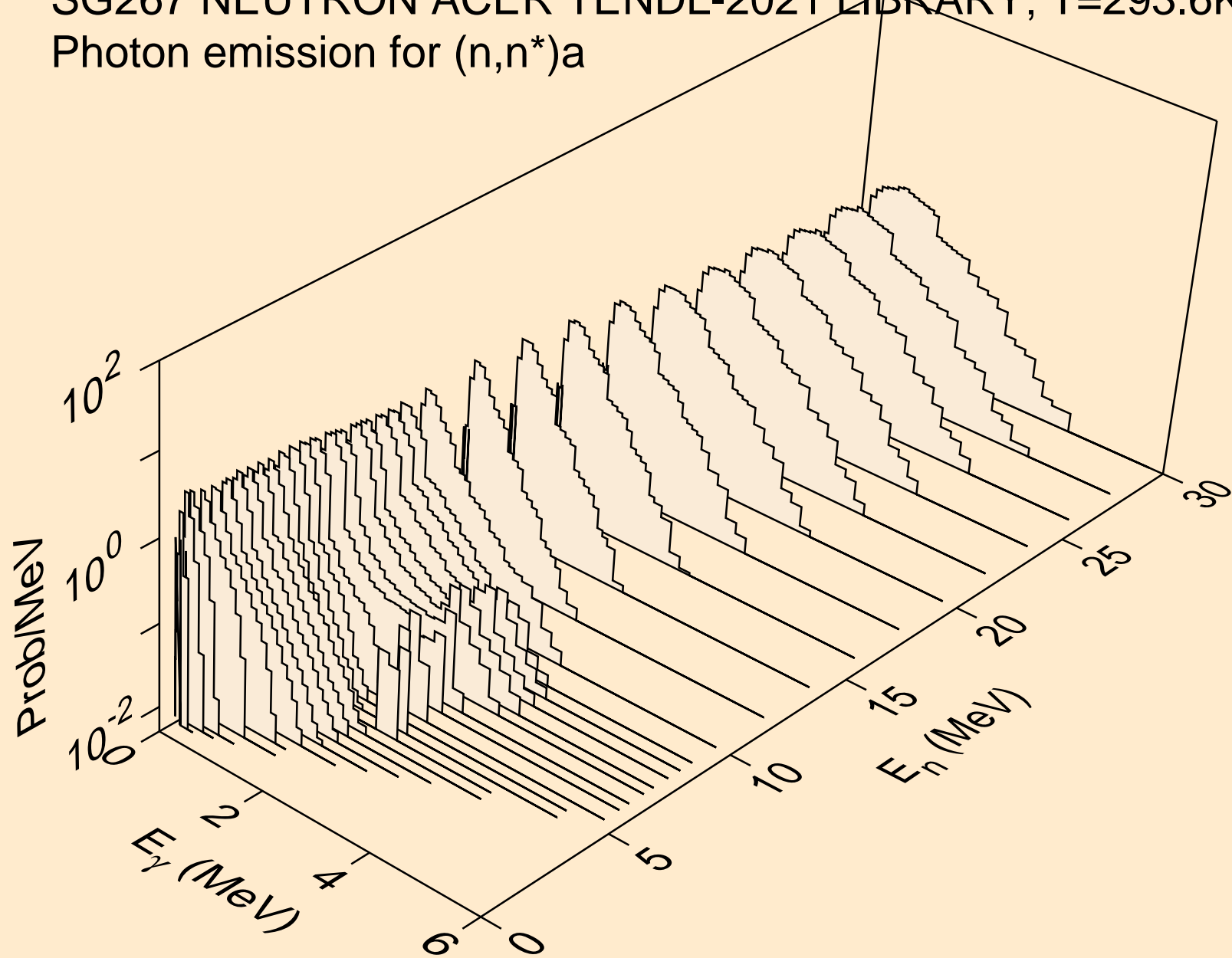

SG267 NEUTRON ACER TENDL-2021 LIBRARY; T=293.6K
Photon emission for (n,2n) α

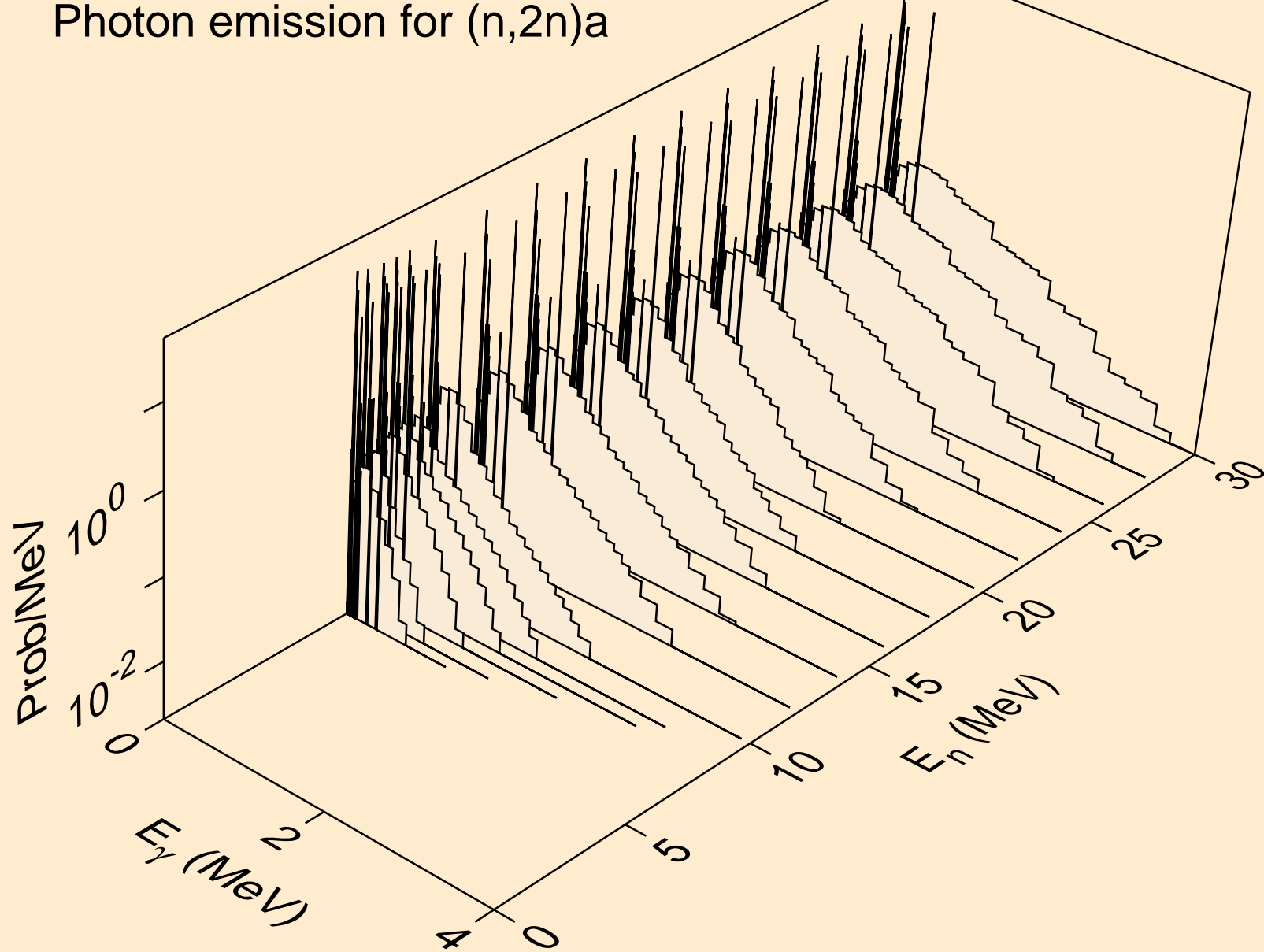

SG267 NEUTRON ACER TENDL-2021 LIBRARY; T=293.6K
Photon emission for (n,3n)a

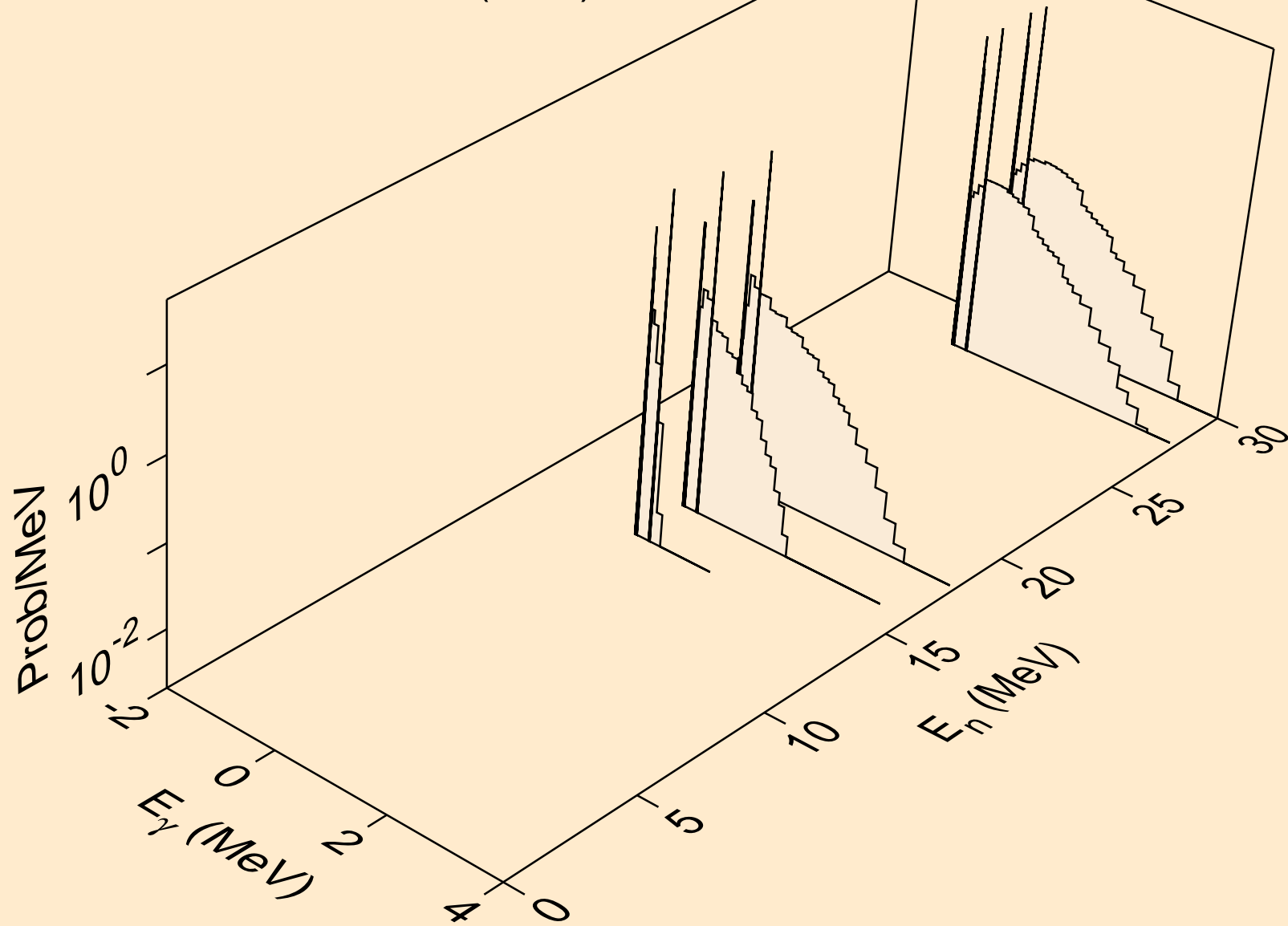

SG267 NEUTRON ACER TENDL-2021 LIBRARY; T=293.6K
Photon emission for (n,n*)p

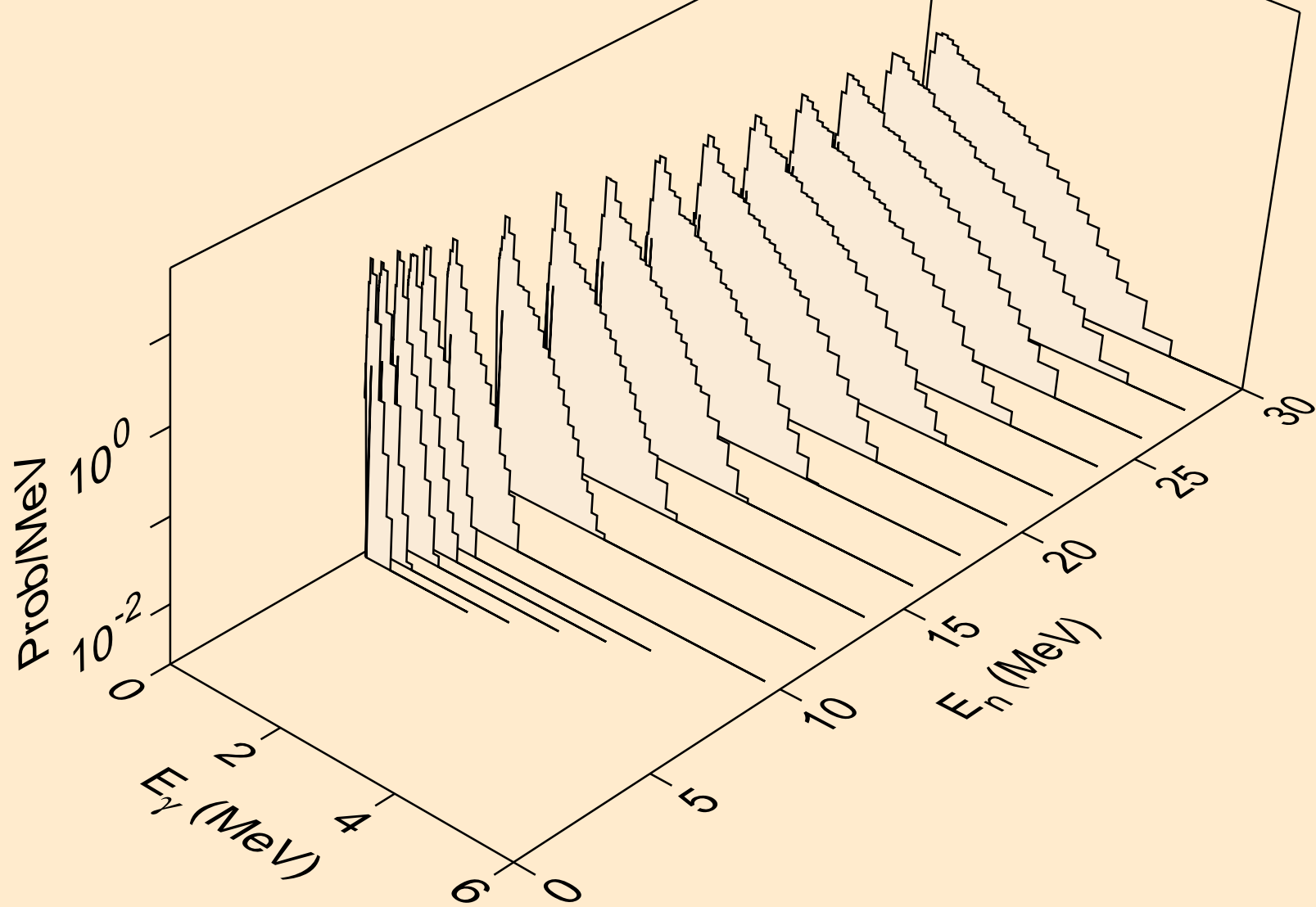

SG267 NEUTRON ACER TENDL-2021 LIBRARY; T=293.6K
Photon emission for (n,n*)2a

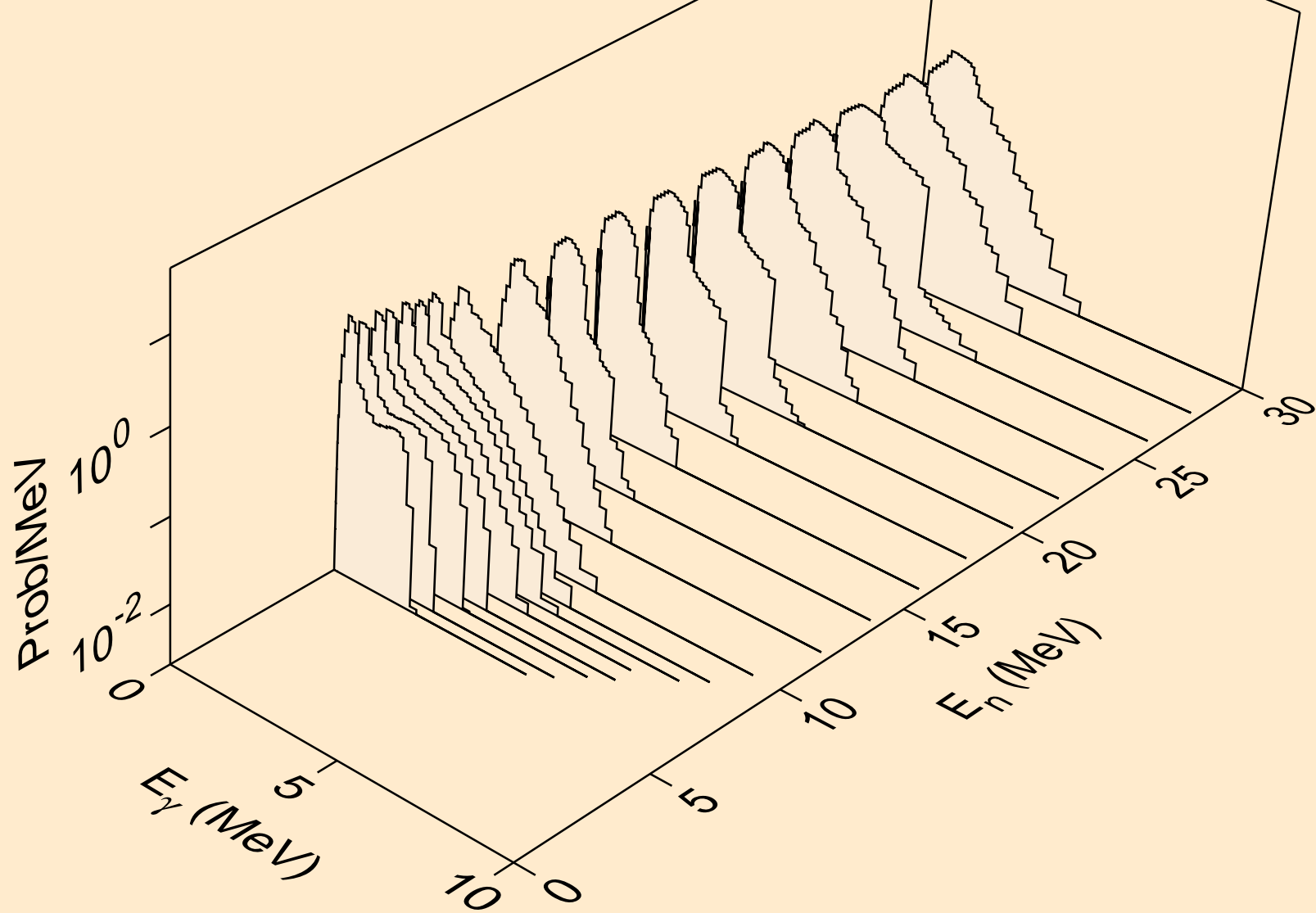

SG267 NEUTRON ACER TENDL-2021 LIBRARY; T=293.6K
Photon emission for (n,n*)d

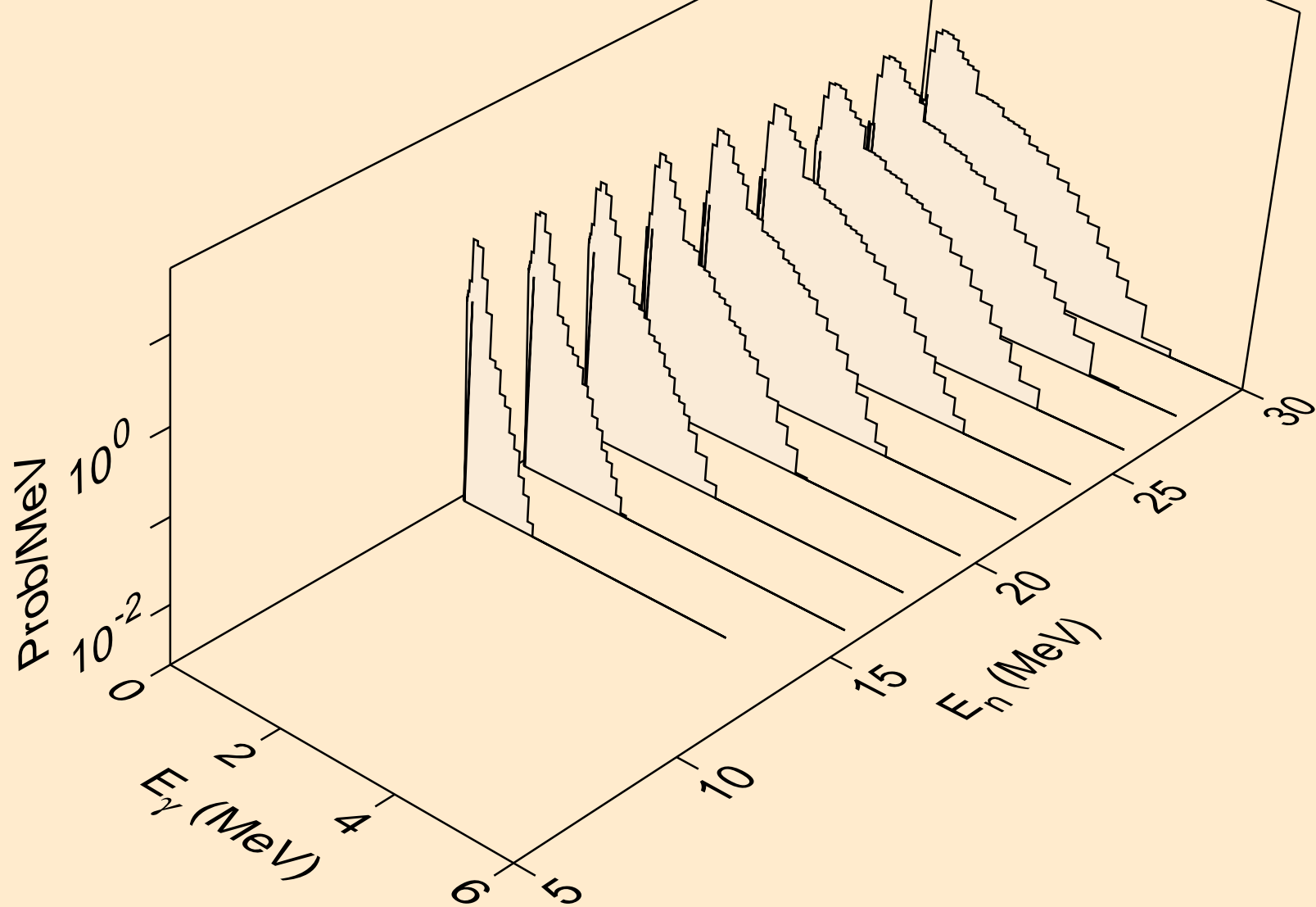

SG267 NEUTRON ACER TENDL-2021 LIBRARY; T=293.6K
Photon emission for (n,n*)t

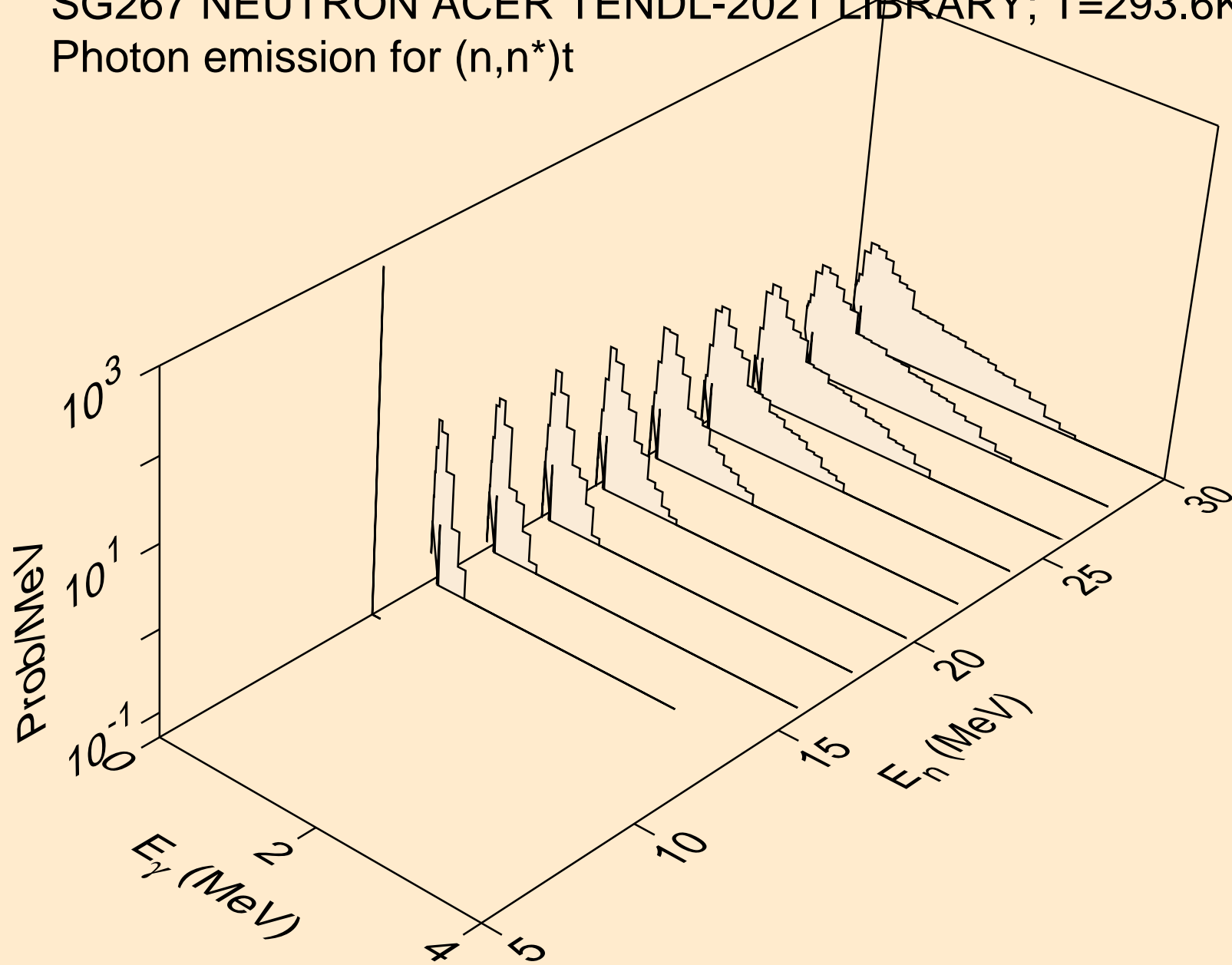

SG267 NEUTRON ACER TENDL-2021 LIBRARY; T=293.6K
Photon emission for (n,n*)he3

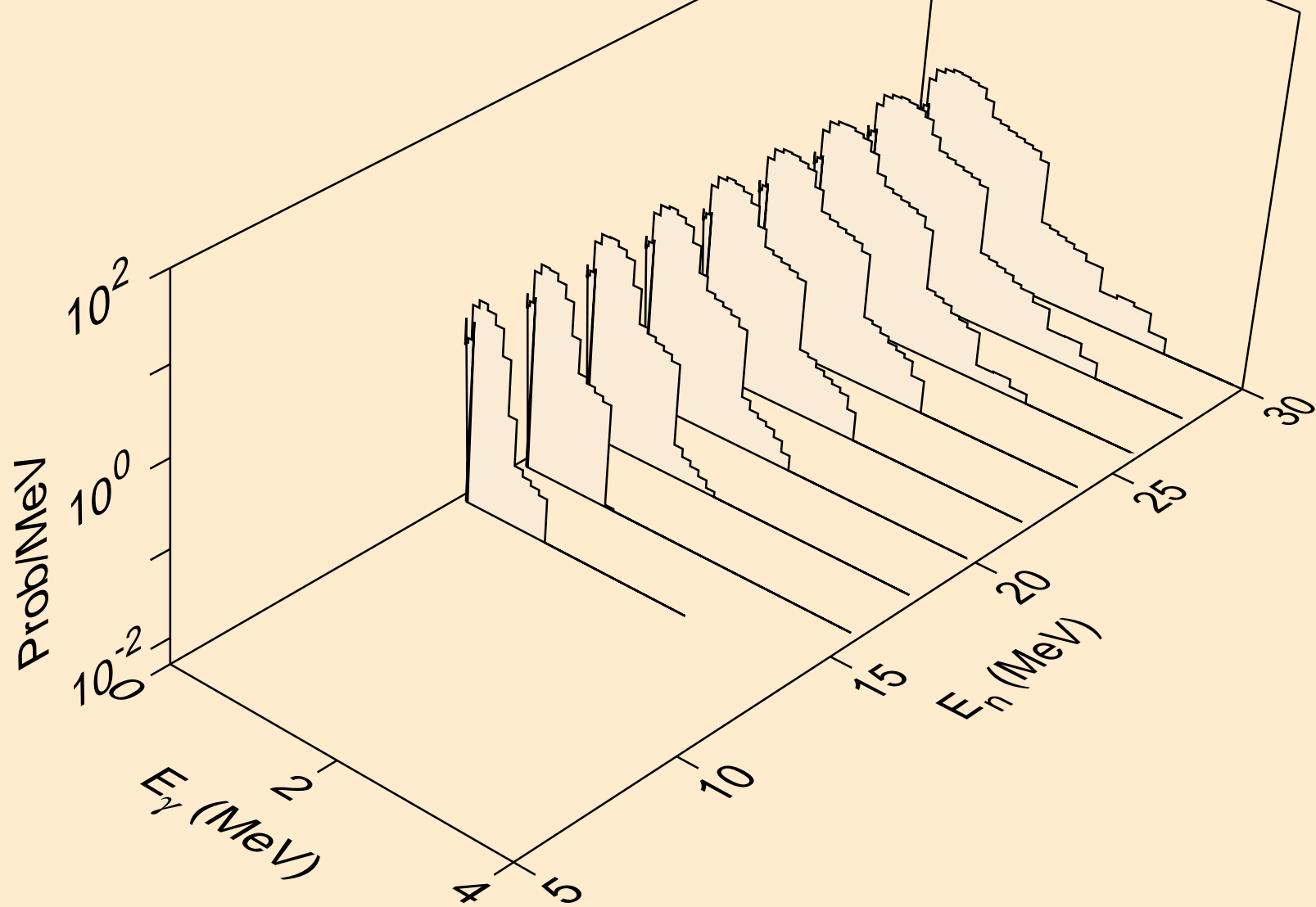

SG267 NEUTRON ACER TENDL-2021 LIBRARY; T=293.6K
Photon emission for (n,4n)

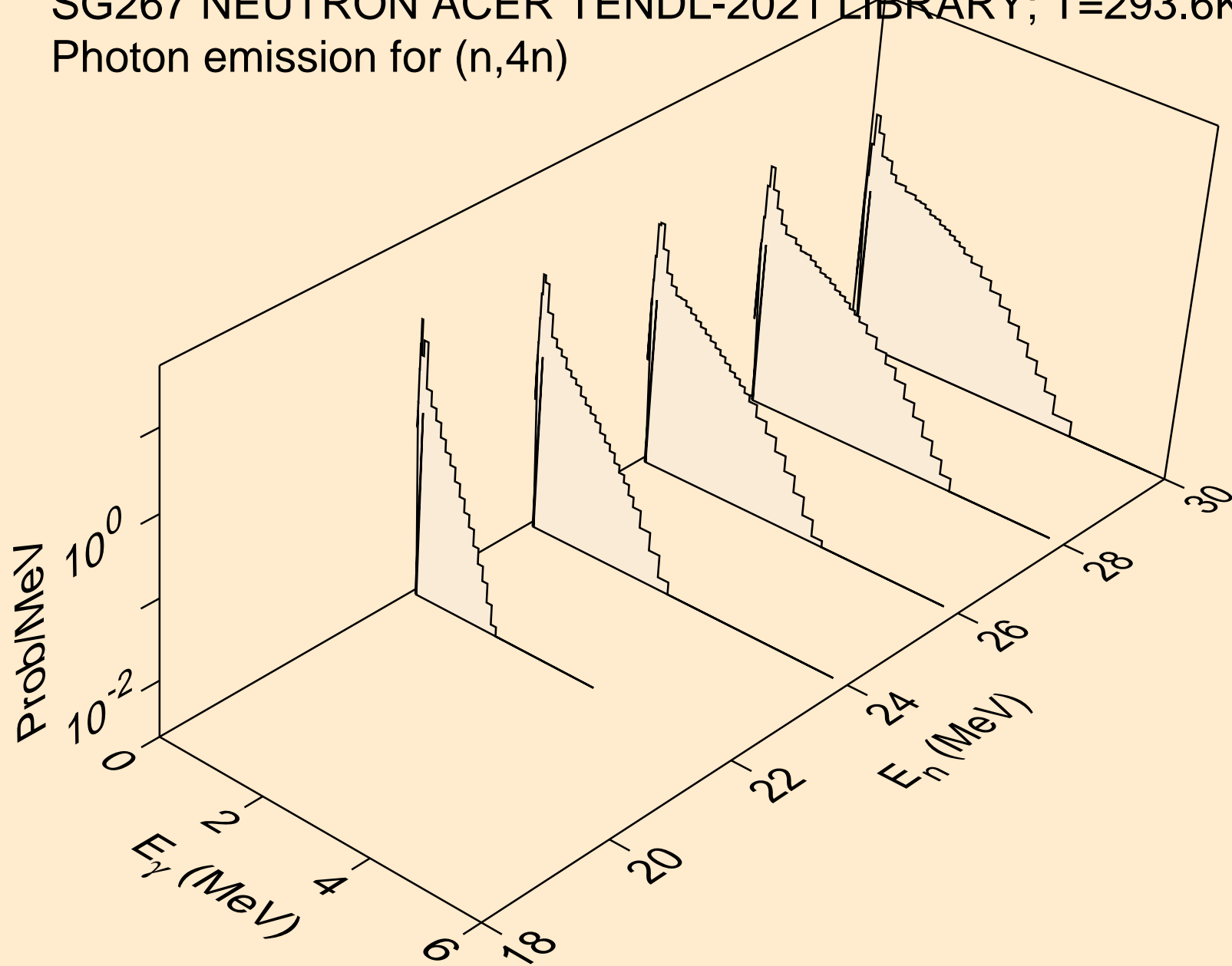

SG267 NEUTRON ACER TENDL-2021 LIBRARY; T=293.6K
Photon emission for (n,2np)

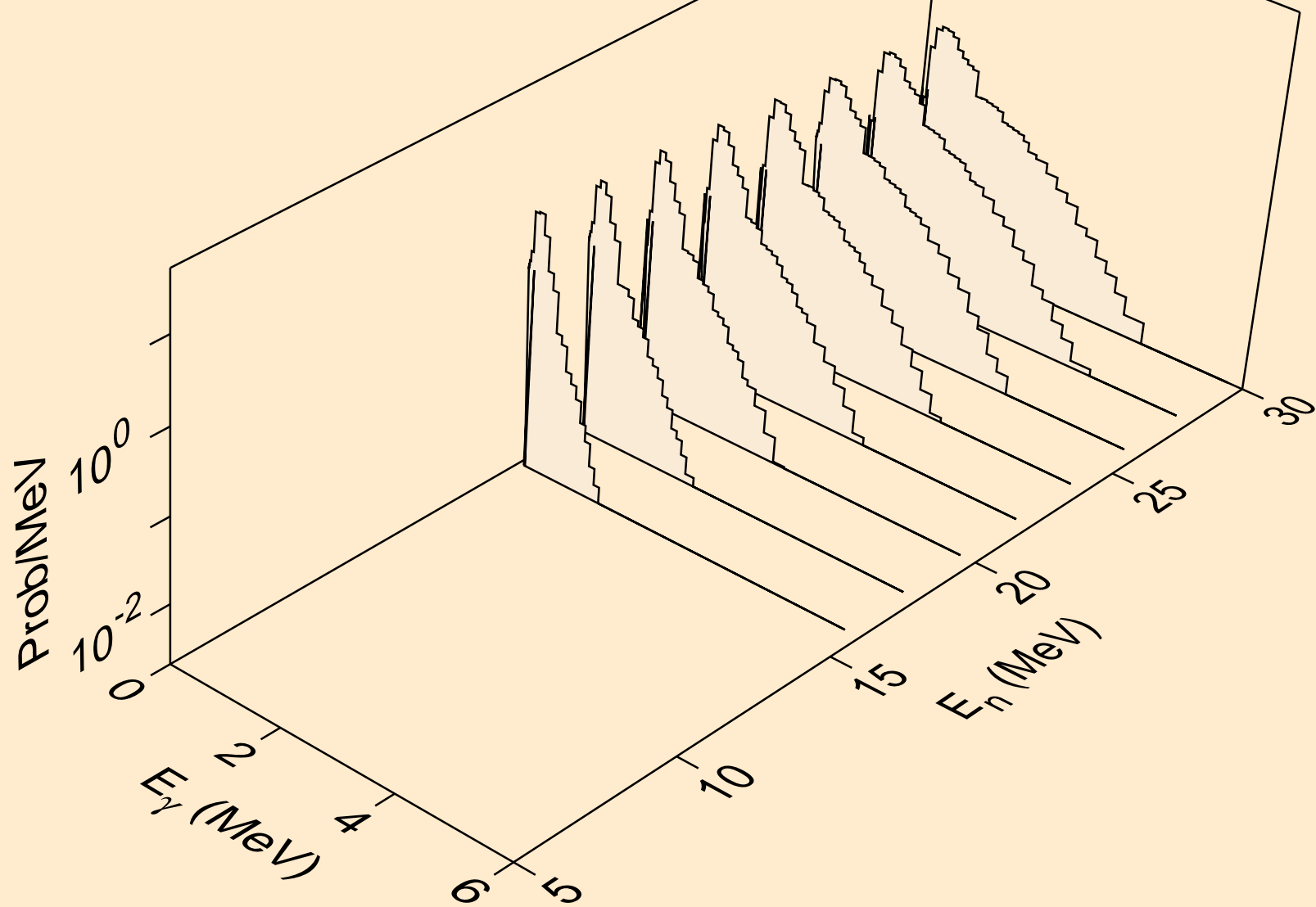

SG267 NEUTRON ACER TENDL-2021 LIBRARY; T=293.6K
Photon emission for (n,3np)

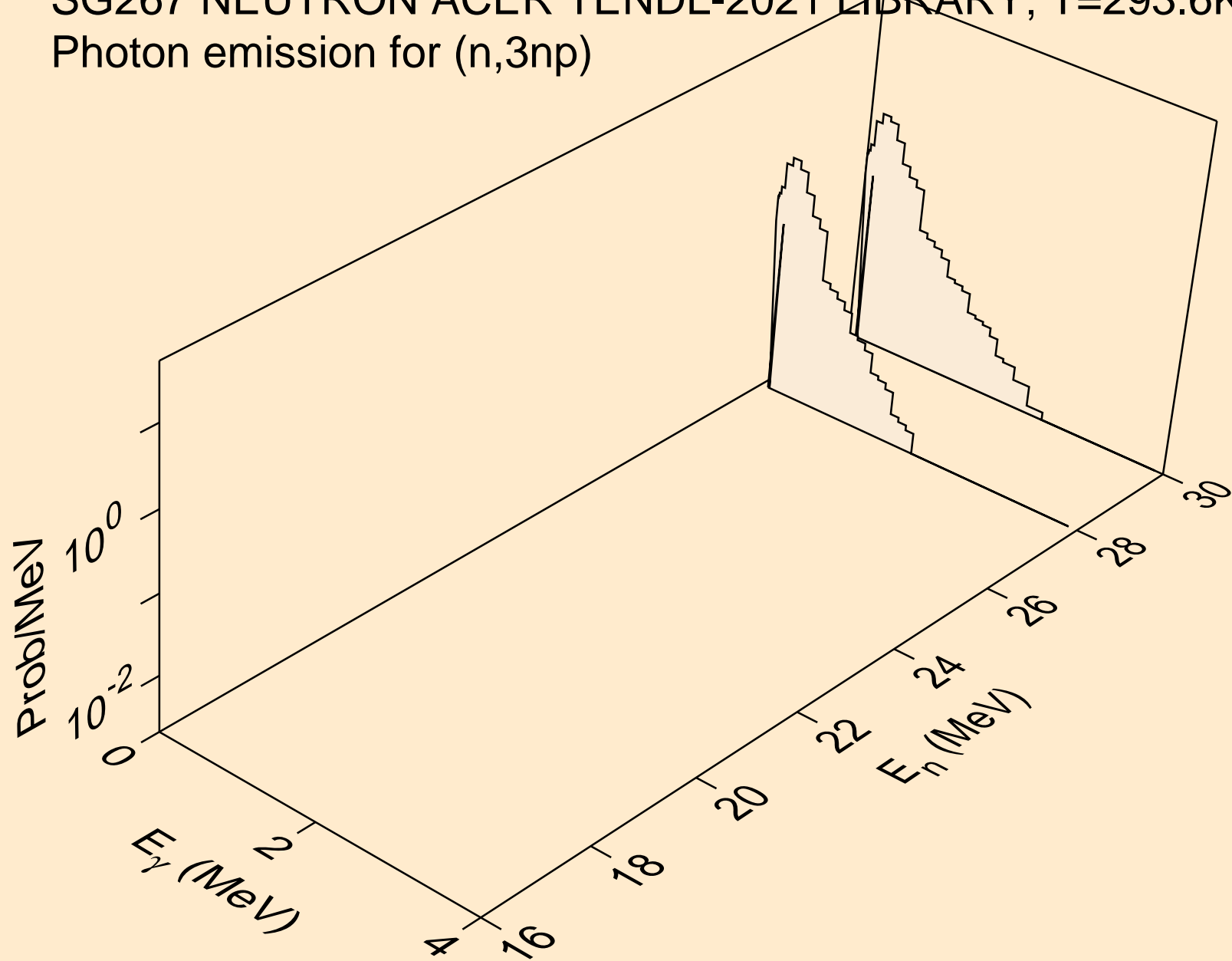

SG267 NEUTRON ACER TENDL-2021 LIBRARY; T=293.6K
Photon emission for (n,2np)

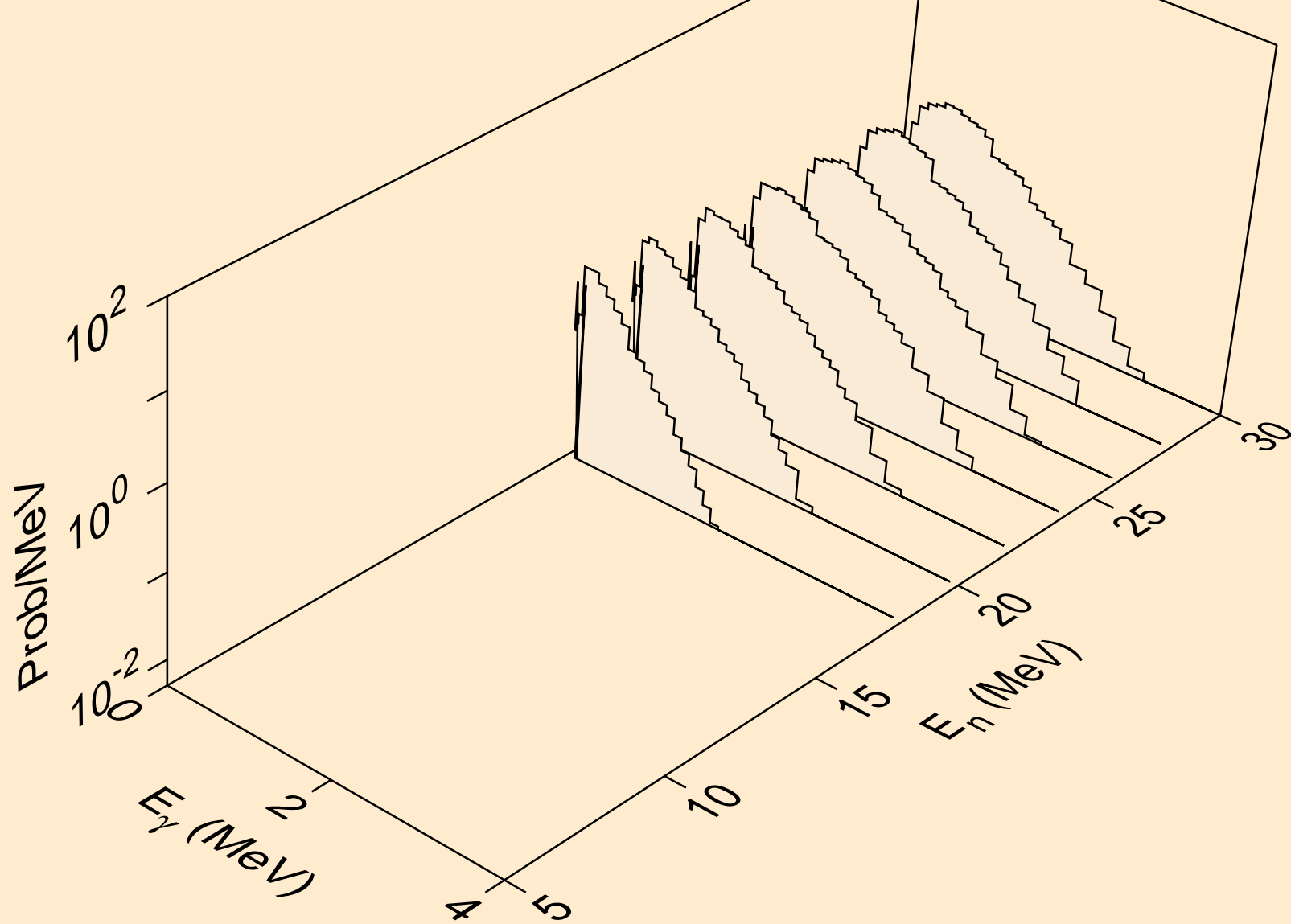

SG267 NEUTRON ACER TENDL-2021 LIBRARY; T=293.6K
Photon emission for (n,npa)

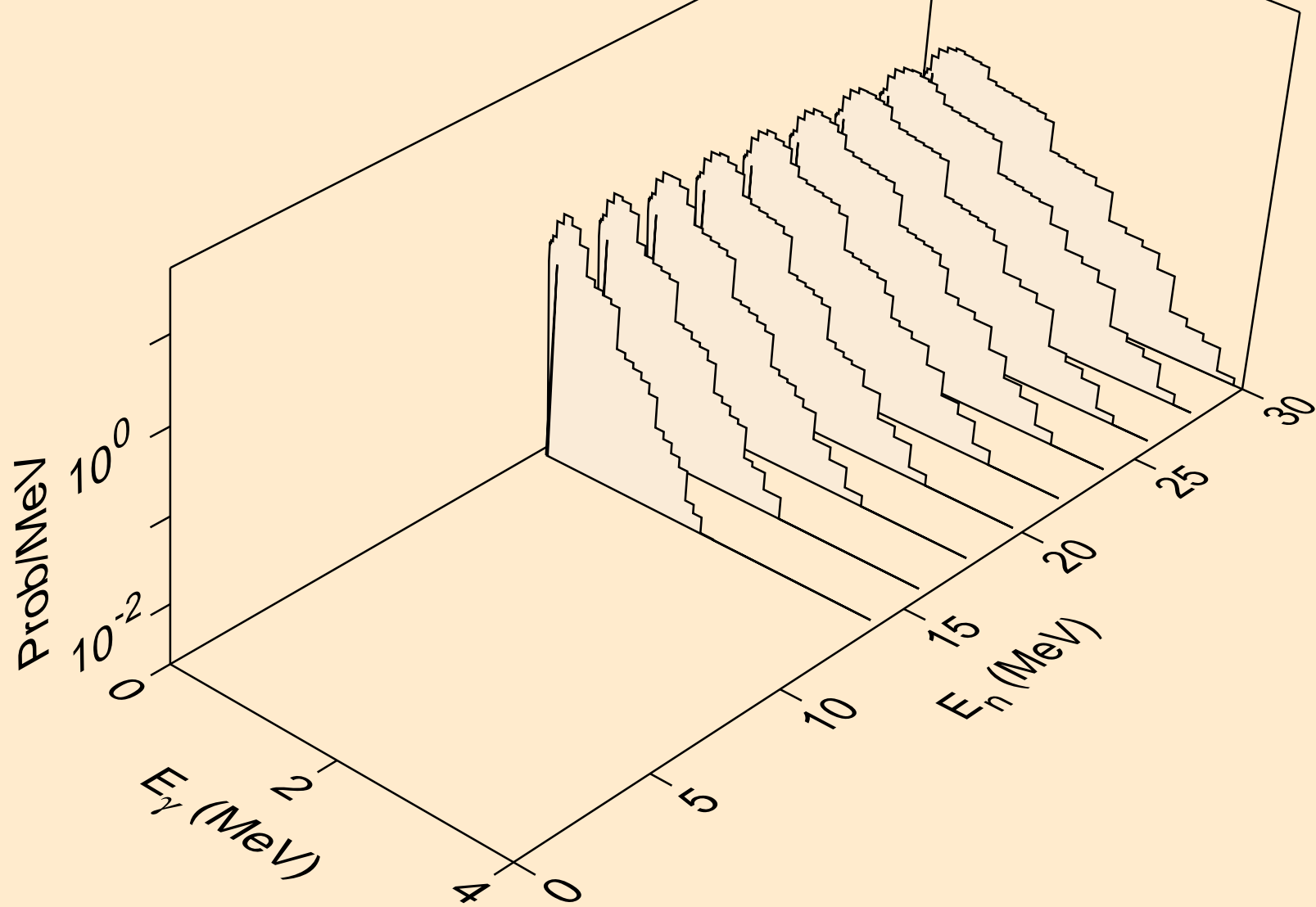

SG267 NEUTRON ACER TENDL-2021 LIBRARY; T=293.6K
Photon emission for (n,n*c)

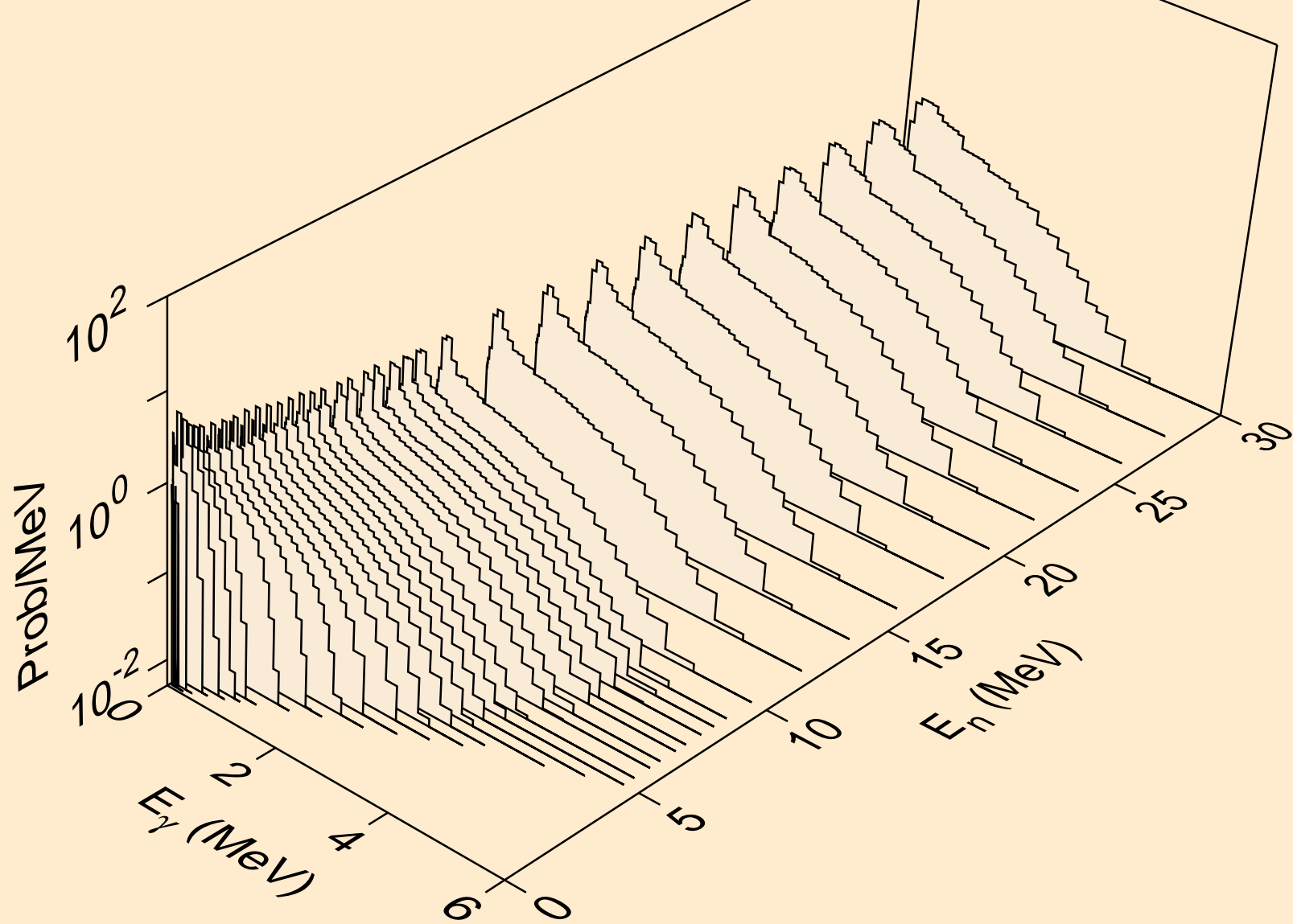

SG267 NEUTRON ACER TENDL-2021 LIBRARY; T=293.6K
Photon emission for (n,gma)

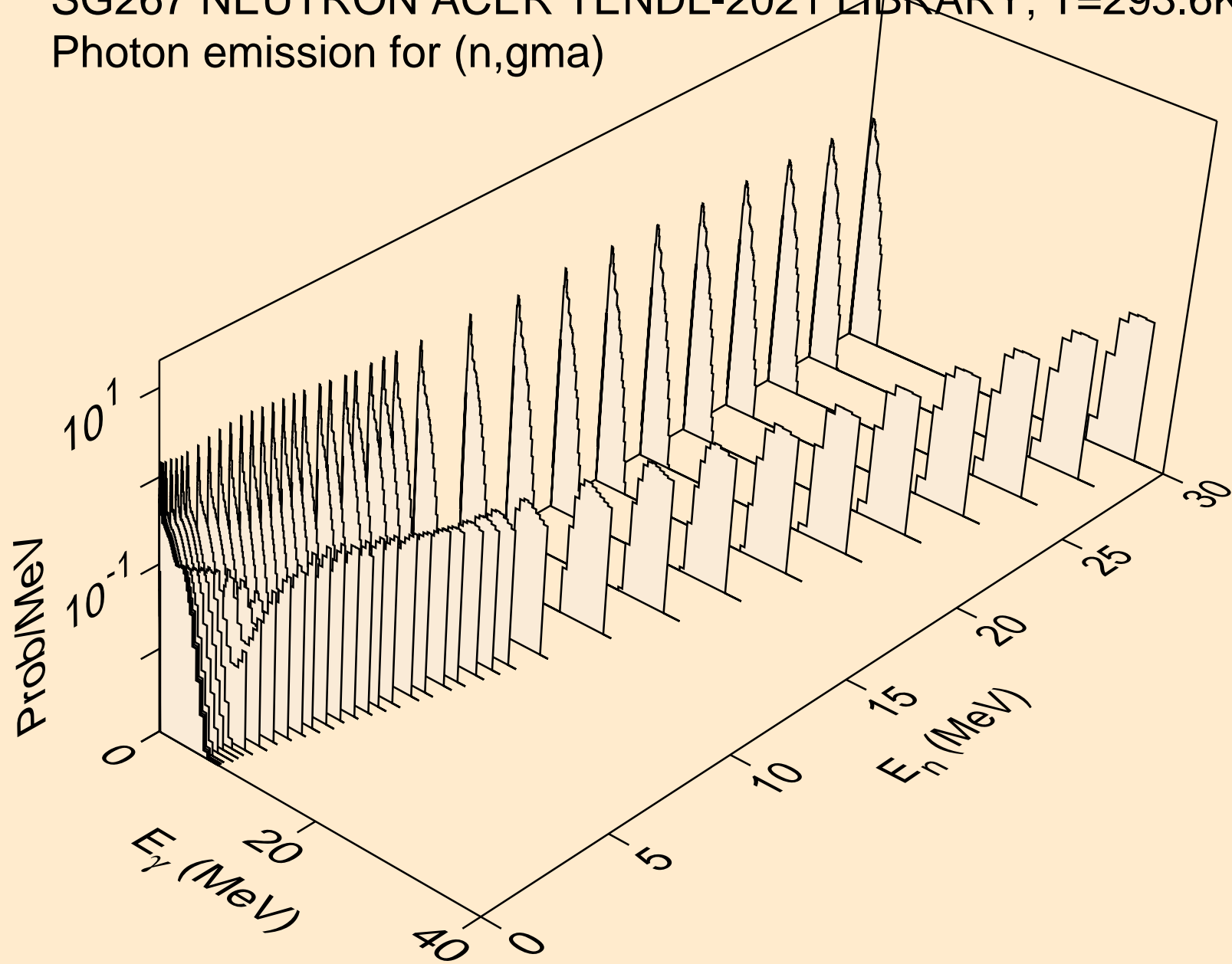

SG267 NEUTRON ACER TENDL-2021 LIBRARY; T=293.6K
Photon emission for (n,p)

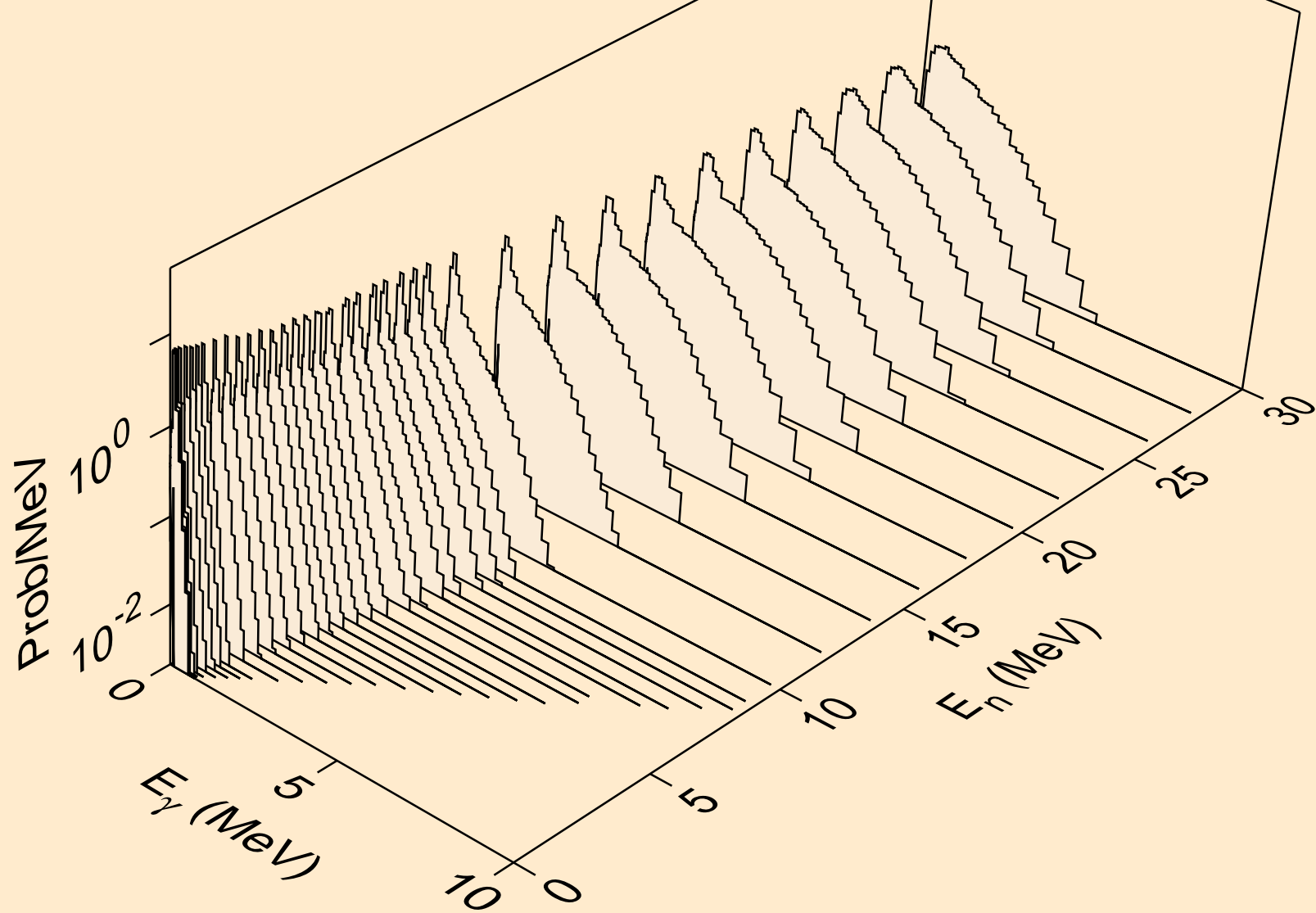

SG267 NEUTRON ACER TENDL-2021 LIBRARY; T=293.6K
Photon emission for (n,d)

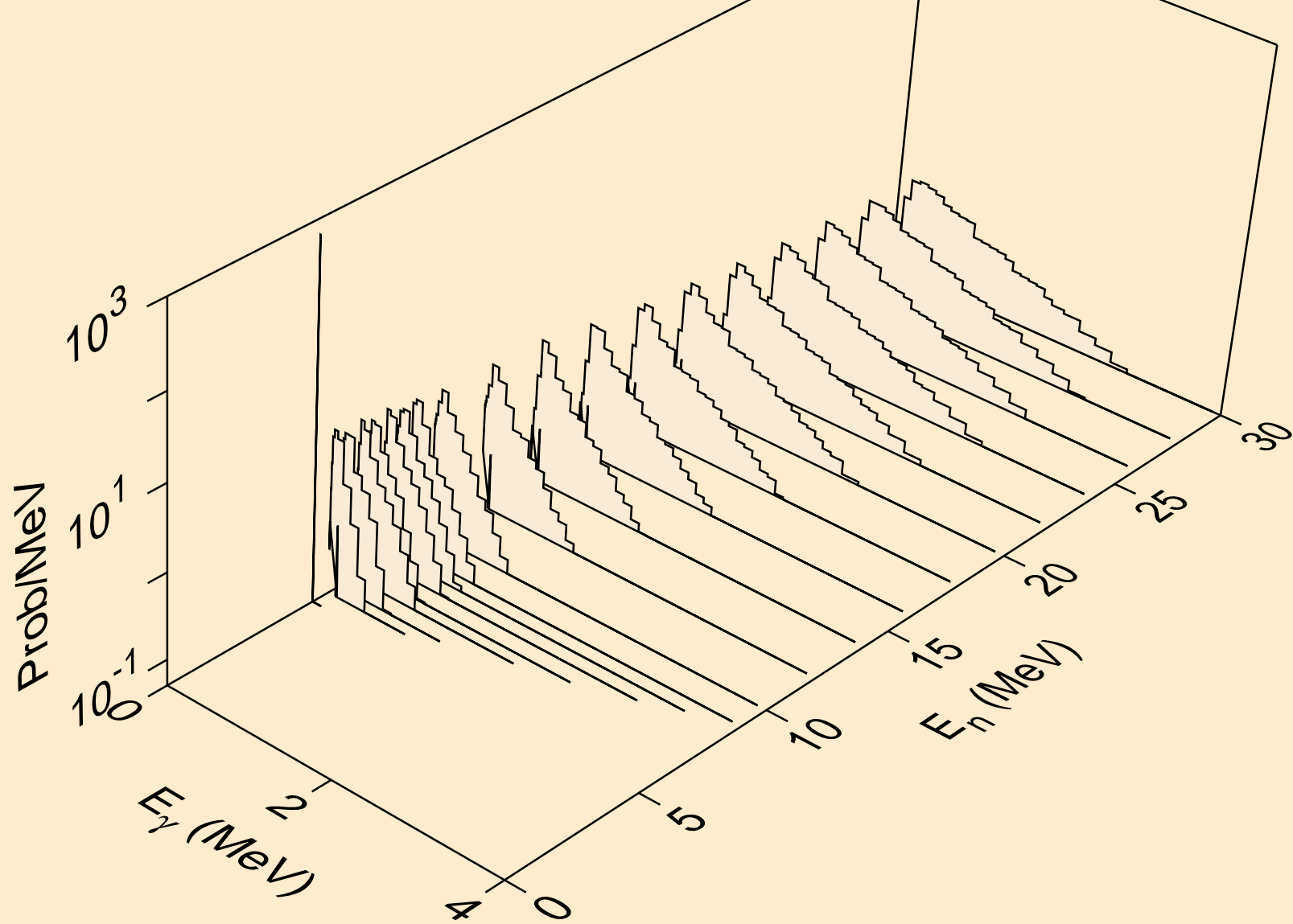

SG267 NEUTRON ACER TENDL-2021 LIBRARY; T=293.6K
Photon emission for (n,t)

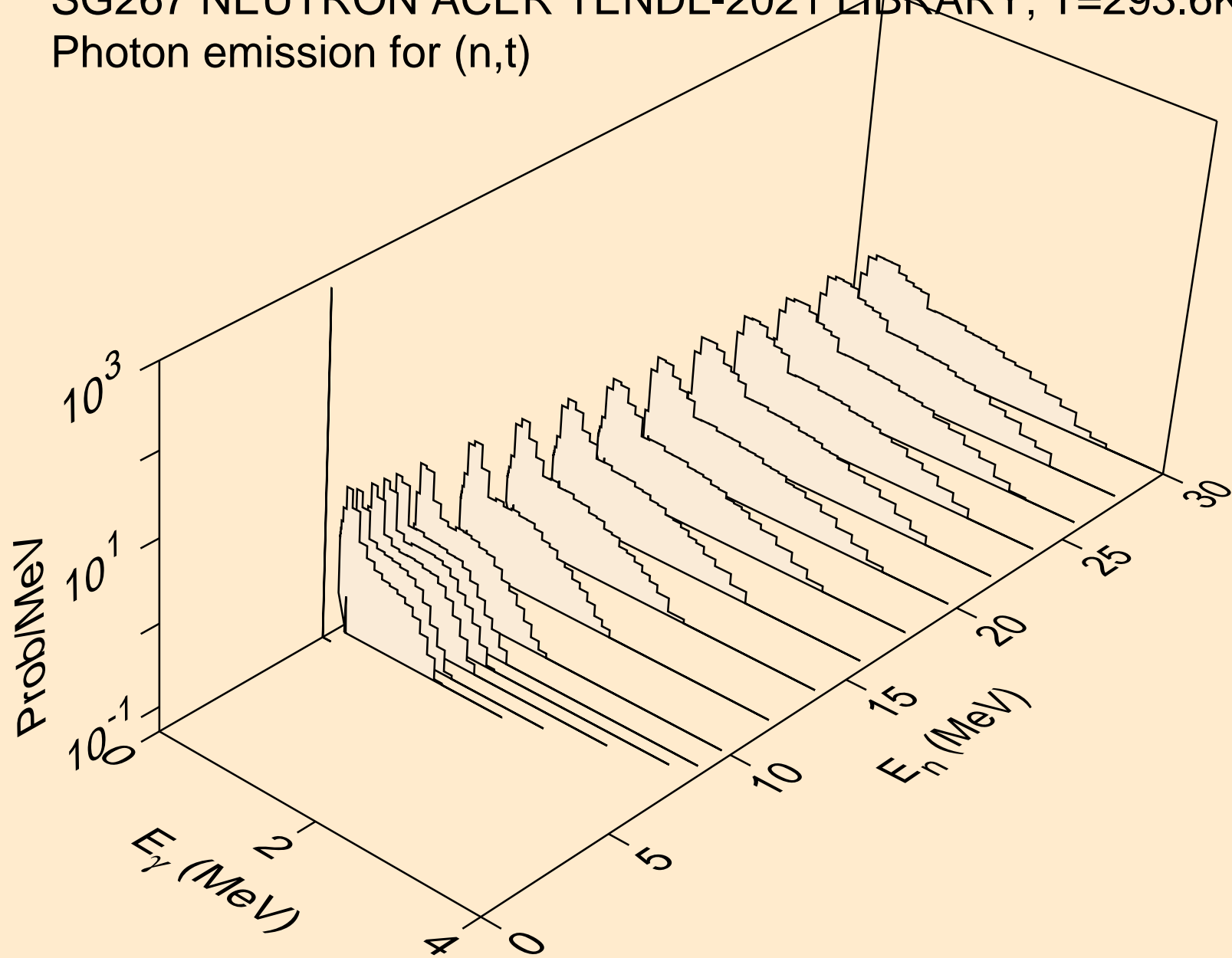

SG267 NEUTRON ACER TENDL-2021 LIBRARY; T=293.6K
Photon emission for (n,he3)

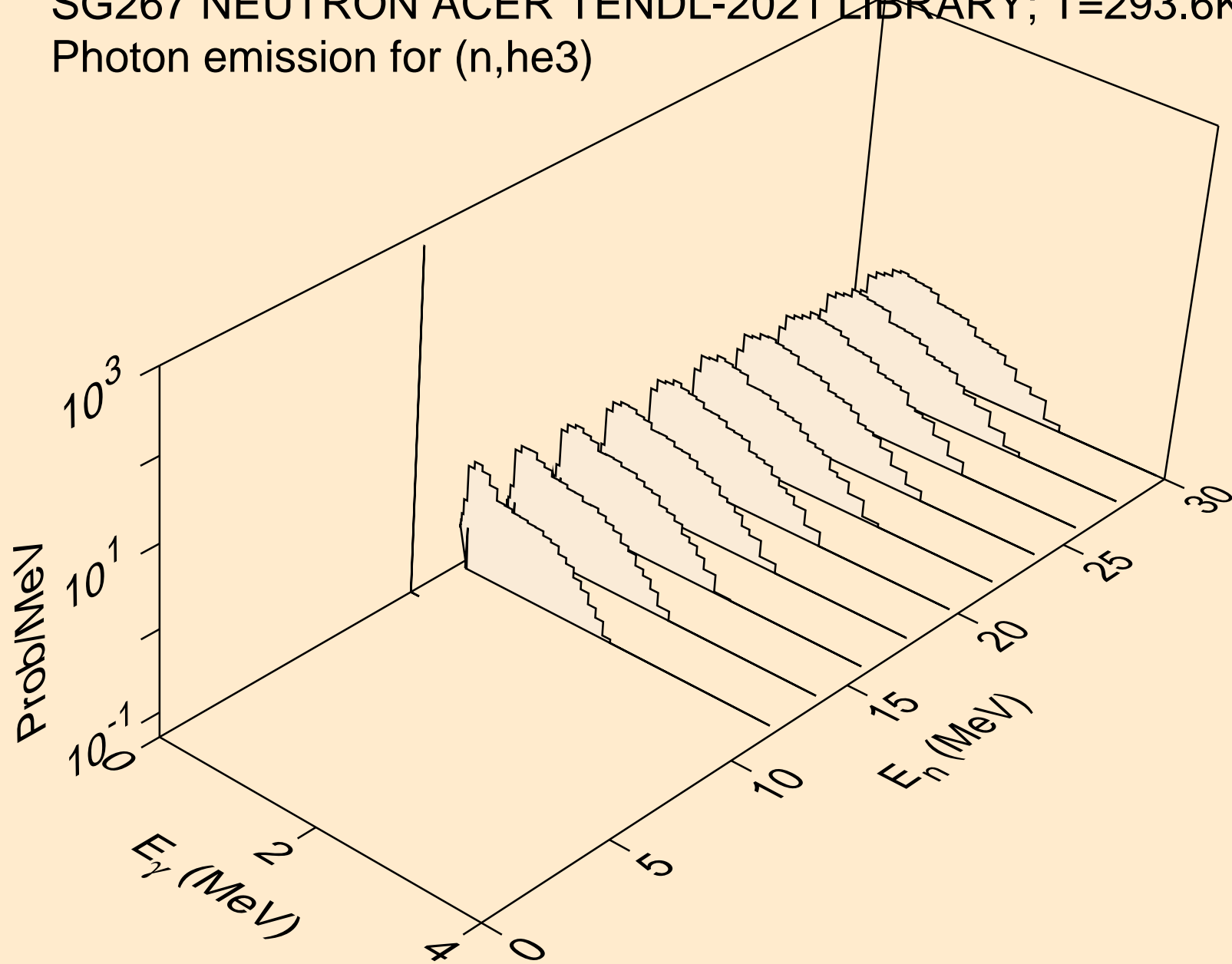

SG267 NEUTRON ACER TENDL-2021 LIBRARY; T=293.6K
Photon emission for (n,a)

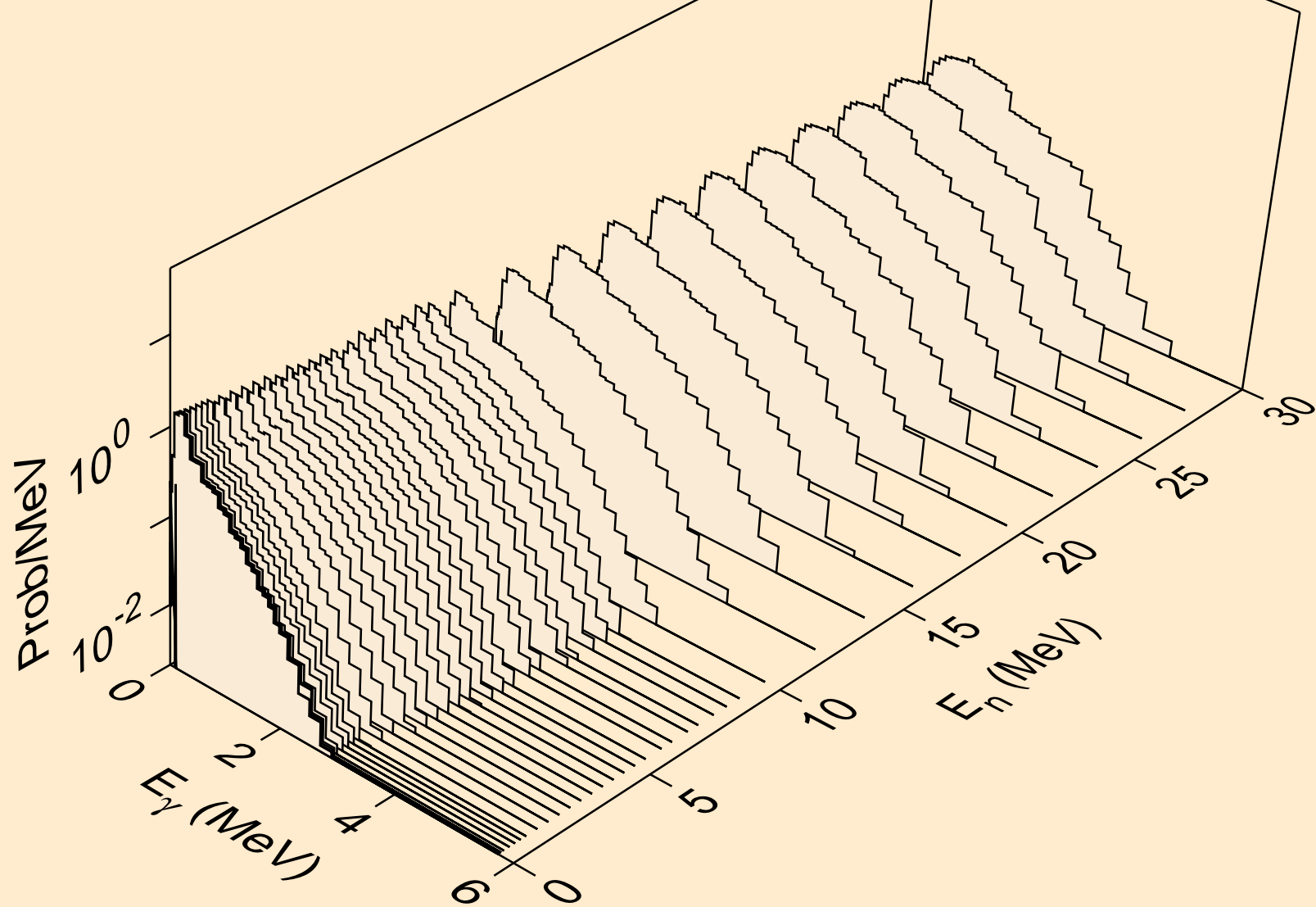

SG267 NEUTRON ACER TENDL-2021 LIBRARY; T=293.6K
Photon emission for (n,pd)

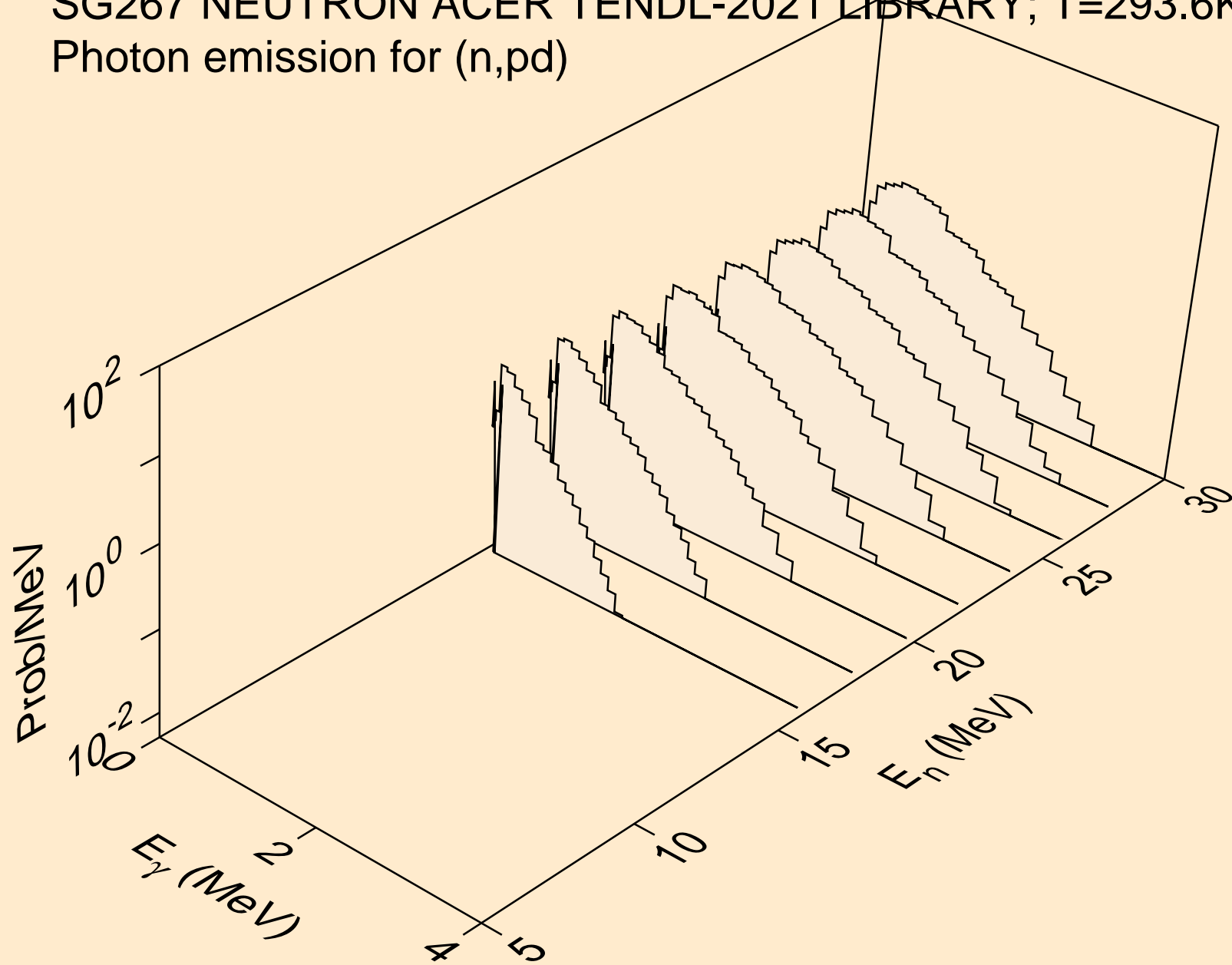

SG267 NEUTRON ACER TENDL-2021 LIBRARY; T=293.6K
Photon emission for (n,pt)

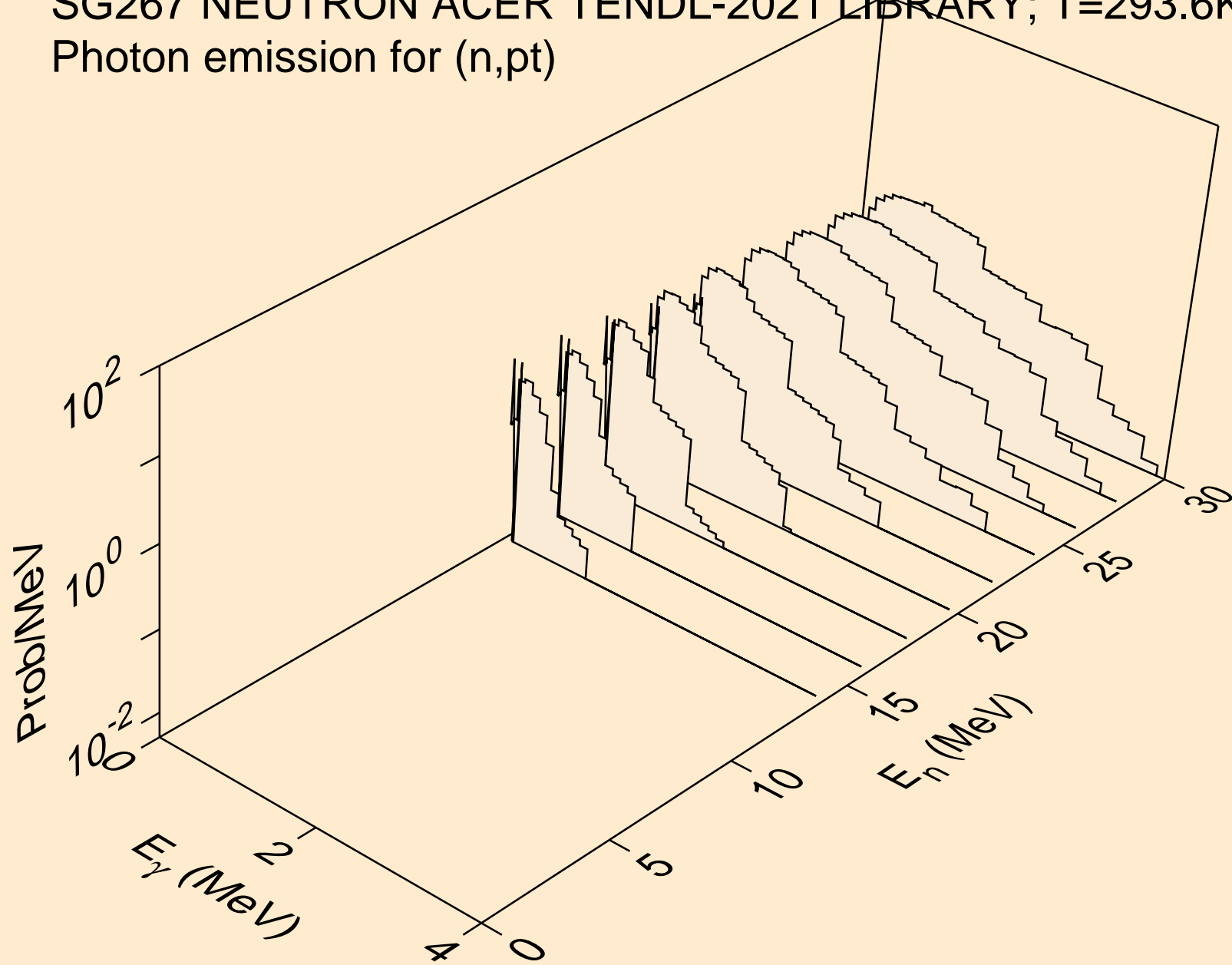

SG267 NEUTRON ACER TENDL-2021 LIBRARY; T=293.6K
Photon emission for (n,da)

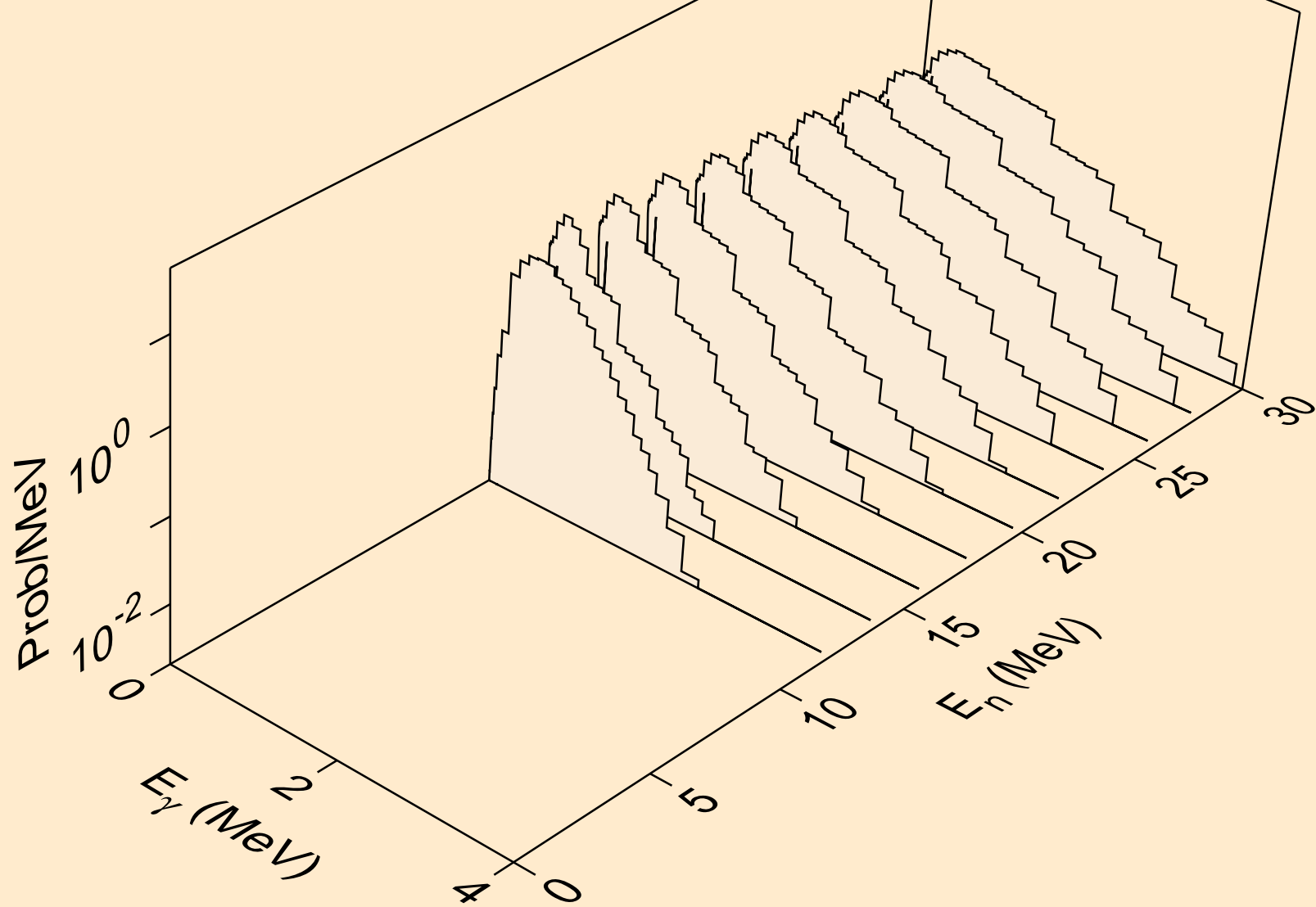

SG267 NEUTRON ACER TENDL-2021 LIBRARY; T=293.6K
thermal capture photon spectrum

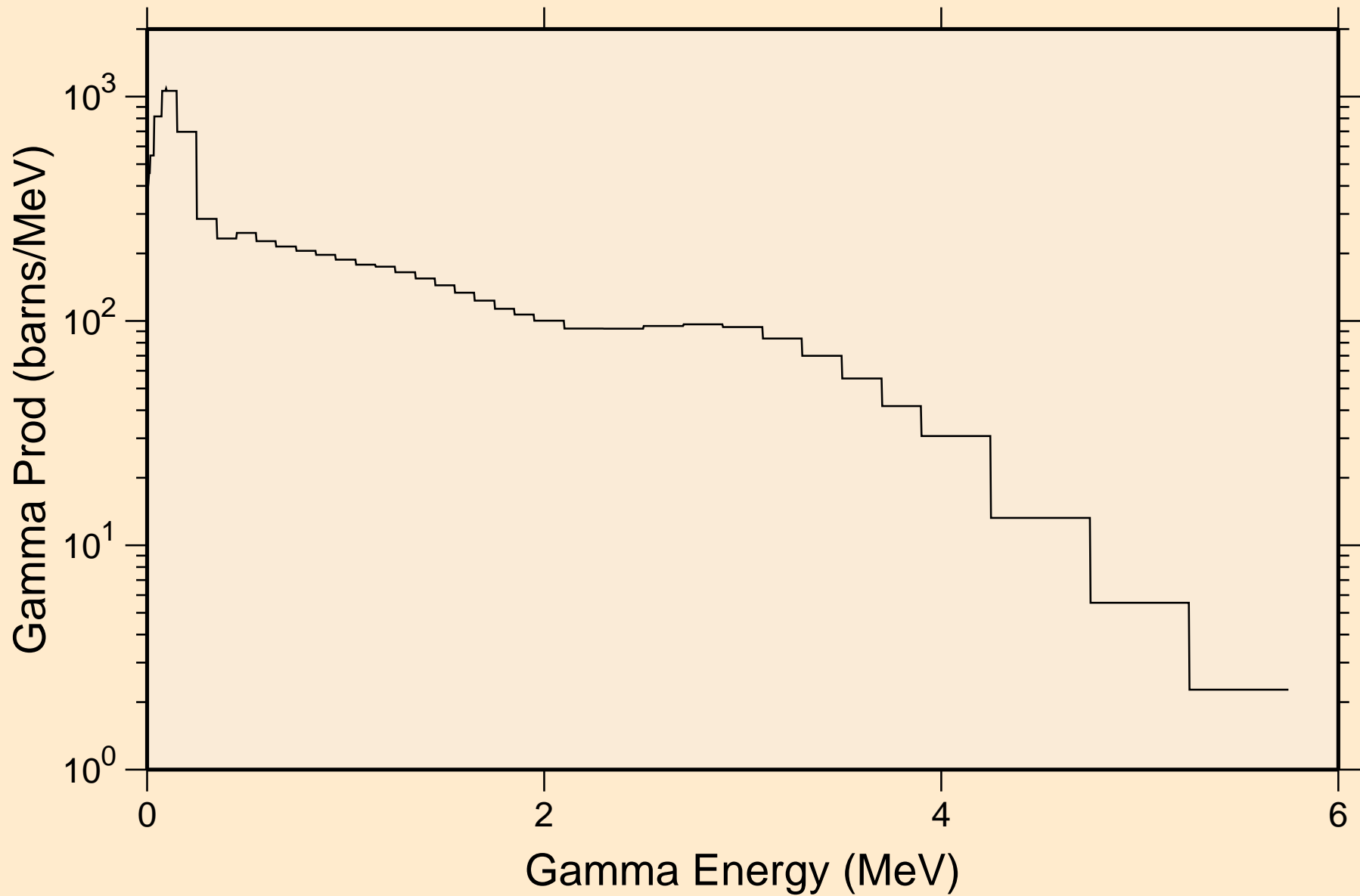

SG267 NEUTRON ACER TENDL-2021 LIBRARY; T=293.6K
14 MeV photon spectrum

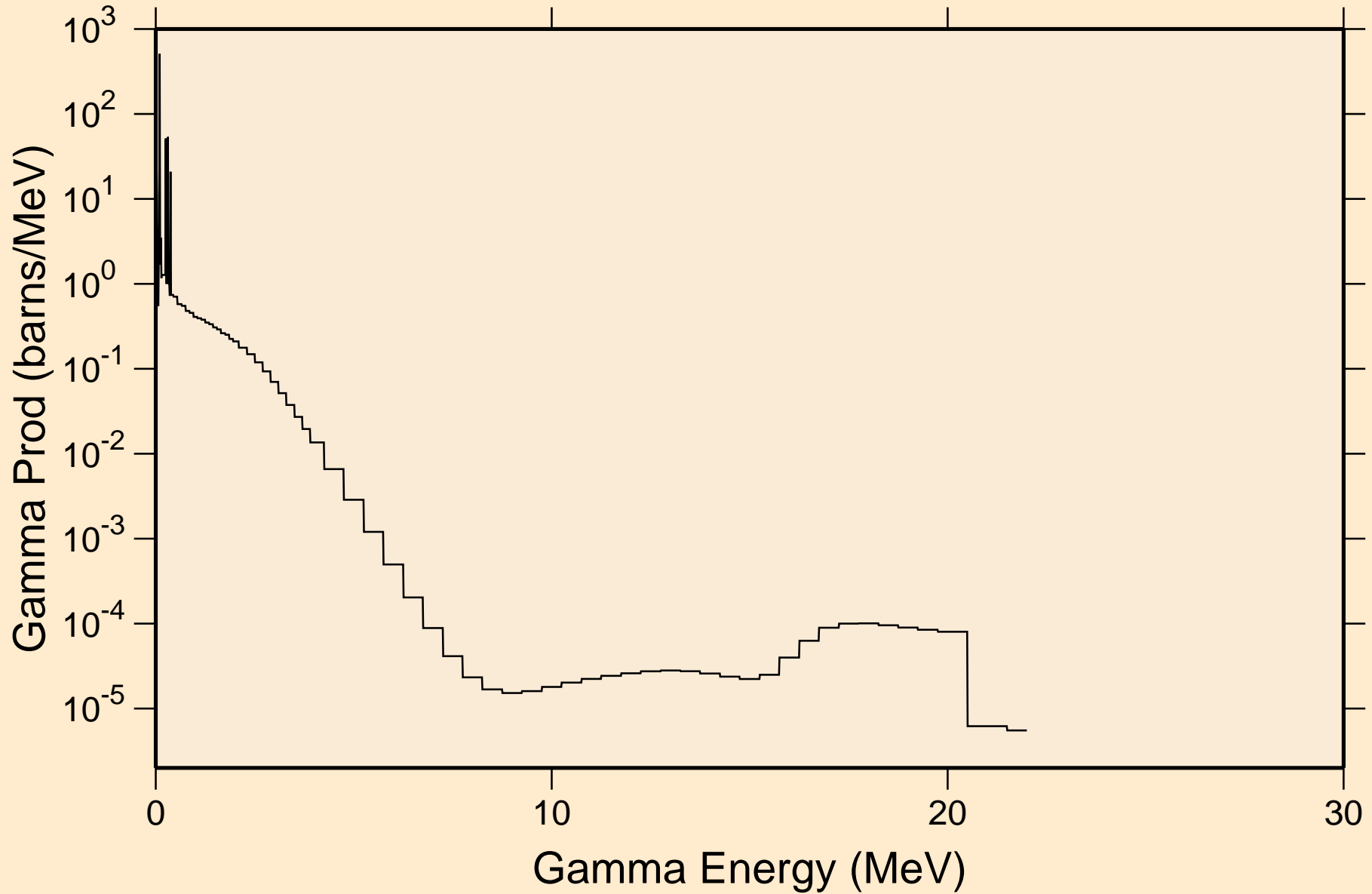

SG267 NEUTRON ACER TENDL-2021 LIBRARY; T=293.6K

Particle heating contributions

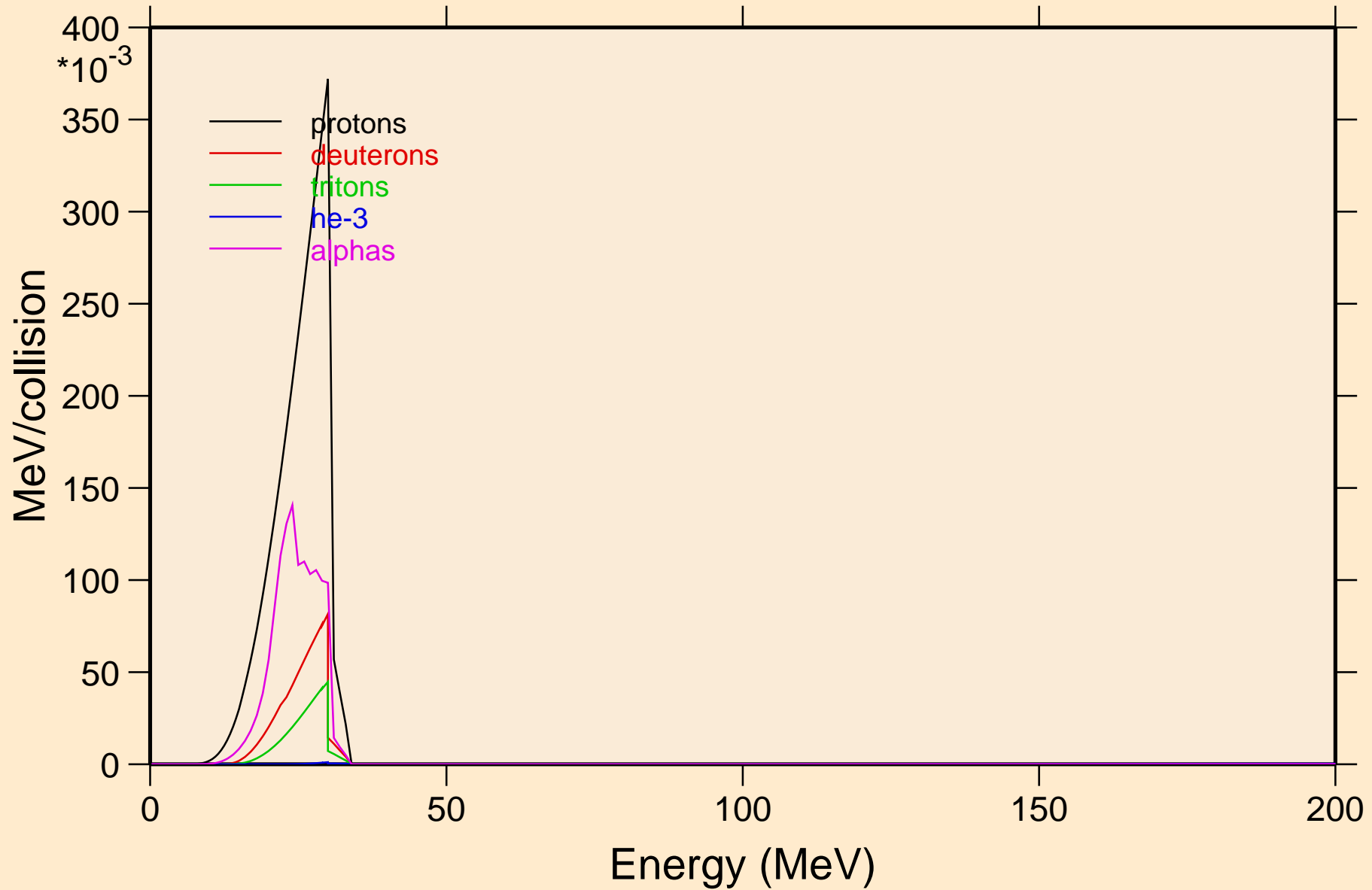

SG267 NEUTRON ACER TENDL-2021 LIBRARY; T=293.6K

Recoil Heating

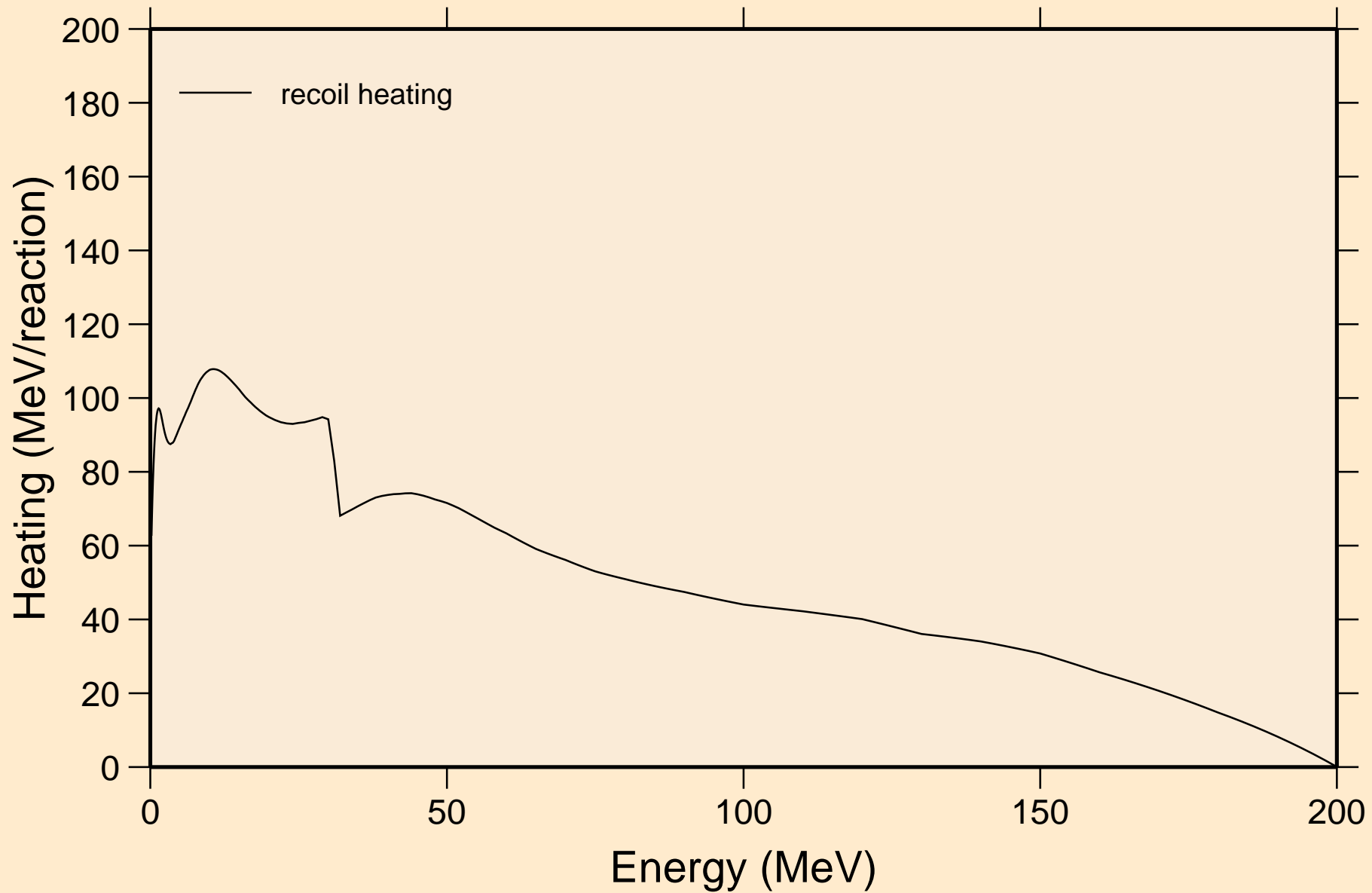

SG267 NEUTRON ACER TENDL-2021 LIBRARY; T=293.6K

Particle production cross sections

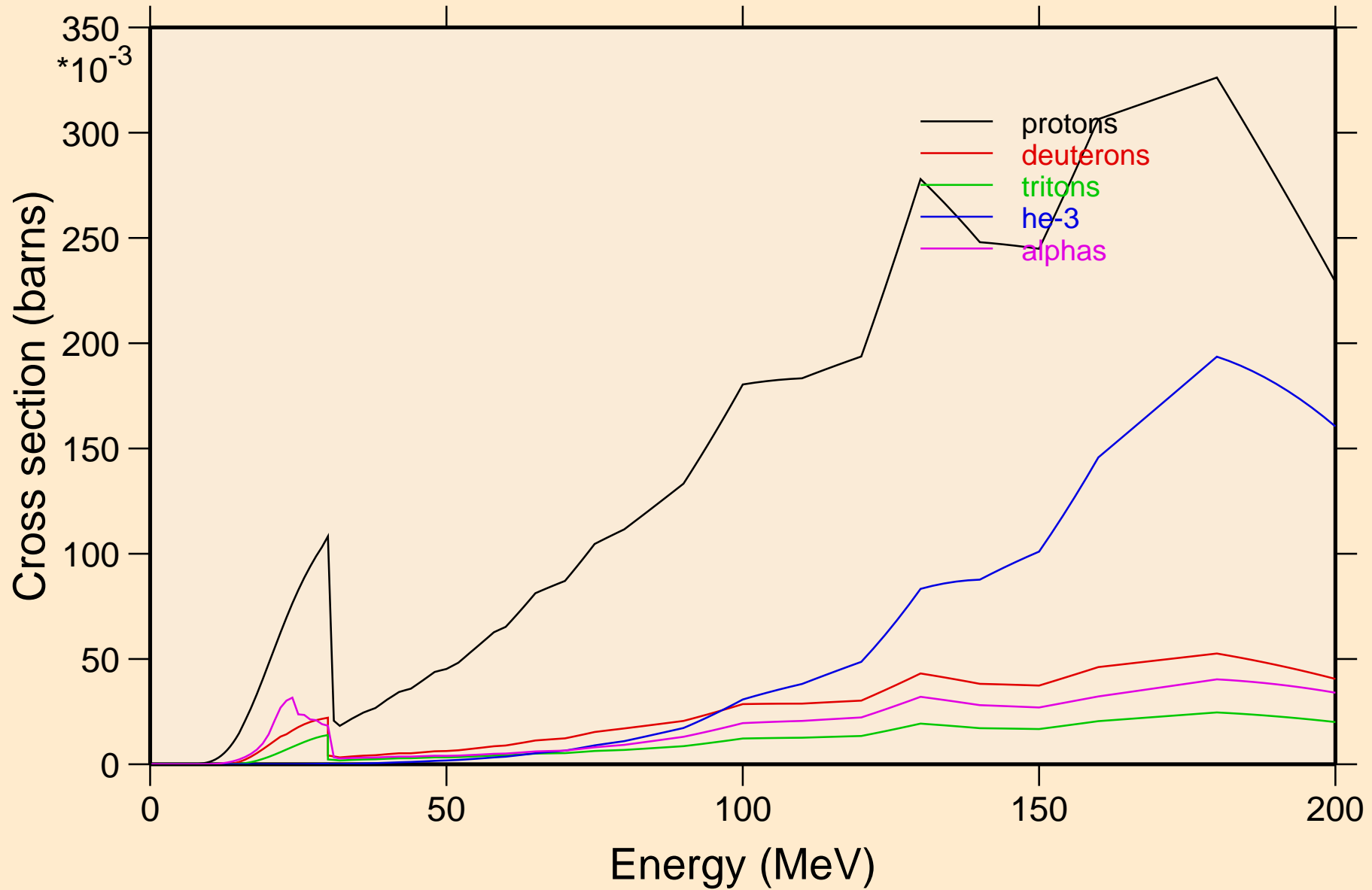

SG267 NEUTRON ACER TENDL-2021 LIBRARY; T=293.6K
protons from (n,x)

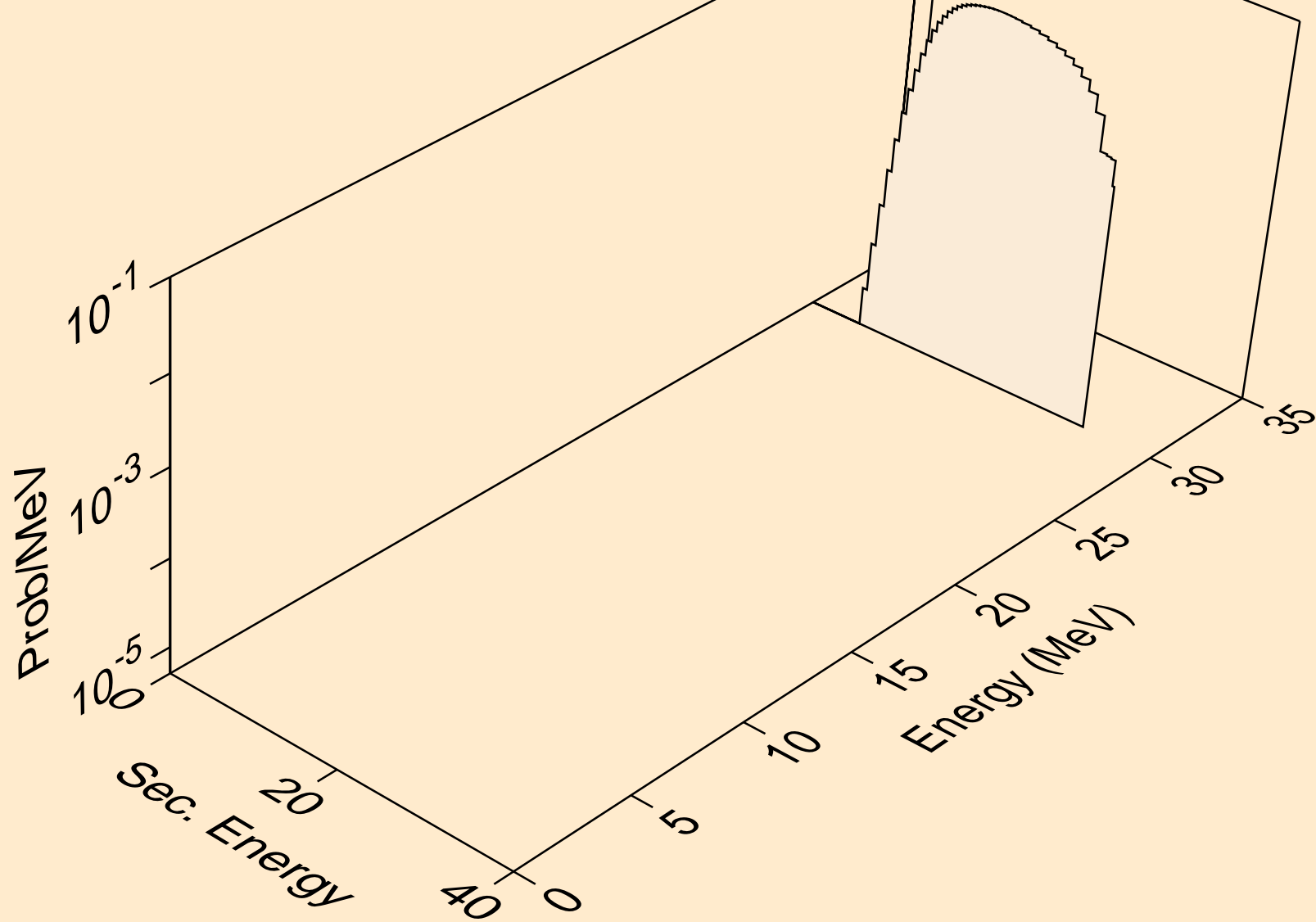

SG267 NEUTRON ACER TENDL-2021 LIBRARY; T=293.6K
protons from (n,n*)p

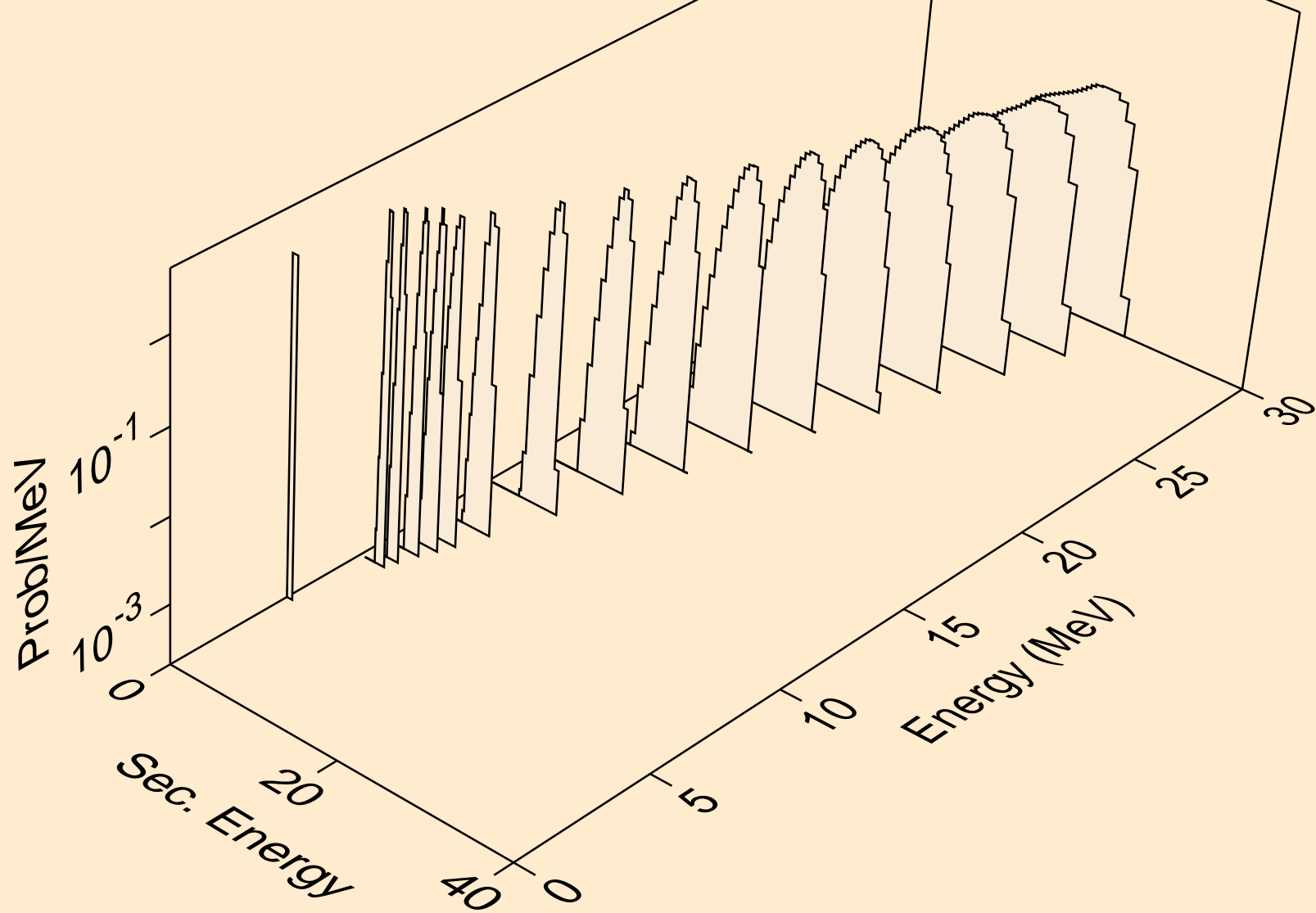

SG267 NEUTRON ACER TENDL-2021 LIBRARY; T=293.6K
protons from (n,2np)

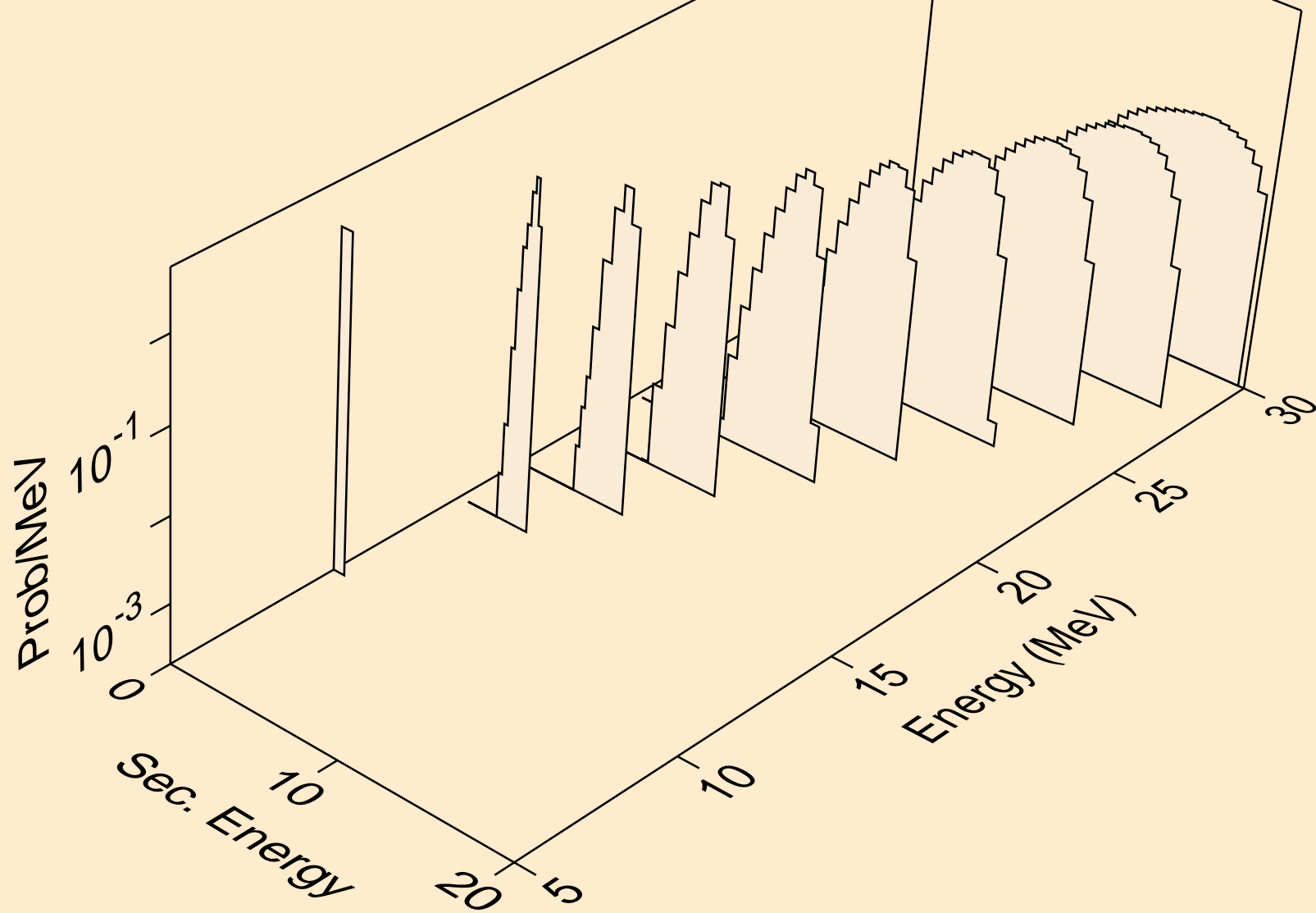

SG267 NEUTRON ACER TENDL-2021 LIBRARY; T=293.6K
protons from (n,3np)

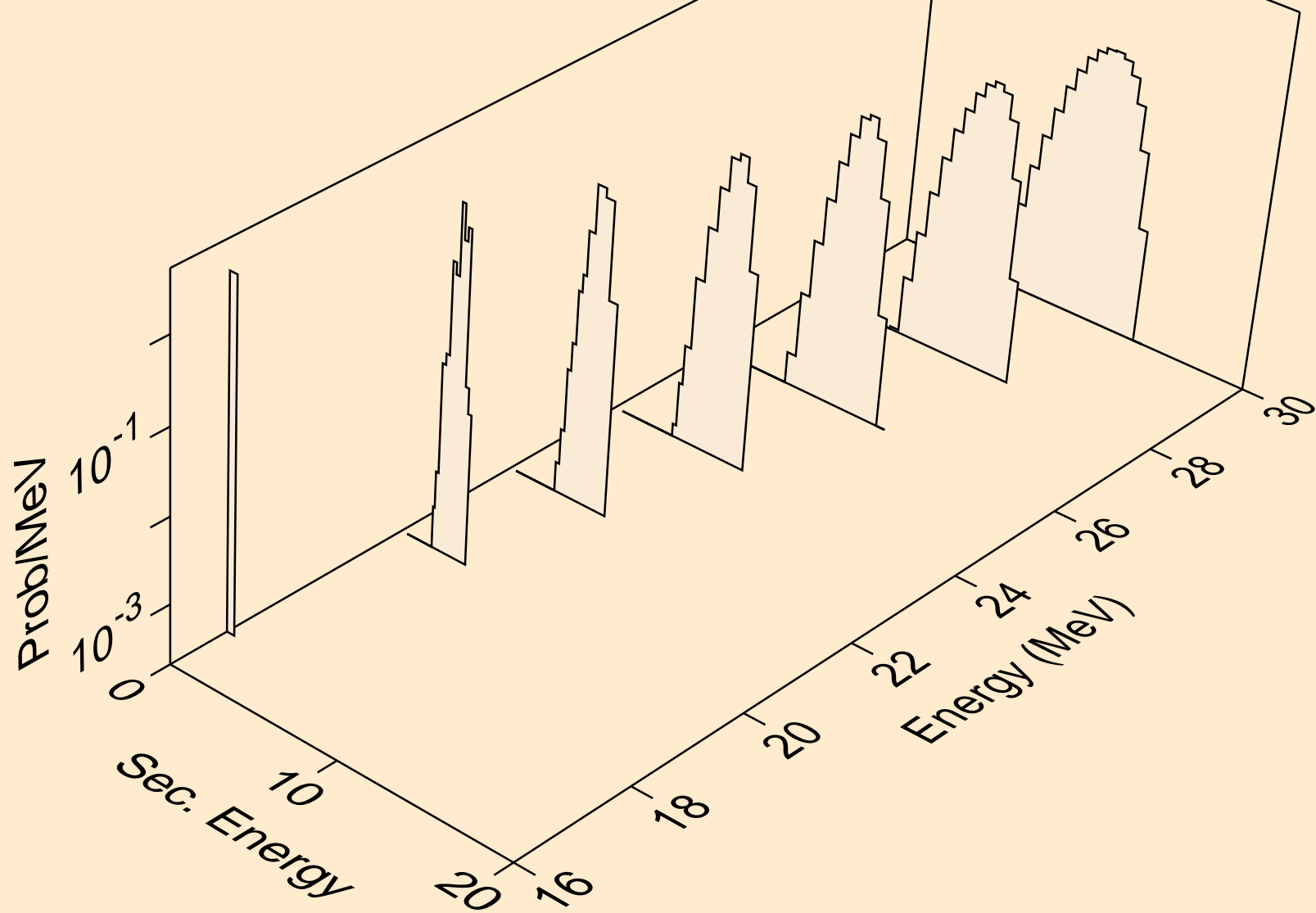

SG267 NEUTRON ACER TENDL-2021 LIBRARY; T=293.6K
protons from (n,2np)

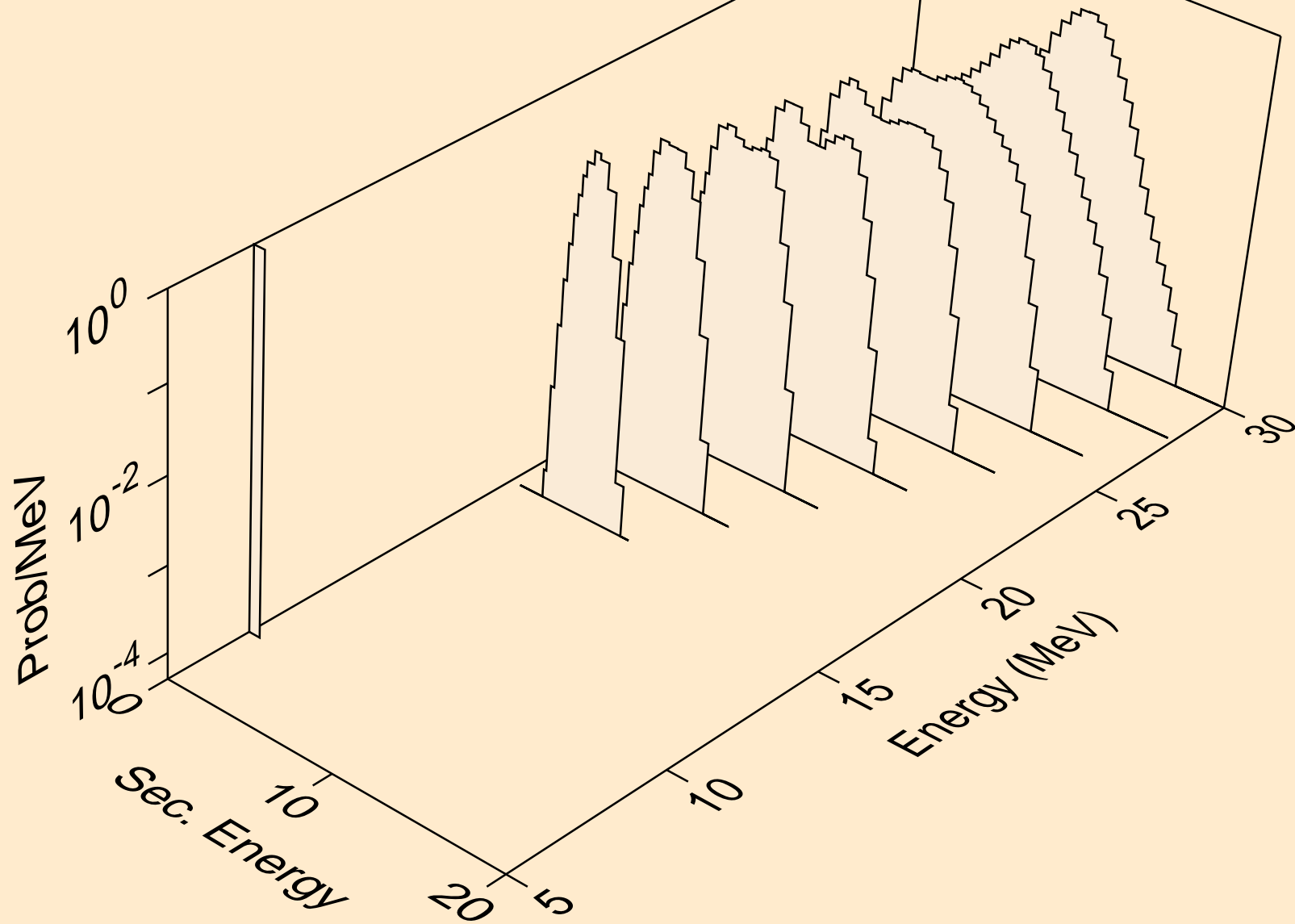

SG267 NEUTRON ACER TENDL-2021 LIBRARY; T=293.6K
protons from (n,npa)

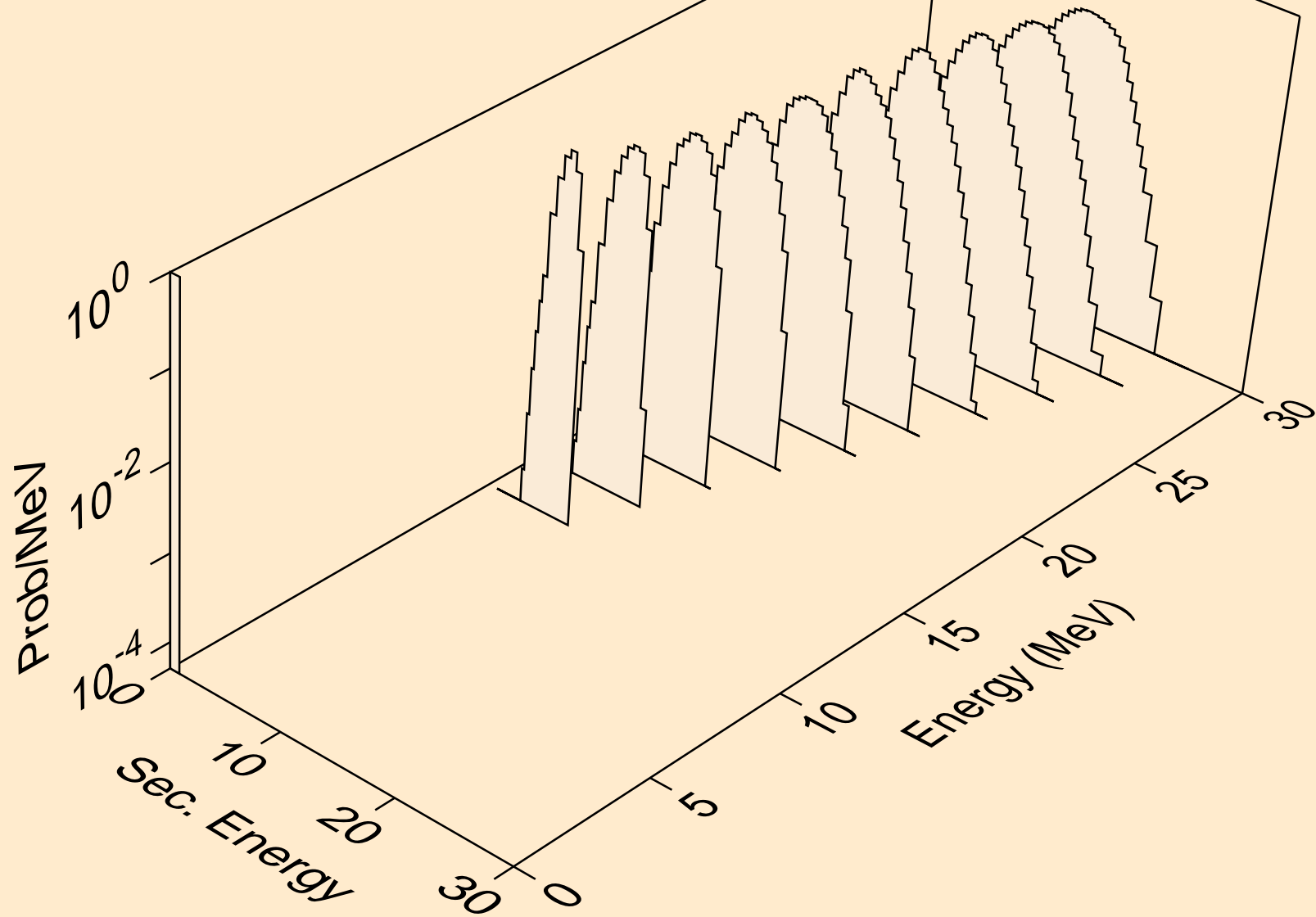

SG267 NEUTRON ACER TENDL-2021 LIBRARY; T=293.6K
protons from (n,p)

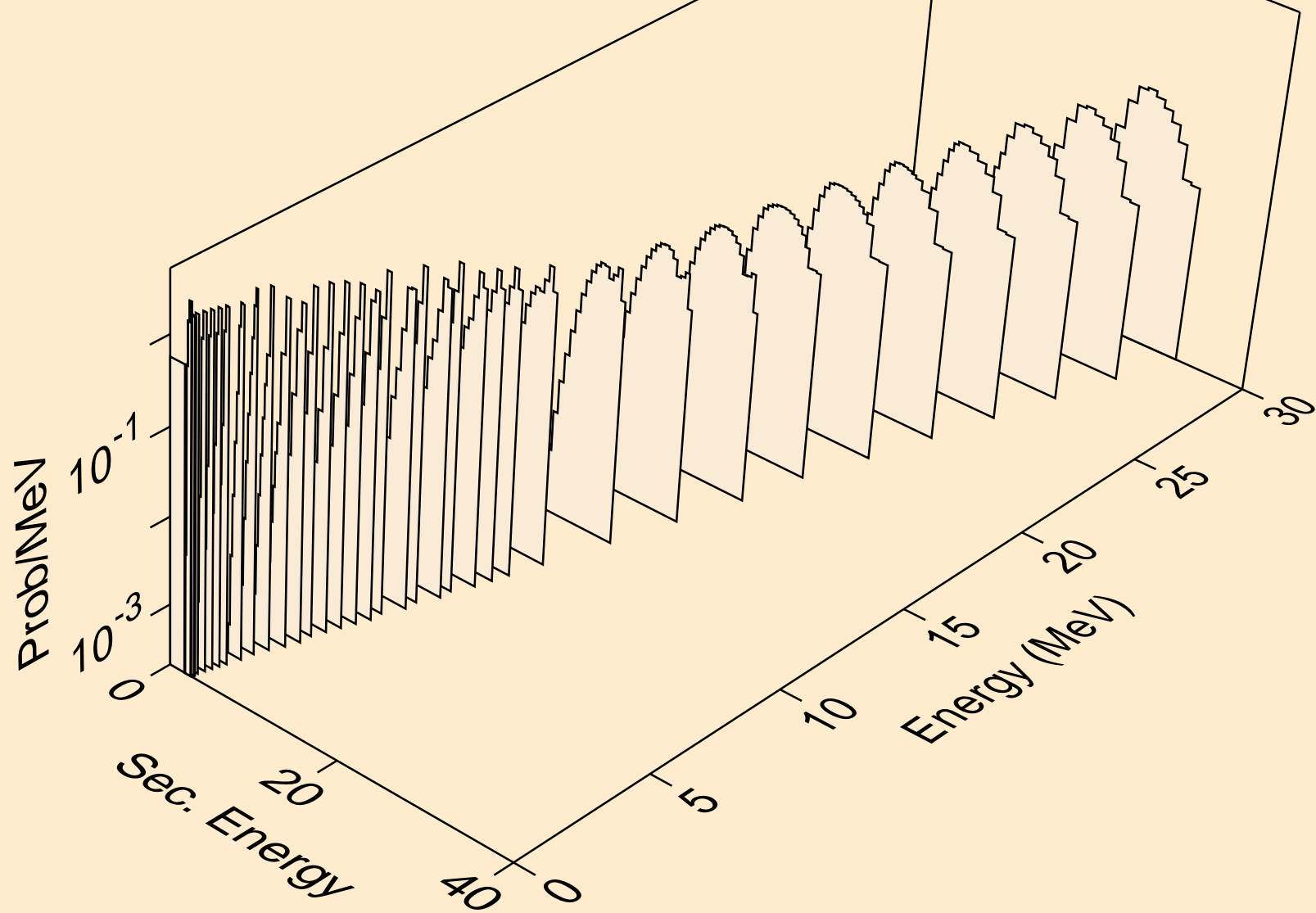

SG267 NEUTRON ACER TENDL-2021 LIBRARY; T=293.6K
protons from (n,pd)

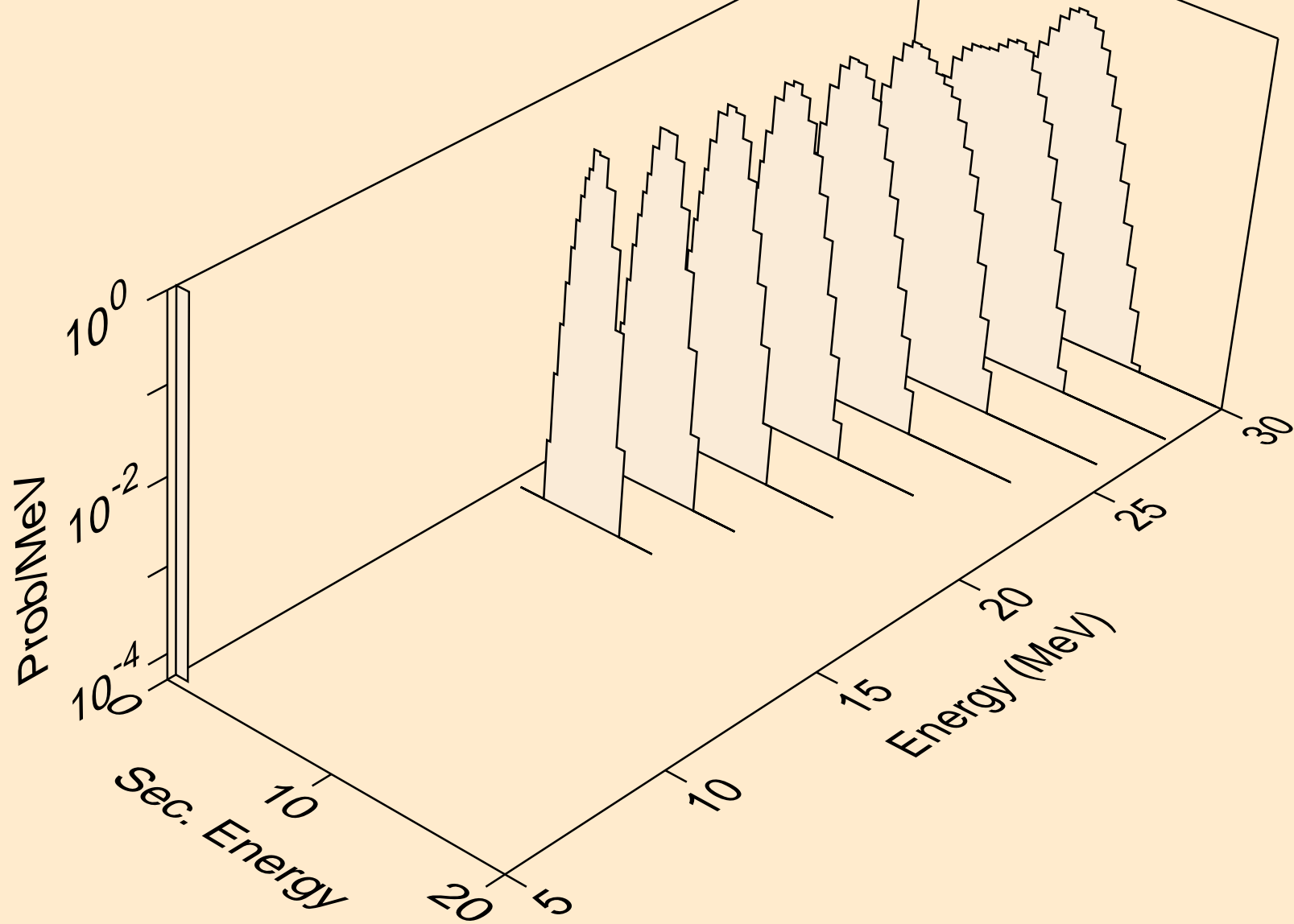

SG267 NEUTRON ACER TENDL-2021 LIBRARY; T=293.6K
protons from (n,pt)

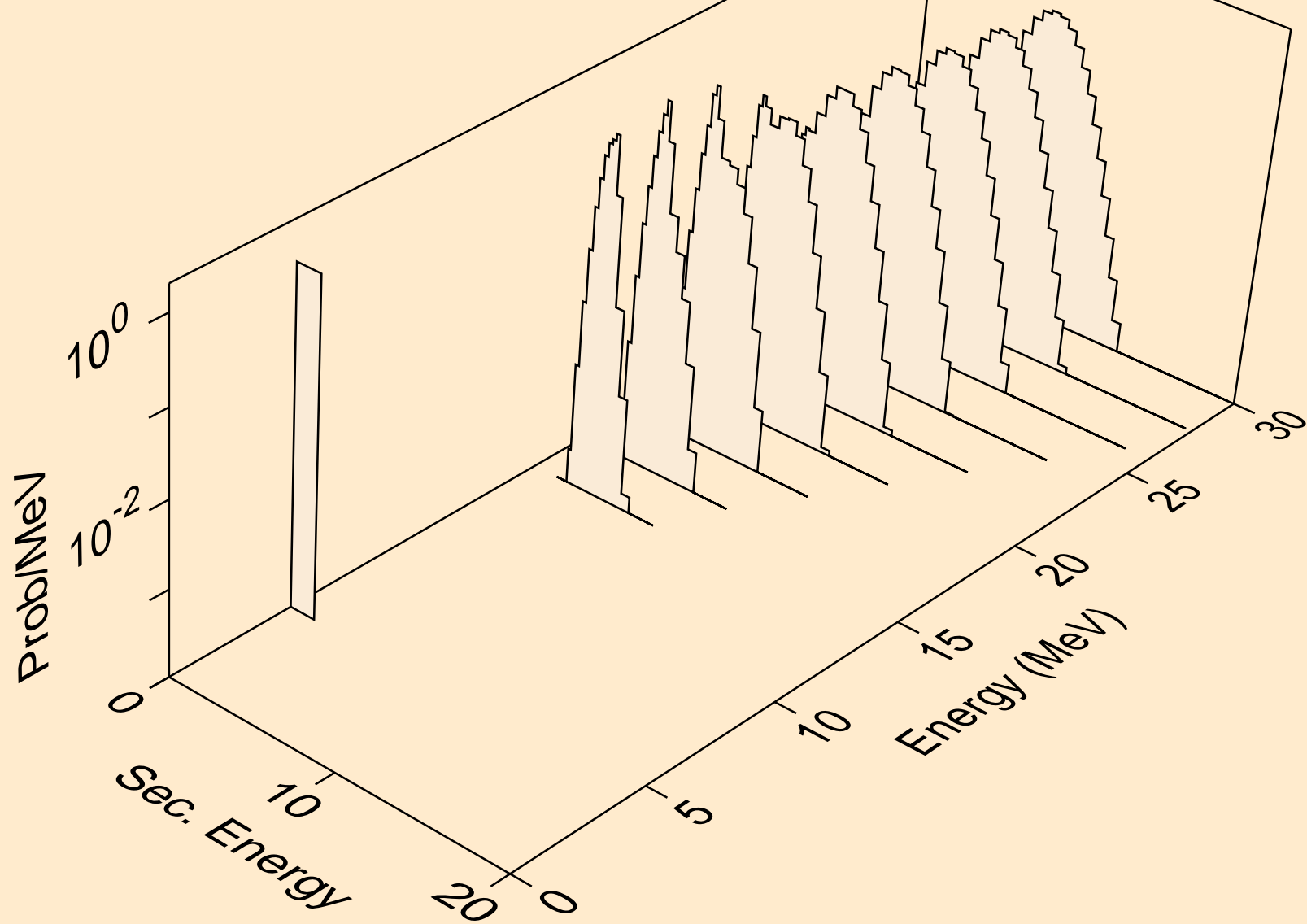

SG267 NEUTRON ACER TENDL-2021 LIBRARY; T=293.6K
deuterons from (n,x)

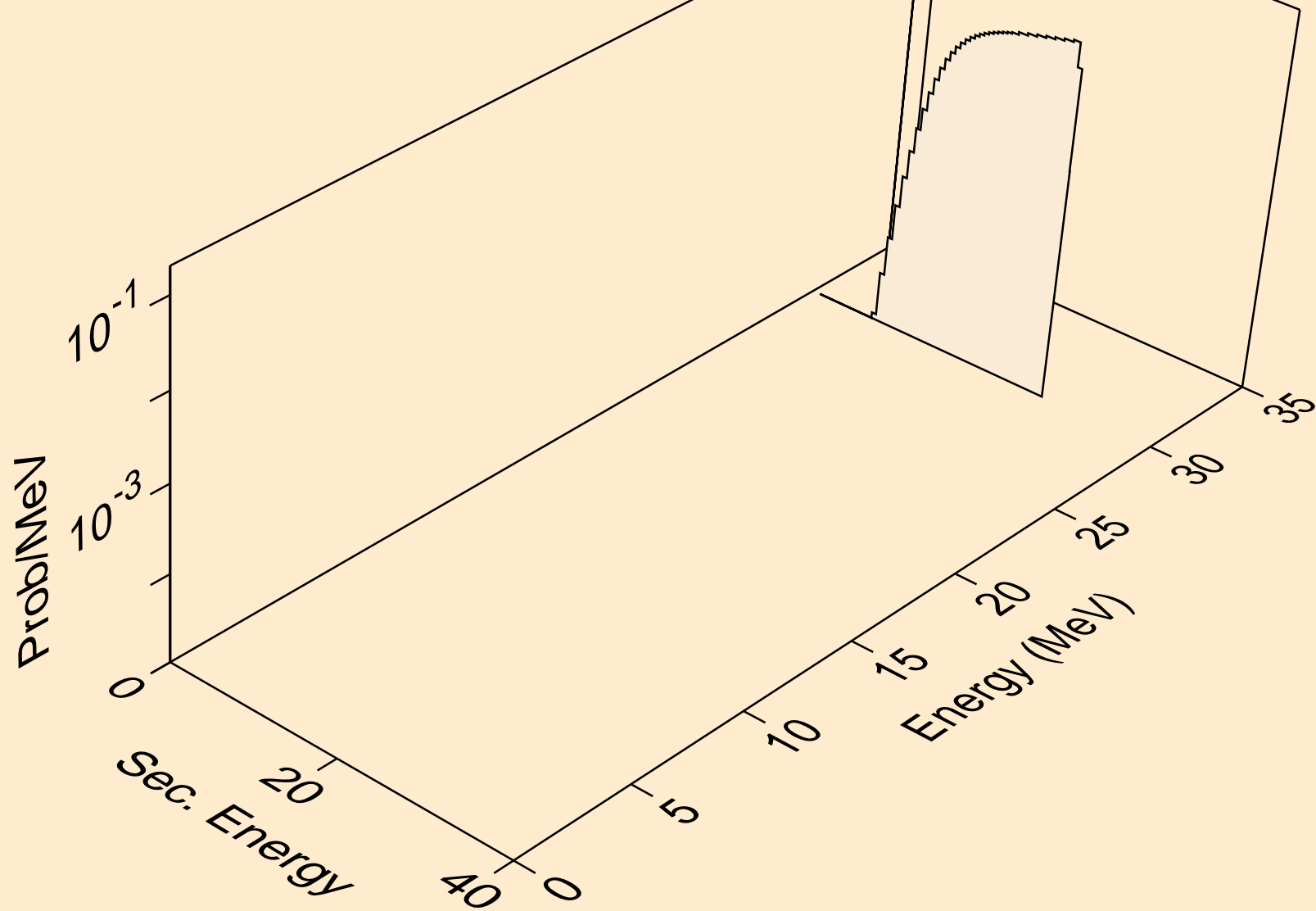

SG267 NEUTRON ACER TENDL-2021 LIBRARY; T=293.6K
deuterons from (n,2nd)

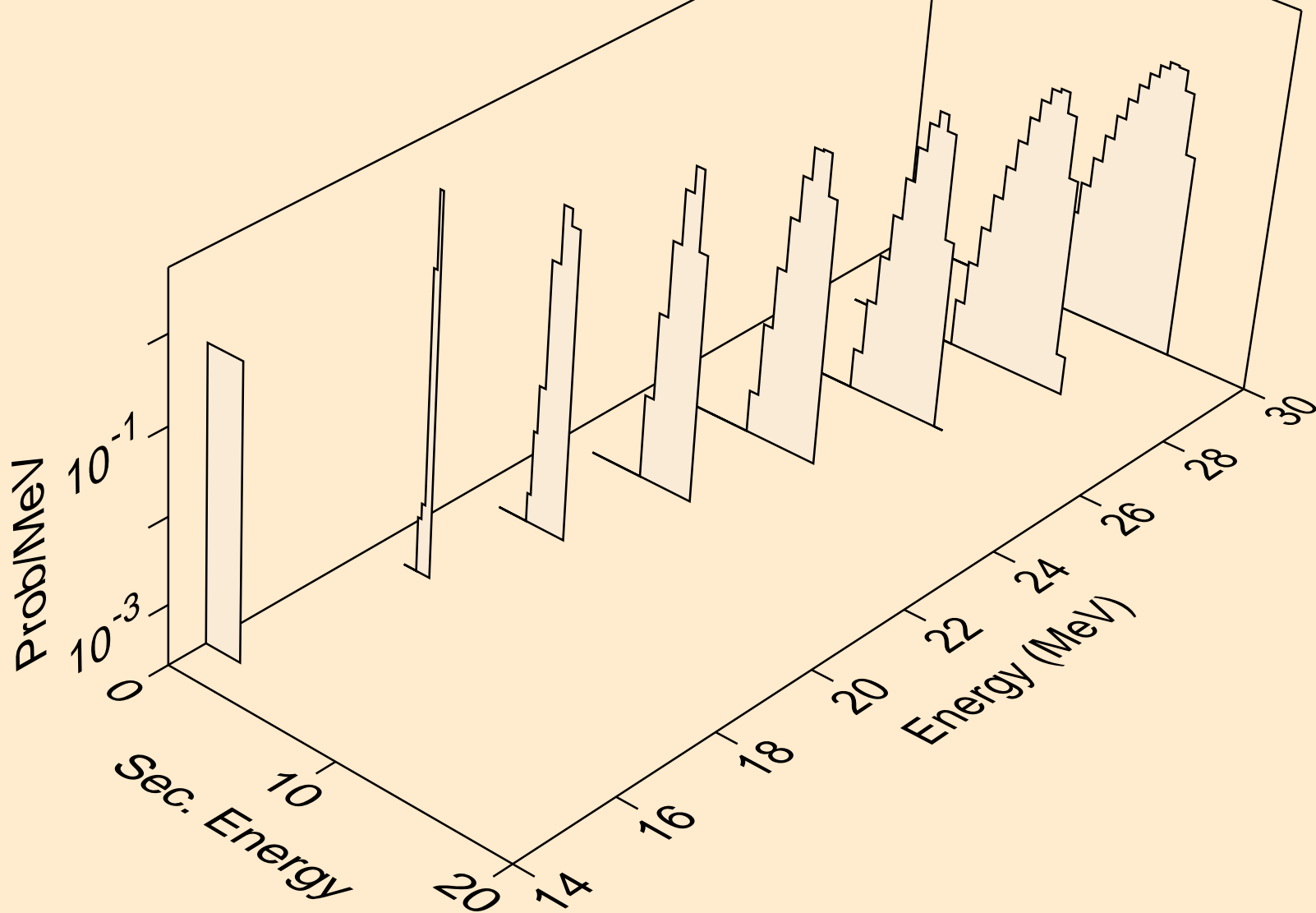

SG267 NEUTRON ACER TENDL-2021 LIBRARY; T=293.6K
deuterons from (n,n*)d

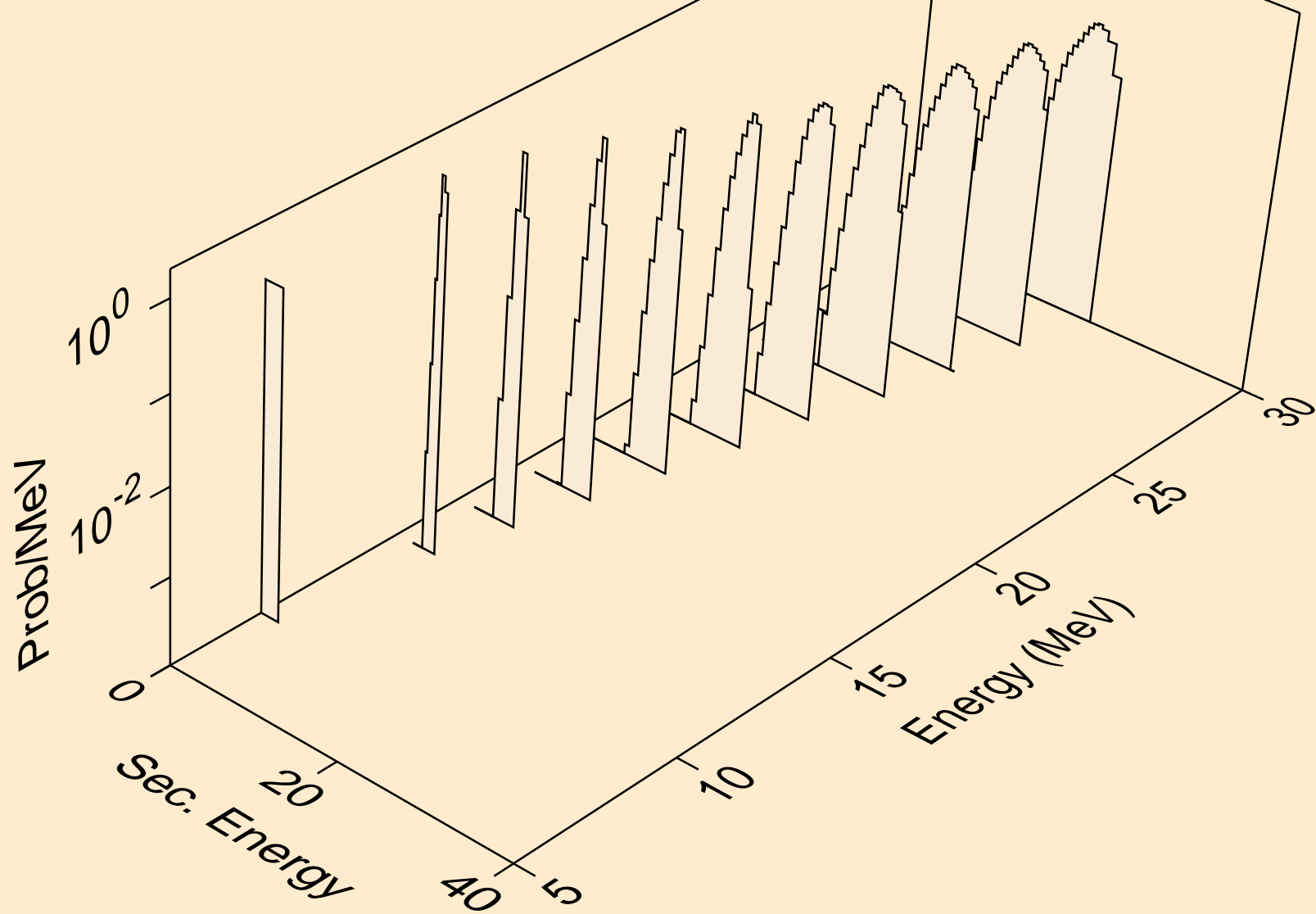

SG267 NEUTRON ACER TENDL-2021 LIBRARY; T=293.6K
deuterons from (n,d)

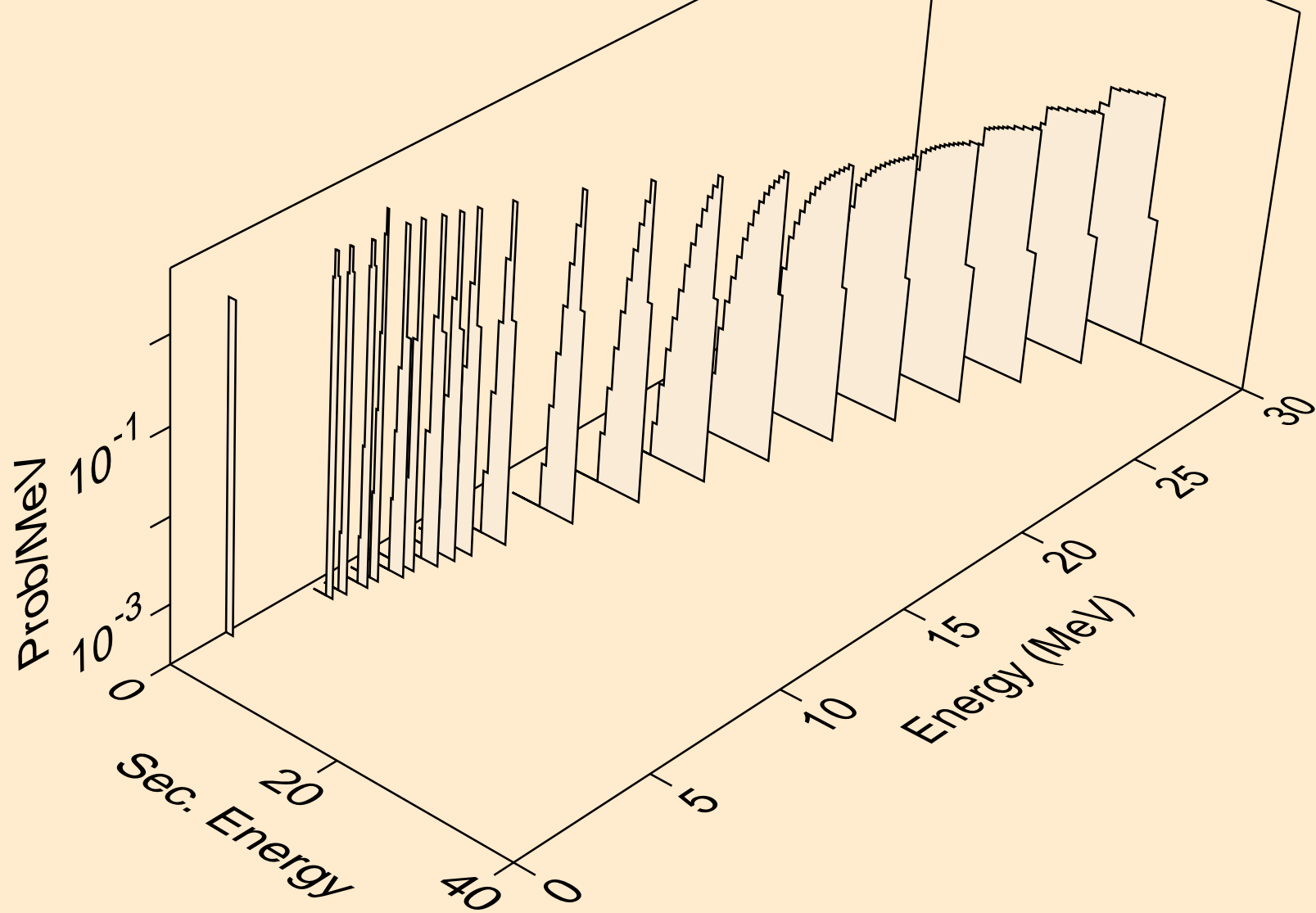

SG267 NEUTRON ACER TENDL-2021 LIBRARY; T=293.6K
deuterons from (n,pd)

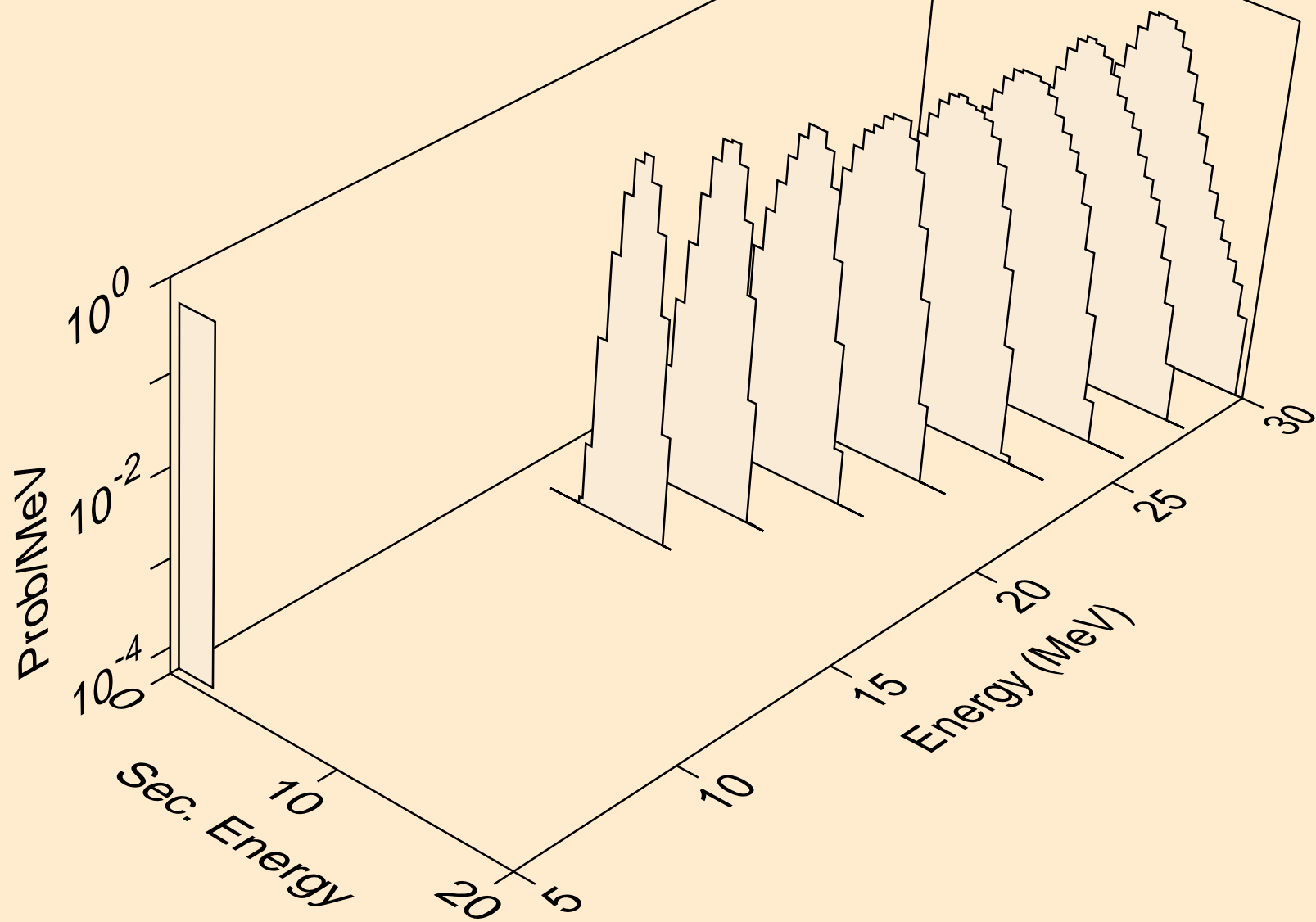

SG267 NEUTRON ACER TENDL-2021 LIBRARY; T=293.6K
deuterons from (n,da)

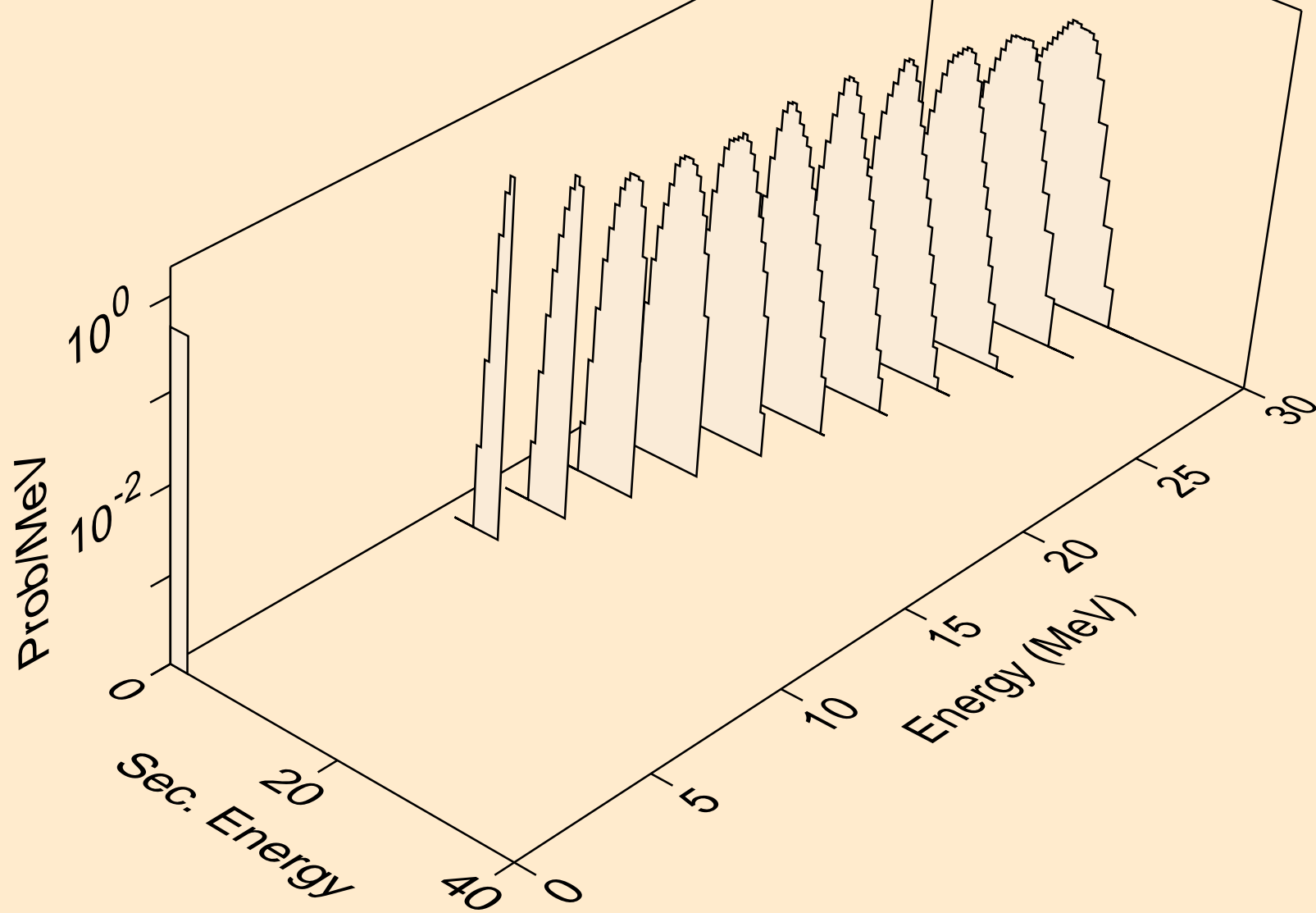

SG267 NEUTRON ACER TENDL-2021 LIBRARY; T=293.6K
tritons from (n,x)

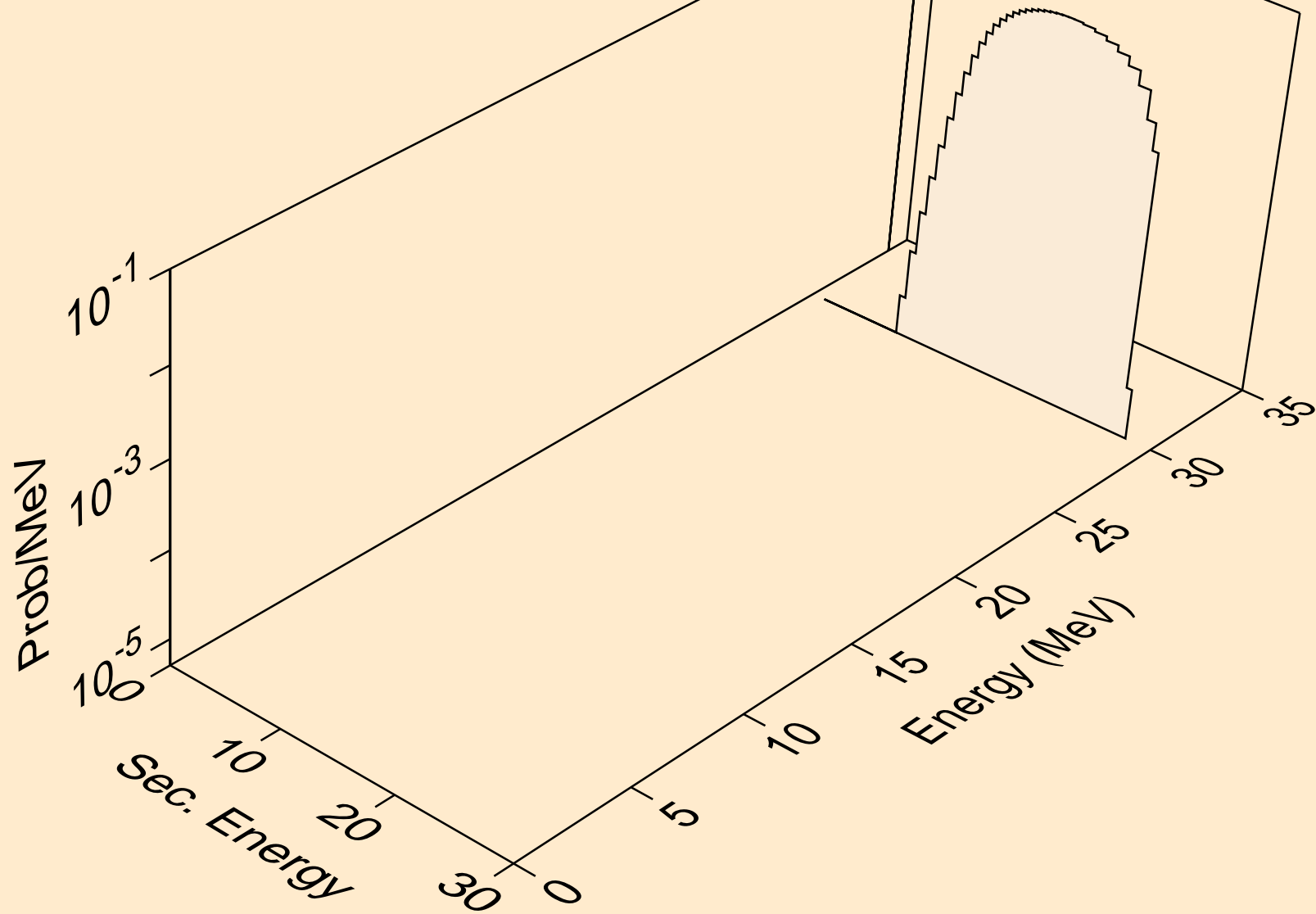

SG267 NEUTRON ACER TENDL-2021 LIBRARY; T=293.6K
tritons from (n,n*)t

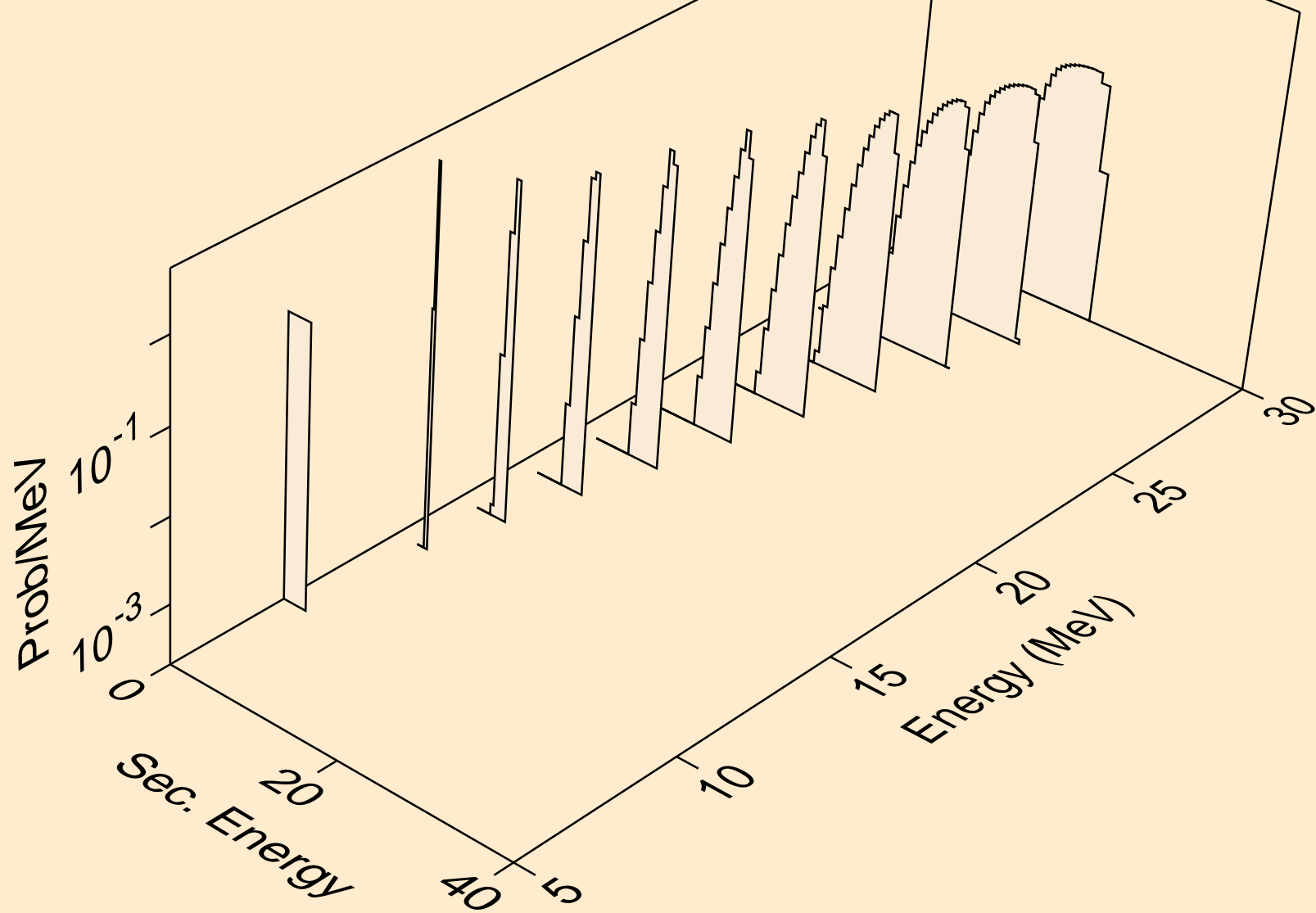

SG267 NEUTRON ACER TENDL-2021 LIBRARY; T=293.6K
tritons from (n,t)

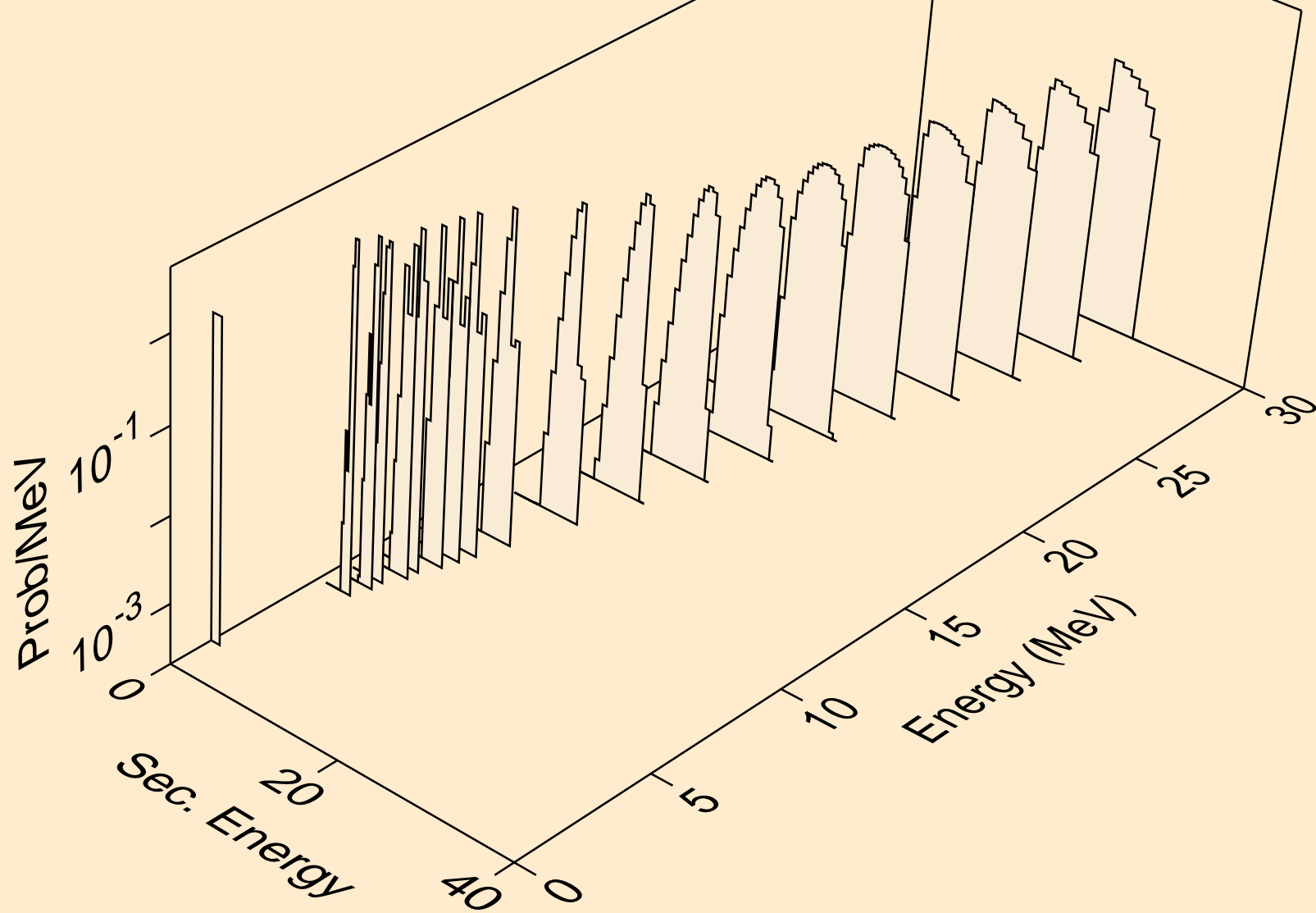

SG267 NEUTRON ACER TENDL-2021 LIBRARY; T=293.6K
tritons from (n,pt)

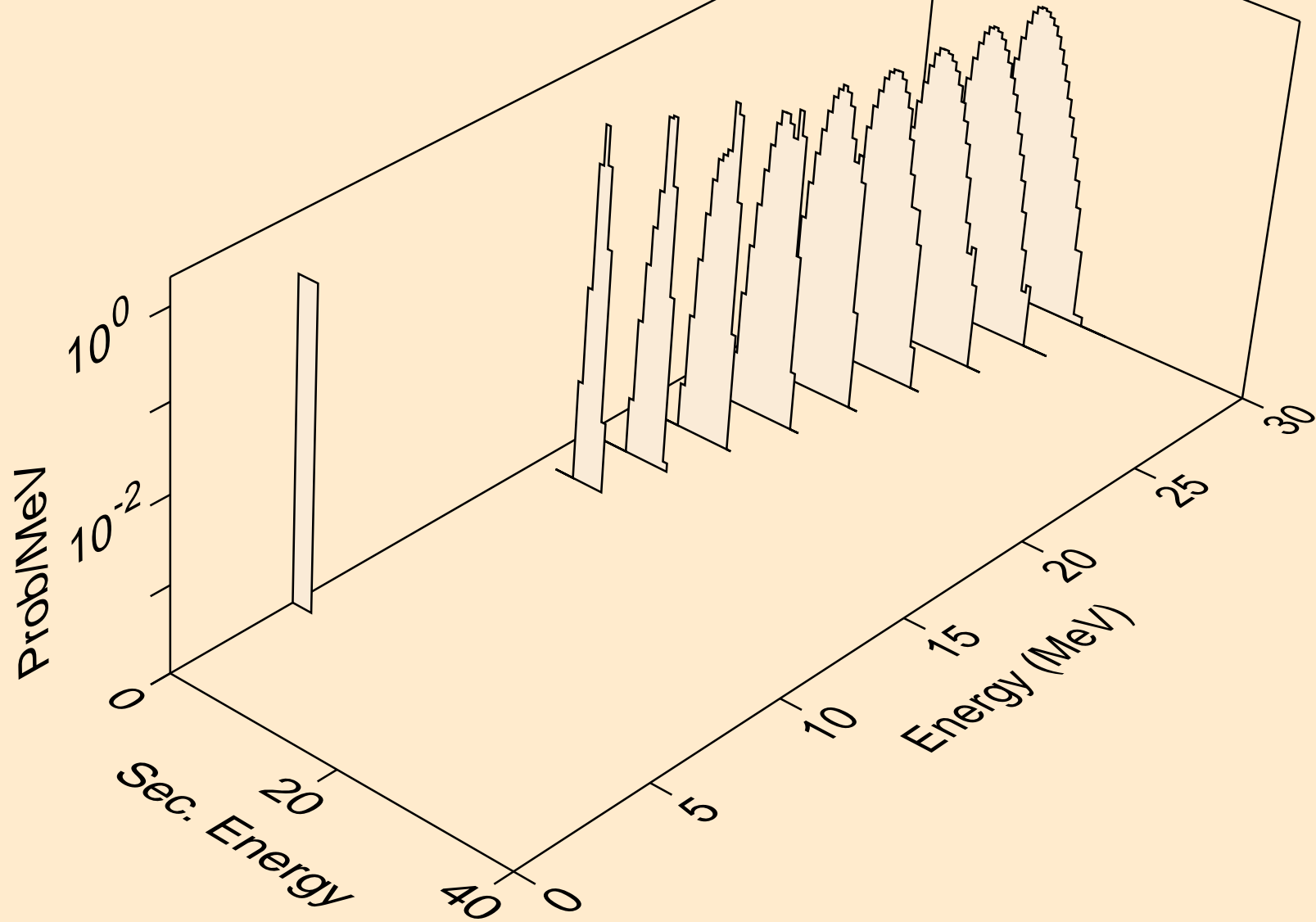

SG267 NEUTRON ACER TENDL-2021 LIBRARY; T=293.6K
he3s from (n,x)

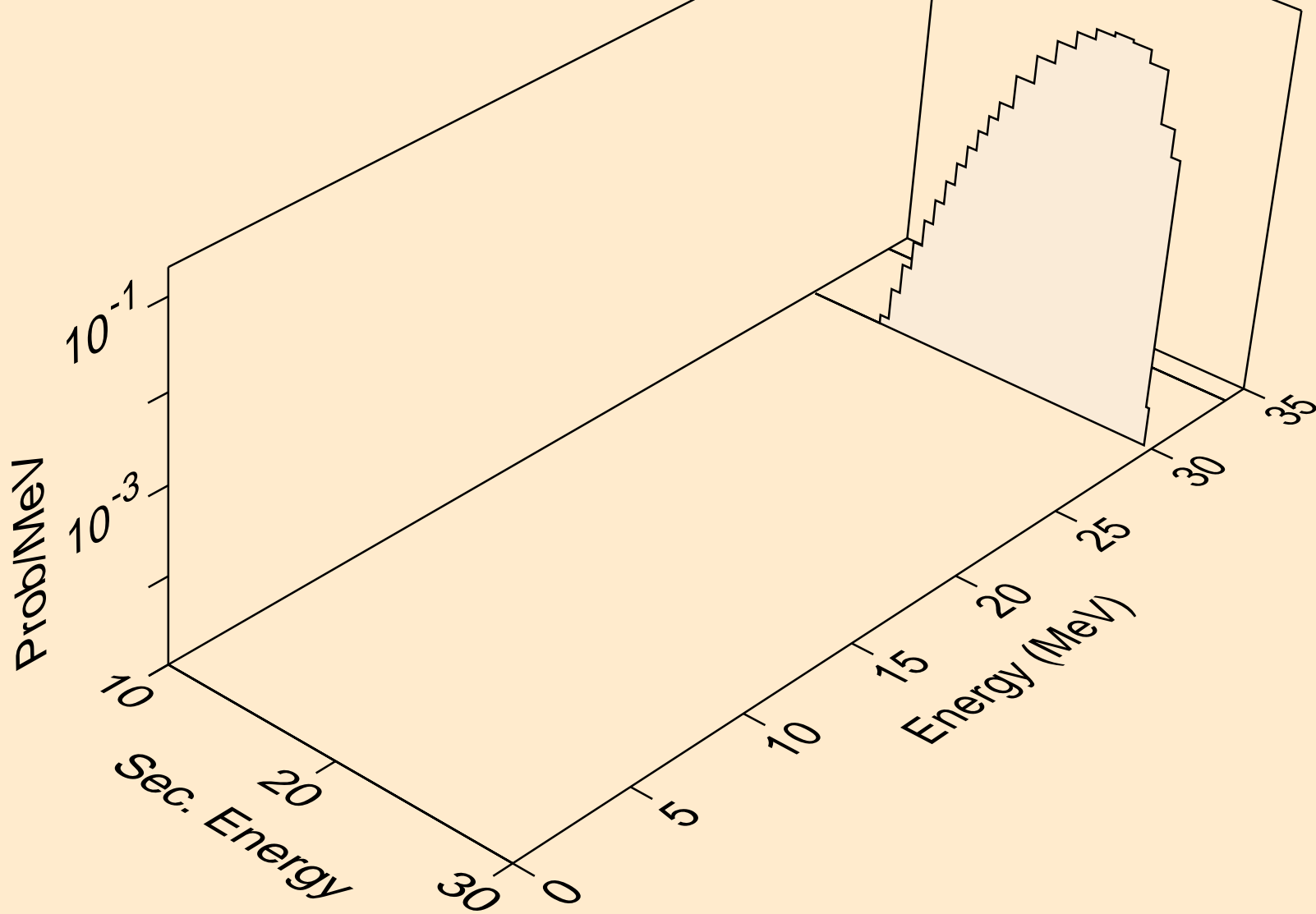

SG267 NEUTRON ACER TENDL-2021 LIBRARY; T=293.6K
he3s from (n,n*)he3

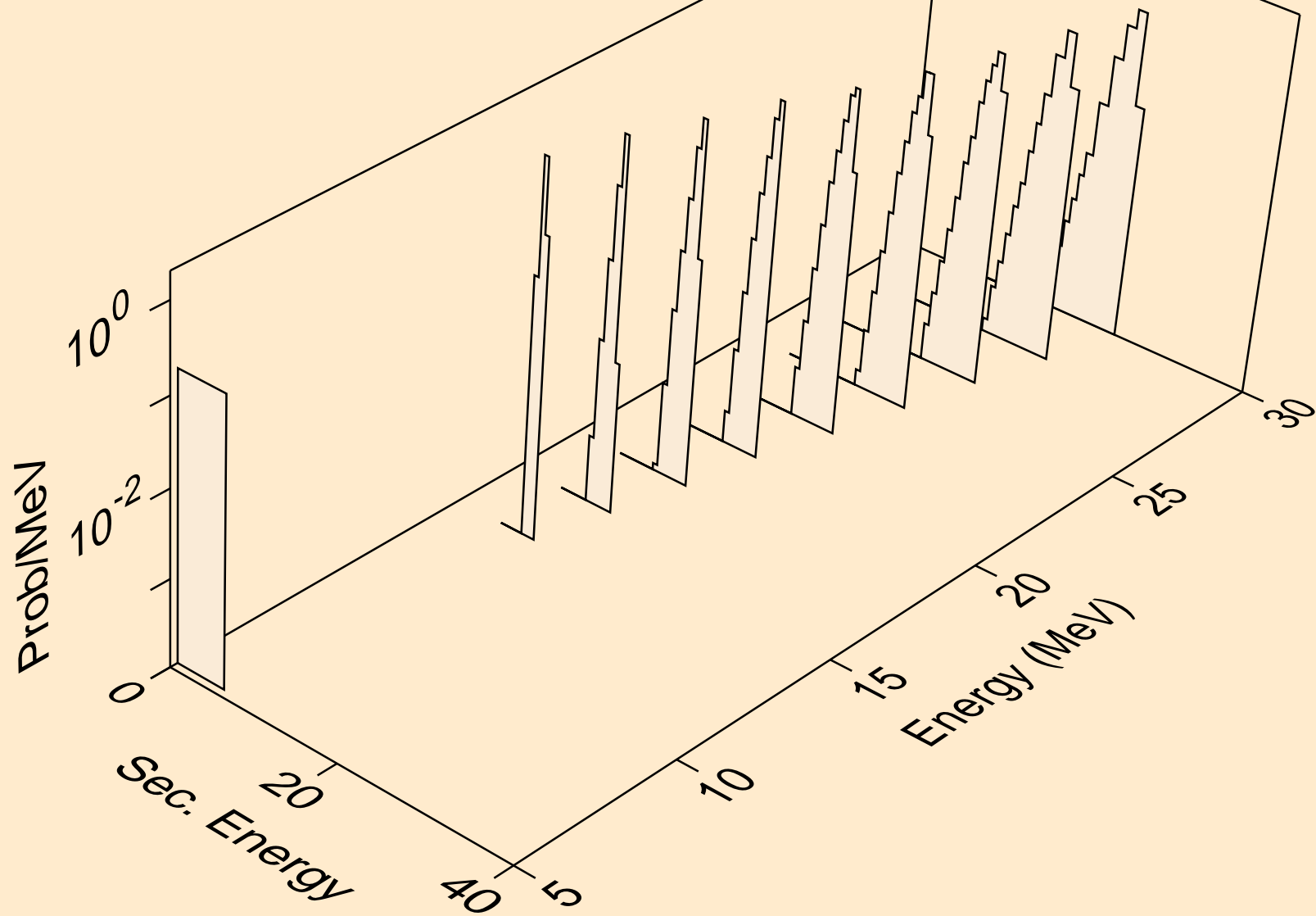

SG267 NEUTRON ACER TENDL-2021 LIBRARY; T=293.6K
he3s from (n,he3)

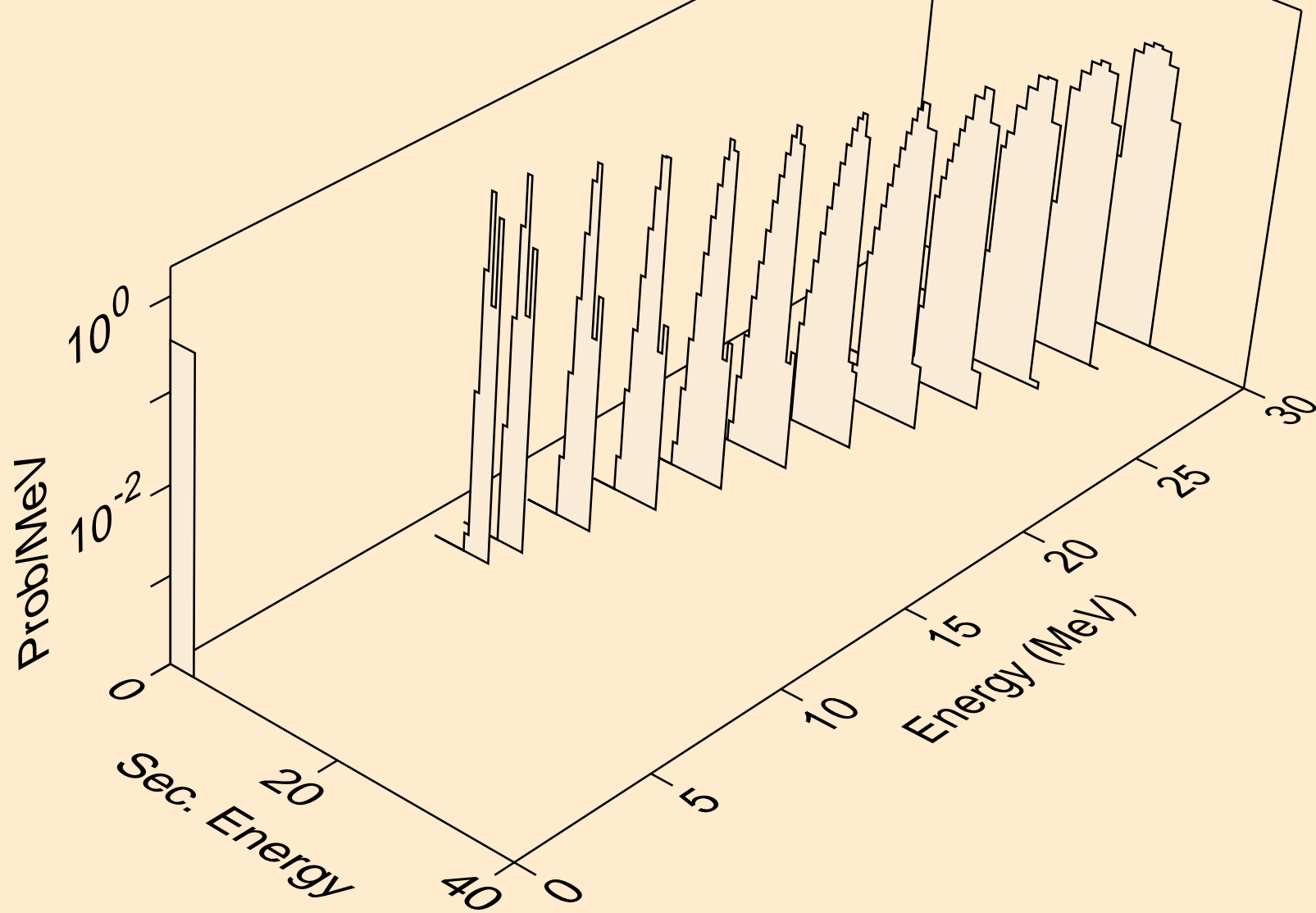

SG267 NEUTRON ACER TENDL-2021 LIBRARY; T=293.6K
alphas from (n,x)

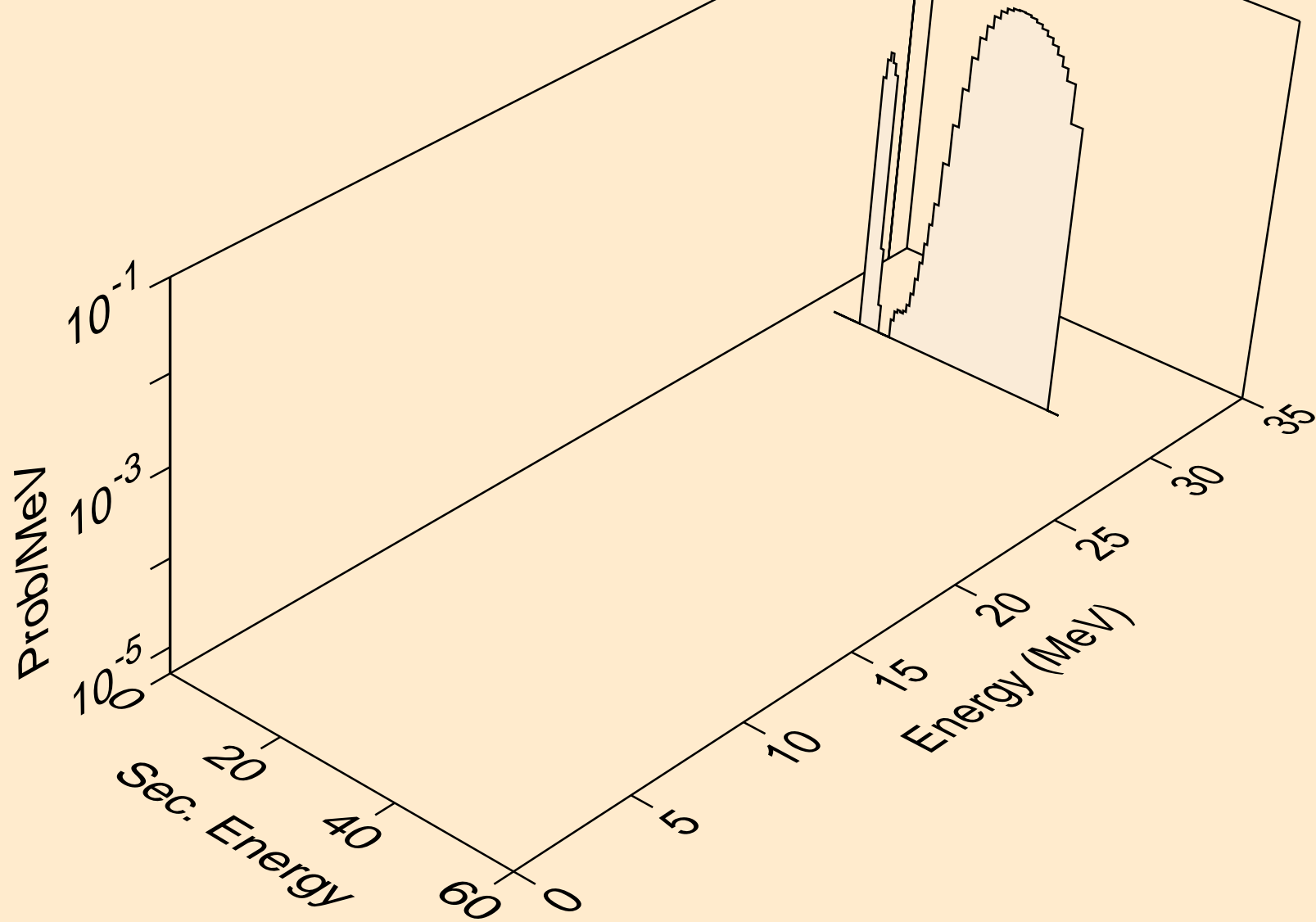

SG267 NEUTRON ACER TENDL-2021 LIBRARY; T=293.6K
alphas from (n,n*)a

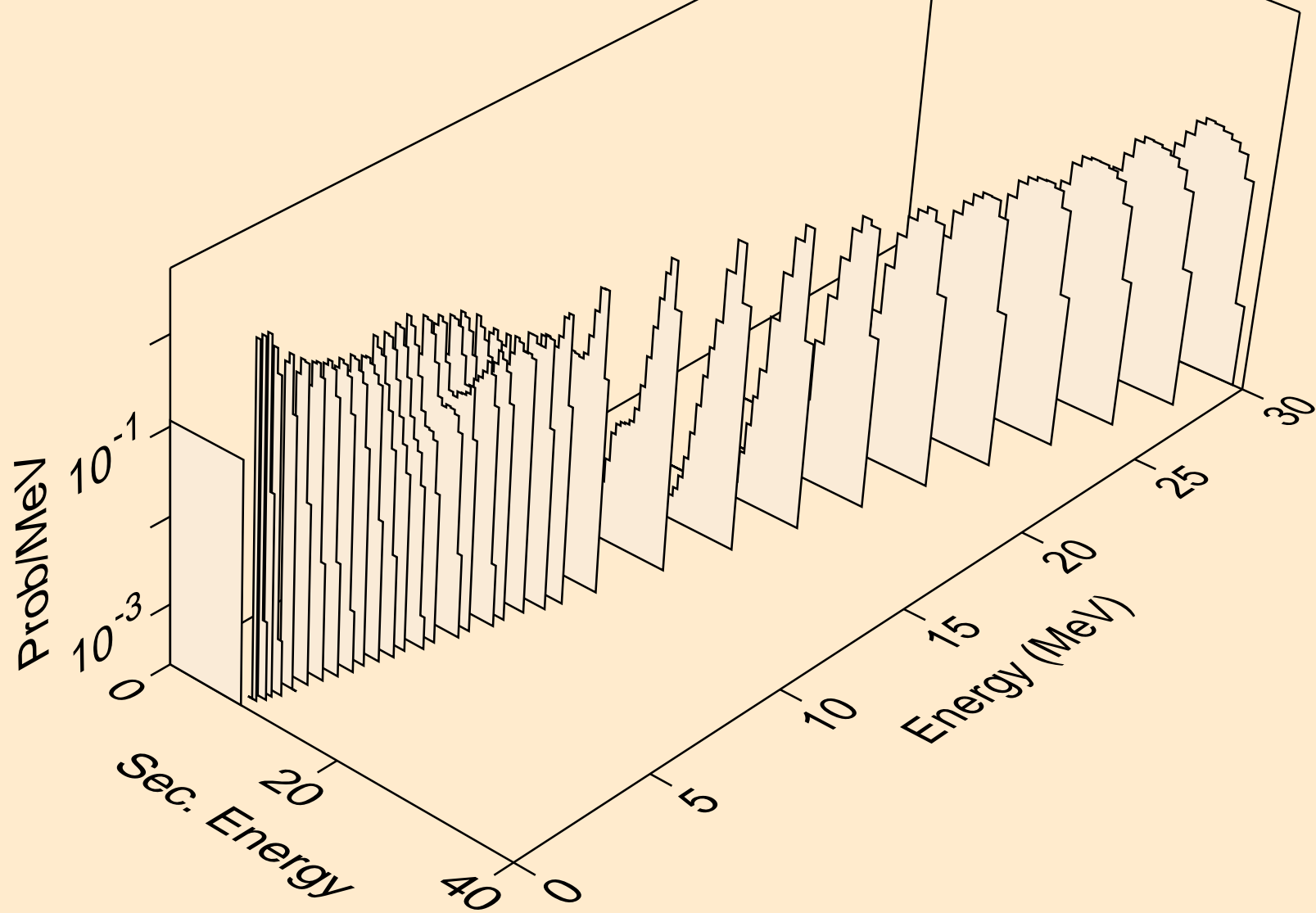

SG267 NEUTRON ACER TENDL-2021 LIBRARY; T=293.6K
alphas from (n,2n)a

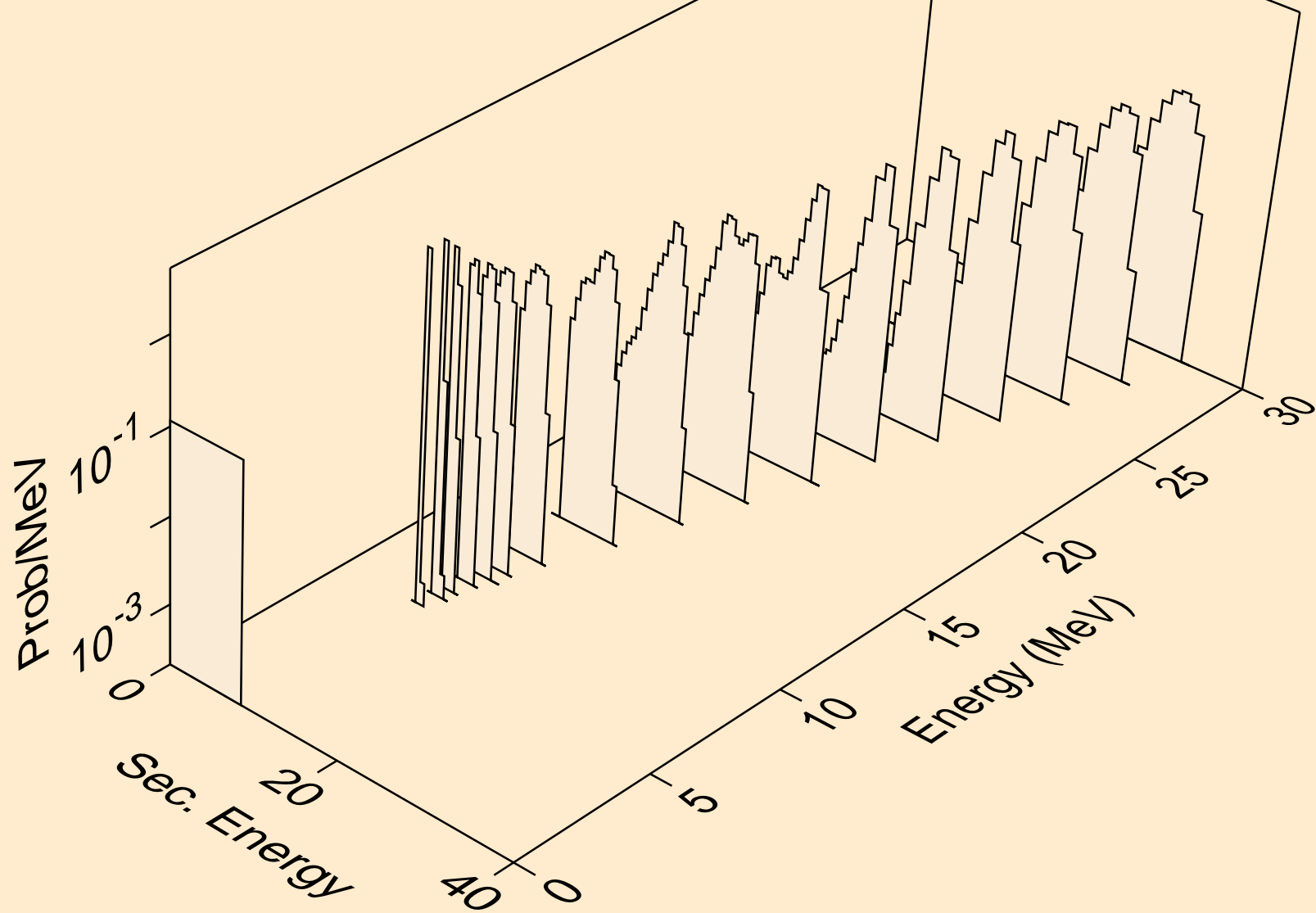

SG267 NEUTRON ACER TENDL-2021 LIBRARY; T=293.6K
alphas from (n,3n)a

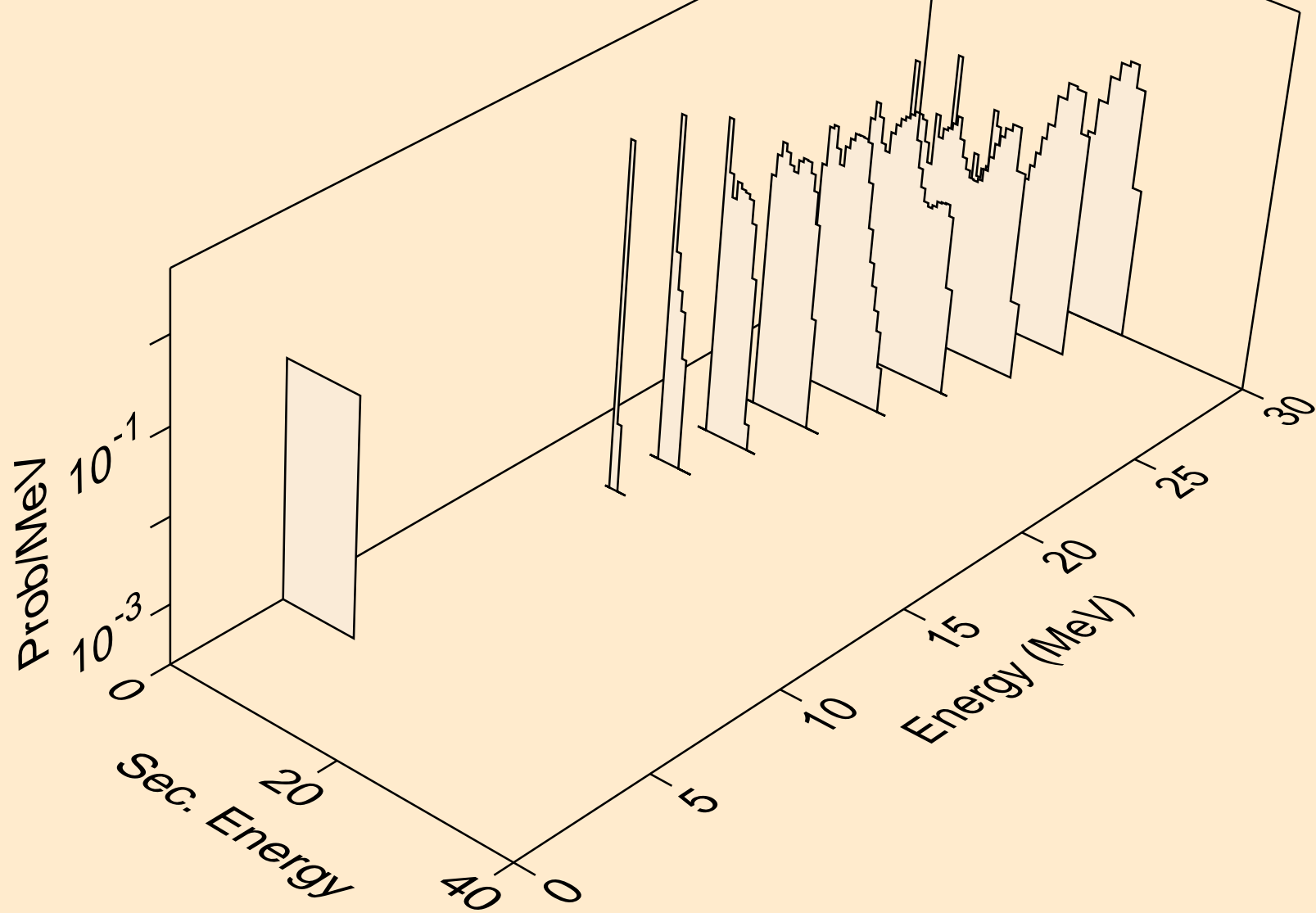

SG267 NEUTRON ACER TENDL-2021 LIBRARY; T=293.6K
alphas from (n,n*)2a

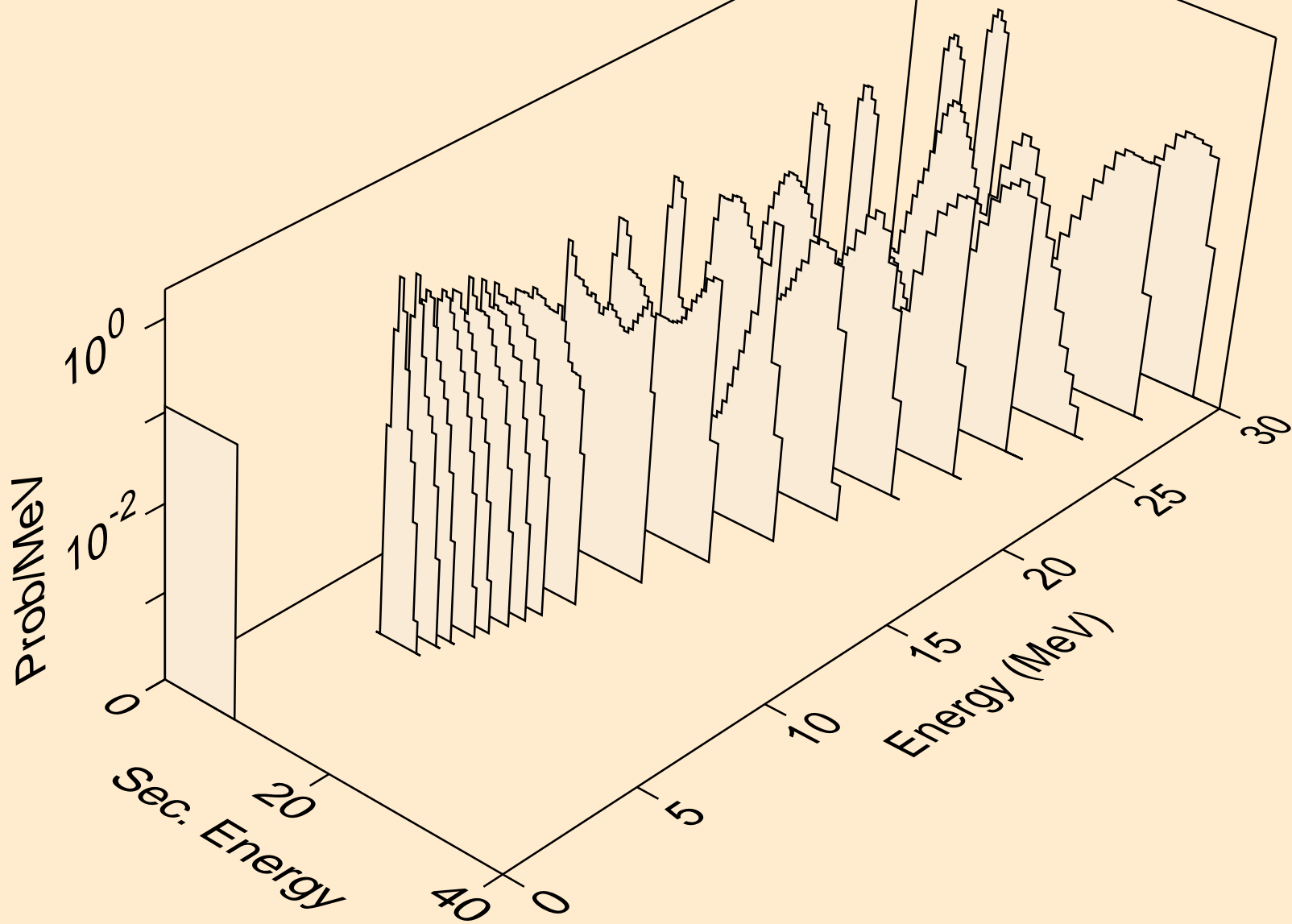

SG267 NEUTRON ACER TENDL-2021 LIBRARY; T=293.6K
alphas from (n,npa)

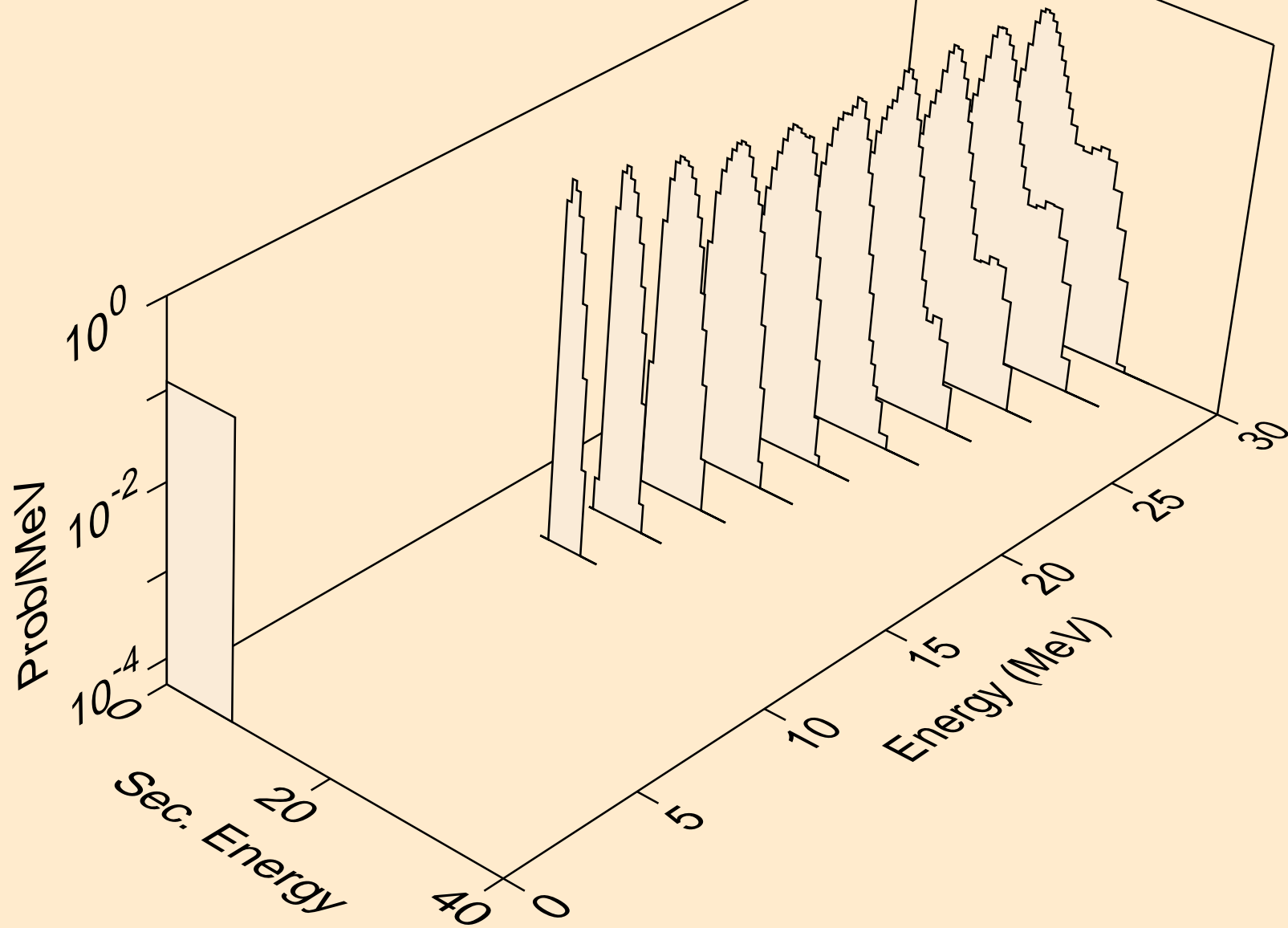

SG267 NEUTRON ACER TENDL-2021 LIBRARY; T=293.6K
alphas from (n,a)

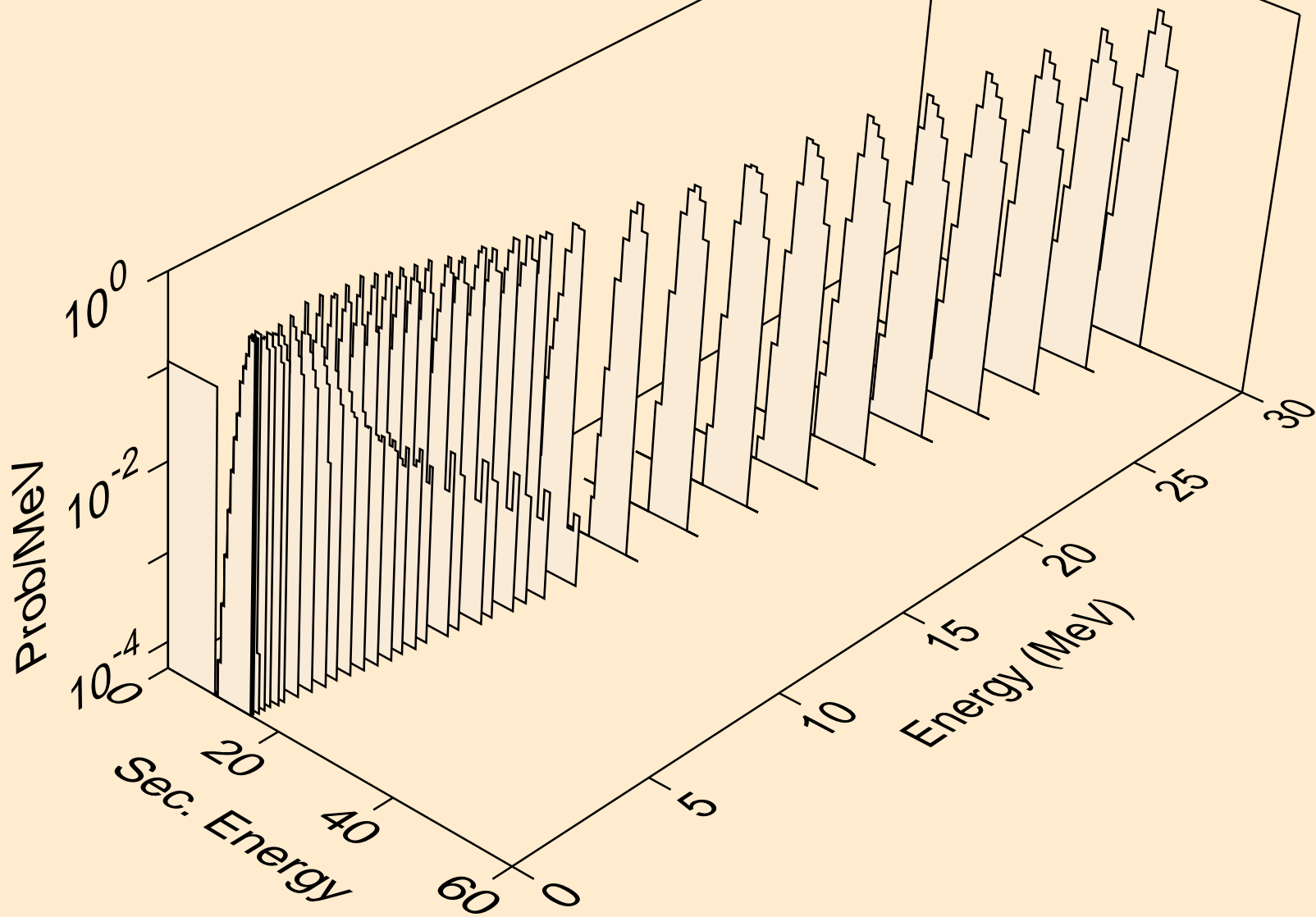

SG267 NEUTRON ACER TENDL-2021 LIBRARY; T=293.6K
alphas from (n,da)

