

SI034 NEUTRON ACER TENDL-2021 LIBRARY; T=293.6K

Principal cross sections

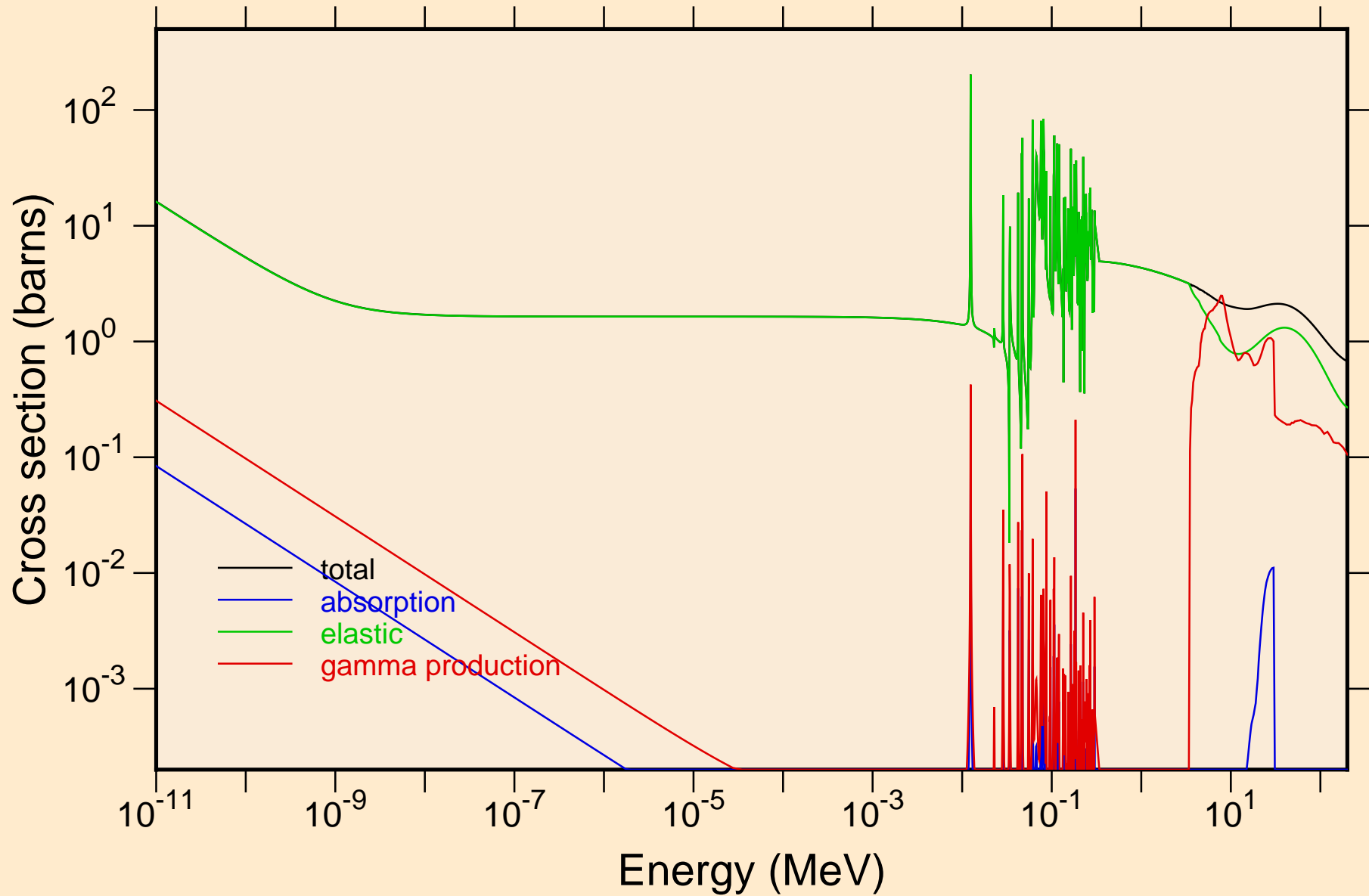

SI034 NEUTRON ACER TENDL-2021 LIBRARY; T=293.6K
resonance total cross section

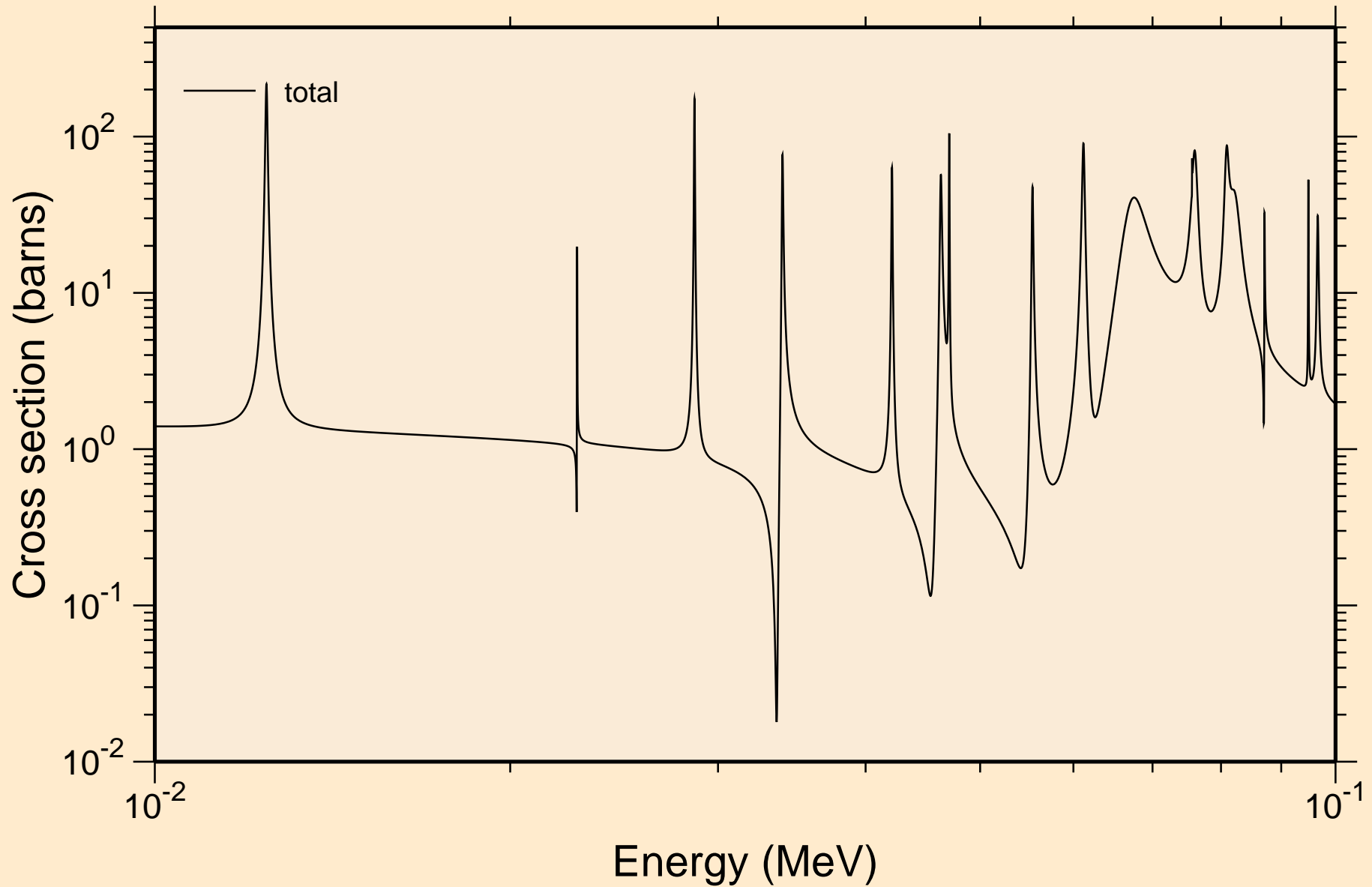

SI034 NEUTRON ACER TENDL-2021 LIBRARY; T=293.6K
resonance total cross section

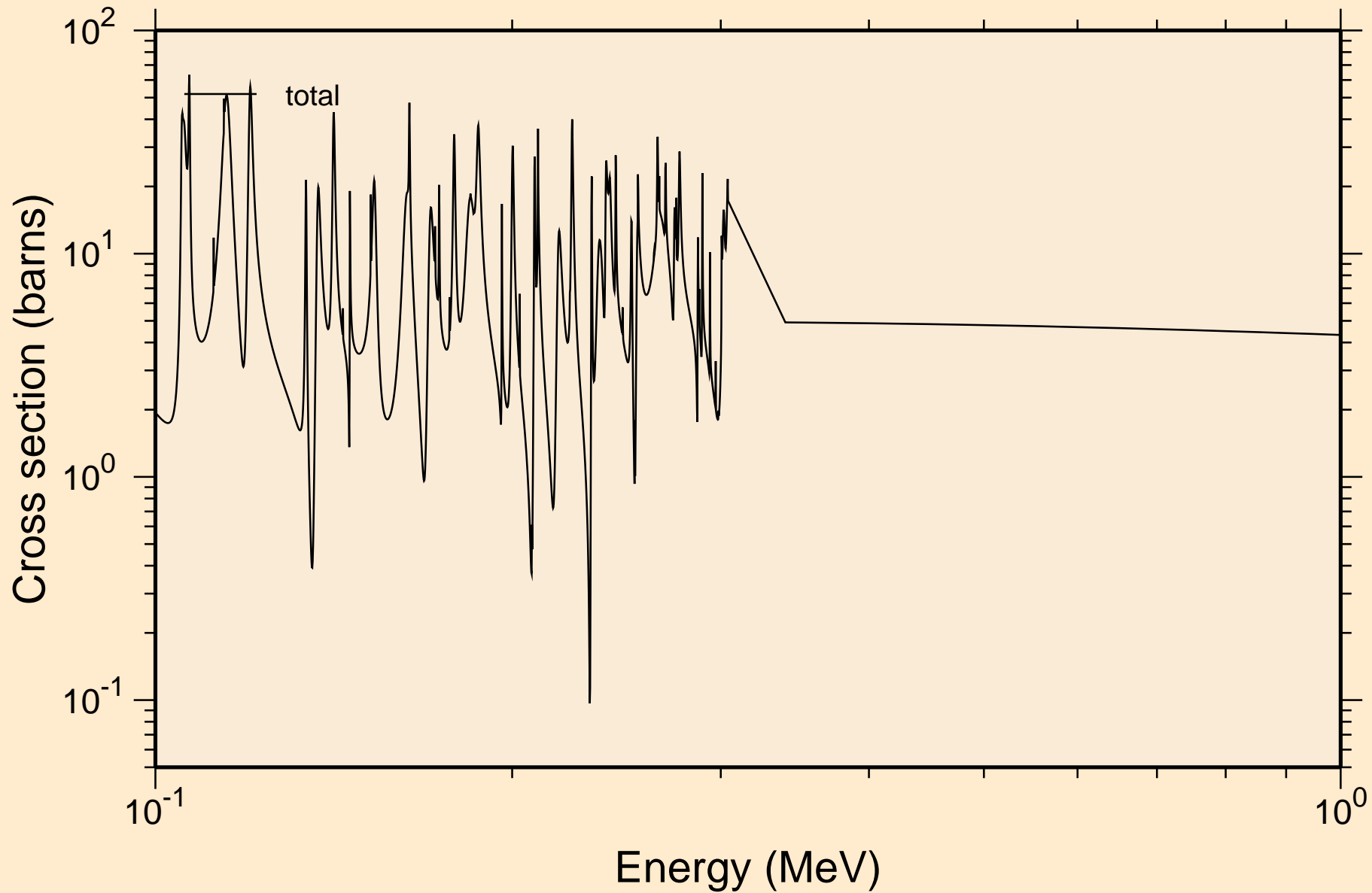

SI034 NEUTRON ACER TENDL-2021 LIBRARY; T=293.6K
resonance total cross section

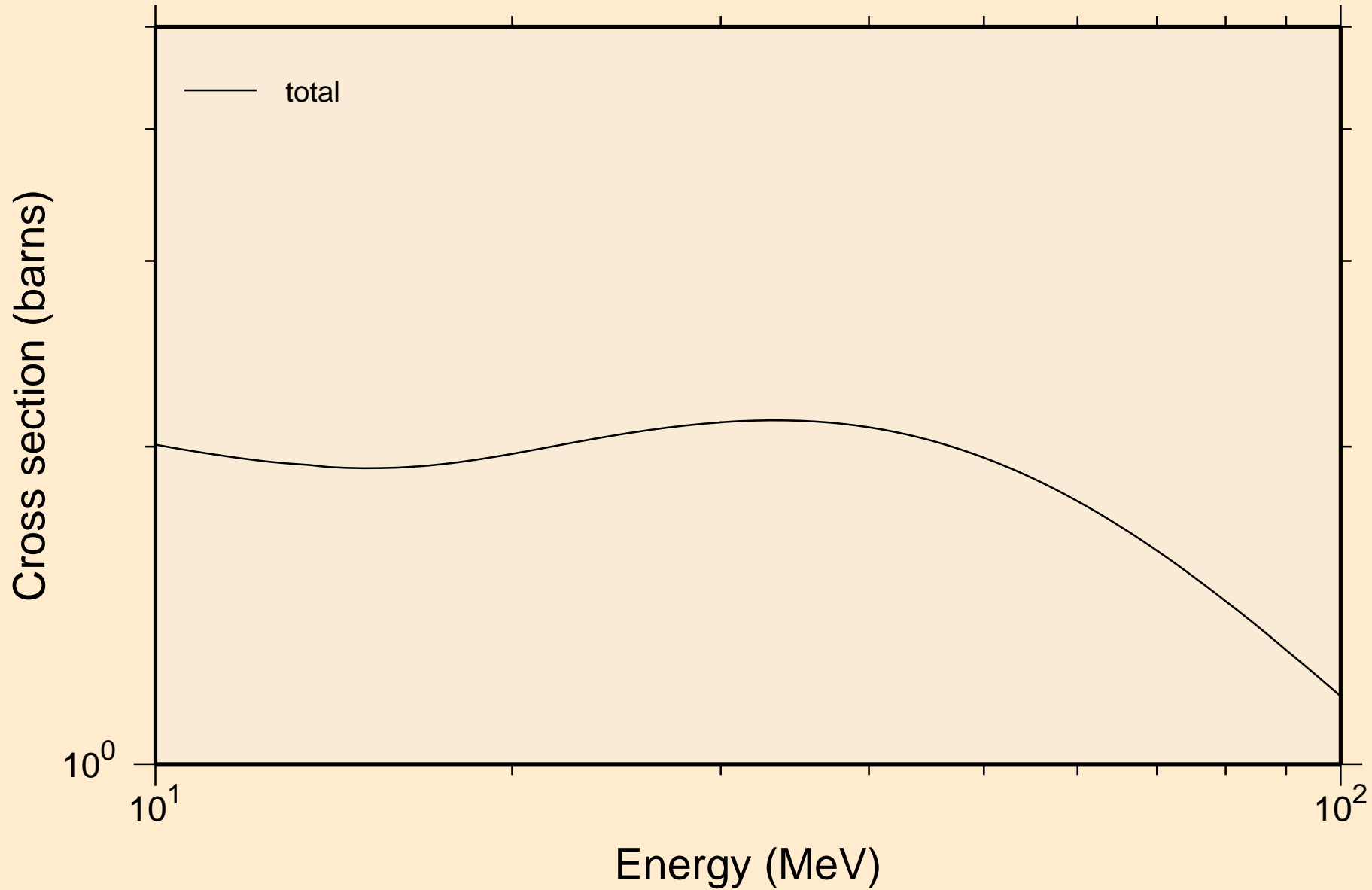

SI034 NEUTRON ACER TENDL-2021 LIBRARY; T=293.6K
resonance absorption cross sections

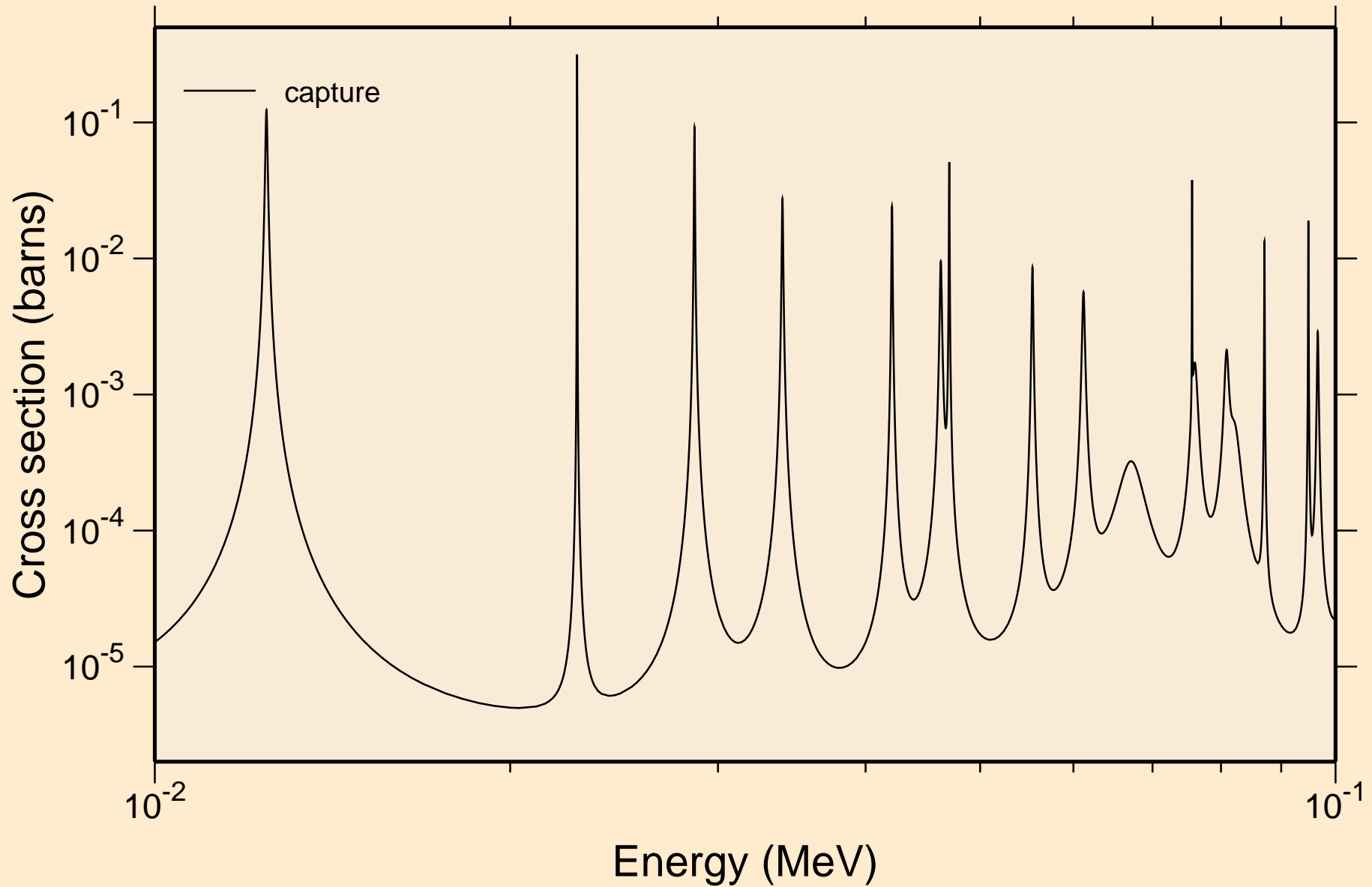

SI034 NEUTRON ACER TENDL-2021 LIBRARY; T=293.6K
resonance absorption cross sections

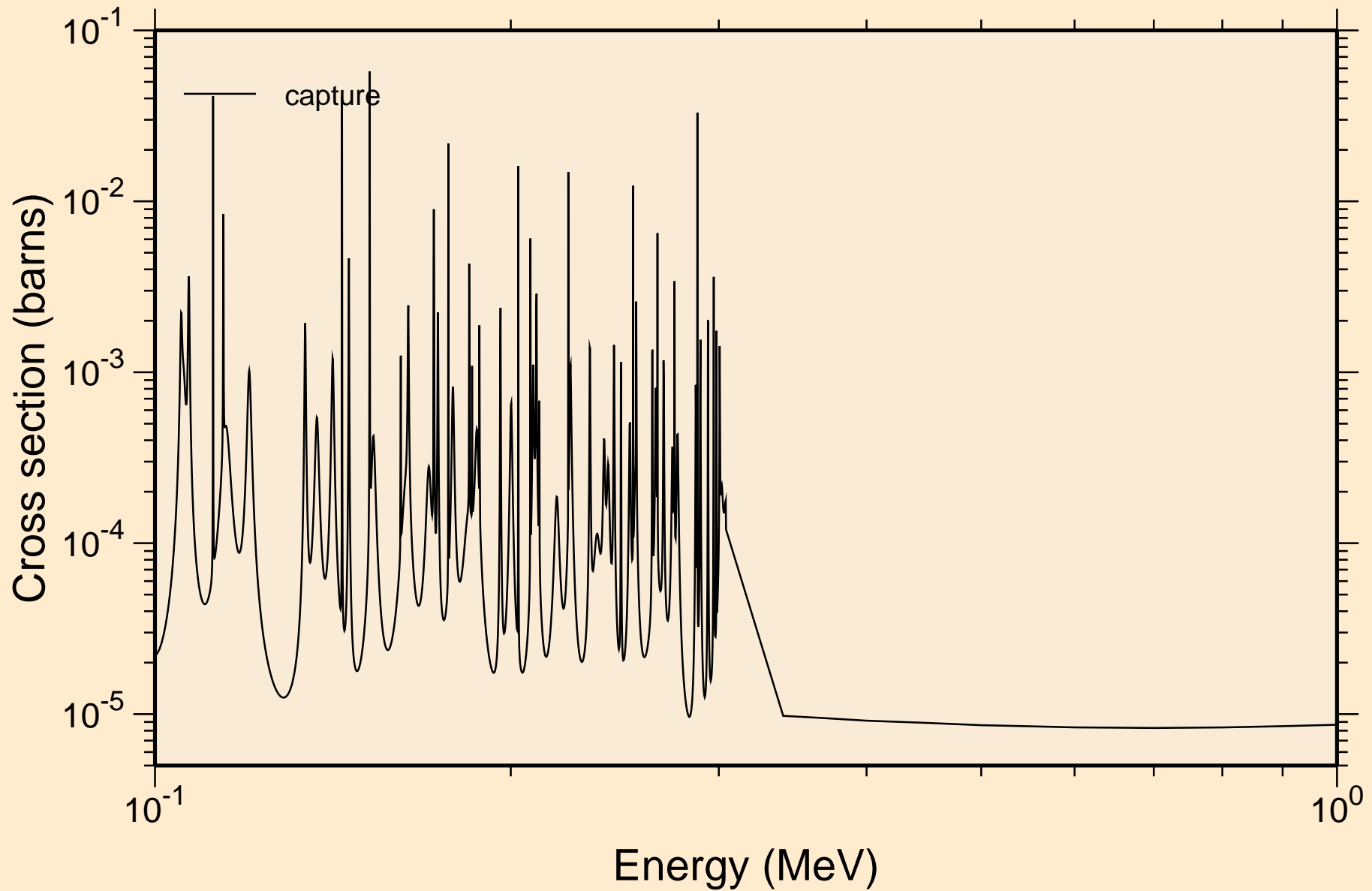

SI034 NEUTRON ACER TENDL-2021 LIBRARY; T=293.6K
resonance absorption cross sections

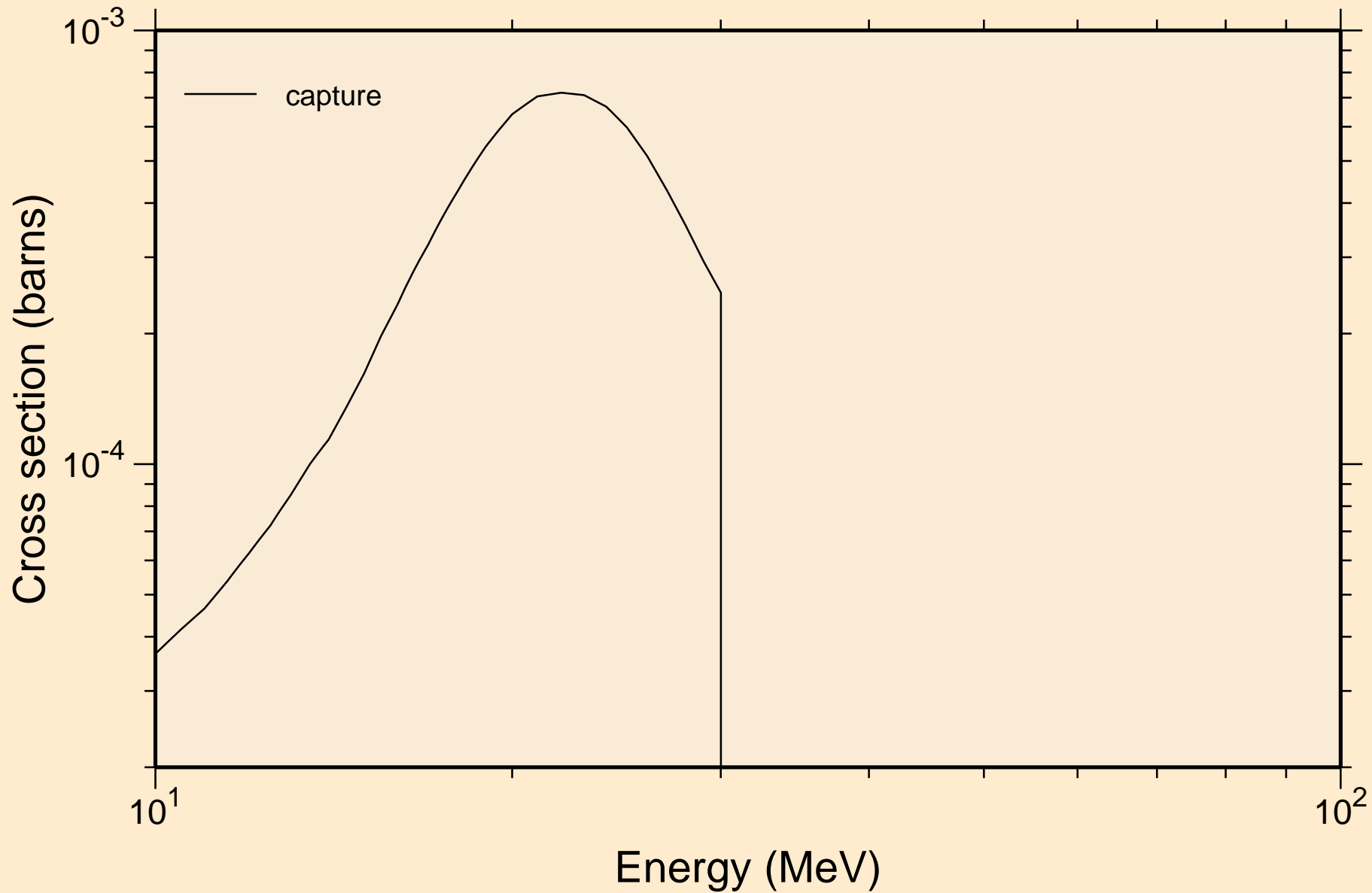

SI034 NEUTRON ACER TENDL-2021 LIBRARY; T=293.6K
Heating

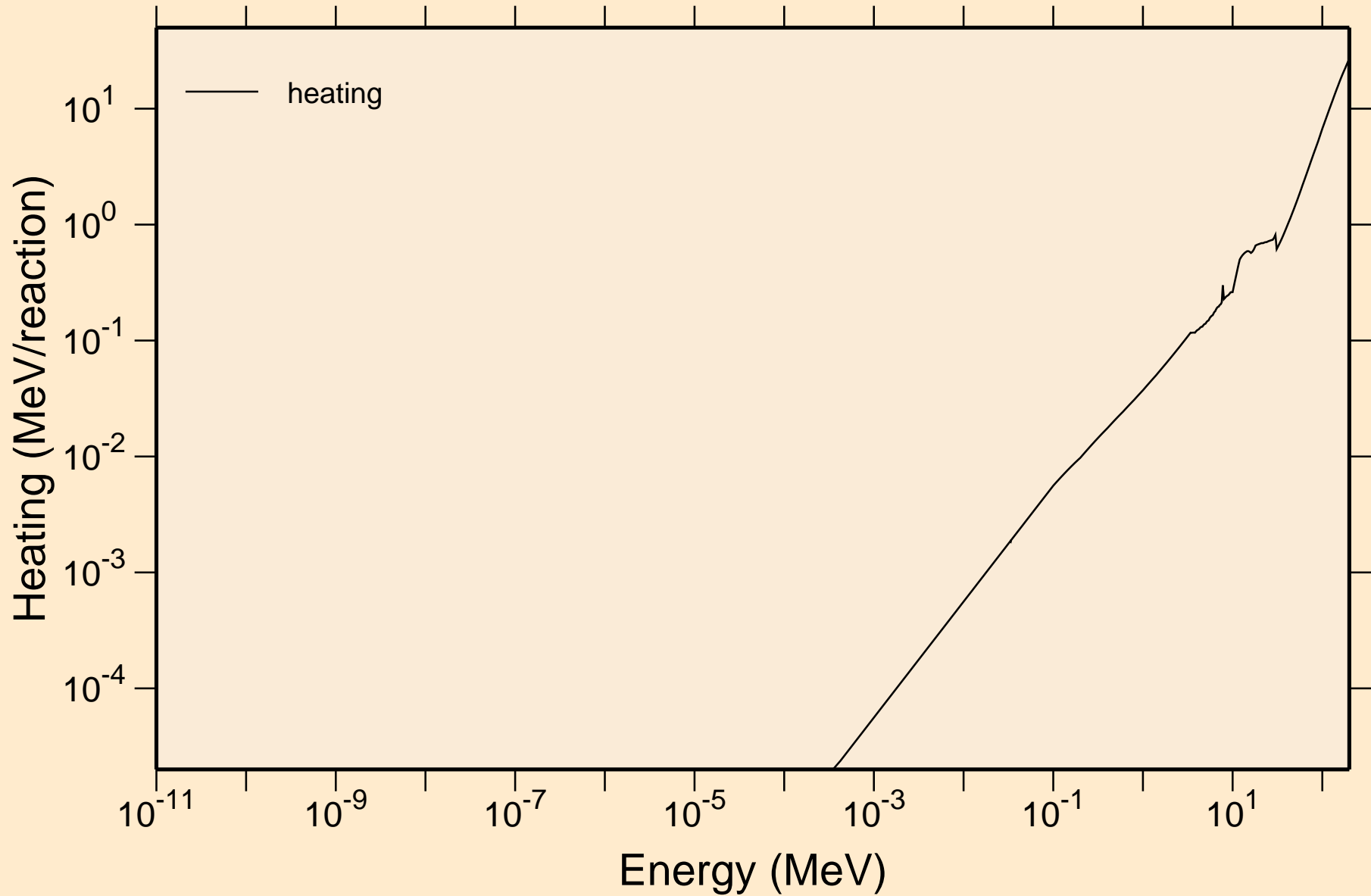

SI034 NEUTRON ACER TENDL-2021 LIBRARY; T=293.6K
Damage

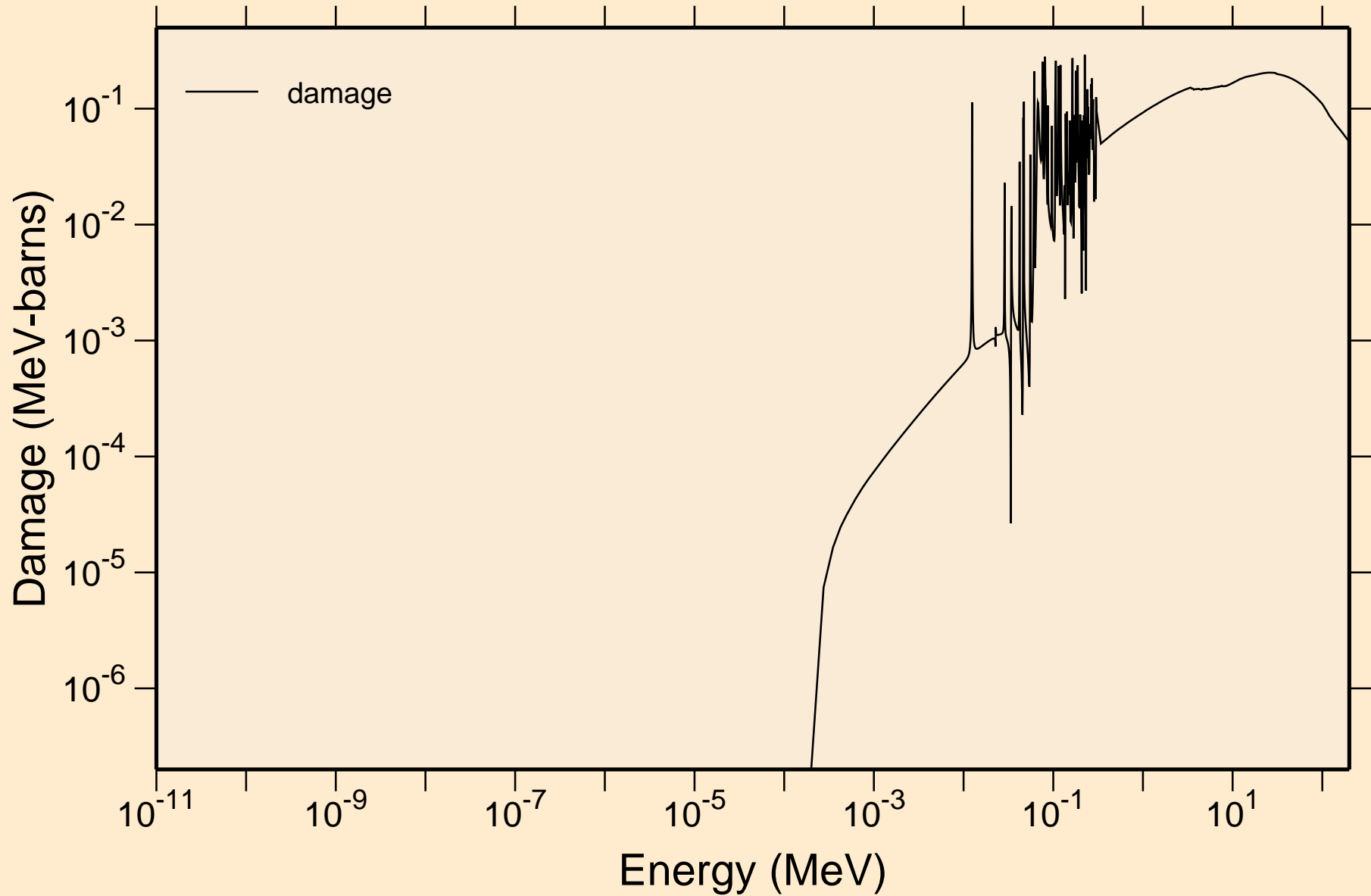

SI034 NEUTRON ACER TENDL-2021 LIBRARY; T=293.6K
Non-threshold reactions

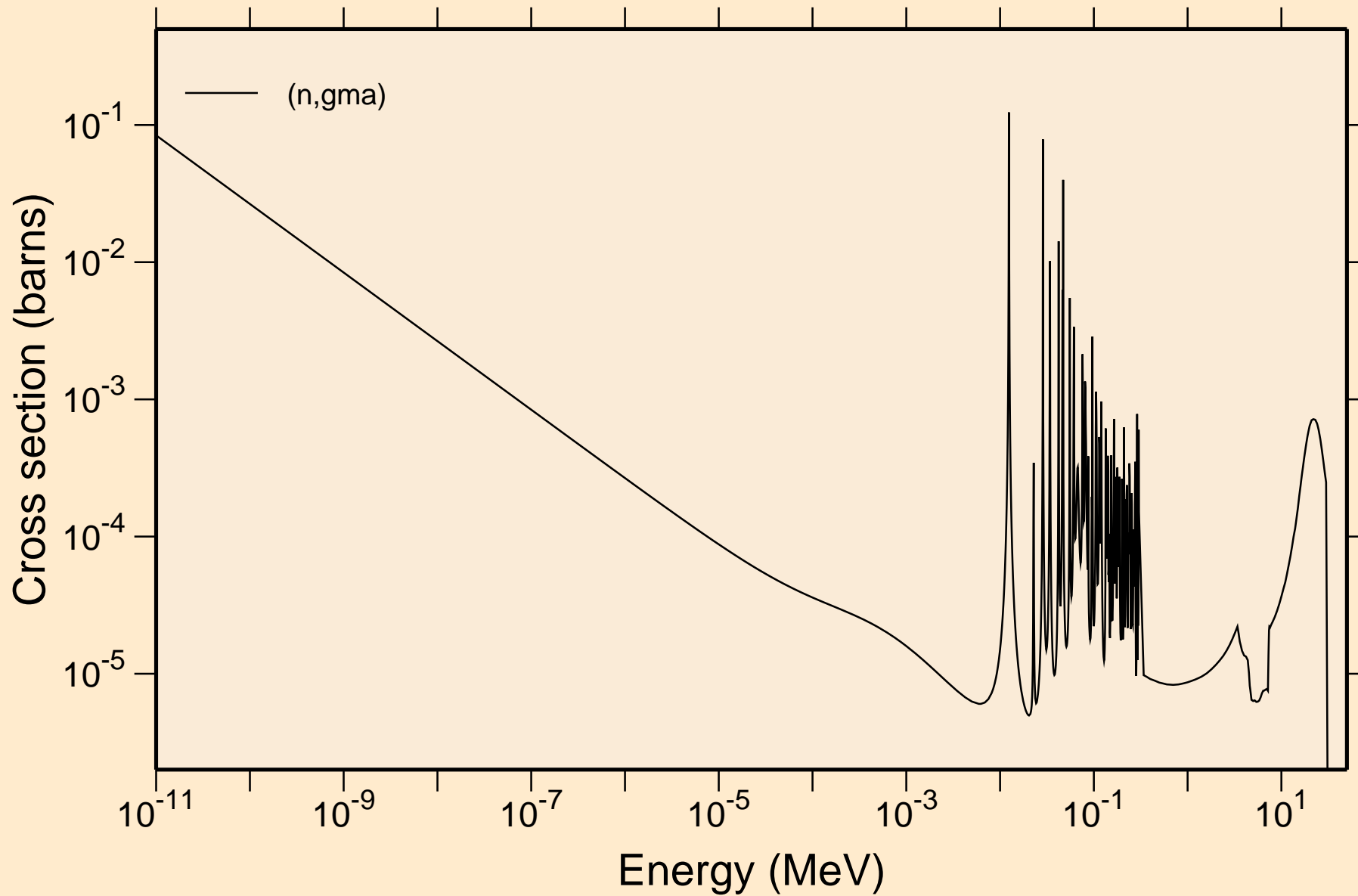

SI034 NEUTRON ACER TENDL-2021 LIBRARY; T=293.6K

Principal cross sections

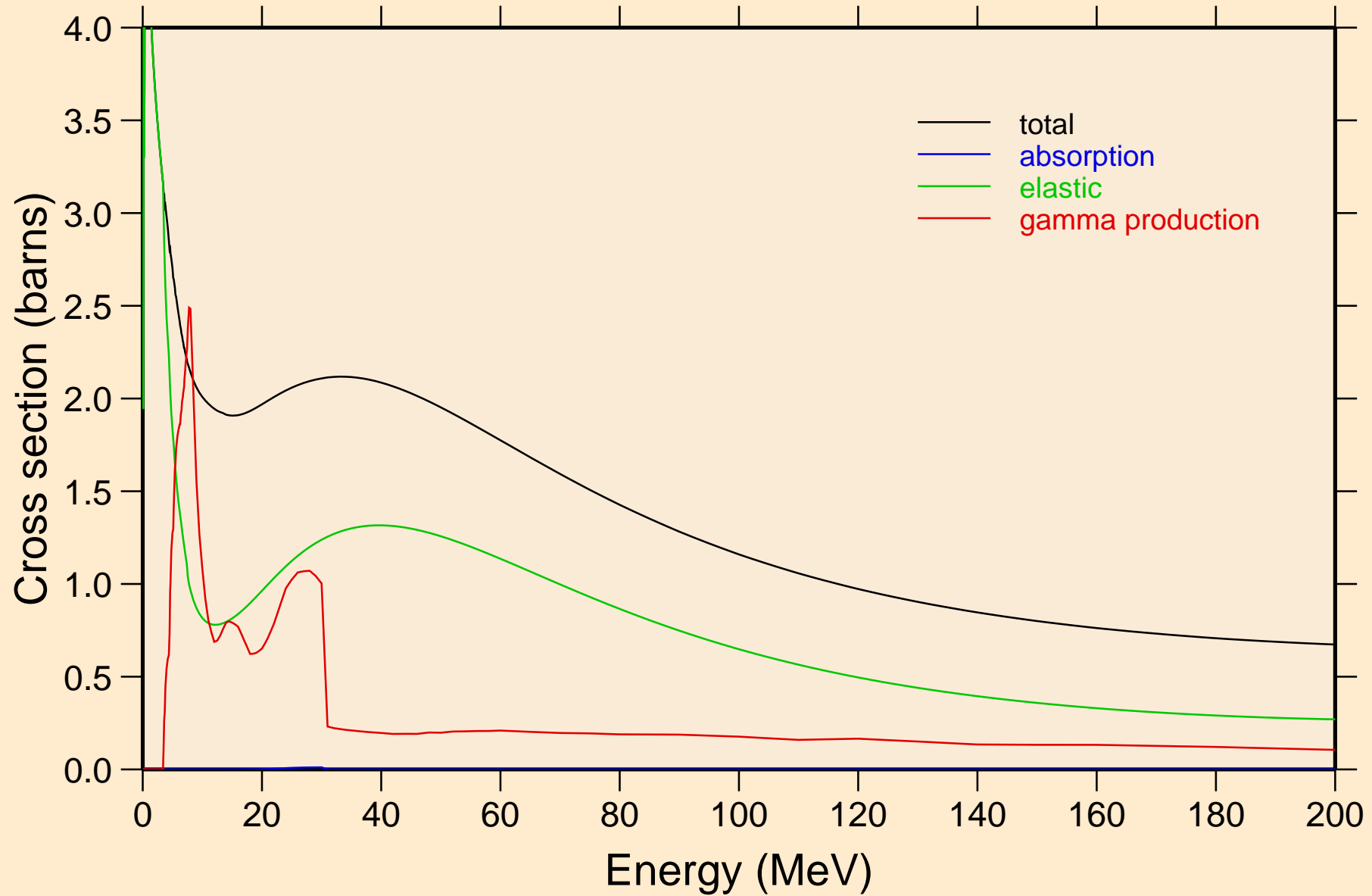

SI034 NEUTRON ACER TENDL-2021 LIBRARY; T=293.6K

Heating

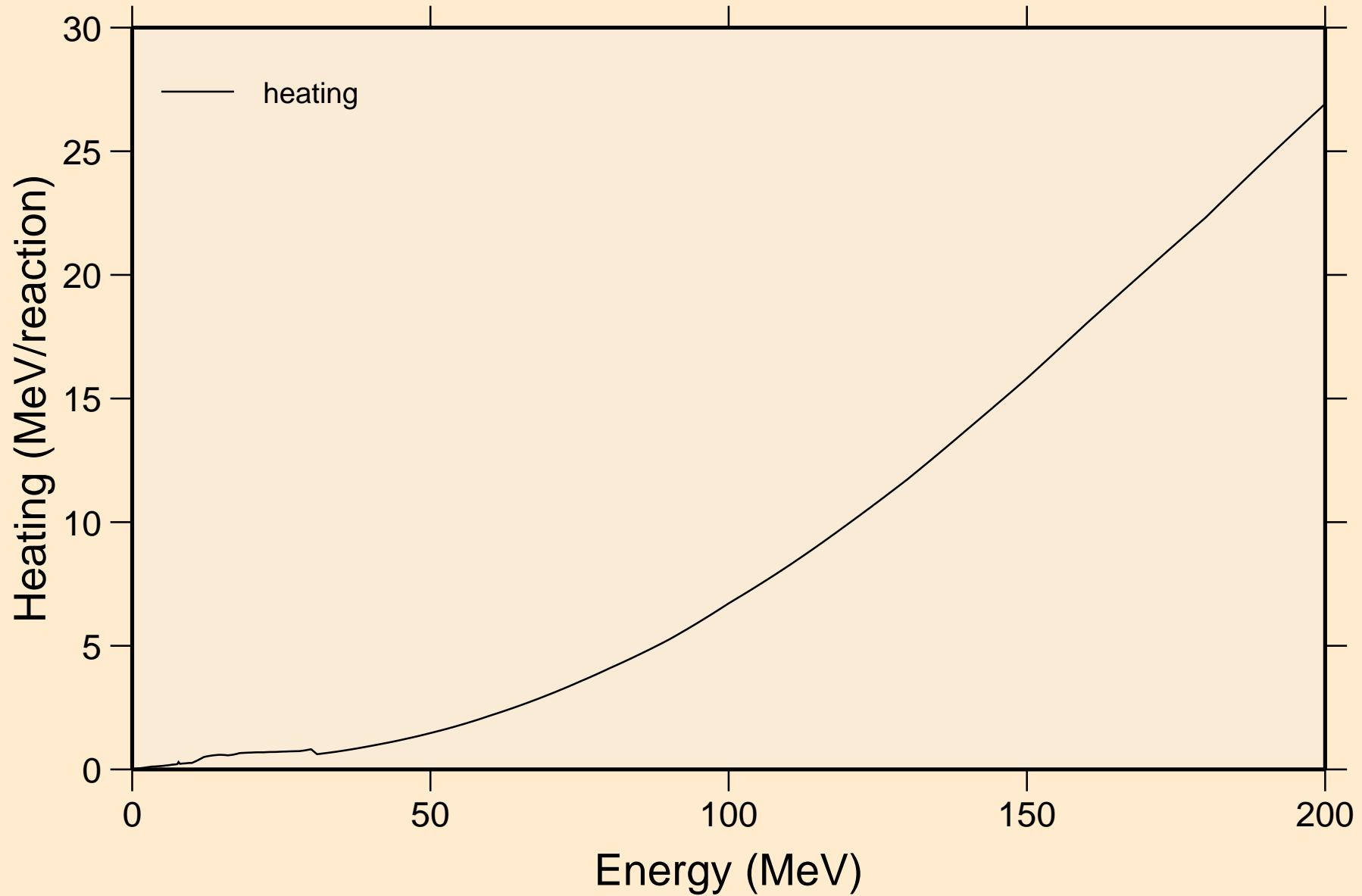

SI034 NEUTRON ACER TENDL-2021 LIBRARY; T=293.6K
Damage

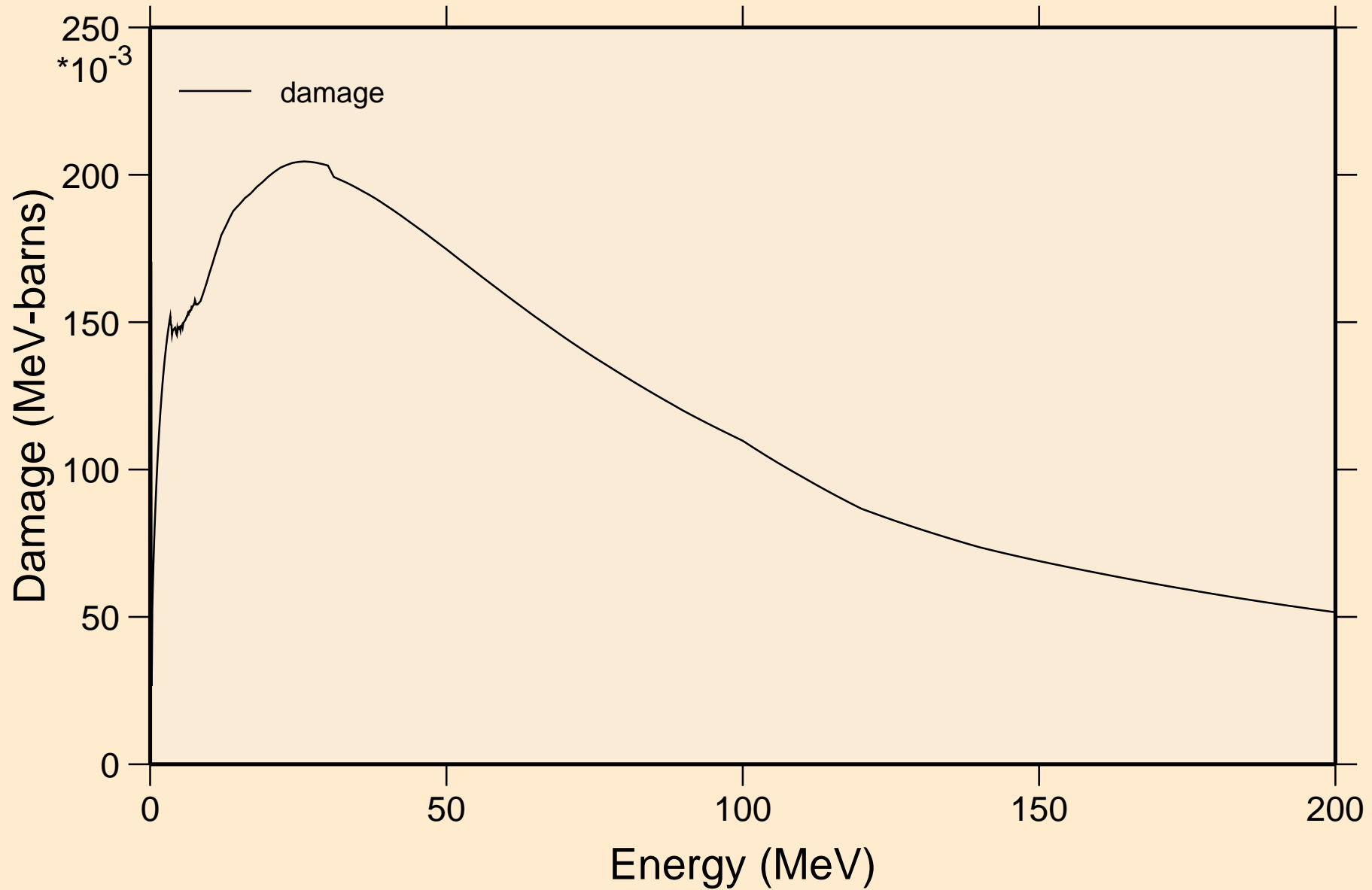

SI034 NEUTRON ACER TENDL-2021 LIBRARY; T=293.6K
Non-threshold reactions

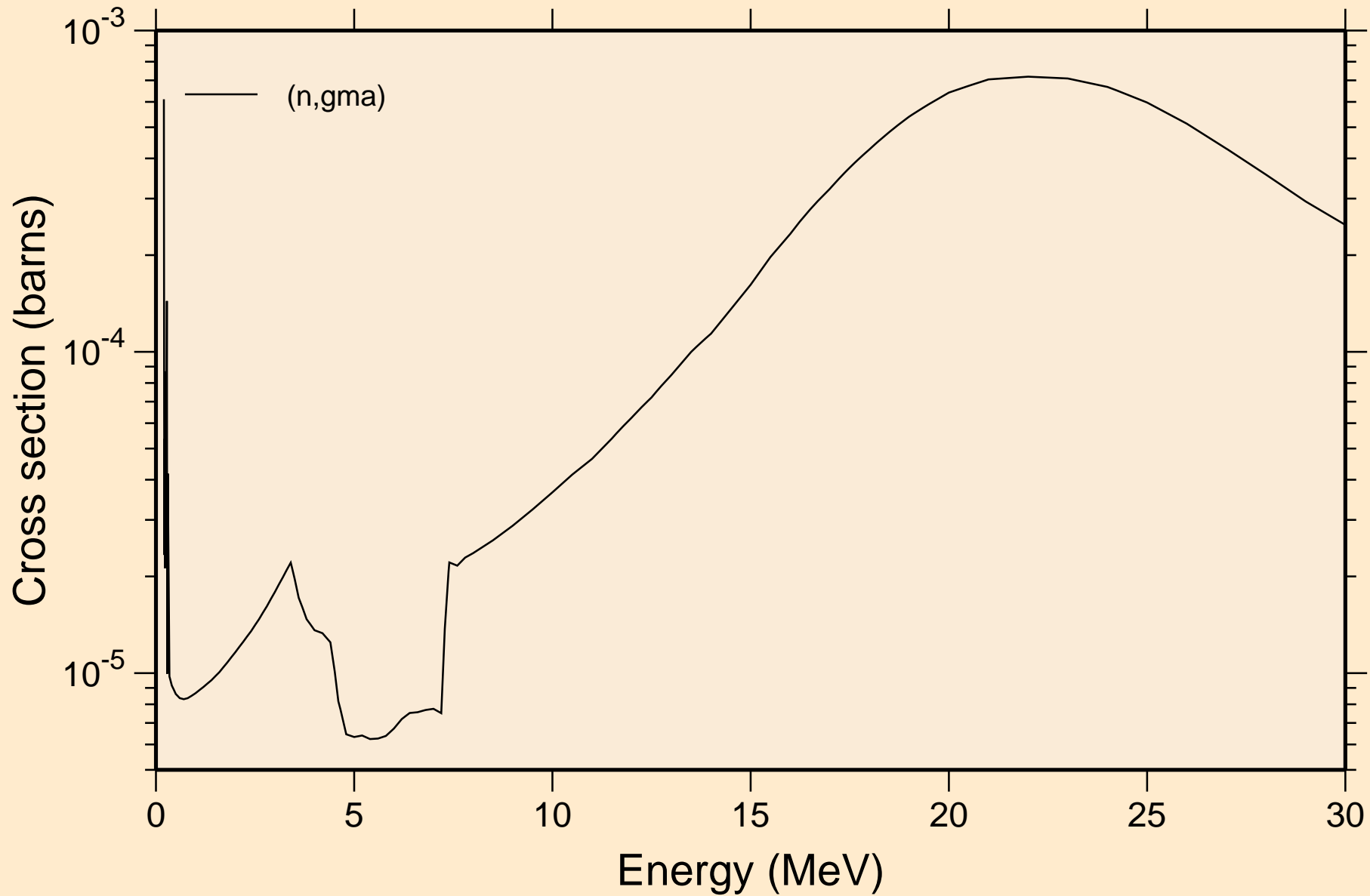

SI034 NEUTRON ACER TENDL-2021 LIBRARY; T=293.6K
Inelastic levels

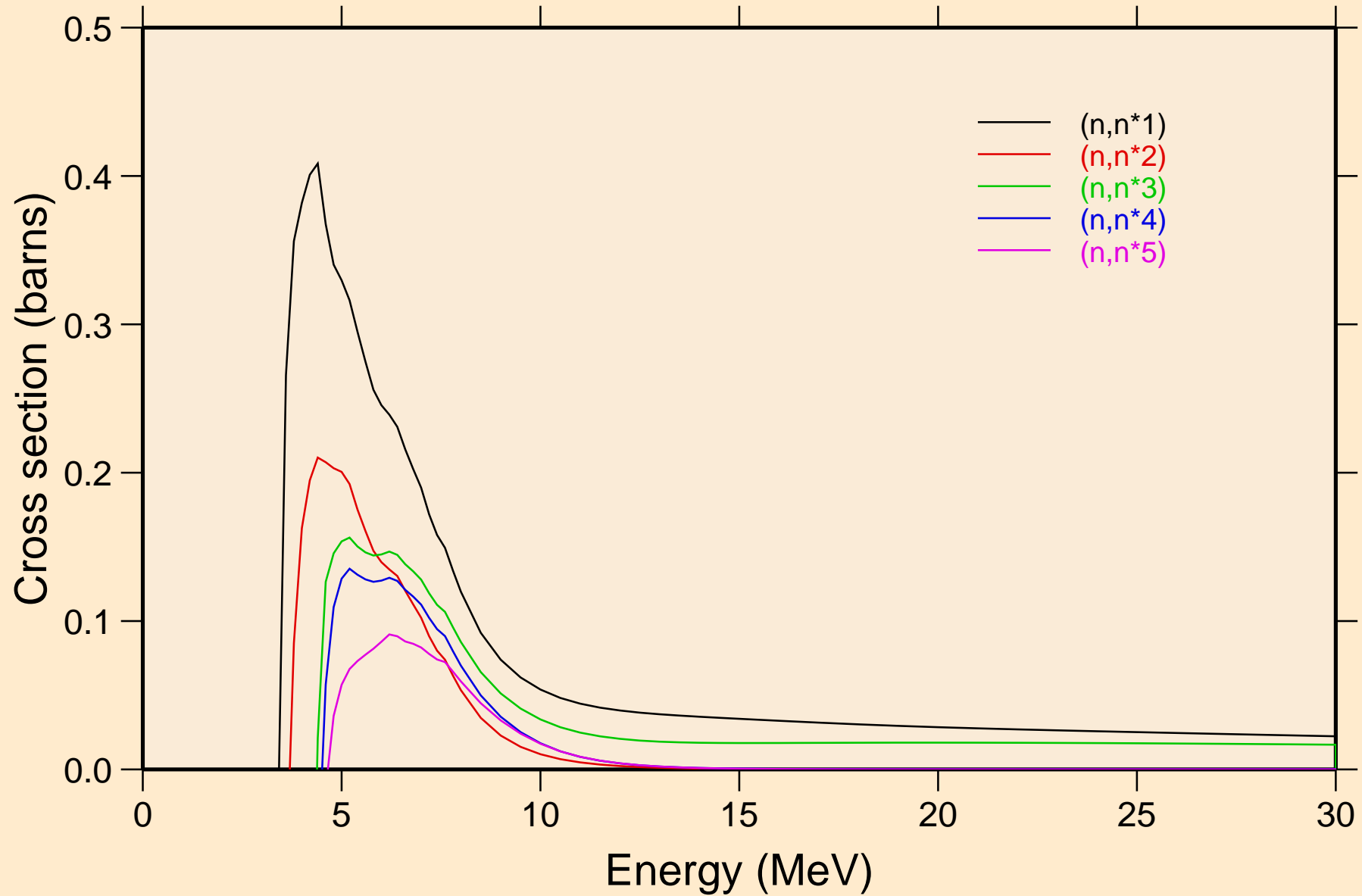

SI034 NEUTRON ACER TENDL-2021 LIBRARY; T=293.6K
Inelastic levels

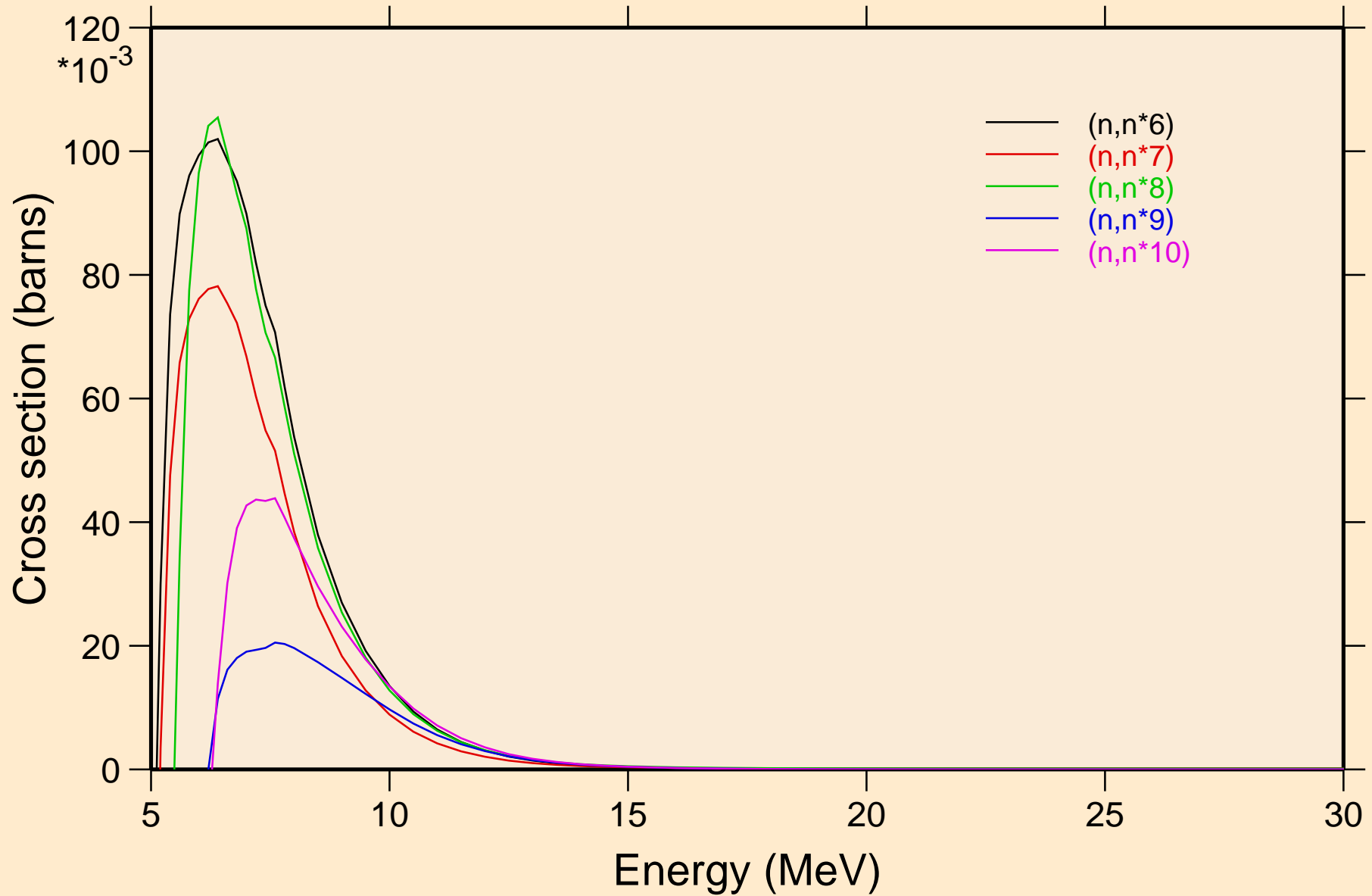

SI034 NEUTRON ACER TENDL-2021 LIBRARY; T=293.6K
Inelastic levels

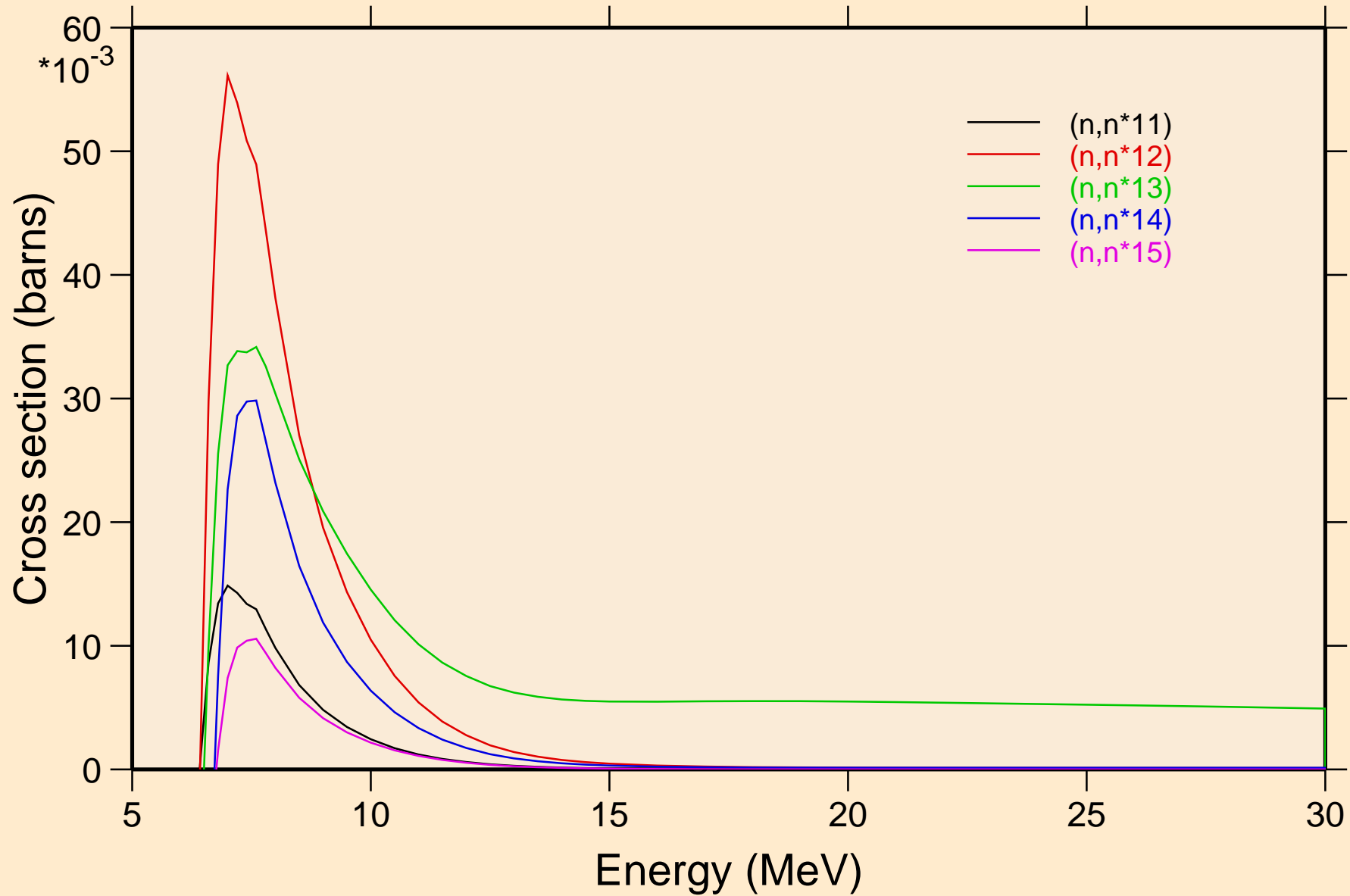

SI034 NEUTRON ACER TENDL-2021 LIBRARY; T=293.6K
Inelastic levels

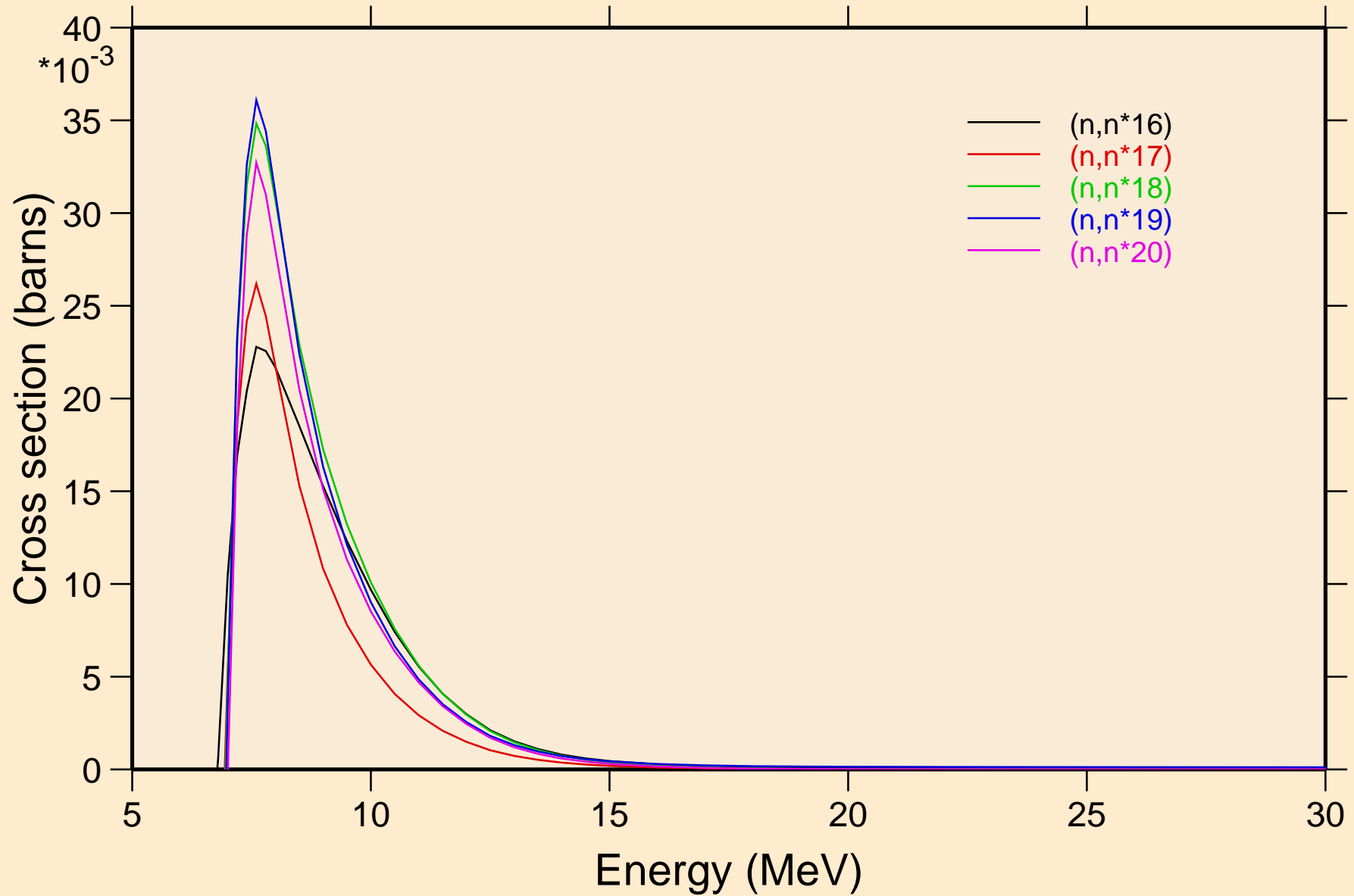

SI034 NEUTRON ACER TENDL-2021 LIBRARY; T=293.6K
Inelastic levels

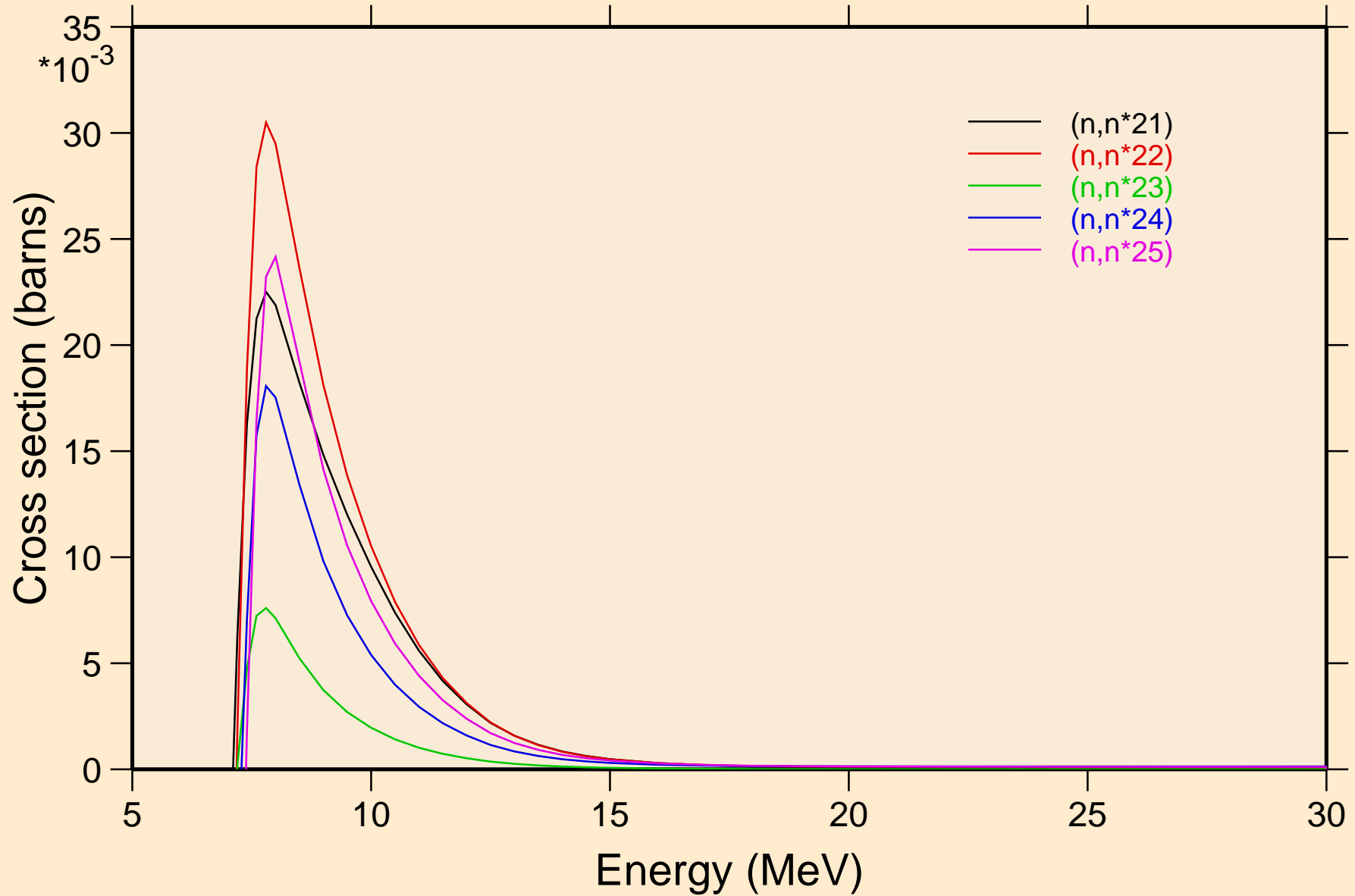

SI034 NEUTRON ACER TENDL-2021 LIBRARY; T=293.6K
Inelastic levels

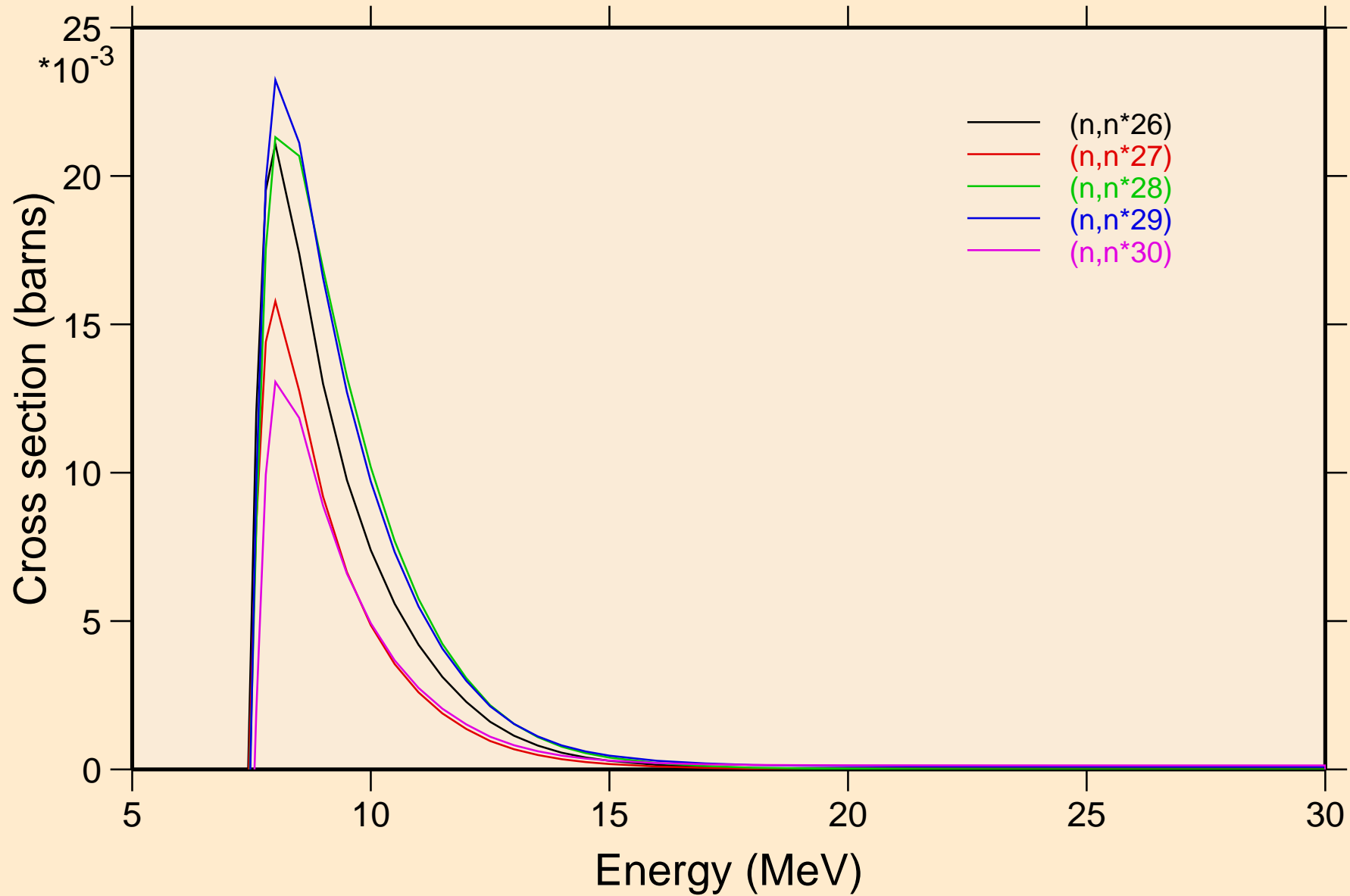

SI034 NEUTRON ACER TENDL-2021 LIBRARY; T=293.6K
Threshold reactions

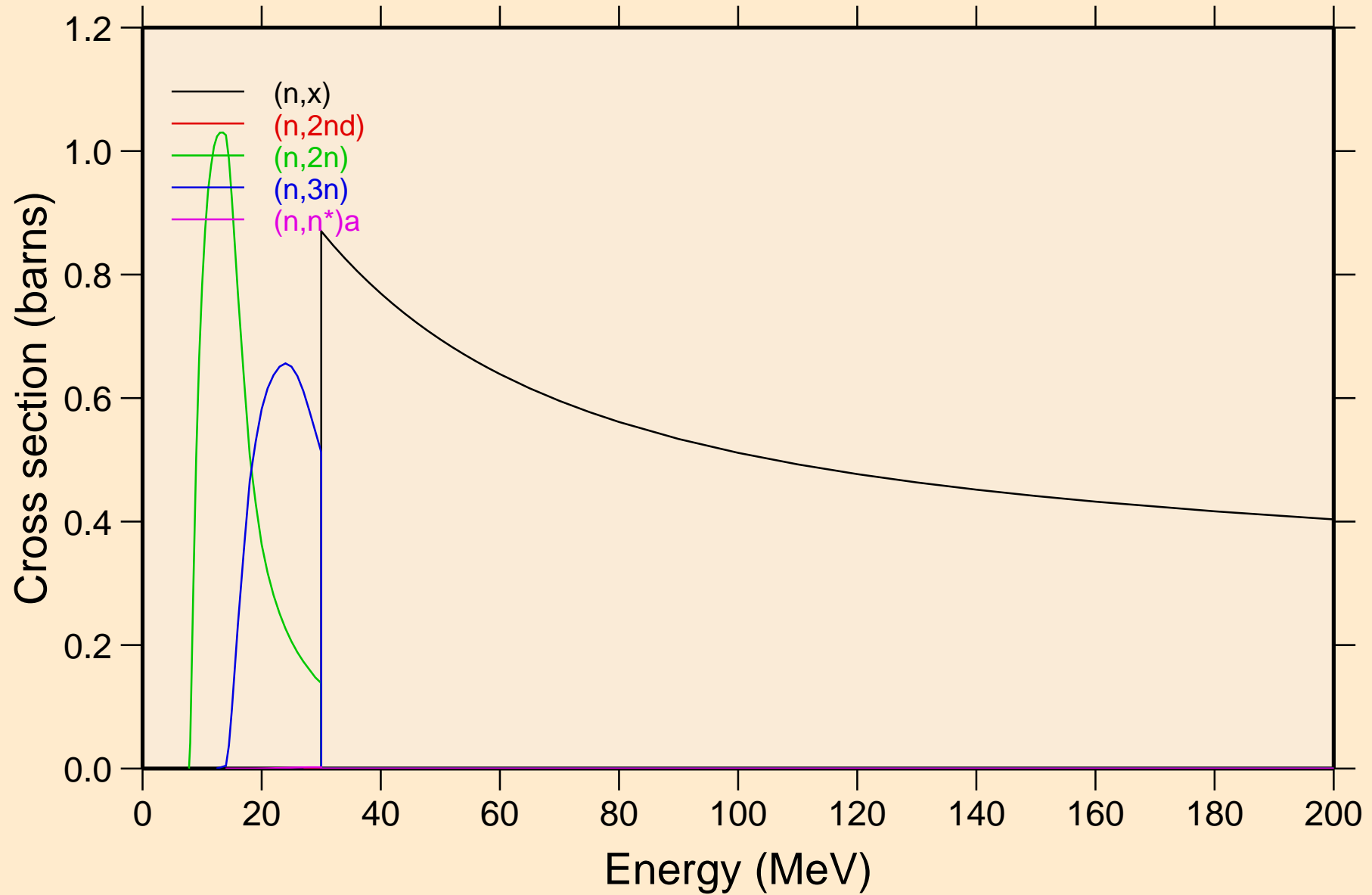

SI034 NEUTRON ACER TENDL-2021 LIBRARY; T=293.6K
Threshold reactions

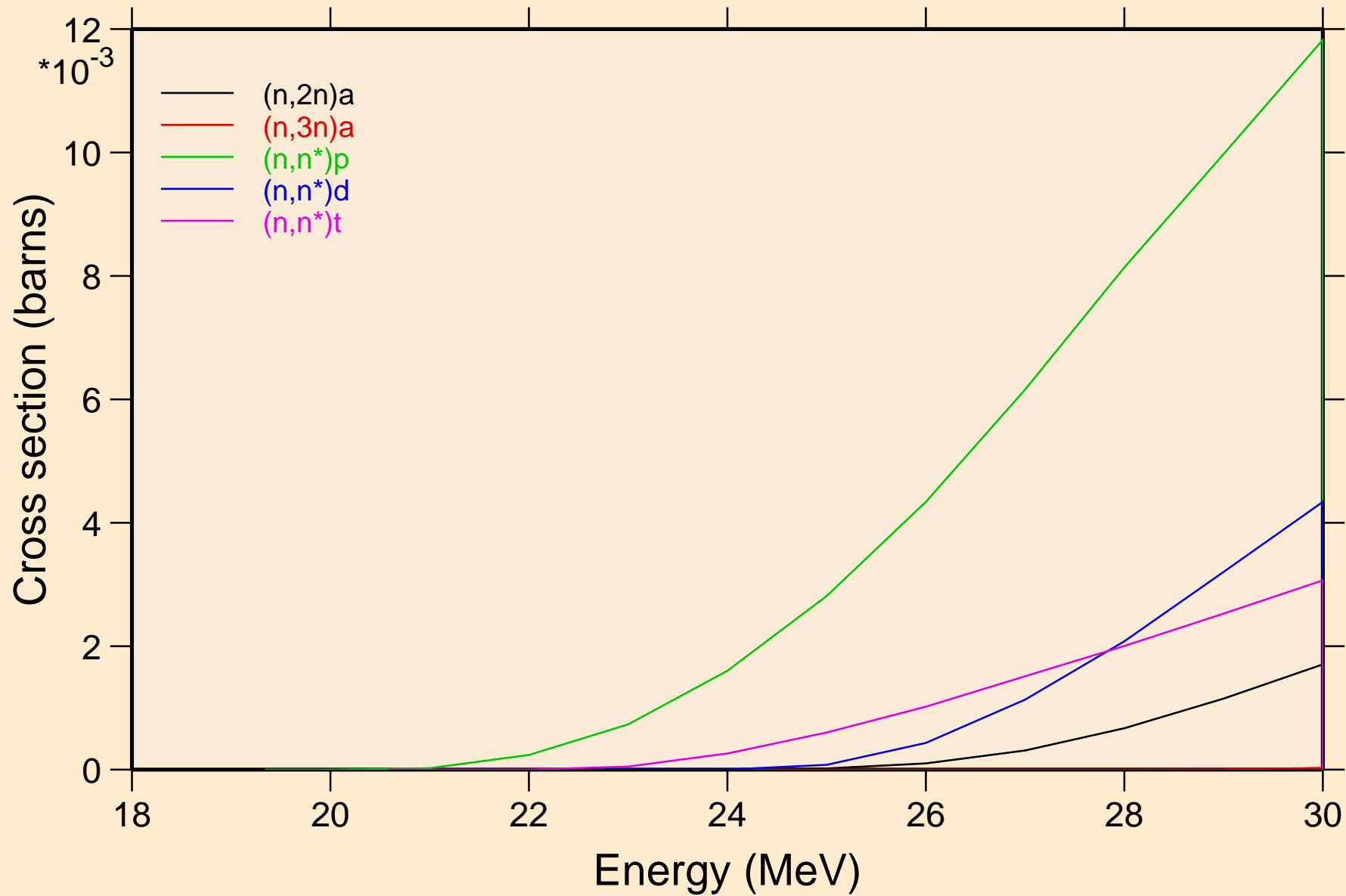

SI034 NEUTRON ACER TENDL-2021 LIBRARY; T=293.6K

Threshold reactions

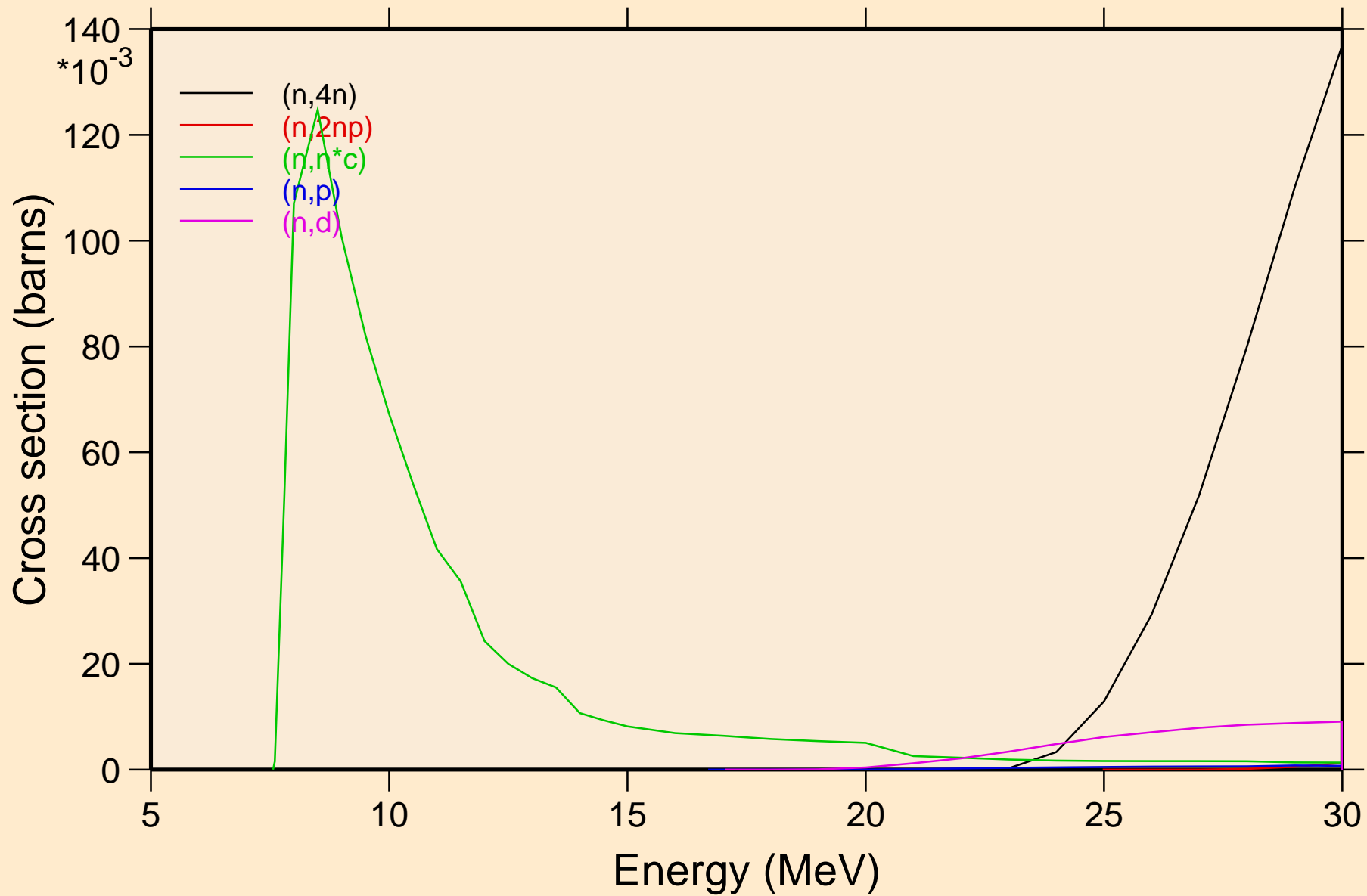

SI034 NEUTRON ACER TENDL-2021 LIBRARY; T=293.6K
Threshold reactions

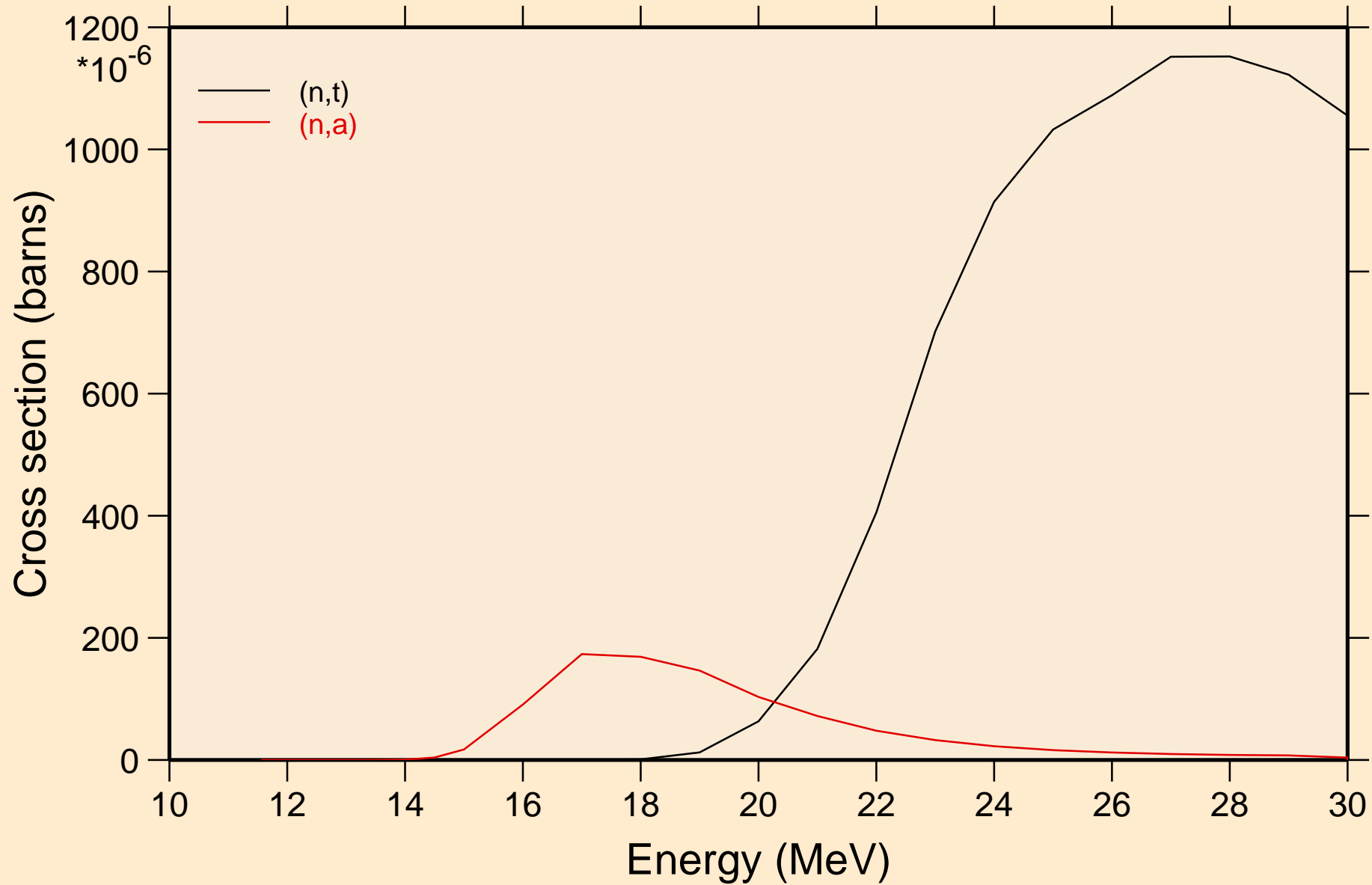

SI034 NEUTRON ACER TENDL-2021 LIBRARY; T=293.6K
Threshold reactions

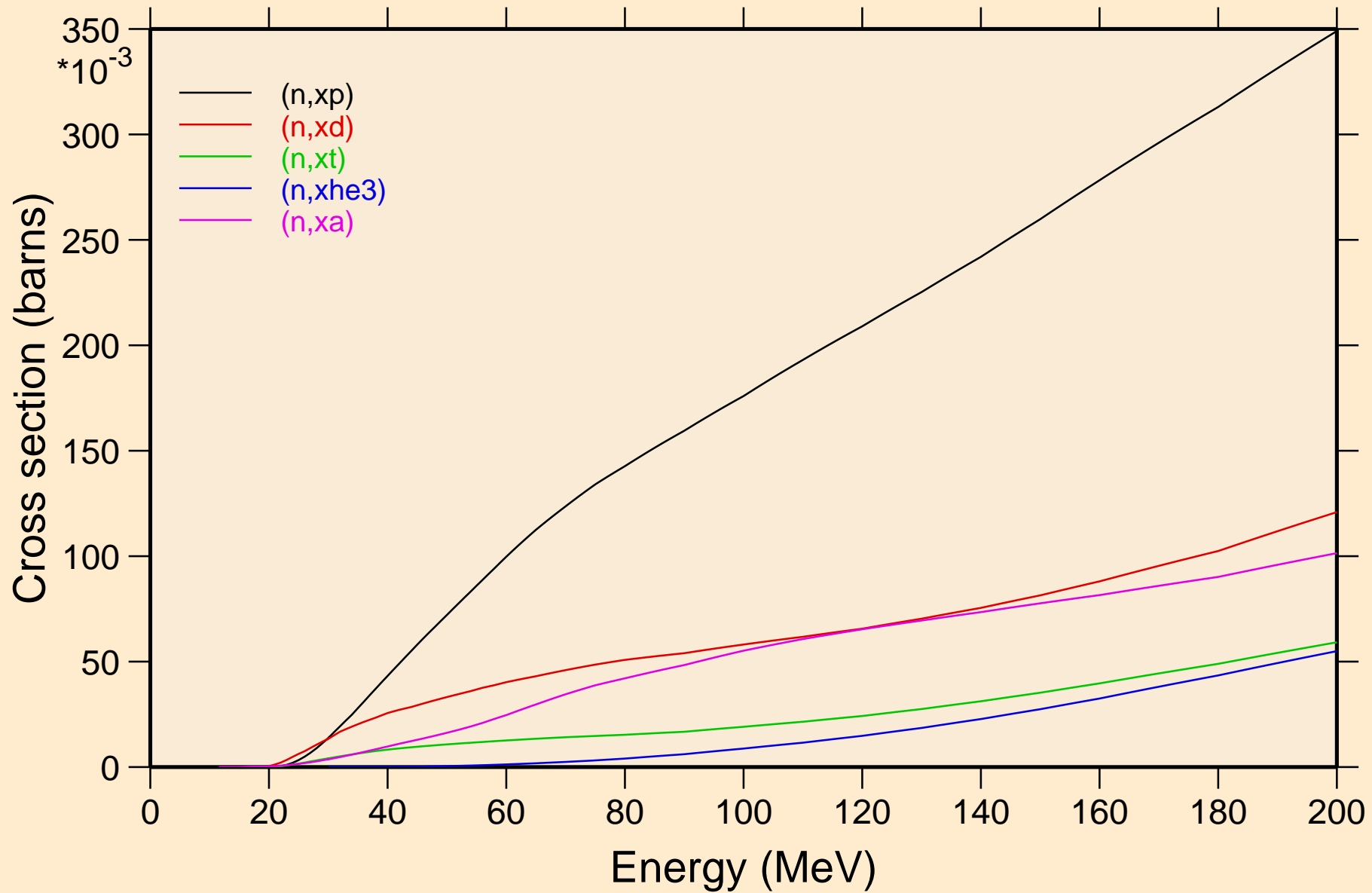

SI034 NEUTRON ACER TENDL-2021 LIBRARY; T=293.6K
angular distribution for elastic

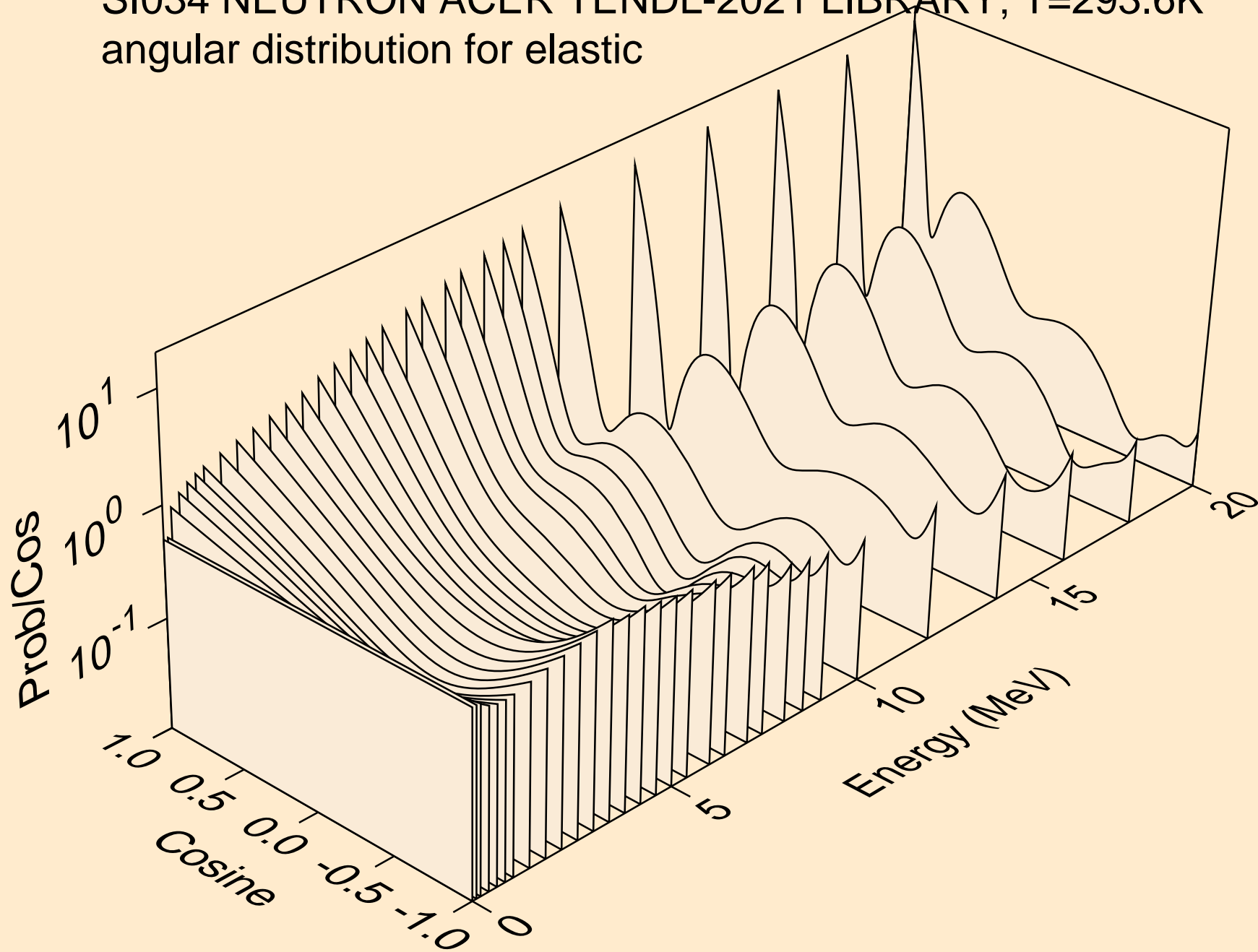

SI034 NEUTRON ACER TENDL-2021 LIBRARY; T=293.6K
angular distribution for elastic

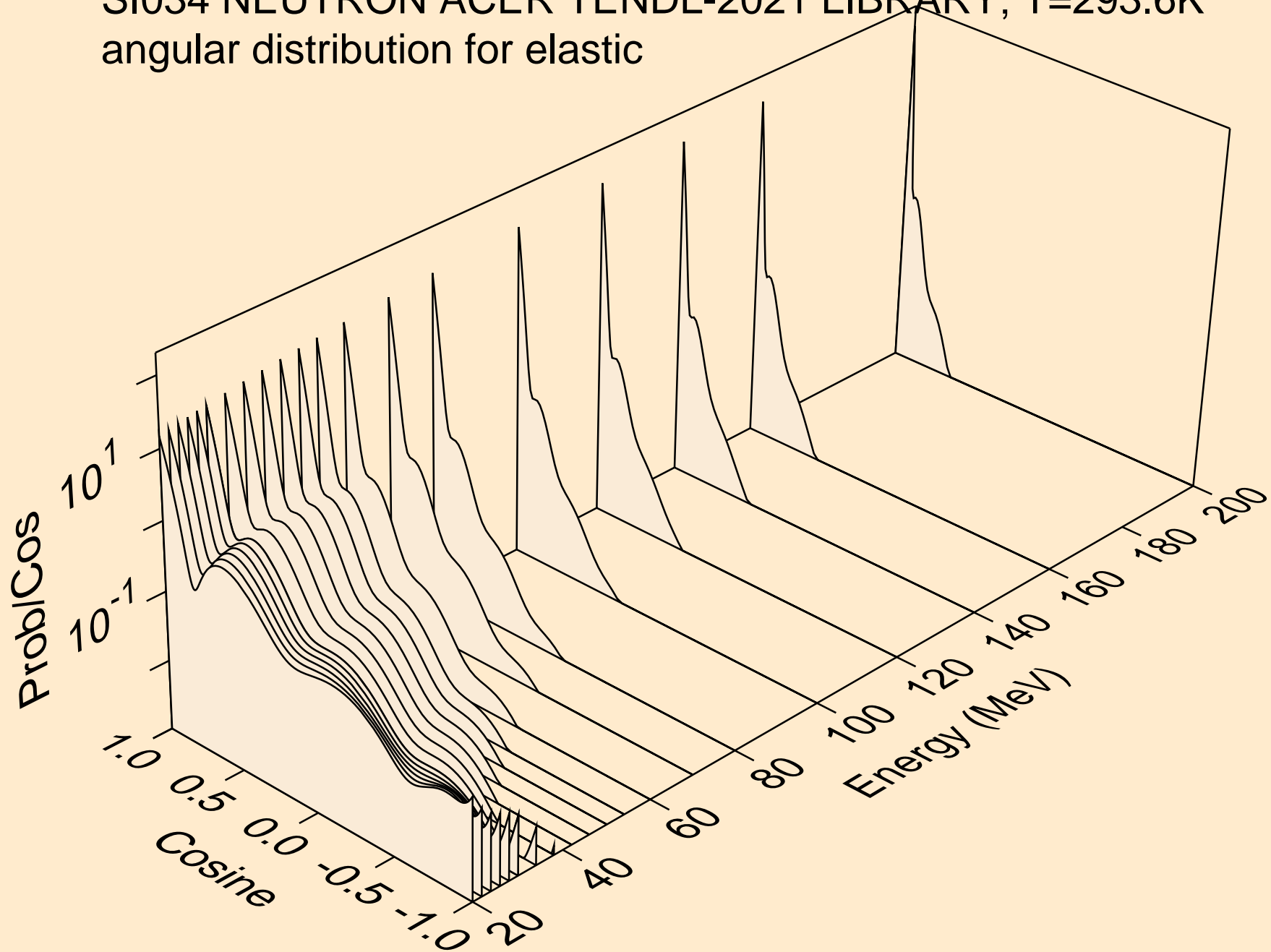

SI034 NEUTRON ACER TENDL-2021 LIBRARY; T=293.6K
angular distribution for (n,n*1)

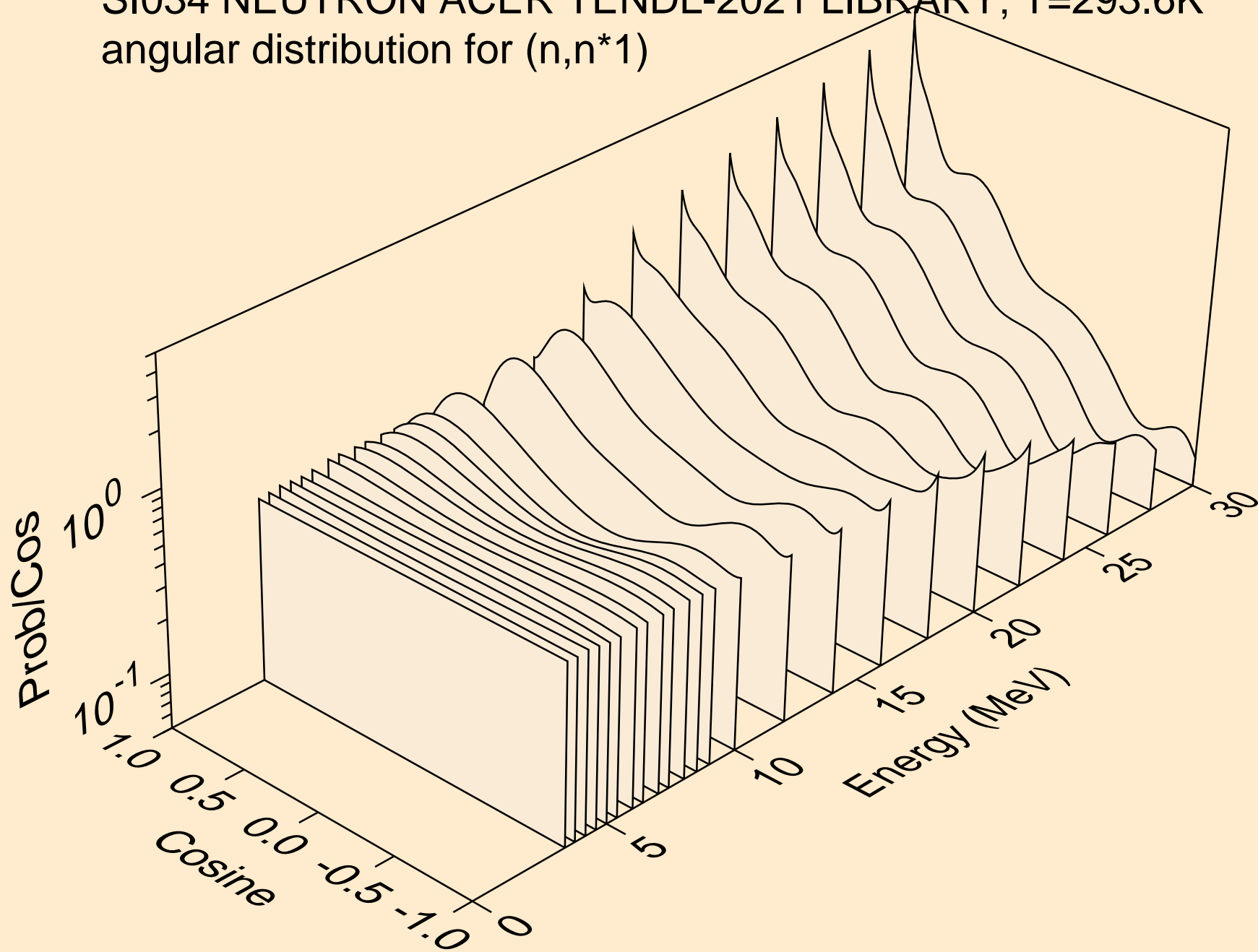

SI034 NEUTRON ACER TENDL-2021 LIBRARY; T=293.6K
angular distribution for (n,n*2)

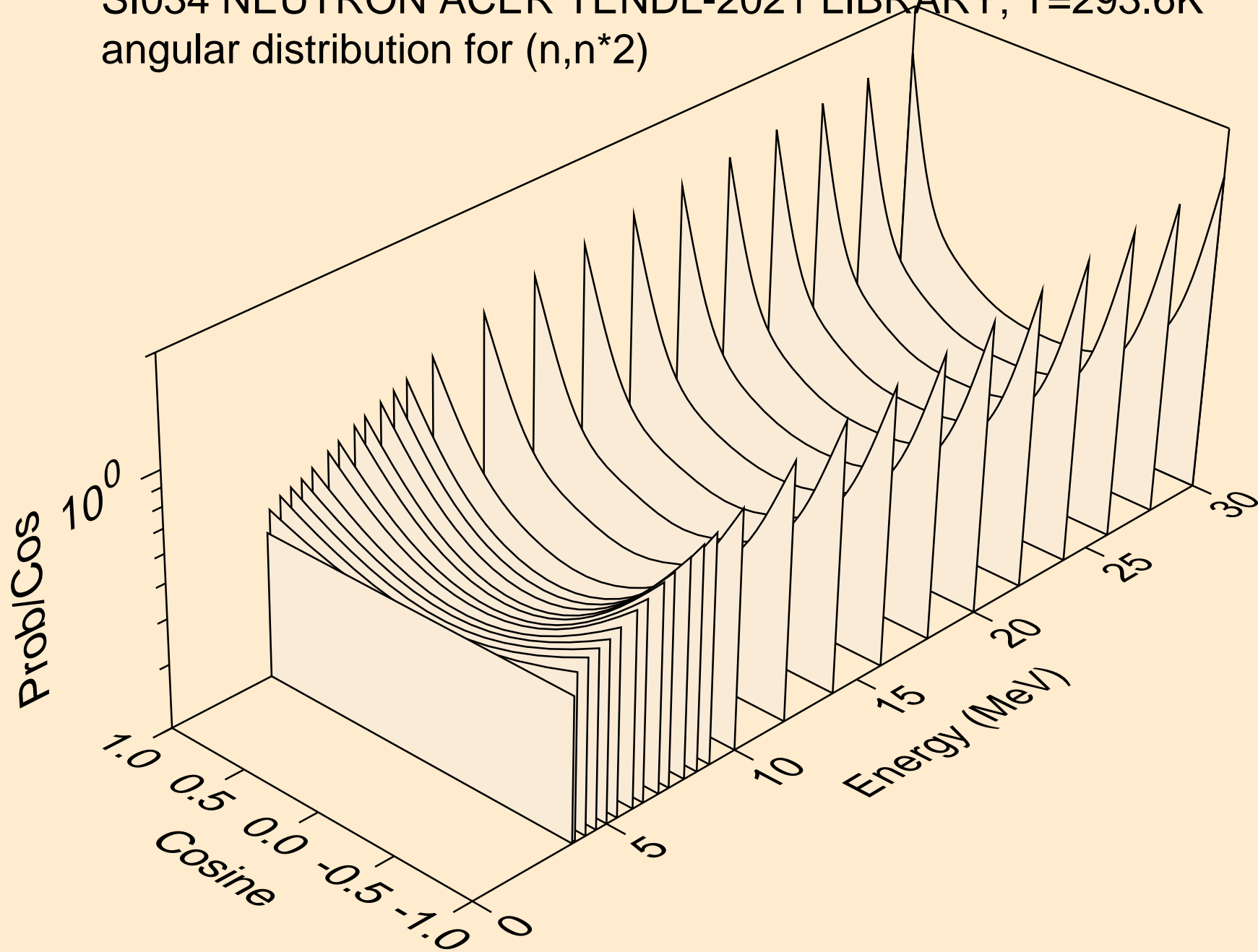

SI034 NEUTRON ACER TENDL-2021 LIBRARY; T=293.6K
angular distribution for (n,n*3)

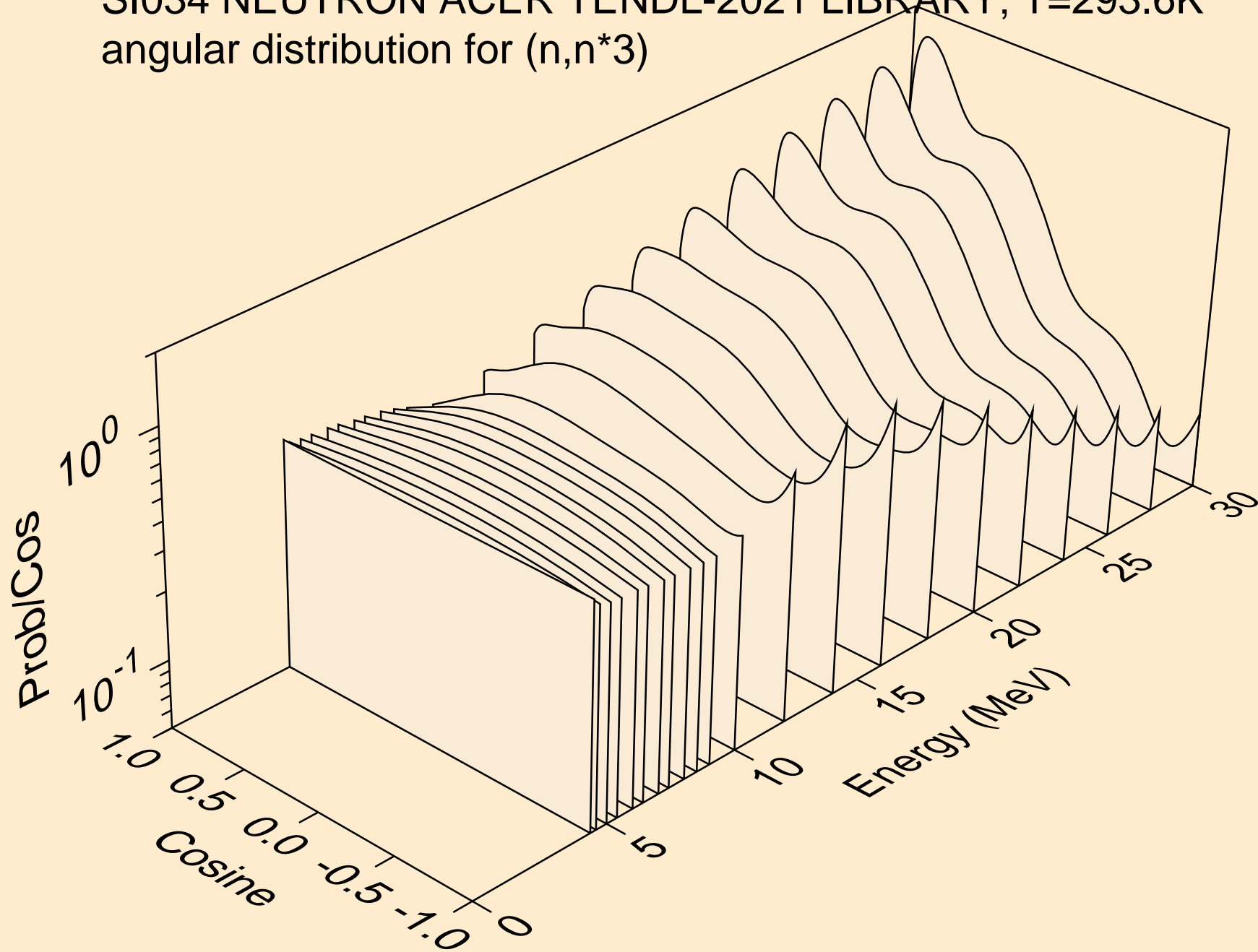

SI034 NEUTRON ACER TENDL-2021 LIBRARY; T=293.6K
angular distribution for (n,n*4)

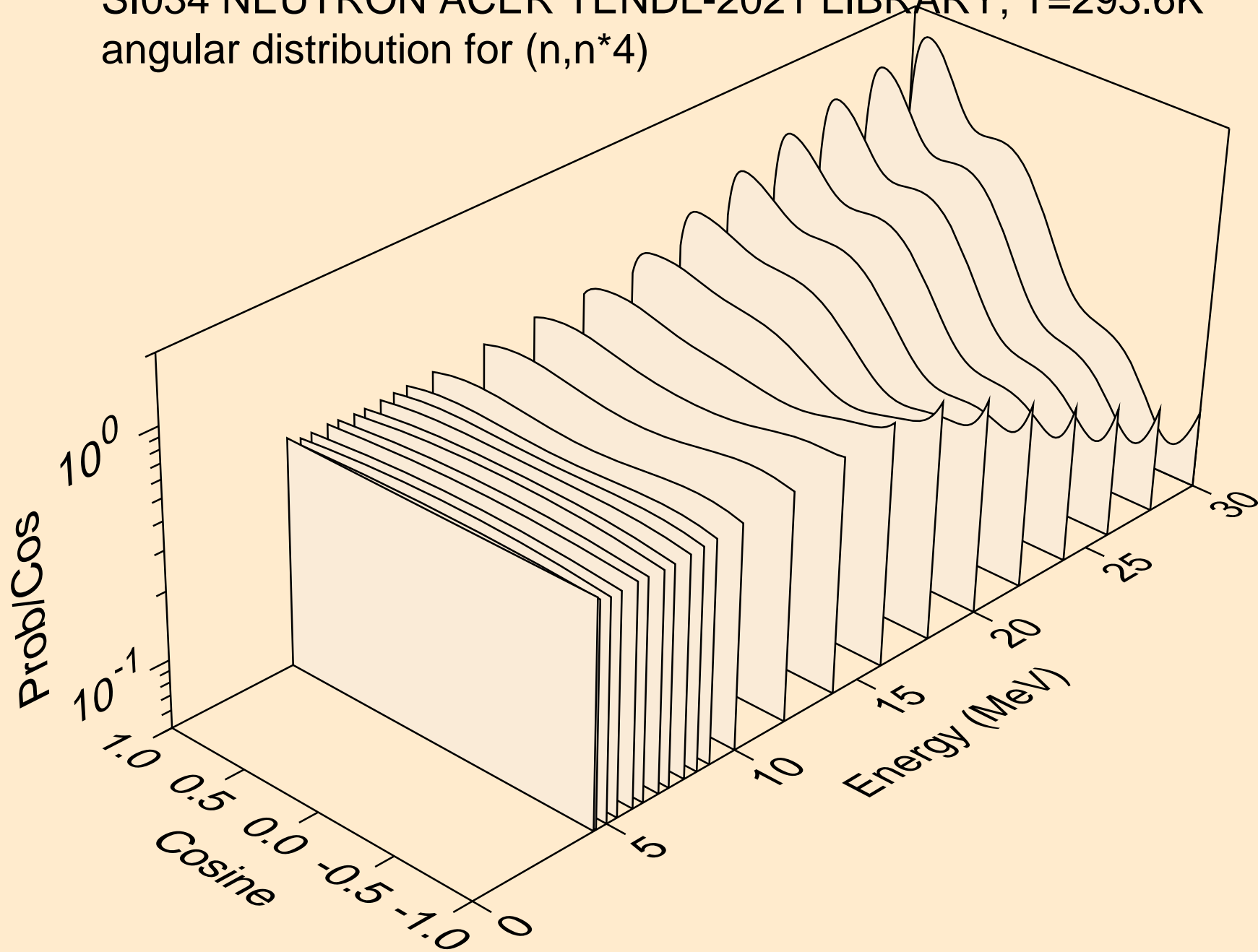

SI034 NEUTRON ACER TENDL-2021 LIBRARY; T=293.6K
angular distribution for (n,n*5)

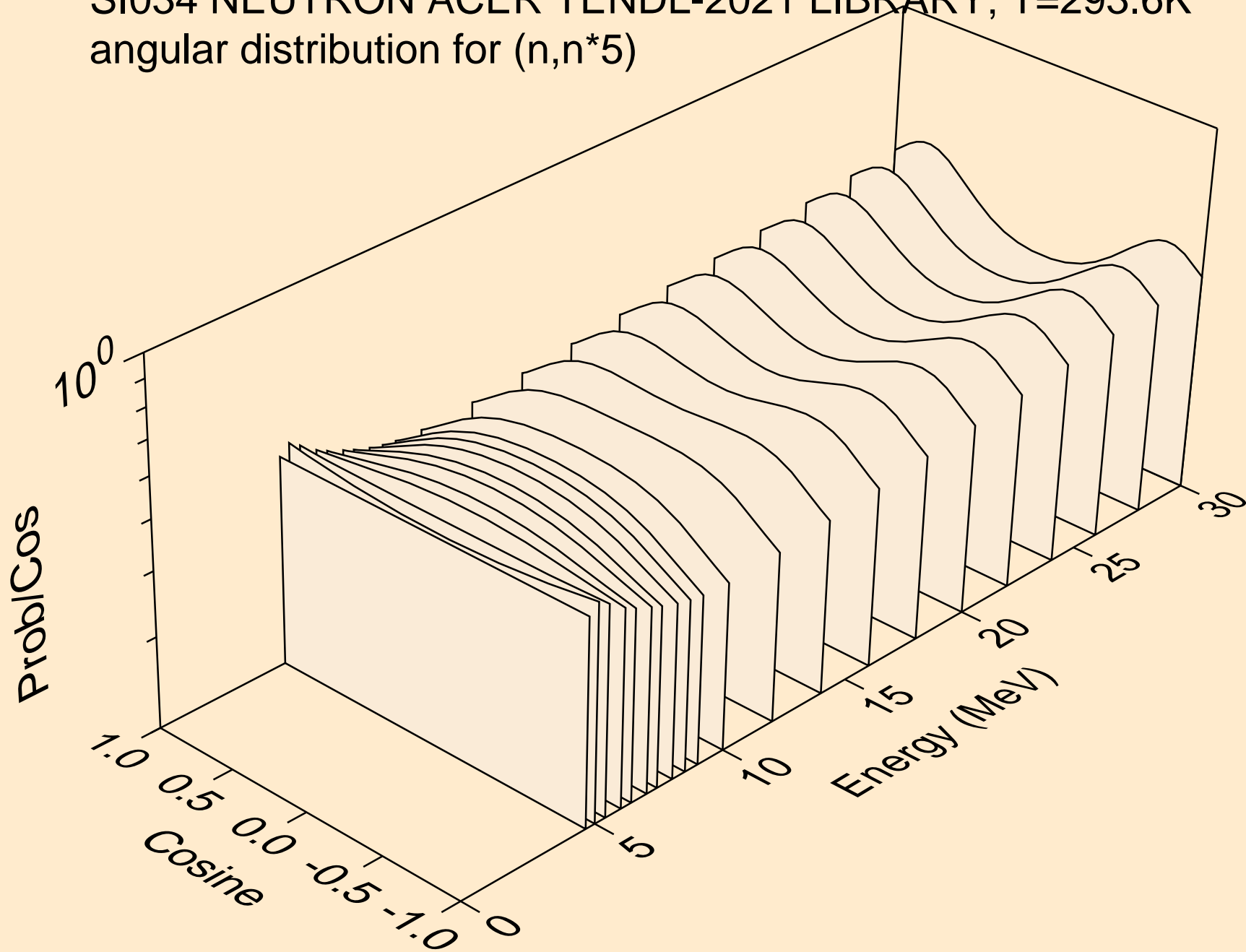

SI034 NEUTRON ACER TENDL-2021 LIBRARY; T=293.6K
angular distribution for (n,n*6)

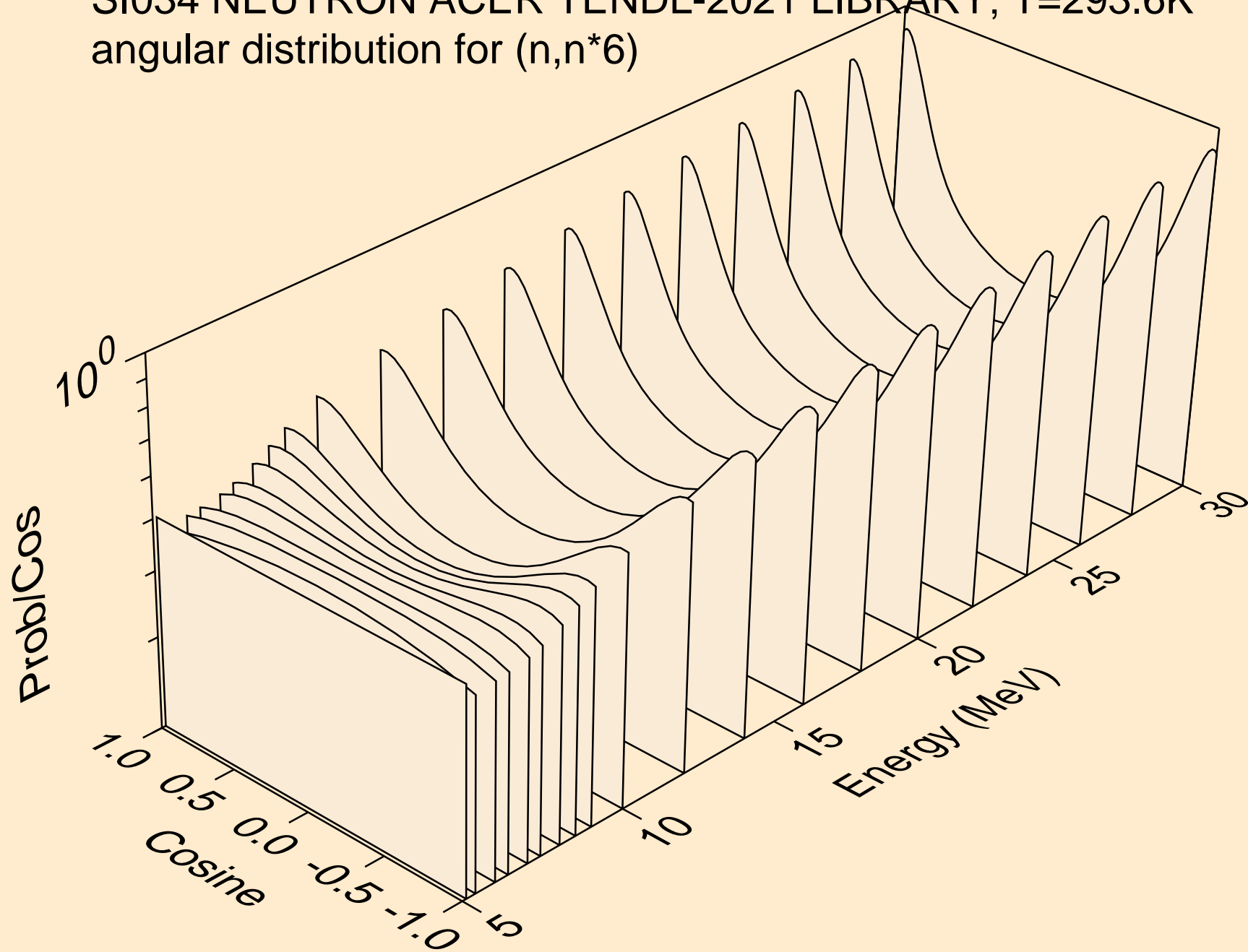

SI034 NEUTRON ACER TENDL-2021 LIBRARY; T=293.6K
angular distribution for (n,n*7)

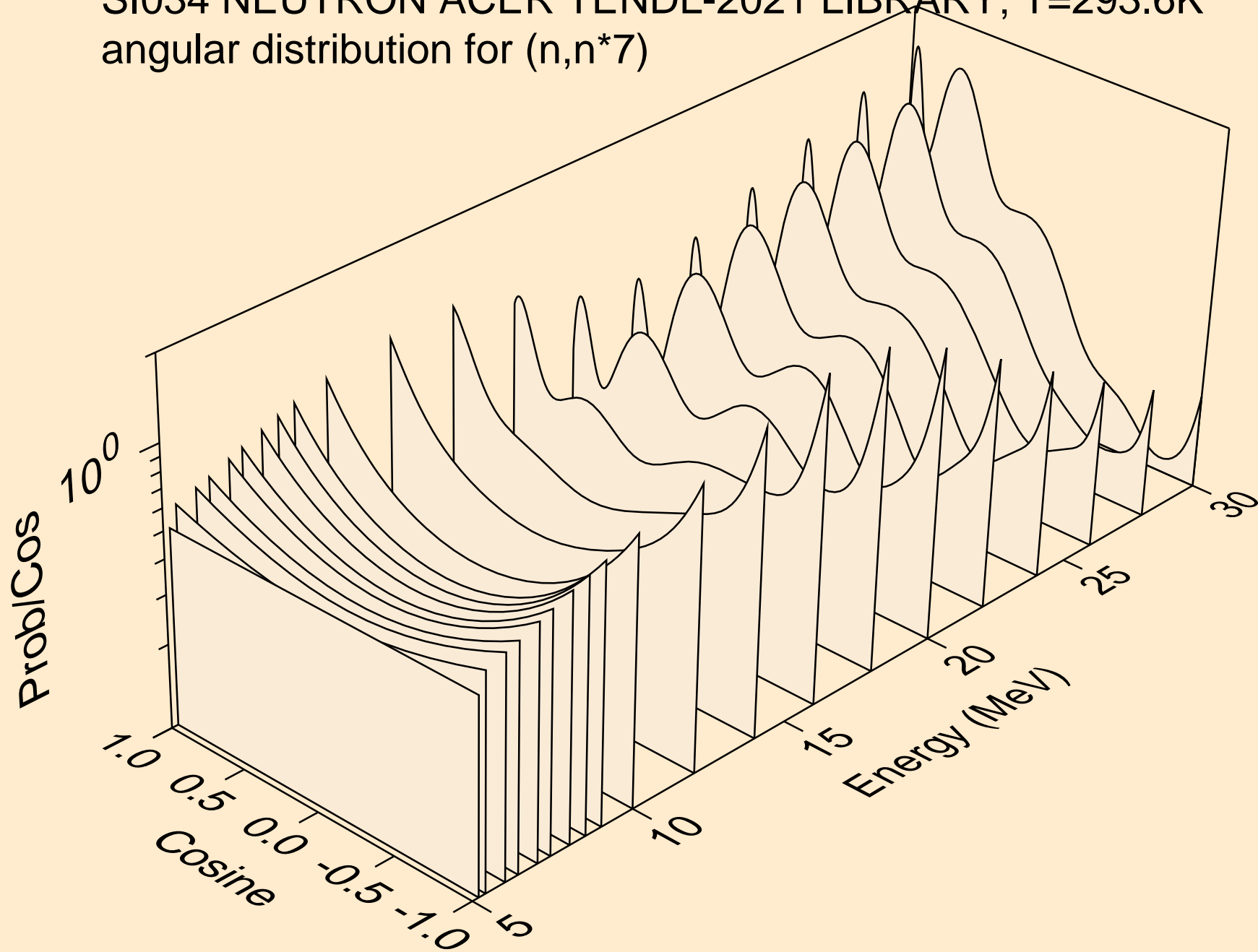

SI034 NEUTRON ACER TENDL-2021 LIBRARY; T=293.6K
angular distribution for (n,n*8)

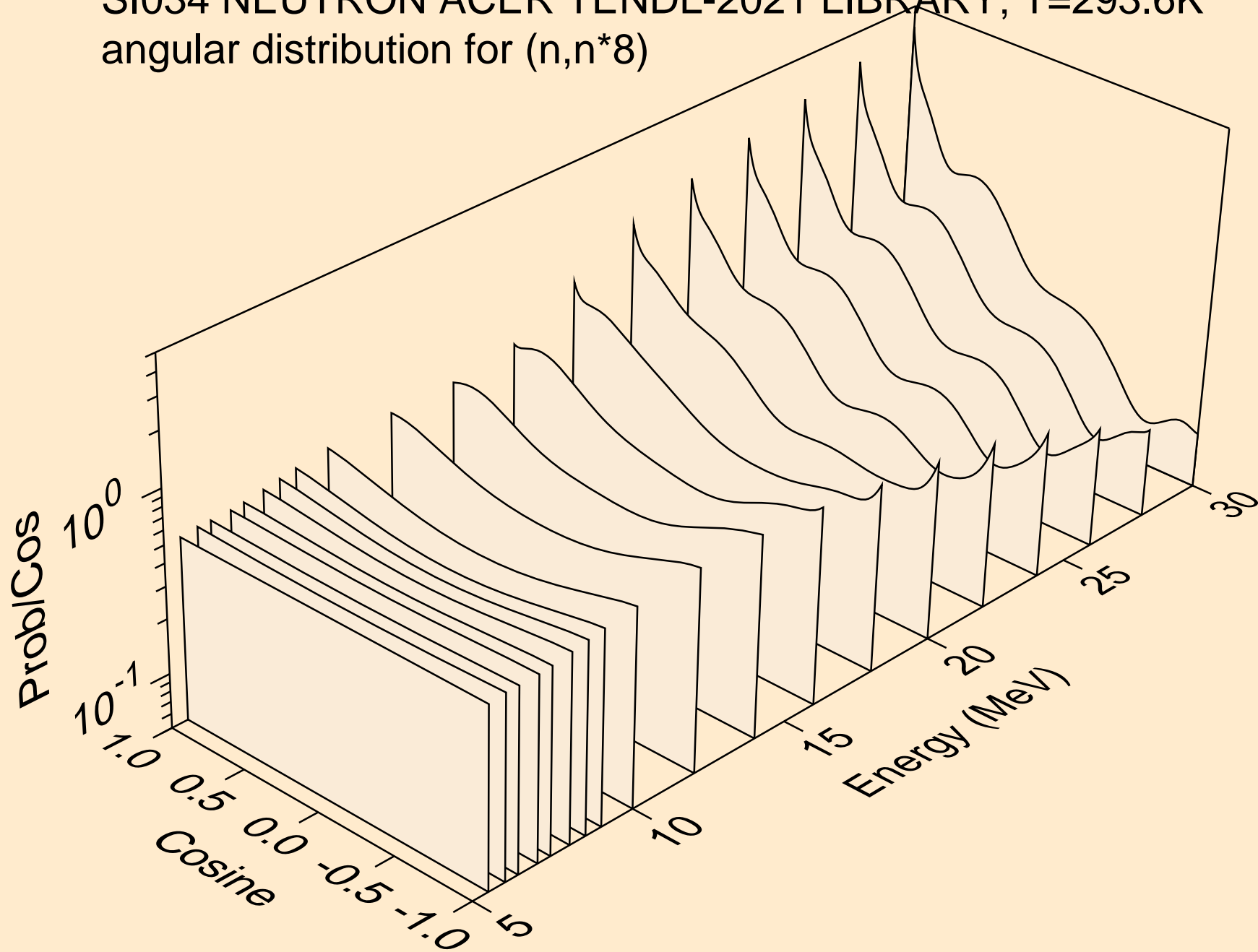

SI034 NEUTRON ACER TENDL-2021 LIBRARY; T=293.6K
angular distribution for (n,n*9)

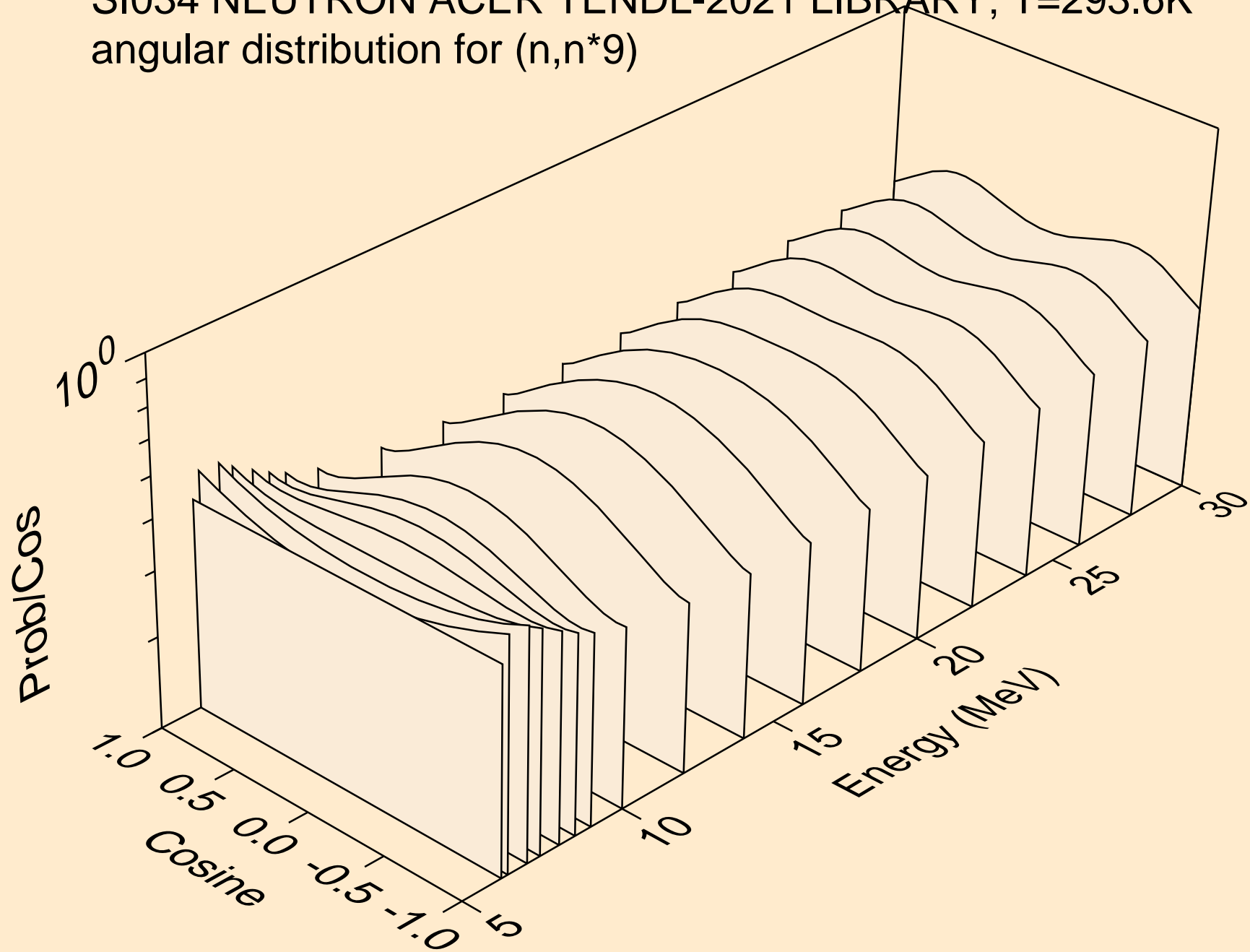

SI034 NEUTRON ACER TENDL-2021 LIBRARY; T=293.6K
angular distribution for (n,n*10)

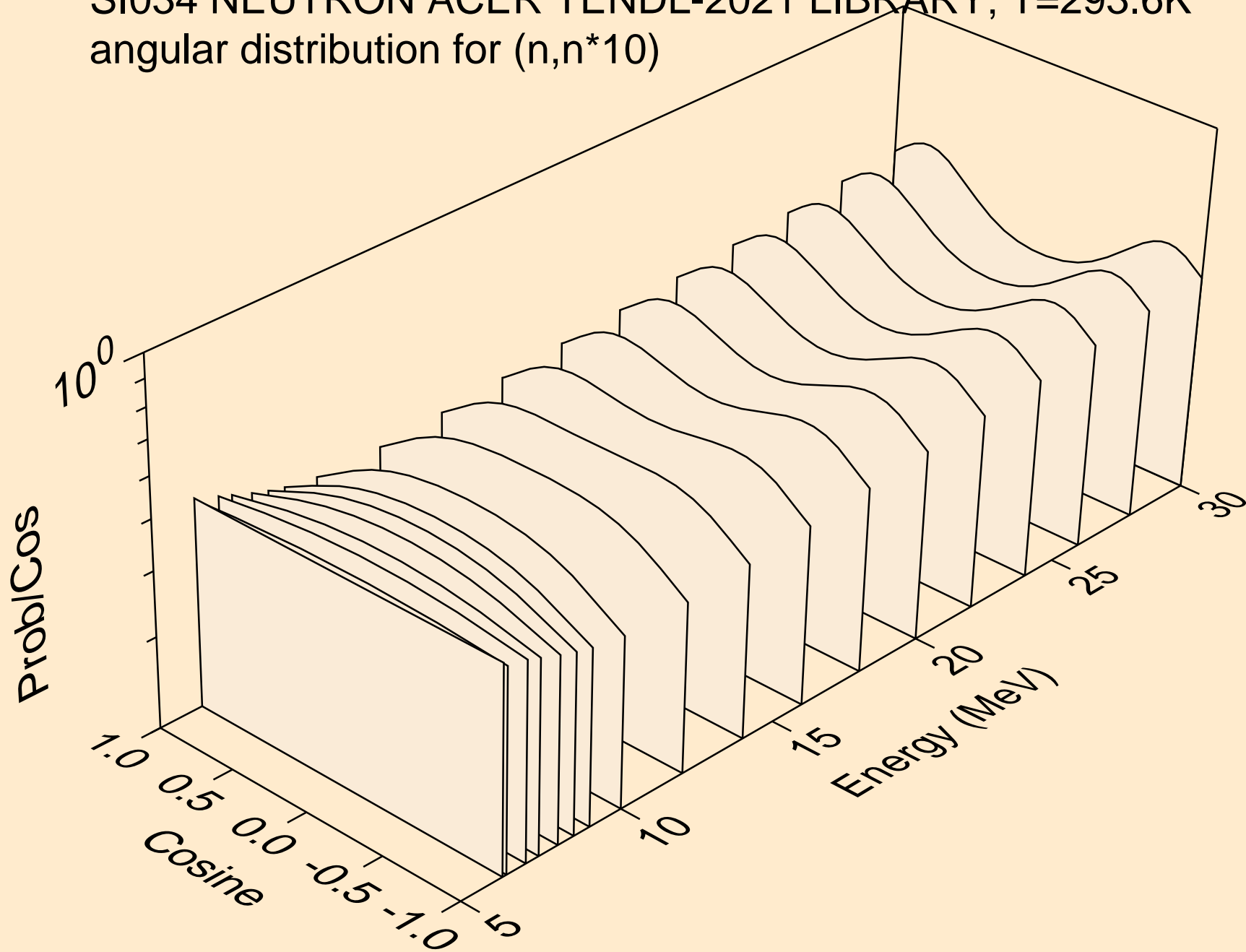

SI034 NEUTRON ACER TENDL-2021 LIBRARY; T=293.6K
angular distribution for (n,n*11)

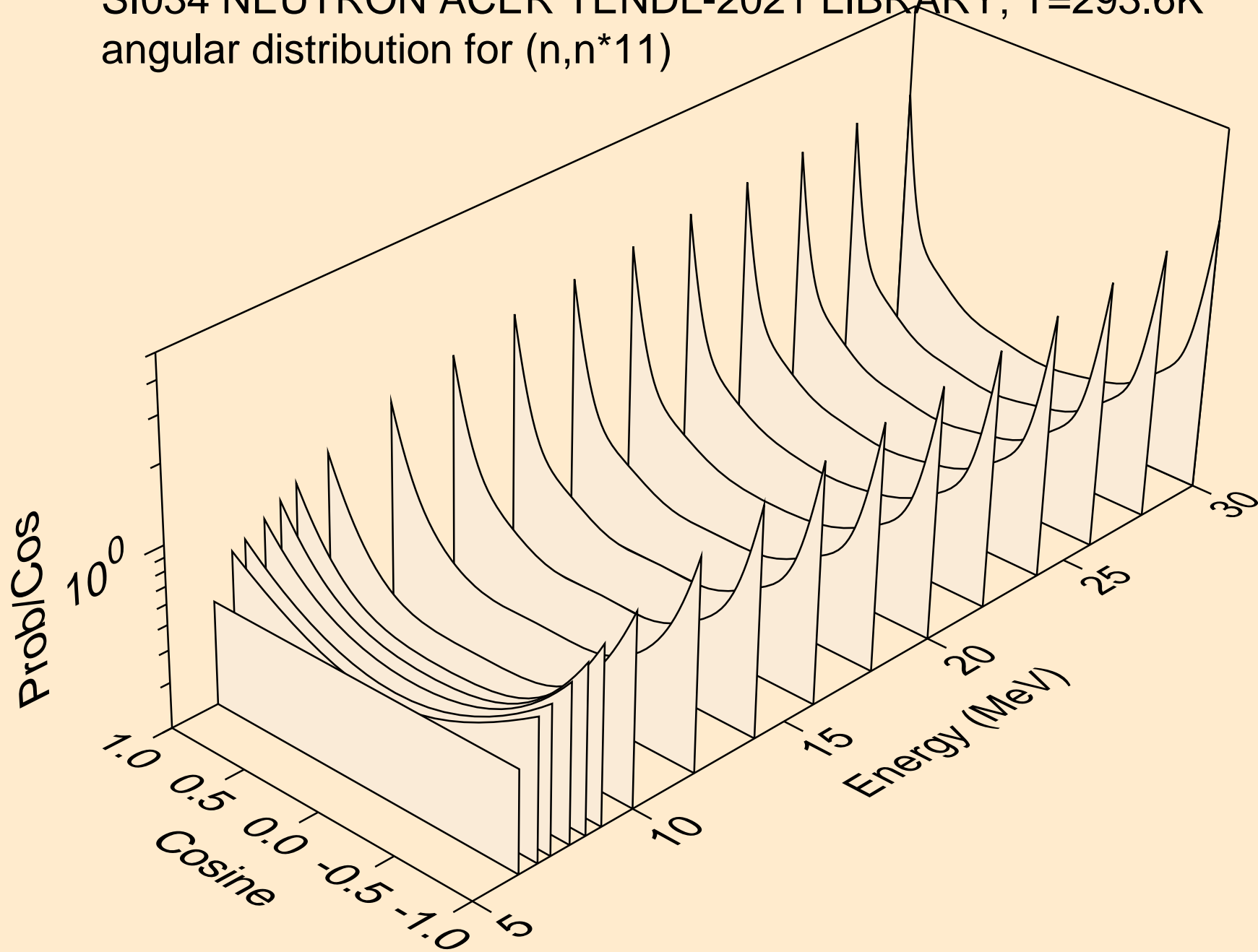

SI034 NEUTRON ACER TENDL-2021 LIBRARY; T=293.6K
angular distribution for (n,n*12)

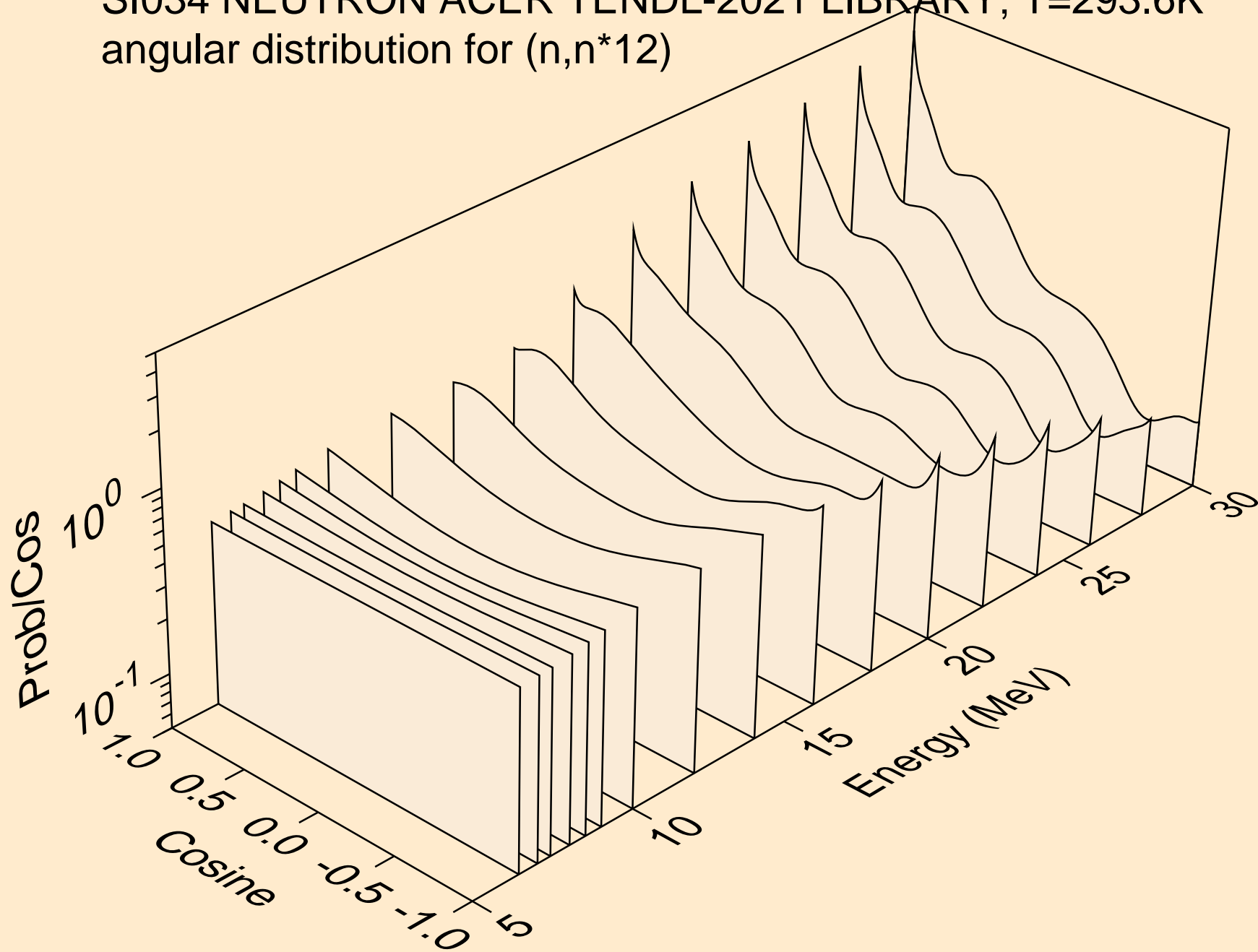

SI034 NEUTRON ACER TENDL-2021 LIBRARY; T=293.6K
angular distribution for (n,n*13)

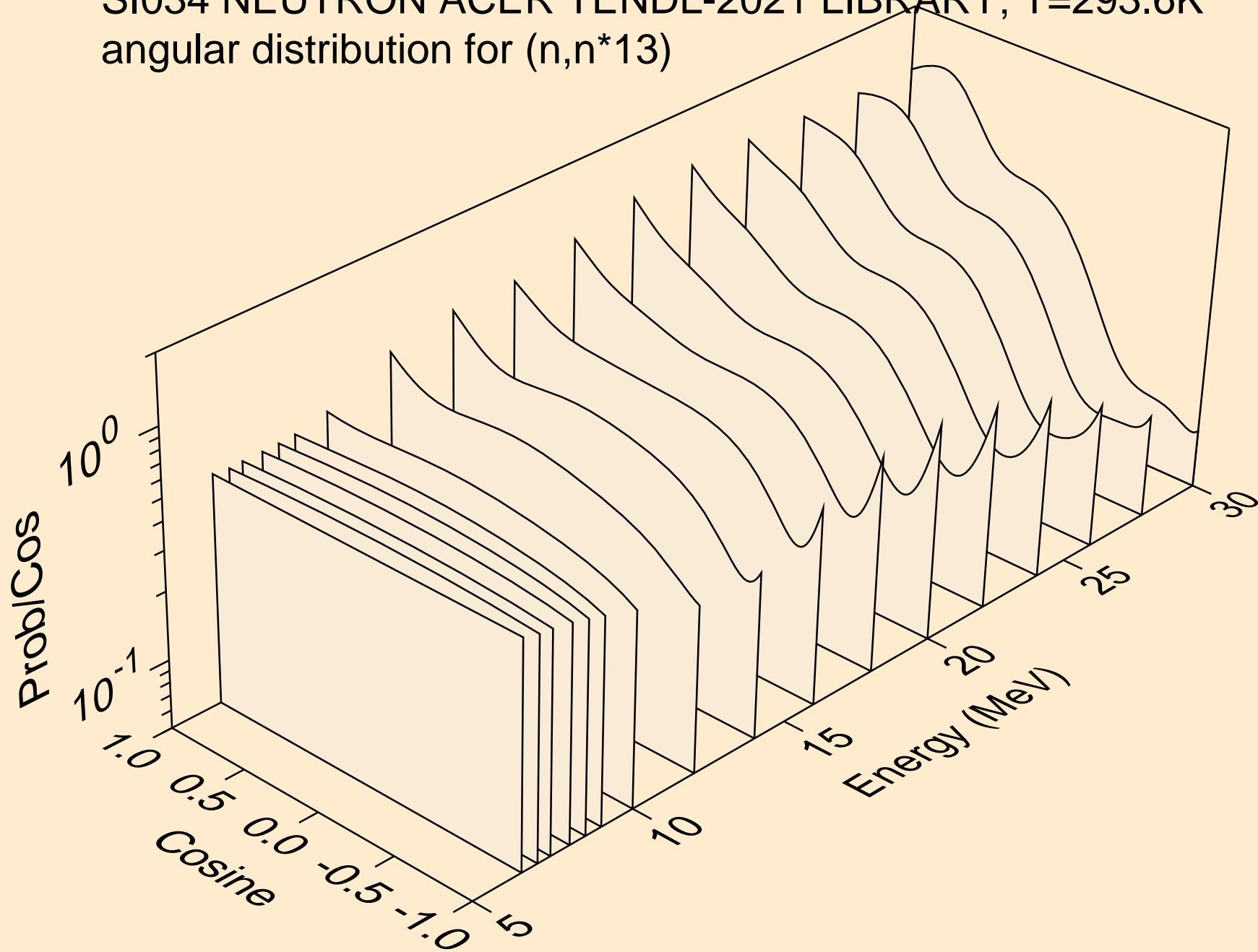

SI034 NEUTRON ACER TENDL-2021 LIBRARY; T=293.6K
angular distribution for (n,n*14)

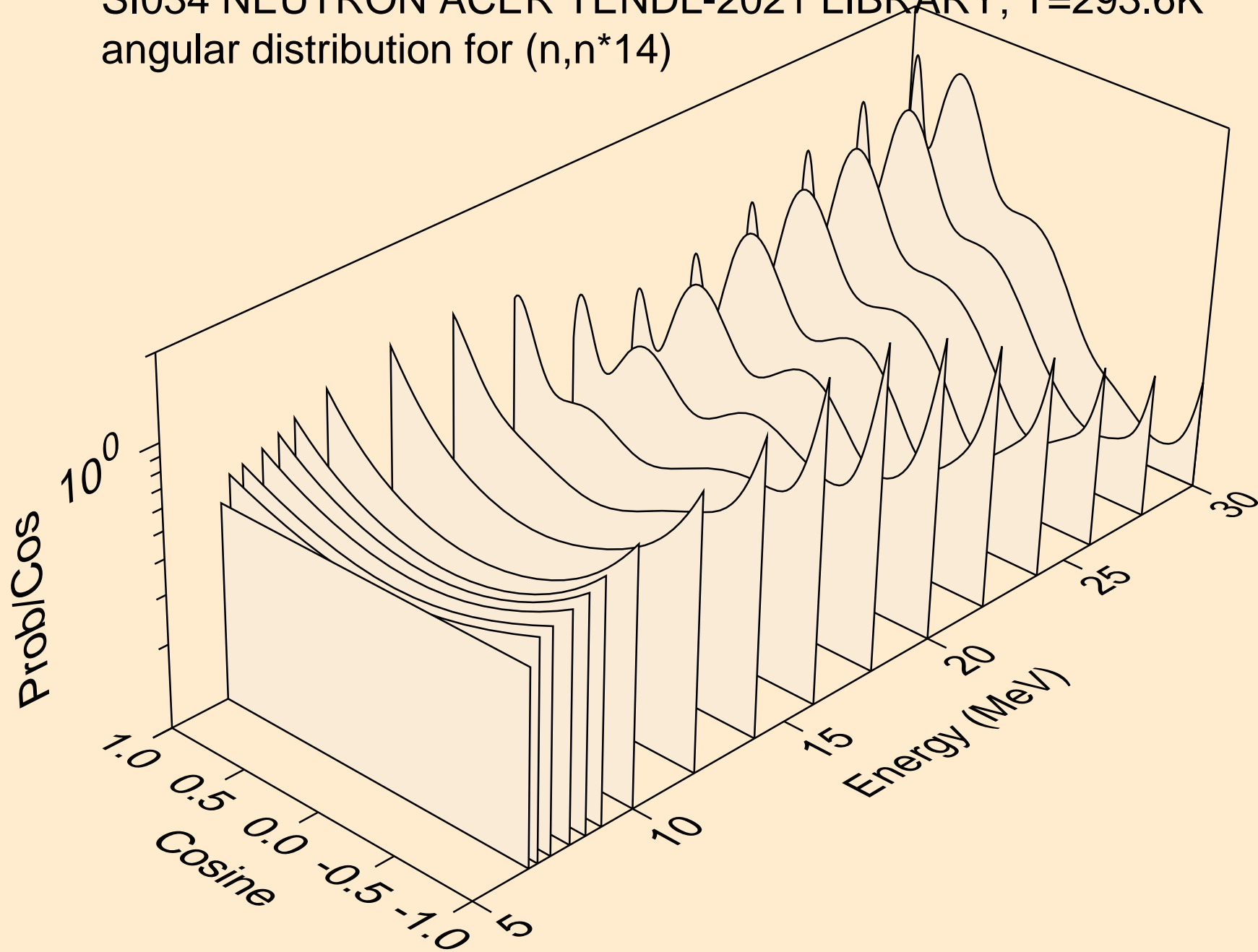

SI034 NEUTRON ACER TENDL-2021 LIBRARY; T=293.6K
angular distribution for (n,n*15)

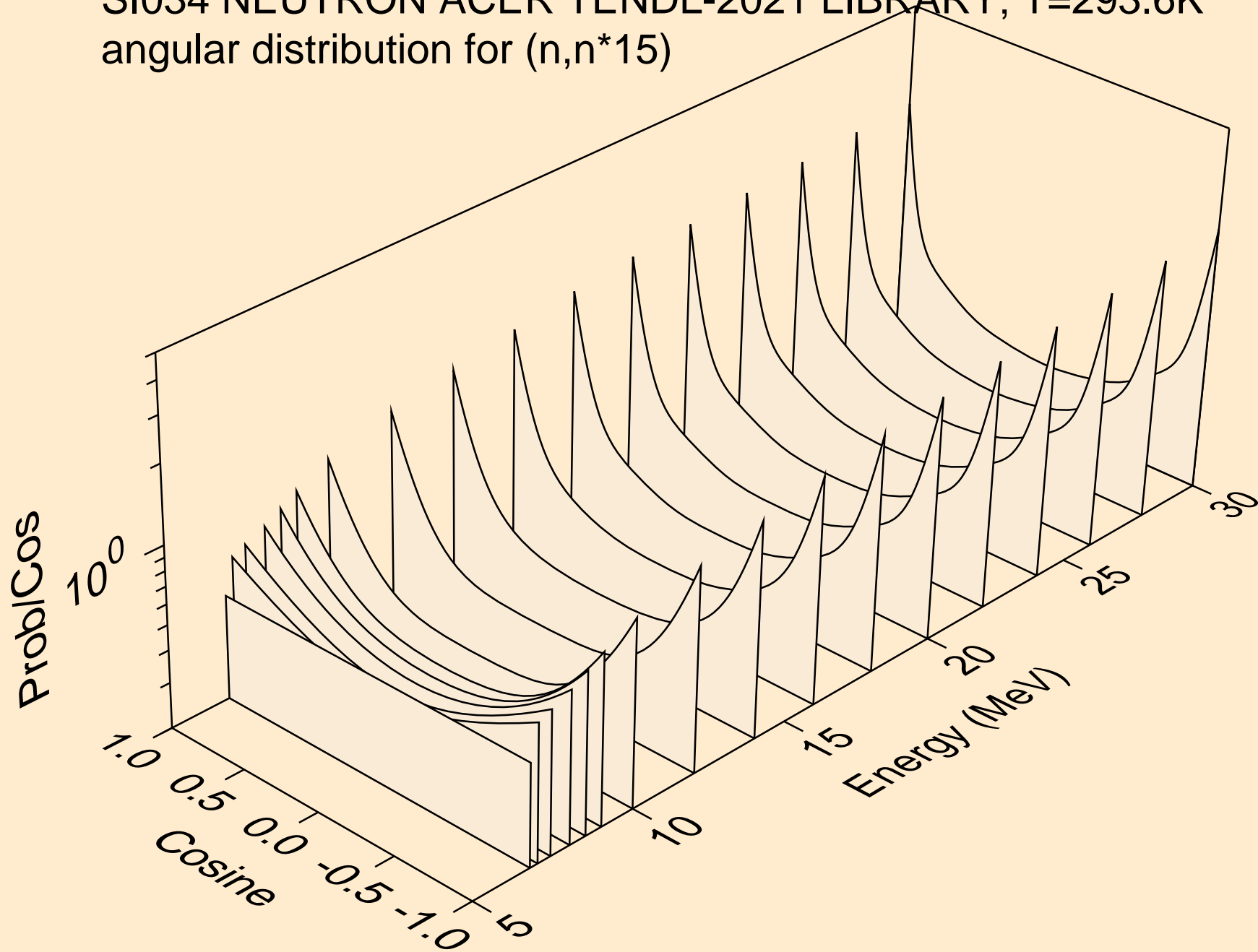

SI034 NEUTRON ACER TENDL-2021 LIBRARY; T=293.6K
angular distribution for (n,n*16)

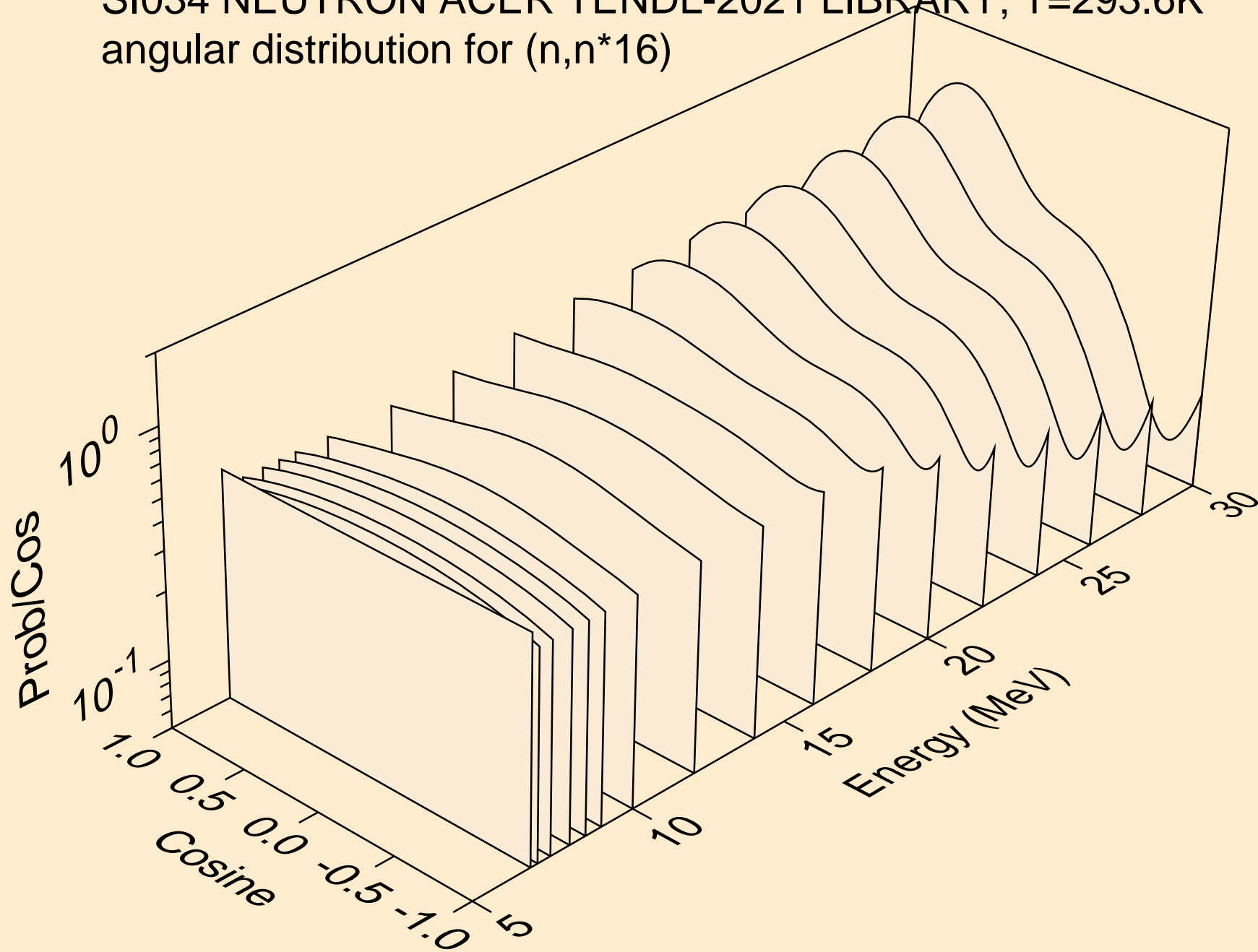

SI034 NEUTRON ACER TENDL-2021 LIBRARY; T=293.6K
angular distribution for (n,n*17)

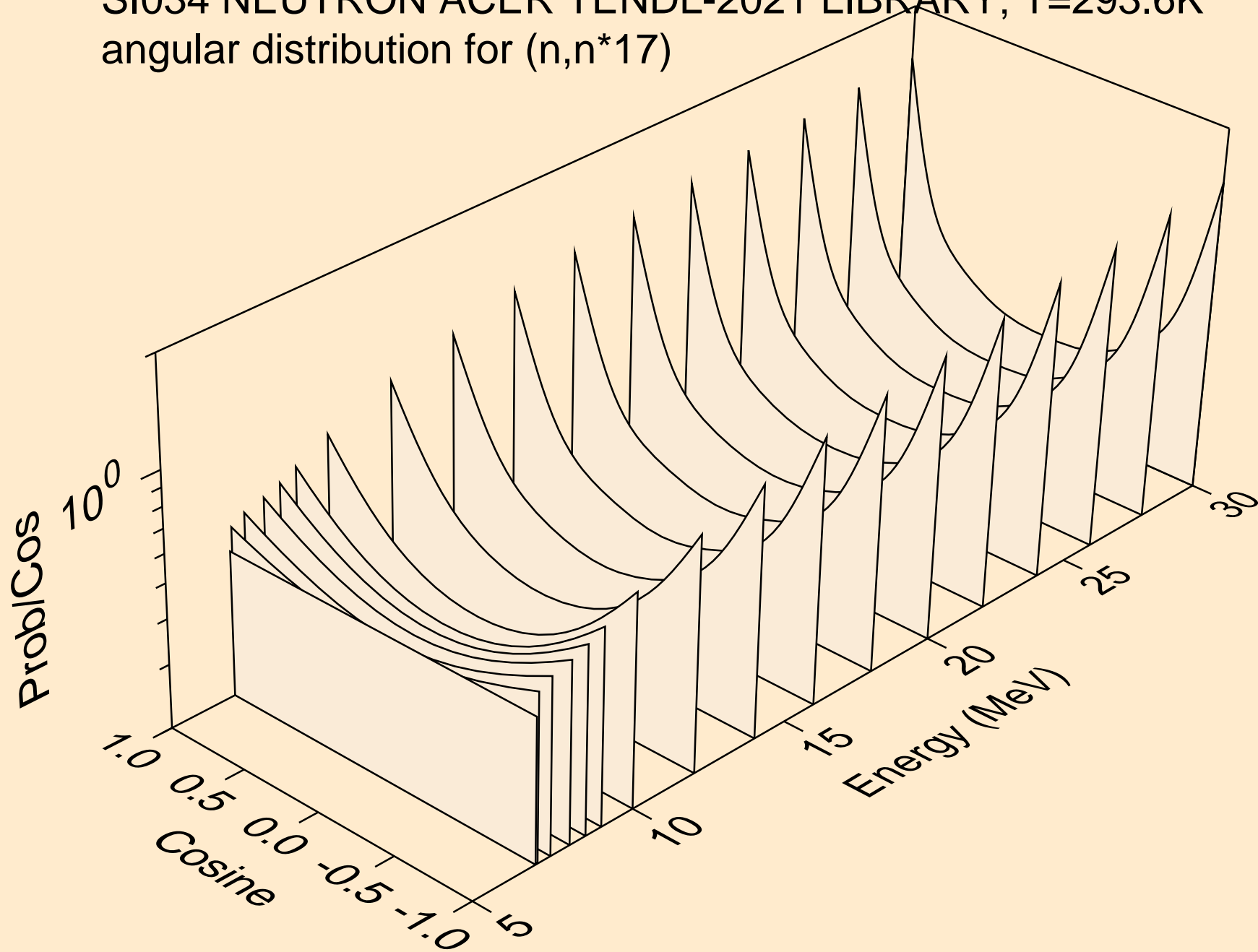

SI034 NEUTRON ACER TENDL-2021 LIBRARY; T=293.6K
angular distribution for (n,n*18)

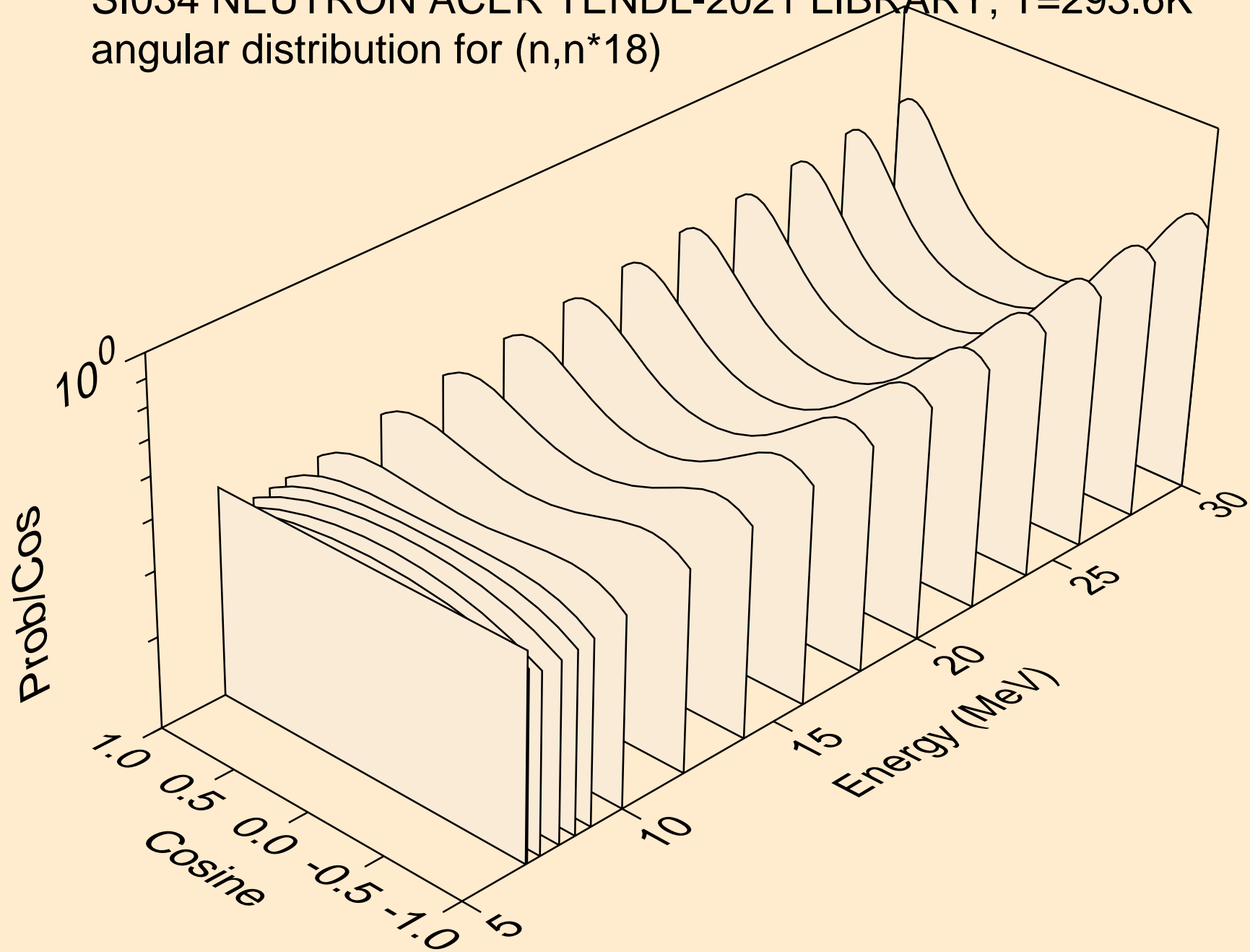

SI034 NEUTRON ACER TENDL-2021 LIBRARY; T=293.6K
angular distribution for (n,n*19)

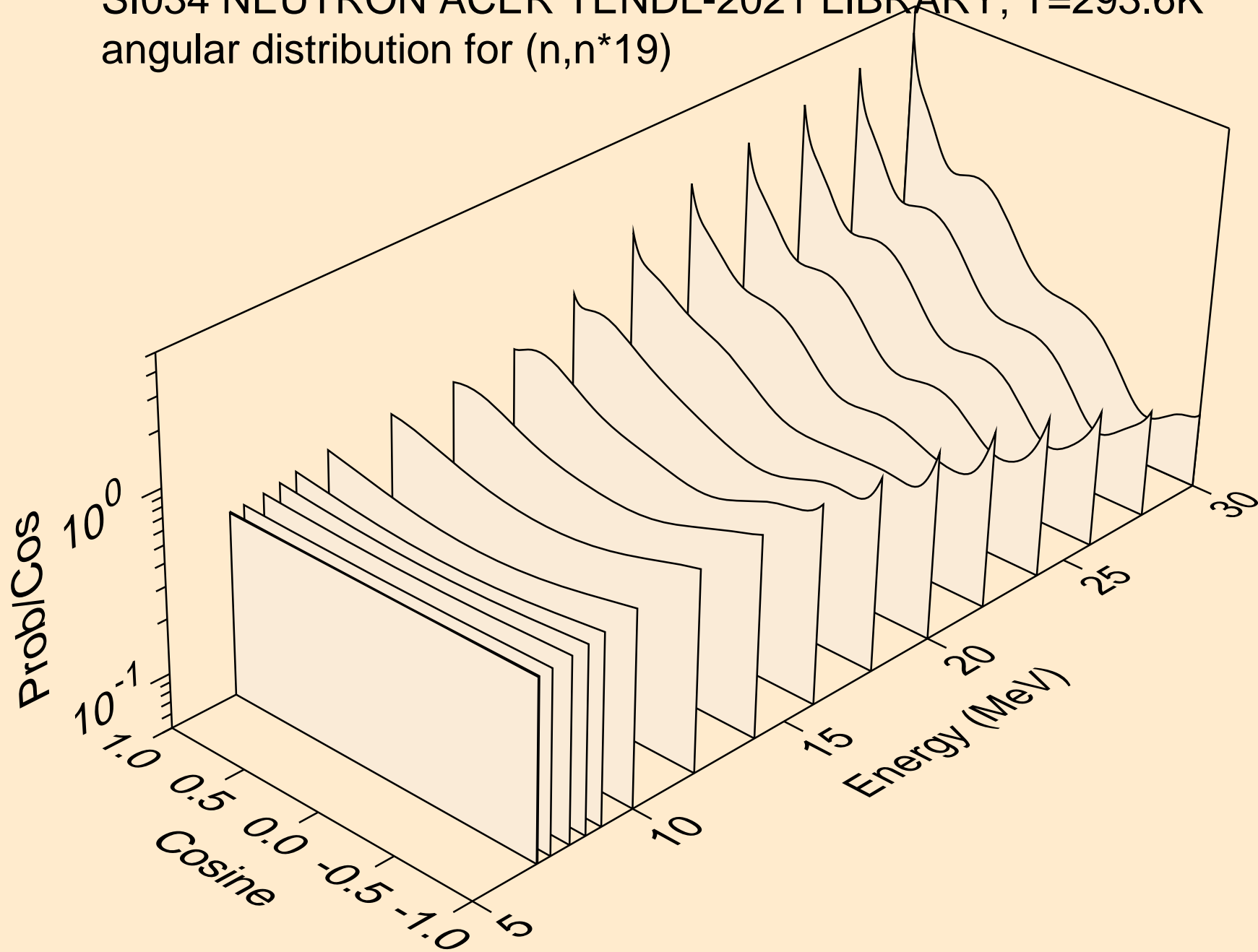

SI034 NEUTRON ACER TENDL-2021 LIBRARY; T=293.6K
angular distribution for (n,n*20)

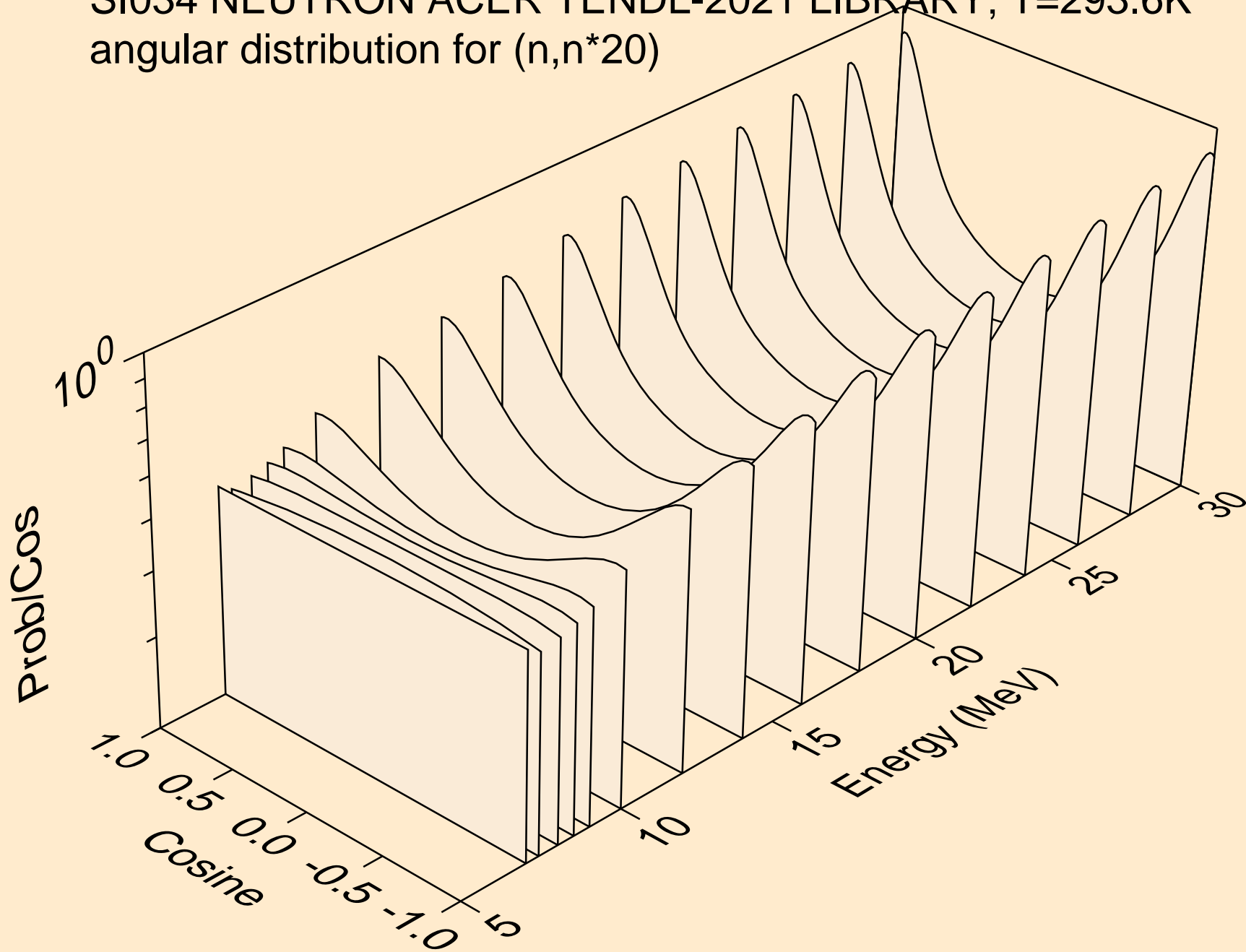

SI034 NEUTRON ACER TENDL-2021 LIBRARY; T=293.6K
angular distribution for (n,n*21)

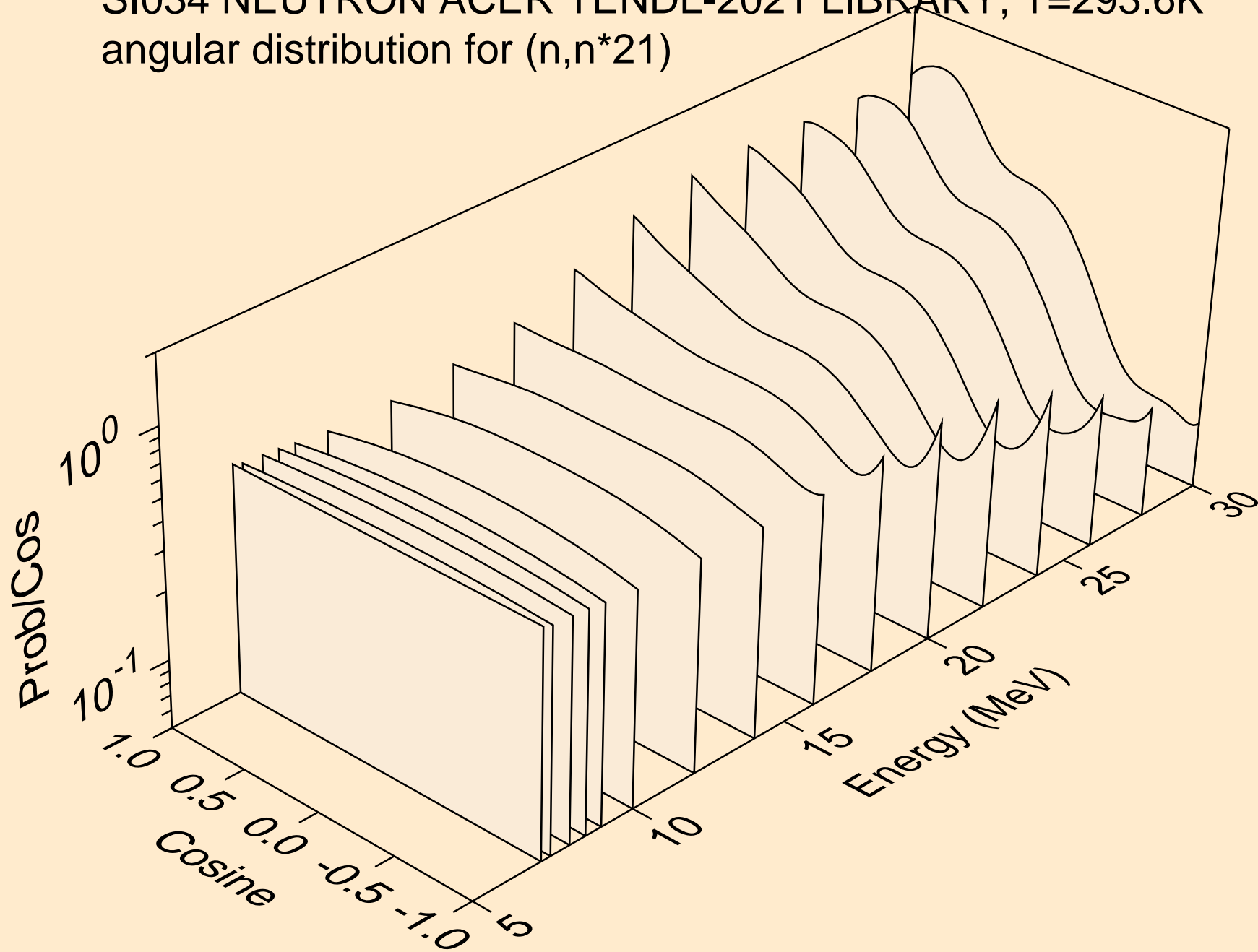

SI034 NEUTRON ACER TENDL-2021 LIBRARY; T=293.6K
angular distribution for (n,n*22)

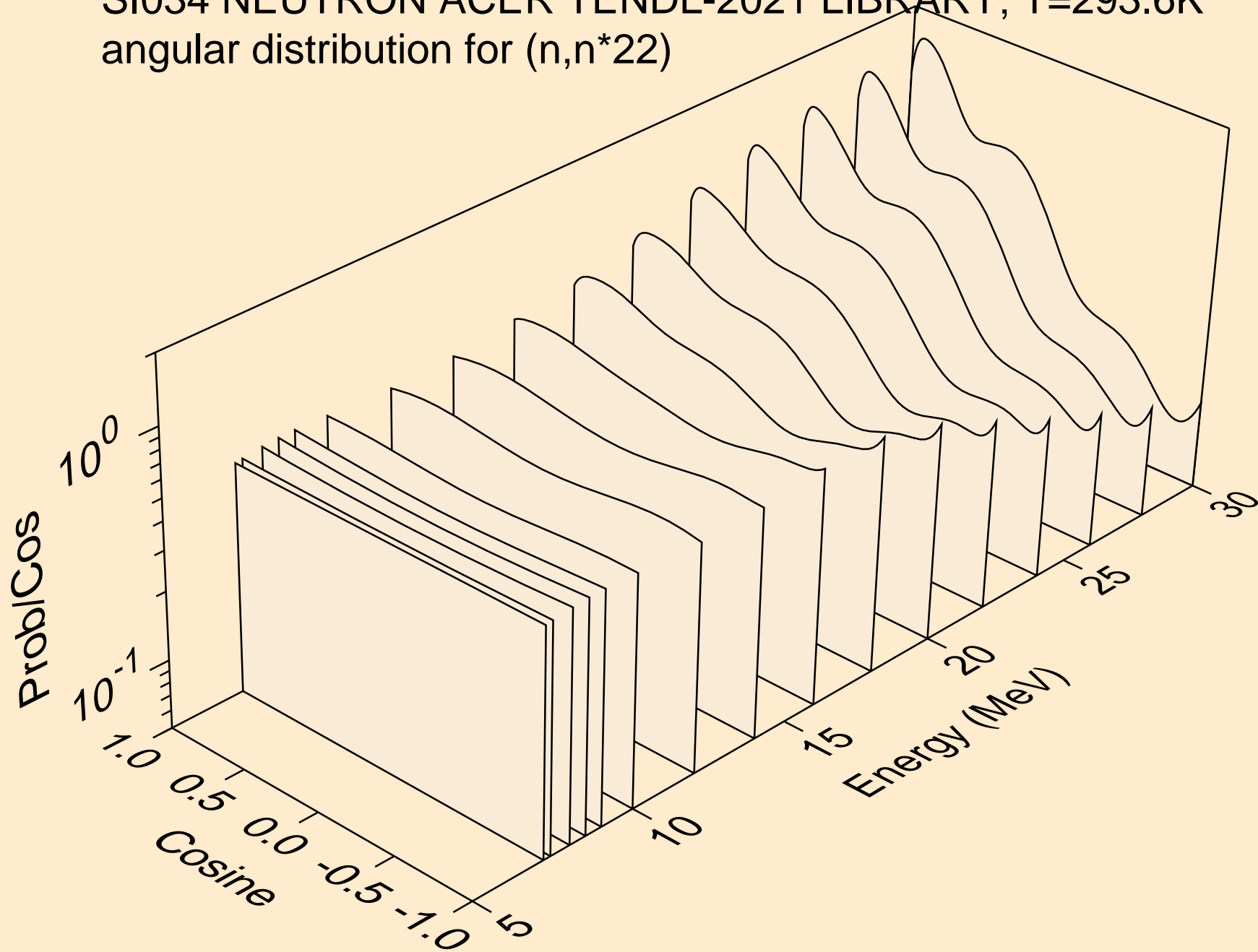

SI034 NEUTRON ACER TENDL-2021 LIBRARY; T=293.6K
angular distribution for (n,n*23)

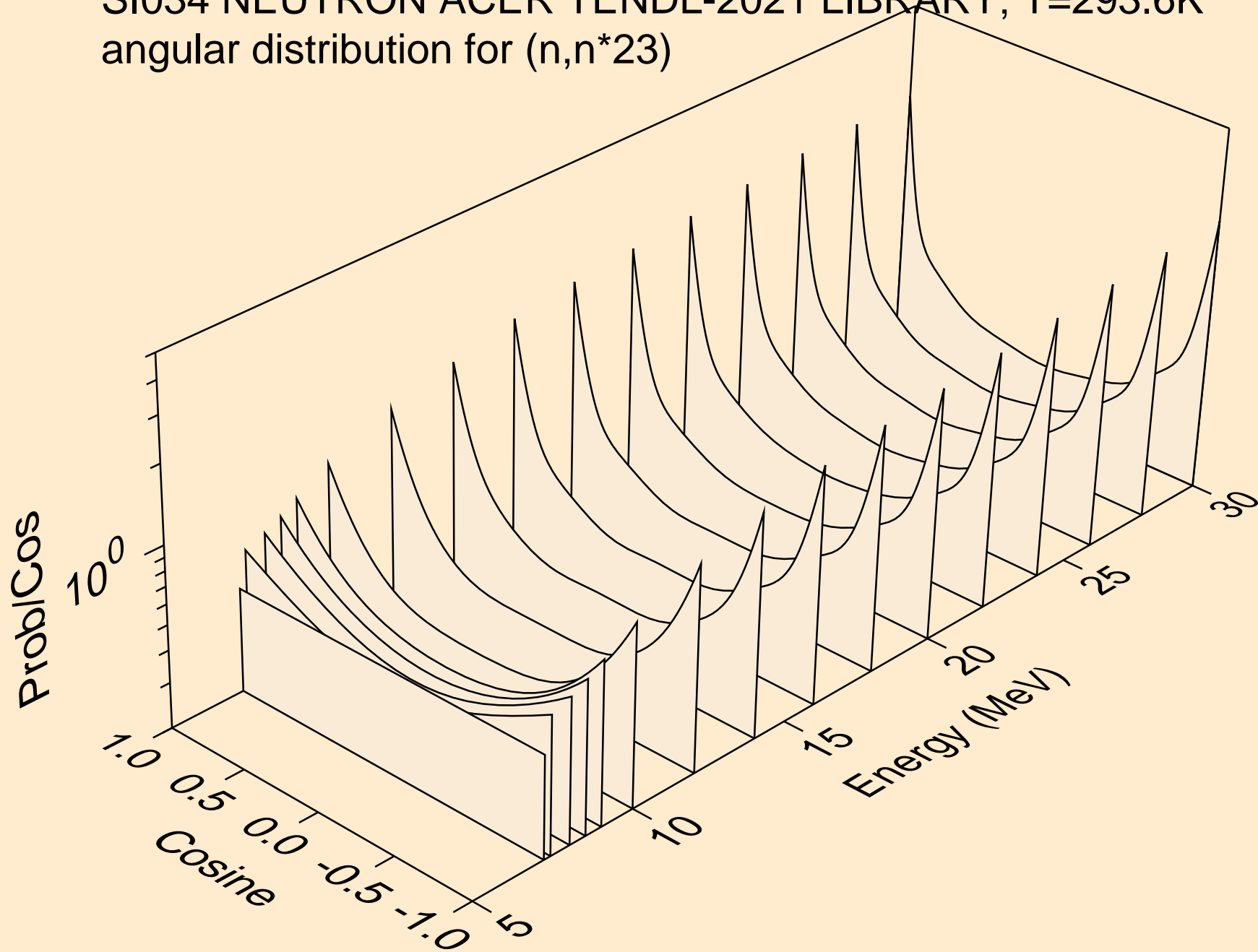

SI034 NEUTRON ACER TENDL-2021 LIBRARY; T=293.6K
angular distribution for (n,n*24)

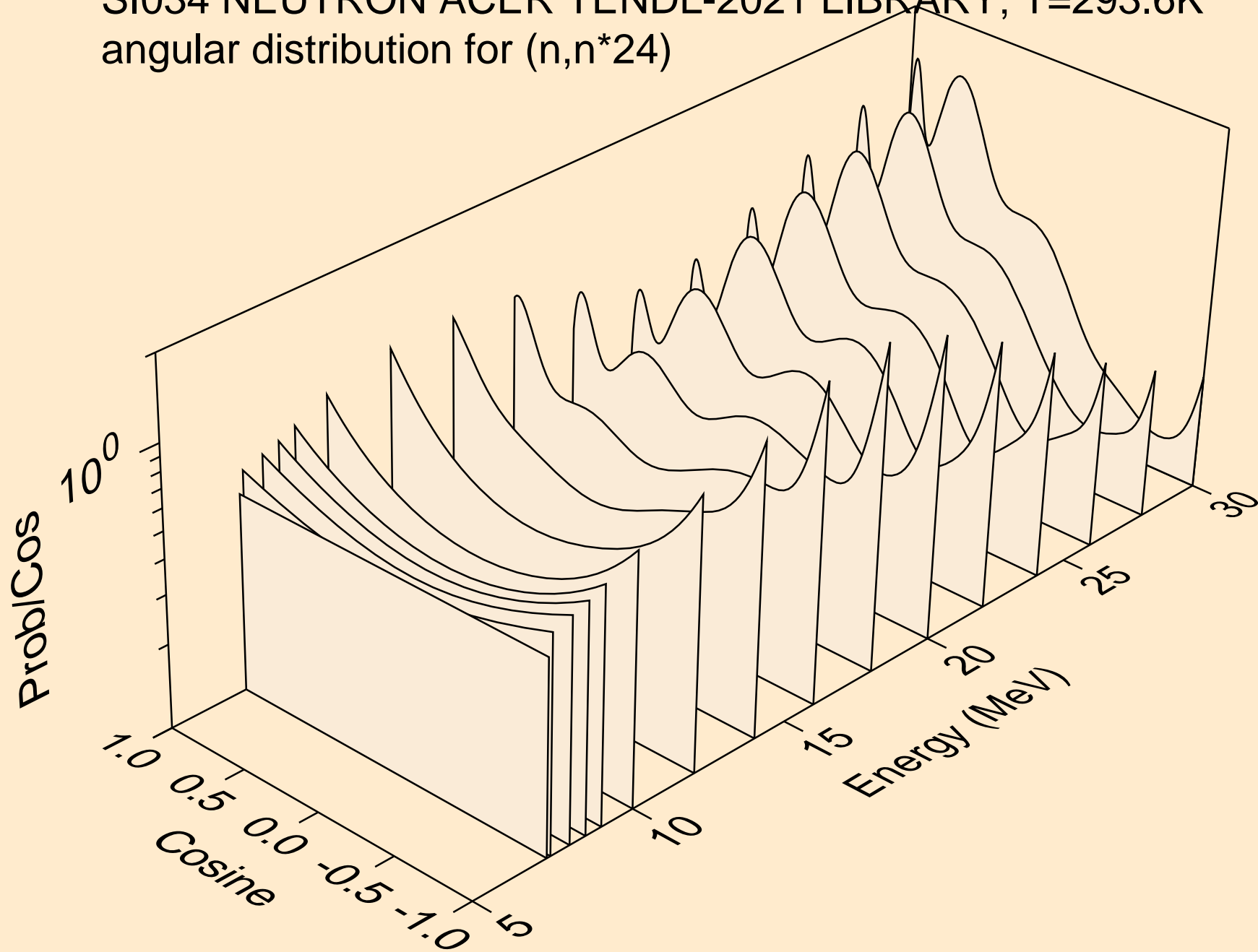

SI034 NEUTRON ACER TENDL-2021 LIBRARY; T=293.6K
angular distribution for (n,n*25)

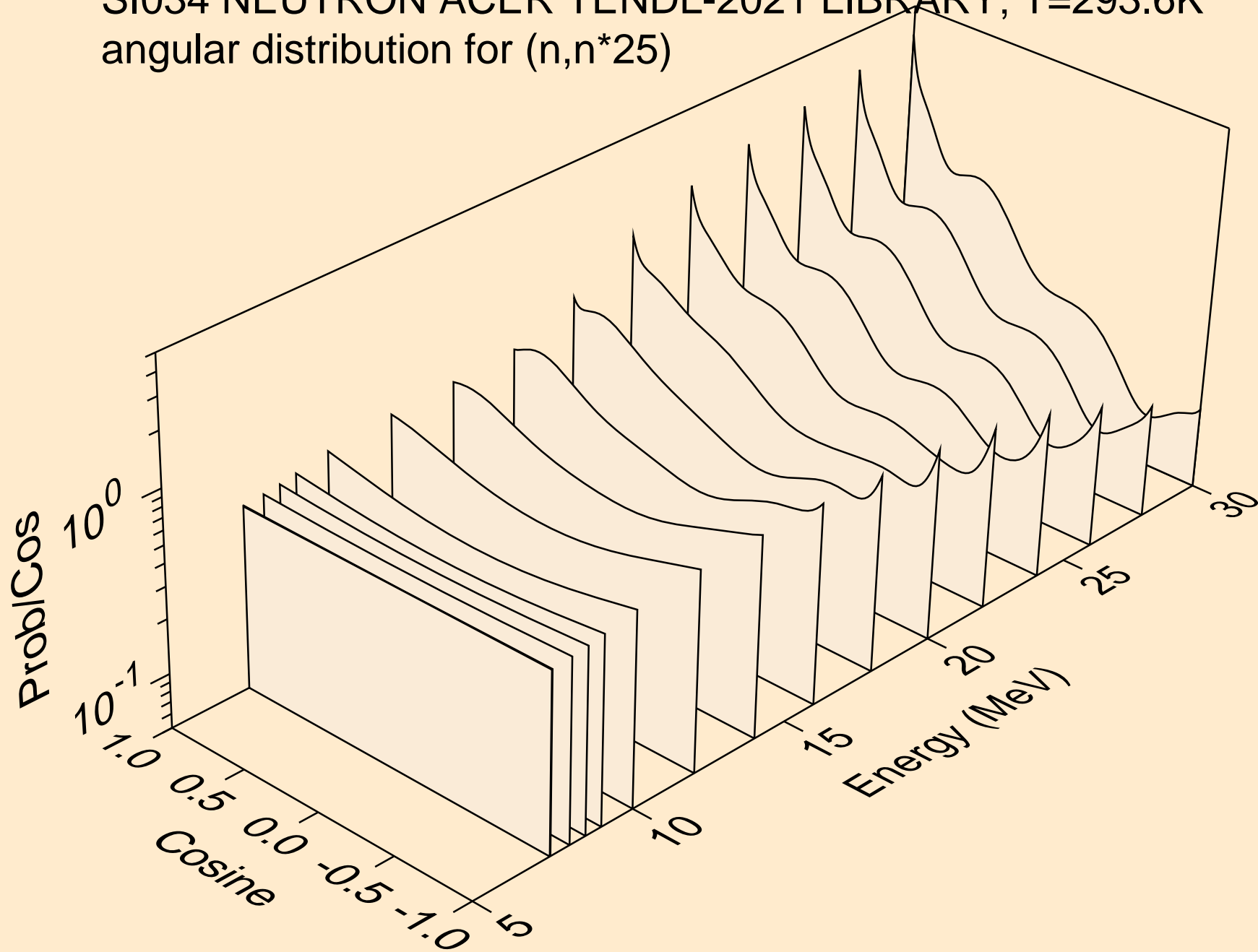

SI034 NEUTRON ACER TENDL-2021 LIBRARY; T=293.6K
angular distribution for (n,n*26)

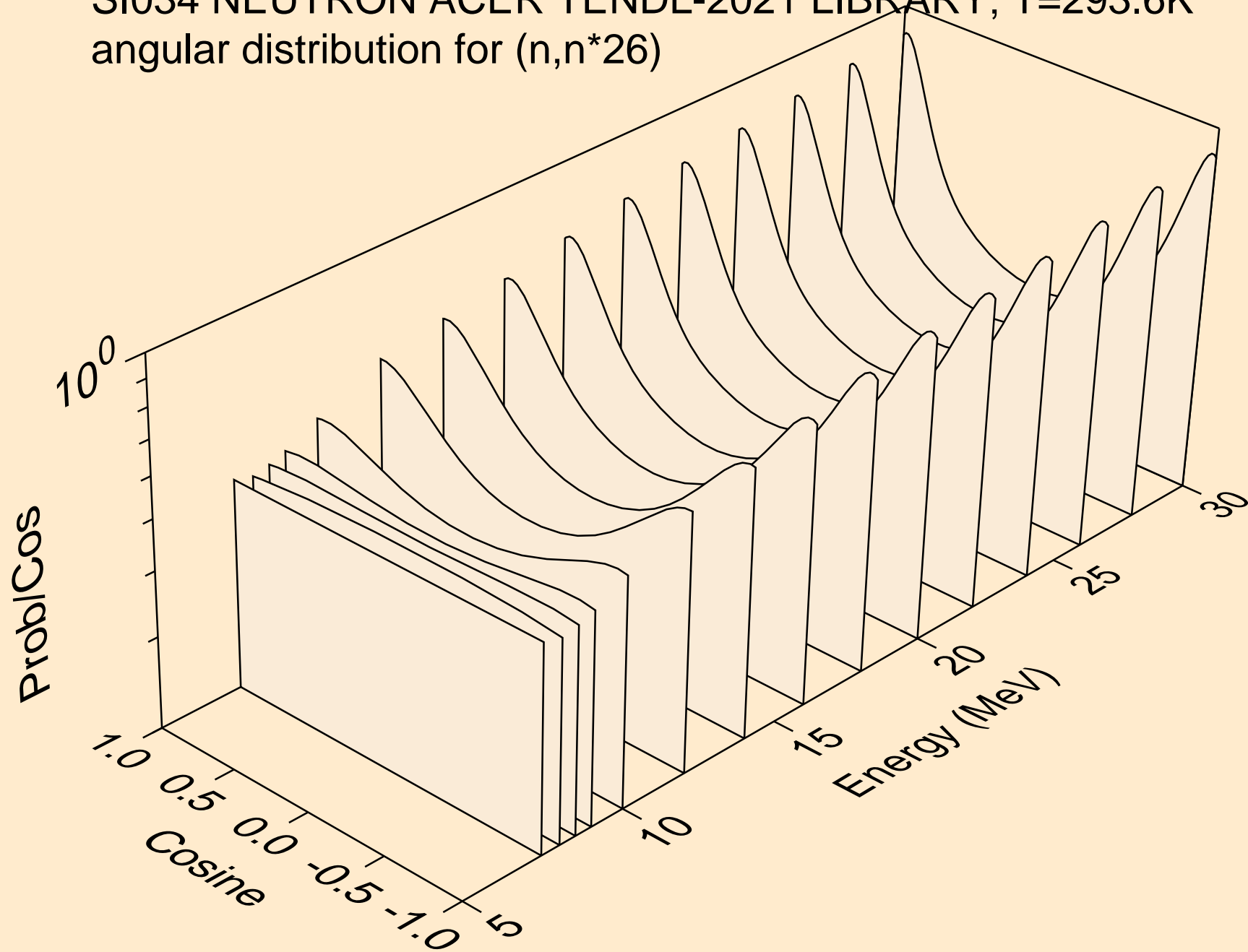

SI034 NEUTRON ACER TENDL-2021 LIBRARY; T=293.6K
angular distribution for (n,n*27)

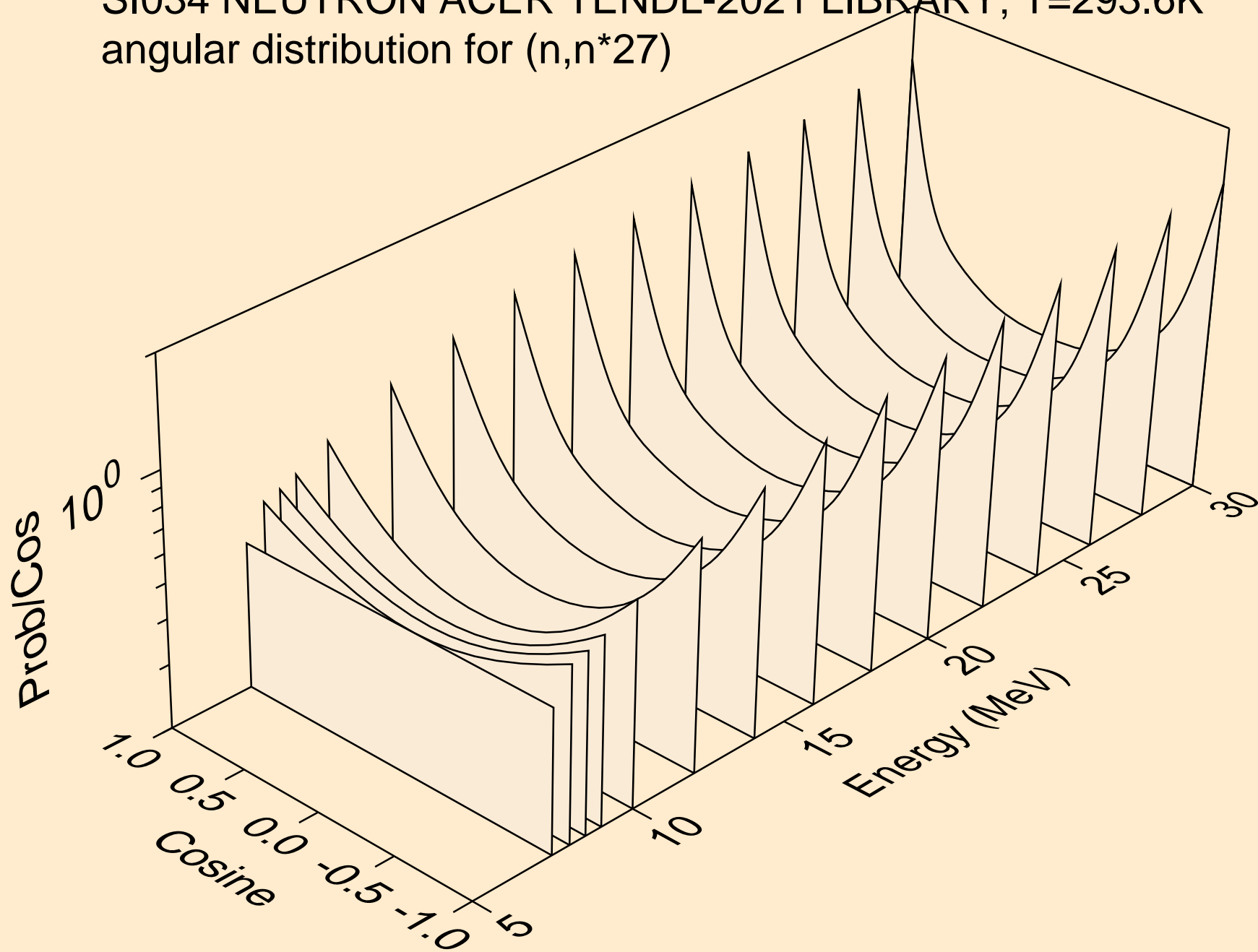

SI034 NEUTRON ACER TENDL-2021 LIBRARY; T=293.6K
angular distribution for (n,n*28)

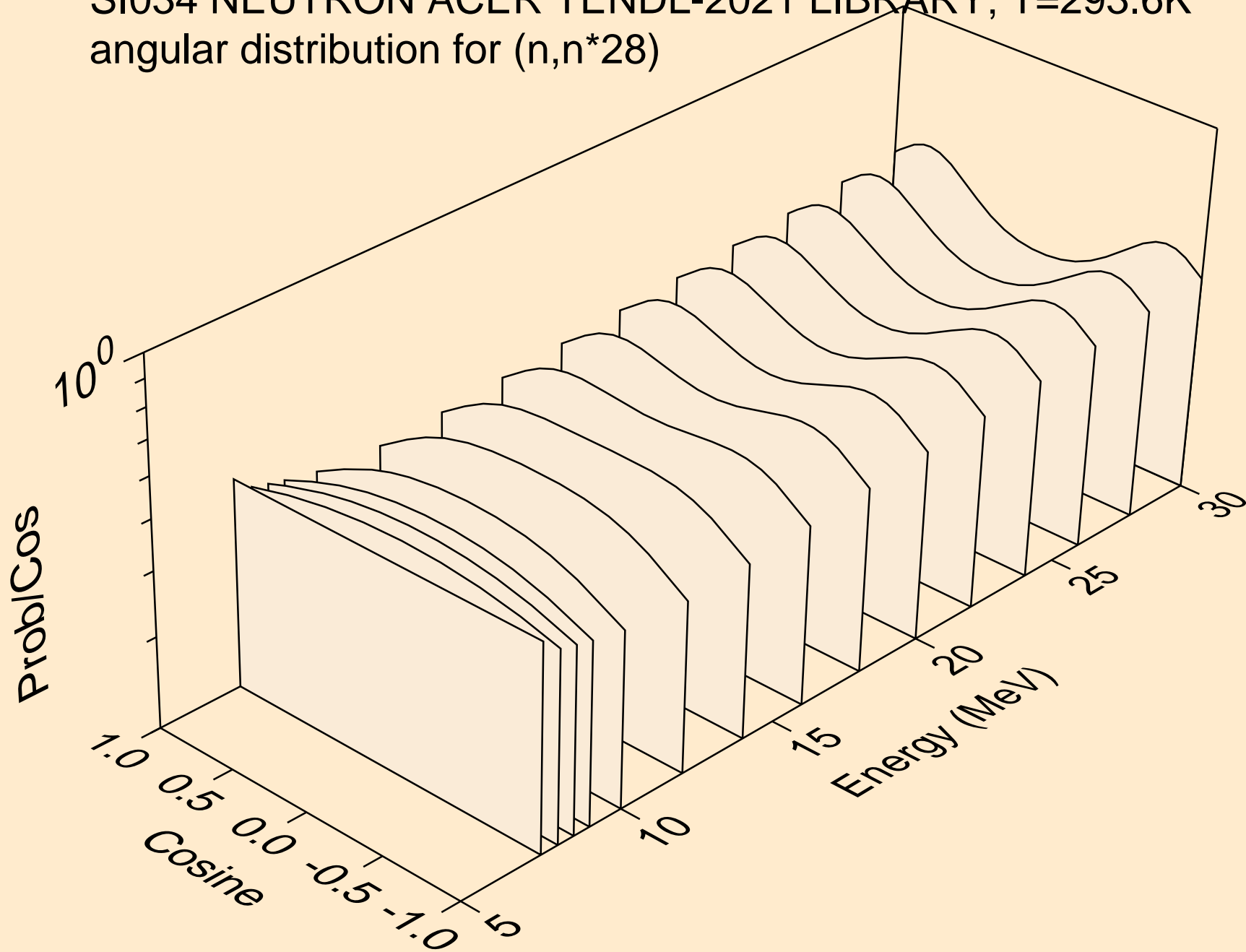

SI034 NEUTRON ACER TENDL-2021 LIBRARY; T=293.6K
angular distribution for (n,n*29)

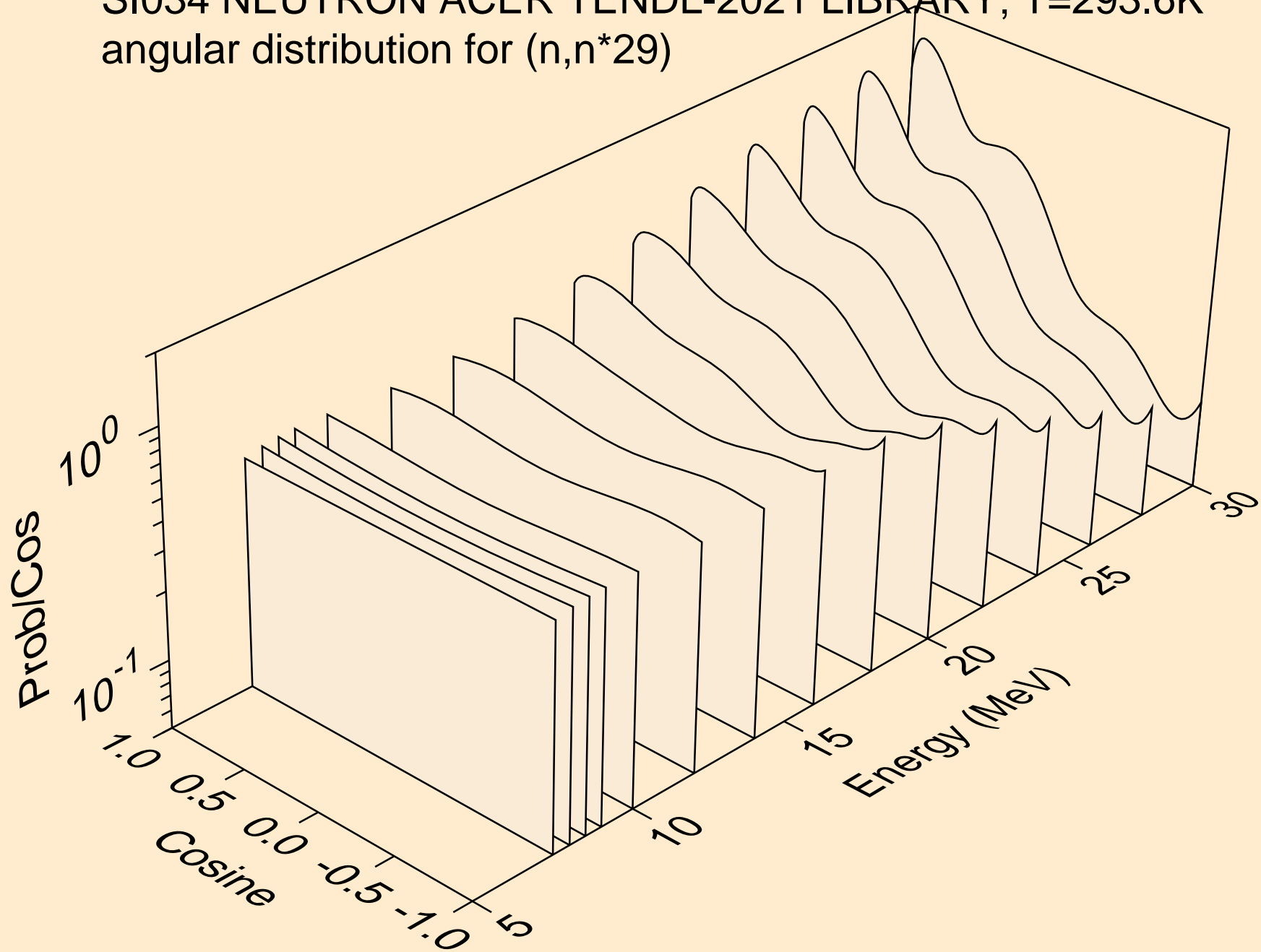

SI034 NEUTRON ACER TENDL-2021 LIBRARY; T=293.6K
angular distribution for (n,n*30)

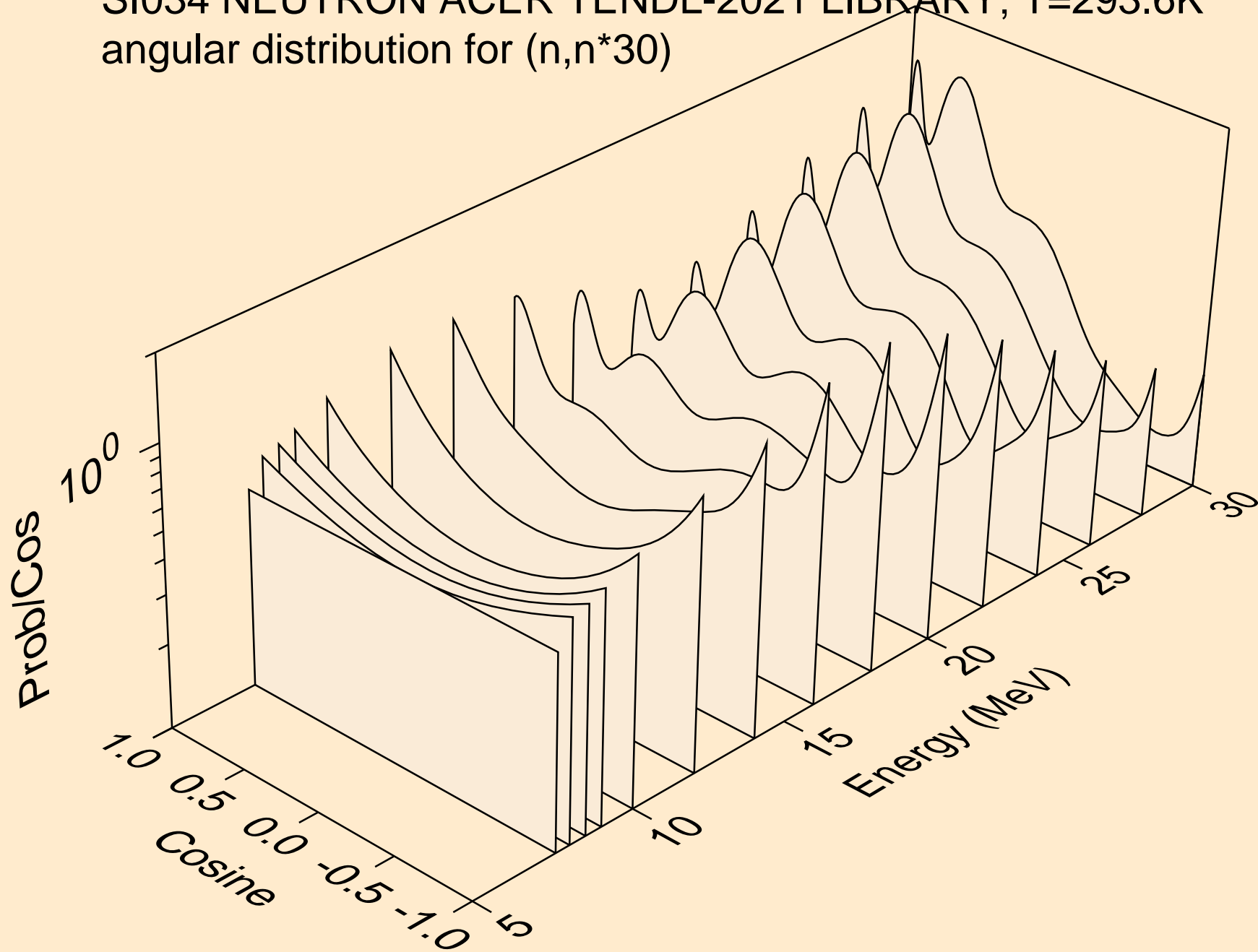

SI034 NEUTRON ACER TENDL-2021 LIBRARY; T=293.6K
Neutron emission for (n,x)

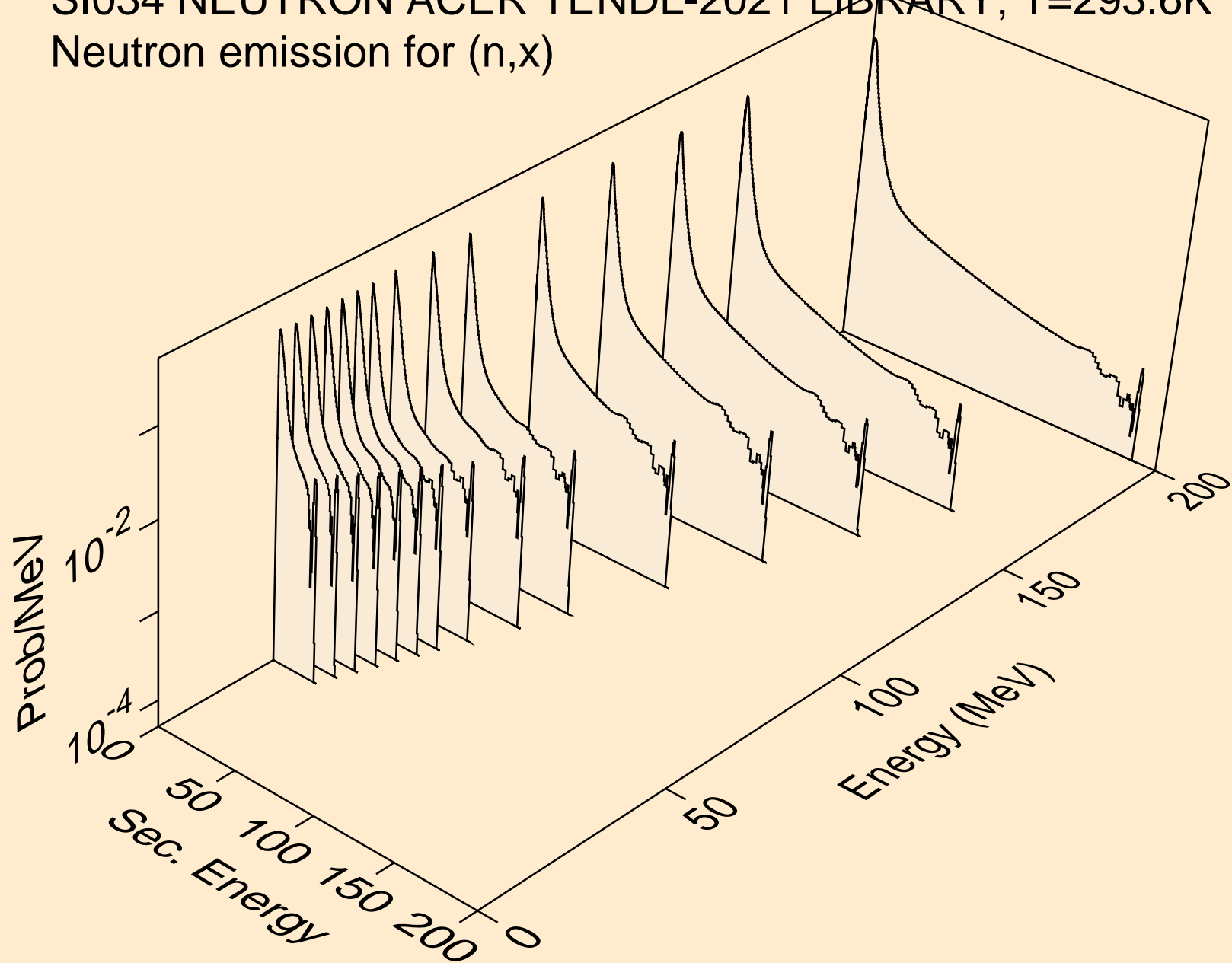

SI034 NEUTRON ACER TENDL-2021 LIBRARY; T=293.6K
Neutron emission for (n,2nd)

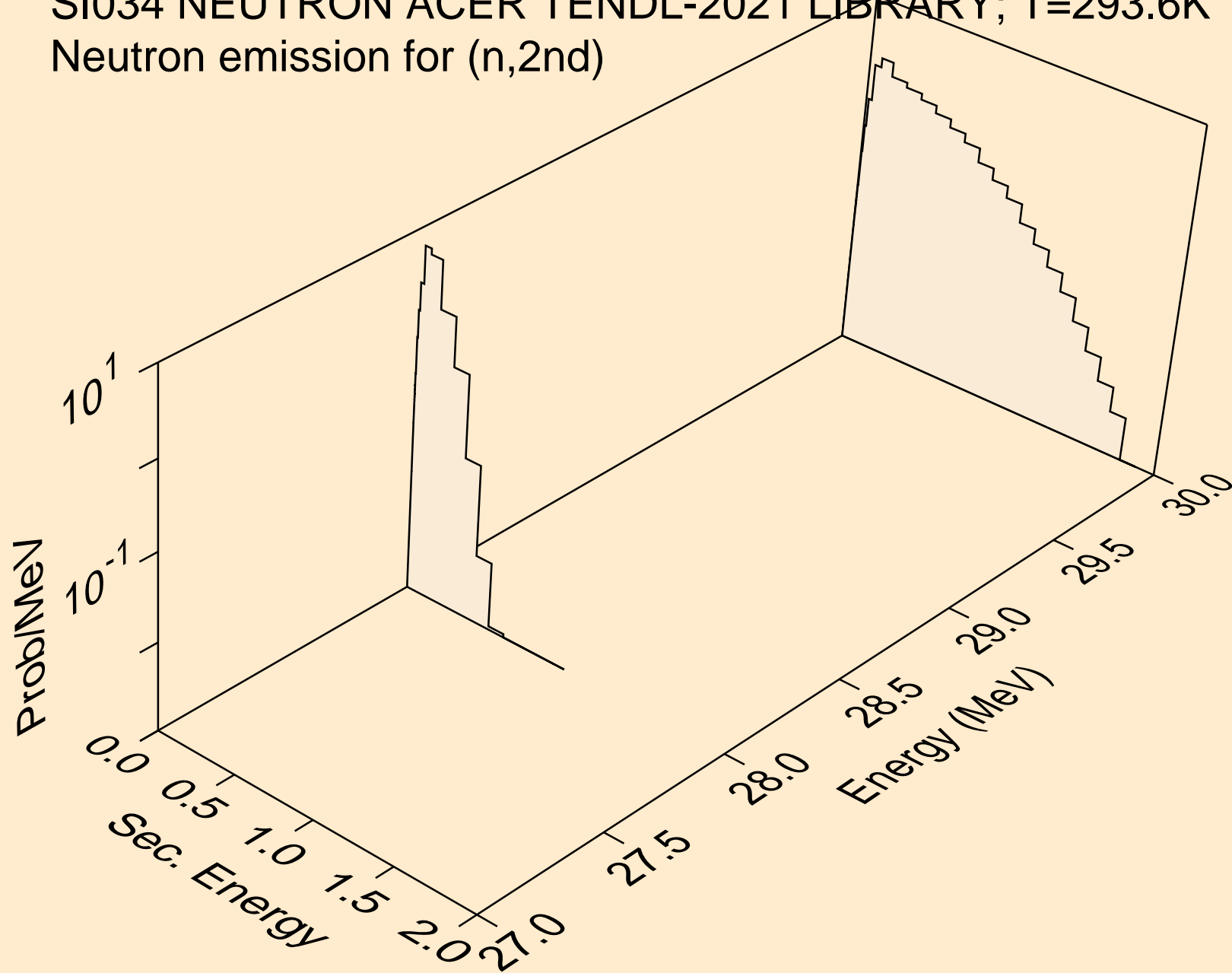

SI034 NEUTRON ACER TENDL-2021 LIBRARY; T=293.6K
Neutron emission for (n,2n)

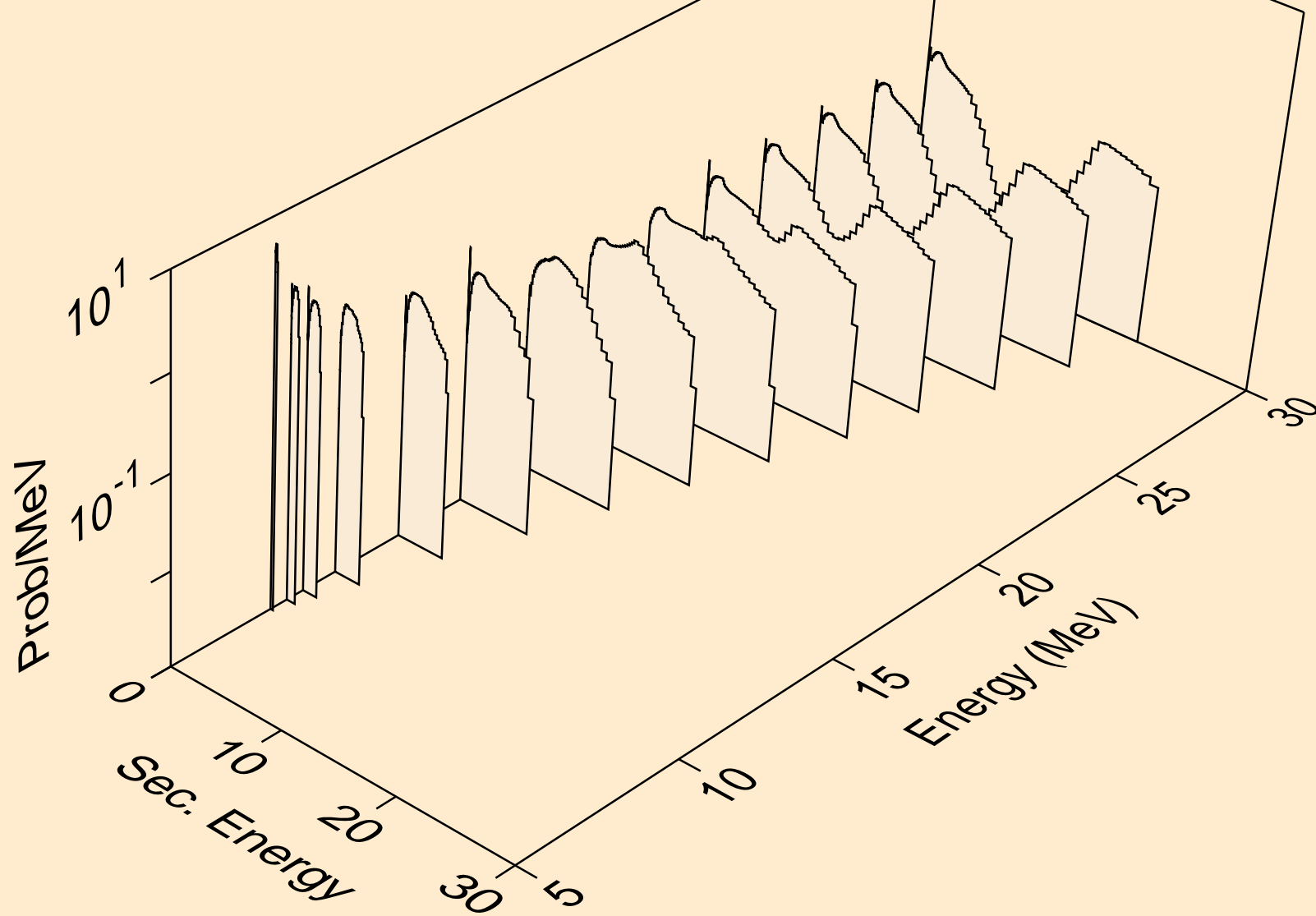

SI034 NEUTRON ACER TENDL-2021 LIBRARY; T=293.6K
Neutron emission for (n,3n)

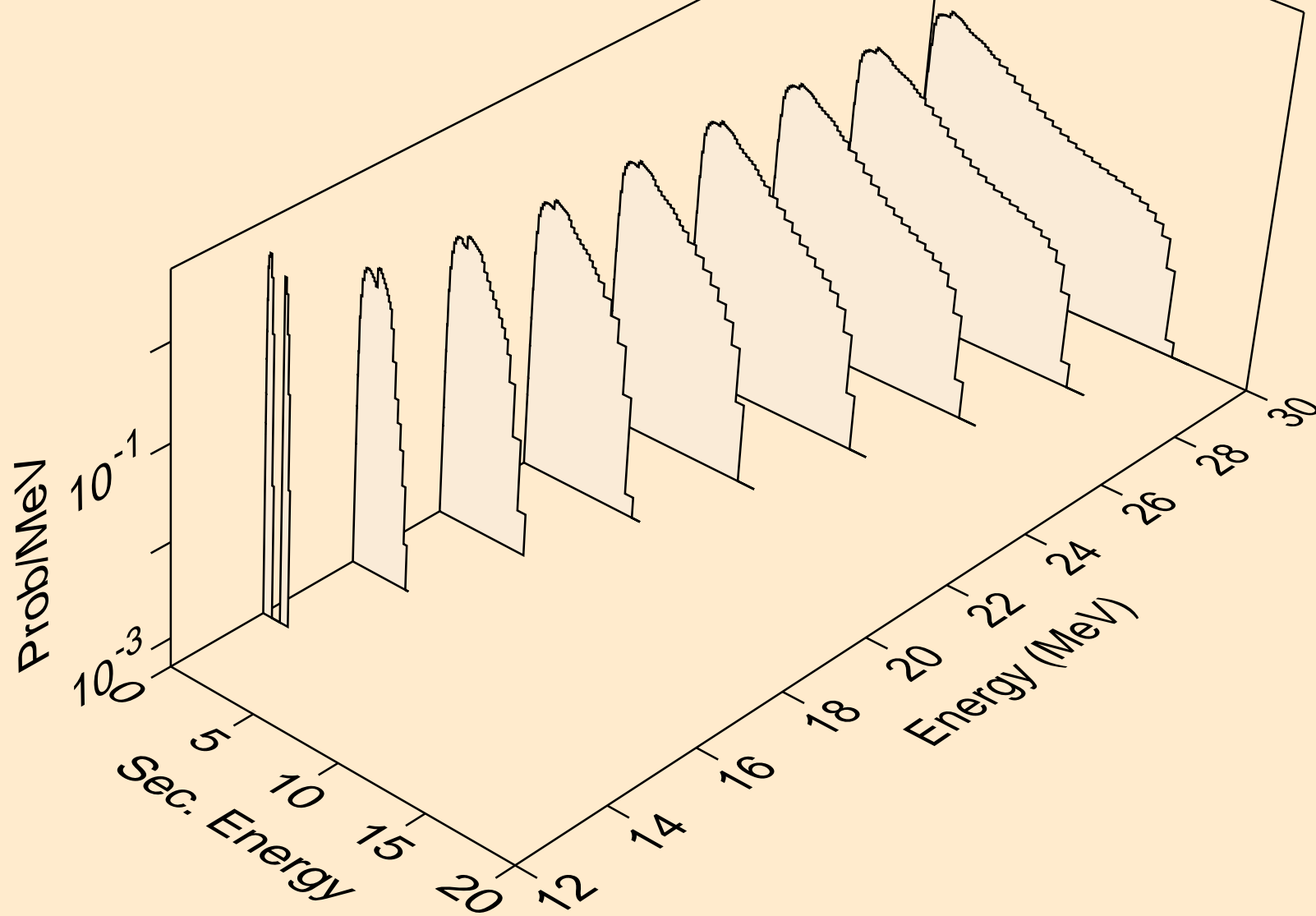

SI034 NEUTRON ACER TENDL-2021 LIBRARY; T=293.6K
Neutron emission for (n,n*)a

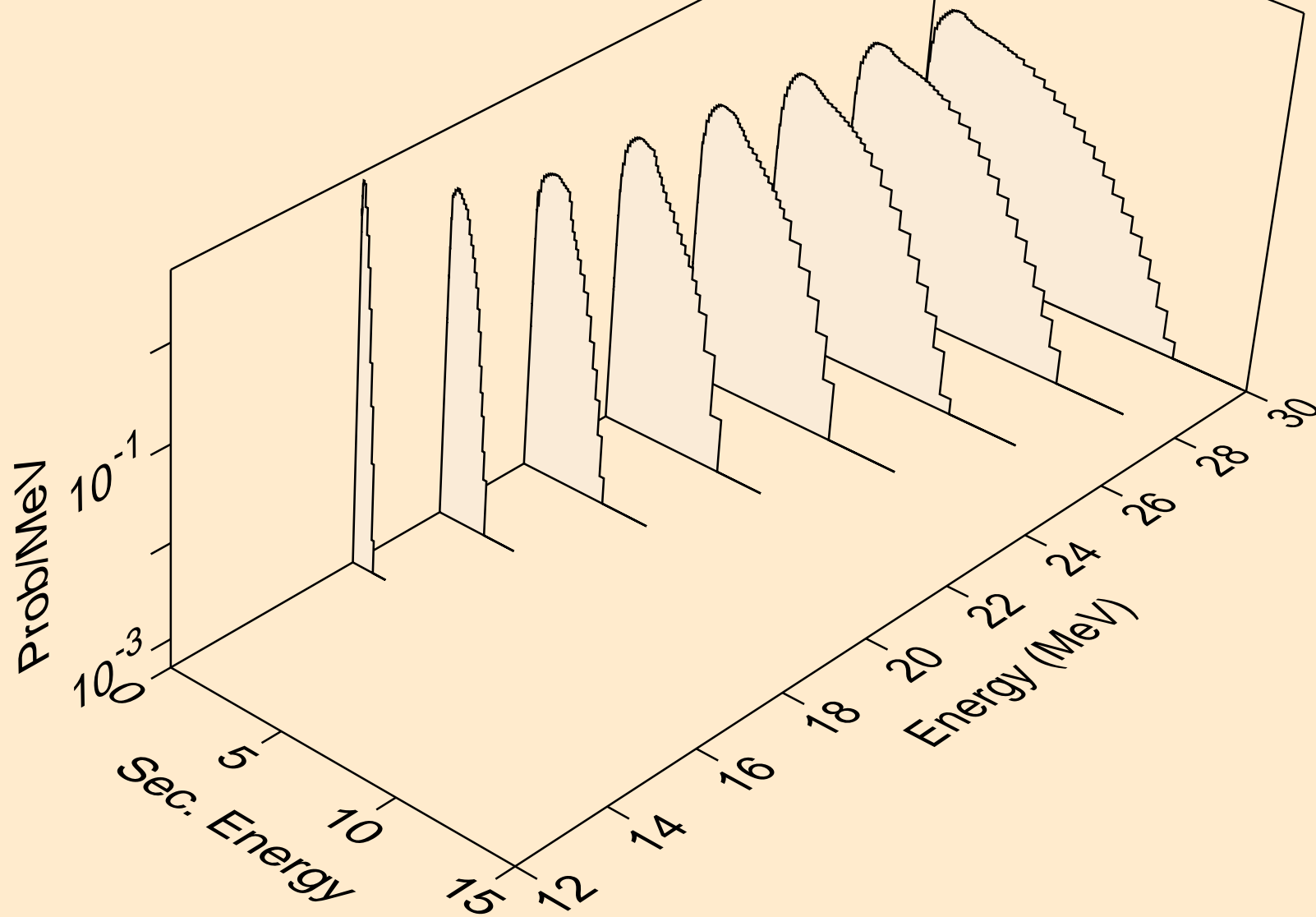

SI034 NEUTRON ACER TENDL-2021 LIBRARY; T=293.6K
Neutron emission for (n,2n)a

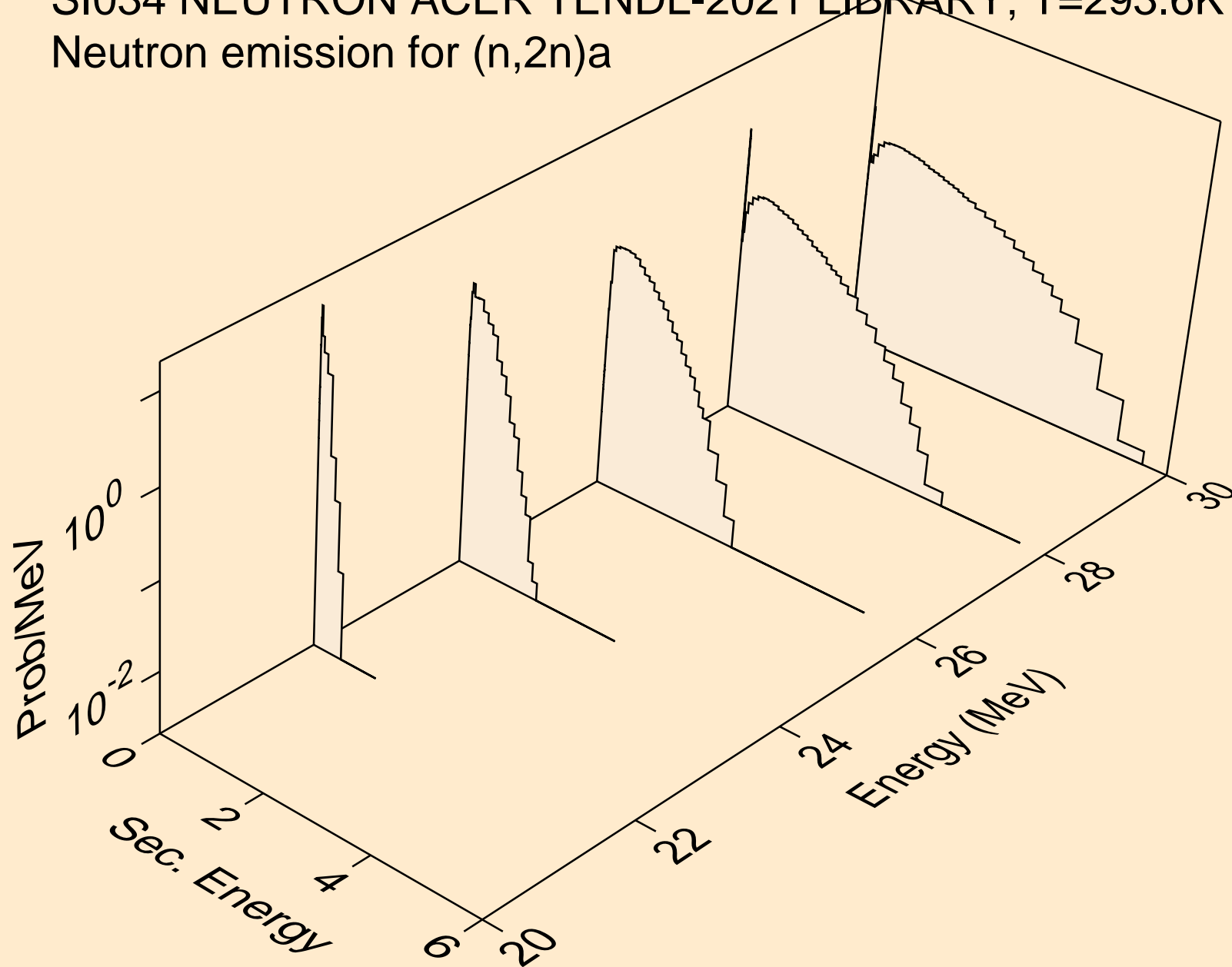

SI034 NEUTRON ACER TENDL-2021 LIBRARY; T=293.6K
Neutron emission for (n,3n)a

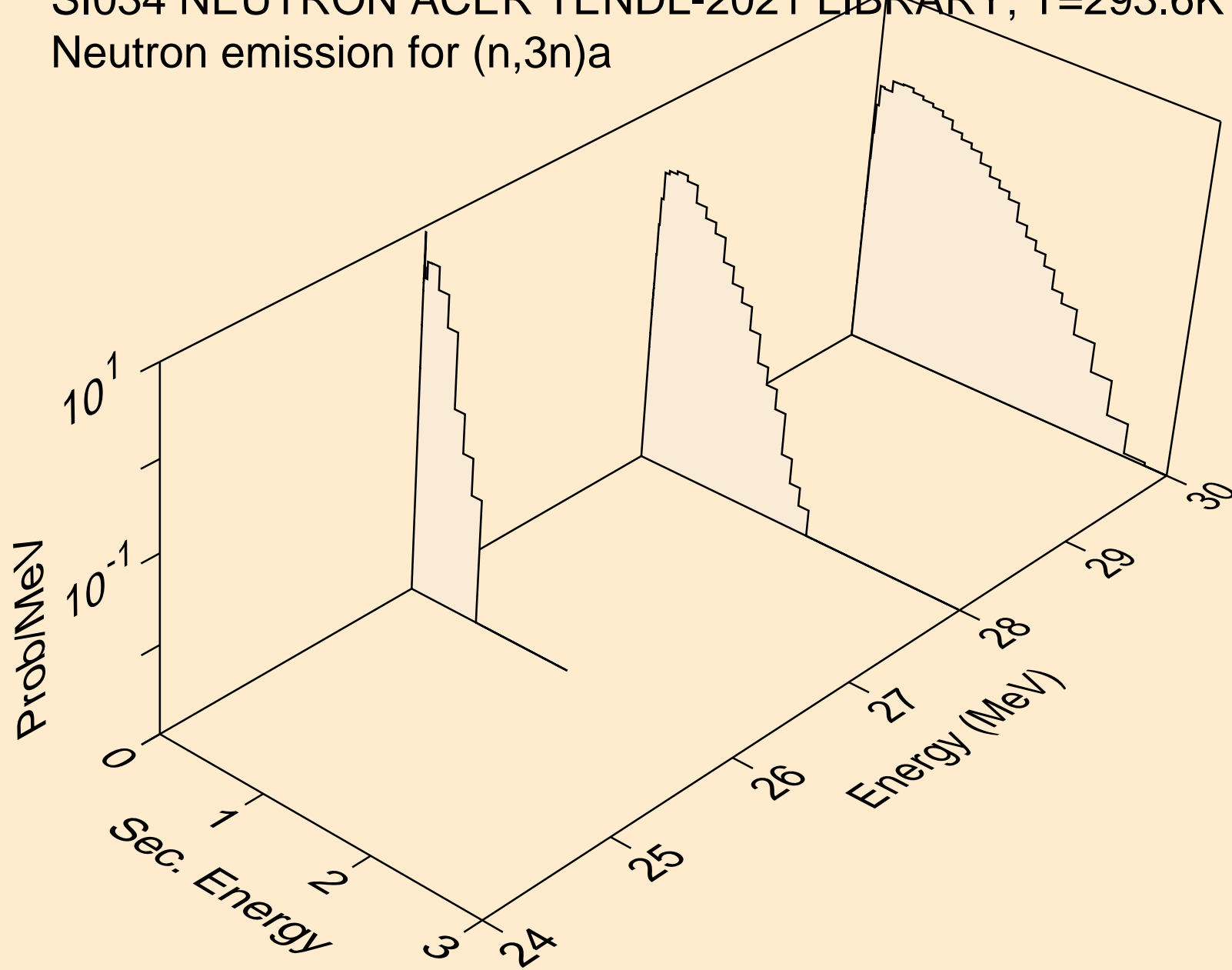

SI034 NEUTRON ACER TENDL-2021 LIBRARY; T=293.6K
Neutron emission for (n,n*)p

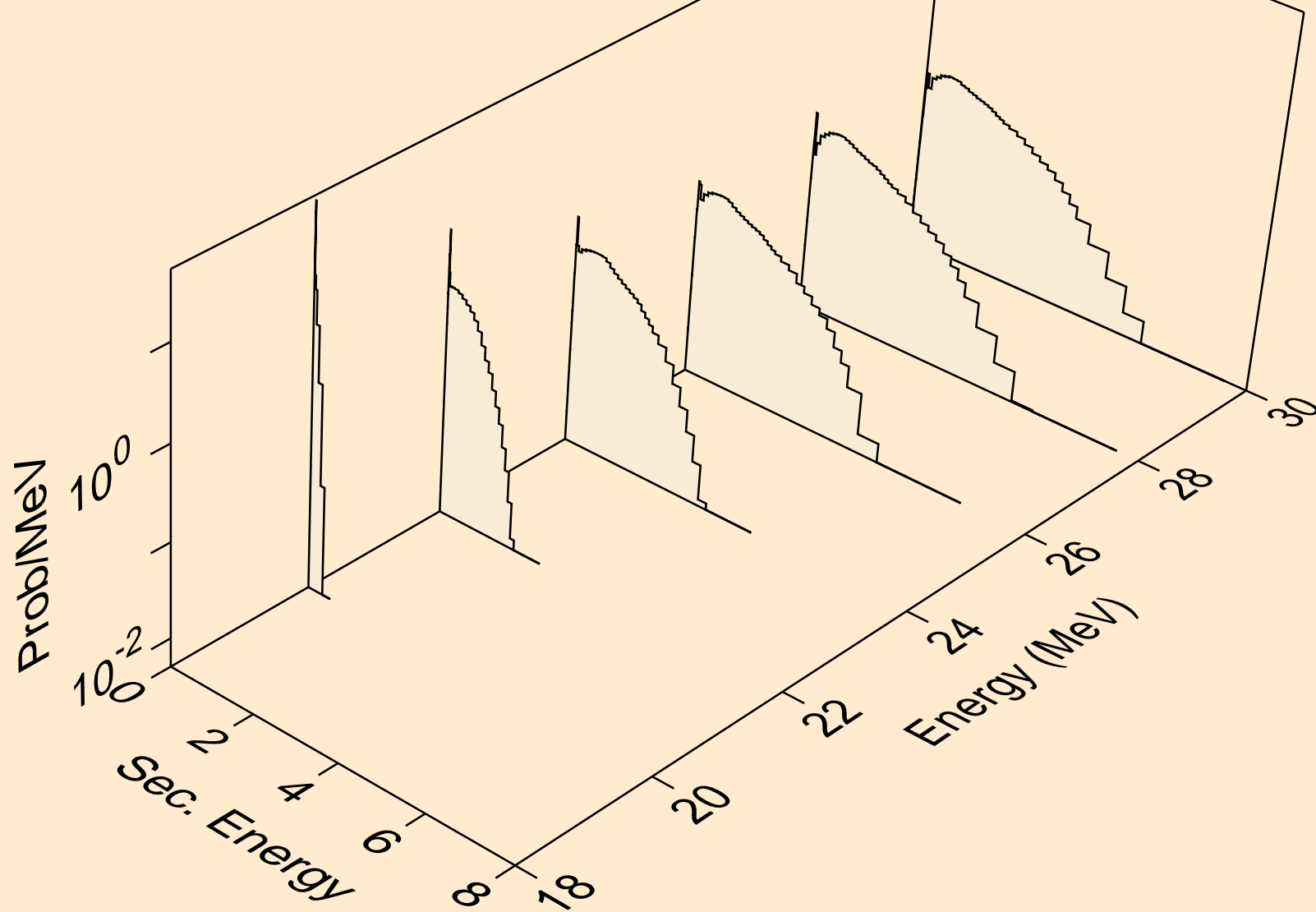

SI034 NEUTRON ACER TENDL-2021 LIBRARY; T=293.6K
Neutron emission for (n,n*)d

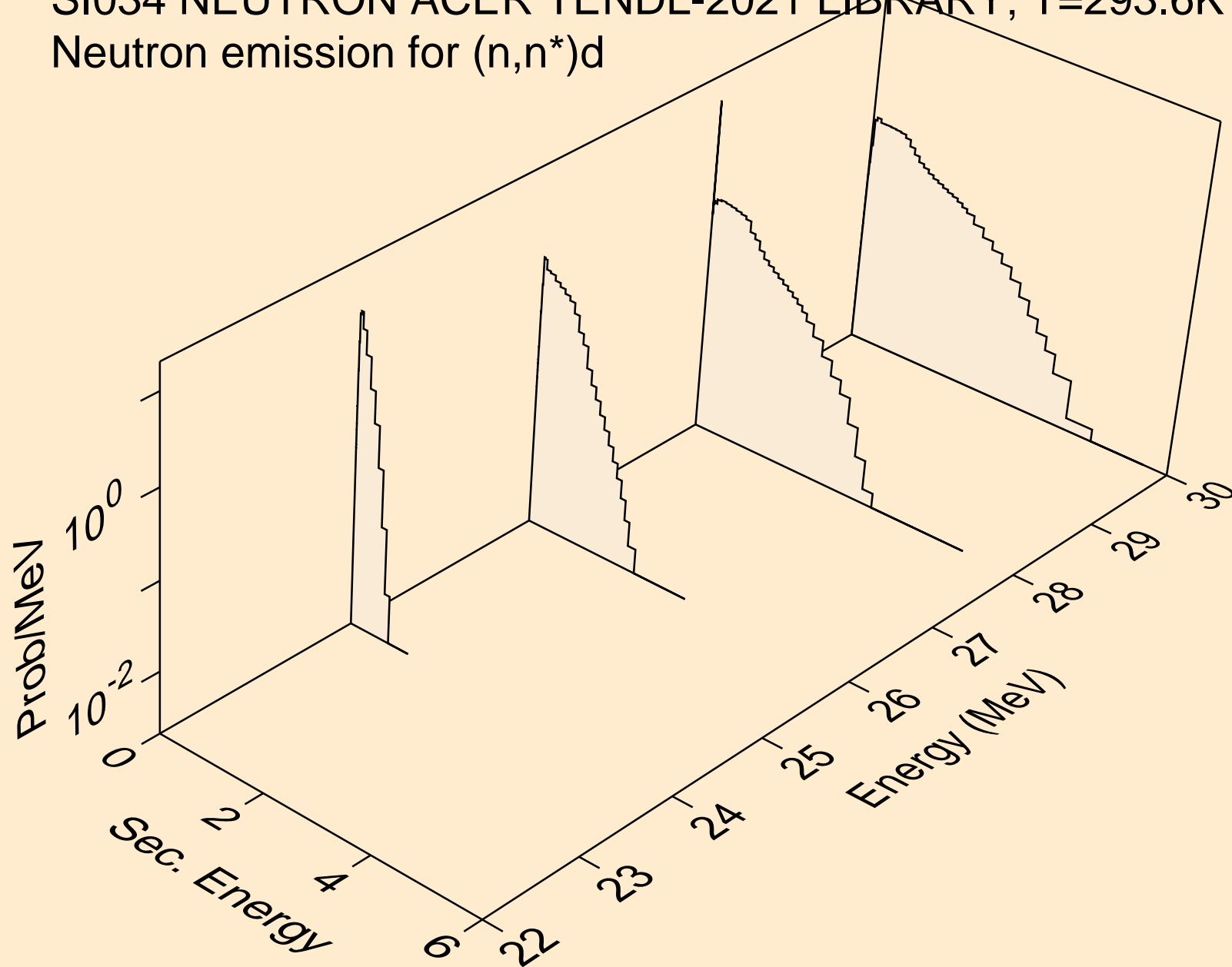

SI034 NEUTRON ACER TENDL-2021 LIBRARY; T=293.6K
Neutron emission for (n,n*)t

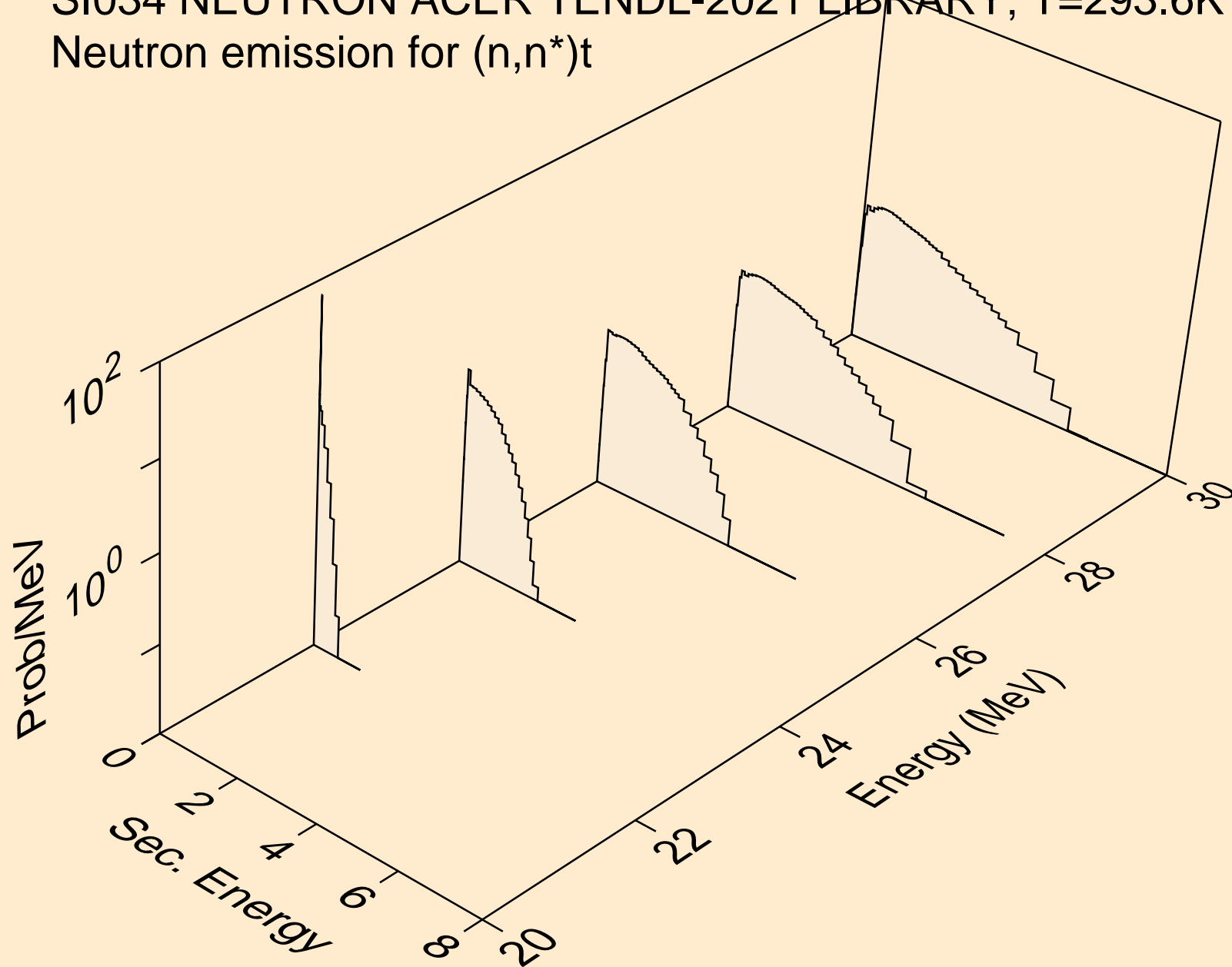

SI034 NEUTRON ACER TENDL-2021 LIBRARY; T=293.6K
Neutron emission for (n,4n)

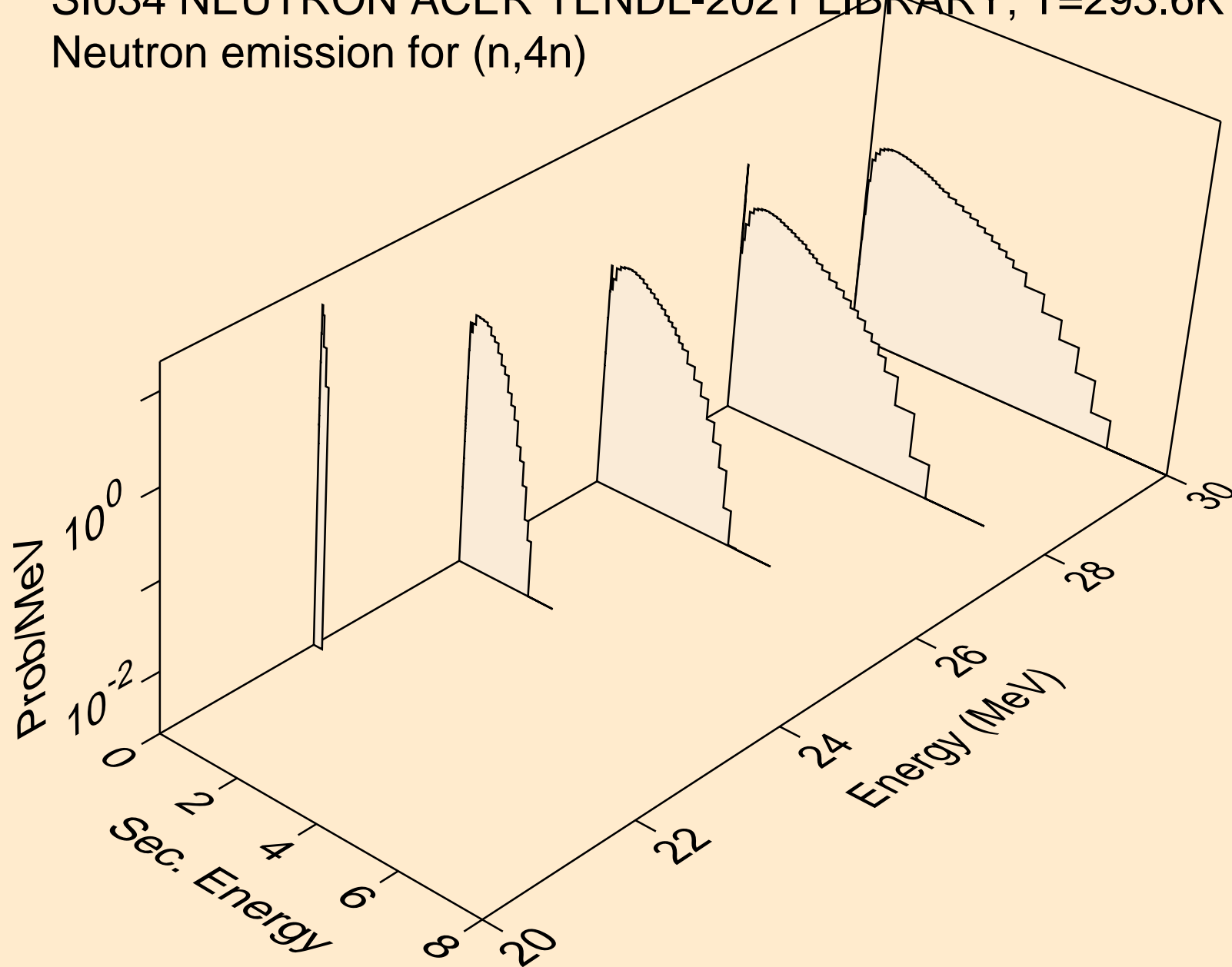

SI034 NEUTRON ACER TENDL-2021 LIBRARY; T=293.6K
Neutron emission for (n,2np)

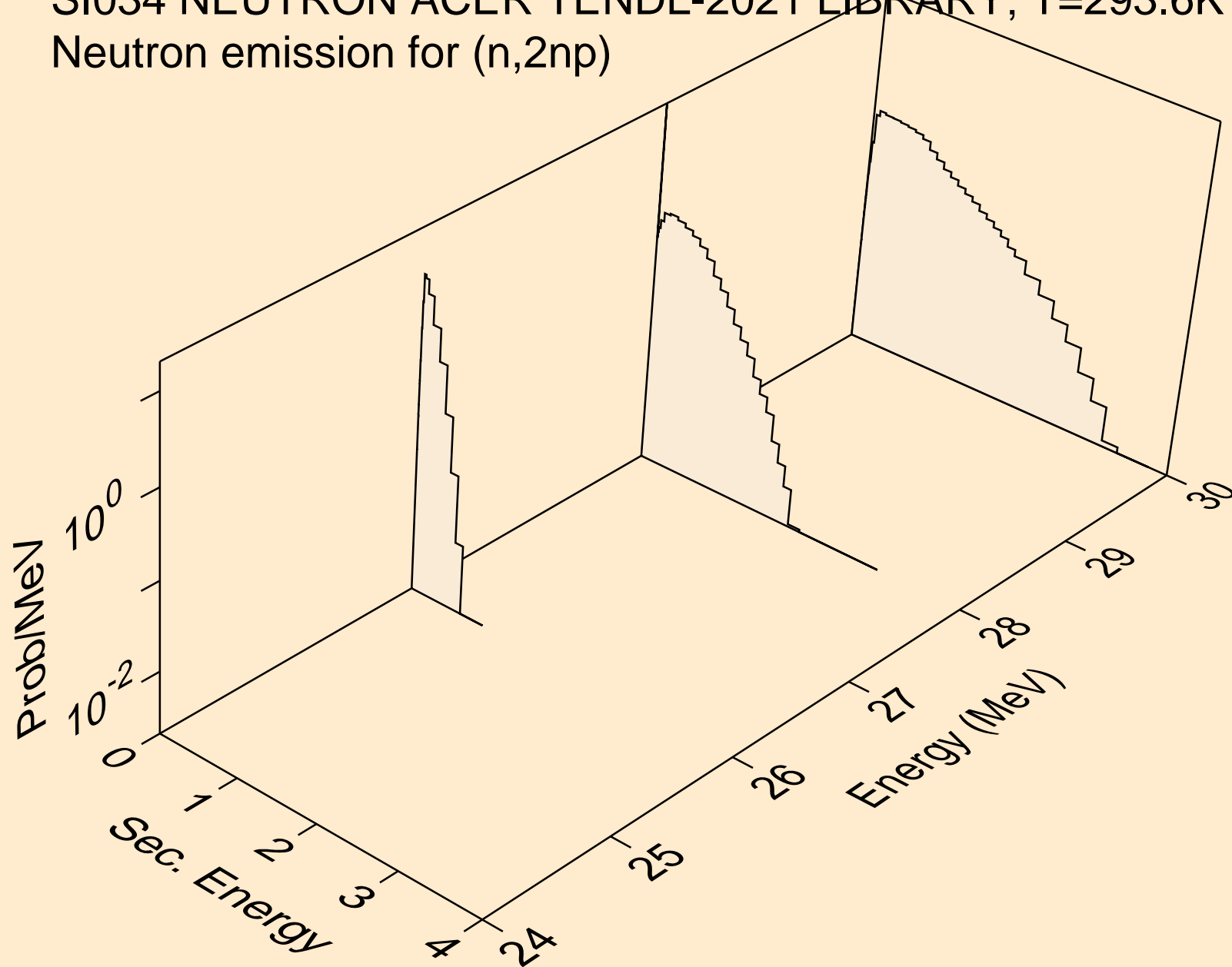

SI034 NEUTRON ACER TENDL-2021 LIBRARY; T=293.6K
Neutron emission for (n,n*c)

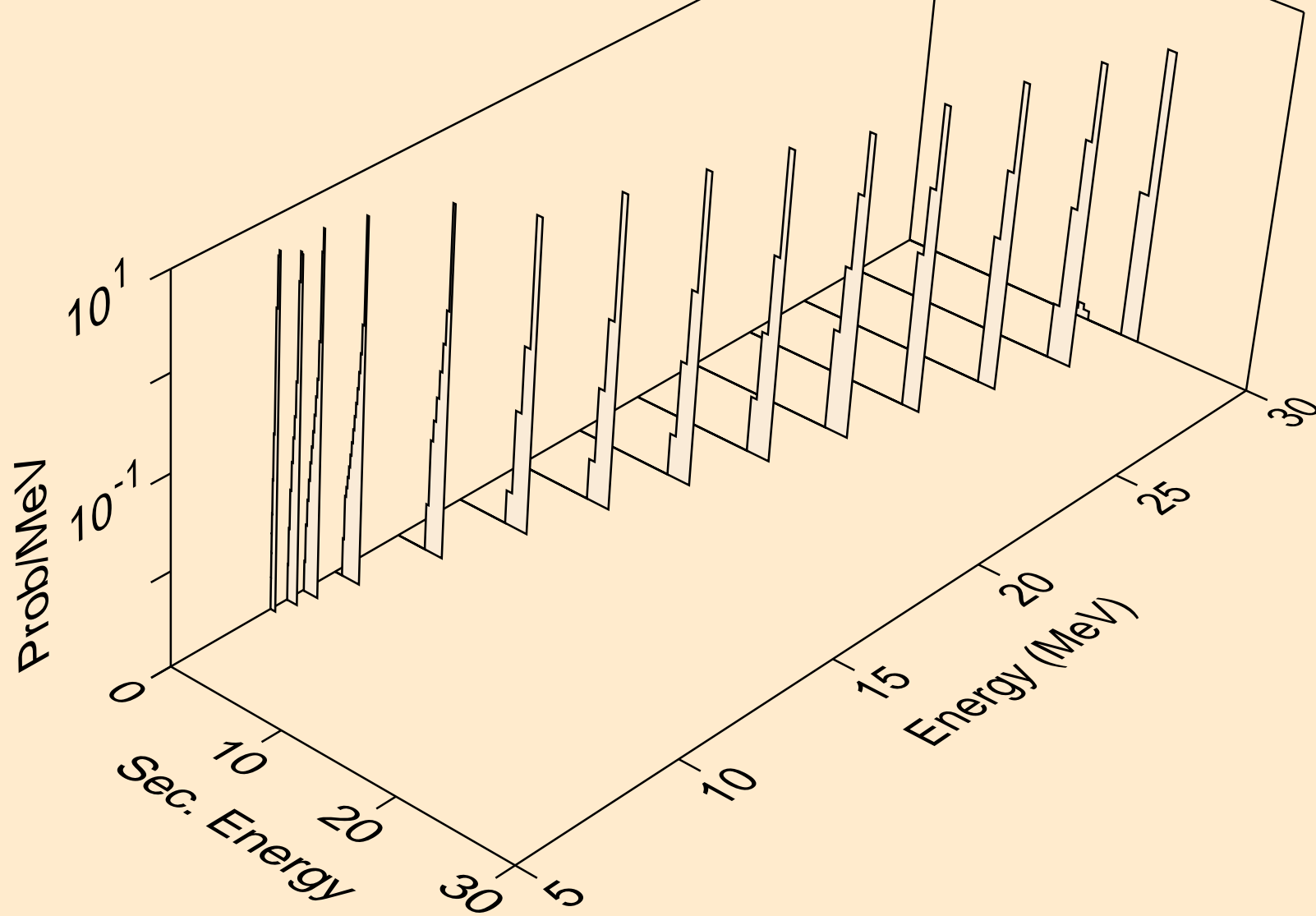

SI034 NEUTRON ACER TENDL-2021 LIBRARY; T=293.6K
Photon emission for (n,x)

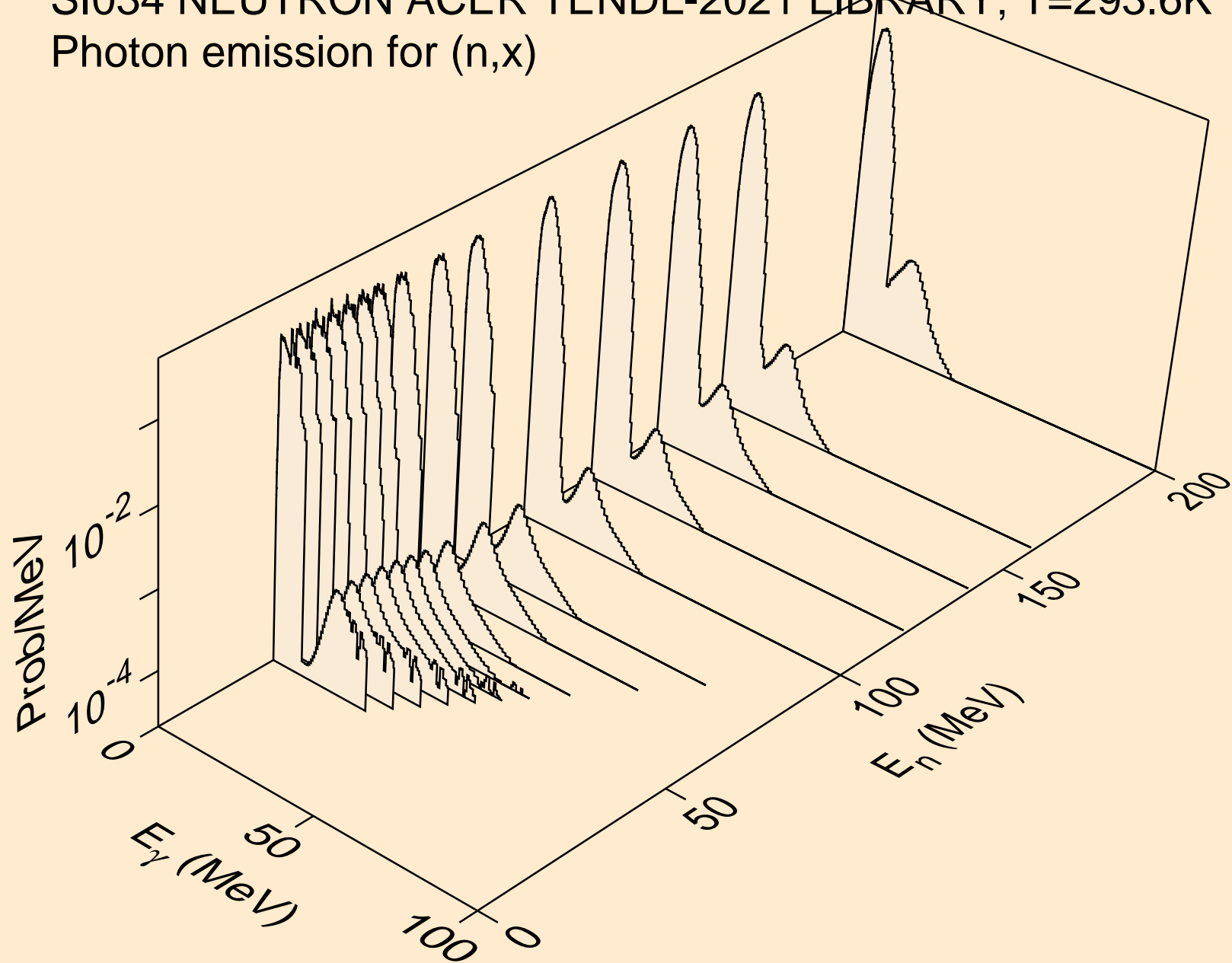

SI034 NEUTRON ACER TENDL-2021 LIBRARY; T=293.6K
Photon emission for (n,2nd)

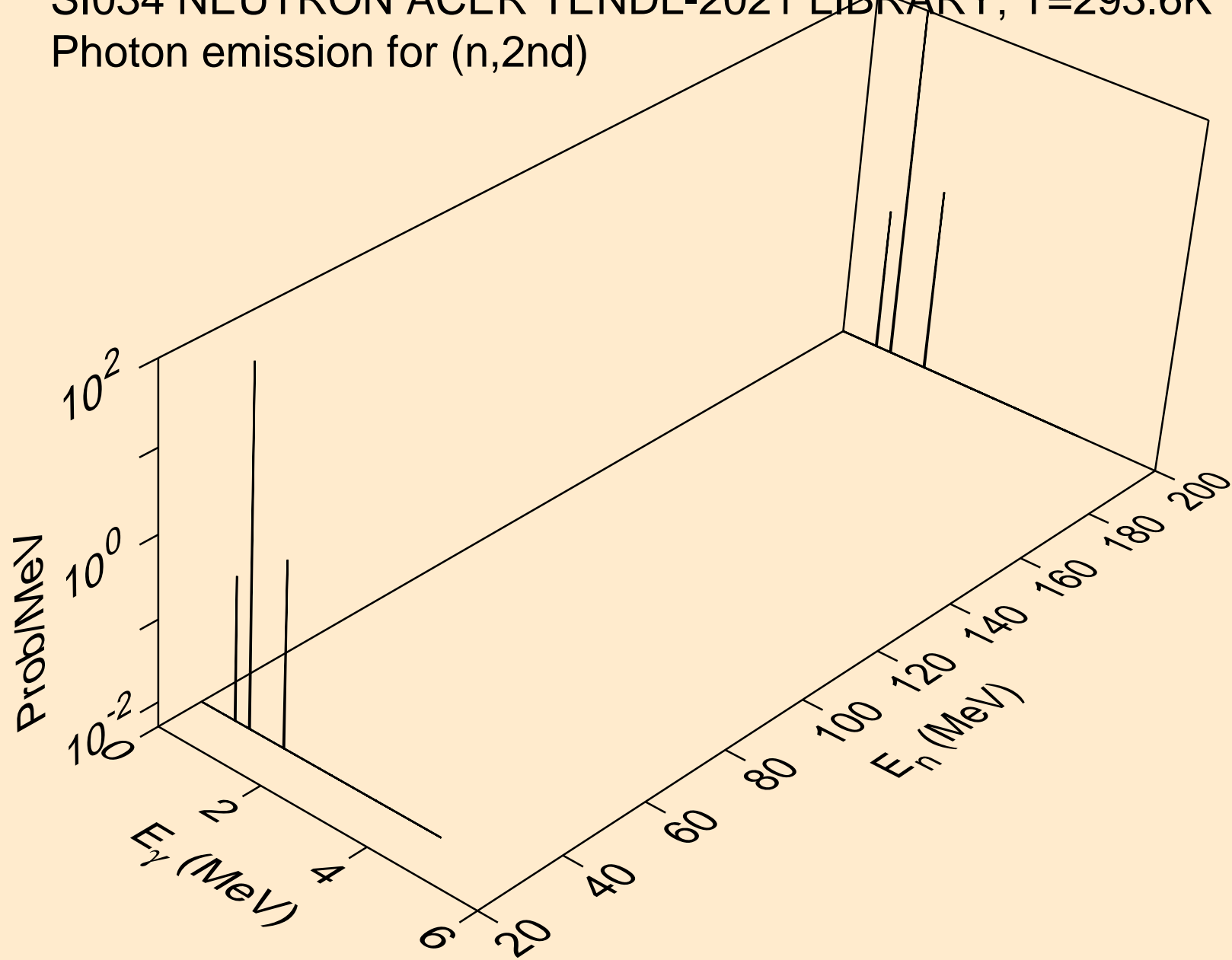

SI034 NEUTRON ACER TENDL-2021 LIBRARY; T=293.6K
Photon emission for (n,2n)

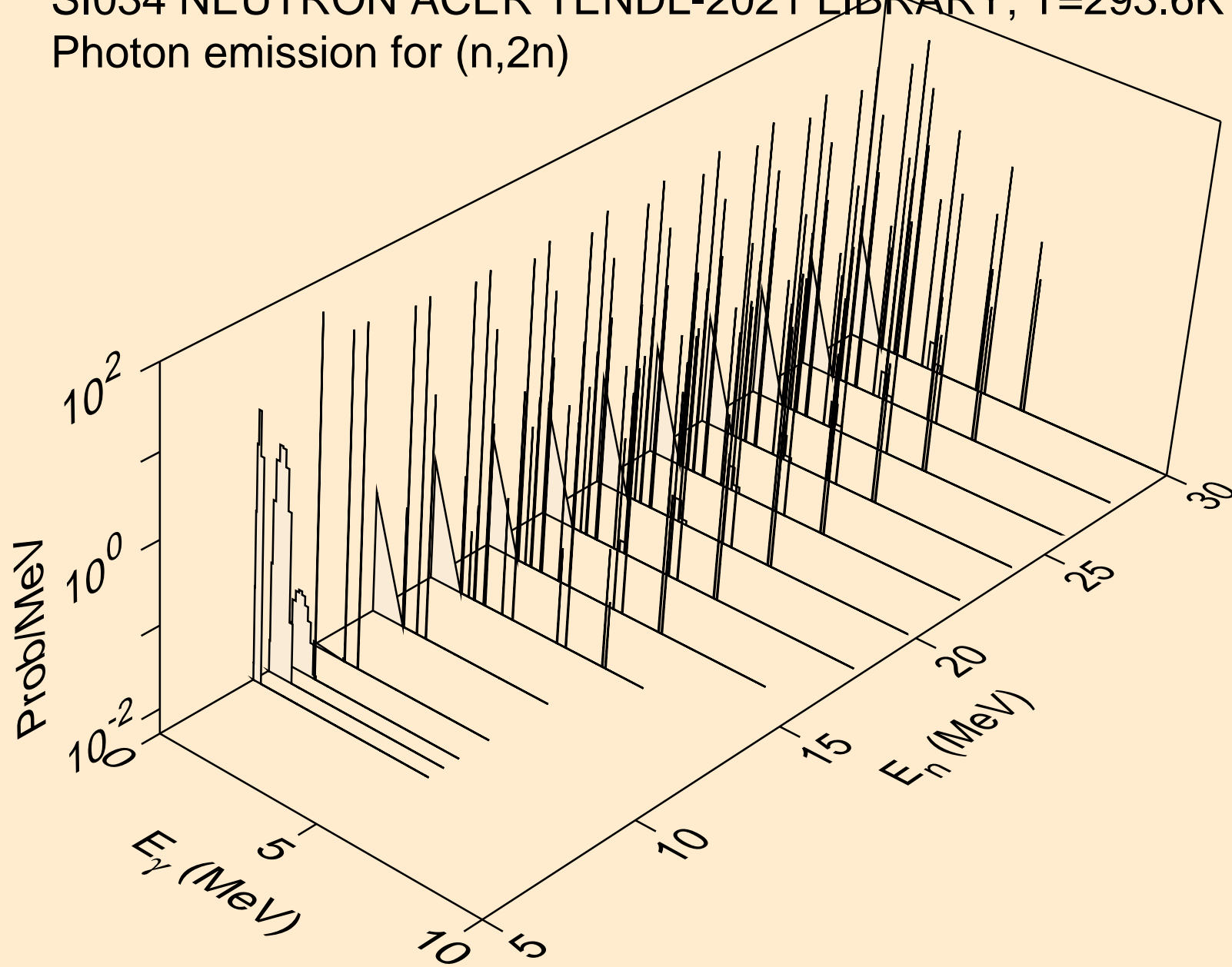

SI034 NEUTRON ACER TENDL-2021 LIBRARY; T=293.6K
Photon emission for (n,3n)

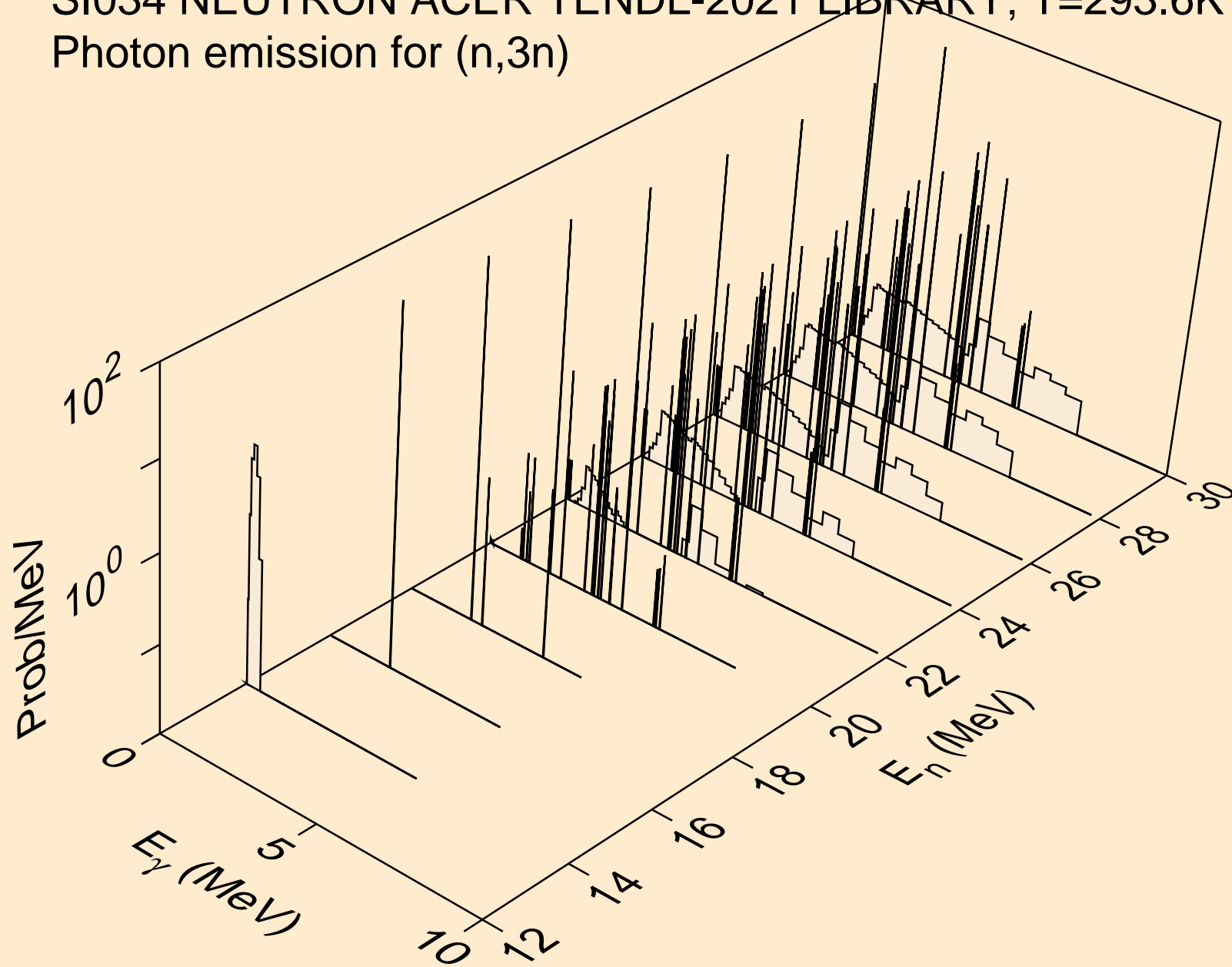

SI034 NEUTRON ACER TENDL-2021 LIBRARY; T=293.6K
Photon emission for (n,n*)a

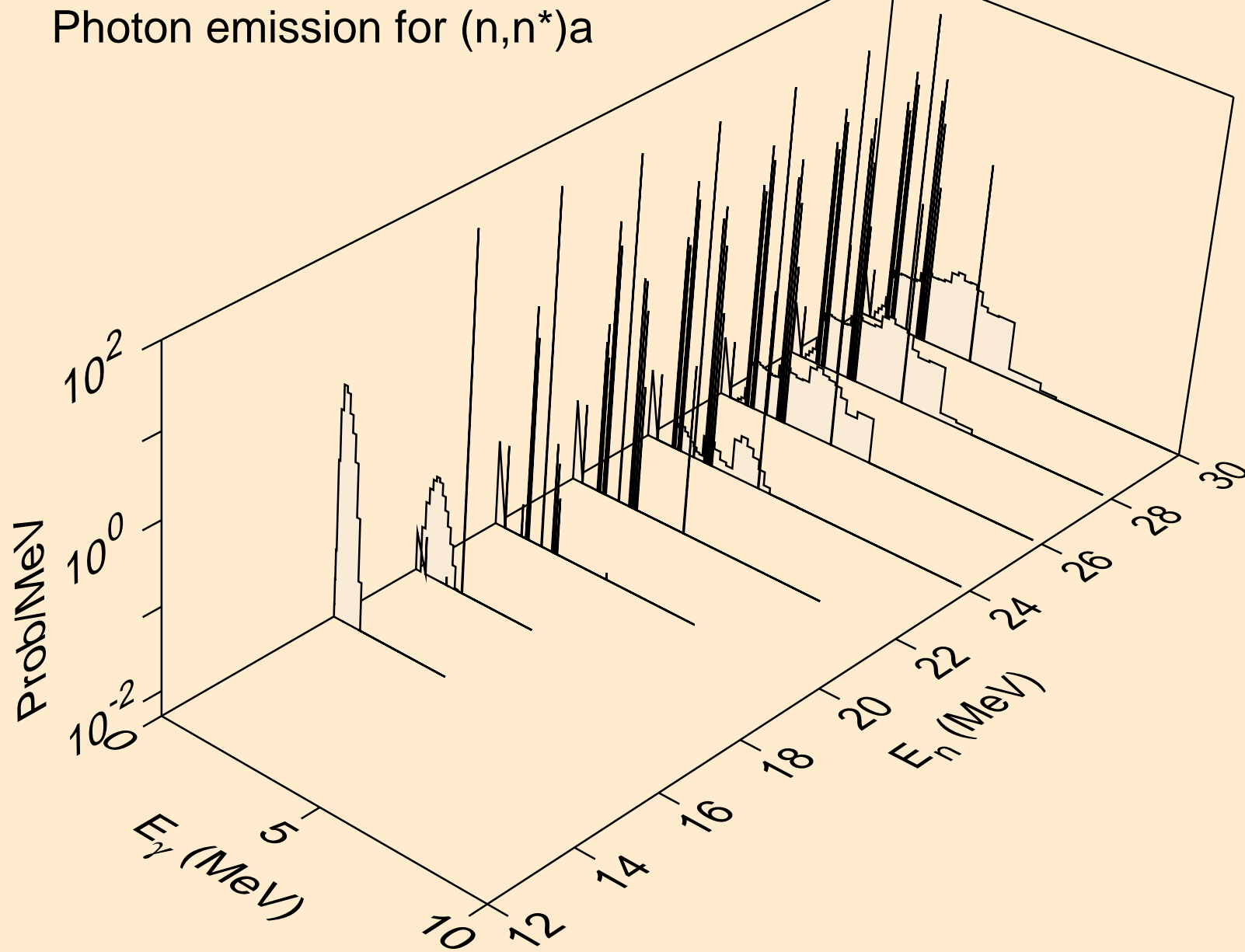

SI034 NEUTRON ACER TENDL-2021 LIBRARY; T=293.6K
Photon emission for (n,2n)a

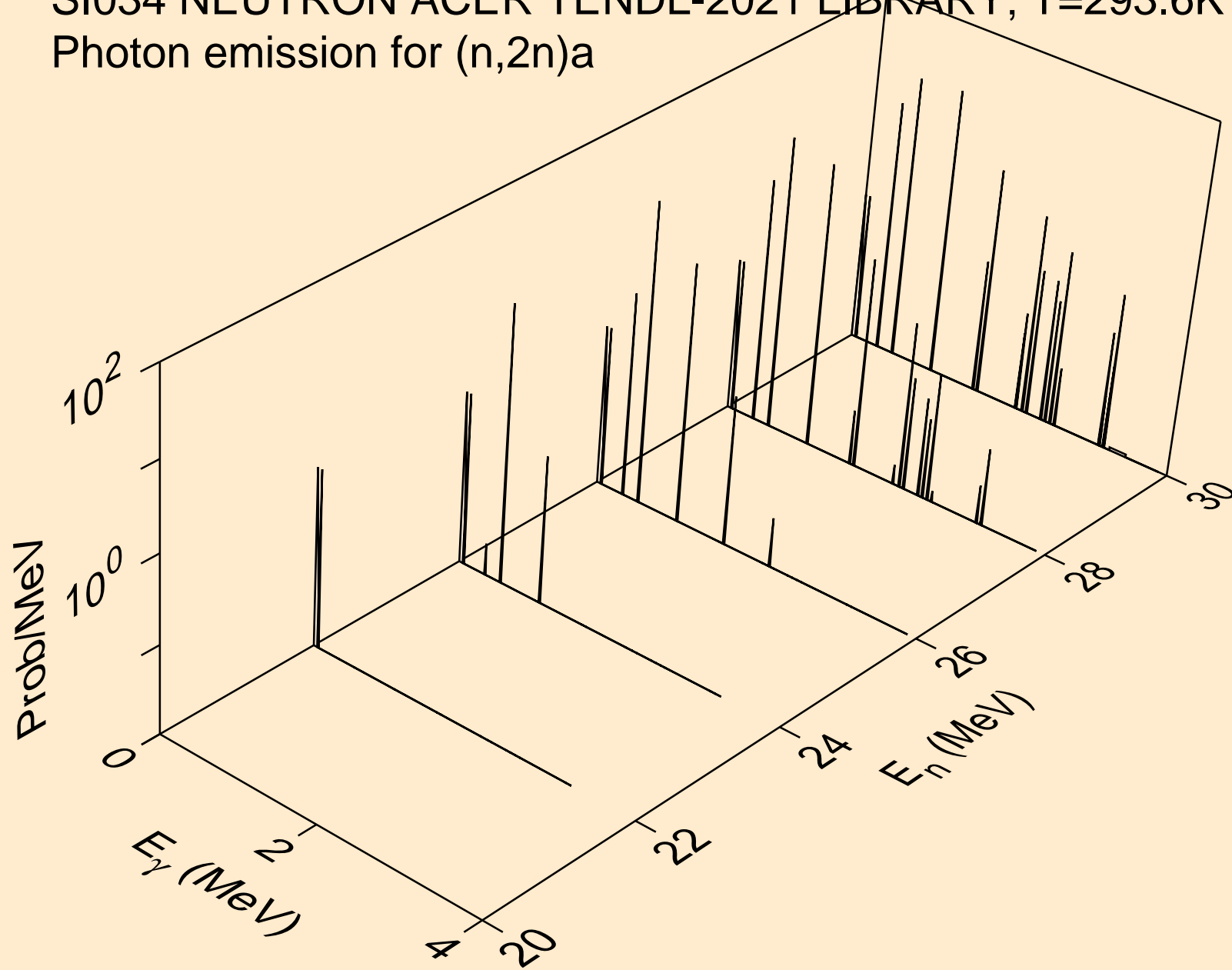

SI034 NEUTRON ACER TENDL-2021 LIBRARY; T=293.6K
Photon emission for (n,3n)a

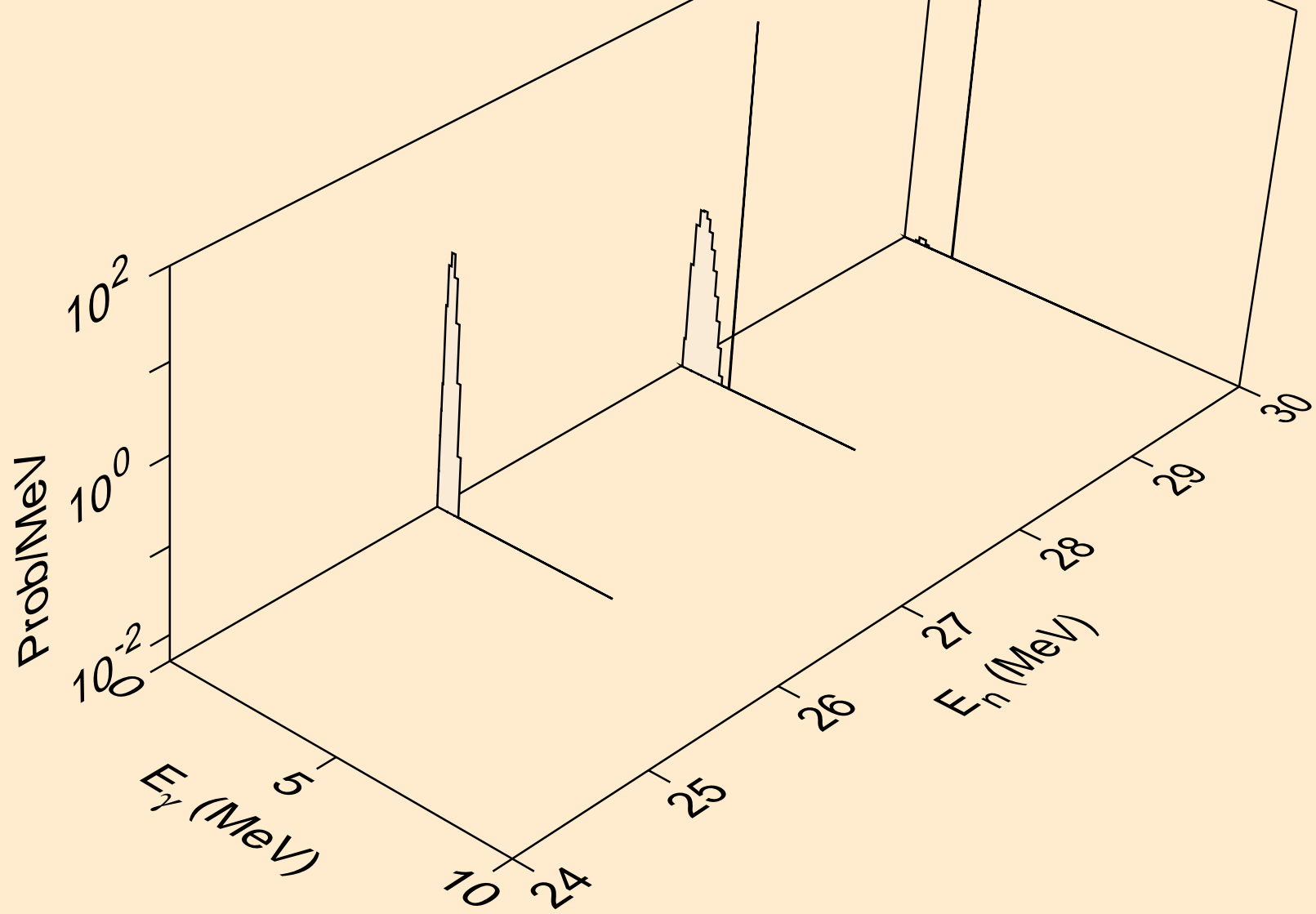

SI034 NEUTRON ACER TENDL-2021 LIBRARY; T=293.6K
Photon emission for (n,n*)p

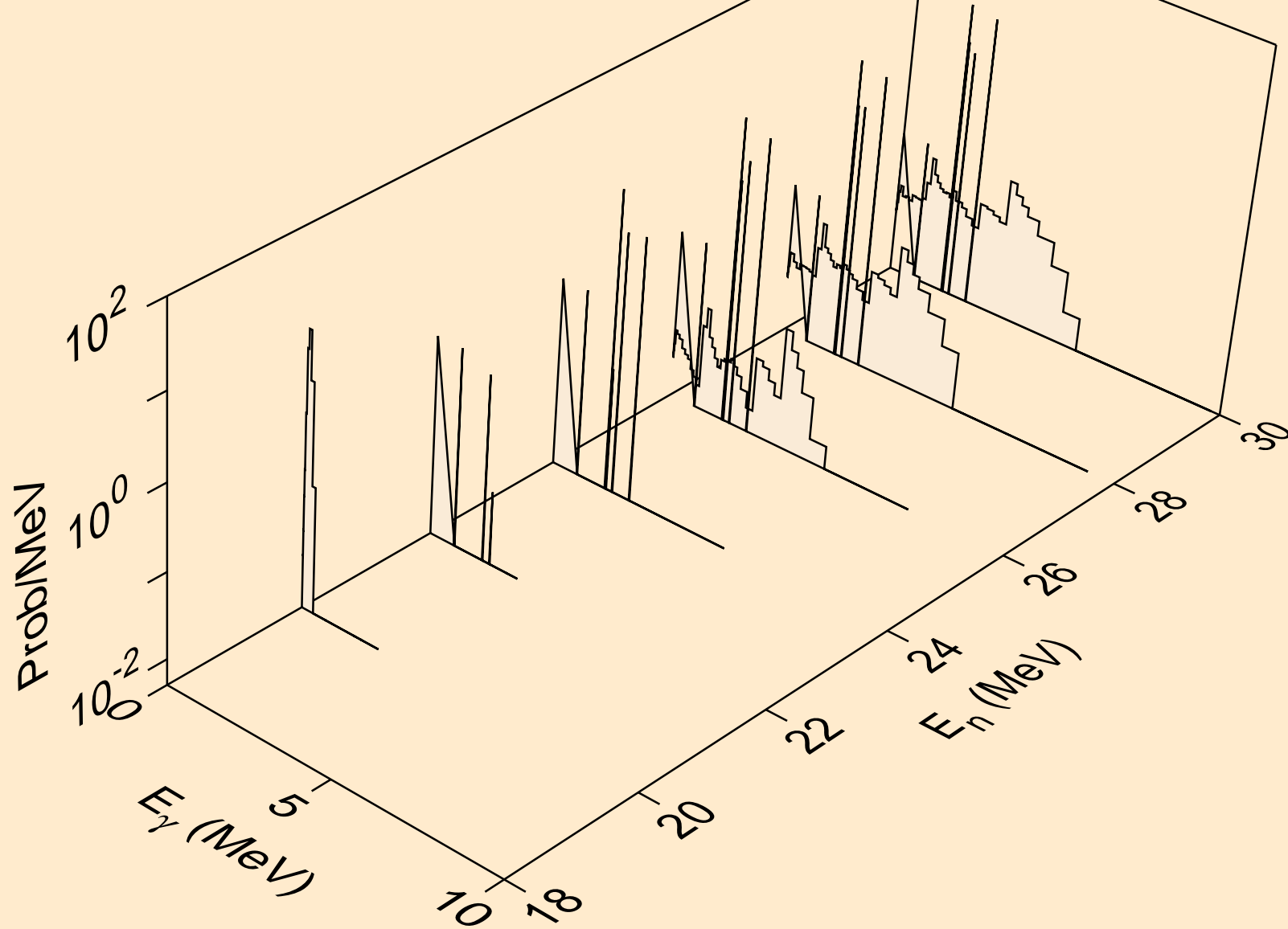

SI034 NEUTRON ACER TENDL-2021 LIBRARY; T=293.6K
Photon emission for (n,n*)d

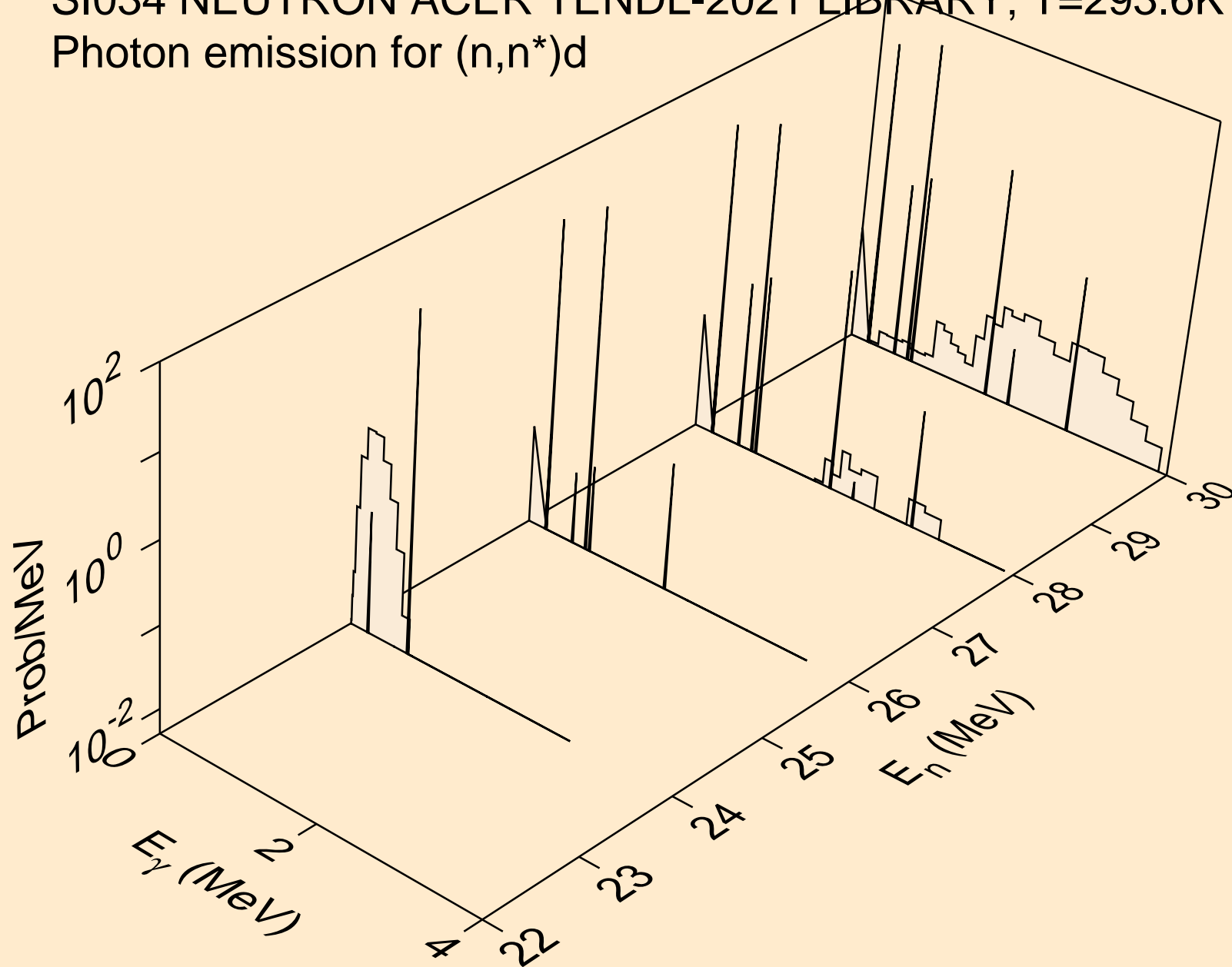

SI034 NEUTRON ACER TENDL-2021 LIBRARY; T=293.6K
Photon emission for (n,n*)t

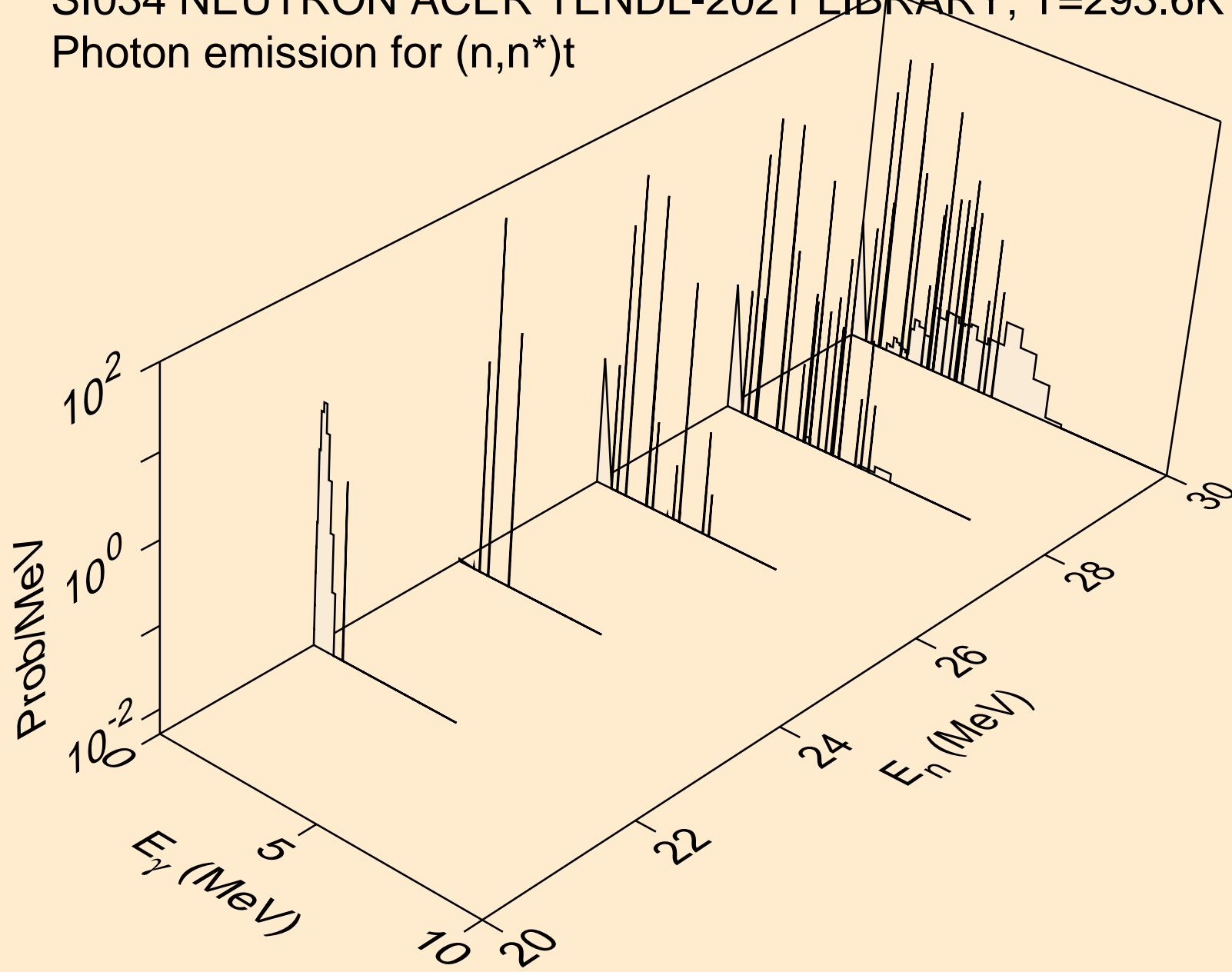

SI034 NEUTRON ACER TENDL-2021 LIBRARY; T=293.6K
Photon emission for (n,4n)

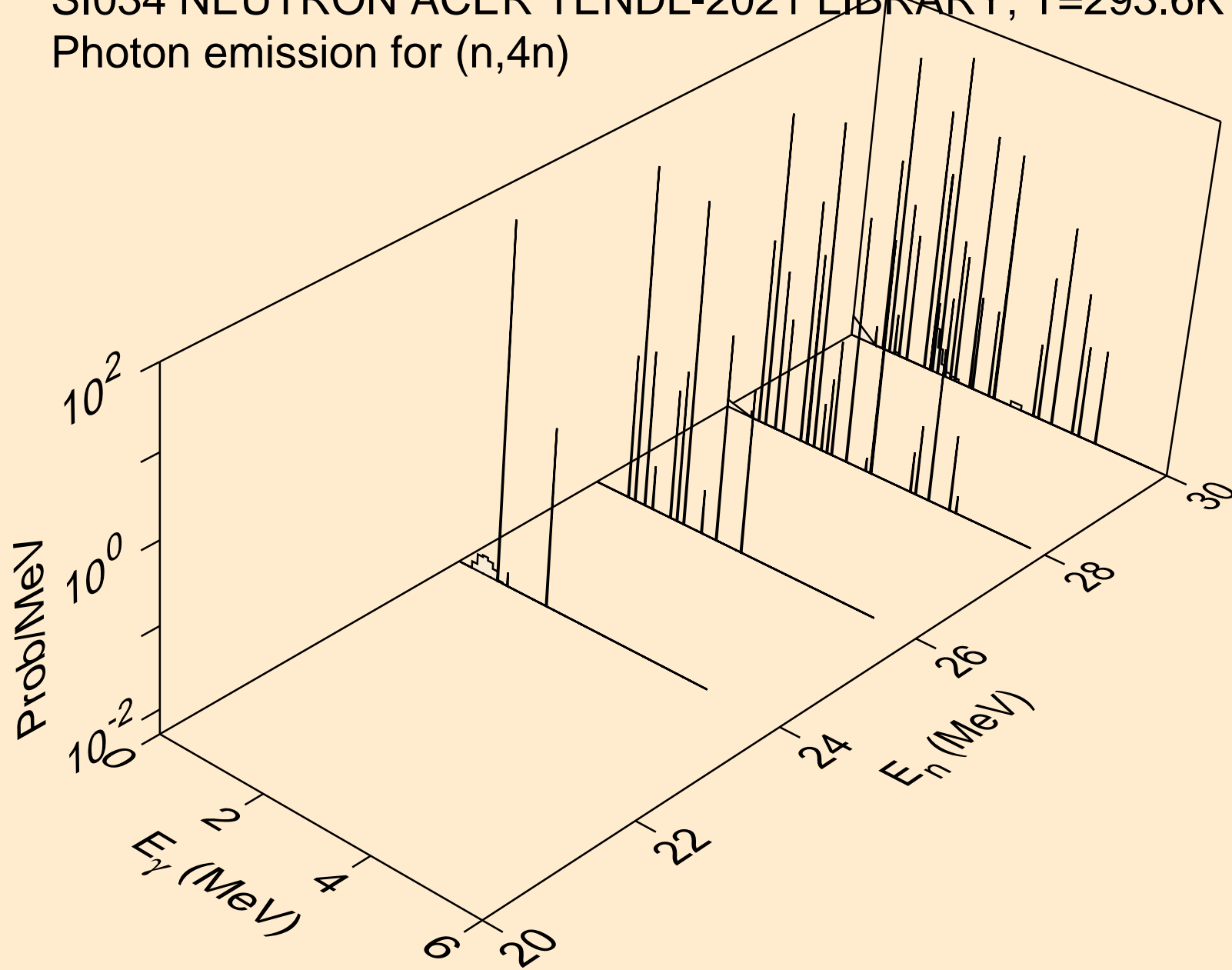

SI034 NEUTRON ACER TENDL-2021 LIBRARY; T=293.6K
Photon emission for (n,2np)

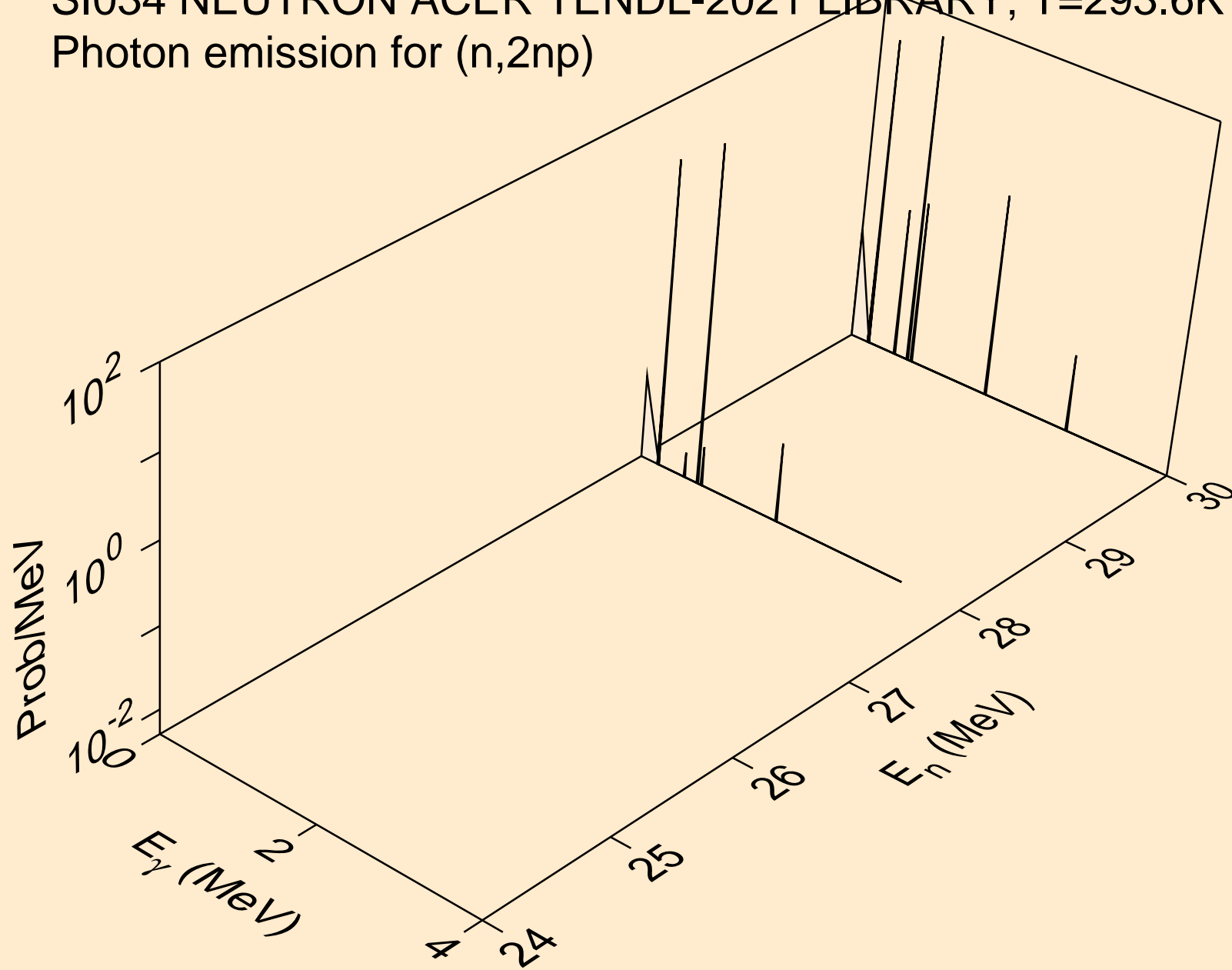

SI034 NEUTRON ACER TENDL-2021 LIBRARY; T=293.6K
Photon emission for (n,n*c)

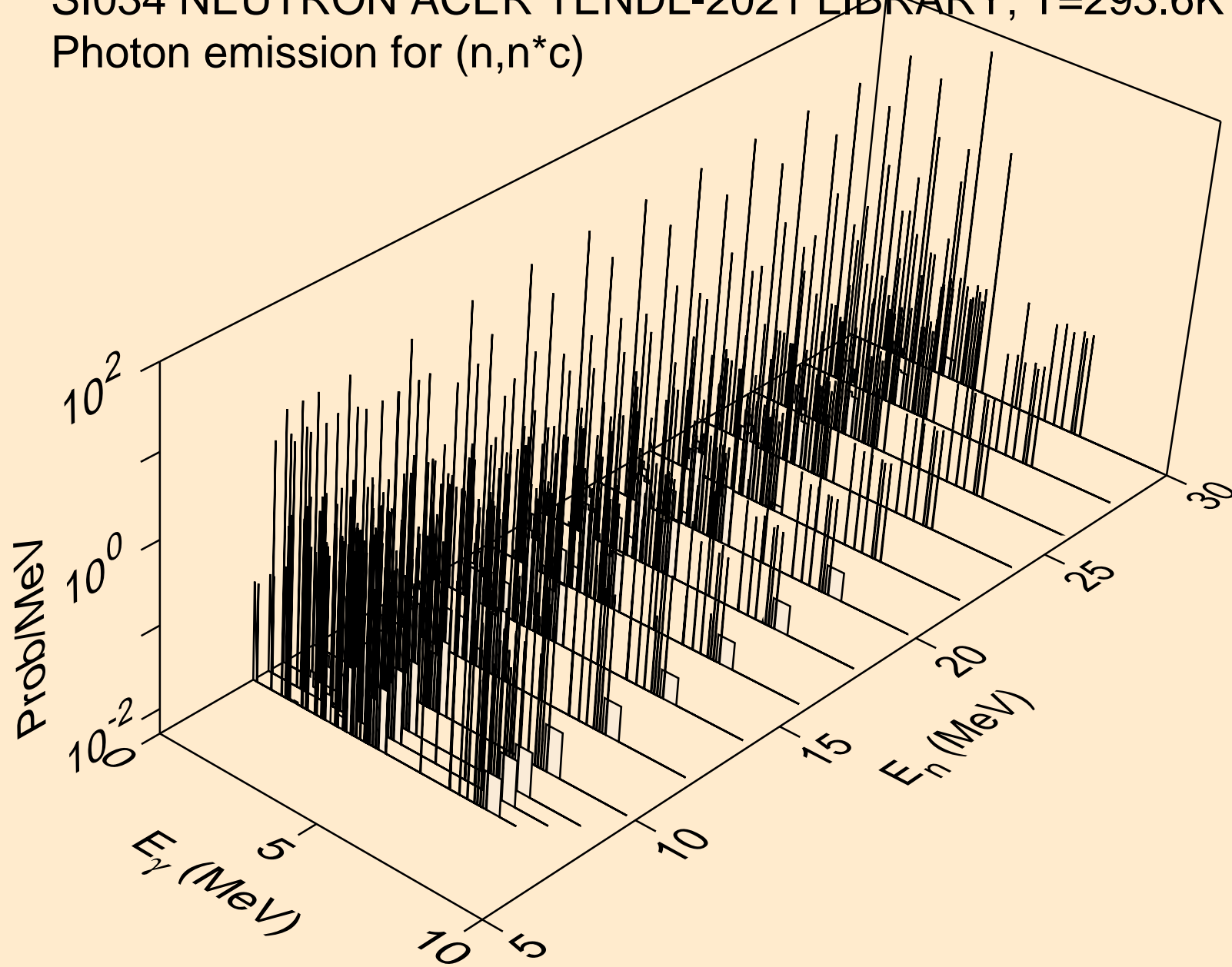

SI034 NEUTRON ACER TENDL-2021 LIBRARY; T=293.6K
Photon emission for (n,gma)

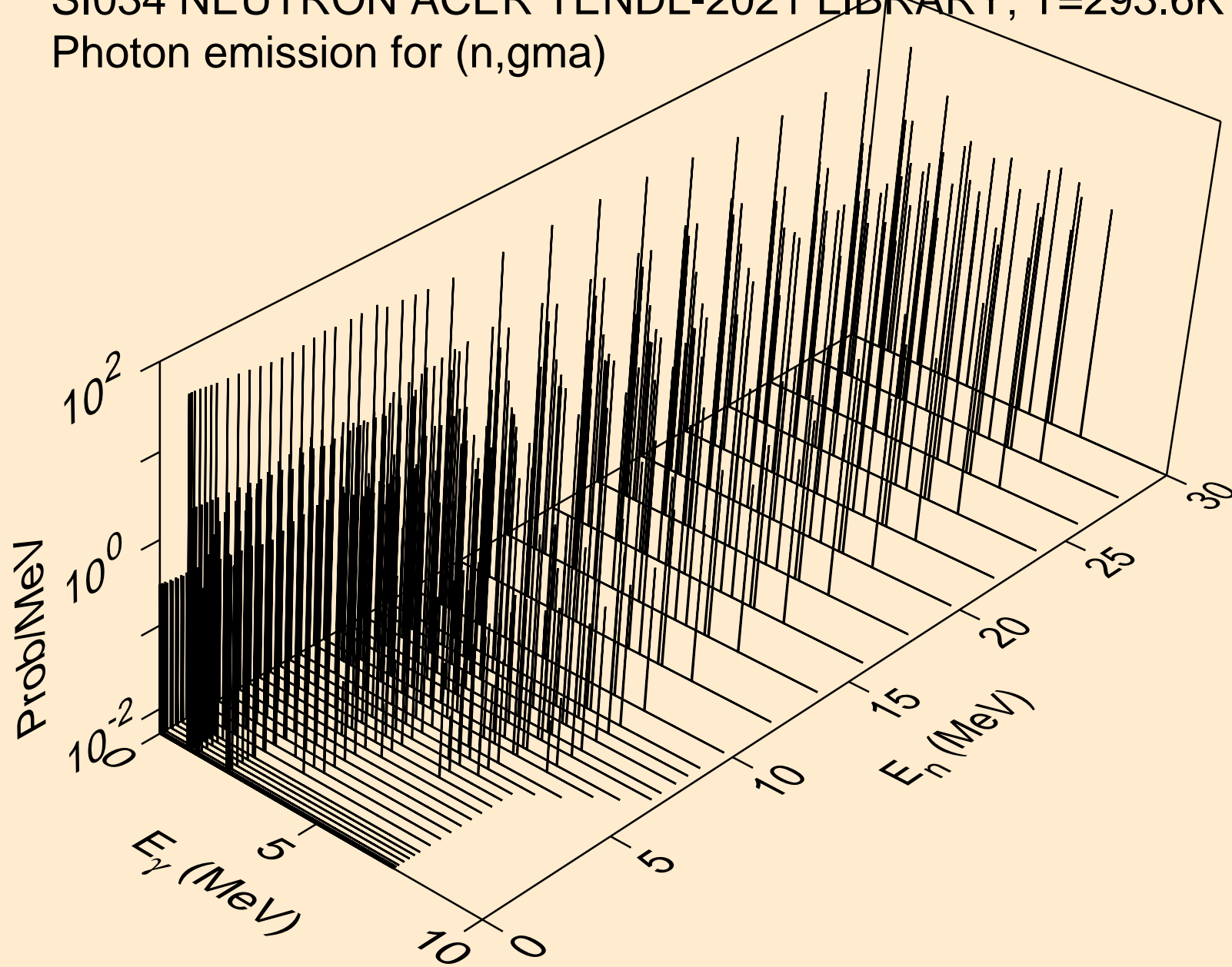

SI034 NEUTRON ACER TENDL-2021 LIBRARY; T=293.6K
Photon emission for (n,p)

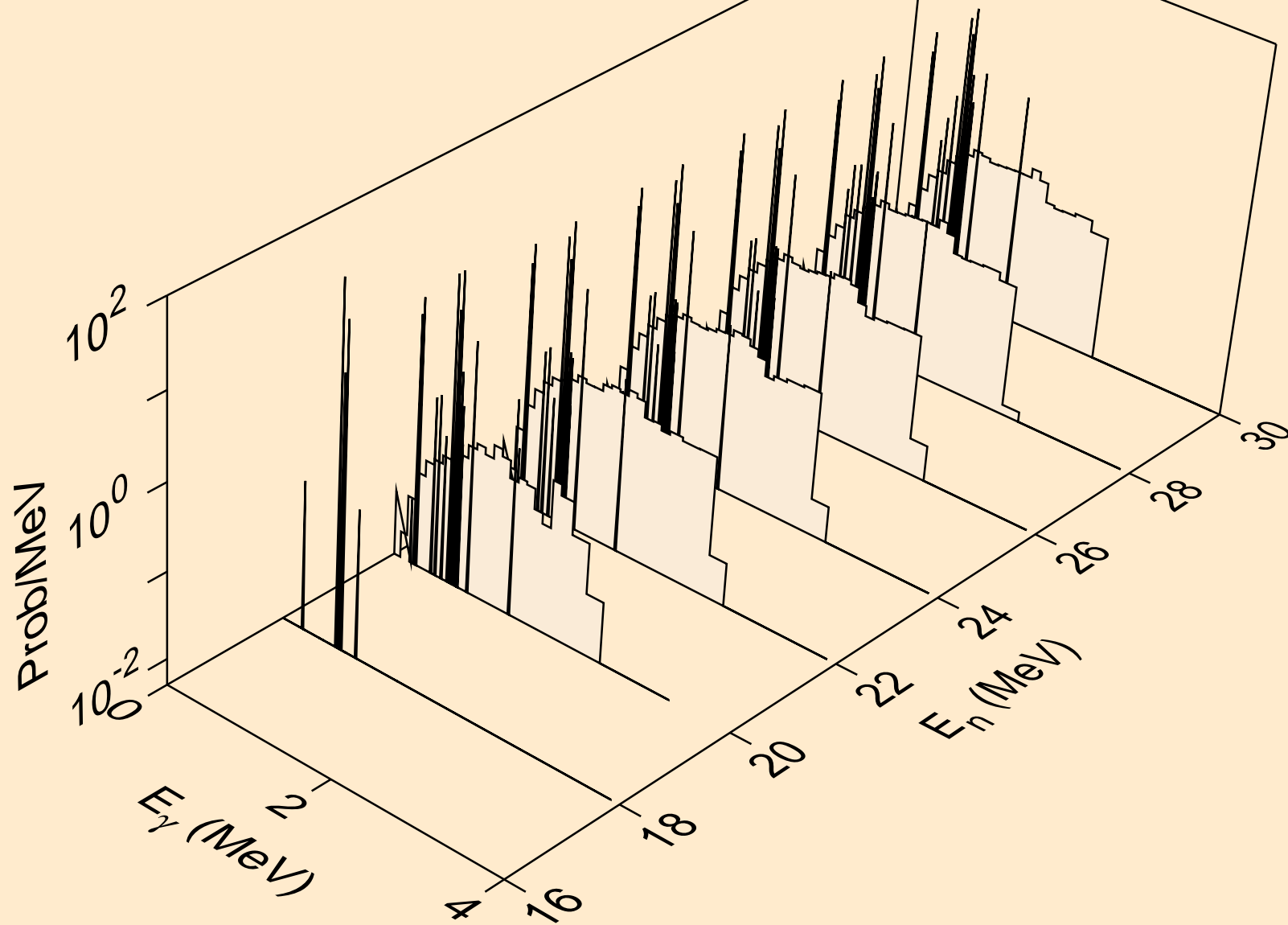

SI034 NEUTRON ACER TENDL-2021 LIBRARY; T=293.6K
Photon emission for (n,d)

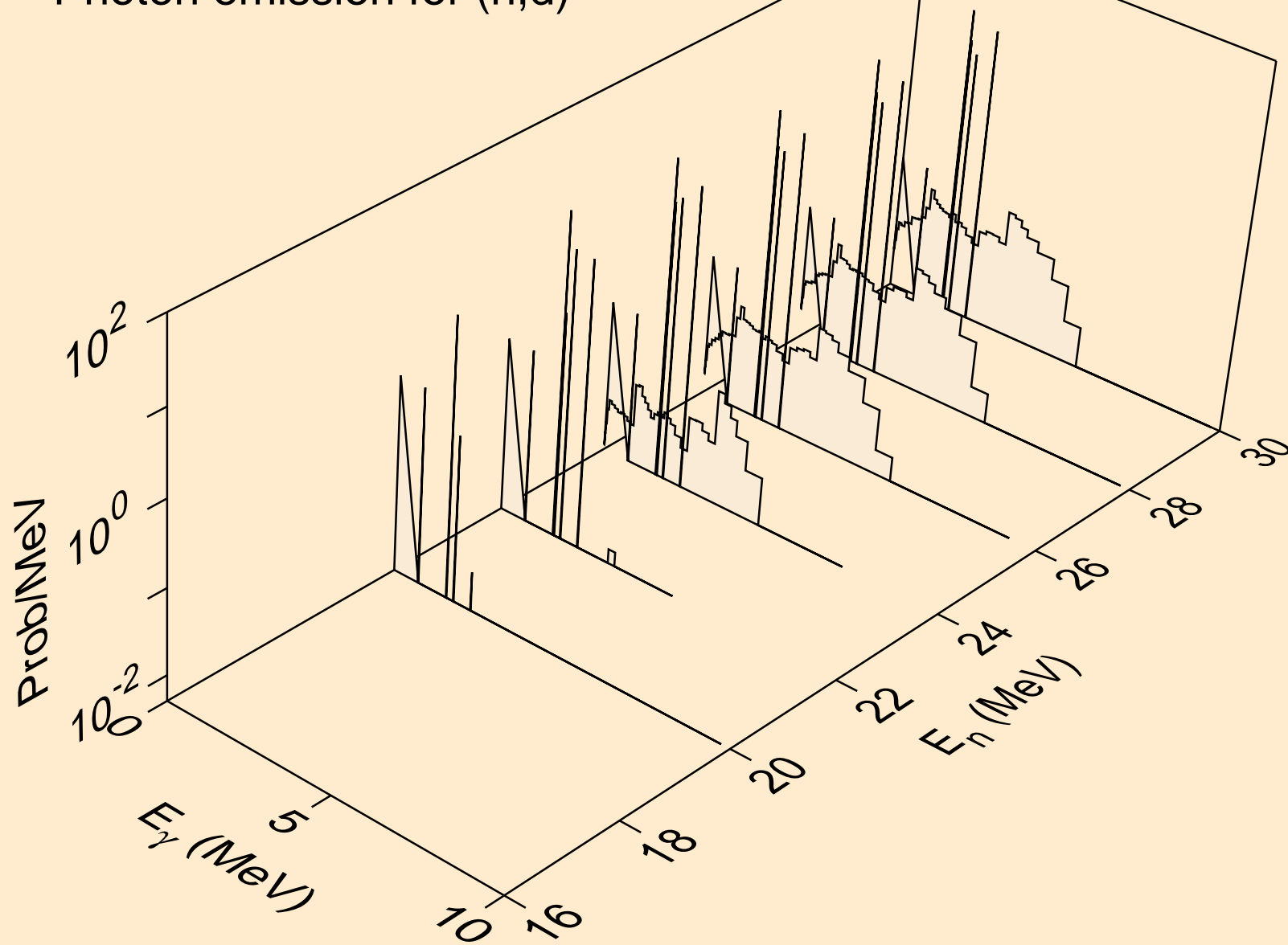

SI034 NEUTRON ACER TENDL-2021 LIBRARY; T=293.6K
Photon emission for (n,t)

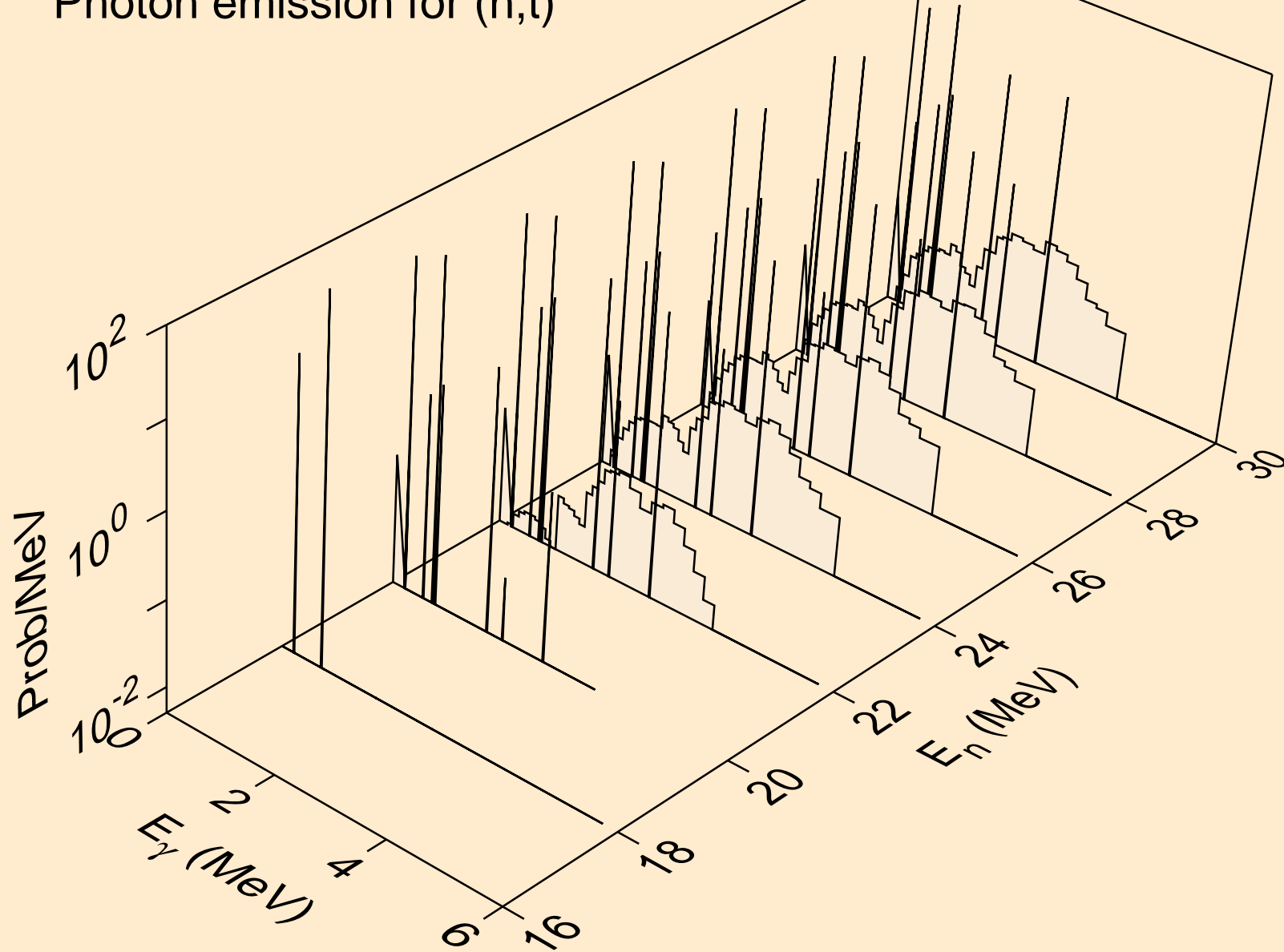

SI034 NEUTRON ACER TENDL-2021 LIBRARY; T=293.6K
Photon emission for (n,a)

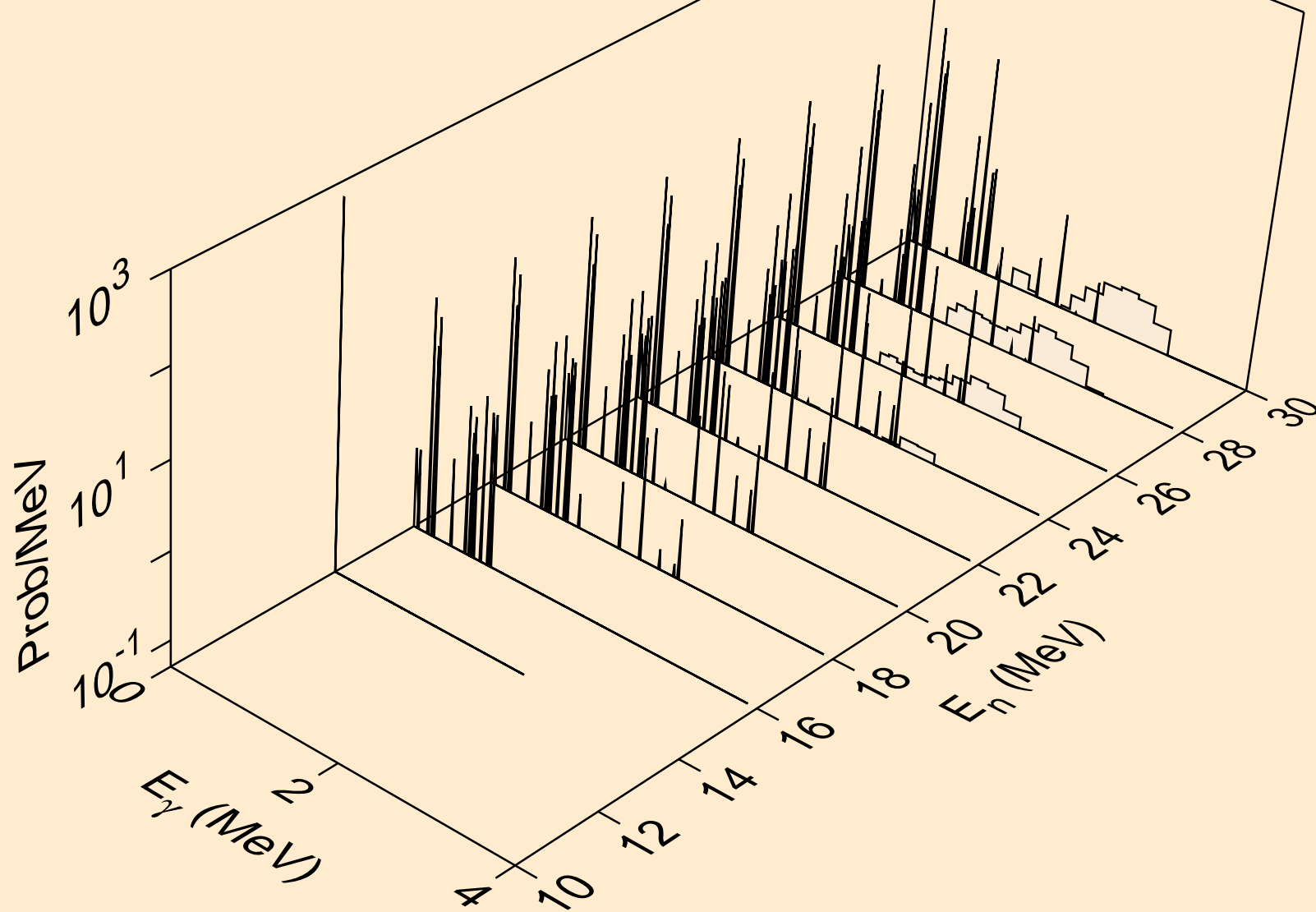

SI034 NEUTRON ACER TENDL-2021 LIBRARY; T=293.6K
thermal capture photon spectrum

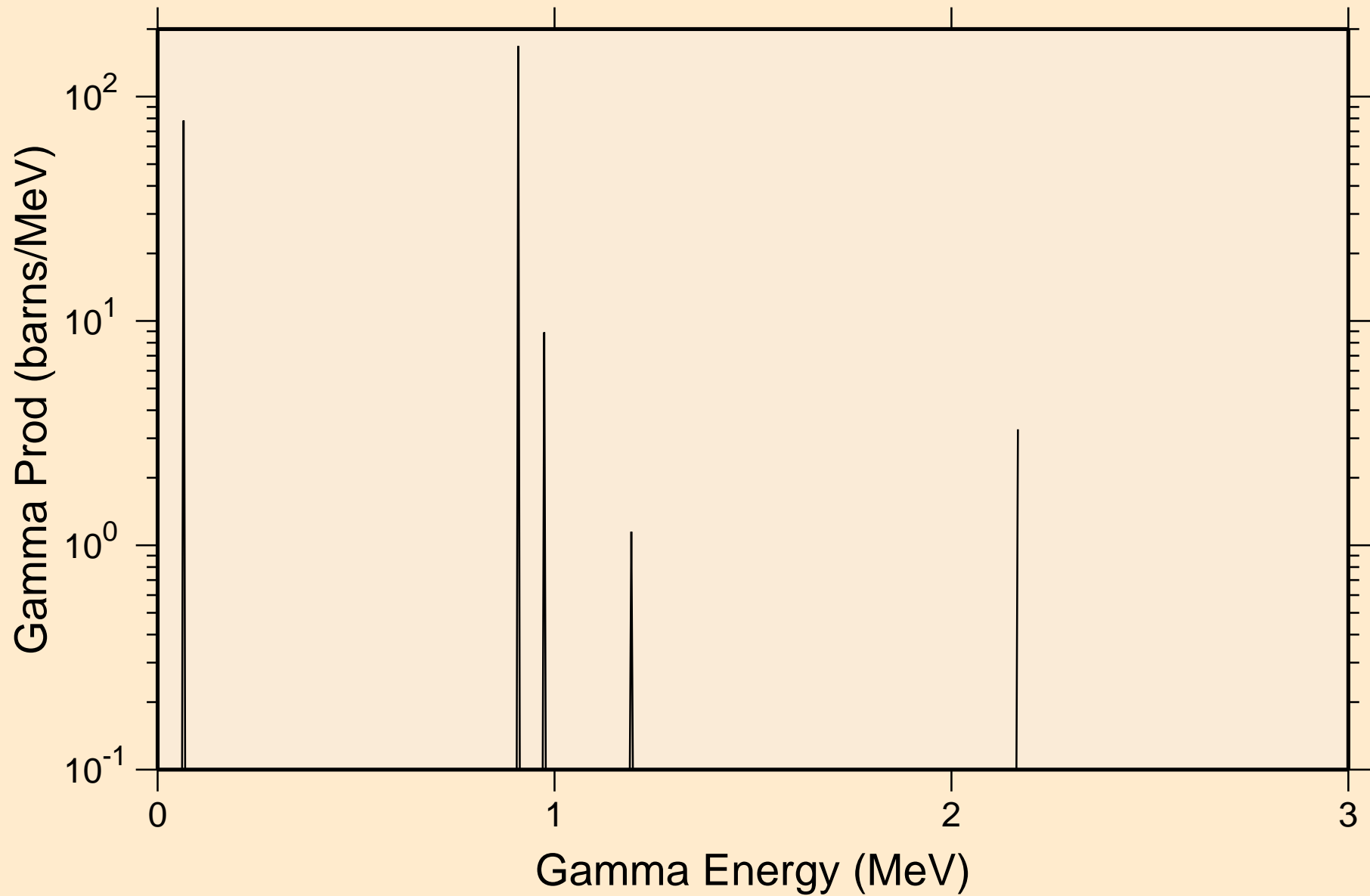

SI034 NEUTRON ACER TENDL-2021 LIBRARY; T=293.6K
14 MeV photon spectrum

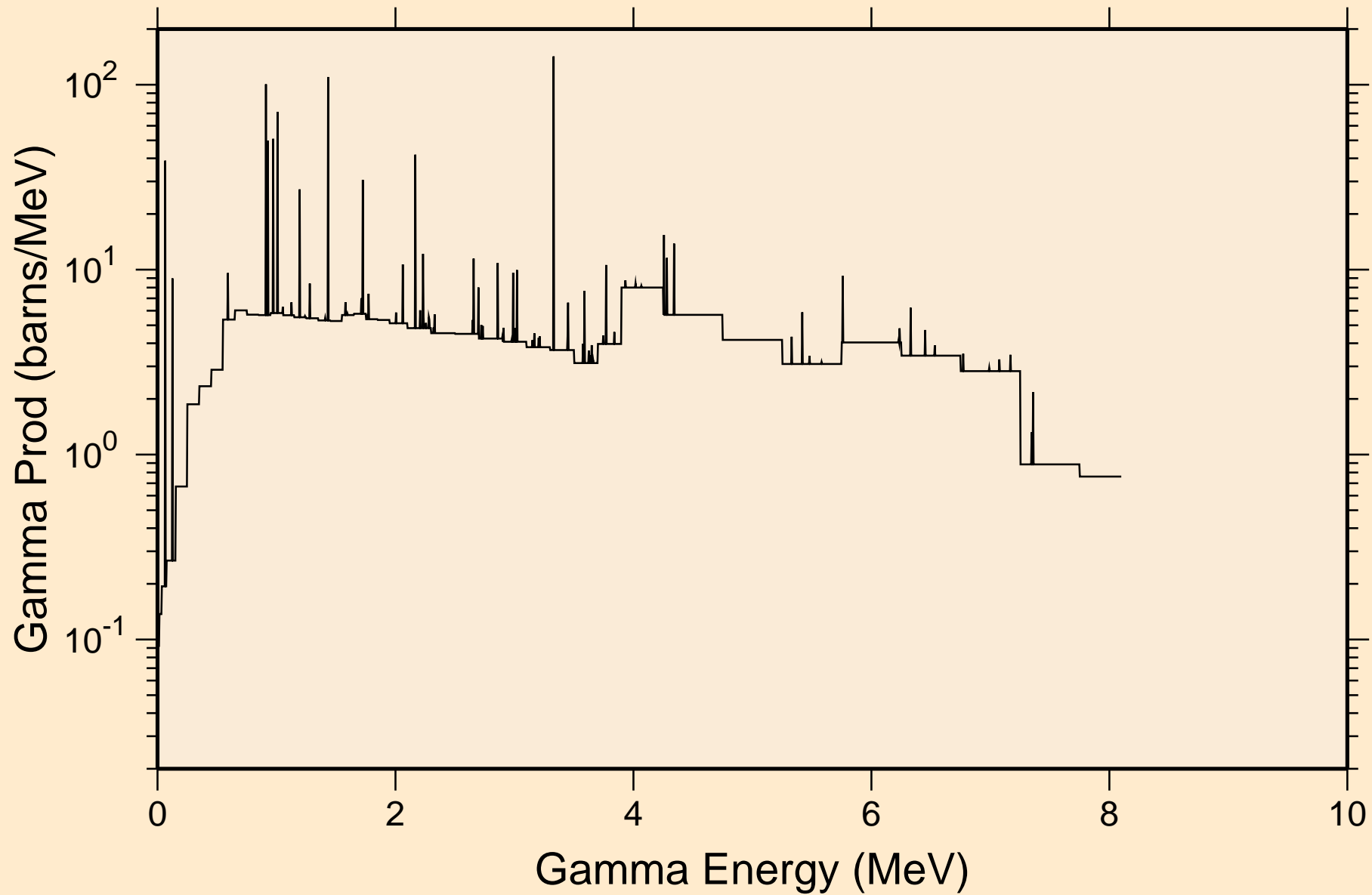

SI034 NEUTRON ACER TENDL-2021 LIBRARY; T=293.6K
Particle heating contributions

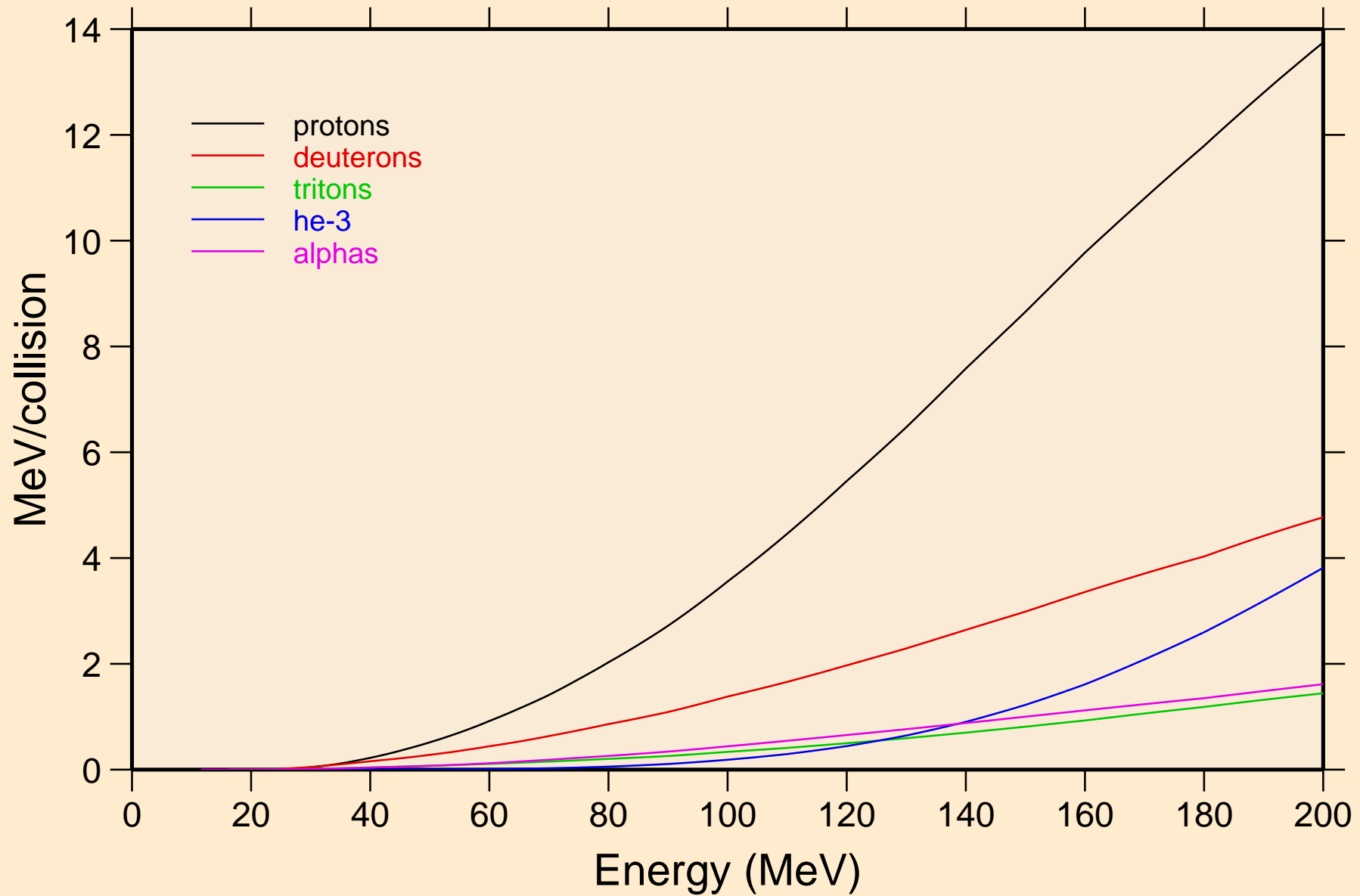

SI034 NEUTRON ACER TENDL-2021 LIBRARY; T=293.6K
Recoil Heating

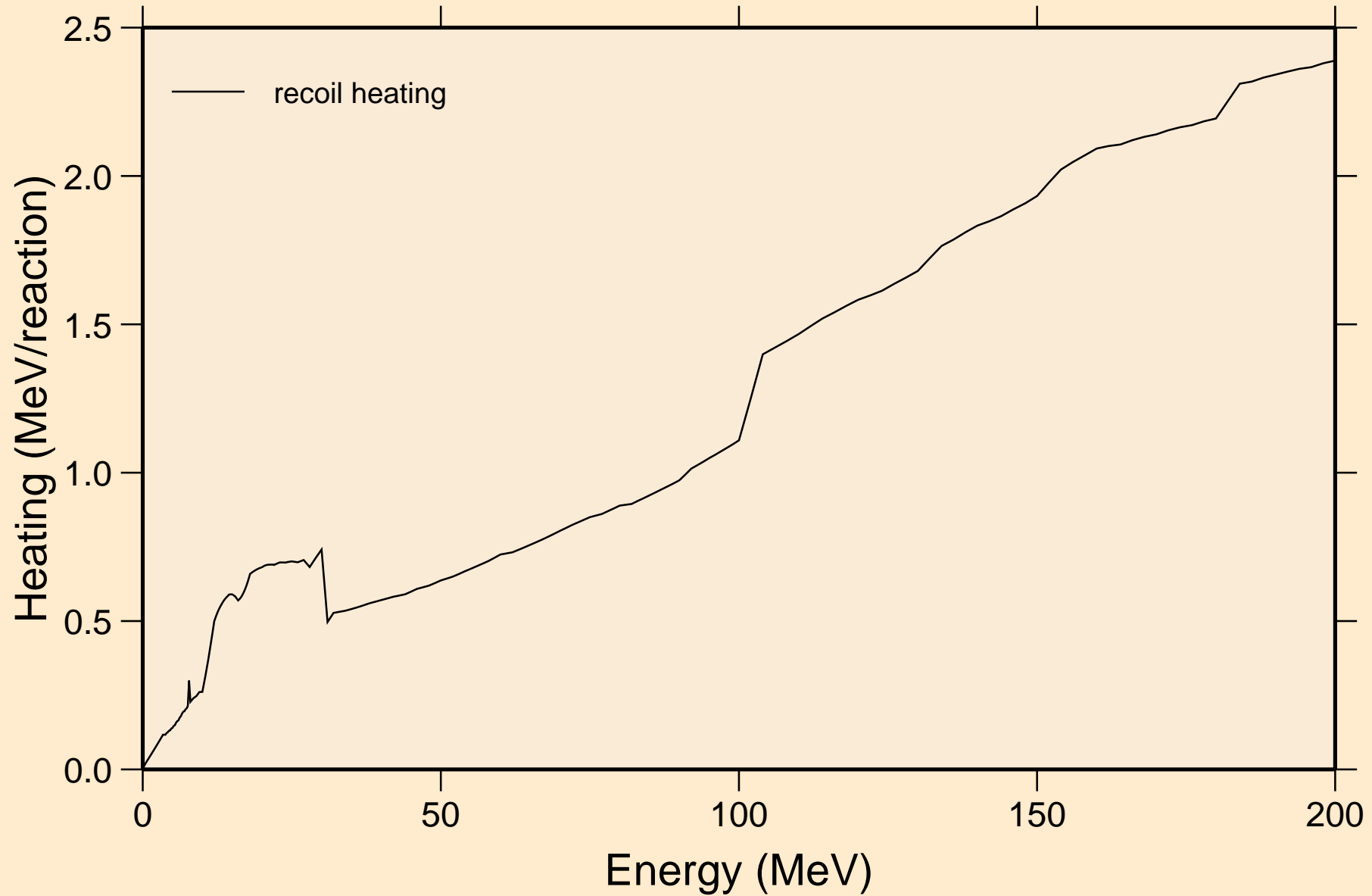

SI034 NEUTRON ACER TENDL-2021 LIBRARY; T=293.6K
Particle production cross sections

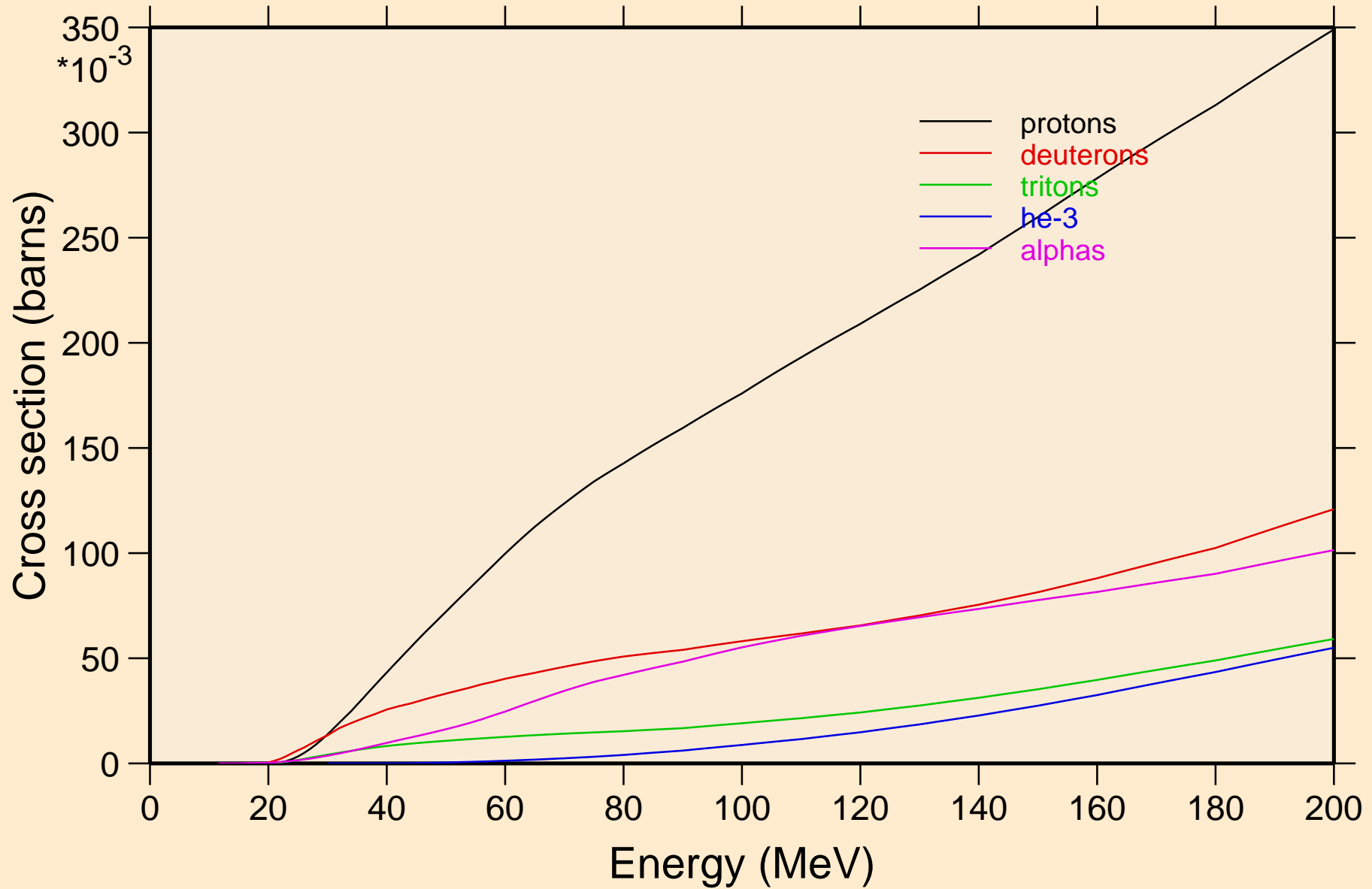

SI034 NEUTRON ACER TENDL-2021 LIBRARY; T=293.6K
protons from (n,x)

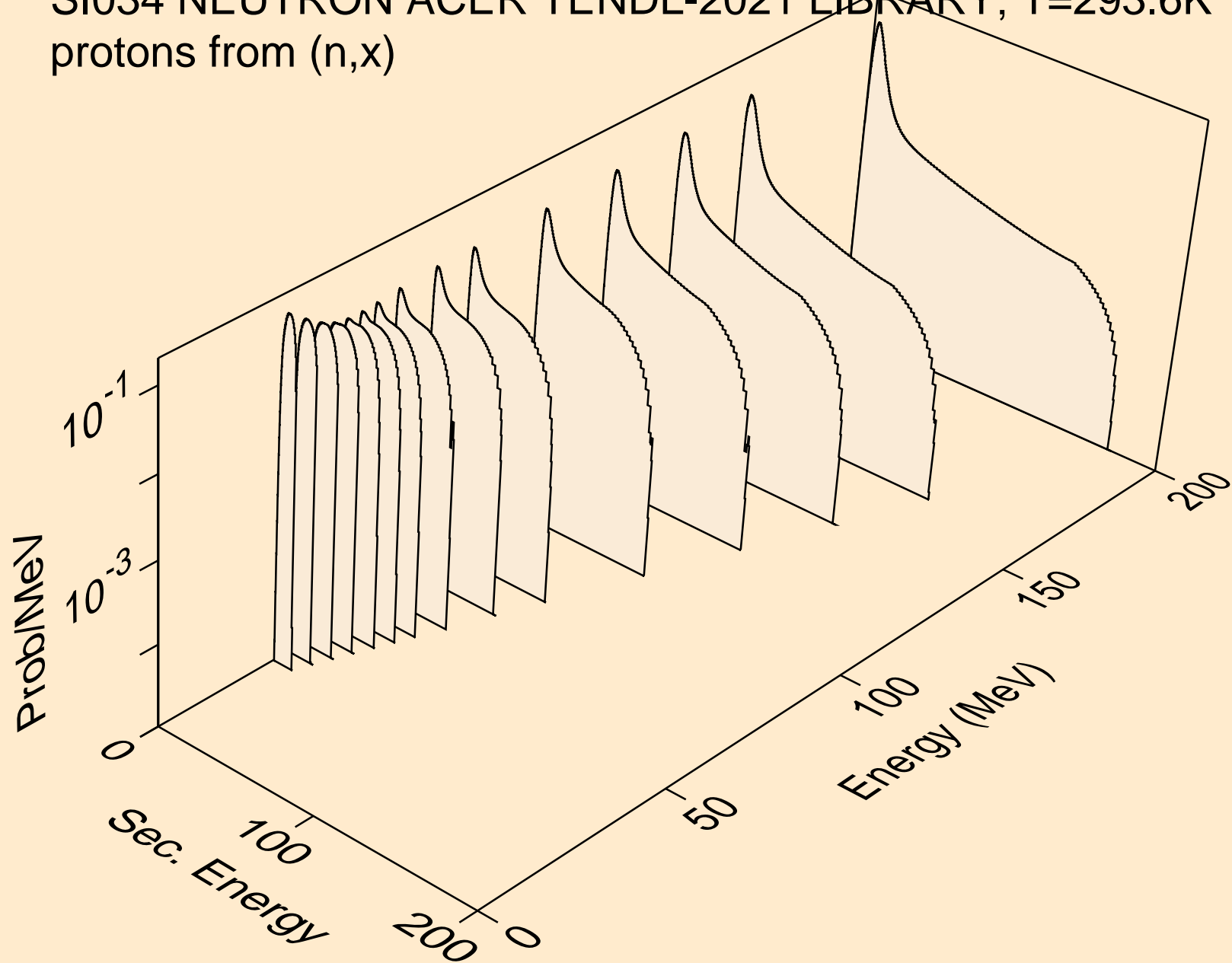

SI034 NEUTRON ACER TENDL-2021 LIBRARY; T=293.6K
protons from (n,n*)p

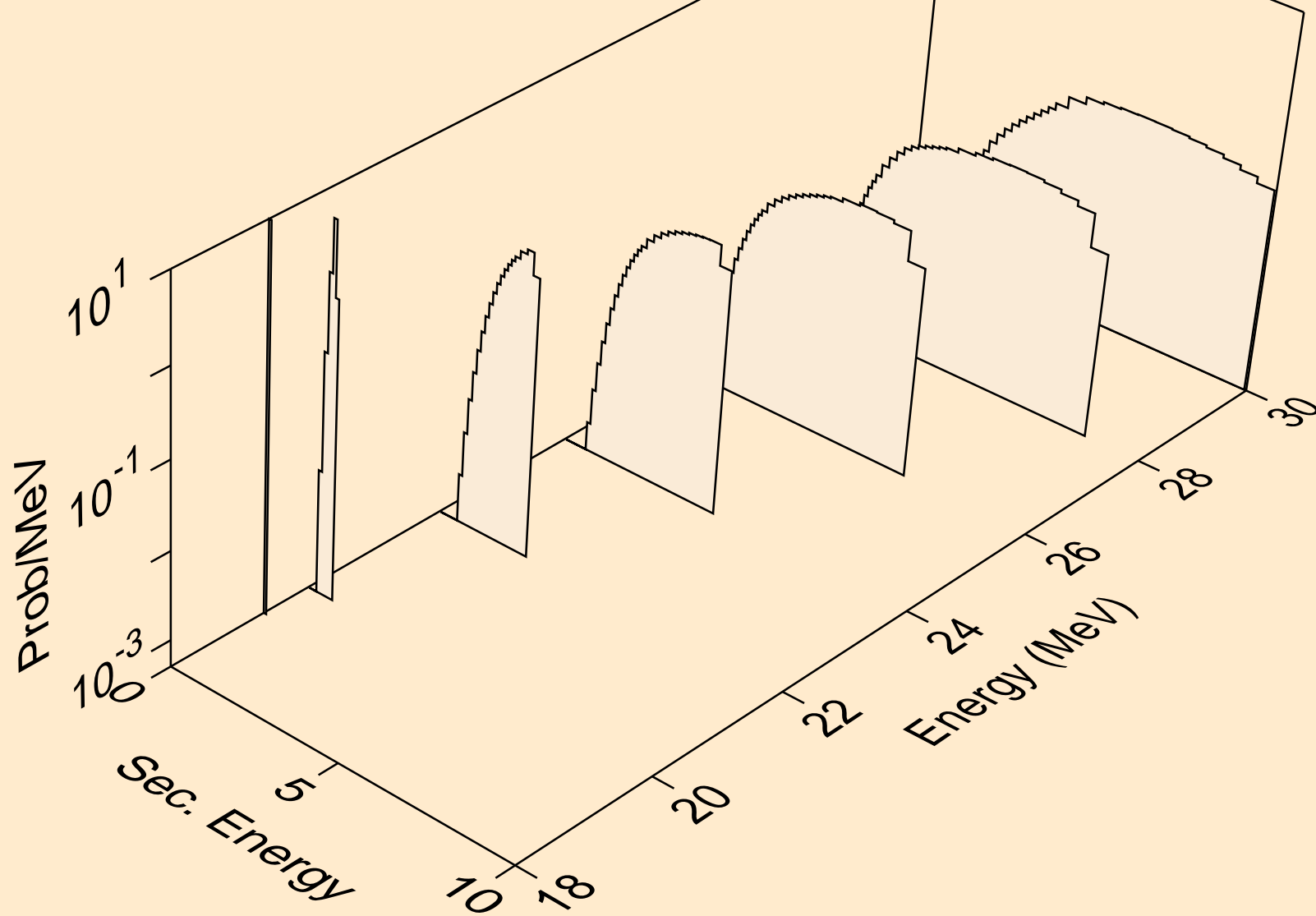

SI034 NEUTRON ACER TENDL-2021 LIBRARY; T=293.6K
protons from (n,2np)

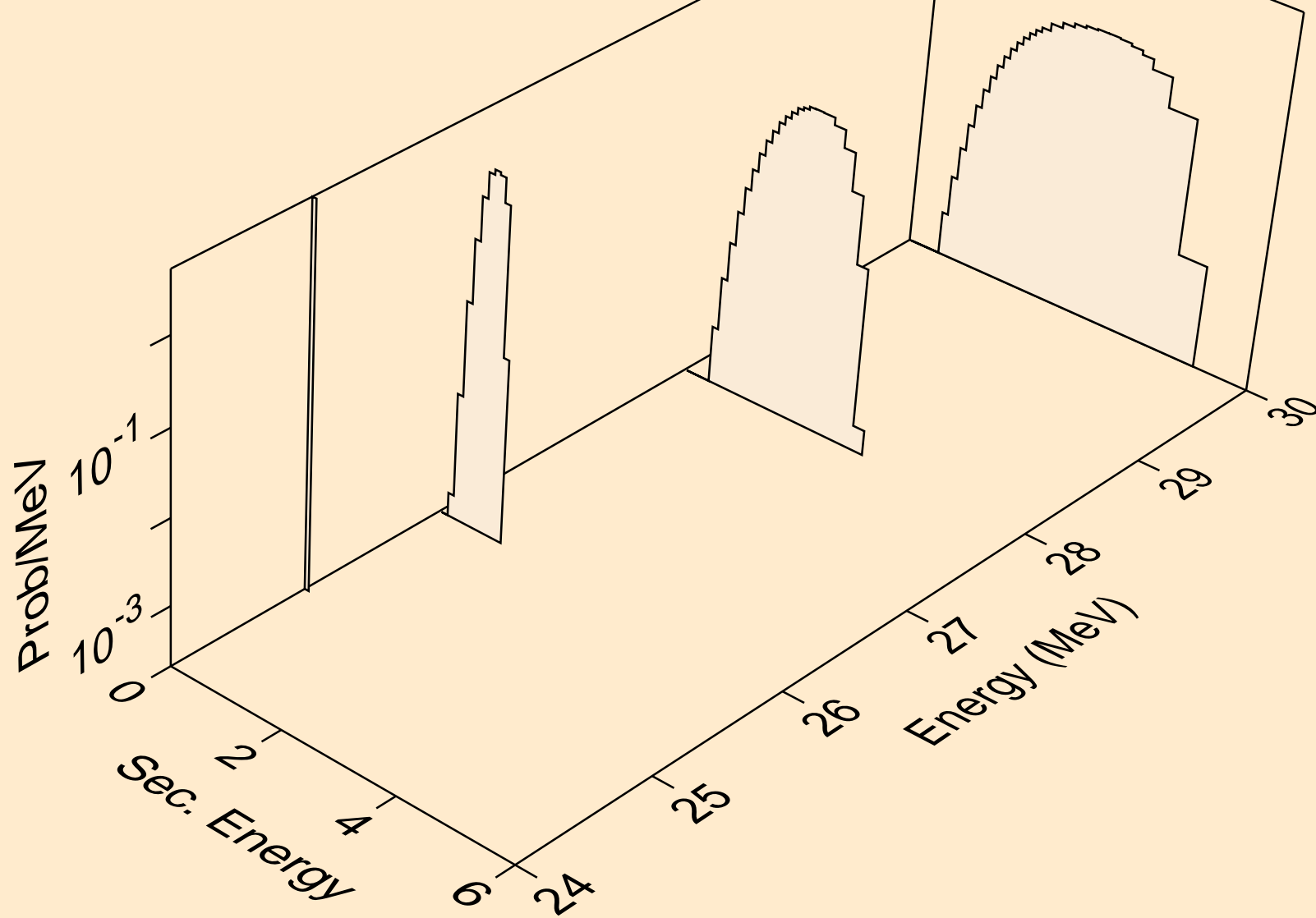

SI034 NEUTRON ACER TENDL-2021 LIBRARY; T=293.6K
protons from (n,p)

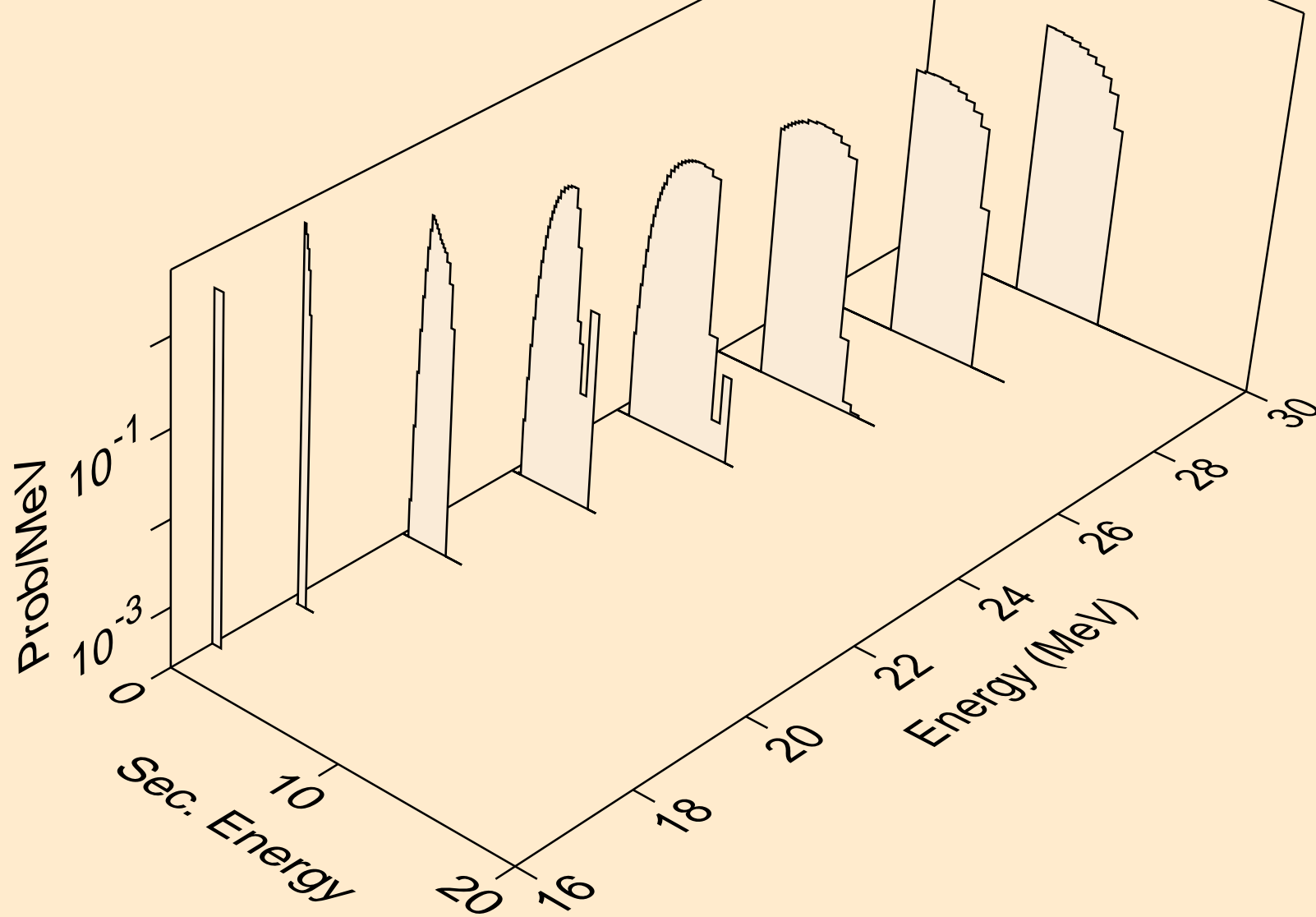

SI034 NEUTRON ACER TENDL-2021 LIBRARY; T=293.6K
deuterons from (n,x)

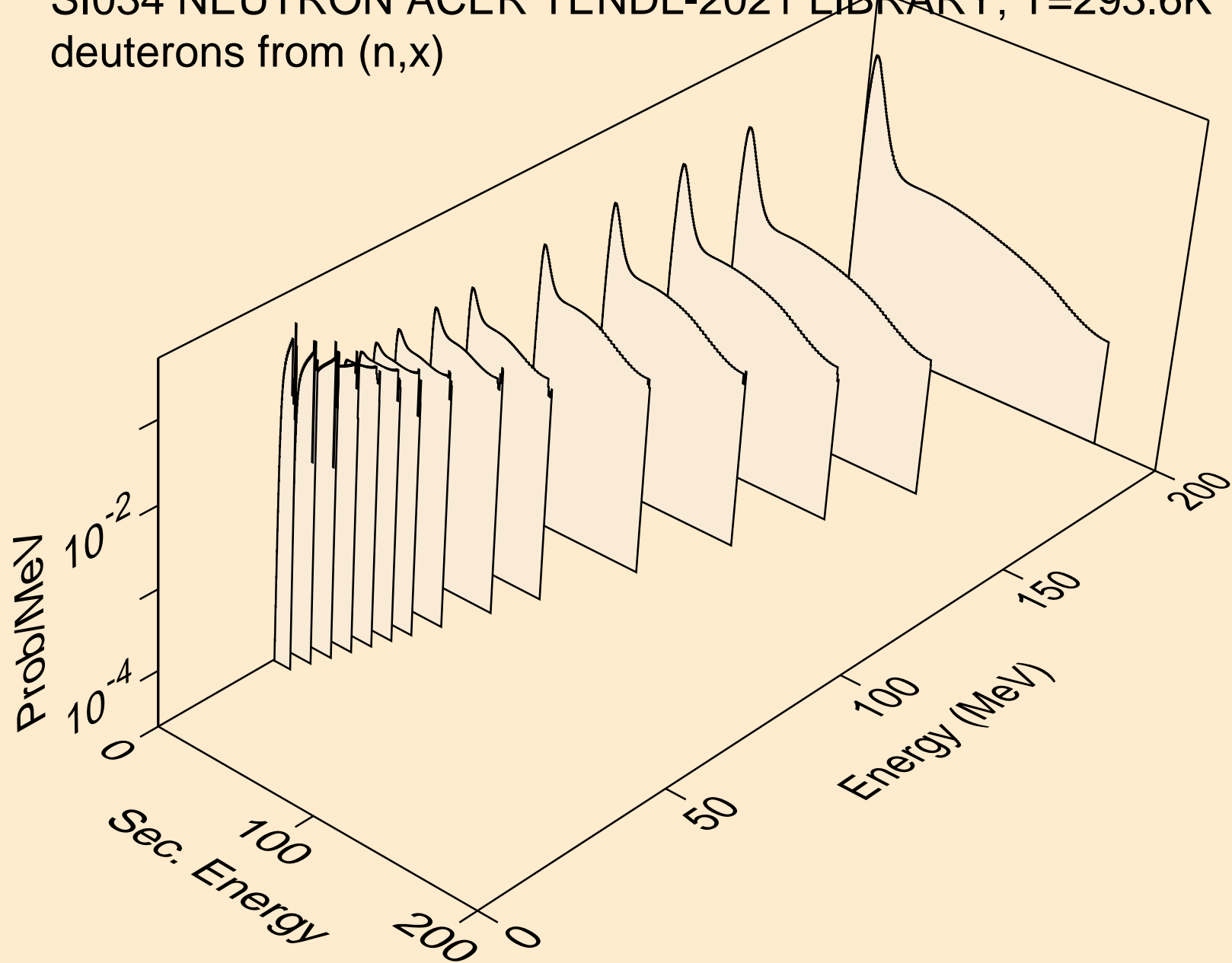

SI034 NEUTRON ACER TENDL-2021 LIBRARY; T=293.6K
deuterons from (n,2nd)

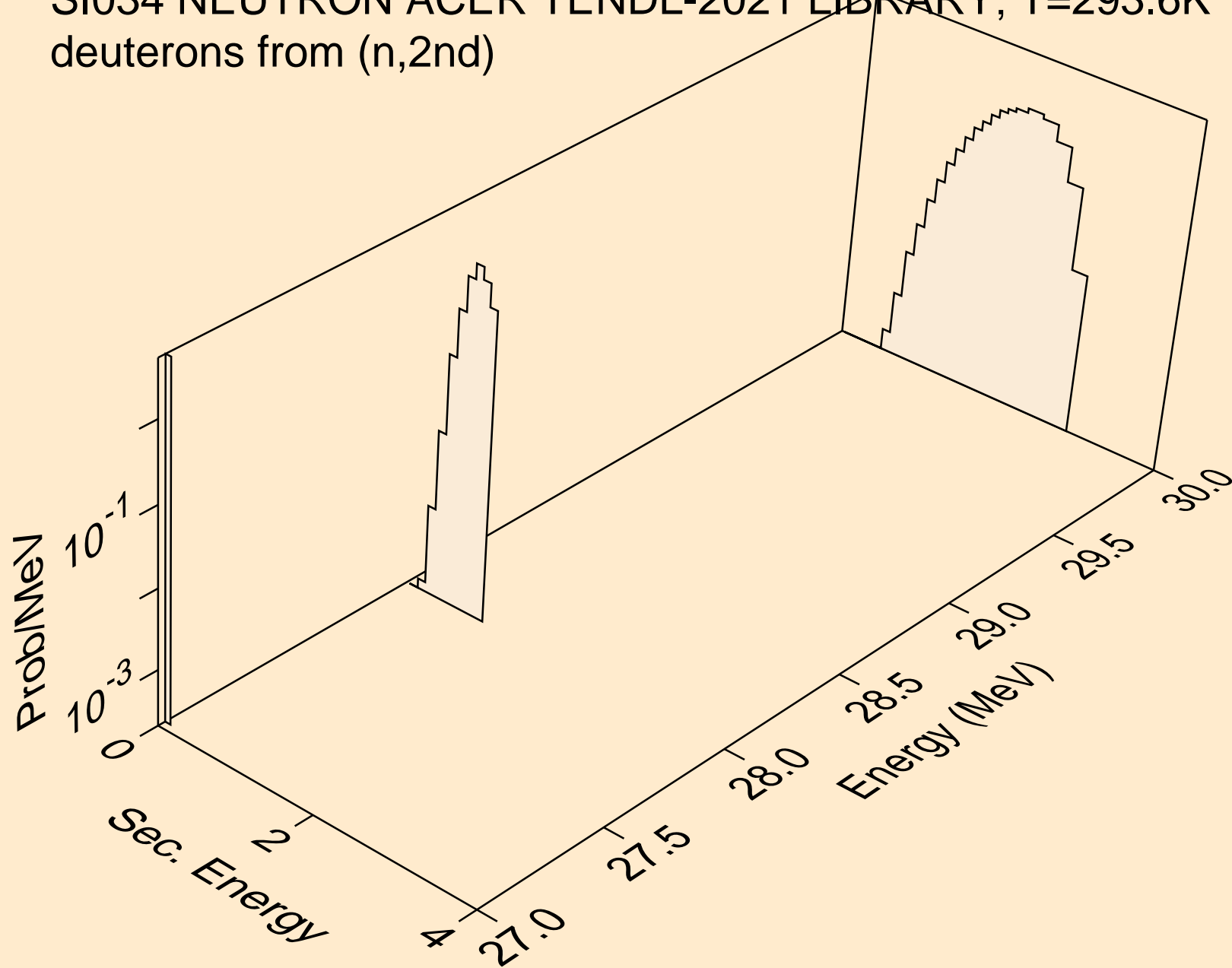

SI034 NEUTRON ACER TENDL-2021 LIBRARY; T=293.6K
deuterons from (n,n*)d

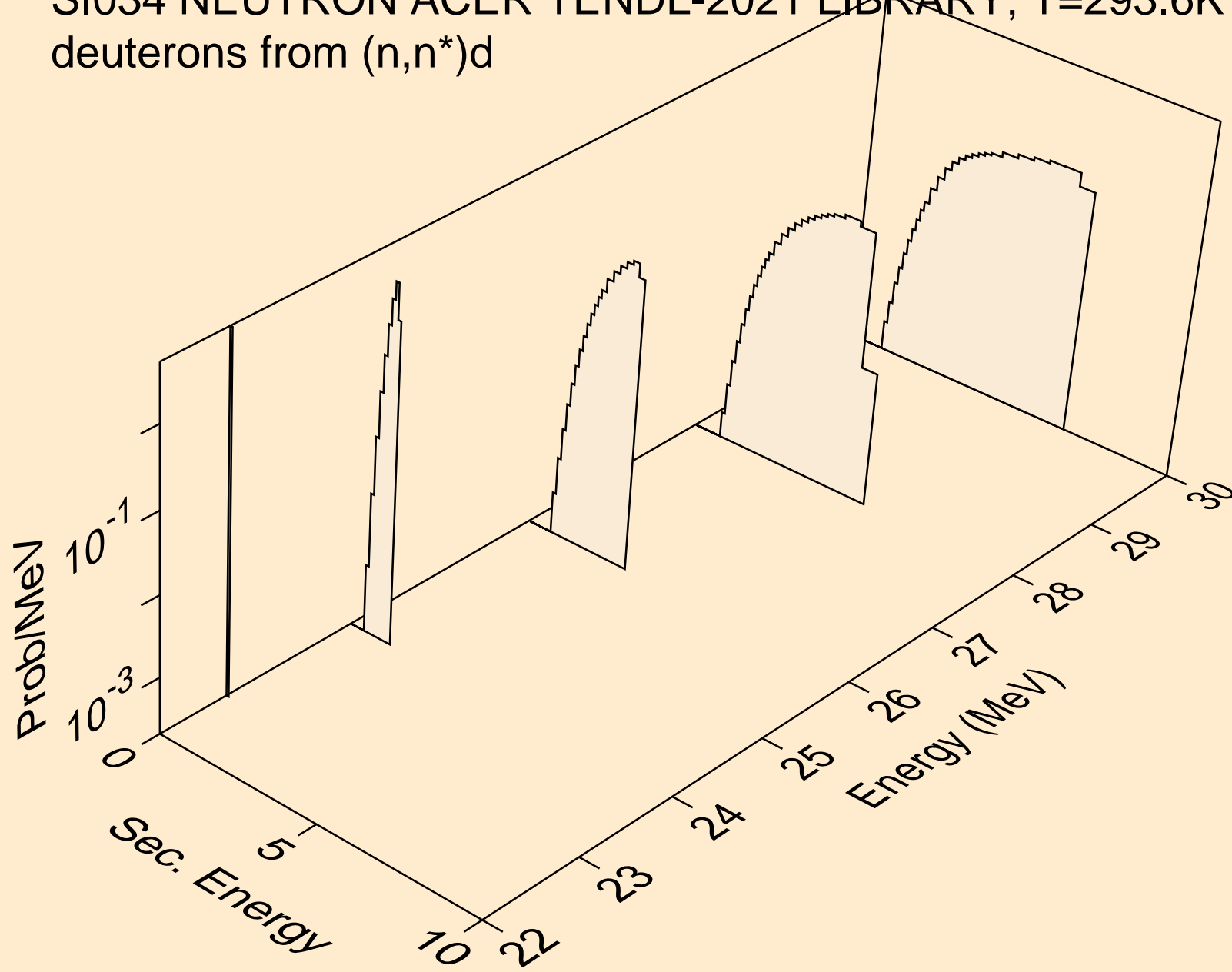

SI034 NEUTRON ACER TENDL-2021 LIBRARY; T=293.6K
deuterons from (n,d)

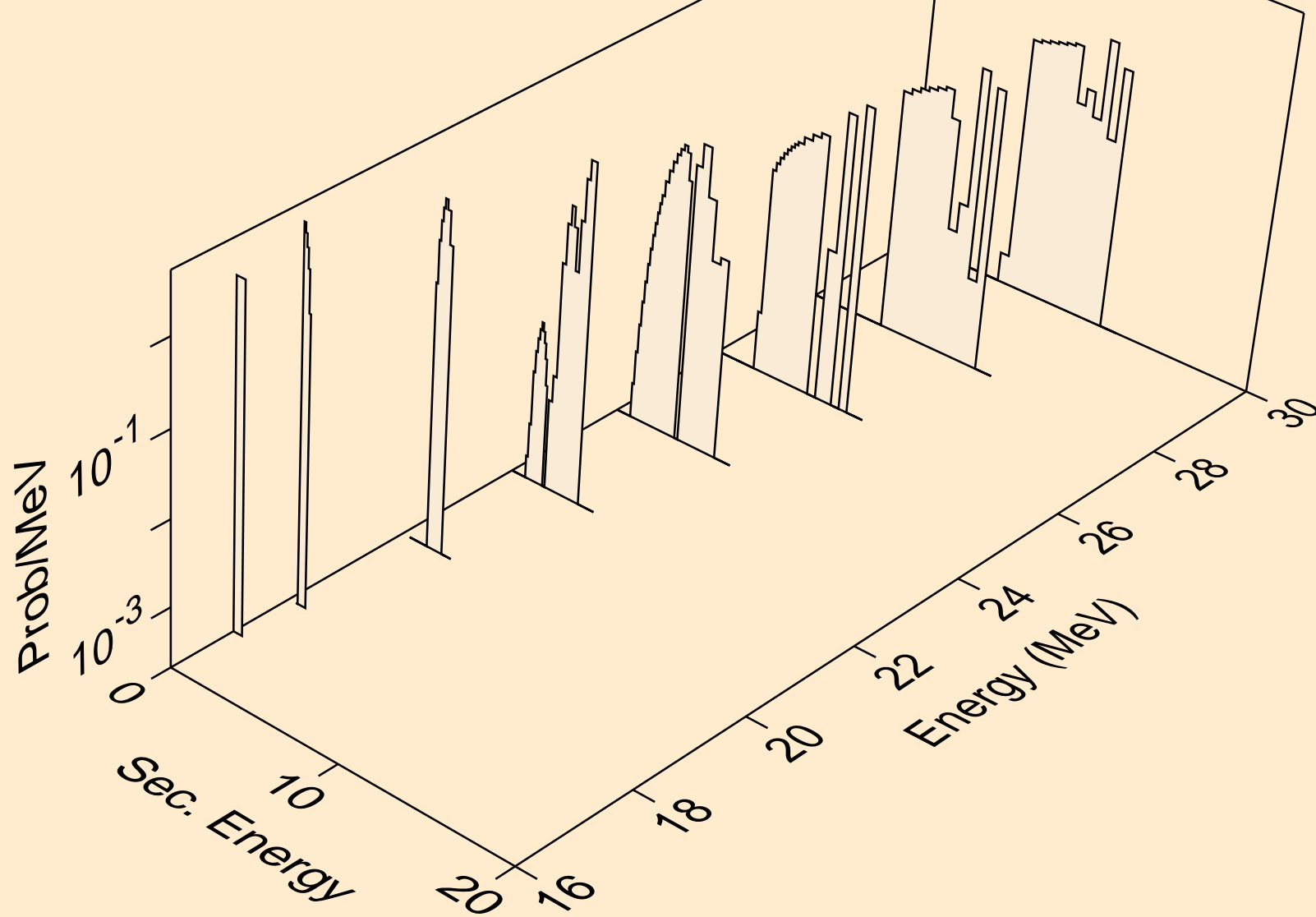

SI034 NEUTRON ACER TENDL-2021 LIBRARY; T=293.6K
tritons from (n,x)

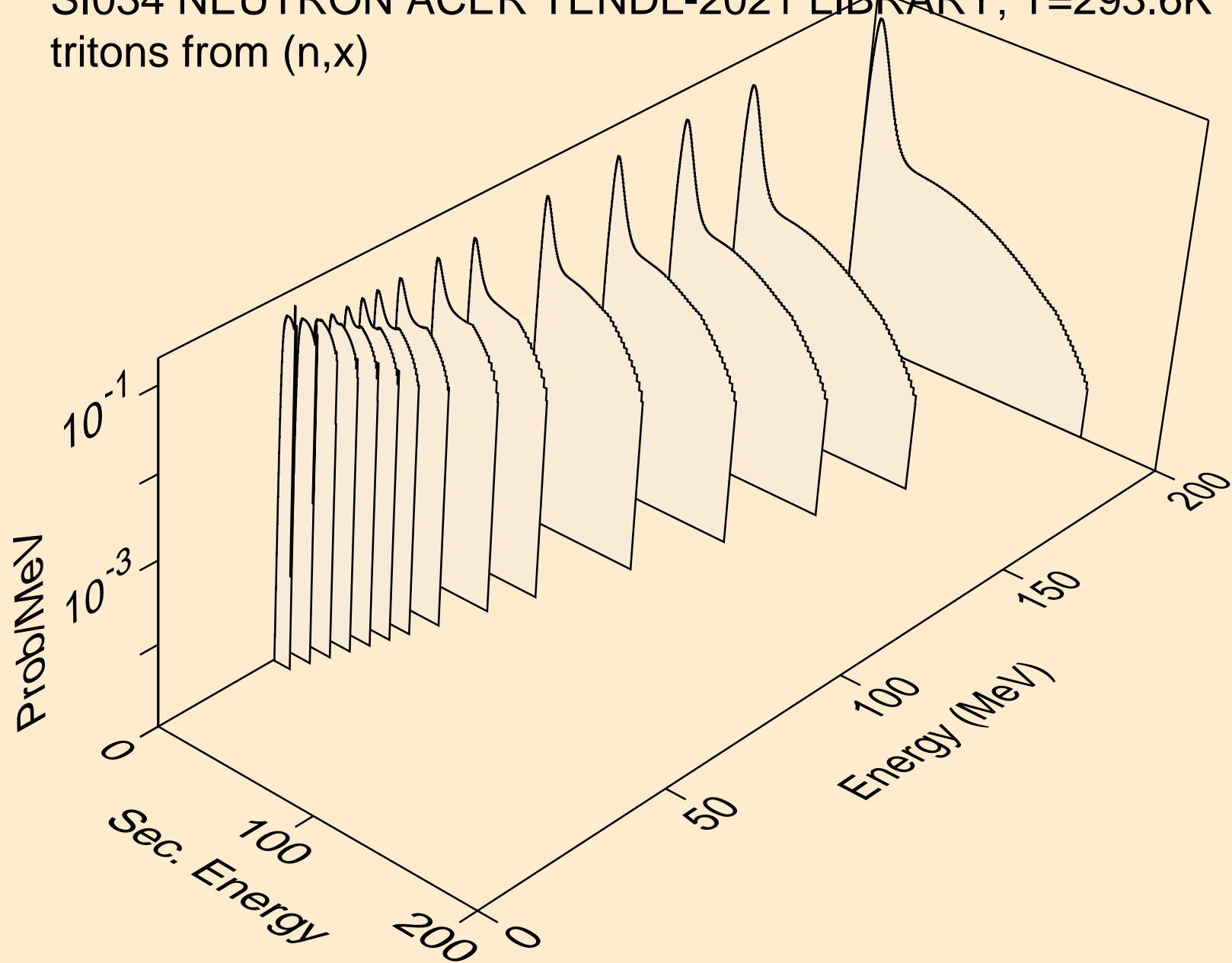

SI034 NEUTRON ACER TENDL-2021 LIBRARY; T=293.6K
tritons from (n,n*)t

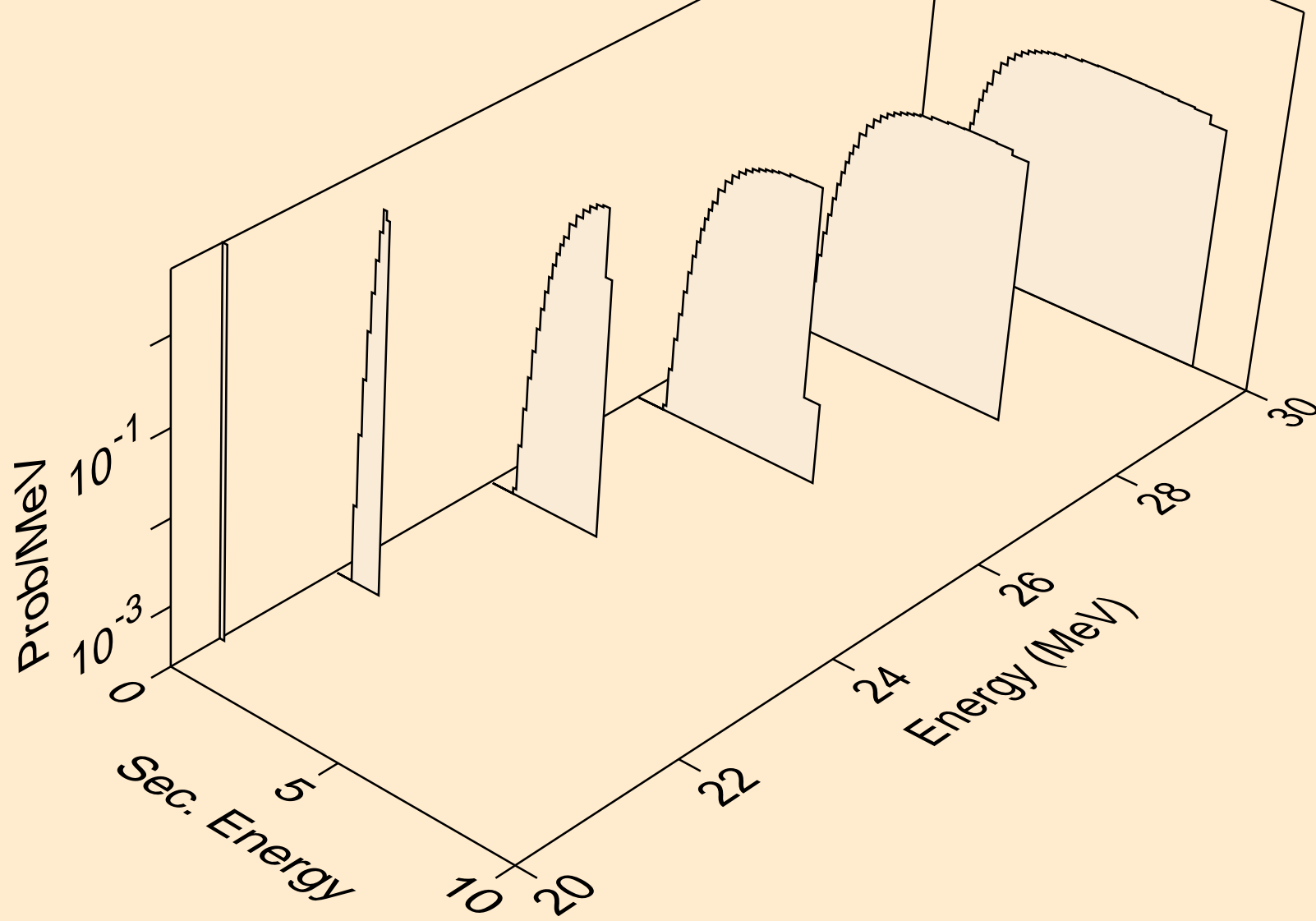

SI034 NEUTRON ACER TENDL-2021 LIBRARY; T=293.6K
tritons from (n,t)

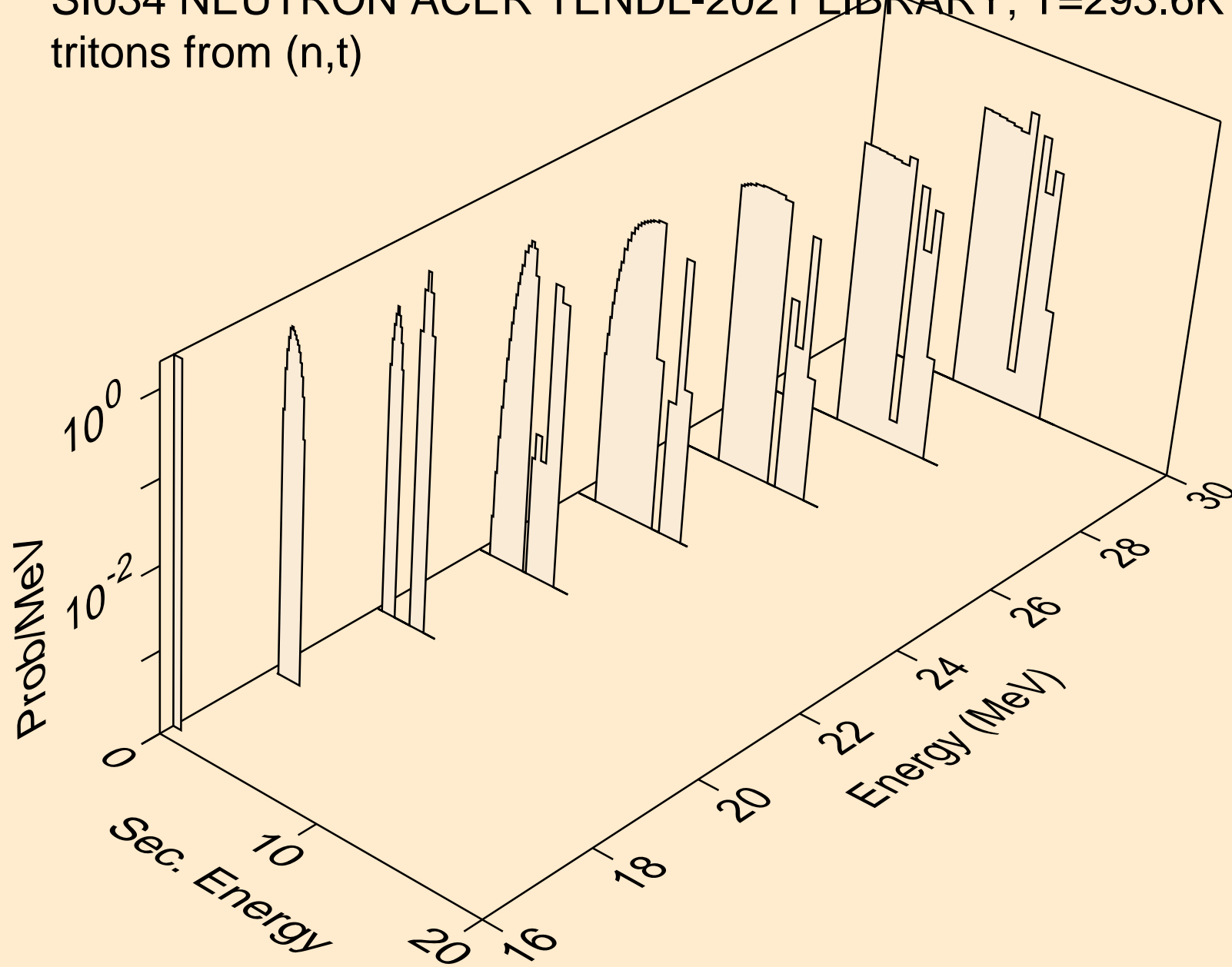

SI034 NEUTRON ACER TENDL-2021 LIBRARY; T=293.6K
he3s from (n,x)

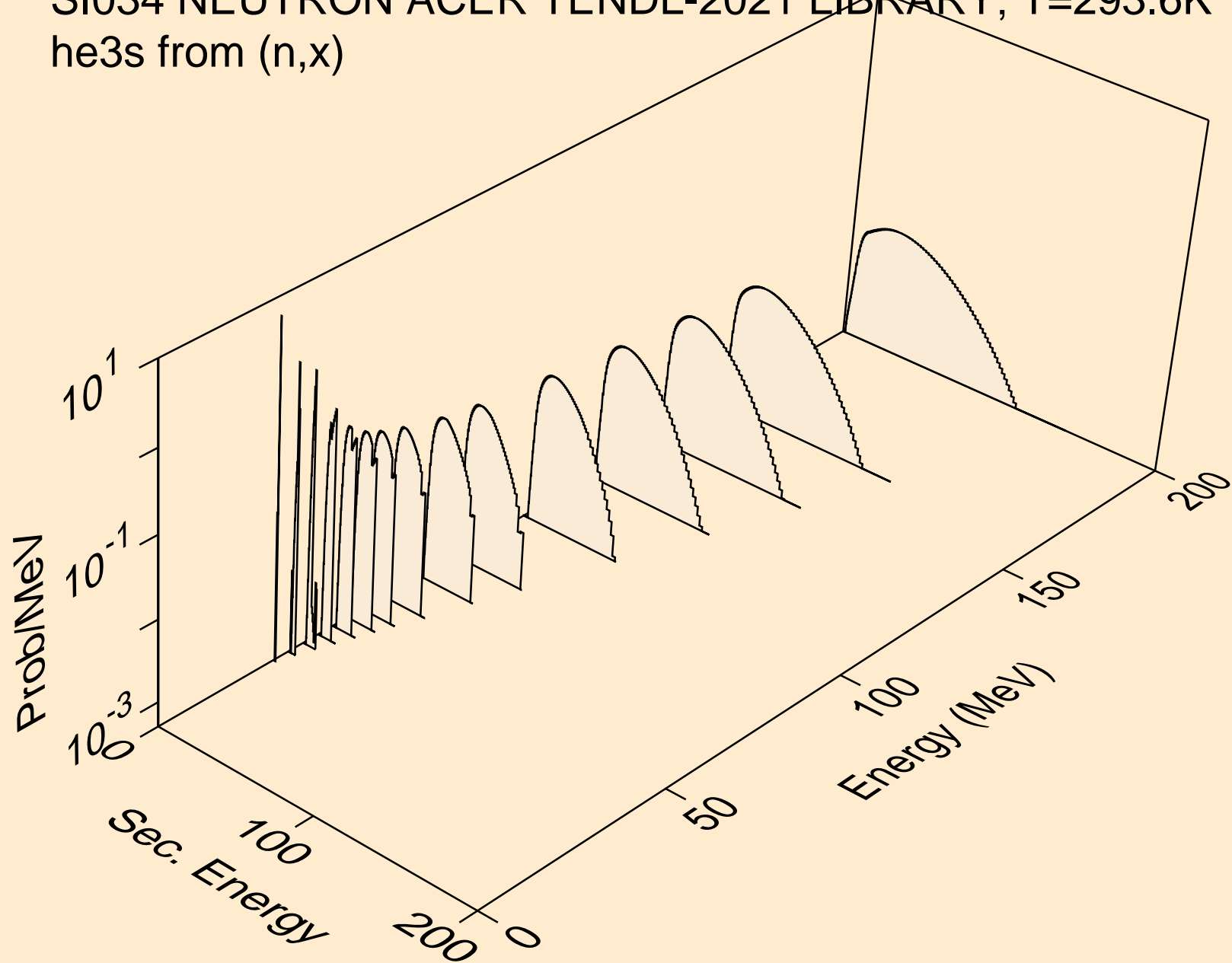

SI034 NEUTRON ACER TENDL-2021 LIBRARY; T=293.6K
alphas from (n,x)

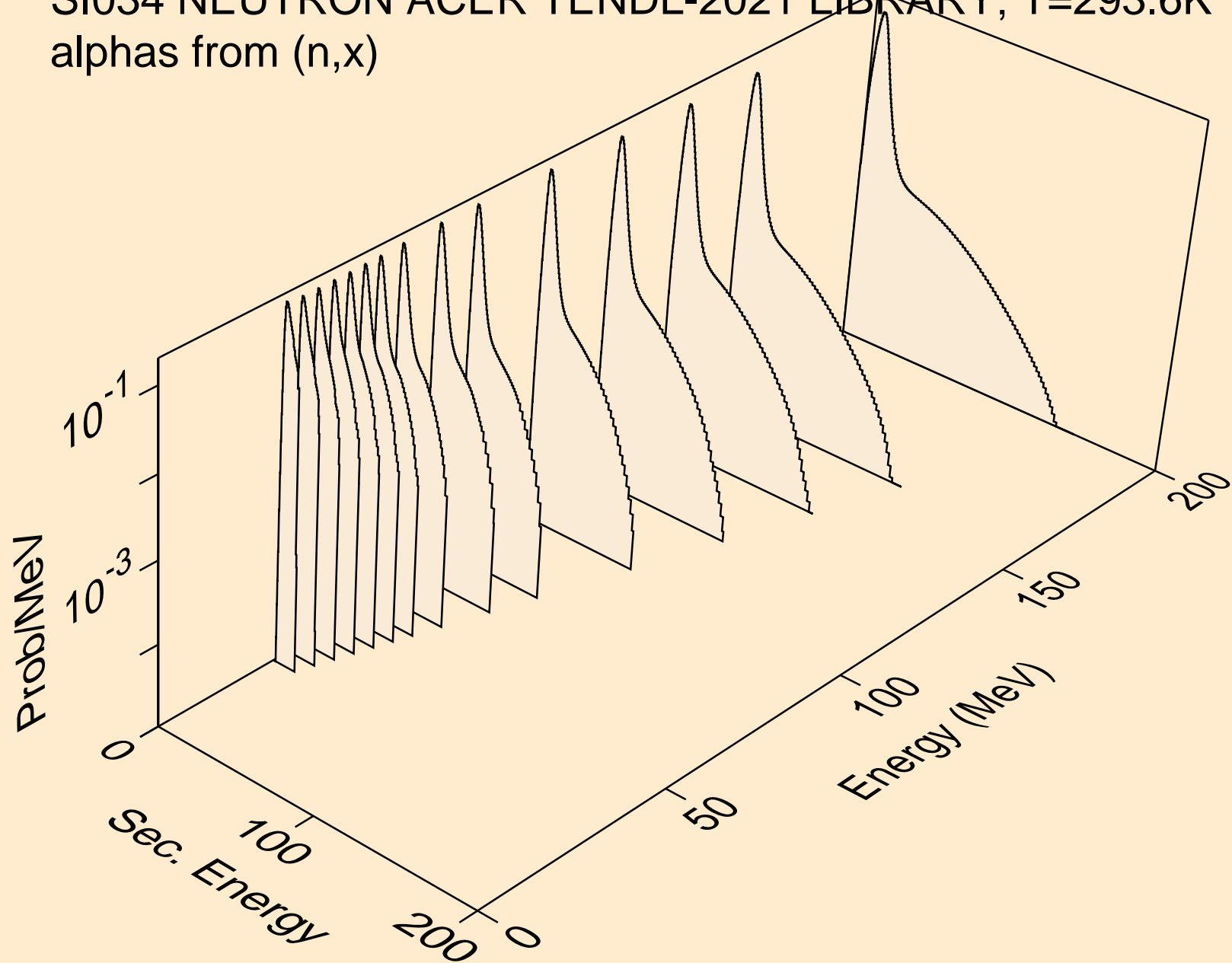

SI034 NEUTRON ACER TENDL-2021 LIBRARY; T=293.6K
alphas from (n,n*)a

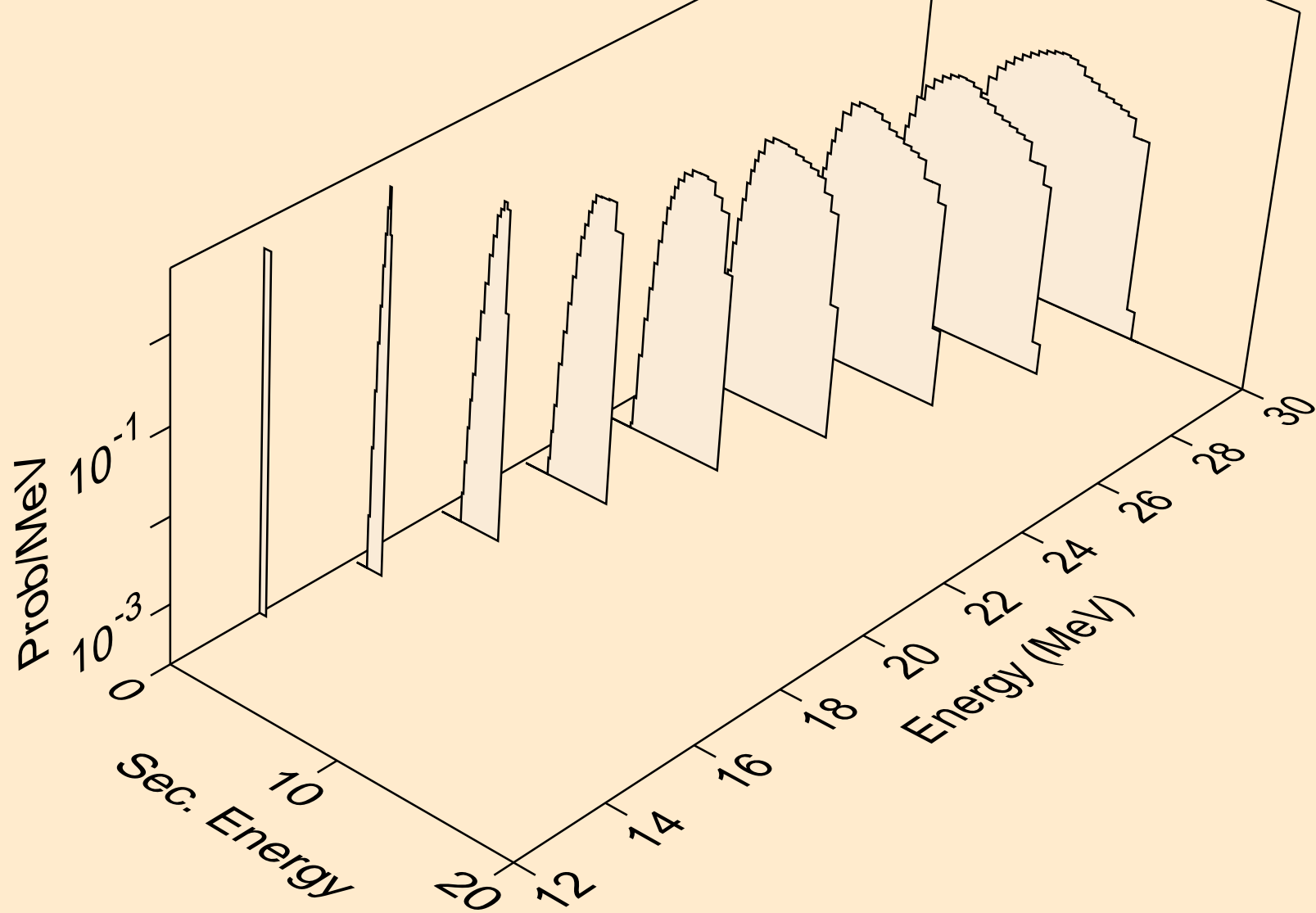

SI034 NEUTRON ACER TENDL-2021 LIBRARY; T=293.6K
alphas from (n,2n)a

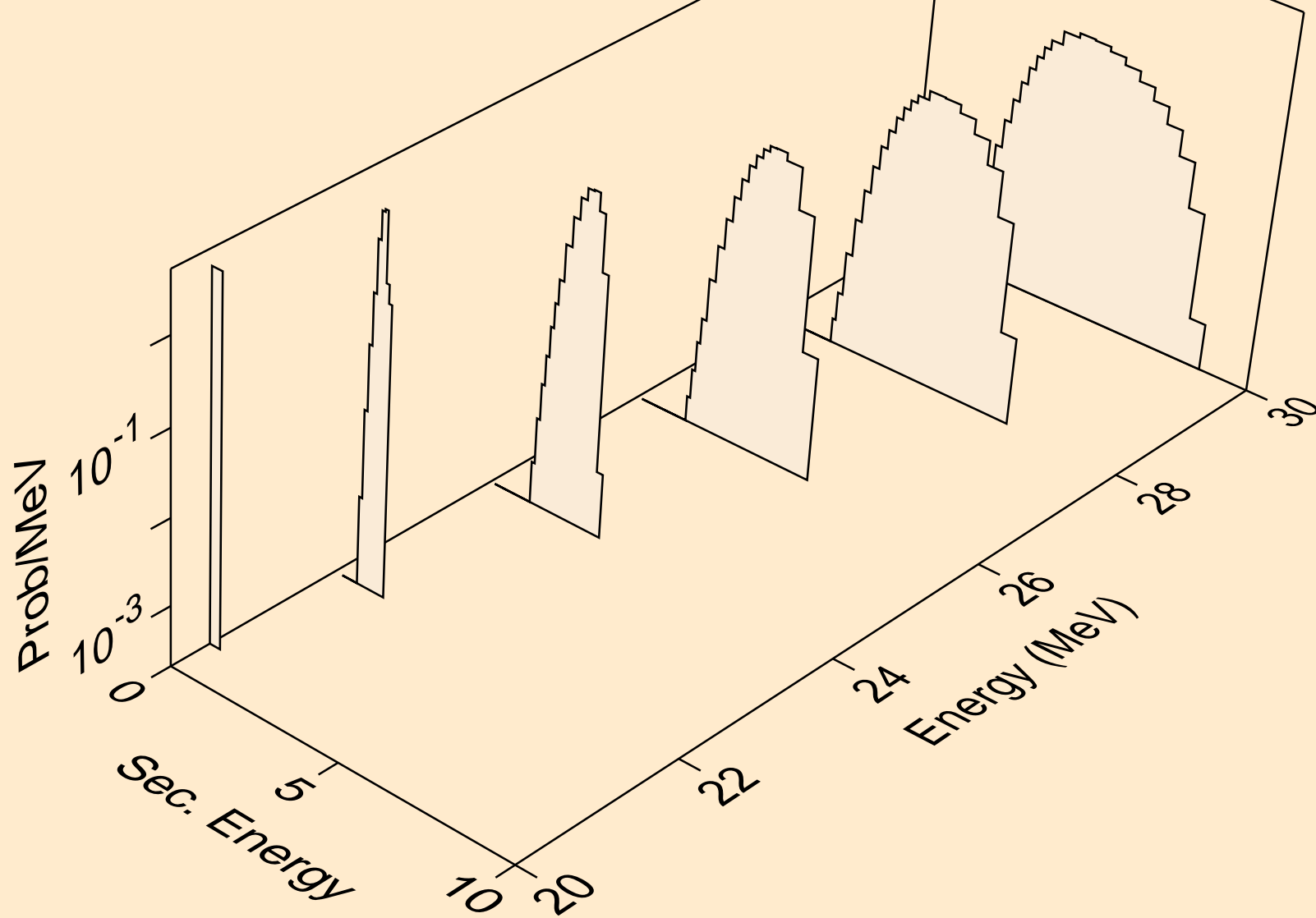

SI034 NEUTRON ACER TENDL-2021 LIBRARY; T=293.6K
alphas from (n,3n)a

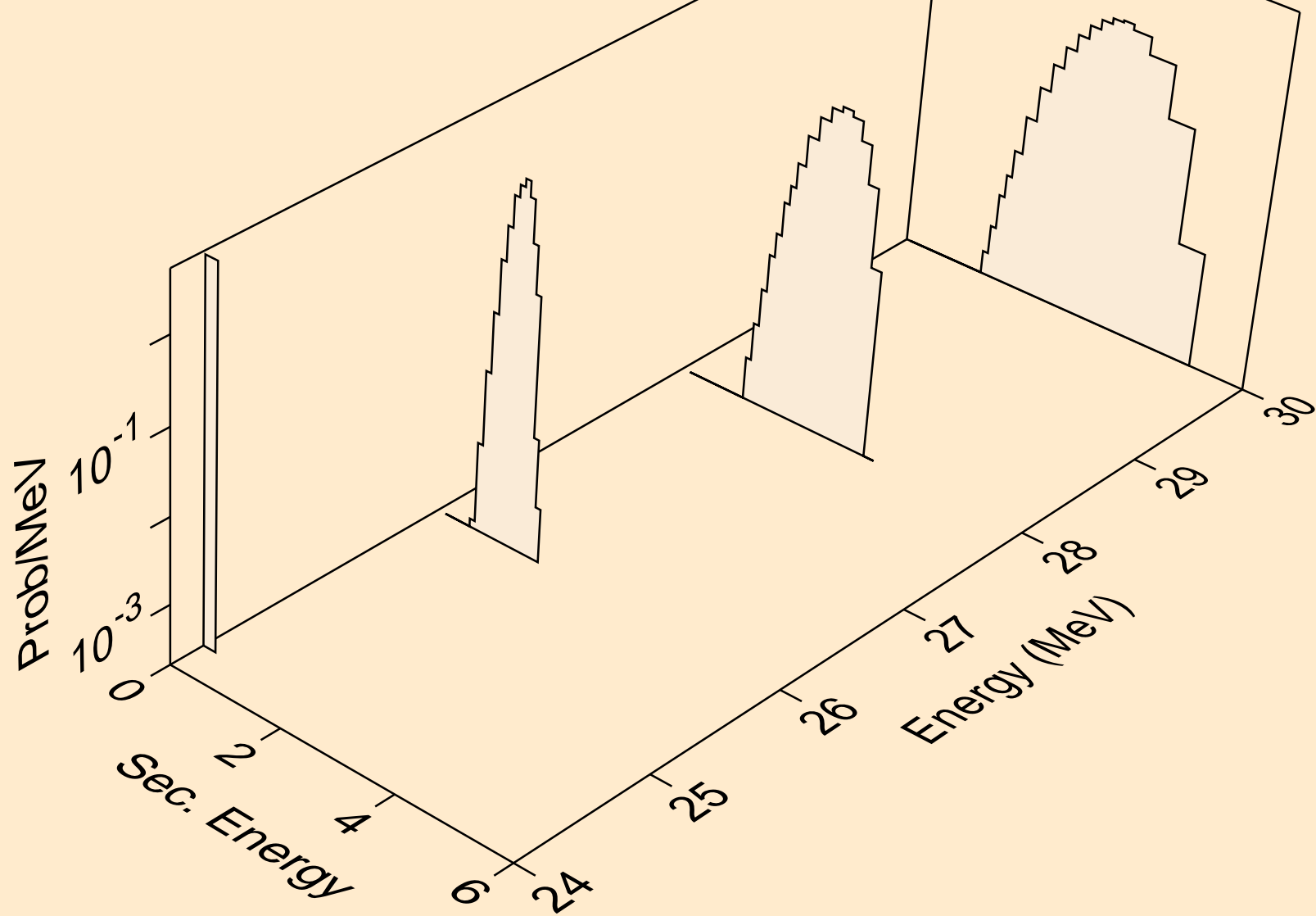

SI034 NEUTRON ACER TENDL-2021 LIBRARY; T=293.6K
alphas from (n,a)

