

SN131M NEUTRON ACER TENDL-2021 LIBRARY; T=293.6K

Principal cross sections

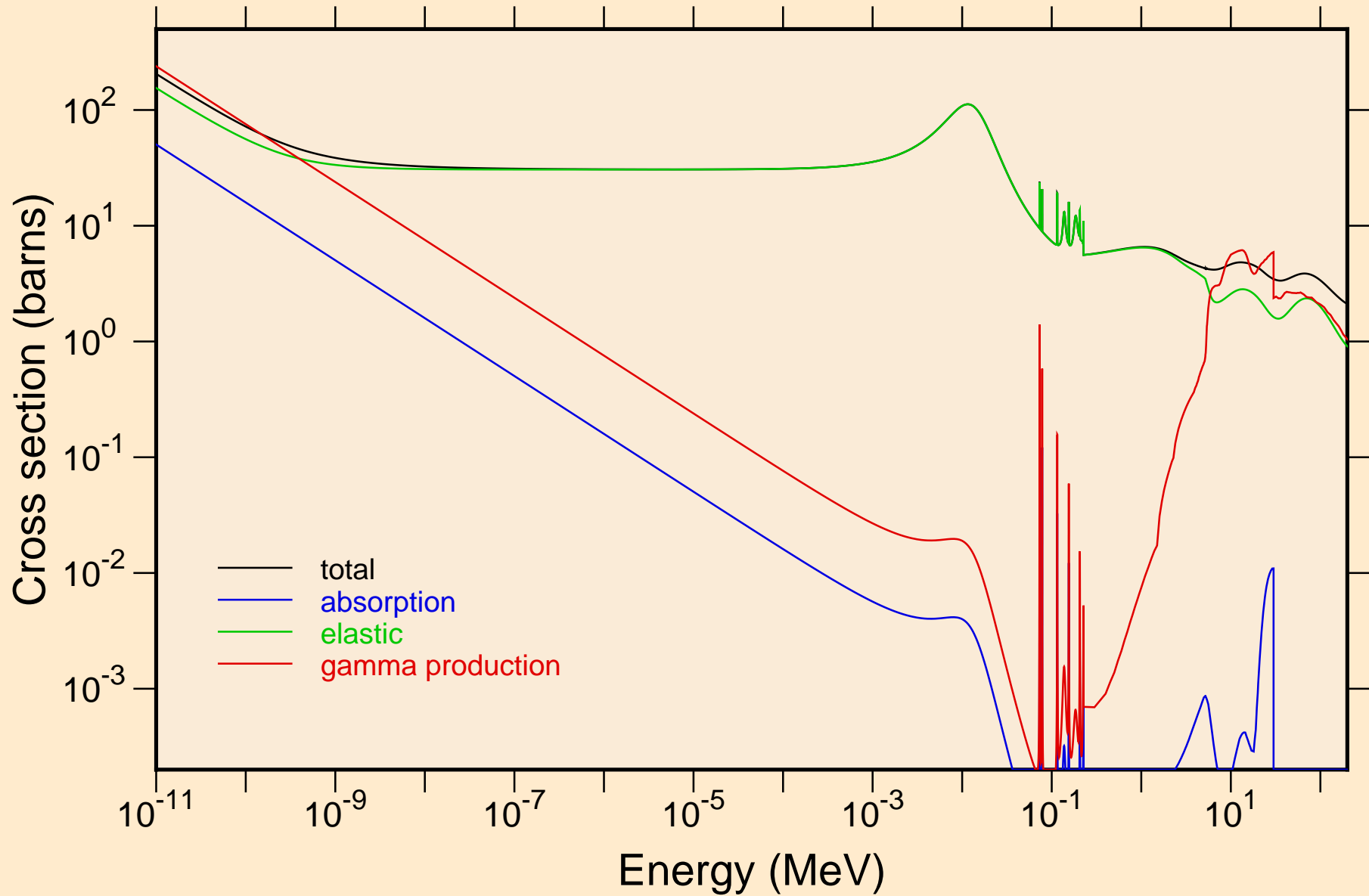

SN131M NEUTRON ACER TENDL-2021 LIBRARY; T=293.6K
resonance total cross section

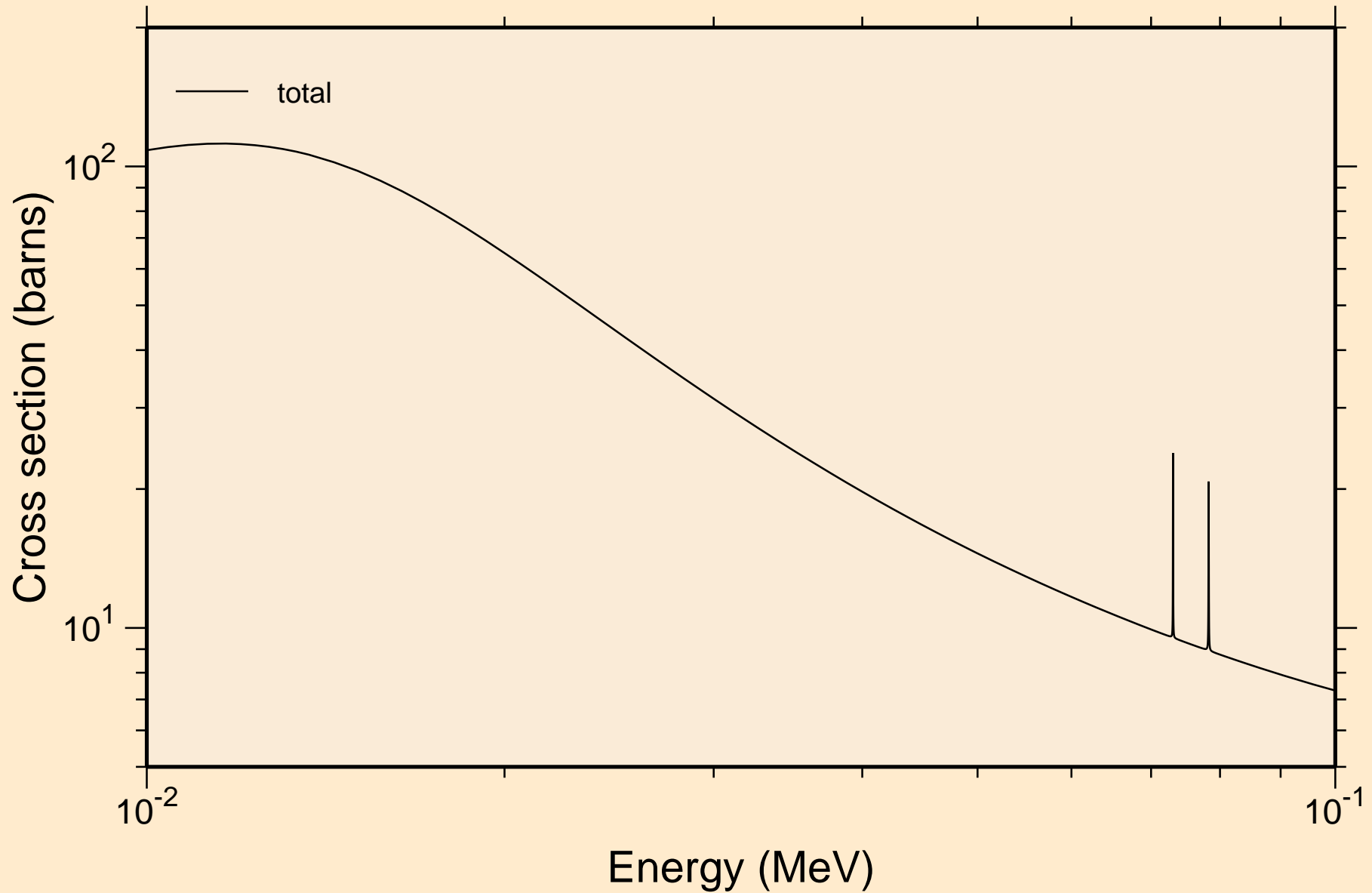

SN131M NEUTRON ACER TENDL-2021 LIBRARY; T=293.6K
resonance total cross section

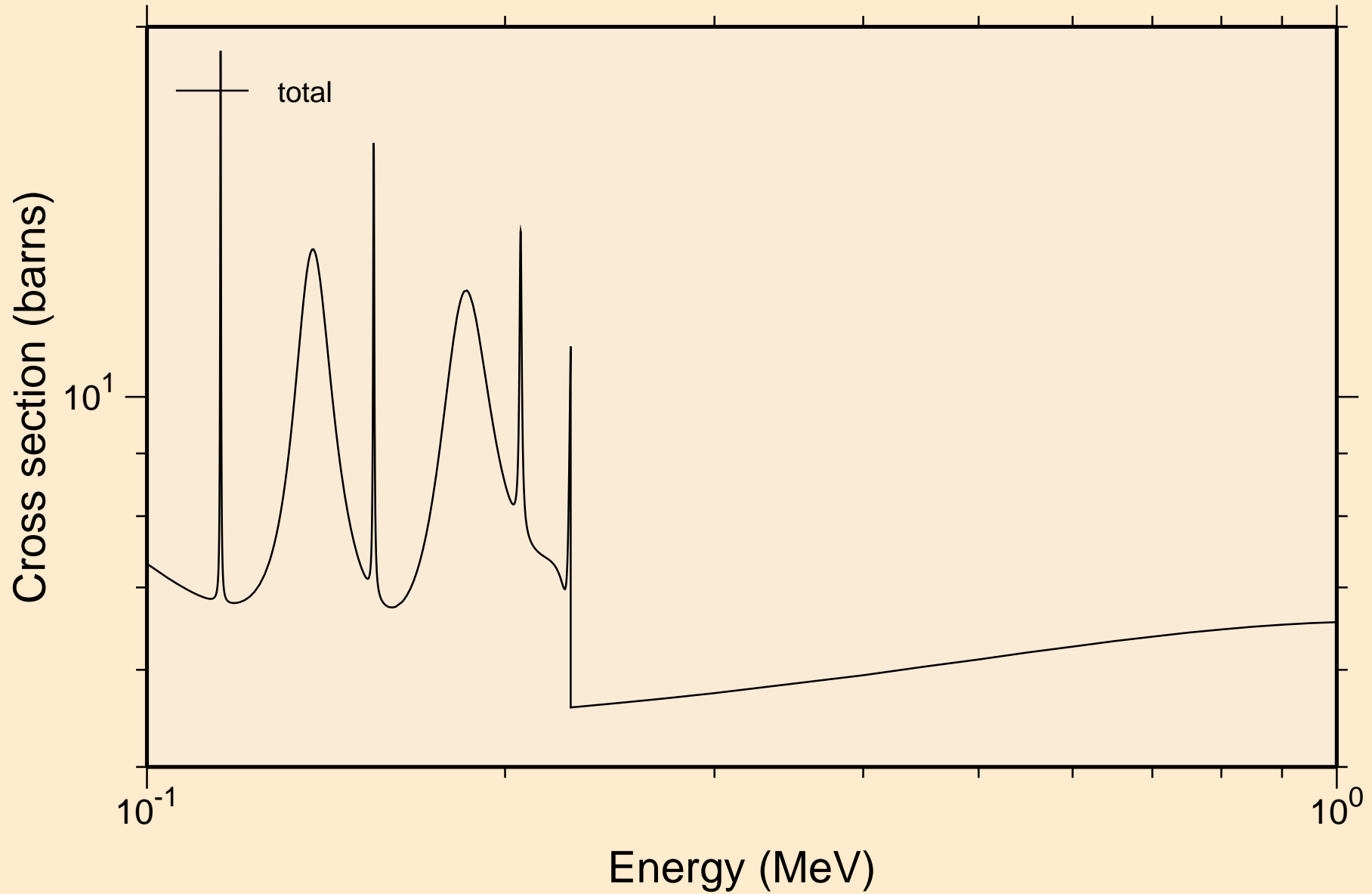

$\bar{S}N131M$ NEUTRON ACER TENDL-2021 LIBRARY; T=293.6K
resonance total cross section

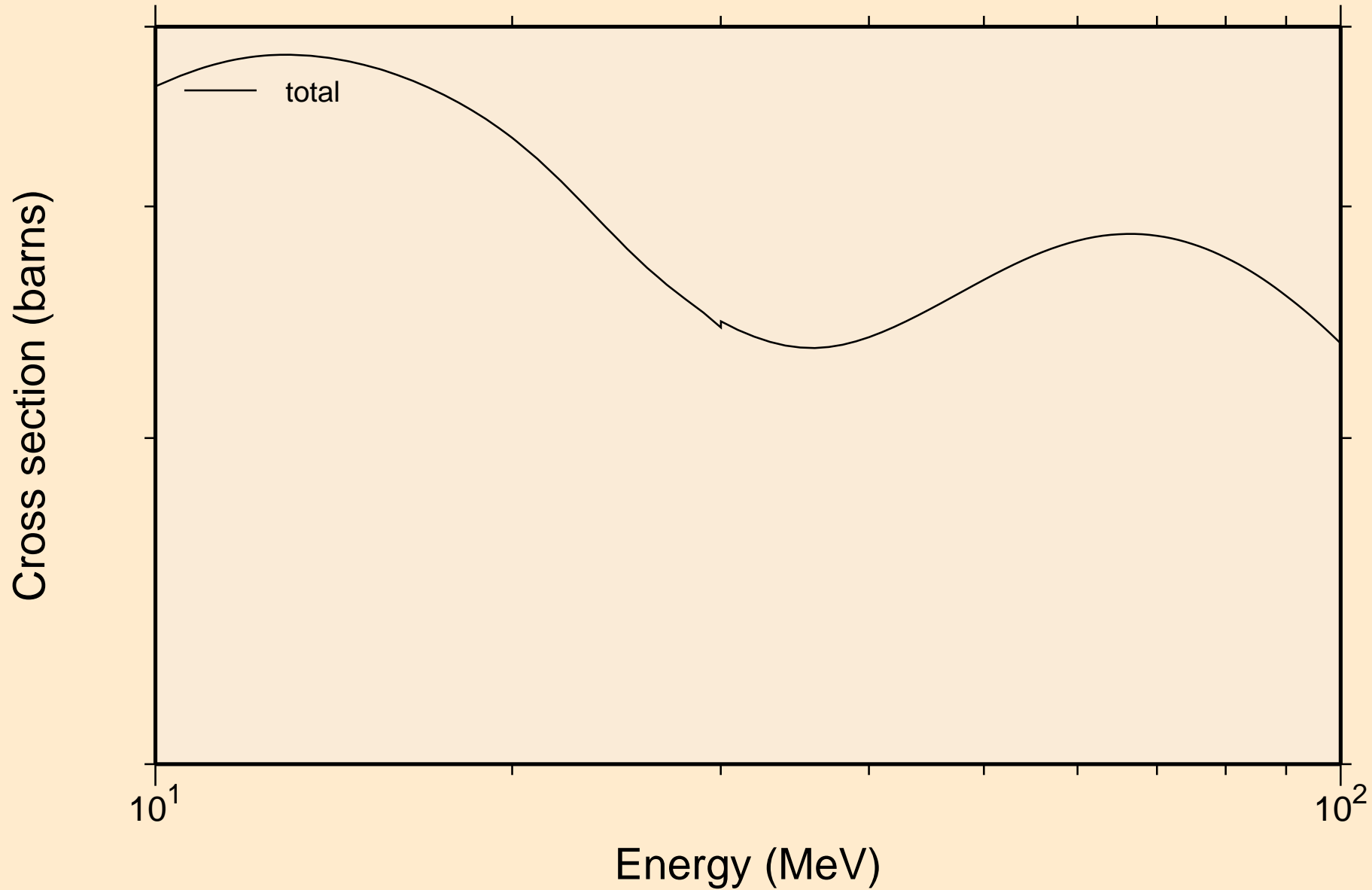

SN131M NEUTRON ACER TENDL-2021 LIBRARY; T=293.6K
resonance absorption cross sections



SN131M NEUTRON ACER TENDL-2021 LIBRARY; T=293.6K
resonance absorption cross sections

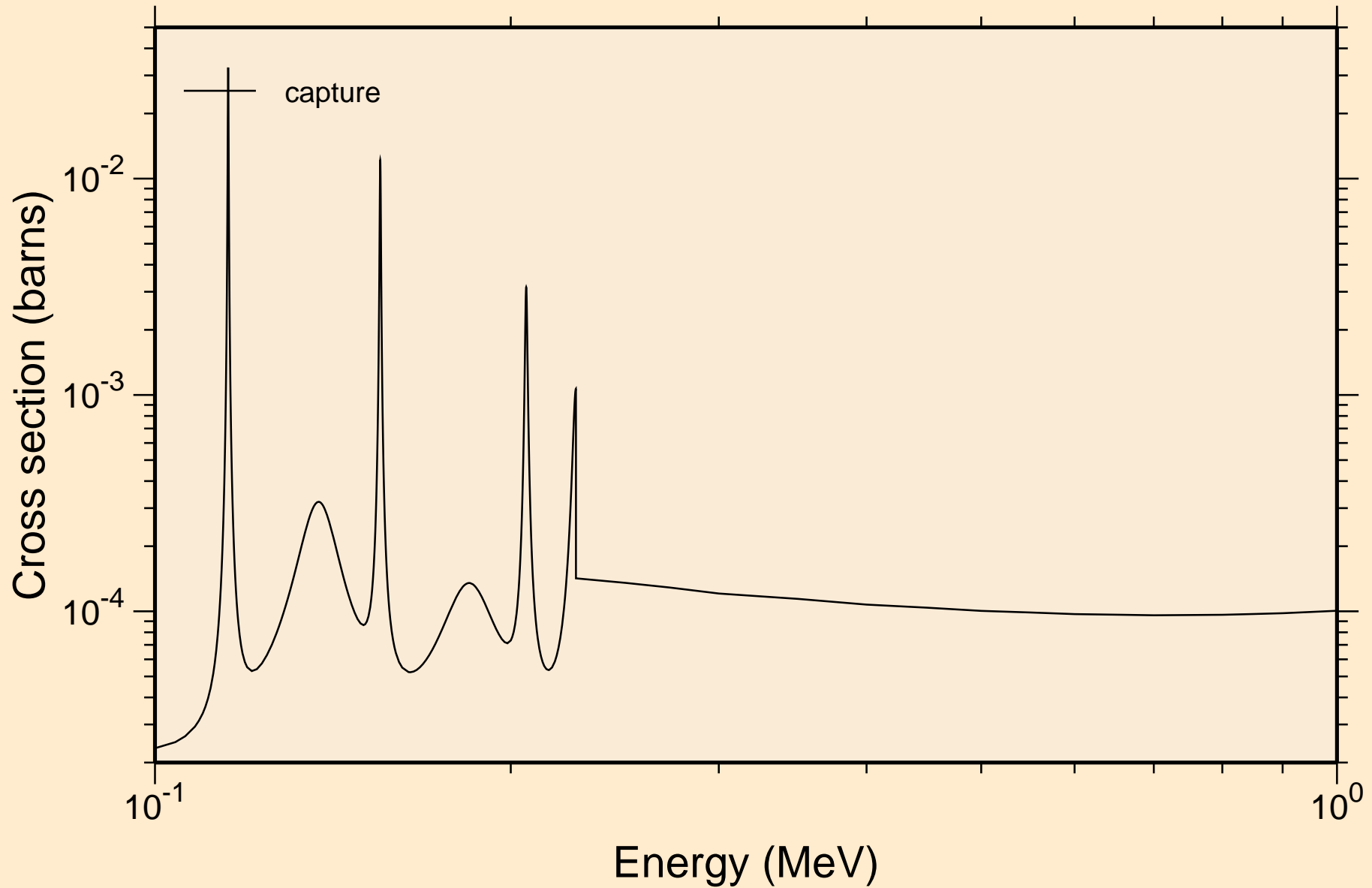

SN131M NEUTRON ACER TENDL-2021 LIBRARY; T=293.6K
resonance absorption cross sections

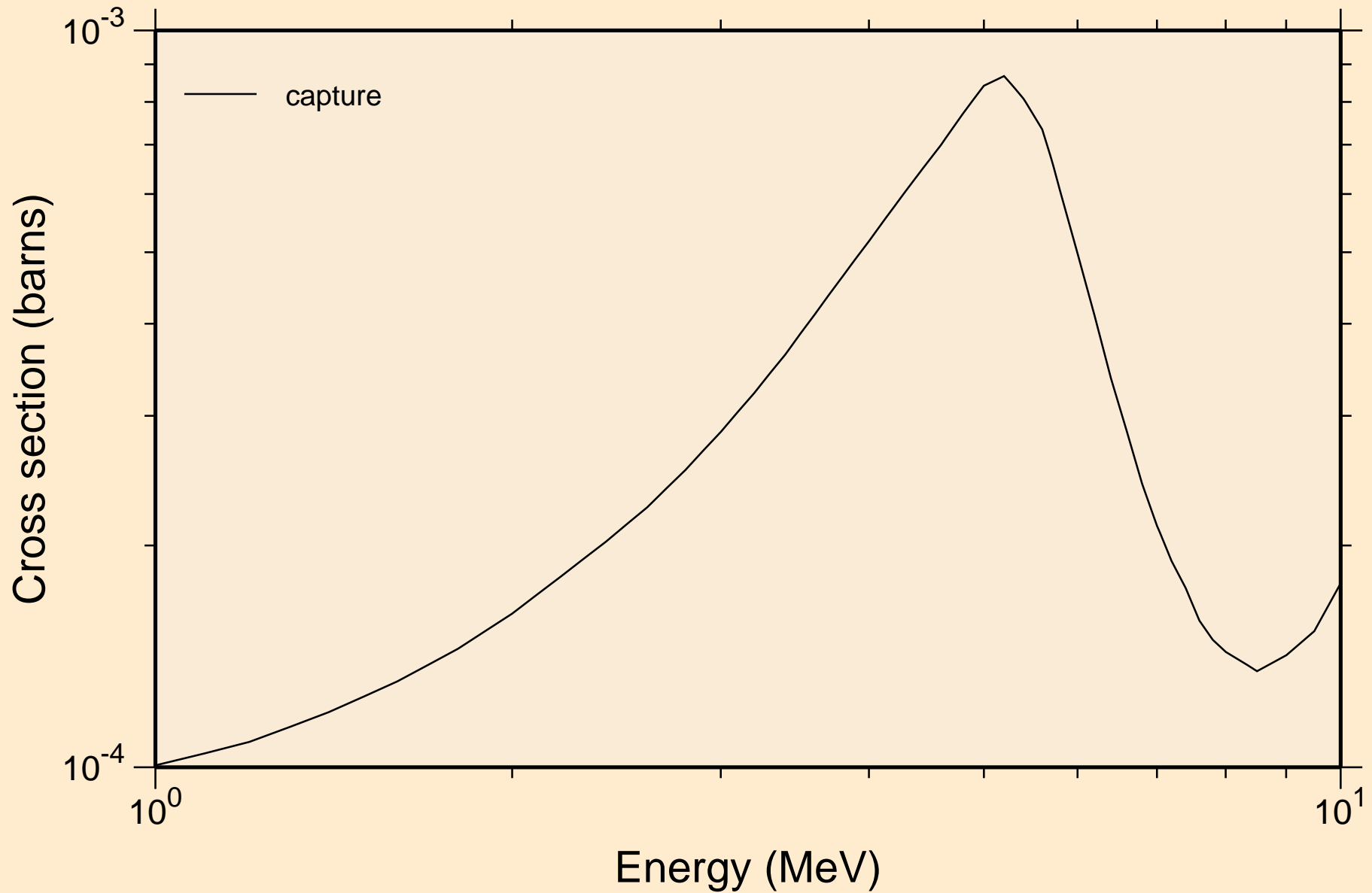

SN131M NEUTRON ACER TENDL-2021 LIBRARY; T=293.6K
Heating

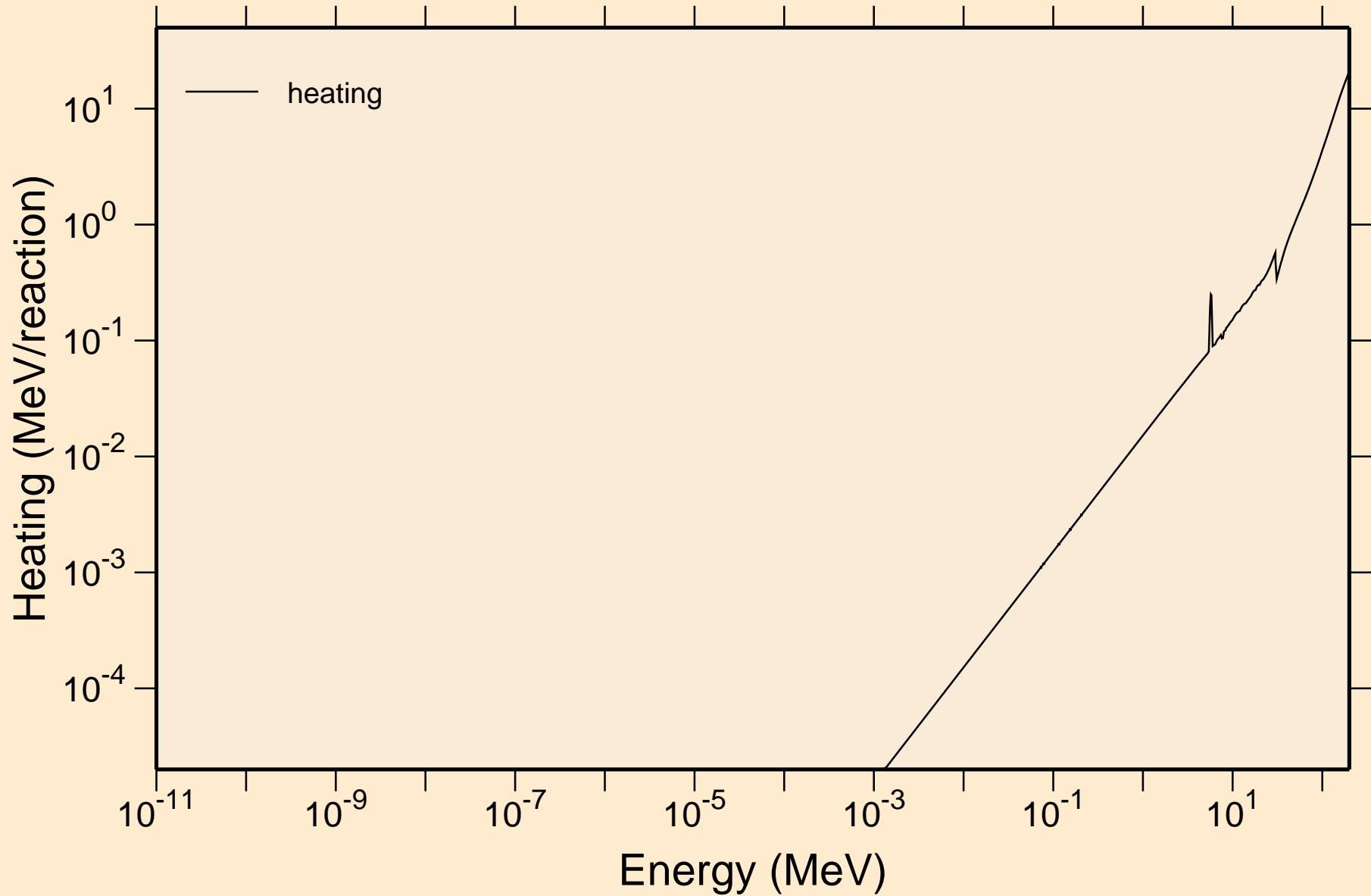

SN131M NEUTRON ACER TENDL-2021 LIBRARY; T=293.6K Damage

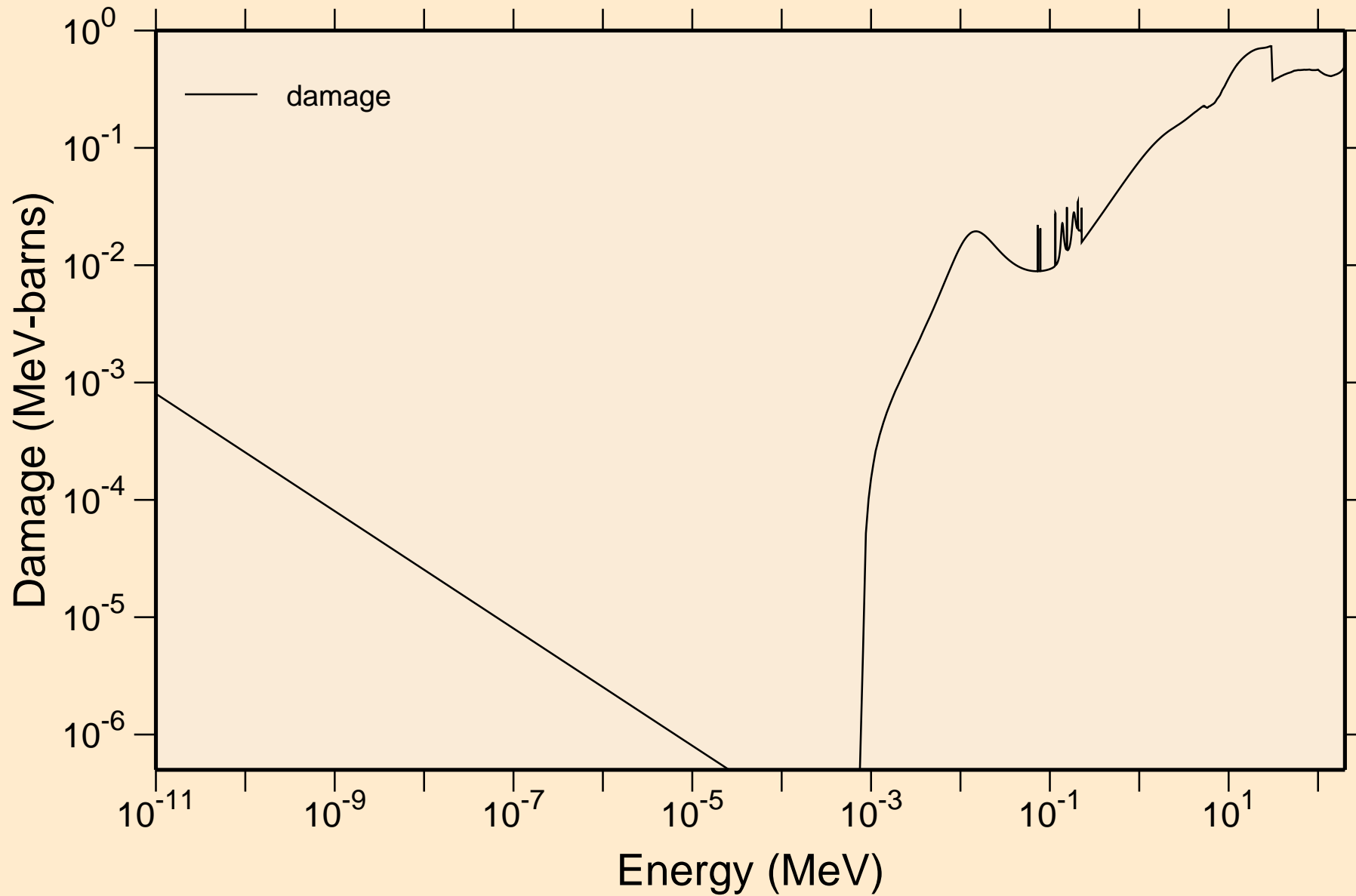

SN131M NEUTRON ACER TENDL-2021 LIBRARY; T=293.6K
Non-threshold reactions

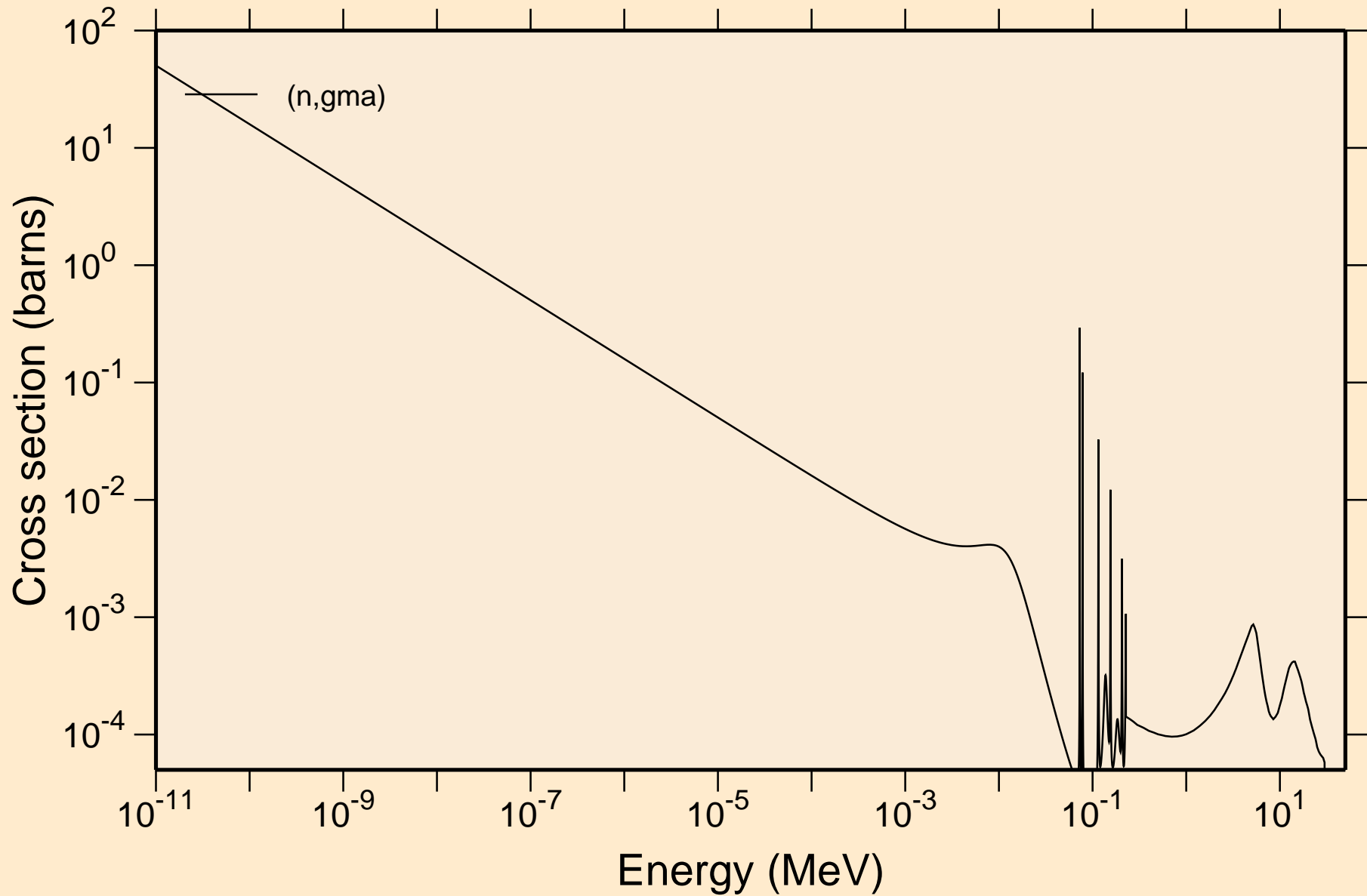

SN131M NEUTRON ACER TENDL-2021 LIBRARY; T=293.6K

Principal cross sections

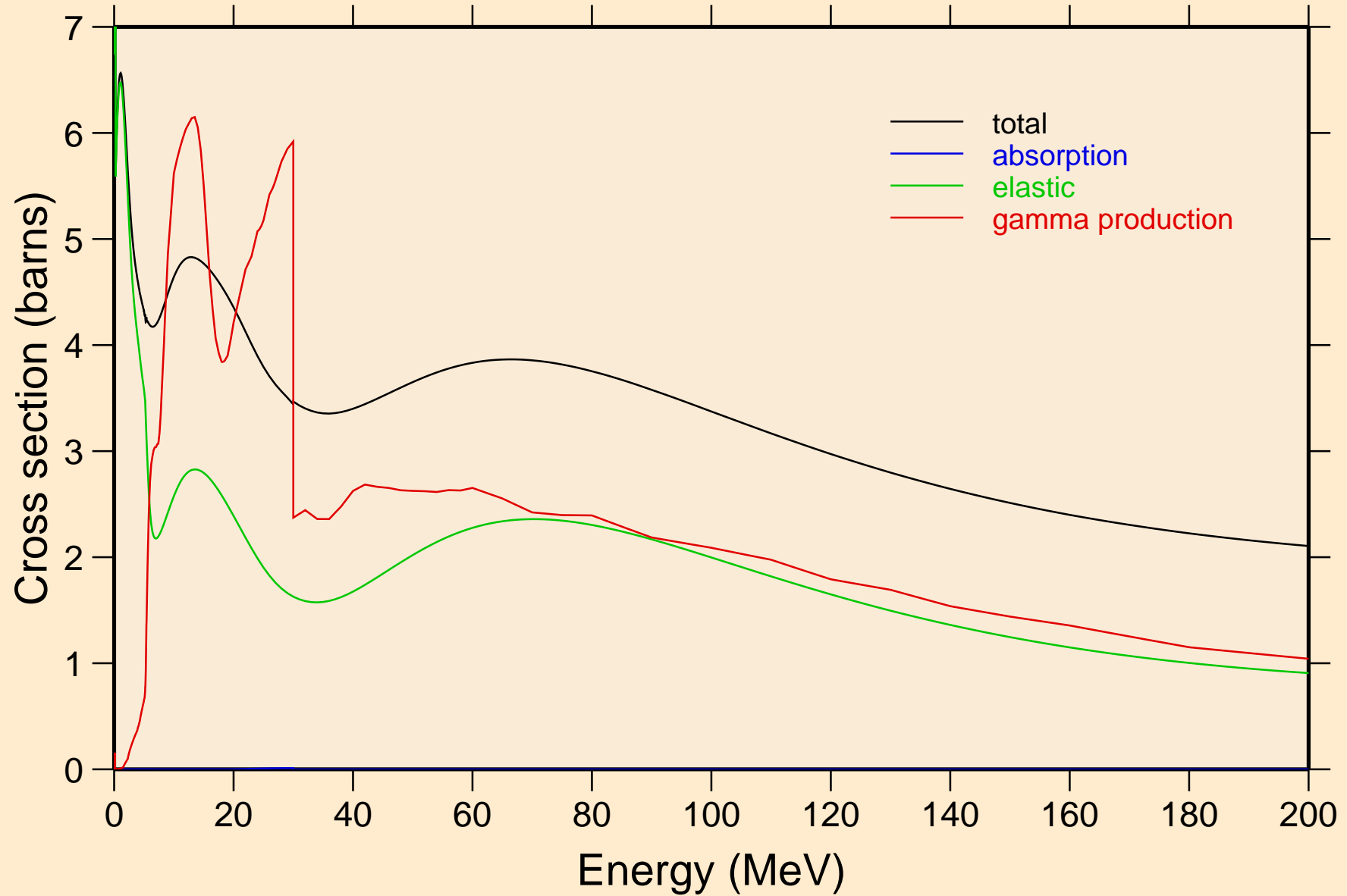

SN131M NEUTRON ACER TENDL-2021 LIBRARY; T=293.6K
Heating

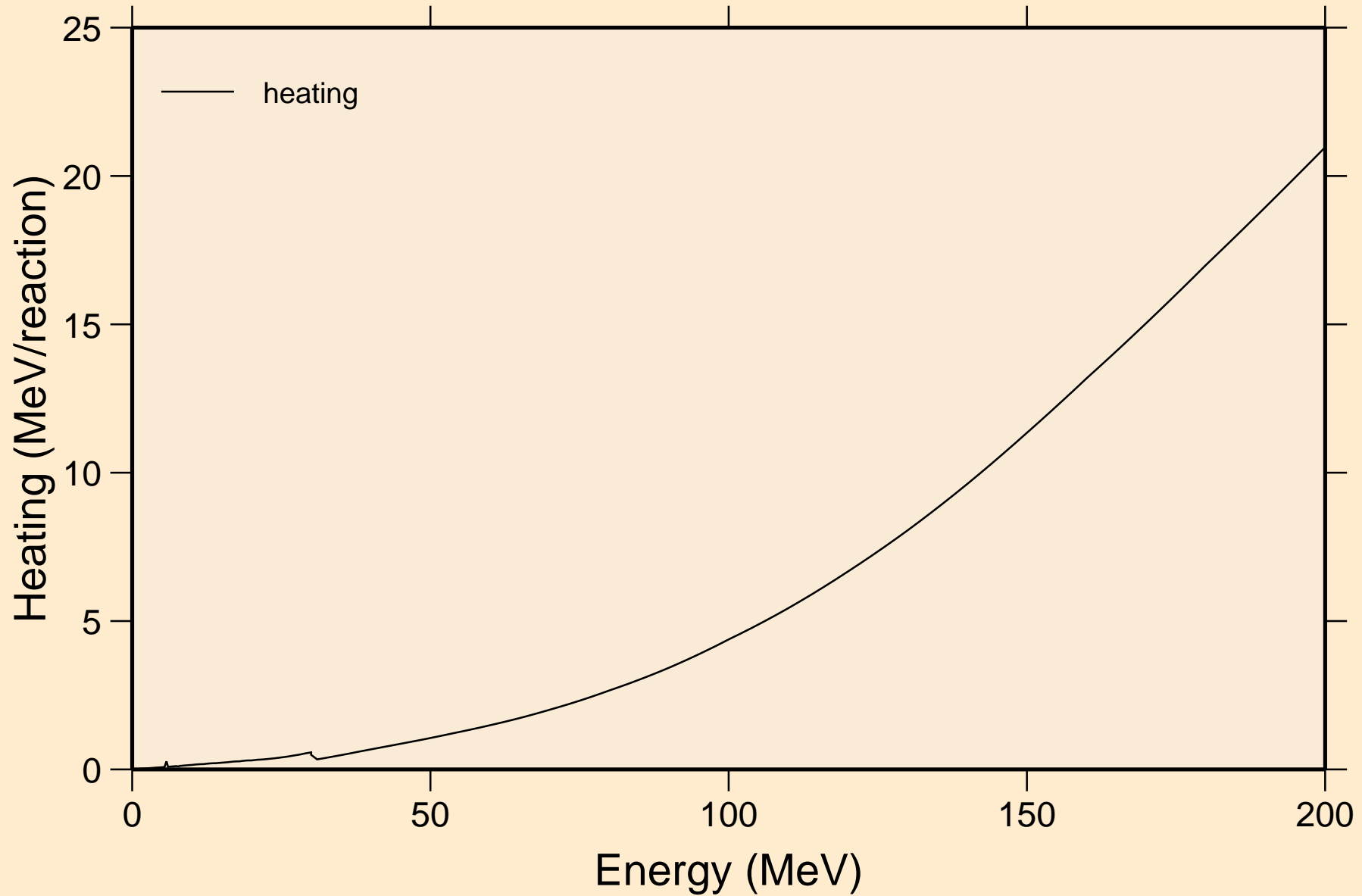

SN131M NEUTRON ACER TENDL-2021 LIBRARY; T=293.6K Damage

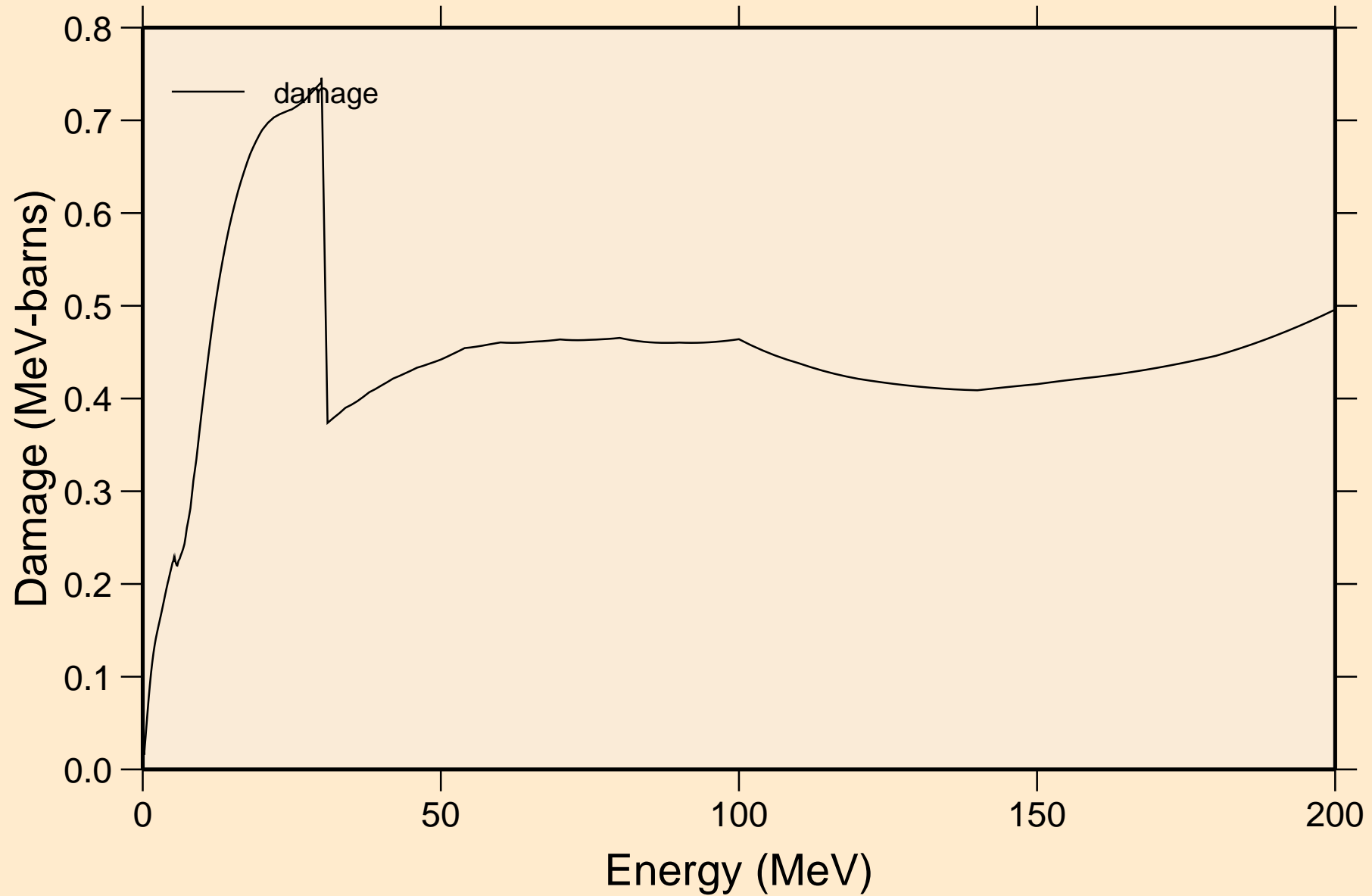

SN131M NEUTRON ACER TENDL-2021 LIBRARY; T=293.6K
Non-threshold reactions

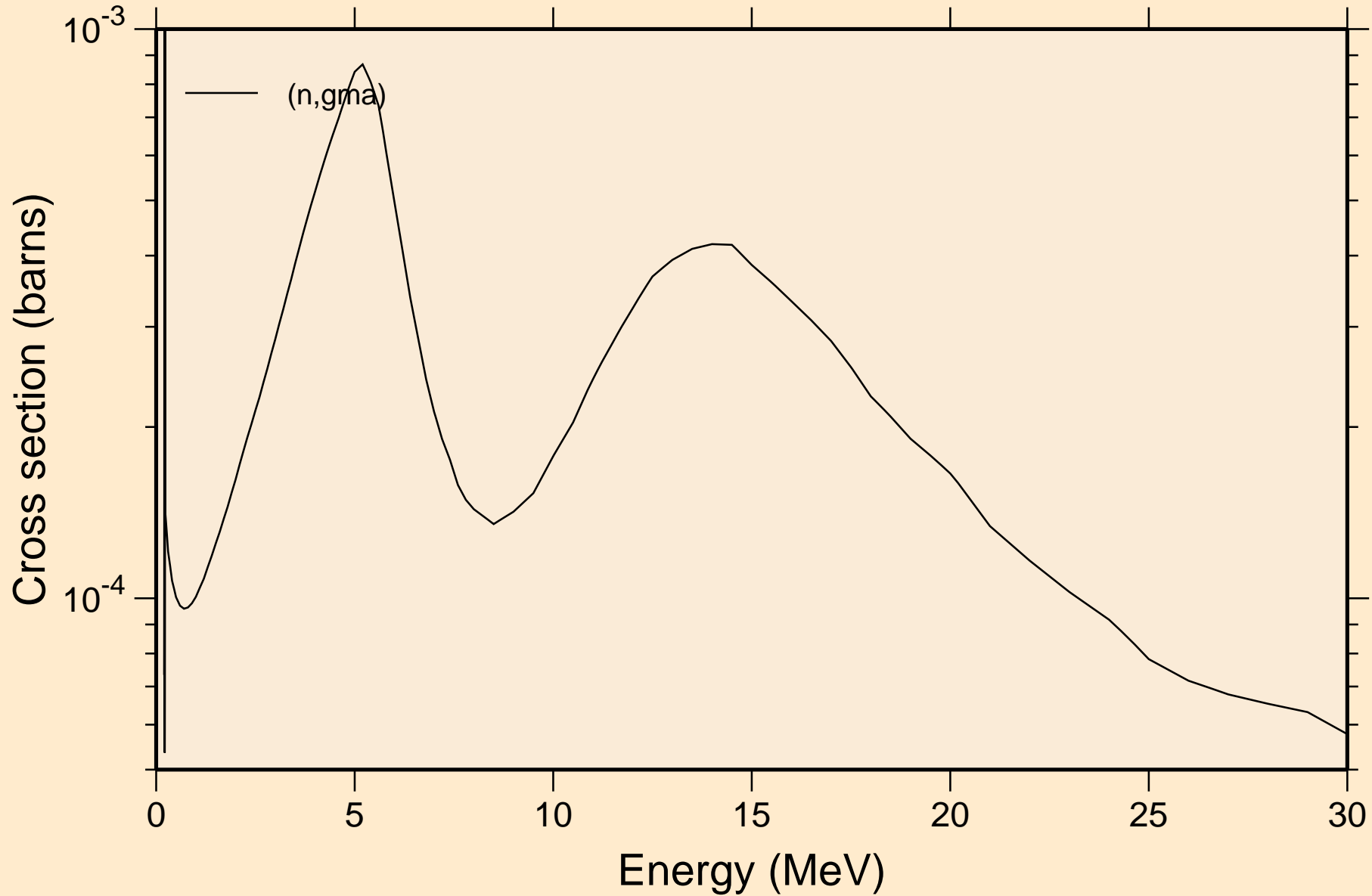

SN131M NEUTRON ACER TENDL-2021 LIBRARY; T=293.6K
Inelastic levels

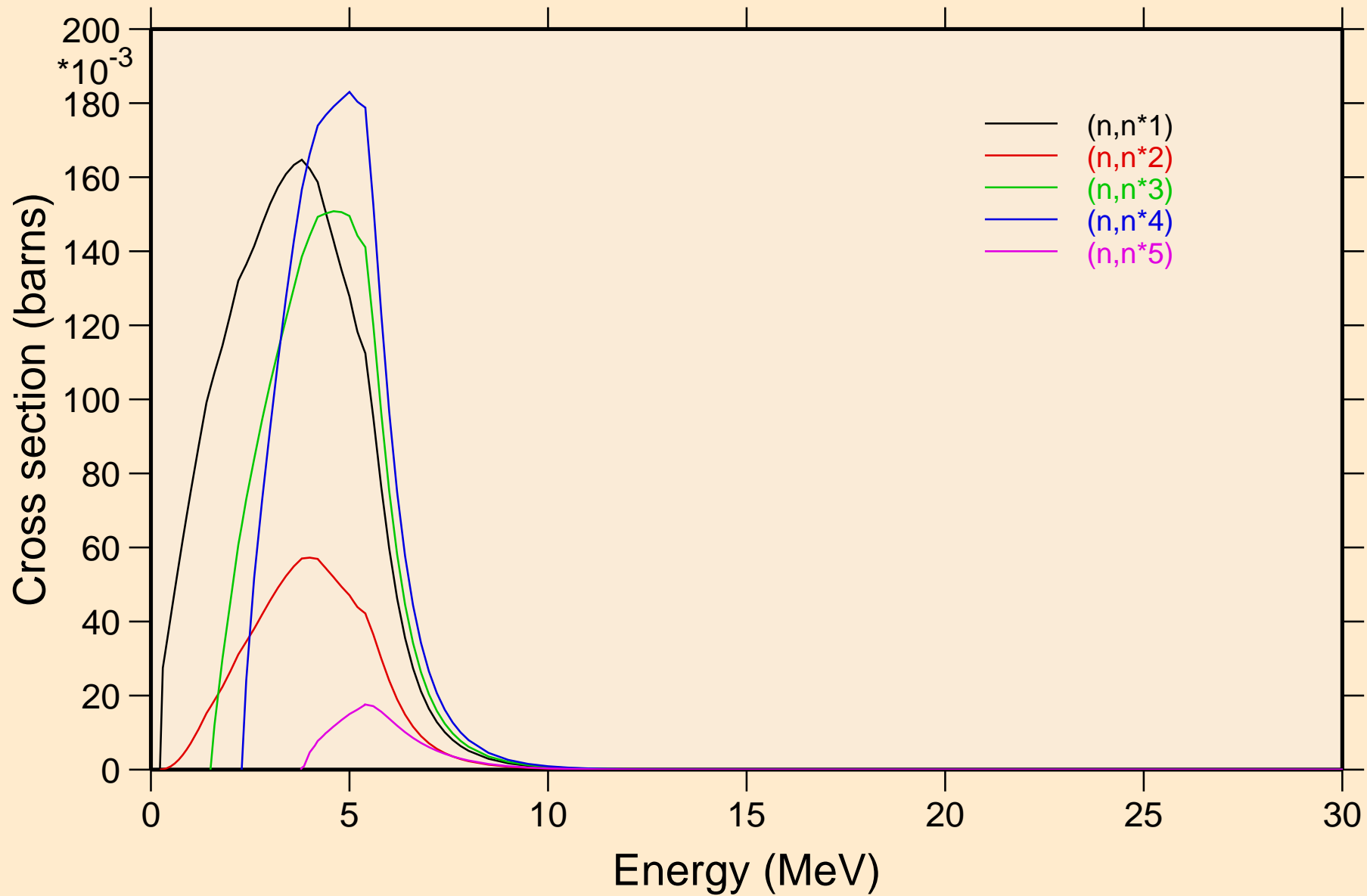

SN131M NEUTRON ACER TENDL-2021 LIBRARY; T=293.6K
Inelastic levels

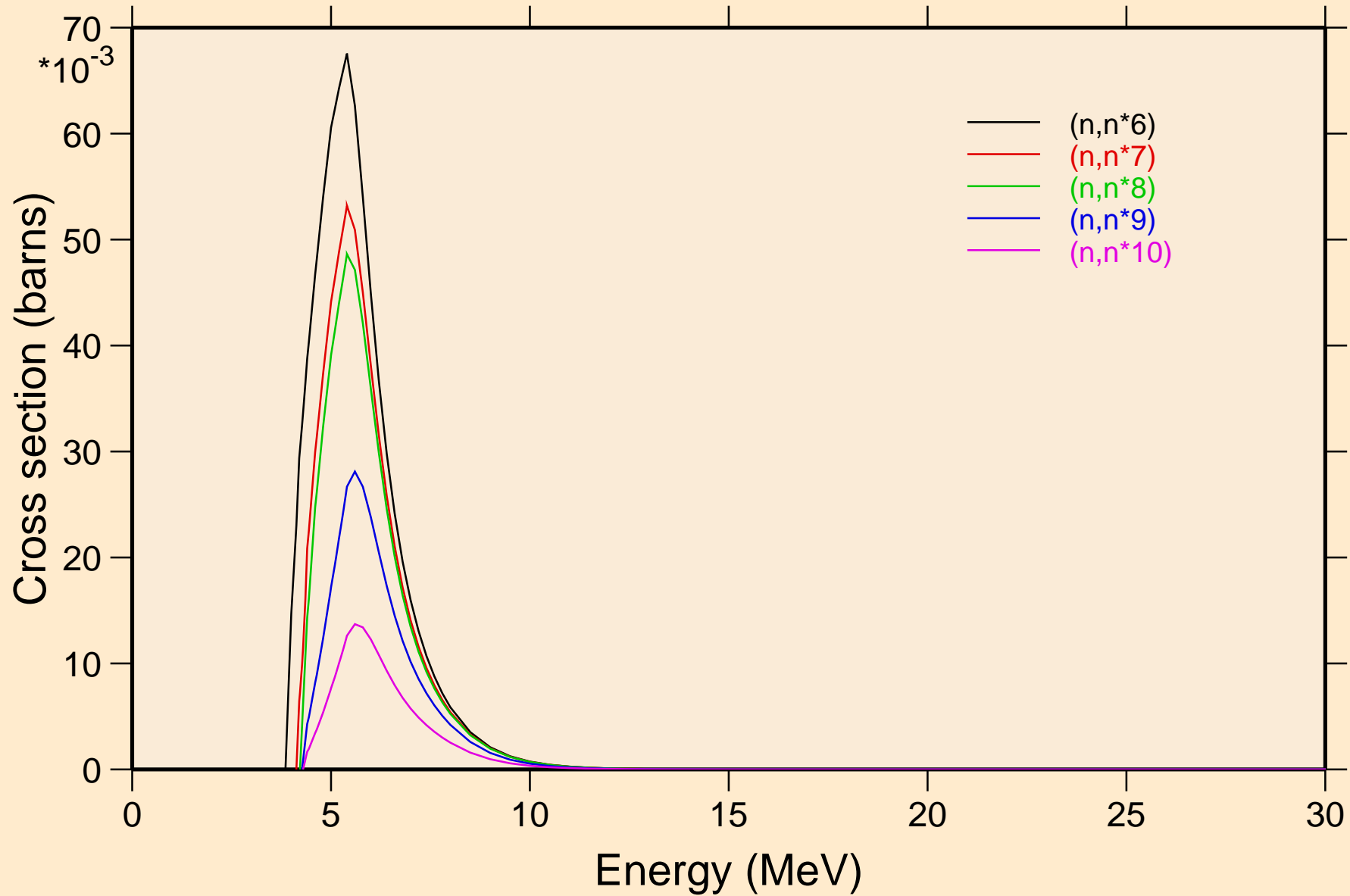

SN131M NEUTRON ACER TENDL-2021 LIBRARY; T=293.6K

Inelastic levels

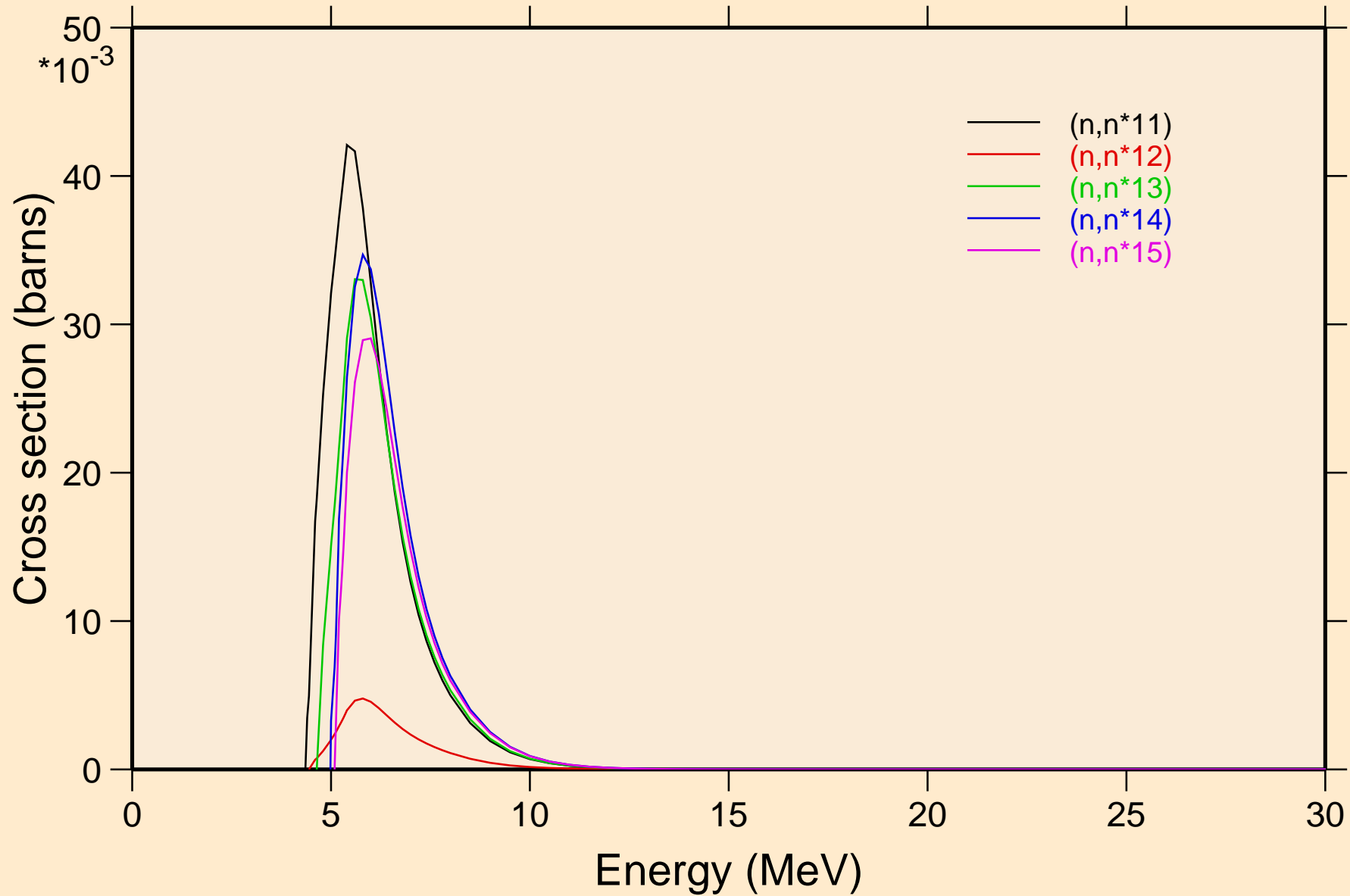

SN131M NEUTRON ACER TENDL-2021 LIBRARY; T=293.6K
Inelastic levels

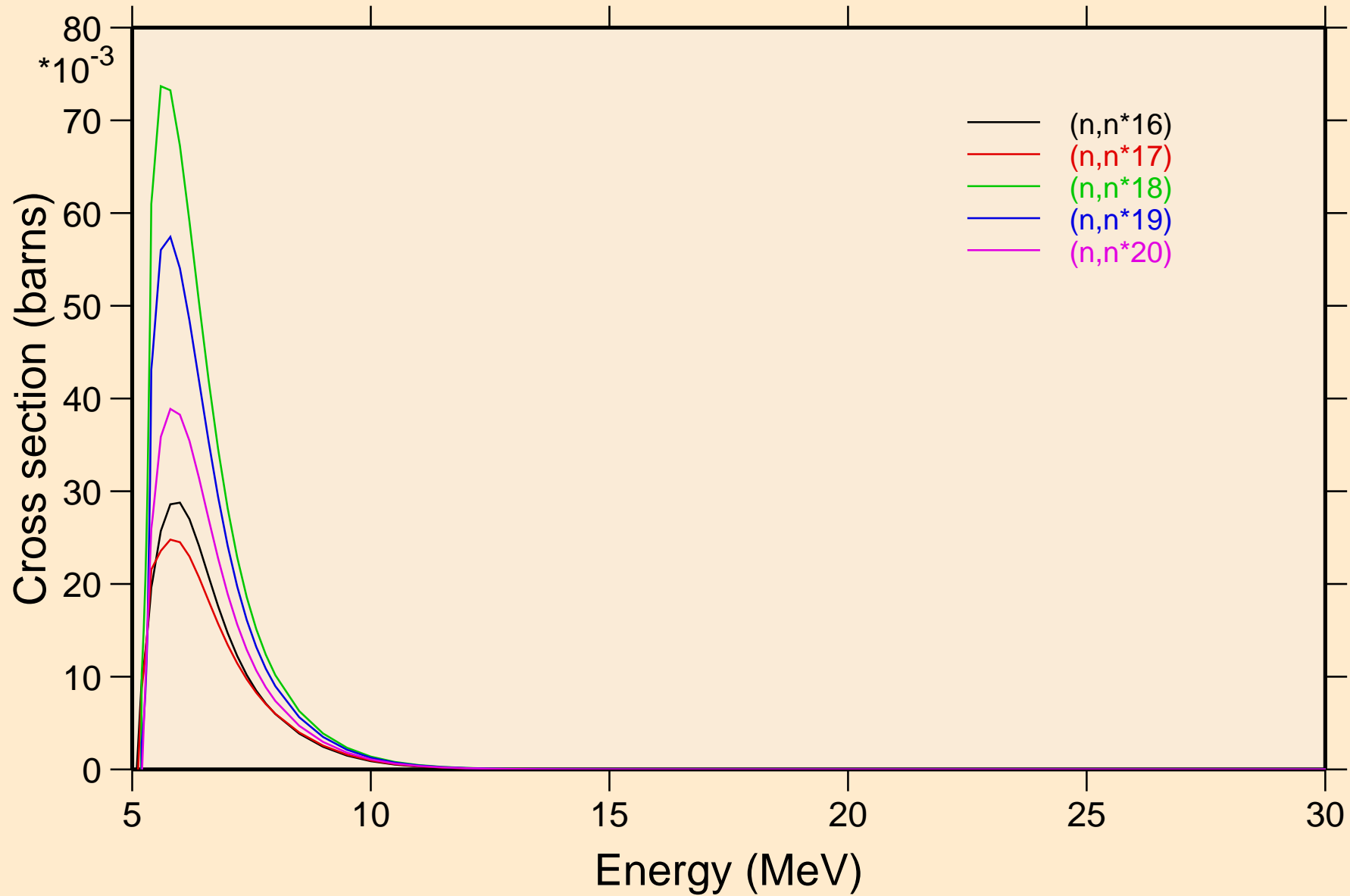

SN131M NEUTRON ACER TENDL-2021 LIBRARY; T=293.6K
Inelastic levels

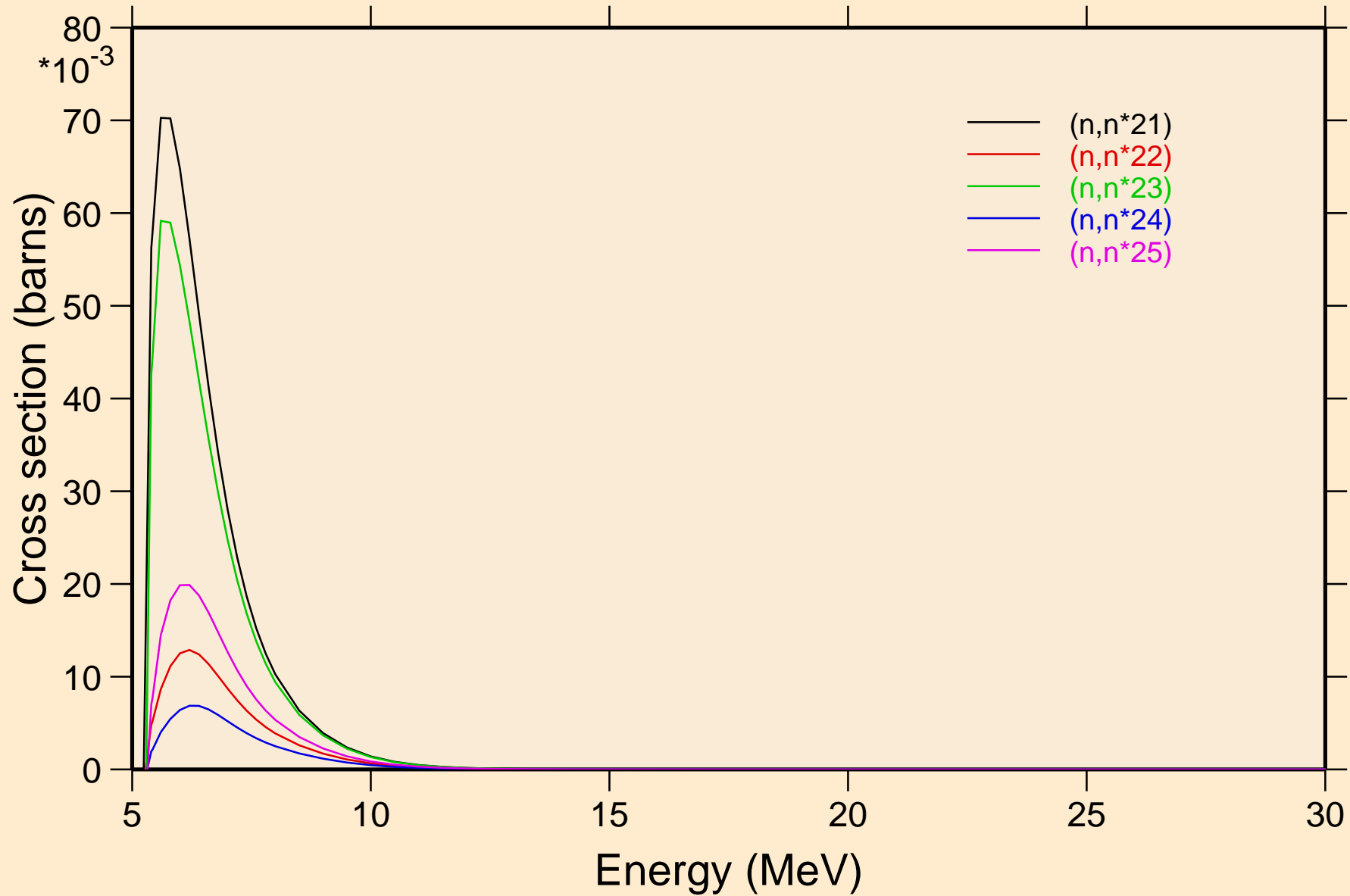

SN131M NEUTRON ACER TENDL-2021 LIBRARY; T=293.6K

Inelastic levels

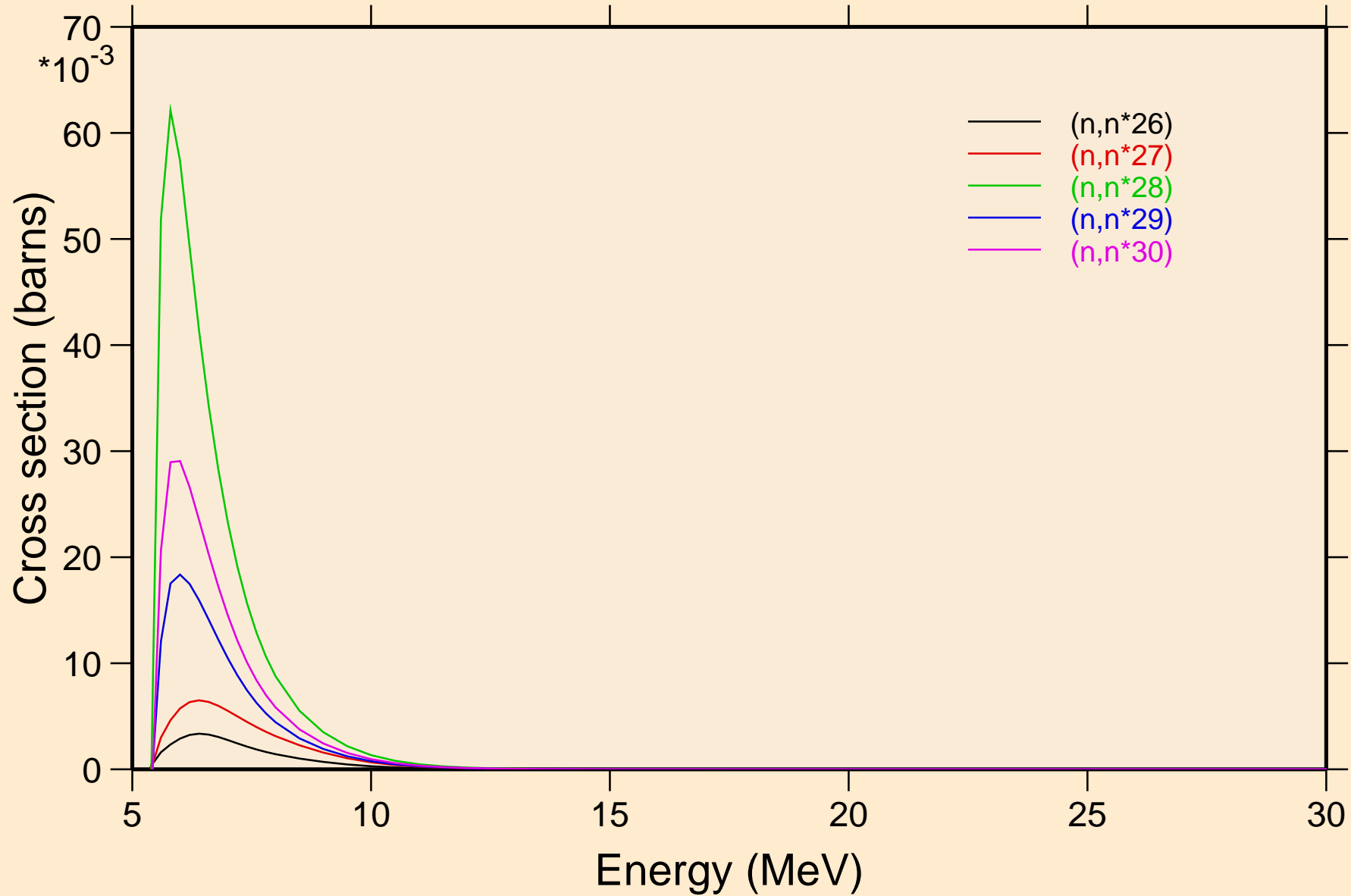

SN131M NEUTRON ACER TENDL-2021 LIBRARY; T=293.6K

Threshold reactions

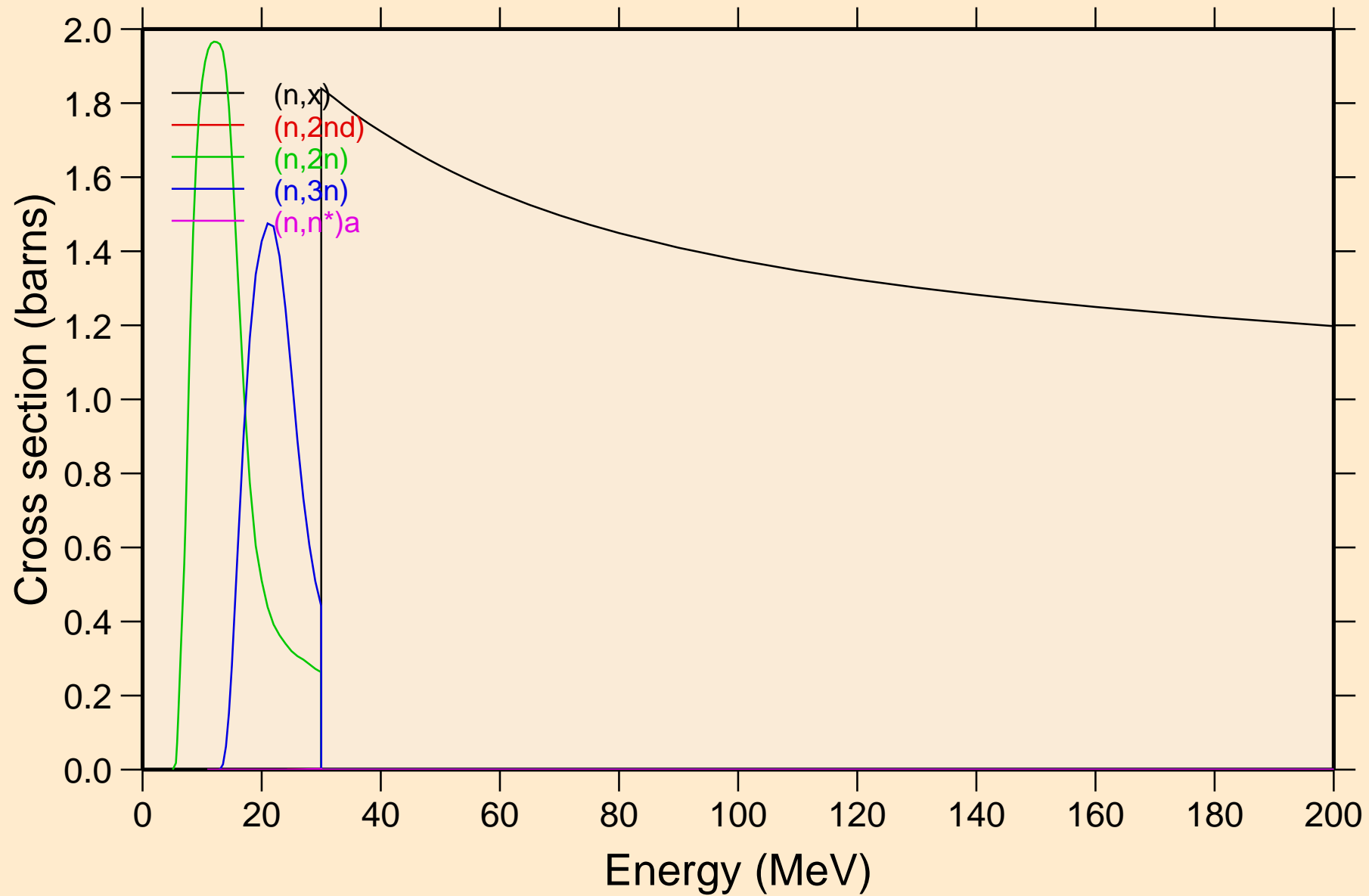

SN131M NEUTRON ACER TENDL-2021 LIBRARY; T=293.6K
Threshold reactions

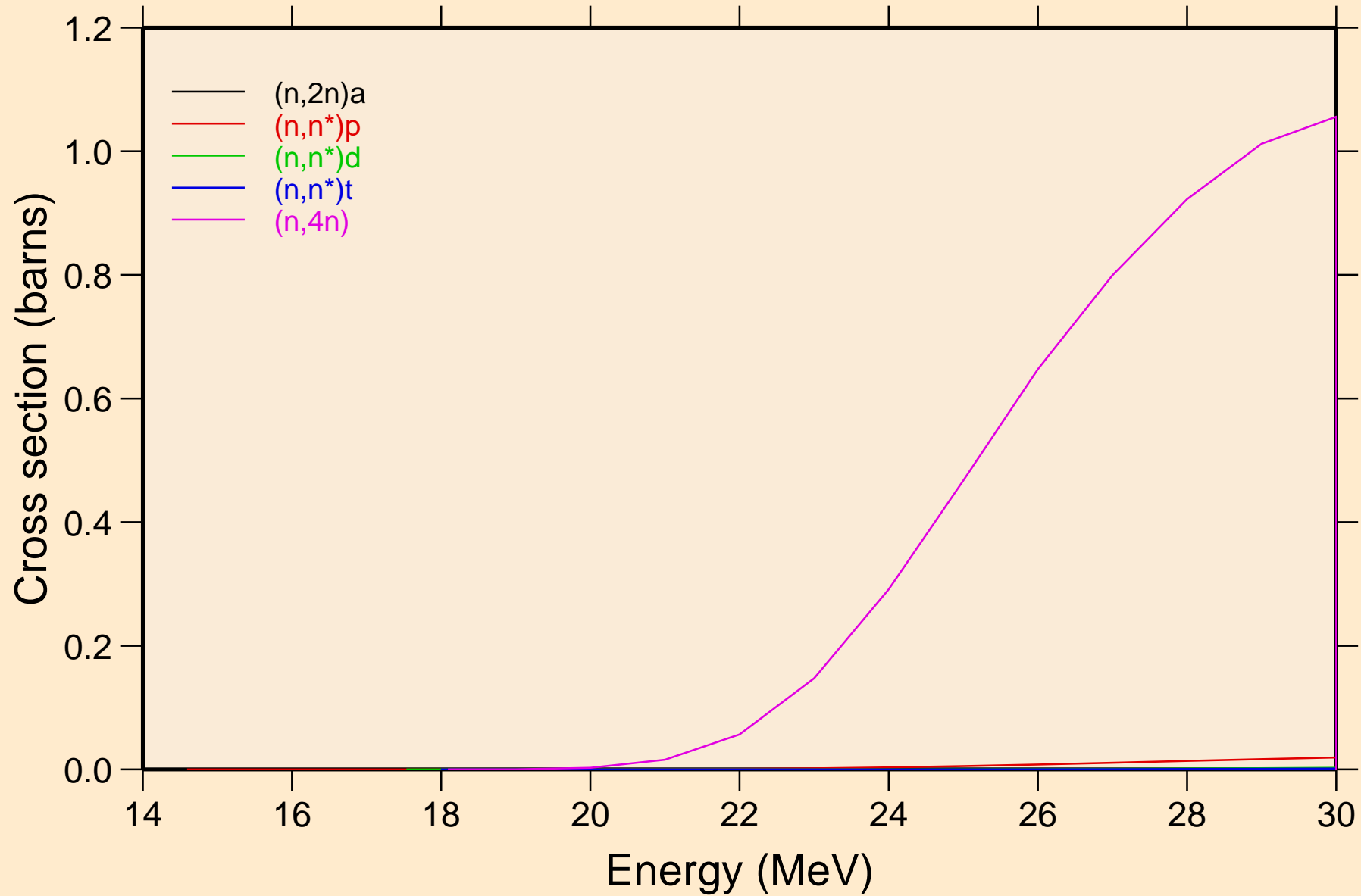

SN131M NEUTRON ACER TENDL-2021 LIBRARY; T=293.6K

Threshold reactions

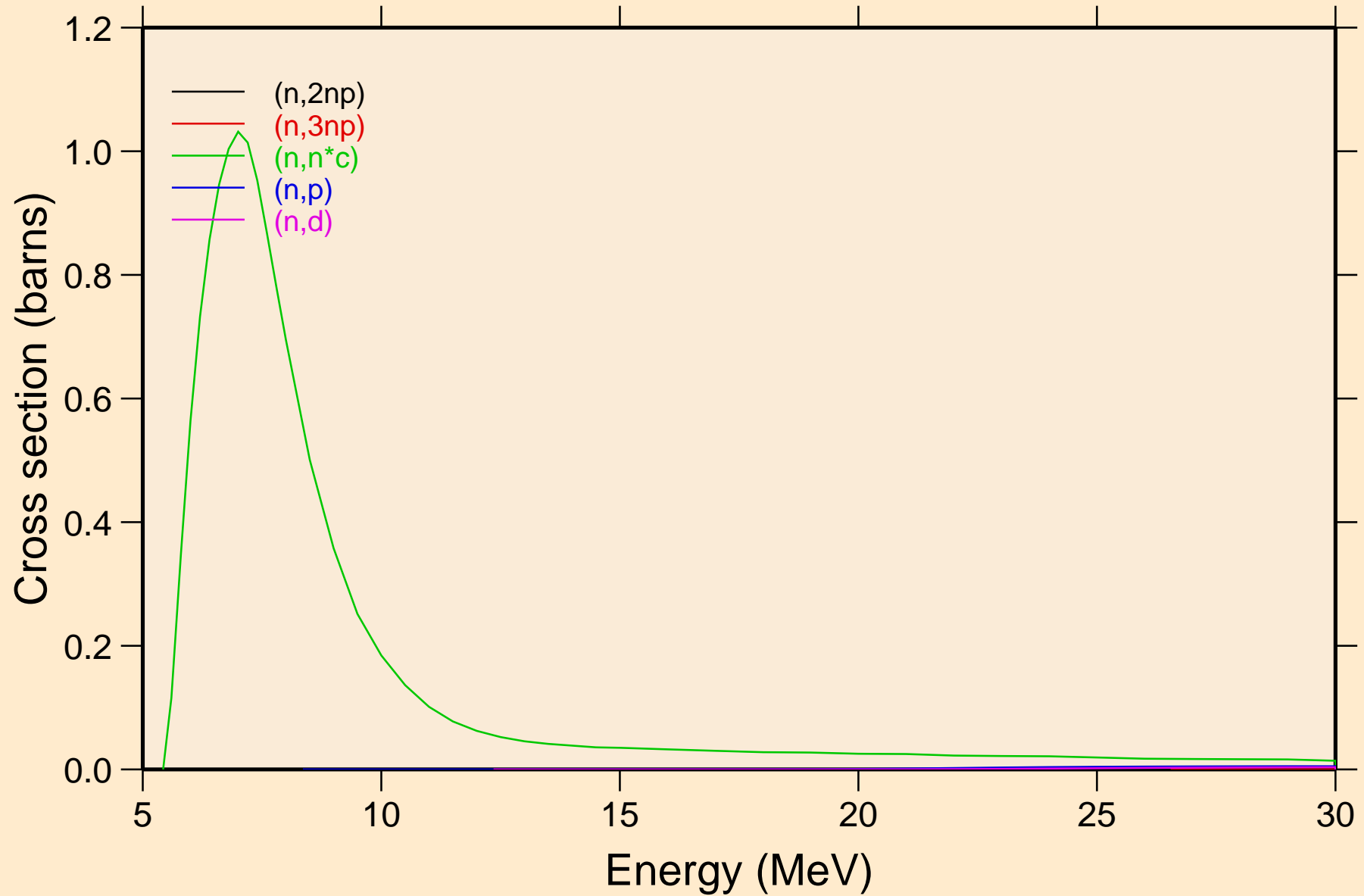

SN131M NEUTRON ACER TENDL-2021 LIBRARY; T=293.6K
Threshold reactions

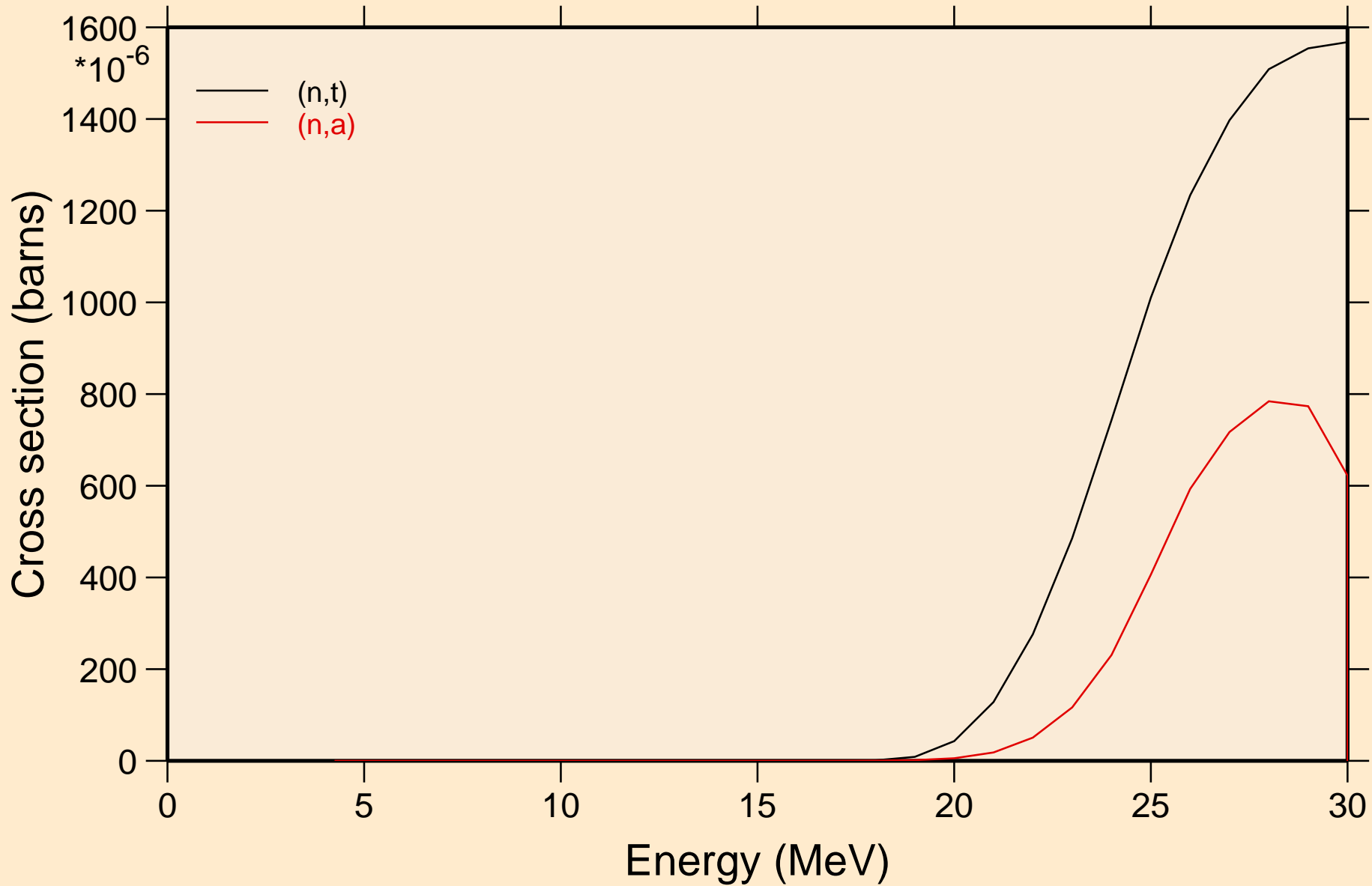

SN131M NEUTRON ACER TENDL-2021 LIBRARY; T=293.6K

Threshold reactions

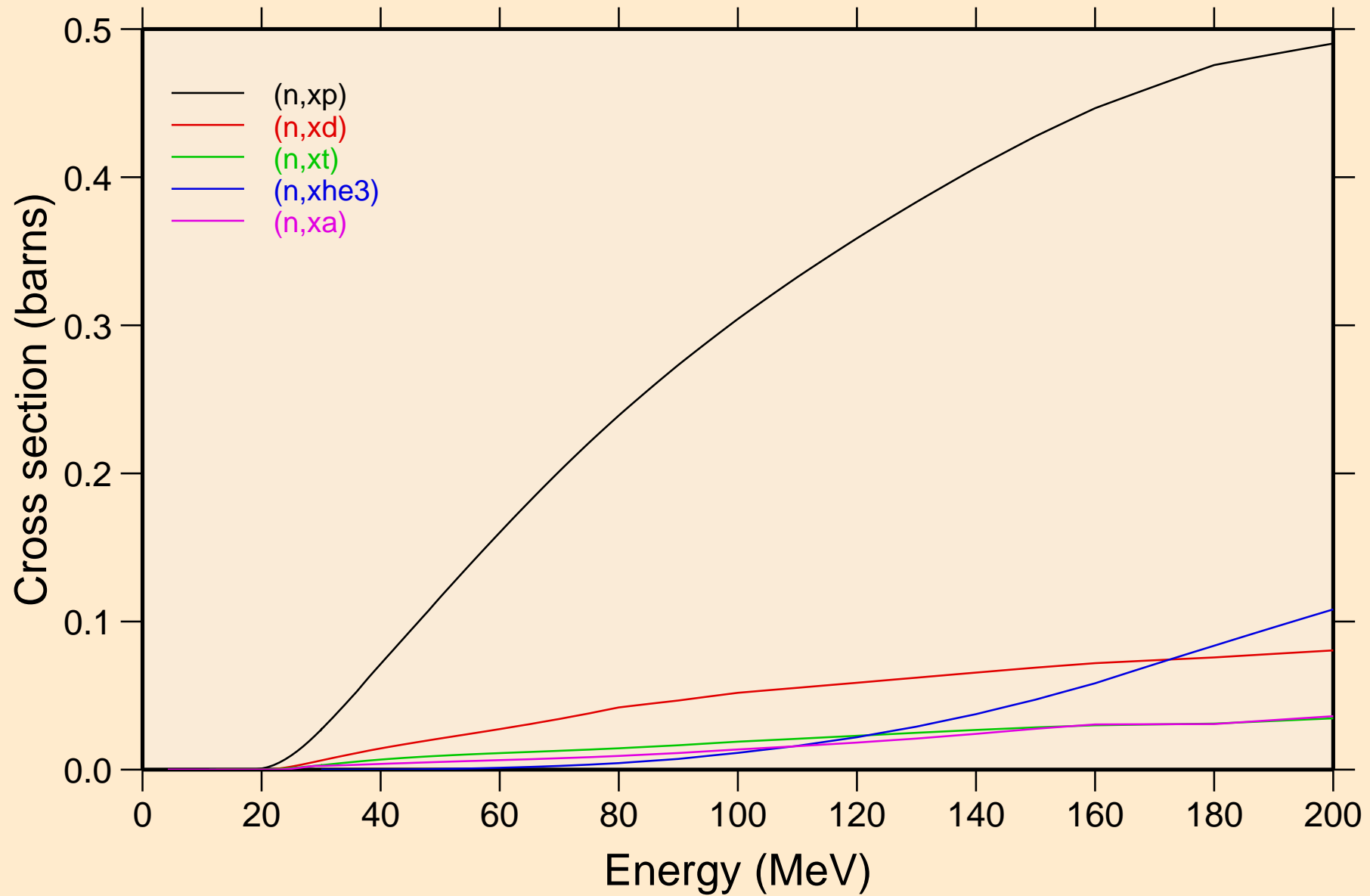

SN131M NEUTRON ACER TENDL-2021 LIBRARY; T=293.6K
angular distribution for elastic

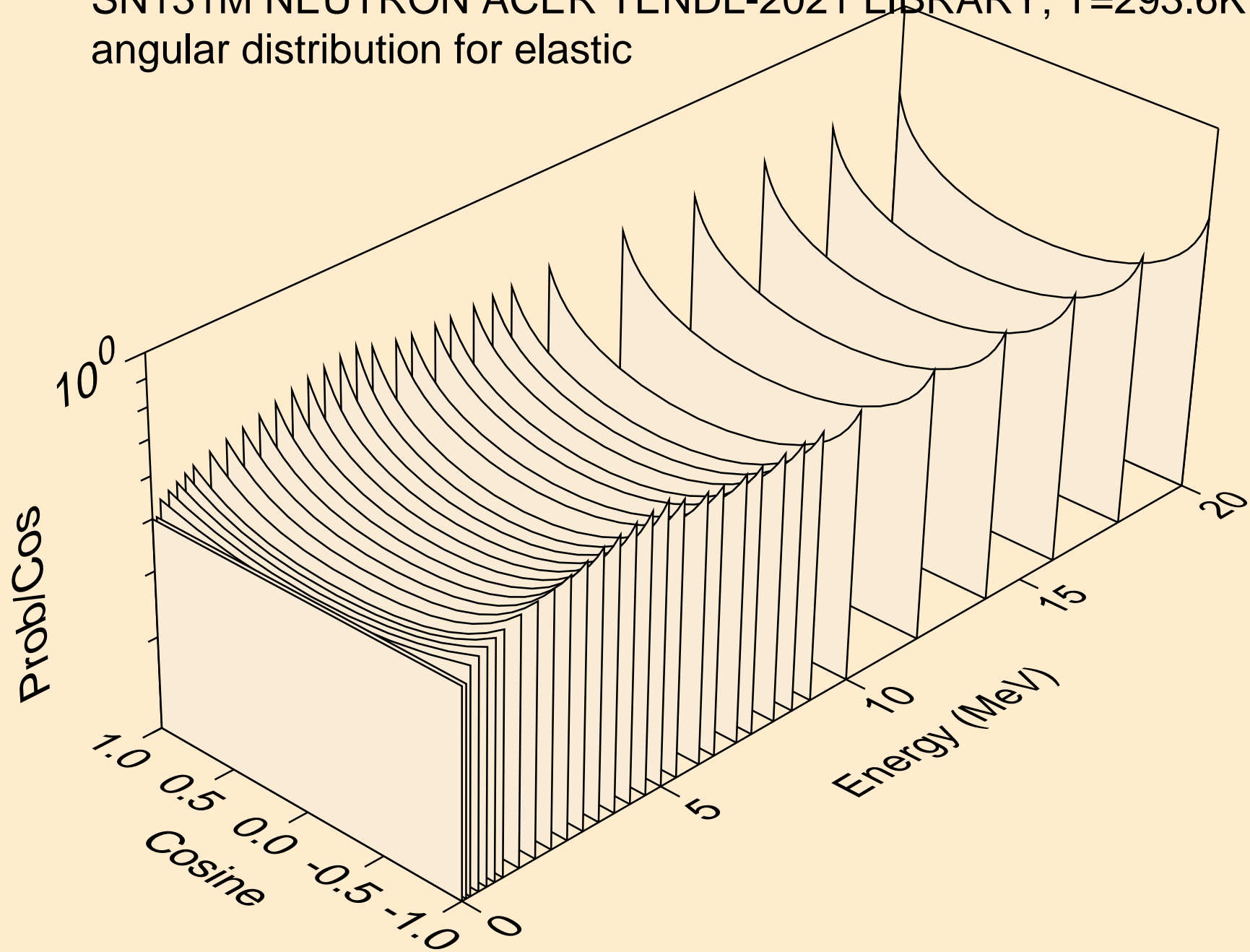

SN131M NEUTRON ACER TENDL-2021 LIBRARY; T=293.6K
angular distribution for elastic

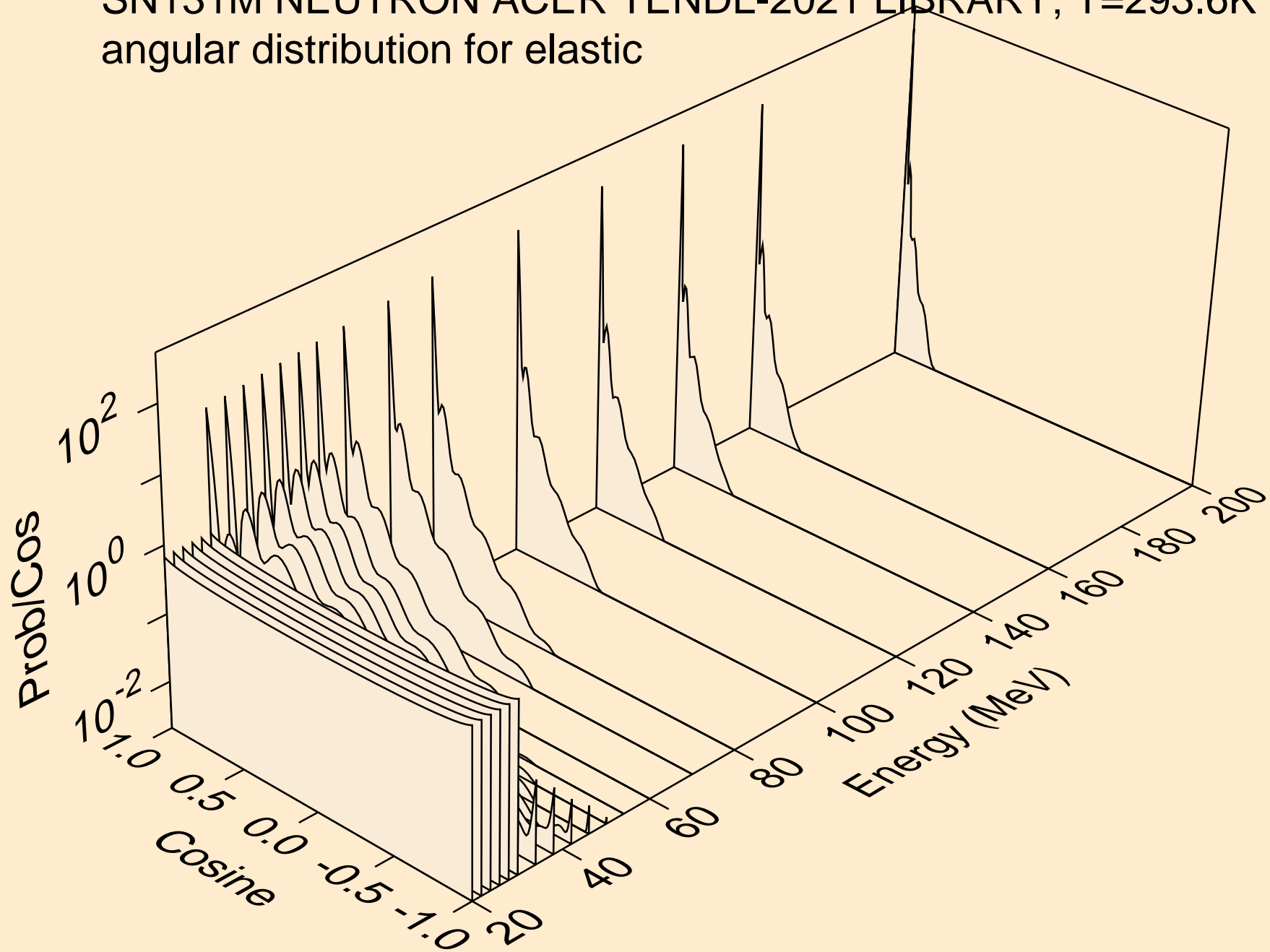

SN131M NEUTRON ACER TENDL-2021 LIBRARY; T=293.6K
angular distribution for (n,n*1)

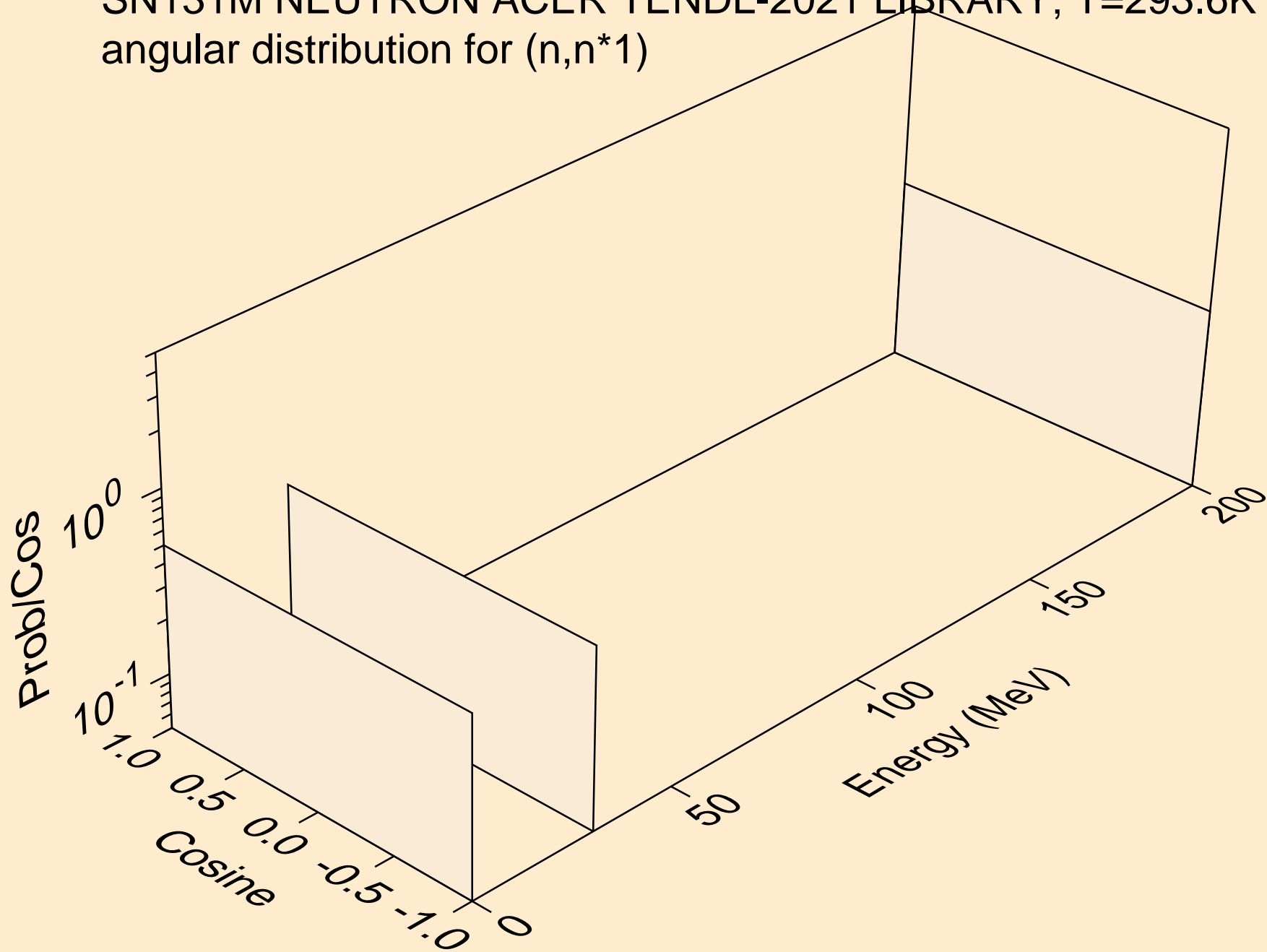

SN131M NEUTRON ACER TENDL-2021 LIBRARY; T=293.6K
angular distribution for (n,n*2)

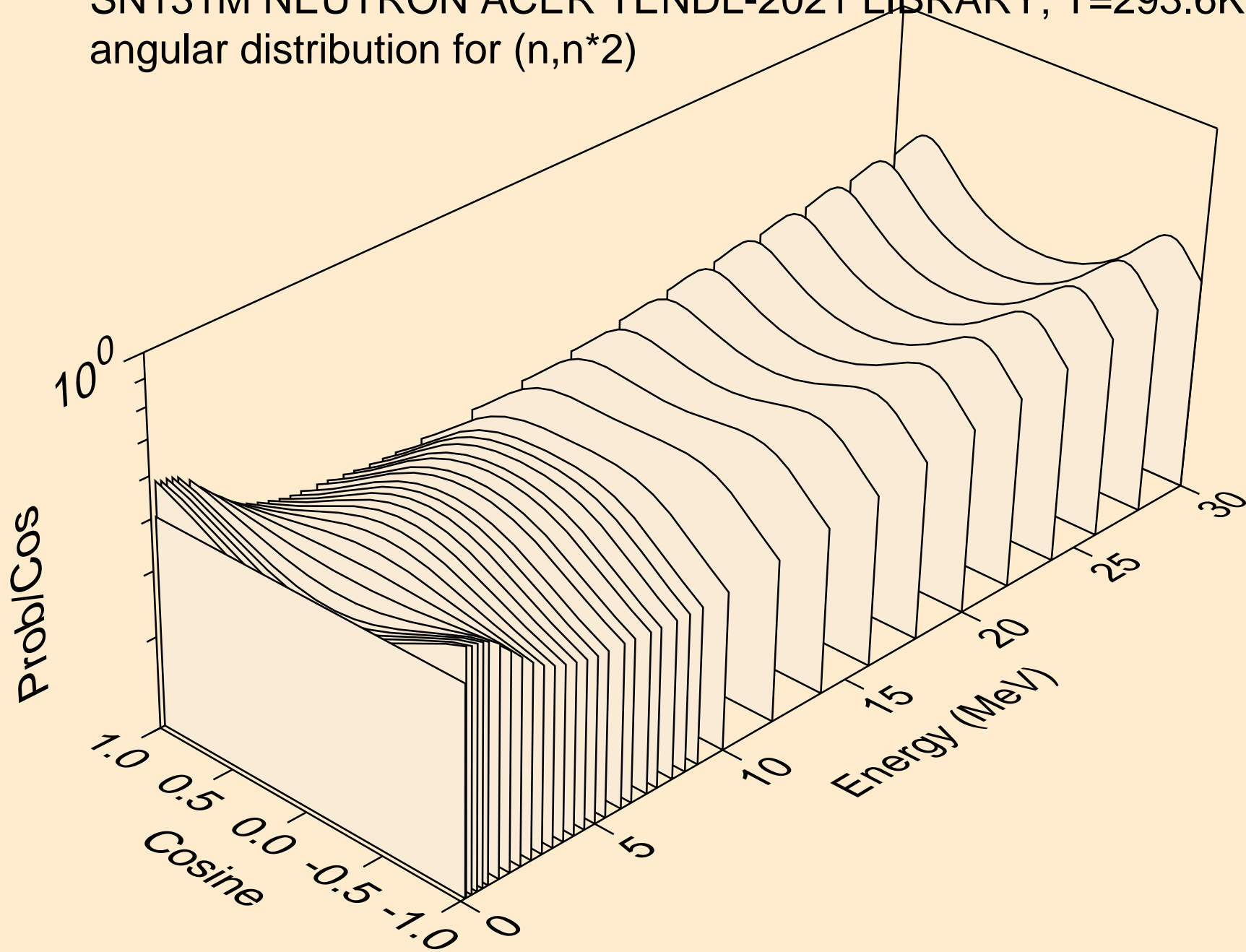

SN131M NEUTRON ACER TENDL-2021 LIBRARY; T=293.6K
angular distribution for (n,n*3)

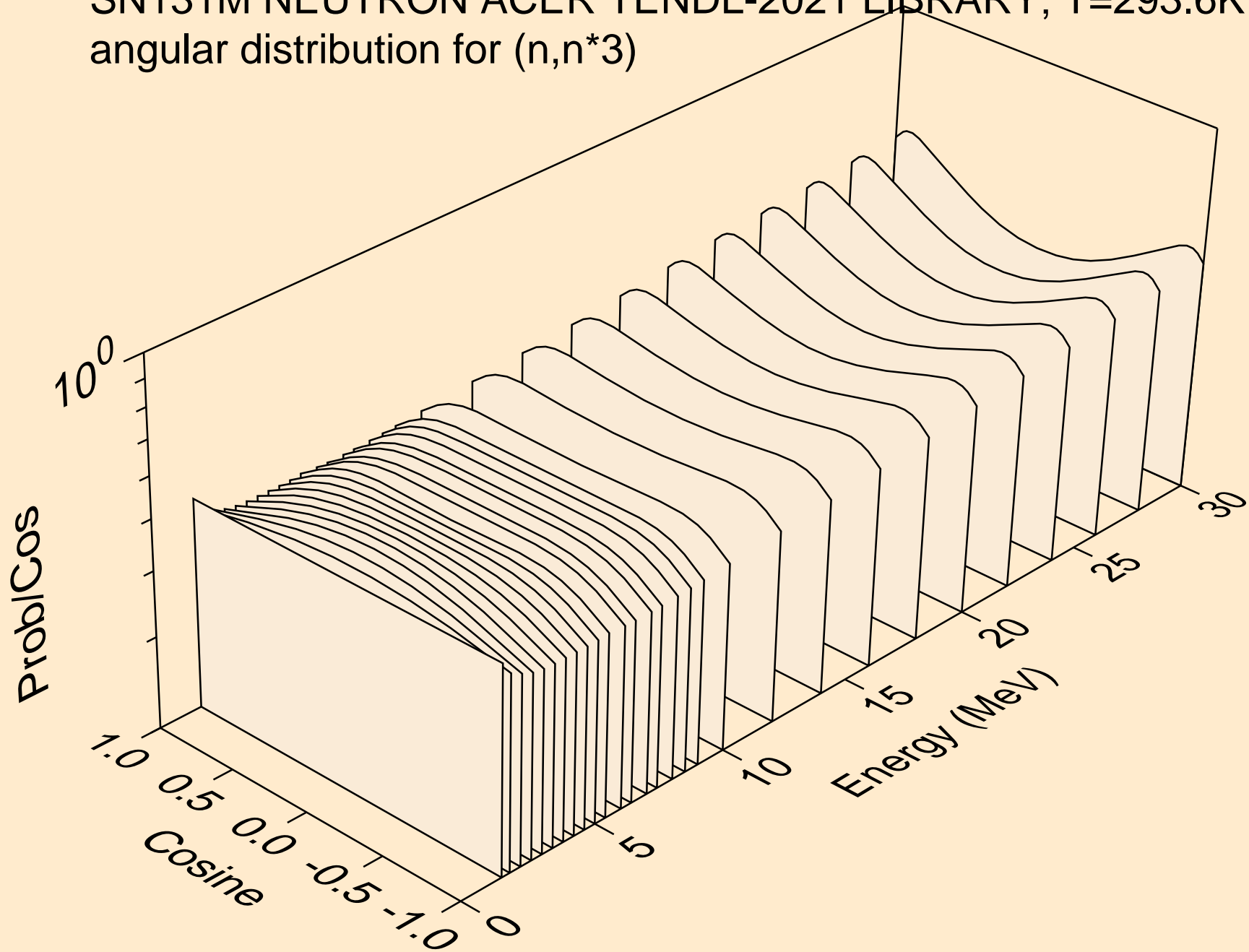

SN131M NEUTRON ACER TENDL-2021 LIBRARY; T=293.6K
angular distribution for (n,n*4)

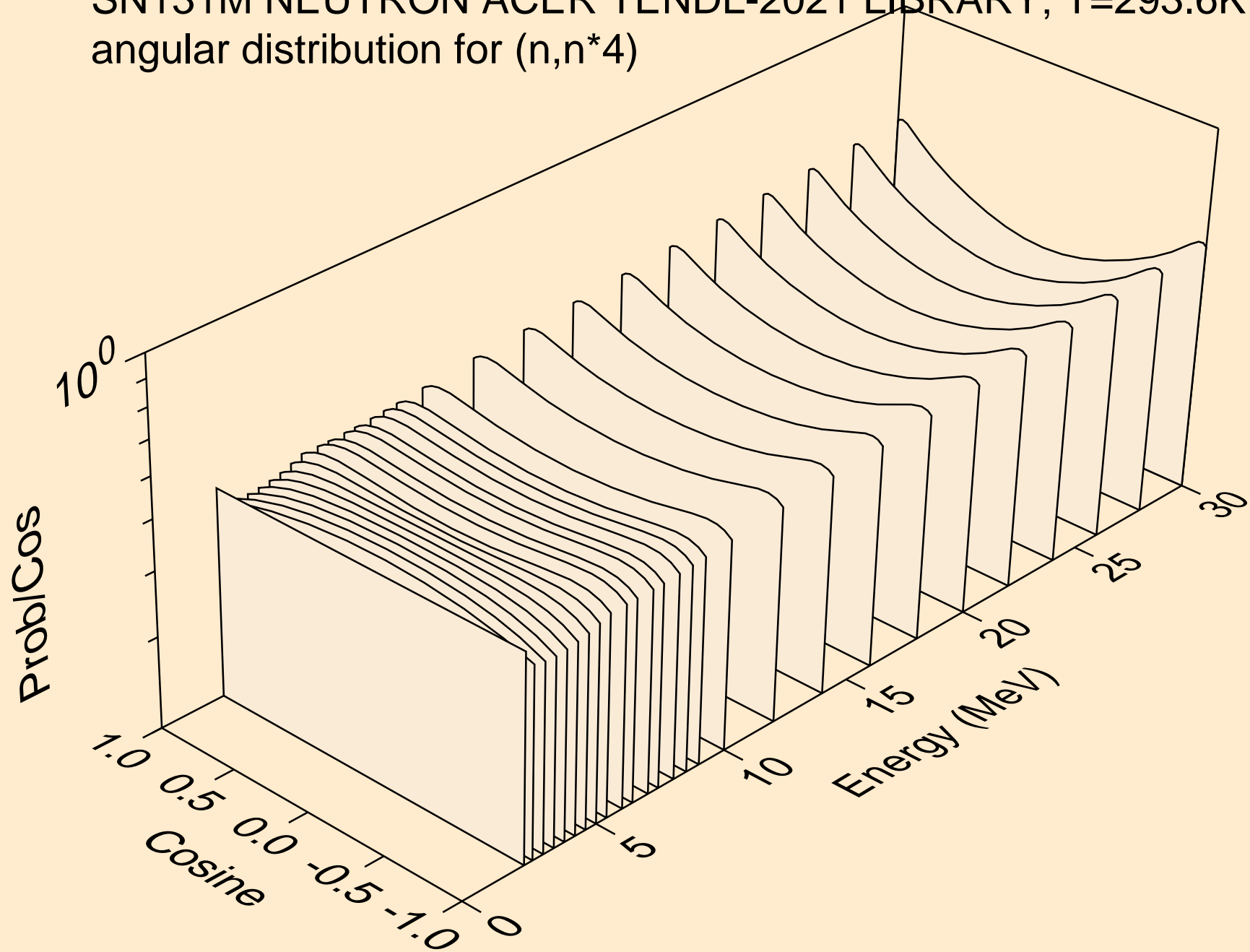

SN131M NEUTRON ACER TENDL-2021 LIBRARY; T=293.6K
angular distribution for (n,n*5)

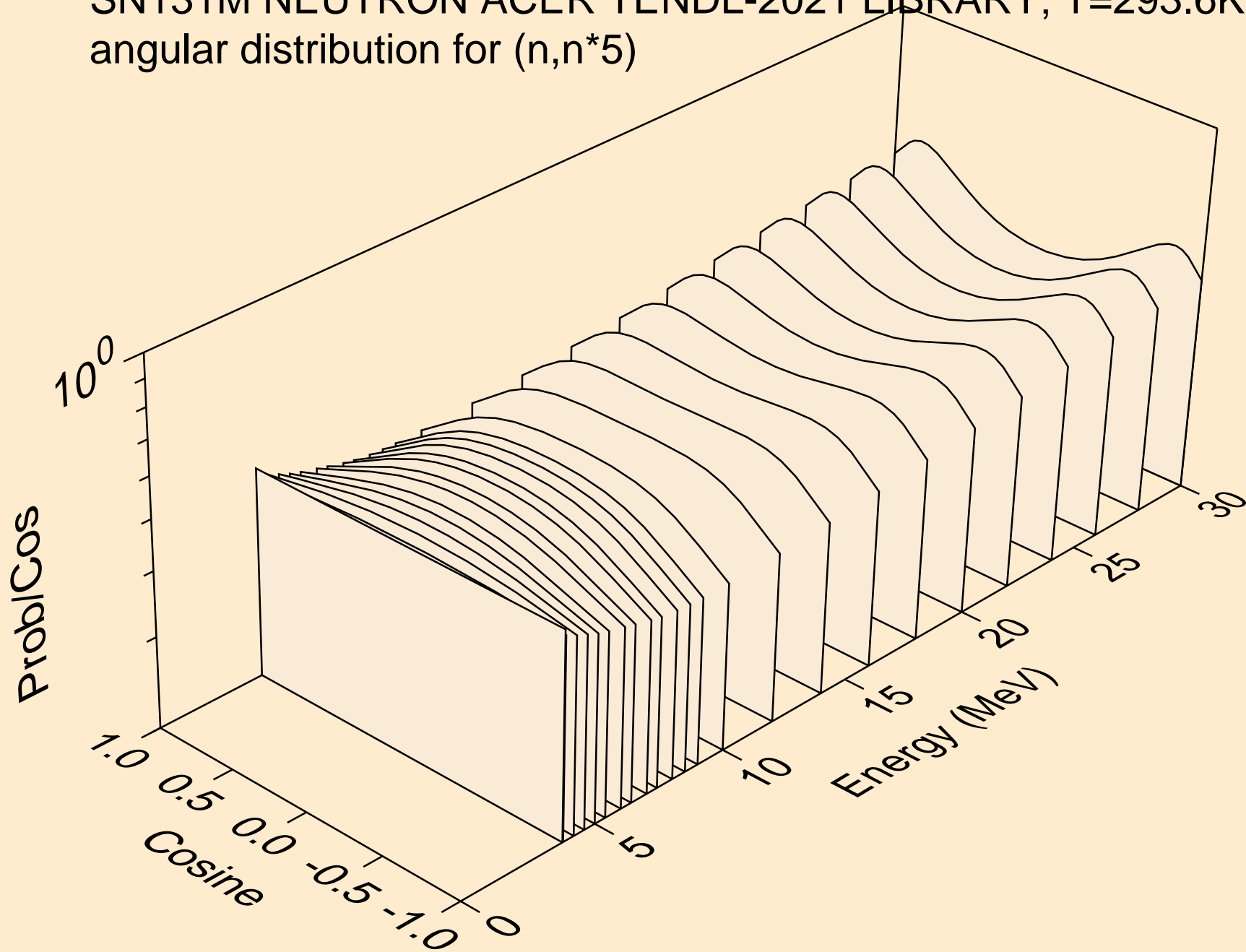

SN131M NEUTRON ACER TENDL-2021 LIBRARY; T=293.6K
angular distribution for (n,n*6)

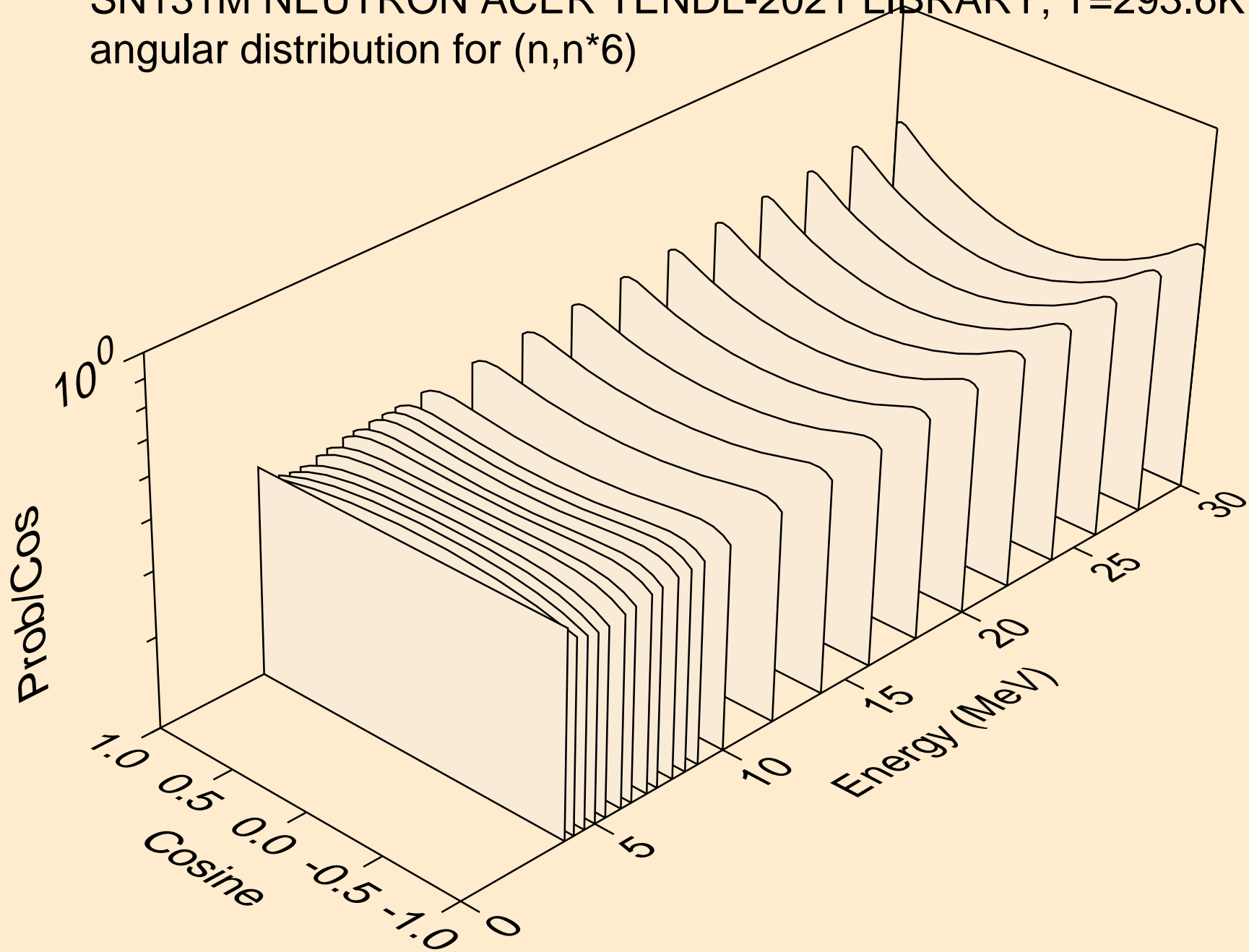

SN131M NEUTRON ACER TENDL-2021 LIBRARY; T=293.6K
angular distribution for (n,n*7)

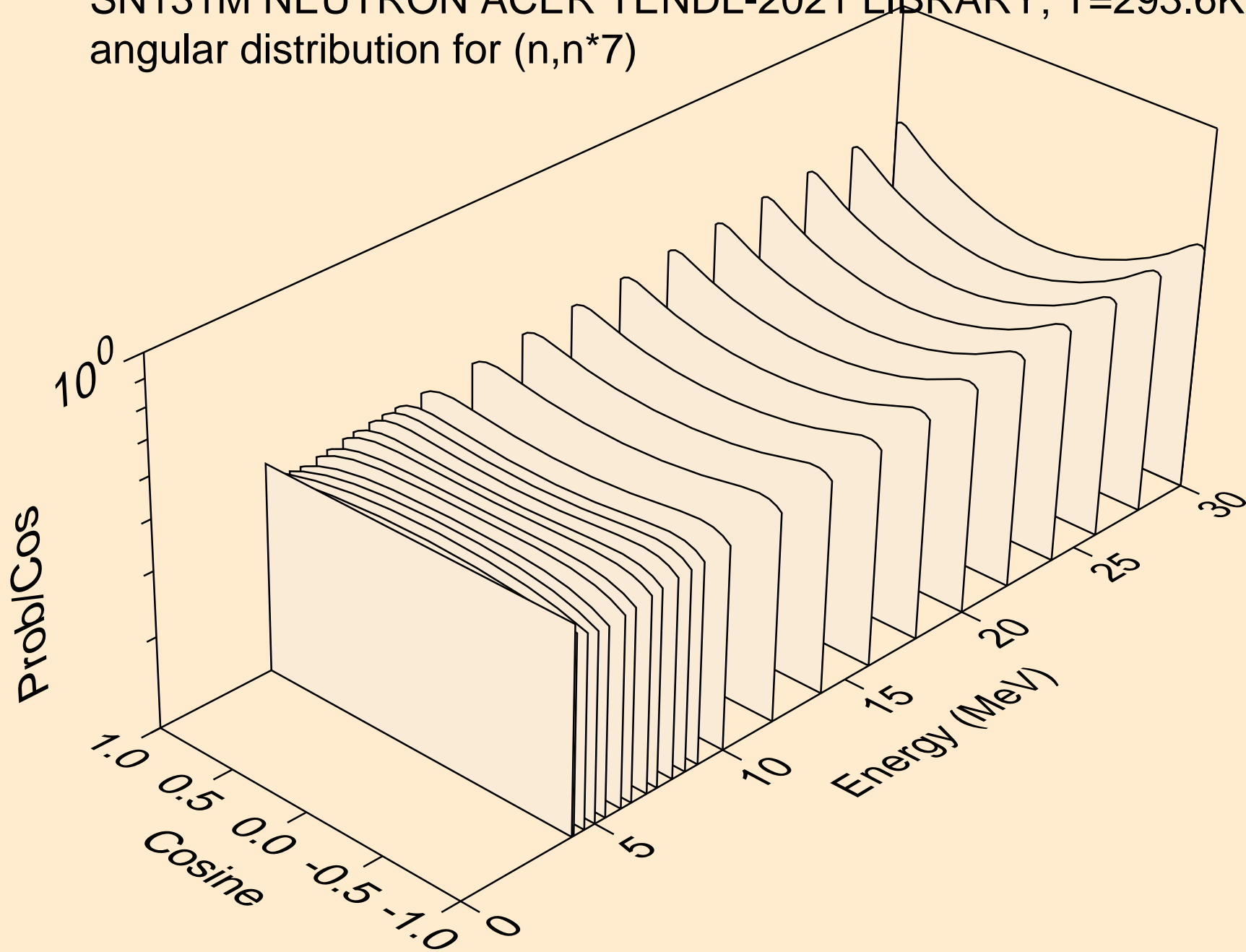

SN131M NEUTRON ACER TENDL-2021 LIBRARY; T=293.6K
angular distribution for (n,n*8)

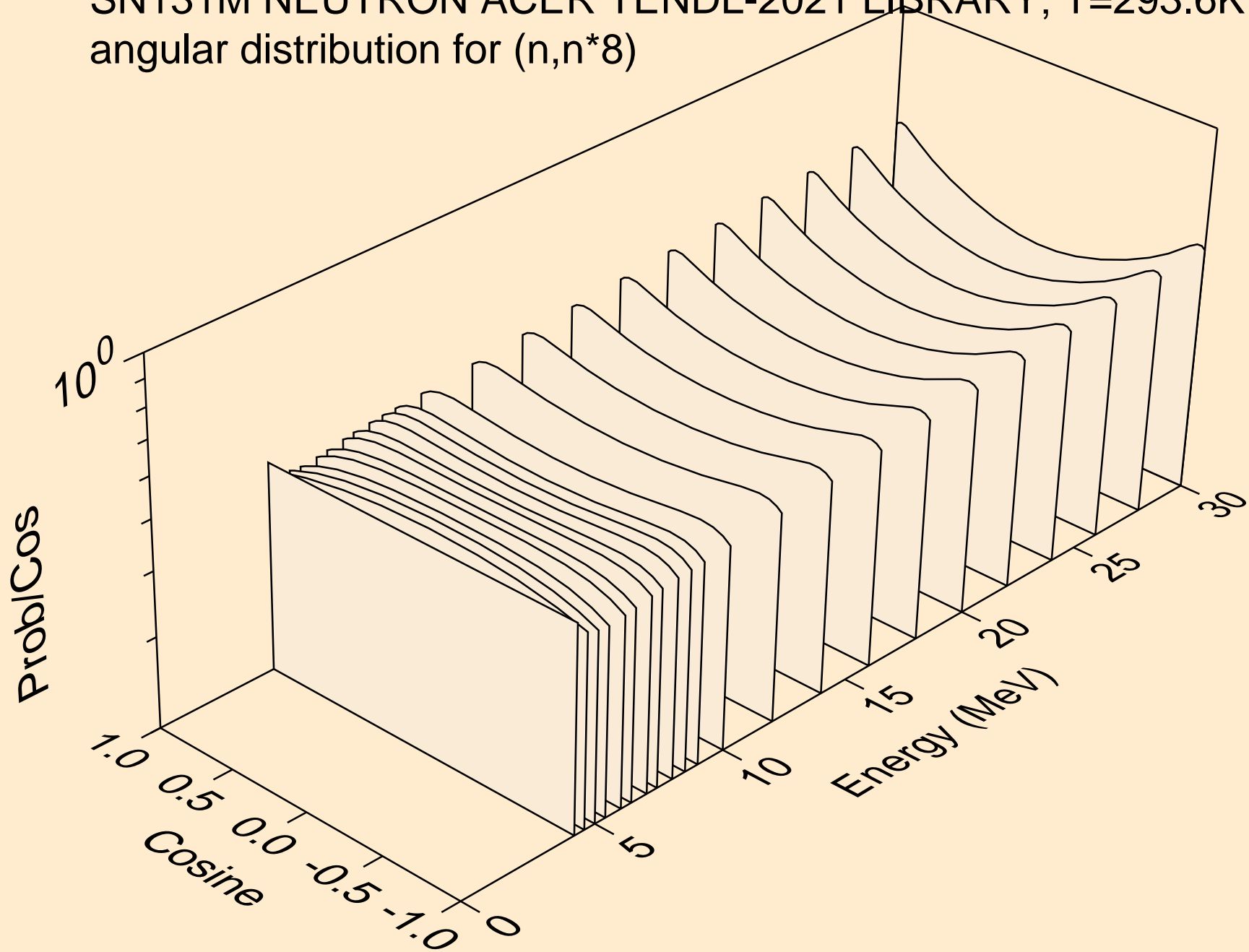

SN131M NEUTRON ACER TENDL-2021 LIBRARY; T=293.6K
angular distribution for (n,n*9)

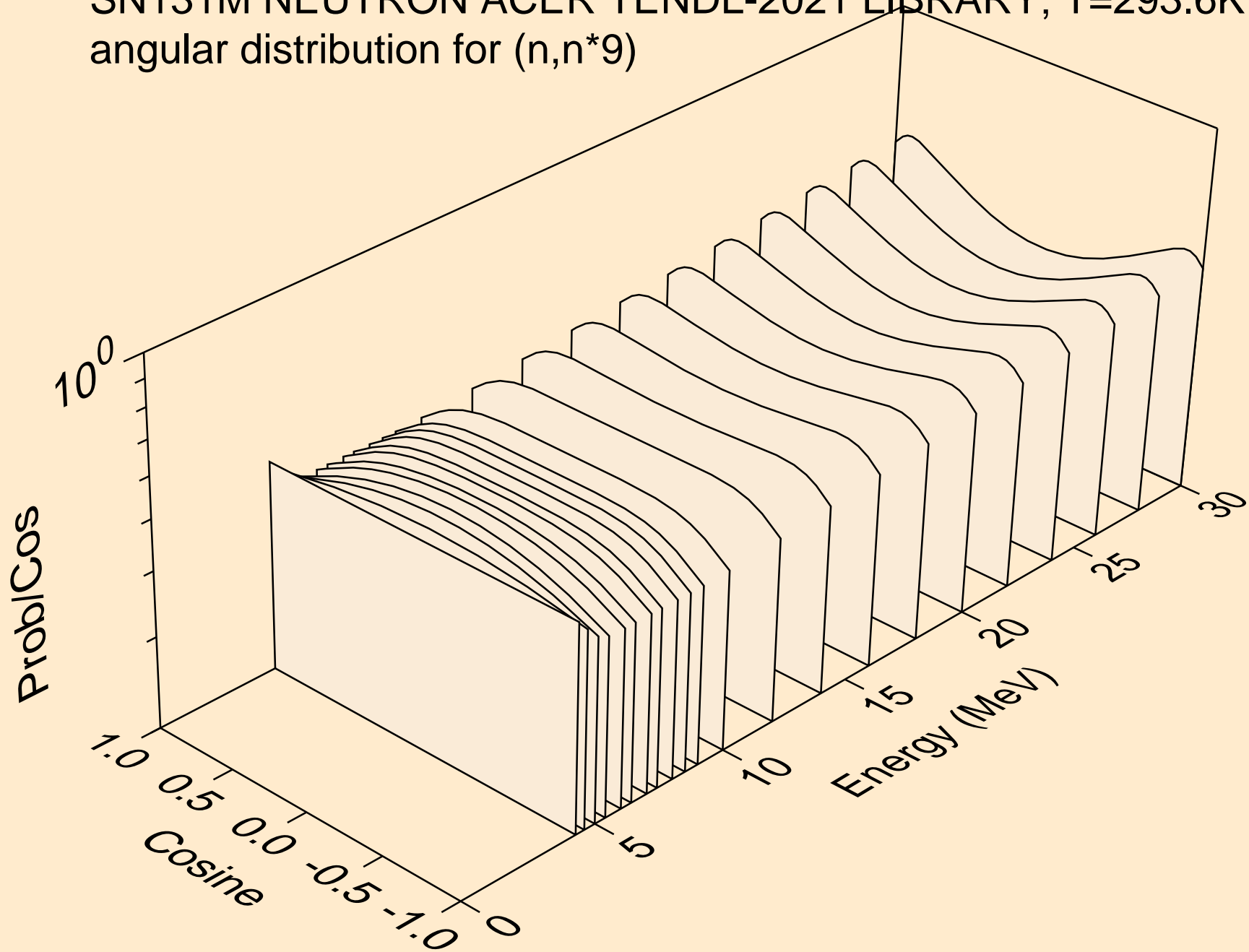

SN131M NEUTRON ACER TENDL-2021 LIBRARY; T=293.6K
angular distribution for (n,n*10)

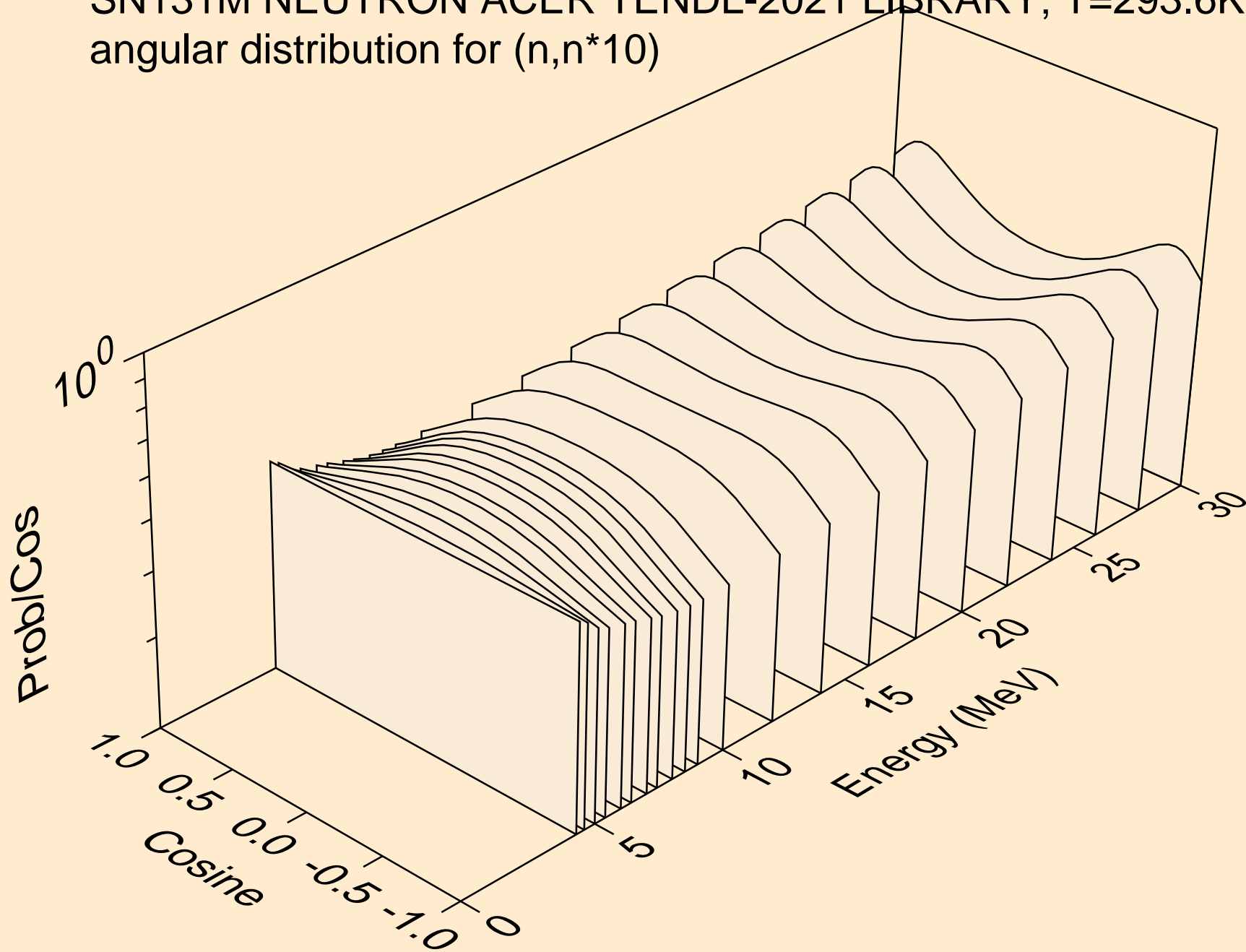

SN131M NEUTRON ACER TENDL-2021 LIBRARY; T=293.6K
angular distribution for (n,n*11)

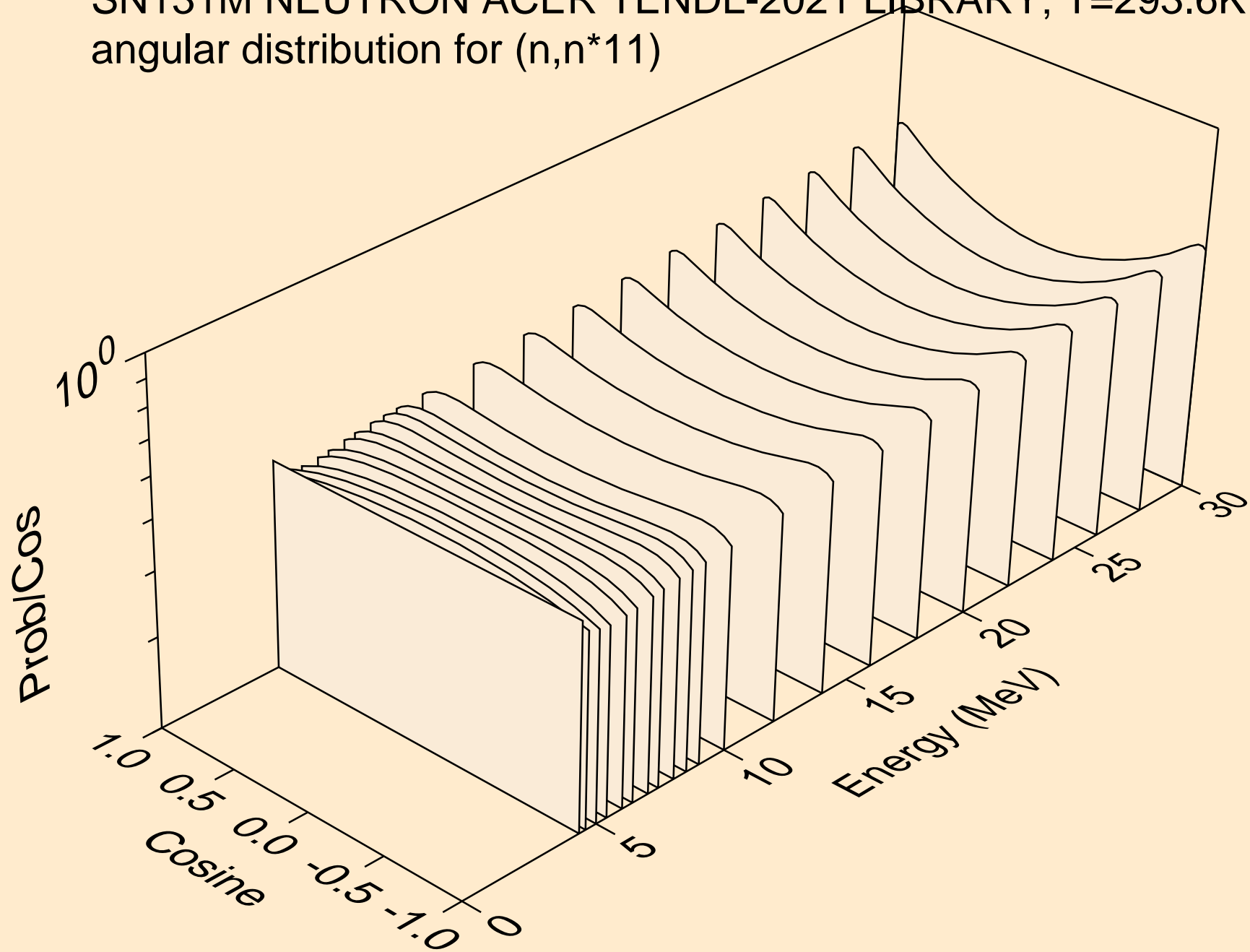

SN131M NEUTRON ACER TENDL-2021 LIBRARY; T=293.6K
angular distribution for (n,n*12)

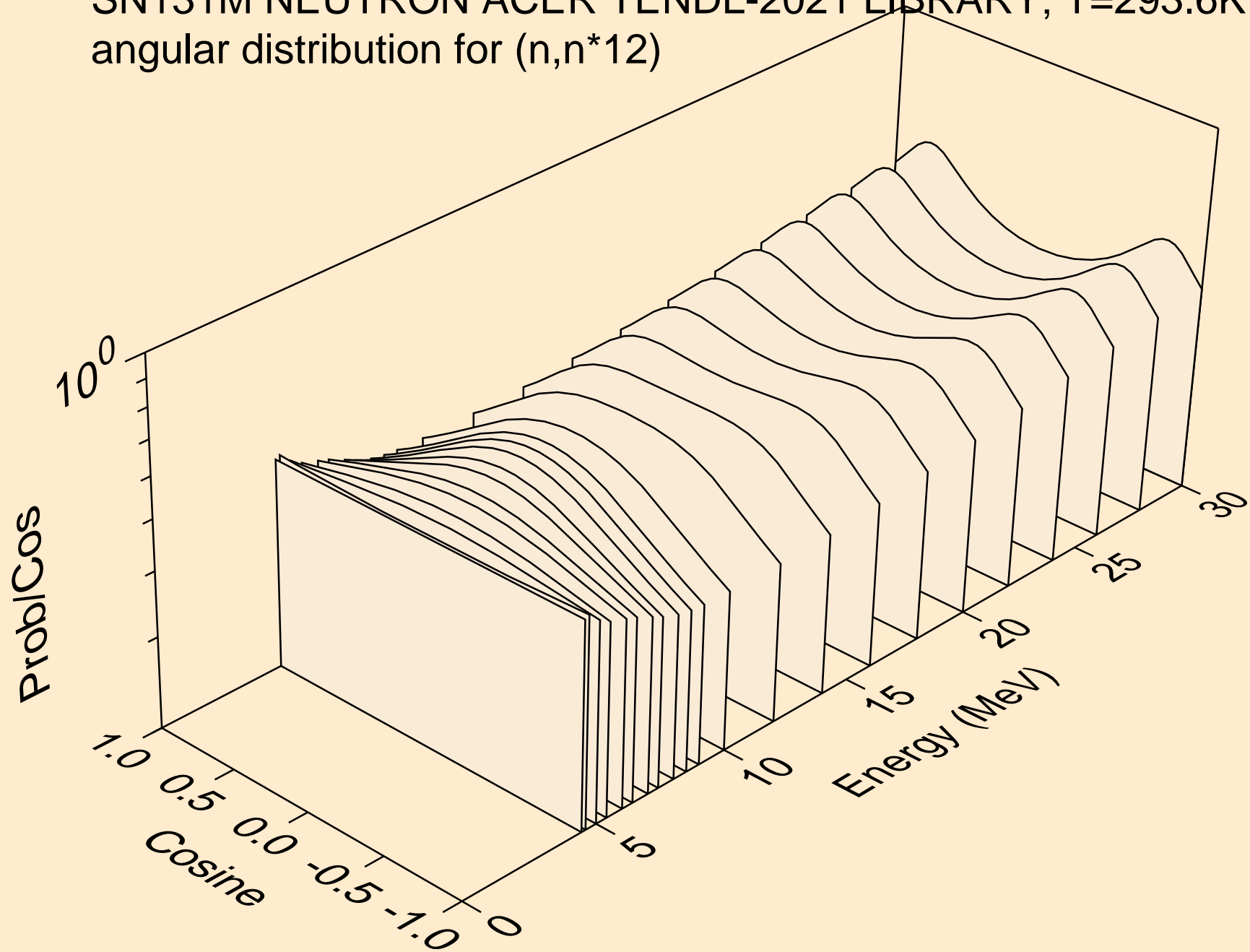

SN131M NEUTRON ACER TENDL-2021 LIBRARY; T=293.6K
angular distribution for (n,n*13)

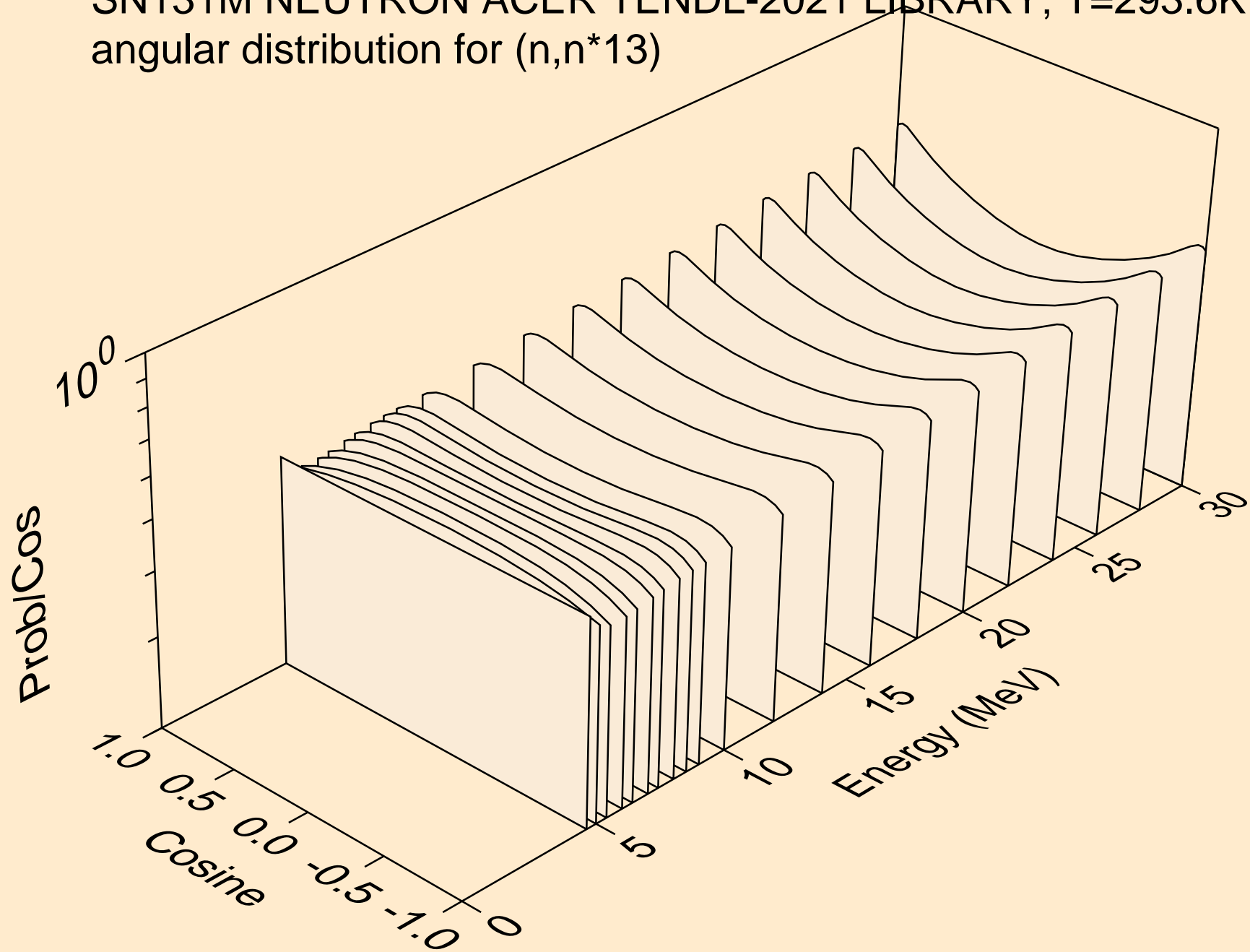

SN131M NEUTRON ACER TENDL-2021 LIBRARY; T=293.6K
angular distribution for (n,n*14)

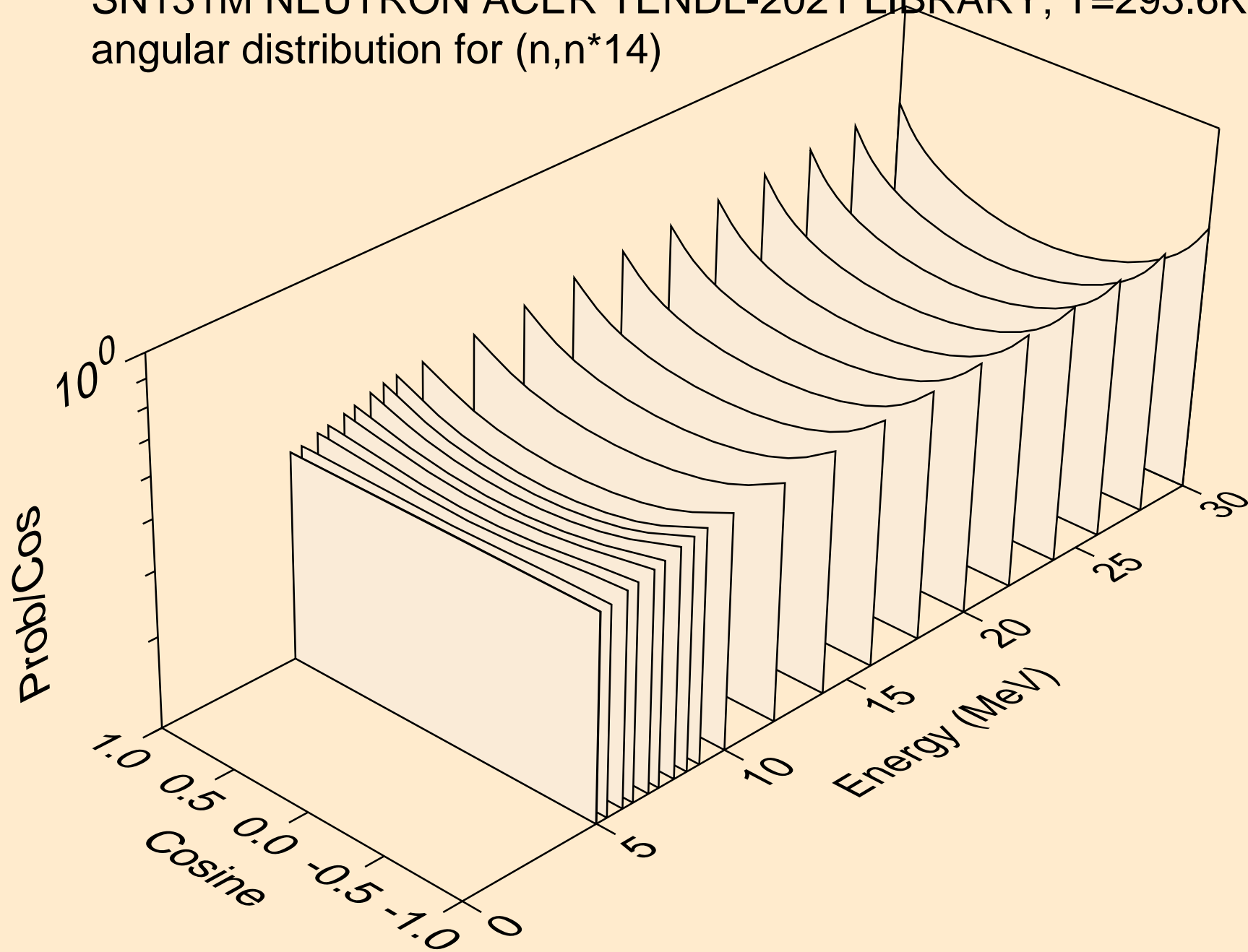

SN131M NEUTRON ACER TENDL-2021 LIBRARY; T=293.6K
angular distribution for (n,n*15)

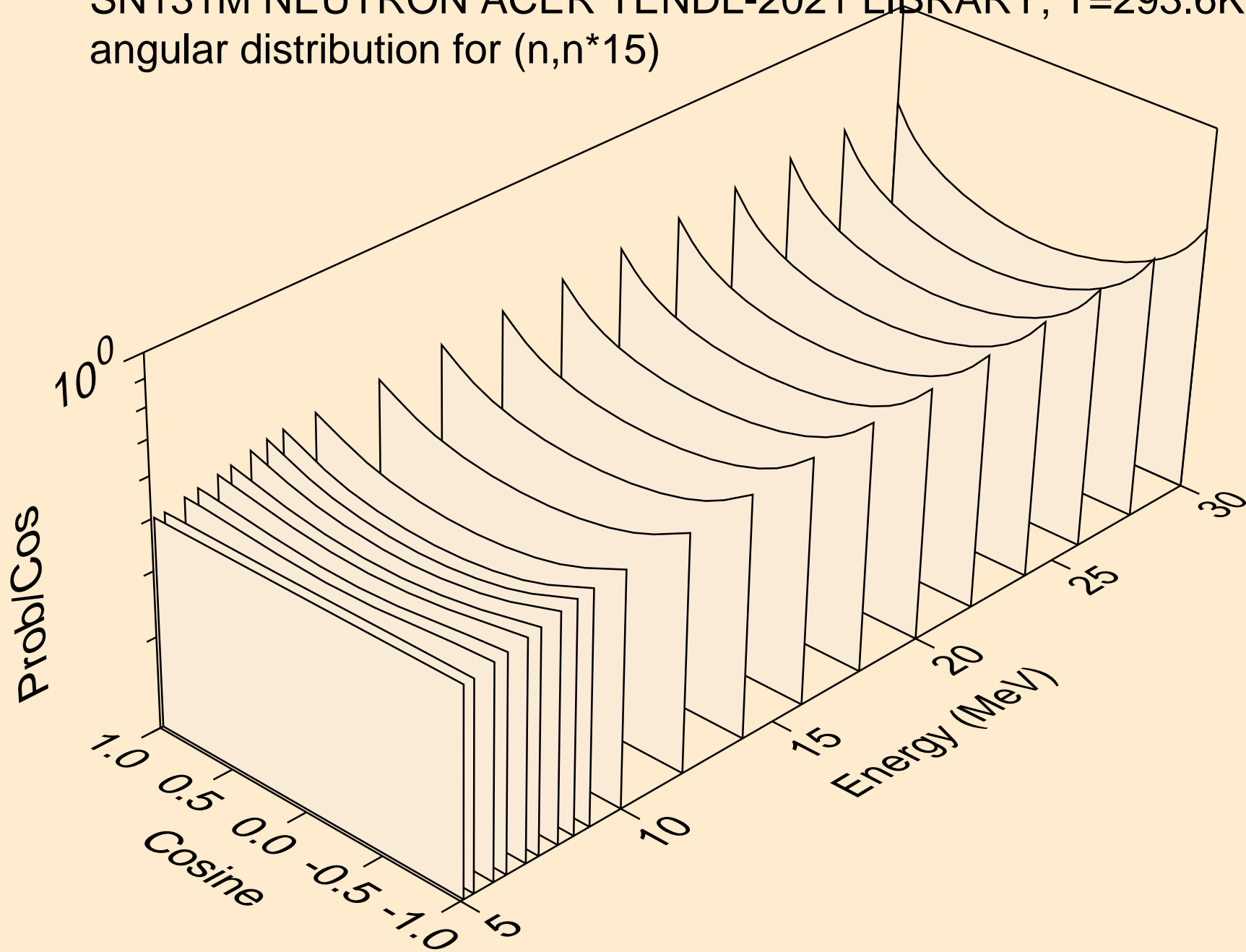

SN131M NEUTRON ACER TENDL-2021 LIBRARY; T=293.6K
angular distribution for (n,n*16)

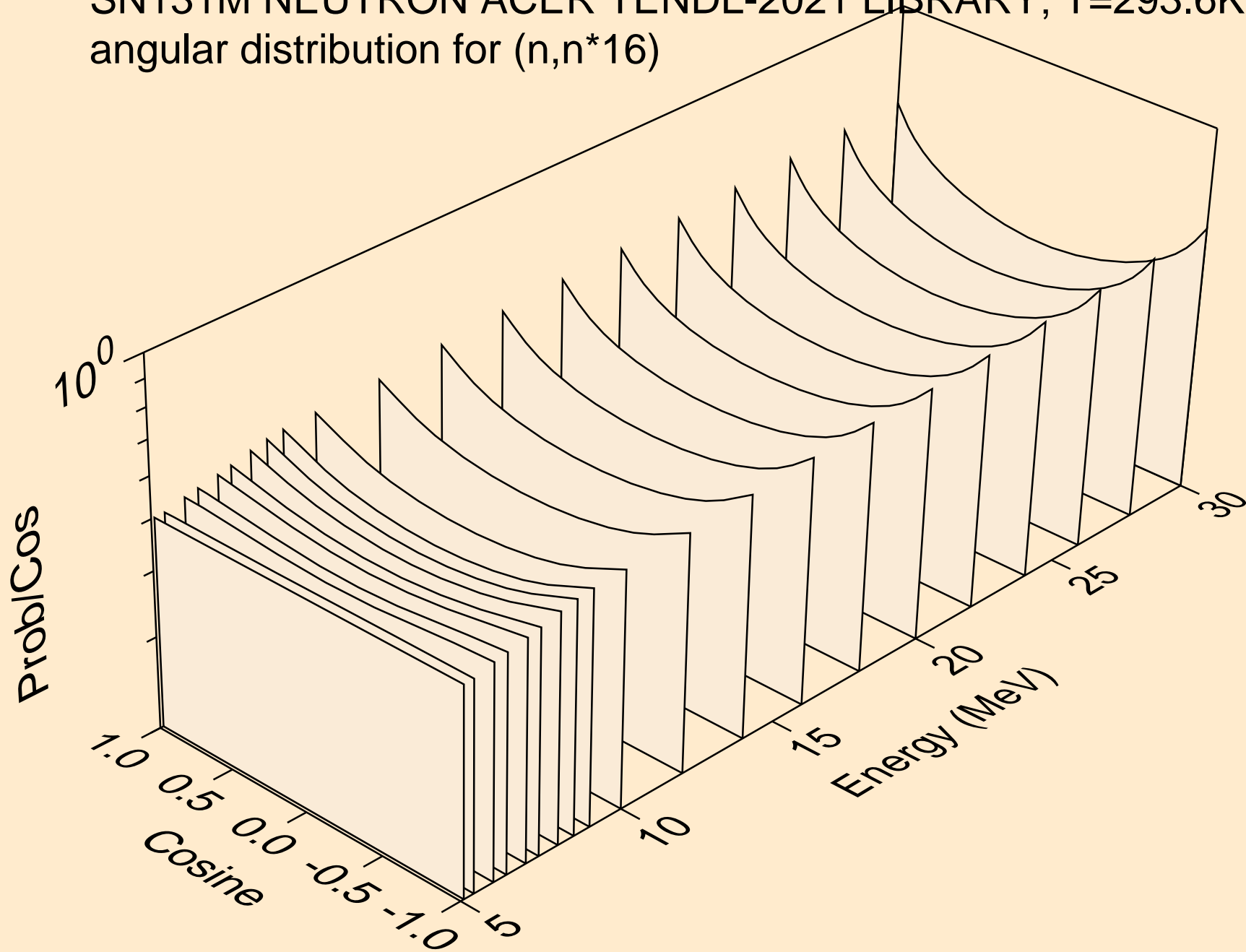

SN131M NEUTRON ACER TENDL-2021 LIBRARY; T=293.6K
angular distribution for (n,n*17)

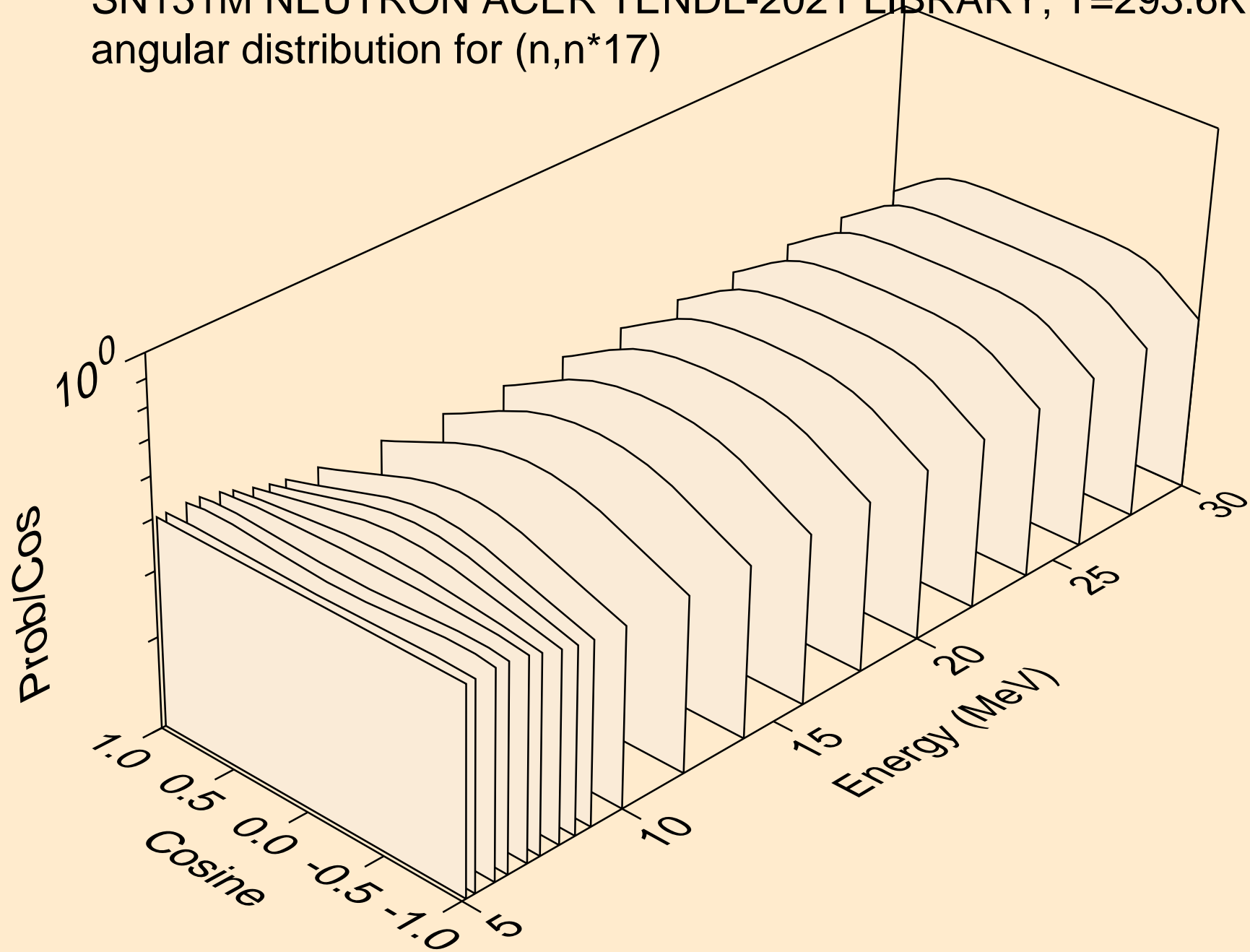

SN131M NEUTRON ACER TENDL-2021 LIBRARY; T=293.6K
angular distribution for (n,n*18)

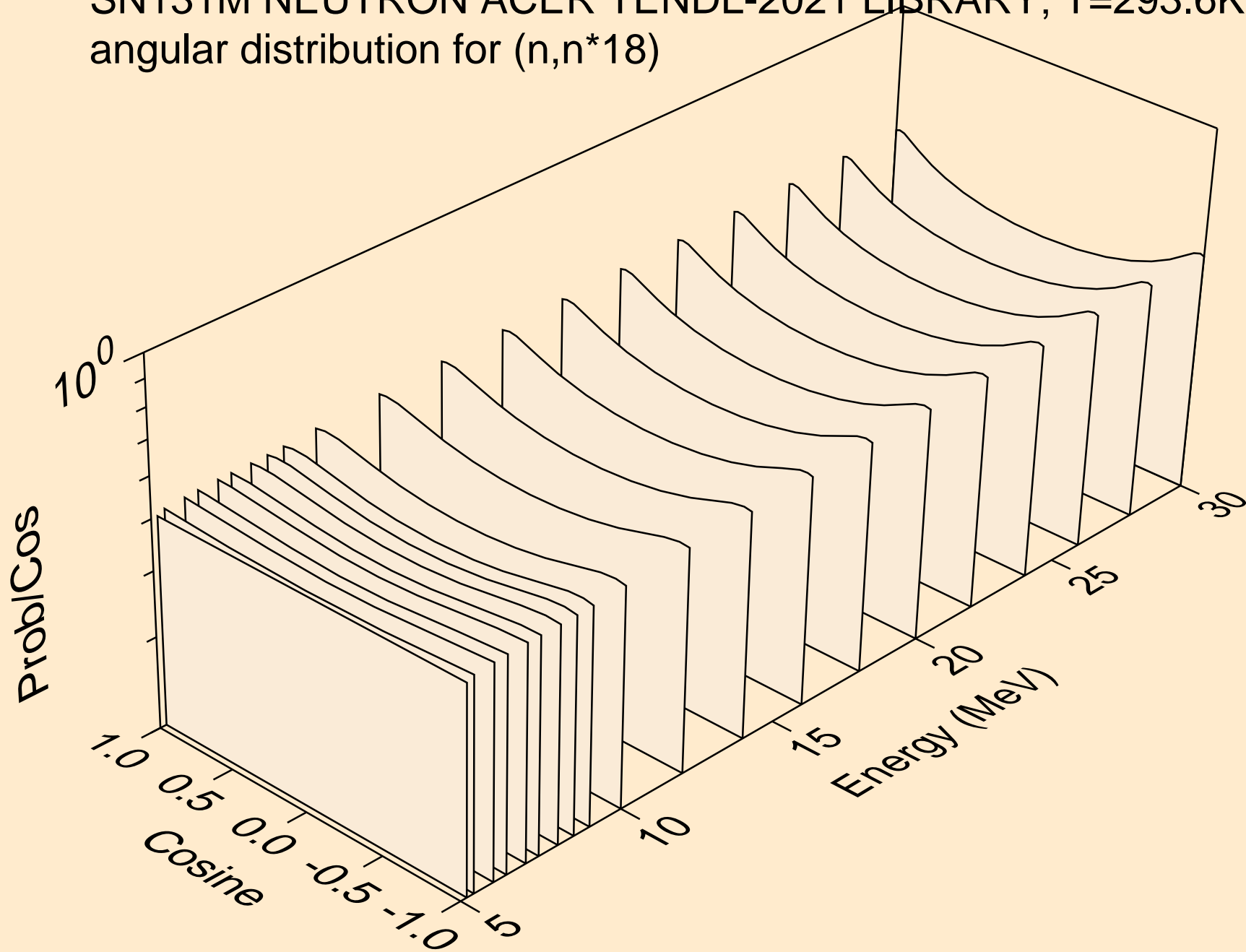

SN131M NEUTRON ACER TENDL-2021 LIBRARY; T=293.6K
angular distribution for (n,n*19)

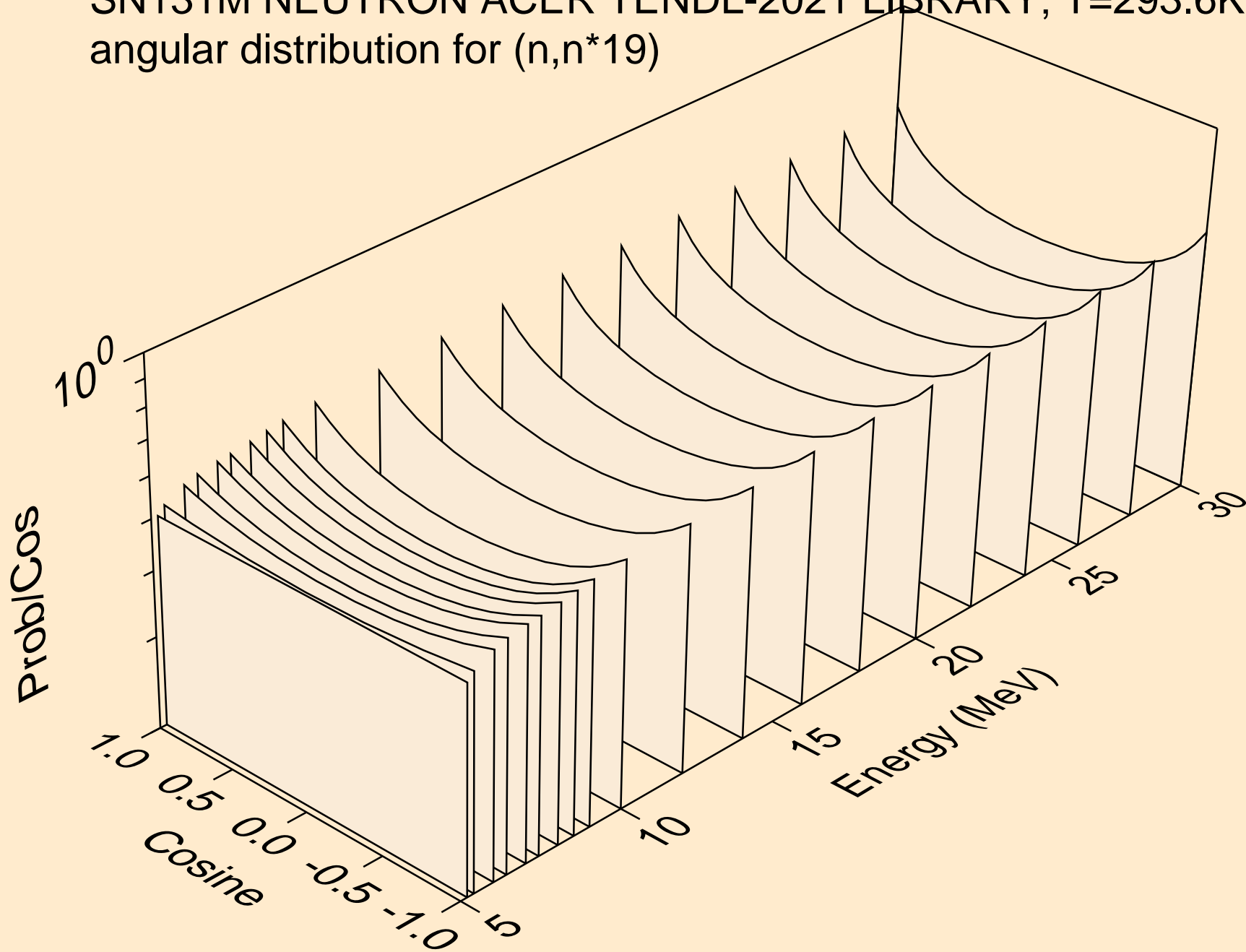

SN131M NEUTRON ACER TENDL-2021 LIBRARY; T=293.6K
angular distribution for (n,n*20)

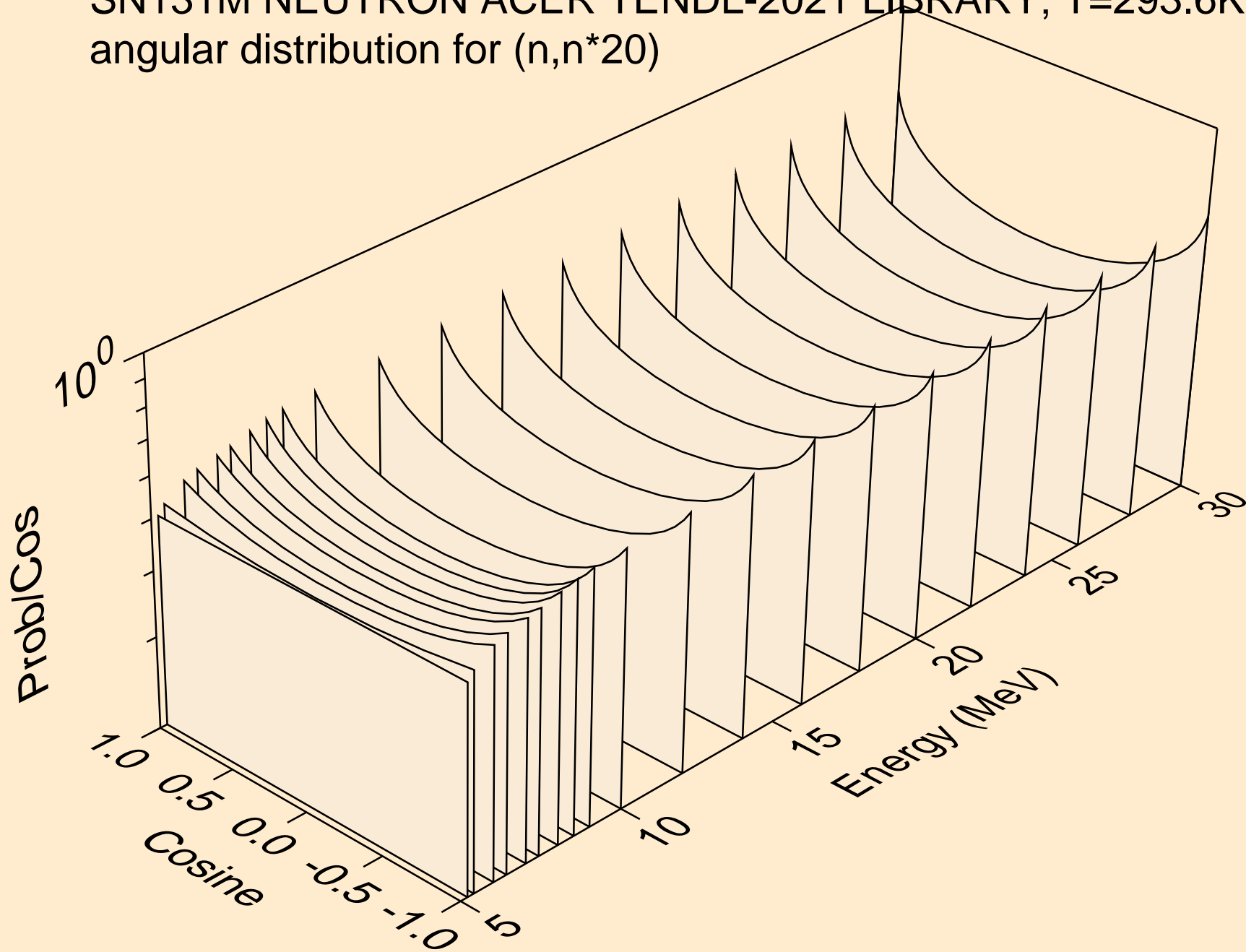

SN131M NEUTRON ACER TENDL-2021 LIBRARY; T=293.6K
angular distribution for (n,n*21)

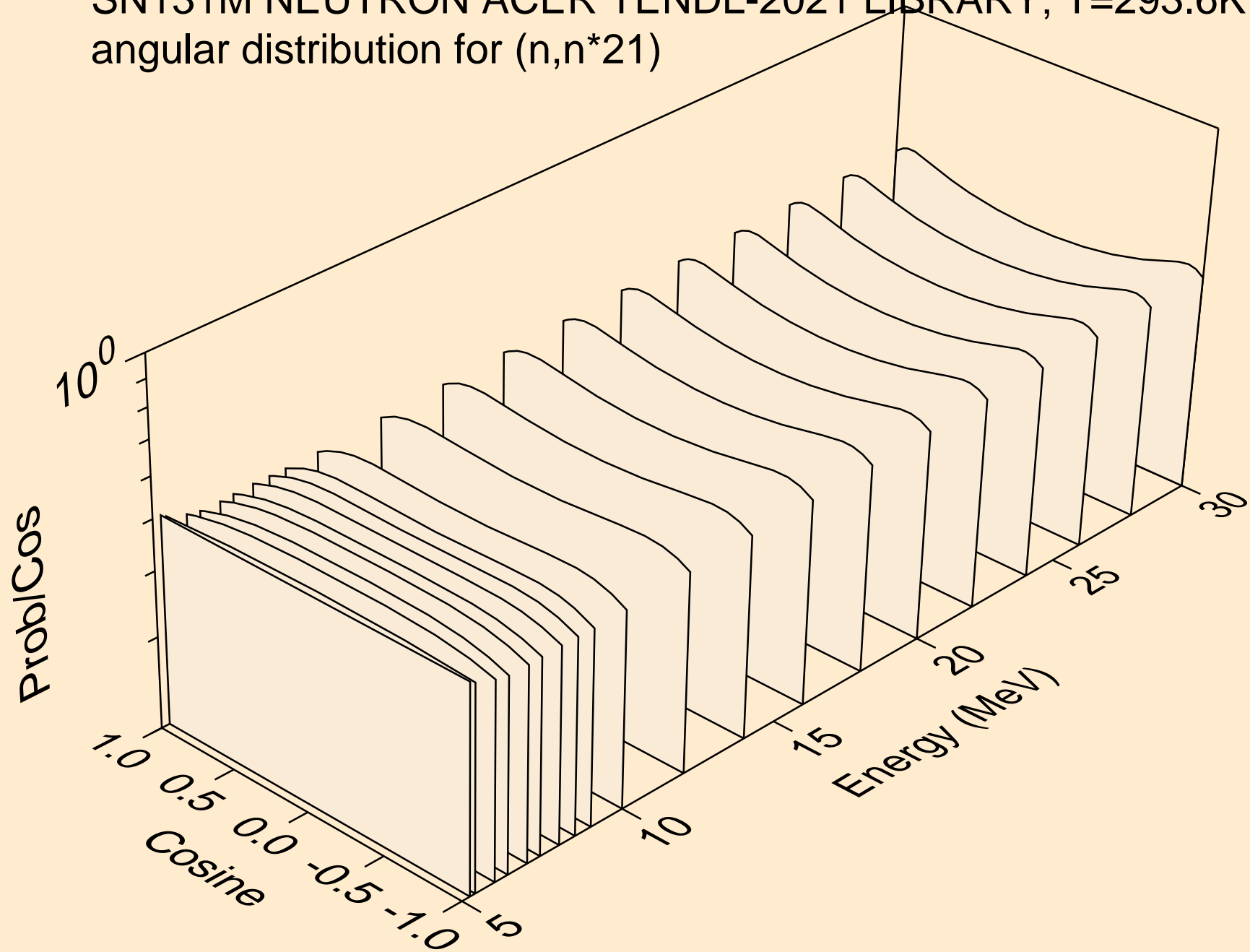

SN131M NEUTRON ACER TENDL-2021 LIBRARY; T=293.6K
angular distribution for (n,n*22)

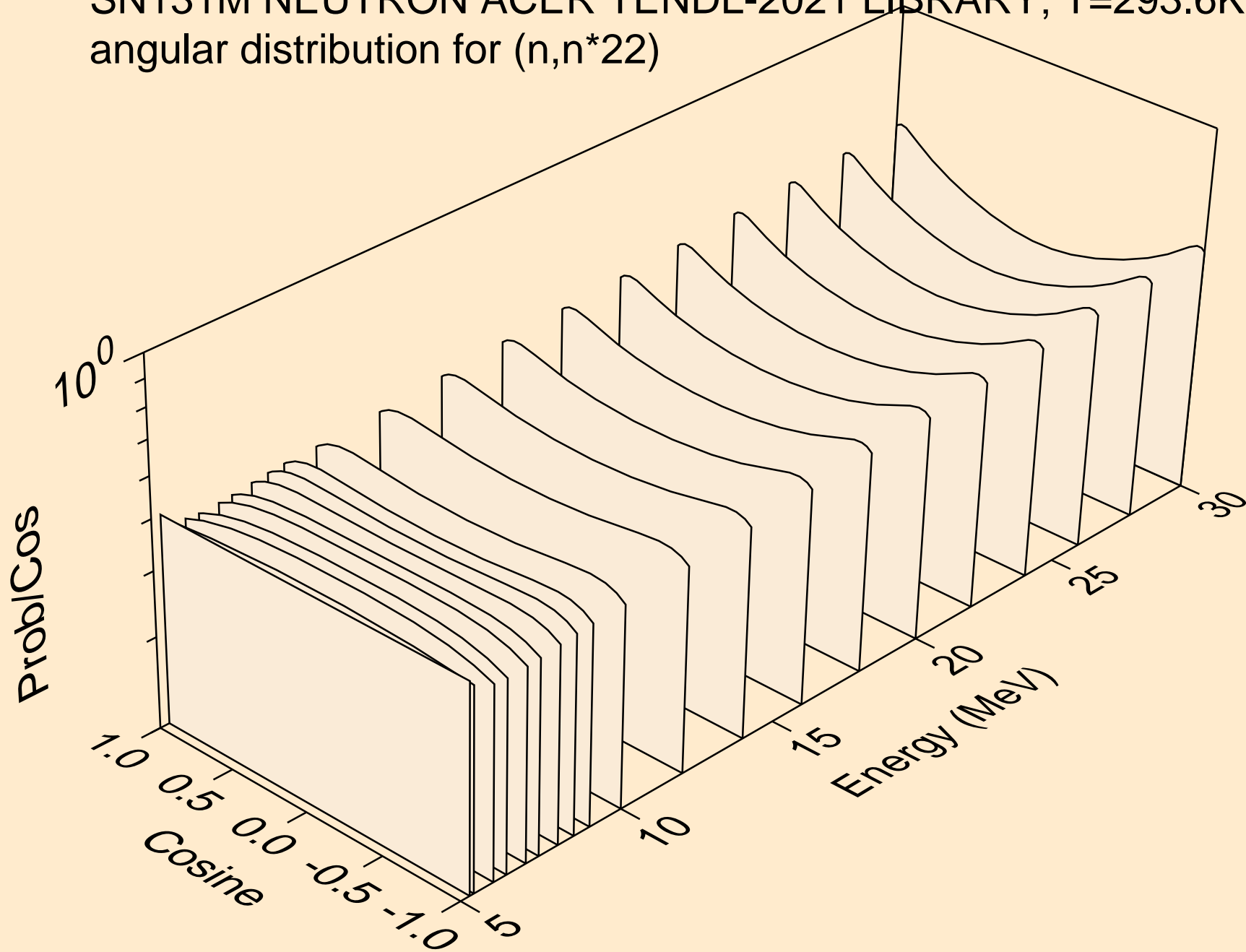

SN131M NEUTRON ACER TENDL-2021 LIBRARY; T=293.6K
angular distribution for (n,n*23)

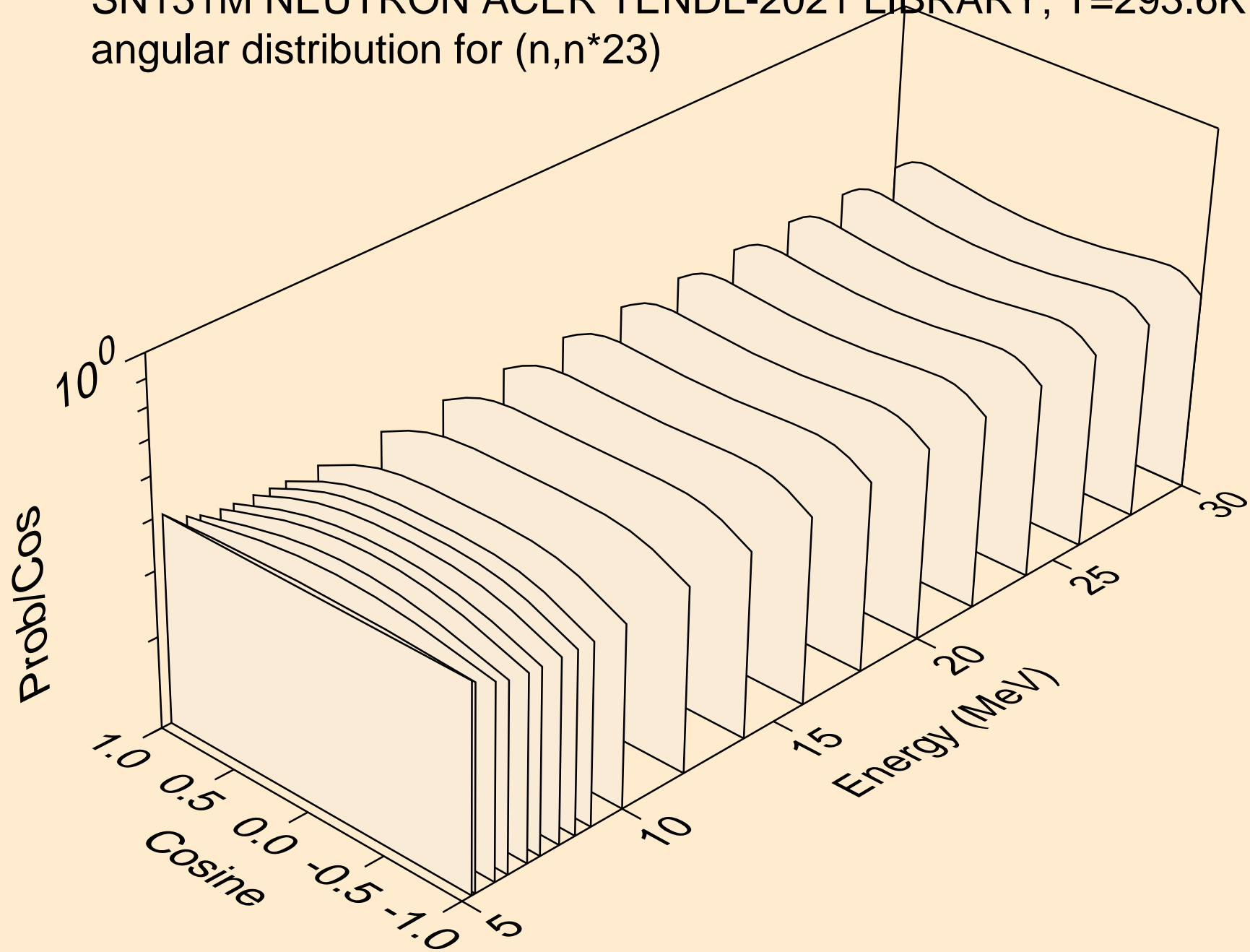

SN131M NEUTRON ACER TENDL-2021 LIBRARY; T=293.6K
angular distribution for (n,n*24)

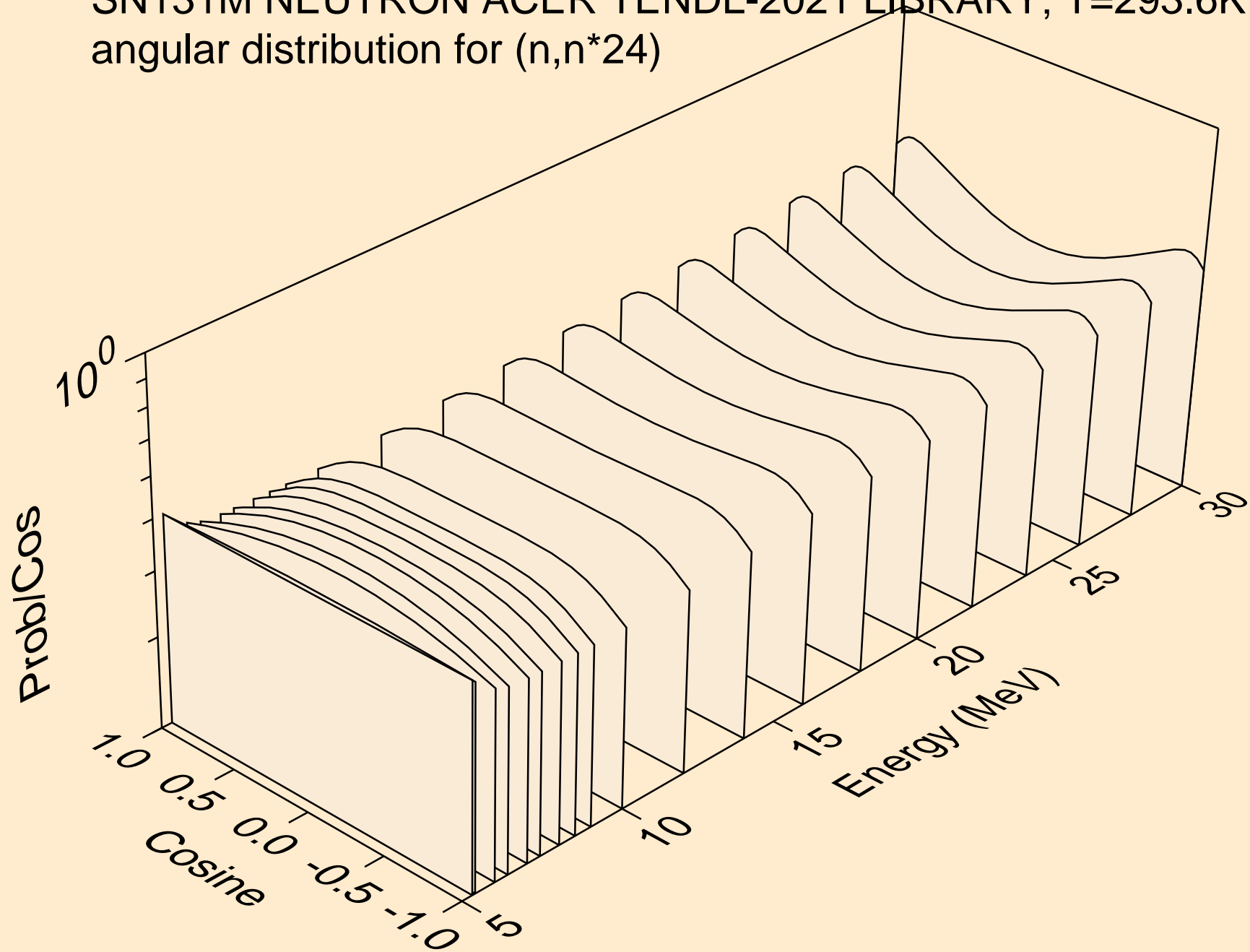

SN131M NEUTRON ACER TENDL-2021 LIBRARY; T=293.6K
angular distribution for (n,n*25)

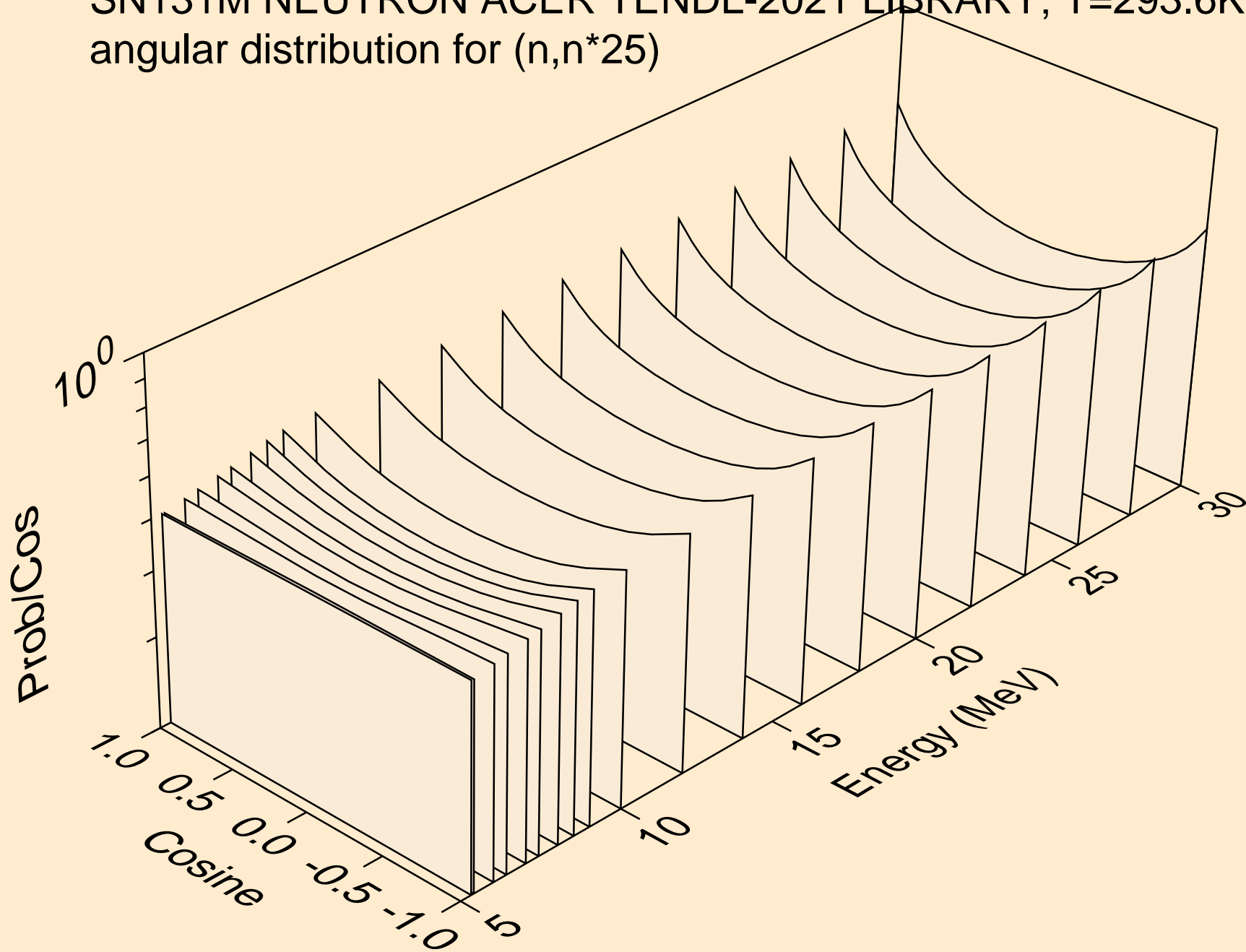

SN131M NEUTRON ACER TENDL-2021 LIBRARY; T=293.6K
angular distribution for (n,n*26)

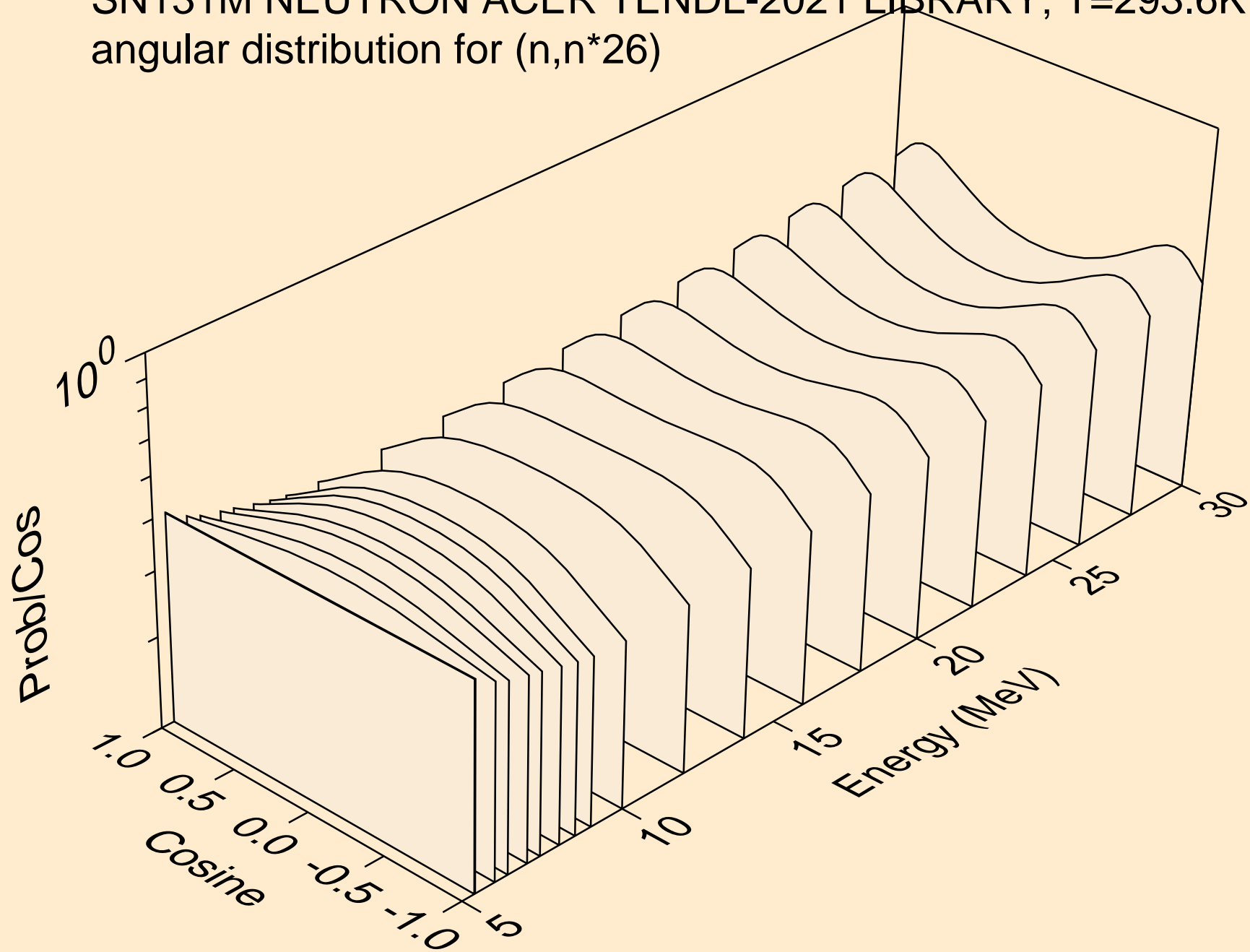

SN131M NEUTRON ACER TENDL-2021 LIBRARY; T=293.6K
angular distribution for (n,n*27)

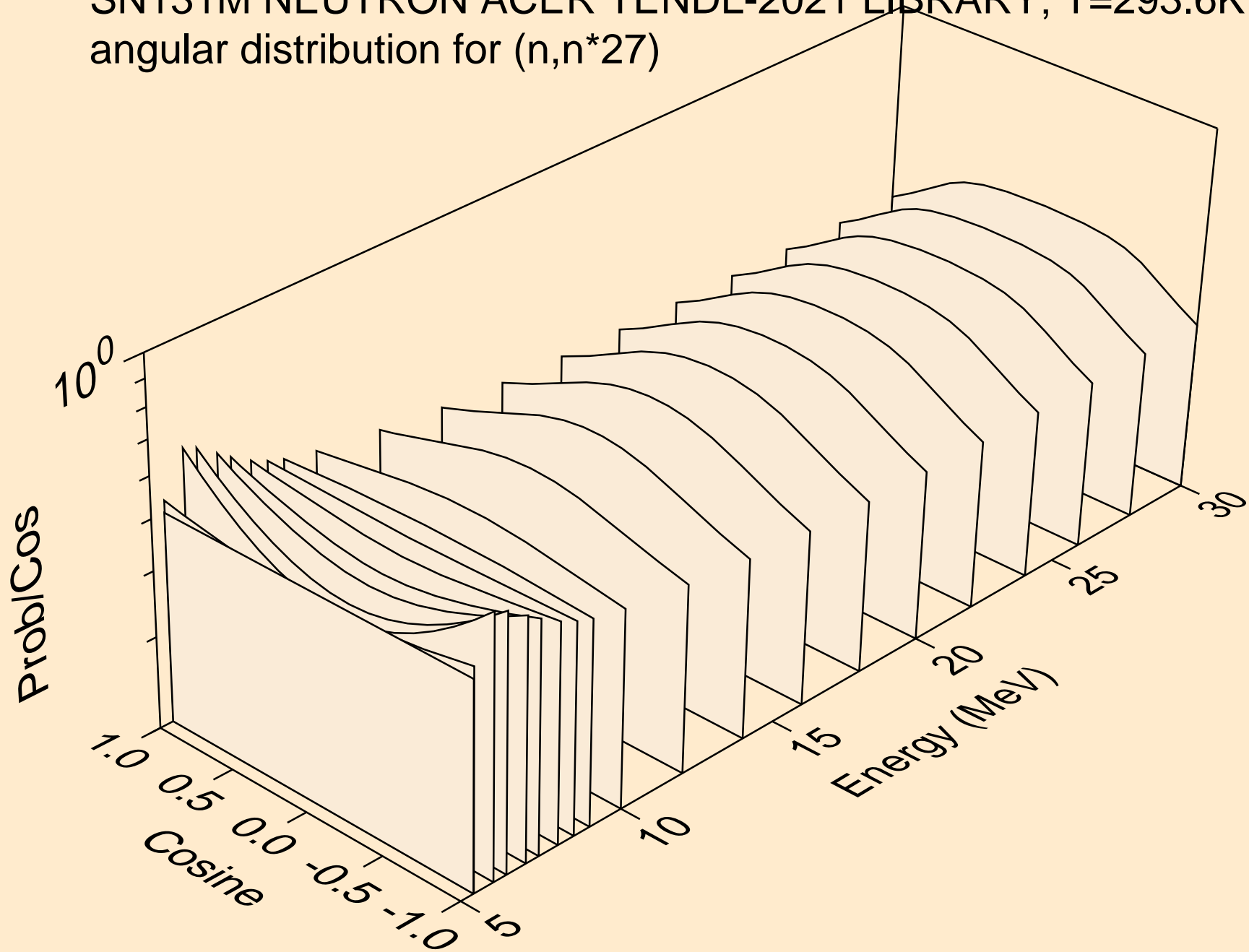

SN131M NEUTRON ACER TENDL-2021 LIBRARY; T=293.6K
angular distribution for (n,n*28)

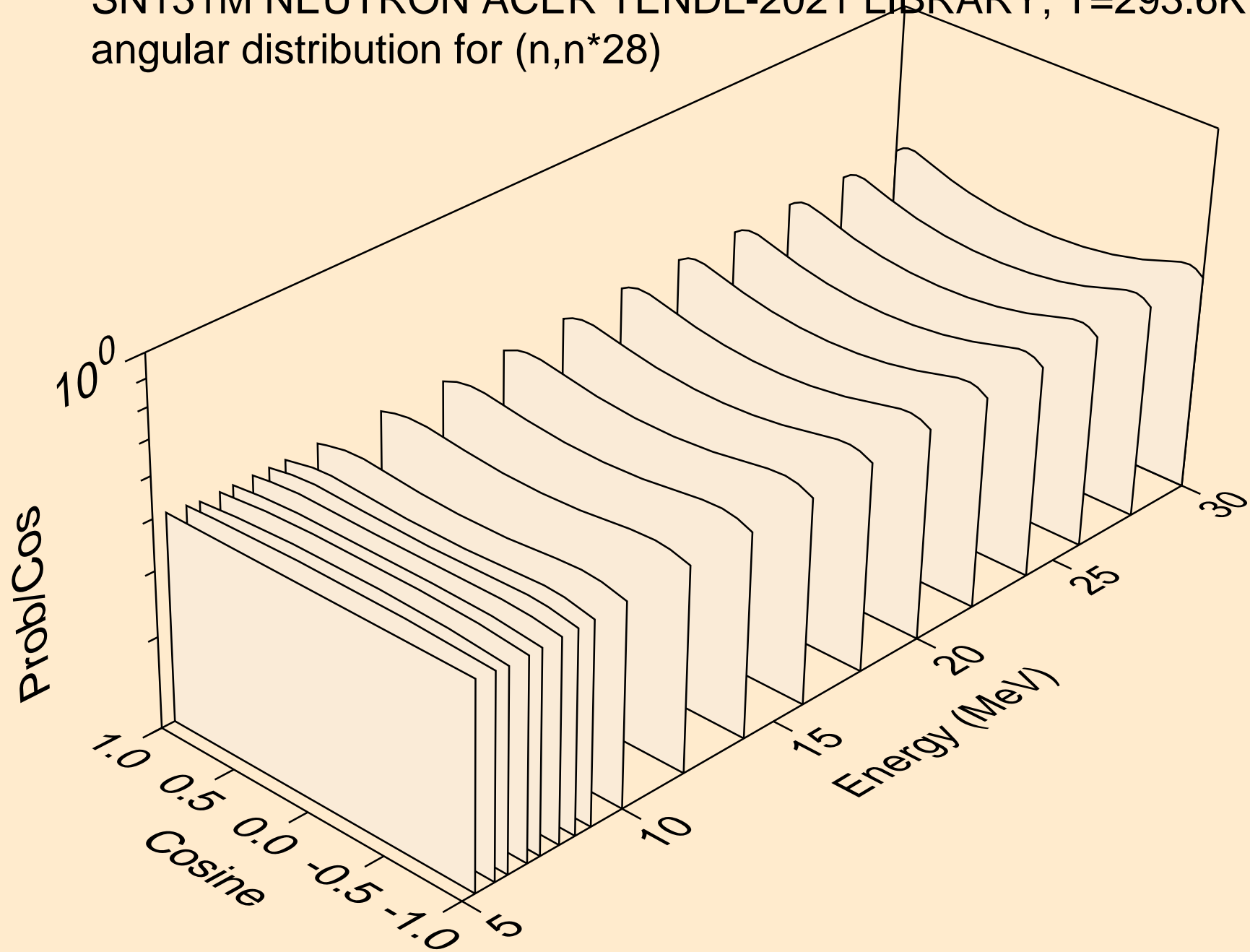

SN131M NEUTRON ACER TENDL-2021 LIBRARY; T=293.6K
angular distribution for (n,n*29)

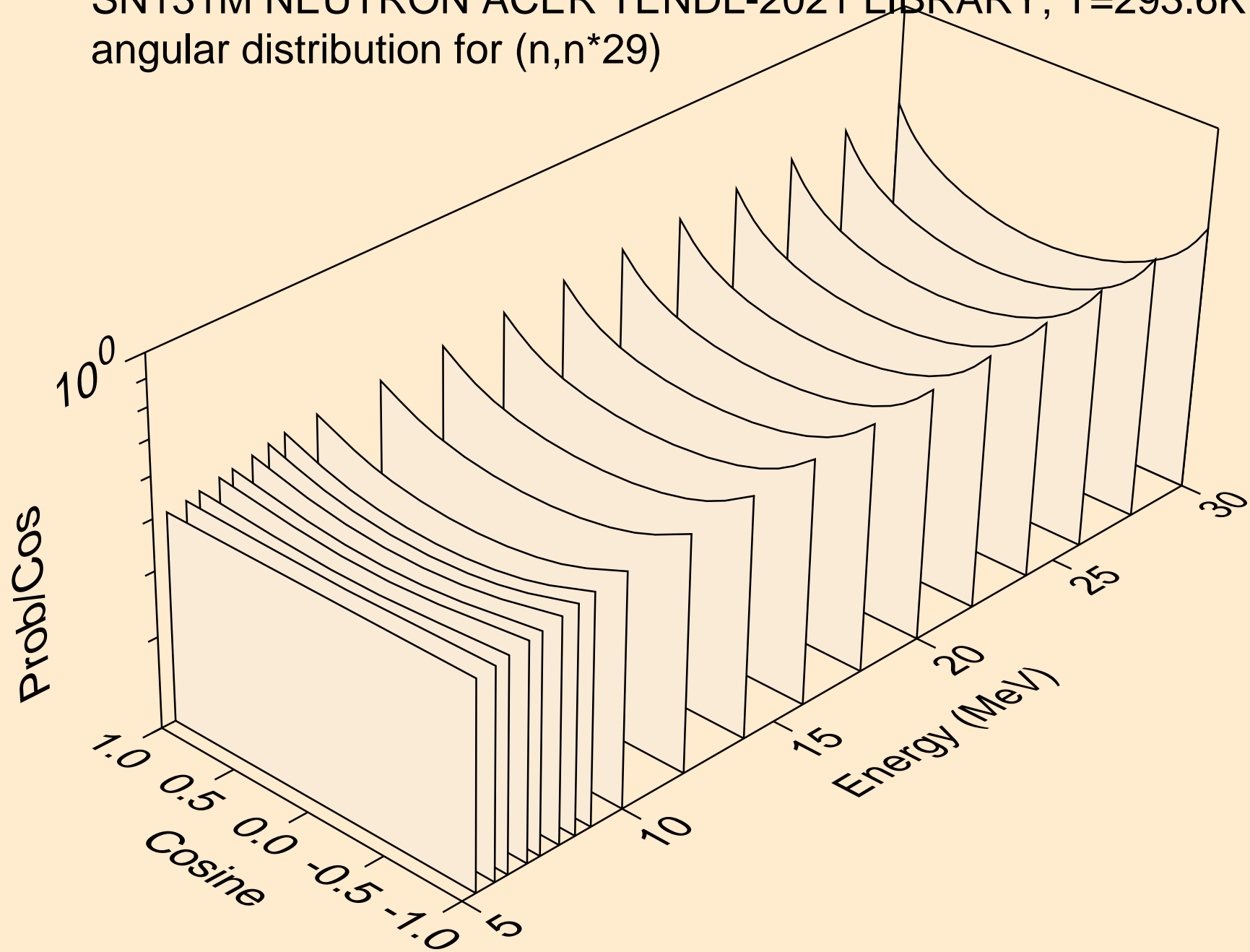

SN131M NEUTRON ACER TENDL-2021 LIBRARY; T=293.6K
angular distribution for (n,n*30)

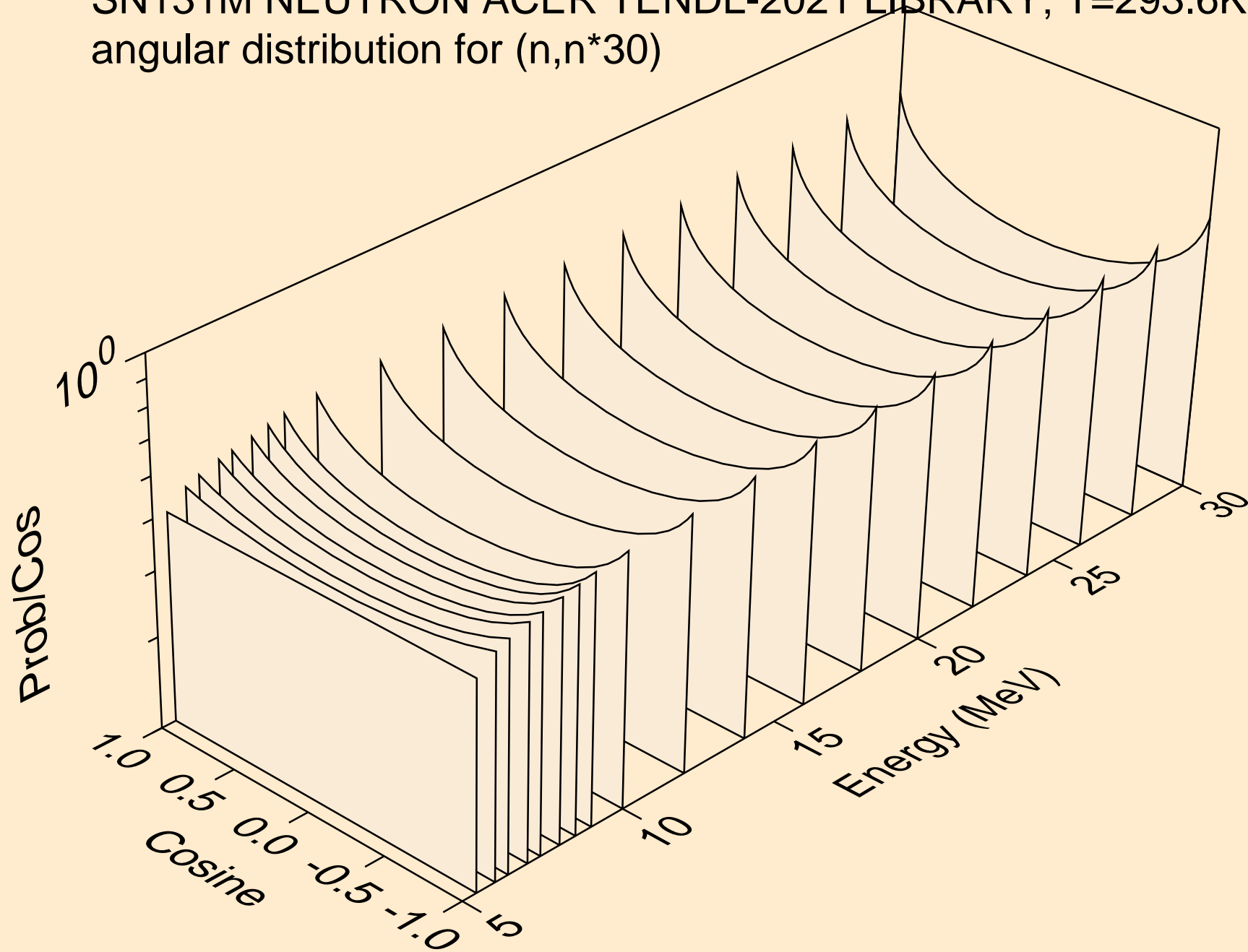

SN131M NEUTRON ACER TENDL-2021 LIBRARY; T=293.6K
Neutron emission for (n,x)

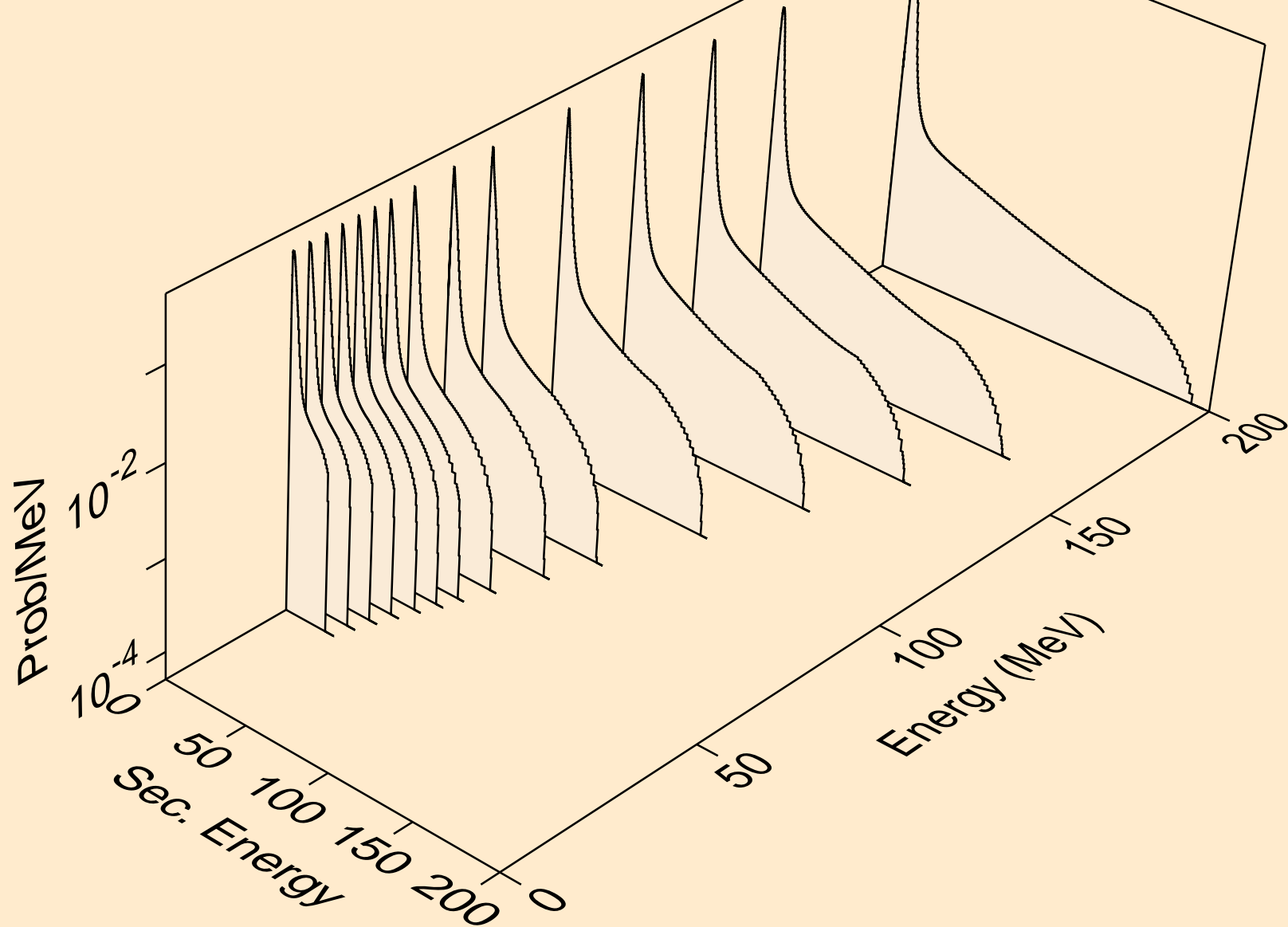

SN131M NEUTRON ACER TENDL-2021 LIBRARY; T=293.6K
Neutron emission for (n,2nd)

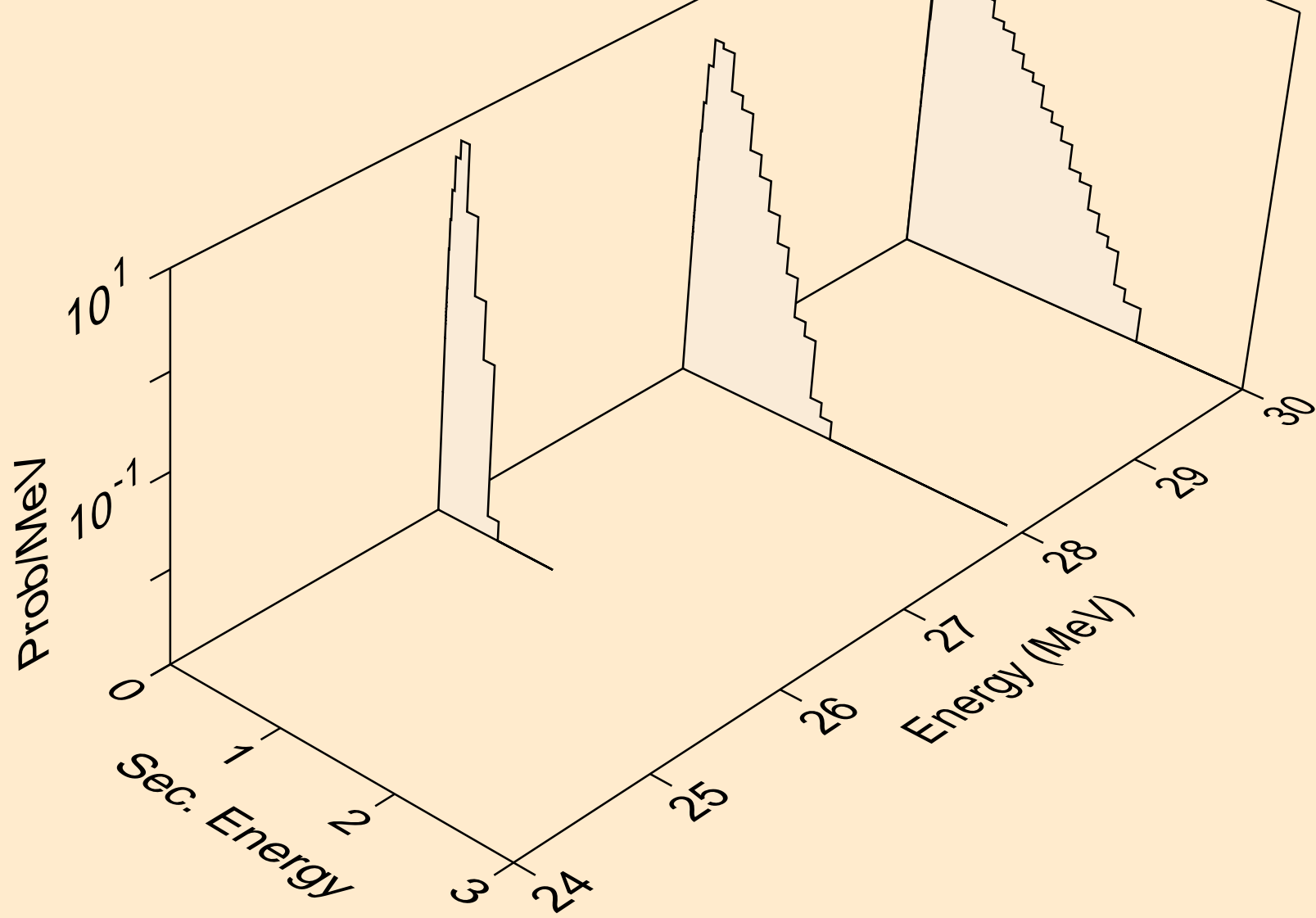

SN131M NEUTRON ACER TENDL-2021 LIBRARY; T=293.6K
Neutron emission for (n,2n)

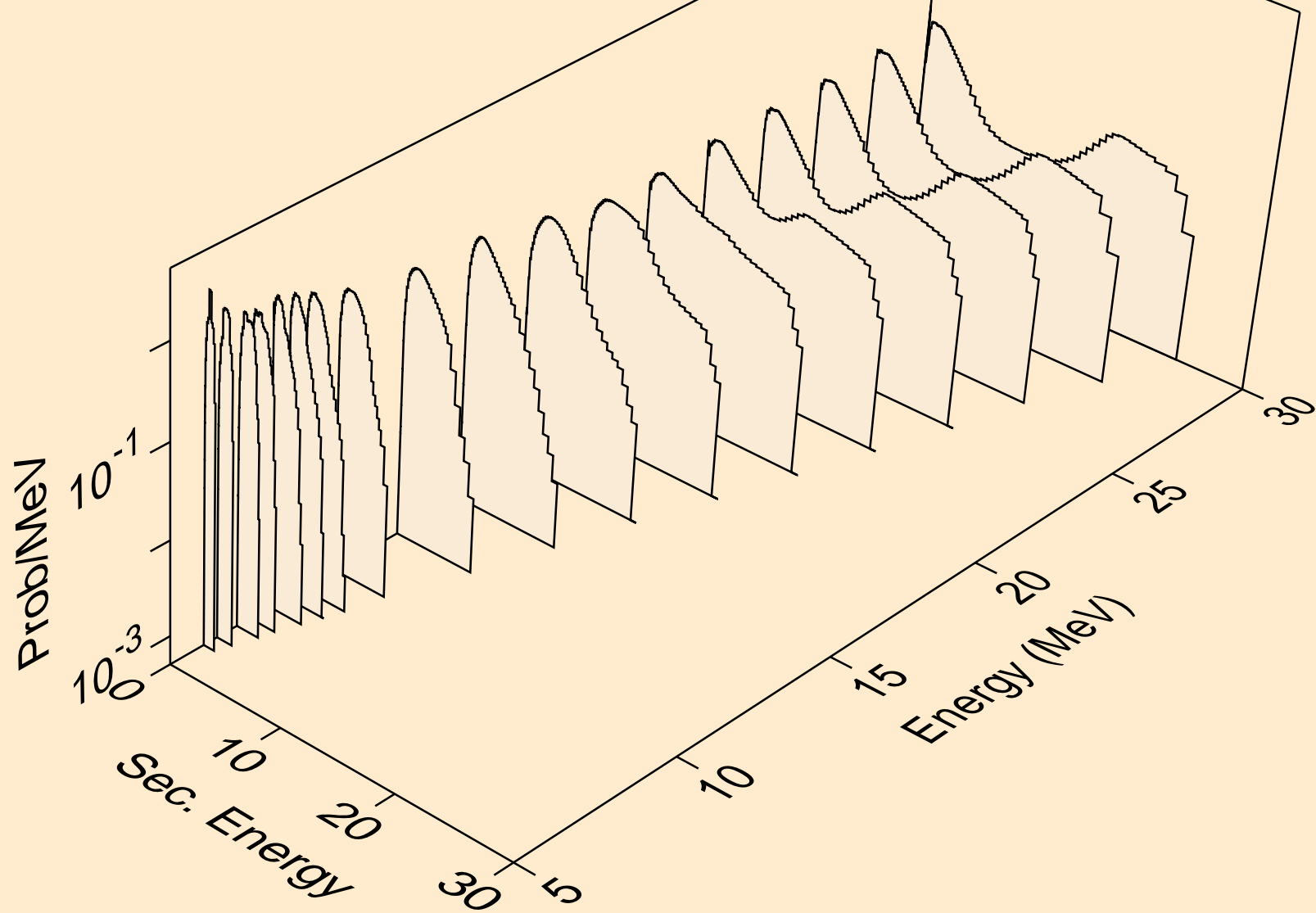

SN131M NEUTRON ACER TENDL-2021 LIBRARY; T=293.6K
Neutron emission for (n,3n)

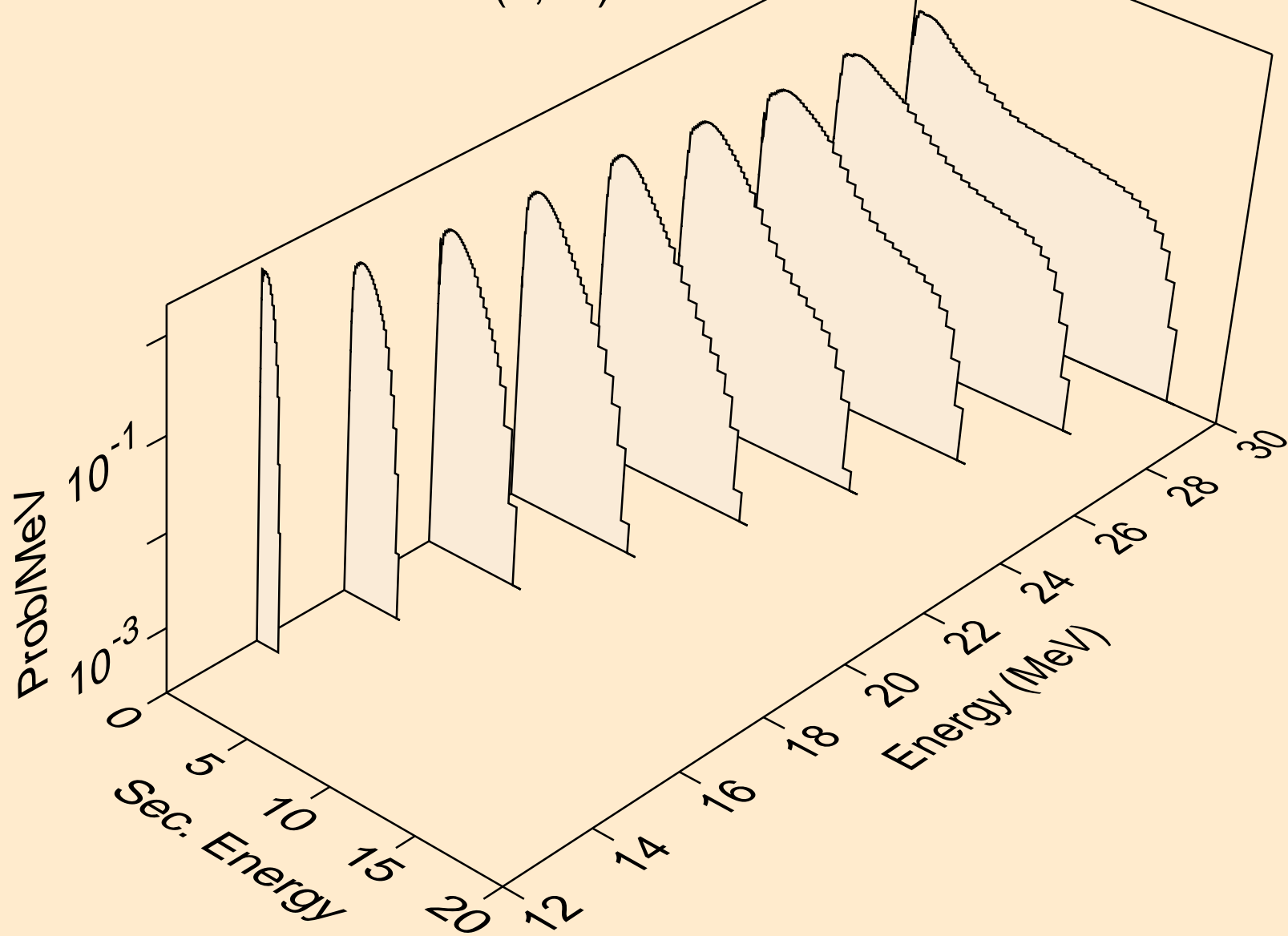

SN131M NEUTRON ACER TENDL-2021 LIBRARY; T=293.6K
Neutron emission for (n,n*)a

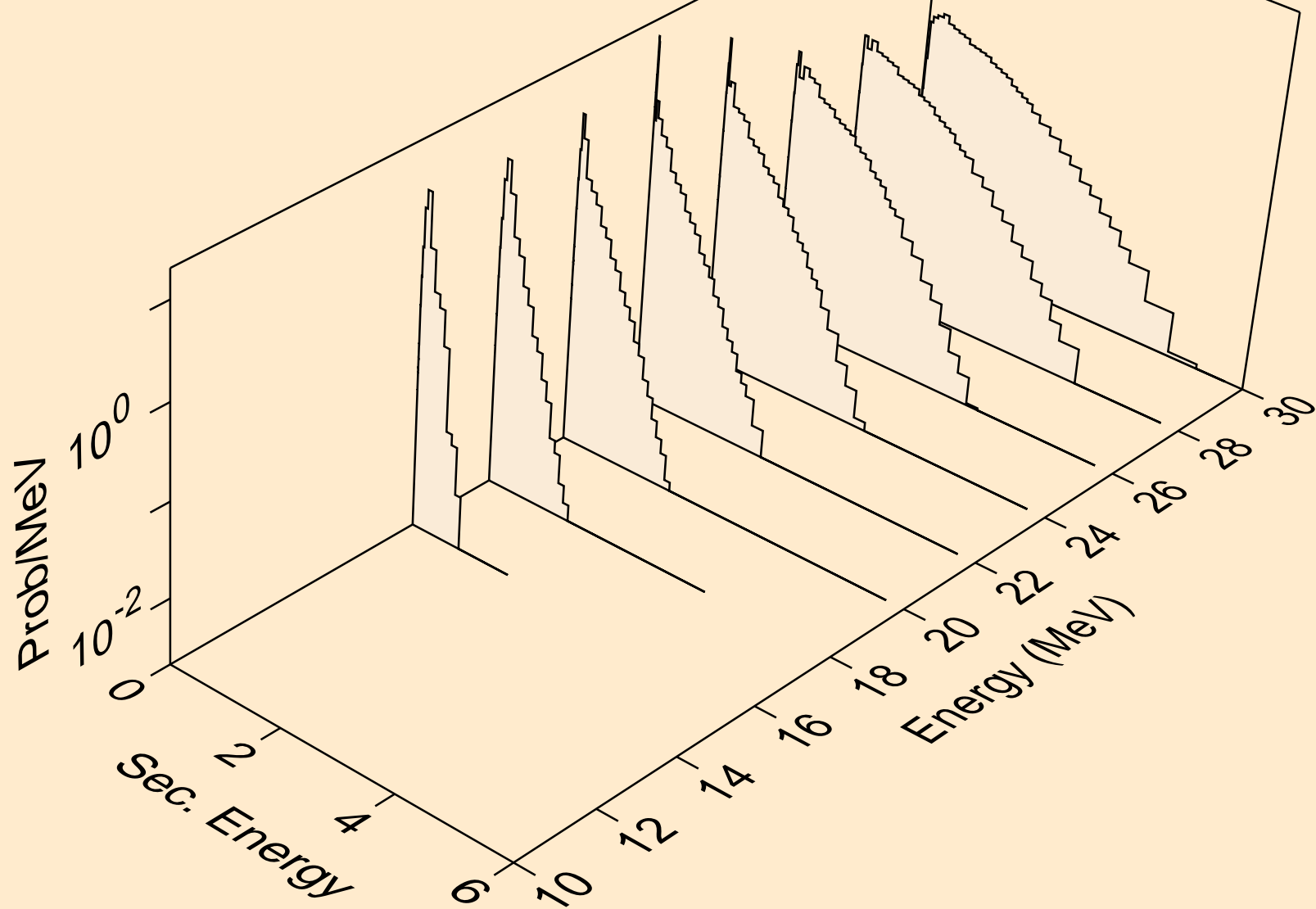

SN131M NEUTRON ACER TENDL-2021 LIBRARY; T=293.6K
Neutron emission for (n,2n)_a

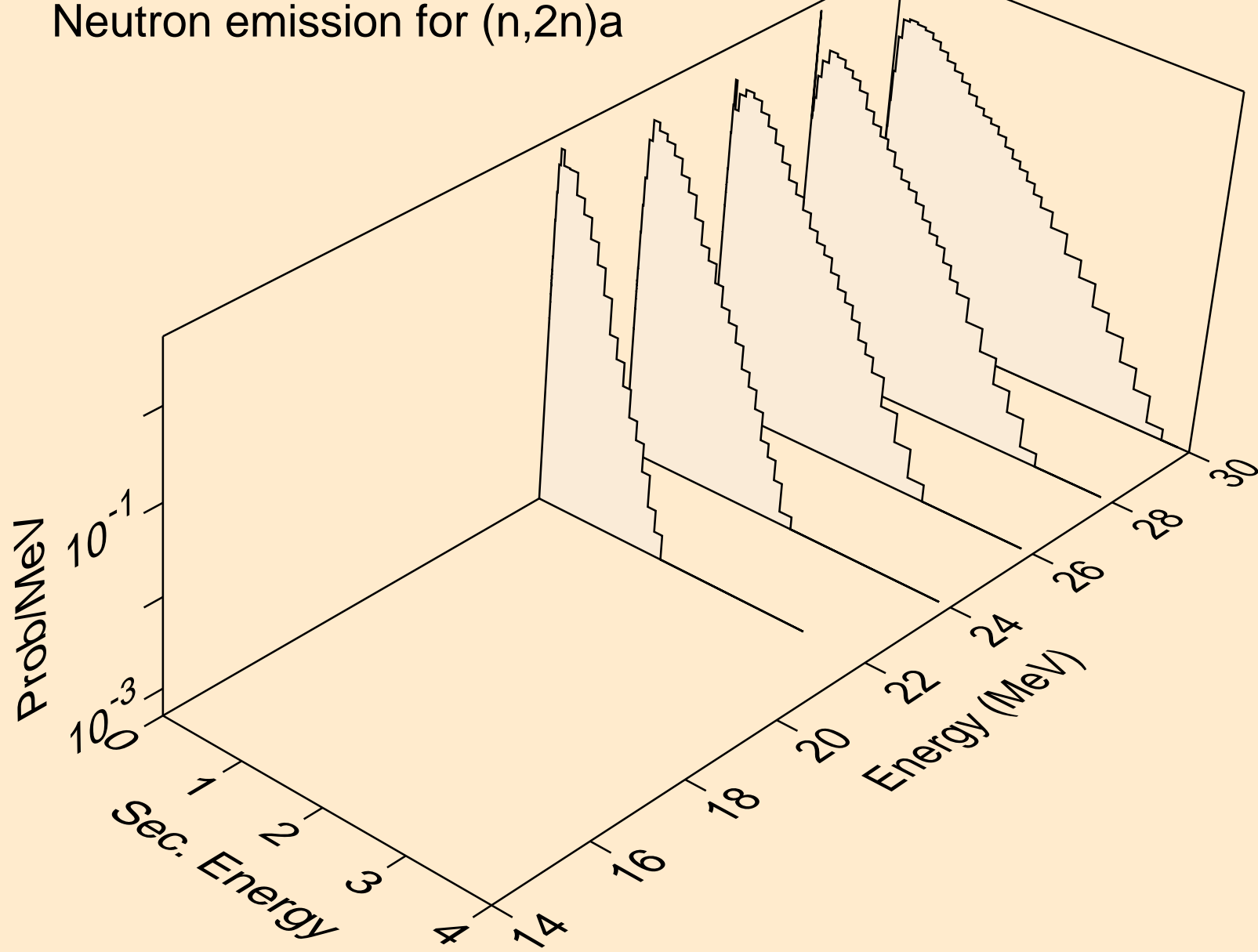

SN131M NEUTRON ACER TENDL-2021 LIBRARY; T=293.6K
Neutron emission for (n,n*)p

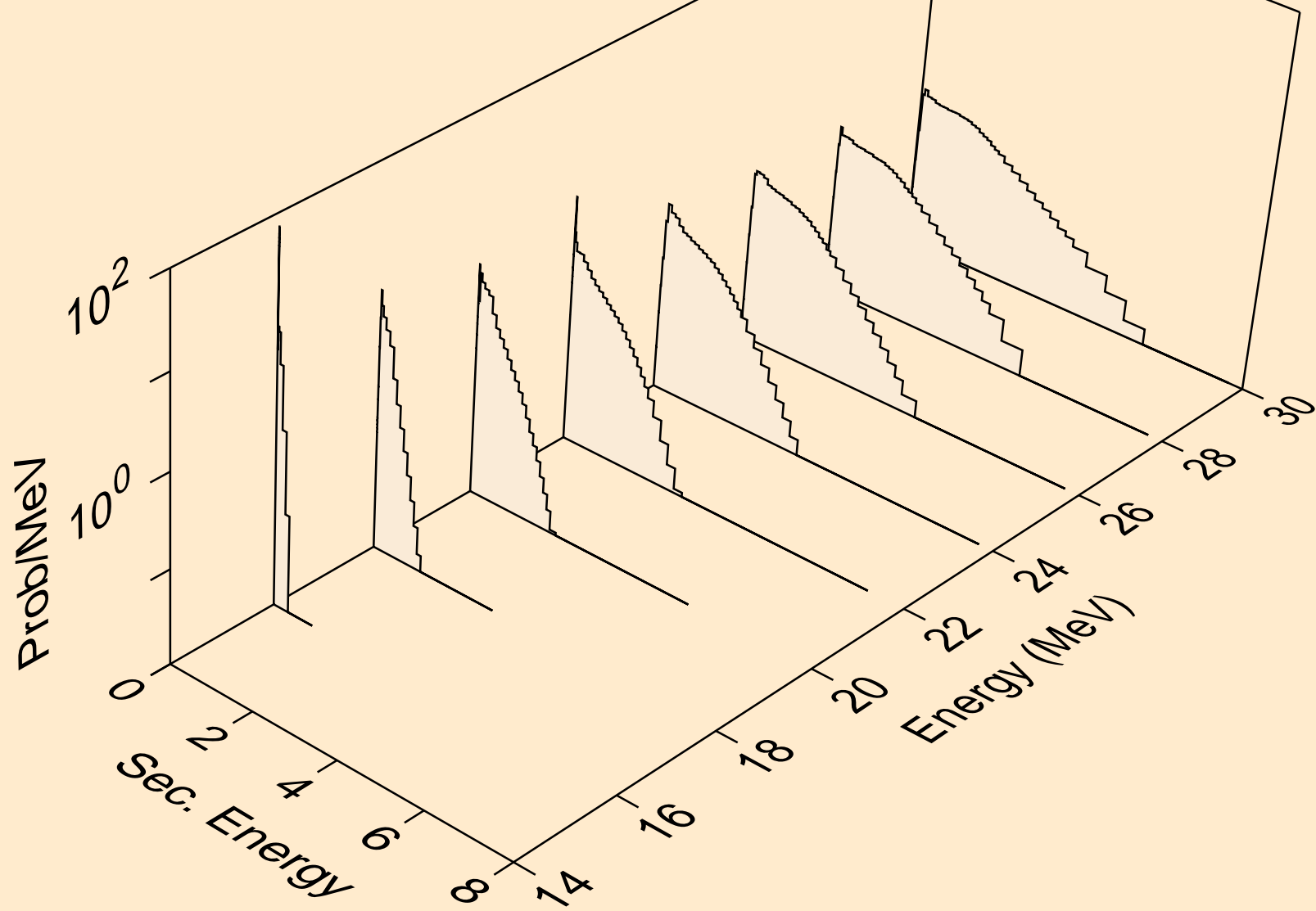

SN131M NEUTRON ACER TENDL-2021 LIBRARY; T=293.6K
Neutron emission for (n,n*)d

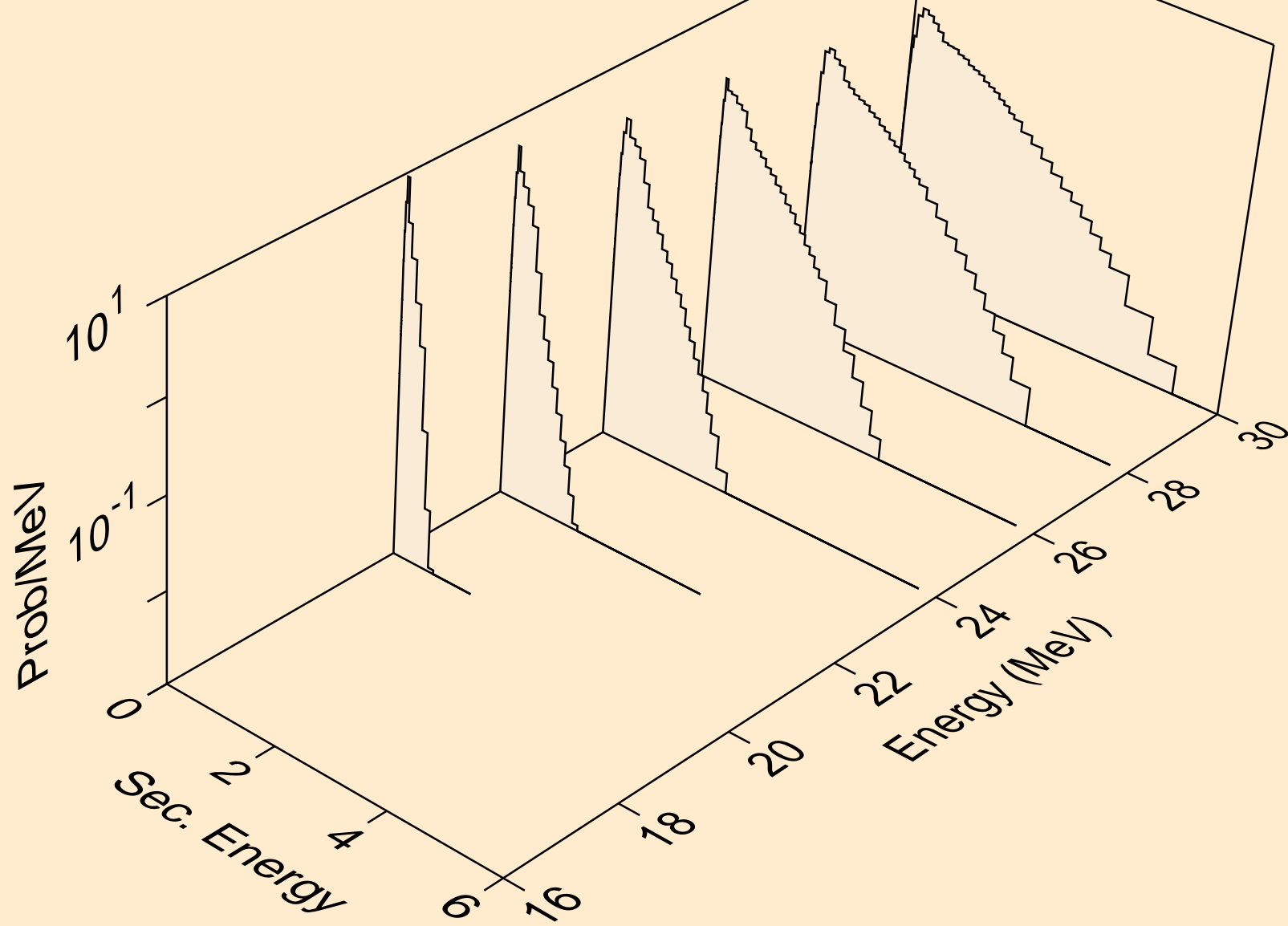

SN131M NEUTRON ACER TENDL-2021 LIBRARY; T=293.6K
Neutron emission for (n,n*)t

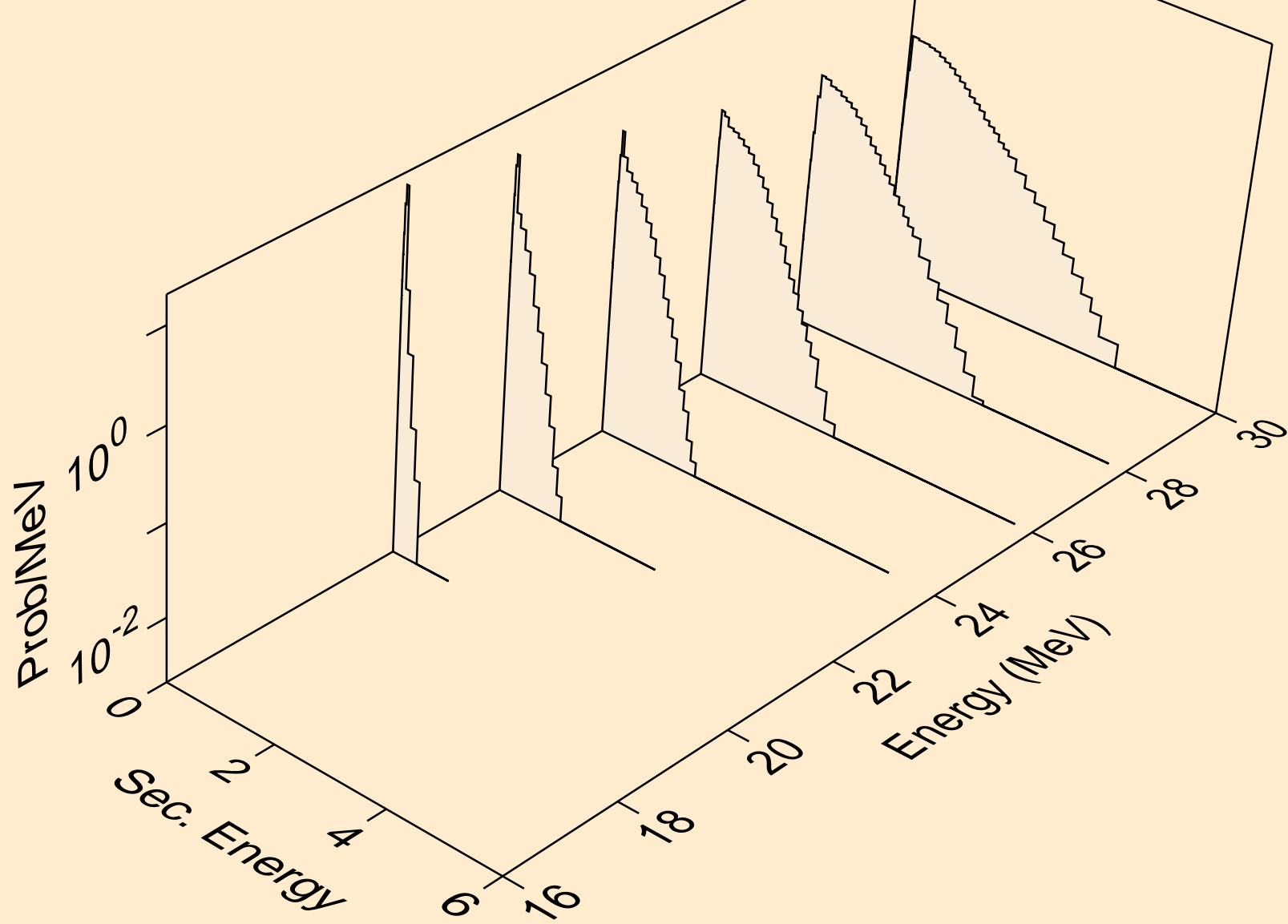

SN131M NEUTRON ACER TENDL-2021 LIBRARY; T=293.6K
Neutron emission for (n,4n)

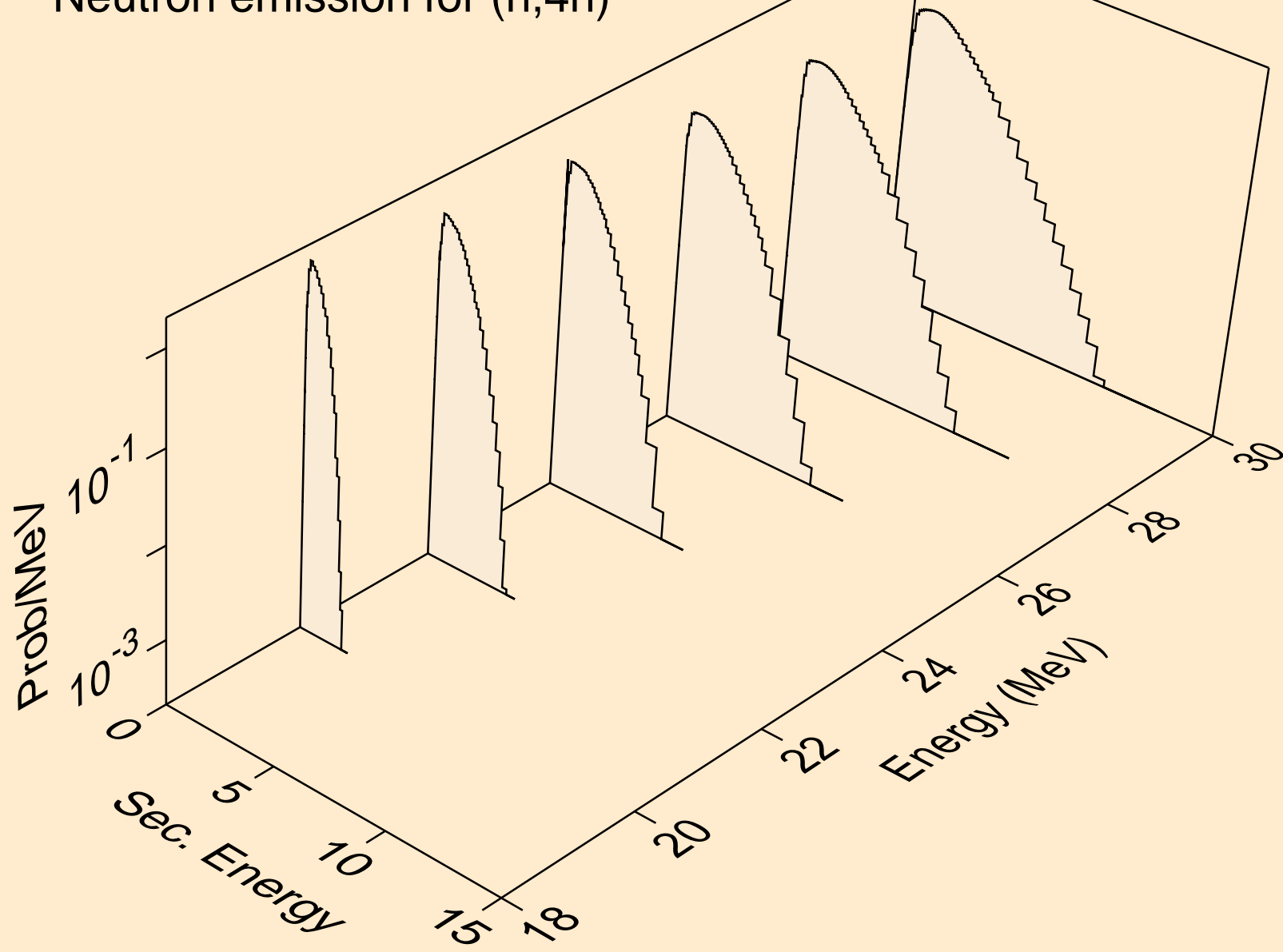

SN131M NEUTRON ACER TENDL-2021 LIBRARY; T=293.6K
Neutron emission for (n,2np)

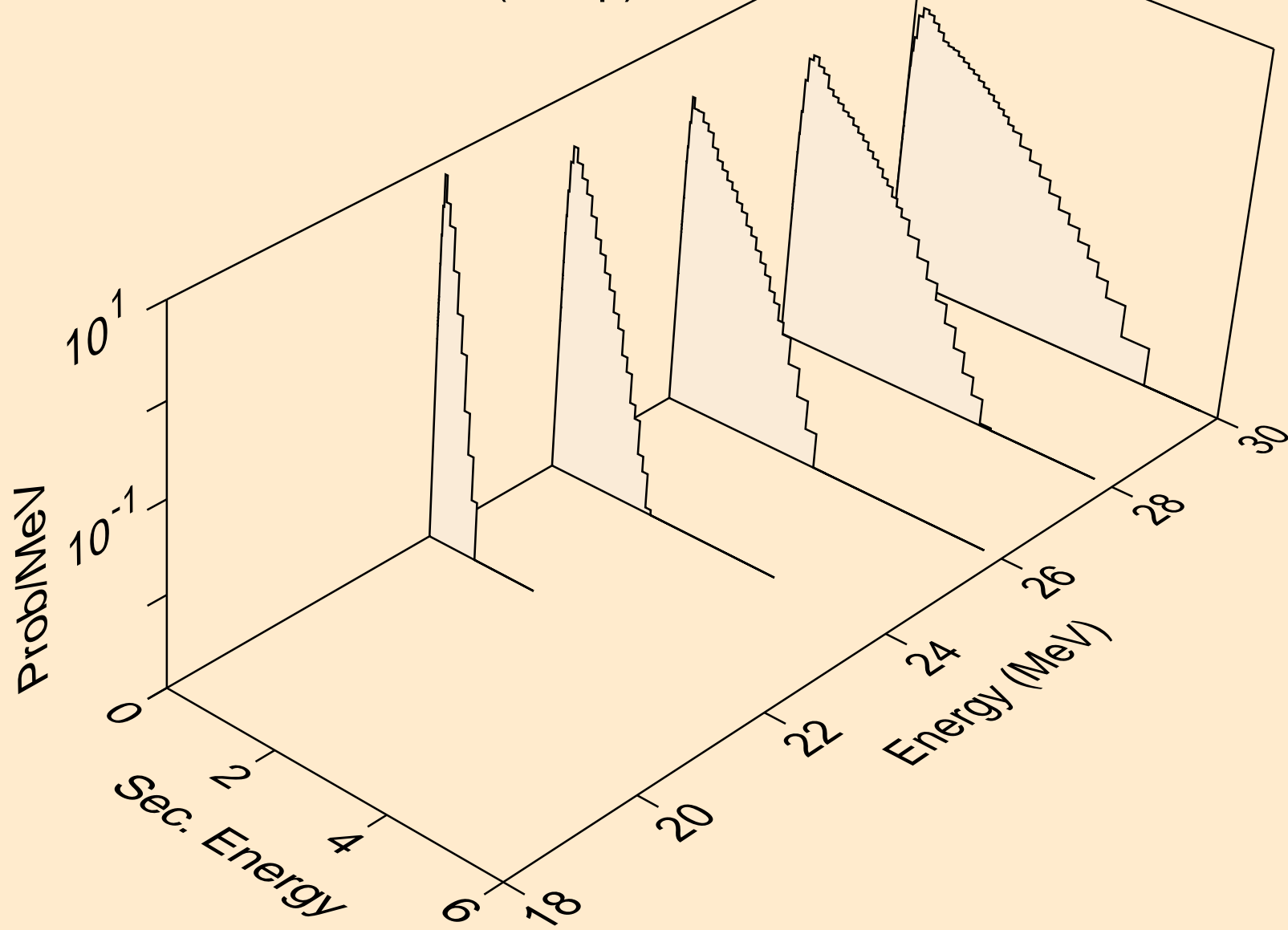

SN131M NEUTRON ACER TENDL-2021 LIBRARY; T=293.6K
Neutron emission for (n,3np)

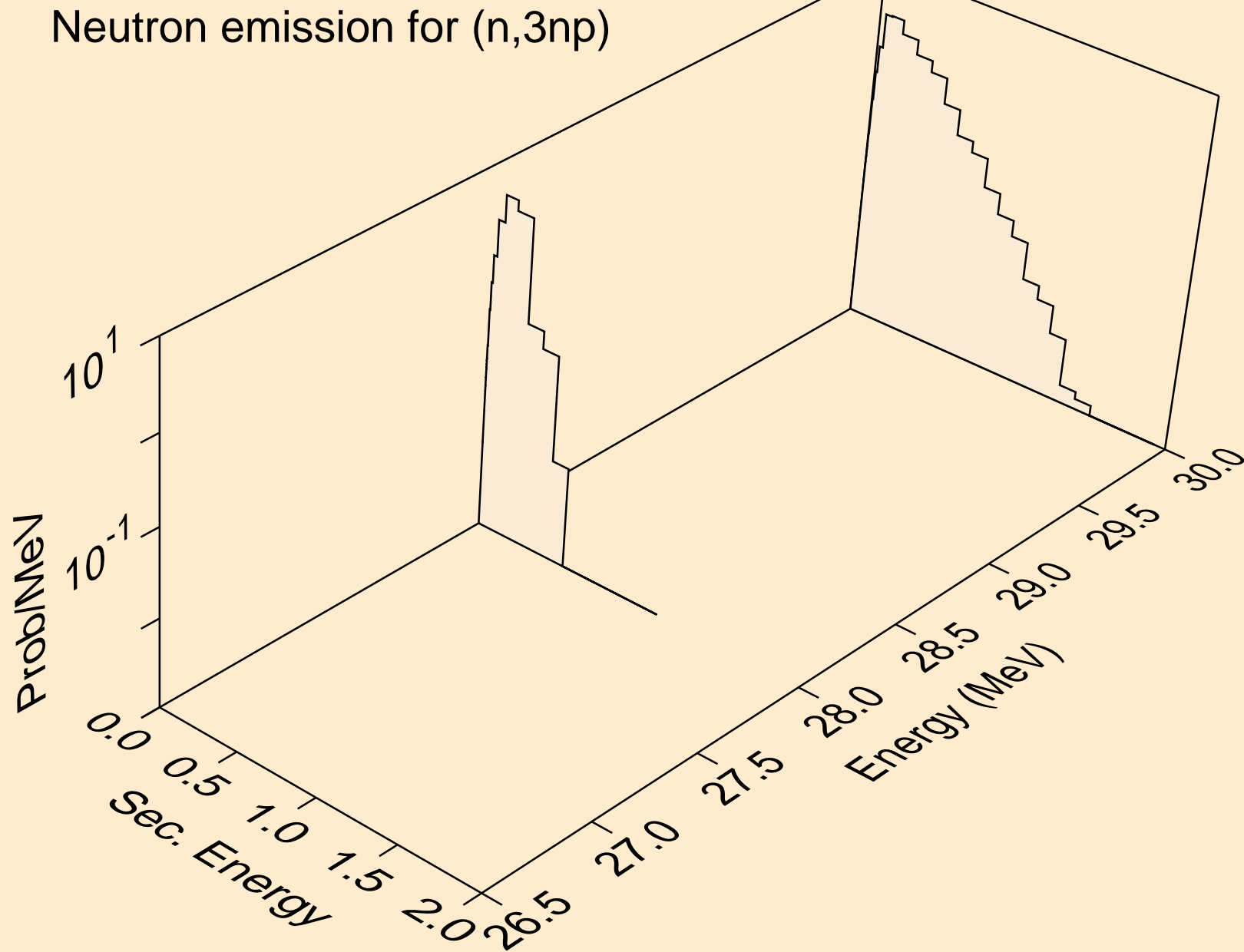

SN131M NEUTRON ACER TENDL-2021 LIBRARY; T=293.6K
Neutron emission for (n,n*c)

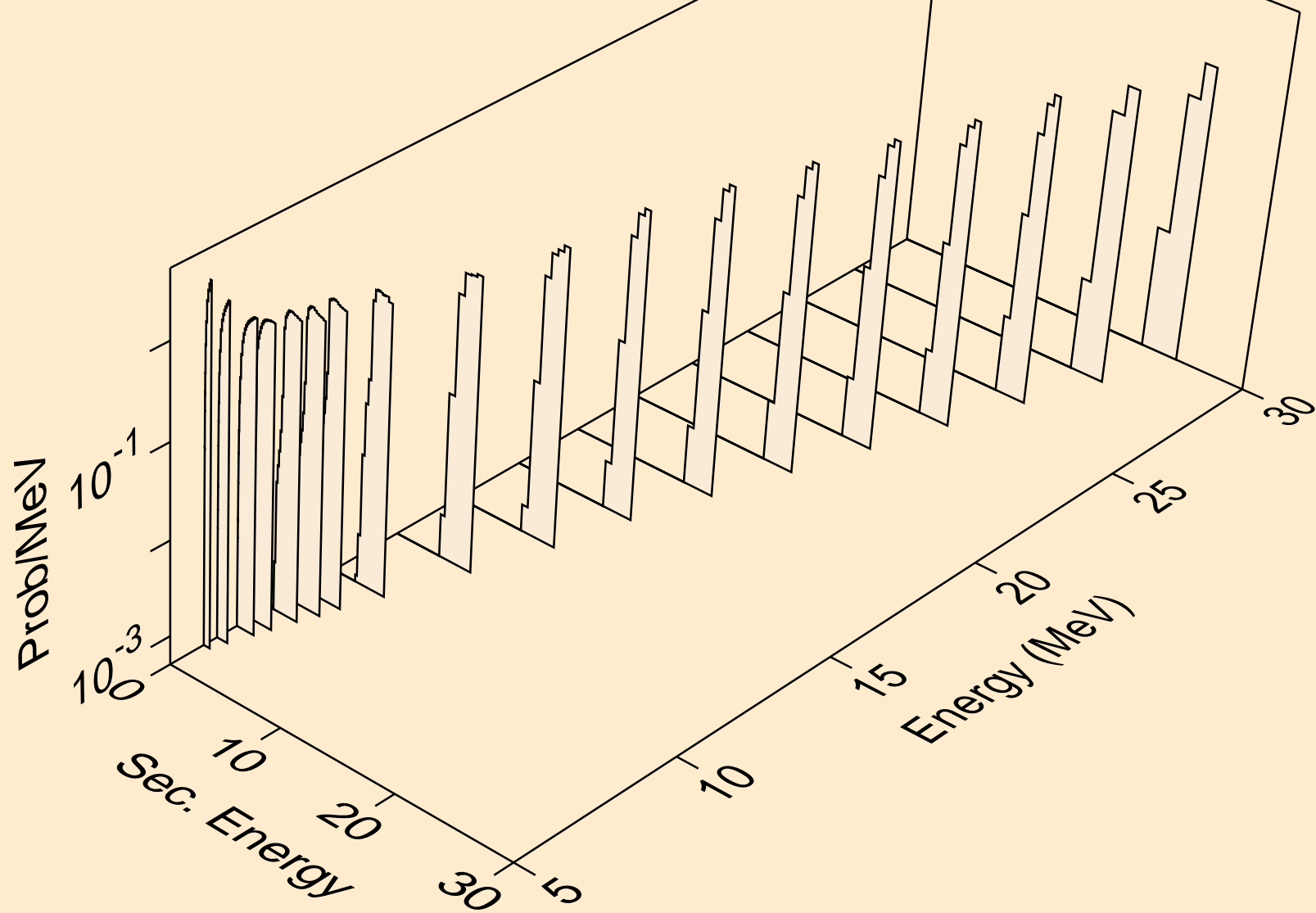

SN131M NEUTRON ACER TENDL-2021 LIBRARY; T=293.6K
Photon emission for (n,x)

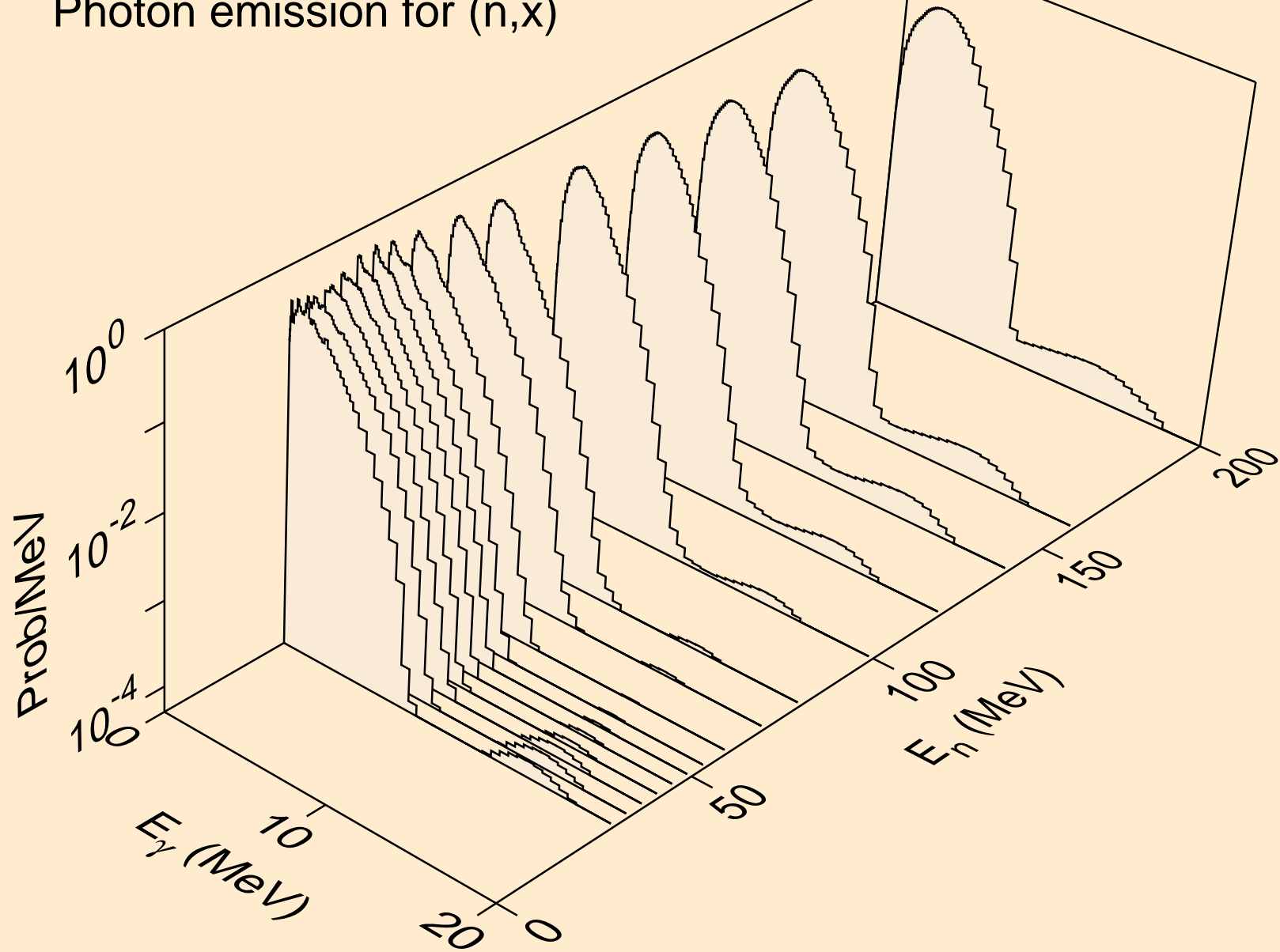

SN131M NEUTRON ACER TENDL-2021 LIBRARY; T=293.6K
Photon emission for (n,2nd)

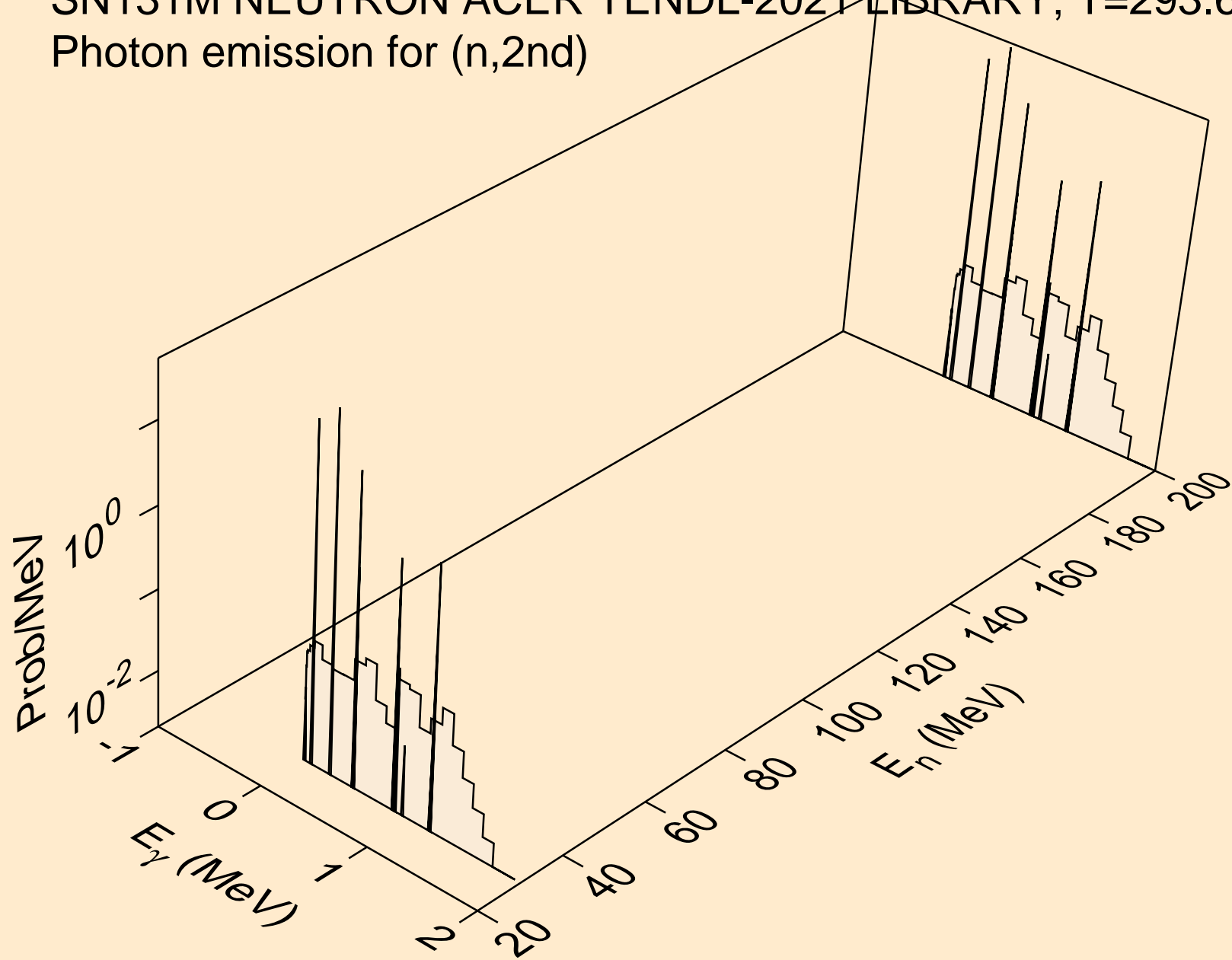

SN131M NEUTRON ACER TENDL-2021 LIBRARY; T=293.6K
Photon emission for (n,2n)

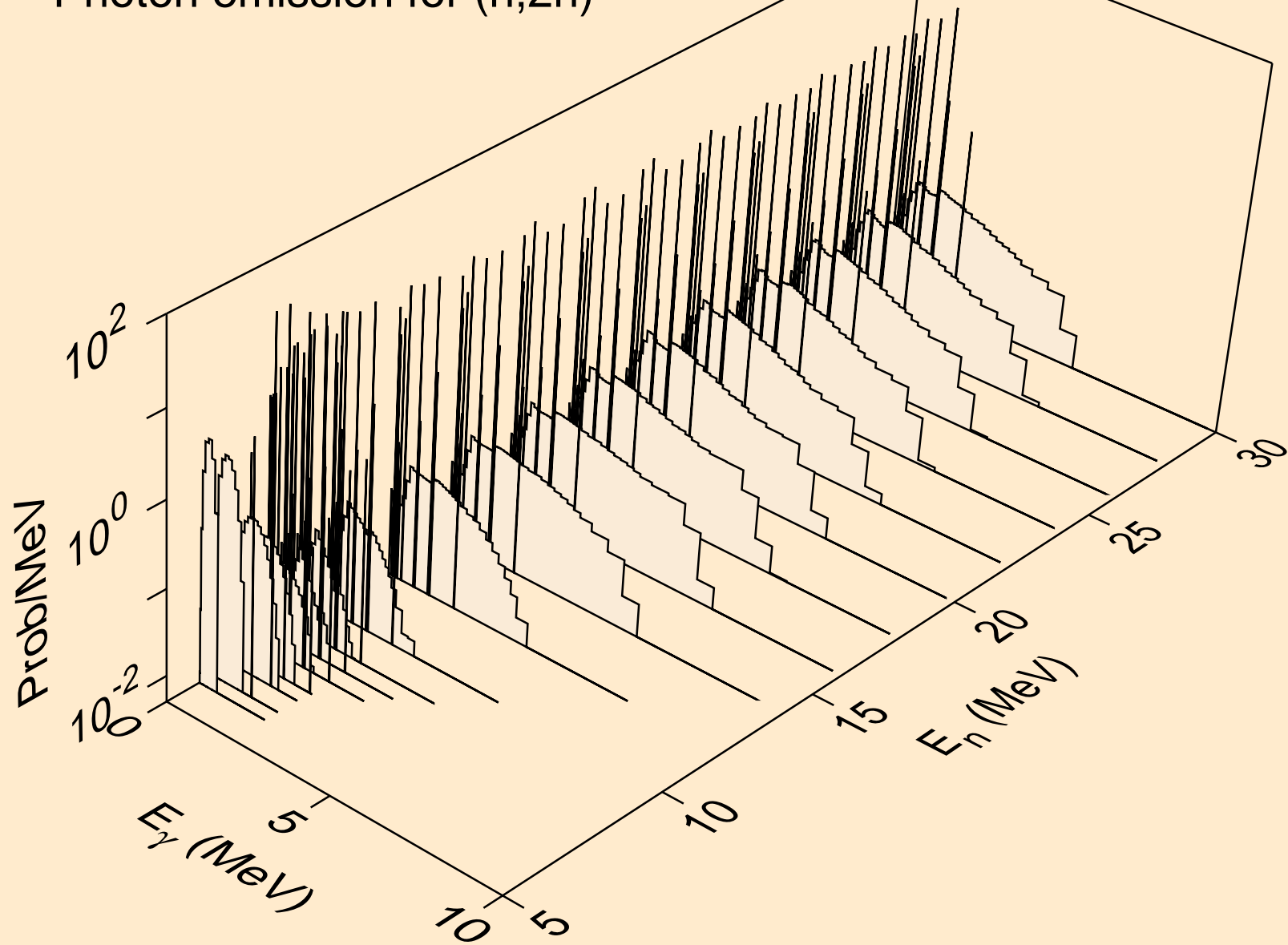

SN131M NEUTRON ACER TENDL-2021 LIBRARY; T=293.6K
Photon emission for (n,3n)

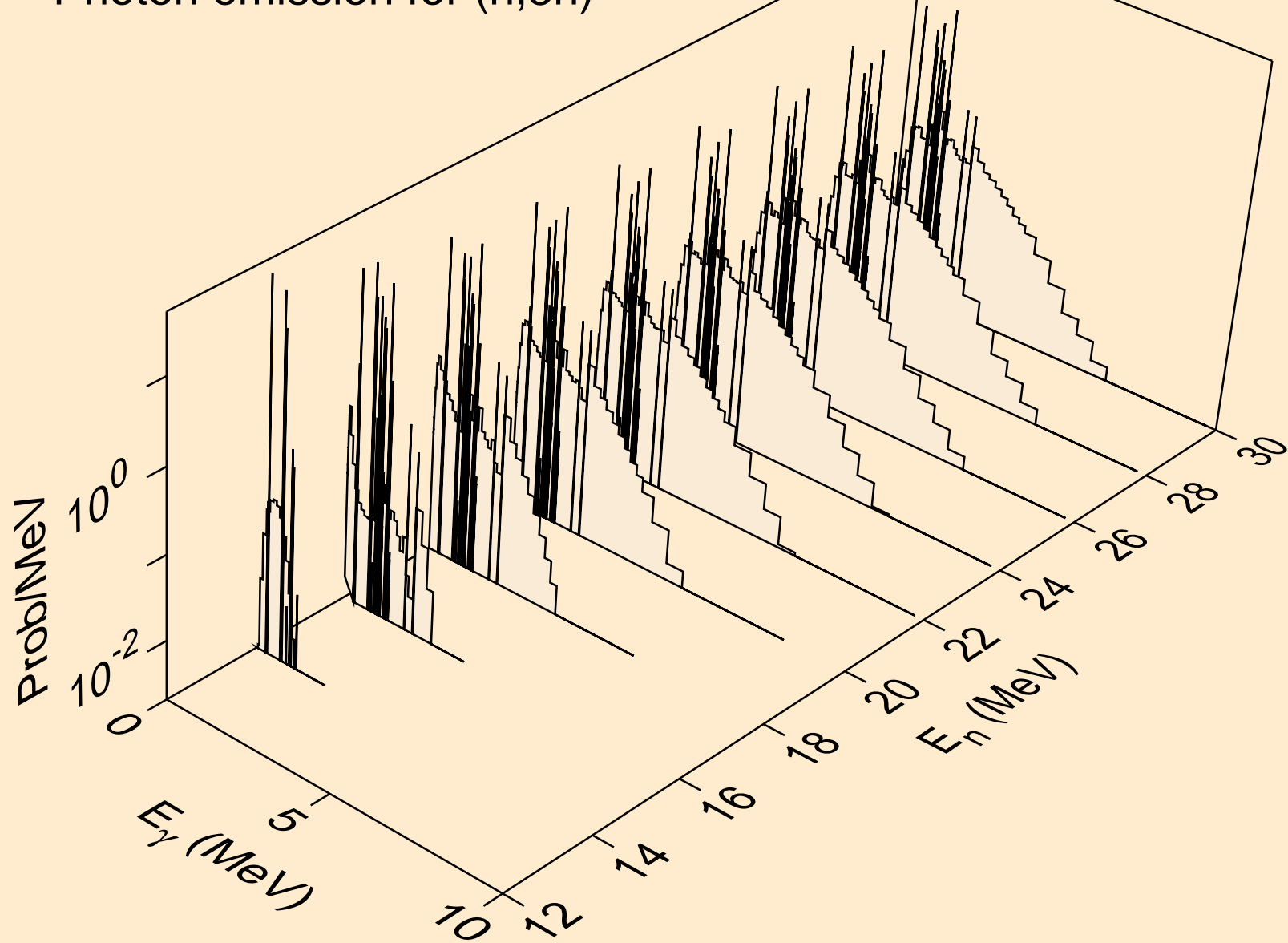

SN131M NEUTRON ACER TENDL-2021 LIBRARY; T=293.6K
Photon emission for (n,n*)a

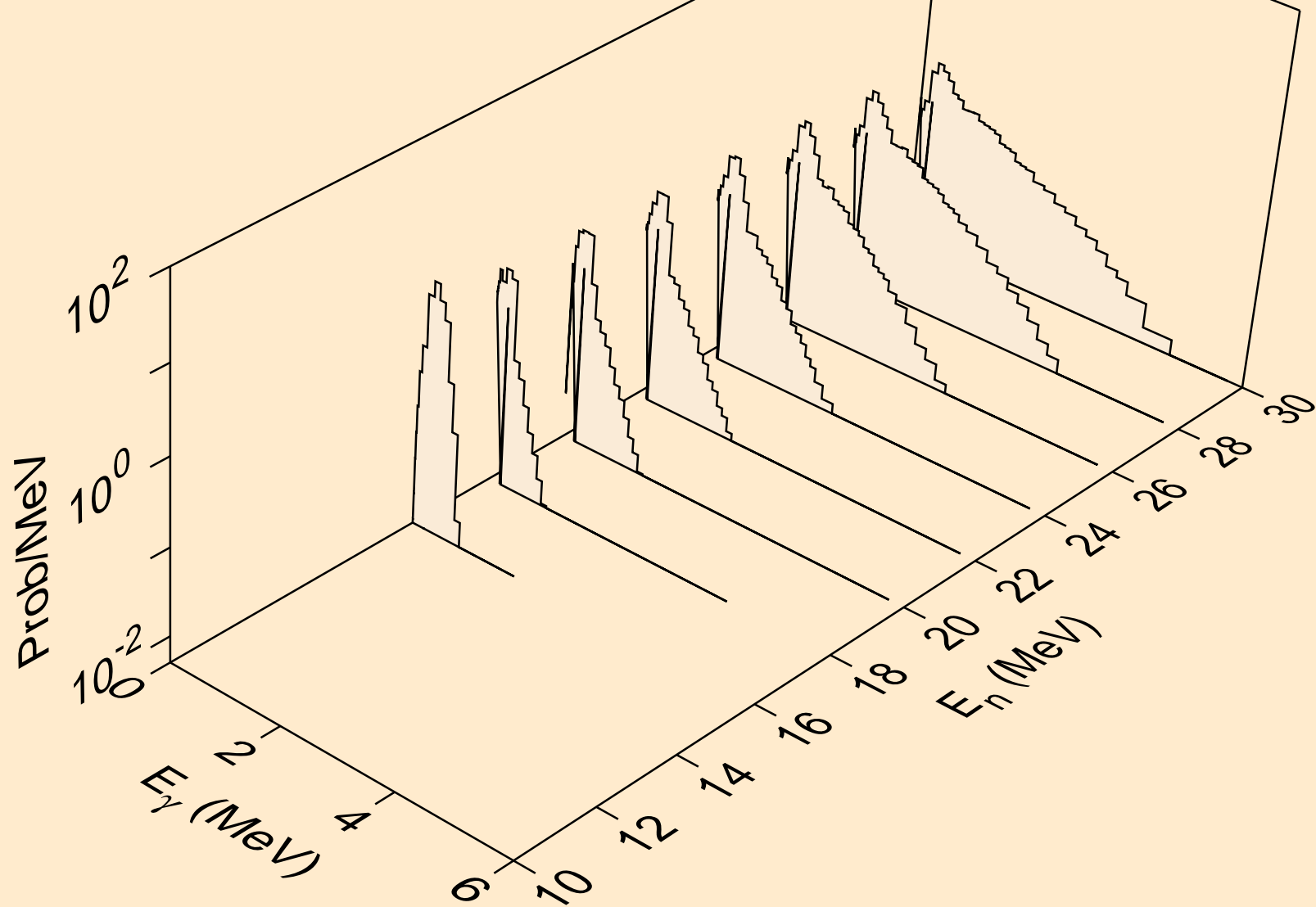

SN131M NEUTRON ACER TENDL-2021 LIBRARY; T=293.6K
Photon emission for (n,2n)a

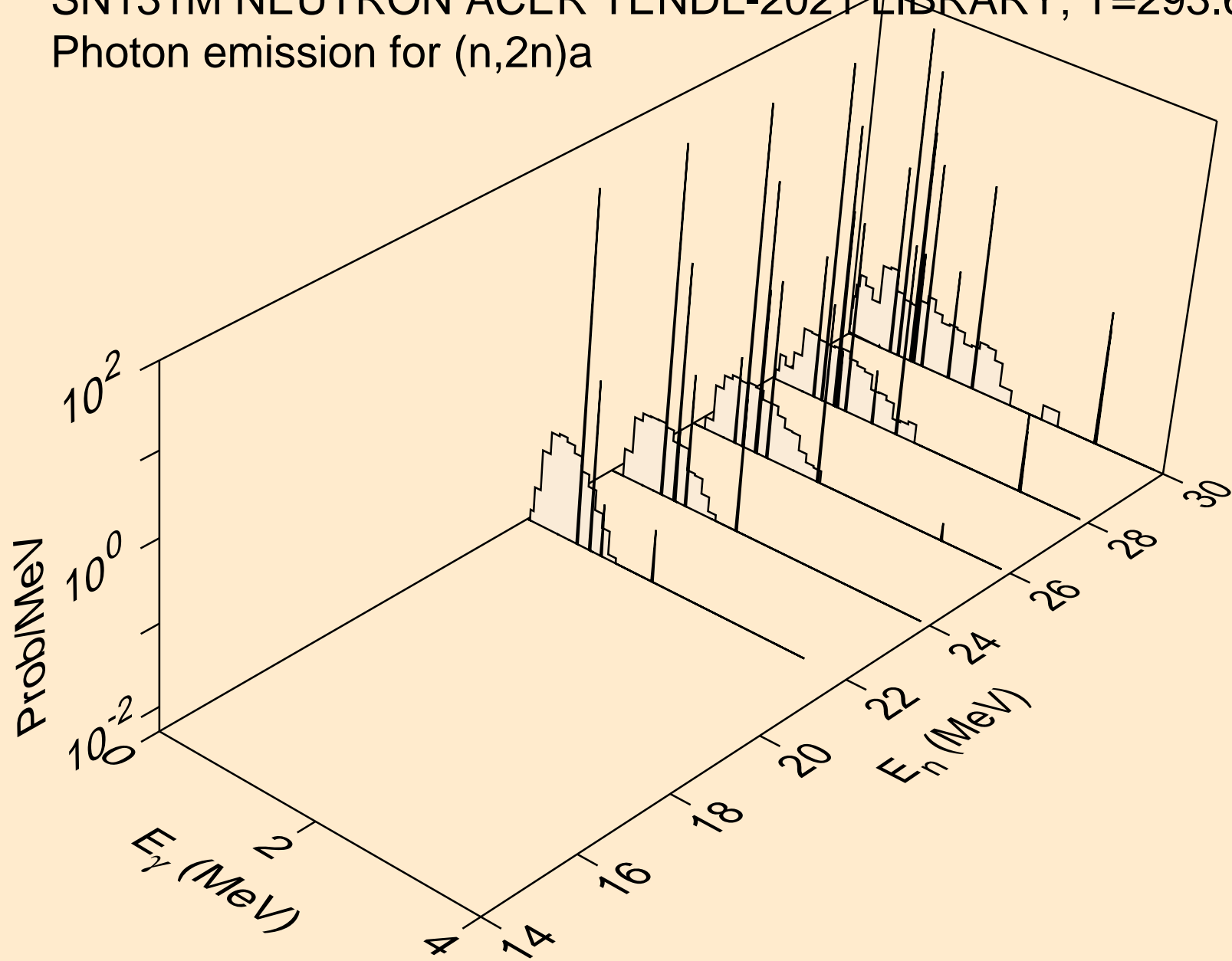

SN131M NEUTRON ACER TENDL-2021 LIBRARY; T=293.6K
Photon emission for (n,n*)p

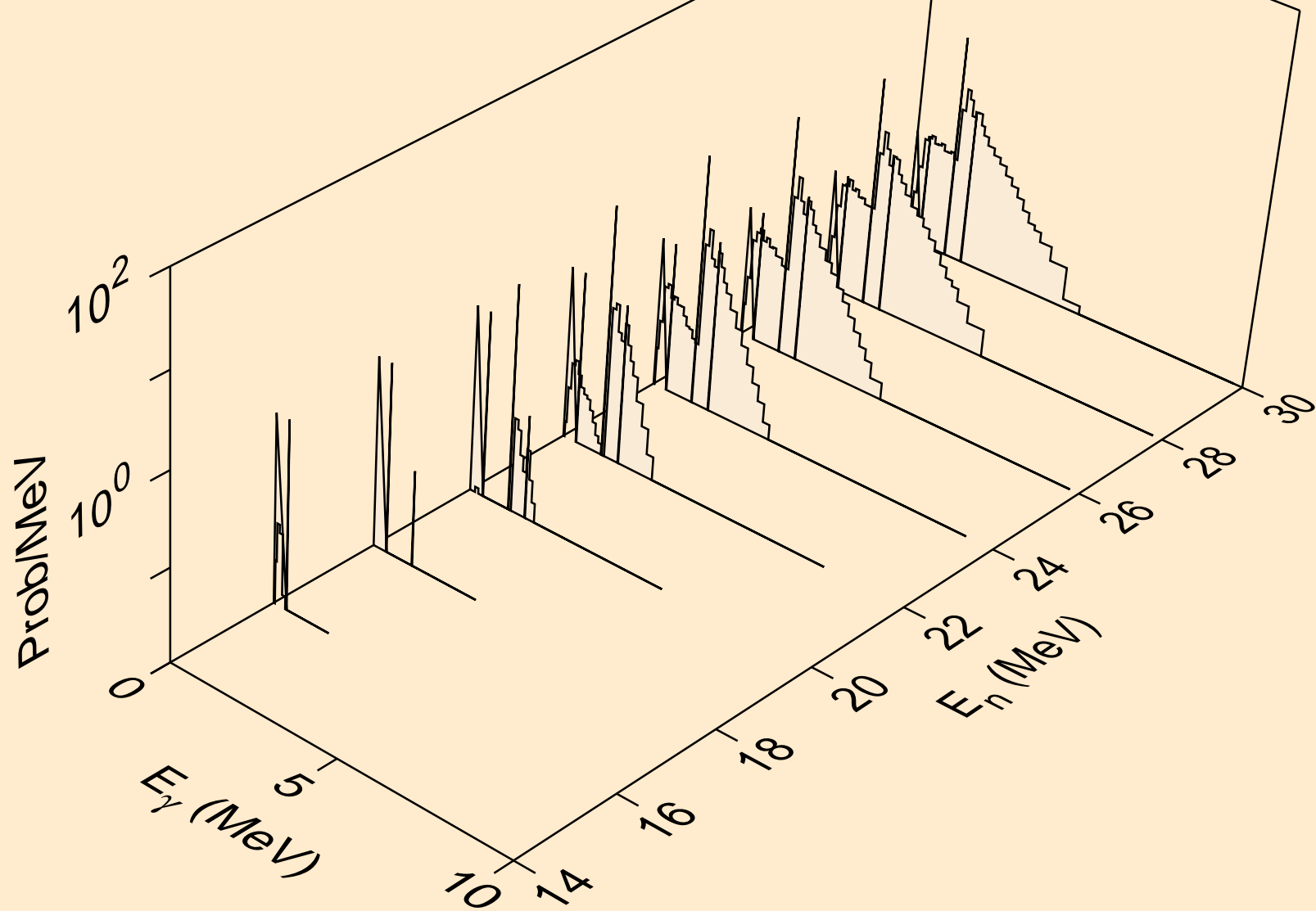

SN131M NEUTRON ACER TENDL-2021 LIBRARY; T=293.6K
Photon emission for (n,n*)d

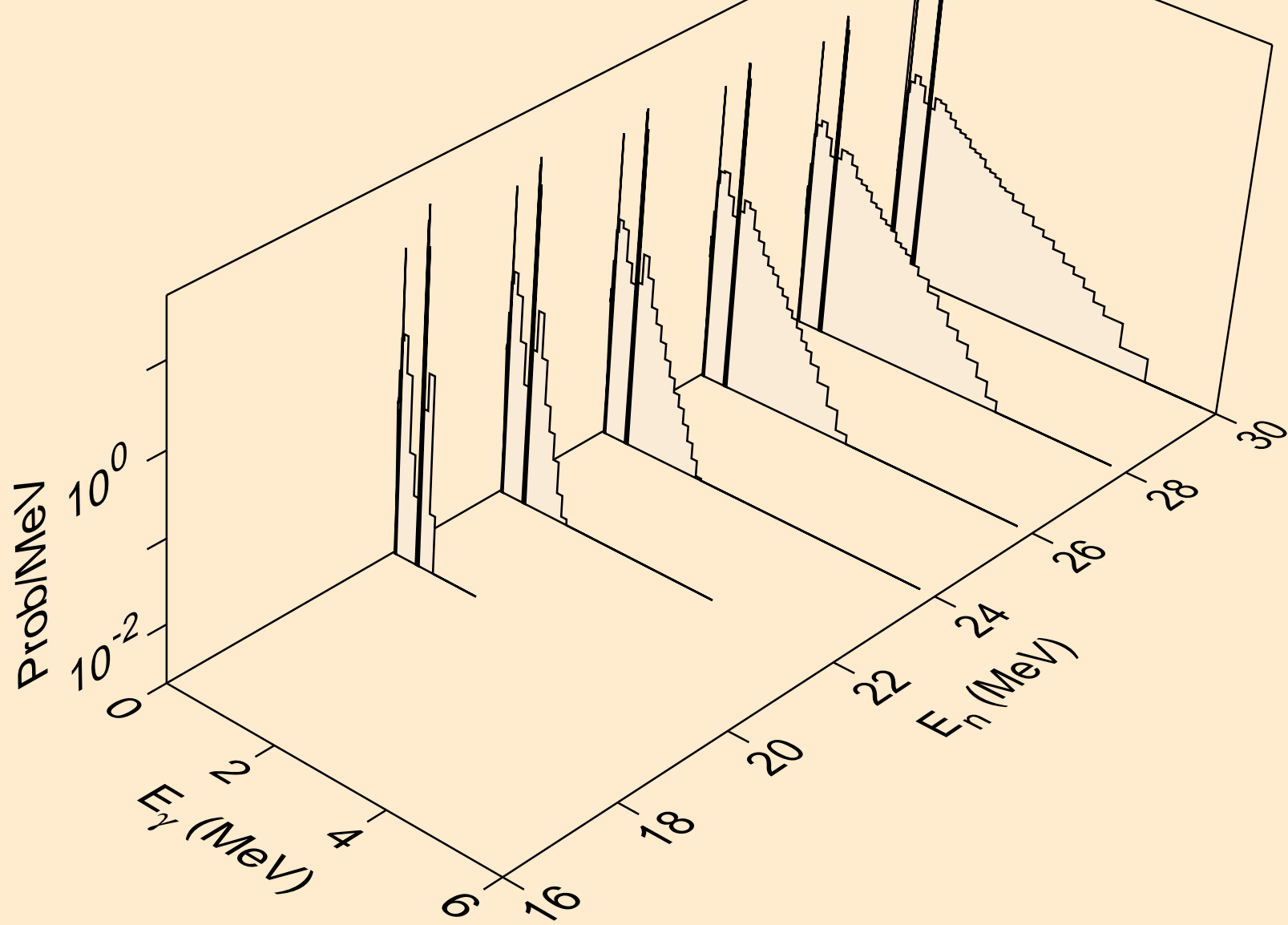

SN131M NEUTRON ACER TENDL-2021 LIBRARY; T=293.6K
Photon emission for (n,n*)t

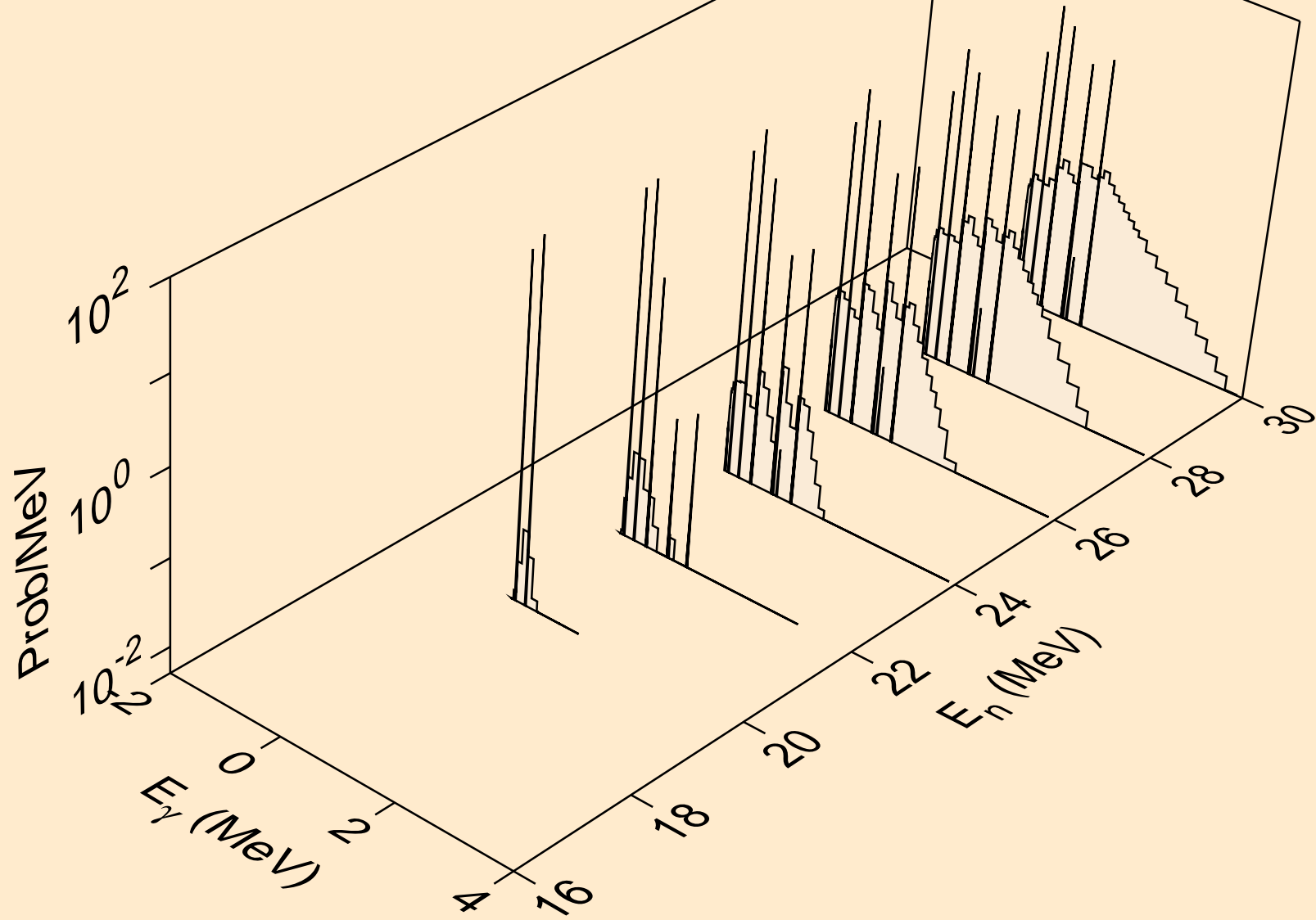

SN131M NEUTRON ACER TENDL-2021 LIBRARY; T=293.6K
Photon emission for (n,4n)

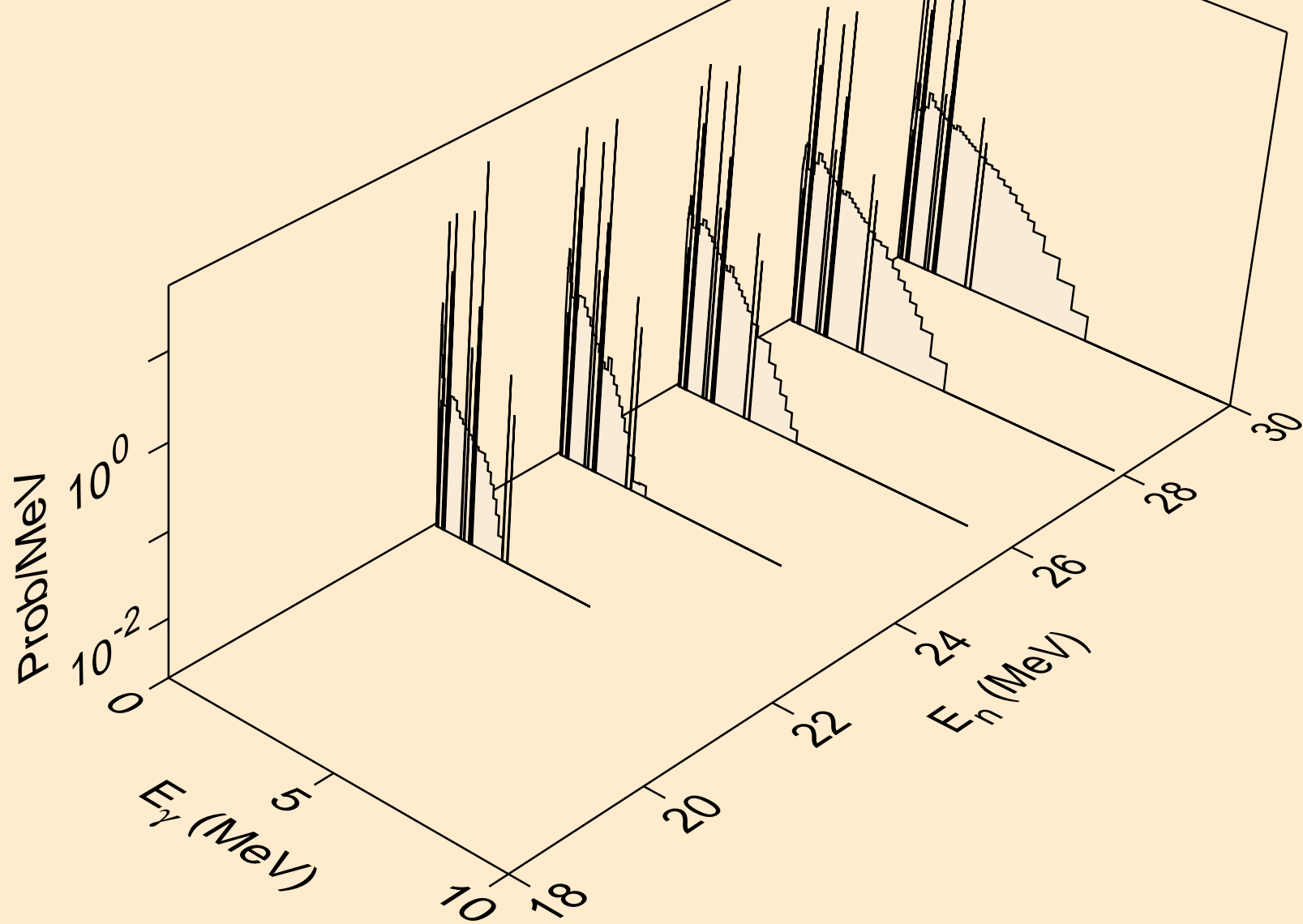

SN131M NEUTRON ACER TENDL-2021 LIBRARY; T=293.6K
Photon emission for (n,2np)

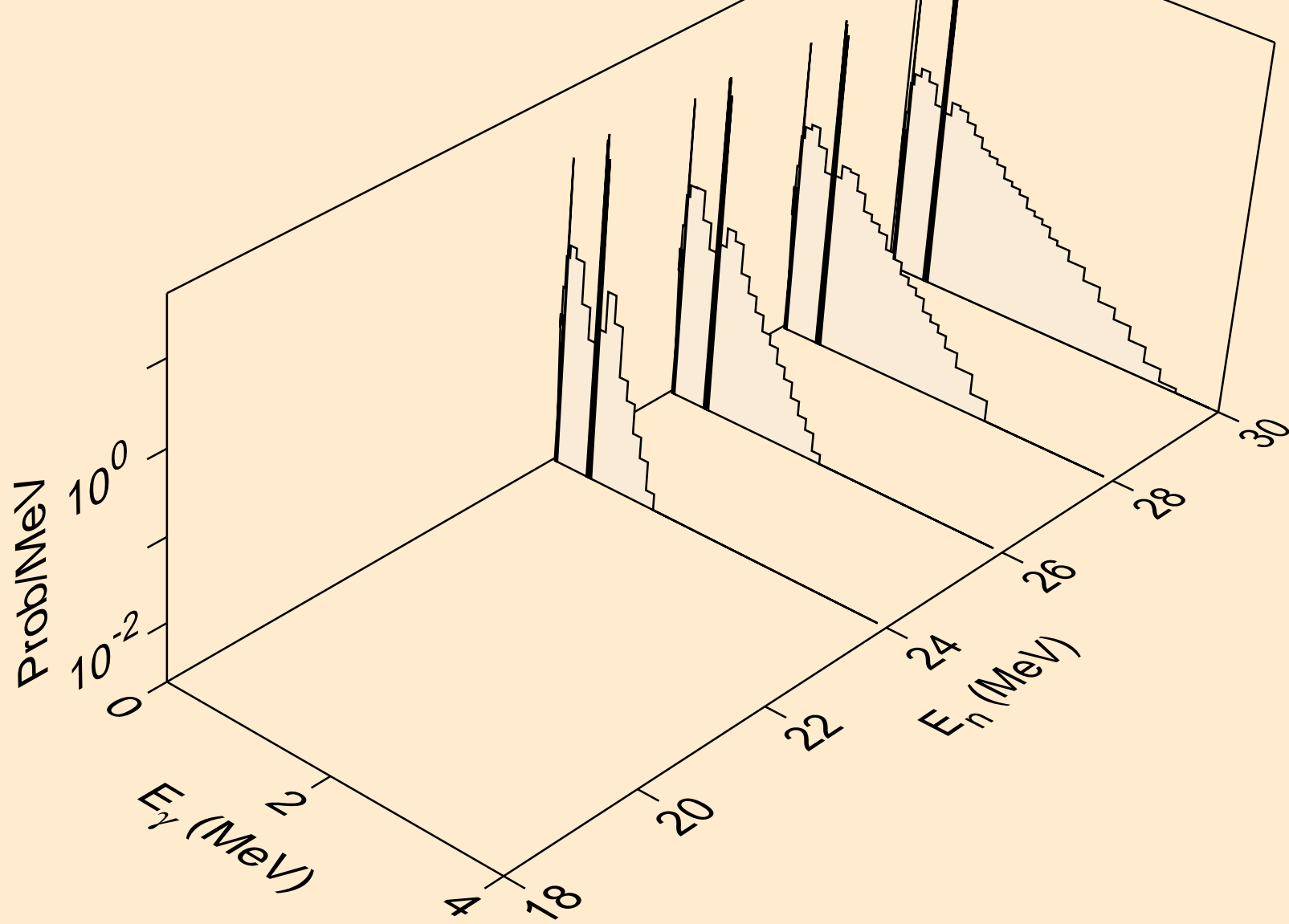

SN131M NEUTRON ACER TENDL-2021 LIBRARY; T=293.6K
Photon emission for (n,3np)

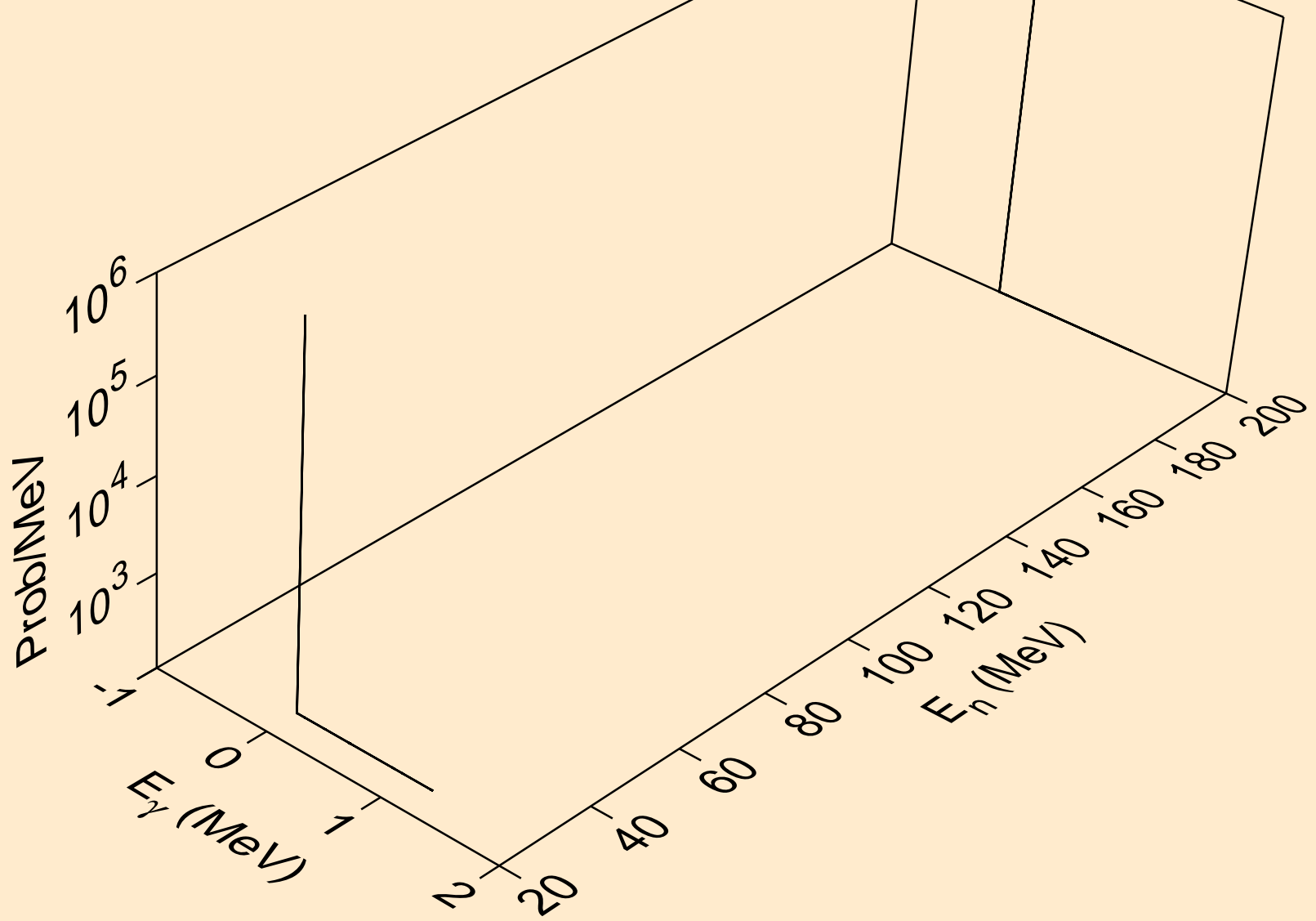

SN131M NEUTRON ACER TENDL-2021 LIBRARY; T=293.6K
Photon emission for (n,n*2)

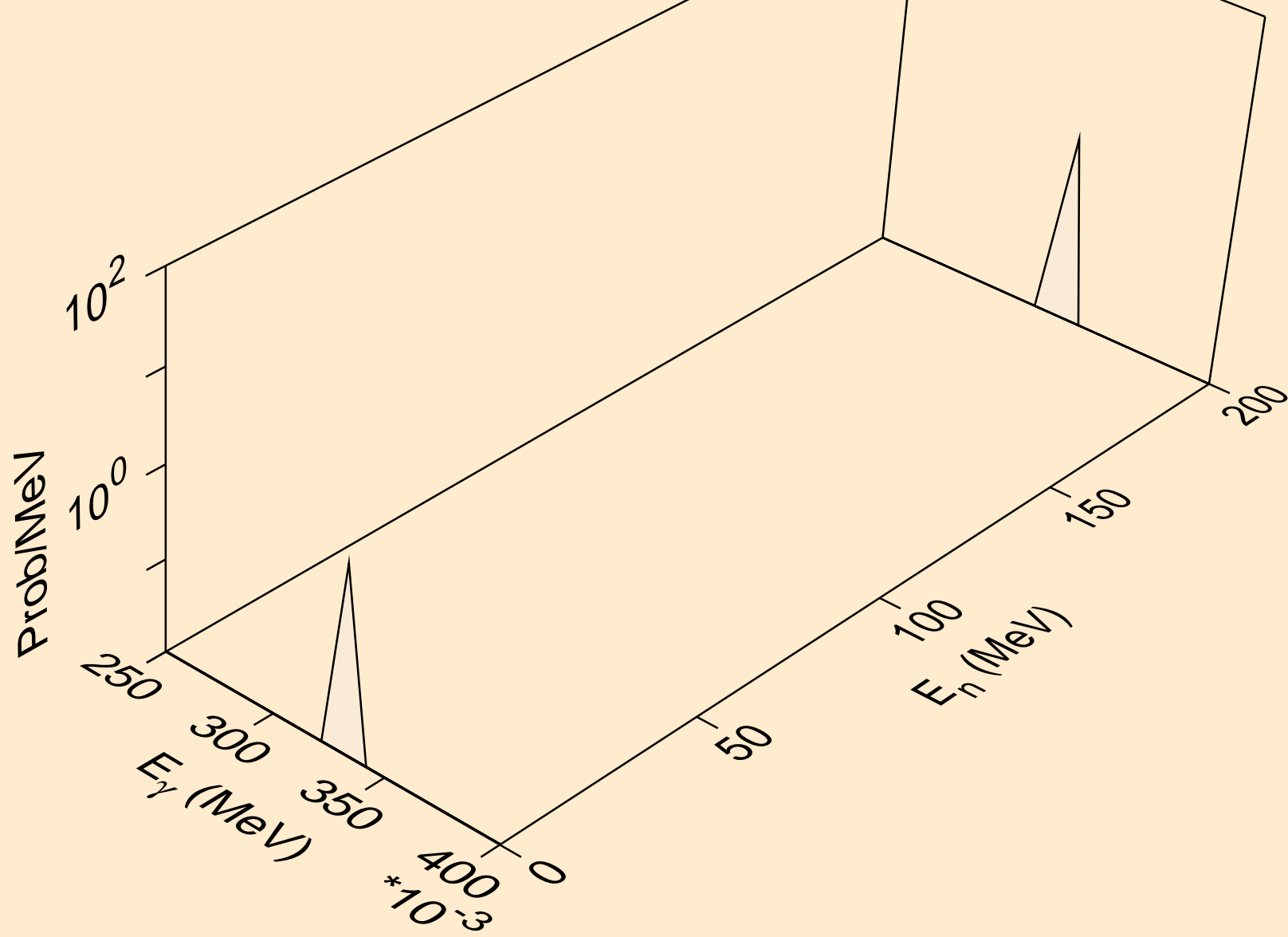

SN131M NEUTRON ACER TENDL-2021 LIBRARY; T=293.6K
Photon emission for (n,n*3)

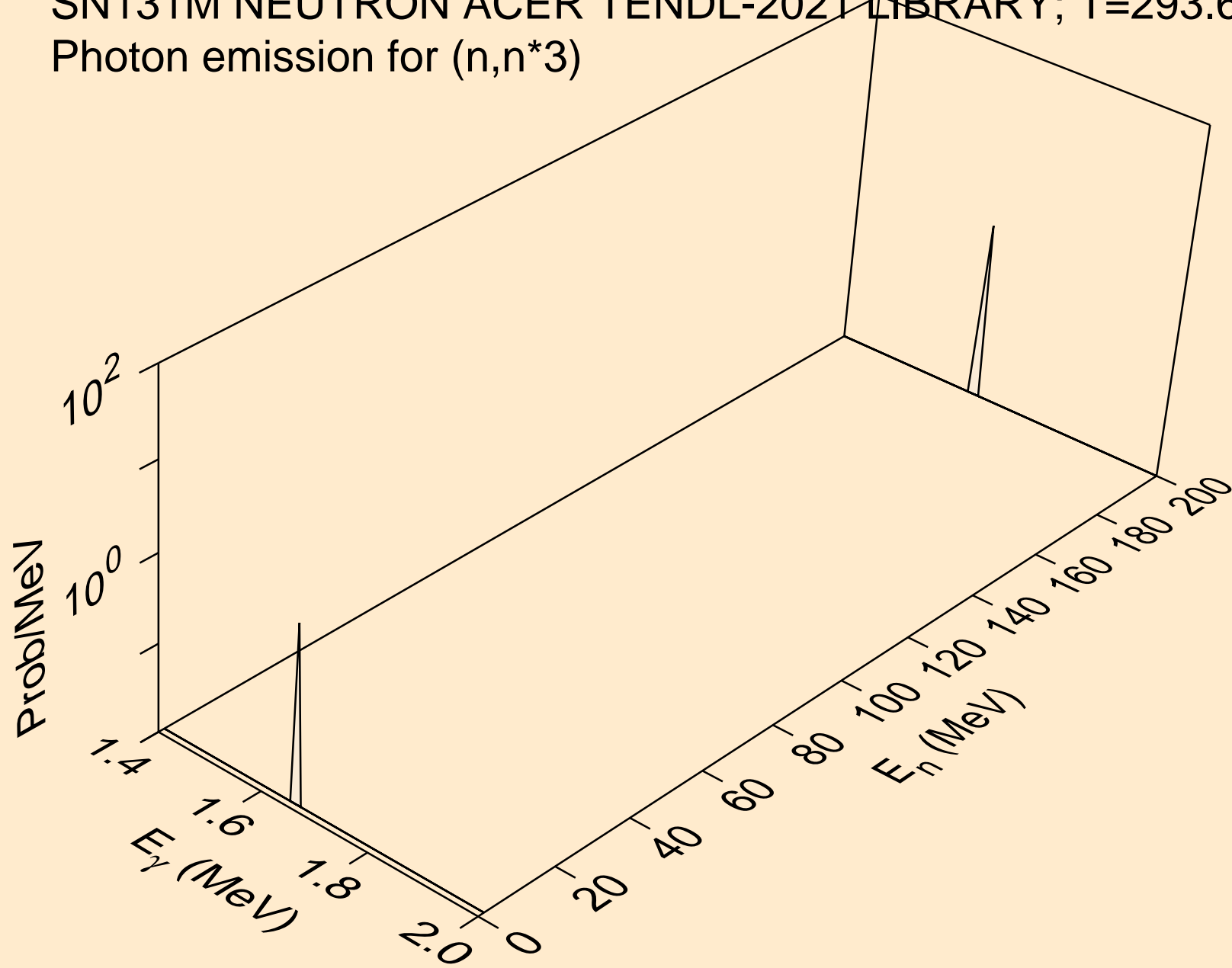

SN131M NEUTRON ACER TENDL-2021 LIBRARY; T=293.6K
Photon emission for (n,n*4)

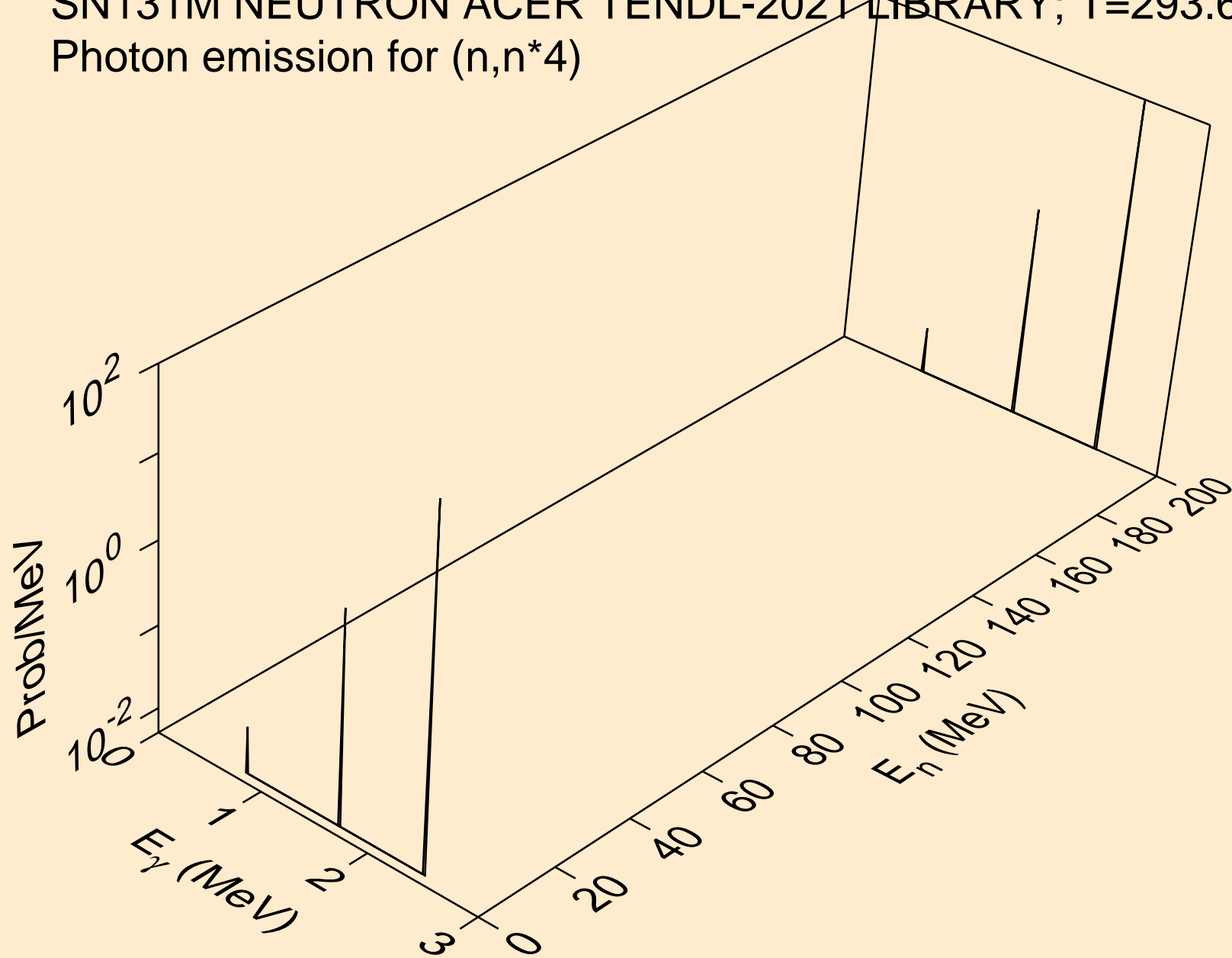

SN131M NEUTRON ACER TENDL-2021 LIBRARY; T=293.6K
Photon emission for (n,n*5)

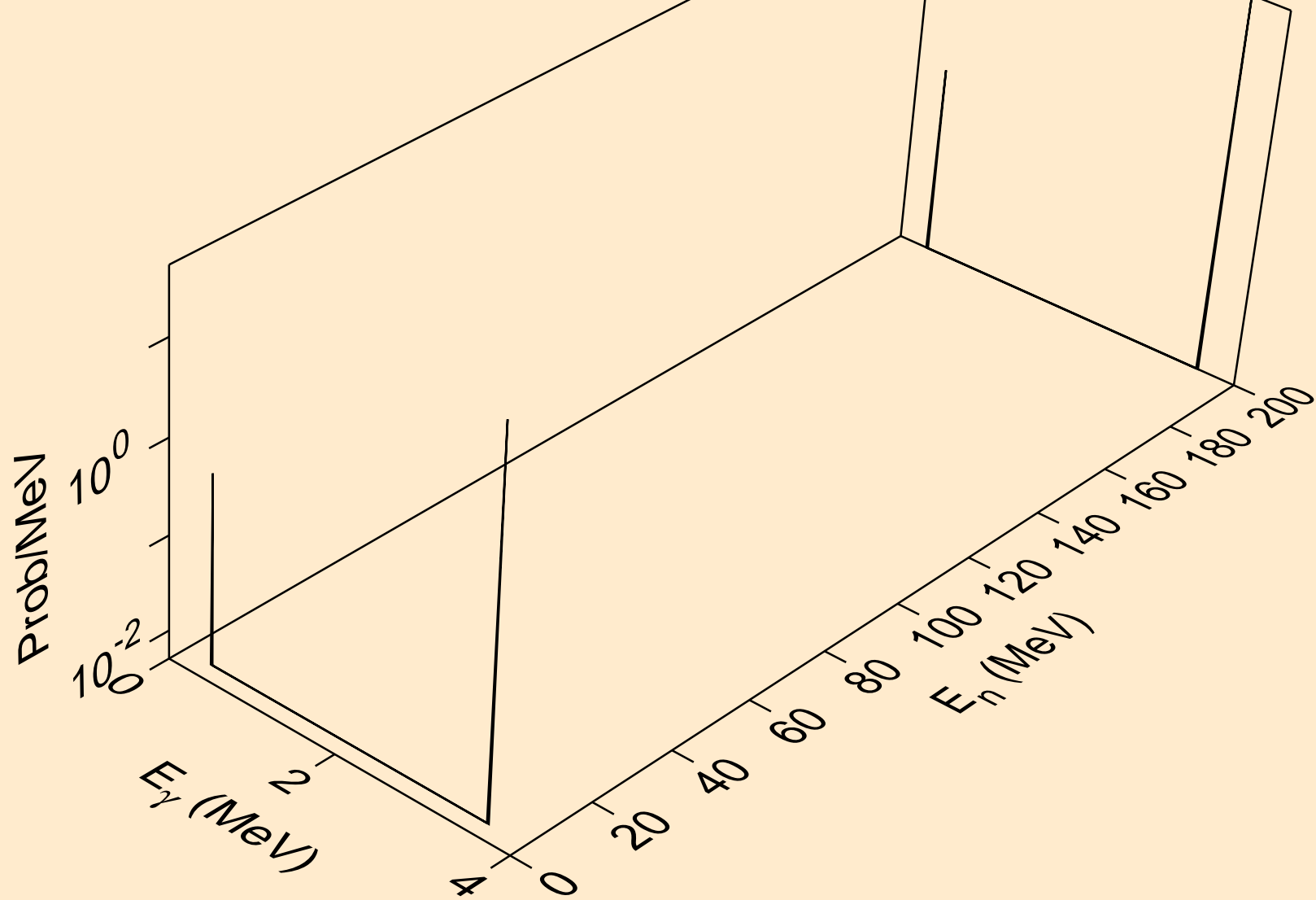

SN131M NEUTRON ACER TENDL-2021 LIBRARY; T=293.6K
Photon emission for (n,n*6)

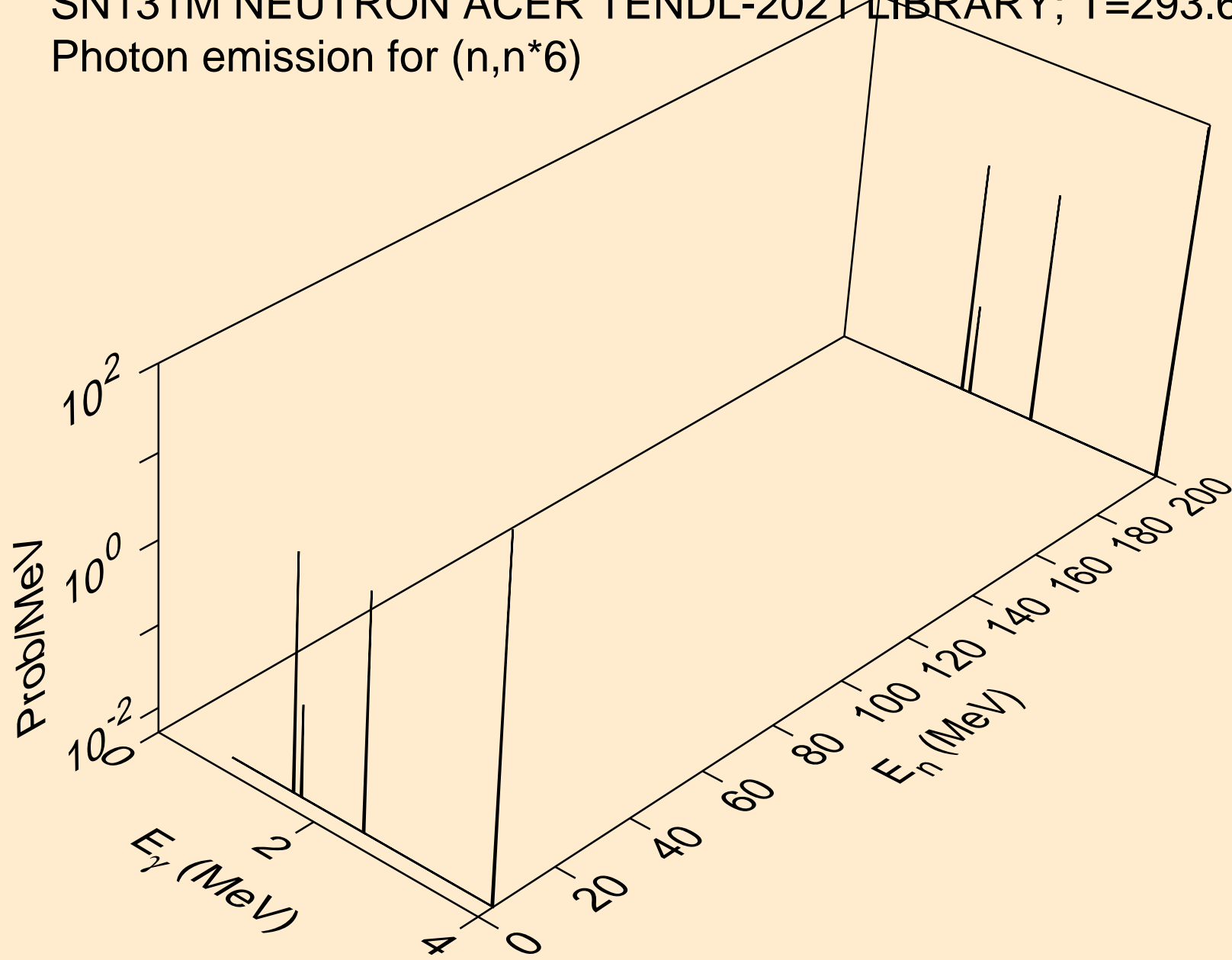

SN131M NEUTRON ACER TENDL-2021 LIBRARY; T=293.6K
Photon emission for (n,n*7)

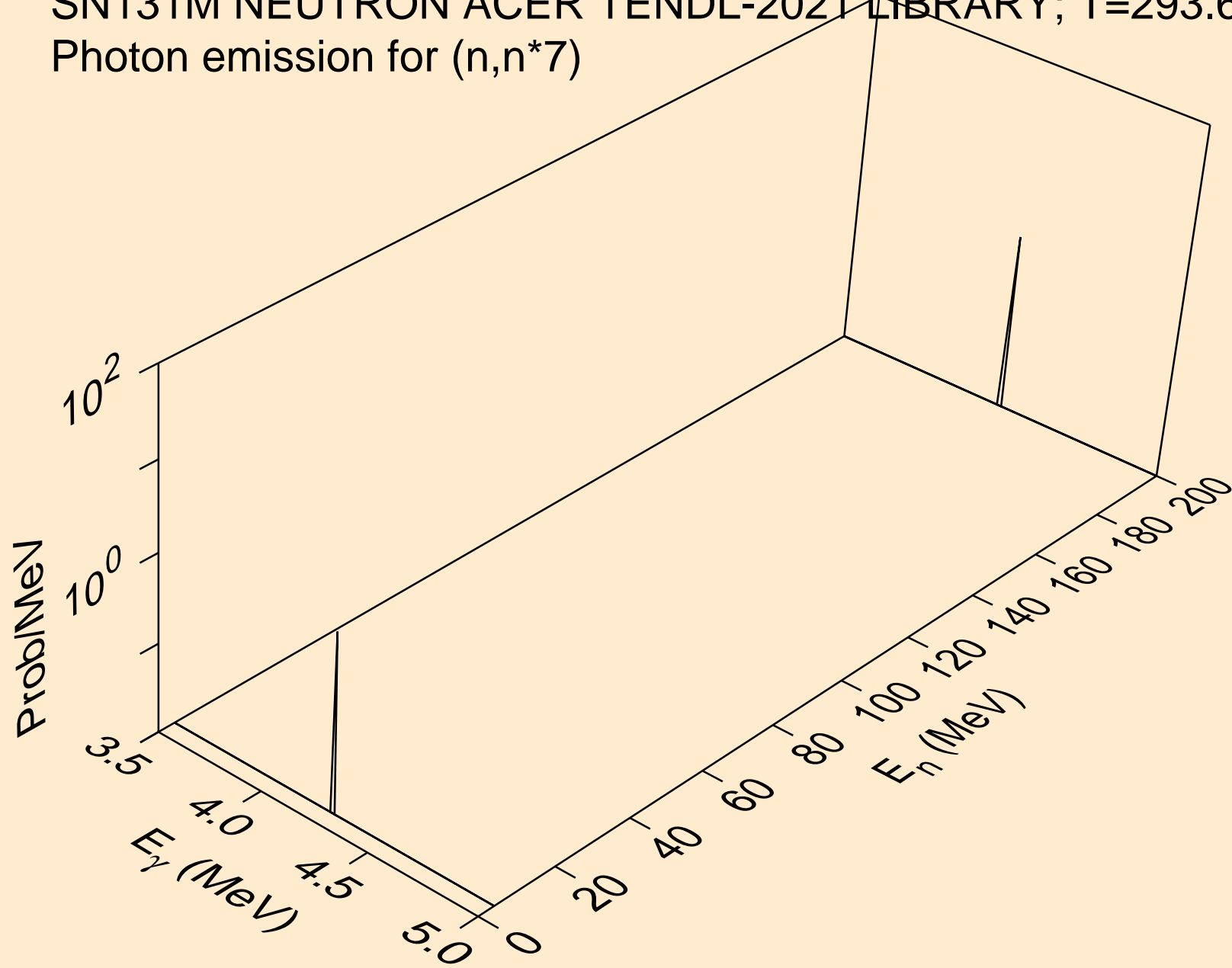

SN131M NEUTRON ACER TENDL-2021 LIBRARY; T=293.6K
Photon emission for (n,n*8)

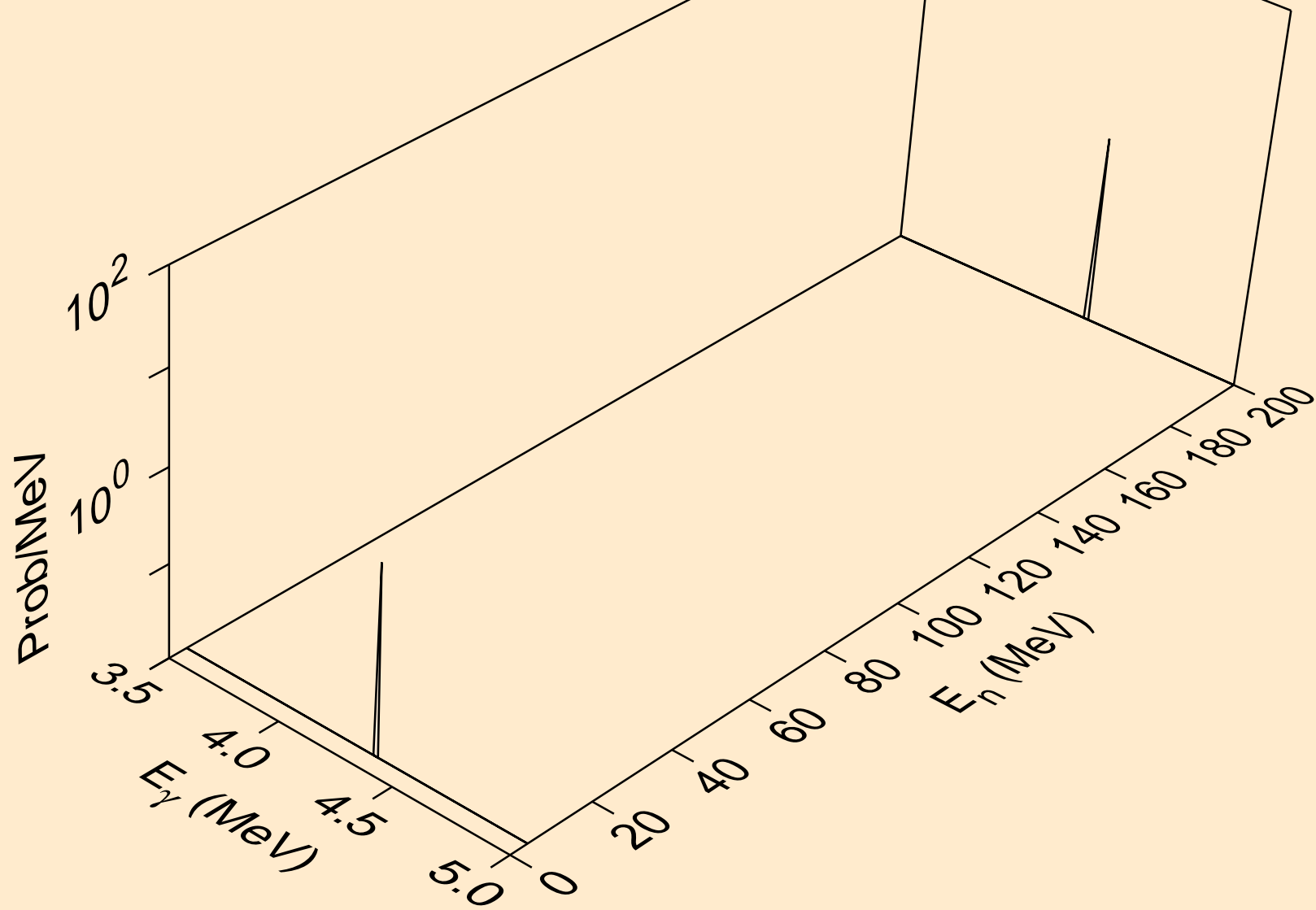

SN131M NEUTRON ACER TENDL-2021 LIBRARY; T=293.6K
Photon emission for (n,n*9)

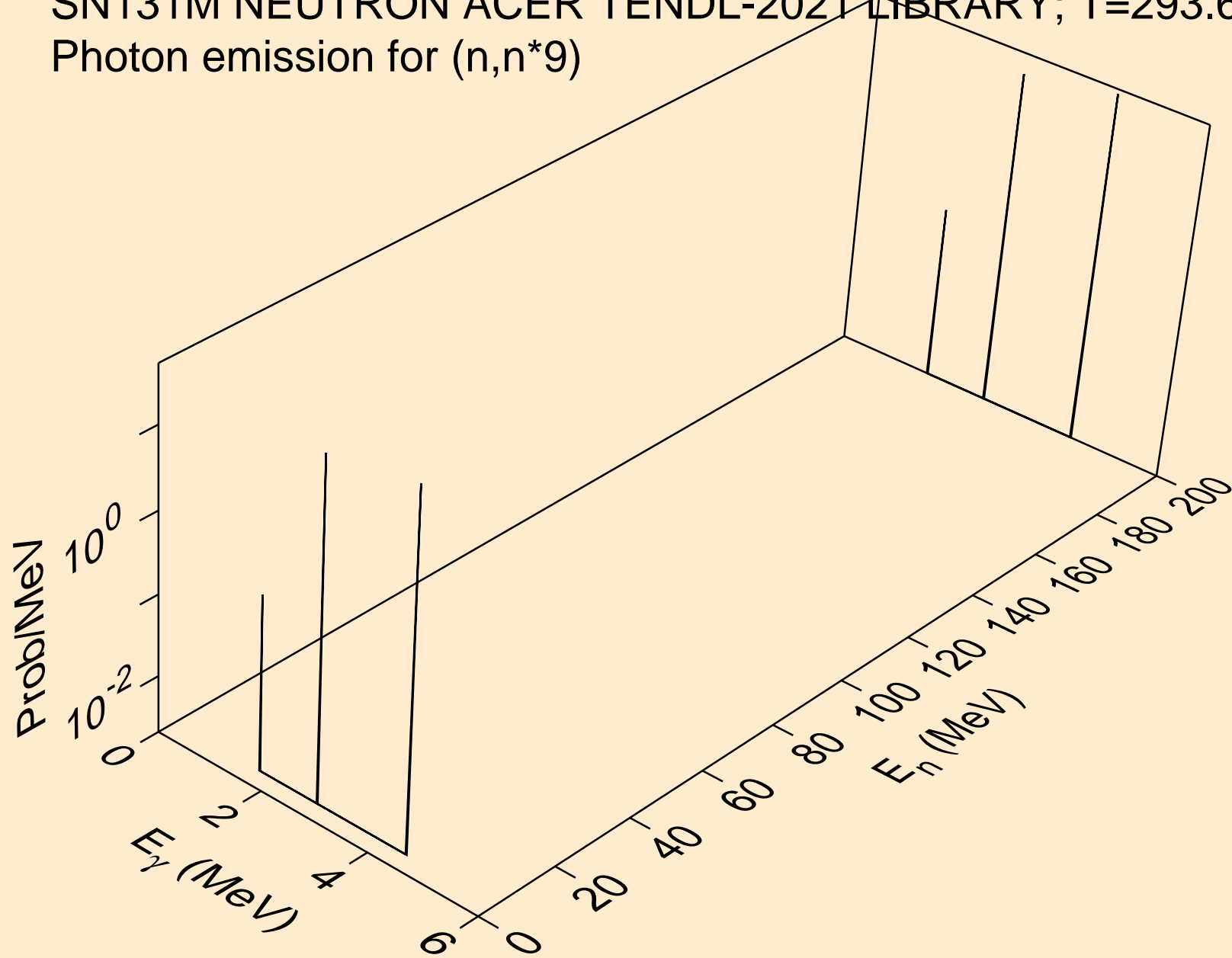

SN131M NEUTRON ACER TENDL-2021 LIBRARY; T=293.6K
Photon emission for (n,n*10)

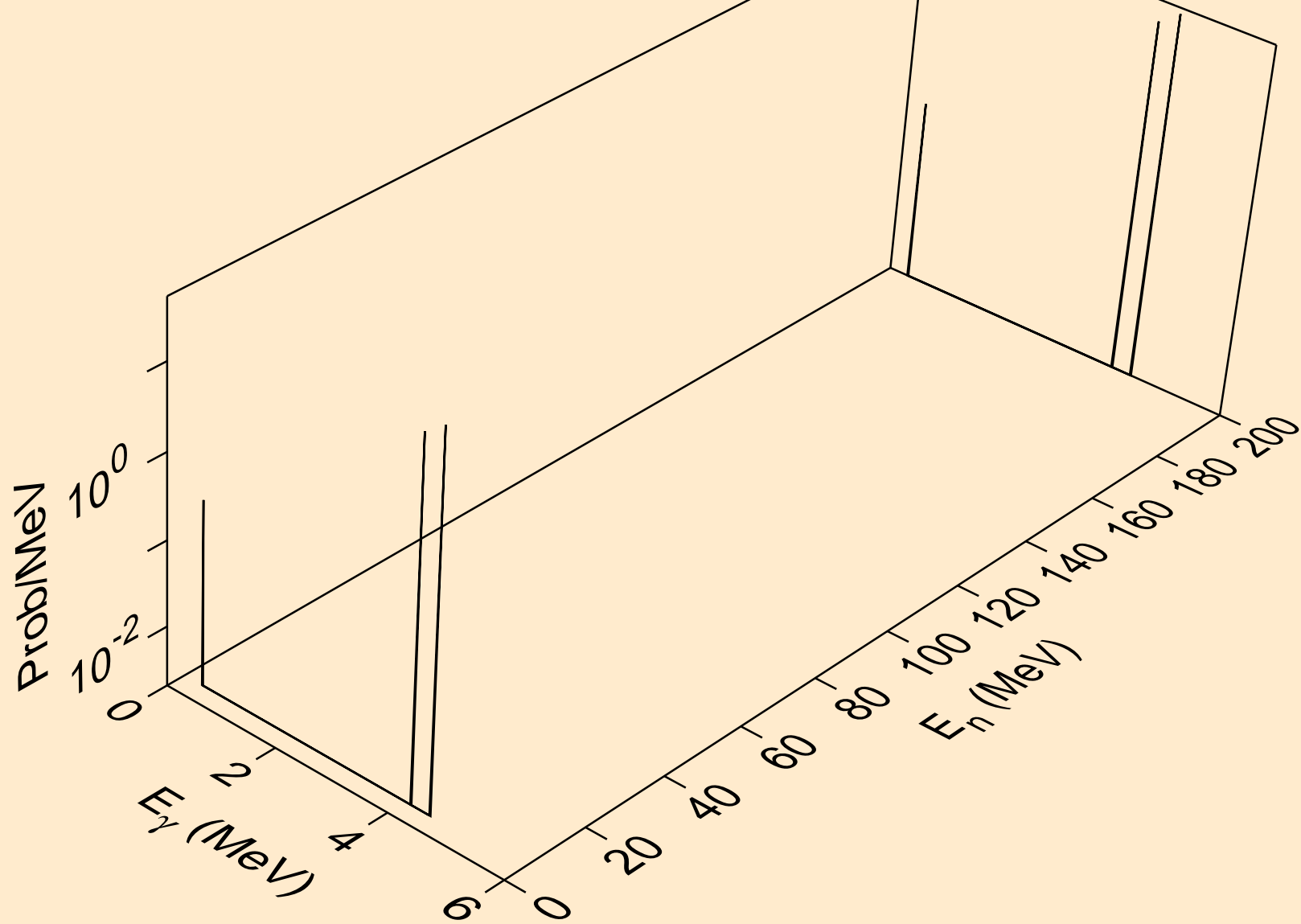

SN131M NEUTRON ACER TENDL-2021 LIBRARY; T=293.6K
Photon emission for (n,n*11)

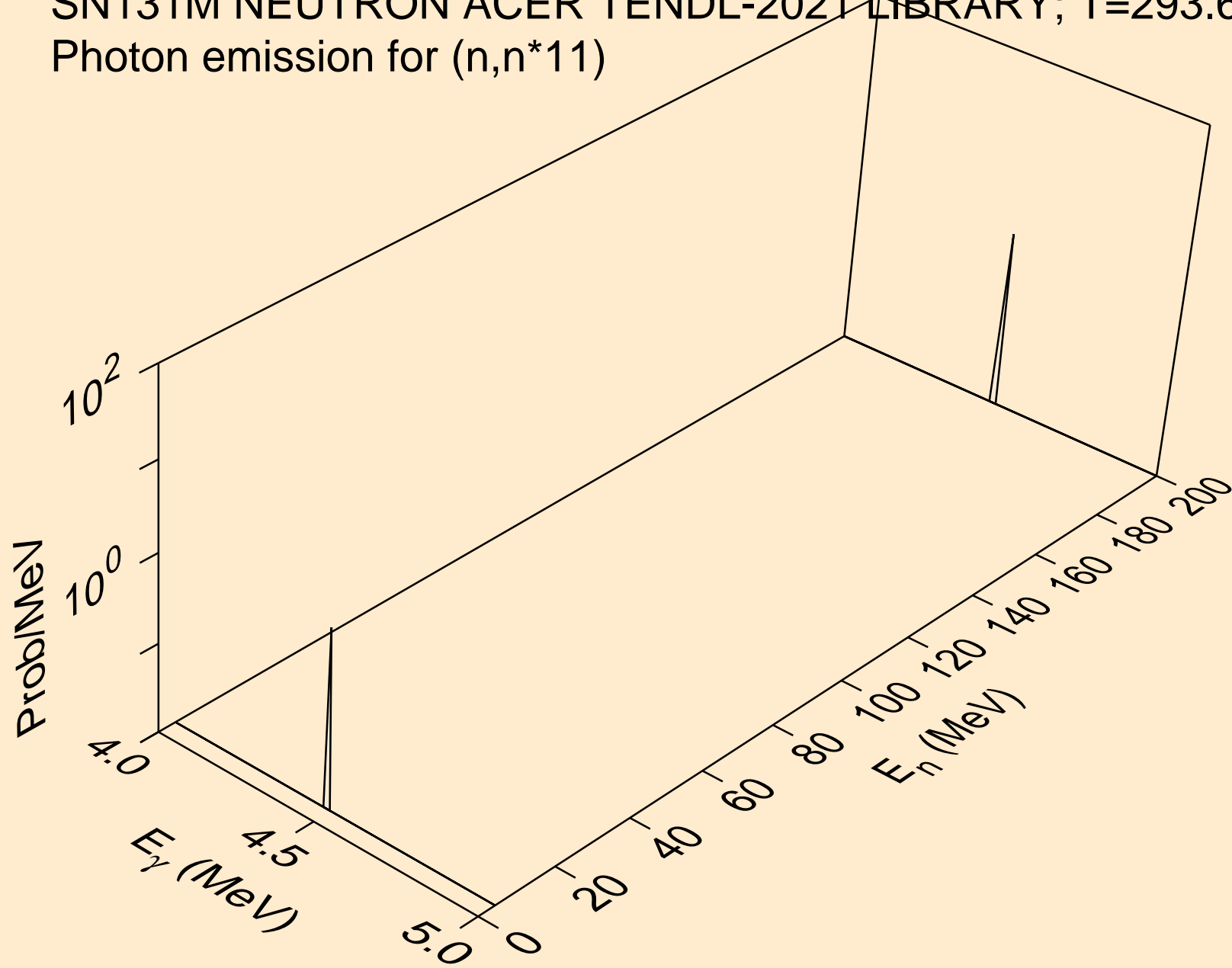

SN131M NEUTRON ACER TENDL-2021 LIBRARY; T=293.6K
Photon emission for (n,n*12)

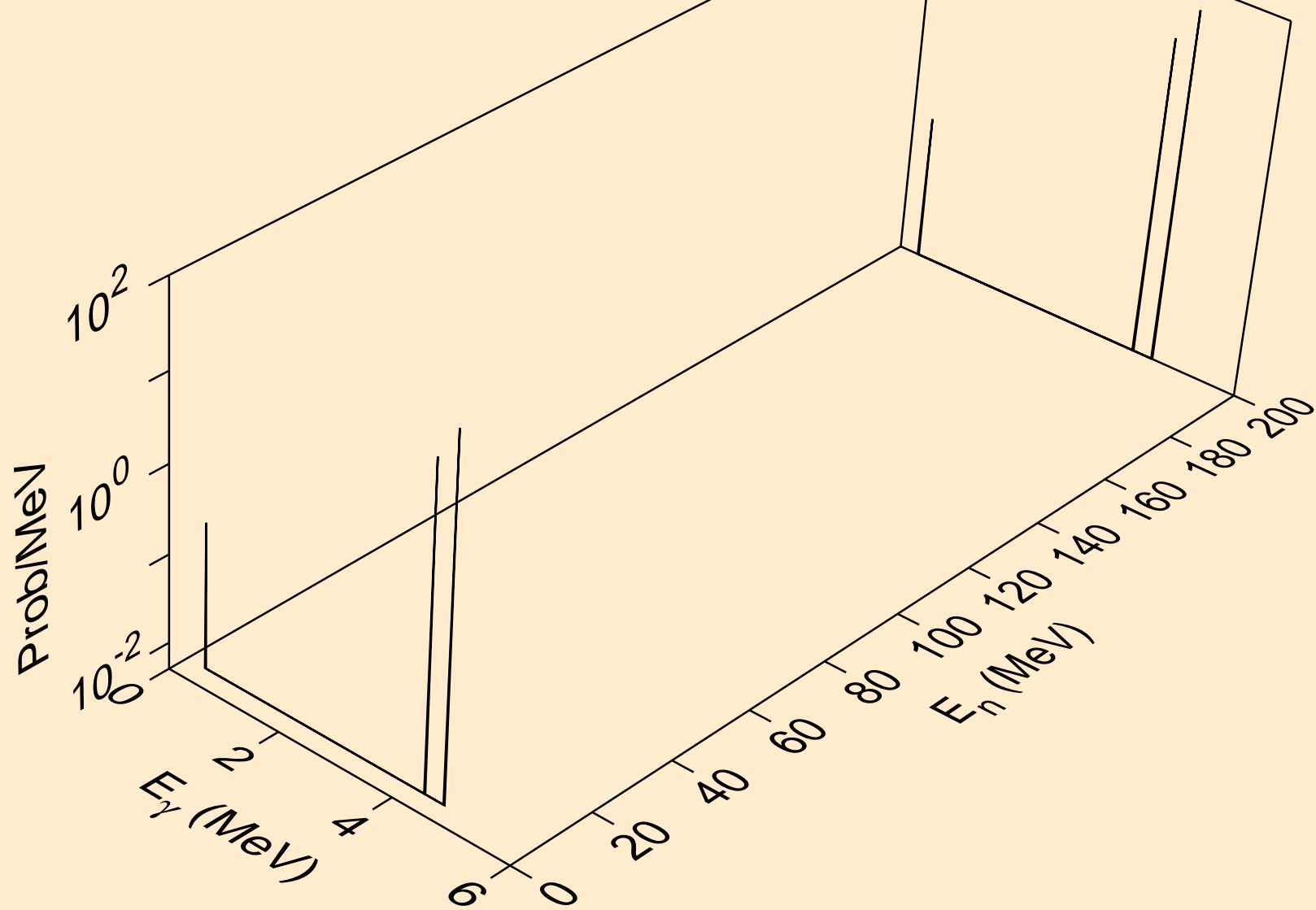

SN131M NEUTRON ACER TENDL-2021 LIBRARY; T=293.6K
Photon emission for (n,n*13)

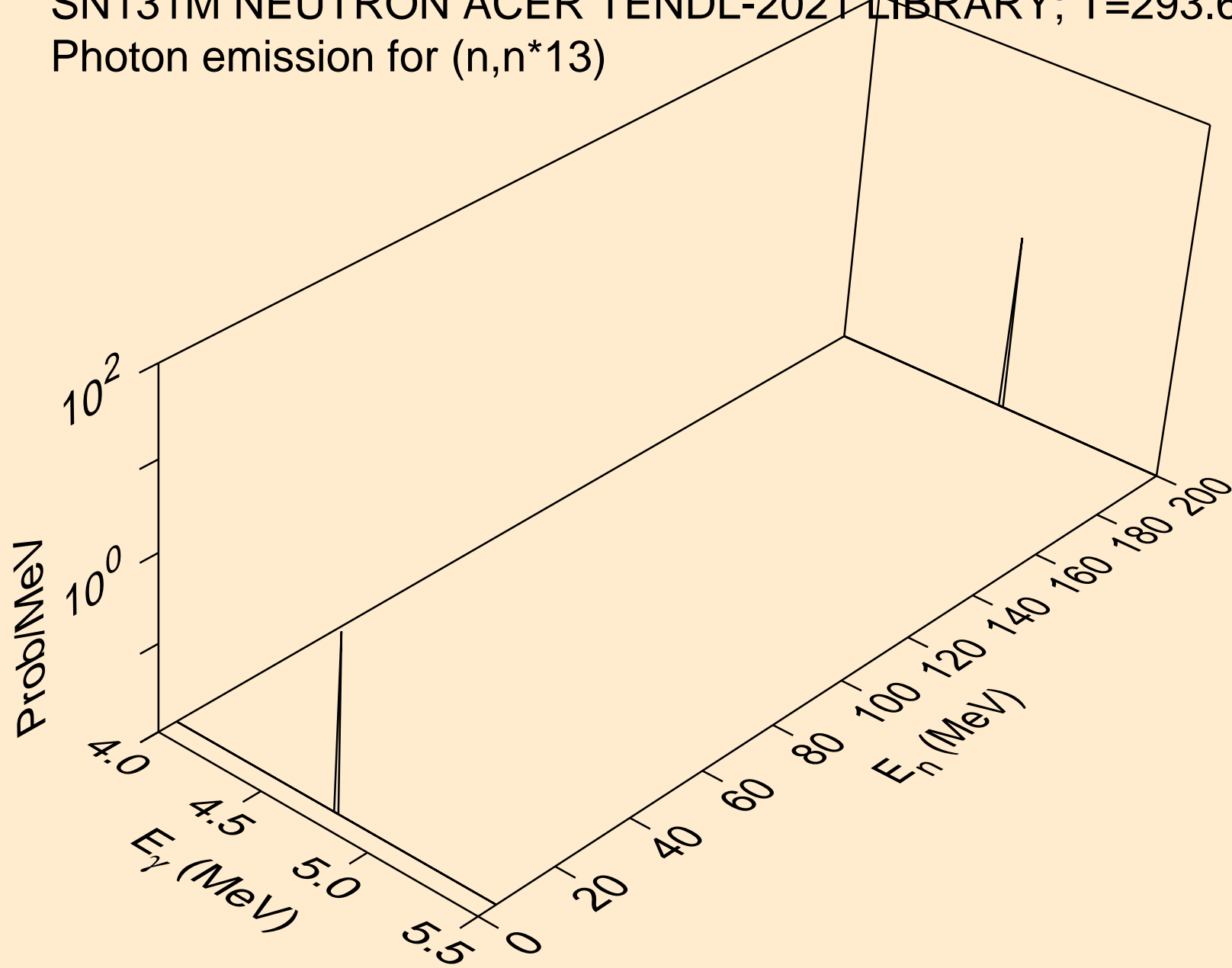

SN131M NEUTRON ACER TENDL-2021 LIBRARY; T=293.6K
Photon emission for (n,n*14)

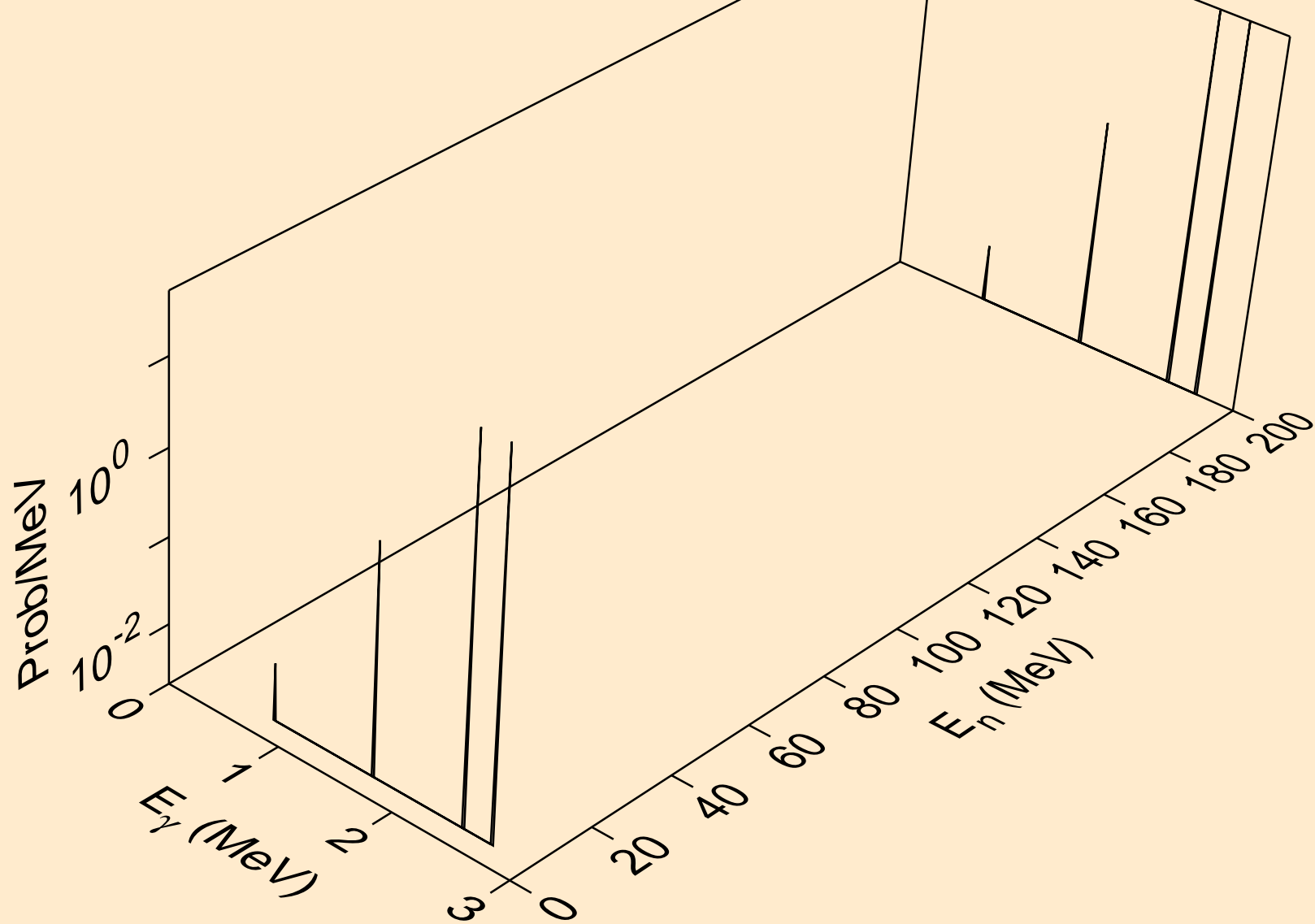

SN131M NEUTRON ACER TENDL-2021 LIBRARY; T=293.6K
Photon emission for (n,n*15)

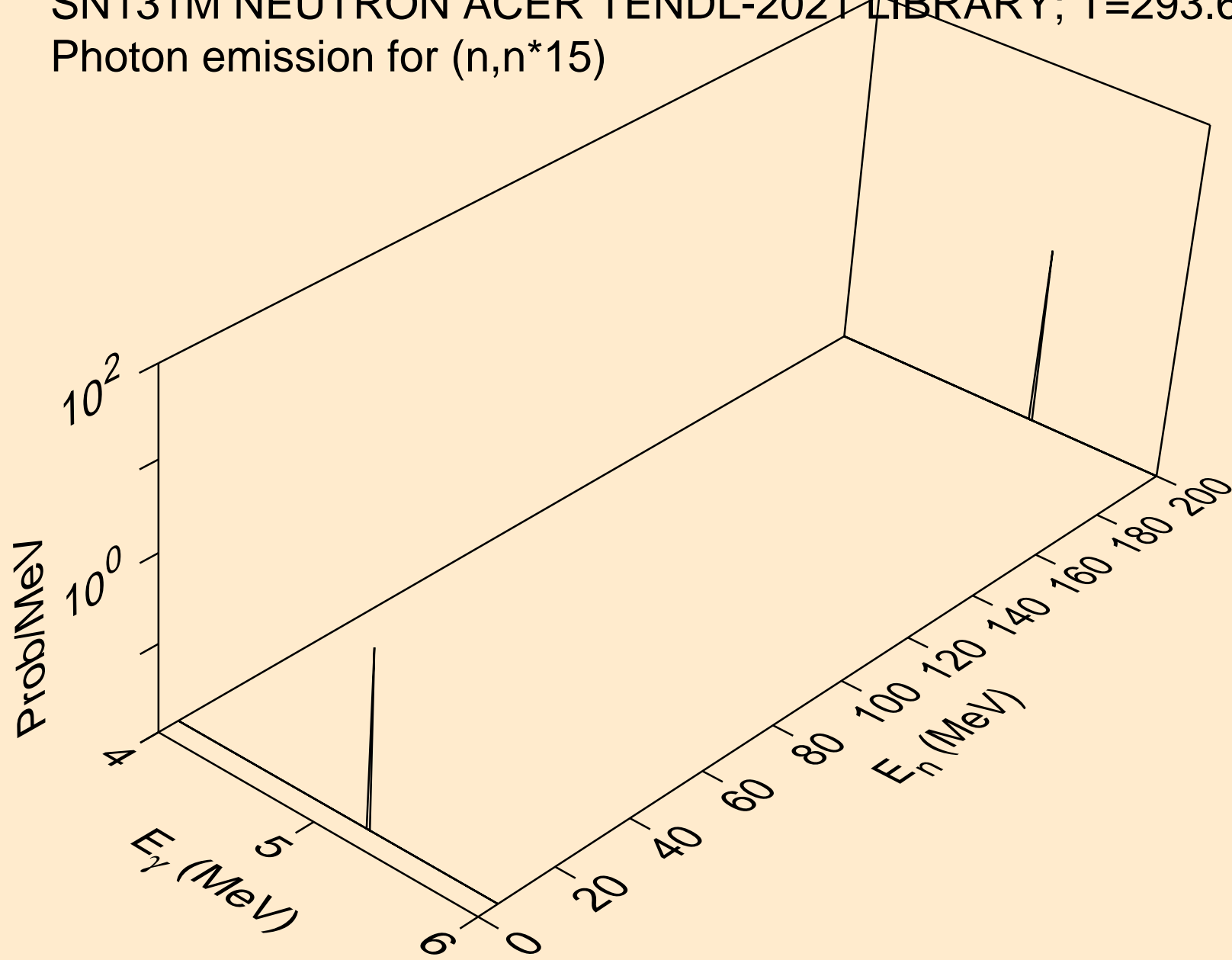

SN131M NEUTRON ACER TENDL-2021 LIBRARY; T=293.6K
Photon emission for (n,n*16)

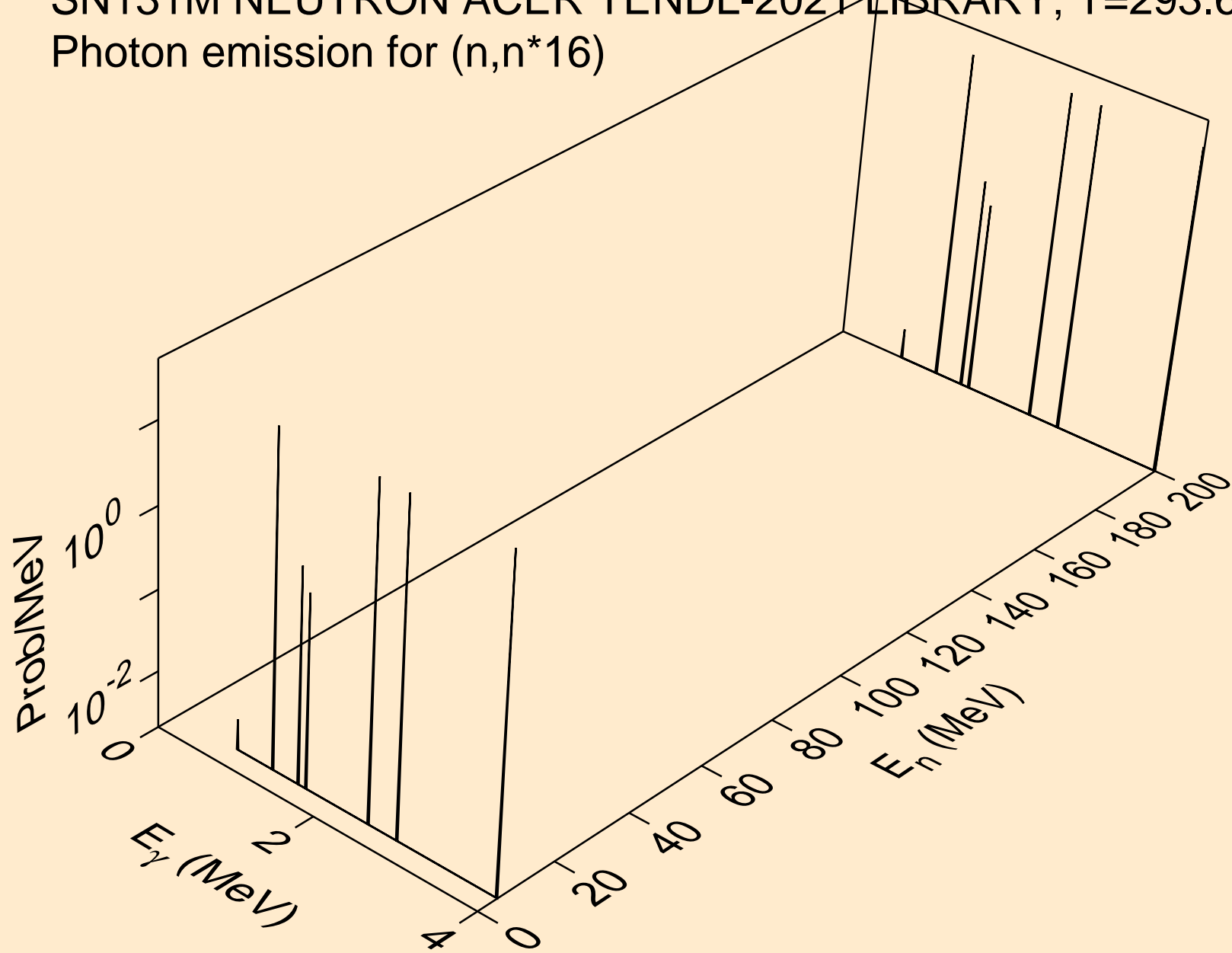

SN131M NEUTRON ACER TENDL-2021 LIBRARY; T=293.6K
Photon emission for (n,n*17)

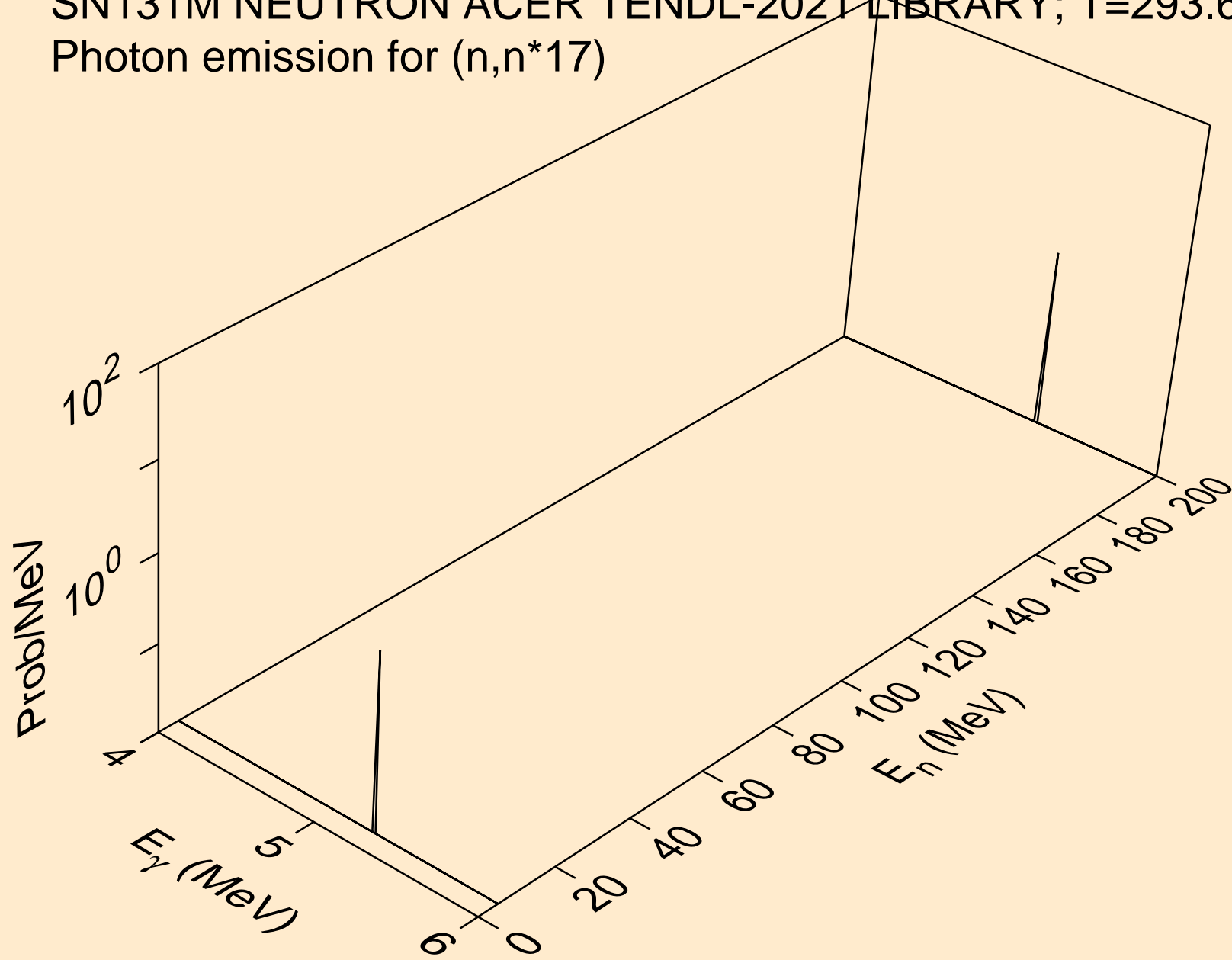

SN131M NEUTRON ACER TENDL-2021 LIBRARY; T=293.6K
Photon emission for (n,n*18)

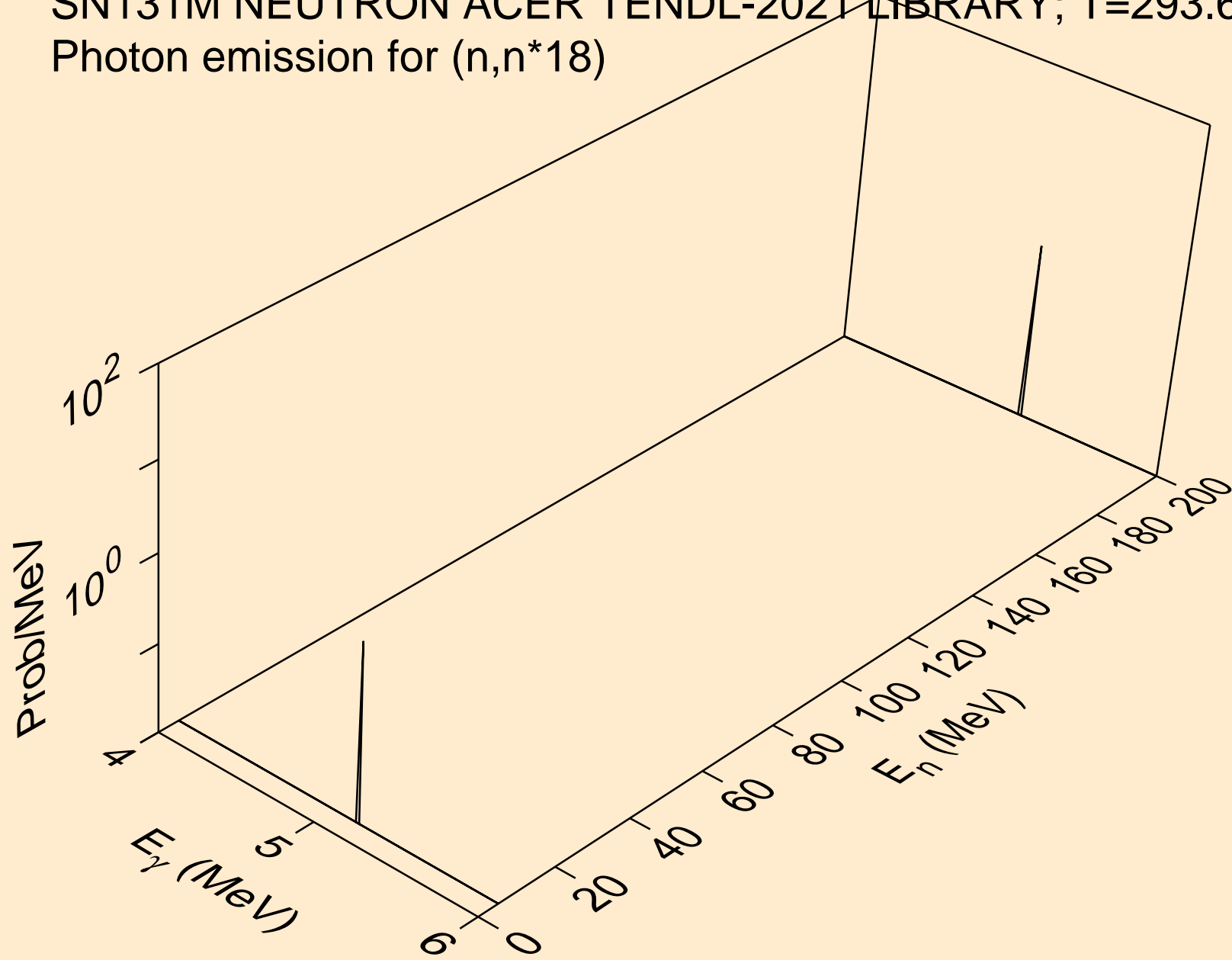

SN131M NEUTRON ACER TENDL-2021 LIBRARY; T=293.6K
Photon emission for (n,n*19)

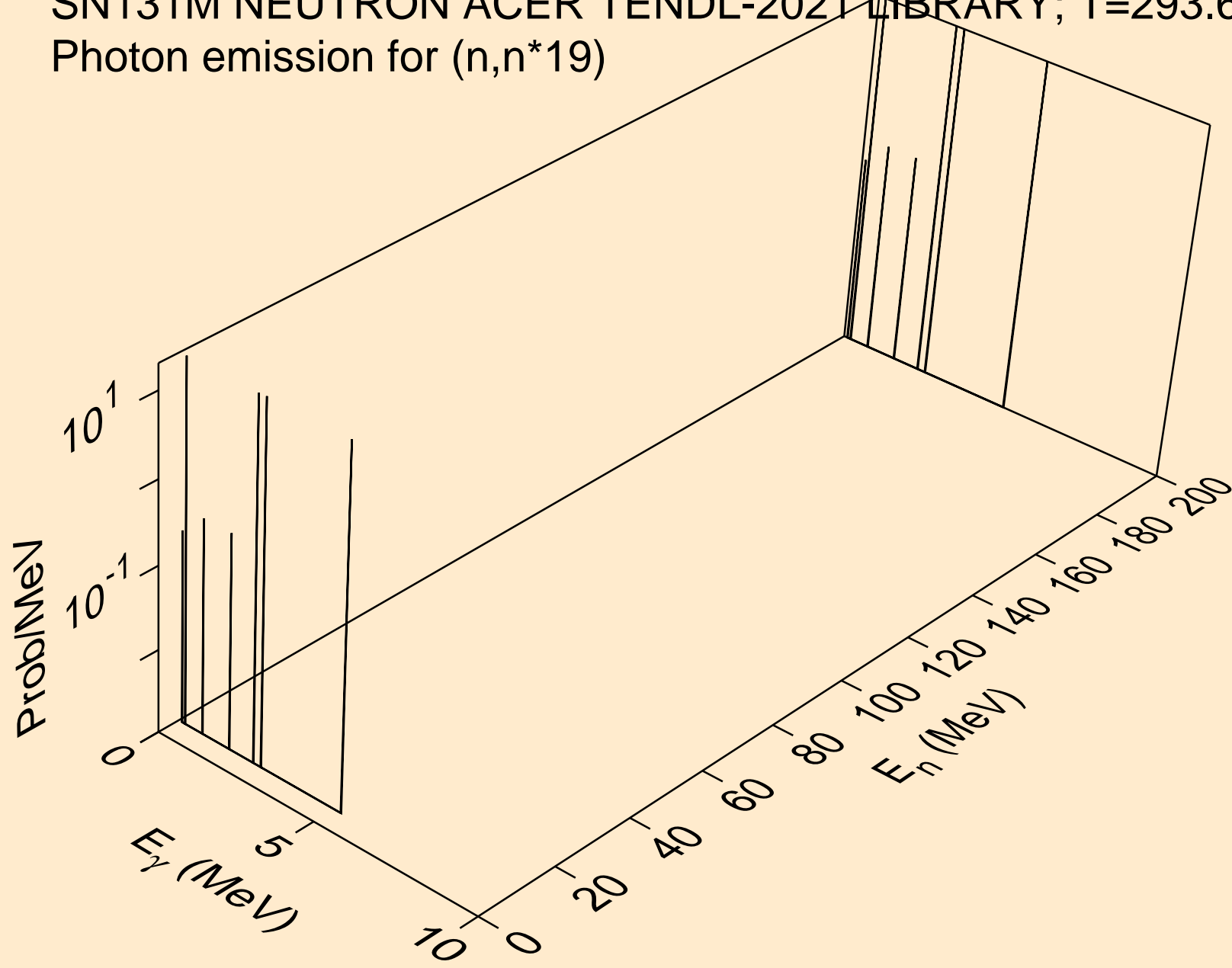

SN131M NEUTRON ACER TENDL-2021 LIBRARY; T=293.6K
Photon emission for (n,n*20)

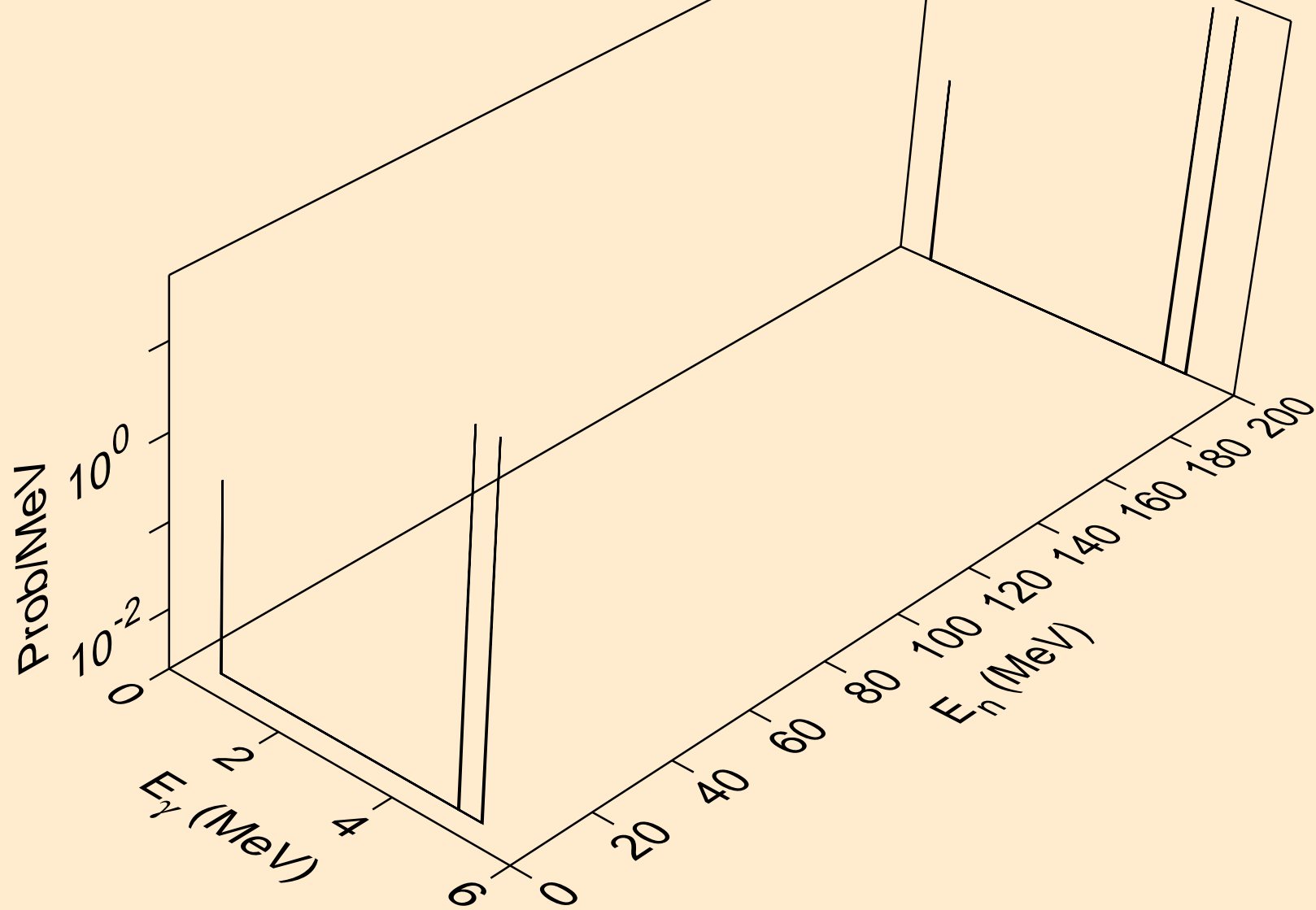

SN131M NEUTRON ACER TENDL-2021 LIBRARY; T=293.6K
Photon emission for (n,n*21)

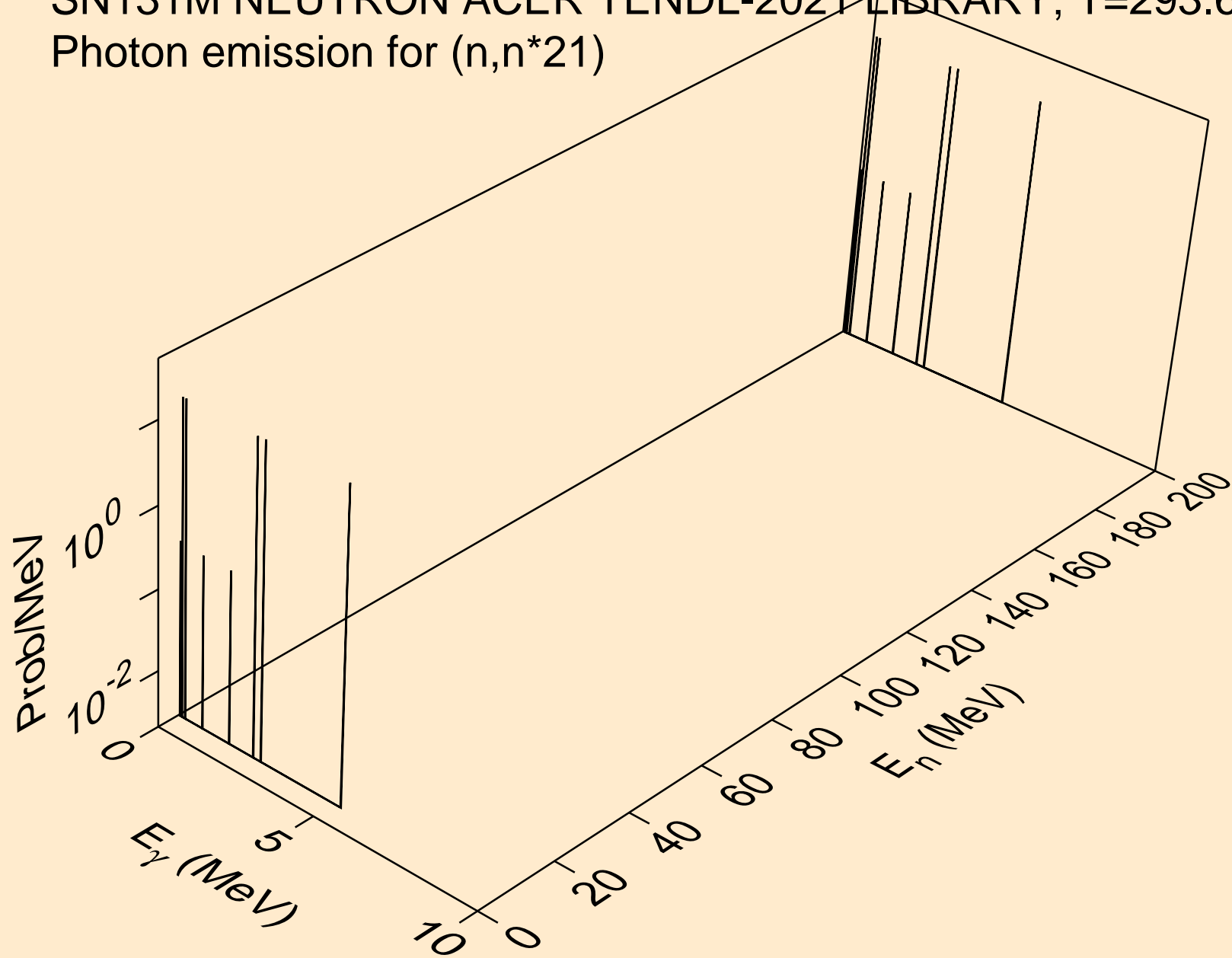

SN131M NEUTRON ACER TENDL-2021 LIBRARY; T=293.6K
Photon emission for (n,n*22)

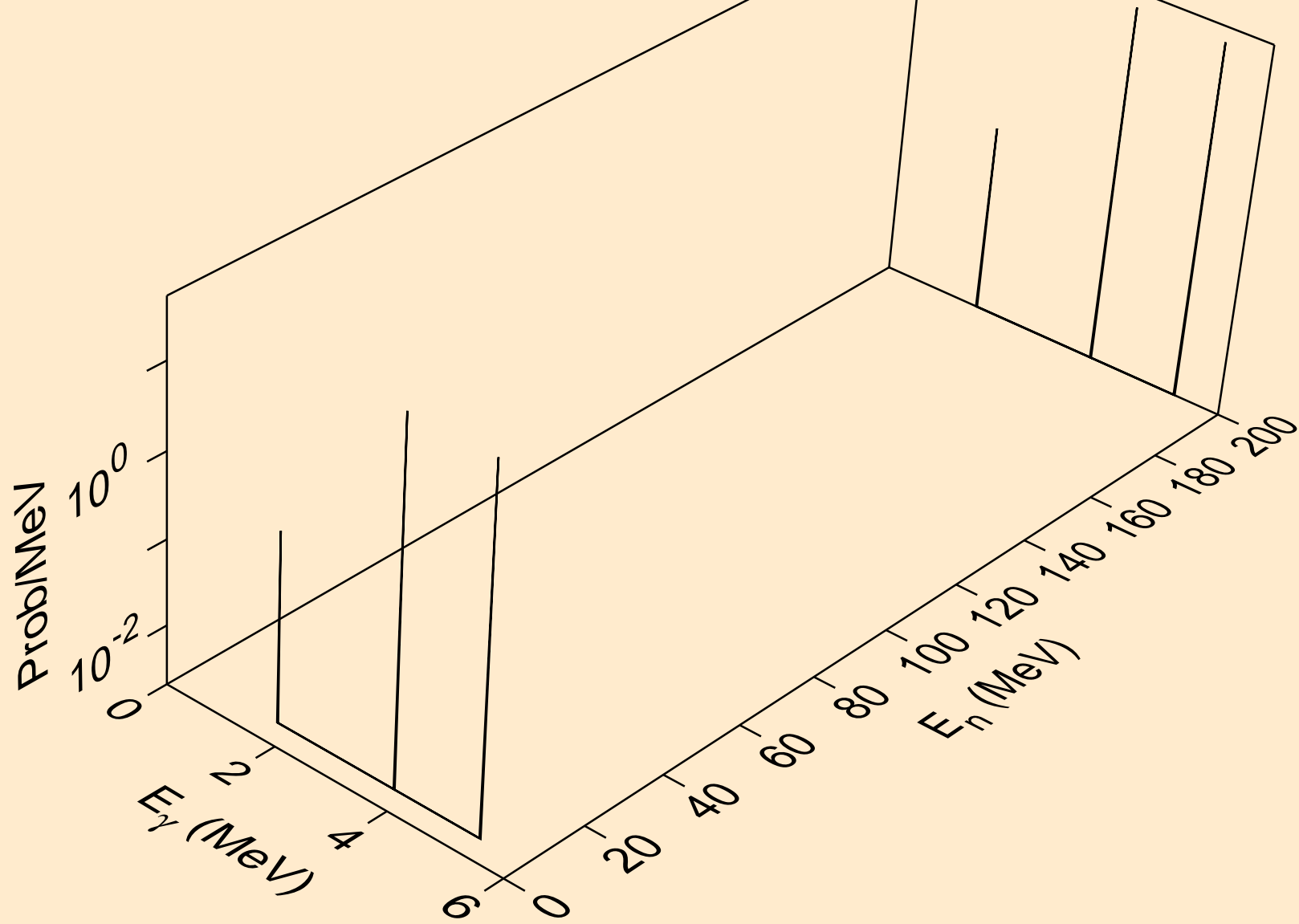

SN131M NEUTRON ACER TENDL-2021 LIBRARY; T=293.6K
Photon emission for (n,n*23)

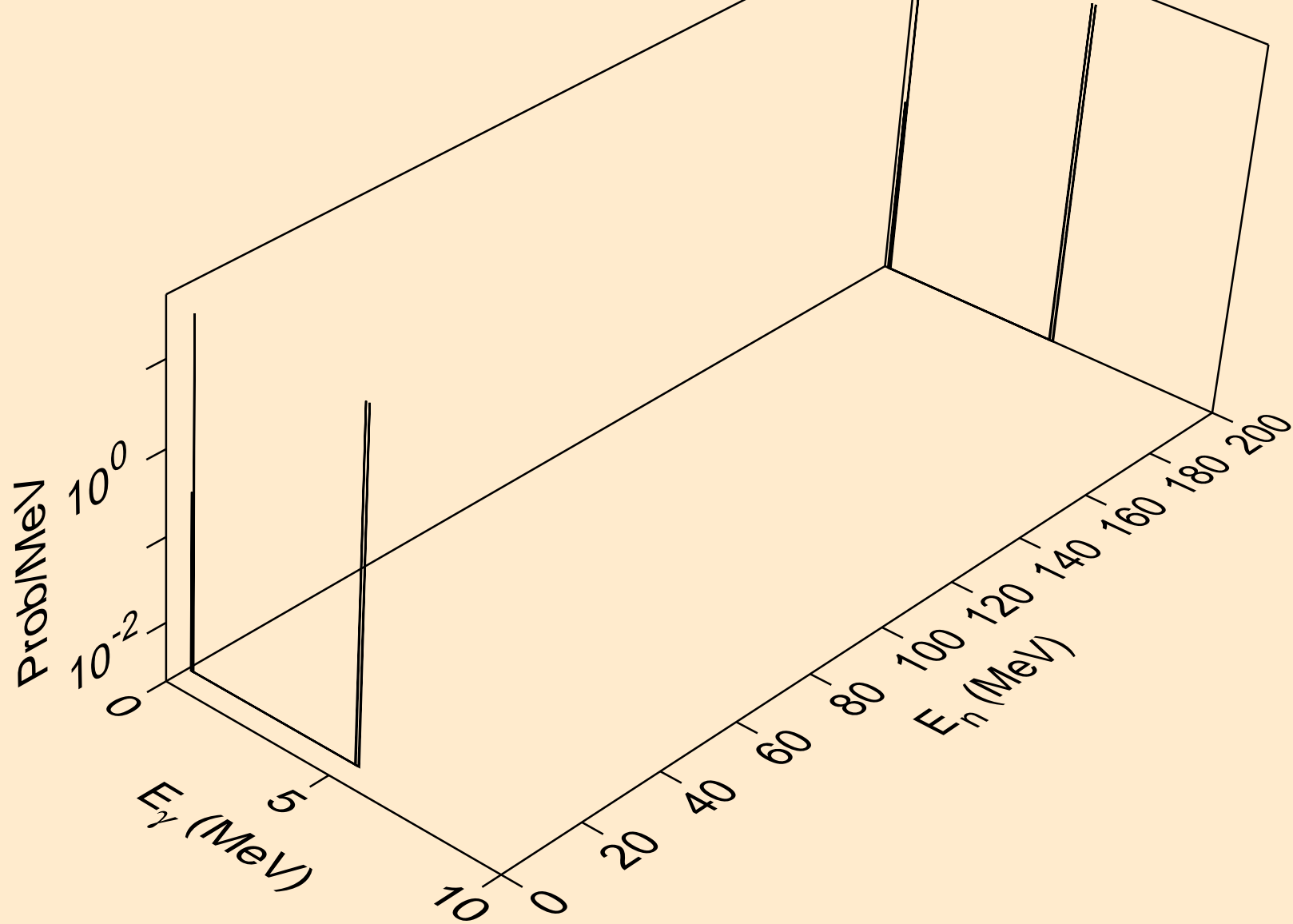

SN131M NEUTRON ACER TENDL-2021 LIBRARY; T=293.6K
Photon emission for (n,n*24)

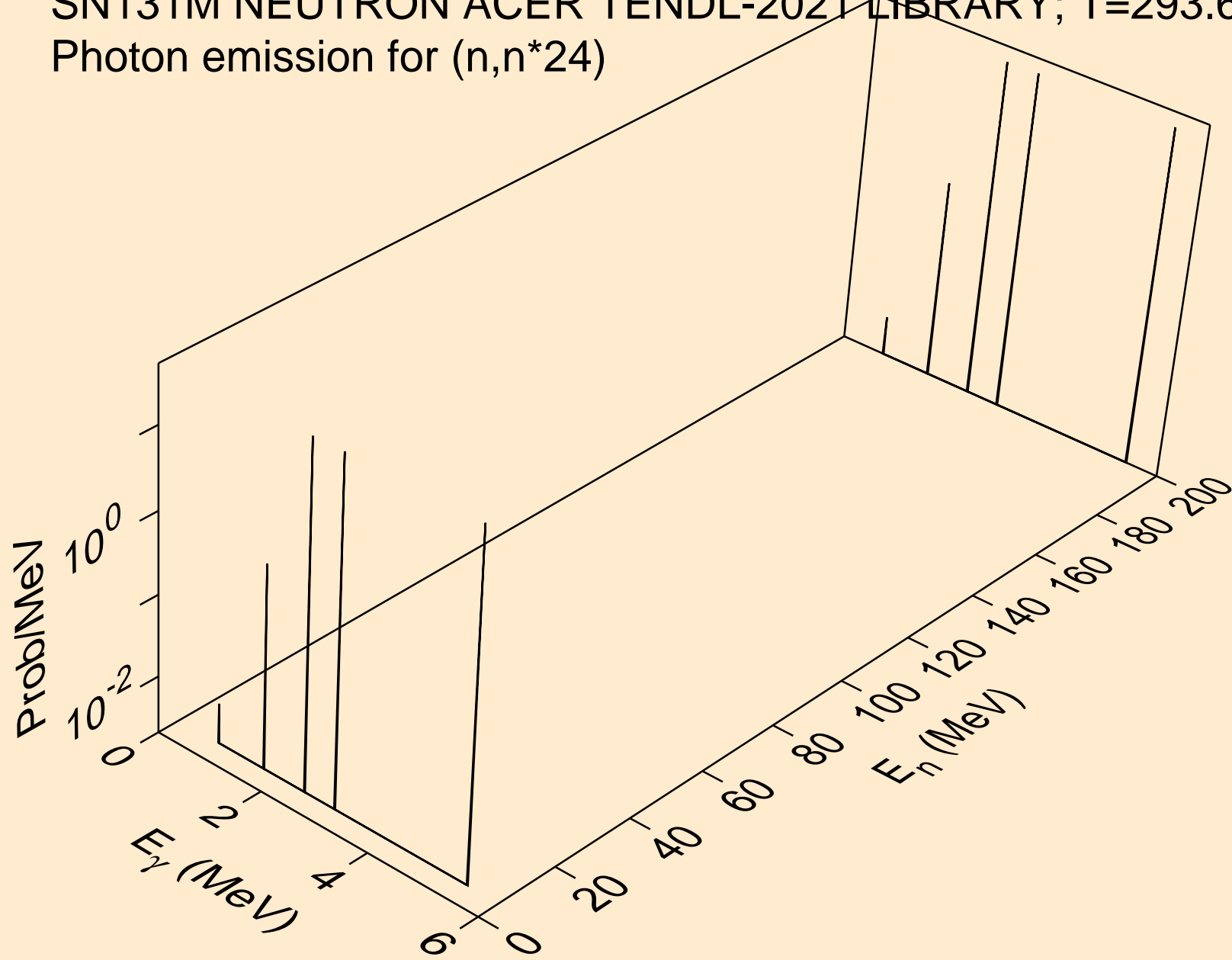

SN131M NEUTRON ACER TENDL-2021 LIBRARY; T=293.6K
Photon emission for (n,n*25)

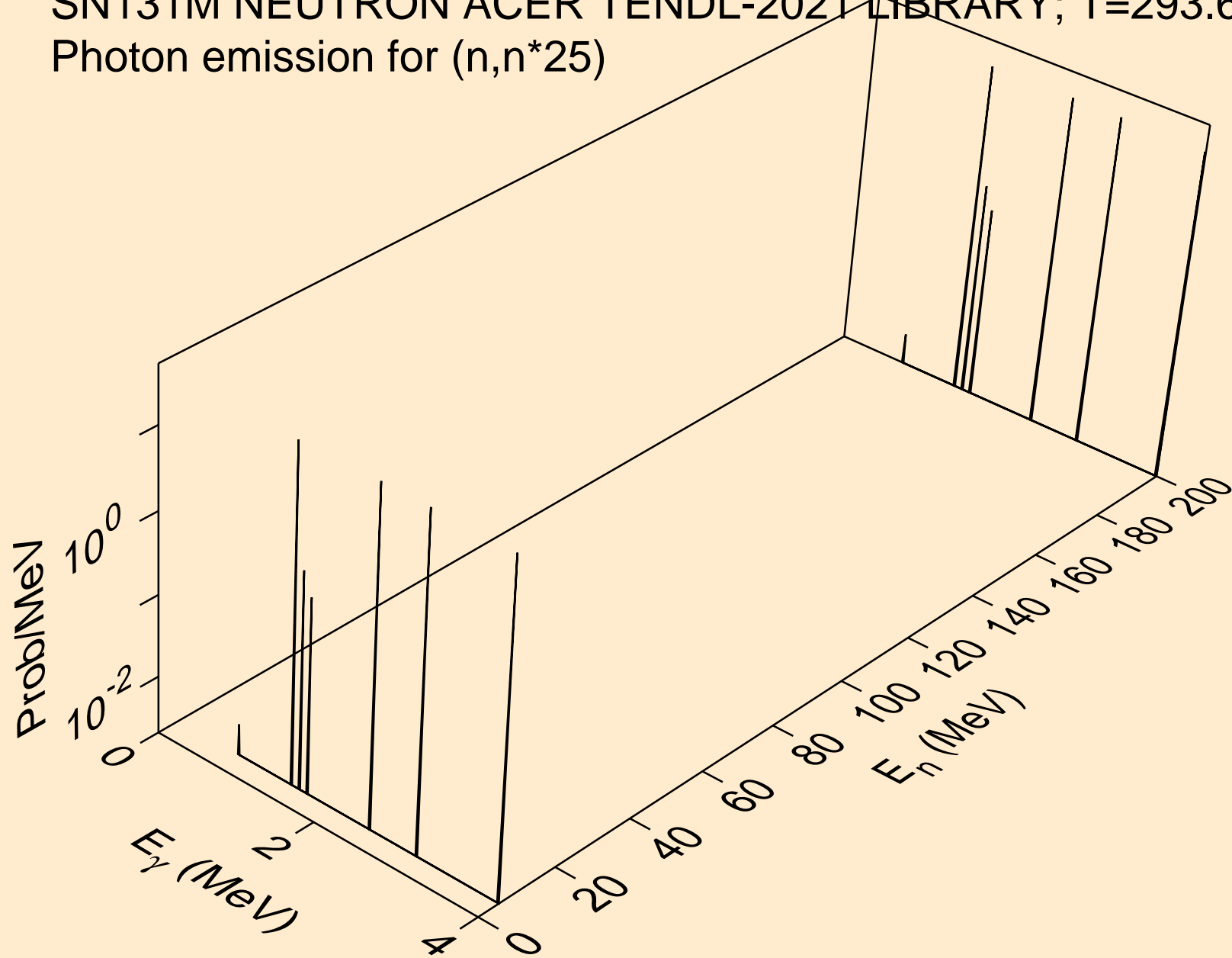

SN131M NEUTRON ACER TENDL-2021 LIBRARY; T=293.6K
Photon emission for (n,n*26)

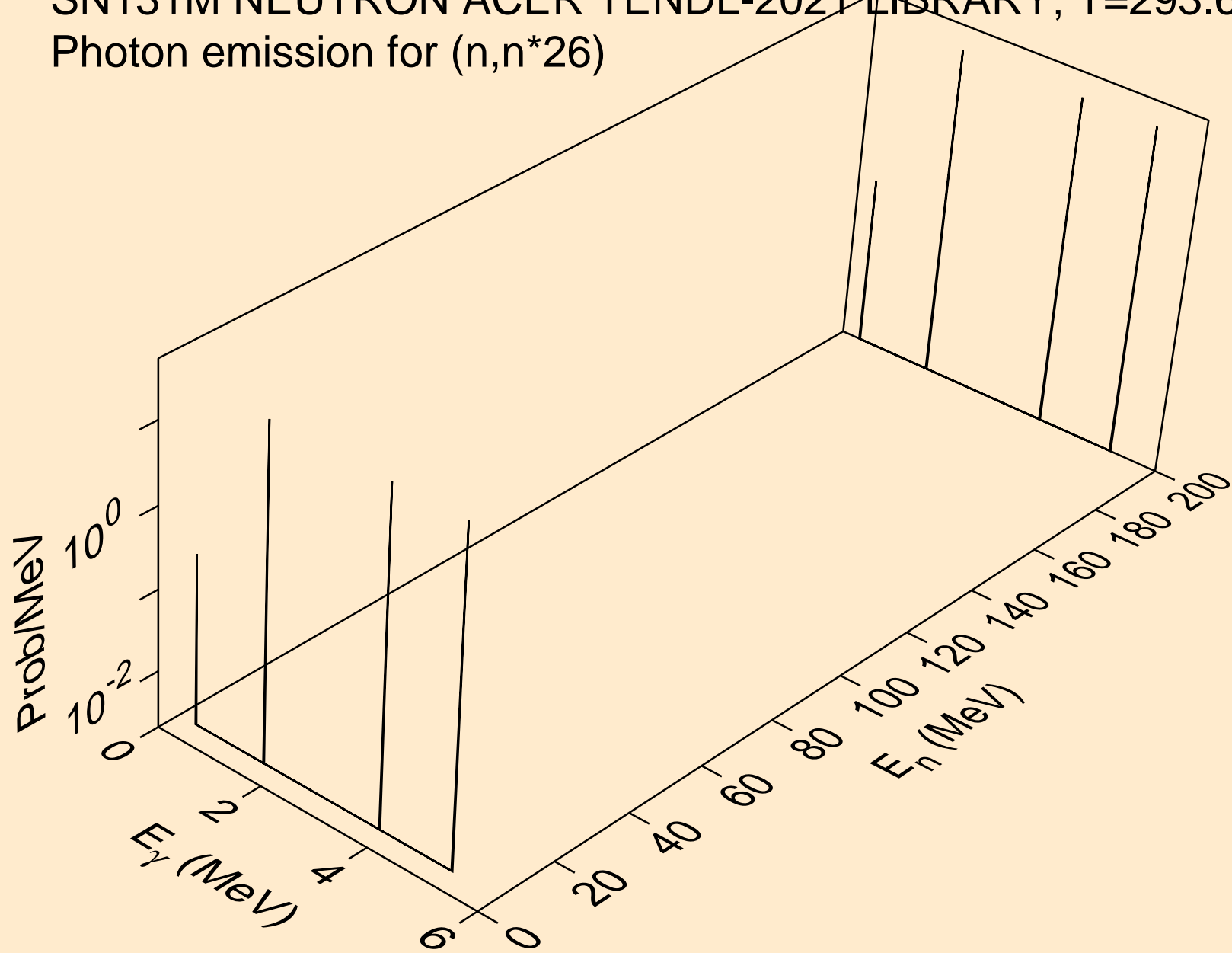

SN131M NEUTRON ACER TENDL-2021 LIBRARY; T=293.6K
Photon emission for (n,n*27)

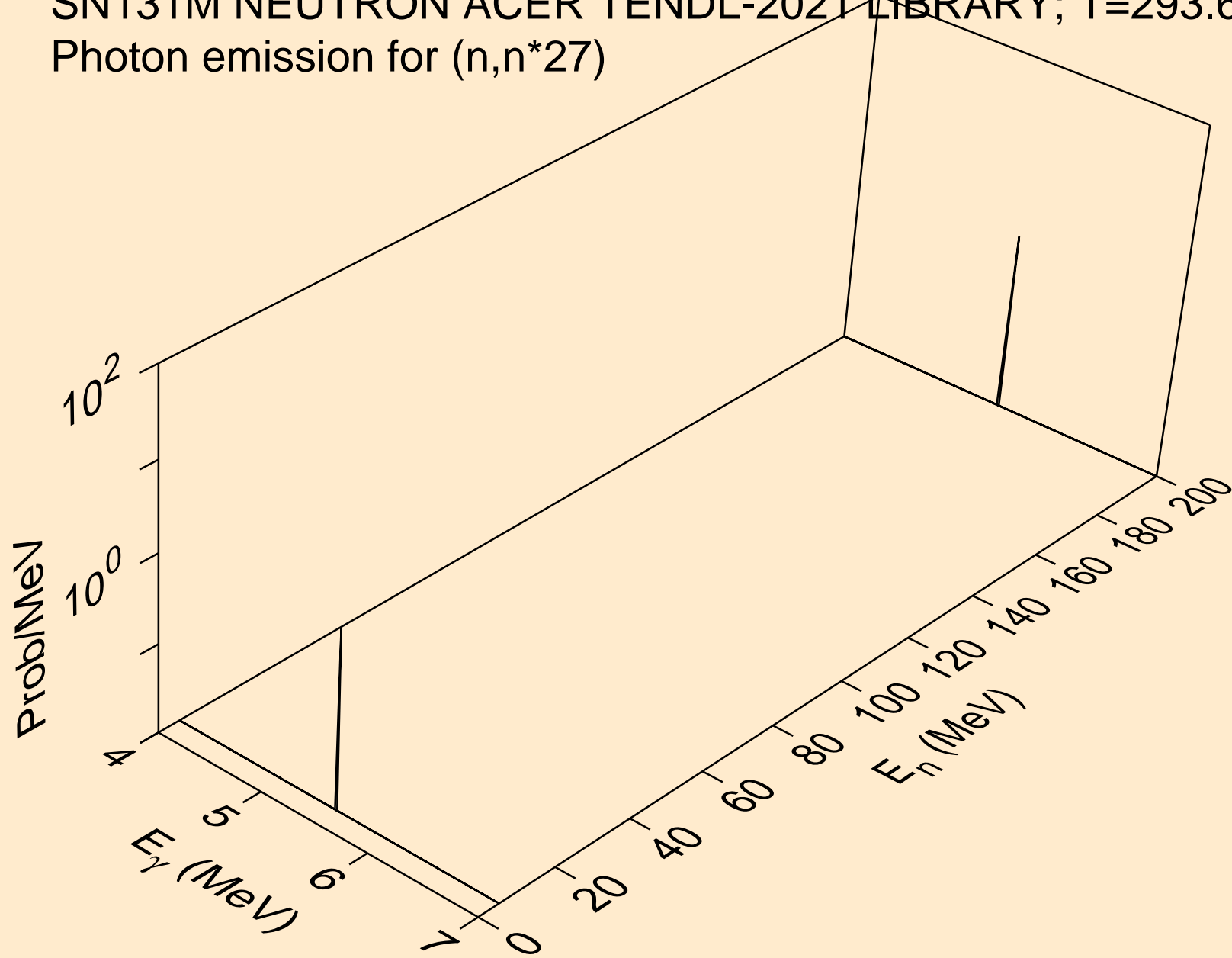

SN131M NEUTRON ACER TENDL-2021 LIBRARY; T=293.6K
Photon emission for (n,n*28)

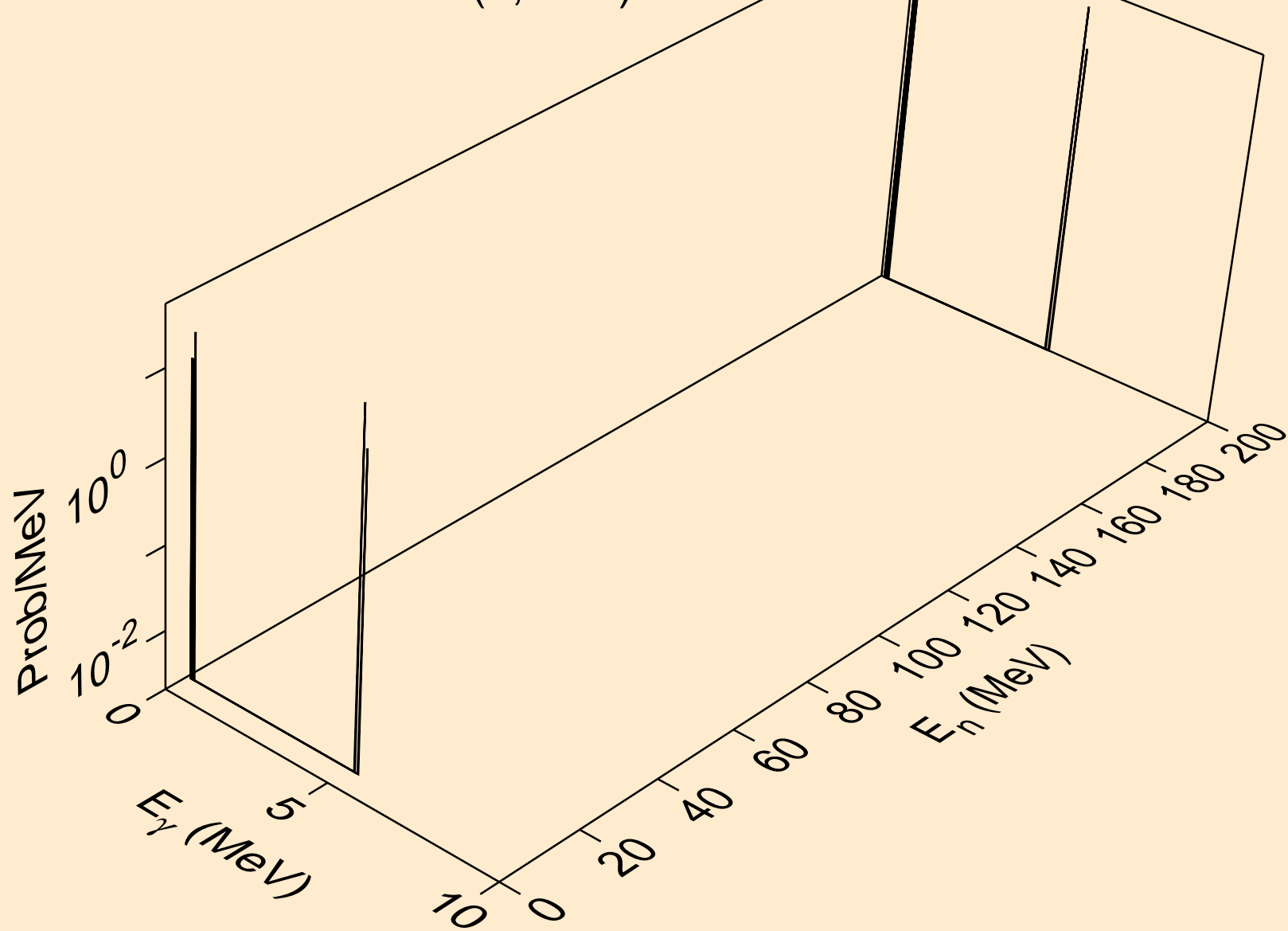

SN131M NEUTRON ACER TENDL-2021 LIBRARY; T=293.6K
Photon emission for (n,n*29)

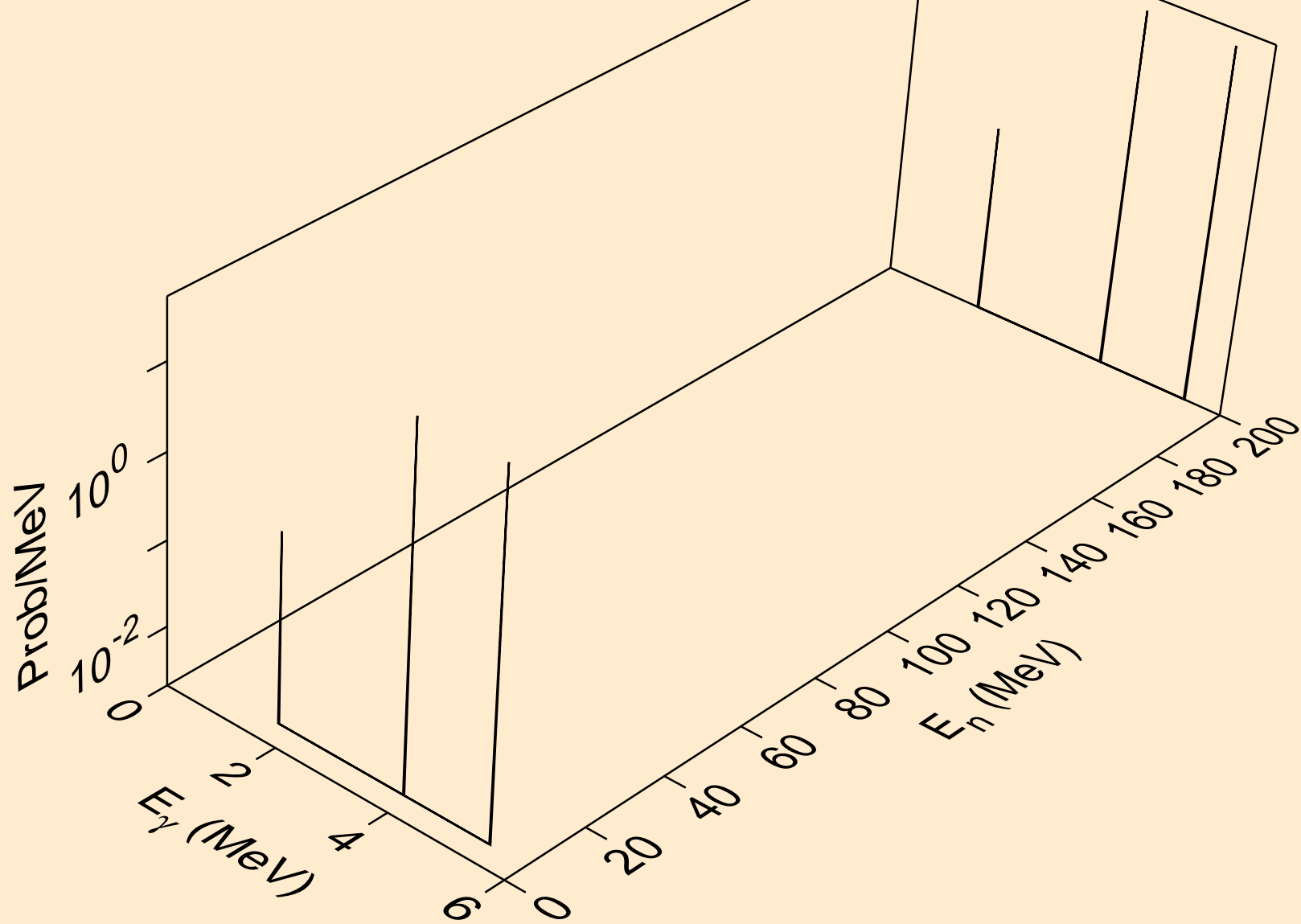

SN131M NEUTRON ACER TENDL-2021 LIBRARY; T=293.6K
Photon emission for (n,n*30)

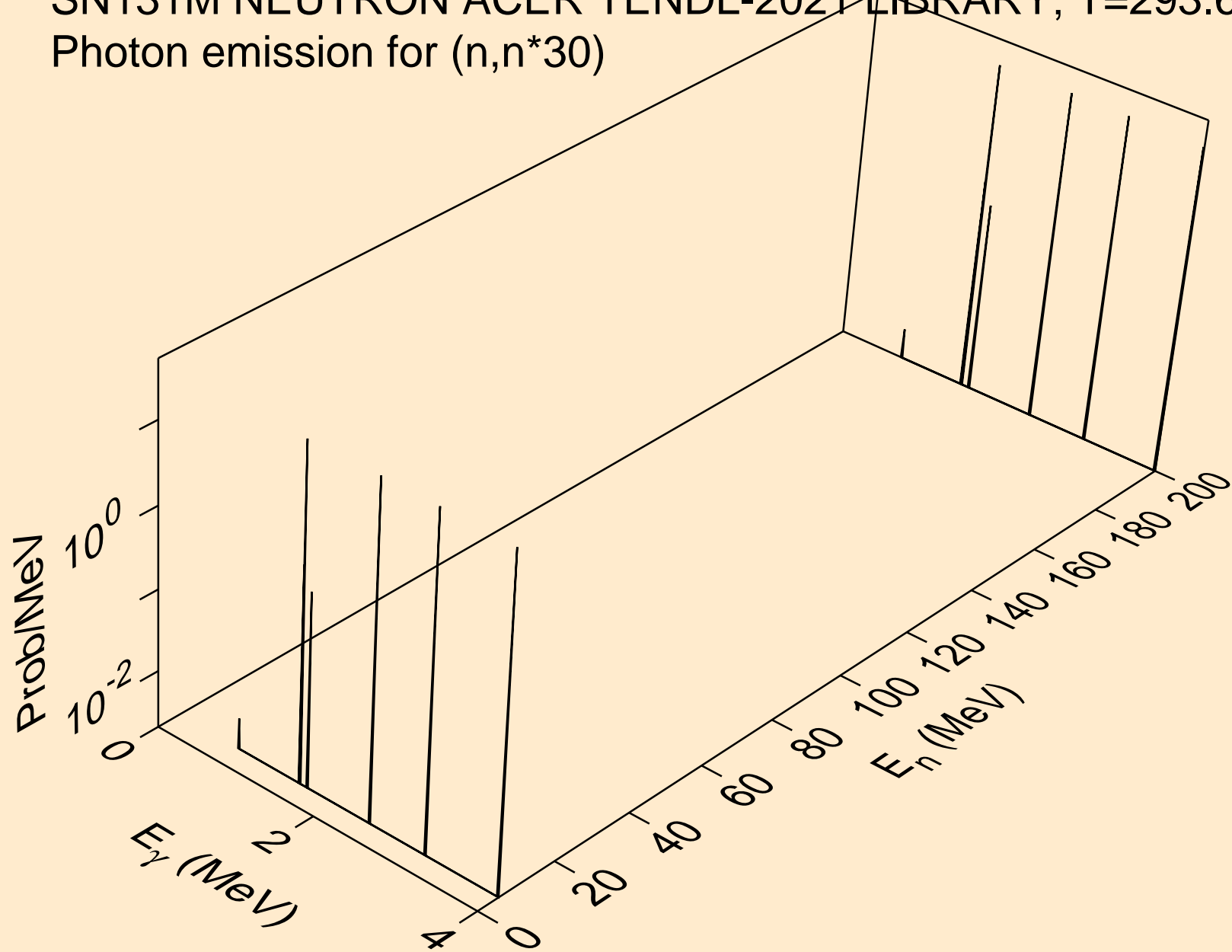

SN131M NEUTRON ACER TENDL-2021 LIBRARY; T=293.6K
Photon emission for (n,n*c)

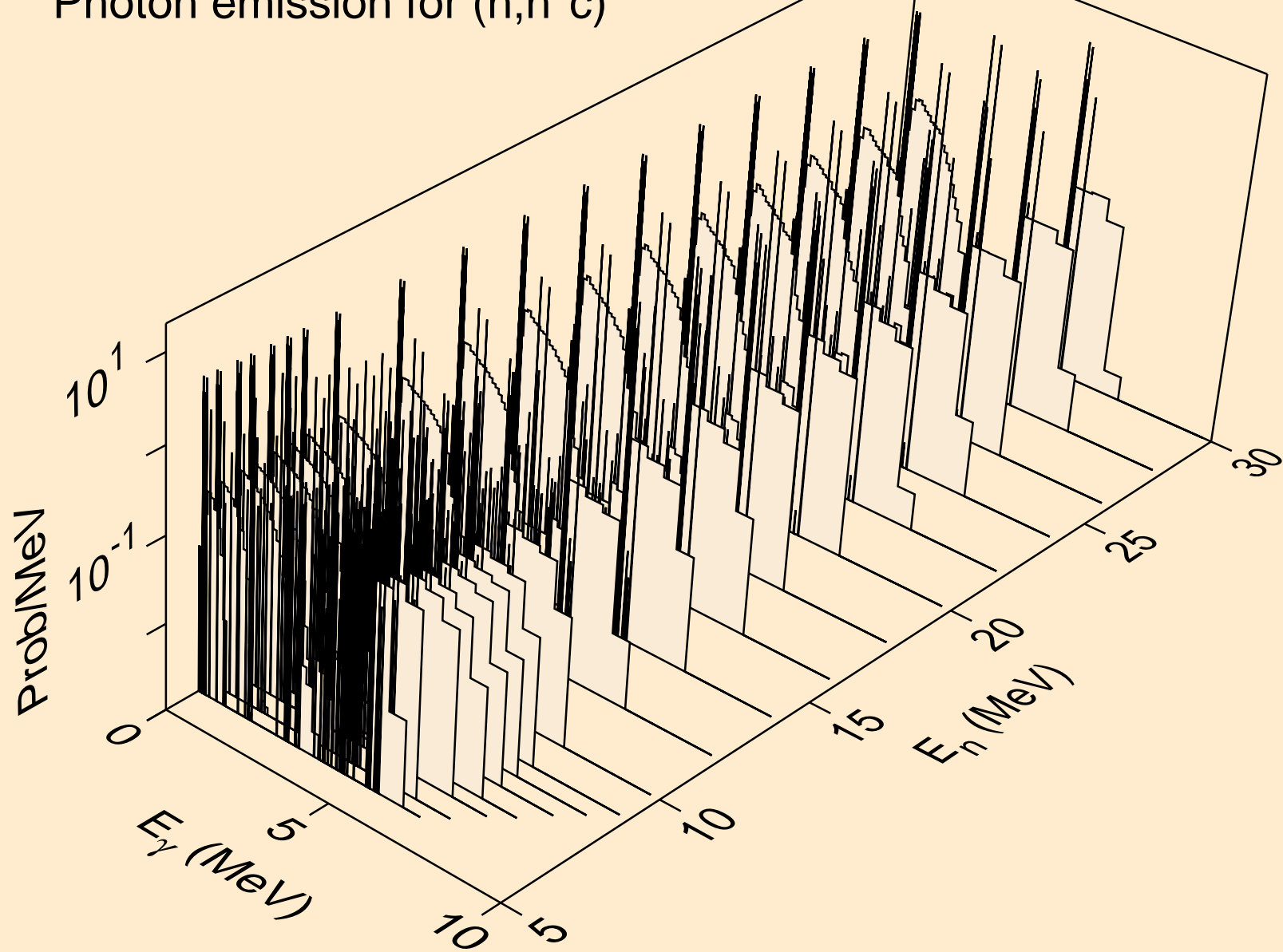

SN131M NEUTRON ACER TENDL-2021 LIBRARY; T=293.6K
Photon emission for (n,gma)

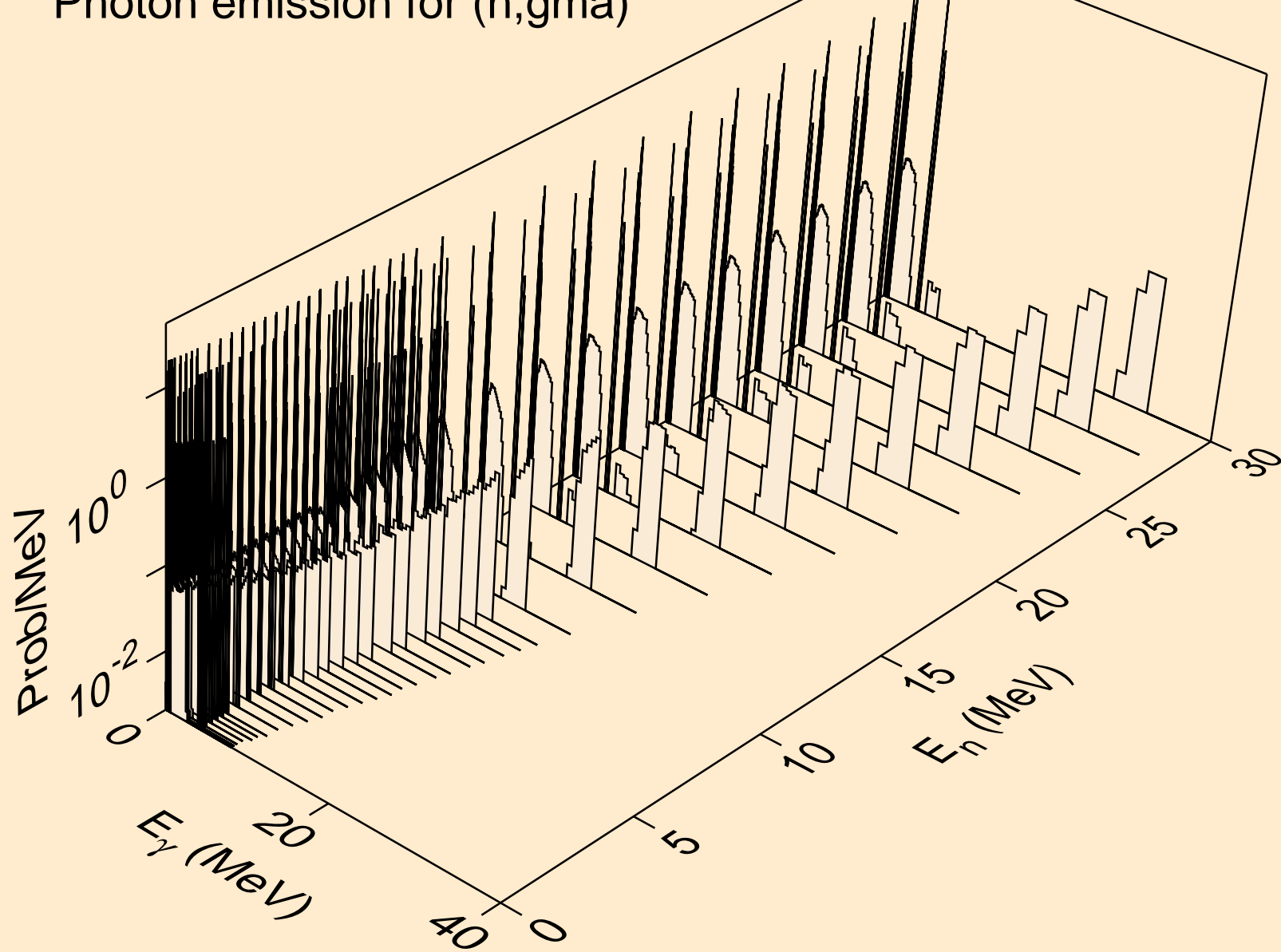

SN131M NEUTRON ACER TENDL-2021 LIBRARY; T=293.6K
Photon emission for (n,p)

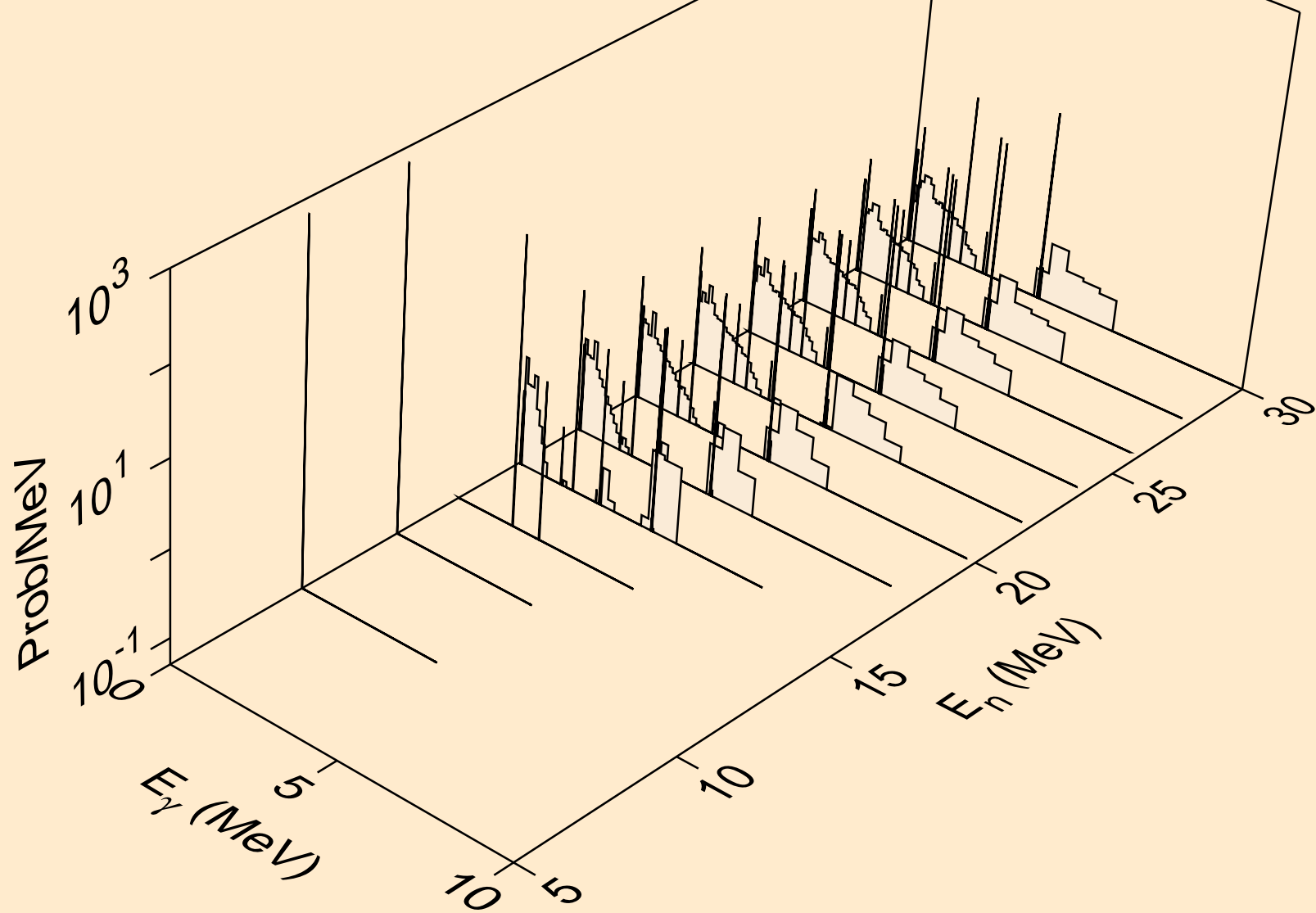

SN131M NEUTRON ACER TENDL-2021 LIBRARY; T=293.6K
Photon emission for (n,d)

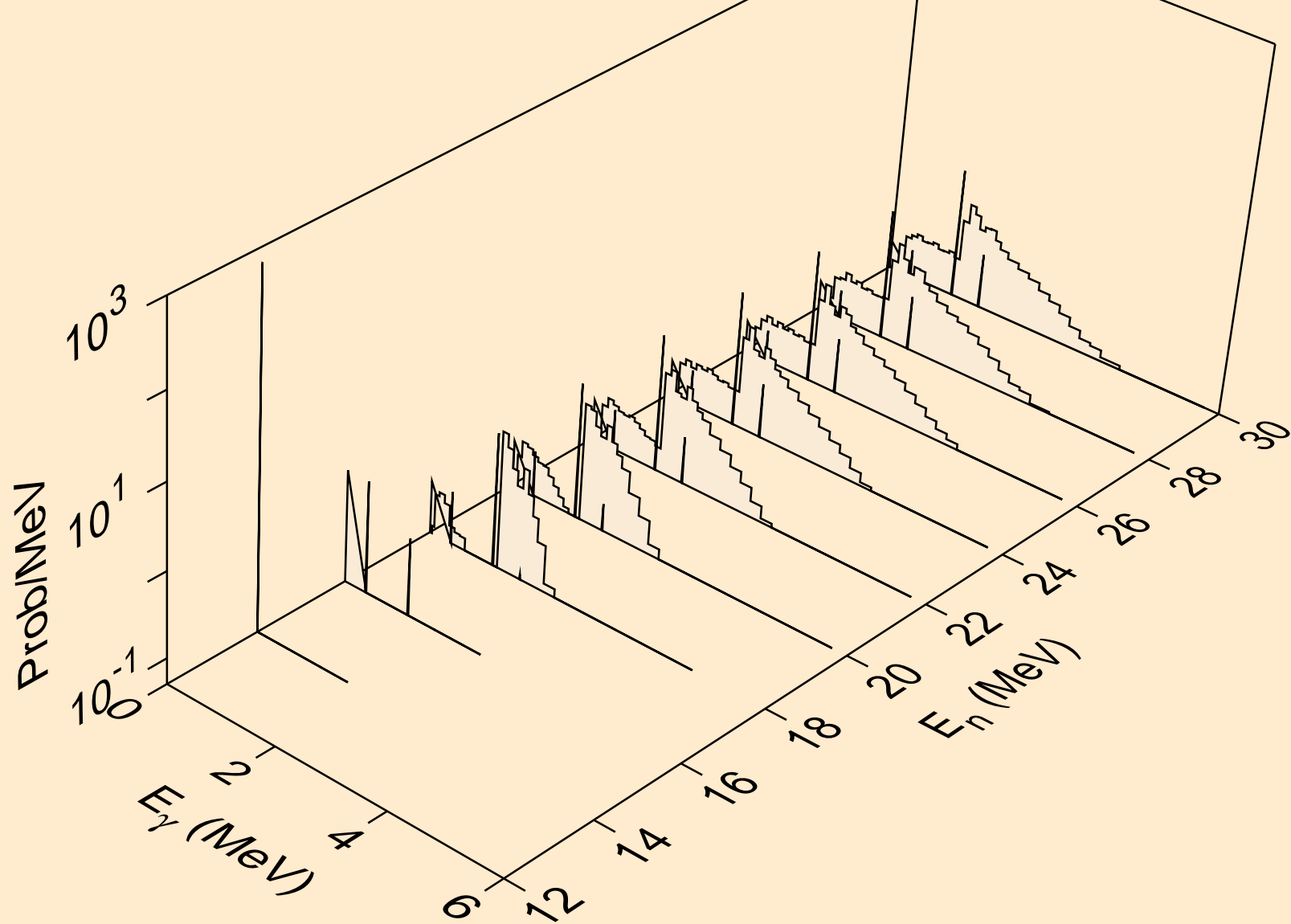

SN131M NEUTRON ACER TENDL-2021 LIBRARY; T=293.6K
Photon emission for (n,t)

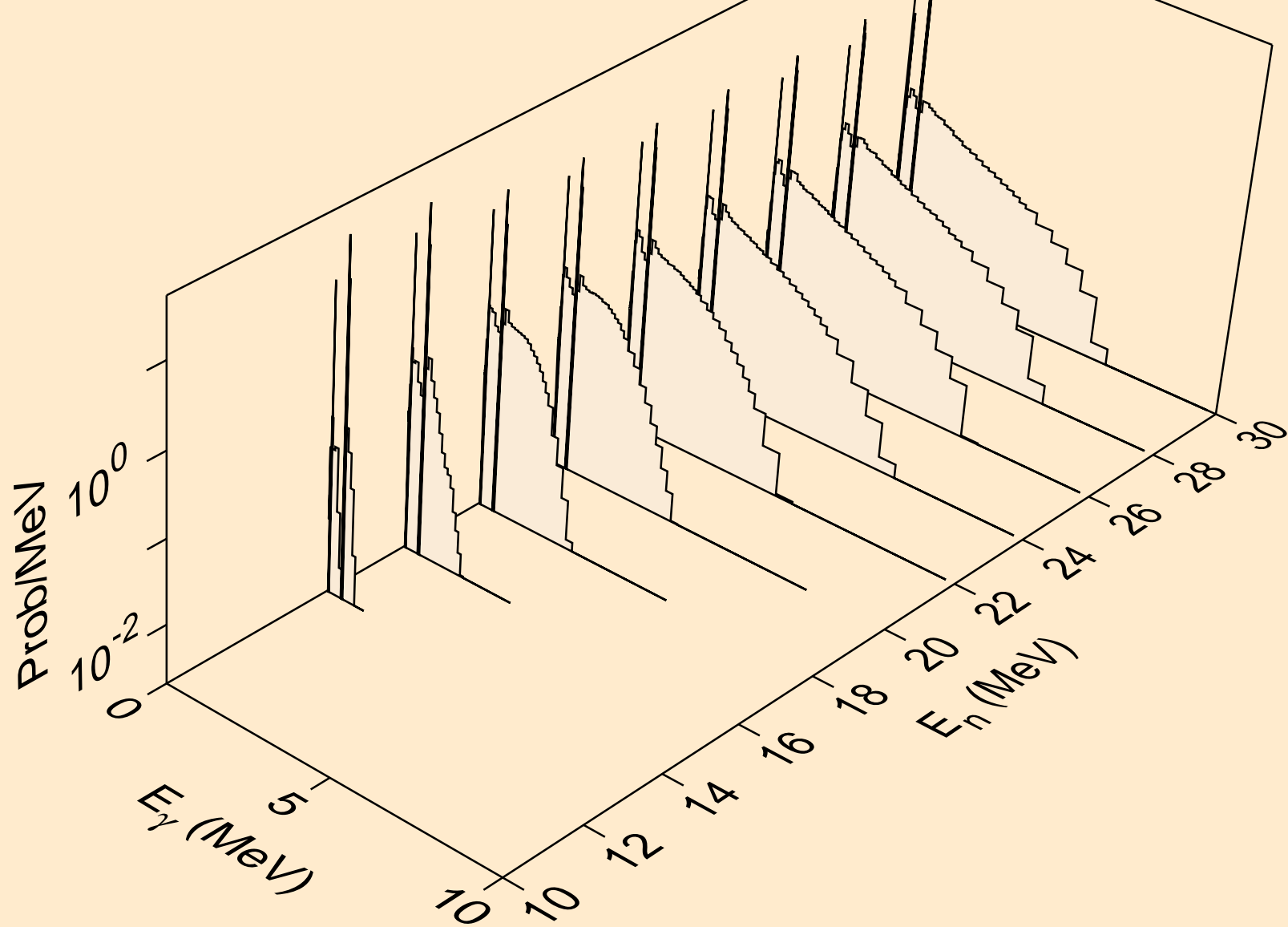

SN131M NEUTRON ACER TENDL-2021 LIBRARY; T=293.6K
Photon emission for (n,a)

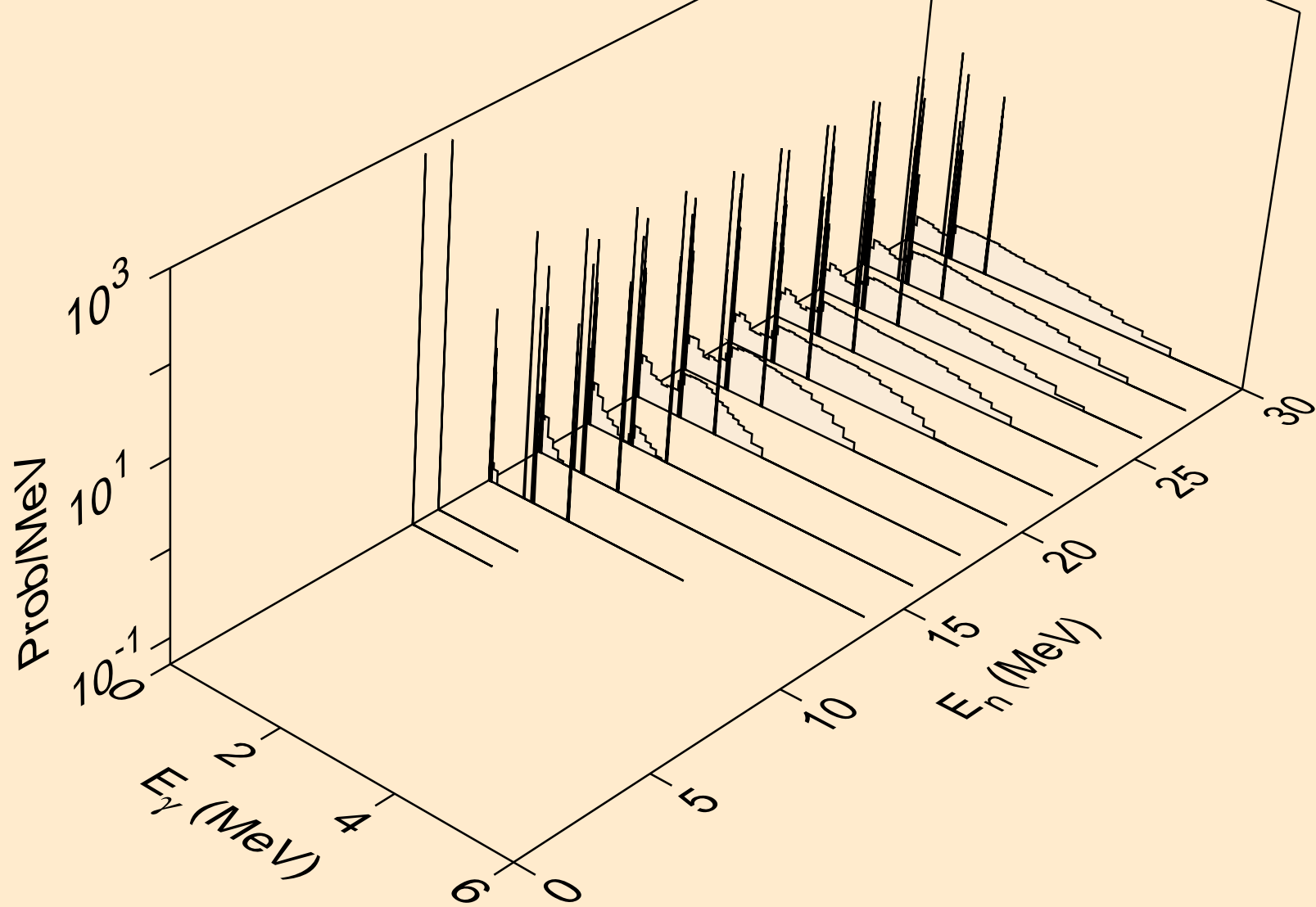

SN131M NEUTRON ACER TENDL-2021 LIBRARY; T=293.6K
thermal capture photon spectrum

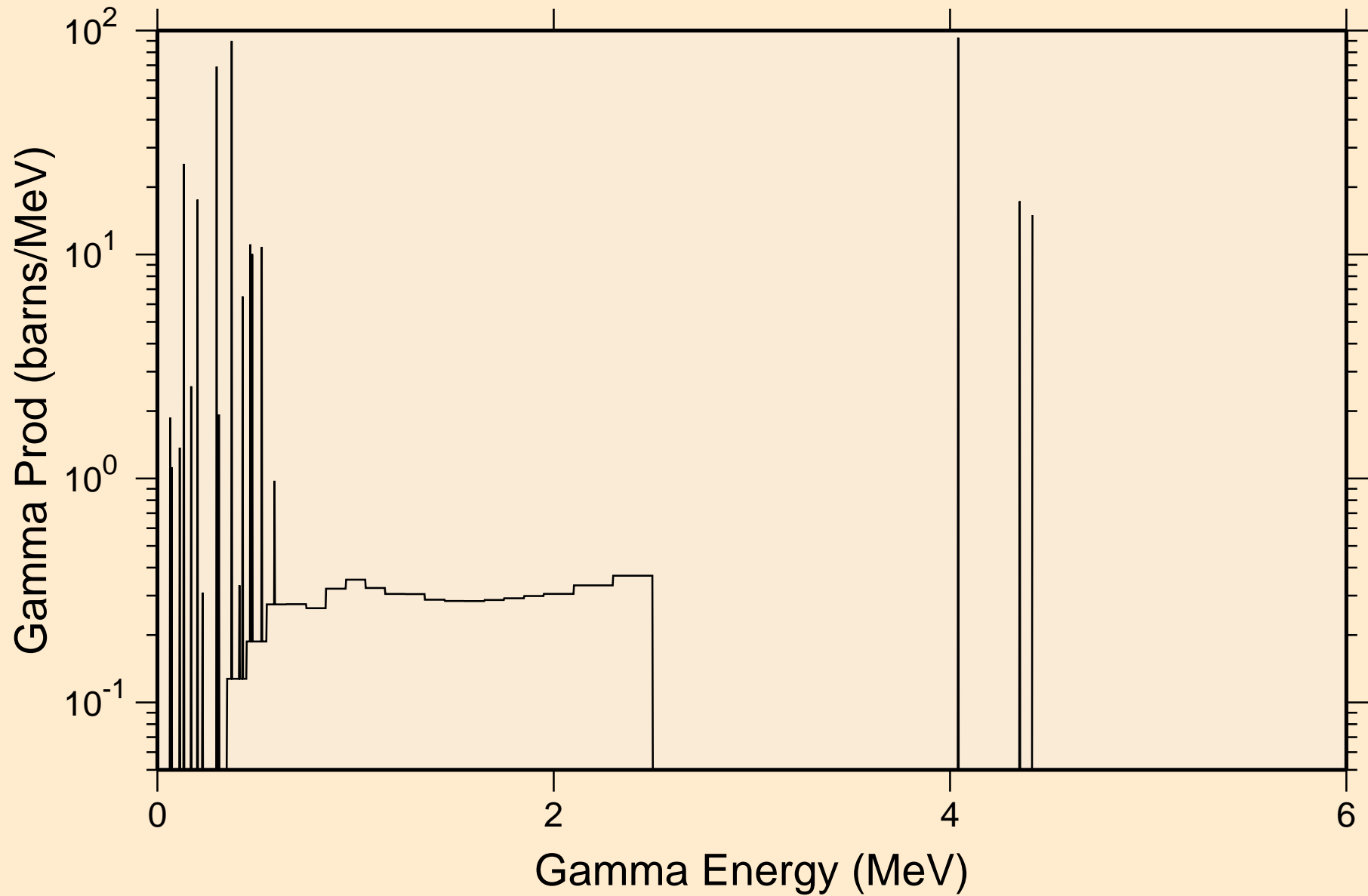

SN131M NEUTRON ACER TENDL-2021 LIBRARY; T=293.6K
14 MeV photon spectrum

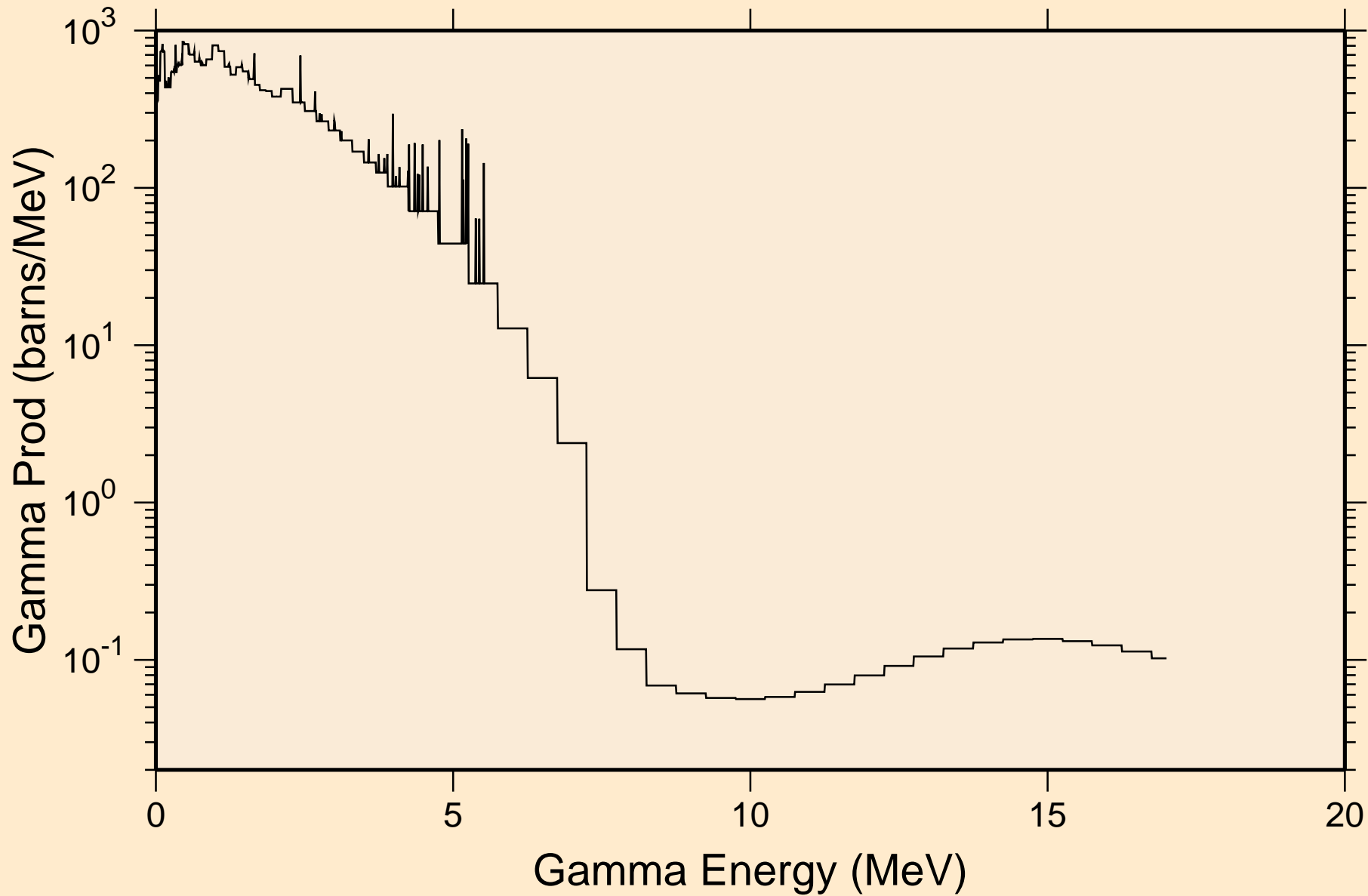

SN131M NEUTRON ACER TENDL-2021 LIBRARY; T=293.6K

Particle heating contributions

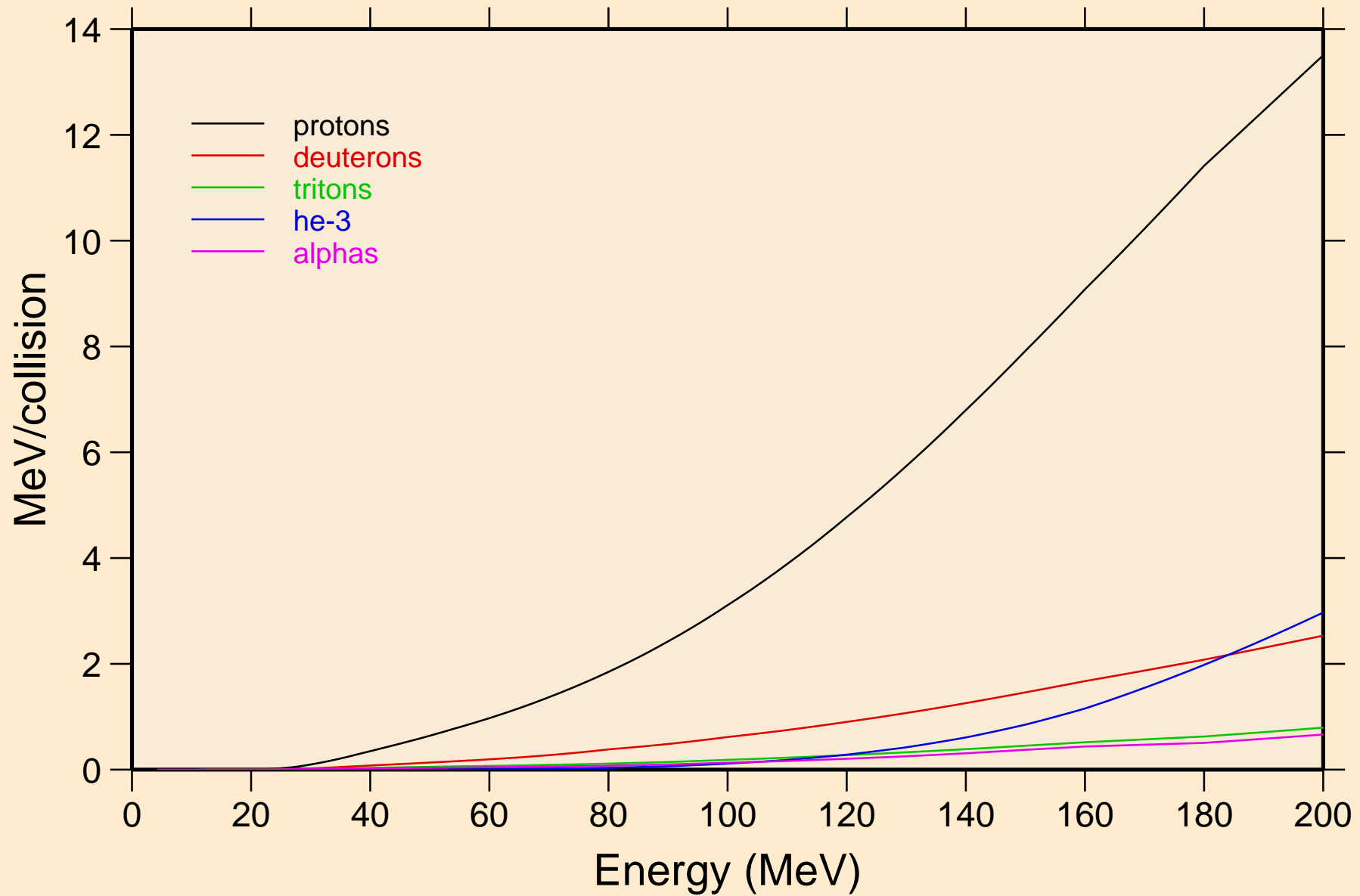

SN131M NEUTRON ACER TENDL-2021 LIBRARY; T=293.6K

Recoil Heating

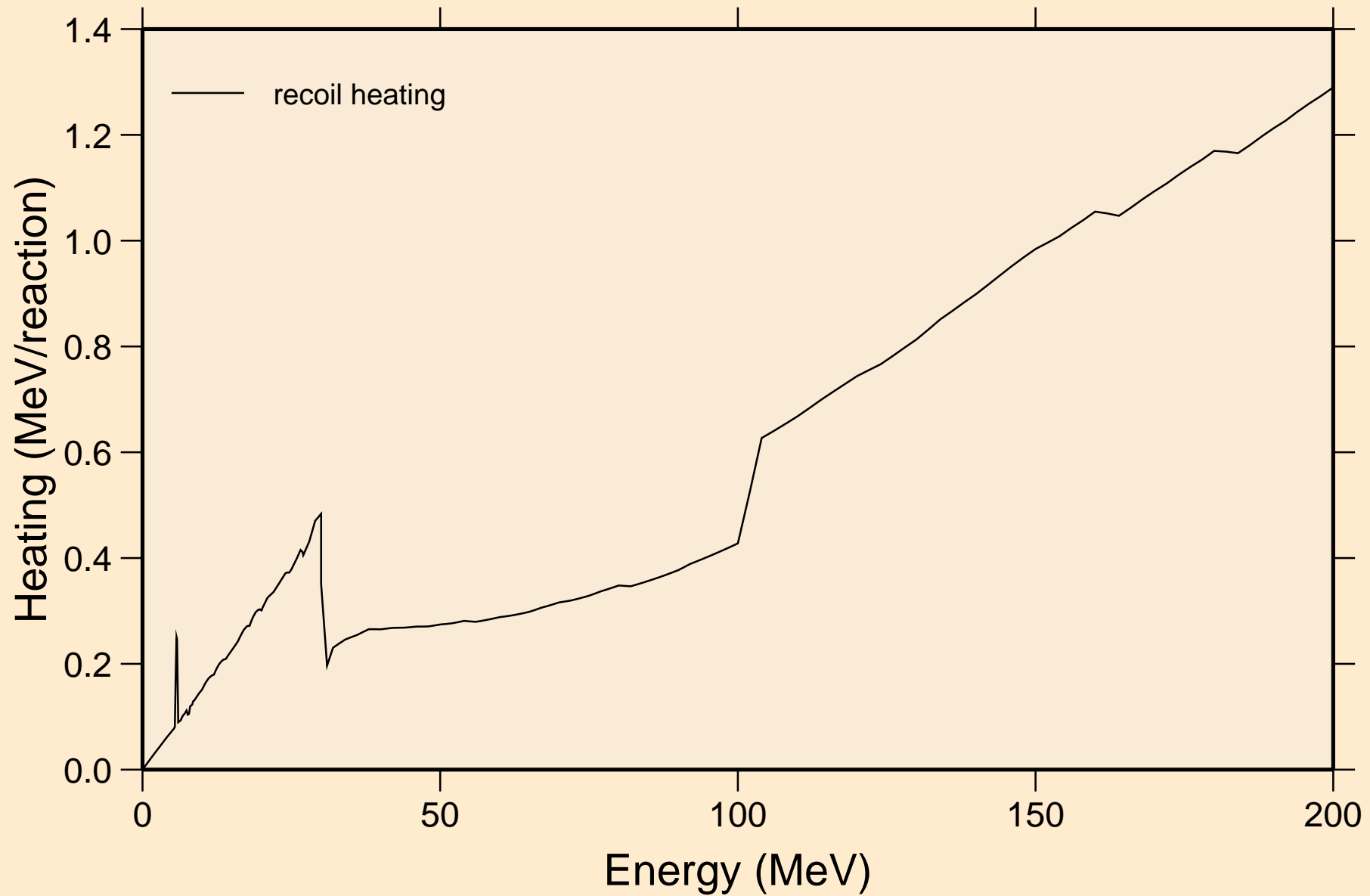

SN131M NEUTRON ACER TENDL-2021 LIBRARY; T=293.6K
Particle production cross sections

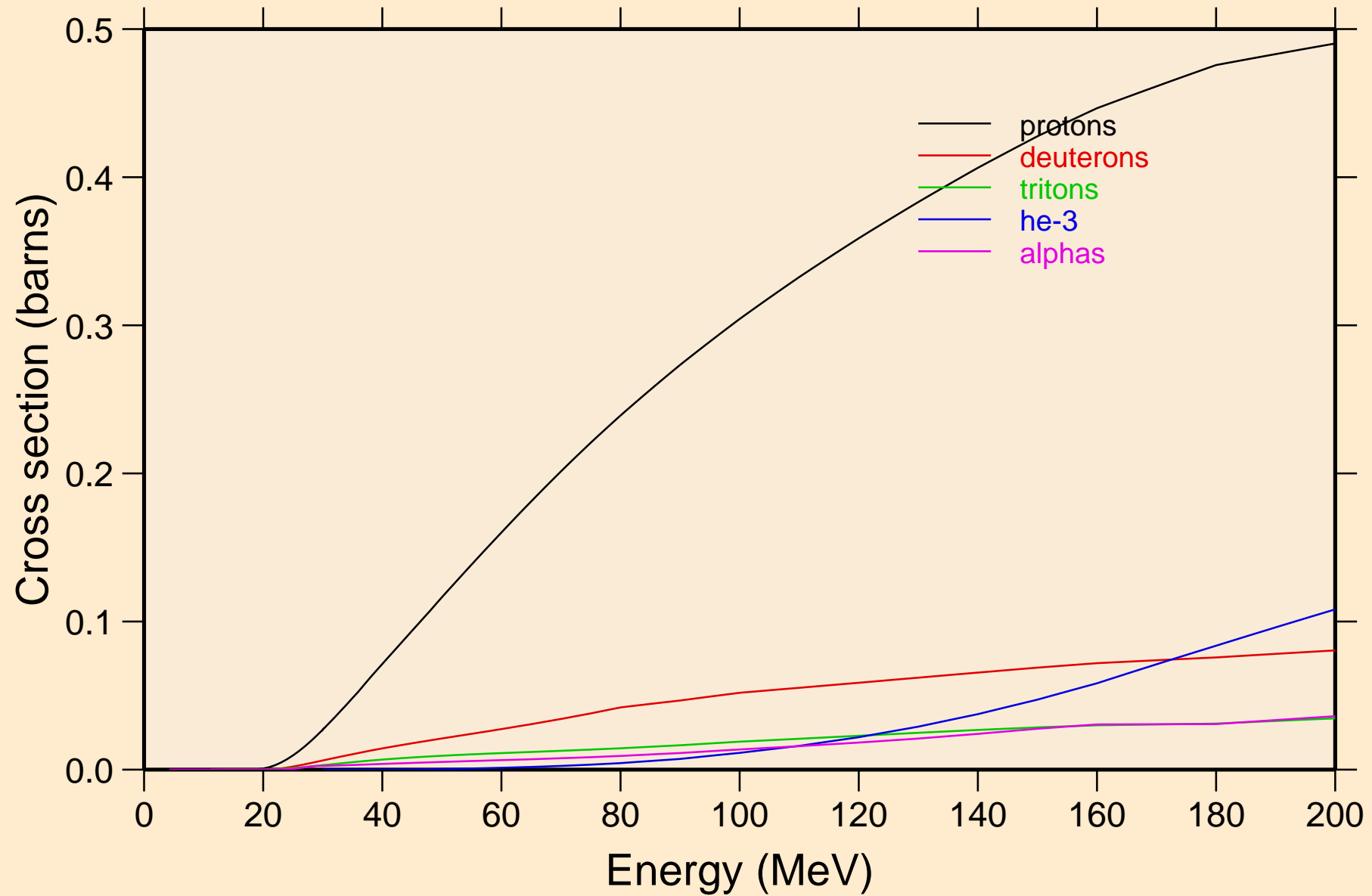

SN131M NEUTRON ACER TENDL-2021 LIBRARY; T=293.6K
protons from (n,x)

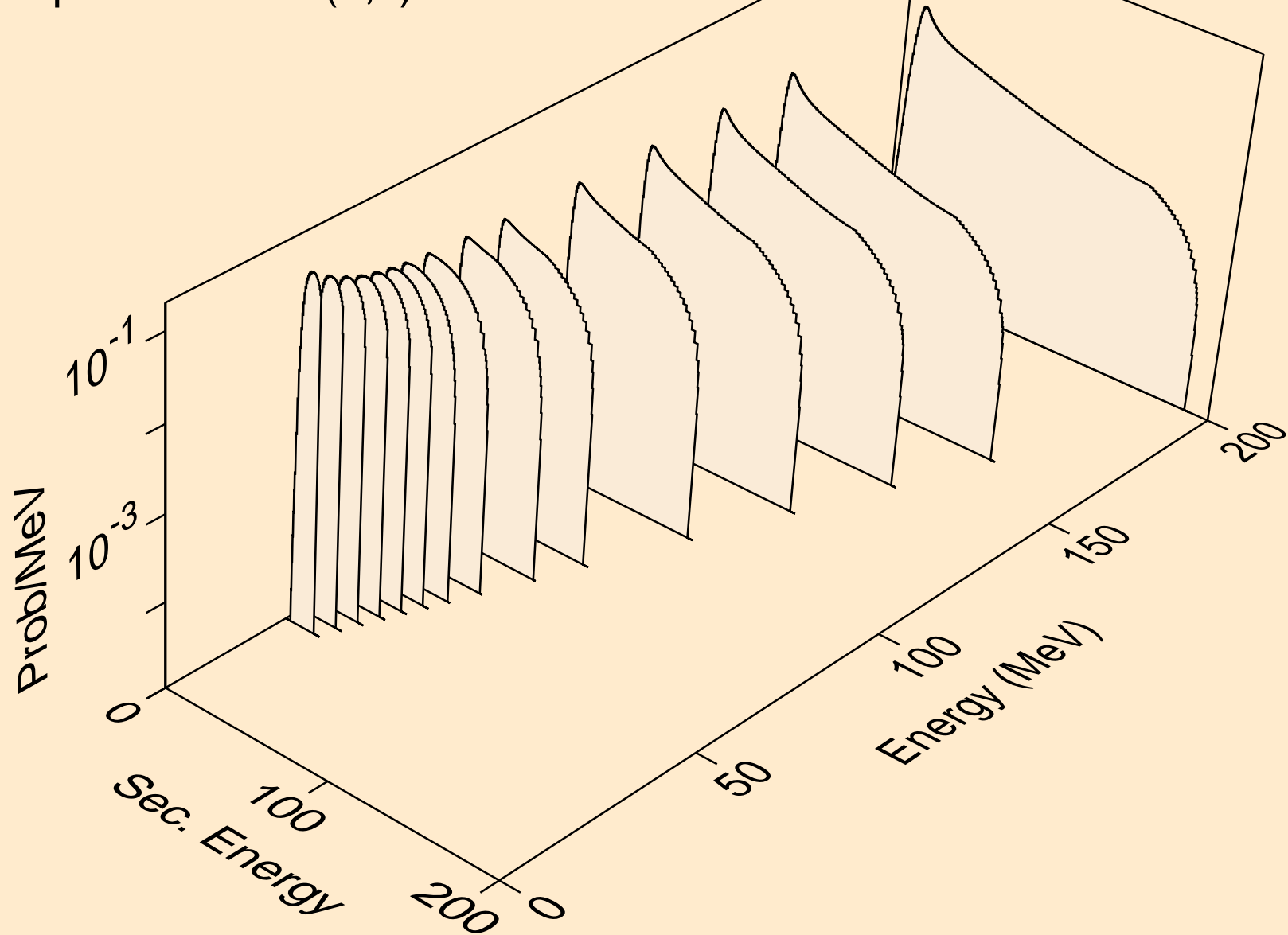

SN131M NEUTRON ACER TENDL-2021 LIBRARY; T=293.6K
protons from (n,n*)p

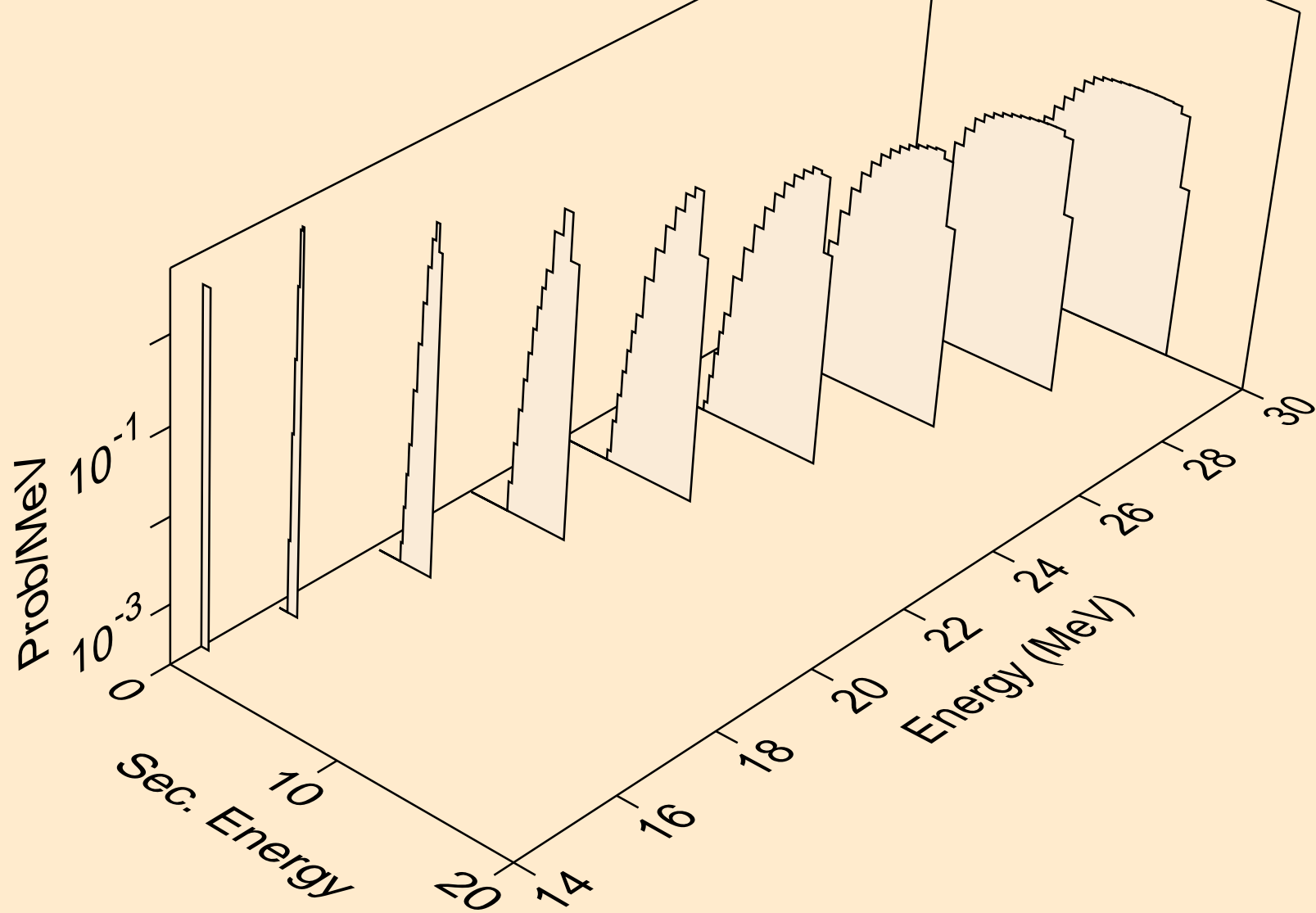

SN131M NEUTRON ACER TENDL-2021 LIBRARY; T=293.6K
protons from (n,2np)

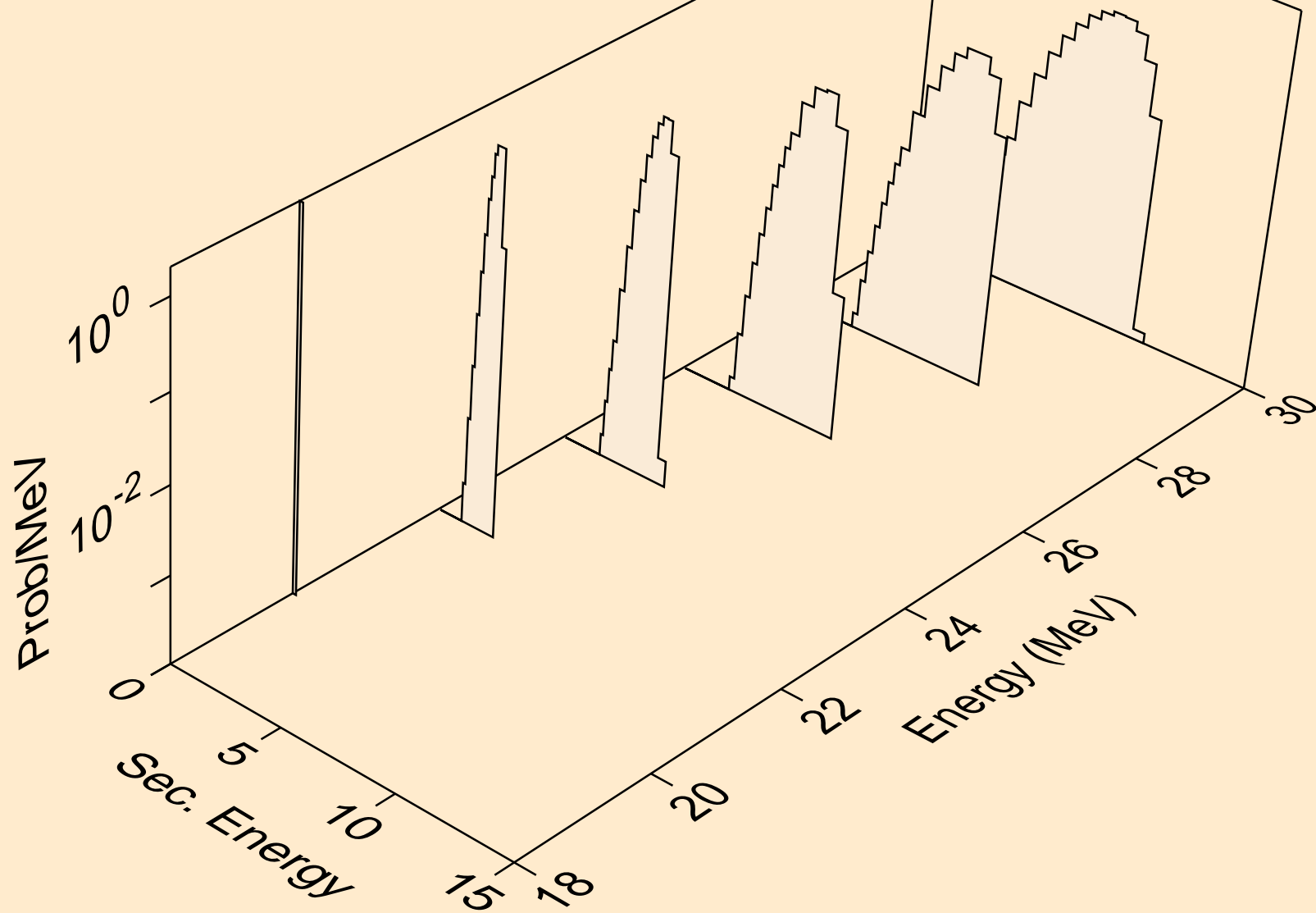

SN131M NEUTRON ACER TENDL-2021 LIBRARY; T=293.6K
protons from (n,3np)

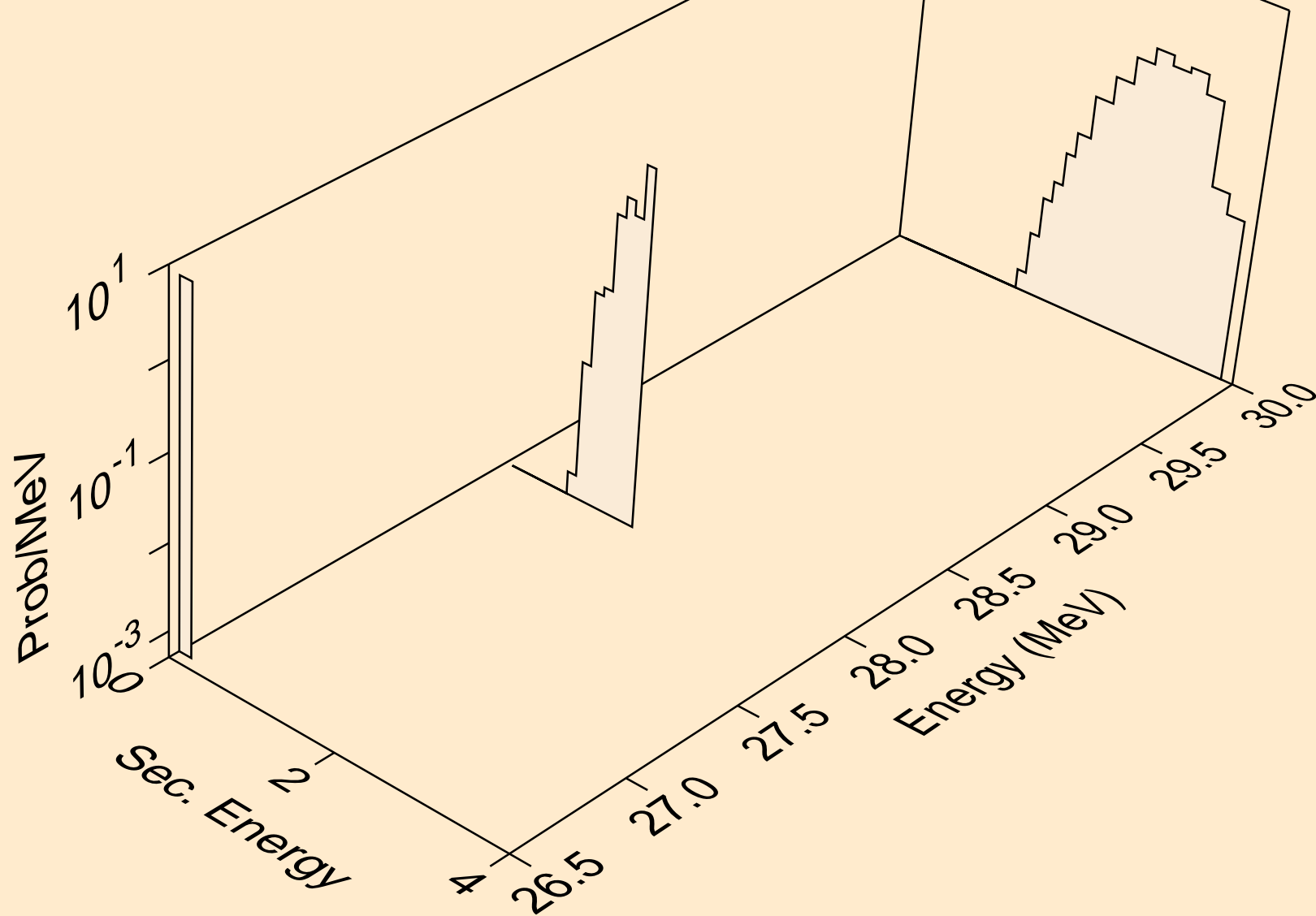

SN131M NEUTRON ACER TENDL-2021 LIBRARY; T=293.6K
protons from (n,p)

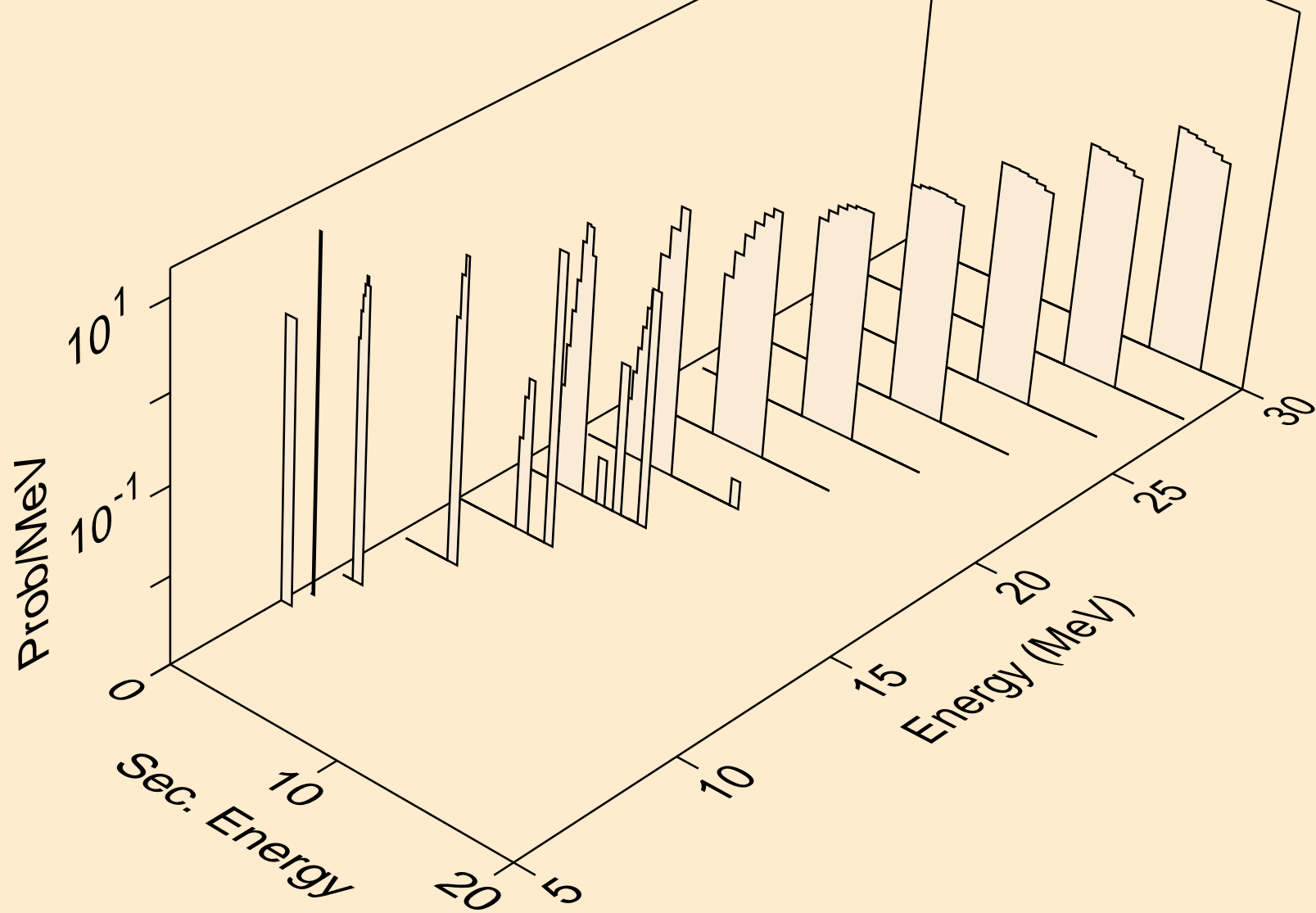

SN131M NEUTRON ACER TENDL-2021 LIBRARY; T=293.6K
deuterons from (n,x)

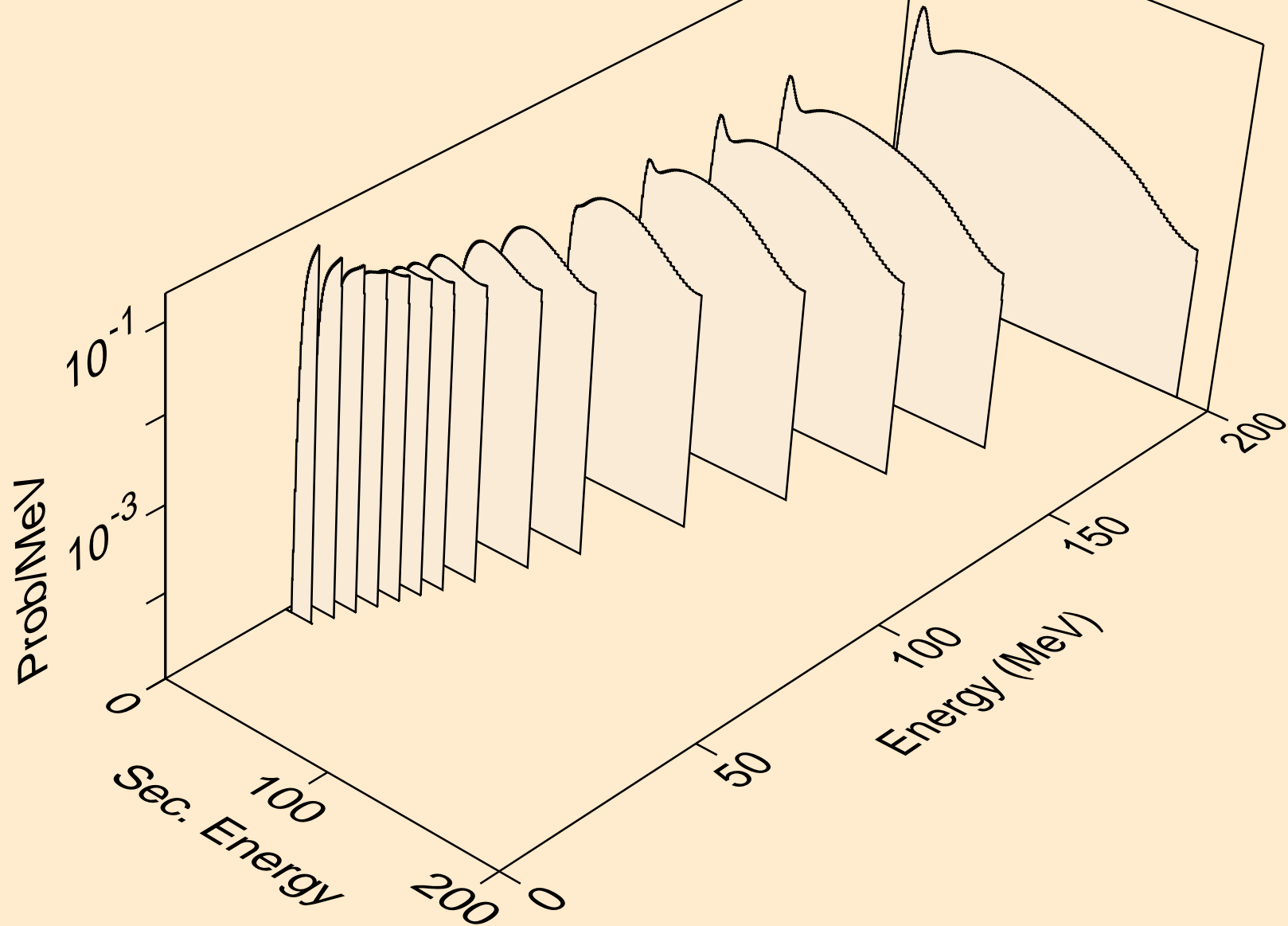

SN131M NEUTRON ACER TENDL-2021 LIBRARY; T=293.6K
deuterons from (n,2nd)

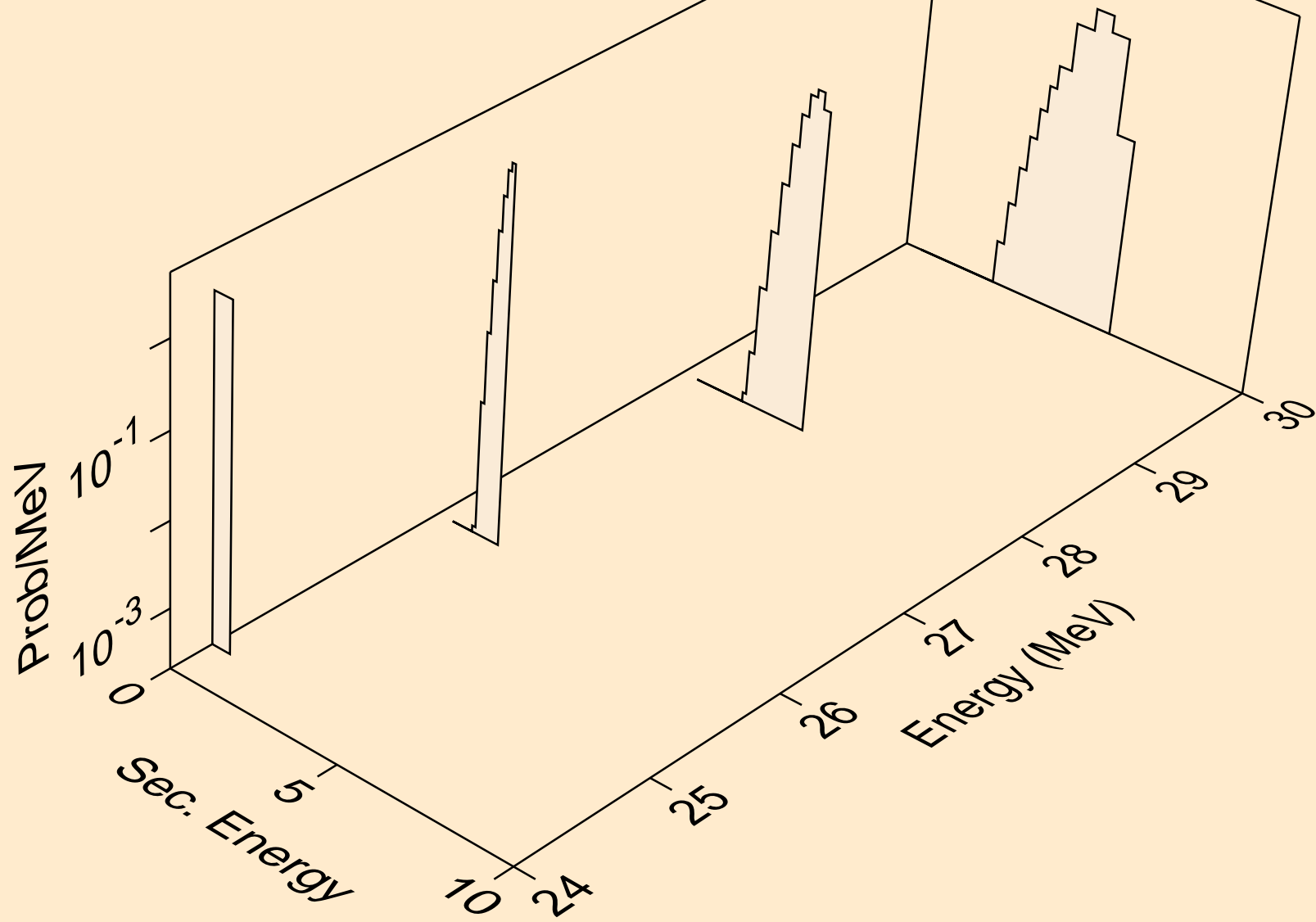

SN131M NEUTRON ACER TENDL-2021 LIBRARY; T=293.6K
deuterons from (n,n*)d

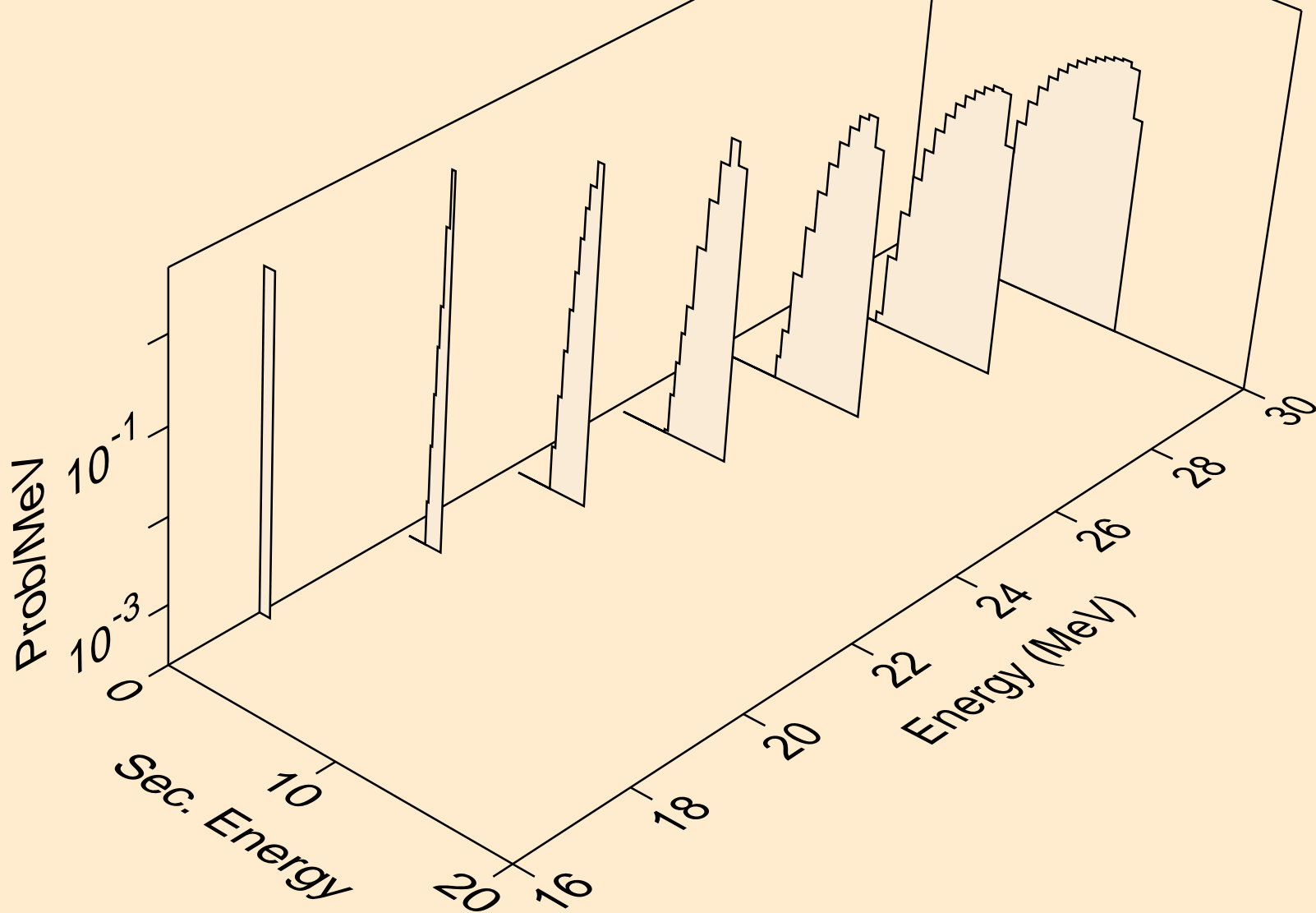

SN131M NEUTRON ACER TENDL-2021 LIBRARY; T=293.6K
deuterons from (n,d)

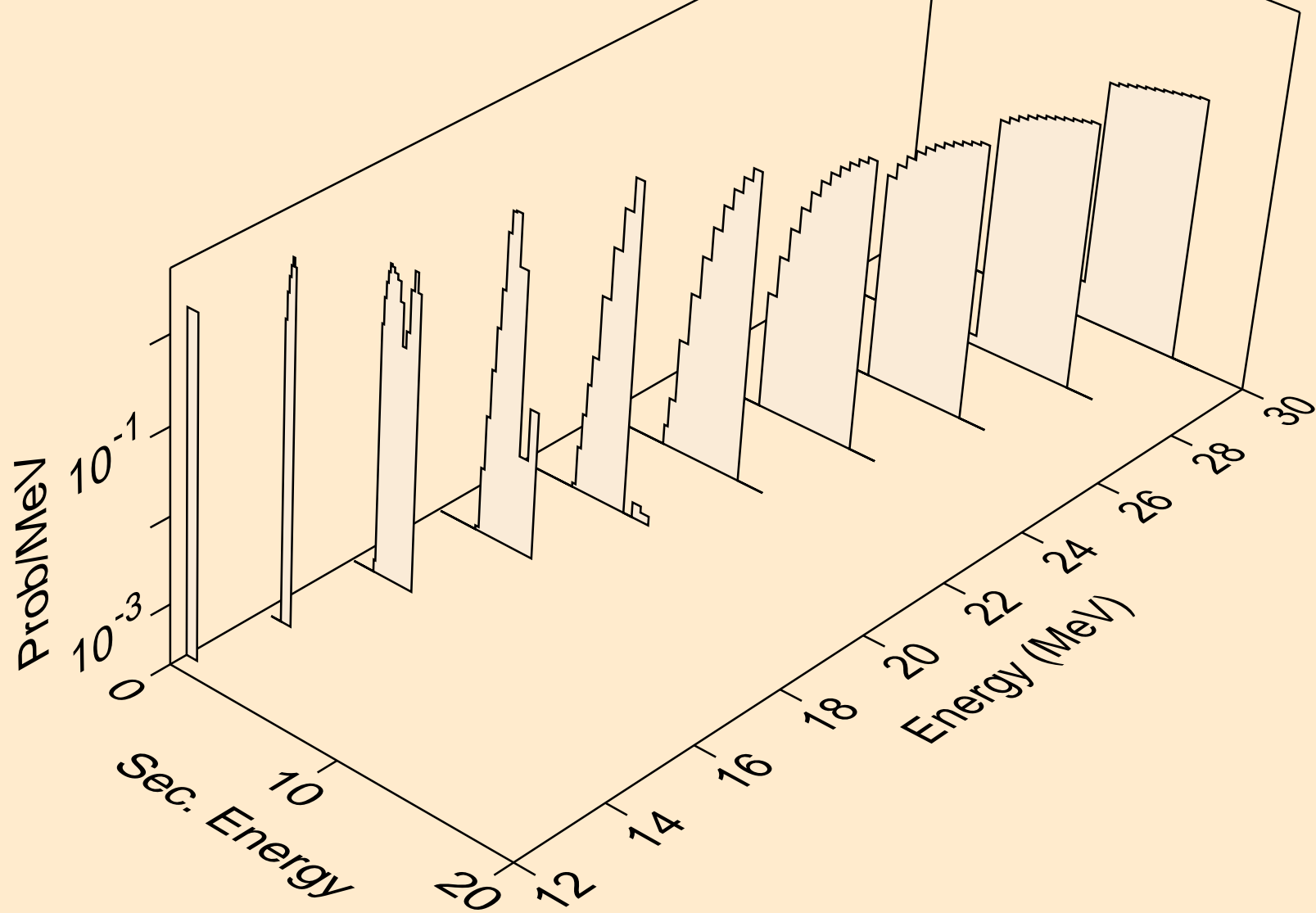

SN131M NEUTRON ACER TENDL-2021 LIBRARY; T=293.6K
tritons from (n,x)

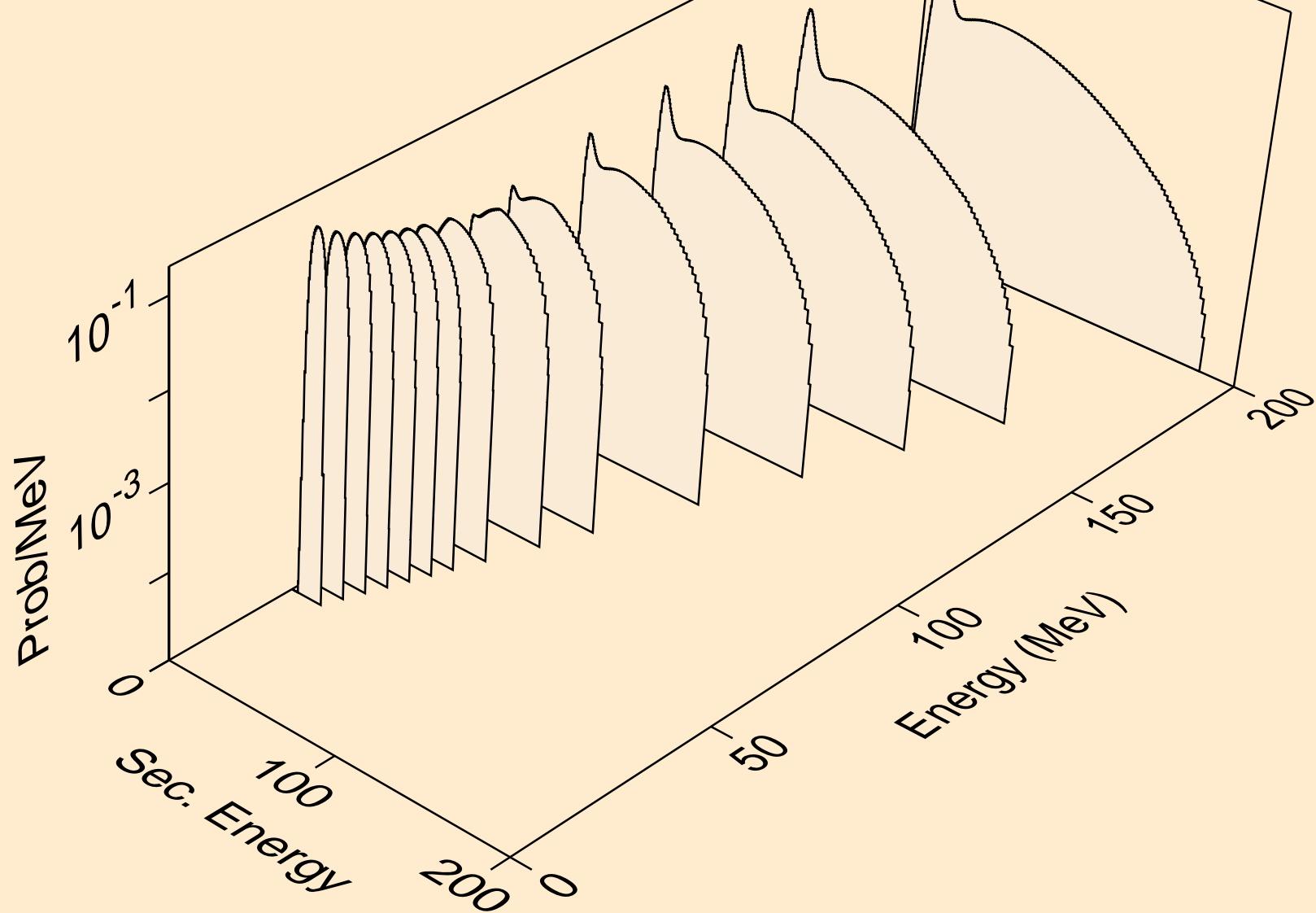

SN131M NEUTRON ACER TENDL-2021 LIBRARY; T=293.6K
tritons from (n,n*)t

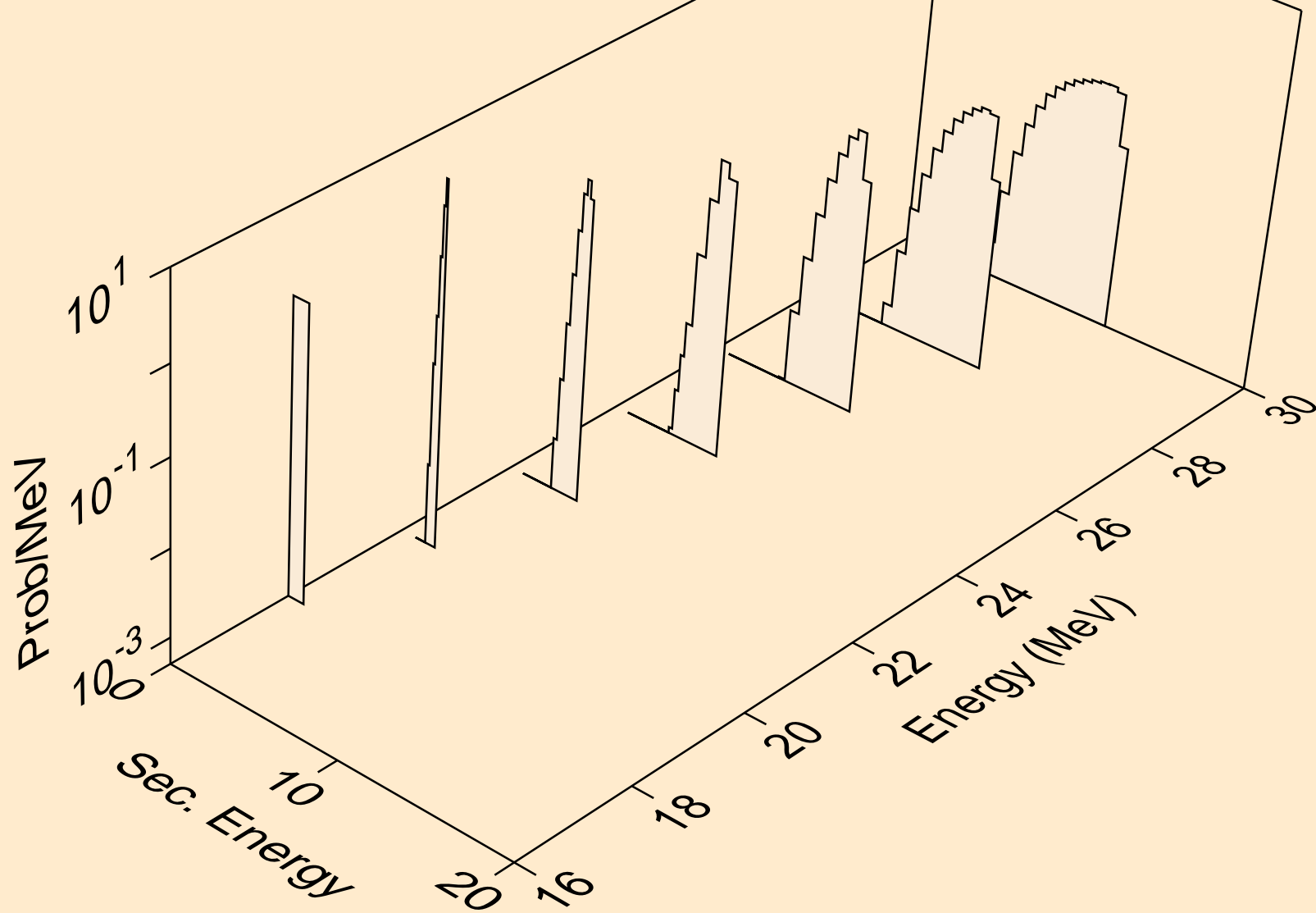

SN131M NEUTRON ACER TENDL-2021 LIBRARY; T=293.6K
tritons from (n,t)

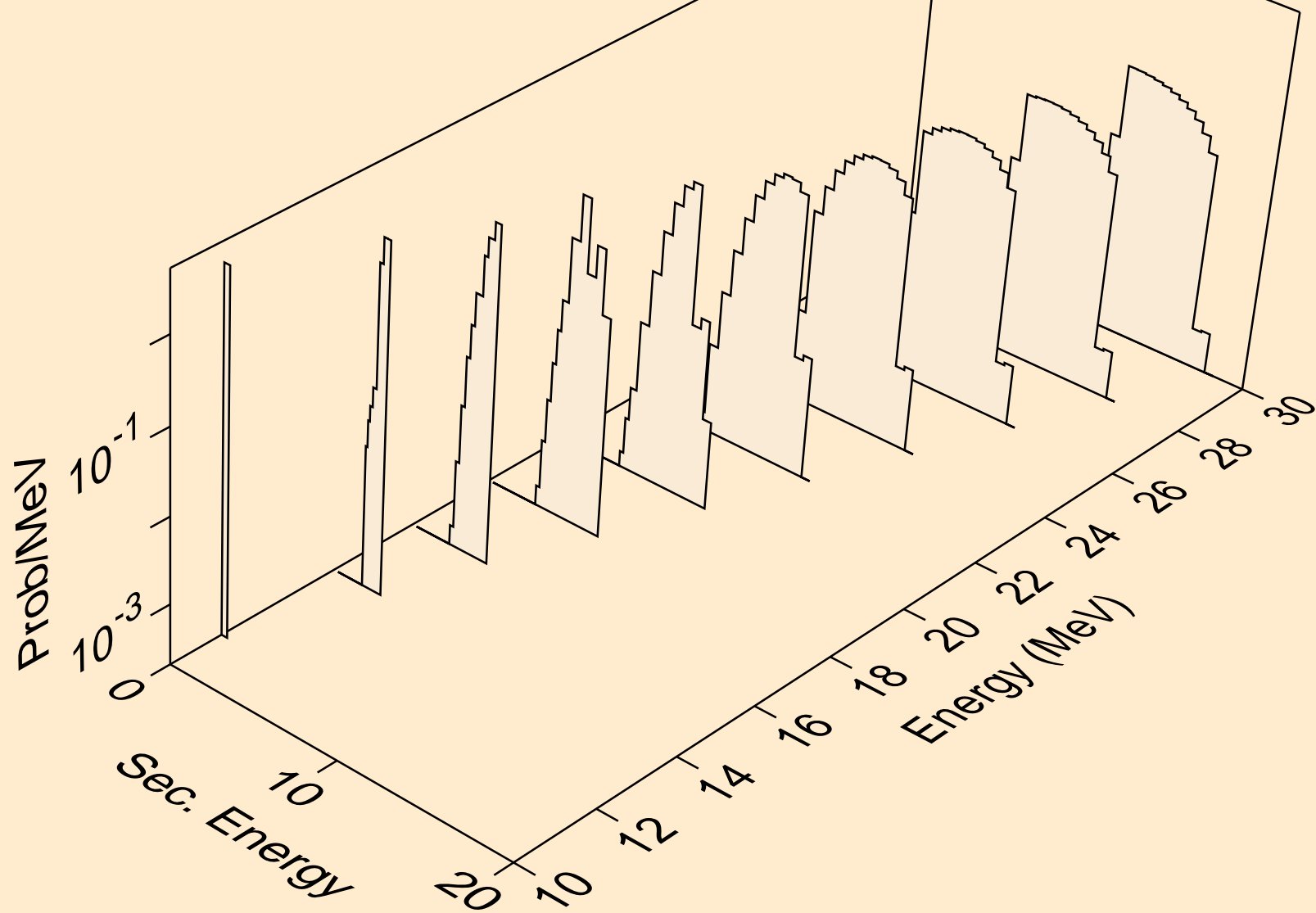

SN131M NEUTRON ACER TENDL-2021 LIBRARY; T=293.6K
he3s from (n,x)

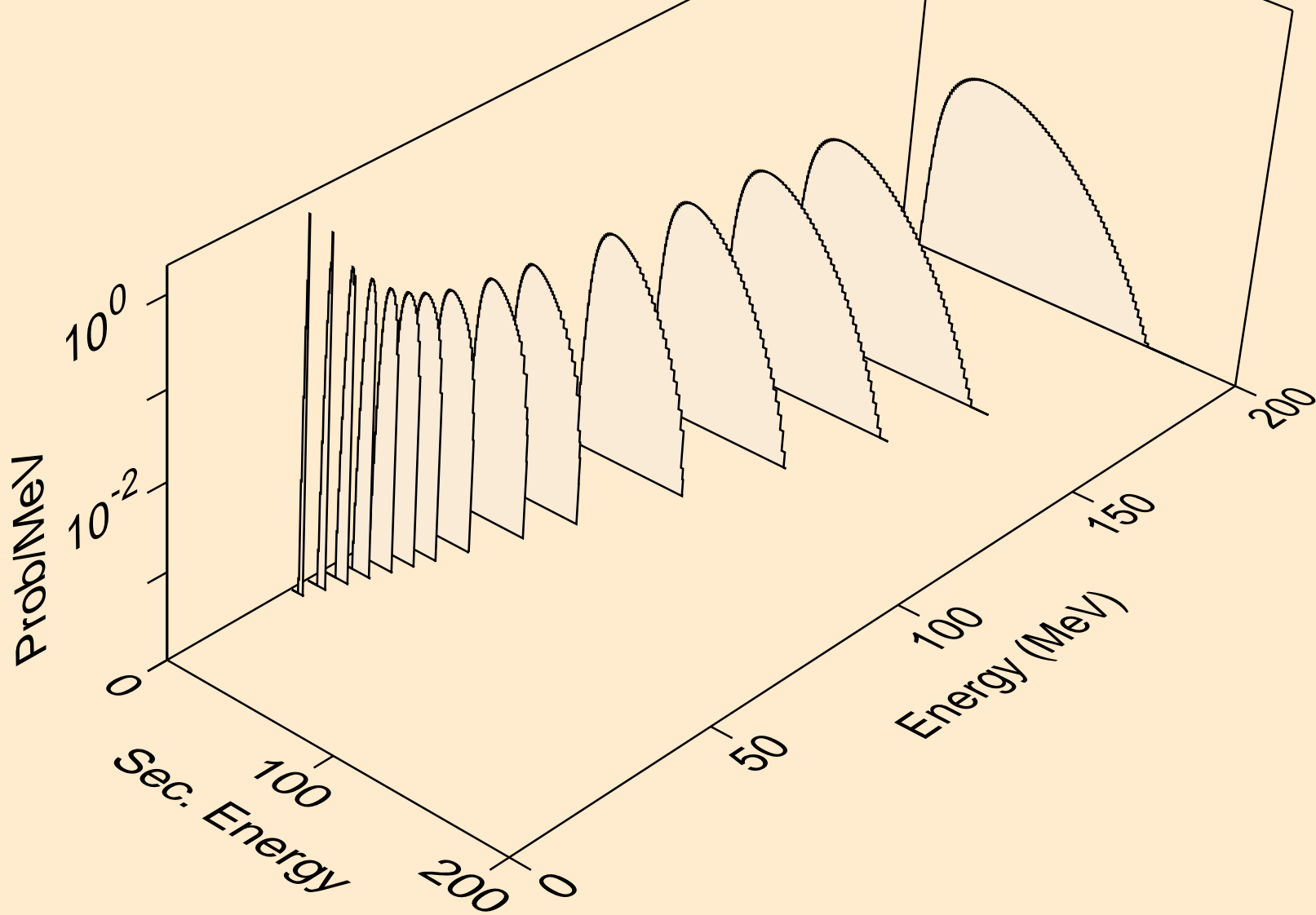

SN131M NEUTRON ACER TENDL-2021 LIBRARY; T=293.6K
alphas from (n,x)

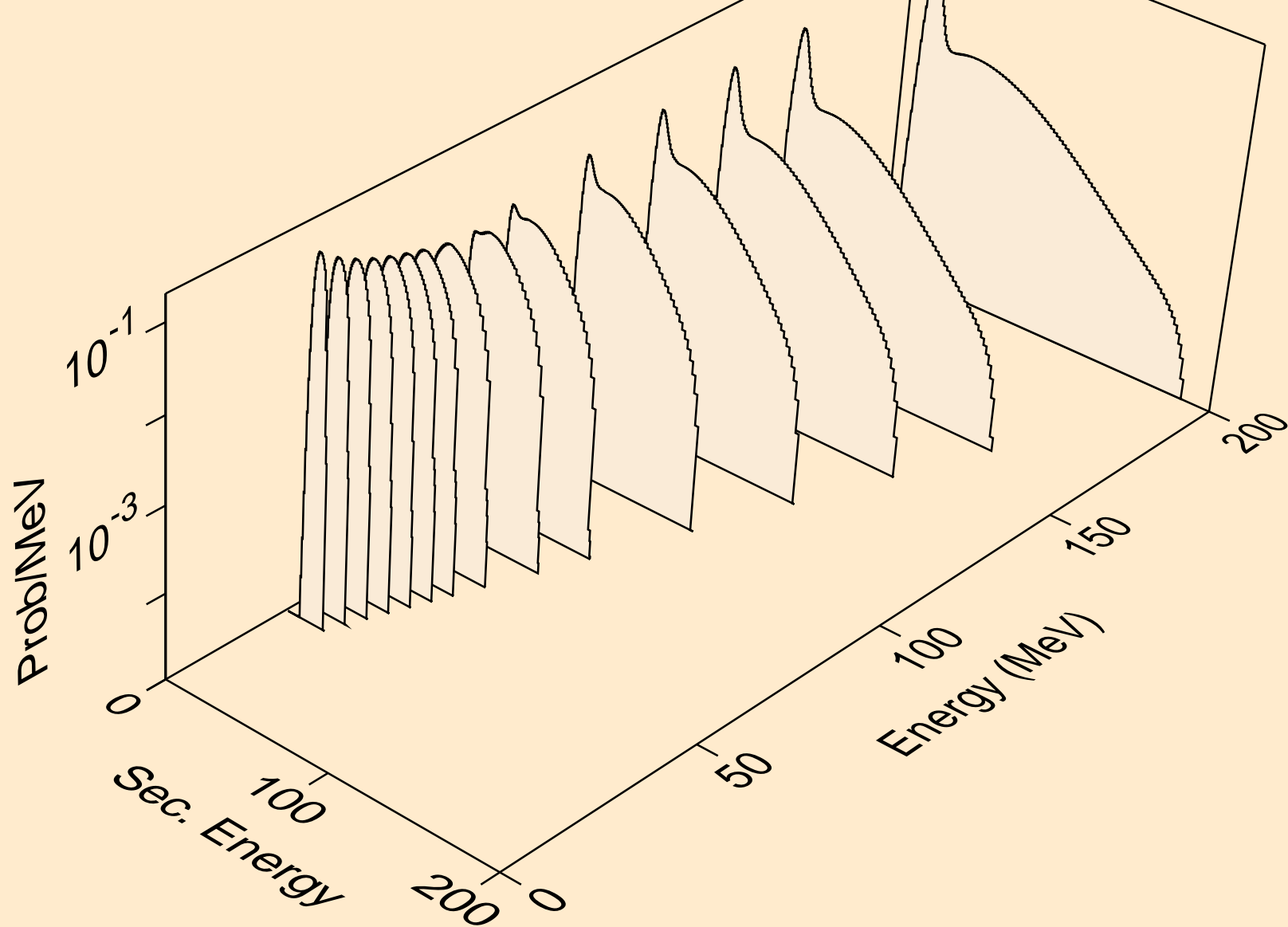

SN131M NEUTRON ACER TENDL-2021 LIBRARY; T=293.6K
alphas from (n,n*)a

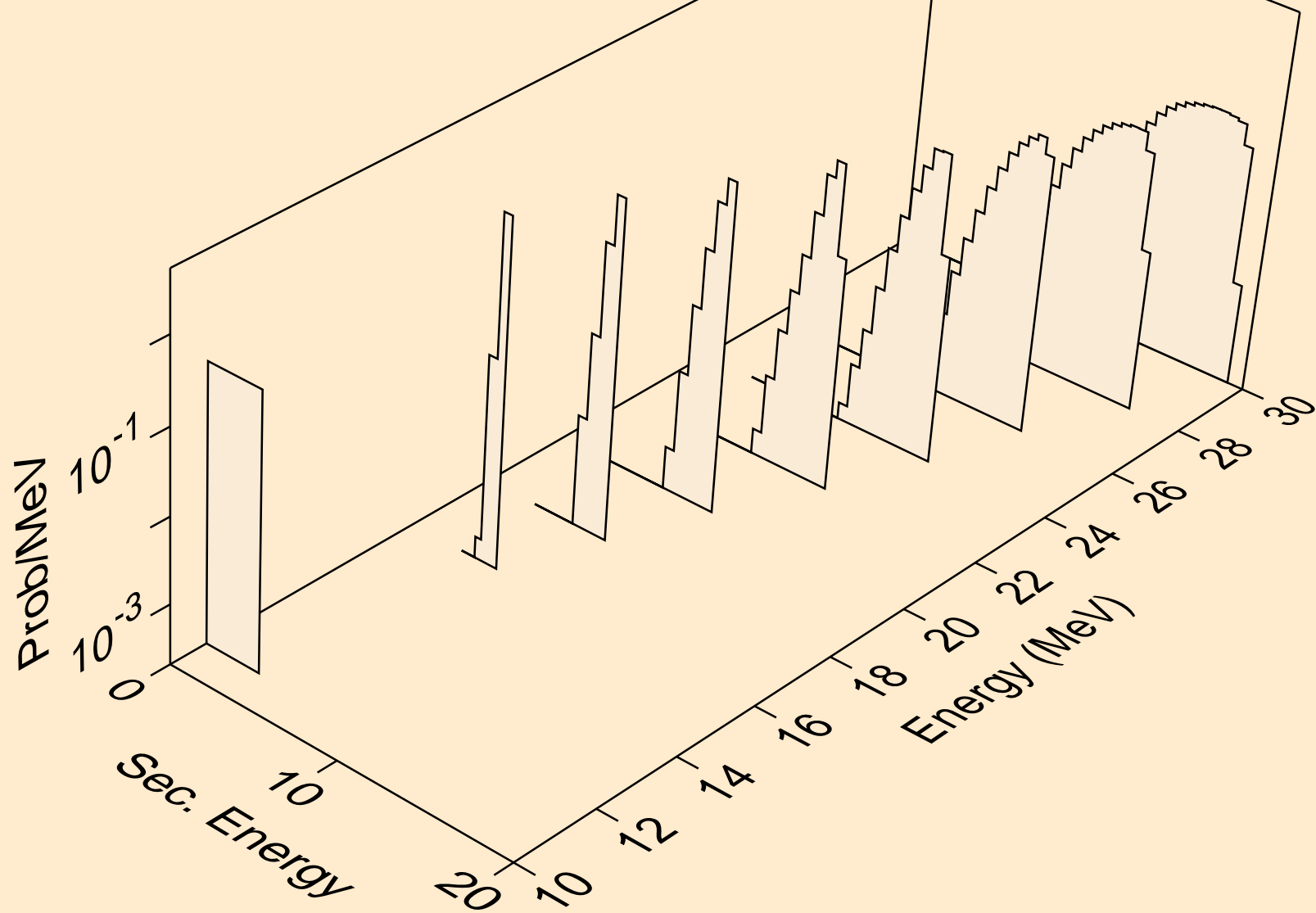

SN131M NEUTRON ACER TENDL-2021 LIBRARY; T=293.6K
alphas from (n,2n)a

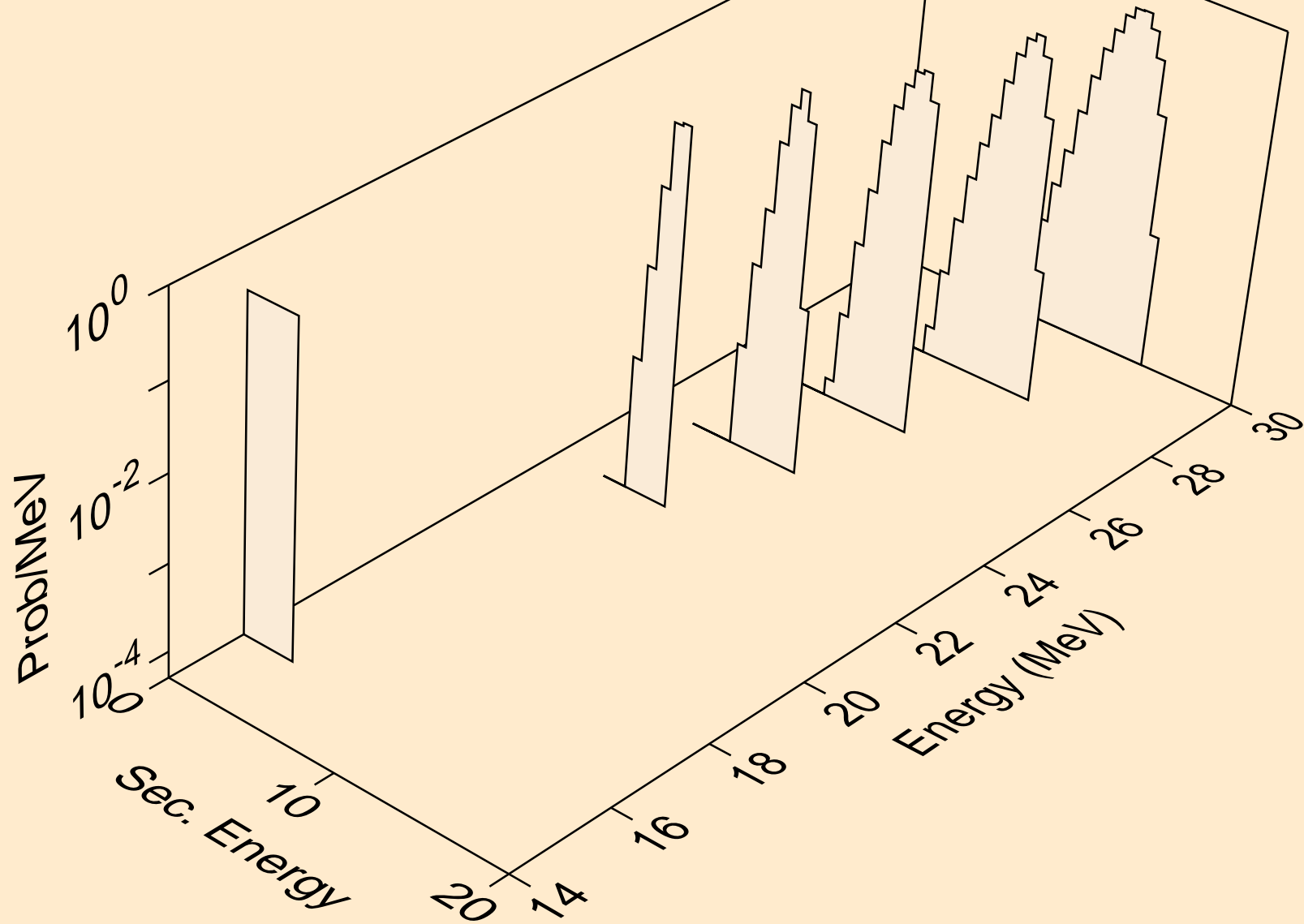

SN131M NEUTRON ACER TENDL-2021 LIBRARY; T=293.6K
alphas from (n,a)

