

SR082 NEUTRON ACER TENDL-2021 LIBRARY; T=293.6K
Principal cross sections

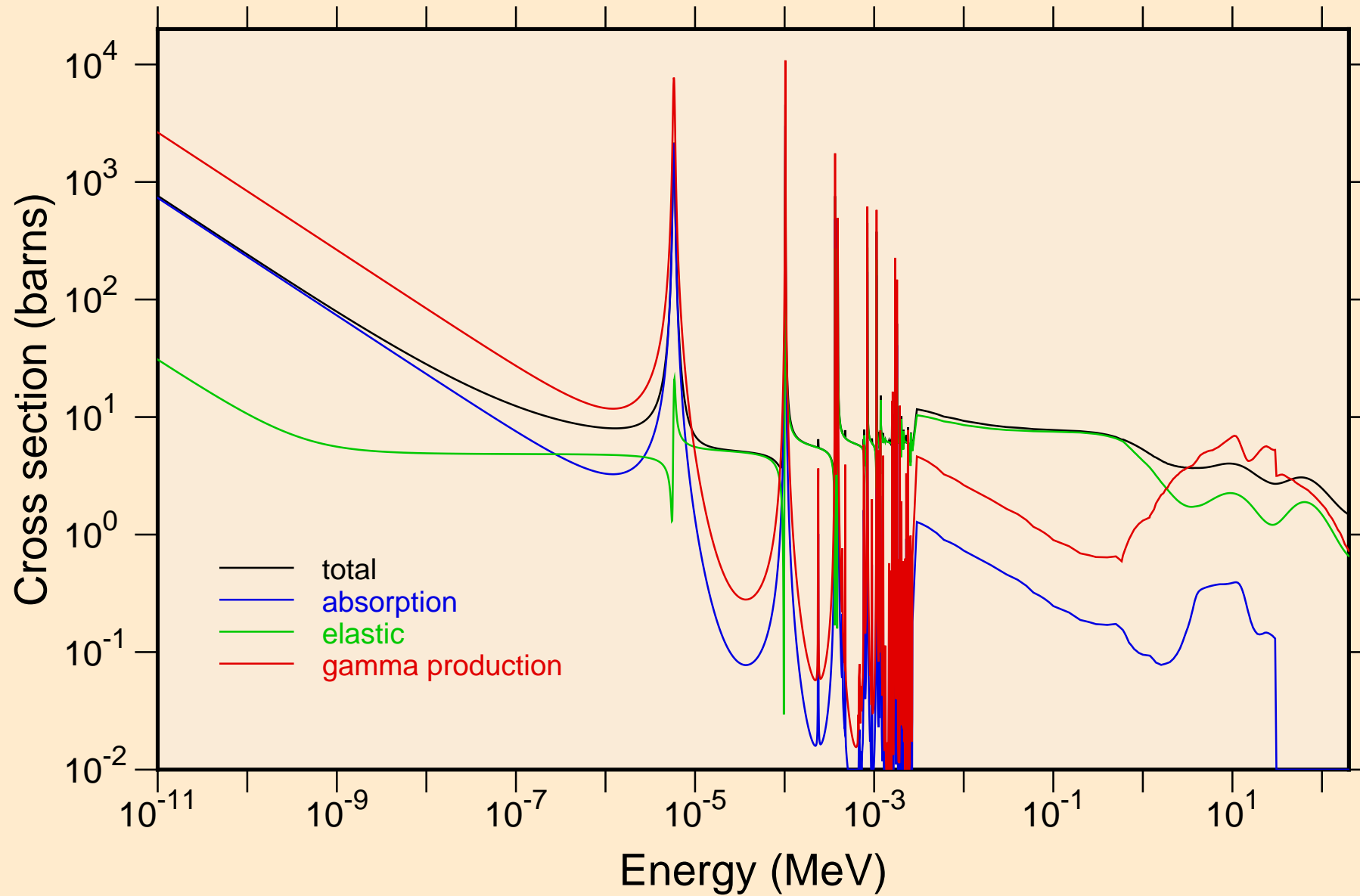

SR082 NEUTRON ACER TENDL-2021 LIBRARY; T=293.6K
resonance total cross section

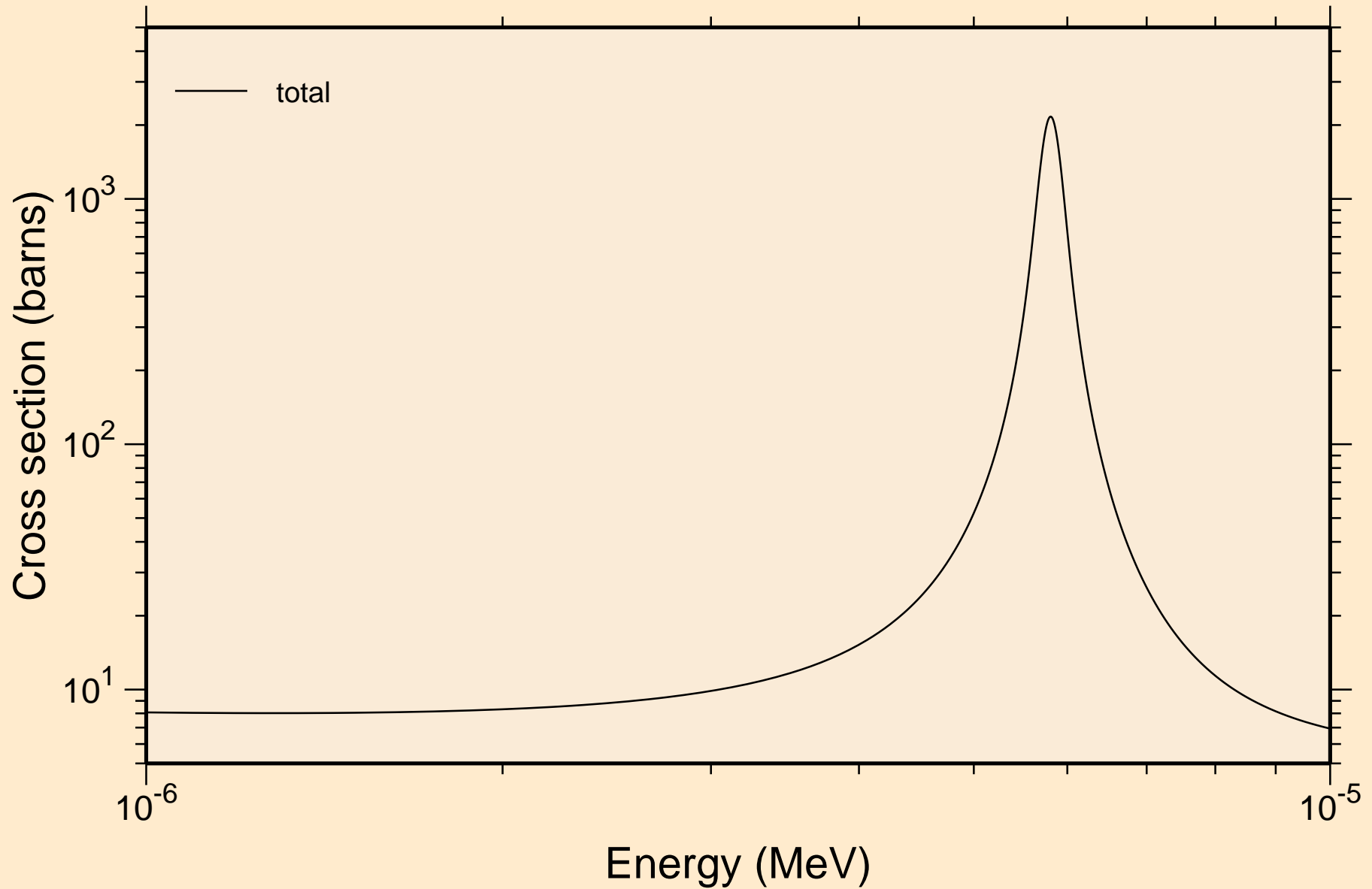

SR082 NEUTRON ACER TENDL-2021 LIBRARY; T=293.6K
resonance total cross section

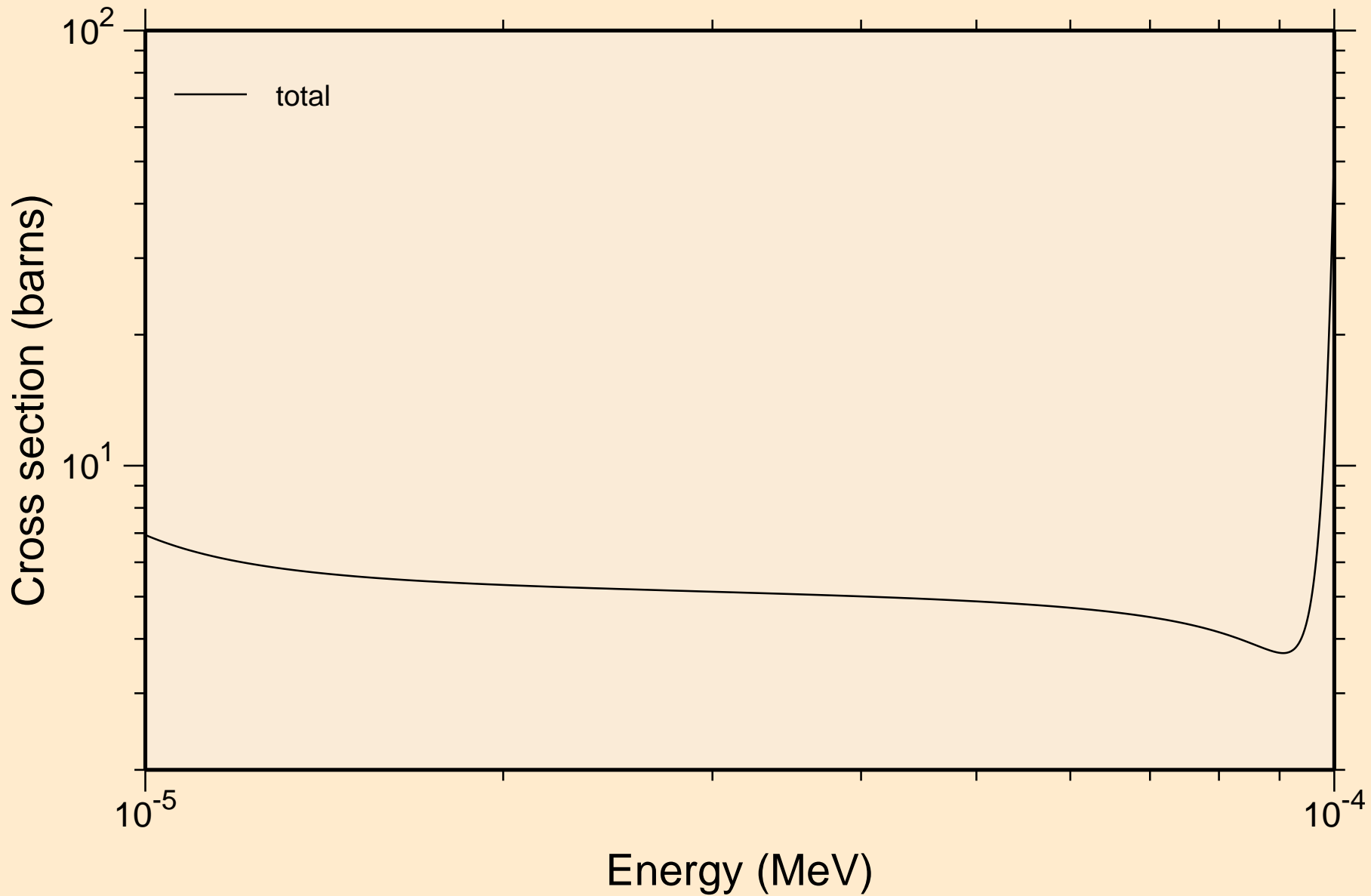

SR082 NEUTRON ACER TENDL-2021 LIBRARY; T=293.6K
resonance total cross section

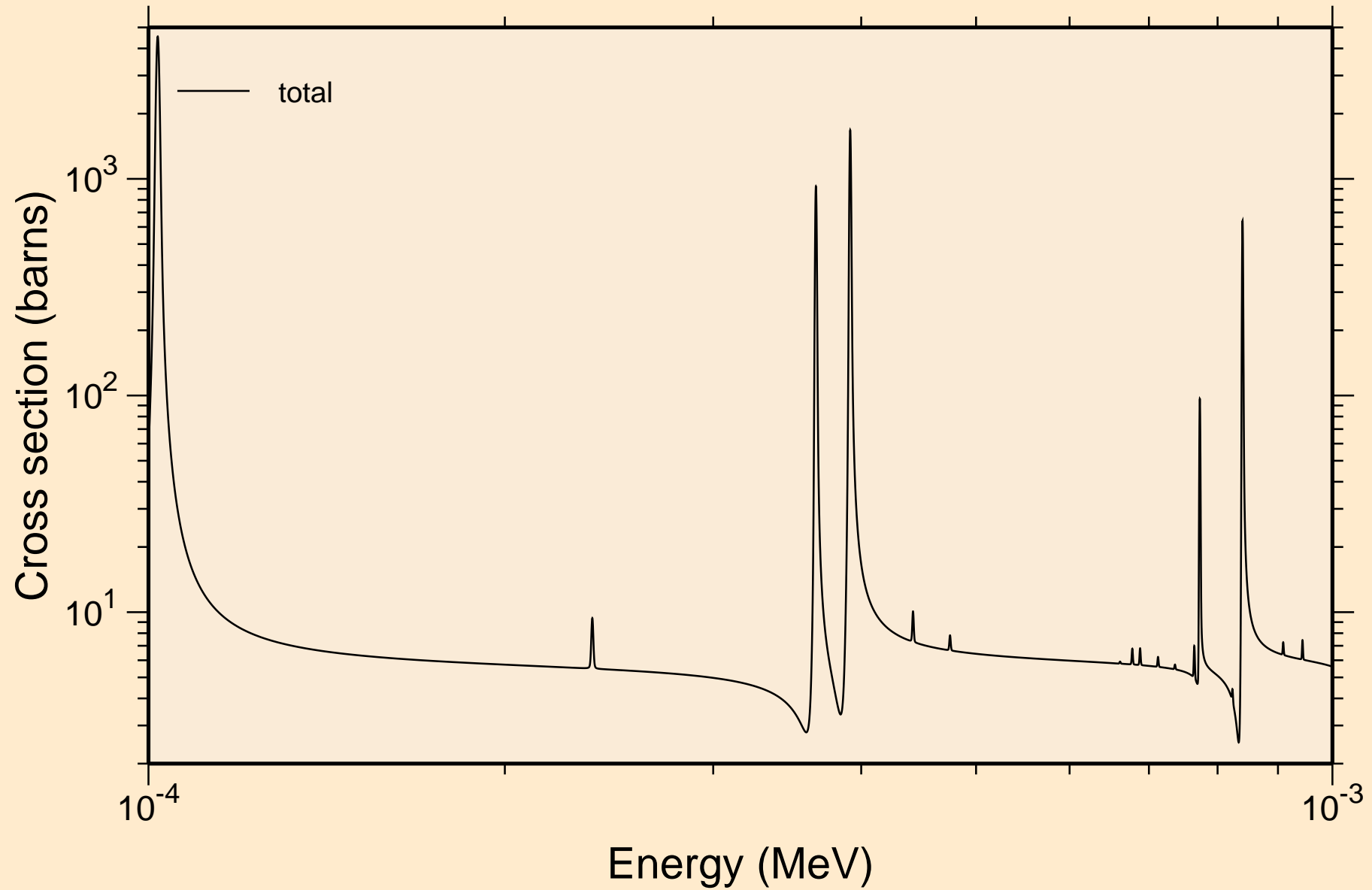

SR082 NEUTRON ACER TENDL-2021 LIBRARY; T=293.6K
resonance total cross section

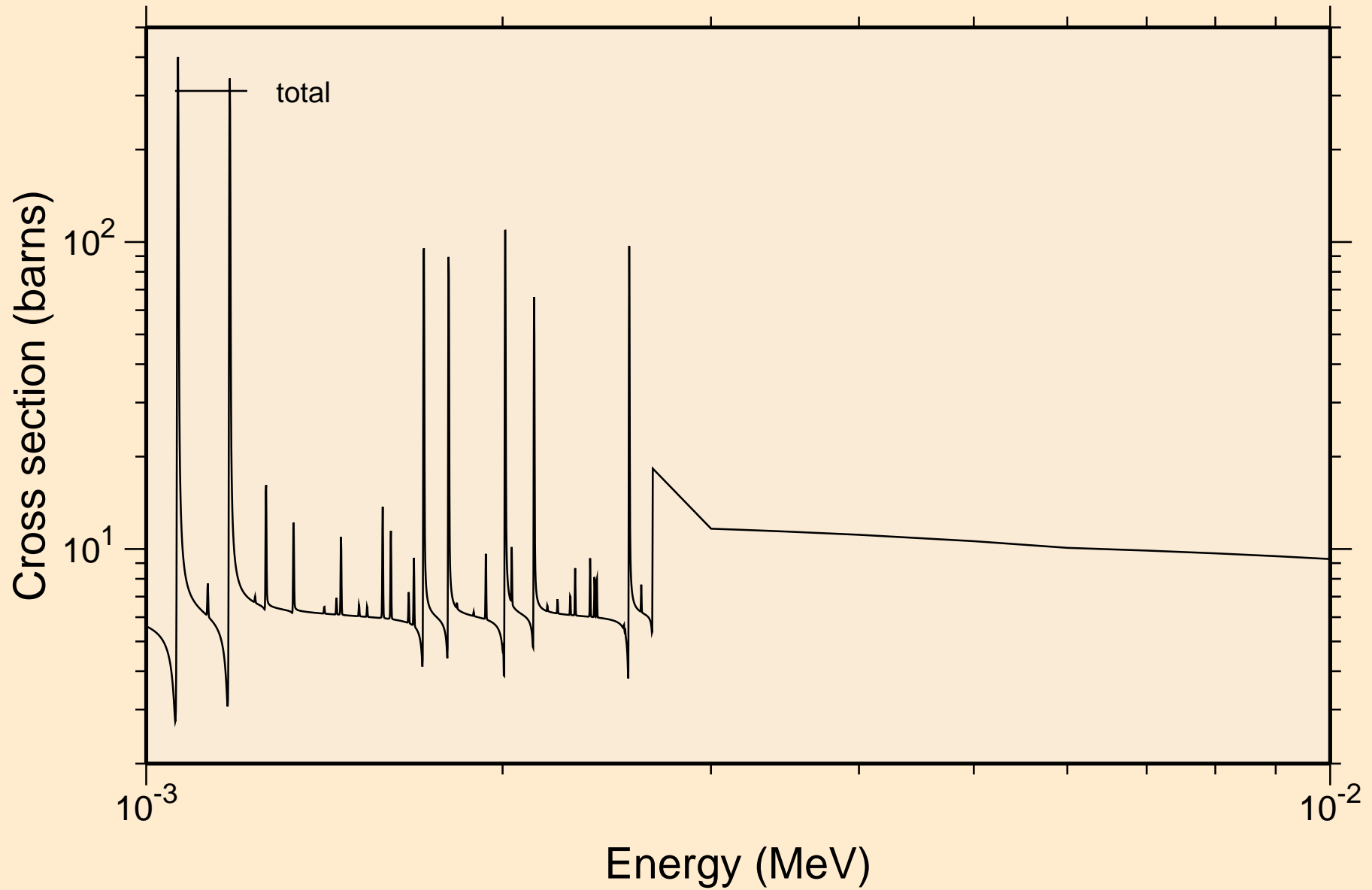

SR082 NEUTRON ACER TENDL-2021 LIBRARY; T=293.6K
resonance total cross section

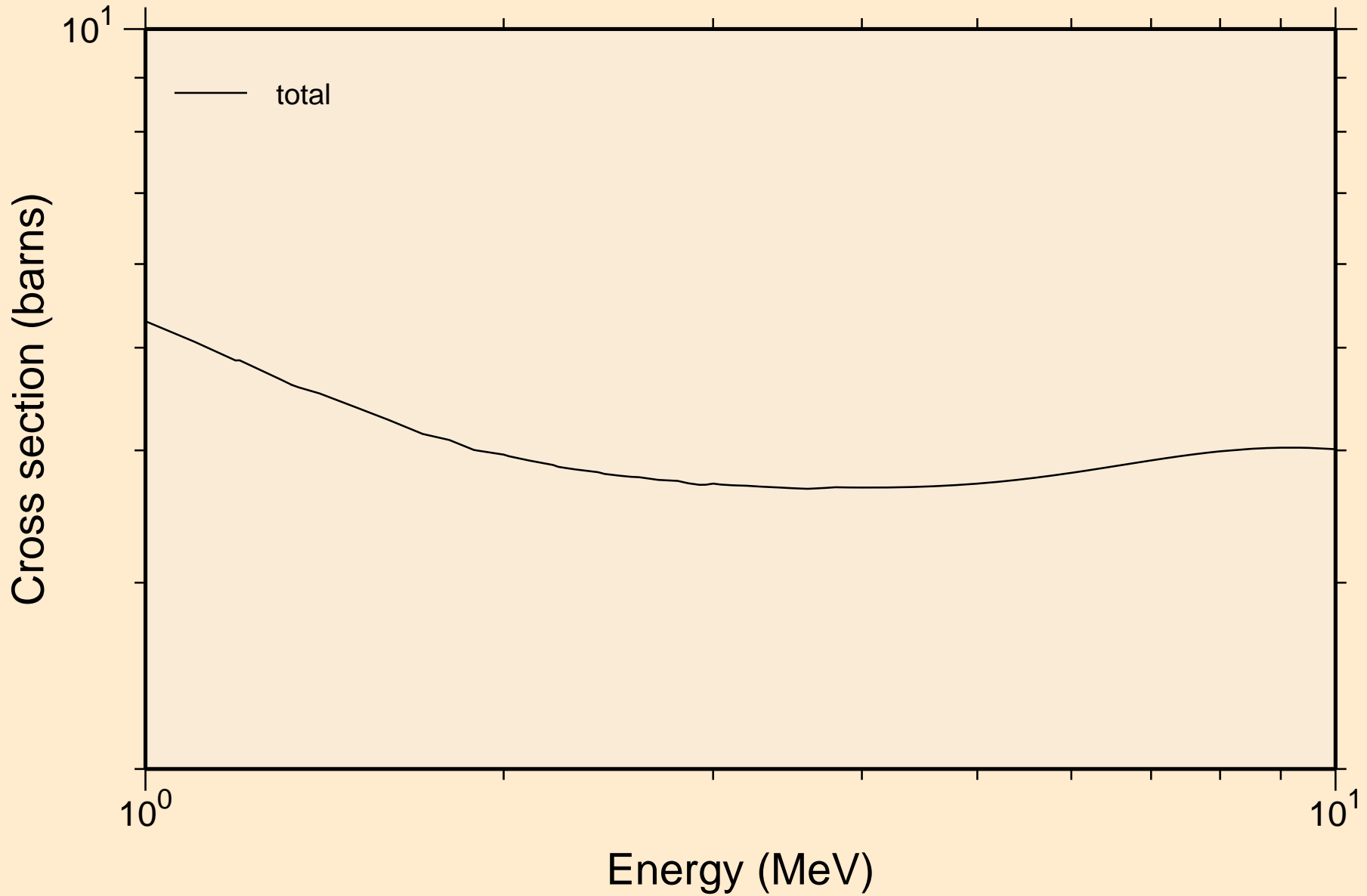

SR082 NEUTRON ACER TENDL-2021 LIBRARY; T=293.6K
resonance absorption cross sections

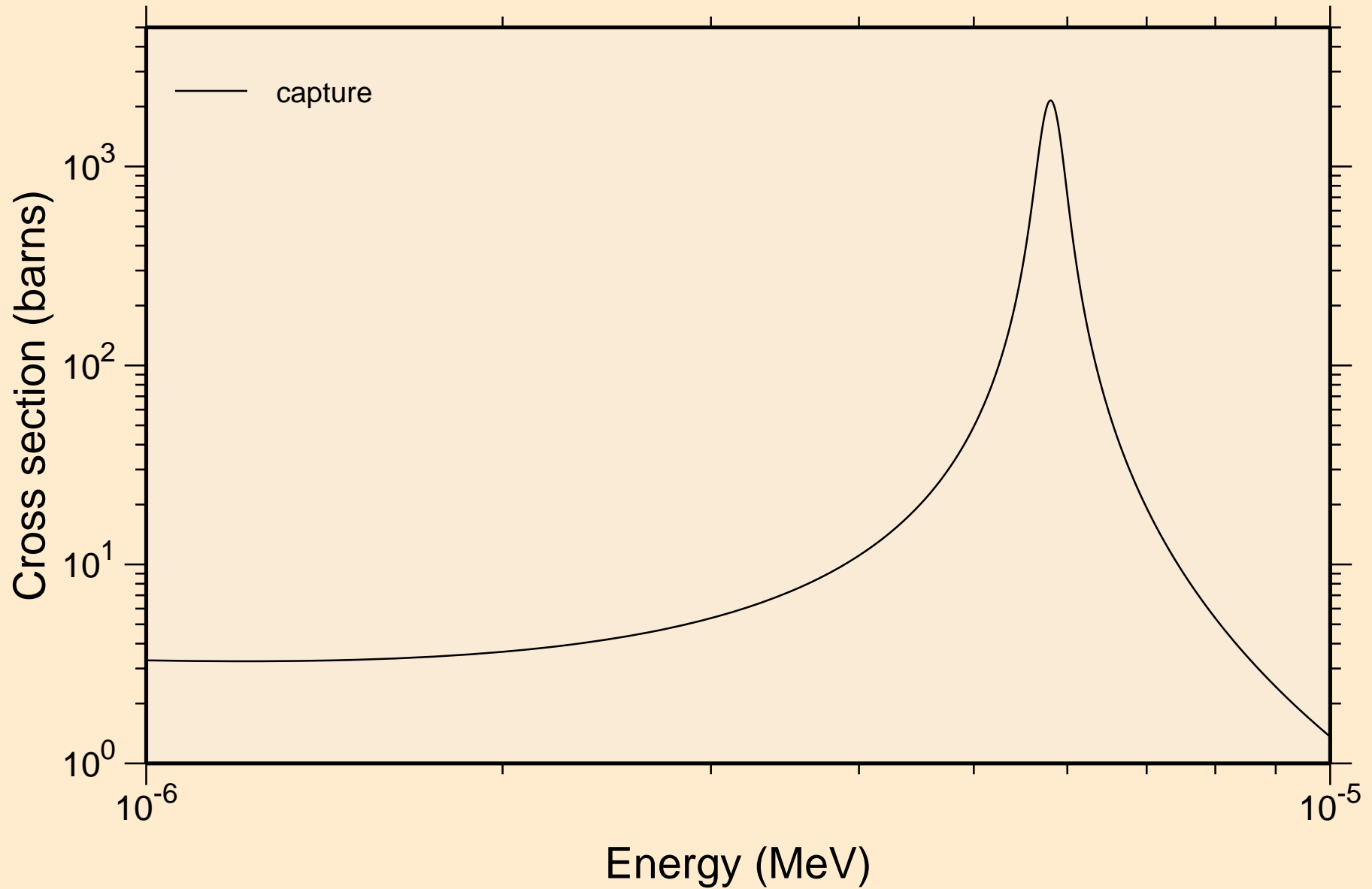

SR082 NEUTRON ACER TENDL-2021 LIBRARY; T=293.6K
resonance absorption cross sections

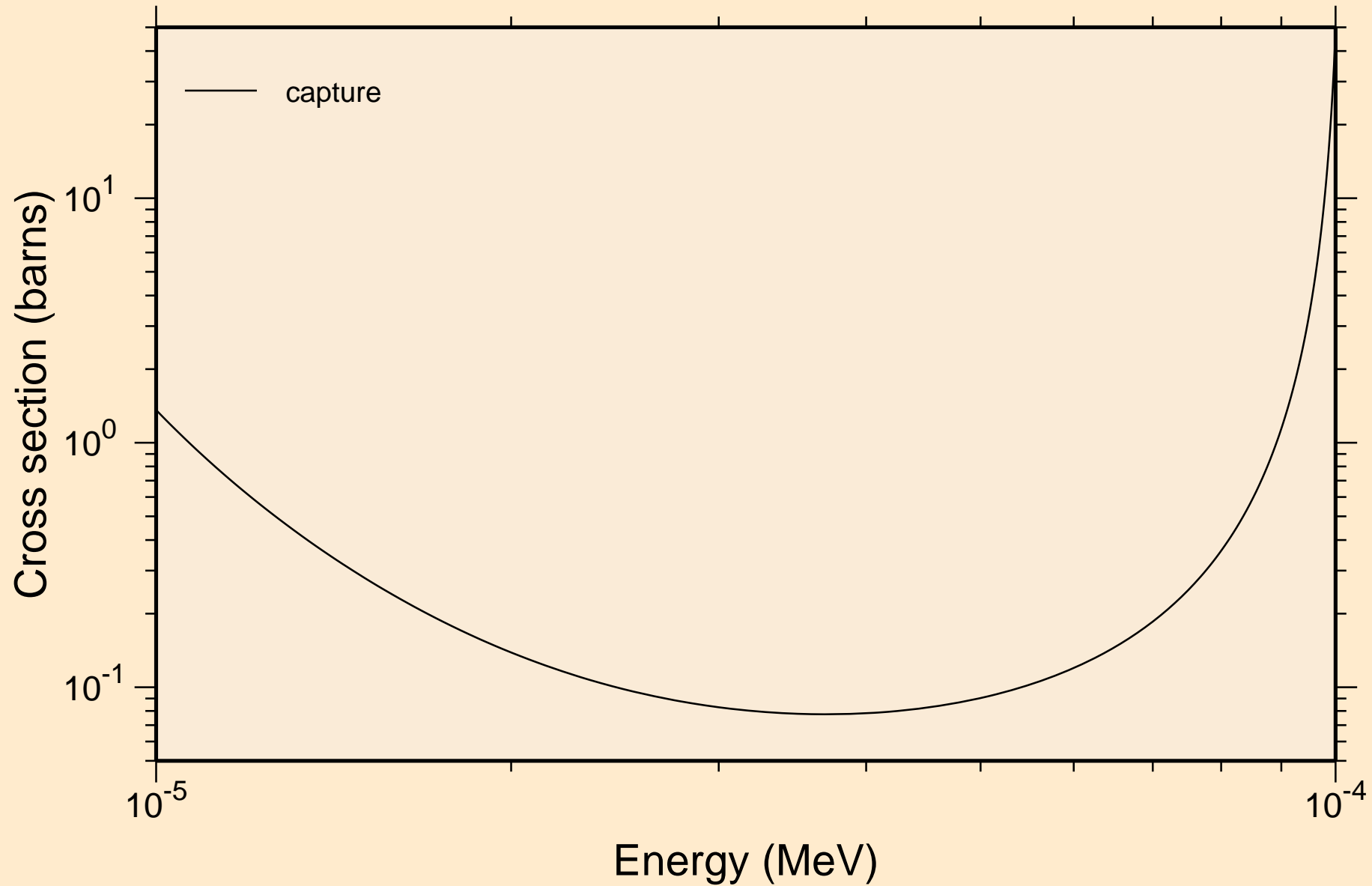

SR082 NEUTRON ACER TENDL-2021 LIBRARY; T=293.6K
resonance absorption cross sections

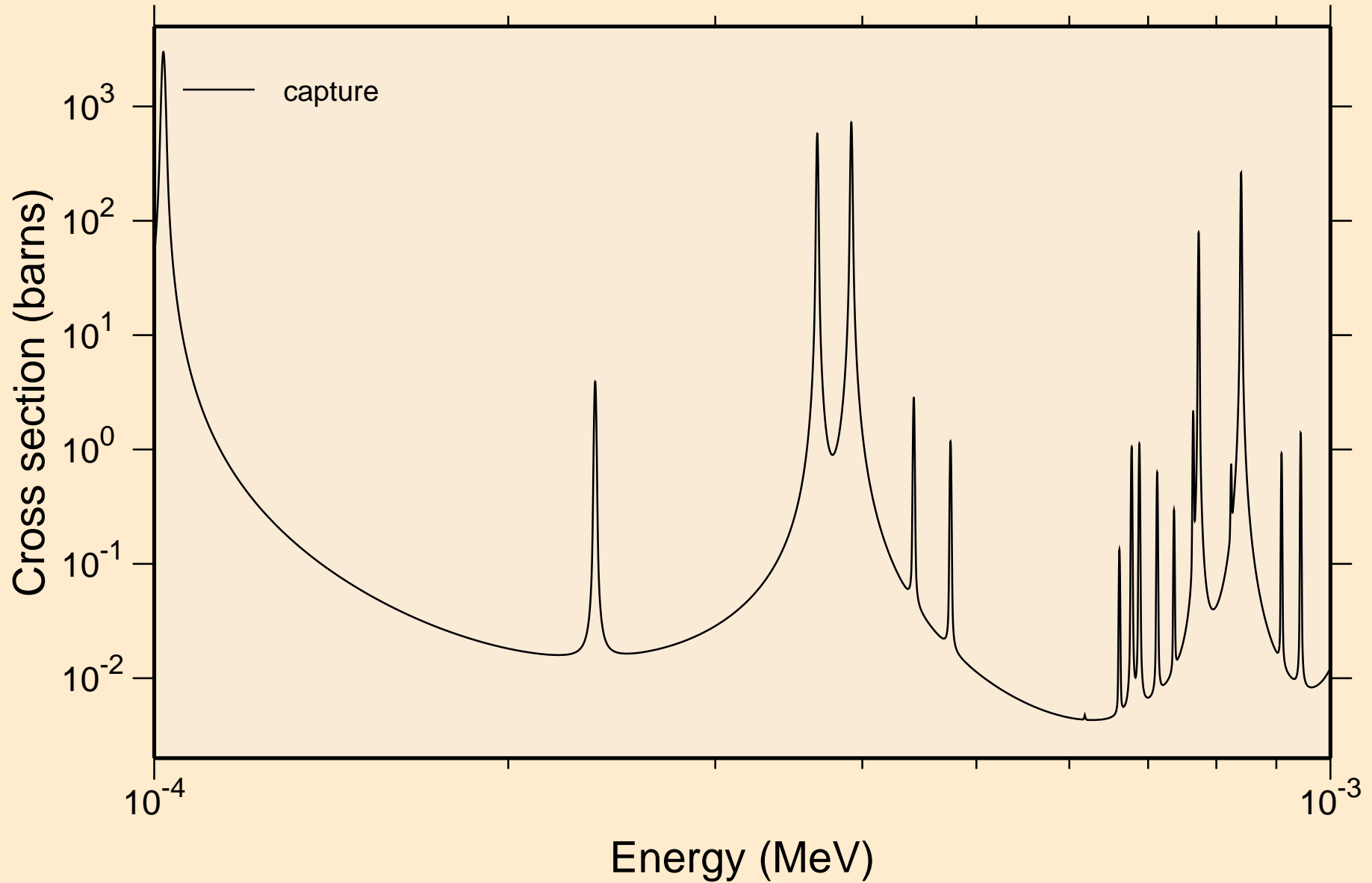

SR082 NEUTRON ACER TENDL-2021 LIBRARY; T=293.6K
resonance absorption cross sections

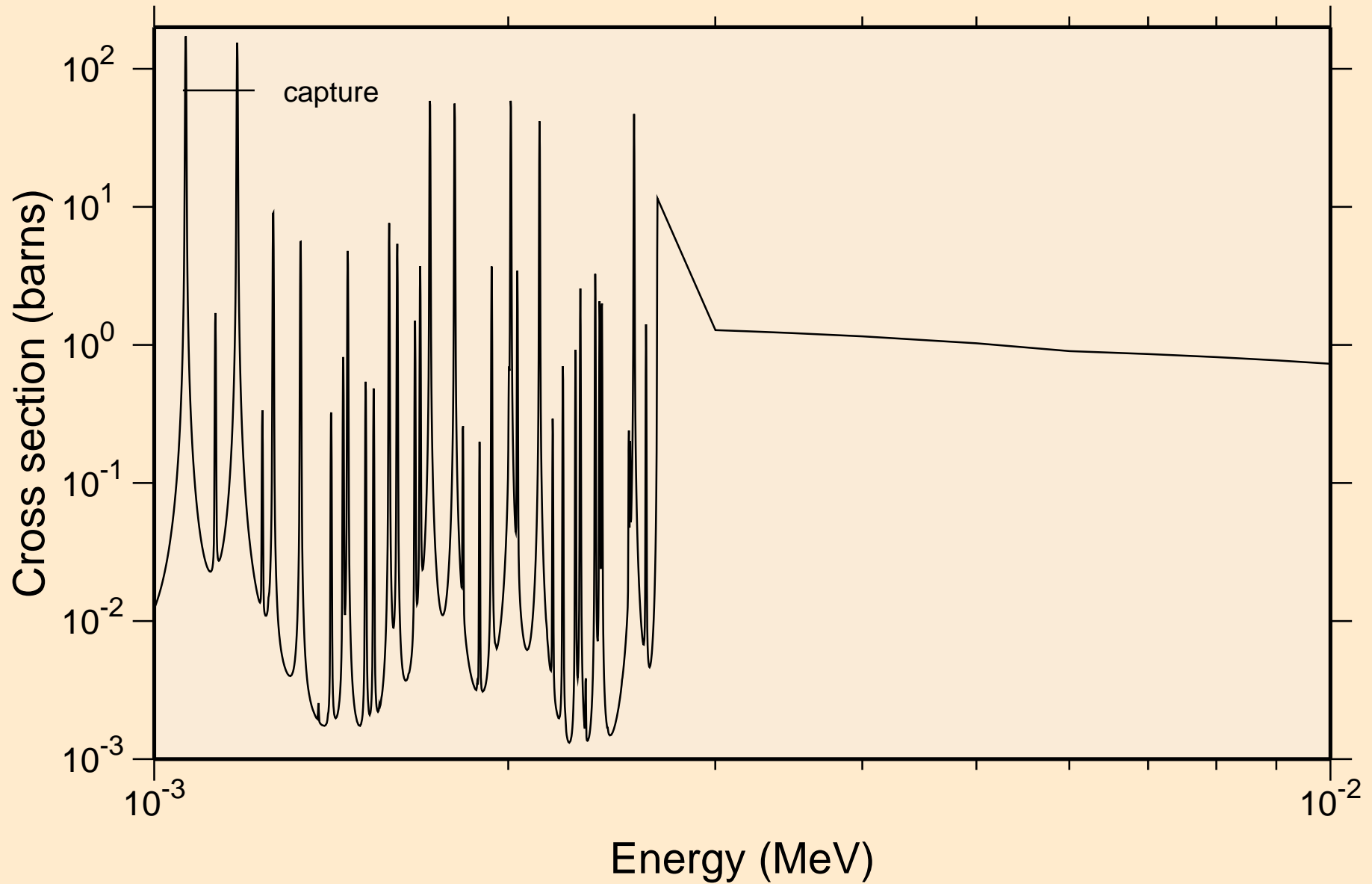

SR082 NEUTRON ACER TENDL-2021 LIBRARY; T=293.6K
resonance absorption cross sections

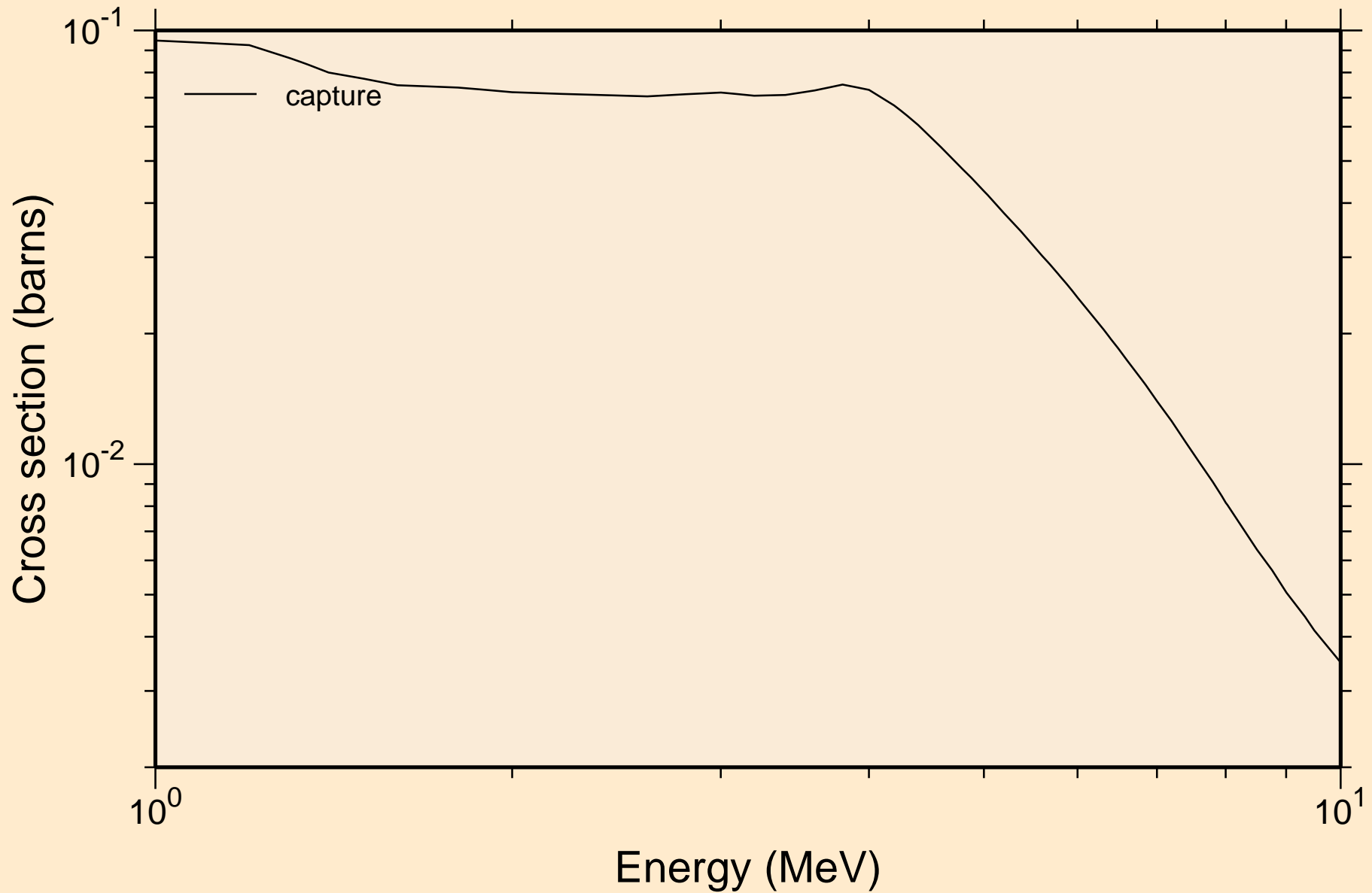

SR082 NEUTRON ACER TENDL-2021 LIBRARY; T=293.6K
Heating

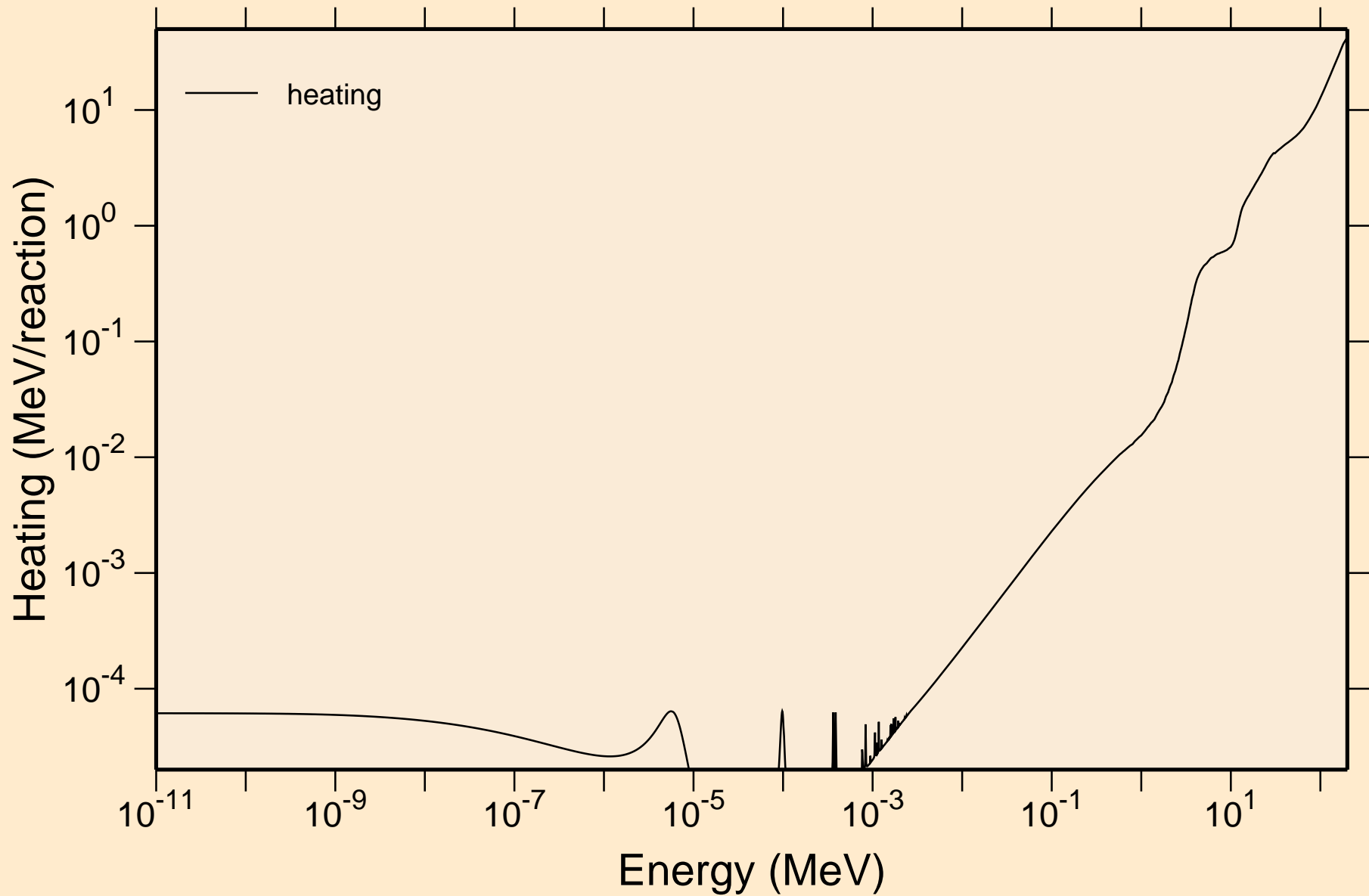

SR082 NEUTRON ACER TENDL-2021 LIBRARY; T=293.6K
Damage

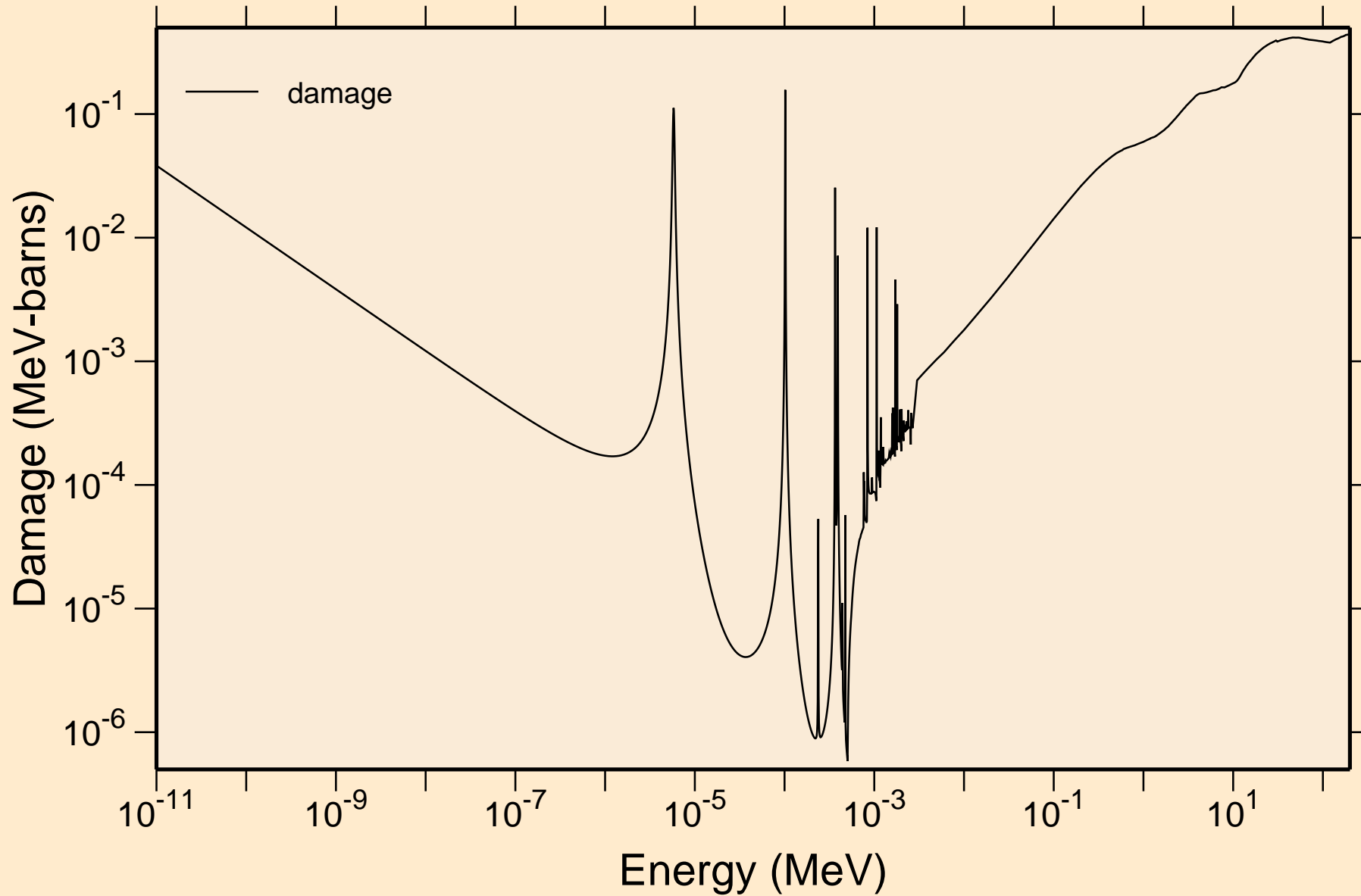

SR082 NEUTRON ACER TENDL-2021 LIBRARY; T=293.6K
Non-threshold reactions

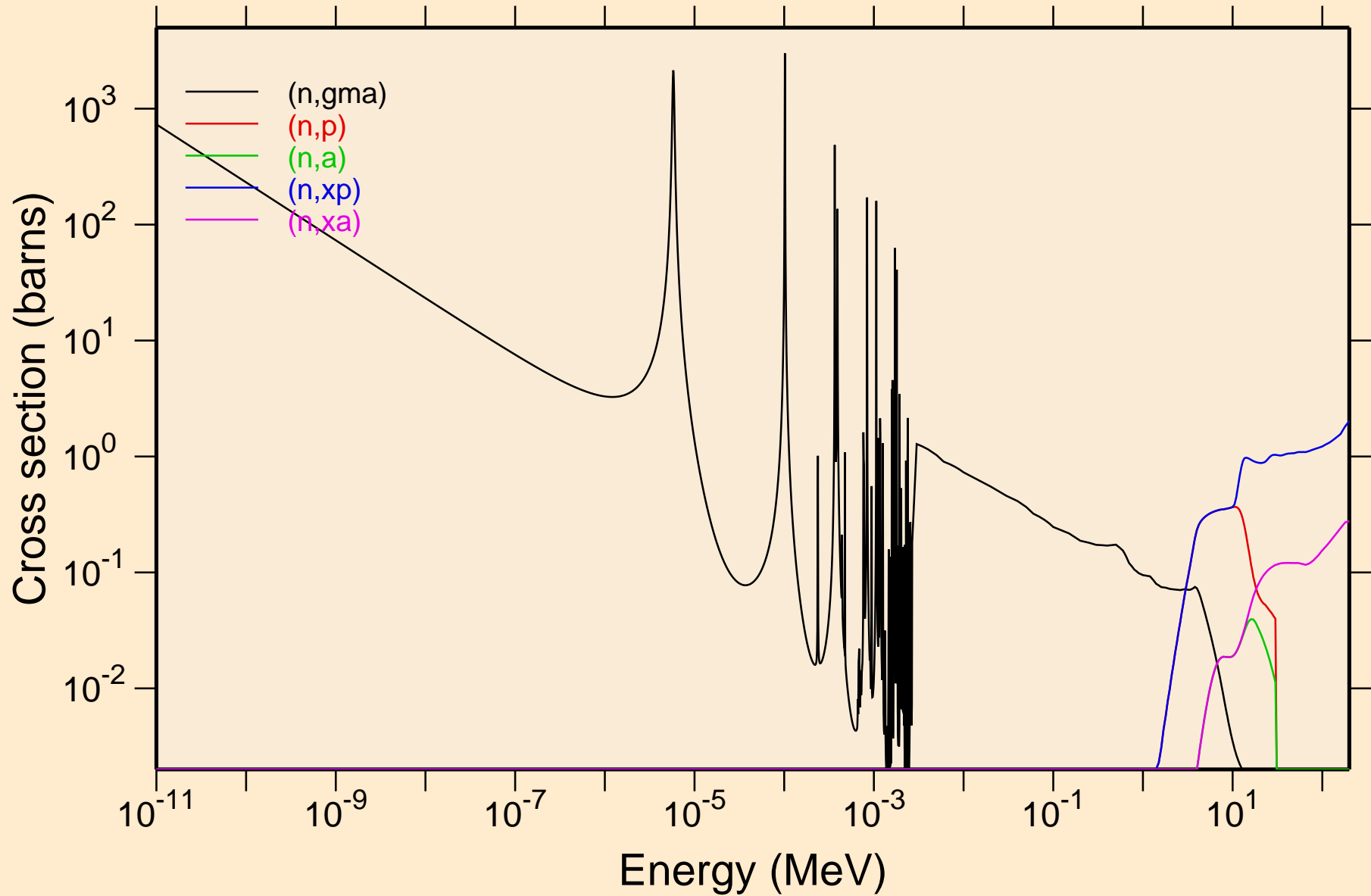

SR082 NEUTRON ACER TENDL-2021 LIBRARY; T=293.6K
Principal cross sections

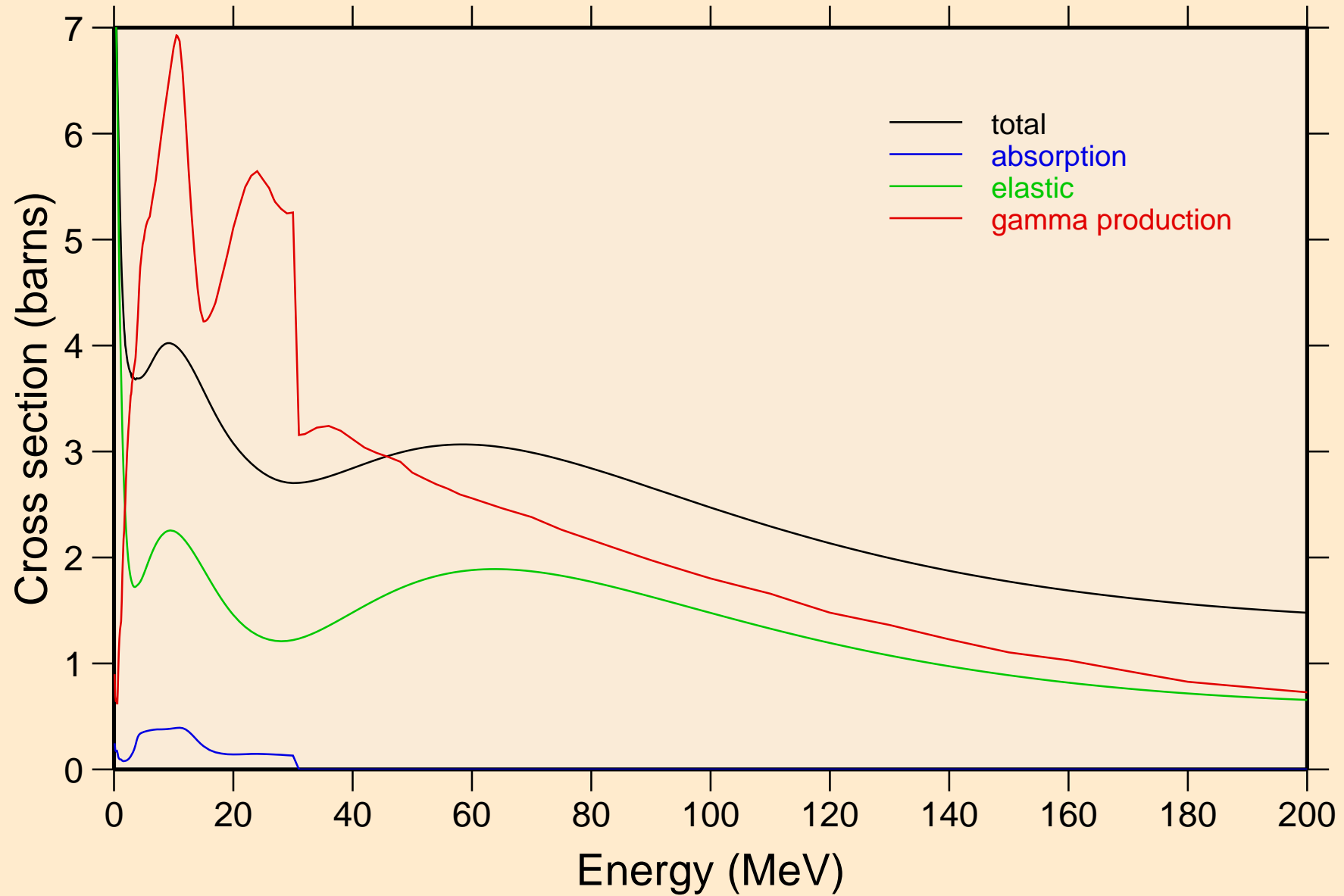

SR082 NEUTRON ACER TENDL-2021 LIBRARY; T=293.6K

Heating

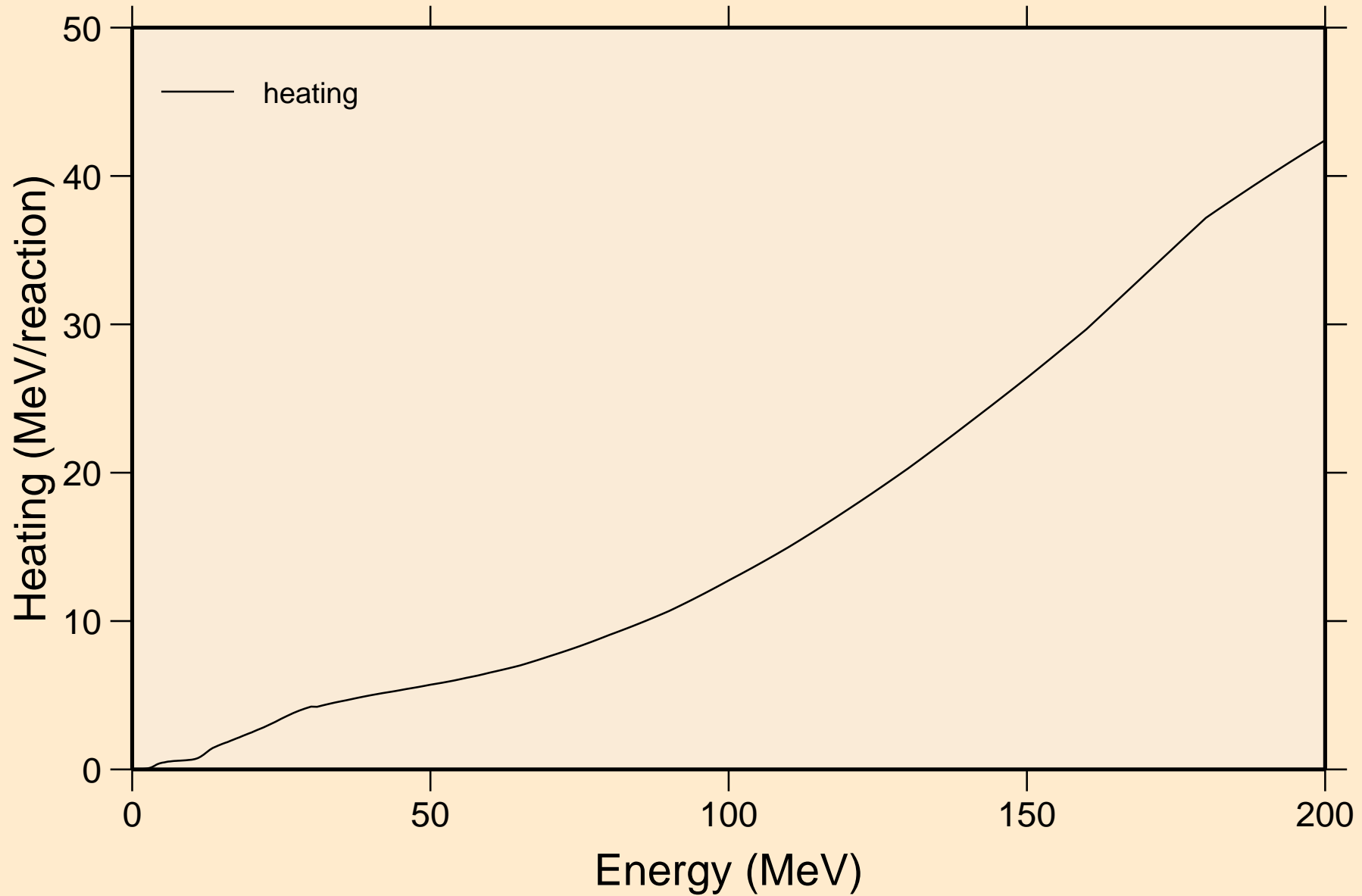

SR082 NEUTRON ACER TENDL-2021 LIBRARY; T=293.6K
Damage

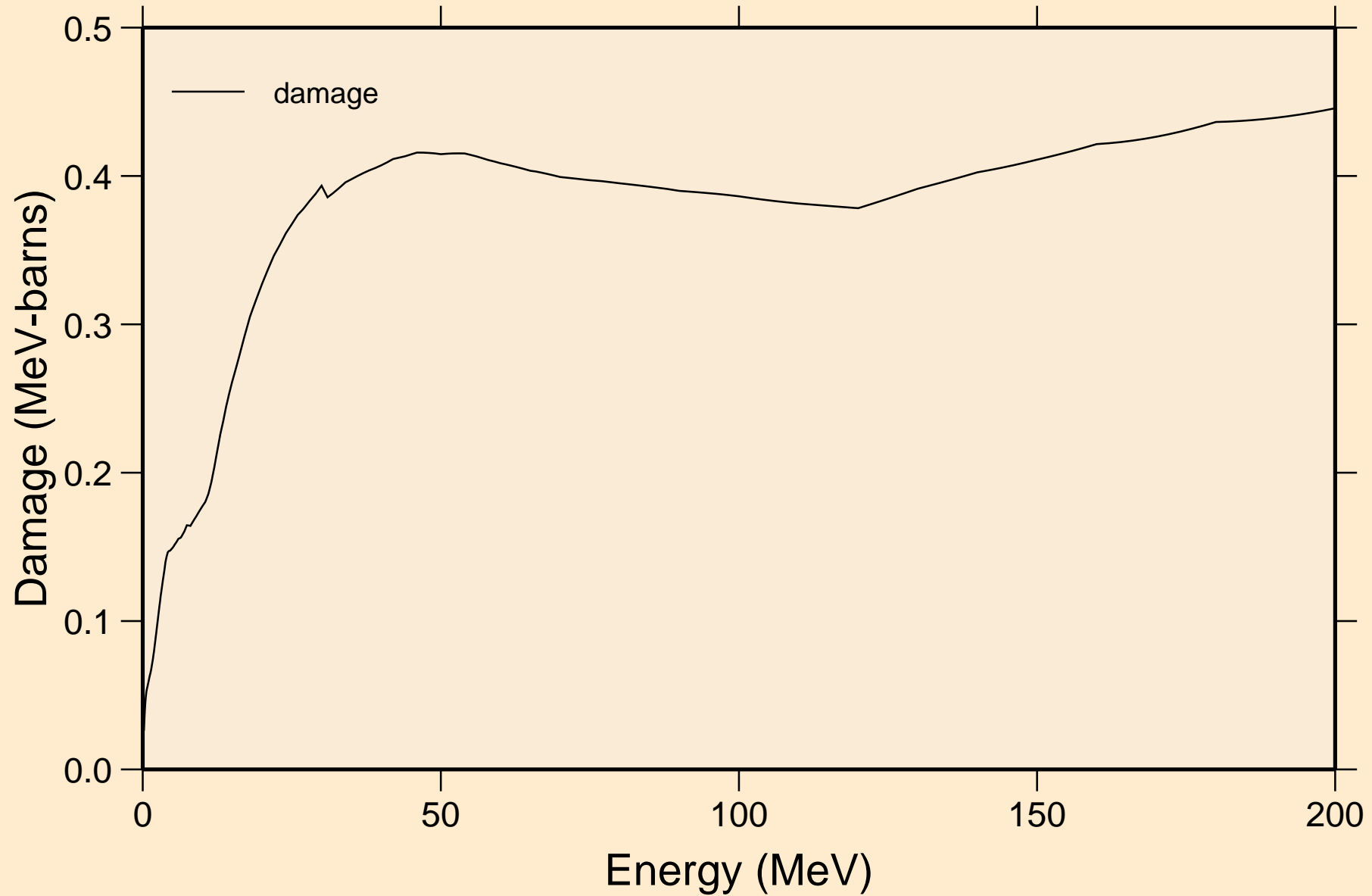

SR082 NEUTRON ACER TENDL-2021 LIBRARY; T=293.6K
Non-threshold reactions

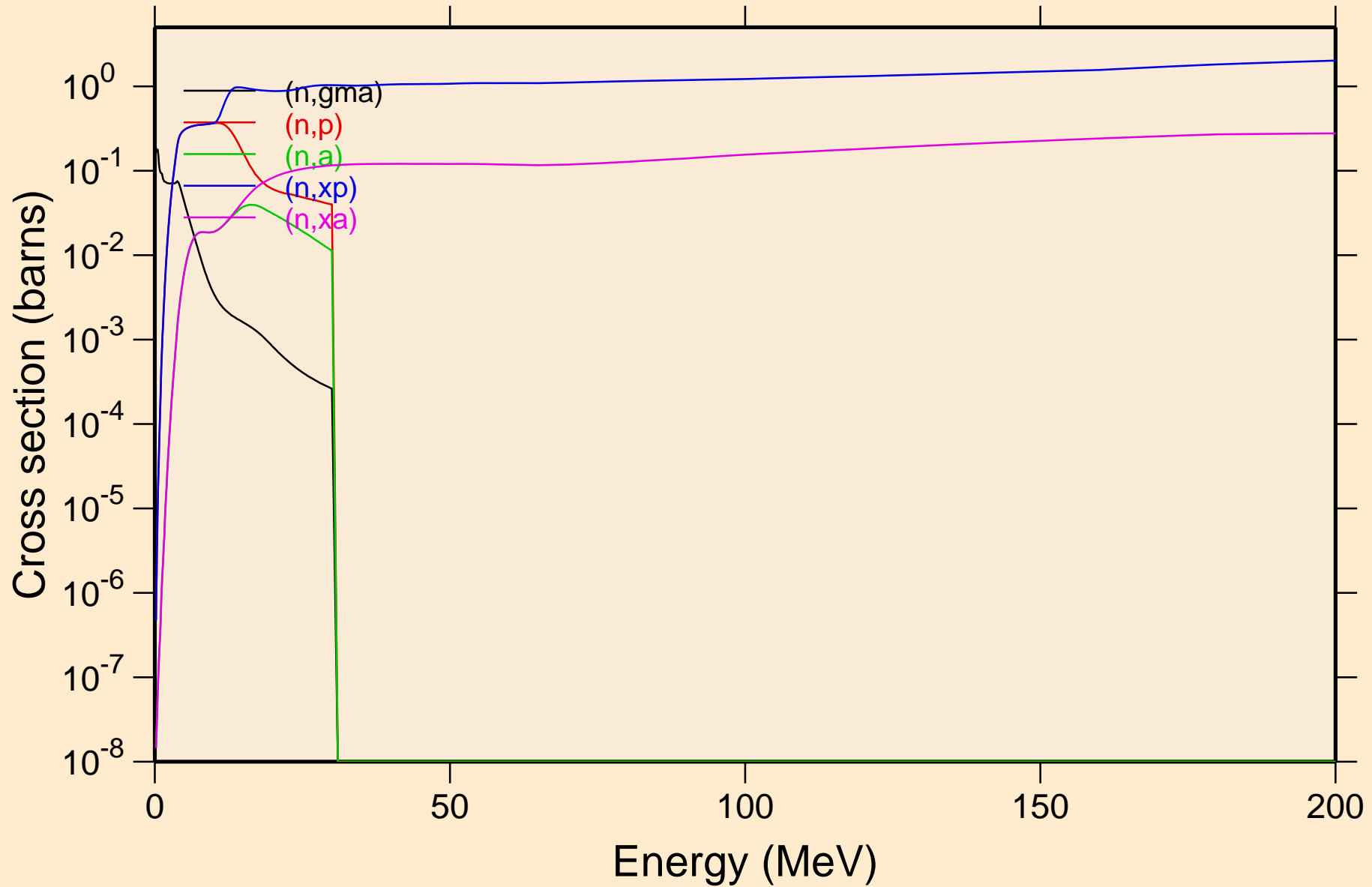

SR082 NEUTRON ACER TENDL-2021 LIBRARY; T=293.6K
Inelastic levels

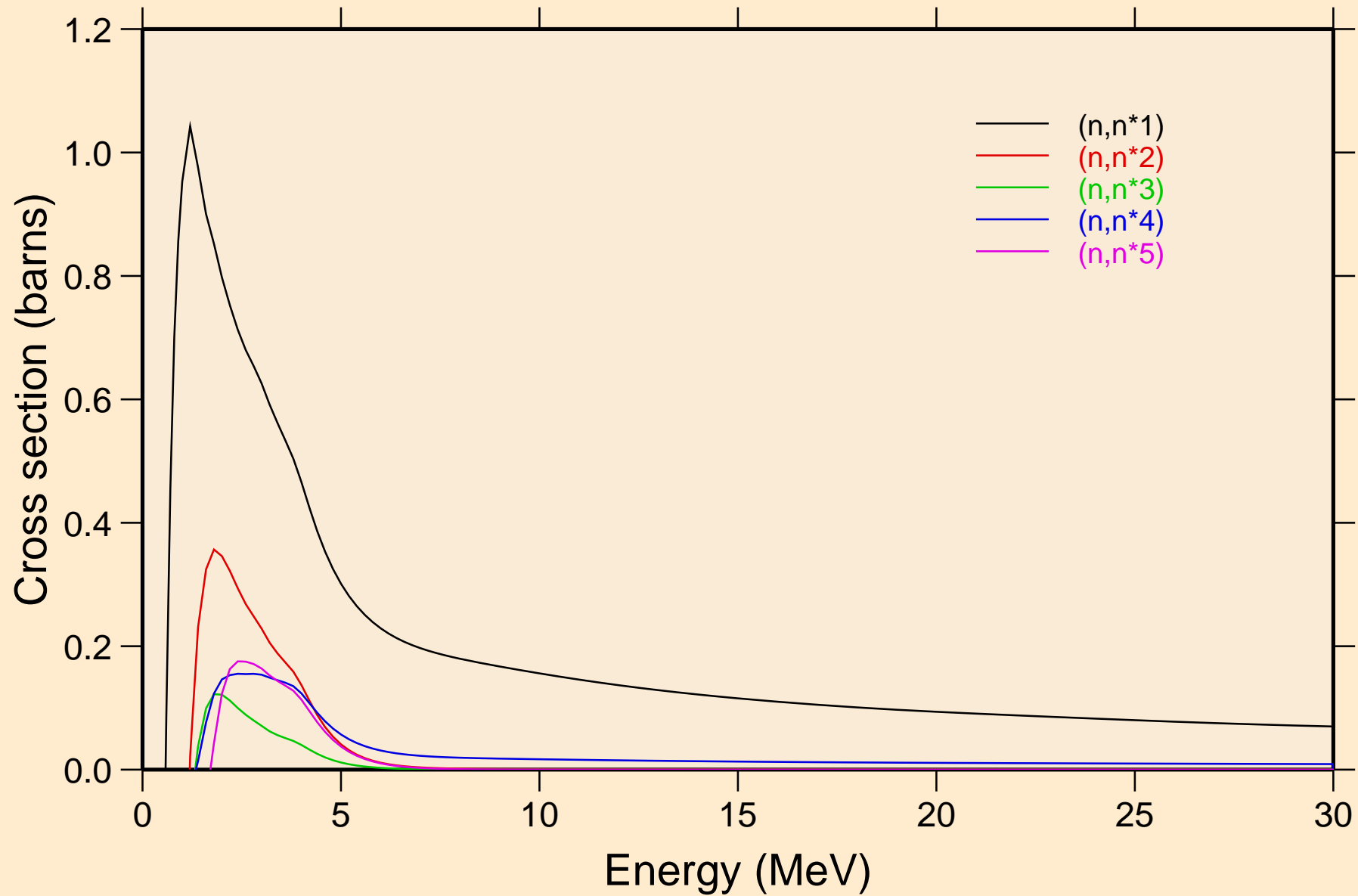

SR082 NEUTRON ACER TENDL-2021 LIBRARY; T=293.6K
Inelastic levels

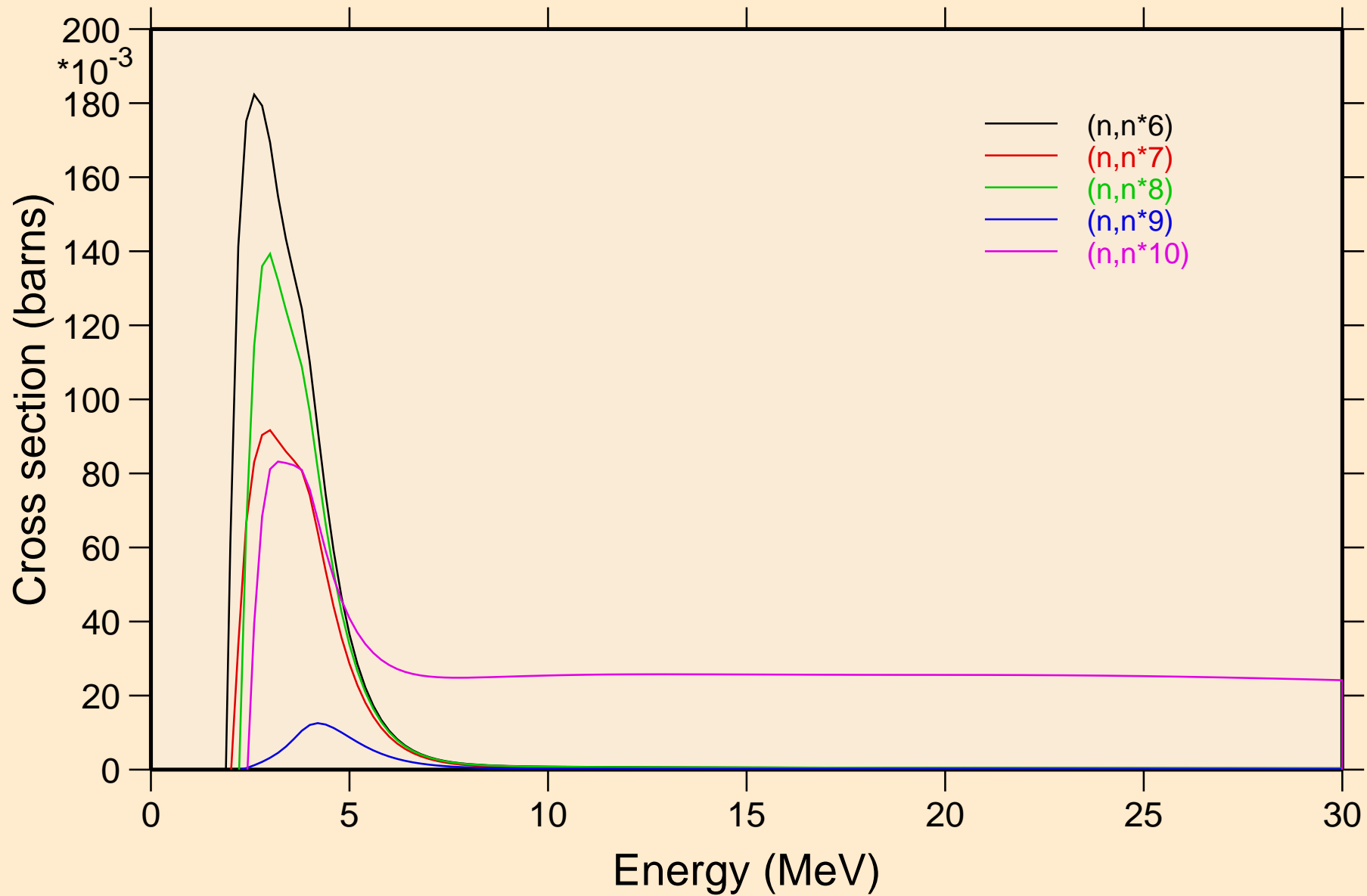

SR082 NEUTRON ACER TENDL-2021 LIBRARY; T=293.6K
Inelastic levels

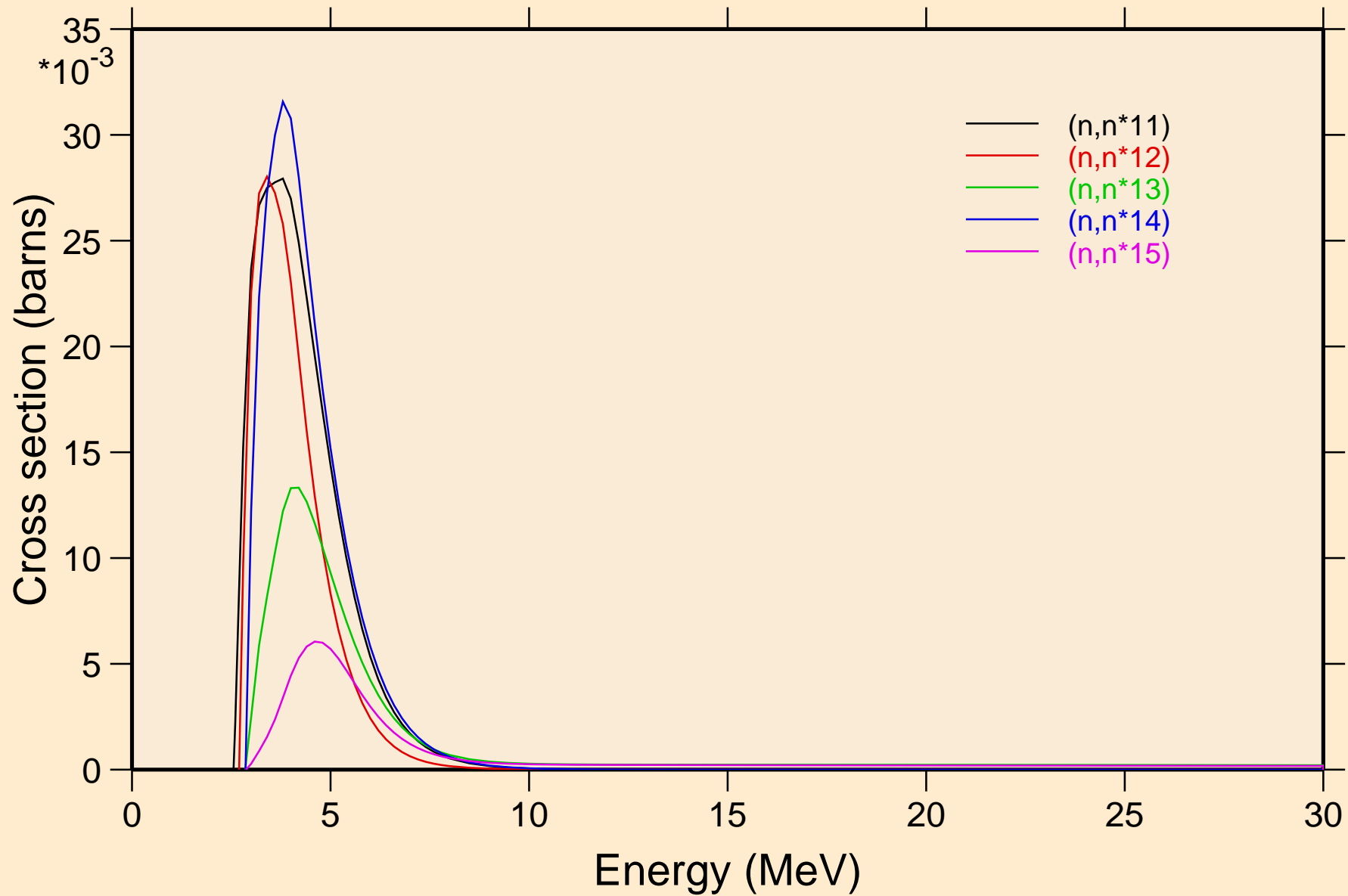

SR082 NEUTRON ACER TENDL-2021 LIBRARY; T=293.6K
Inelastic levels

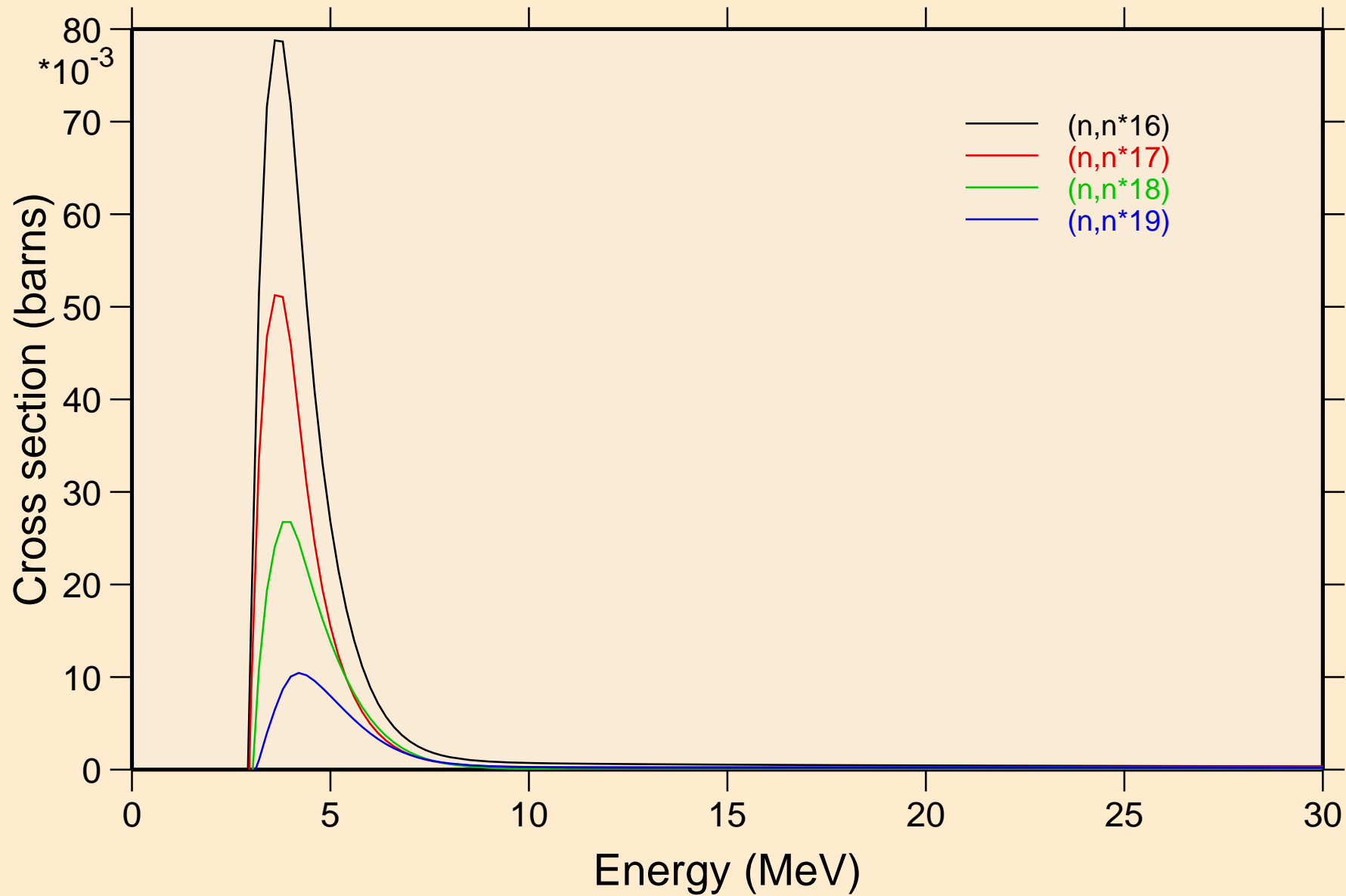

SR082 NEUTRON ACER TENDL-2021 LIBRARY; T=293.6K
Threshold reactions

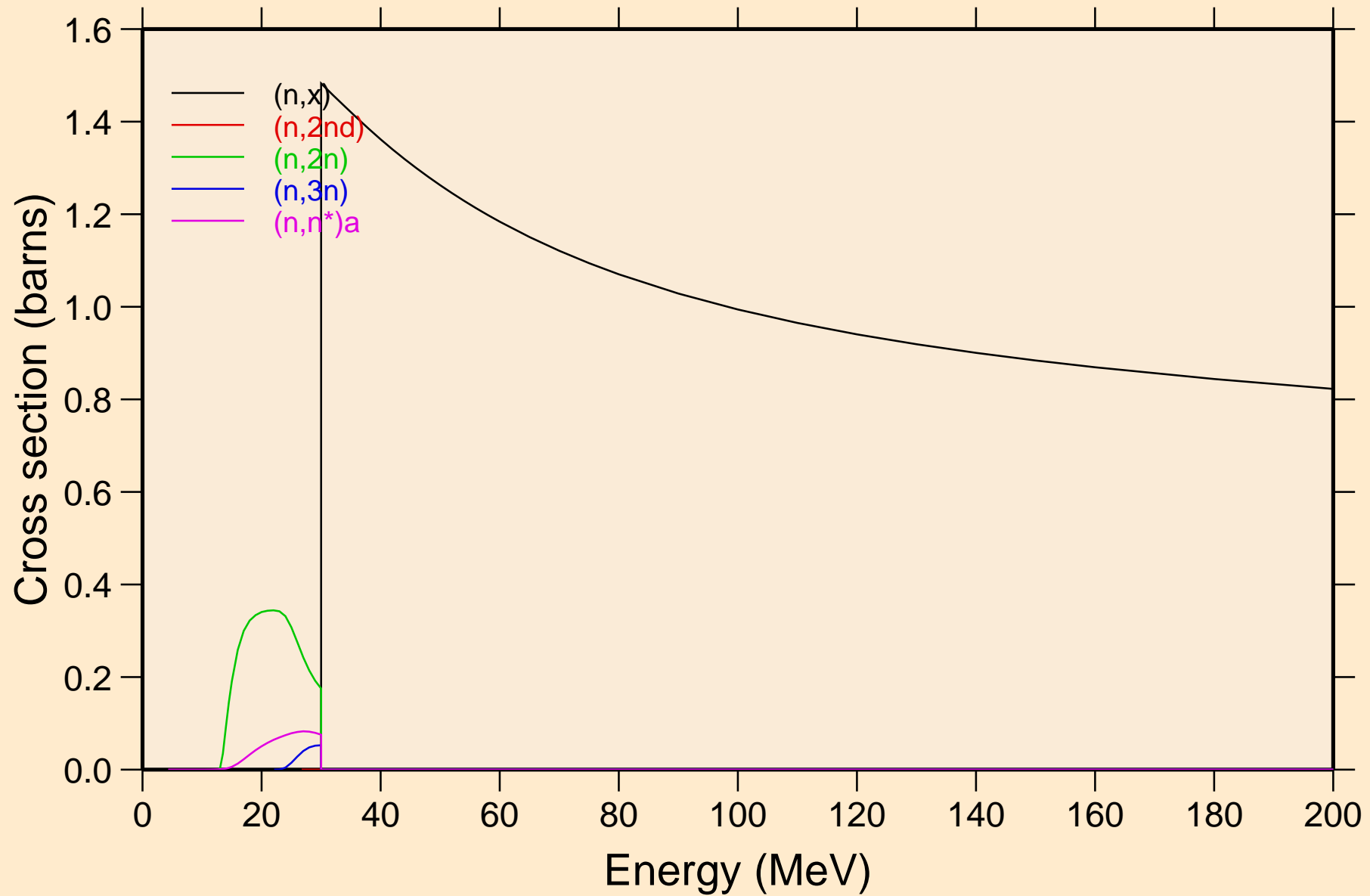

SR082 NEUTRON ACER TENDL-2021 LIBRARY; T=293.6K
Threshold reactions

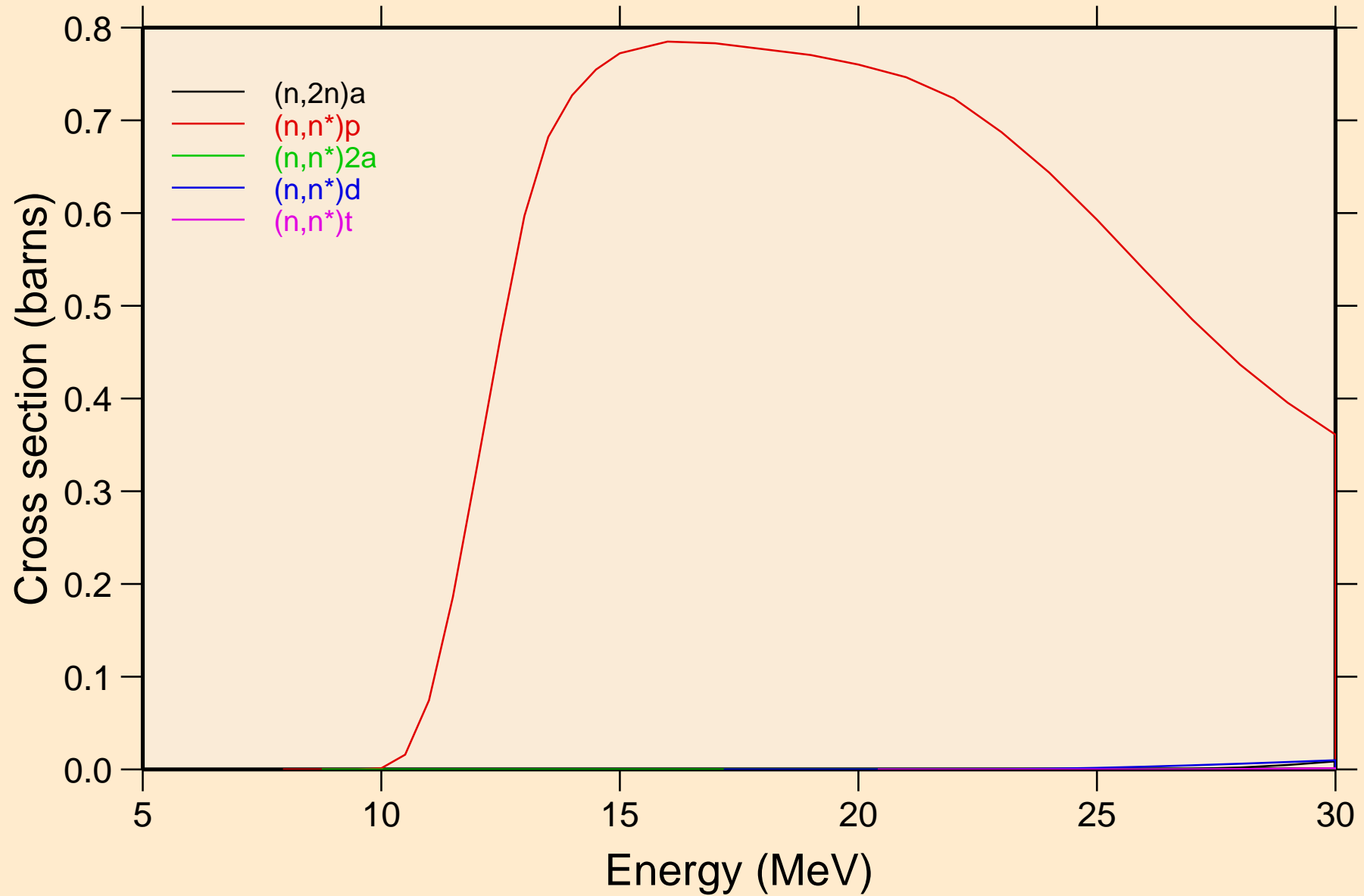

SR082 NEUTRON ACER TENDL-2021 LIBRARY; T=293.6K
Threshold reactions

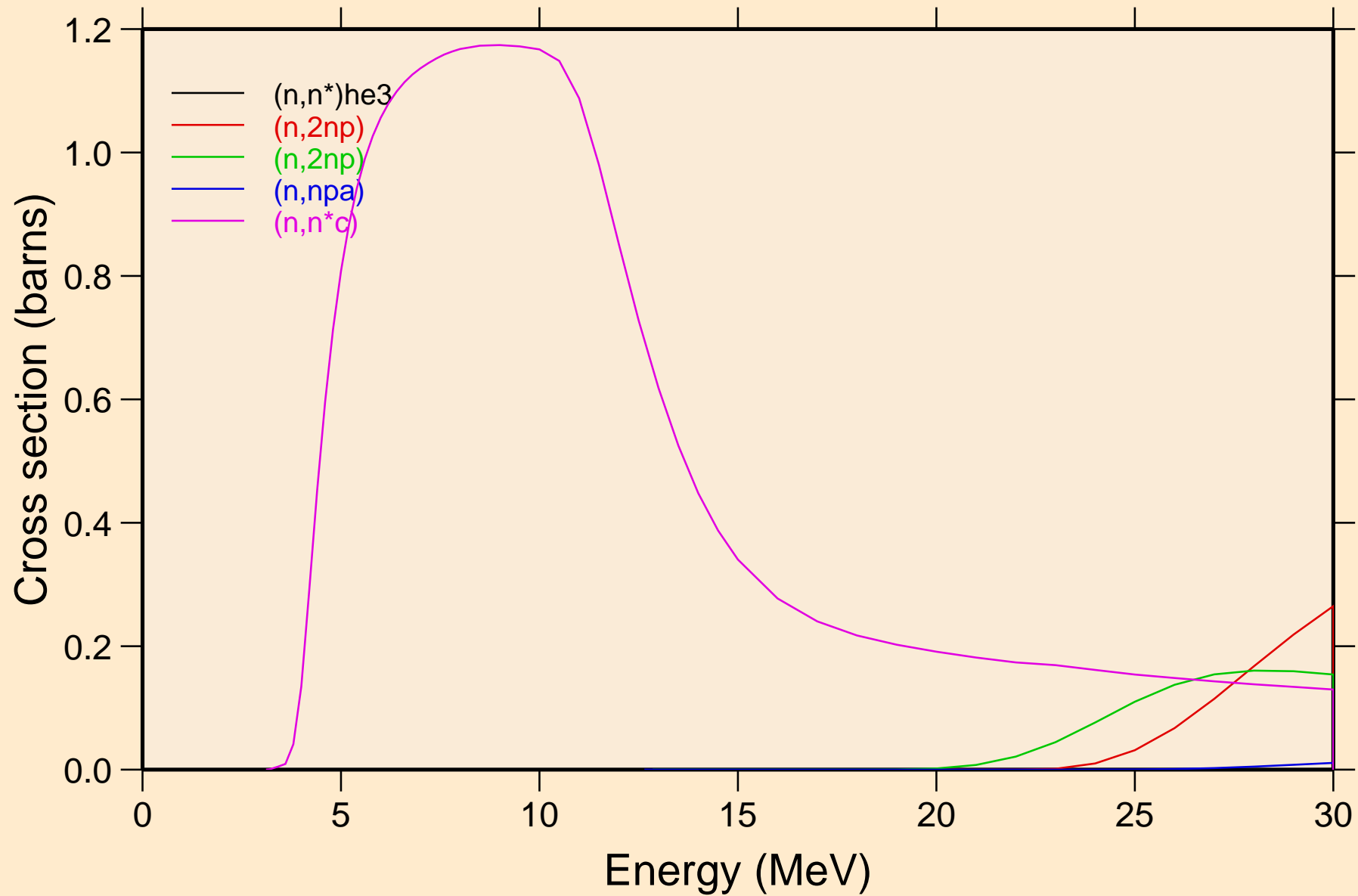

SR082 NEUTRON ACER TENDL-2021 LIBRARY; T=293.6K
Threshold reactions

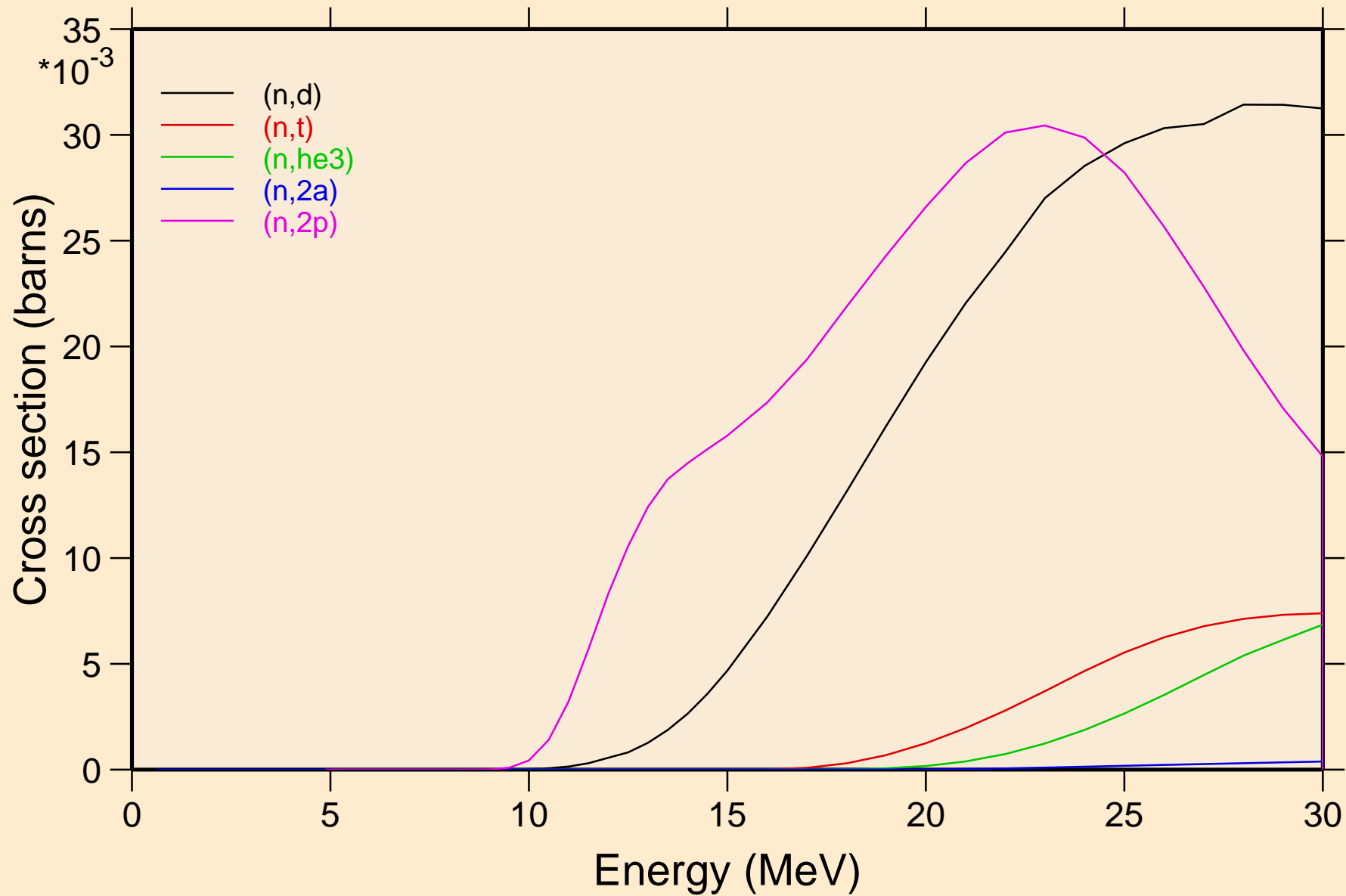

SR082 NEUTRON ACER TENDL-2021 LIBRARY; T=293.6K
Threshold reactions

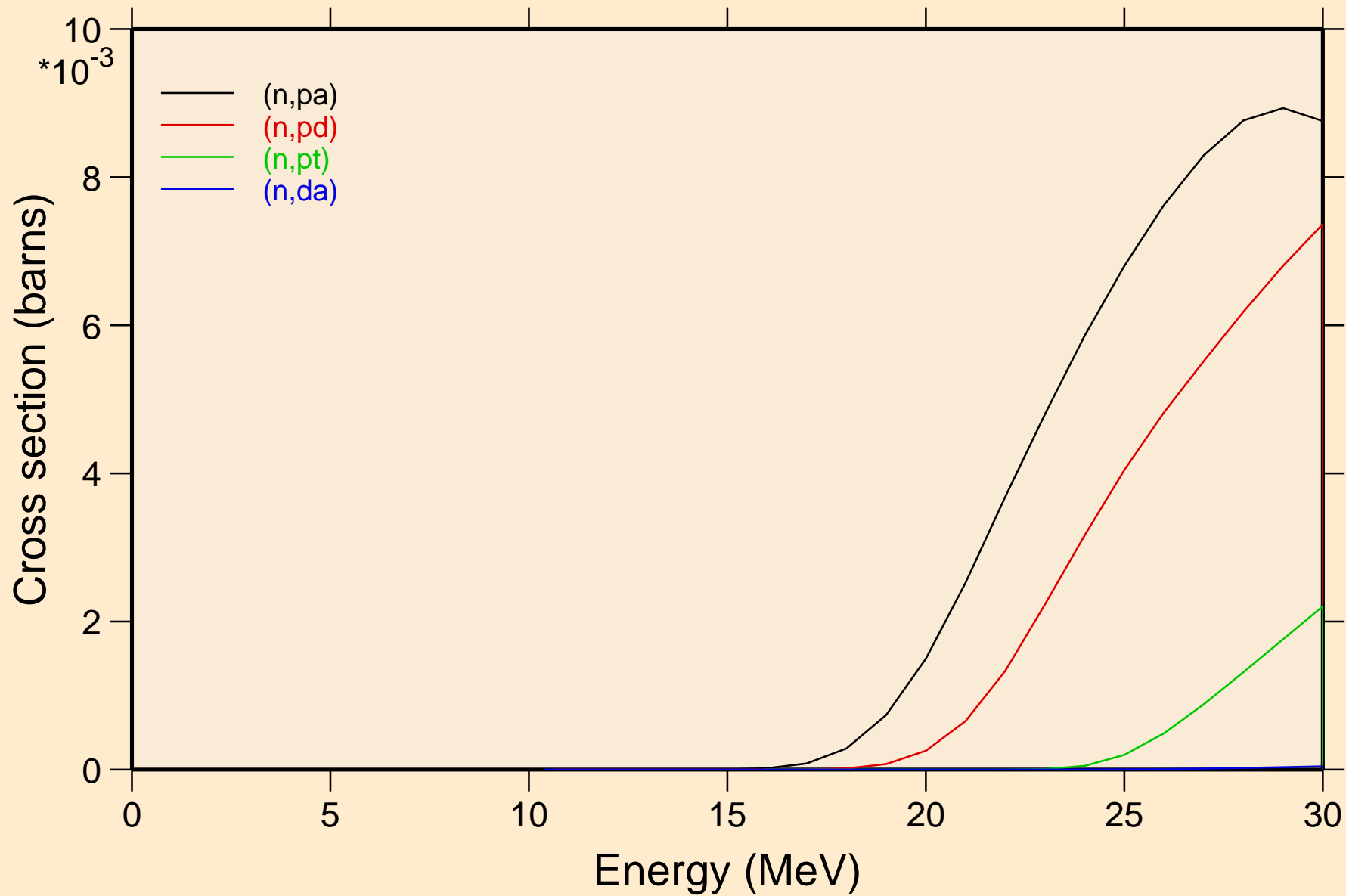

SR082 NEUTRON ACER TENDL-2021 LIBRARY; T=293.6K
Threshold reactions

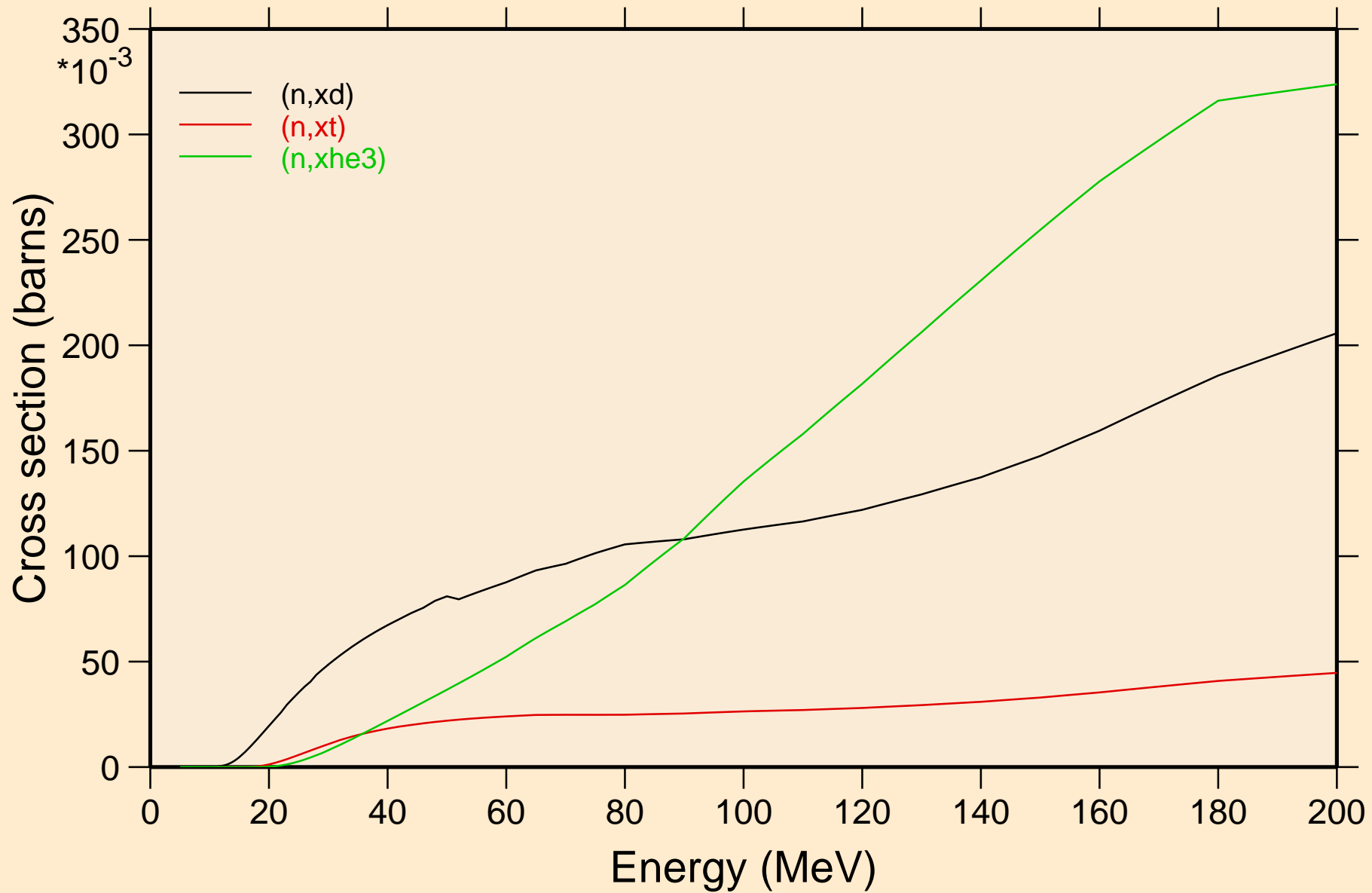

SR082 NEUTRON ACER TENDL-2021 LIBRARY; T=293.6K
angular distribution for elastic

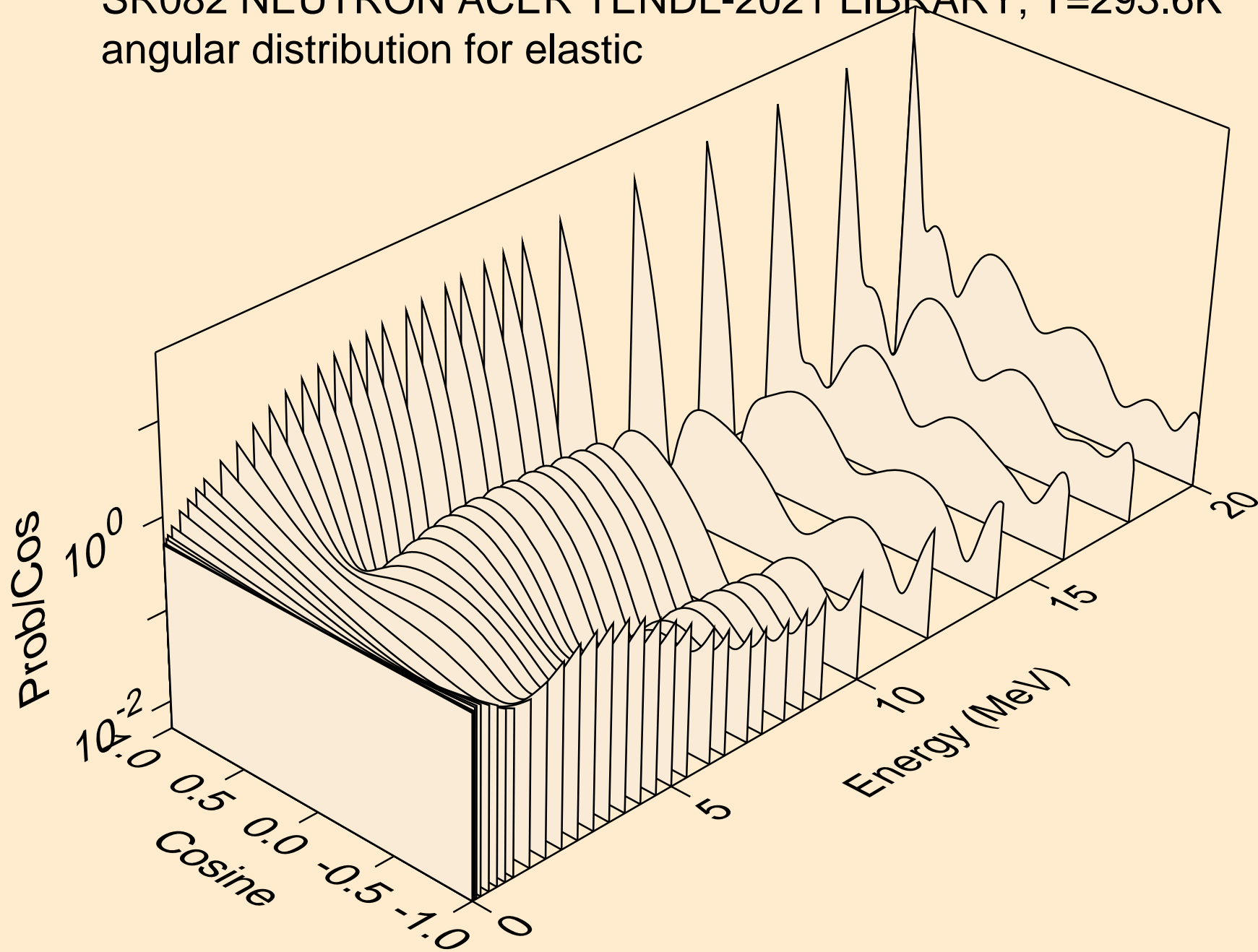

SR082 NEUTRON ACER TENDL-2021 LIBRARY; T=293.6K
angular distribution for elastic

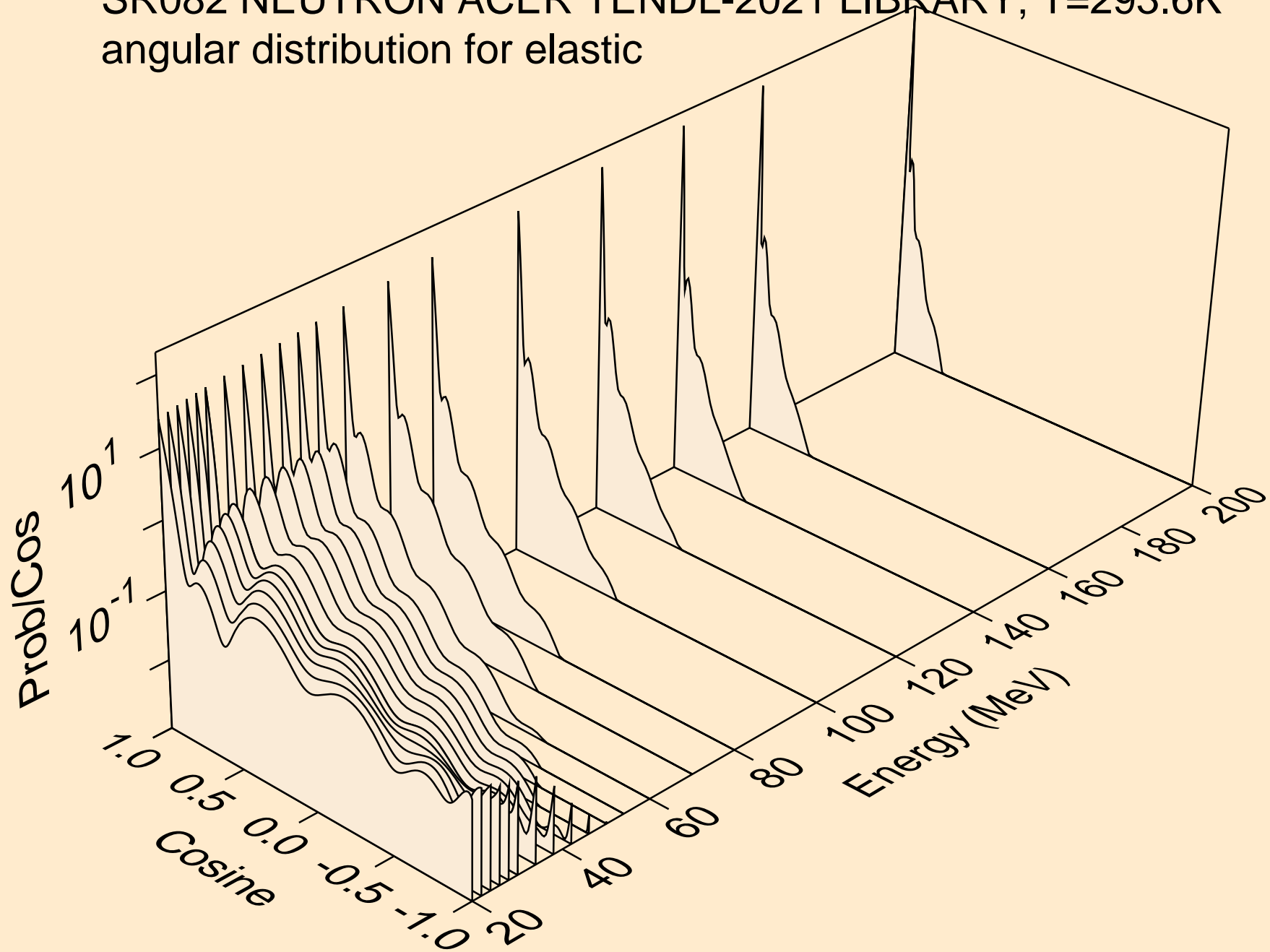

SR082 NEUTRON ACER TENDL-2021 LIBRARY; T=293.6K
angular distribution for (n,n*1)

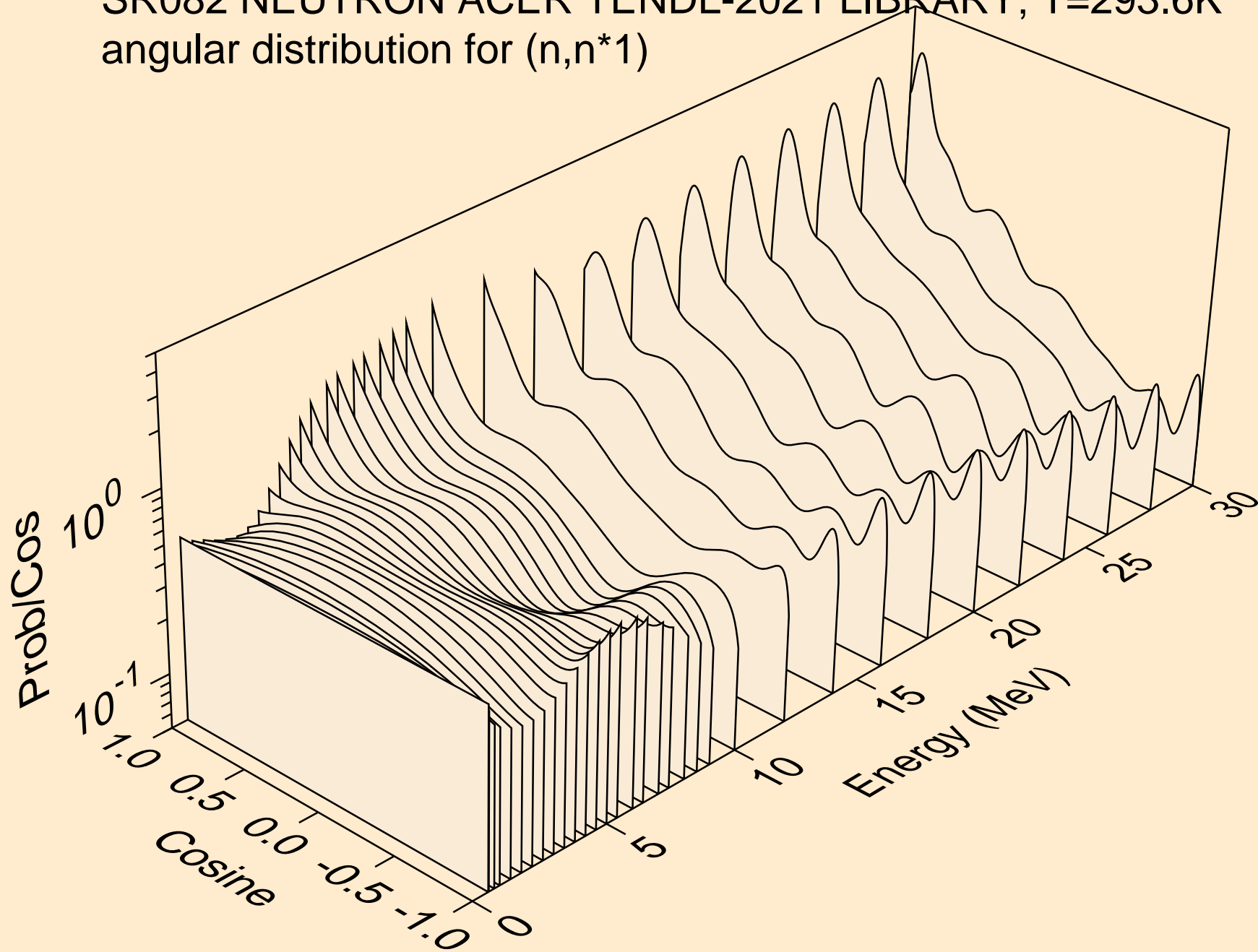

SR082 NEUTRON ACER TENDL-2021 LIBRARY; T=293.6K
angular distribution for (n,n*2)

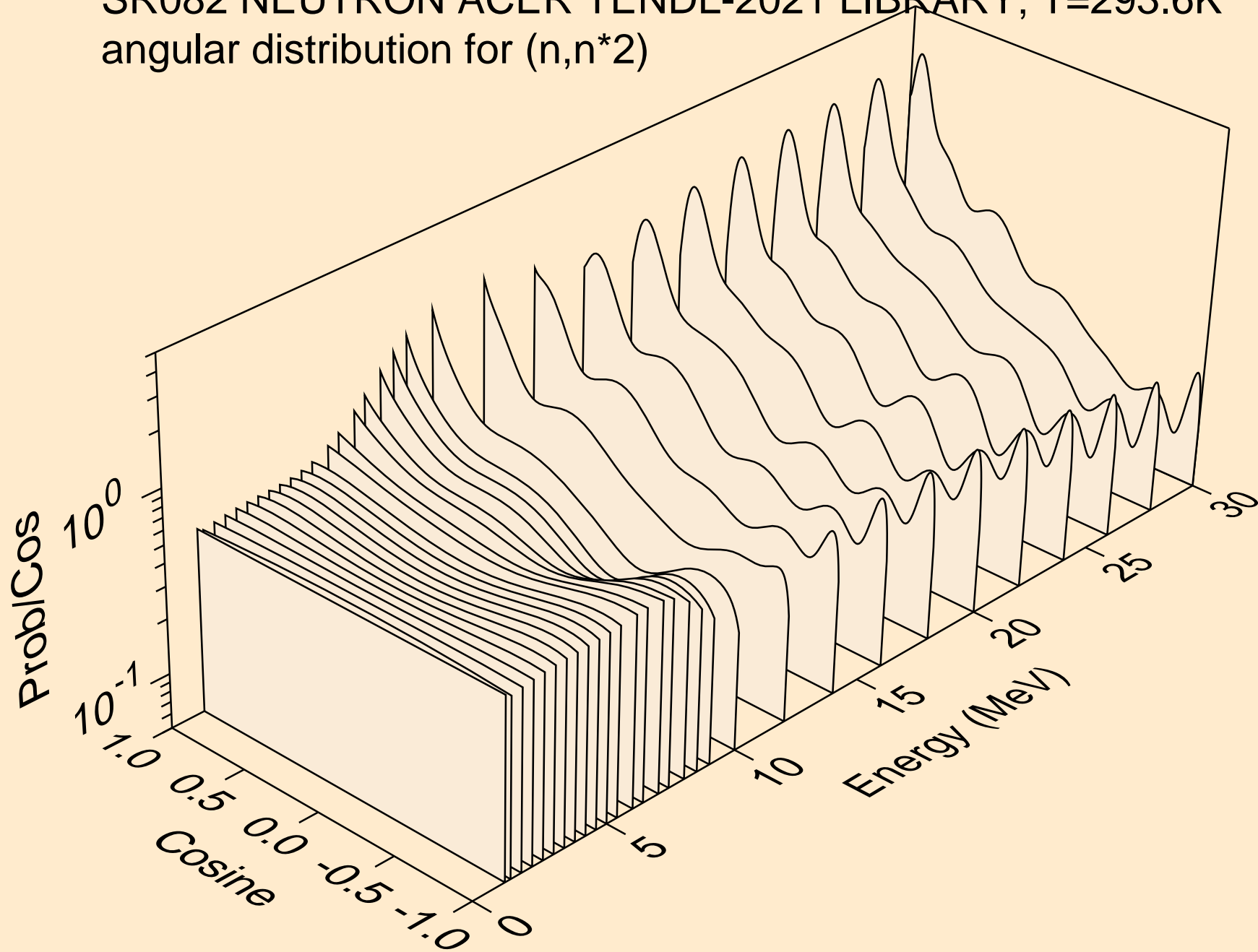

SR082 NEUTRON ACER TENDL-2021 LIBRARY; T=293.6K
angular distribution for (n,n*3)

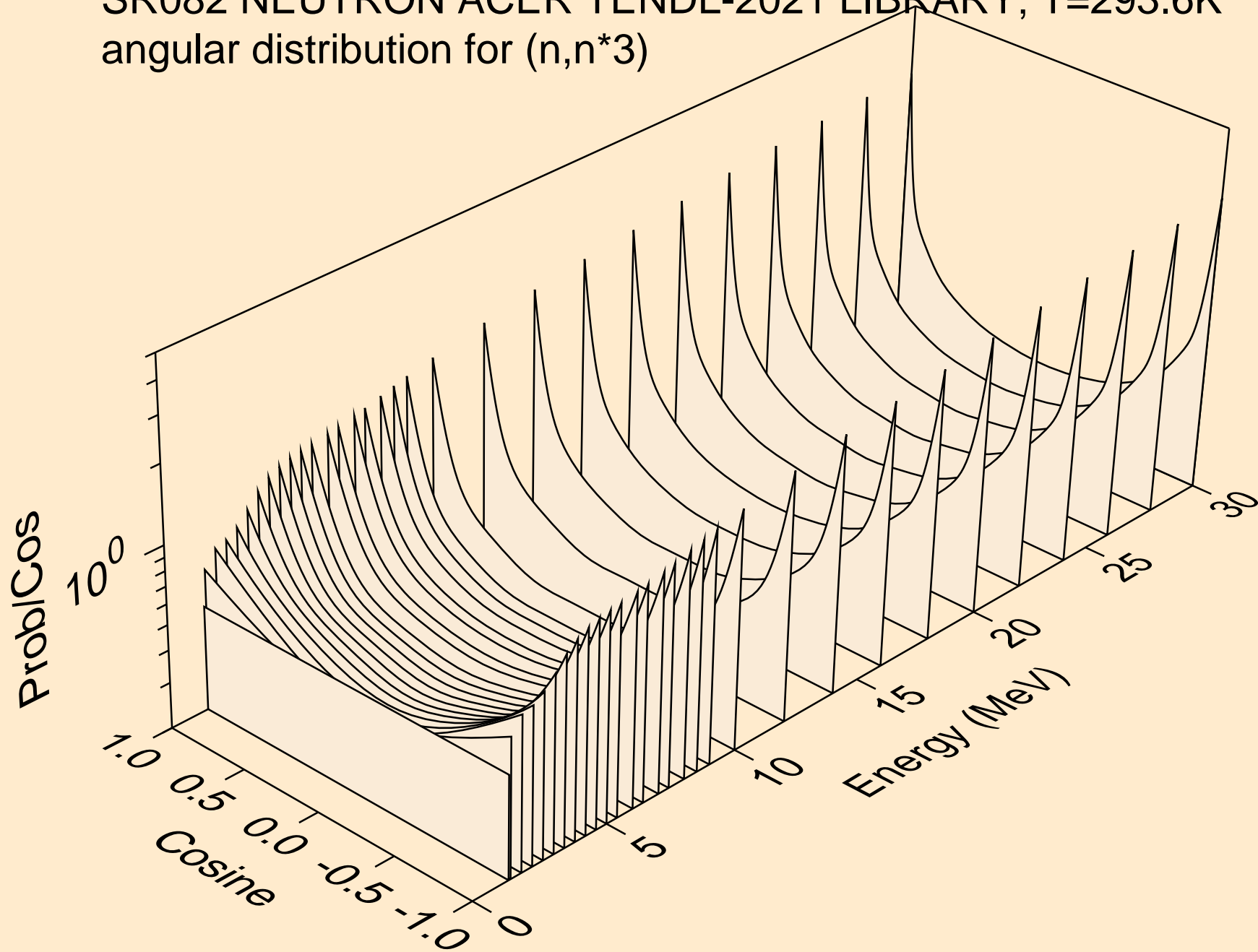

SR082 NEUTRON ACER TENDL-2021 LIBRARY; T=293.6K
angular distribution for (n,n*4)

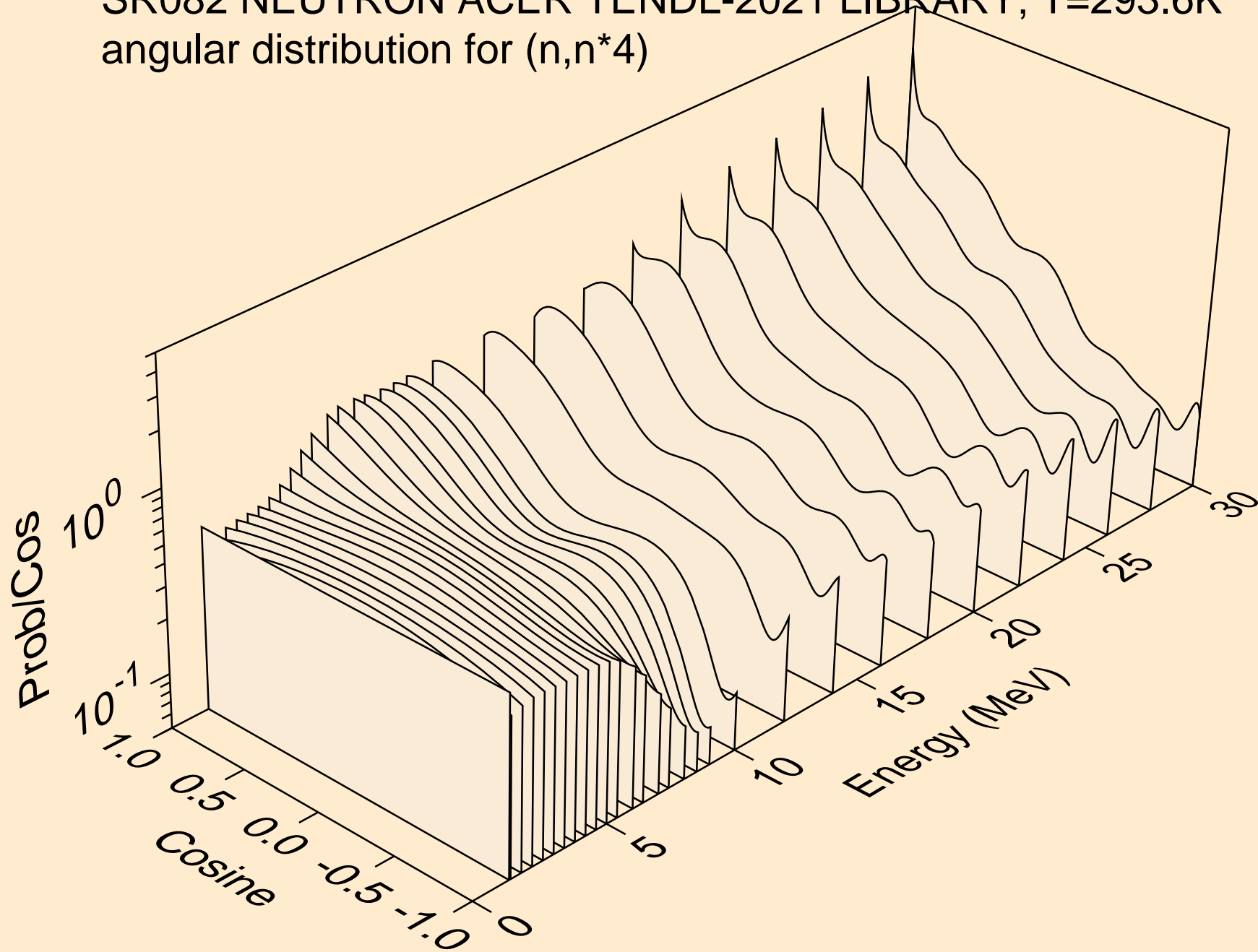

SR082 NEUTRON ACER TENDL-2021 LIBRARY; T=293.6K
angular distribution for (n,n*5)

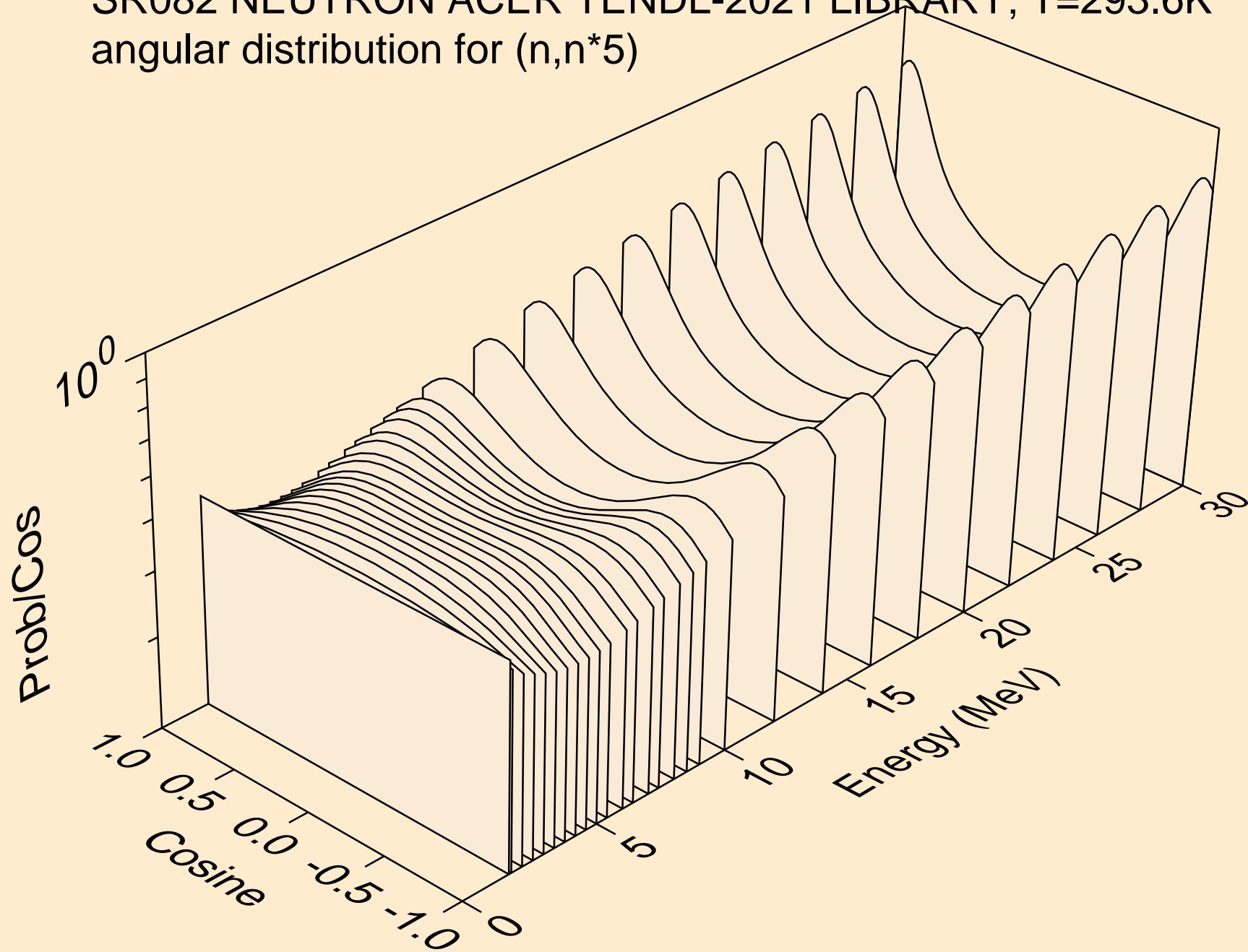

SR082 NEUTRON ACER TENDL-2021 LIBRARY; T=293.6K
angular distribution for (n,n*6)

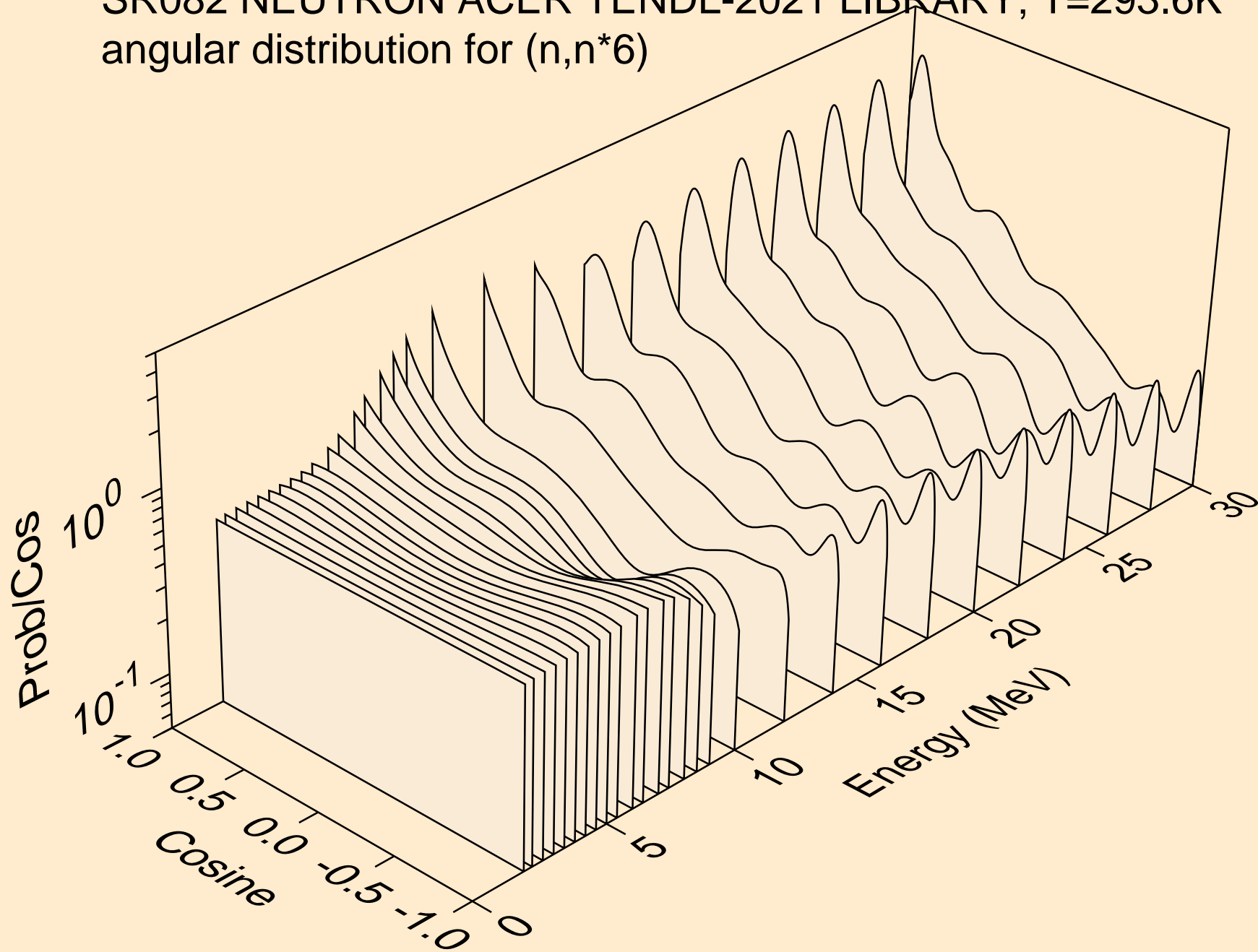

SR082 NEUTRON ACER TENDL-2021 LIBRARY; T=293.6K
angular distribution for (n,n*7)

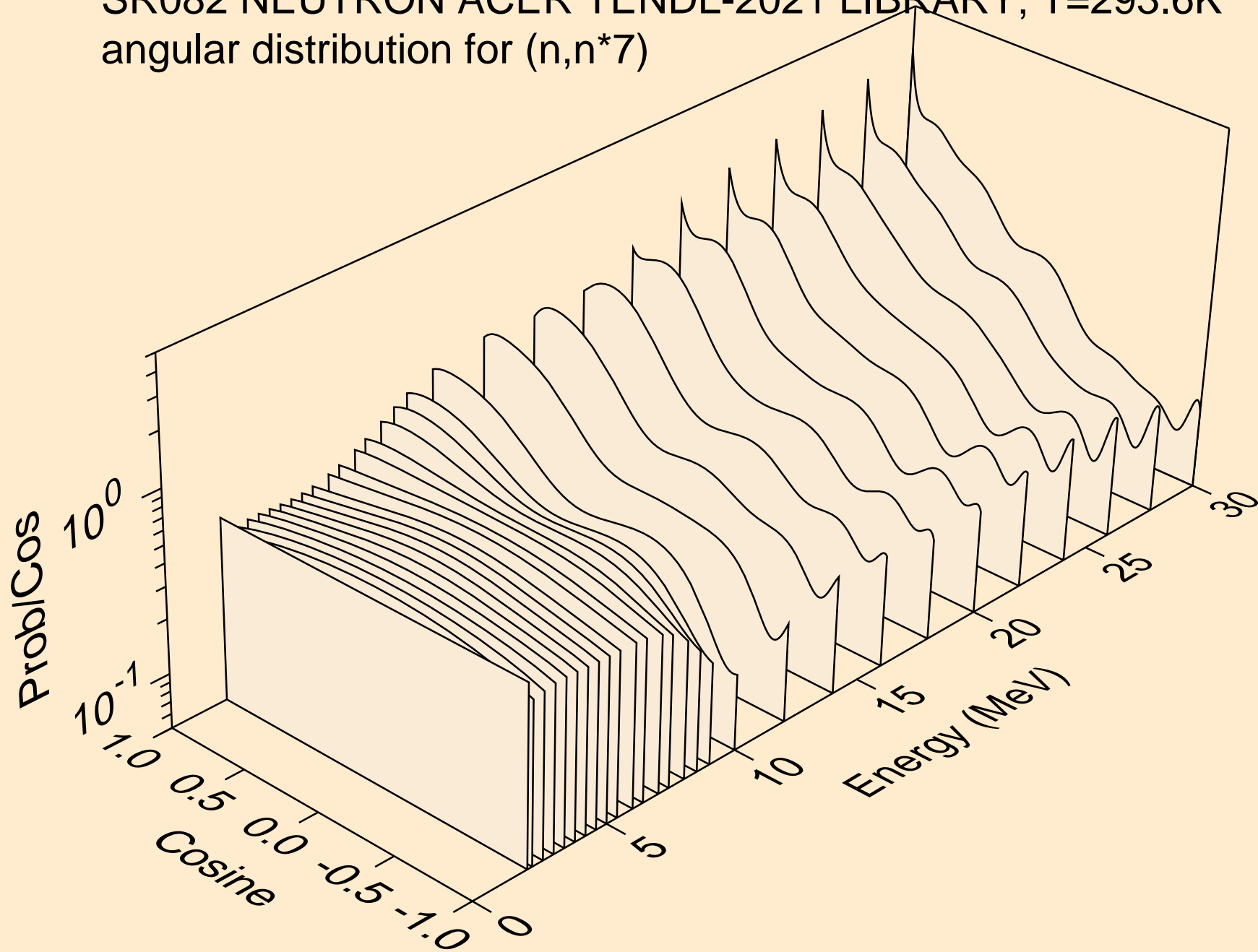

SR082 NEUTRON ACER TENDL-2021 LIBRARY; T=293.6K
angular distribution for (n,n*8)

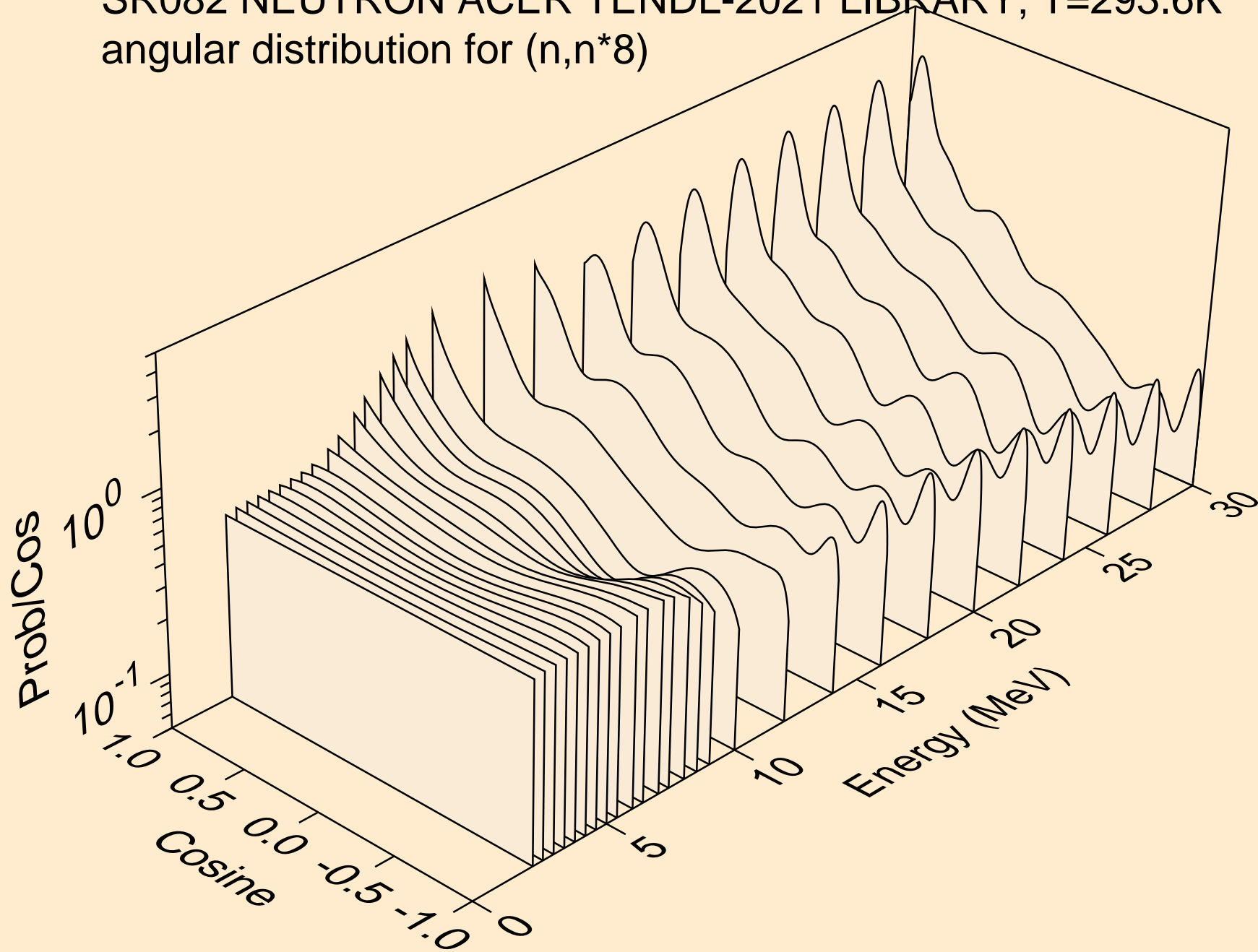

SR082 NEUTRON ACER TENDL-2021 LIBRARY; T=293.6K
angular distribution for (n,n*9)

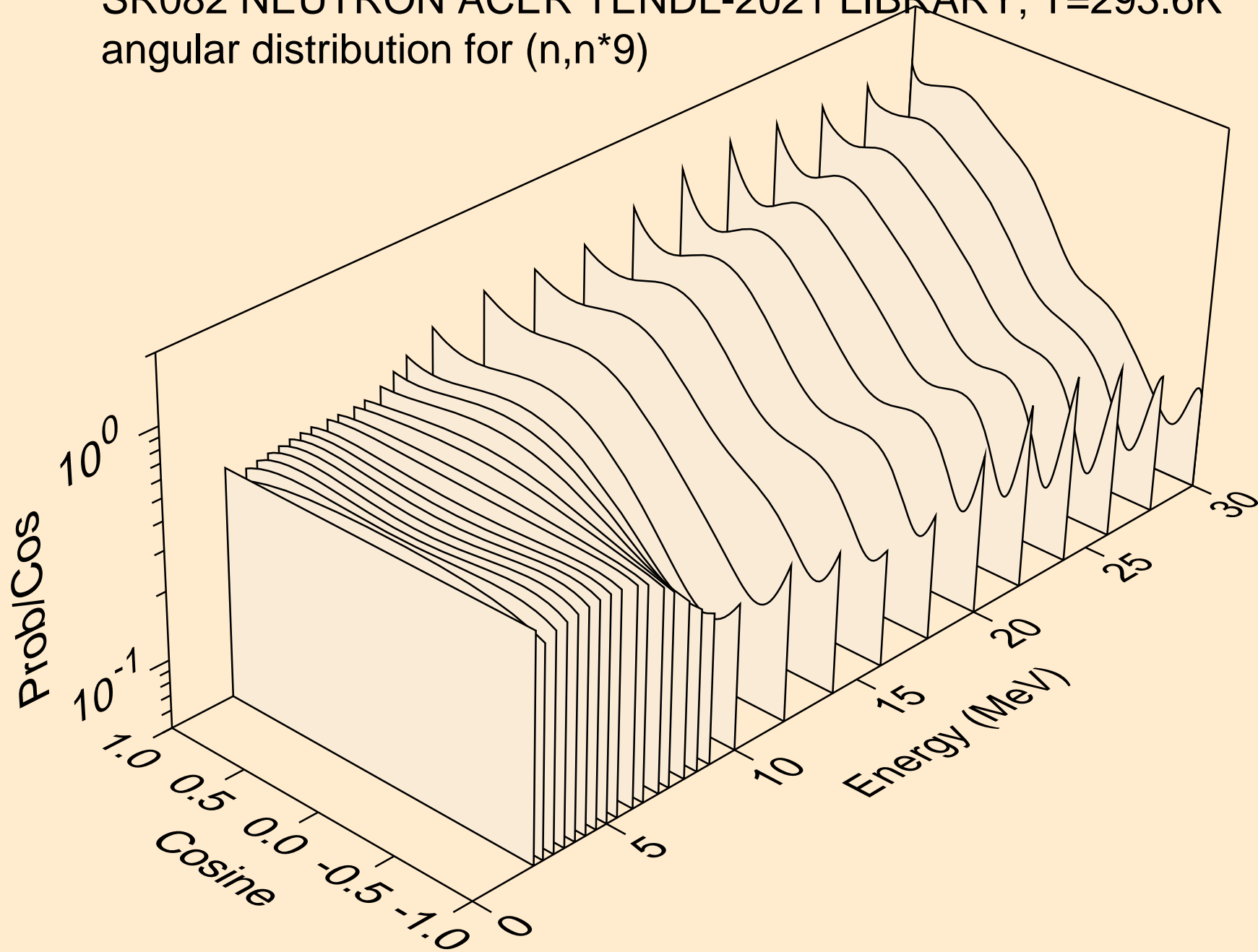

SR082 NEUTRON ACER TENDL-2021 LIBRARY; T=293.6K
angular distribution for (n,n*10)

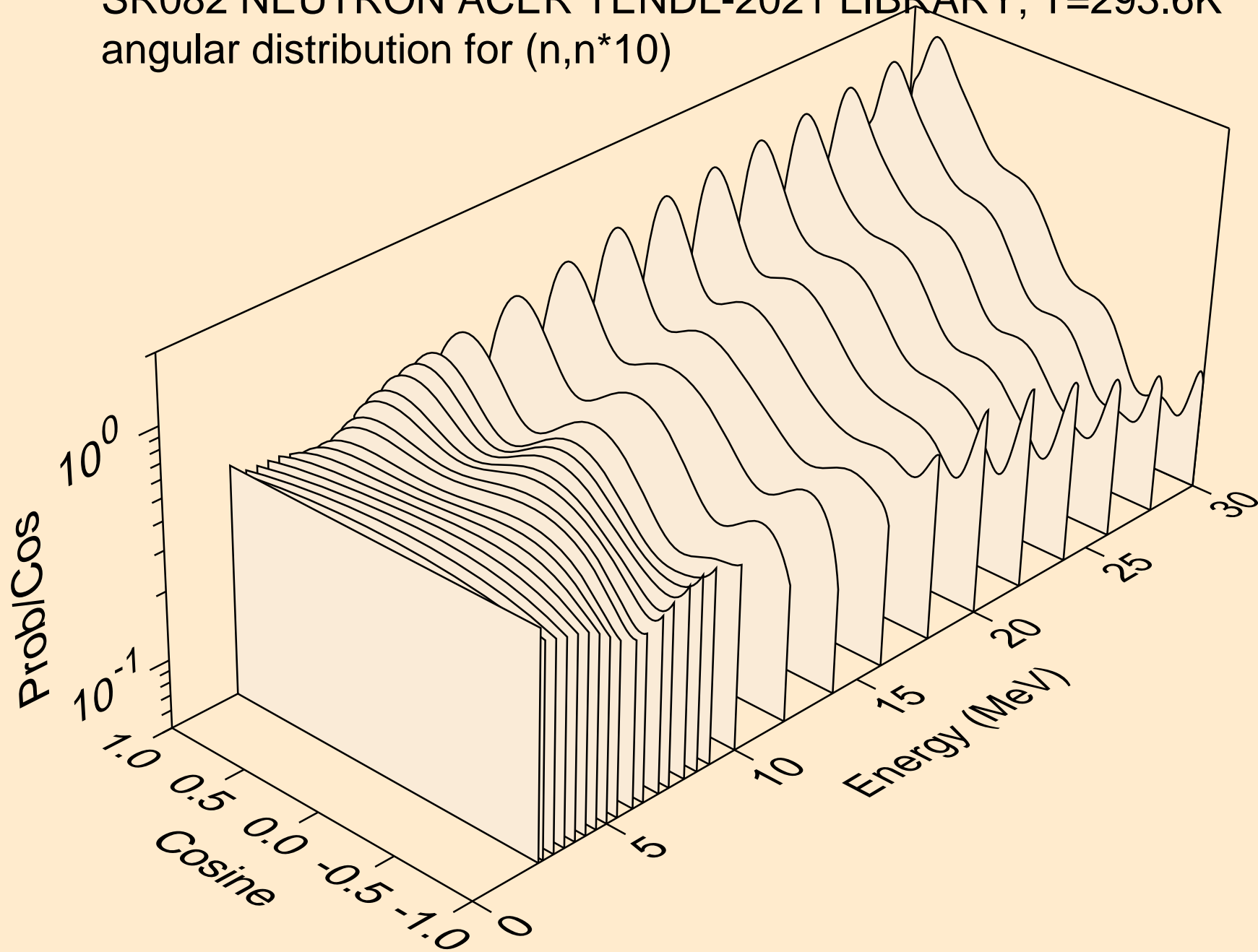

SR082 NEUTRON ACER TENDL-2021 LIBRARY; T=293.6K
angular distribution for (n,n*11)

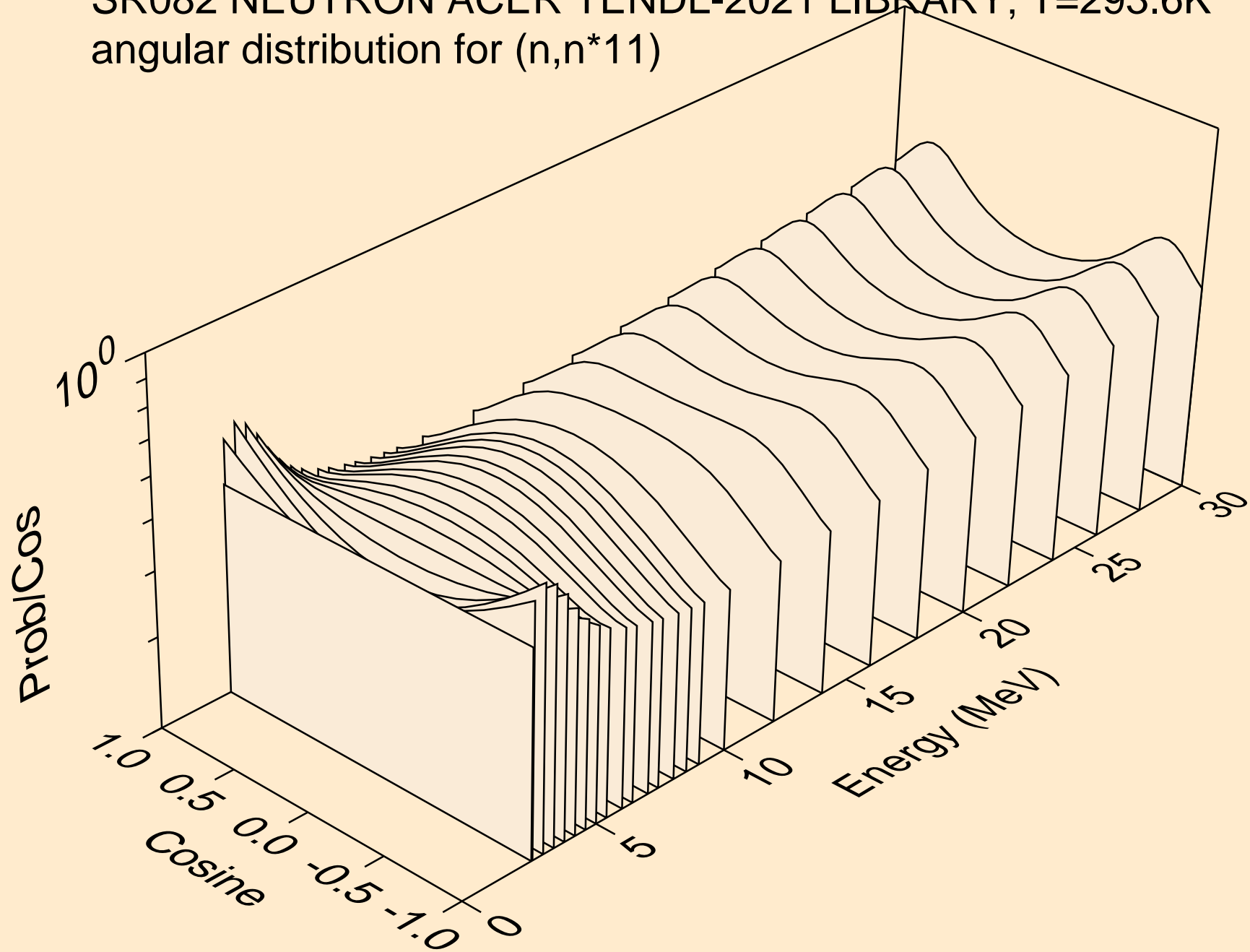

SR082 NEUTRON ACER TENDL-2021 LIBRARY; T=293.6K
angular distribution for (n,n*12)

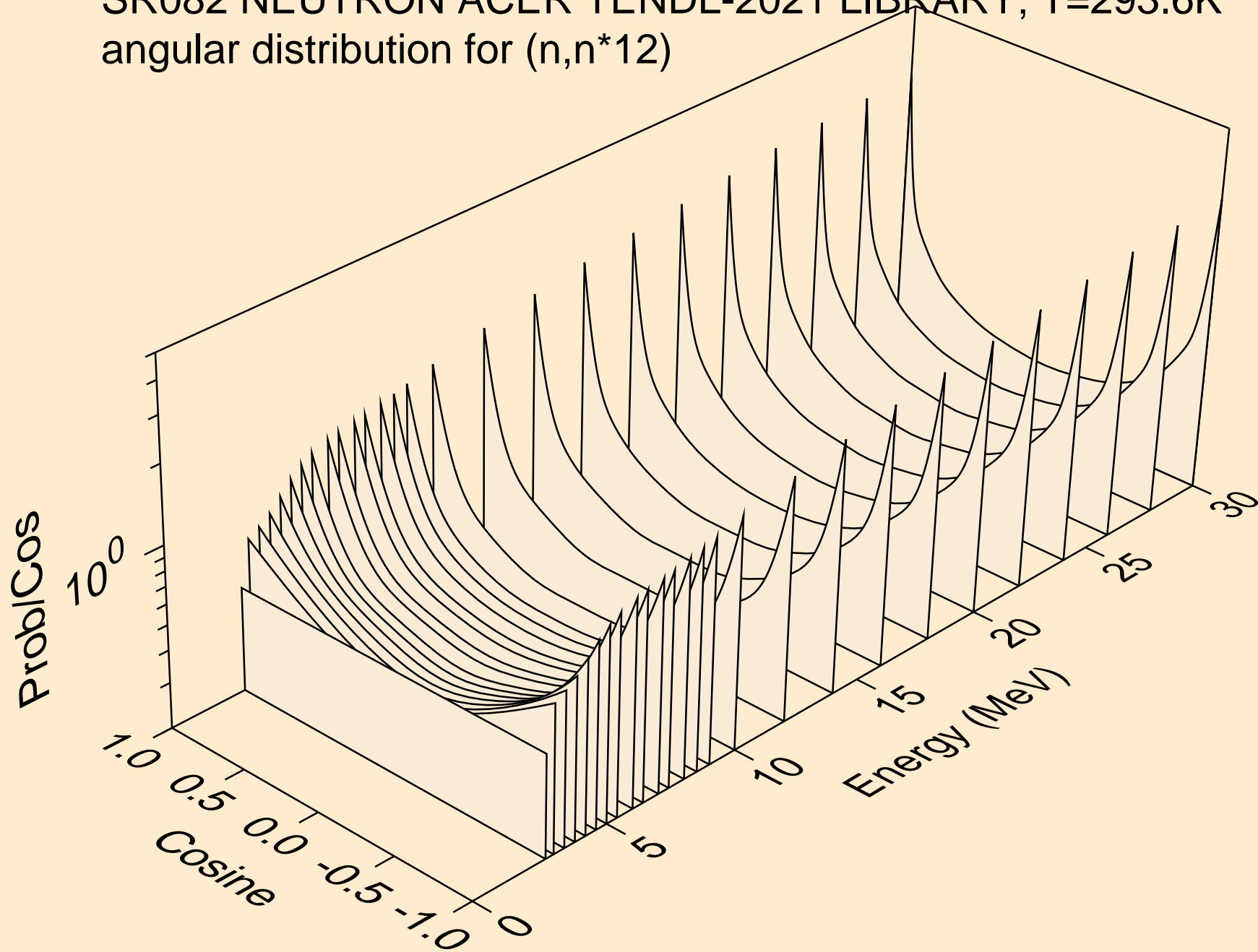

SR082 NEUTRON ACER TENDL-2021 LIBRARY; T=293.6K
angular distribution for (n,n*13)

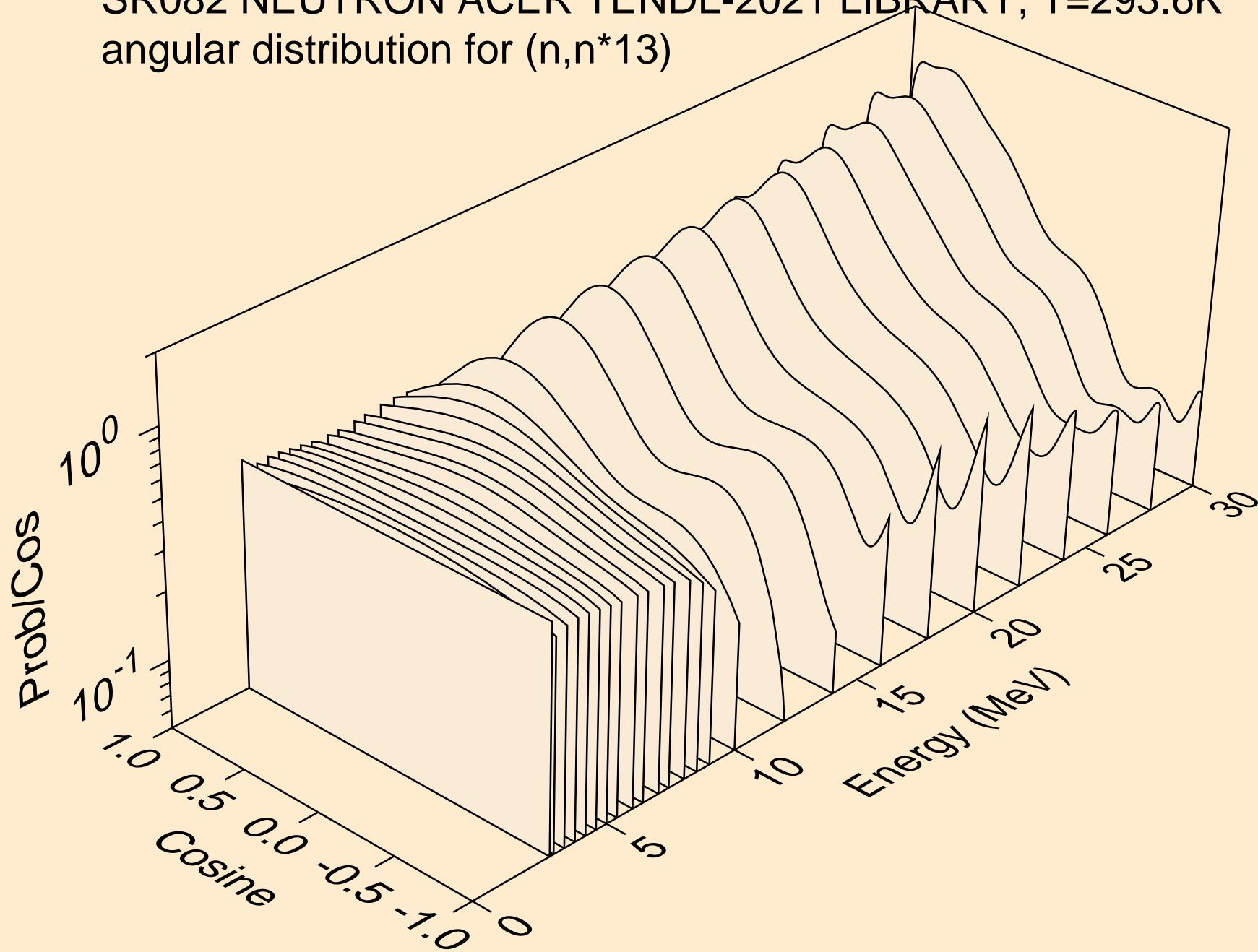

SR082 NEUTRON ACER TENDL-2021 LIBRARY; T=293.6K
angular distribution for (n,n*14)

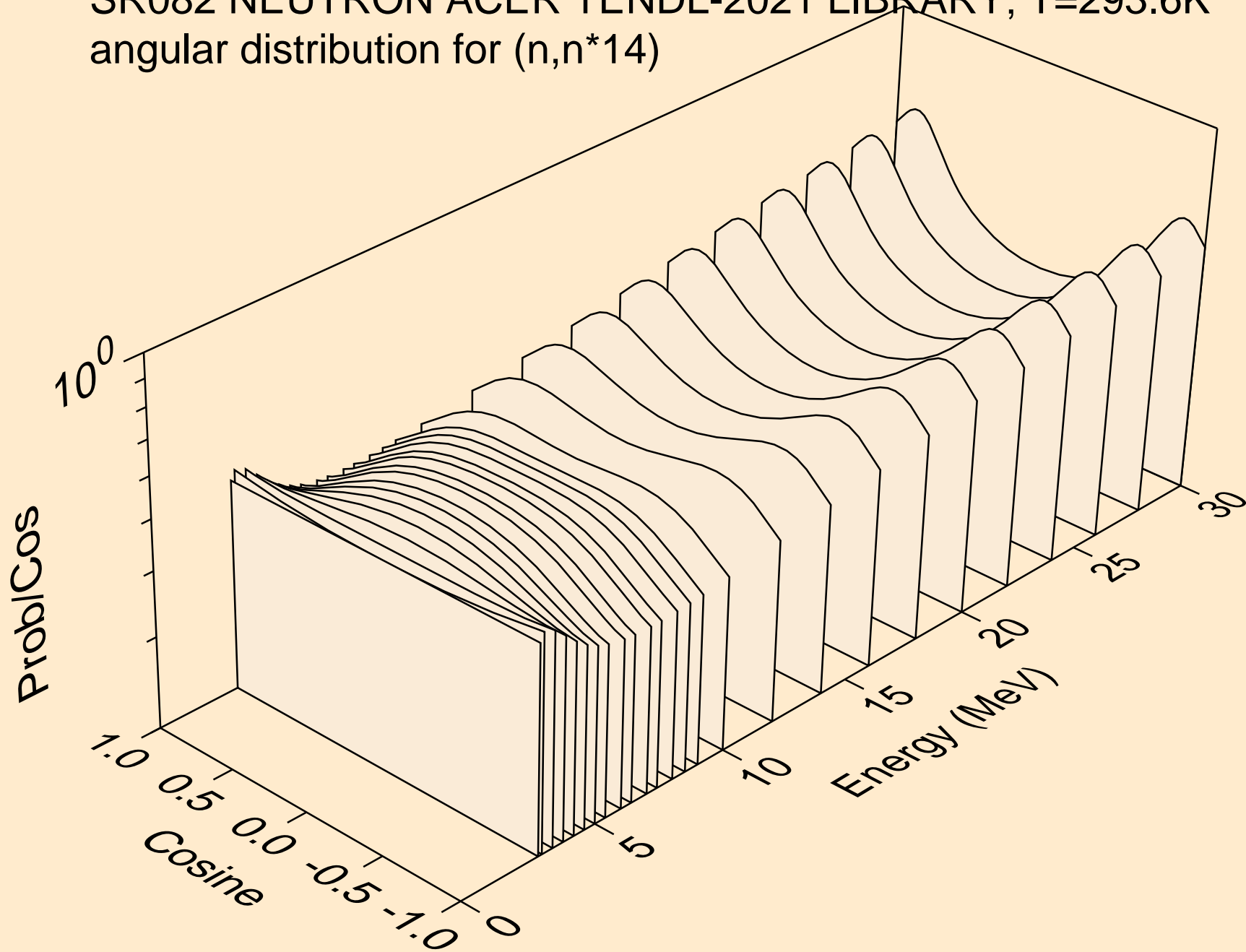

SR082 NEUTRON ACER TENDL-2021 LIBRARY; T=293.6K
angular distribution for (n,n*15)

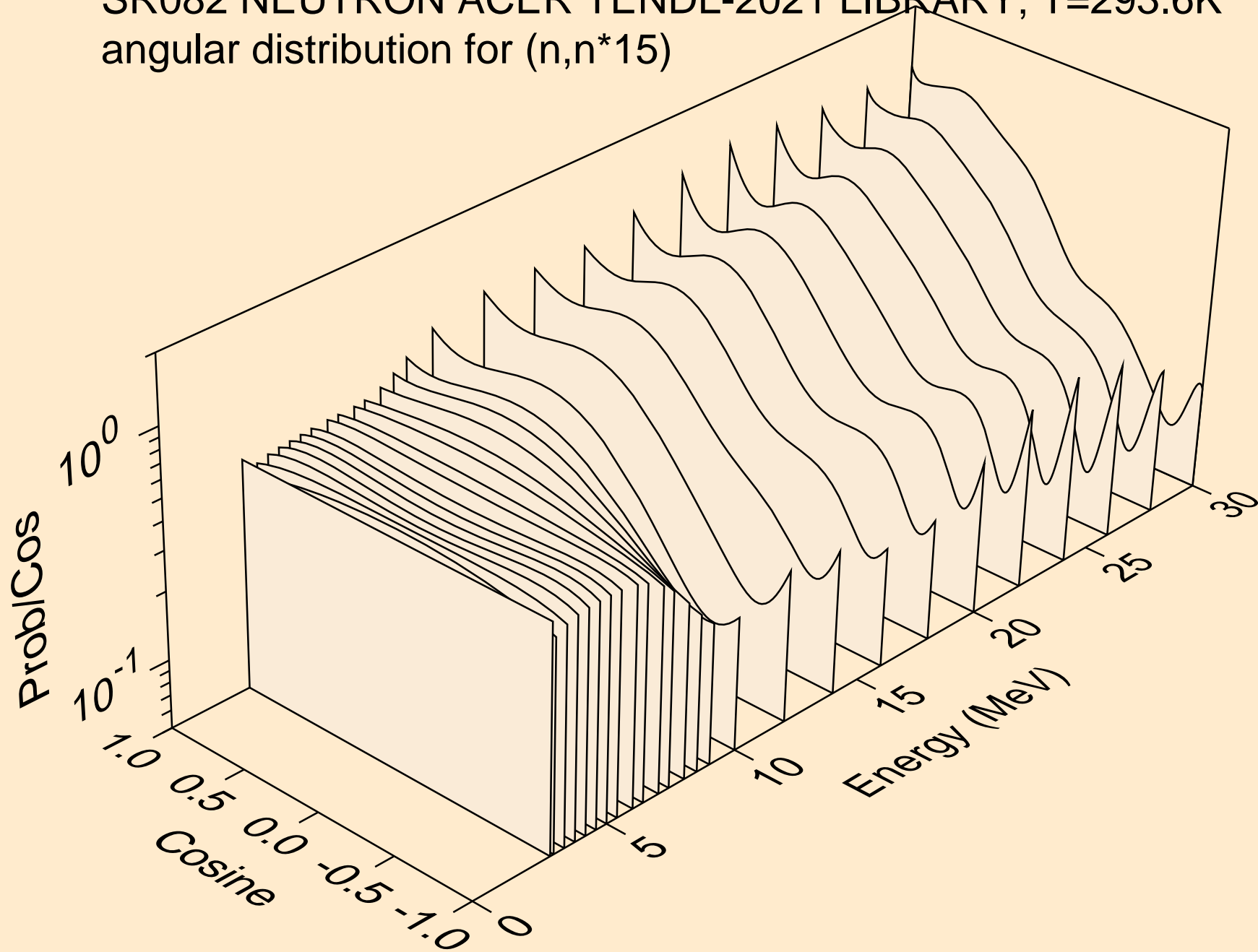

SR082 NEUTRON ACER TENDL-2021 LIBRARY; T=293.6K
angular distribution for (n,n*16)

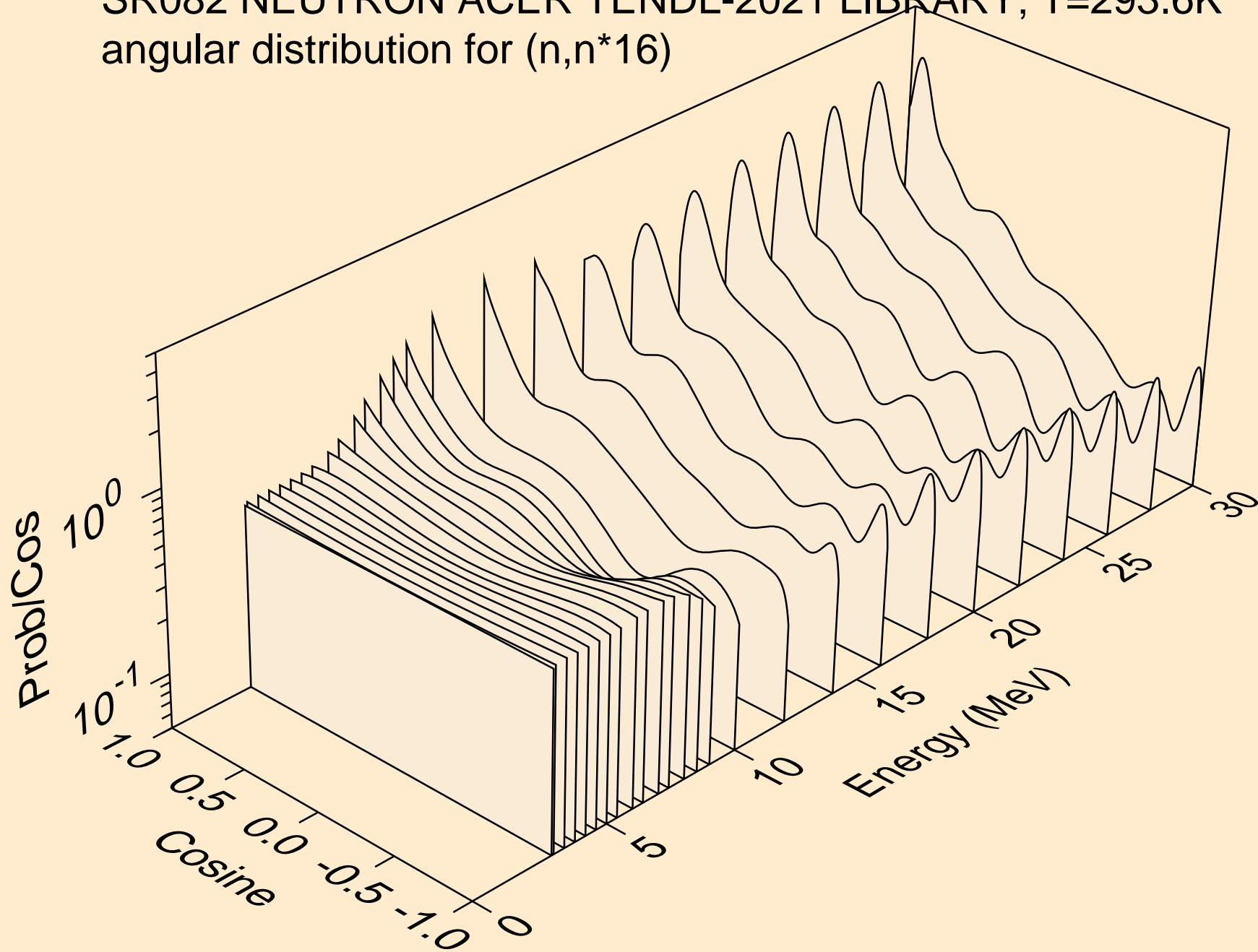

SR082 NEUTRON ACER TENDL-2021 LIBRARY; T=293.6K
angular distribution for (n,n*17)

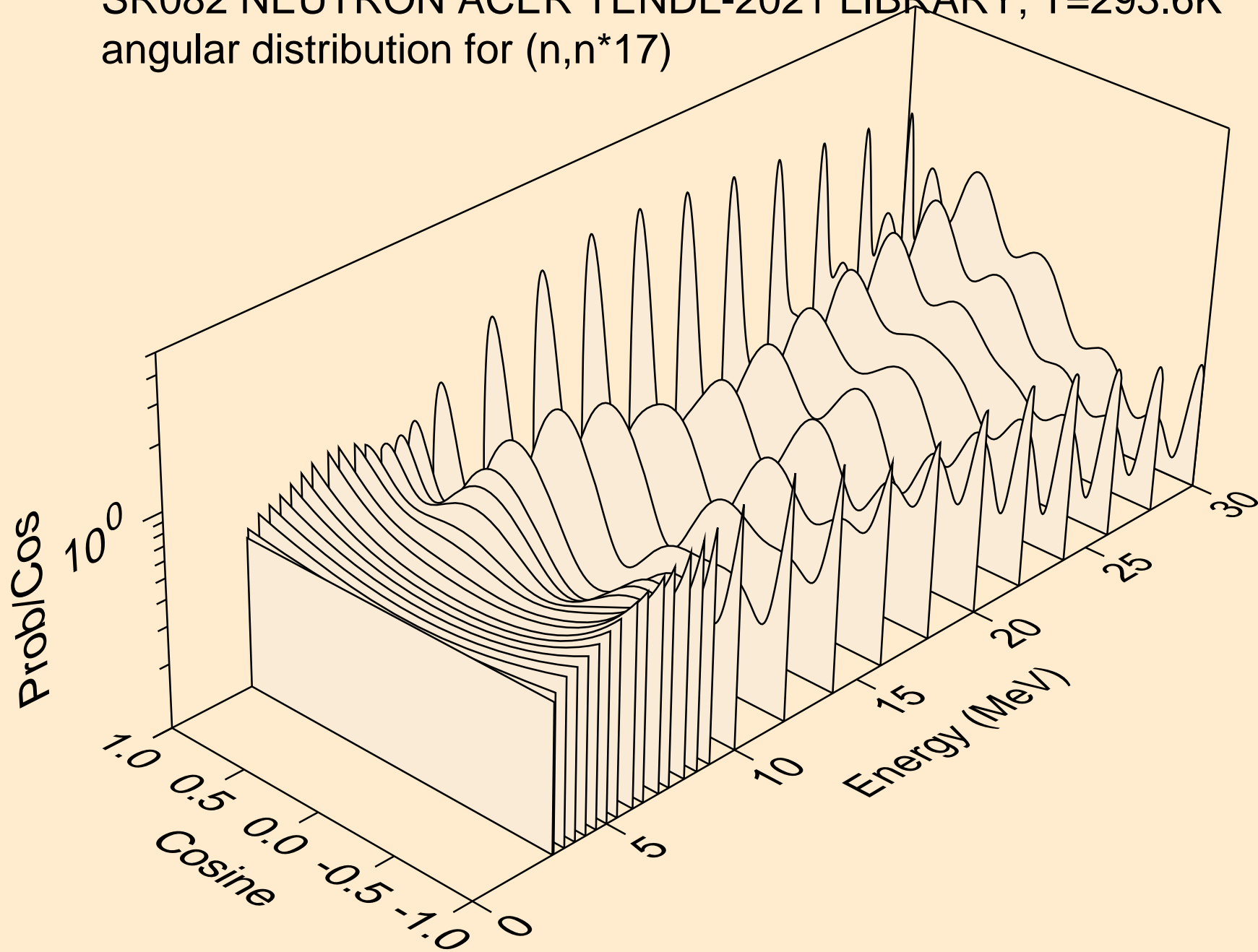

SR082 NEUTRON ACER TENDL-2021 LIBRARY; T=293.6K
angular distribution for (n,n*18)

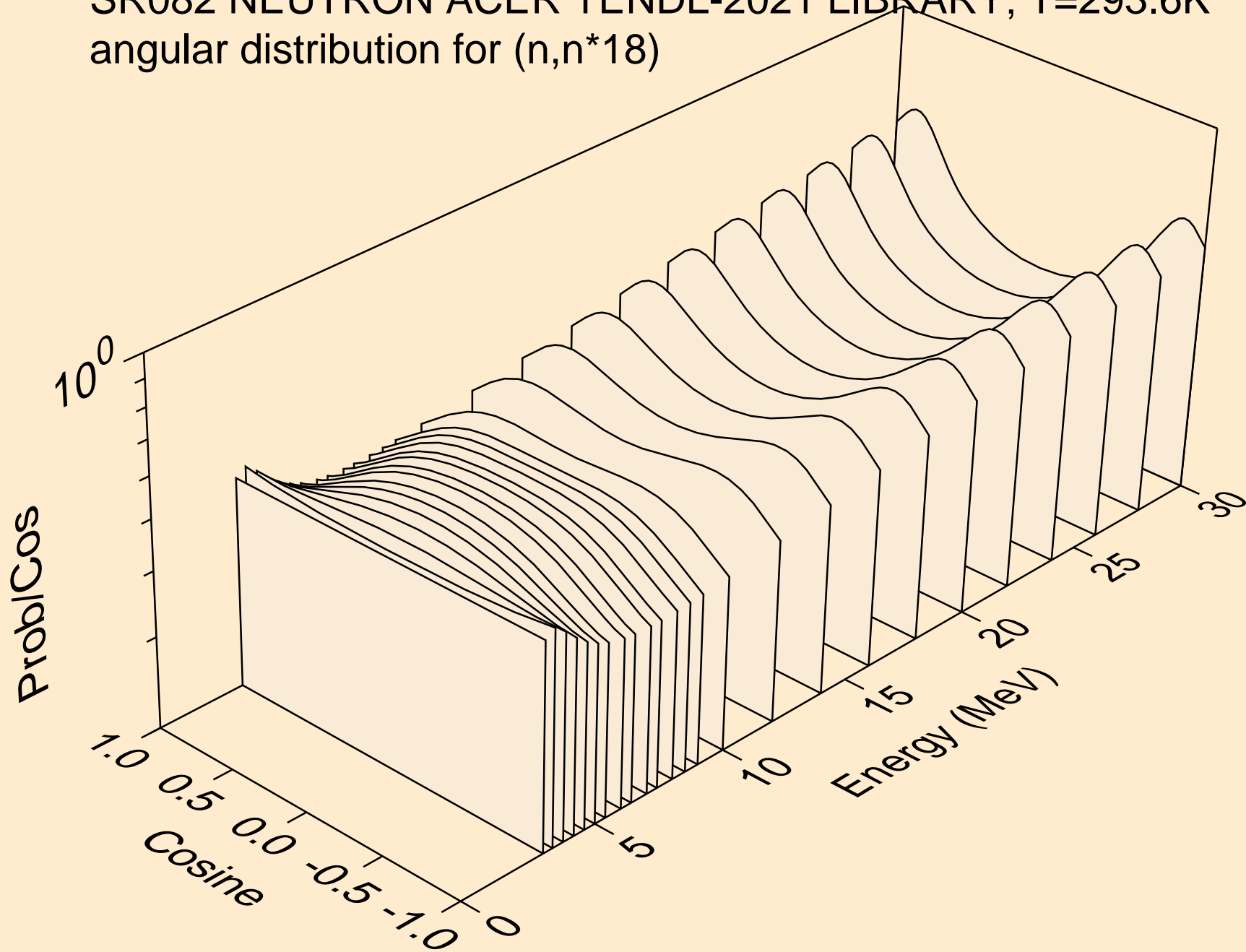

SR082 NEUTRON ACER TENDL-2021 LIBRARY; T=293.6K
angular distribution for (n,n*19)

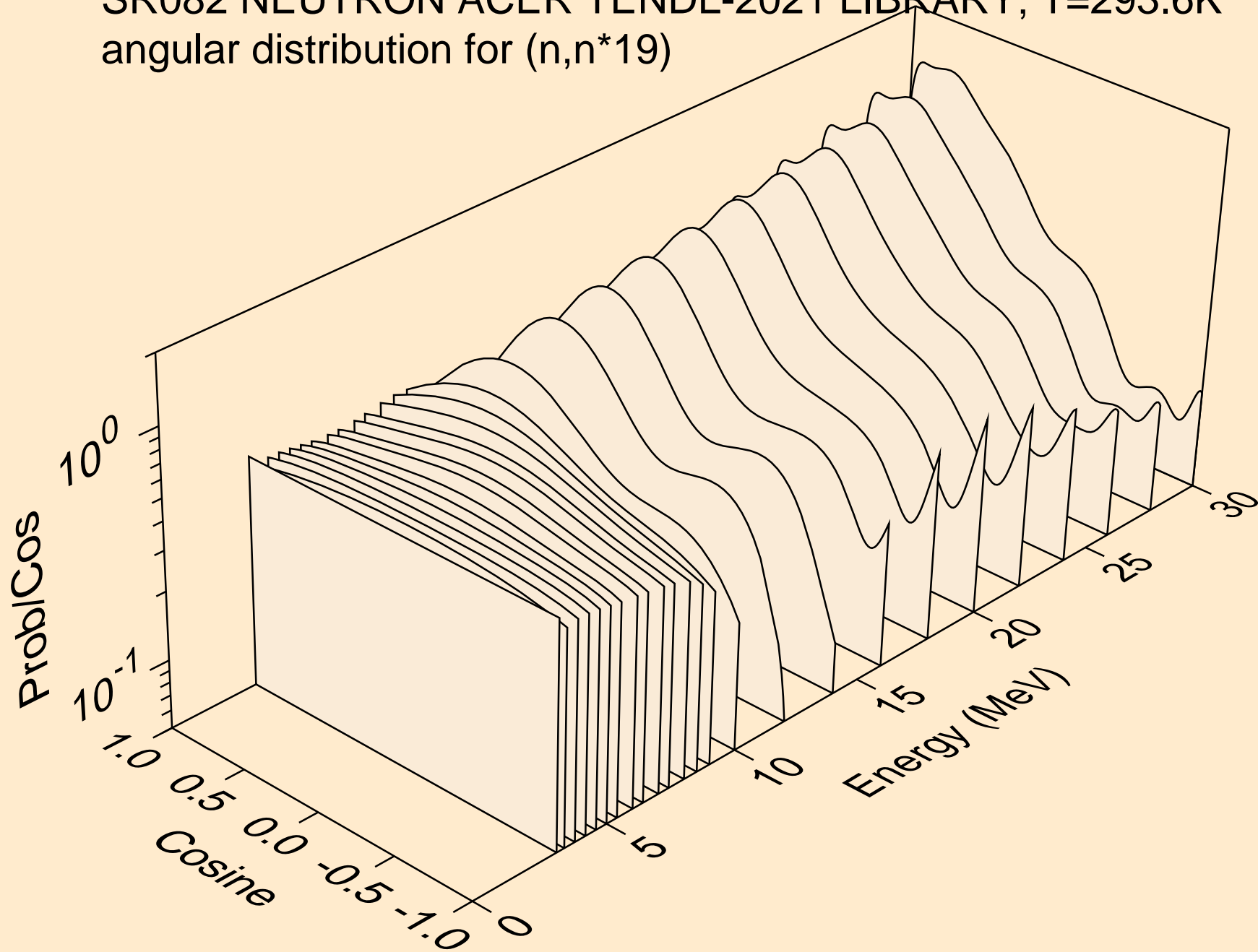

SR082 NEUTRON ACER TENDL-2021 LIBRARY; T=293.6K
Neutron emission for (n,x)

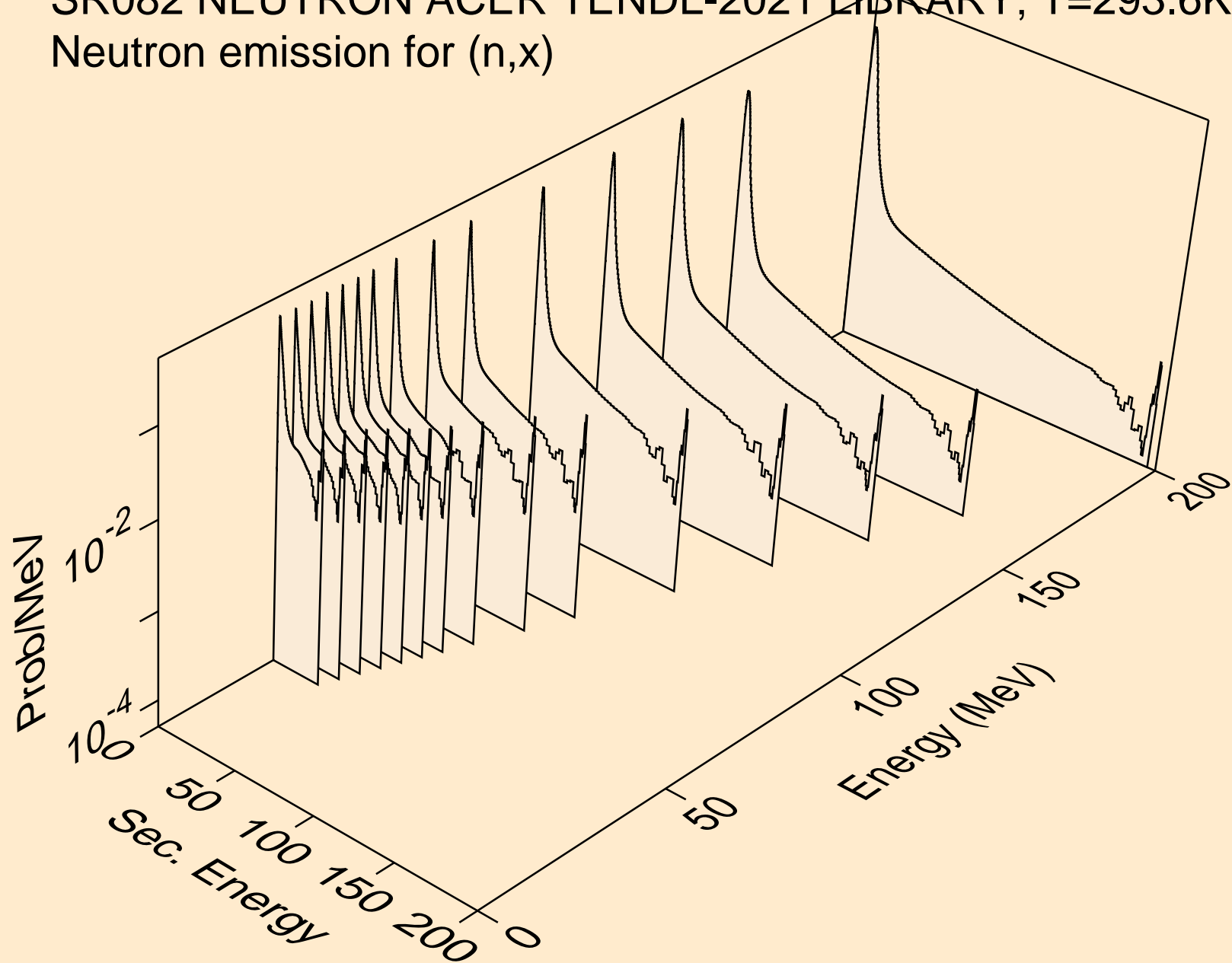

SR082 NEUTRON ACER TENDL-2021 LIBRARY; T=293.6K
Neutron emission for (n,2nd)

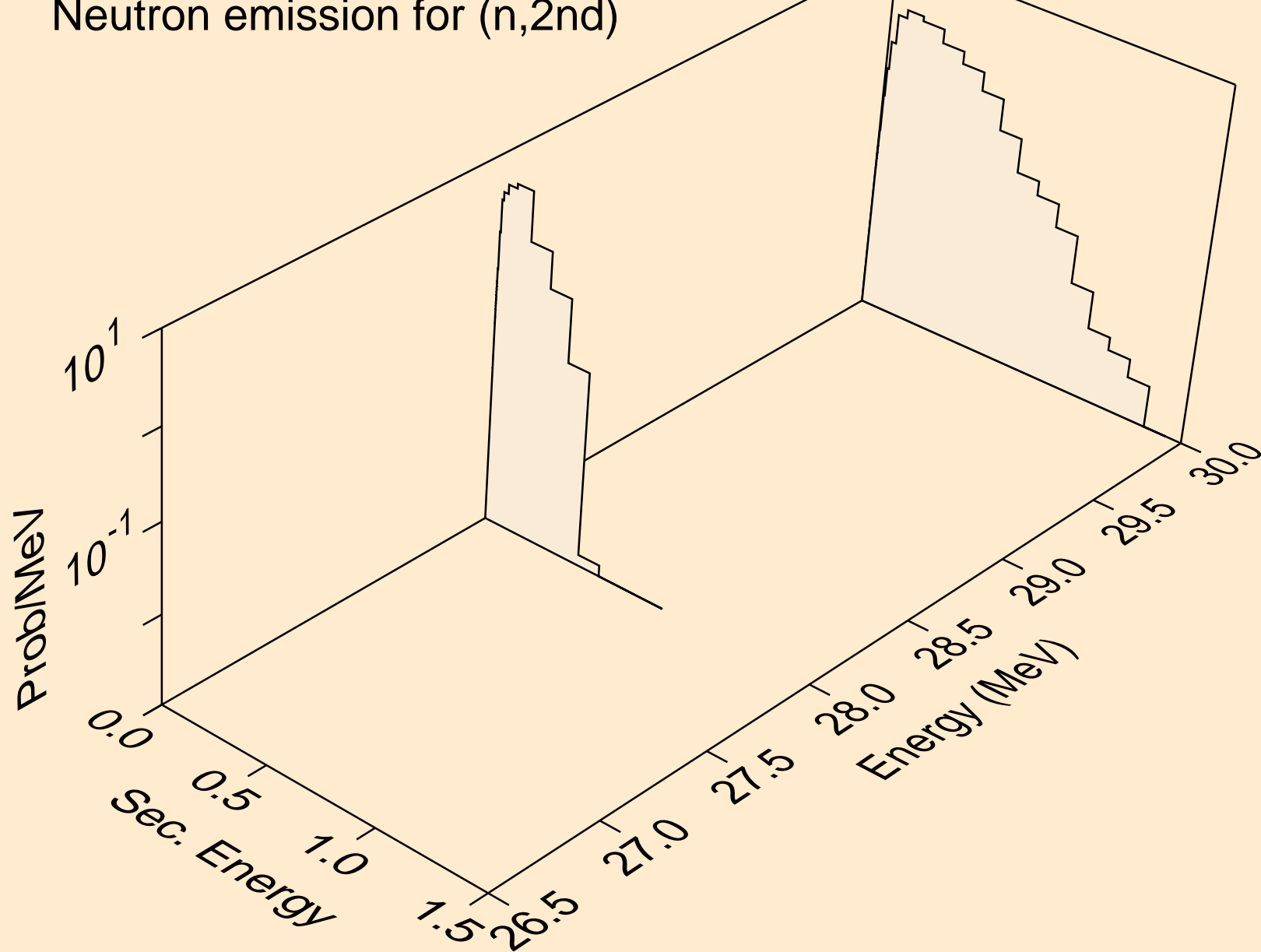

SR082 NEUTRON ACER TENDL-2021 LIBRARY; T=293.6K
Neutron emission for (n,2n)

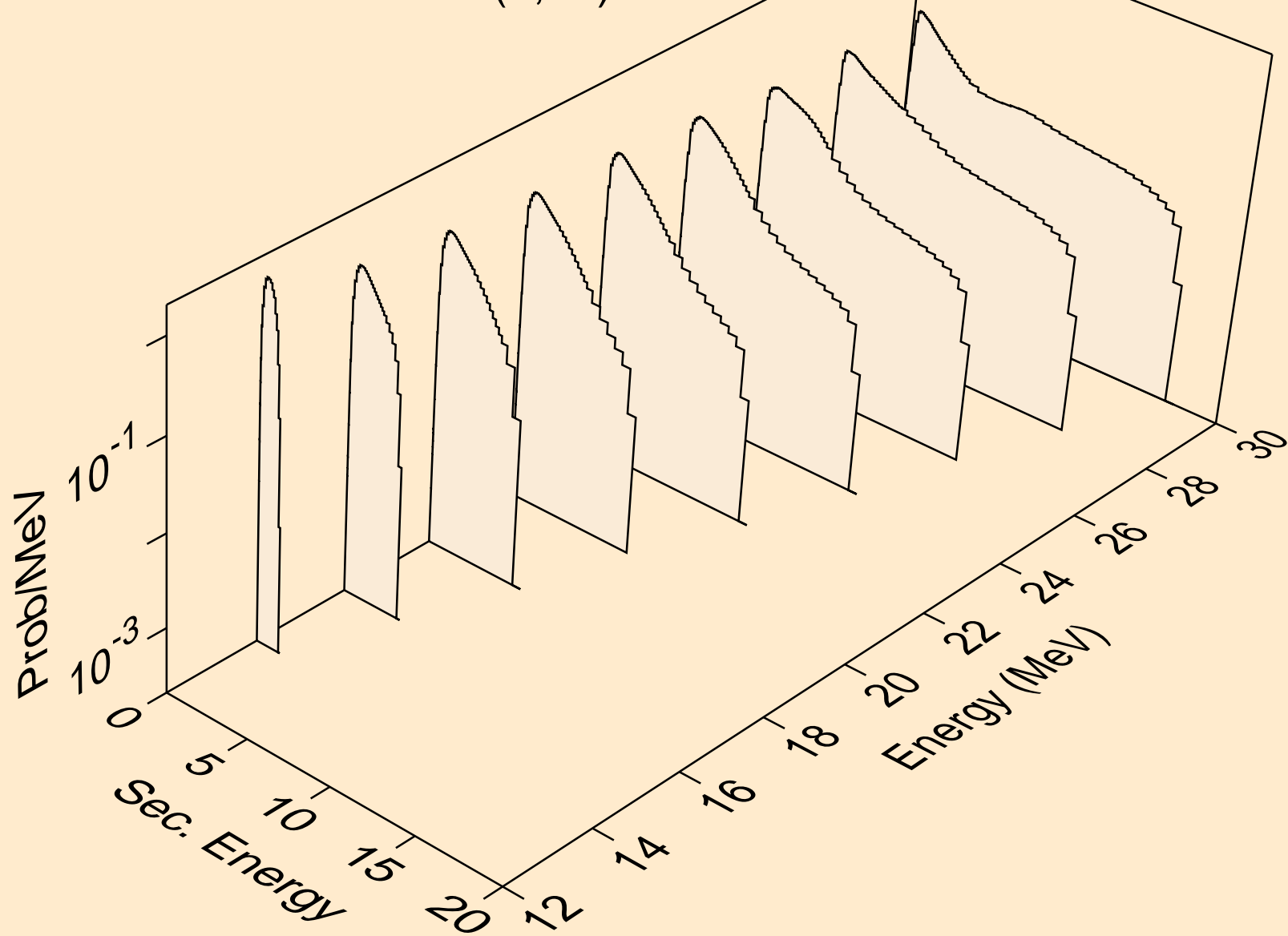

SR082 NEUTRON ACER TENDL-2021 LIBRARY; T=293.6K
Neutron emission for (n,3n)

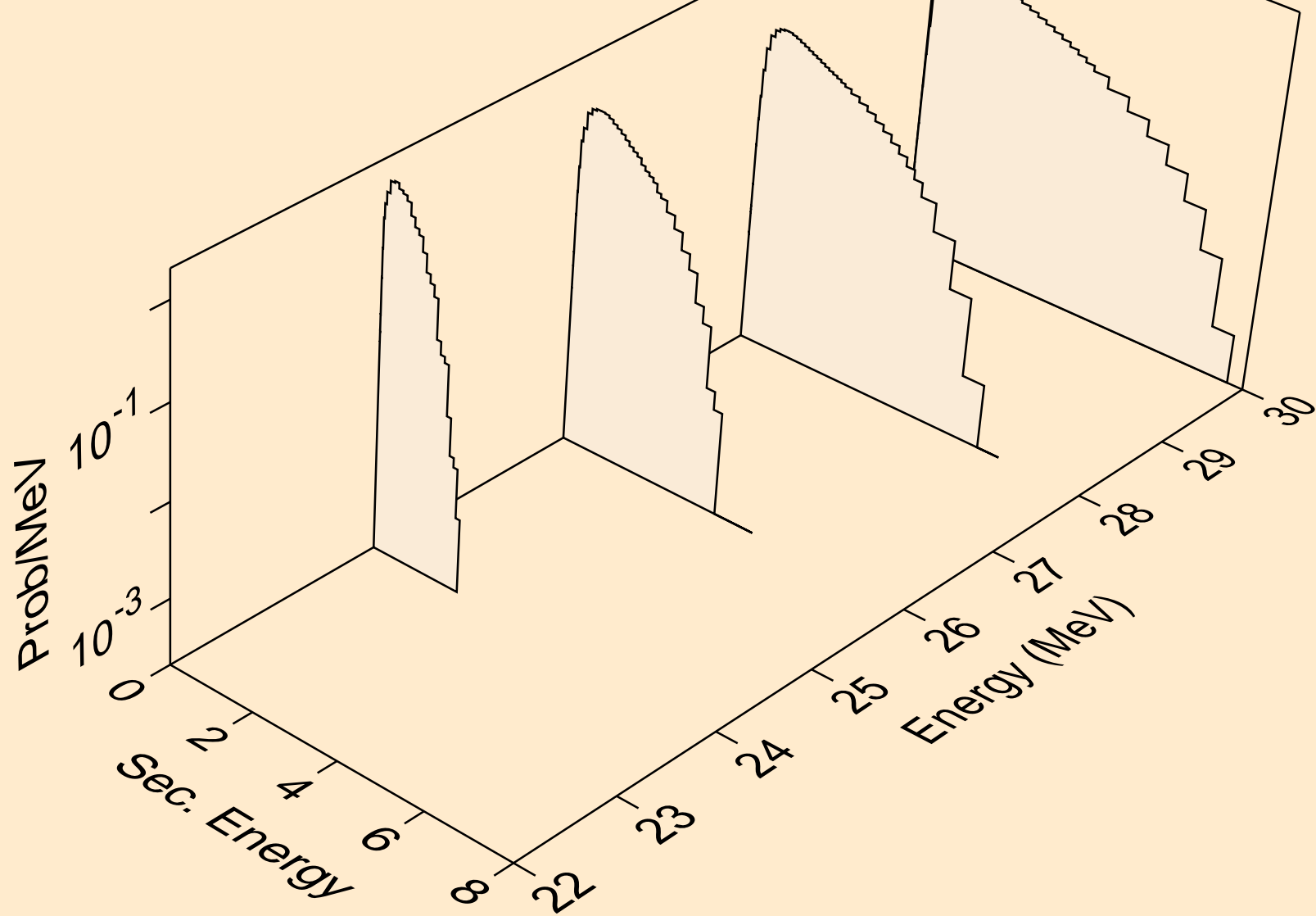

SR082 NEUTRON ACER TENDL-2021 LIBRARY; T=293.6K
Neutron emission for (n,n*)a

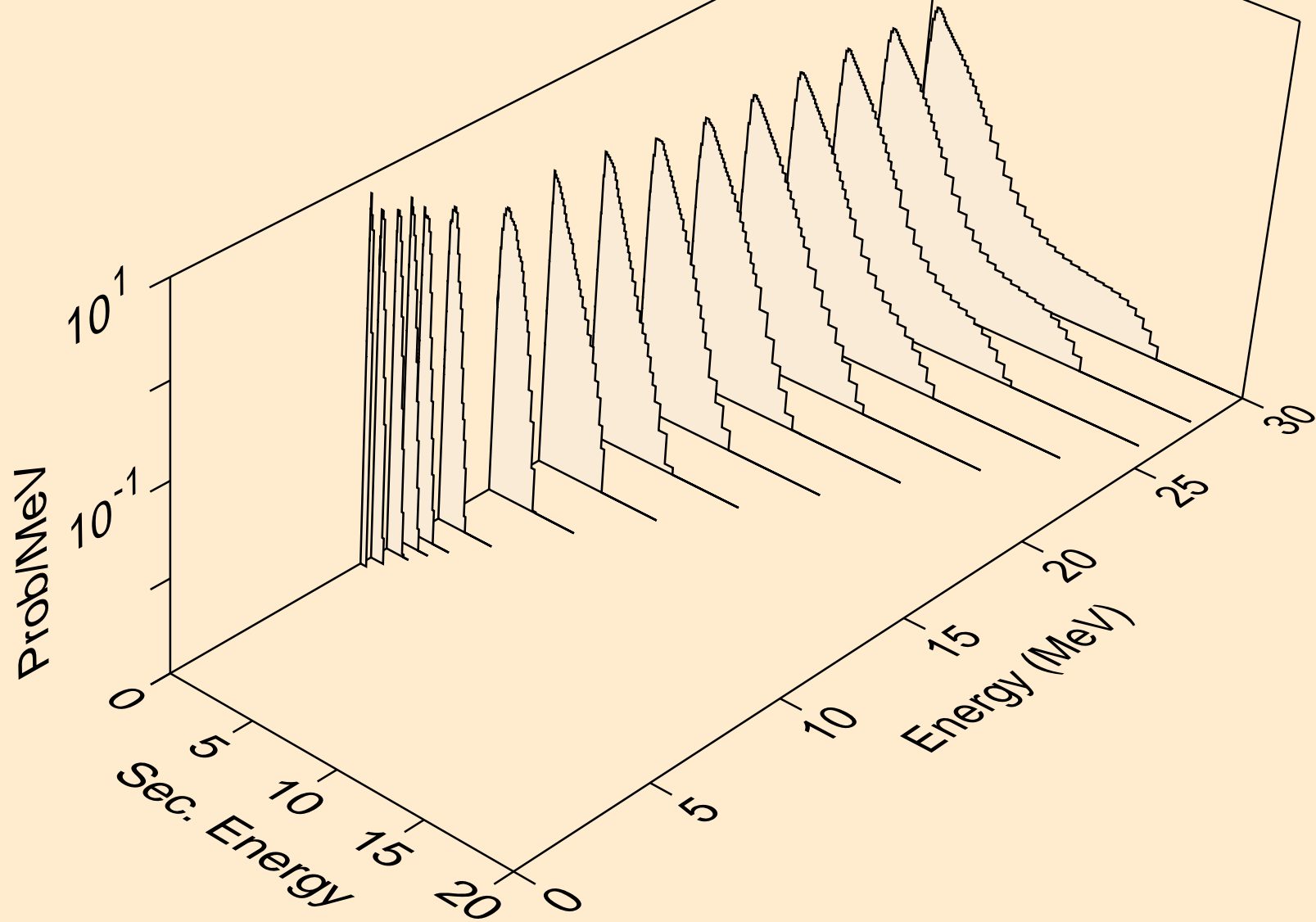

SR082 NEUTRON ACER TENDL-2021 LIBRARY; T=293.6K
Neutron emission for (n,2n)a

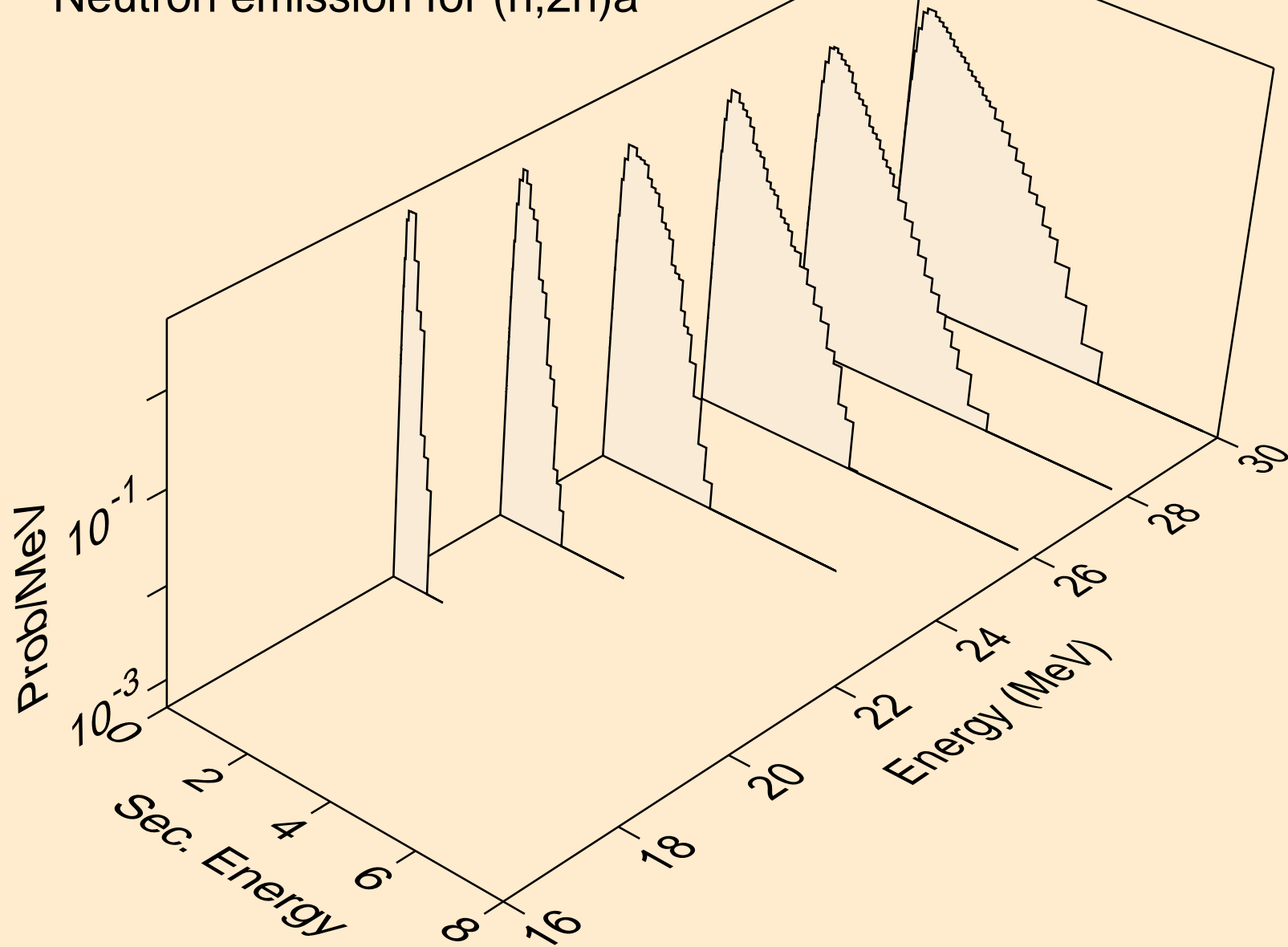

SR082 NEUTRON ACER TENDL-2021 LIBRARY; T=293.6K
Neutron emission for (n,n*)p

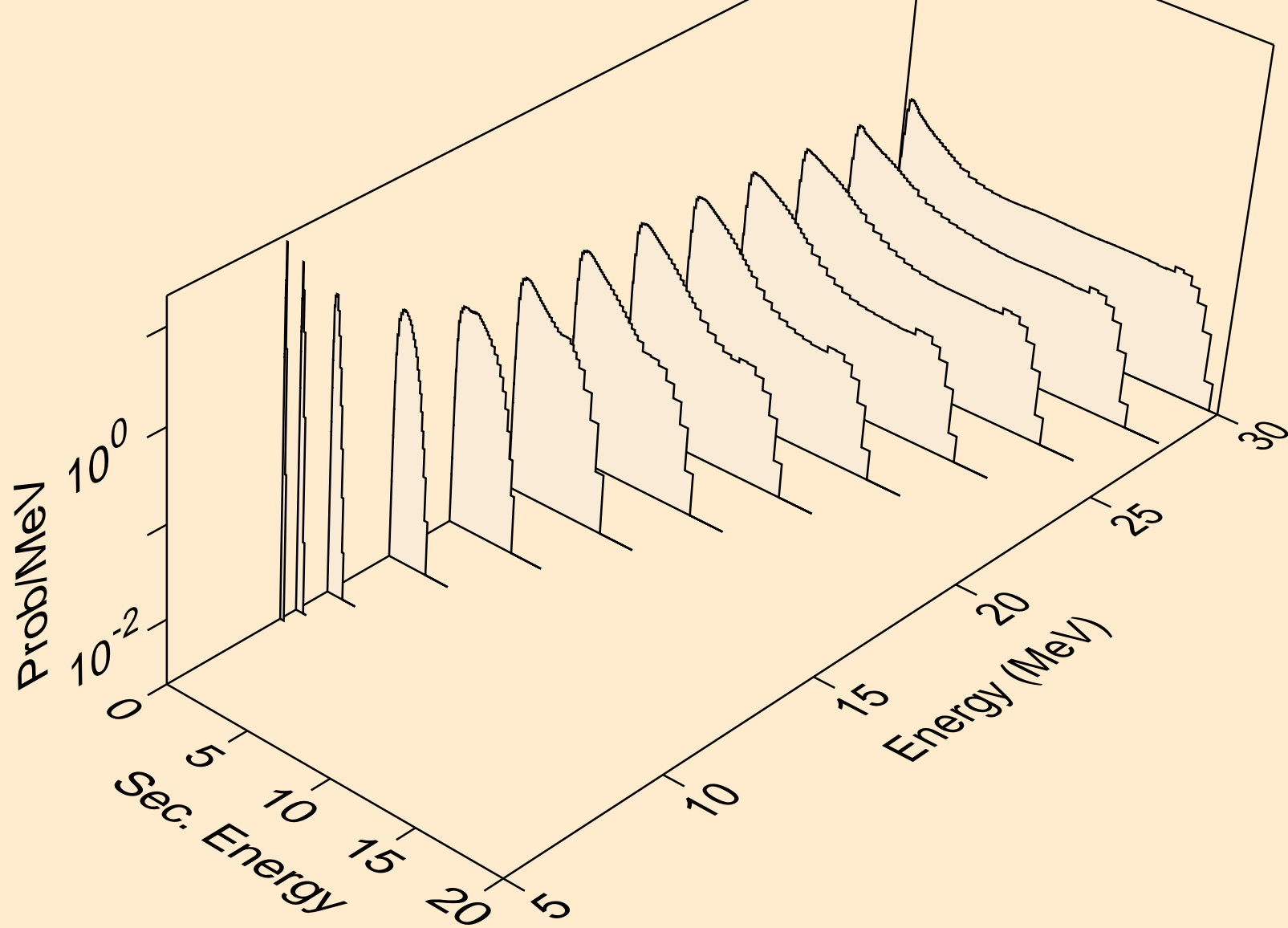

SR082 NEUTRON ACER TENDL-2021 LIBRARY; T=293.6K
Neutron emission for (n,n*)2a

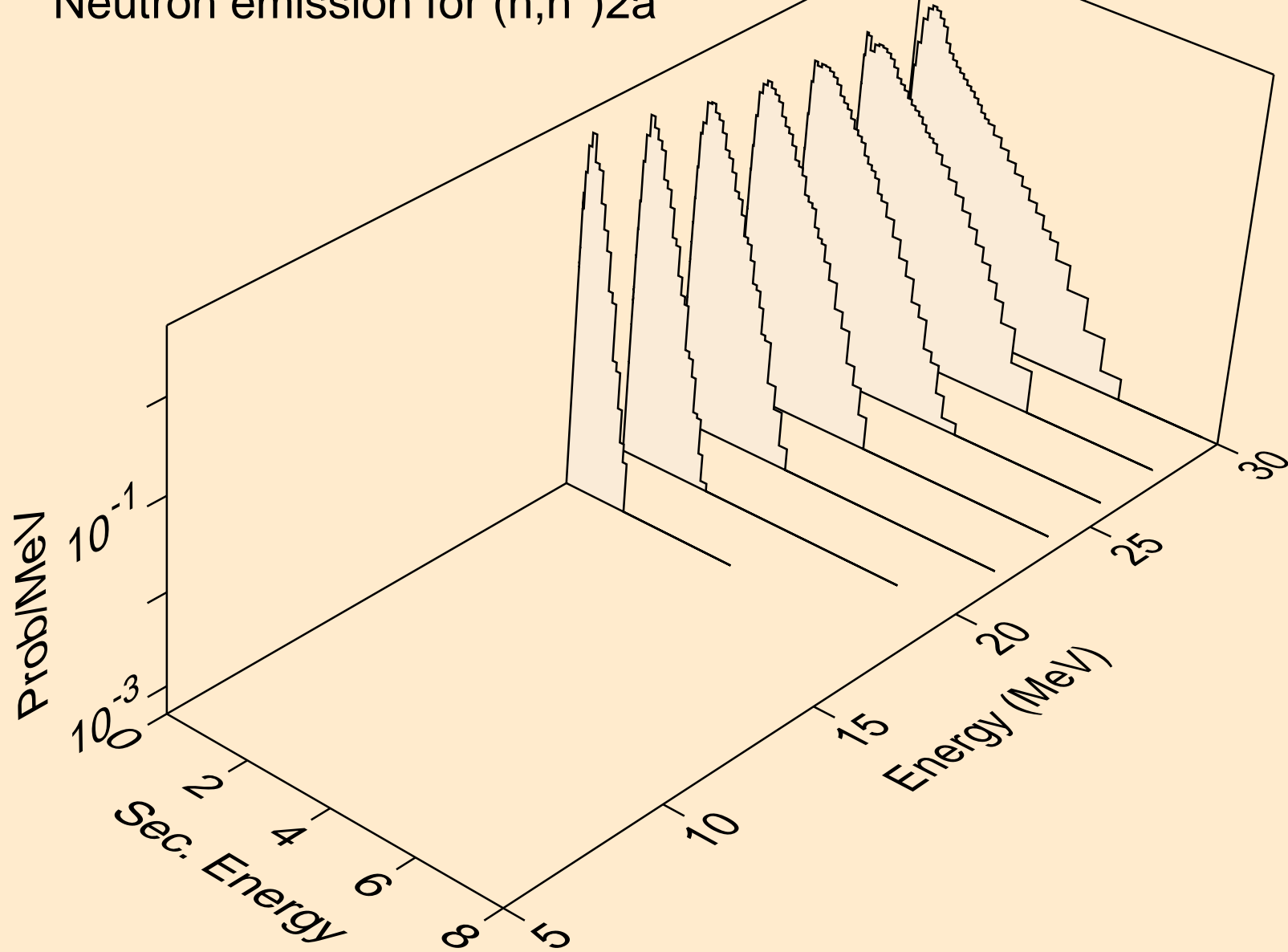

SR082 NEUTRON ACER TENDL-2021 LIBRARY; T=293.6K
Neutron emission for (n,n*)d

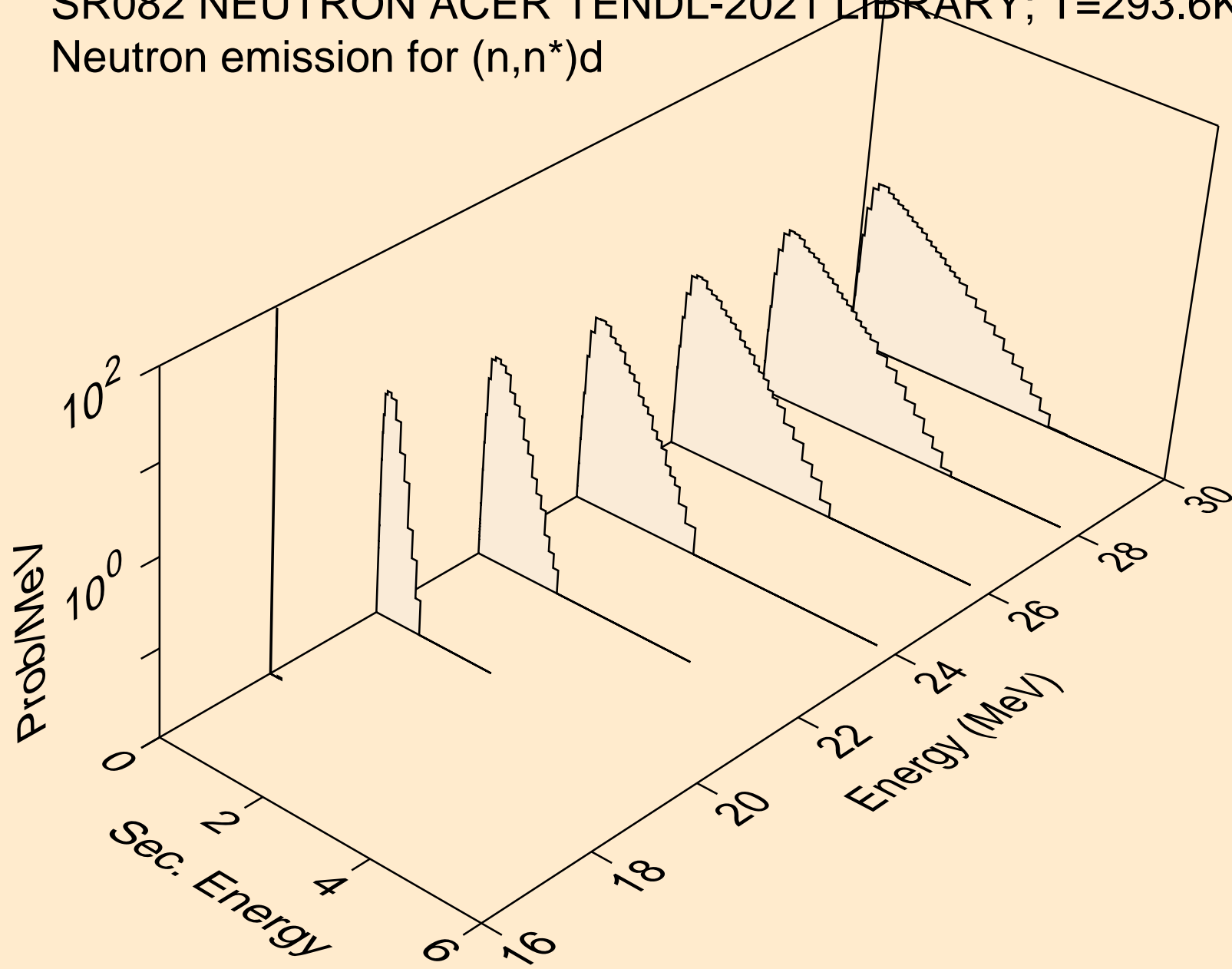

SR082 NEUTRON ACER TENDL-2021 LIBRARY; T=293.6K
Neutron emission for (n,n*)t

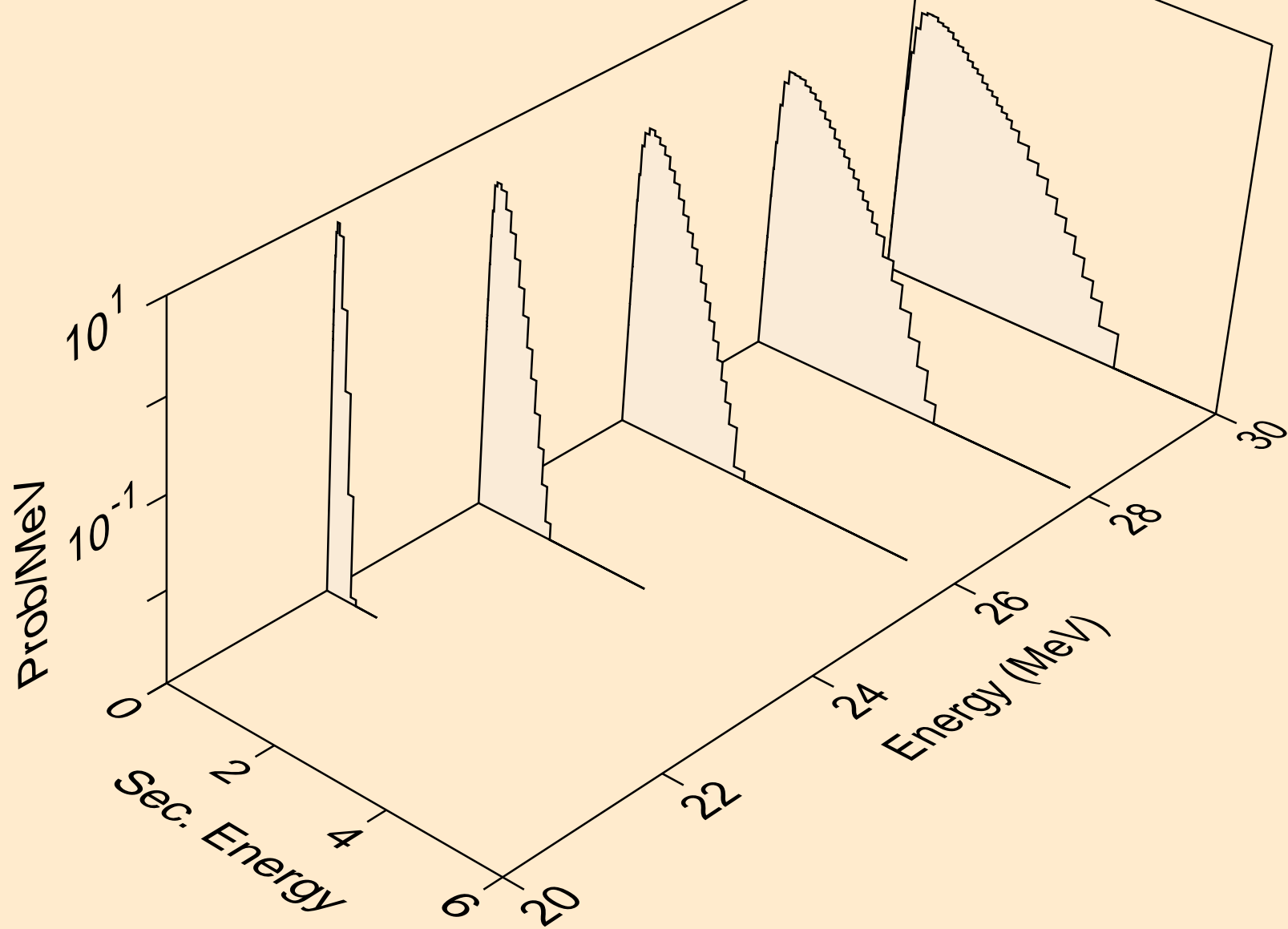

SR082 NEUTRON ACER TENDL-2021 LIBRARY; T=293.6K
Neutron emission for (n,n*)he3

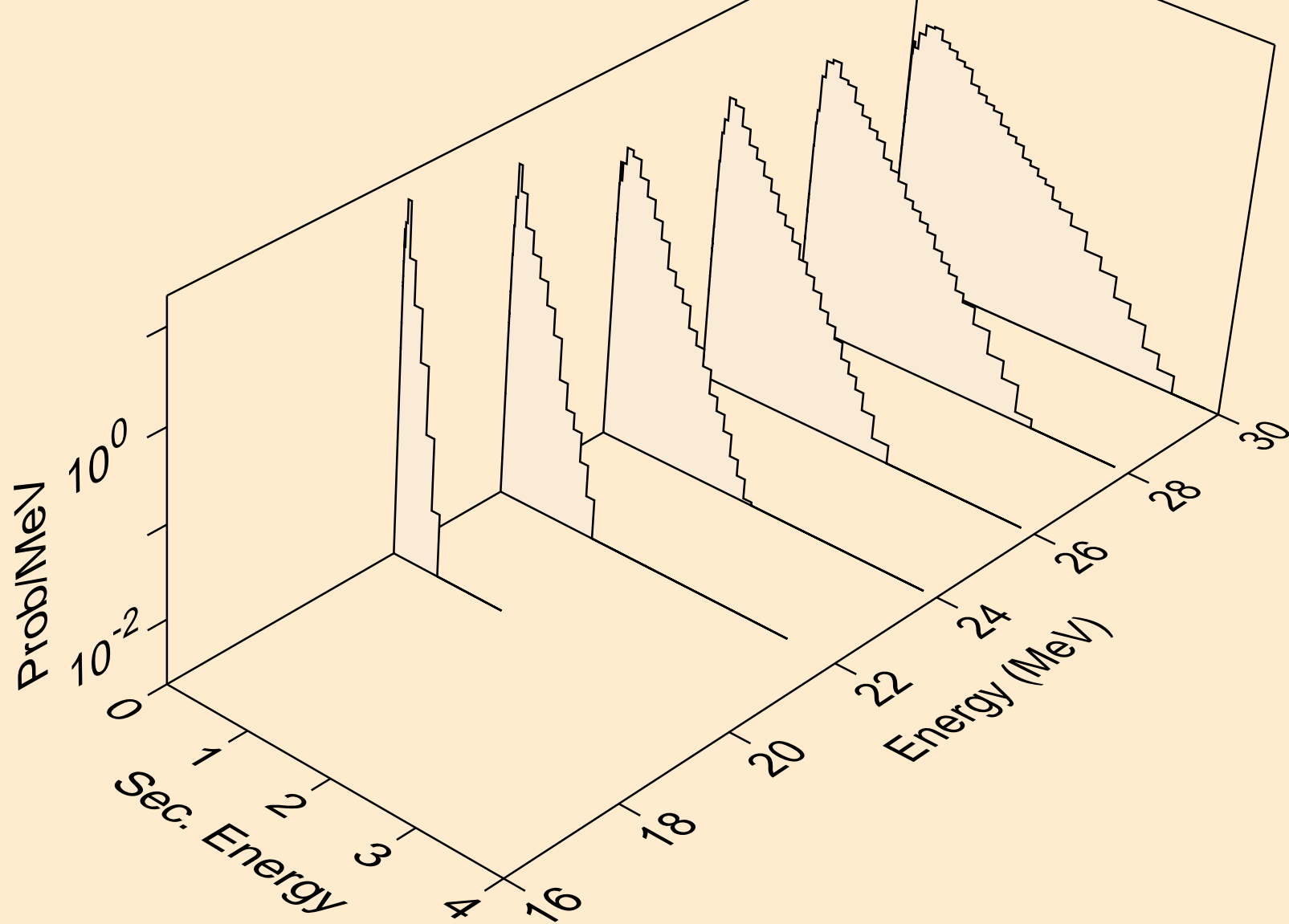

SR082 NEUTRON ACER TENDL-2021 LIBRARY; T=293.6K
Neutron emission for (n,2np)

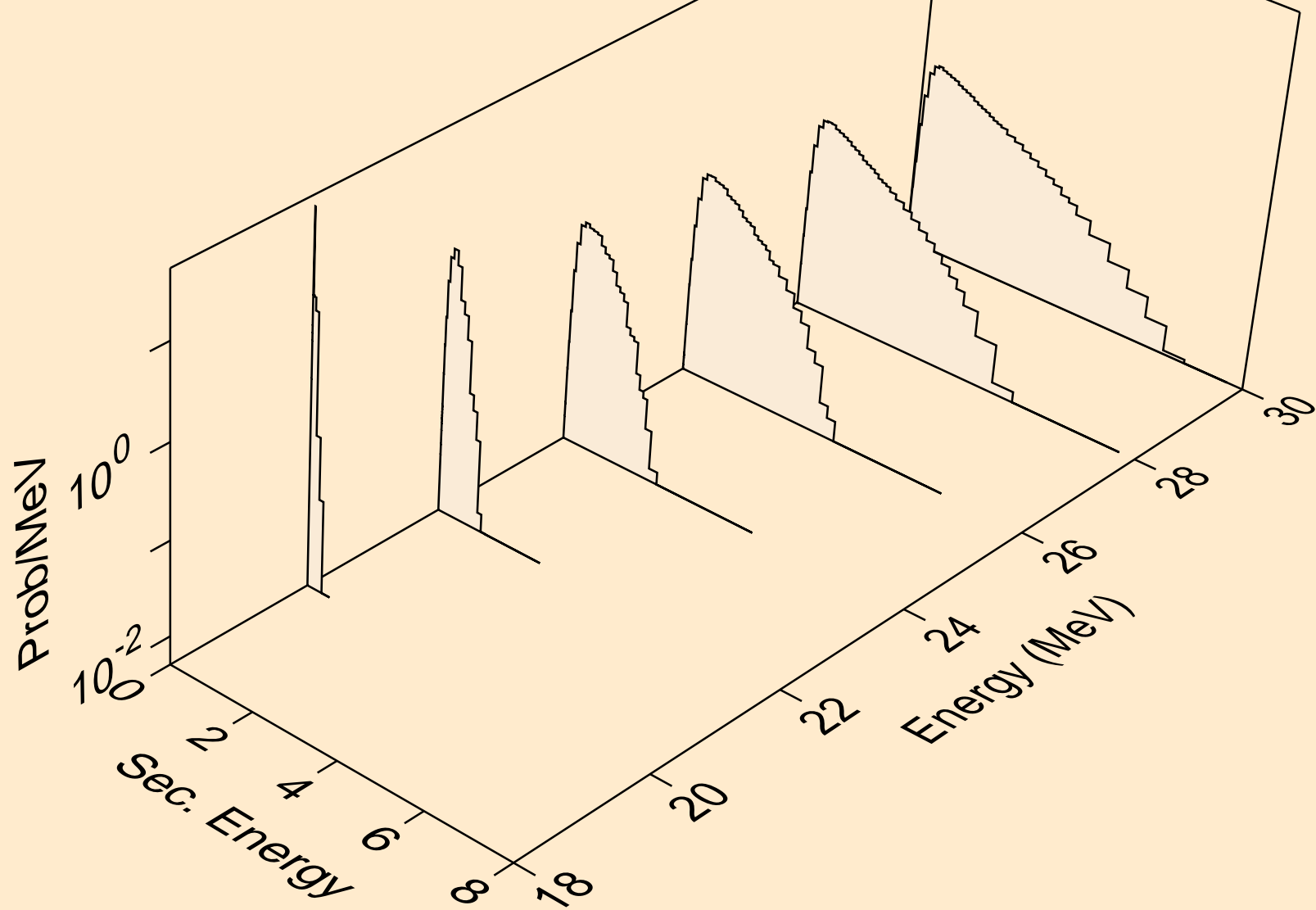

SR082 NEUTRON ACER TENDL-2021 LIBRARY; T=293.6K
Neutron emission for (n,2np)

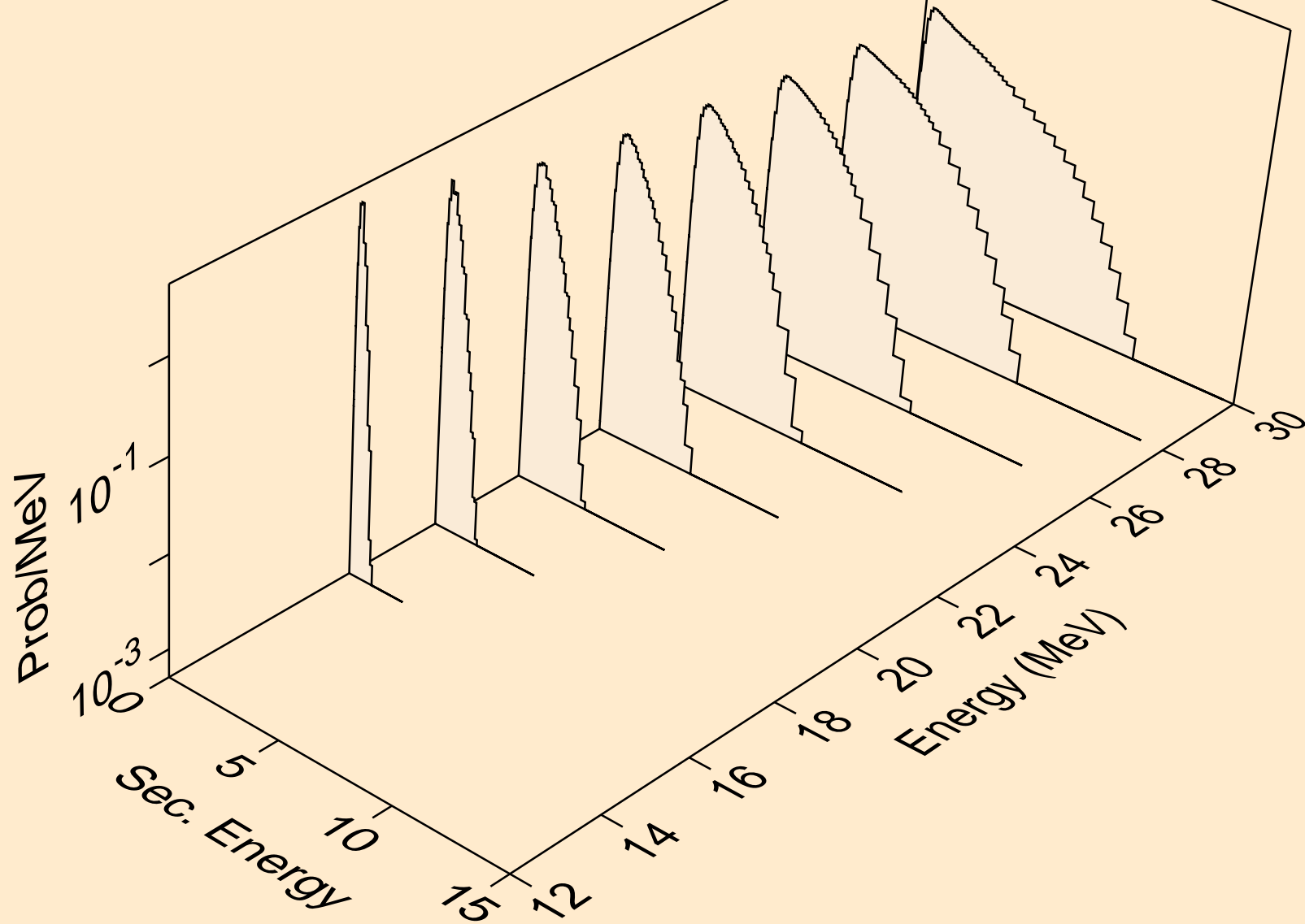

SR082 NEUTRON ACER TENDL-2021 LIBRARY; T=293.6K
Neutron emission for (n,npa)

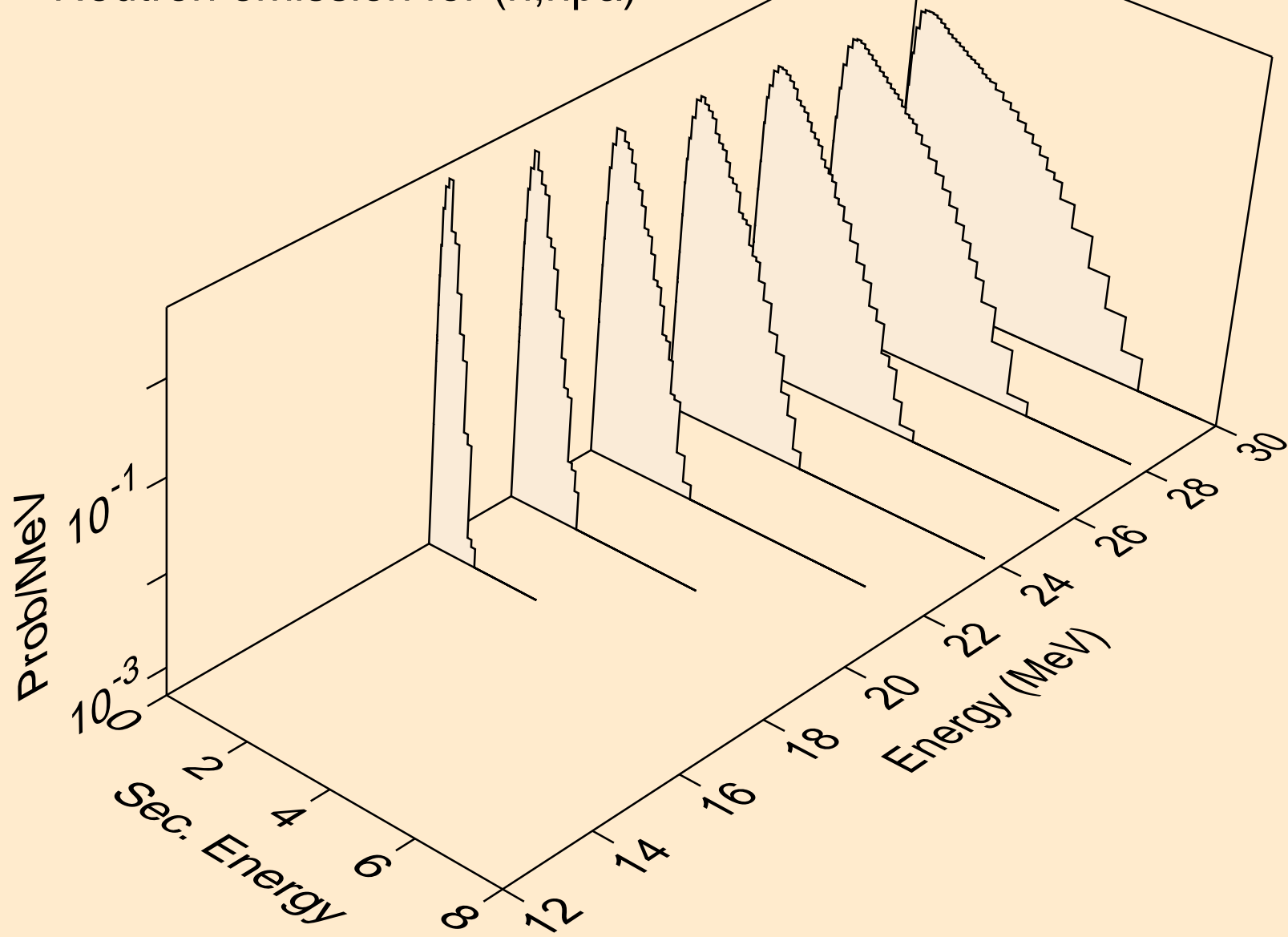

SR082 NEUTRON ACER TENDL-2021 LIBRARY; T=293.6K
Neutron emission for (n,n*c)

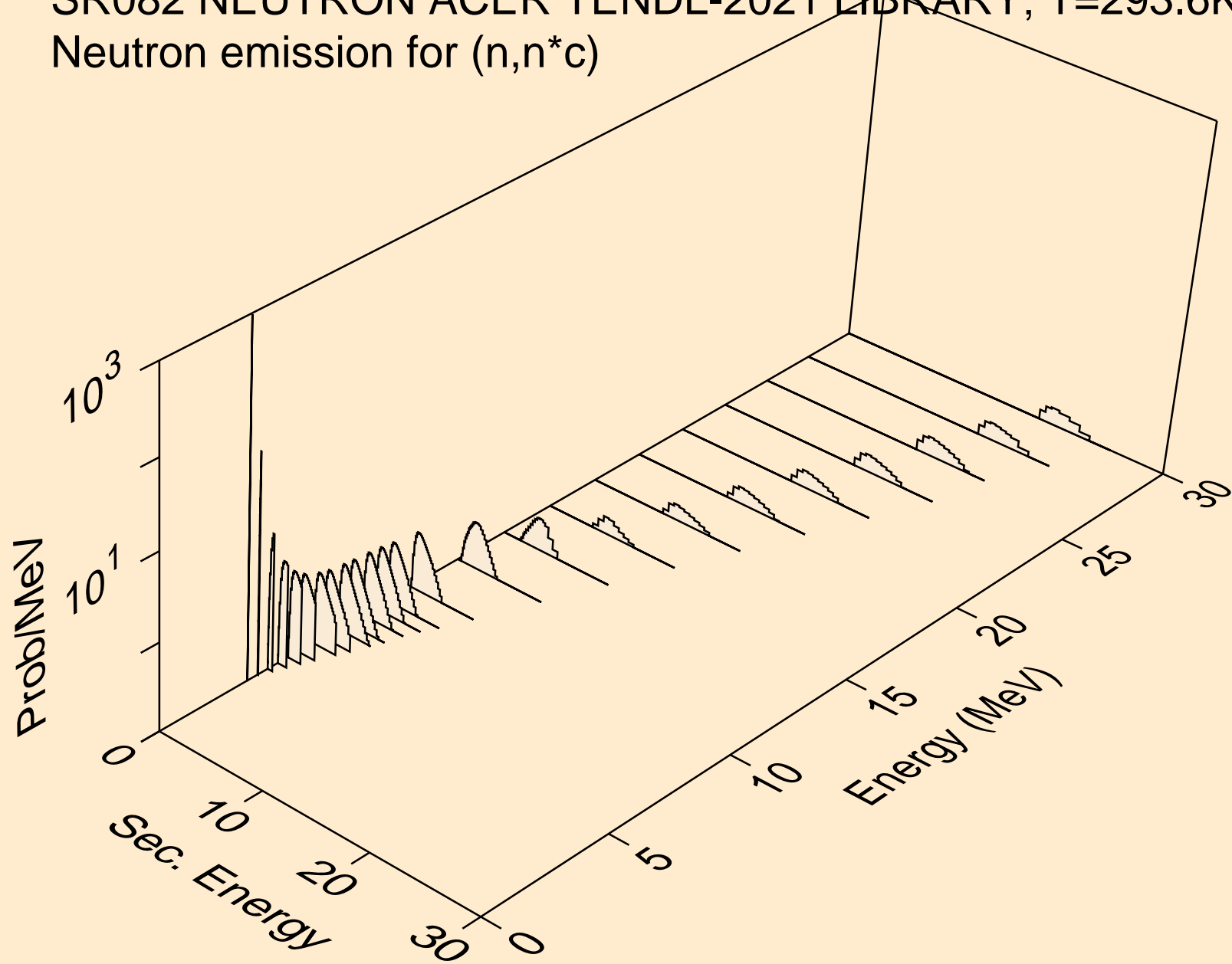

SR082 NEUTRON ACER TENDL-2021 LIBRARY; T=293.6K
Photon emission for (n,x)

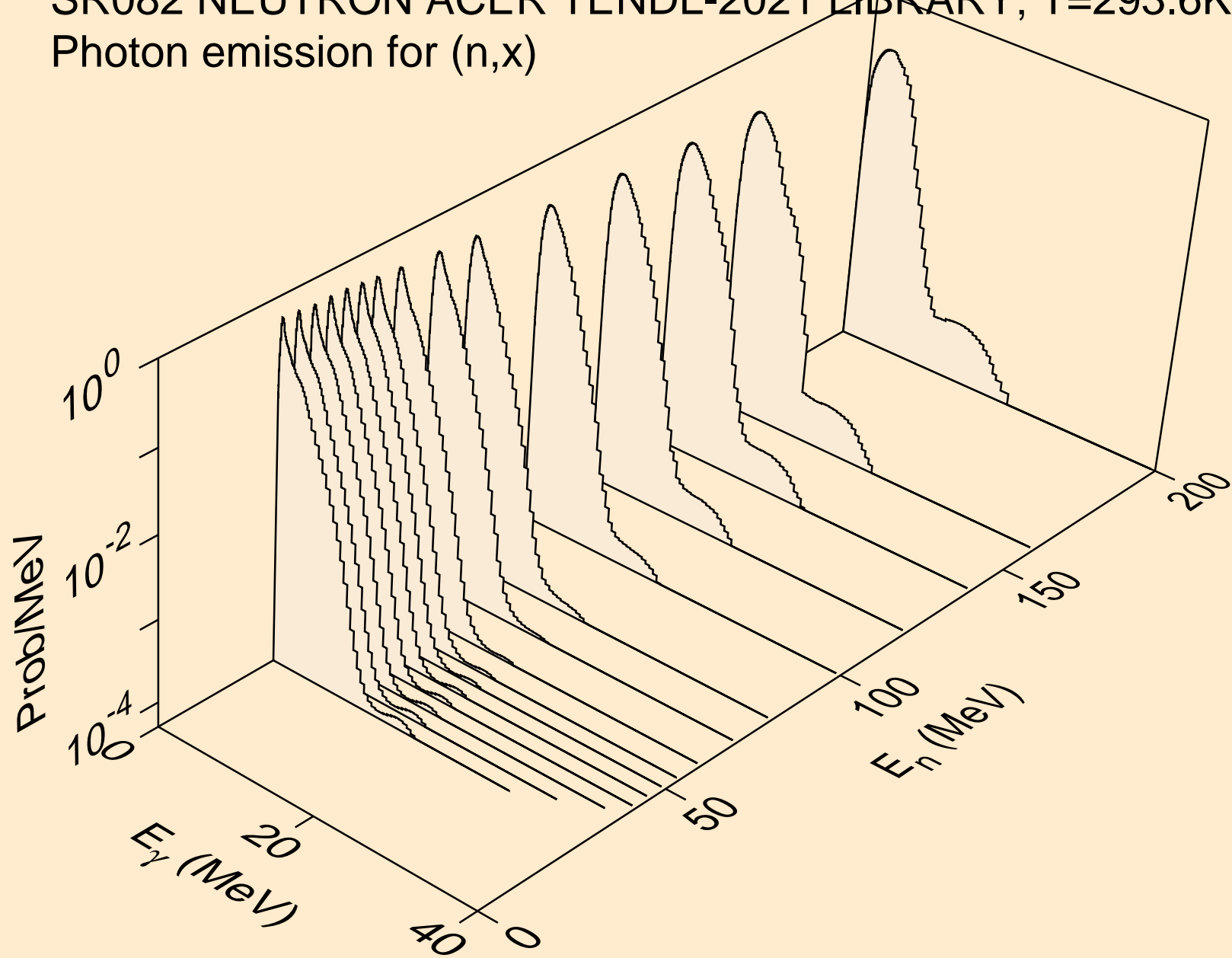

SR082 NEUTRON ACER TENDL-2021 LIBRARY; T=293.6K
Photon emission for (n,2nd)

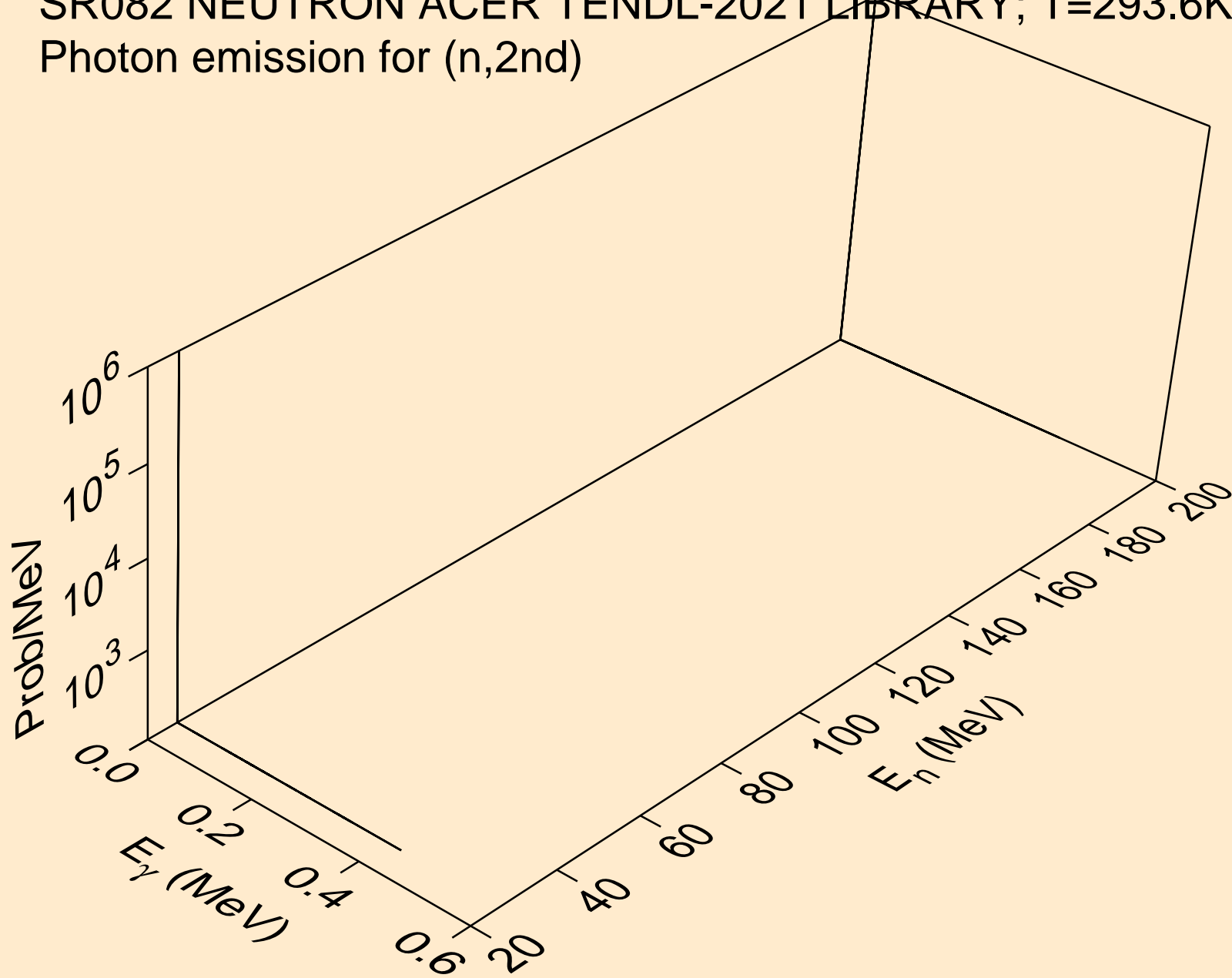

SR082 NEUTRON ACER TENDL-2021 LIBRARY; T=293.6K
Photon emission for (n,2n)

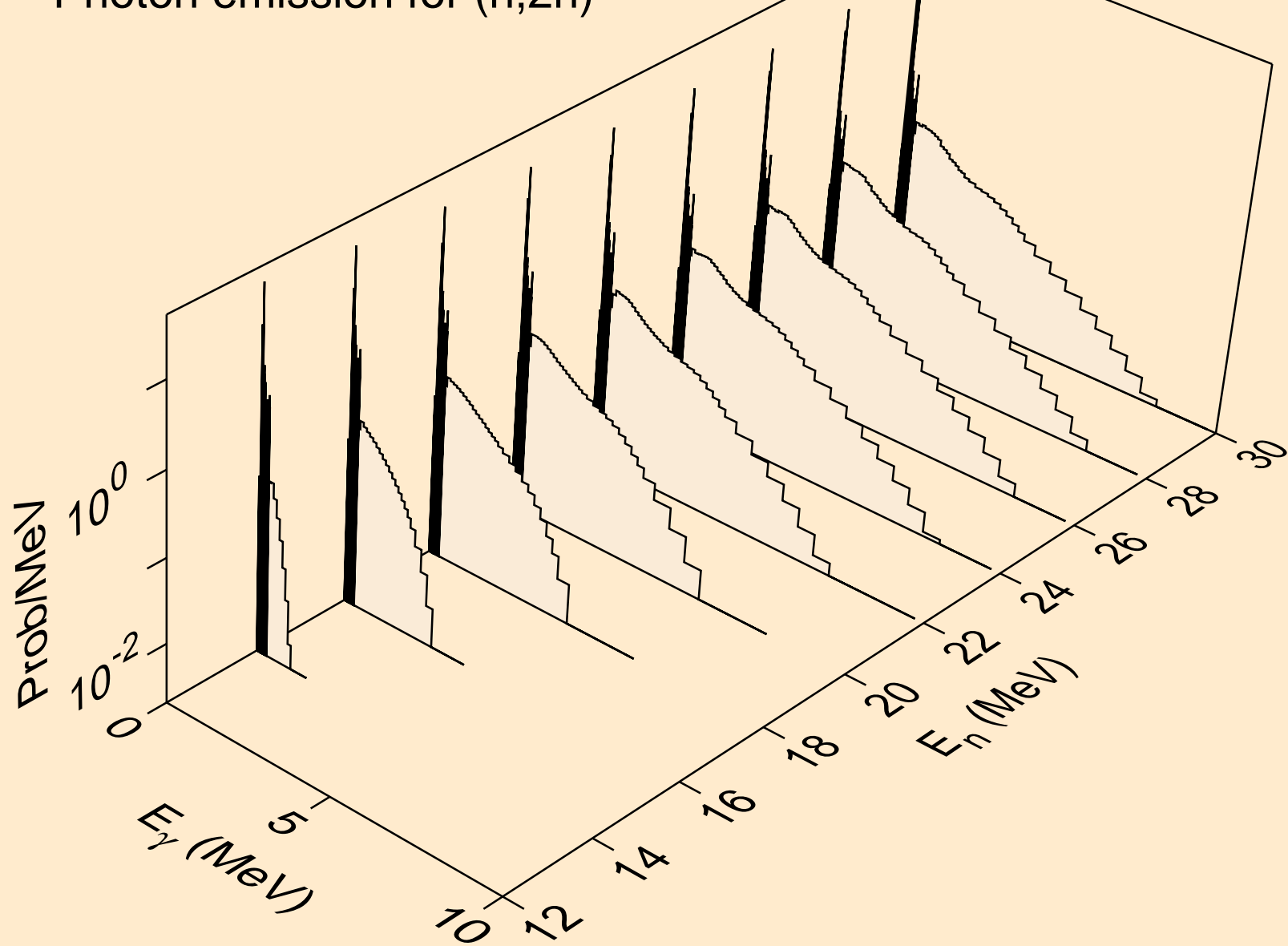

SR082 NEUTRON ACER TENDL-2021 LIBRARY; T=293.6K
Photon emission for (n,3n)

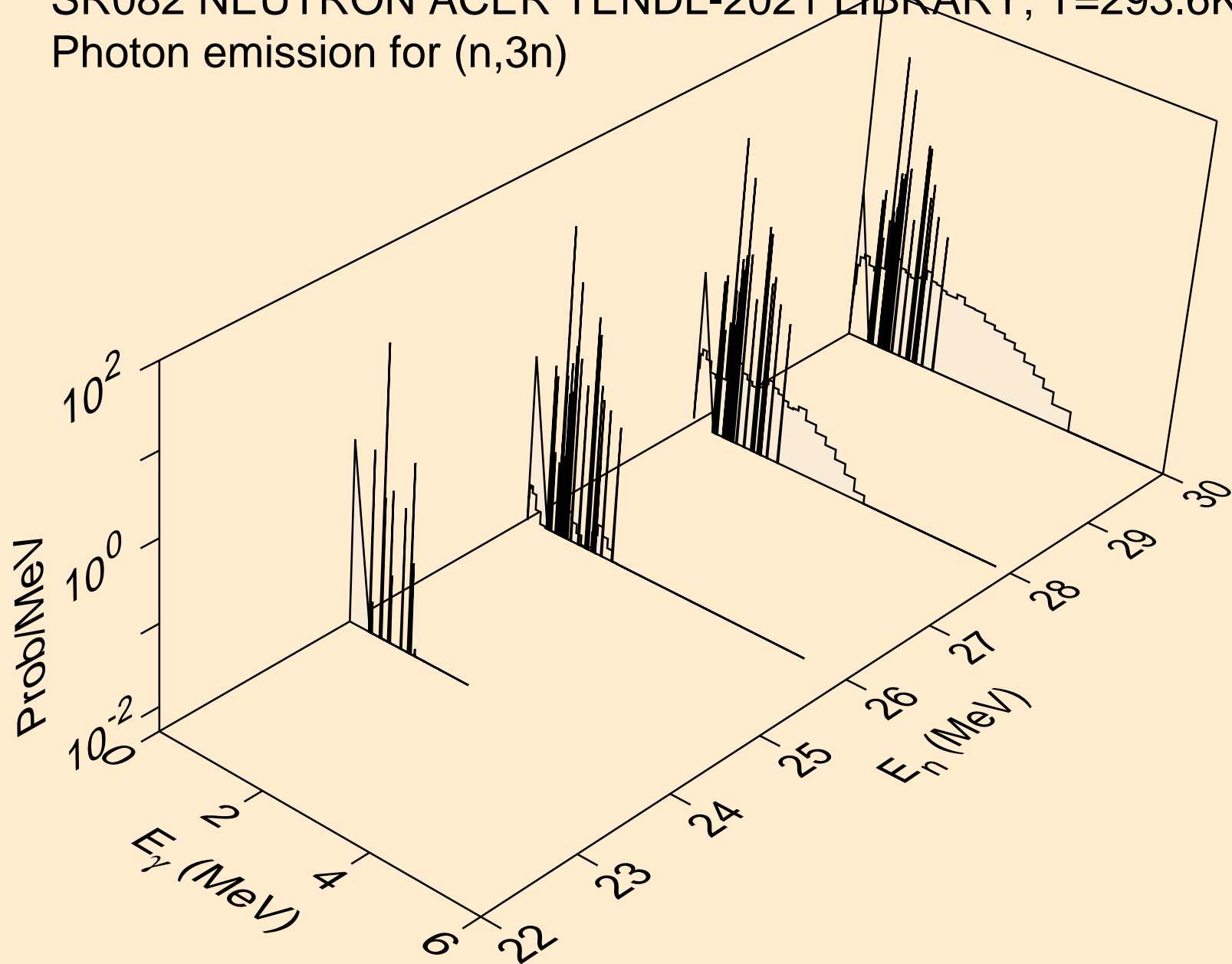

SR082 NEUTRON ACER TENDL-2021 LIBRARY; T=293.6K
Photon emission for (n,n*)a

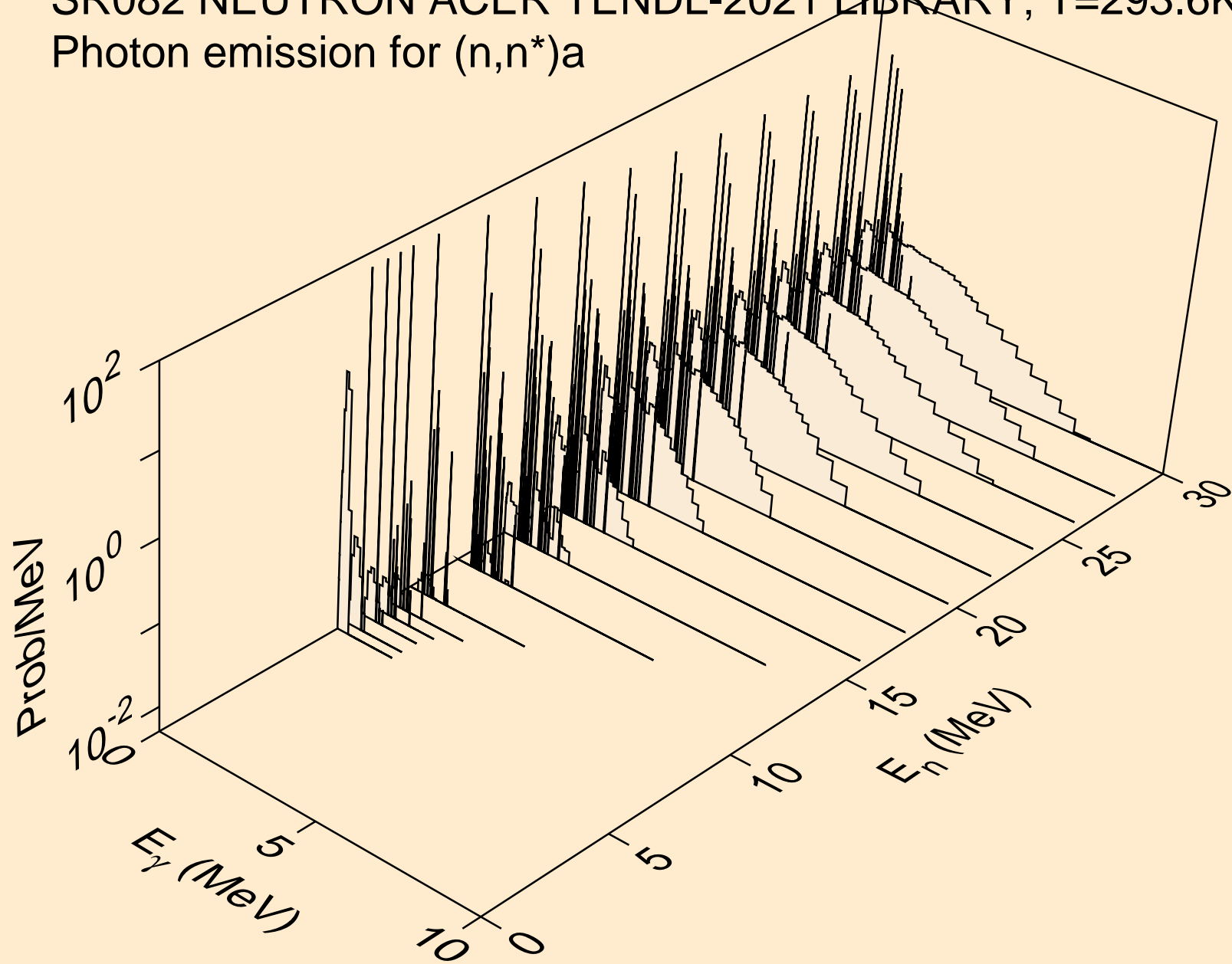

SR082 NEUTRON ACER TENDL-2021 LIBRARY; T=293.6K
Photon emission for (n,2n)a

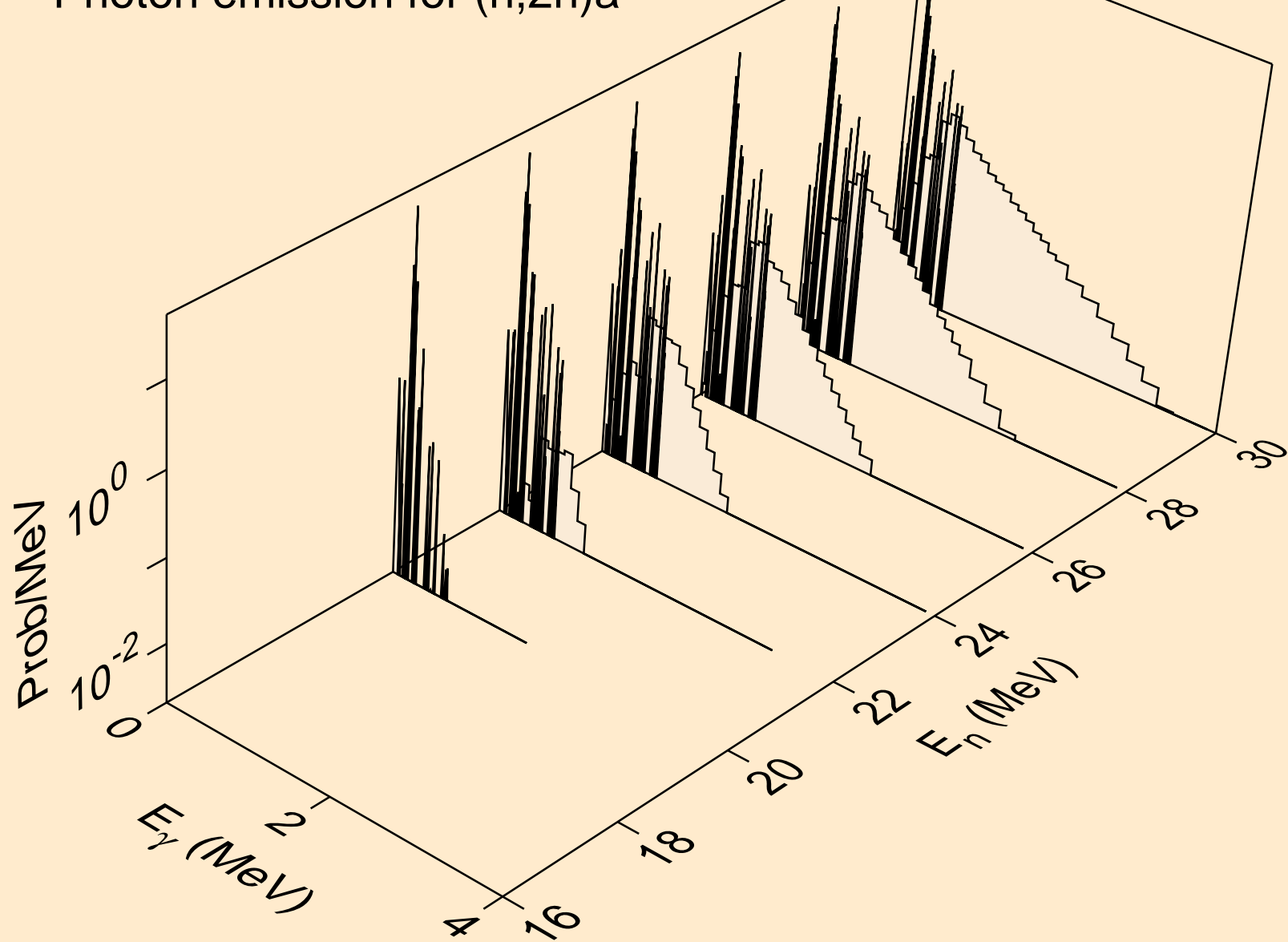

SR082 NEUTRON ACER TENDL-2021 LIBRARY; T=293.6K
Photon emission for (n,n*)p

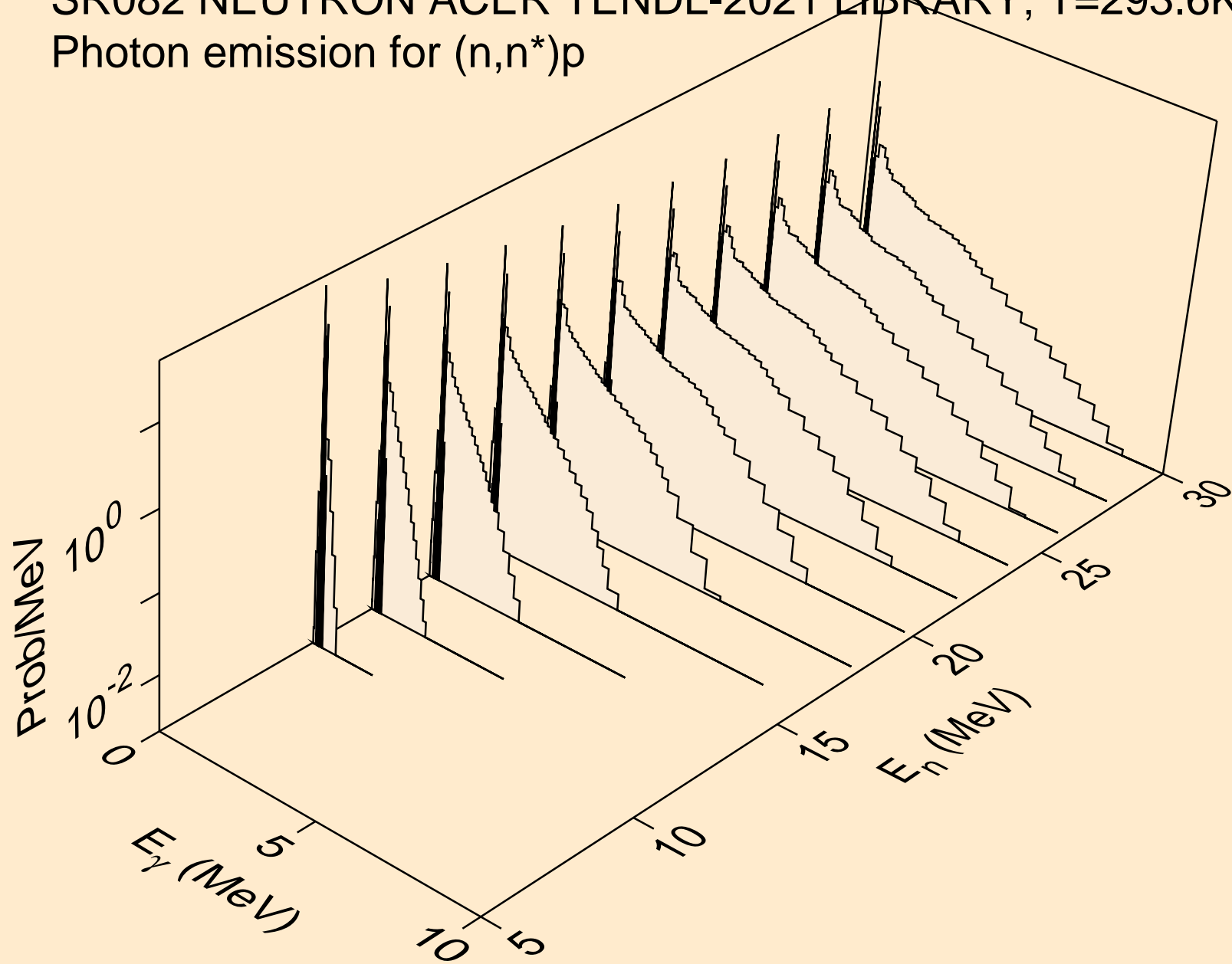

SR082 NEUTRON ACER TENDL-2021 LIBRARY; T=293.6K
Photon emission for (n,n*)2a

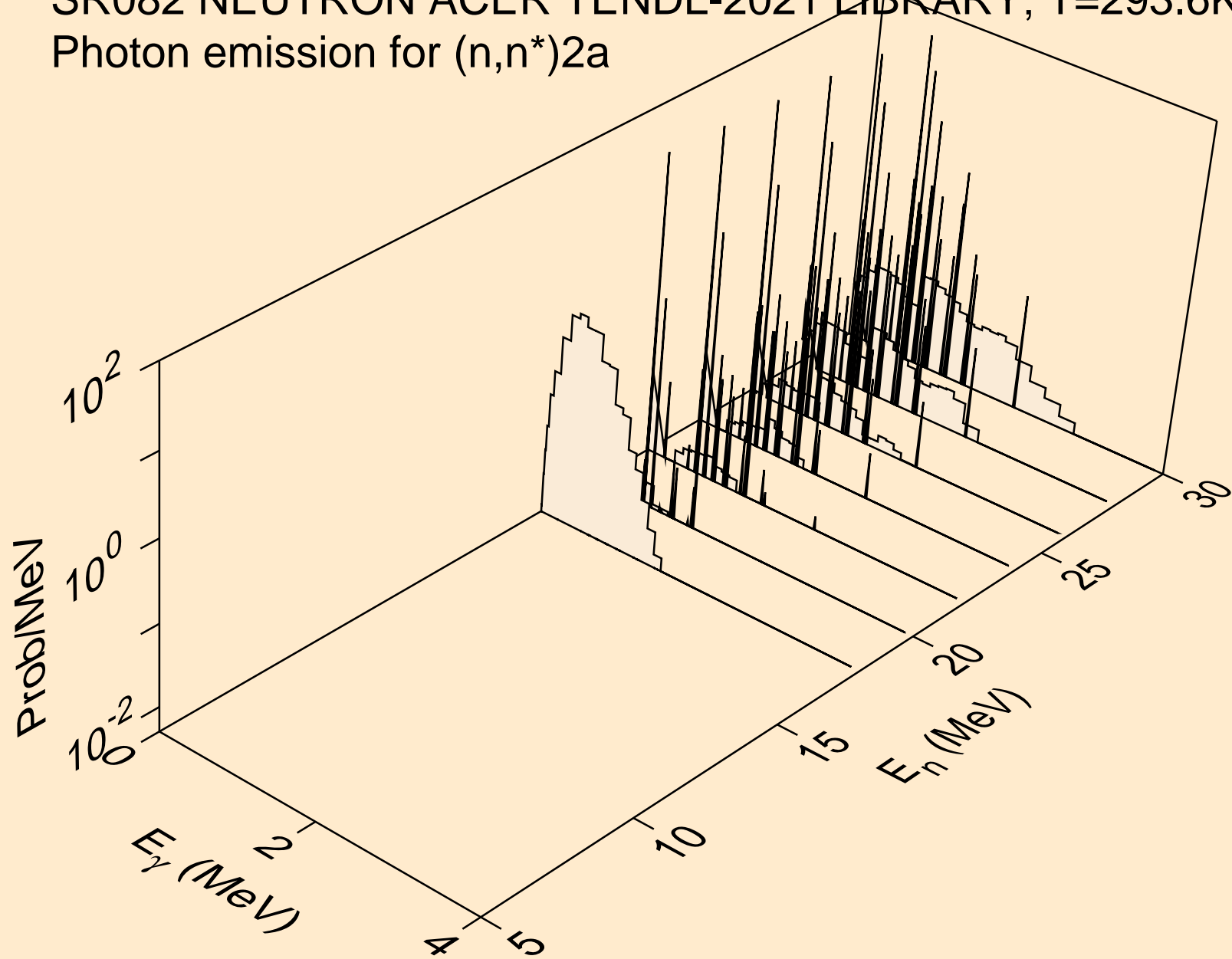

SR082 NEUTRON ACER TENDL-2021 LIBRARY; T=293.6K
Photon emission for (n,n*)d

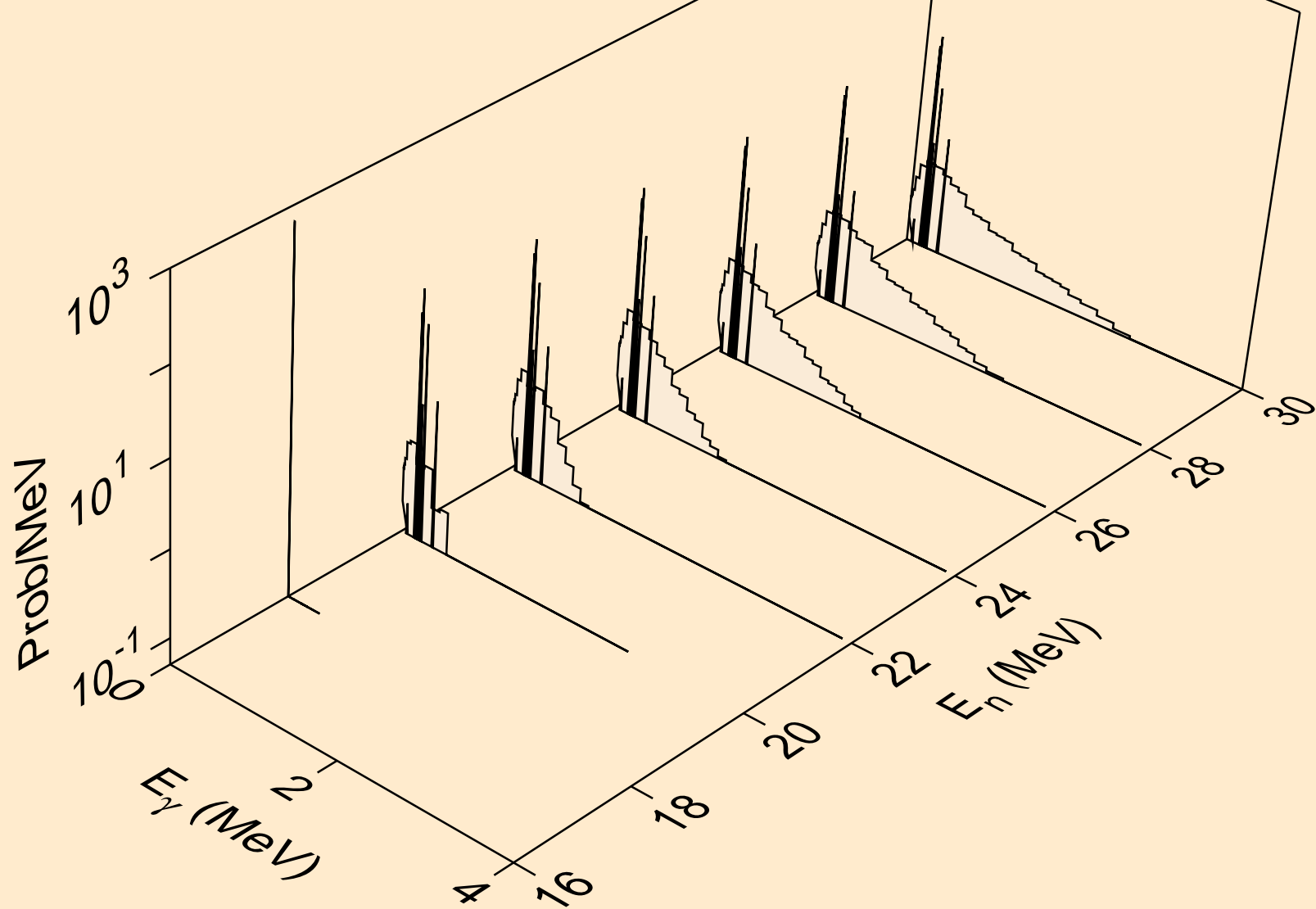

SR082 NEUTRON ACER TENDL-2021 LIBRARY; T=293.6K
Photon emission for (n,n*)t

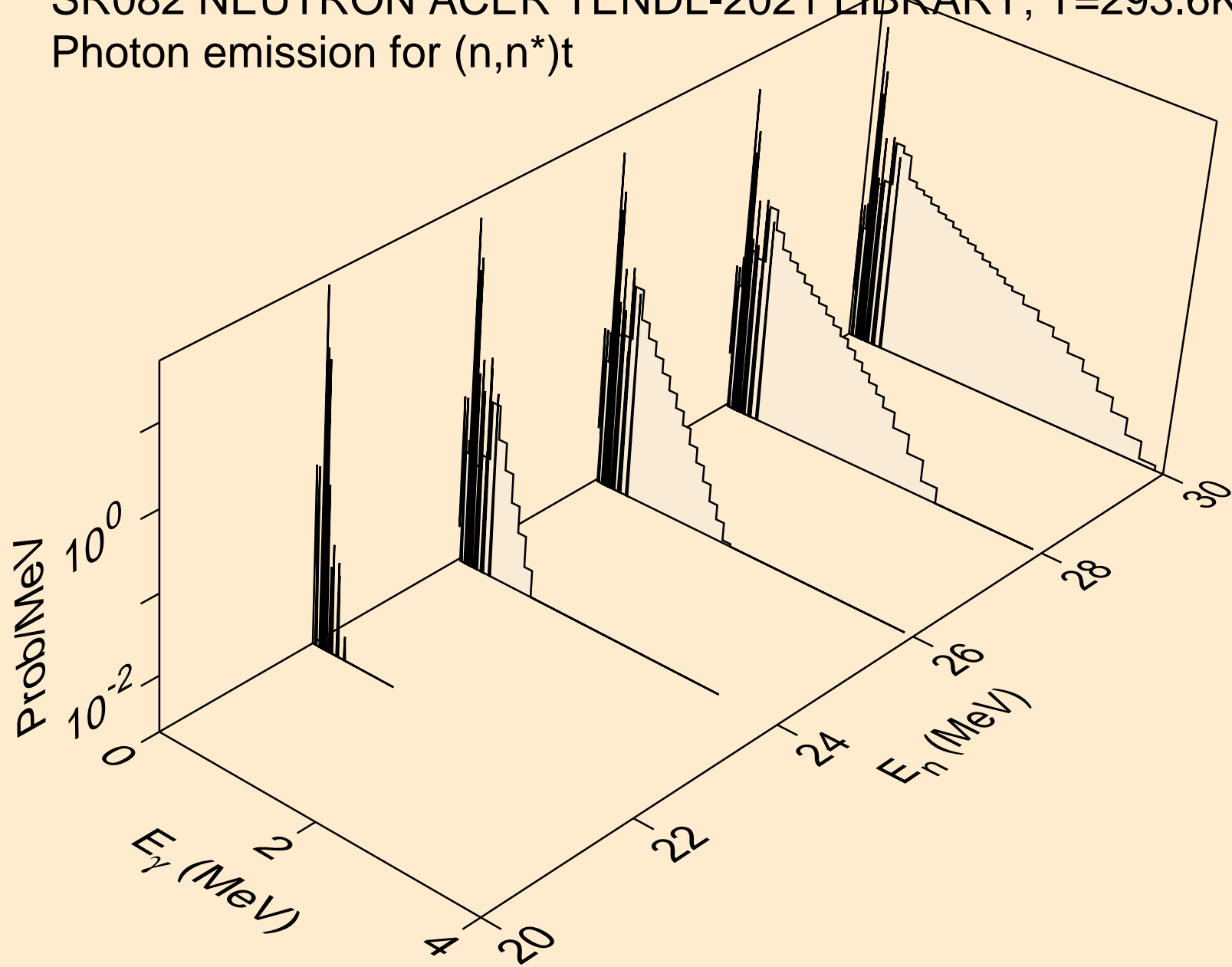

SR082 NEUTRON ACER TENDL-2021 LIBRARY; T=293.6K
Photon emission for (n,n*)he3

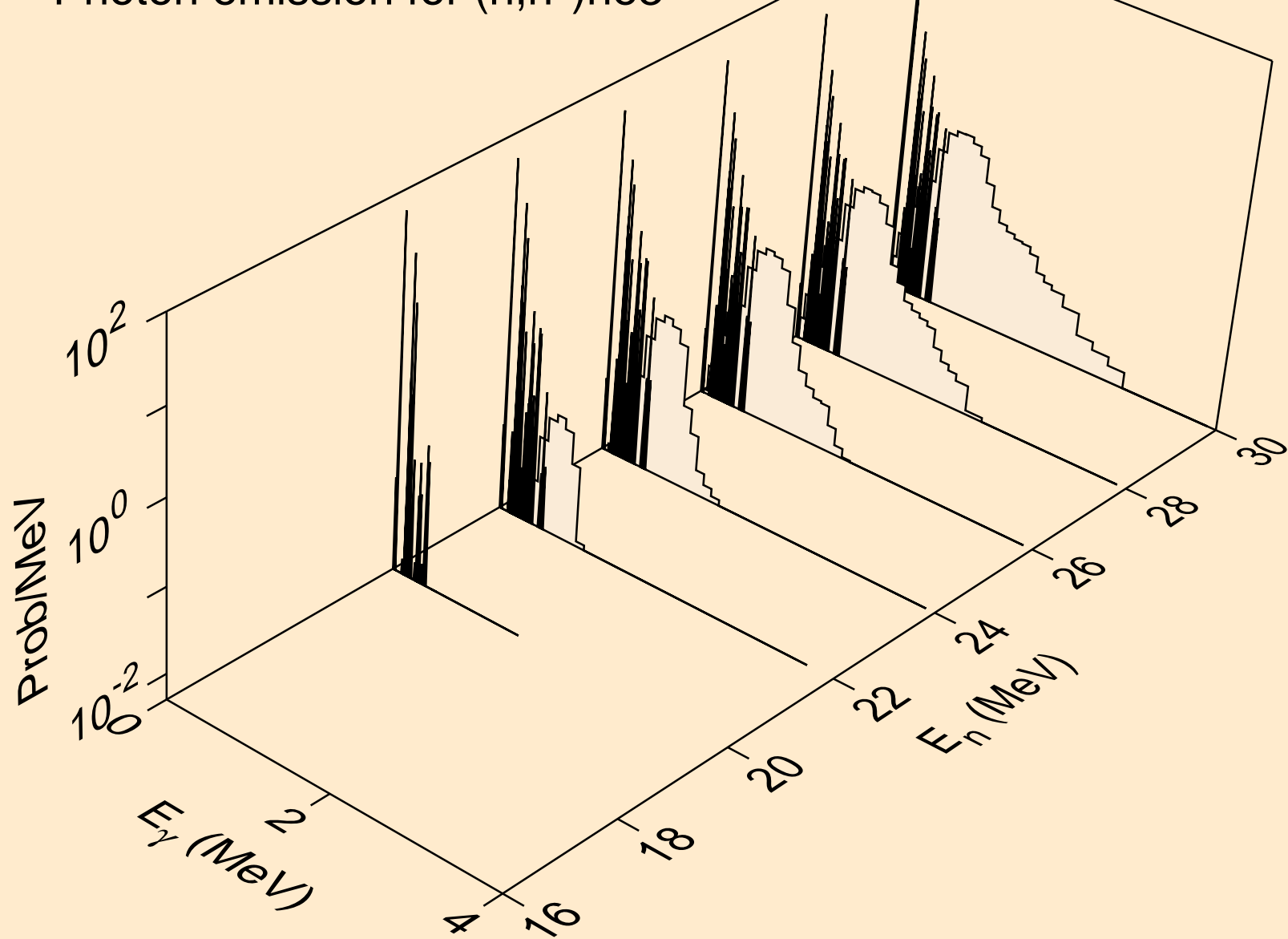

SR082 NEUTRON ACER TENDL-2021 LIBRARY; T=293.6K
Photon emission for (n,2np)

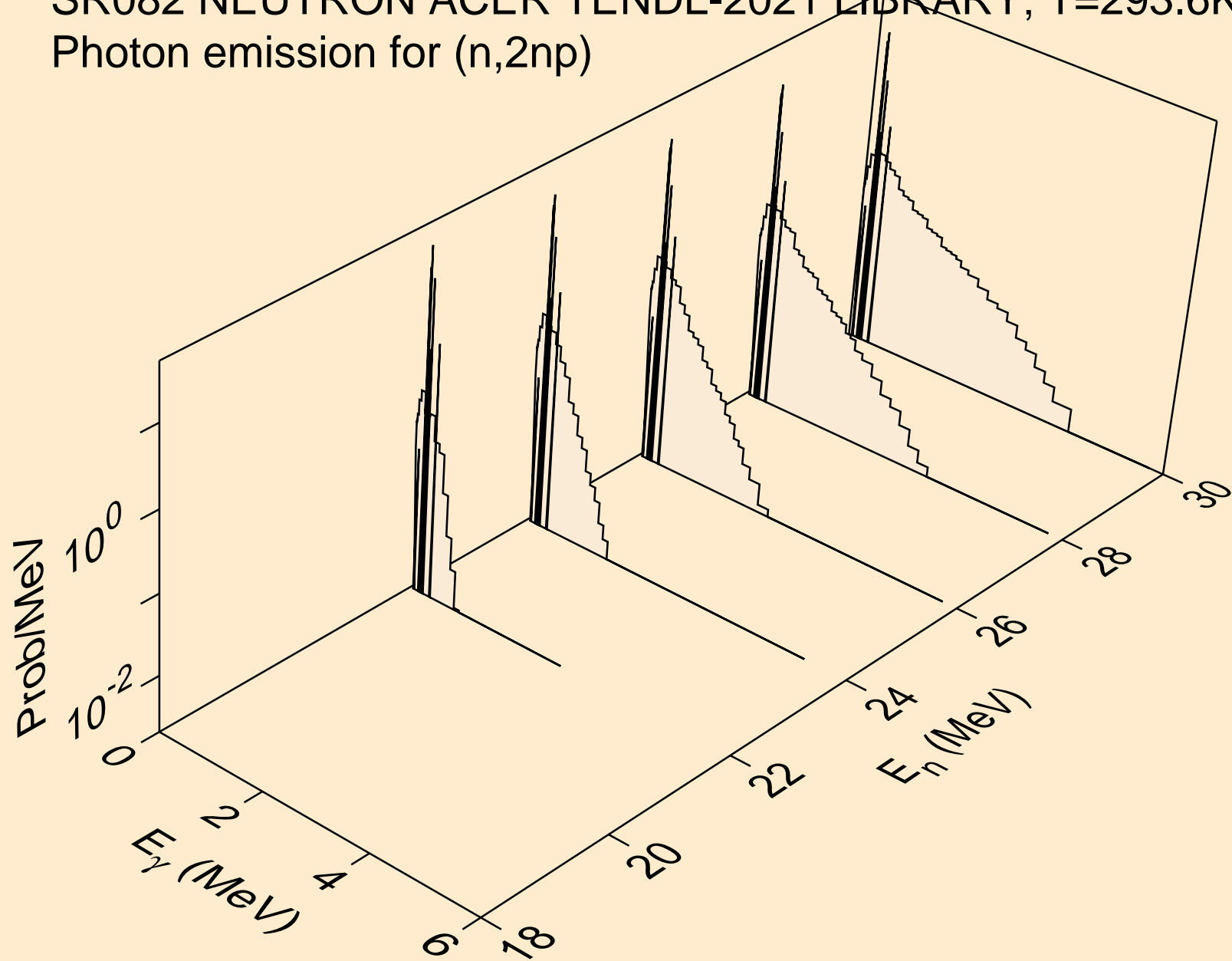

SR082 NEUTRON ACER TENDL-2021 LIBRARY; T=293.6K
Photon emission for (n,2np)

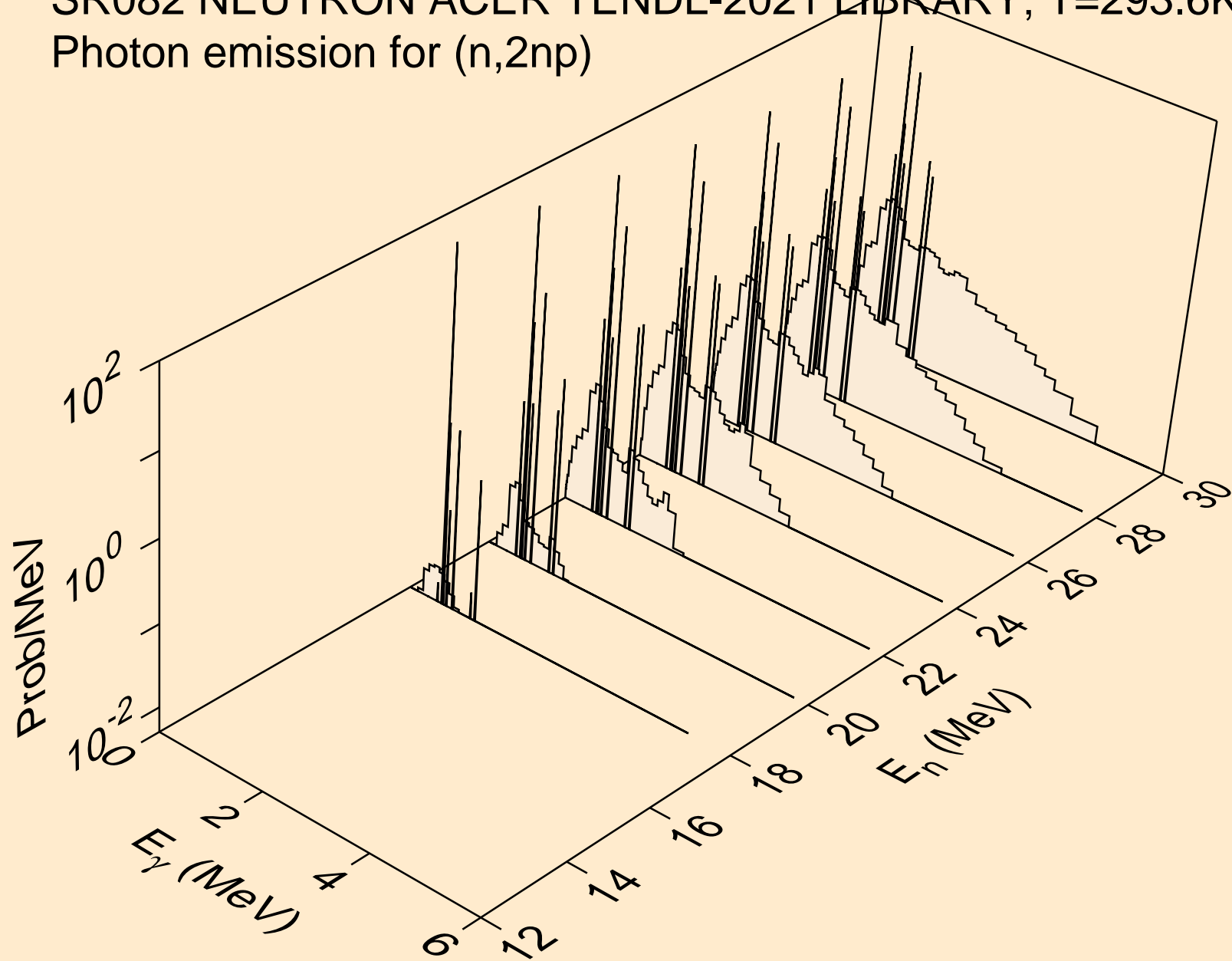

SR082 NEUTRON ACER TENDL-2021 LIBRARY; T=293.6K
Photon emission for (n,npa)

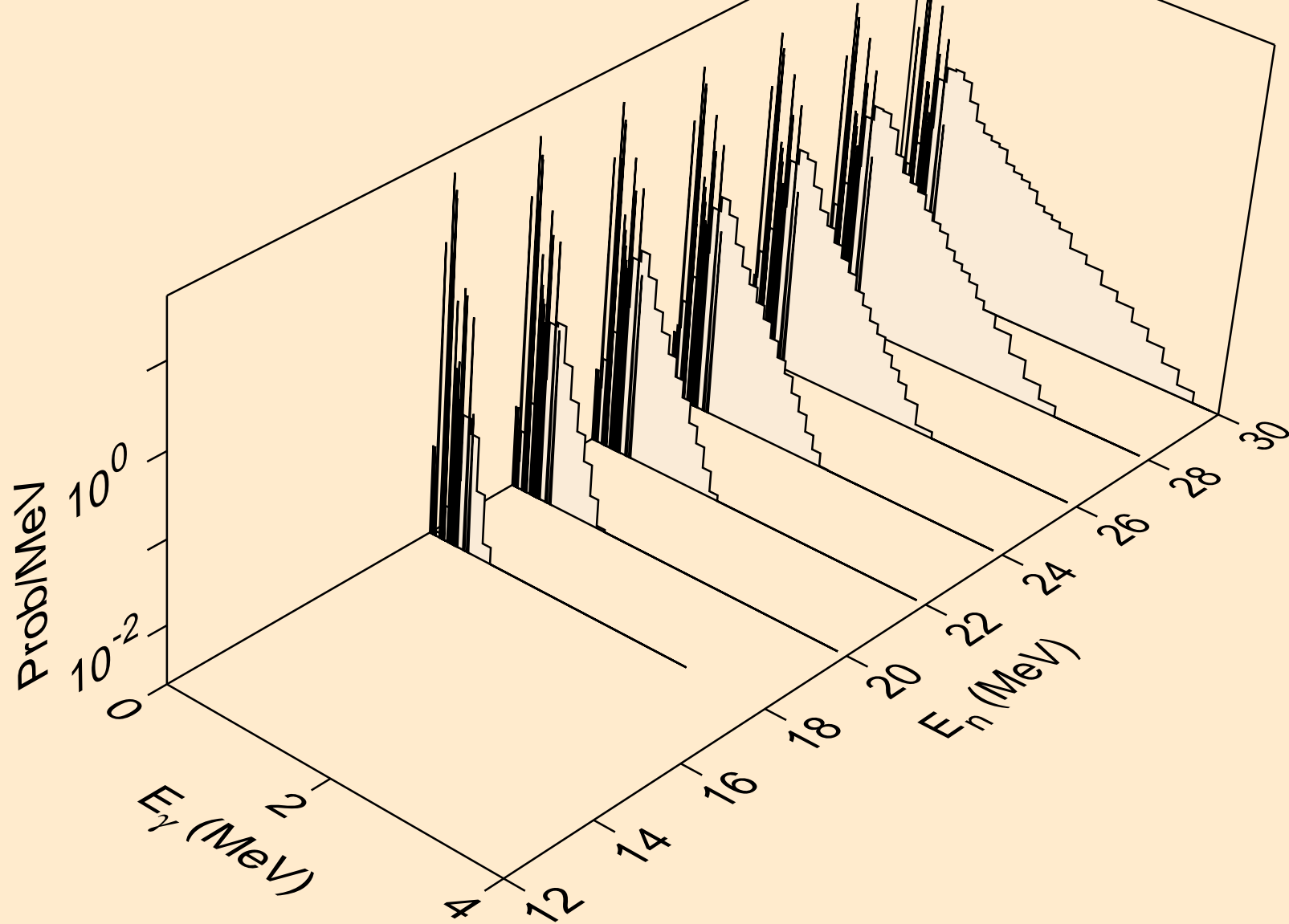

SR082 NEUTRON ACER TENDL-2021 LIBRARY; T=293.6K
Photon emission for (n,n*c)

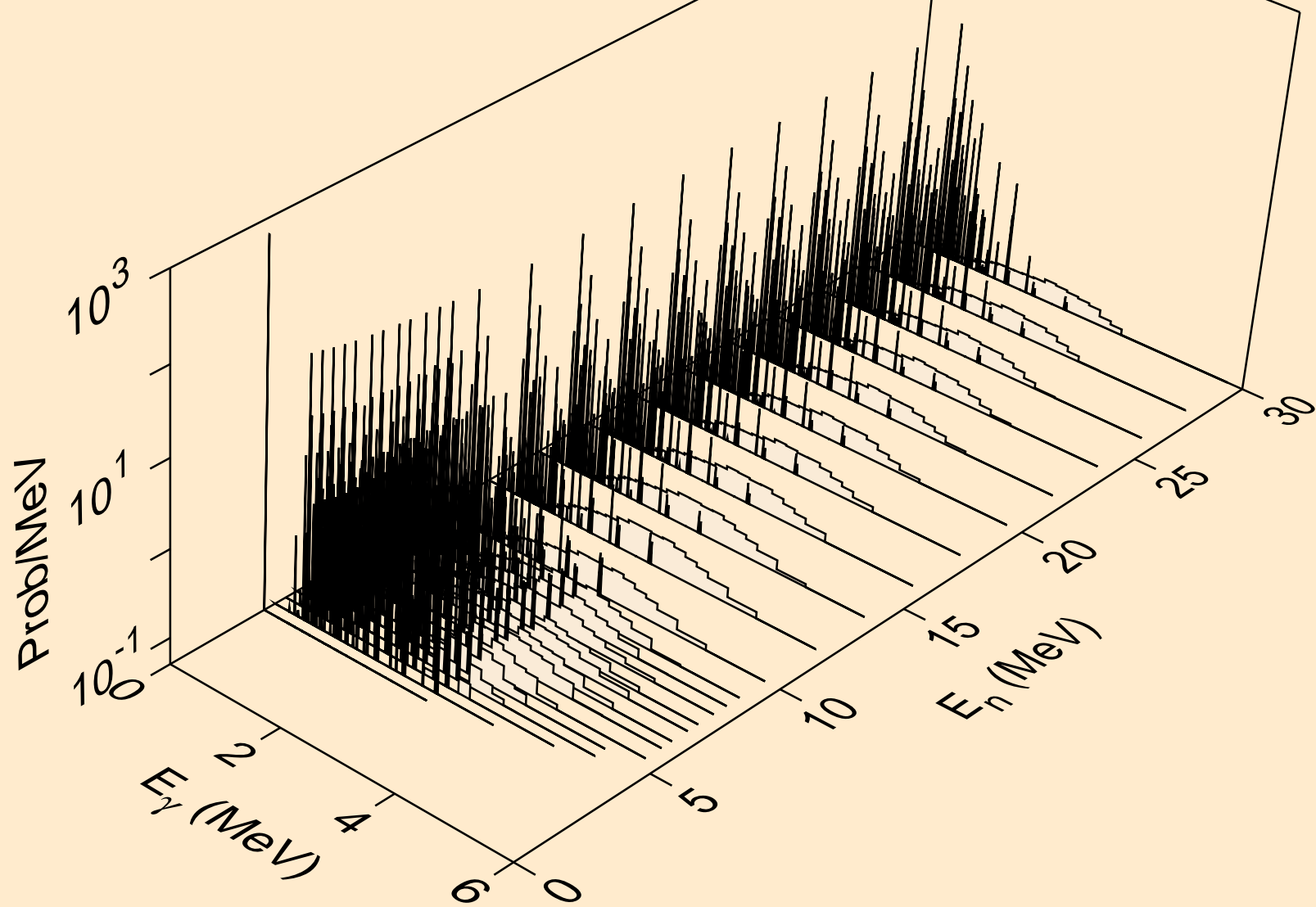

SR082 NEUTRON ACER TENDL-2021 LIBRARY; T=293.6K
Photon emission for (n,gma)

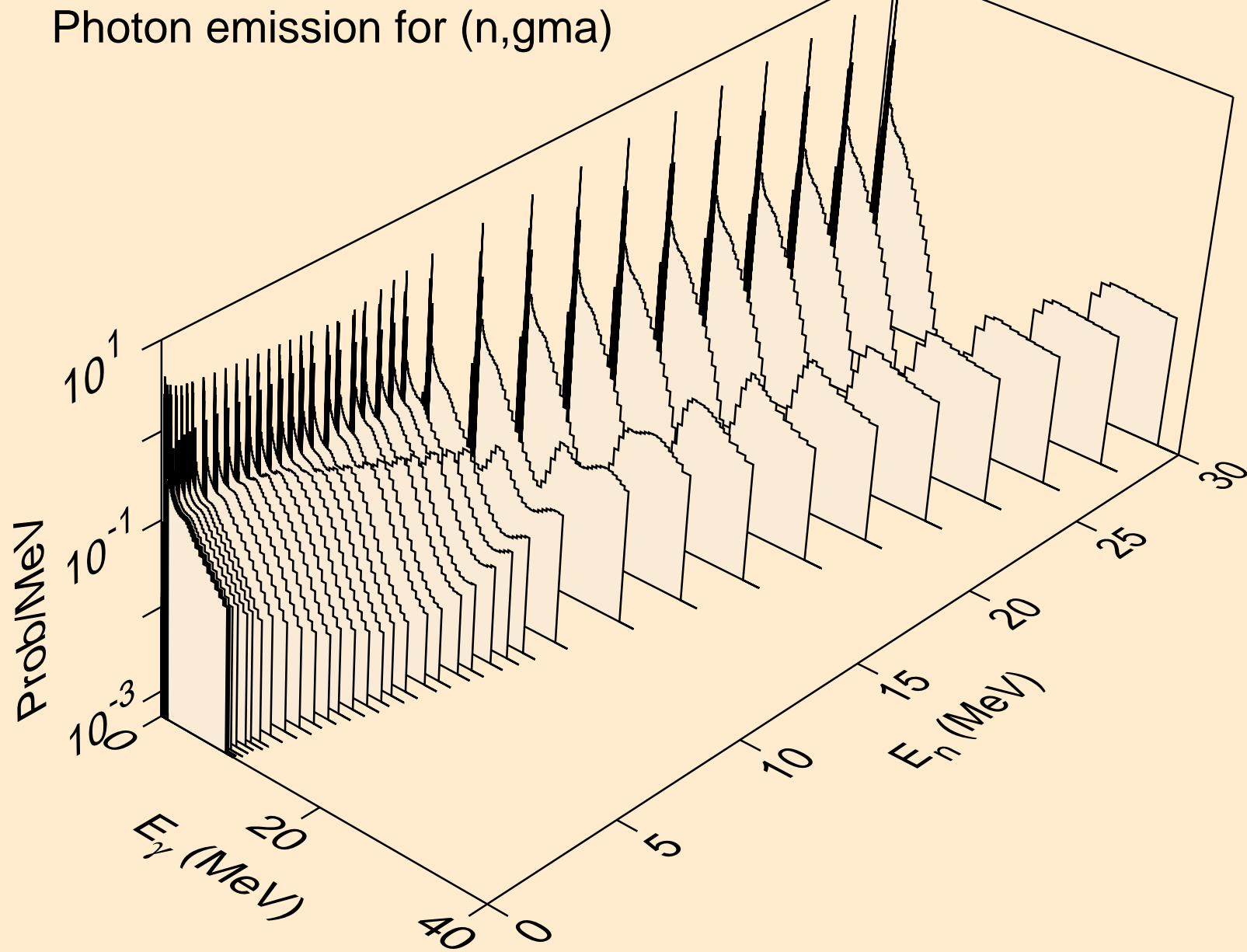

SR082 NEUTRON ACER TENDL-2021 LIBRARY; T=293.6K
Photon emission for (n,p)

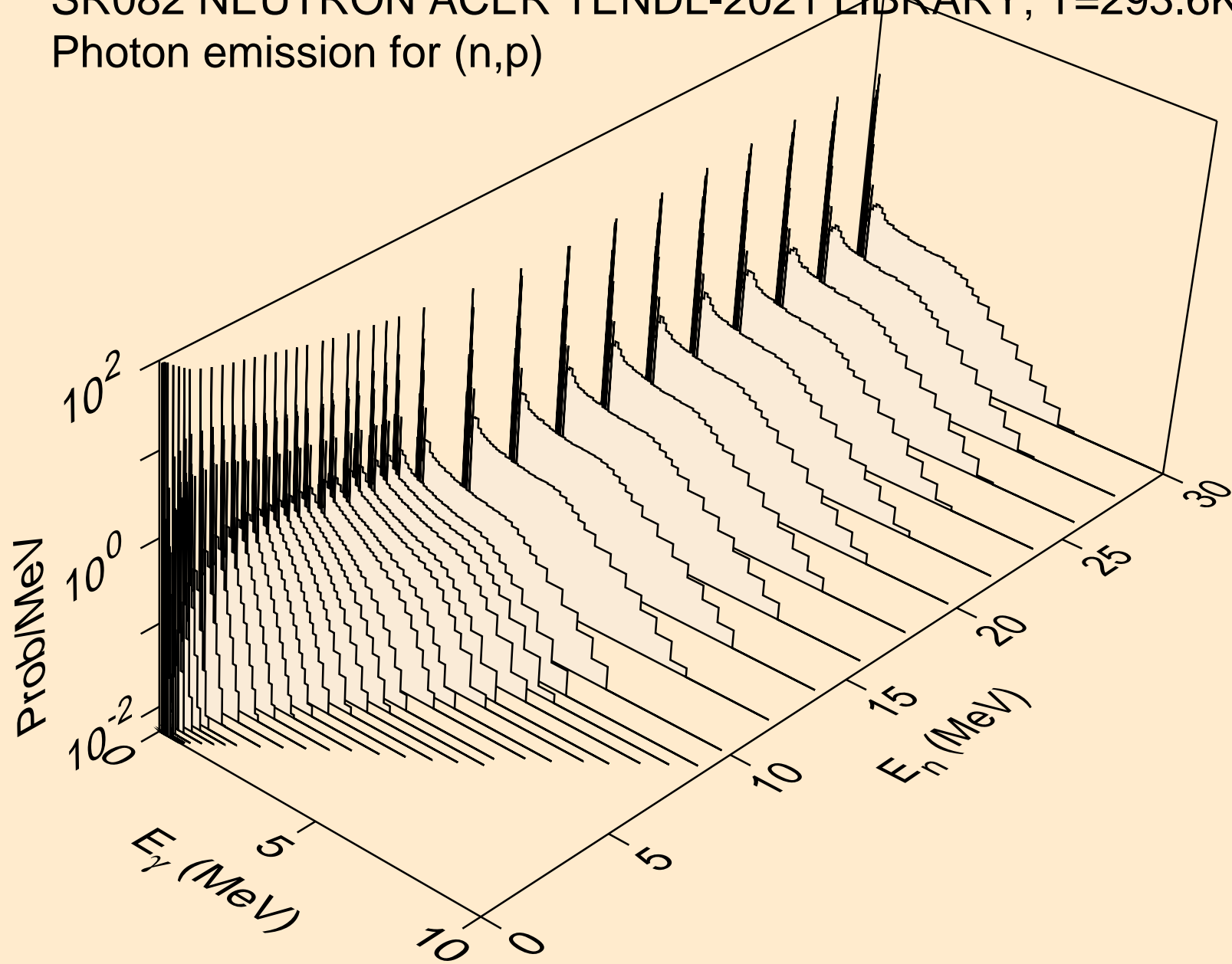

SR082 NEUTRON ACER TENDL-2021 LIBRARY; T=293.6K
Photon emission for (n,d)

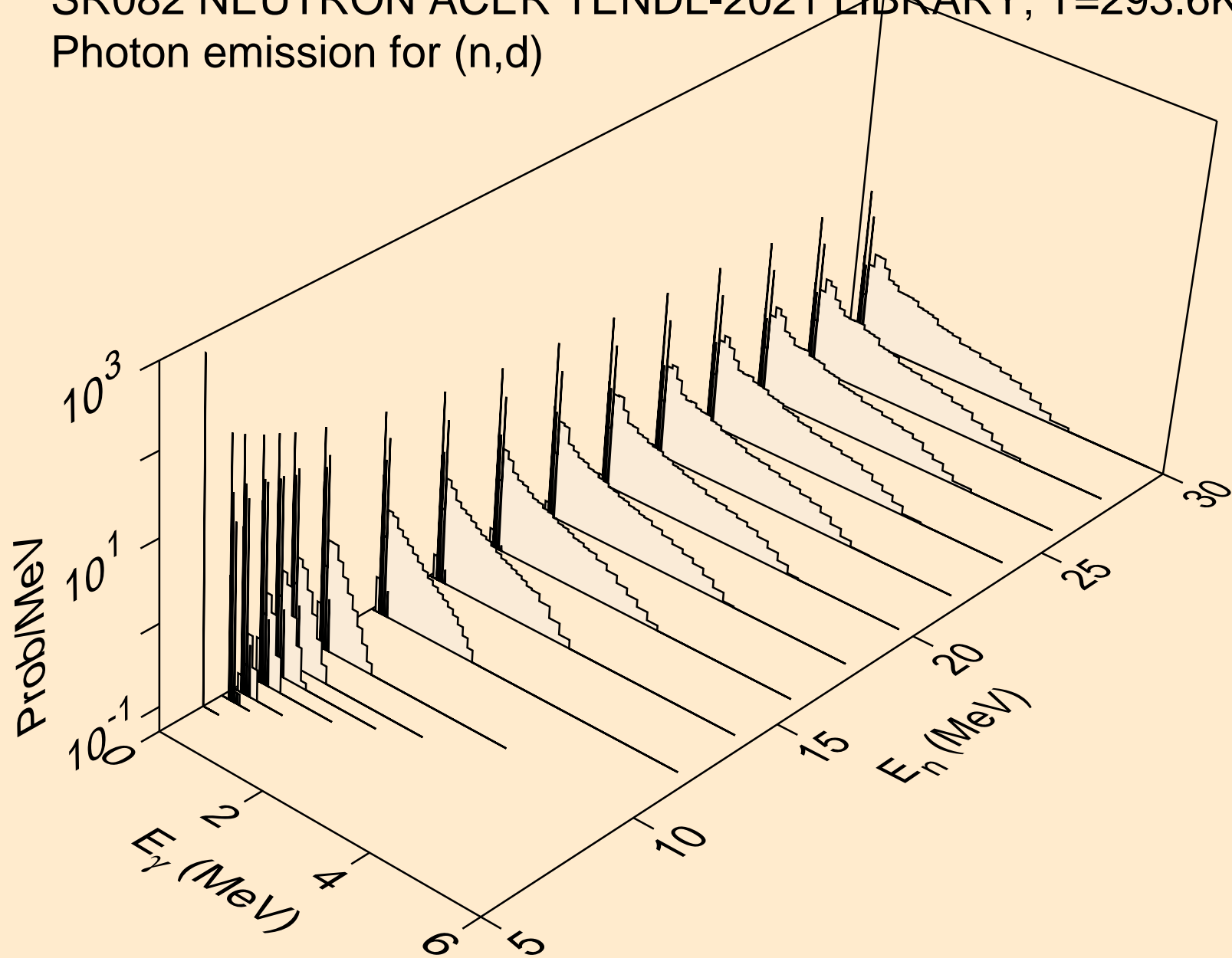

SR082 NEUTRON ACER TENDL-2021 LIBRARY; T=293.6K
Photon emission for (n,t)

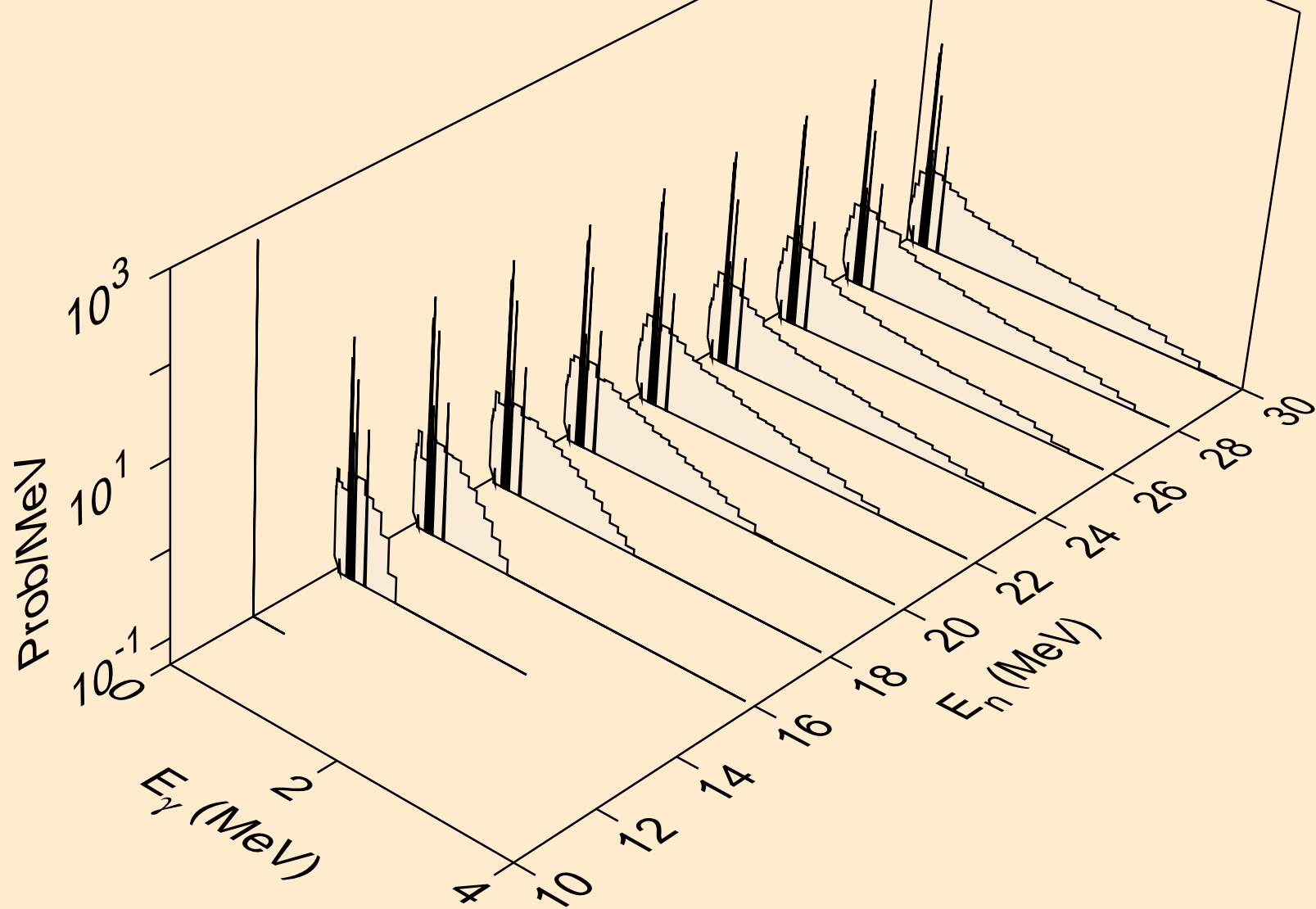

SR082 NEUTRON ACER TENDL-2021 LIBRARY; T=293.6K
Photon emission for (n,he3)

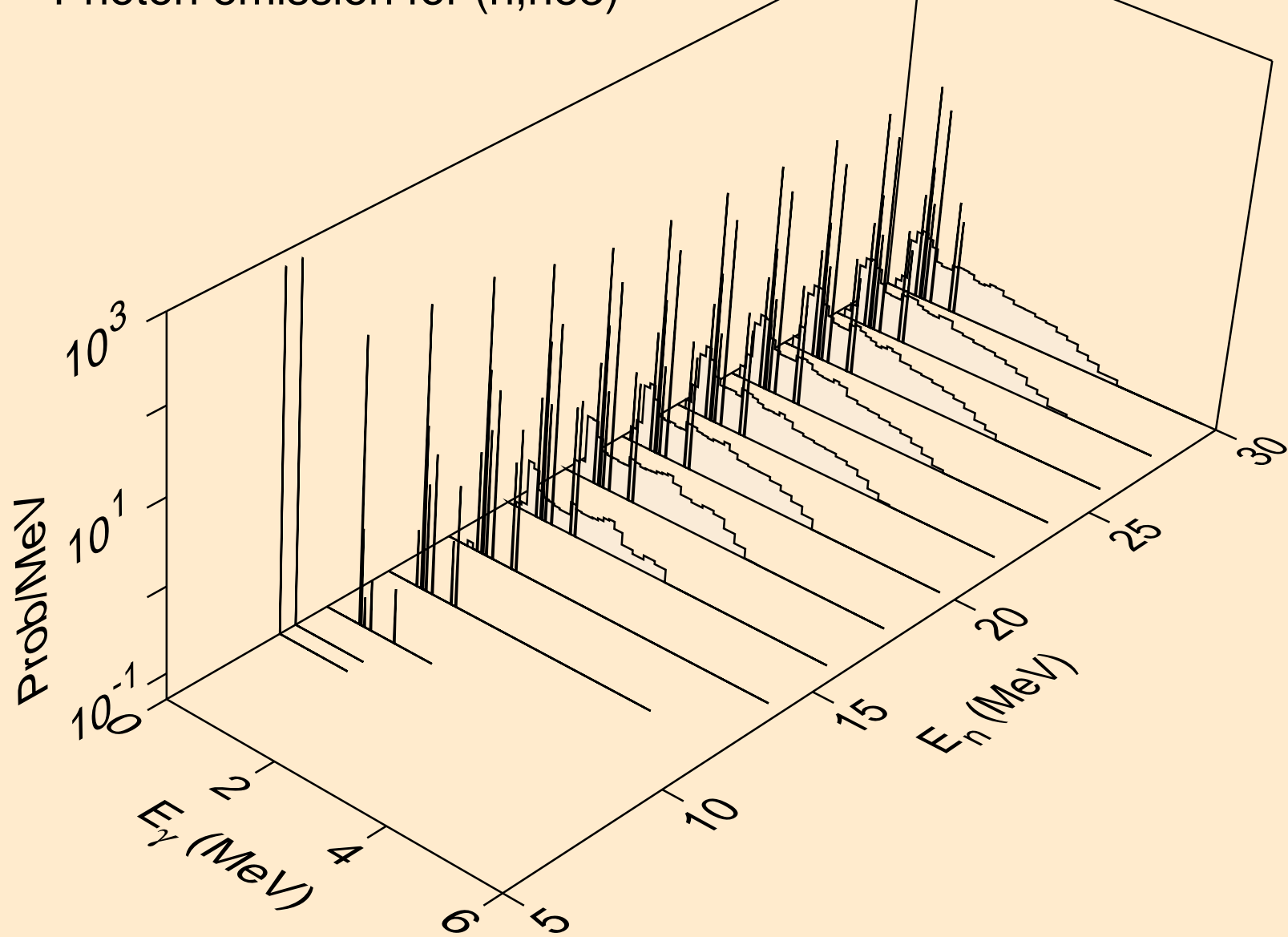

SR082 NEUTRON ACER TENDL-2021 LIBRARY; T=293.6K
Photon emission for (n,a)

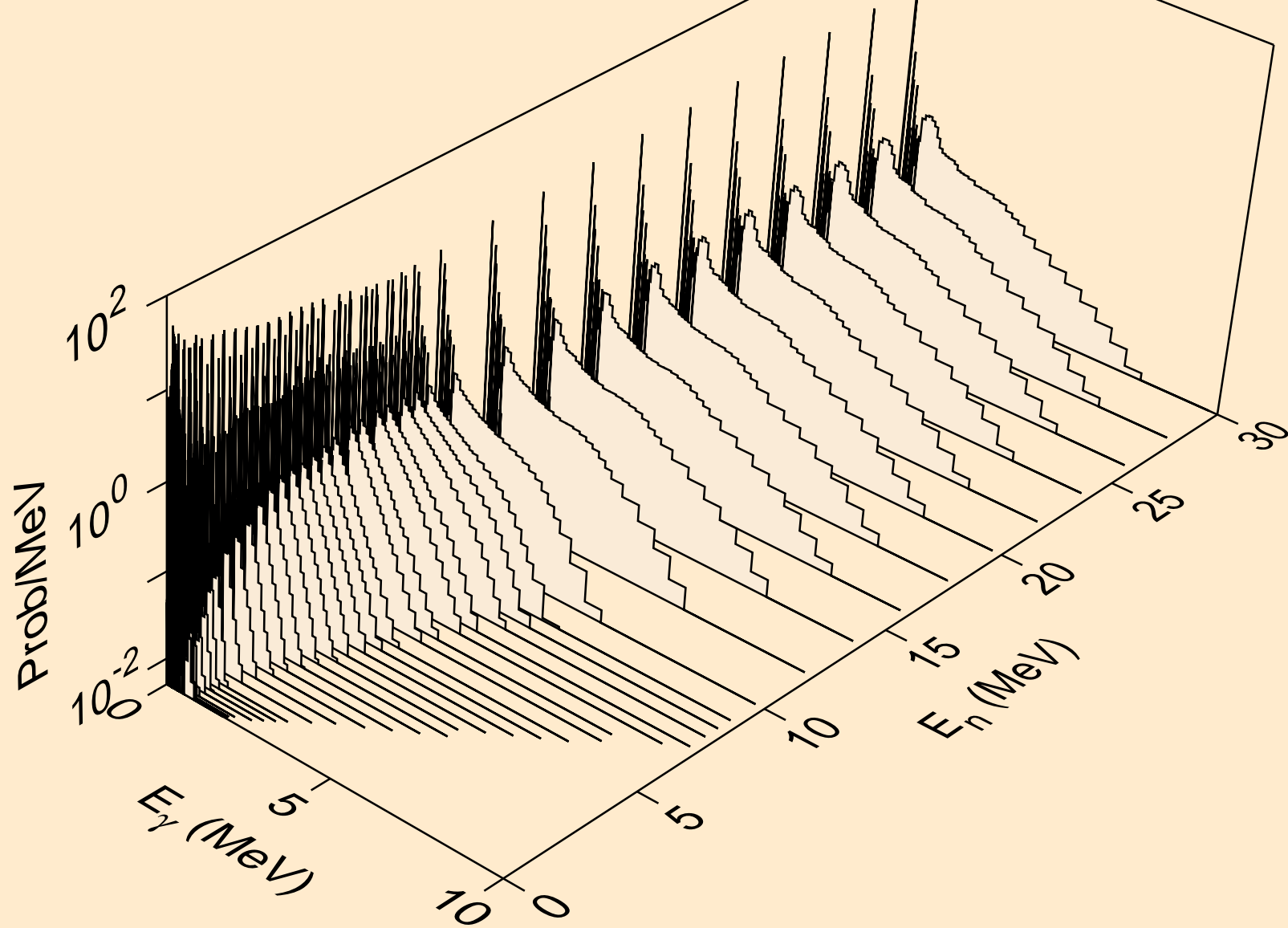

SR082 NEUTRON ACER TENDL-2021 LIBRARY; T=293.6K
Photon emission for (n,2a)

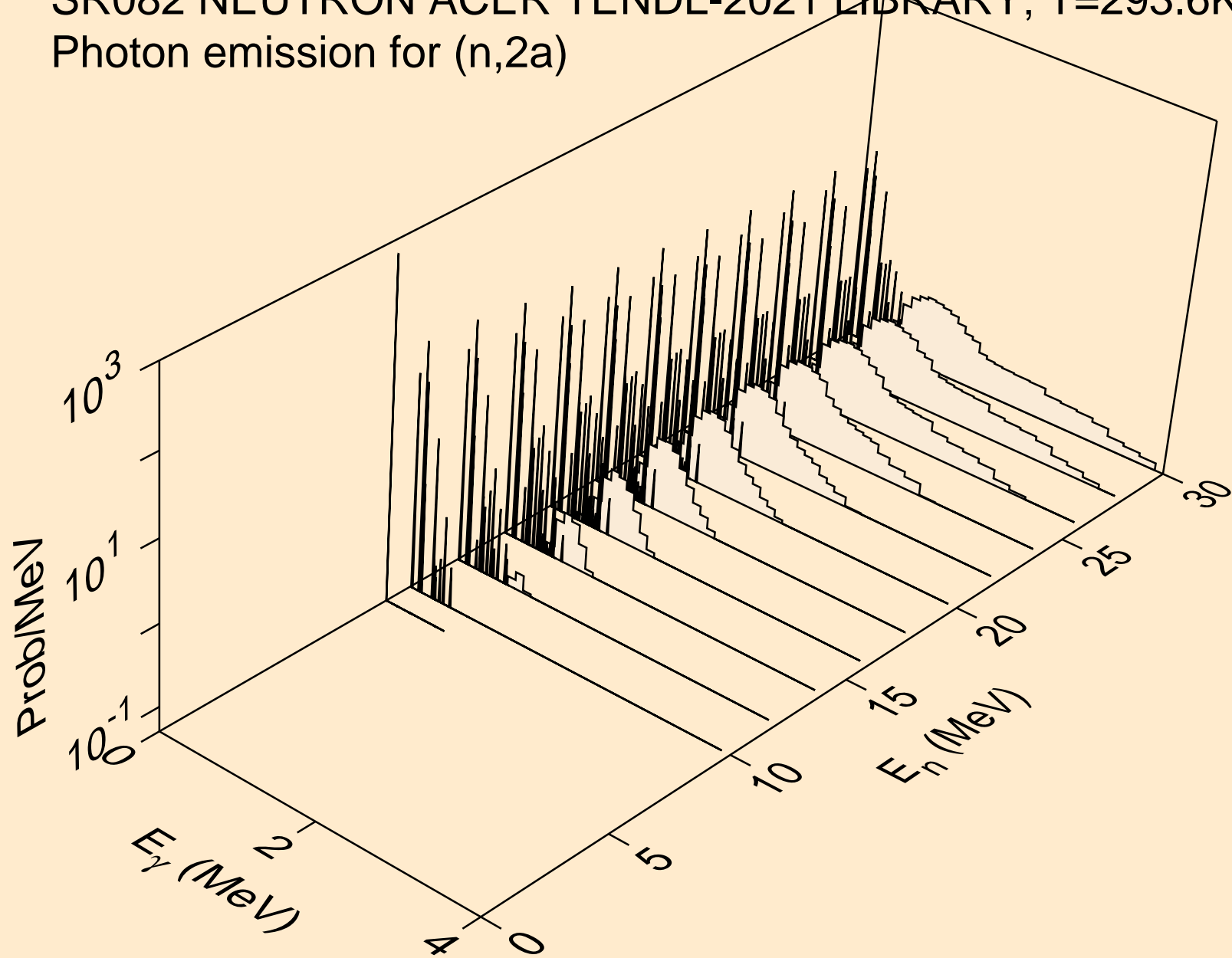

SR082 NEUTRON ACER TENDL-2021 LIBRARY; T=293.6K
Photon emission for (n,2p)

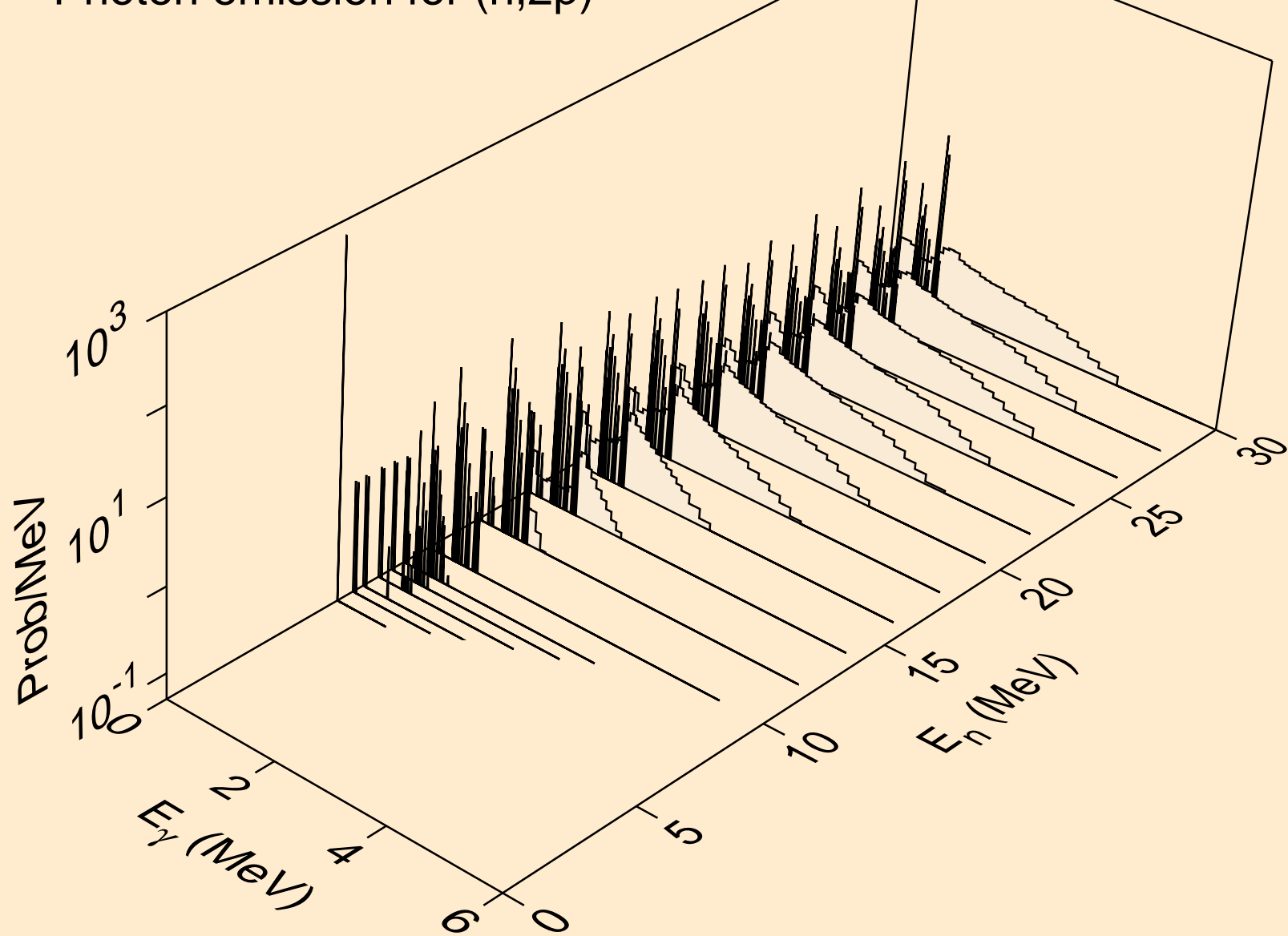

SR082 NEUTRON ACER TENDL-2021 LIBRARY; T=293.6K
Photon emission for (n,p α)

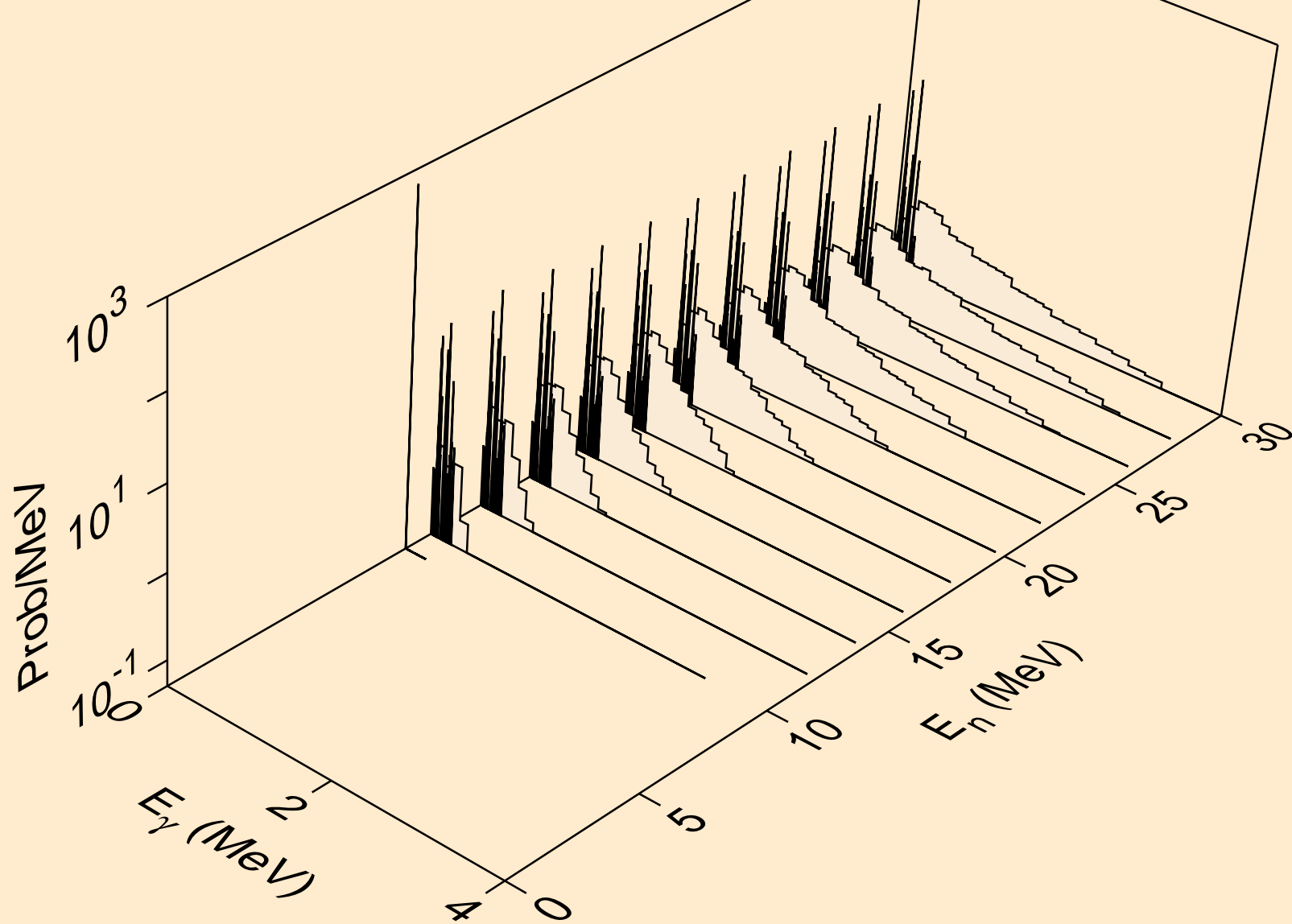

SR082 NEUTRON ACER TENDL-2021 LIBRARY; T=293.6K
Photon emission for (n,pd)

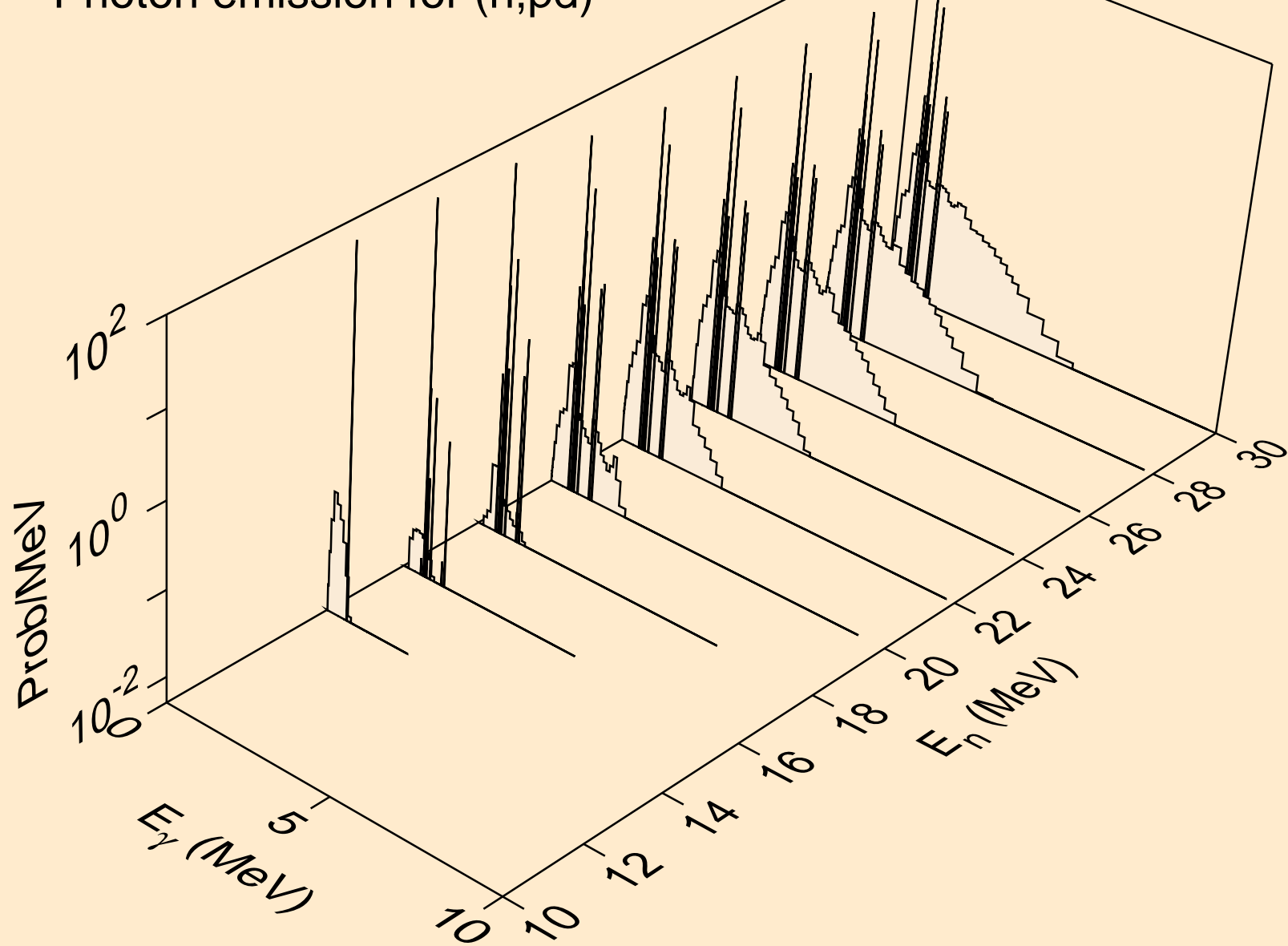

SR082 NEUTRON ACER TENDL-2021 LIBRARY; T=293.6K
Photon emission for (n,pt)

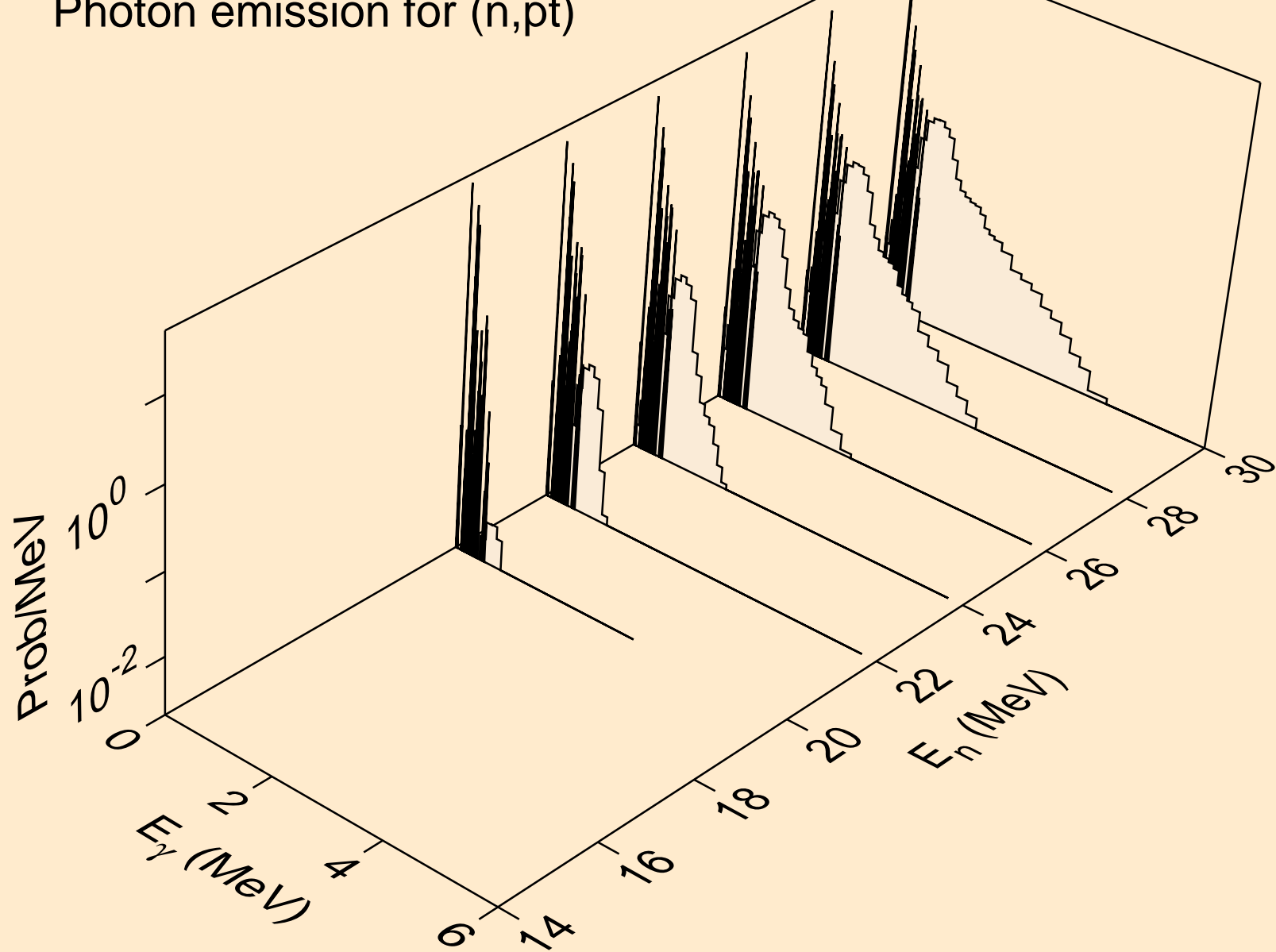

SR082 NEUTRON ACER TENDL-2021 LIBRARY; T=293.6K
Photon emission for (n,da)

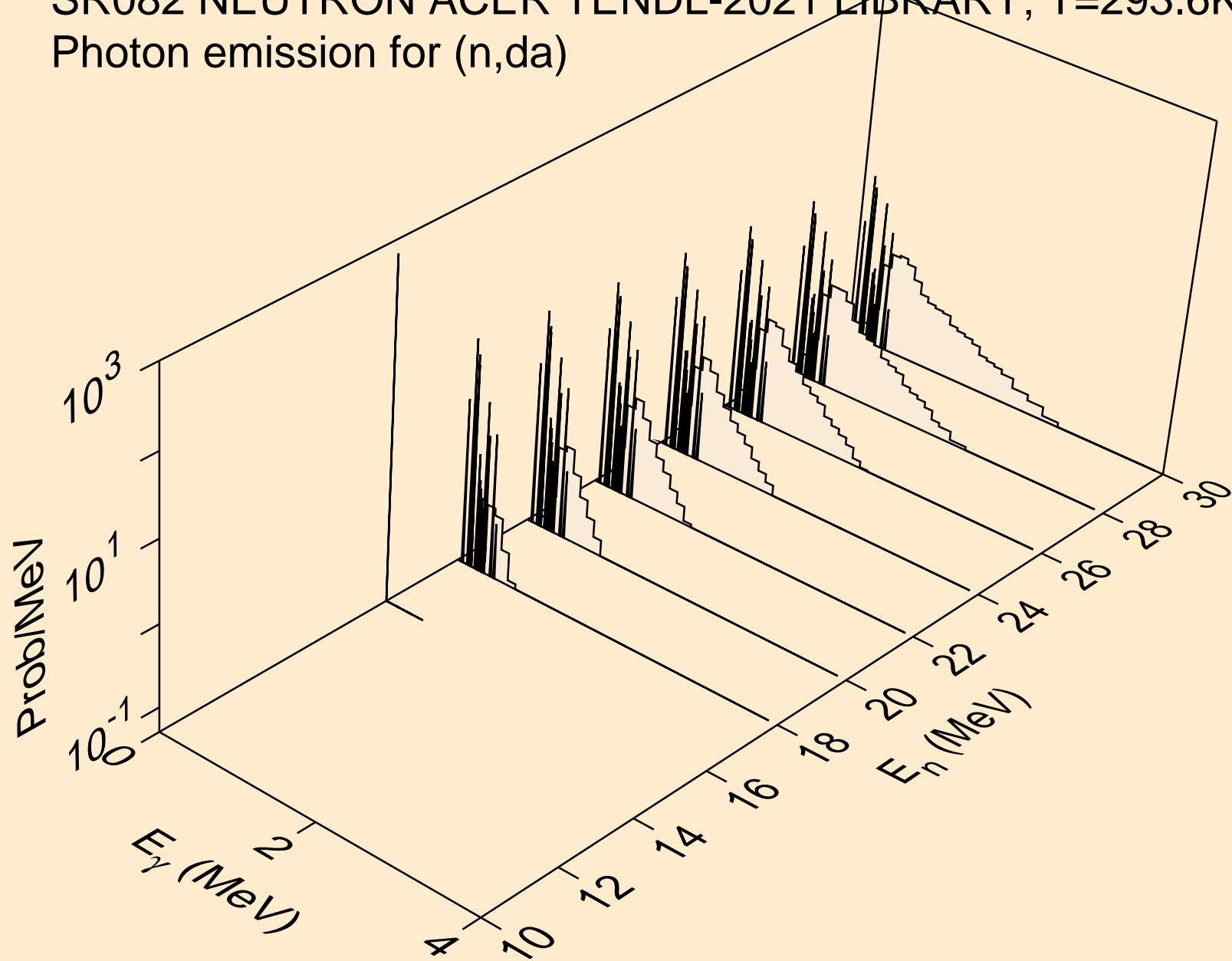

SR082 NEUTRON ACER TENDL-2021 LIBRARY; T=293.6K
thermal capture photon spectrum

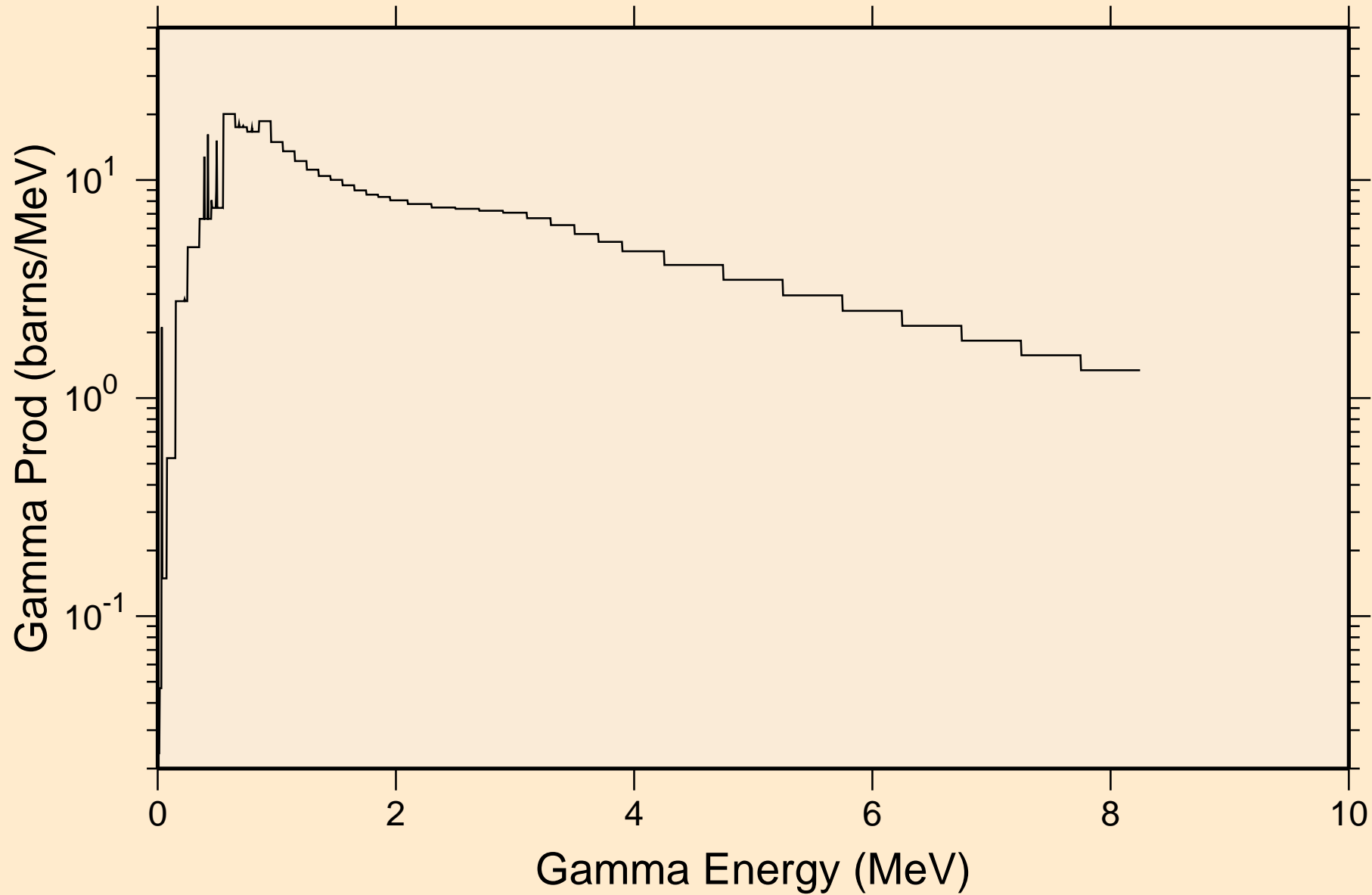

SR082 NEUTRON ACER TENDL-2021 LIBRARY; T=293.6K
14 MeV photon spectrum

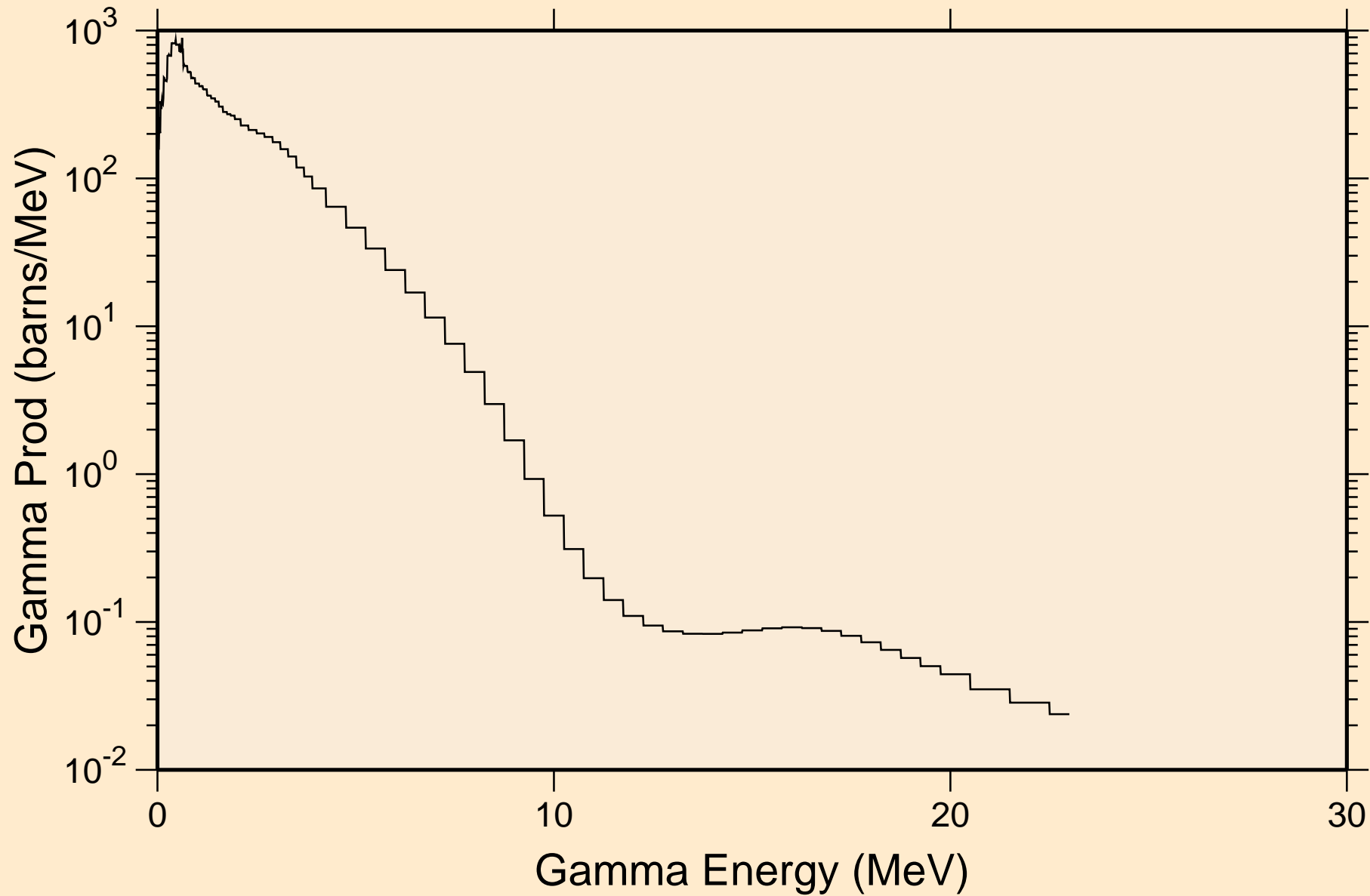

SR082 NEUTRON ACER TENDL-2021 LIBRARY; T=293.6K
Particle heating contributions

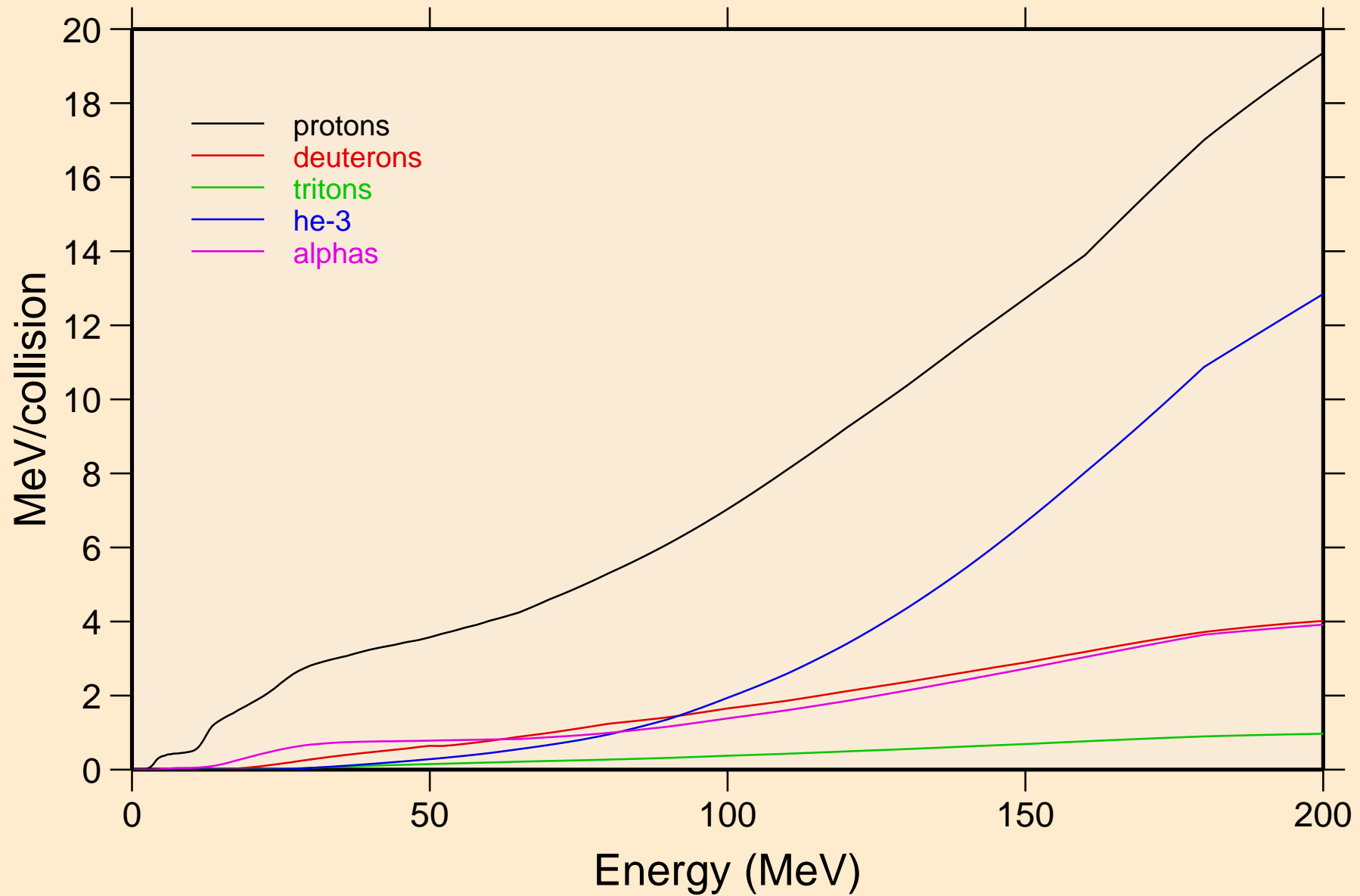

SR082 NEUTRON ACER TENDL-2021 LIBRARY; T=293.6K
Recoil Heating

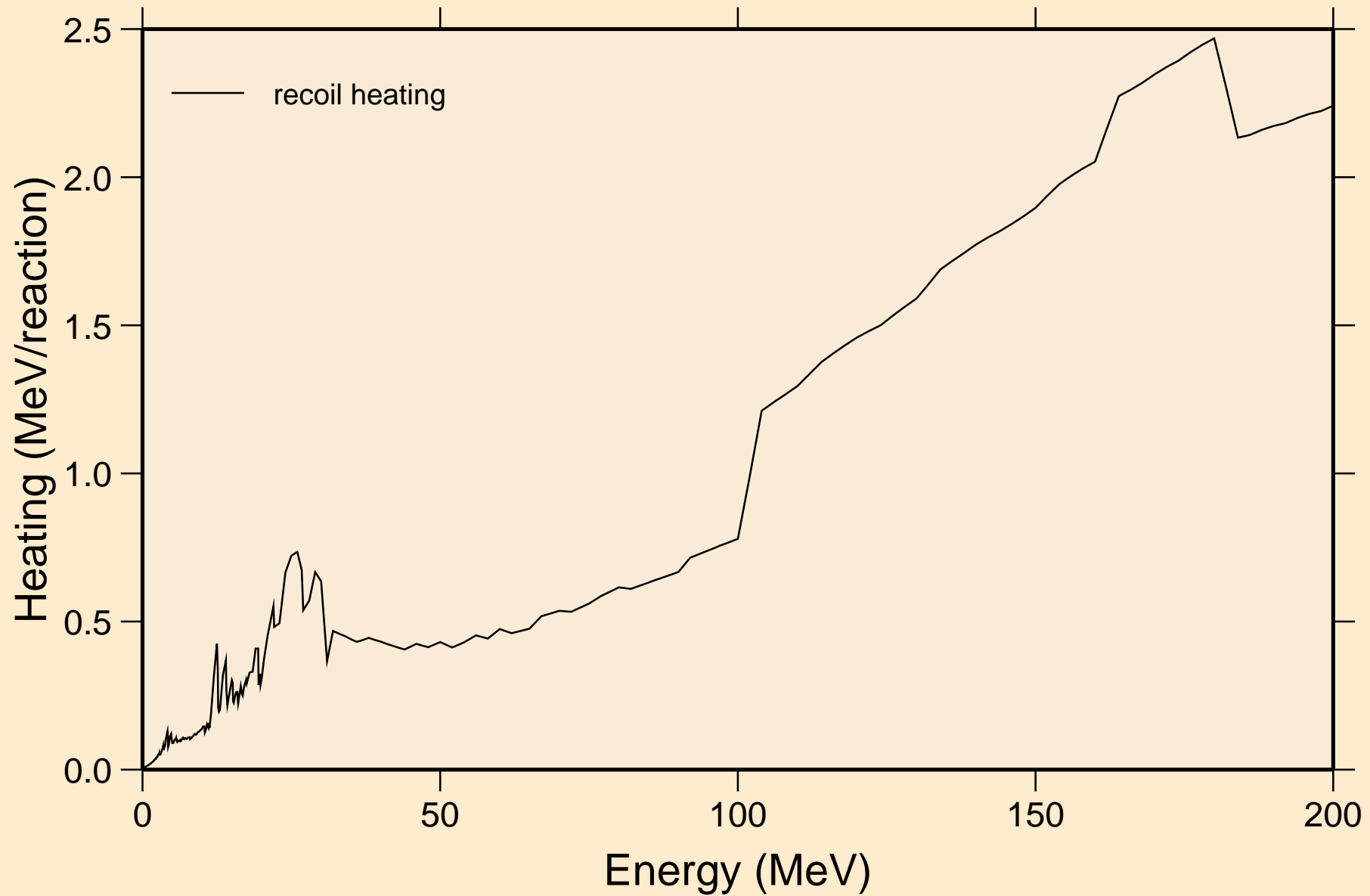

SR082 NEUTRON ACER TENDL-2021 LIBRARY; T=293.6K
Particle production cross sections

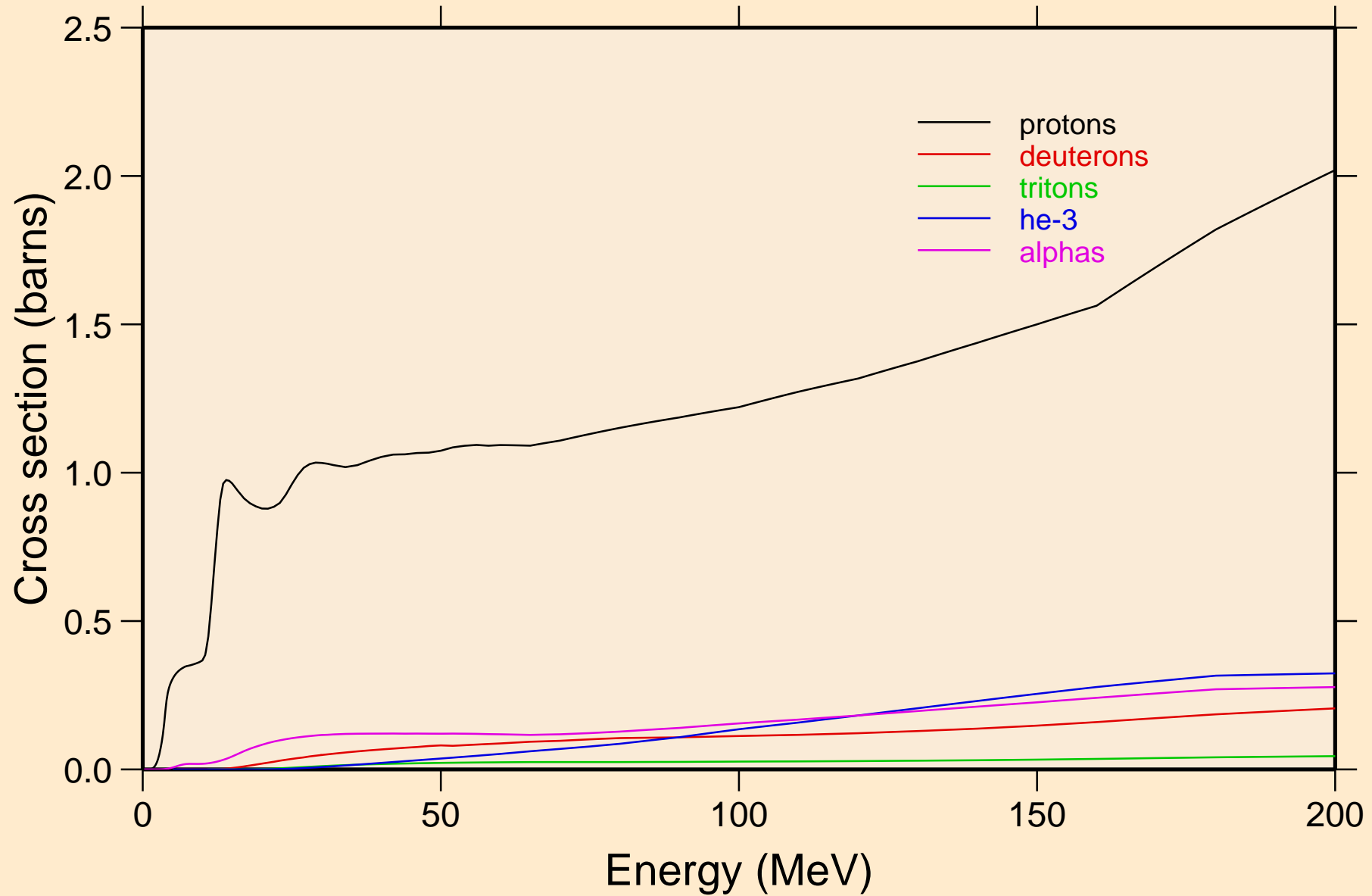

SR082 NEUTRON ACER TENDL-2021 LIBRARY; T=293.6K
protons from (n,x)

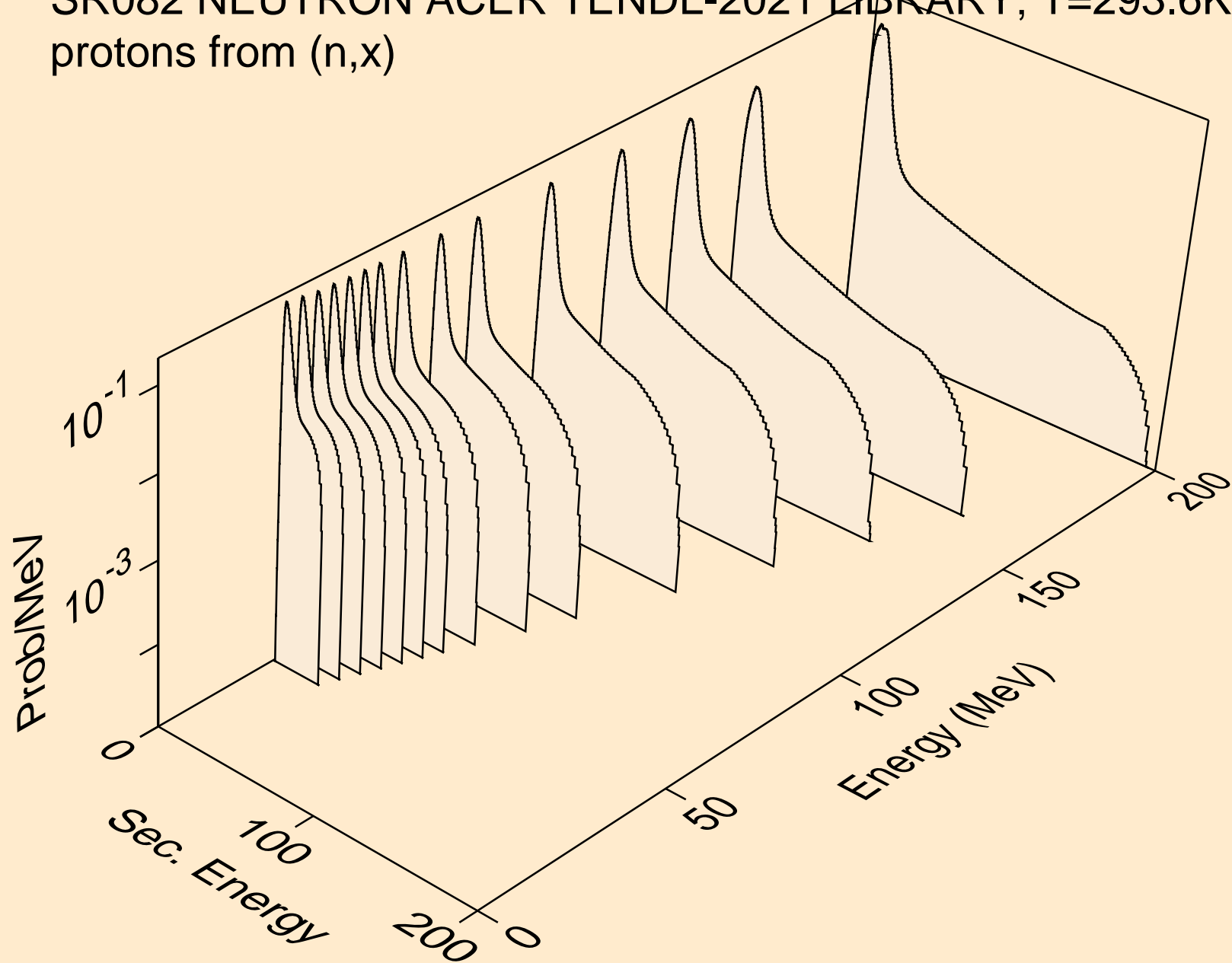

SR082 NEUTRON ACER TENDL-2021 LIBRARY; T=293.6K
protons from (n,n*)p

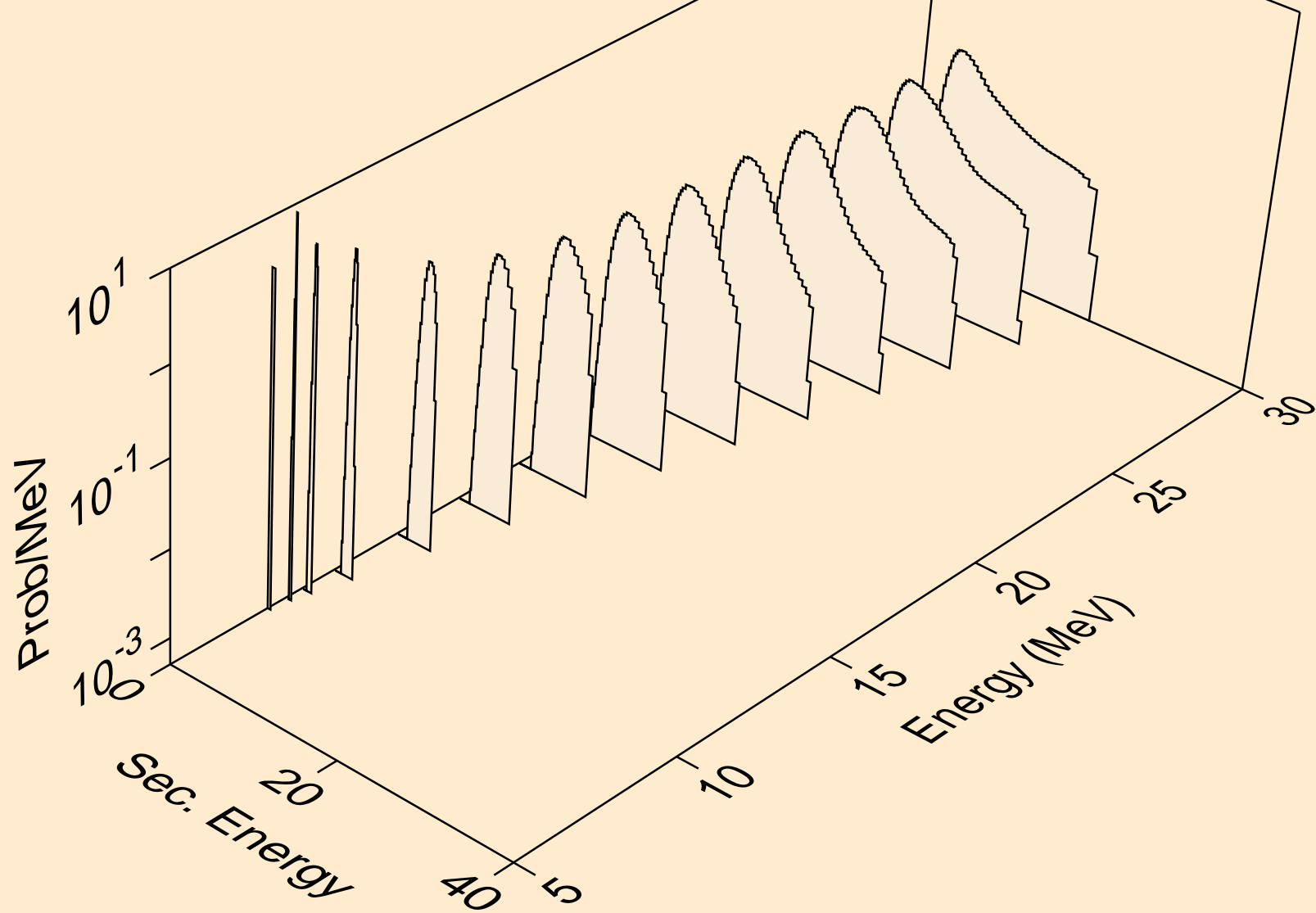

SR082 NEUTRON ACER TENDL-2021 LIBRARY; T=293.6K
protons from (n,2np)

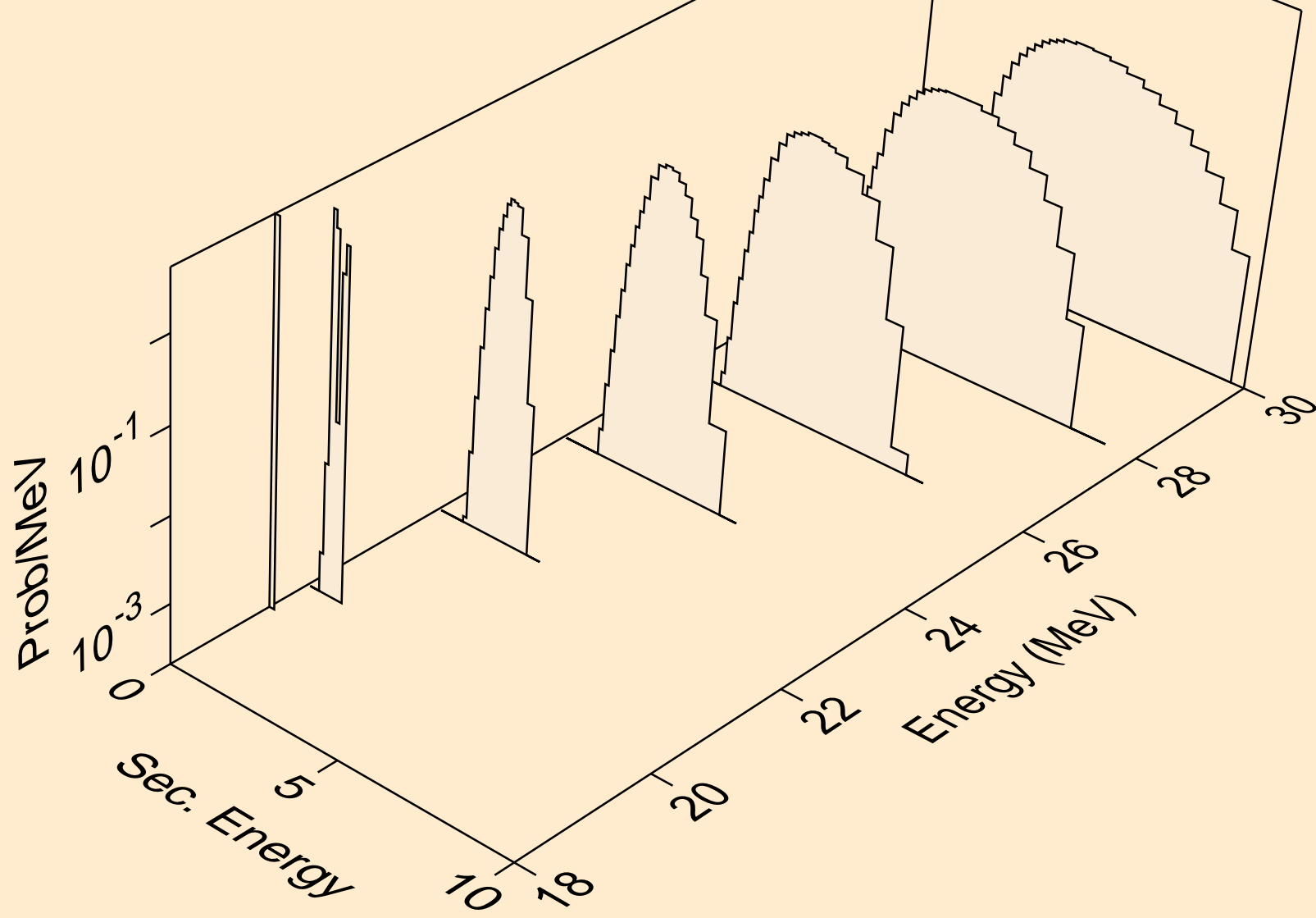

SR082 NEUTRON ACER TENDL-2021 LIBRARY; T=293.6K
protons from (n,2np)

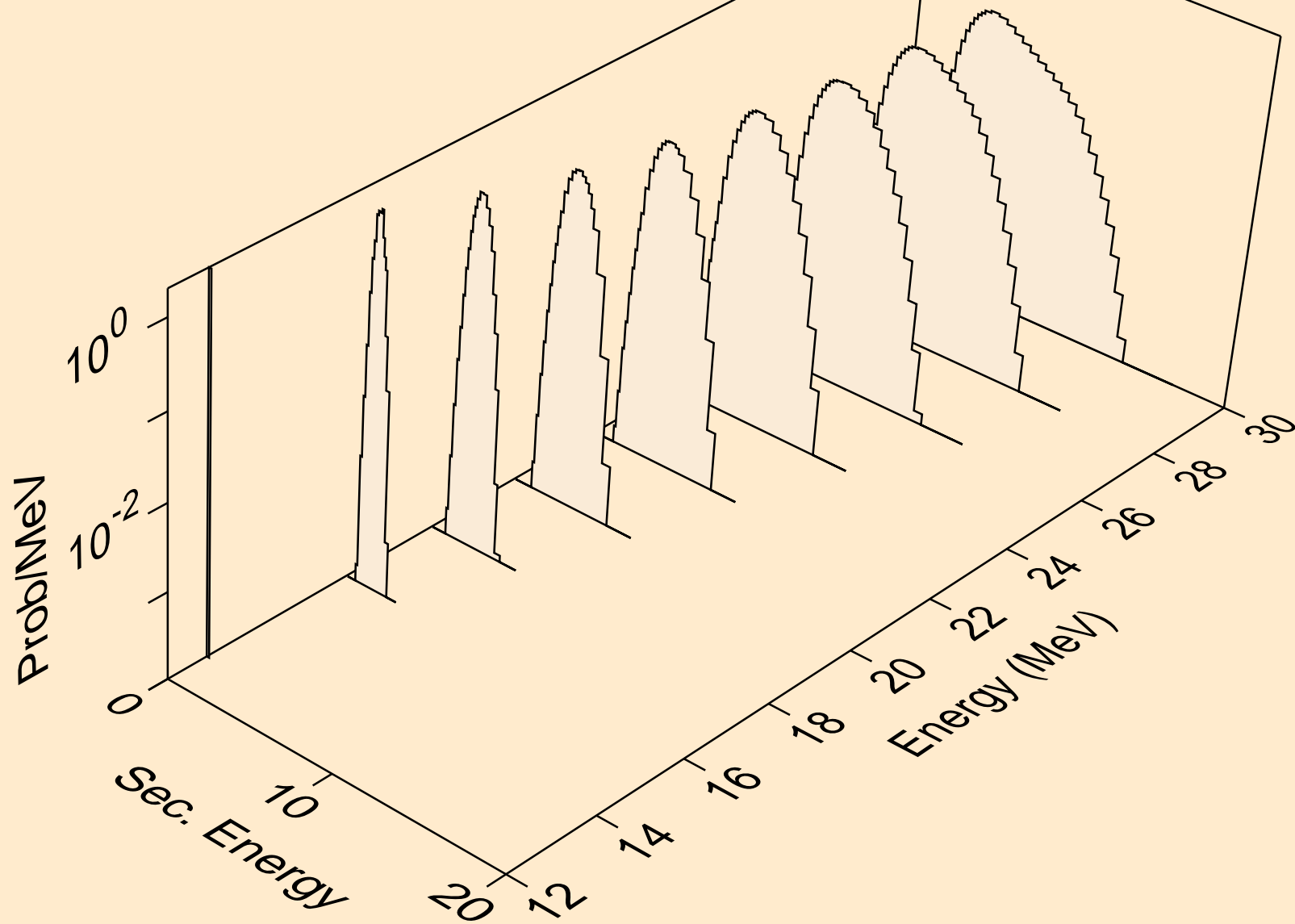

SR082 NEUTRON ACER TENDL-2021 LIBRARY; T=293.6K
protons from (n,npa)

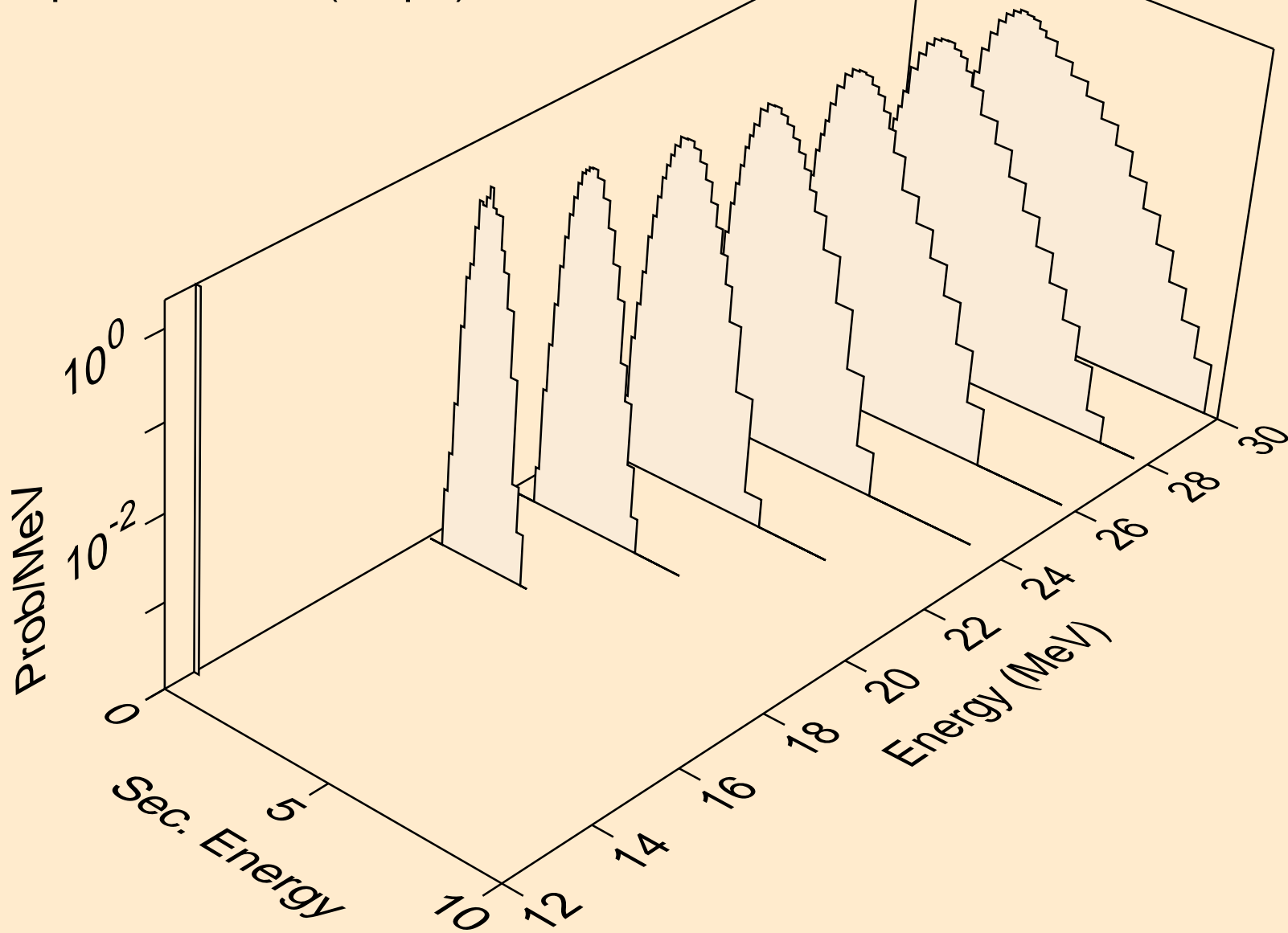

SR082 NEUTRON ACER TENDL-2021 LIBRARY; T=293.6K
protons from (n,p)

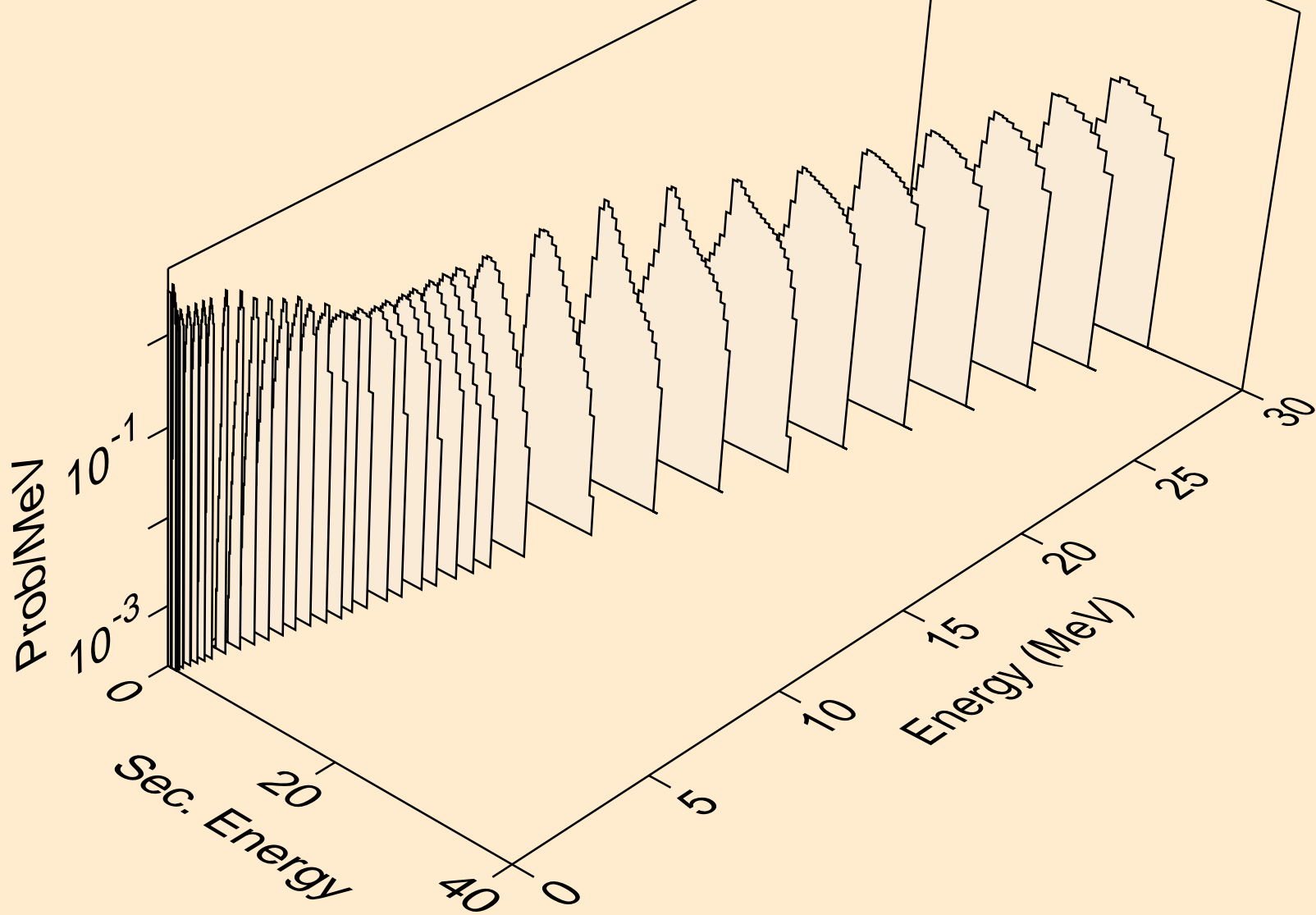

SR082 NEUTRON ACER TENDL-2021 LIBRARY; T=293.6K
protons from (n,2p)

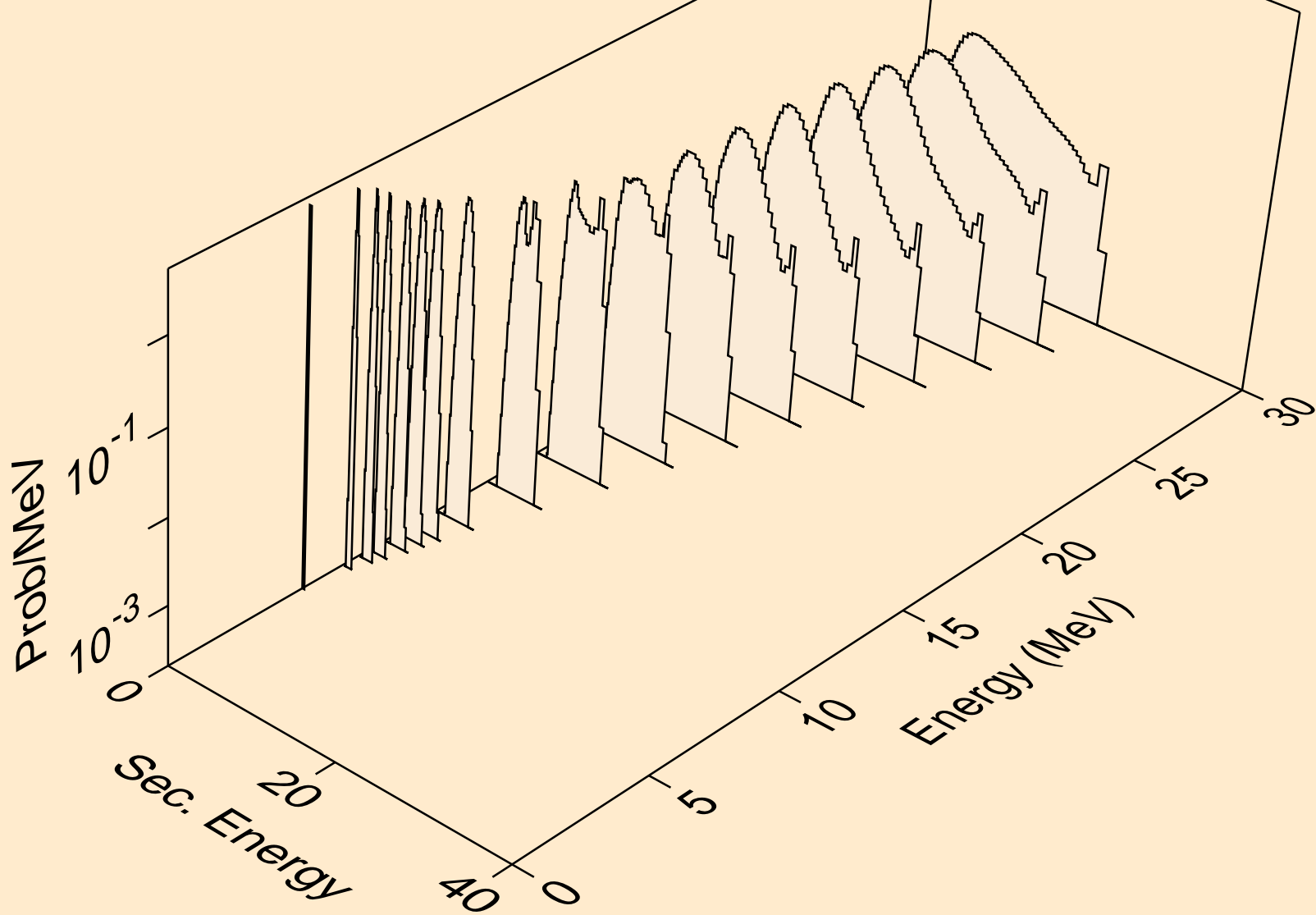

SR082 NEUTRON ACER TENDL-2021 LIBRARY; T=293.6K
protons from (n,p)

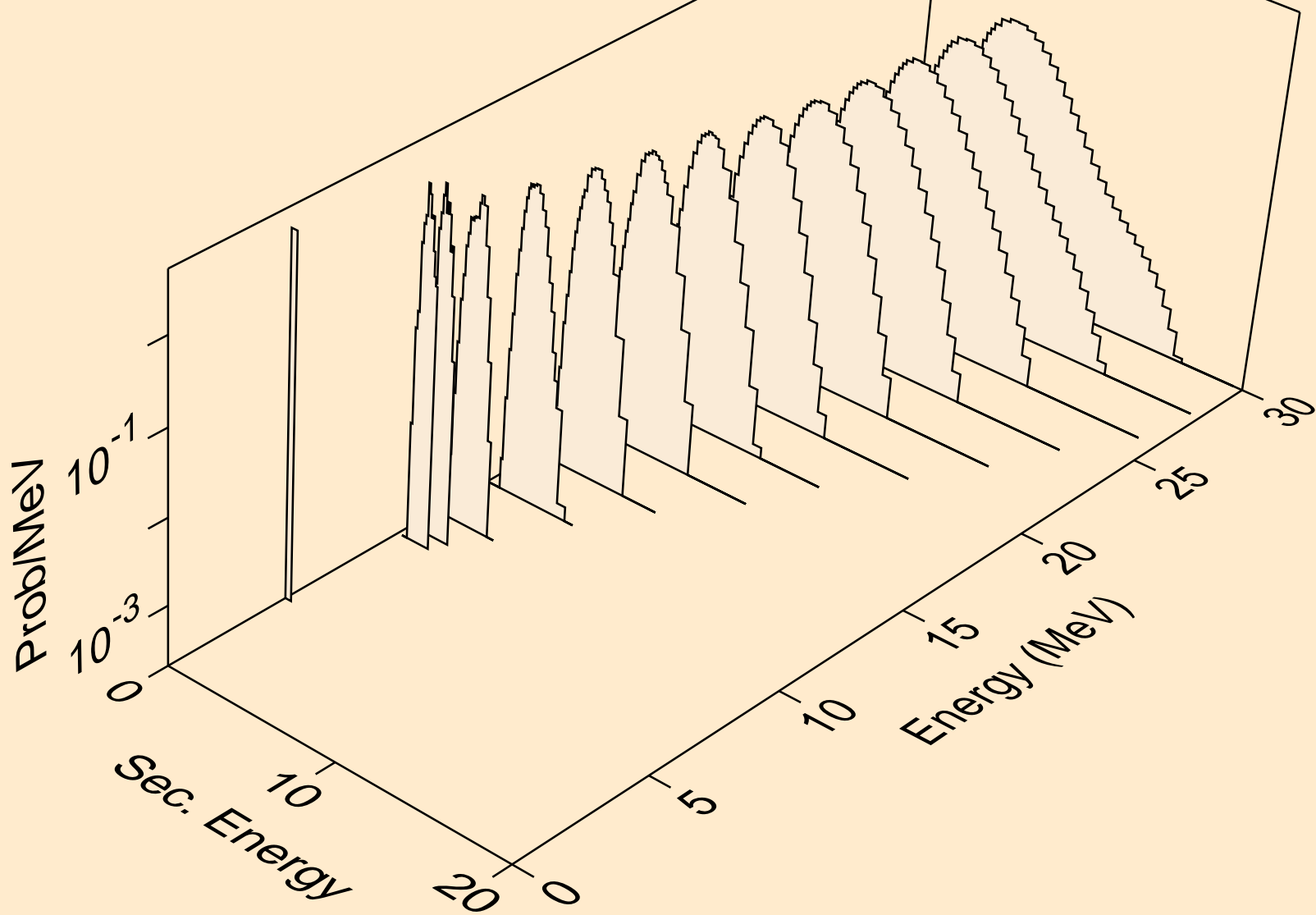

SR082 NEUTRON ACER TENDL-2021 LIBRARY; T=293.6K
protons from (n,pd)

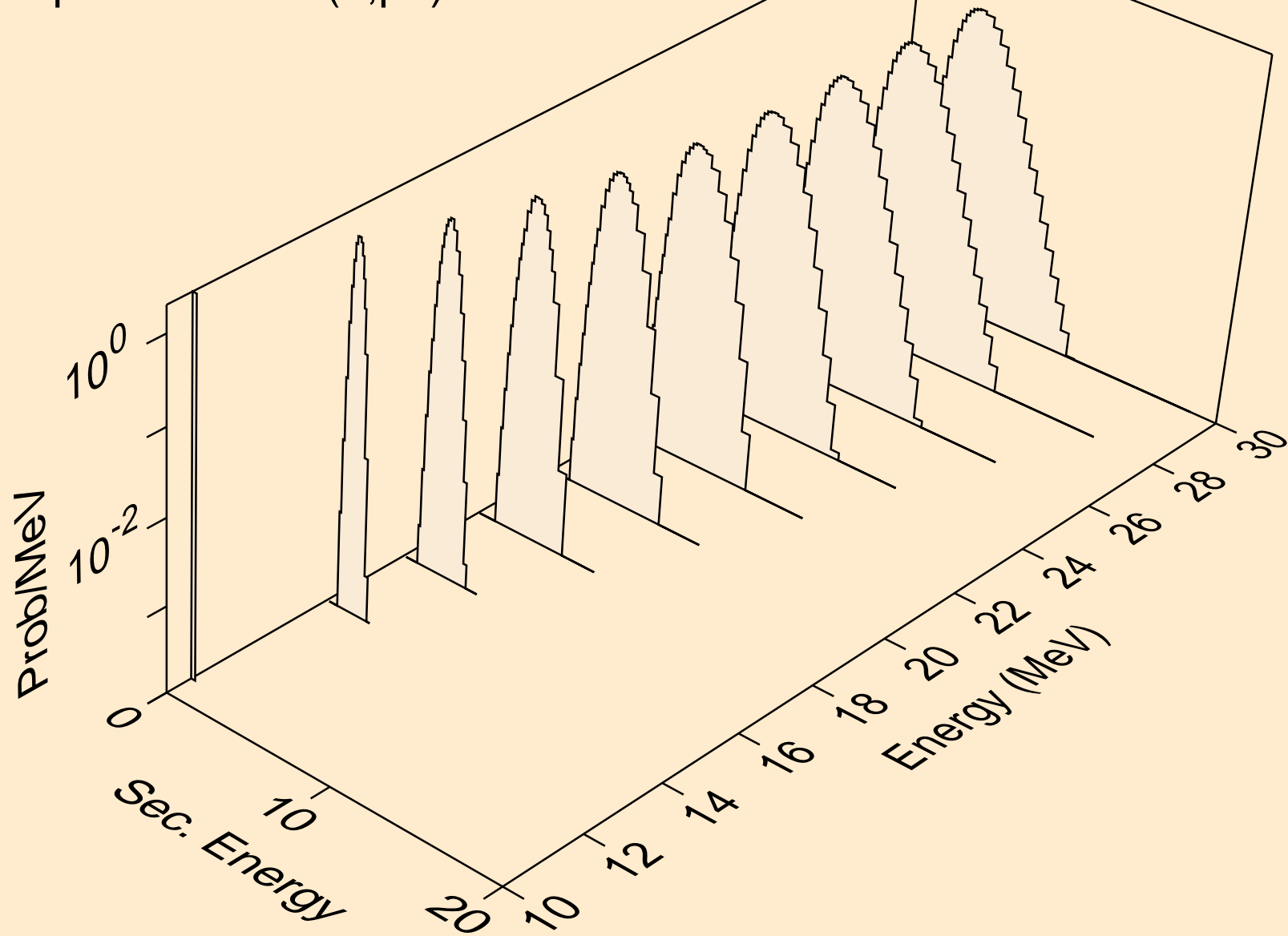

SR082 NEUTRON ACER TENDL-2021 LIBRARY; T=293.6K
protons from (n,pt)

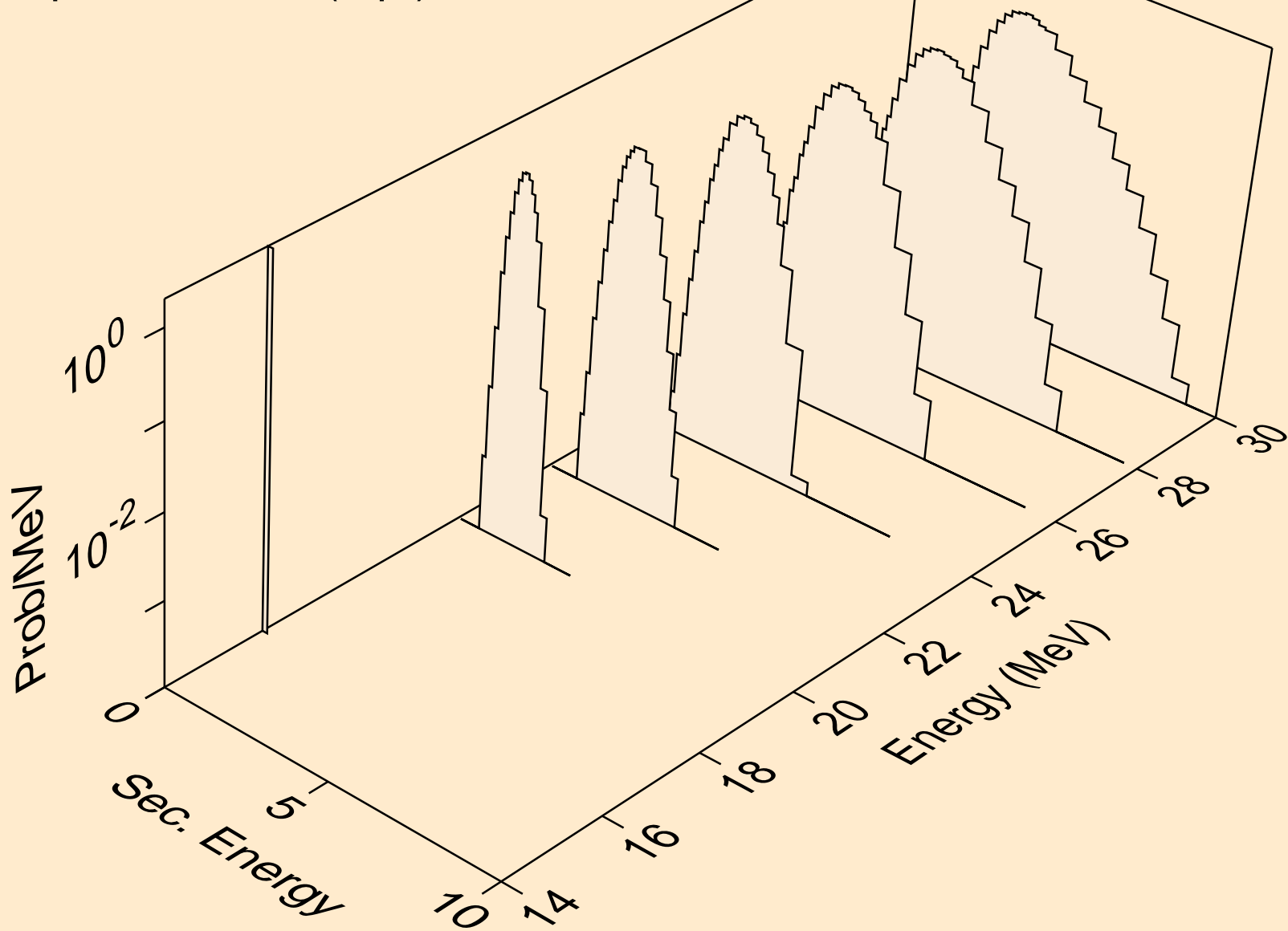

SR082 NEUTRON ACER TENDL-2021 LIBRARY; T=293.6K
deuterons from (n,x)

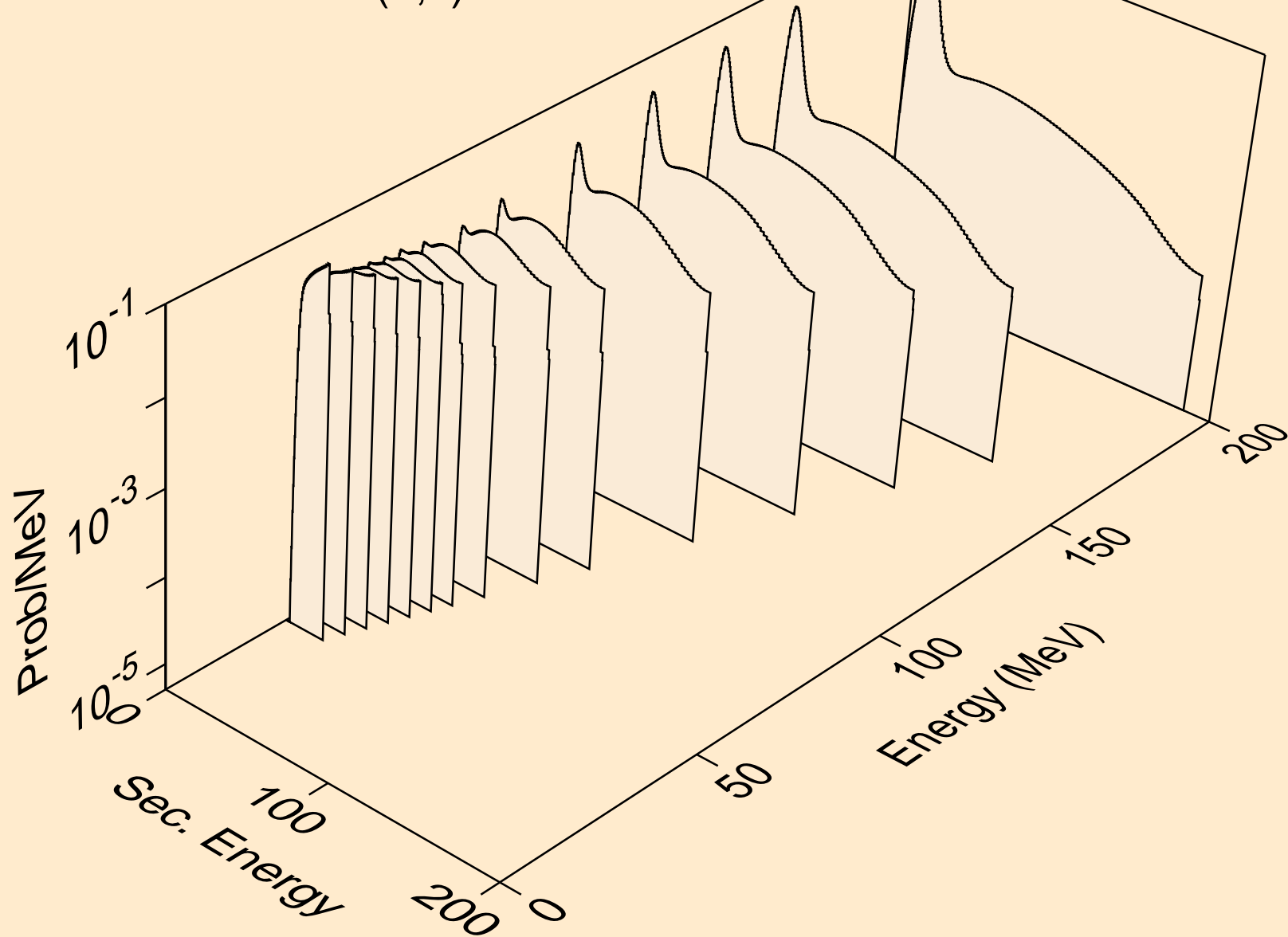

SR082 NEUTRON ACER TENDL-2021 LIBRARY; T=293.6K
deuterons from (n,2nd)

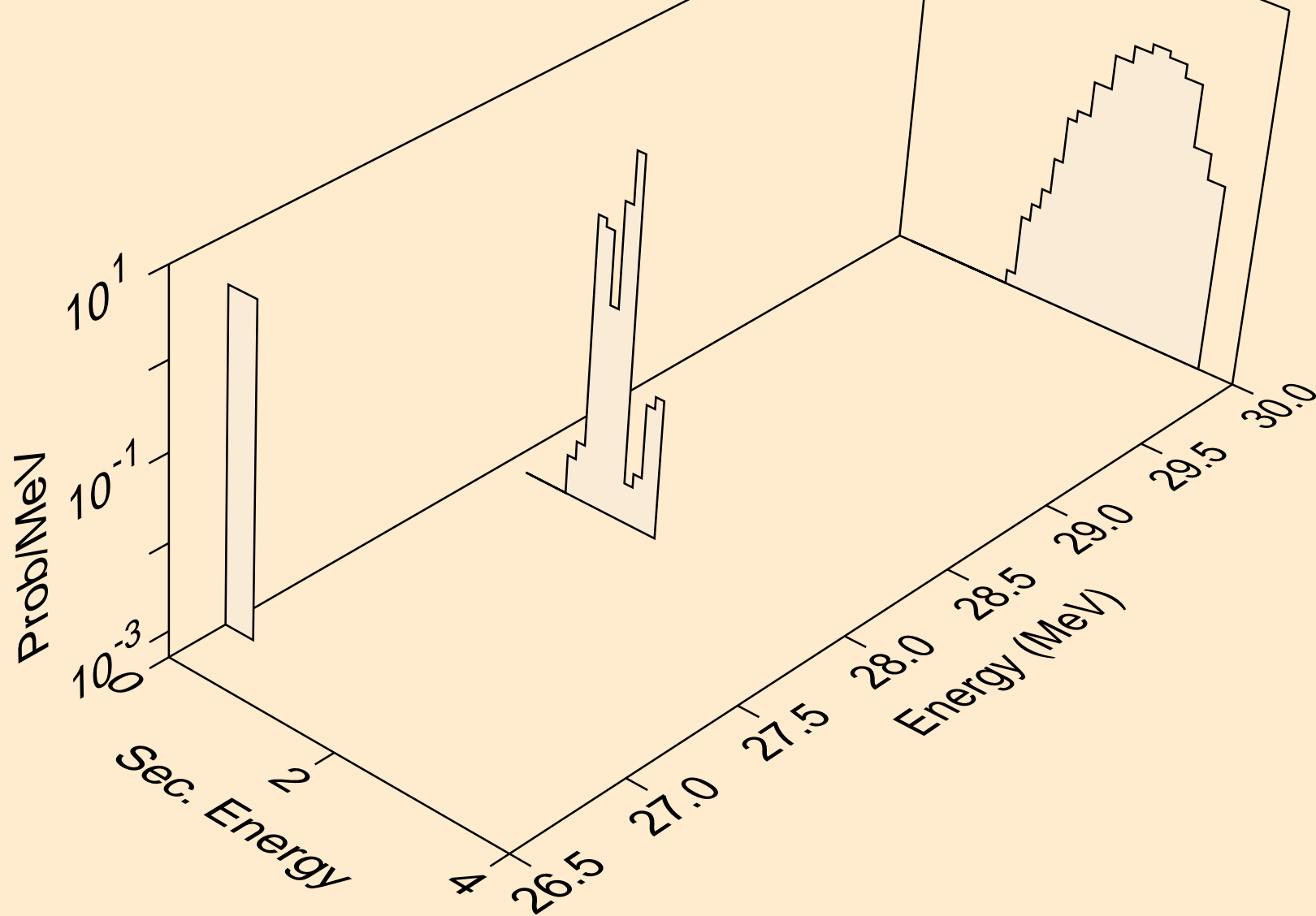

SR082 NEUTRON ACER TENDL-2021 LIBRARY; T=293.6K
deuterons from (n,n*)d

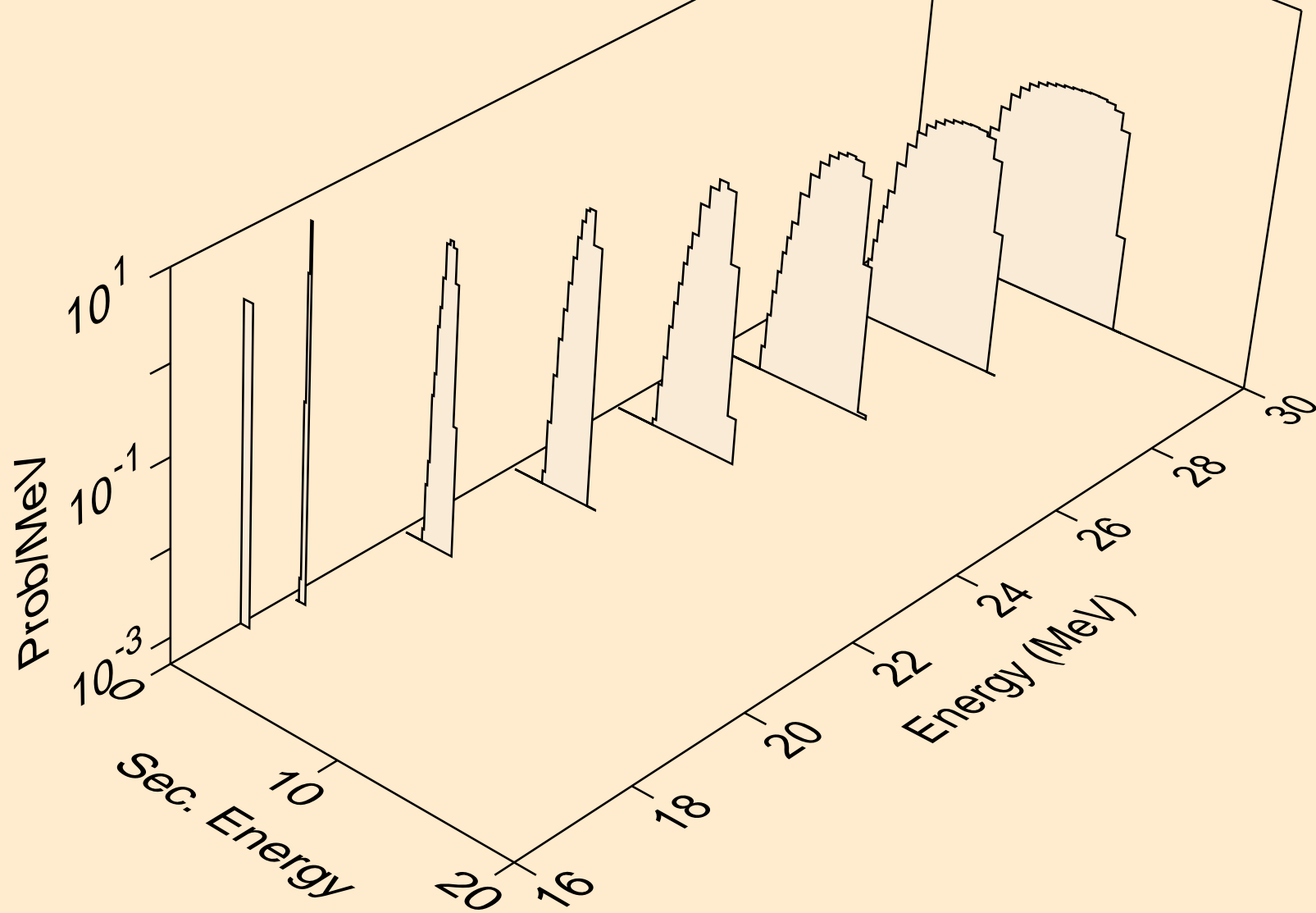

SR082 NEUTRON ACER TENDL-2021 LIBRARY; T=293.6K
deuterons from (n,d)

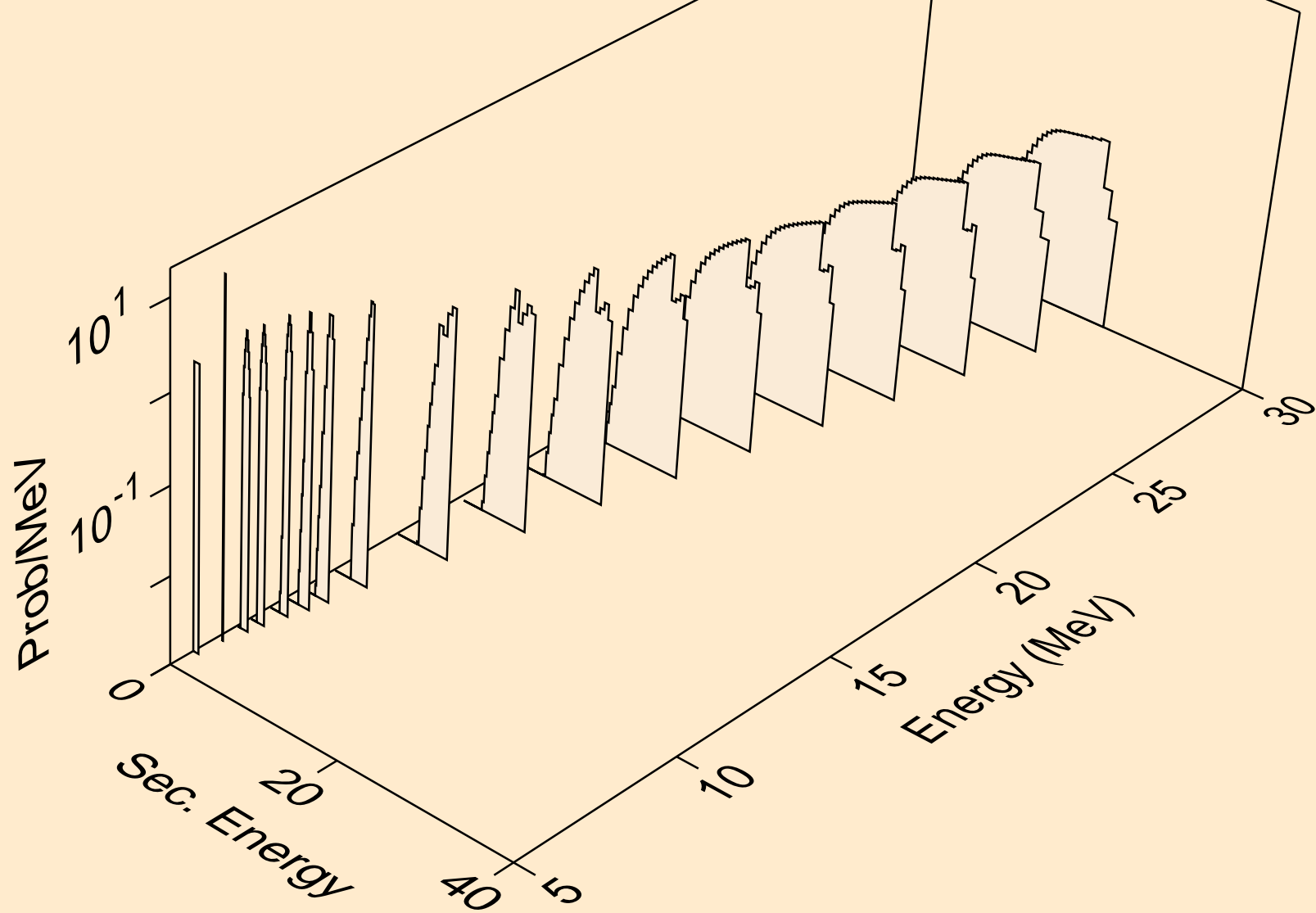

SR082 NEUTRON ACER TENDL-2021 LIBRARY; T=293.6K
deuterons from (n,pd)

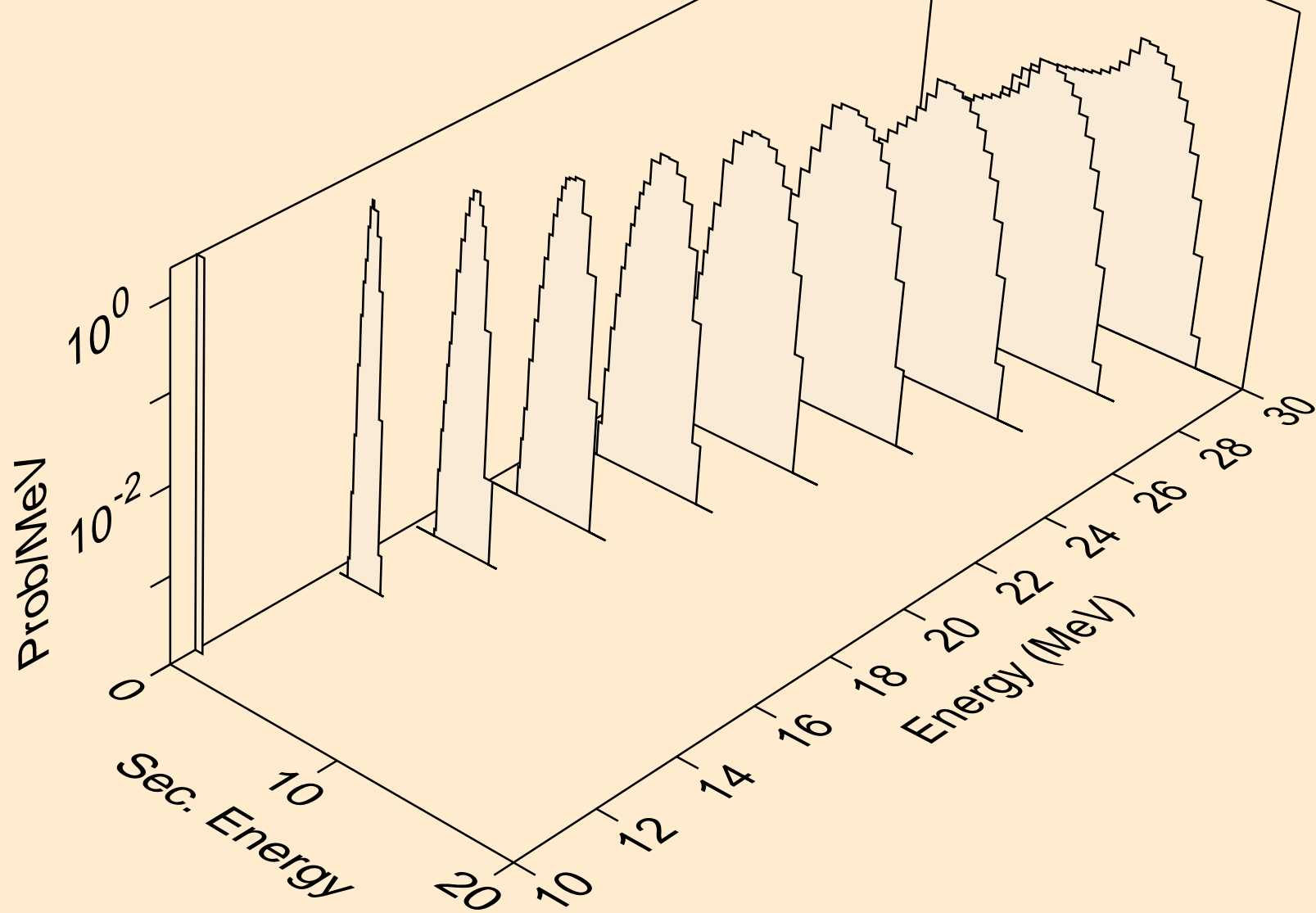

SR082 NEUTRON ACER TENDL-2021 LIBRARY; T=293.6K
deuterons from (n,da)

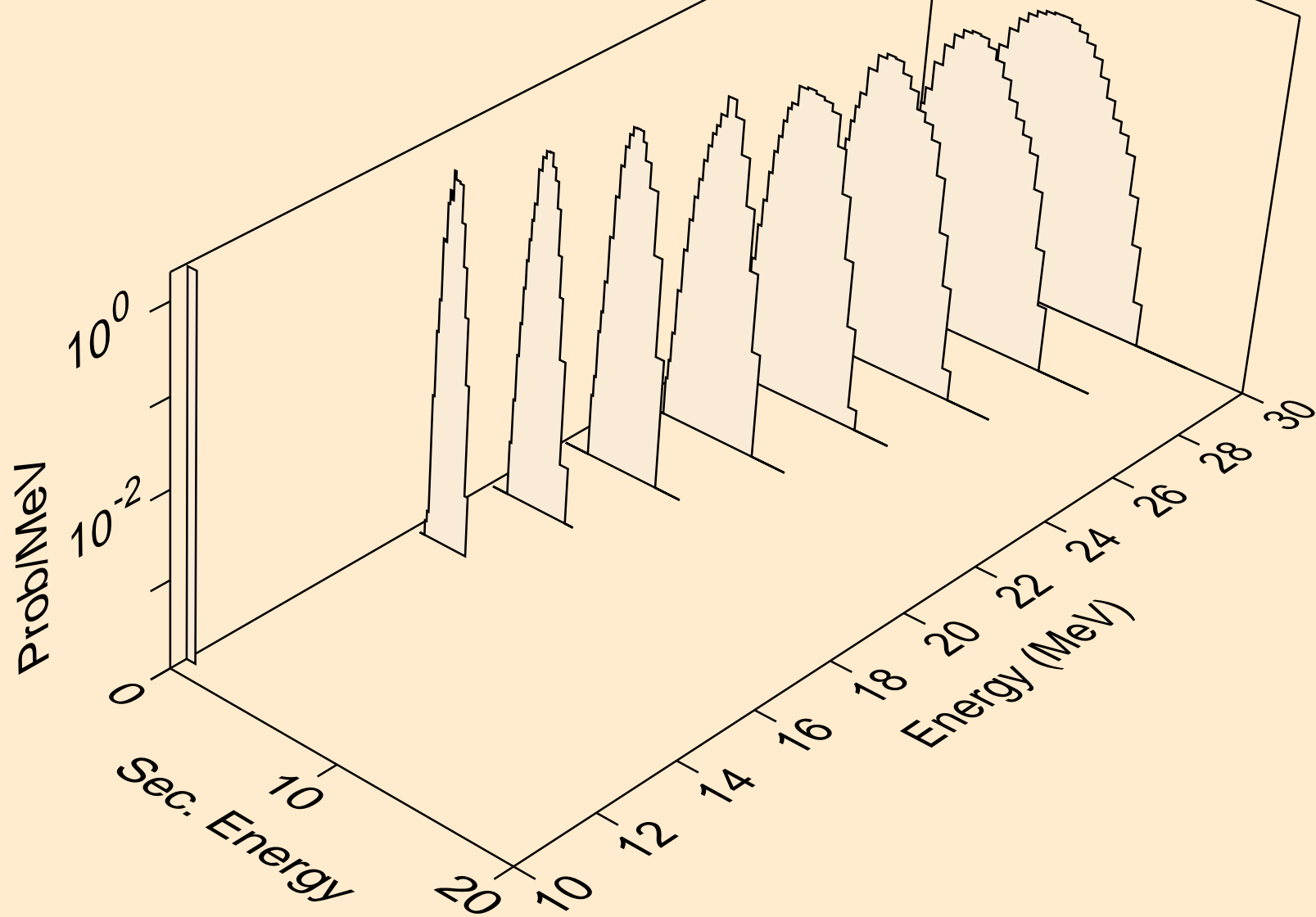

SR082 NEUTRON ACER TENDL-2021 LIBRARY; T=293.6K
tritons from (n,x)

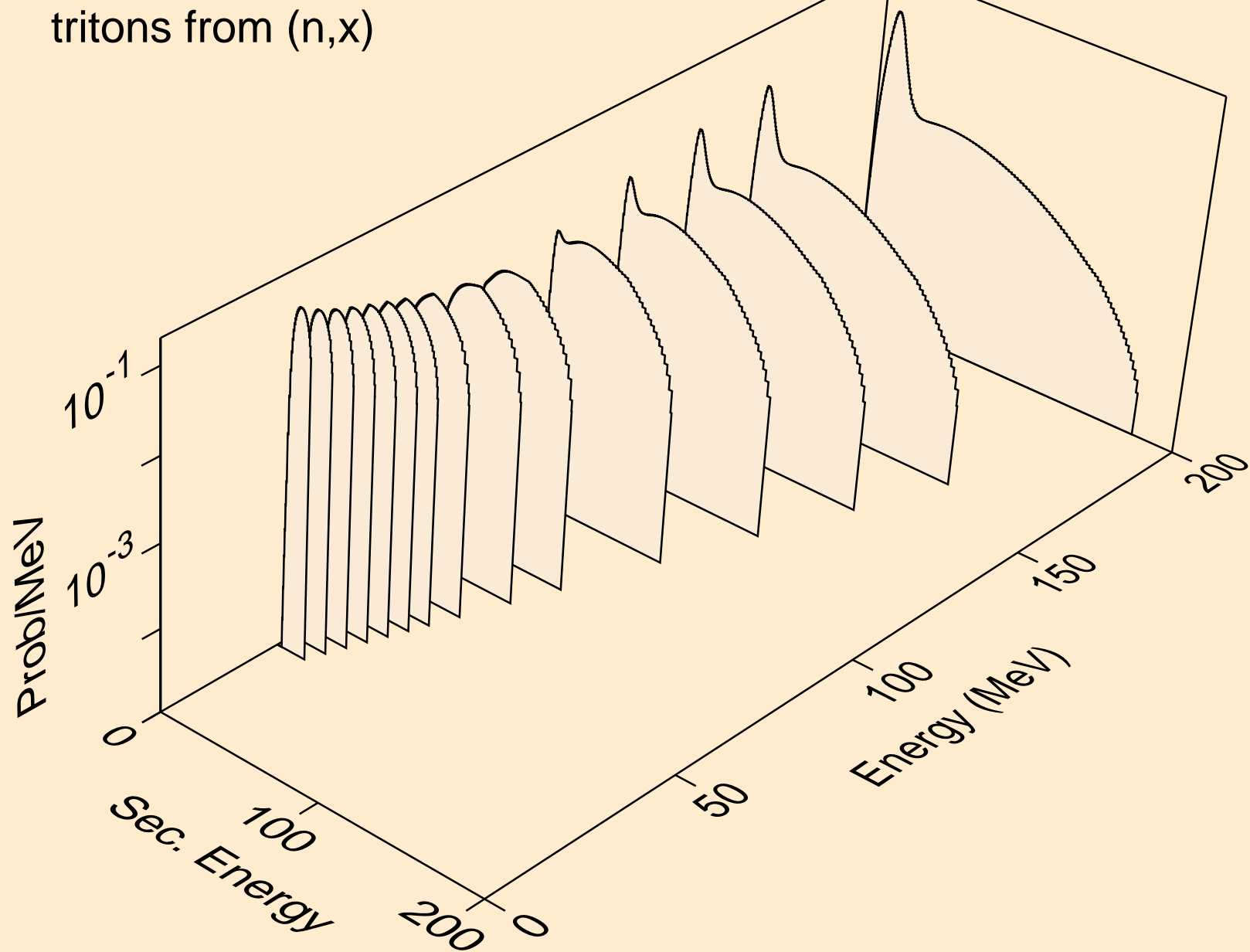

SR082 NEUTRON ACER TENDL-2021 LIBRARY; T=293.6K
tritons from (n,n*)t

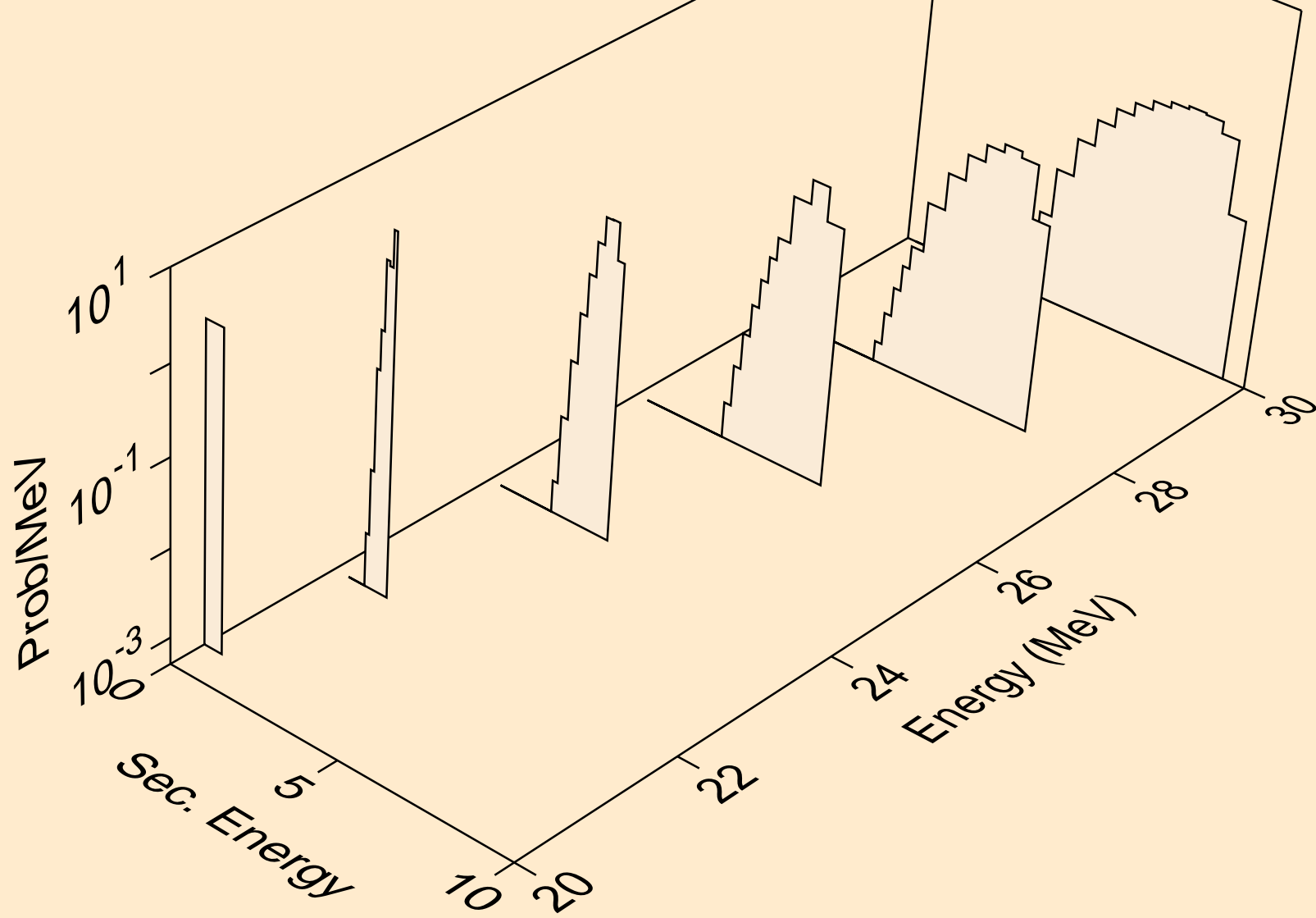

SR082 NEUTRON ACER TENDL-2021 LIBRARY; T=293.6K
tritons from (n,t)

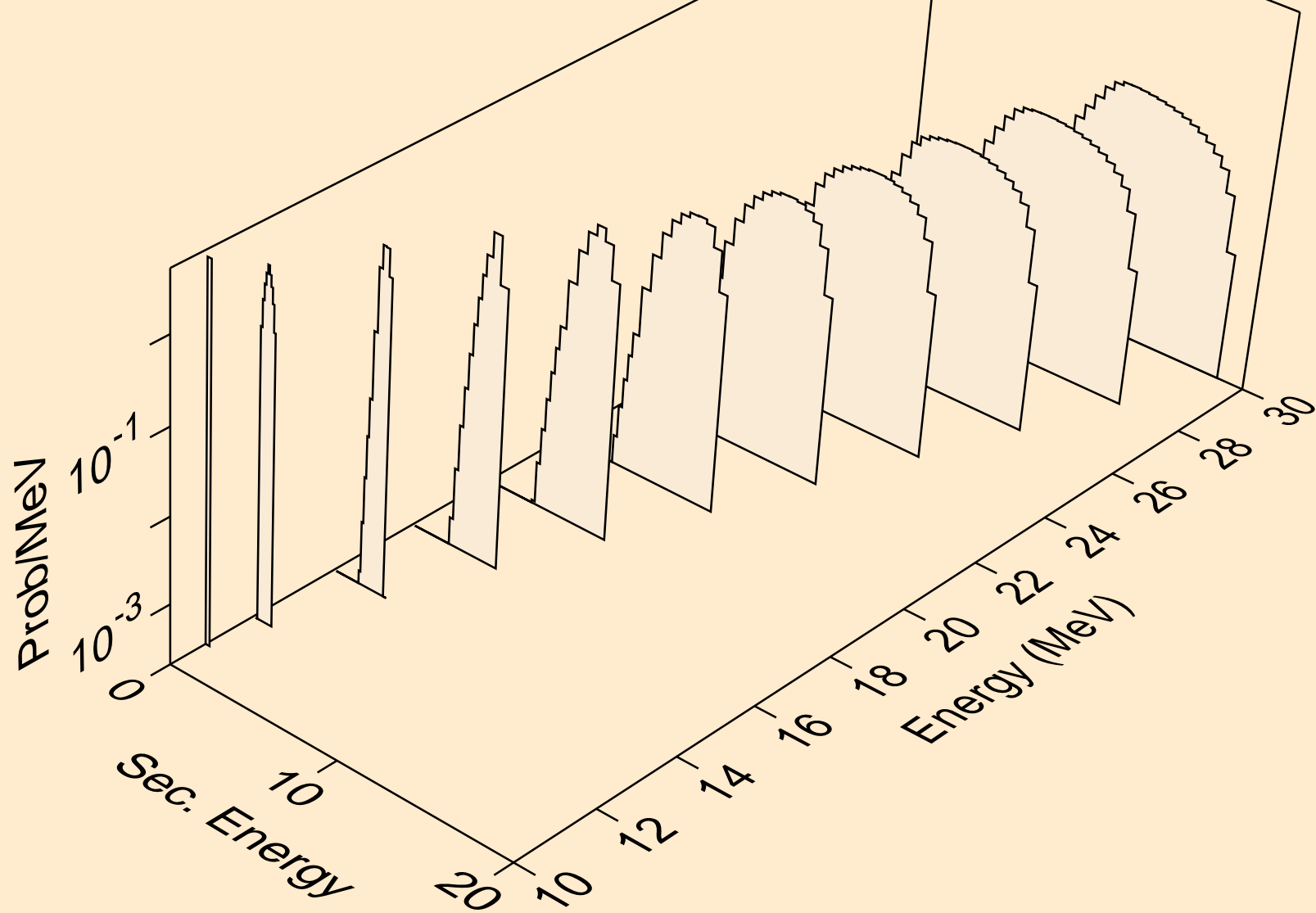

SR082 NEUTRON ACER TENDL-2021 LIBRARY; T=293.6K
tritons from (n,pt)

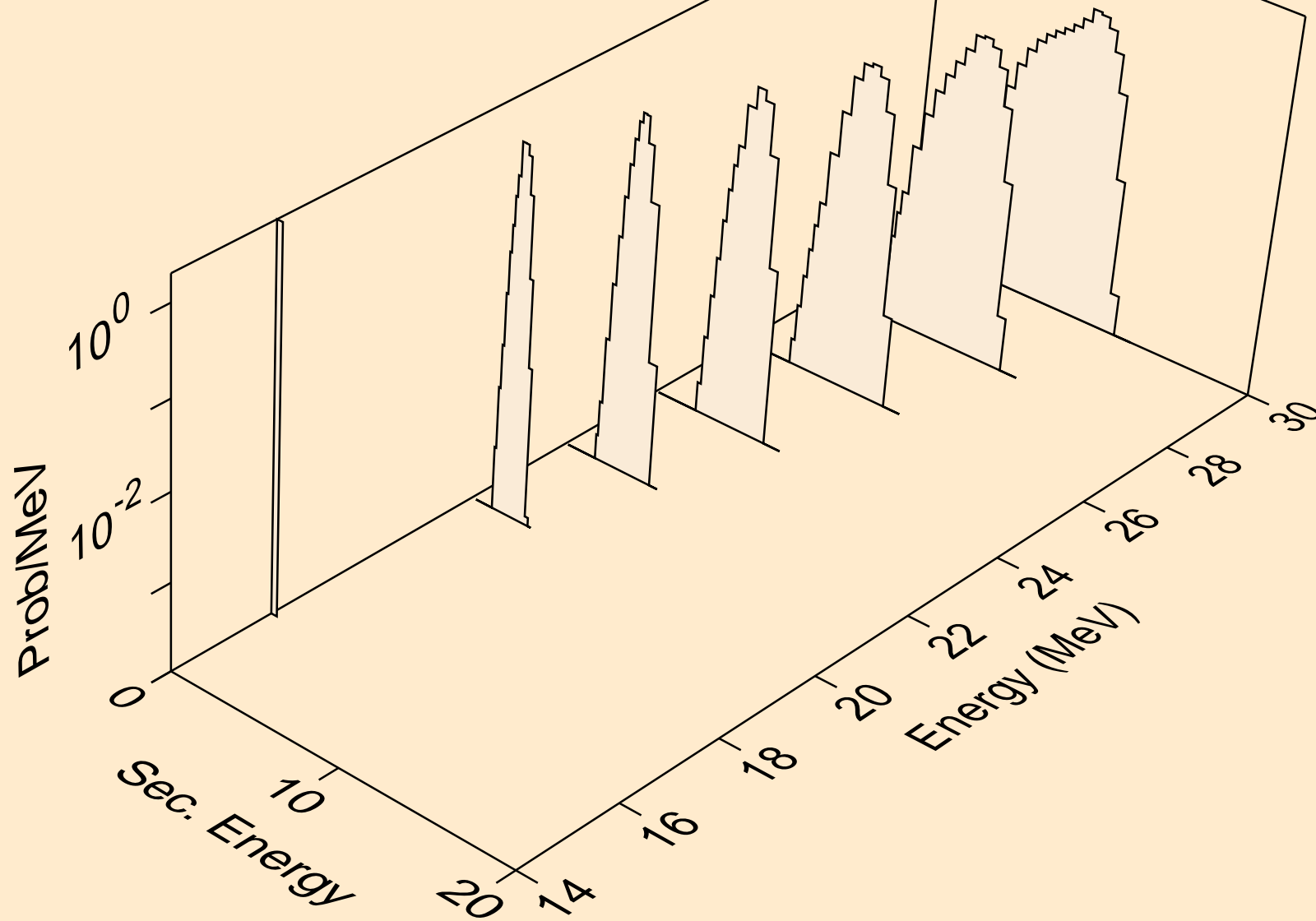

SR082 NEUTRON ACER TENDL-2021 LIBRARY; T=293.6K
he3s from (n,x)

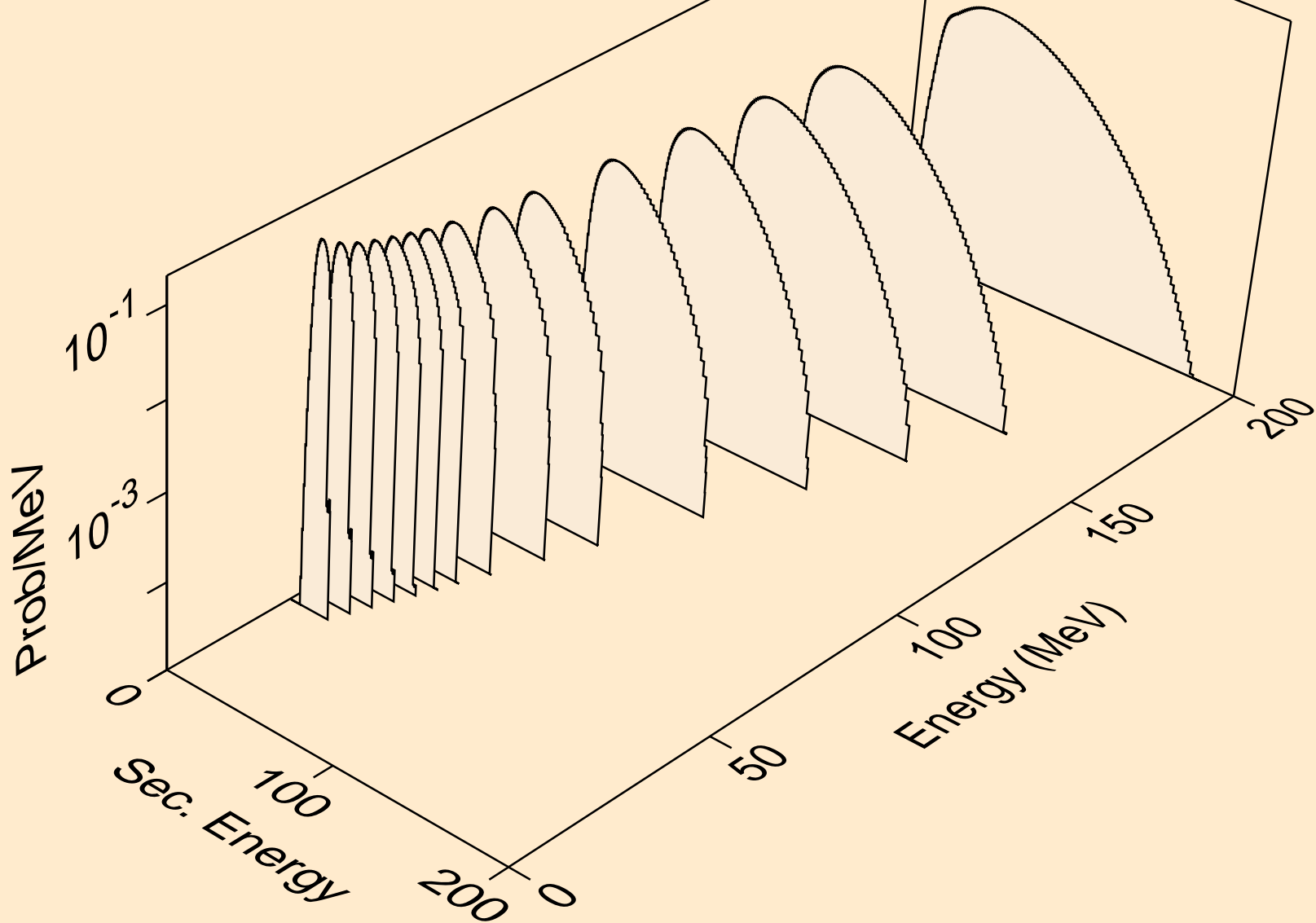

SR082 NEUTRON ACER TENDL-2021 LIBRARY; T=293.6K
he3s from (n,n*)he3

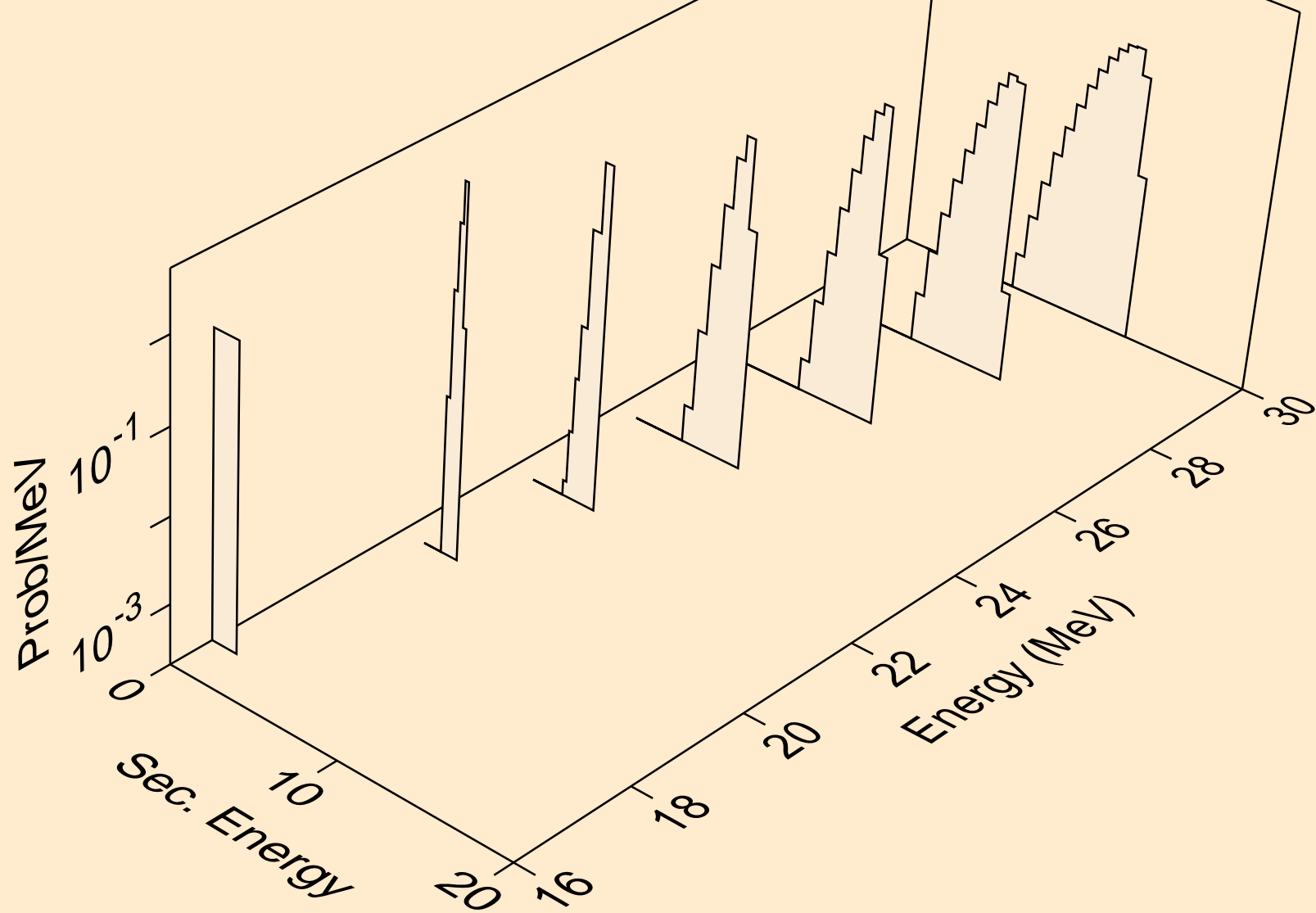

SR082 NEUTRON ACER TENDL-2021 LIBRARY; T=293.6K
he3s from (n,he3)

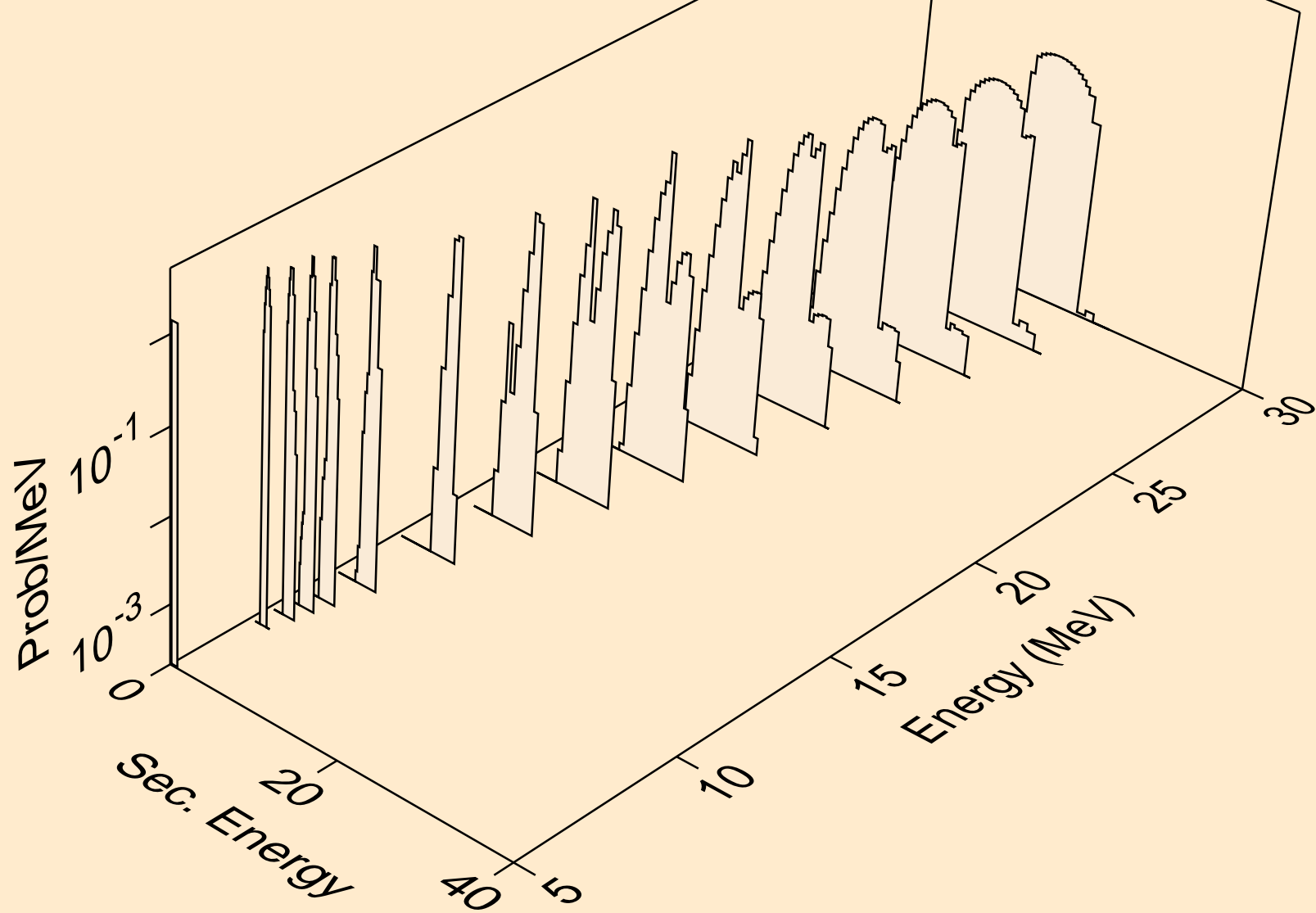

SR082 NEUTRON ACER TENDL-2021 LIBRARY; T=293.6K
alphas from (n,x)

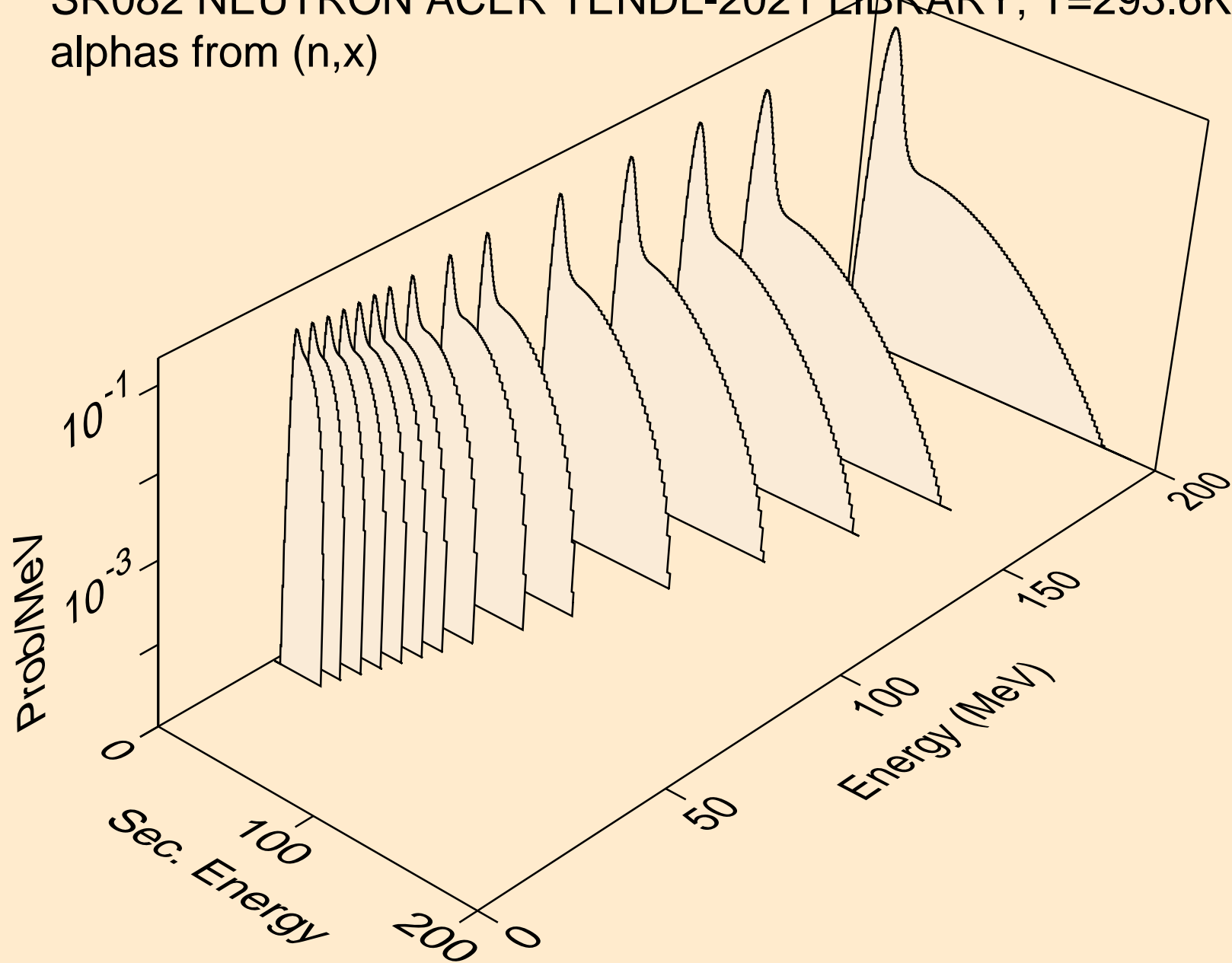

SR082 NEUTRON ACER TENDL-2021 LIBRARY; T=293.6K
alphas from (n,n*)a

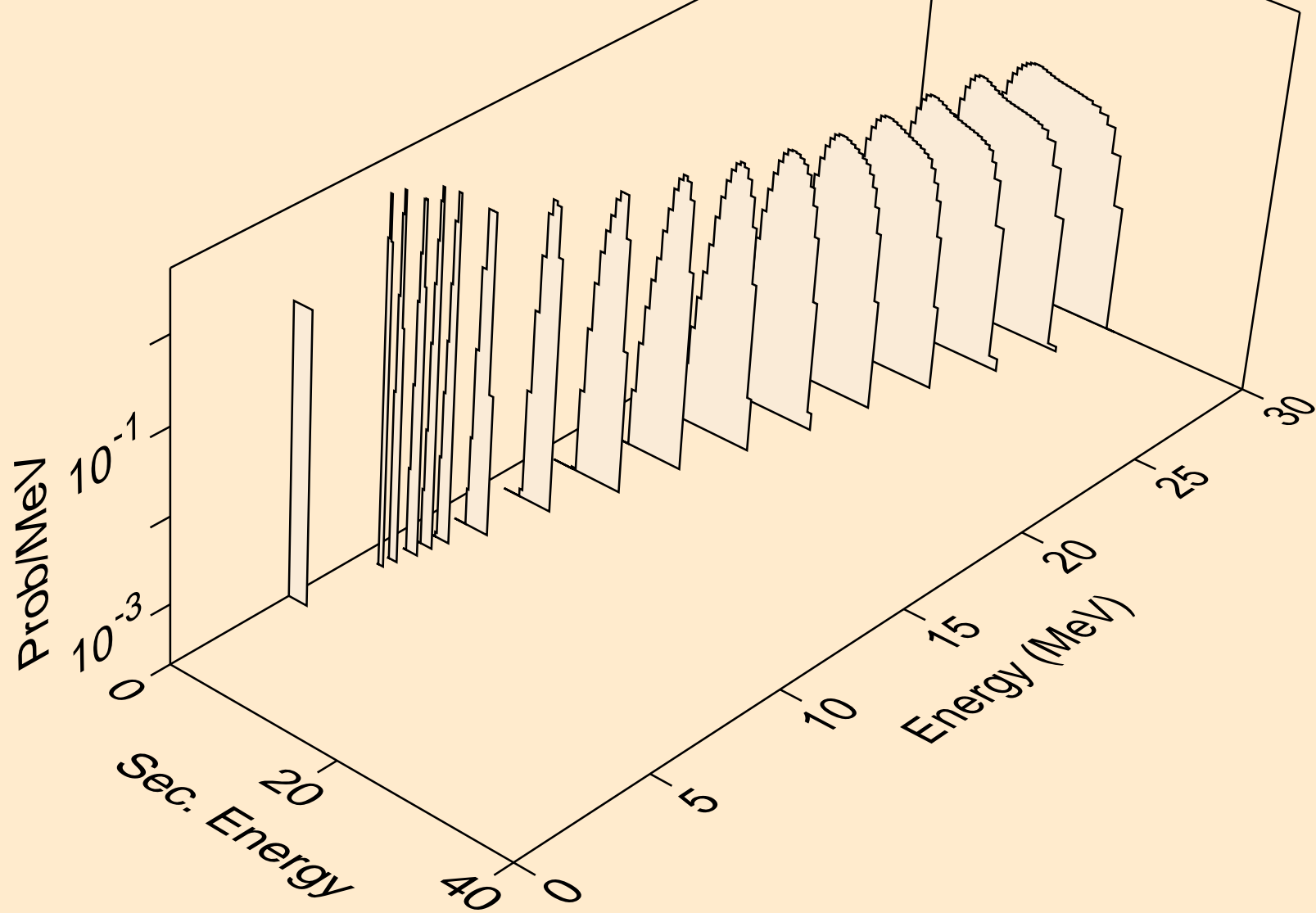

SR082 NEUTRON ACER TENDL-2021 LIBRARY; T=293.6K
alphas from (n,2n)a

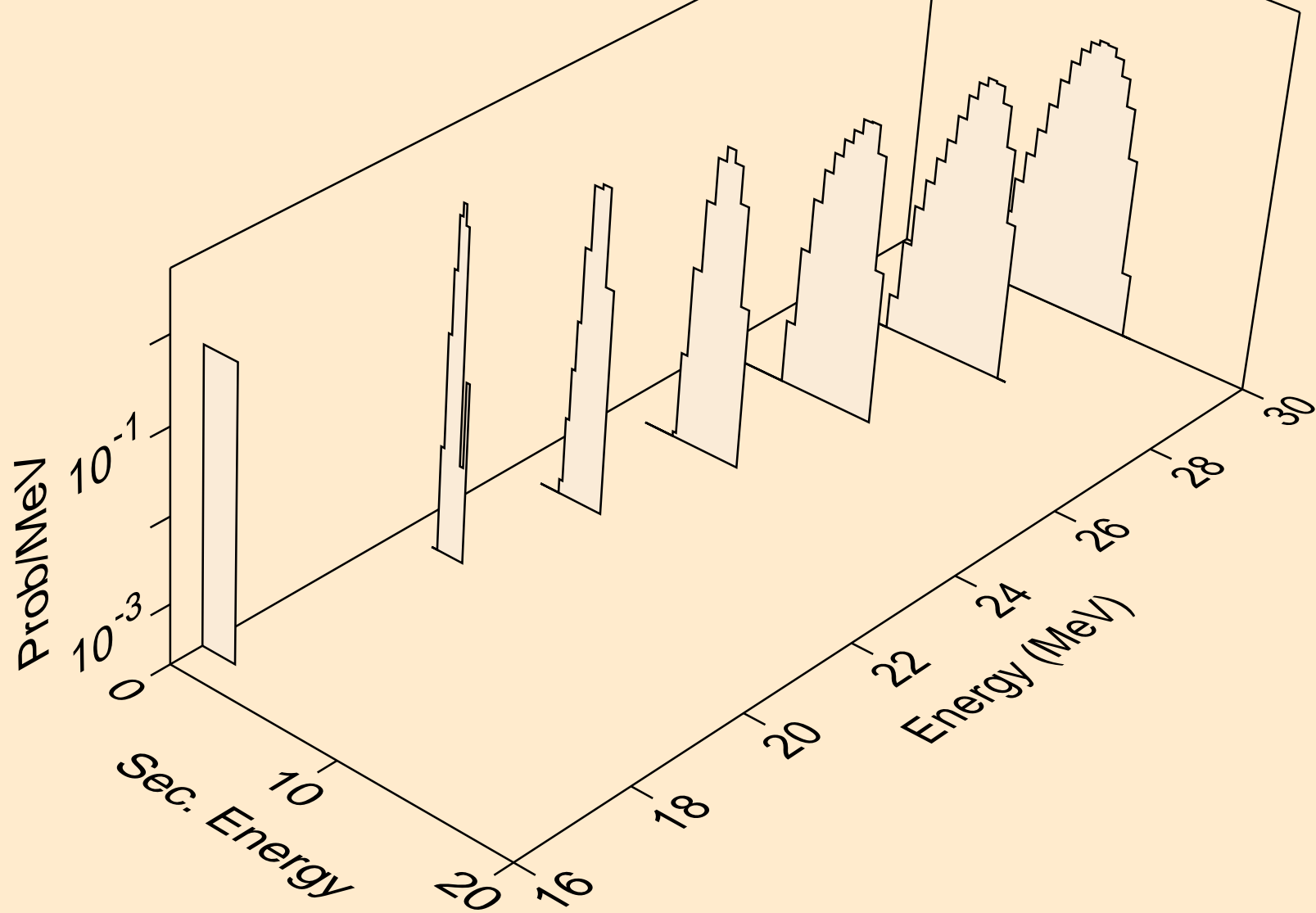

SR082 NEUTRON ACER TENDL-2021 LIBRARY; T=293.6K
alphas from (n,n*)2a

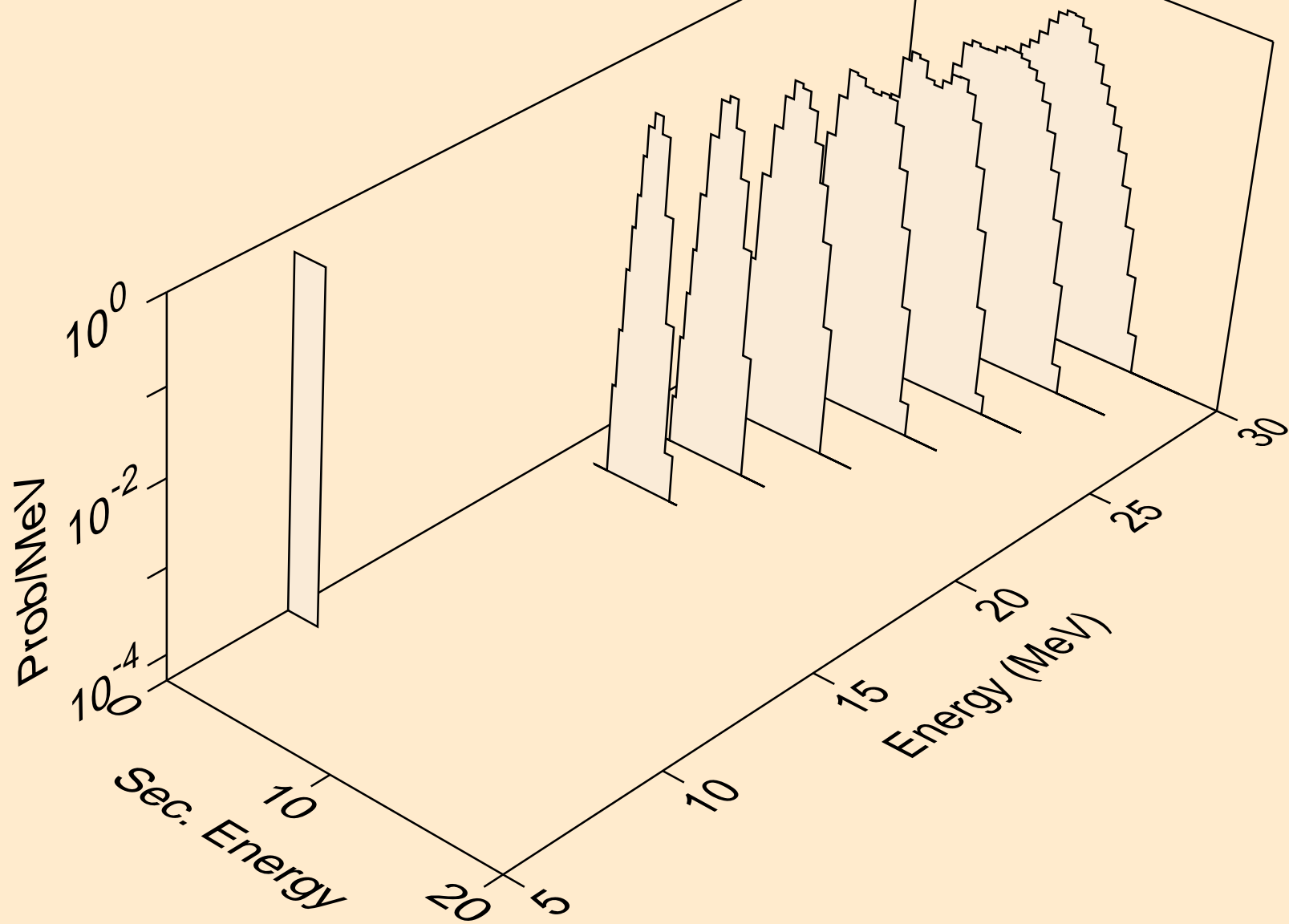

SR082 NEUTRON ACER TENDL-2021 LIBRARY; T=293.6K
alphas from (n,npa)

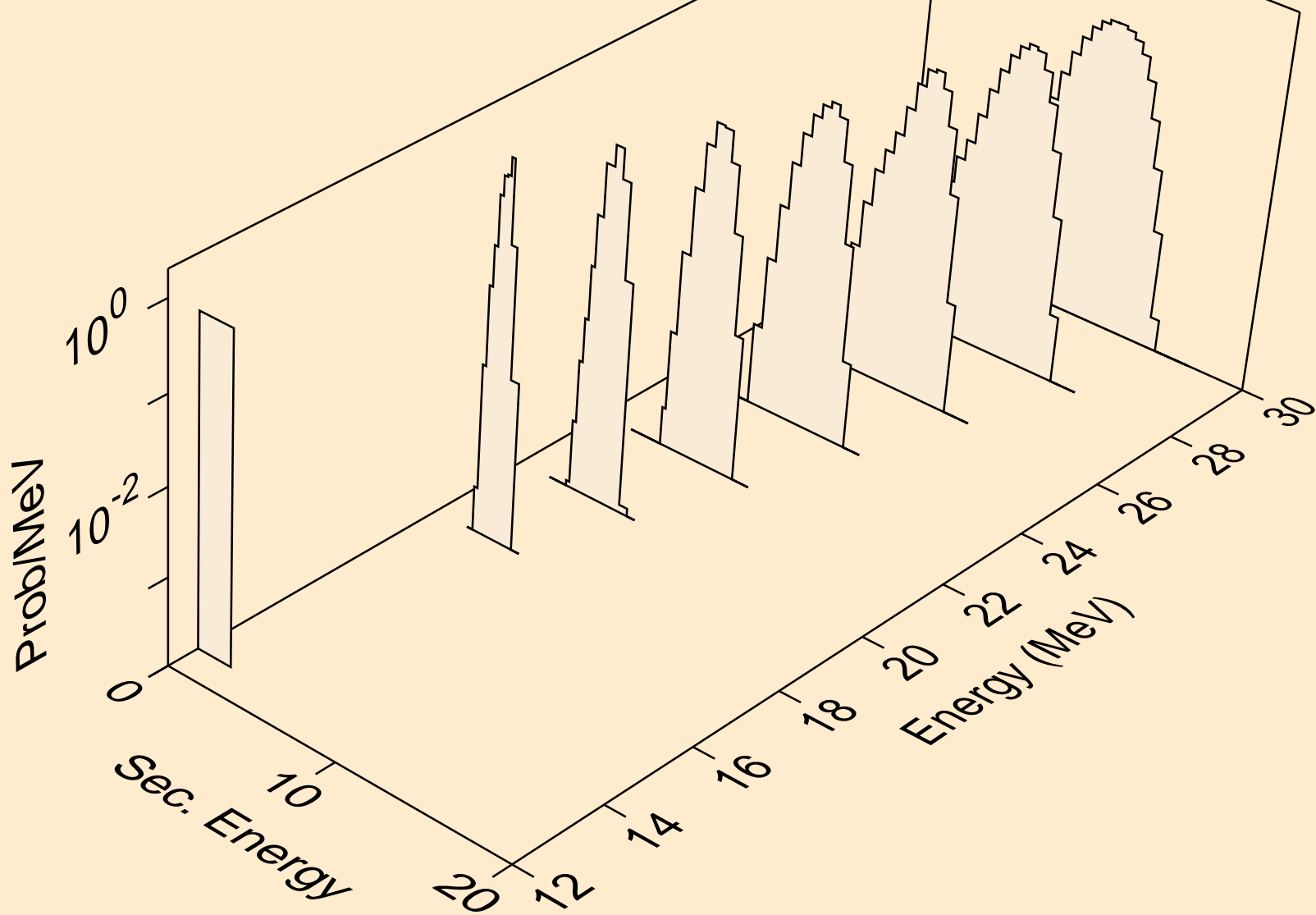

SR082 NEUTRON ACER TENDL-2021 LIBRARY; T=293.6K
alphas from (n,a)

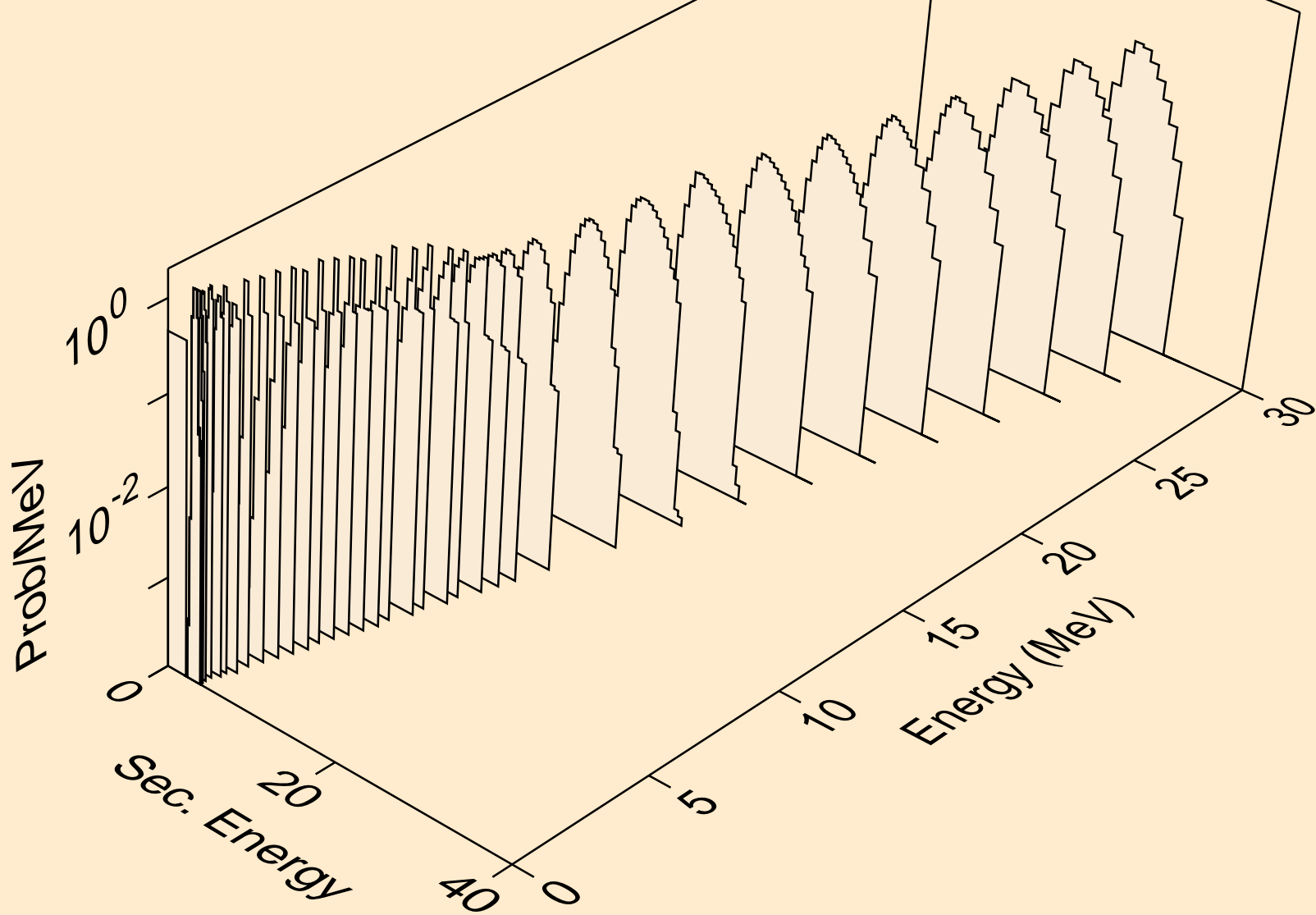

SR082 NEUTRON ACER TENDL-2021 LIBRARY; T=293.6K
alphas from (n,2a)

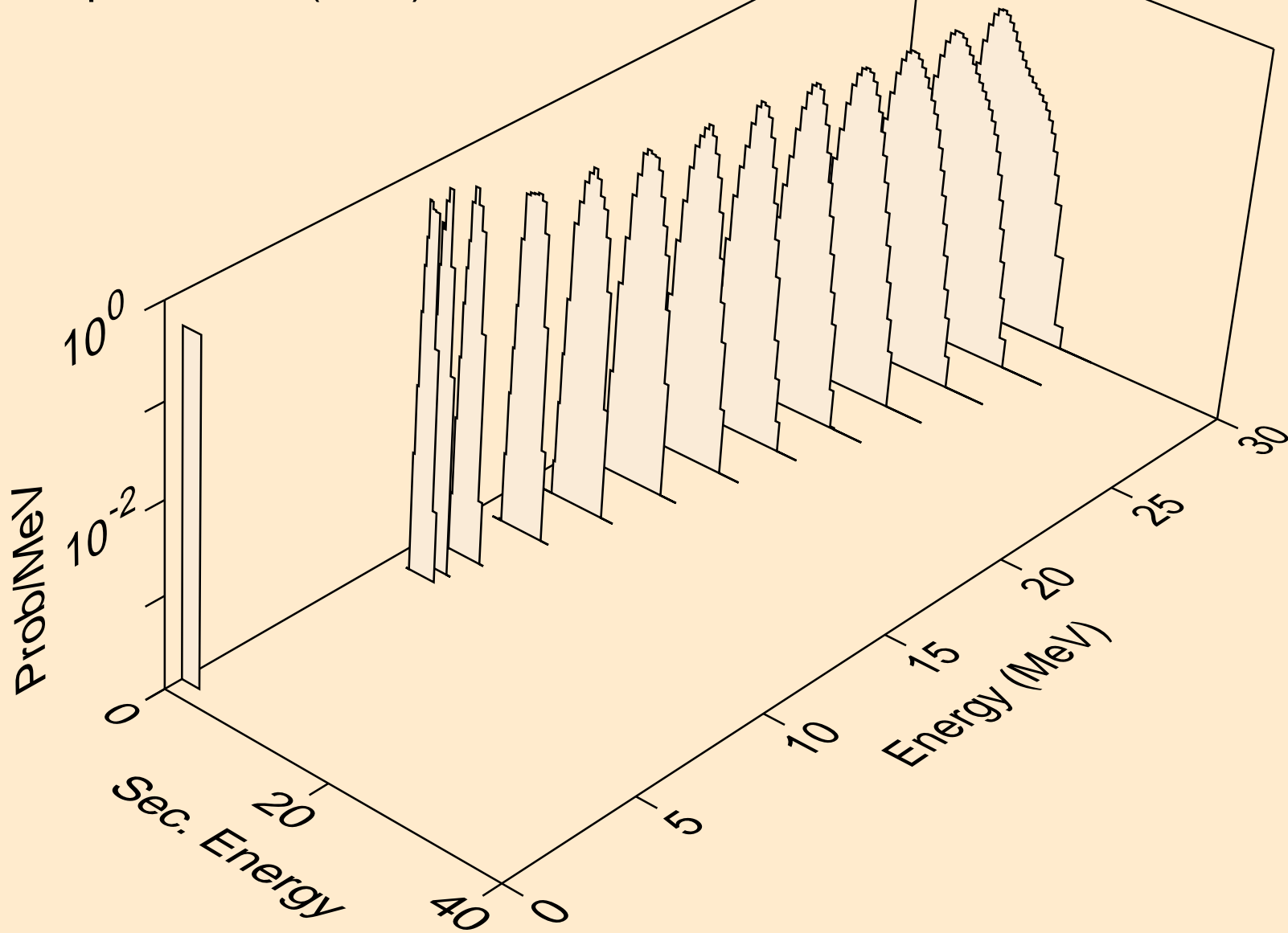

SR082 NEUTRON ACER TENDL-2021 LIBRARY; T=293.6K
alphas from (n,pa)

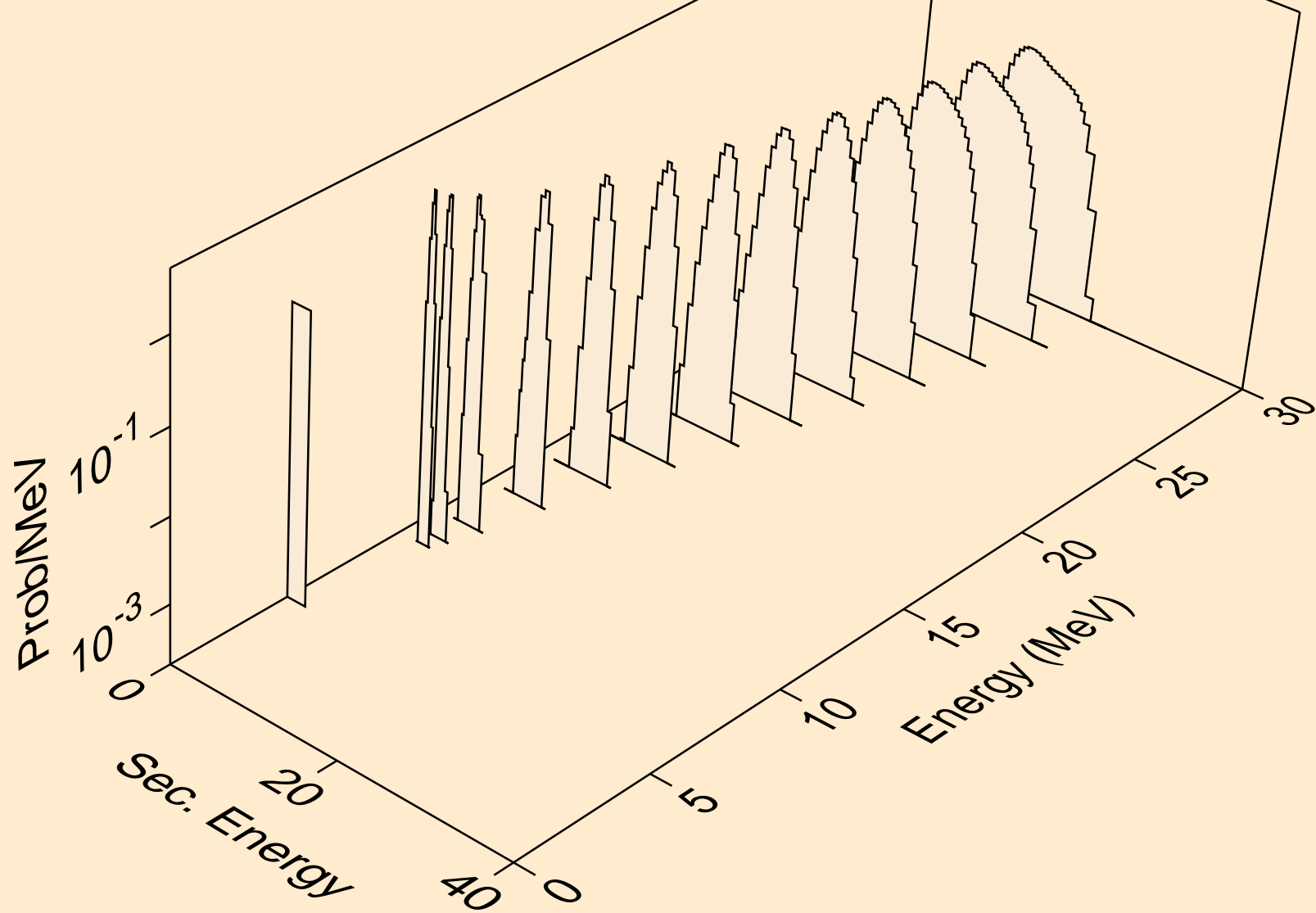

SR082 NEUTRON ACER TENDL-2021 LIBRARY; T=293.6K
alphas from (n,da)

