

SR088 NEUTRON ACER TENDL-2021 LIBRARY; T=293.6K
Principal cross sections

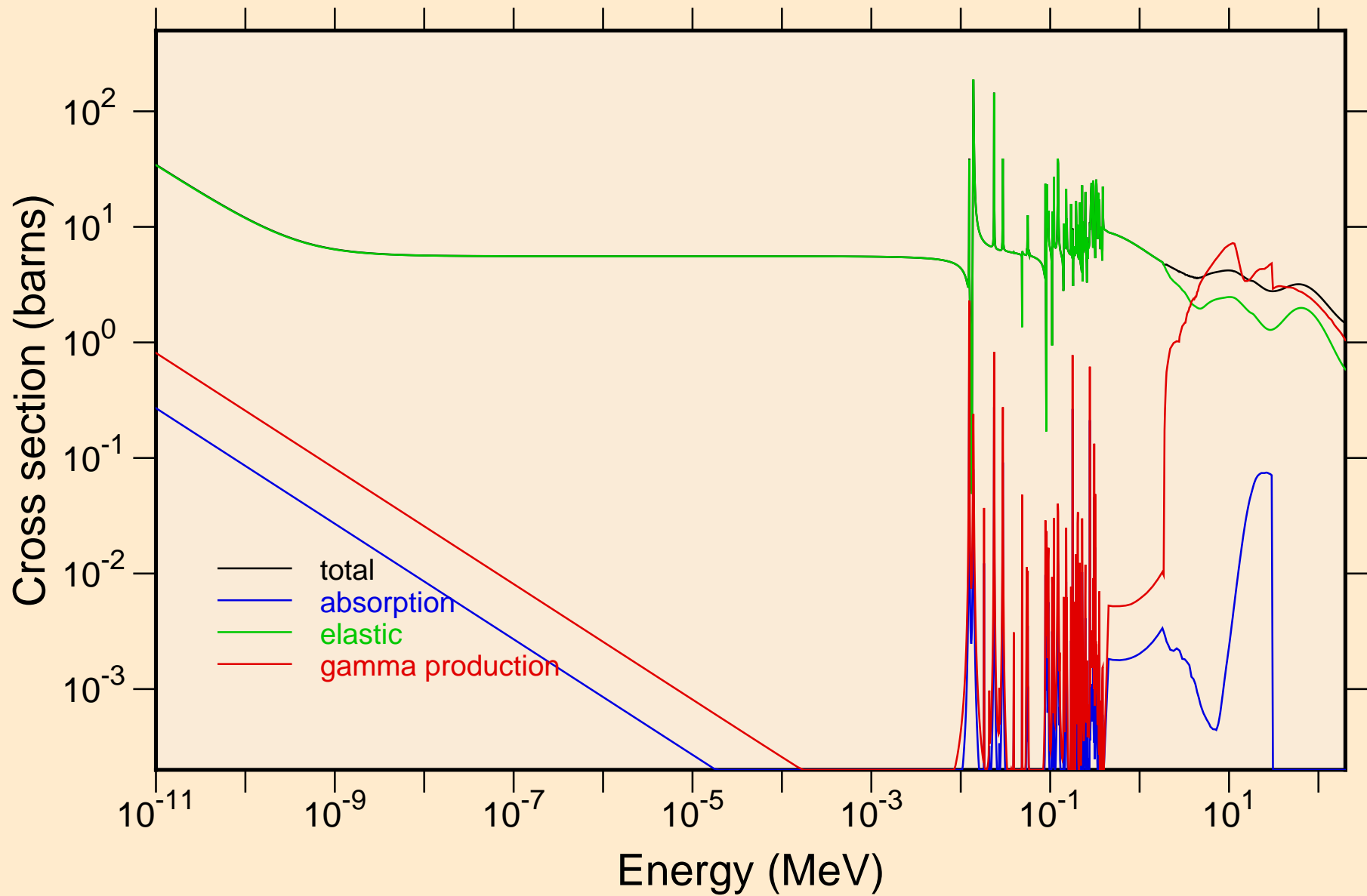

SR088 NEUTRON ACER TENDL-2021 LIBRARY; T=293.6K
resonance total cross section

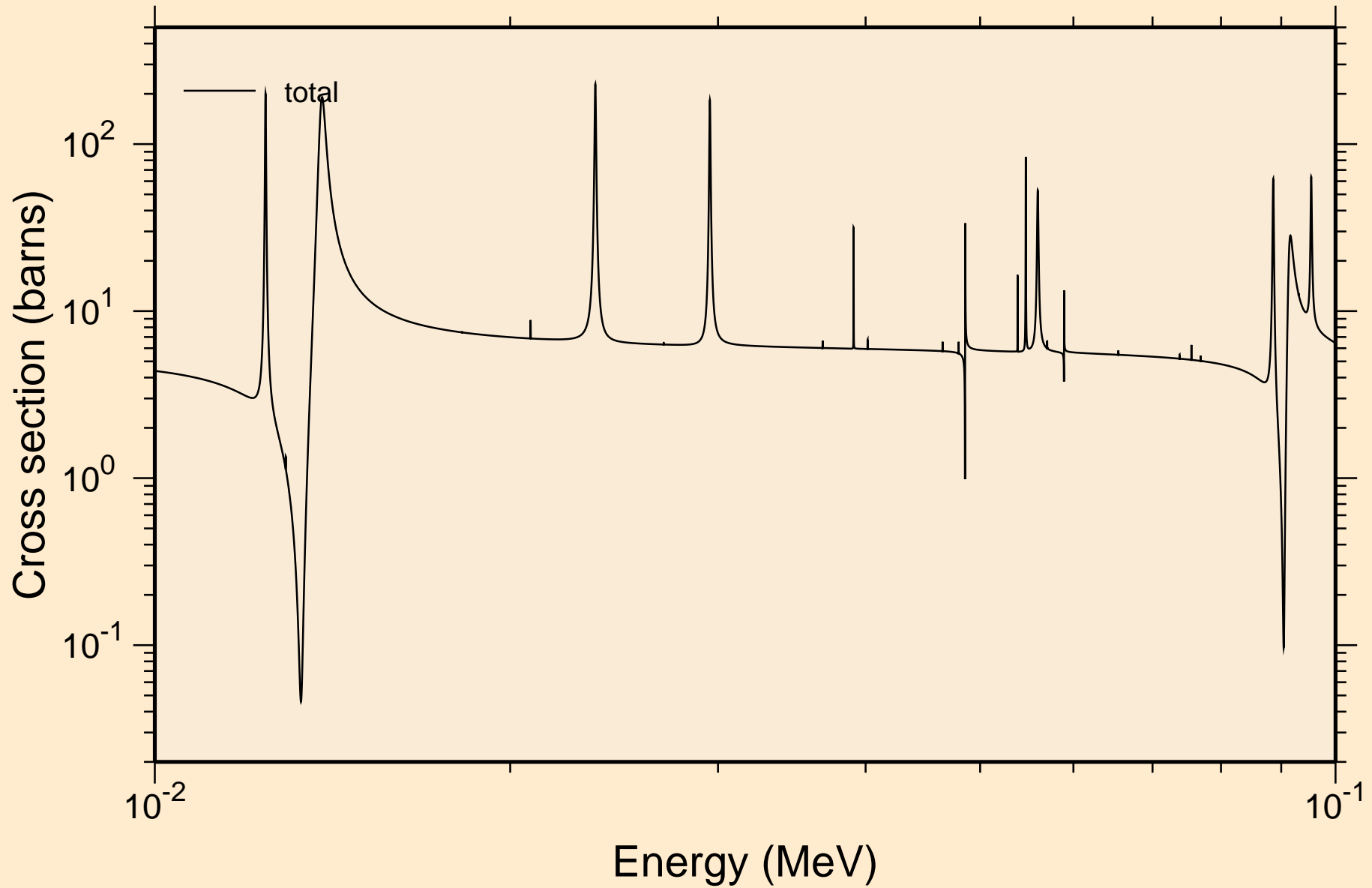

SR088 NEUTRON ACER TENDL-2021 LIBRARY; T=293.6K
resonance total cross section

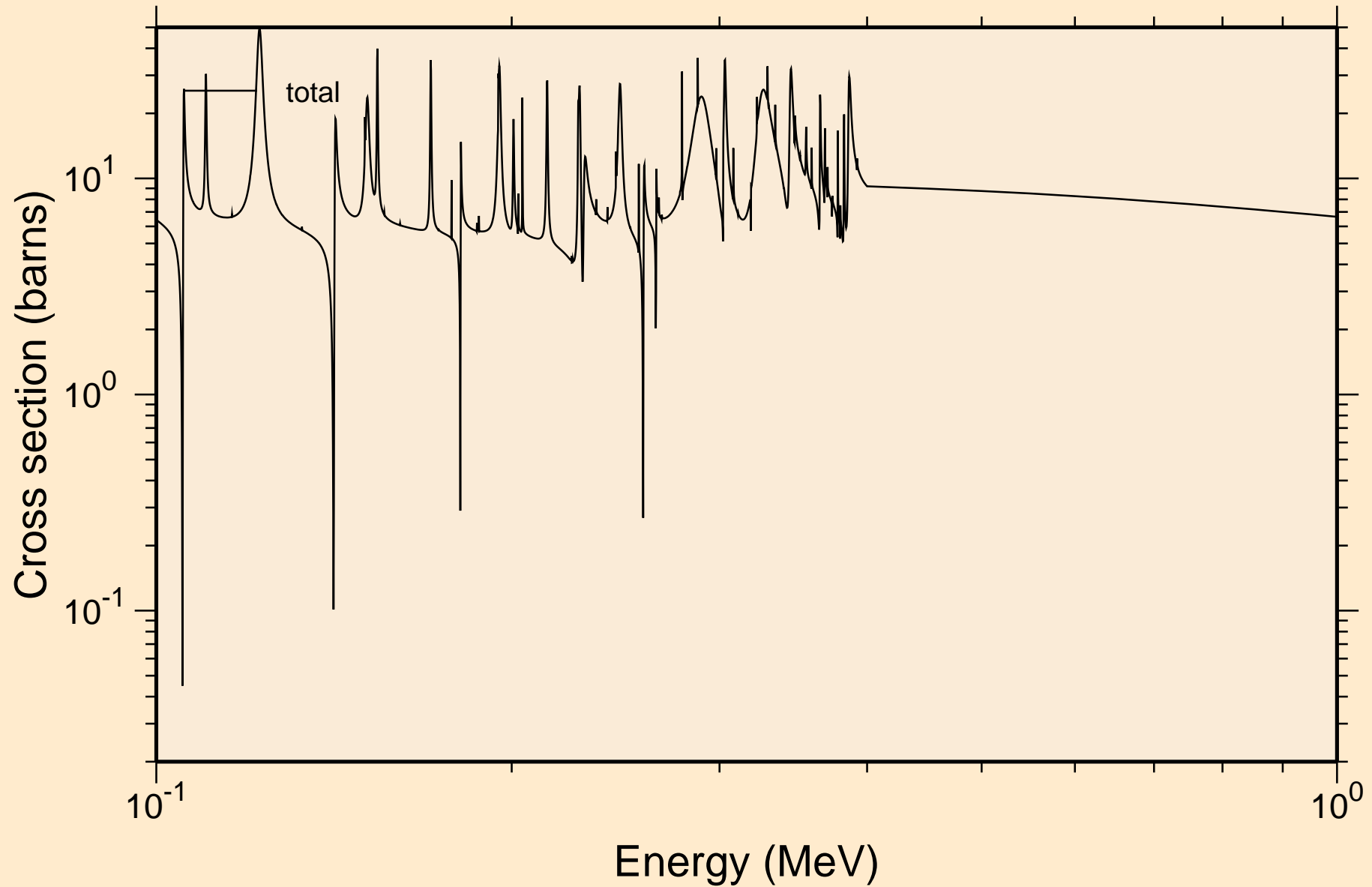

SR088 NEUTRON ACER TENDL-2021 LIBRARY; T=293.6K
resonance total cross section

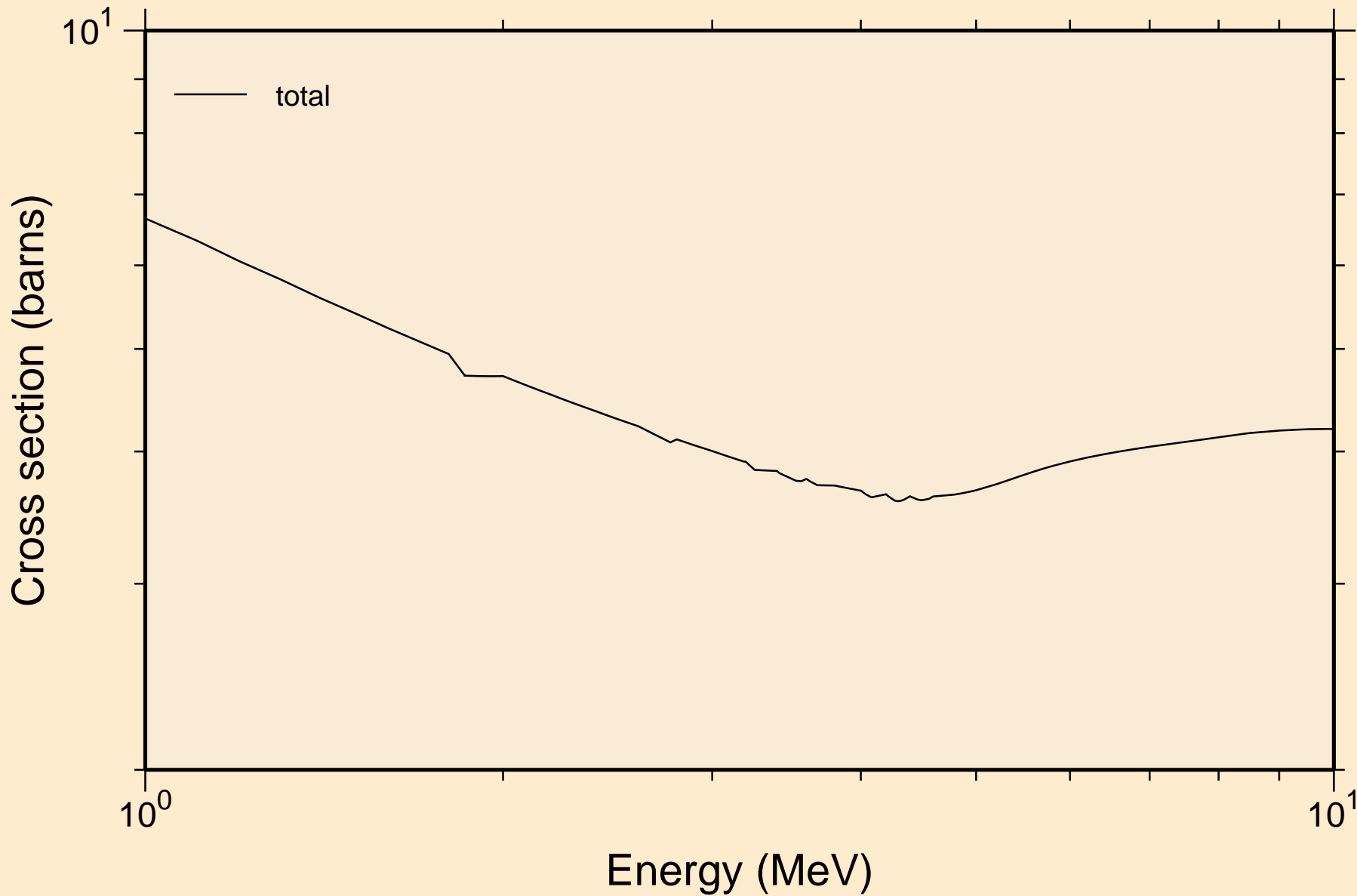

SR088 NEUTRON ACER TENDL-2021 LIBRARY; T=293.6K
resonance absorption cross sections

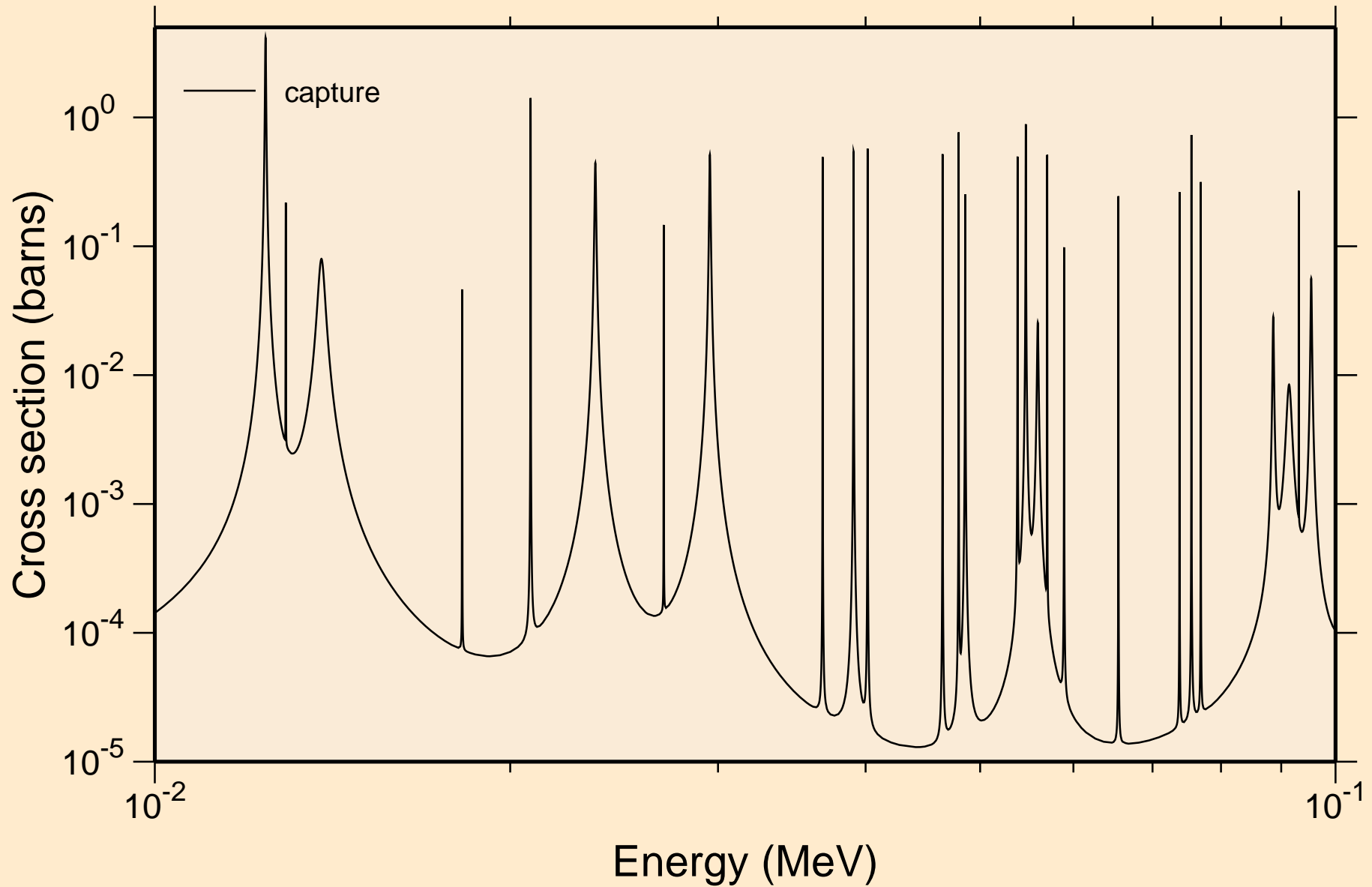

SR088 NEUTRON ACER TENDL-2021 LIBRARY; T=293.6K
resonance absorption cross sections

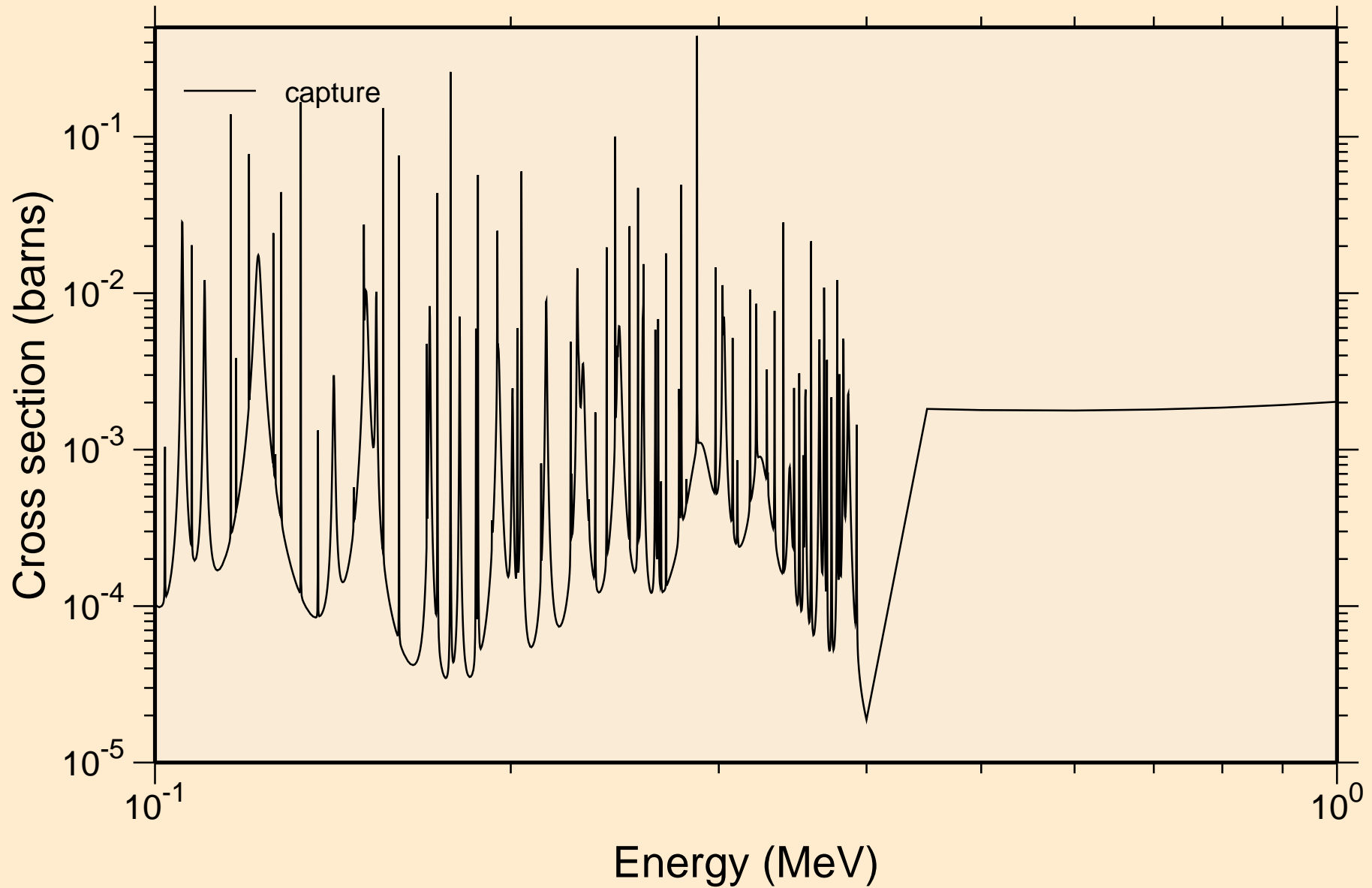

SR088 NEUTRON ACER TENDL-2021 LIBRARY; T=293.6K
resonance absorption cross sections

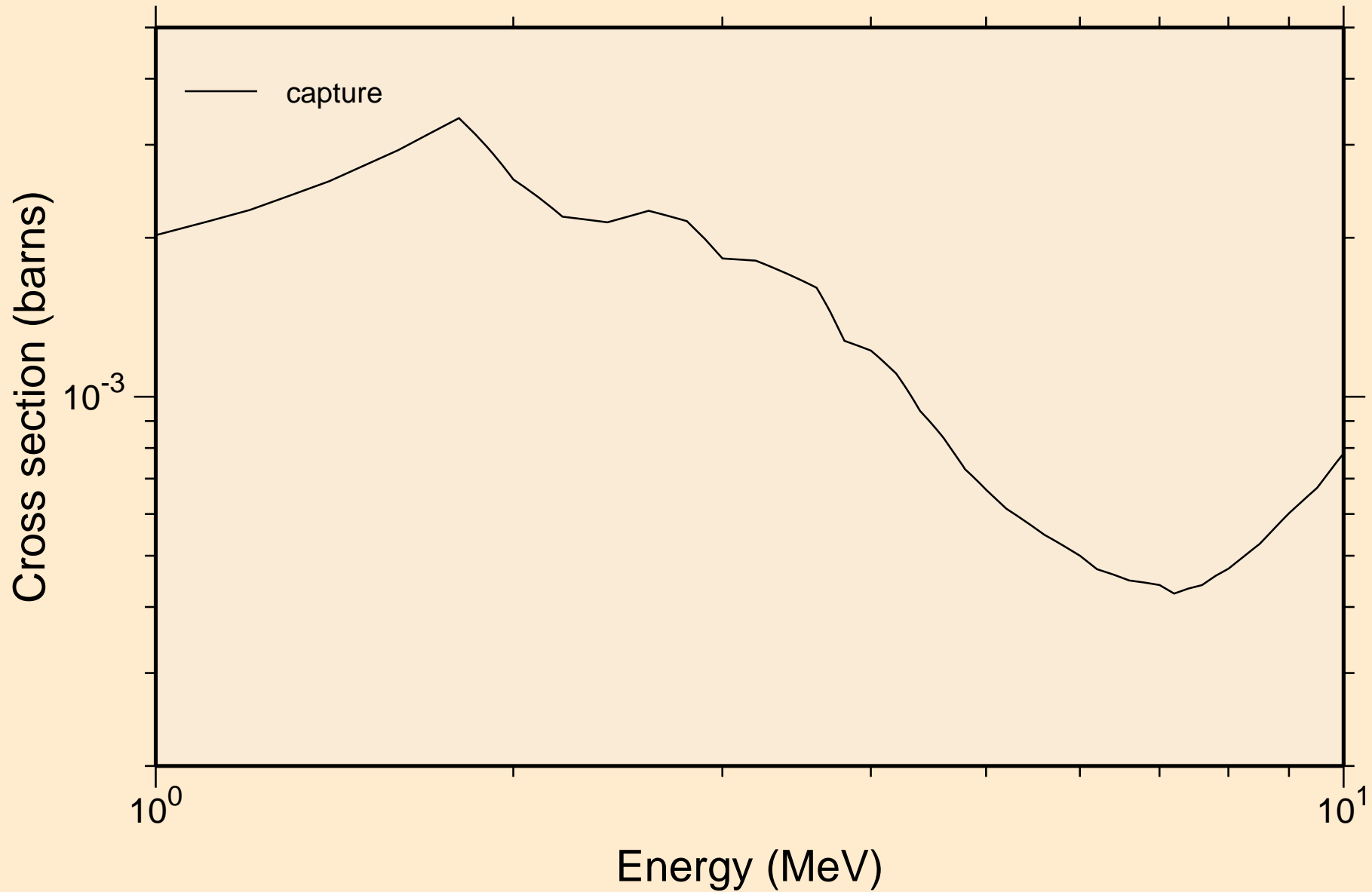

SR088 NEUTRON ACER TENDL-2021 LIBRARY; T=293.6K
Heating

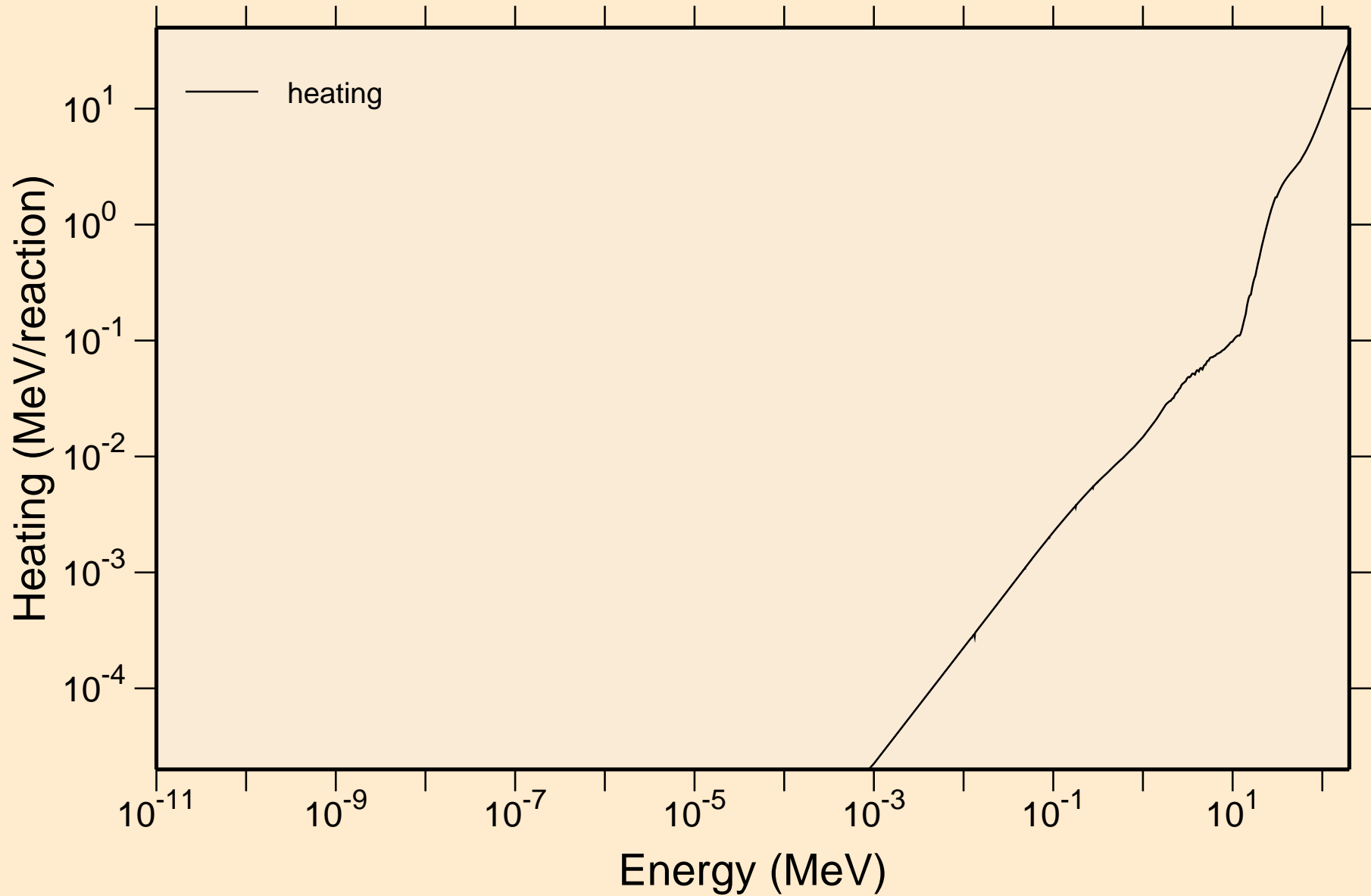

SR088 NEUTRON ACER TENDL-2021 LIBRARY; T=293.6K
Damage

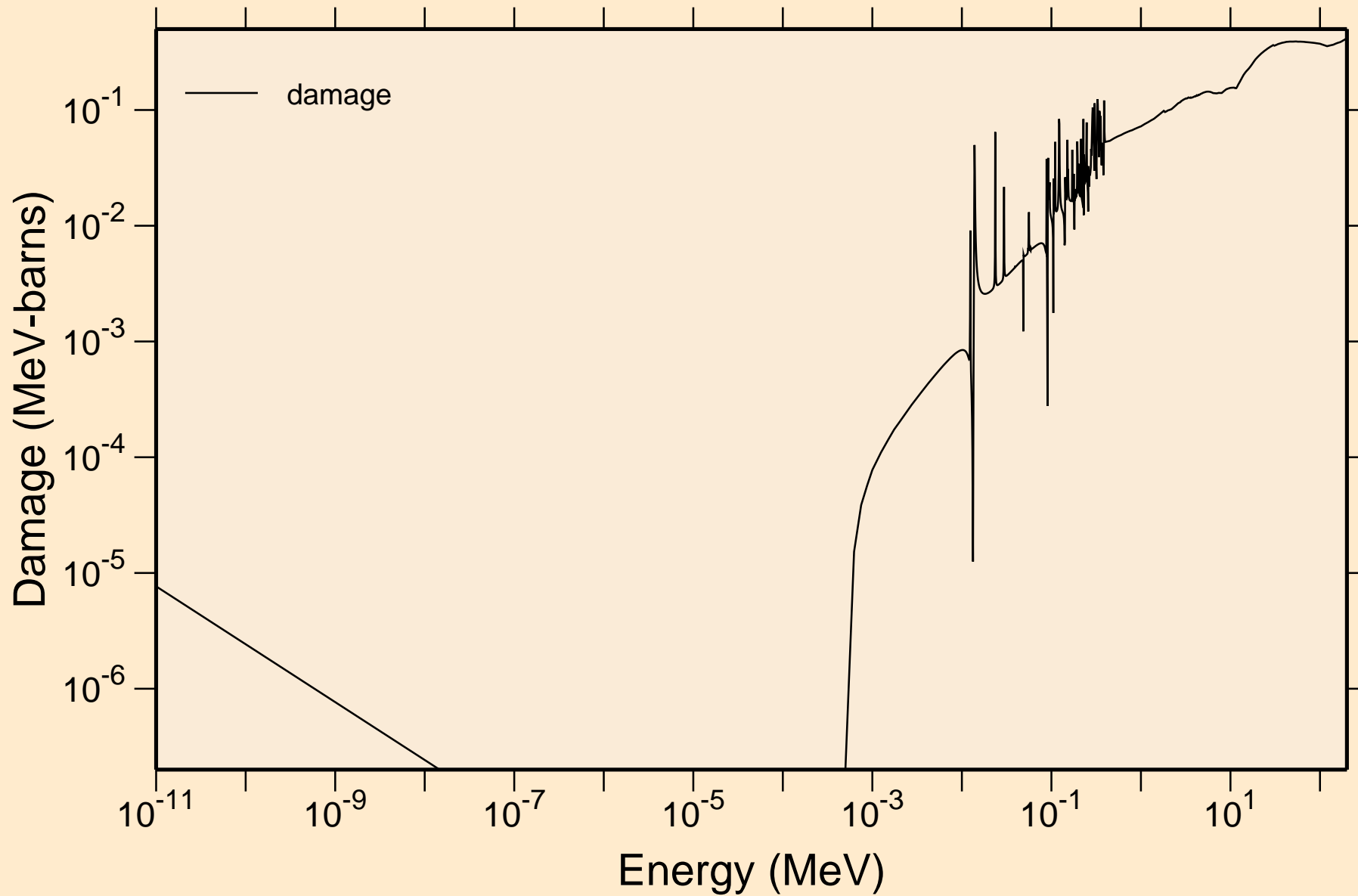

SR088 NEUTRON ACER TENDL-2021 LIBRARY; T=293.6K
Non-threshold reactions

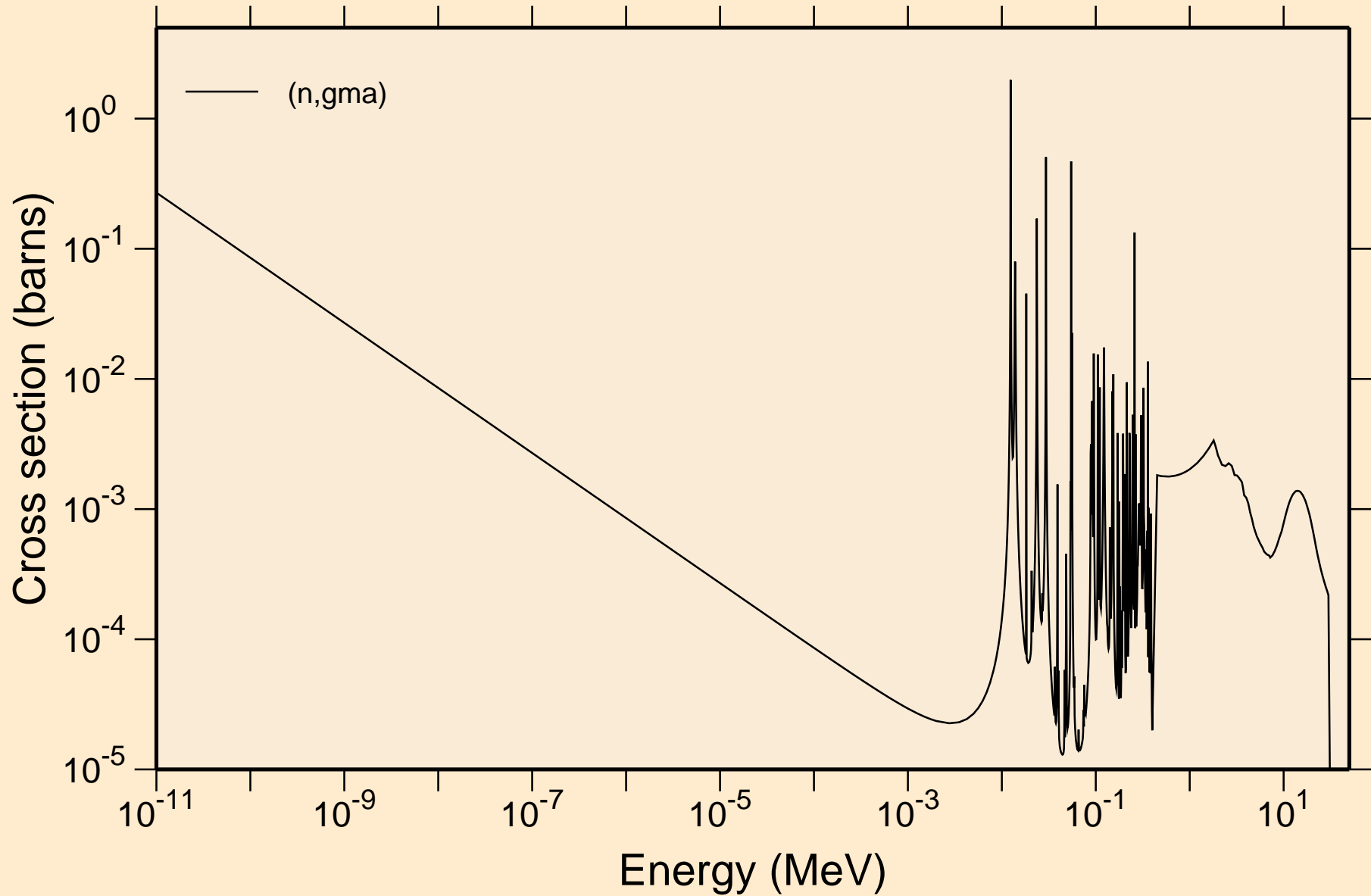

SR088 NEUTRON ACER TENDL-2021 LIBRARY; T=293.6K

Principal cross sections

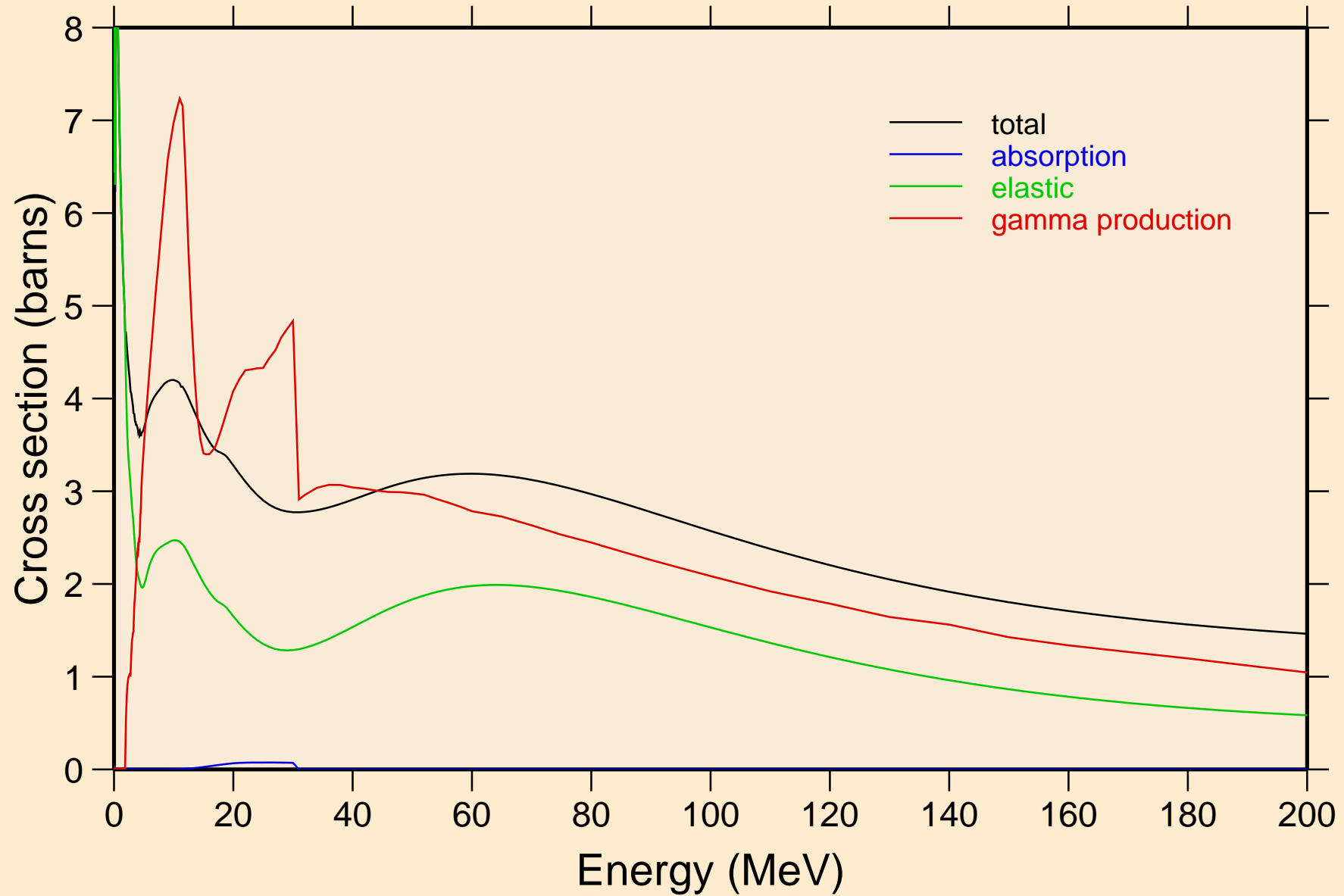

SR088 NEUTRON ACER TENDL-2021 LIBRARY; T=293.6K

Heating

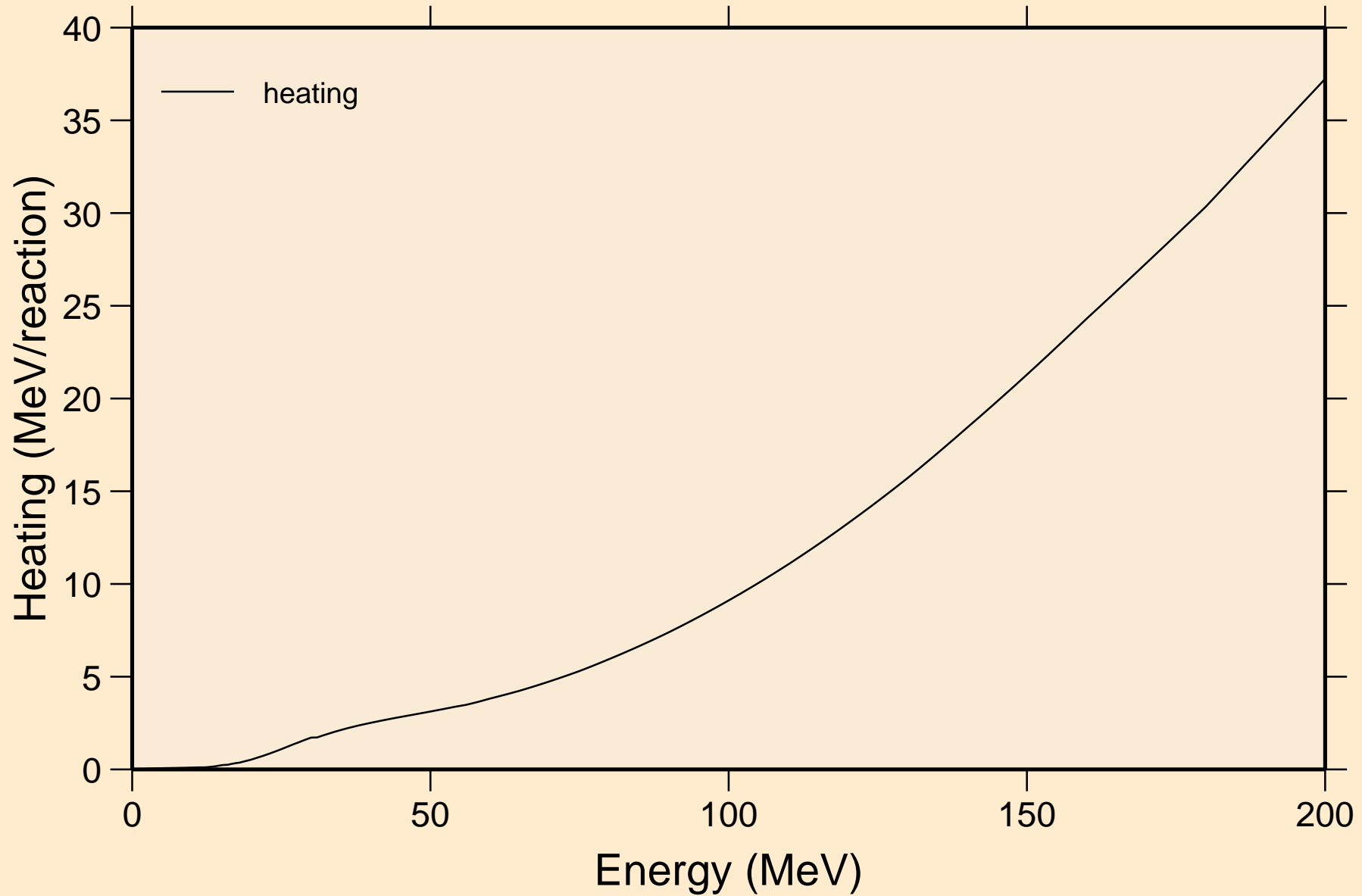

SR088 NEUTRON ACER TENDL-2021 LIBRARY; T=293.6K
Damage

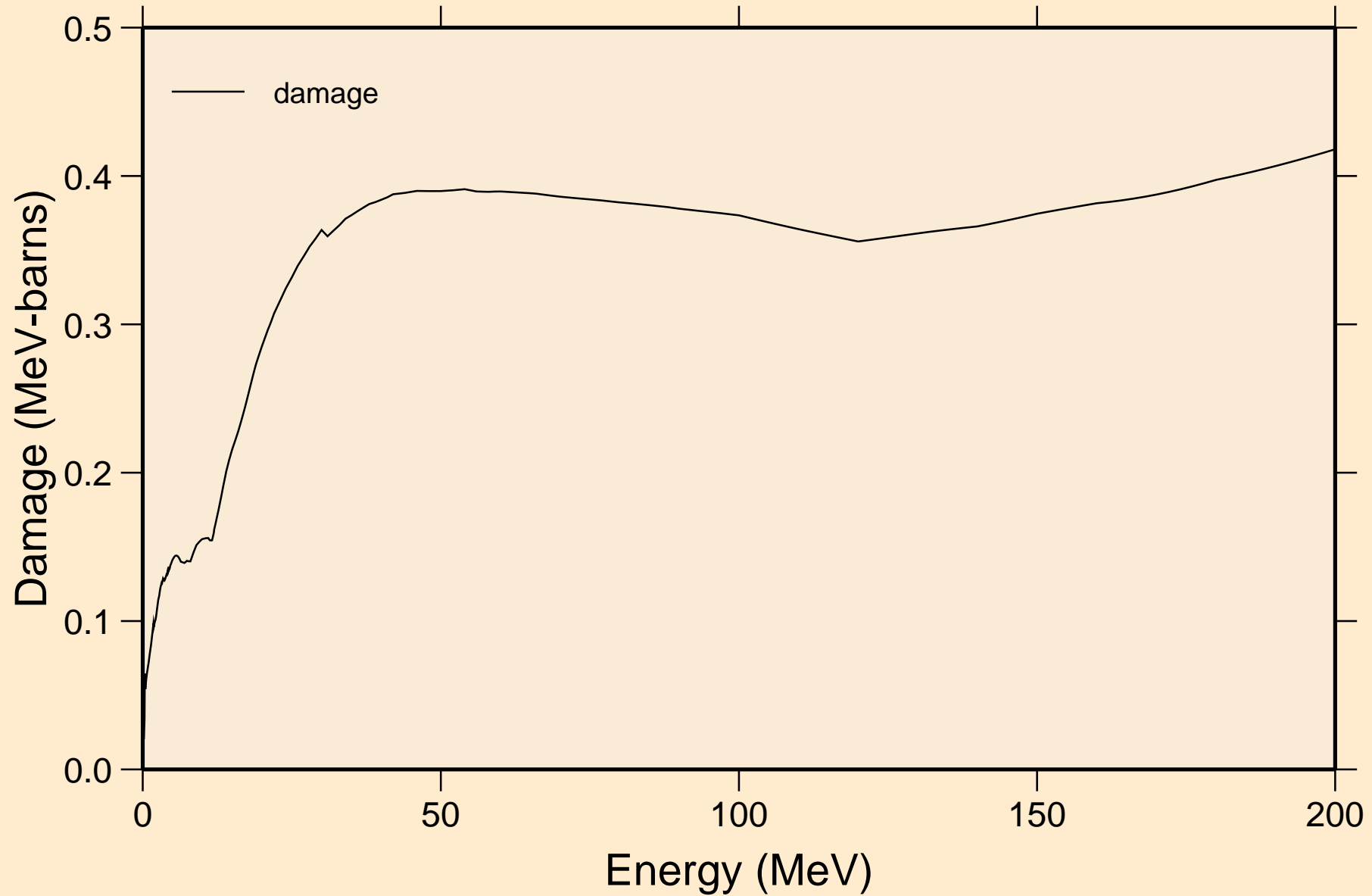

SR088 NEUTRON ACER TENDL-2021 LIBRARY; T=293.6K
Non-threshold reactions

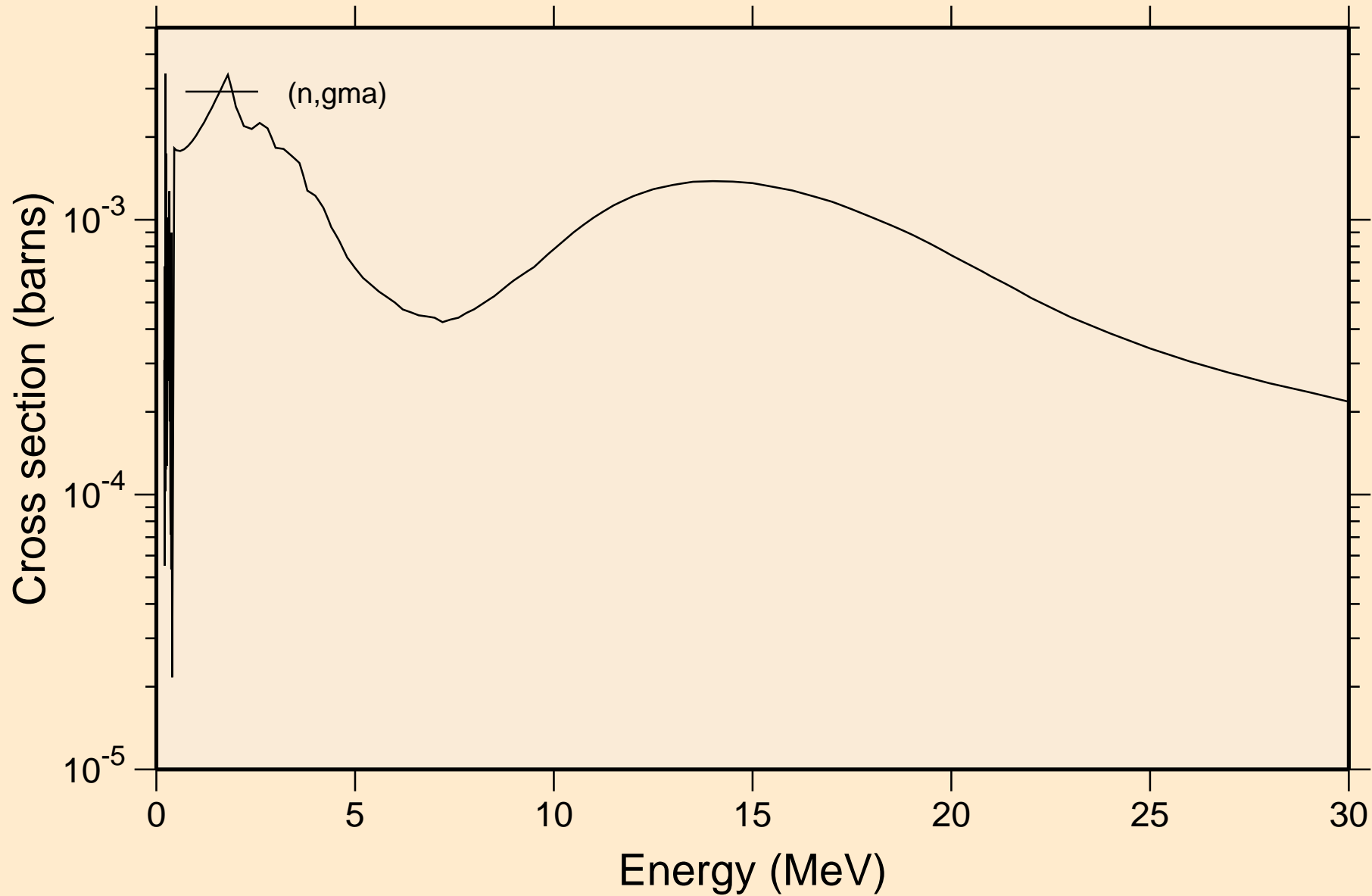

SR088 NEUTRON ACER TENDL-2021 LIBRARY; T=293.6K
Inelastic levels

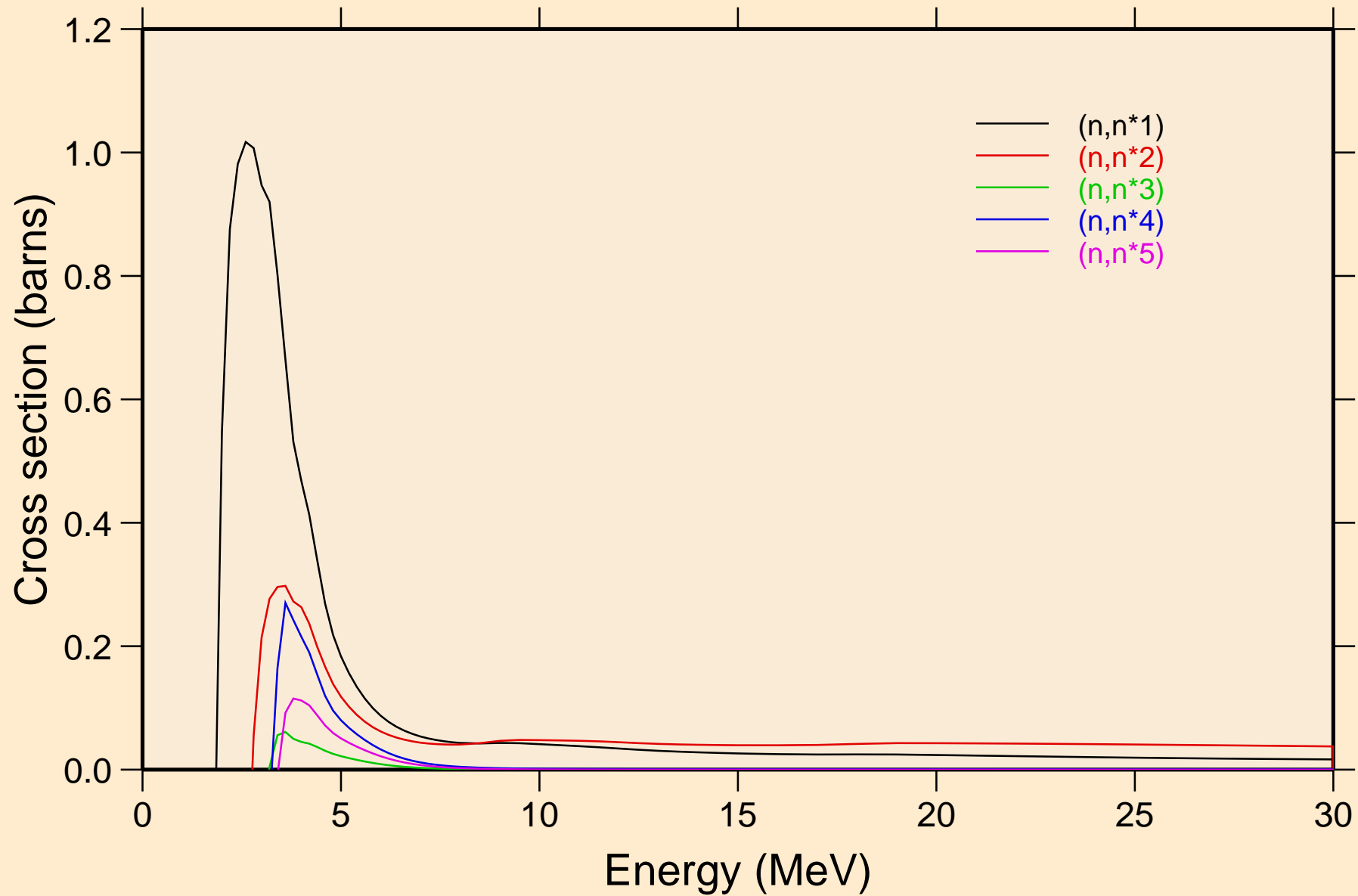

SR088 NEUTRON ACER TENDL-2021 LIBRARY; T=293.6K
Inelastic levels

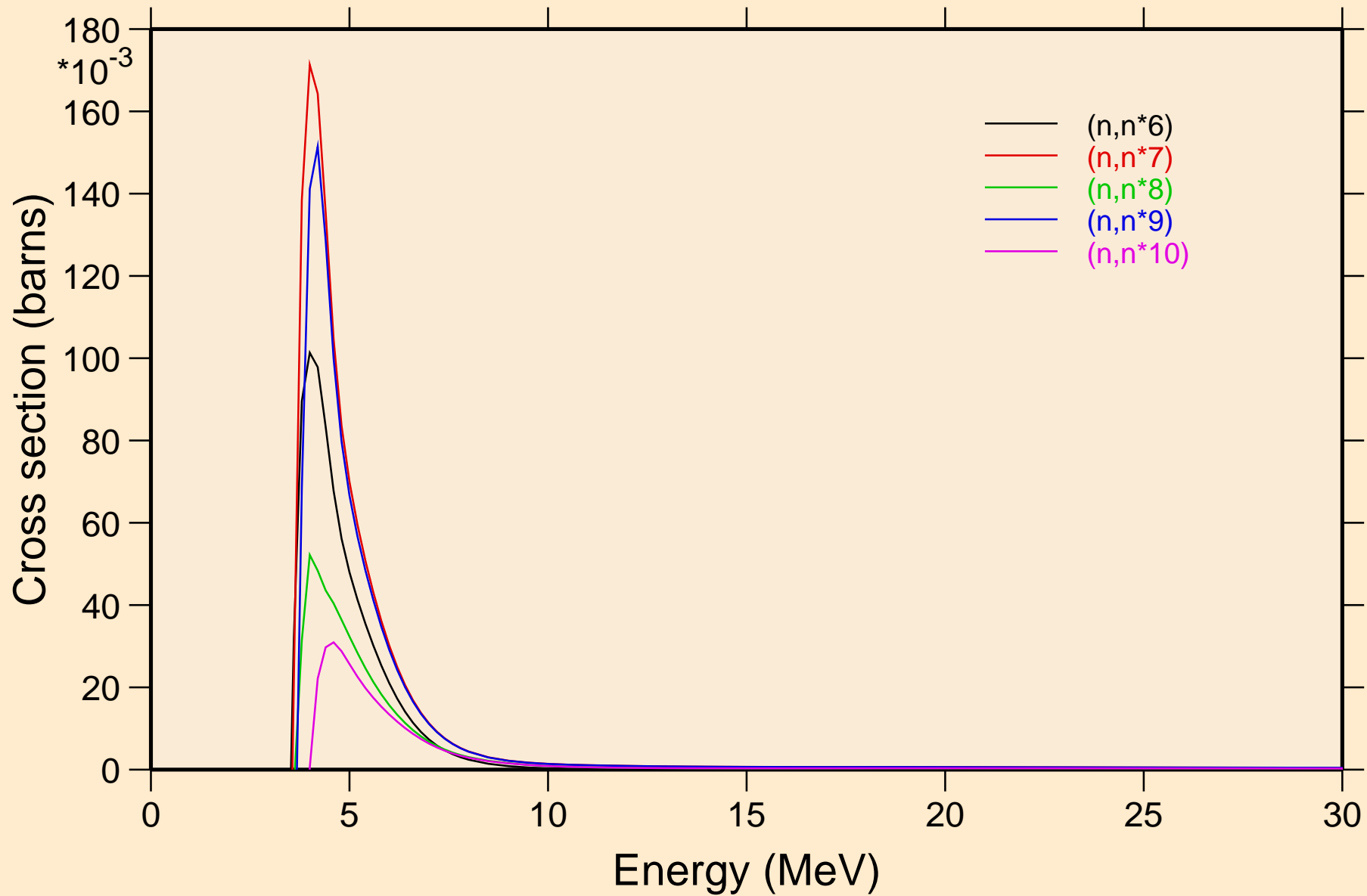

SR088 NEUTRON ACER TENDL-2021 LIBRARY; T=293.6K
Inelastic levels

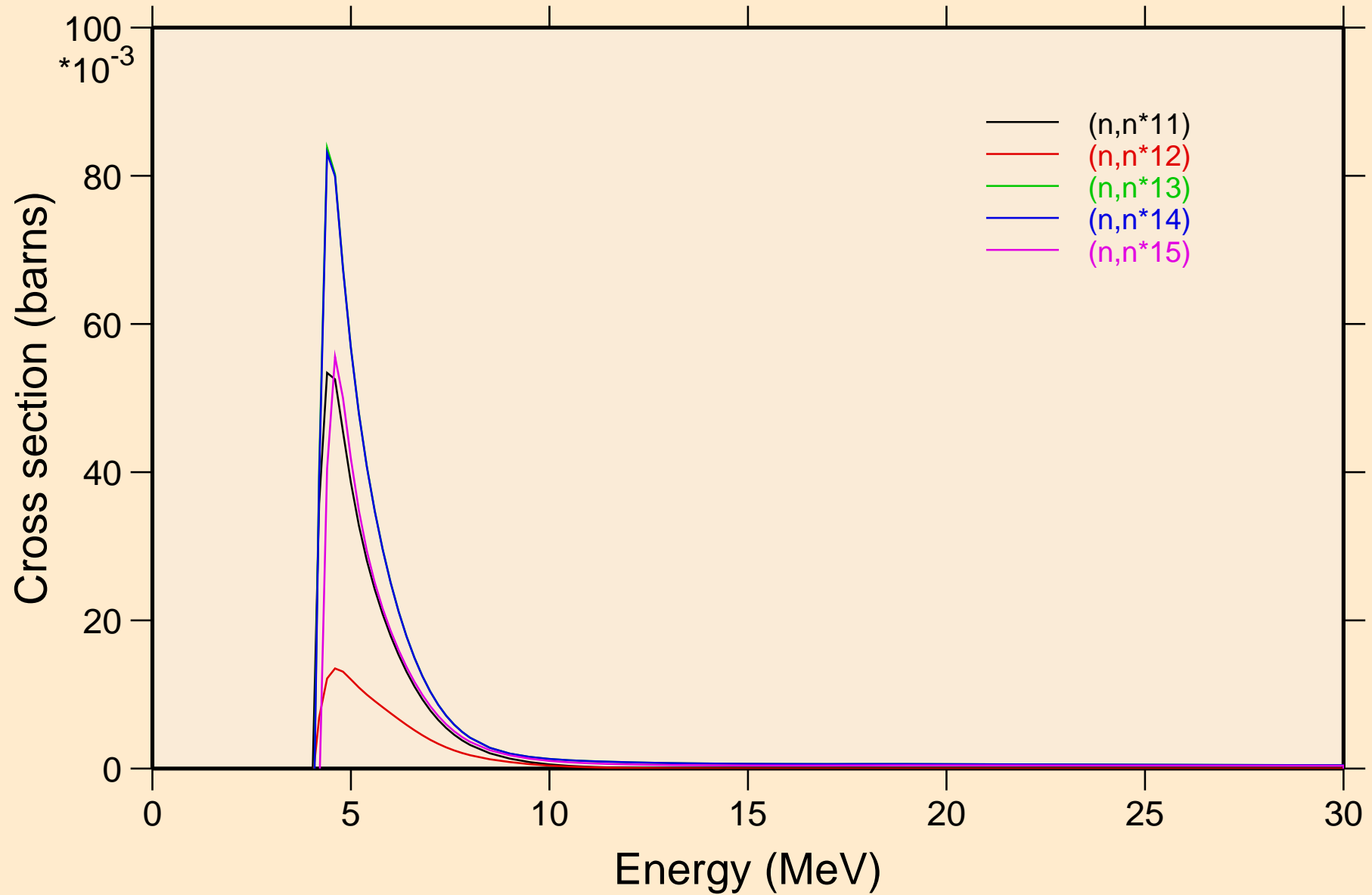

SR088 NEUTRON ACER TENDL-2021 LIBRARY; T=293.6K
Inelastic levels

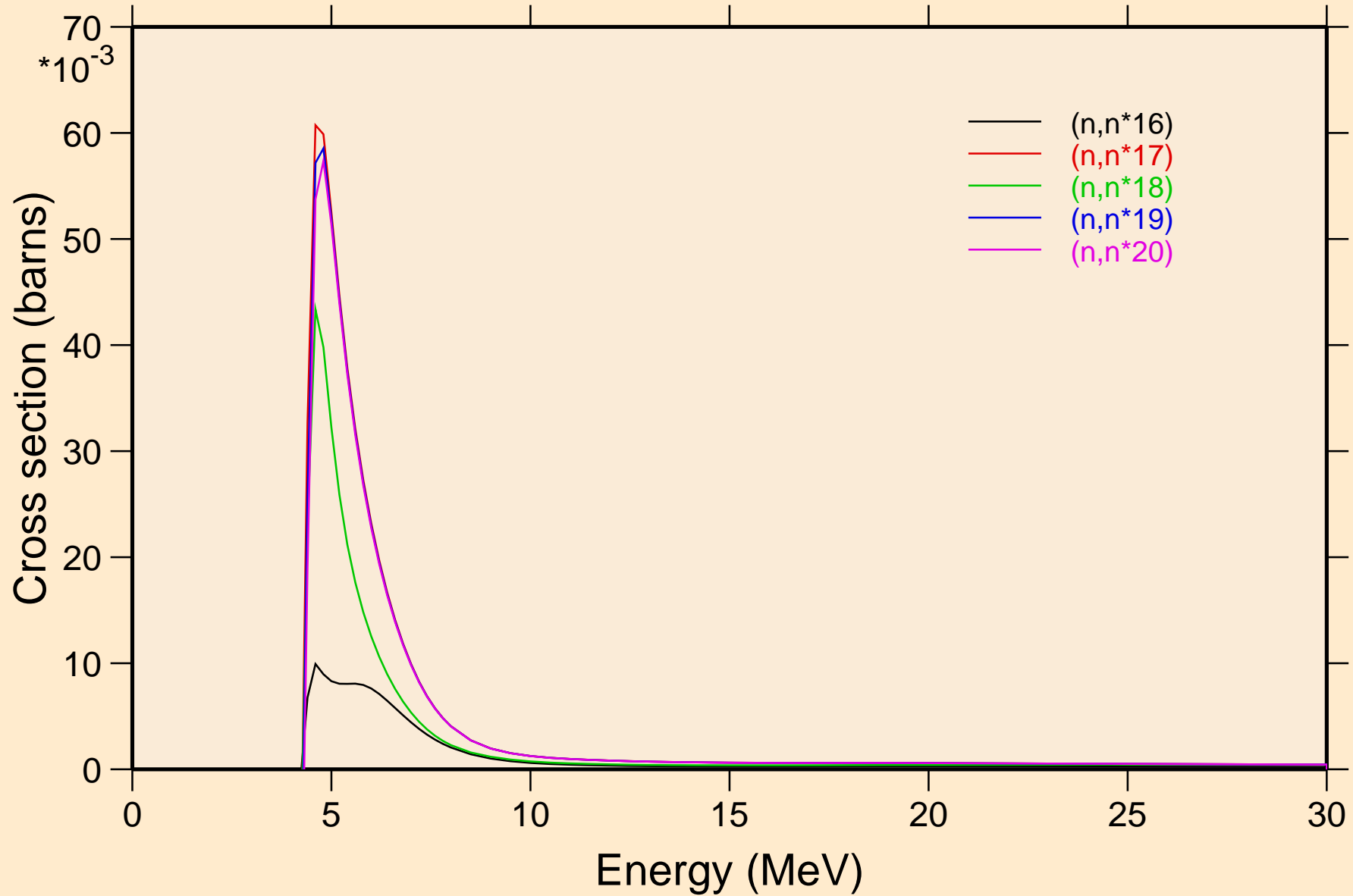

SR088 NEUTRON ACER TENDL-2021 LIBRARY; T=293.6K
Inelastic levels

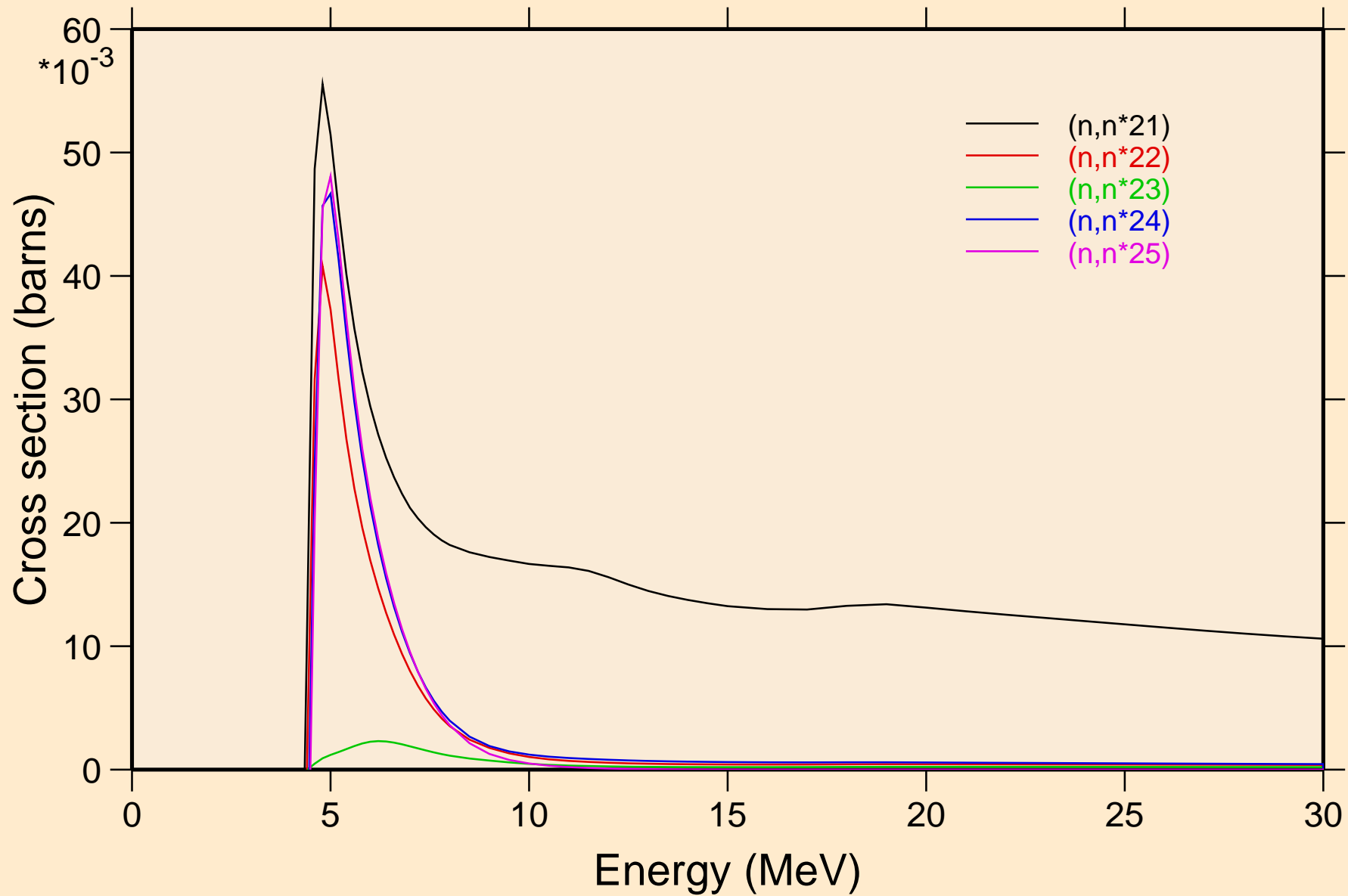

SR088 NEUTRON ACER TENDL-2021 LIBRARY; T=293.6K
Inelastic levels

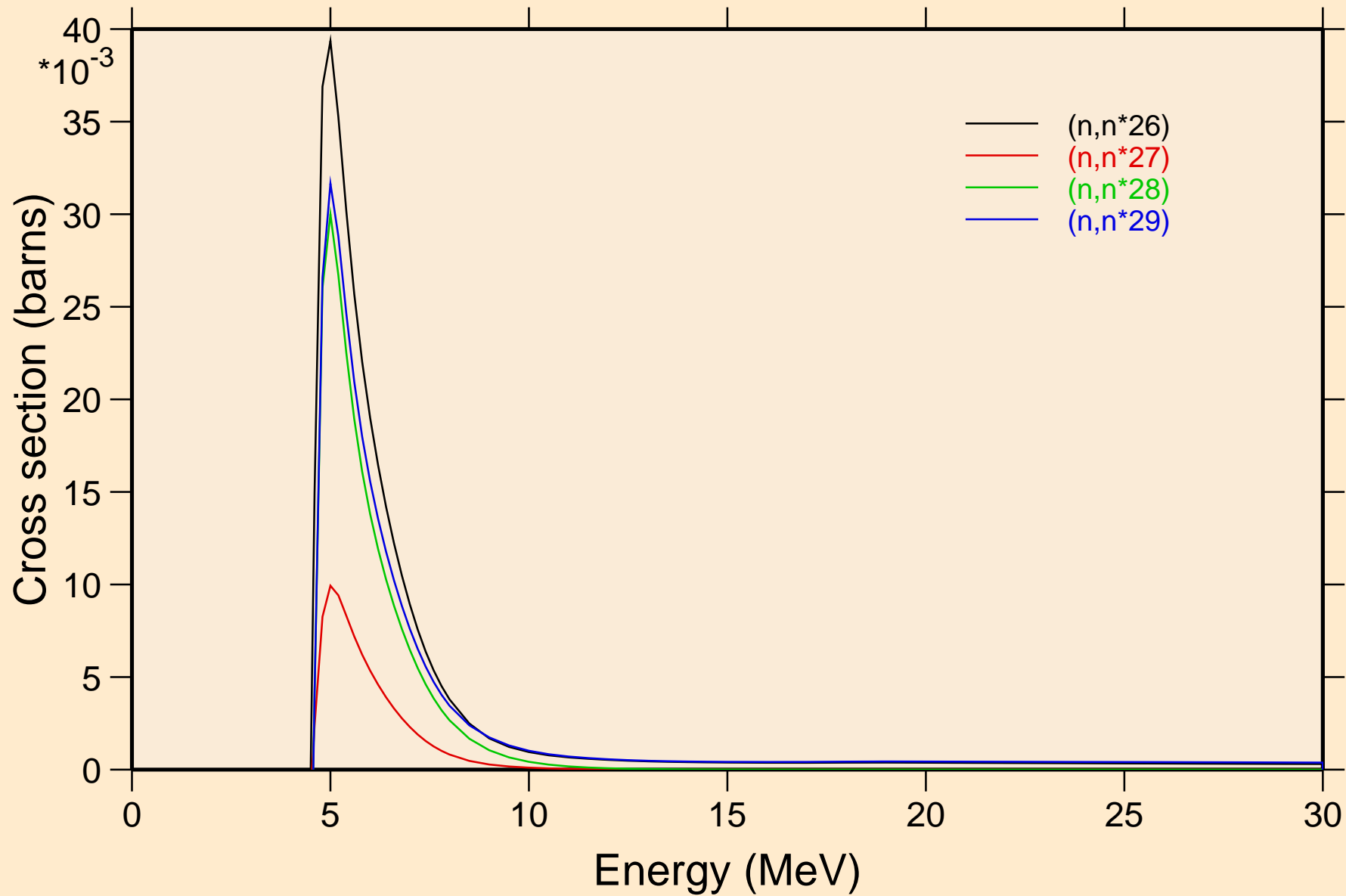

SR088 NEUTRON ACER TENDL-2021 LIBRARY; T=293.6K
Threshold reactions

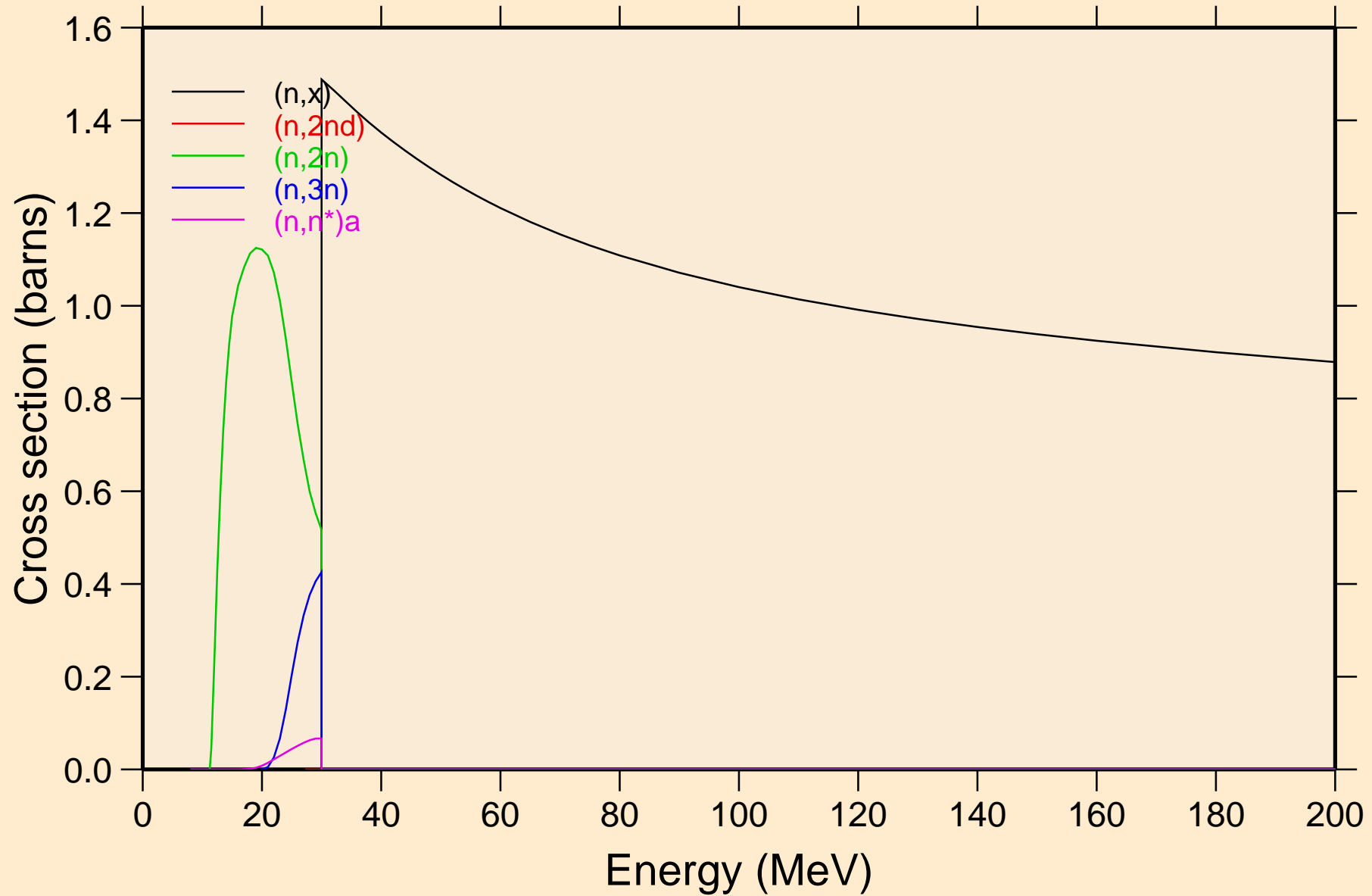

SR088 NEUTRON ACER TENDL-2021 LIBRARY; T=293.6K
Threshold reactions

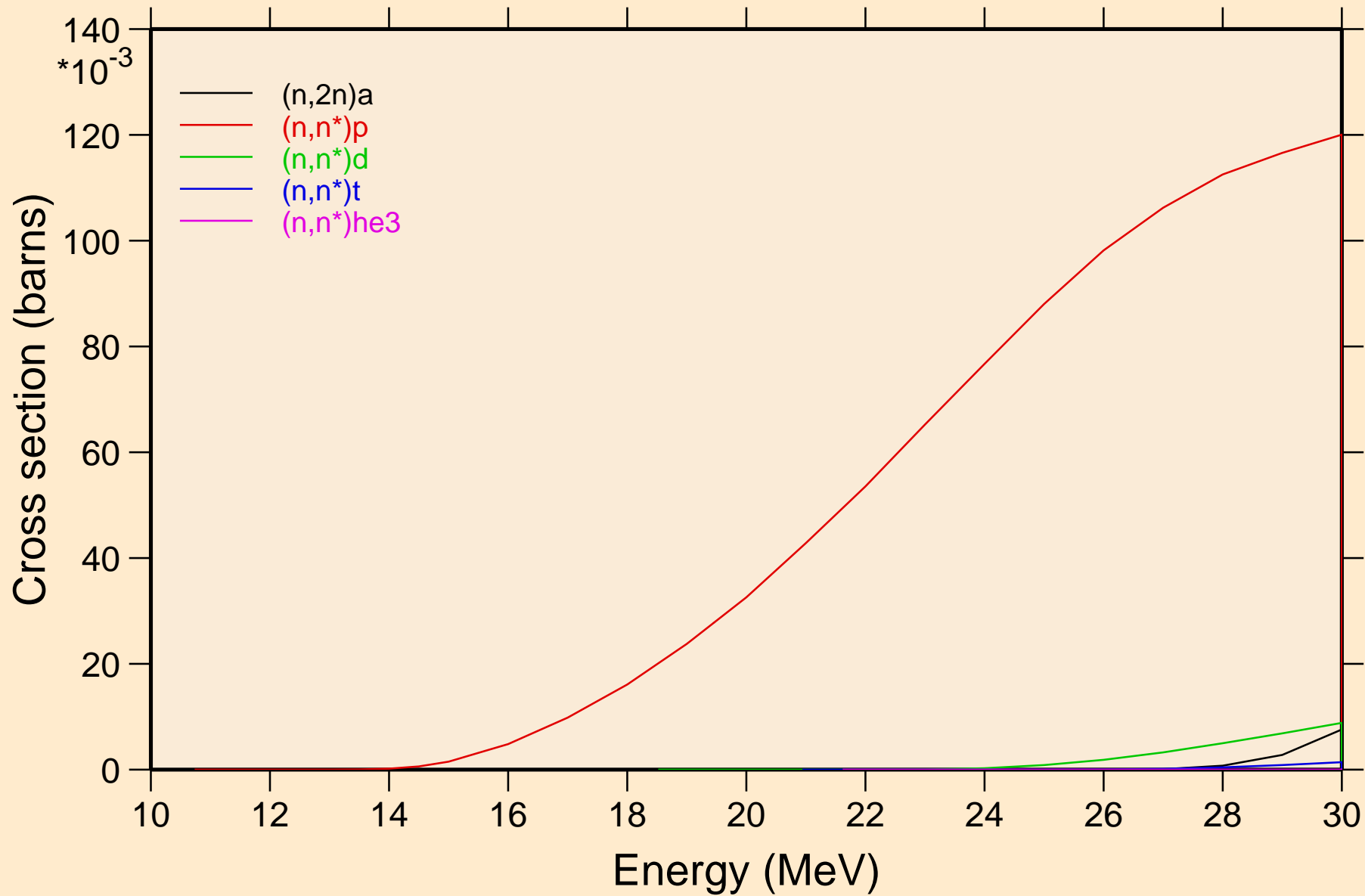

SR088 NEUTRON ACER TENDL-2021 LIBRARY; T=293.6K
Threshold reactions

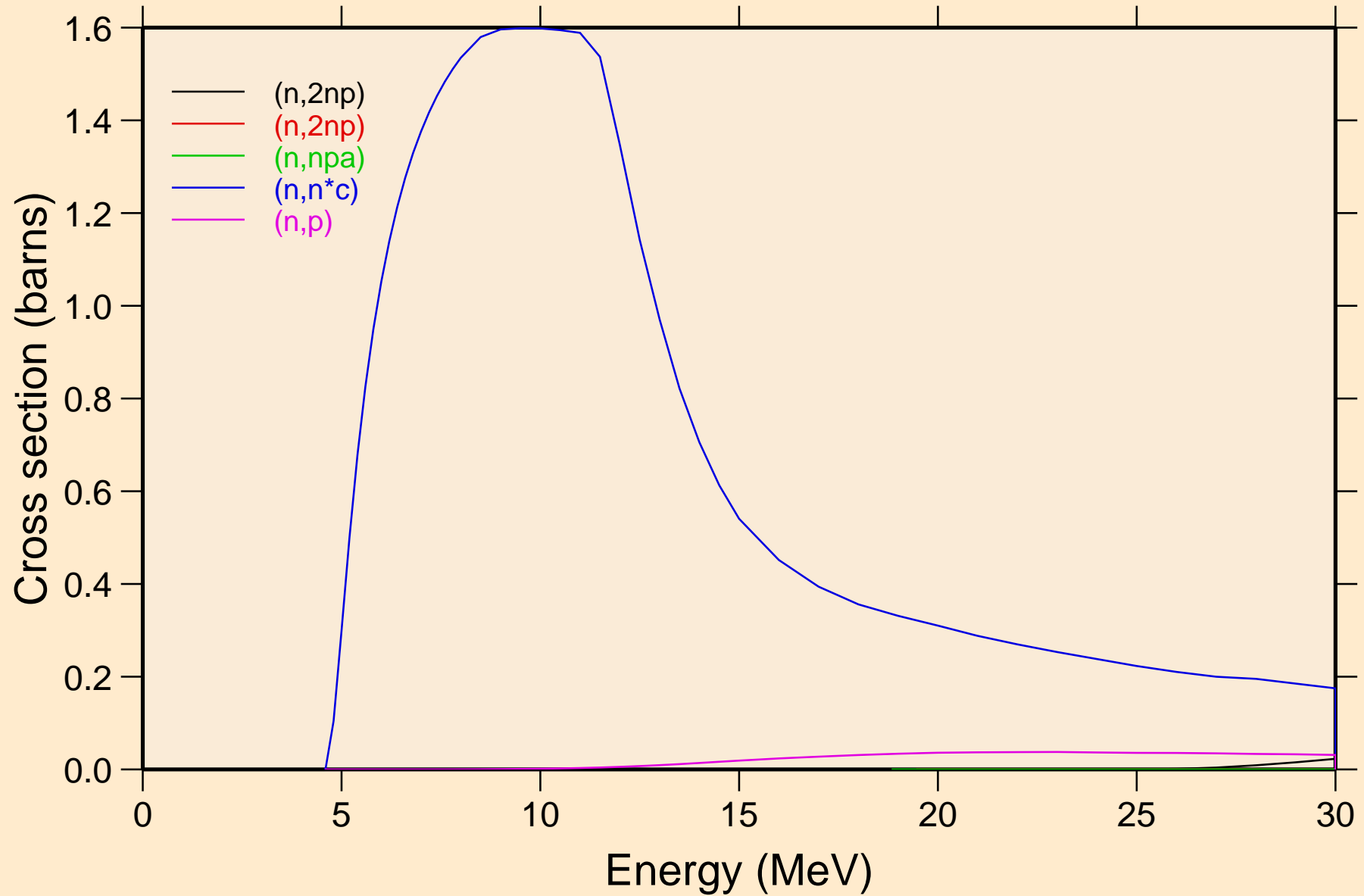

SR088 NEUTRON ACER TENDL-2021 LIBRARY; T=293.6K
Threshold reactions

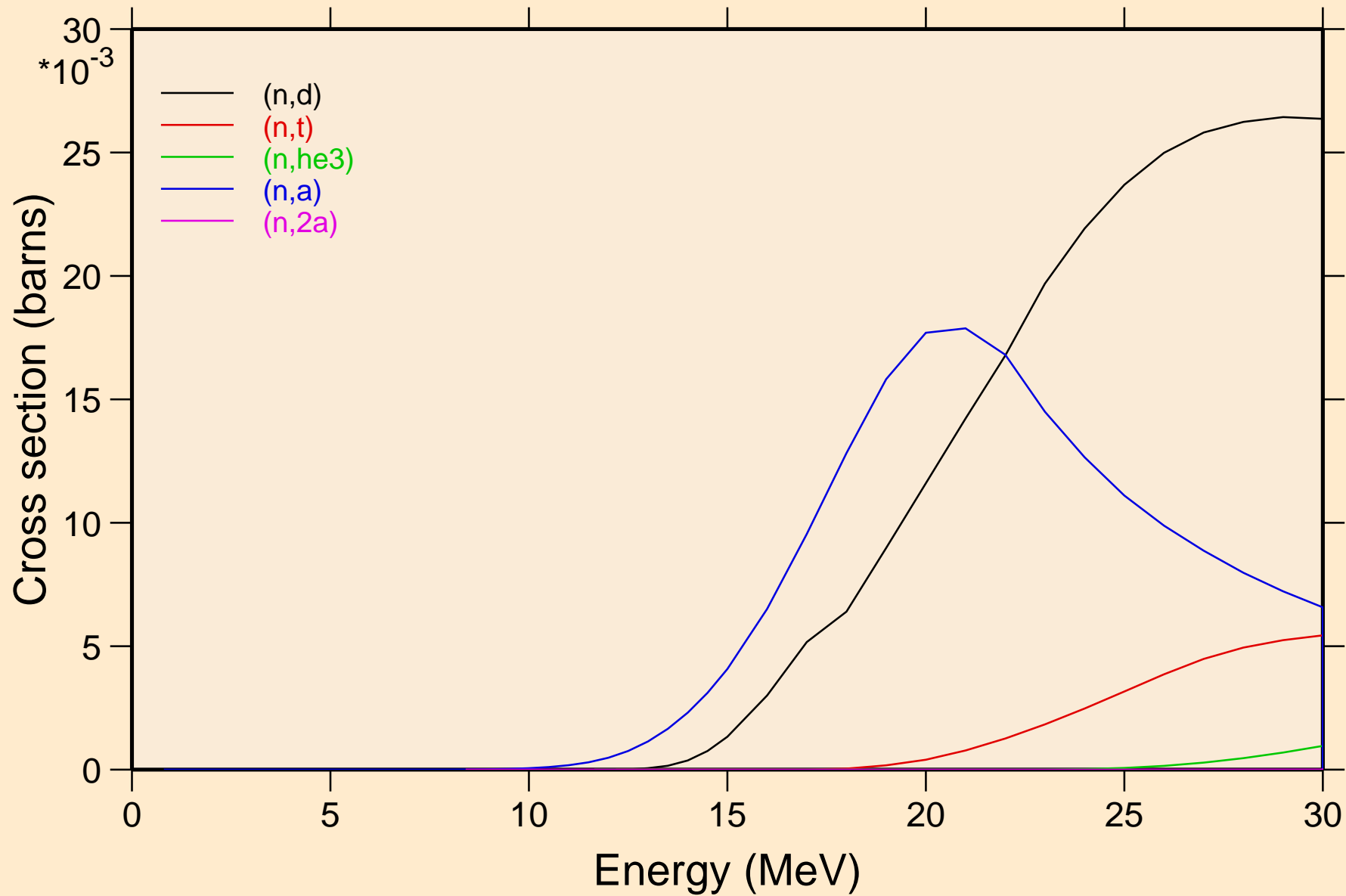

SR088 NEUTRON ACER TENDL-2021 LIBRARY; T=293.6K
Threshold reactions

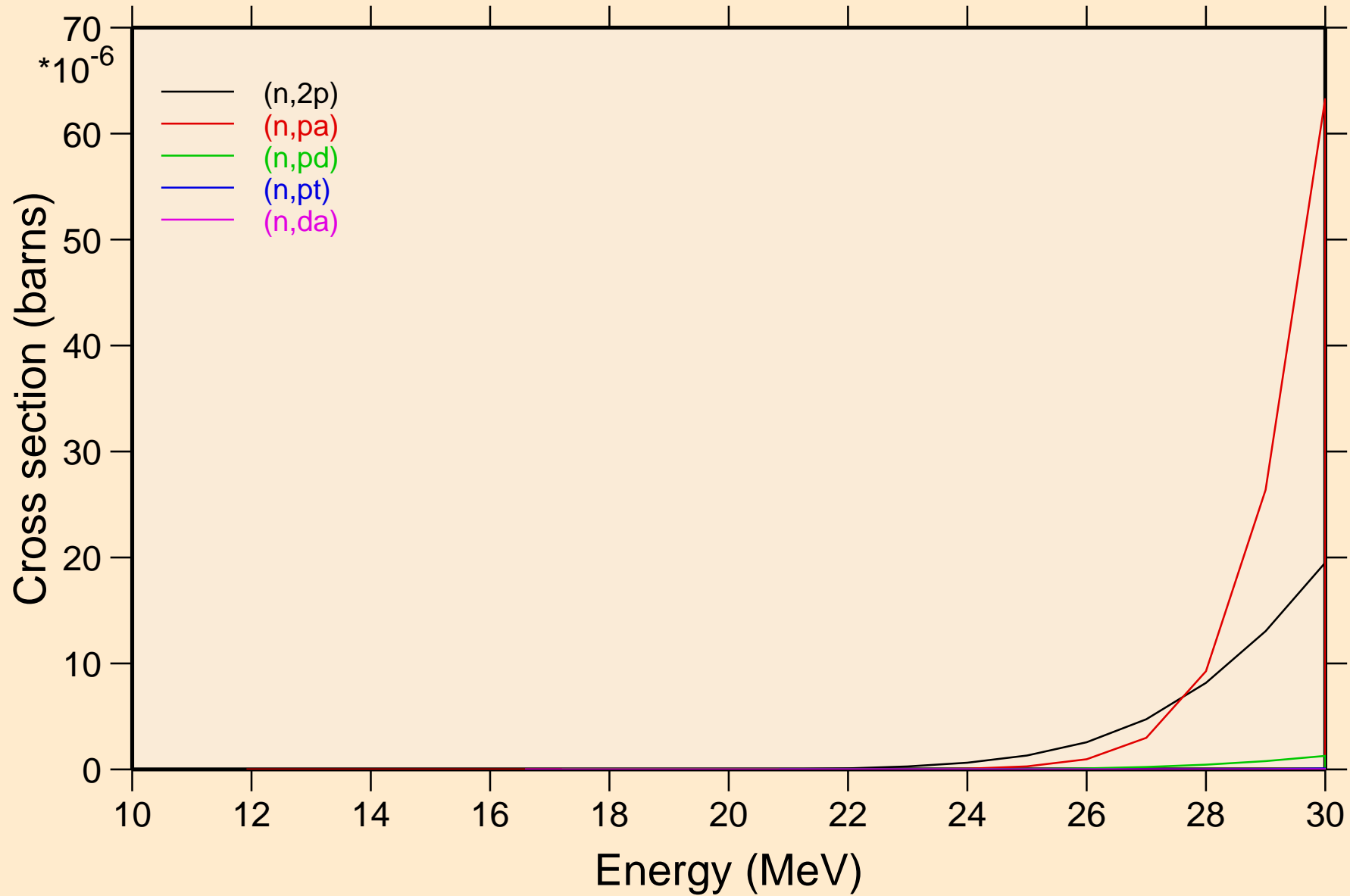

SR088 NEUTRON ACER TENDL-2021 LIBRARY; T=293.6K
Threshold reactions

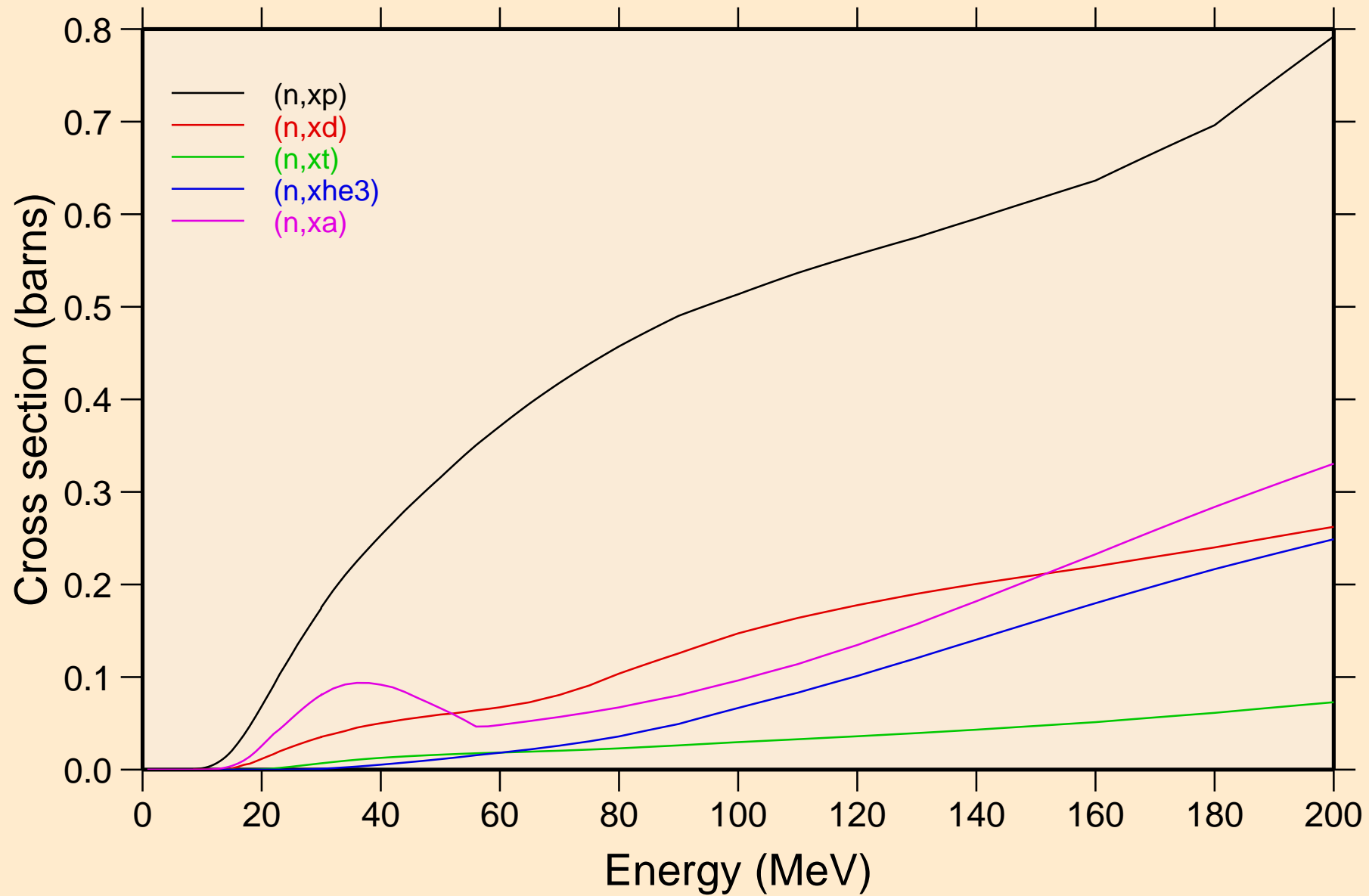

SR088 NEUTRON ACER TENDL-2021 LIBRARY; T=293.6K
angular distribution for elastic

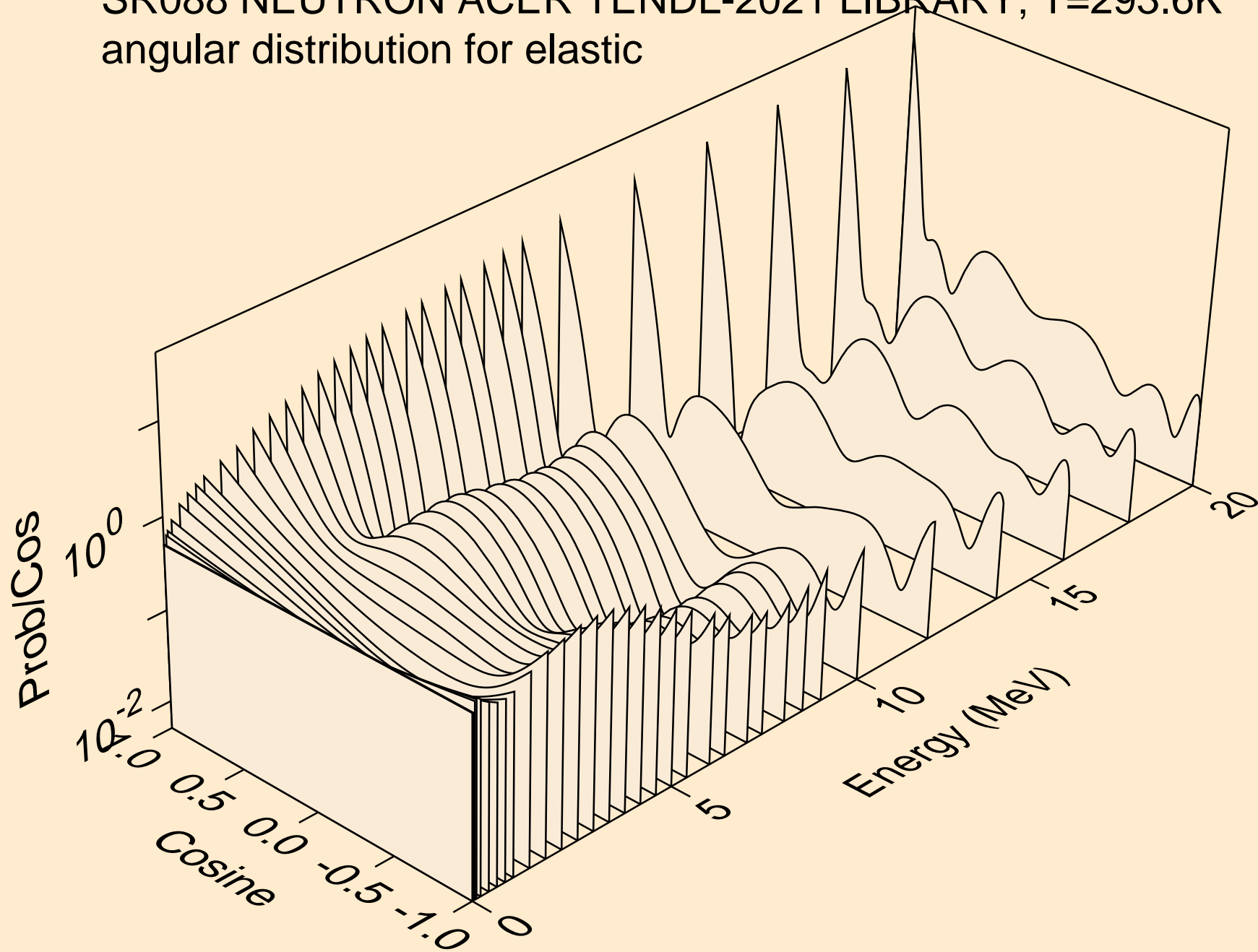

SR088 NEUTRON ACER TENDL-2021 LIBRARY; T=293.6K
angular distribution for elastic

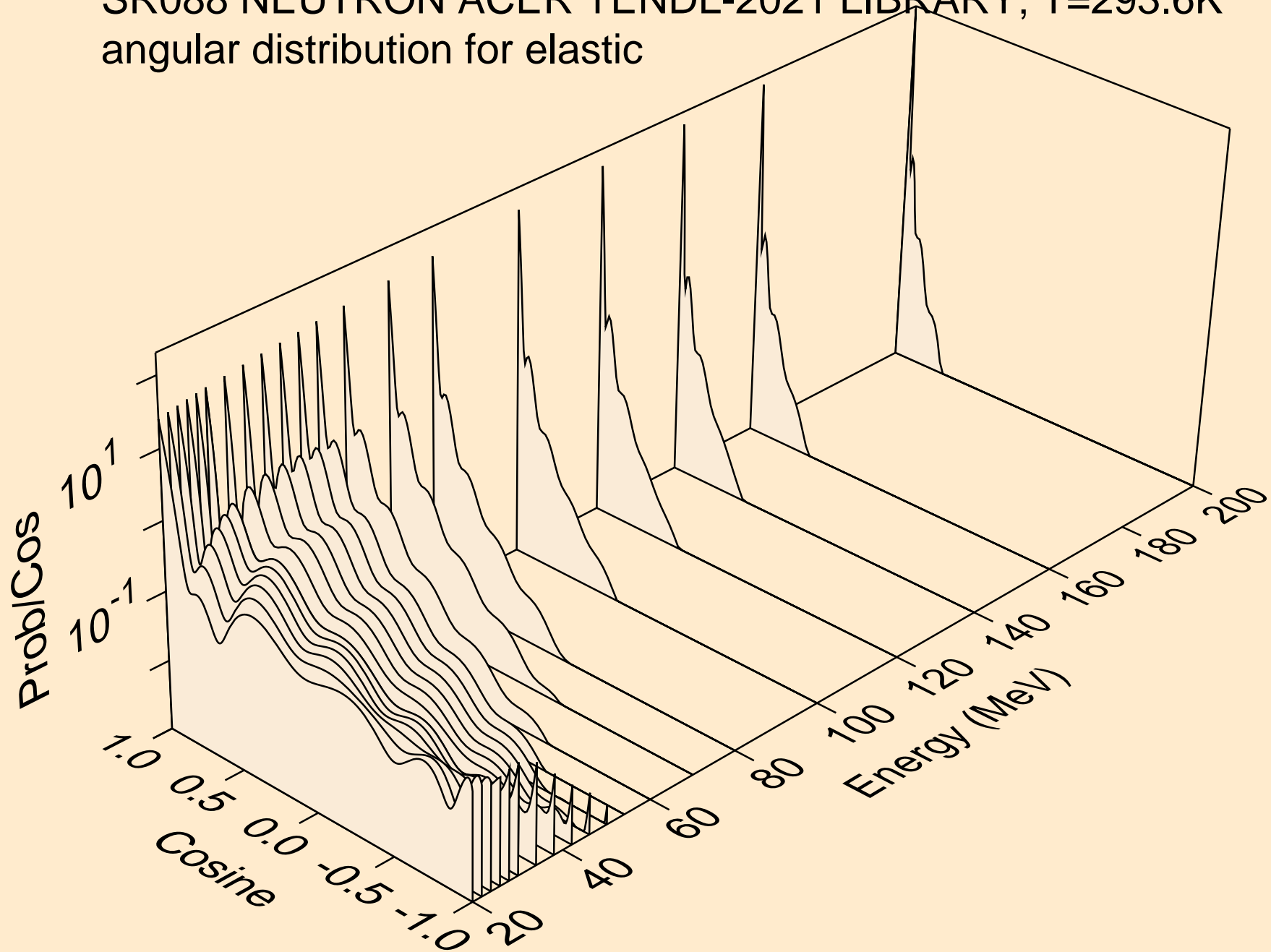

SR088 NEUTRON ACER TENDL-2021 LIBRARY; T=293.6K
angular distribution for (n,n*1)

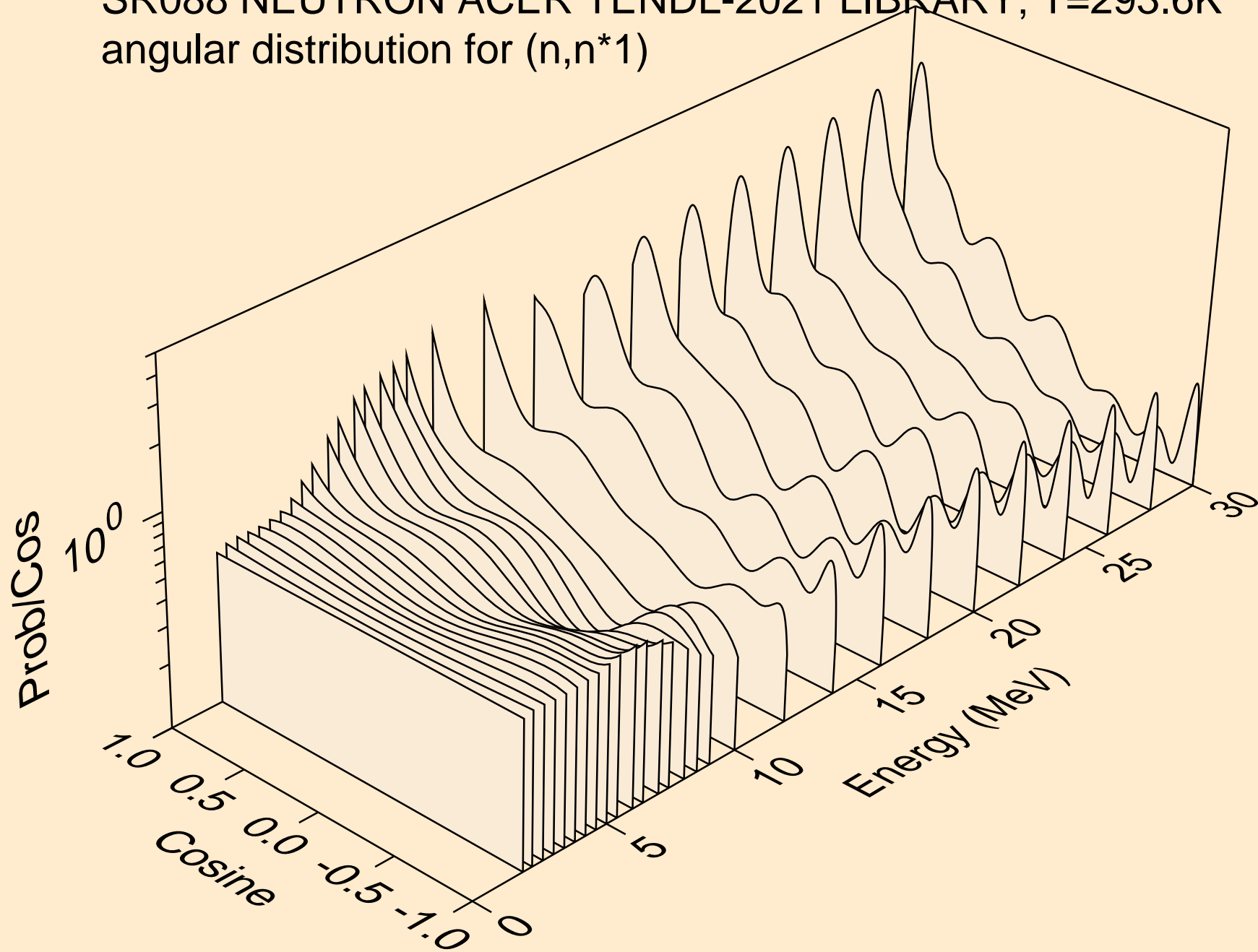

SR088 NEUTRON ACER TENDL-2021 LIBRARY; T=293.6K
angular distribution for (n,n*2)

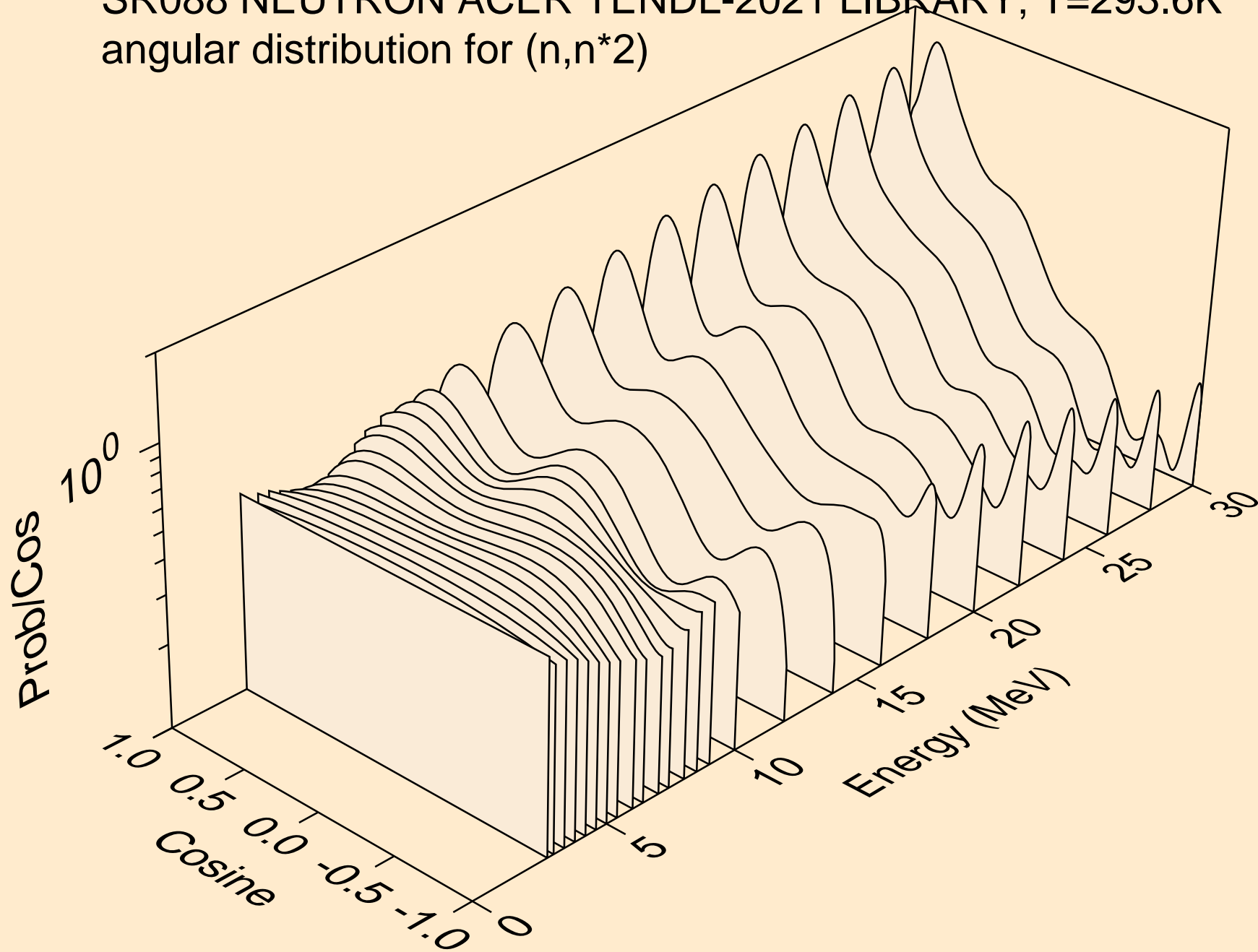

SR088 NEUTRON ACER TENDL-2021 LIBRARY; T=293.6K
angular distribution for (n,n*3)

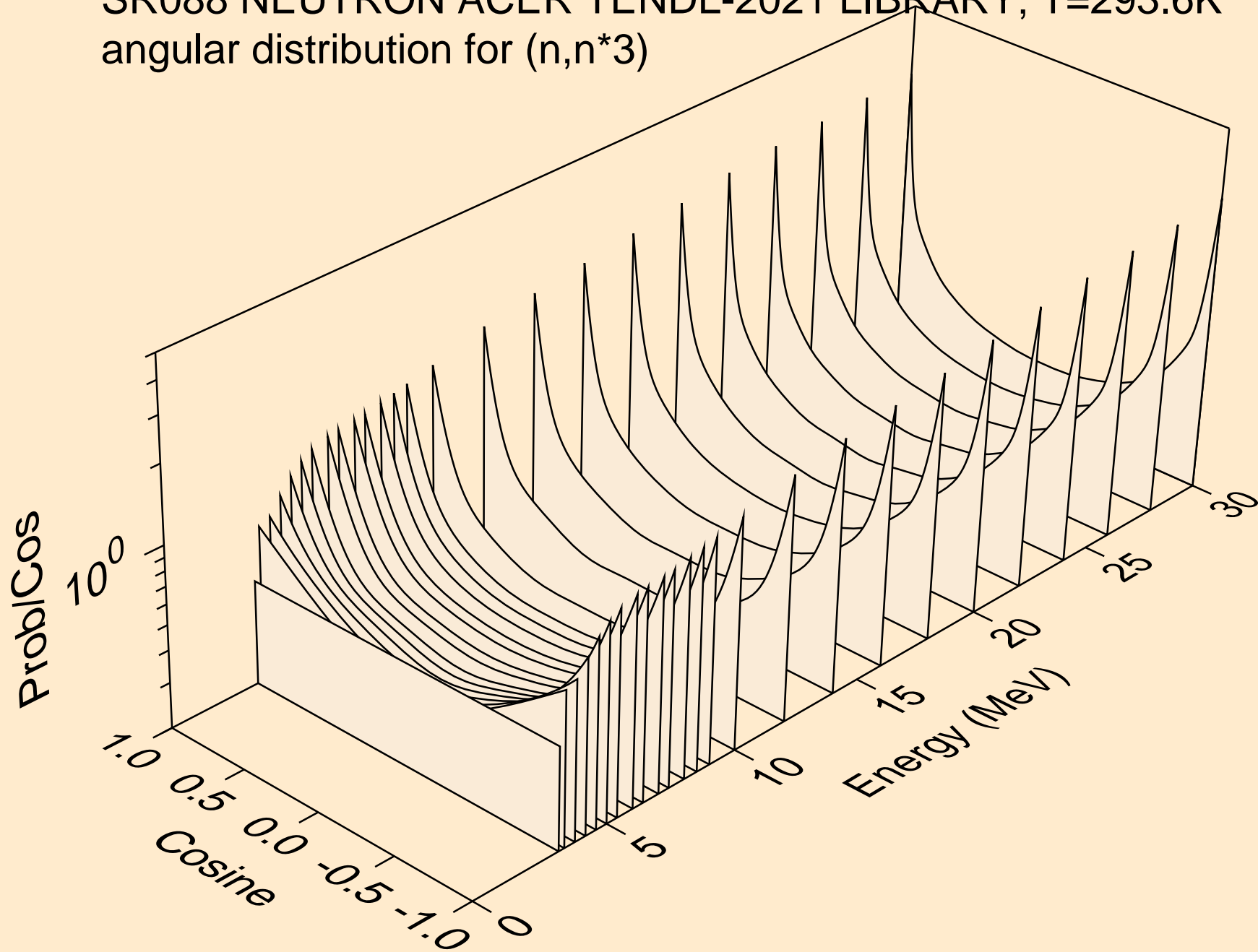

SR088 NEUTRON ACER TENDL-2021 LIBRARY; T=293.6K
angular distribution for (n,n*4)

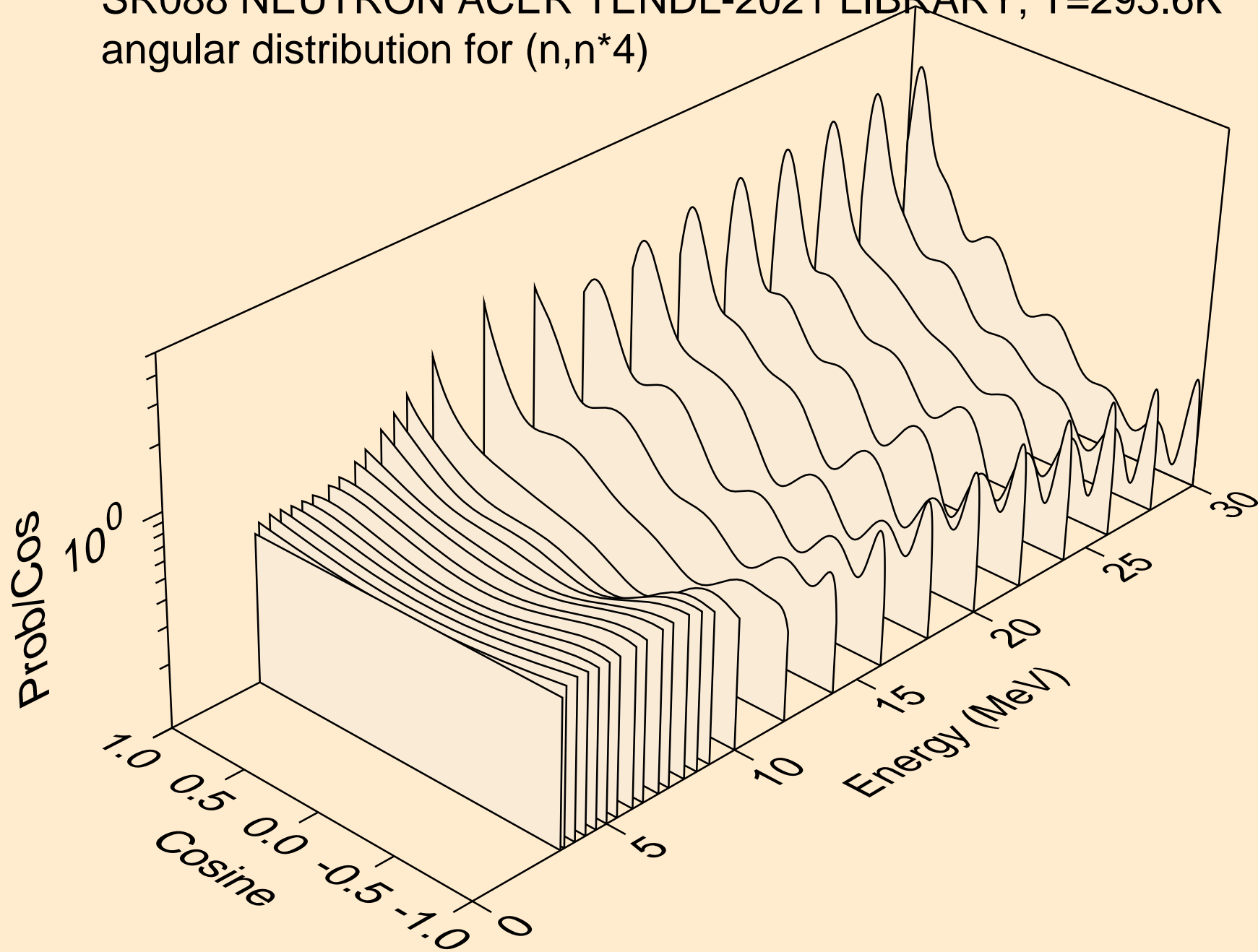

SR088 NEUTRON ACER TENDL-2021 LIBRARY; T=293.6K
angular distribution for (n,n*5)

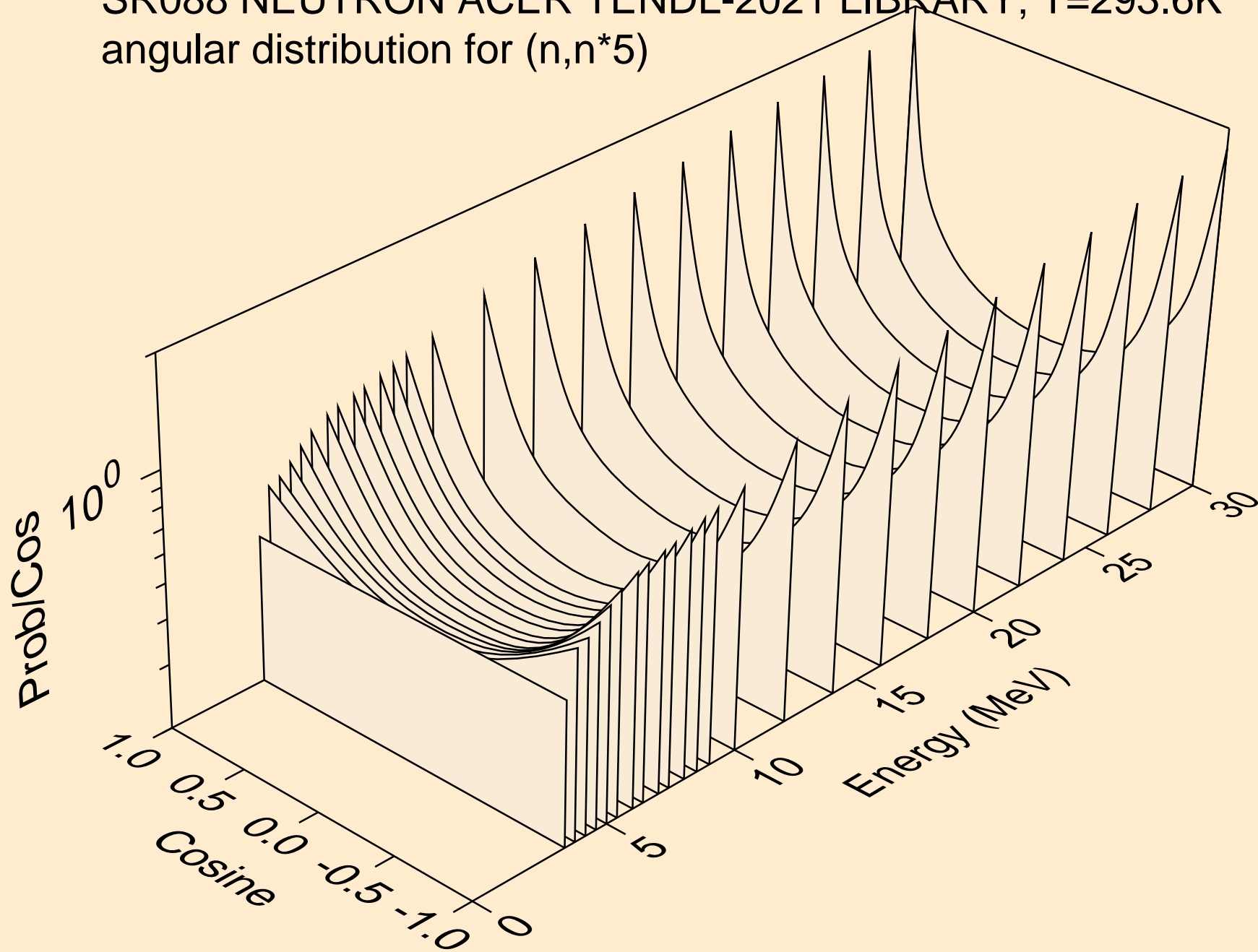

SR088 NEUTRON ACER TENDL-2021 LIBRARY; T=293.6K
angular distribution for (n,n*6)

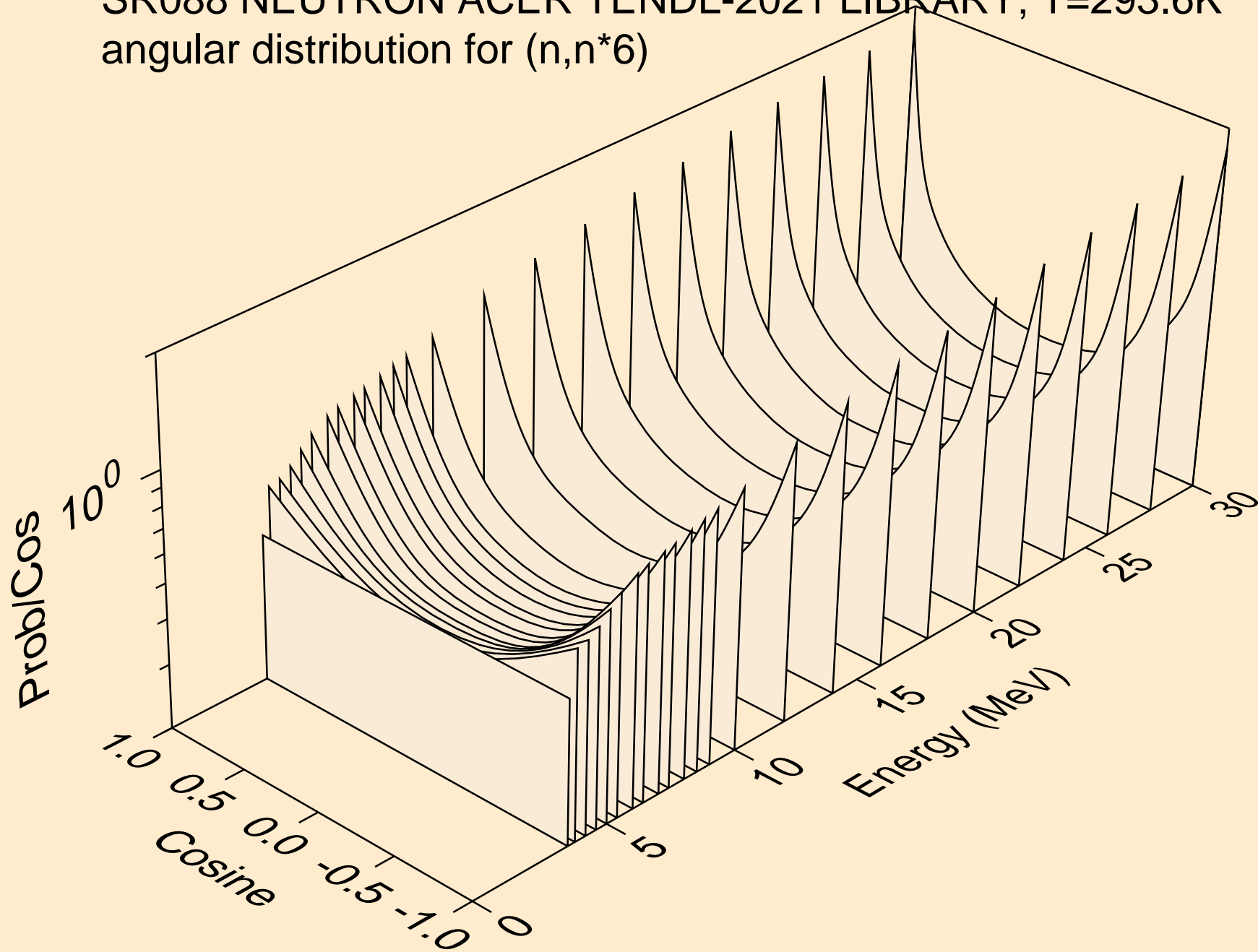

SR088 NEUTRON ACER TENDL-2021 LIBRARY; T=293.6K
angular distribution for (n,n*7)

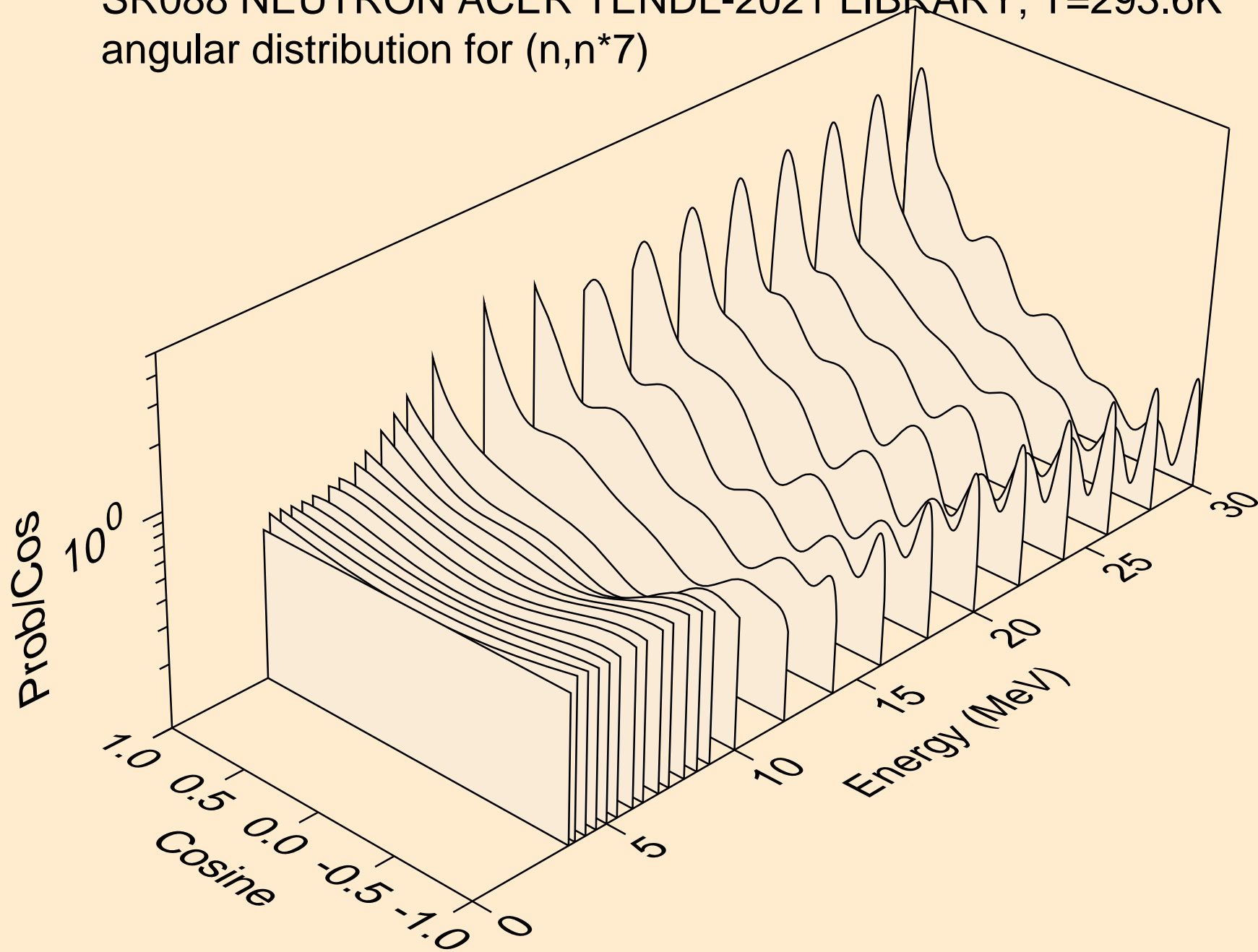

SR088 NEUTRON ACER TENDL-2021 LIBRARY; T=293.6K
angular distribution for (n,n*8)

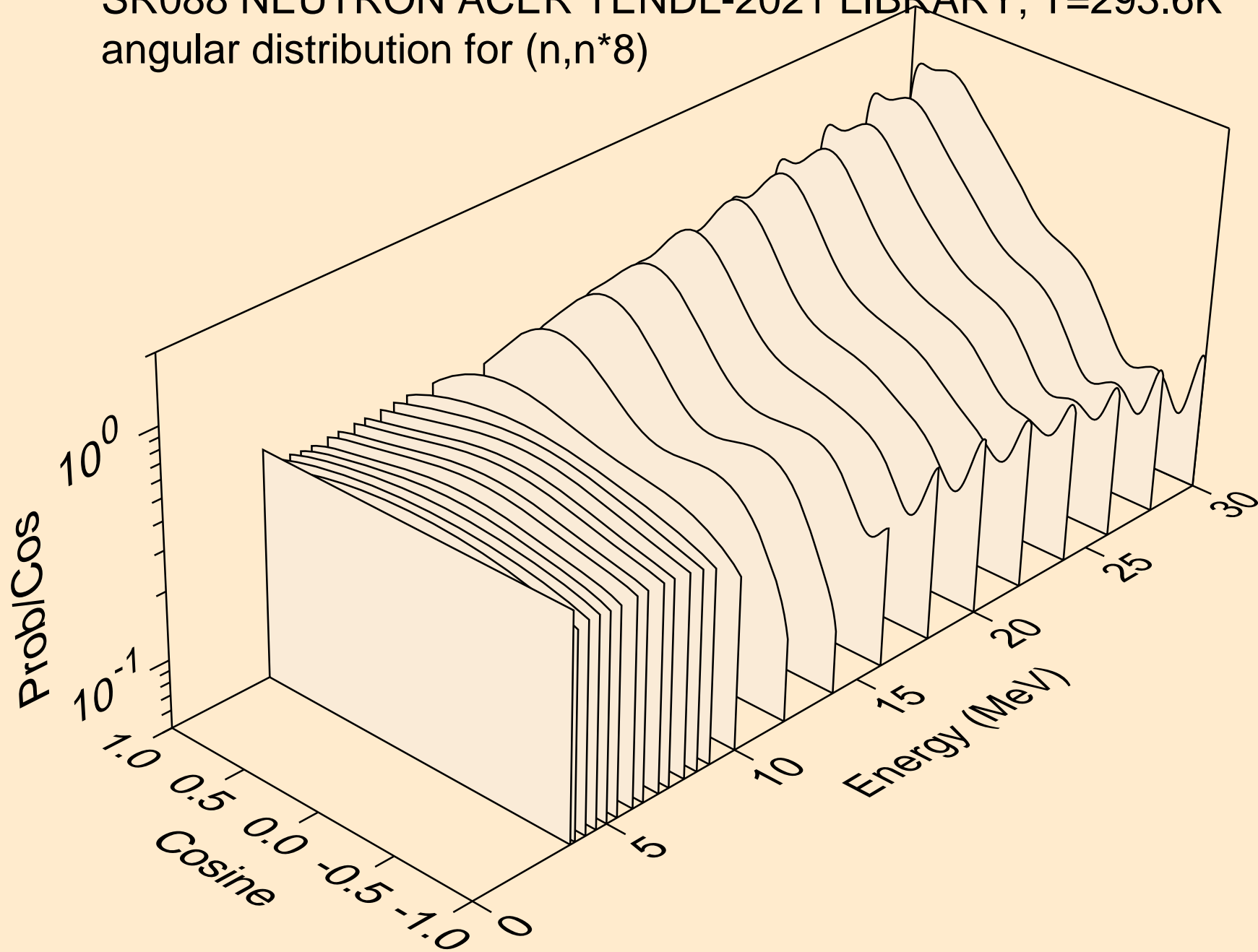

SR088 NEUTRON ACER TENDL-2021 LIBRARY; T=293.6K
angular distribution for (n,n*9)

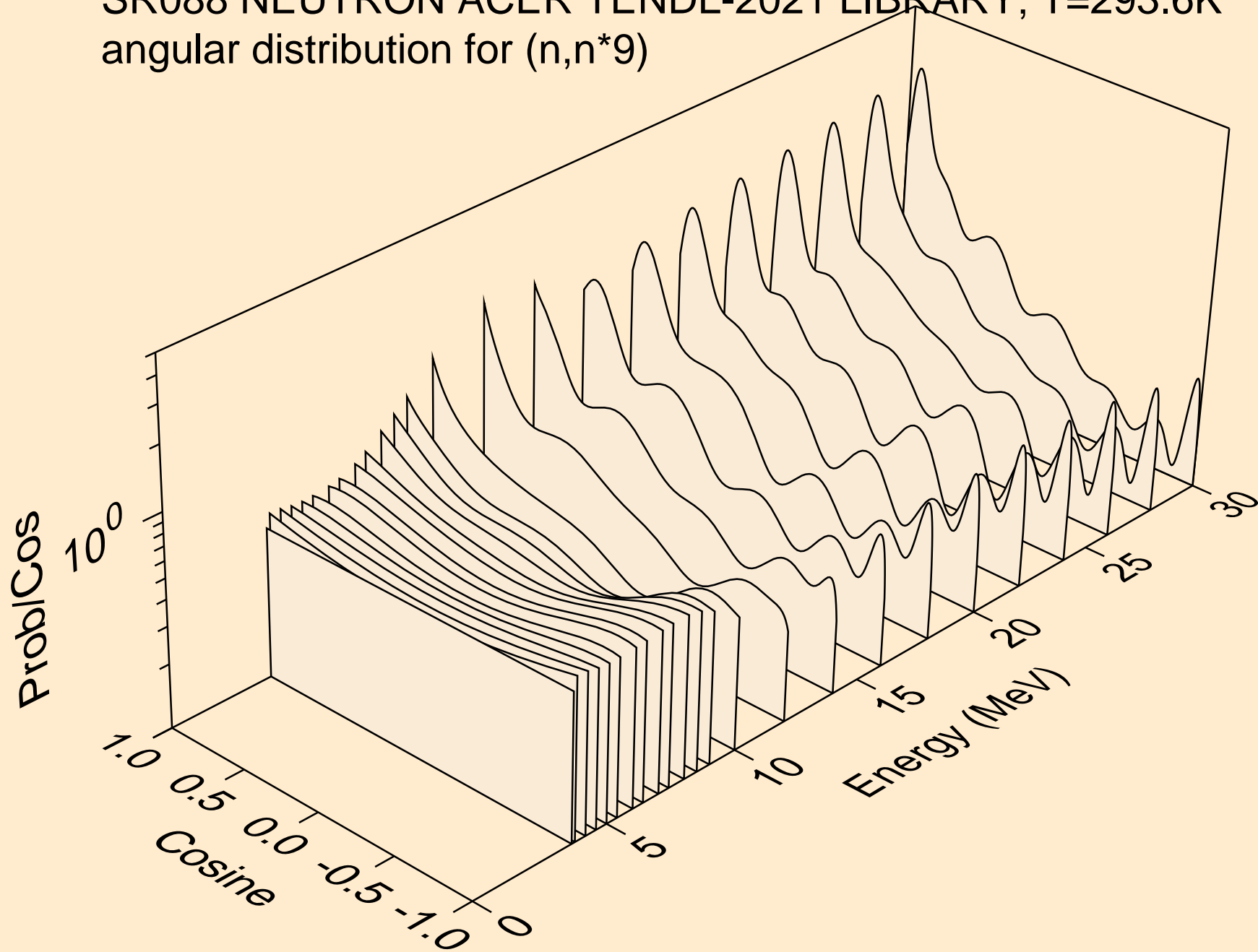

SR088 NEUTRON ACER TENDL-2021 LIBRARY; T=293.6K
angular distribution for (n,n*10)

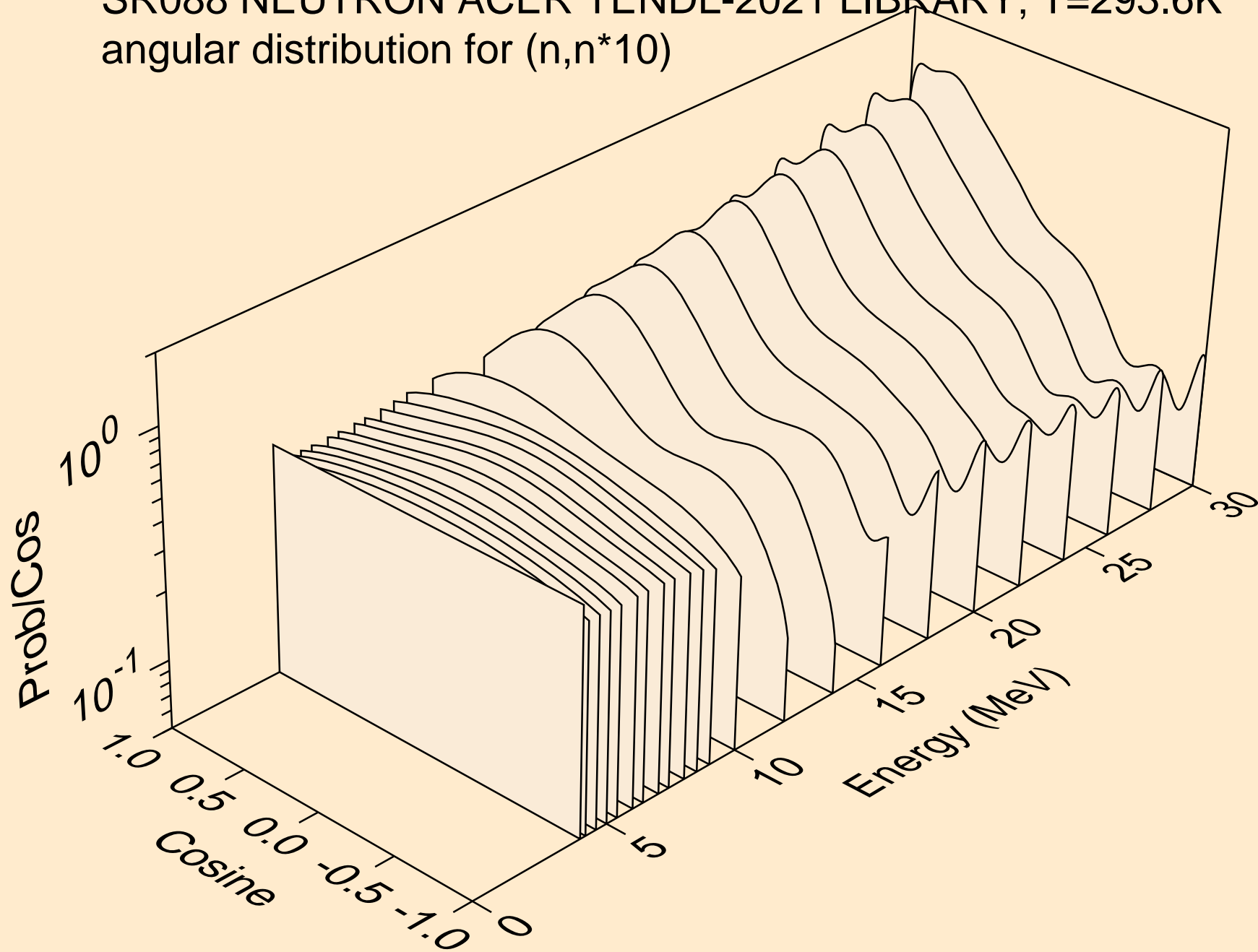

SR088 NEUTRON ACER TENDL-2021 LIBRARY; T=293.6K
angular distribution for (n,n*11)

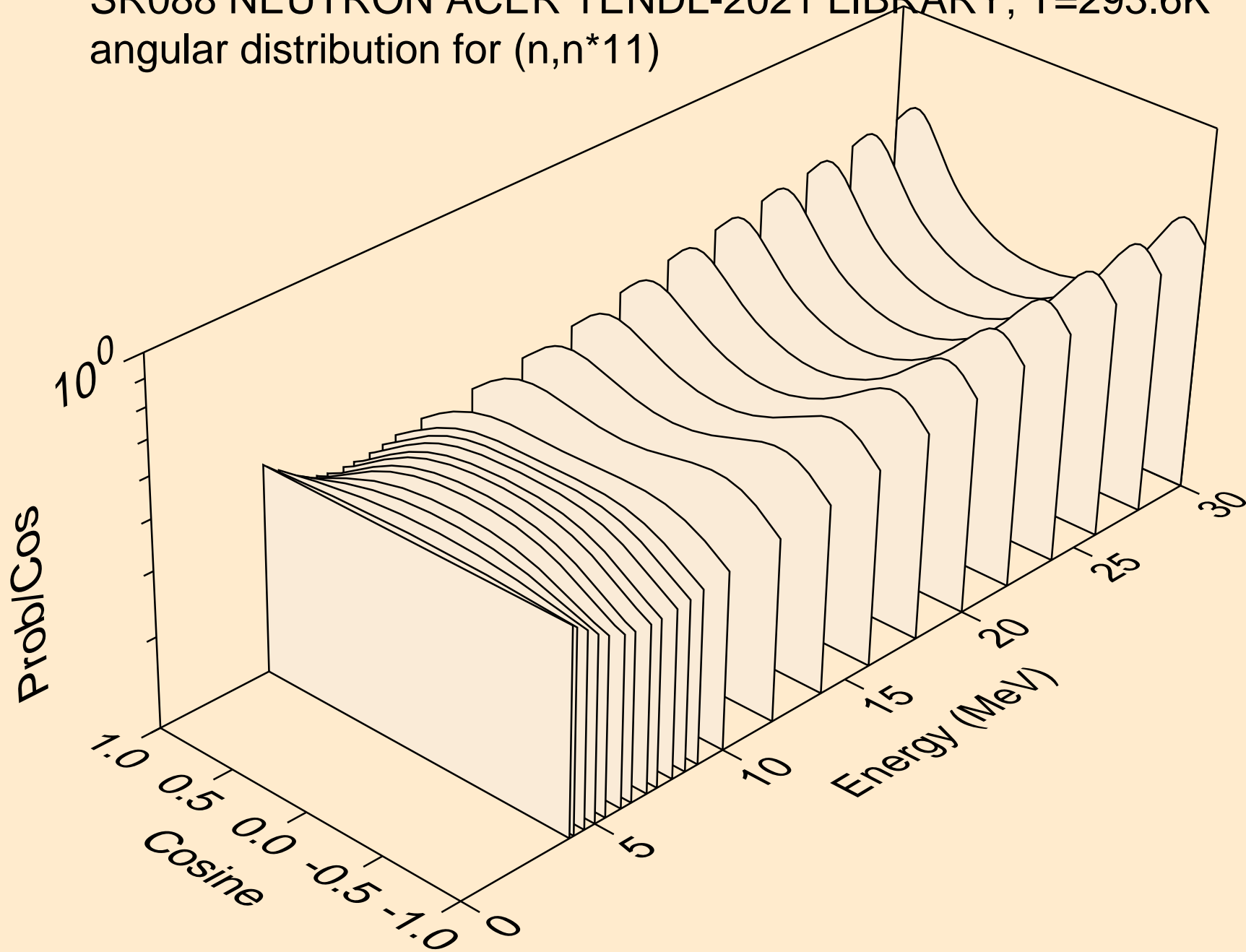

SR088 NEUTRON ACER TENDL-2021 LIBRARY; T=293.6K
angular distribution for (n,n*12)

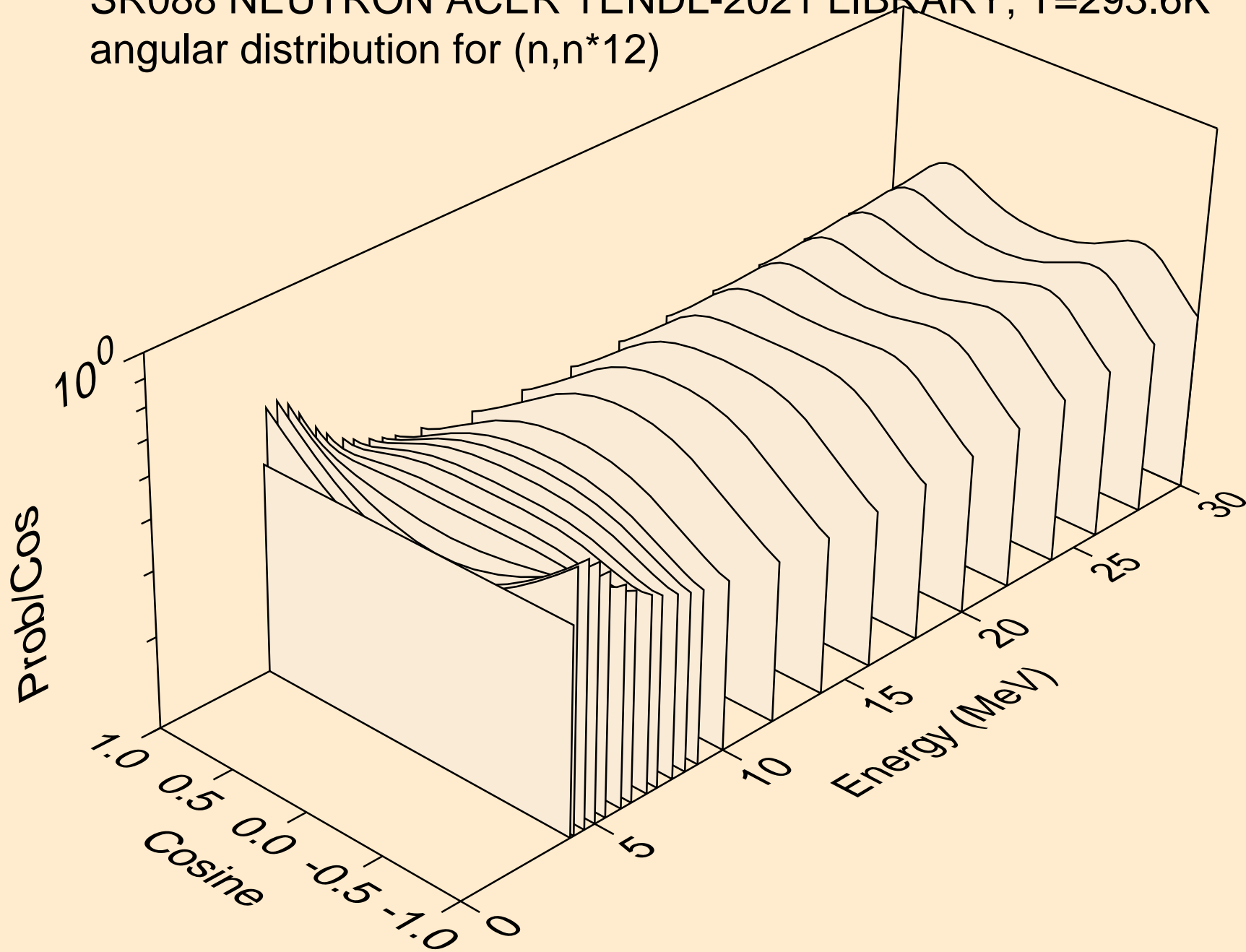

SR088 NEUTRON ACER TENDL-2021 LIBRARY; T=293.6K
angular distribution for (n,n*13)

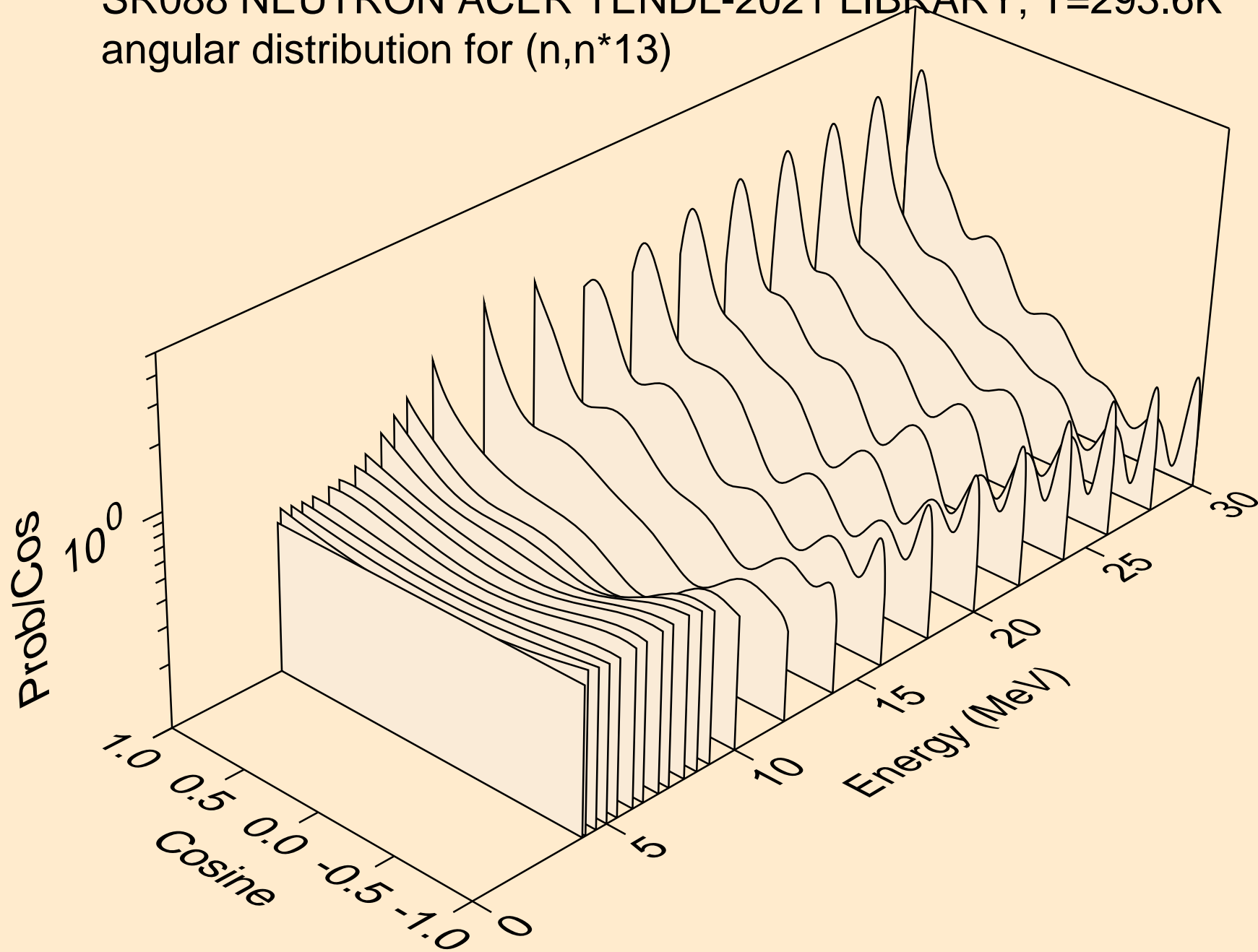

SR088 NEUTRON ACER TENDL-2021 LIBRARY; T=293.6K
angular distribution for (n,n*14)

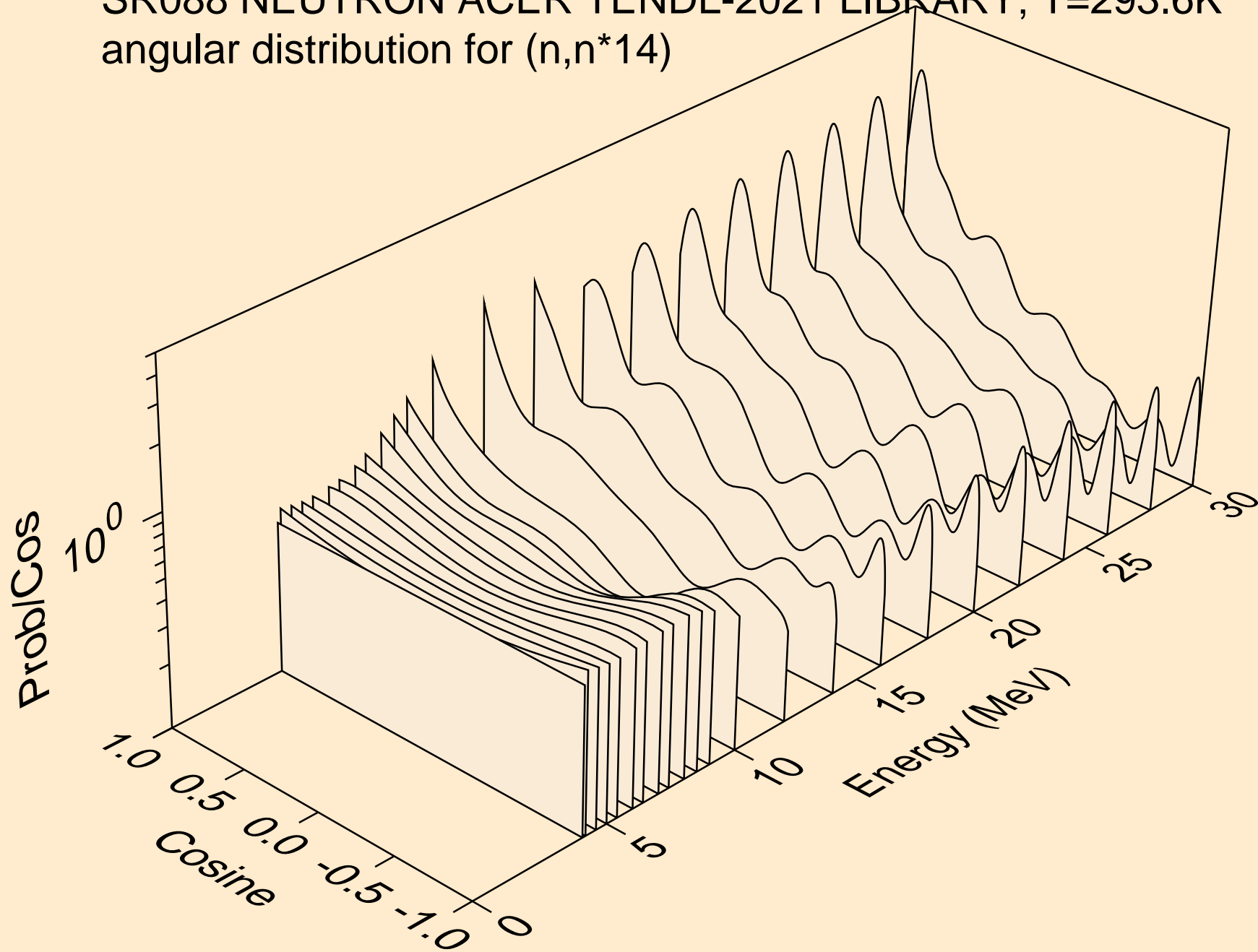

SR088 NEUTRON ACER TENDL-2021 LIBRARY; T=293.6K
angular distribution for (n,n*15)

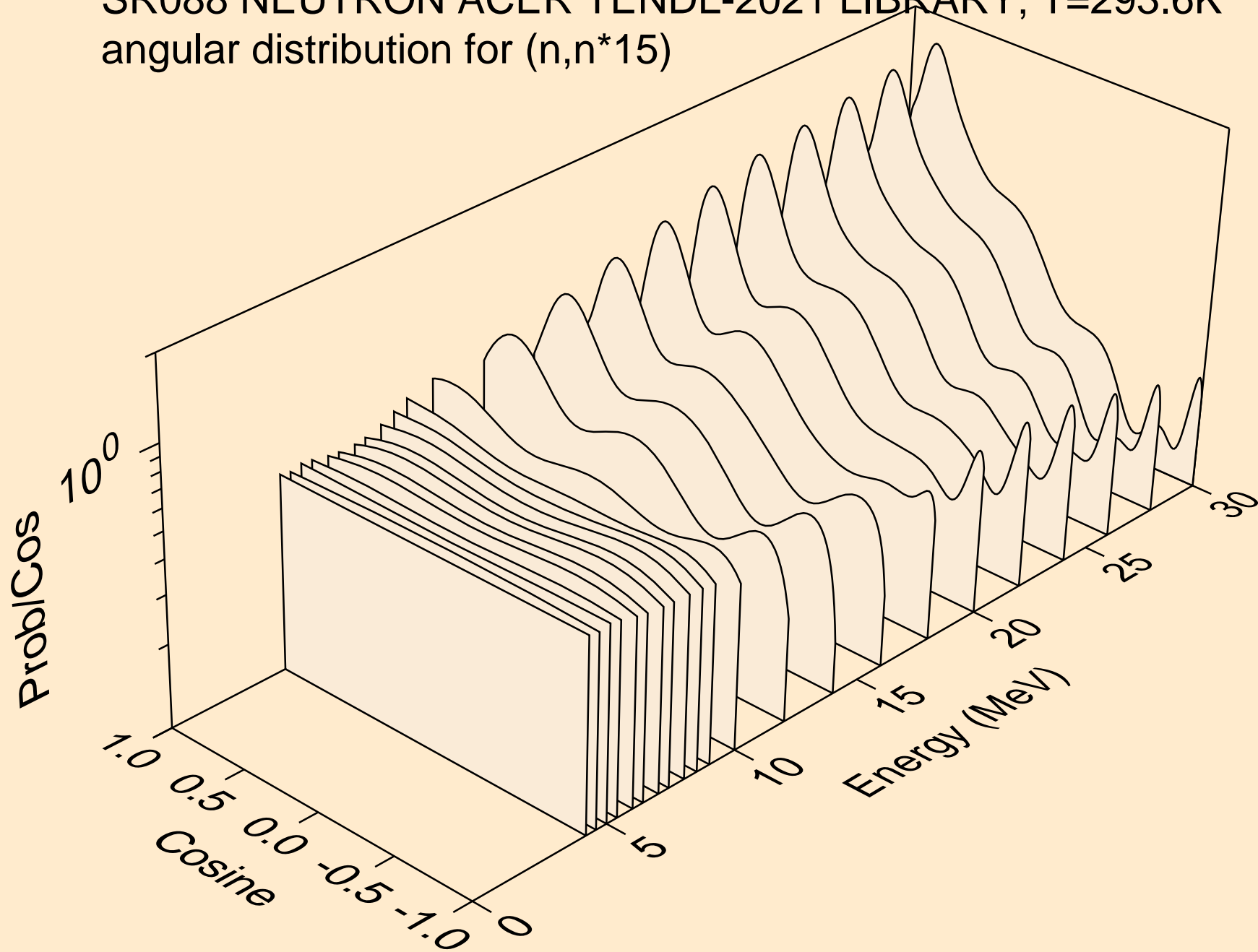

SR088 NEUTRON ACER TENDL-2021 LIBRARY; T=293.6K
angular distribution for (n,n*16)

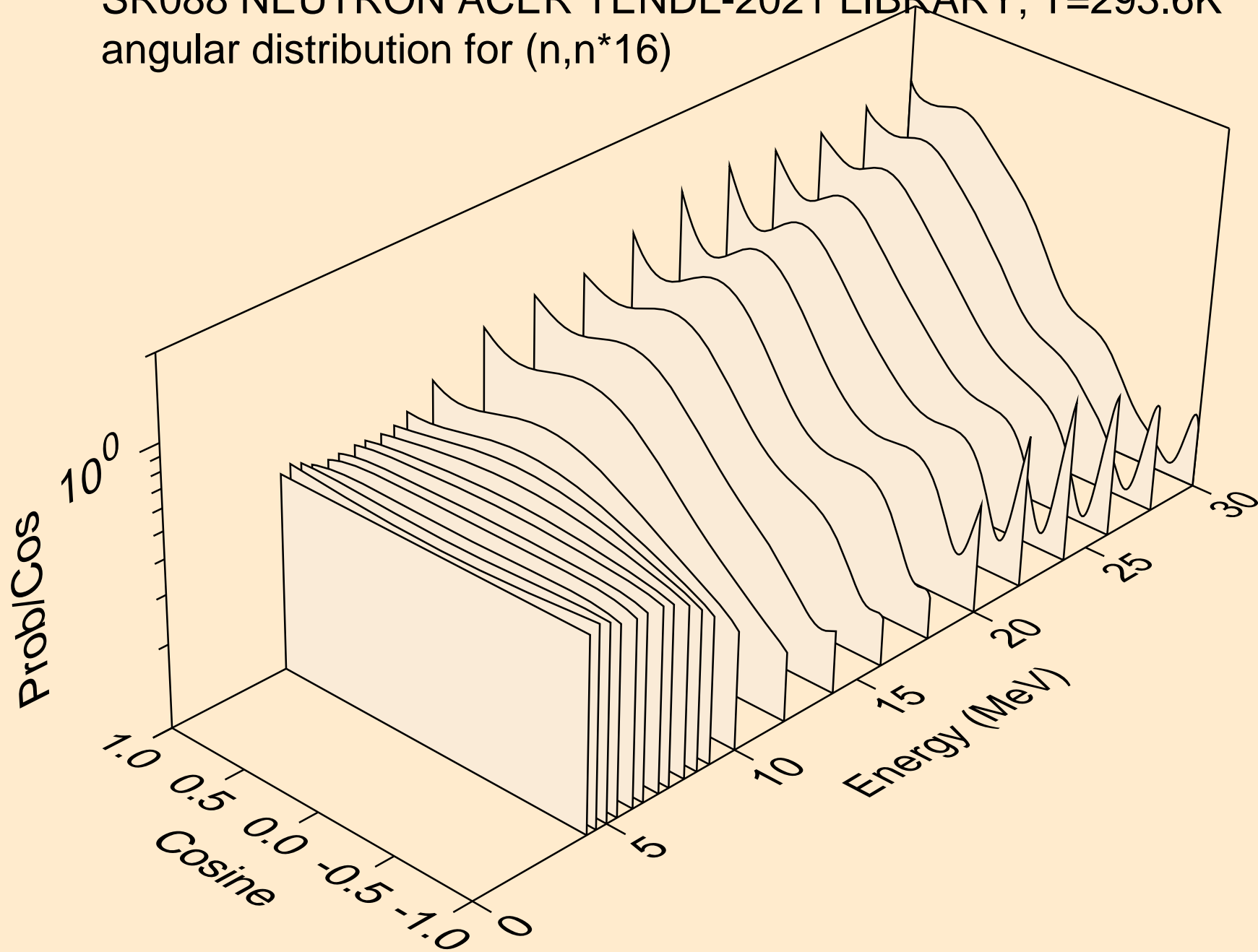

SR088 NEUTRON ACER TENDL-2021 LIBRARY; T=293.6K
angular distribution for (n,n*17)

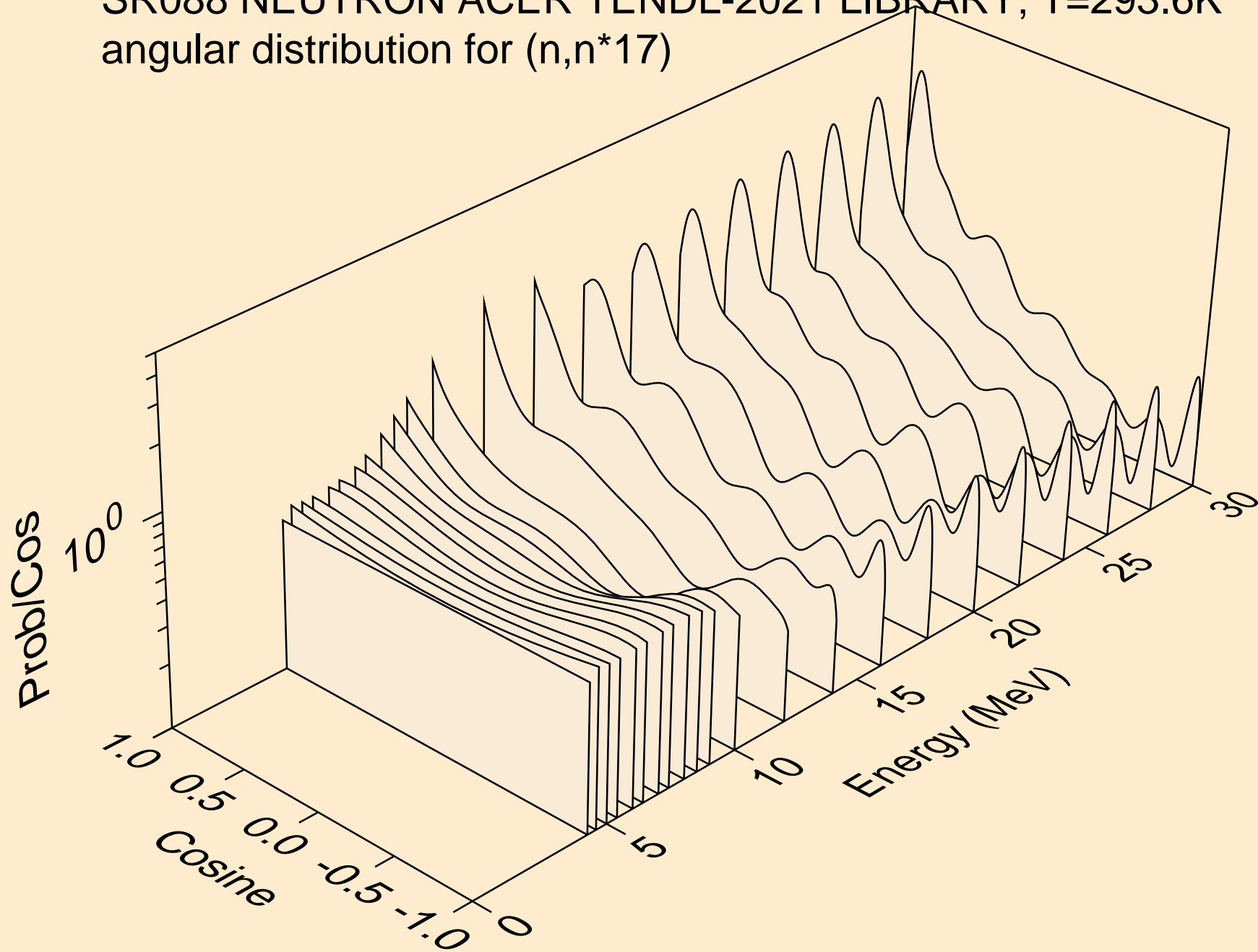

SR088 NEUTRON ACER TENDL-2021 LIBRARY; T=293.6K
angular distribution for (n,n*18)

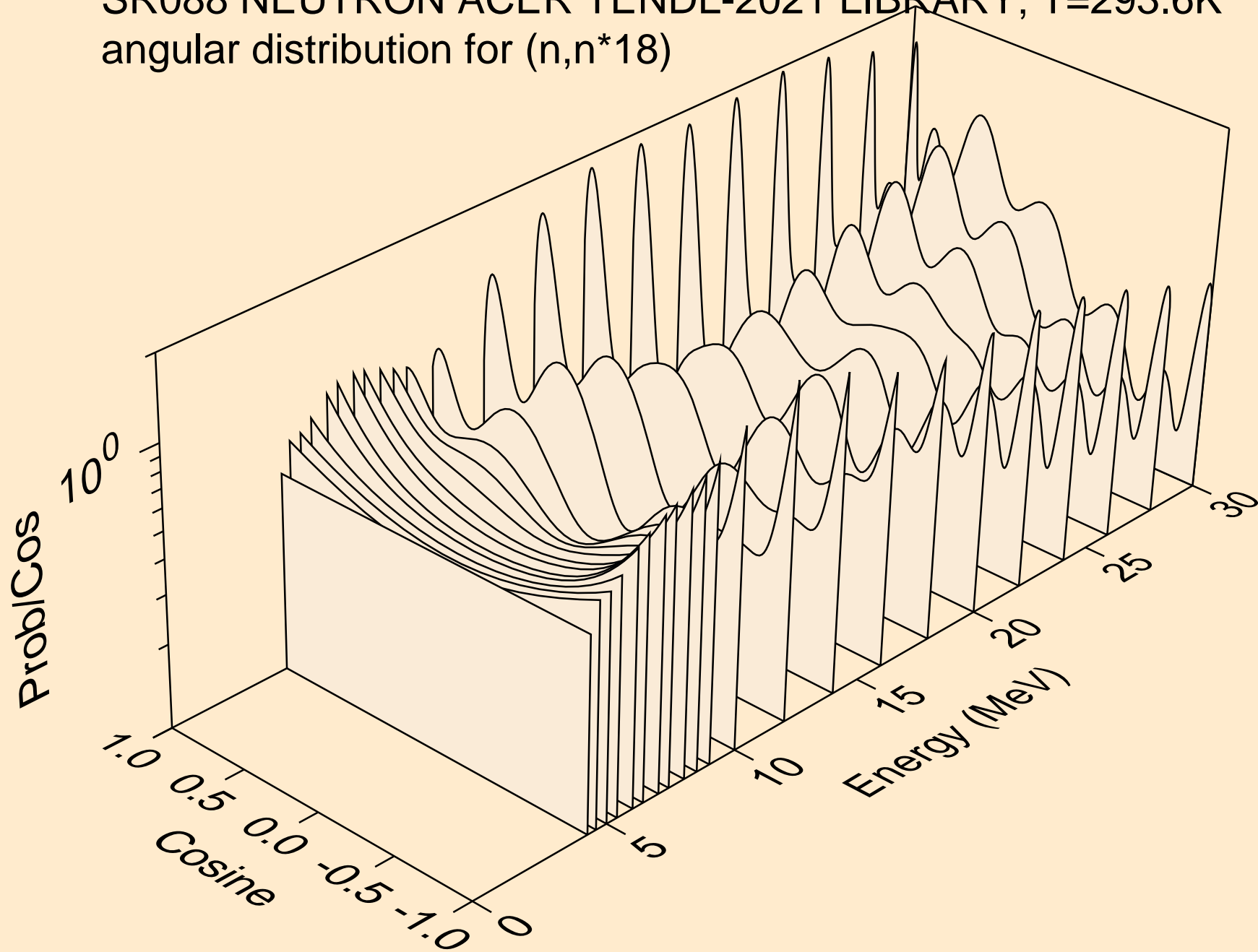

SR088 NEUTRON ACER TENDL-2021 LIBRARY; T=293.6K
angular distribution for (n,n*19)

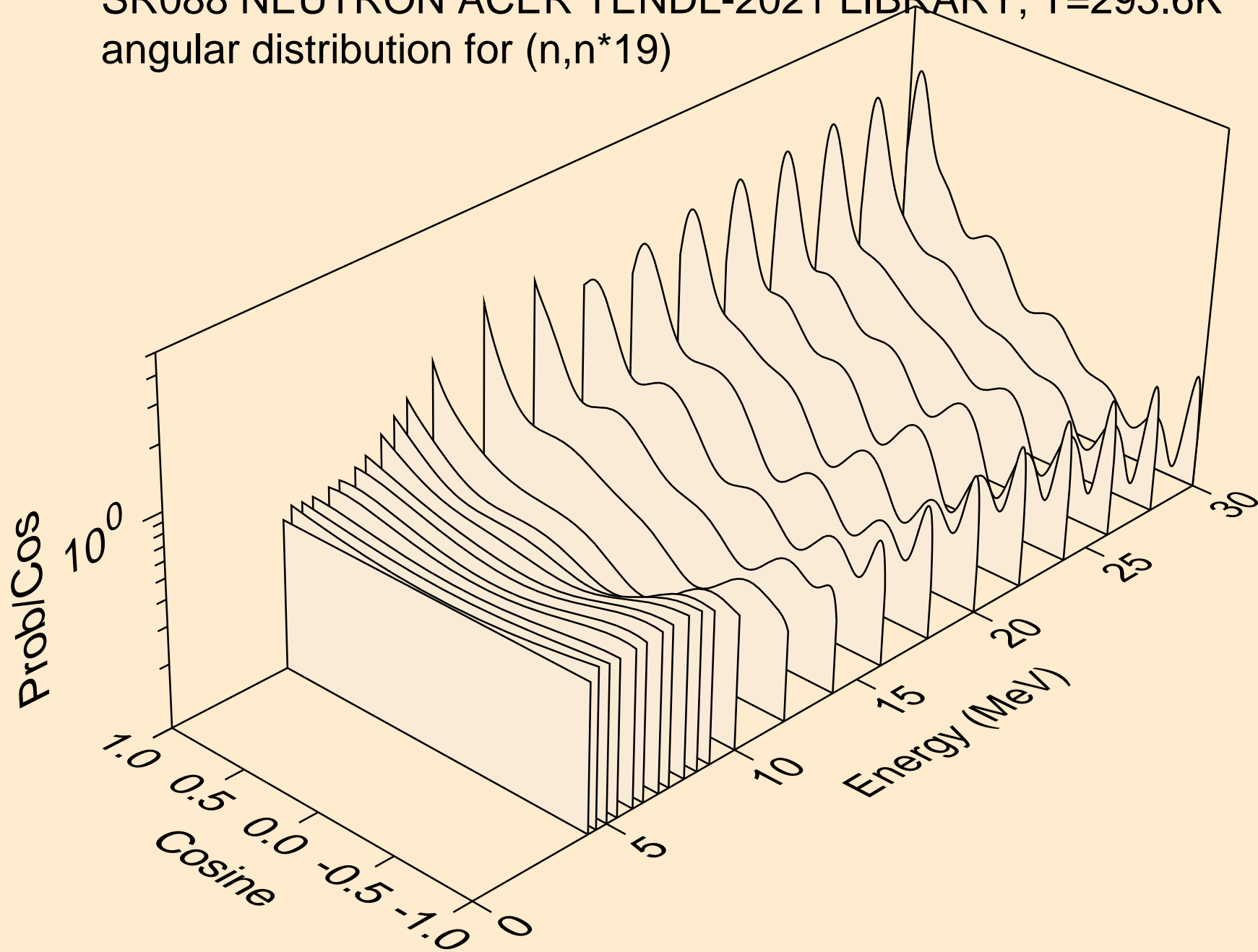

SR088 NEUTRON ACER TENDL-2021 LIBRARY; T=293.6K
angular distribution for (n,n*20)

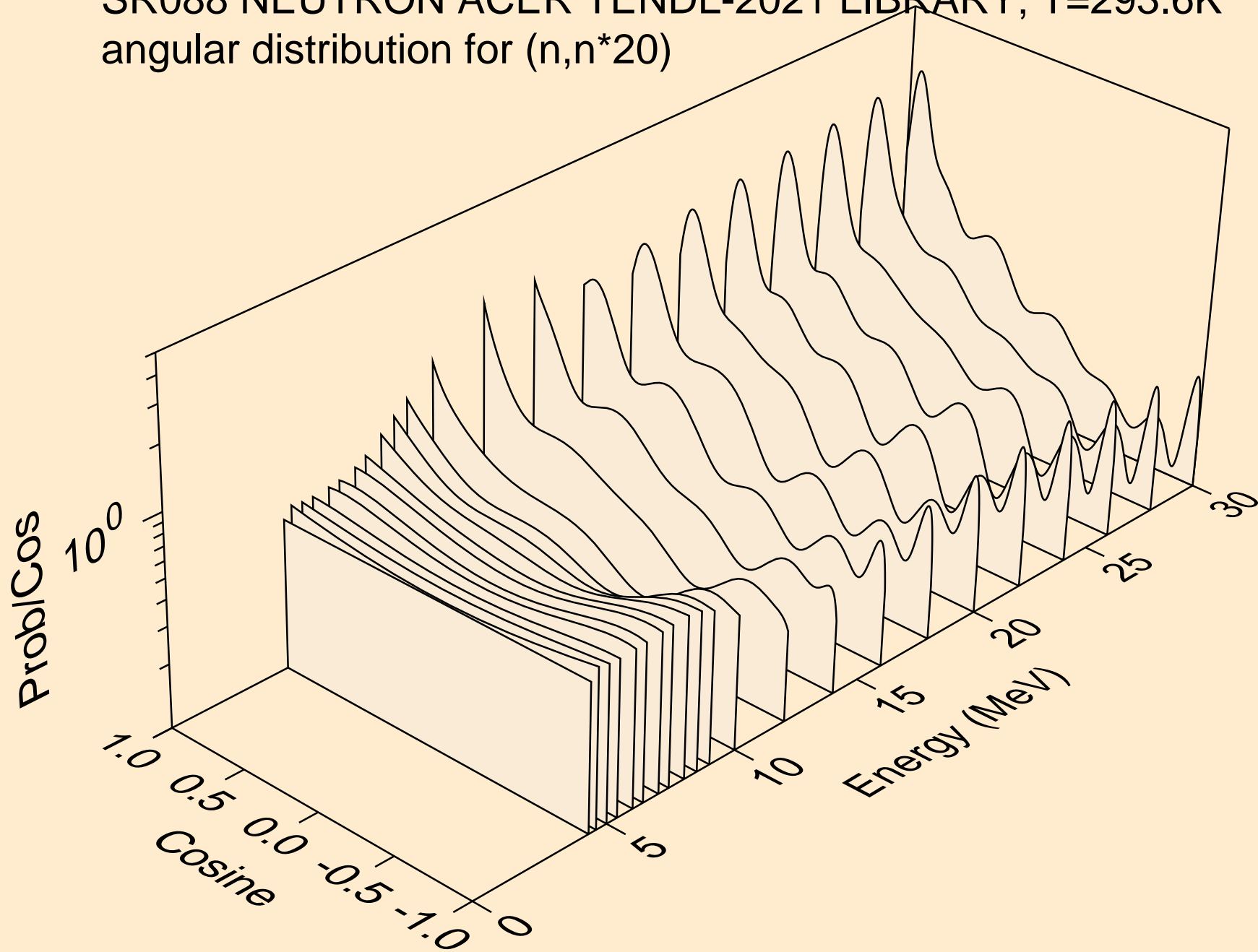

SR088 NEUTRON ACER TENDL-2021 LIBRARY; T=293.6K
angular distribution for (n,n*21)

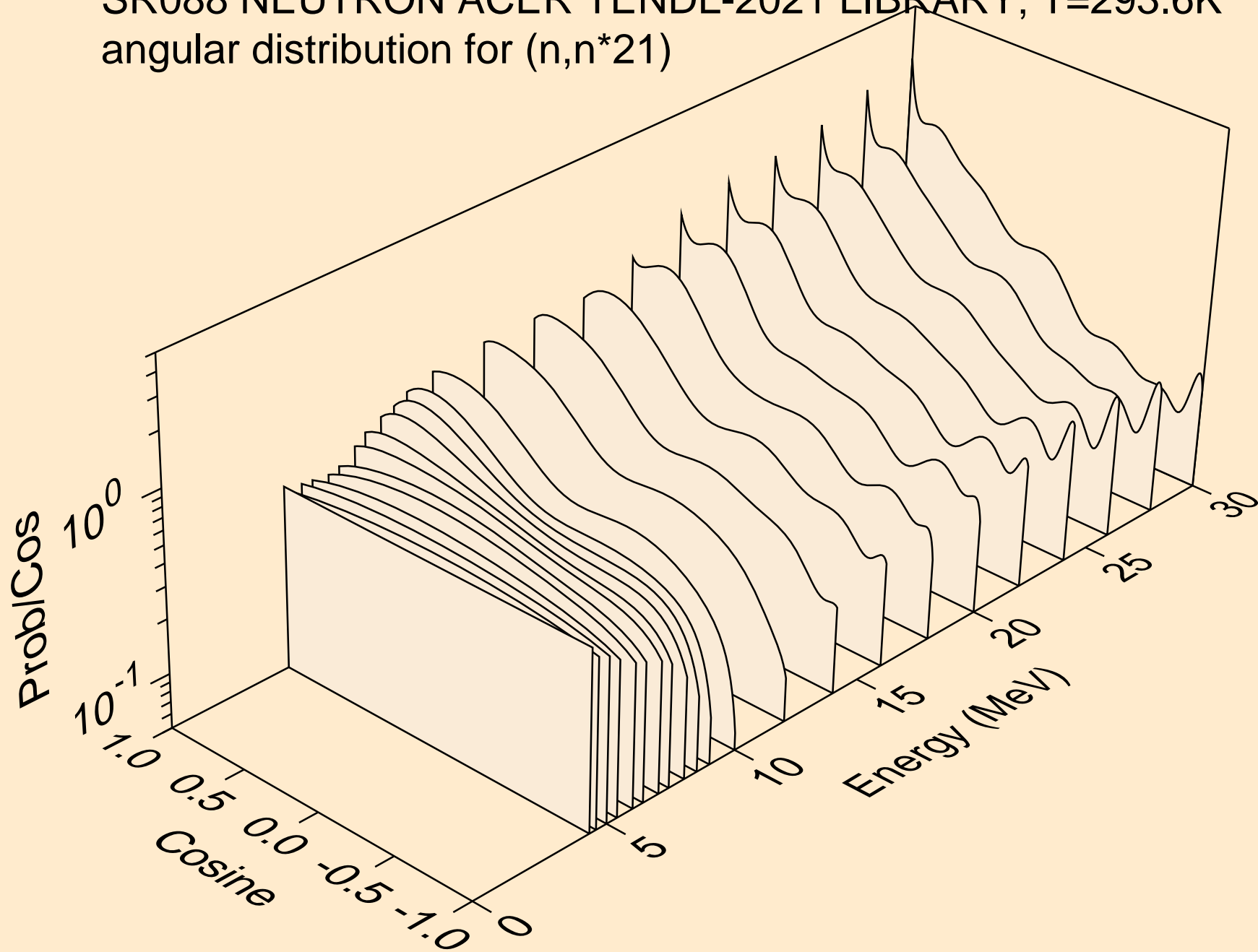

SR088 NEUTRON ACER TENDL-2021 LIBRARY; T=293.6K
angular distribution for (n,n*22)

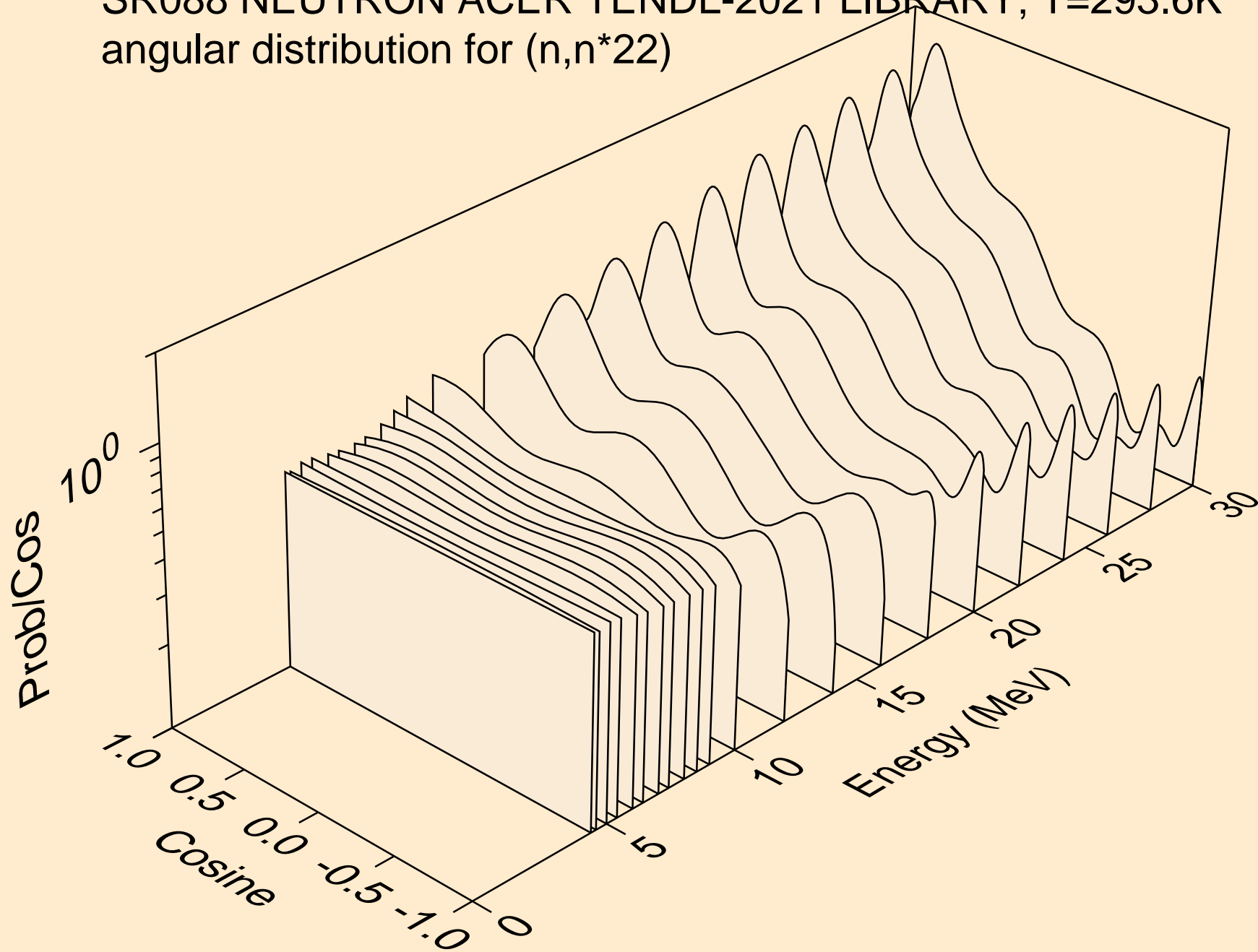

SR088 NEUTRON ACER TENDL-2021 LIBRARY; T=293.6K
angular distribution for (n,n*23)

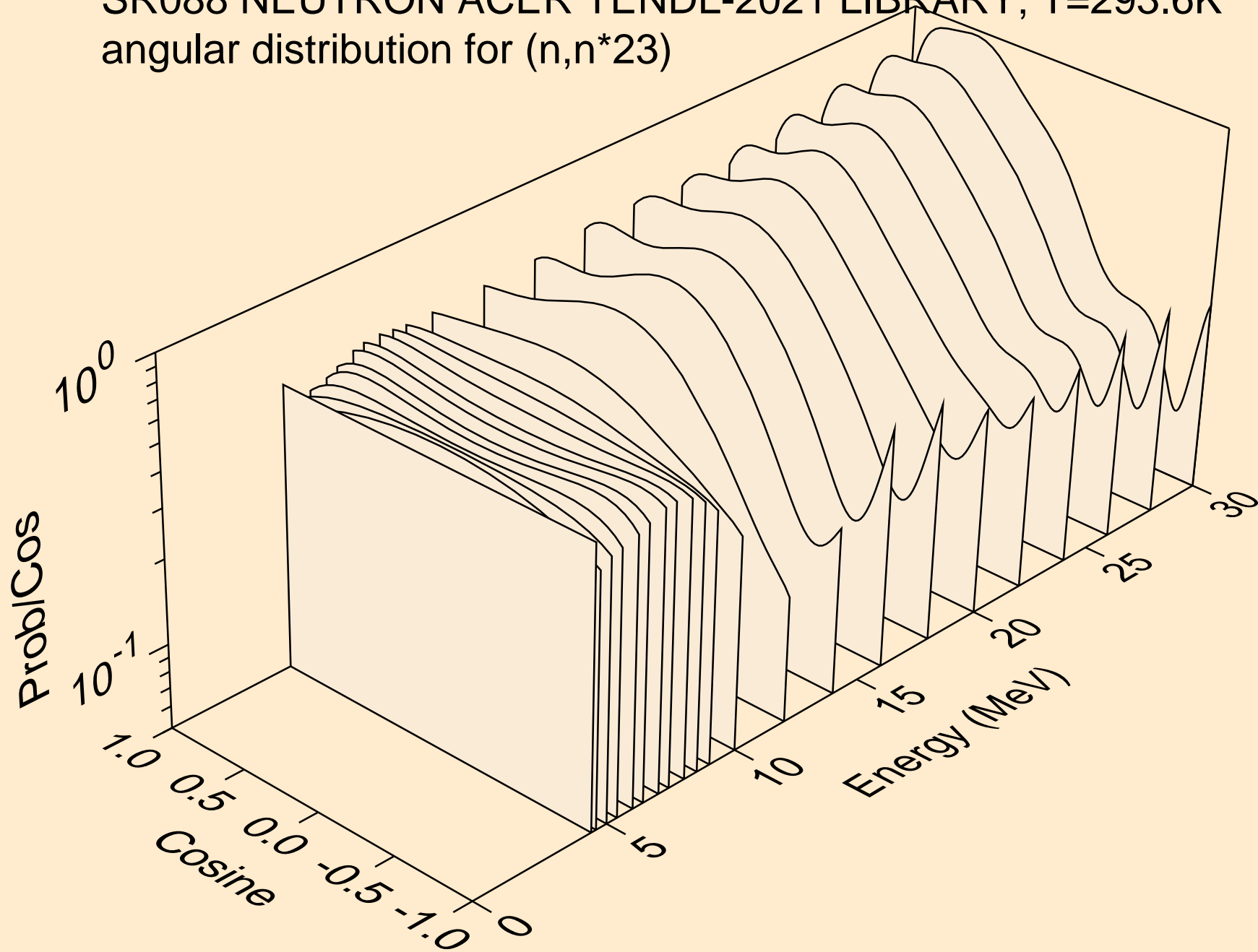

SR088 NEUTRON ACER TENDL-2021 LIBRARY; T=293.6K
angular distribution for (n,n*24)

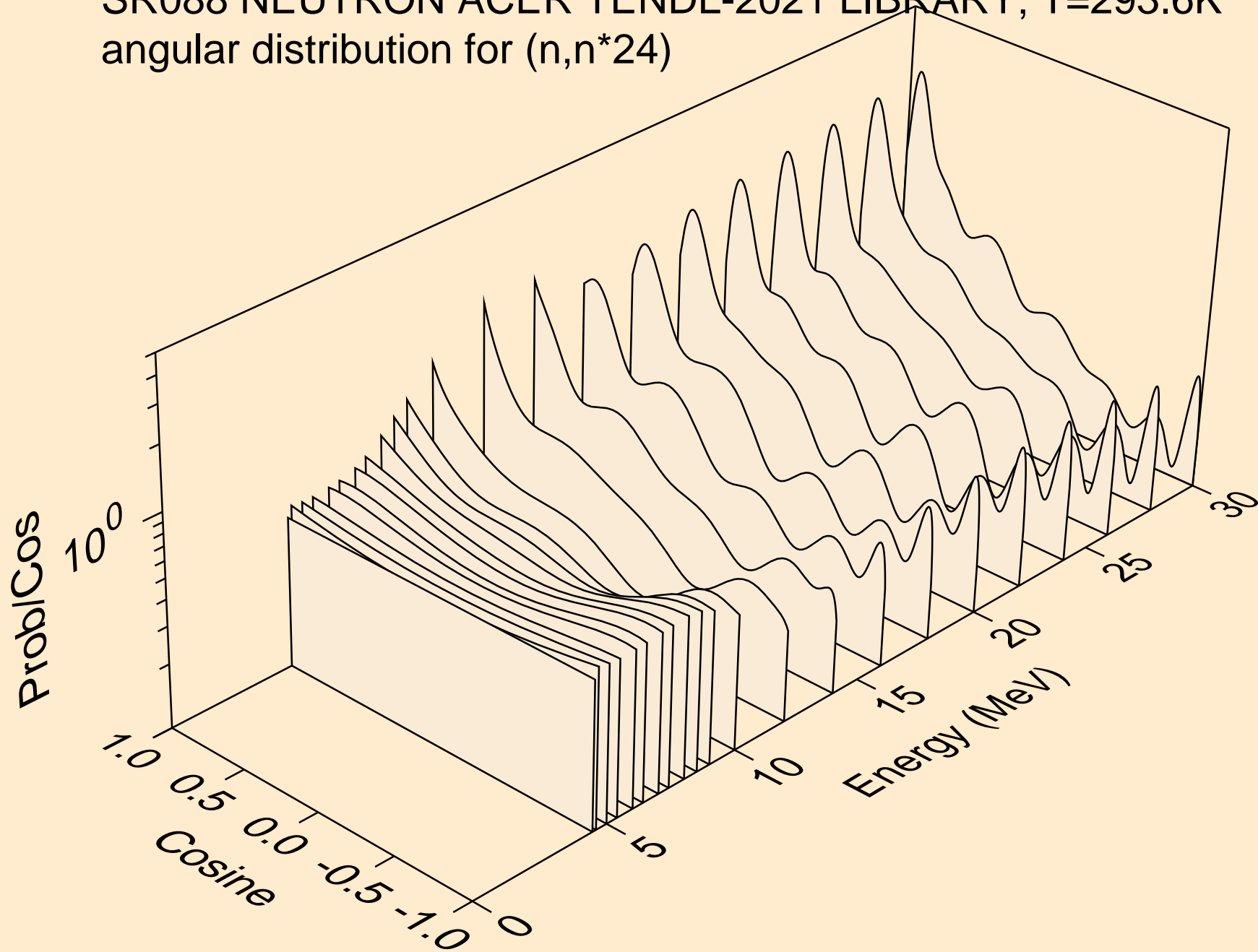

SR088 NEUTRON ACER TENDL-2021 LIBRARY; T=293.6K
angular distribution for (n,n*25)

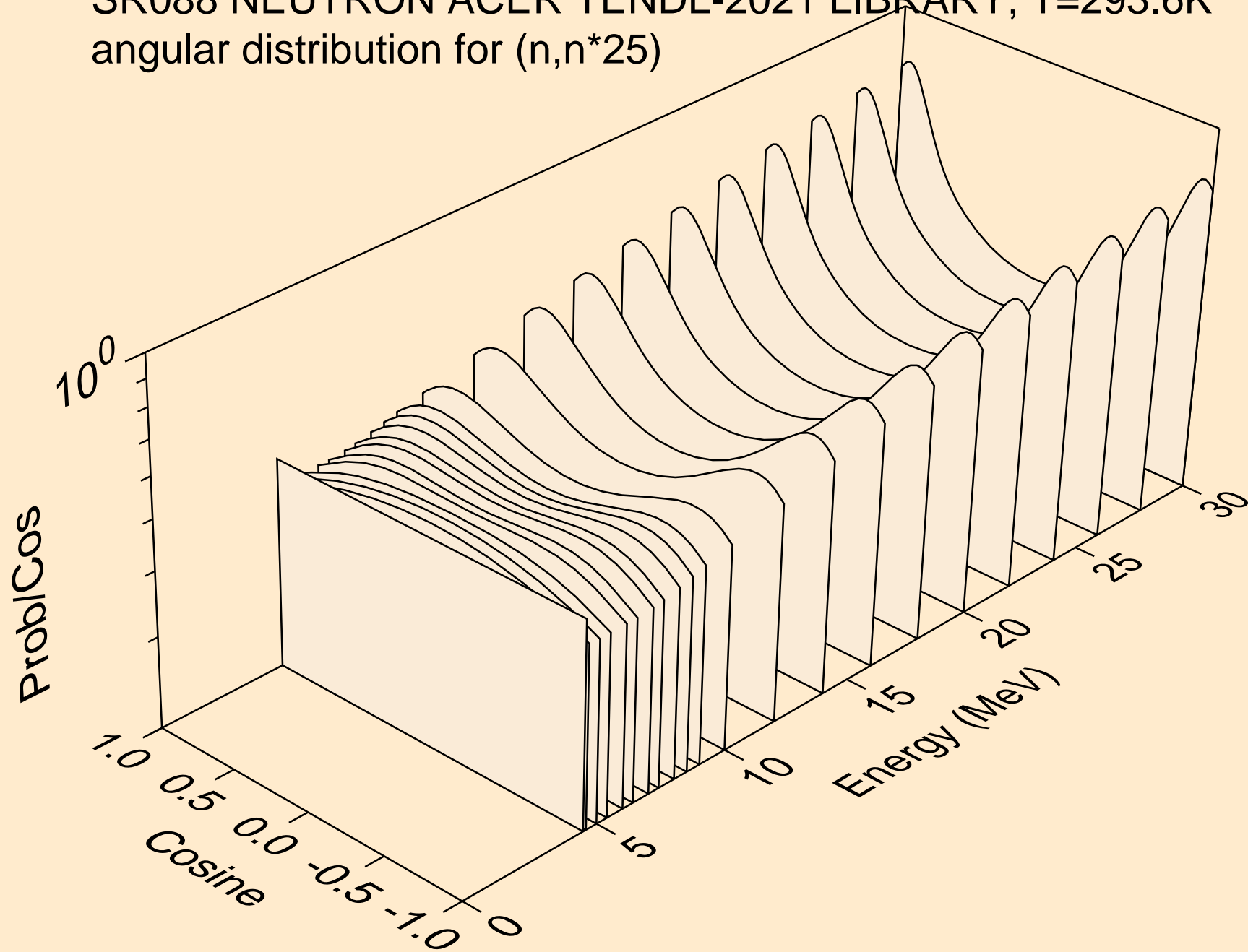

SR088 NEUTRON ACER TENDL-2021 LIBRARY; T=293.6K
angular distribution for (n,n*26)

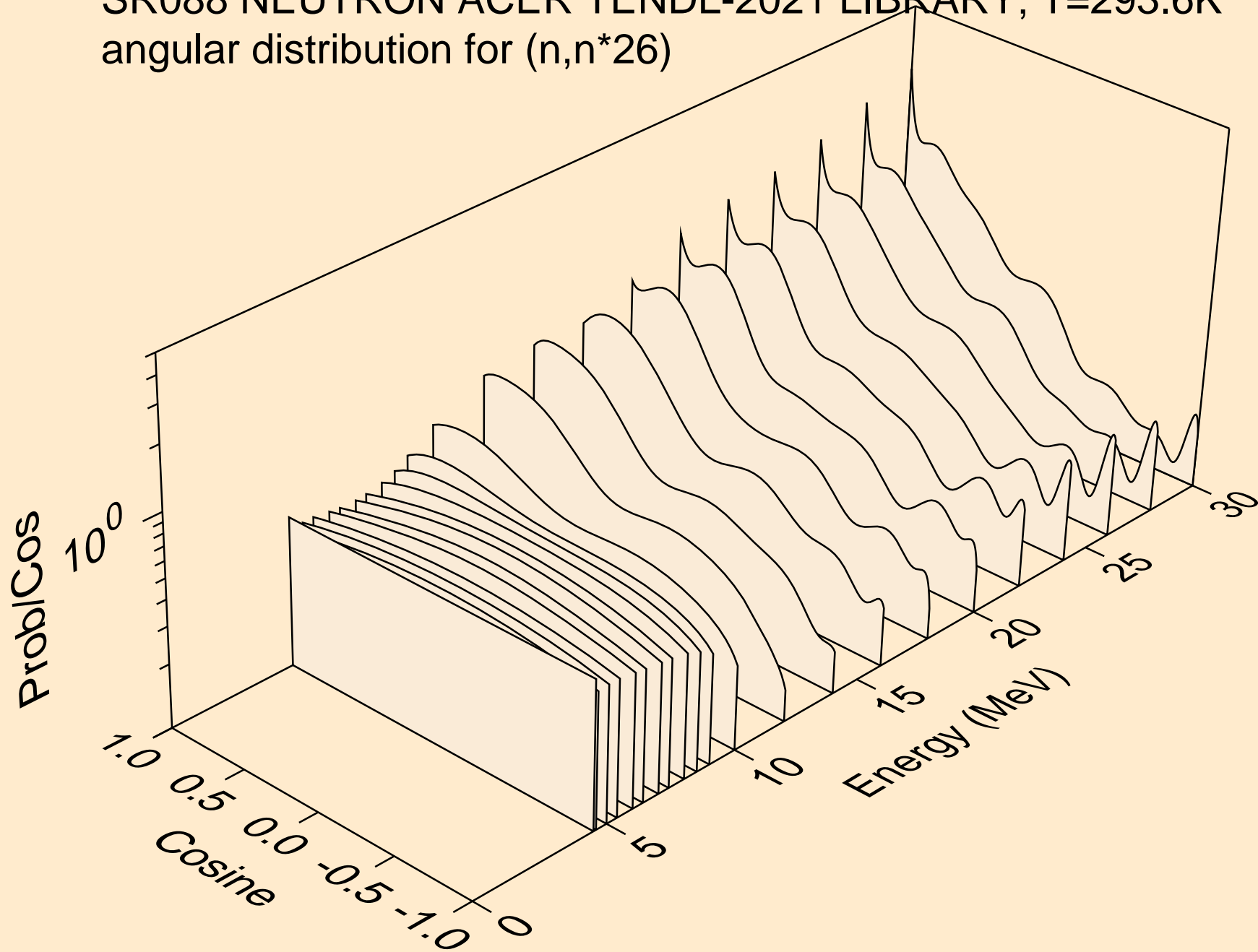

SR088 NEUTRON ACER TENDL-2021 LIBRARY; T=293.6K
angular distribution for (n,n*27)

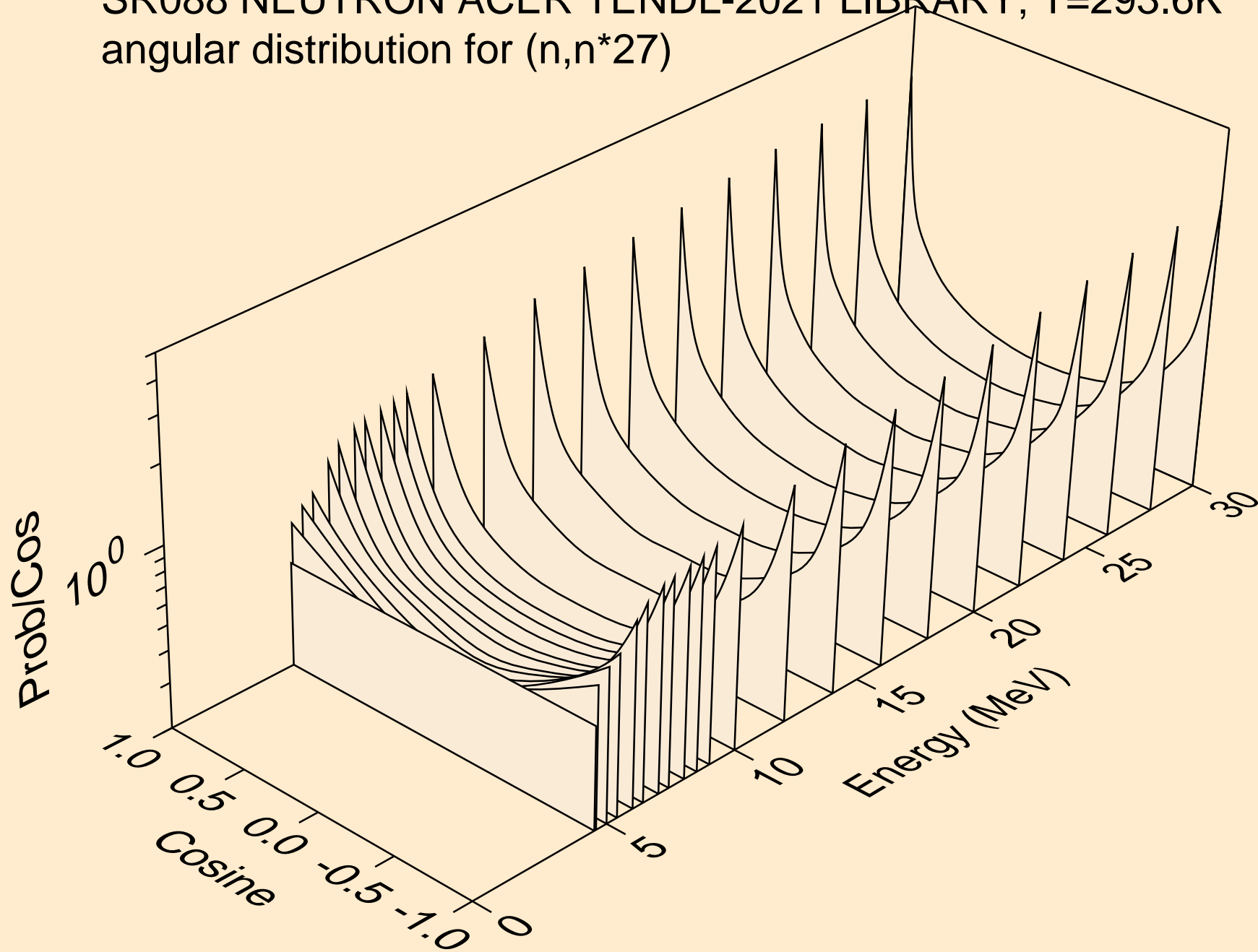

SR088 NEUTRON ACER TENDL-2021 LIBRARY; T=293.6K
angular distribution for (n,n*28)

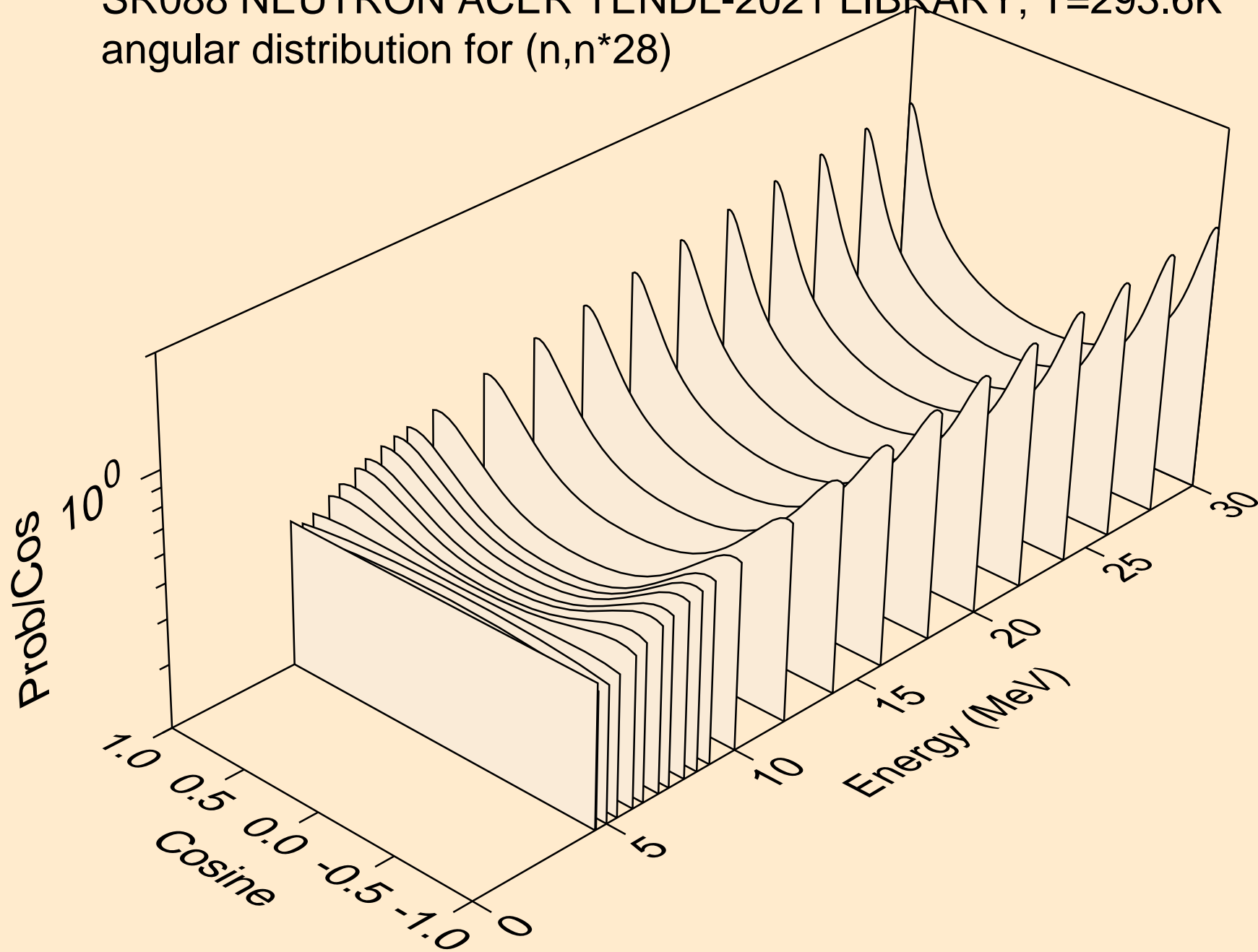

SR088 NEUTRON ACER TENDL-2021 LIBRARY; T=293.6K
angular distribution for (n,n*29)

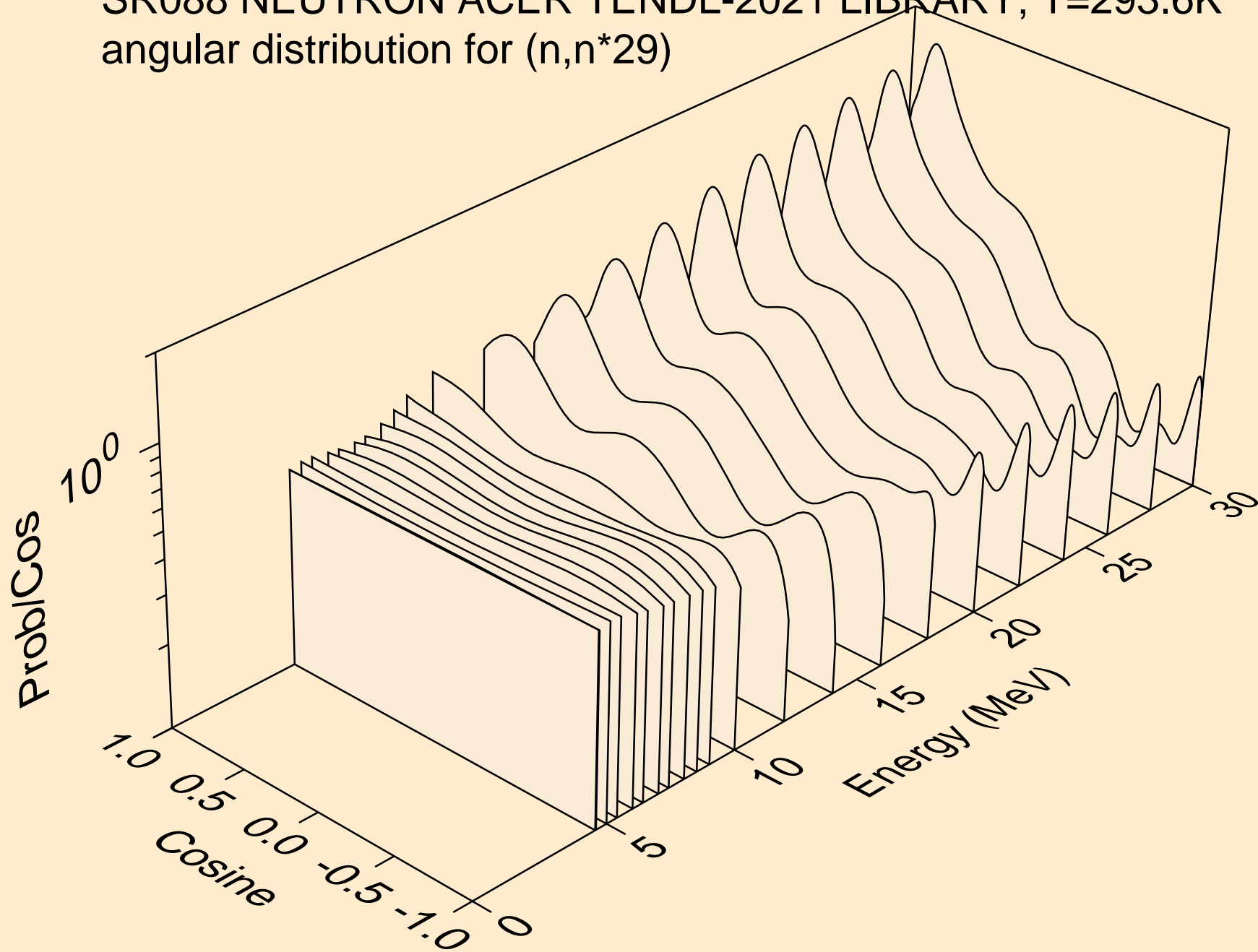

SR088 NEUTRON ACER TENDL-2021 LIBRARY; T=293.6K
Neutron emission for (n,x)

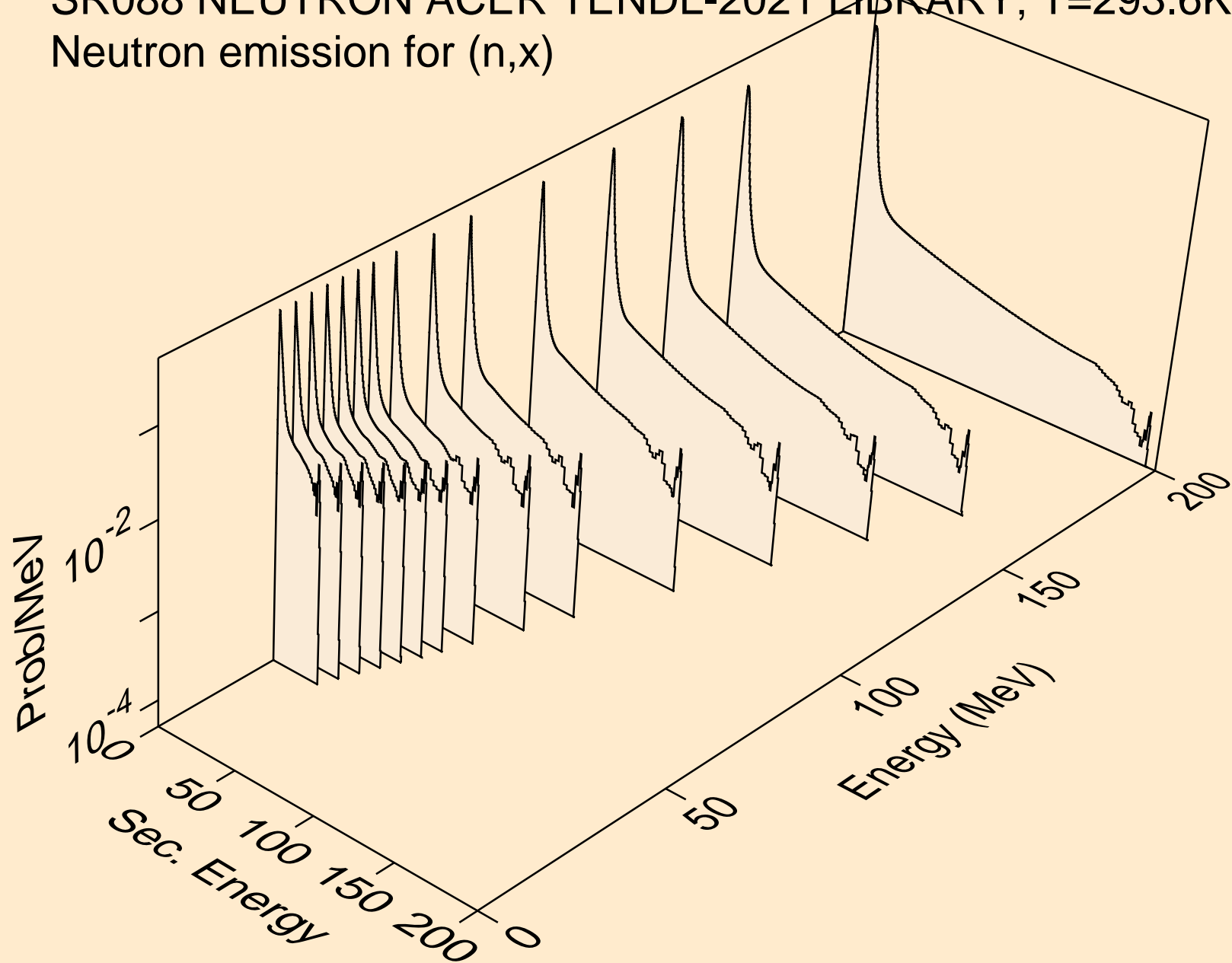

SR088 NEUTRON ACER TENDL-2021 LIBRARY; T=293.6K
Neutron emission for (n,2nd)

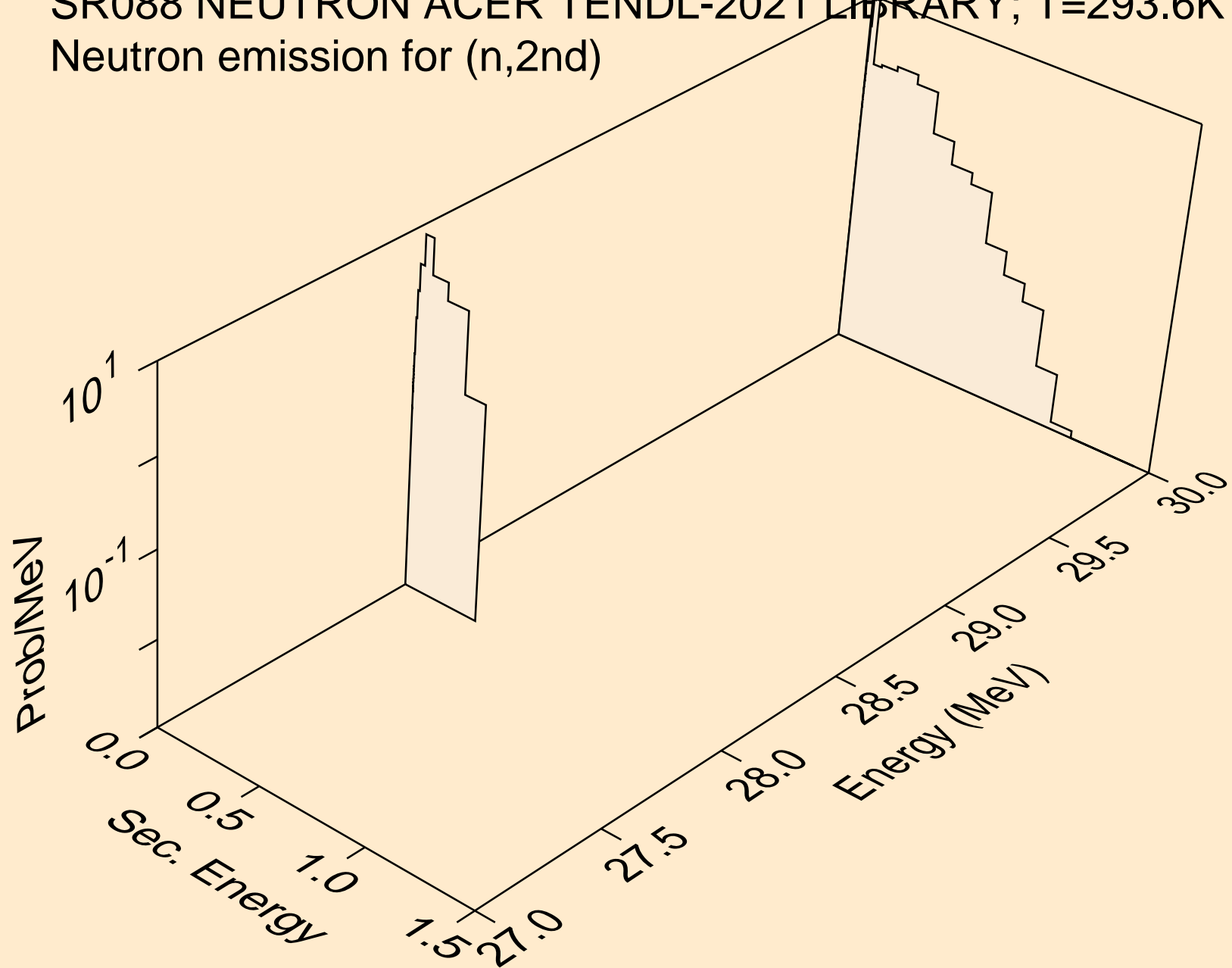

SR088 NEUTRON ACER TENDL-2021 LIBRARY; T=293.6K
Neutron emission for (n,2n)

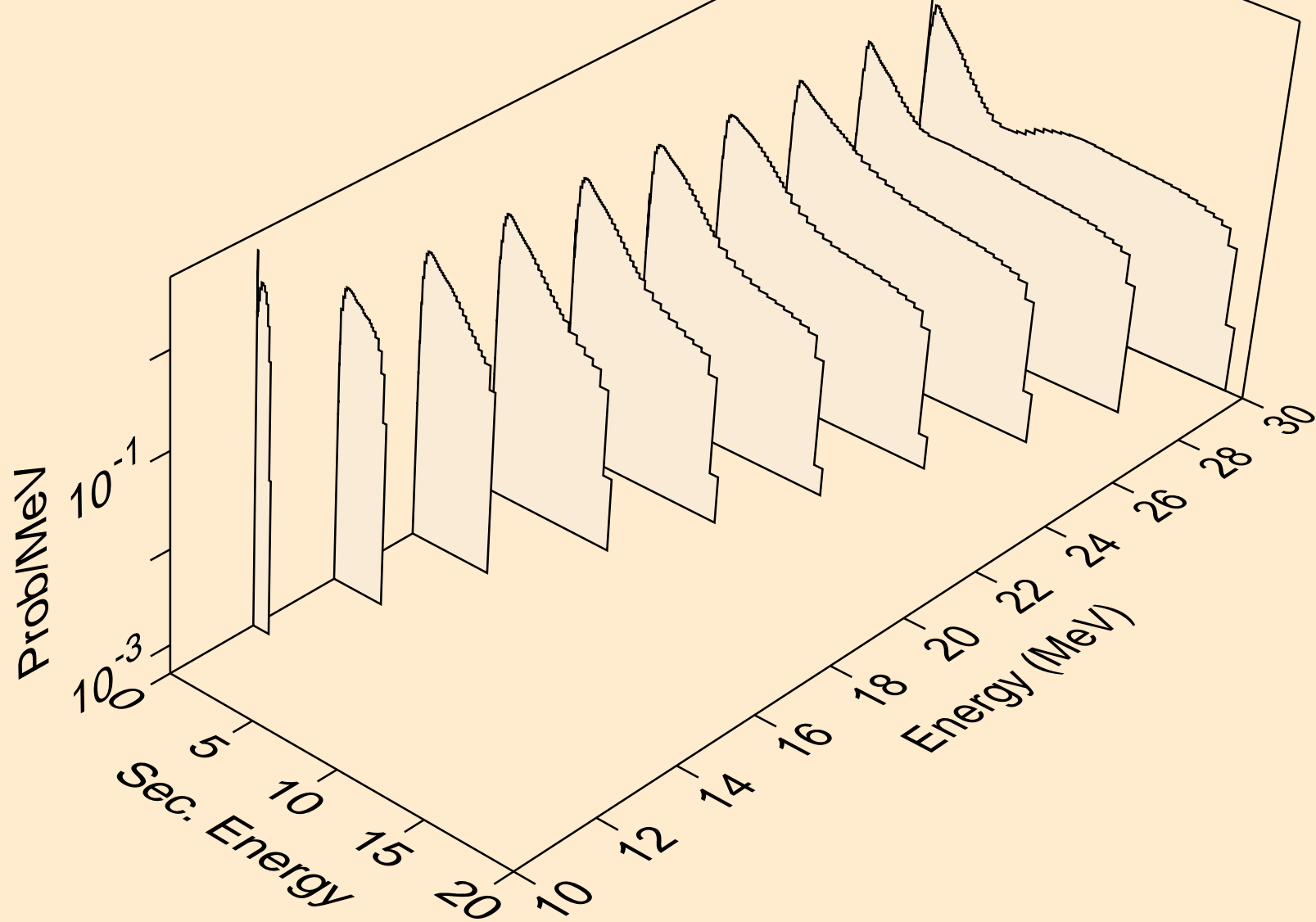

SR088 NEUTRON ACER TENDL-2021 LIBRARY; T=293.6K
Neutron emission for (n,3n)

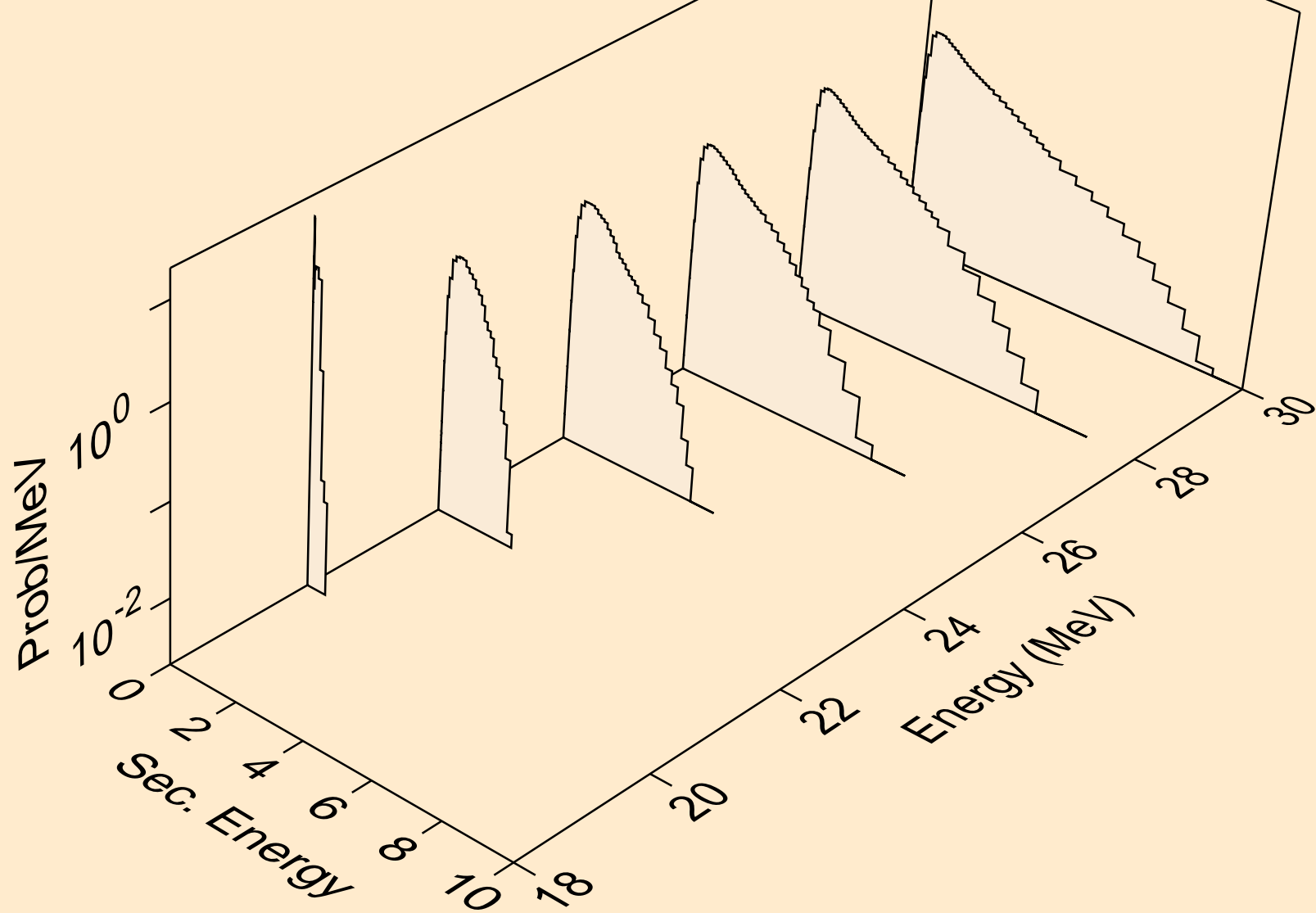

SR088 NEUTRON ACER TENDL-2021 LIBRARY; T=293.6K
Neutron emission for (n,n*)a

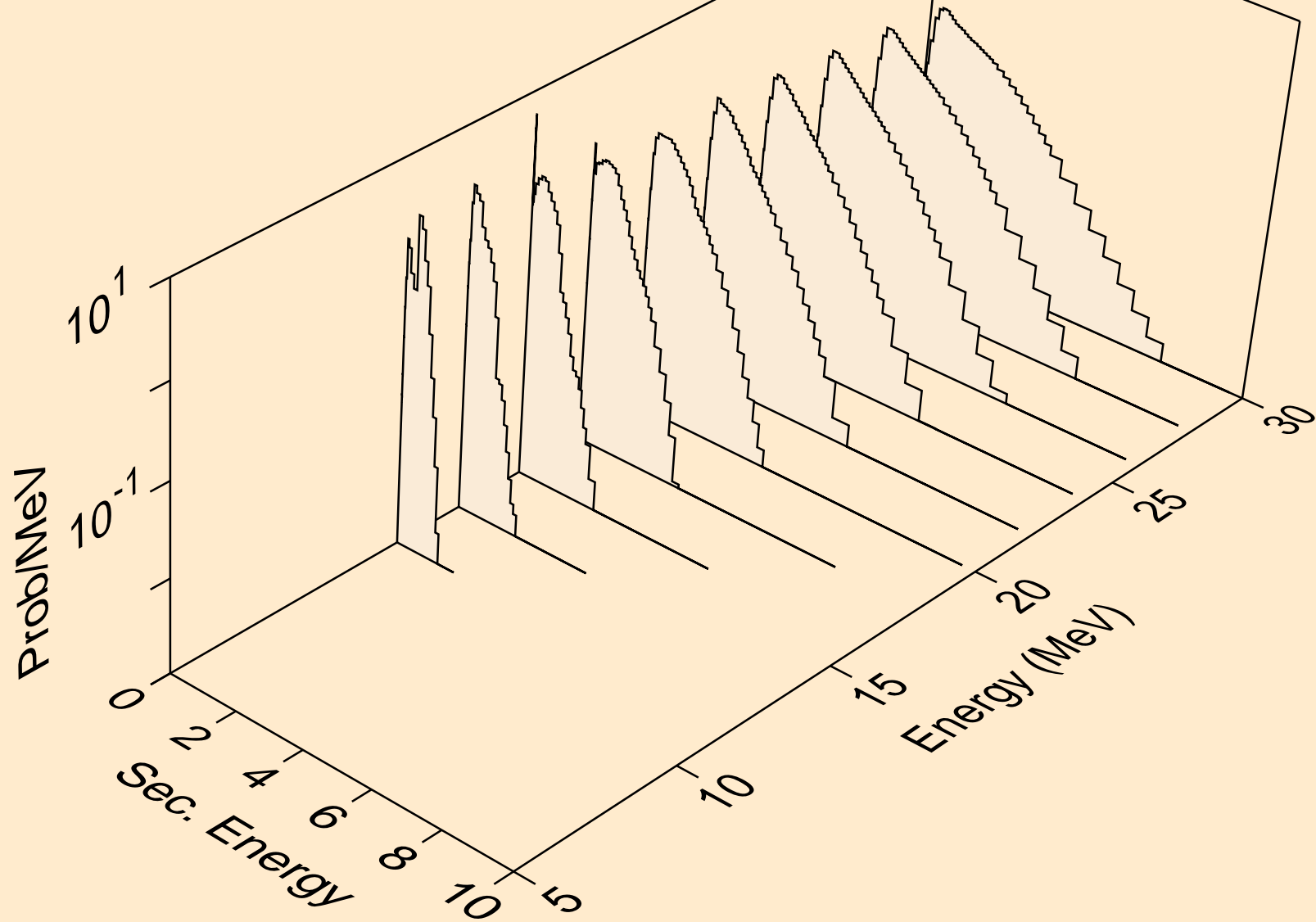

SR088 NEUTRON ACER TENDL-2021 LIBRARY; T=293.6K
Neutron emission for (n,2n)a

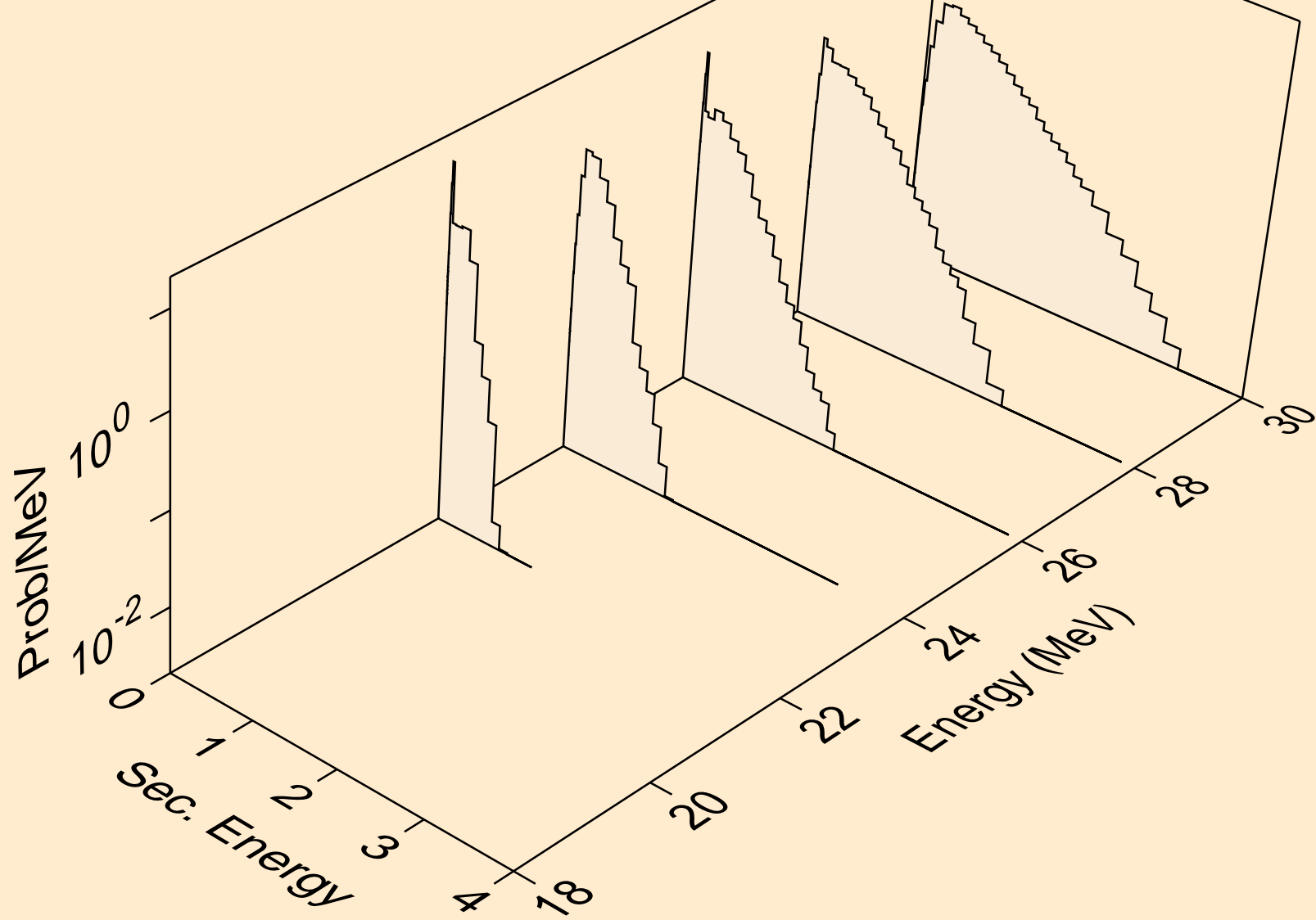

SR088 NEUTRON ACER TENDL-2021 LIBRARY; T=293.6K
Neutron emission for (n,n*)p

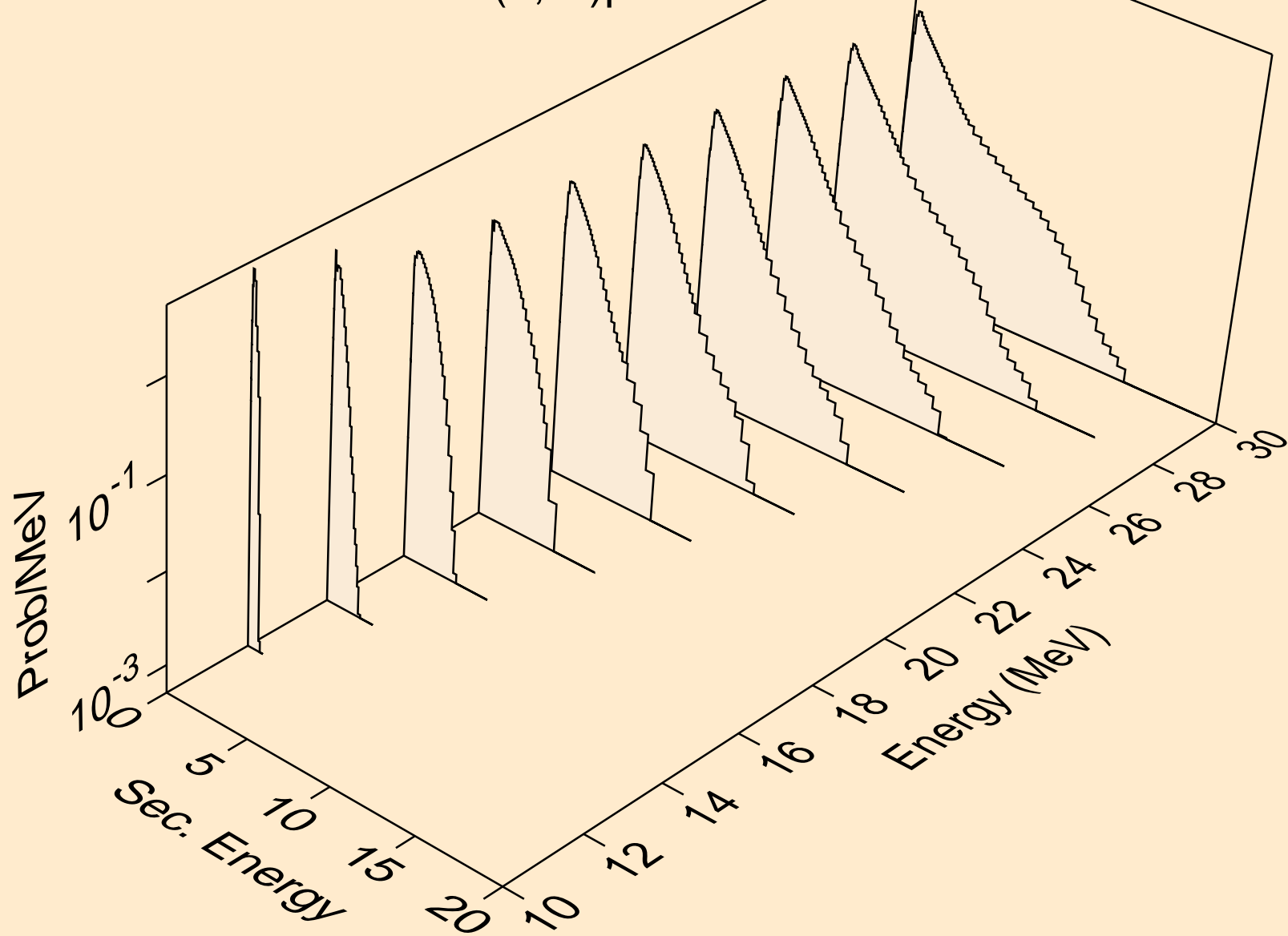

SR088 NEUTRON ACER TENDL-2021 LIBRARY; T=293.6K
Neutron emission for (n,n*)d

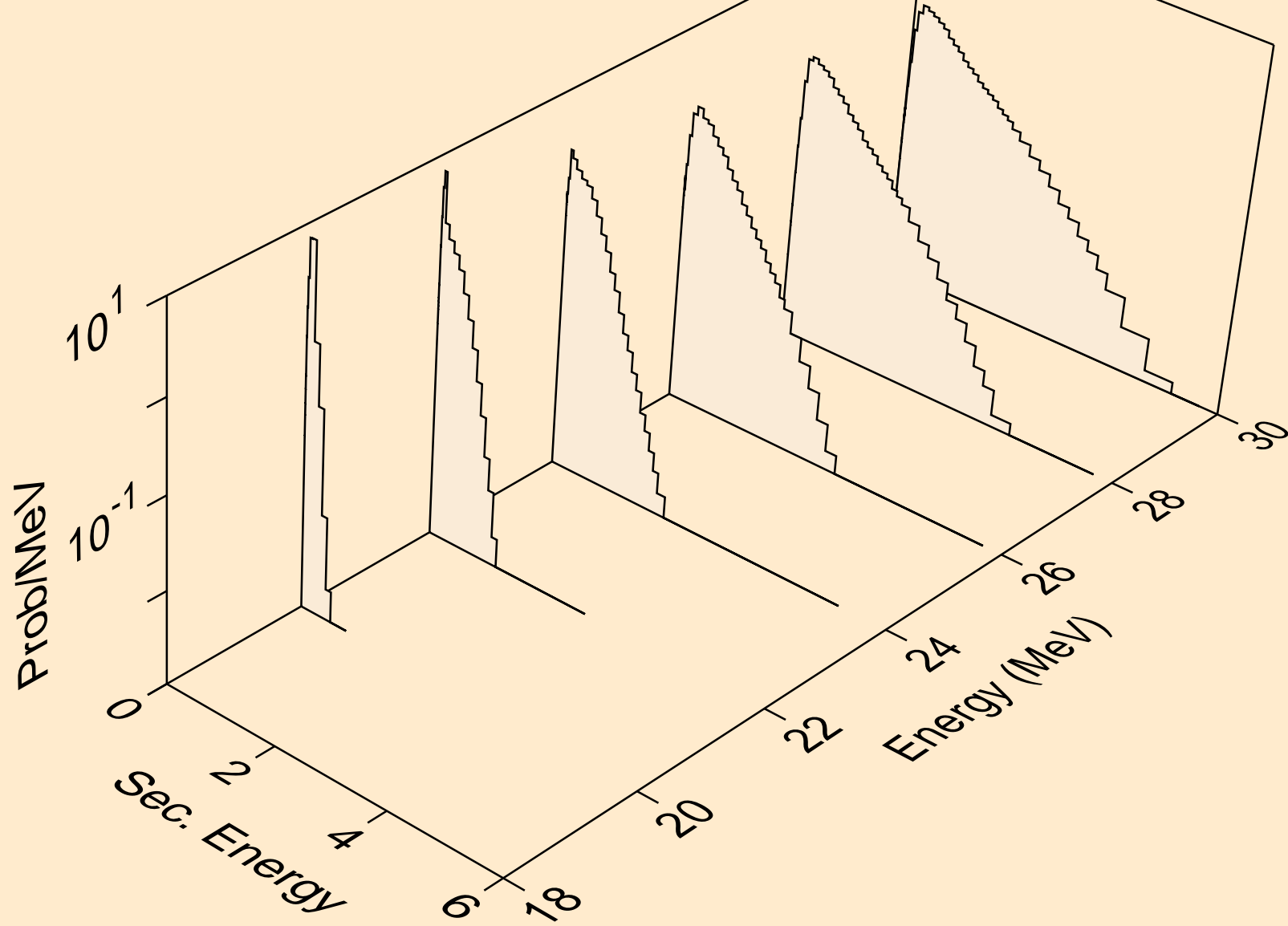

SR088 NEUTRON ACER TENDL-2021 LIBRARY; T=293.6K
Neutron emission for (n,n*)t

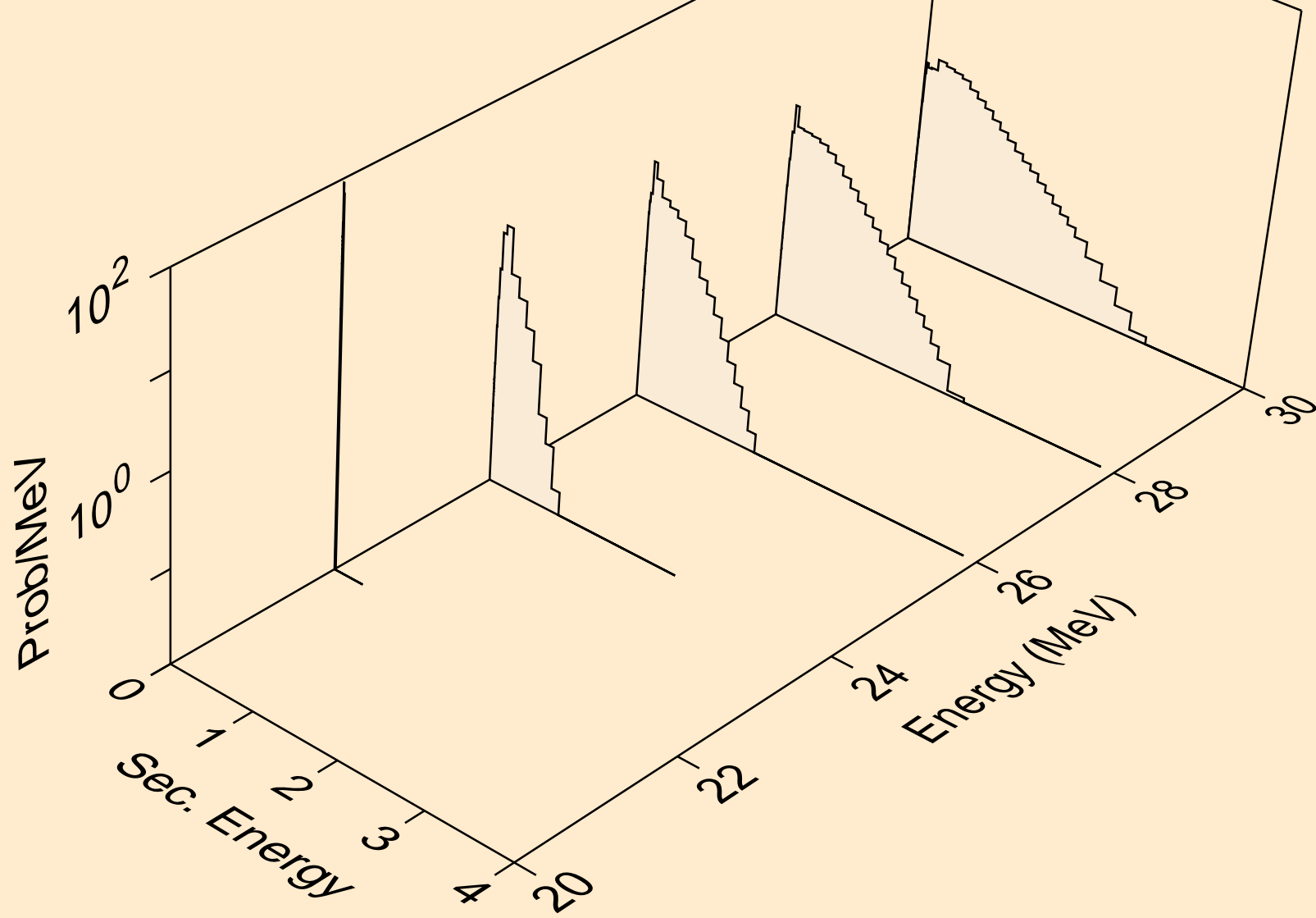

SR088 NEUTRON ACER TENDL-2021 LIBRARY; T=293.6K
Neutron emission for (n,n*)he3

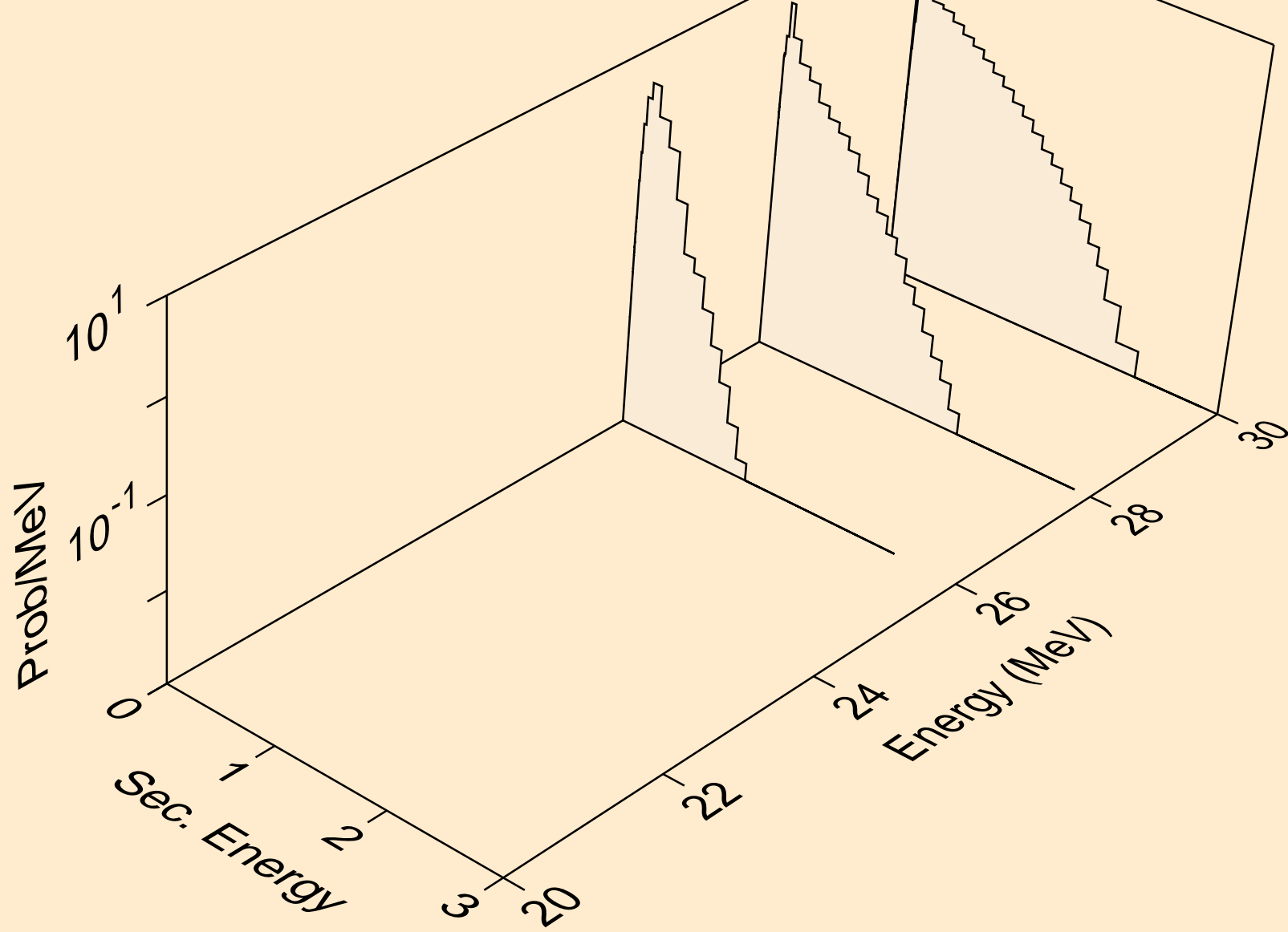

SR088 NEUTRON ACER TENDL-2021 LIBRARY; T=293.6K
Neutron emission for (n,2np)

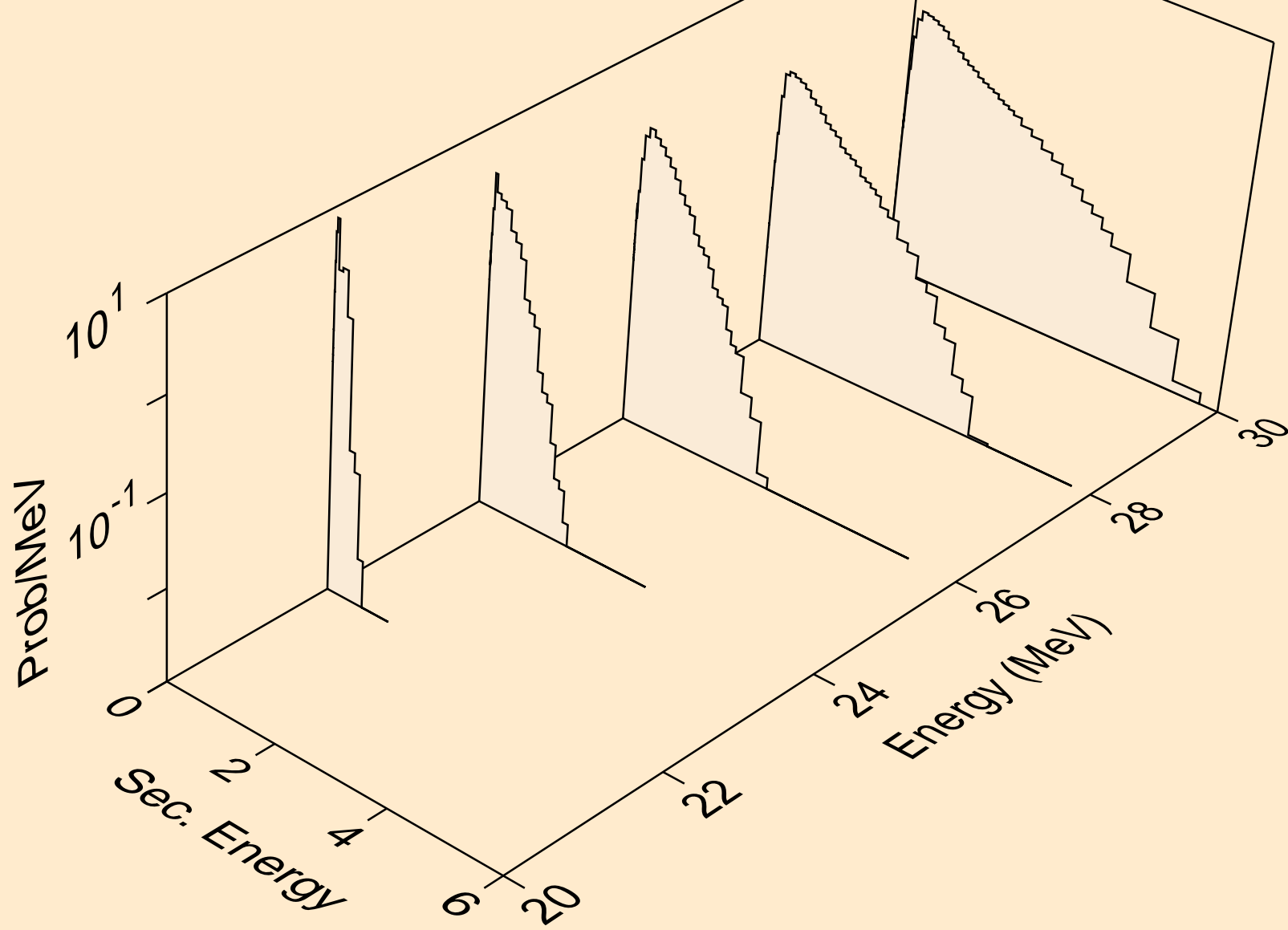

SR088 NEUTRON ACER TENDL-2021 LIBRARY; T=293.6K
Neutron emission for (n,2np)

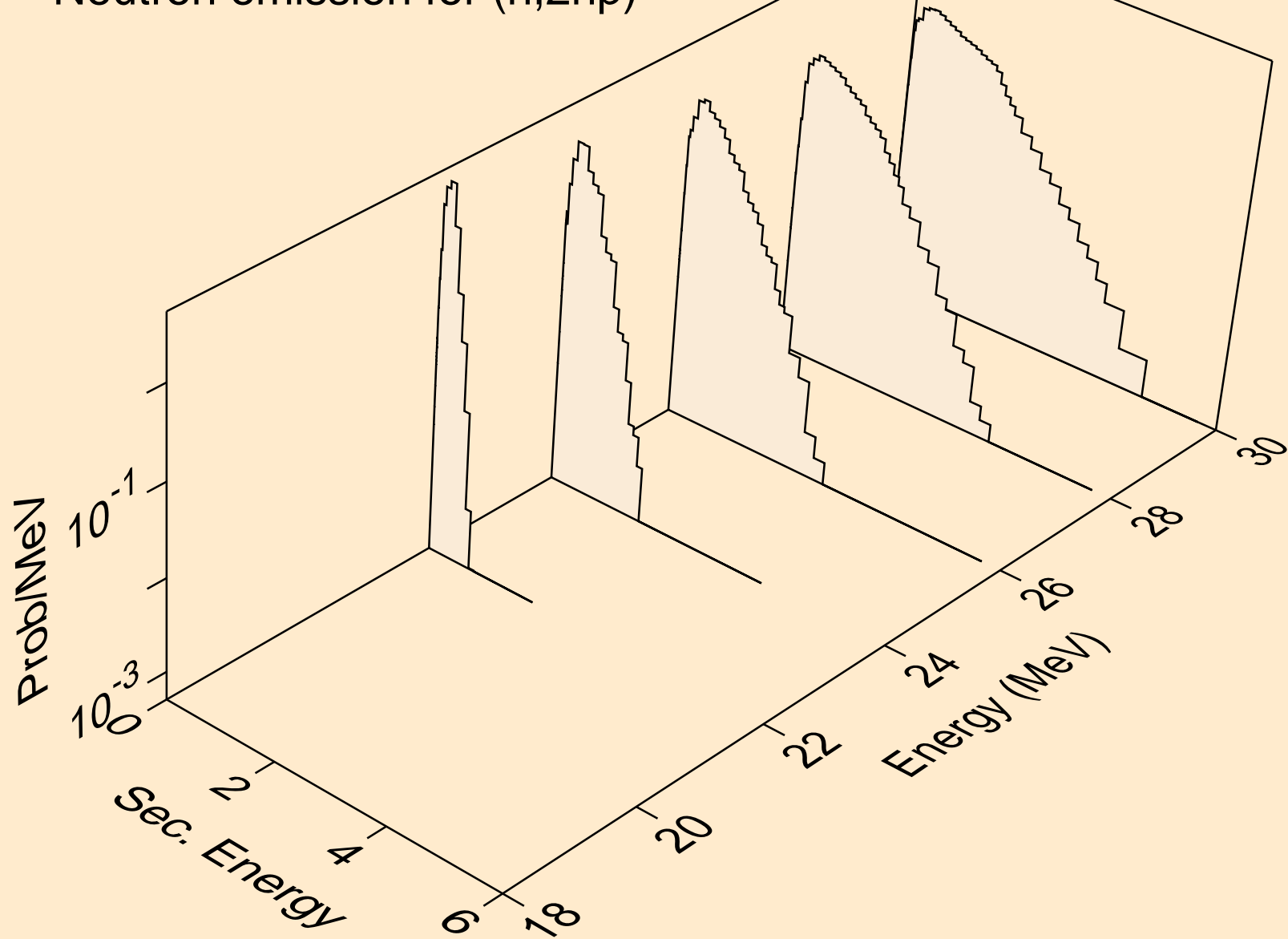

SR088 NEUTRON ACER TENDL-2021 LIBRARY; T=293.6K
Neutron emission for (n,npa)

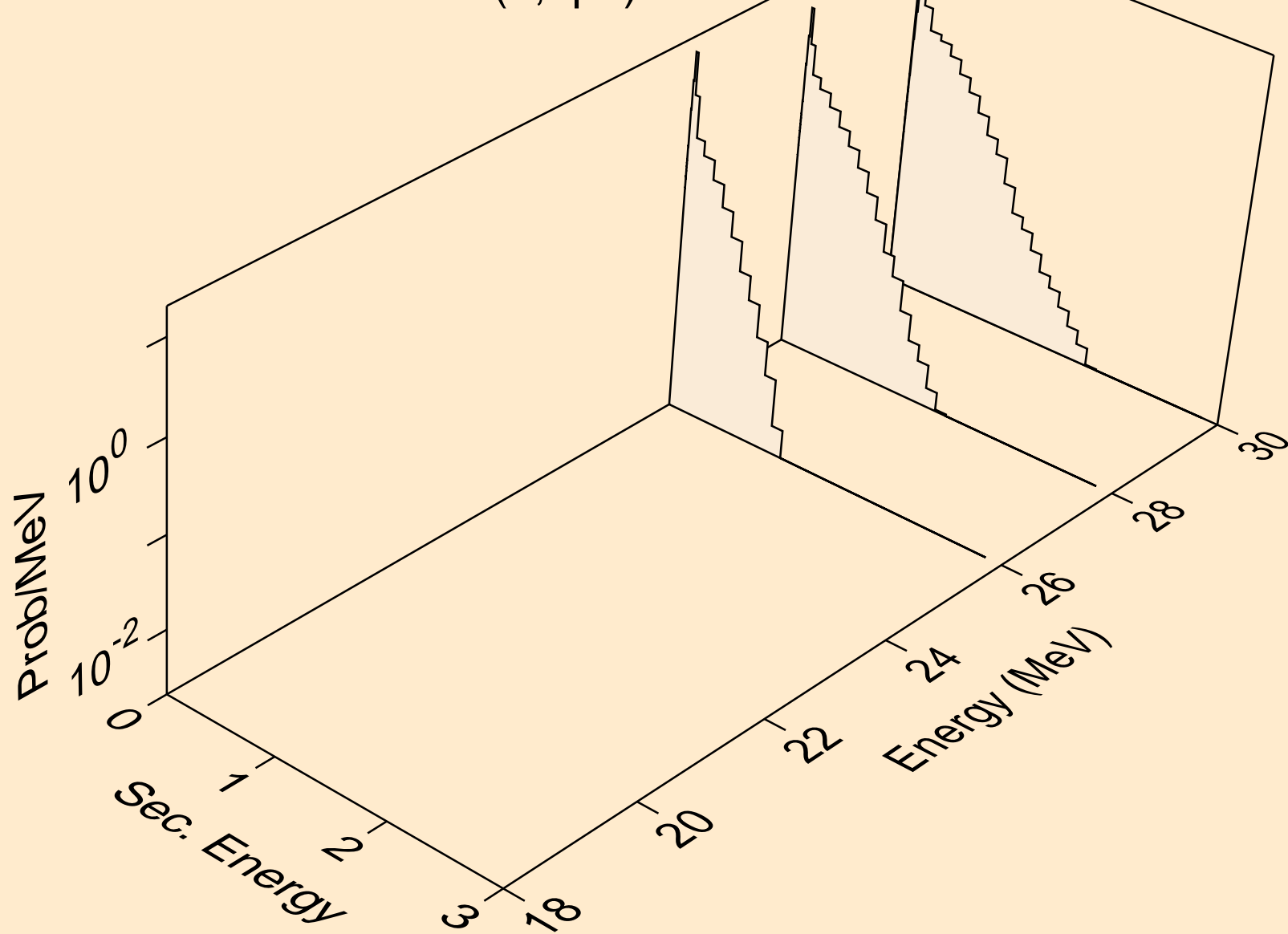

SR088 NEUTRON ACER TENDL-2021 LIBRARY; T=293.6K
Neutron emission for (n,n*c)

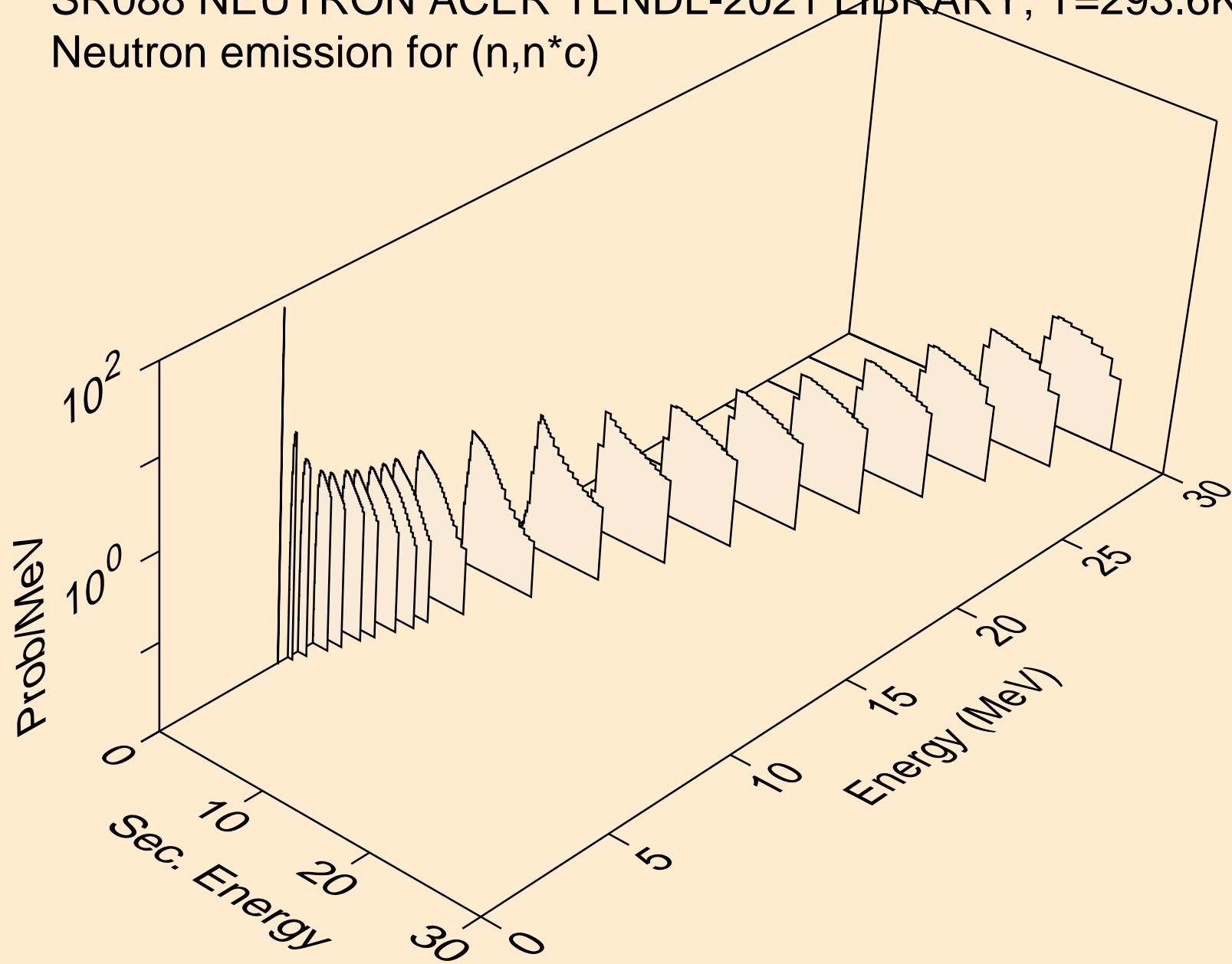

SR088 NEUTRON ACER TENDL-2021 LIBRARY; T=293.6K
Photon emission for (n,x)

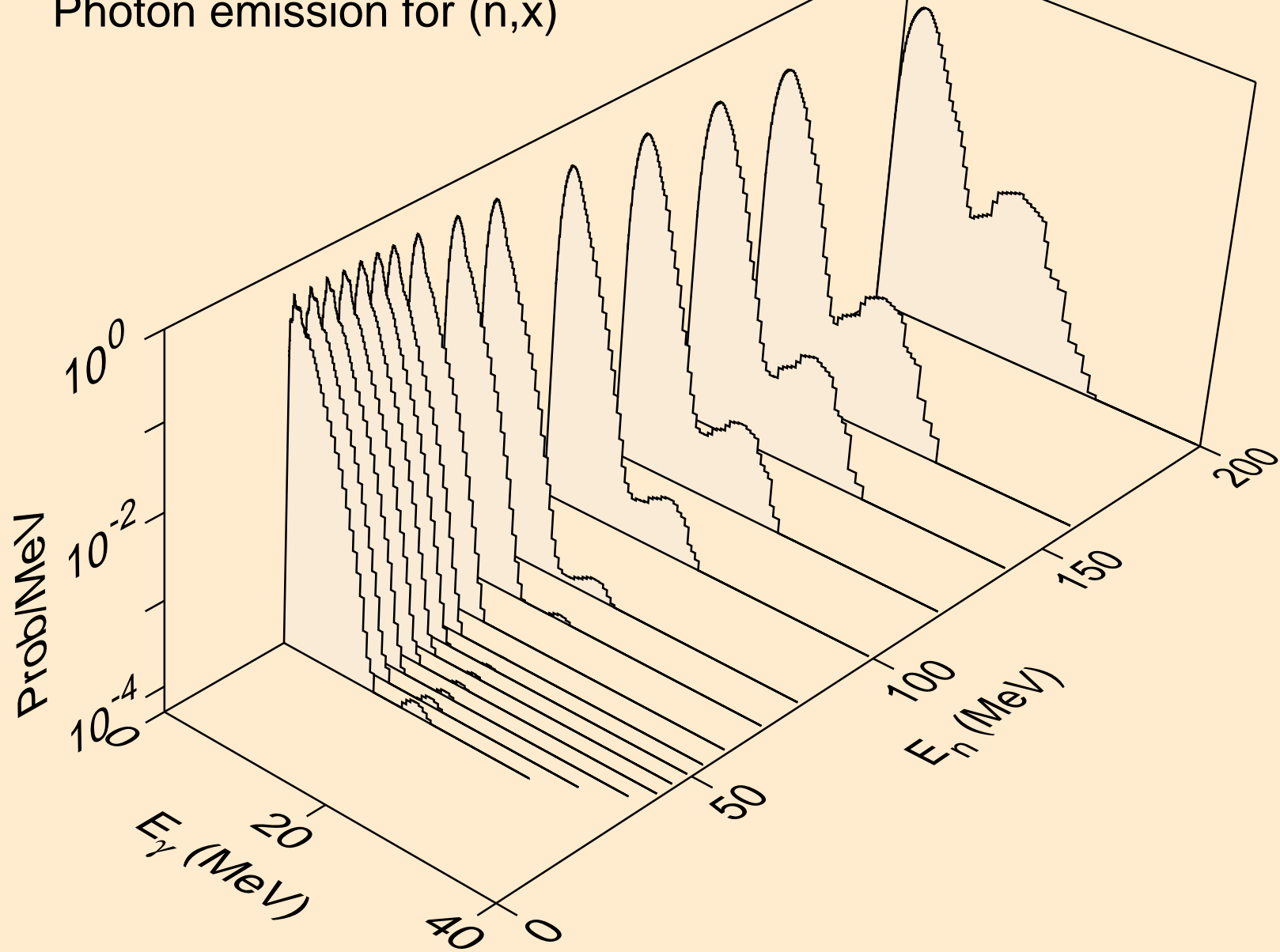

SR088 NEUTRON ACER TENDL-2021 LIBRARY; T=293.6K
Photon emission for (n,2nd)

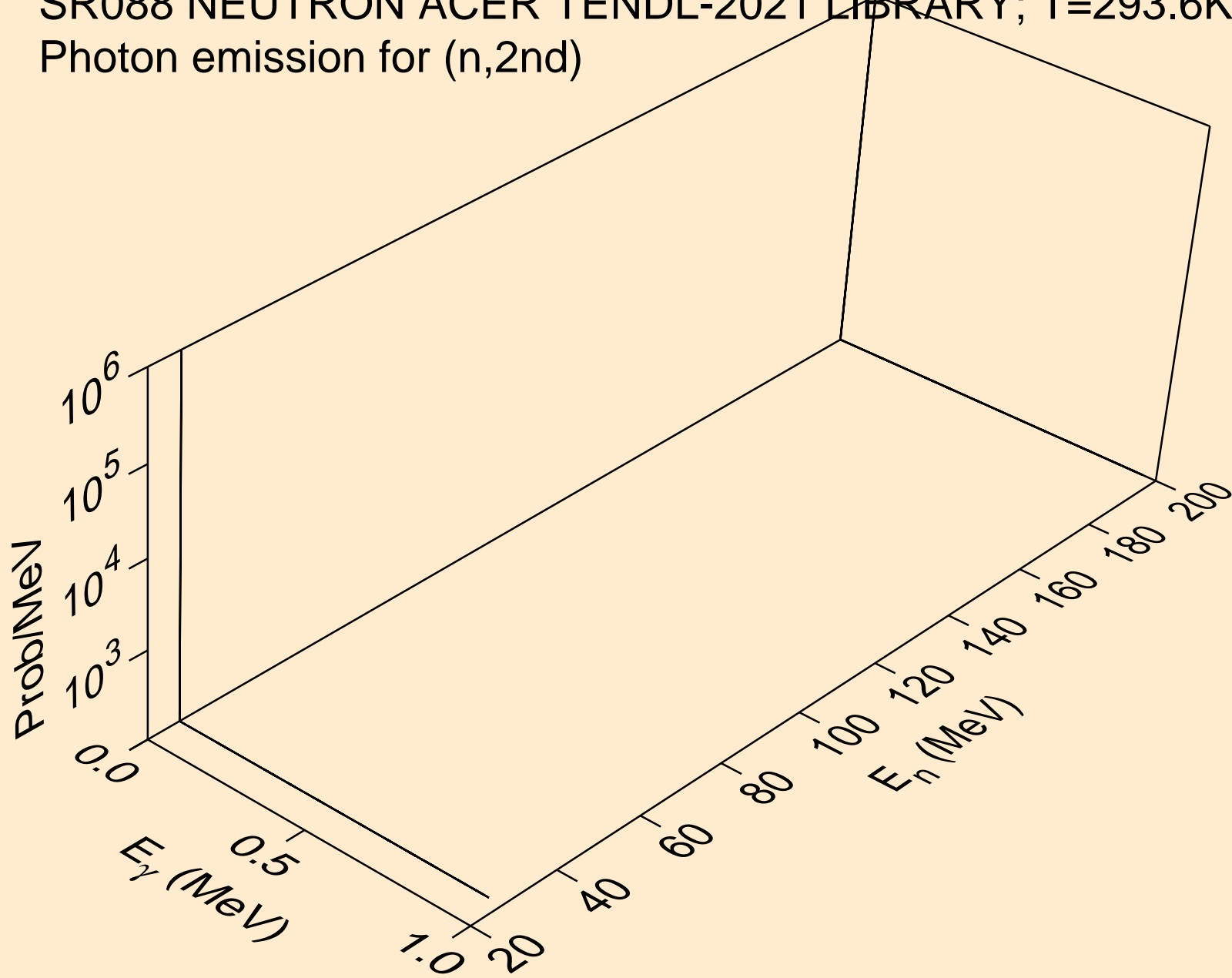

SR088 NEUTRON ACER TENDL-2021 LIBRARY; T=293.6K
Photon emission for (n,2n)

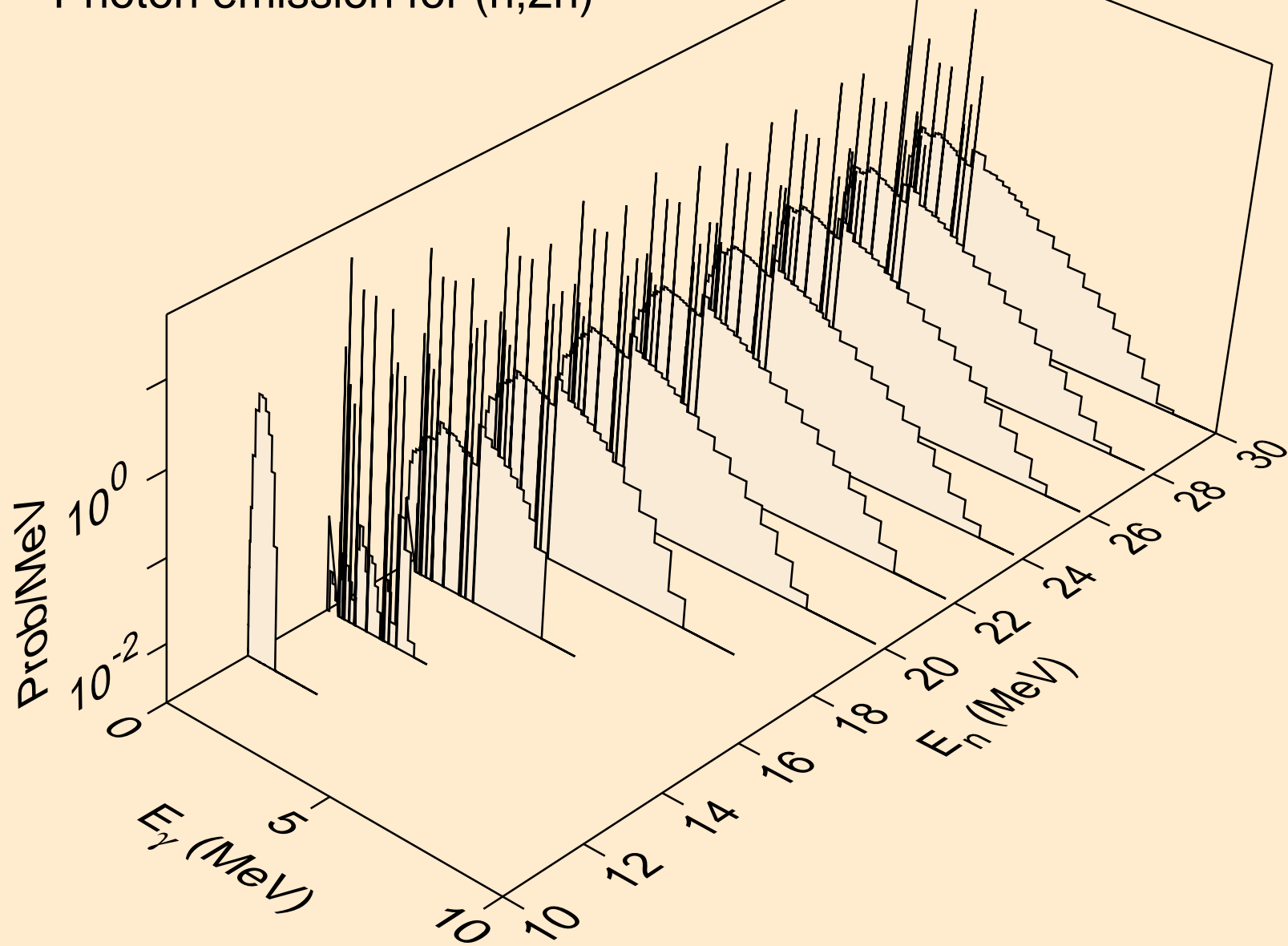

SR088 NEUTRON ACER TENDL-2021 LIBRARY; T=293.6K
Photon emission for (n,3n)

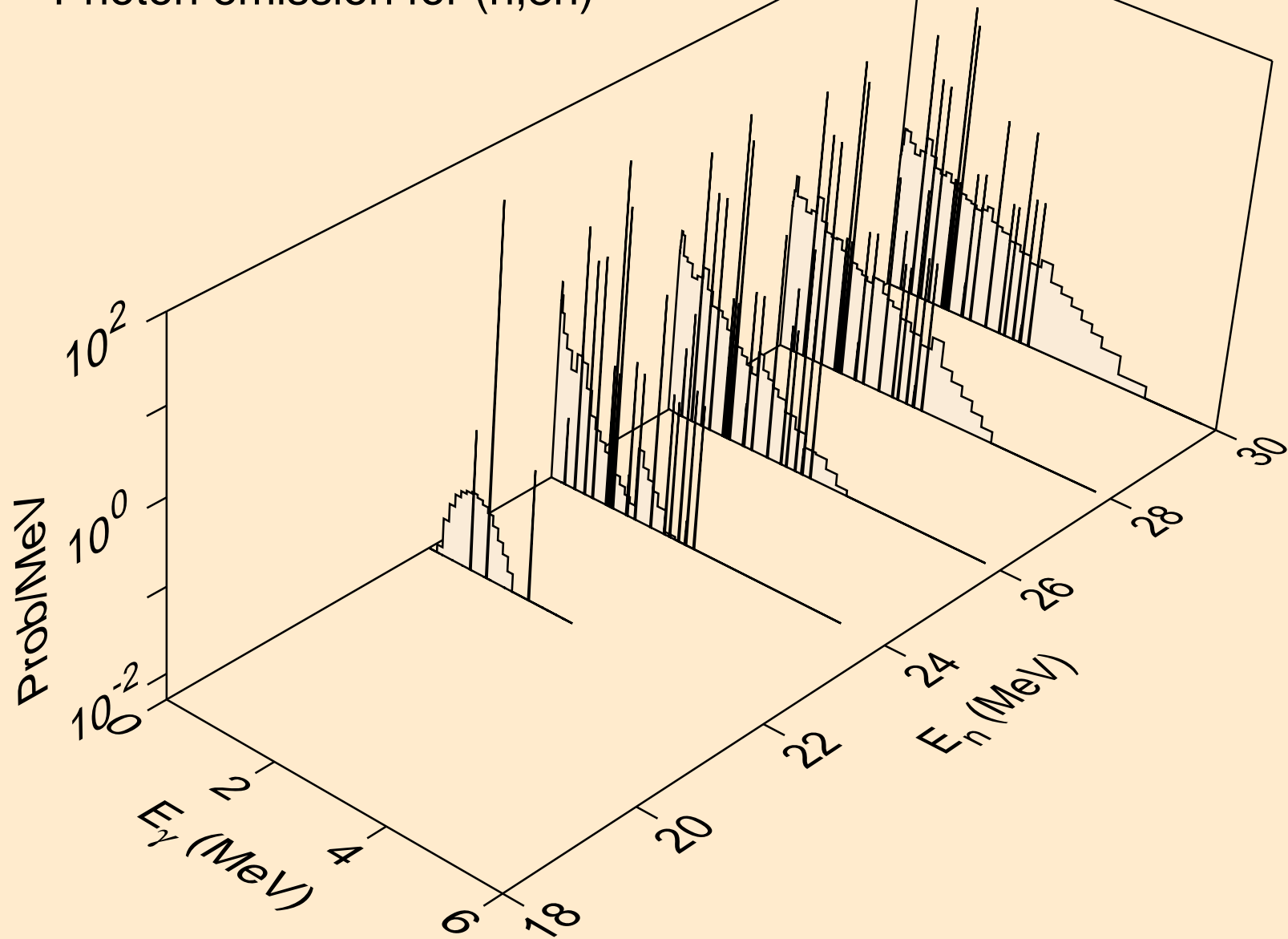

SR088 NEUTRON ACER TENDL-2021 LIBRARY; T=293.6K
Photon emission for (n,n*)a

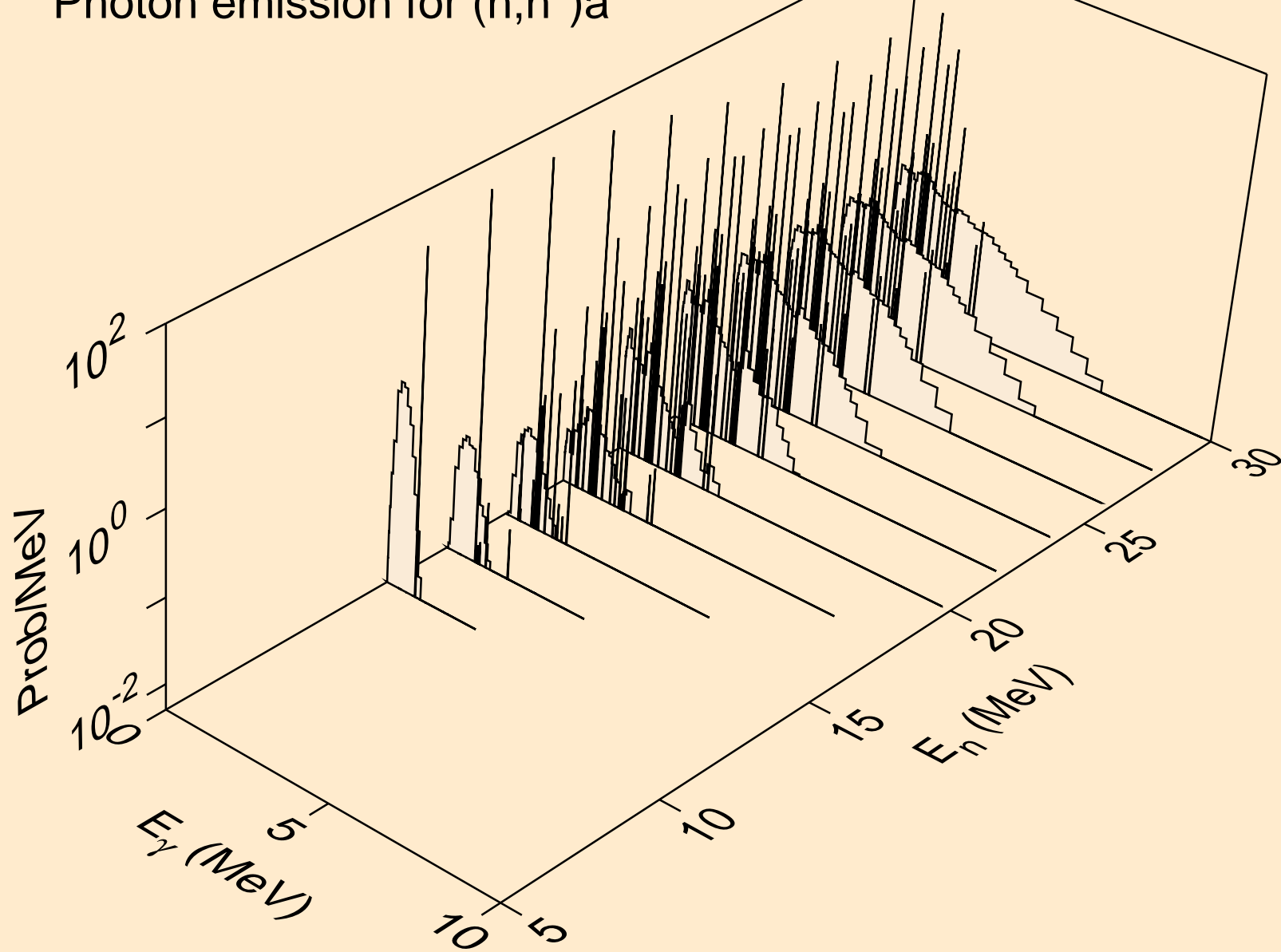

SR088 NEUTRON ACER TENDL-2021 LIBRARY; T=293.6K
Photon emission for (n,2n)a

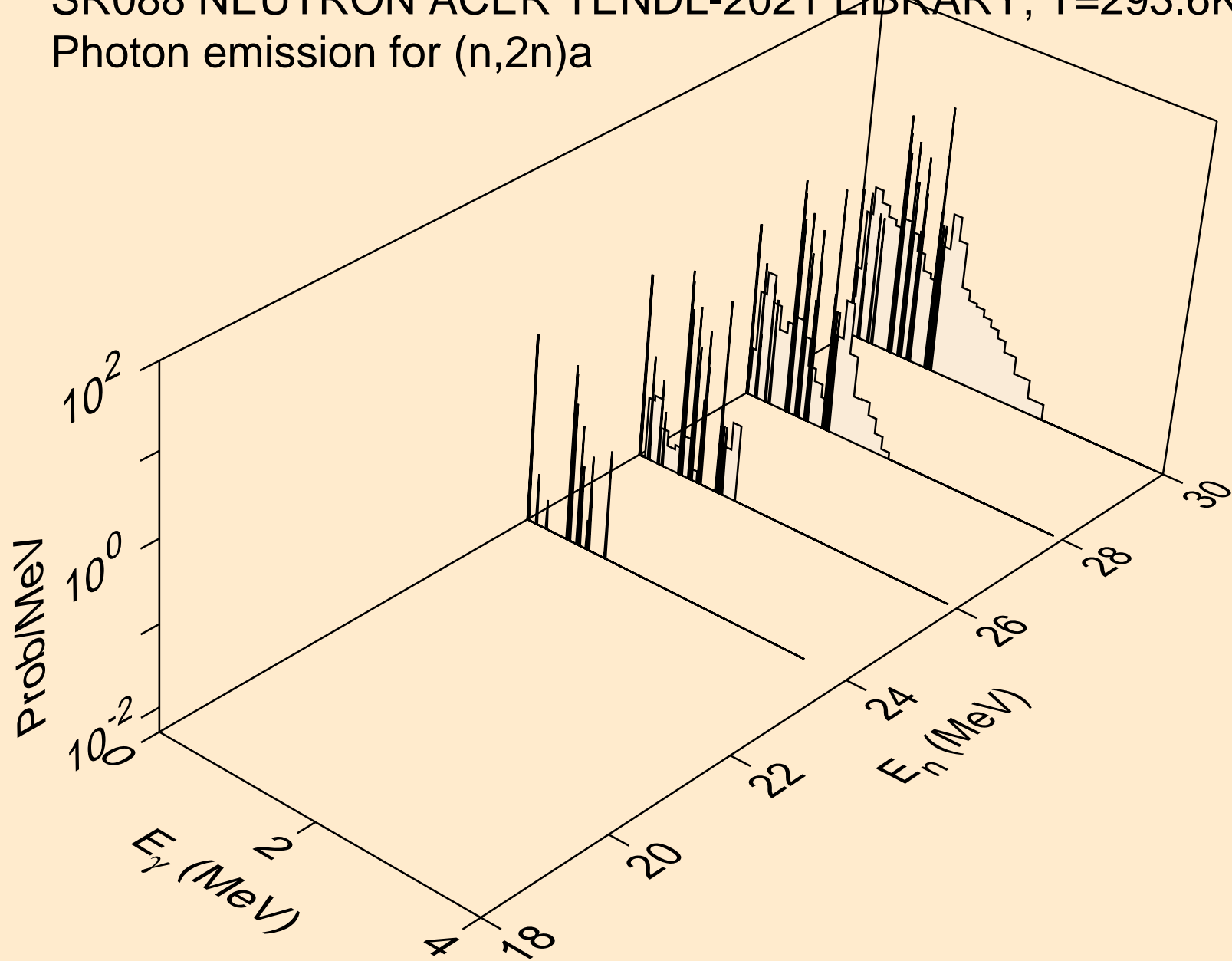

SR088 NEUTRON ACER TENDL-2021 LIBRARY; T=293.6K
Photon emission for (n,n*)p

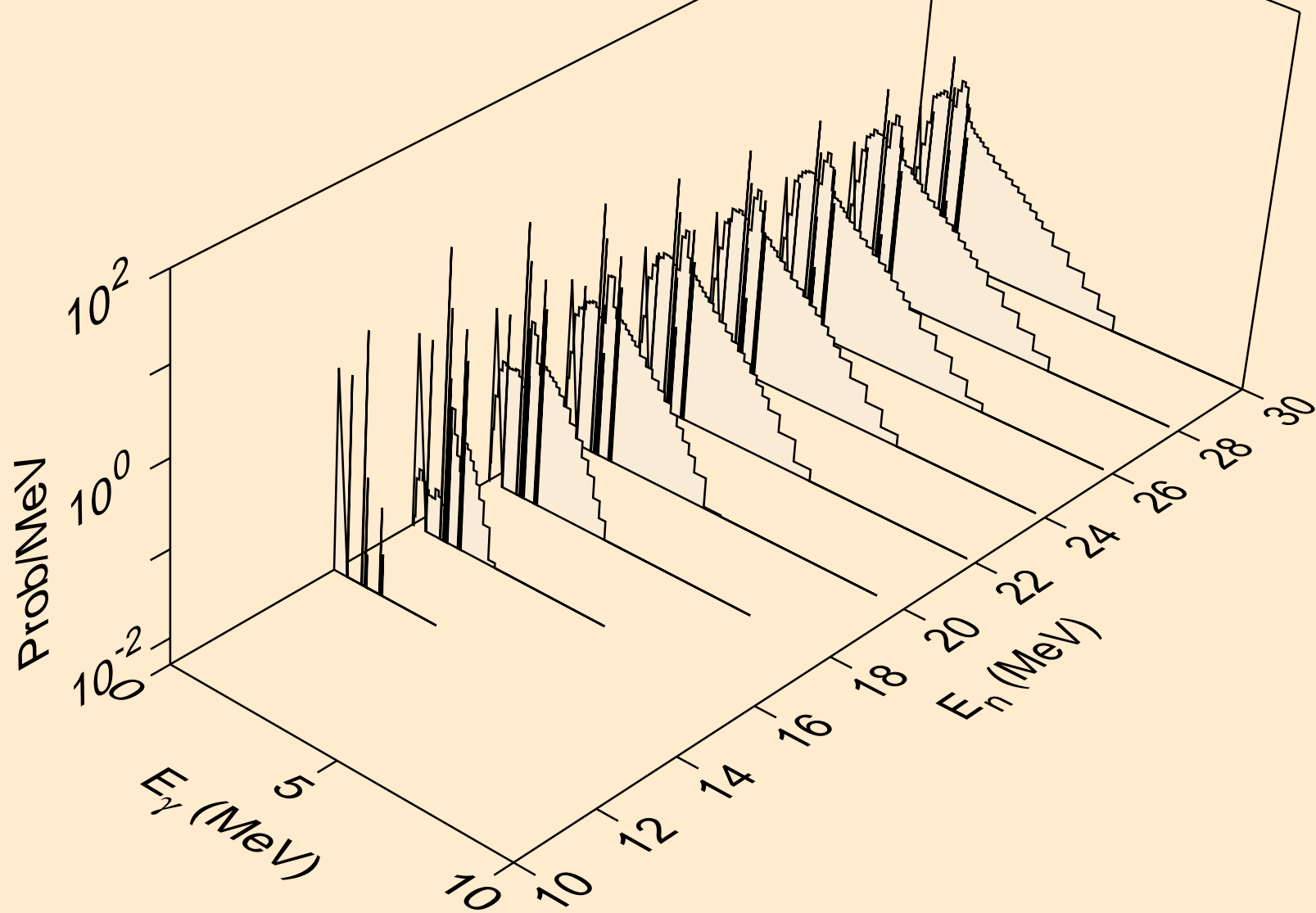

SR088 NEUTRON ACER TENDL-2021 LIBRARY; T=293.6K
Photon emission for (n,n*)d

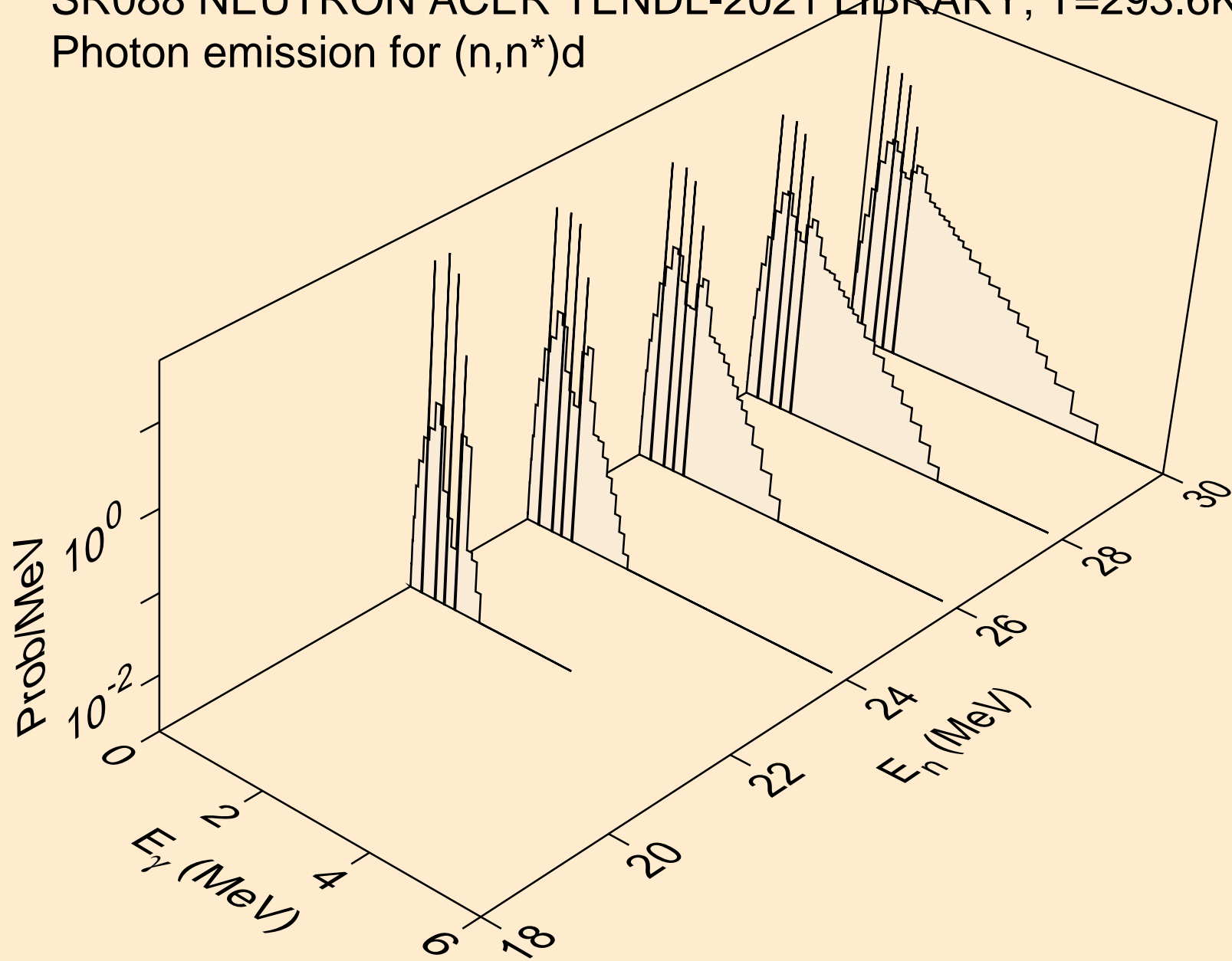

SR088 NEUTRON ACER TENDL-2021 LIBRARY; T=293.6K
Photon emission for (n,n*)t

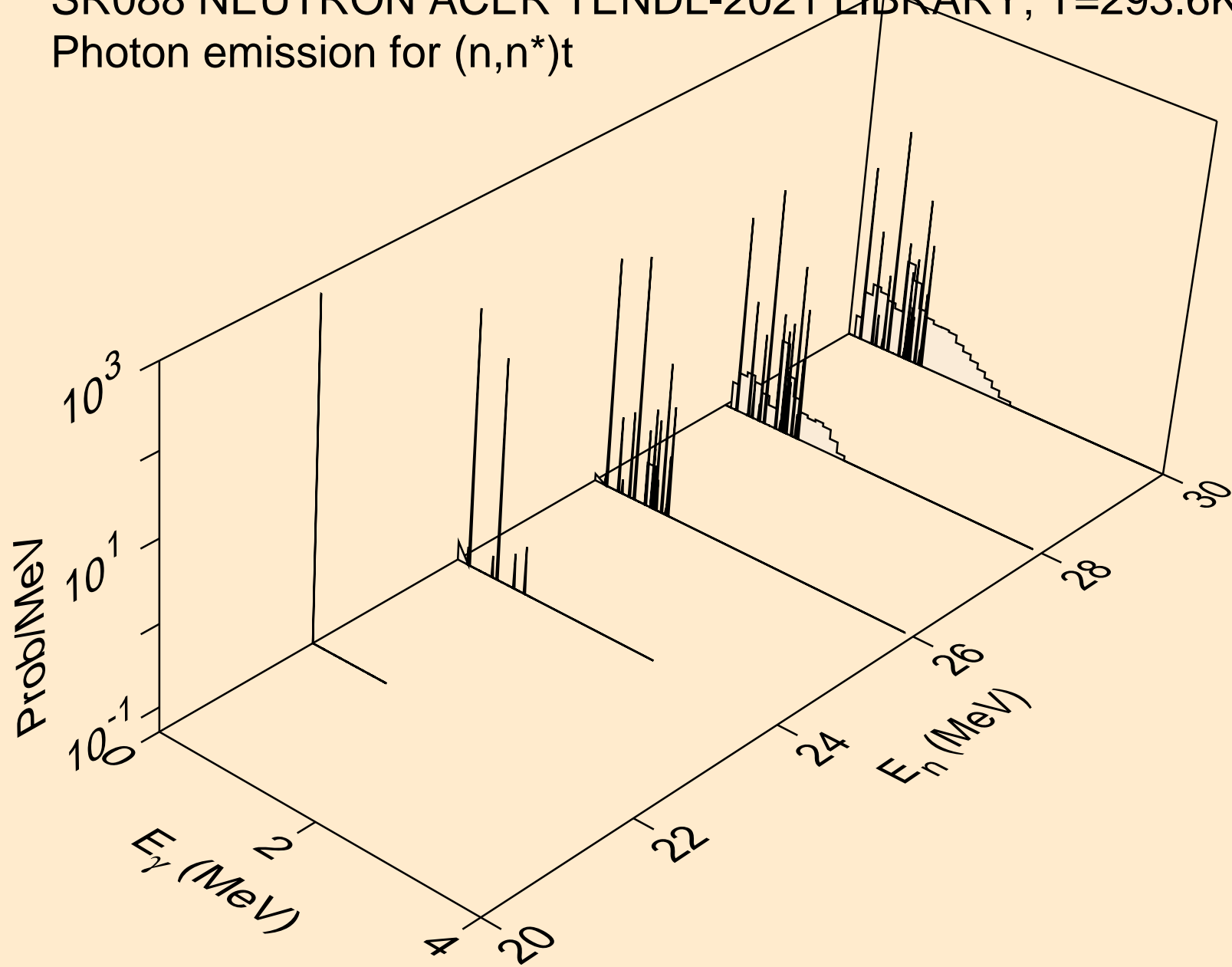

SR088 NEUTRON ACER TENDL-2021 LIBRARY; T=293.6K
Photon emission for (n,n*)he3

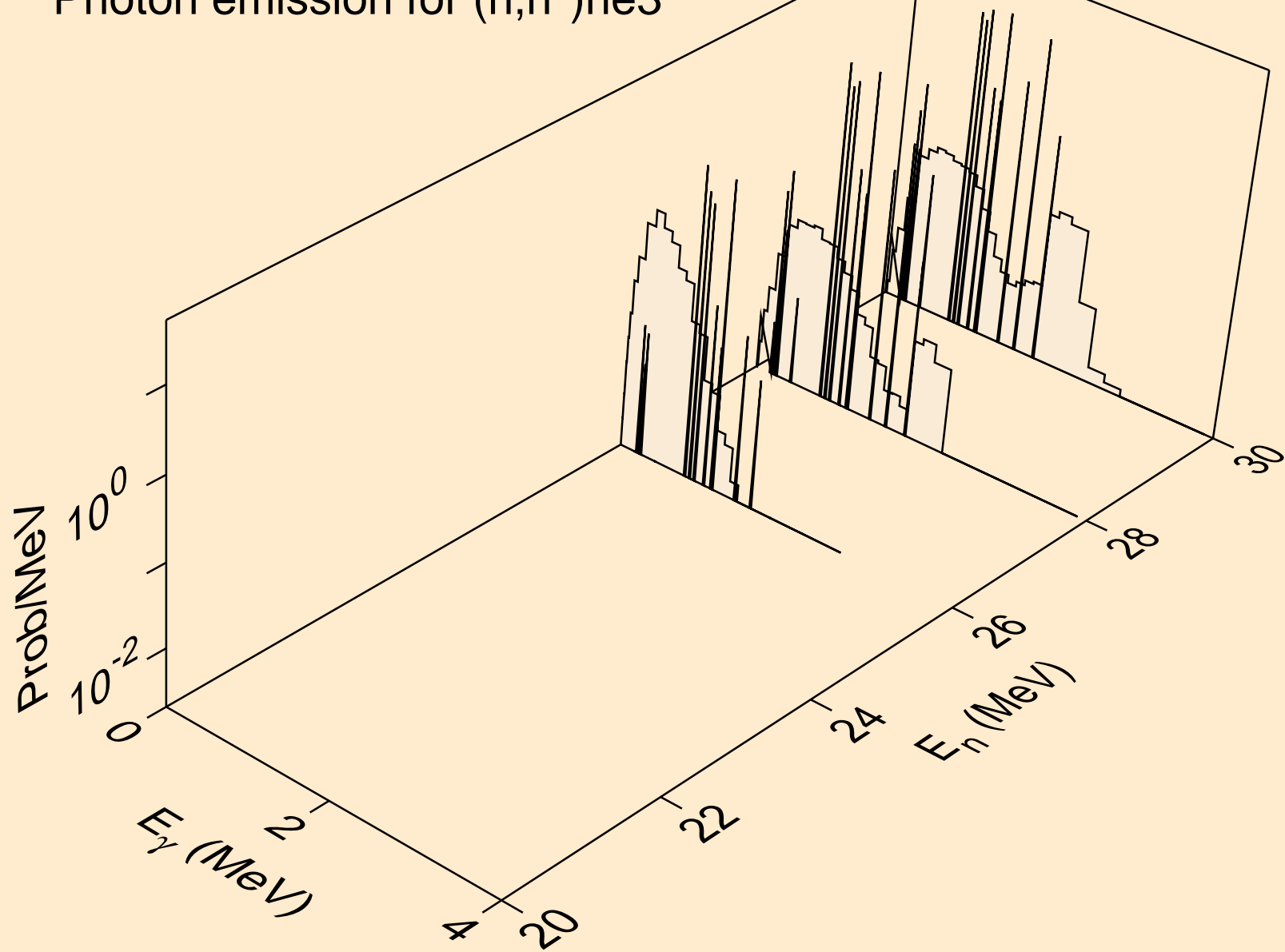

SR088 NEUTRON ACER TENDL-2021 LIBRARY; T=293.6K
Photon emission for (n,2np)

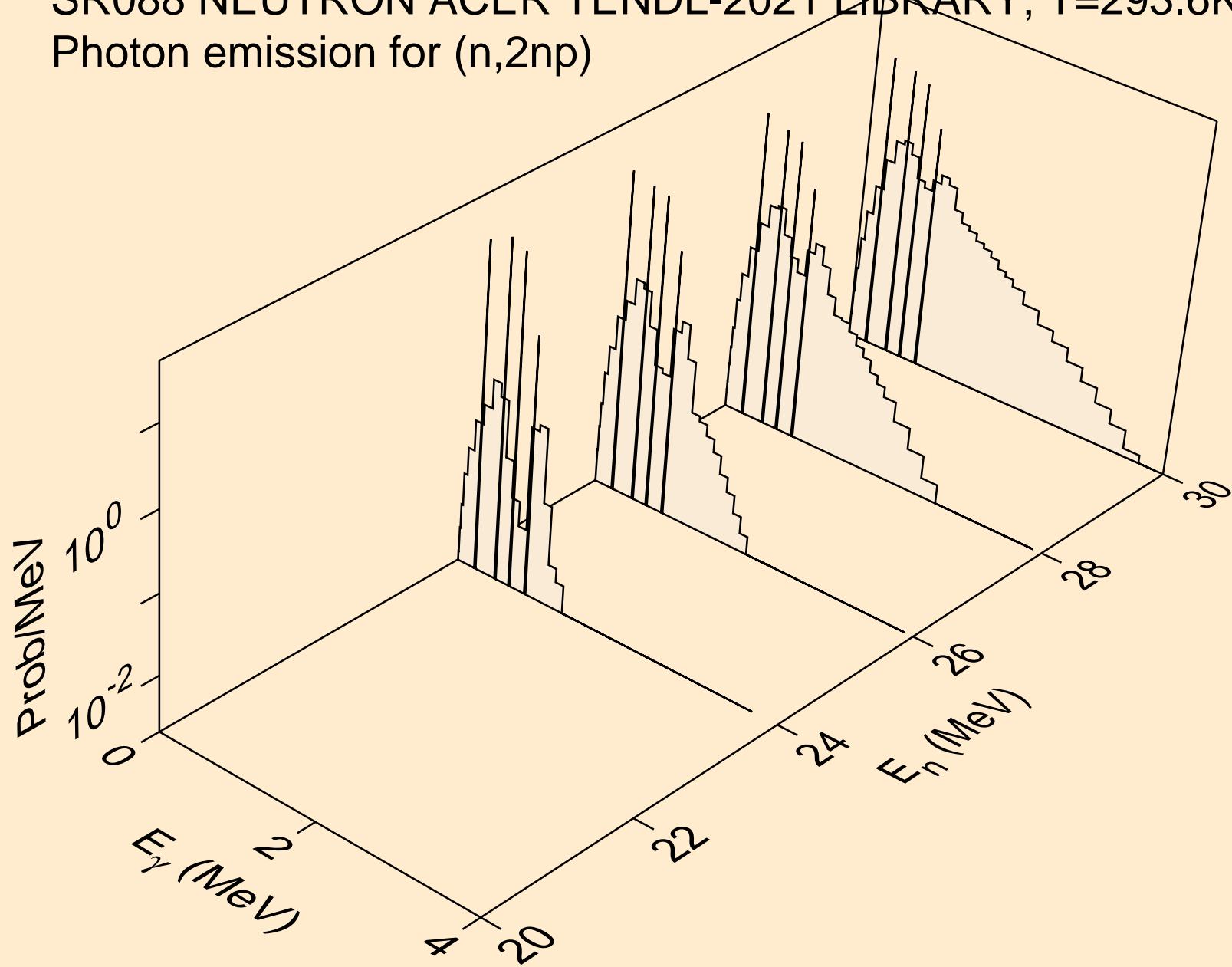

SR088 NEUTRON ACER TENDL-2021 LIBRARY; T=293.6K
Photon emission for (n,2np)

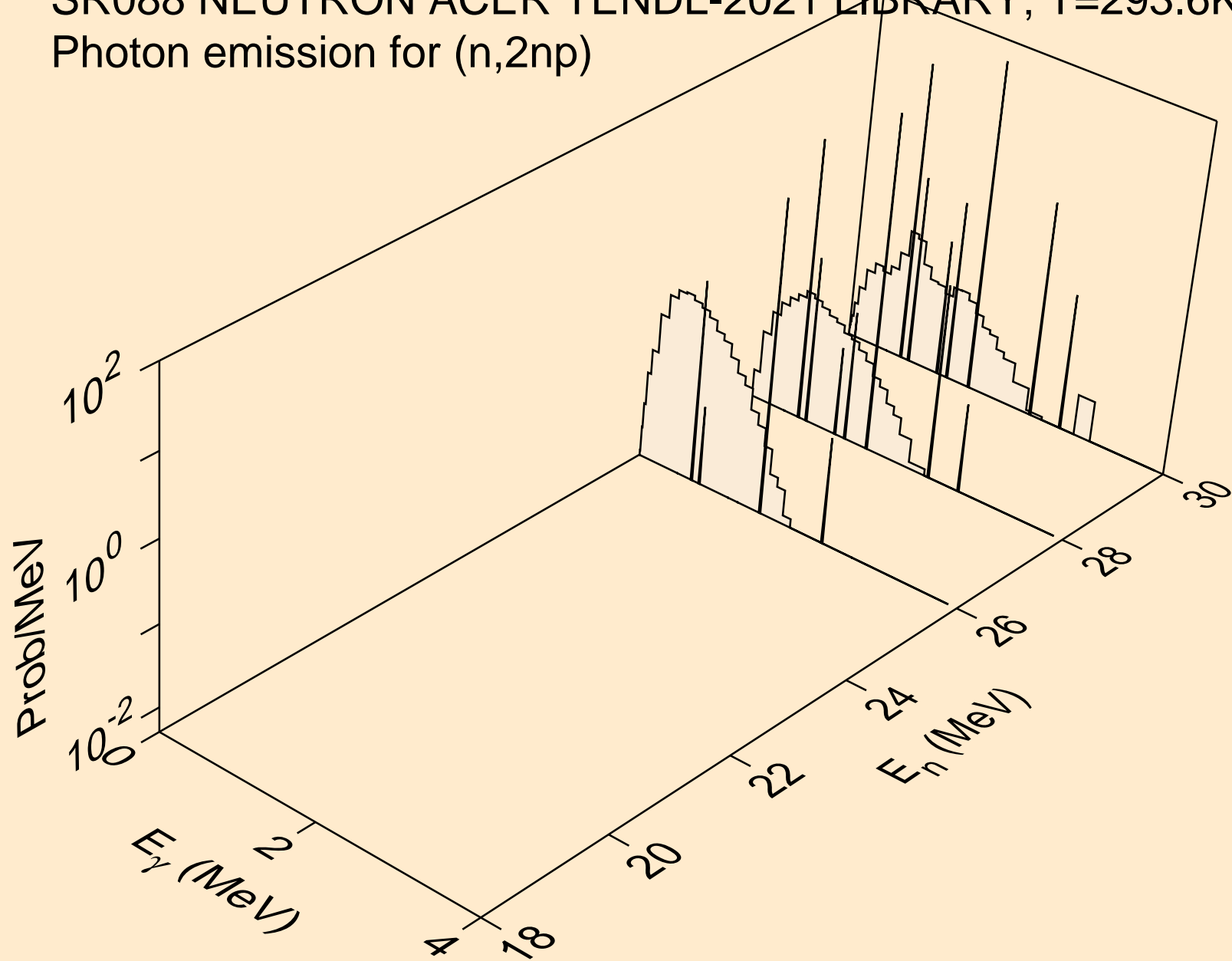

SR088 NEUTRON ACER TENDL-2021 LIBRARY; T=293.6K
Photon emission for (n,npa)

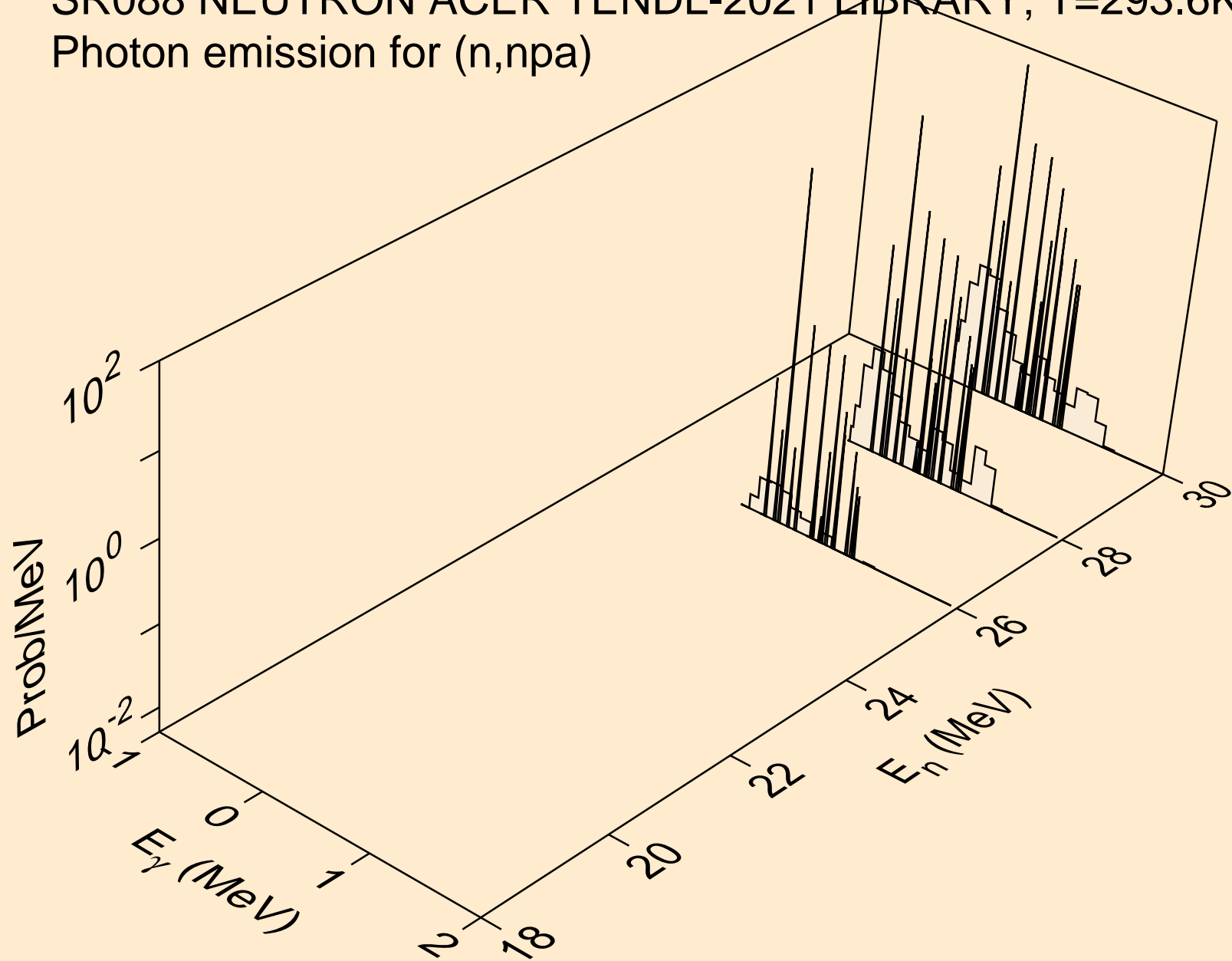

SR088 NEUTRON ACER TENDL-2021 LIBRARY; T=293.6K
Photon emission for (n,n*c)

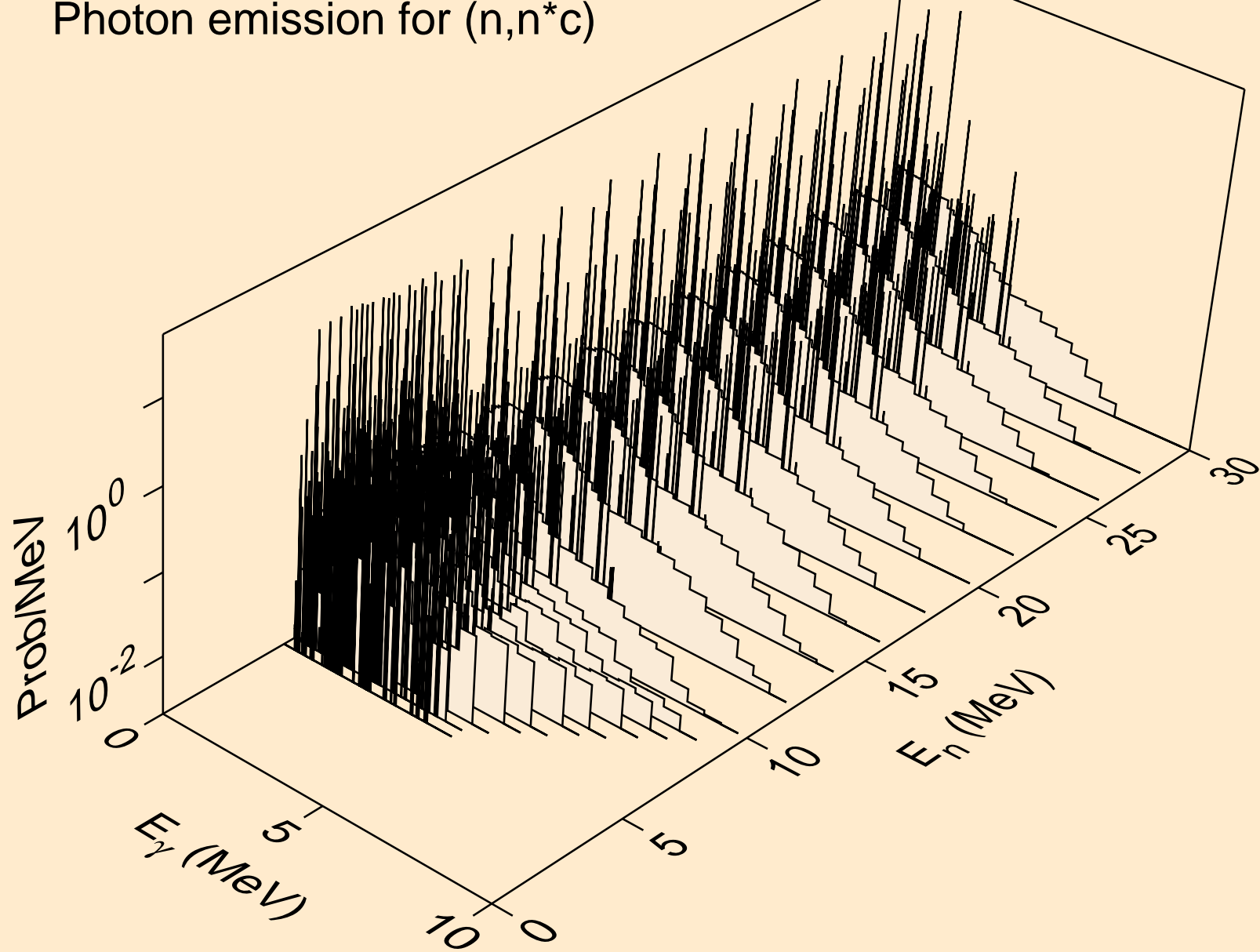

SR088 NEUTRON ACER TENDL-2021 LIBRARY; T=293.6K
Photon emission for (n,gma)

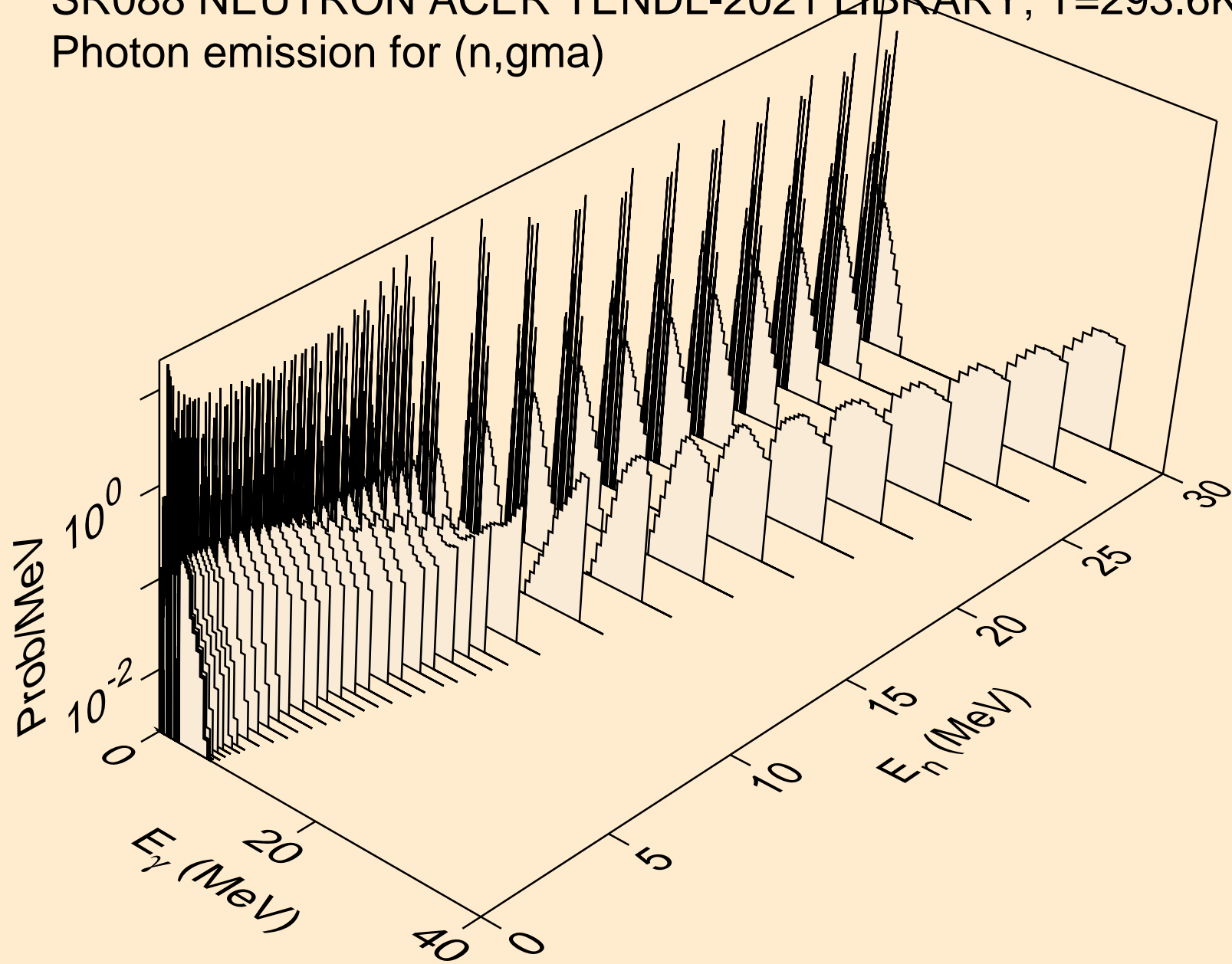

SR088 NEUTRON ACER TENDL-2021 LIBRARY; T=293.6K
Photon emission for (n,p)

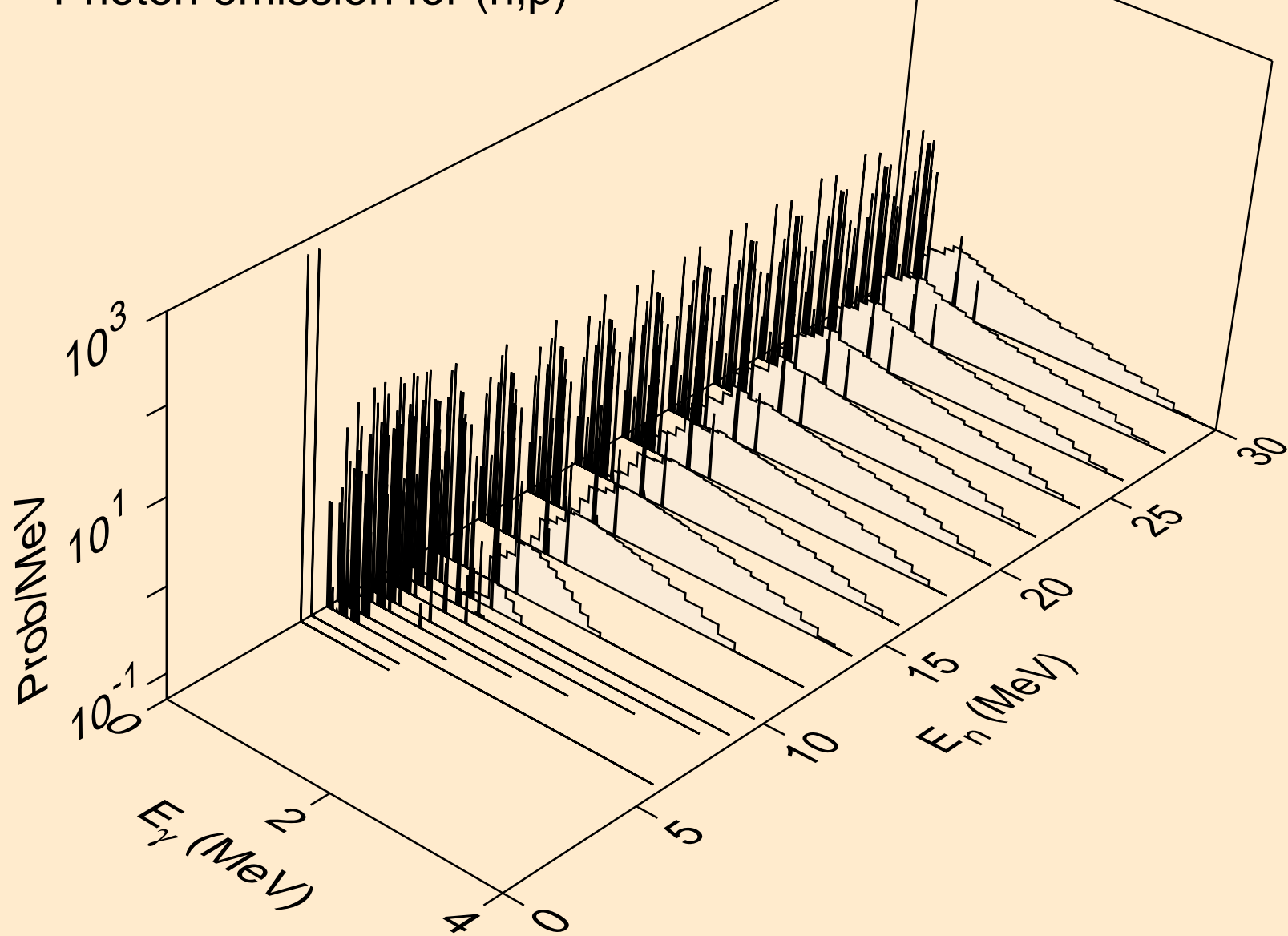

SR088 NEUTRON ACER TENDL-2021 LIBRARY; T=293.6K
Photon emission for (n,d)

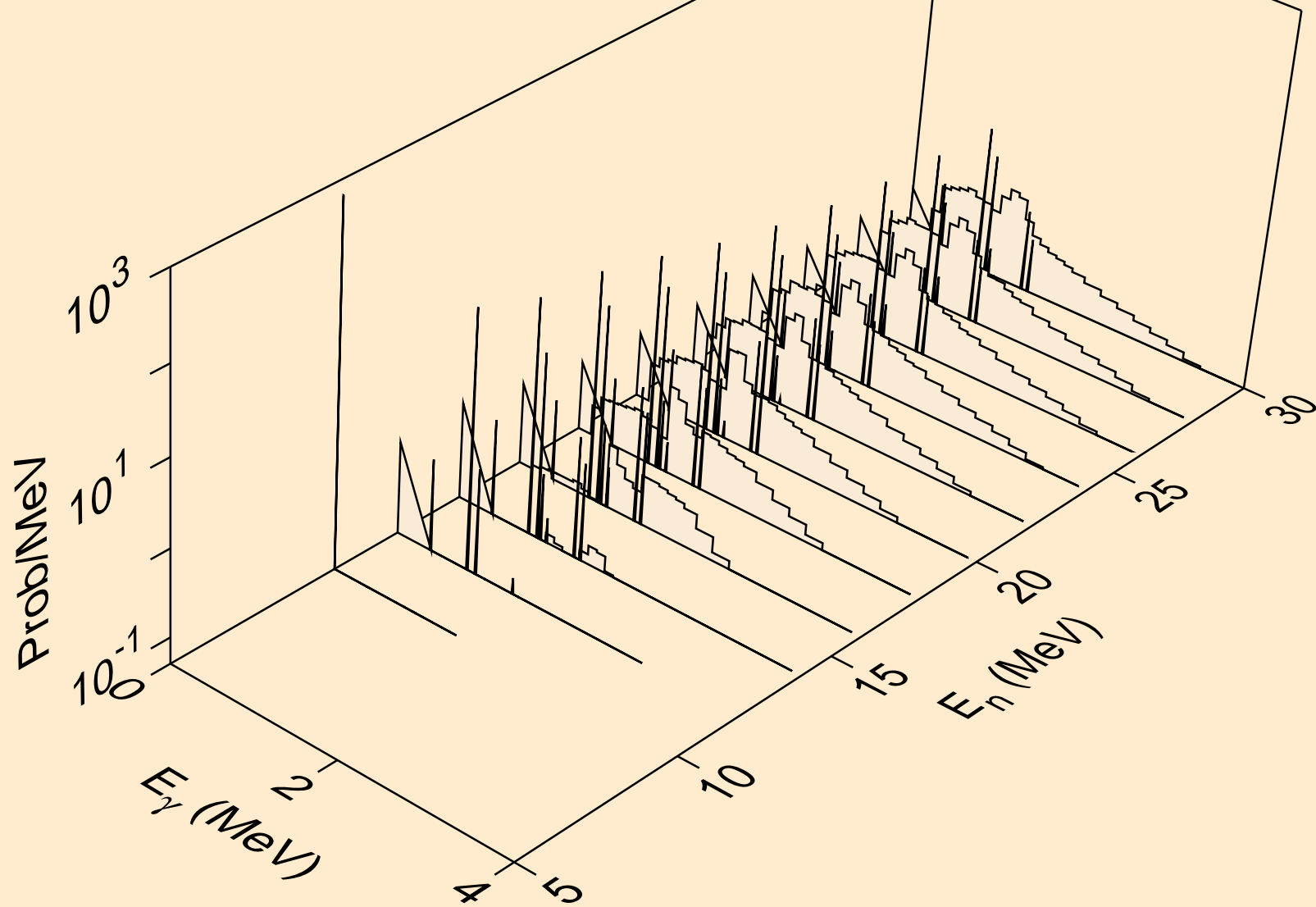

SR088 NEUTRON ACER TENDL-2021 LIBRARY; T=293.6K
Photon emission for (n,t)

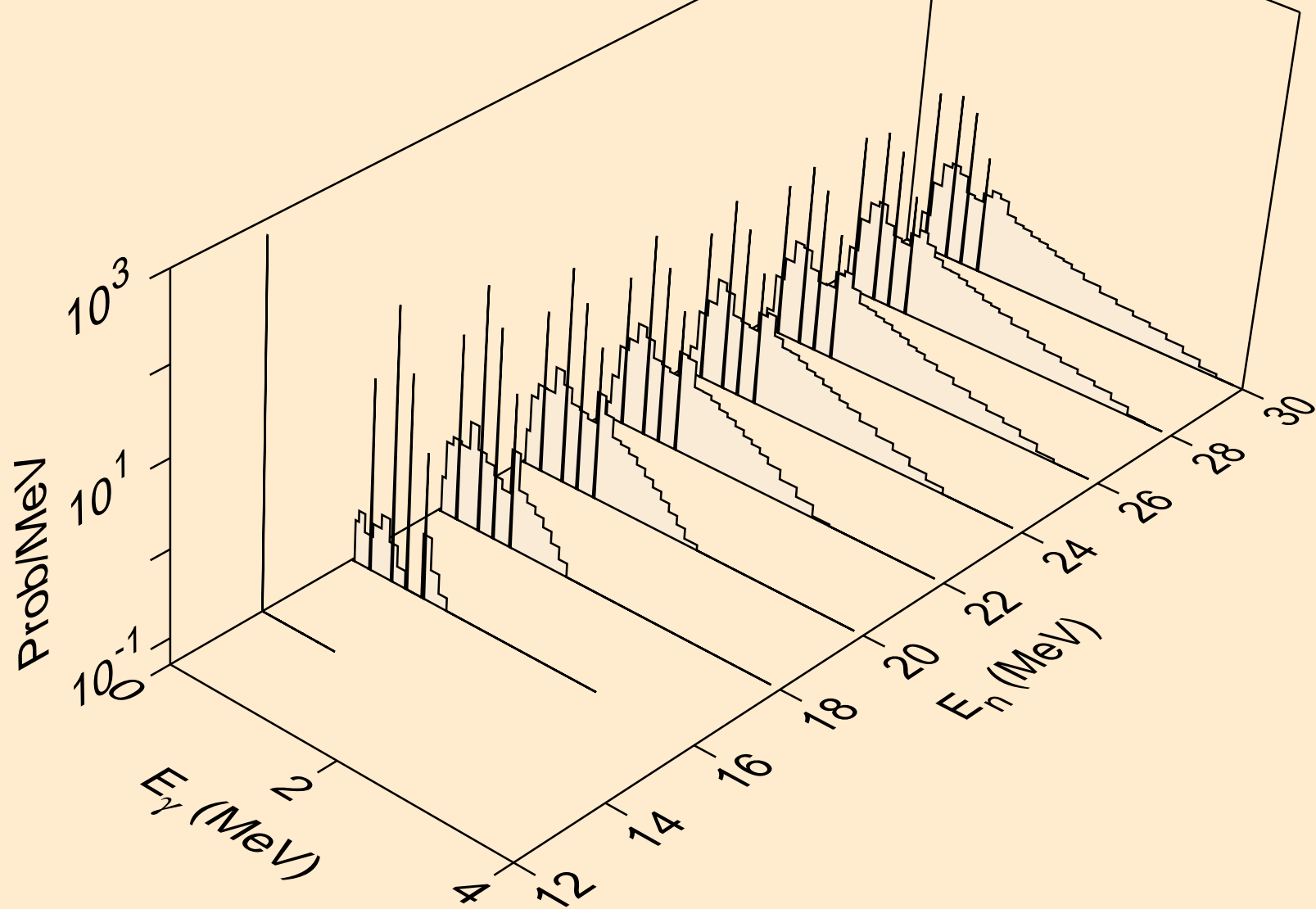

SR088 NEUTRON ACER TENDL-2021 LIBRARY; T=293.6K
Photon emission for (n,he3)

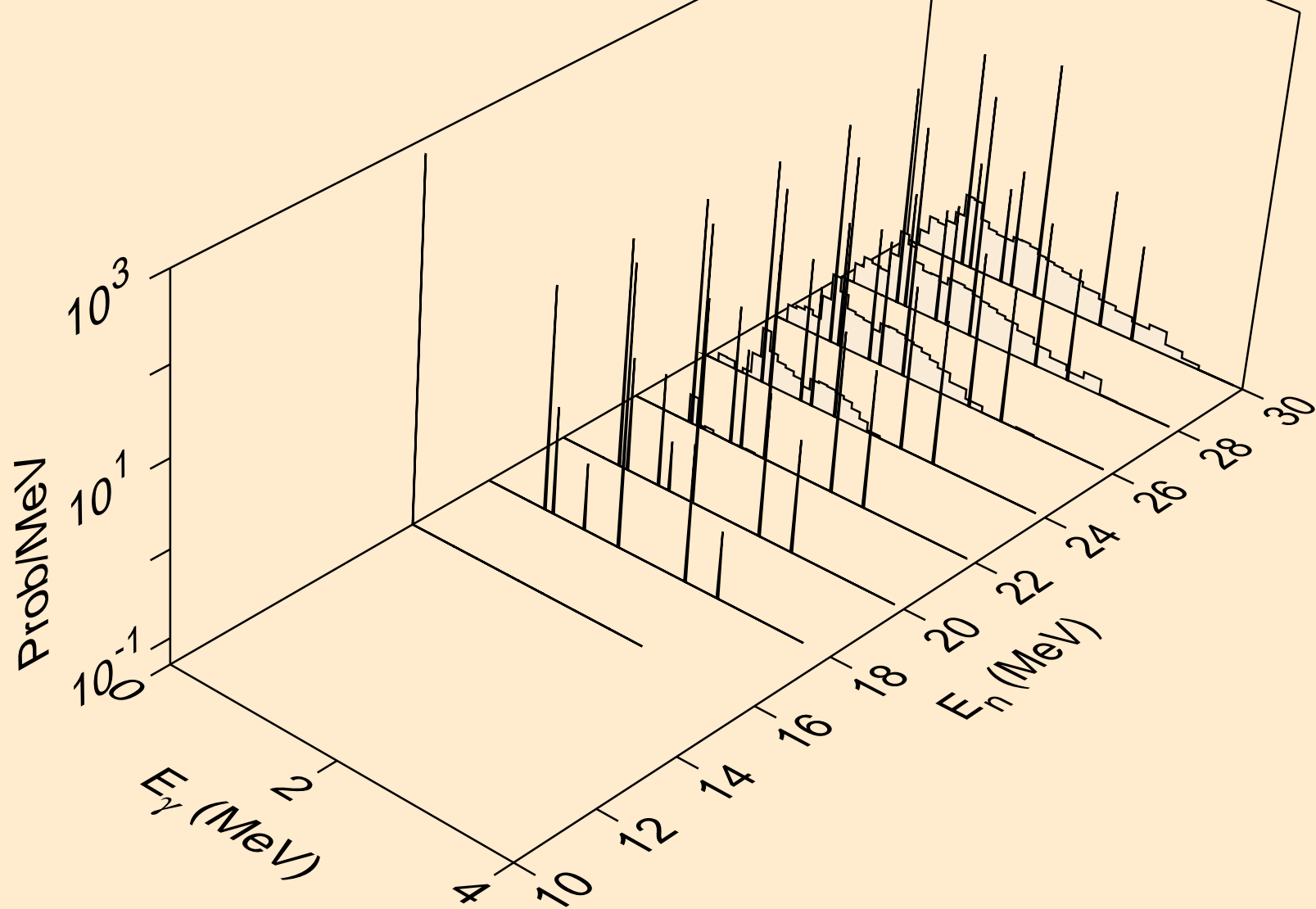

SR088 NEUTRON ACER TENDL-2021 LIBRARY; T=293.6K
Photon emission for (n,a)

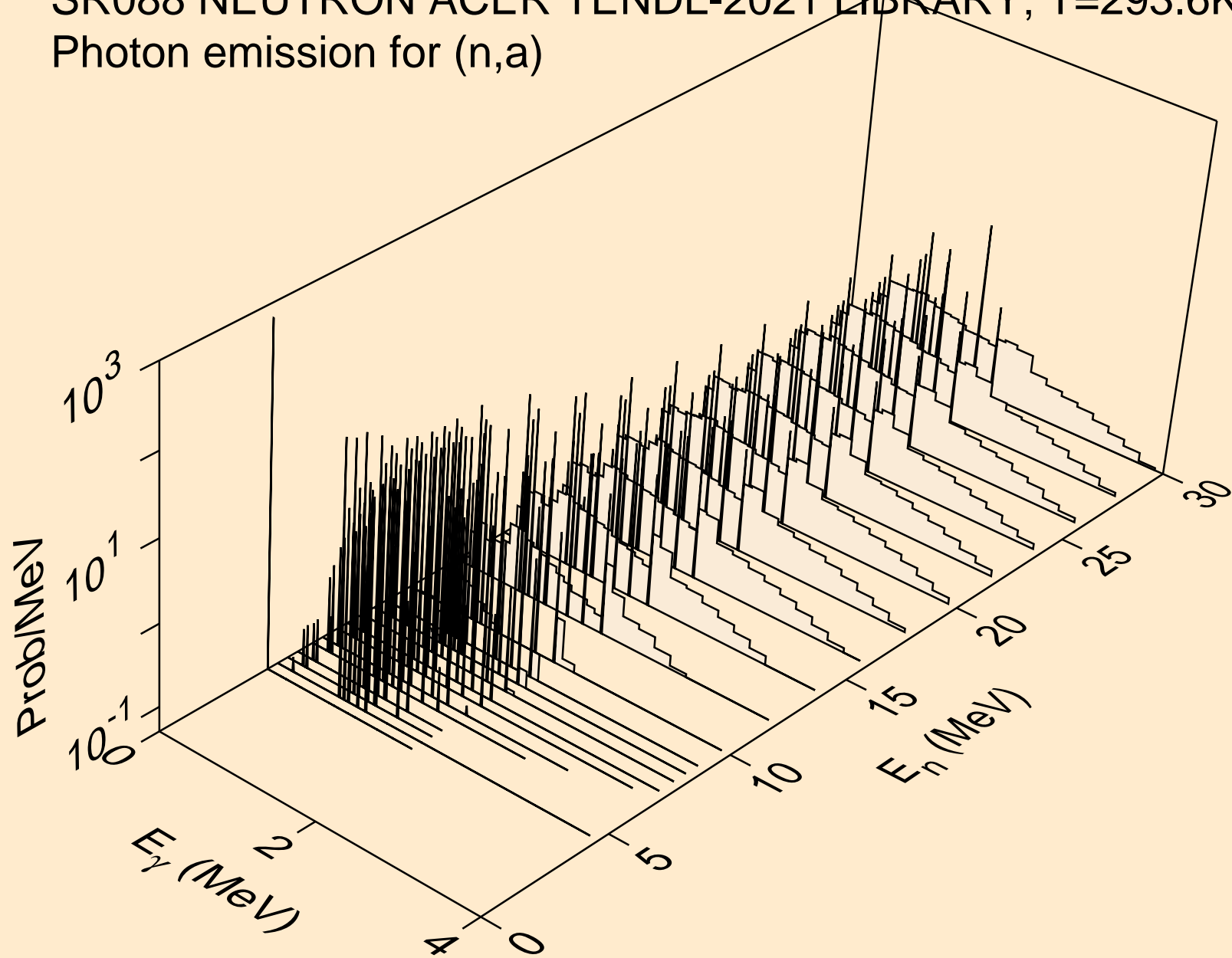

SR088 NEUTRON ACER TENDL-2021 LIBRARY; T=293.6K
Photon emission for (n,2a)

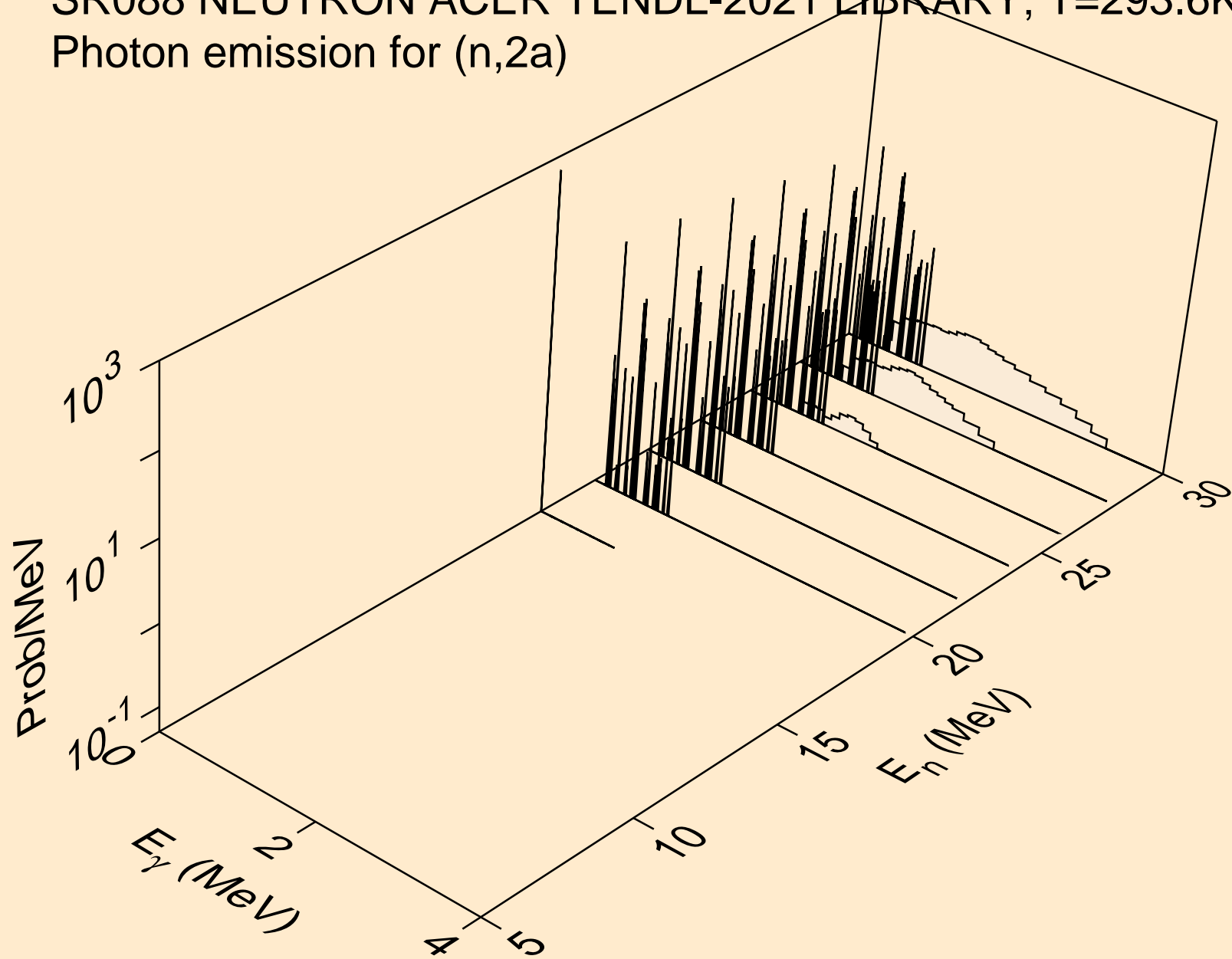

SR088 NEUTRON ACER TENDL-2021 LIBRARY; T=293.6K
Photon emission for (n,2p)

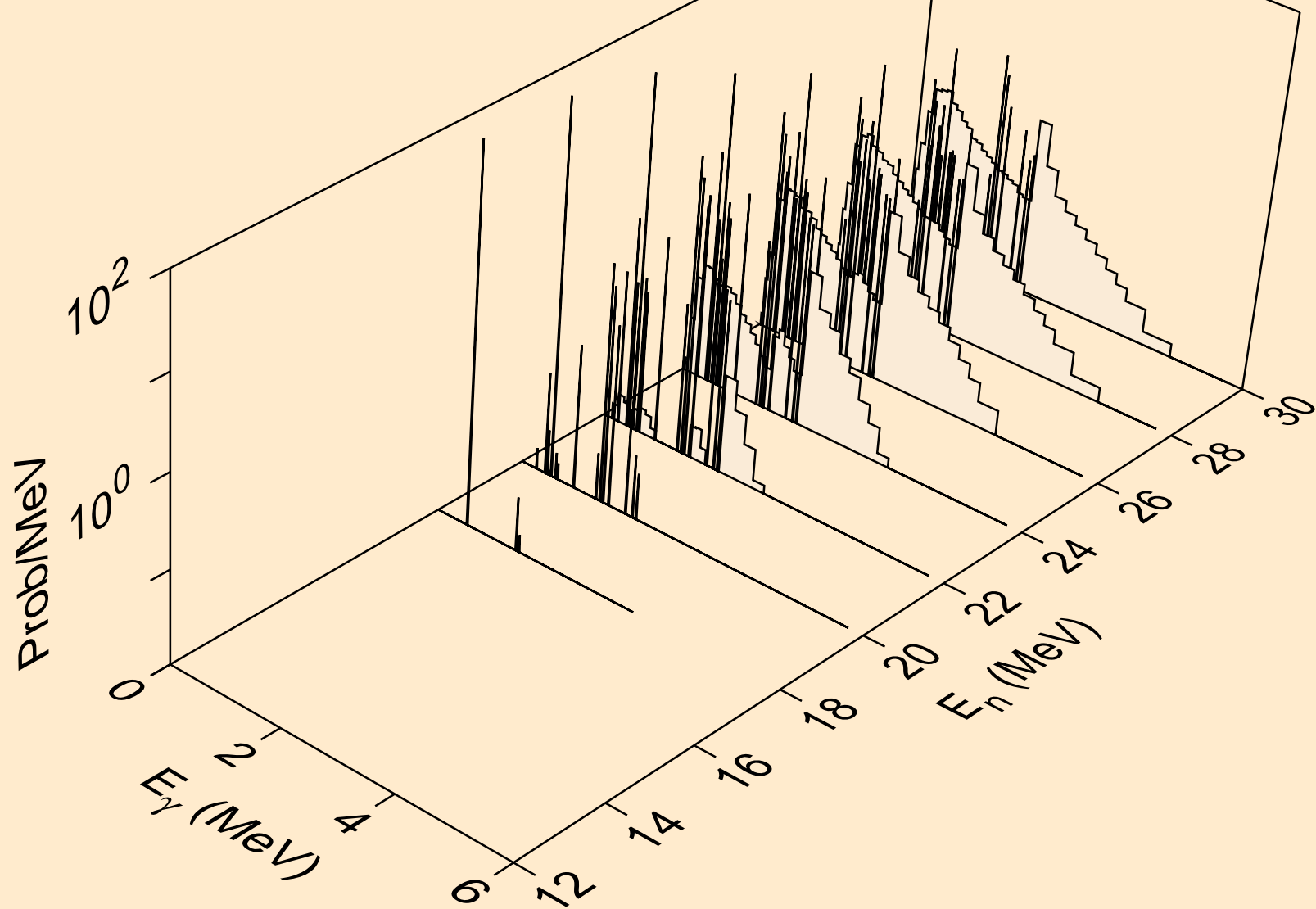

SR088 NEUTRON ACER TENDL-2021 LIBRARY; T=293.6K
Photon emission for (n,p)

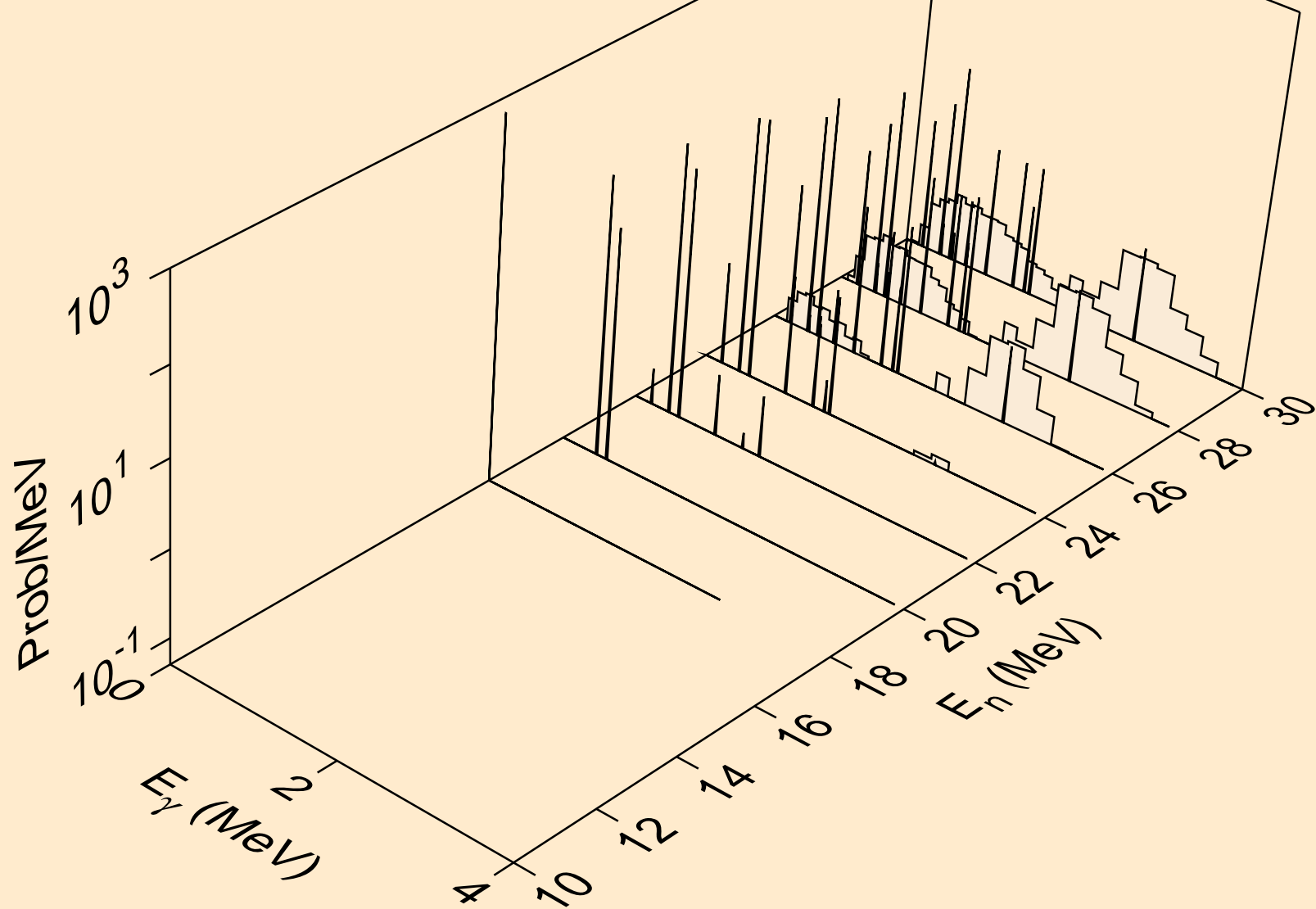

SR088 NEUTRON ACER TENDL-2021 LIBRARY; T=293.6K
Photon emission for (n,pd)

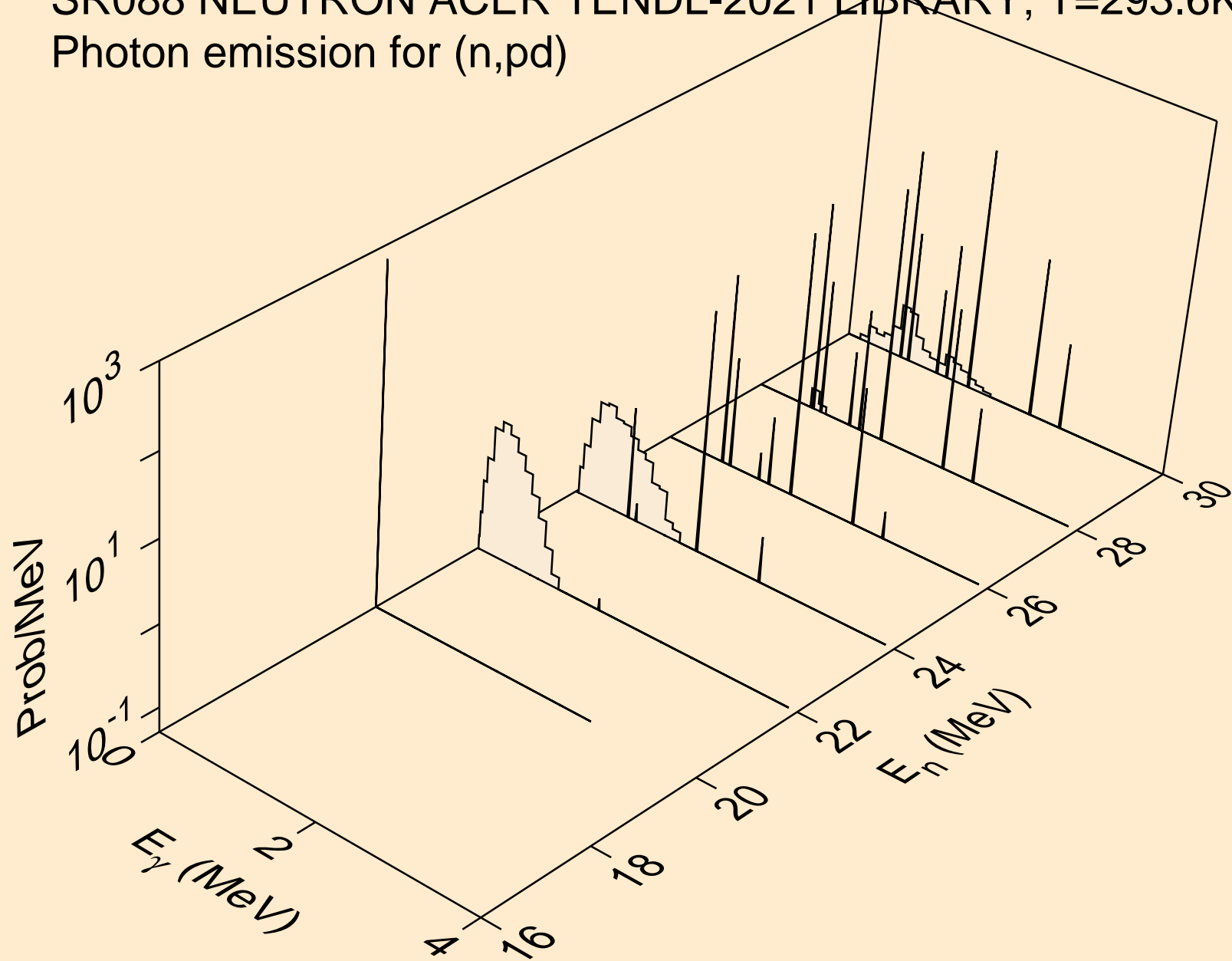

SR088 NEUTRON ACER TENDL-2021 LIBRARY; T=293.6K
Photon emission for (n,pt)

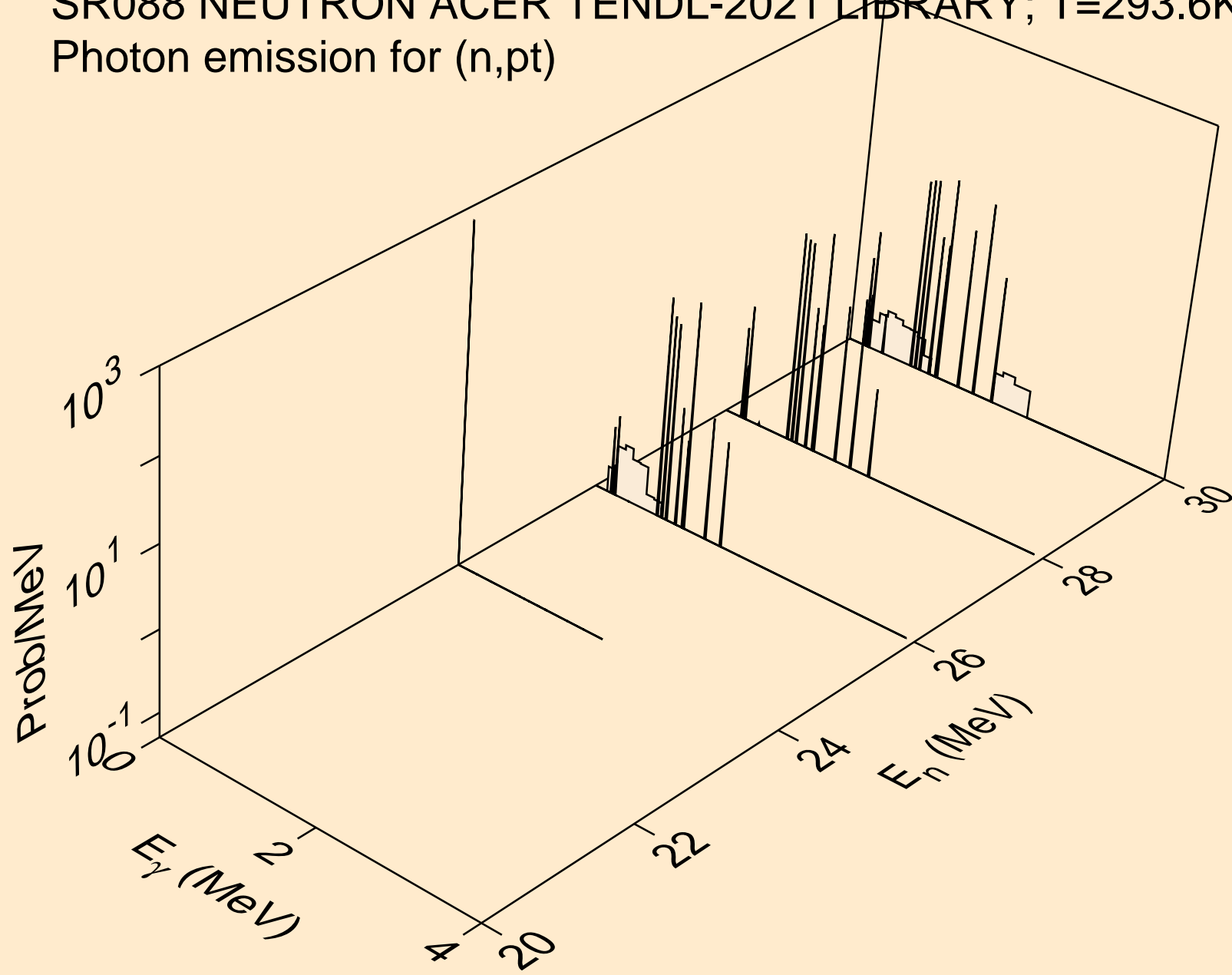

SR088 NEUTRON ACER TENDL-2021 LIBRARY; T=293.6K
Photon emission for (n,da)

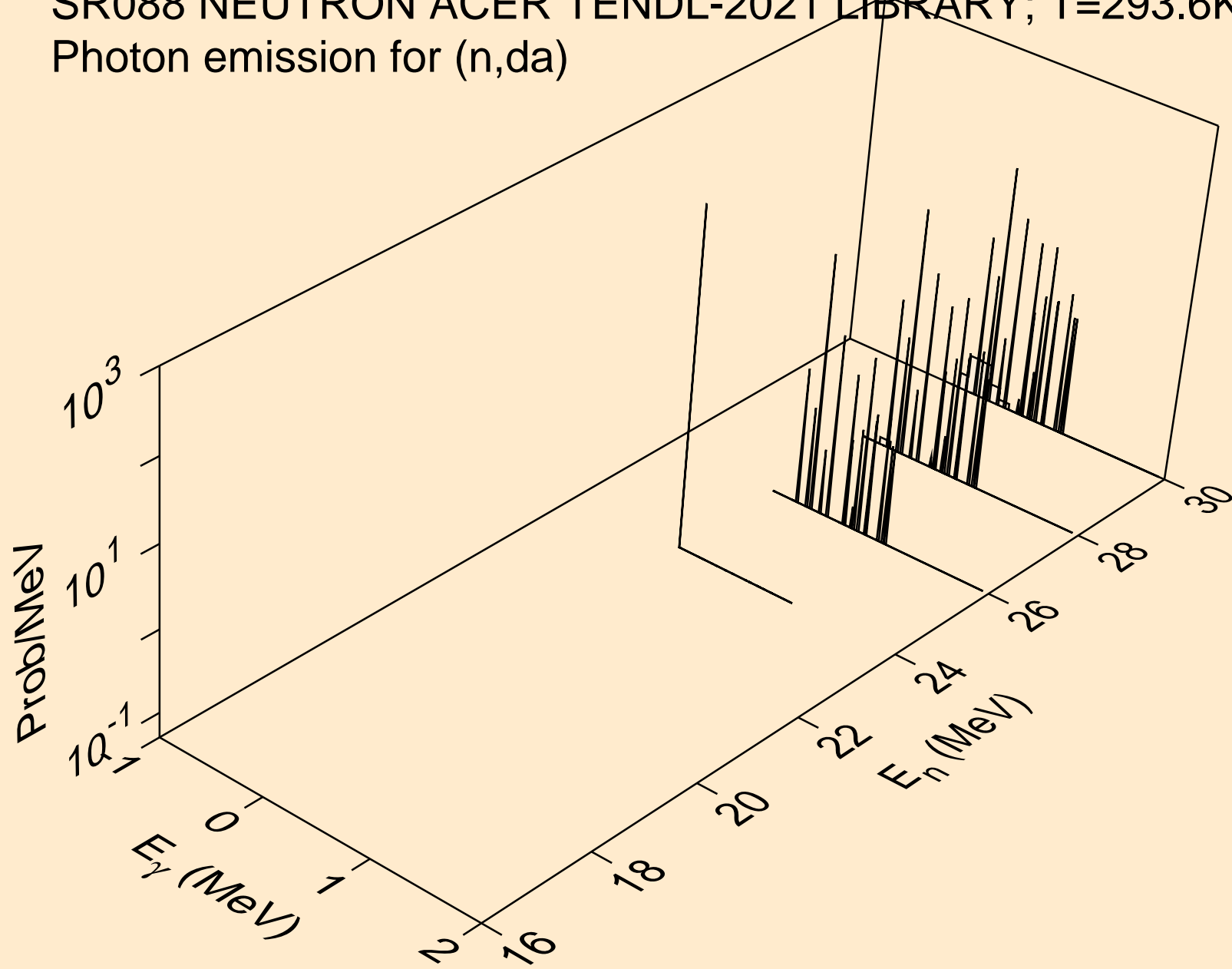

SR088 NEUTRON ACER TENDL-2021 LIBRARY; T=293.6K
thermal capture photon spectrum

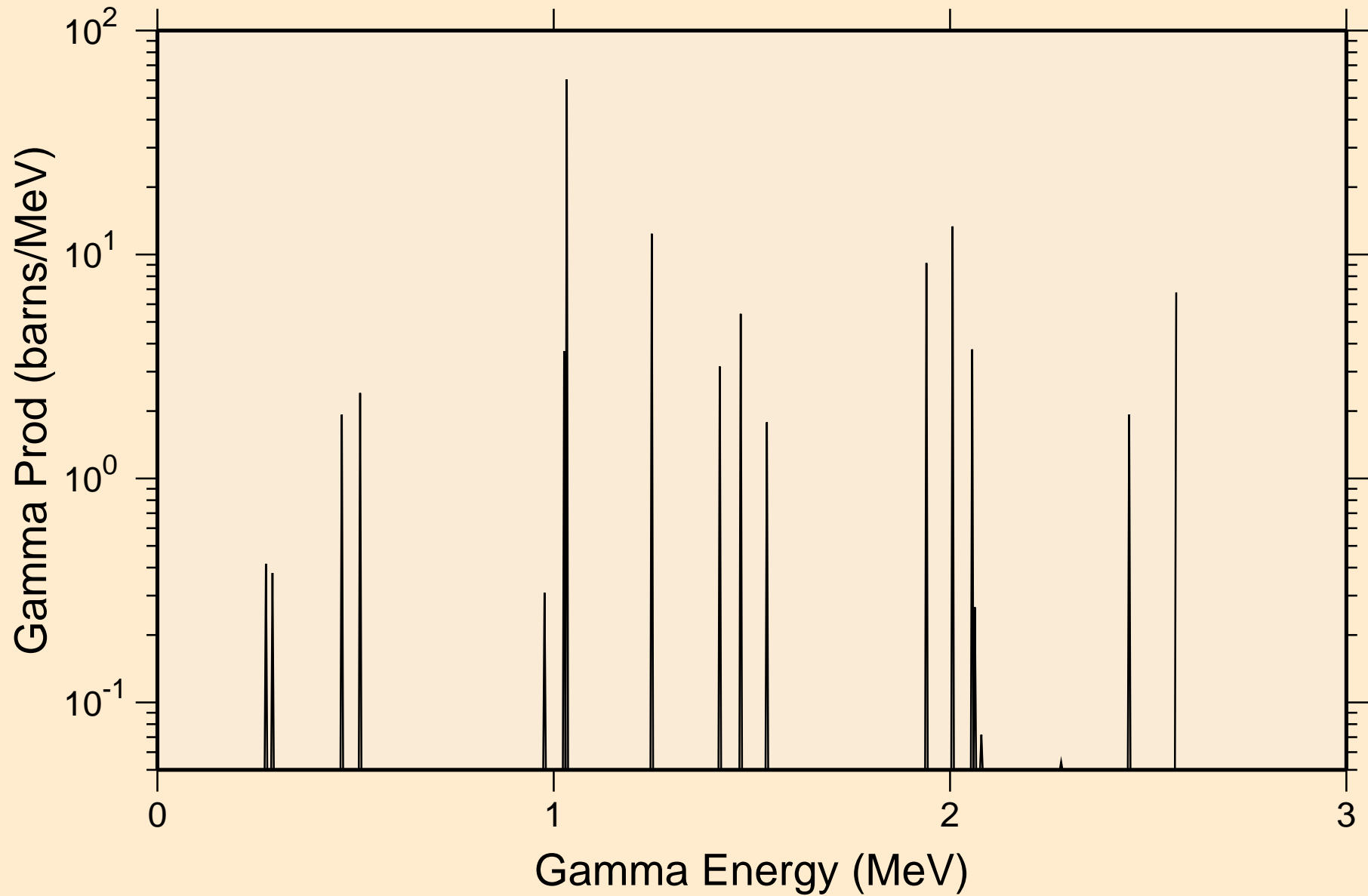

SR088 NEUTRON ACER TENDL-2021 LIBRARY; T=293.6K
14 MeV photon spectrum

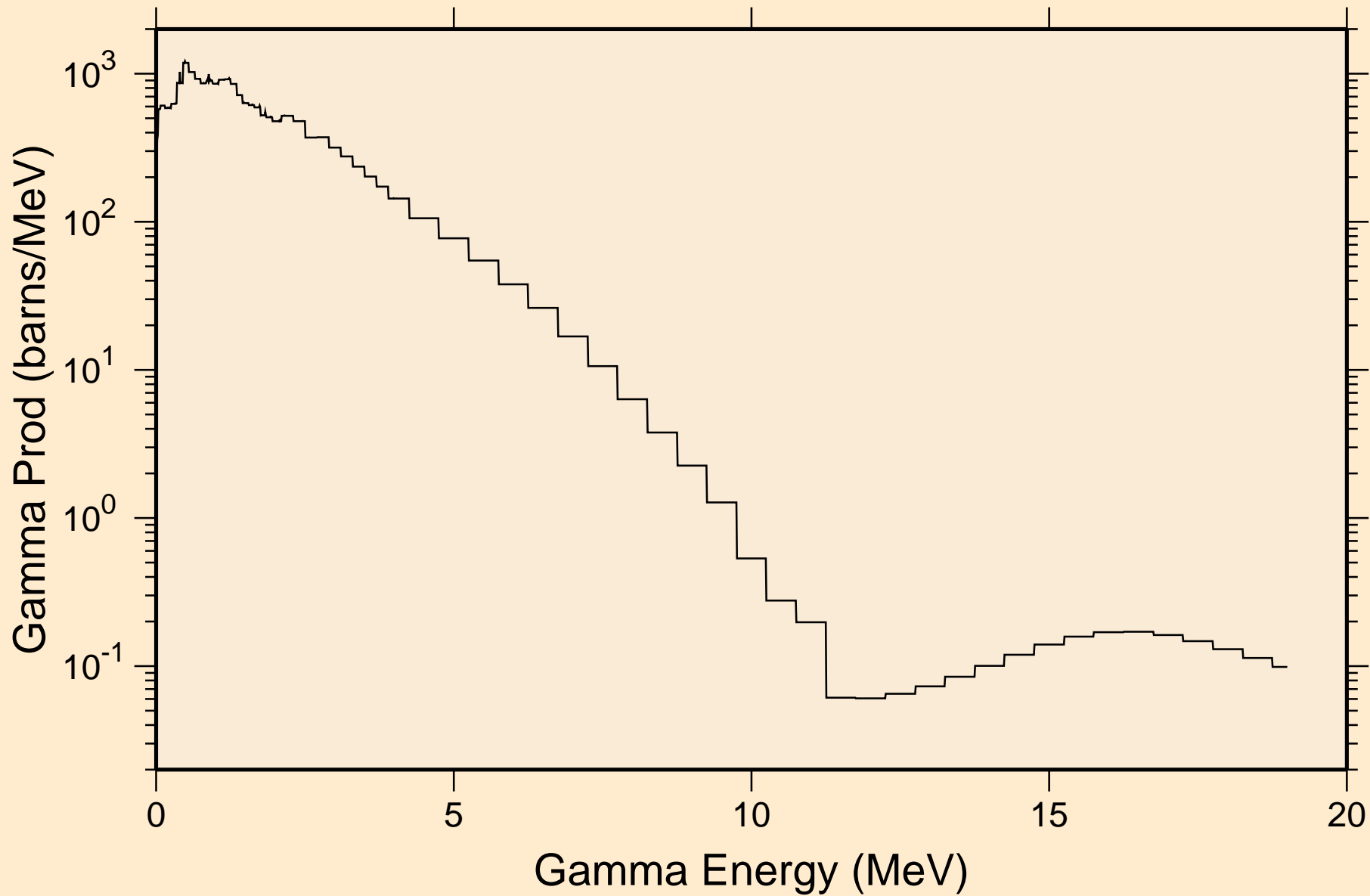

SR088 NEUTRON ACER TENDL-2021 LIBRARY; T=293.6K

Particle heating contributions

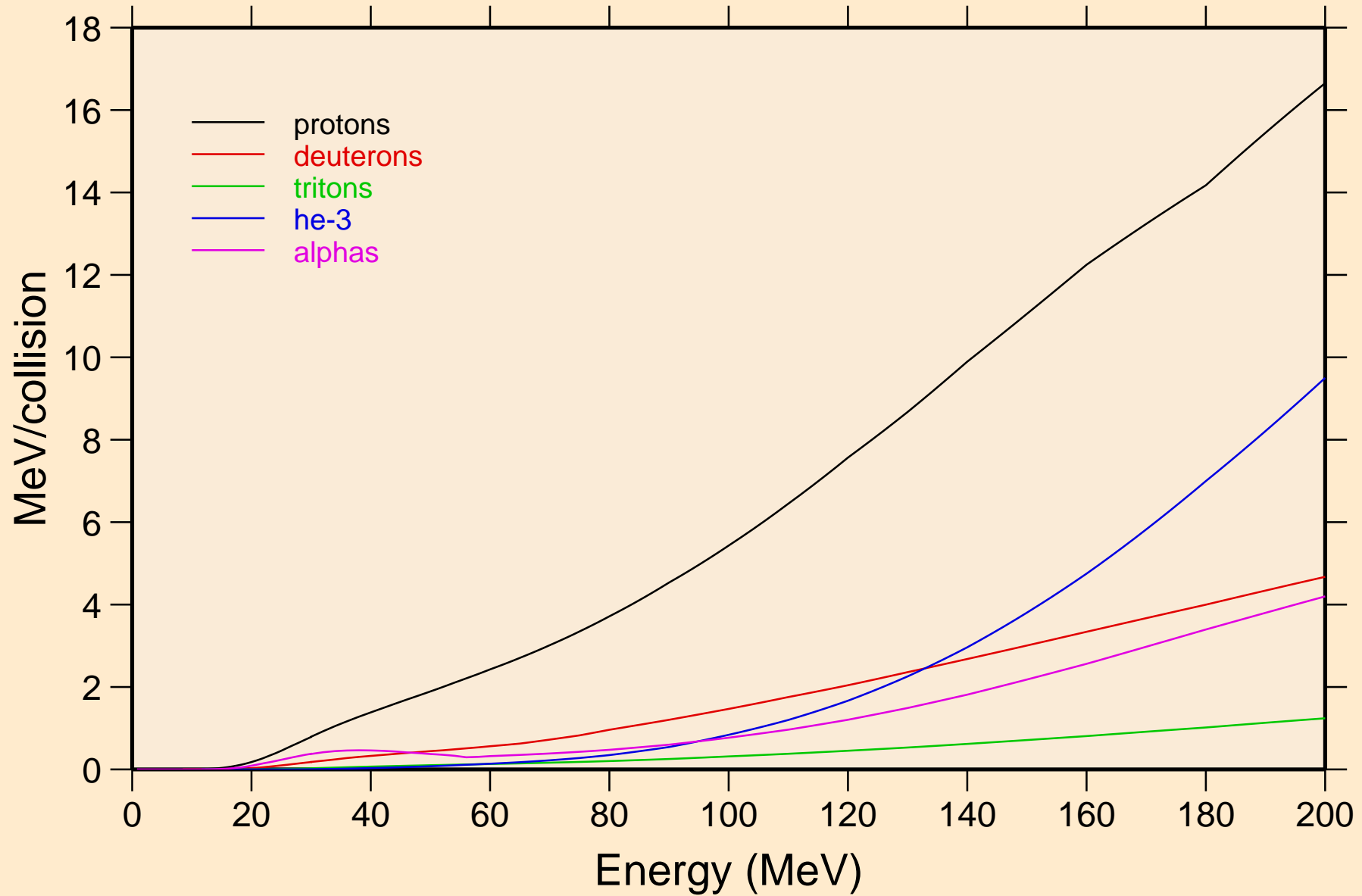

SR088 NEUTRON ACER TENDL-2021 LIBRARY; T=293.6K
Recoil Heating

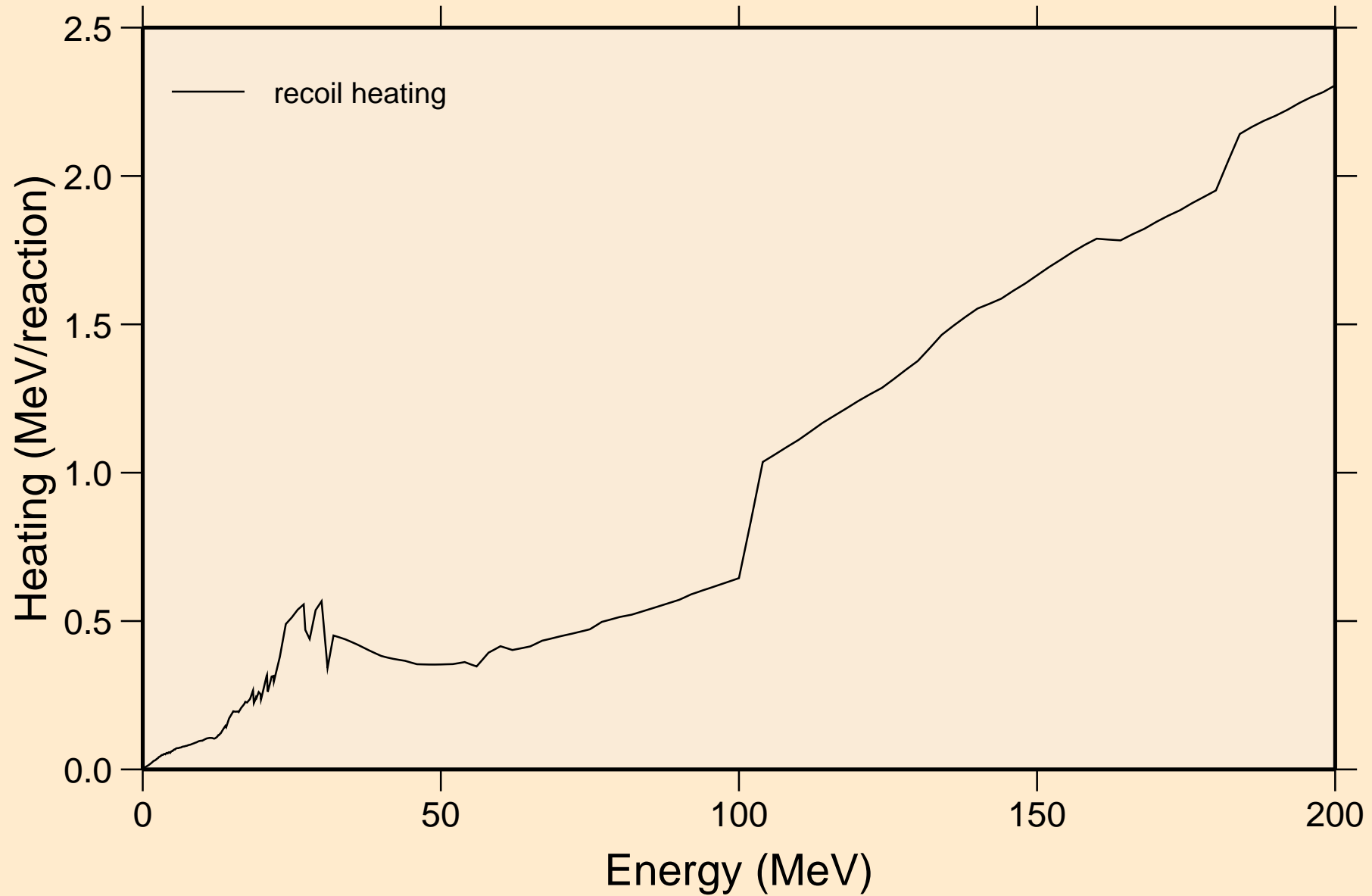

SR088 NEUTRON ACER TENDL-2021 LIBRARY; T=293.6K
Particle production cross sections

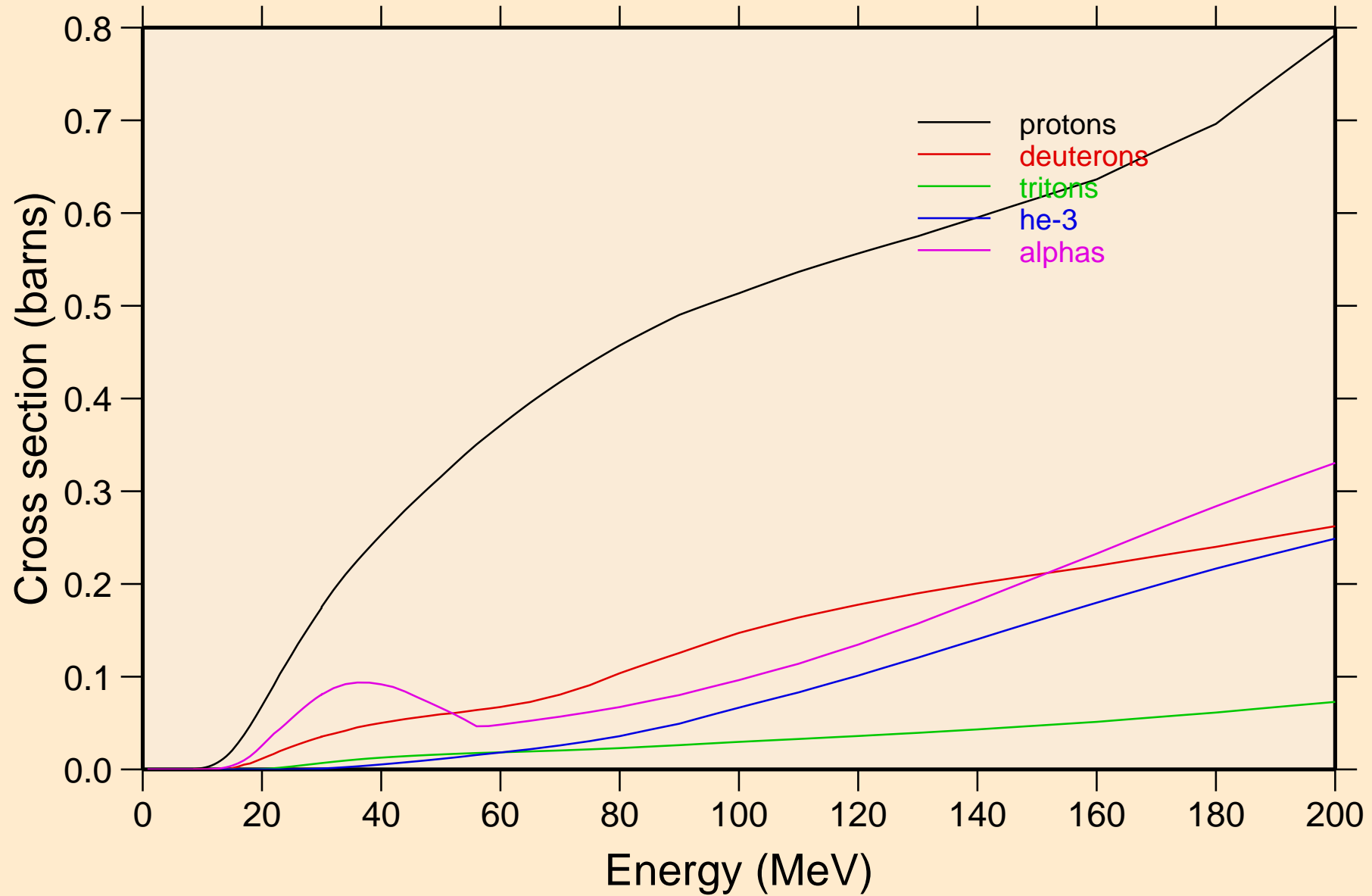

SR088 NEUTRON ACER TENDL-2021 LIBRARY; T=293.6K
protons from (n,x)

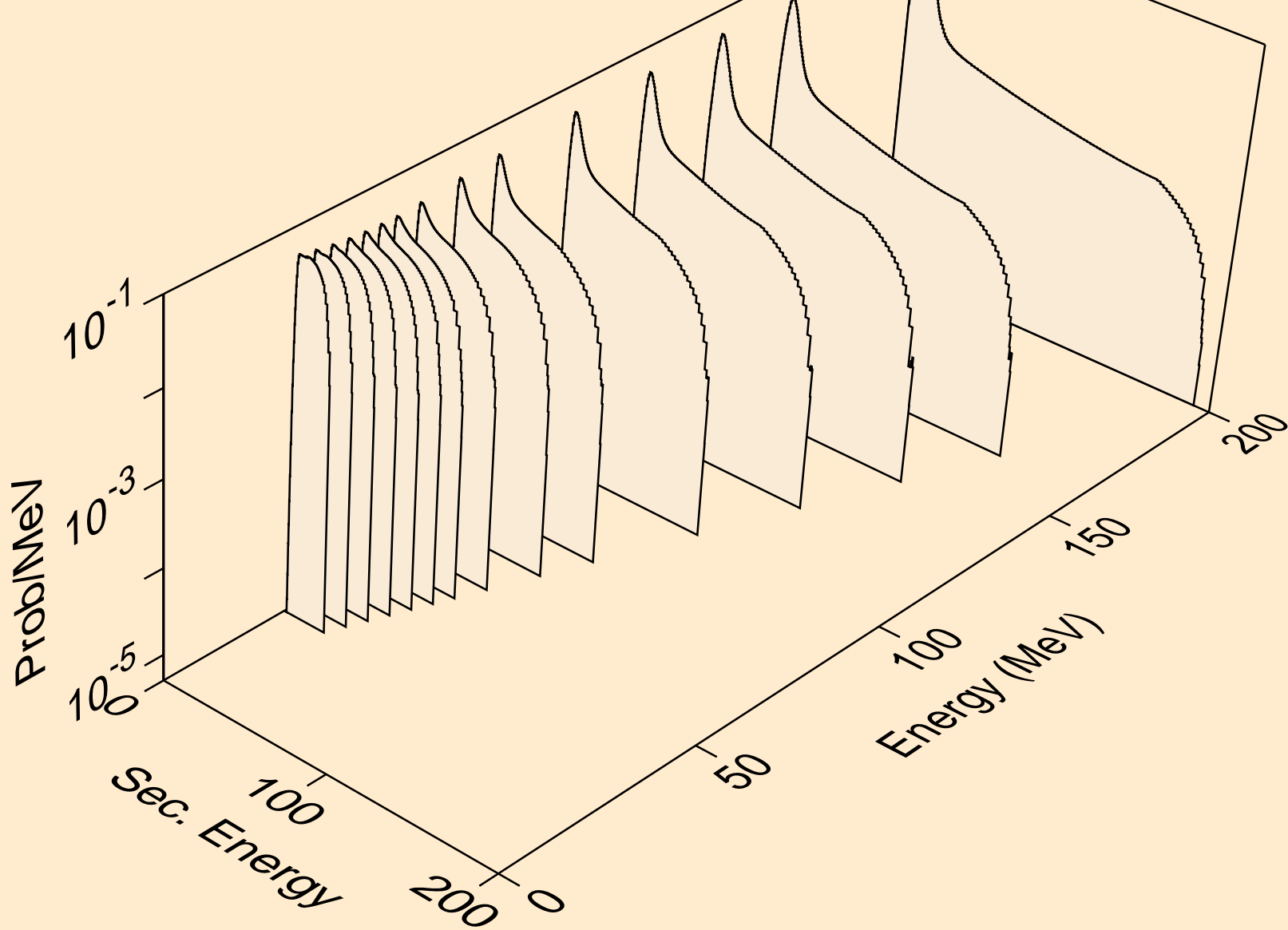

SR088 NEUTRON ACER TENDL-2021 LIBRARY; T=293.6K
protons from (n,n*)p

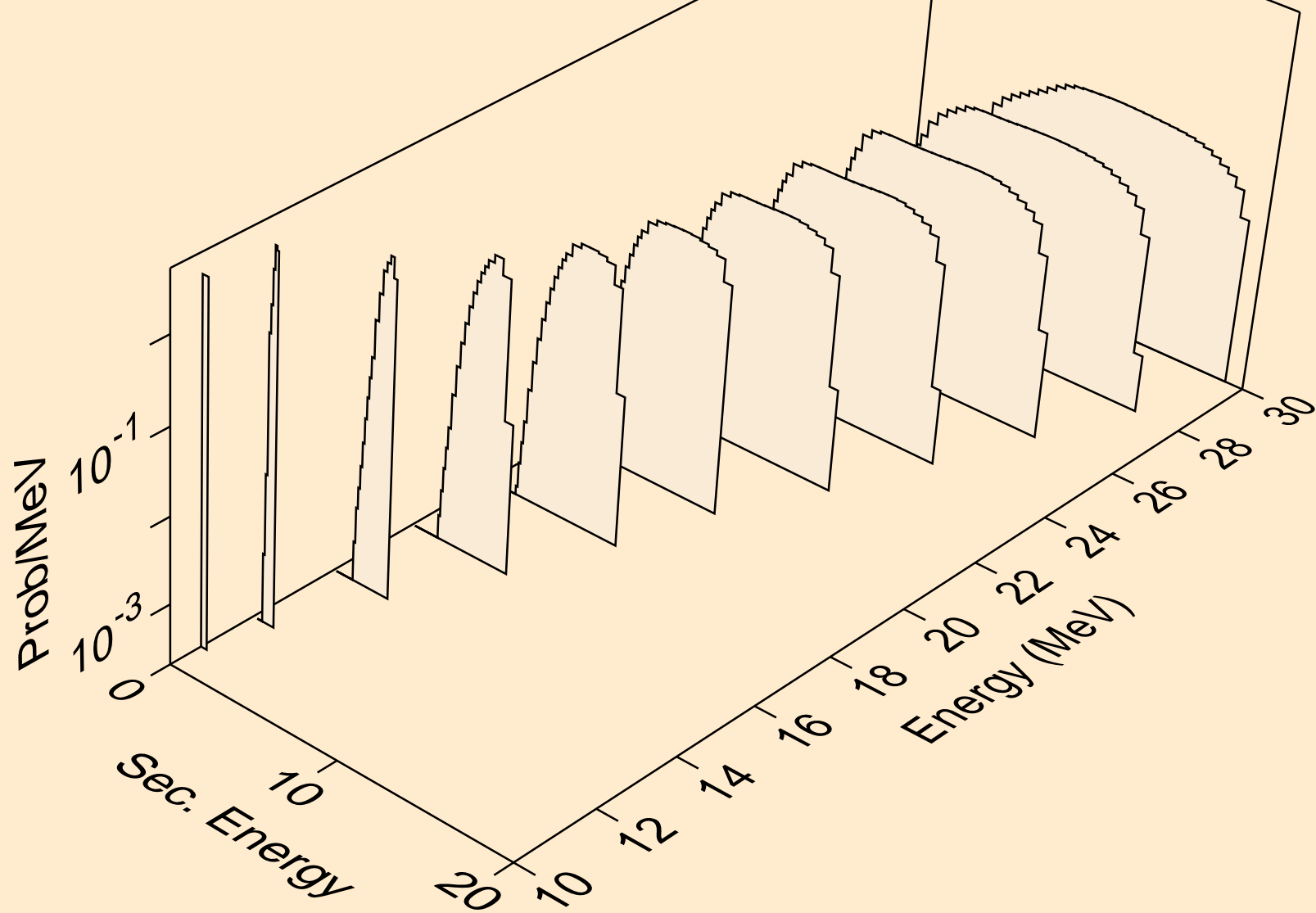

SR088 NEUTRON ACER TENDL-2021 LIBRARY; T=293.6K
protons from (n,2np)

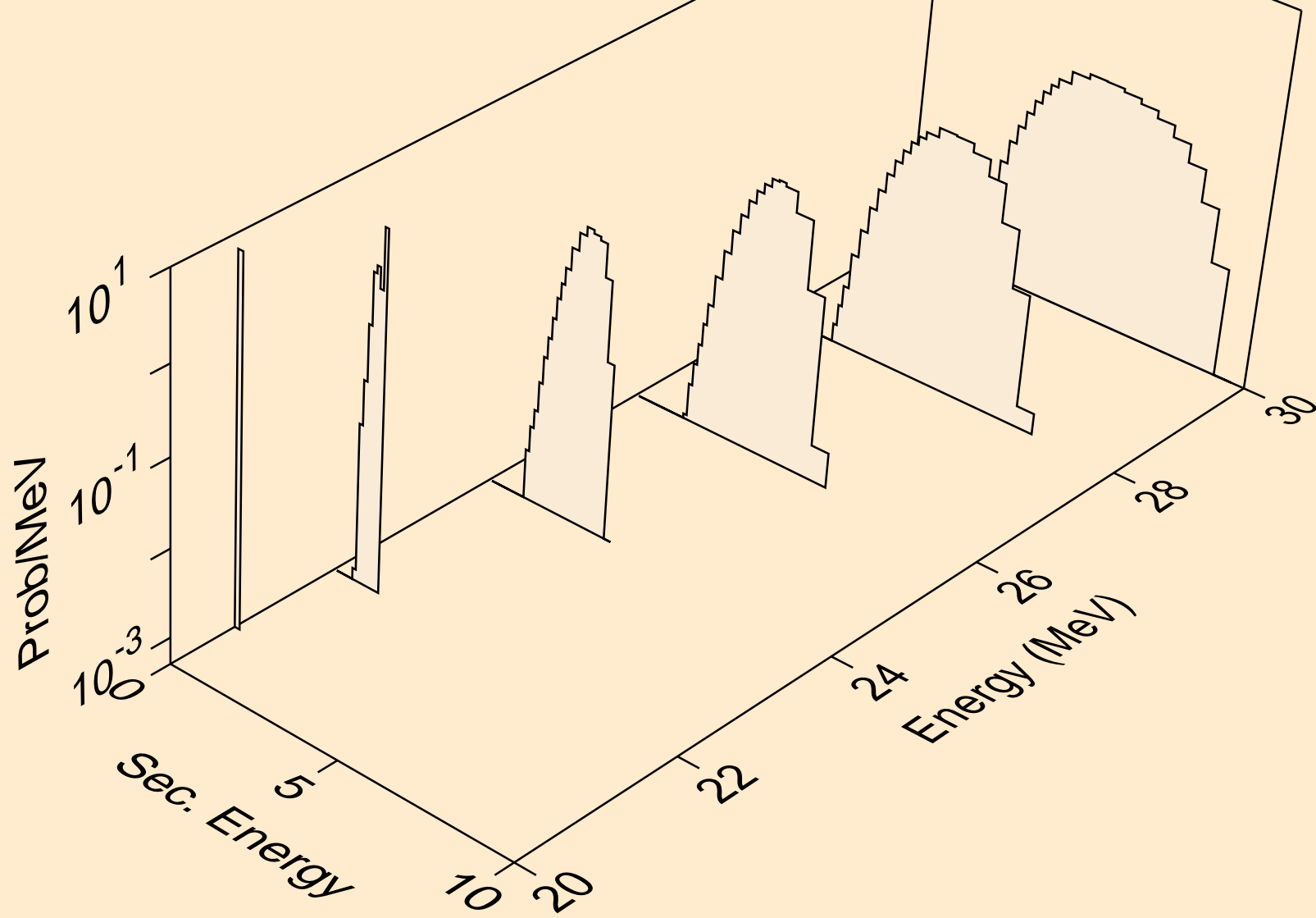

SR088 NEUTRON ACER TENDL-2021 LIBRARY; T=293.6K
protons from (n,2np)

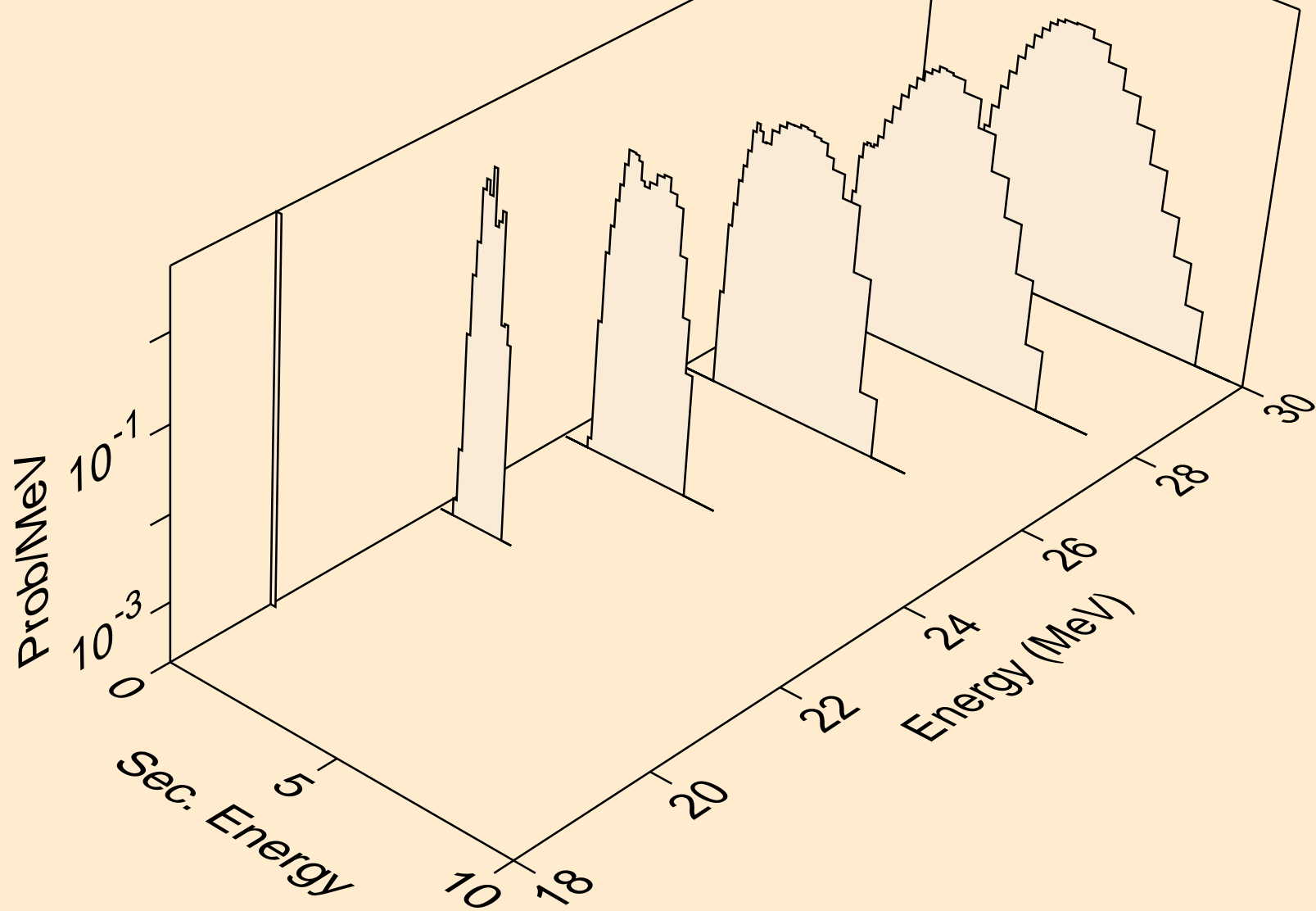

SR088 NEUTRON ACER TENDL-2021 LIBRARY; T=293.6K
protons from (n,npa)

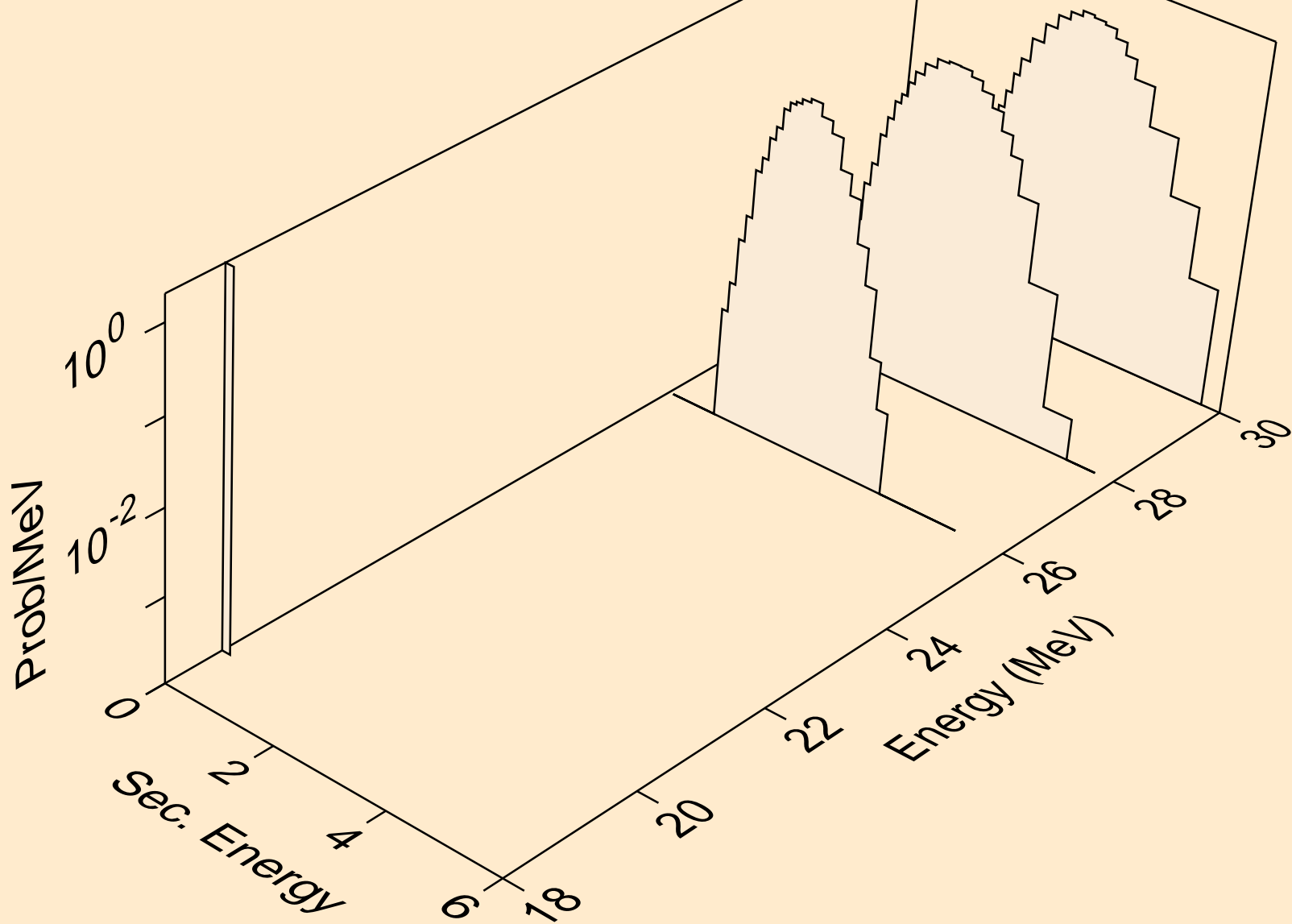

SR088 NEUTRON ACER TENDL-2021 LIBRARY; T=293.6K
protons from (n,p)

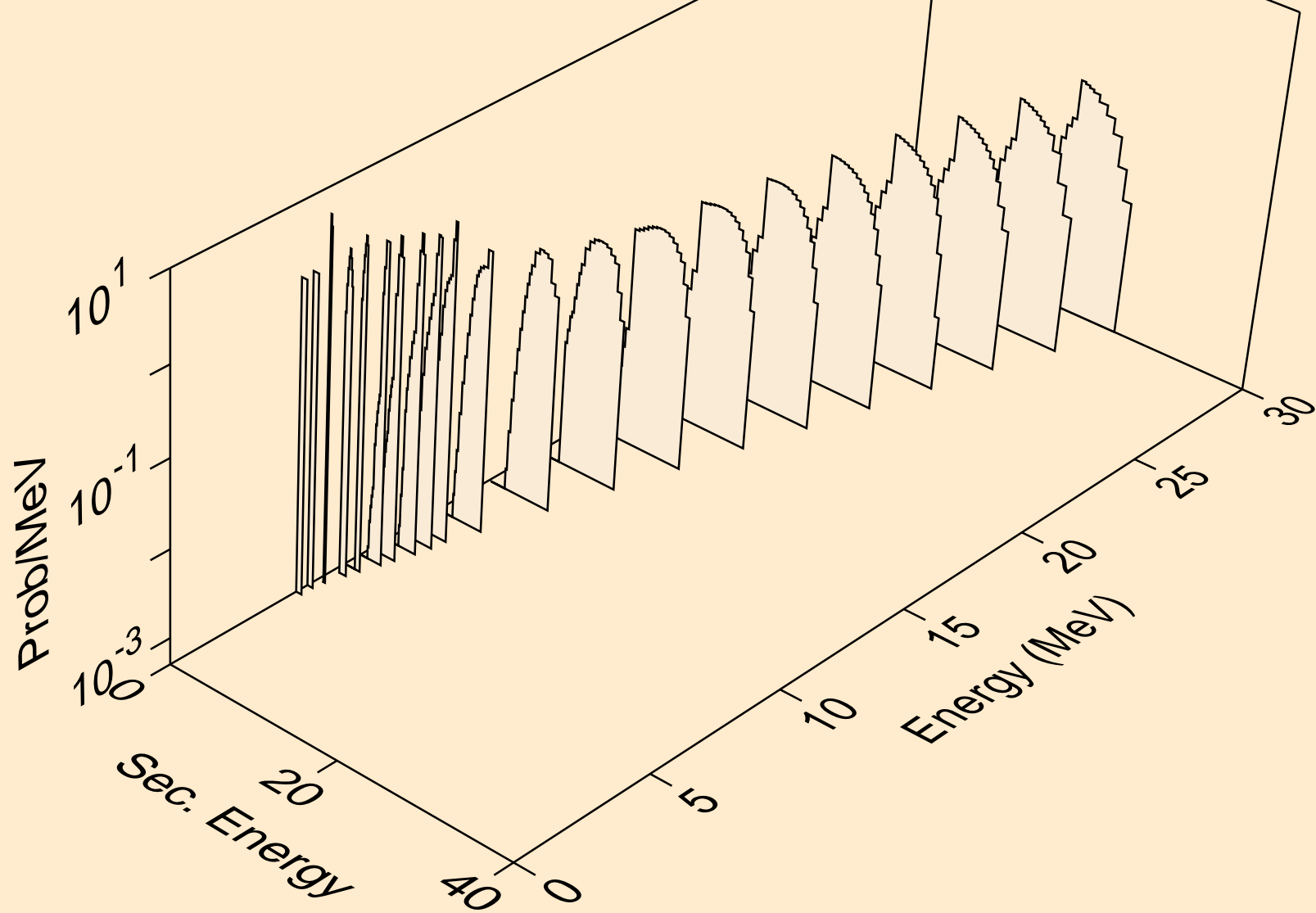

SR088 NEUTRON ACER TENDL-2021 LIBRARY; T=293.6K
protons from (n,2p)

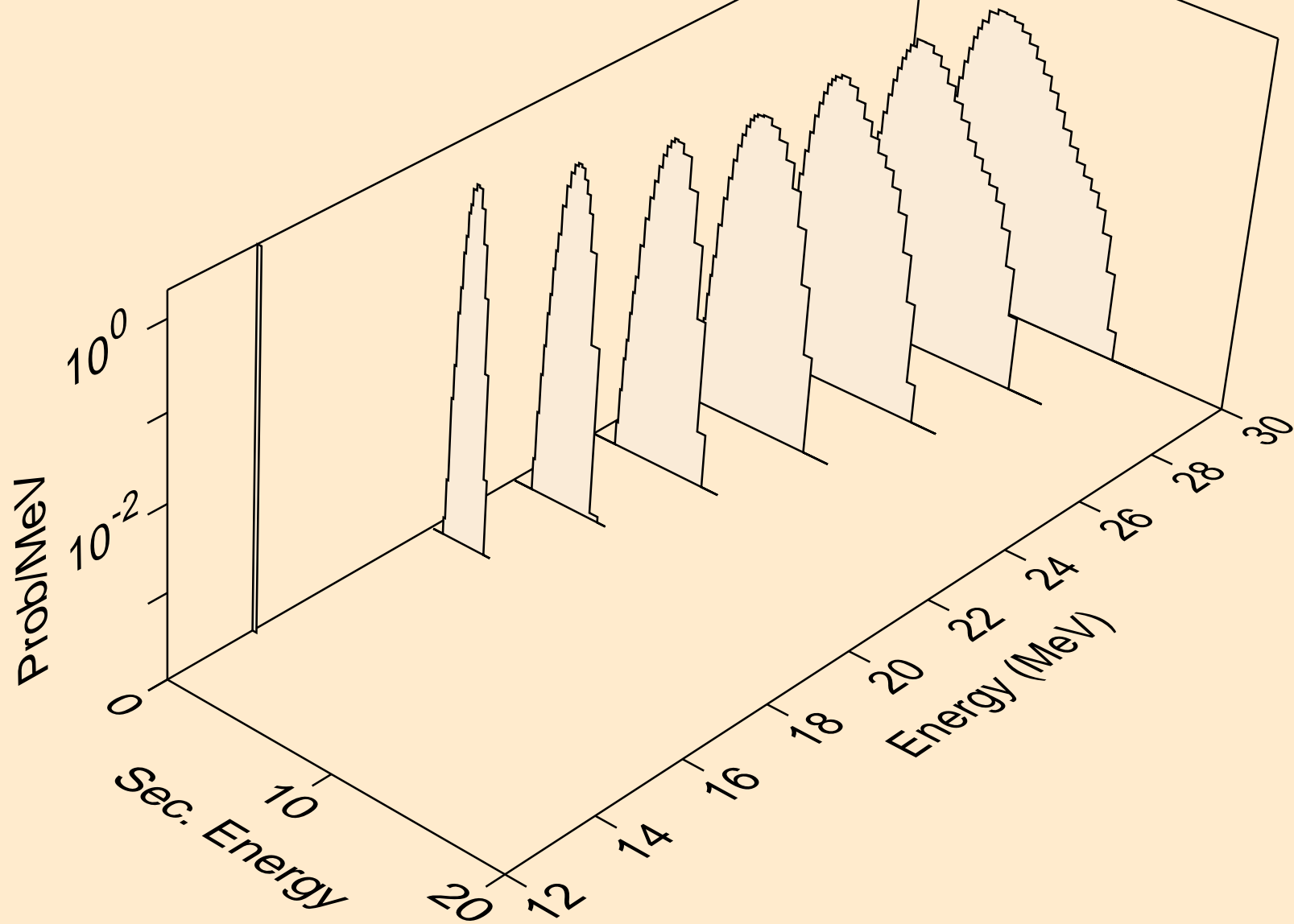

SR088 NEUTRON ACER TENDL-2021 LIBRARY; T=293.6K
protons from (n,p)

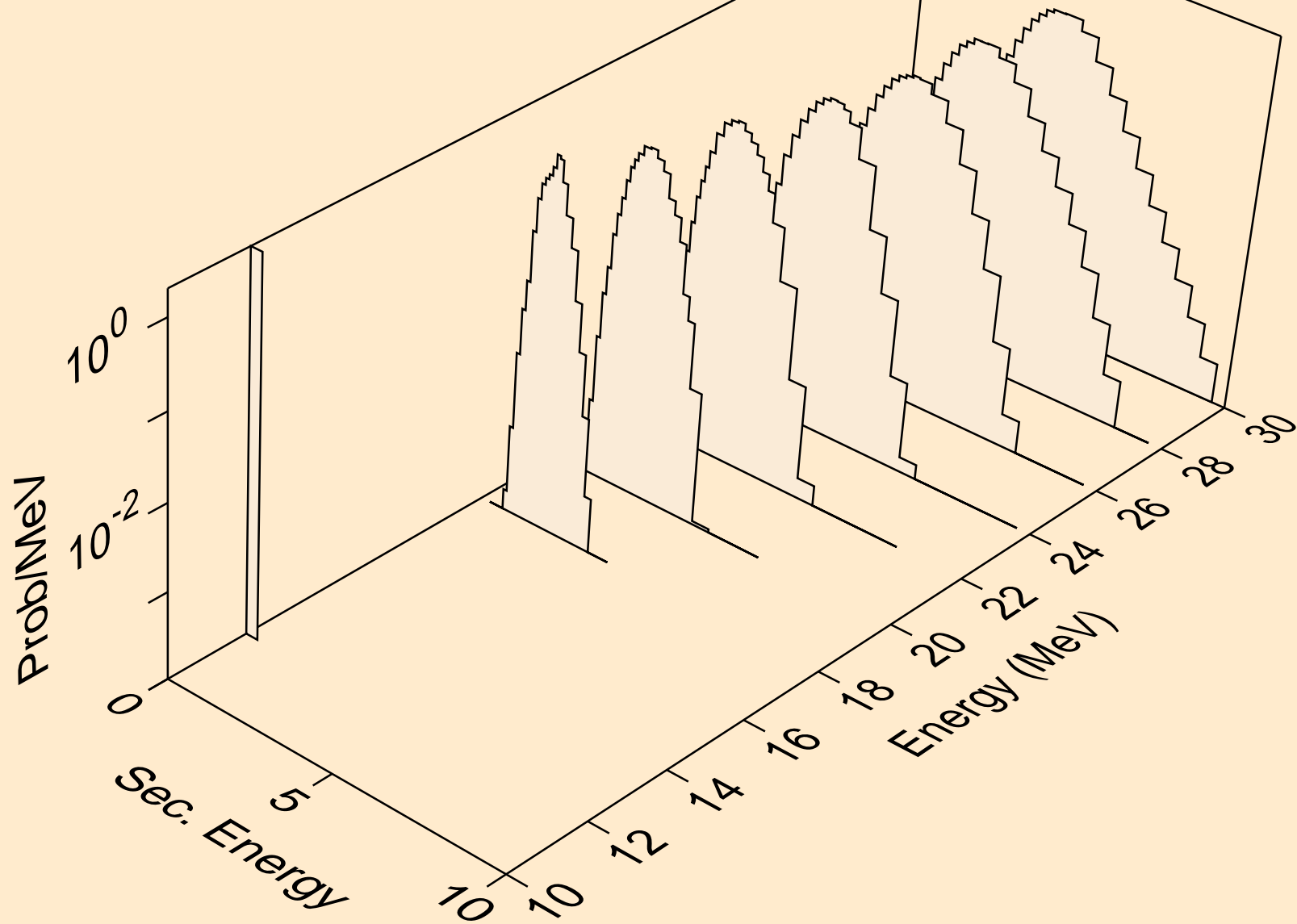

SR088 NEUTRON ACER TENDL-2021 LIBRARY; T=293.6K
protons from (n,pd)

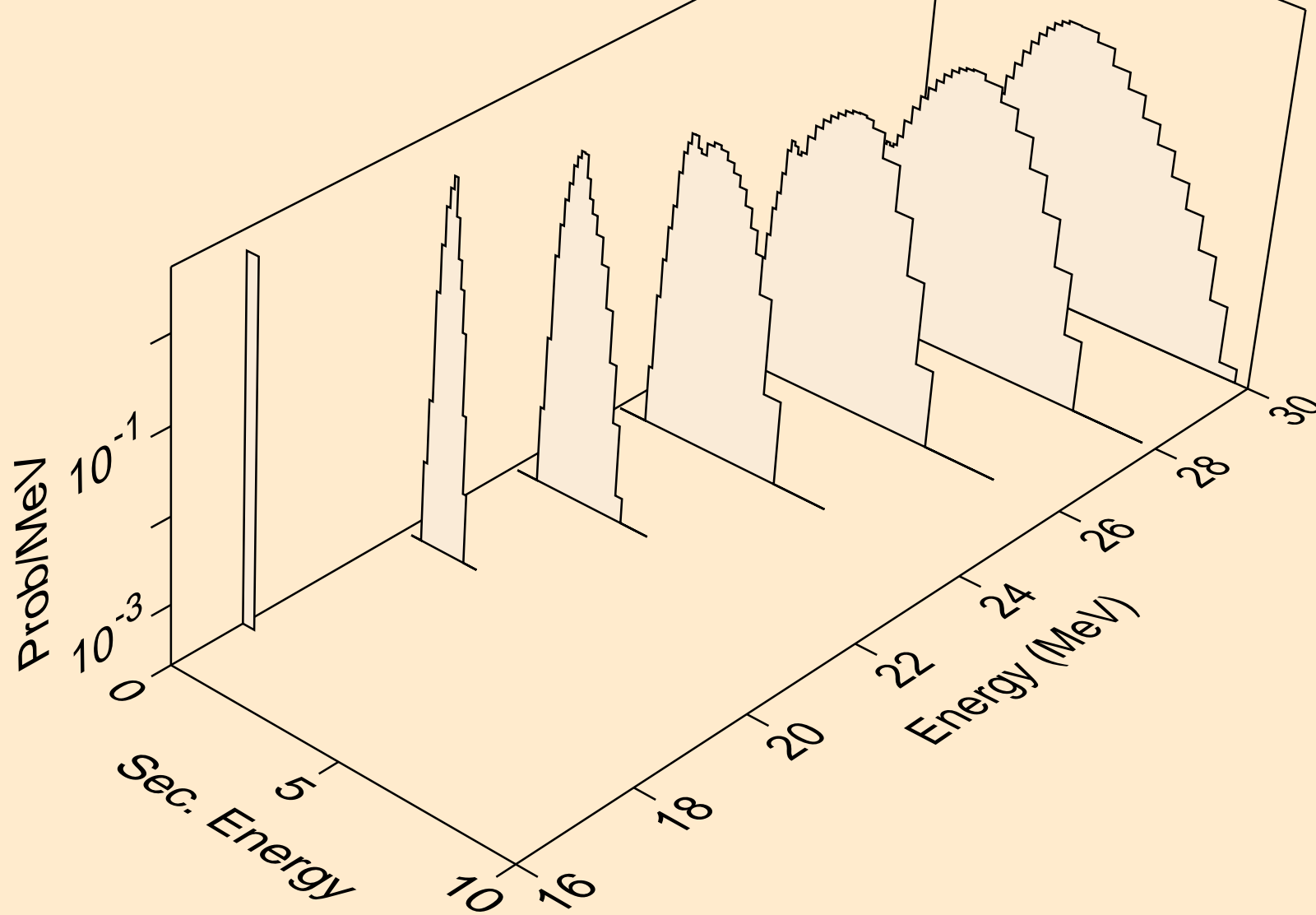

SR088 NEUTRON ACER TENDL-2021 LIBRARY; T=293.6K
protons from (n,pt)

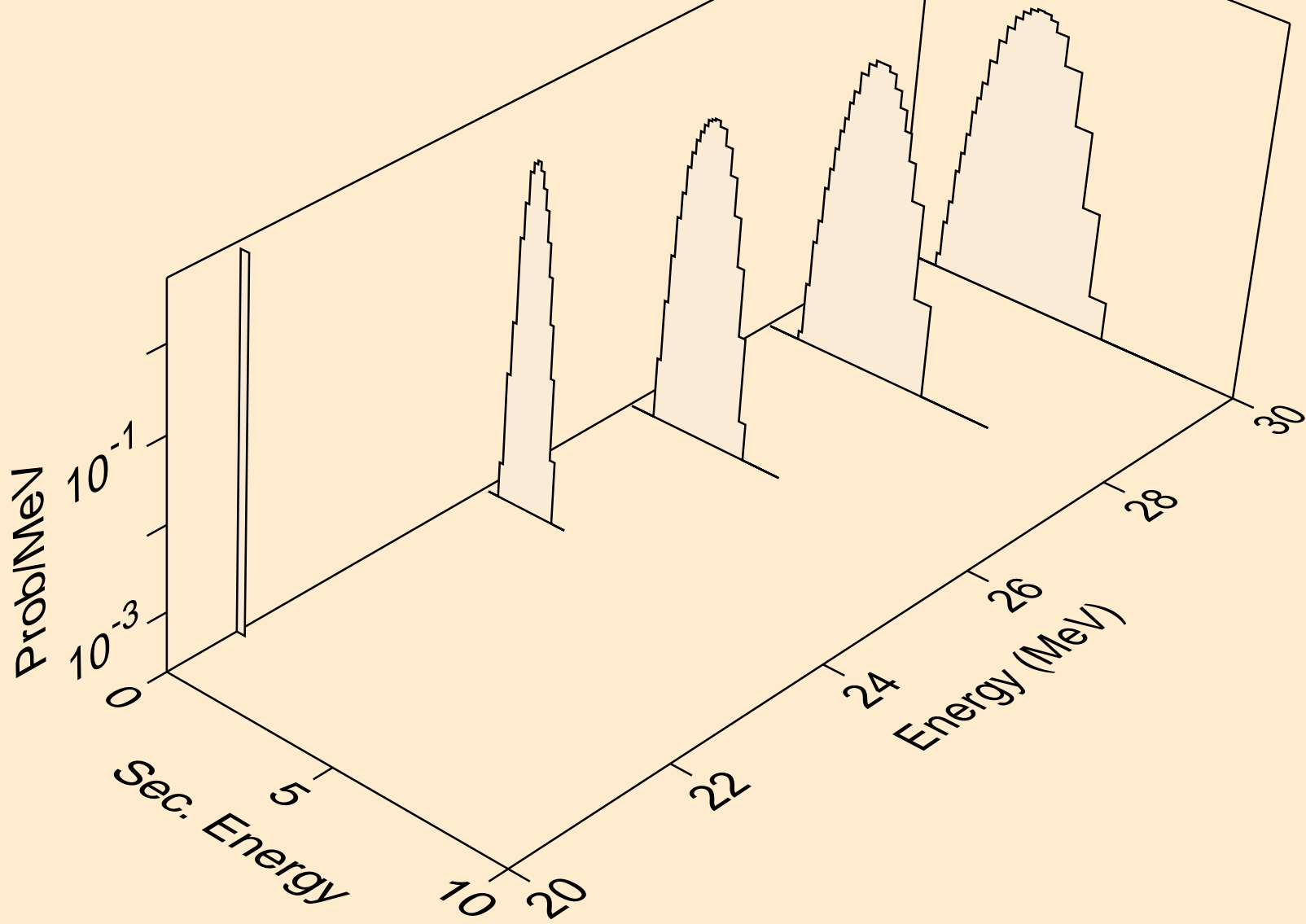

SR088 NEUTRON ACER TENDL-2021 LIBRARY; T=293.6K
deuterons from (n,x)

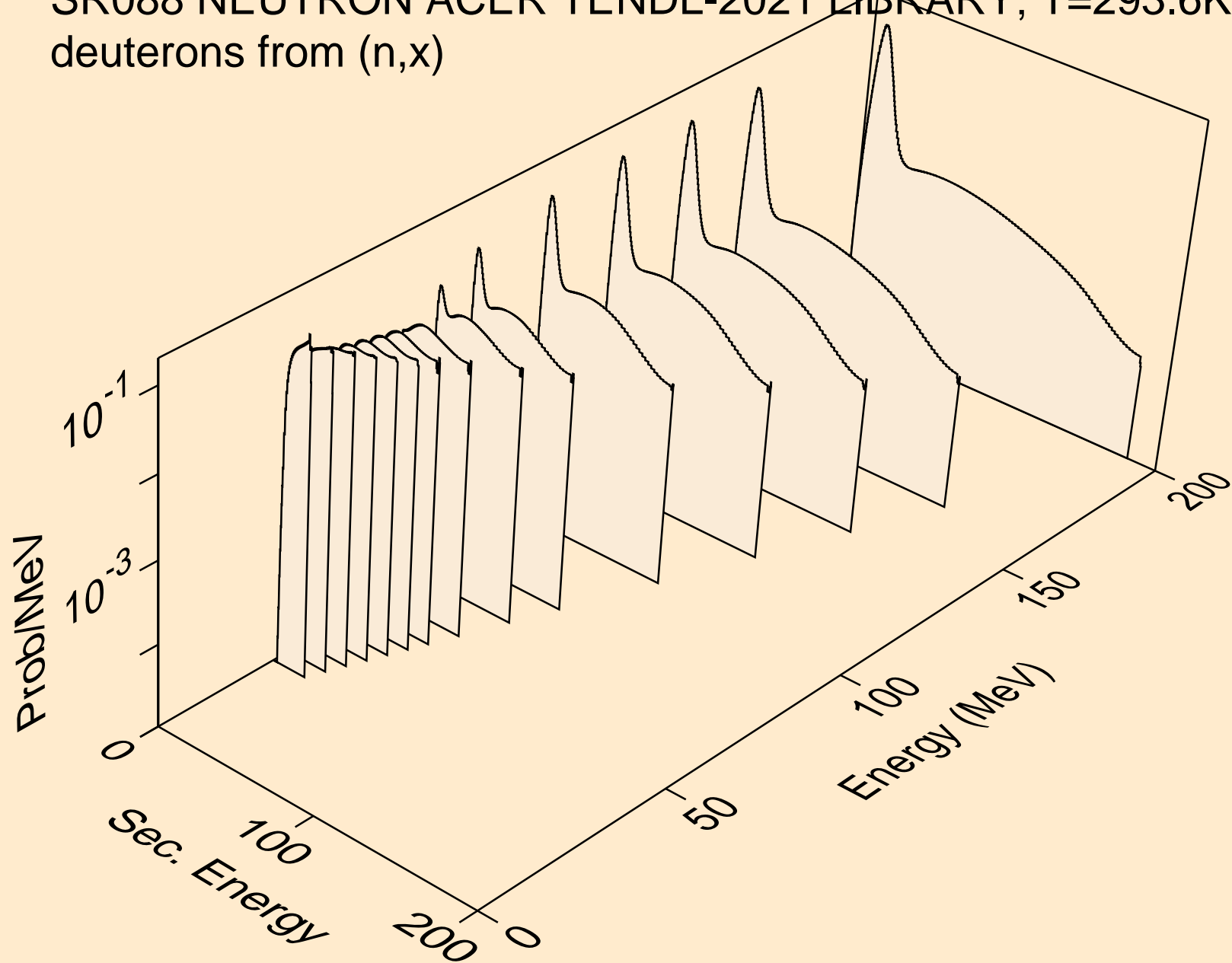

SR088 NEUTRON ACER TENDL-2021 LIBRARY; T=293.6K
deuterons from (n,2nd)

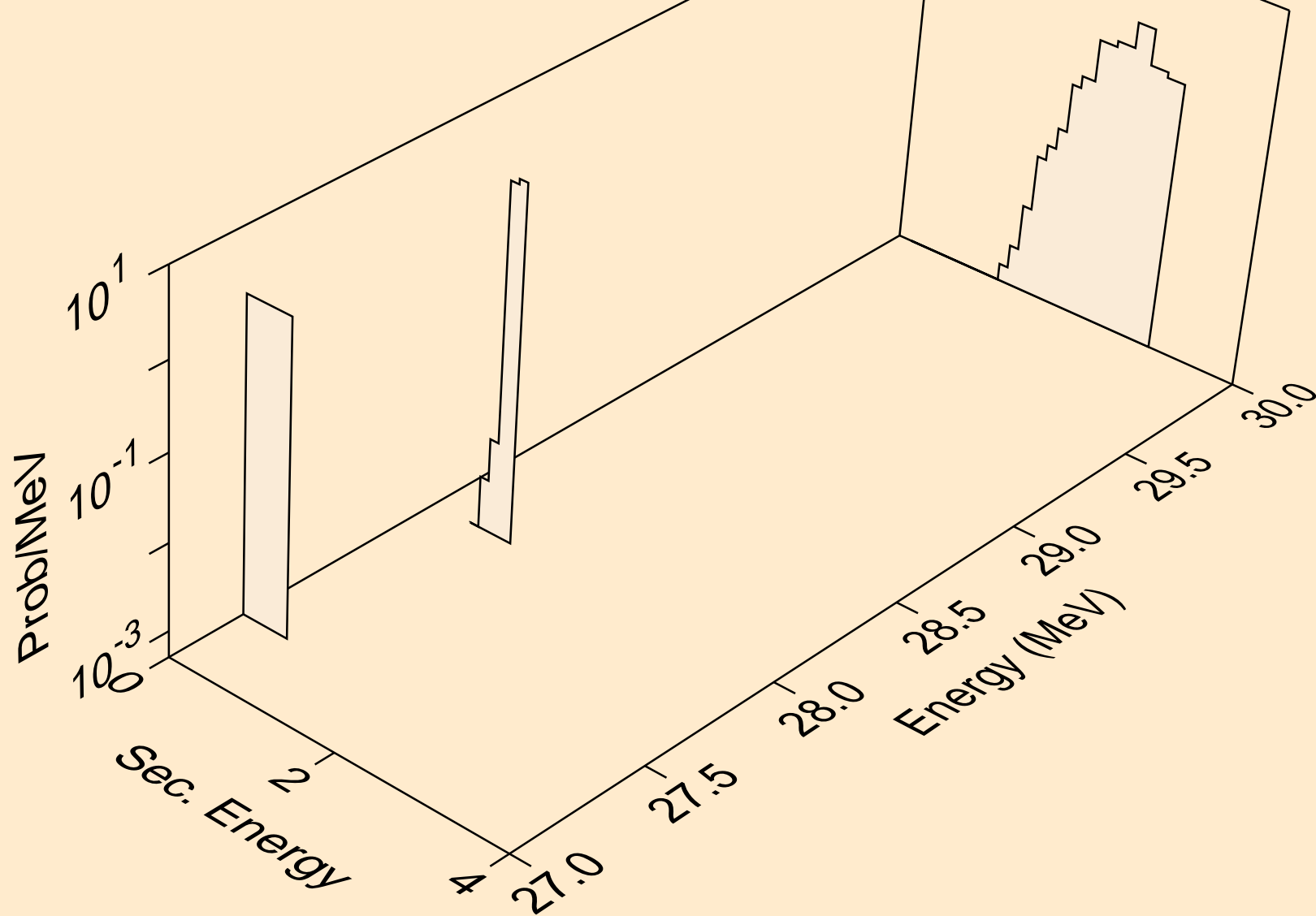

SR088 NEUTRON ACER TENDL-2021 LIBRARY; T=293.6K
deuterons from (n,n*)d

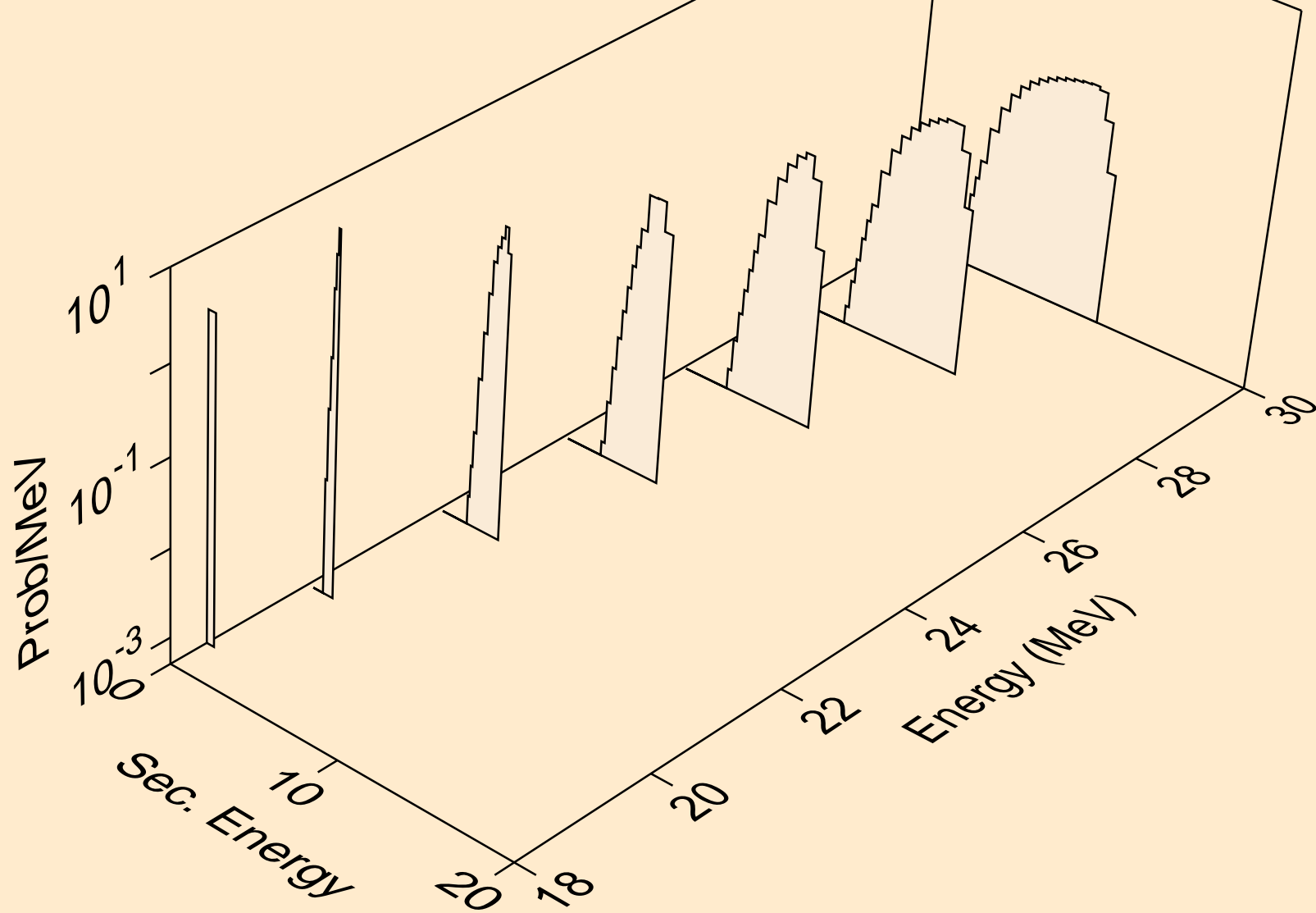

SR088 NEUTRON ACER TENDL-2021 LIBRARY; T=293.6K
deuterons from (n,d)

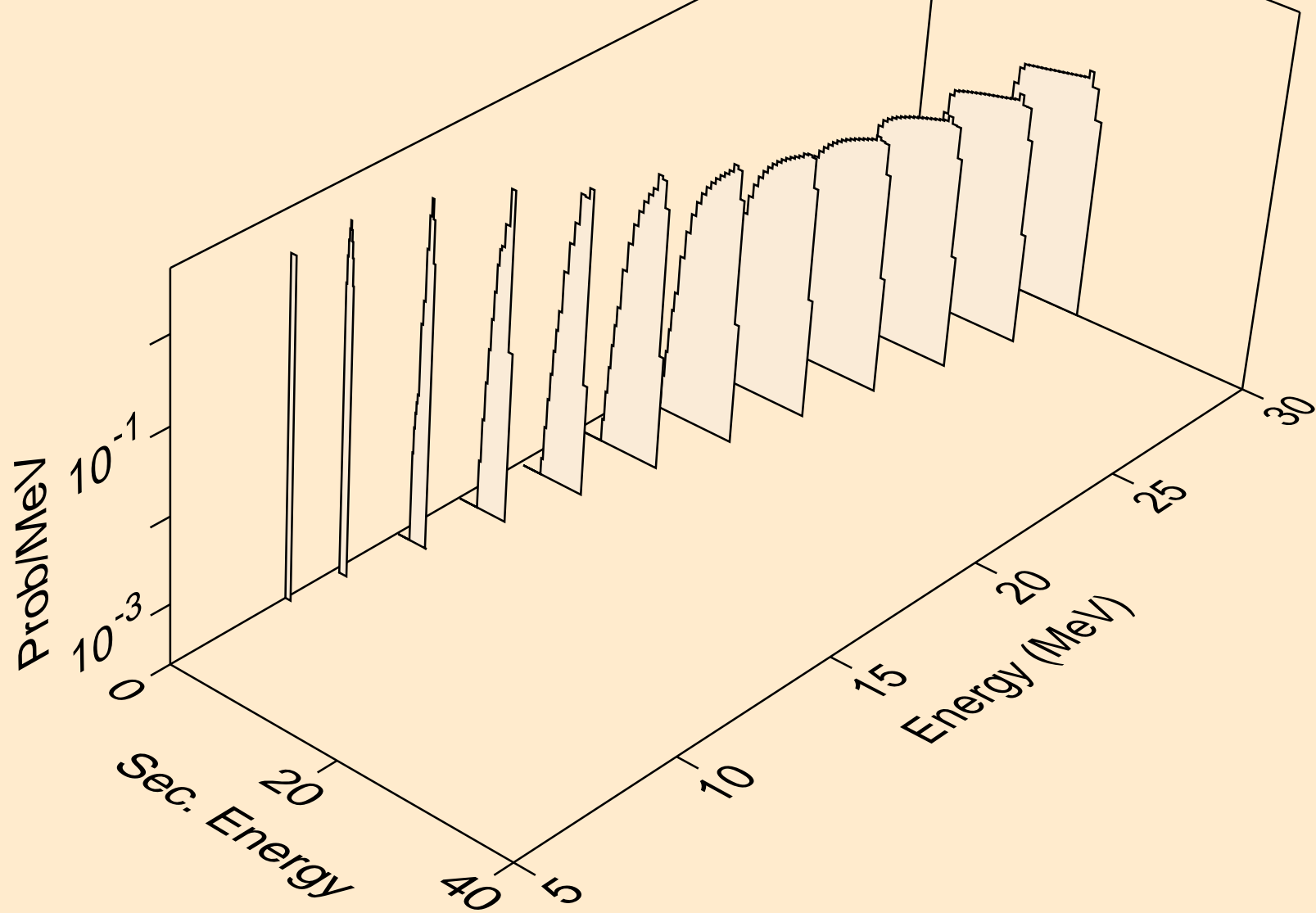

SR088 NEUTRON ACER TENDL-2021 LIBRARY; T=293.6K
deuterons from (n,pd)

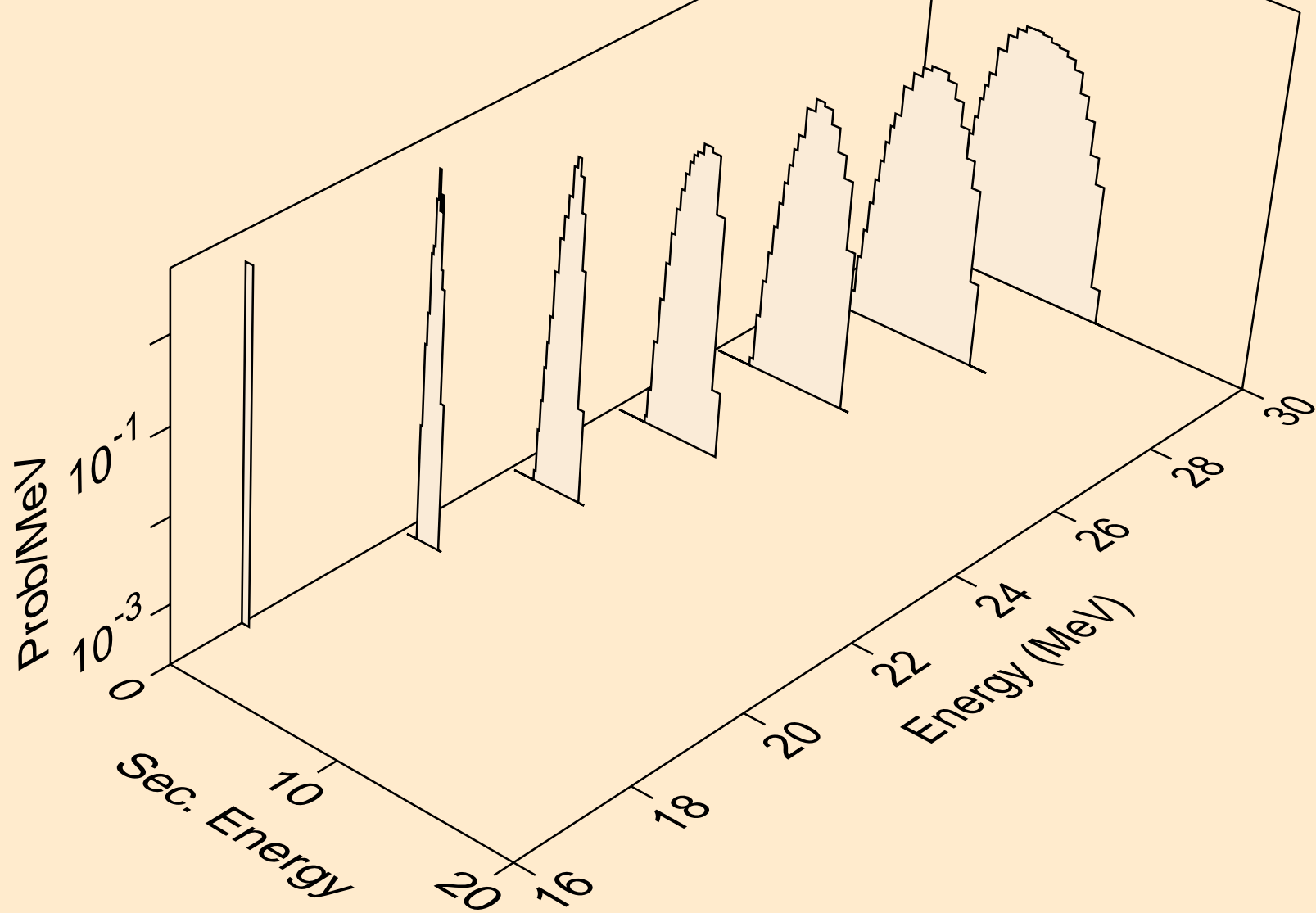

SR088 NEUTRON ACER TENDL-2021 LIBRARY; T=293.6K
deuterons from (n,da)

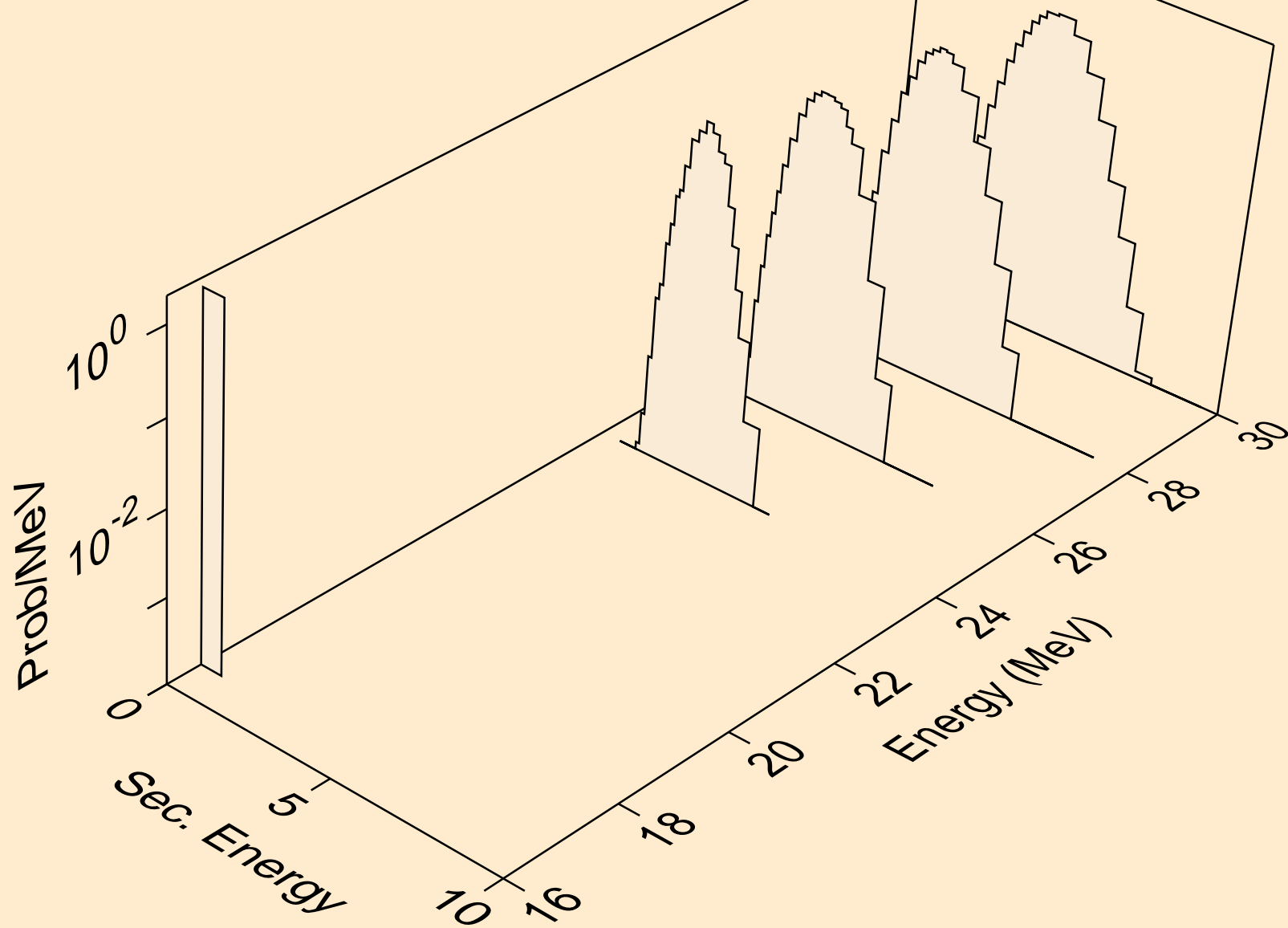

SR088 NEUTRON ACER TENDL-2021 LIBRARY; T=293.6K
tritons from (n,x)

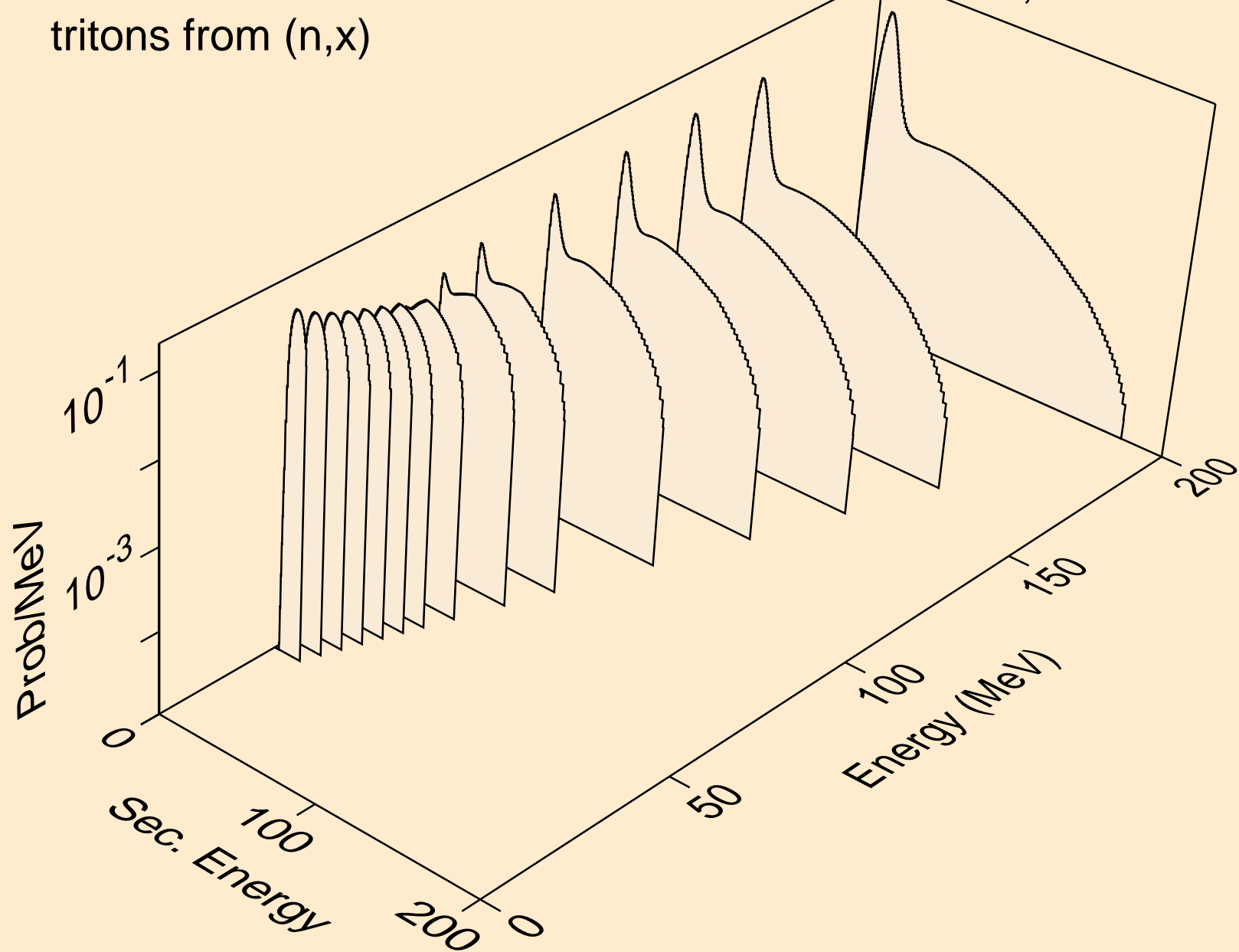

SR088 NEUTRON ACER TENDL-2021 LIBRARY; T=293.6K
tritons from (n,n*)t

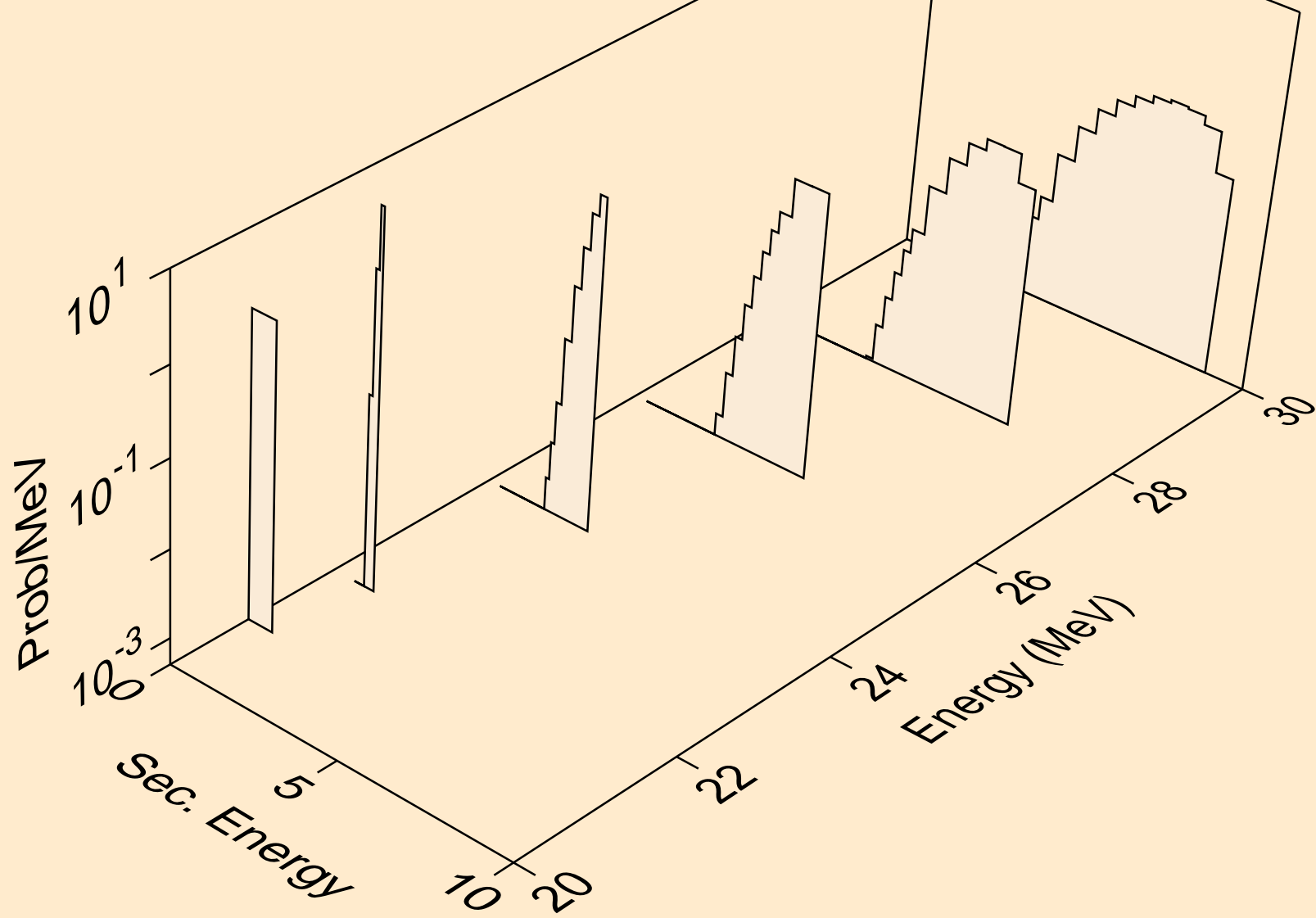

SR088 NEUTRON ACER TENDL-2021 LIBRARY; T=293.6K
tritons from (n,t)

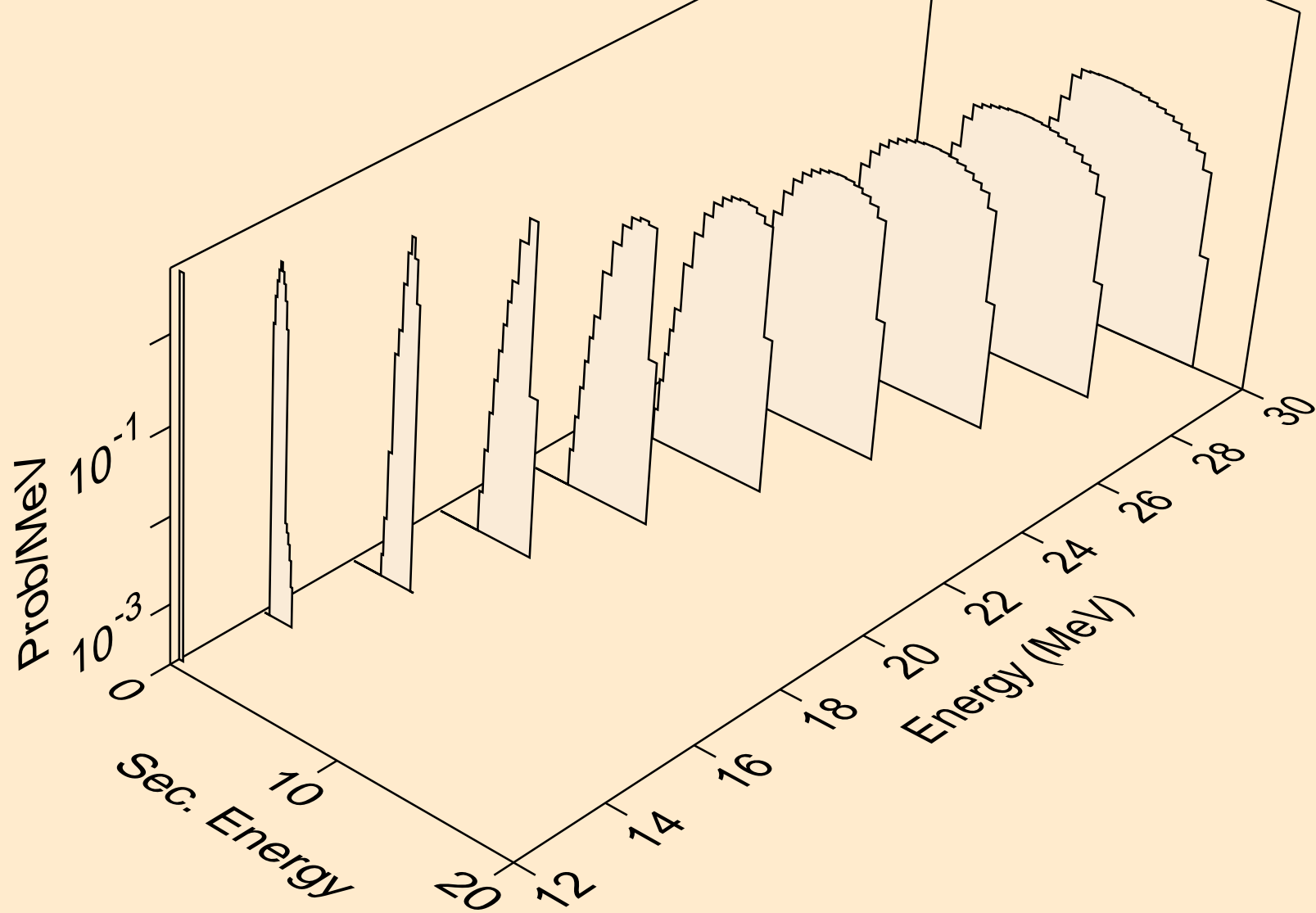

SR088 NEUTRON ACER TENDL-2021 LIBRARY; T=293.6K
tritons from (n,pt)

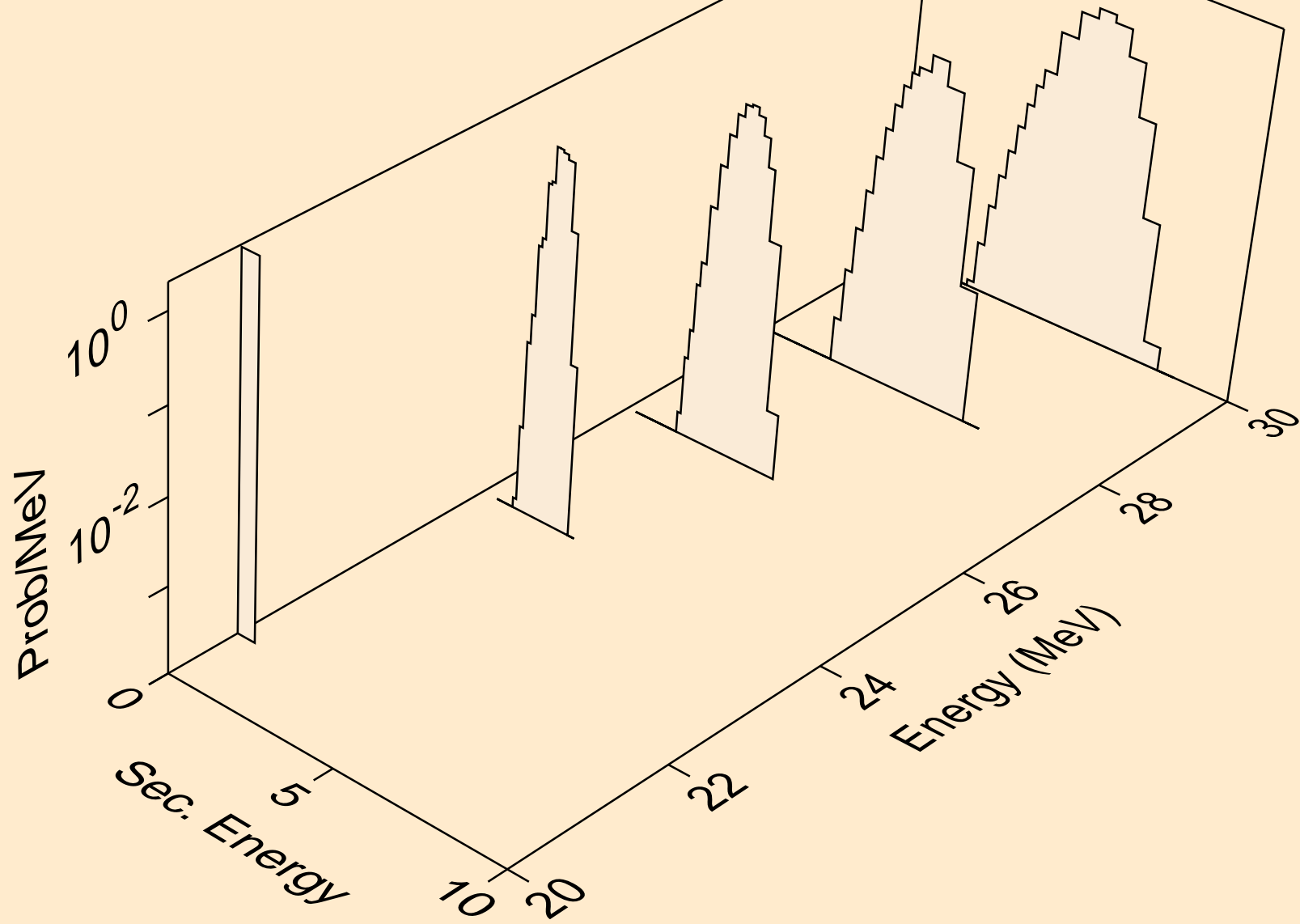

SR088 NEUTRON ACER TENDL-2021 LIBRARY; T=293.6K
he3s from (n,x)

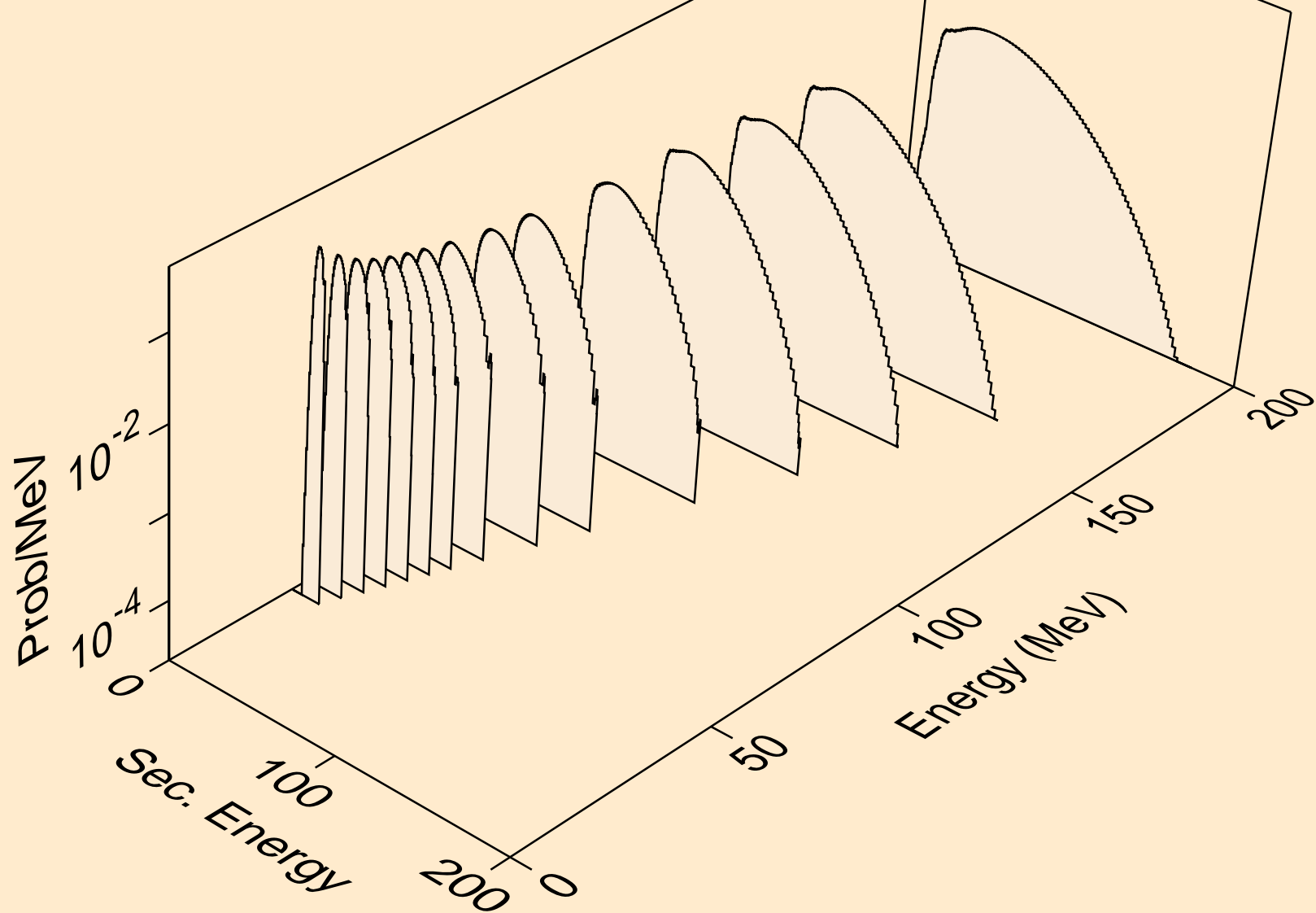

SR088 NEUTRON ACER TENDL-2021 LIBRARY; T=293.6K
he3s from (n,n*)he3

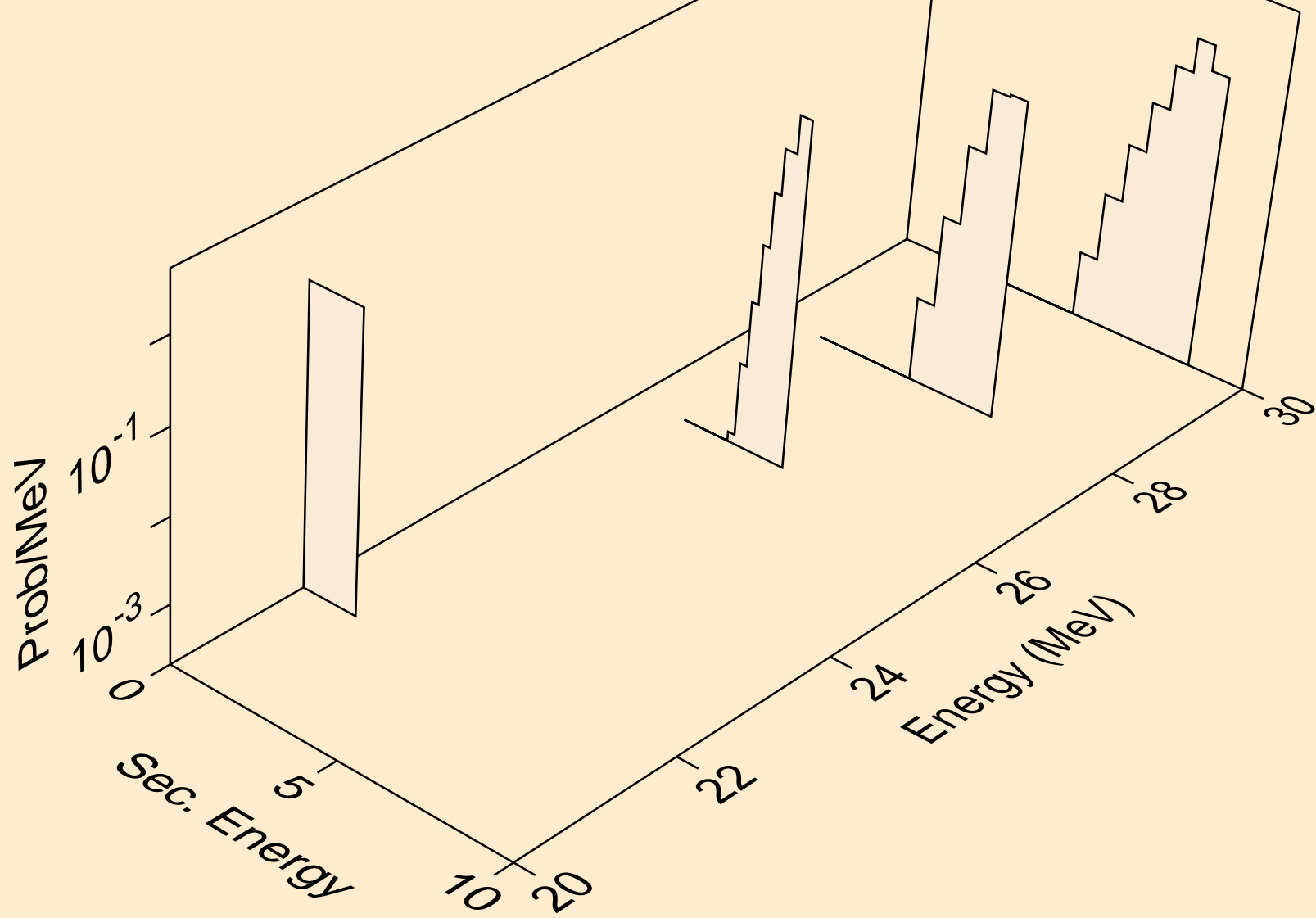

SR088 NEUTRON ACER TENDL-2021 LIBRARY; T=293.6K
he3s from (n,he3)

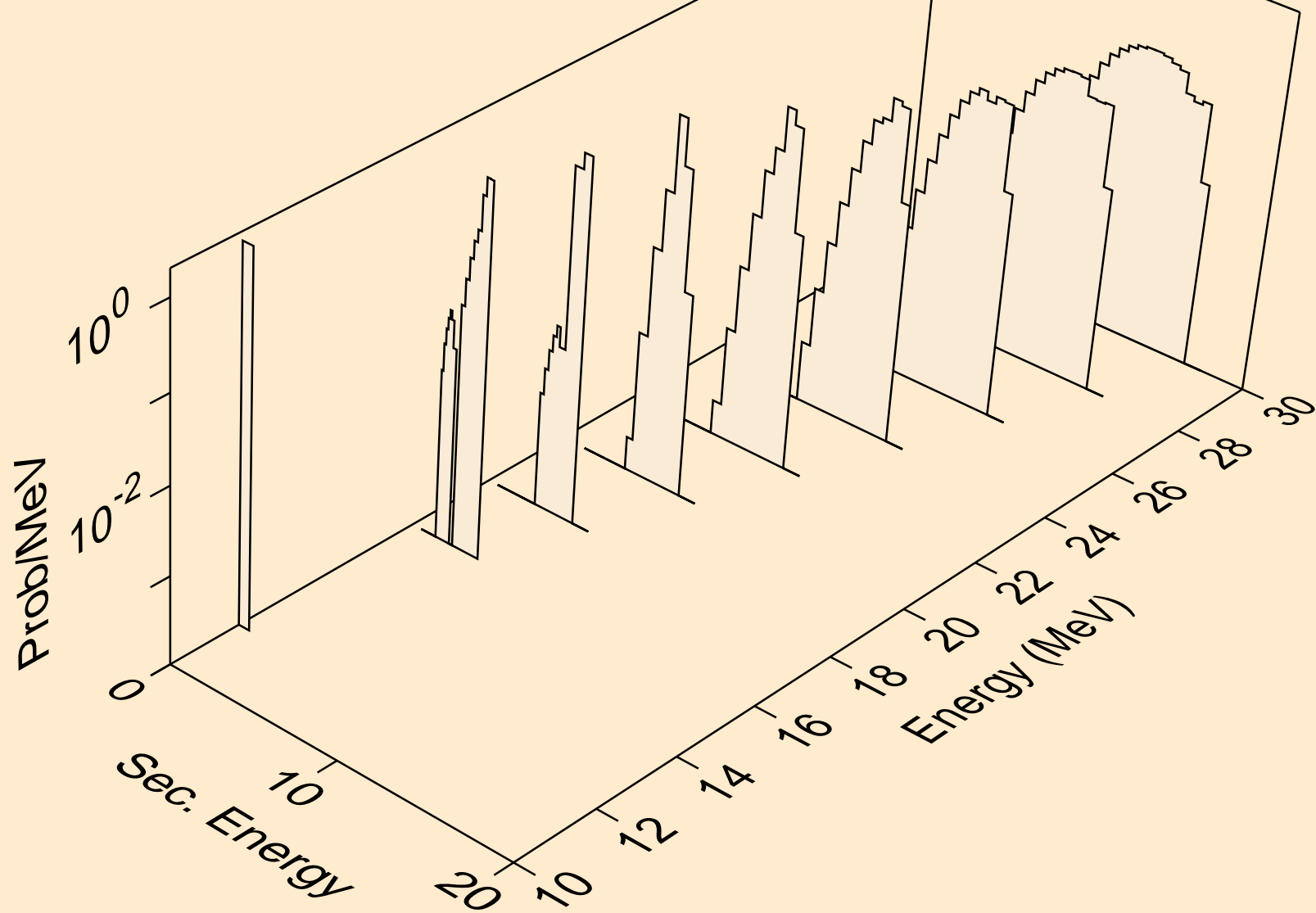

SR088 NEUTRON ACER TENDL-2021 LIBRARY; T=293.6K
alphas from (n,x)

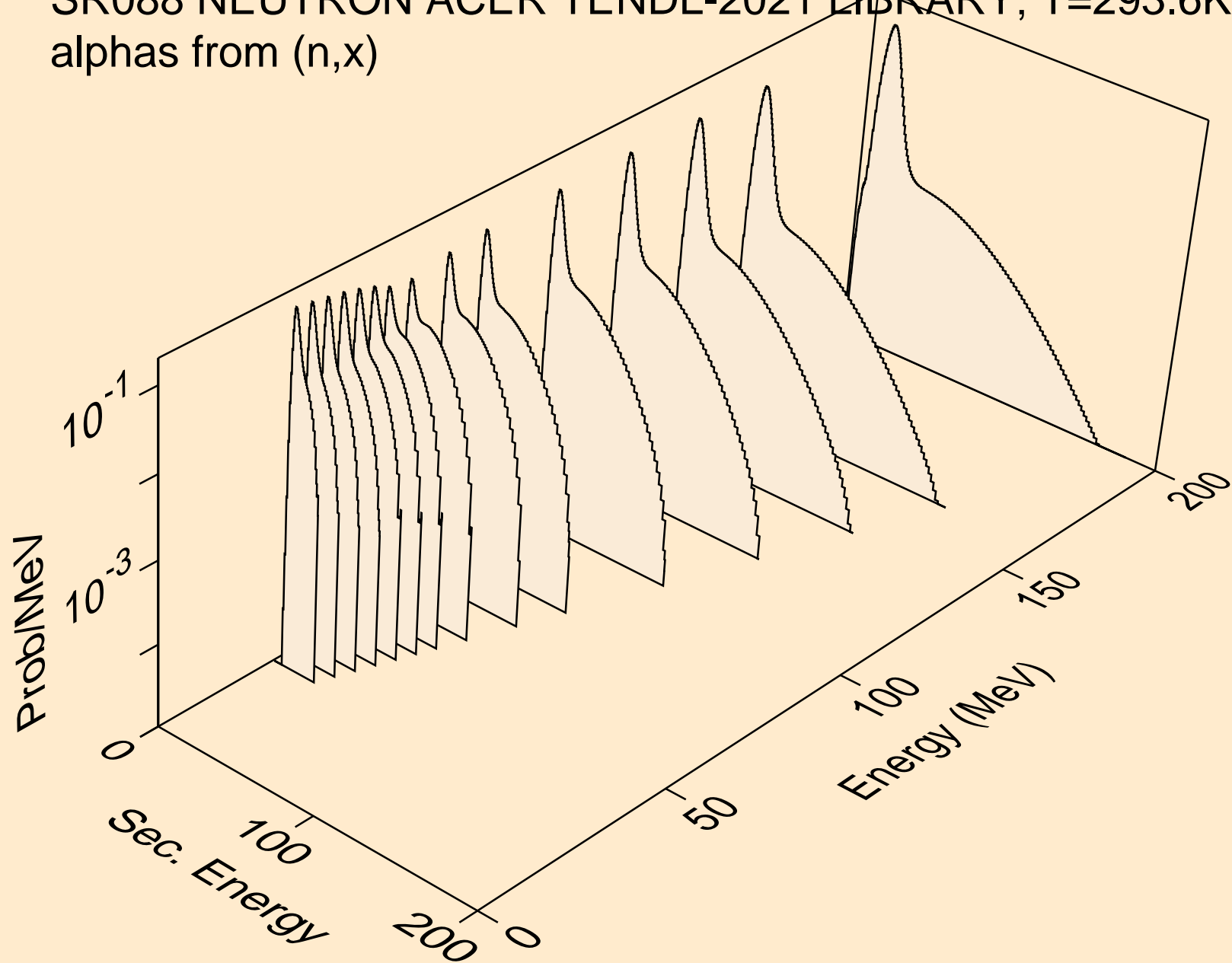

SR088 NEUTRON ACER TENDL-2021 LIBRARY; T=293.6K
alphas from (n,n*)a

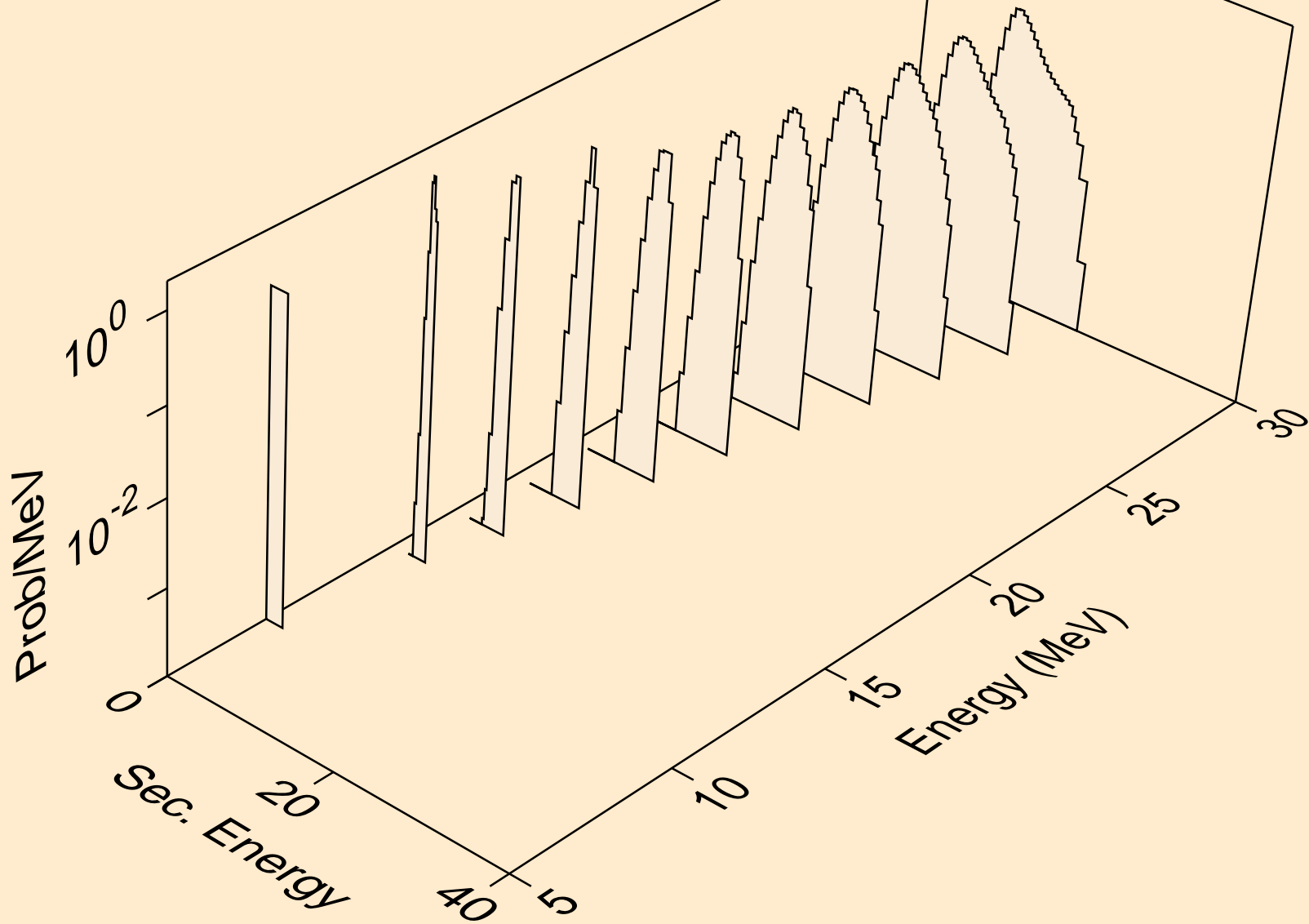

SR088 NEUTRON ACER TENDL-2021 LIBRARY; T=293.6K
alphas from (n,2n)a

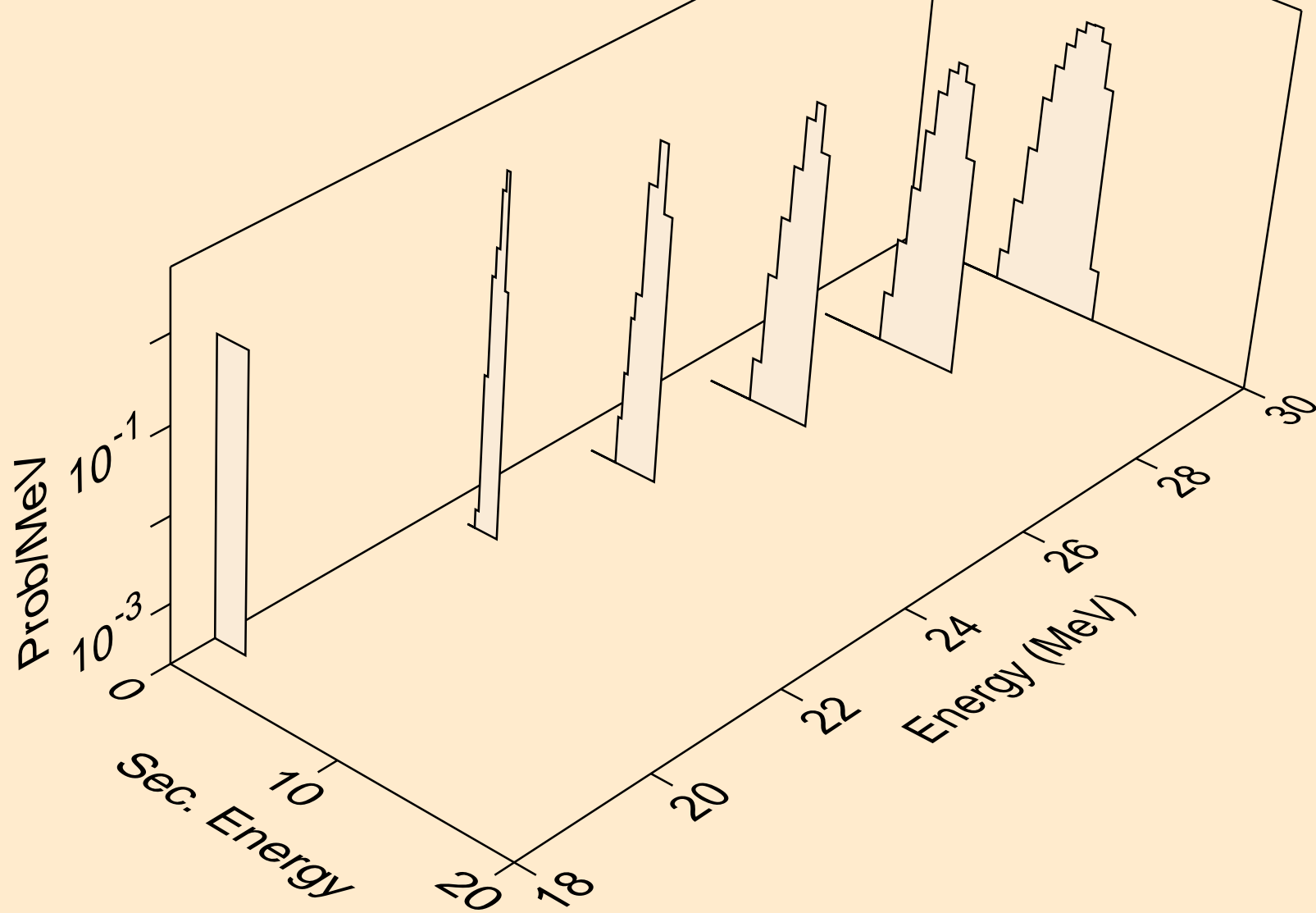

SR088 NEUTRON ACER TENDL-2021 LIBRARY; T=293.6K
alphas from (n,npa)

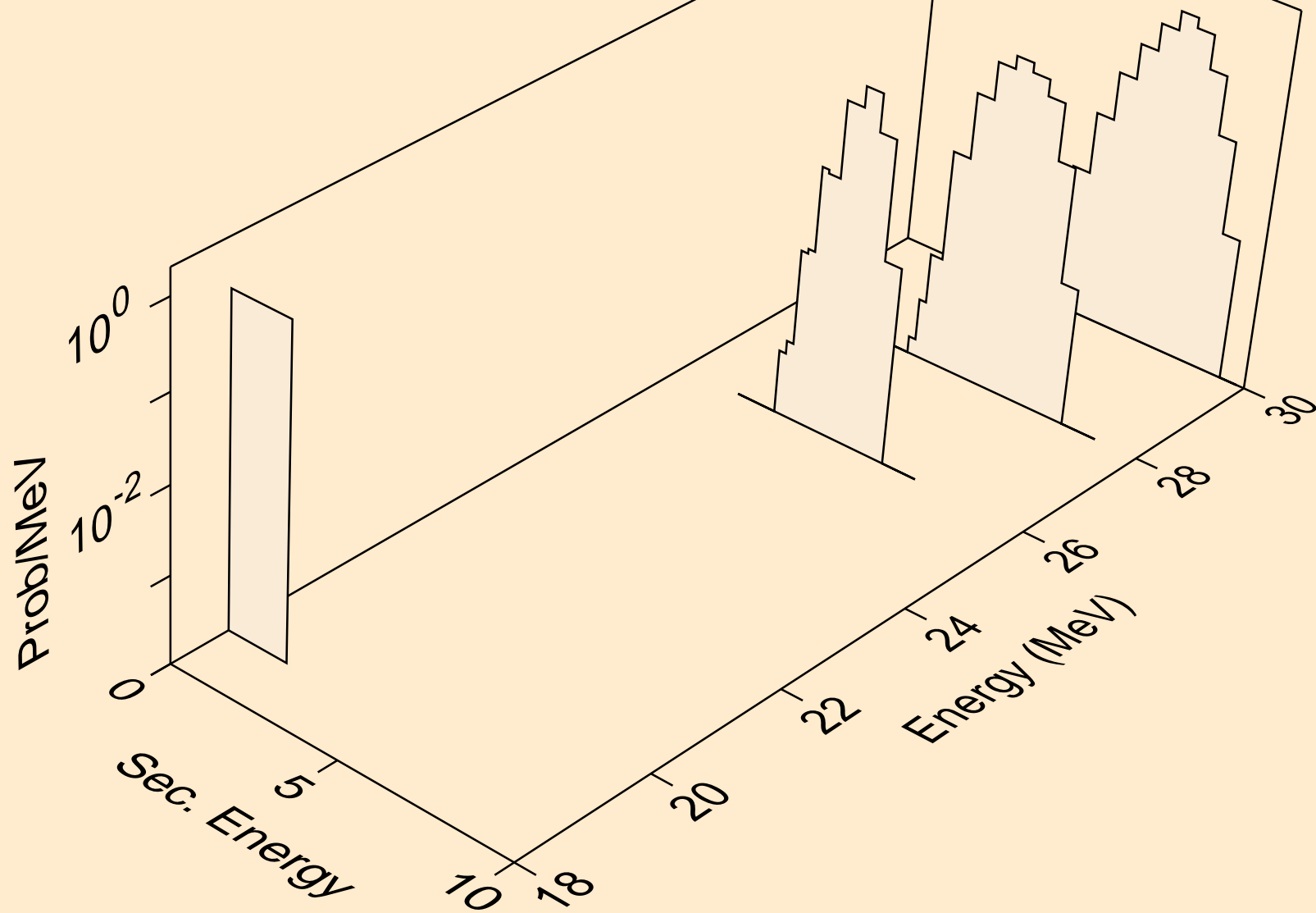

SR088 NEUTRON ACER TENDL-2021 LIBRARY; T=293.6K
alphas from (n,a)

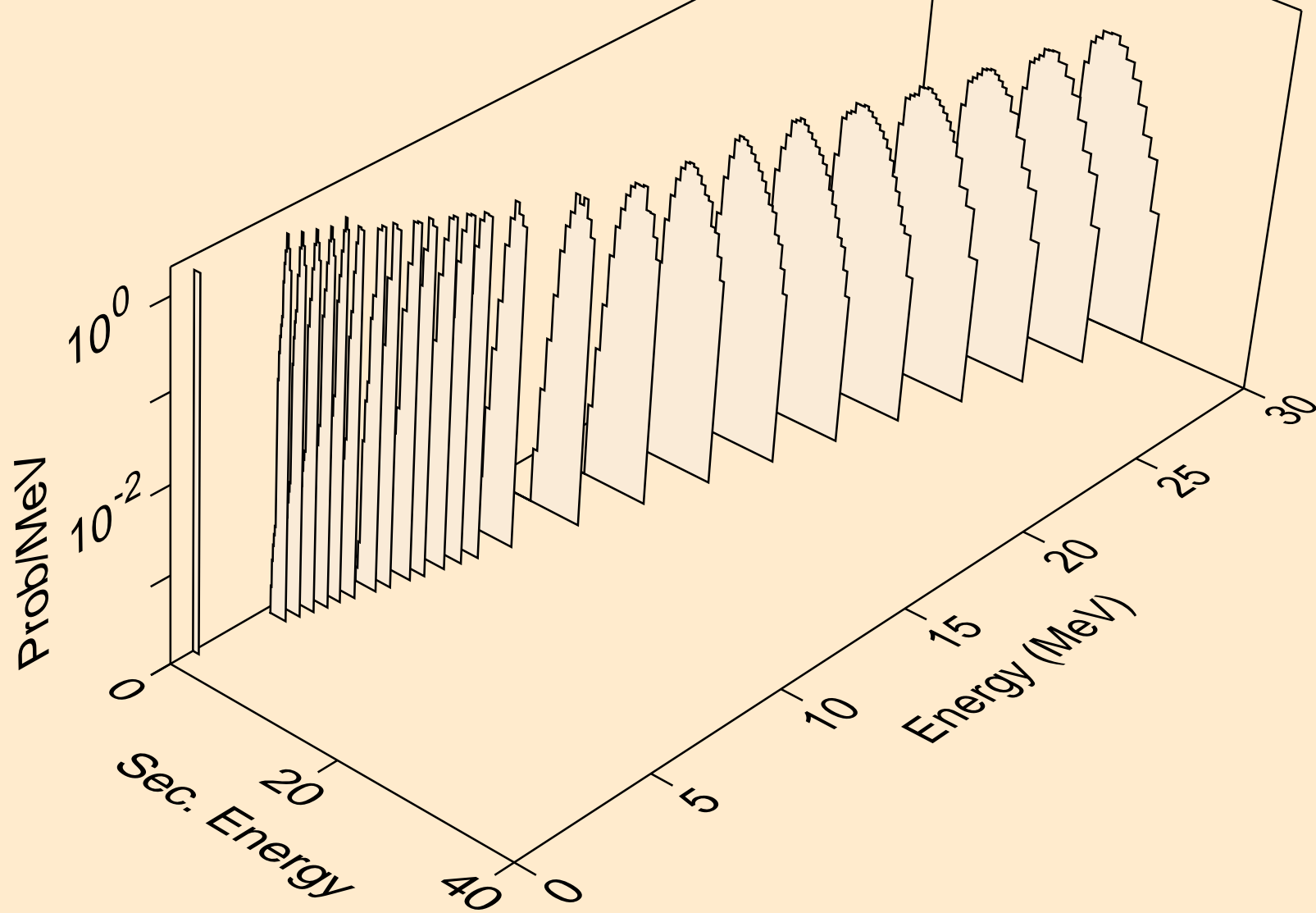

SR088 NEUTRON ACER TENDL-2021 LIBRARY; T=293.6K
alphas from (n,2a)

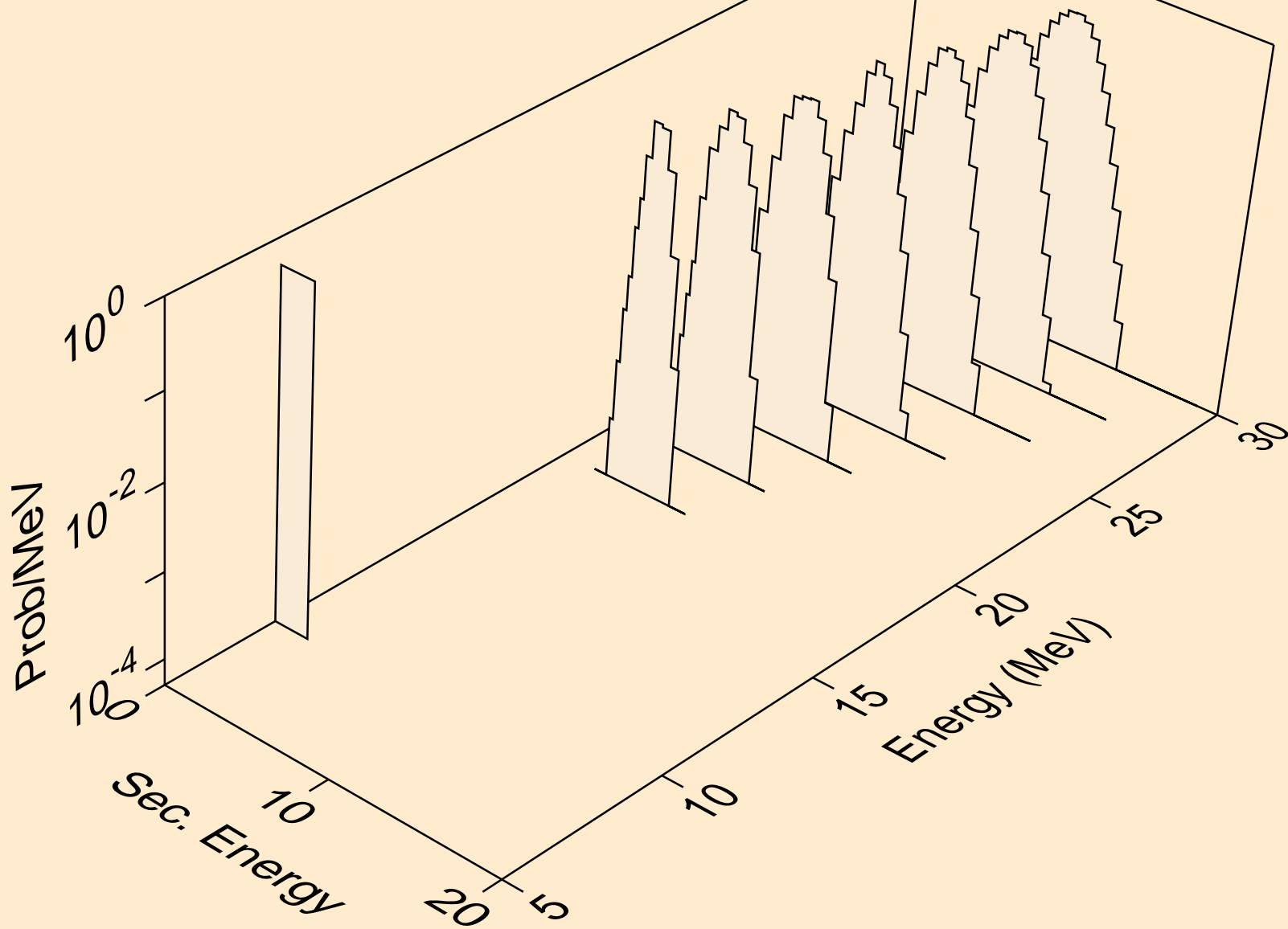

SR088 NEUTRON ACER TENDL-2021 LIBRARY; T=293.6K
alphas from (n,pa)

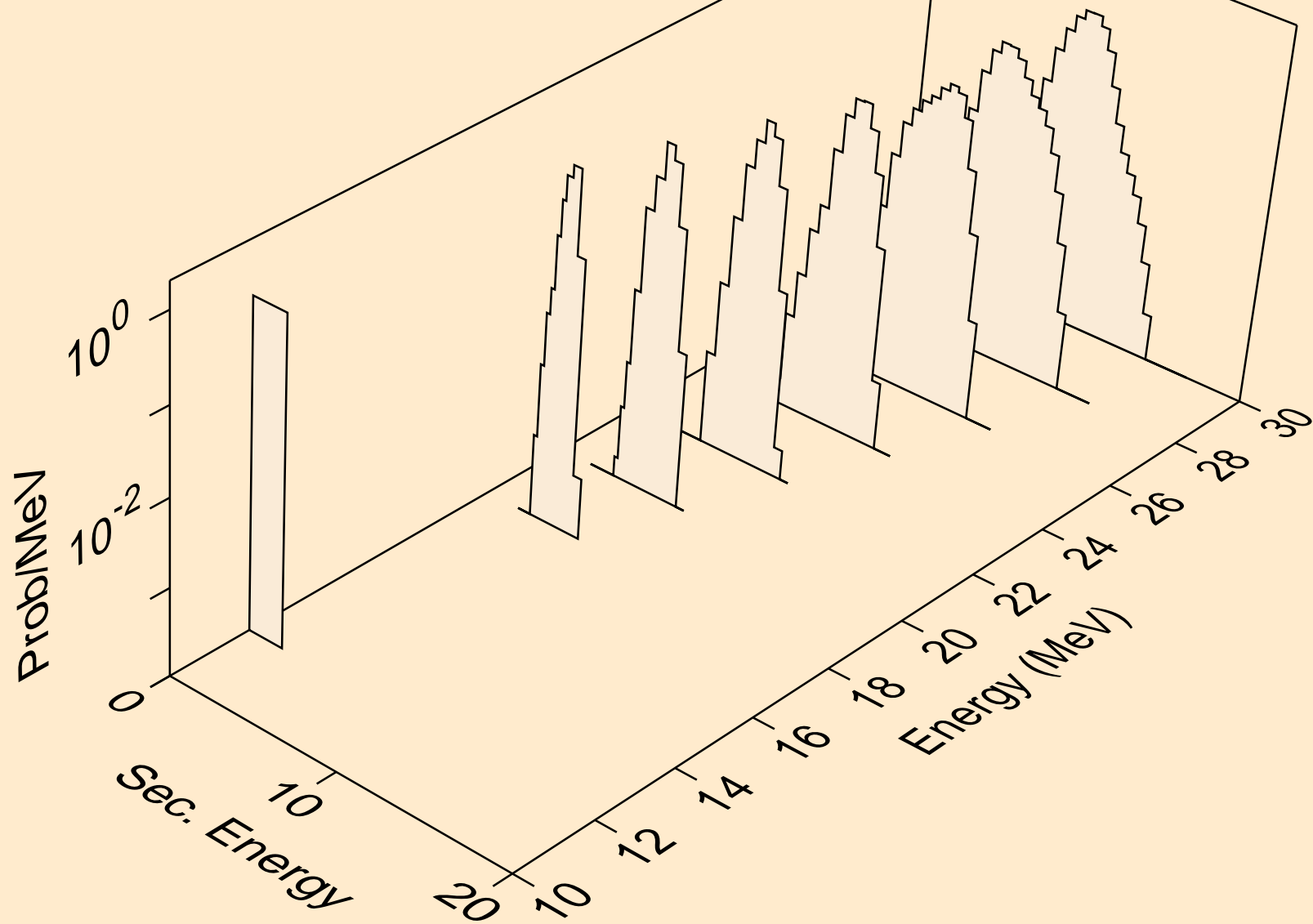

SR088 NEUTRON ACER TENDL-2021 LIBRARY; T=293.6K
alphas from (n,da)

