

TA159 NEUTRON ACER TENDL-2021 LIBRARY; T=293.6K  
Principal cross sections

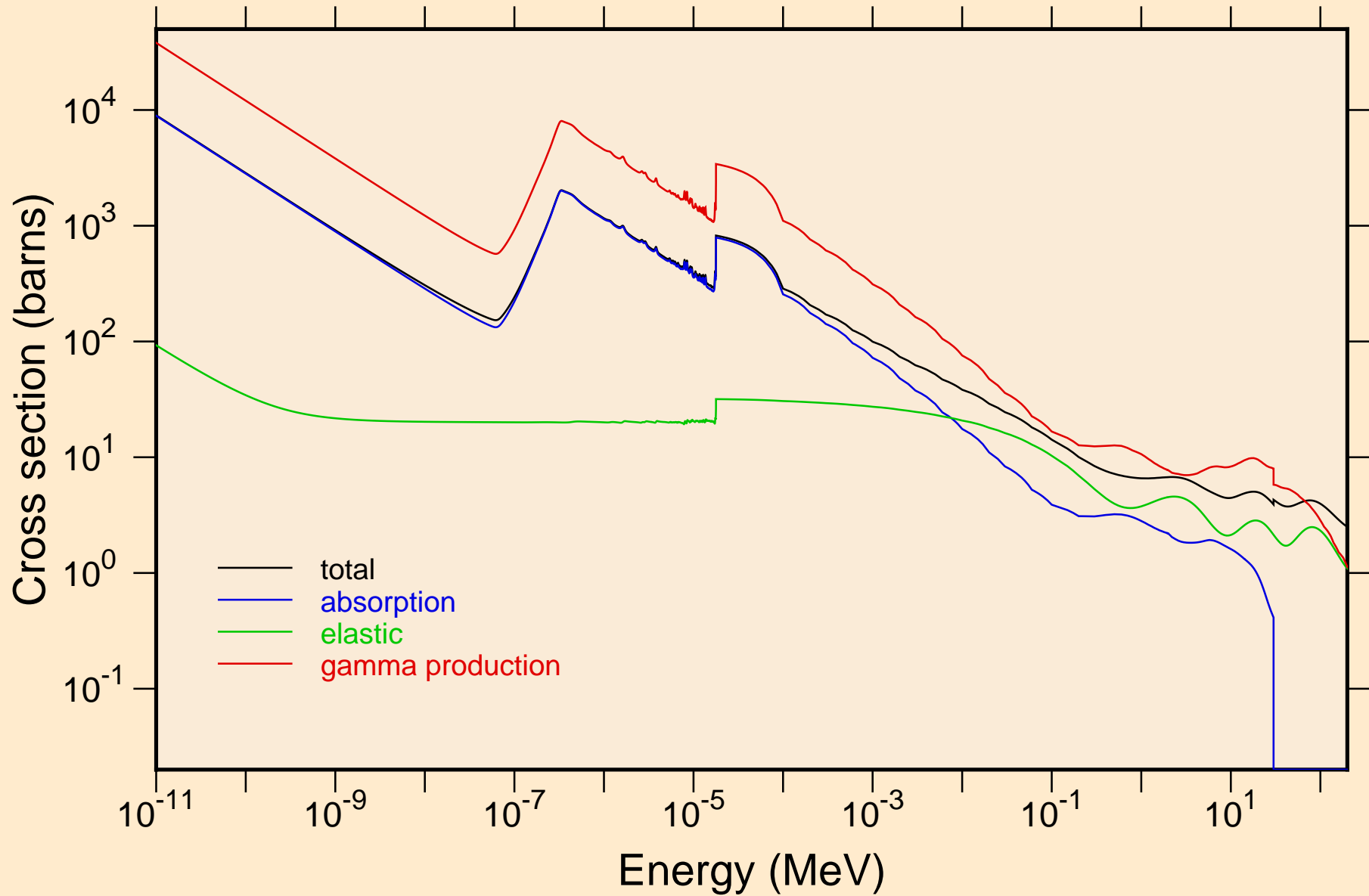

TA159 NEUTRON ACER TENDL-2021 LIBRARY; T=293.6K  
resonance total cross section

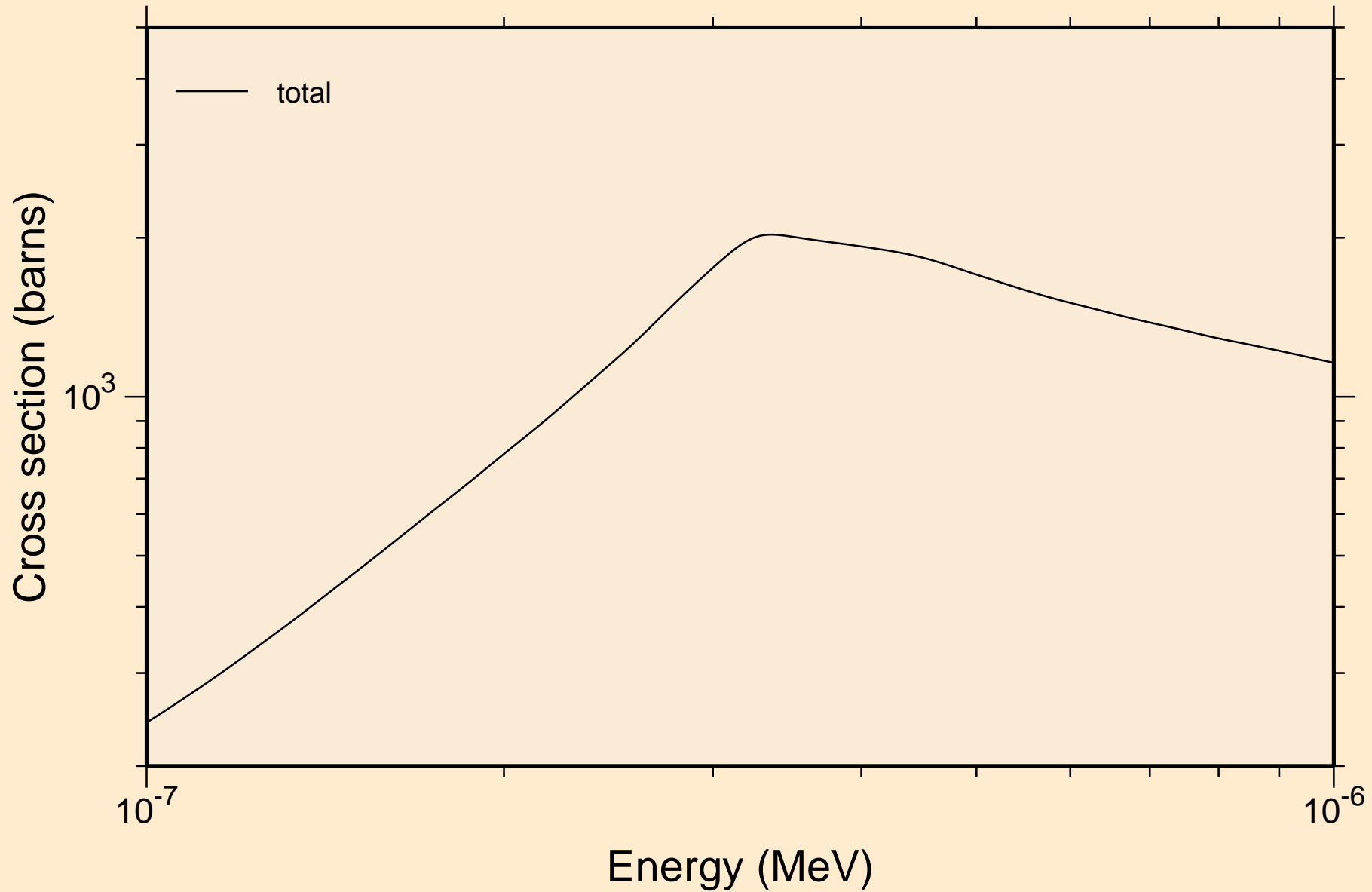

TA159 NEUTRON ACER TENDL-2021 LIBRARY; T=293.6K  
resonance total cross section

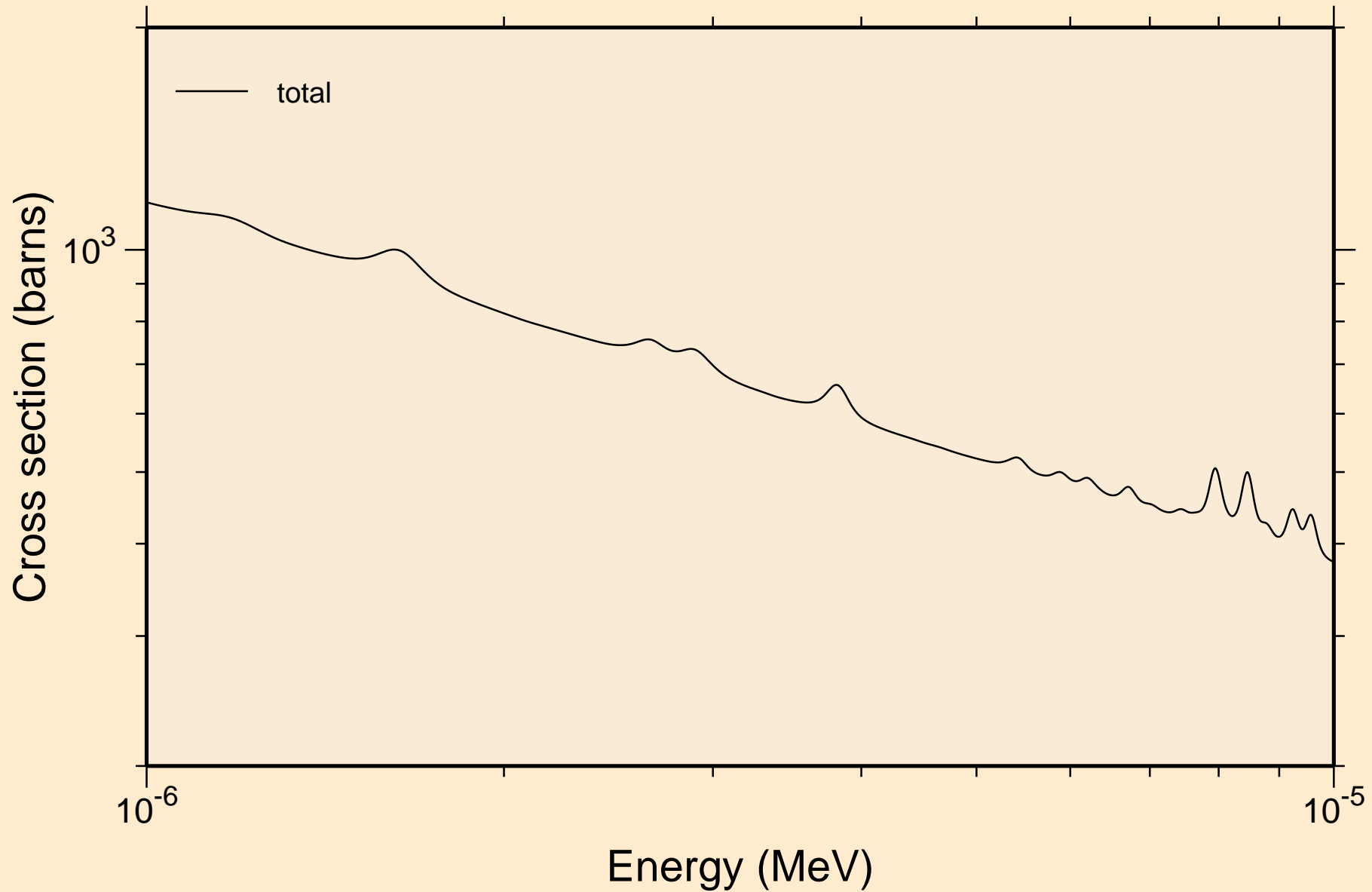

TA159 NEUTRON ACER TENDL-2021 LIBRARY; T=293.6K  
resonance total cross section

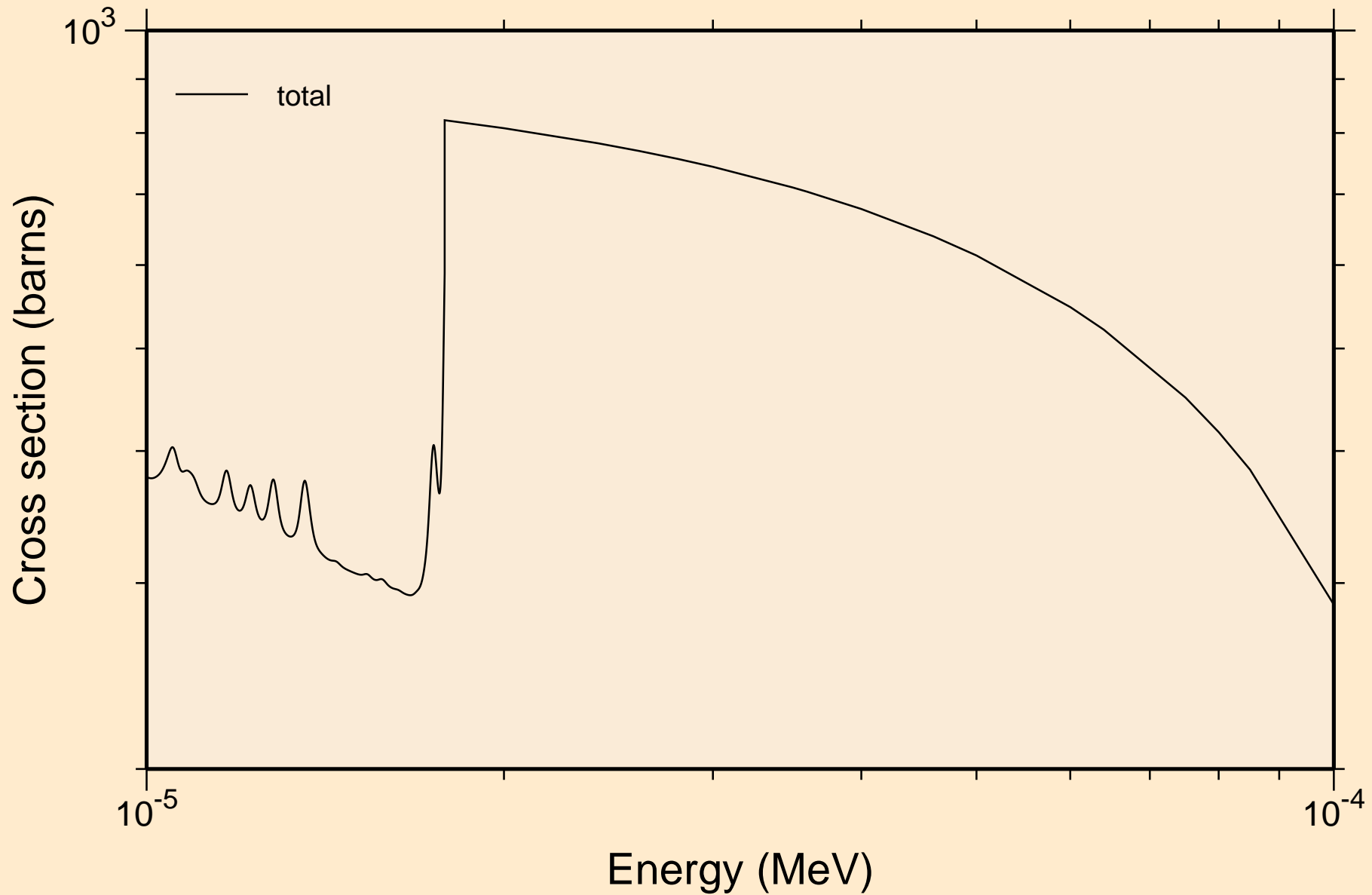

TA159 NEUTRON ACER TENDL-2021 LIBRARY; T=293.6K  
resonance total cross section

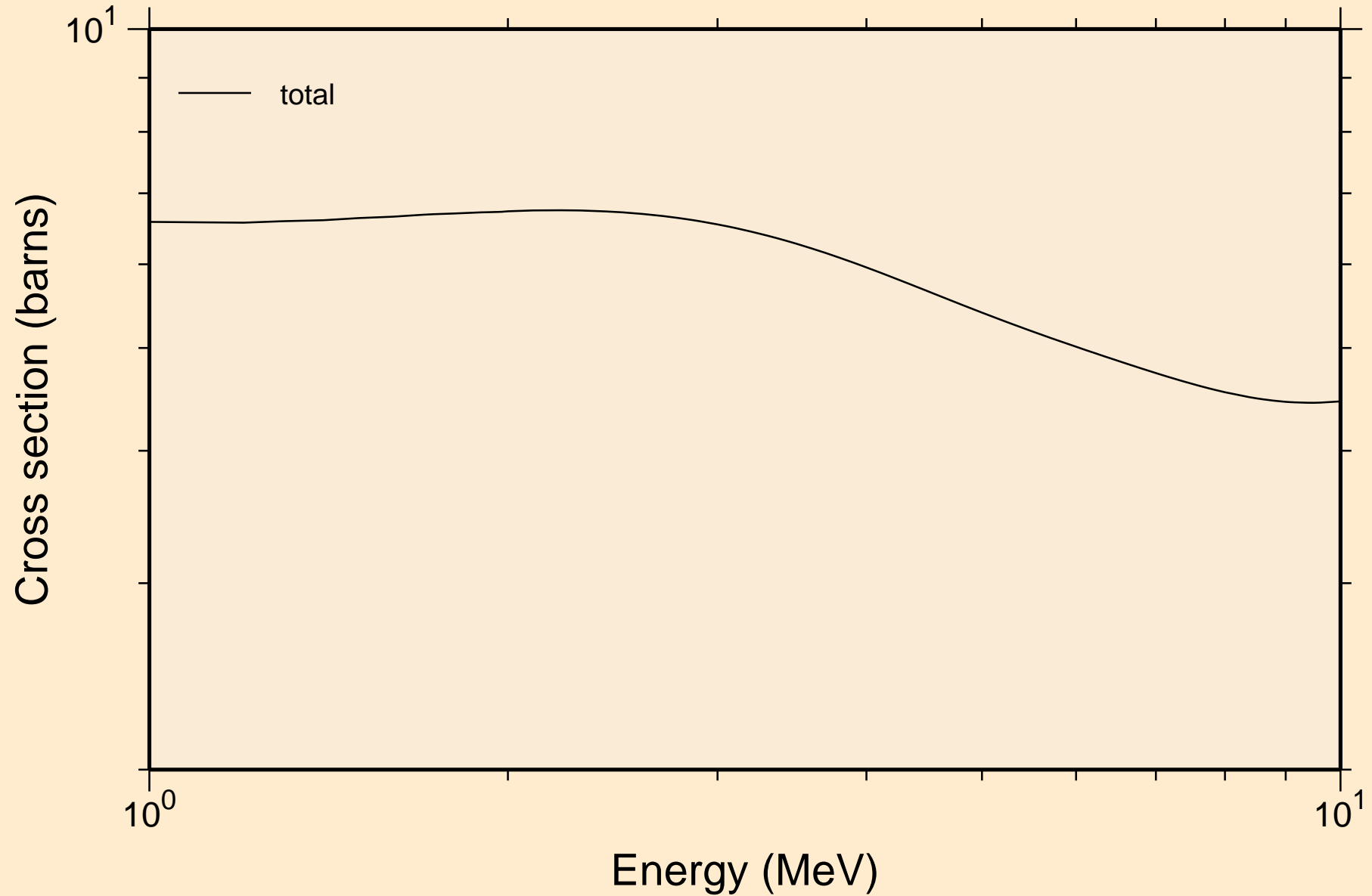

TA159 NEUTRON ACER TENDL-2021 LIBRARY; T=293.6K  
resonance absorption cross sections

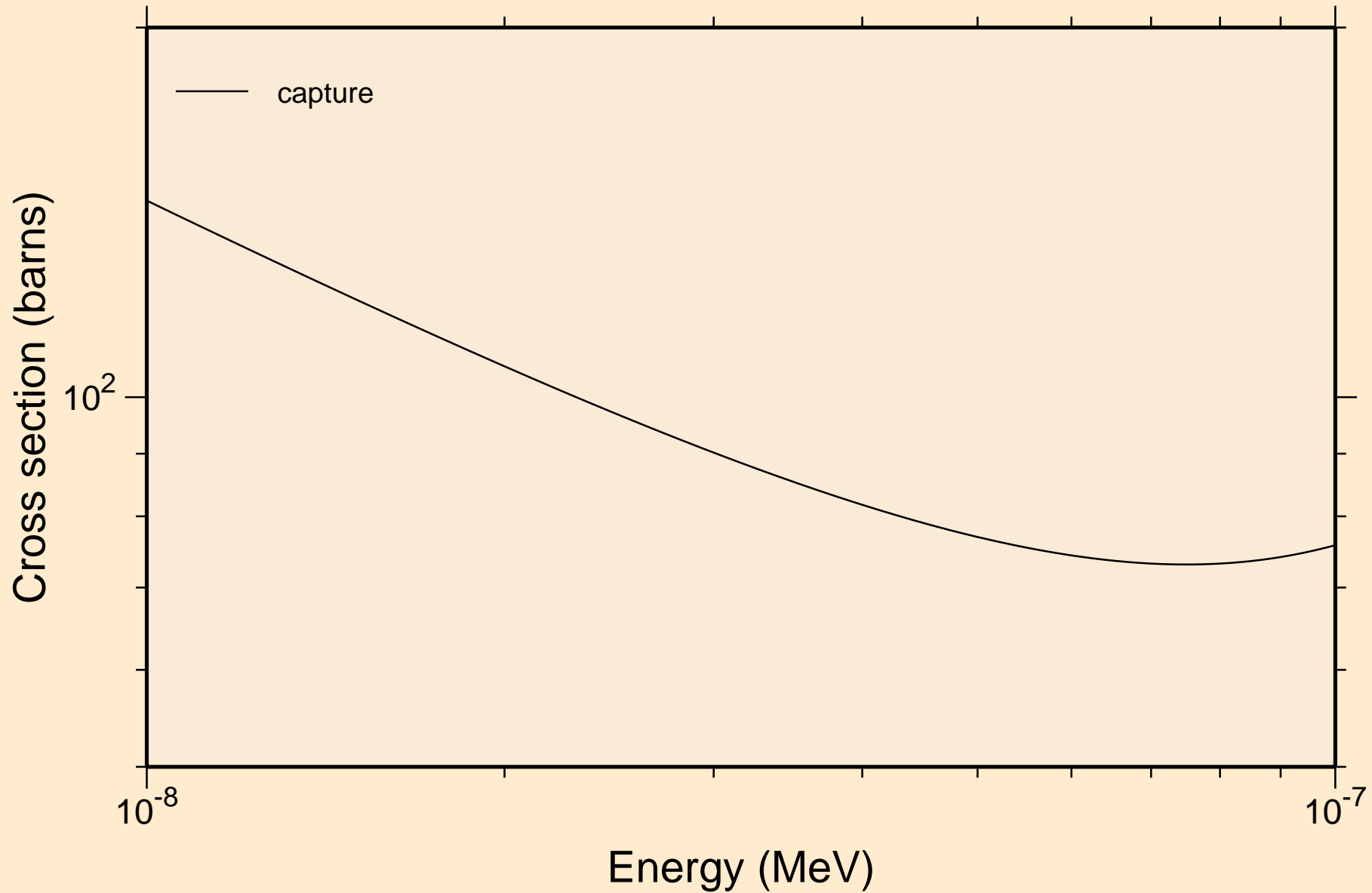

TA159 NEUTRON ACER TENDL-2021 LIBRARY; T=293.6K  
resonance absorption cross sections

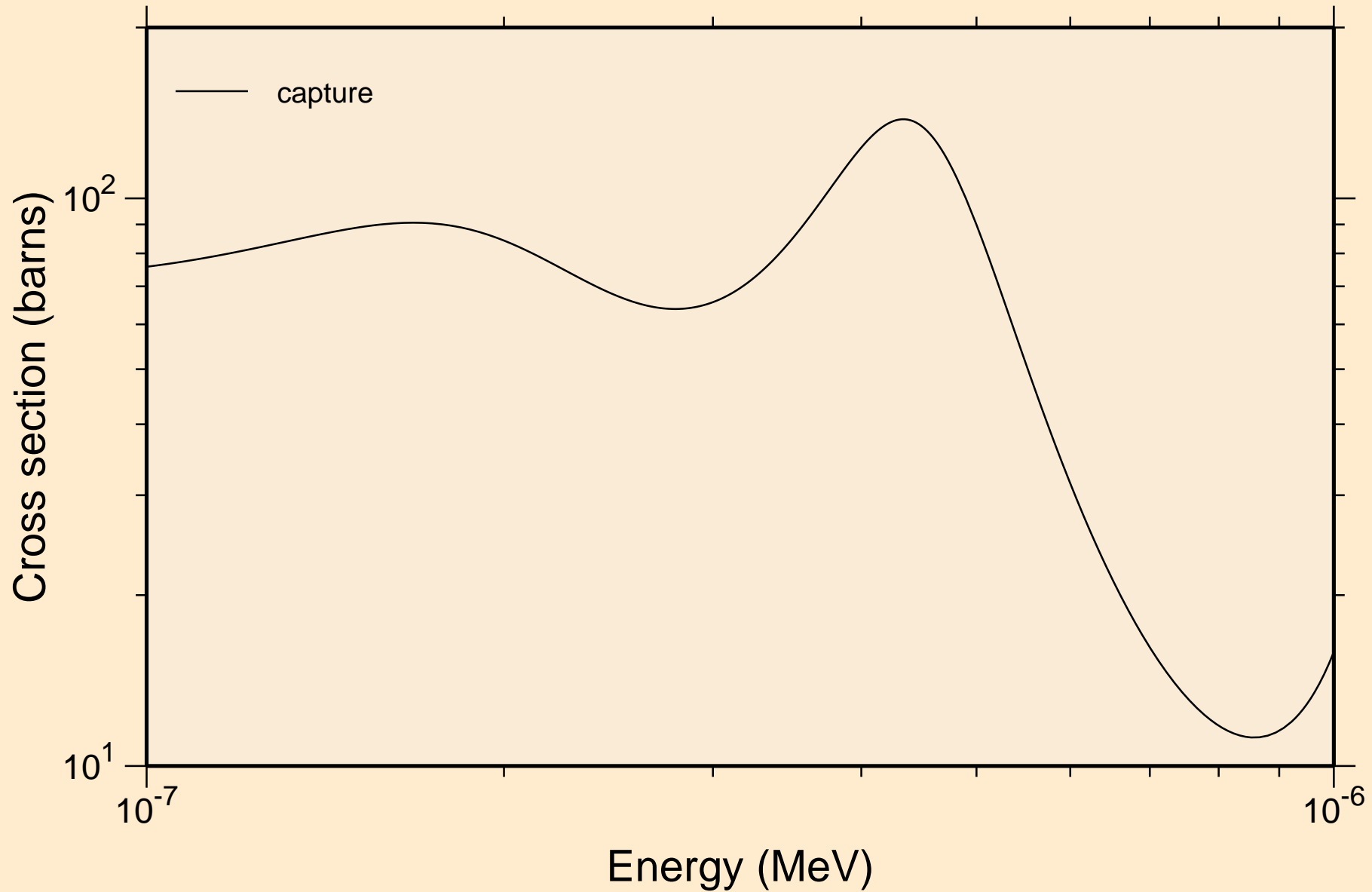

TA159 NEUTRON ACER TENDL-2021 LIBRARY; T=293.6K  
resonance absorption cross sections

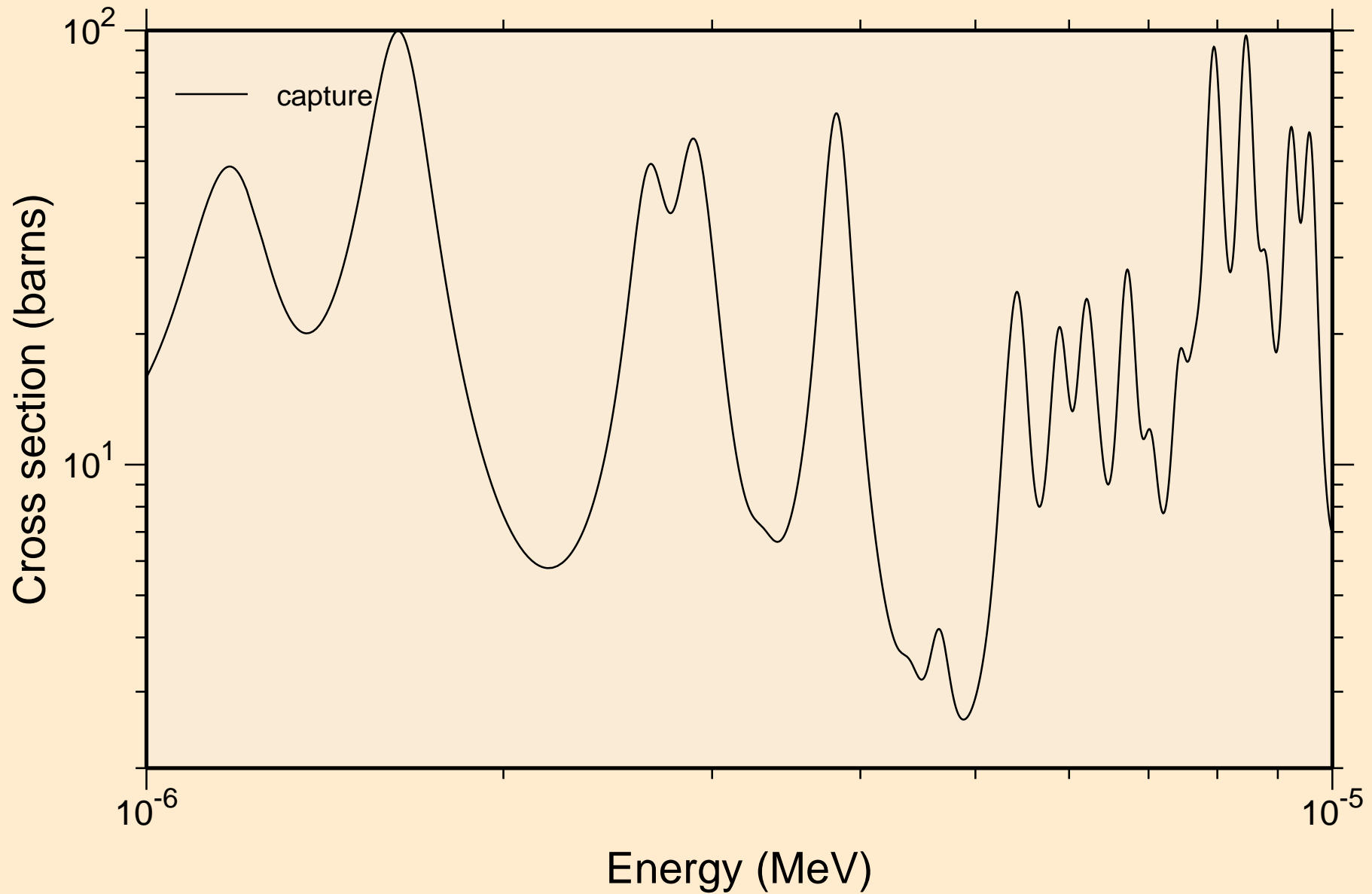



TA159 NEUTRON ACER TENDL-2021 LIBRARY; T=293.6K  
resonance absorption cross sections

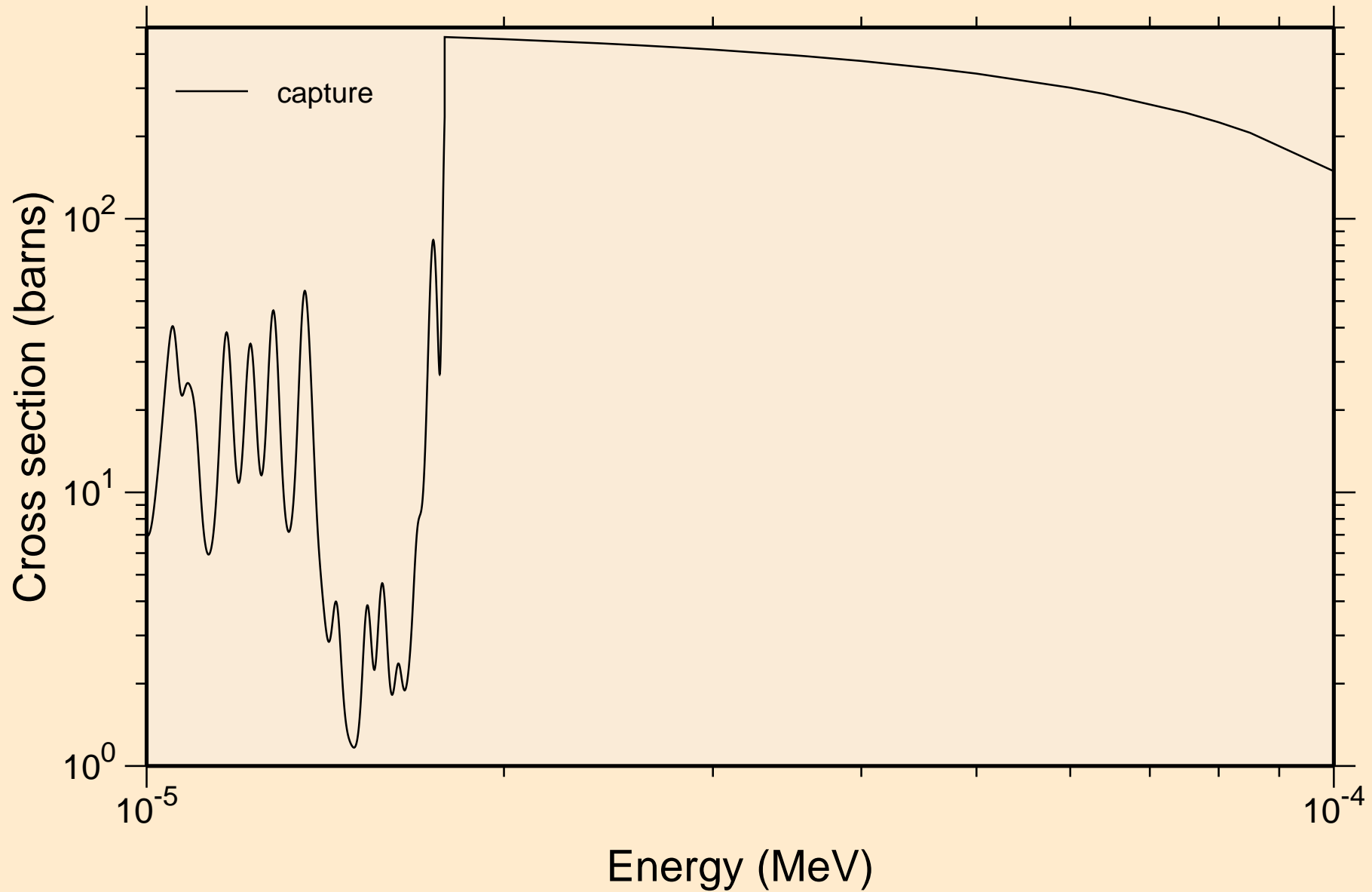

TA159 NEUTRON ACER TENDL-2021 LIBRARY; T=293.6K  
resonance absorption cross sections

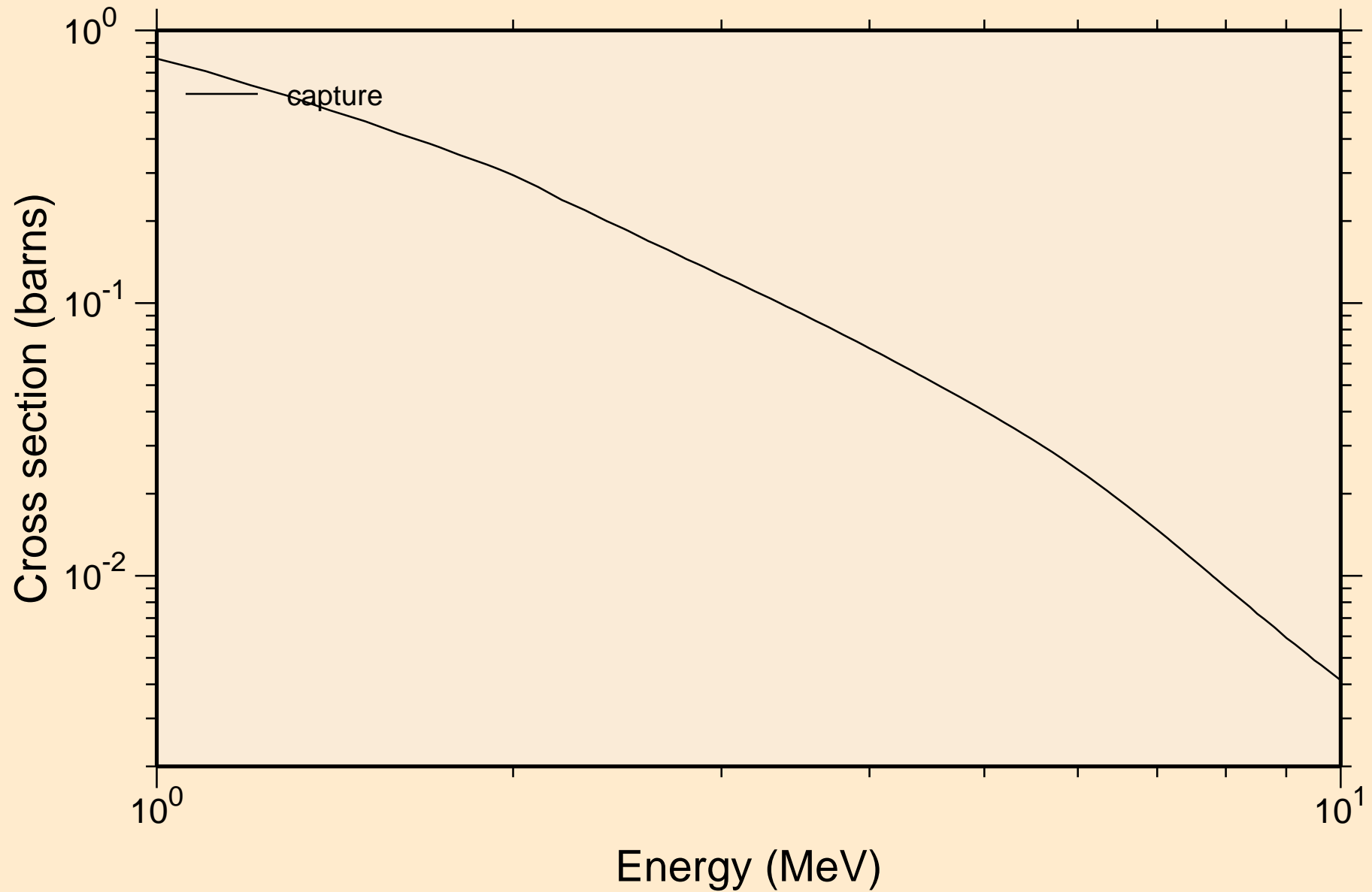

TA159 NEUTRON ACER TENDL-2021 LIBRARY; T=293.6K  
Heating

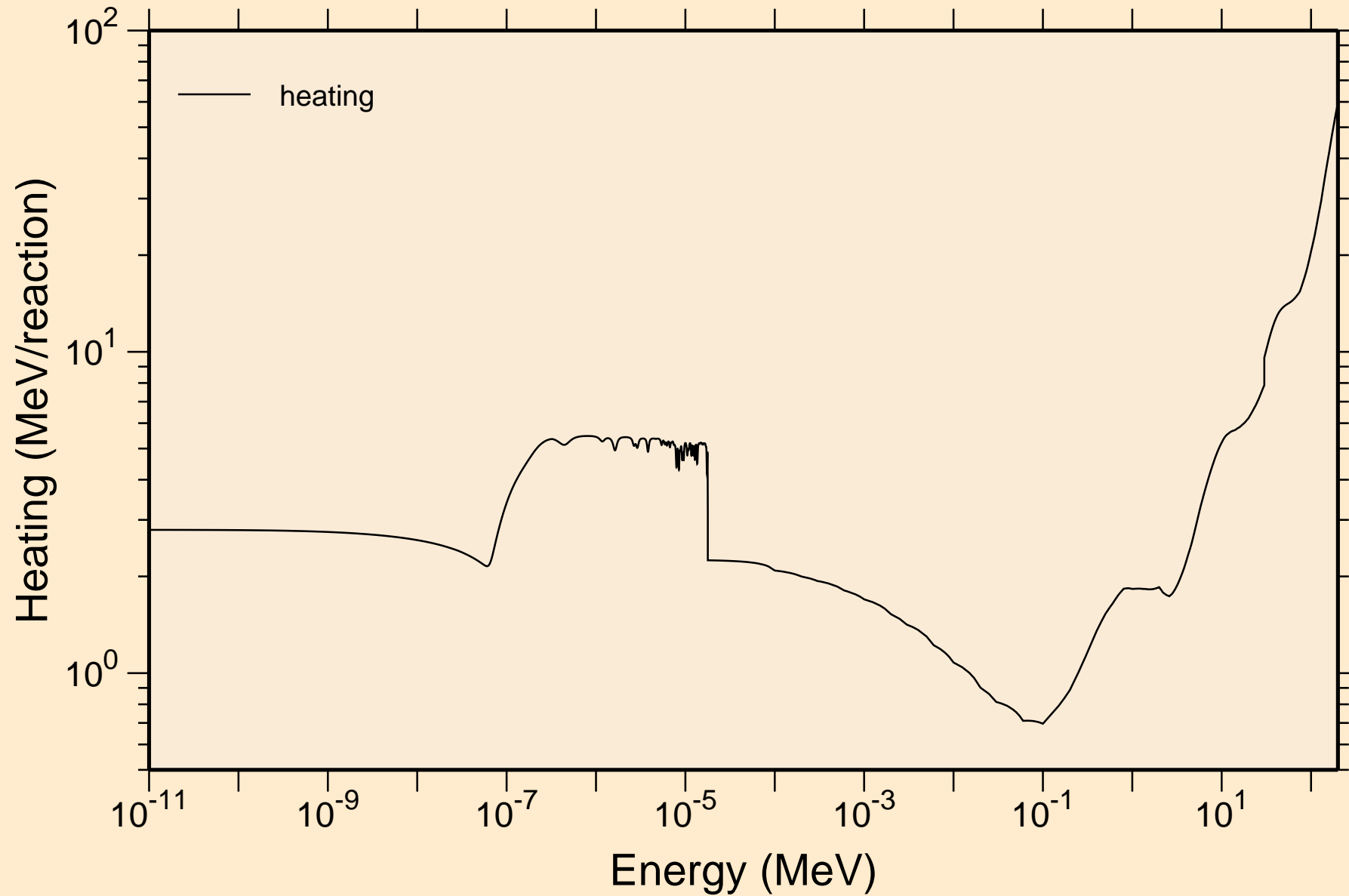

TA159 NEUTRON ACER TENDL-2021 LIBRARY; T=293.6K  
Damage

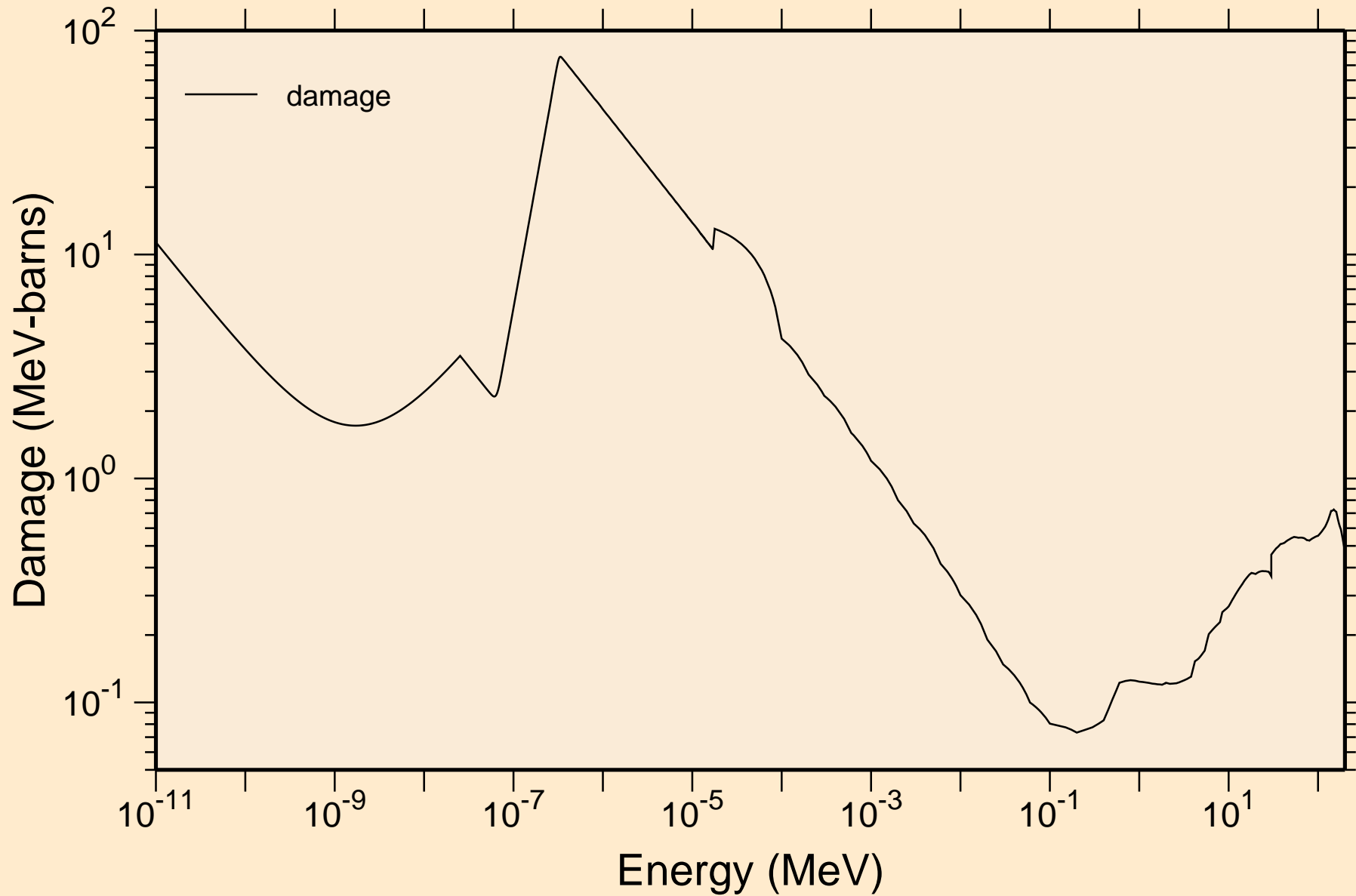

TA159 NEUTRON ACER TENDL-2021 LIBRARY; T=293.6K  
Non-threshold reactions

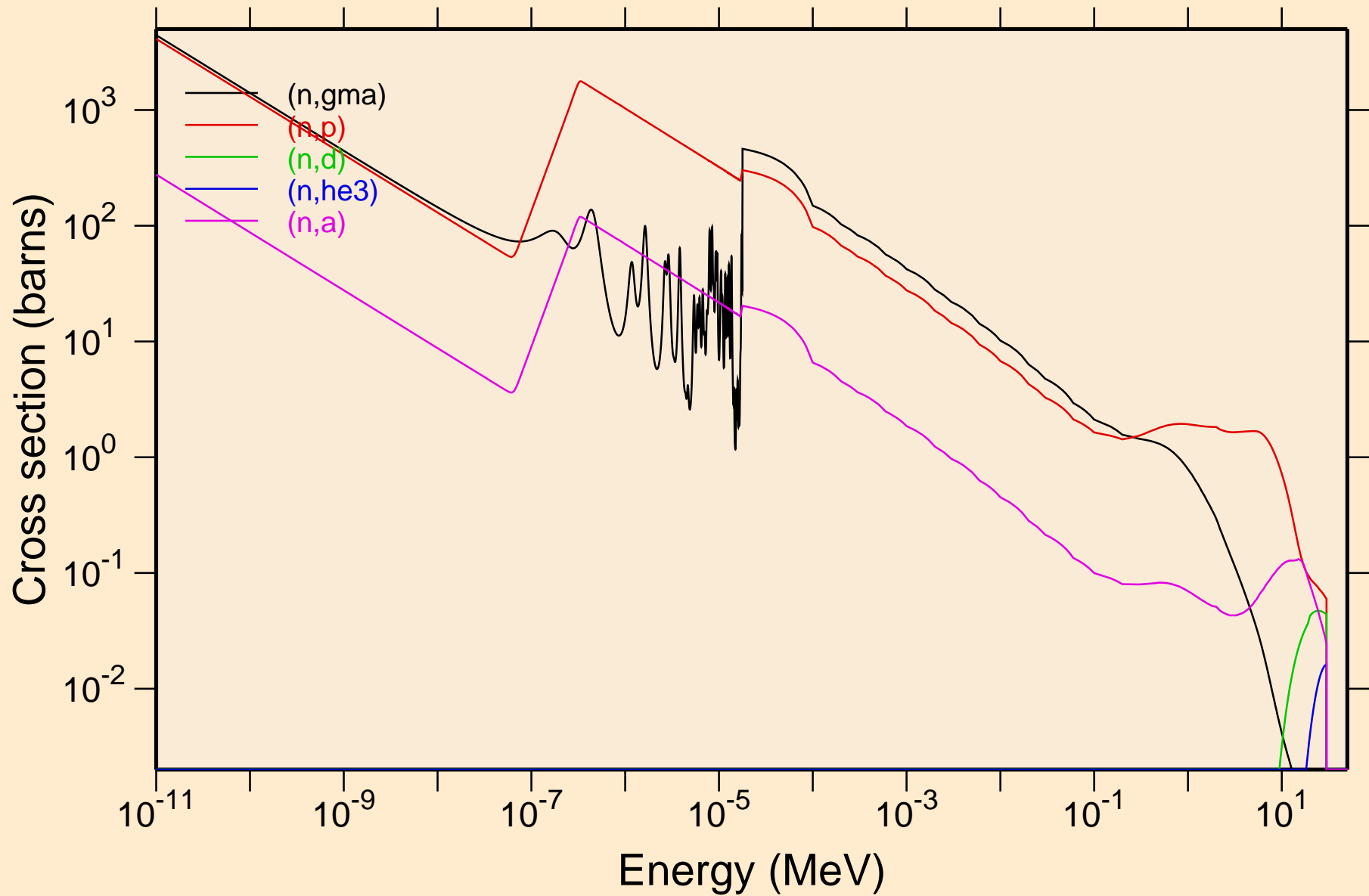

TA159 NEUTRON ACER TENDL-2021 LIBRARY; T=293.6K  
Non-threshold reactions

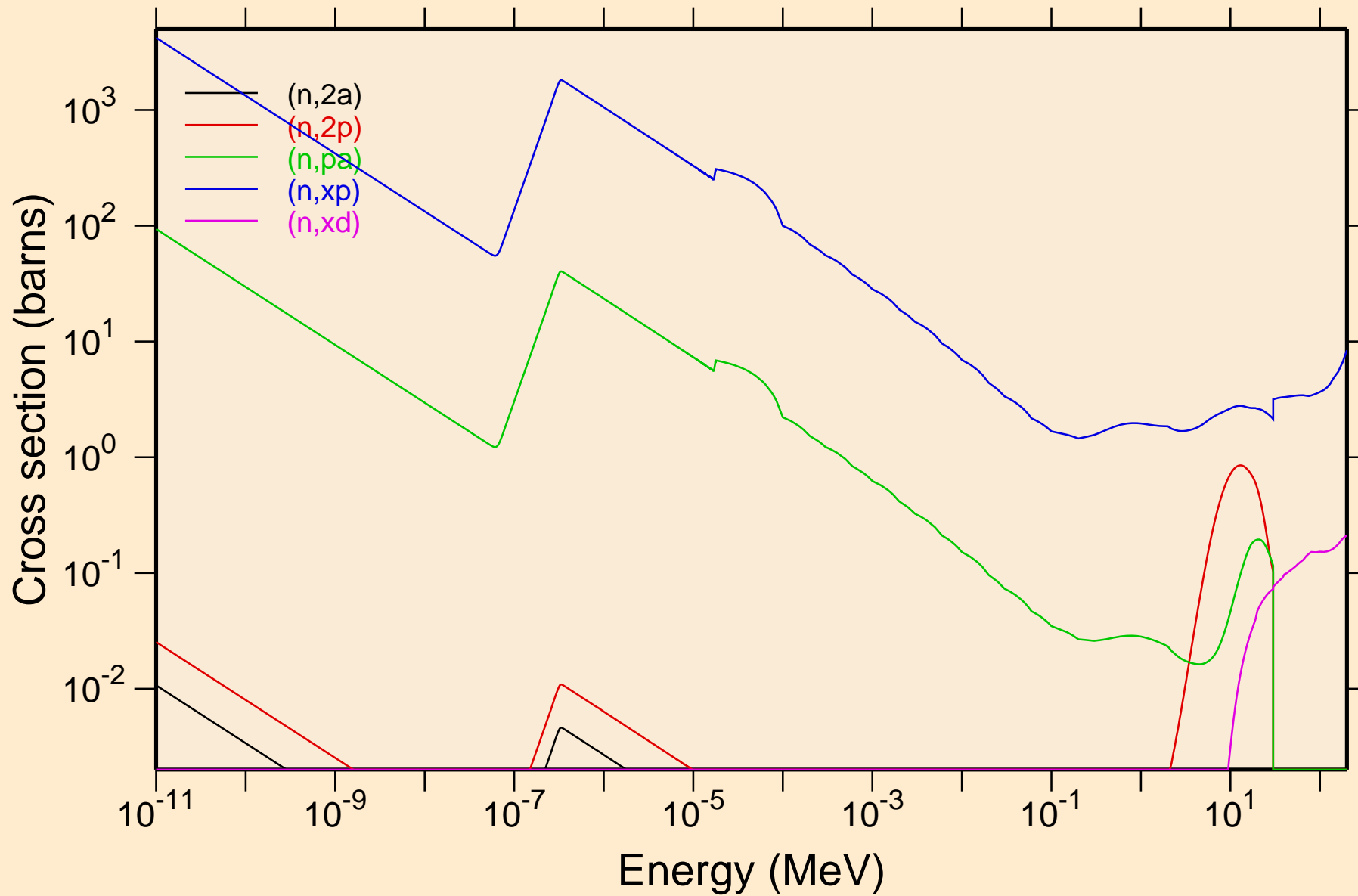

TA159 NEUTRON ACER TENDL-2021 LIBRARY; T=293.6K  
Non-threshold reactions

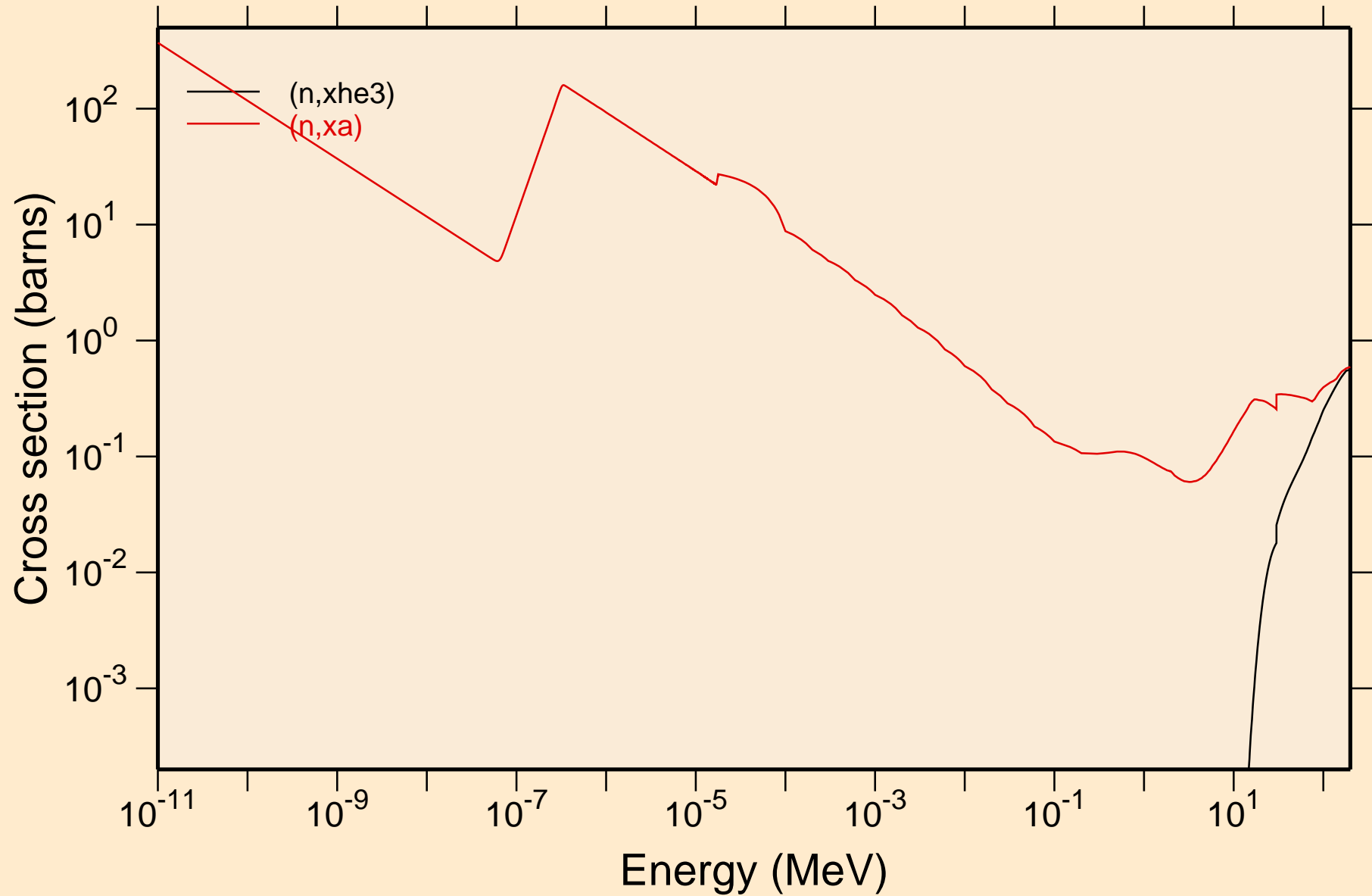

TA159 NEUTRON ACER TENDL-2021 LIBRARY; T=293.6K  
Principal cross sections

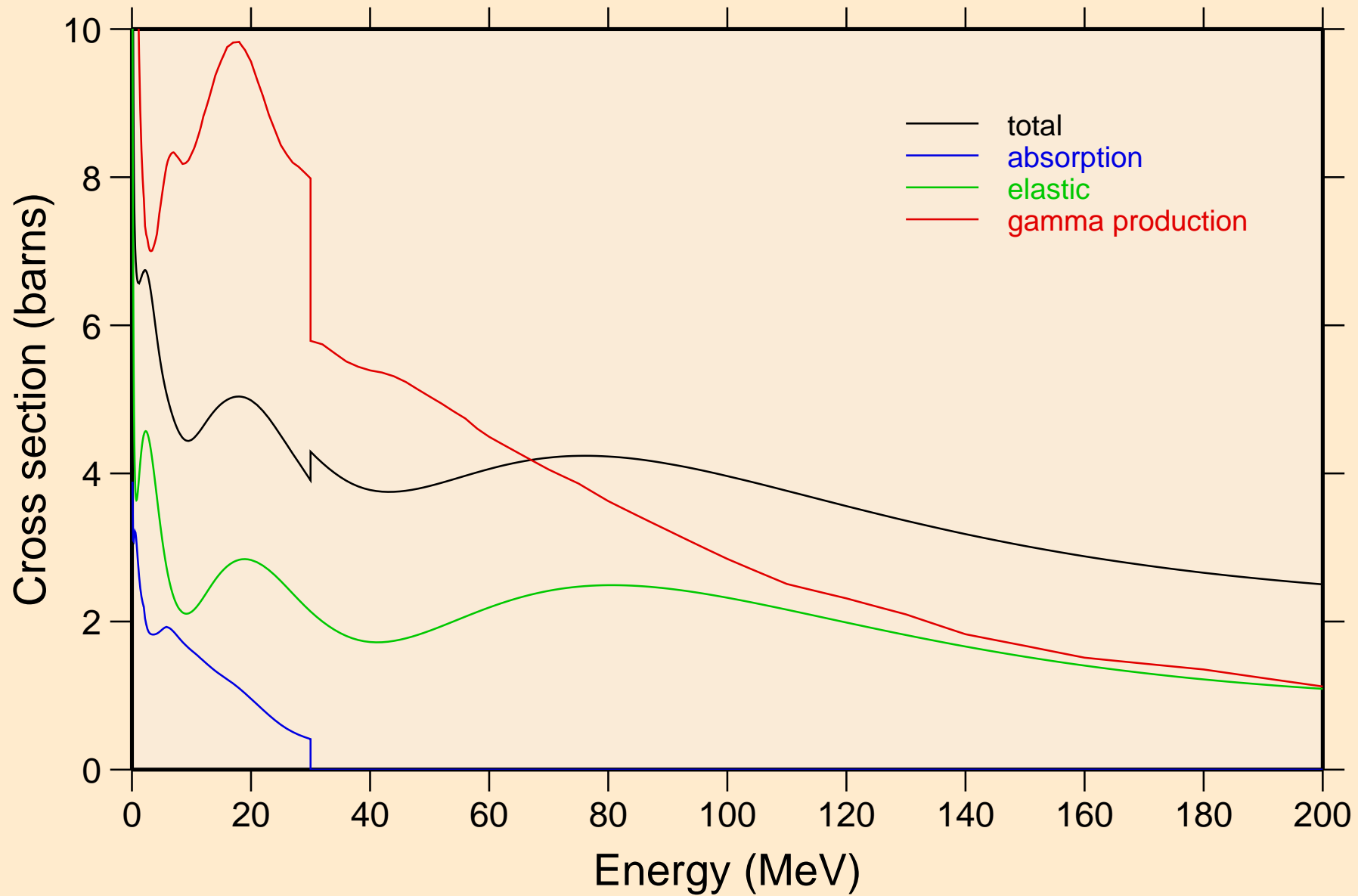



# TA159 NEUTRON ACER TENDL-2021 LIBRARY; T=293.6K

## Heating

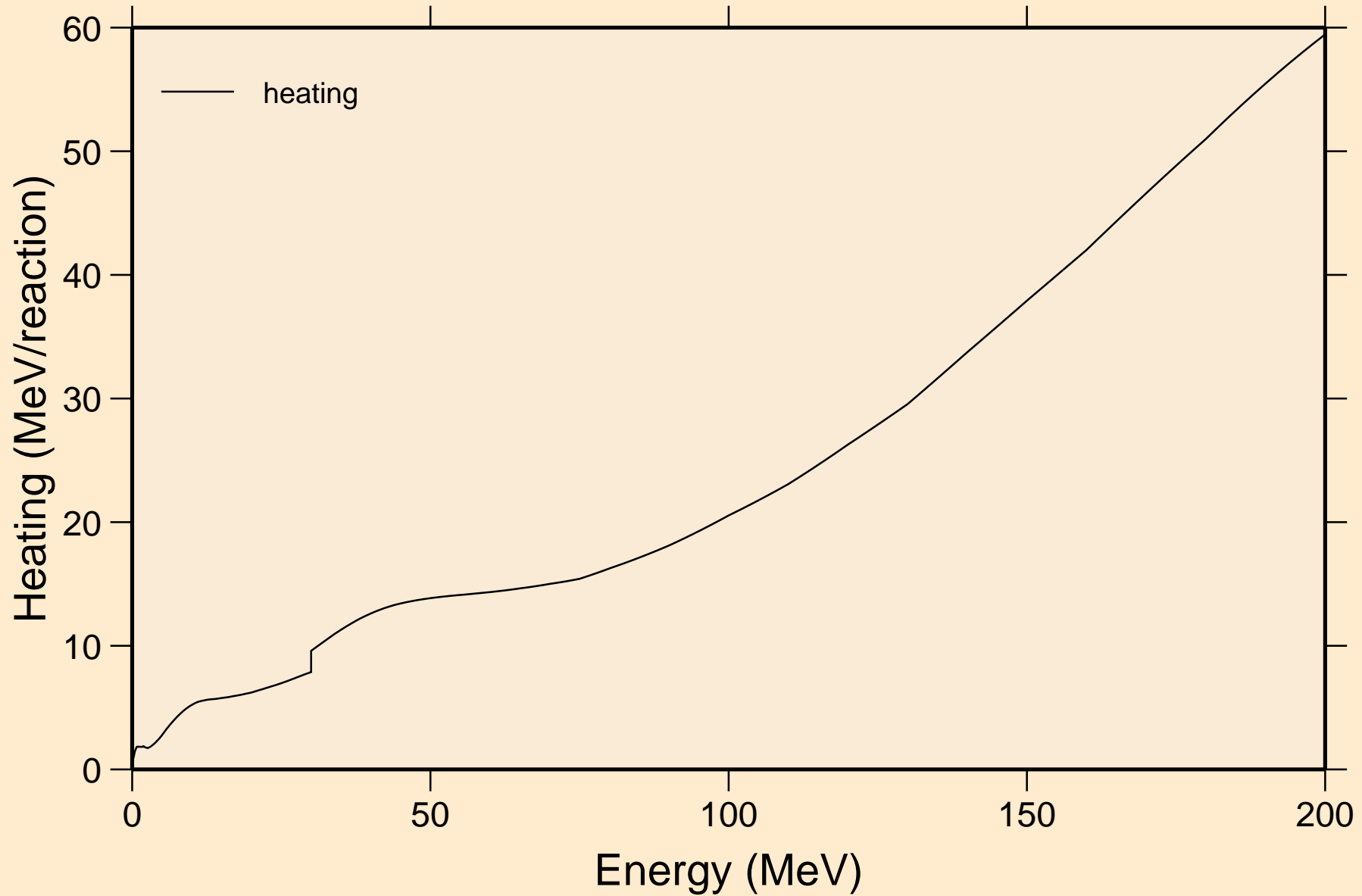

TA159 NEUTRON ACER TENDL-2021 LIBRARY; T=293.6K  
Damage

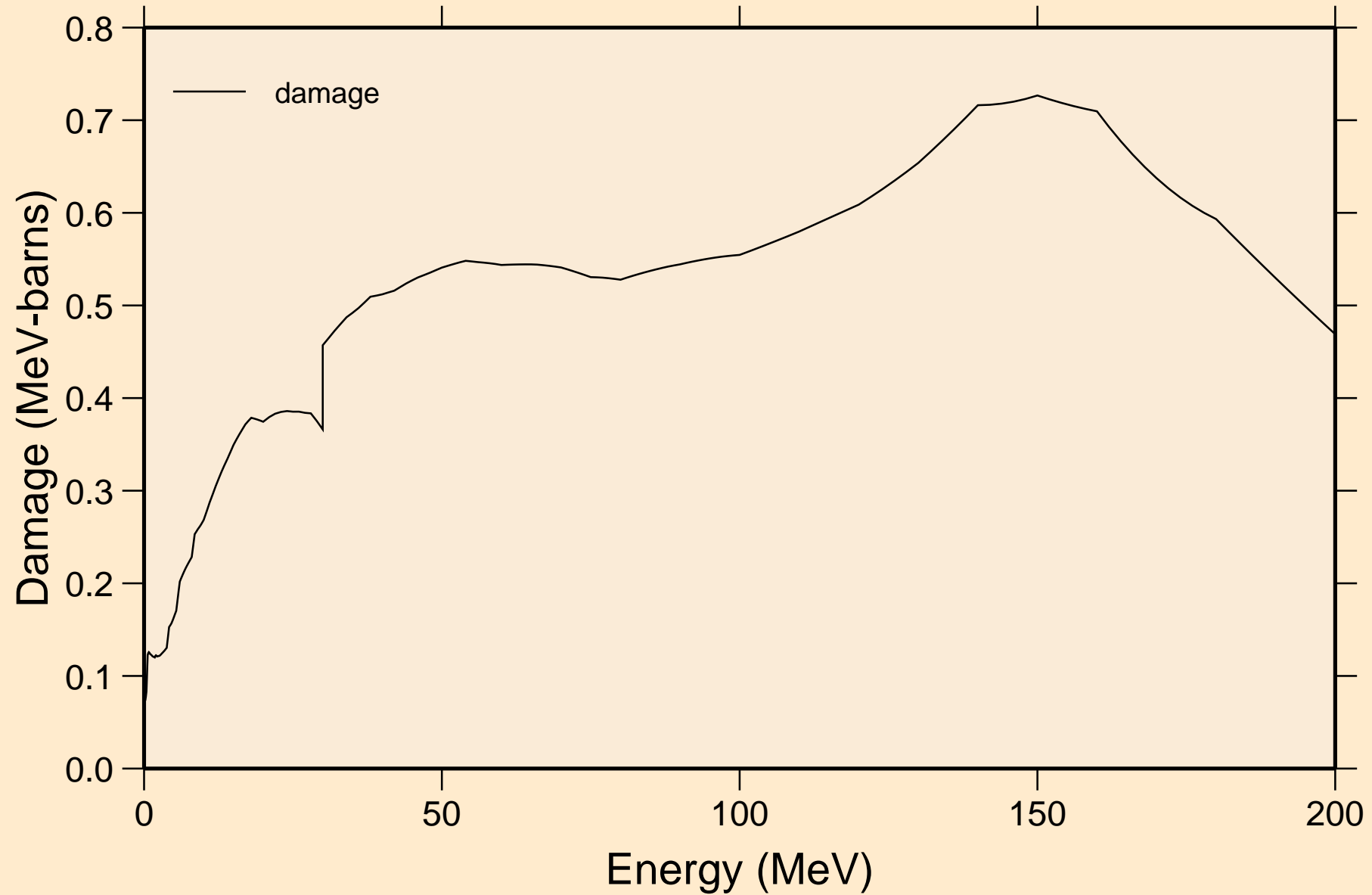

TA159 NEUTRON ACER TENDL-2021 LIBRARY; T=293.6K  
Non-threshold reactions

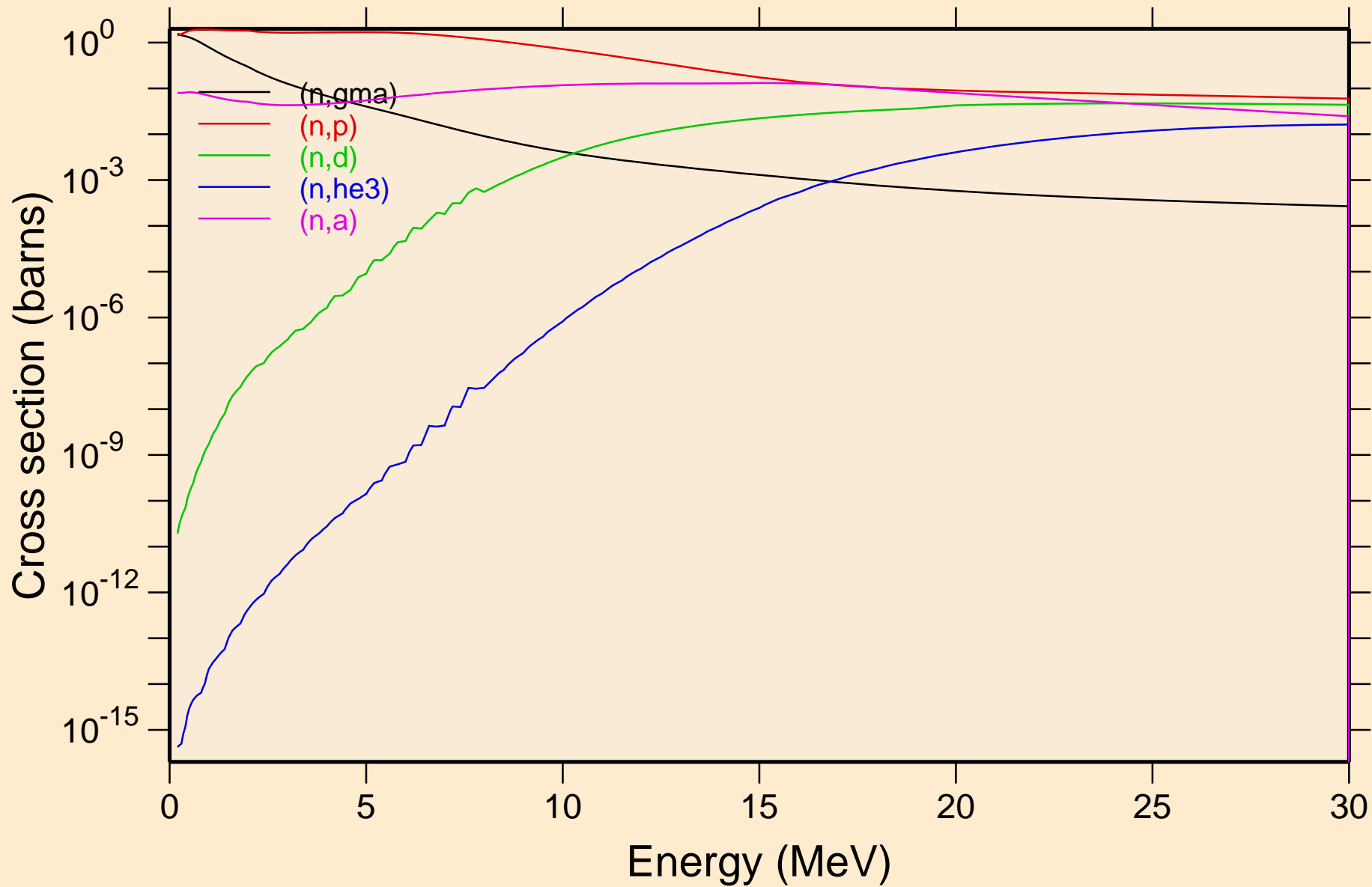

TA159 NEUTRON ACER TENDL-2021 LIBRARY; T=293.6K  
Non-threshold reactions

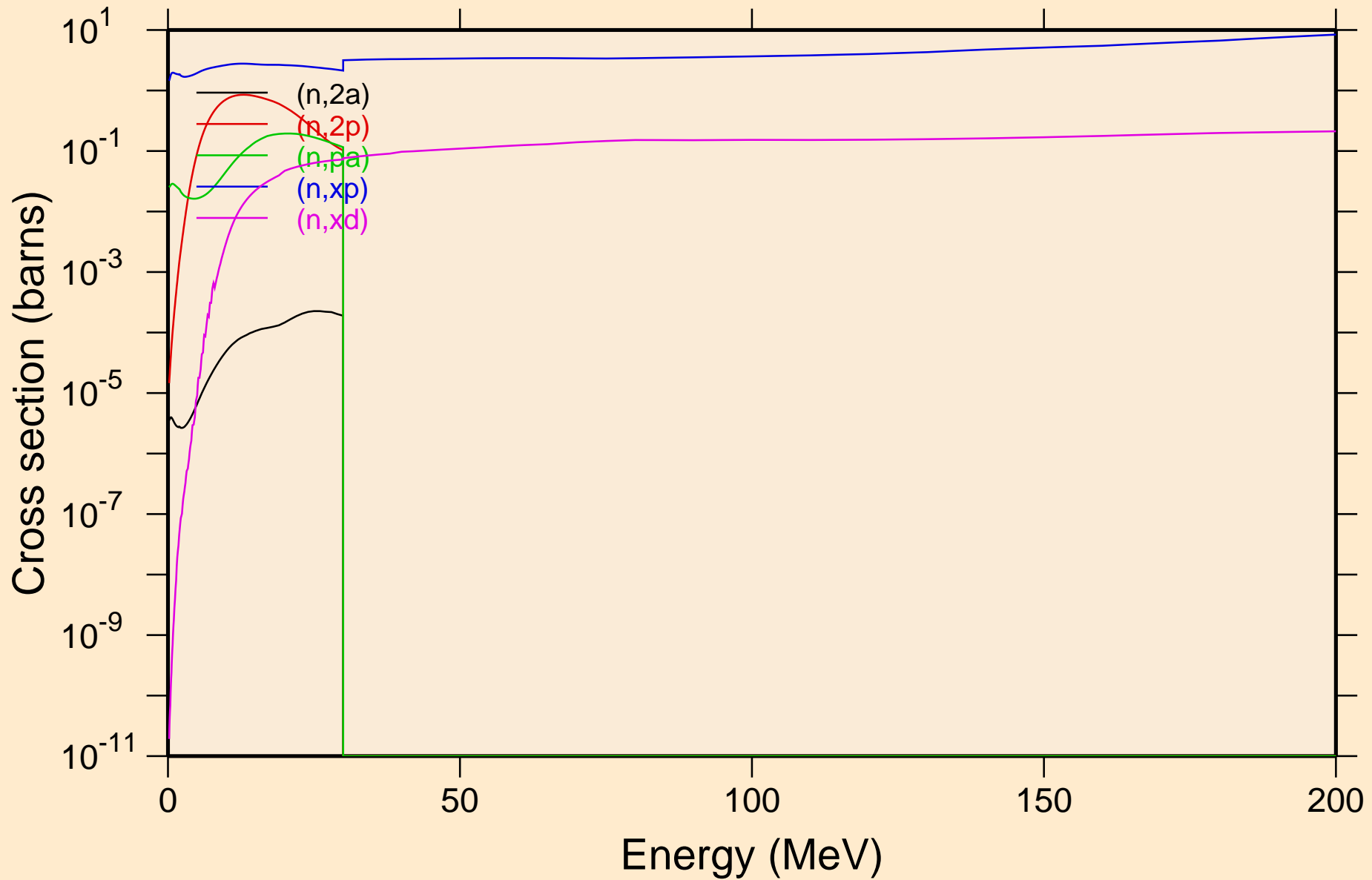

TA159 NEUTRON ACER TENDL-2021 LIBRARY; T=293.6K  
Non-threshold reactions

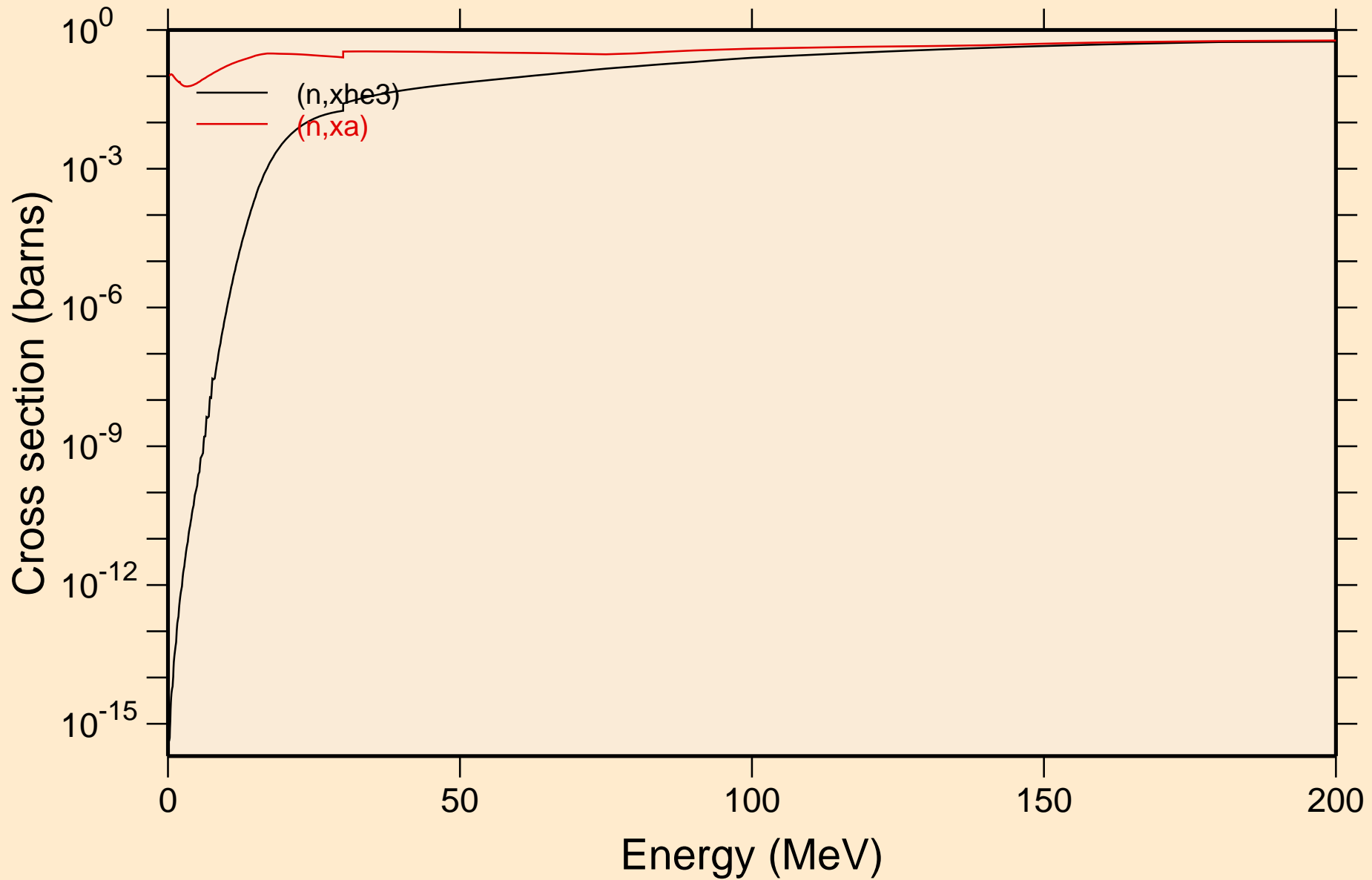

TA159 NEUTRON ACER TENDL-2021 LIBRARY; T=293.6K  
Inelastic levels

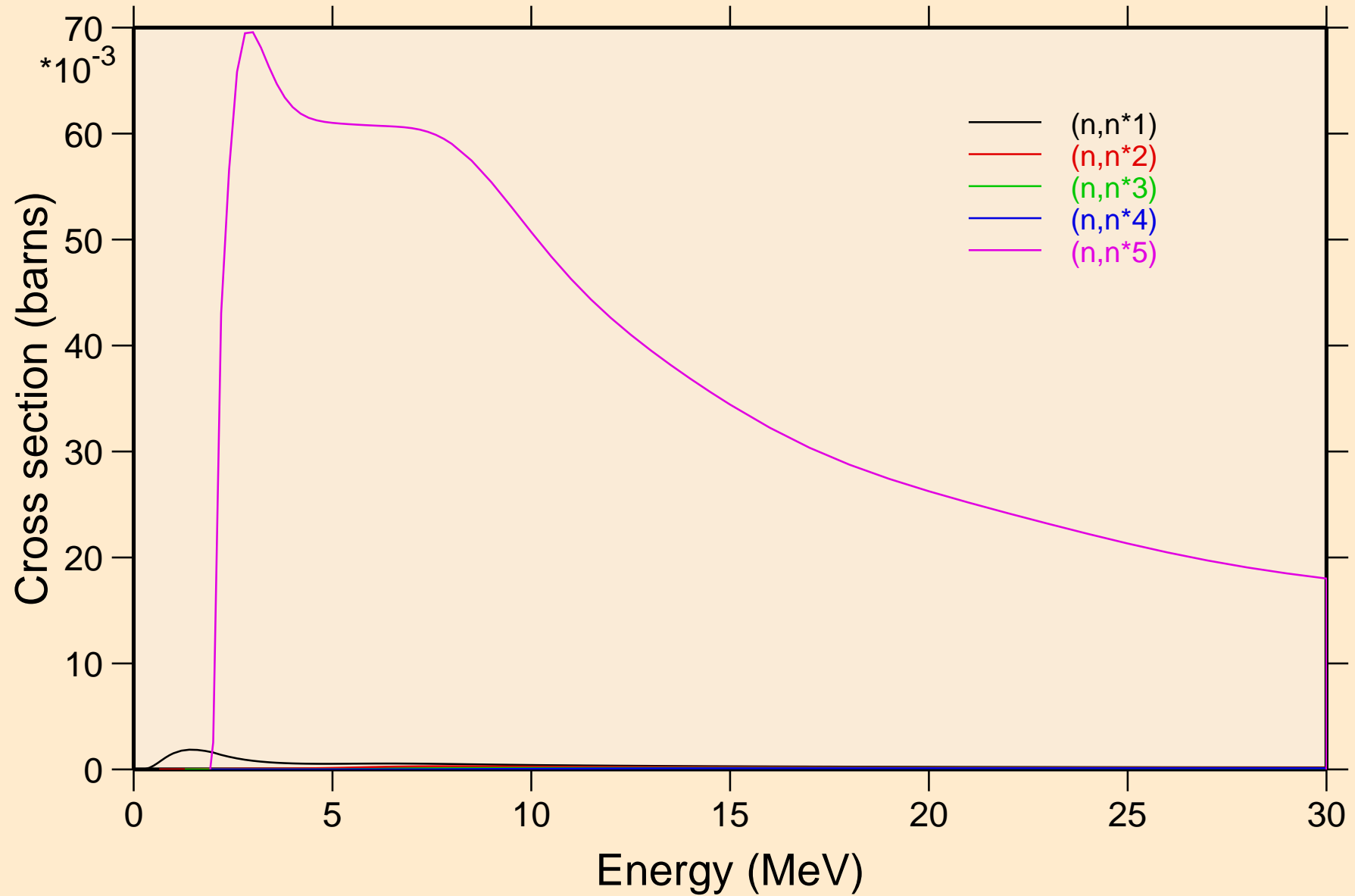

TA159 NEUTRON ACER TENDL-2021 LIBRARY; T=293.6K  
Inelastic levels

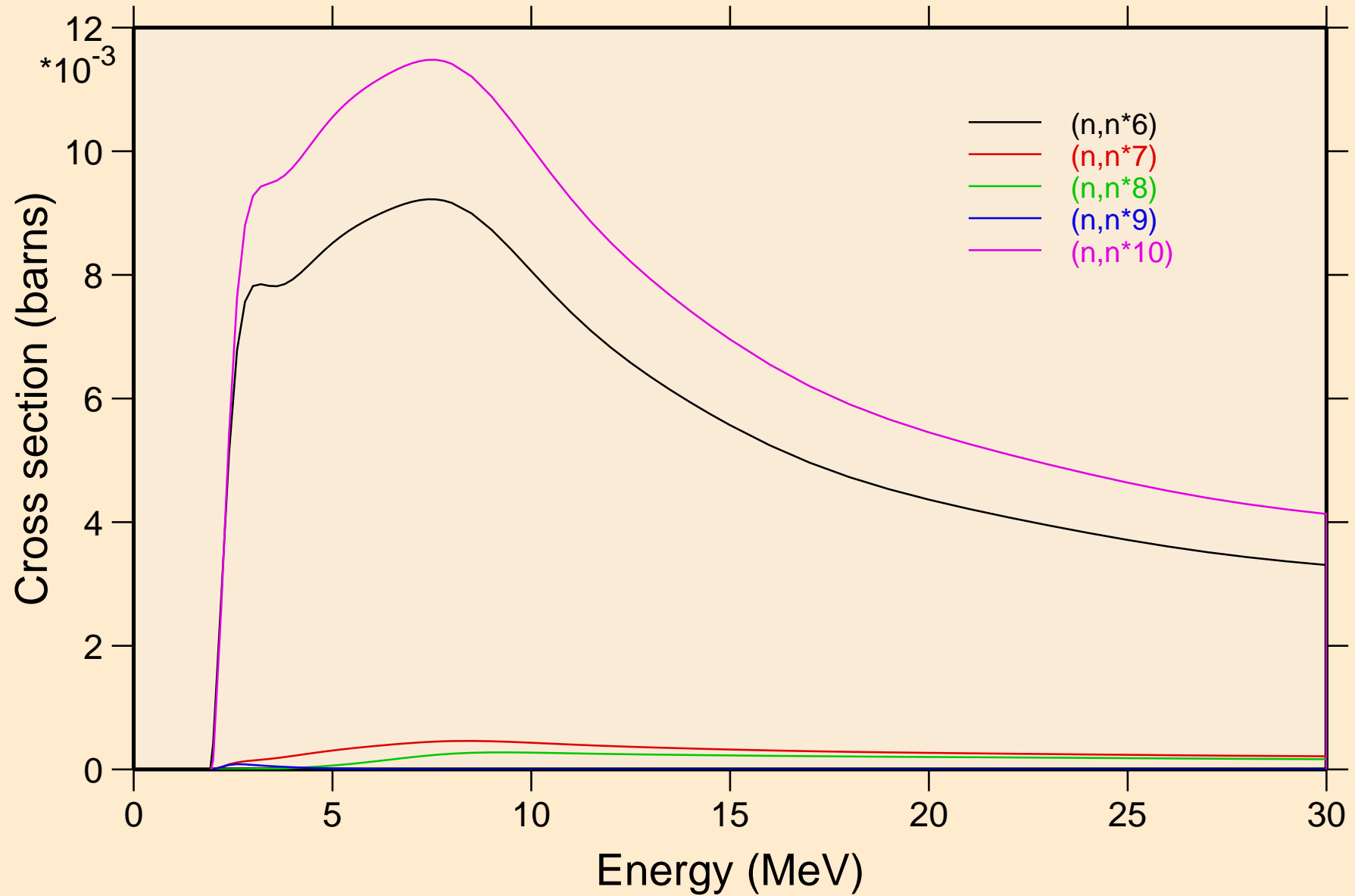

TA159 NEUTRON ACER TENDL-2021 LIBRARY; T=293.6K  
Inelastic levels

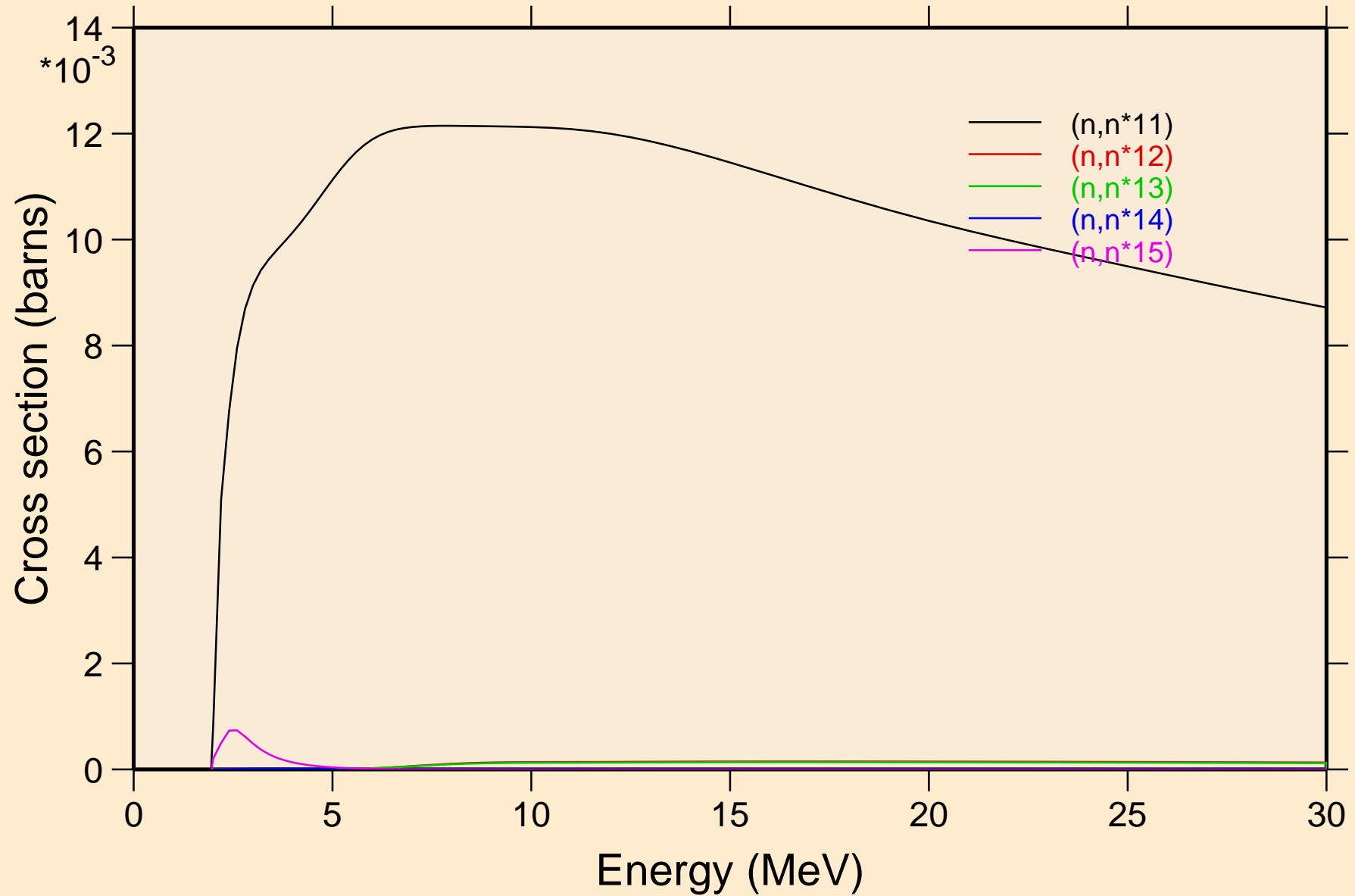



TA159 NEUTRON ACER TENDL-2021 LIBRARY; T=293.6K  
Inelastic levels

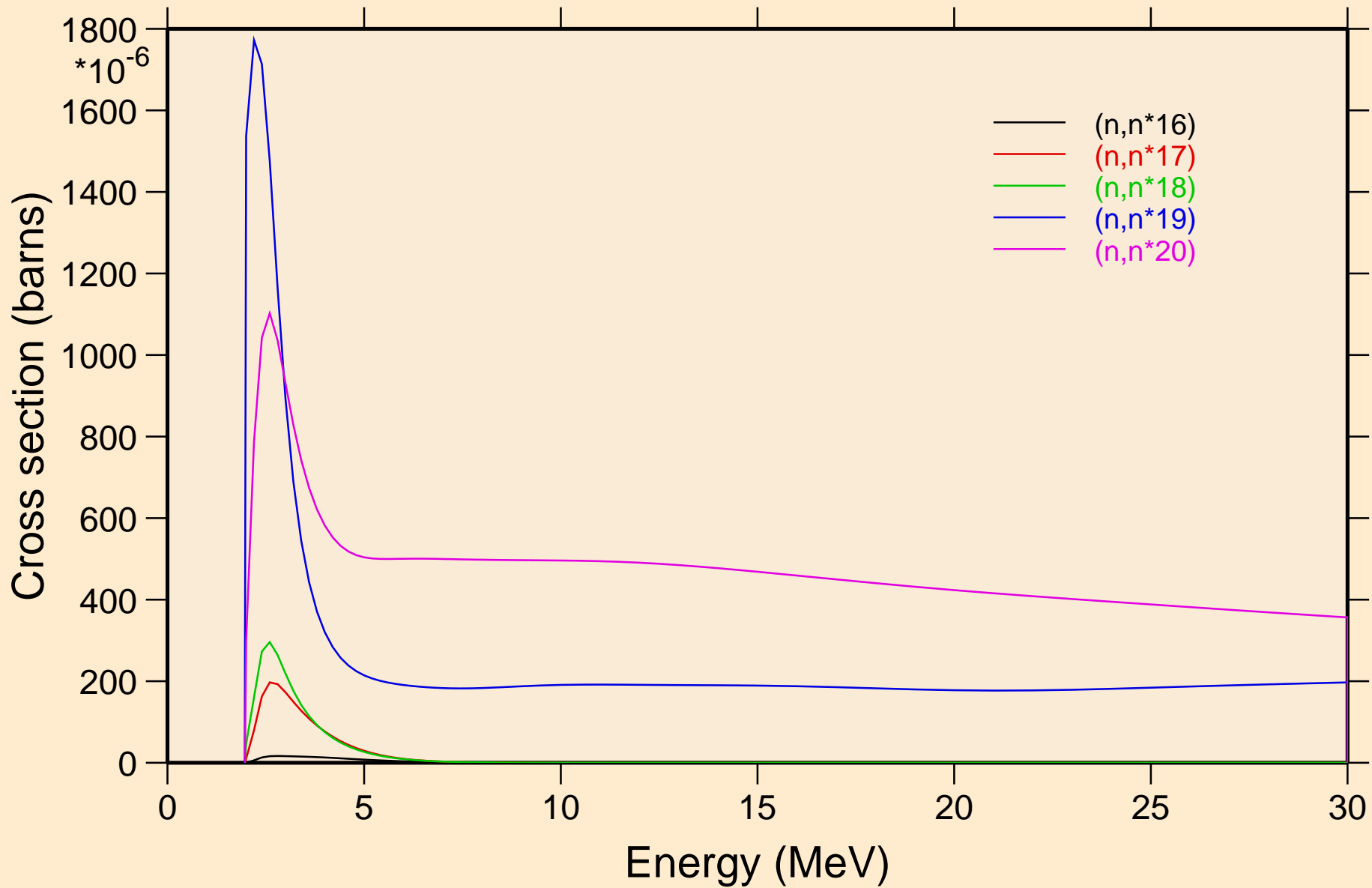

TA159 NEUTRON ACER TENDL-2021 LIBRARY; T=293.6K  
Inelastic levels

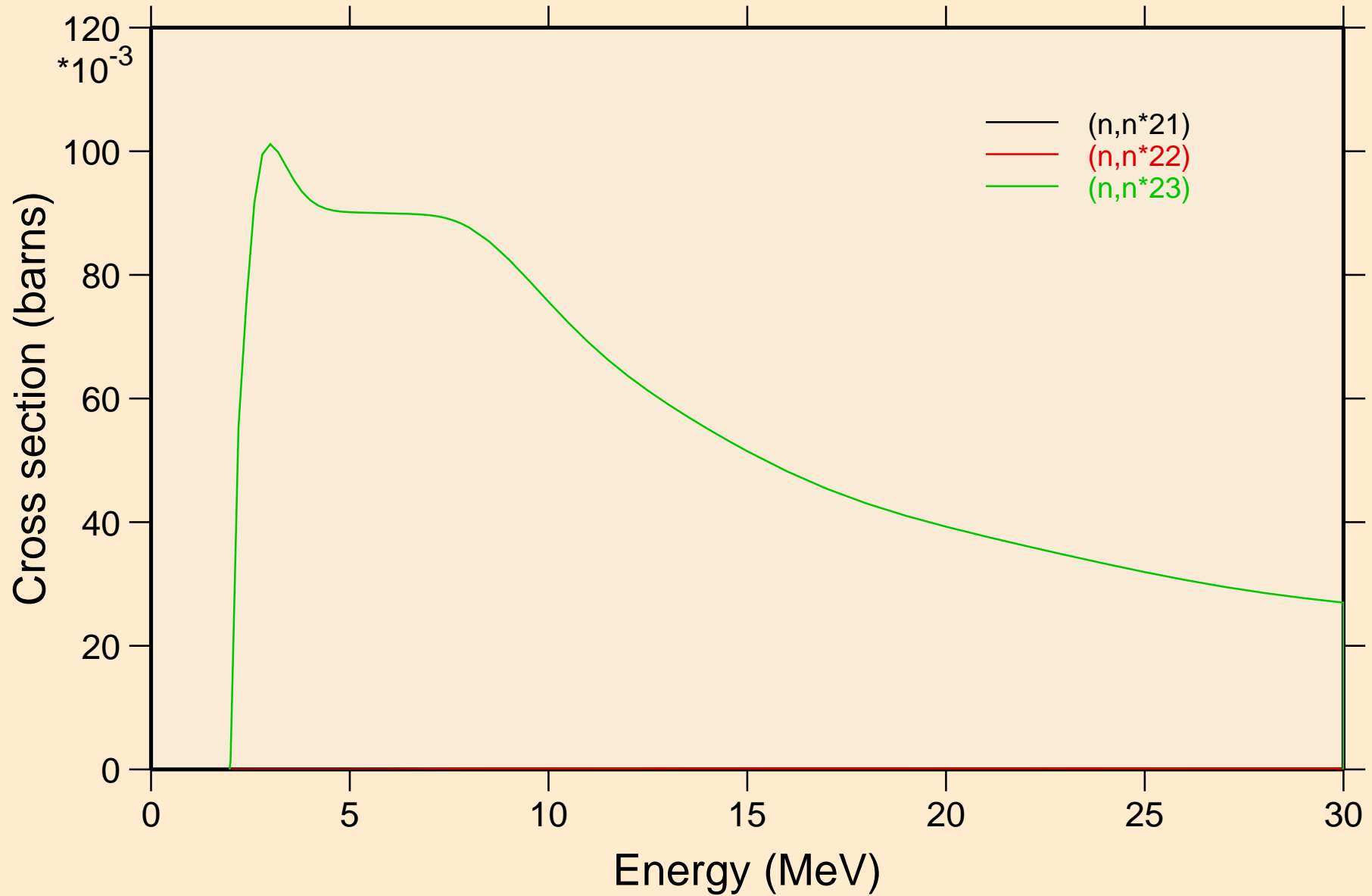

TA159 NEUTRON ACER TENDL-2021 LIBRARY; T=293.6K  
Threshold reactions

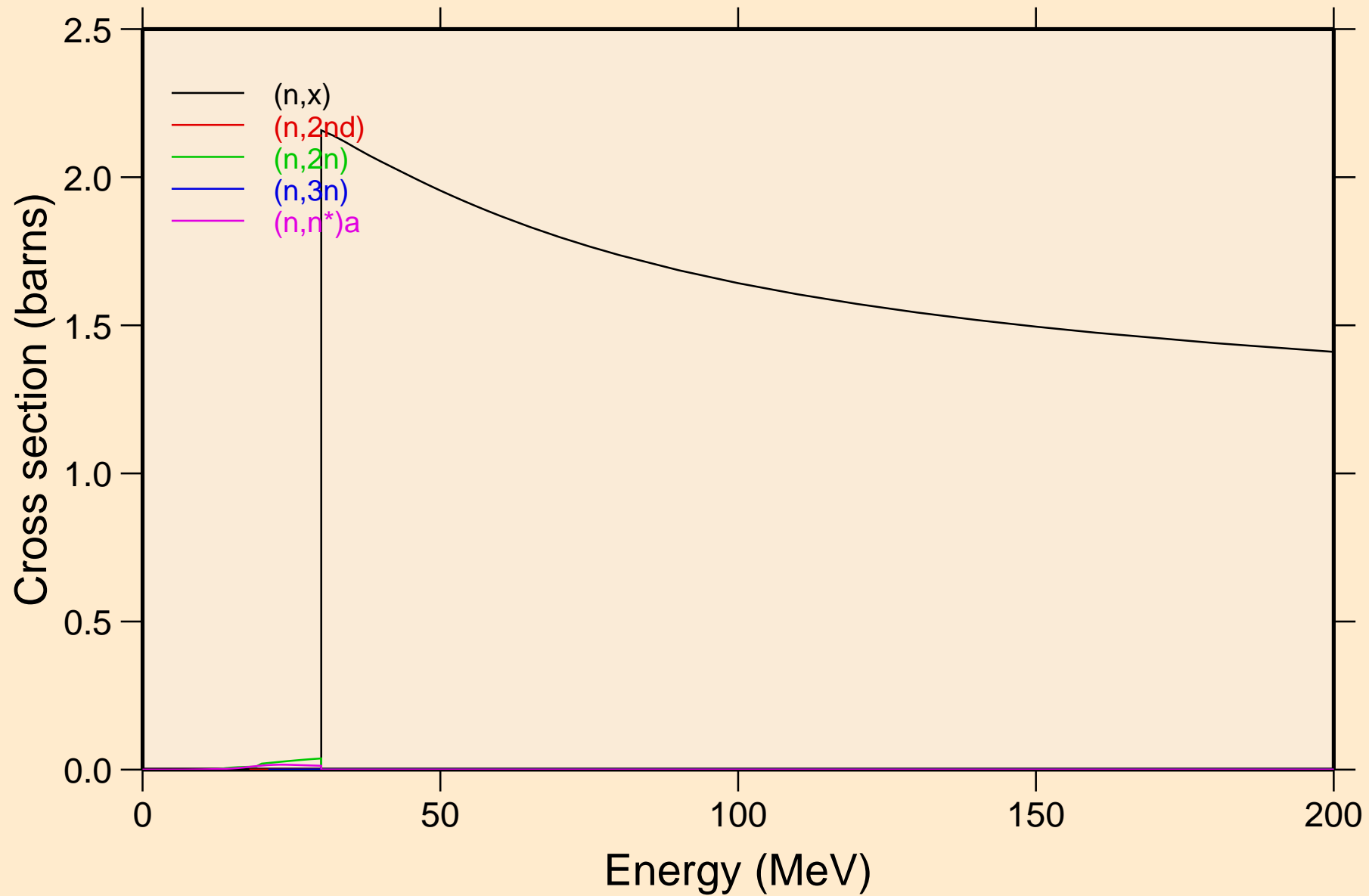

TA159 NEUTRON ACER TENDL-2021 LIBRARY; T=293.6K  
Threshold reactions

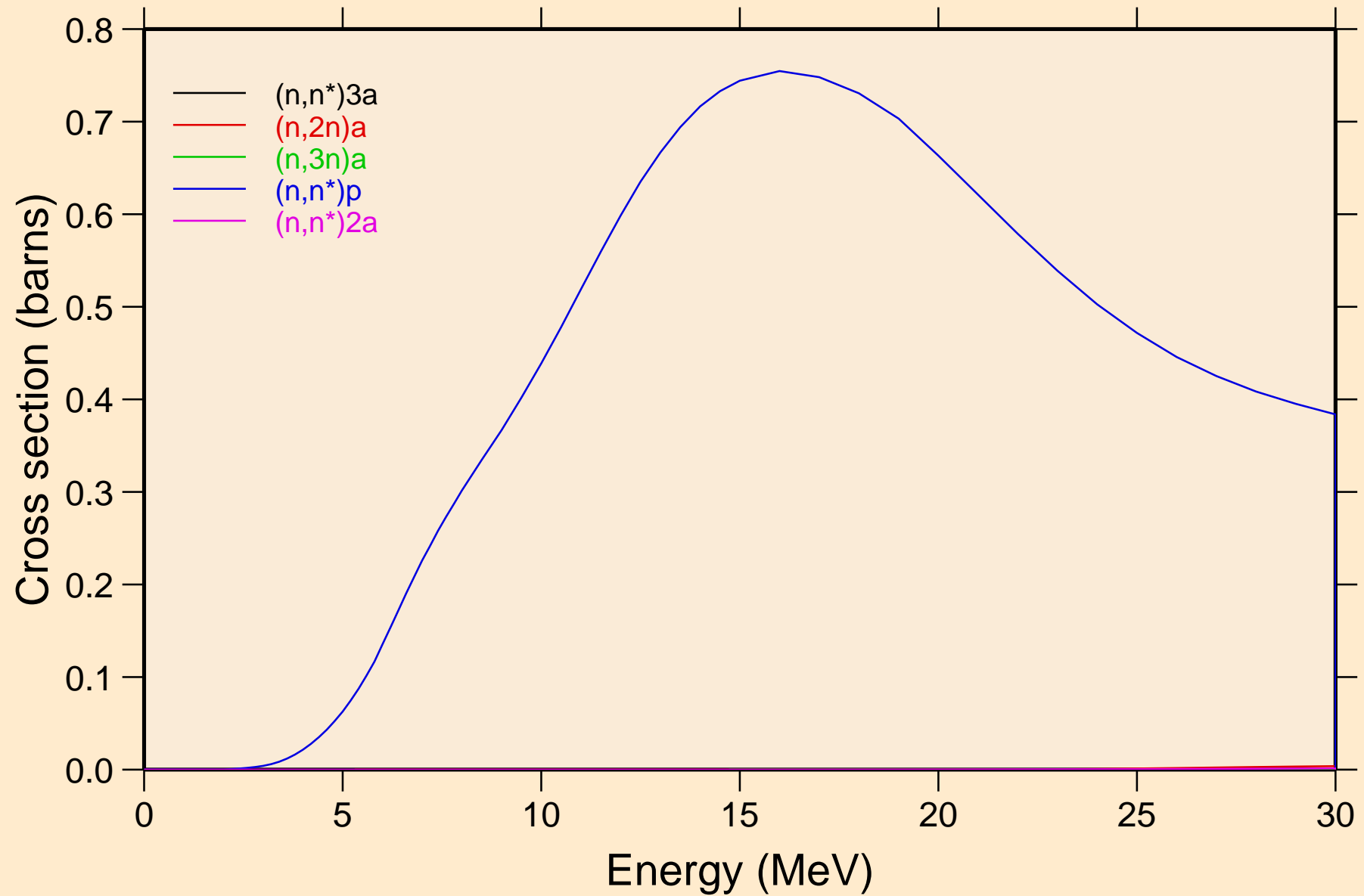

TA159 NEUTRON ACER TENDL-2021 LIBRARY; T=293.6K  
Threshold reactions

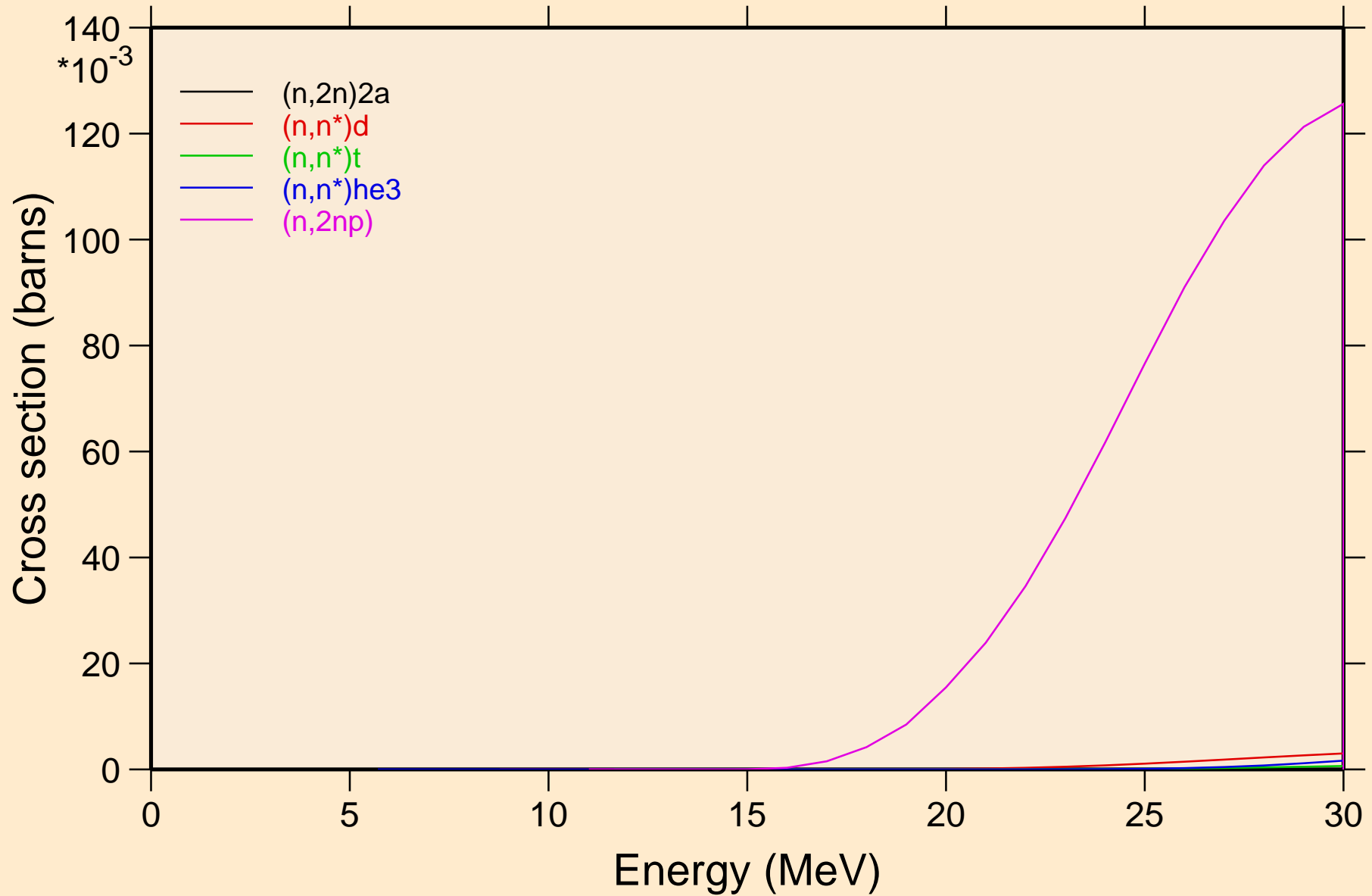

TA159 NEUTRON ACER TENDL-2021 LIBRARY; T=293.6K  
Threshold reactions

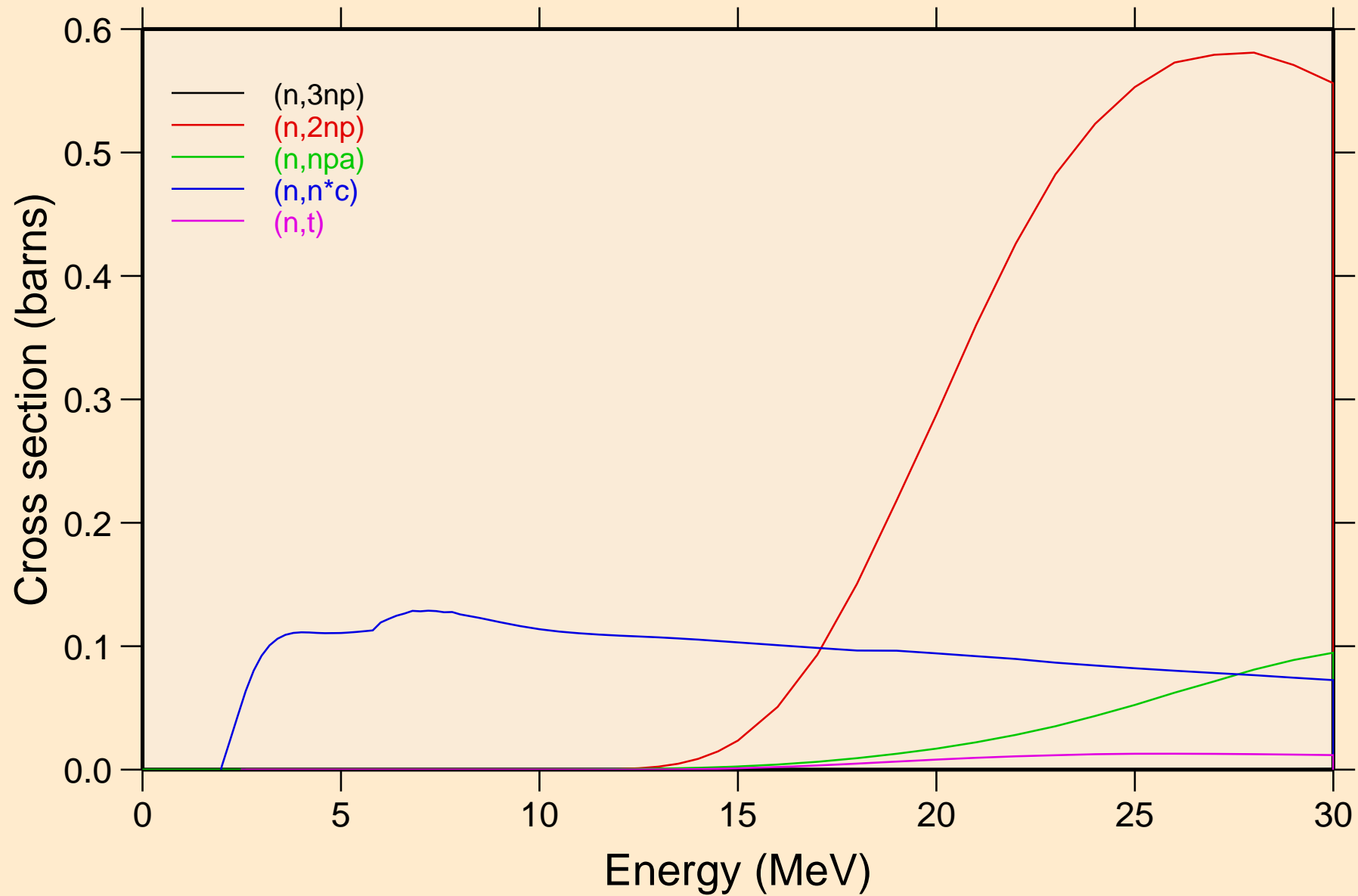

TA159 NEUTRON ACER TENDL-2021 LIBRARY; T=293.6K  
Threshold reactions

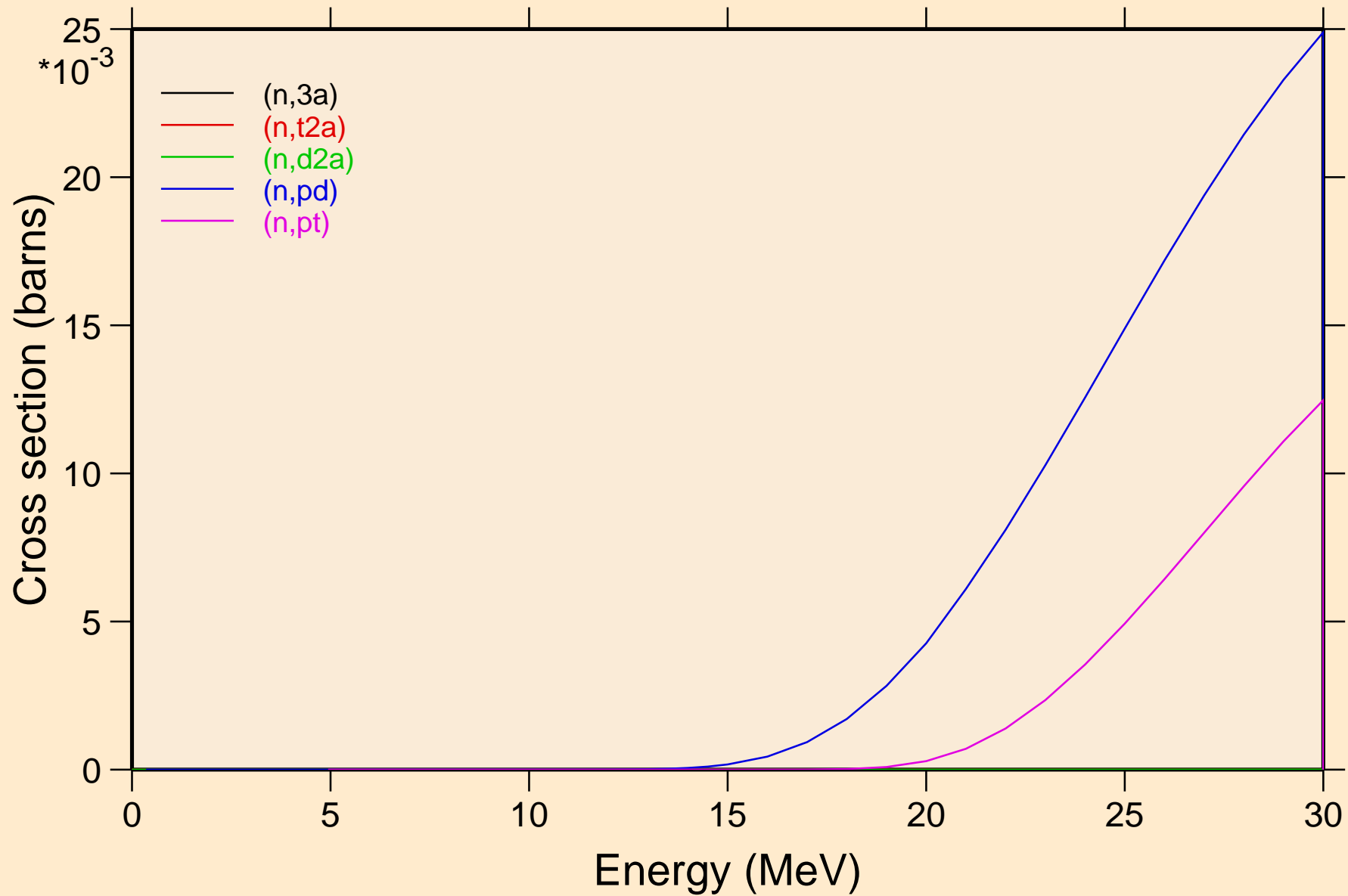

TA159 NEUTRON ACER TENDL-2021 LIBRARY; T=293.6K  
Threshold reactions

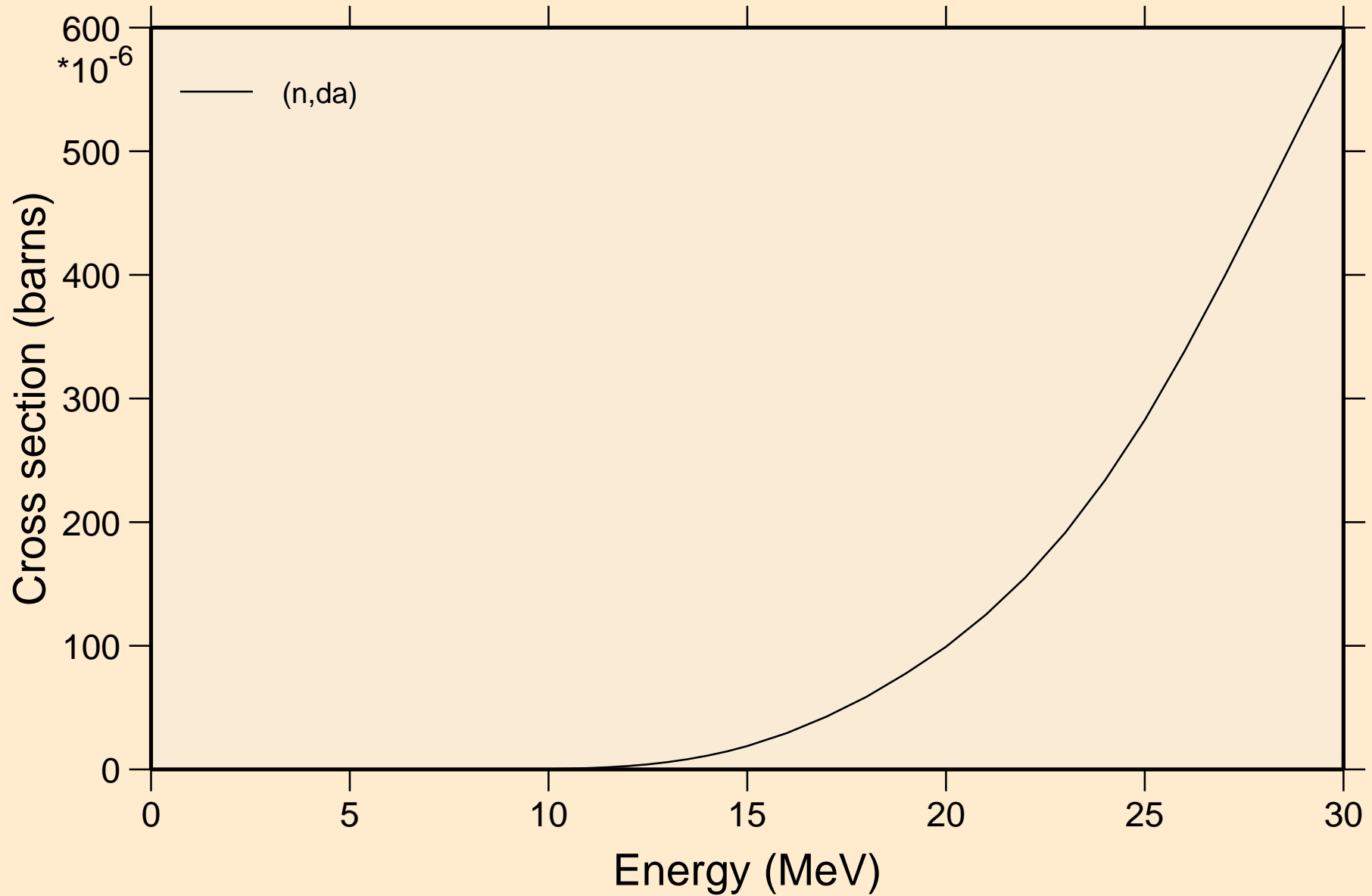



TA159 NEUTRON ACER TENDL-2021 LIBRARY; T=293.6K  
Threshold reactions

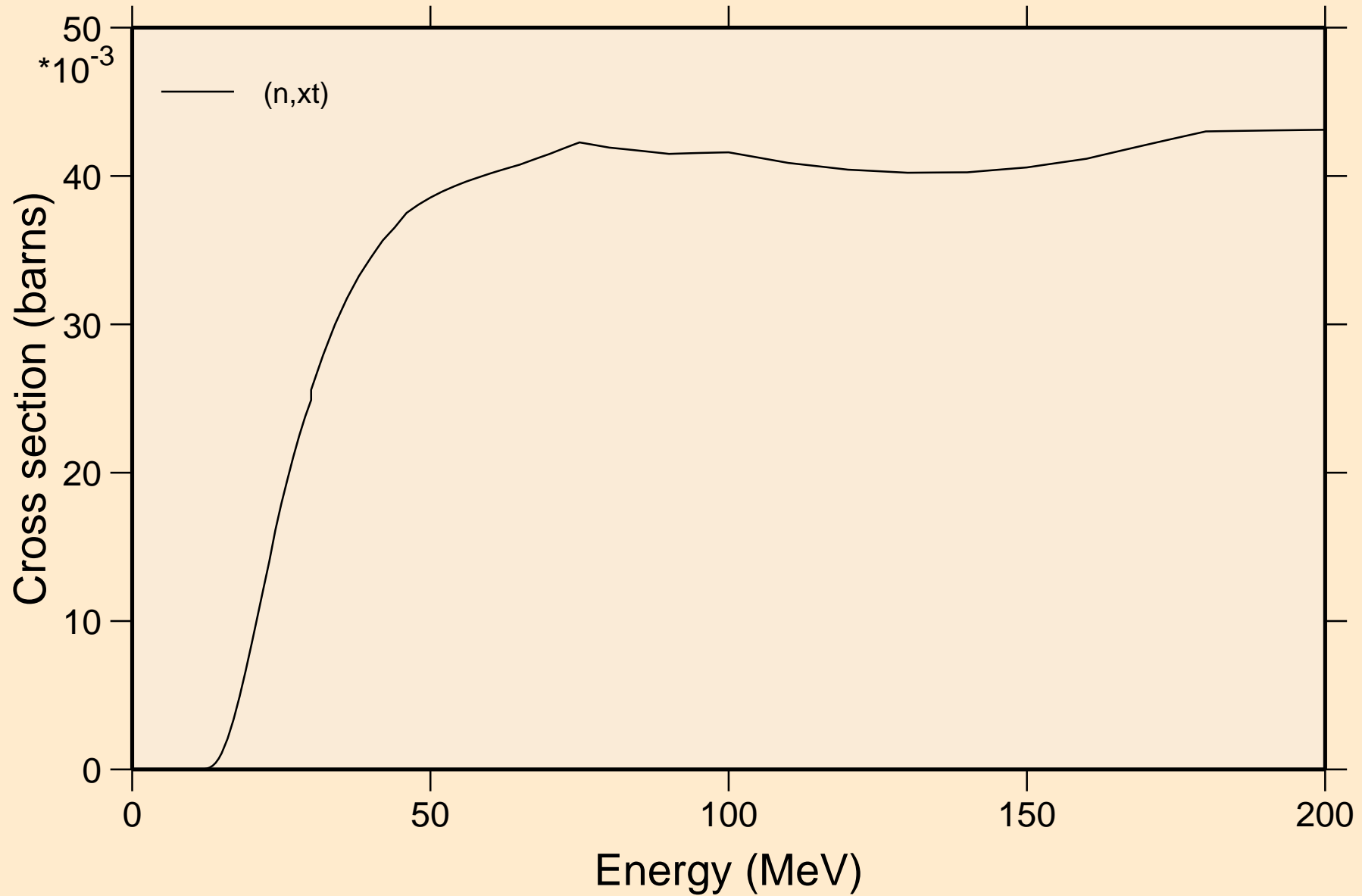

TA159 NEUTRON ACER TENDL-2021 LIBRARY; T=293.6K  
angular distribution for elastic

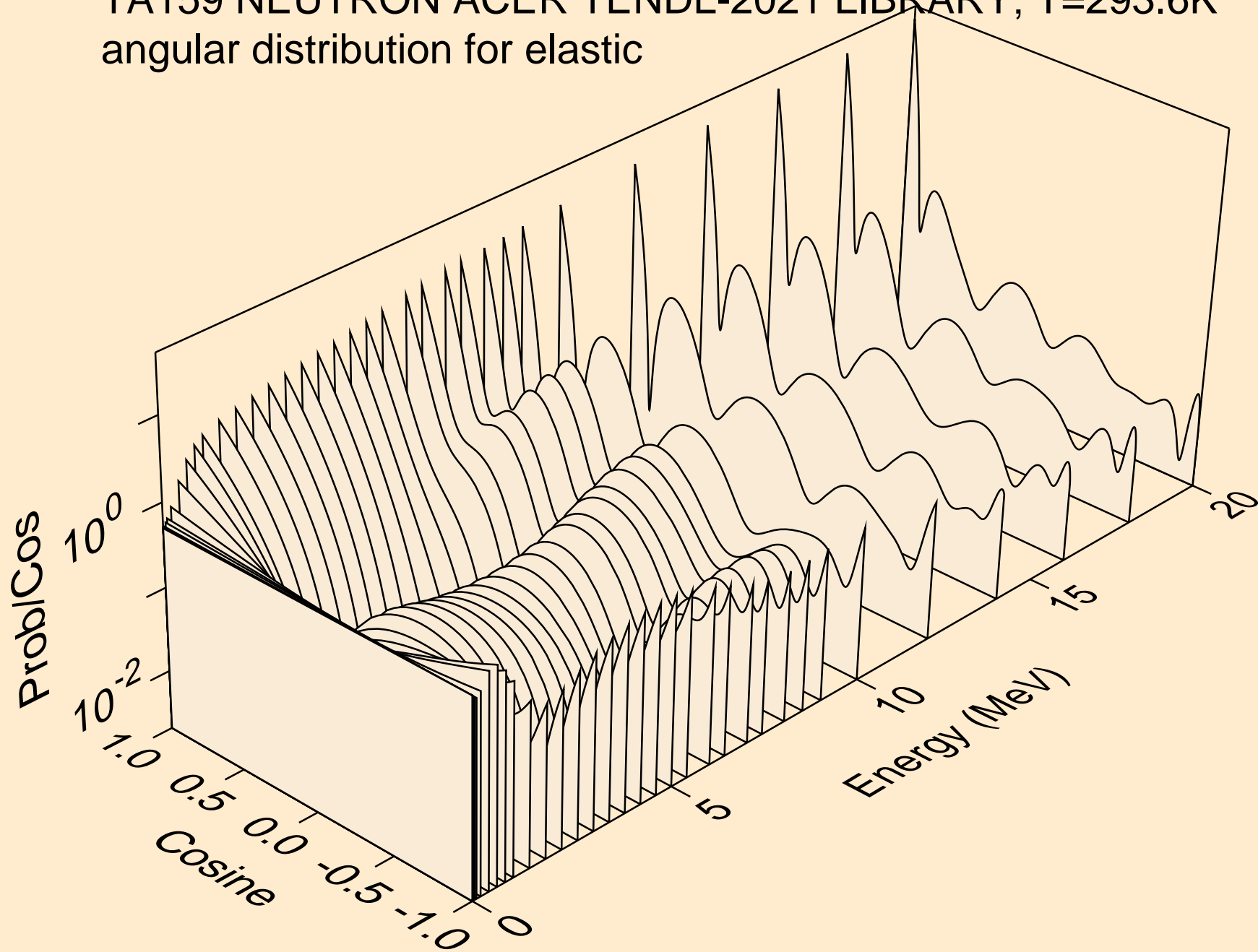

TA159 NEUTRON ACER TENDL-2021 LIBRARY; T=293.6K  
angular distribution for elastic

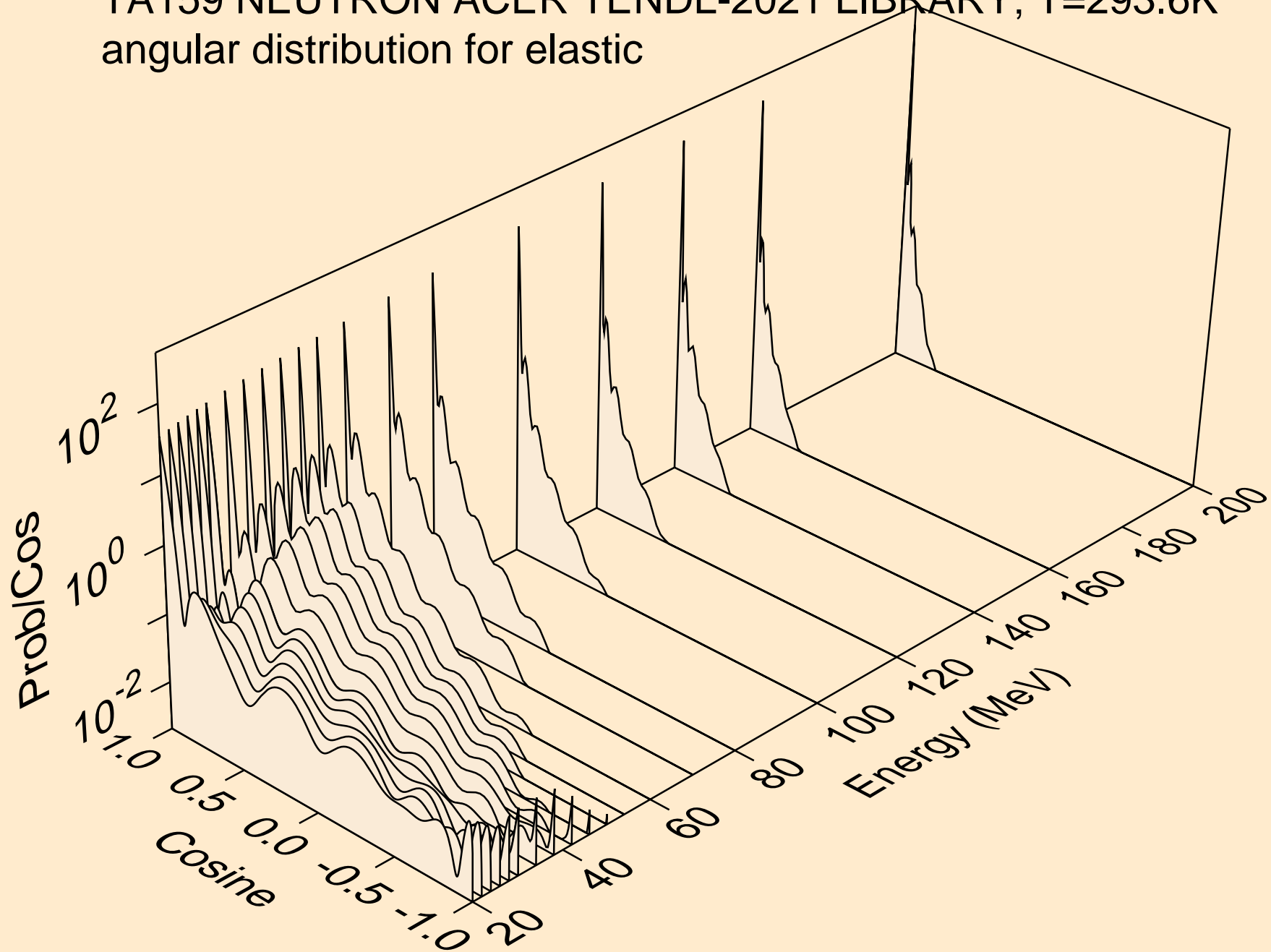

TA159 NEUTRON ACER TENDL-2021 LIBRARY; T=293.6K  
angular distribution for (n,n\*1)

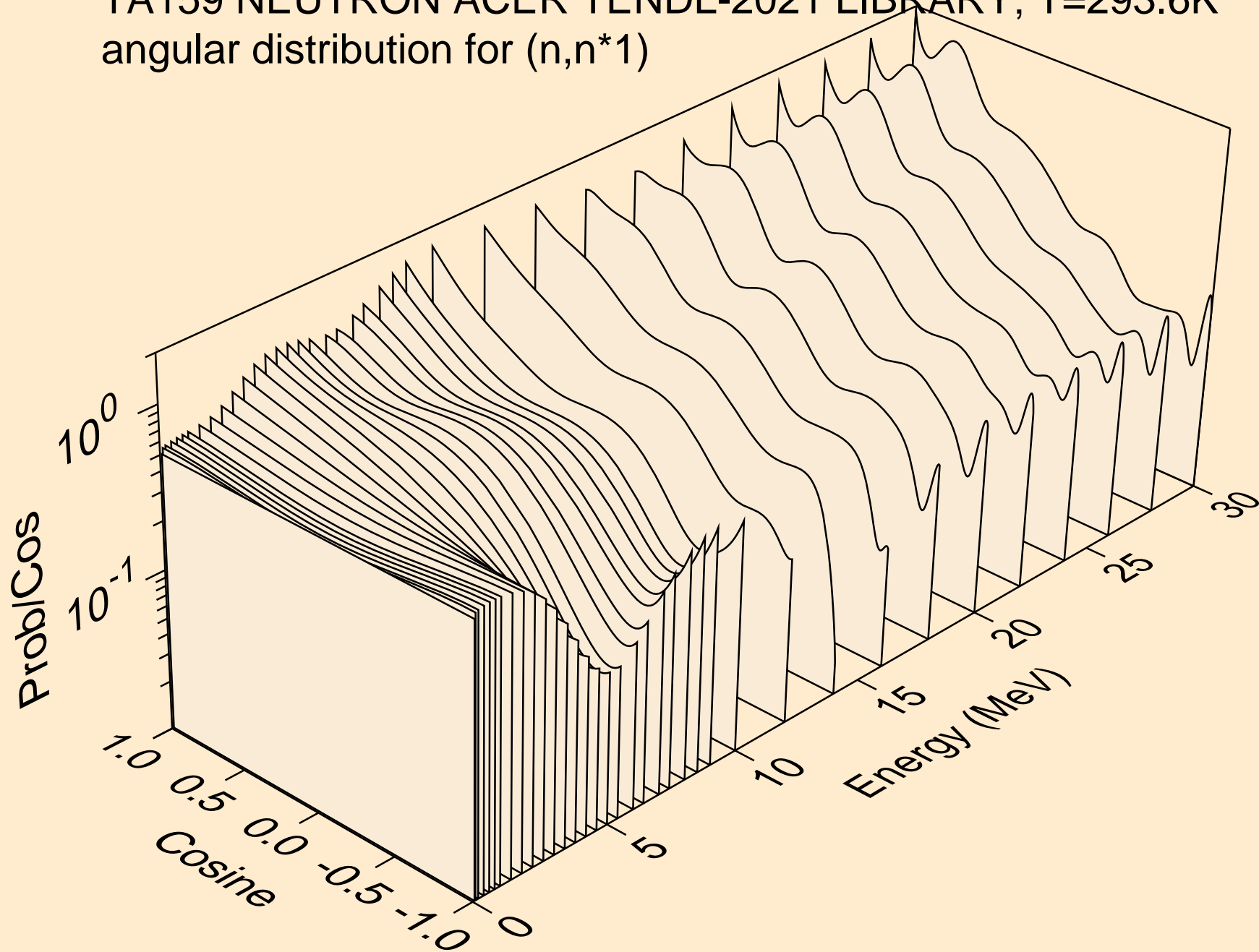

TA159 NEUTRON ACER TENDL-2021 LIBRARY; T=293.6K  
angular distribution for (n,n\*2)

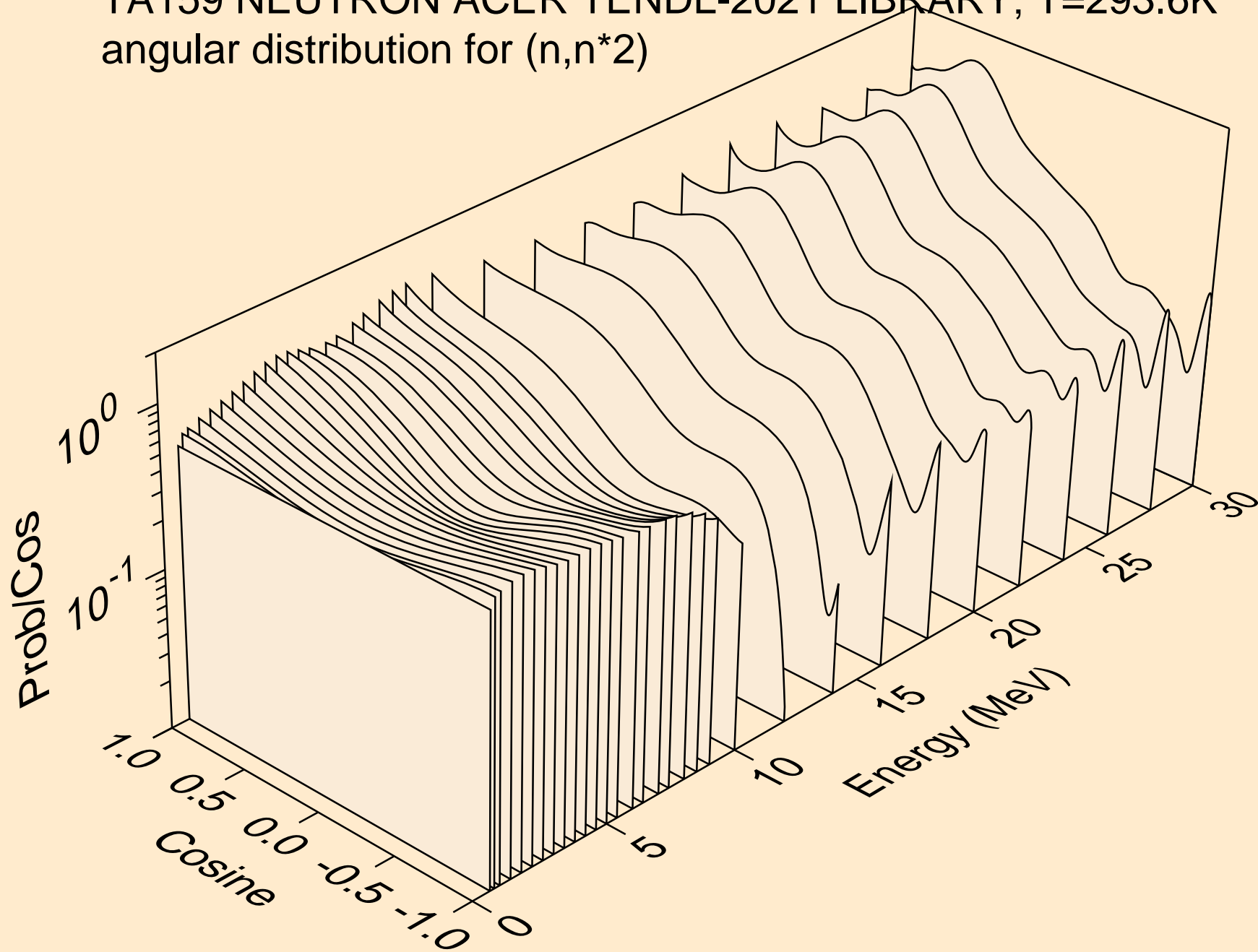

TA159 NEUTRON ACER TENDL-2021 LIBRARY; T=293.6K  
angular distribution for (n,n\*3)

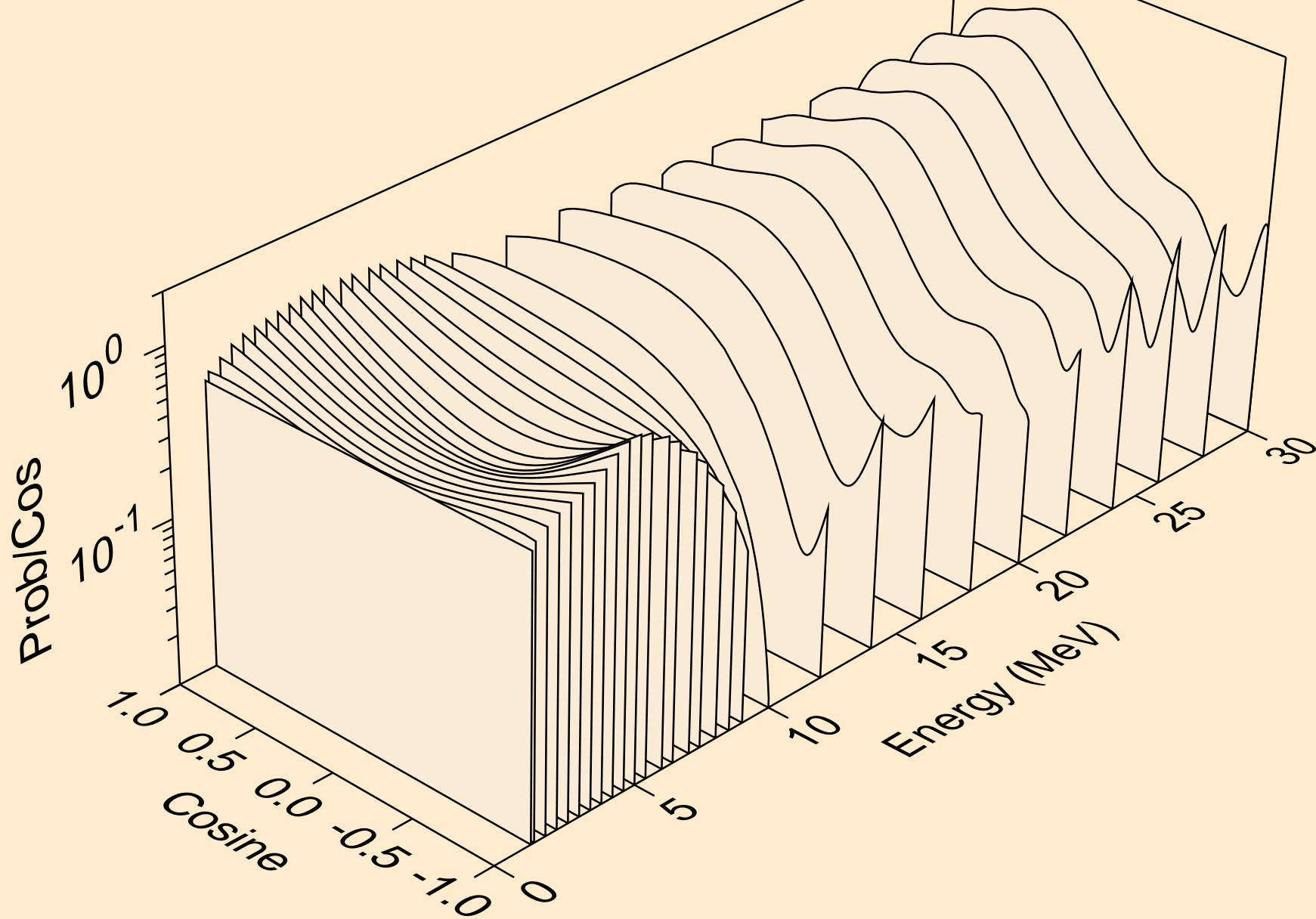

TA159 NEUTRON ACER TENDL-2021 LIBRARY; T=293.6K  
angular distribution for (n,n\*4)

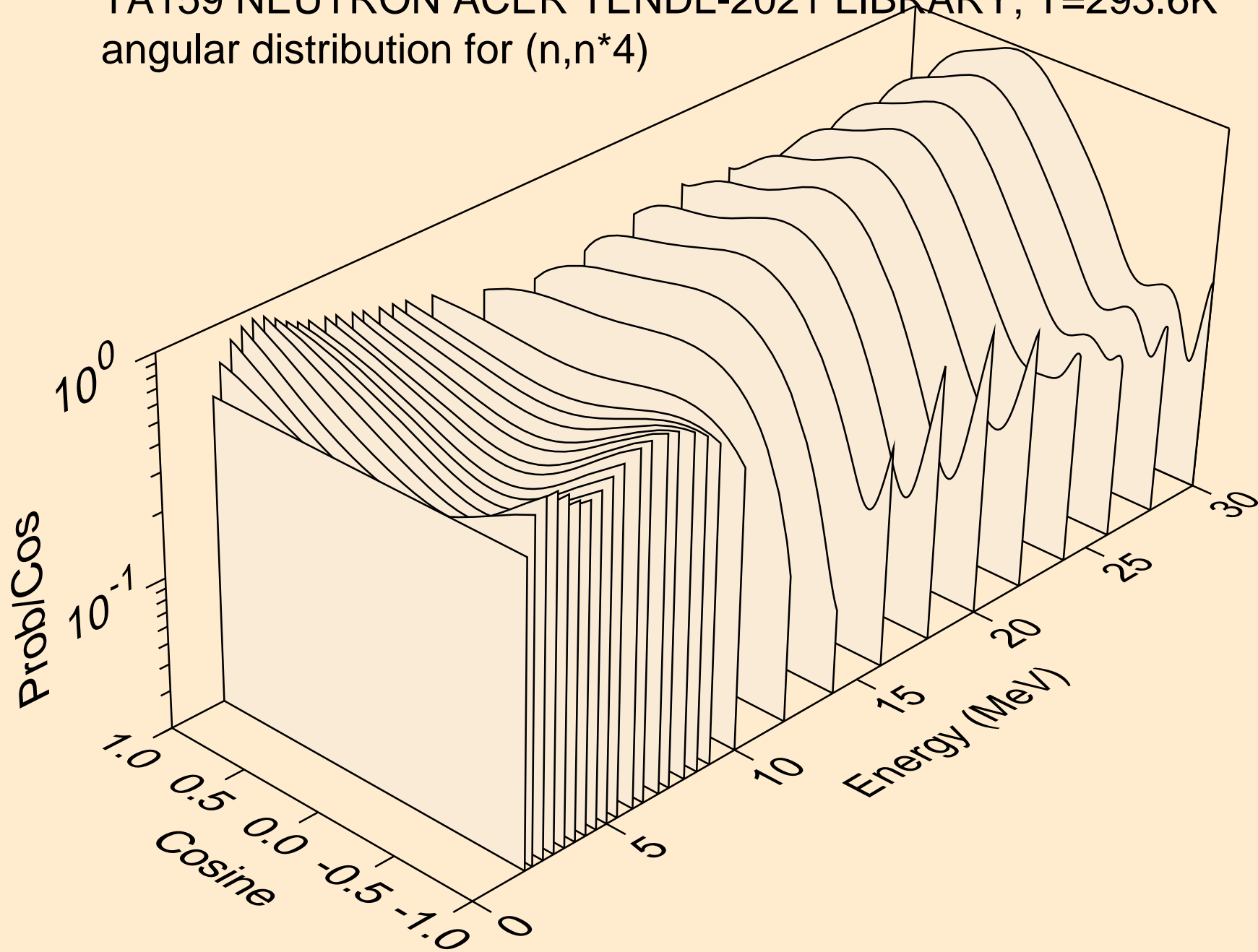

TA159 NEUTRON ACER TENDL-2021 LIBRARY; T=293.6K  
angular distribution for (n,n\*5)

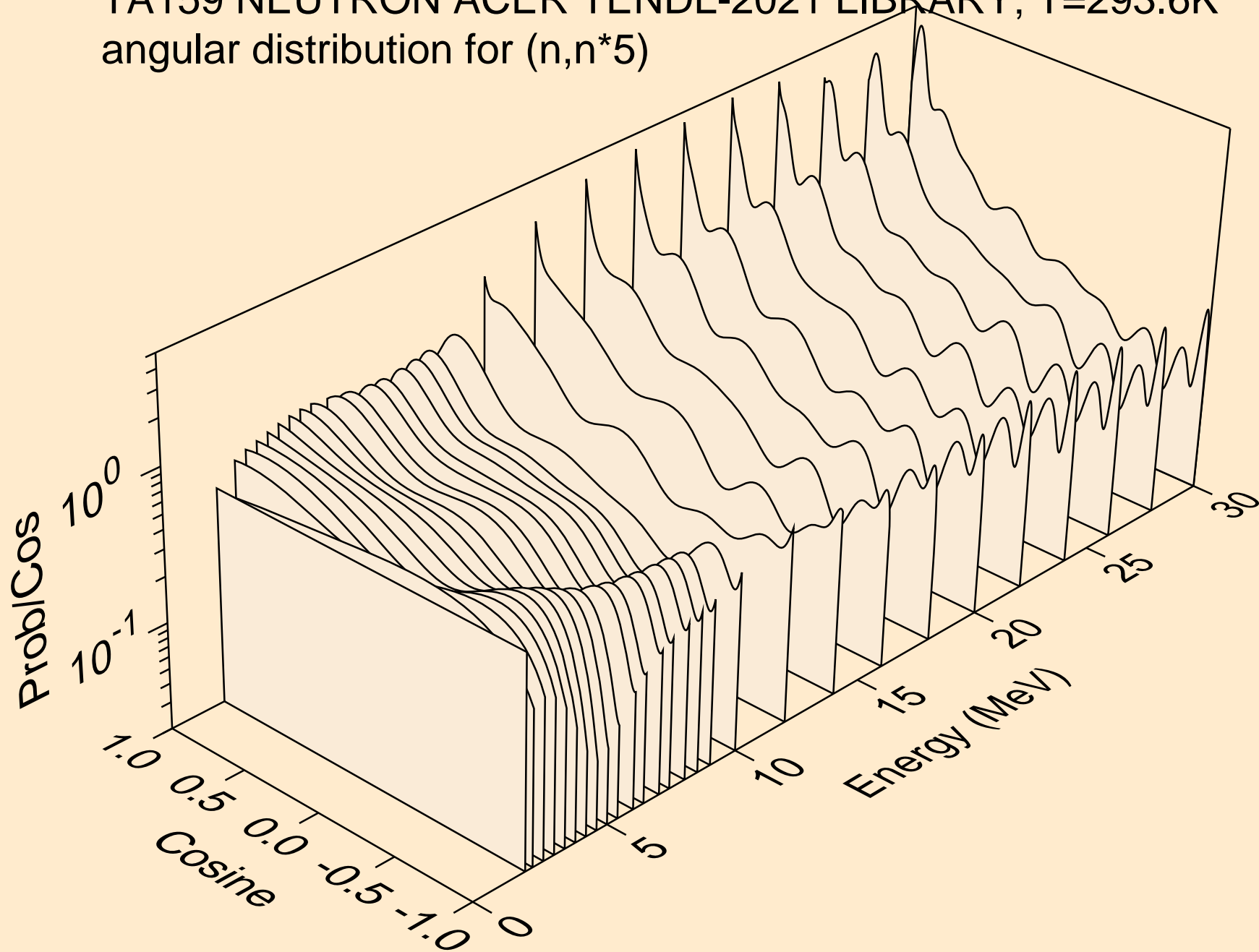



TA159 NEUTRON ACER TENDL-2021 LIBRARY; T=293.6K  
angular distribution for (n,n\*6)

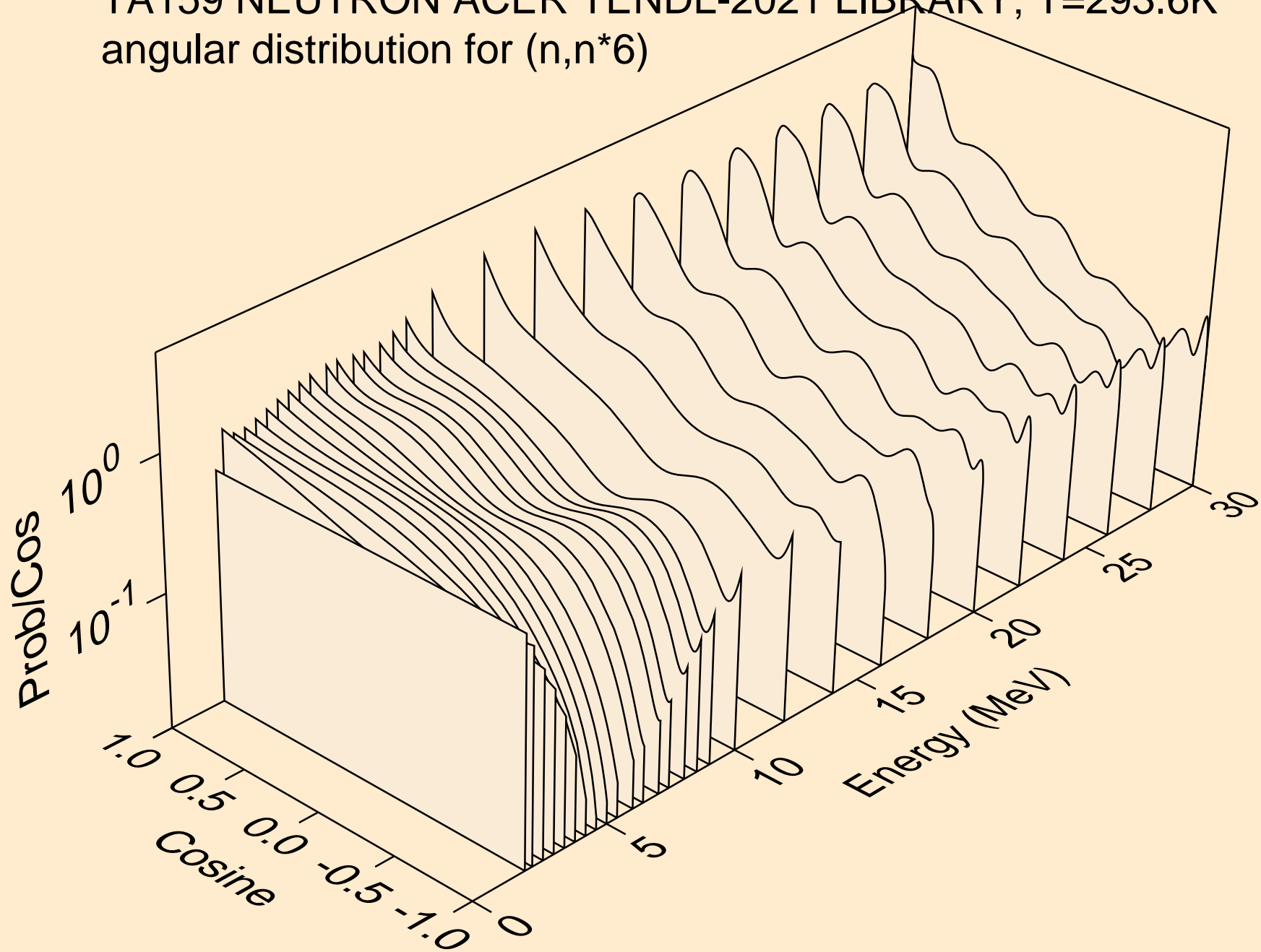

TA159 NEUTRON ACER TENDL-2021 LIBRARY; T=293.6K  
angular distribution for (n,n\*7)

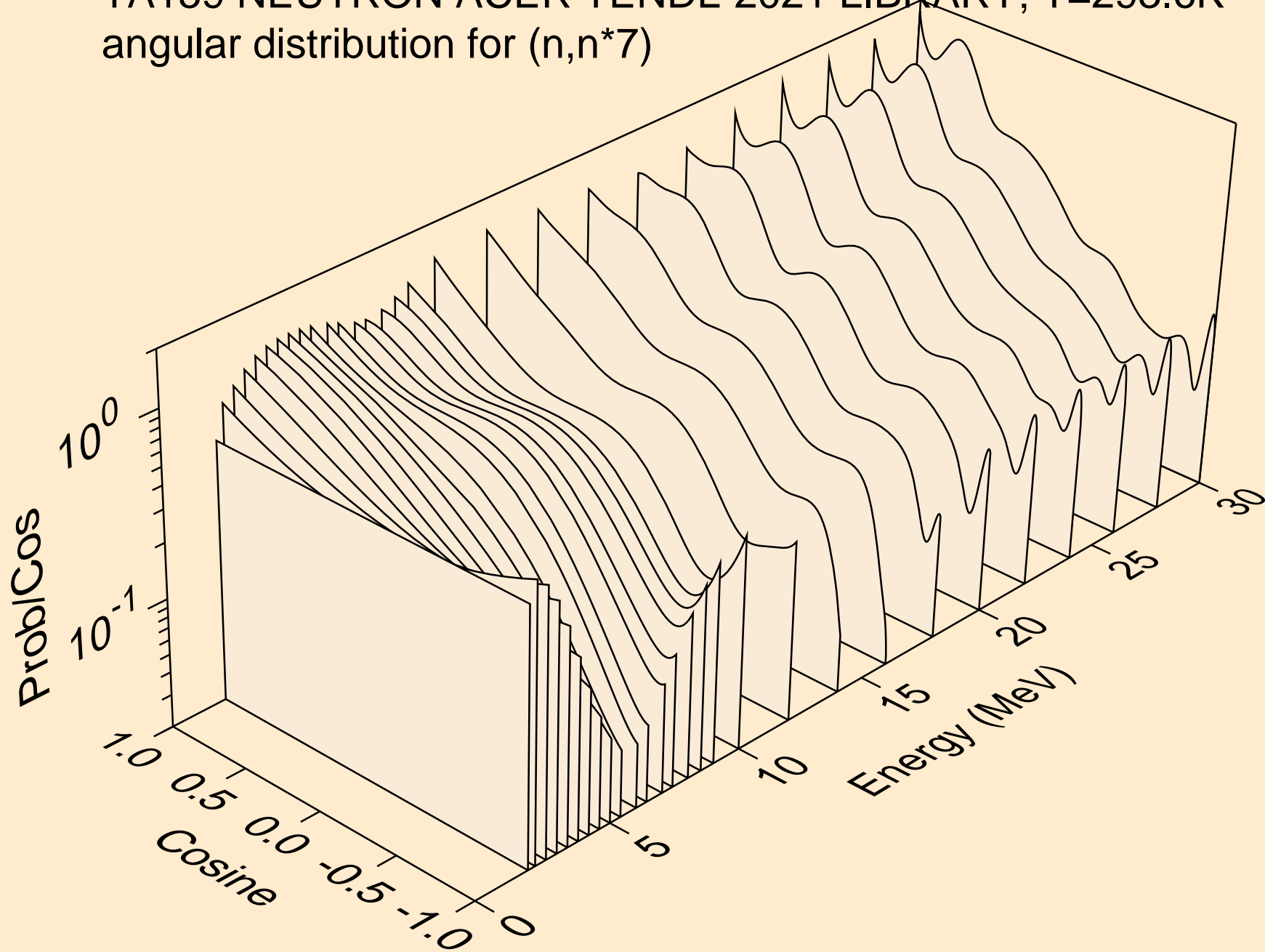

TA159 NEUTRON ACER TENDL-2021 LIBRARY; T=293.6K  
angular distribution for (n,n\*8)

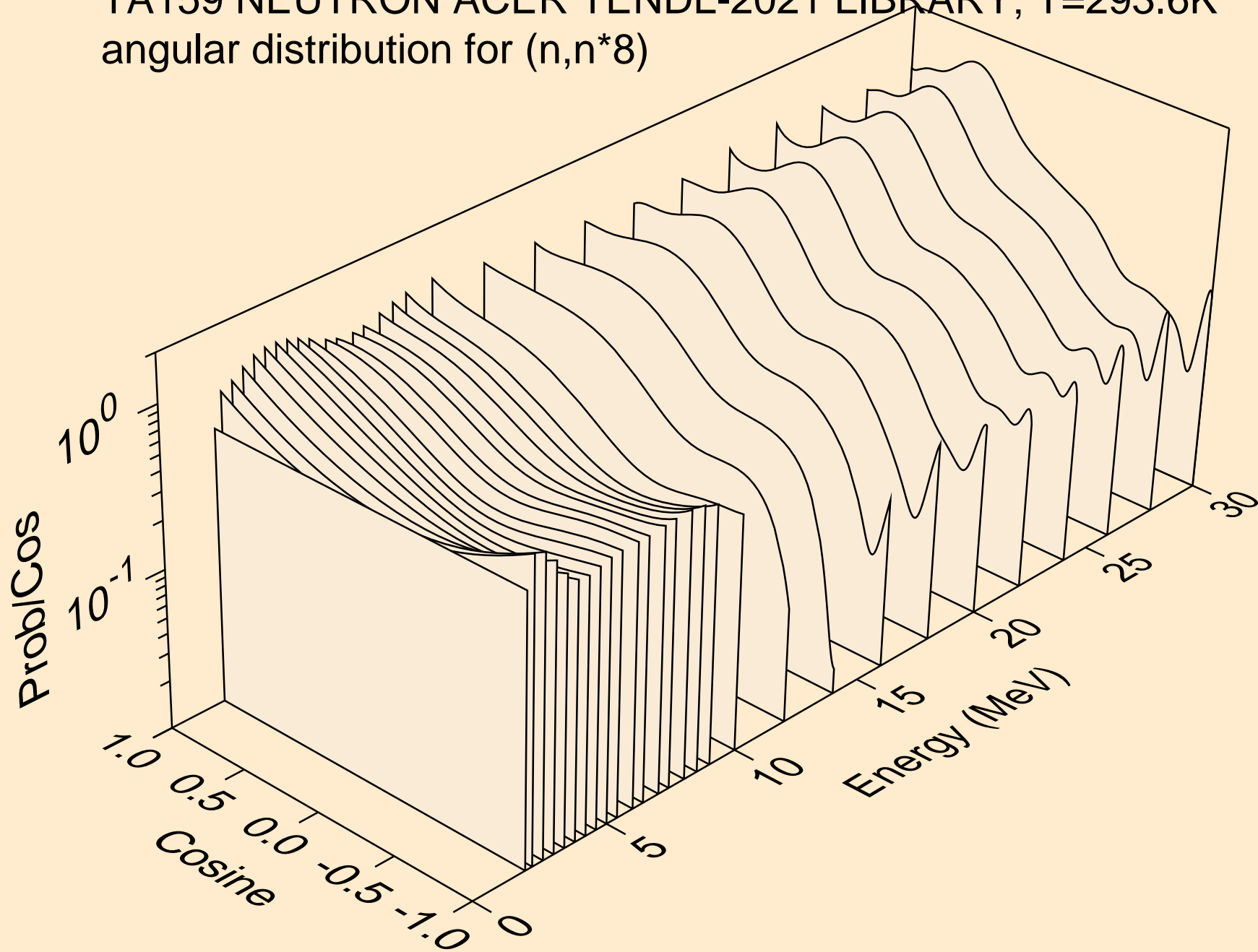

TA159 NEUTRON ACER TENDL-2021 LIBRARY; T=293.6K  
angular distribution for (n,n\*9)

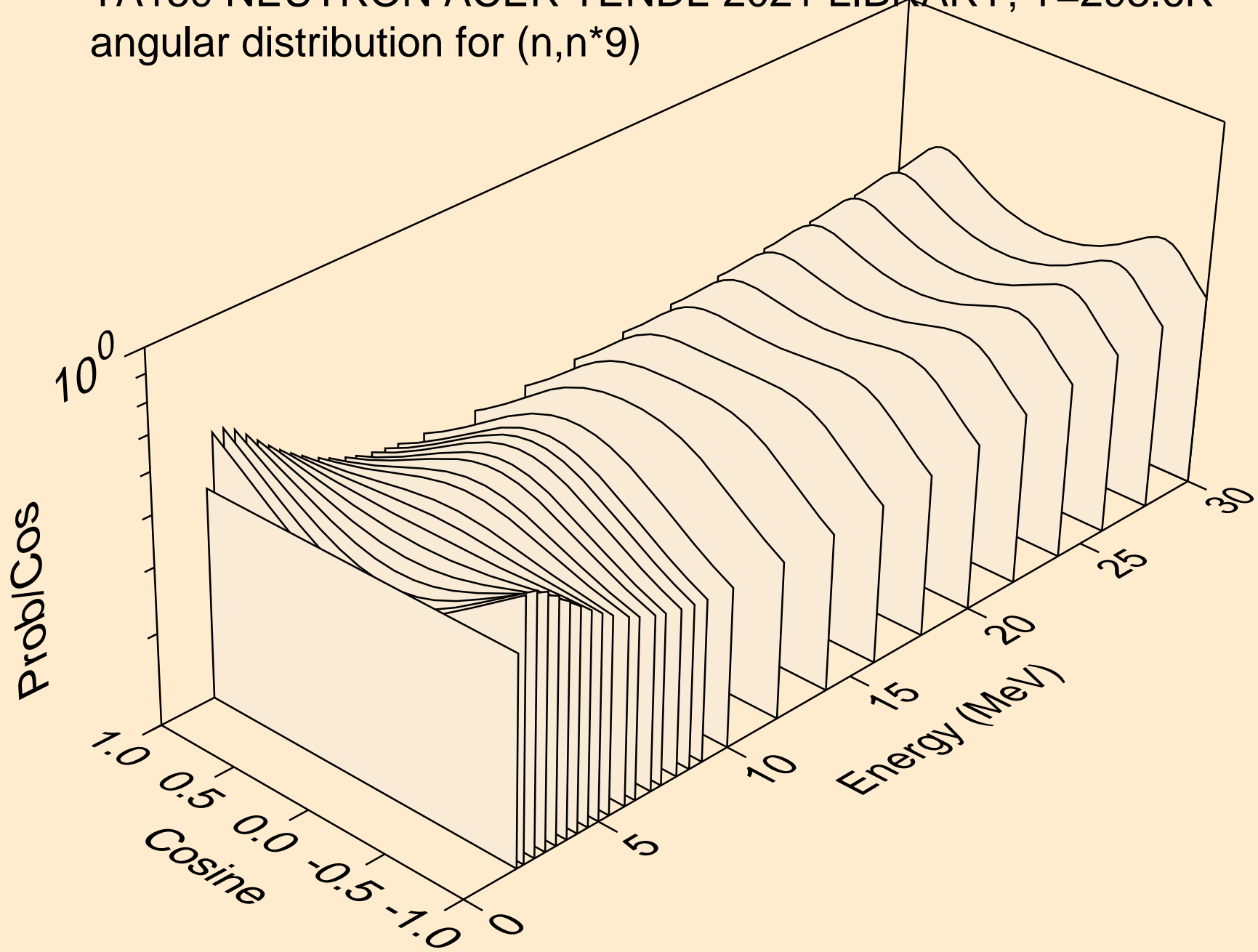

TA159 NEUTRON ACER TENDL-2021 LIBRARY; T=293.6K  
angular distribution for (n,n\*10)

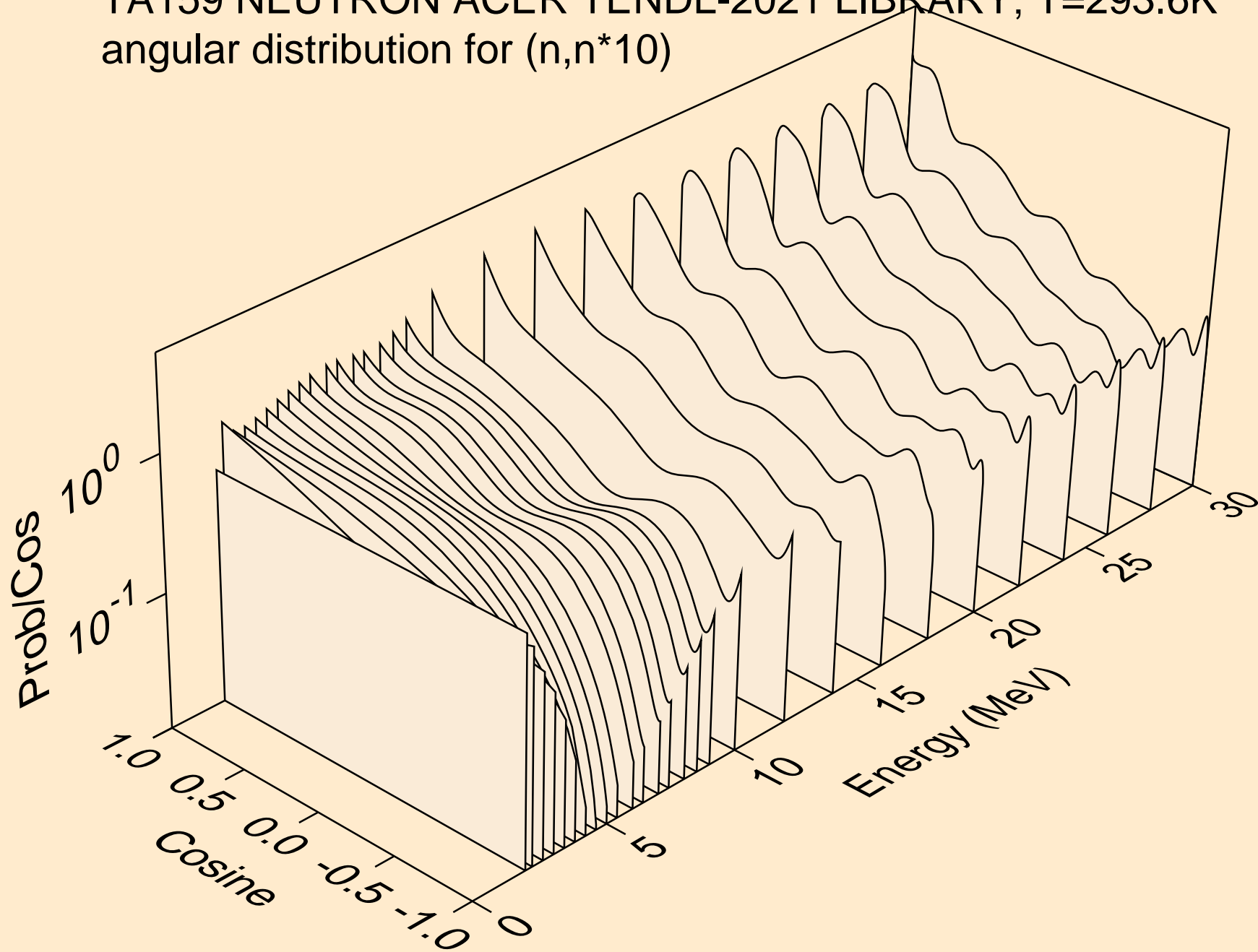

TA159 NEUTRON ACER TENDL-2021 LIBRARY; T=293.6K  
angular distribution for (n,n\*11)

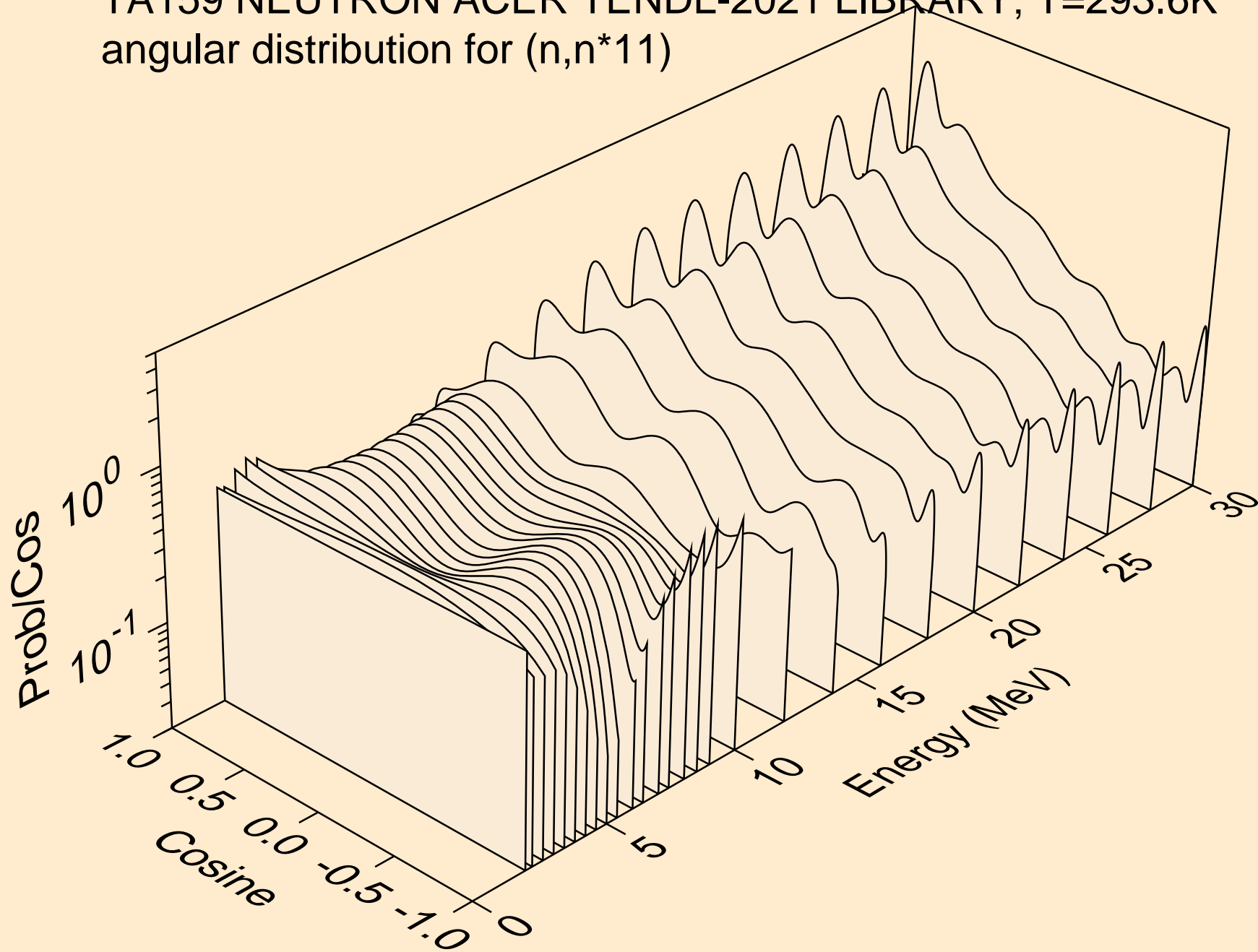

TA159 NEUTRON ACER TENDL-2021 LIBRARY; T=293.6K  
angular distribution for (n,n\*12)

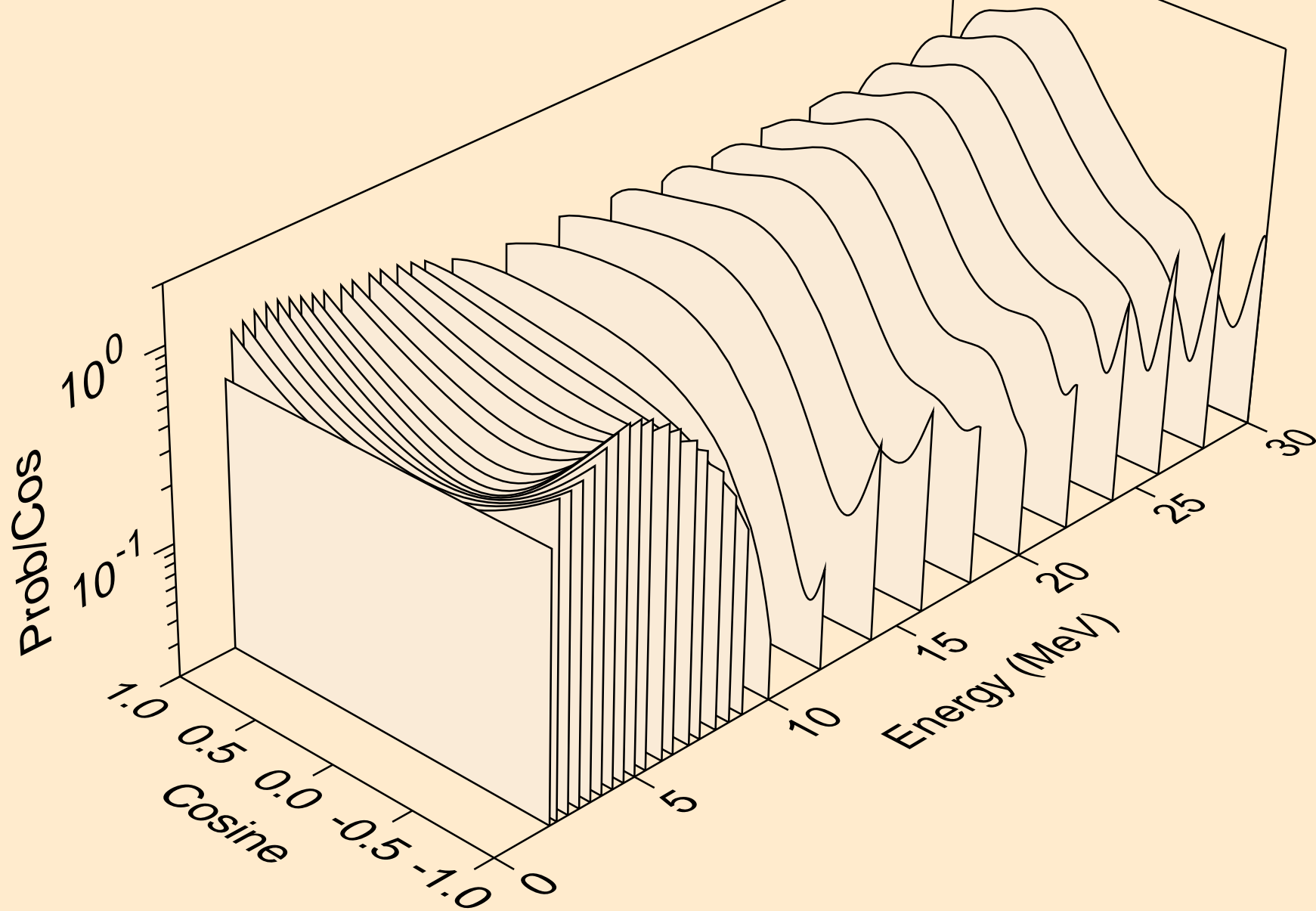

TA159 NEUTRON ACER TENDL-2021 LIBRARY; T=293.6K  
angular distribution for (n,n\*13)

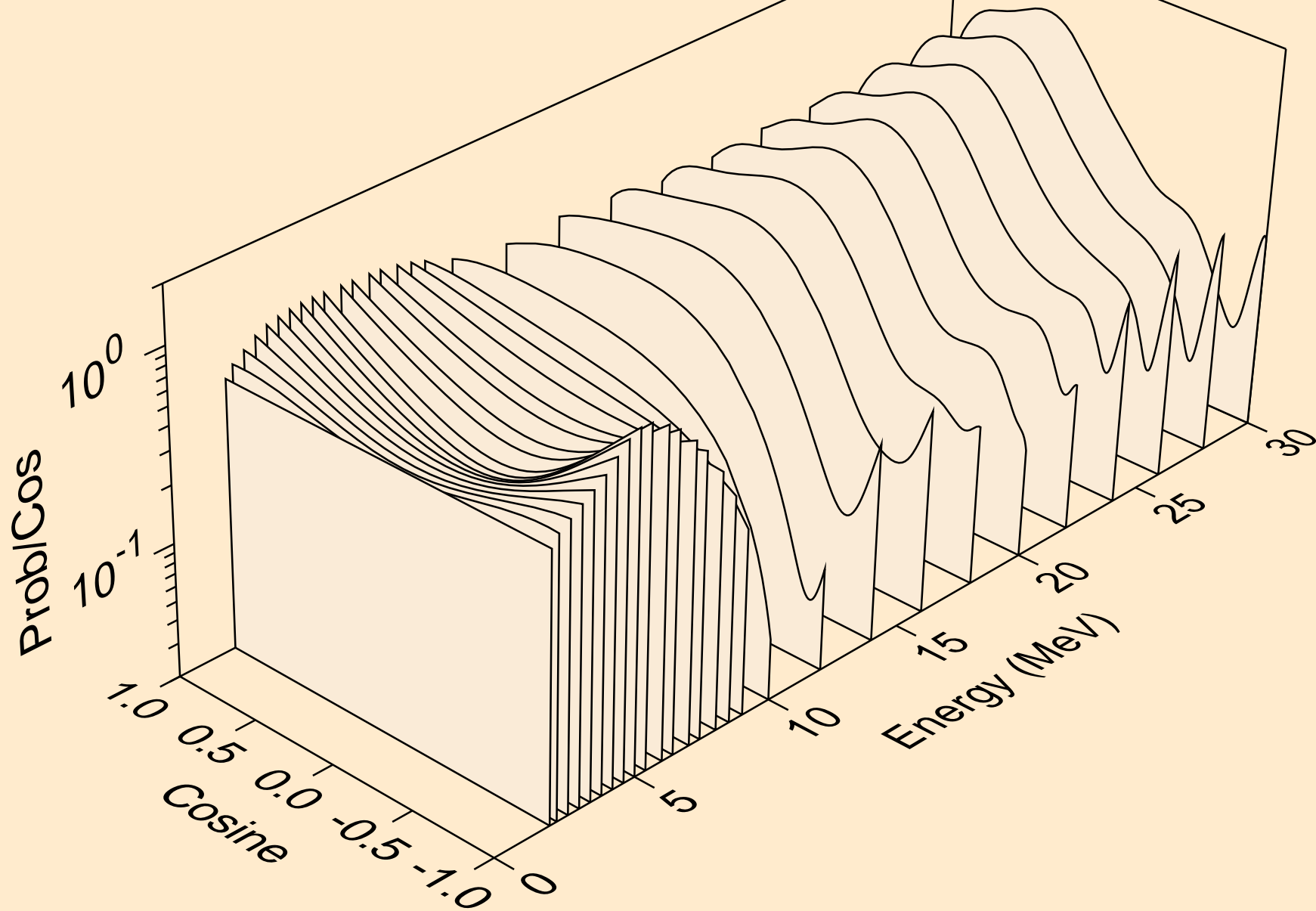



TA159 NEUTRON ACER TENDL-2021 LIBRARY; T=293.6K  
angular distribution for (n,n\*14)

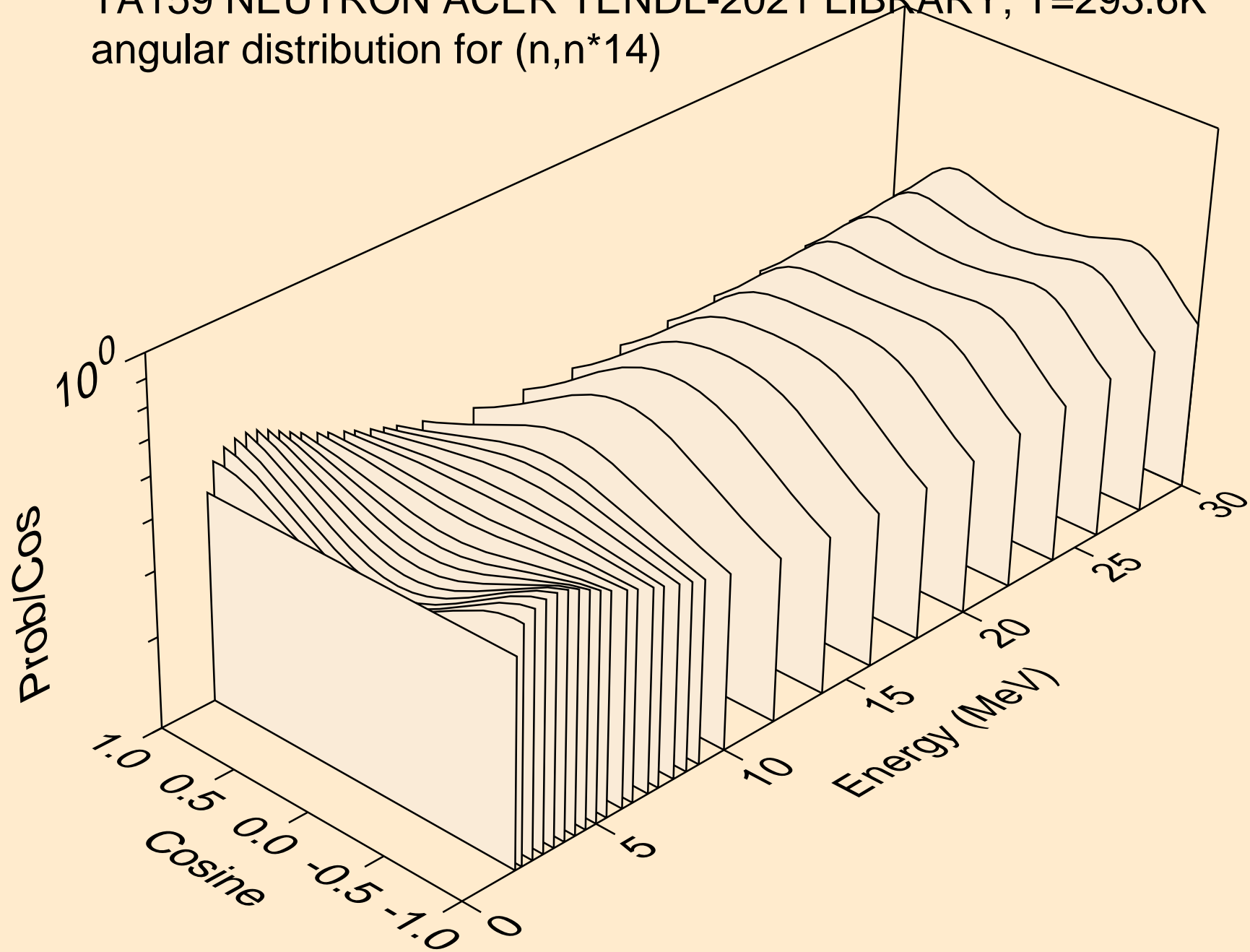

TA159 NEUTRON ACER TENDL-2021 LIBRARY; T=293.6K  
angular distribution for (n,n\*15)

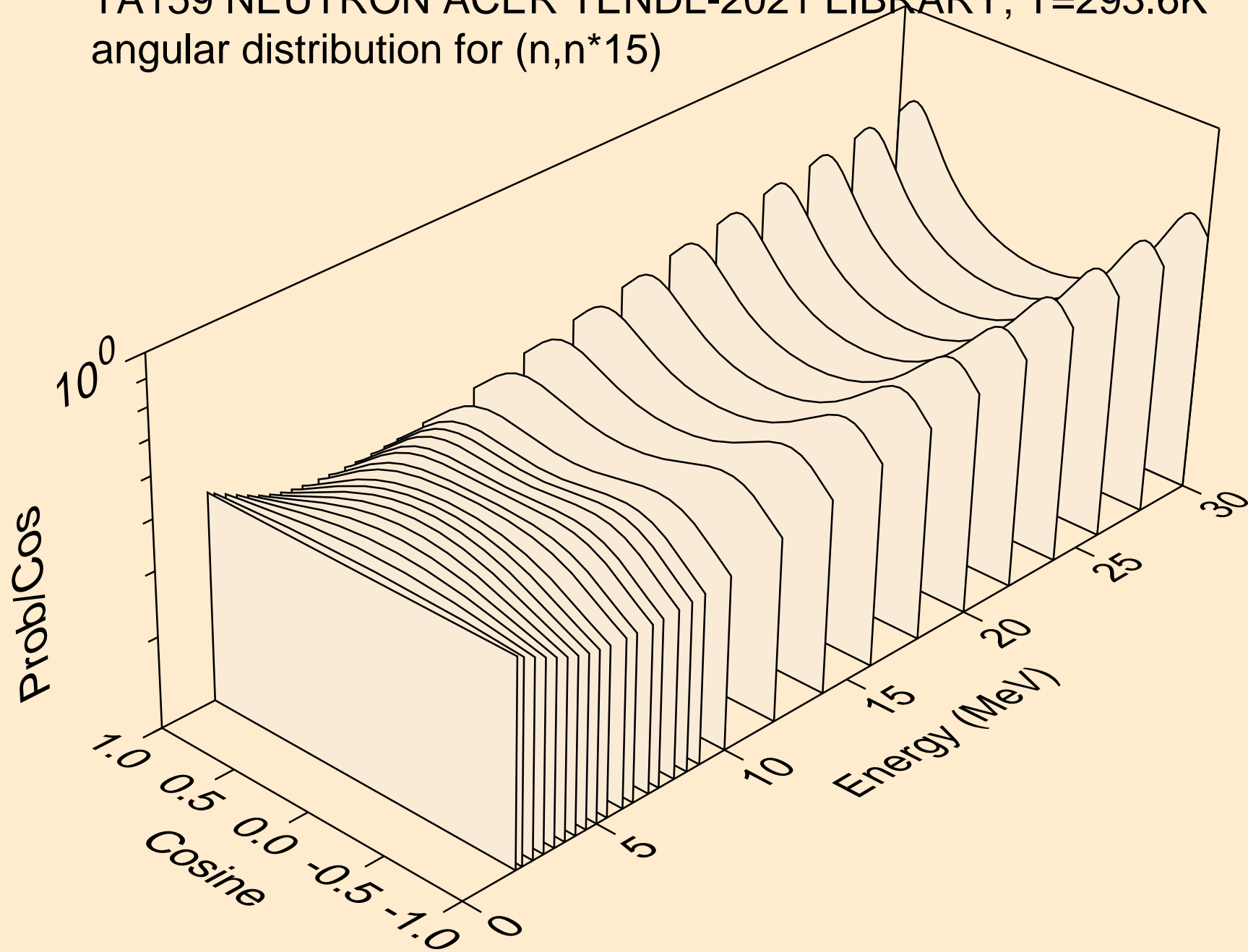

TA159 NEUTRON ACER TENDL-2021 LIBRARY; T=293.6K  
angular distribution for (n,n\*16)

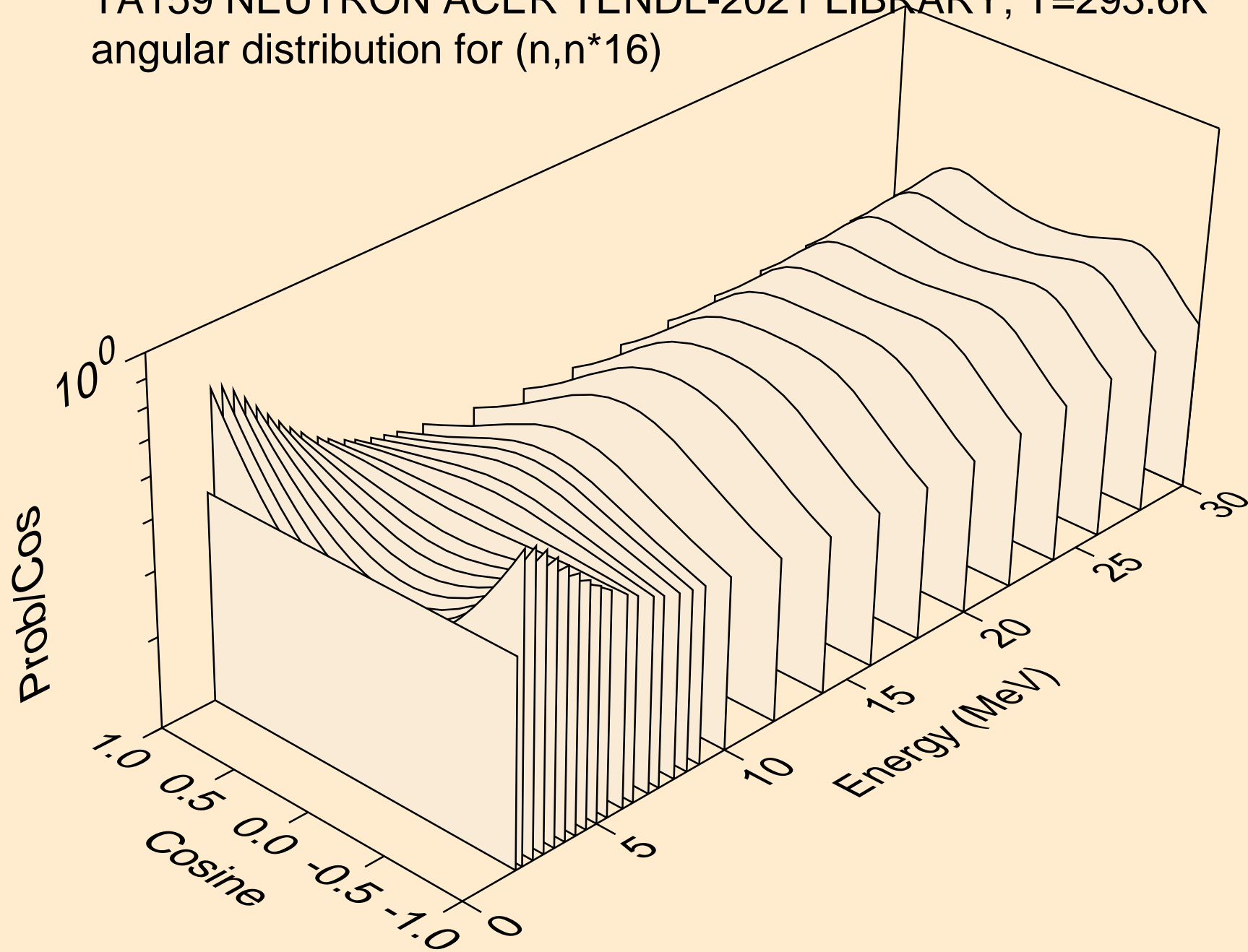

TA159 NEUTRON ACER TENDL-2021 LIBRARY; T=293.6K  
angular distribution for (n,n\*17)

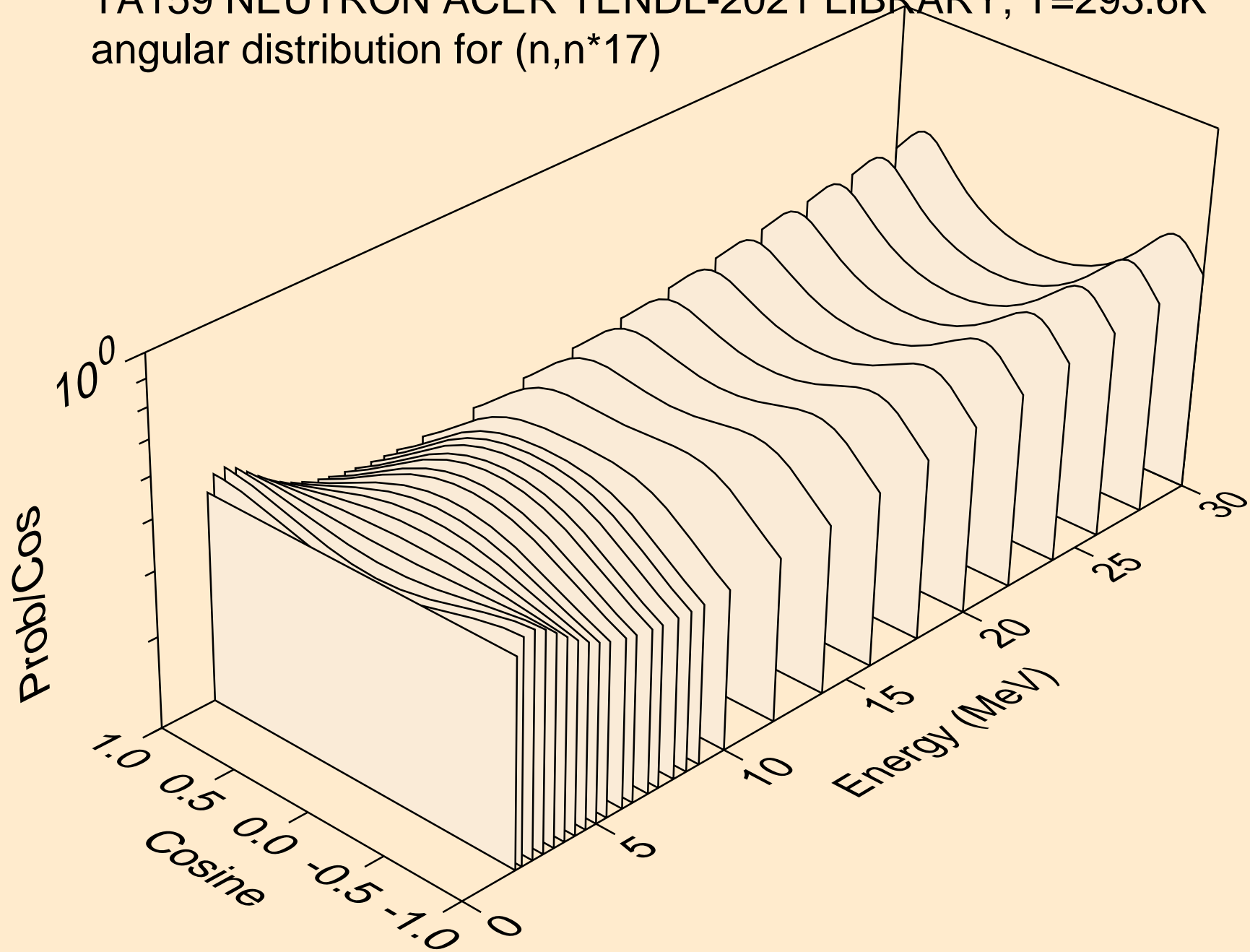

TA159 NEUTRON ACER TENDL-2021 LIBRARY; T=293.6K  
angular distribution for (n,n\*18)

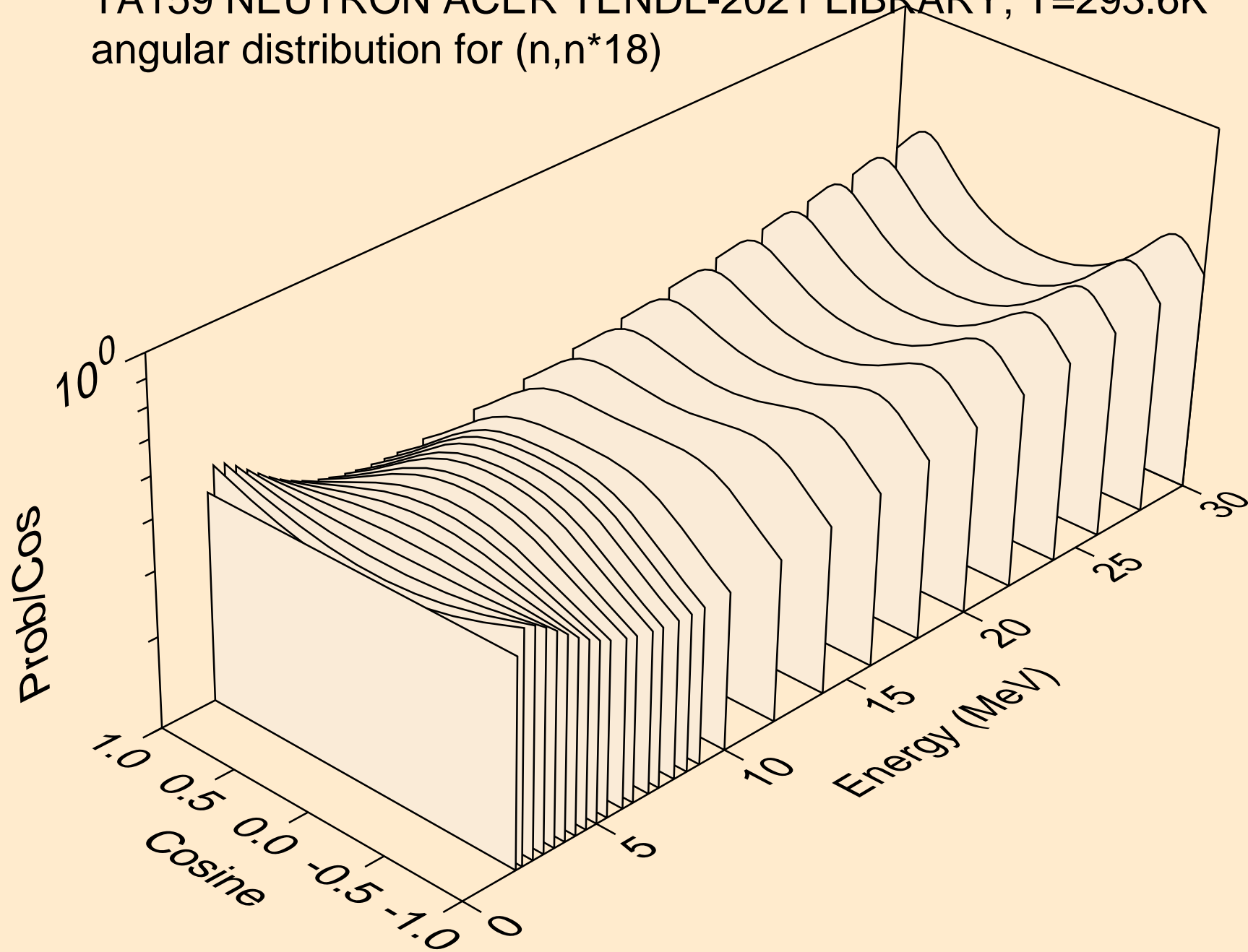

TA159 NEUTRON ACER TENDL-2021 LIBRARY; T=293.6K  
angular distribution for (n,n\*19)

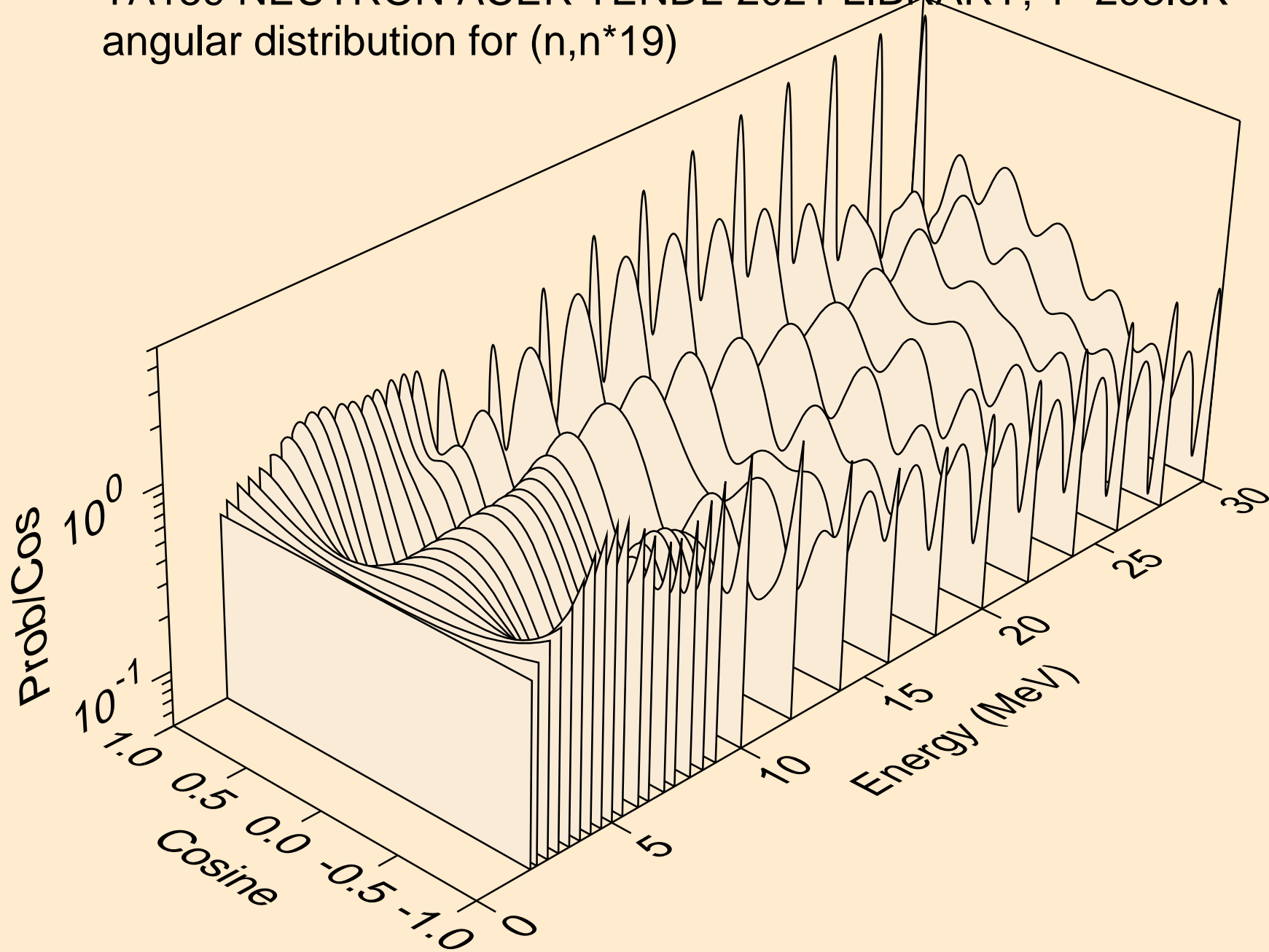

TA159 NEUTRON ACER TENDL-2021 LIBRARY; T=293.6K  
angular distribution for (n,n\*20)

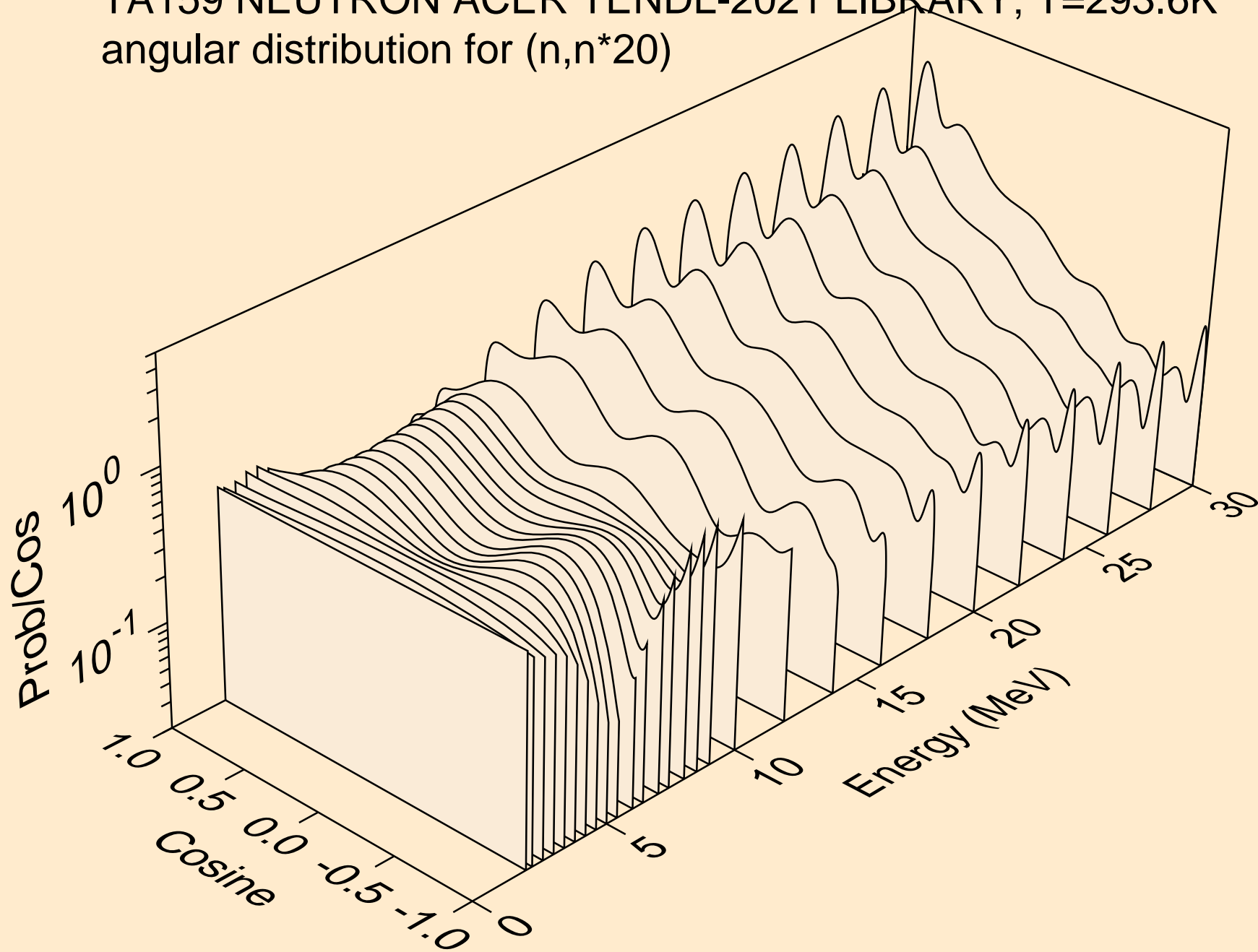

TA159 NEUTRON ACER TENDL-2021 LIBRARY; T=293.6K  
angular distribution for (n,n\*21)

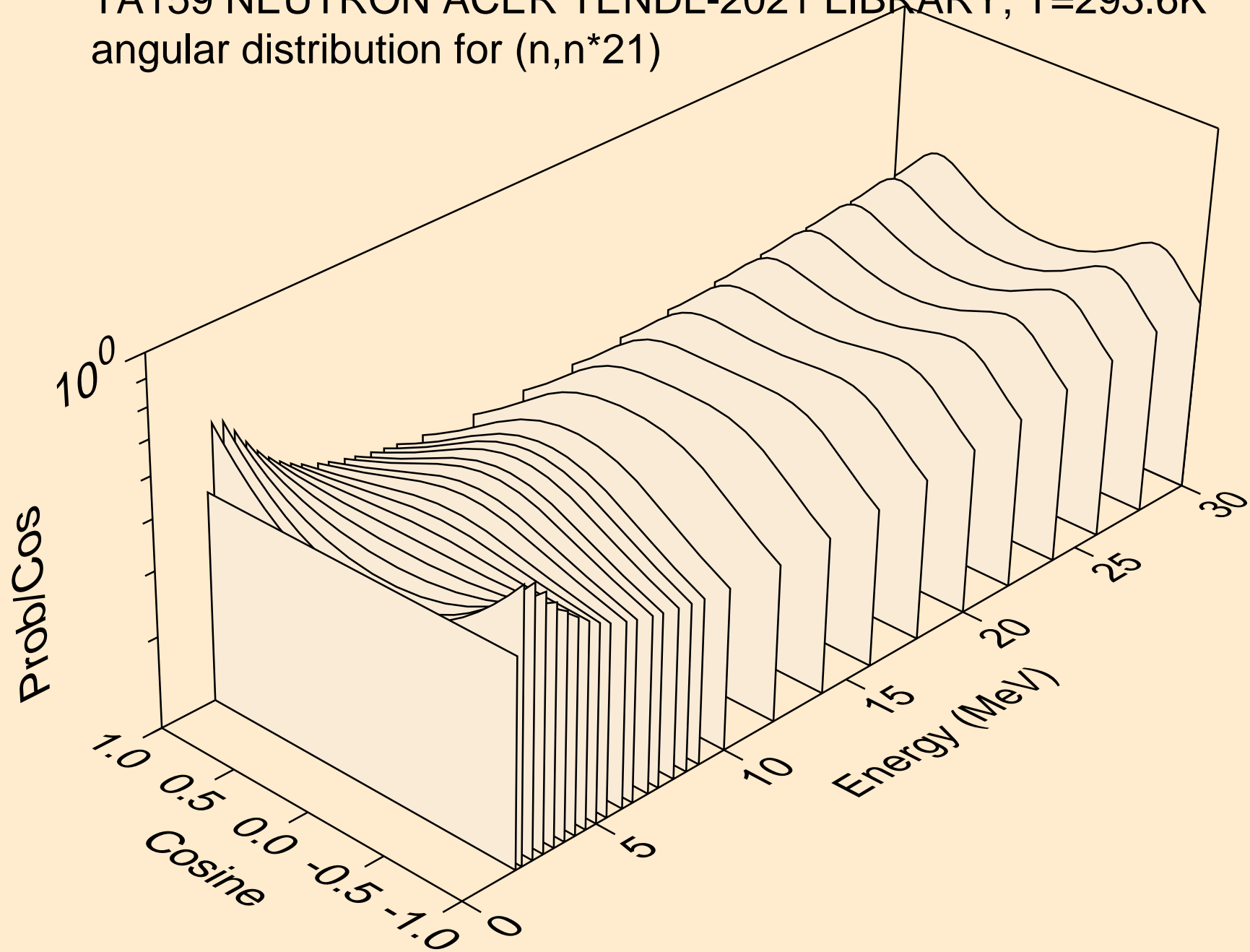



TA159 NEUTRON ACER TENDL-2021 LIBRARY; T=293.6K  
angular distribution for (n,n\*22)

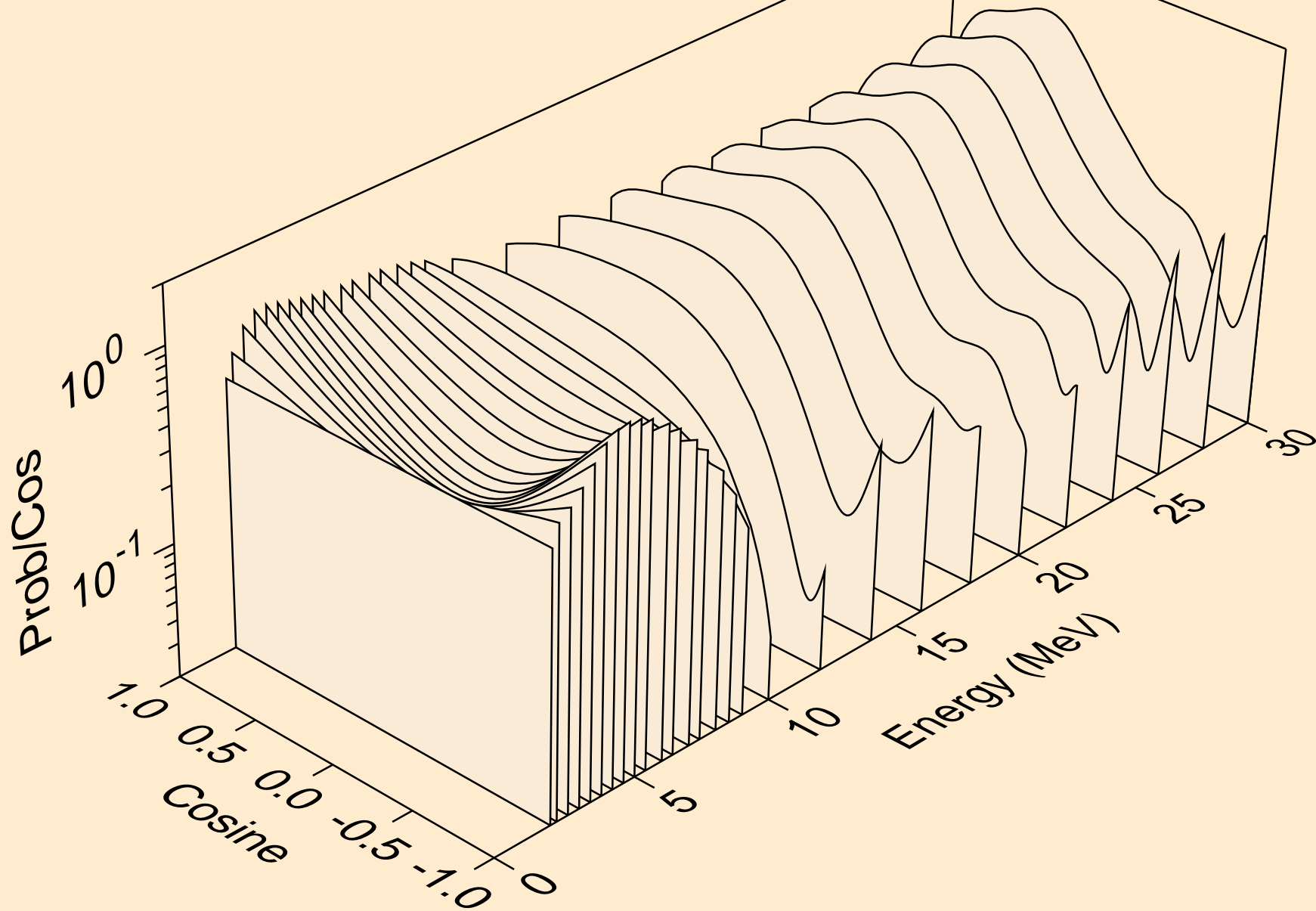

TA159 NEUTRON ACER TENDL-2021 LIBRARY; T=293.6K  
angular distribution for (n,n\*23)

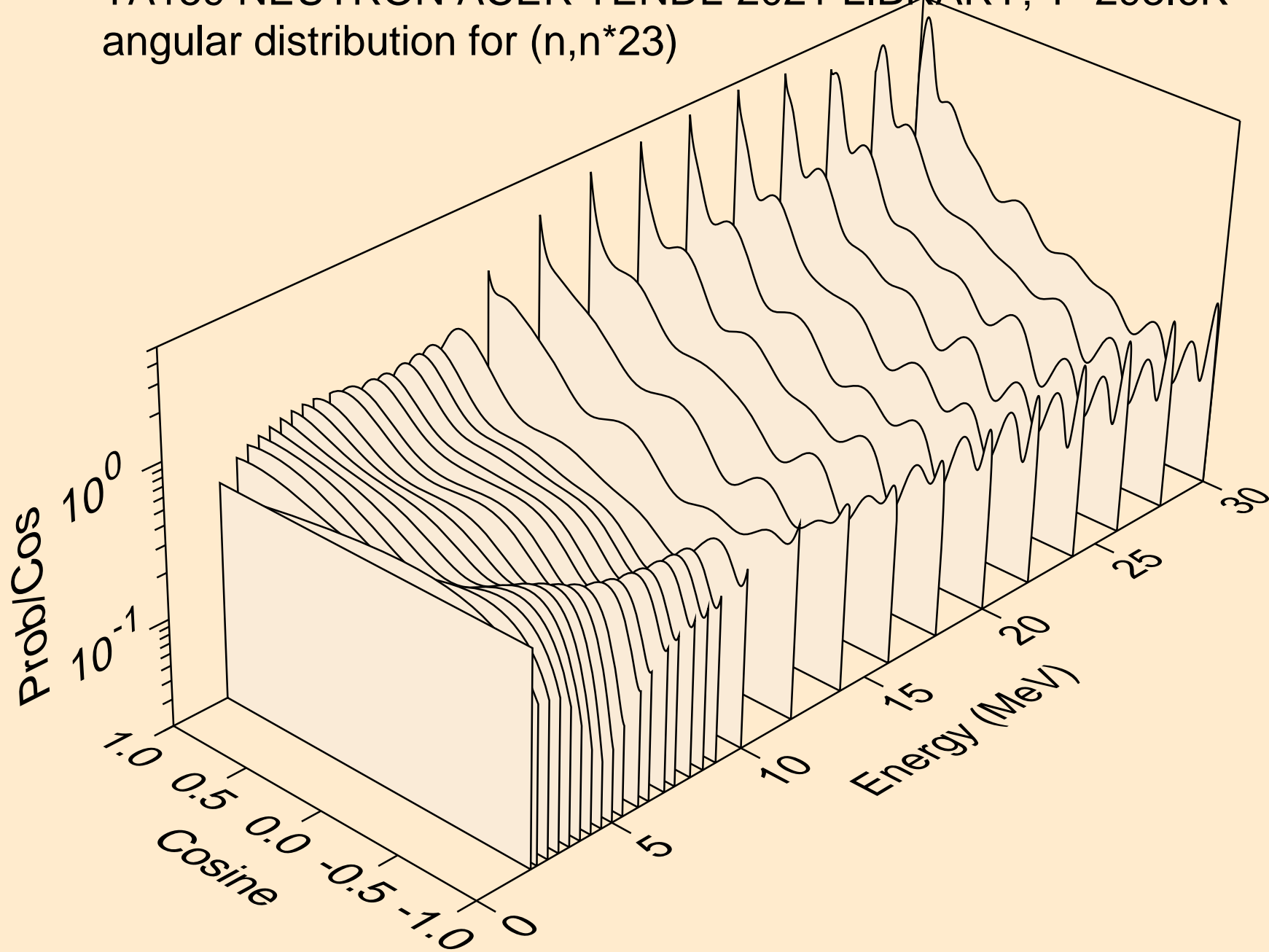

TA159 NEUTRON ACER TENDL-2021 LIBRARY; T=293.6K  
Neutron emission for (n,x)

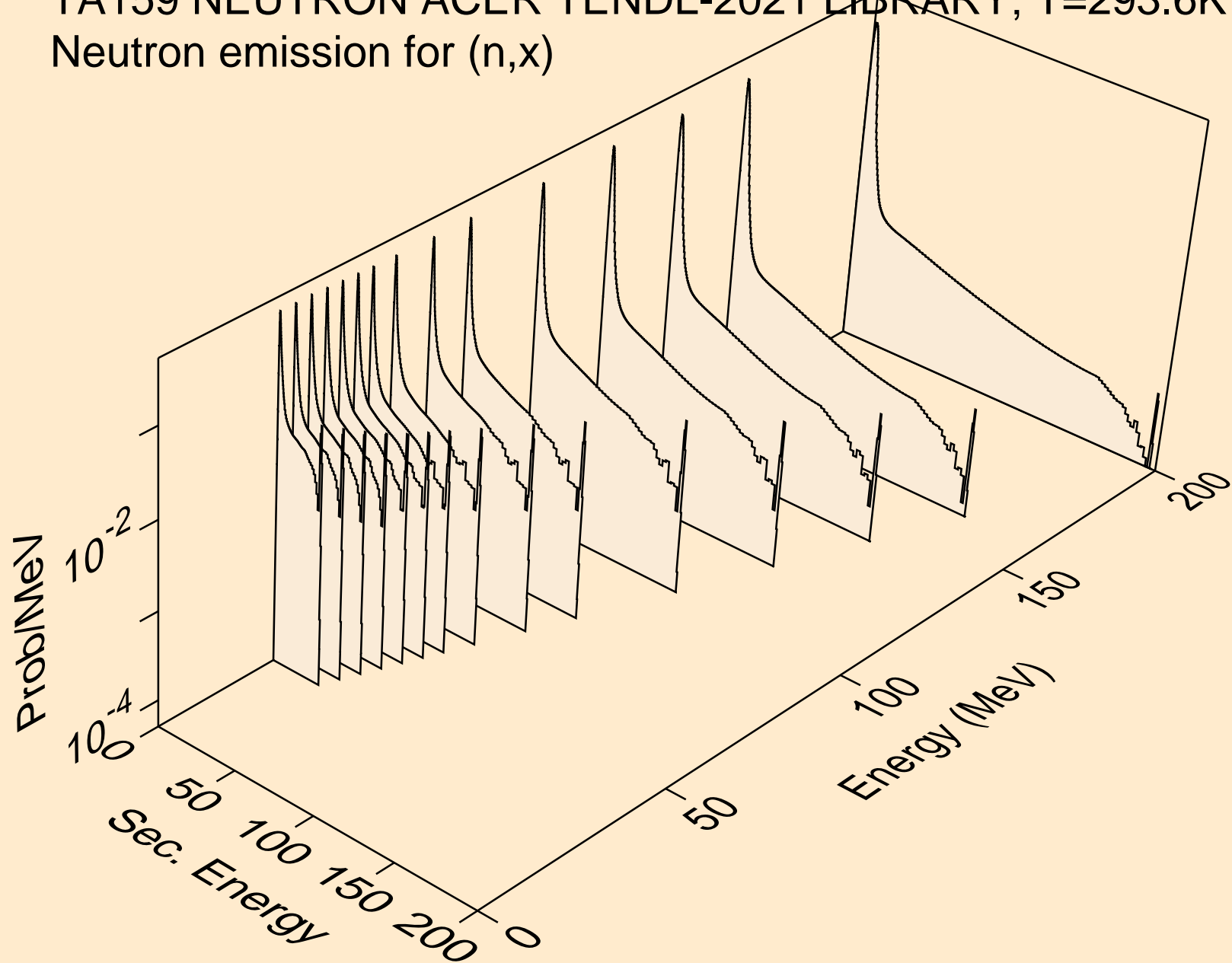

TA159 NEUTRON ACER TENDL-2021 LIBRARY; T=293.6K  
Neutron emission for (n,2nd)

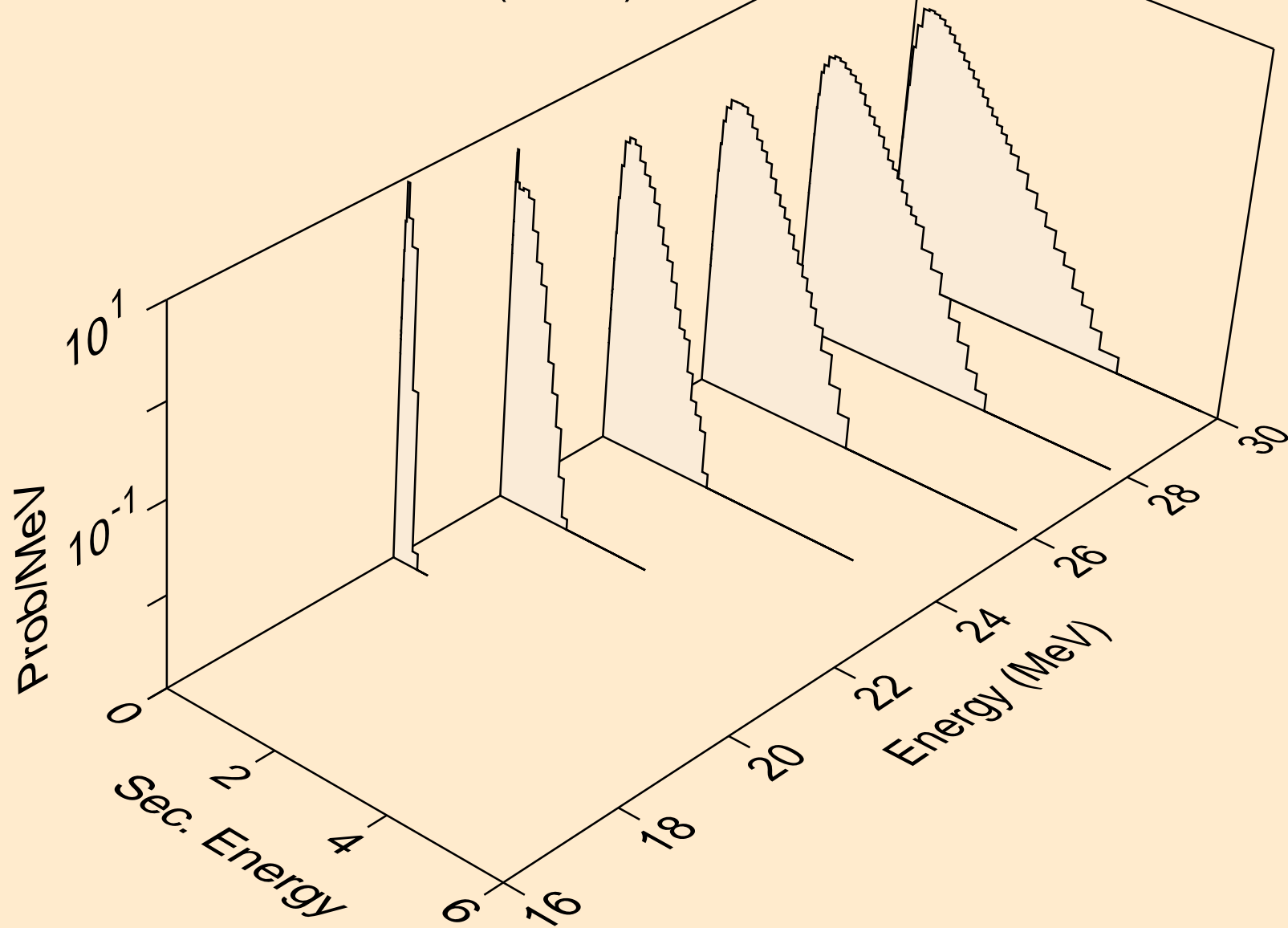

TA159 NEUTRON ACER TENDL-2021 LIBRARY; T=293.6K  
Neutron emission for (n,2n)

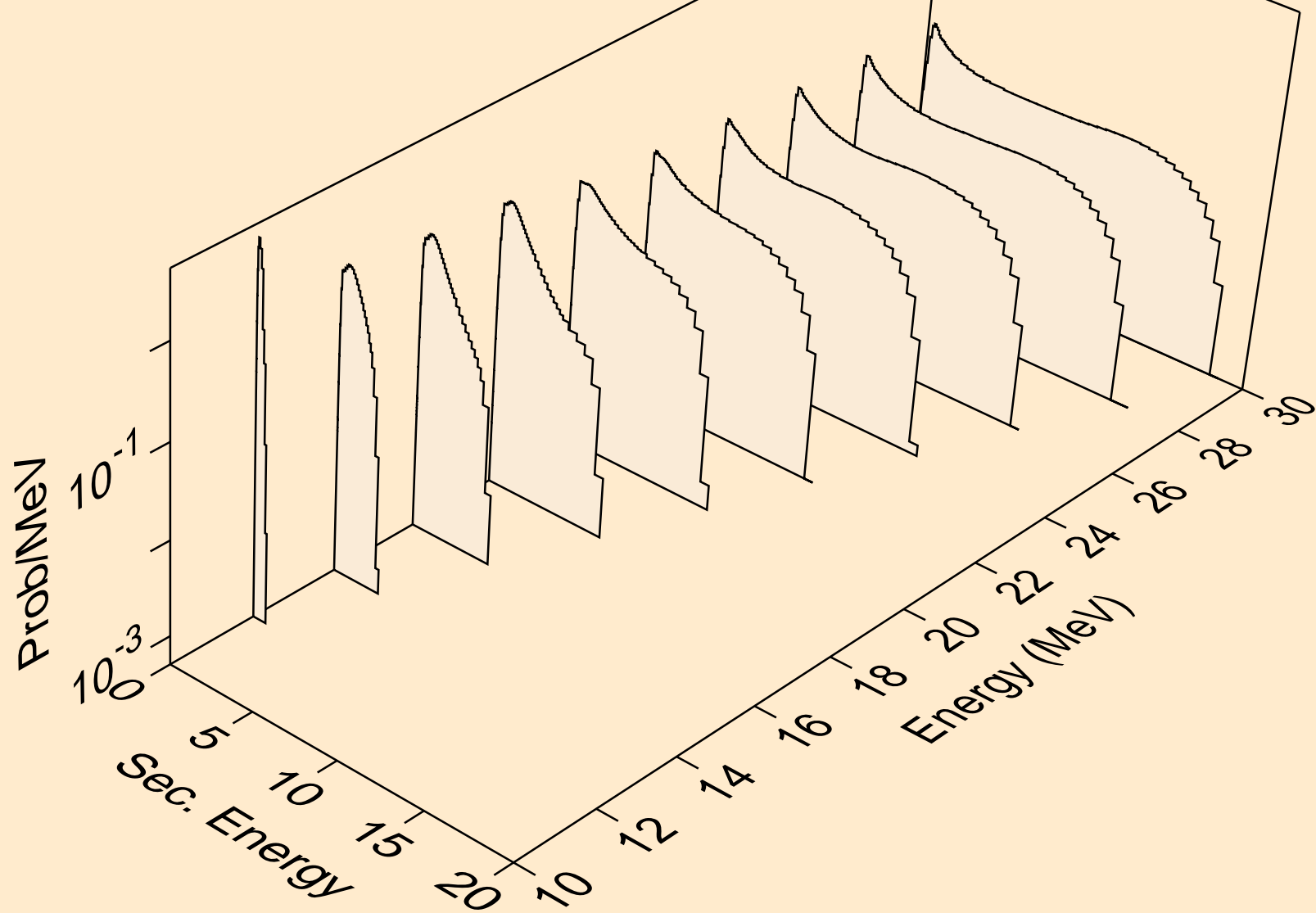

TA159 NEUTRON ACER TENDL-2021 LIBRARY; T=293.6K  
Neutron emission for (n,3n)

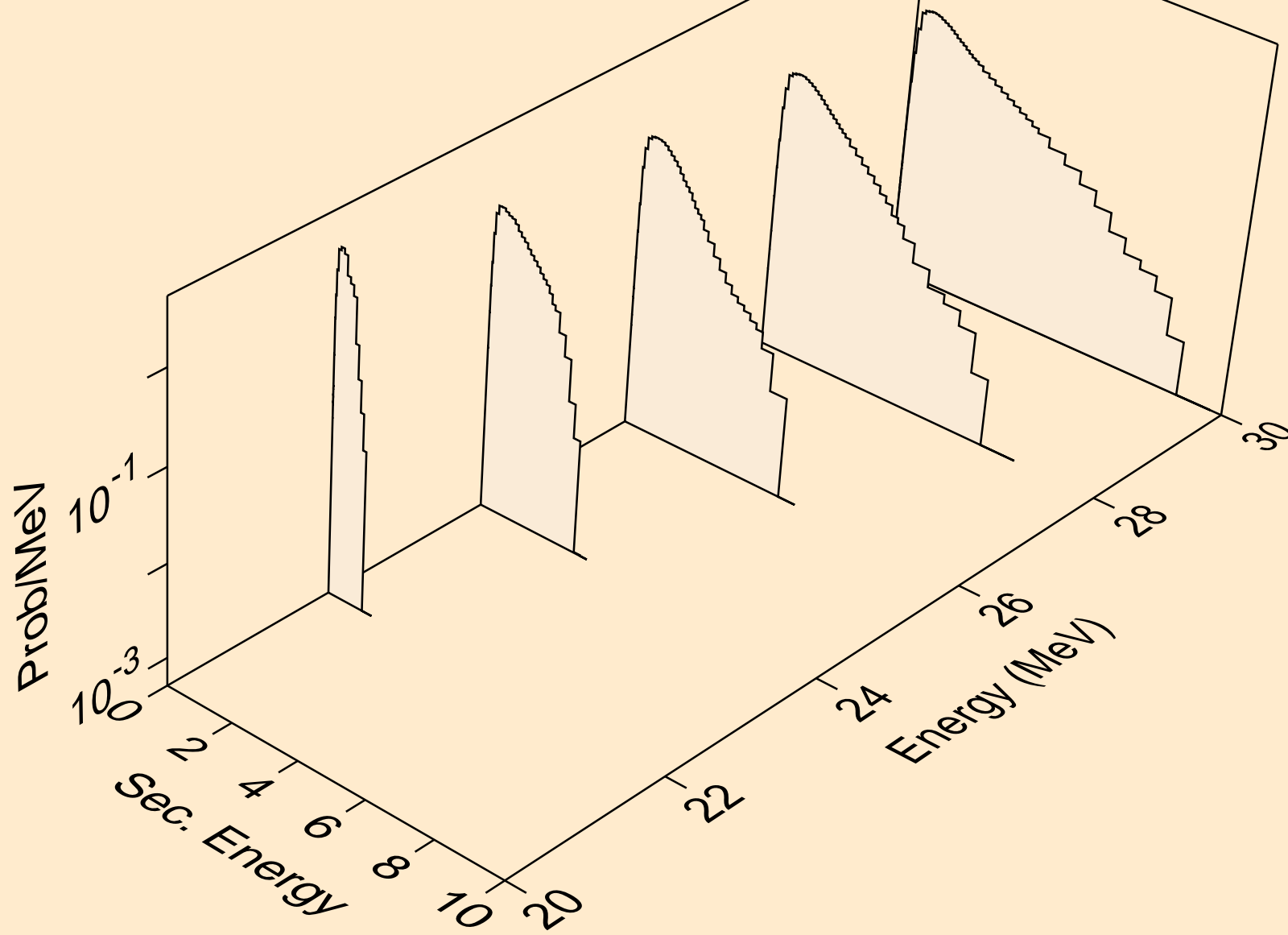

TA159 NEUTRON ACER TENDL-2021 LIBRARY; T=293.6K  
Neutron emission for (n,n\*)a

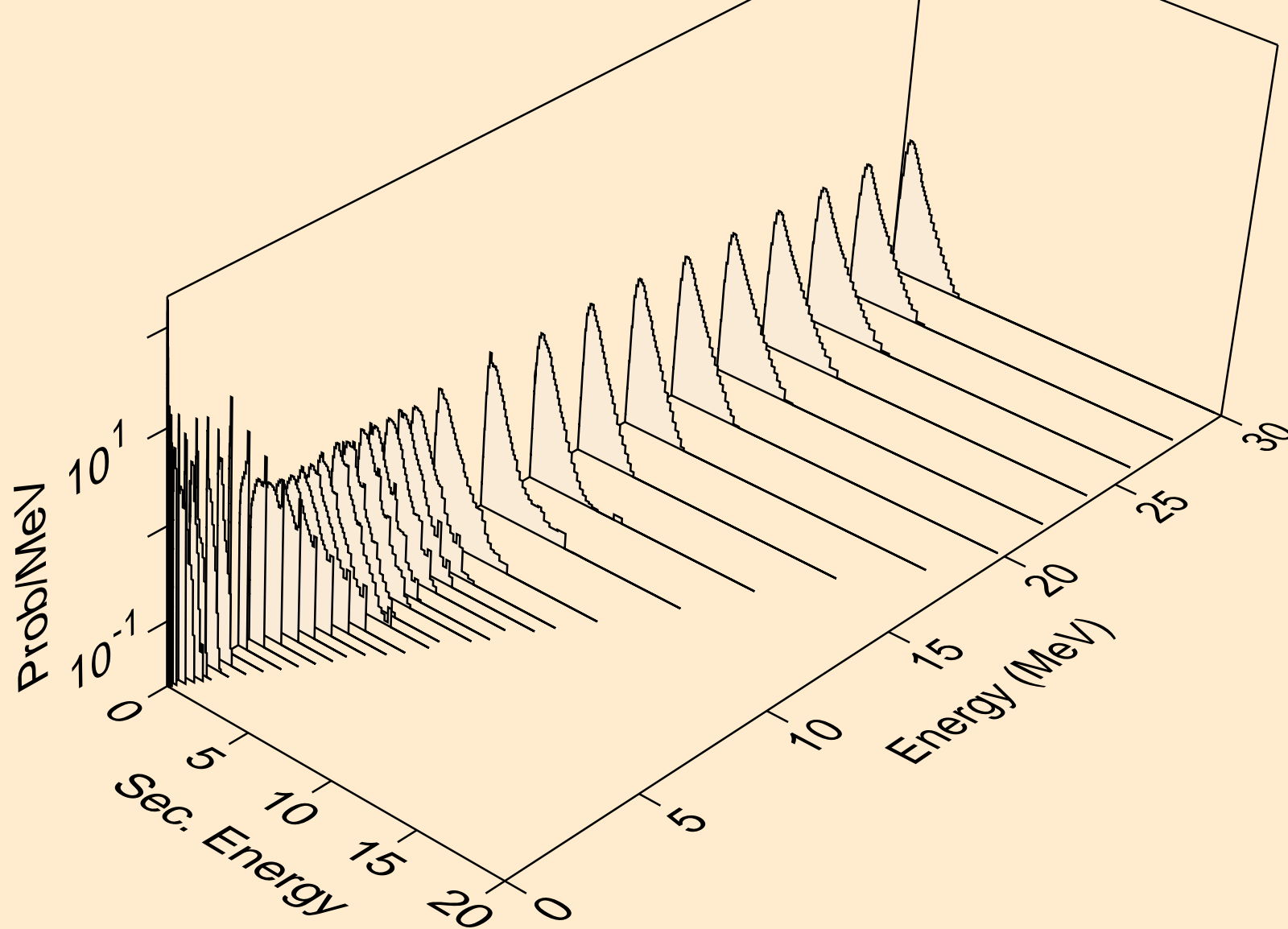

TA159 NEUTRON ACER TENDL-2021 LIBRARY; T=293.6K  
Neutron emission for (n,n\*)3a

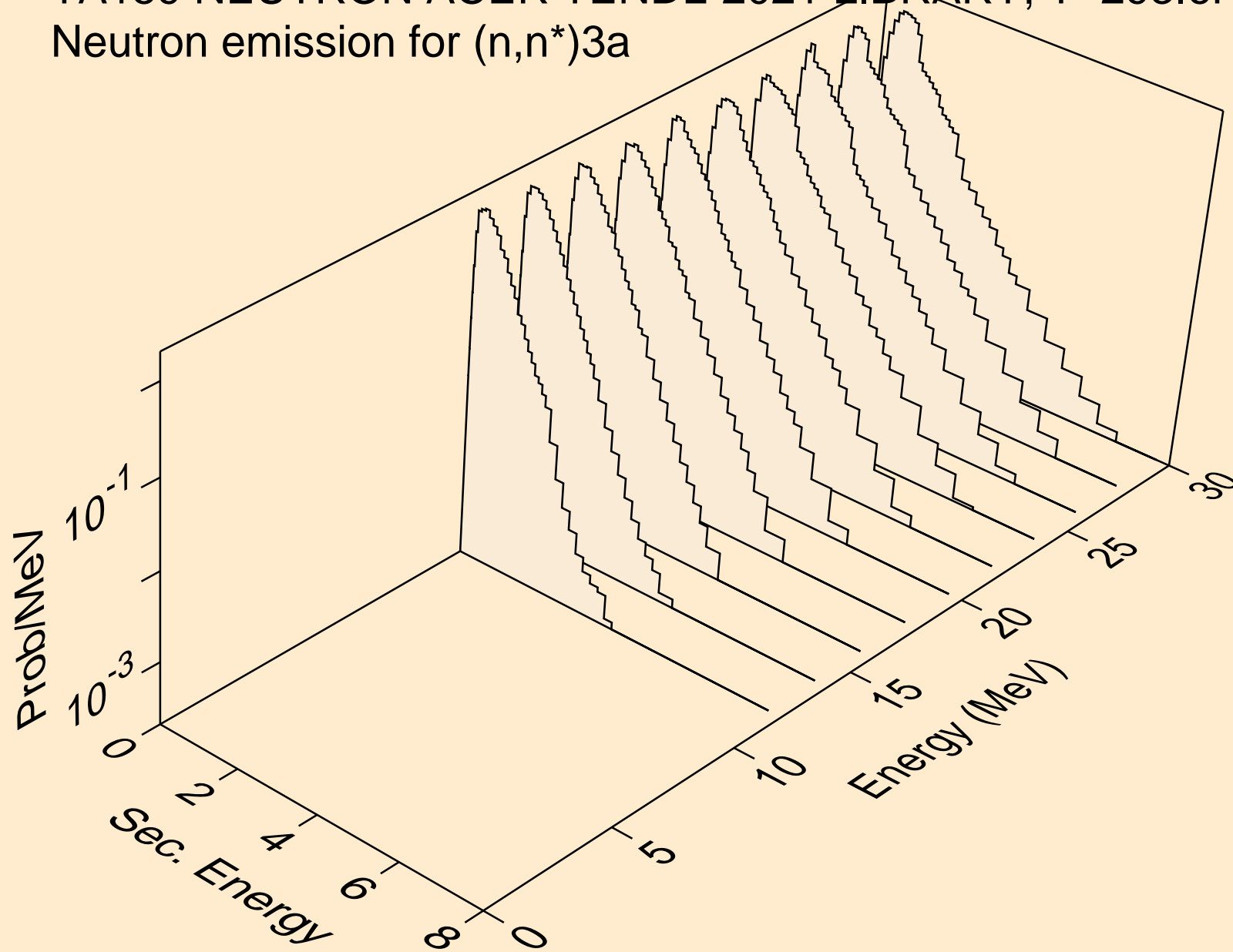



TA159 NEUTRON ACER TENDL-2021 LIBRARY; T=293.6K  
Neutron emission for (n,2n)<sub>a</sub>

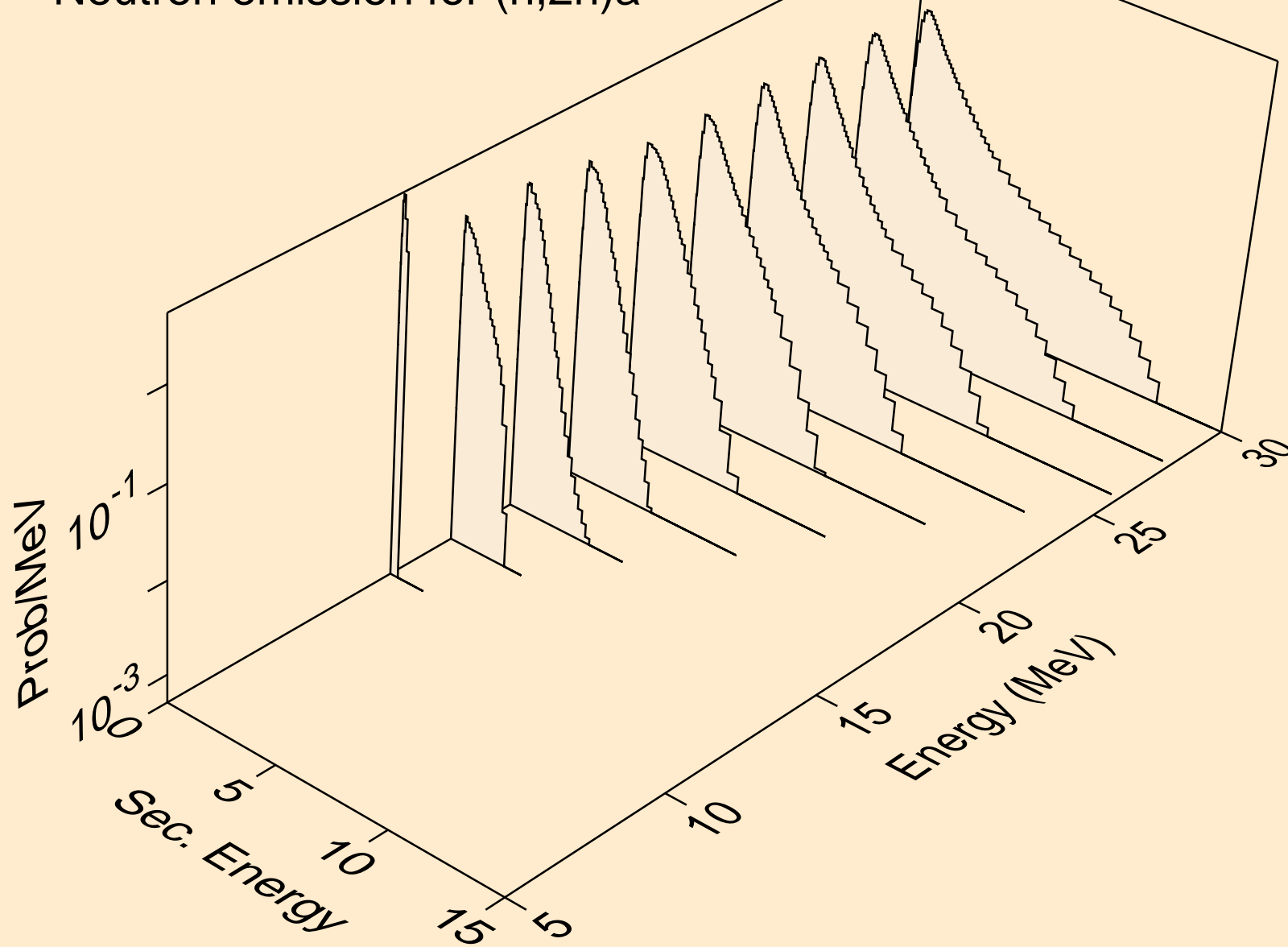

TA159 NEUTRON ACER TENDL-2021 LIBRARY; T=293.6K  
Neutron emission for (n,3n)a

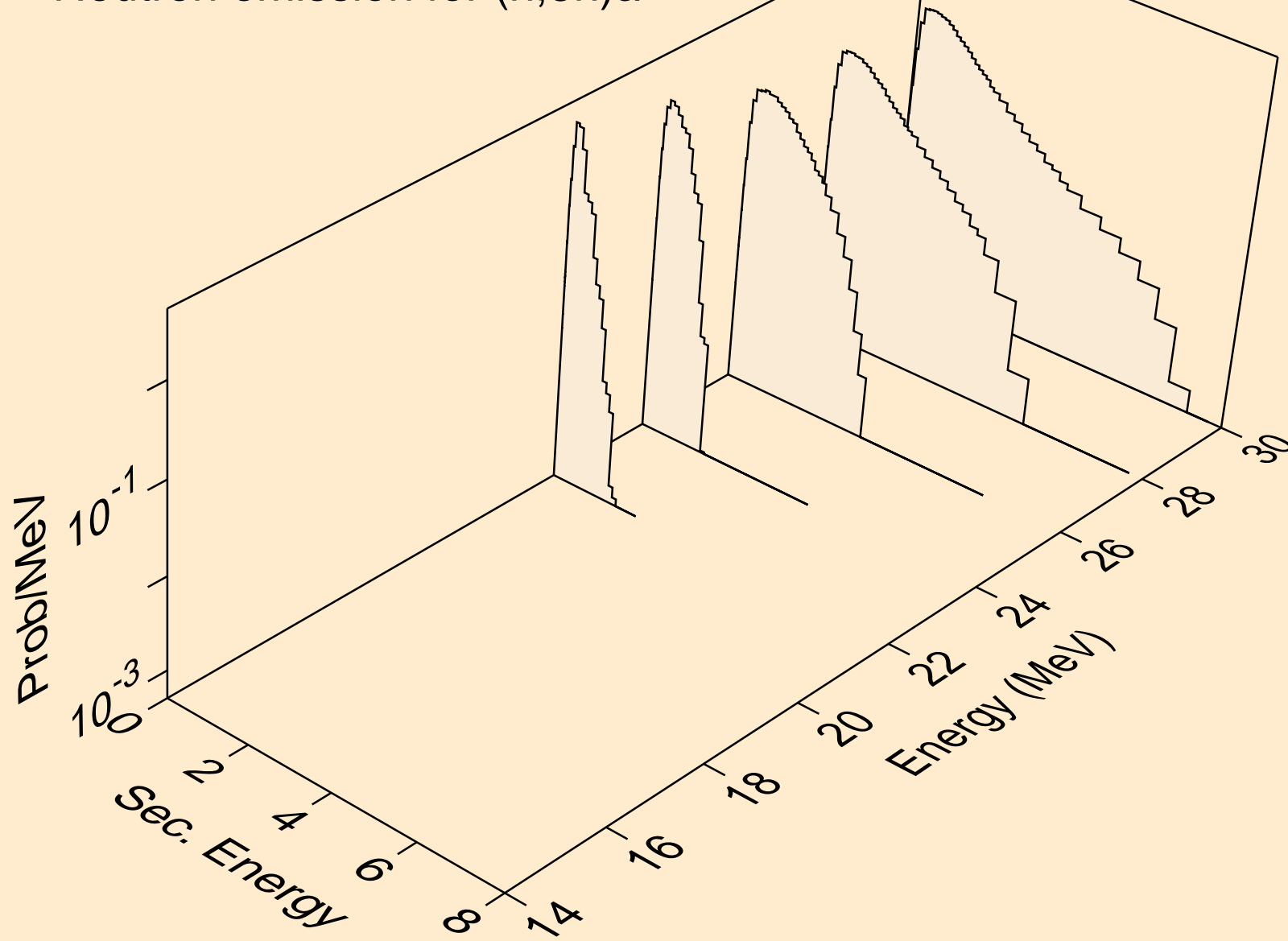

TA159 NEUTRON ACER TENDL-2021 LIBRARY; T=293.6K  
Neutron emission for (n,n\*)p

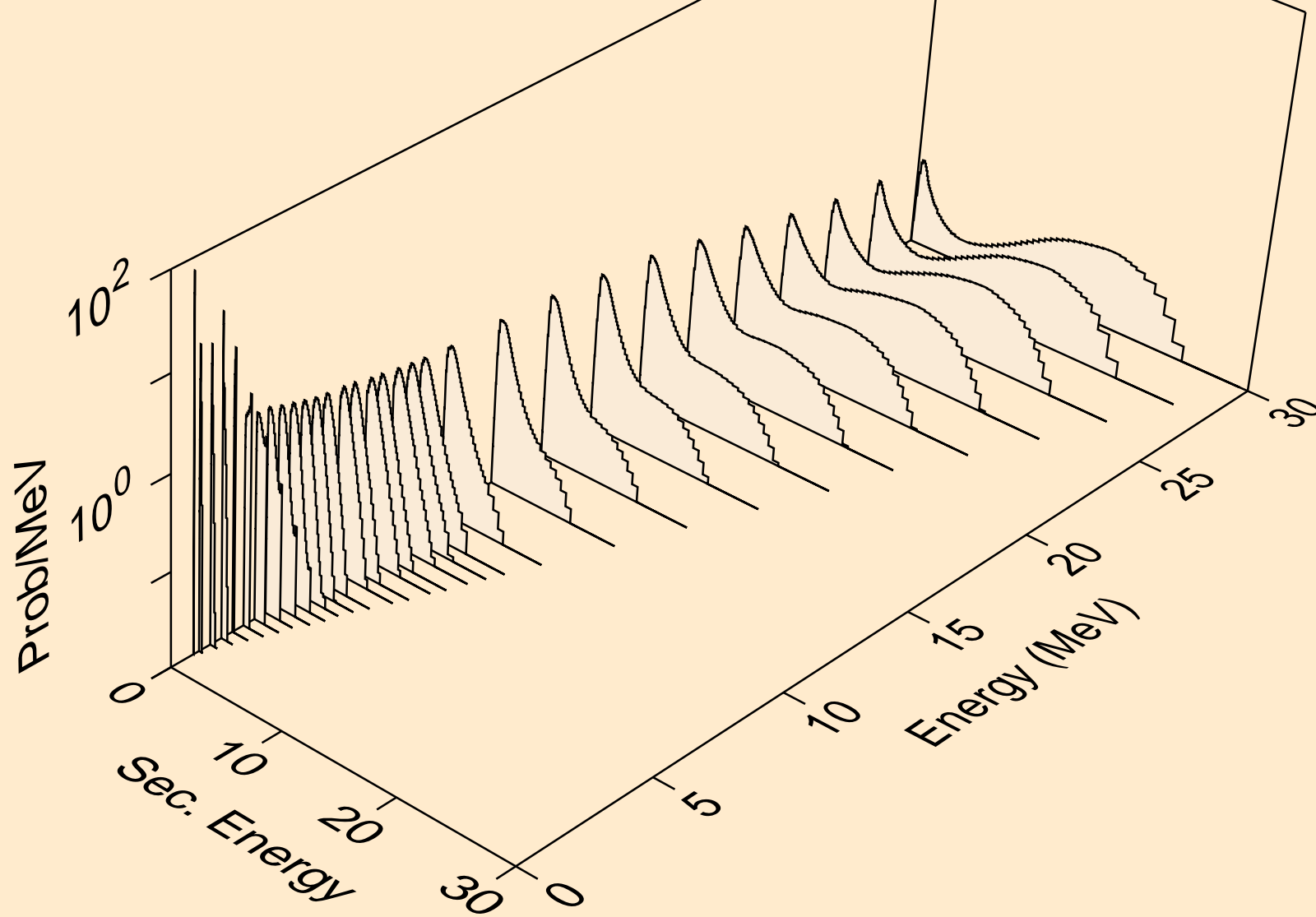

TA159 NEUTRON ACER TENDL-2021 LIBRARY; T=293.6K  
Neutron emission for (n,n\*)2a

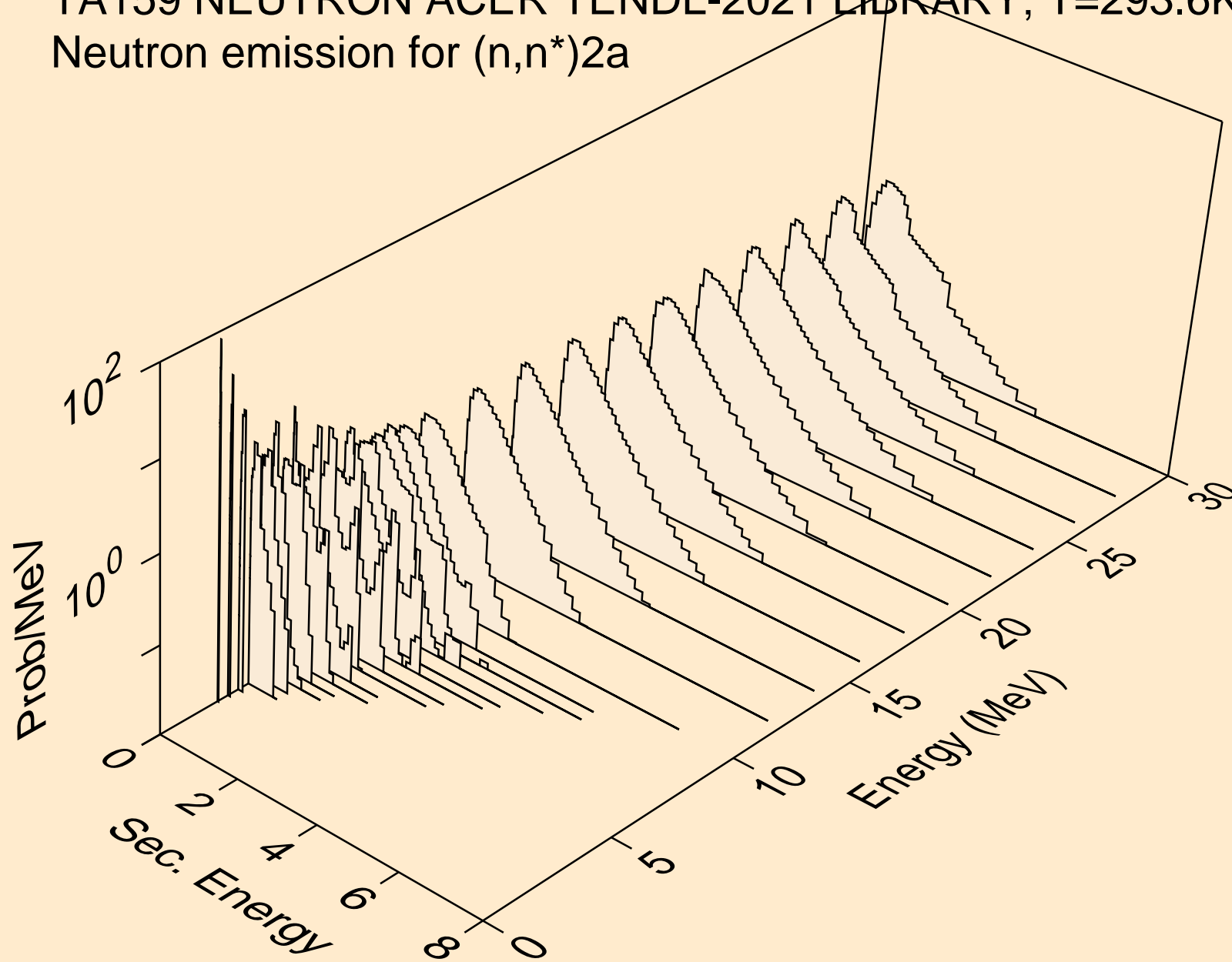

TA159 NEUTRON ACER TENDL-2021 LIBRARY; T=293.6K  
Neutron emission for (n,2n)2a

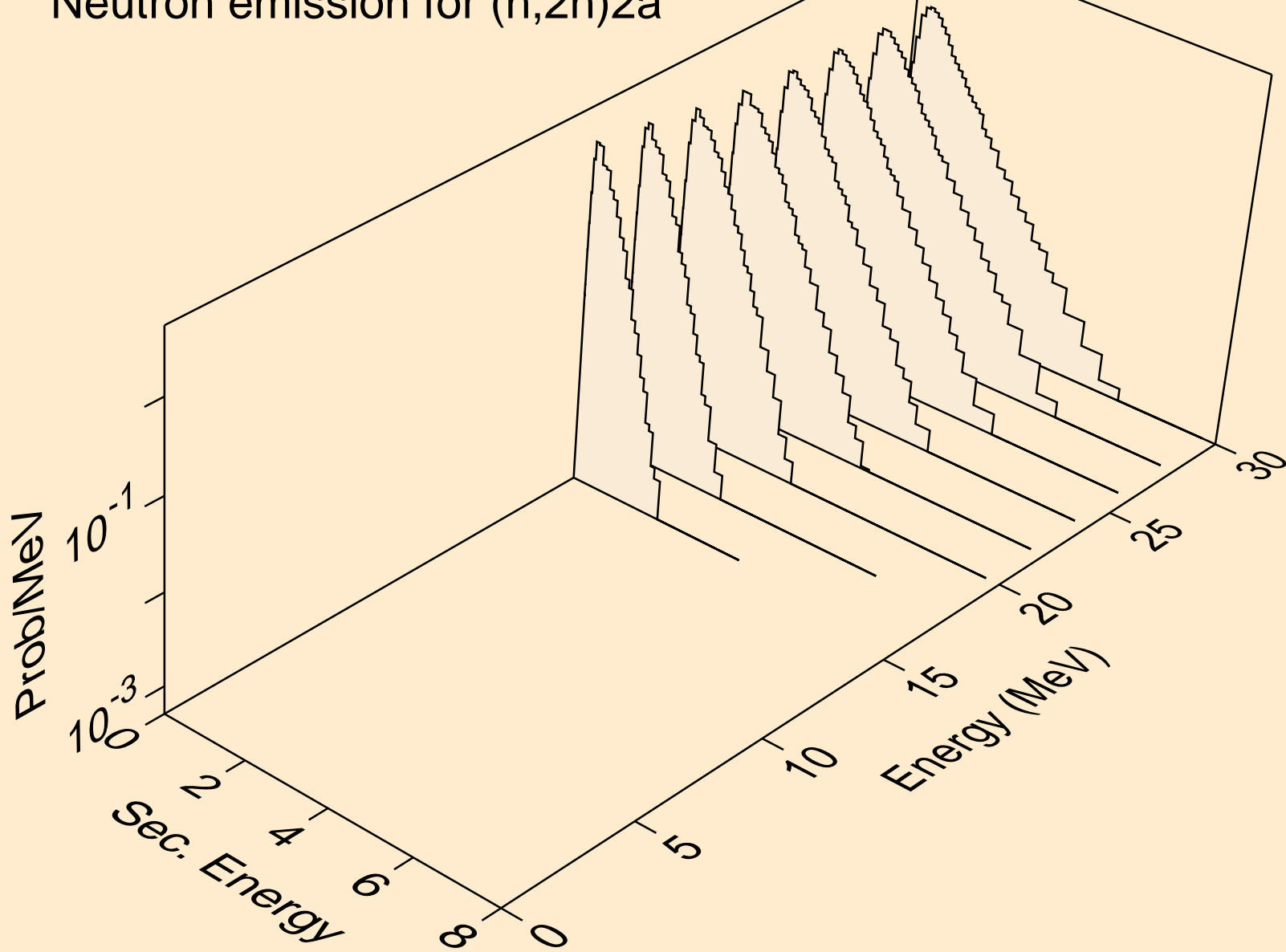

TA159 NEUTRON ACER TENDL-2021 LIBRARY; T=293.6K  
Neutron emission for (n,n\*)d

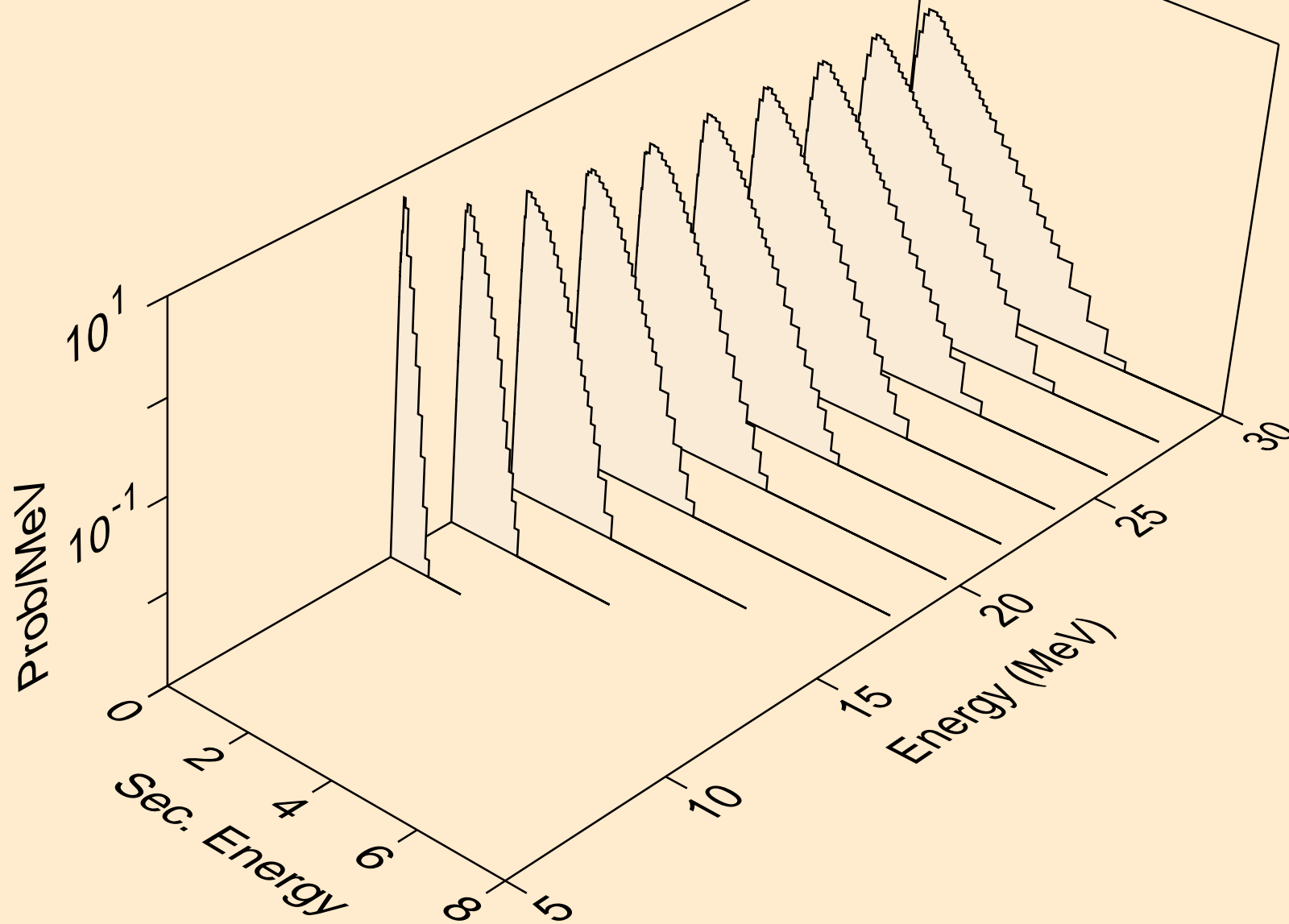

TA159 NEUTRON ACER TENDL-2021 LIBRARY; T=293.6K  
Neutron emission for (n,n\*)t

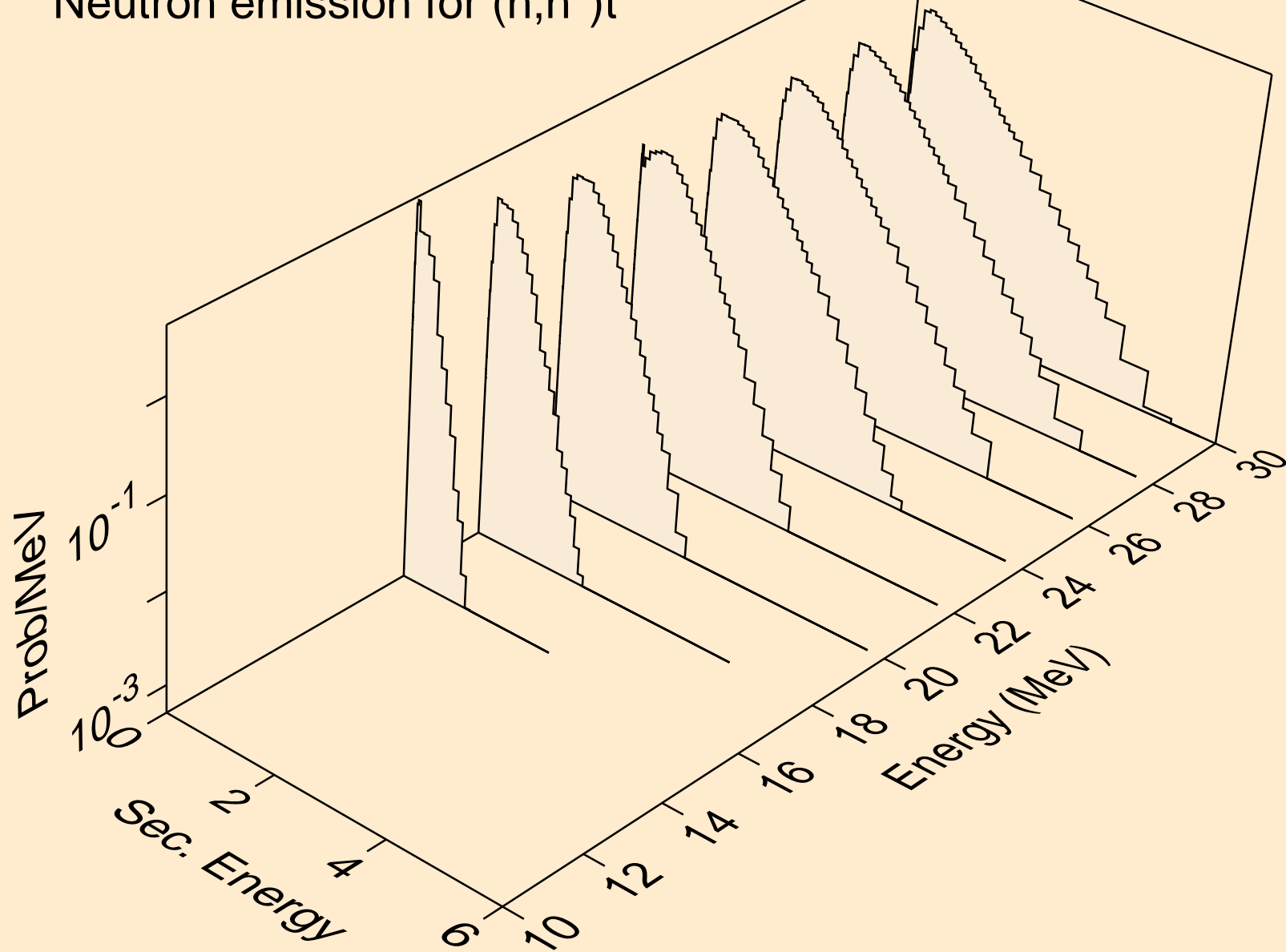

TA159 NEUTRON ACER TENDL-2021 LIBRARY; T=293.6K  
Neutron emission for (n,n\*)he3

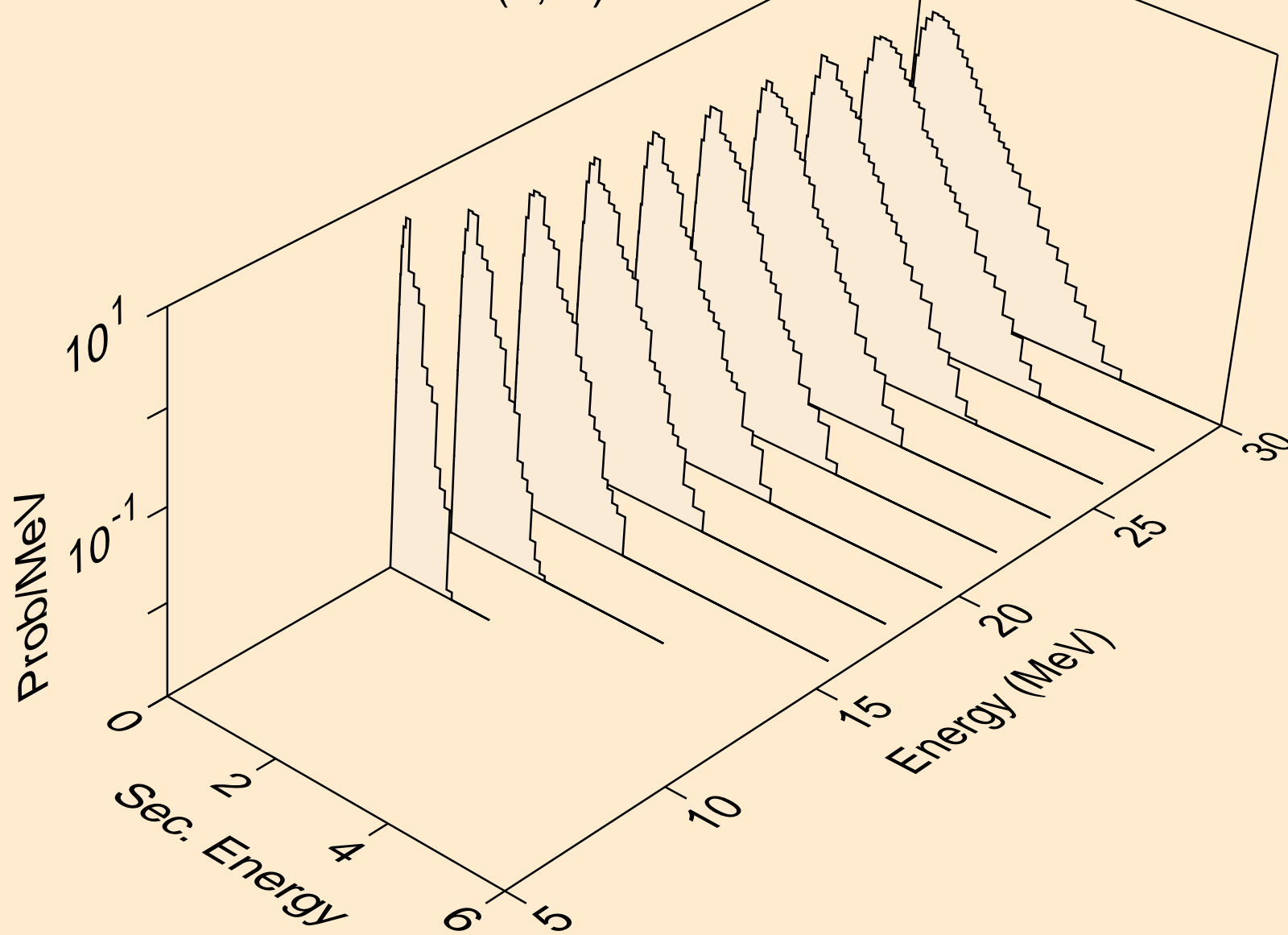



TA159 NEUTRON ACER TENDL-2021 LIBRARY; T=293.6K  
Neutron emission for (n,2np)

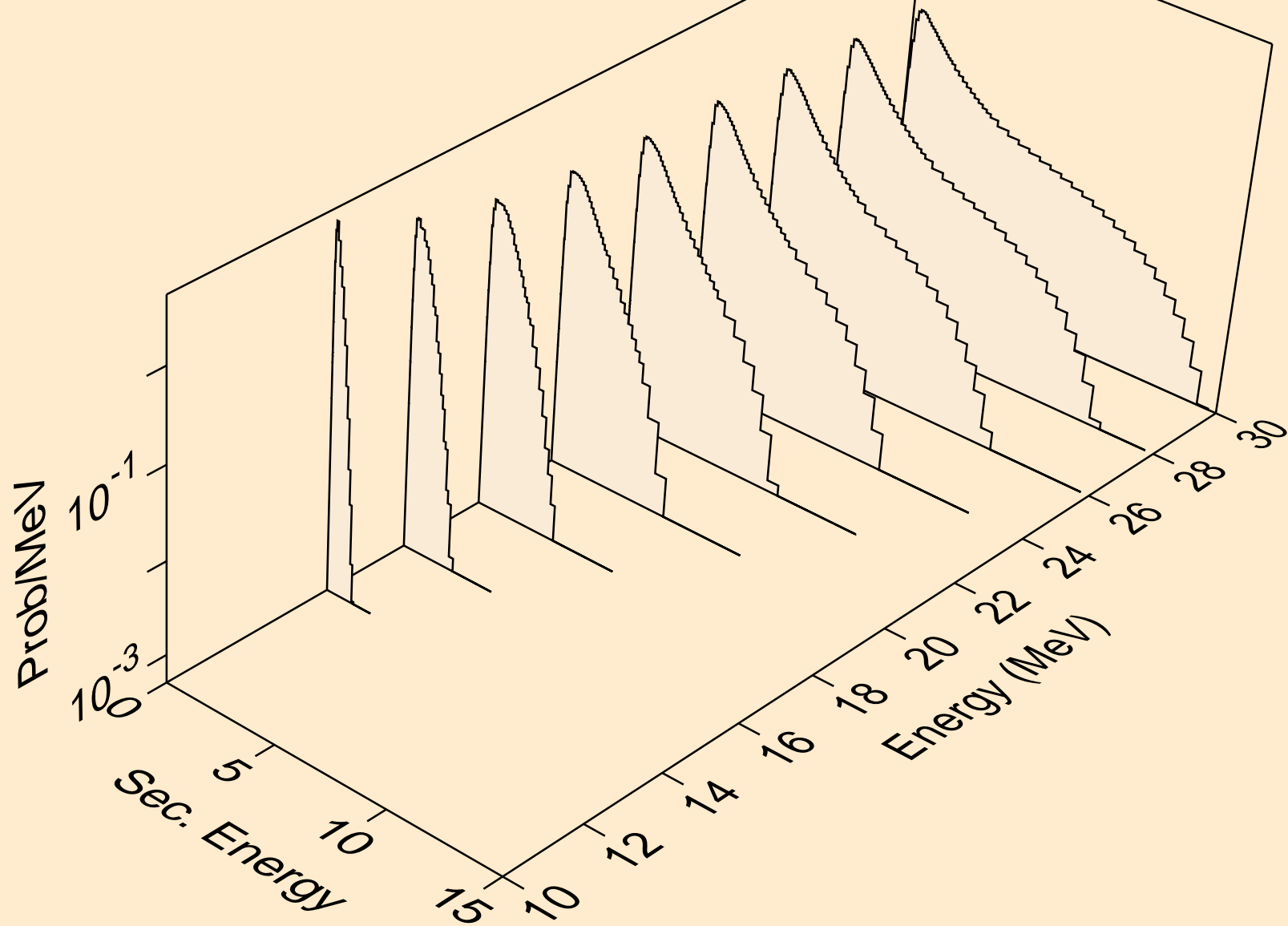

TA159 NEUTRON ACER TENDL-2021 LIBRARY; T=293.6K  
Neutron emission for (n,3np)

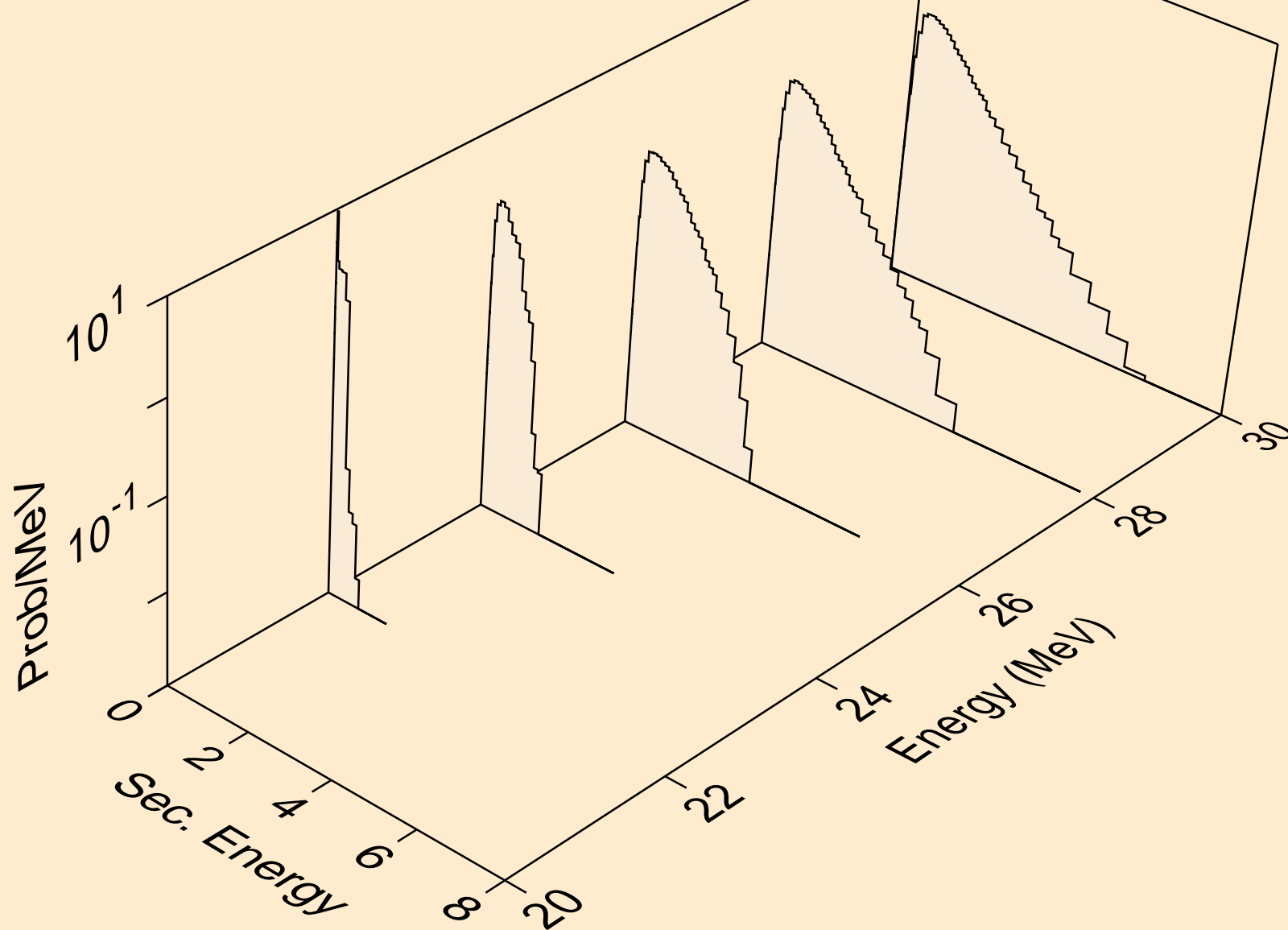

TA159 NEUTRON ACER TENDL-2021 LIBRARY; T=293.6K  
Neutron emission for (n,2np)

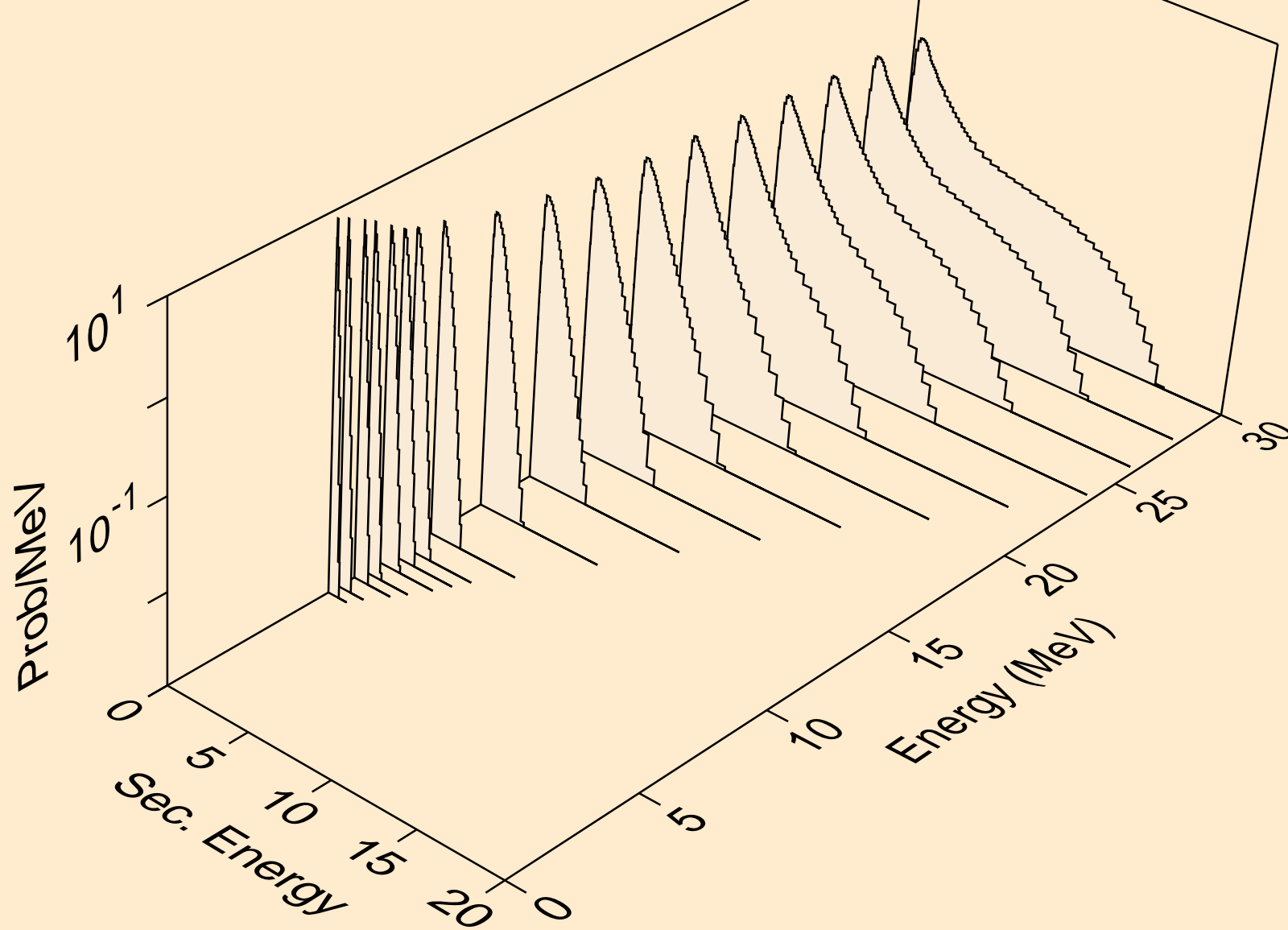

TA159 NEUTRON ACER TENDL-2021 LIBRARY; T=293.6K  
Neutron emission for (n,npa)

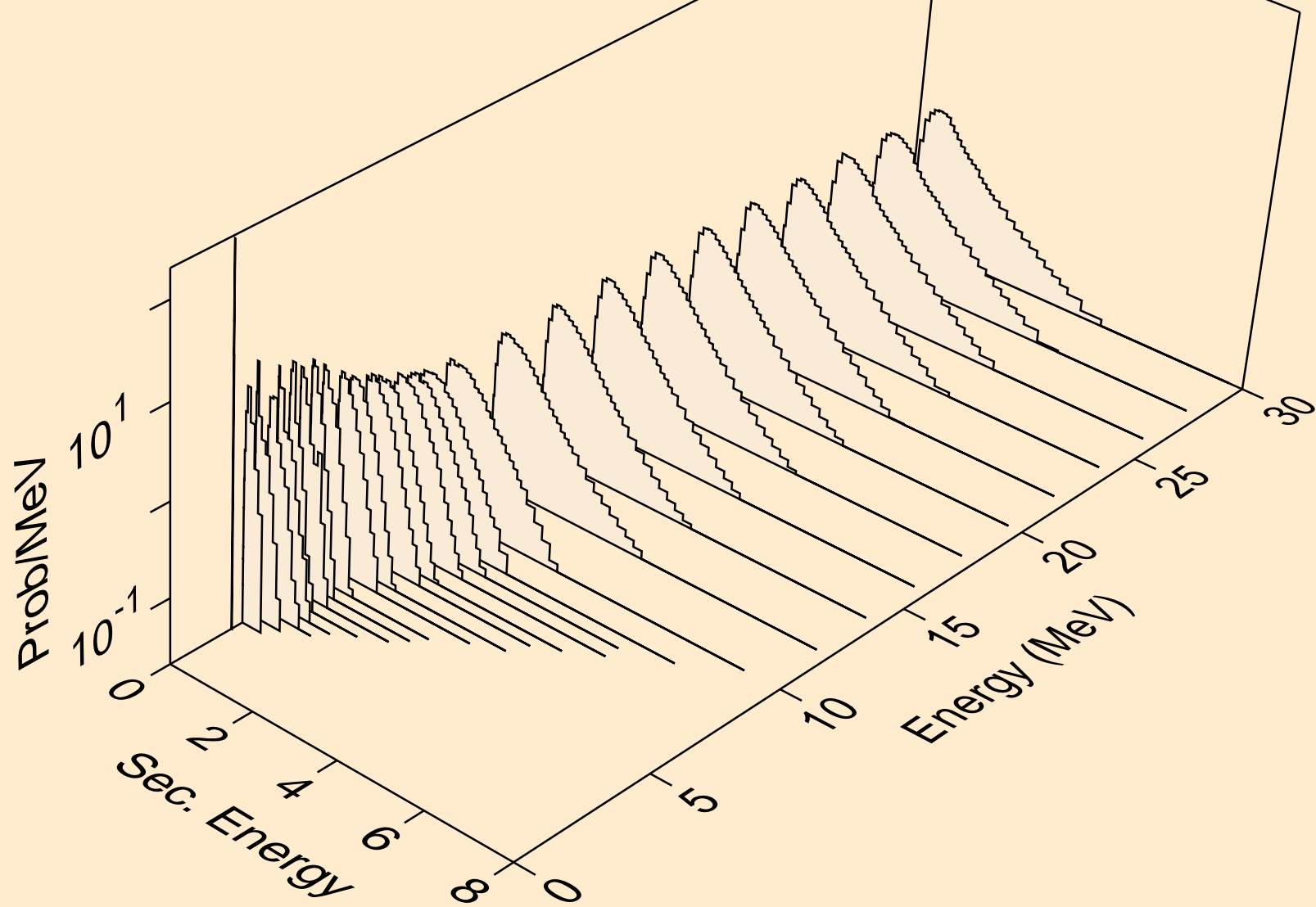

TA159 NEUTRON ACER TENDL-2021 LIBRARY; T=293.6K  
Neutron emission for (n,n\*c)

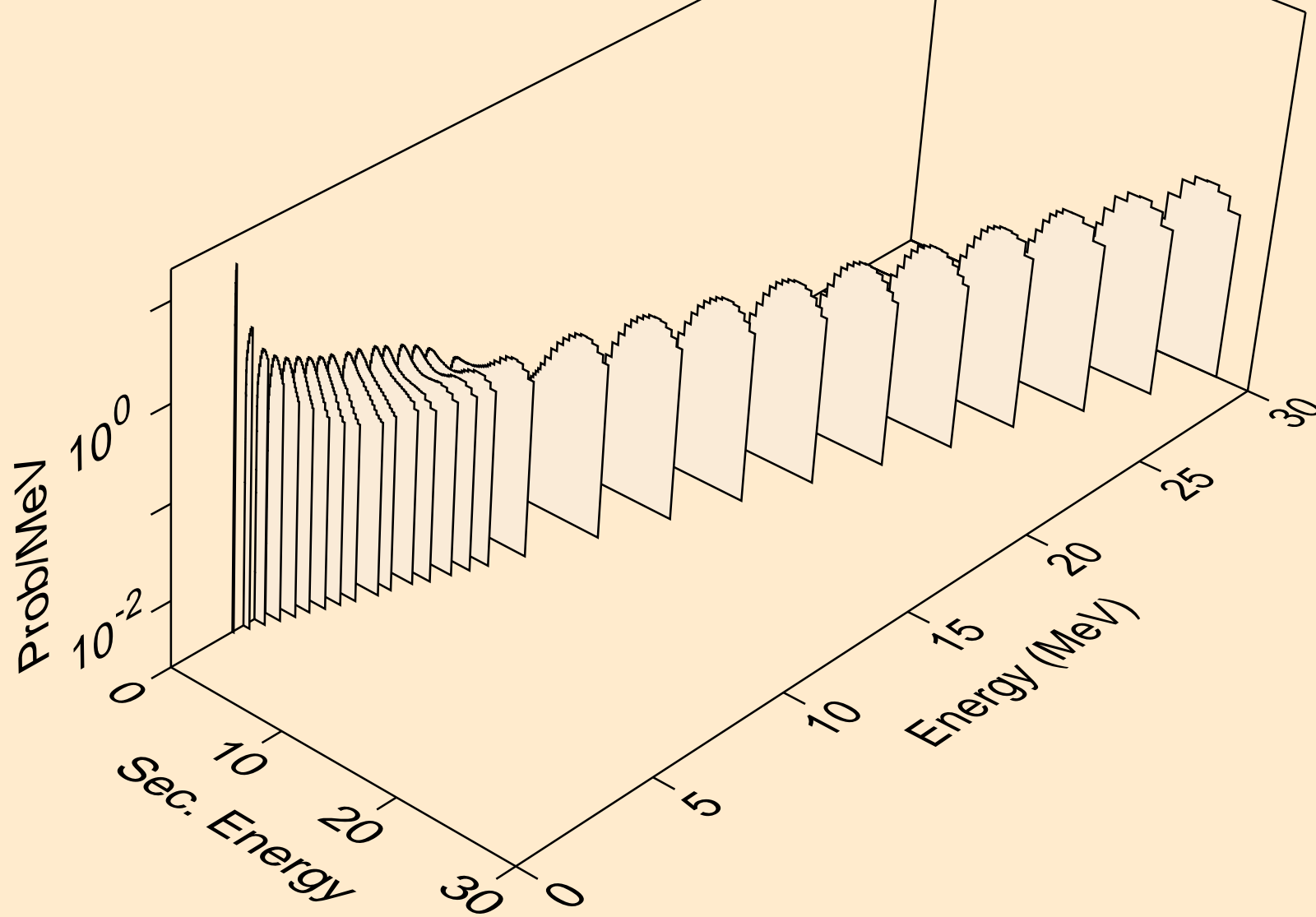

TA159 NEUTRON ACER TENDL-2021 LIBRARY; T=293.6K  
Photon emission for (n,x)

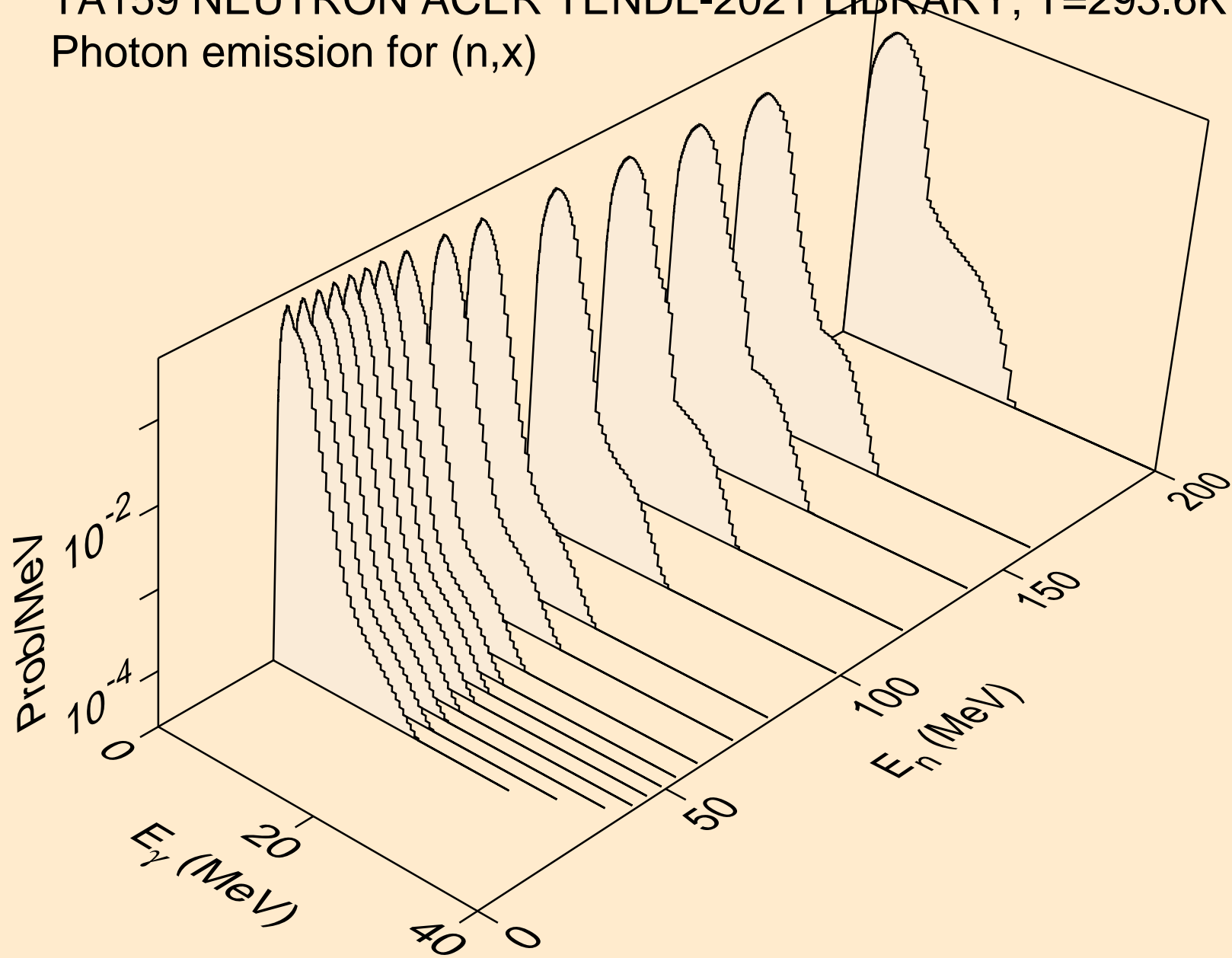

TA159 NEUTRON ACER TENDL-2021 LIBRARY; T=293.6K  
Photon emission for (n,2nd)

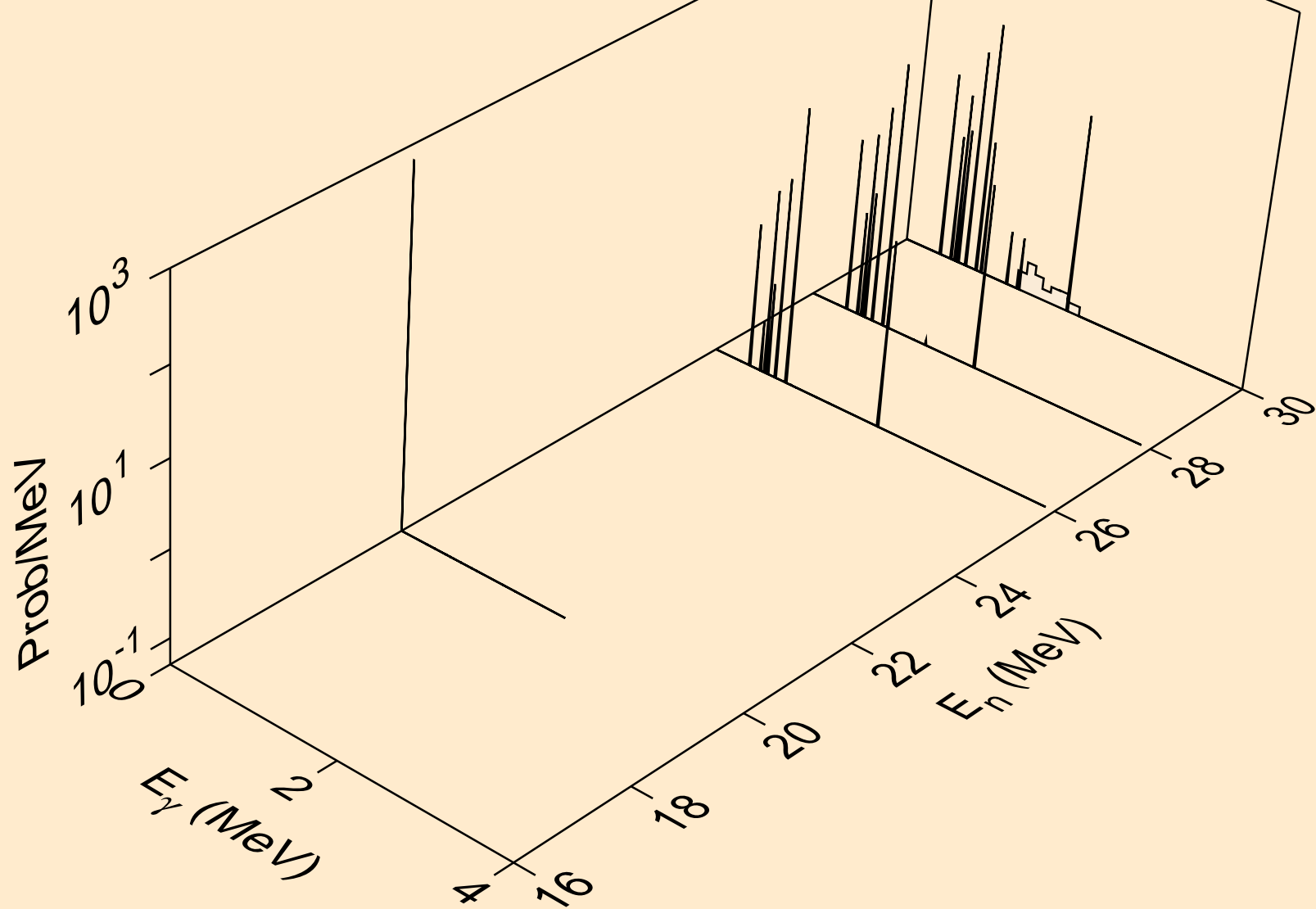

TA159 NEUTRON ACER TENDL-2021 LIBRARY; T=293.6K  
Photon emission for (n,2n)

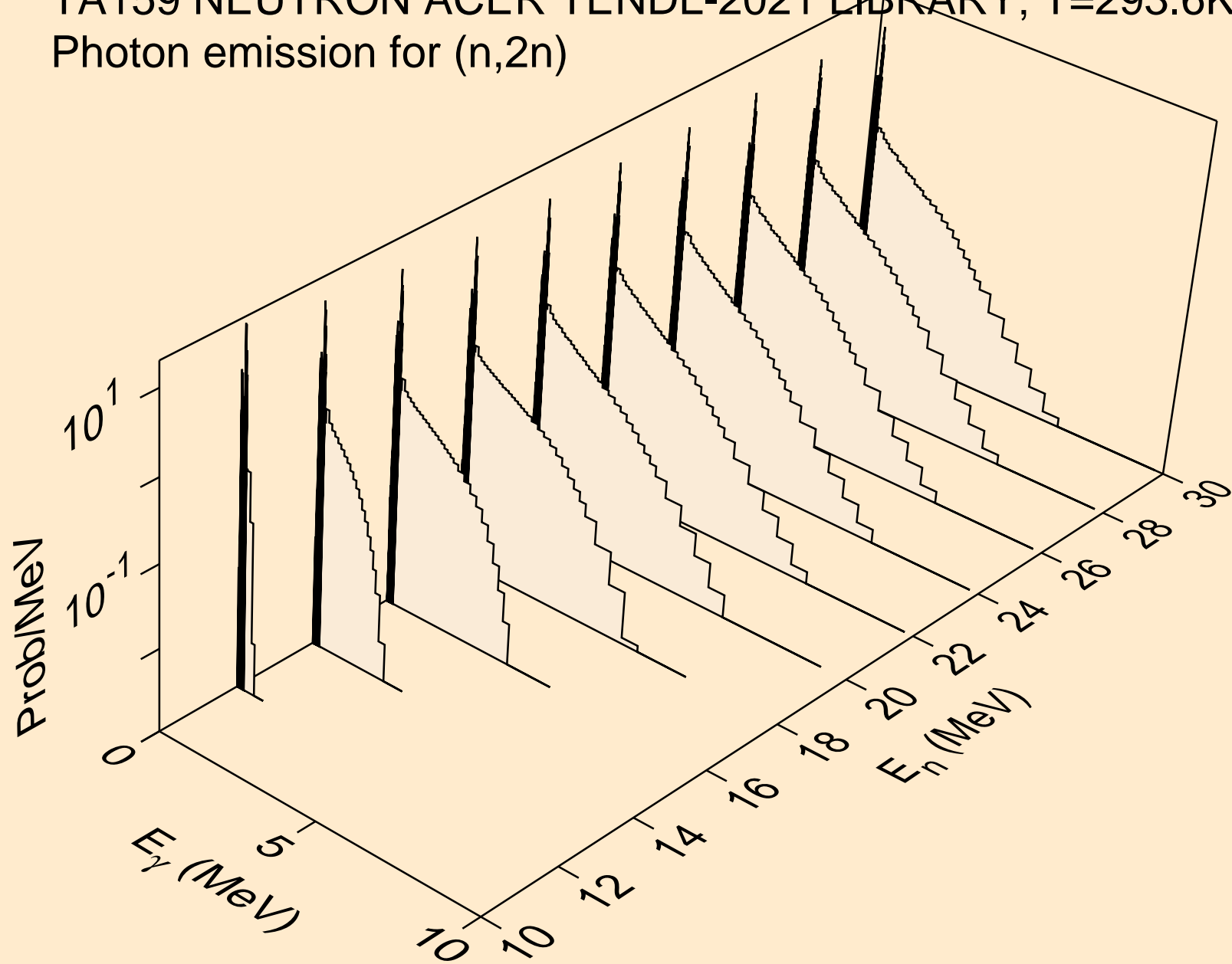



TA159 NEUTRON ACER TENDL-2021 LIBRARY; T=293.6K  
Photon emission for (n,3n)

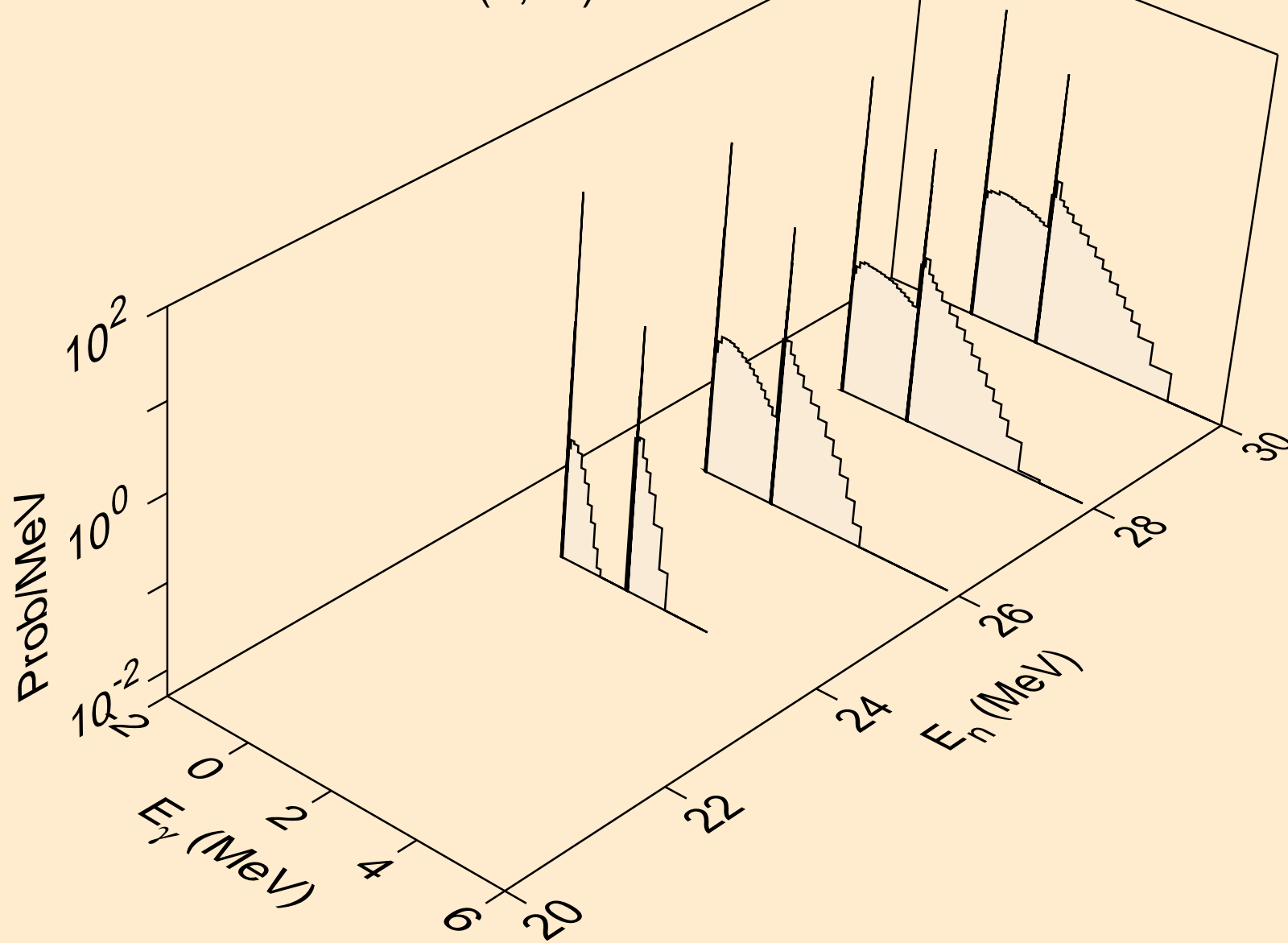

TA159 NEUTRON ACER TENDL-2021 LIBRARY; T=293.6K  
Photon emission for (n,n\*)a

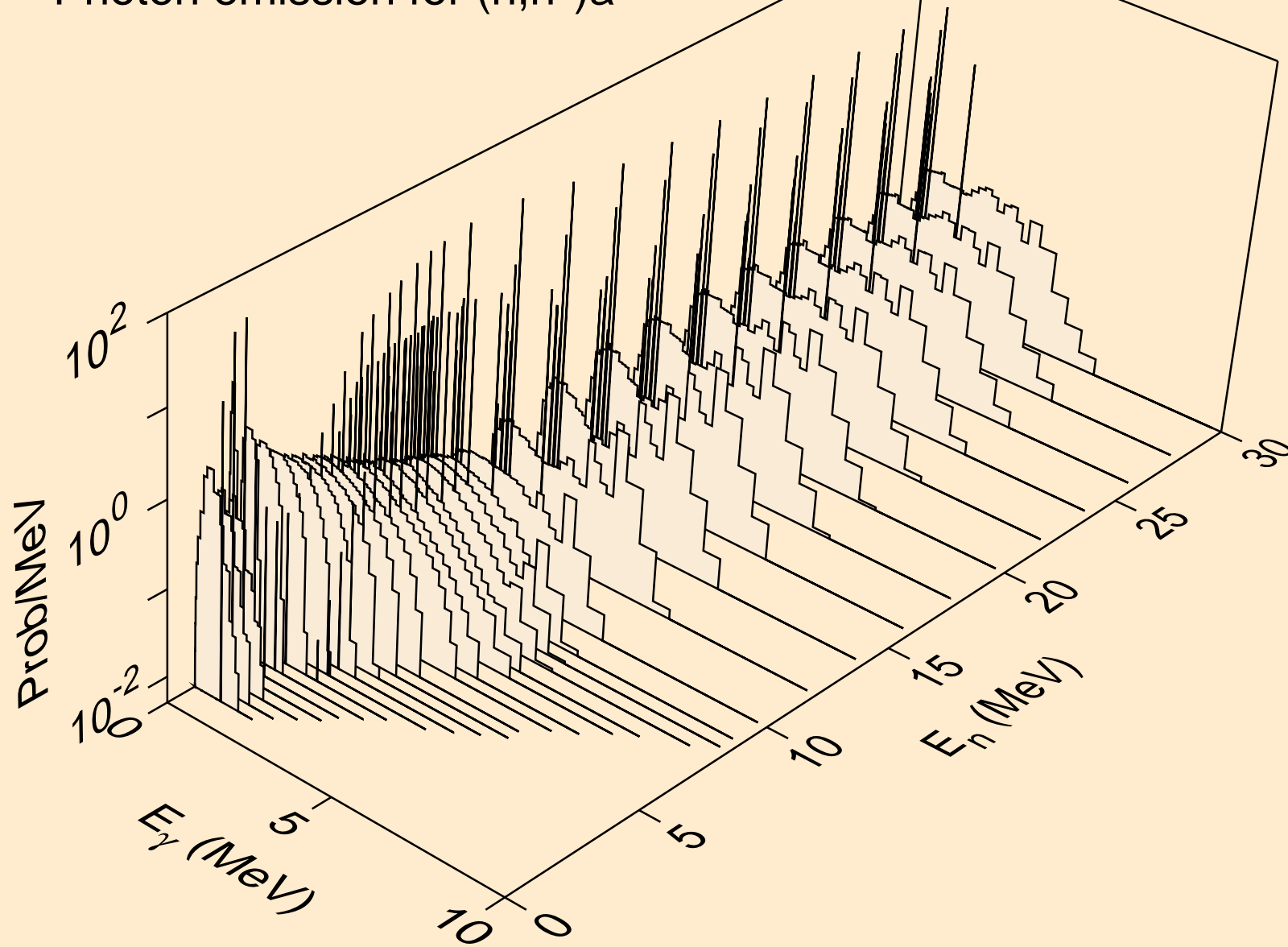

TA159 NEUTRON ACER TENDL-2021 LIBRARY; T=293.6K  
Photon emission for (n,n\*)3a

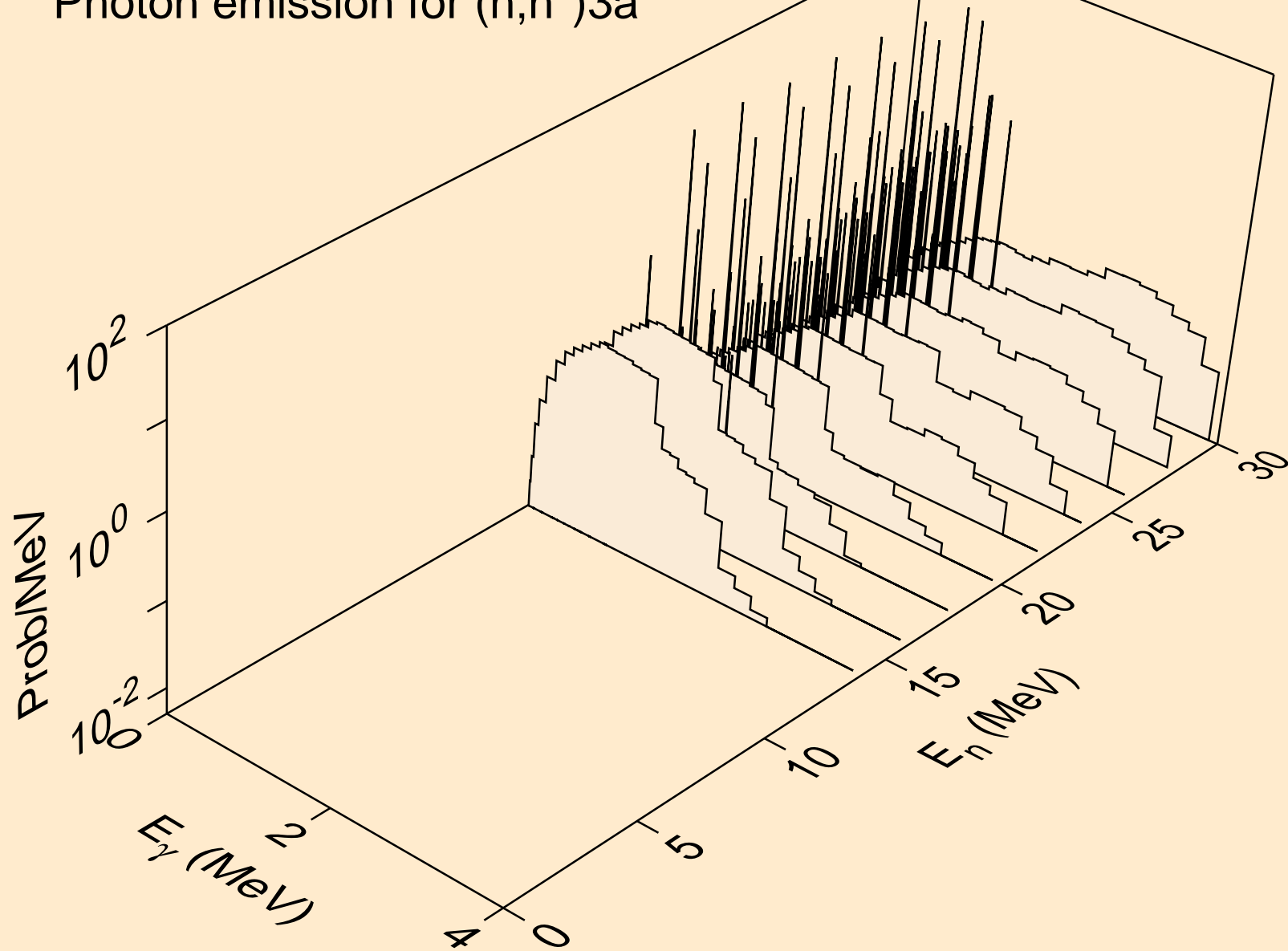

TA159 NEUTRON ACER TENDL-2021 LIBRARY; T=293.6K  
Photon emission for (n,2n)a

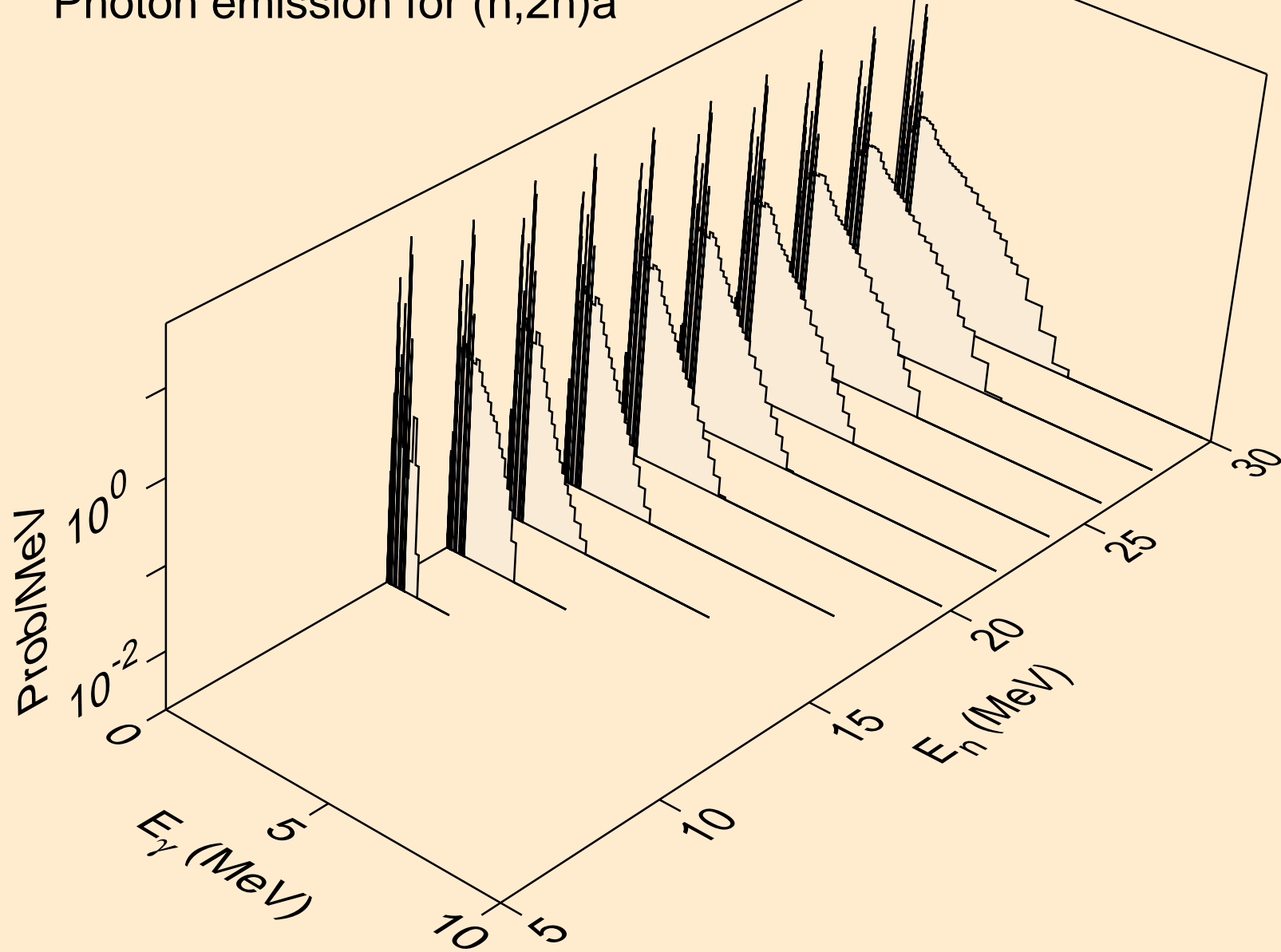

TA159 NEUTRON ACER TENDL-2021 LIBRARY; T=293.6K  
Photon emission for (n,3n)a

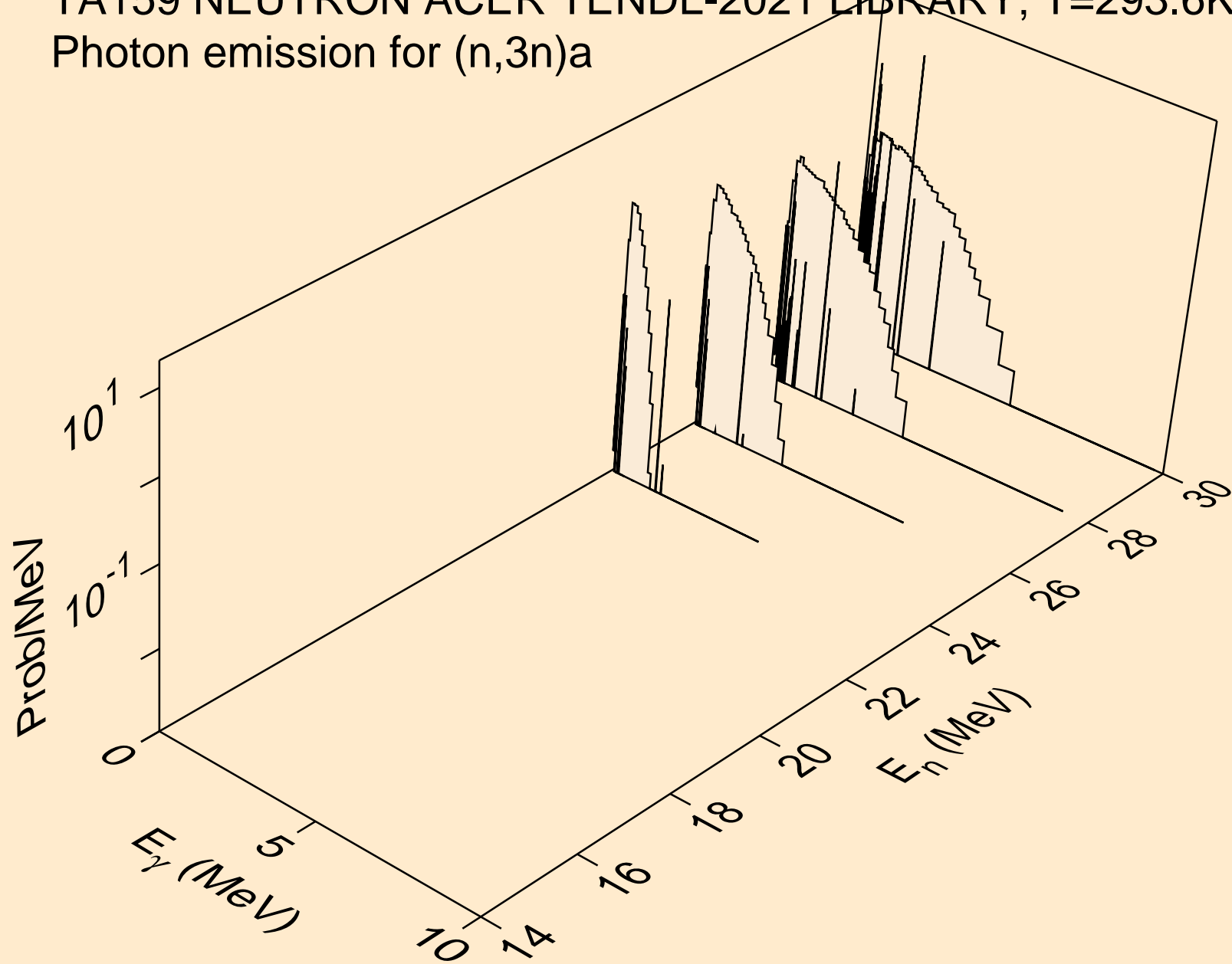

TA159 NEUTRON ACER TENDL-2021 LIBRARY; T=293.6K  
Photon emission for (n,n\*)p

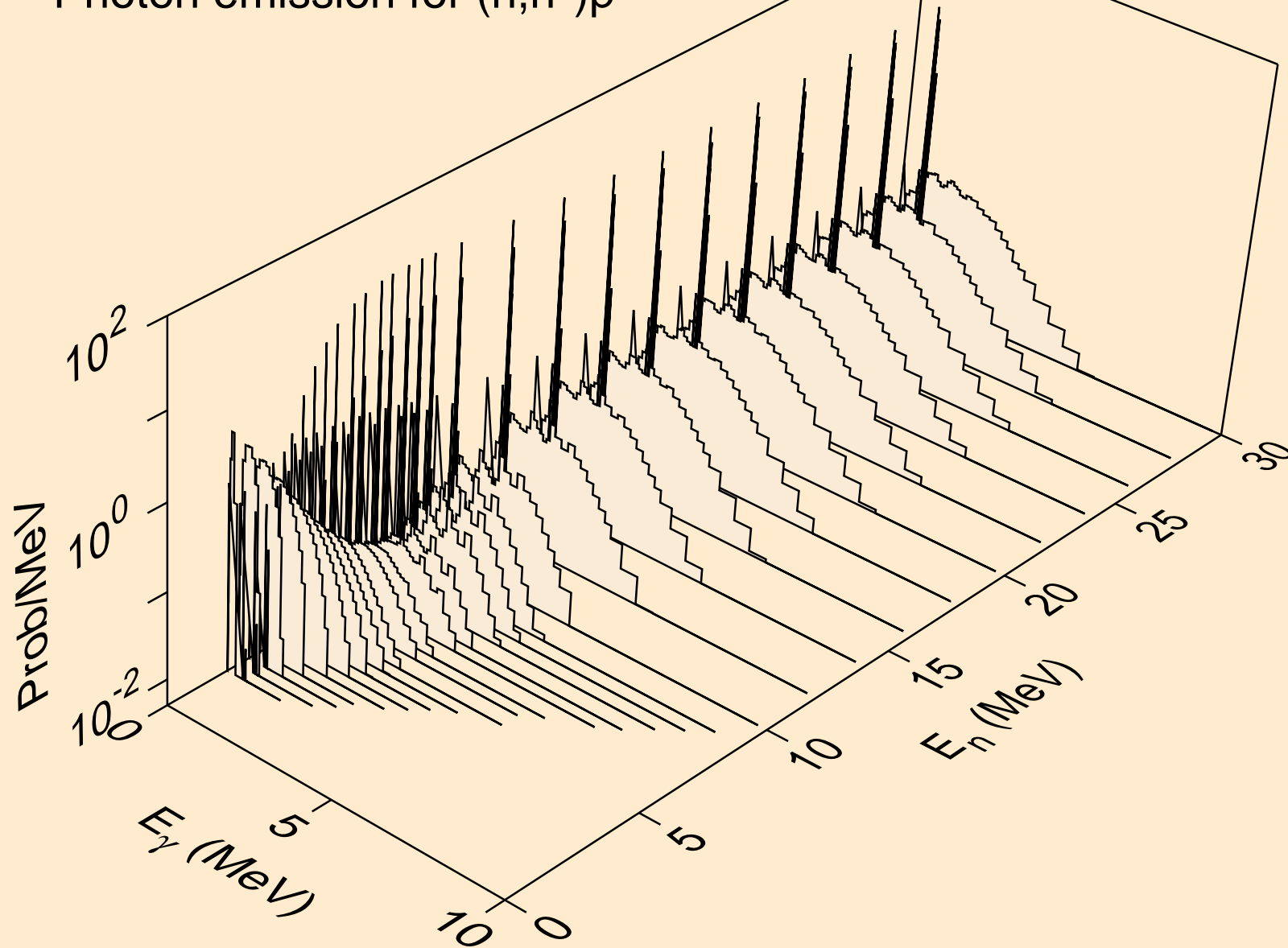

TA159 NEUTRON ACER TENDL-2021 LIBRARY; T=293.6K  
Photon emission for (n,n\*)2a

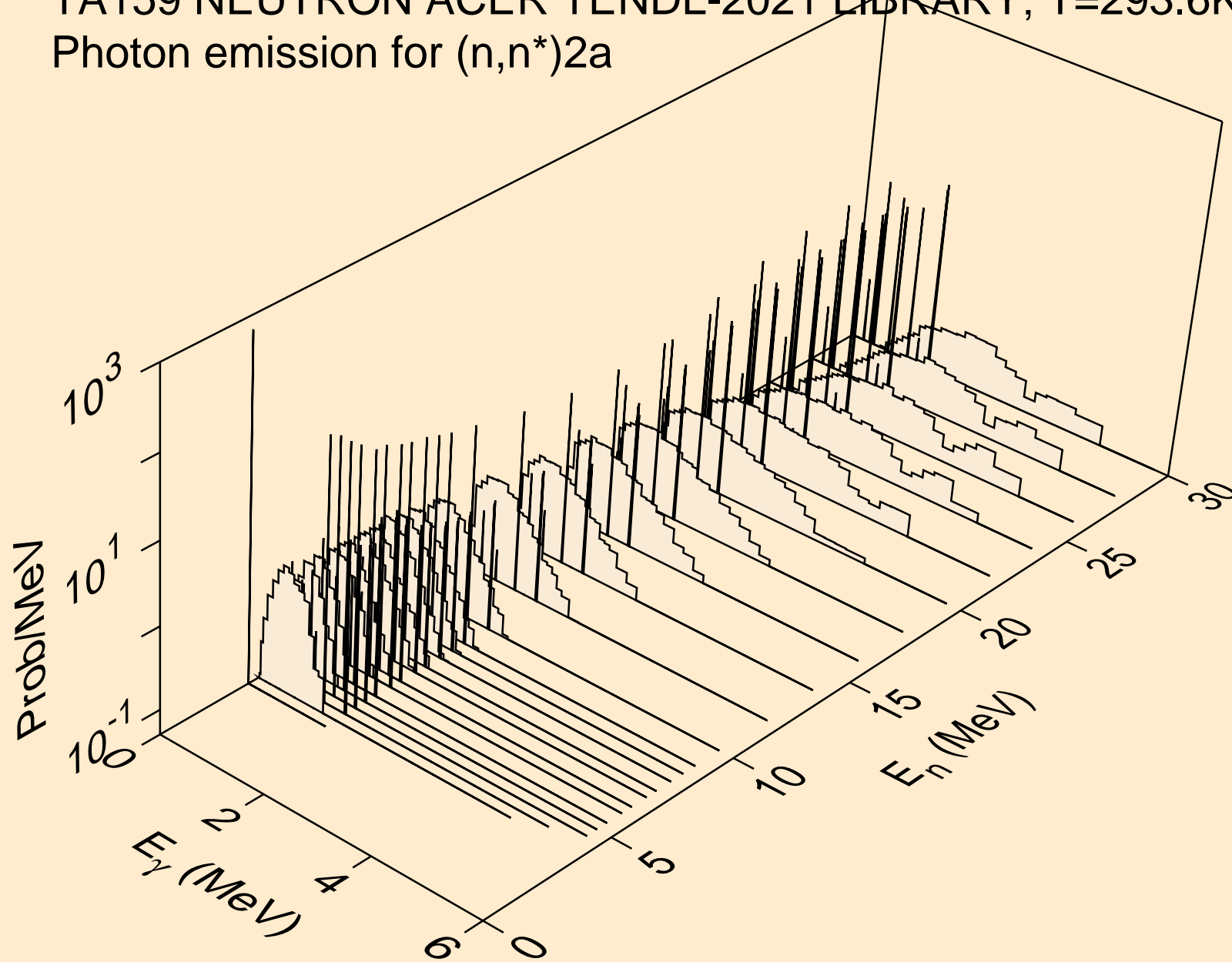

TA159 NEUTRON ACER TENDL-2021 LIBRARY; T=293.6K  
Photon emission for (n,2n)2a

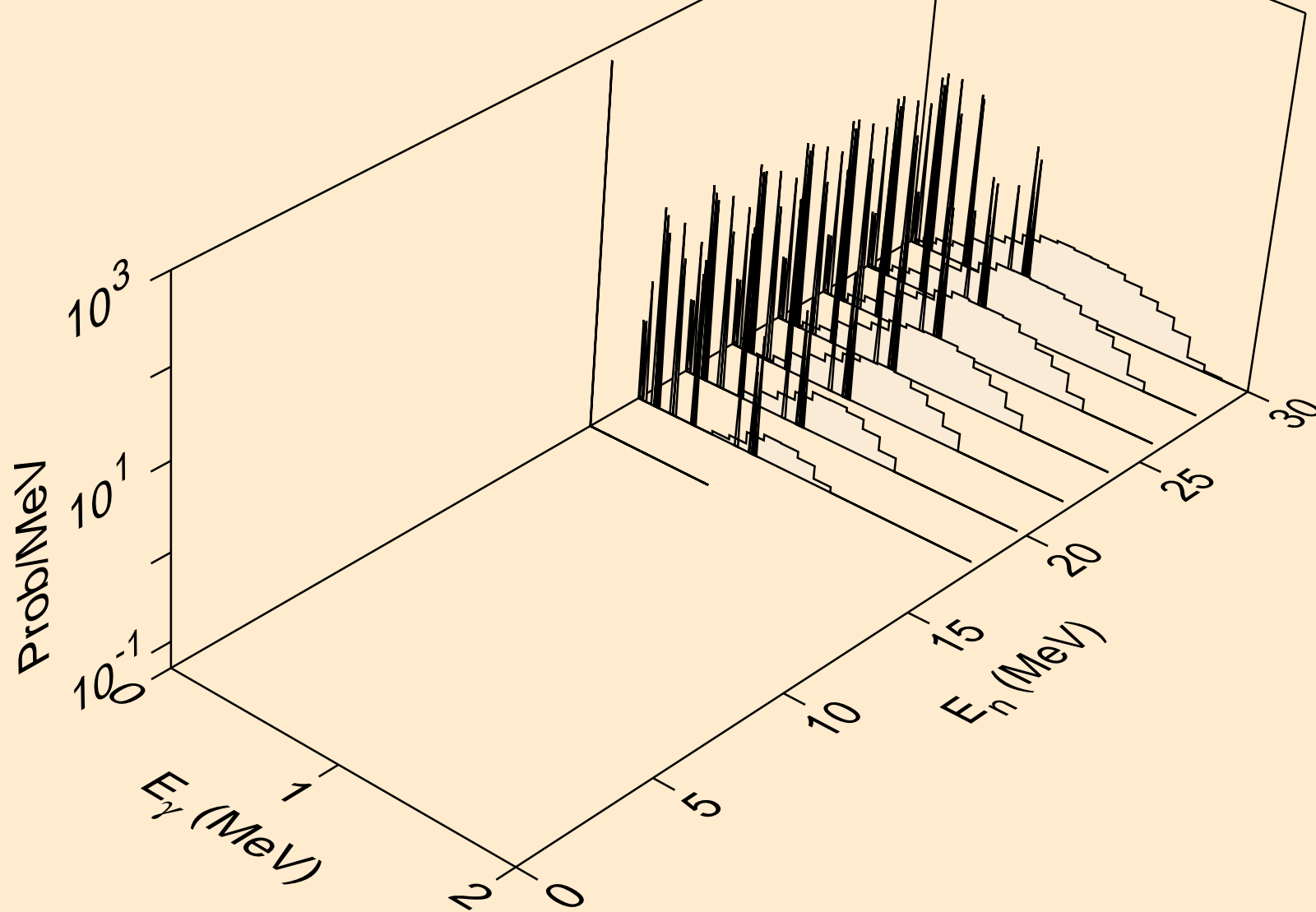



TA159 NEUTRON ACER TENDL-2021 LIBRARY; T=293.6K  
Photon emission for (n,n\*)d

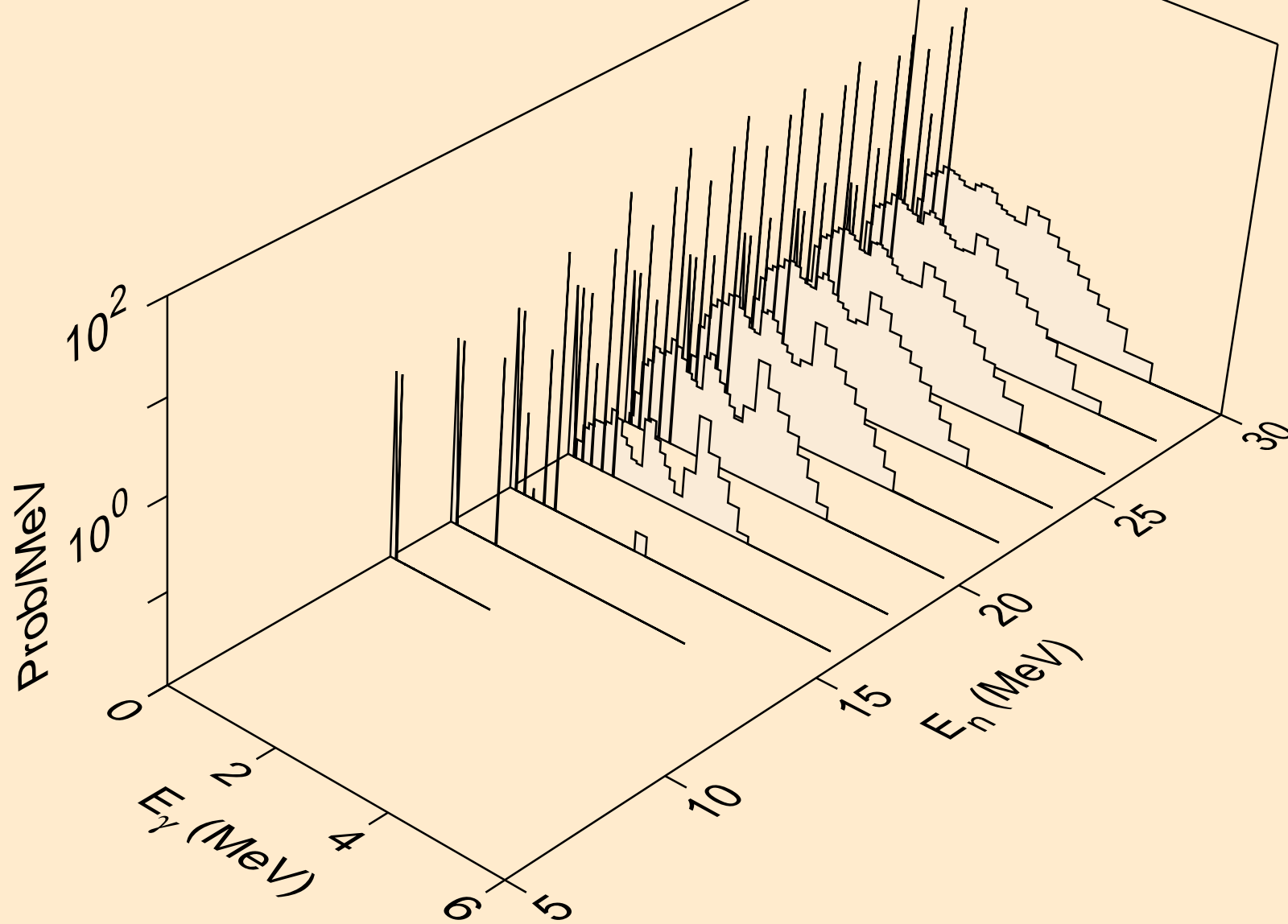

TA159 NEUTRON ACER TENDL-2021 LIBRARY; T=293.6K  
Photon emission for (n,n\*)t

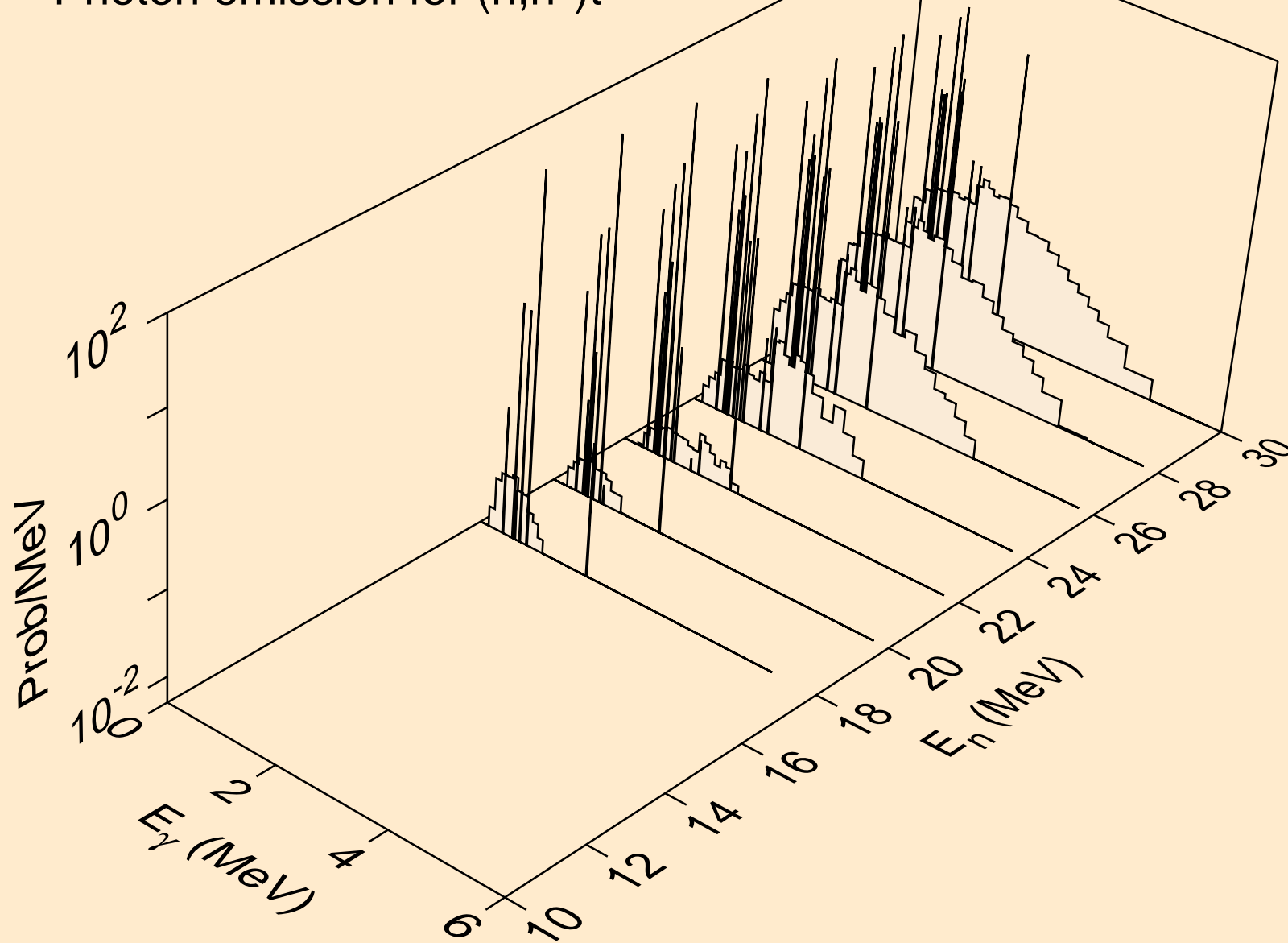

TA159 NEUTRON ACER TENDL-2021 LIBRARY; T=293.6K  
Photon emission for (n,n\*)he3

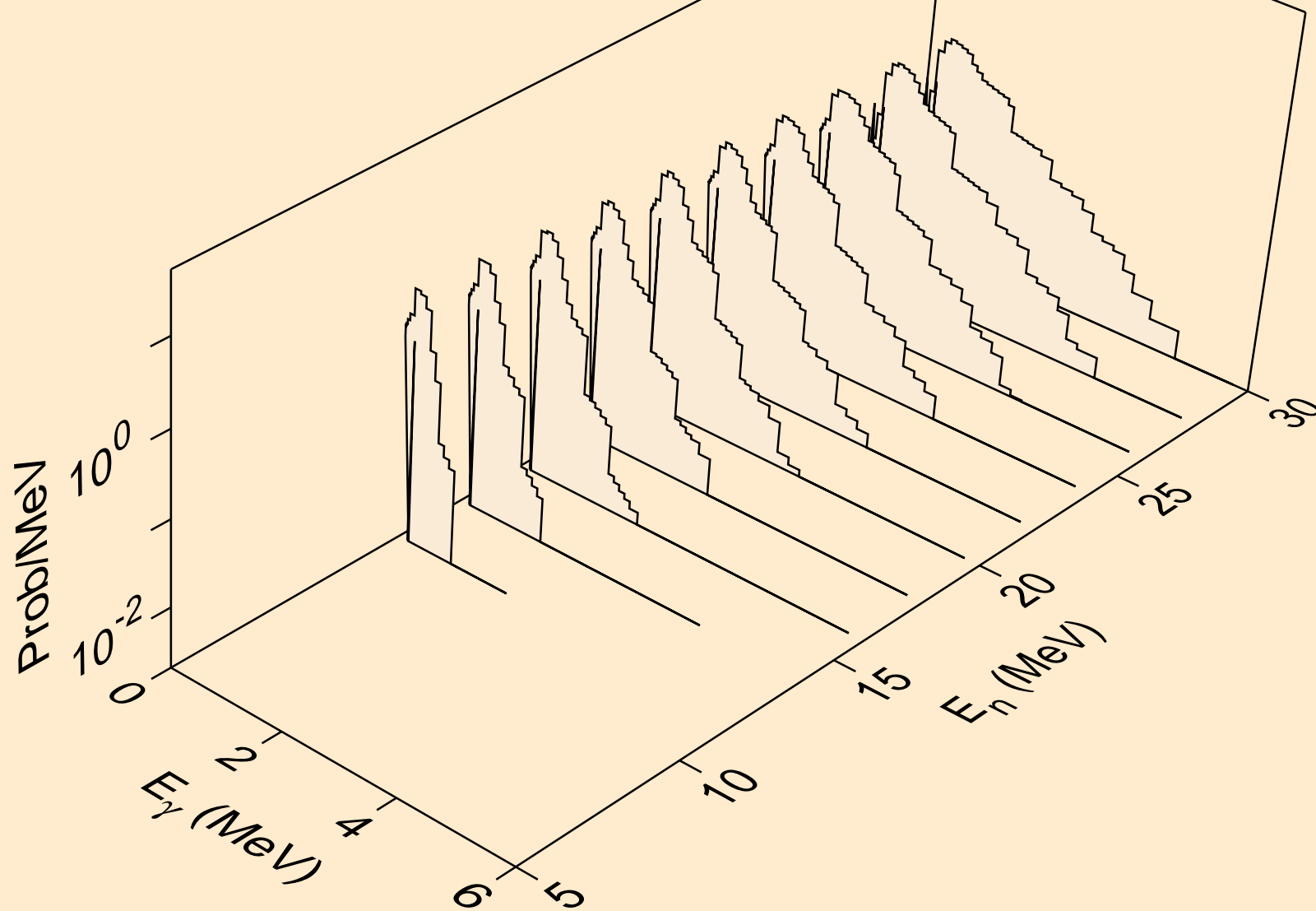

TA159 NEUTRON ACER TENDL-2021 LIBRARY; T=293.6K  
Photon emission for (n,2np)

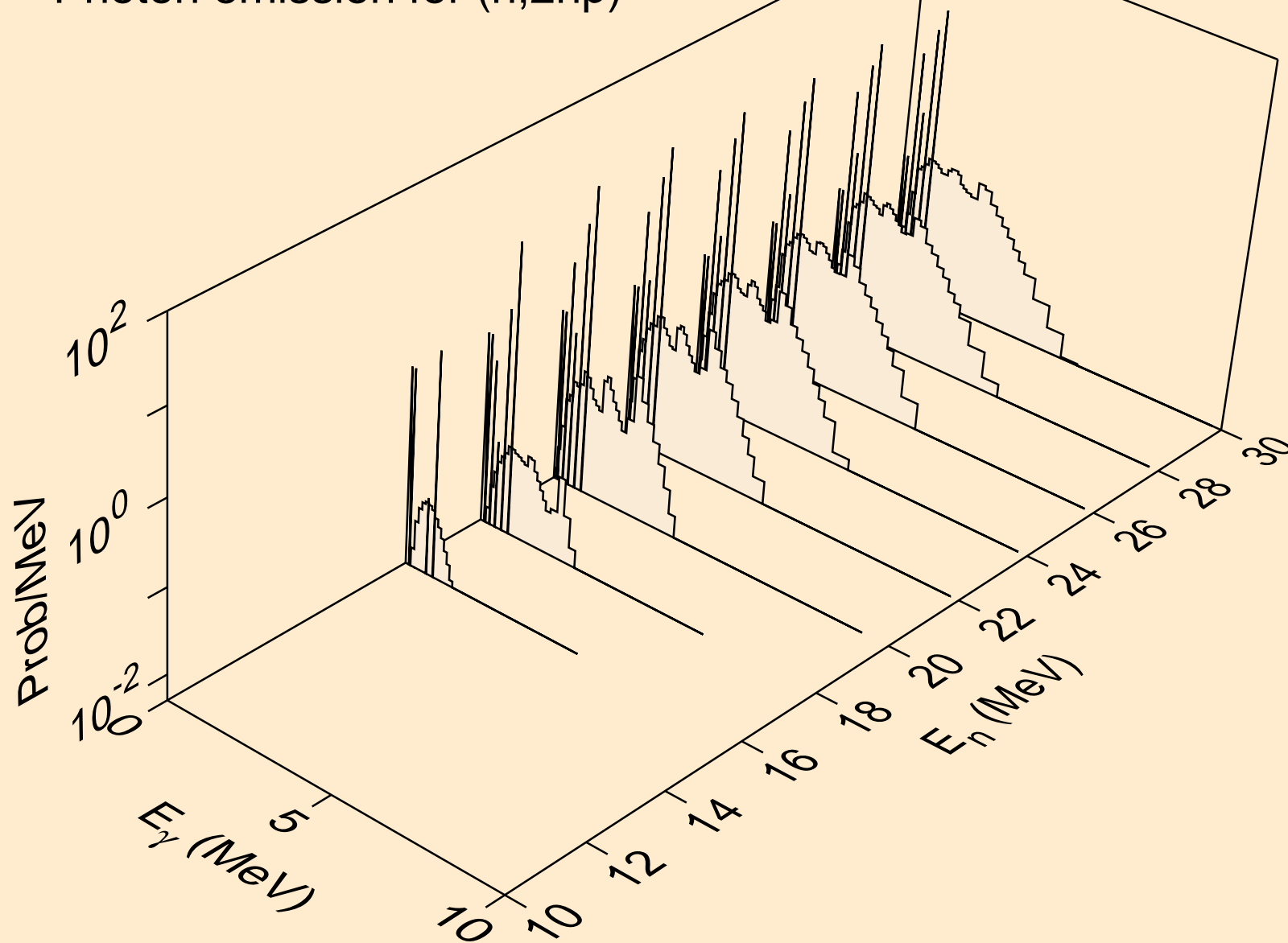

TA159 NEUTRON ACER TENDL-2021 LIBRARY; T=293.6K  
Photon emission for (n,3np)

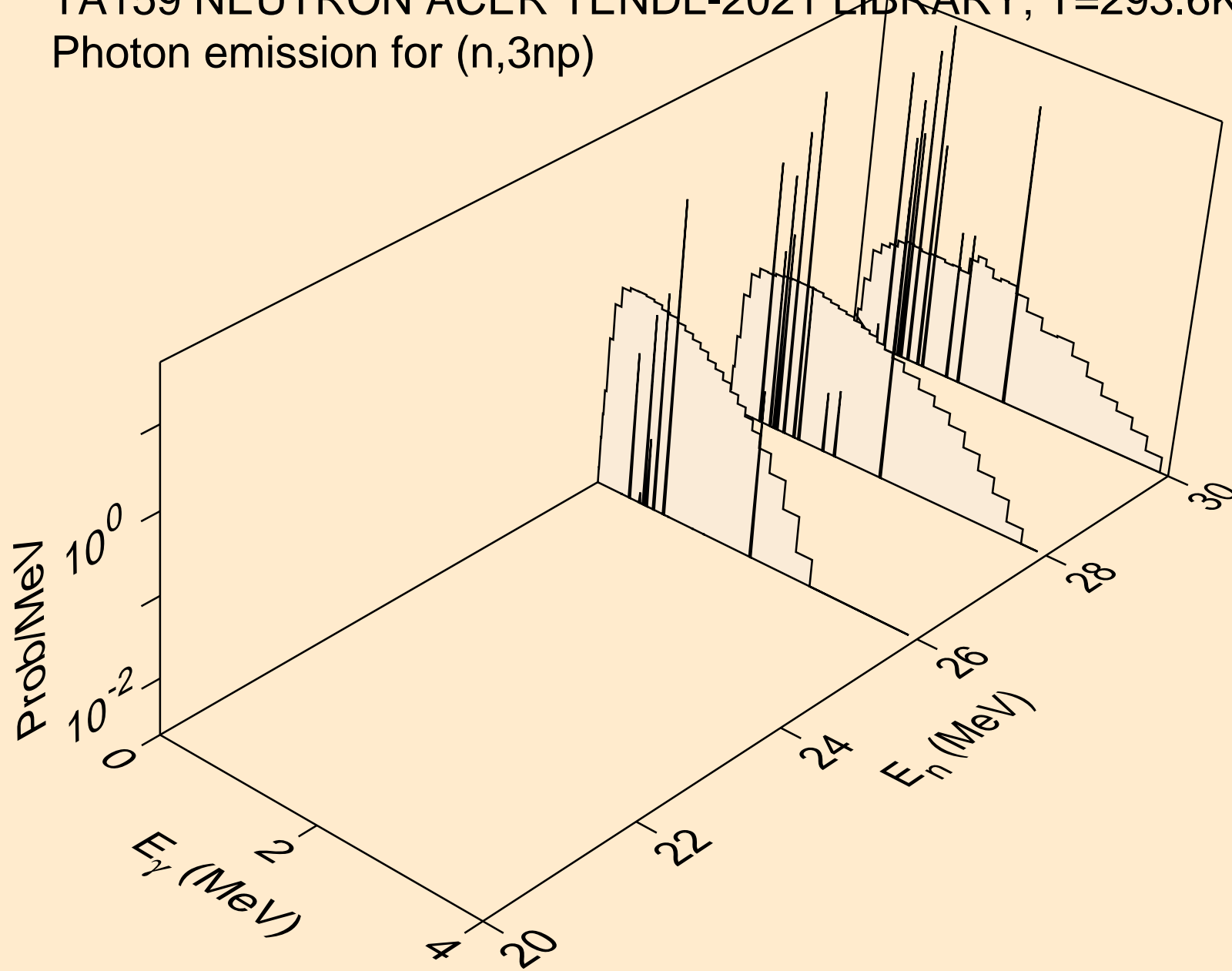

TA159 NEUTRON ACER TENDL-2021 LIBRARY; T=293.6K  
Photon emission for (n,2np)

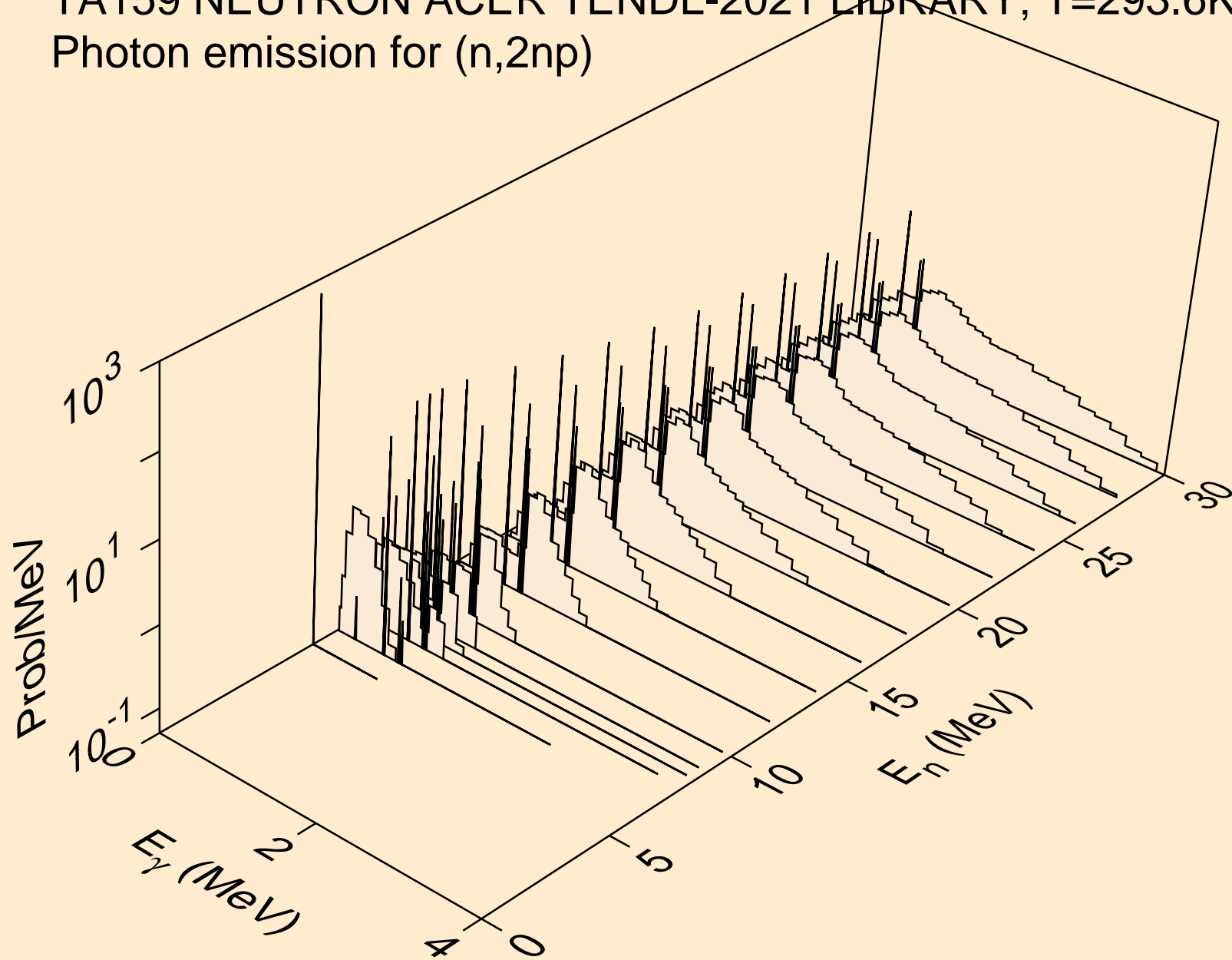

TA159 NEUTRON ACER TENDL-2021 LIBRARY; T=293.6K  
Photon emission for (n,npa)

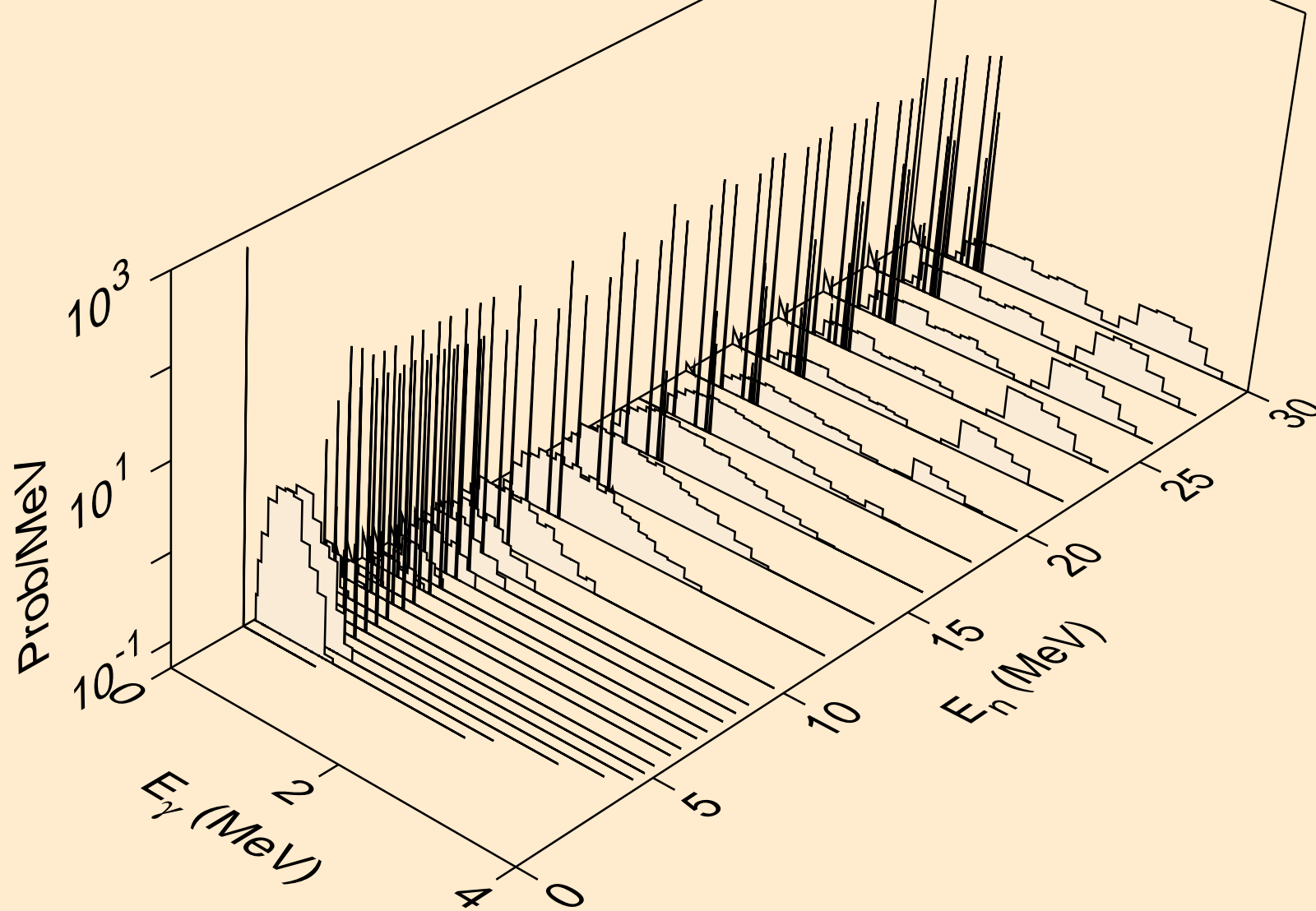

TA159 NEUTRON ACER TENDL-2021 LIBRARY; T=293.6K  
Photon emission for (n,n\*c)

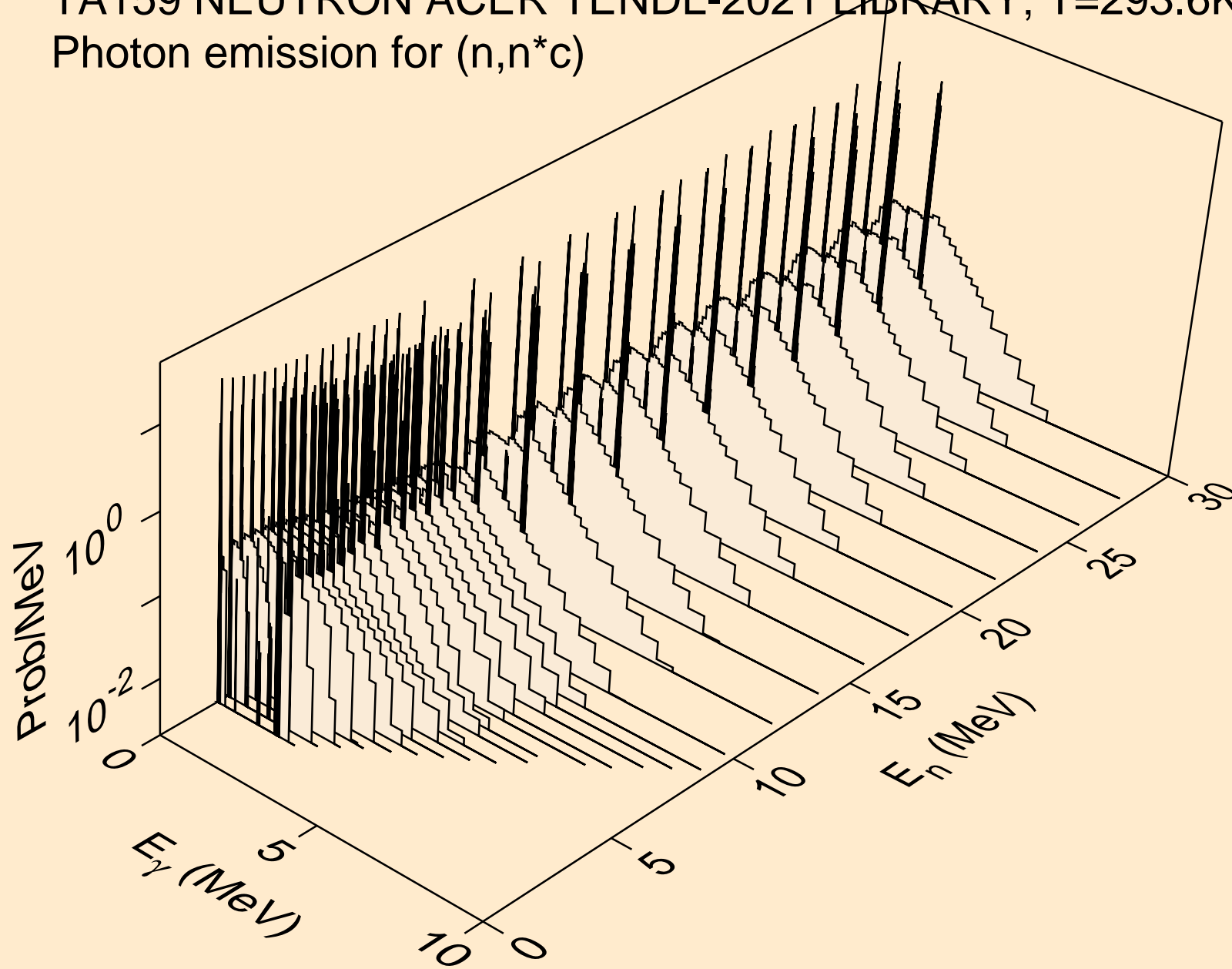



TA159 NEUTRON ACER TENDL-2021 LIBRARY; T=293.6K  
Photon emission for (n,gma)

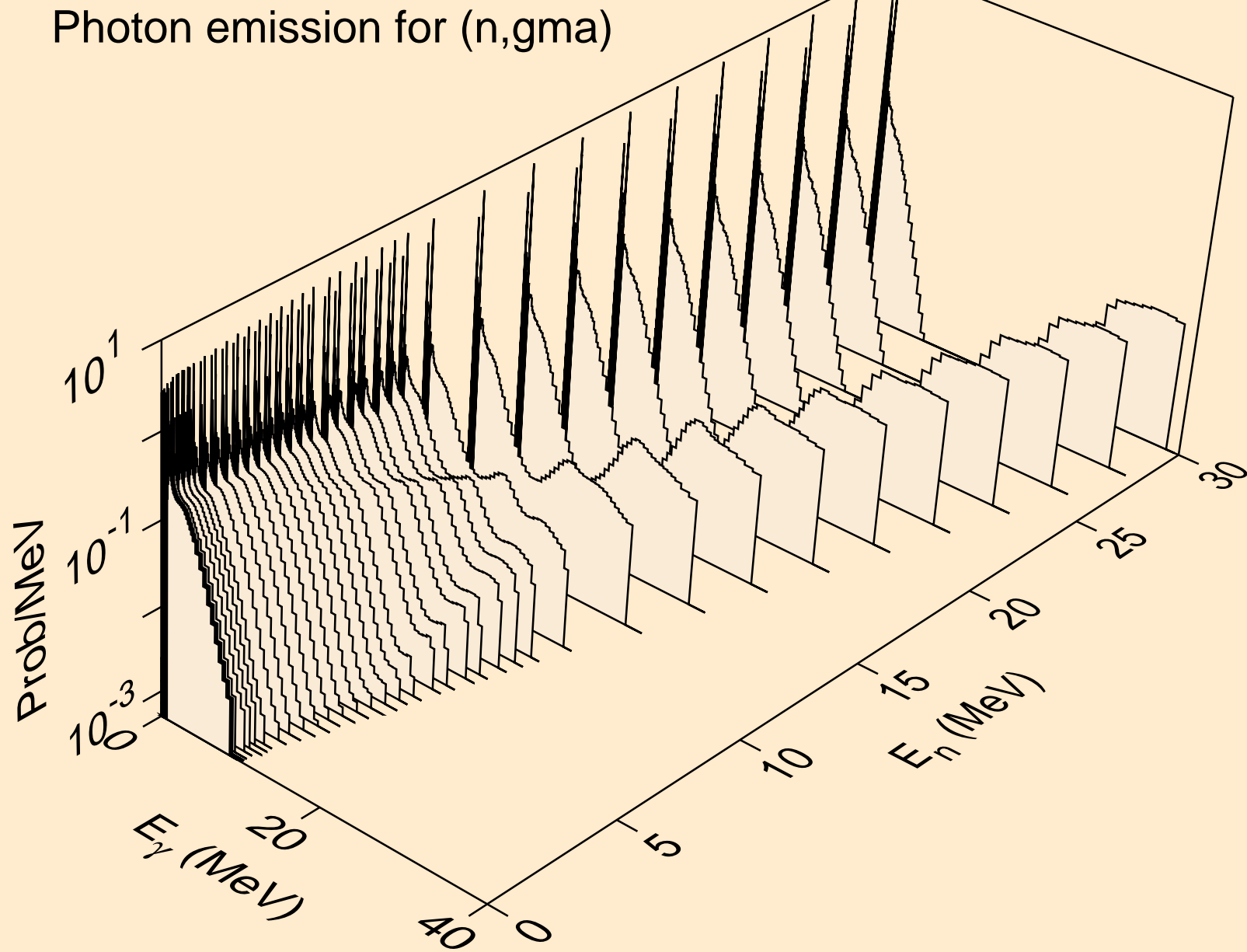

TA159 NEUTRON ACER TENDL-2021 LIBRARY; T=293.6K  
Photon emission for (n,p)

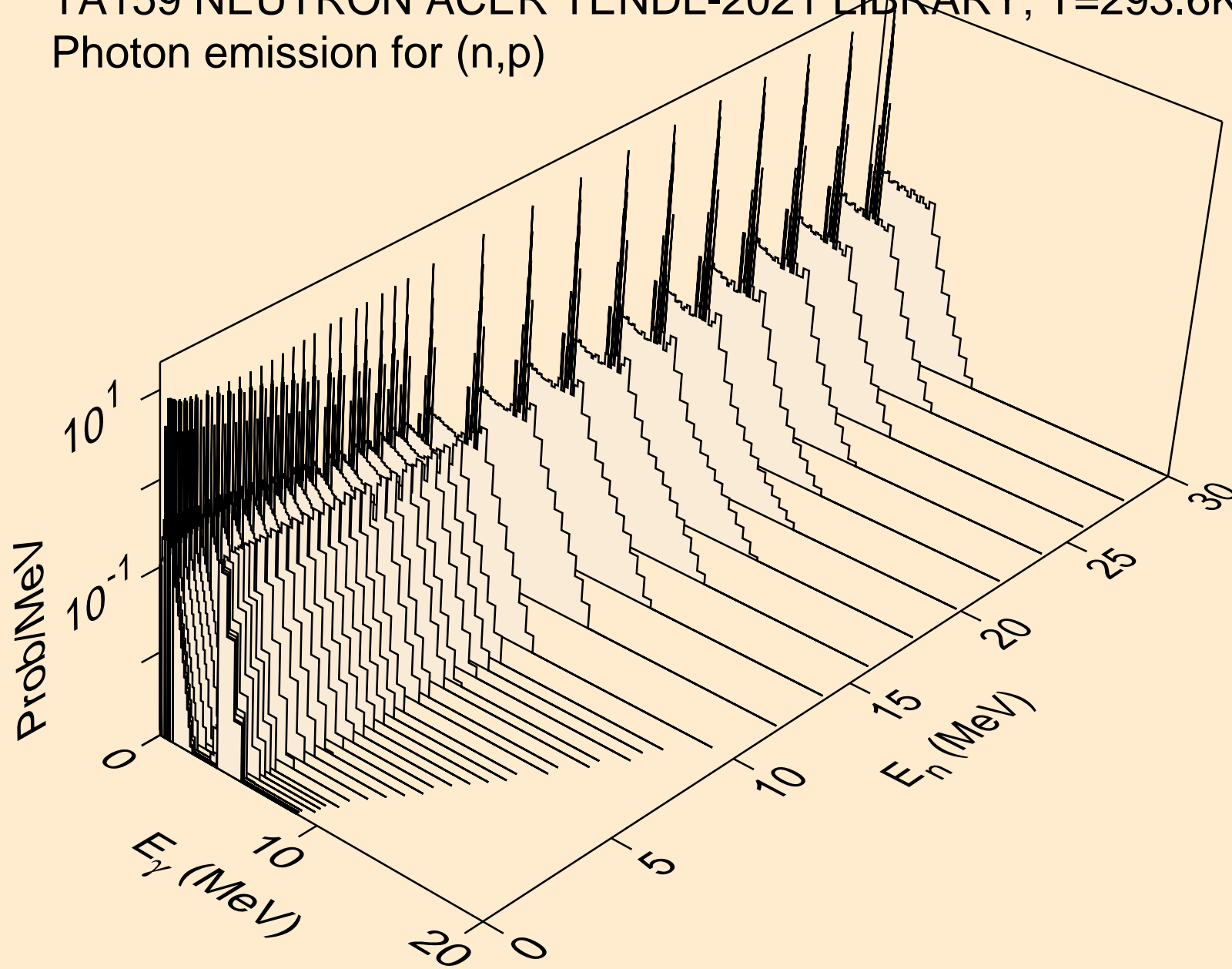

TA159 NEUTRON ACER TENDL-2021 LIBRARY; T=293.6K  
Photon emission for (n,d)

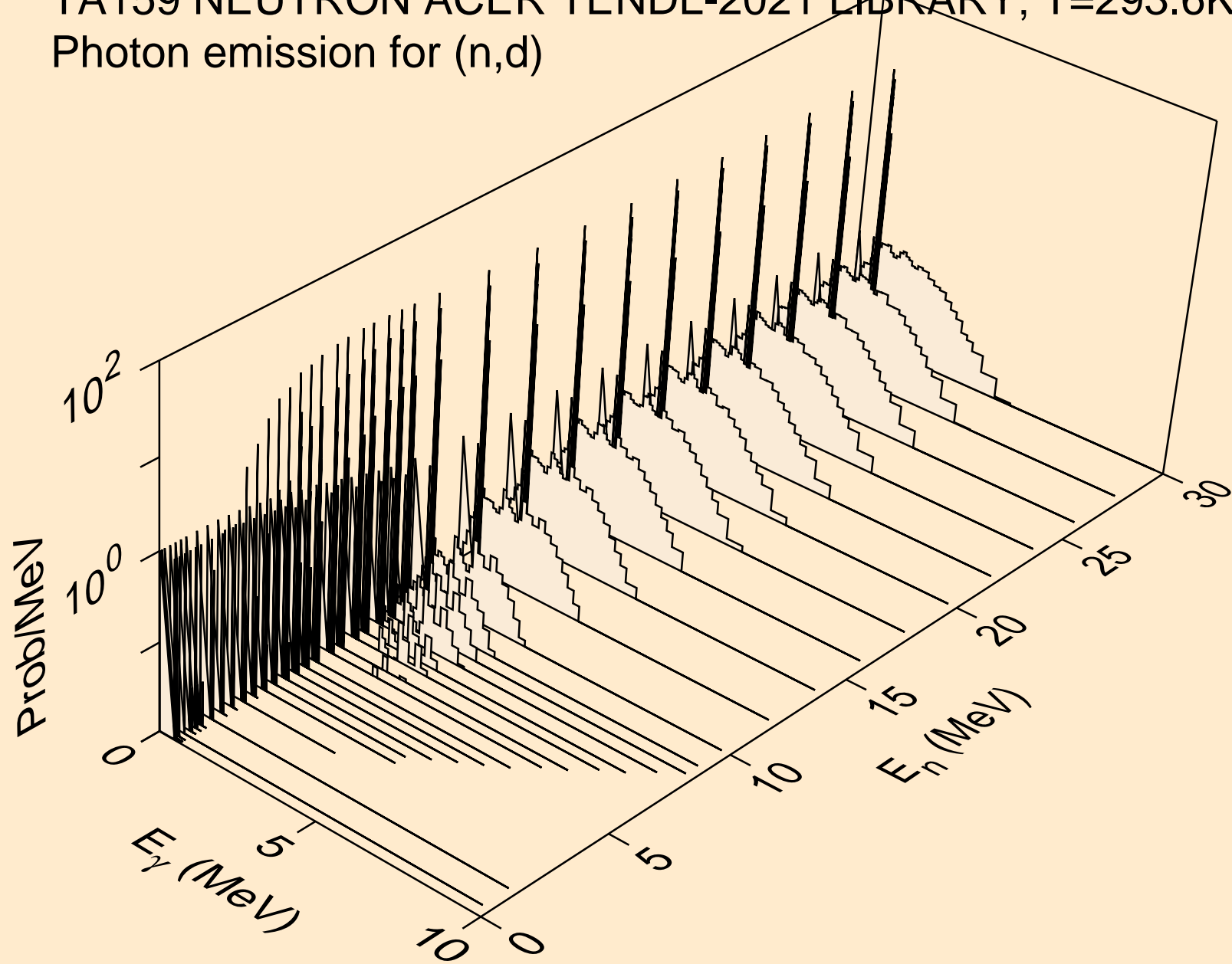

TA159 NEUTRON ACER TENDL-2021 LIBRARY; T=293.6K  
Photon emission for (n,t)

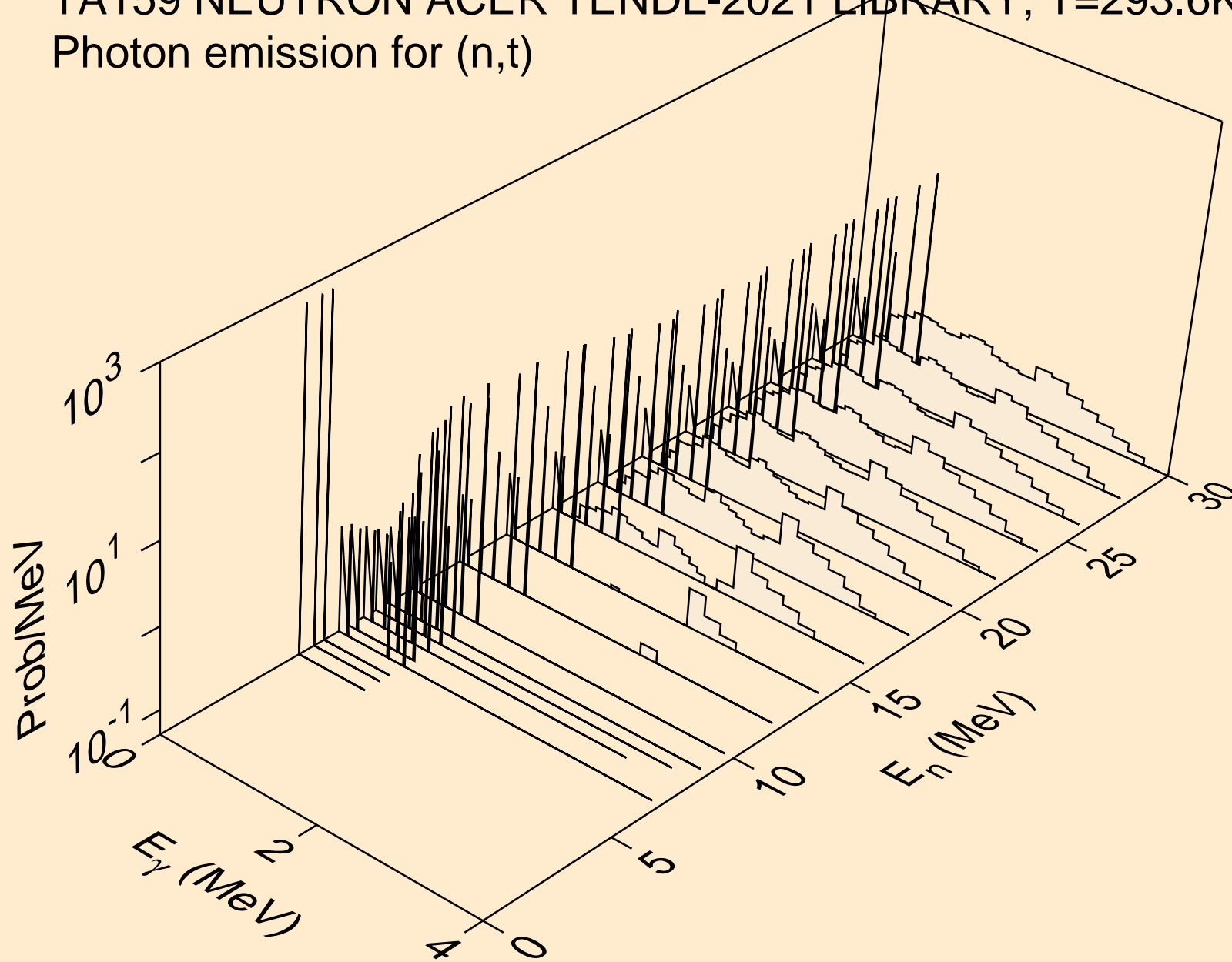

TA159 NEUTRON ACER TENDL-2021 LIBRARY; T=293.6K  
Photon emission for (n,he3)

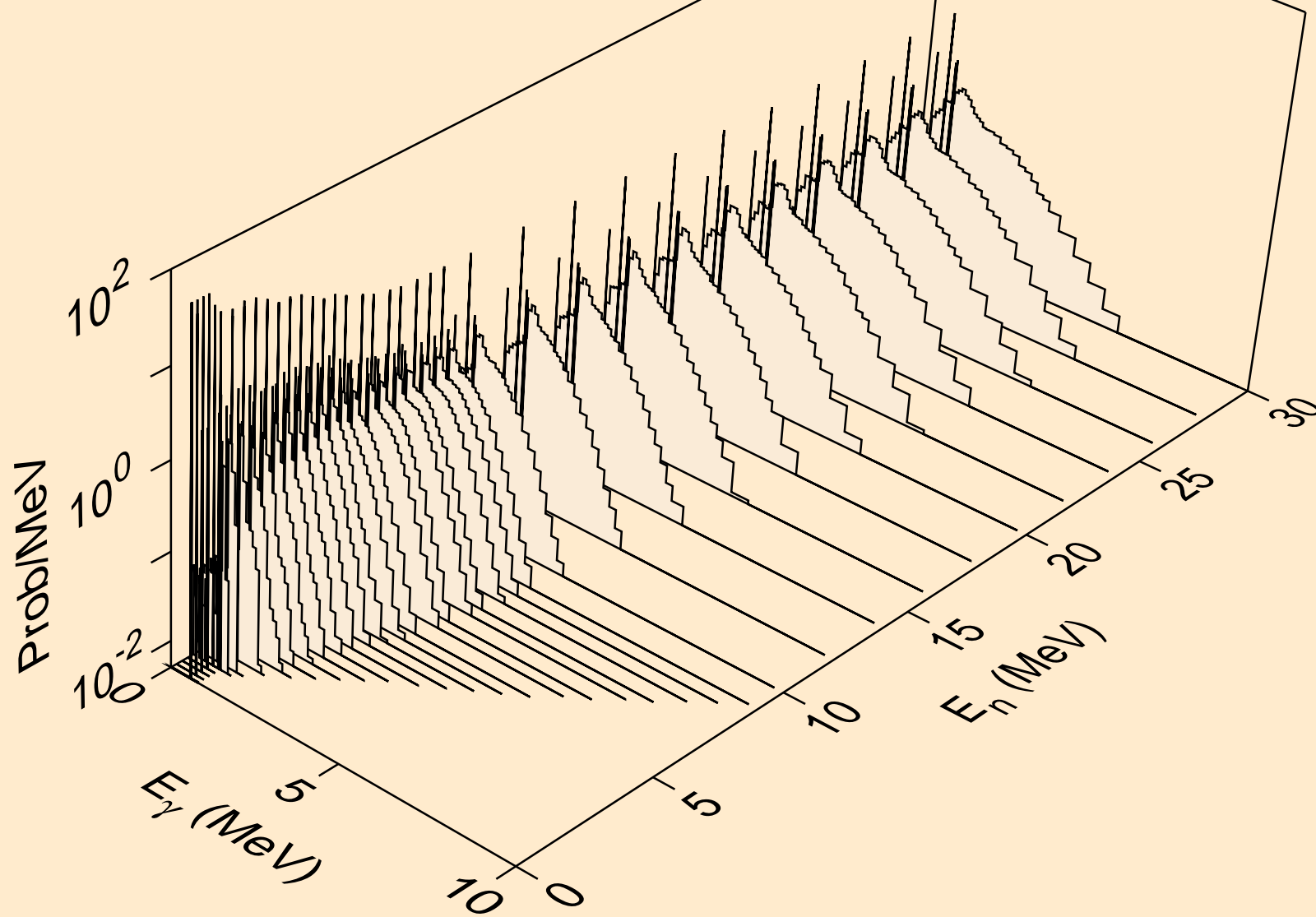

TA159 NEUTRON ACER TENDL-2021 LIBRARY; T=293.6K  
Photon emission for (n,a)

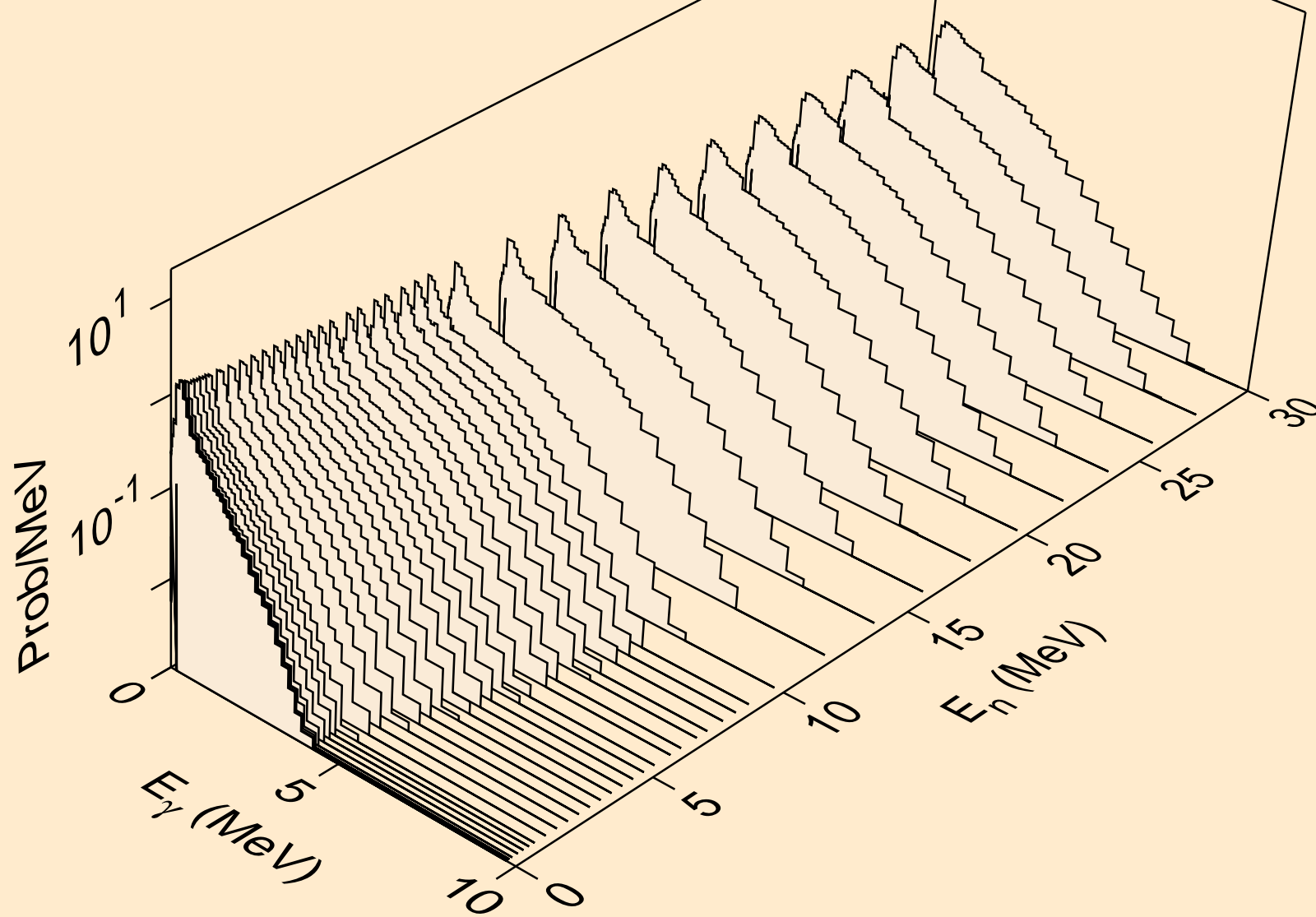

TA159 NEUTRON ACER TENDL-2021 LIBRARY; T=293.6K  
Photon emission for (n,2a)

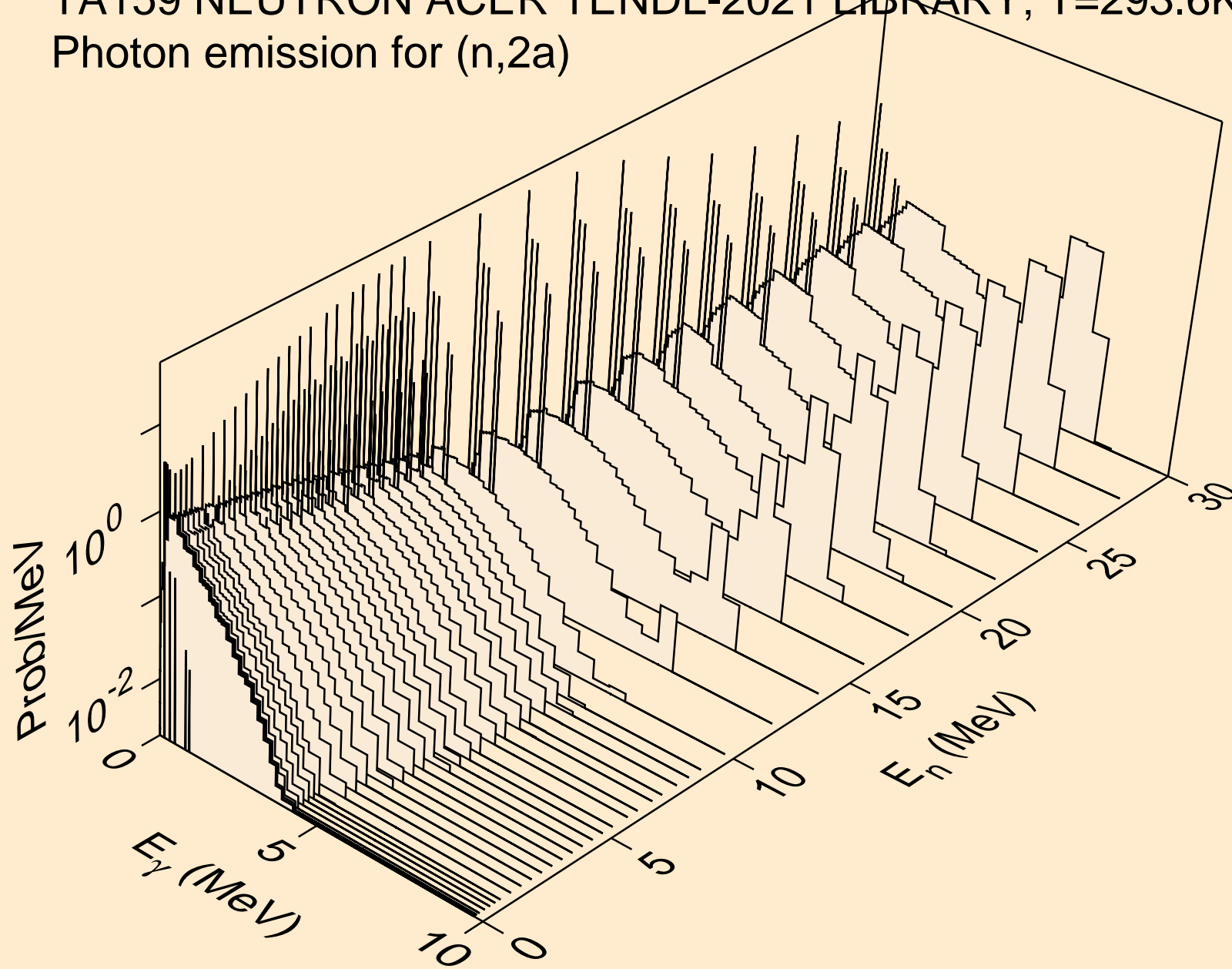

TA159 NEUTRON ACER TENDL-2021 LIBRARY; T=293.6K  
Photon emission for (n,3a)

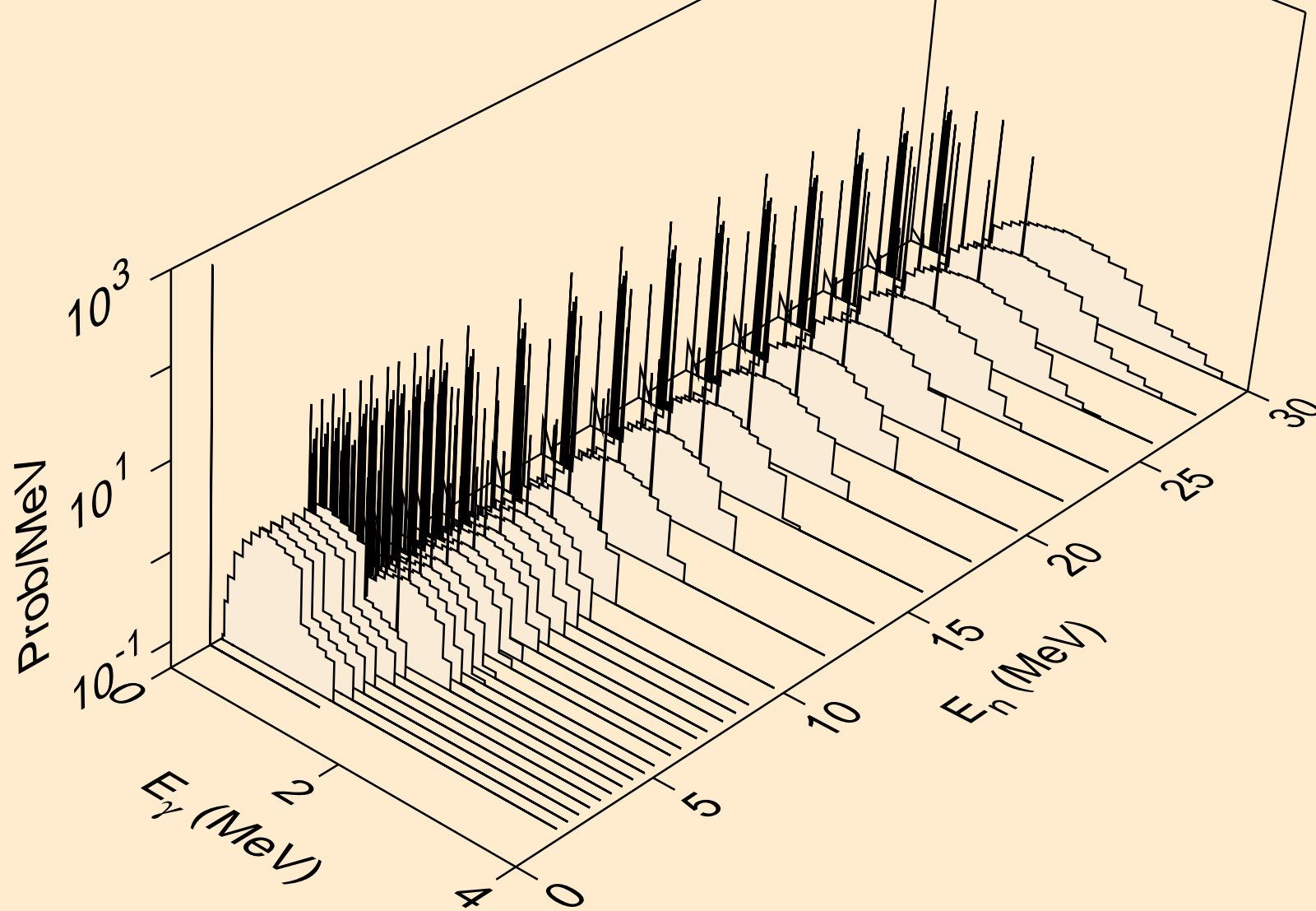



TA159 NEUTRON ACER TENDL-2021 LIBRARY; T=293.6K  
Photon emission for (n,2p)

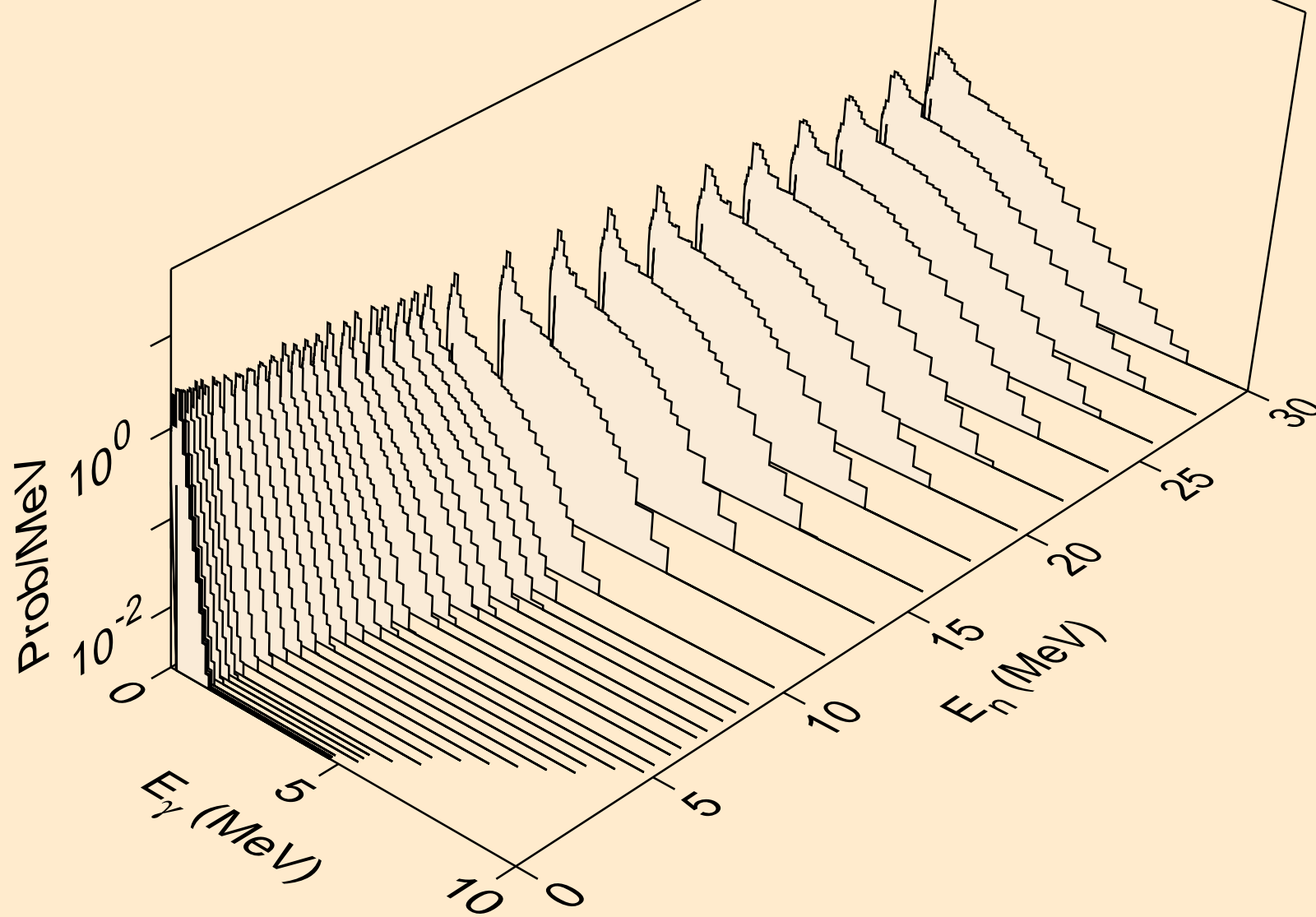

TA159 NEUTRON ACER TENDL-2021 LIBRARY; T=293.6K  
Photon emission for (n,p $\alpha$ )

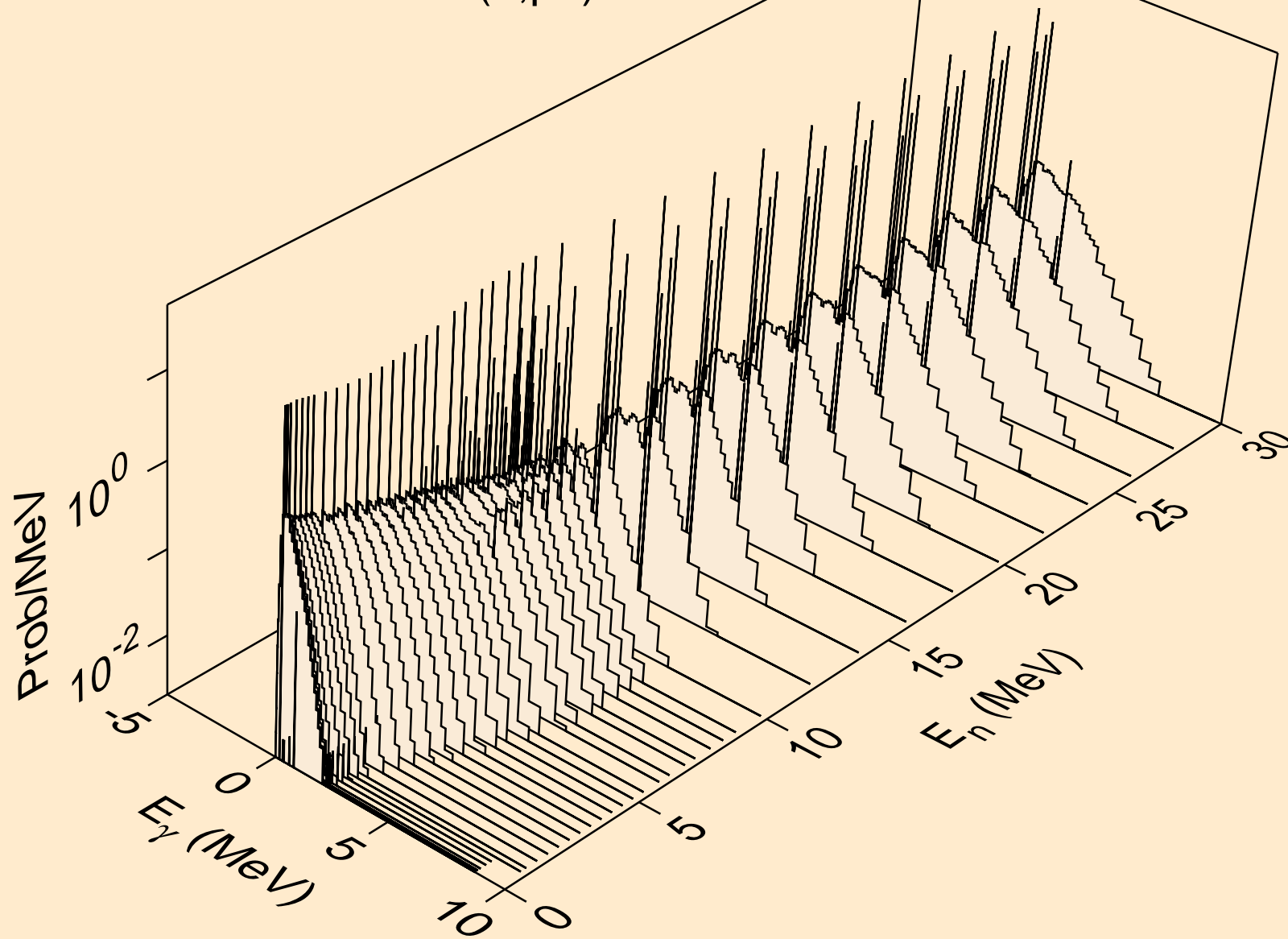

TA159 NEUTRON ACER TENDL-2021 LIBRARY; T=293.6K  
Photon emission for (n,t2a)

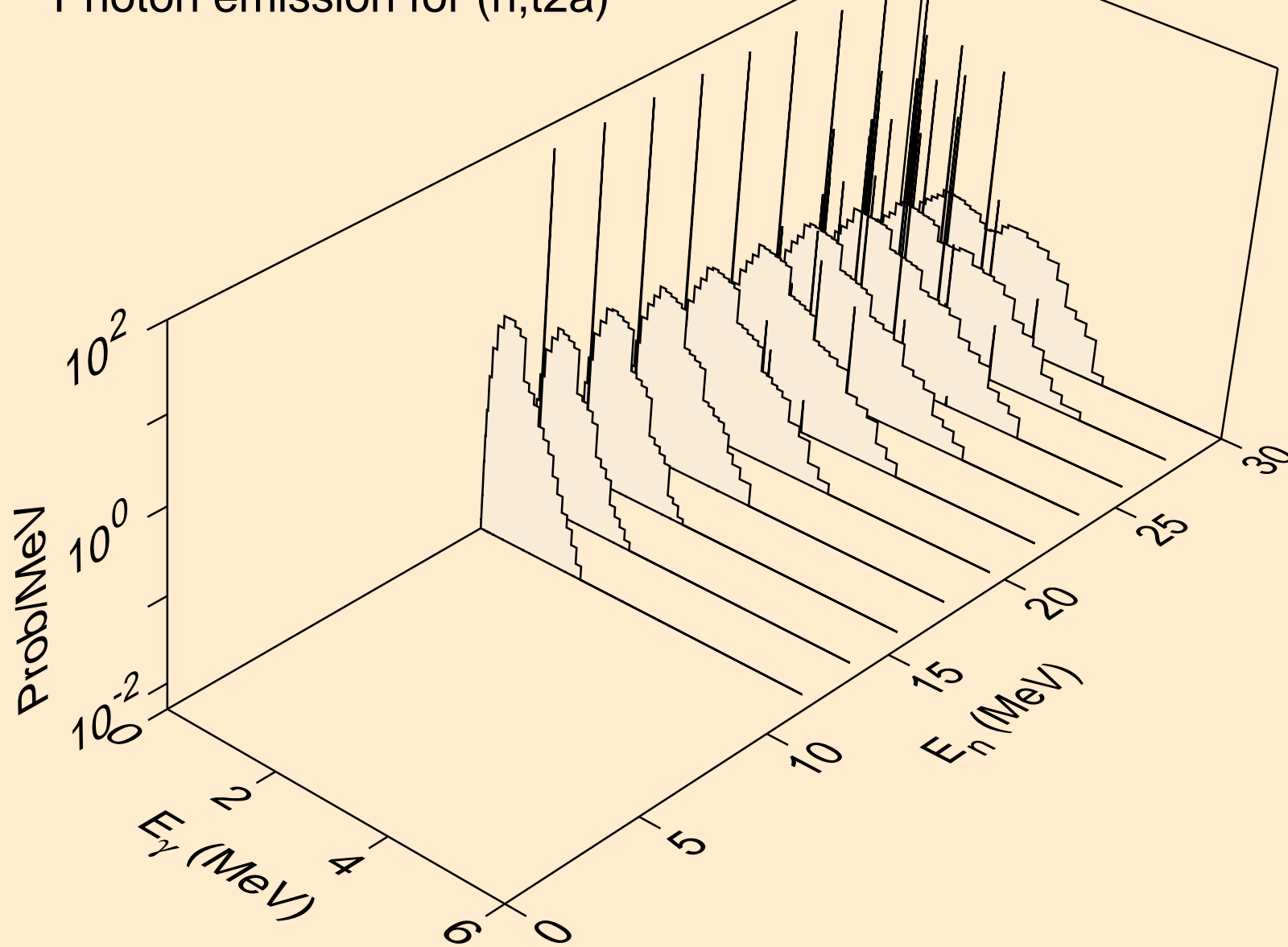

TA159 NEUTRON ACER TENDL-2021 LIBRARY; T=293.6K  
Photon emission for (n,d2a)

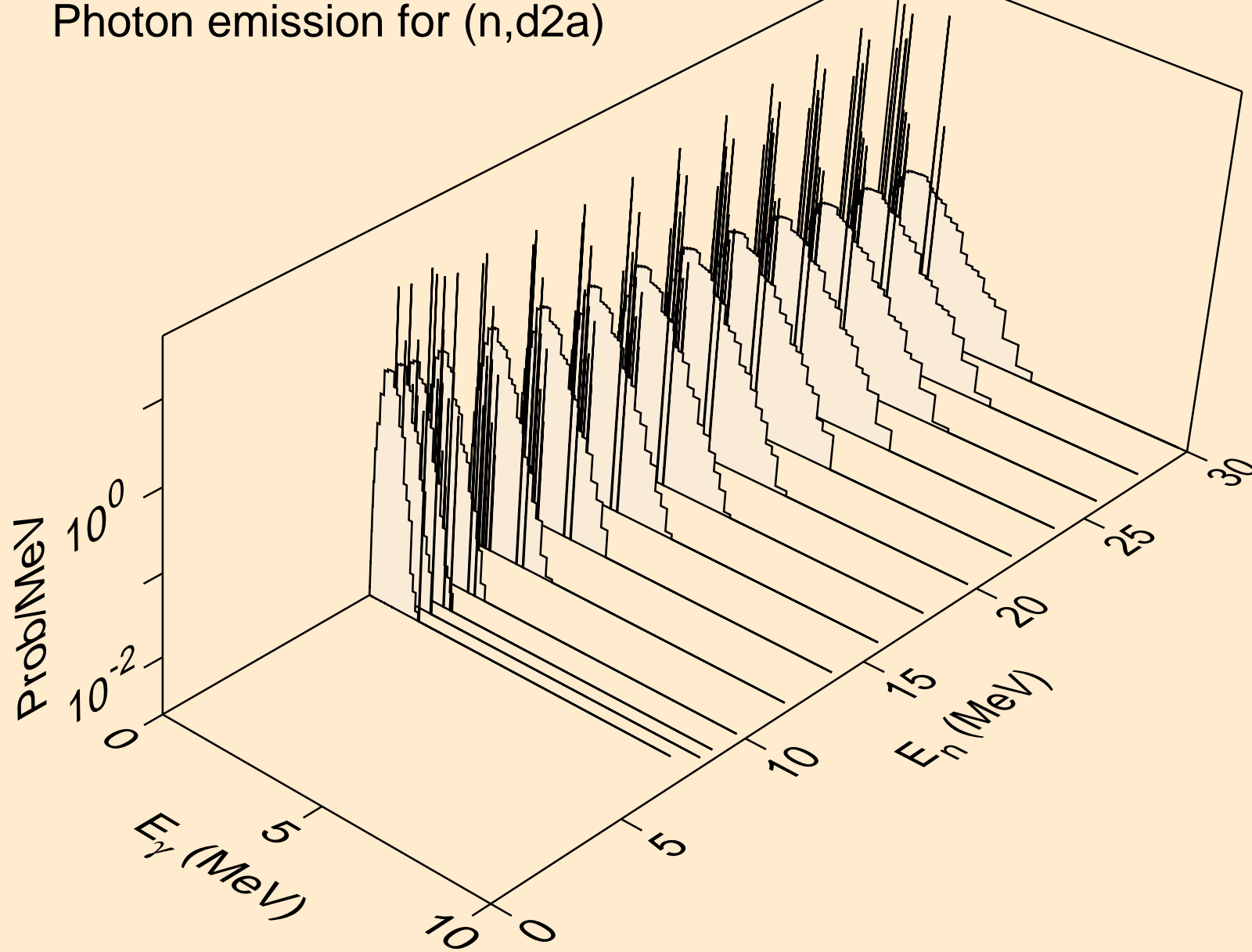

TA159 NEUTRON ACER TENDL-2021 LIBRARY; T=293.6K  
Photon emission for (n,pd)

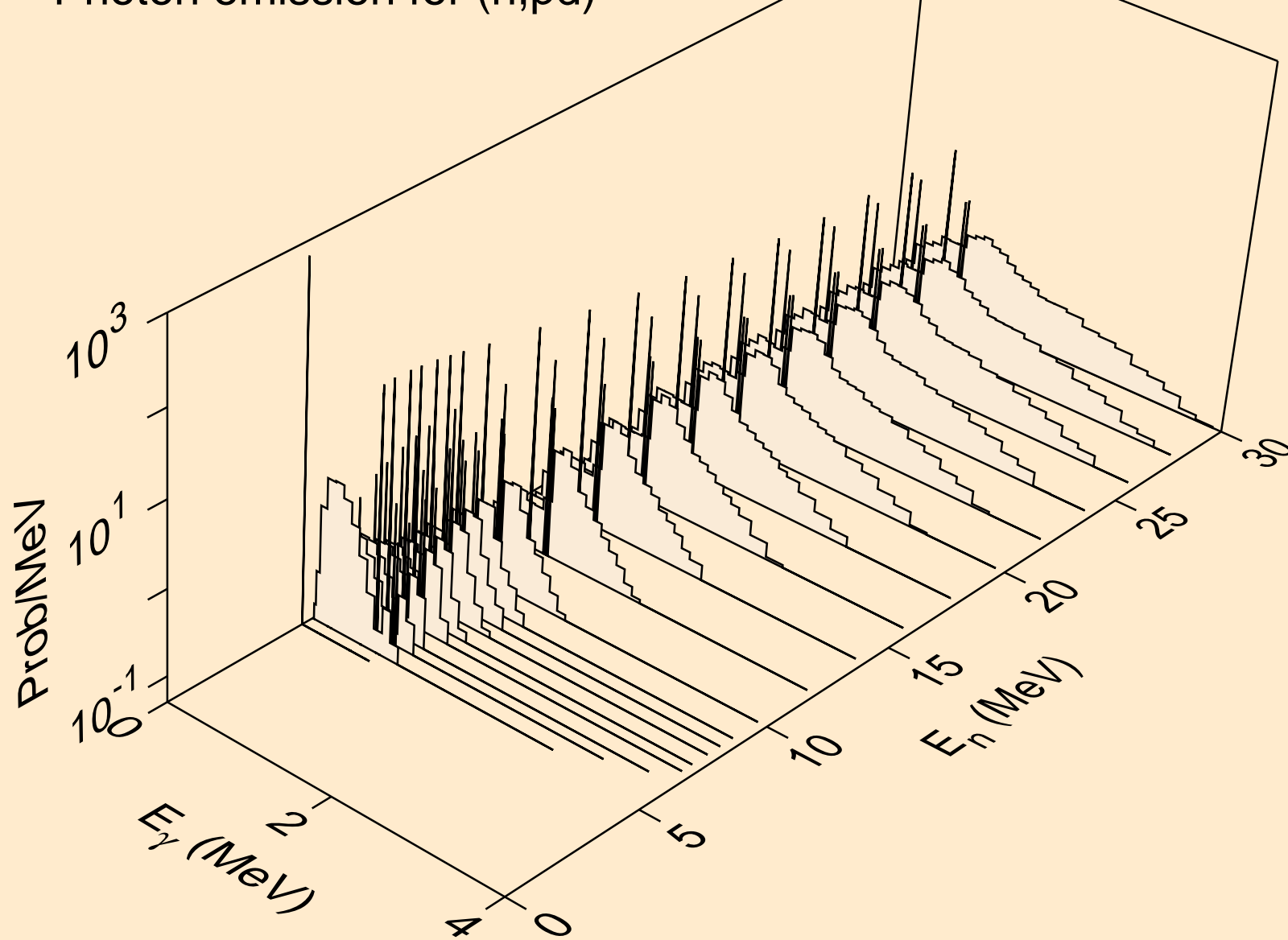

TA159 NEUTRON ACER TENDL-2021 LIBRARY; T=293.6K  
Photon emission for (n,pt)

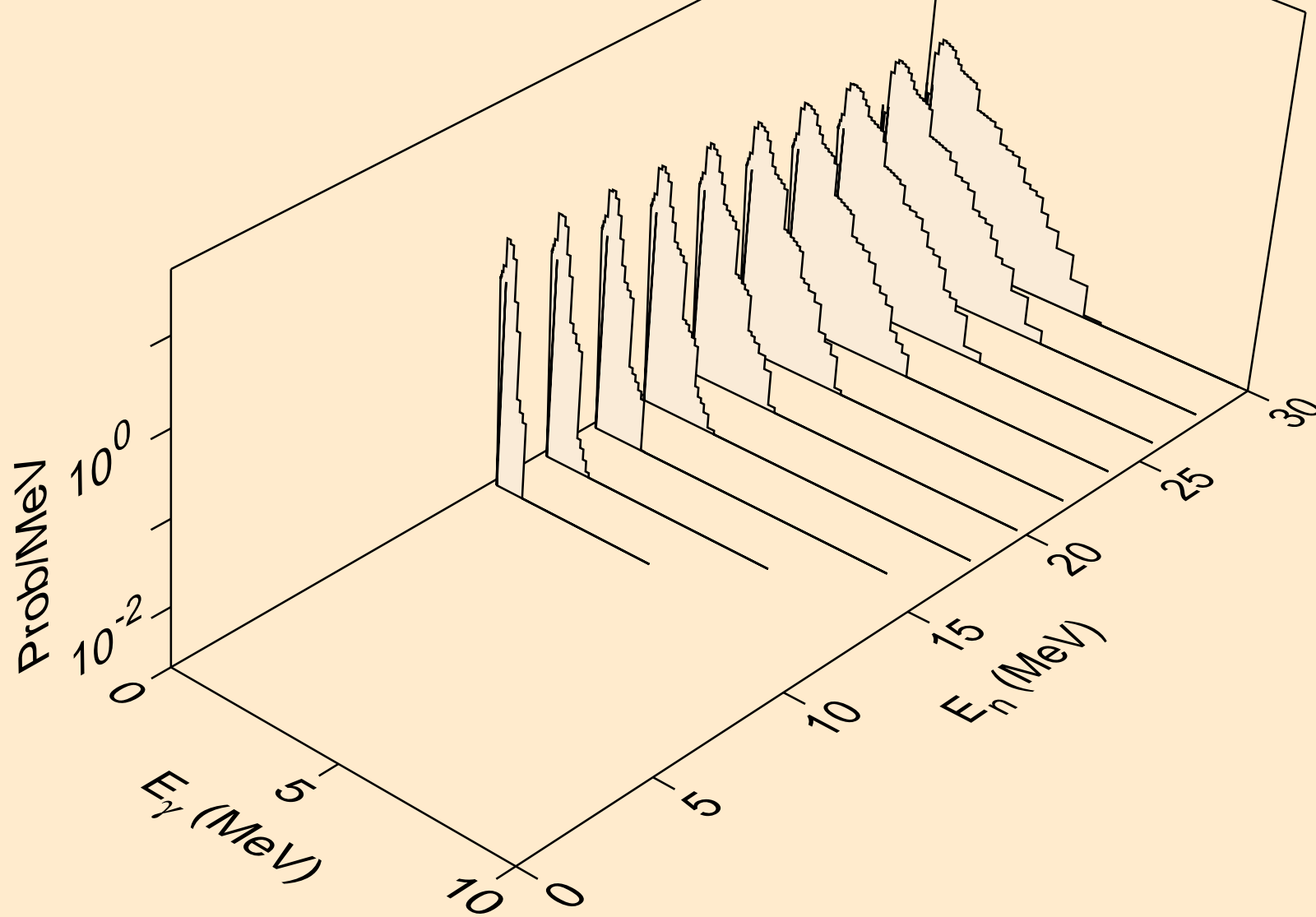

TA159 NEUTRON ACER TENDL-2021 LIBRARY; T=293.6K  
Photon emission for (n,da)

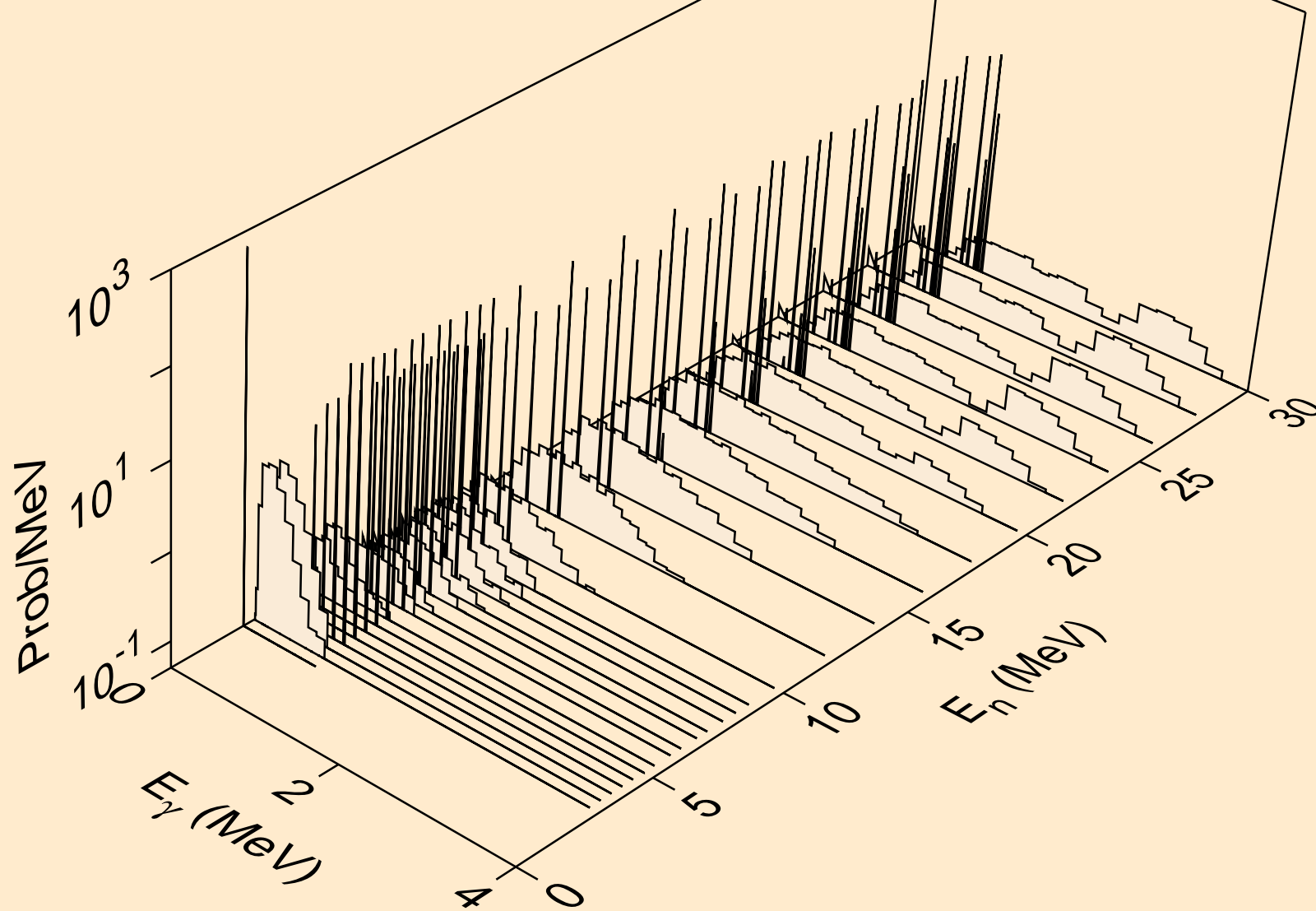

TA159 NEUTRON ACER TENDL-2021 LIBRARY; T=293.6K  
thermal capture photon spectrum

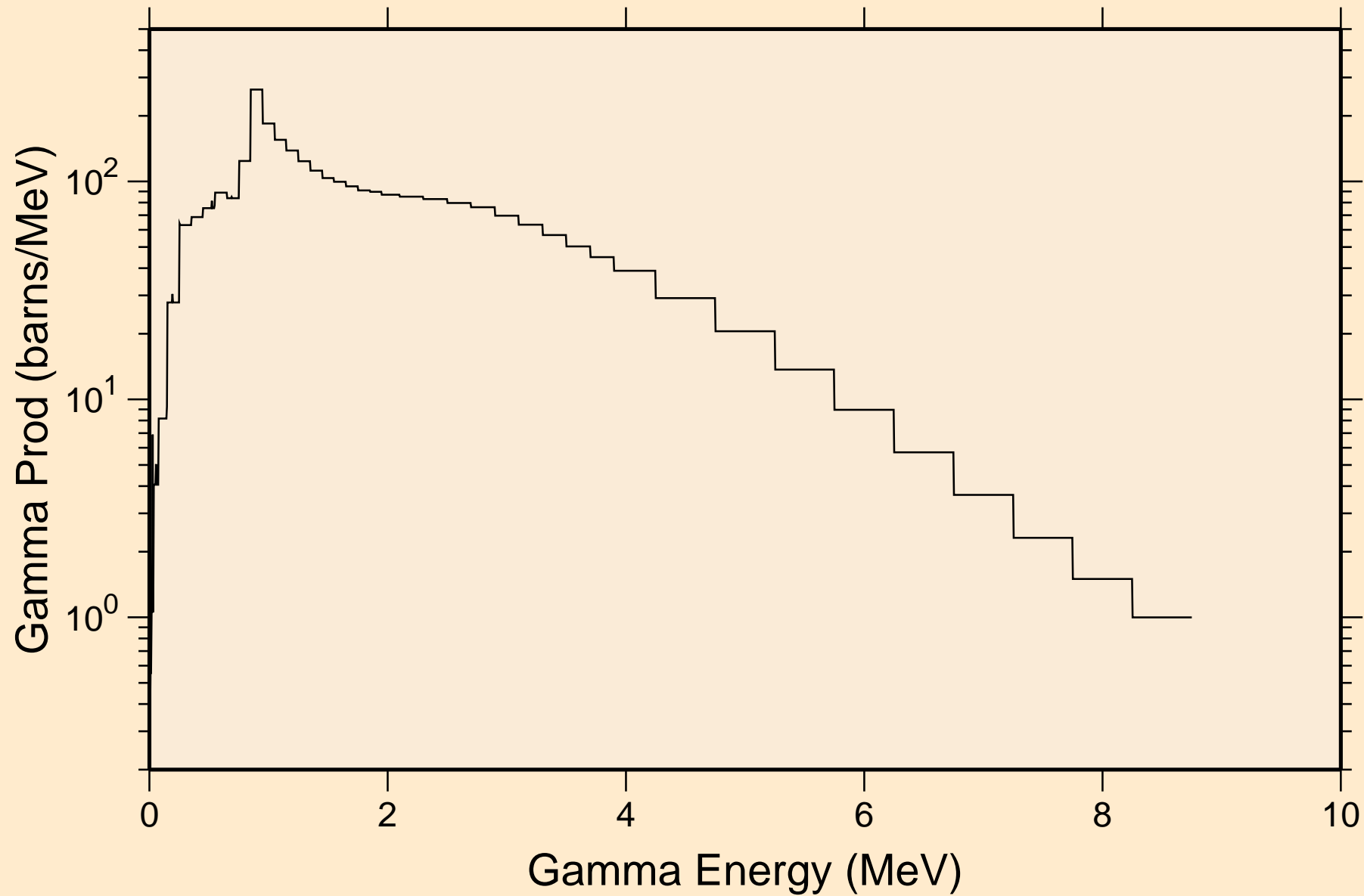



TA159 NEUTRON ACER TENDL-2021 LIBRARY; T=293.6K  
14 MeV photon spectrum

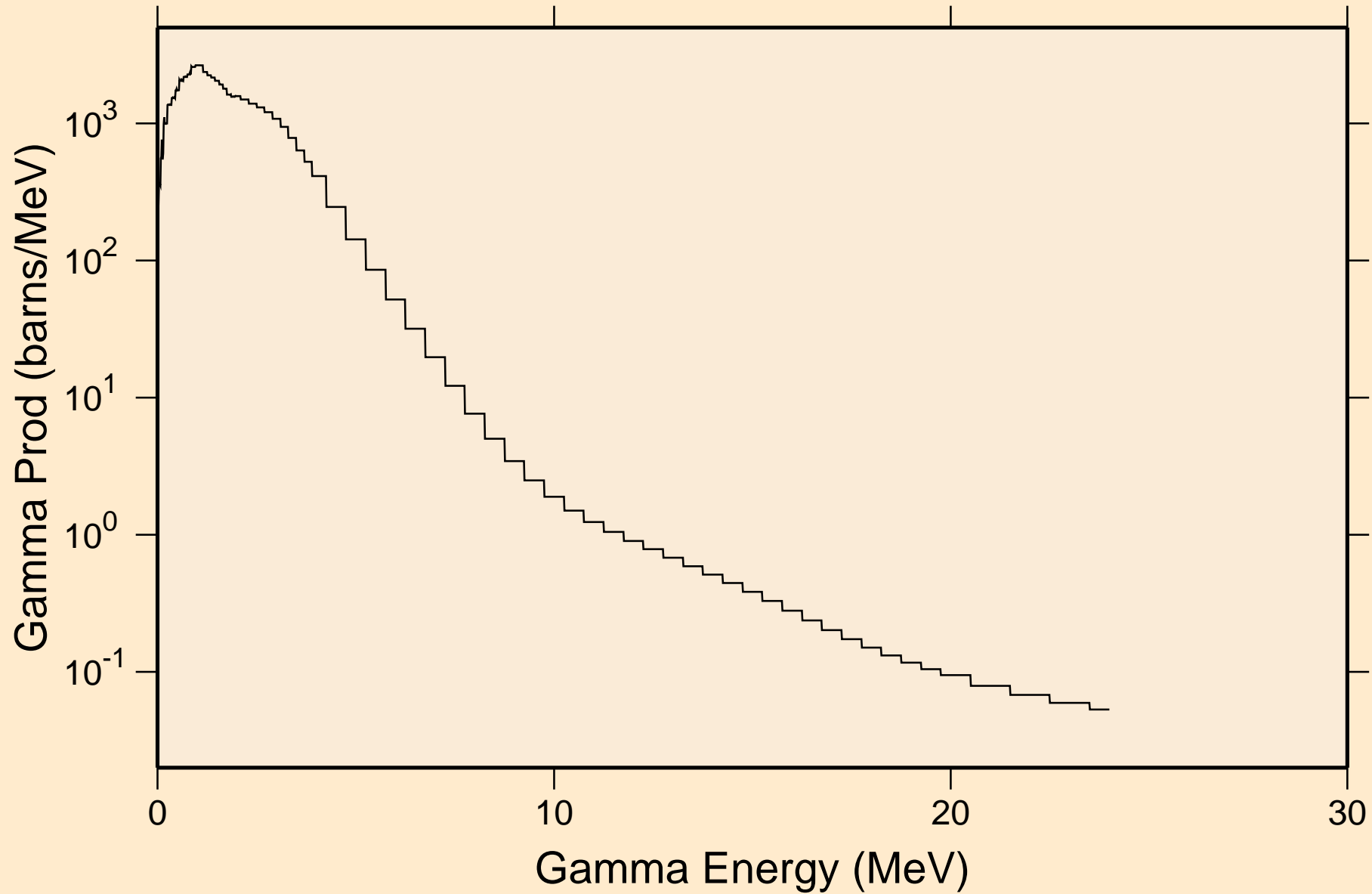

# TA159 NEUTRON ACER TENDL-2021 LIBRARY; T=293.6K

## Particle heating contributions

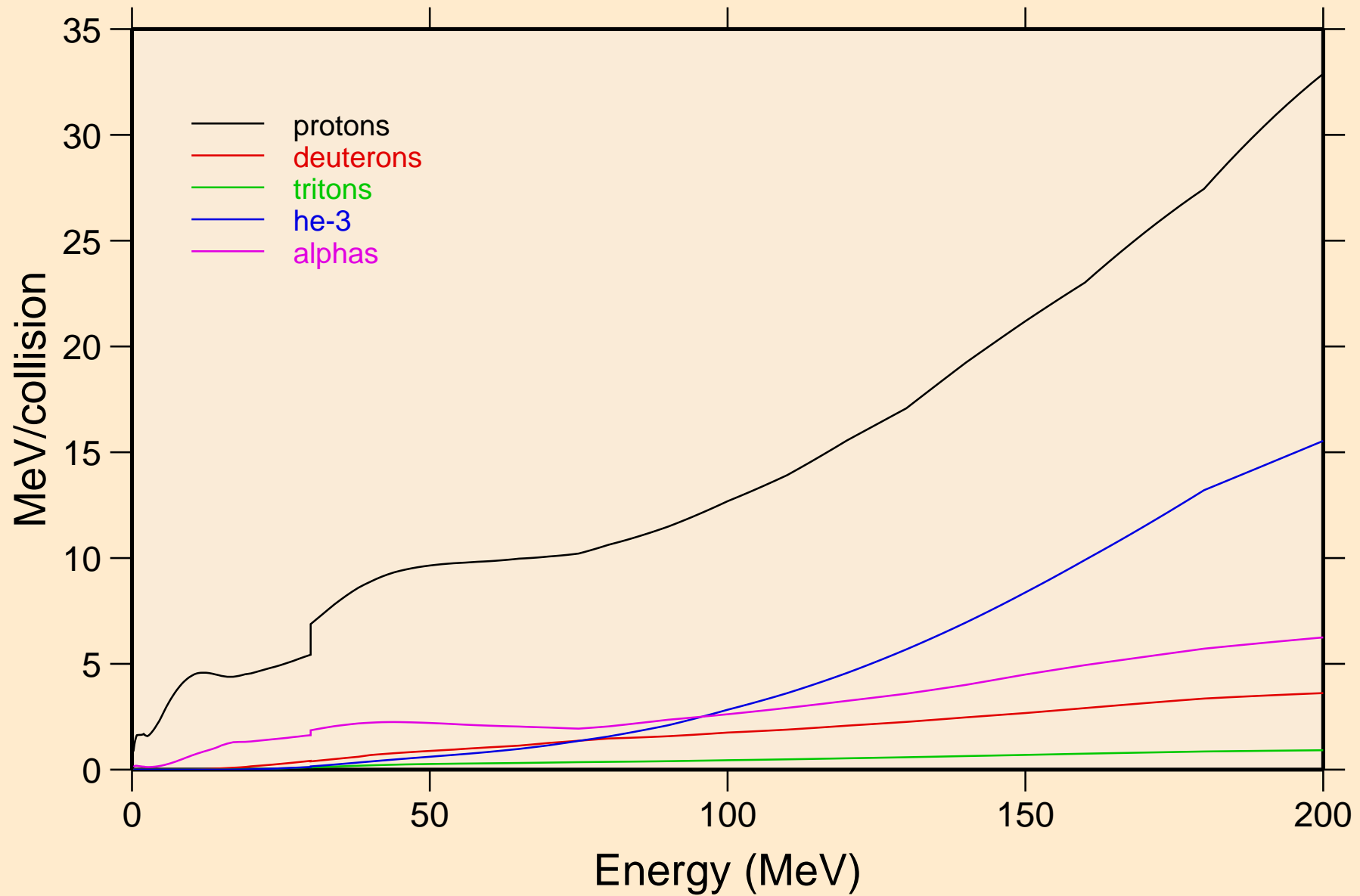

TA159 NEUTRON ACER TENDL-2021 LIBRARY; T=293.6K  
Recoil Heating

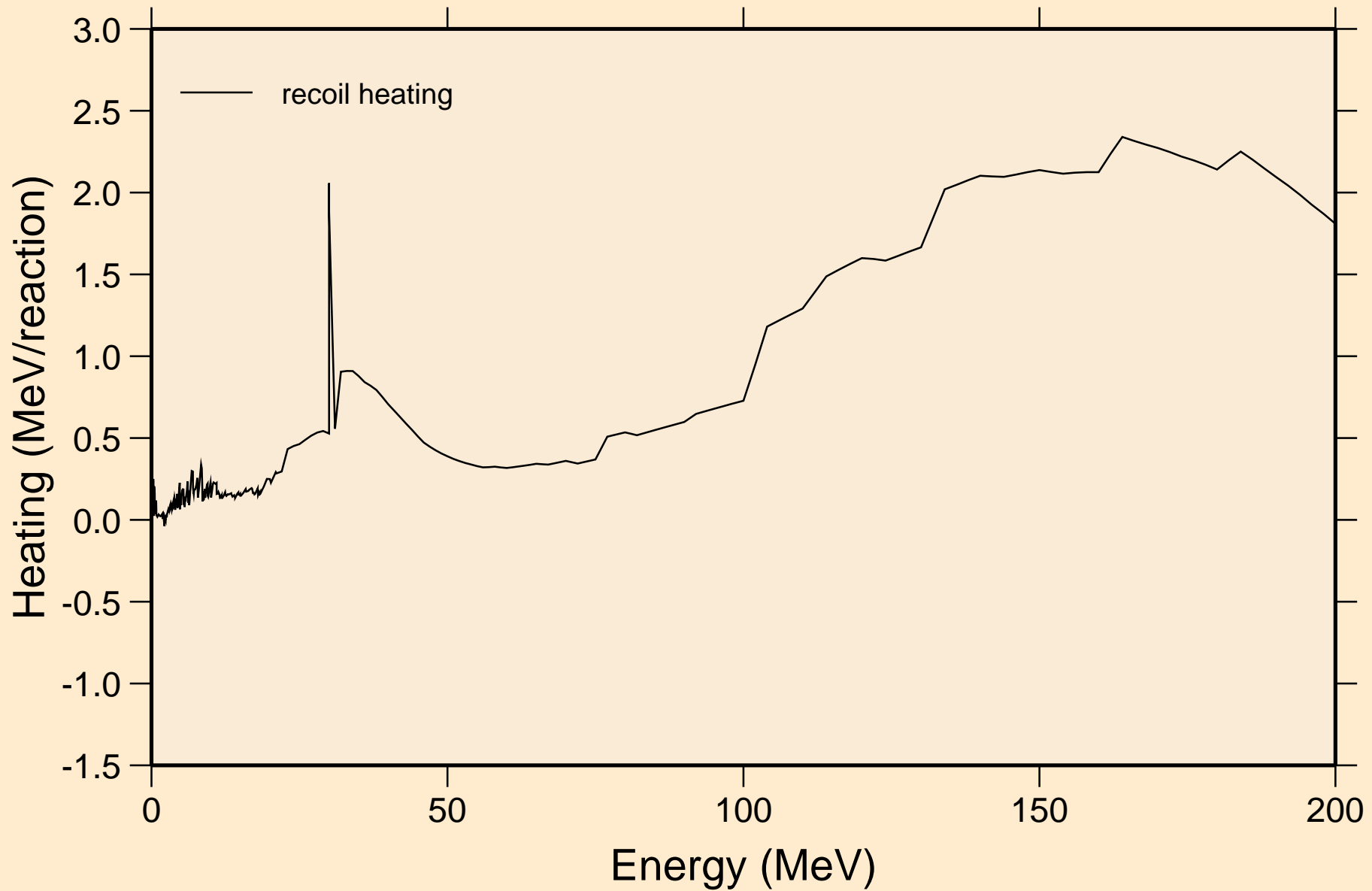

TA159 NEUTRON ACER TENDL-2021 LIBRARY; T=293.6K  
Particle production cross sections

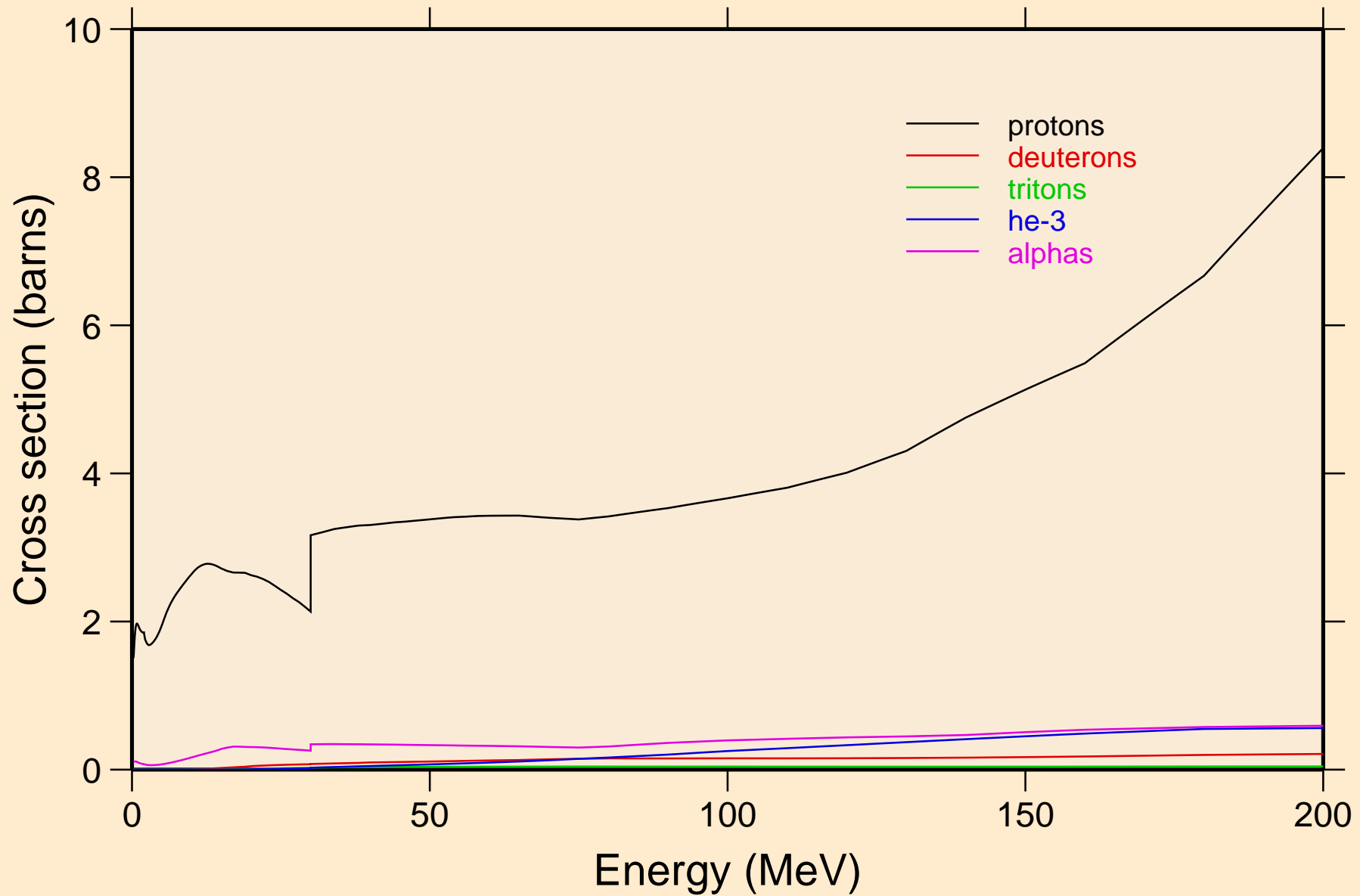

TA159 NEUTRON ACER TENDL-2021 LIBRARY; T=293.6K  
protons from (n,x)

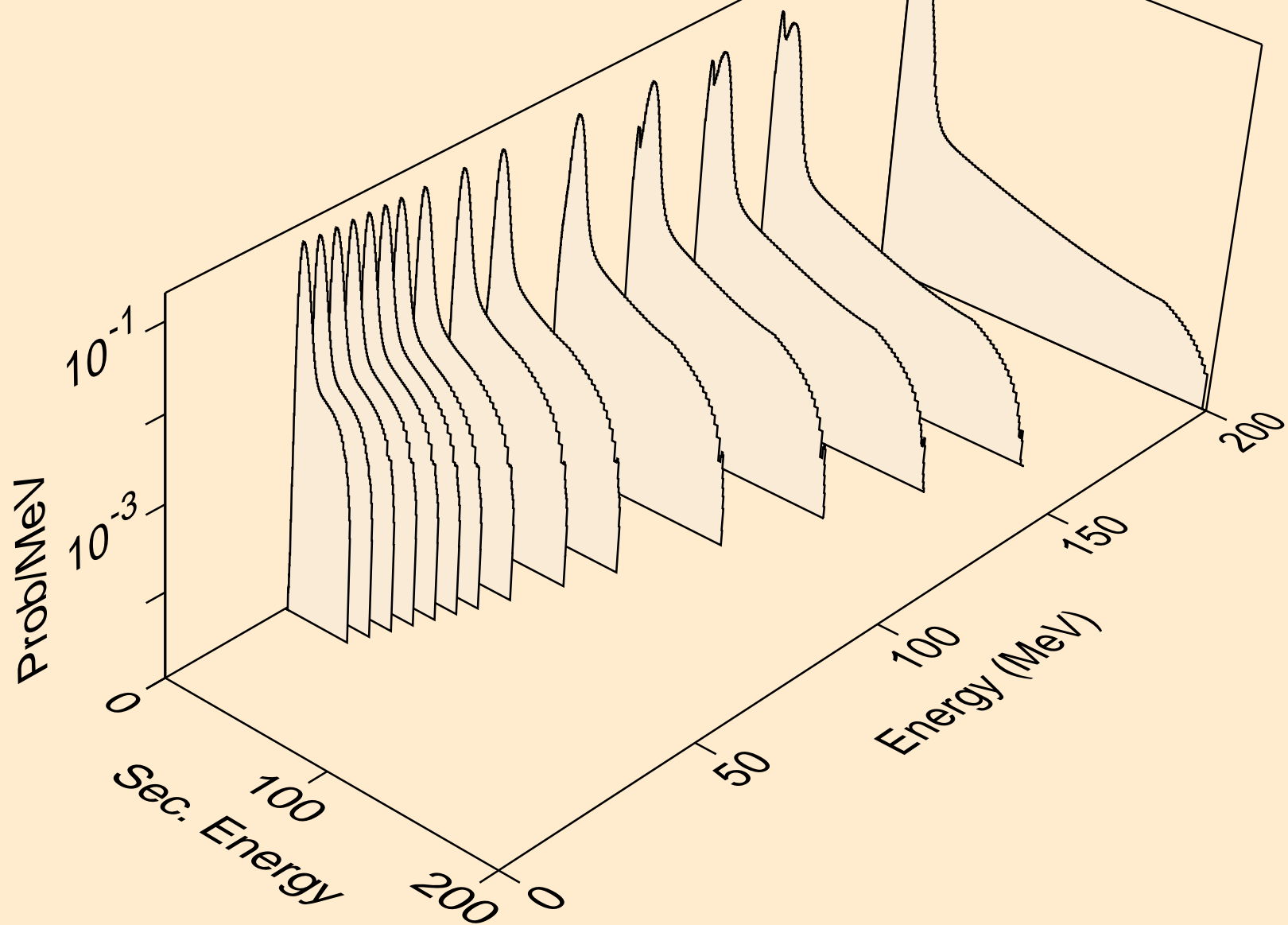

TA159 NEUTRON ACER TENDL-2021 LIBRARY; T=293.6K  
protons from (n,n\*)p

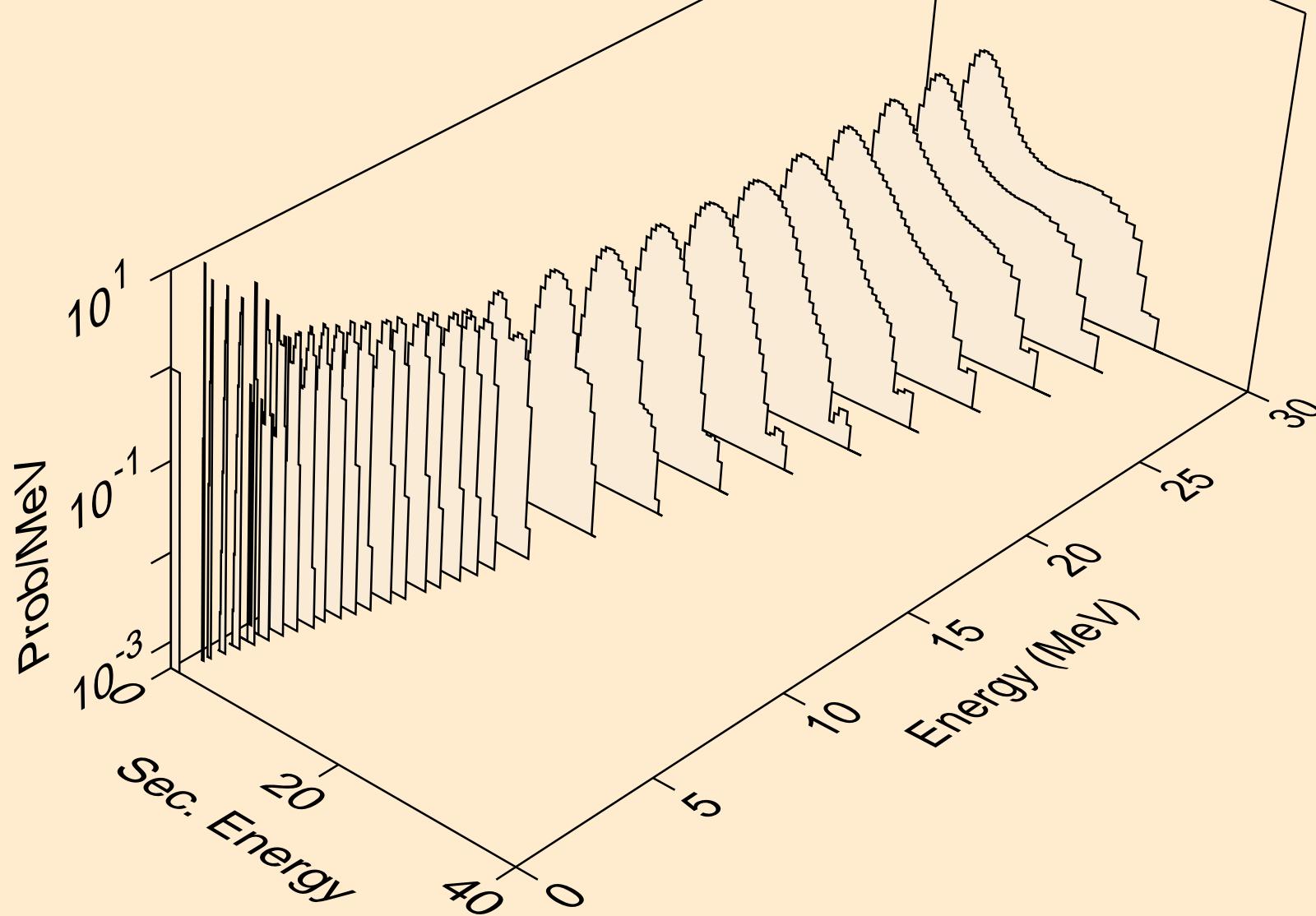

TA159 NEUTRON ACER TENDL-2021 LIBRARY; T=293.6K  
protons from (n,2np)

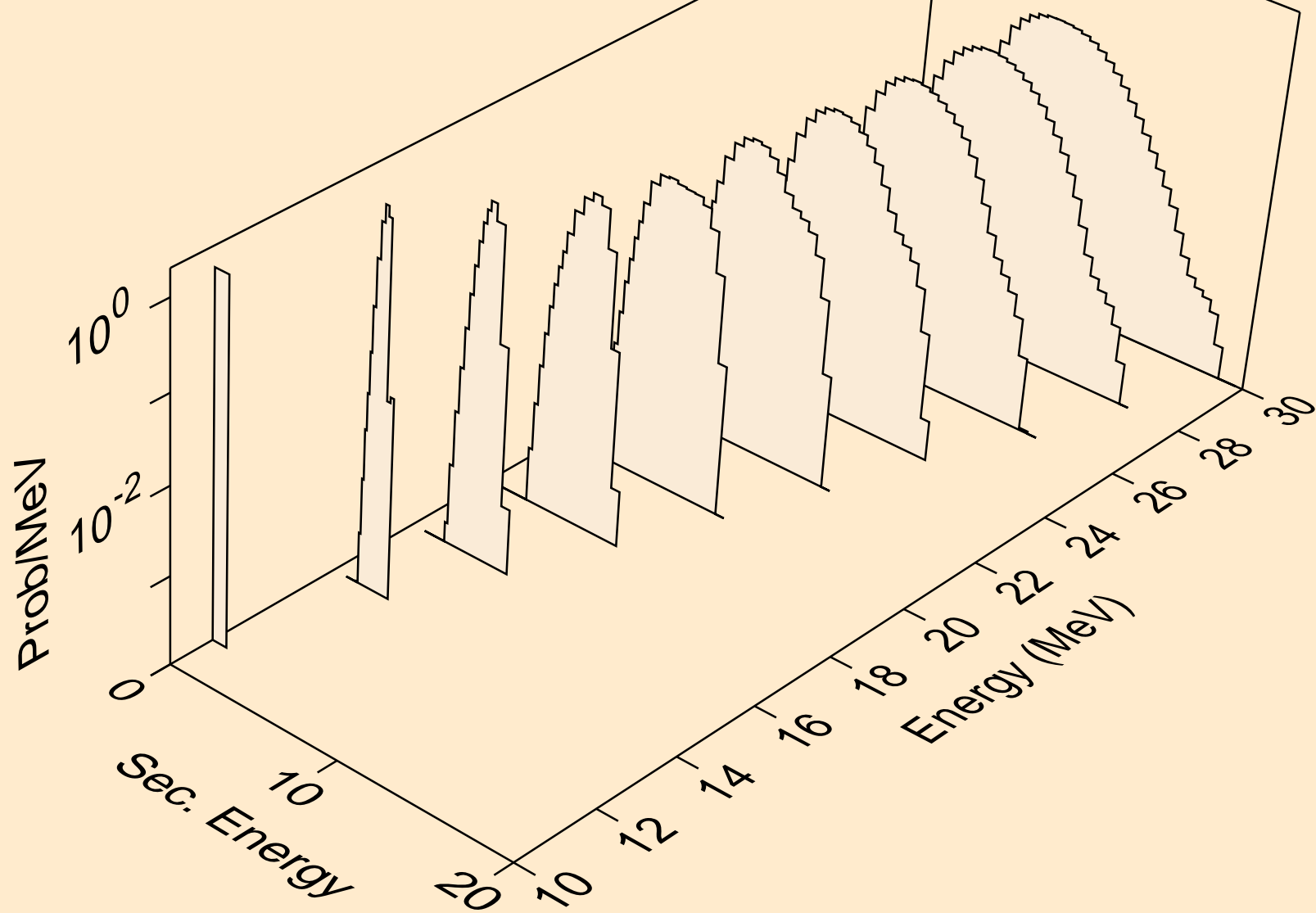

TA159 NEUTRON ACER TENDL-2021 LIBRARY; T=293.6K  
protons from (n,3np)

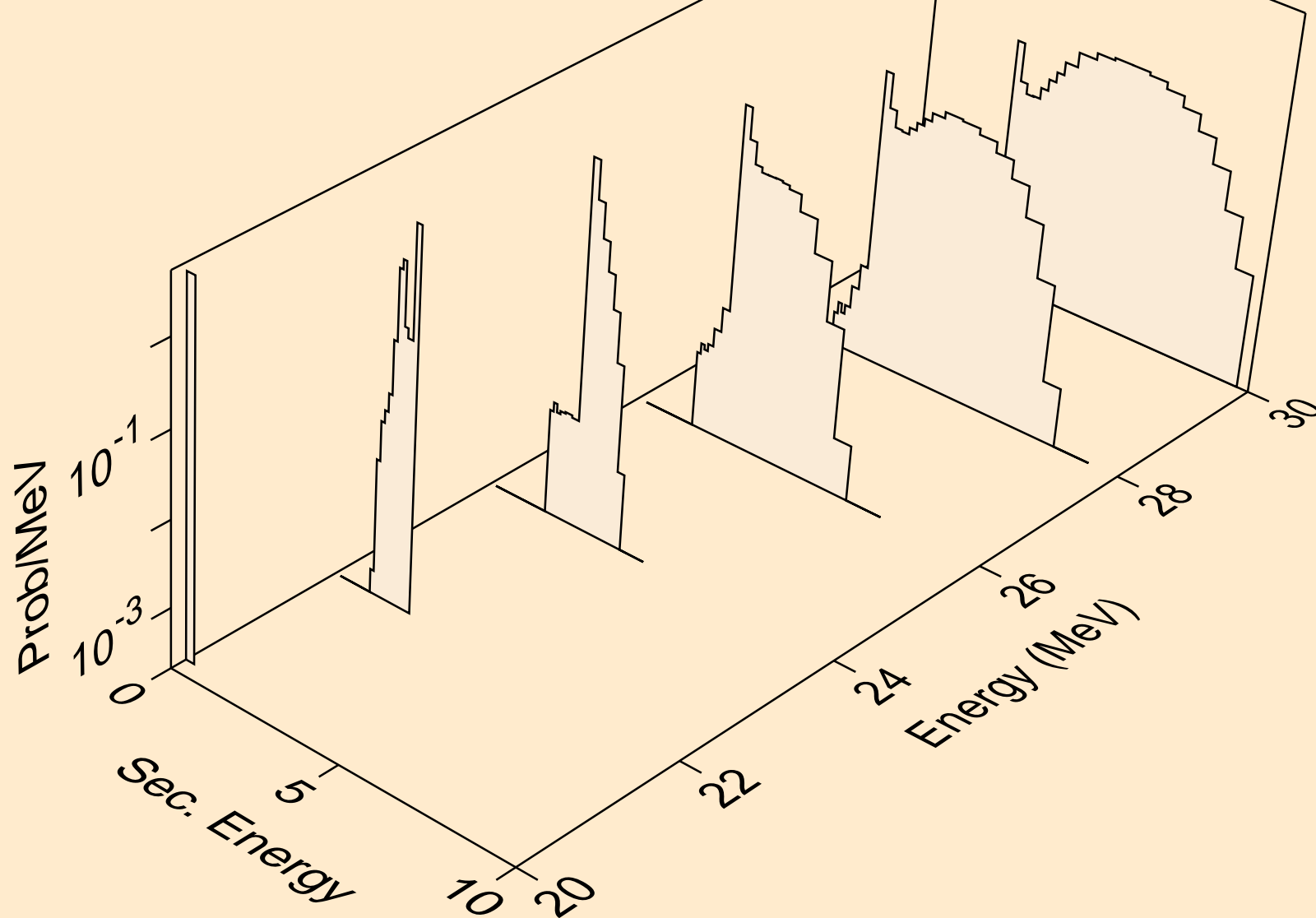



TA159 NEUTRON ACER TENDL-2021 LIBRARY; T=293.6K  
protons from (n,2np)

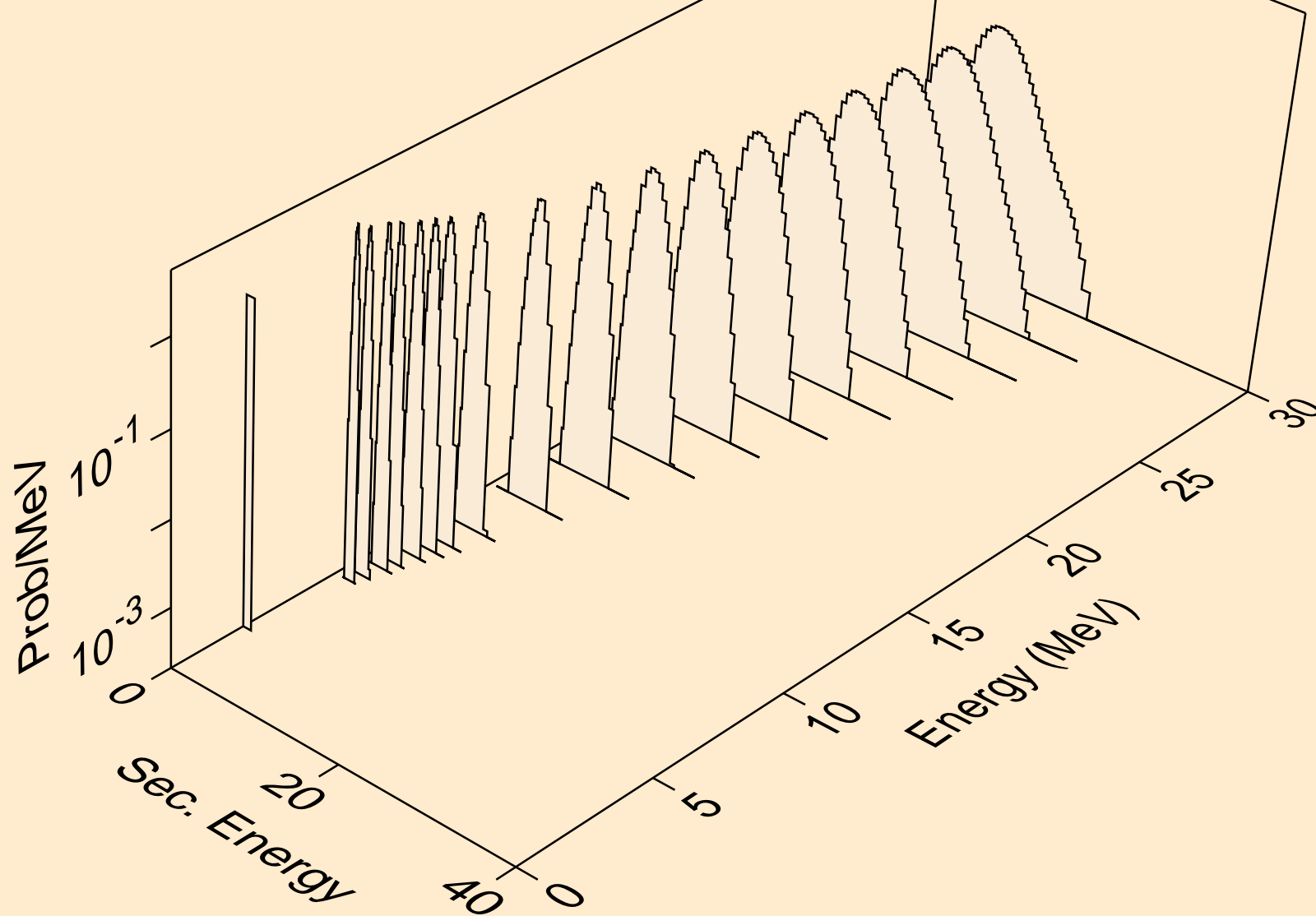

TA159 NEUTRON ACER TENDL-2021 LIBRARY; T=293.6K  
protons from (n,npa)

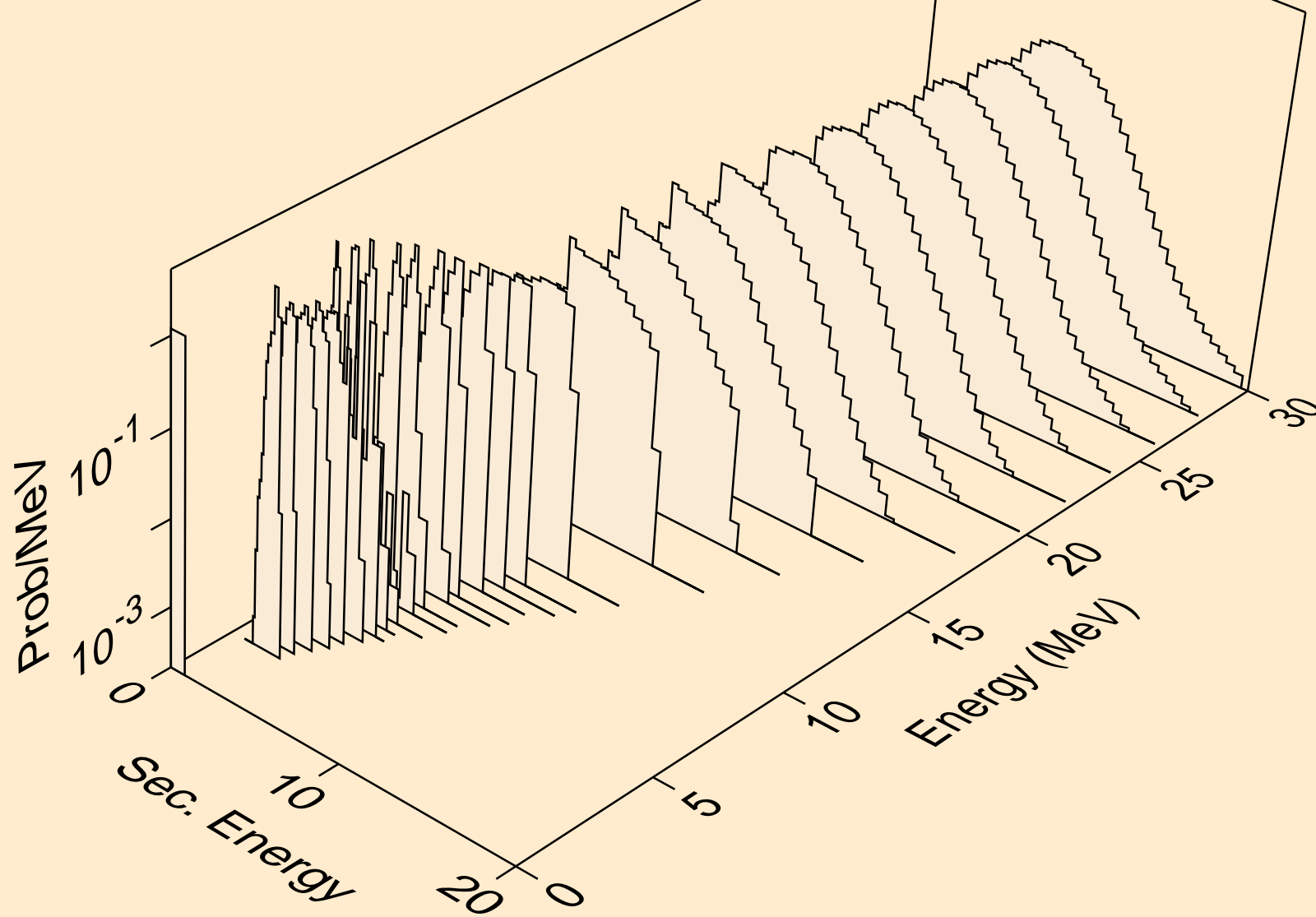

TA159 NEUTRON ACER TENDL-2021 LIBRARY; T=293.6K  
protons from (n,p)

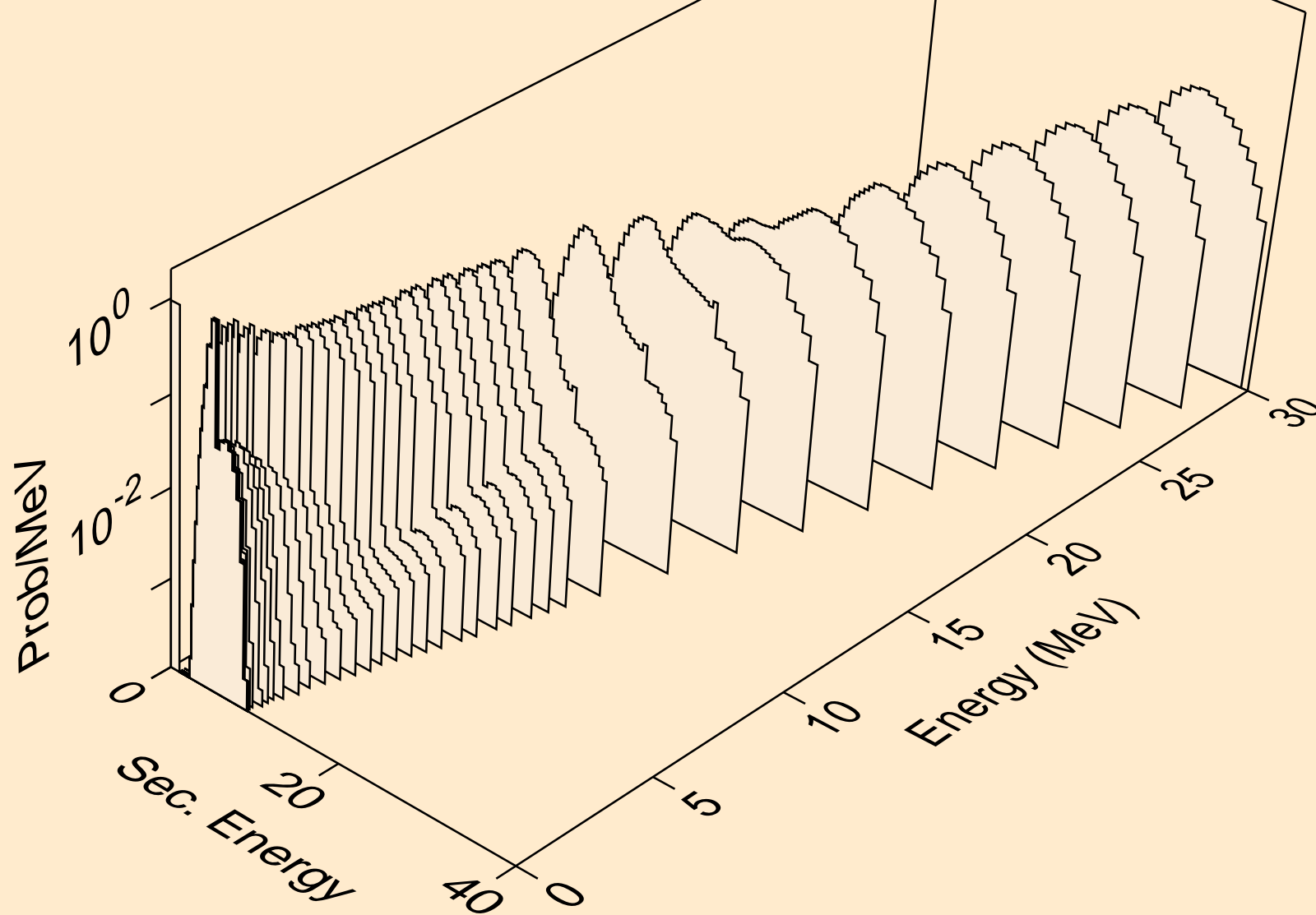

TA159 NEUTRON ACER TENDL-2021 LIBRARY; T=293.6K  
protons from (n,2p)

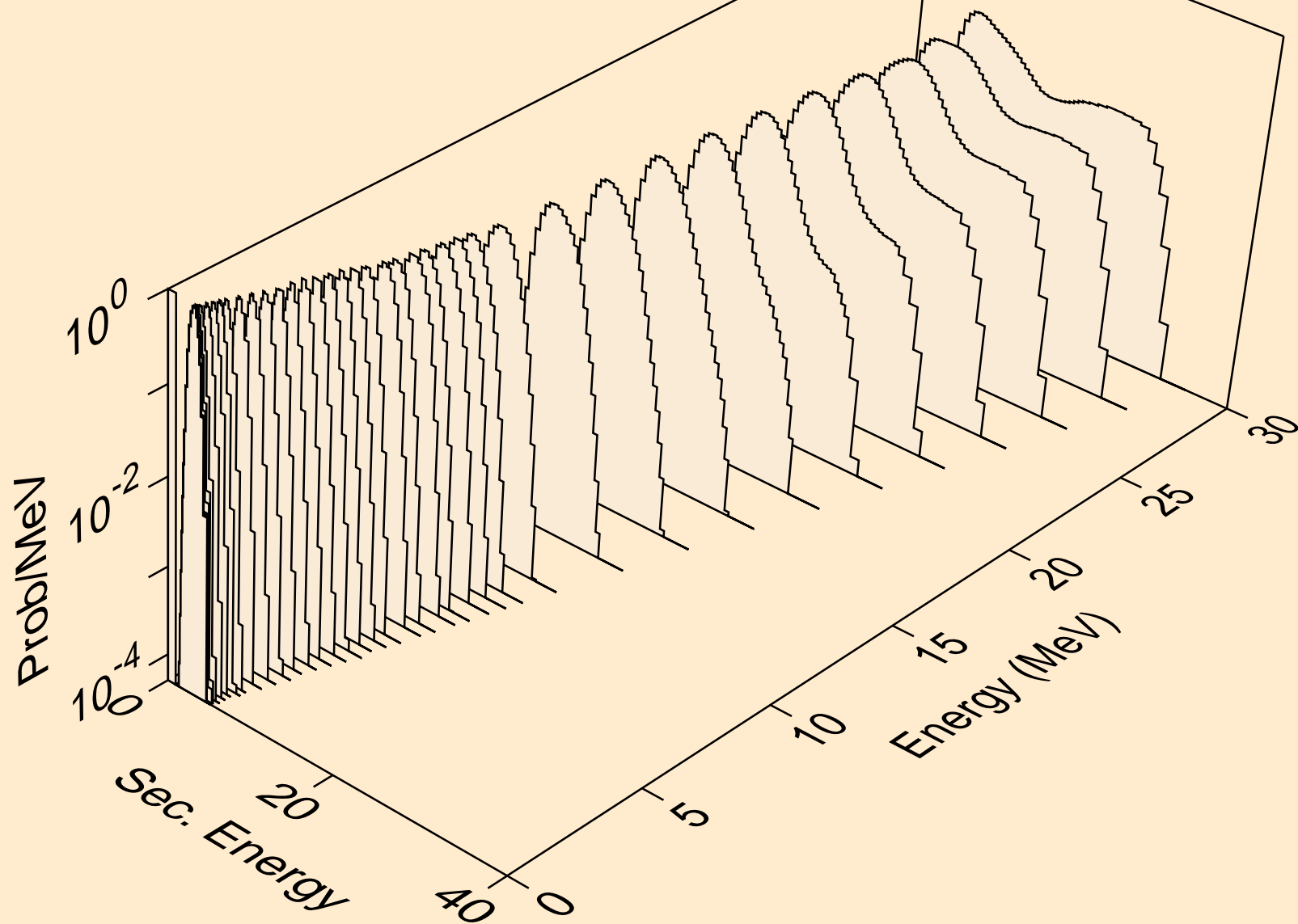

TA159 NEUTRON ACER TENDL-2021 LIBRARY; T=293.6K  
protons from (n,p)

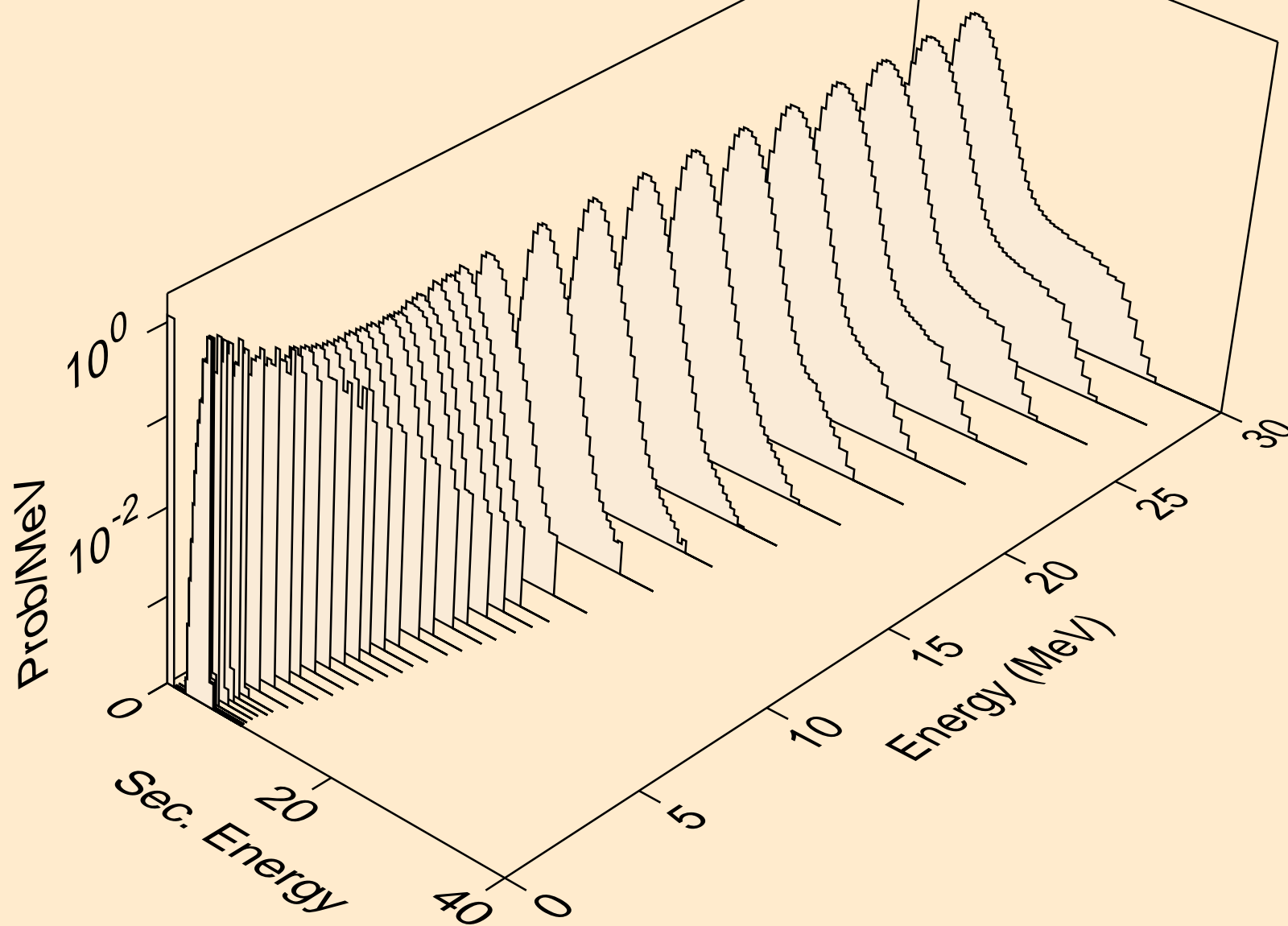

TA159 NEUTRON ACER TENDL-2021 LIBRARY; T=293.6K  
protons from (n,pd)

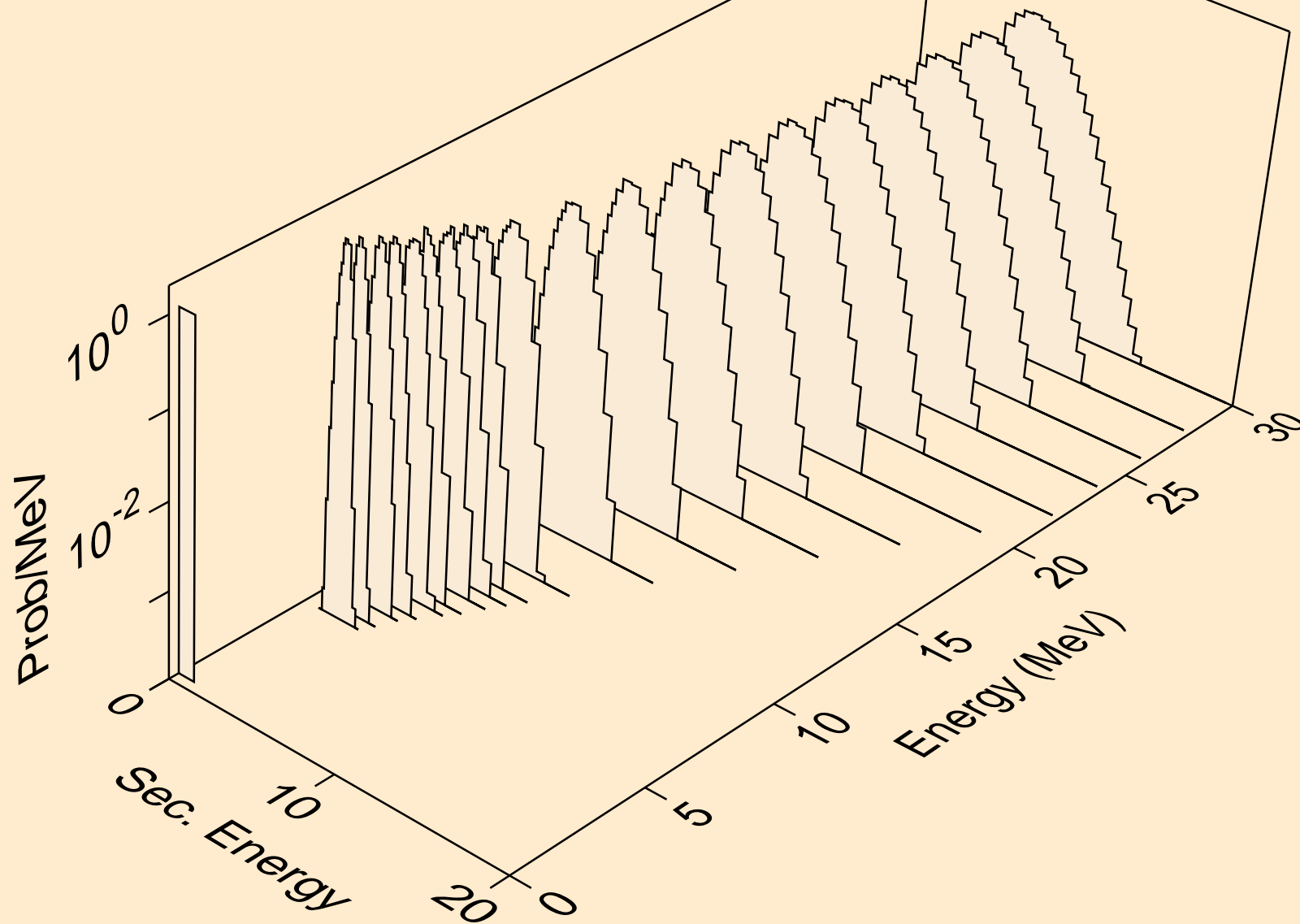

TA159 NEUTRON ACER TENDL-2021 LIBRARY; T=293.6K  
protons from (n,pt)

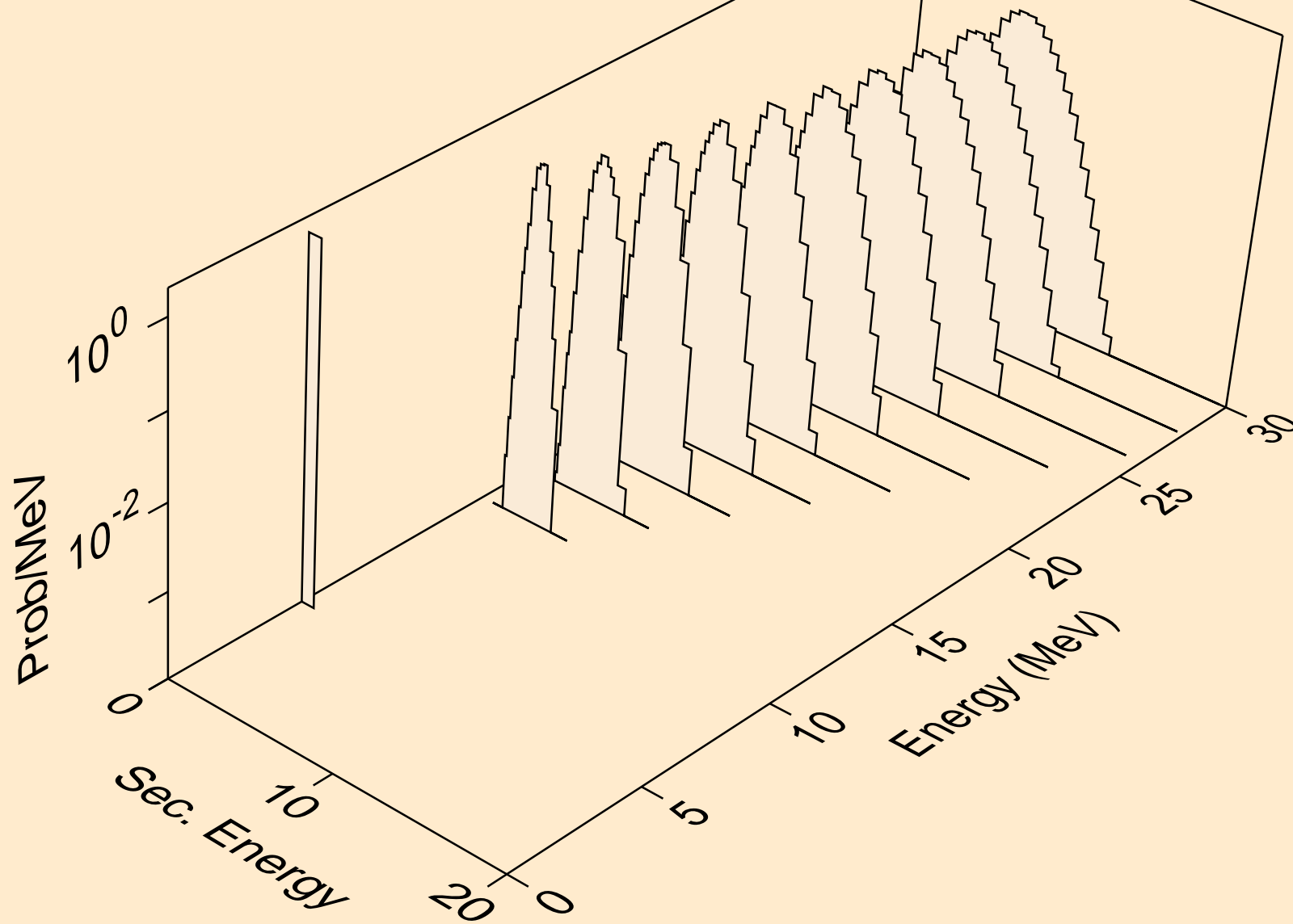

TA159 NEUTRON ACER TENDL-2021 LIBRARY; T=293.6K  
deuterons from (n,x)

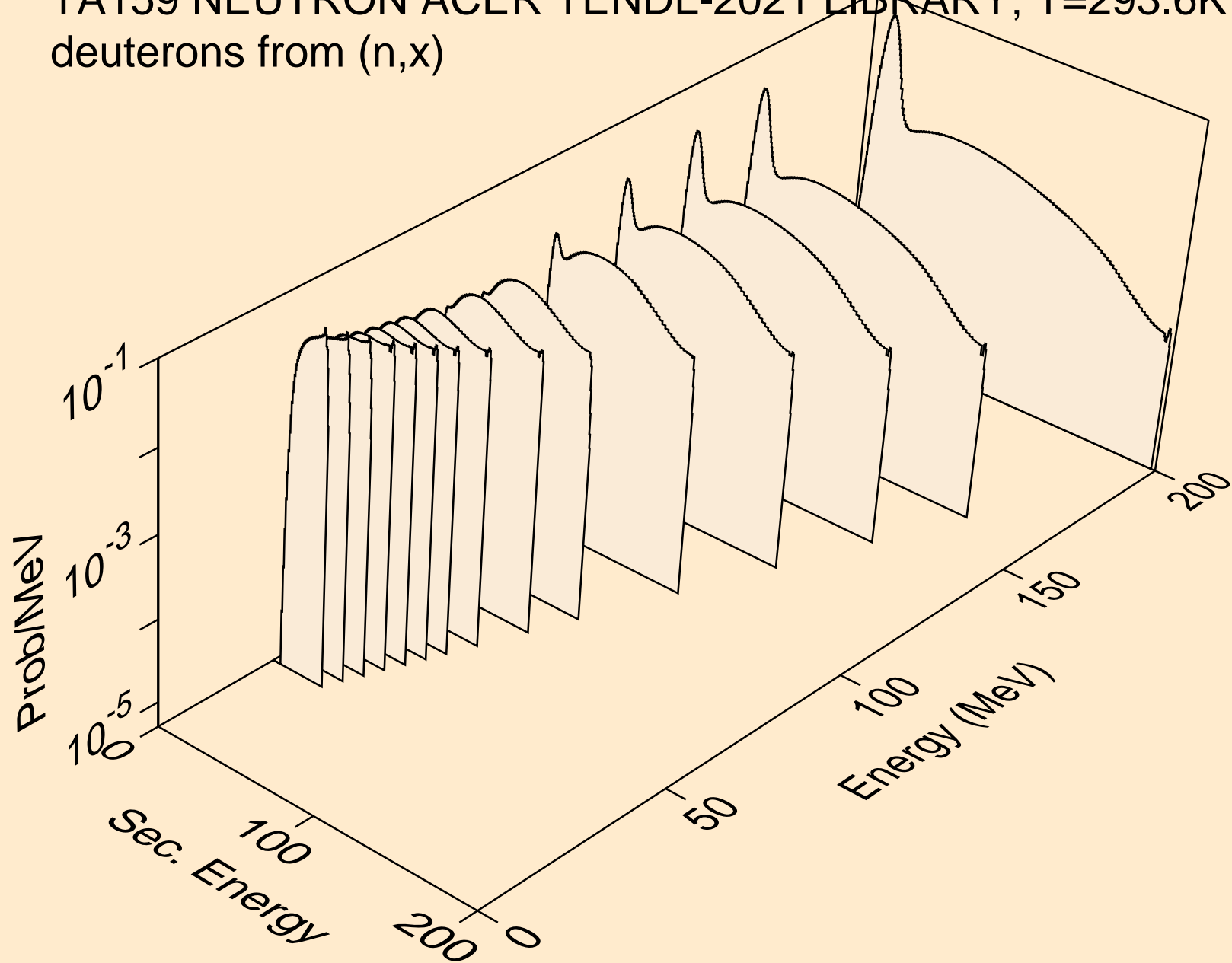



TA159 NEUTRON ACER TENDL-2021 LIBRARY; T=293.6K  
deuterons from (n,2nd)

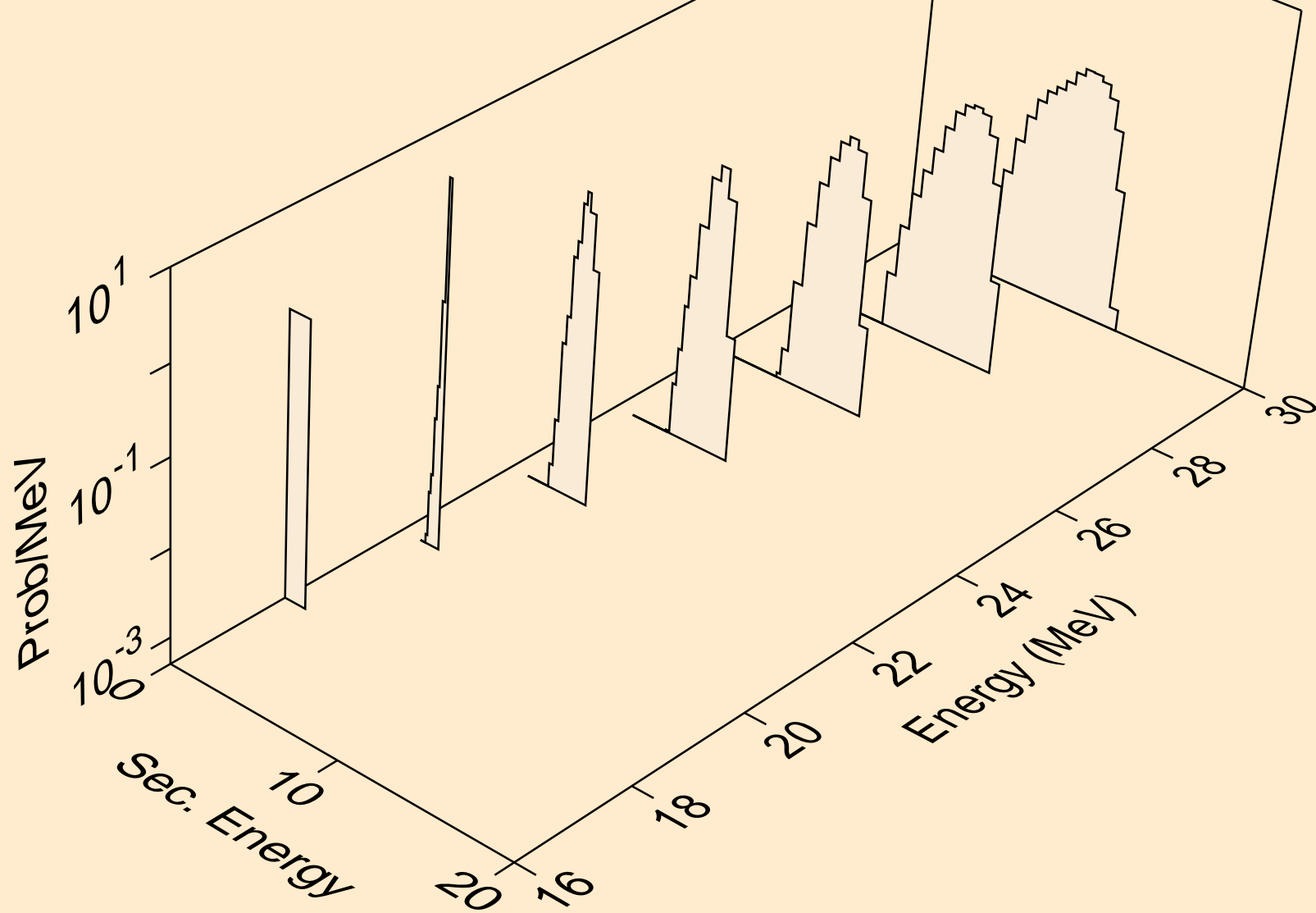

TA159 NEUTRON ACER TENDL-2021 LIBRARY; T=293.6K  
deuterons from (n,n\*)d

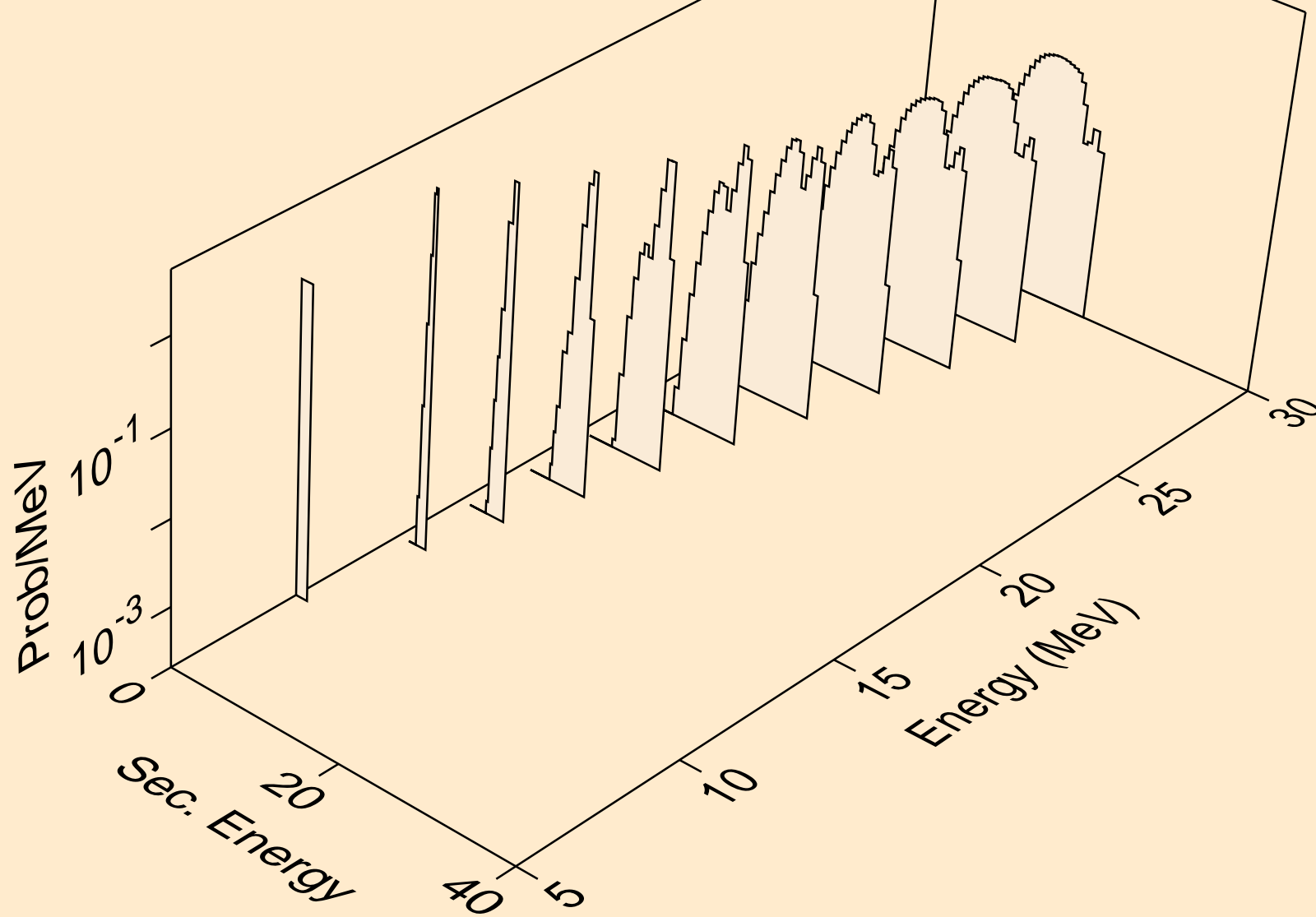

TA159 NEUTRON ACER TENDL-2021 LIBRARY; T=293.6K  
deuterons from (n,d)

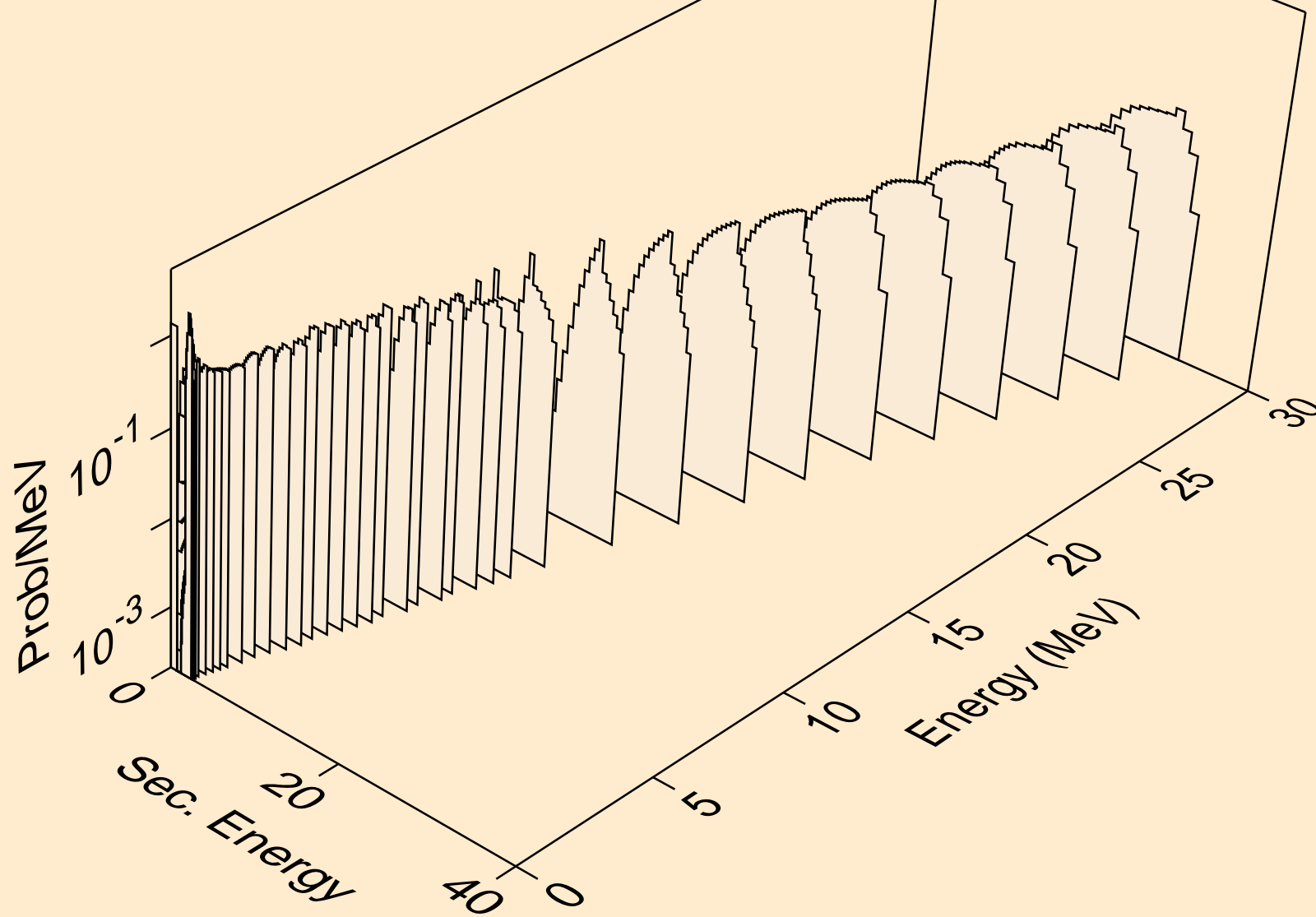

TA159 NEUTRON ACER TENDL-2021 LIBRARY; T=293.6K  
deuterons from (n,d2a)

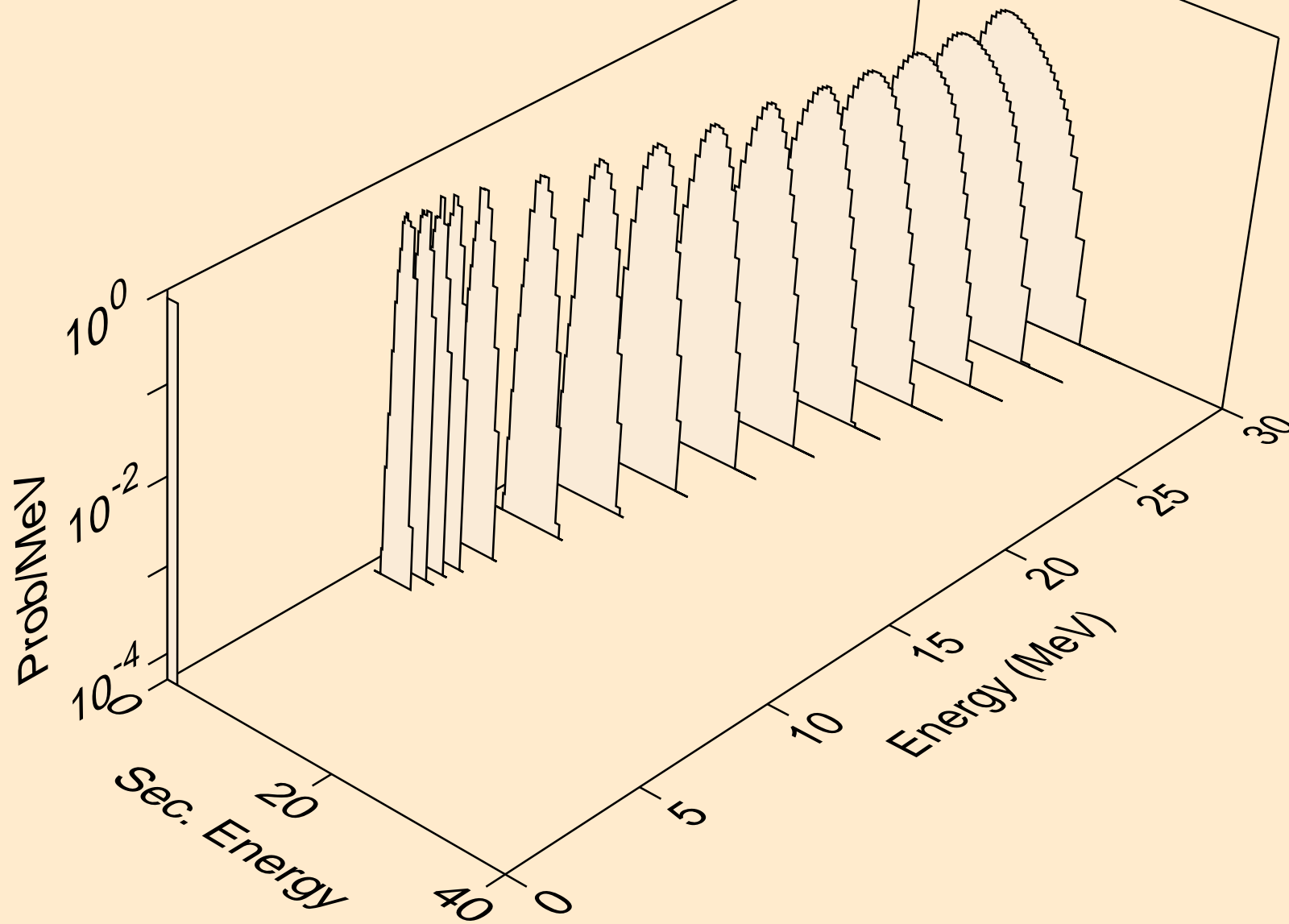

TA159 NEUTRON ACER TENDL-2021 LIBRARY; T=293.6K  
deuterons from (n,pd)

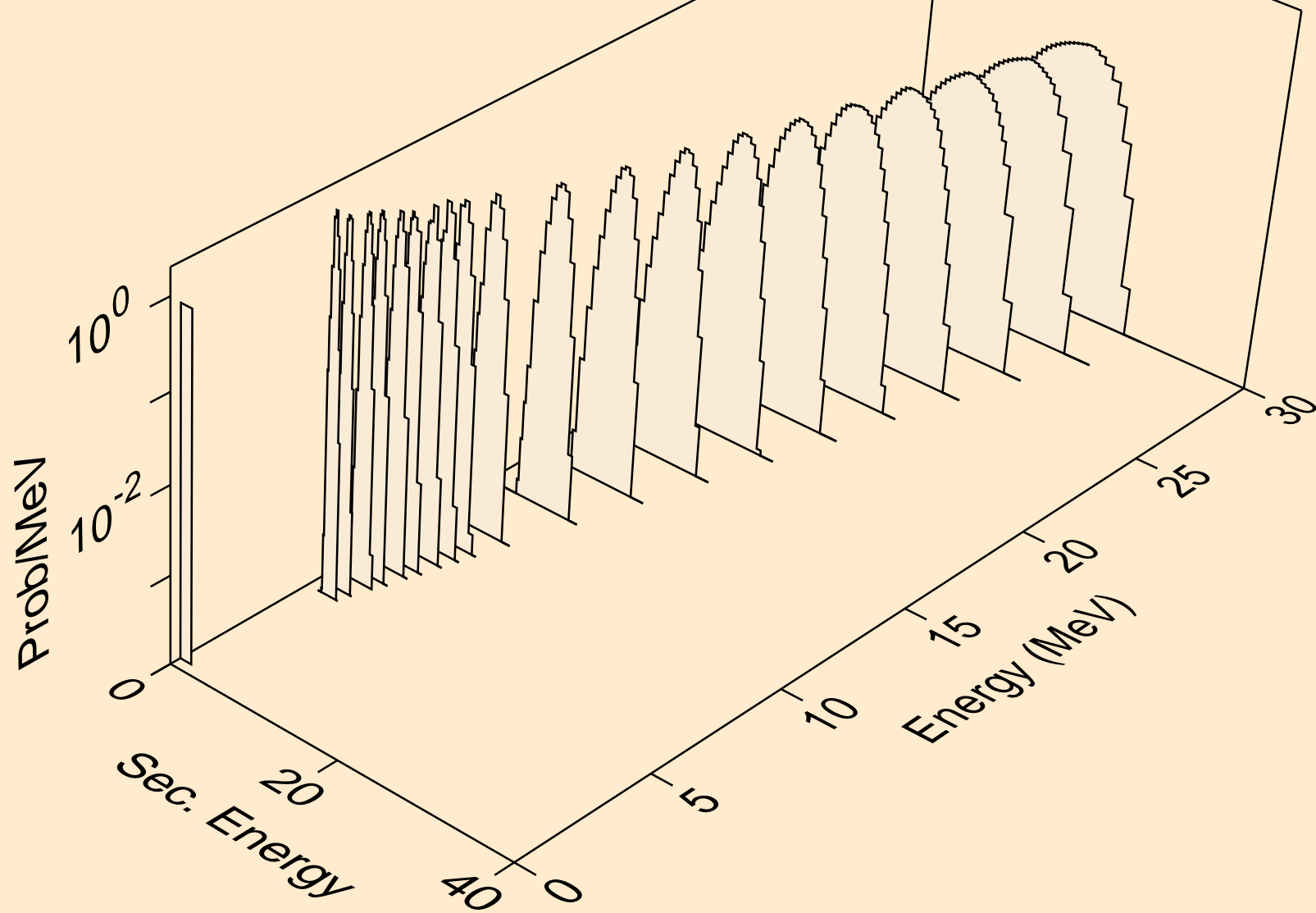

TA159 NEUTRON ACER TENDL-2021 LIBRARY; T=293.6K  
deuterons from (n,da)

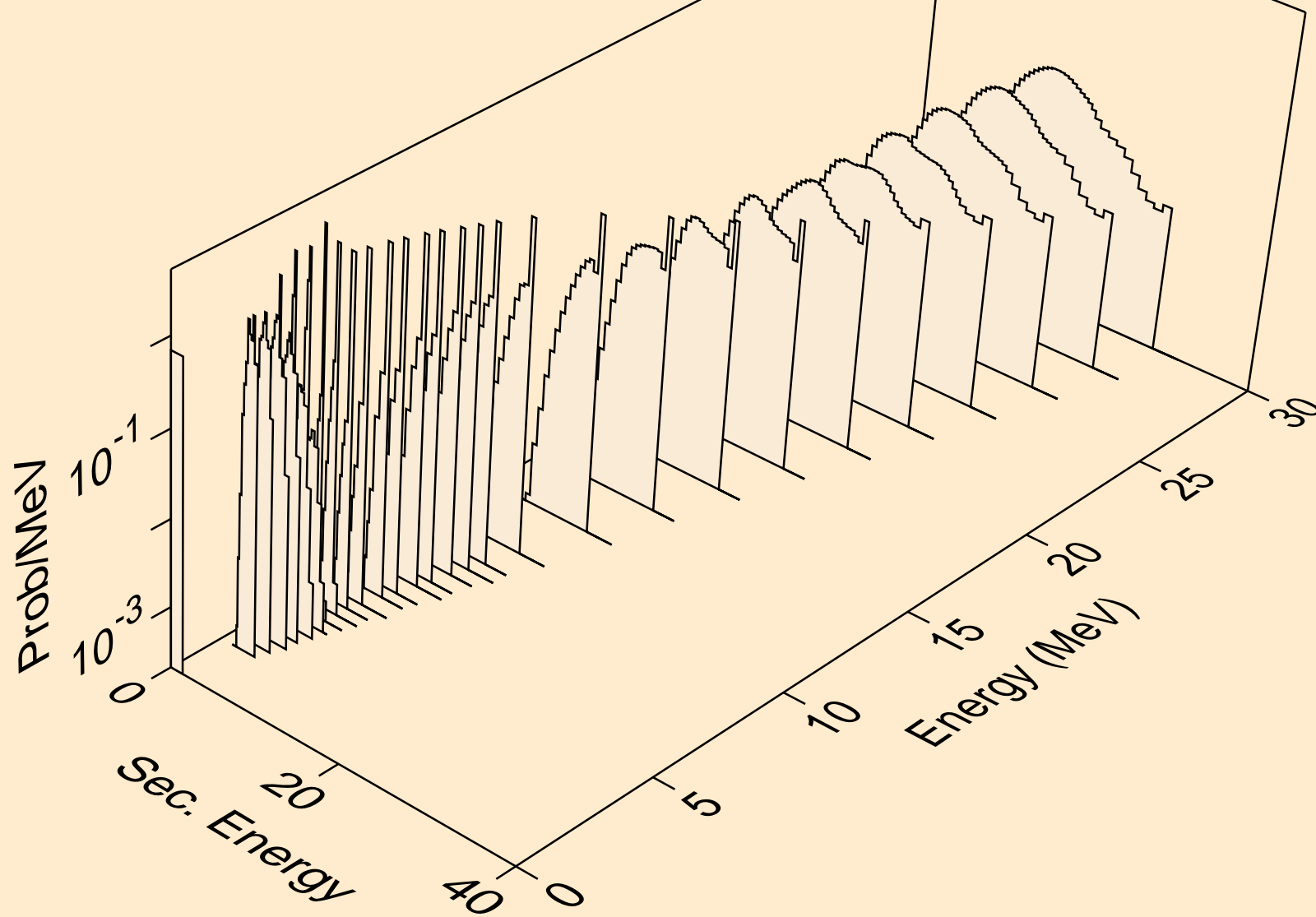

TA159 NEUTRON ACER TENDL-2021 LIBRARY; T=293.6K  
tritons from (n,x)

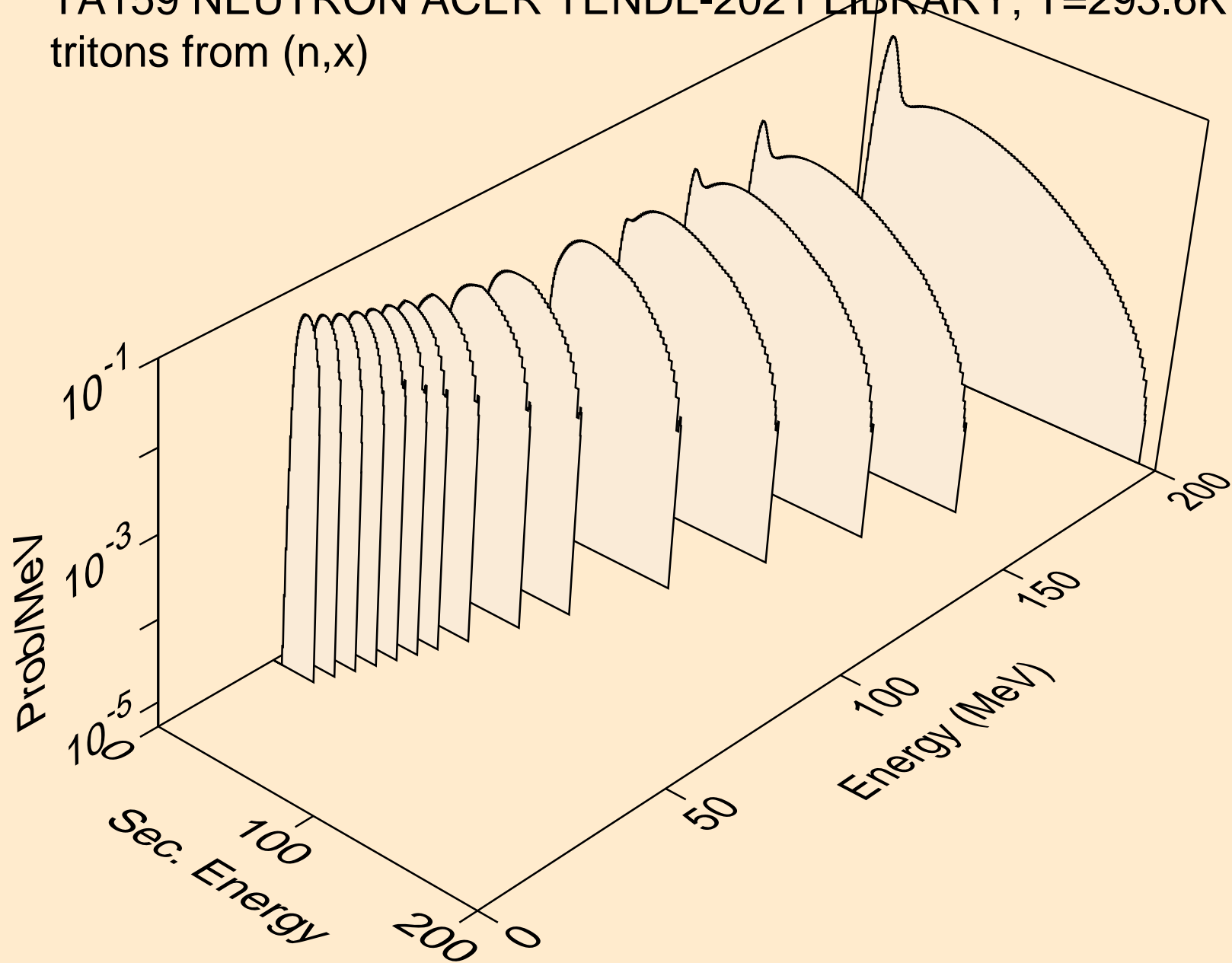

TA159 NEUTRON ACER TENDL-2021 LIBRARY; T=293.6K  
tritons from (n,n\*)t

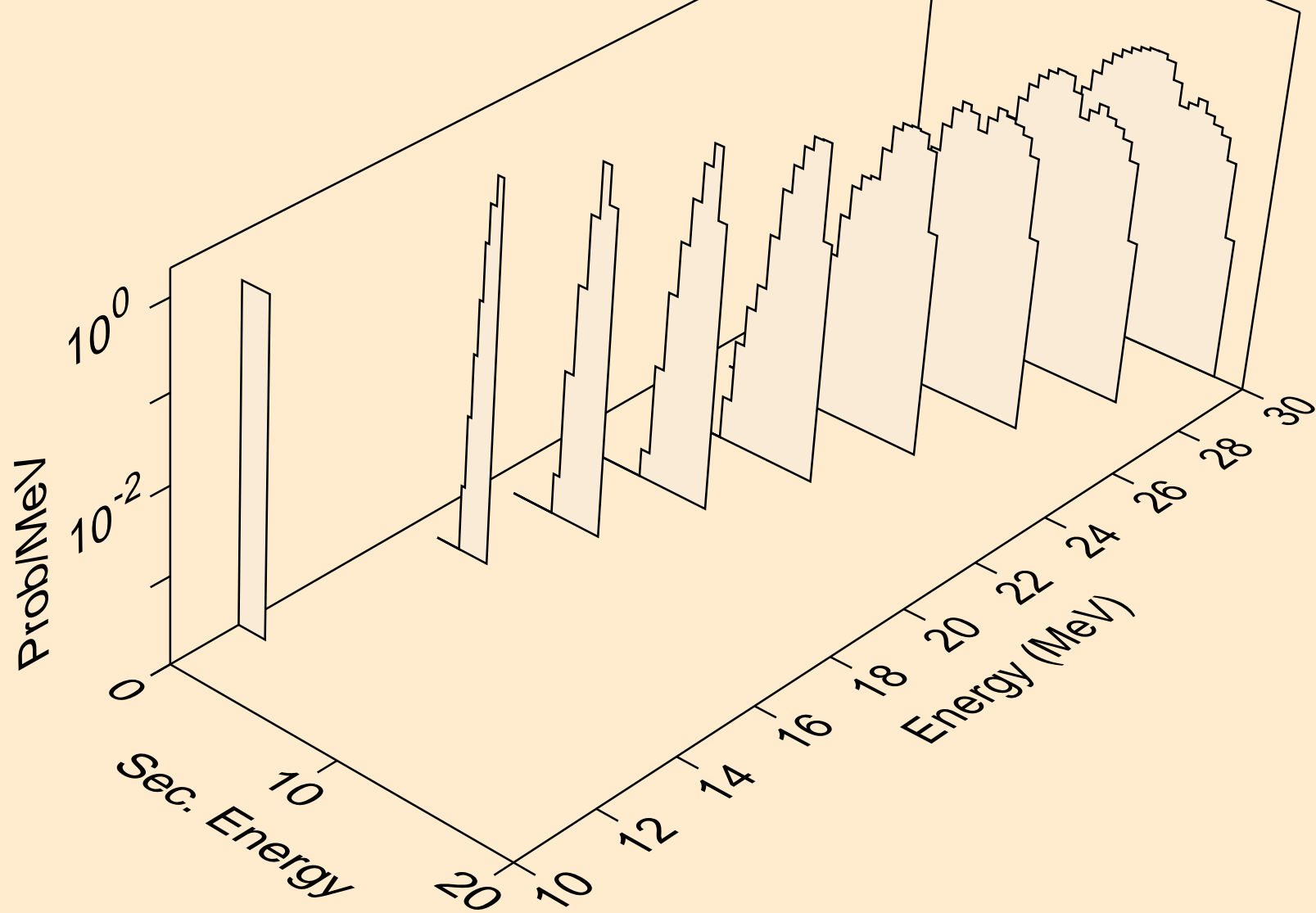



TA159 NEUTRON ACER TENDL-2021 LIBRARY; T=293.6K  
tritons from (n,t)

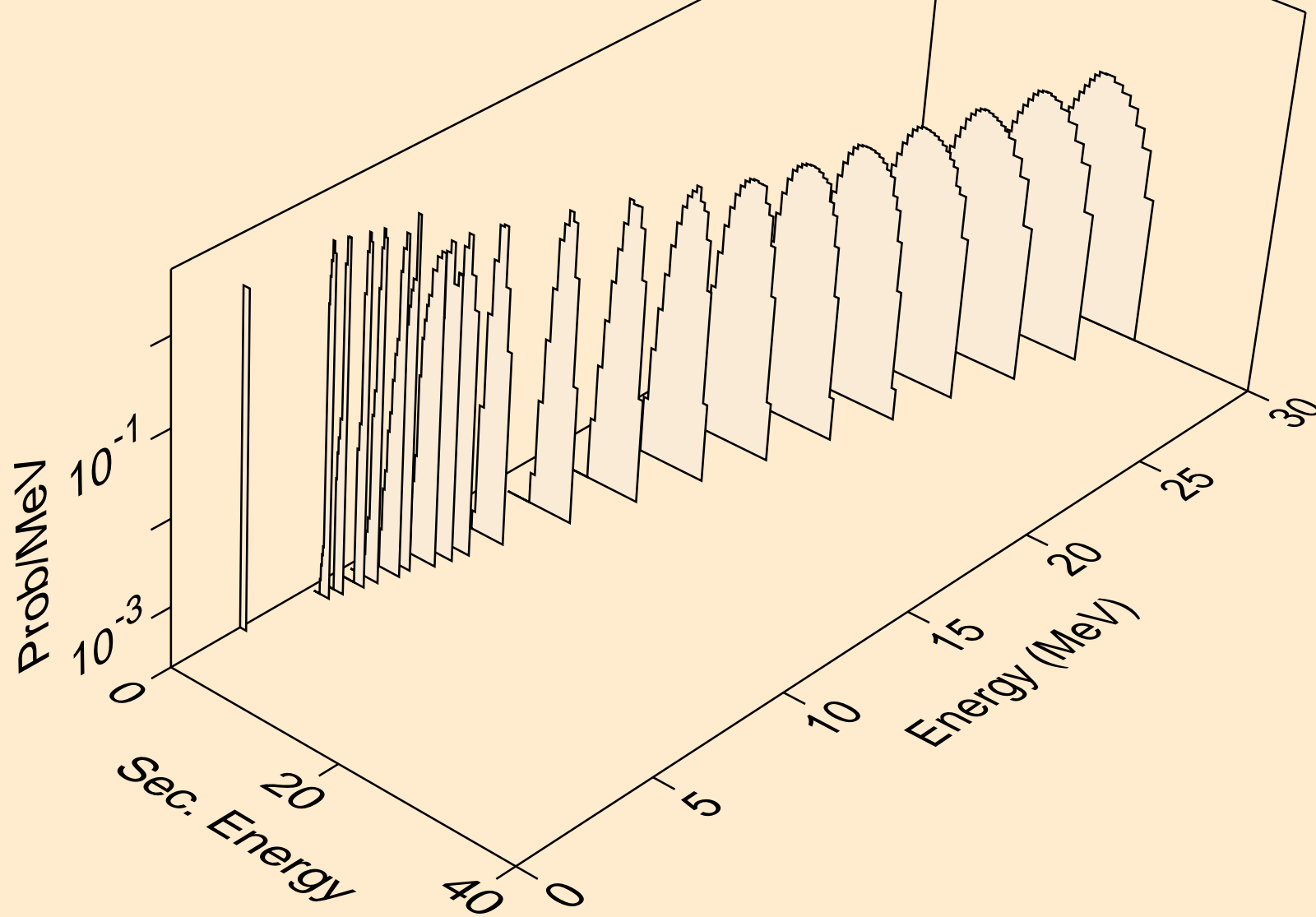

TA159 NEUTRON ACER TENDL-2021 LIBRARY; T=293.6K  
tritons from (n,t2a)

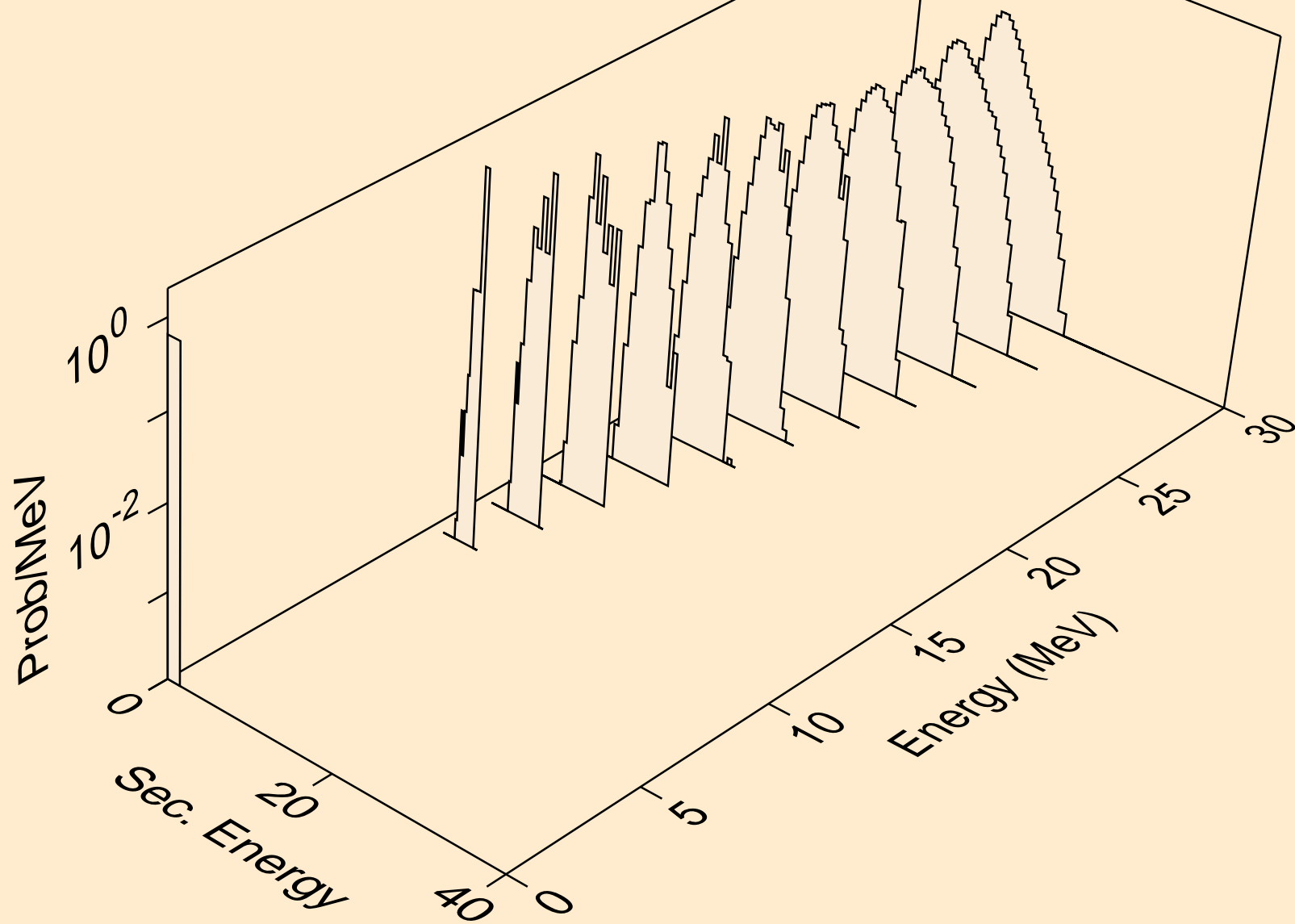

TA159 NEUTRON ACER TENDL-2021 LIBRARY; T=293.6K  
tritons from (n,pt)

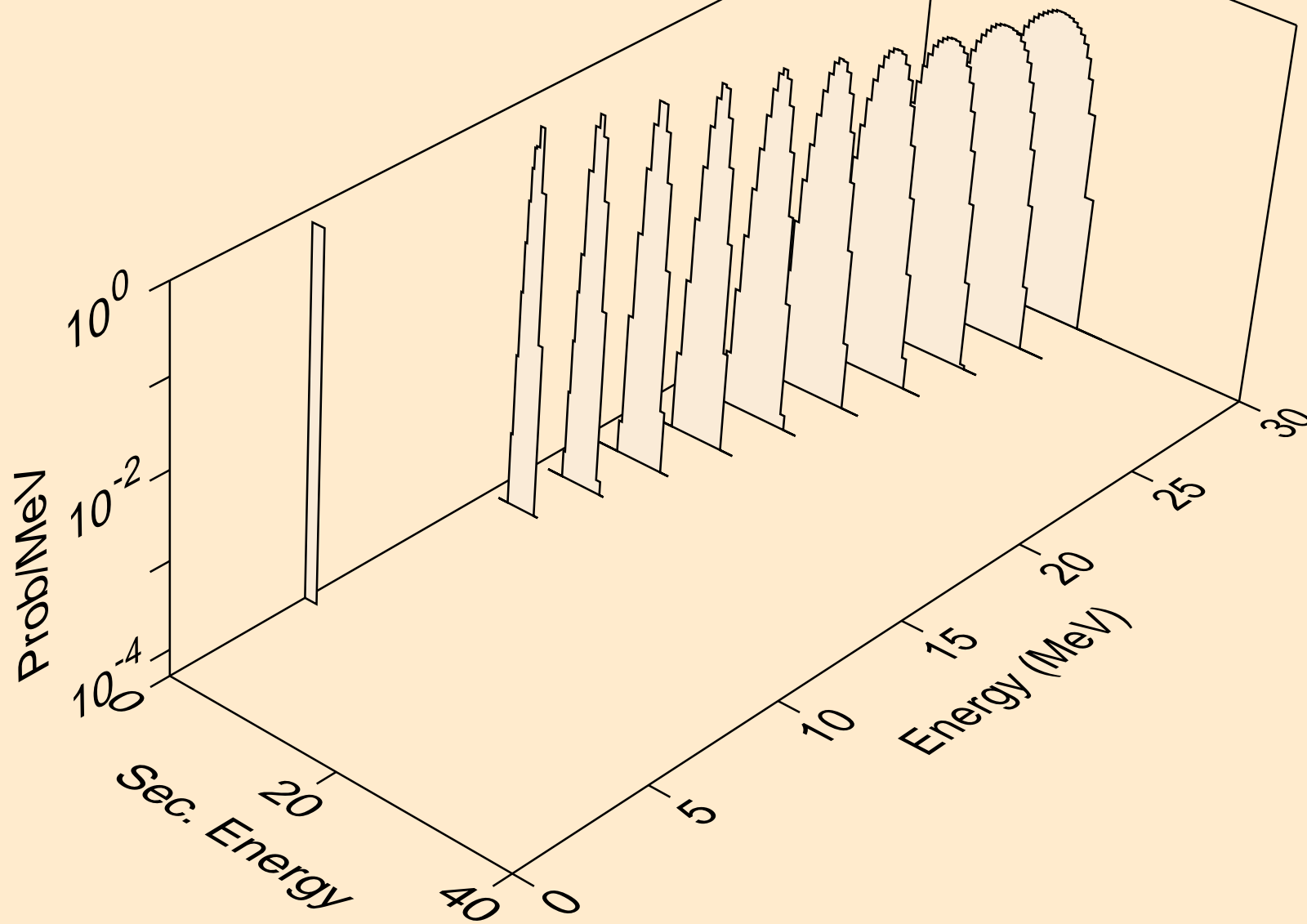

TA159 NEUTRON ACER TENDL-2021 LIBRARY; T=293.6K  
he3s from (n,x)

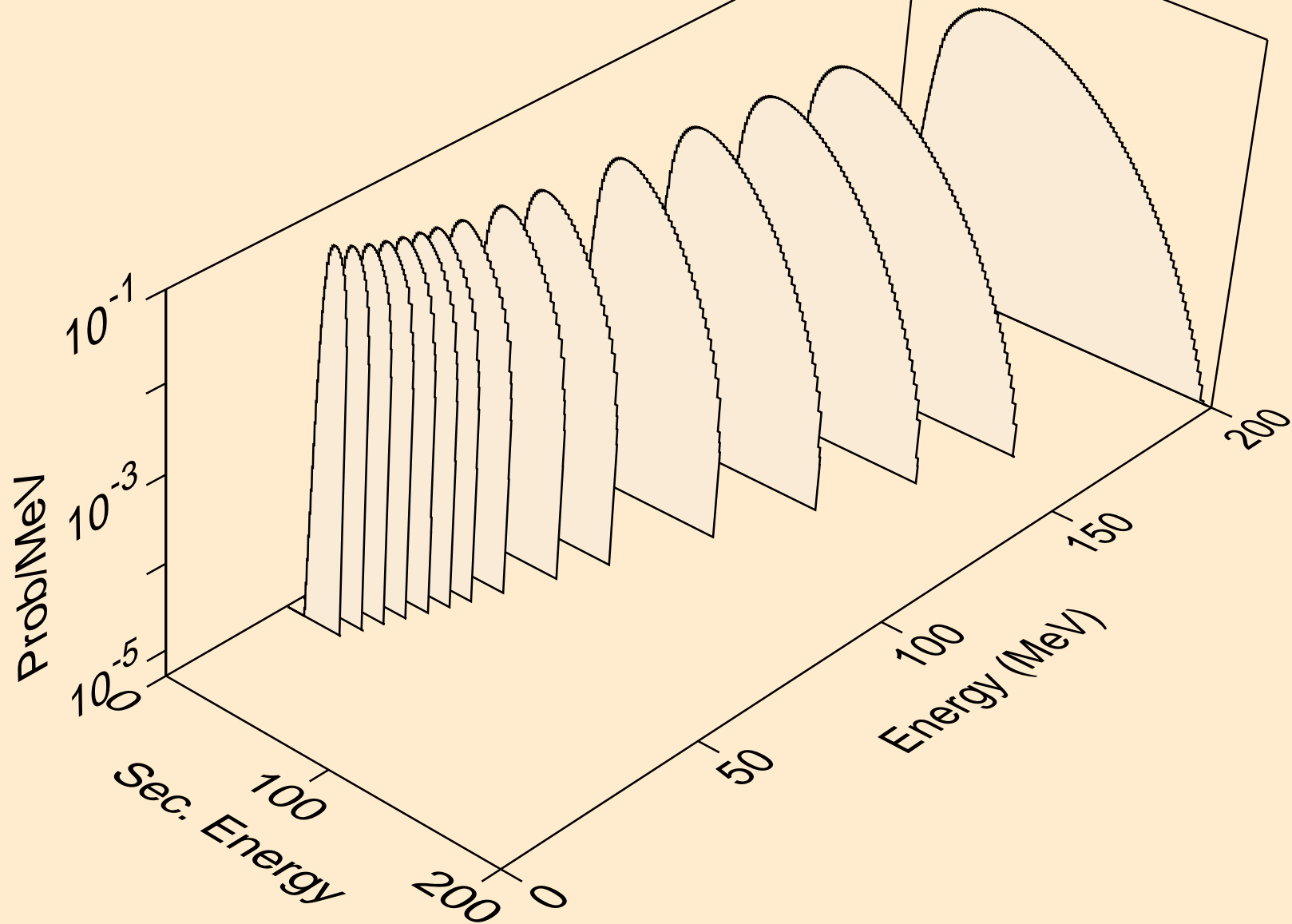

TA159 NEUTRON ACER TENDL-2021 LIBRARY; T=293.6K  
he3s from (n,n\*)he3

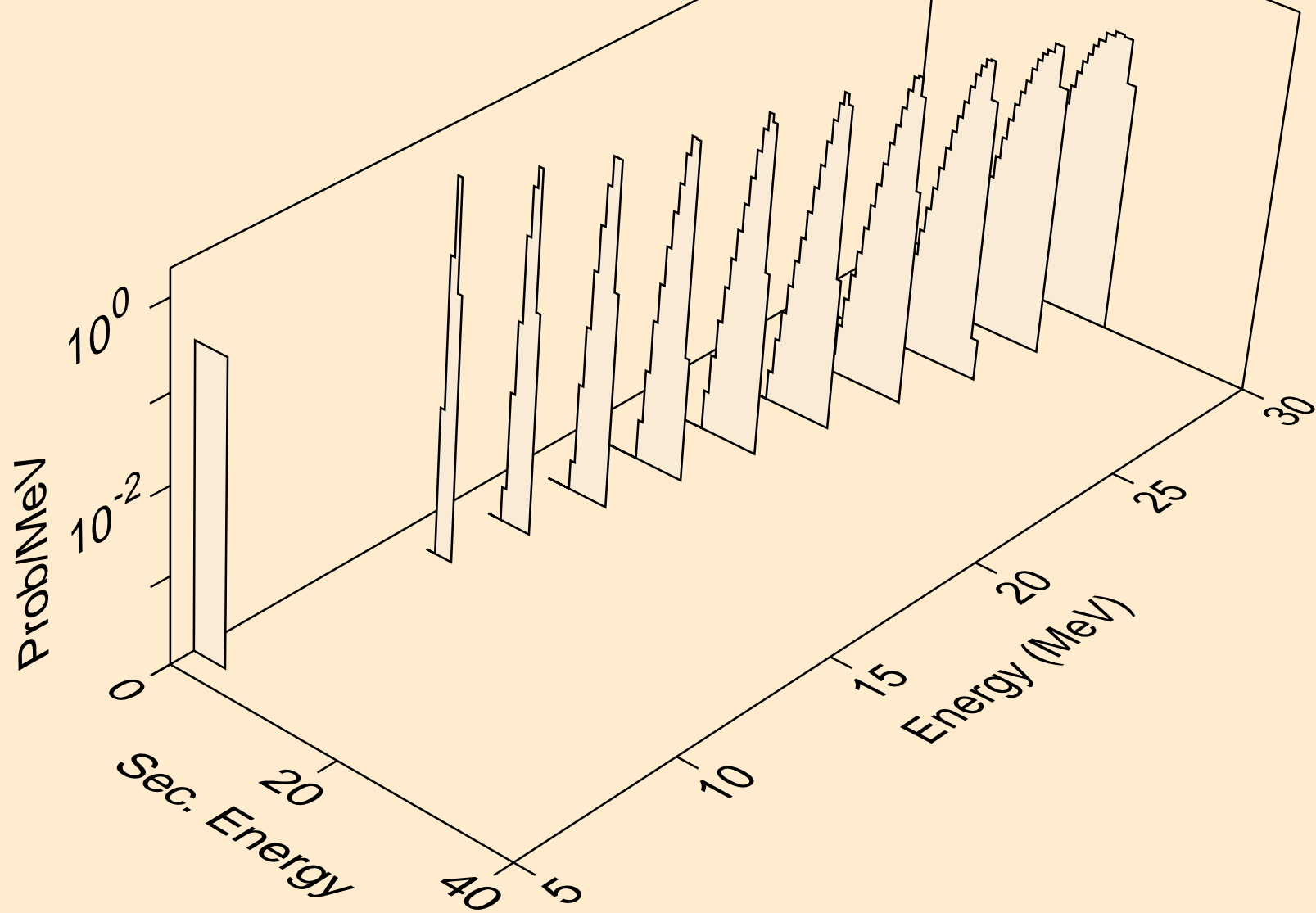

TA159 NEUTRON ACER TENDL-2021 LIBRARY; T=293.6K  
he3s from (n,he3)

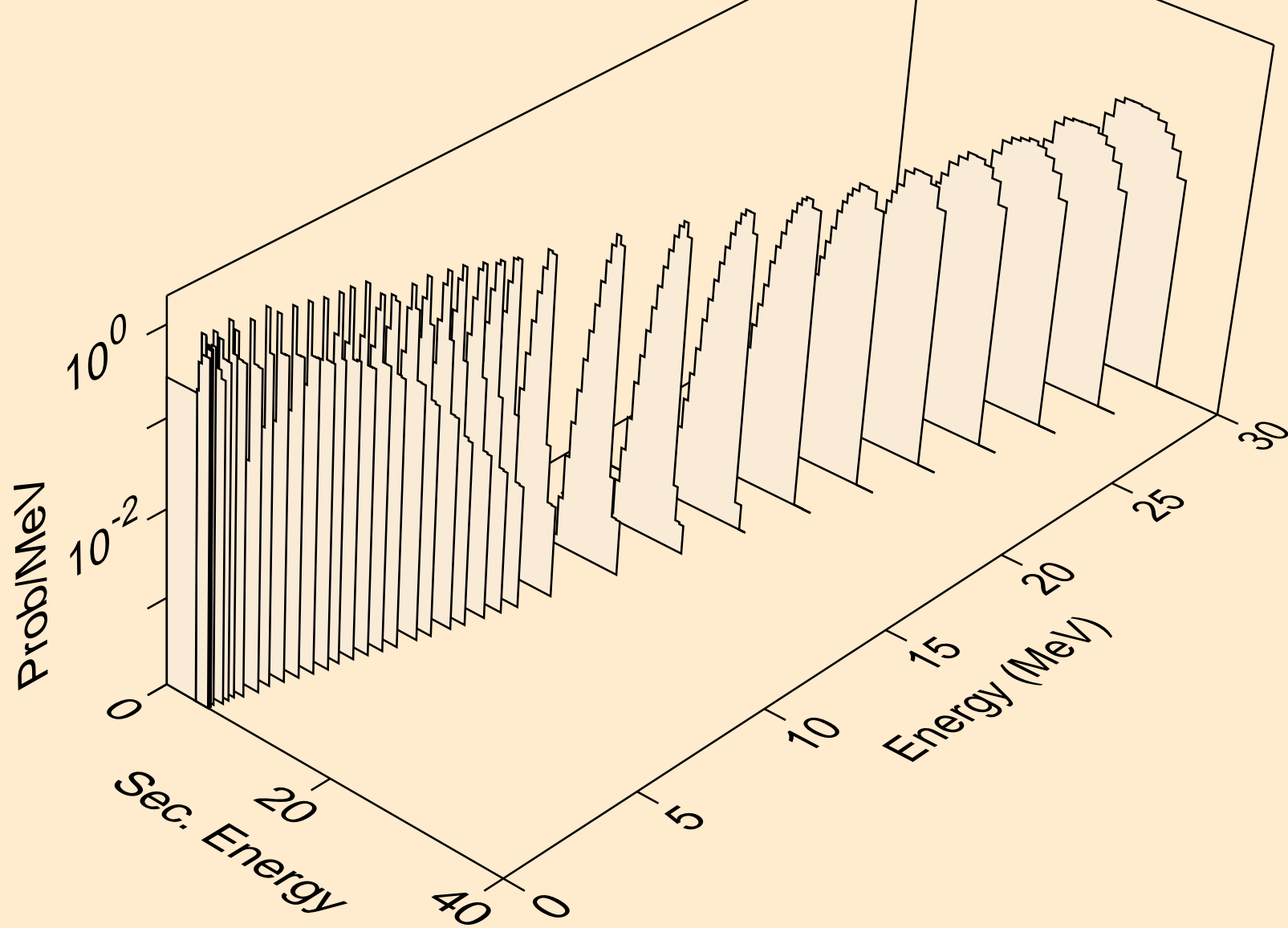

TA159 NEUTRON ACER TENDL-2021 LIBRARY; T=293.6K  
alphas from (n,x)

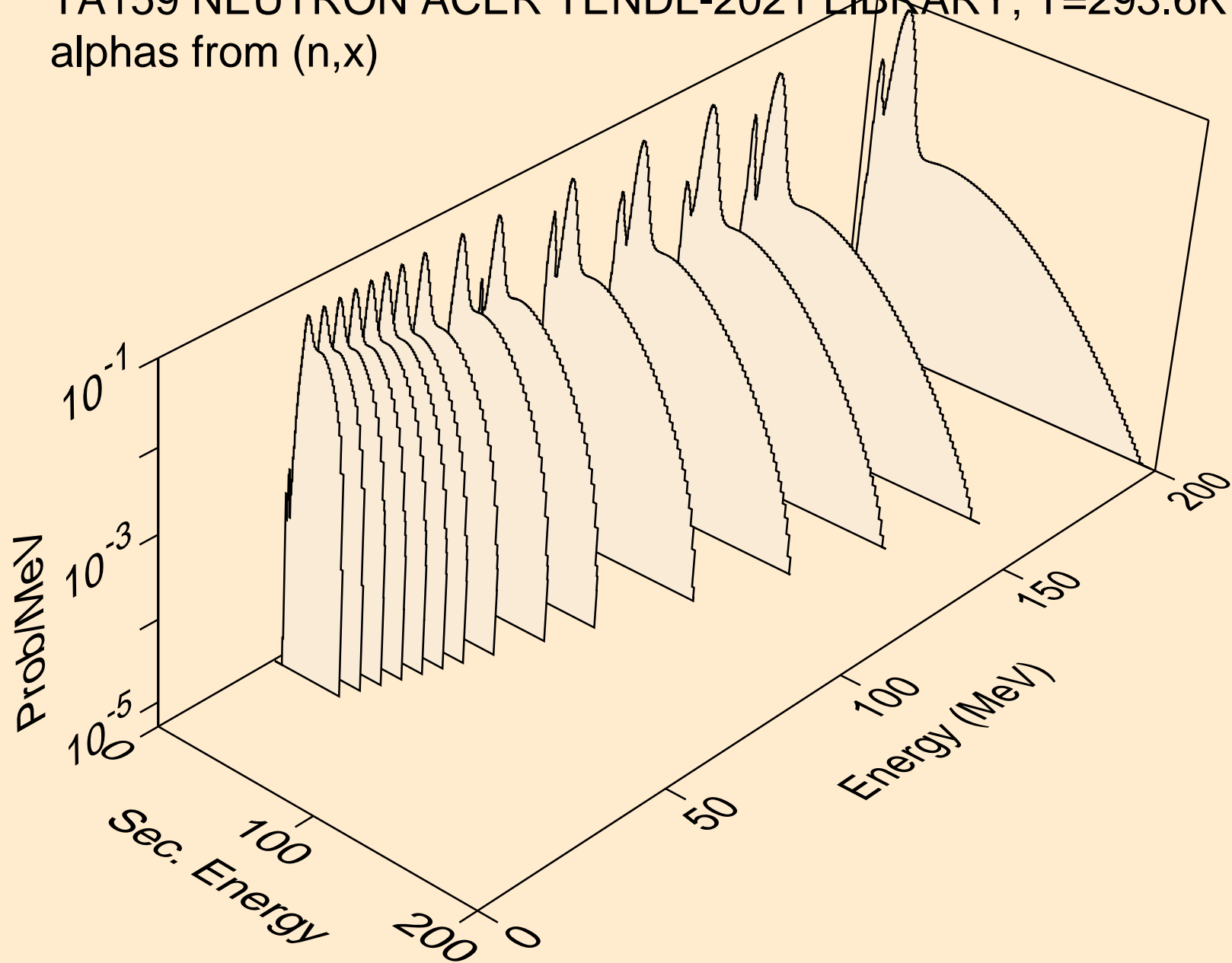

TA159 NEUTRON ACER TENDL-2021 LIBRARY; T=293.6K  
alphas from (n,n\*)a

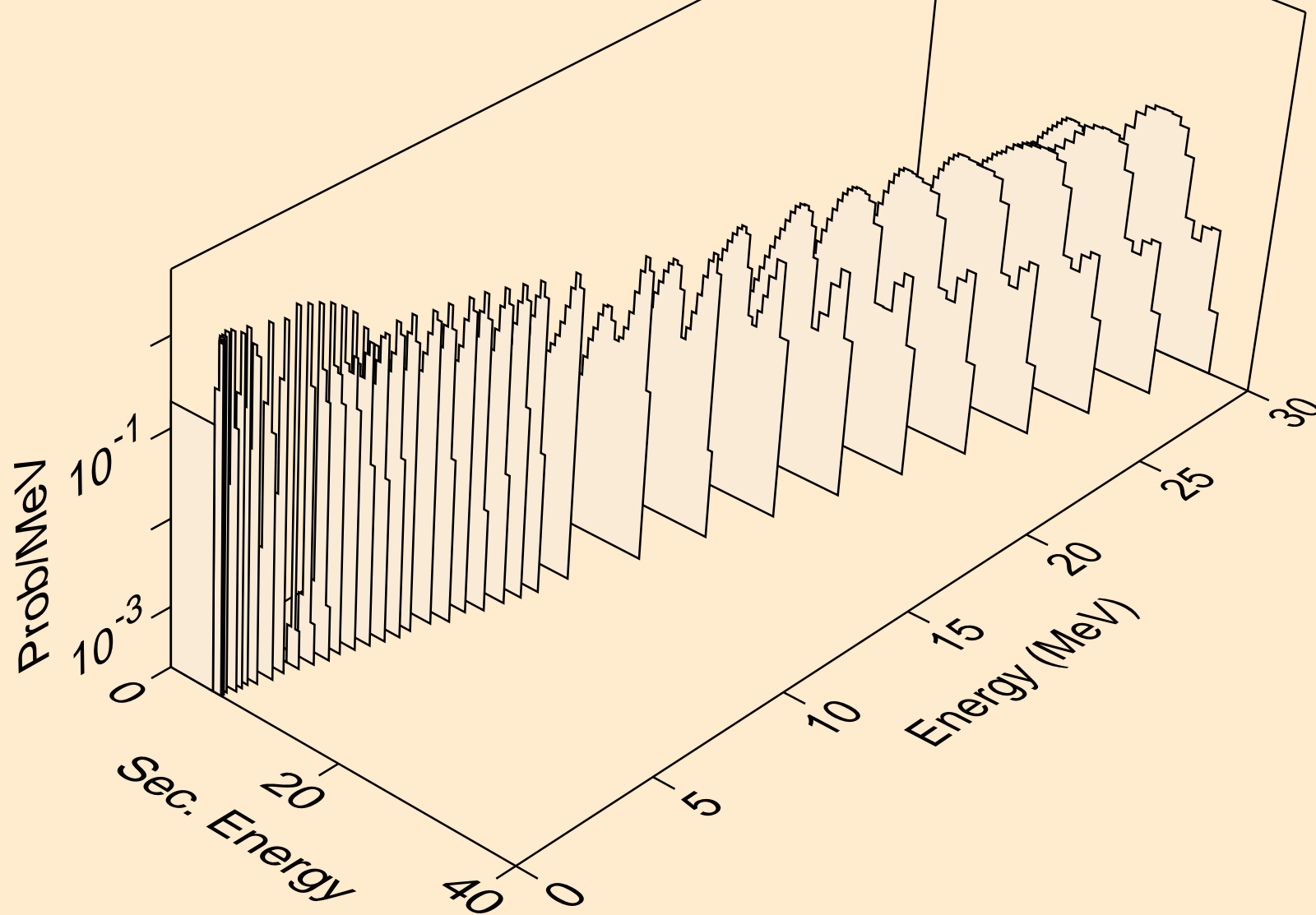



TA159 NEUTRON ACER TENDL-2021 LIBRARY; T=293.6K  
alphas from (n,n\*)3a

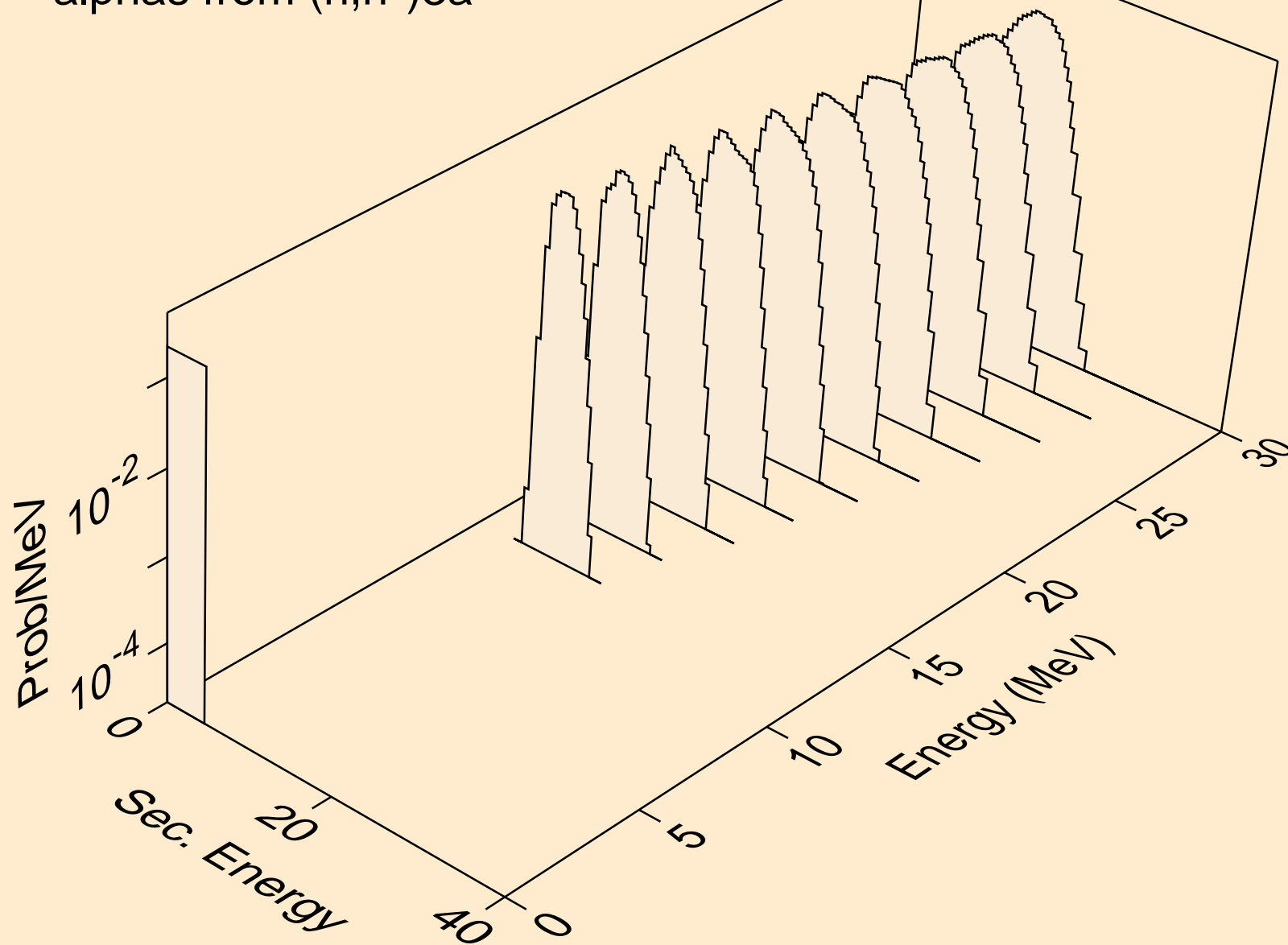

TA159 NEUTRON ACER TENDL-2021 LIBRARY; T=293.6K  
alphas from (n,2n)a

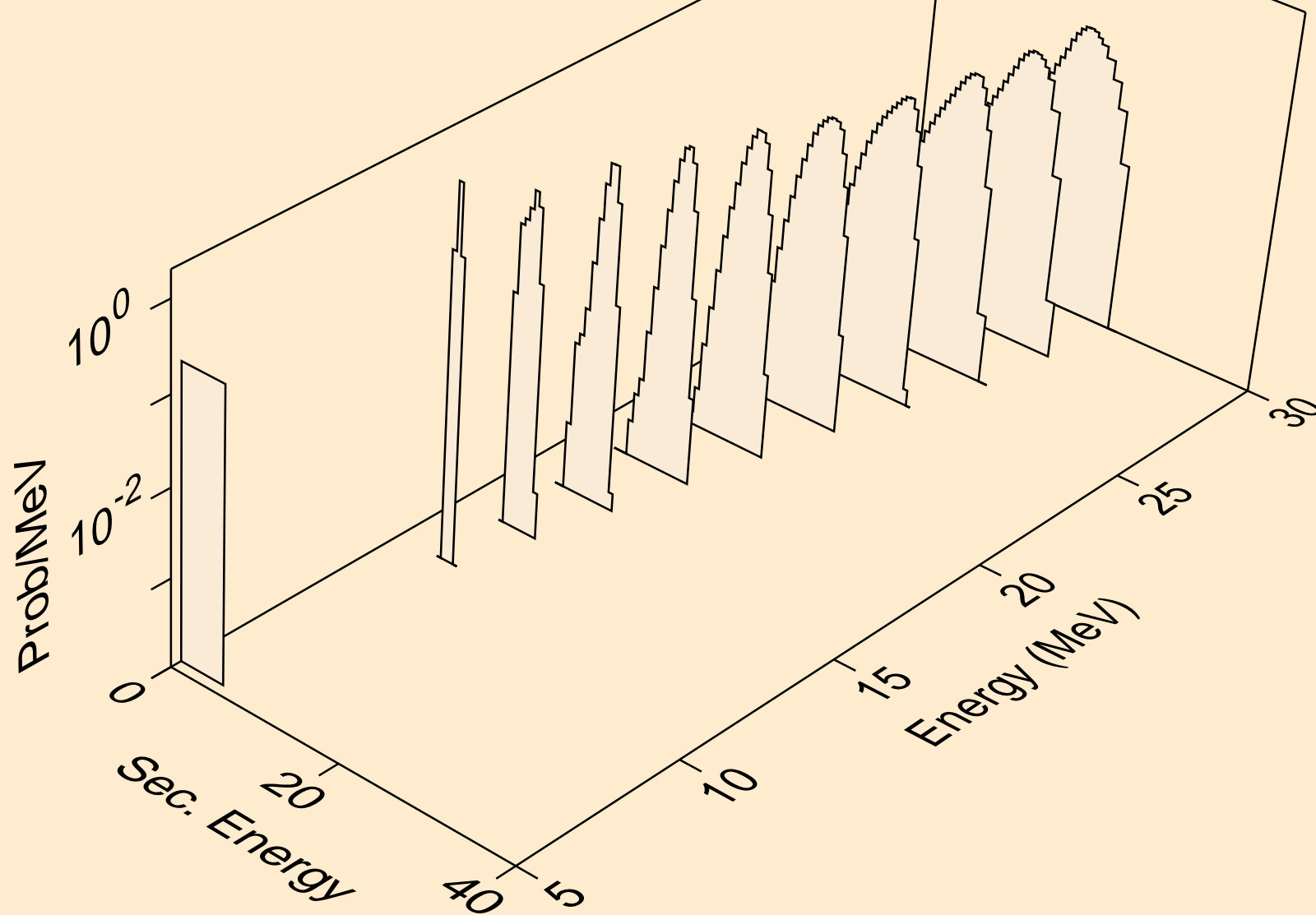

TA159 NEUTRON ACER TENDL-2021 LIBRARY; T=293.6K  
alphas from (n,3n)a

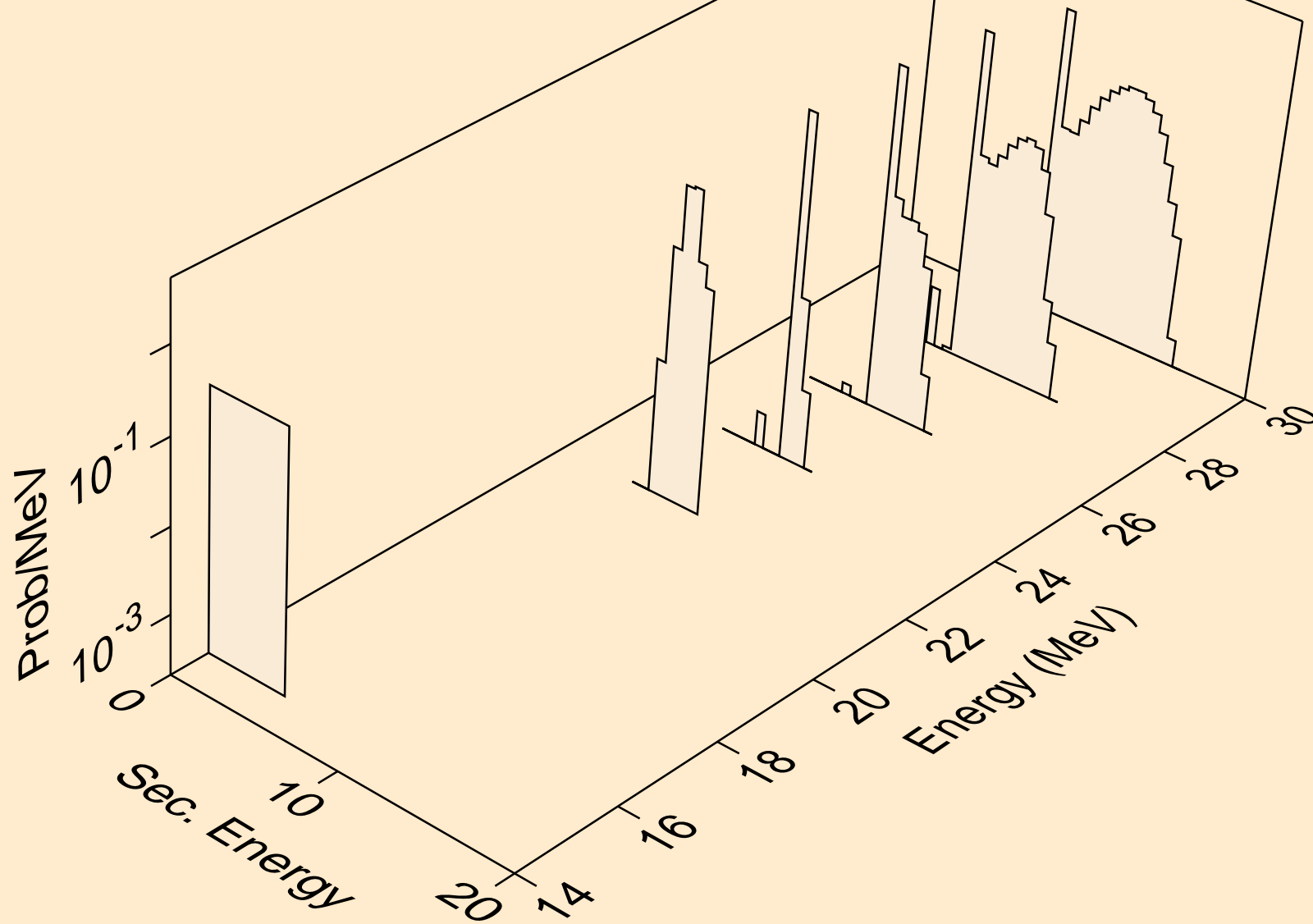

TA159 NEUTRON ACER TENDL-2021 LIBRARY; T=293.6K  
alphas from (n,n\*)2a

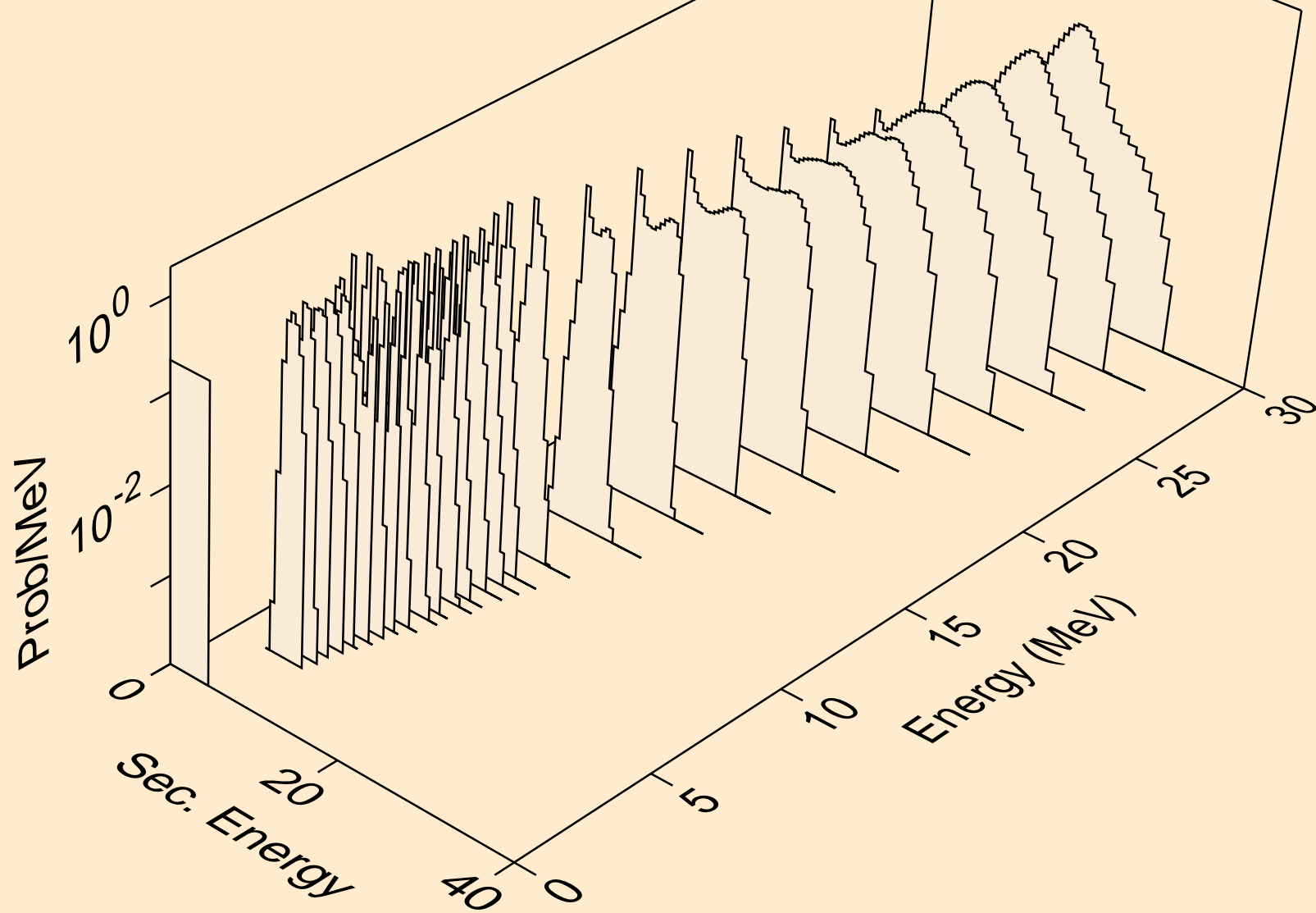

TA159 NEUTRON ACER TENDL-2021 LIBRARY; T=293.6K  
alphas from (n,2n)2a

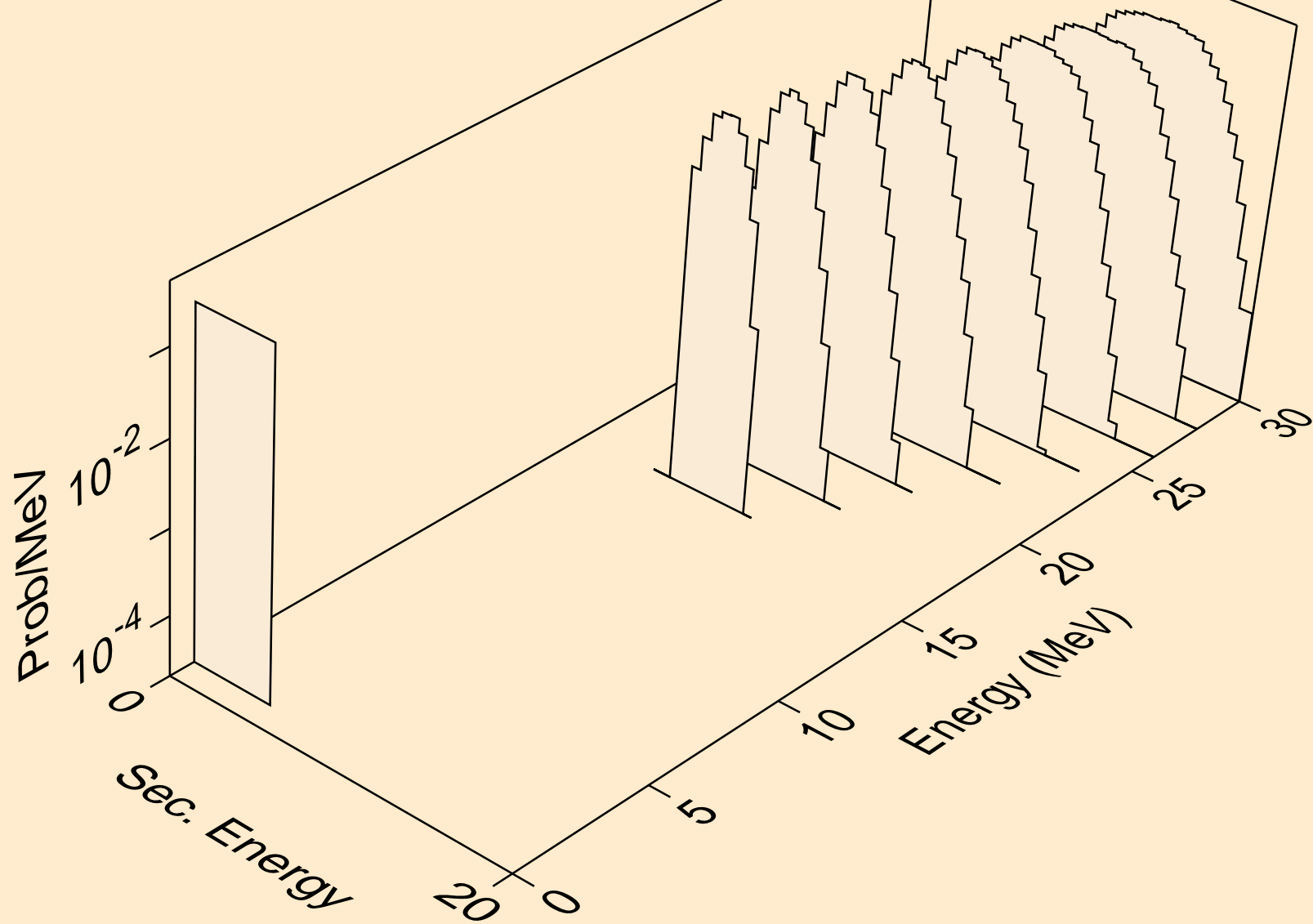

TA159 NEUTRON ACER TENDL-2021 LIBRARY; T=293.6K  
alphas from (n,npa)

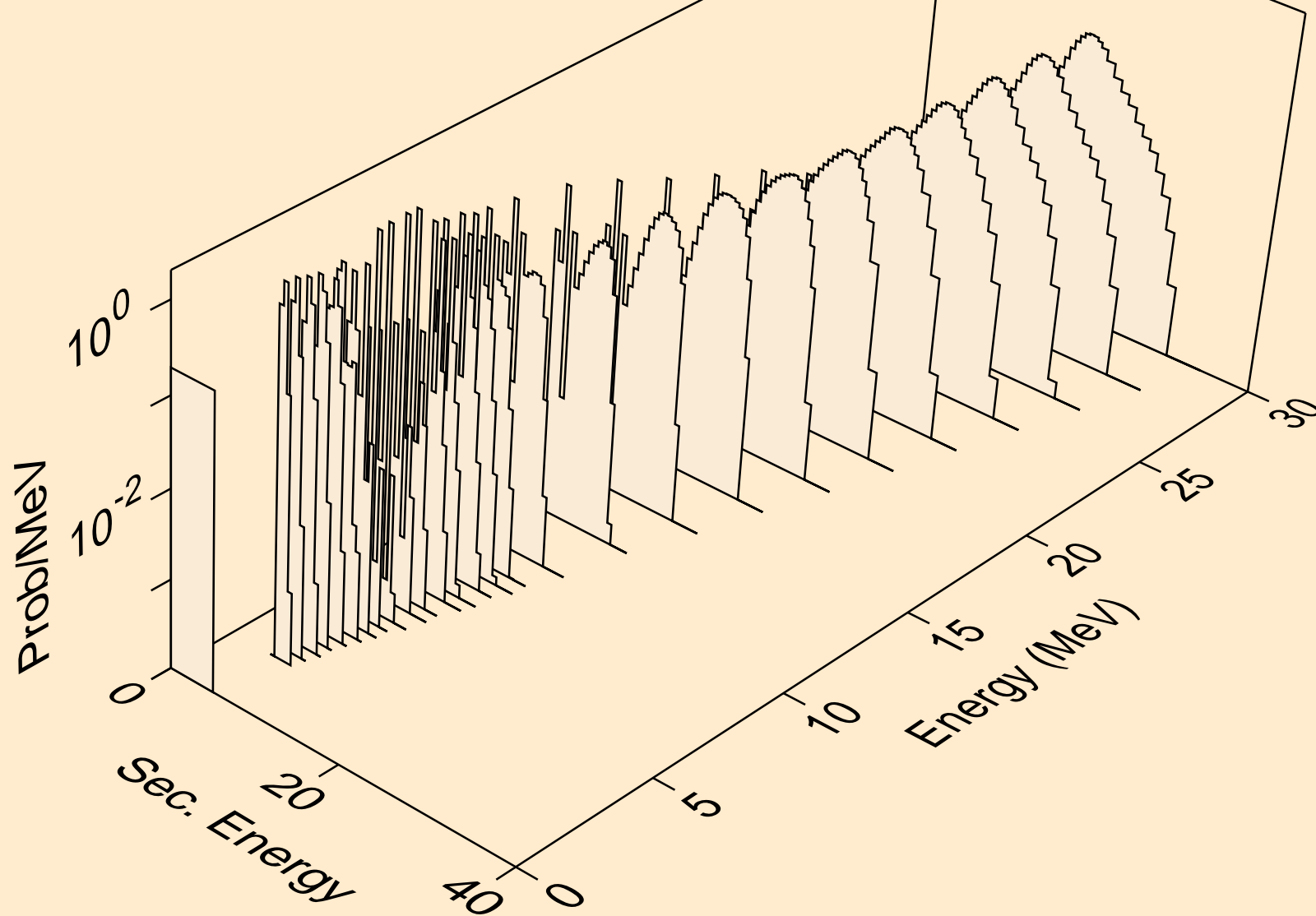

TA159 NEUTRON ACER TENDL-2021 LIBRARY; T=293.6K  
alphas from (n,a)

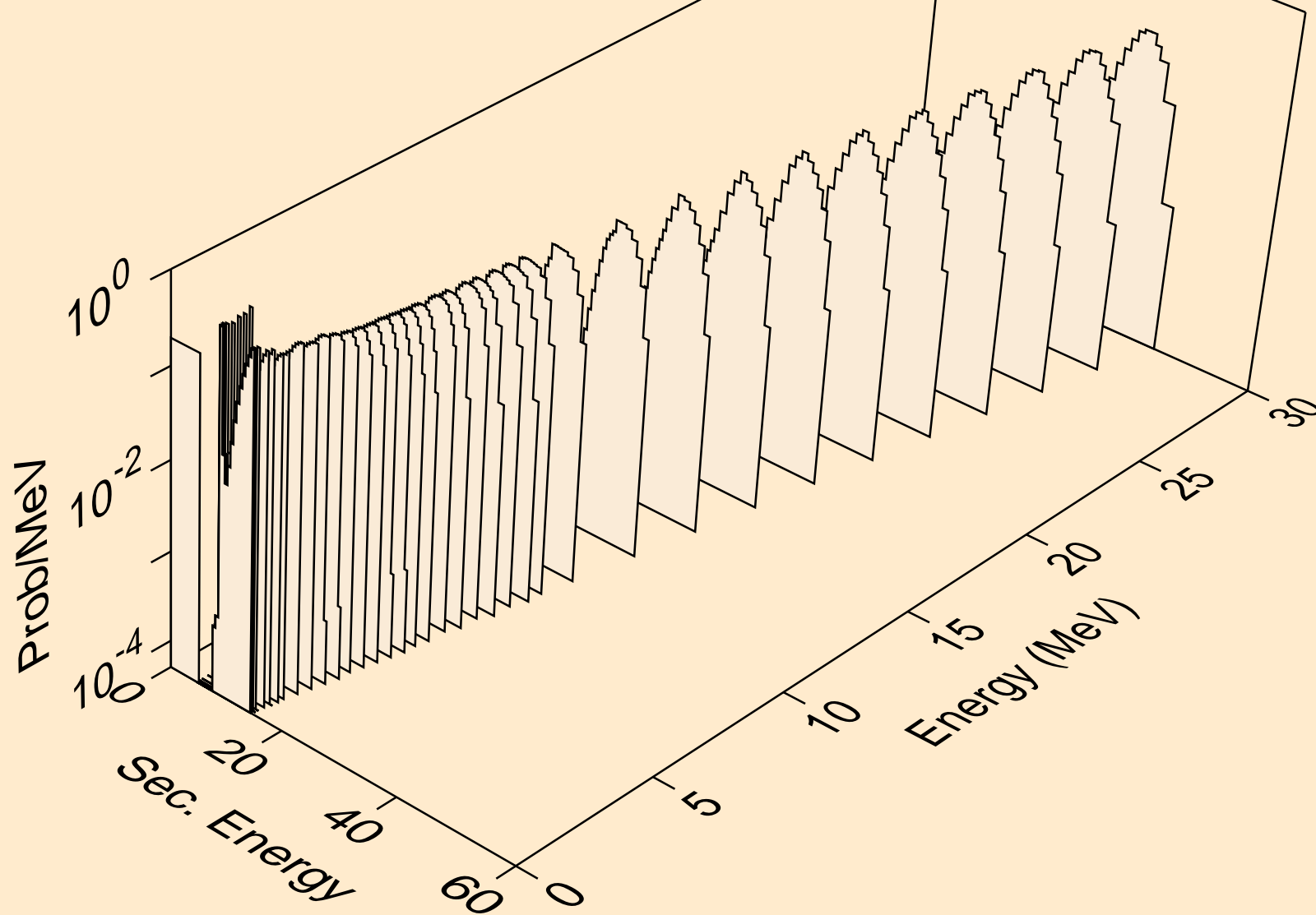

TA159 NEUTRON ACER TENDL-2021 LIBRARY; T=293.6K  
alphas from (n,2a)

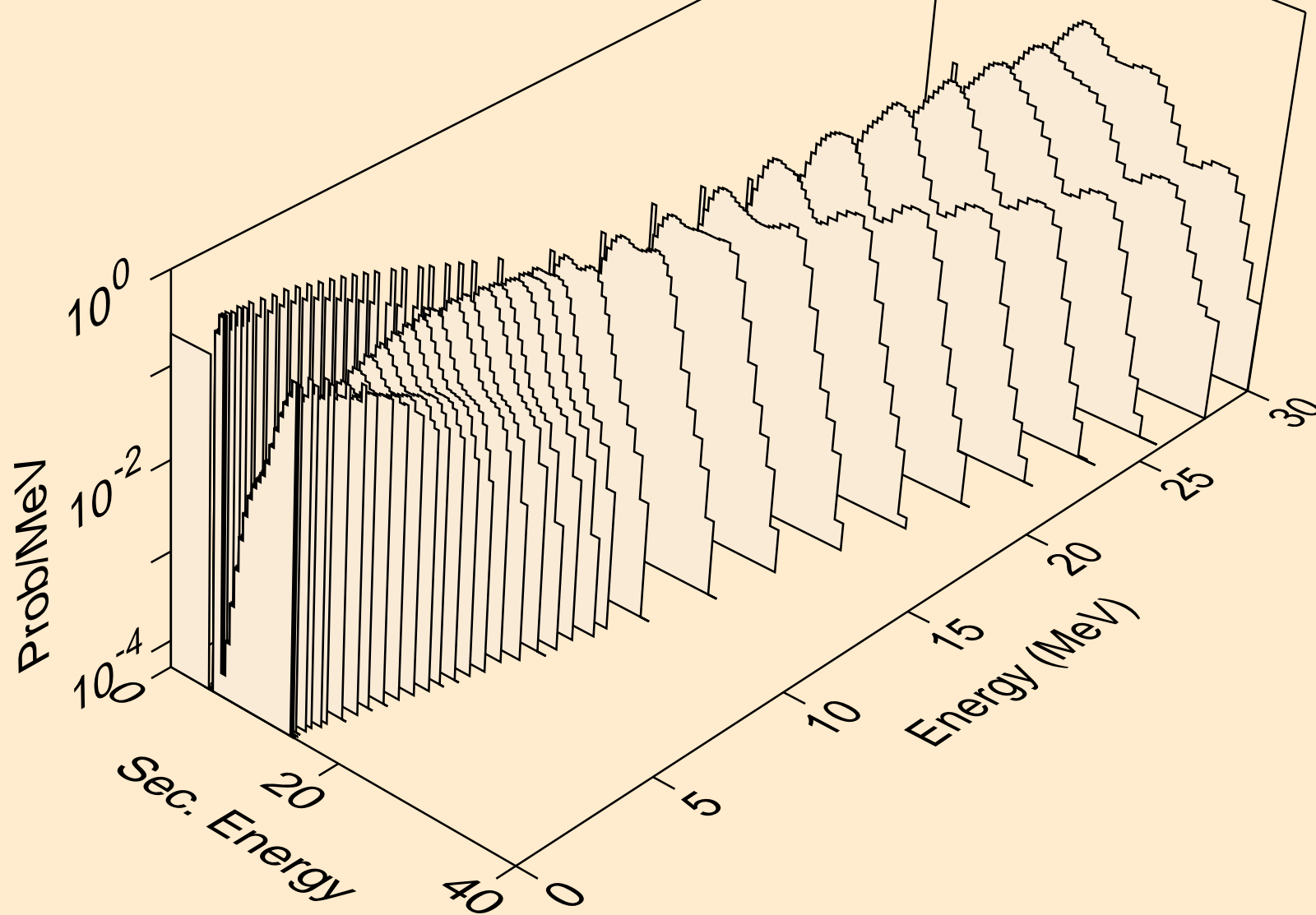



TA159 NEUTRON ACER TENDL-2021 LIBRARY; T=293.6K  
alphas from (n,3a)

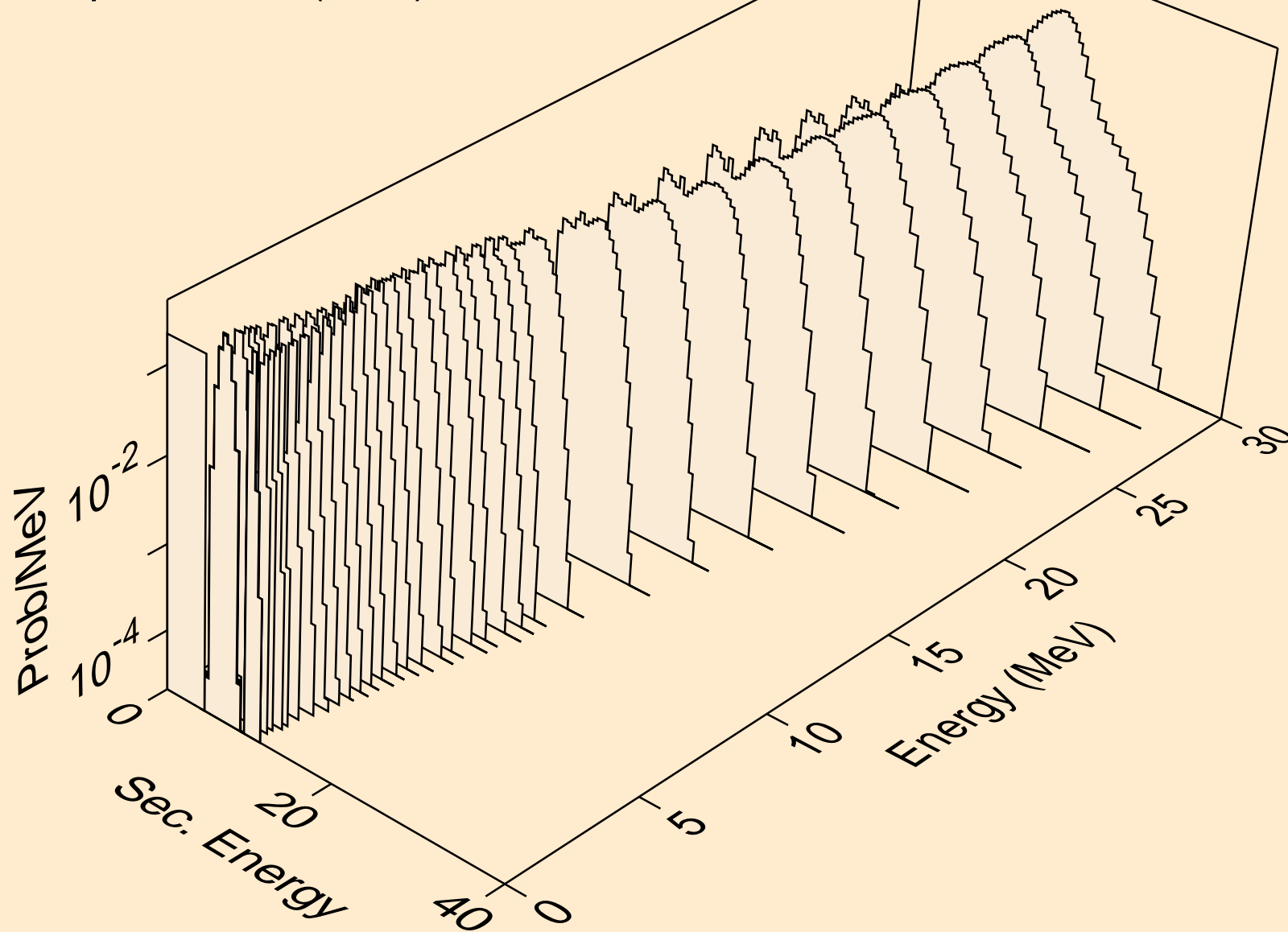

TA159 NEUTRON ACER TENDL-2021 LIBRARY; T=293.6K  
alphas from (n,pa)

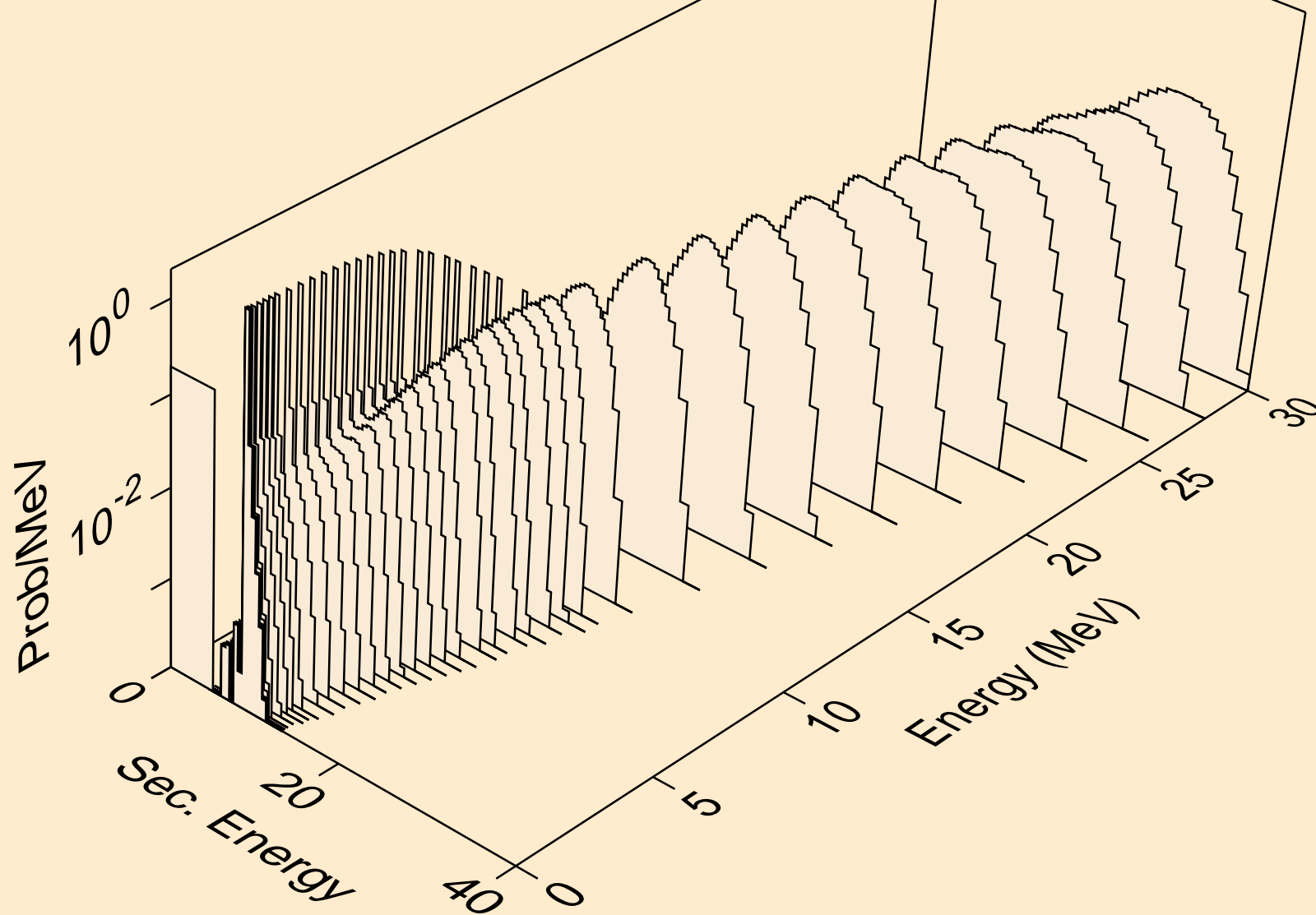

TA159 NEUTRON ACER TENDL-2021 LIBRARY; T=293.6K  
alphas from (n,t2a)

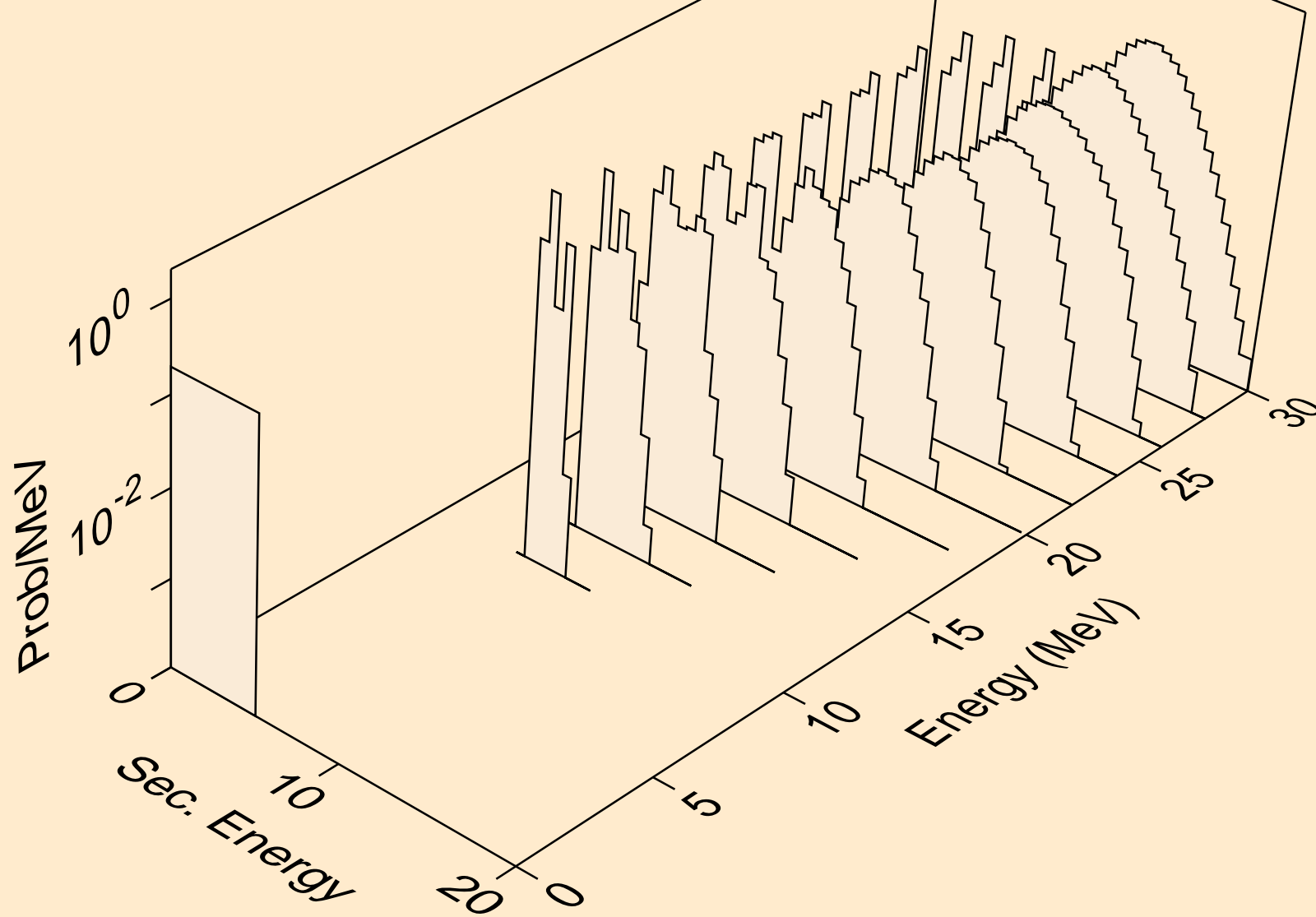

TA159 NEUTRON ACER TENDL-2021 LIBRARY; T=293.6K  
alphas from (n,d2a)

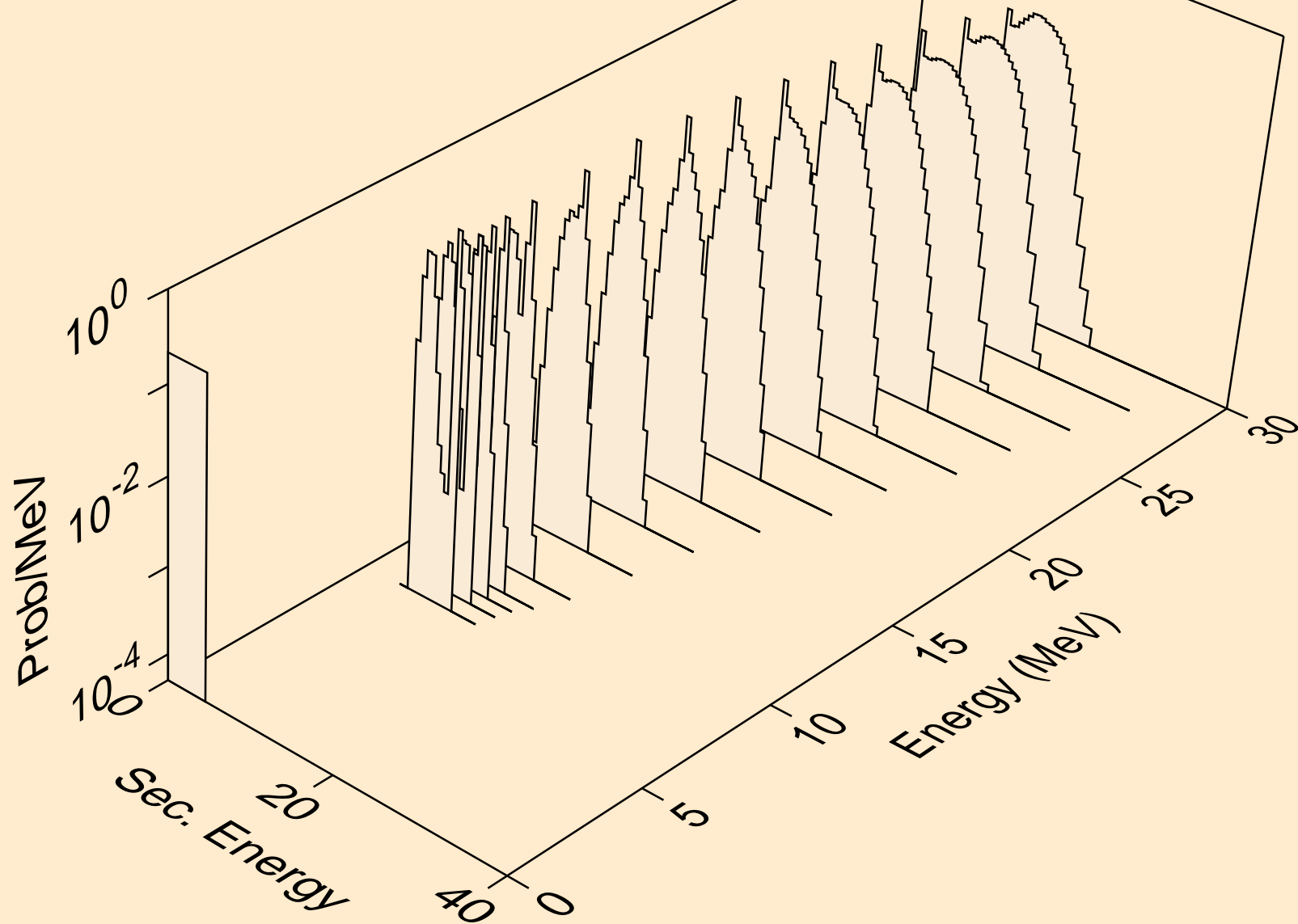

TA159 NEUTRON ACER TENDL-2021 LIBRARY; T=293.6K  
alphas from (n,da)

