

TA161M NEUTRON ACER TENDL-2021 LIBRARY; T=293.6K
Principal cross sections

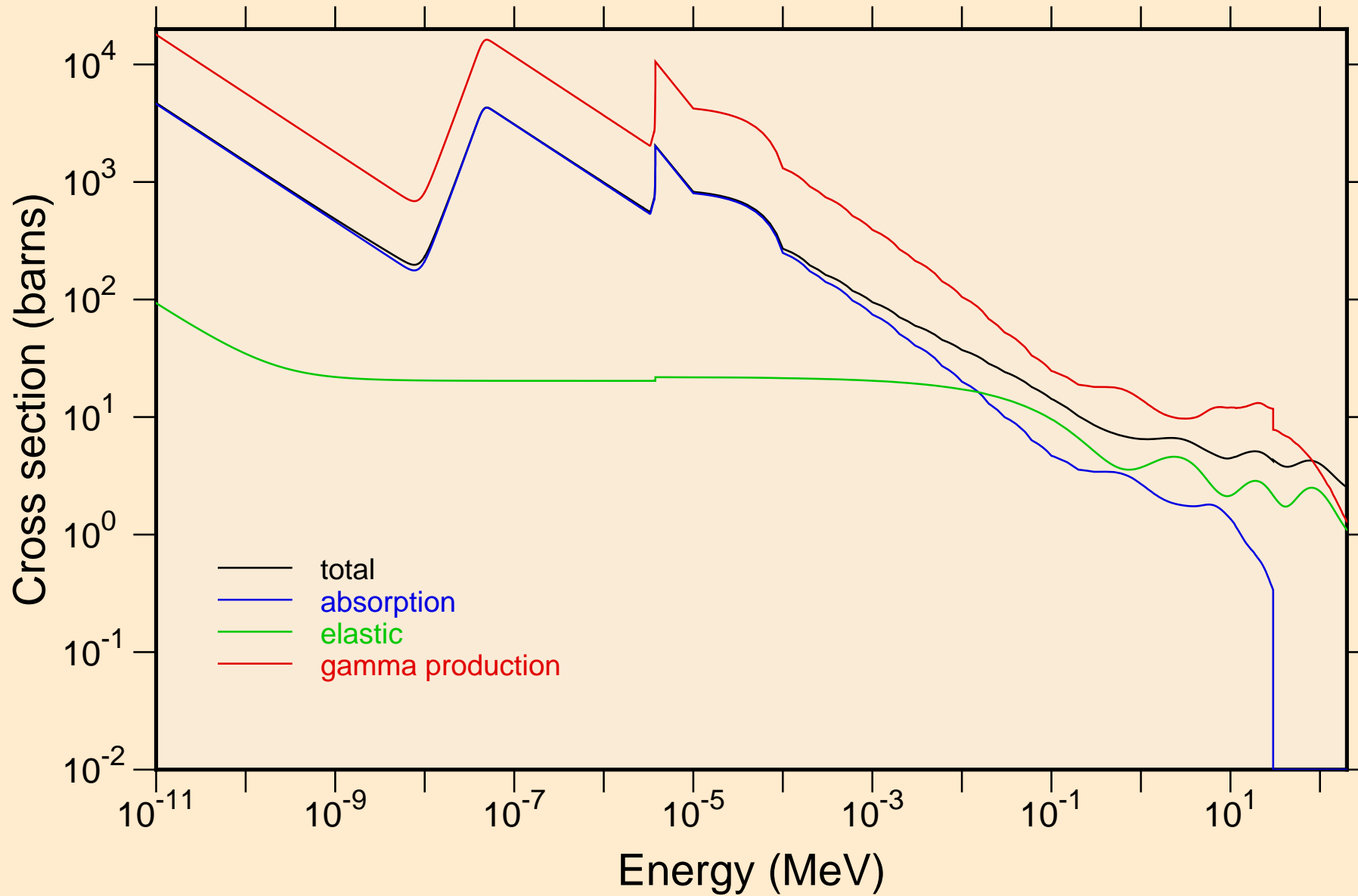

TA161M NEUTRON ACER TENDL-2021 LIBRARY; T=293.6K
Heating

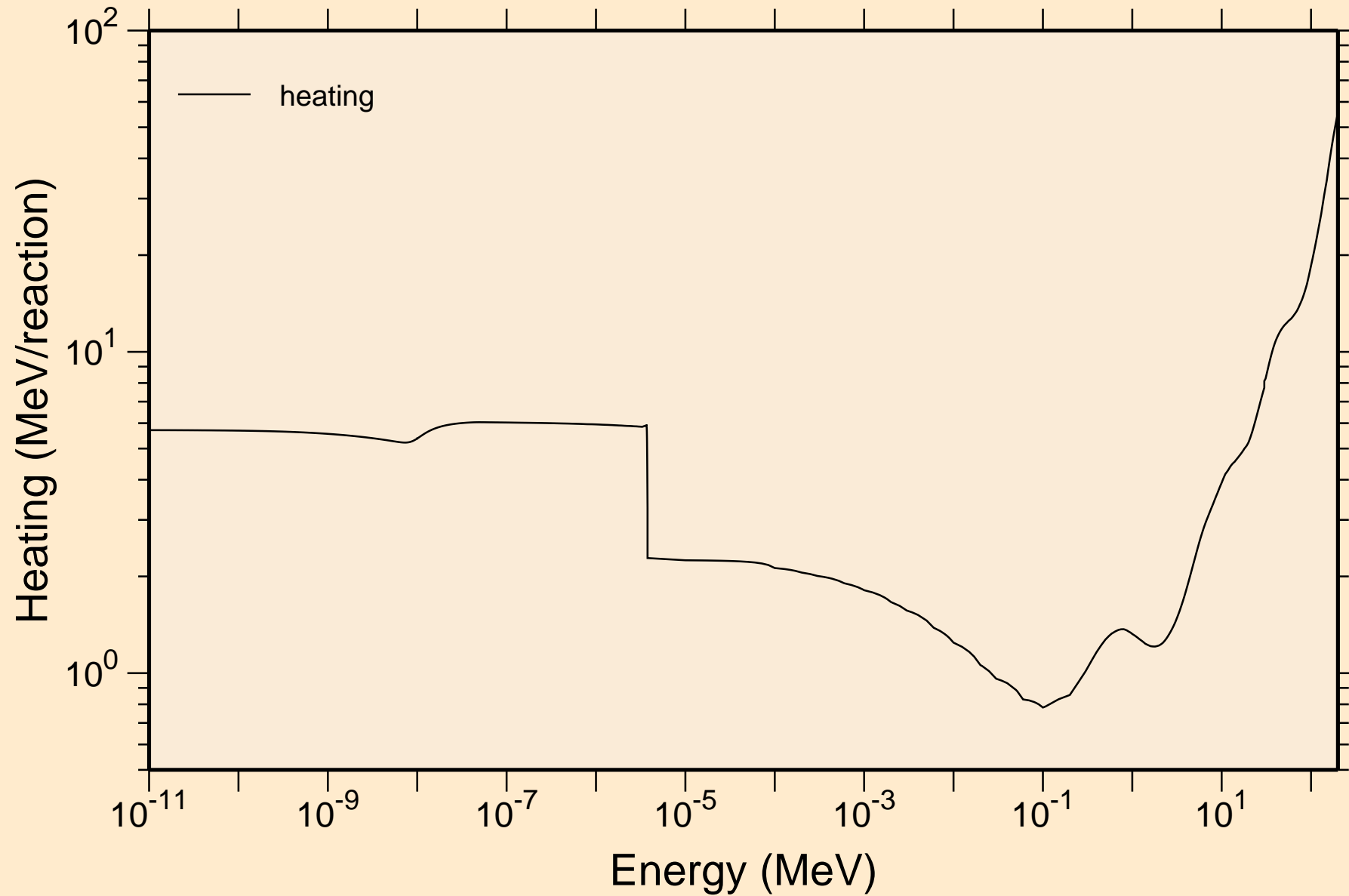

TA161M NEUTRON ACER TENDL-2021 LIBRARY; T=293.6K
Damage

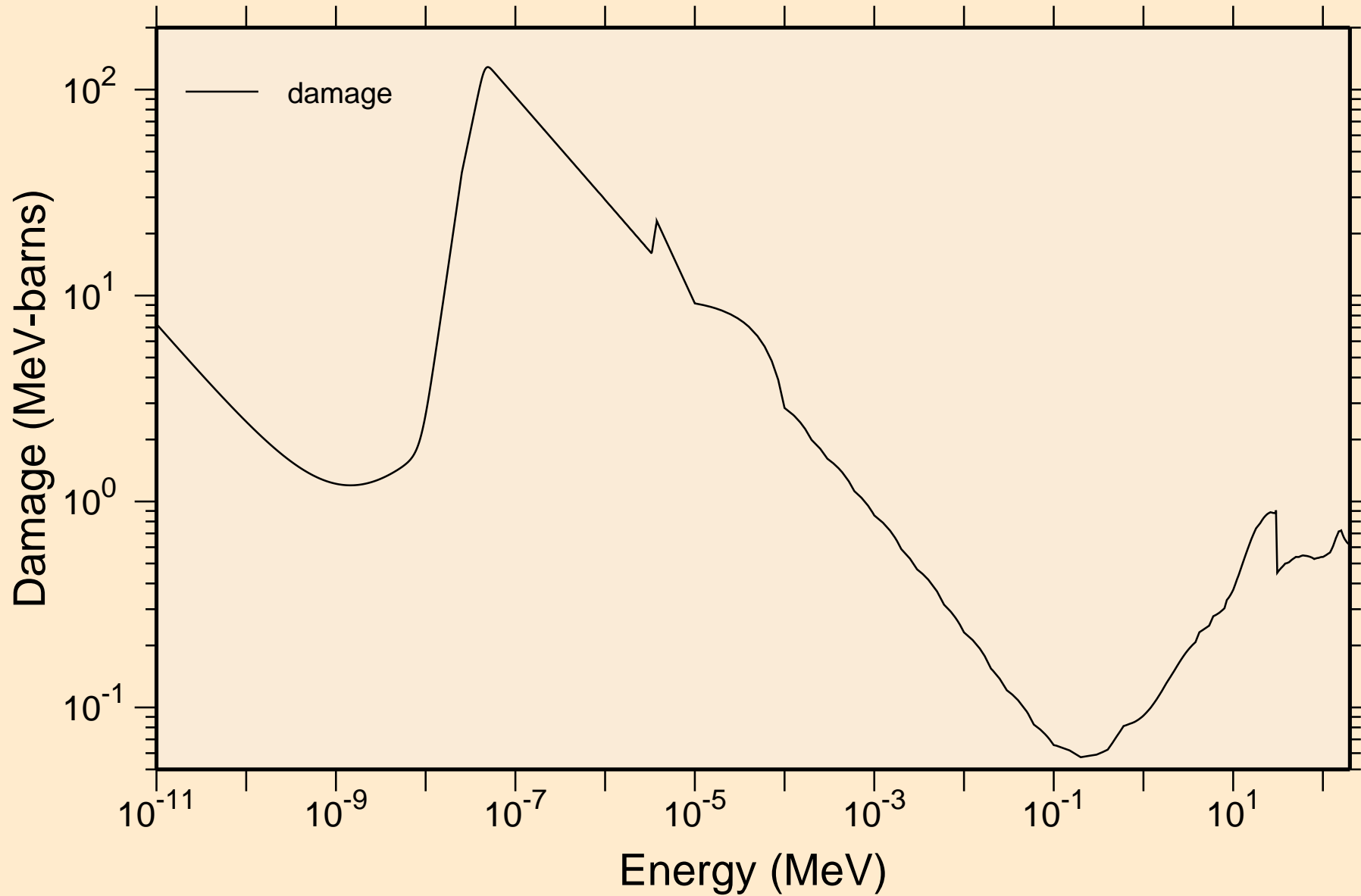

TA161M NEUTRON ACER TENDL-2021 LIBRARY; T=293.6K
Non-threshold reactions

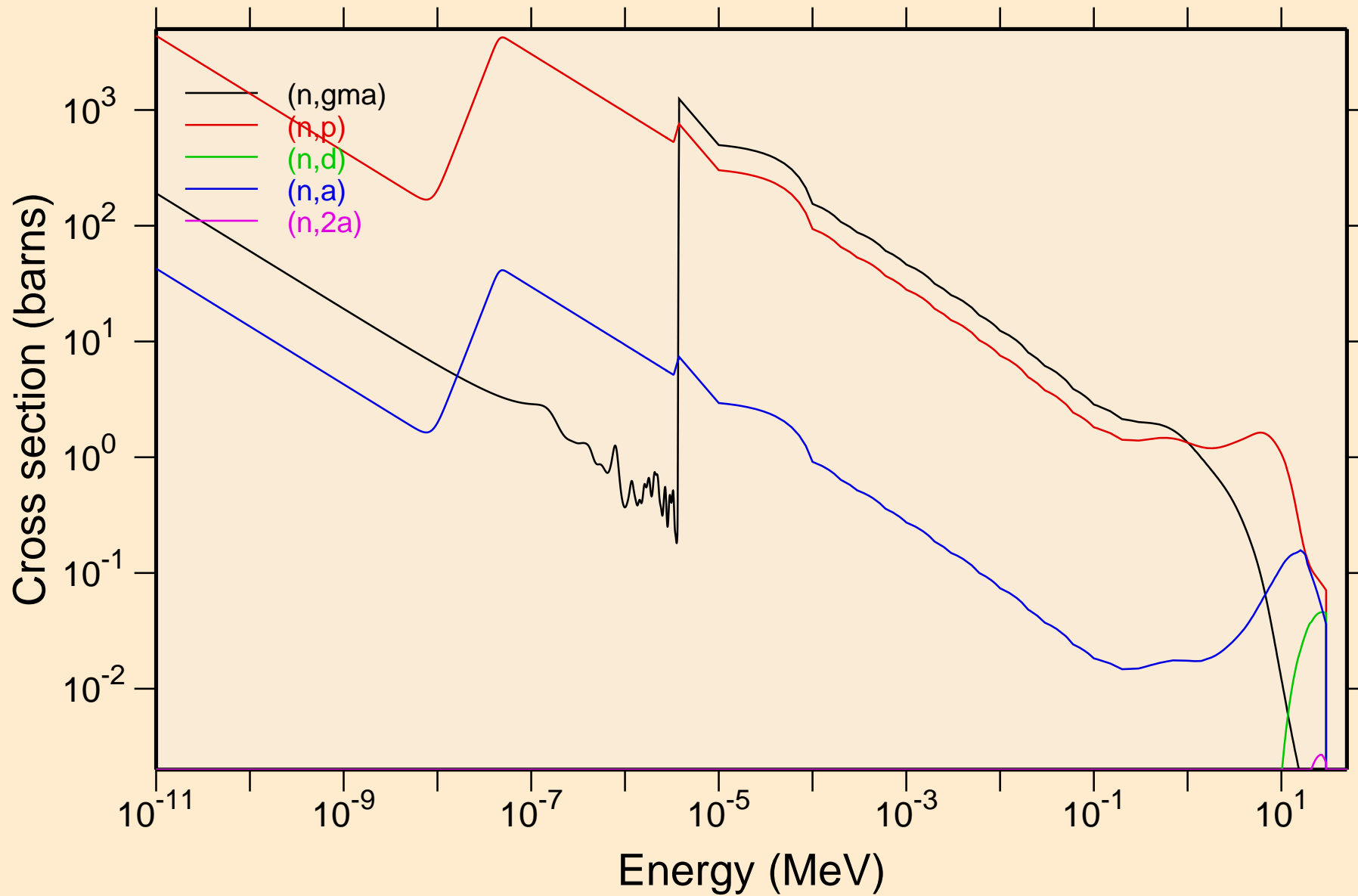

TA161M NEUTRON ACER TENDL-2021 LIBRARY; T=293.6K
Non-threshold reactions

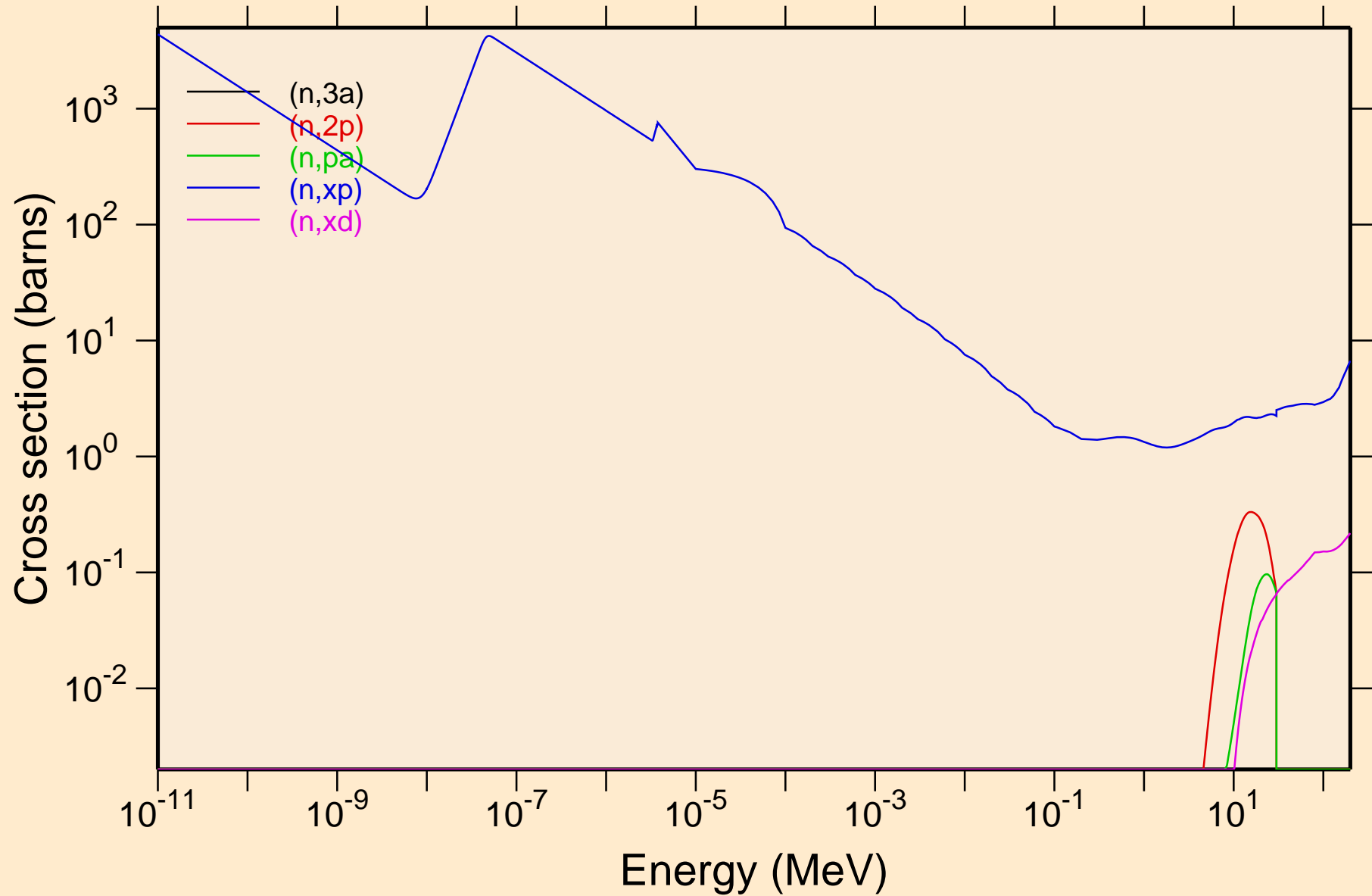

TA161M NEUTRON ACER TENDL-2021 LIBRARY; T=293.6K
Non-threshold reactions

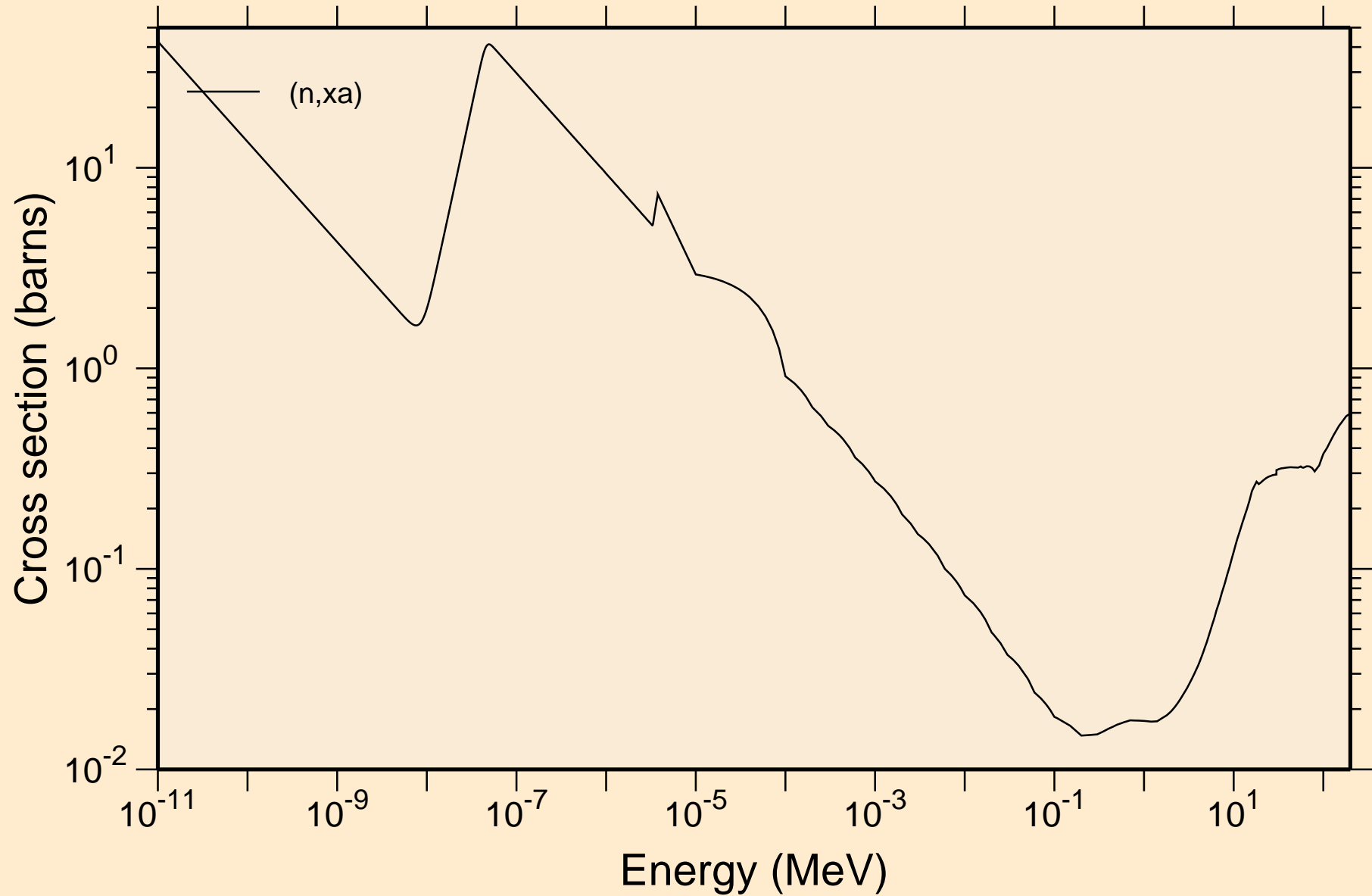

TA161M NEUTRON ACER TENDL-2021 LIBRARY; T=293.6K
Principal cross sections

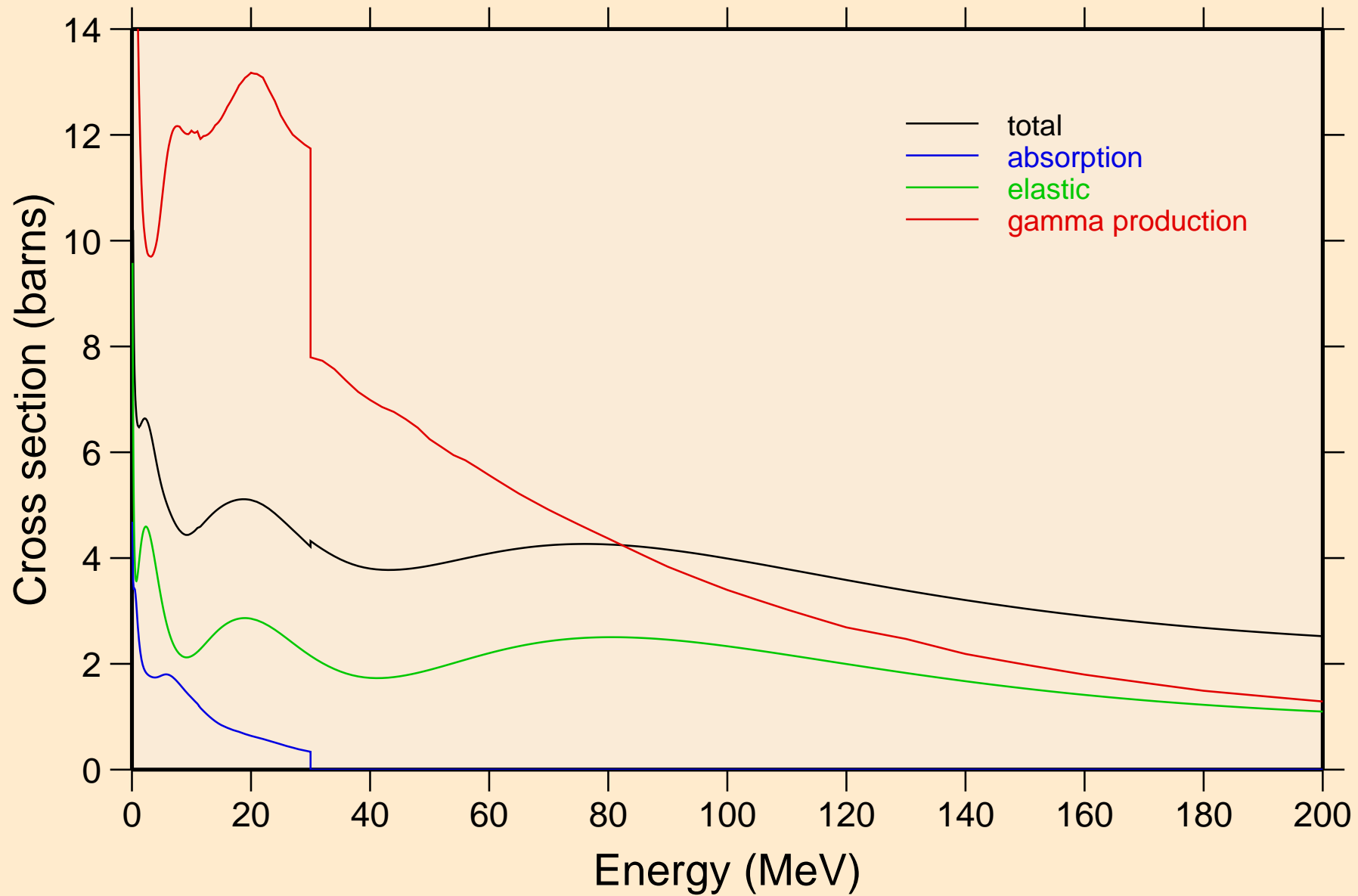

TA161M NEUTRON ACER TENDL-2021 LIBRARY; T=293.6K
Heating

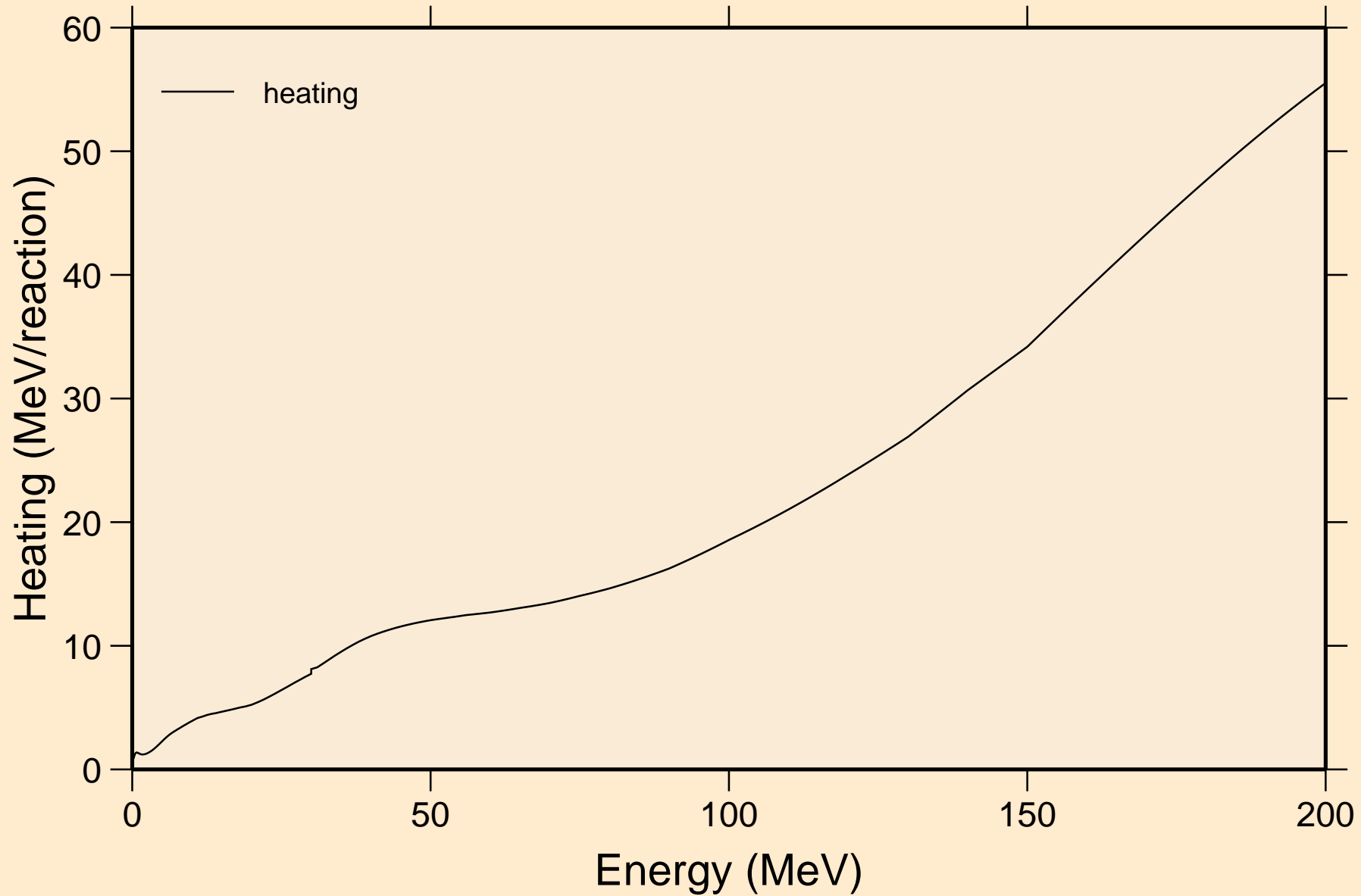

TA161M NEUTRON ACER TENDL-2021 LIBRARY; T=293.6K
Damage

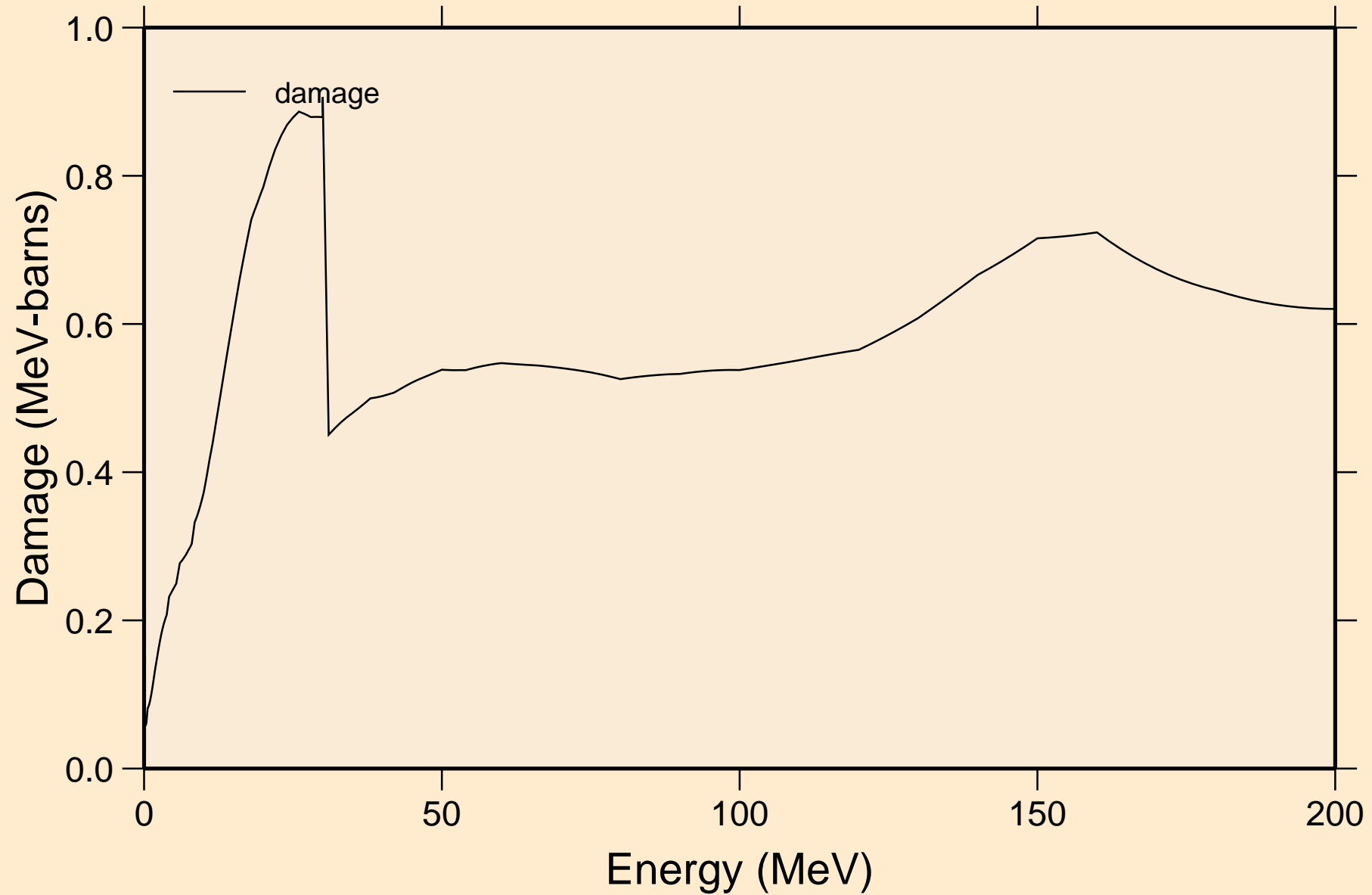

TA161M NEUTRON ACER TENDL-2021 LIBRARY; T=293.6K
Non-threshold reactions

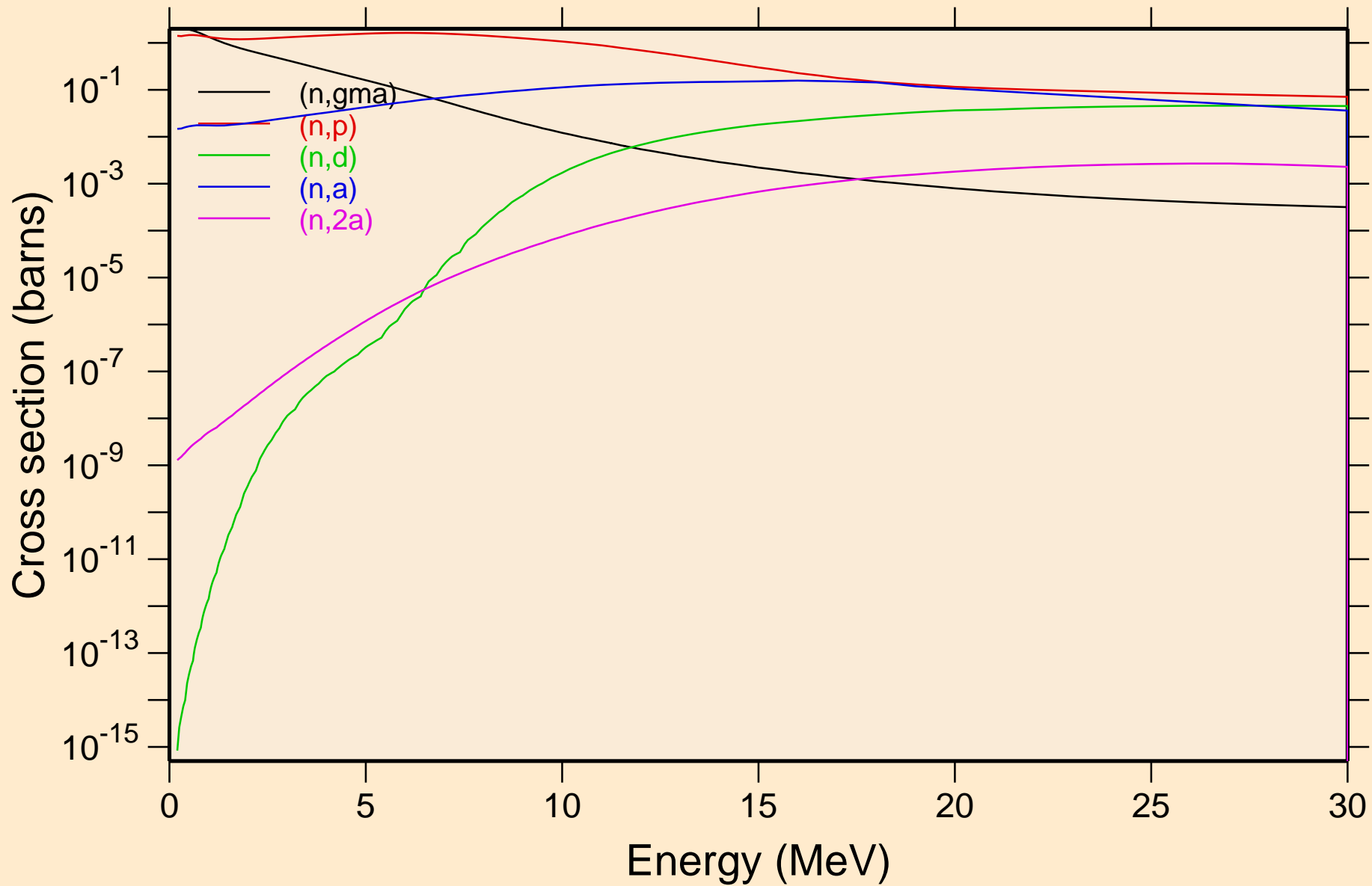

TA161M NEUTRON ACER TENDL-2021 LIBRARY; T=293.6K
Non-threshold reactions

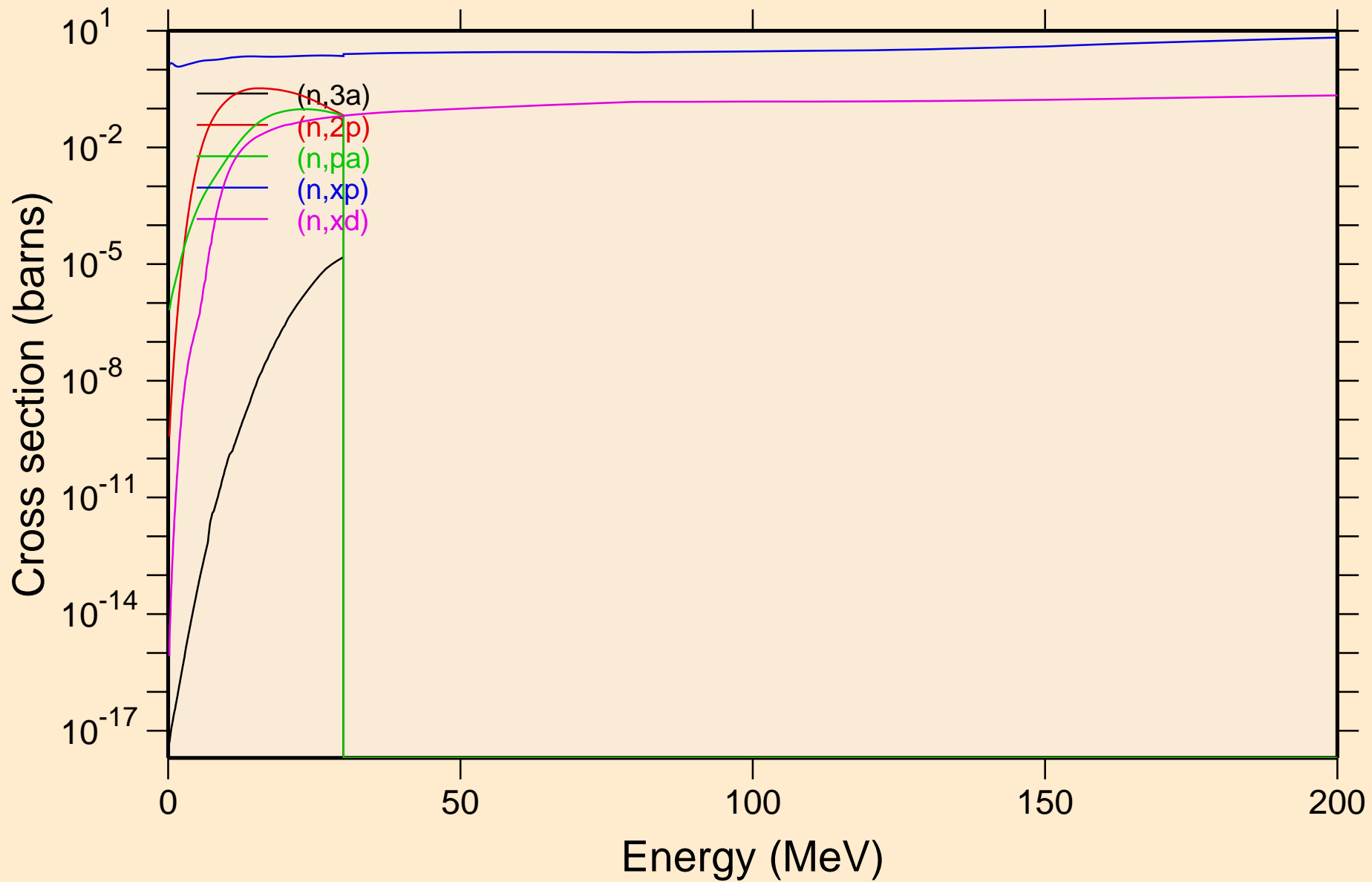

TA161M NEUTRON ACER TENDL-2021 LIBRARY; T=293.6K
Non-threshold reactions

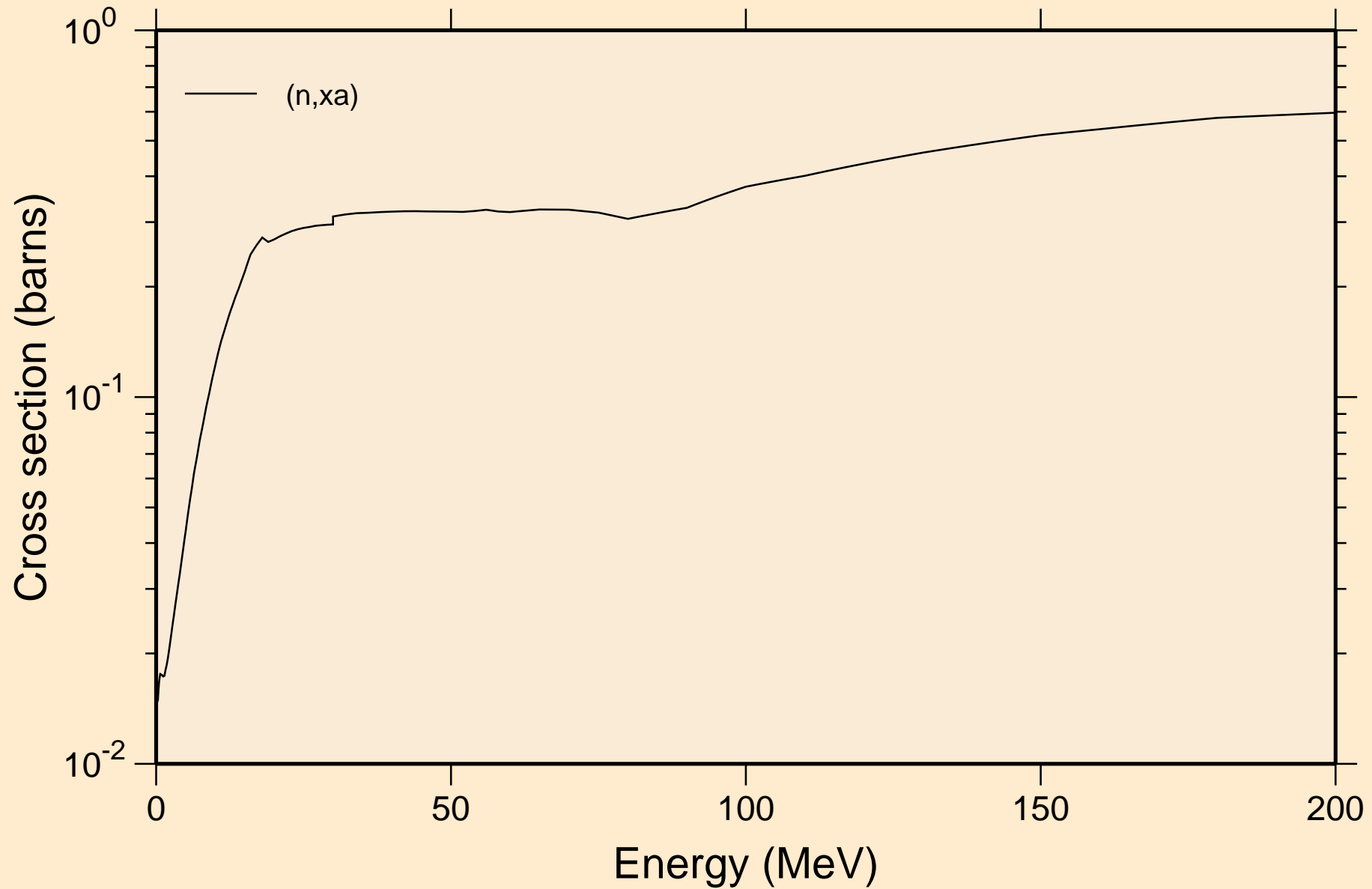

TA161M NEUTRON ACER TENDL-2021 LIBRARY; T=293.6K
Inelastic levels

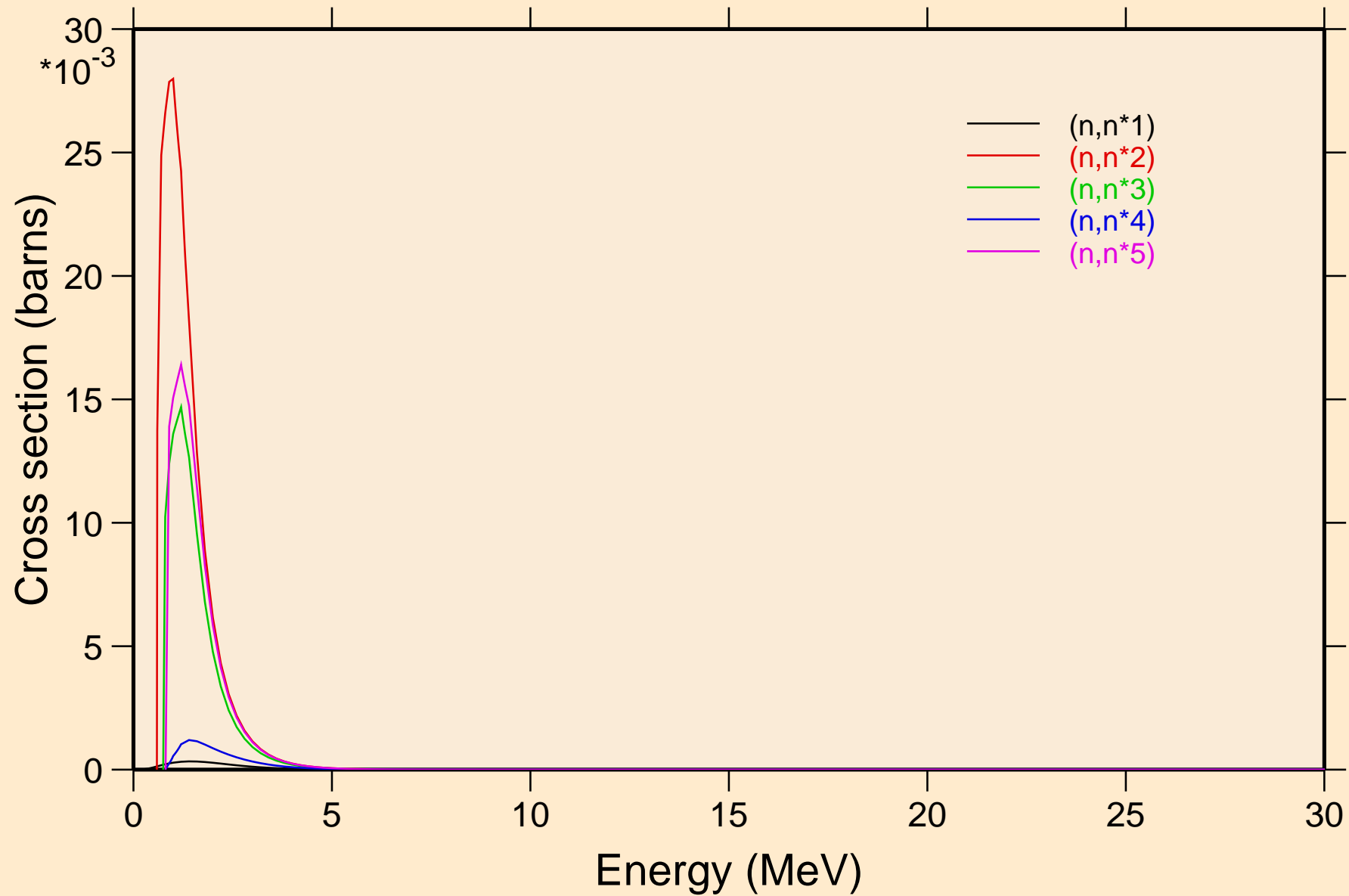

TA161M NEUTRON ACER TENDL-2021 LIBRARY; T=293.6K
Inelastic levels

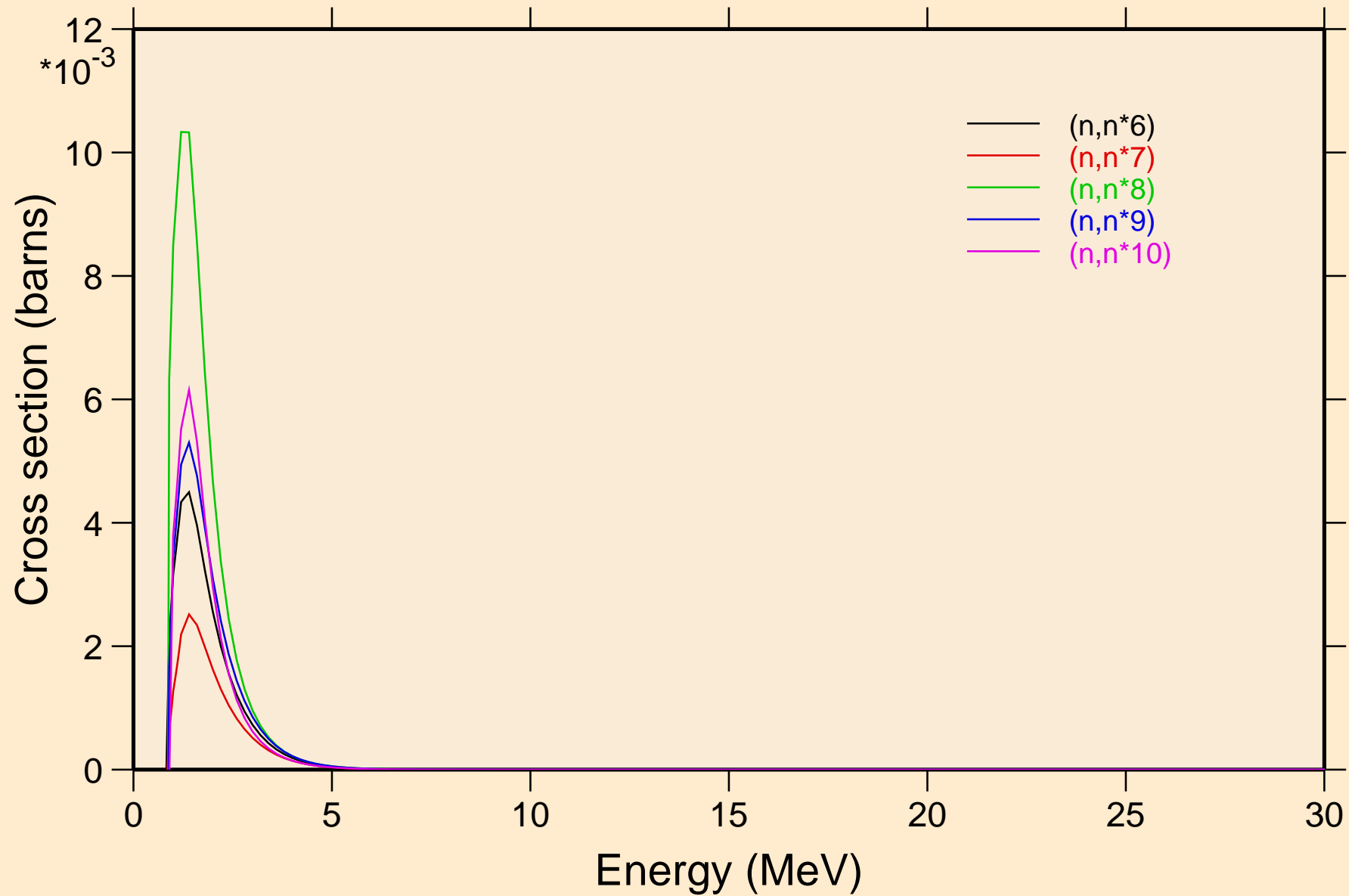

TA161M NEUTRON ACER TENDL-2021 LIBRARY; T=293.6K
Inelastic levels

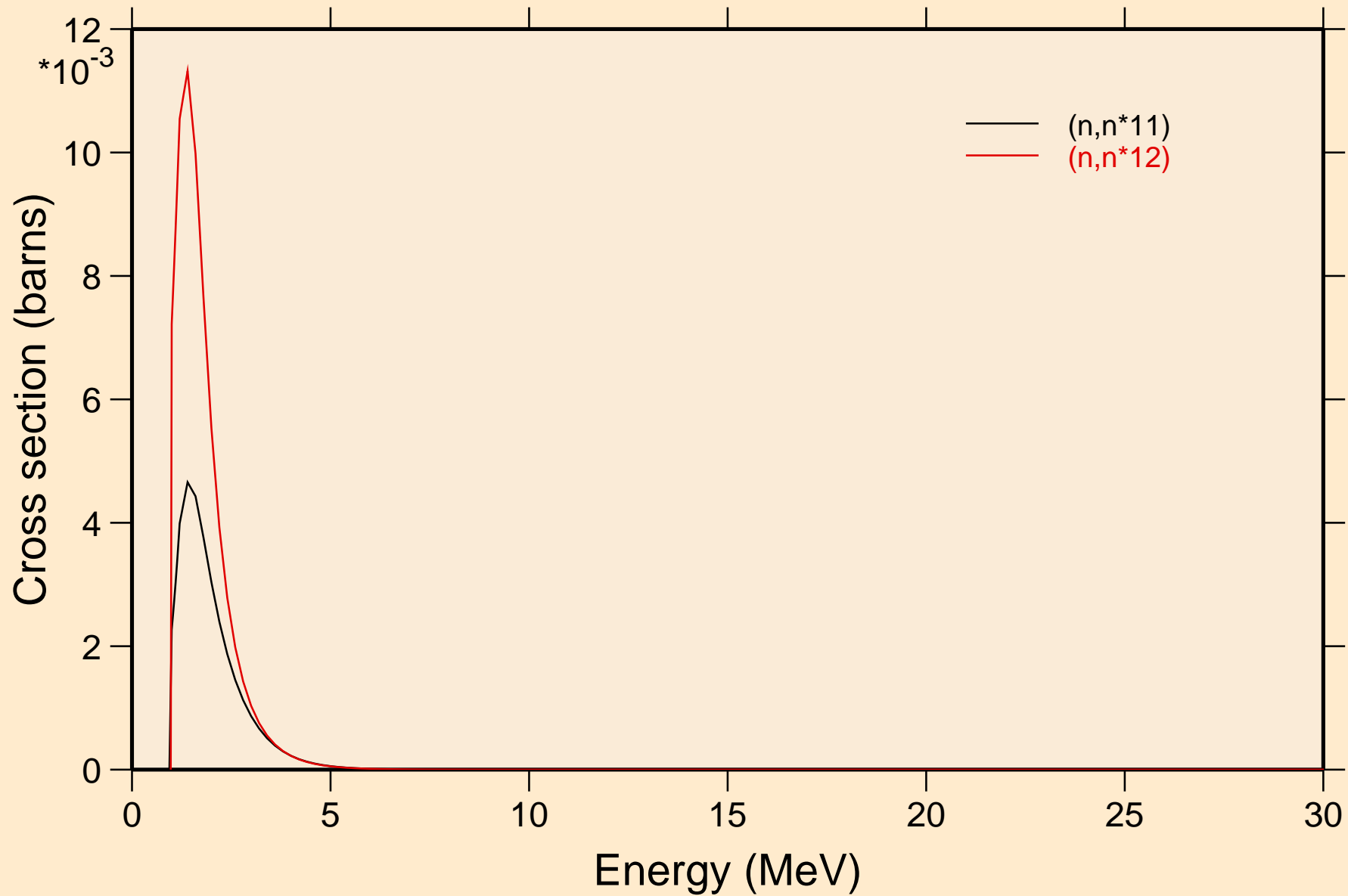

TA161M NEUTRON ACER TENDL-2021 LIBRARY; T=293.6K
Threshold reactions

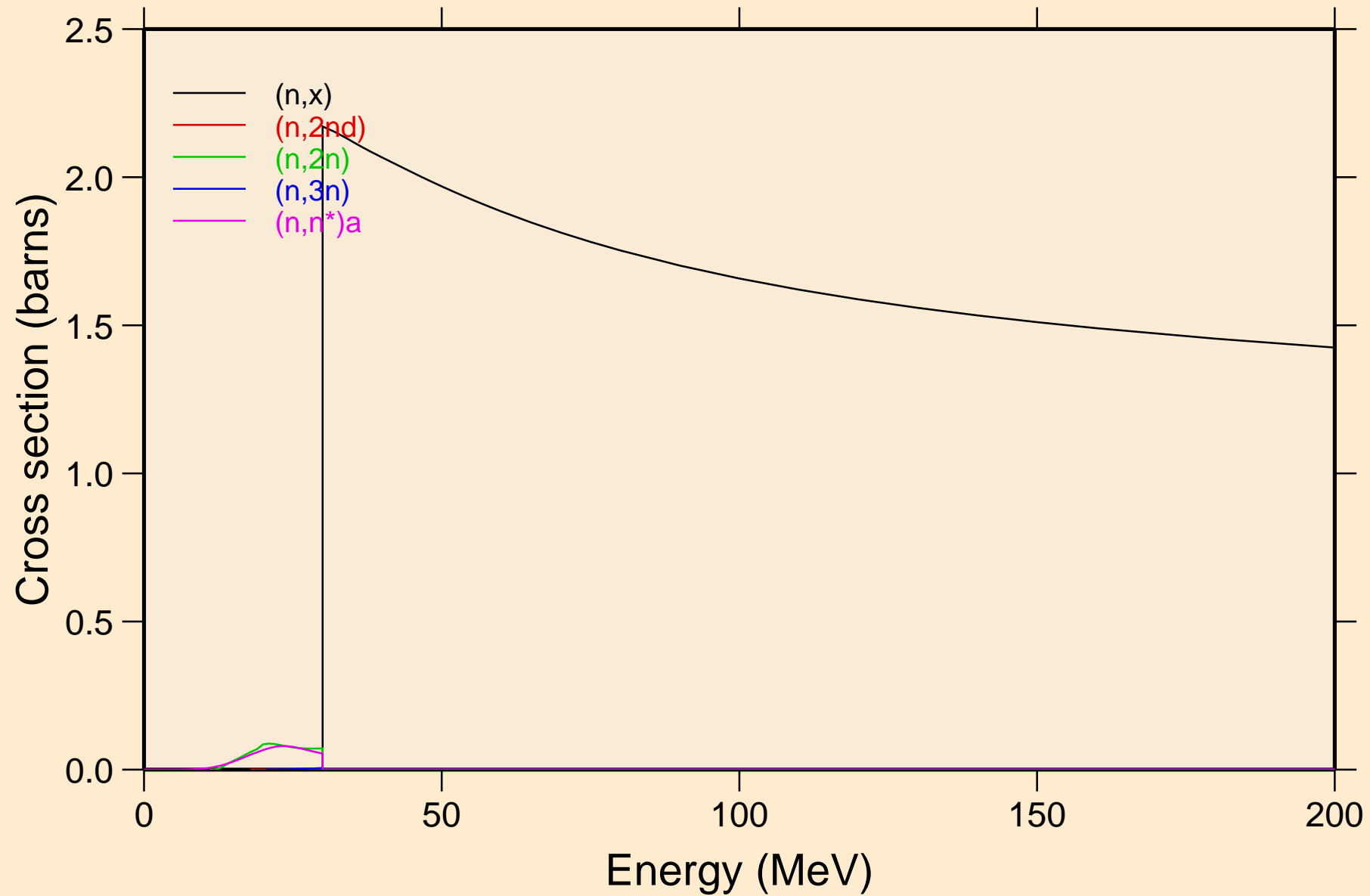

TA161M NEUTRON ACER TENDL-2021 LIBRARY; T=293.6K
Threshold reactions

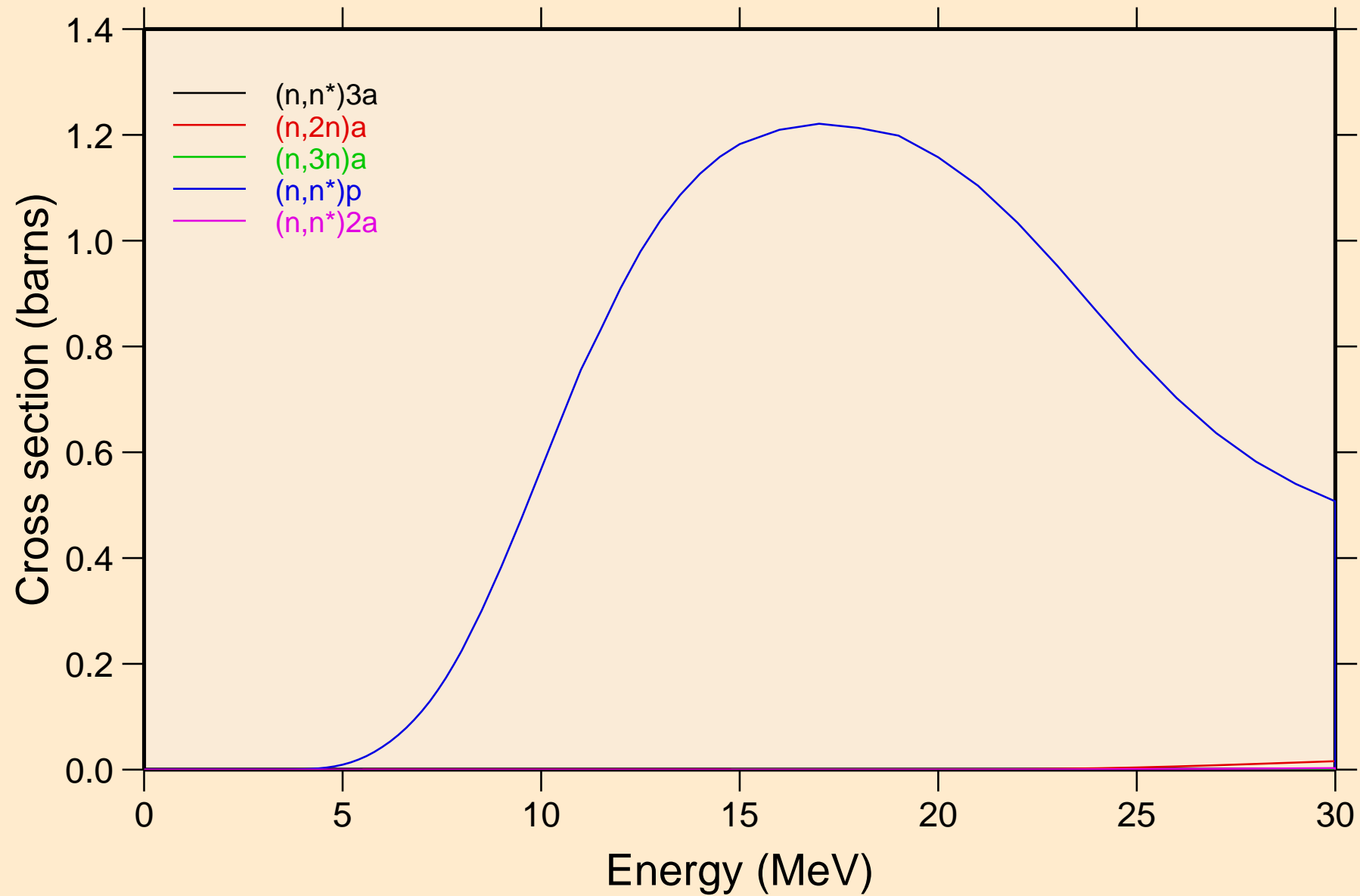

TA161M NEUTRON ACER TENDL-2021 LIBRARY; T=293.6K
Threshold reactions

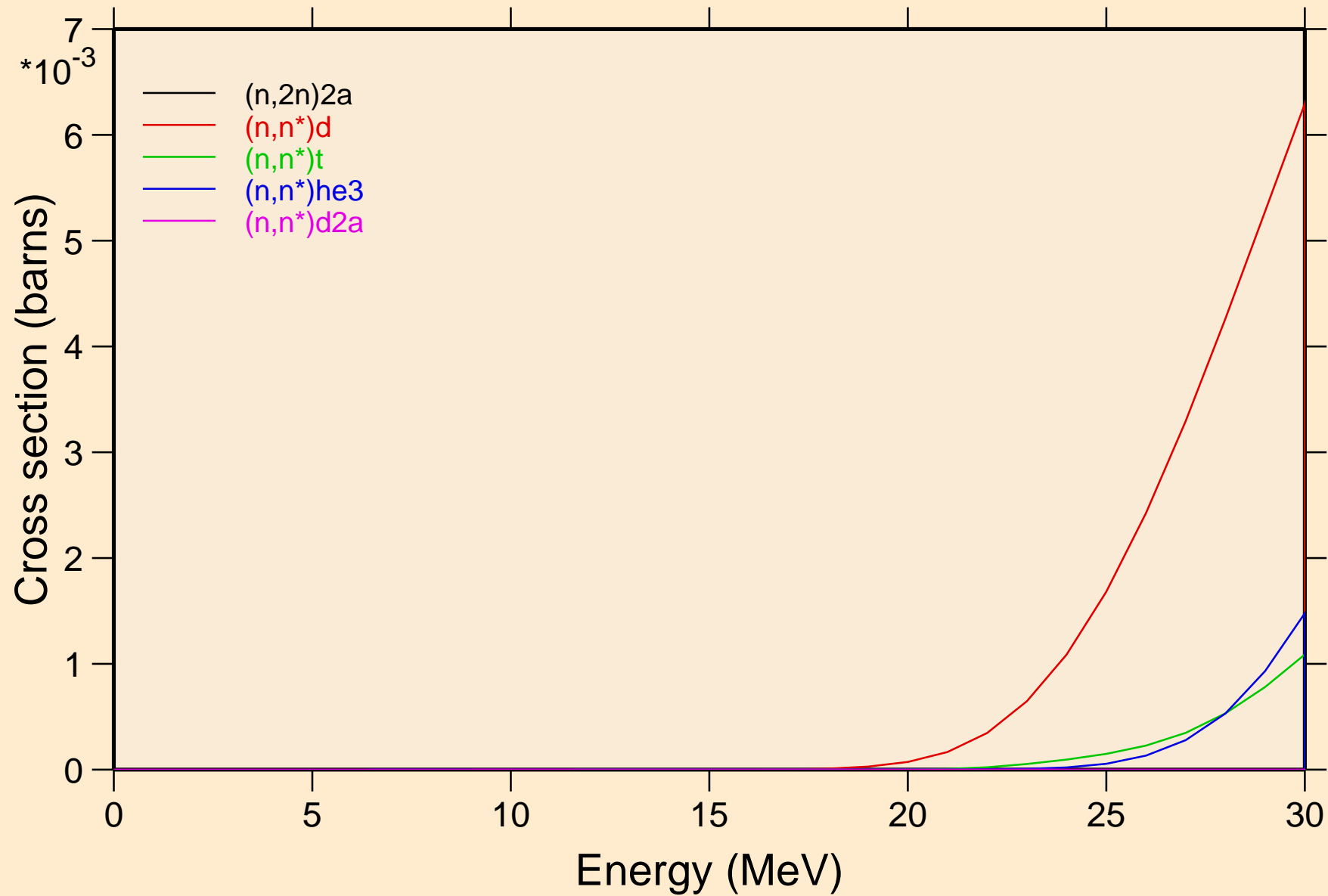

TA161M NEUTRON ACER TENDL-2021 LIBRARY; T=293.6K
Threshold reactions

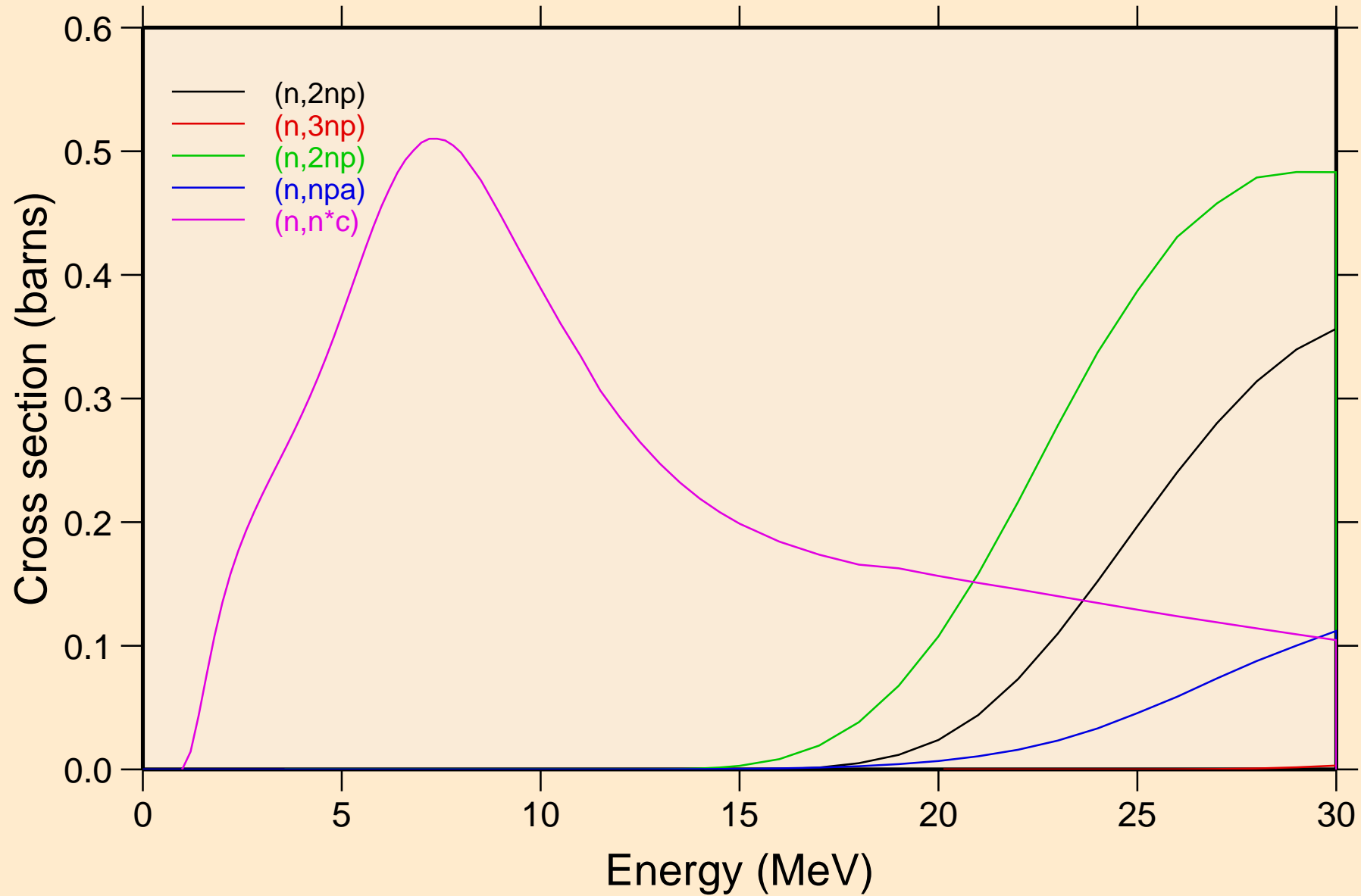

TA161M NEUTRON ACER TENDL-2021 LIBRARY; T=293.6K
Threshold reactions

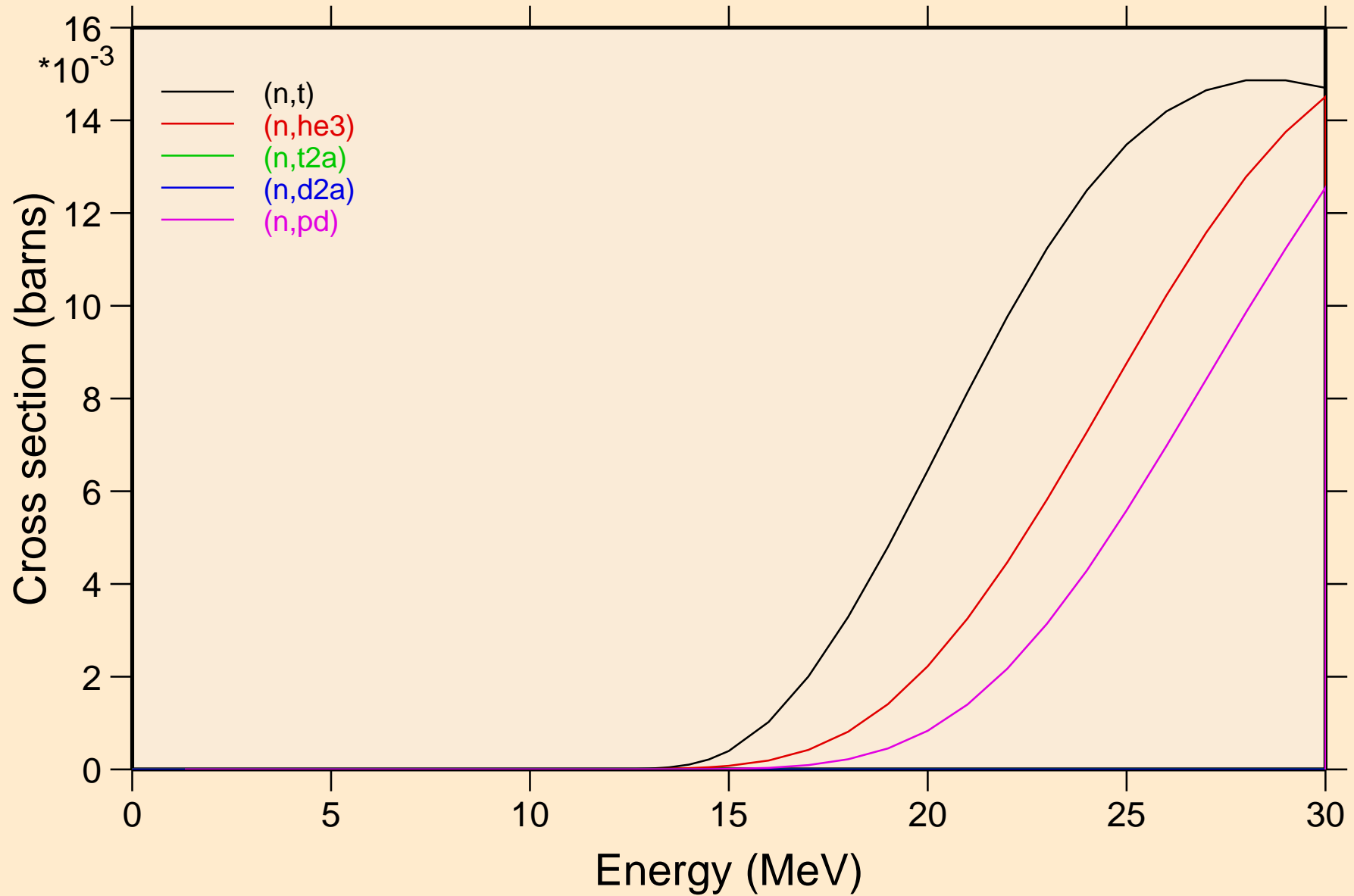

TA161M NEUTRON ACER TENDL-2021 LIBRARY; T=293.6K
Threshold reactions

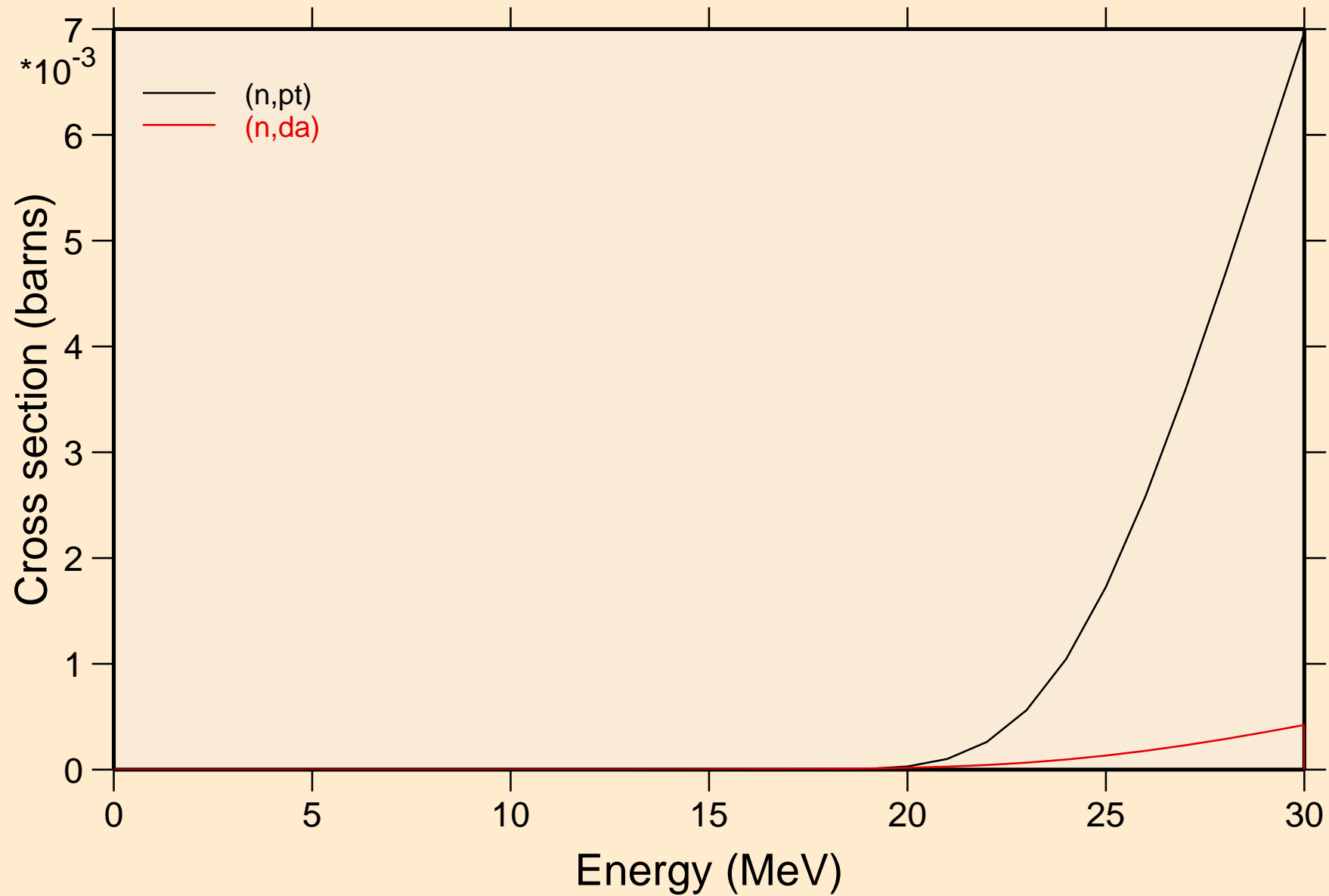

TA161M NEUTRON ACER TENDL-2021 LIBRARY; T=293.6K
Threshold reactions

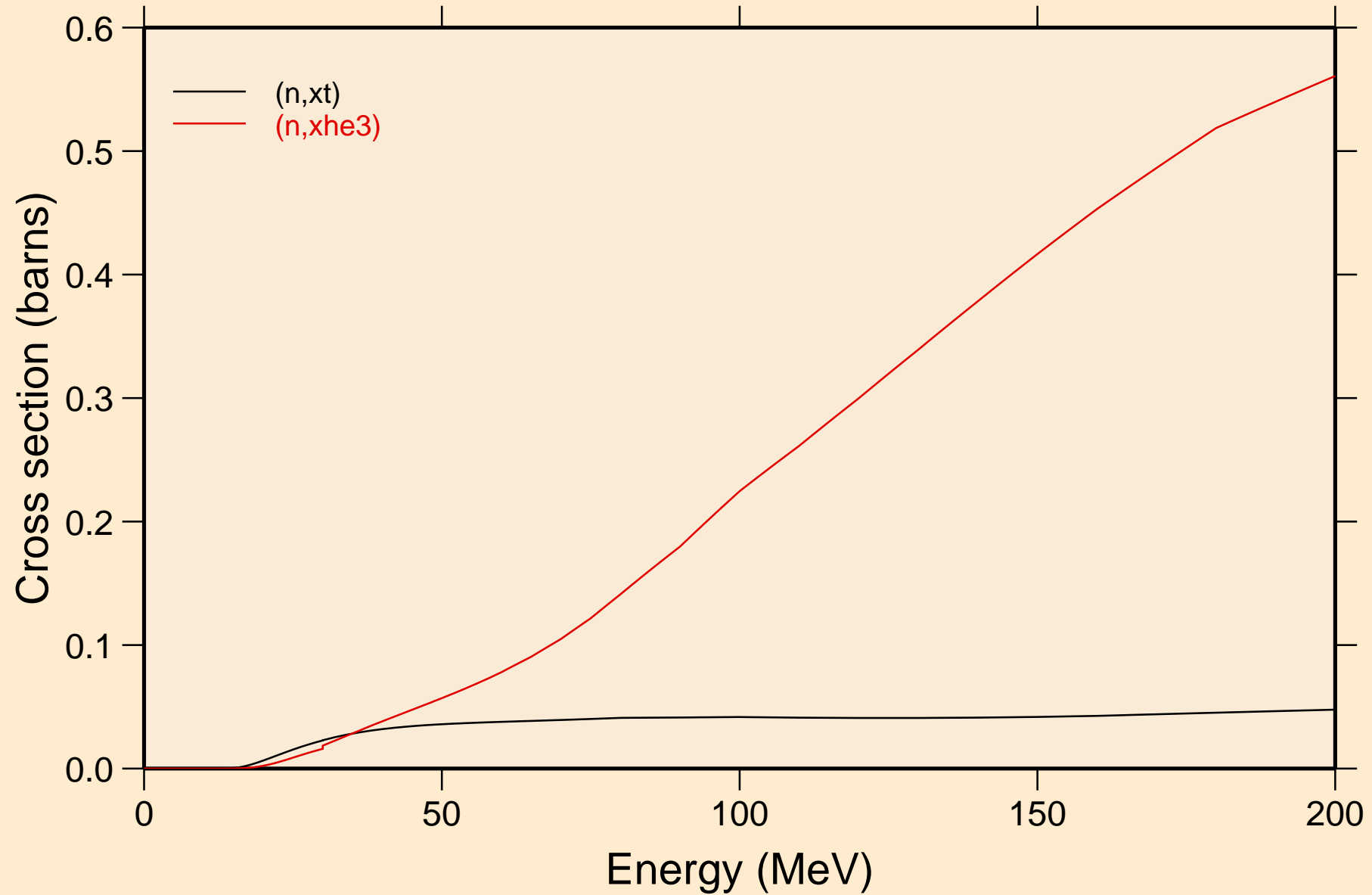

TA161M NEUTRON ACER TENDL-2021 LIBRARY; T=293.6K
angular distribution for elastic

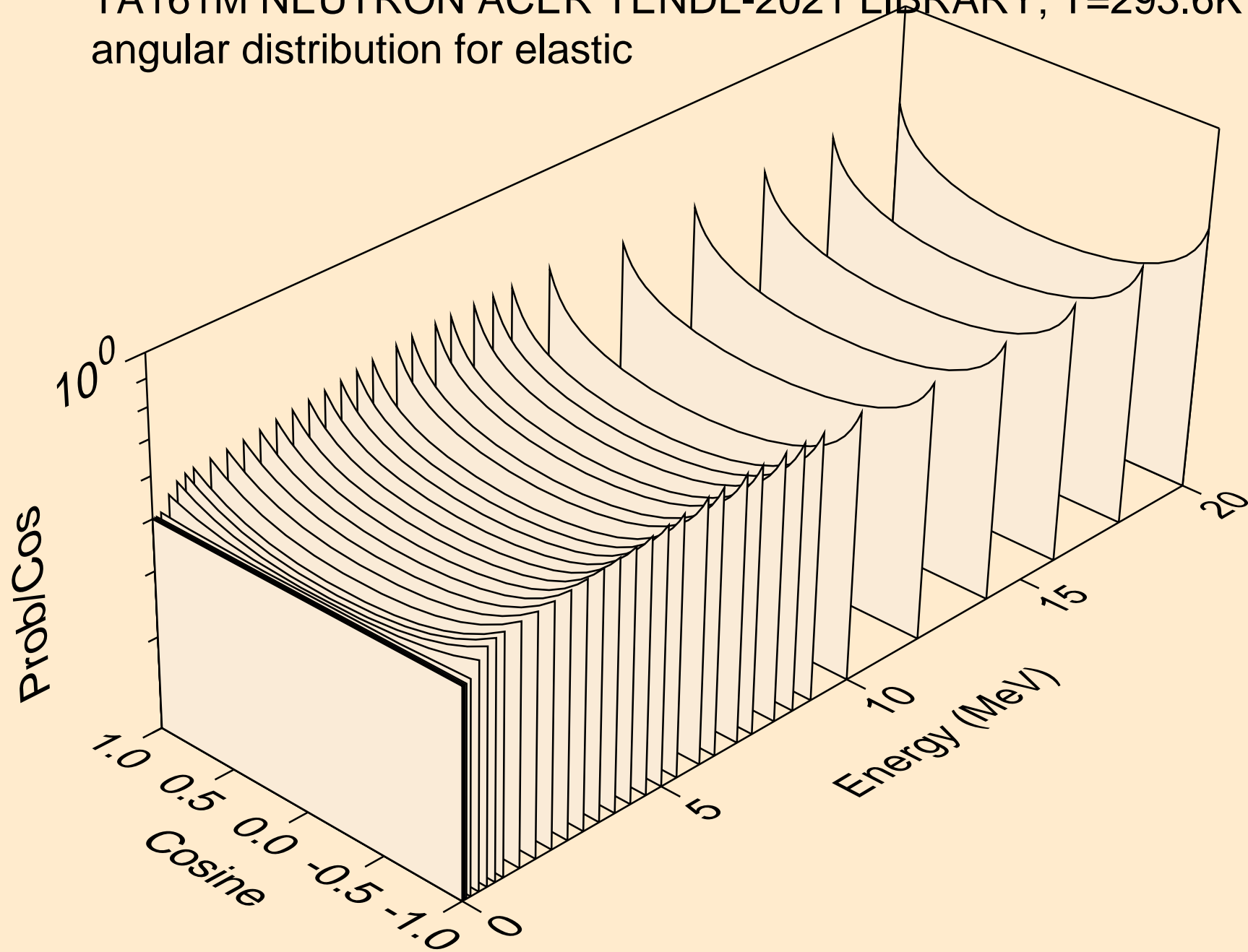

TA161M NEUTRON ACER TENDL-2021 LIBRARY; T=293.6K
angular distribution for elastic

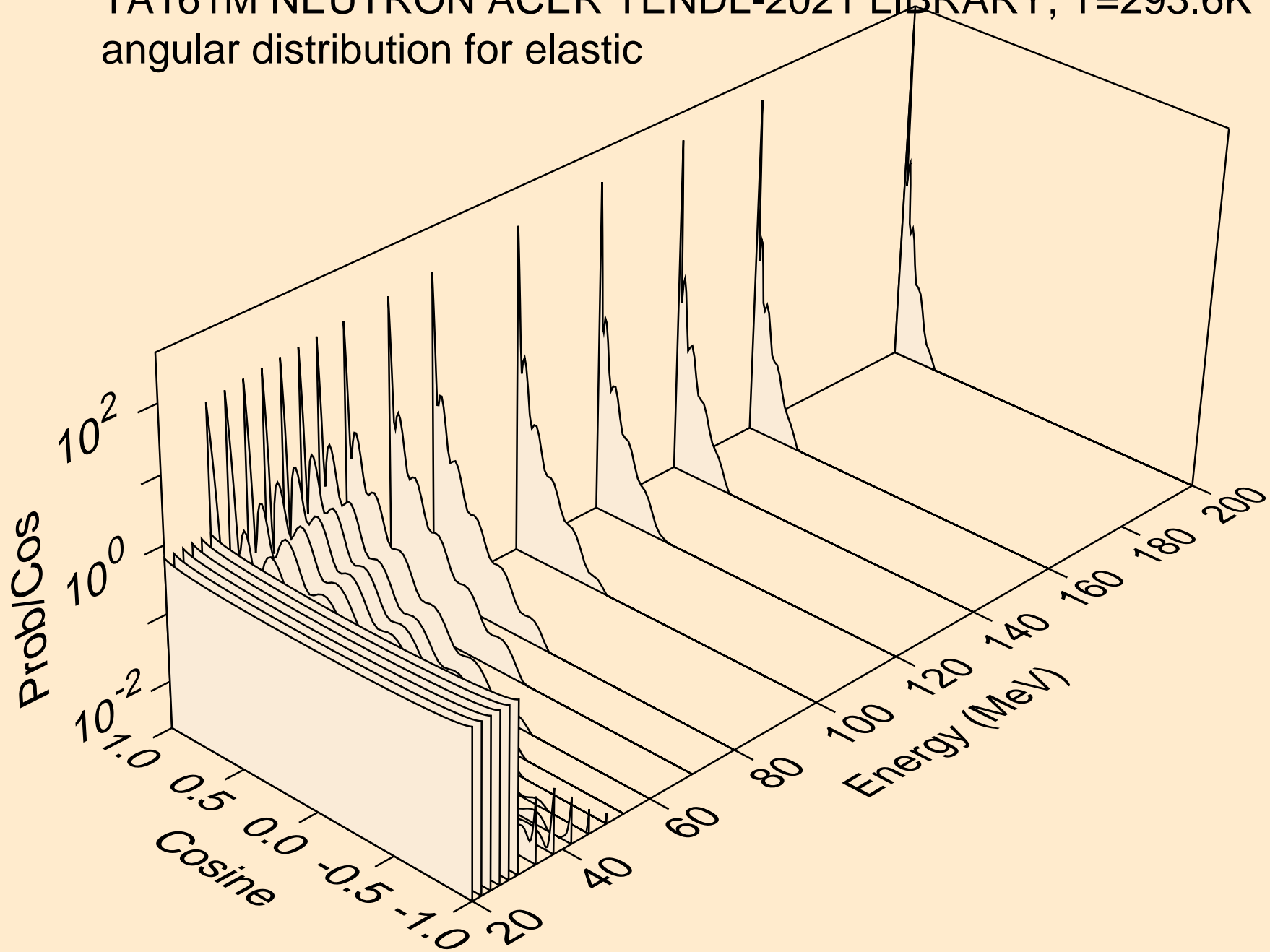

TA161M NEUTRON ACER TENDL-2021 LIBRARY; T=293.6K
angular distribution for (n,n*1)

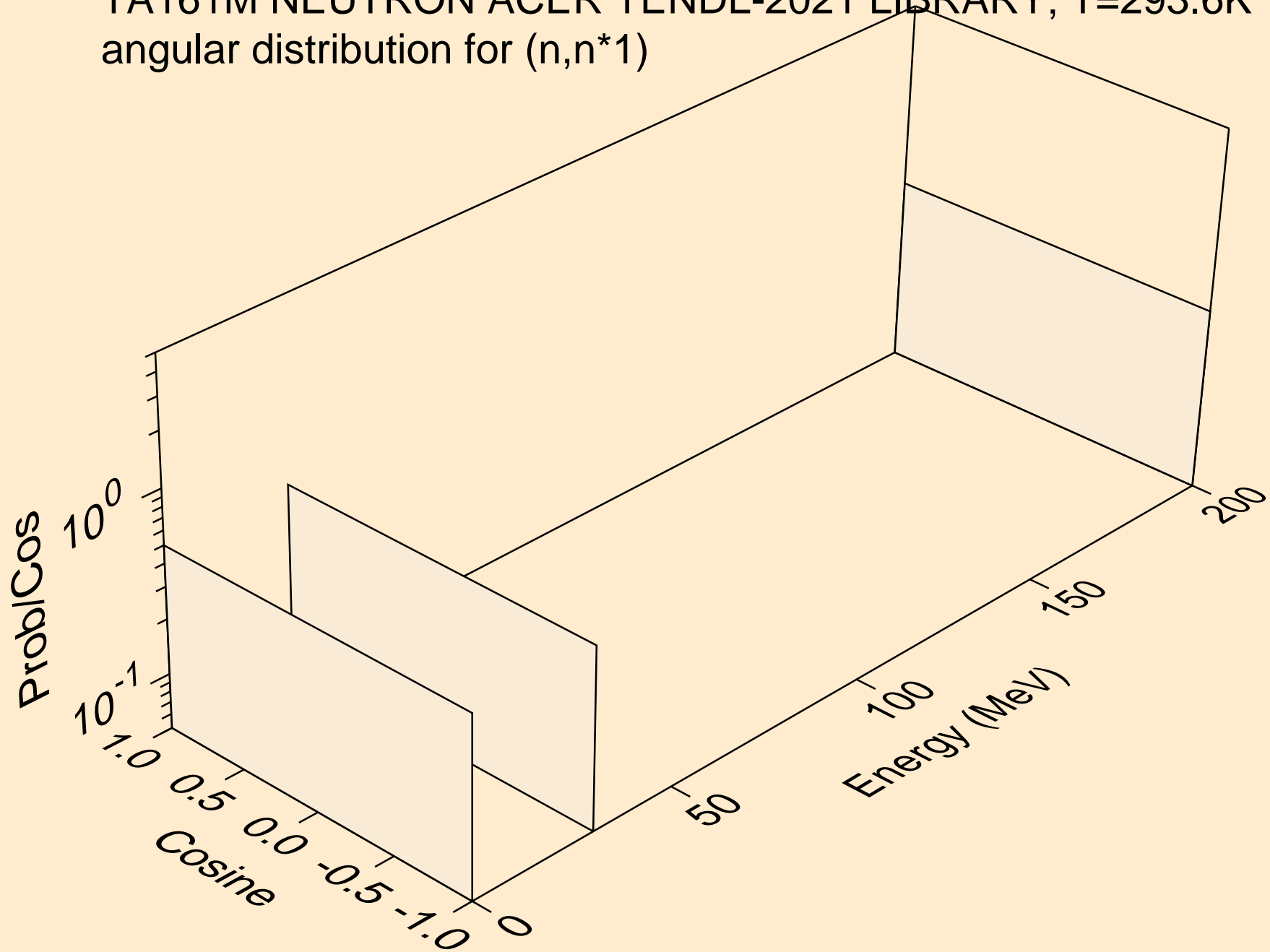

TA161M NEUTRON ACER TENDL-2021 LIBRARY; T=293.6K
angular distribution for (n,n*2)

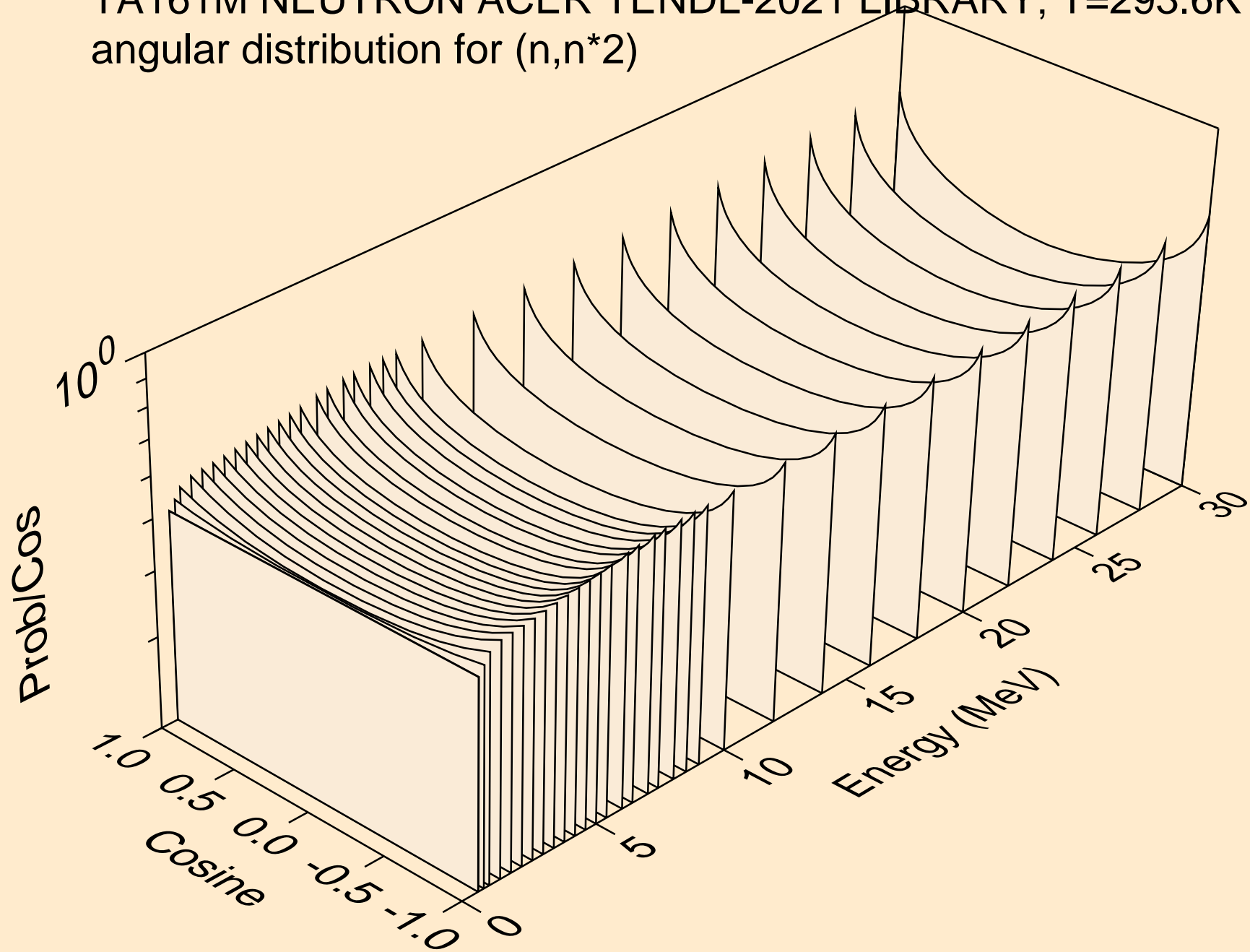

TA161M NEUTRON ACER TENDL-2021 LIBRARY; T=293.6K
angular distribution for (n,n*3)

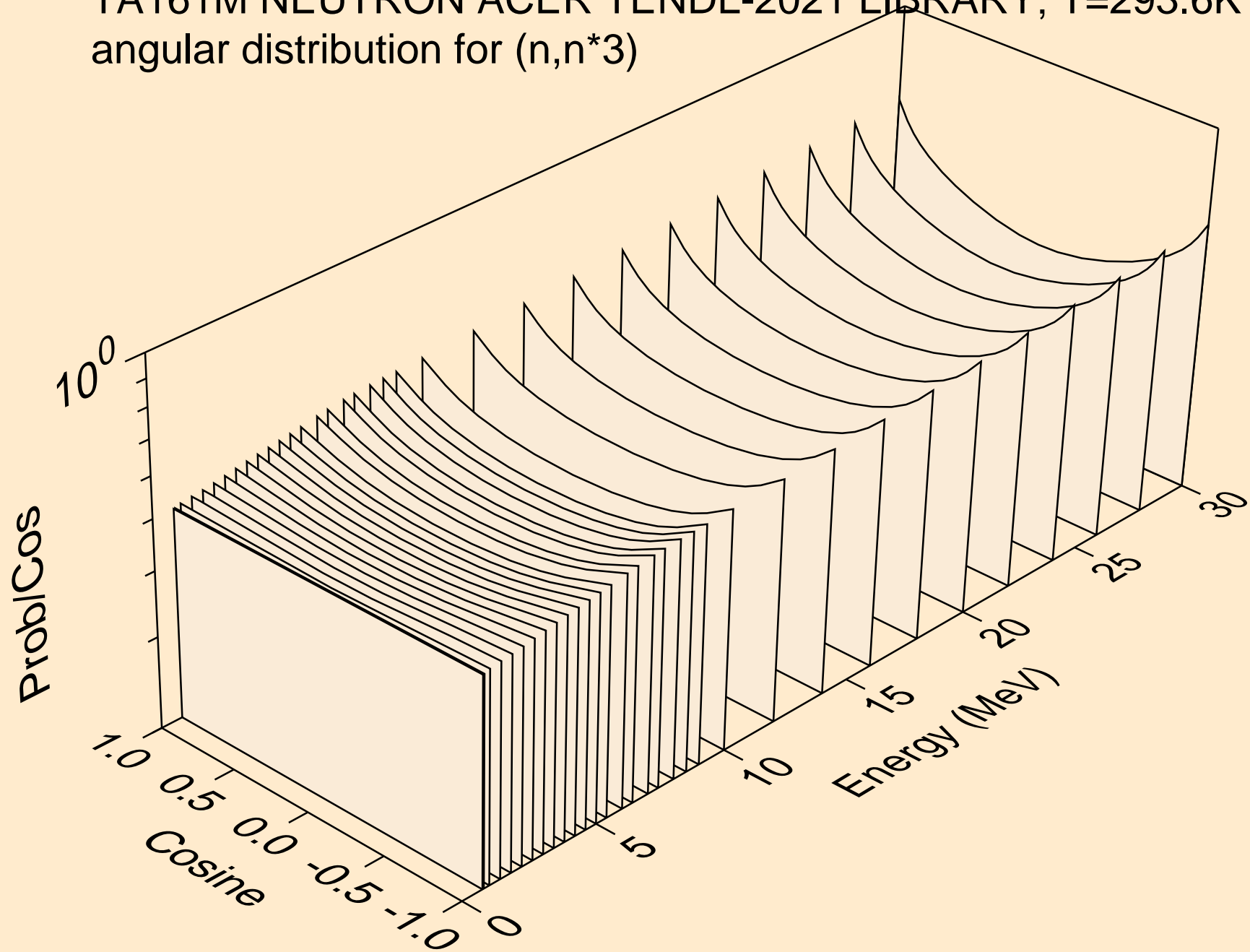

TA161M NEUTRON ACER TENDL-2021 LIBRARY; T=293.6K
angular distribution for (n,n*4)

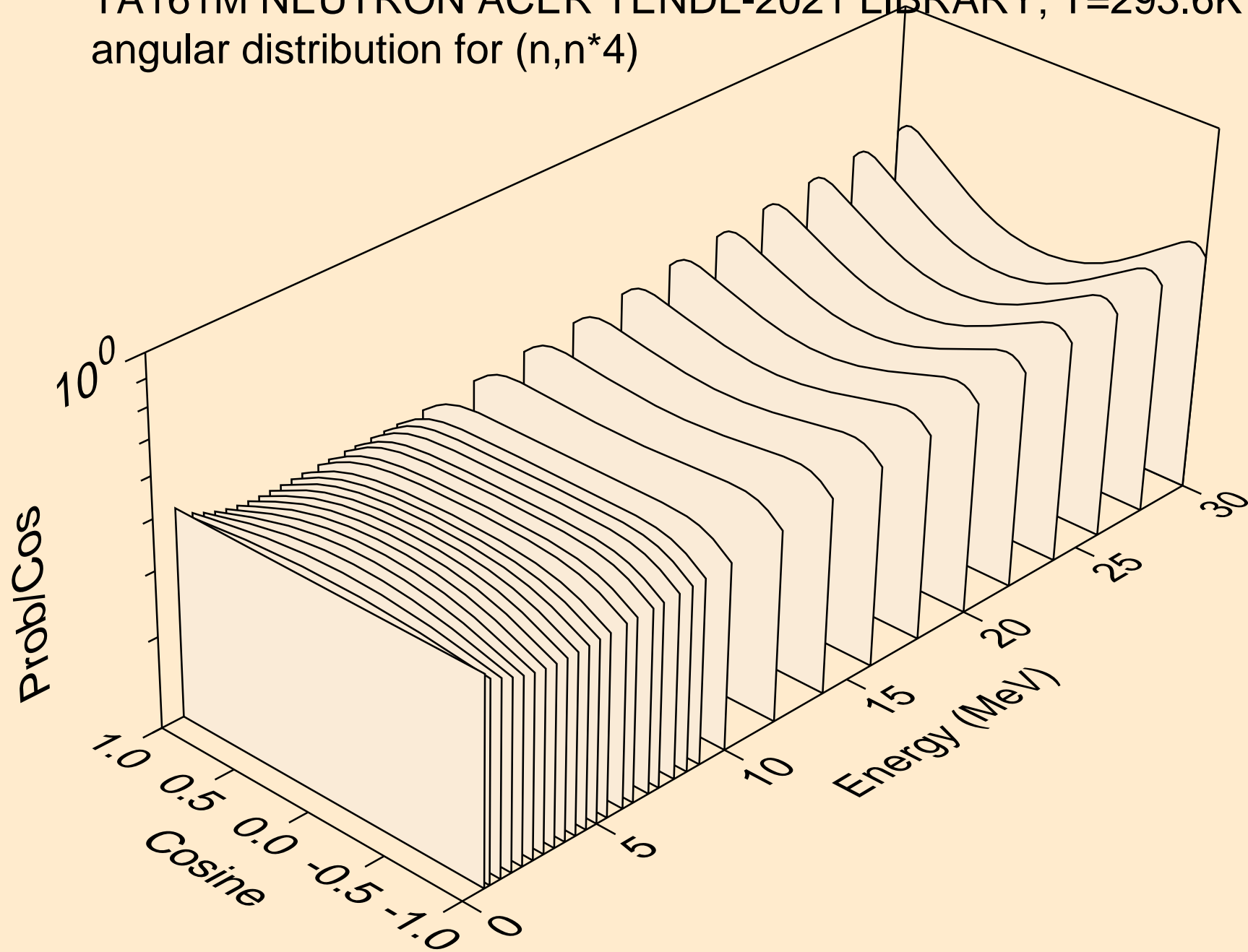

TA161M NEUTRON ACER TENDL-2021 LIBRARY; T=293.6K
angular distribution for (n,n*5)

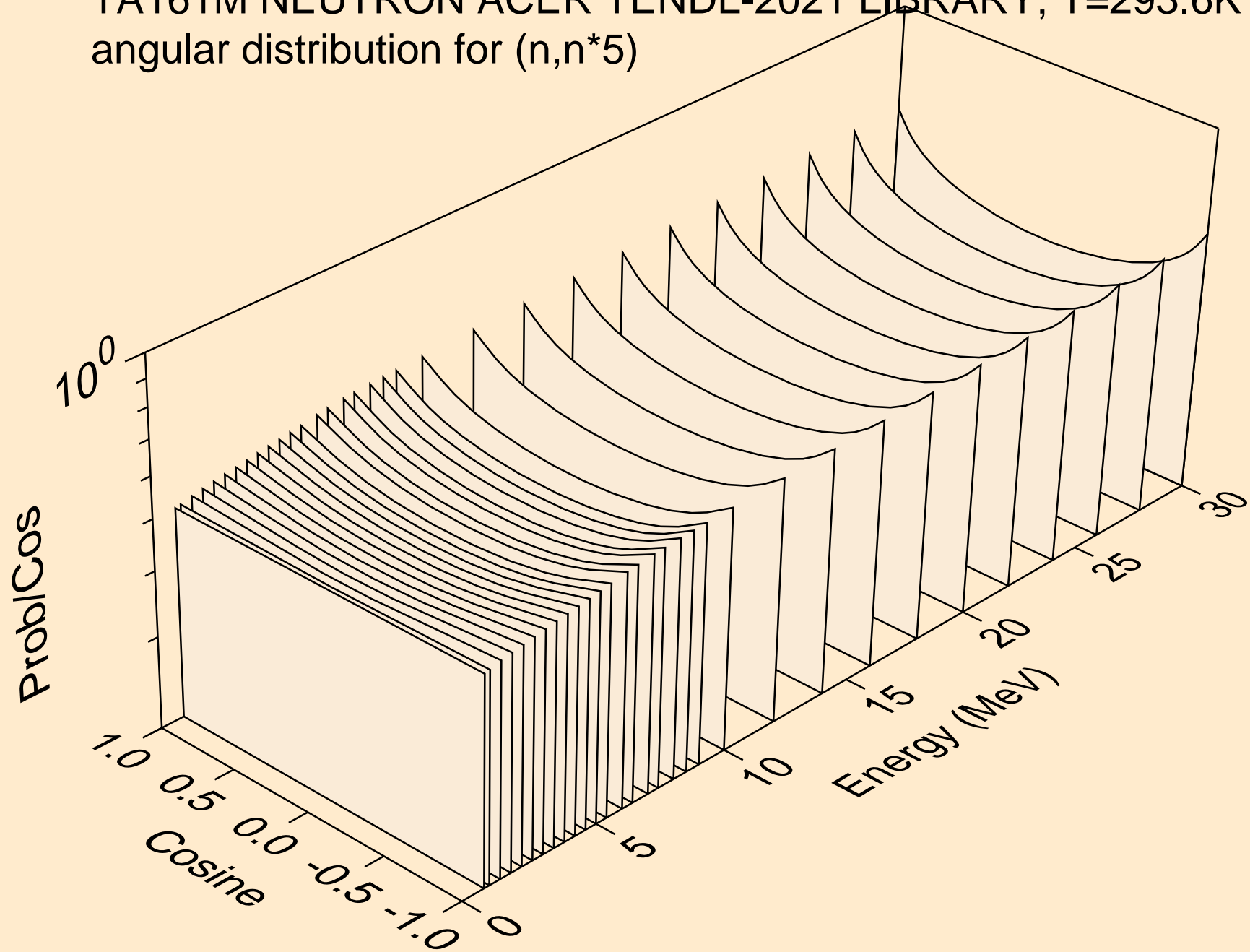

TA161M NEUTRON ACER TENDL-2021 LIBRARY; T=293.6K
angular distribution for (n,n*6)

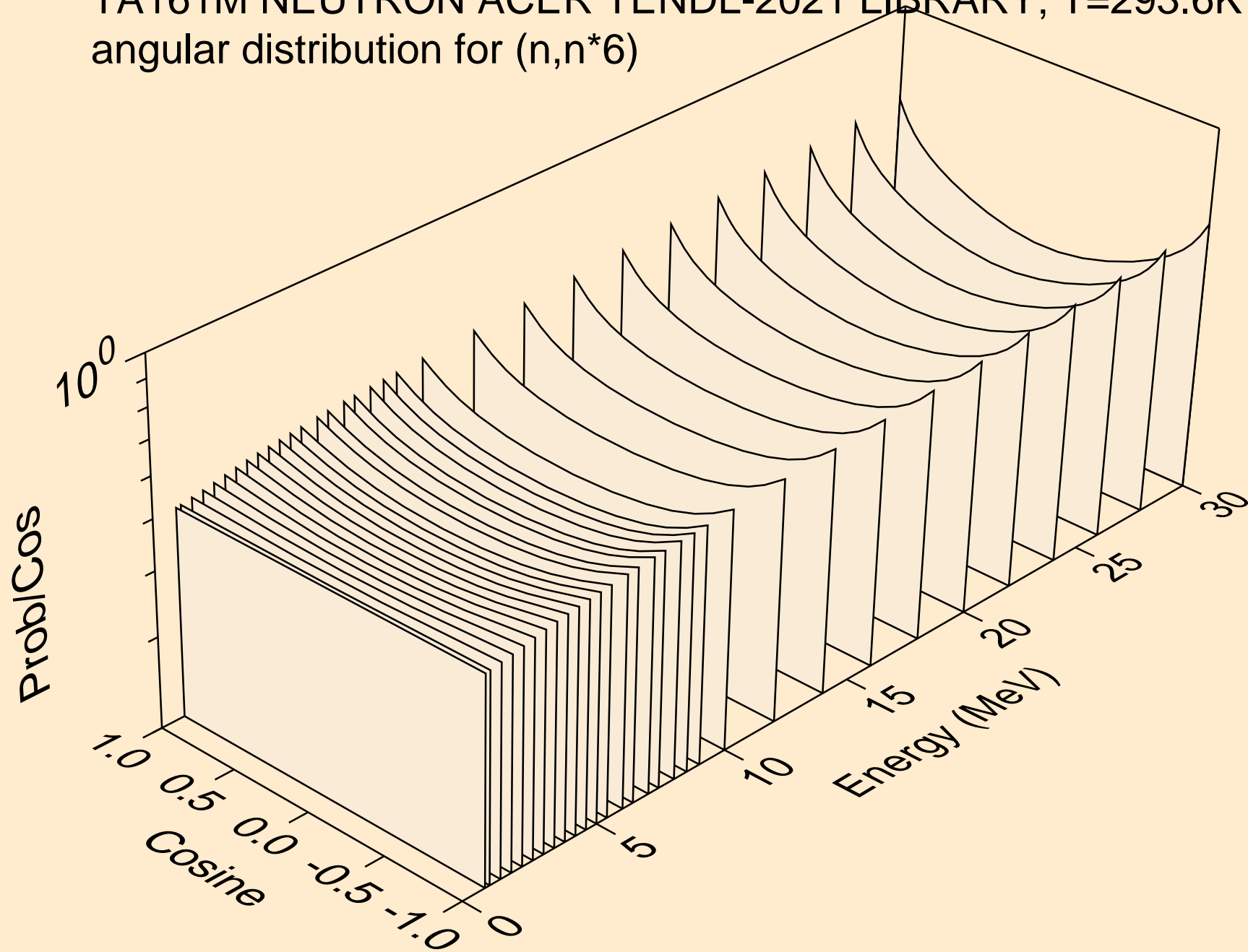

TA161M NEUTRON ACER TENDL-2021 LIBRARY; T=293.6K
angular distribution for (n,n*7)

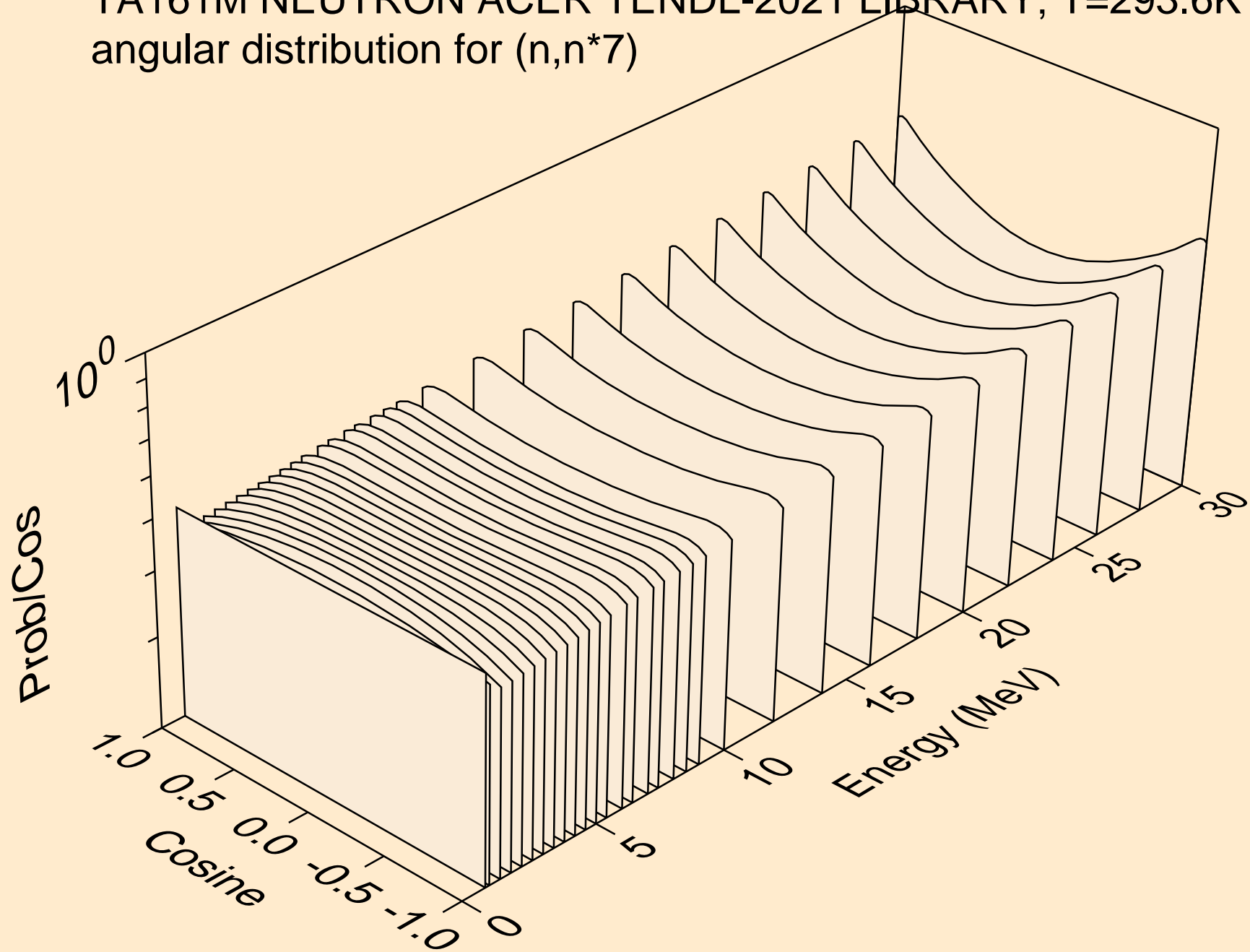

TA161M NEUTRON ACER TENDL-2021 LIBRARY; T=293.6K
angular distribution for (n,n*8)

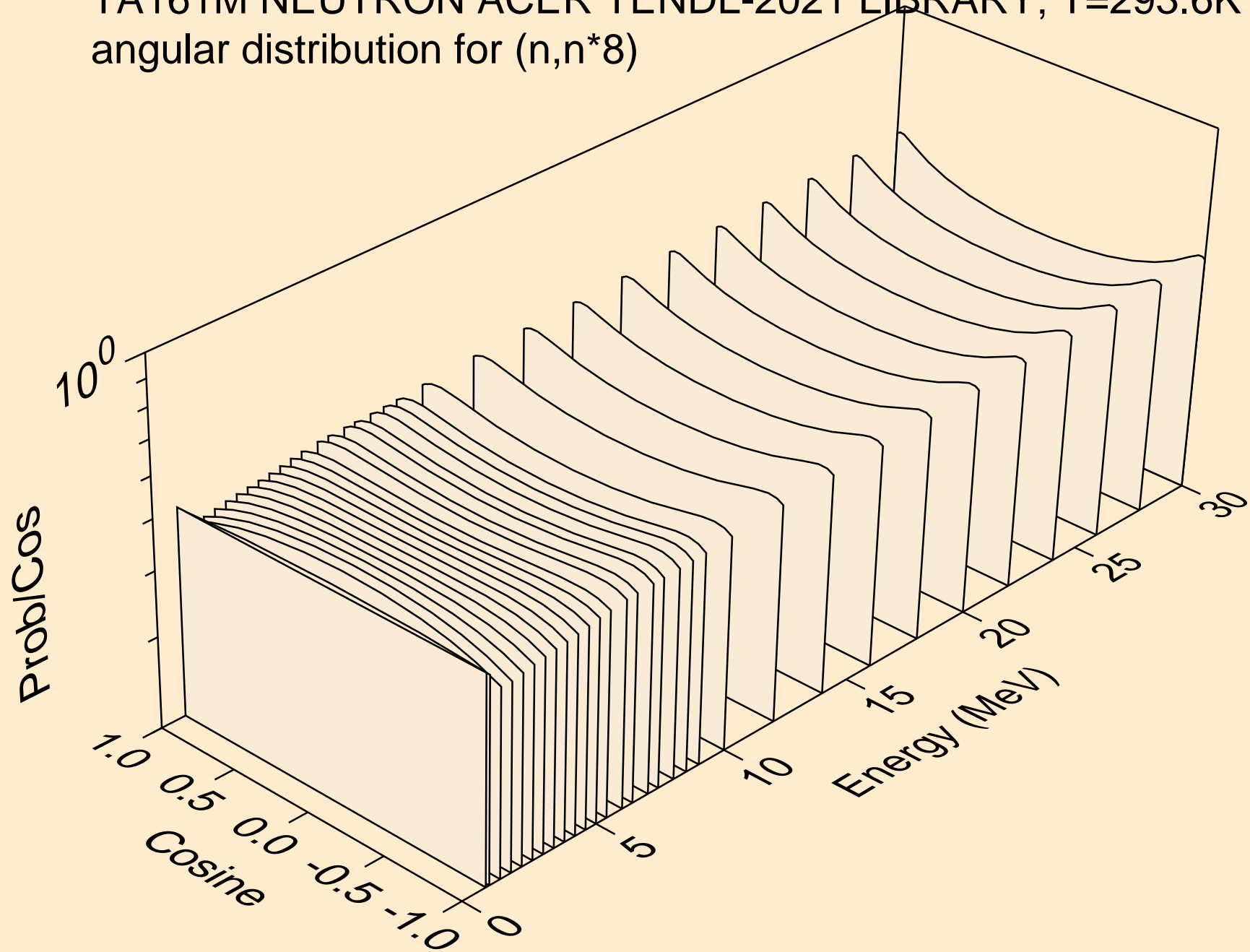

TA161M NEUTRON ACER TENDL-2021 LIBRARY; T=293.6K
angular distribution for (n,n*9)

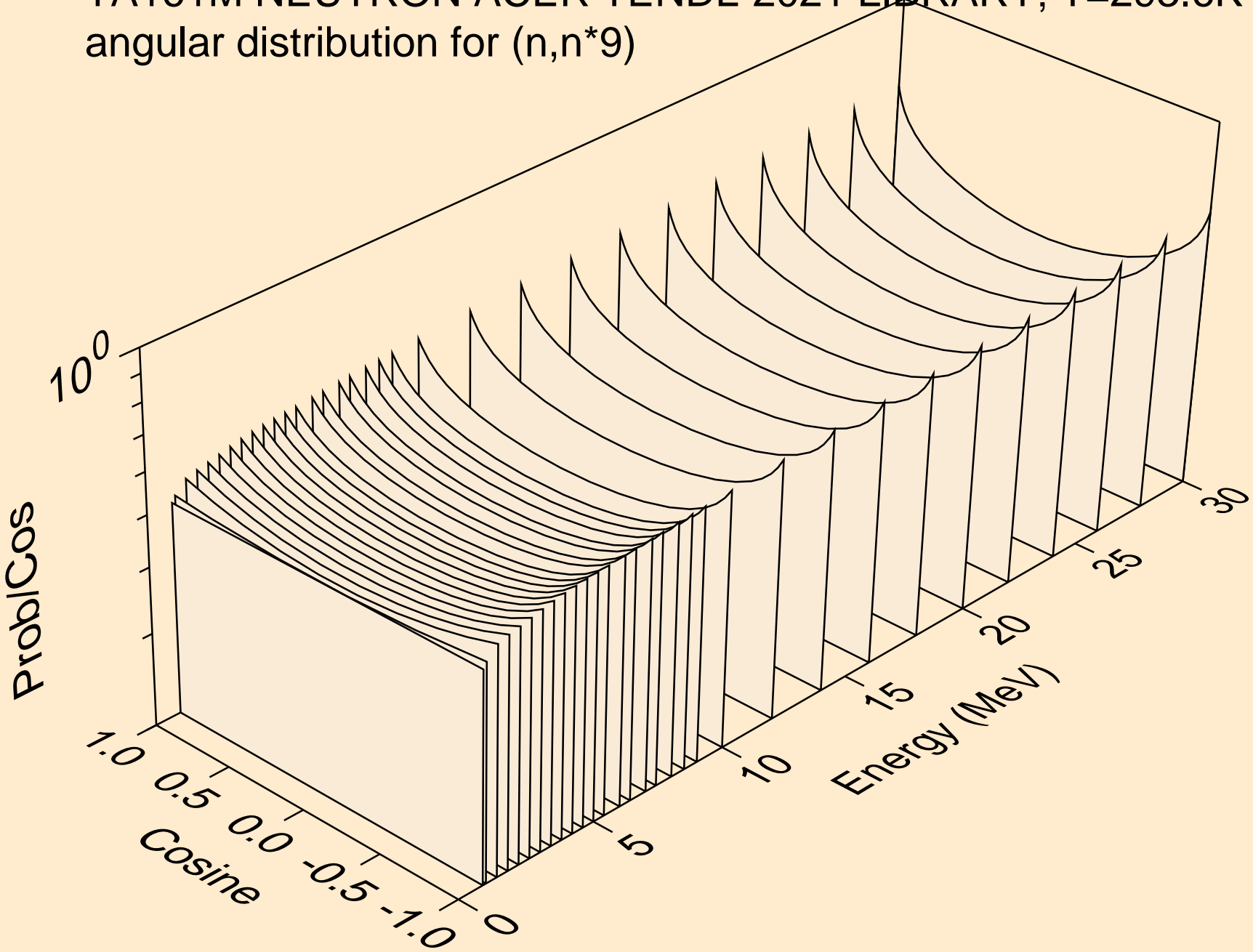

TA161M NEUTRON ACER TENDL-2021 LIBRARY; T=293.6K
angular distribution for (n,n*10)

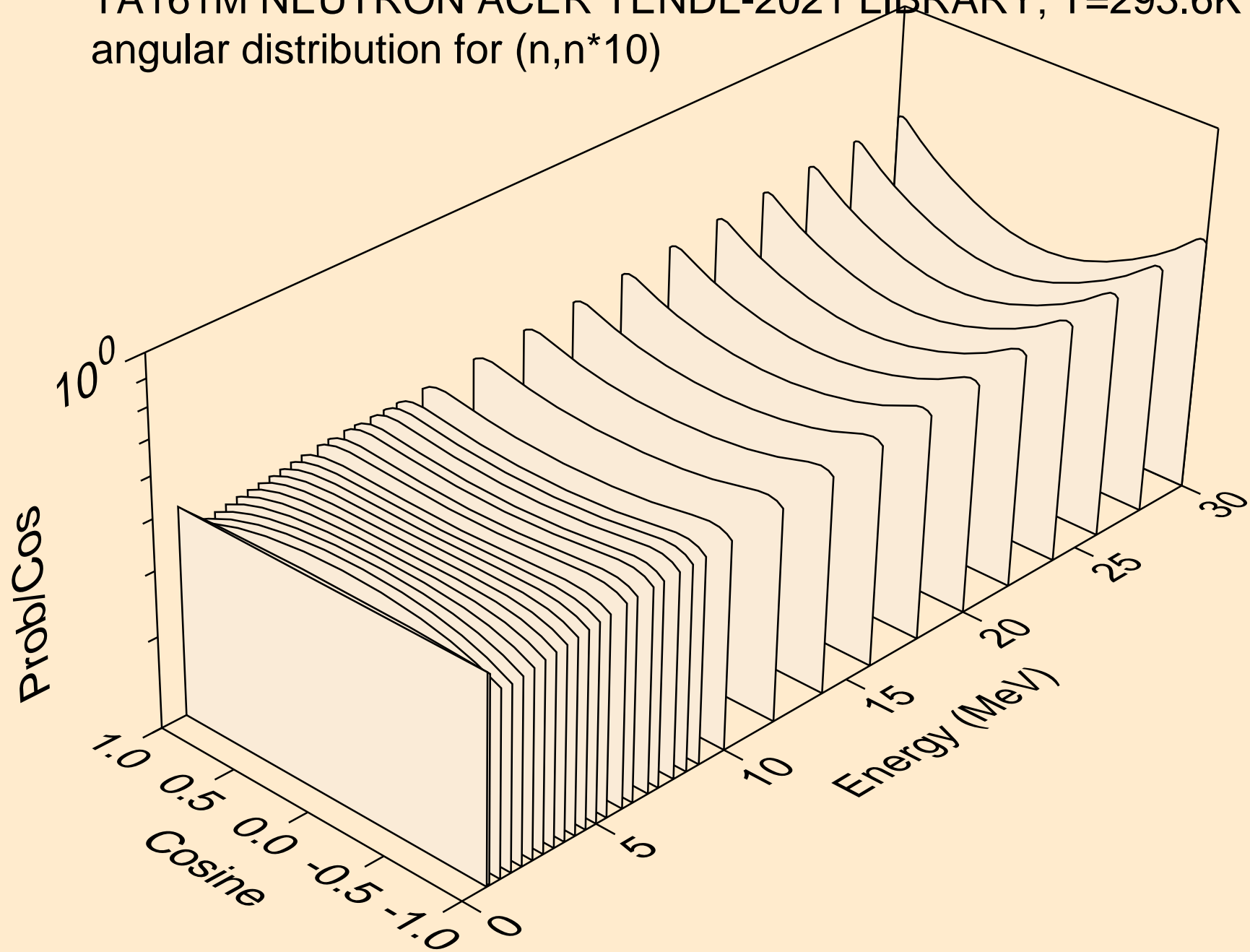

TA161M NEUTRON ACER TENDL-2021 LIBRARY; T=293.6K
angular distribution for (n,n*11)

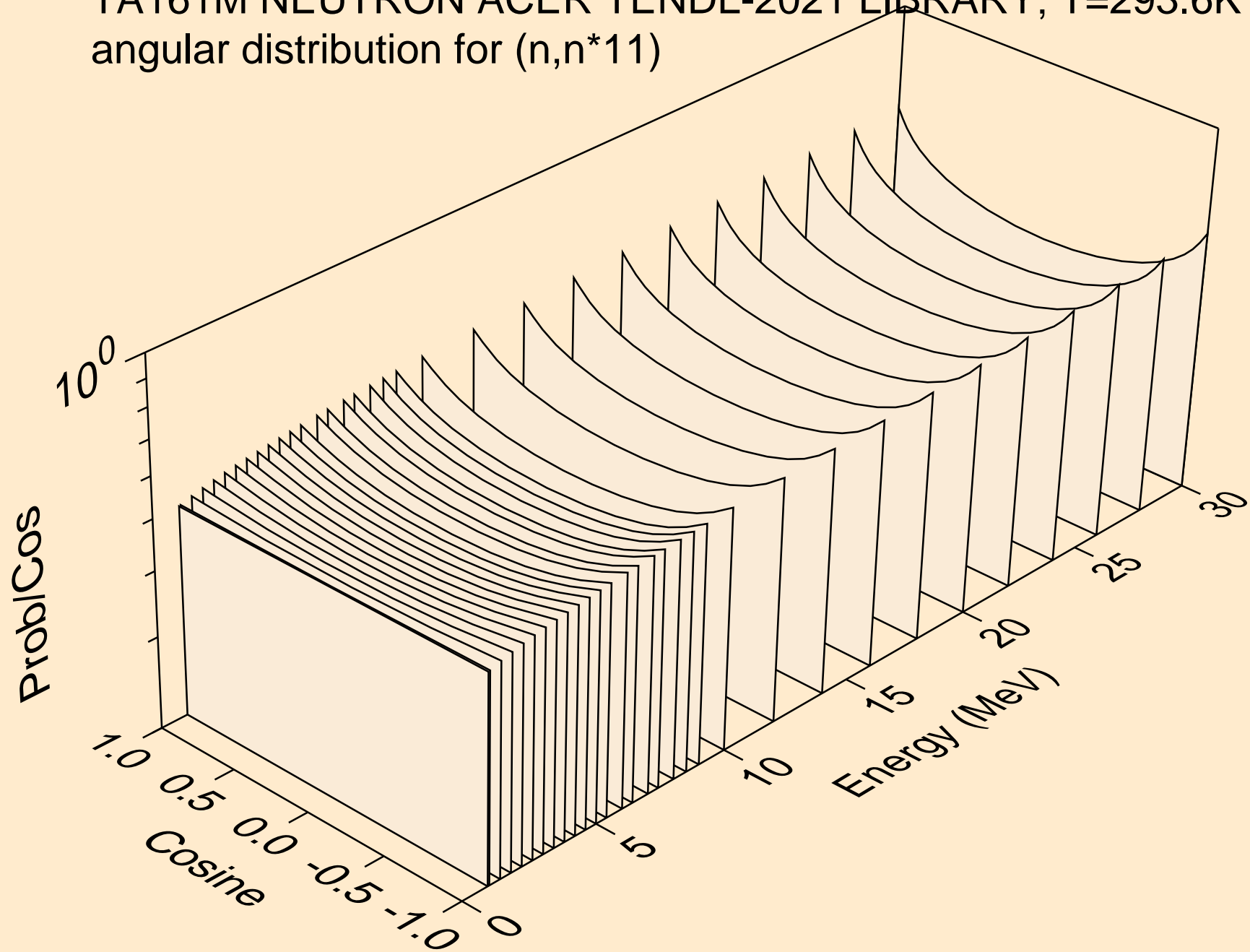

TA161M NEUTRON ACER TENDL-2021 LIBRARY; T=293.6K
angular distribution for (n,n*12)

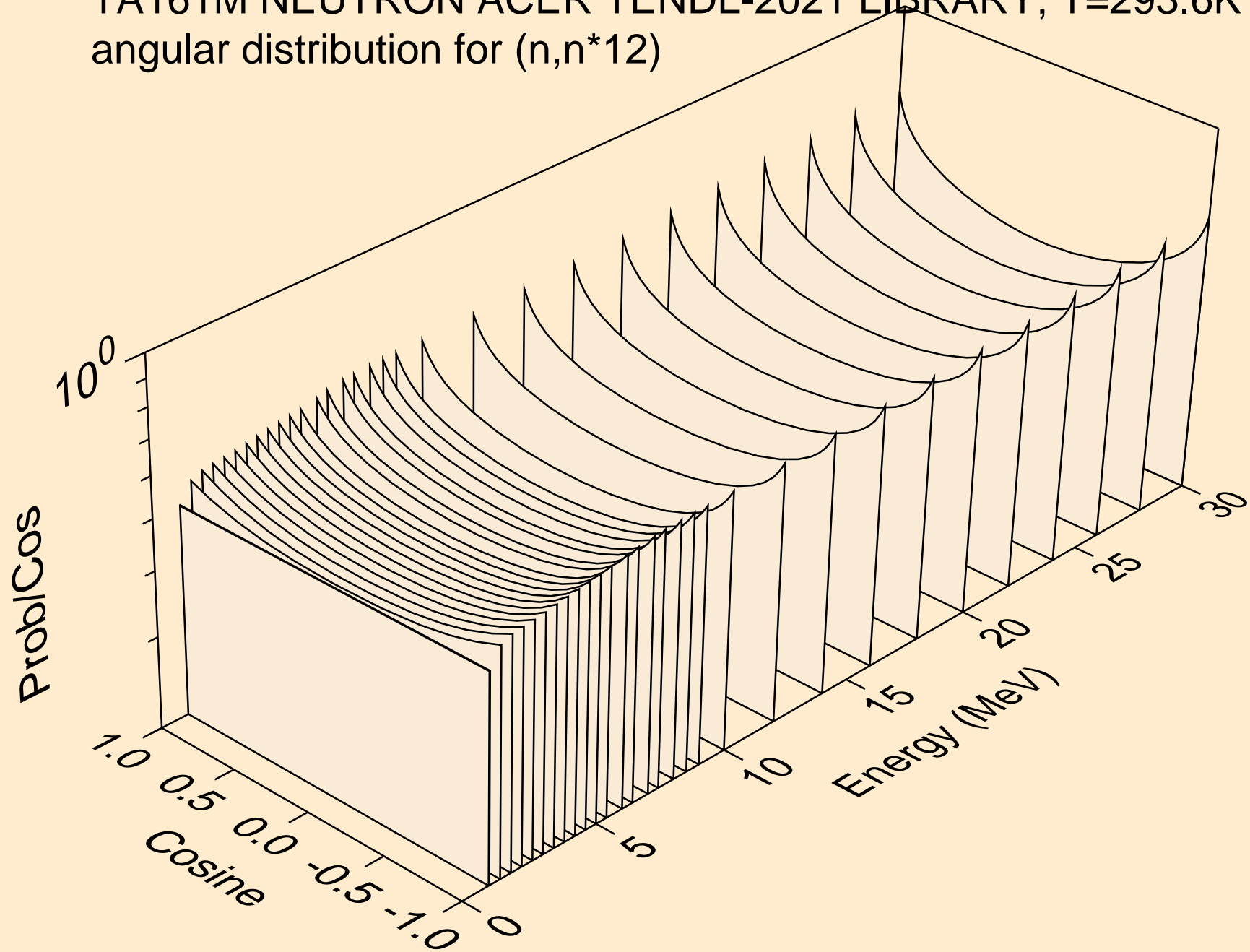

TA161M NEUTRON ACER TENDL-2021 LIBRARY; T=293.6K
Neutron emission for (n,x)

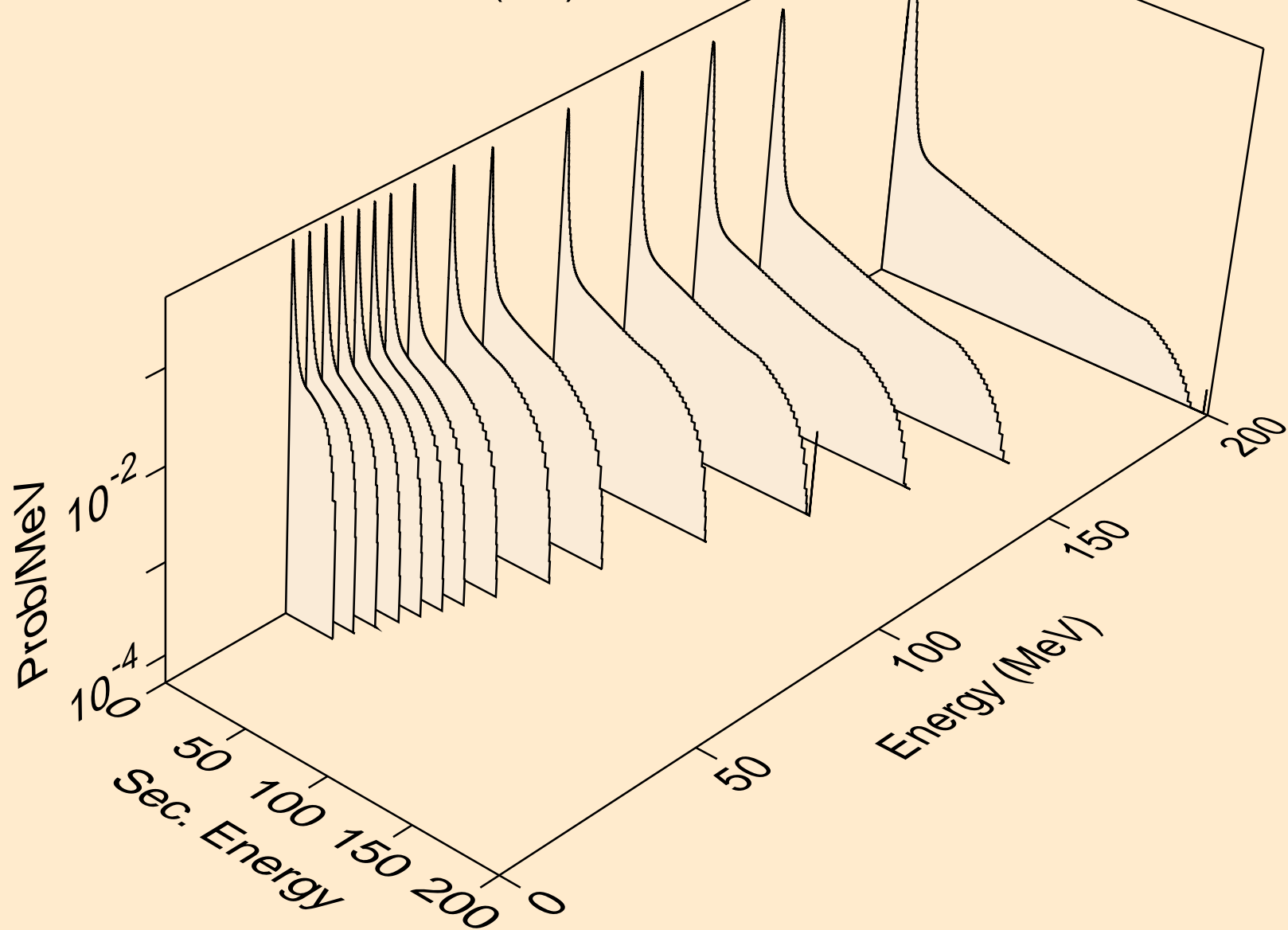

TA161M NEUTRON ACER TENDL-2021 LIBRARY; T=293.6K
Neutron emission for (n,2nd)

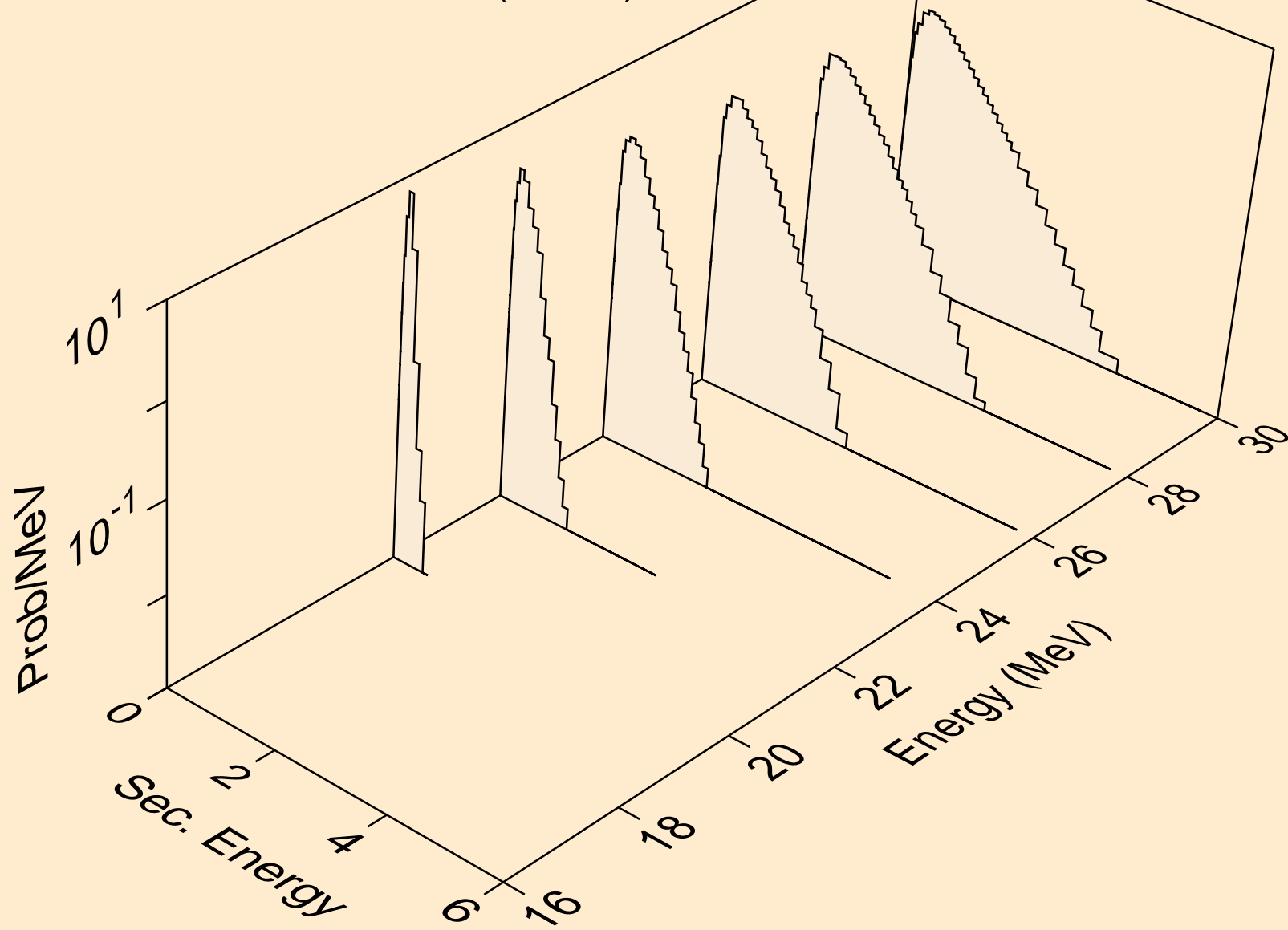

TA161M NEUTRON ACER TENDL-2021 LIBRARY; T=293.6K
Neutron emission for (n,2n)

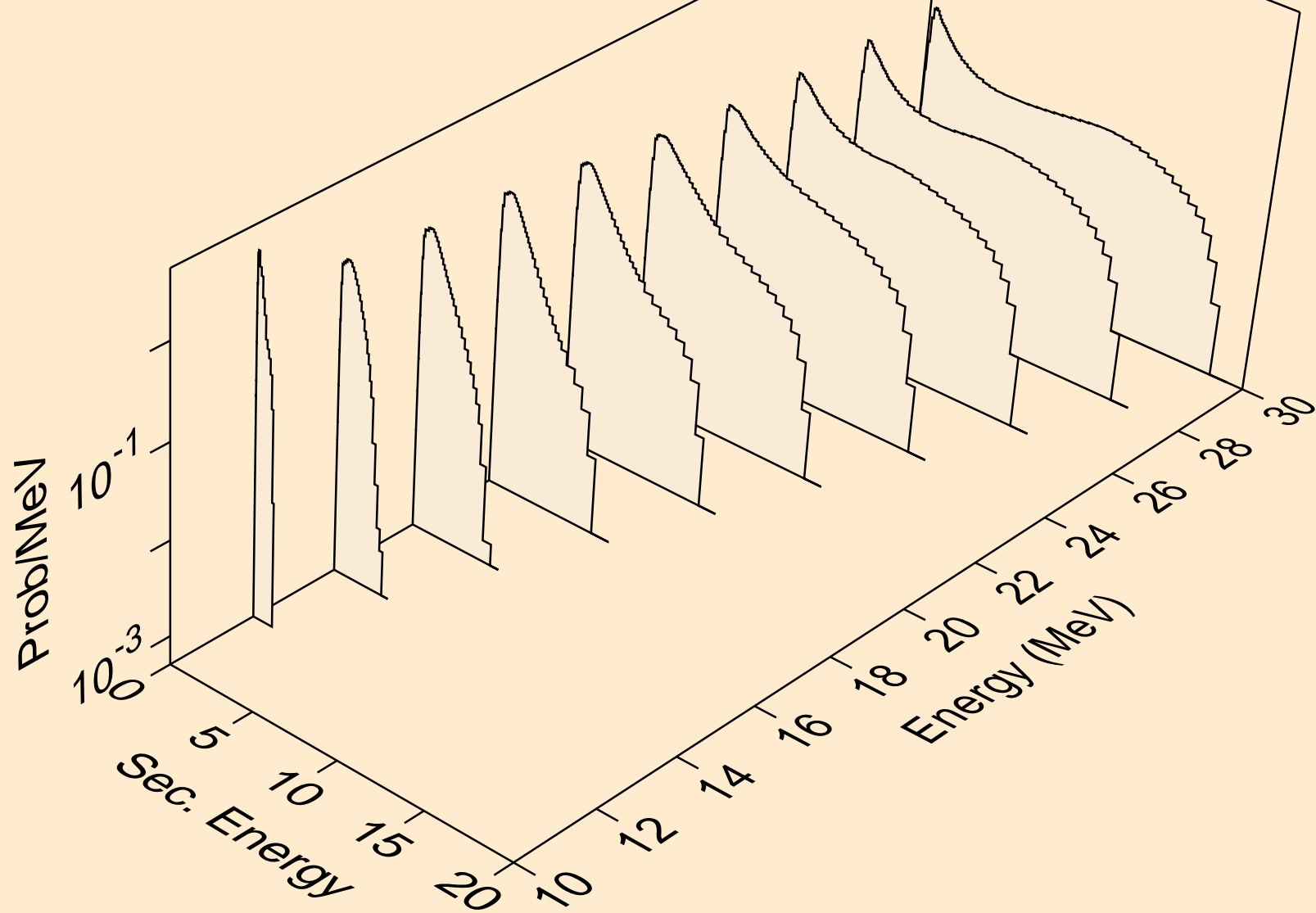

TA161M NEUTRON ACER TENDL-2021 LIBRARY; T=293.6K
Neutron emission for (n,3n)

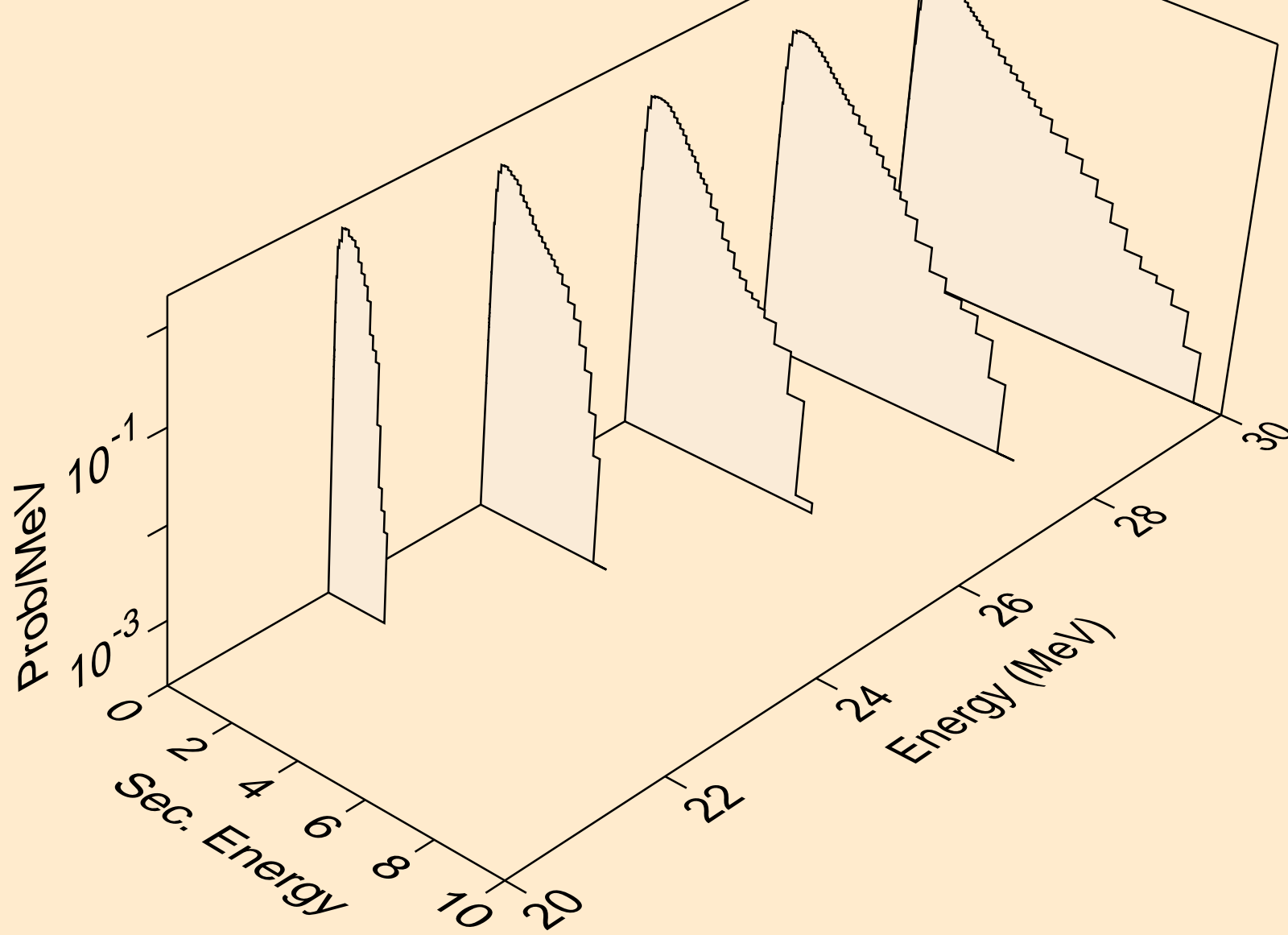

TA161M NEUTRON ACER TENDL-2021 LIBRARY; T=293.6K
Neutron emission for (n,n*)a

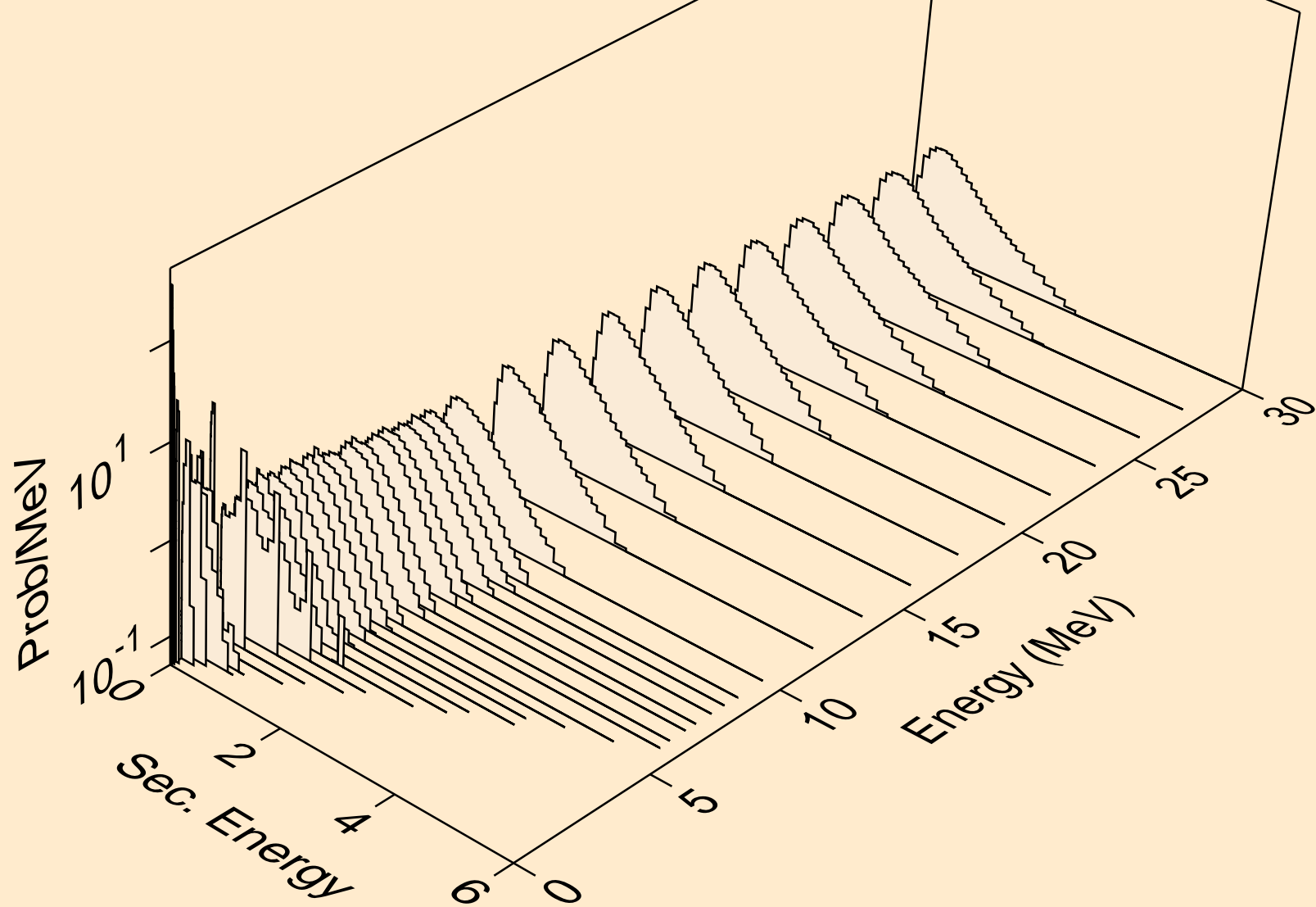

TA161M NEUTRON ACER TENDL-2021 LIBRARY; T=293.6K
Neutron emission for (n,n*)3a

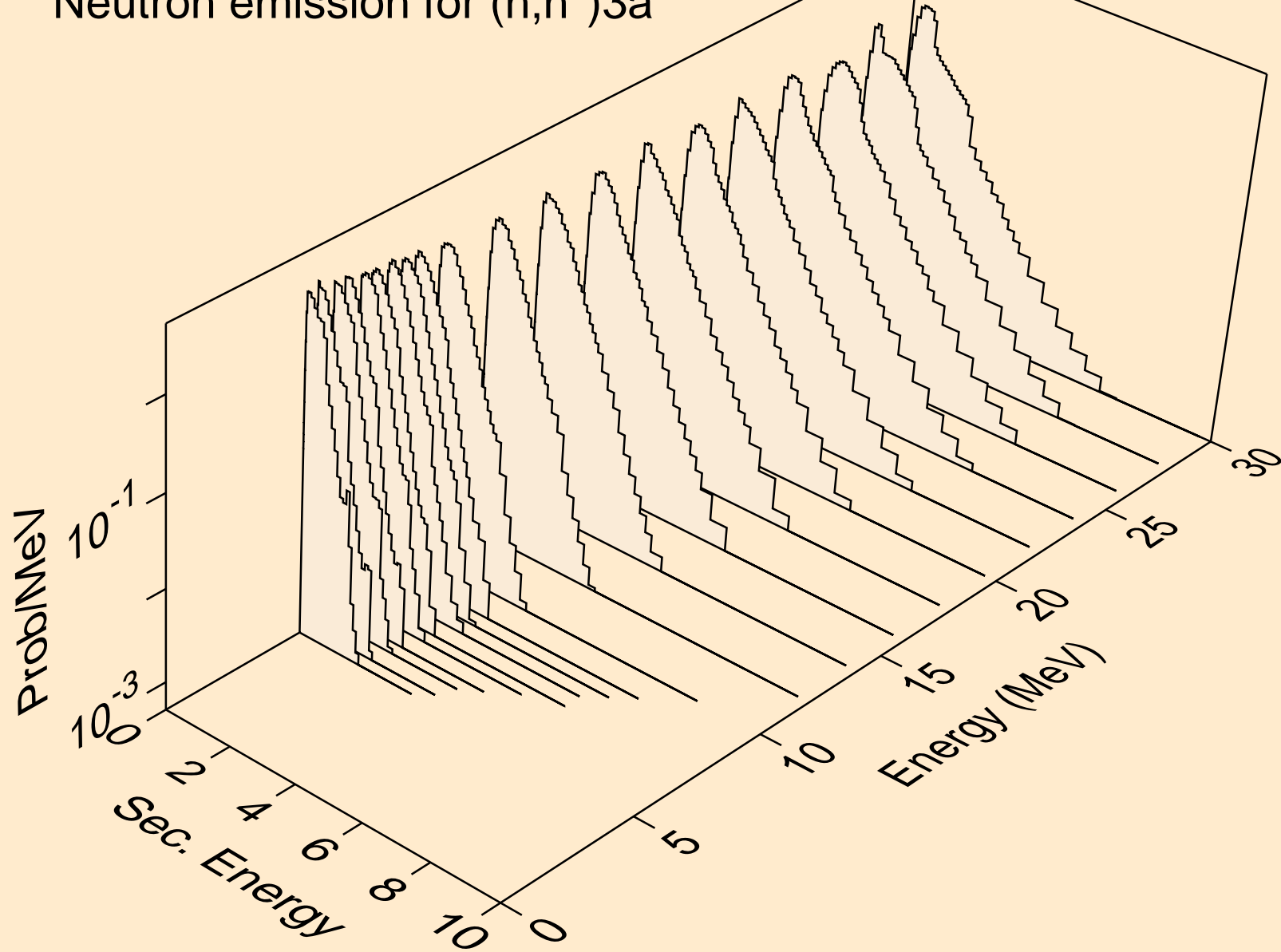

TA161M NEUTRON ACER TENDL-2021 LIBRARY; T=293.6K
Neutron emission for (n,2n)a

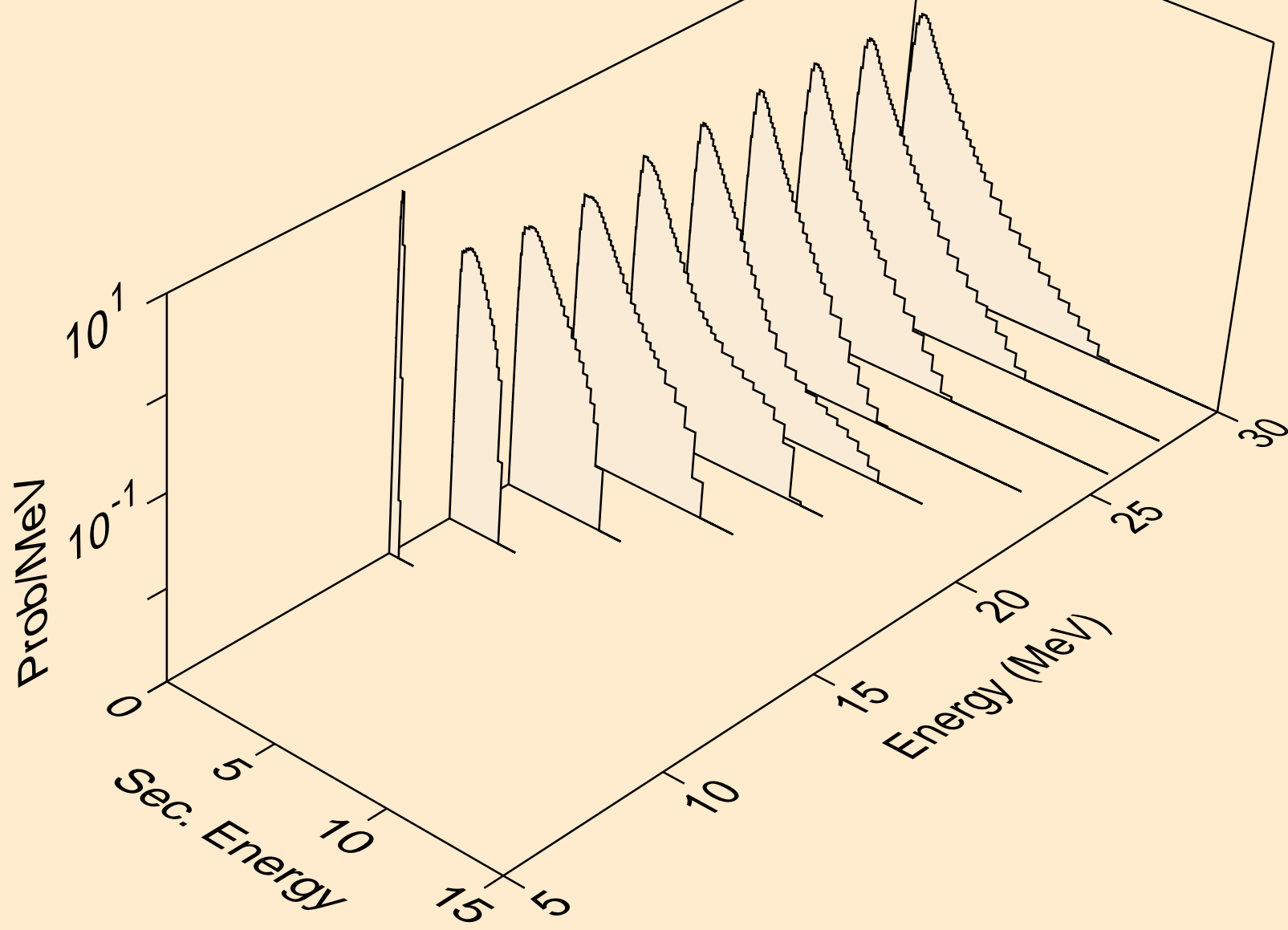

TA161M NEUTRON ACER TENDL-2021 LIBRARY; T=293.6K
Neutron emission for (n,3n)a

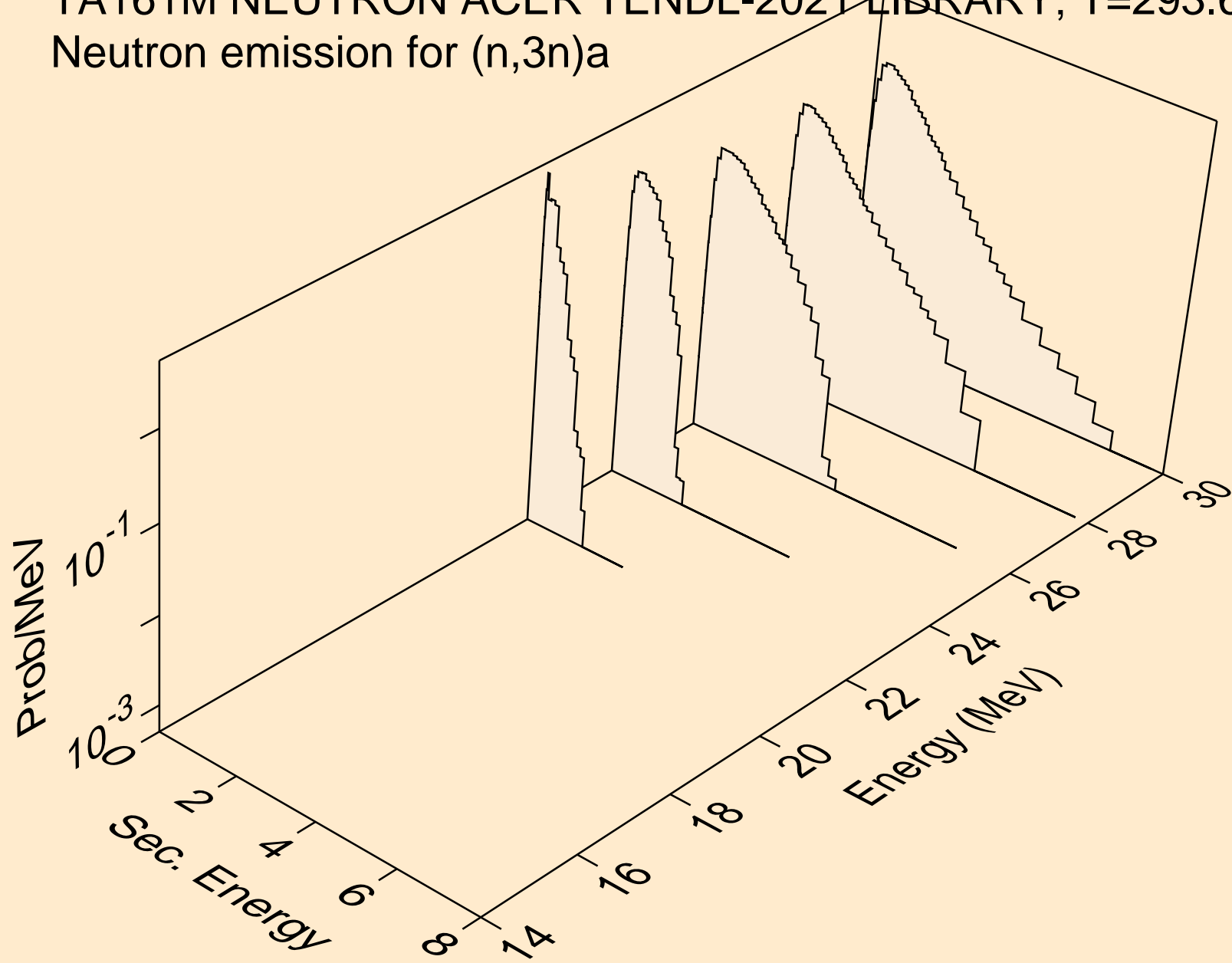

TA161M NEUTRON ACER TENDL-2021 LIBRARY; T=293.6K
Neutron emission for (n,n*)p

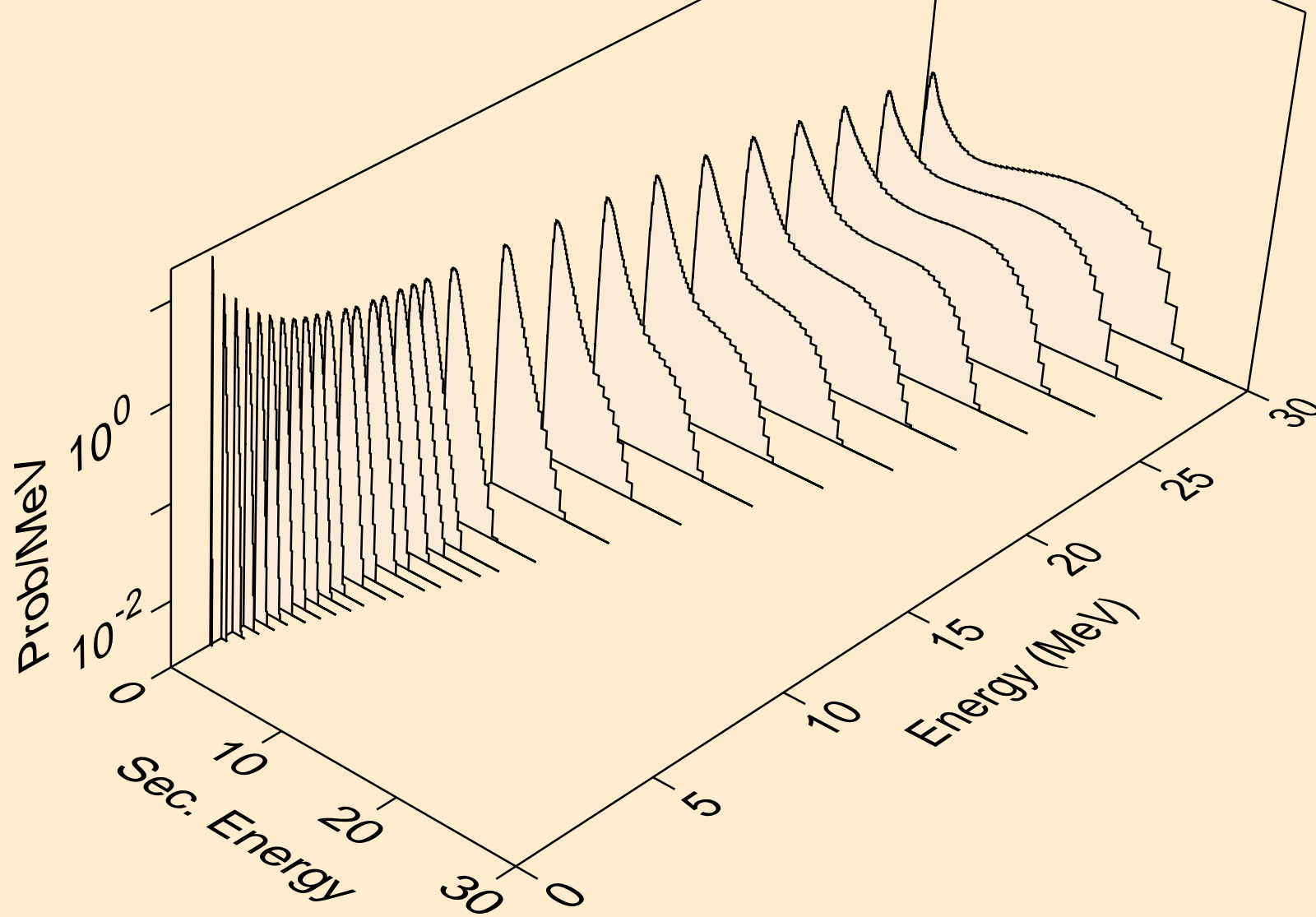

TA161M NEUTRON ACER TENDL-2021 LIBRARY; T=293.6K
Neutron emission for (n,n*)2a

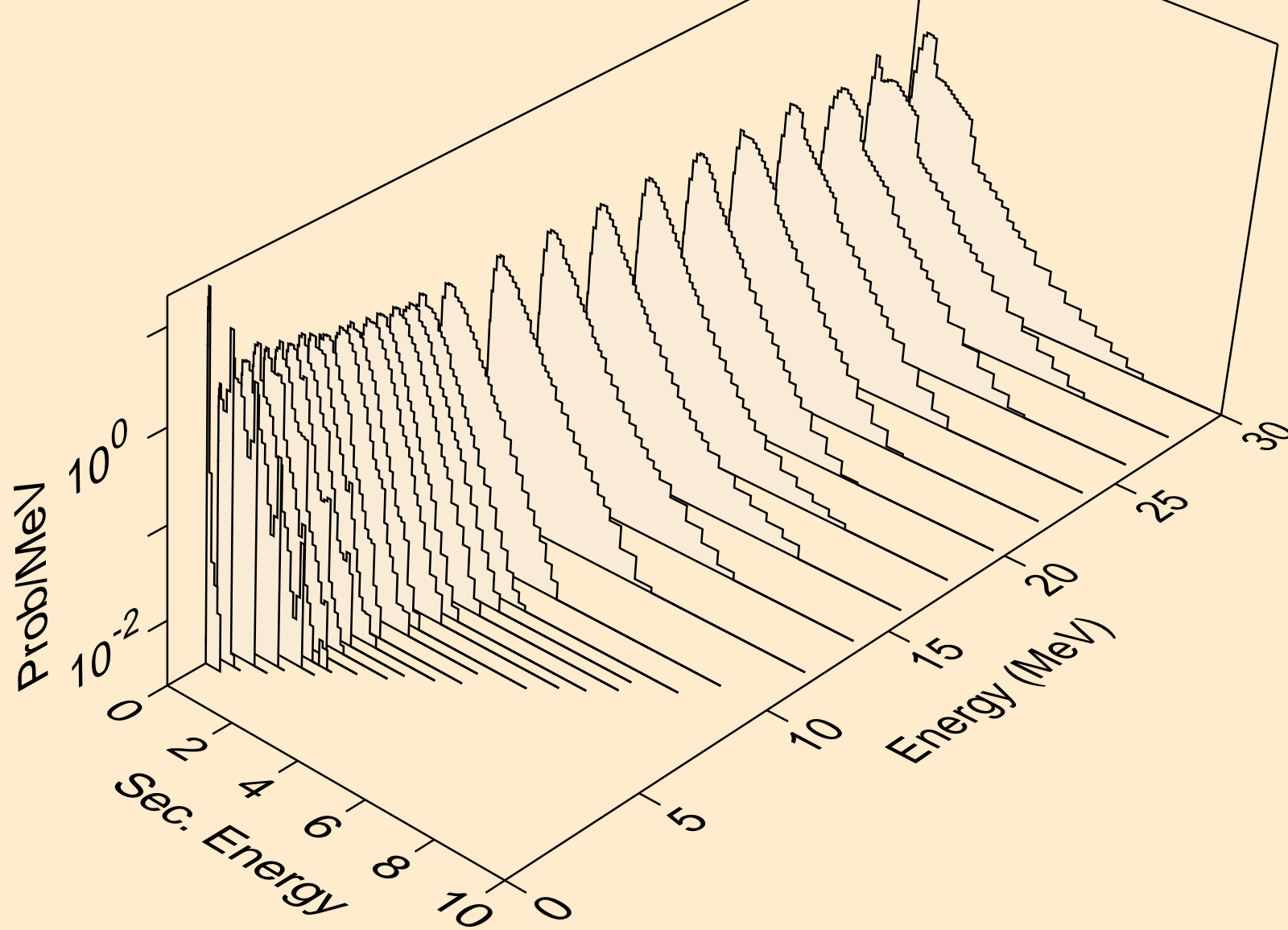

TA161M NEUTRON ACER TENDL-2021 LIBRARY; T=293.6K
Neutron emission for (n,2n)2a

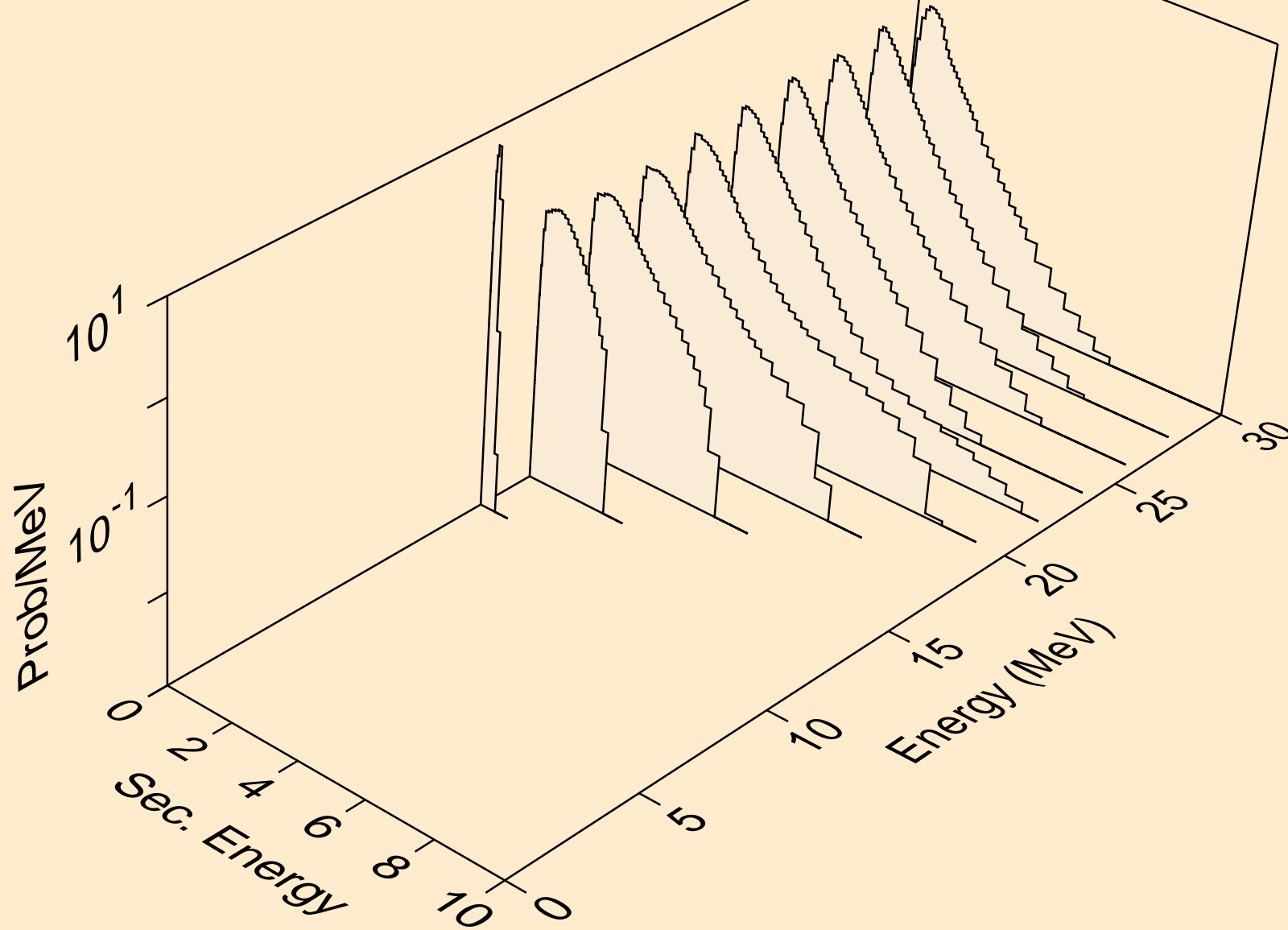

TA161M NEUTRON ACER TENDL-2021 LIBRARY; T=293.6K
Neutron emission for (n,n*)d

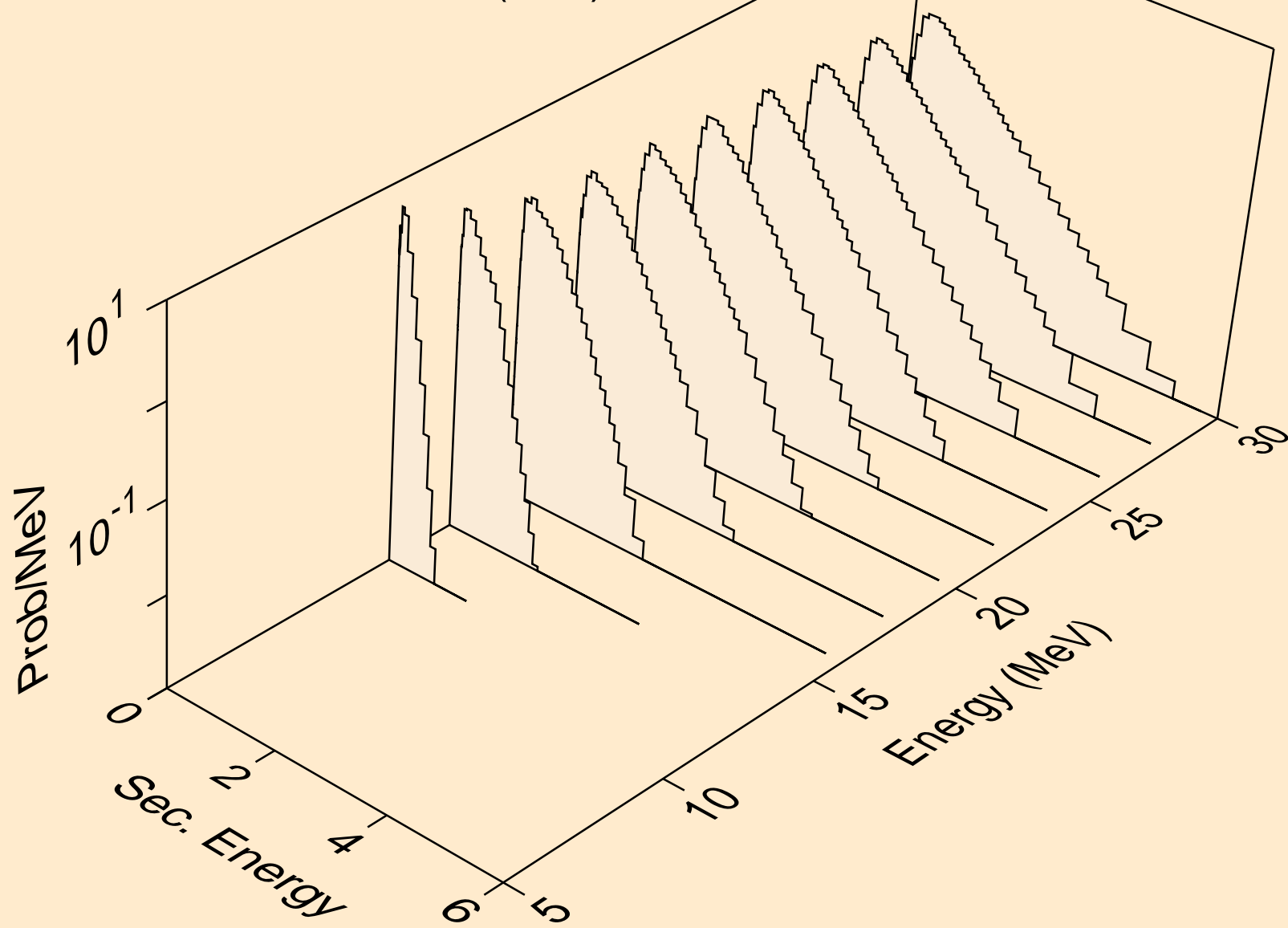

TA161M NEUTRON ACER TENDL-2021 LIBRARY; T=293.6K
Neutron emission for (n,n*)t

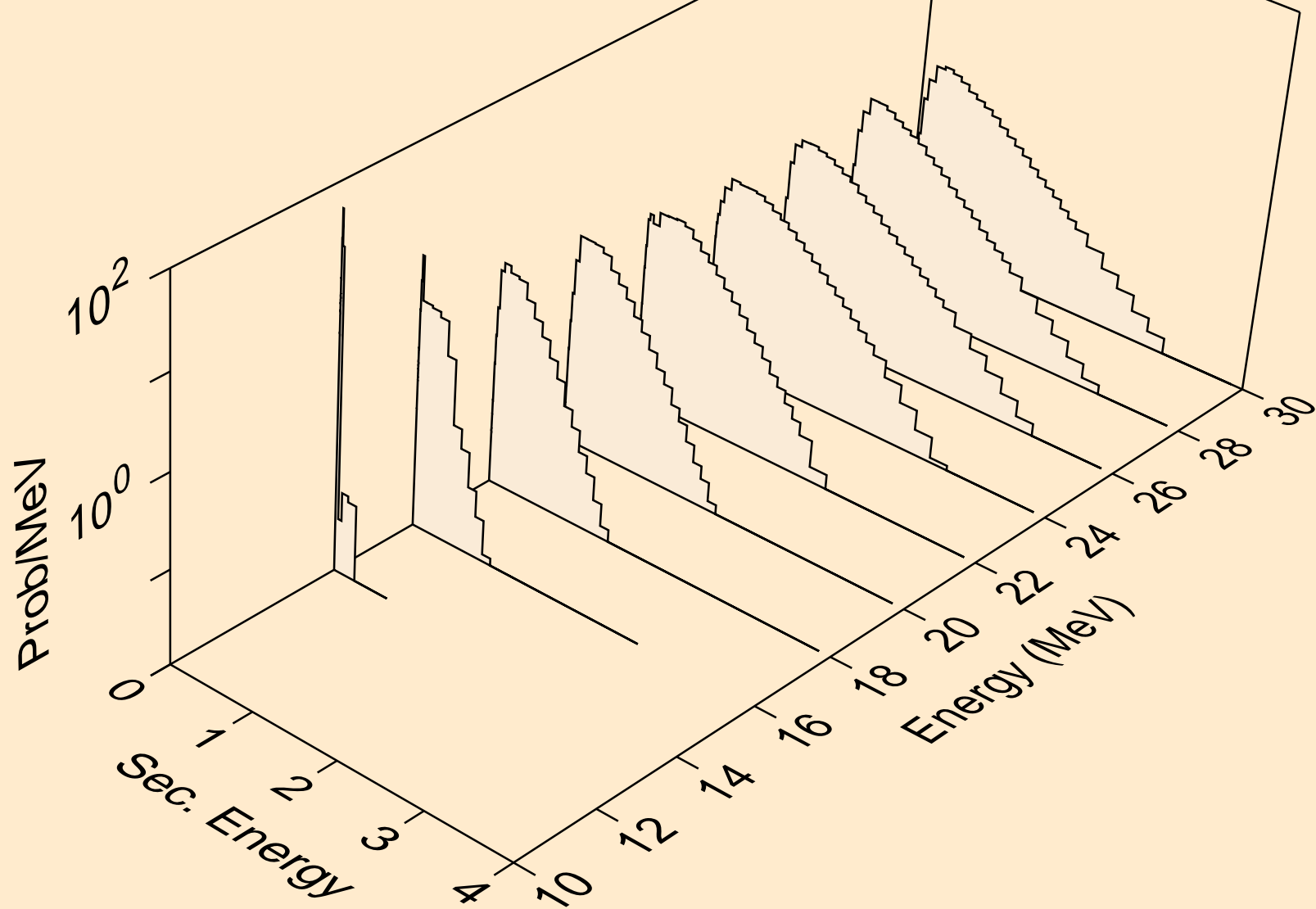

TA161M NEUTRON ACER TENDL-2021 LIBRARY; T=293.6K
Neutron emission for (n,n*)he3

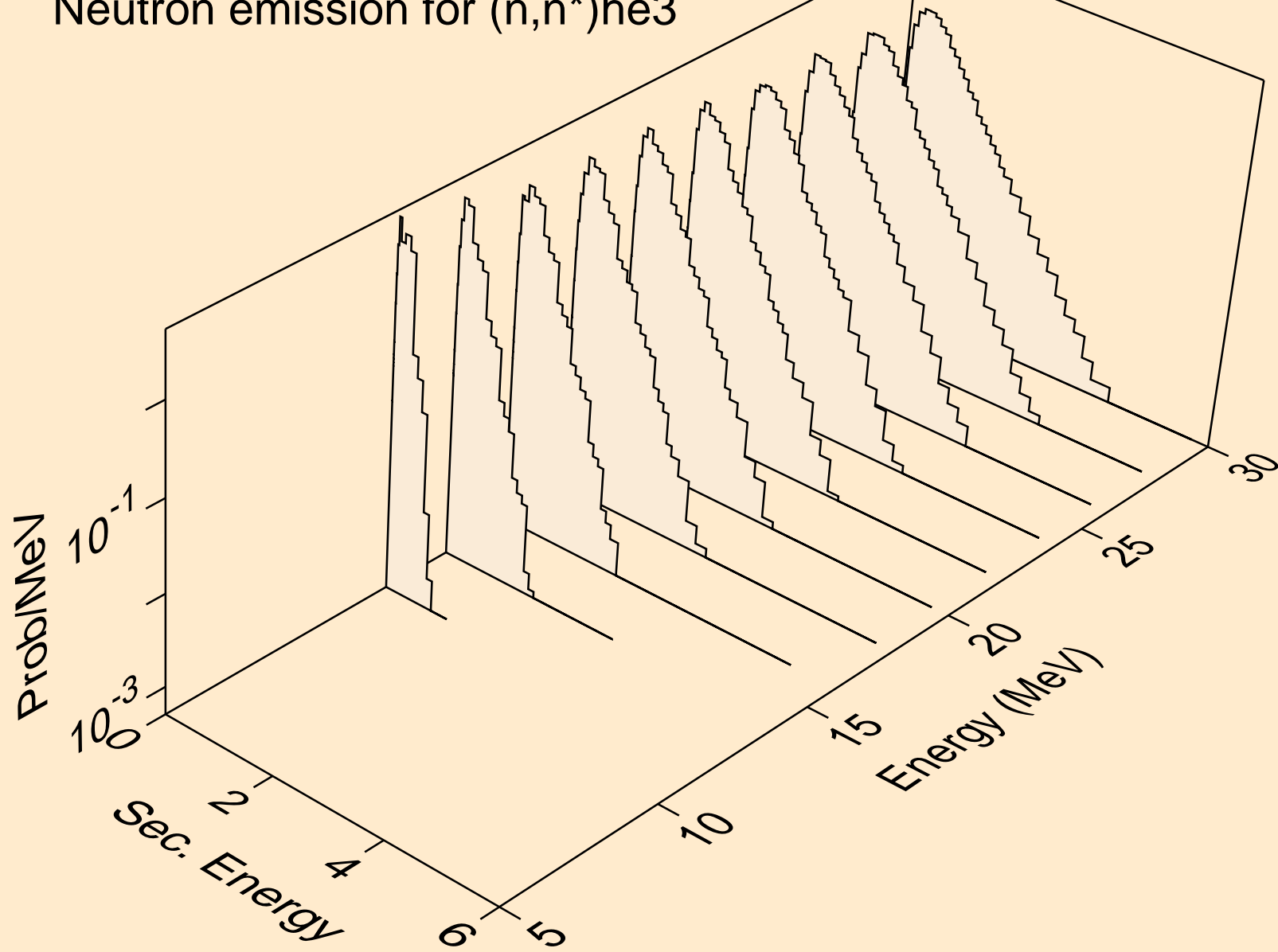

TA161M NEUTRON ACER TENDL-2021 LIBRARY; T=293.6K
Neutron emission for (n,n*)d2a

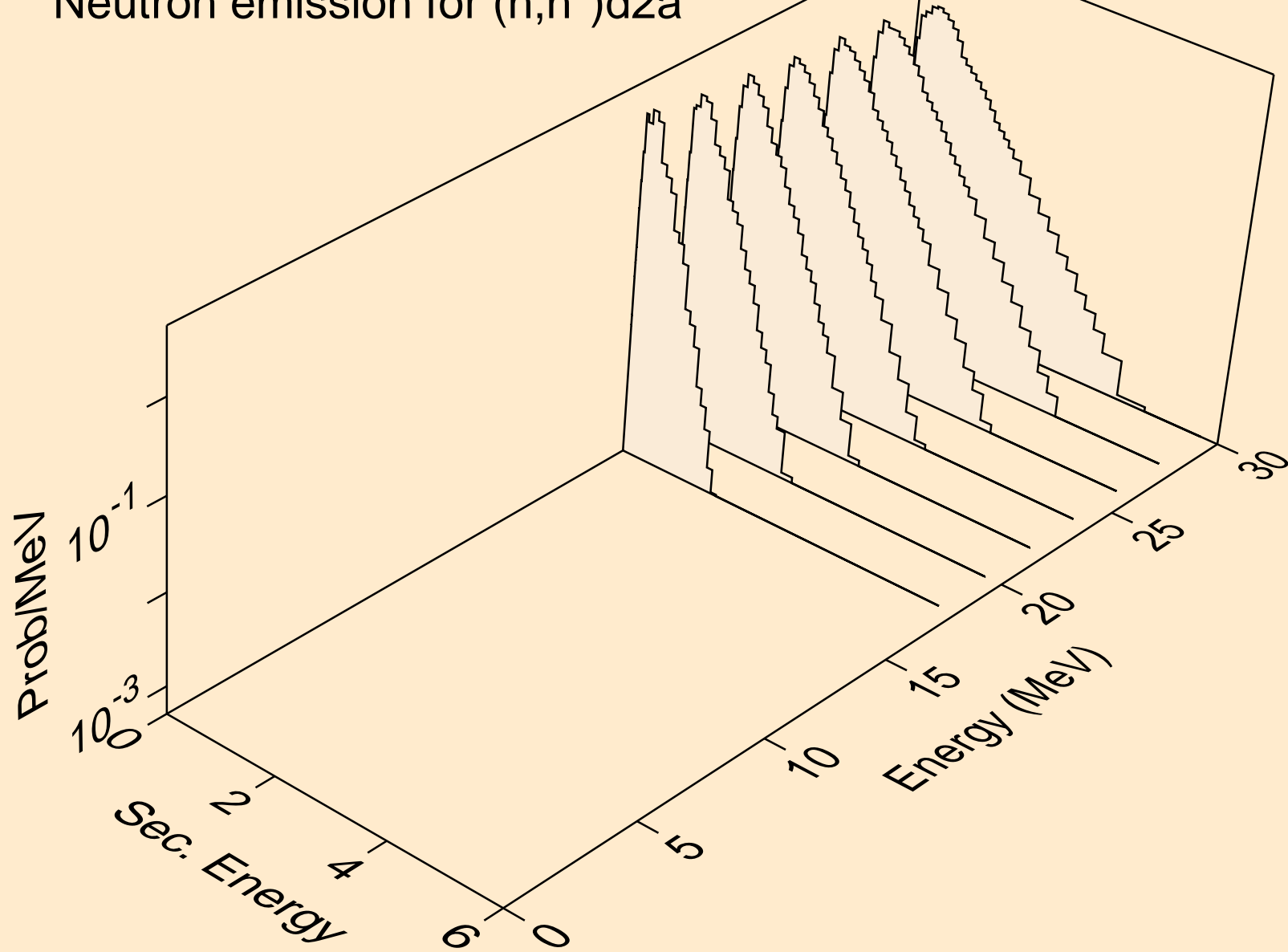

TA161M NEUTRON ACER TENDL-2021 LIBRARY; T=293.6K
Neutron emission for (n,2np)

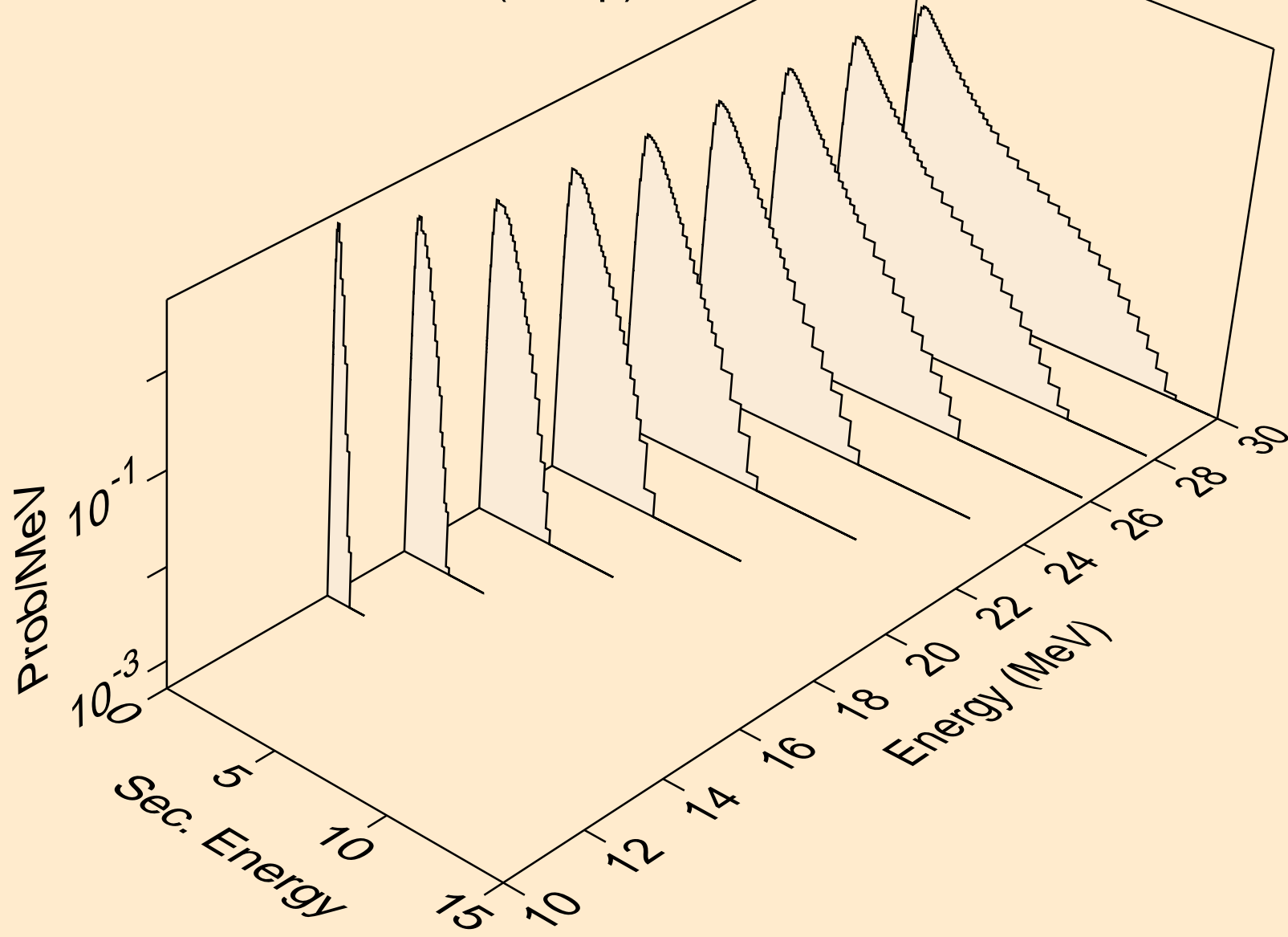

TA161M NEUTRON ACER TENDL-2021 LIBRARY; T=293.6K
Neutron emission for (n,3np)

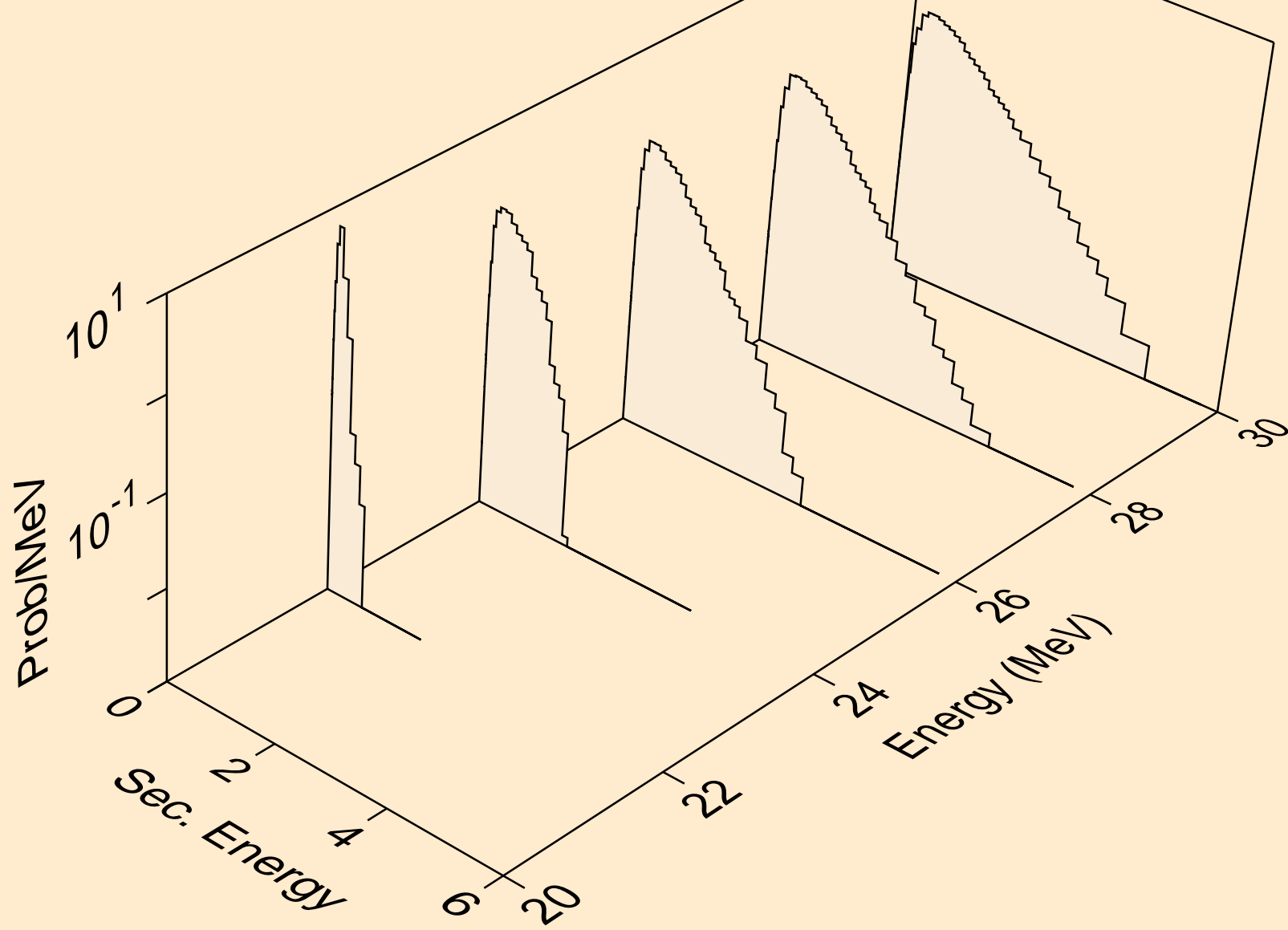

TA161M NEUTRON ACER TENDL-2021 LIBRARY; T=293.6K
Neutron emission for (n,2np)

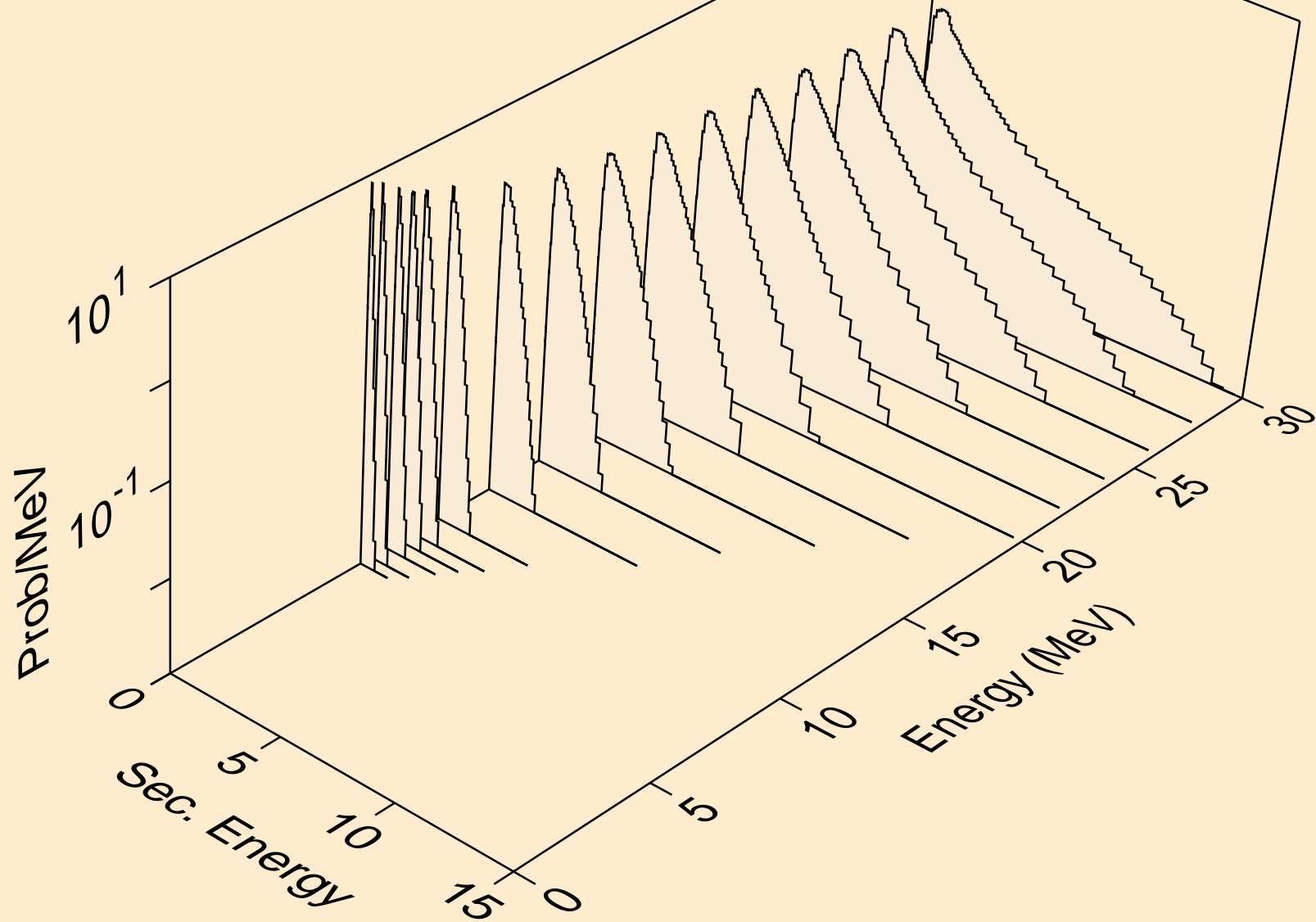

TA161M NEUTRON ACER TENDL-2021 LIBRARY; T=293.6K
Neutron emission for (n,npa)

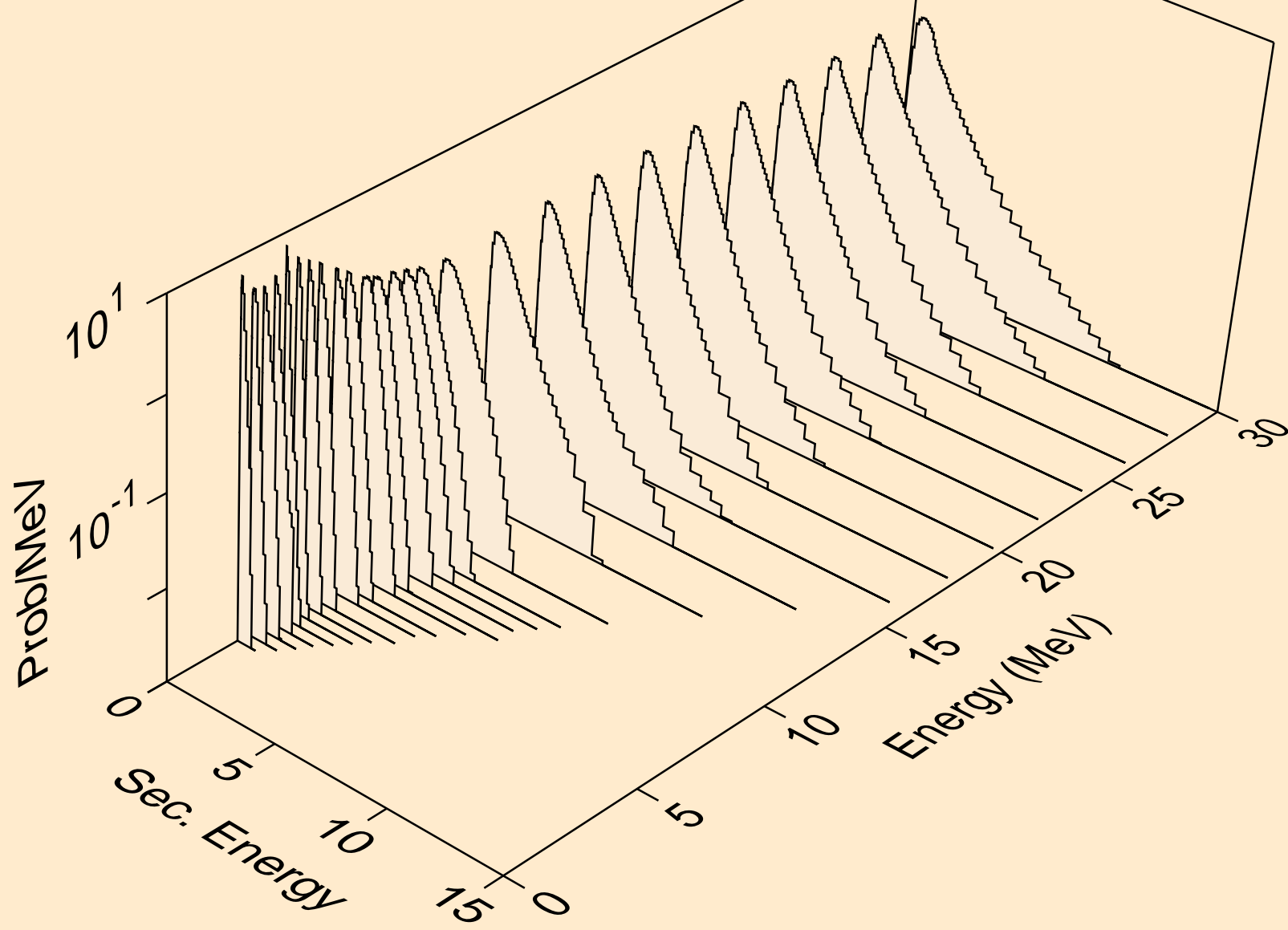

TA161M NEUTRON ACER TENDL-2021 LIBRARY; T=293.6K
Neutron emission for (n,n*c)

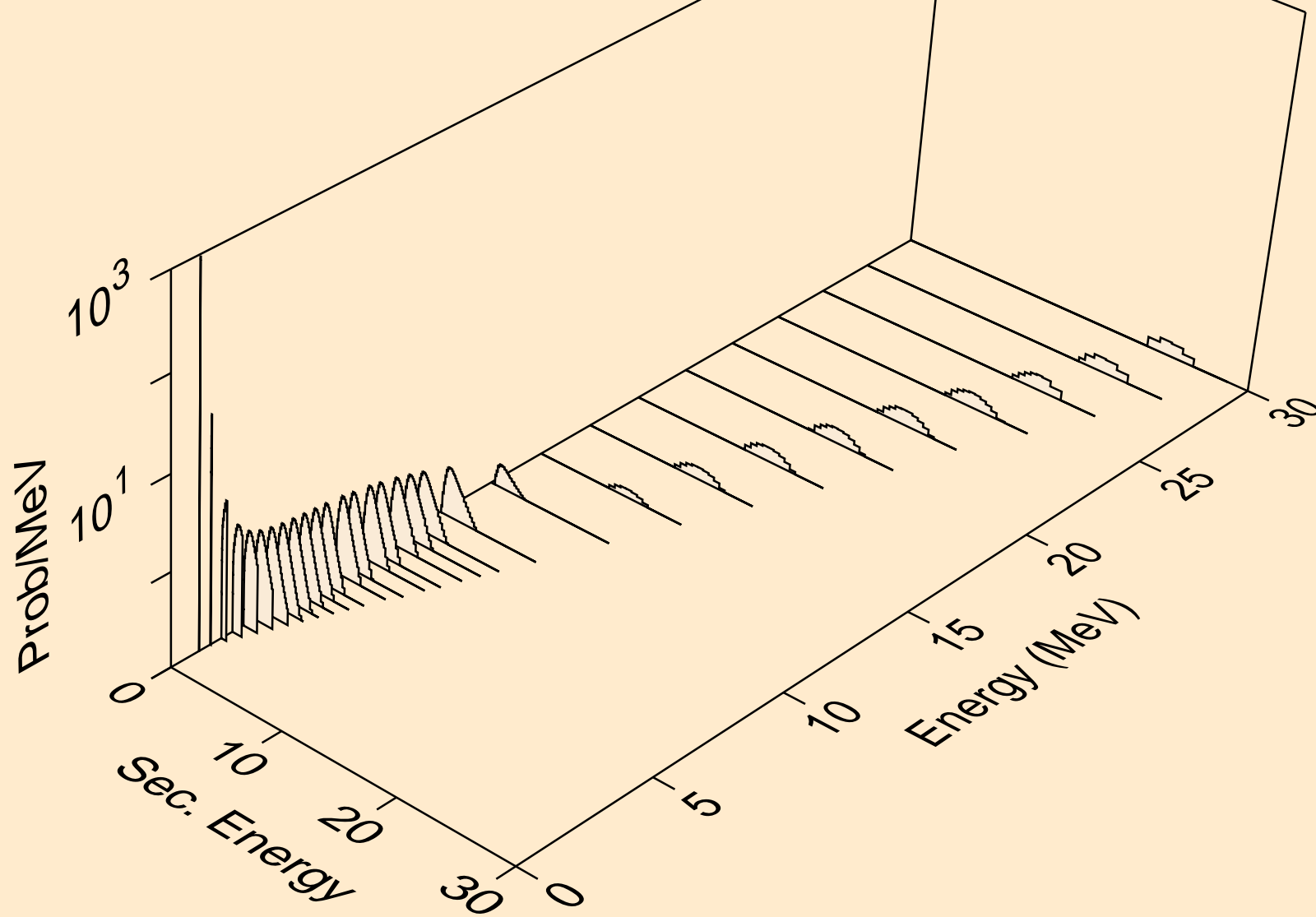

TA161M NEUTRON ACER TENDL-2021 LIBRARY; T=293.6K
Photon emission for (n,x)

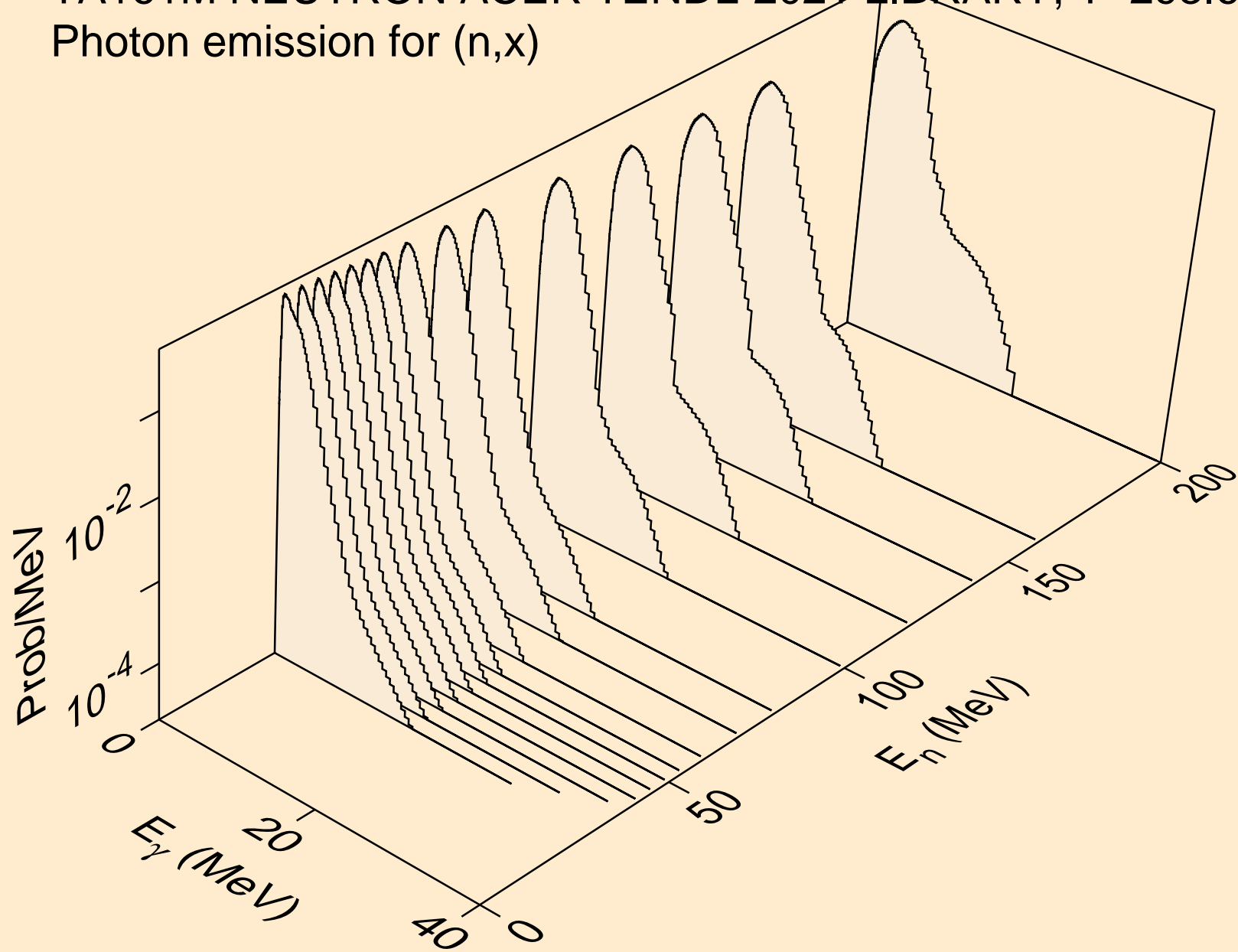

TA161M NEUTRON ACER TENDL-2021 LIBRARY; T=293.6K
Photon emission for (n,2nd)

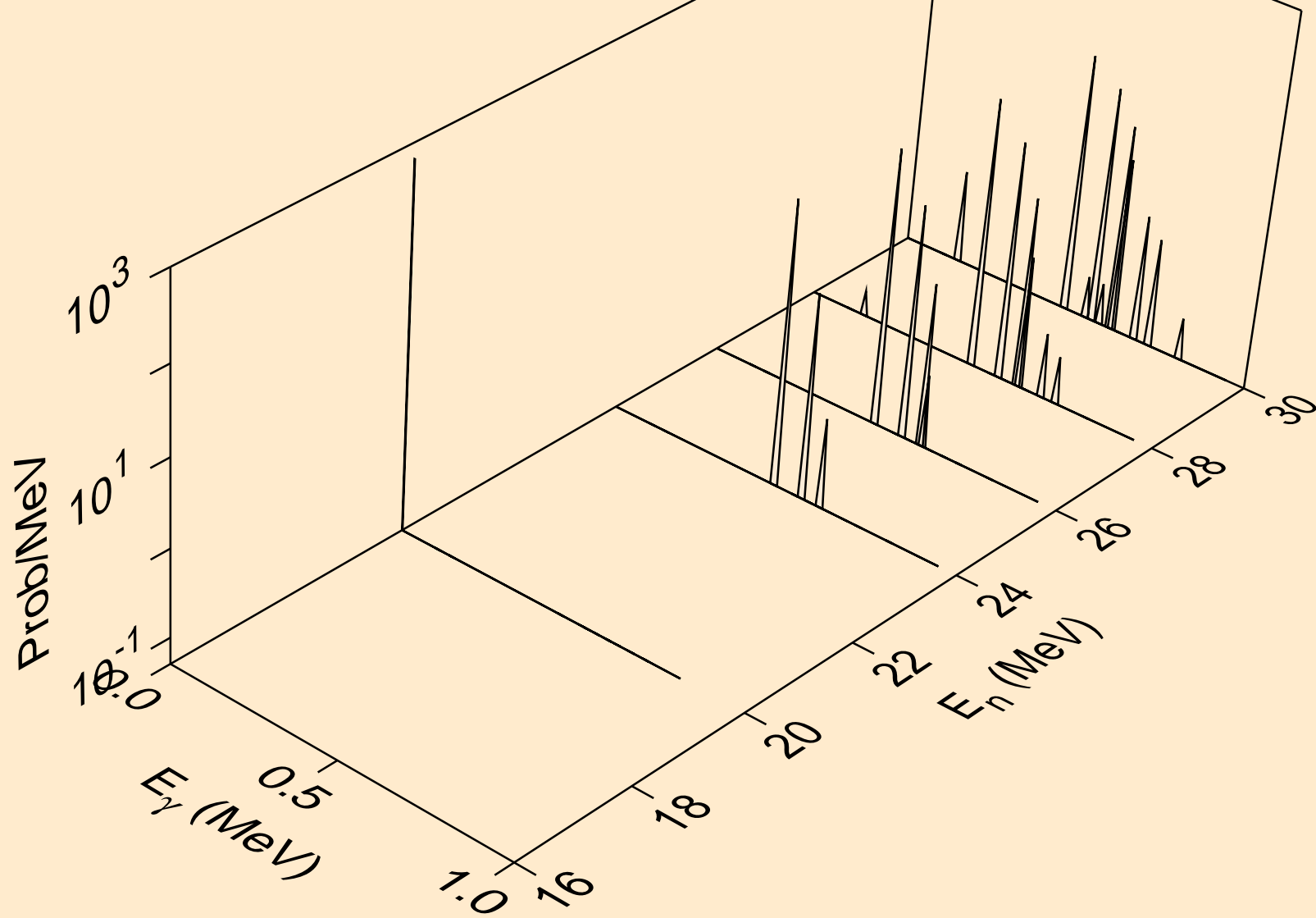

TA161M NEUTRON ACER TENDL-2021 LIBRARY; T=293.6K
Photon emission for (n,2n)

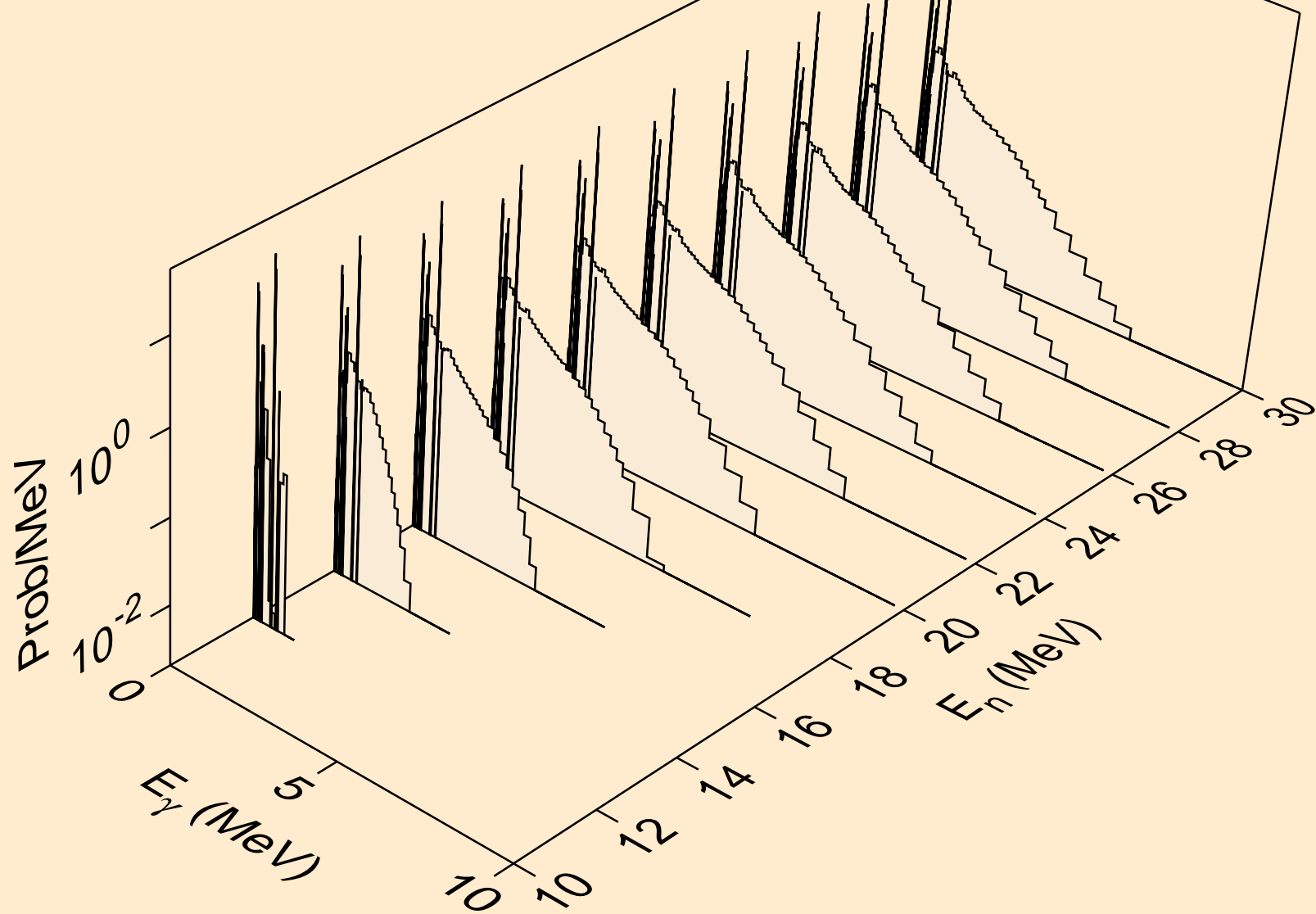

TA161M NEUTRON ACER TENDL-2021 LIBRARY; T=293.6K
Photon emission for (n,3n)

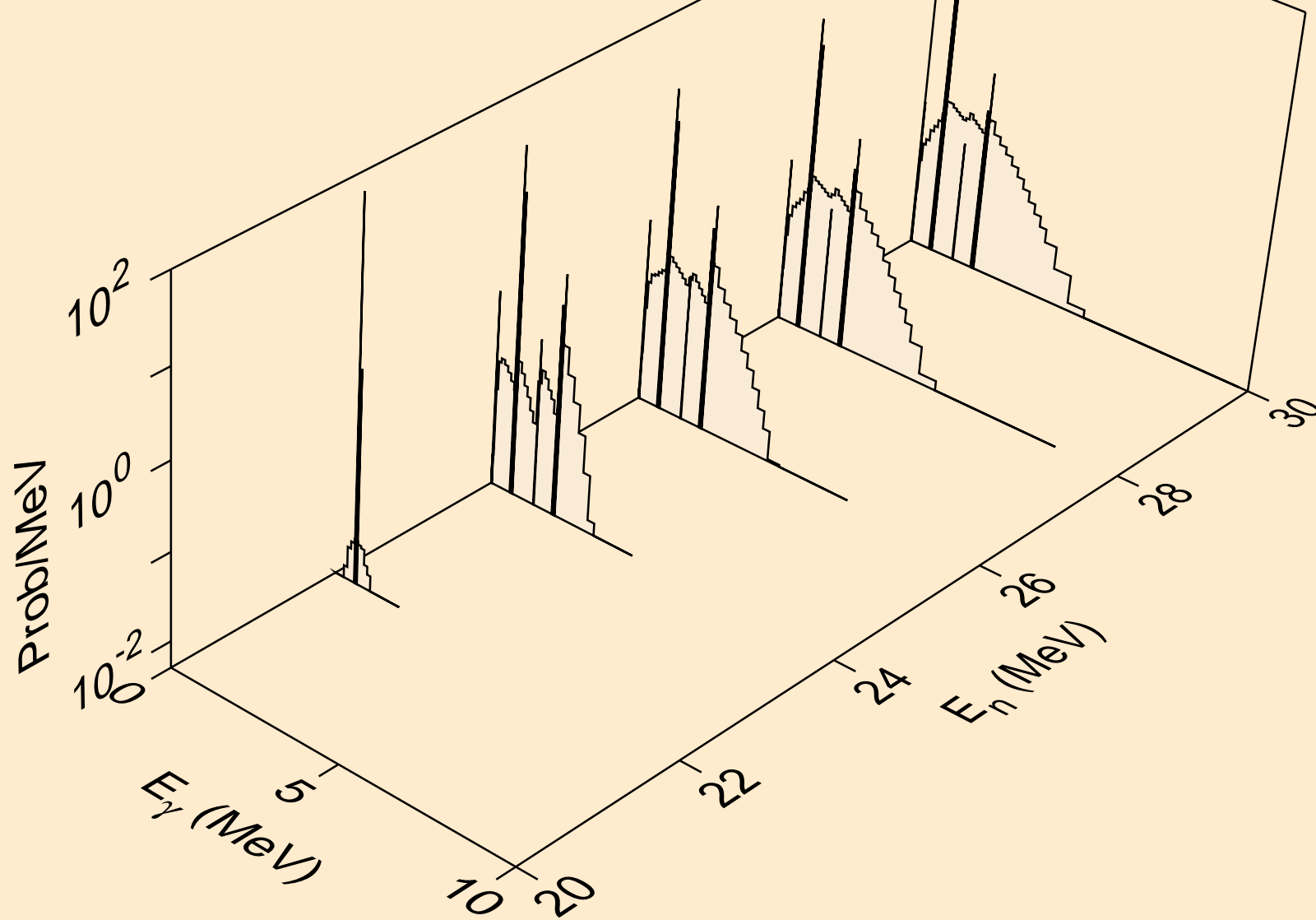

TA161M NEUTRON ACER TENDL-2021 LIBRARY; T=293.6K
Photon emission for (n,n*)a

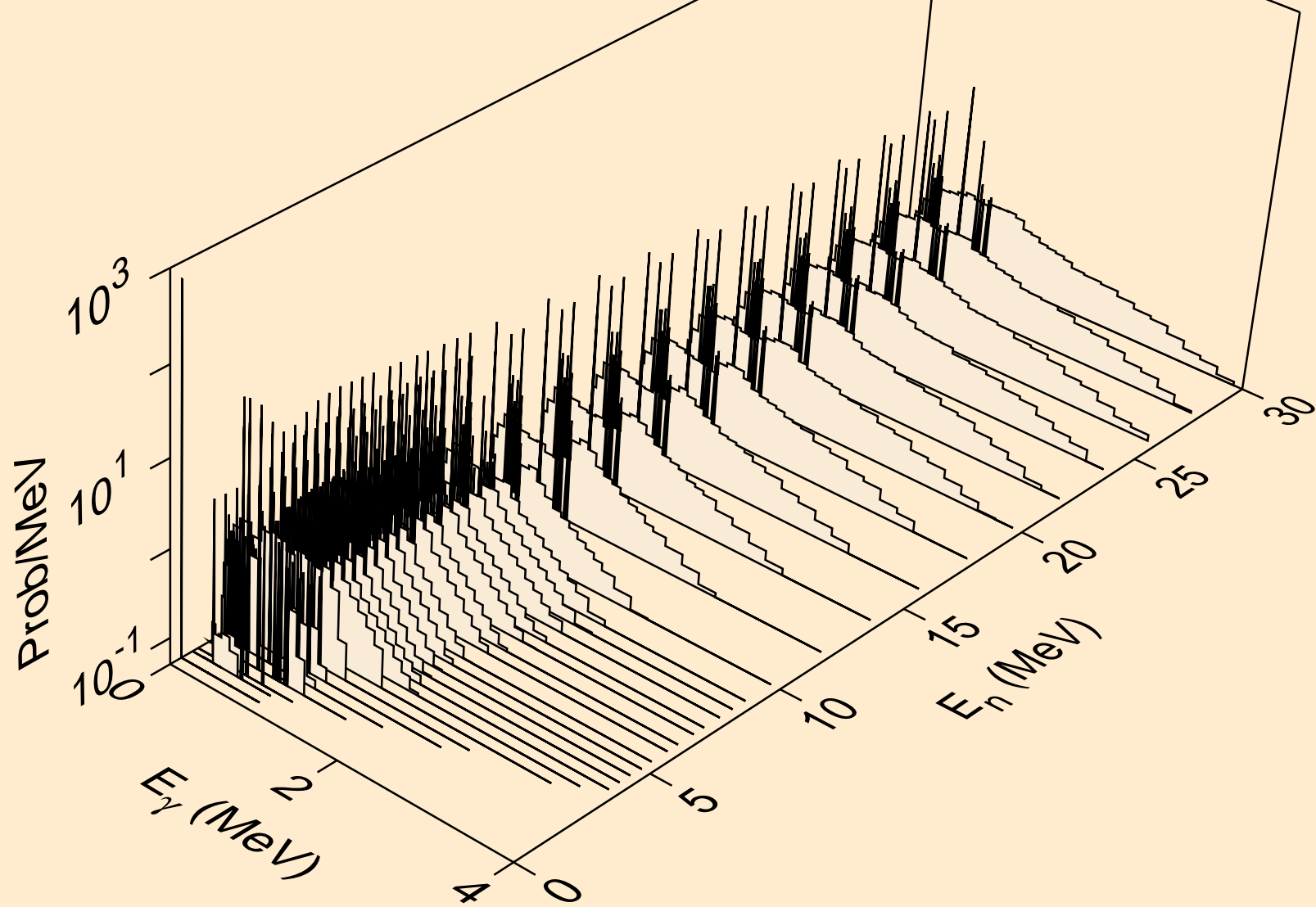

TA161M NEUTRON ACER TENDL-2021 LIBRARY; T=293.6K
Photon emission for (n,n*)3a

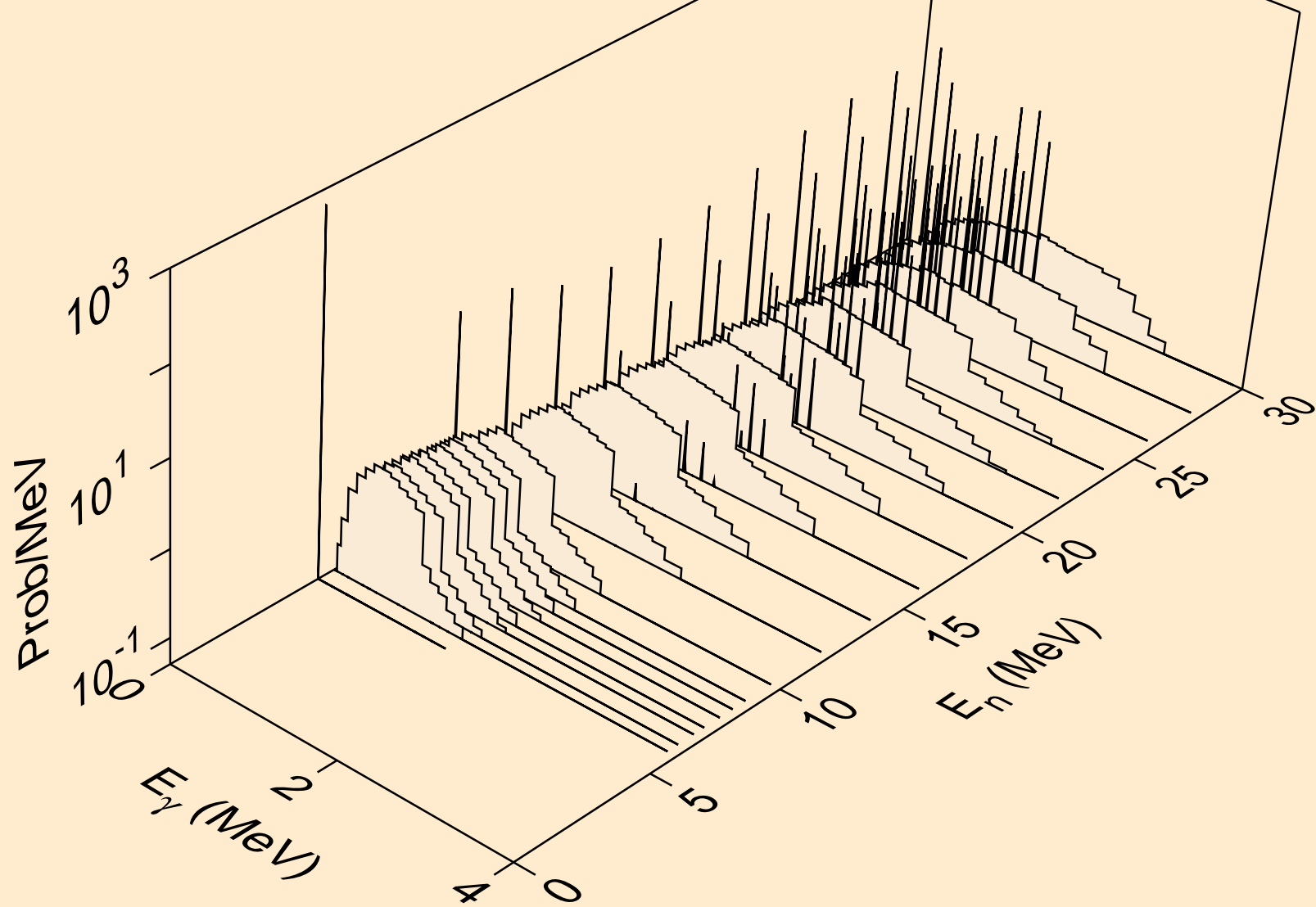

TA161M NEUTRON ACER TENDL-2021 LIBRARY; T=293.6K
Photon emission for (n,2n)a

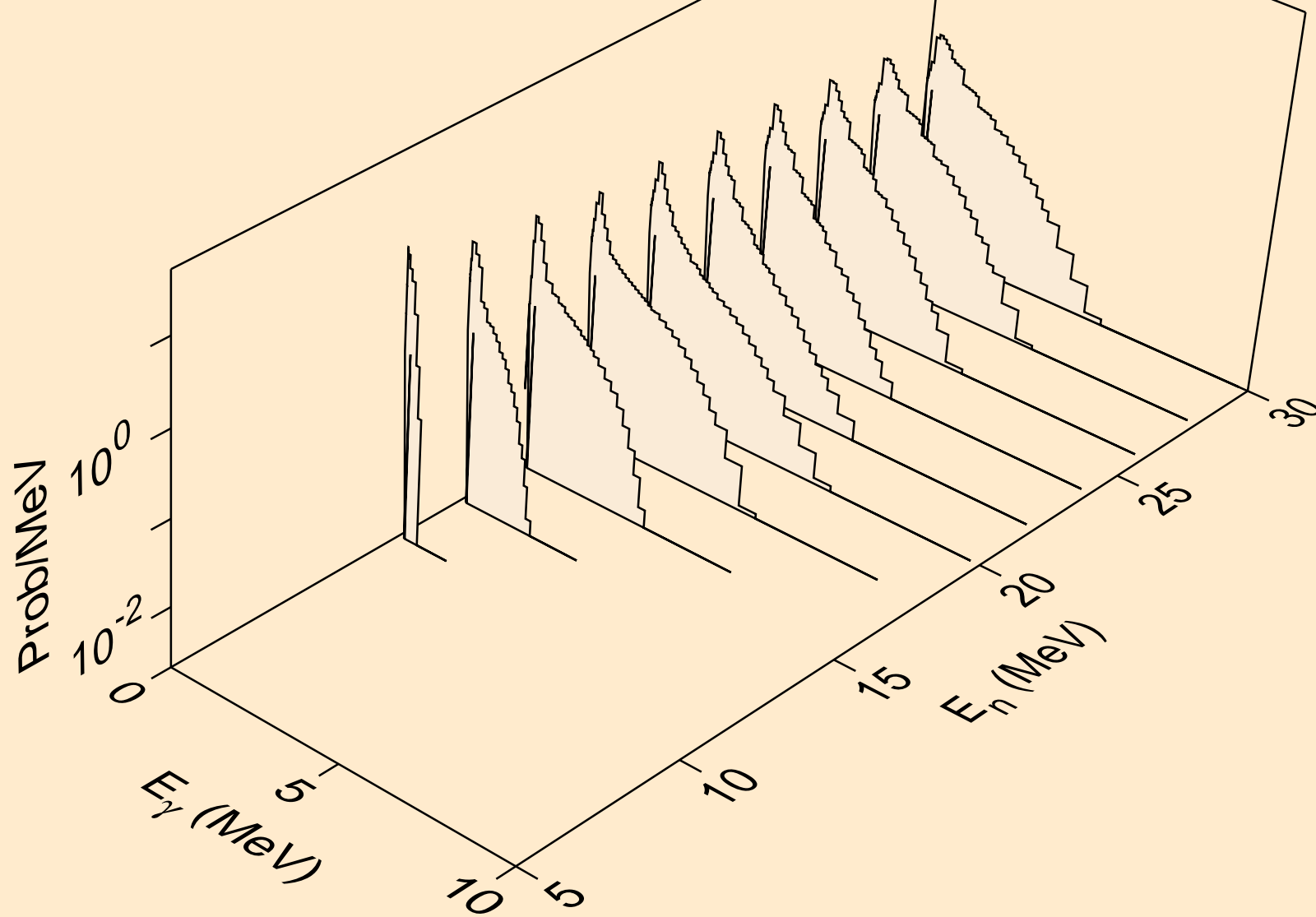

TA161M NEUTRON ACER TENDL-2021 LIBRARY; T=293.6K
Photon emission for (n,3n)a

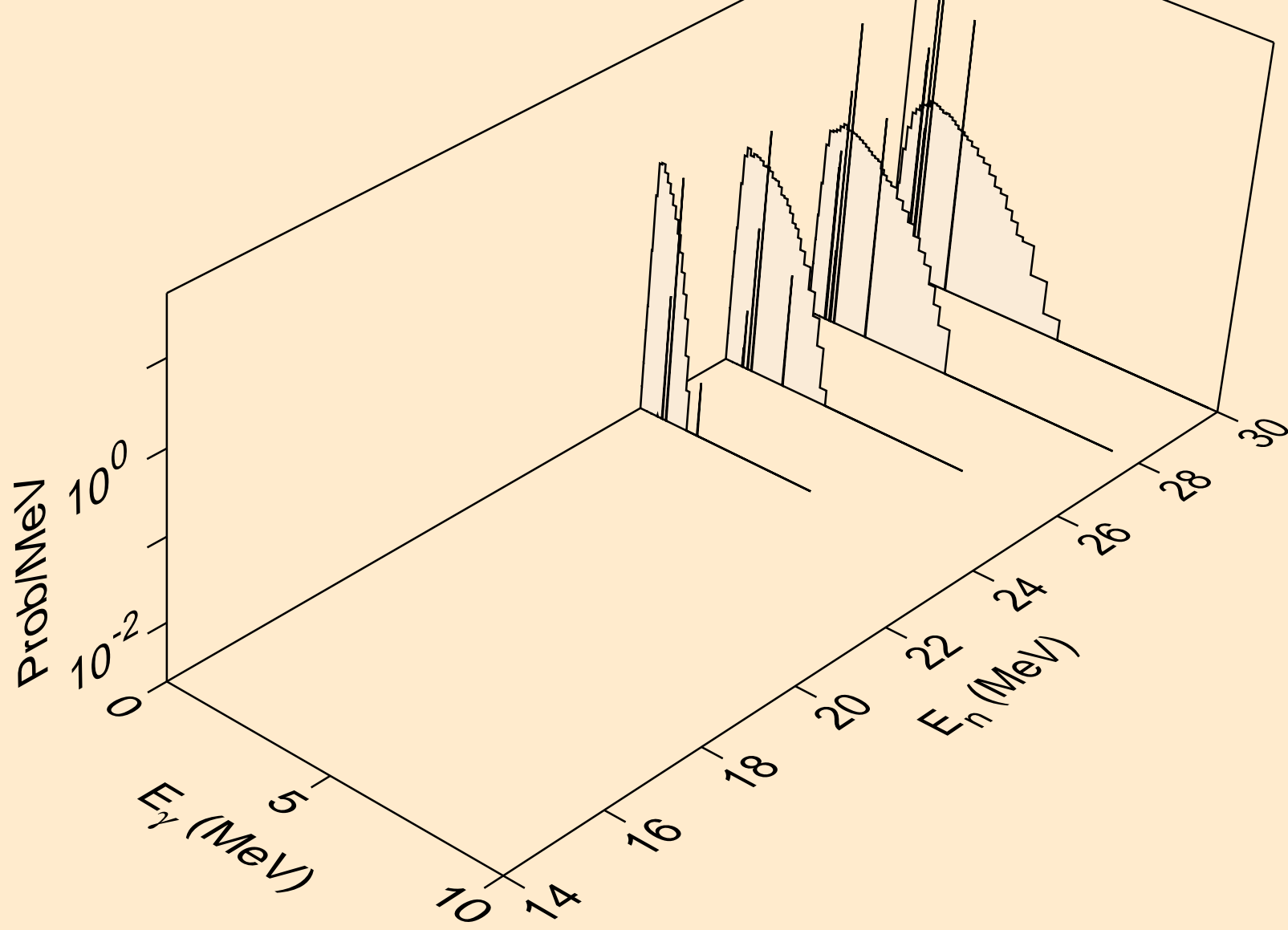

TA161M NEUTRON ACER TENDL-2021 LIBRARY; T=293.6K
Photon emission for (n,n*)p

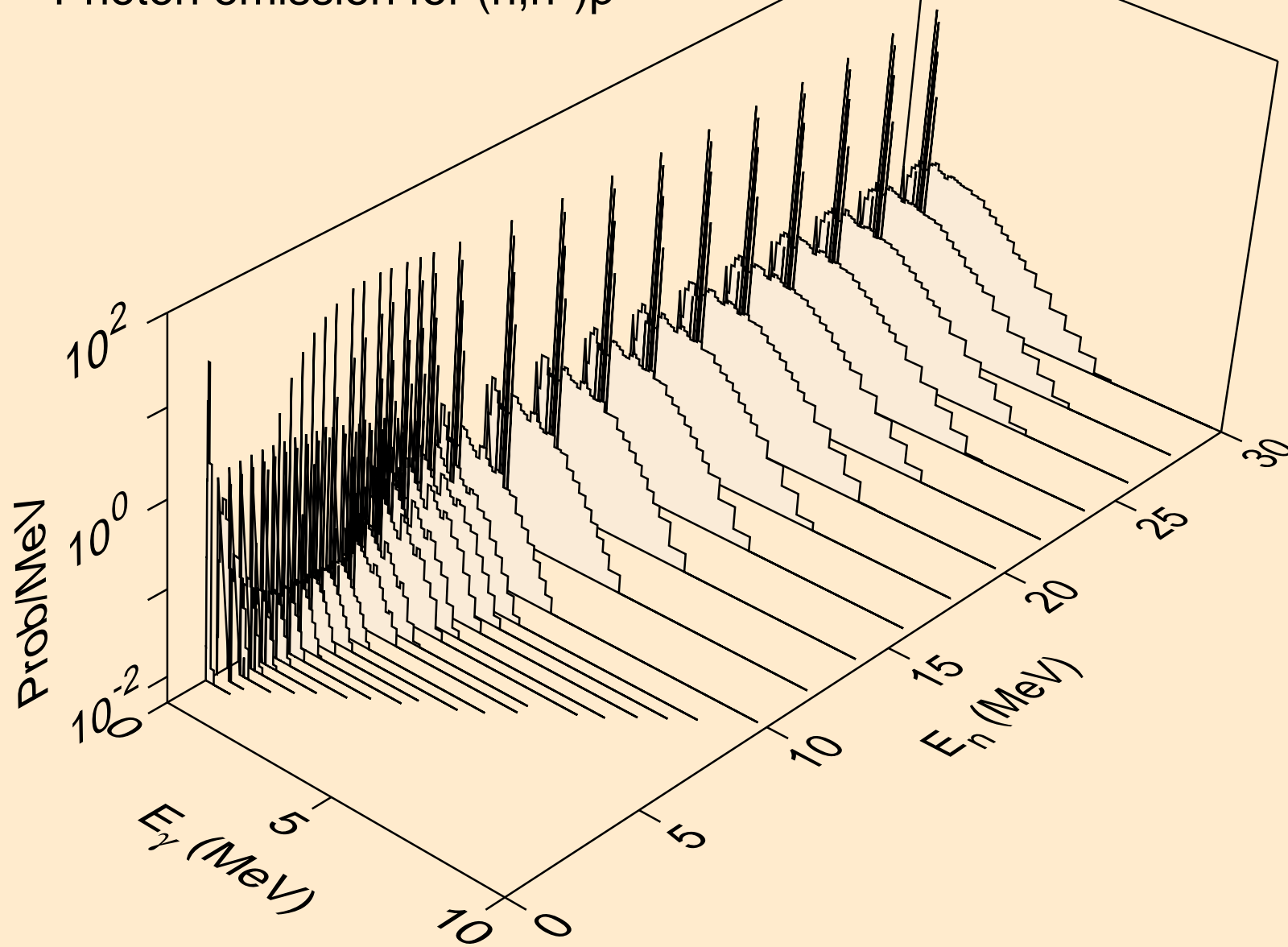

TA161M NEUTRON ACER TENDL-2021 LIBRARY; T=293.6K
Photon emission for (n,n*)2a

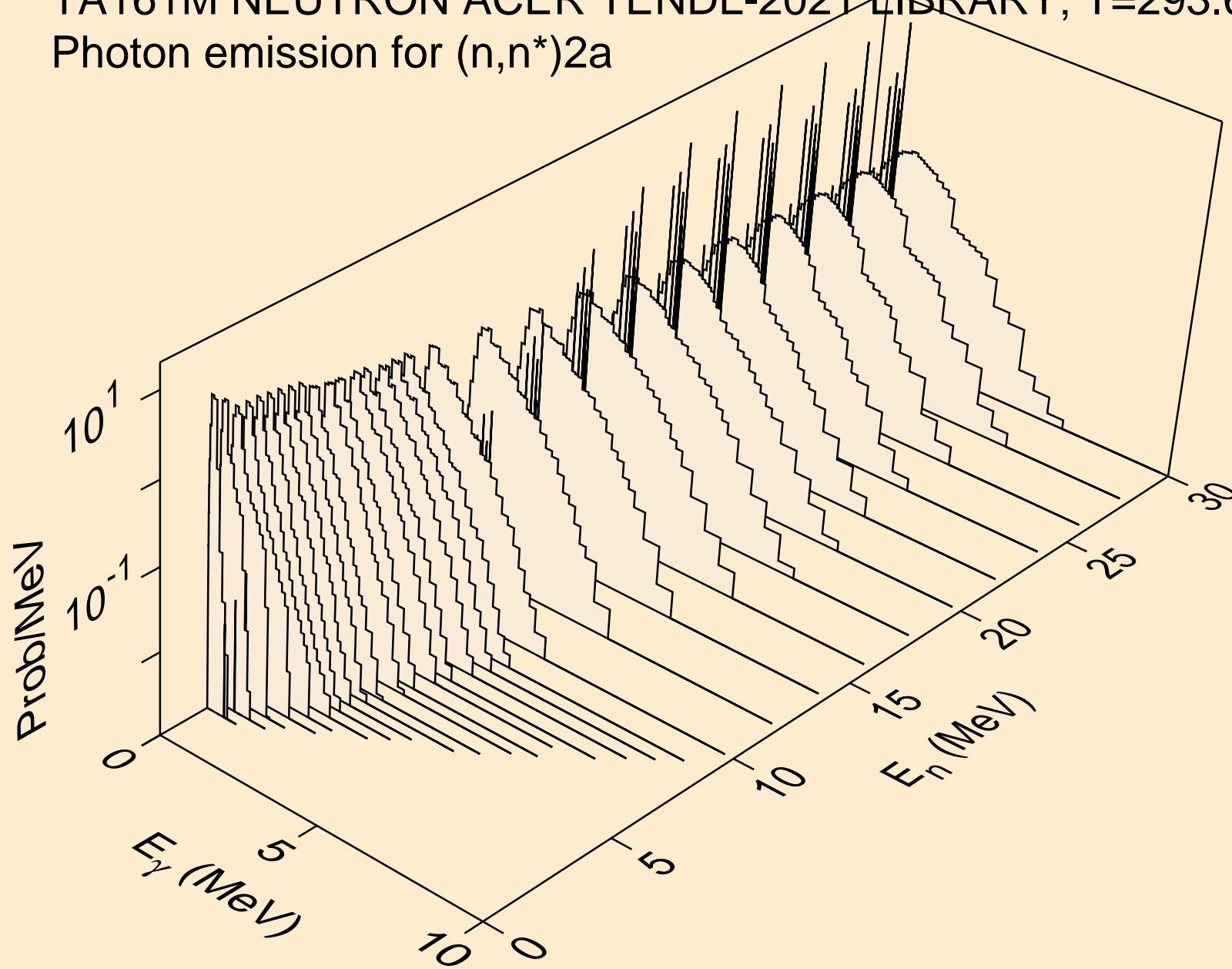

TA161M NEUTRON ACER TENDL-2021 LIBRARY; T=293.6K
Photon emission for (n,2n)2a

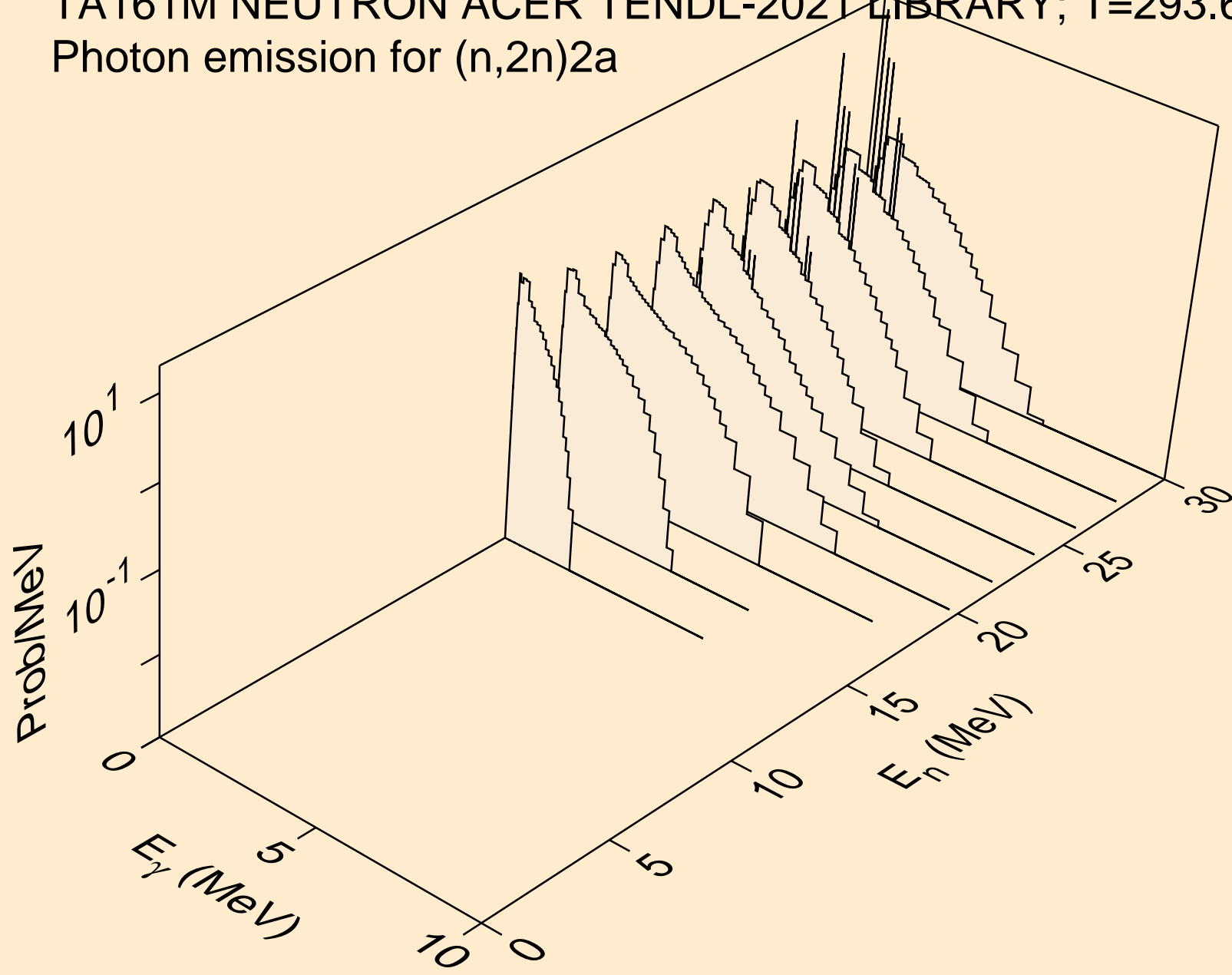

TA161M NEUTRON ACER TENDL-2021 LIBRARY; T=293.6K
Photon emission for (n,n*)d

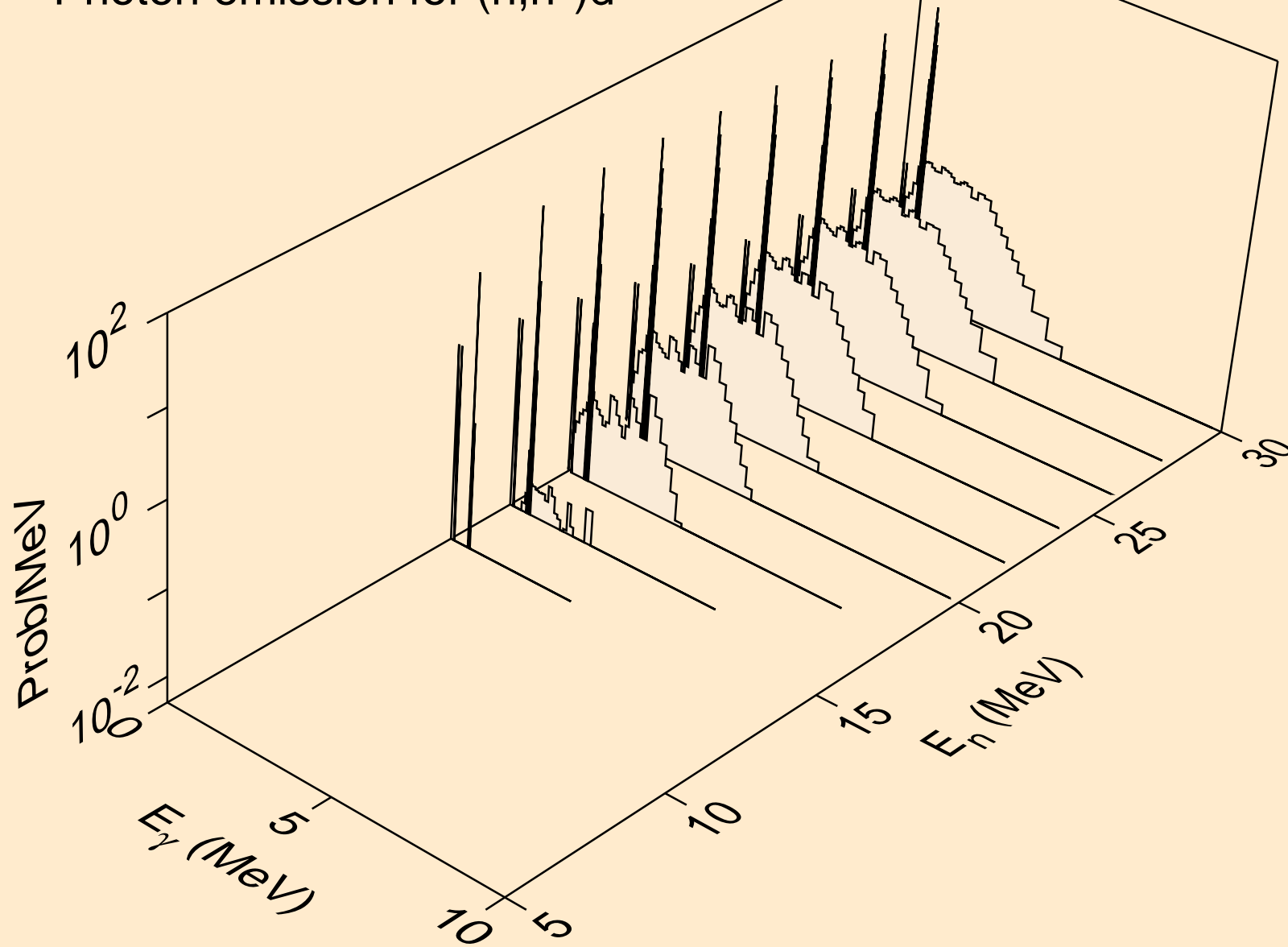

TA161M NEUTRON ACER TENDL-2021 LIBRARY; T=293.6K
Photon emission for (n,n*)t

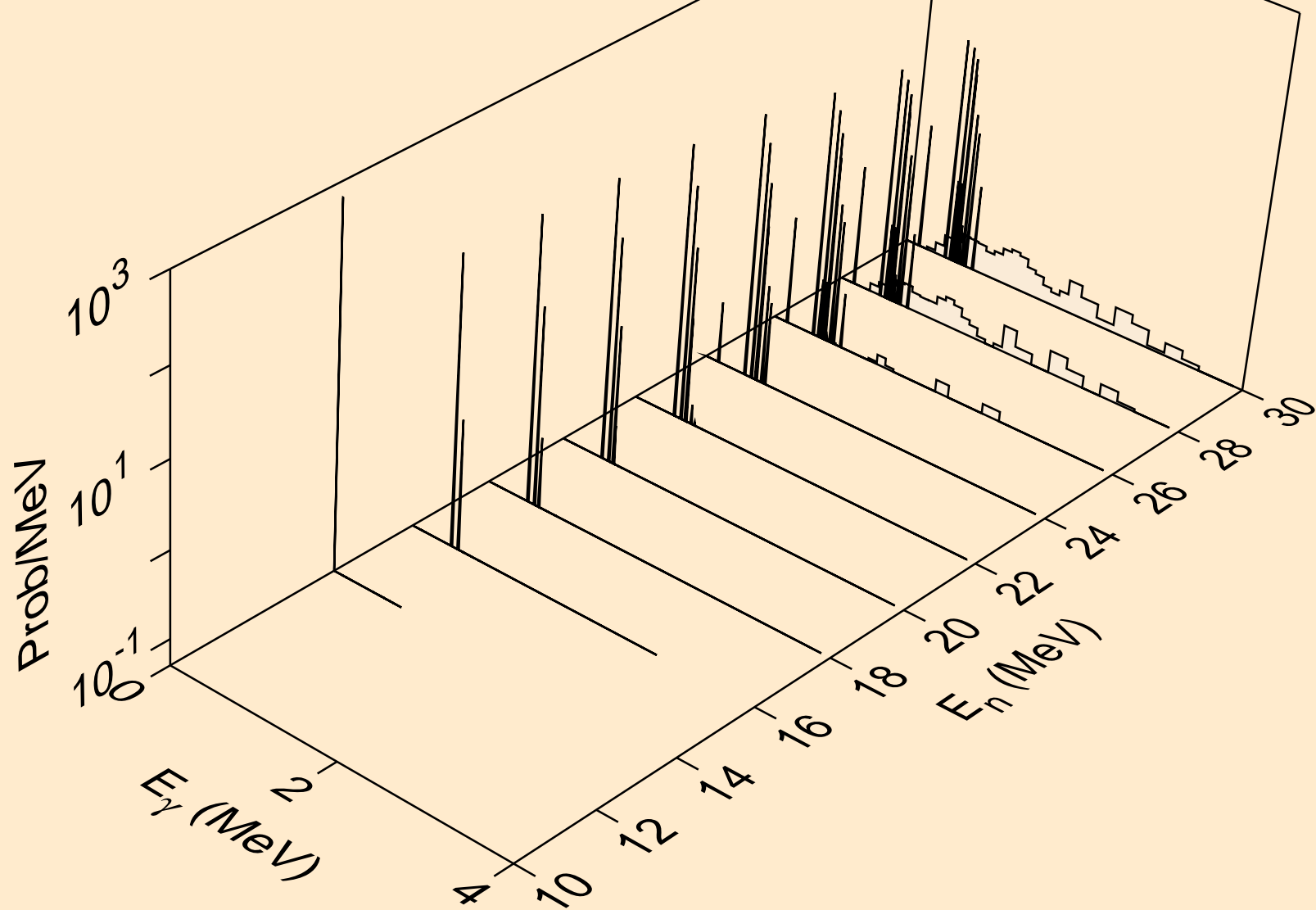

TA161M NEUTRON ACER TENDL-2021 LIBRARY; T=293.6K
Photon emission for (n,n*)he3

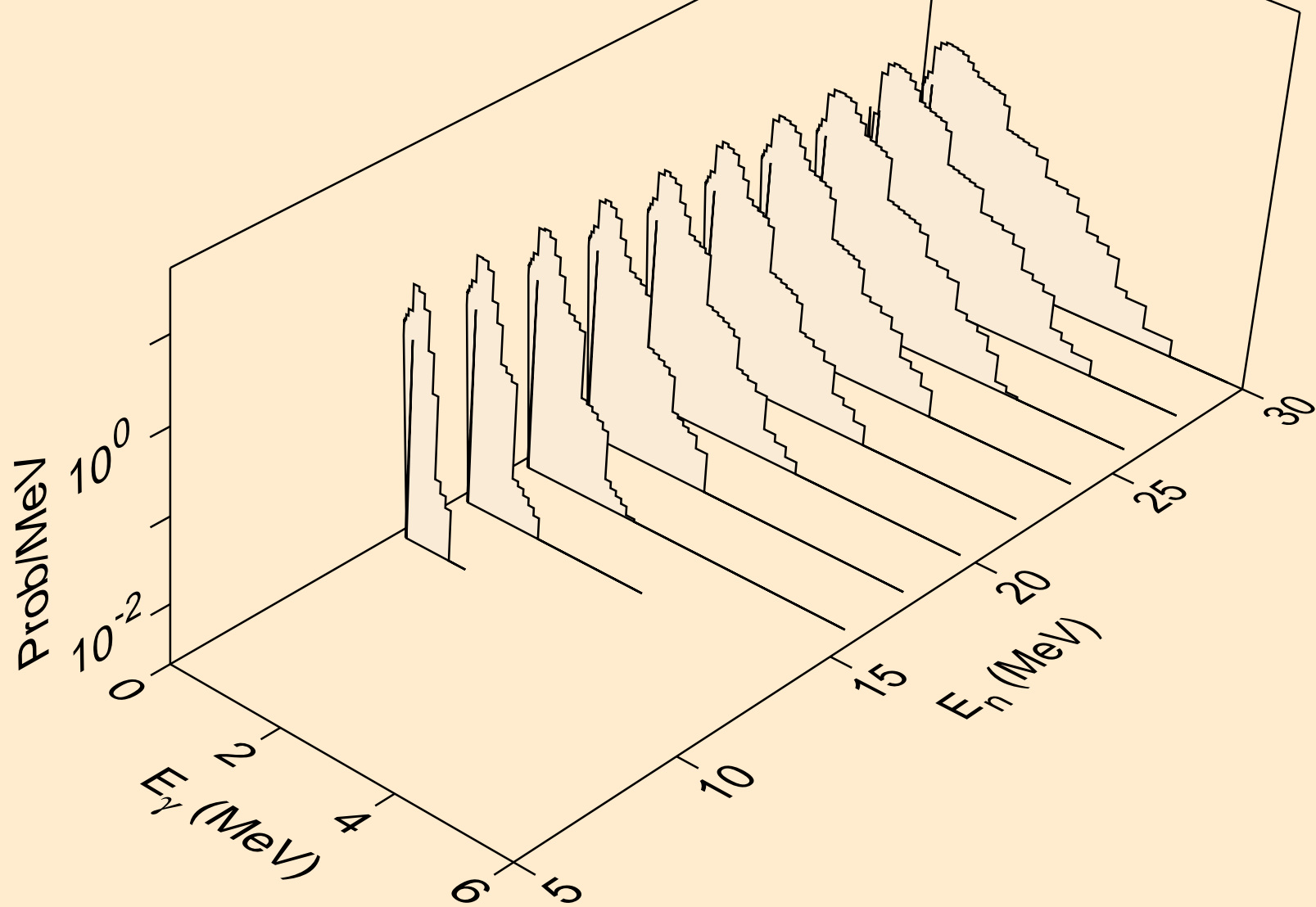

TA161M NEUTRON ACER TENDL-2021 LIBRARY; T=293.6K
Photon emission for (n,n*)d2a

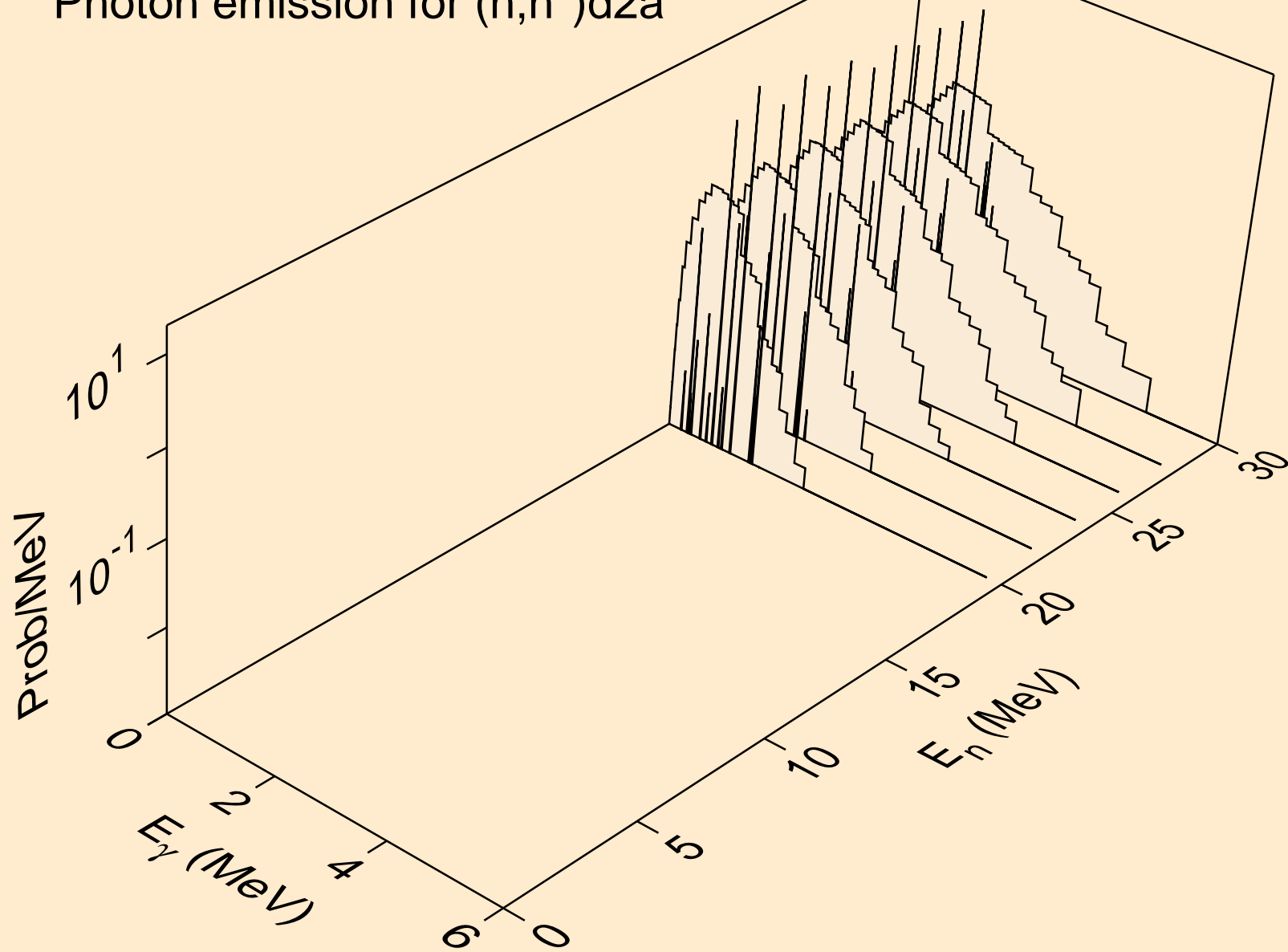

TA161M NEUTRON ACER TENDL-2021 LIBRARY; T=293.6K
Photon emission for (n,2np)

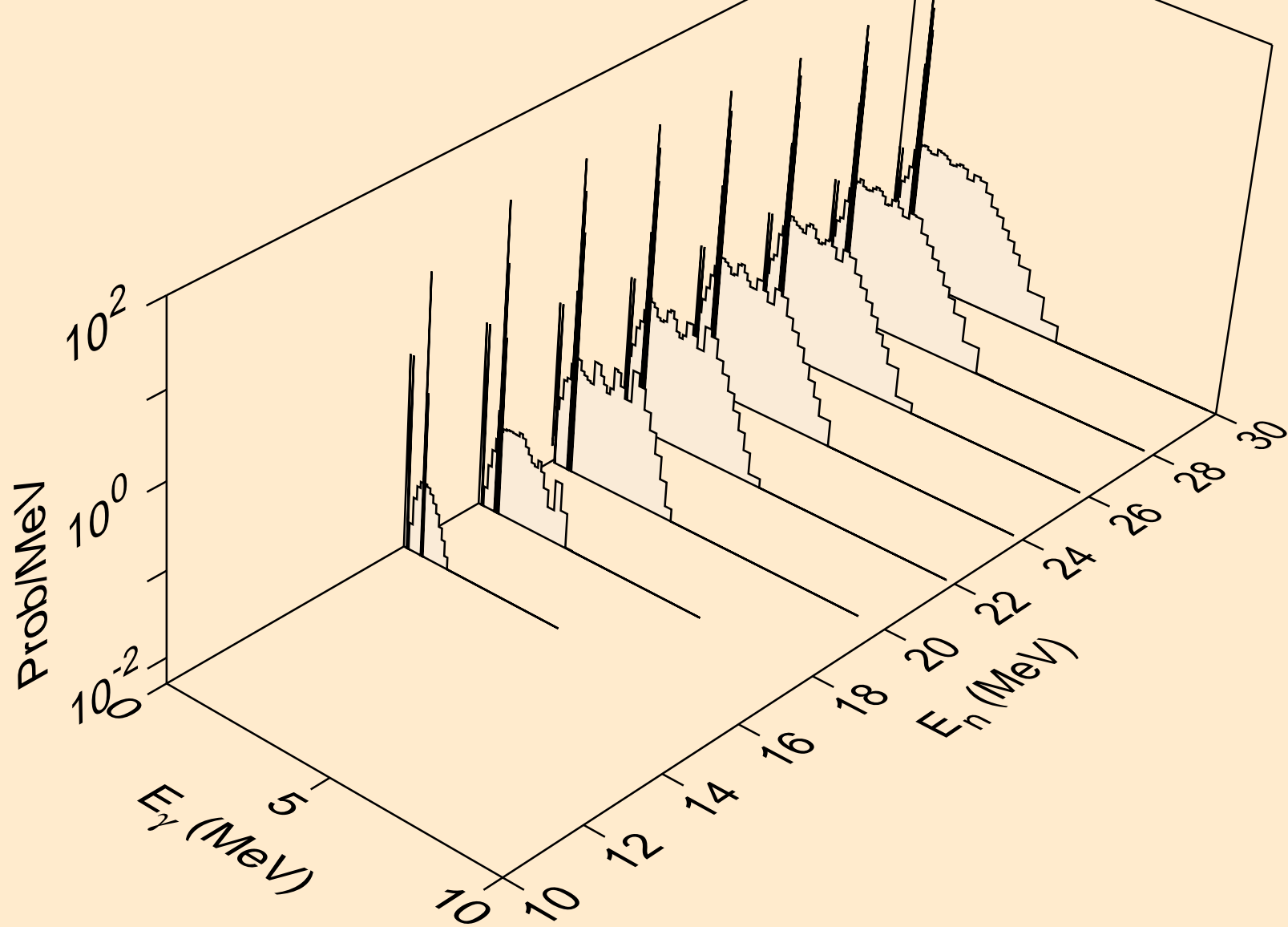

TA161M NEUTRON ACER TENDL-2021 LIBRARY; T=293.6K
Photon emission for (n,3np)

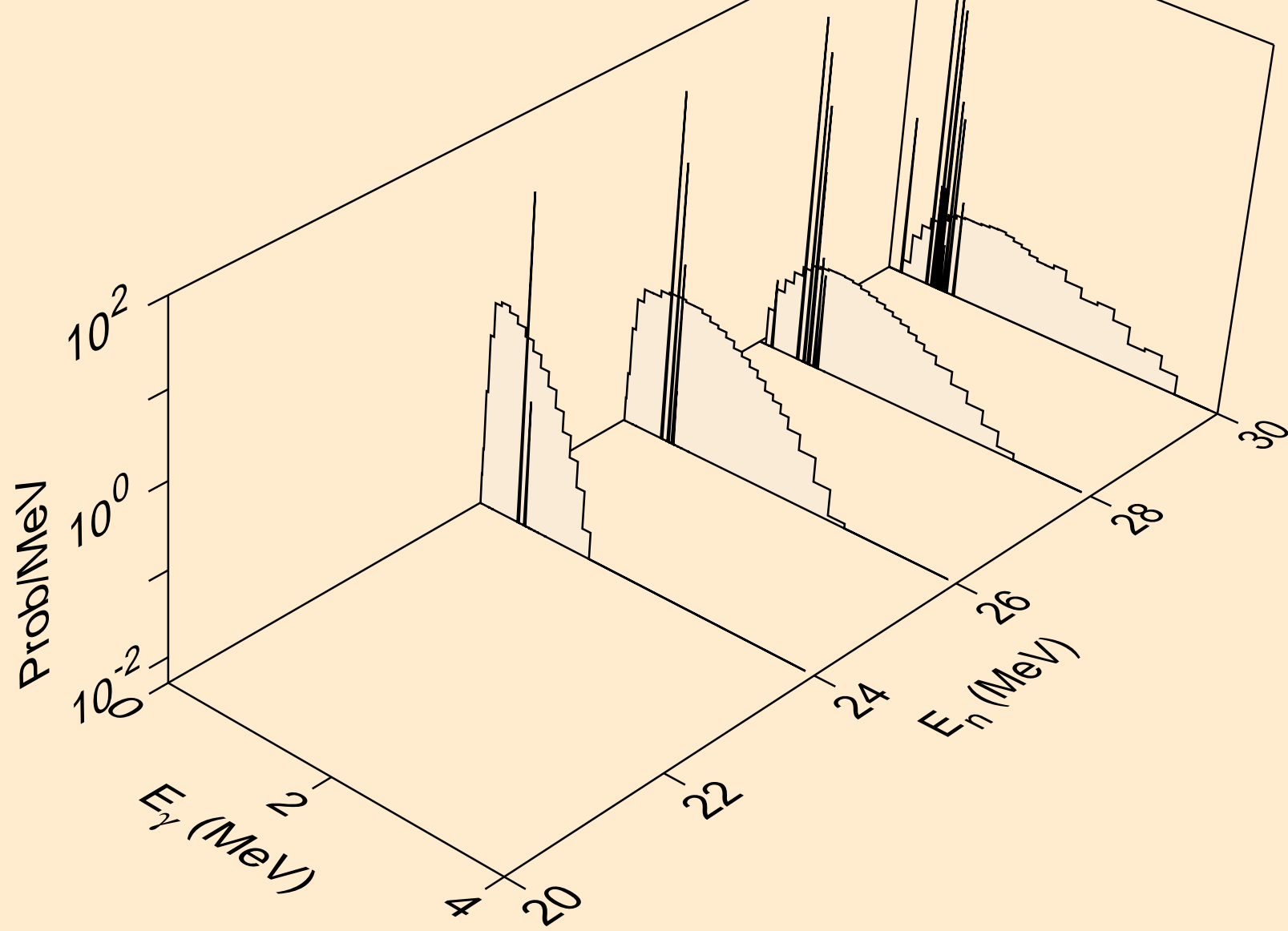

TA161M NEUTRON ACER TENDL-2021 LIBRARY; T=293.6K
Photon emission for (n,2np)

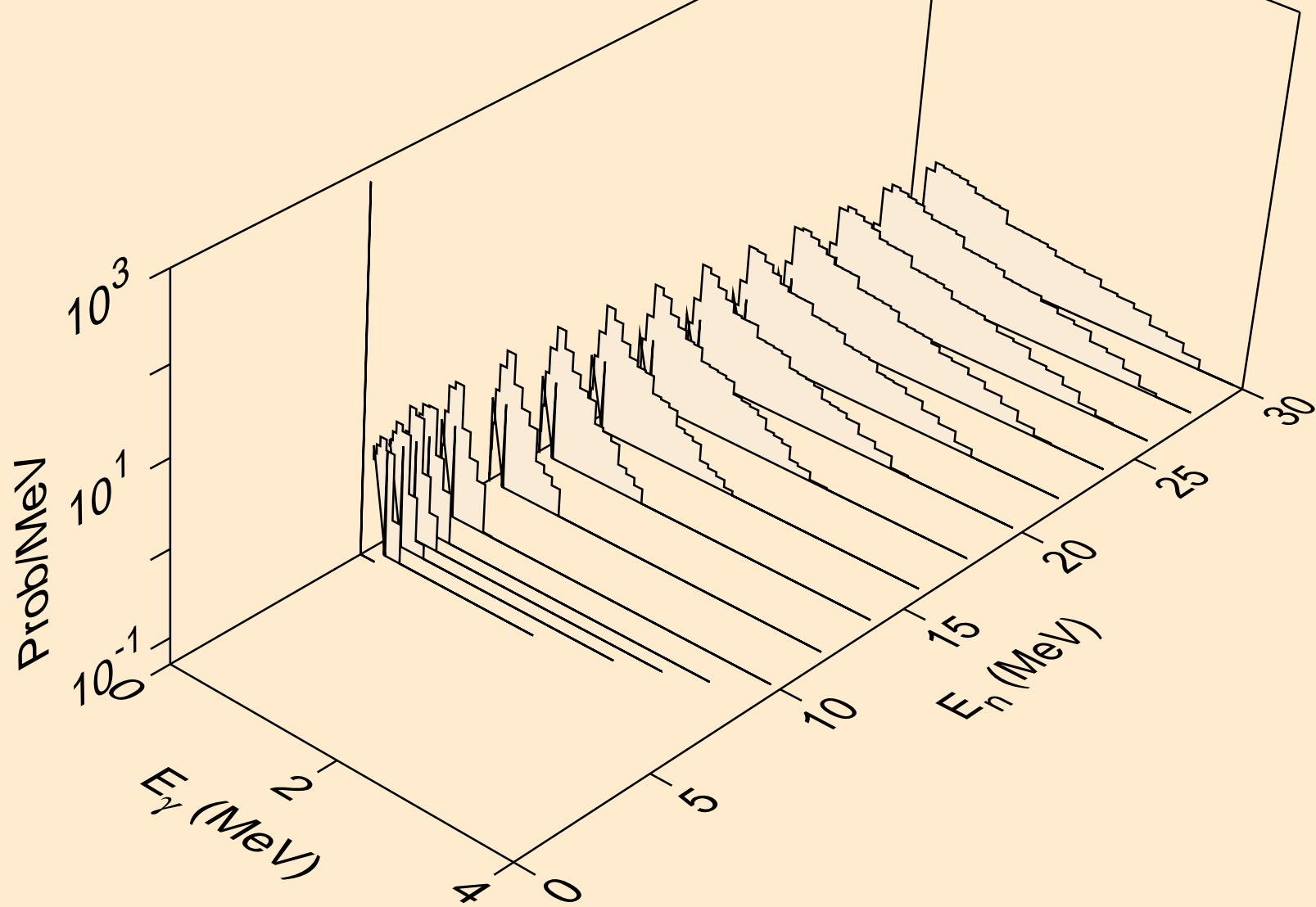

TA161M NEUTRON ACER TENDL-2021 LIBRARY; T=293.6K
Photon emission for (n,npa)

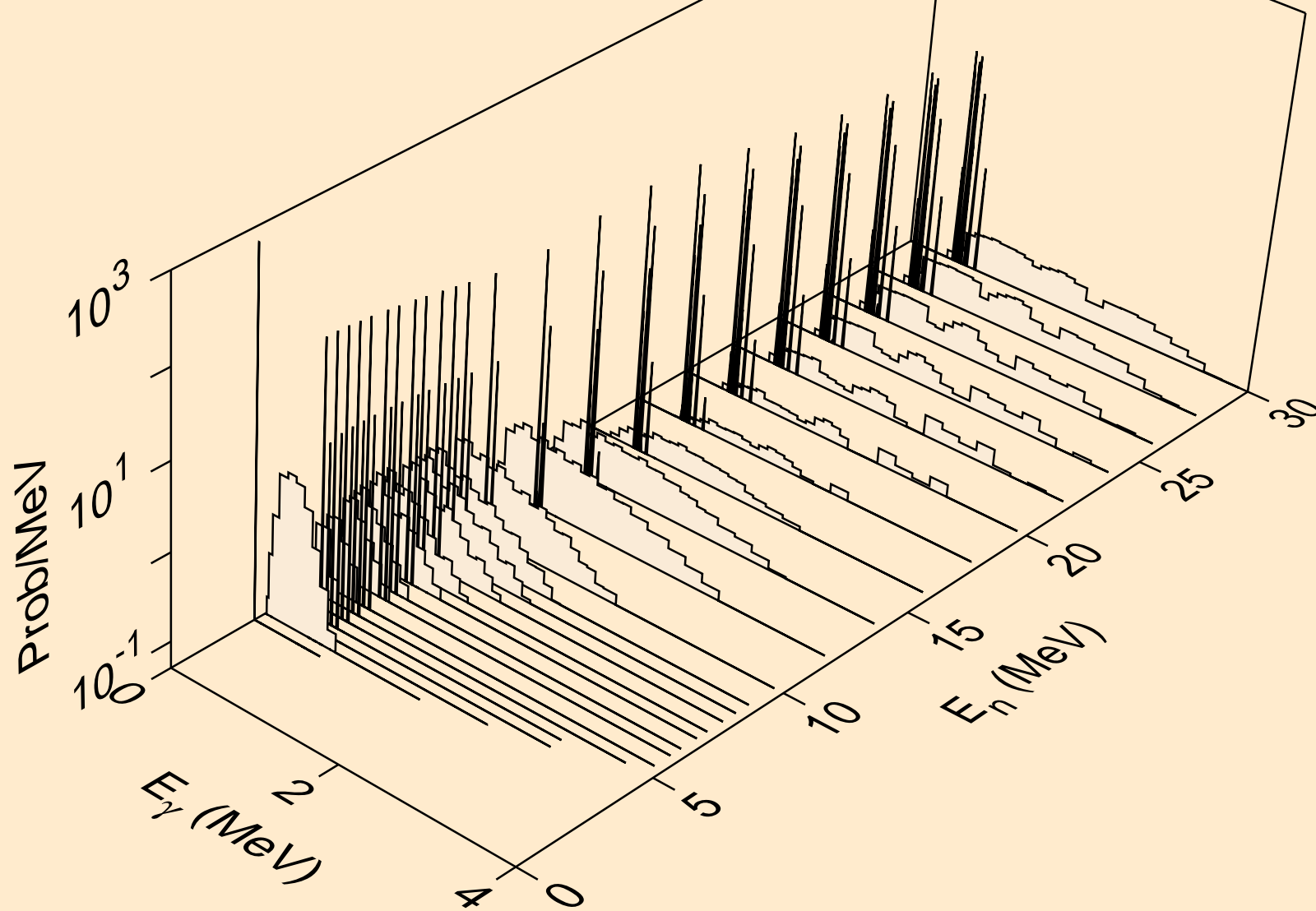

TA161M NEUTRON ACER TENDL-2021 LIBRARY; T=293.6K
Photon emission for (n,n*2)

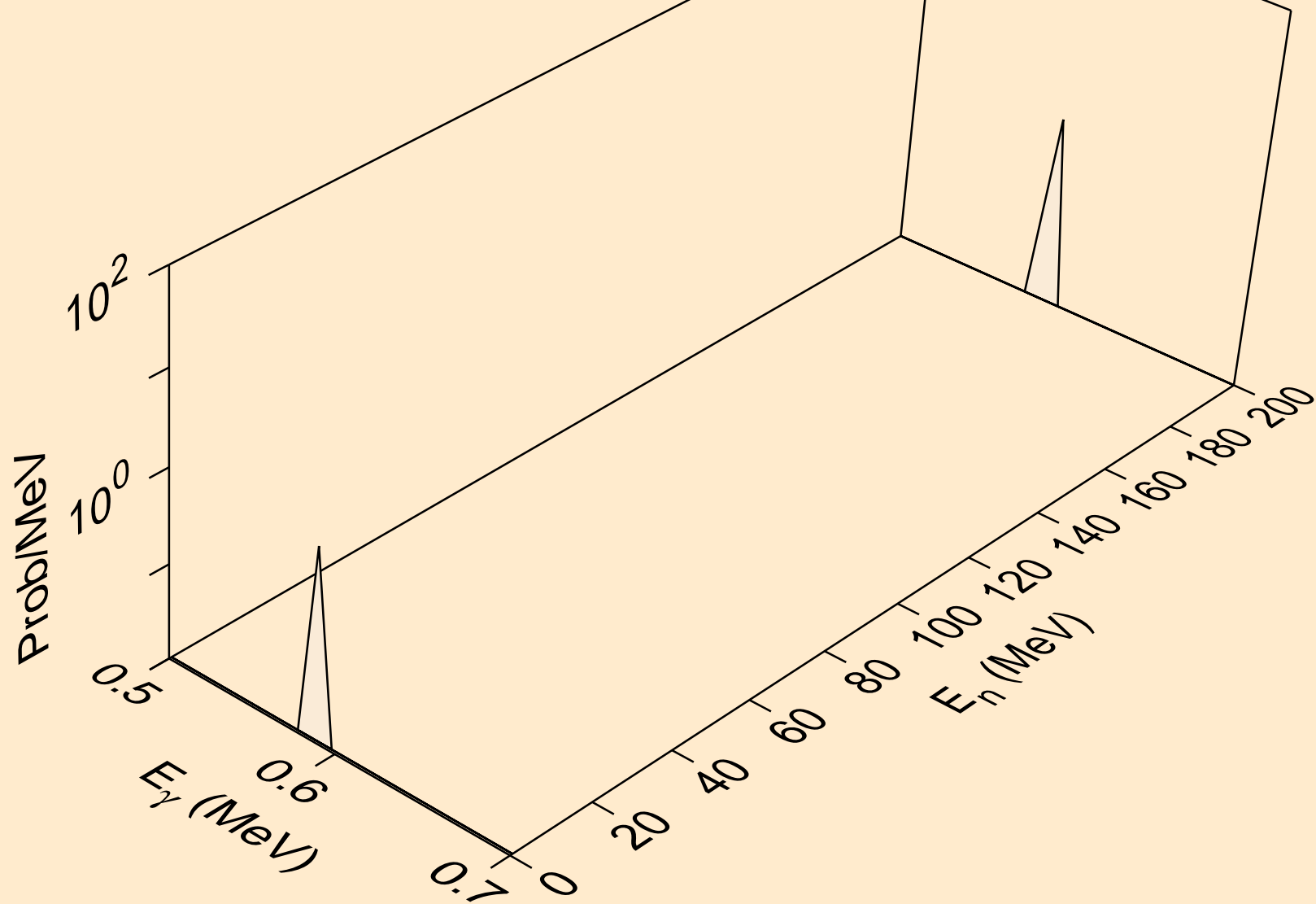

TA161M NEUTRON ACER TENDL-2021 LIBRARY; T=293.6K
Photon emission for (n,n*3)

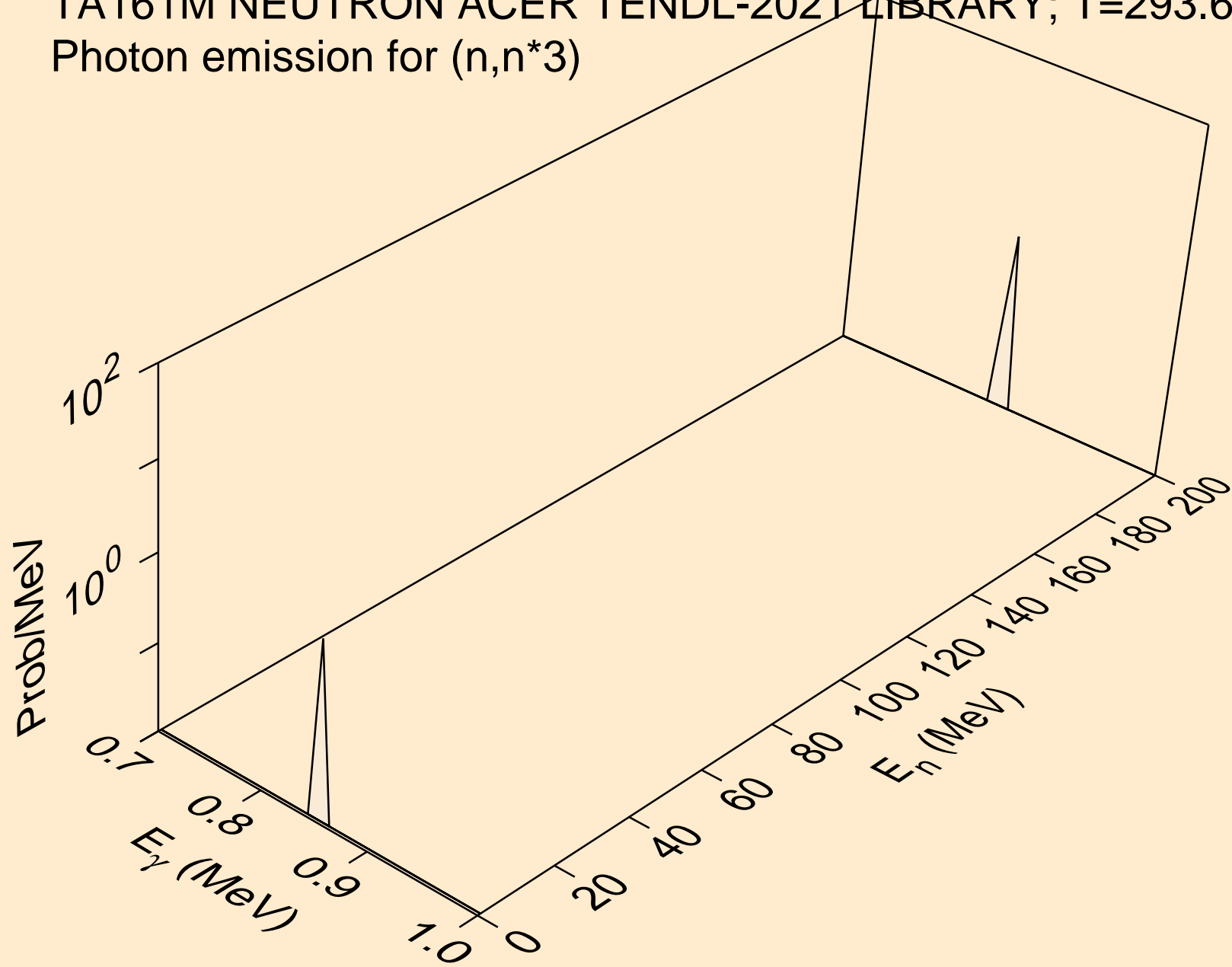

TA161M NEUTRON ACER TENDL-2021 LIBRARY; T=293.6K
Photon emission for (n,n*4)

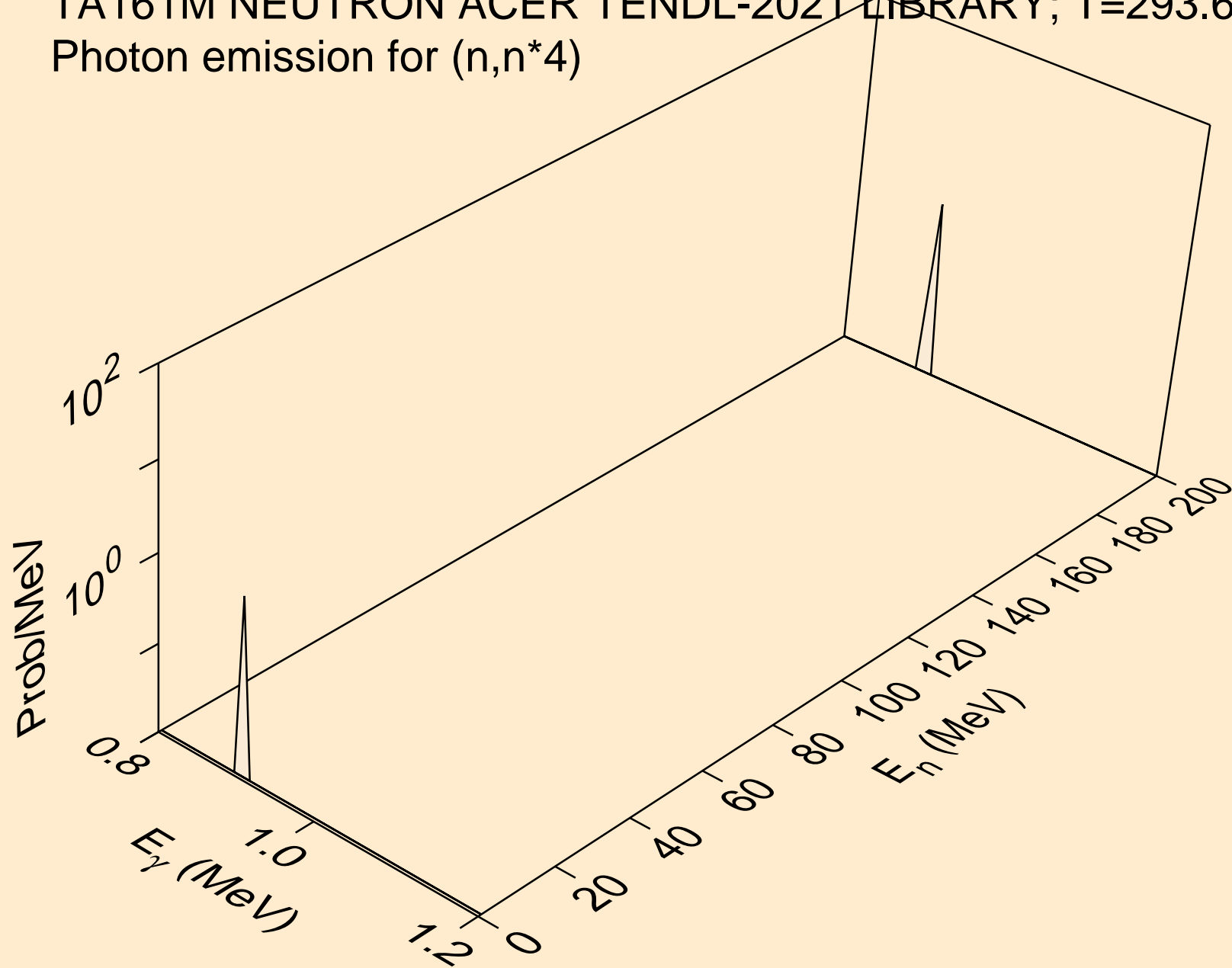

TA161M NEUTRON ACER TENDL-2021 LIBRARY; T=293.6K
Photon emission for (n,n*5)

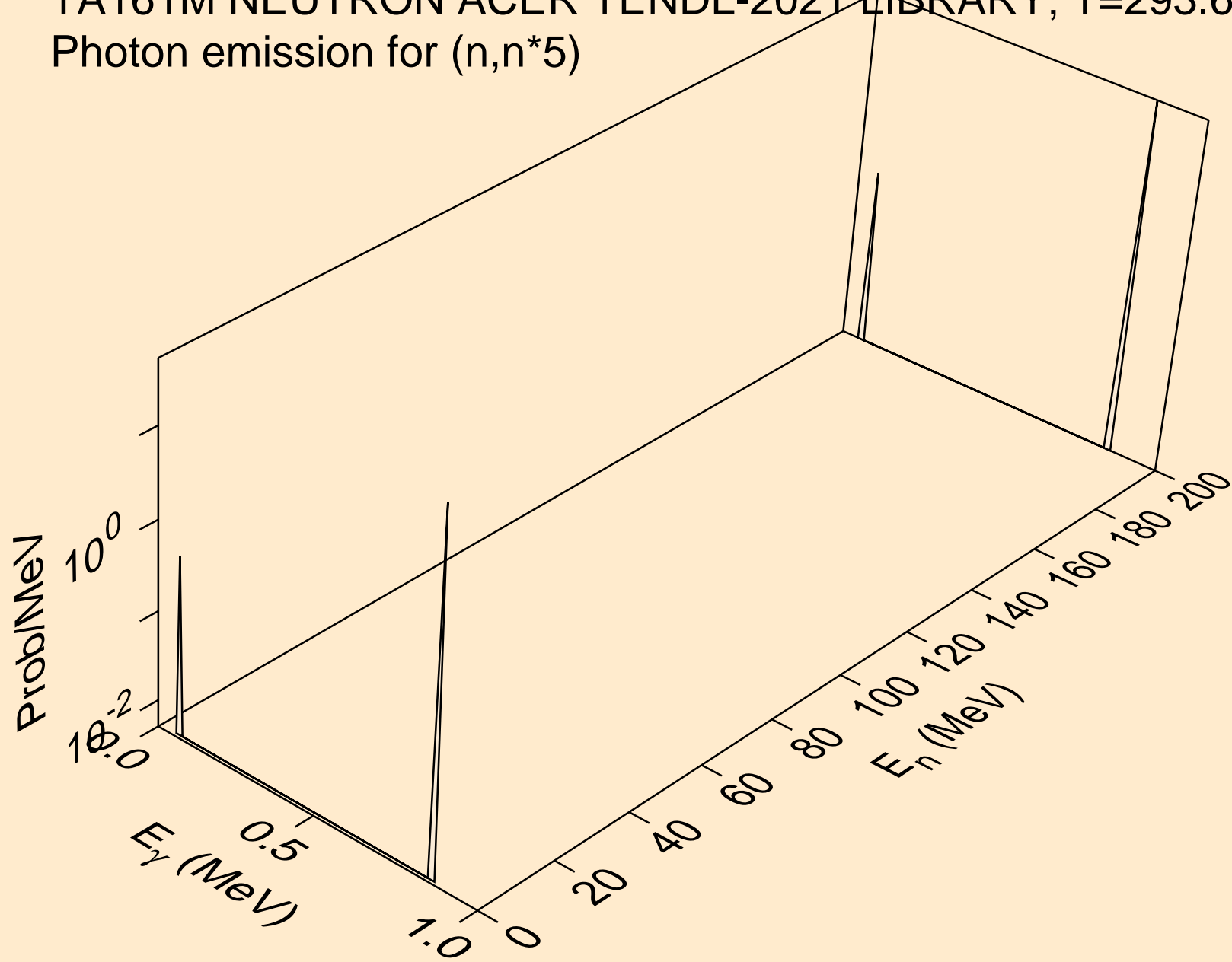

TA161M NEUTRON ACER TENDL-2021 LIBRARY; T=293.6K
Photon emission for (n,n*6)

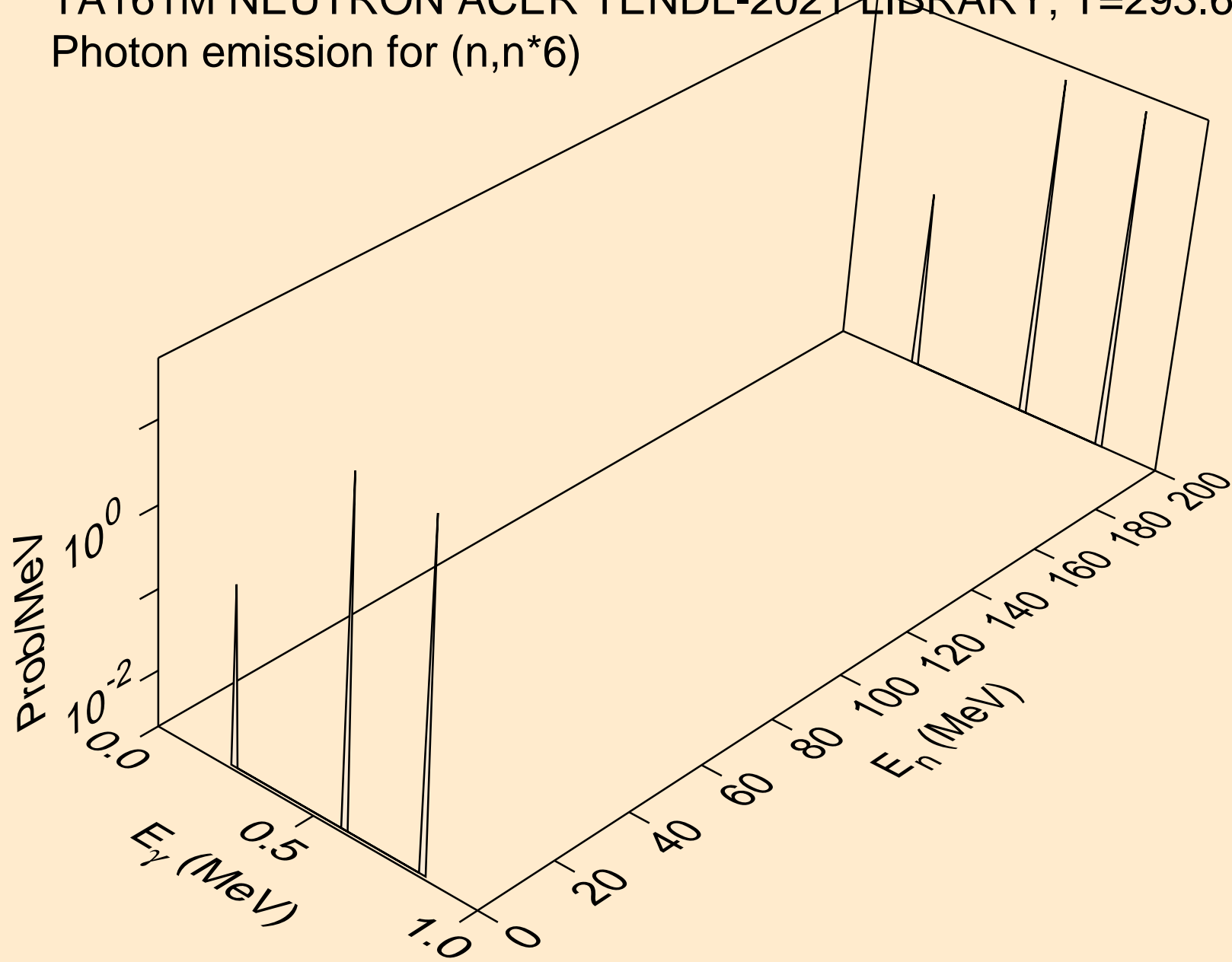

TA161M NEUTRON ACER TENDL-2021 LIBRARY; T=293.6K
Photon emission for (n,n*7)

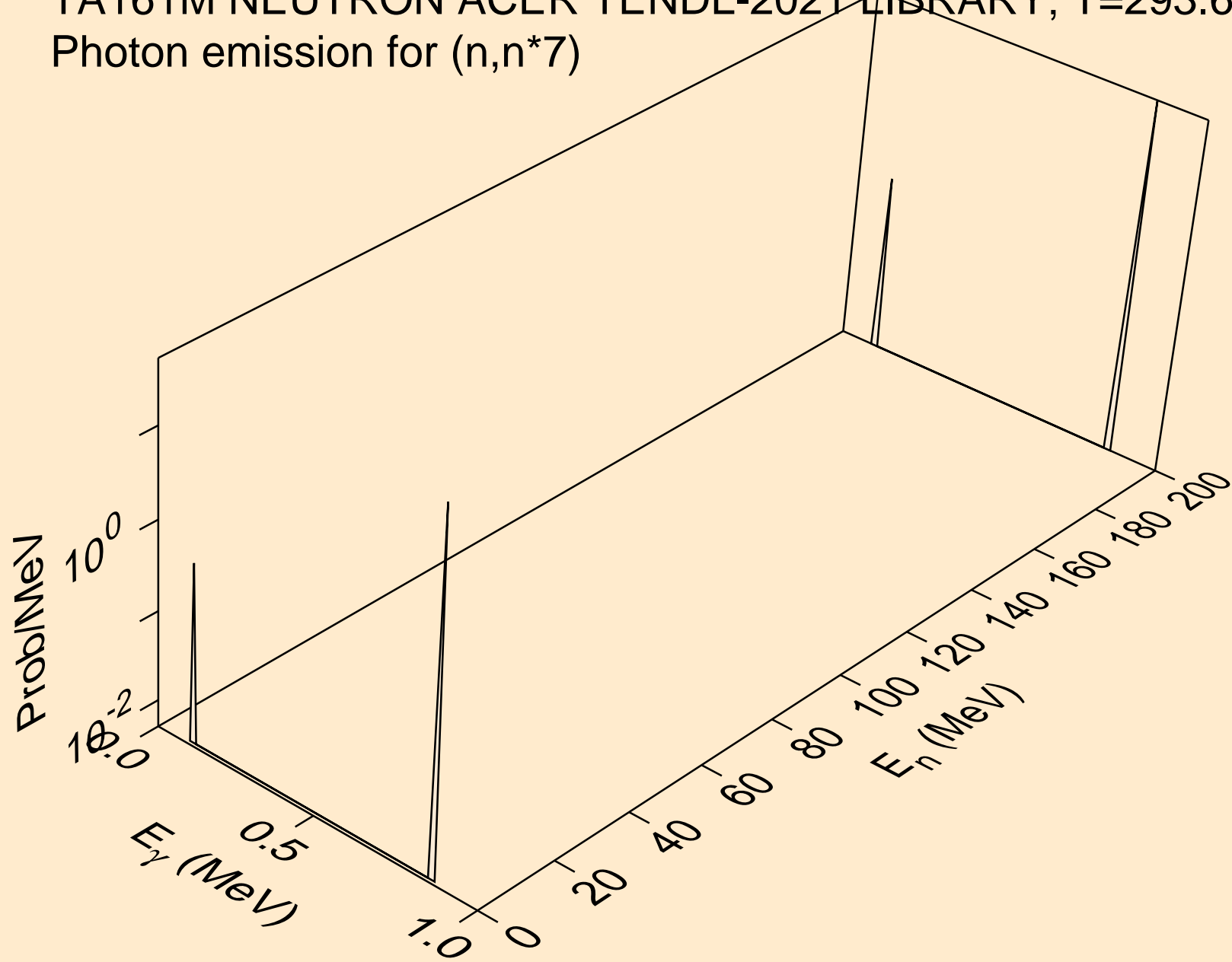

TA161M NEUTRON ACER TENDL-2021 LIBRARY; T=293.6K
Photon emission for (n,n*8)

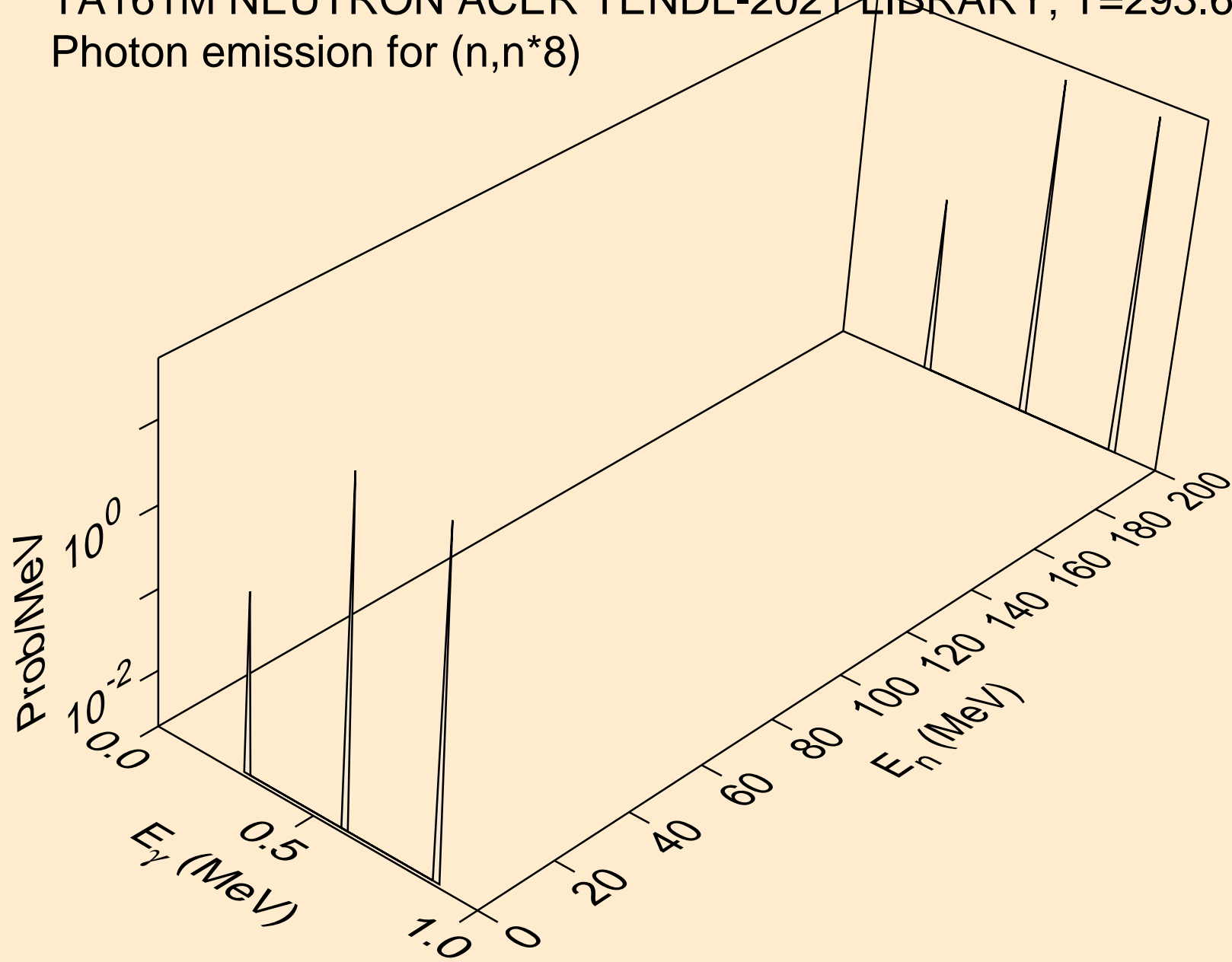

TA161M NEUTRON ACER TENDL-2021 LIBRARY; T=293.6K
Photon emission for (n,n*9)

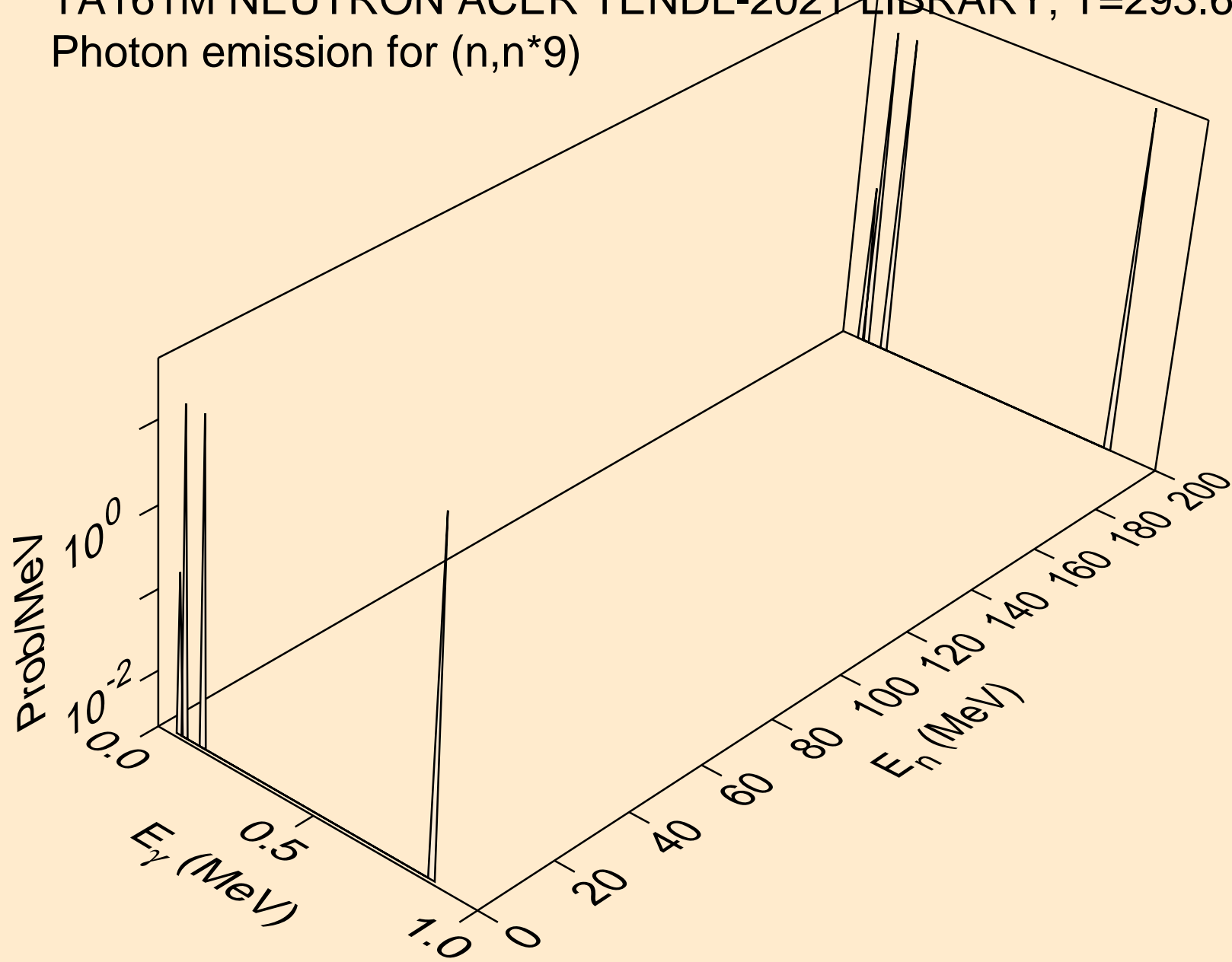

TA161M NEUTRON ACER TENDL-2021 LIBRARY; T=293.6K
Photon emission for (n,n*10)

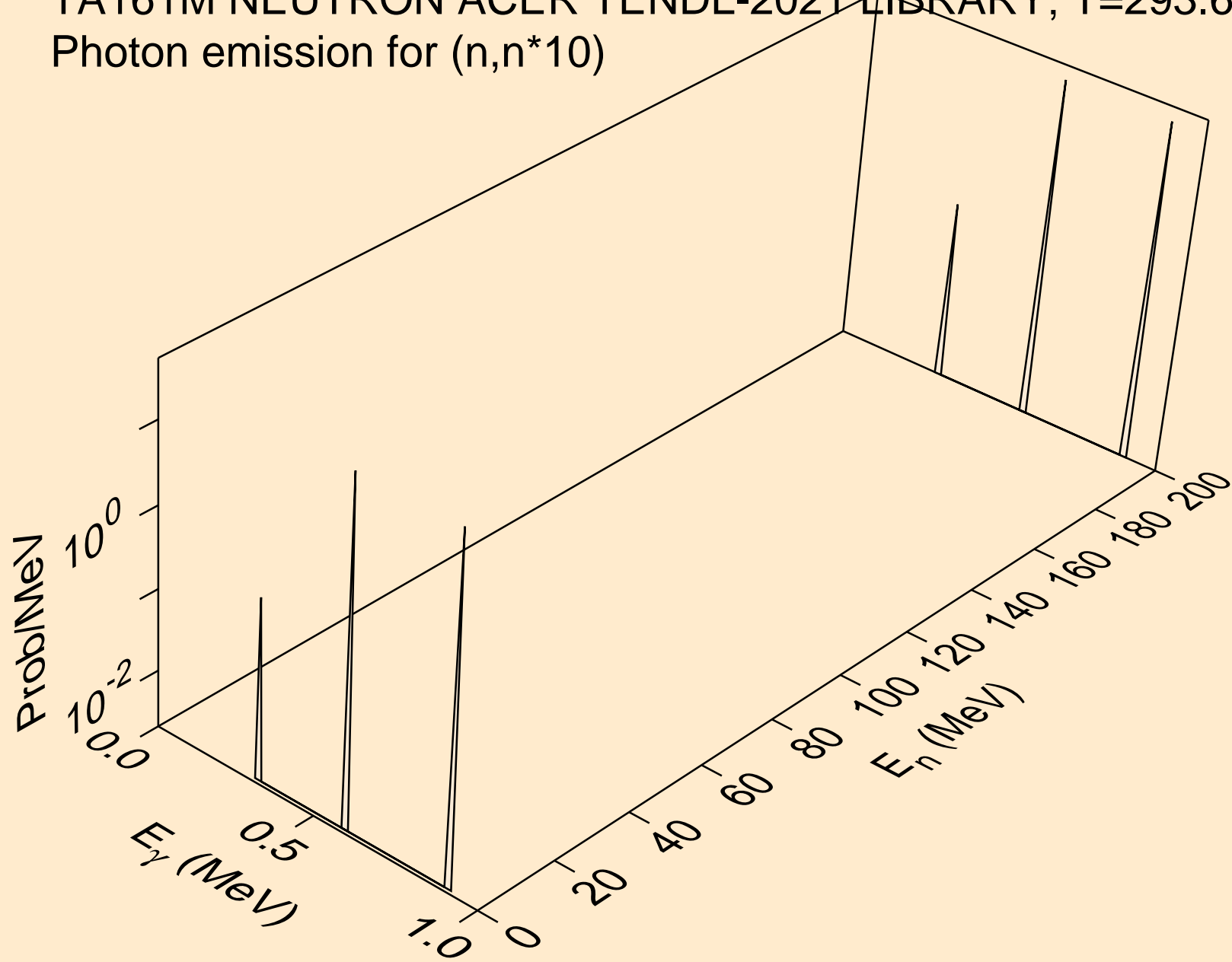

TA161M NEUTRON ACER TENDL-2021 LIBRARY; T=293.6K
Photon emission for (n,n*11)

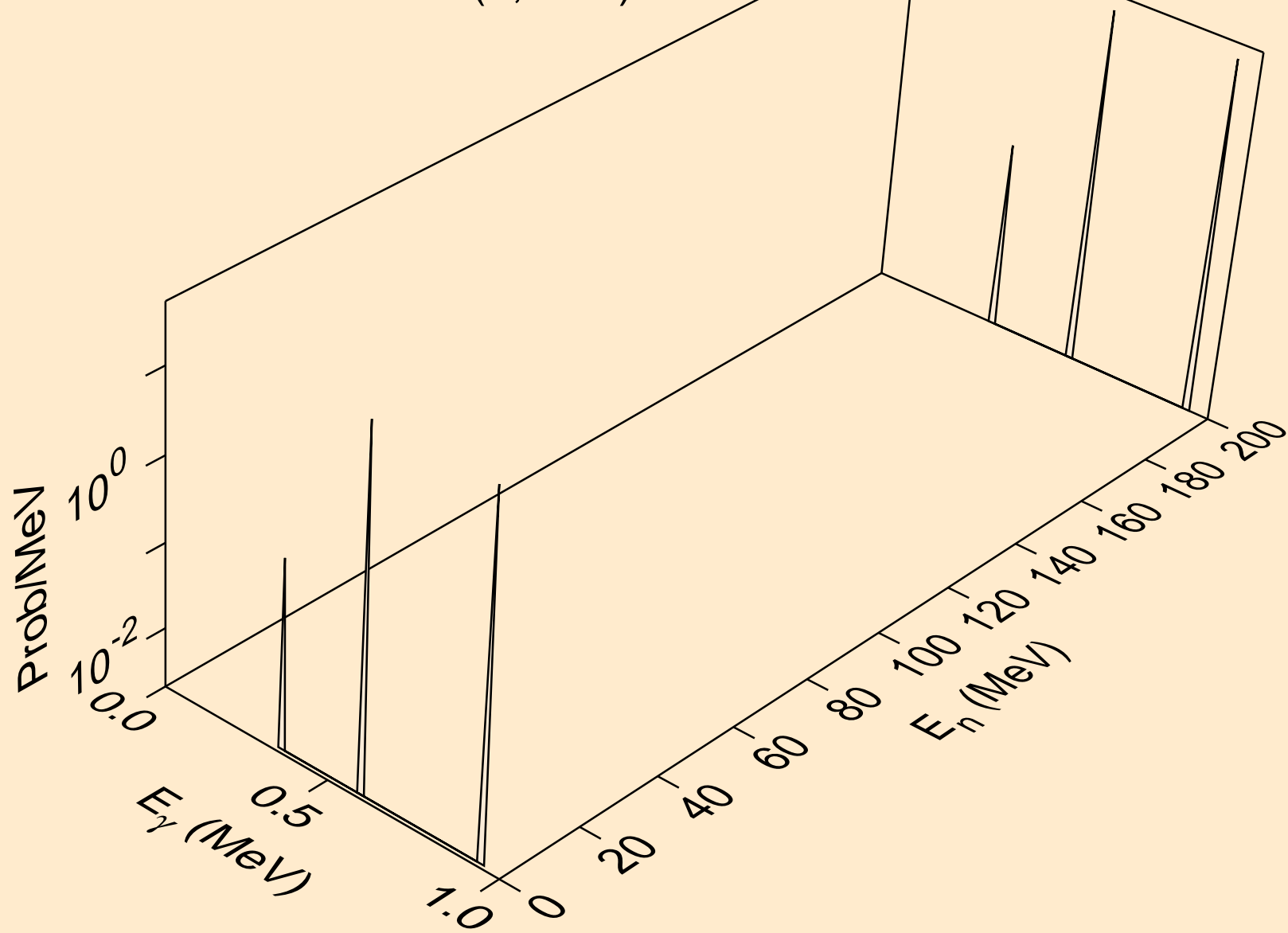

TA161M NEUTRON ACER TENDL-2021 LIBRARY; T=293.6K
Photon emission for (n,n*12)

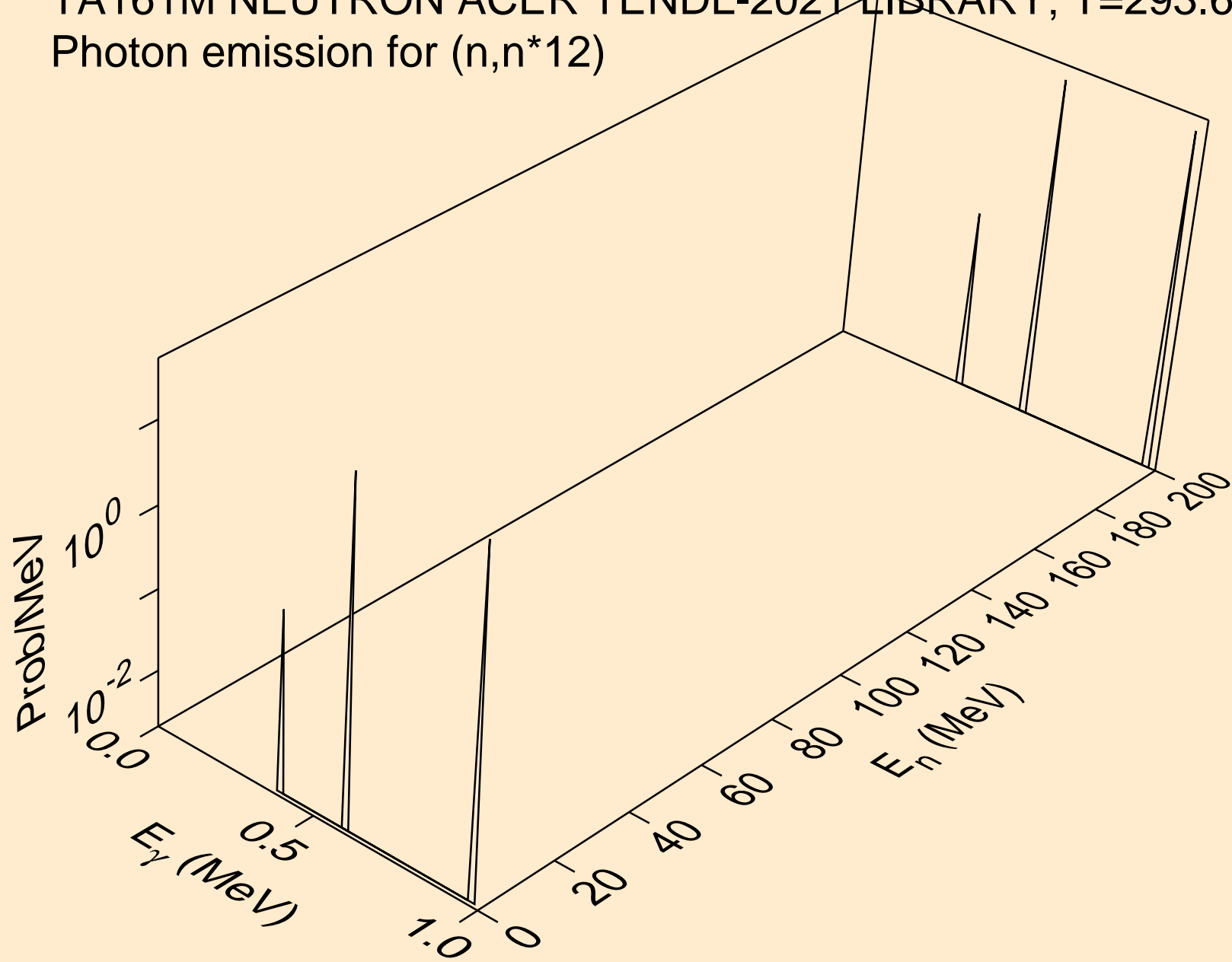

TA161M NEUTRON ACER TENDL-2021 LIBRARY; T=293.6K
Photon emission for (n,n*c)

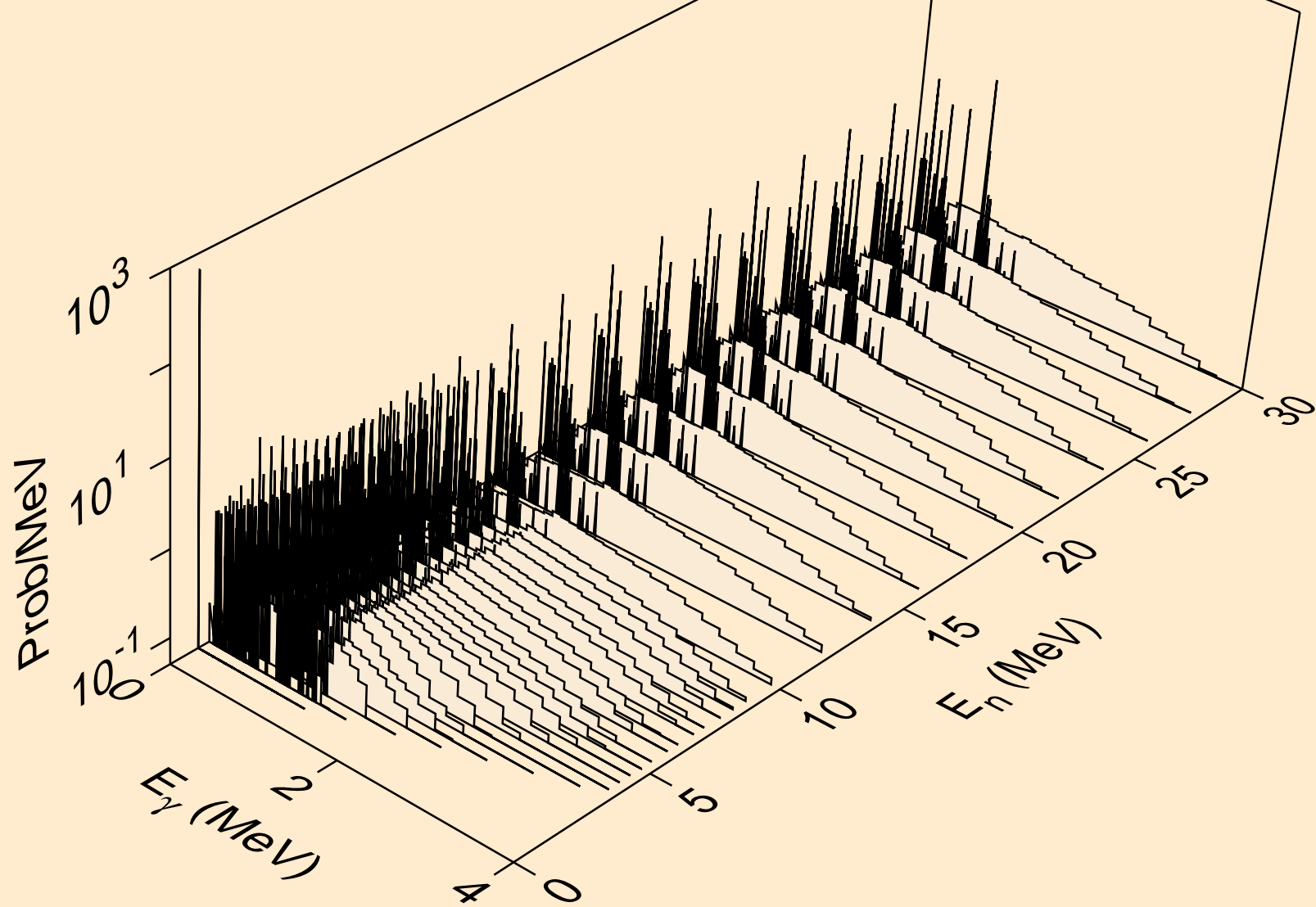

TA161M NEUTRON ACER TENDL-2021 LIBRARY; T=293.6K
Photon emission for (n,gma)

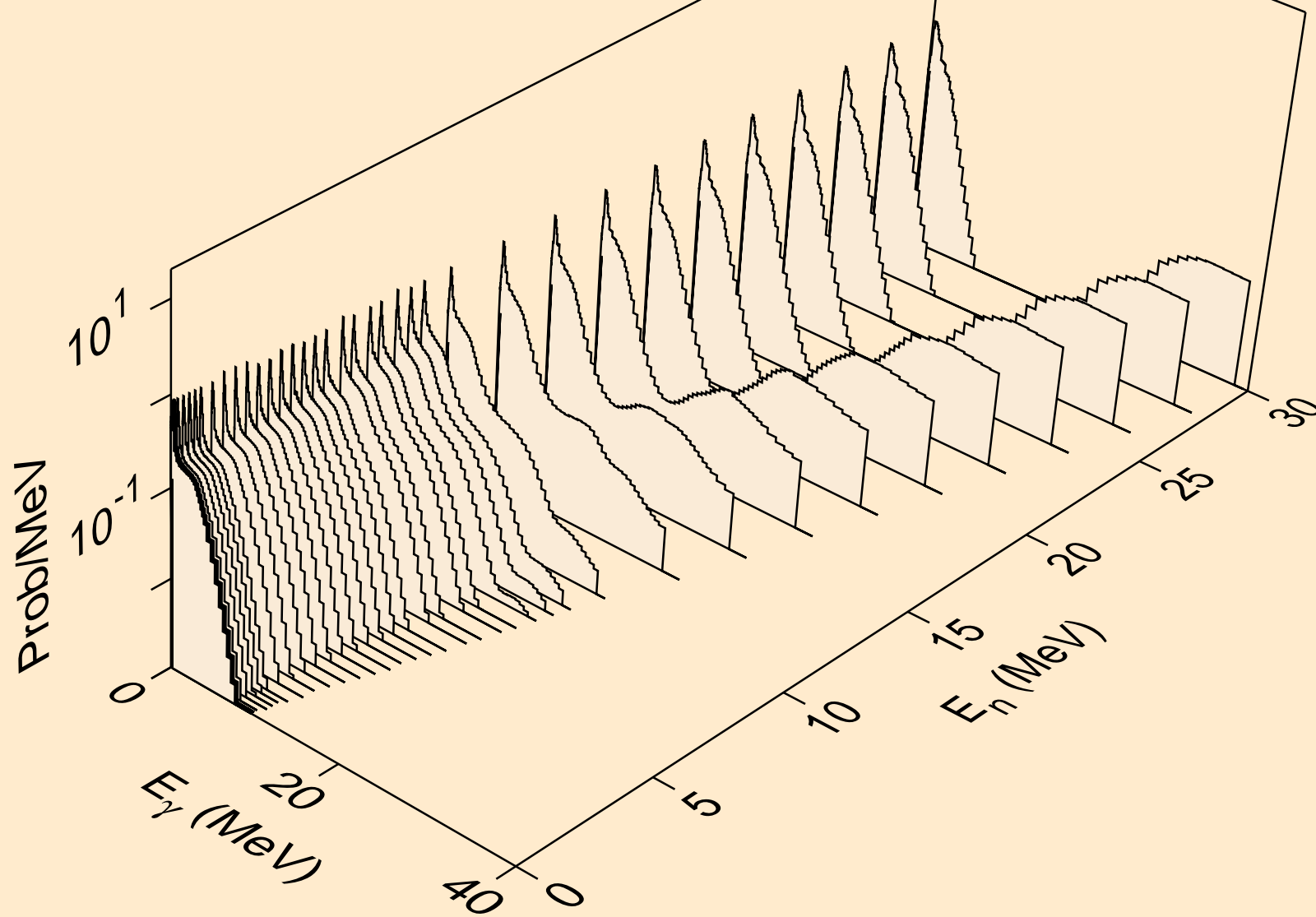

TA161M NEUTRON ACER TENDL-2021 LIBRARY; T=293.6K
Photon emission for (n,p)

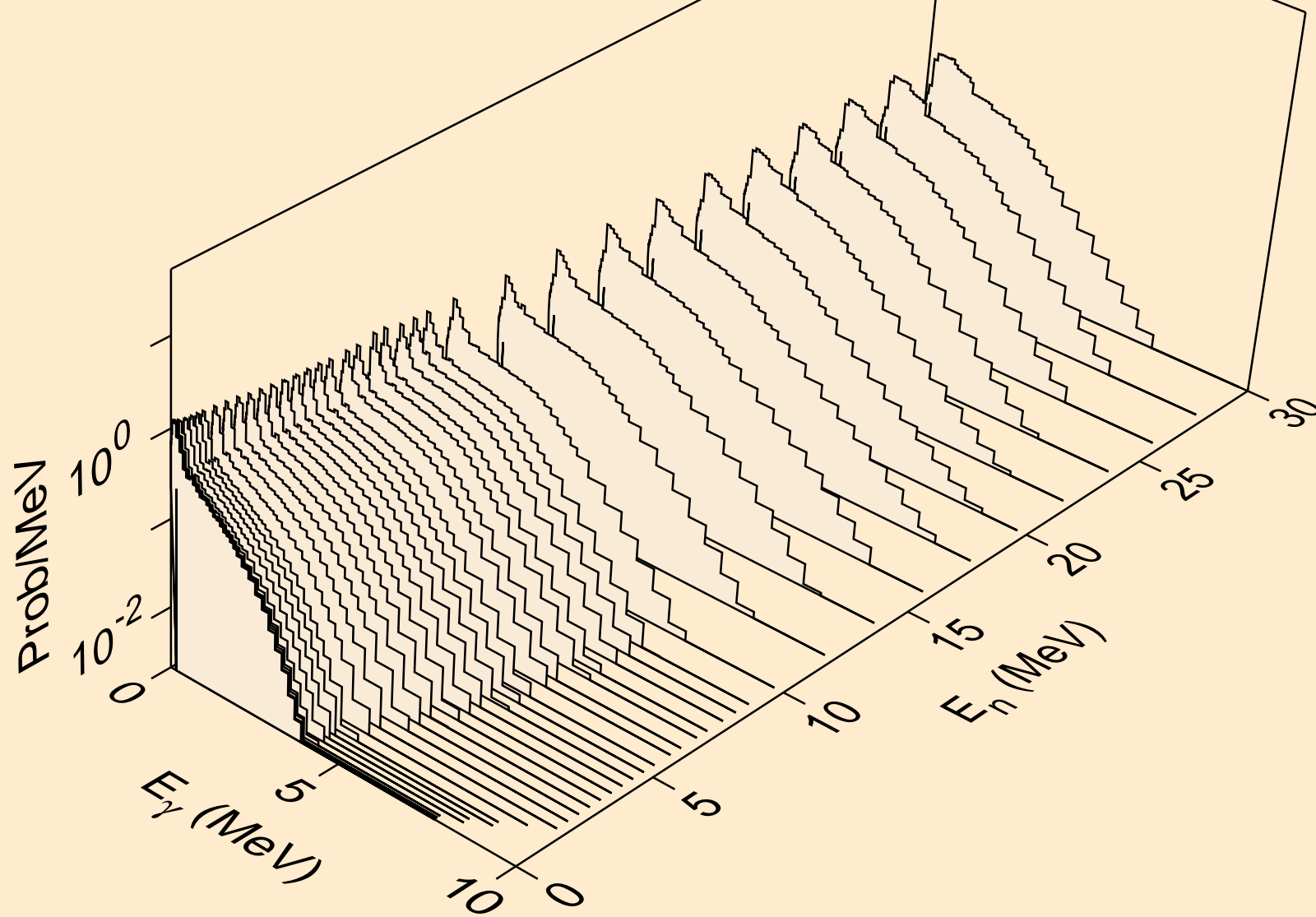

TA161M NEUTRON ACER TENDL-2021 LIBRARY; T=293.6K
Photon emission for (n,d)

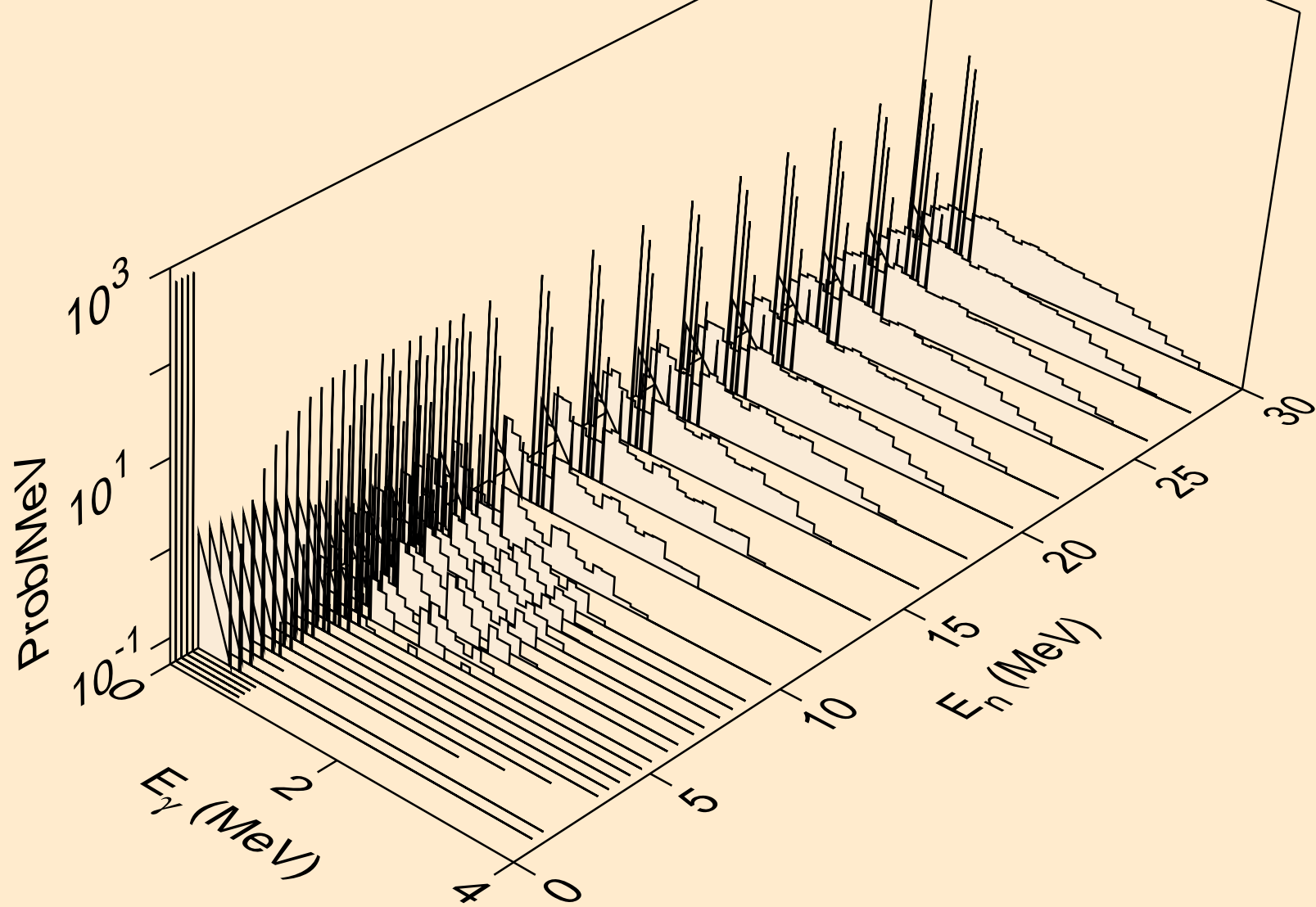

TA161M NEUTRON ACER TENDL-2021 LIBRARY; T=293.6K
Photon emission for (n,t)

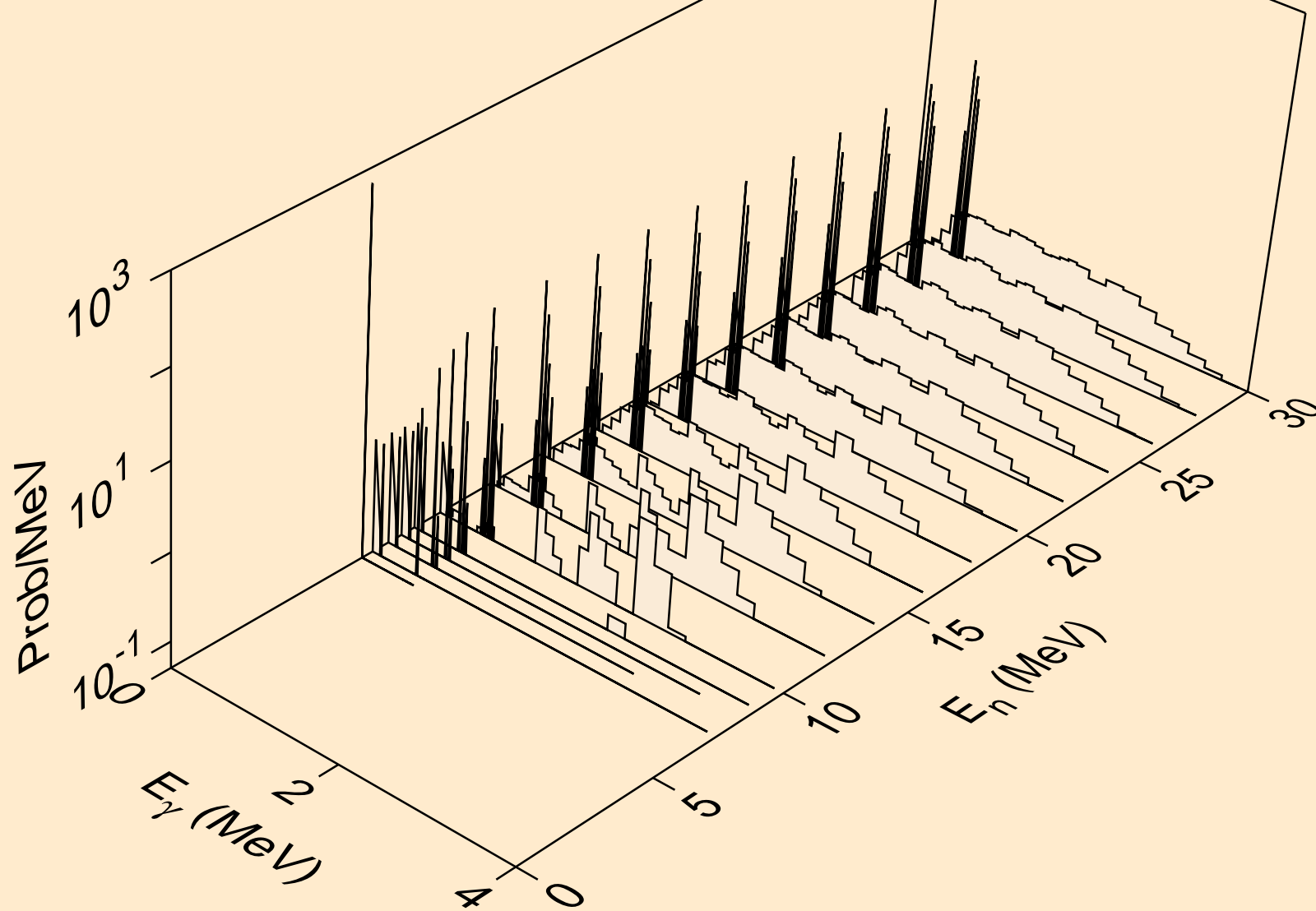

TA161M NEUTRON ACER TENDL-2021 LIBRARY; T=293.6K
Photon emission for (n,he3)

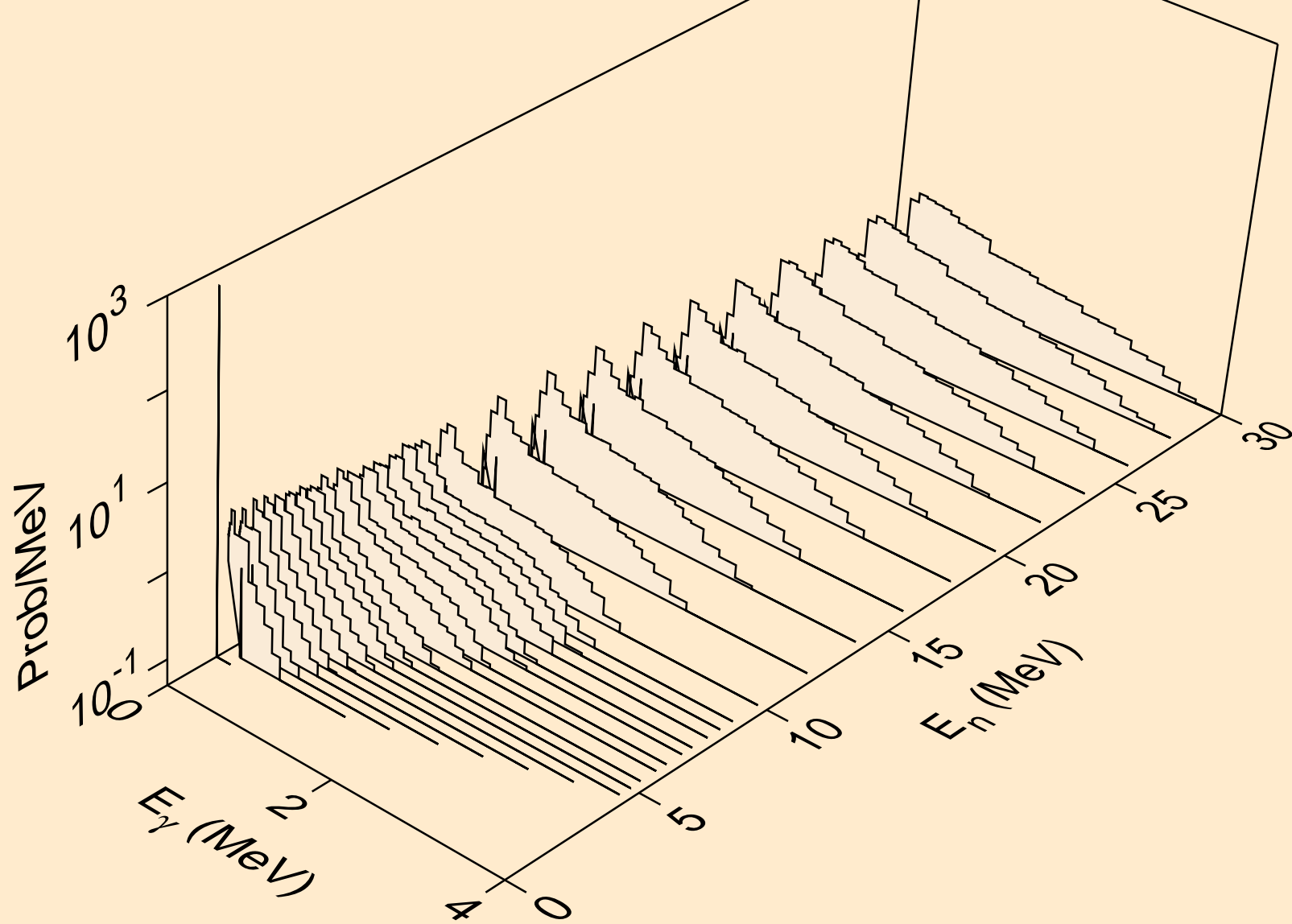

TA161M NEUTRON ACER TENDL-2021 LIBRARY; T=293.6K
Photon emission for (n,a)

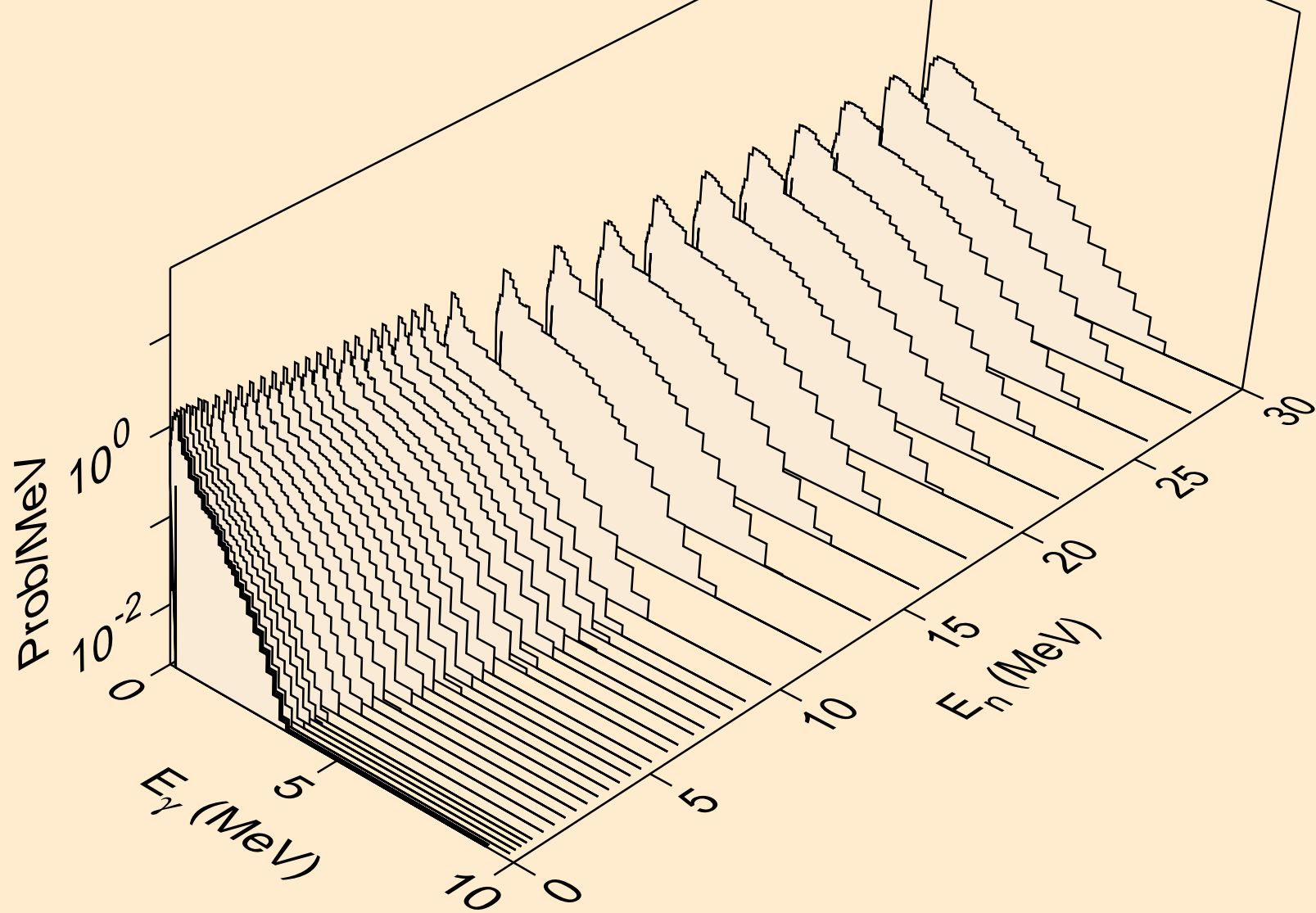

TA161M NEUTRON ACER TENDL-2021 LIBRARY; T=293.6K
Photon emission for (n,2a)

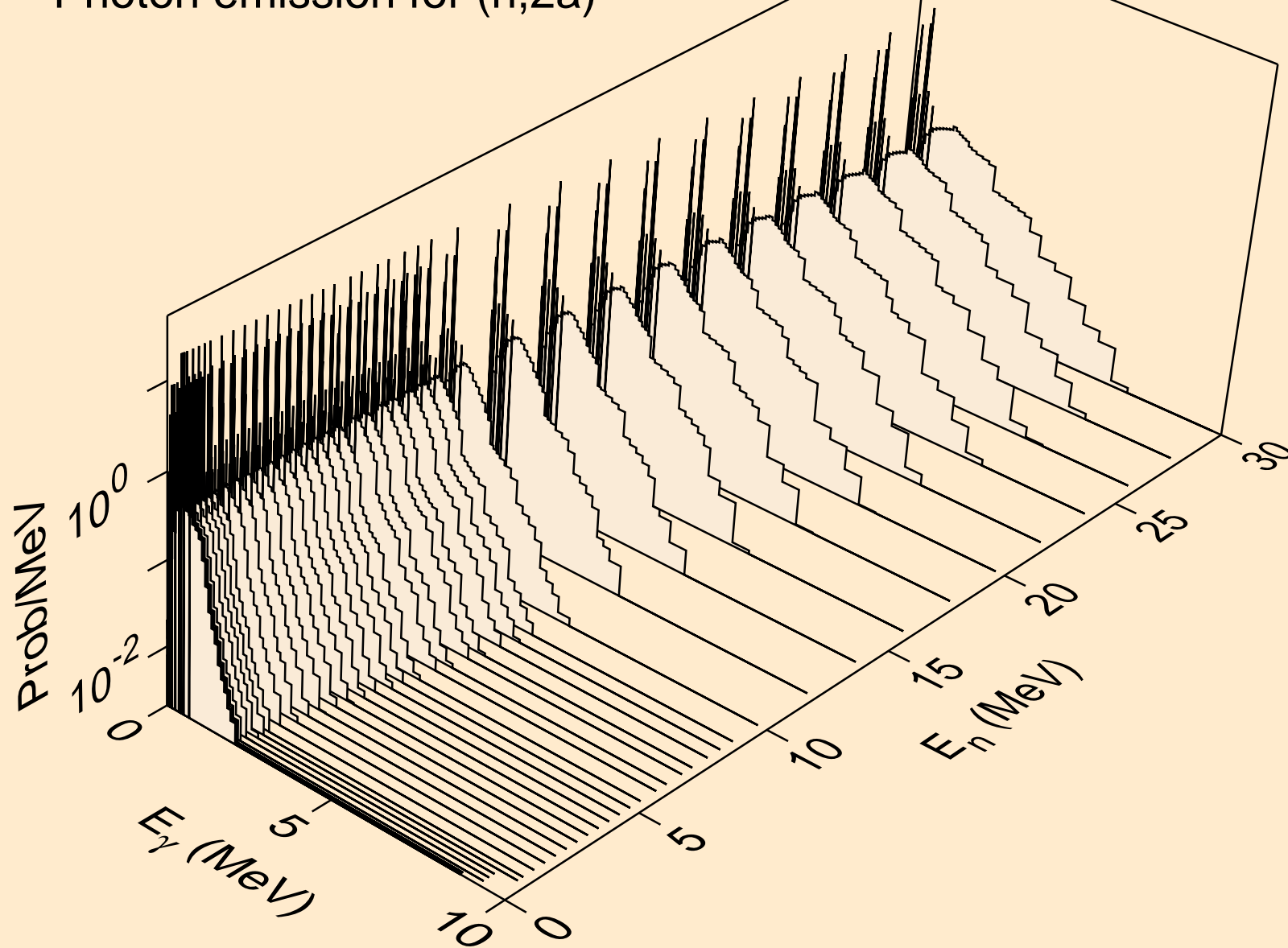

TA161M NEUTRON ACER TENDL-2021 LIBRARY; T=293.6K
Photon emission for (n,3a)

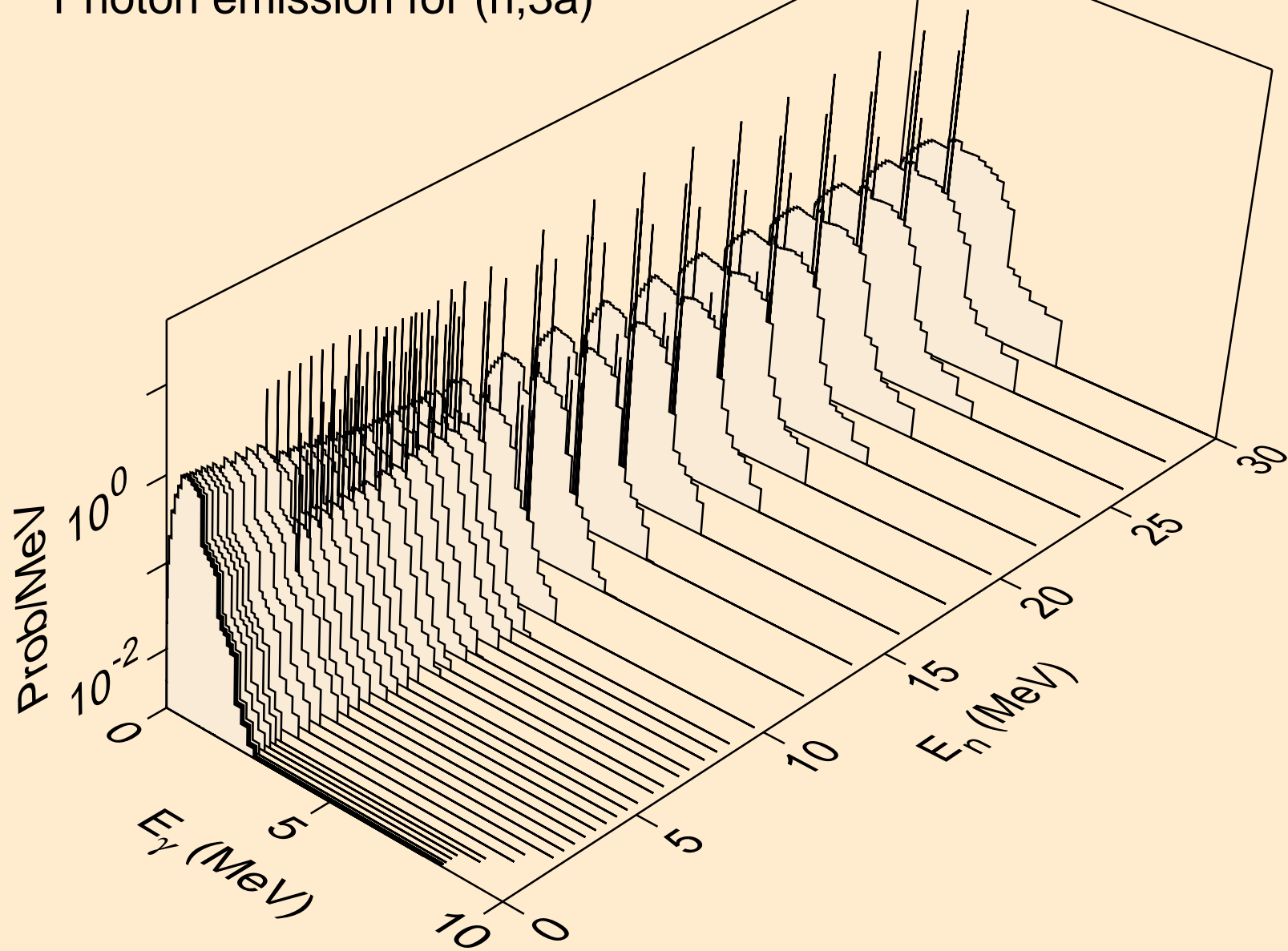

TA161M NEUTRON ACER TENDL-2021 LIBRARY; T=293.6K
Photon emission for (n,2p)

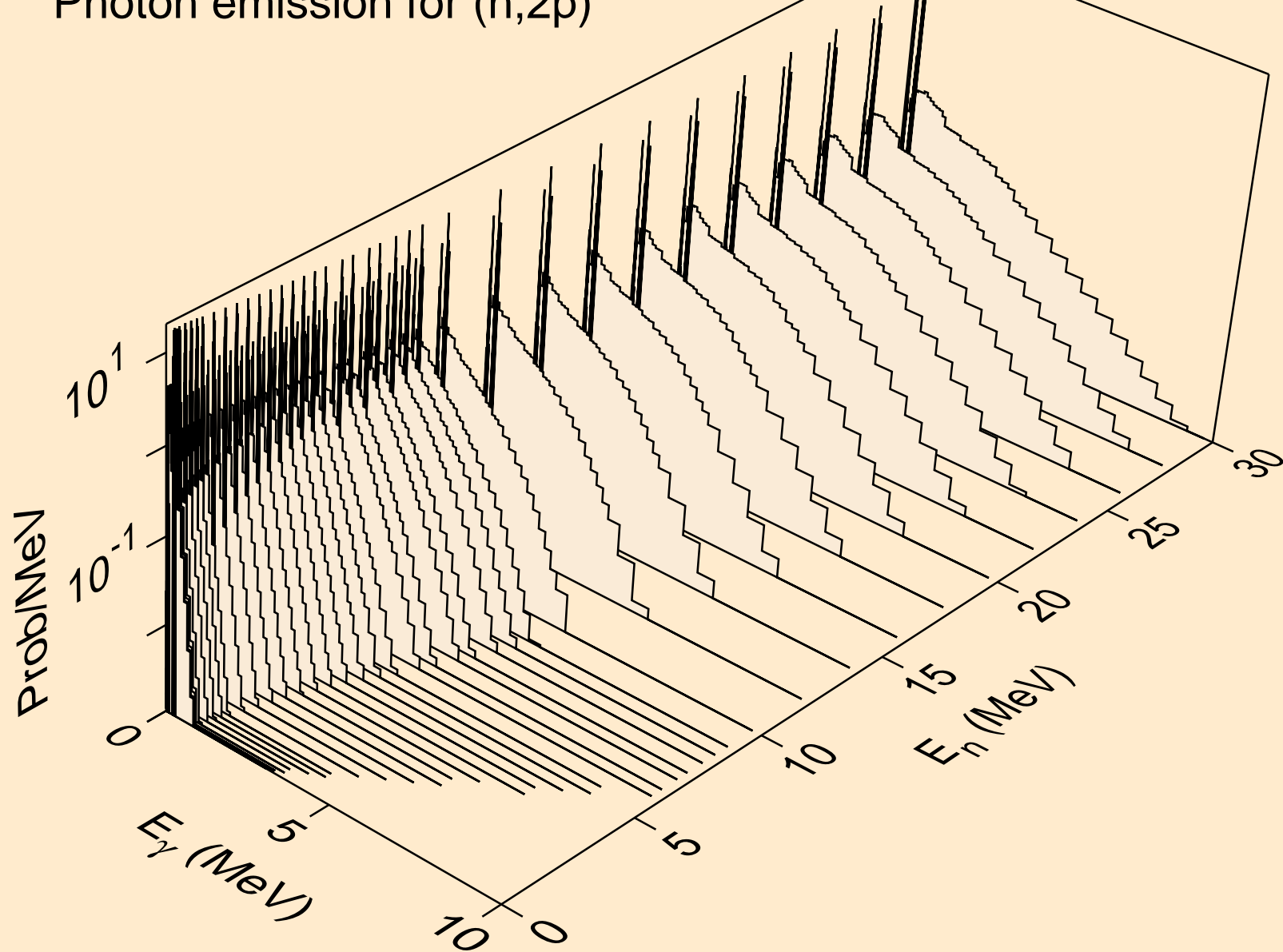

TA161M NEUTRON ACER TENDL-2021 LIBRARY; T=293.6K
Photon emission for (n,p α)

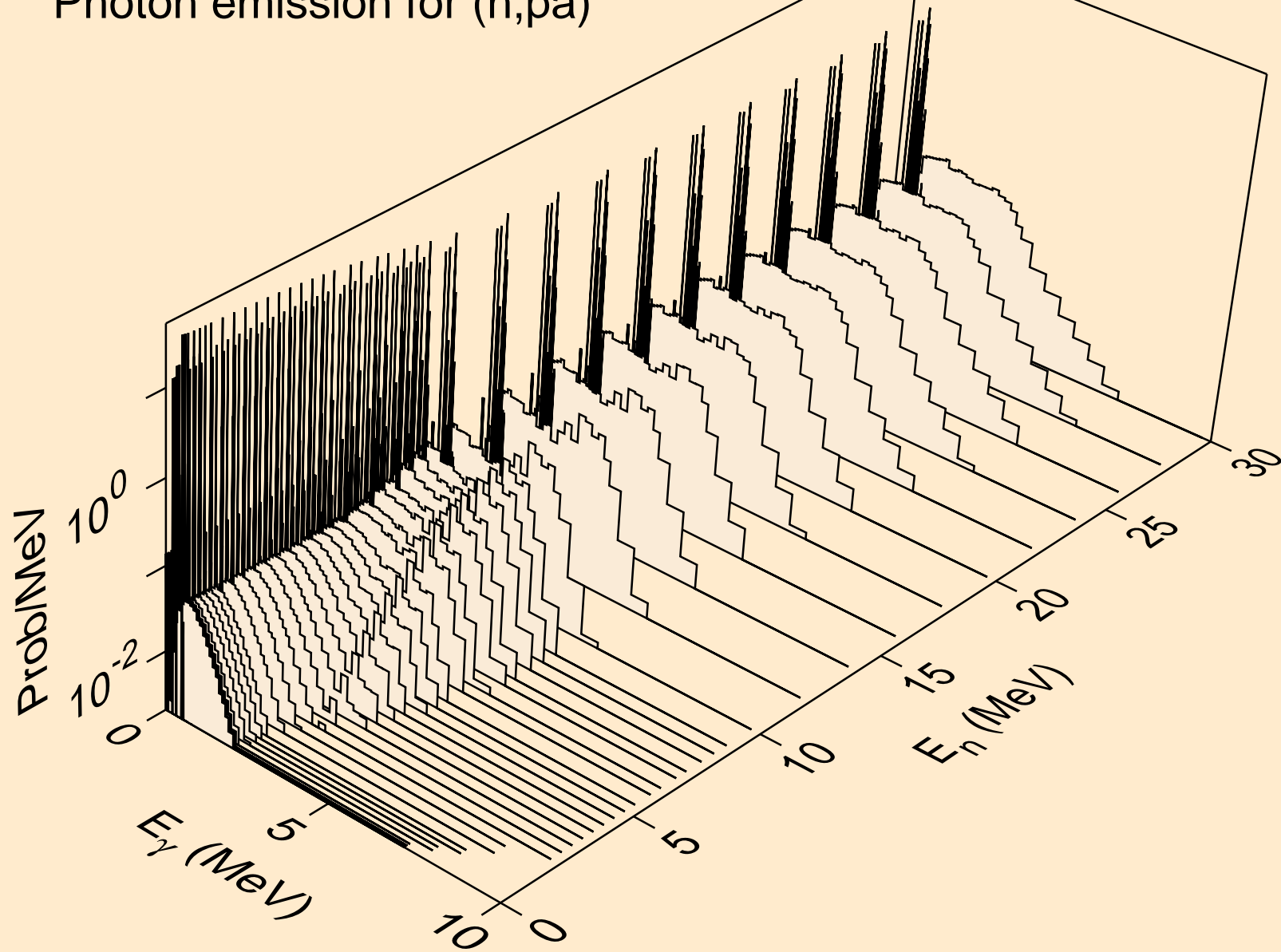

TA161M NEUTRON ACER TENDL-2021 LIBRARY; T=293.6K
Photon emission for (n,t2a)

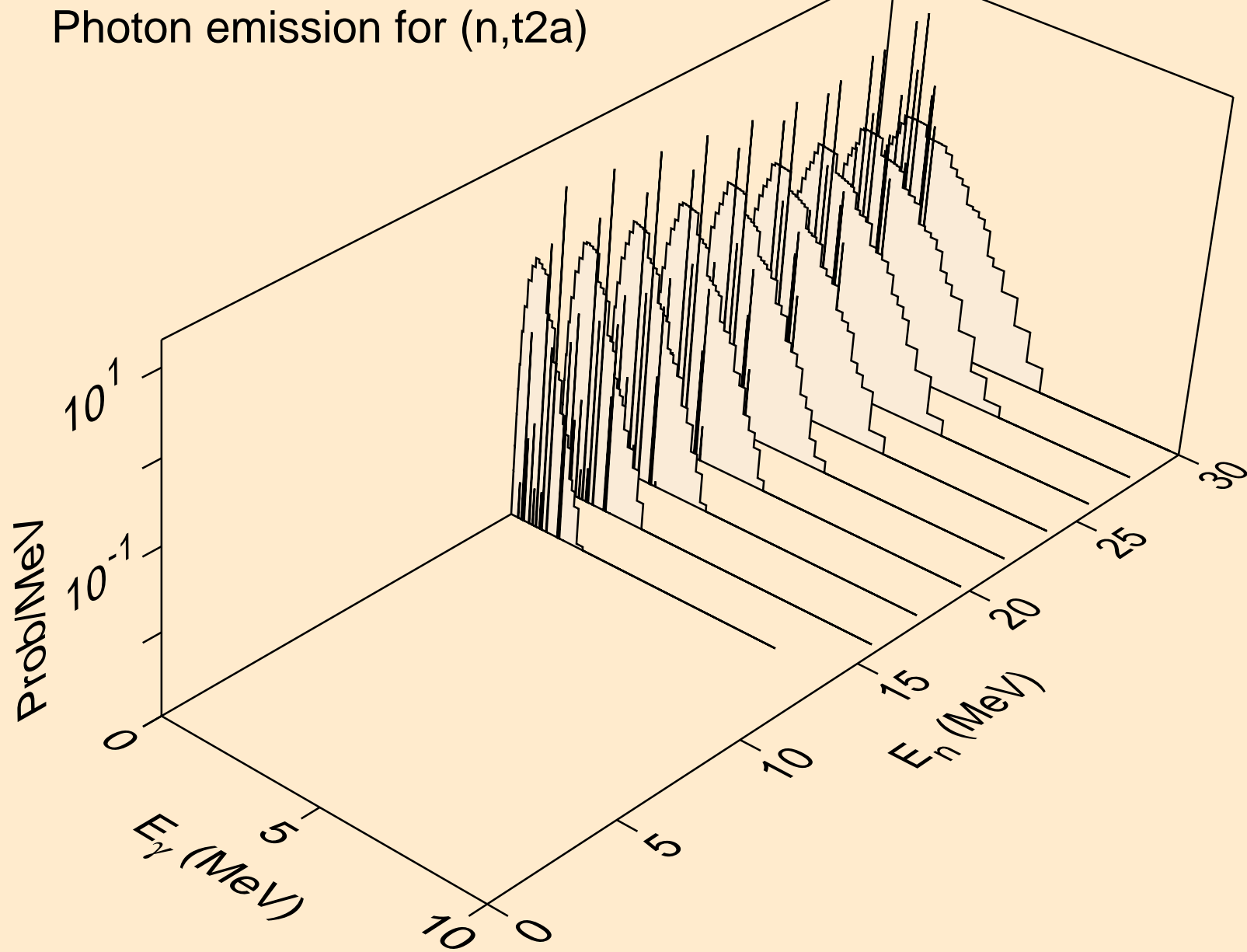

TA161M NEUTRON ACER TENDL-2021 LIBRARY; T=293.6K
Photon emission for (n,d2a)

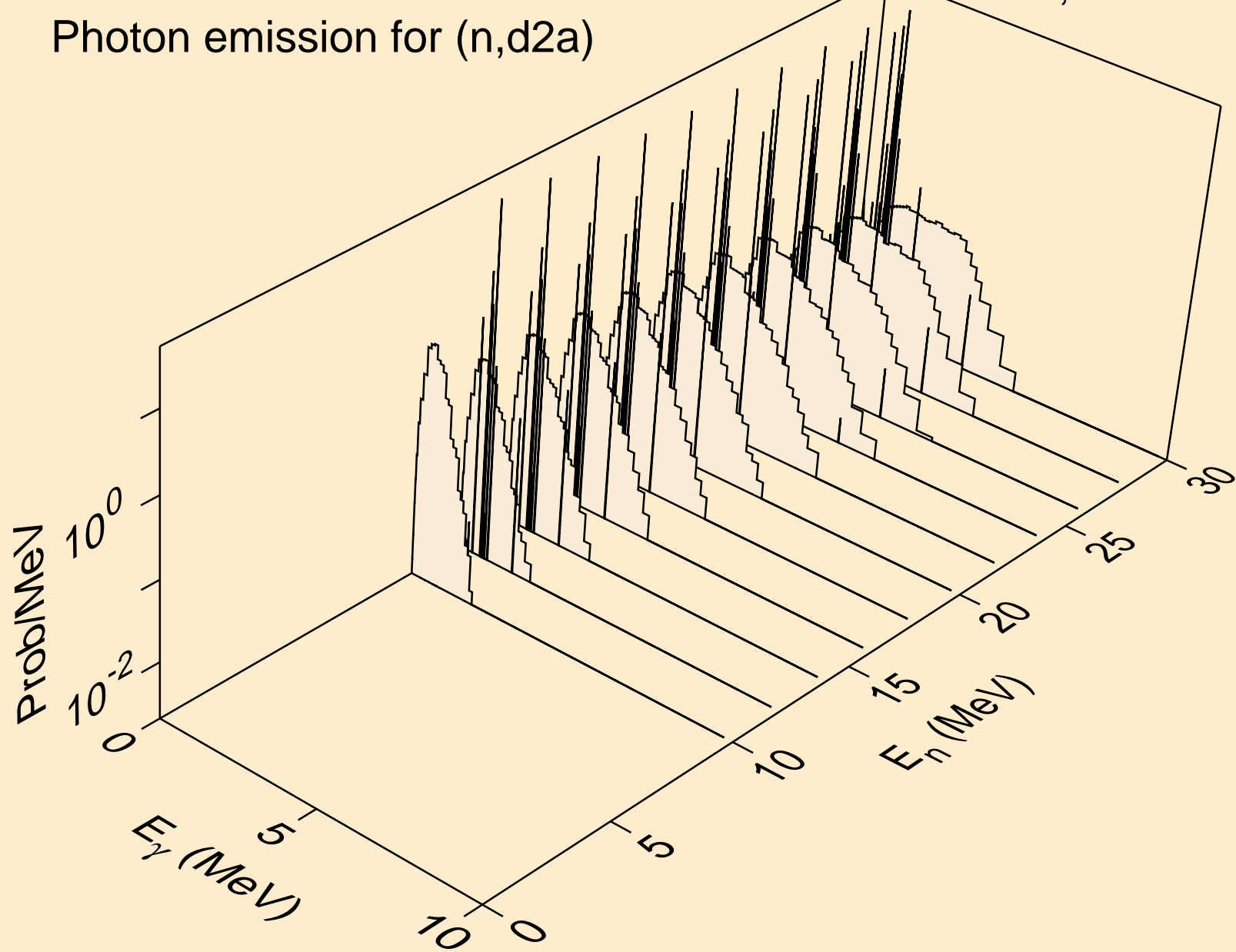

TA161M NEUTRON ACER TENDL-2021 LIBRARY; T=293.6K
Photon emission for (n,pd)

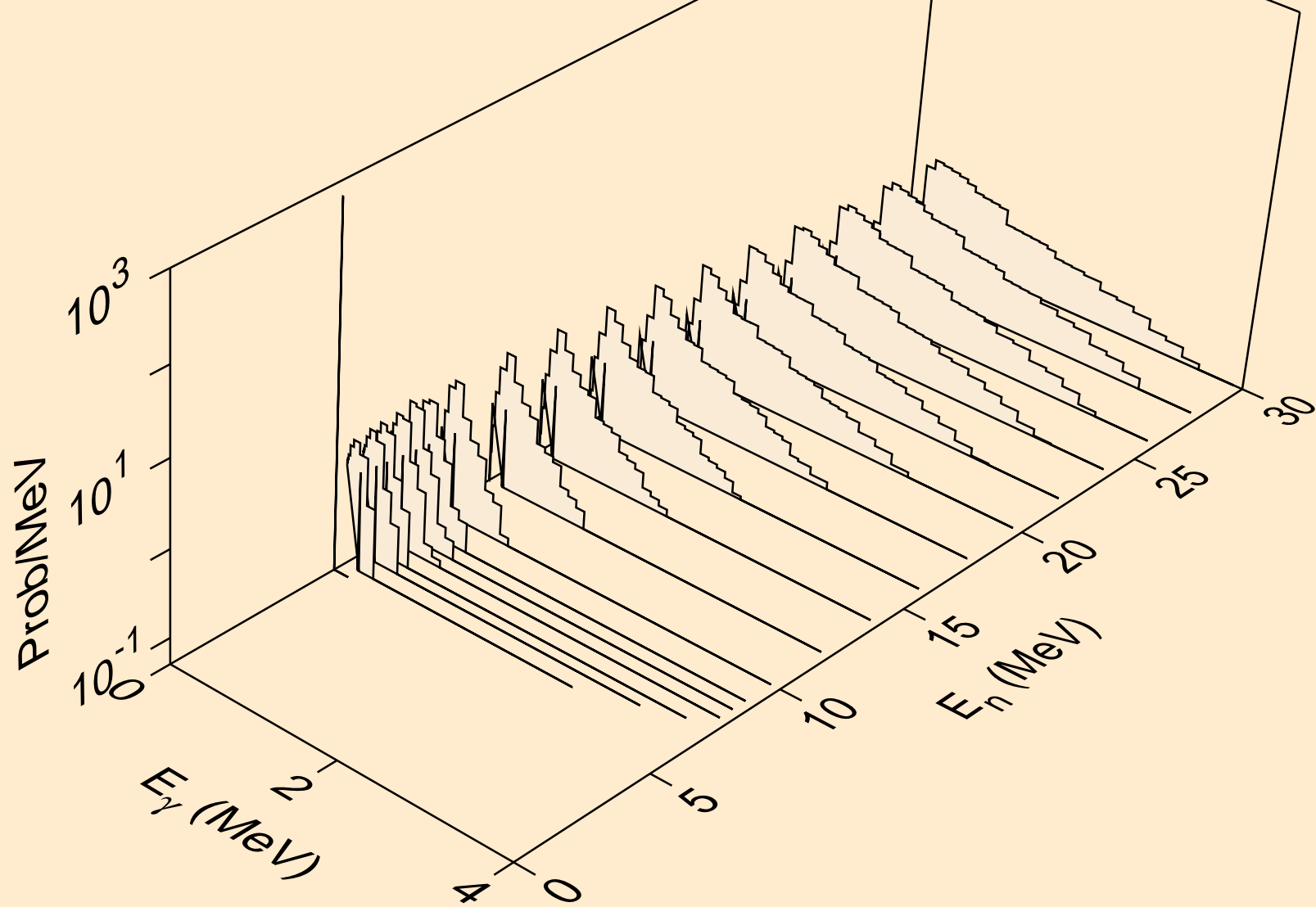

TA161M NEUTRON ACER TENDL-2021 LIBRARY; T=293.6K
Photon emission for (n,pt)

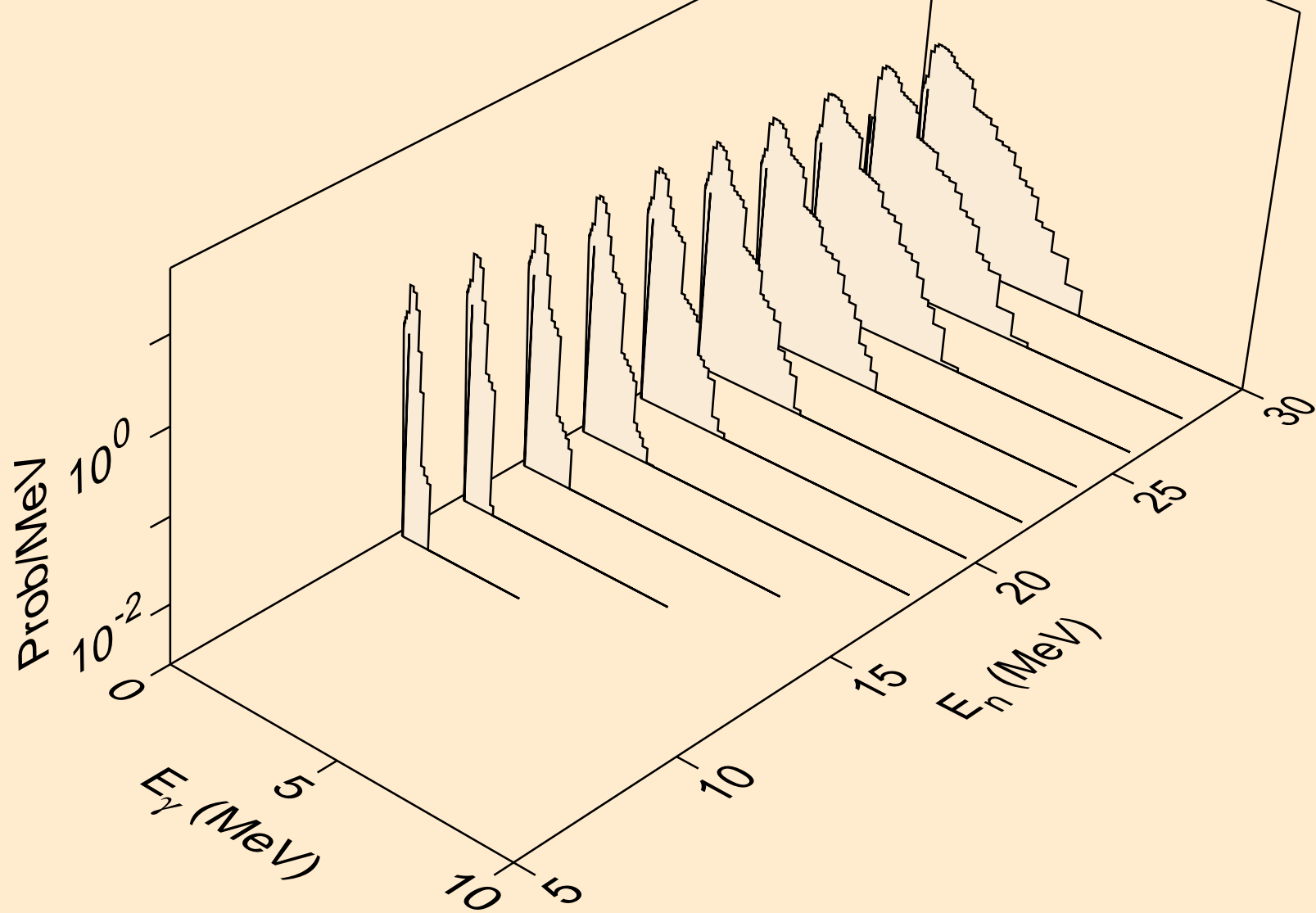

TA161M NEUTRON ACER TENDL-2021 LIBRARY; T=293.6K
Photon emission for (n,da)

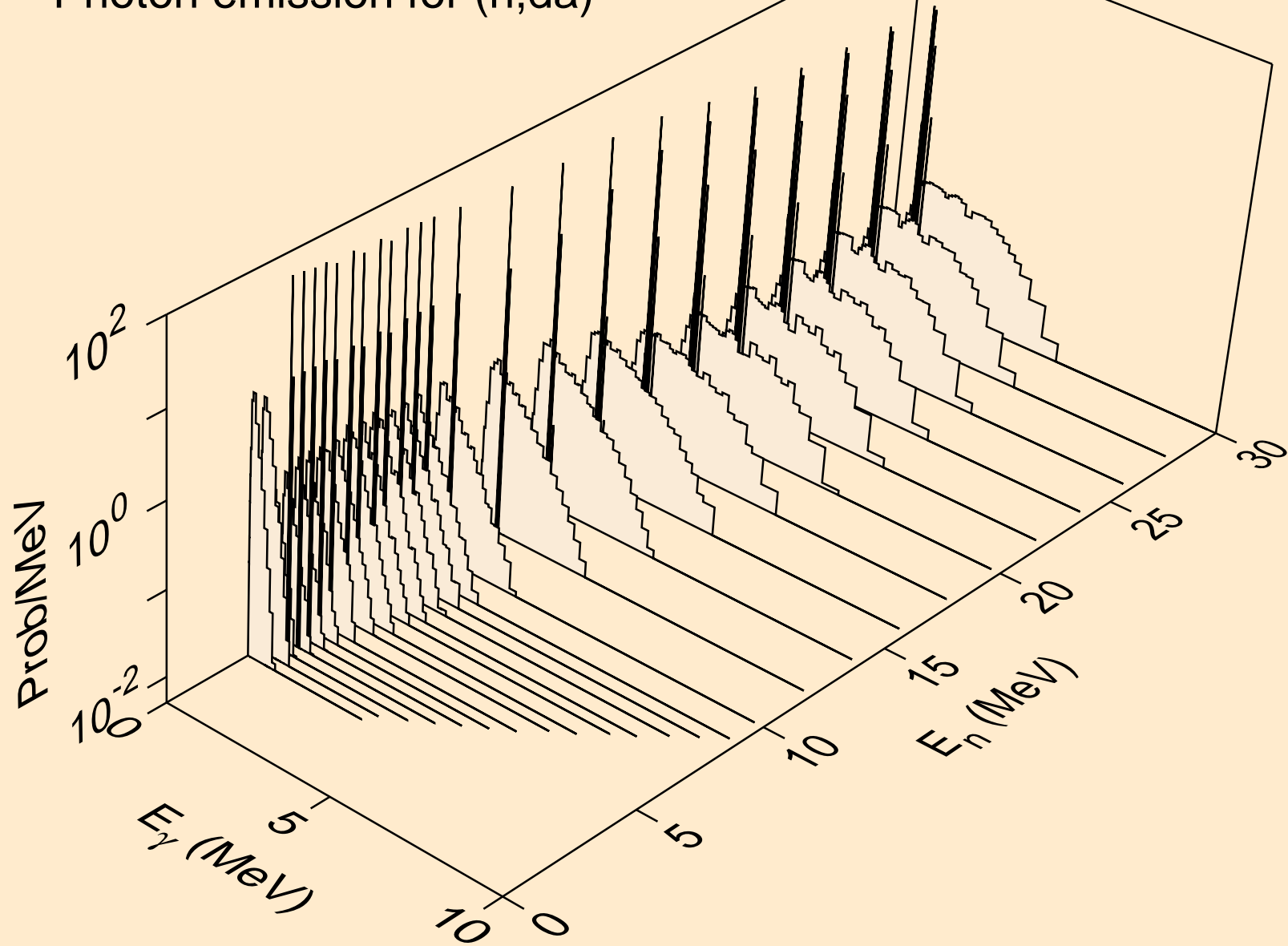

TA161M NEUTRON ACER TENDL-2021 LIBRARY; T=293.6K
thermal capture photon spectrum

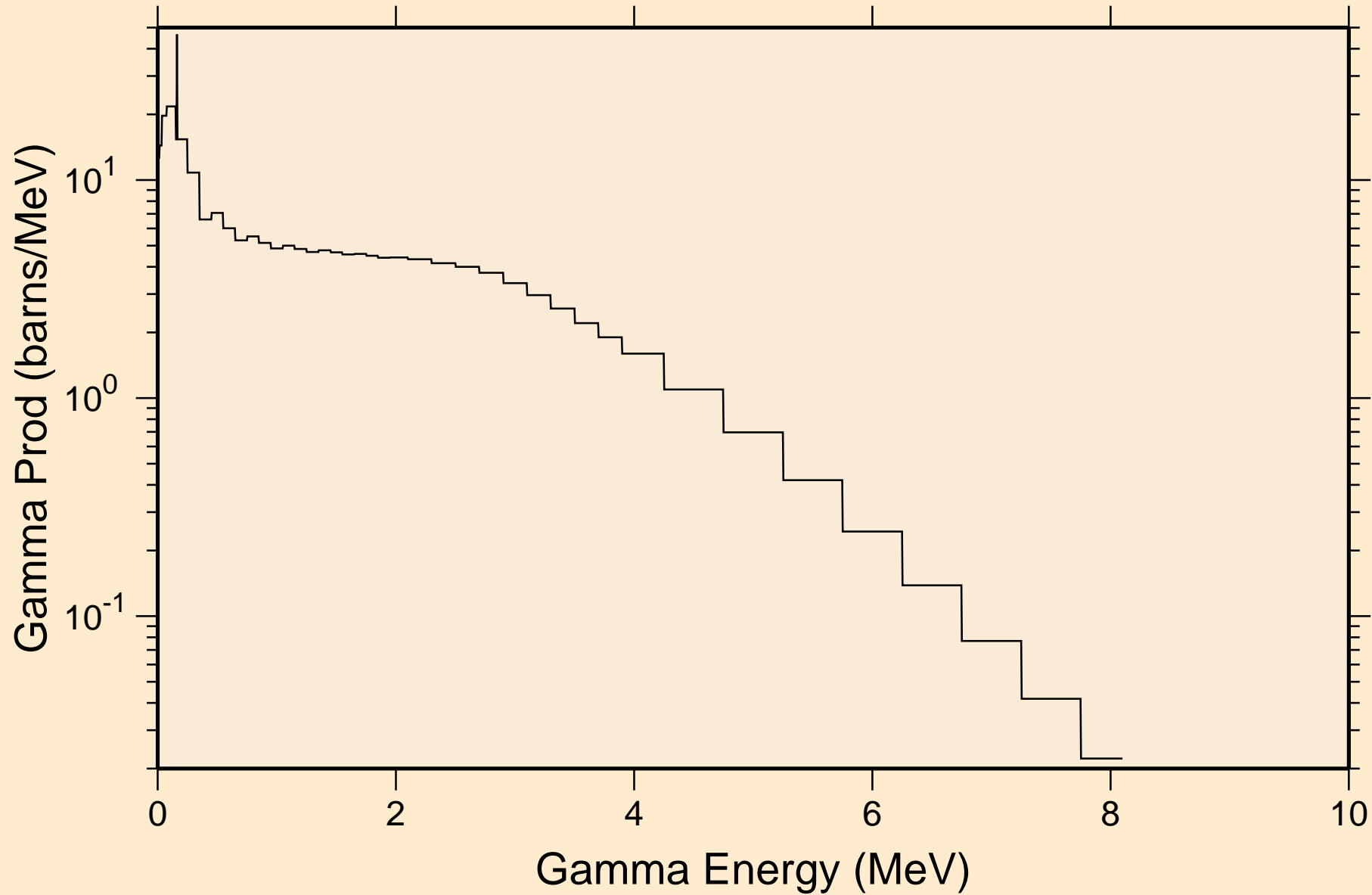

TA161M NEUTRON ACER TENDL-2021 LIBRARY; T=293.6K
14 MeV photon spectrum

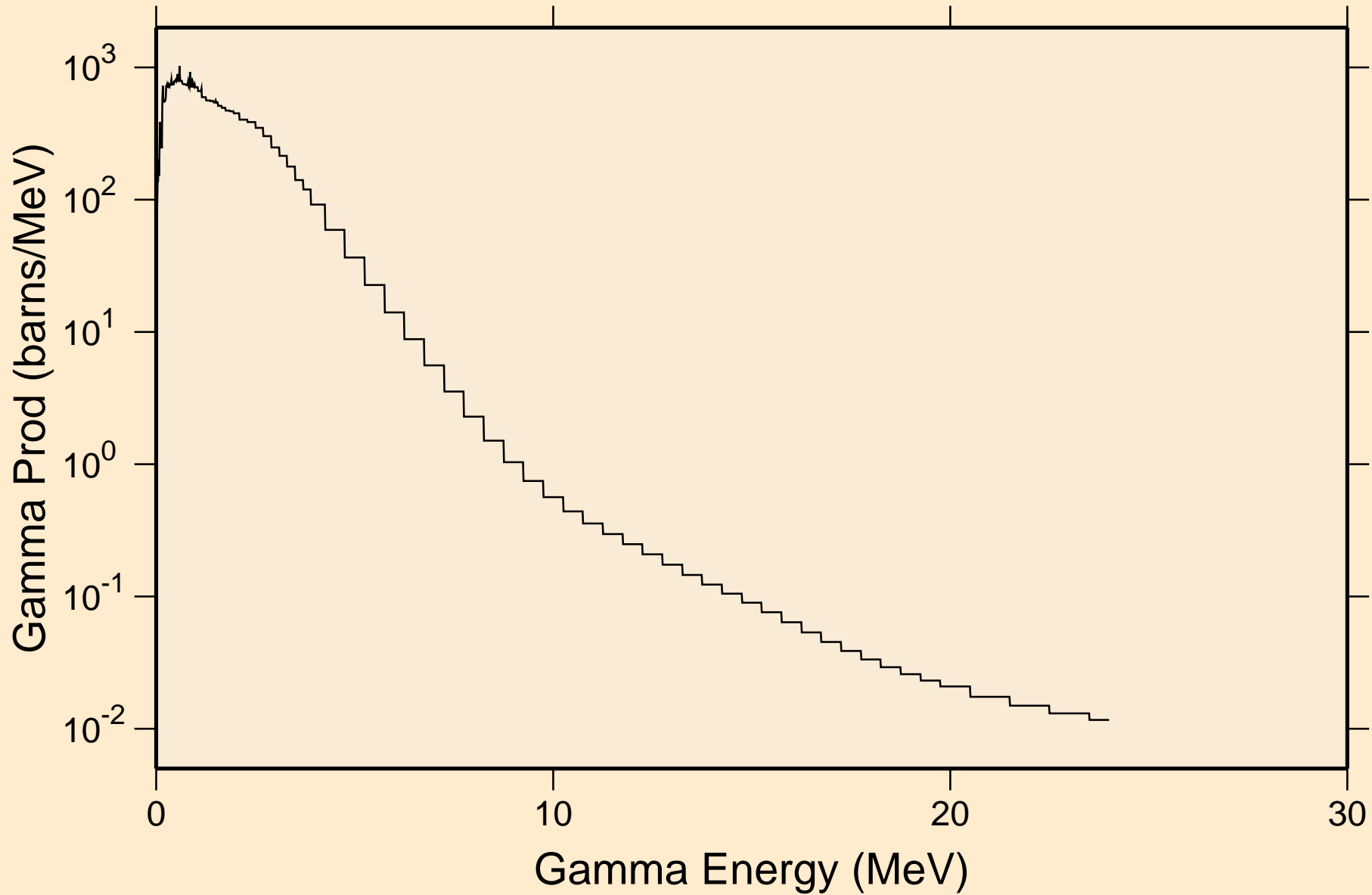

TA161M NEUTRON ACER TENDL-2021 LIBRARY; T=293.6K
Particle heating contributions

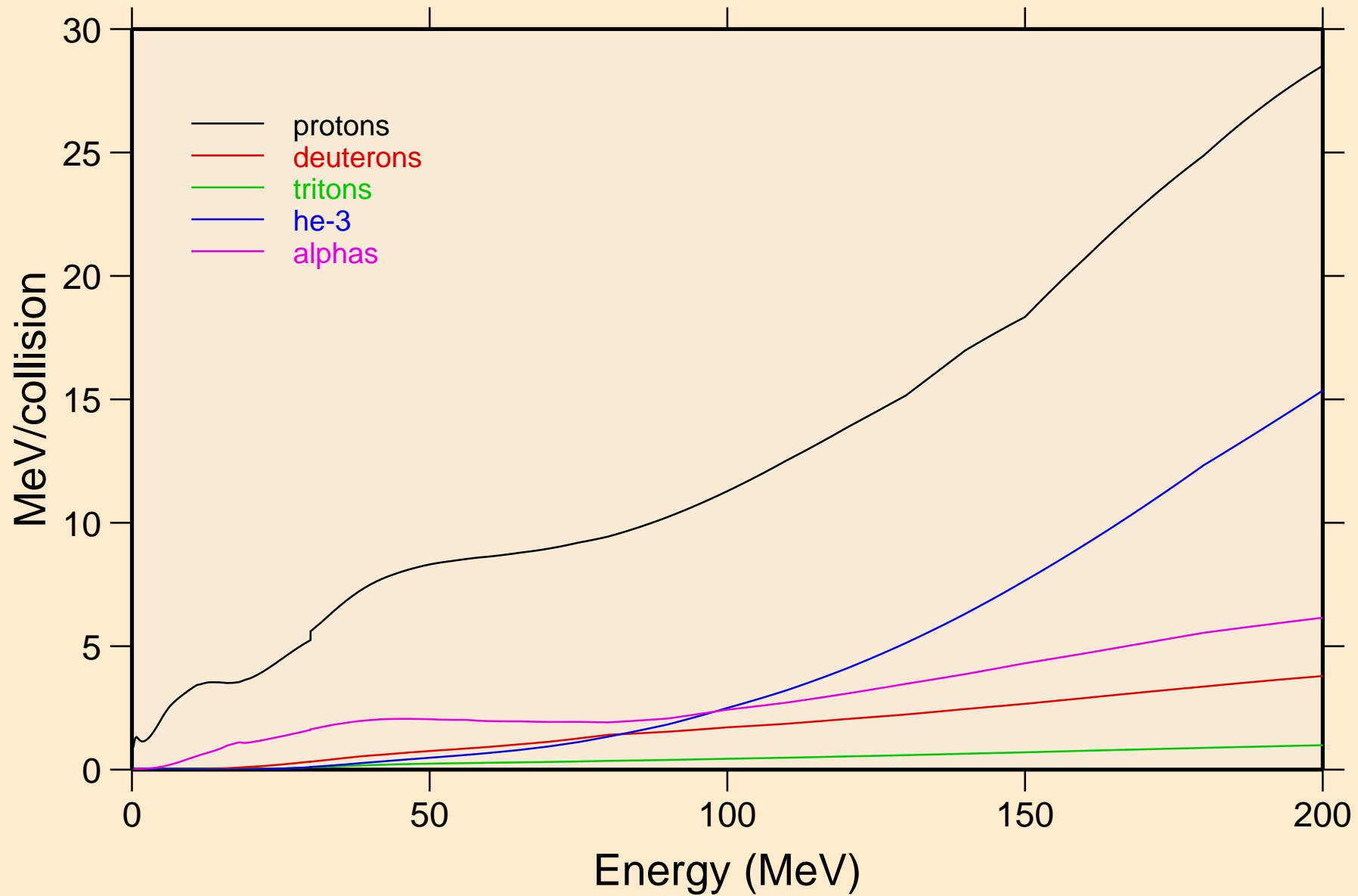

TA161M NEUTRON ACER TENDL-2021 LIBRARY; T=293.6K
Recoil Heating

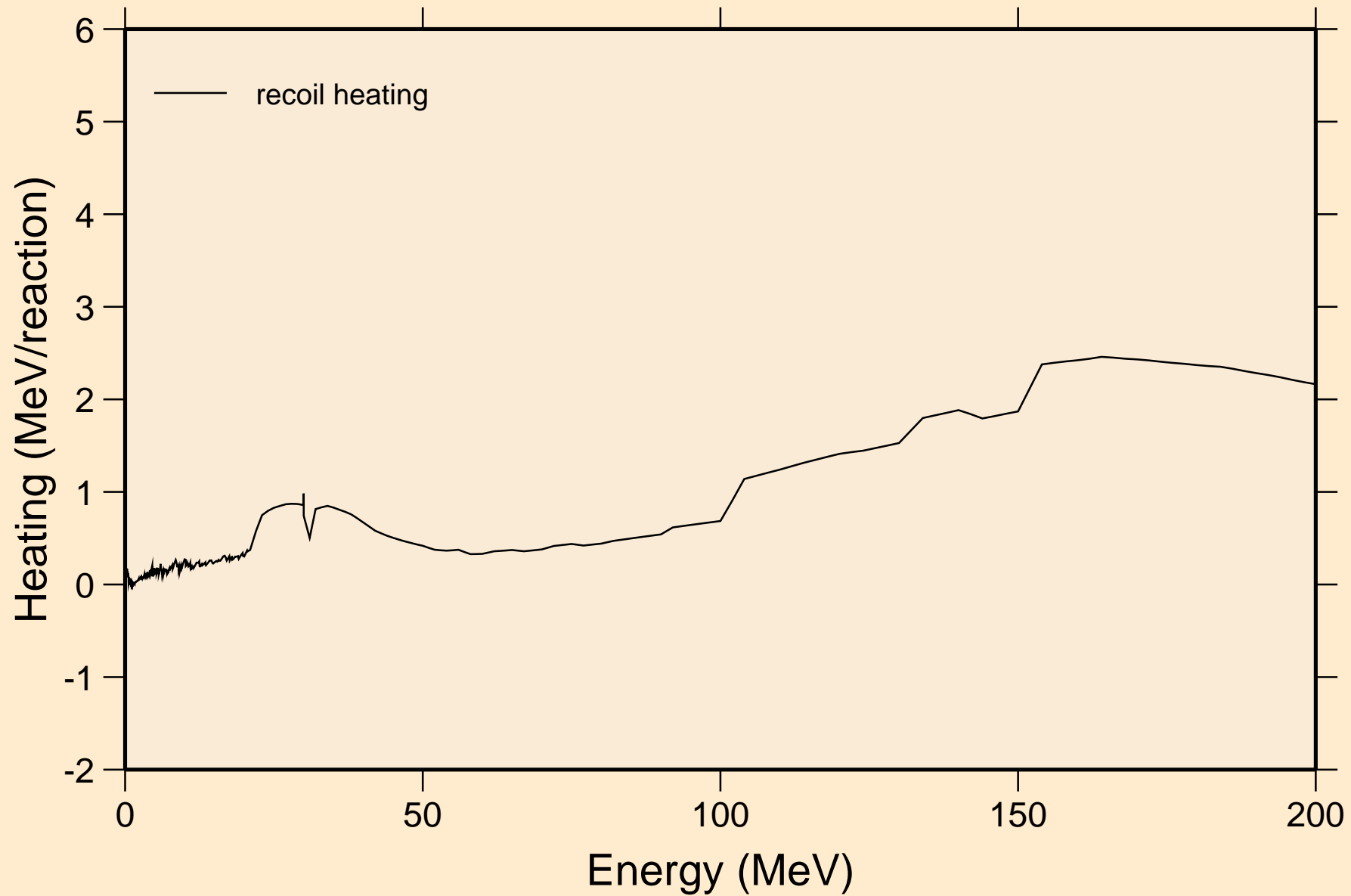

TA161M NEUTRON ACER TENDL-2021 LIBRARY; T=293.6K
Particle production cross sections

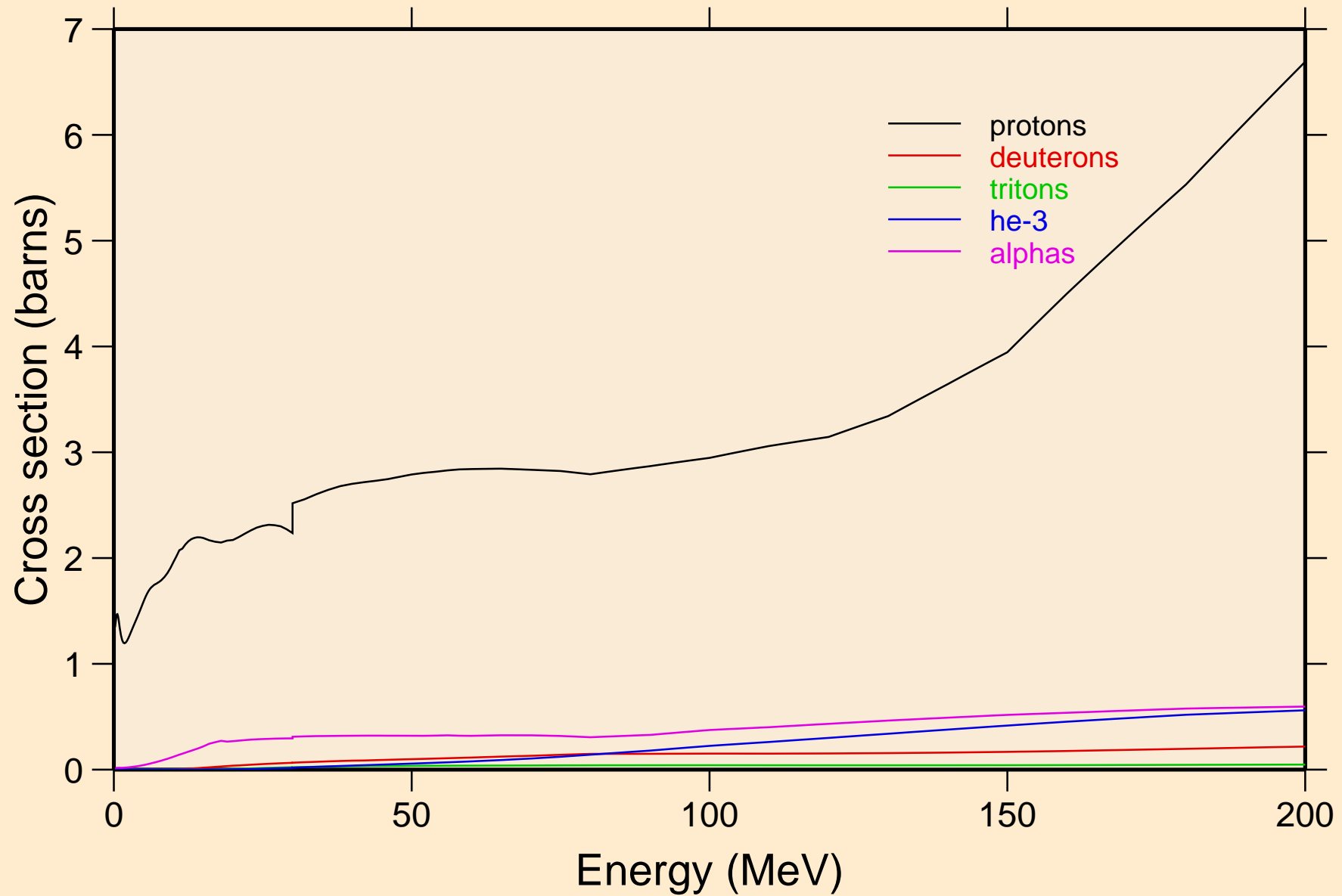

TA161M NEUTRON ACER TENDL-2021 LIBRARY; T=293.6K
protons from (n,x)

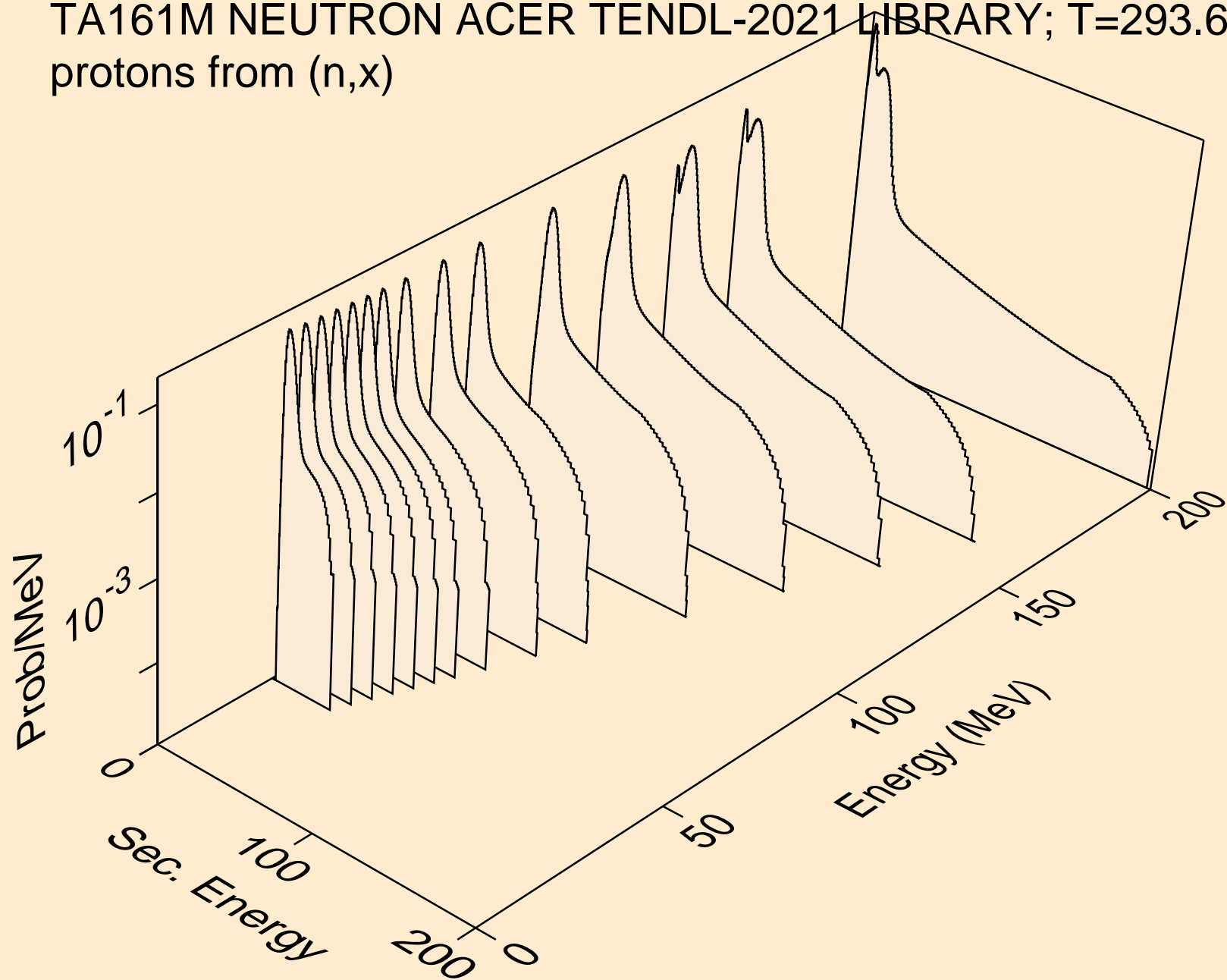

TA161M NEUTRON ACER TENDL-2021 LIBRARY; T=293.6K
protons from (n,n*)p

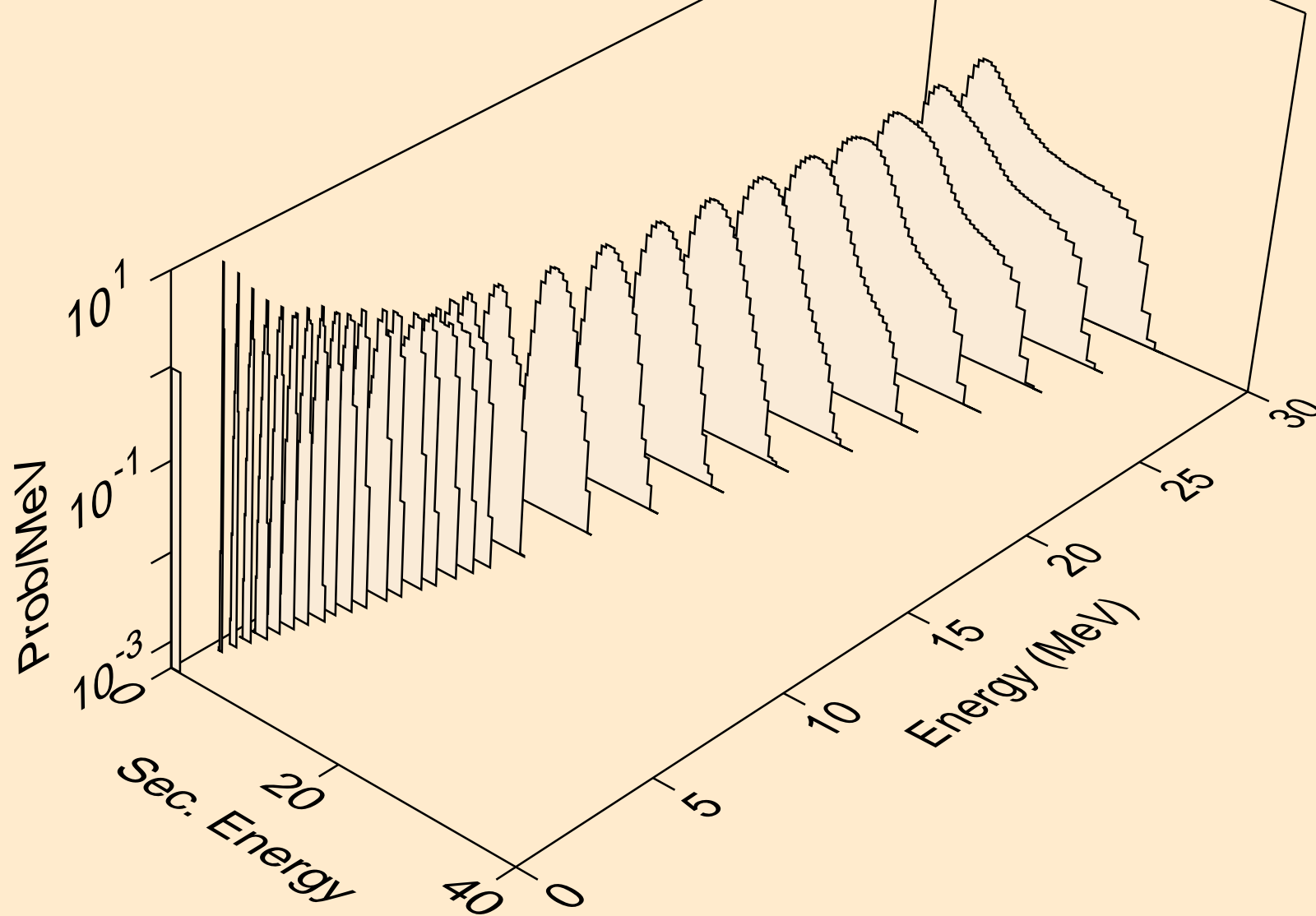

TA161M NEUTRON ACER TENDL-2021 LIBRARY; T=293.6K
protons from (n,2np)

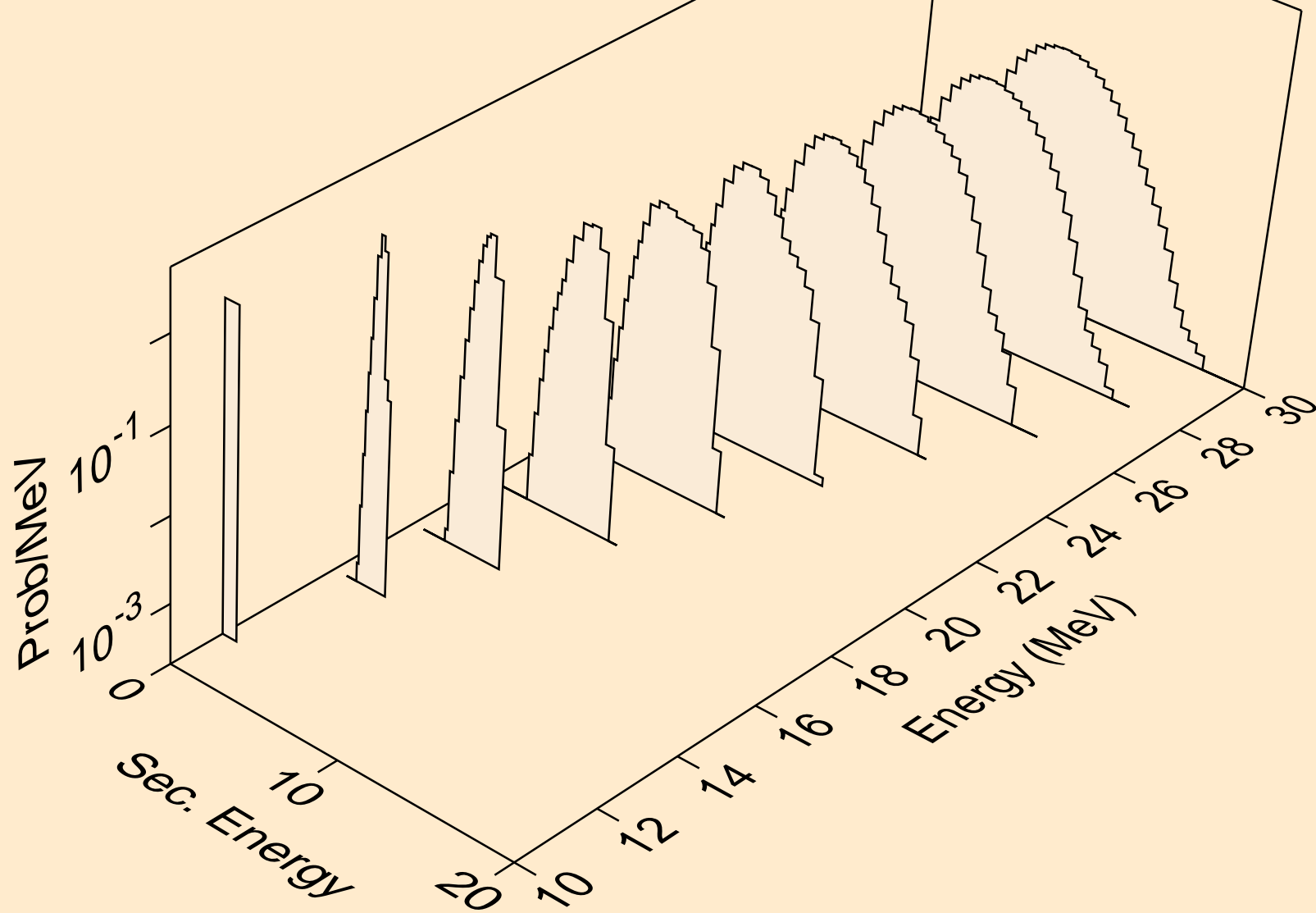

TA161M NEUTRON ACER TENDL-2021 LIBRARY; T=293.6K
protons from (n,3np)

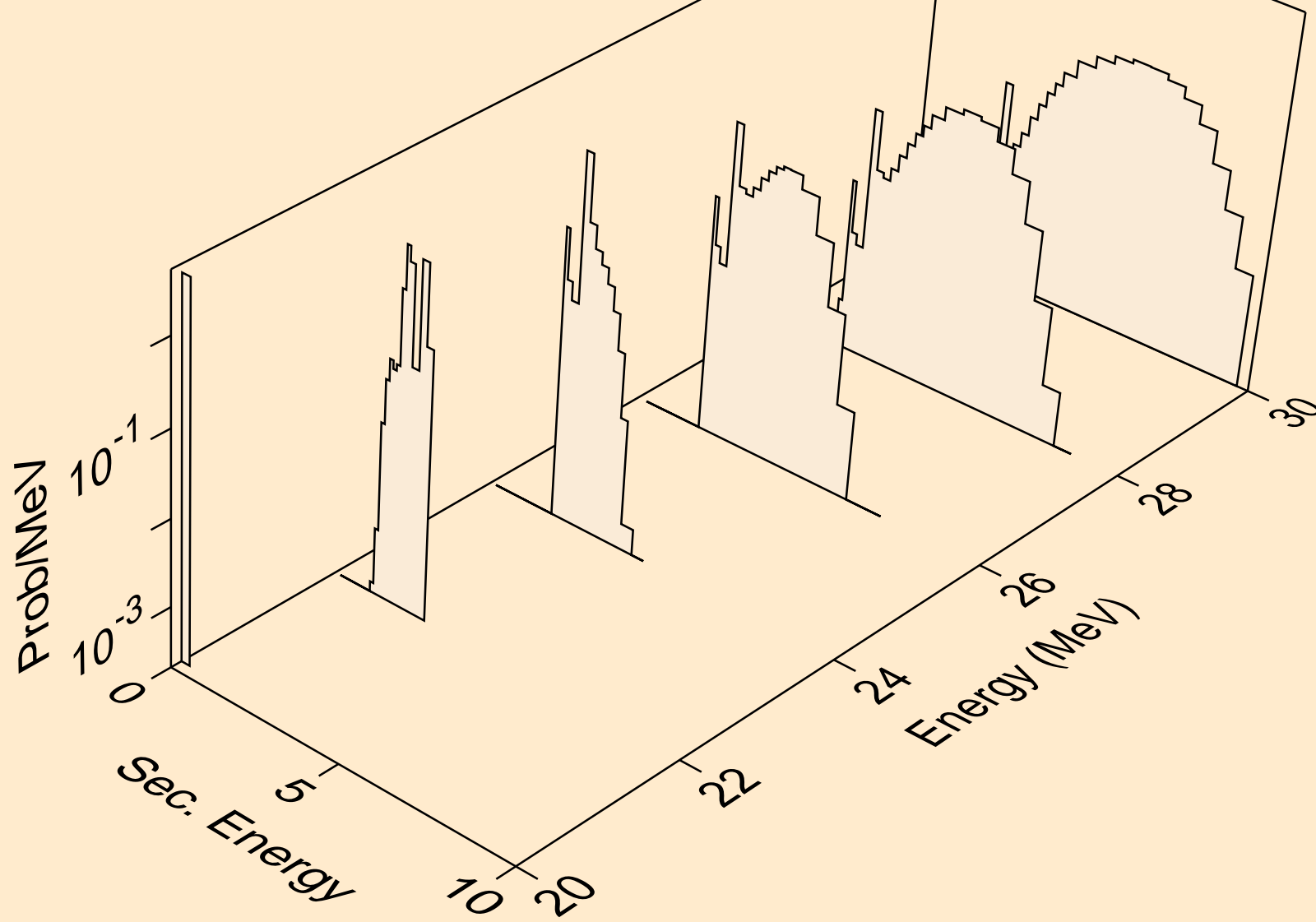

TA161M NEUTRON ACER TENDL-2021 LIBRARY; T=293.6K
protons from (n,2np)

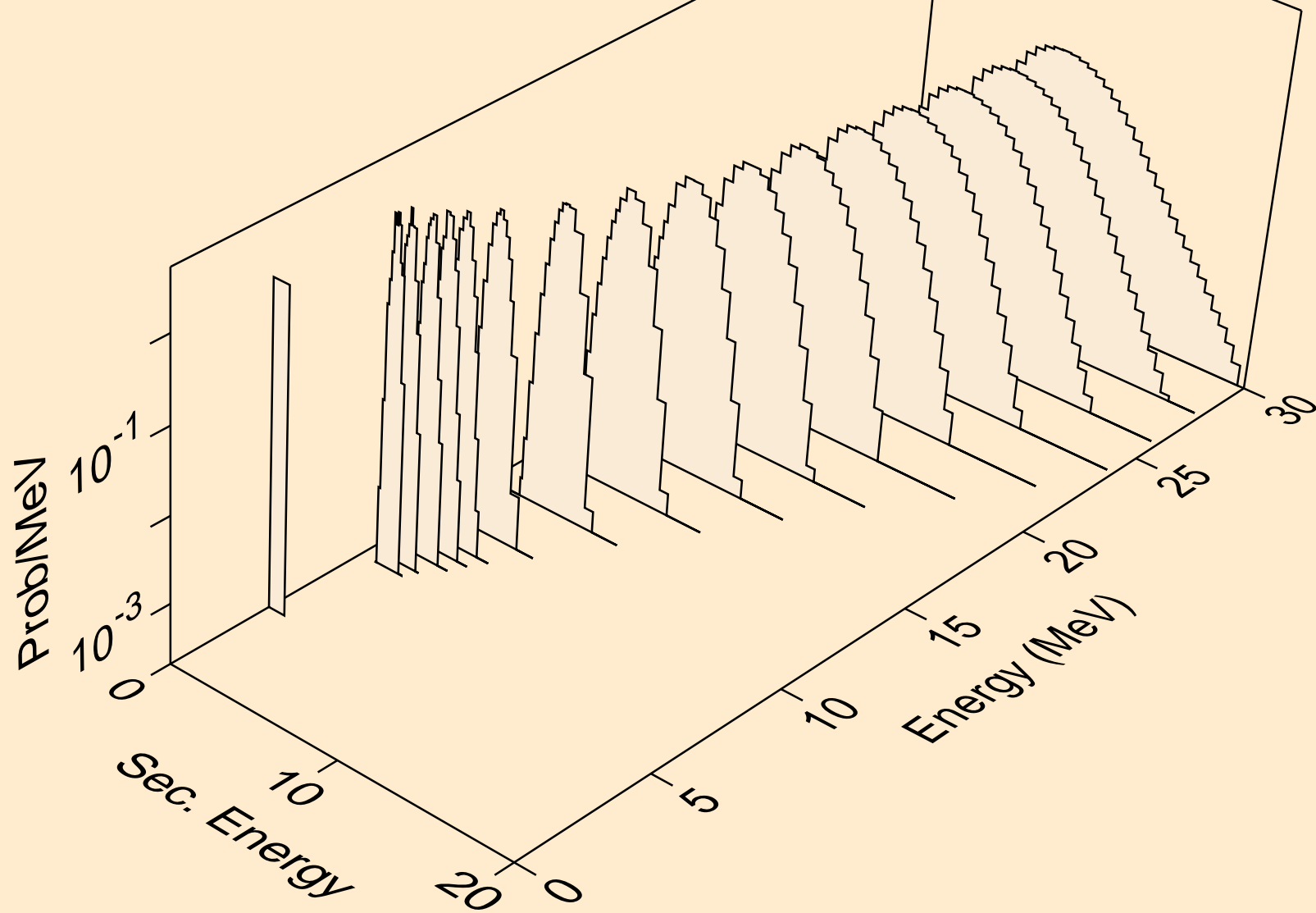

TA161M NEUTRON ACER TENDL-2021 LIBRARY; T=293.6K
protons from (n,npa)

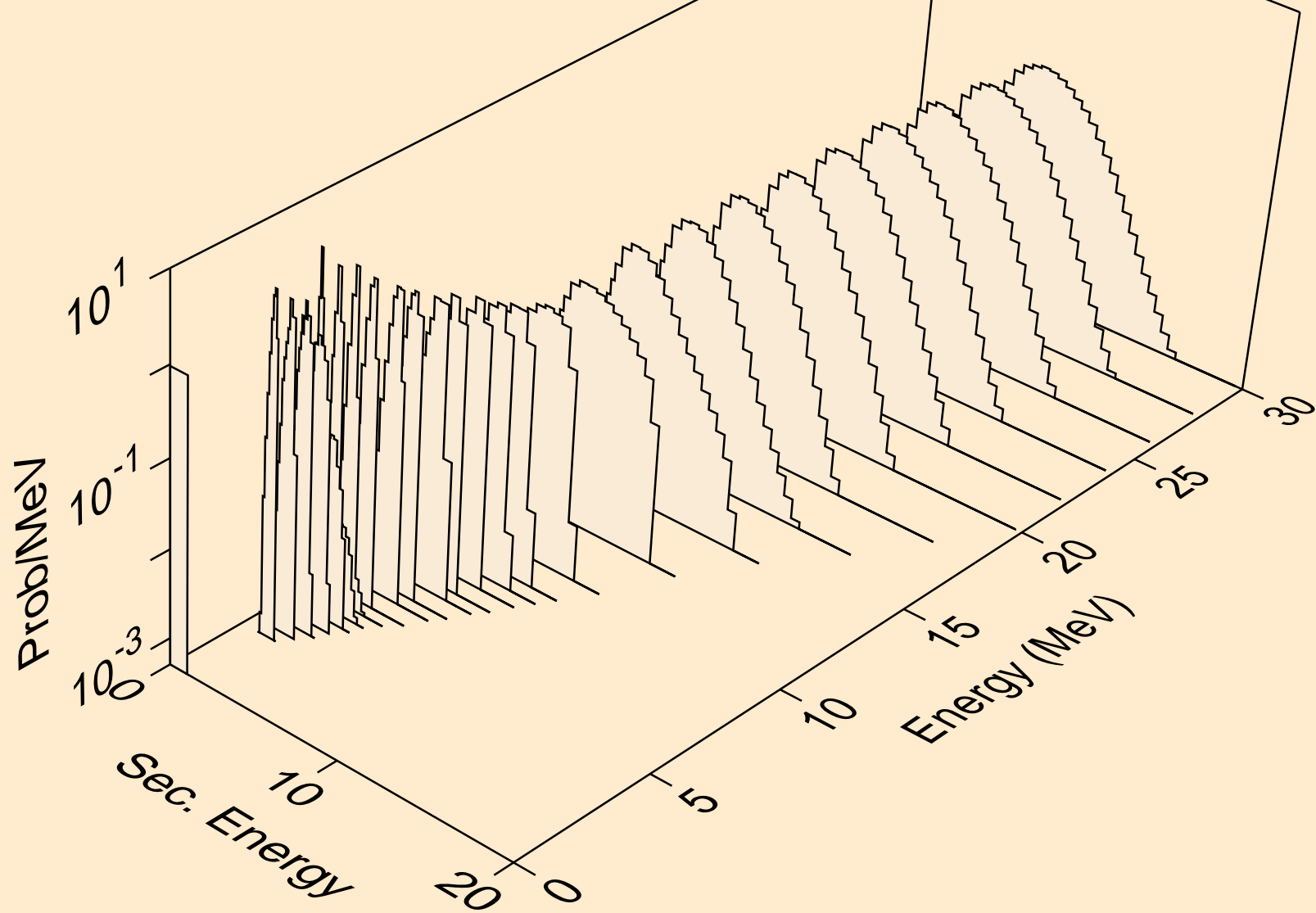

TA161M NEUTRON ACER TENDL-2021 LIBRARY; T=293.6K
protons from (n,p)

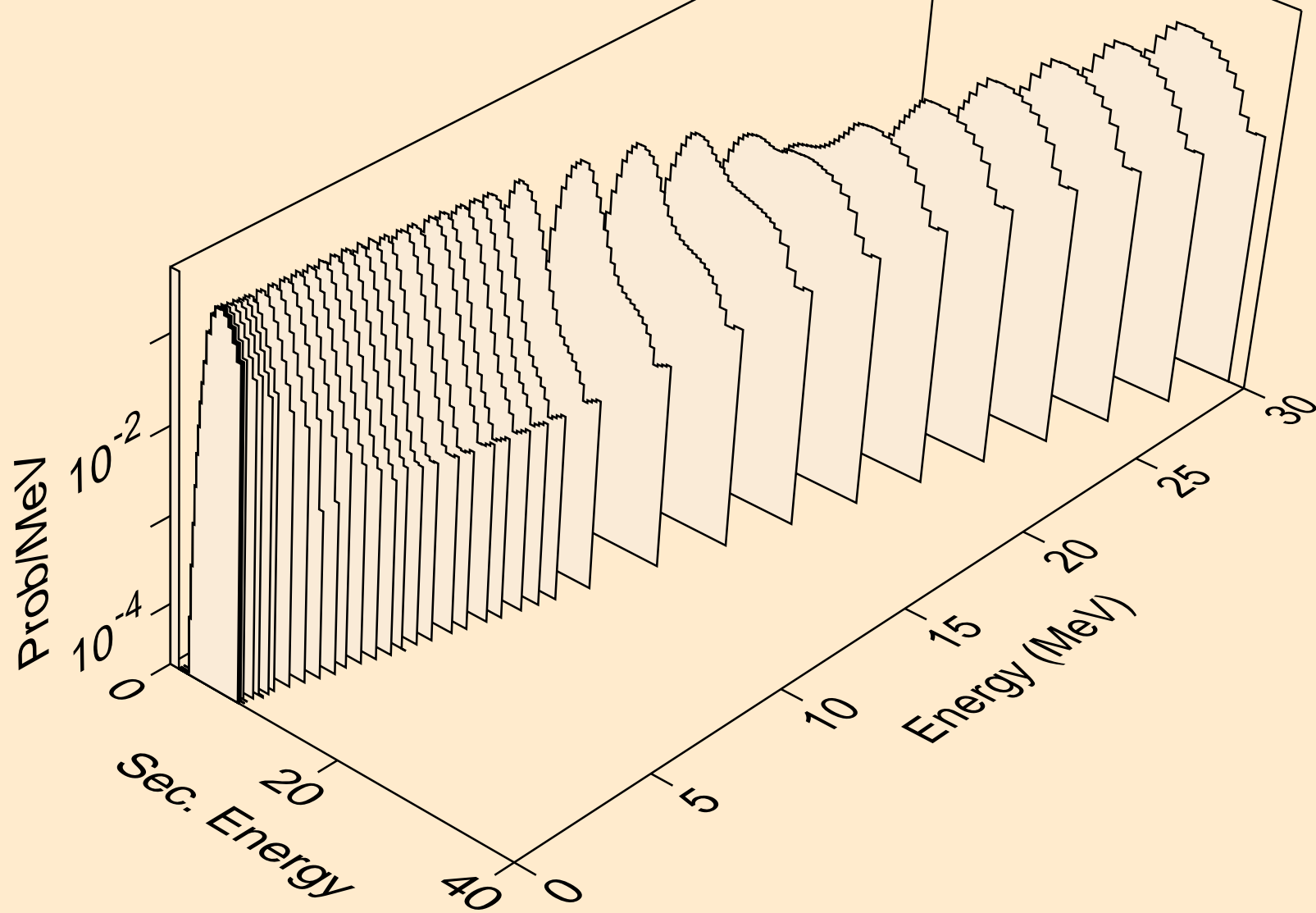

TA161M NEUTRON ACER TENDL-2021 LIBRARY; T=293.6K
protons from (n,2p)

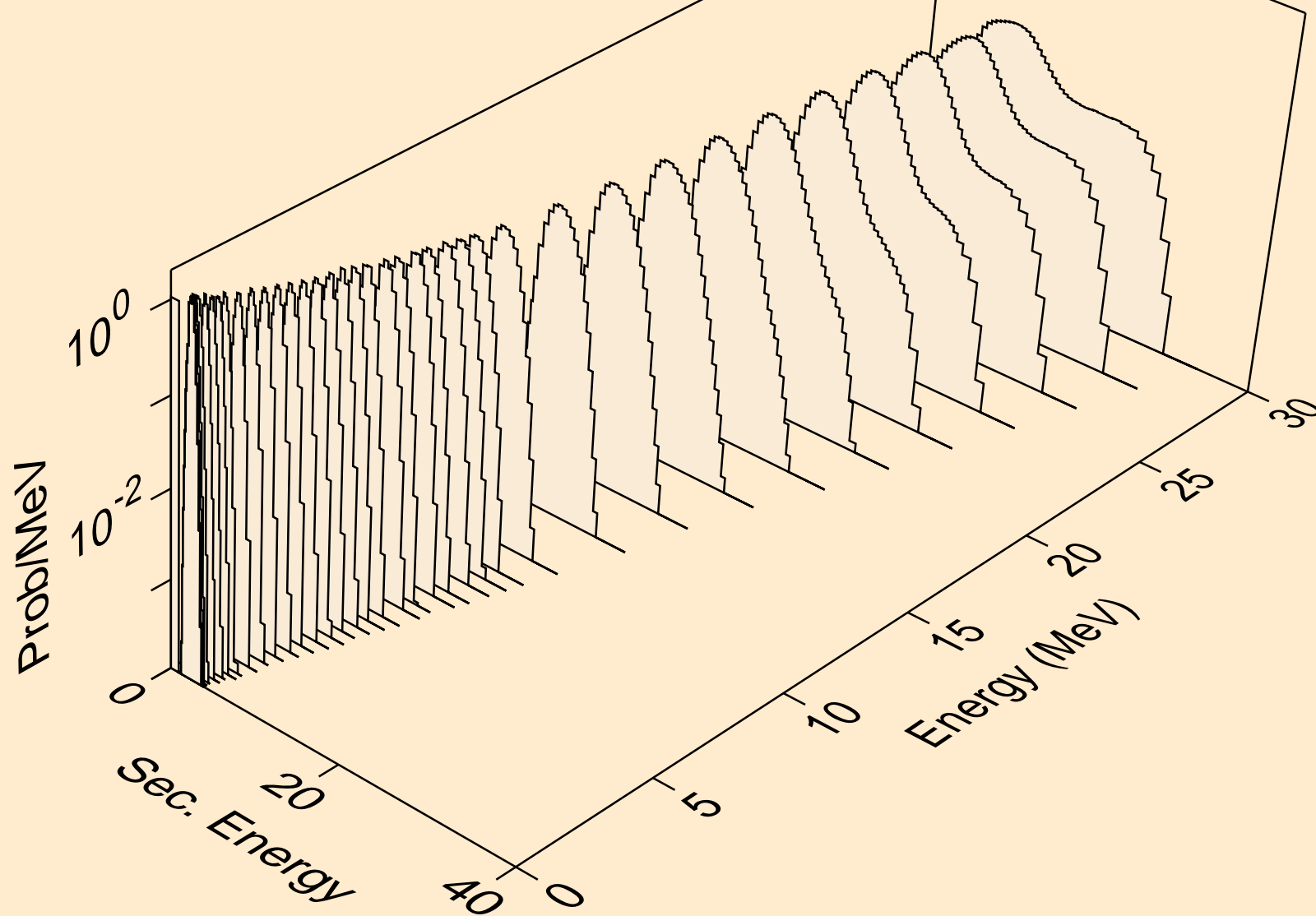

TA161M NEUTRON ACER TENDL-2021 LIBRARY; T=293.6K
protons from (n,p)

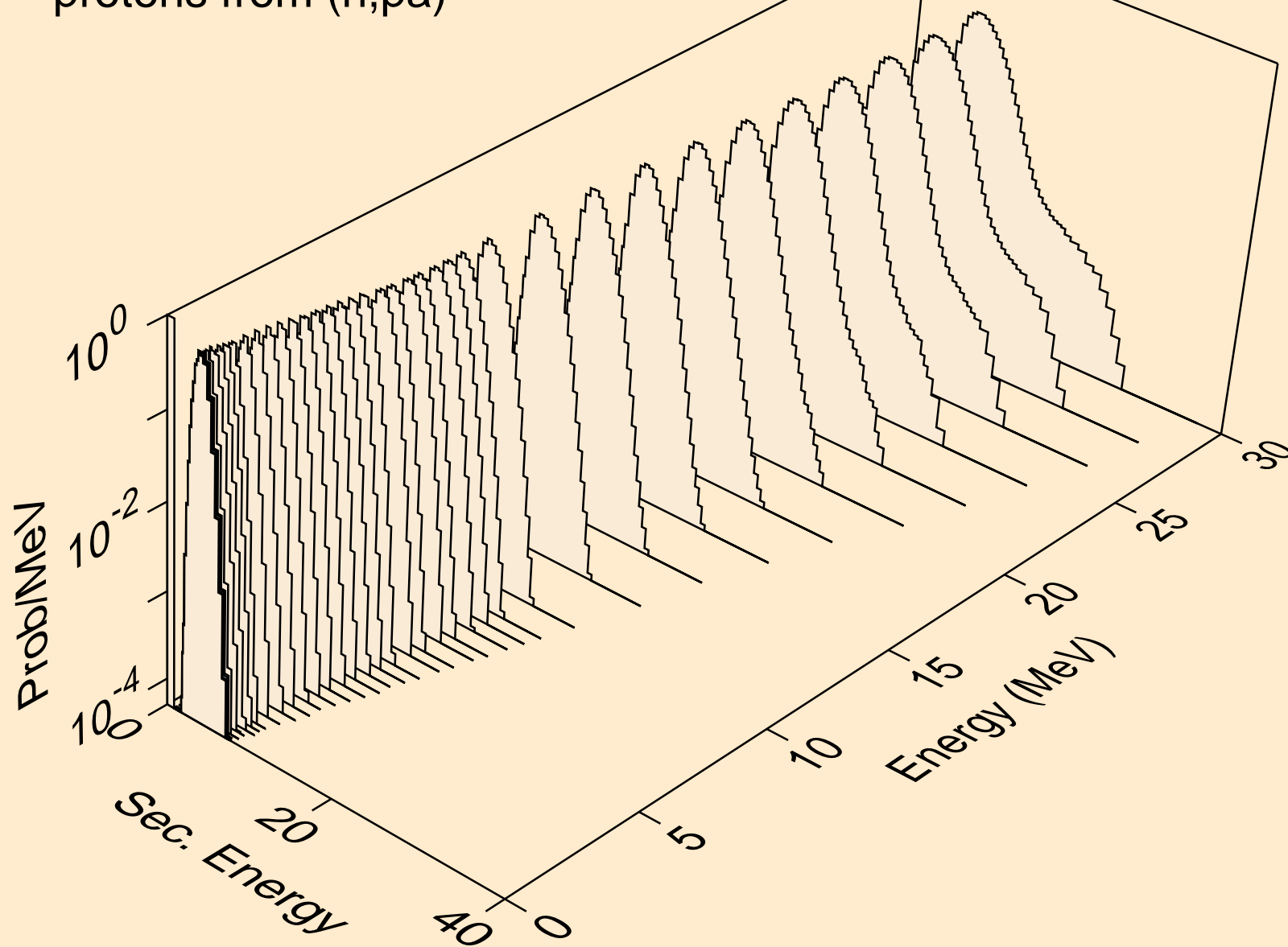

TA161M NEUTRON ACER TENDL-2021 LIBRARY; T=293.6K
protons from (n,pd)

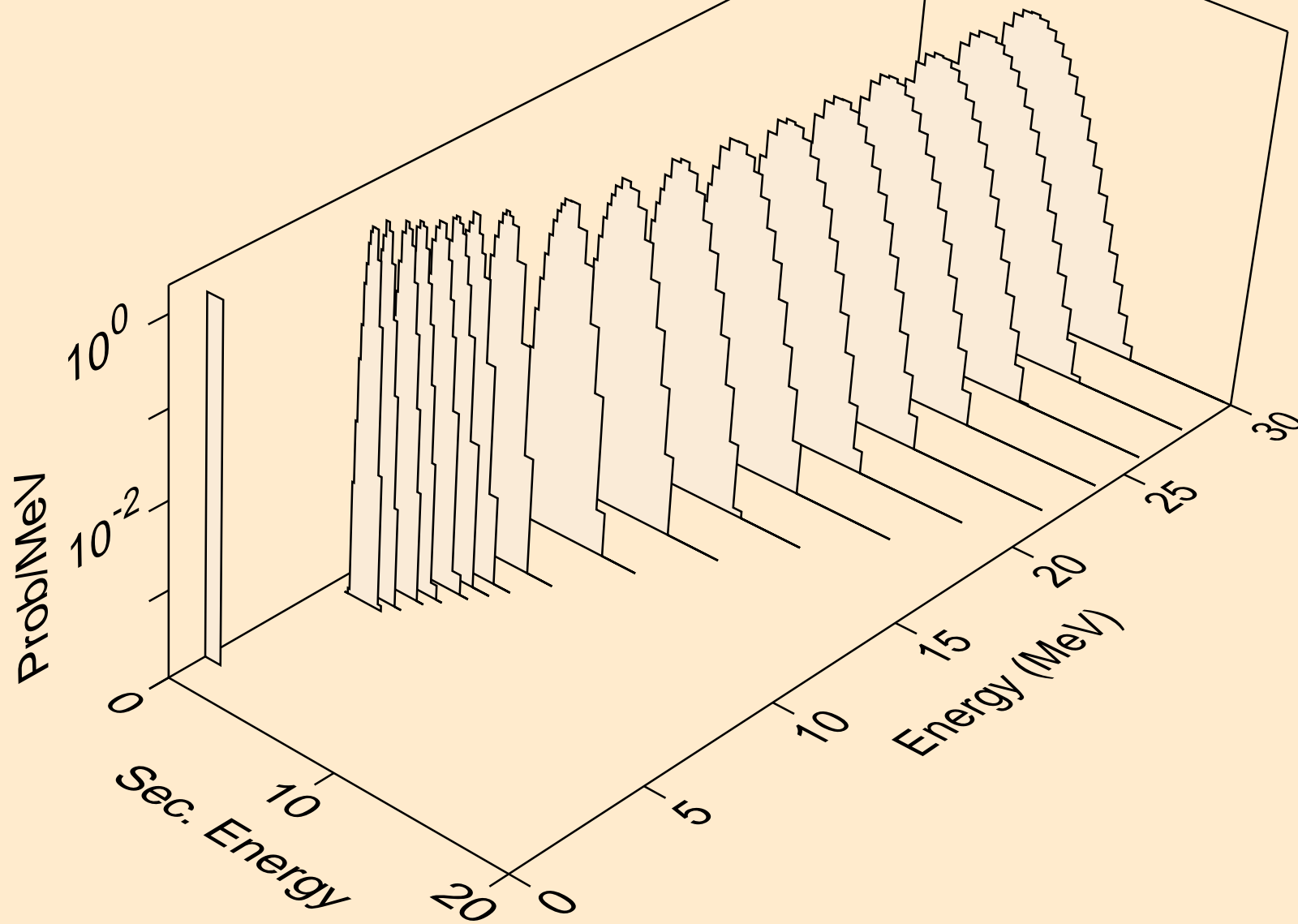

TA161M NEUTRON ACER TENDL-2021 LIBRARY; T=293.6K
protons from (n,pt)

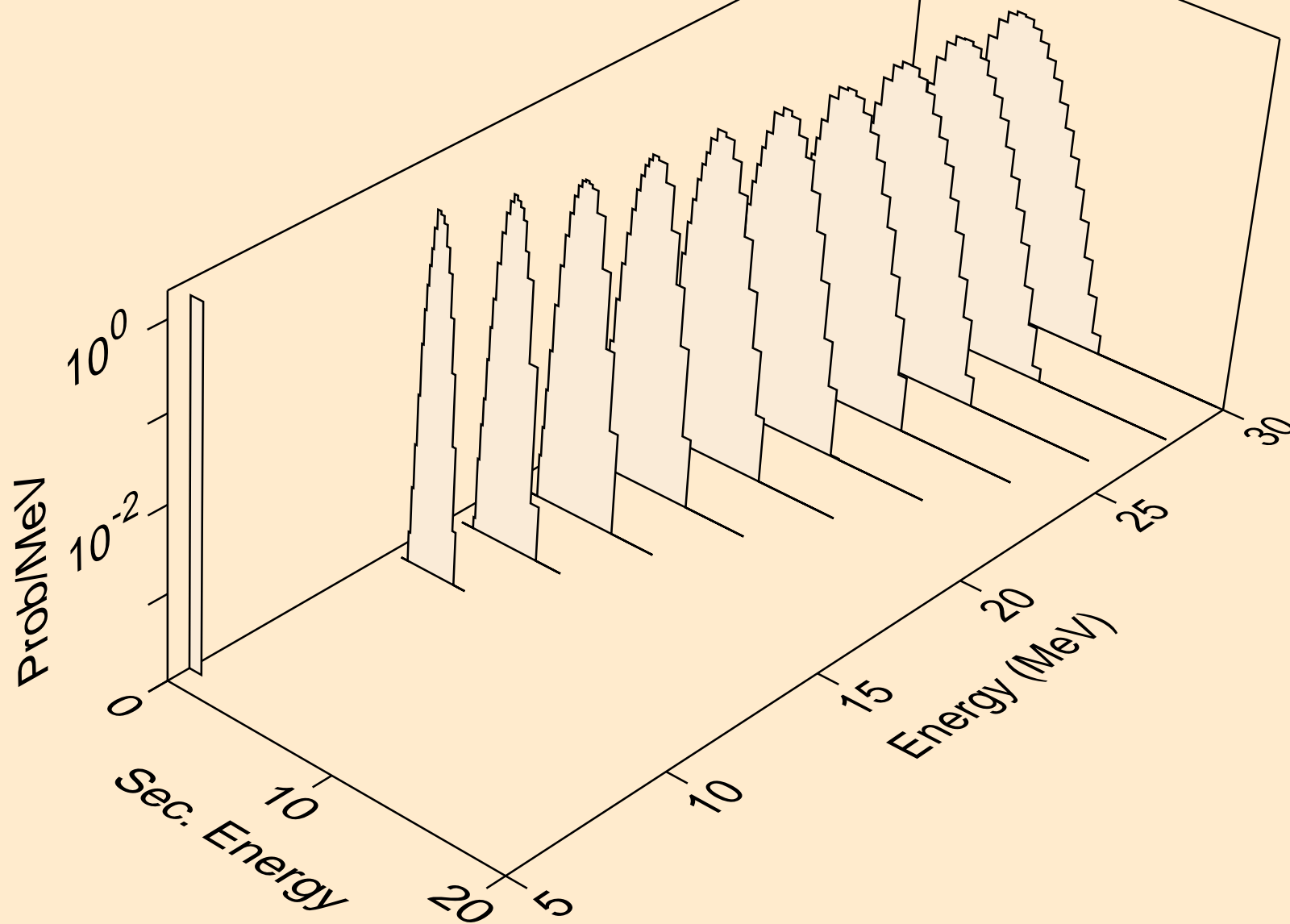

TA161M NEUTRON ACER TENDL-2021 LIBRARY; T=293.6K
deuterons from (n,x)

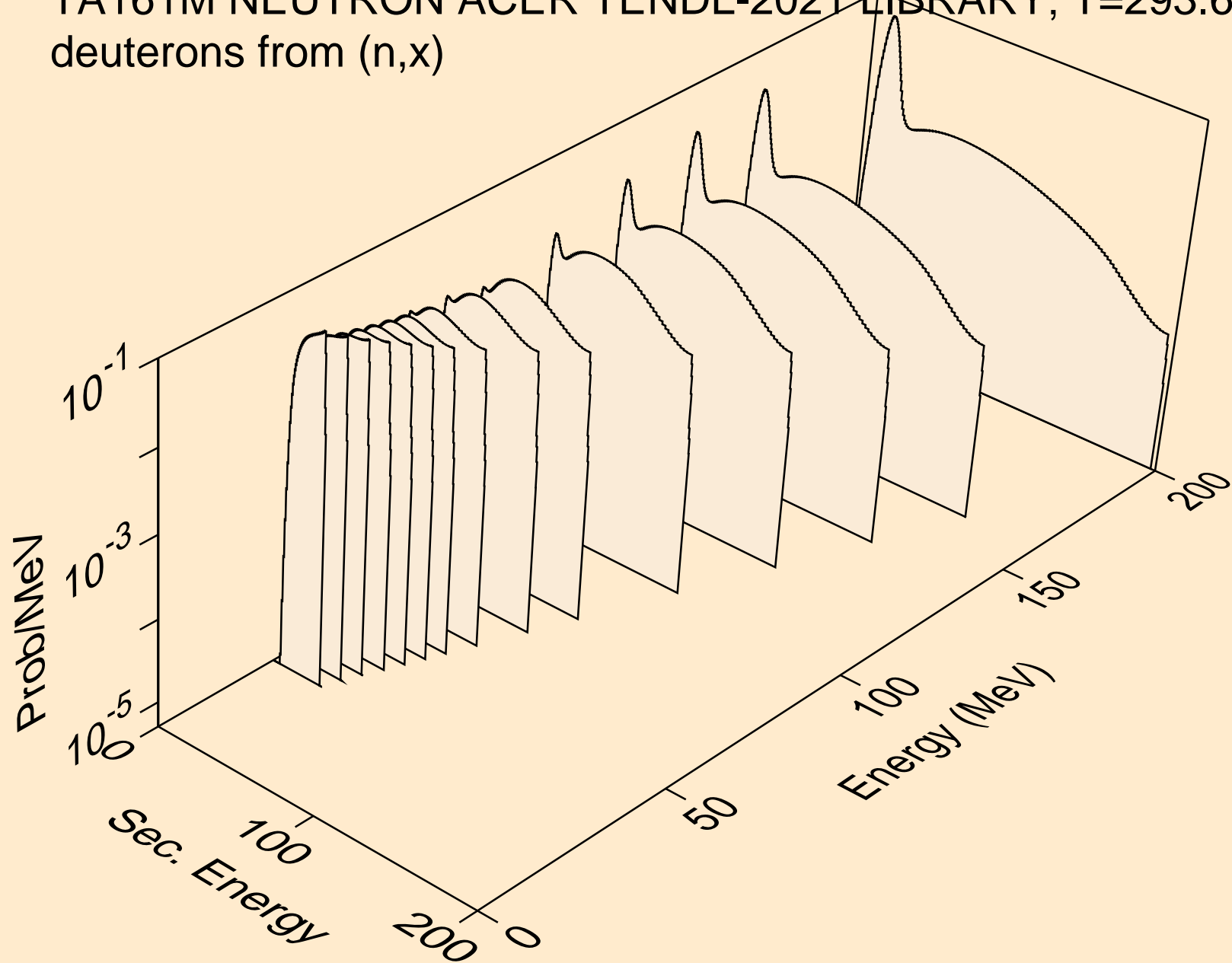

TA161M NEUTRON ACER TENDL-2021 LIBRARY; T=293.6K
deuterons from (n,2nd)

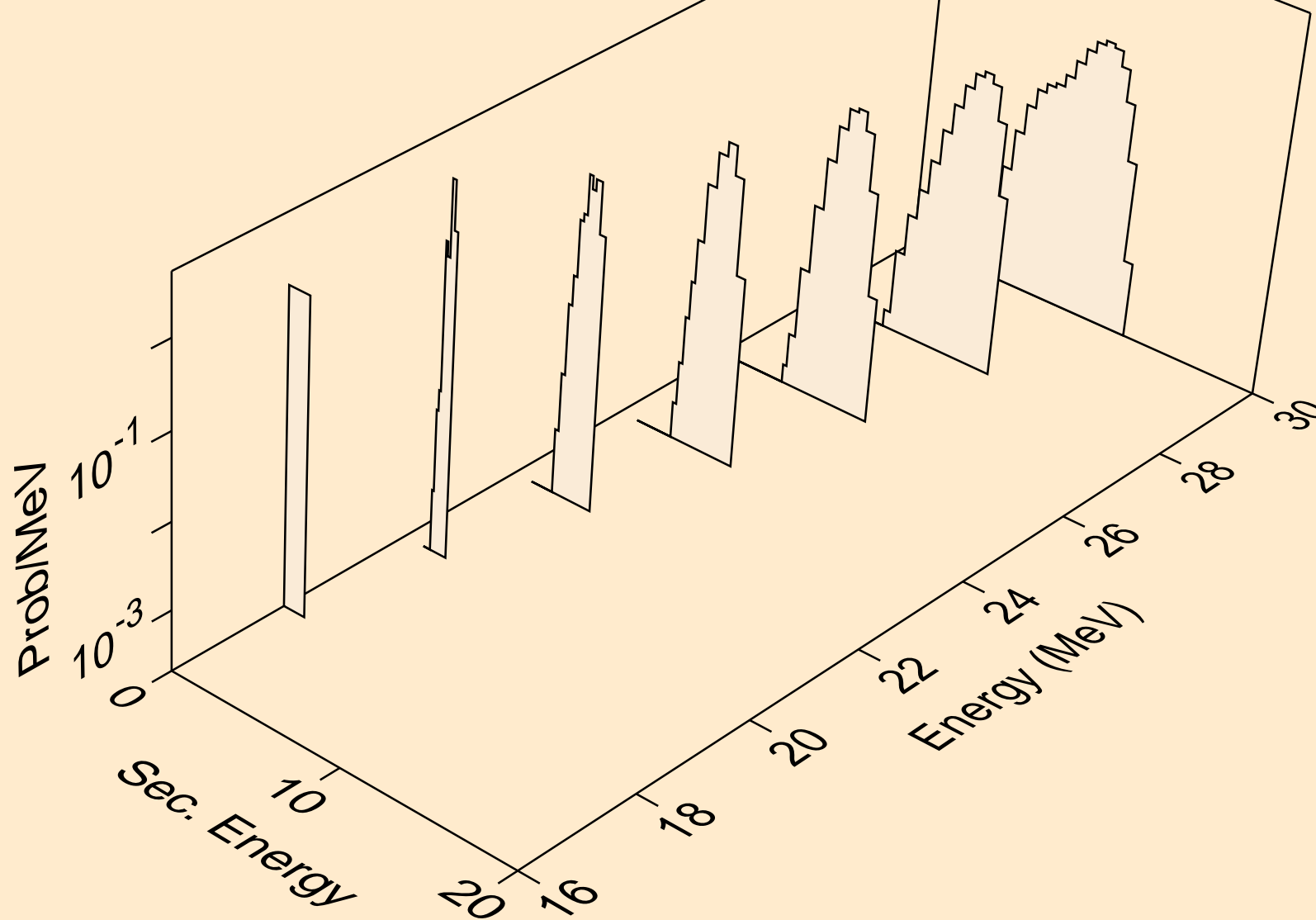

TA161M NEUTRON ACER TENDL-2021 LIBRARY; T=293.6K
deuterons from (n,n*)d

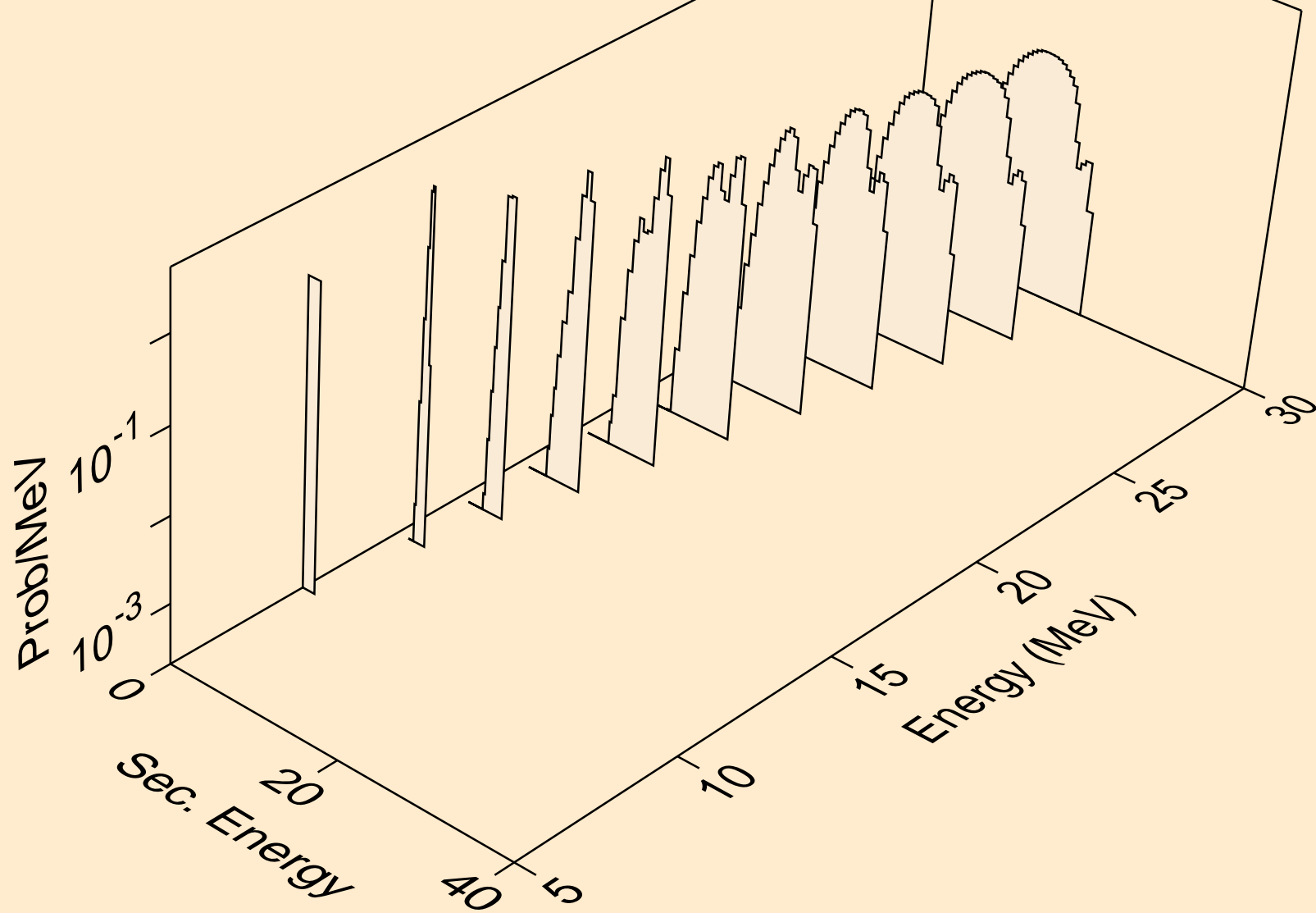

TA161M NEUTRON ACER TENDL-2021 LIBRARY; T=293.6K
deuterons from (n,n*)d2a

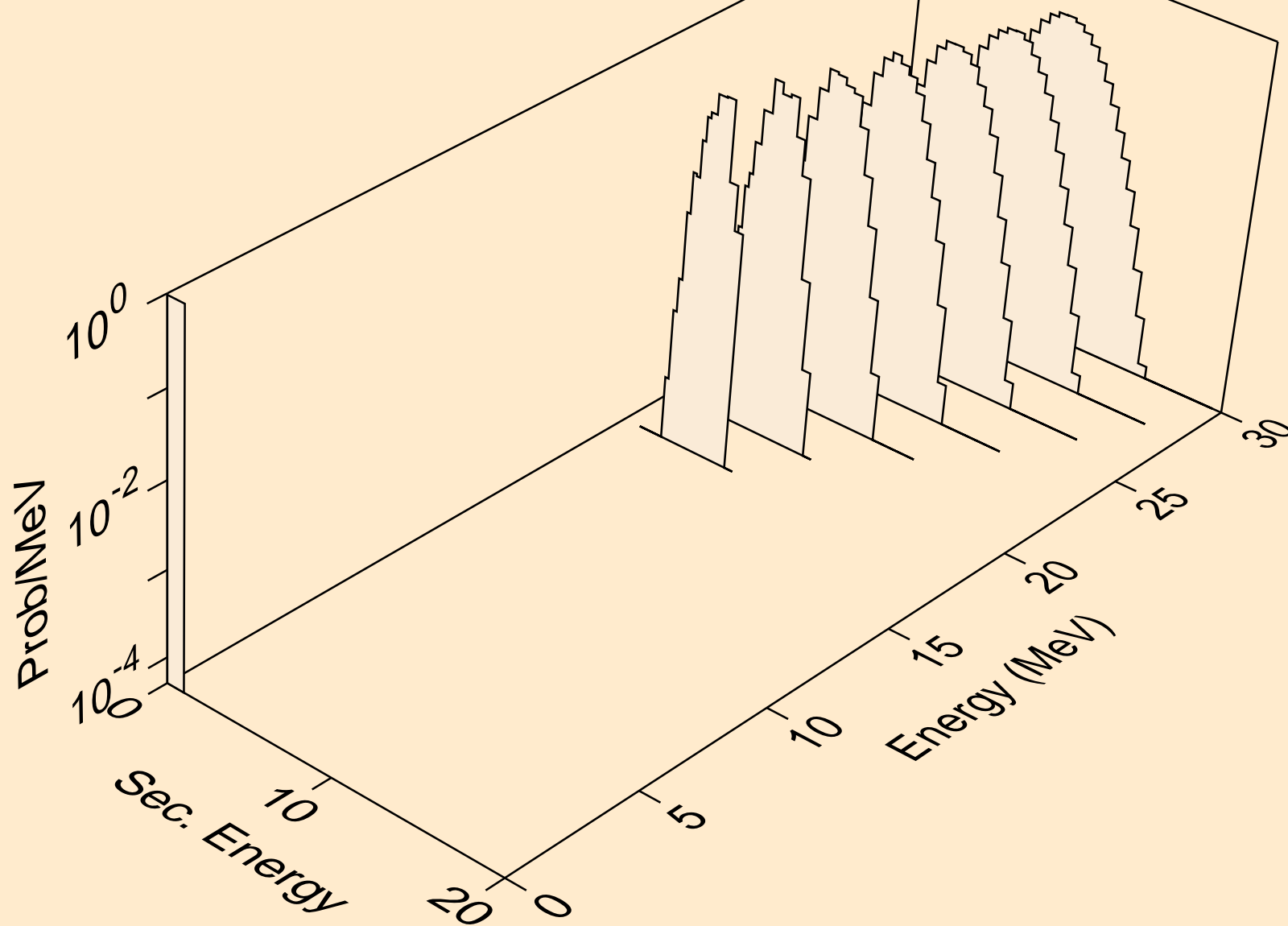

TA161M NEUTRON ACER TENDL-2021 LIBRARY; T=293.6K
deuterons from (n,d)

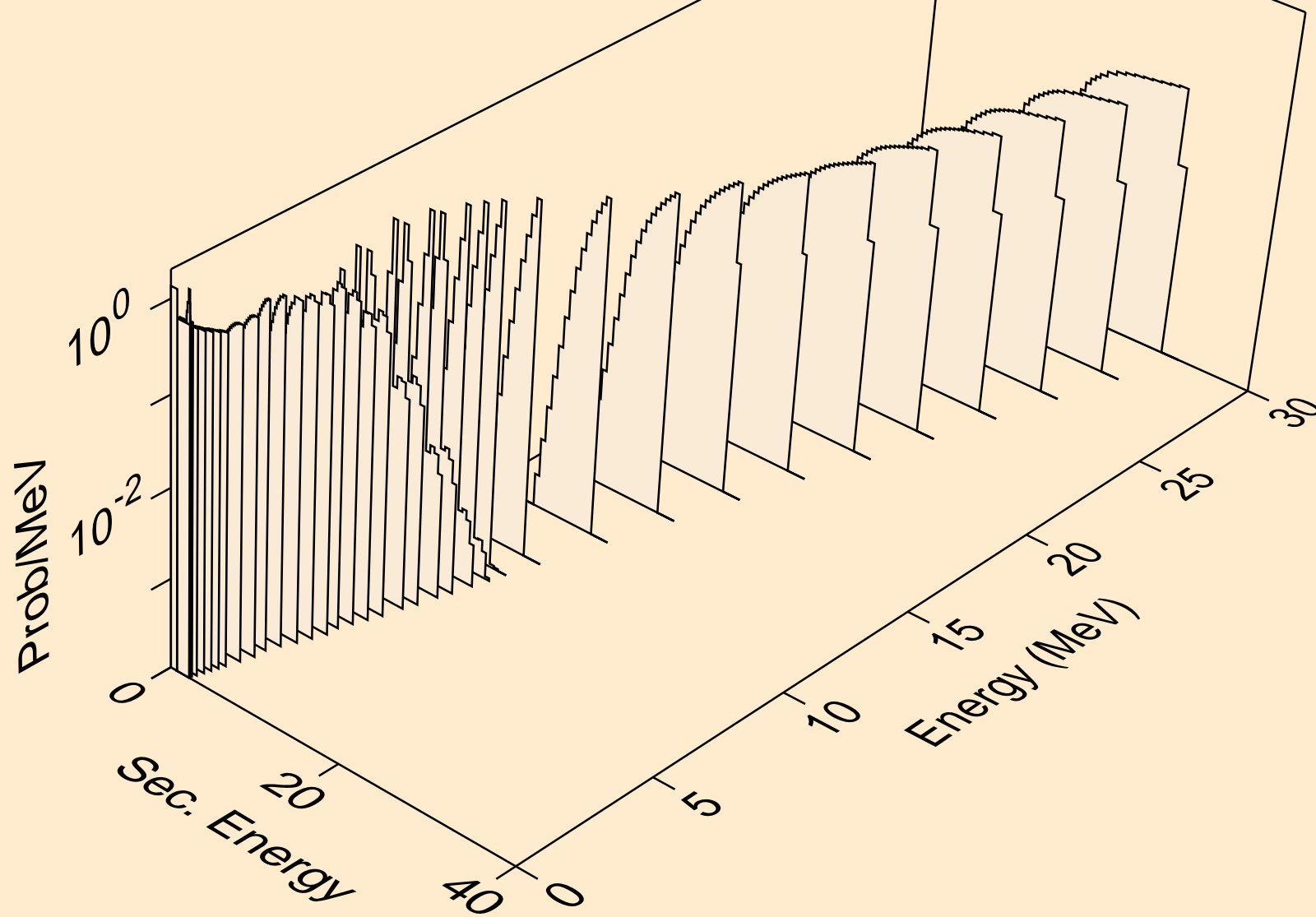

TA161M NEUTRON ACER TENDL-2021 LIBRARY; T=293.6K
deuterons from (n,d2a)

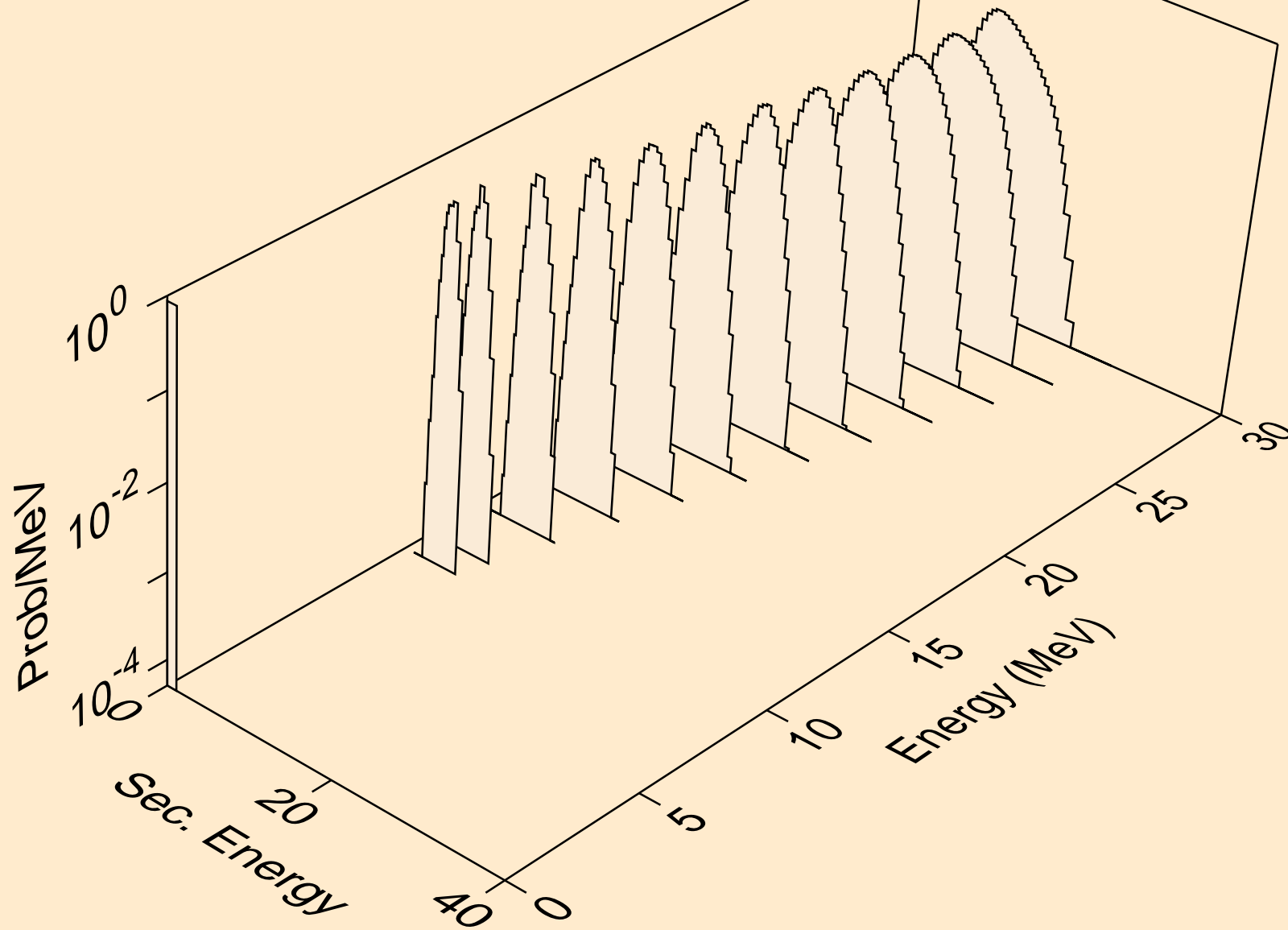

TA161M NEUTRON ACER TENDL-2021 LIBRARY; T=293.6K
deuterons from (n,pd)

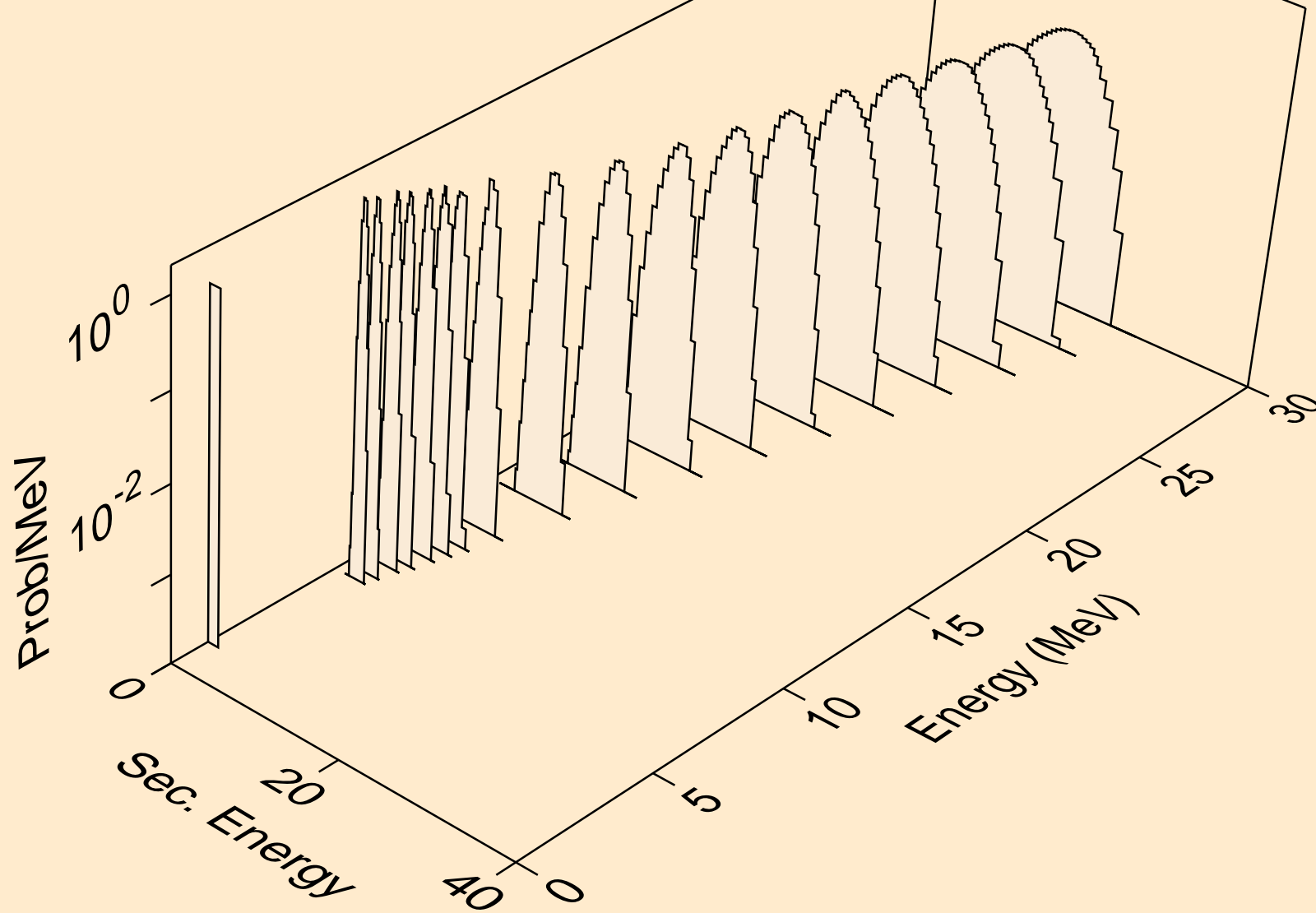

TA161M NEUTRON ACER TENDL-2021 LIBRARY; T=293.6K
deuterons from (n,da)

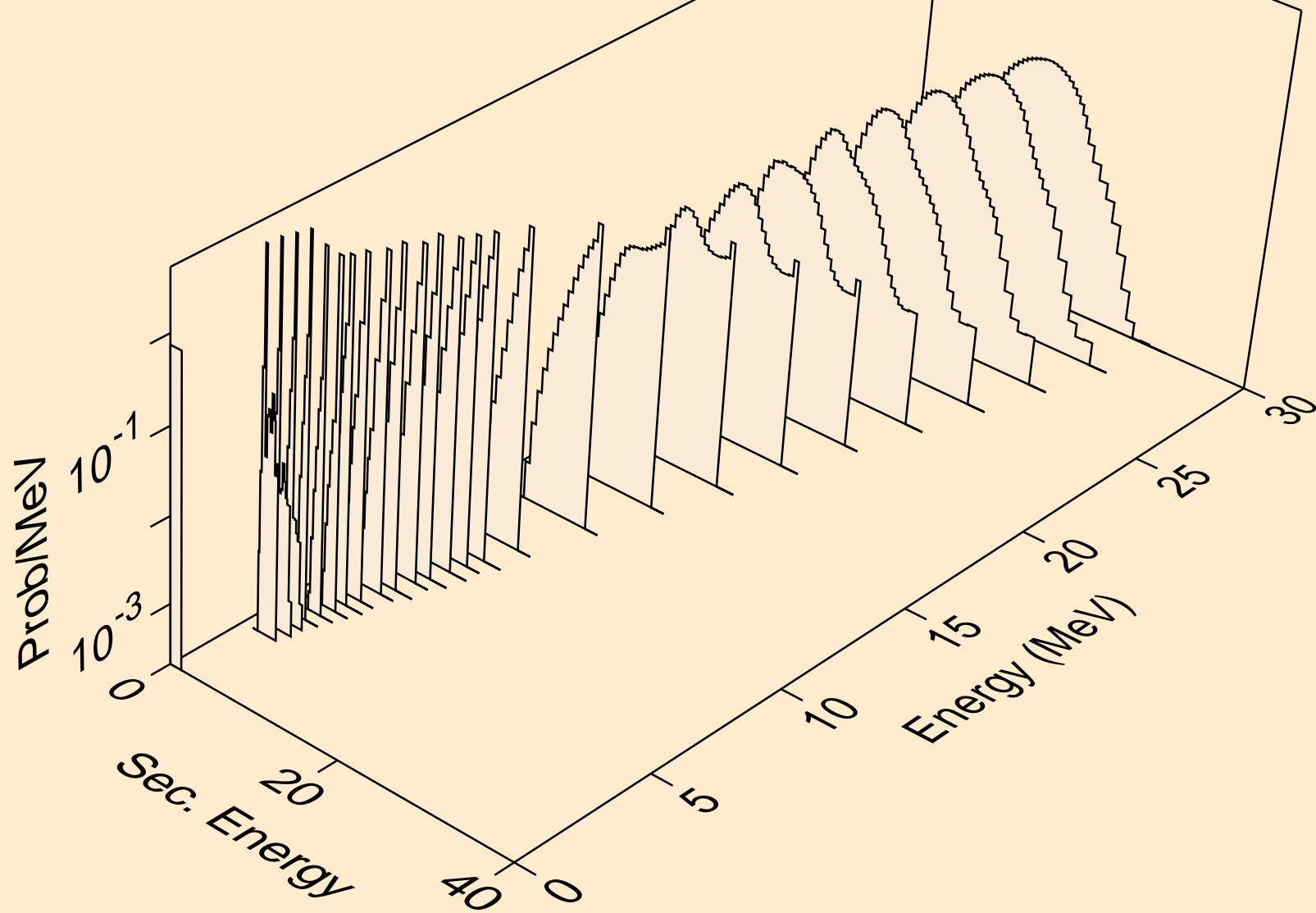

TA161M NEUTRON ACER TENDL-2021 LIBRARY; T=293.6K
tritons from (n,x)

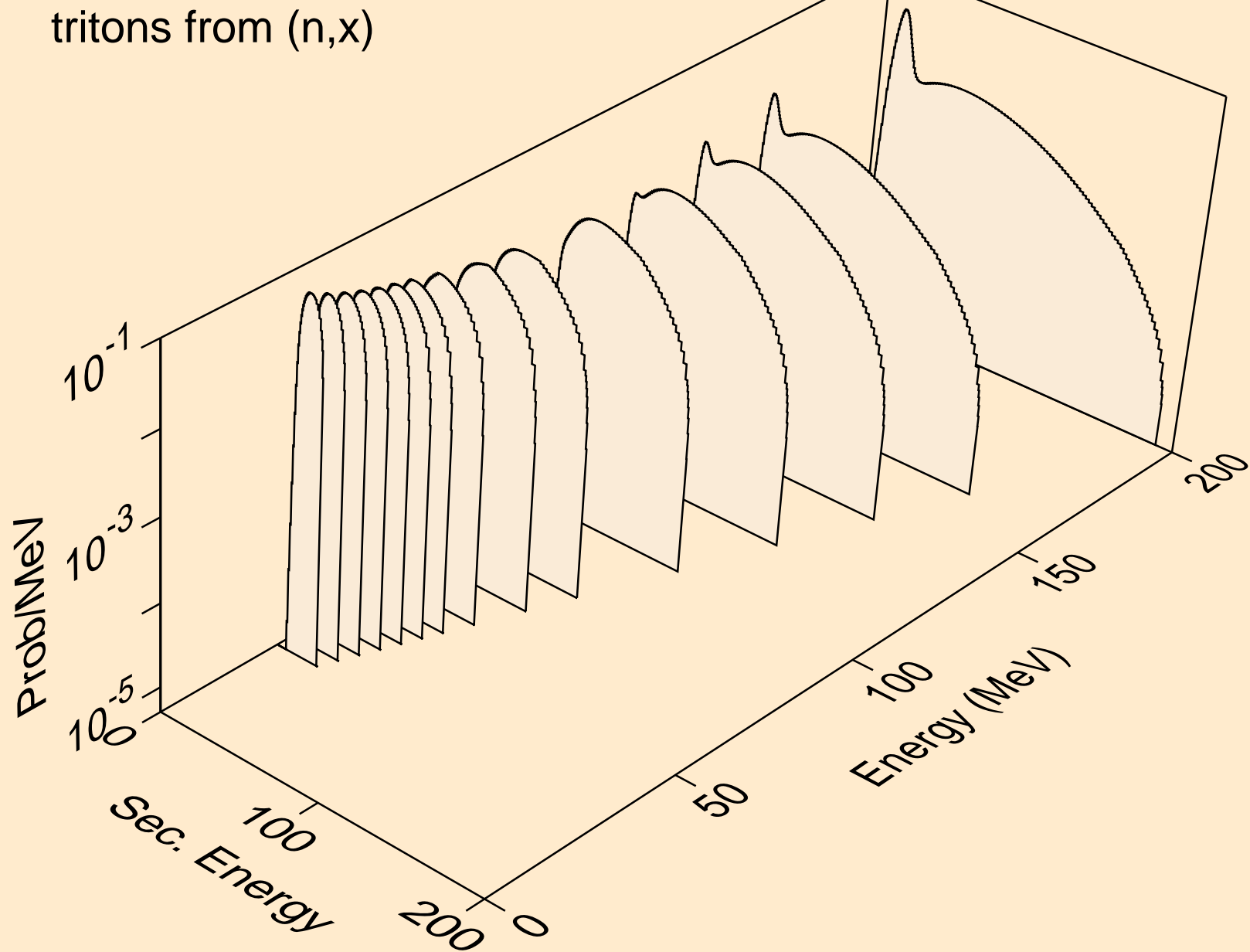

TA161M NEUTRON ACER TENDL-2021 LIBRARY; T=293.6K
tritons from (n,n*)t

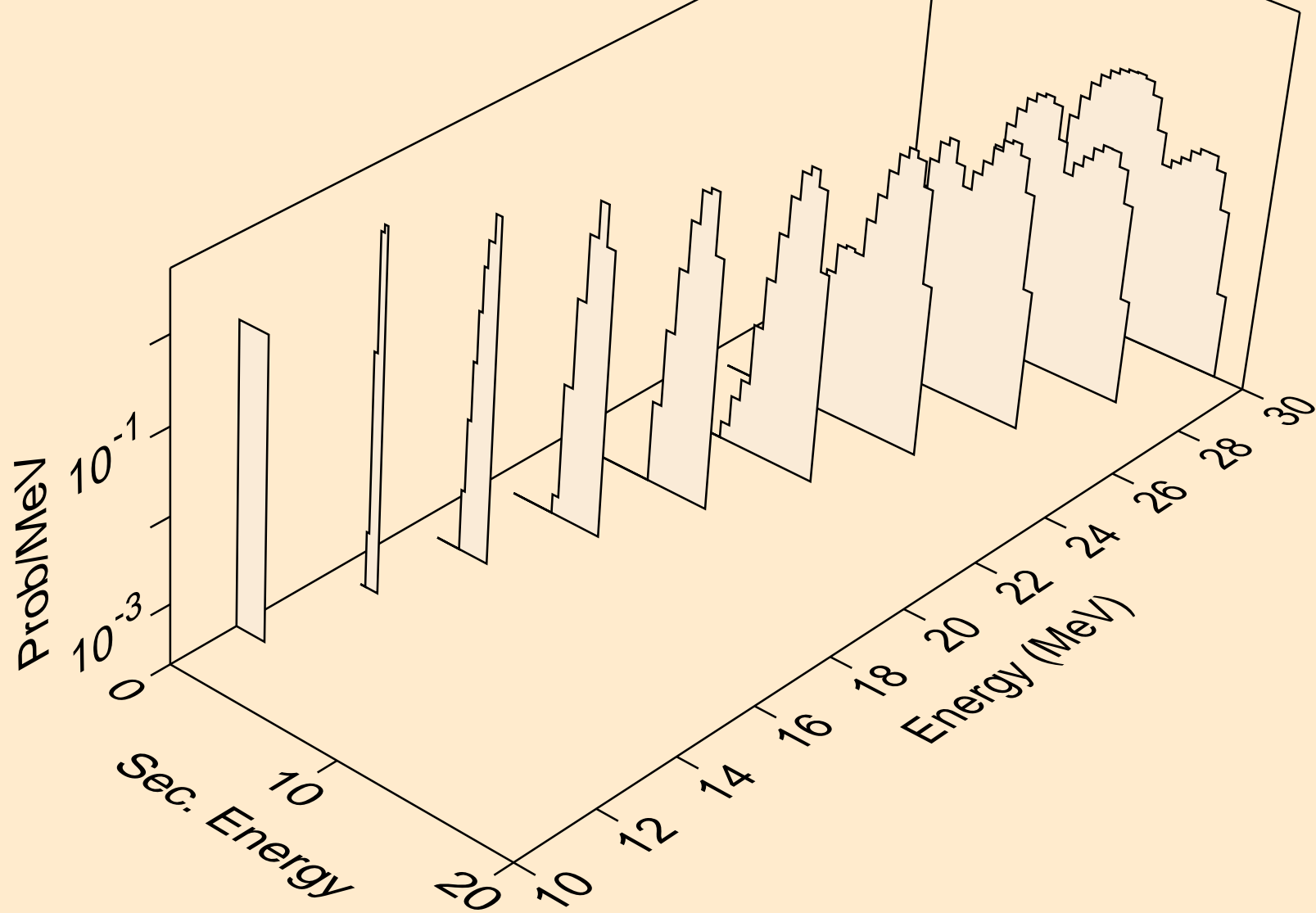

TA161M NEUTRON ACER TENDL-2021 LIBRARY; T=293.6K
tritons from (n,t)

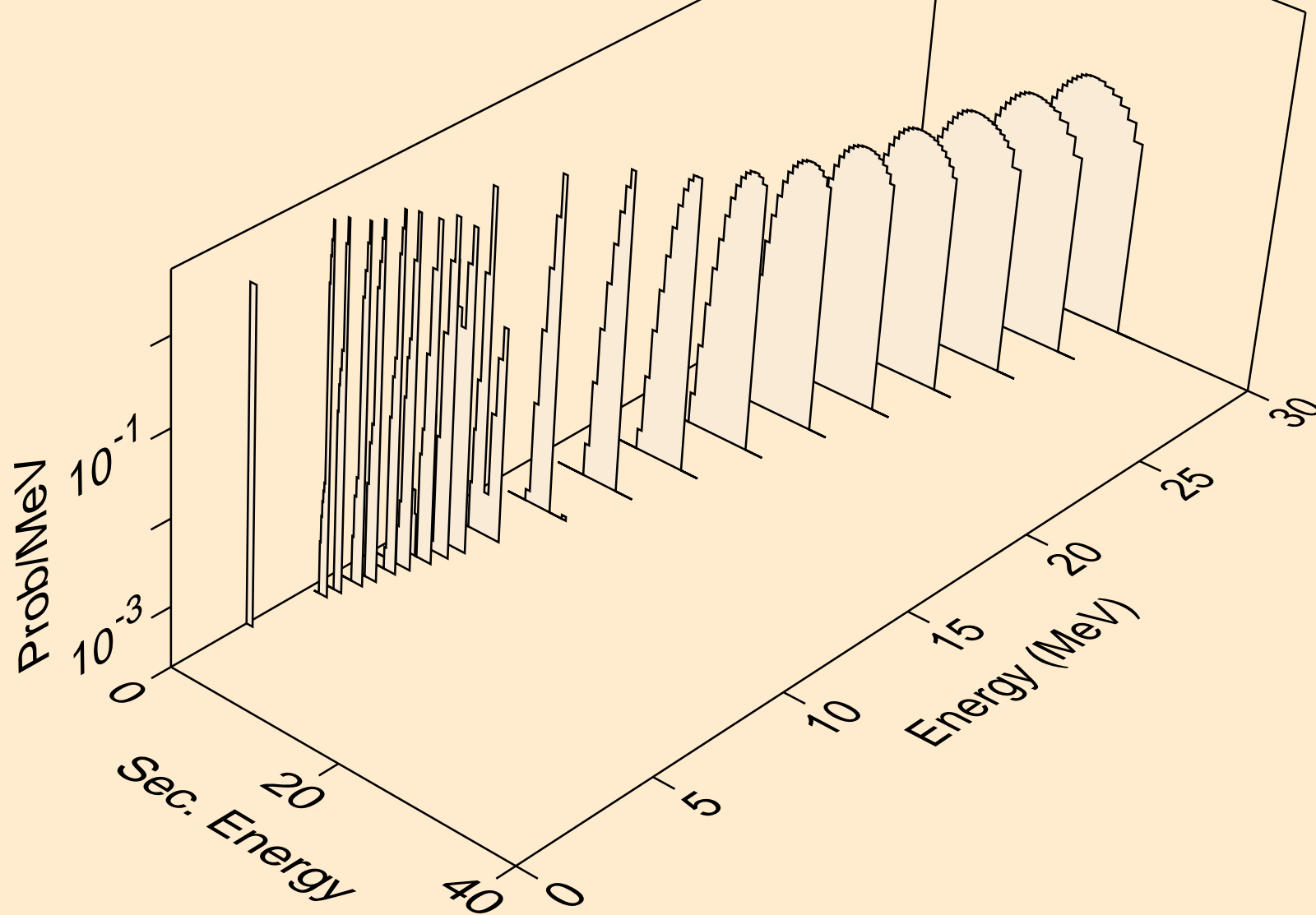

TA161M NEUTRON ACER TENDL-2021 LIBRARY; T=293.6K
tritons from (n,t2a)

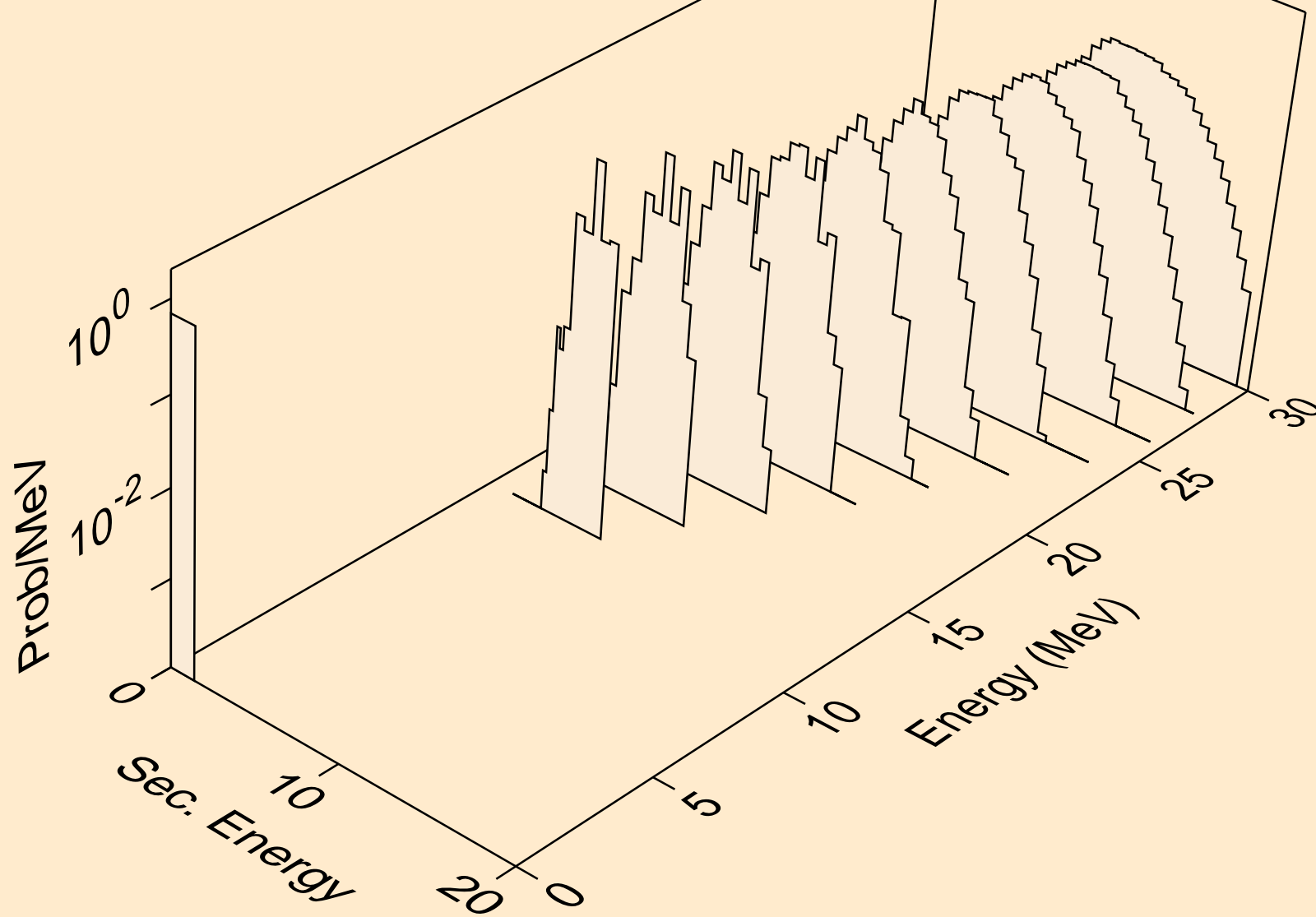

TA161M NEUTRON ACER TENDL-2021 LIBRARY; T=293.6K
tritons from (n,pt)

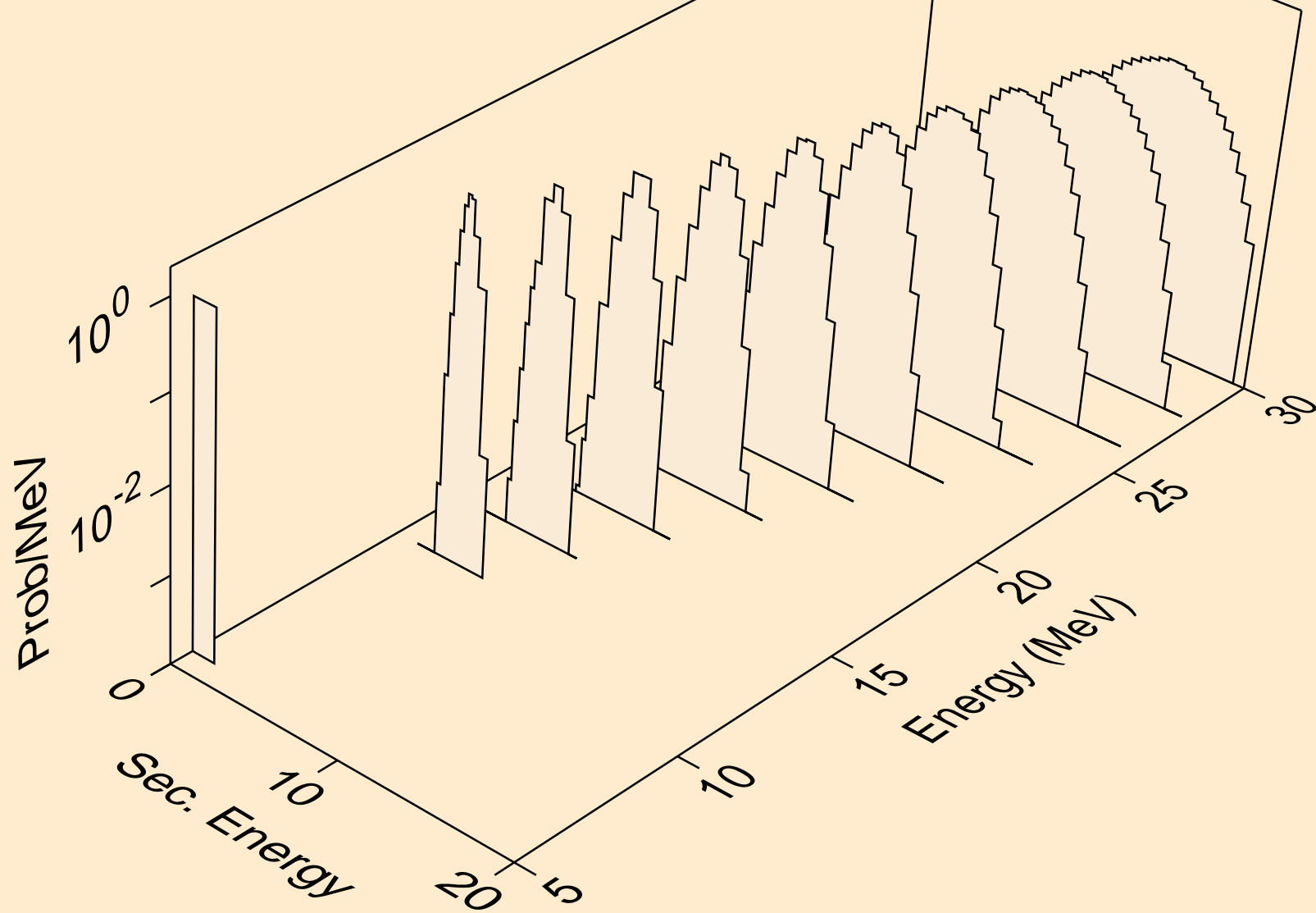

TA161M NEUTRON ACER TENDL-2021 LIBRARY; T=293.6K
he3s from (n,x)

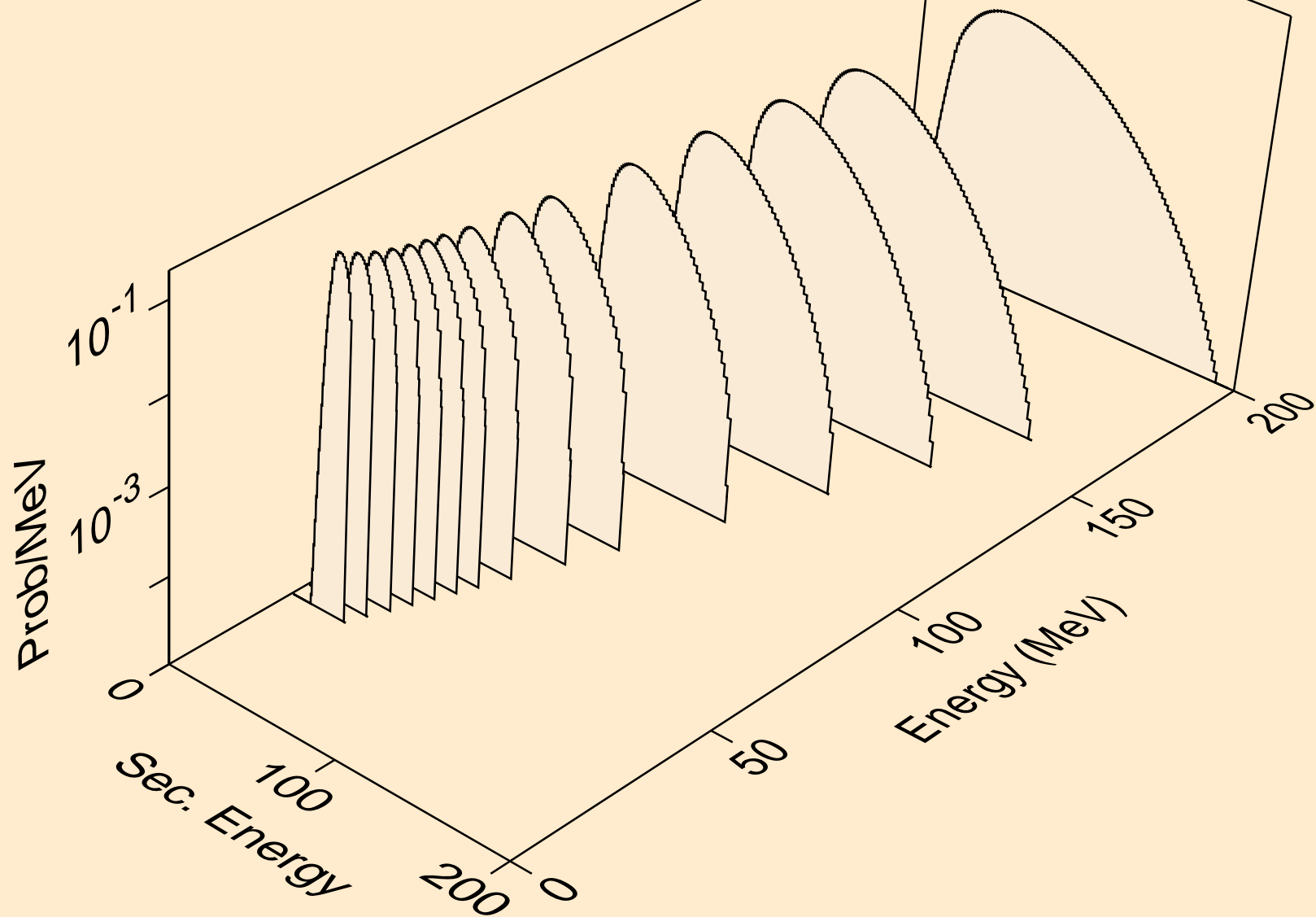

TA161M NEUTRON ACER TENDL-2021 LIBRARY; T=293.6K
he3s from (n,n*)he3

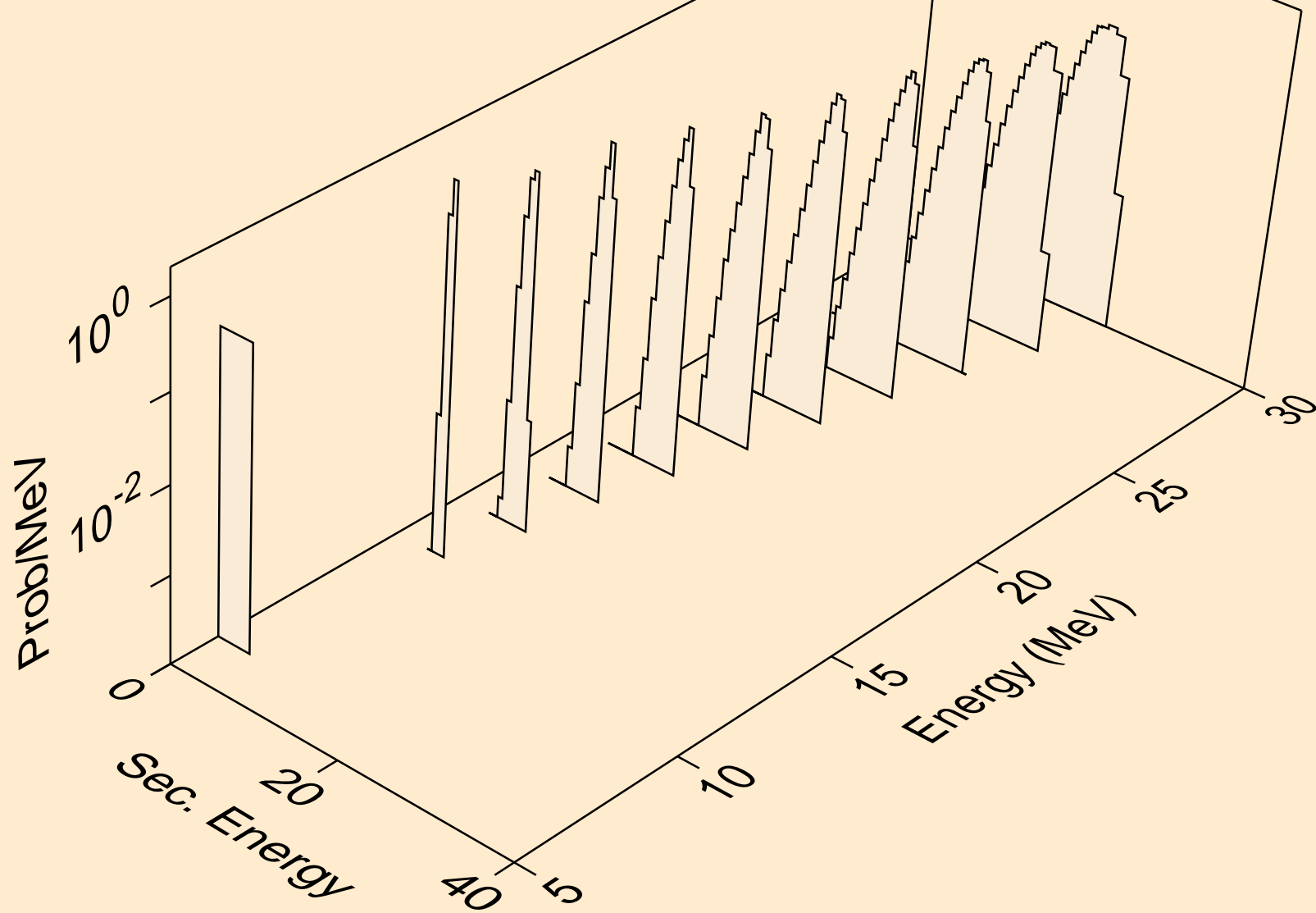

TA161M NEUTRON ACER TENDL-2021 LIBRARY; T=293.6K
he3s from (n,he3)

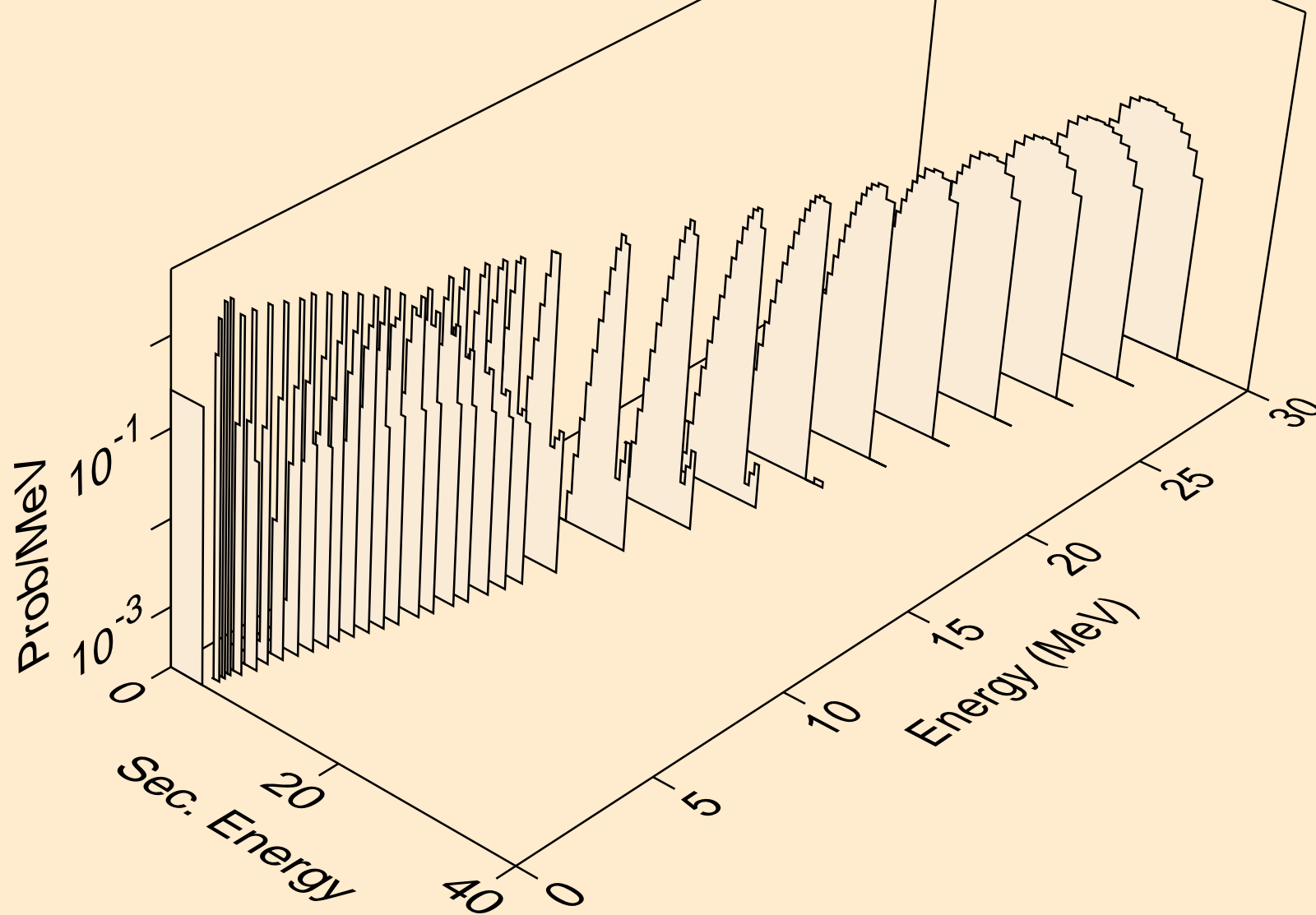

TA161M NEUTRON ACER TENDL-2021 LIBRARY; T=293.6K
alphas from (n,x)

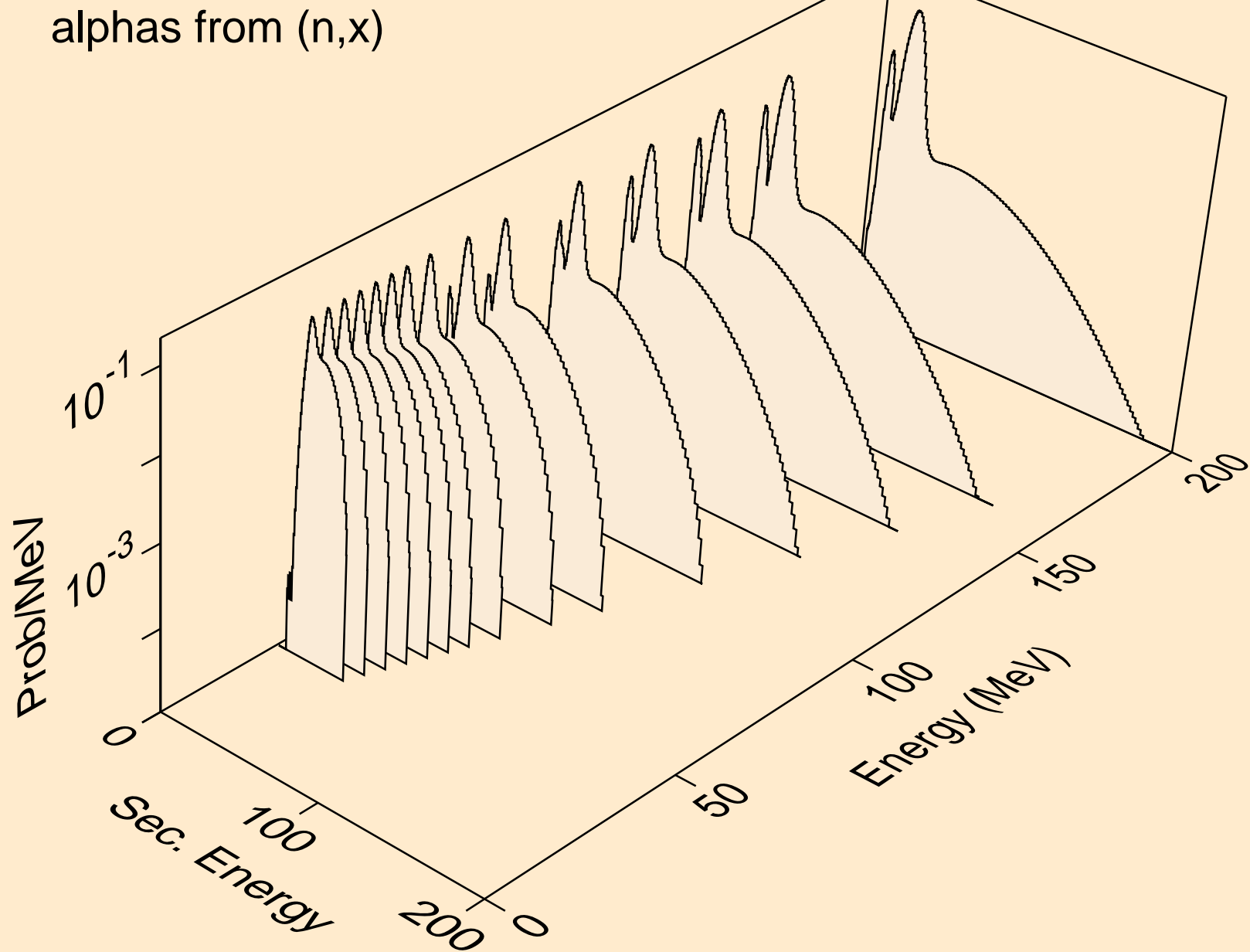

TA161M NEUTRON ACER TENDL-2021 LIBRARY; T=293.6K
alphas from (n,n*)a

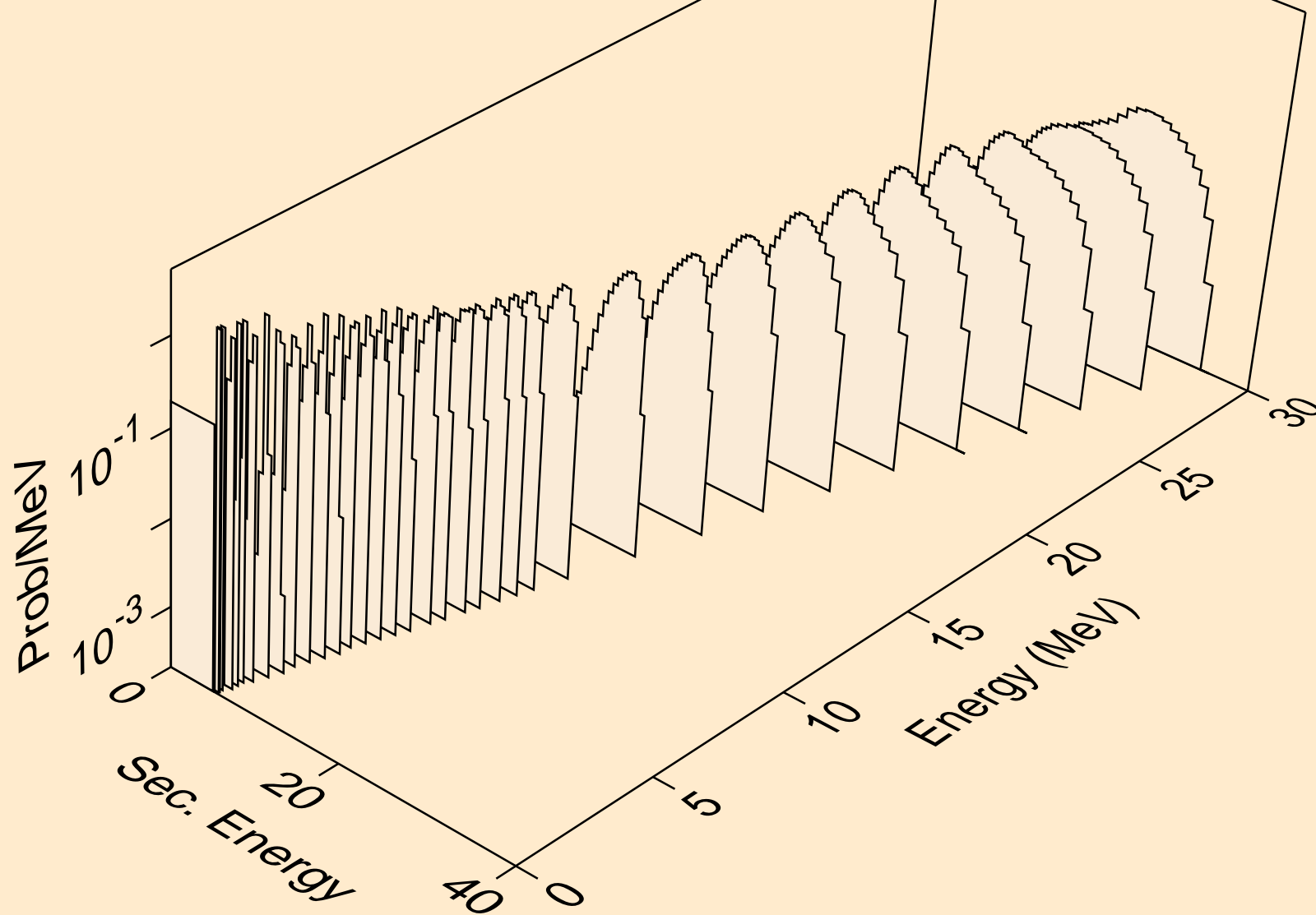

TA161M NEUTRON ACER TENDL-2021 LIBRARY; T=293.6K
alphas from (n,n*)3a

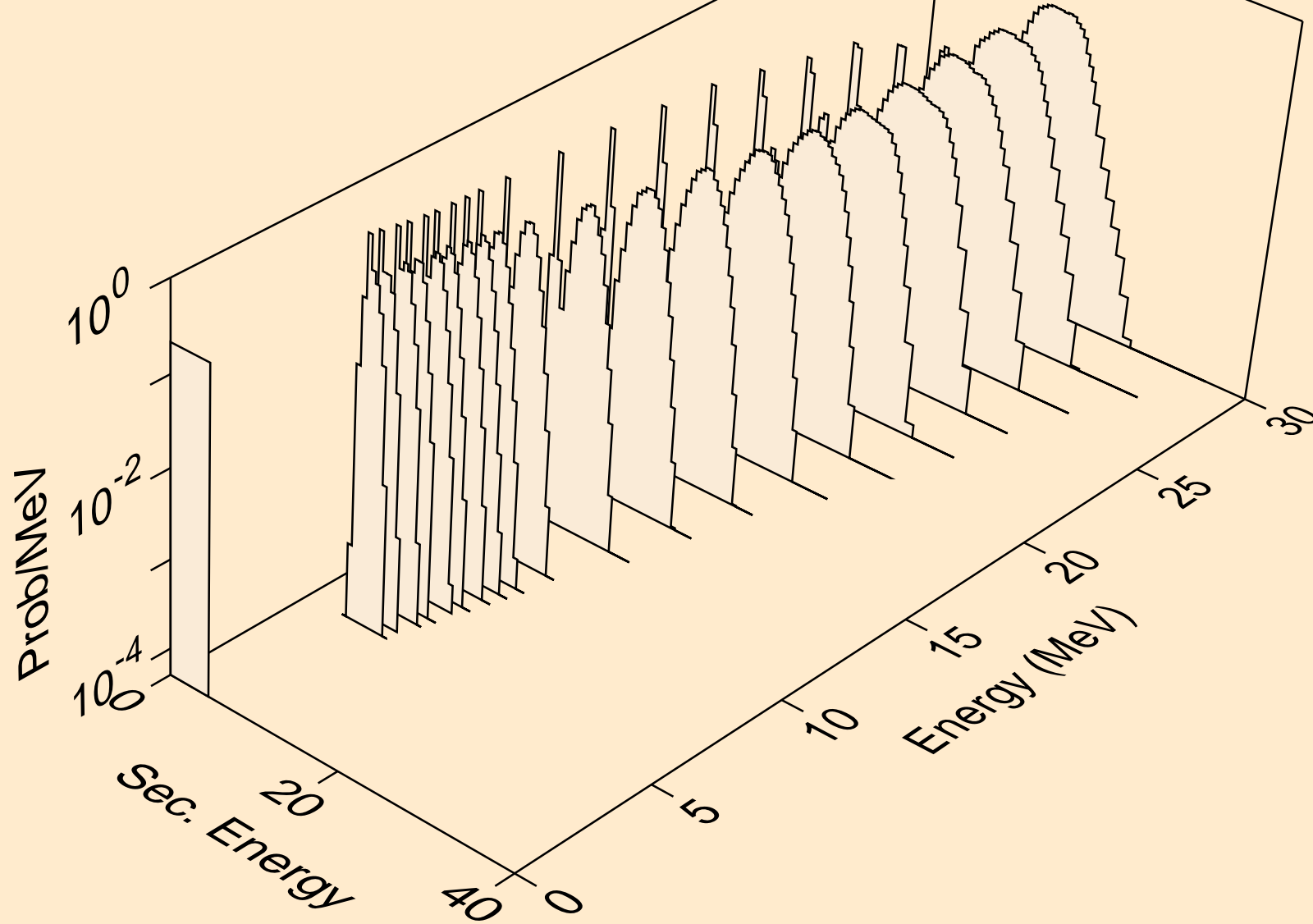

TA161M NEUTRON ACER TENDL-2021 LIBRARY; T=293.6K
alphas from (n,2n)a

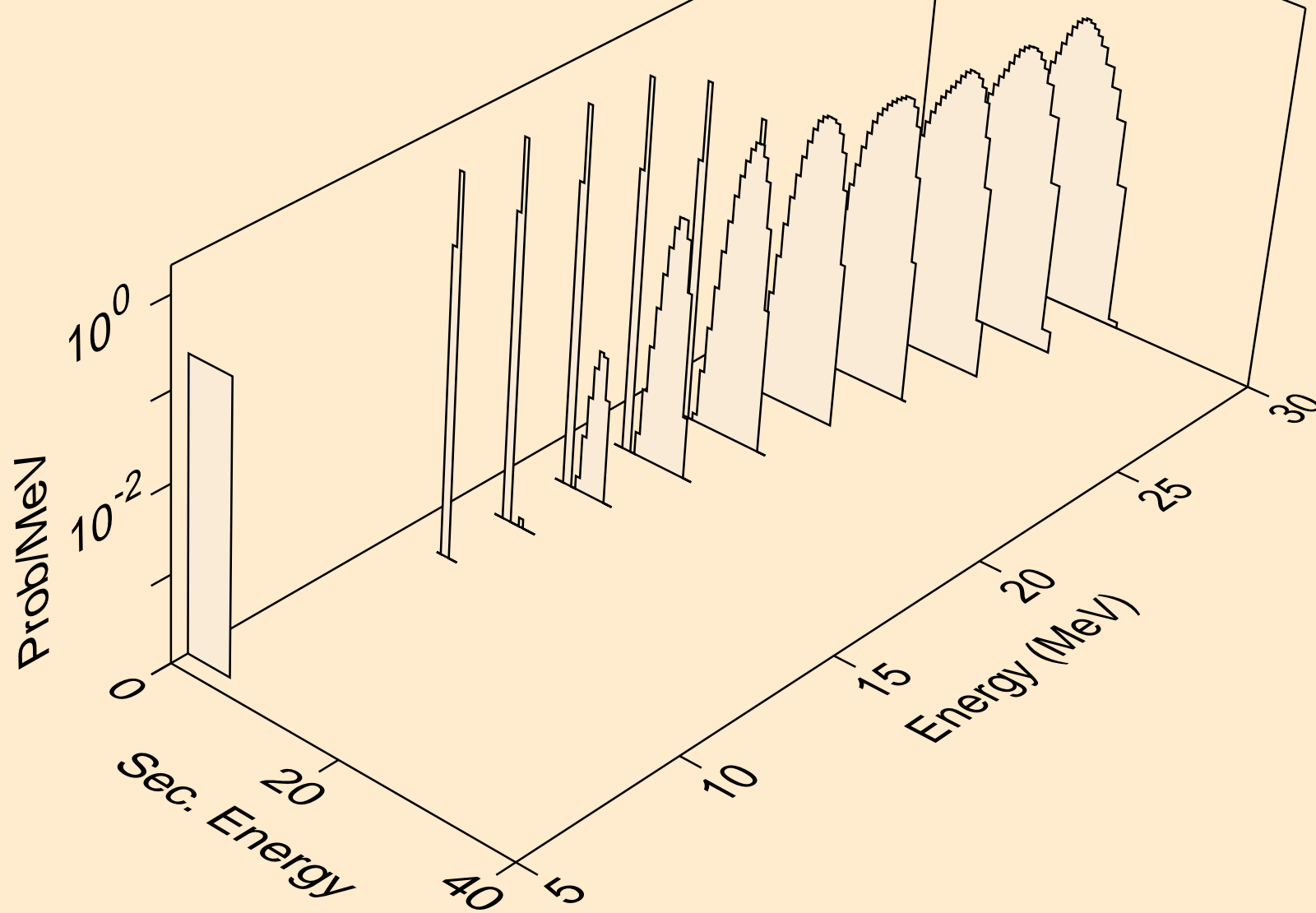

TA161M NEUTRON ACER TENDL-2021 LIBRARY; T=293.6K
alphas from (n,3n)a

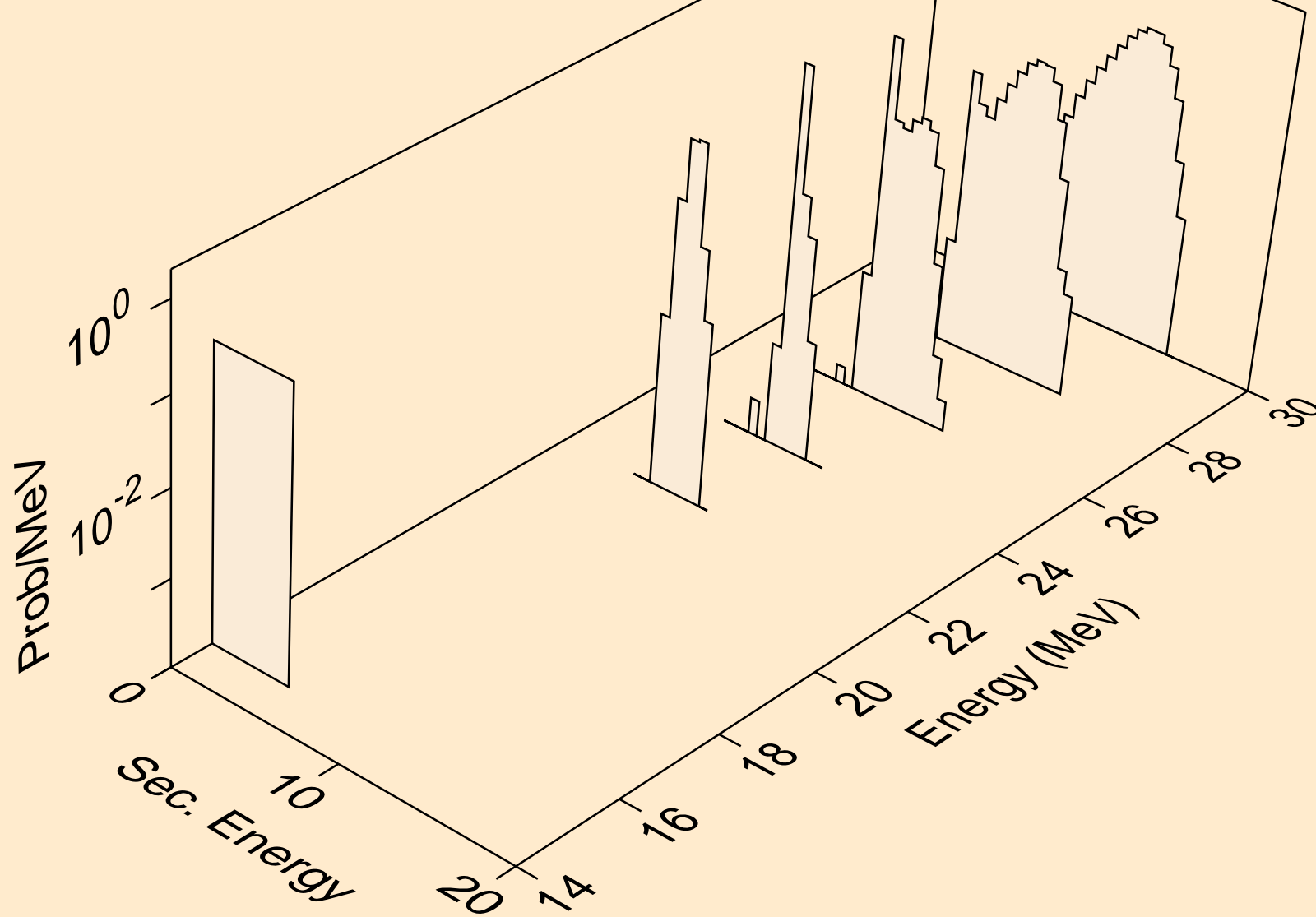

TA161M NEUTRON ACER TENDL-2021 LIBRARY; T=293.6K
alphas from (n,n*)2a

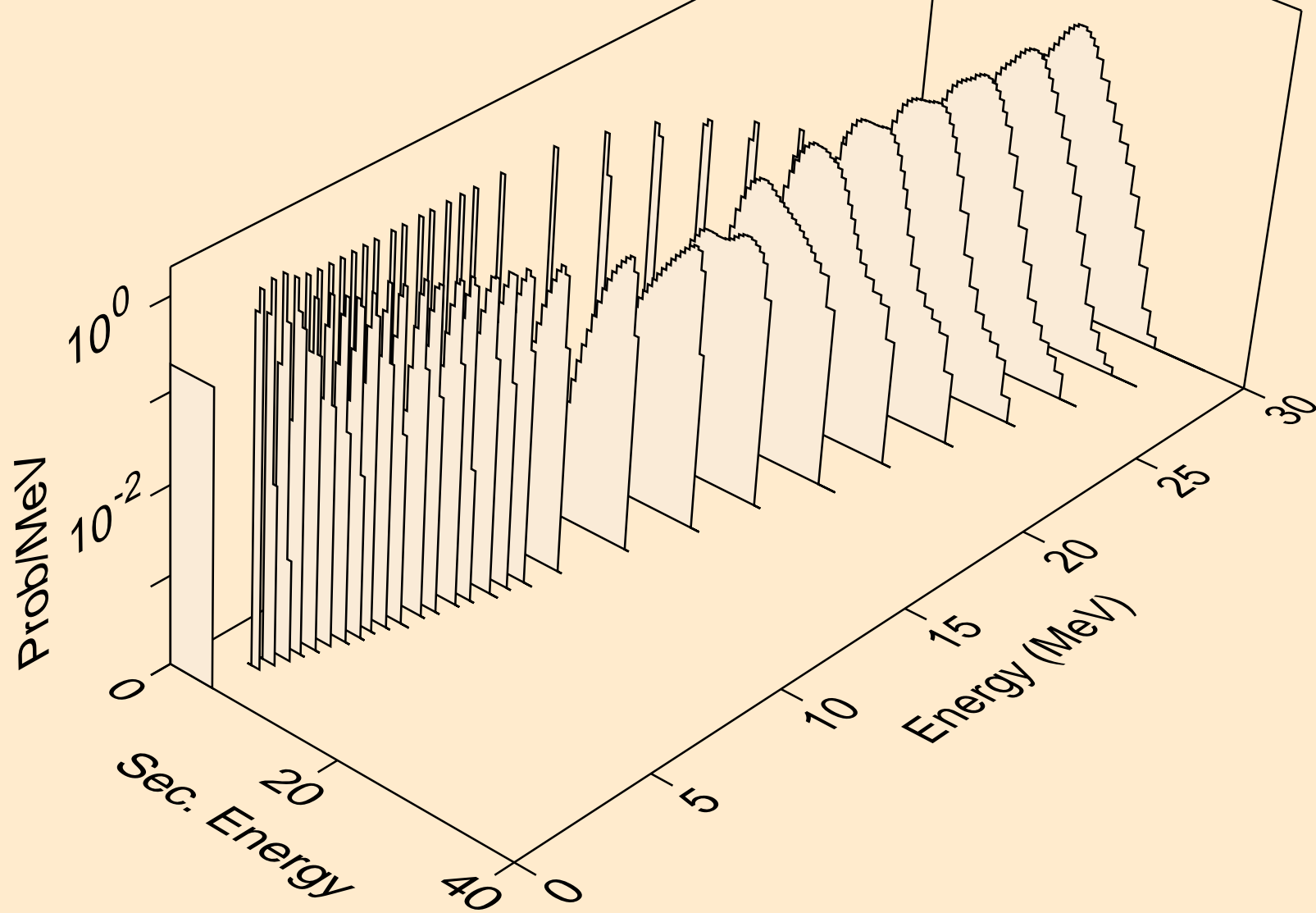

TA161M NEUTRON ACER TENDL-2021 LIBRARY; T=293.6K
alphas from (n,2n)2a

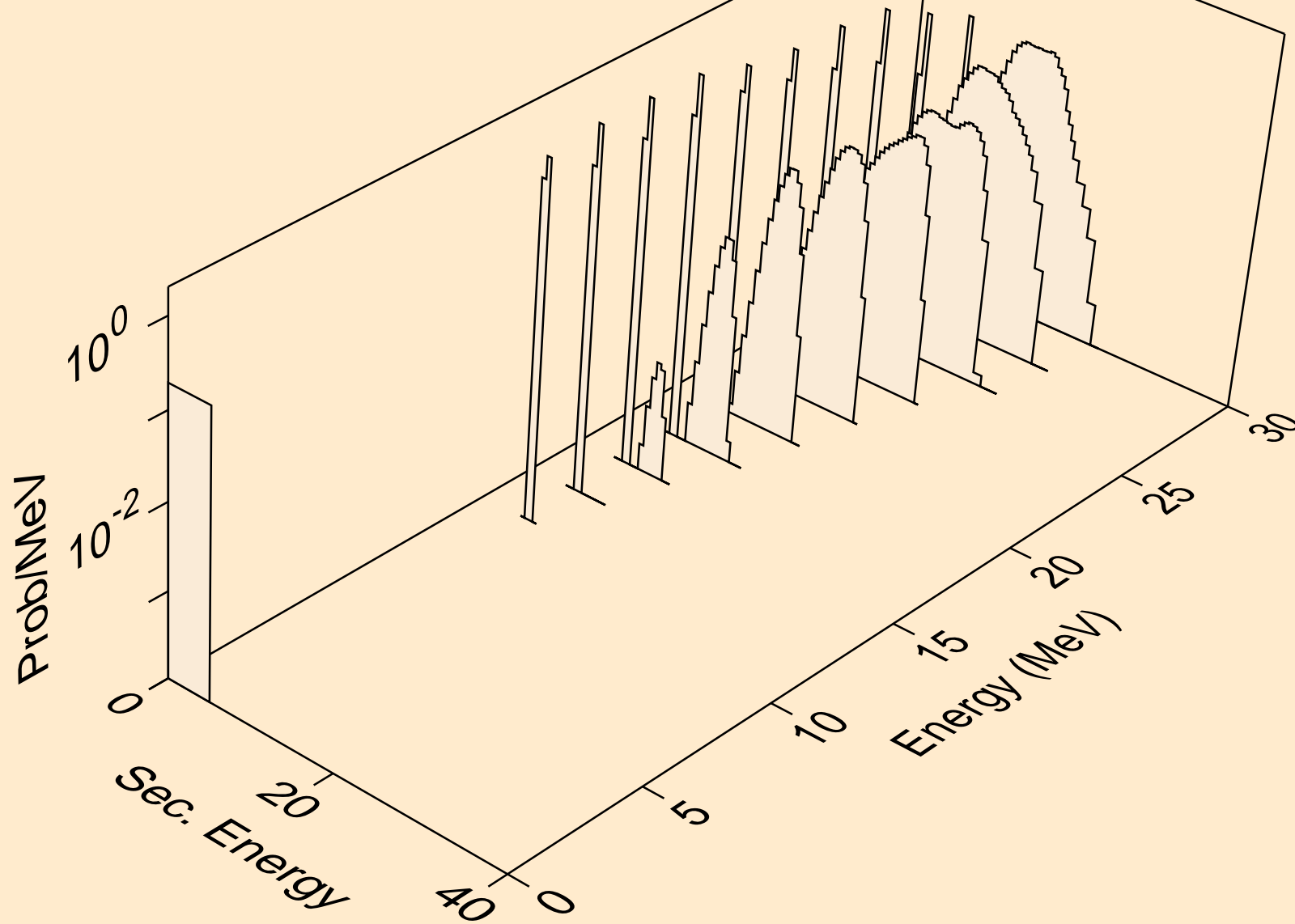

TA161M NEUTRON ACER TENDL-2021 LIBRARY; T=293.6K
alphas from (n,n*)d2a

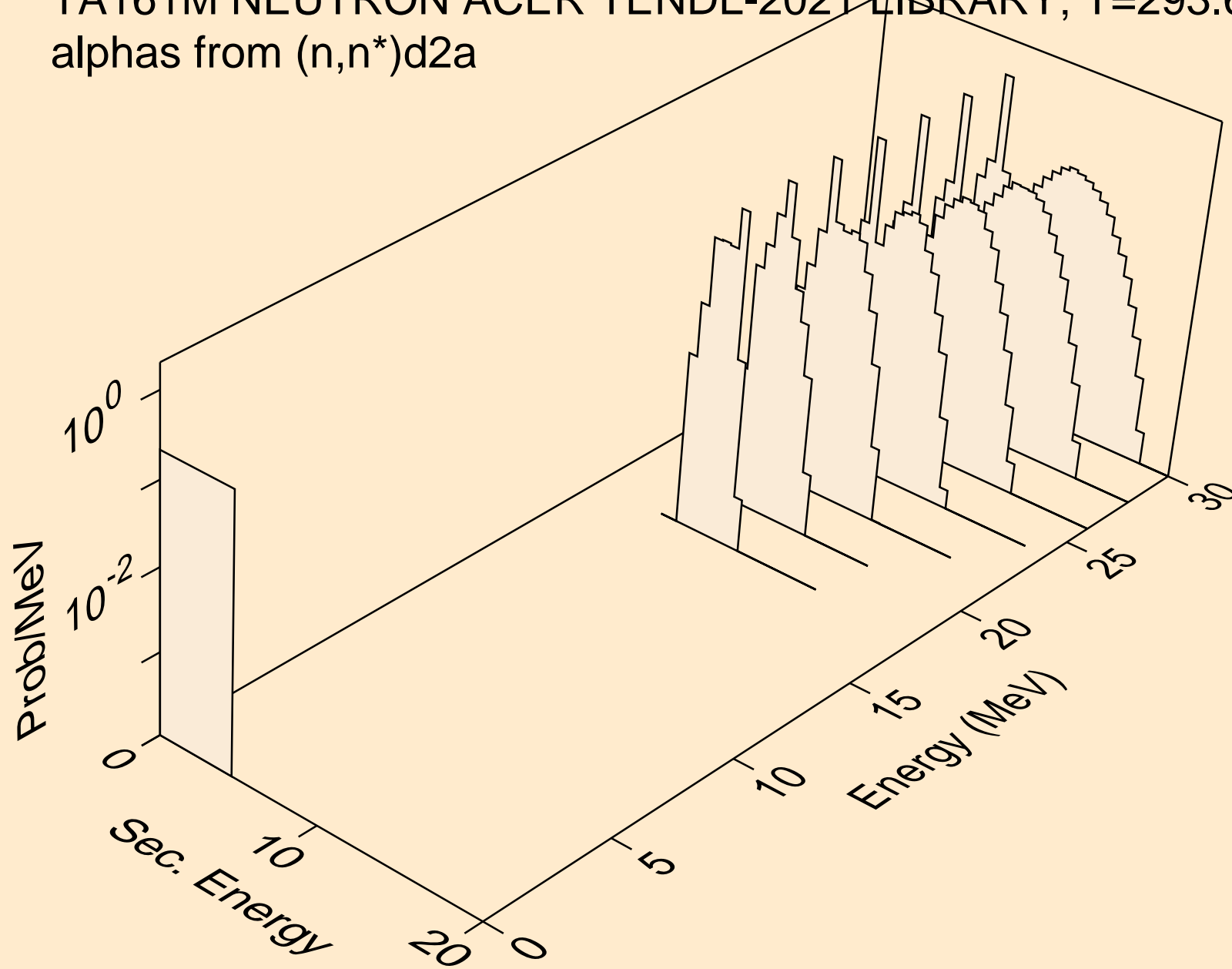

TA161M NEUTRON ACER TENDL-2021 LIBRARY; T=293.6K
alphas from (n,npa)

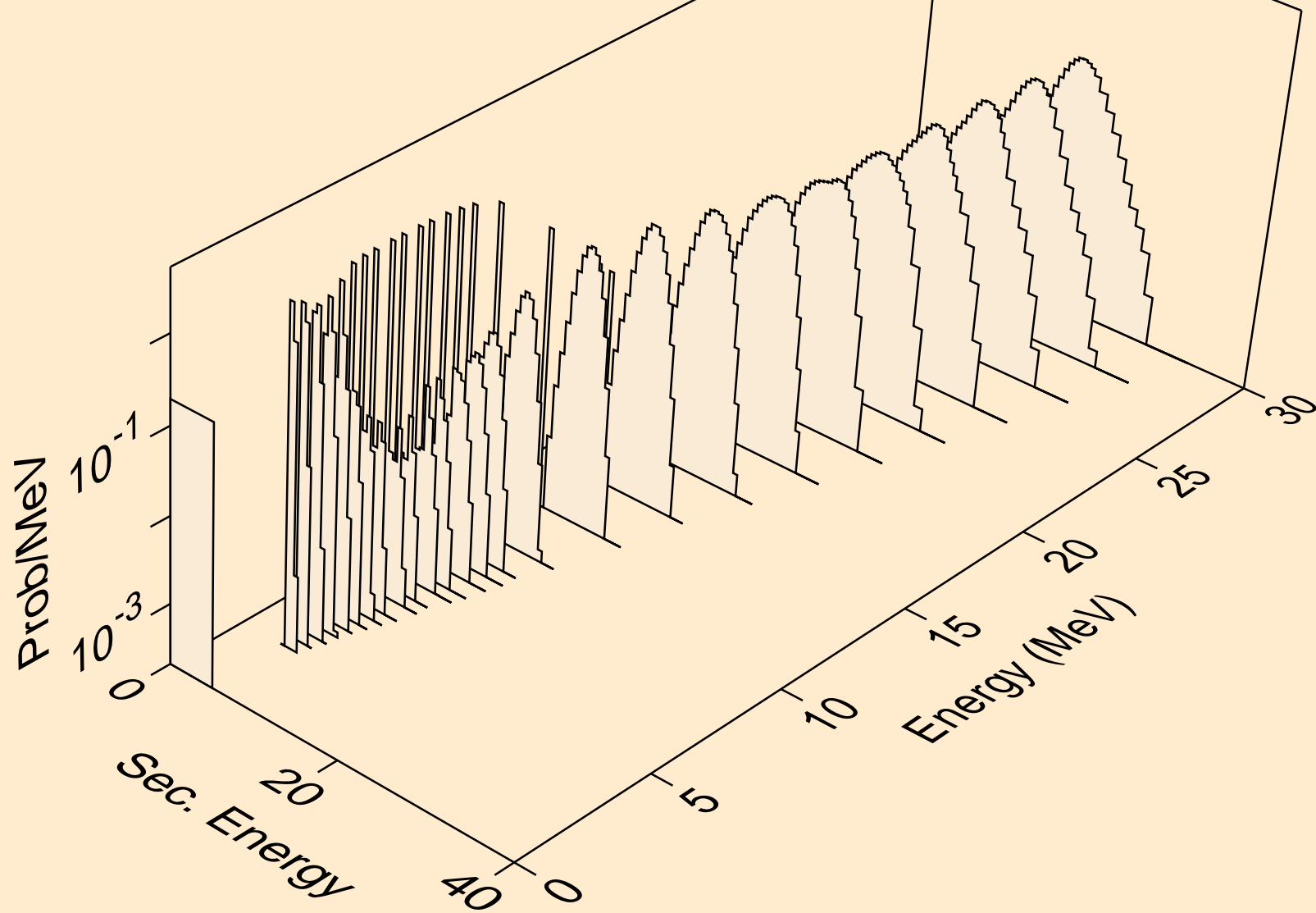

TA161M NEUTRON ACER TENDL-2021 LIBRARY; T=293.6K
alphas from (n,a)

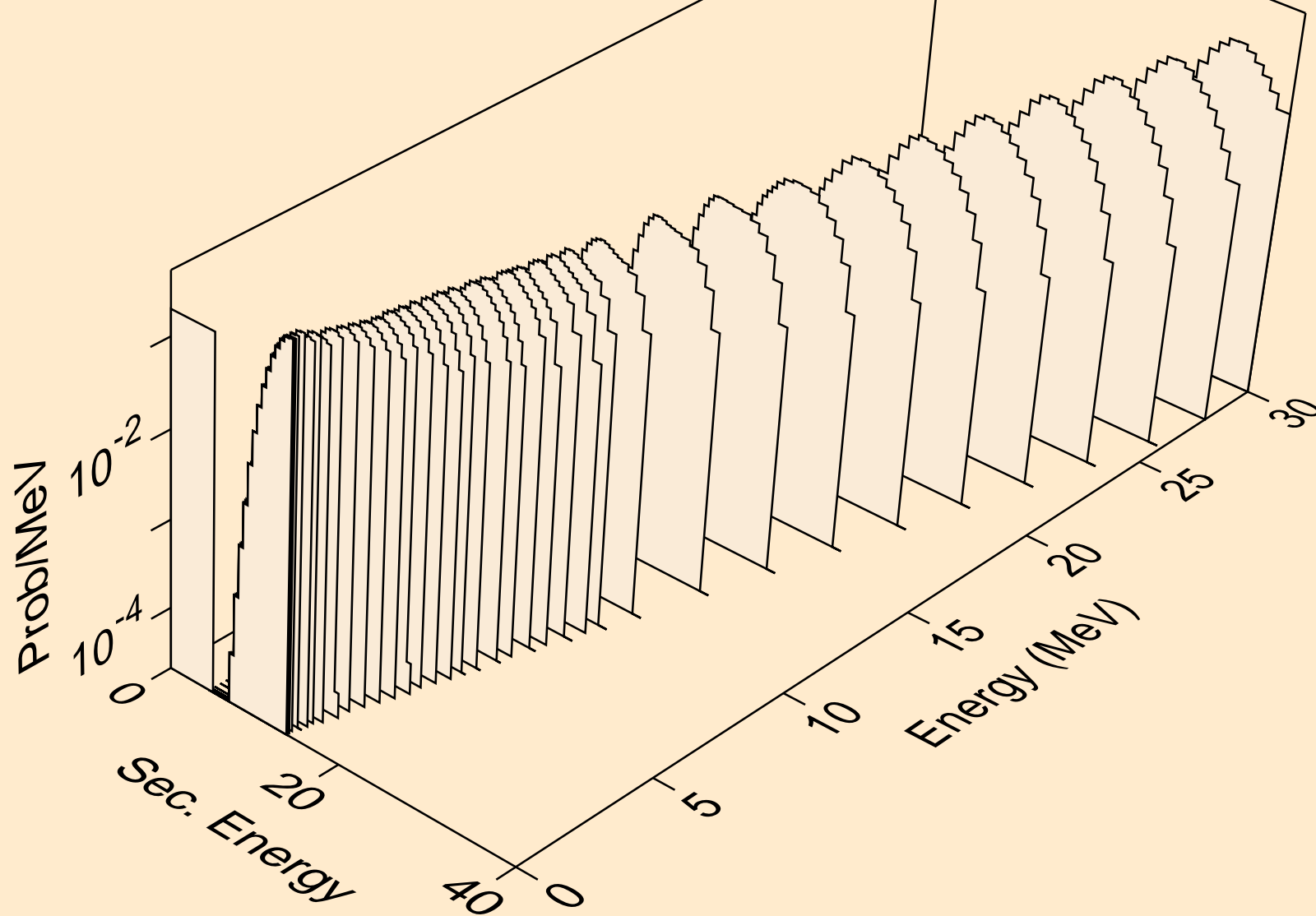

TA161M NEUTRON ACER TENDL-2021 LIBRARY; T=293.6K
alphas from (n,2a)

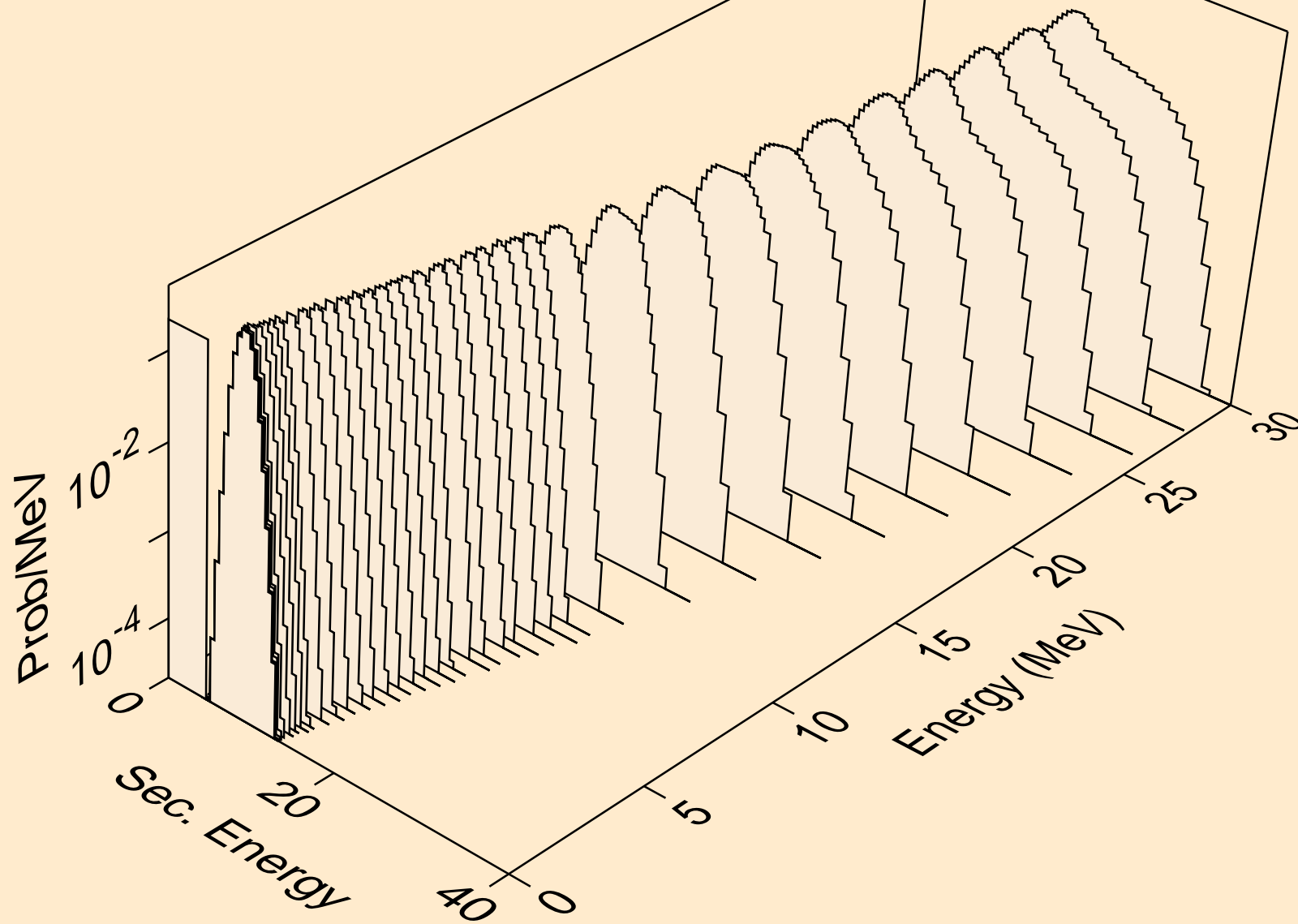

TA161M NEUTRON ACER TENDL-2021 LIBRARY; T=293.6K
alphas from (n,3a)

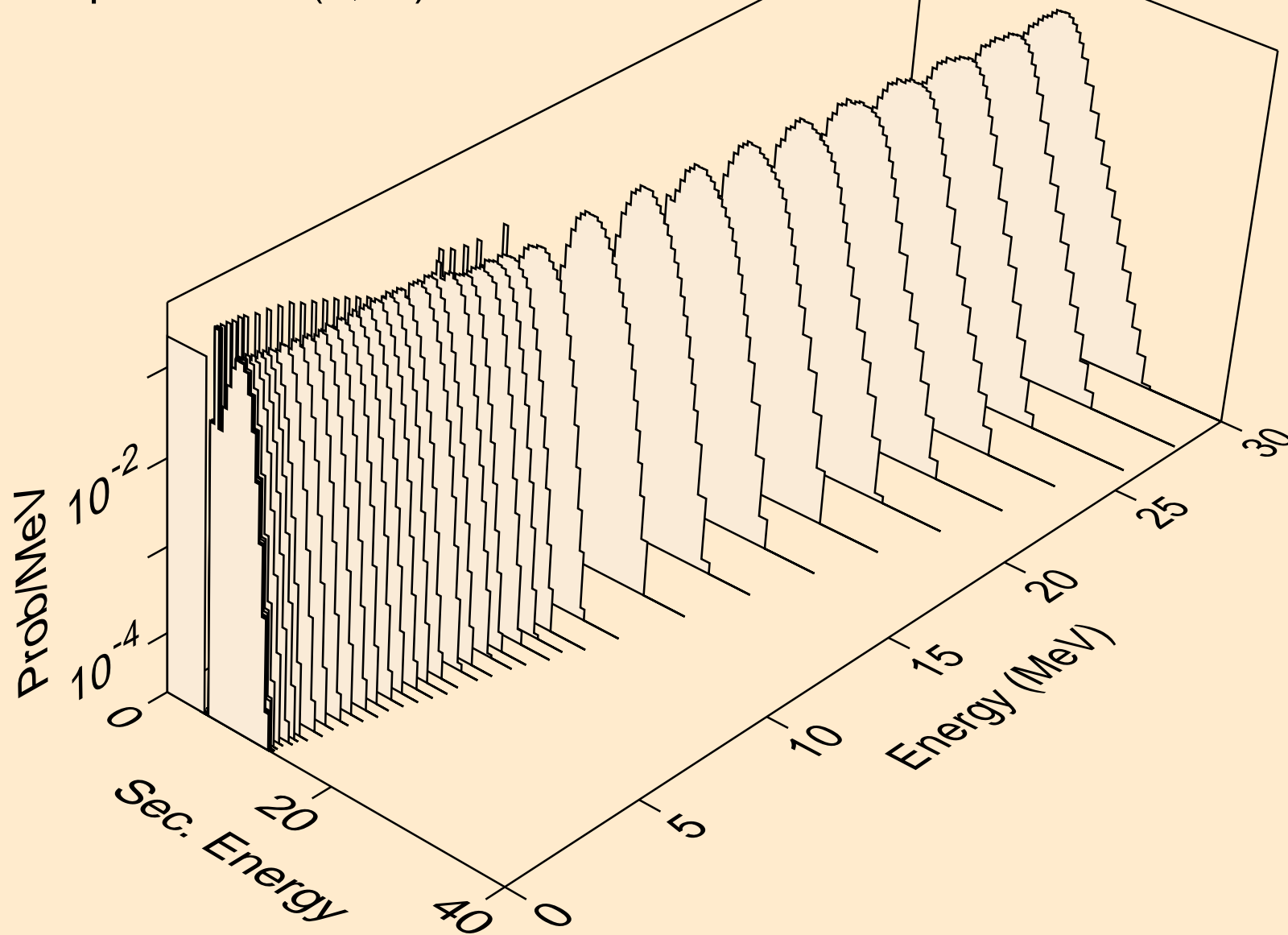

TA161M NEUTRON ACER TENDL-2021 LIBRARY; T=293.6K
alphas from (n,pa)

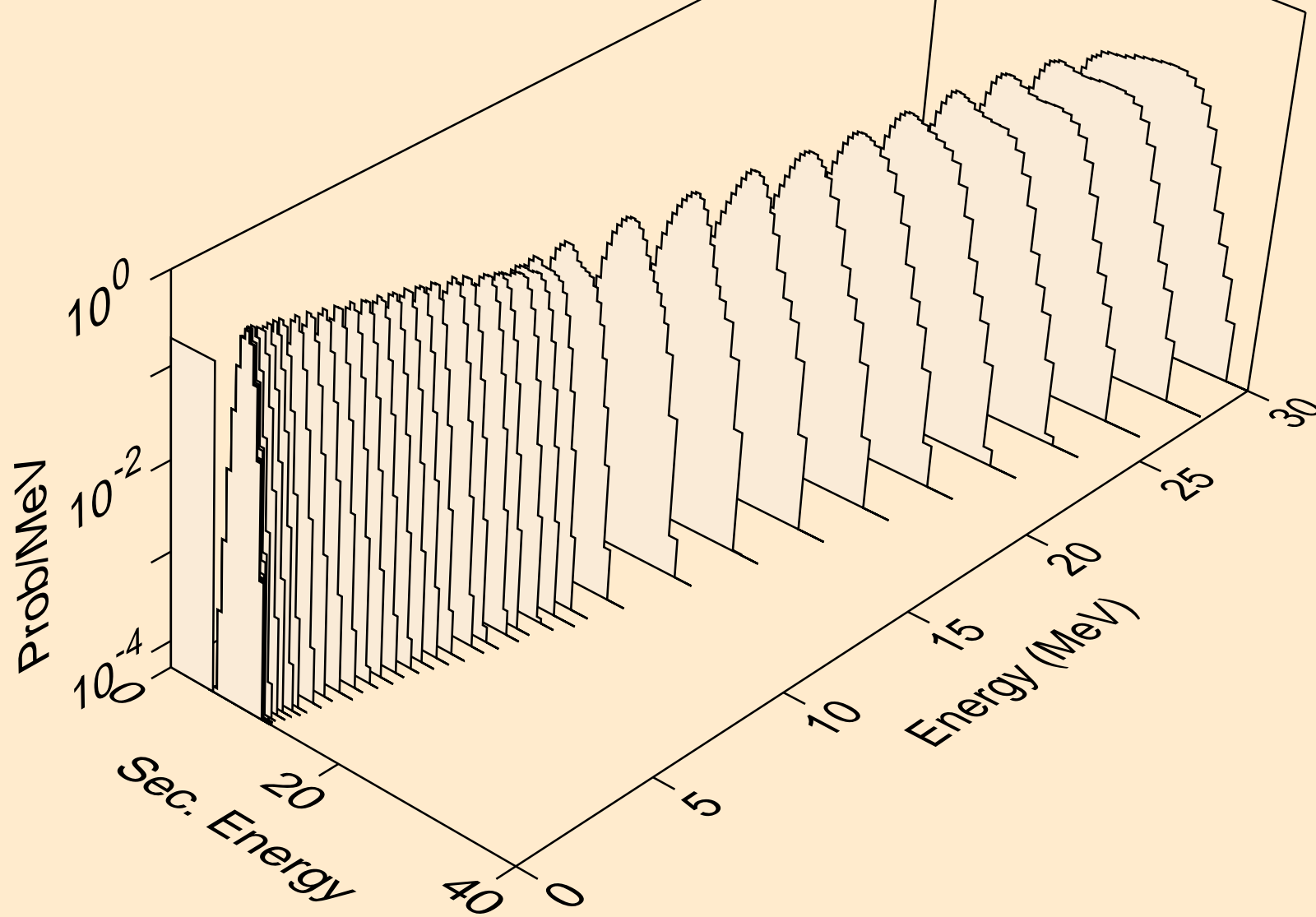

TA161M NEUTRON ACER TENDL-2021 LIBRARY; T=293.6K
alphas from (n,t2a)

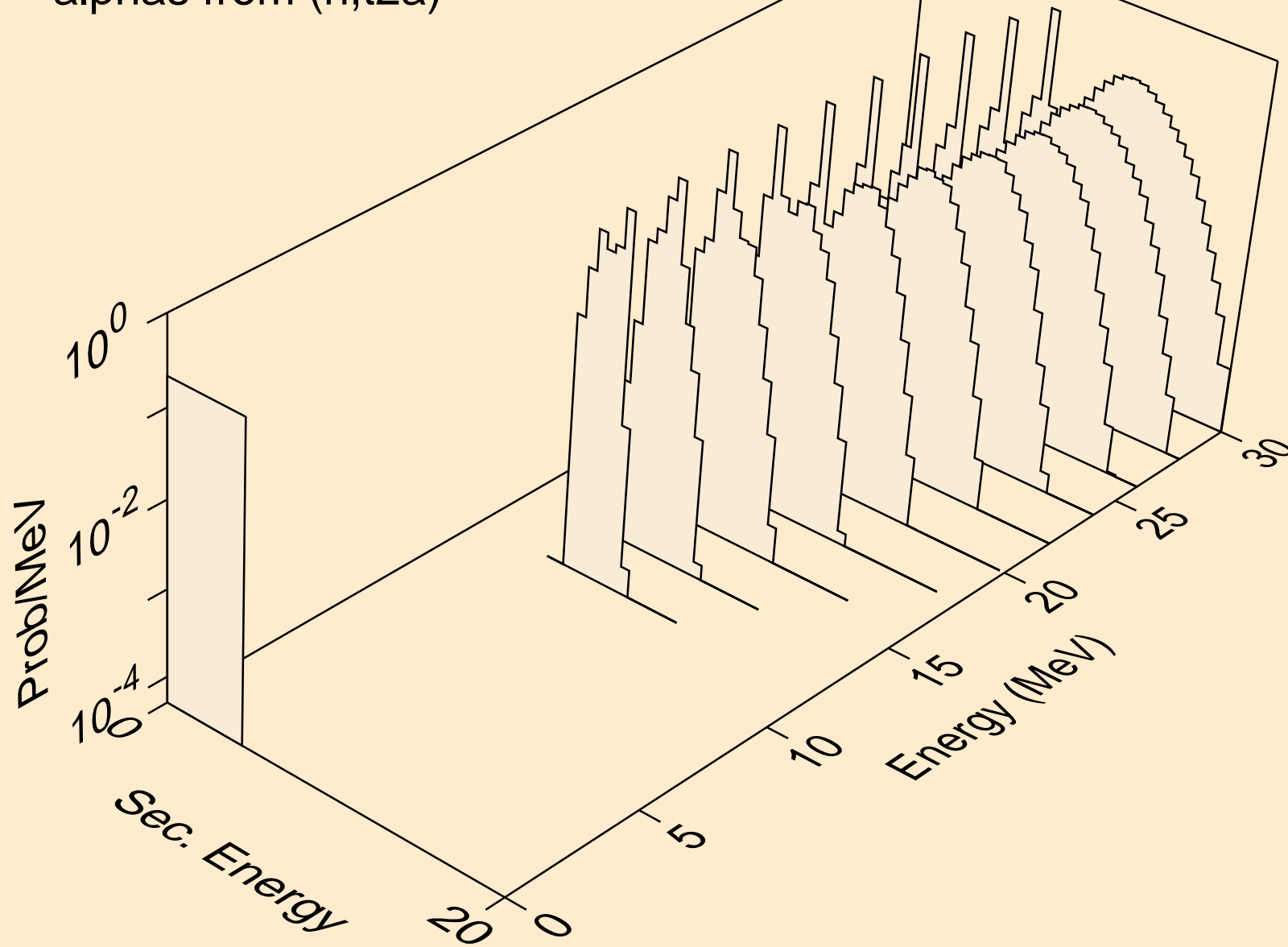

TA161M NEUTRON ACER TENDL-2021 LIBRARY; T=293.6K
alphas from (n,d2a)

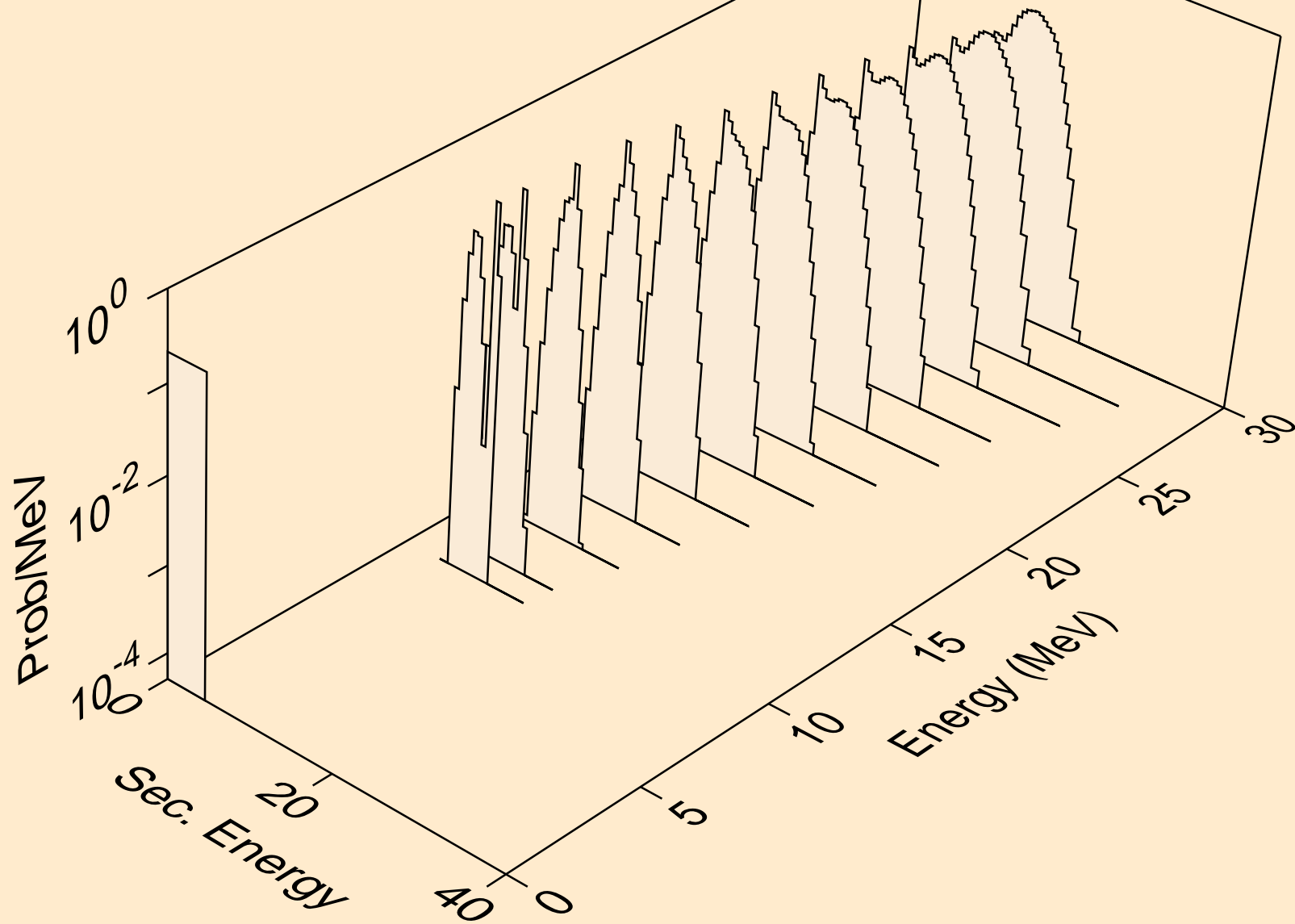

TA161M NEUTRON ACER TENDL-2021 LIBRARY; T=293.6K
alphas from (n,da)

