

TA164 NEUTRON ACER TENDL-2021 LIBRARY; T=293.6K  
Principal cross sections

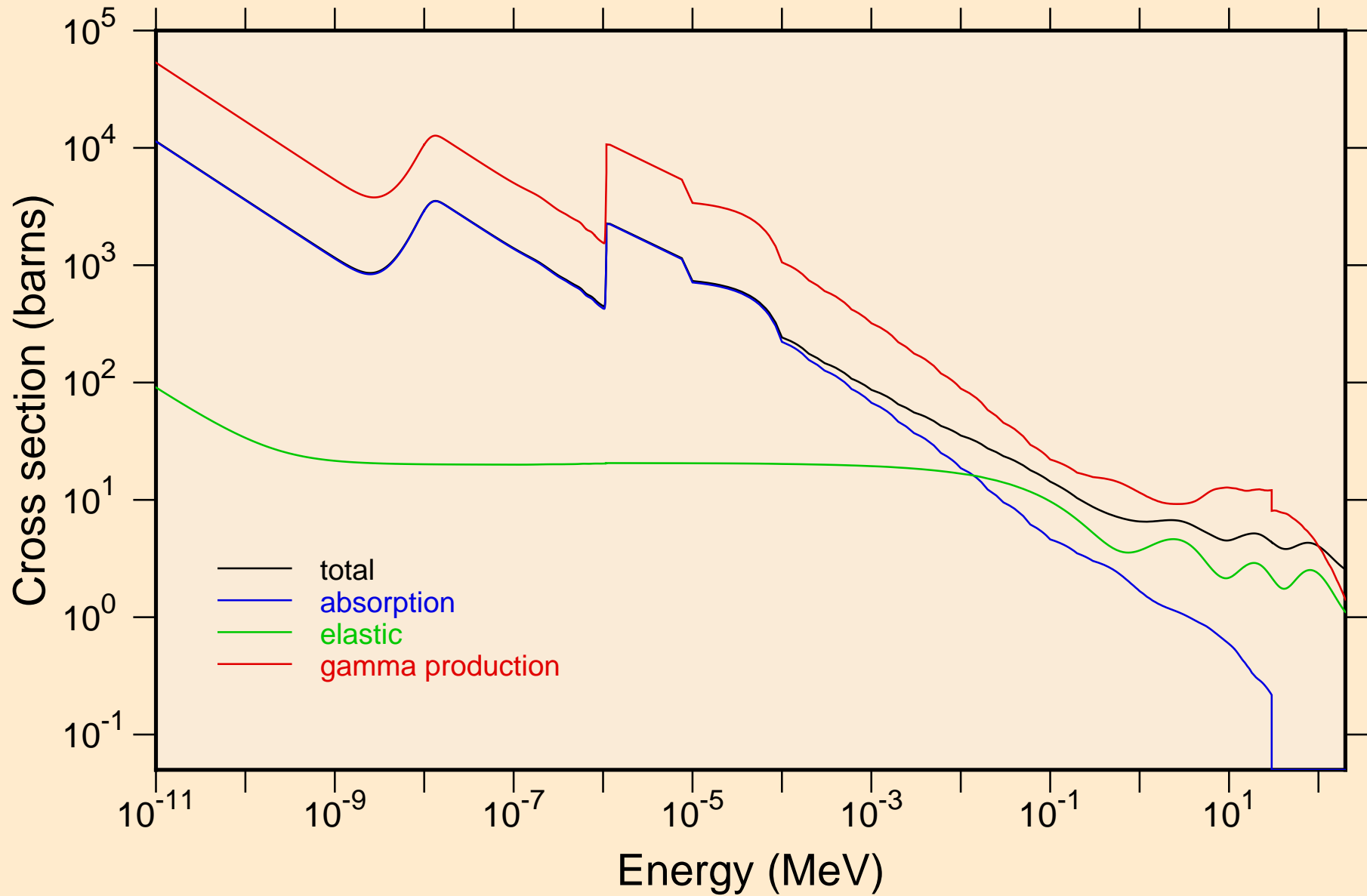

TA164 NEUTRON ACER TENDL-2021 LIBRARY; T=293.6K  
Heating

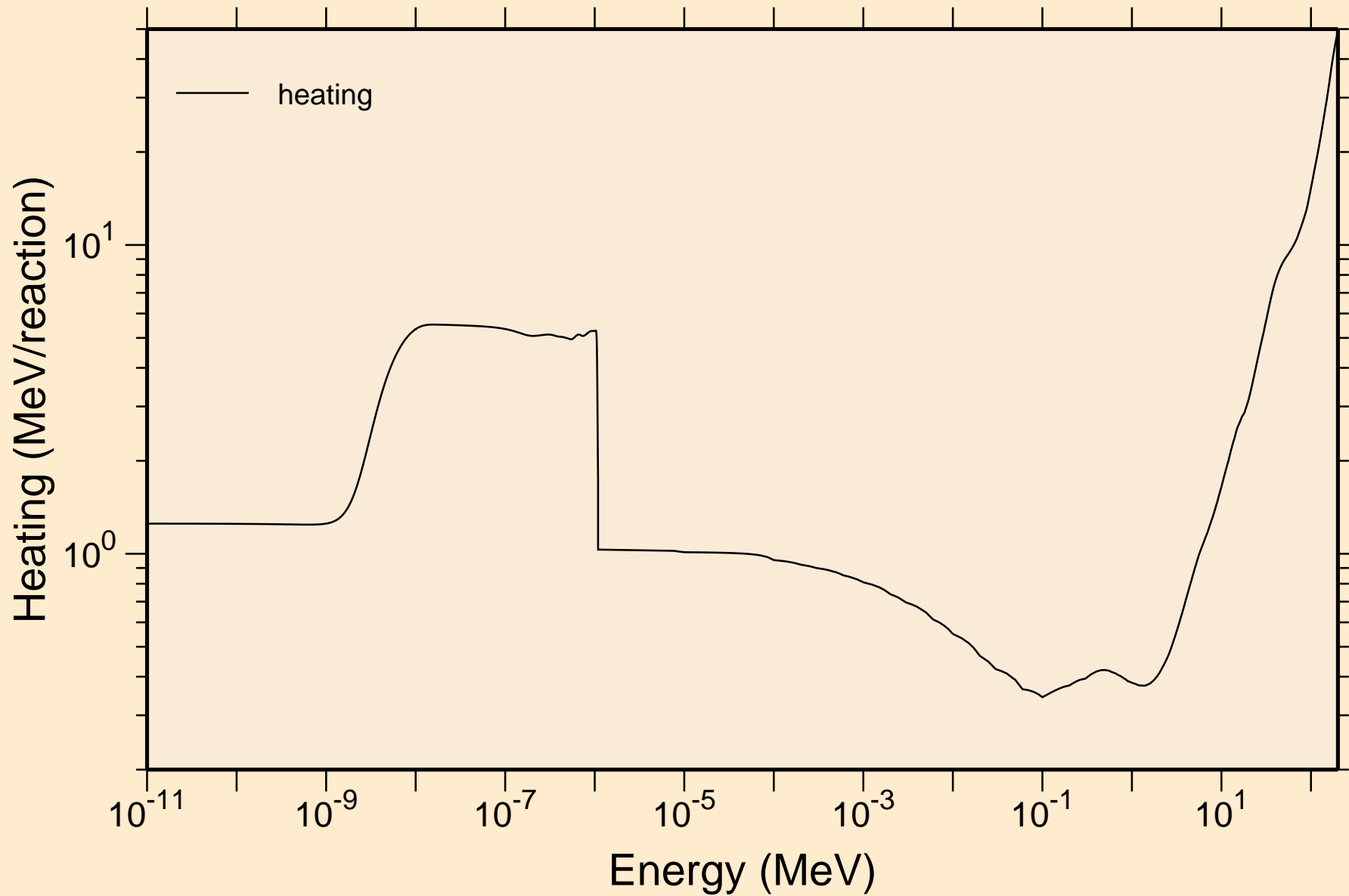

TA164 NEUTRON ACER TENDL-2021 LIBRARY; T=293.6K  
Damage

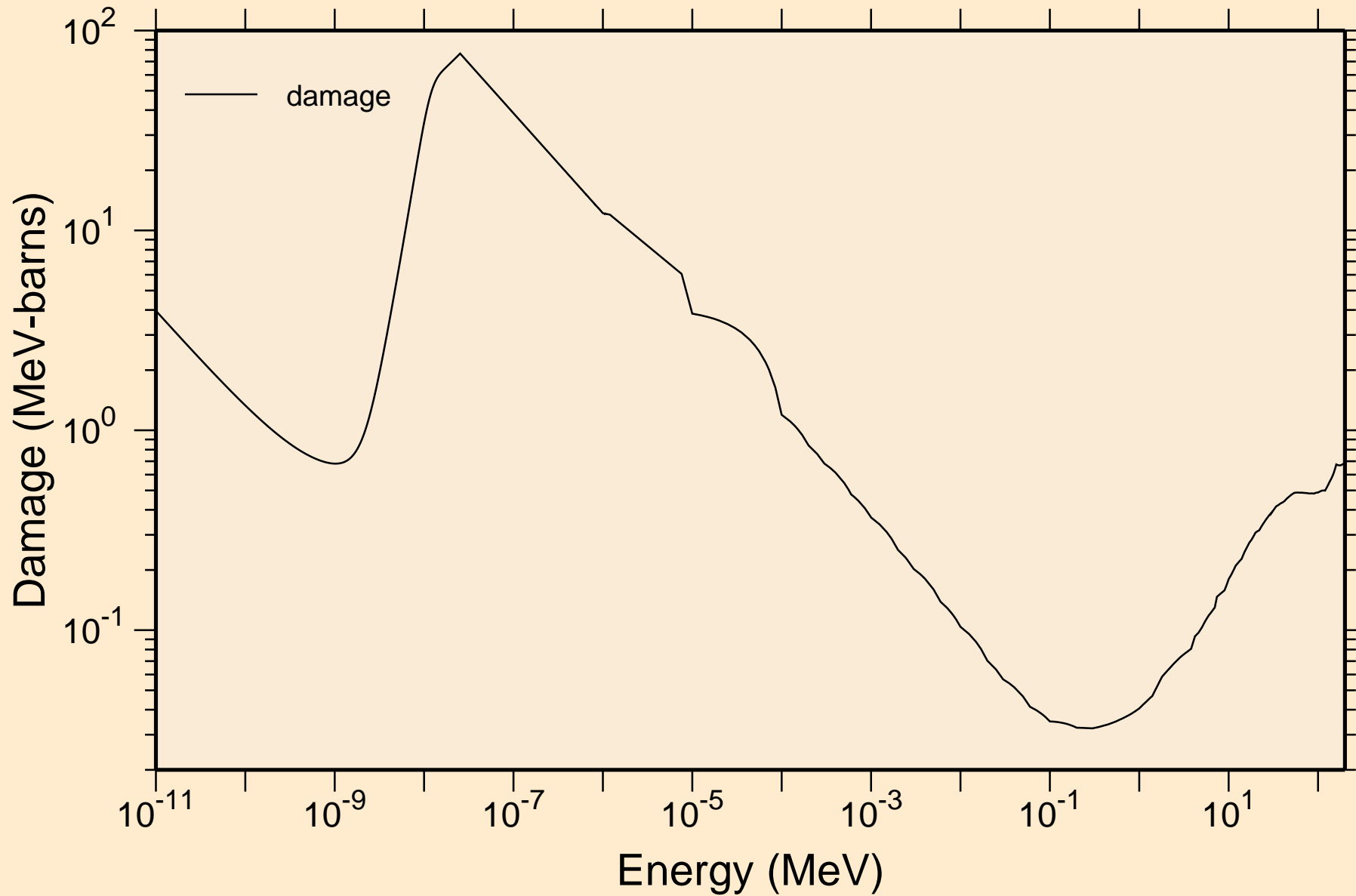

TA164 NEUTRON ACER TENDL-2021 LIBRARY; T=293.6K  
Non-threshold reactions

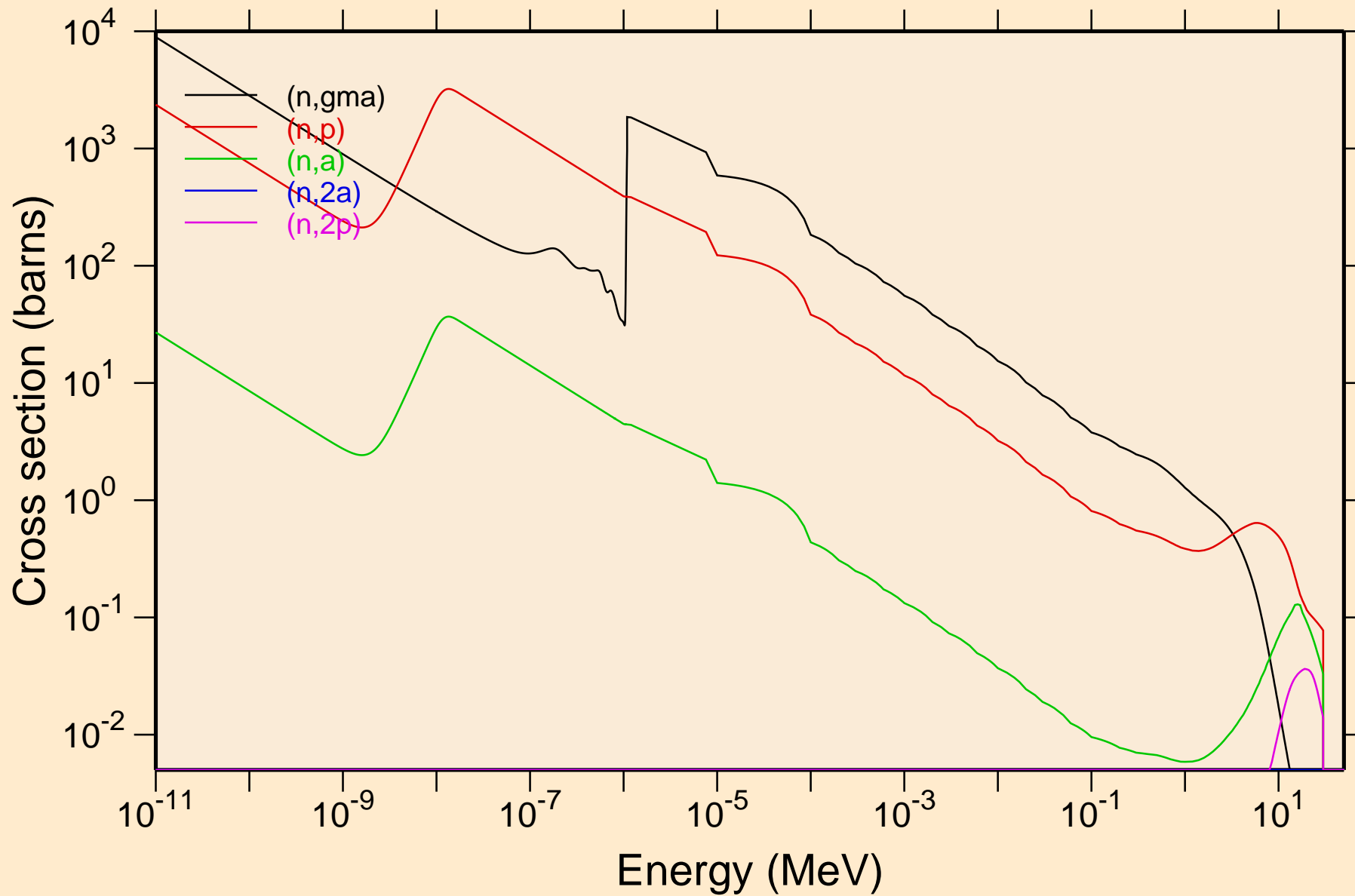

TA164 NEUTRON ACER TENDL-2021 LIBRARY; T=293.6K  
Non-threshold reactions

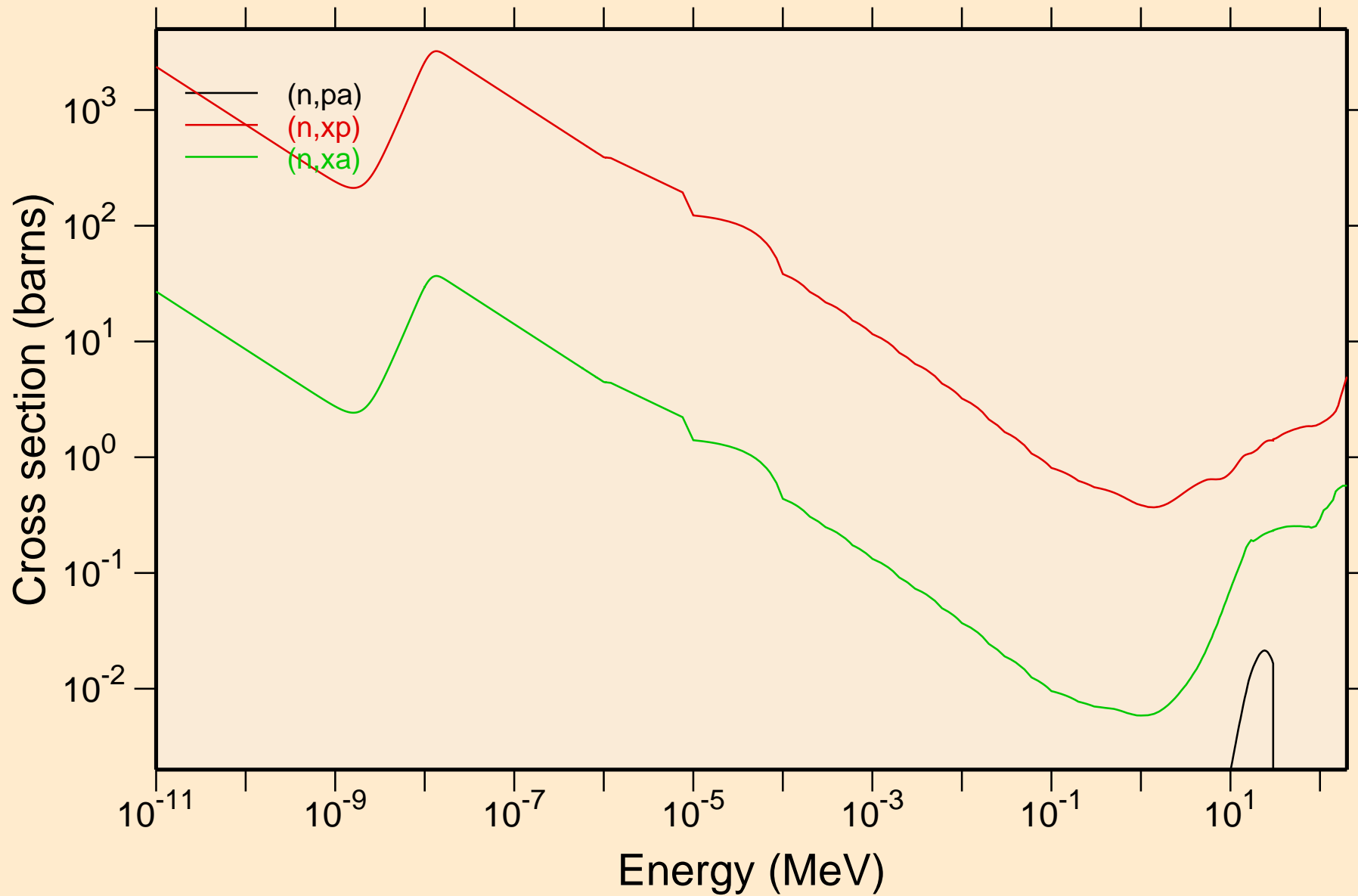

TA164 NEUTRON ACER TENDL-2021 LIBRARY; T=293.6K  
Principal cross sections

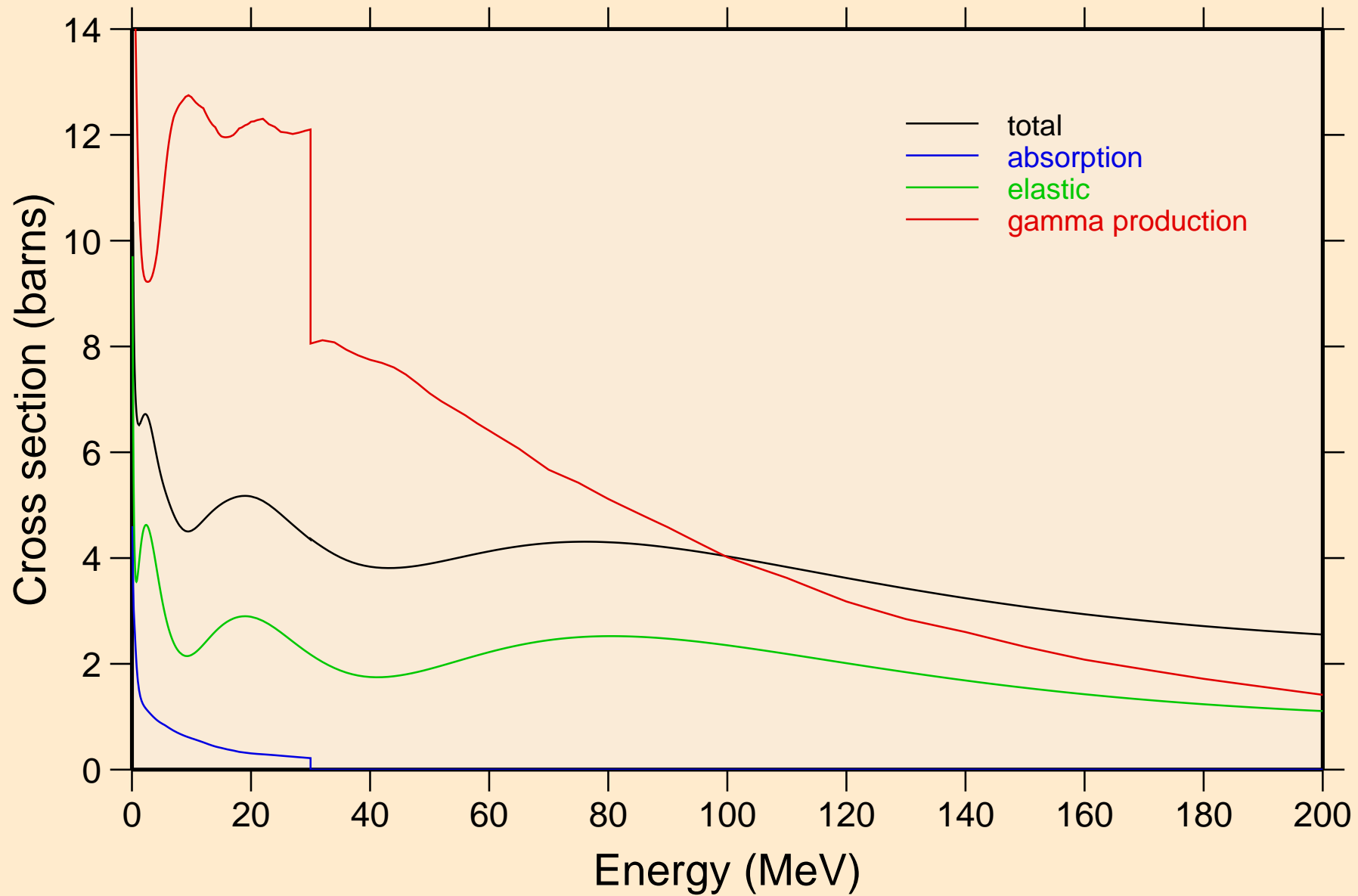

TA164 NEUTRON ACER TENDL-2021 LIBRARY; T=293.6K

Heating

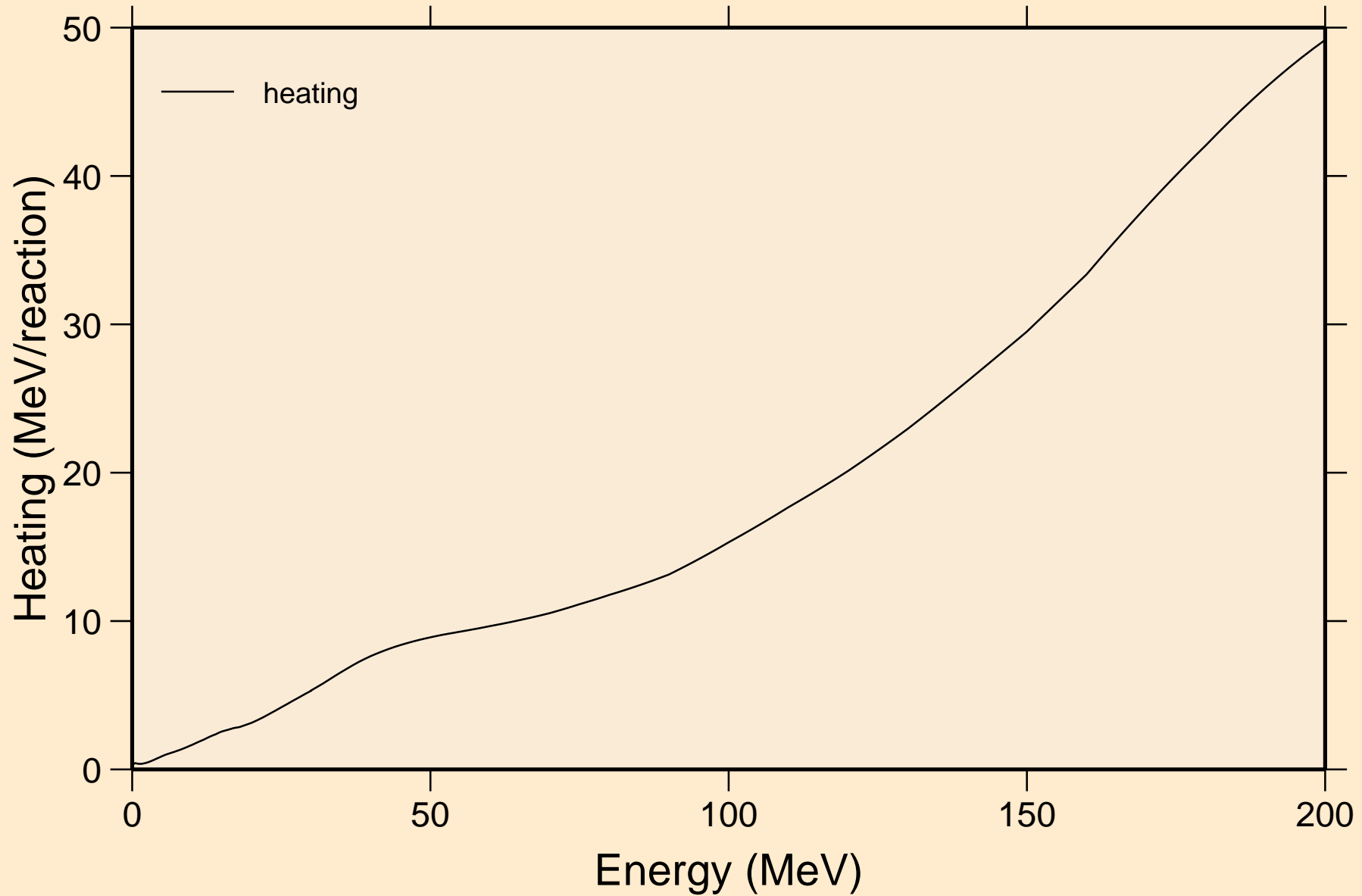

TA164 NEUTRON ACER TENDL-2021 LIBRARY; T=293.6K  
Damage

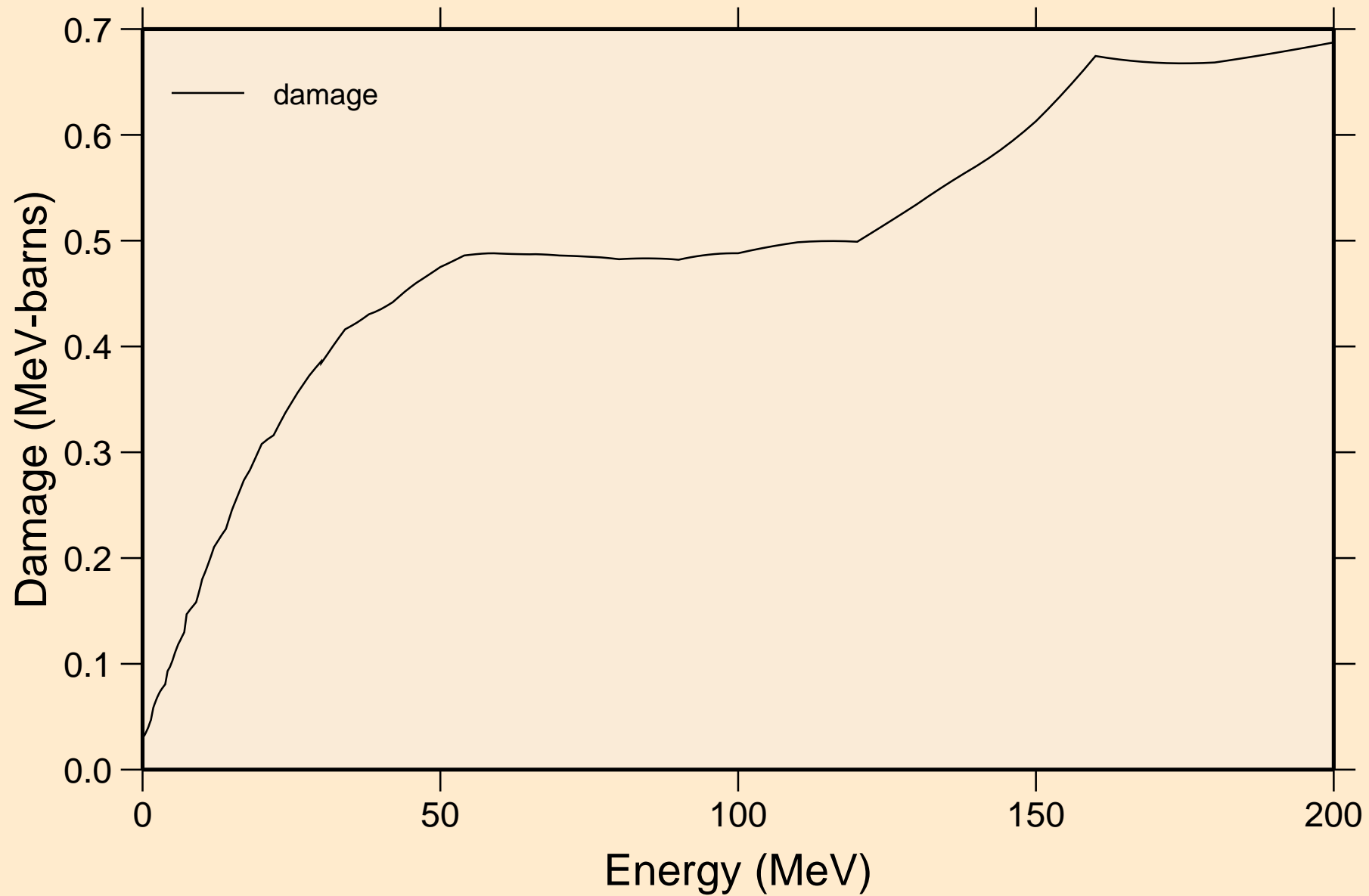



TA164 NEUTRON ACER TENDL-2021 LIBRARY; T=293.6K  
Non-threshold reactions

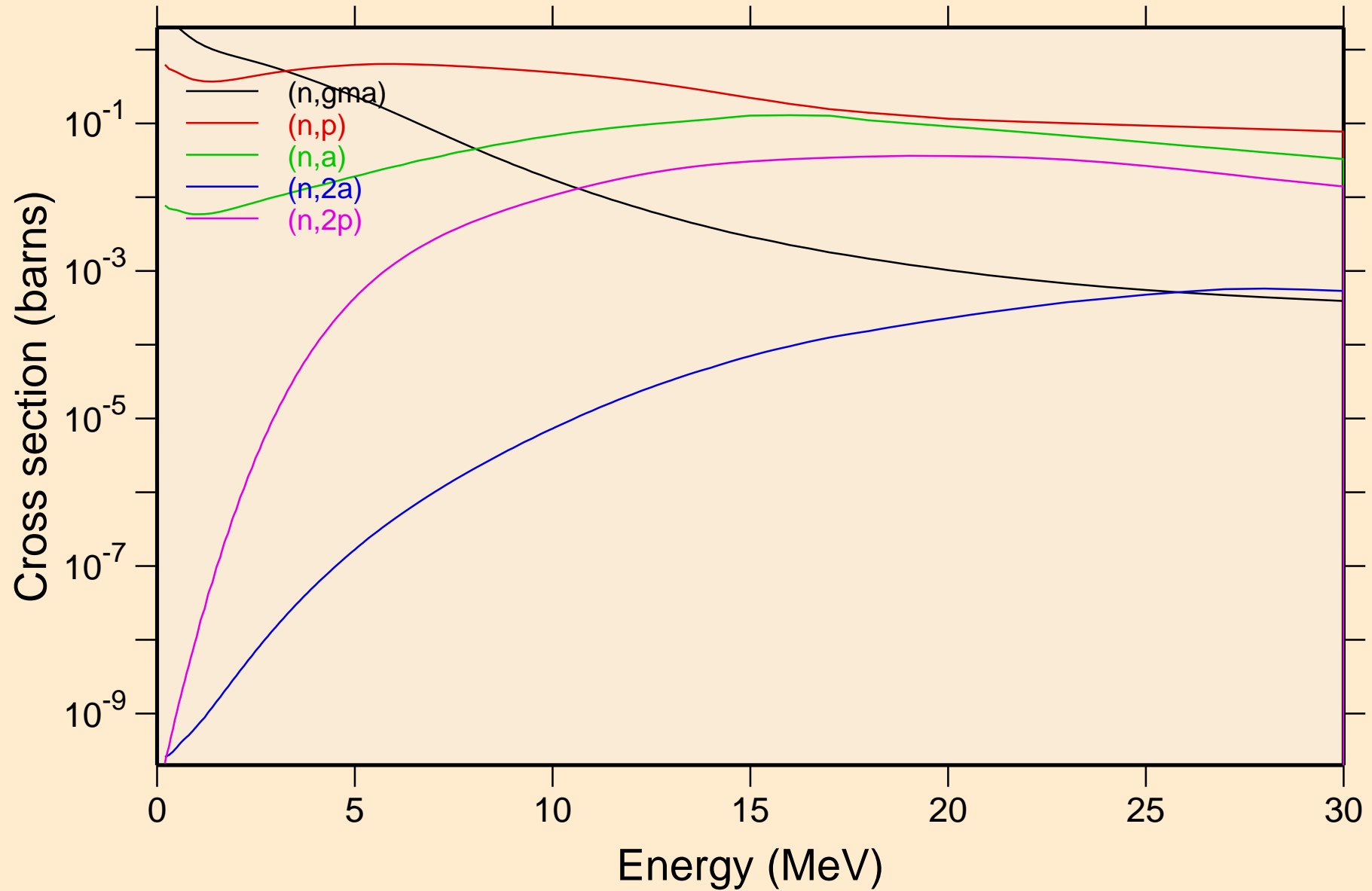

TA164 NEUTRON ACER TENDL-2021 LIBRARY; T=293.6K  
Non-threshold reactions

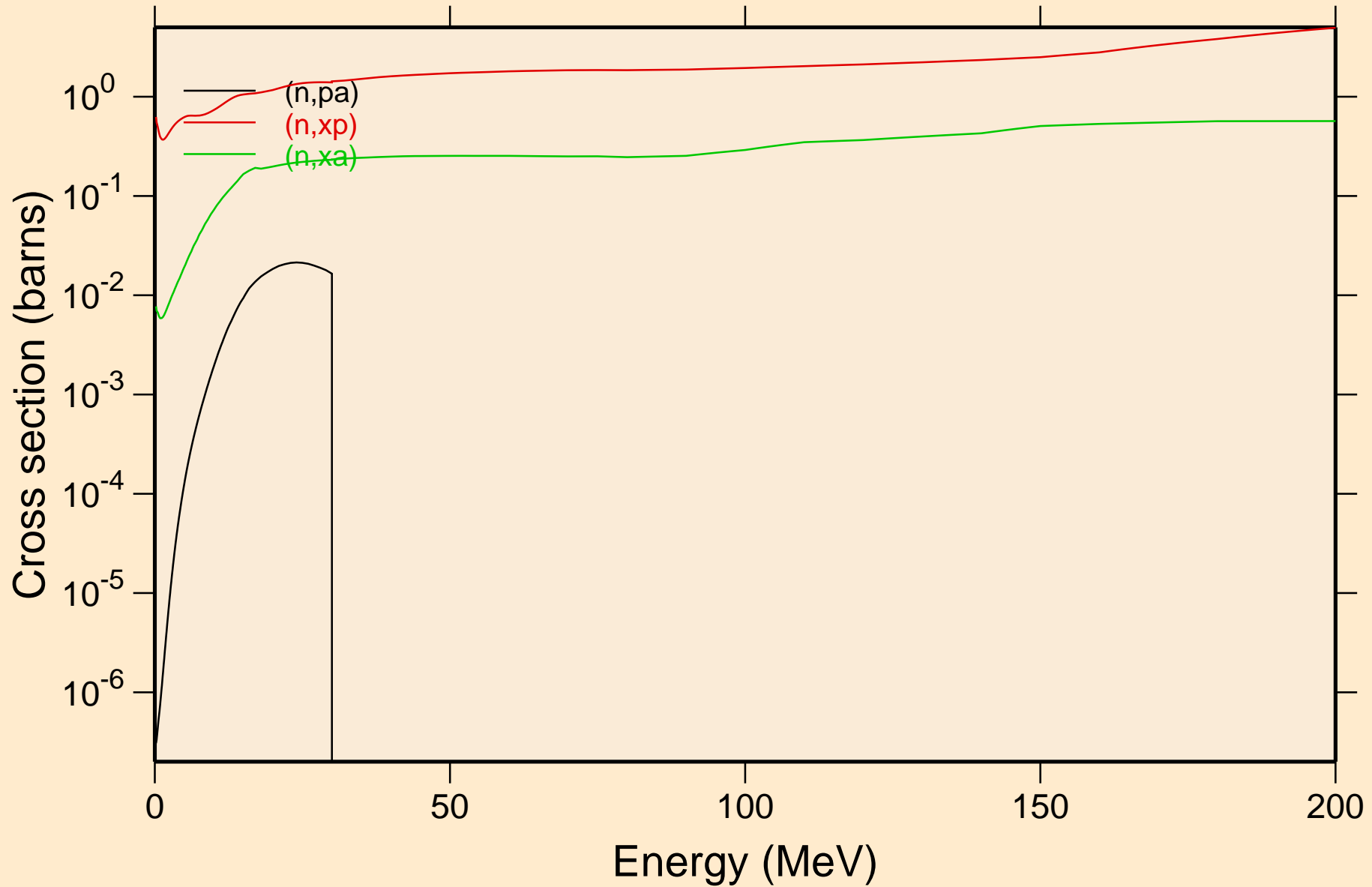

TA164 NEUTRON ACER TENDL-2021 LIBRARY; T=293.6K  
Inelastic levels

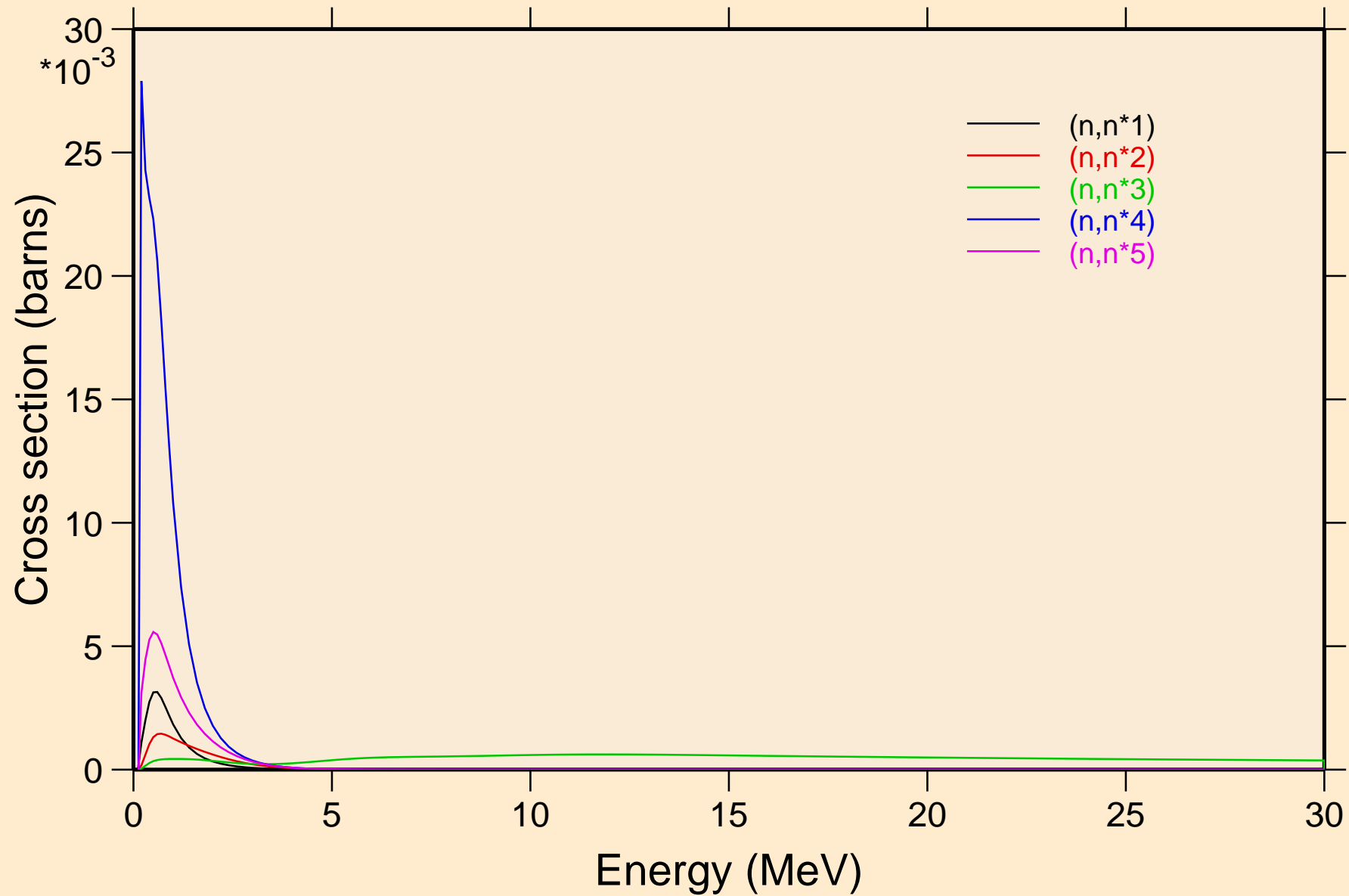

TA164 NEUTRON ACER TENDL-2021 LIBRARY; T=293.6K  
Inelastic levels

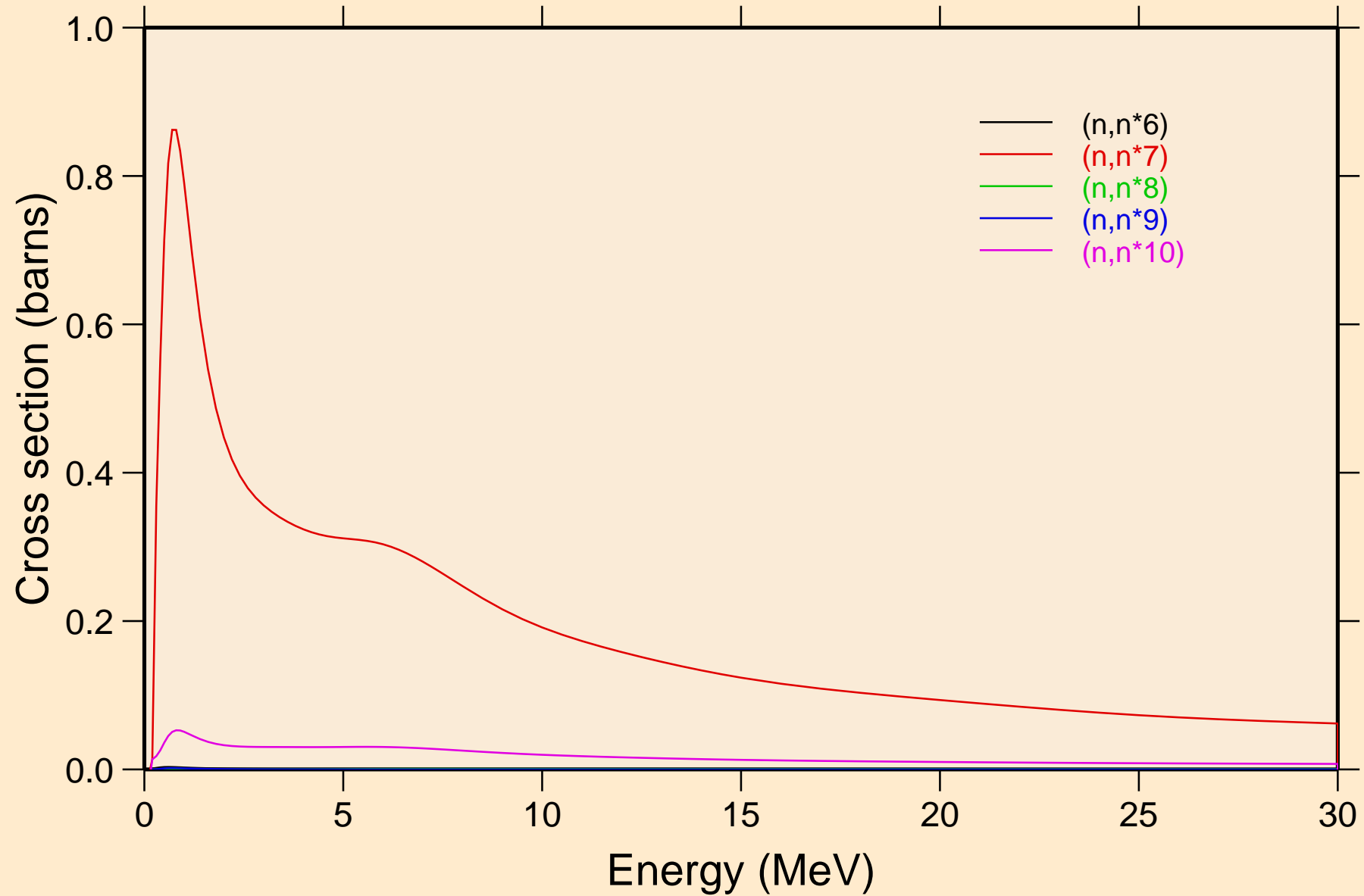

TA164 NEUTRON ACER TENDL-2021 LIBRARY; T=293.6K  
Inelastic levels

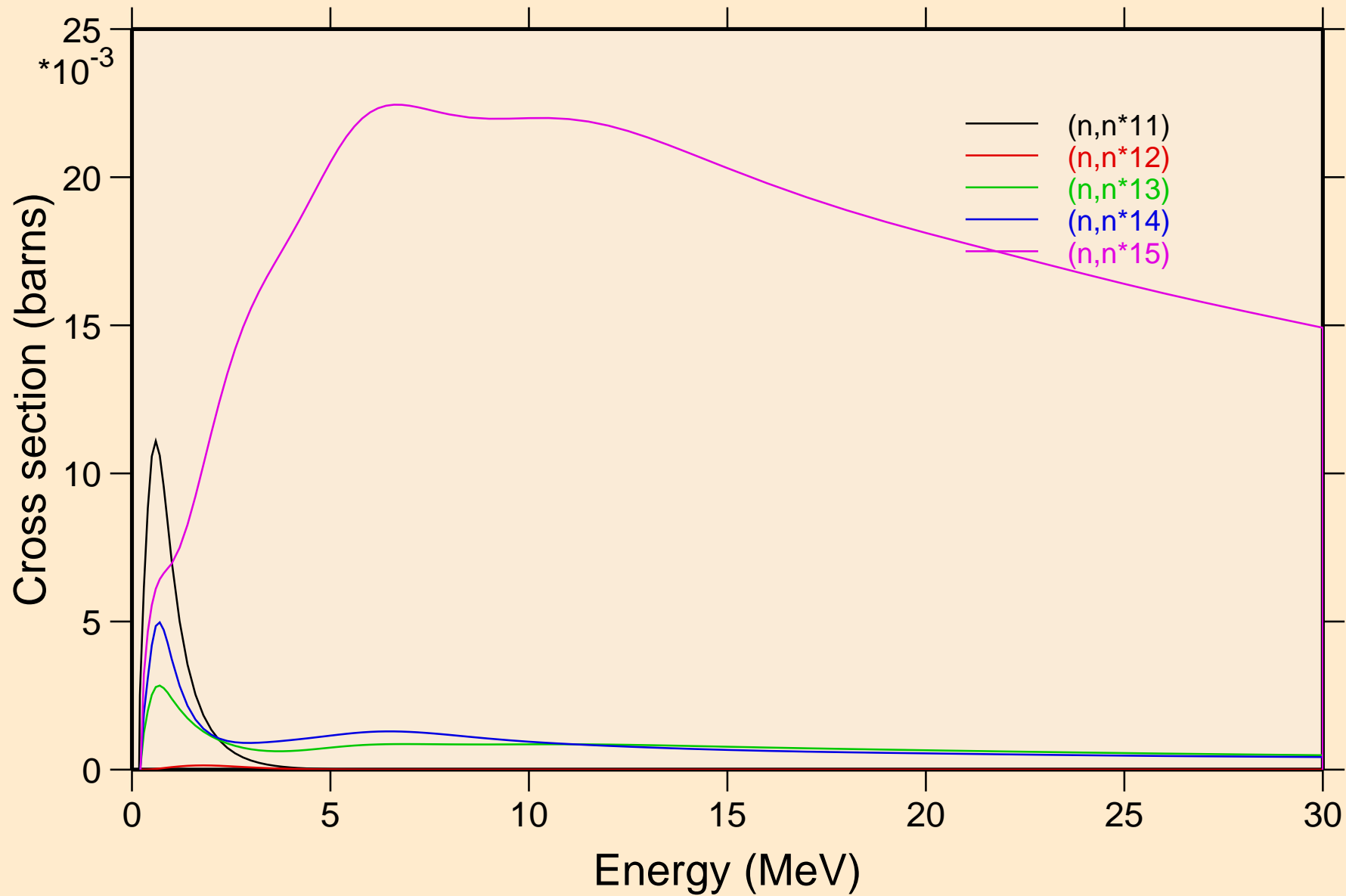

TA164 NEUTRON ACER TENDL-2021 LIBRARY; T=293.6K  
Inelastic levels

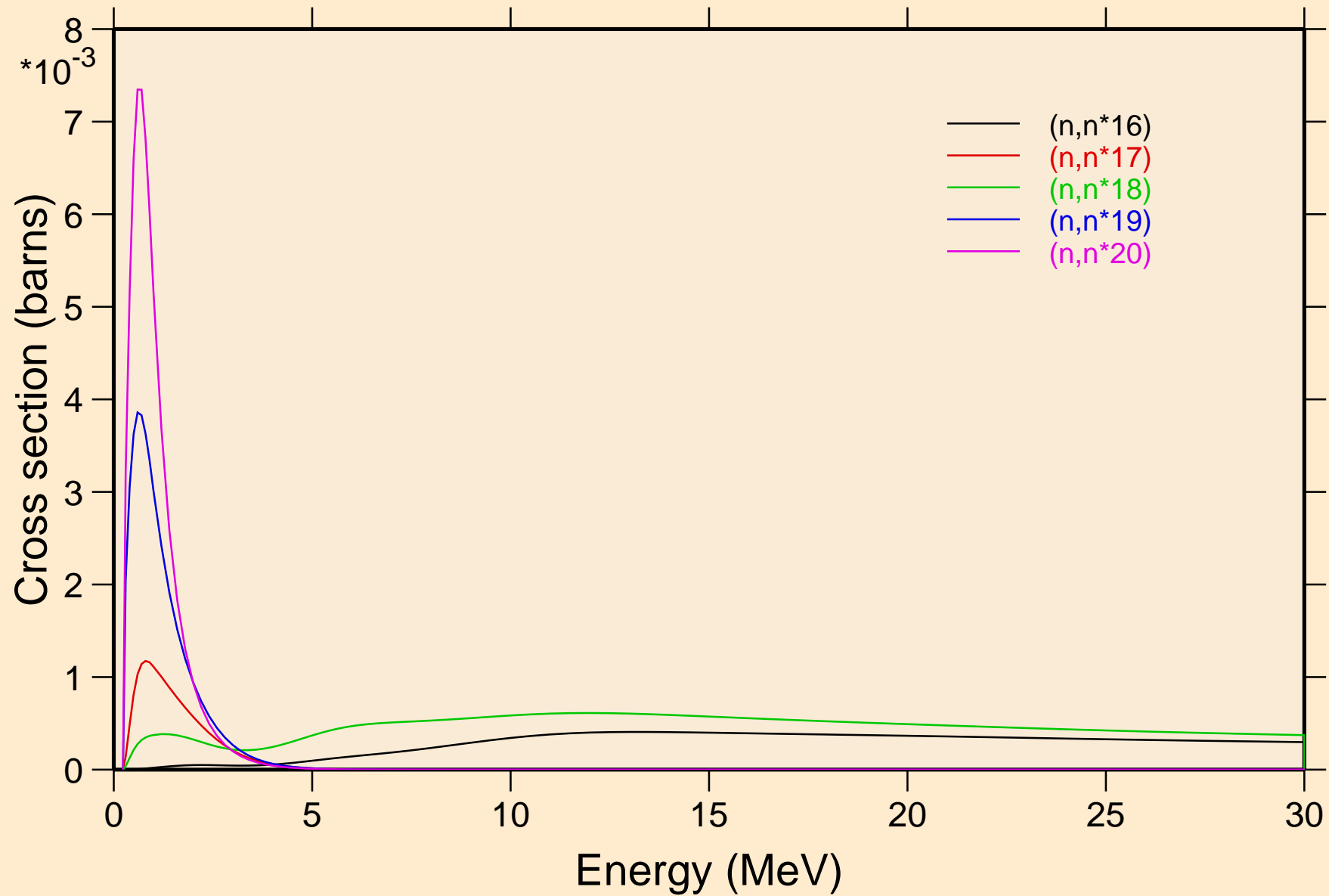

TA164 NEUTRON ACER TENDL-2021 LIBRARY; T=293.6K  
Inelastic levels

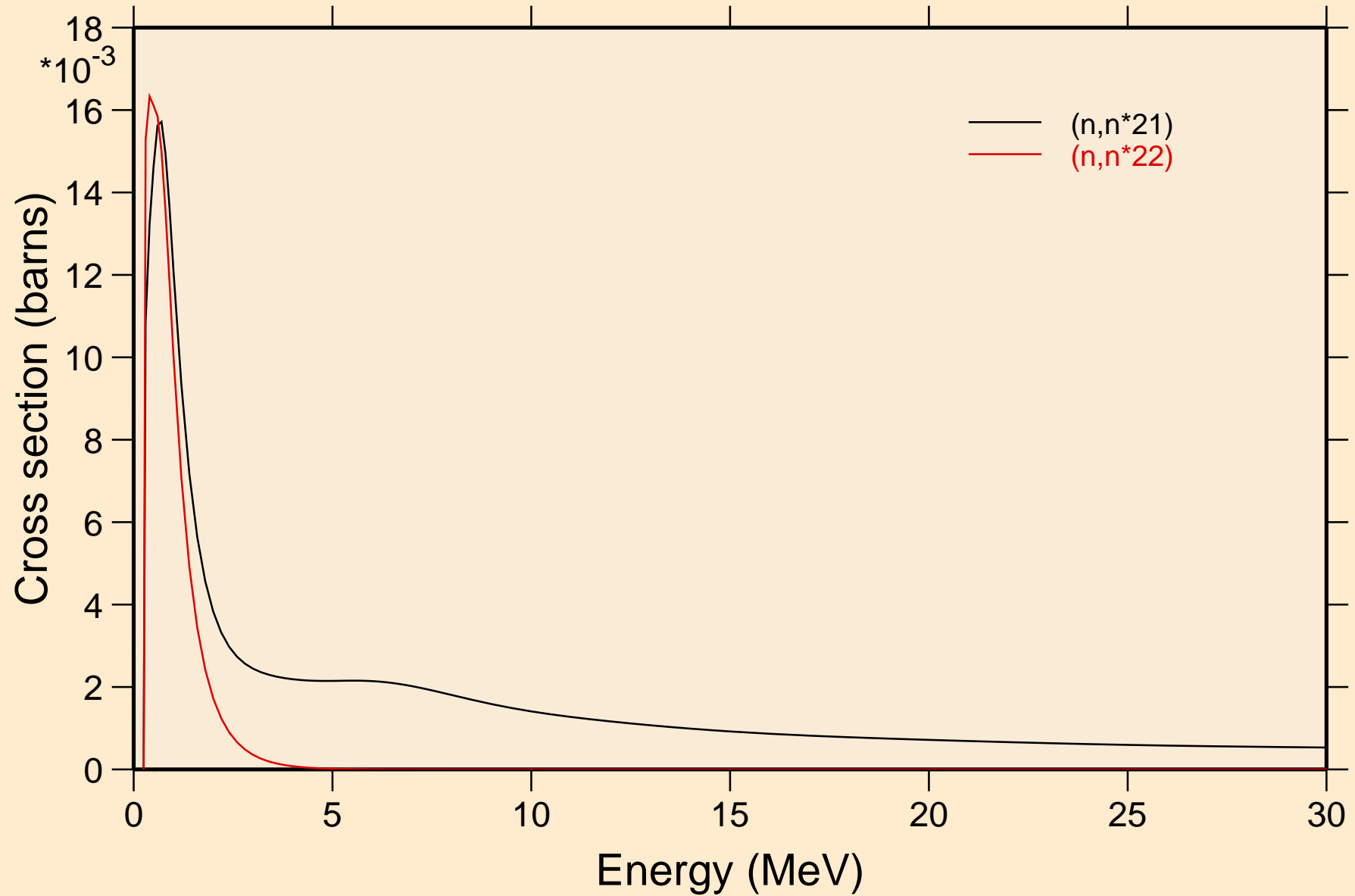

TA164 NEUTRON ACER TENDL-2021 LIBRARY; T=293.6K  
Threshold reactions

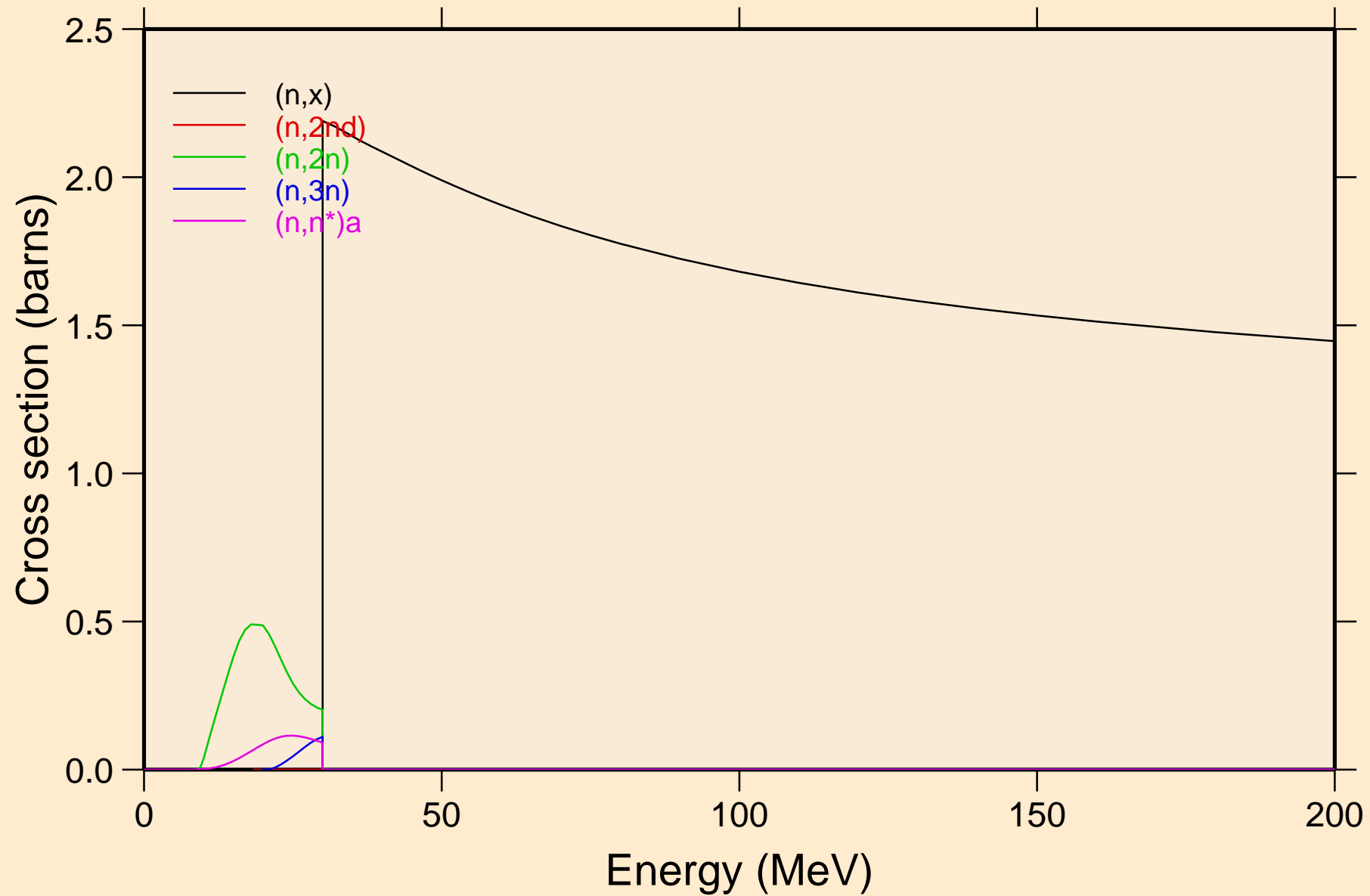



TA164 NEUTRON ACER TENDL-2021 LIBRARY; T=293.6K  
Threshold reactions

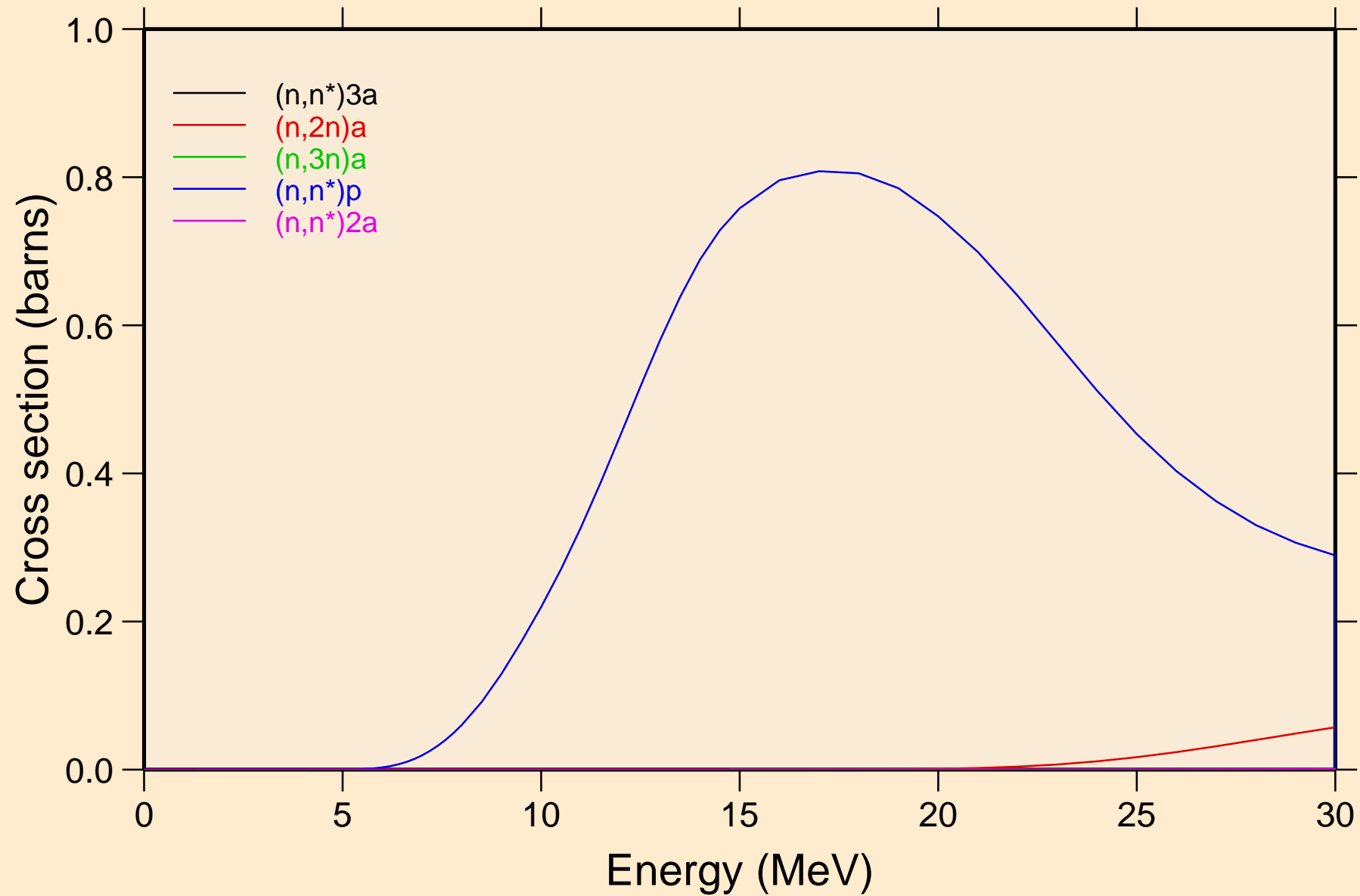

TA164 NEUTRON ACER TENDL-2021 LIBRARY; T=293.6K  
Threshold reactions

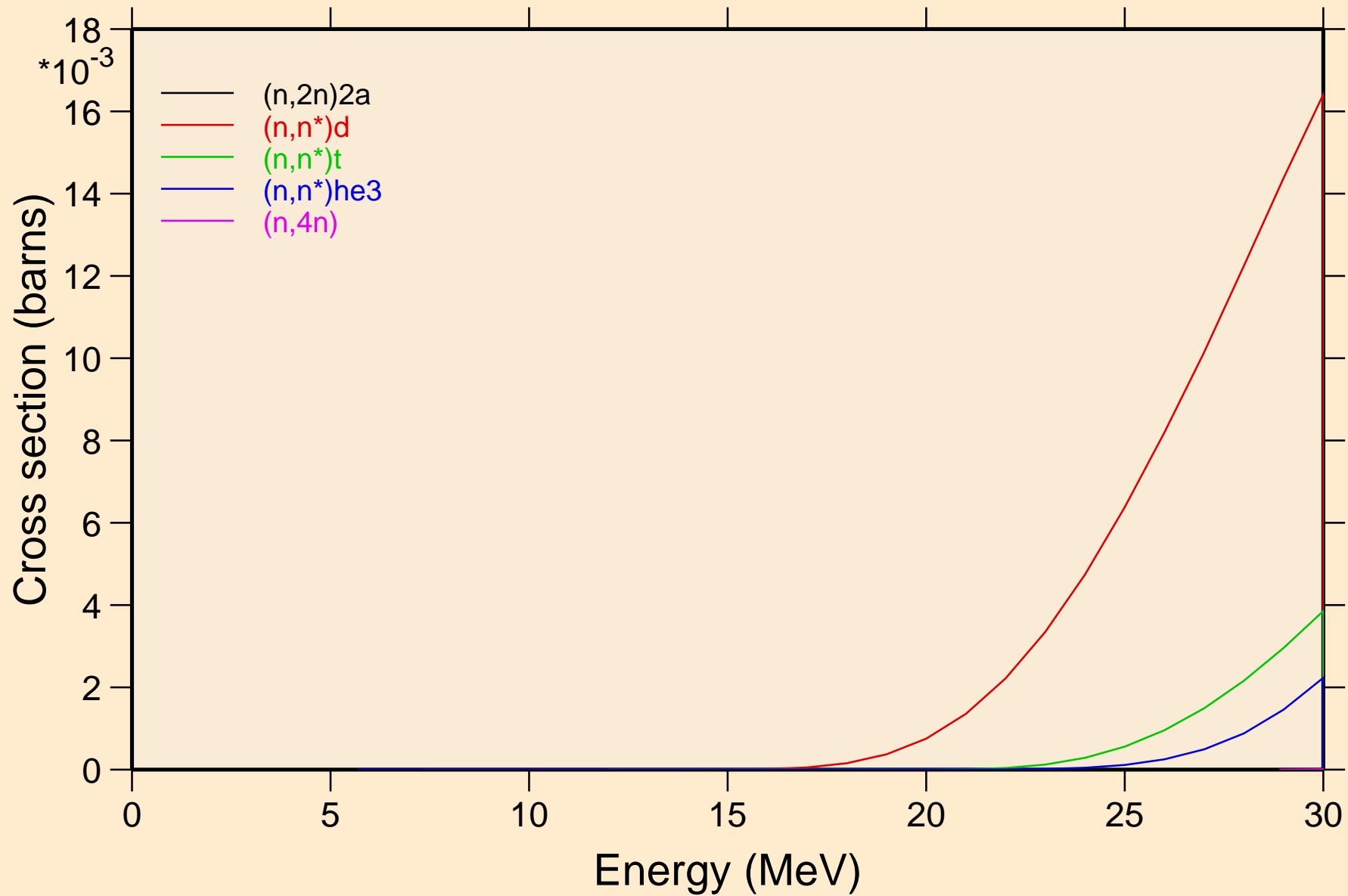

TA164 NEUTRON ACER TENDL-2021 LIBRARY; T=293.6K  
Threshold reactions

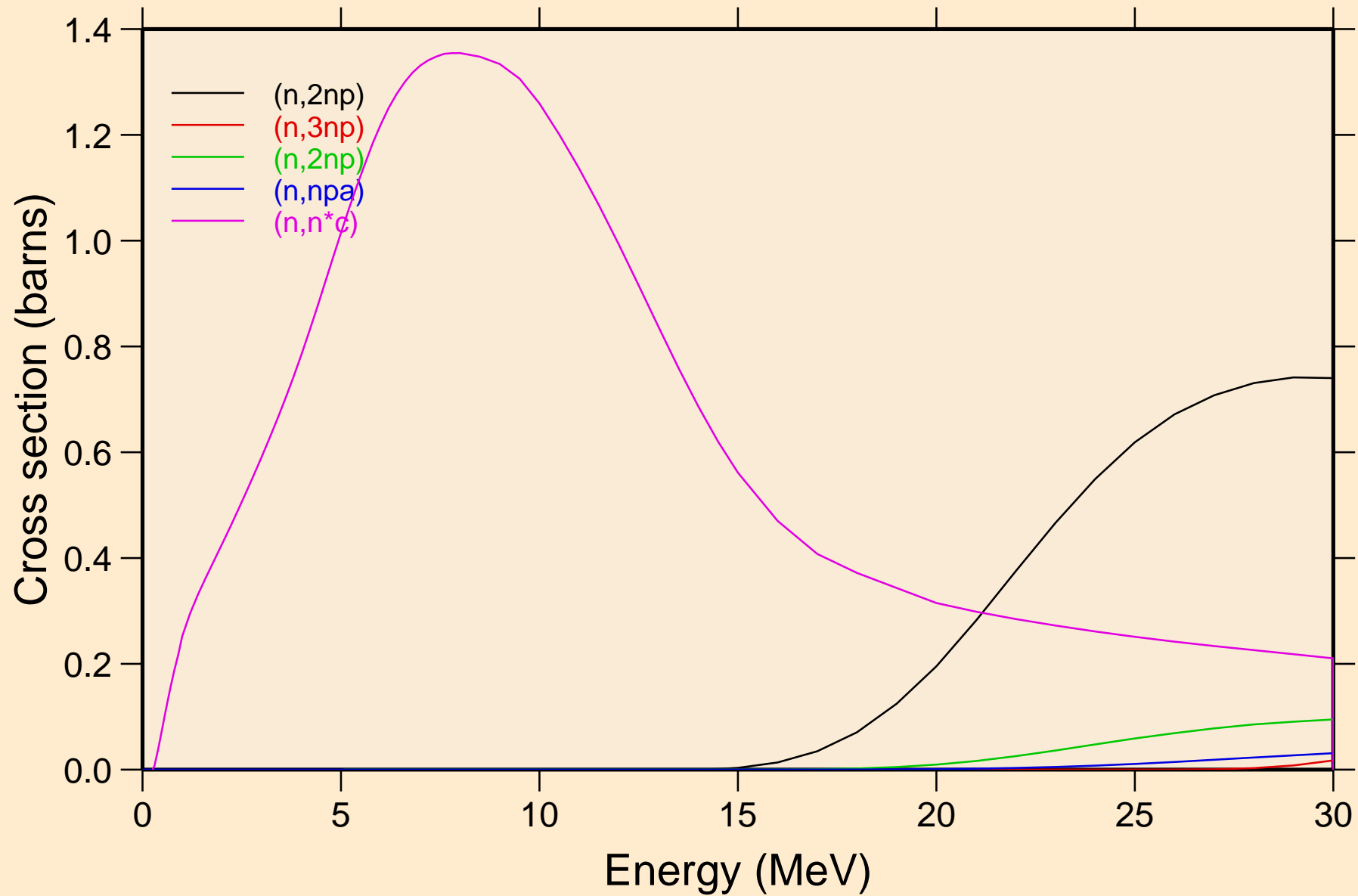

TA164 NEUTRON ACER TENDL-2021 LIBRARY; T=293.6K  
Threshold reactions

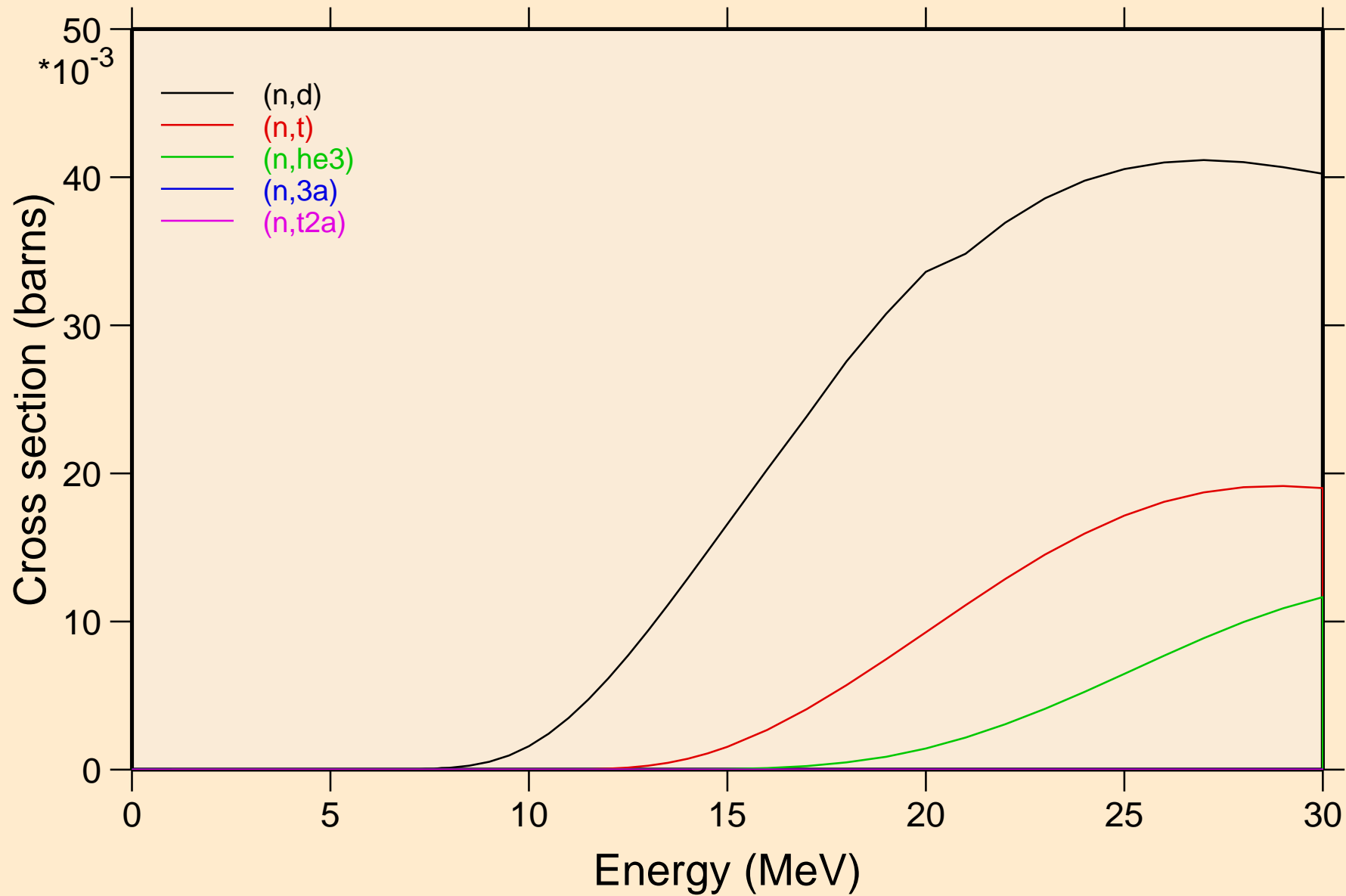

TA164 NEUTRON ACER TENDL-2021 LIBRARY; T=293.6K  
Threshold reactions

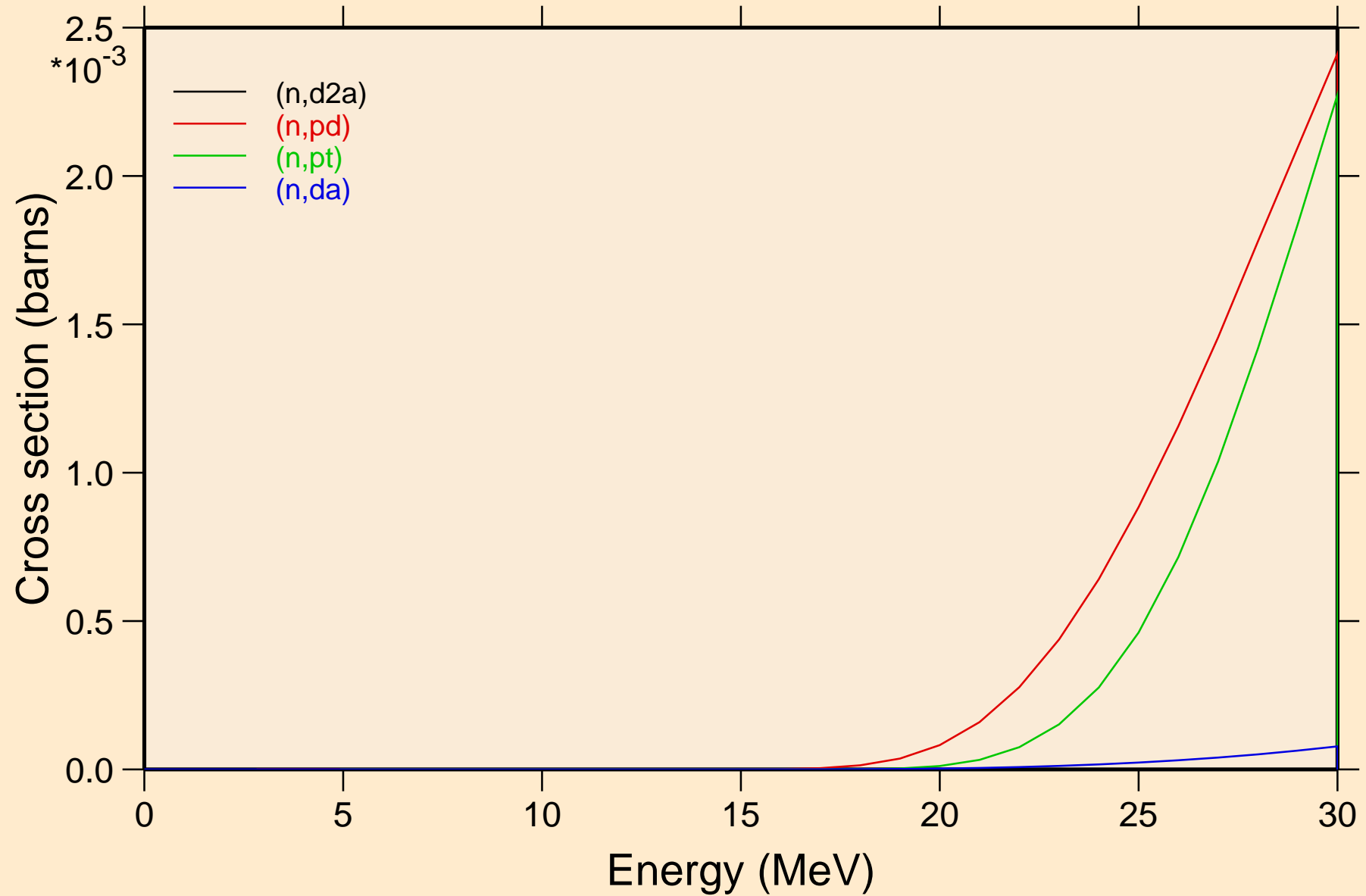

TA164 NEUTRON ACER TENDL-2021 LIBRARY; T=293.6K  
Threshold reactions

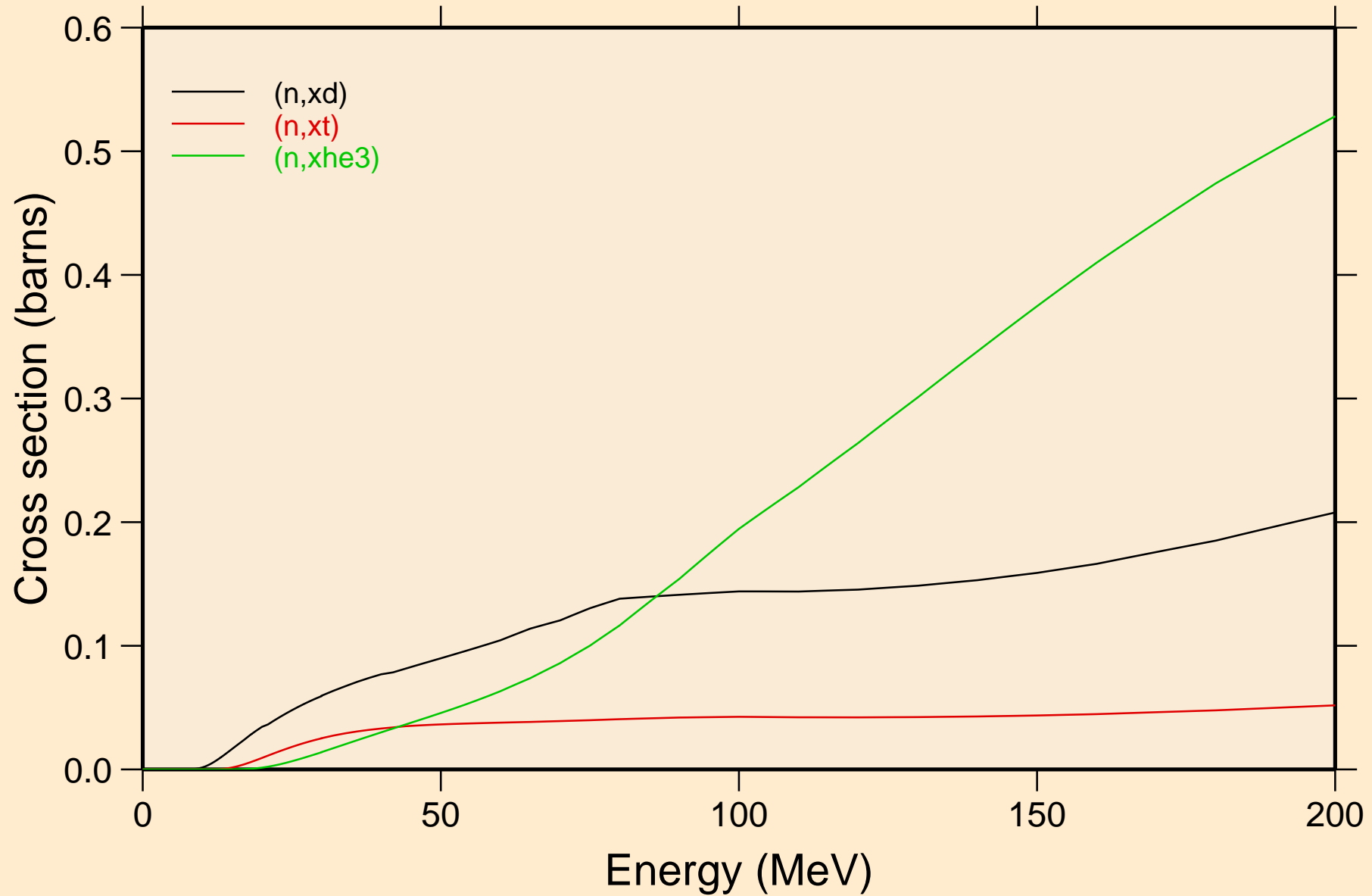

TA164 NEUTRON ACER TENDL-2021 LIBRARY; T=293.6K  
angular distribution for elastic

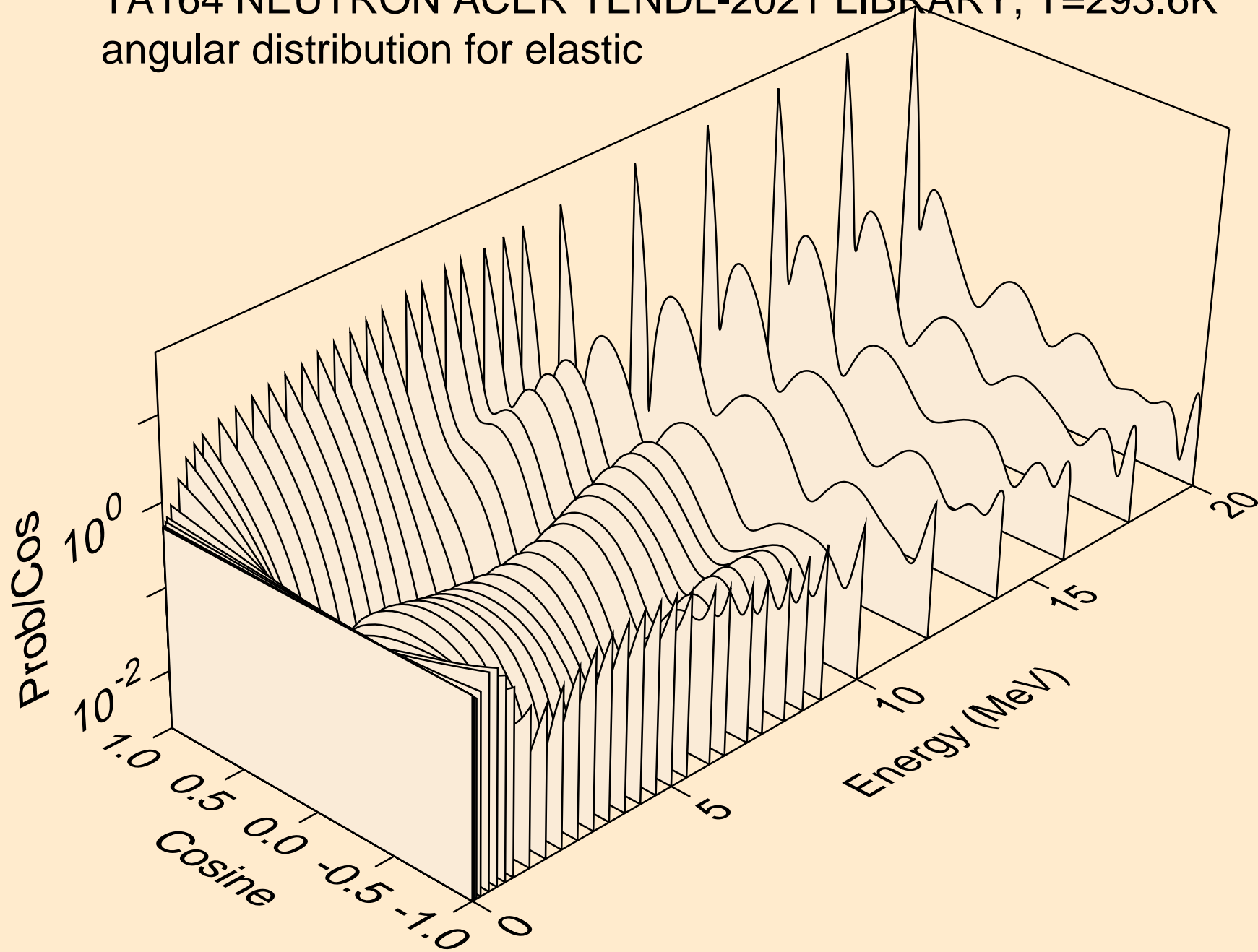

TA164 NEUTRON ACER TENDL-2021 LIBRARY; T=293.6K  
angular distribution for elastic

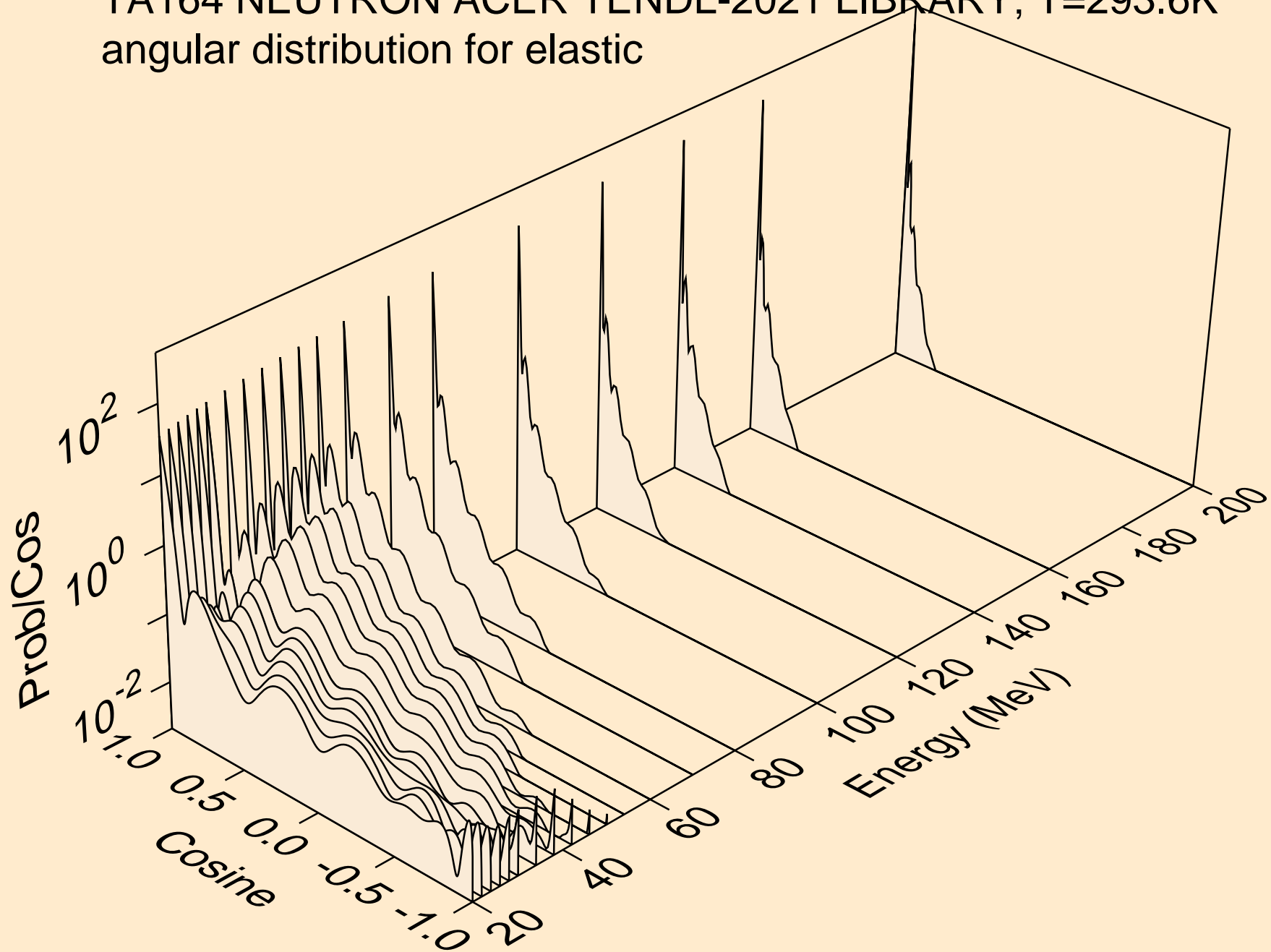



TA164 NEUTRON ACER TENDL-2021 LIBRARY; T=293.6K  
angular distribution for (n,n\*1)

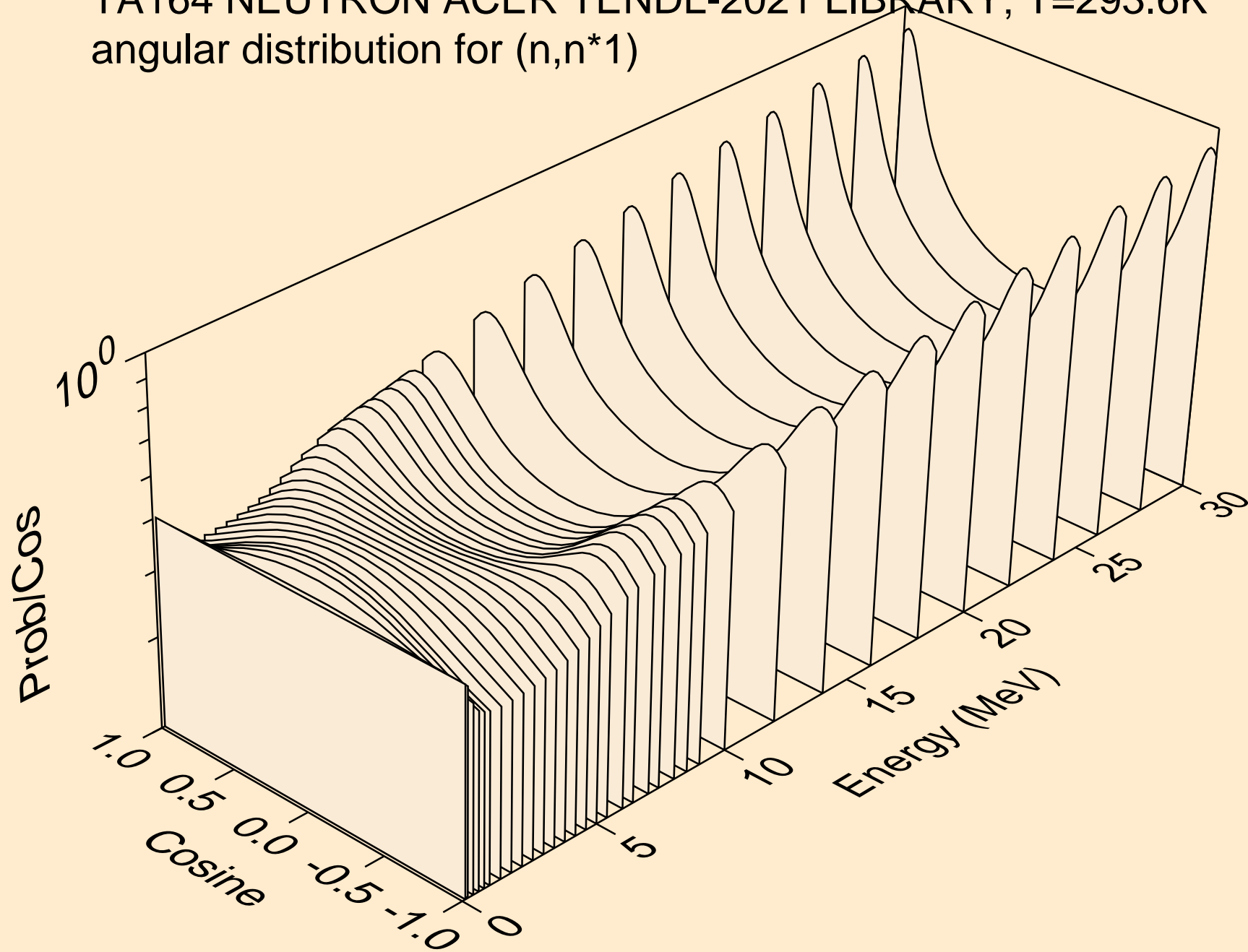

TA164 NEUTRON ACER TENDL-2021 LIBRARY; T=293.6K  
angular distribution for (n,n\*2)

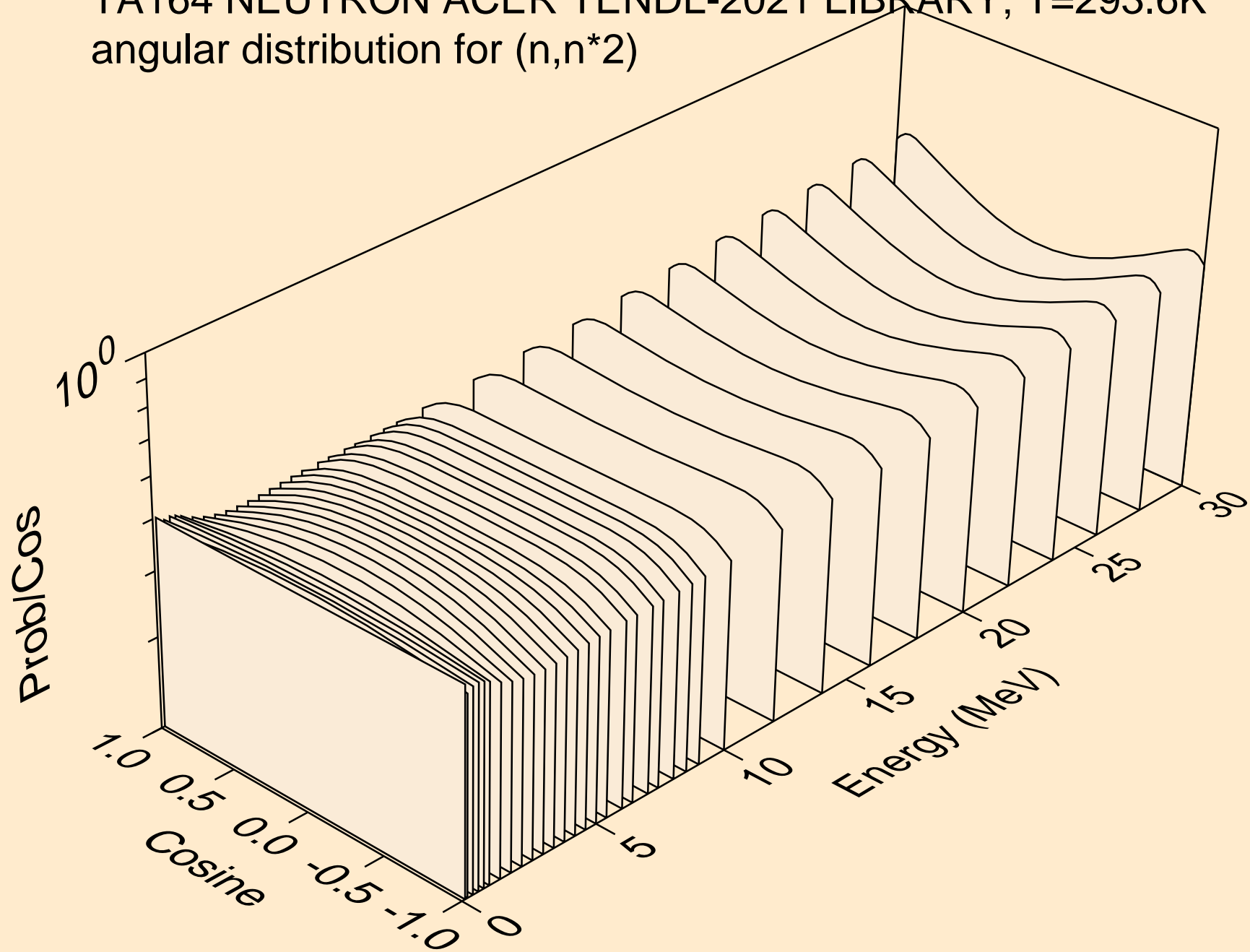

TA164 NEUTRON ACER TENDL-2021 LIBRARY; T=293.6K  
angular distribution for (n,n\*3)

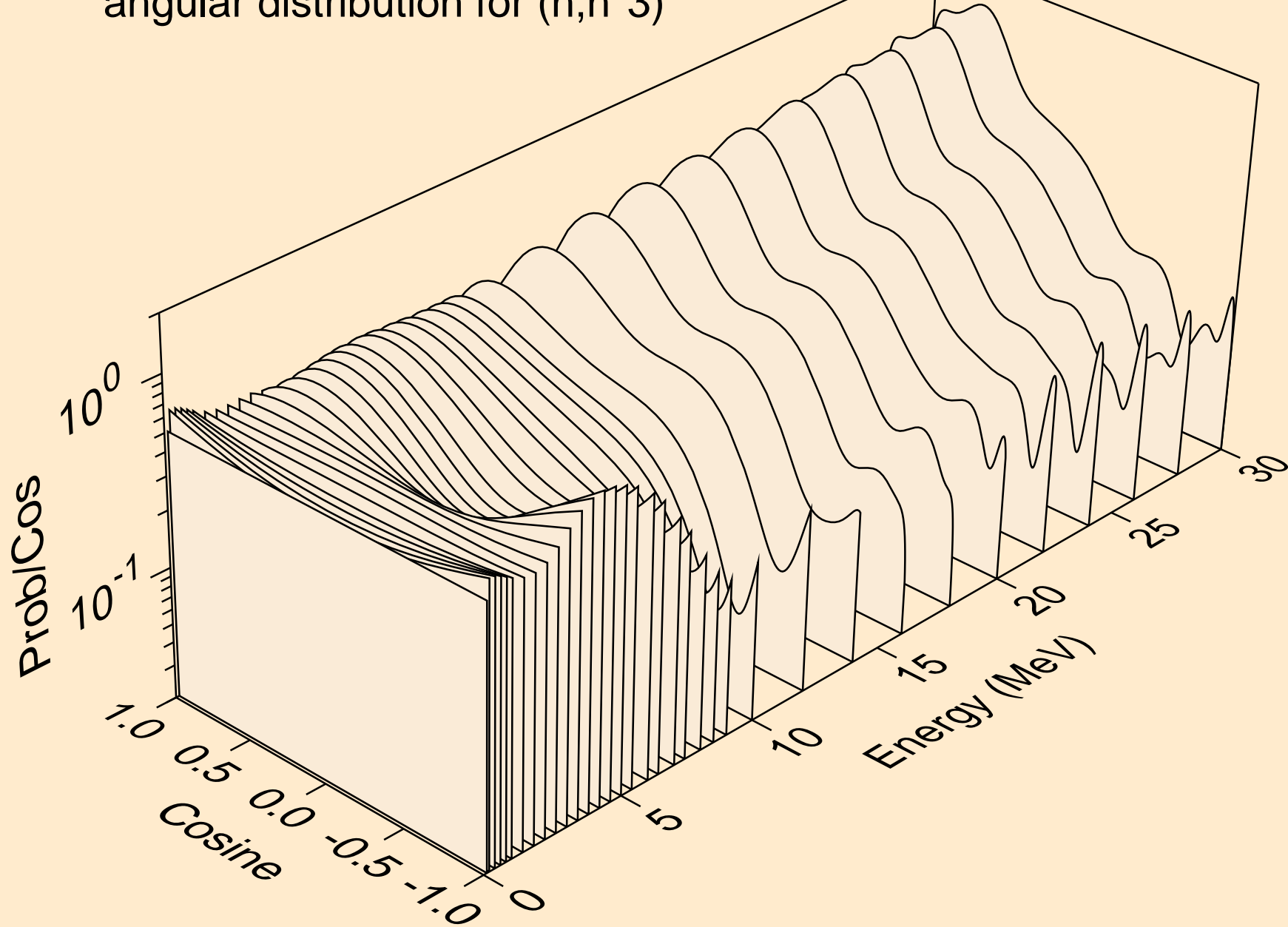

TA164 NEUTRON ACER TENDL-2021 LIBRARY; T=293.6K  
angular distribution for (n,n\*4)

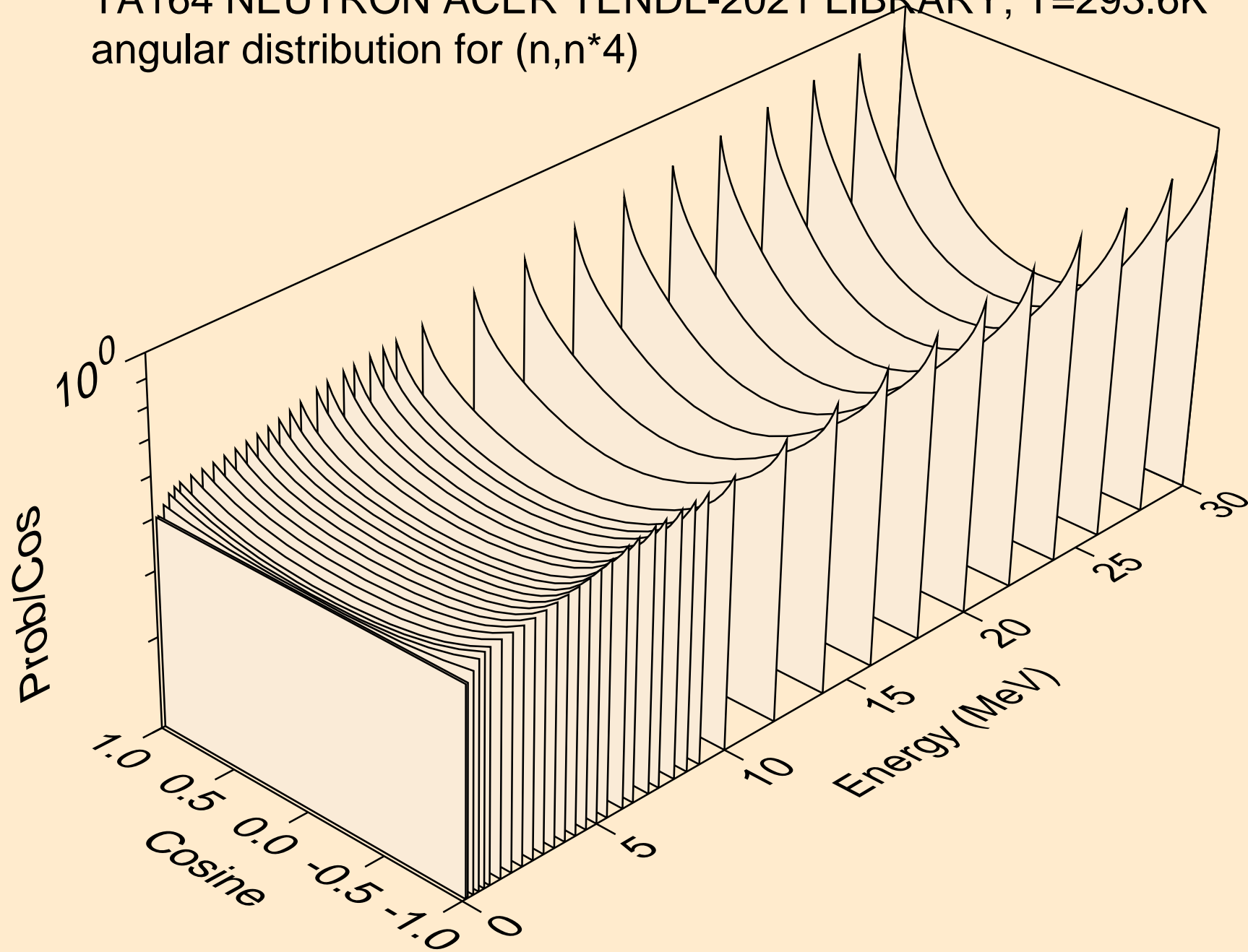

TA164 NEUTRON ACER TENDL-2021 LIBRARY; T=293.6K  
angular distribution for (n,n\*5)

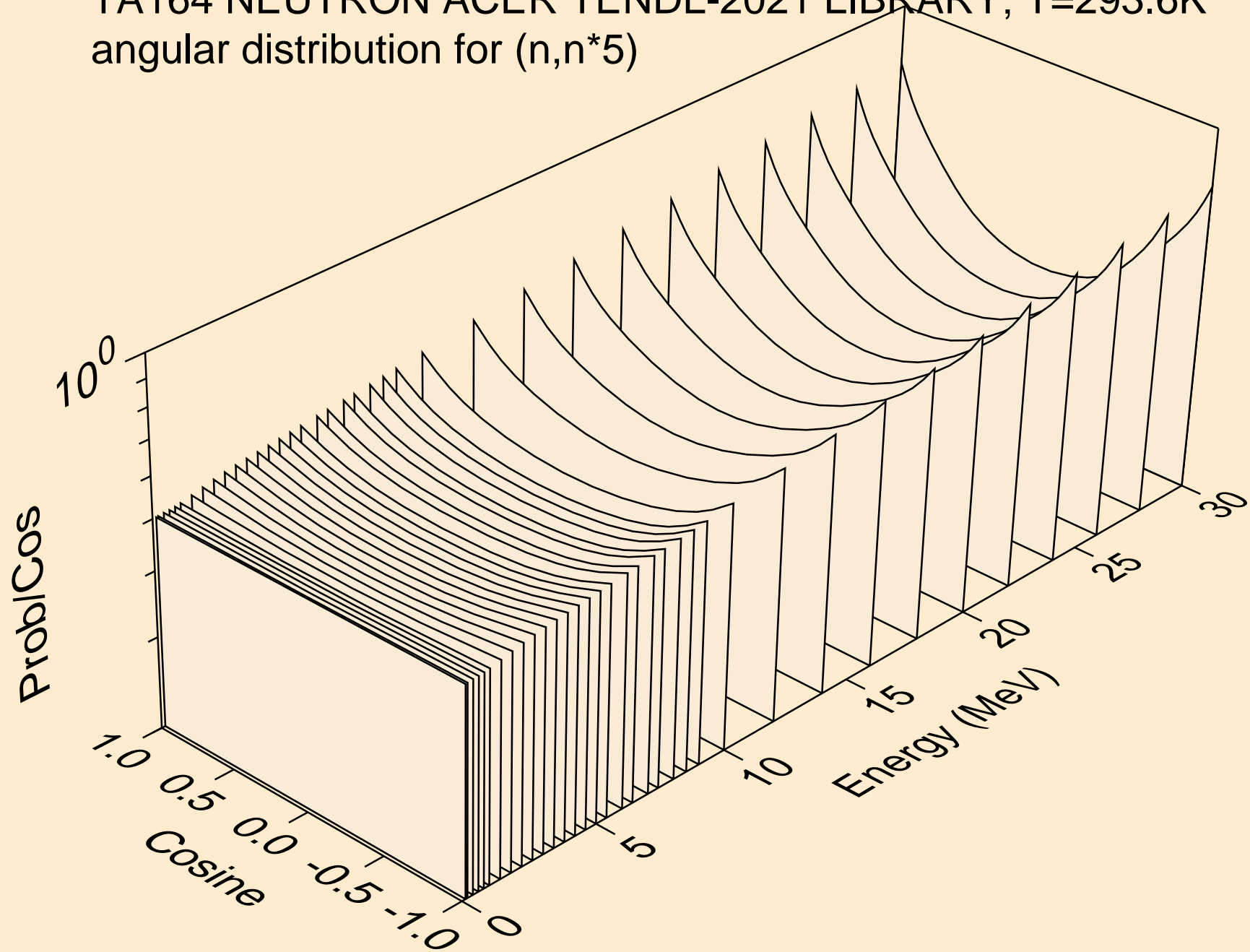

TA164 NEUTRON ACER TENDL-2021 LIBRARY; T=293.6K  
angular distribution for (n,n\*6)

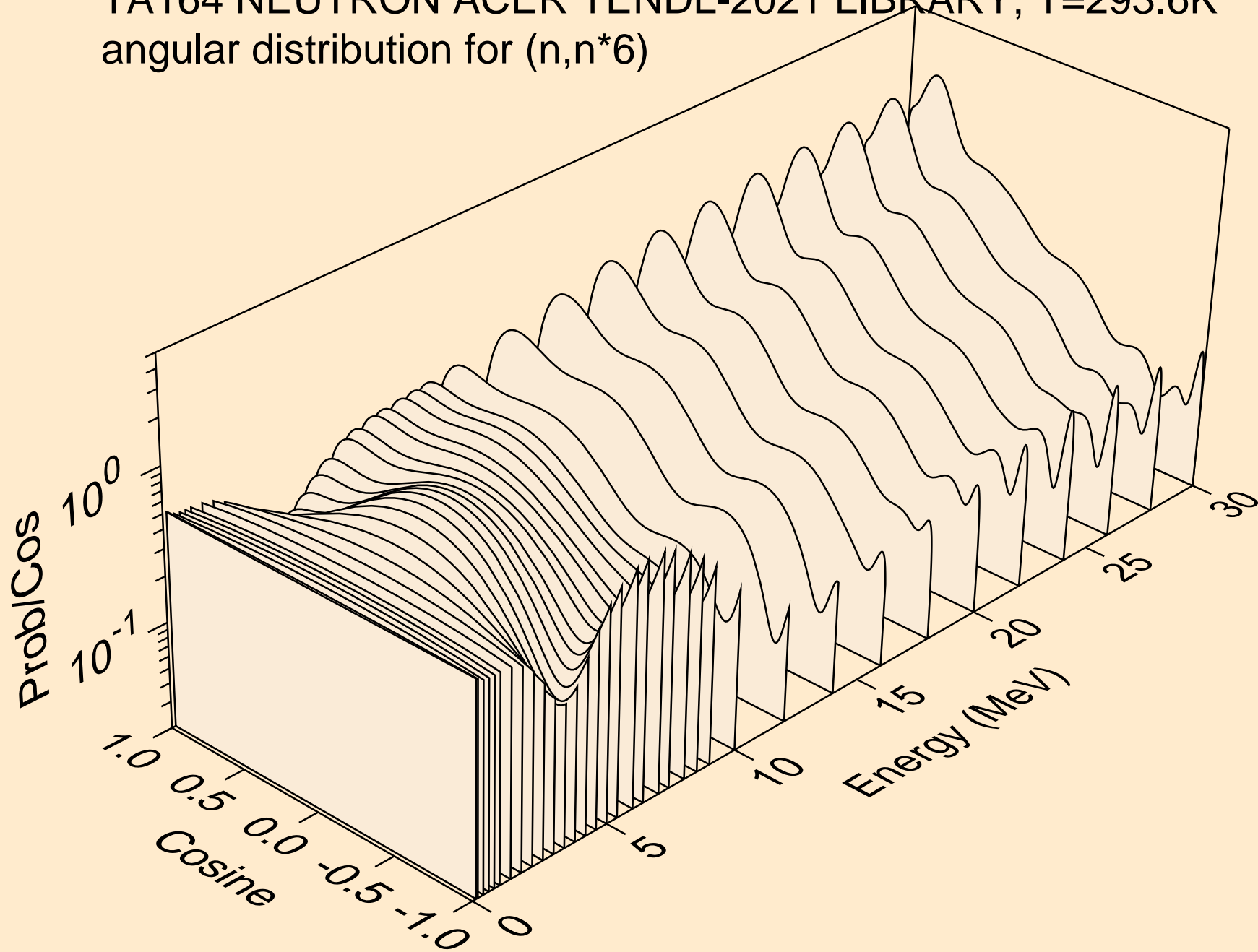

TA164 NEUTRON ACER TENDL-2021 LIBRARY; T=293.6K  
angular distribution for (n,n\*7)

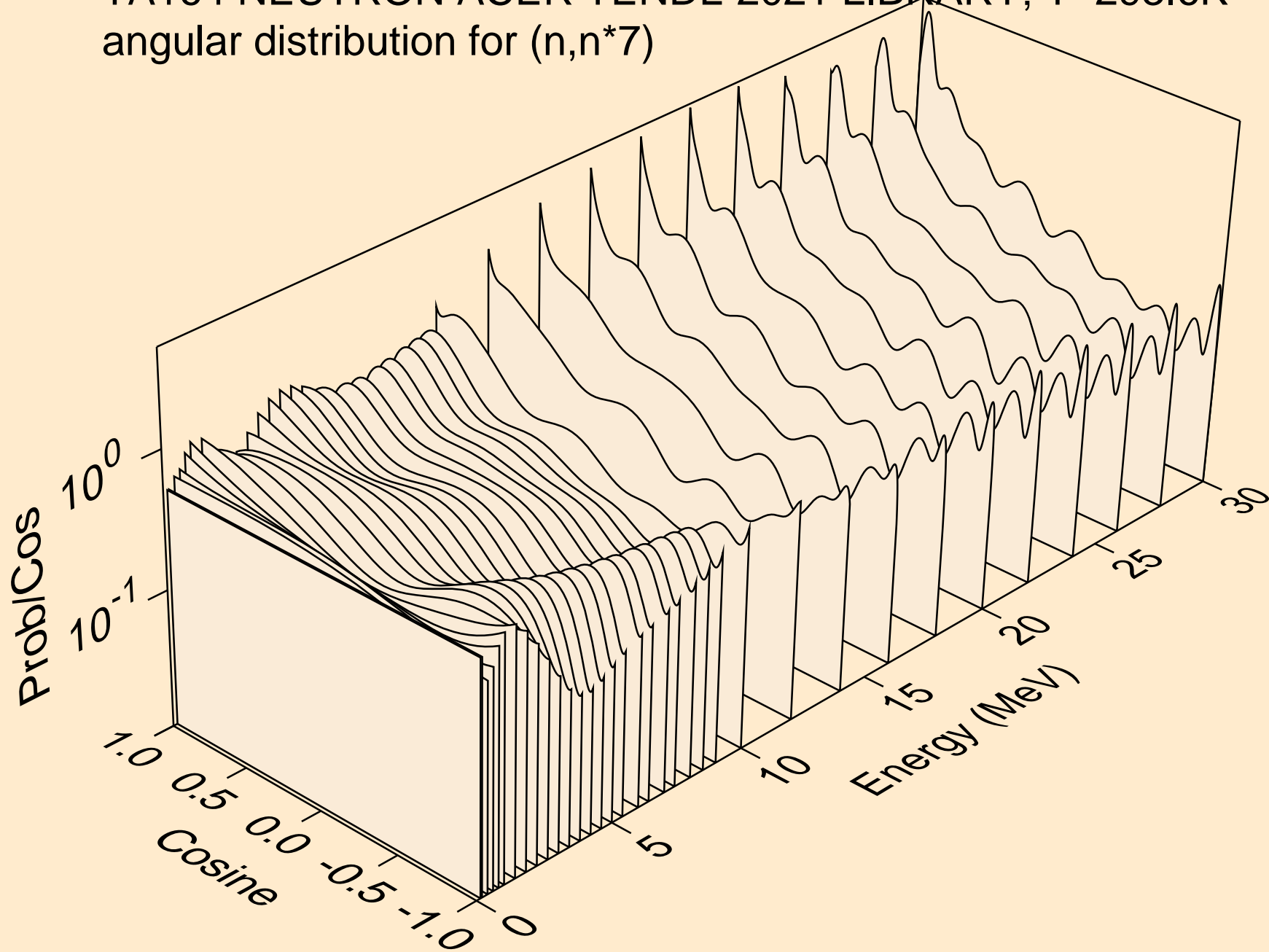

TA164 NEUTRON ACER TENDL-2021 LIBRARY; T=293.6K  
angular distribution for (n,n\*8)

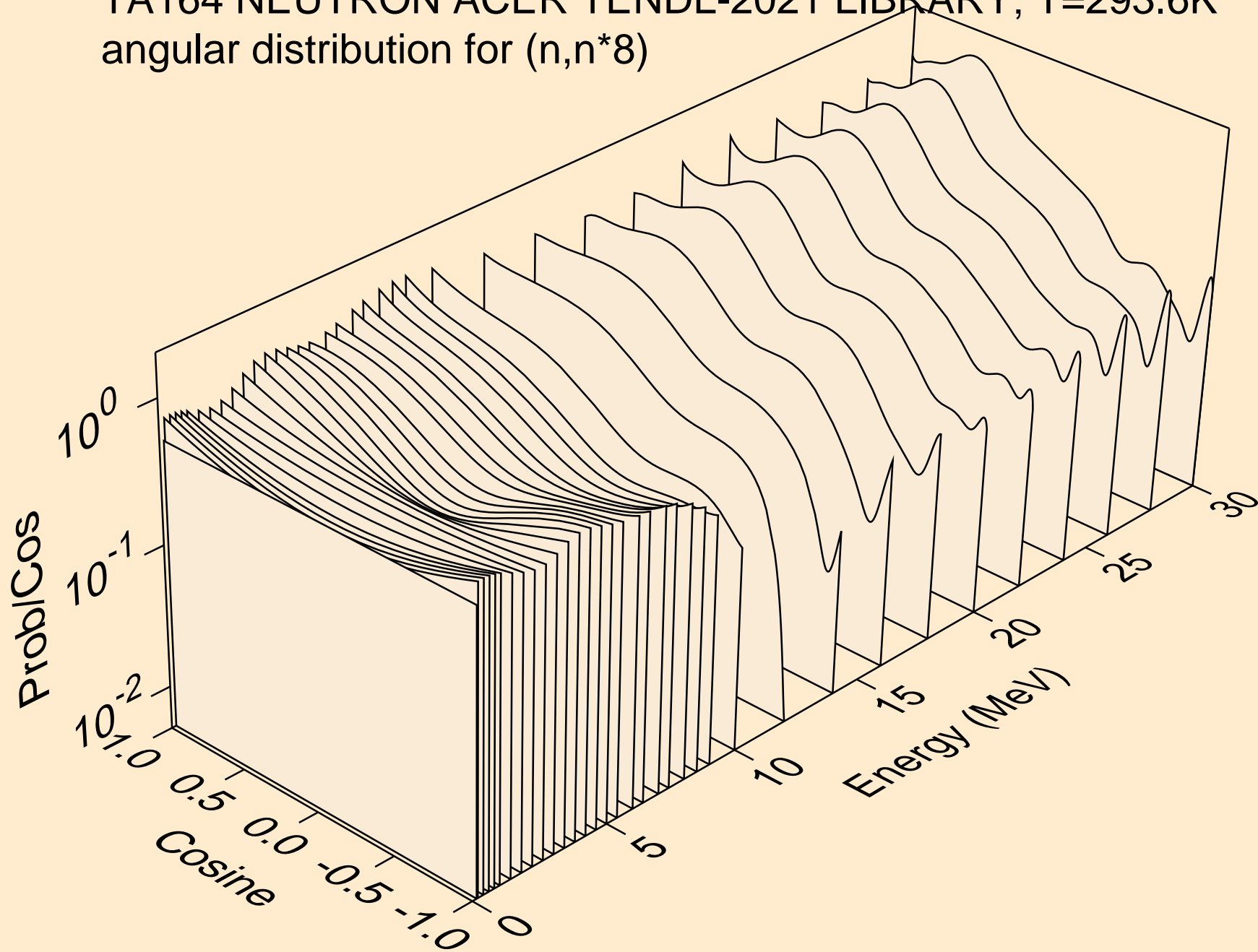



TA164 NEUTRON ACER TENDL-2021 LIBRARY; T=293.6K  
angular distribution for (n,n\*9)

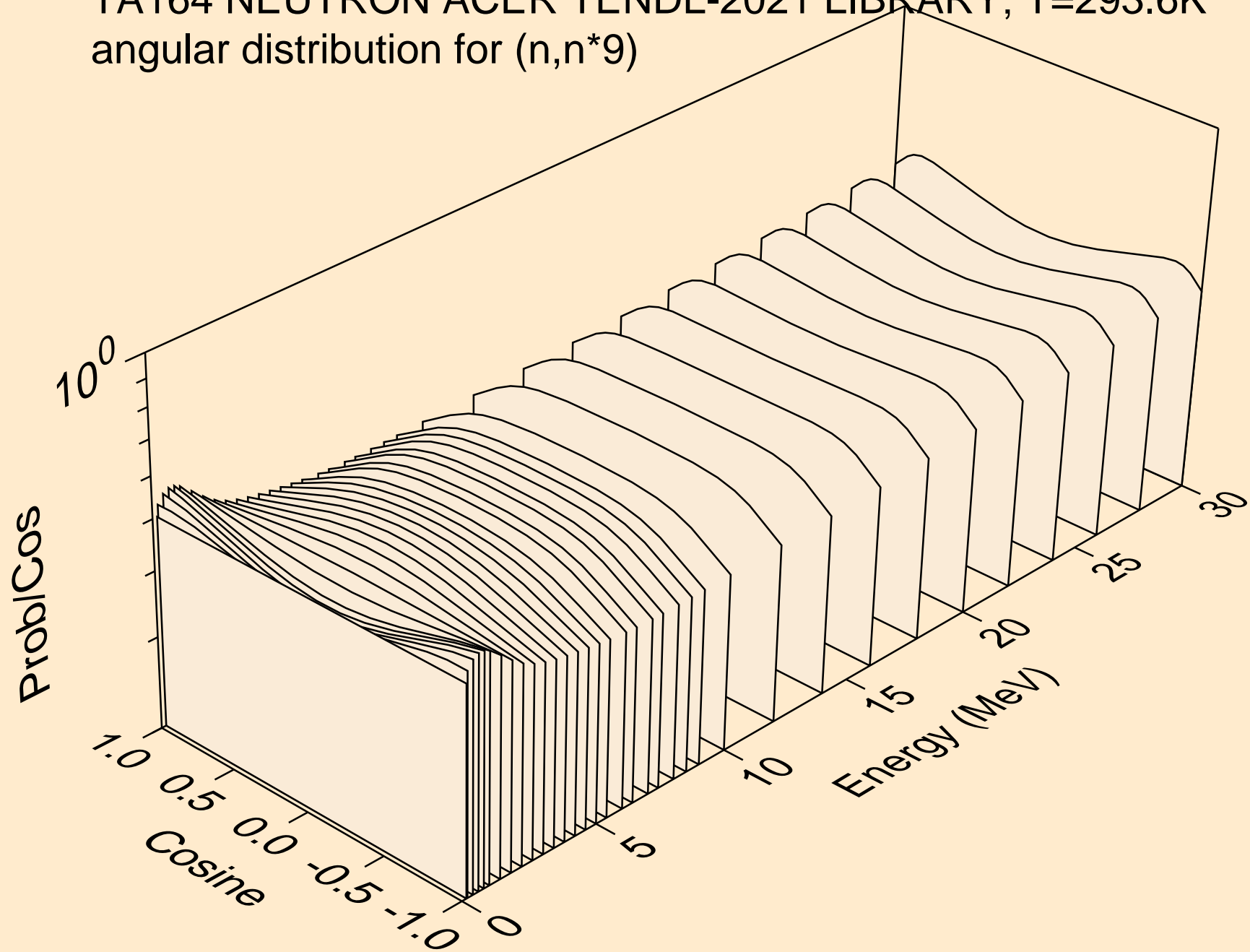

TA164 NEUTRON ACER TENDL-2021 LIBRARY; T=293.6K  
angular distribution for (n,n\*10)

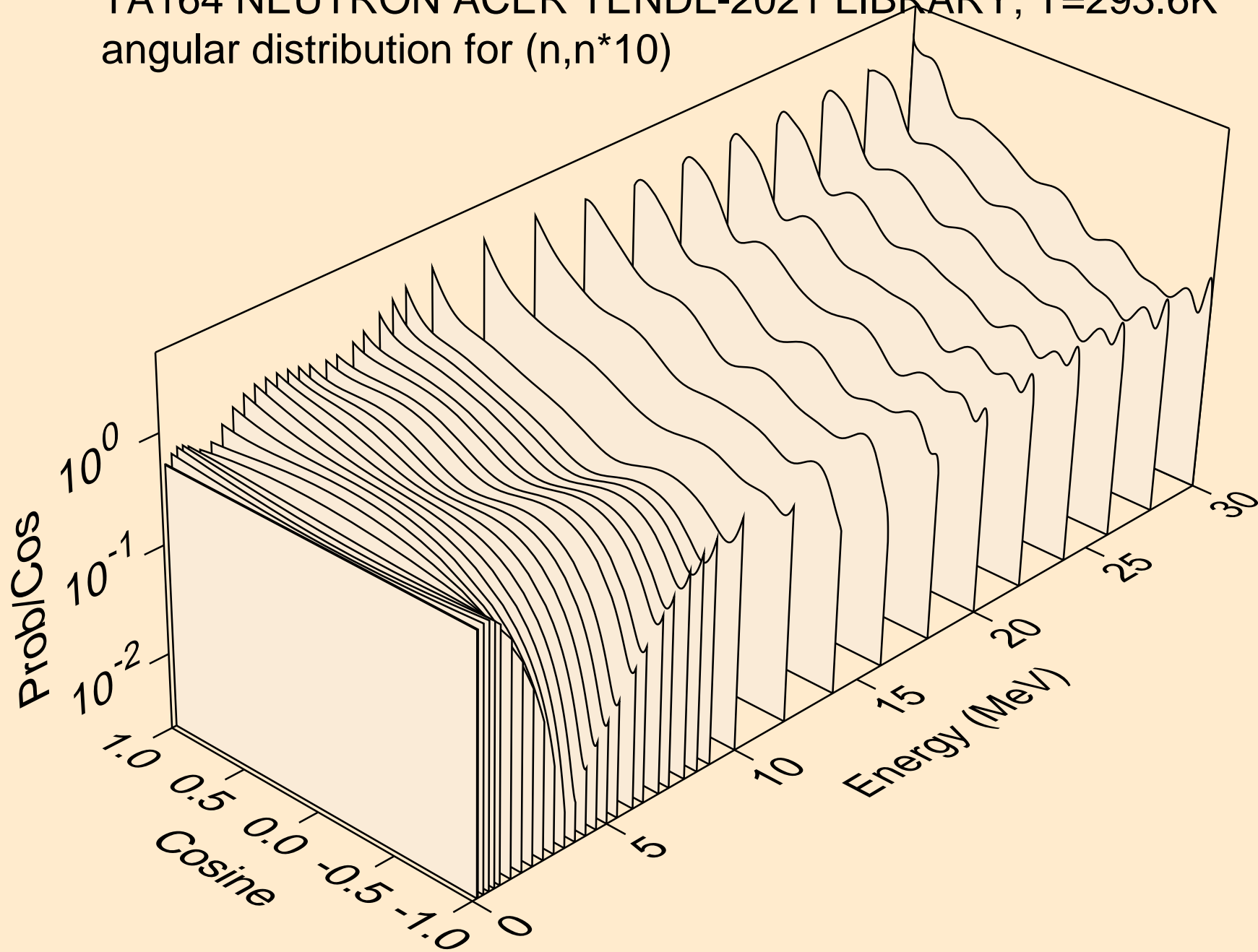

TA164 NEUTRON ACER TENDL-2021 LIBRARY; T=293.6K  
angular distribution for (n,n\*11)

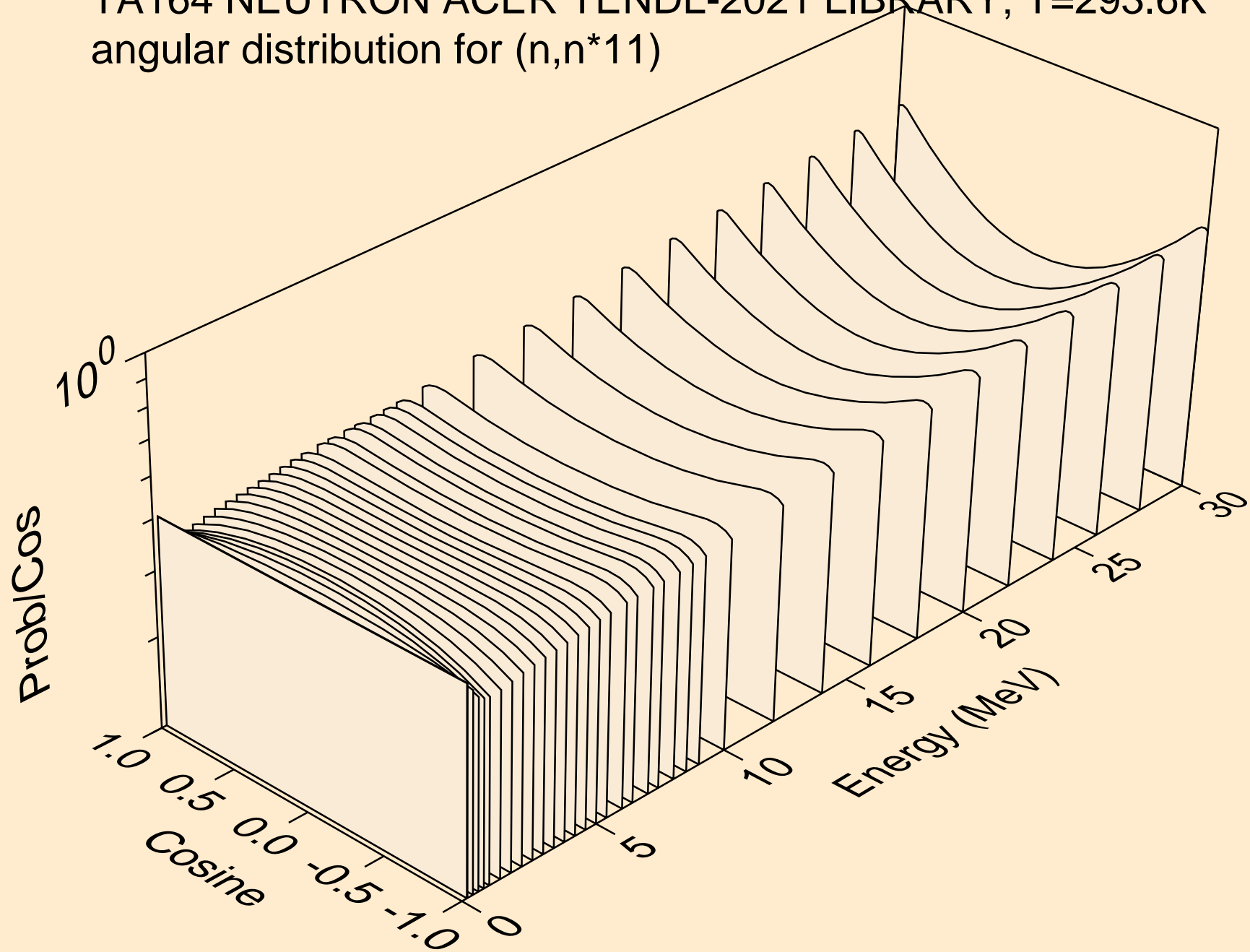

TA164 NEUTRON ACER TENDL-2021 LIBRARY; T=293.6K  
angular distribution for (n,n\*12)

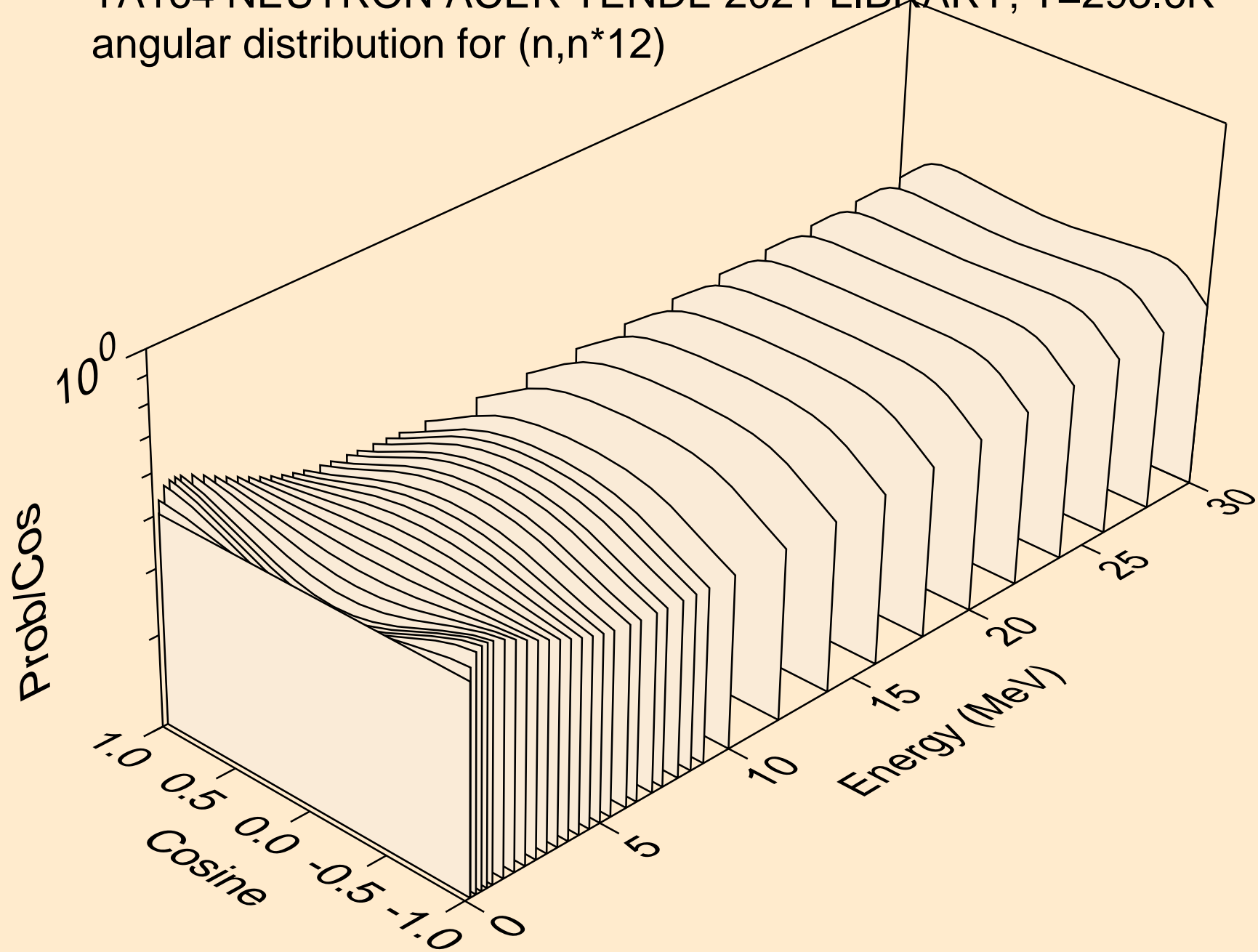

TA164 NEUTRON ACER TENDL-2021 LIBRARY; T=293.6K  
angular distribution for (n,n\*13)

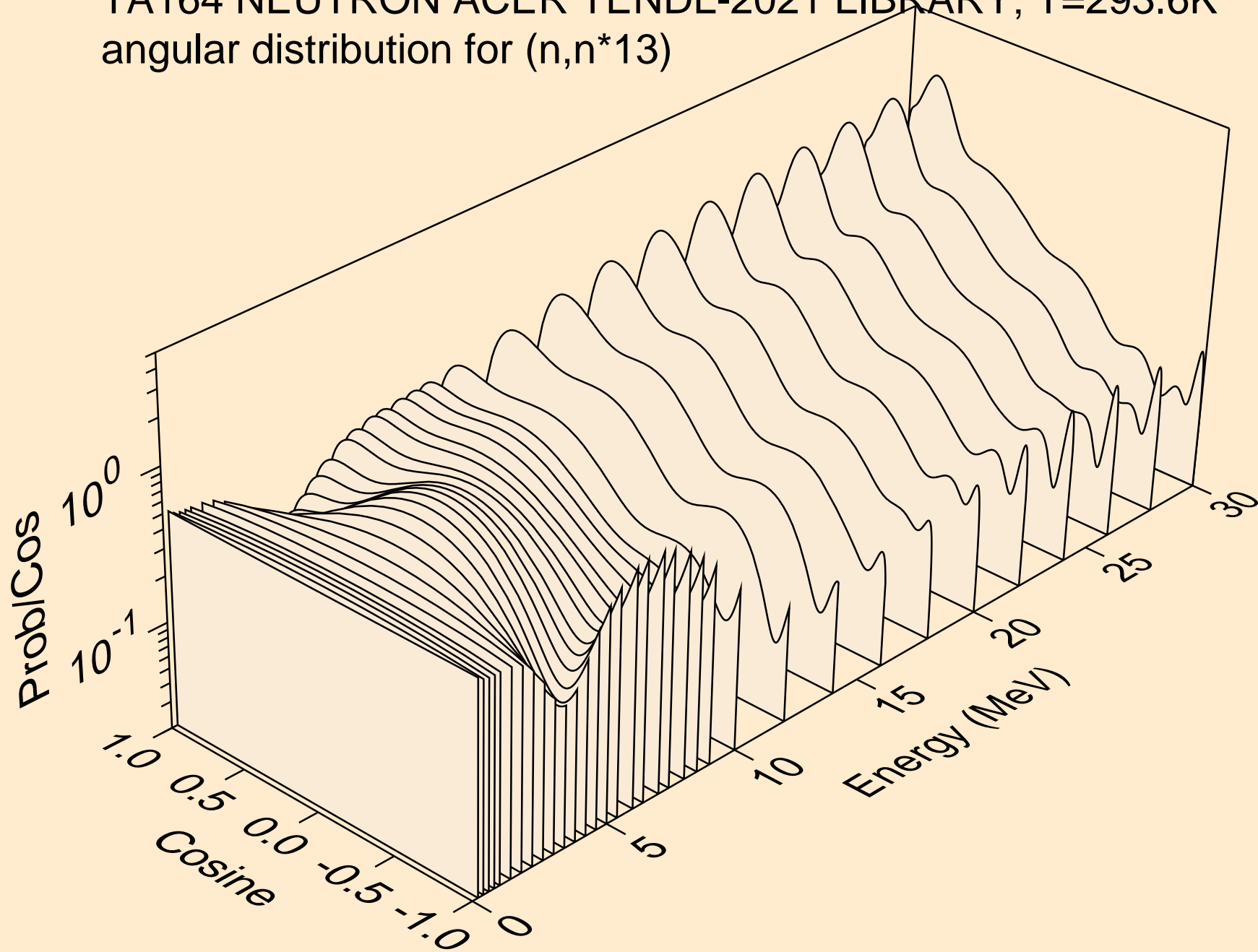

TA164 NEUTRON ACER TENDL-2021 LIBRARY; T=293.6K  
angular distribution for (n,n\*14)

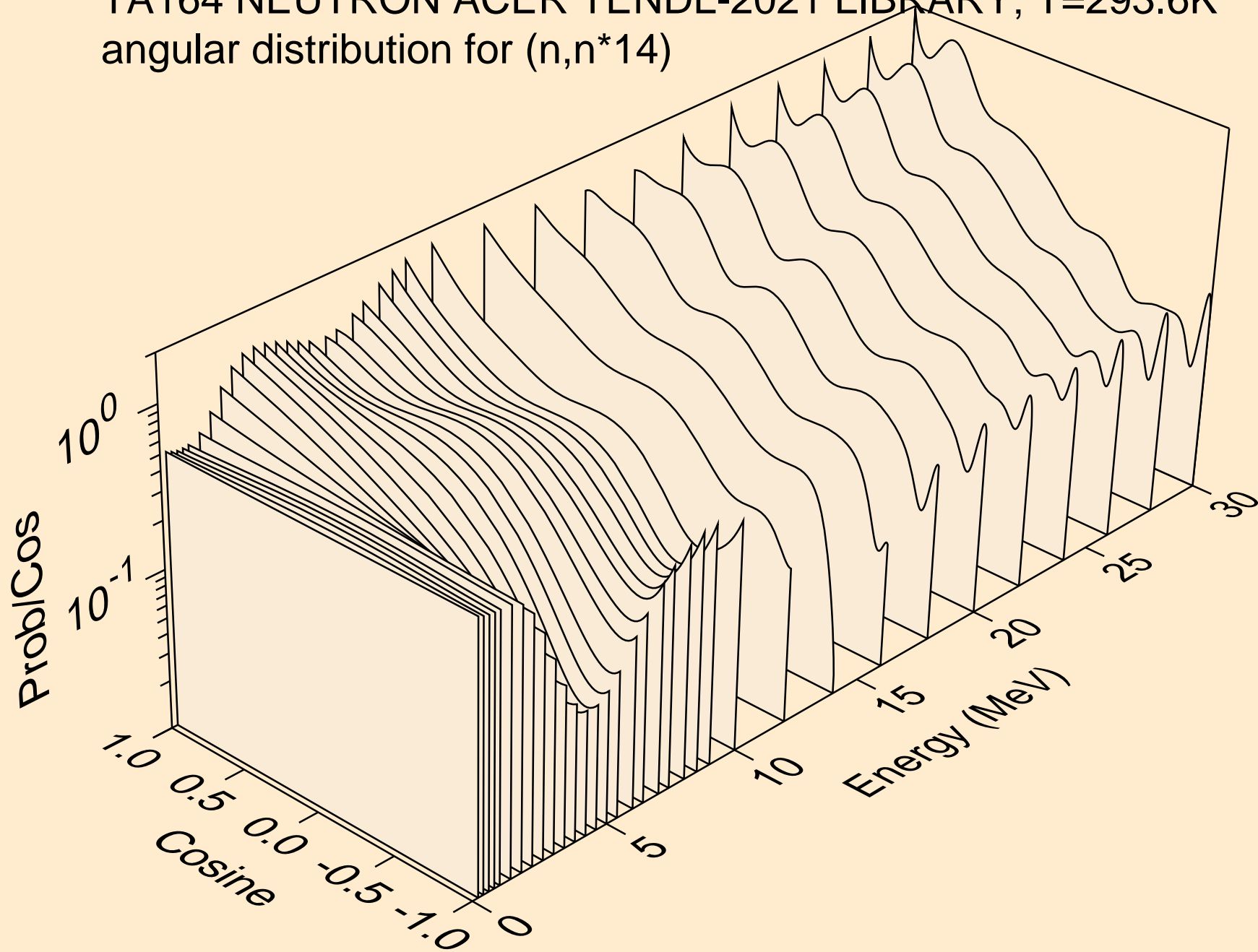

TA164 NEUTRON ACER TENDL-2021 LIBRARY; T=293.6K  
angular distribution for (n,n\*15)

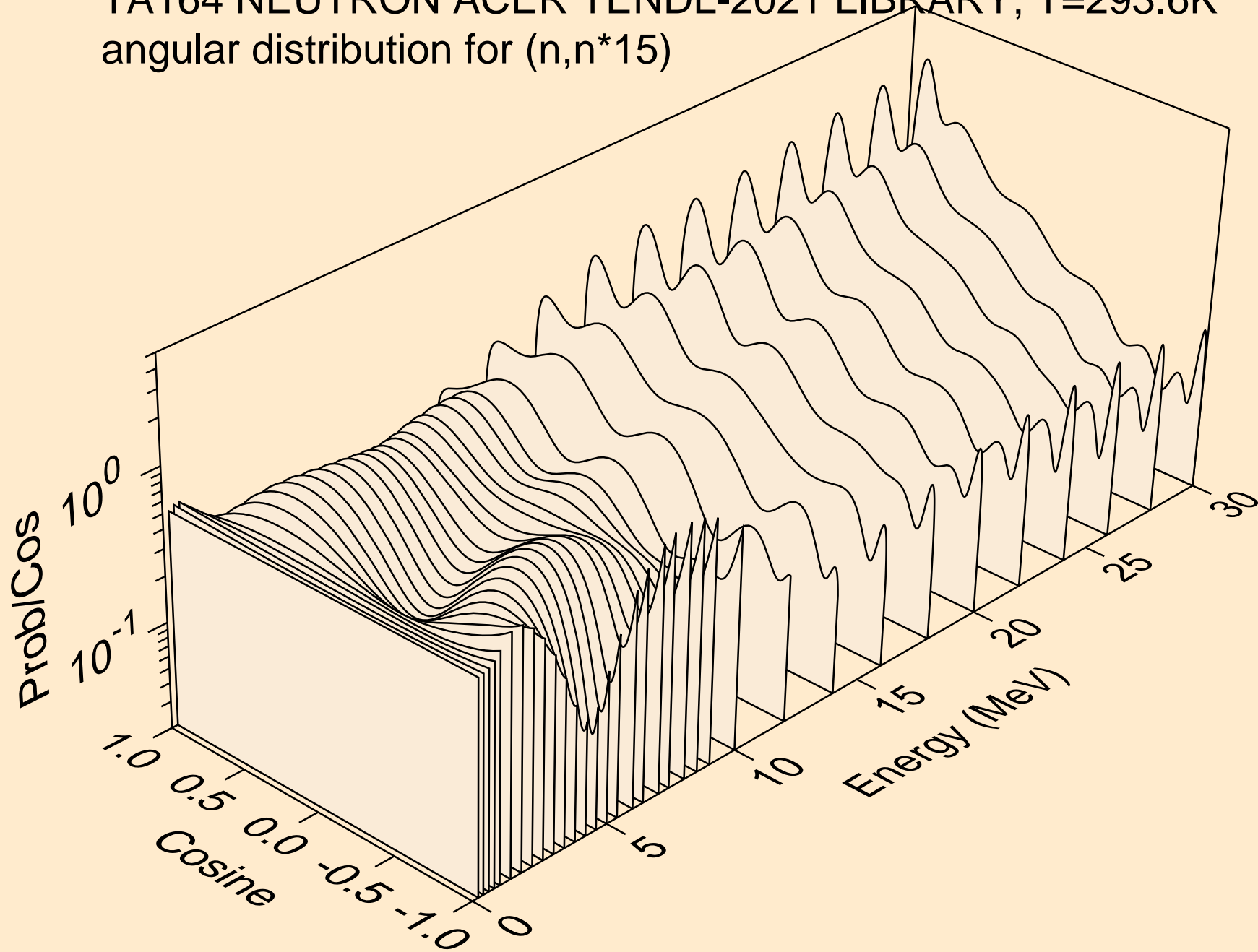

TA164 NEUTRON ACER TENDL-2021 LIBRARY; T=293.6K  
angular distribution for (n,n\*16)

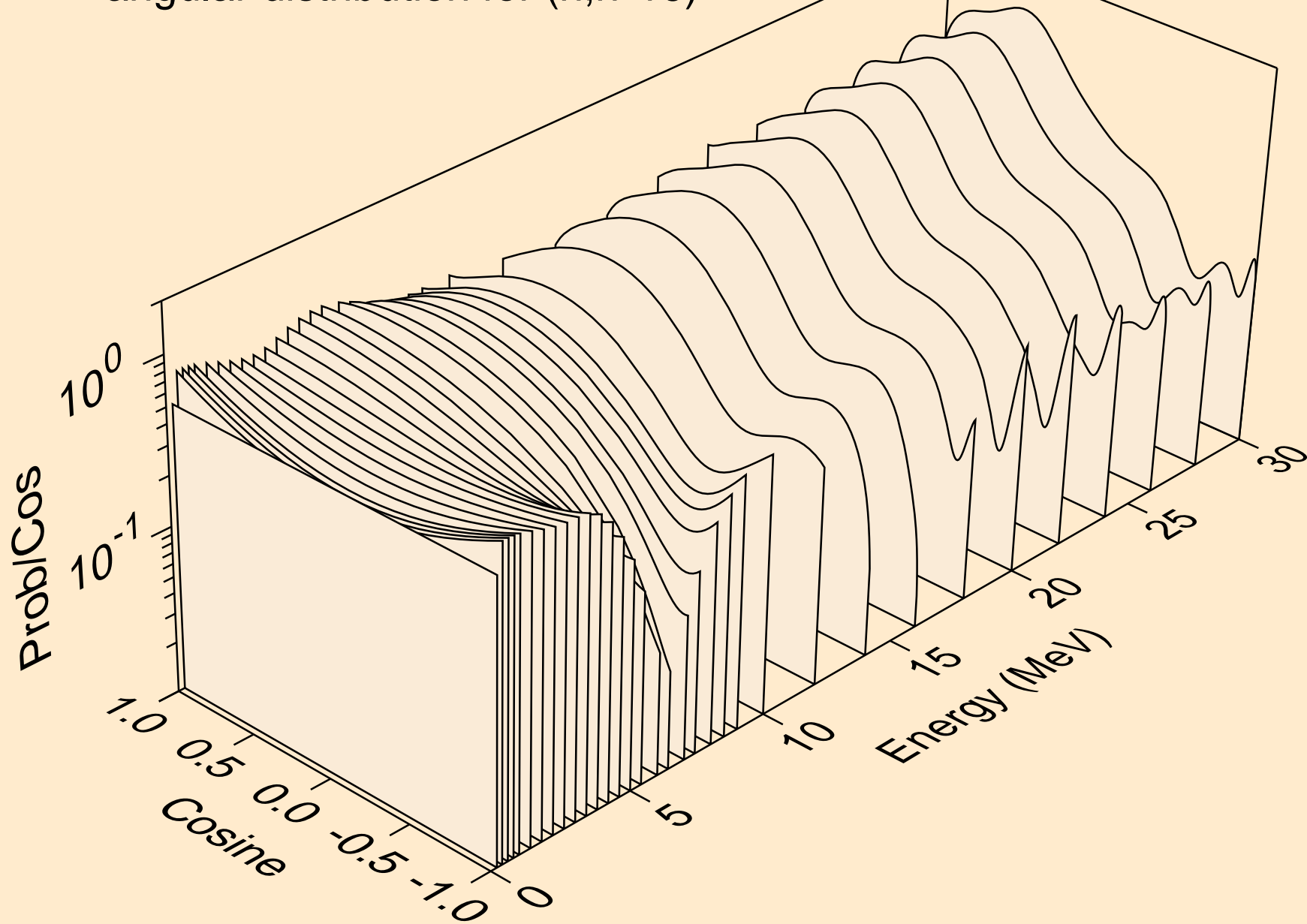



TA164 NEUTRON ACER TENDL-2021 LIBRARY; T=293.6K  
angular distribution for (n,n\*17)

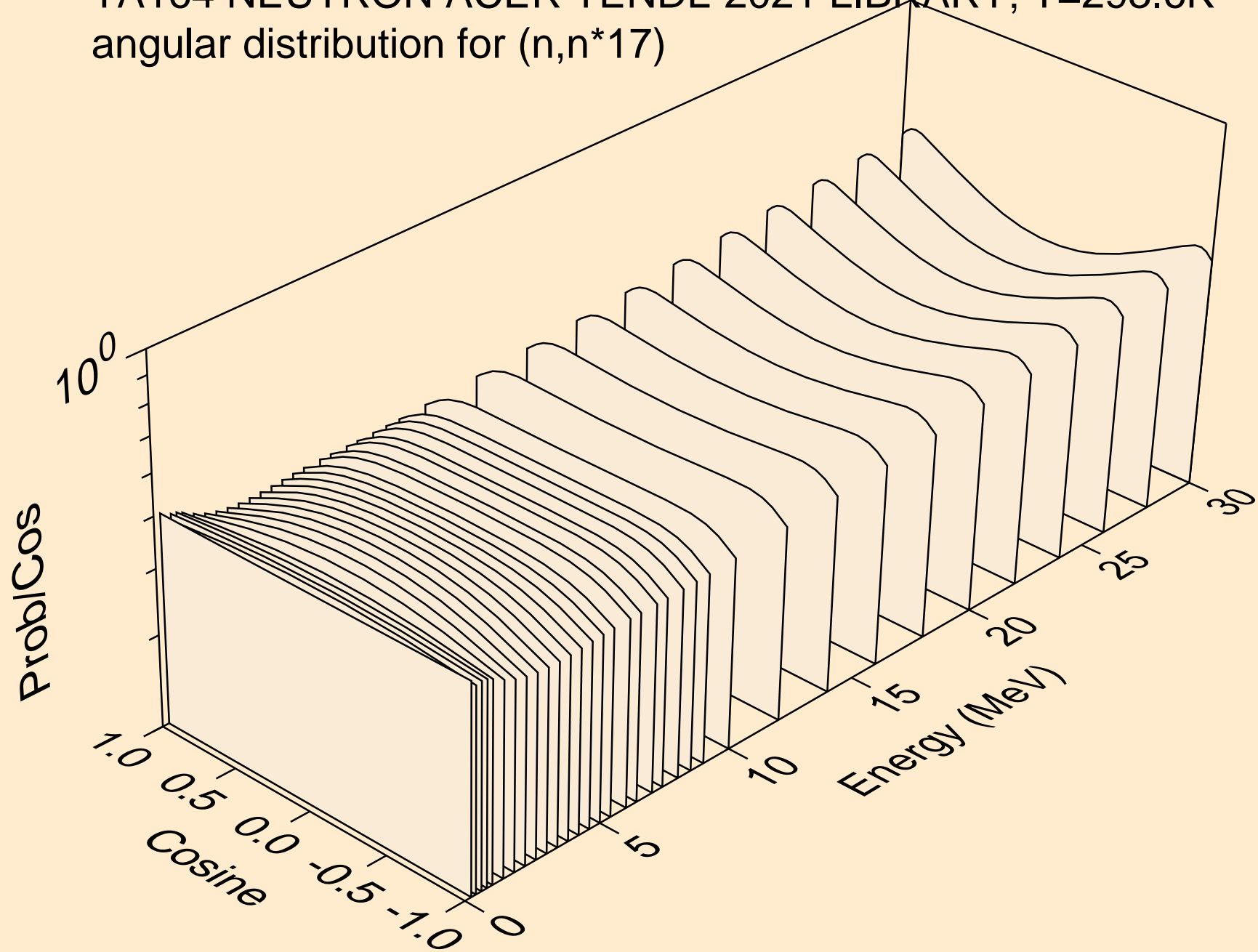

TA164 NEUTRON ACER TENDL-2021 LIBRARY; T=293.6K  
angular distribution for (n,n\*18)

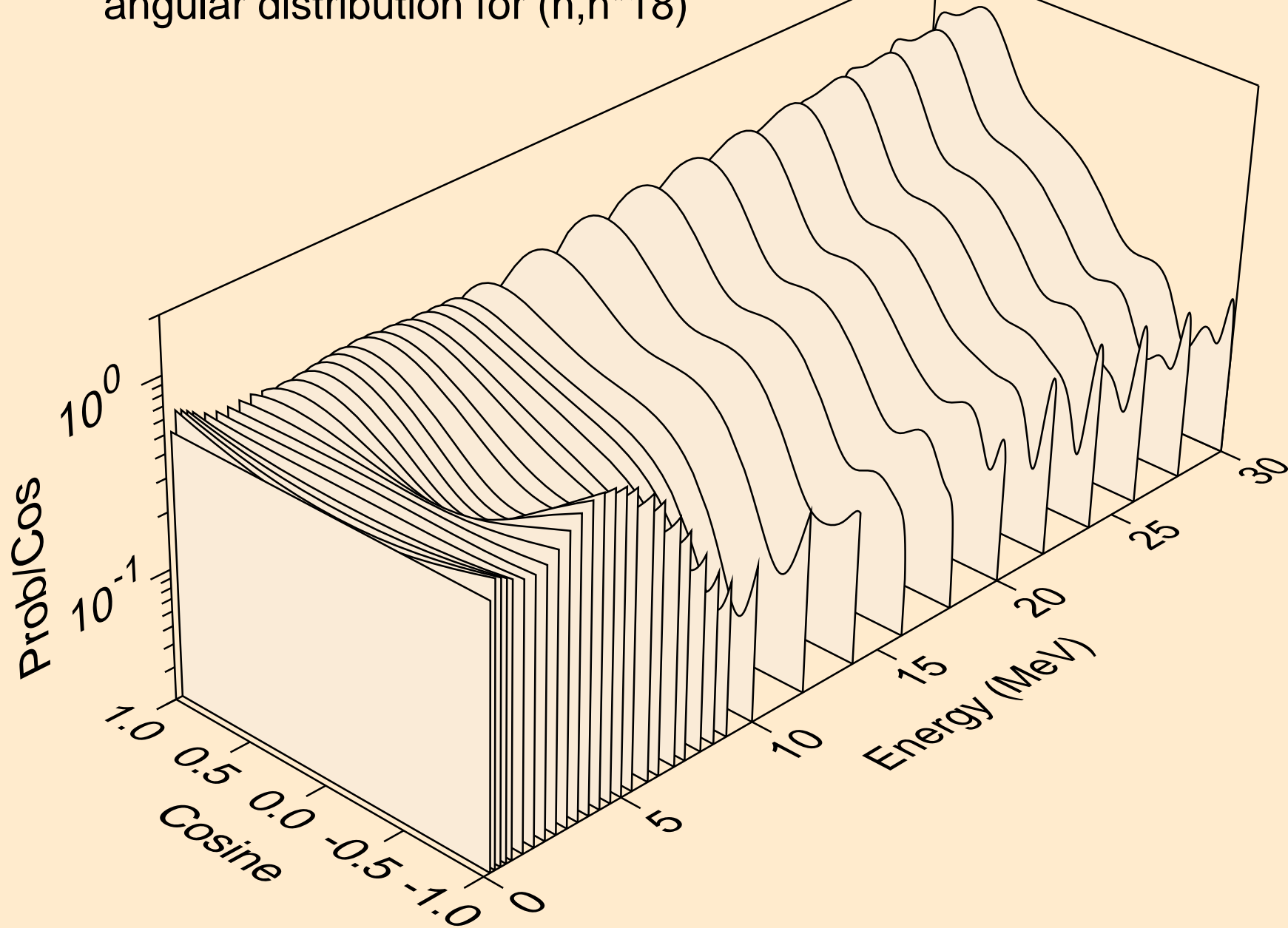

TA164 NEUTRON ACER TENDL-2021 LIBRARY; T=293.6K  
angular distribution for (n,n\*19)

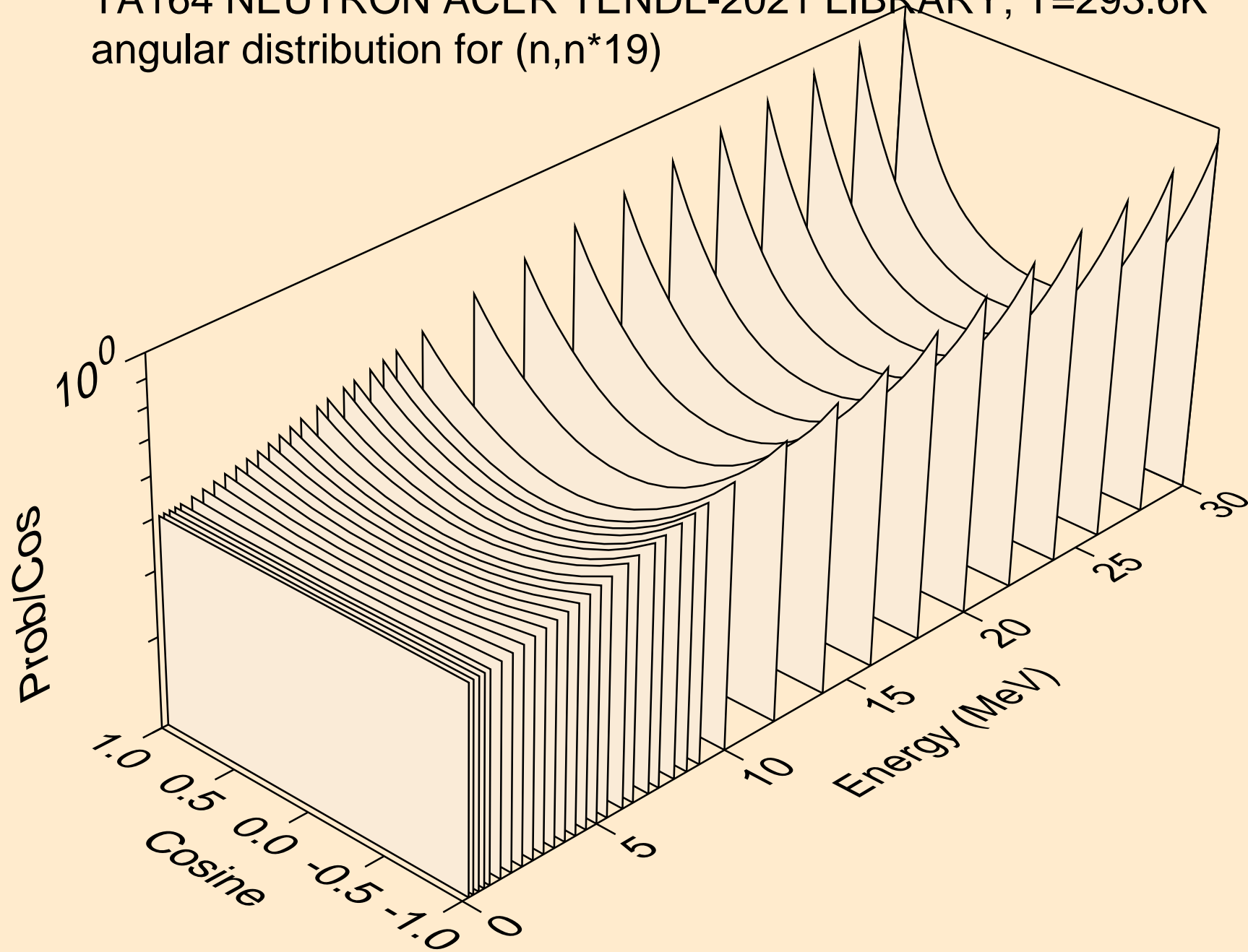

TA164 NEUTRON ACER TENDL-2021 LIBRARY; T=293.6K  
angular distribution for (n,n\*20)

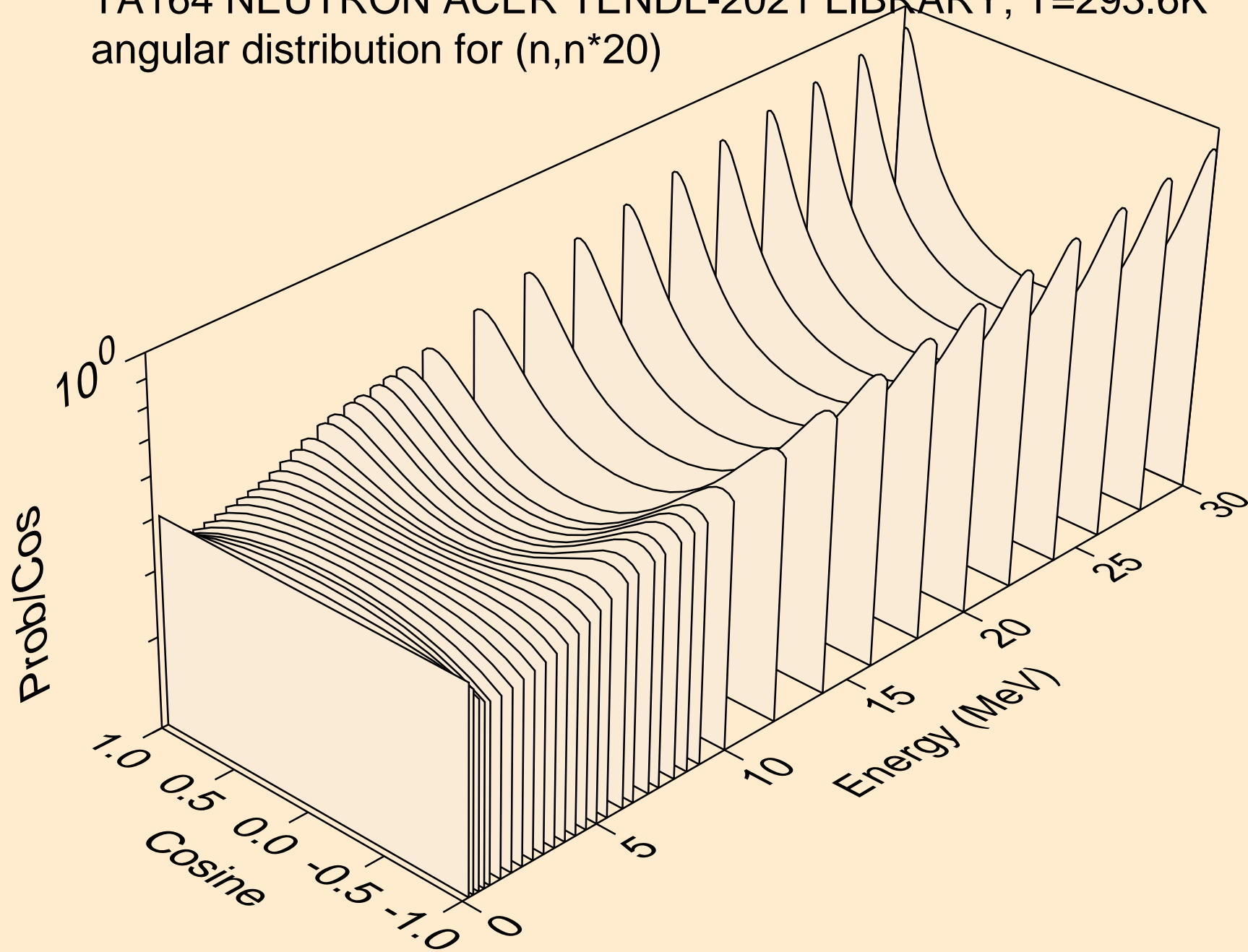

TA164 NEUTRON ACER TENDL-2021 LIBRARY; T=293.6K  
angular distribution for (n,n\*21)

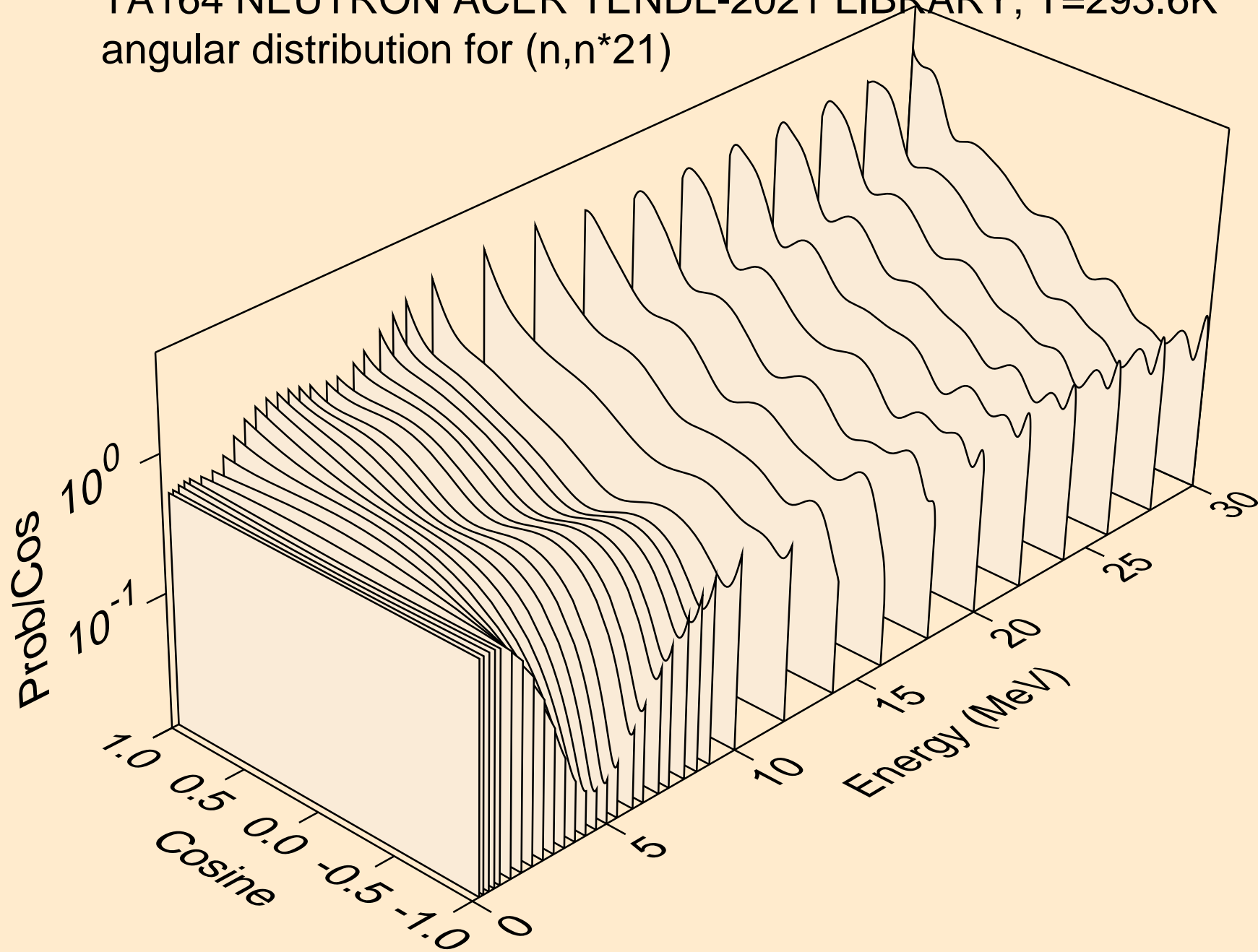

TA164 NEUTRON ACER TENDL-2021 LIBRARY; T=293.6K  
angular distribution for (n,n\*22)

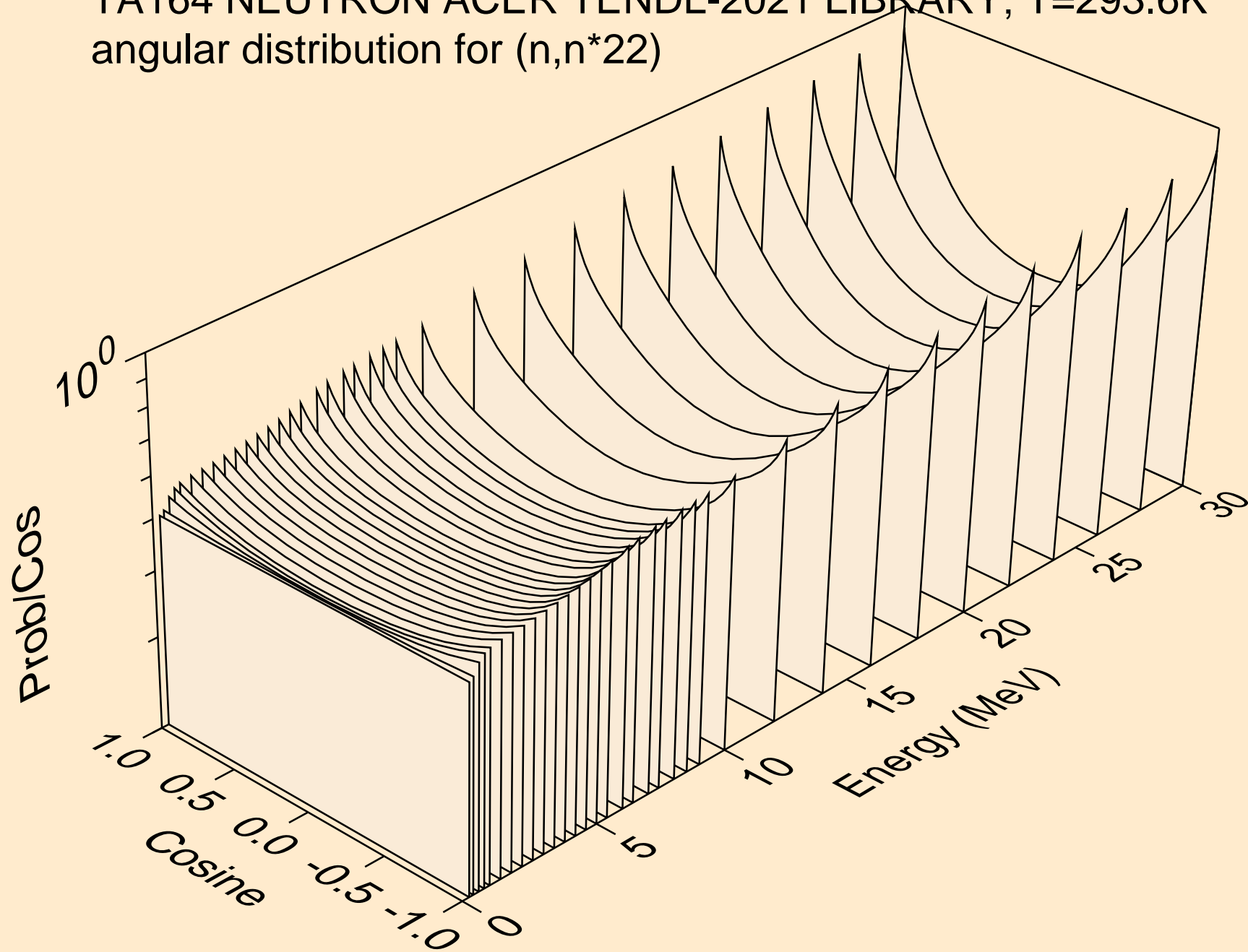

TA164 NEUTRON ACER TENDL-2021 LIBRARY; T=293.6K  
Neutron emission for (n,x)

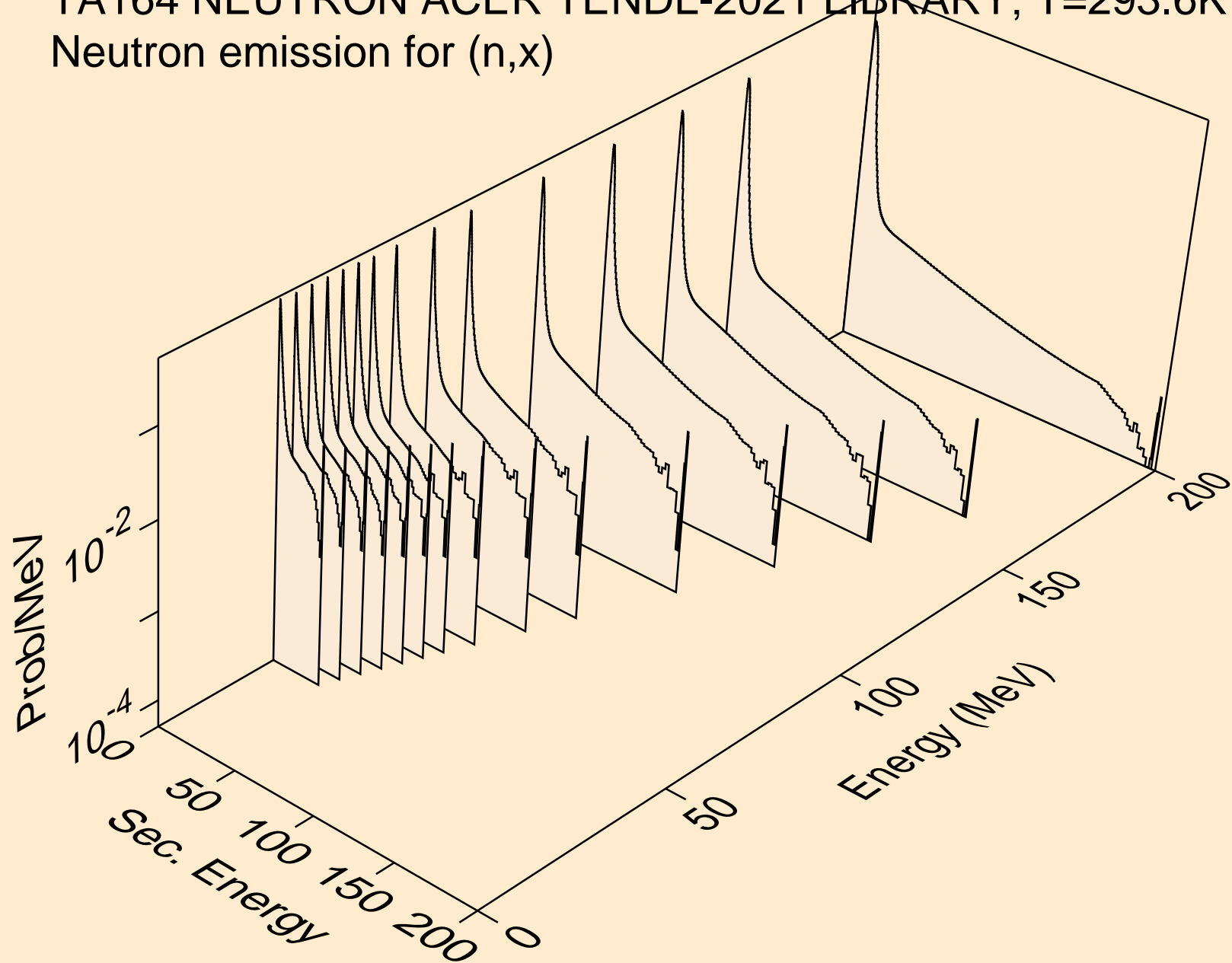

TA164 NEUTRON ACER TENDL-2021 LIBRARY; T=293.6K  
Neutron emission for (n,2nd)

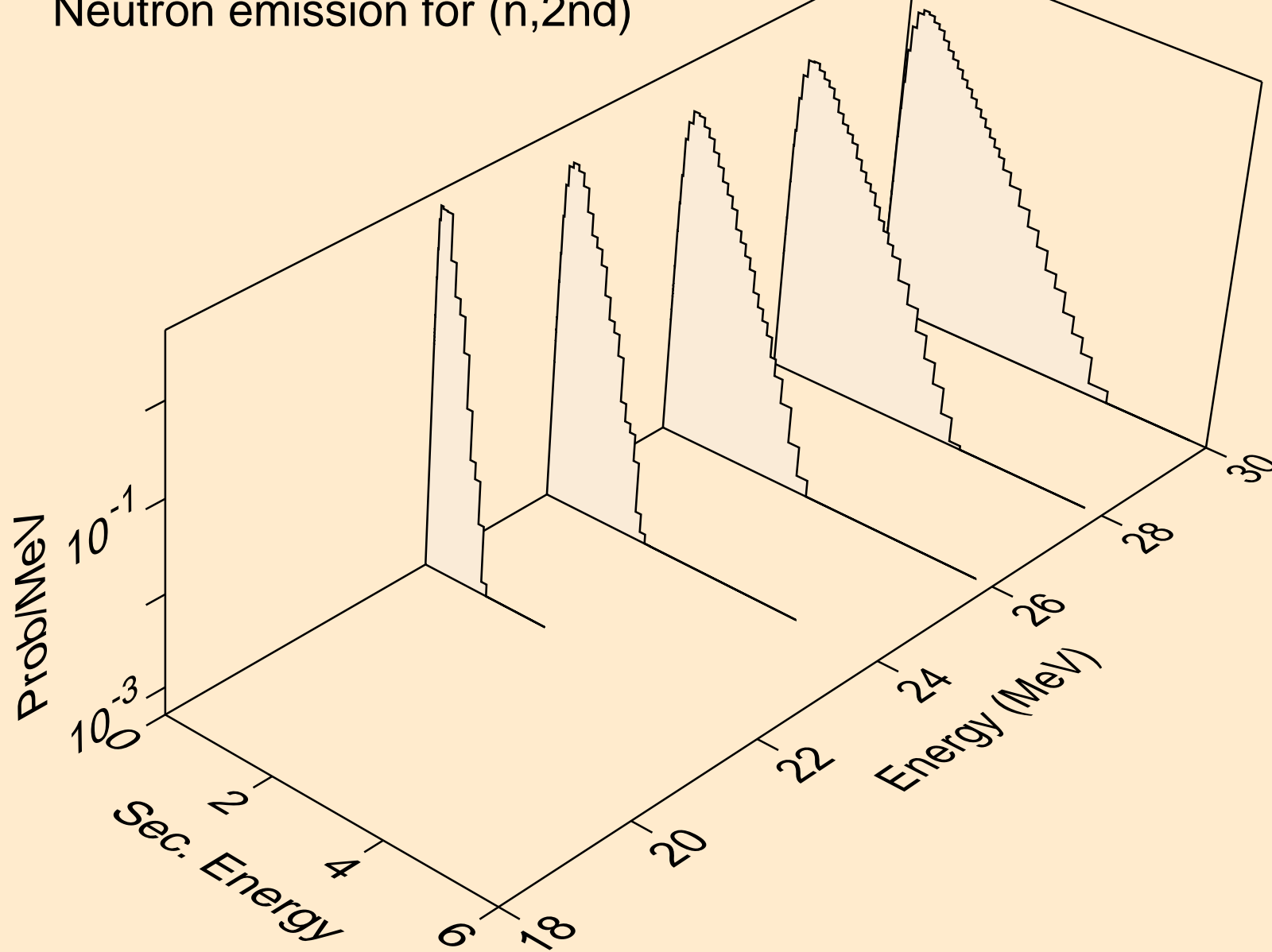



TA164 NEUTRON ACER TENDL-2021 LIBRARY; T=293.6K  
Neutron emission for (n,2n)

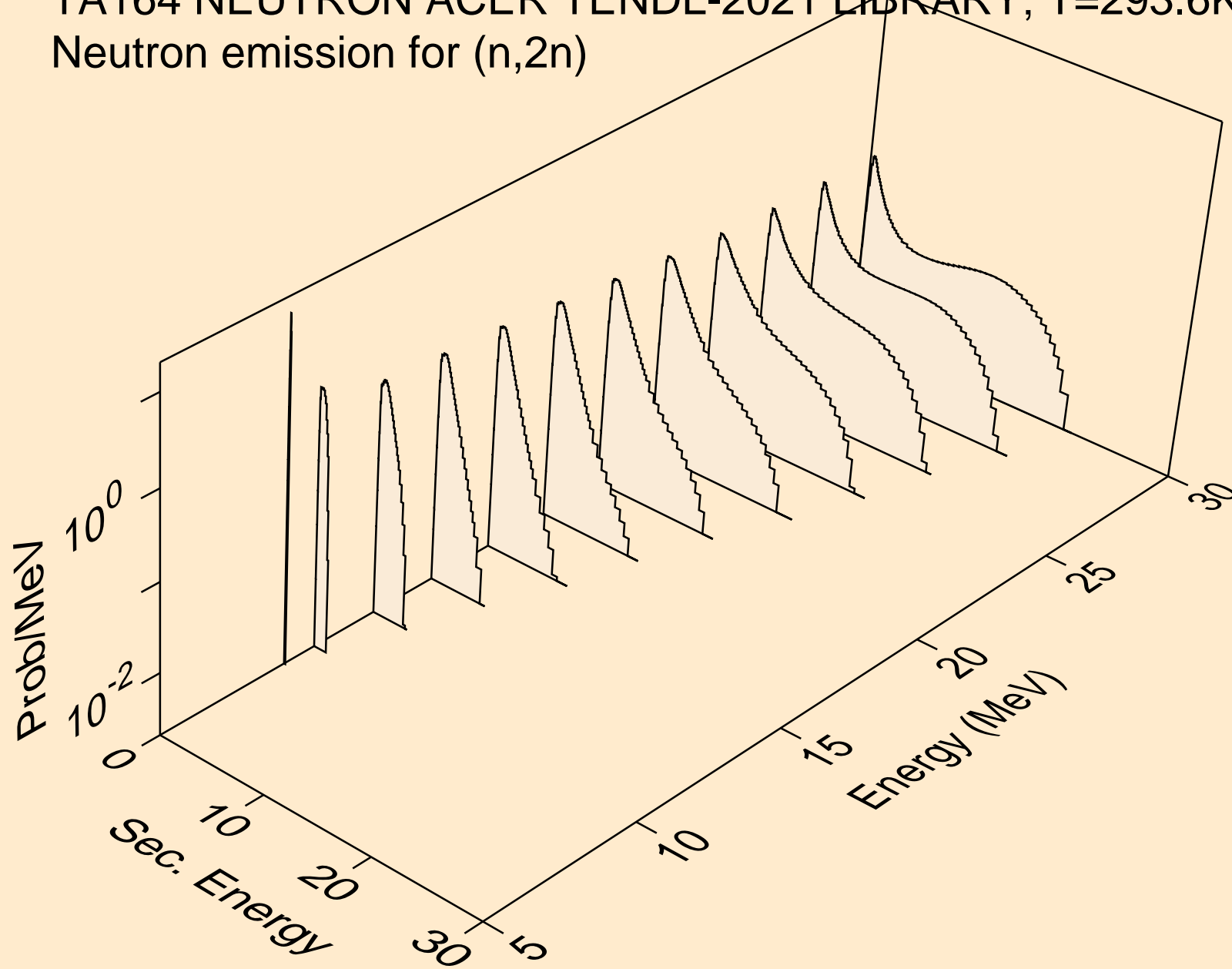

TA164 NEUTRON ACER TENDL-2021 LIBRARY; T=293.6K  
Neutron emission for (n,3n)

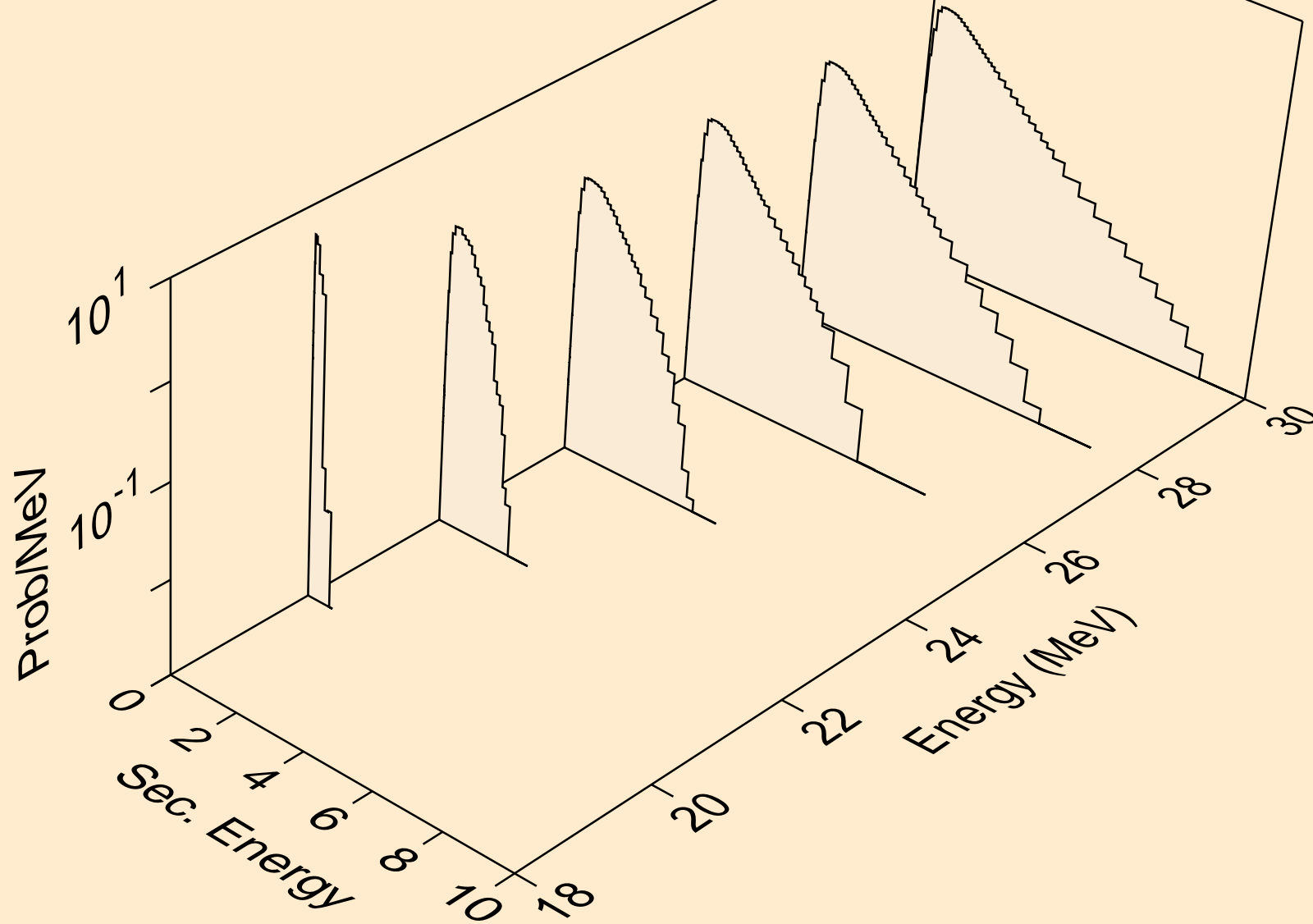

TA164 NEUTRON ACER TENDL-2021 LIBRARY; T=293.6K  
Neutron emission for (n,n\*)a

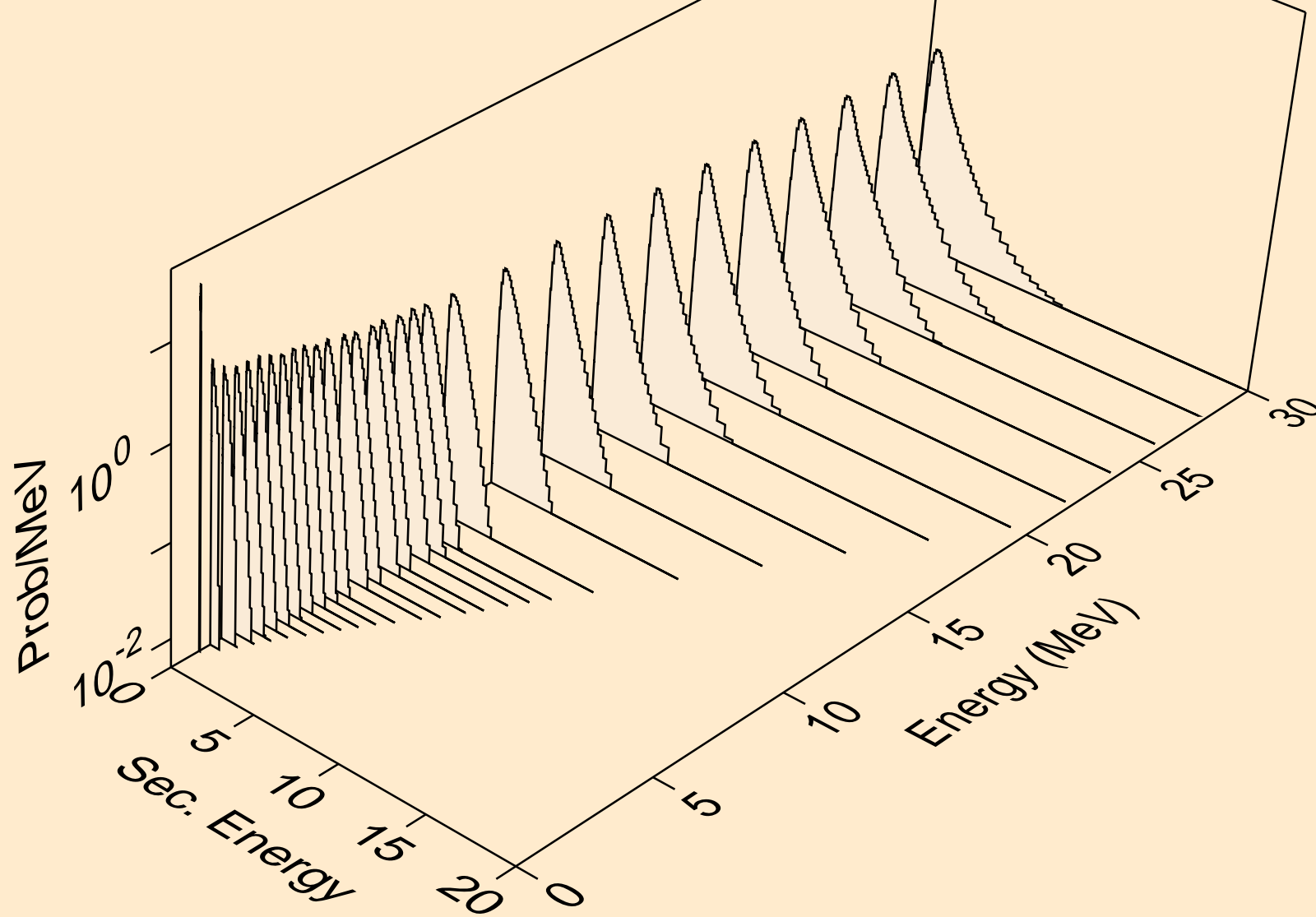

TA164 NEUTRON ACER TENDL-2021 LIBRARY; T=293.6K  
Neutron emission for (n,n\*)3a

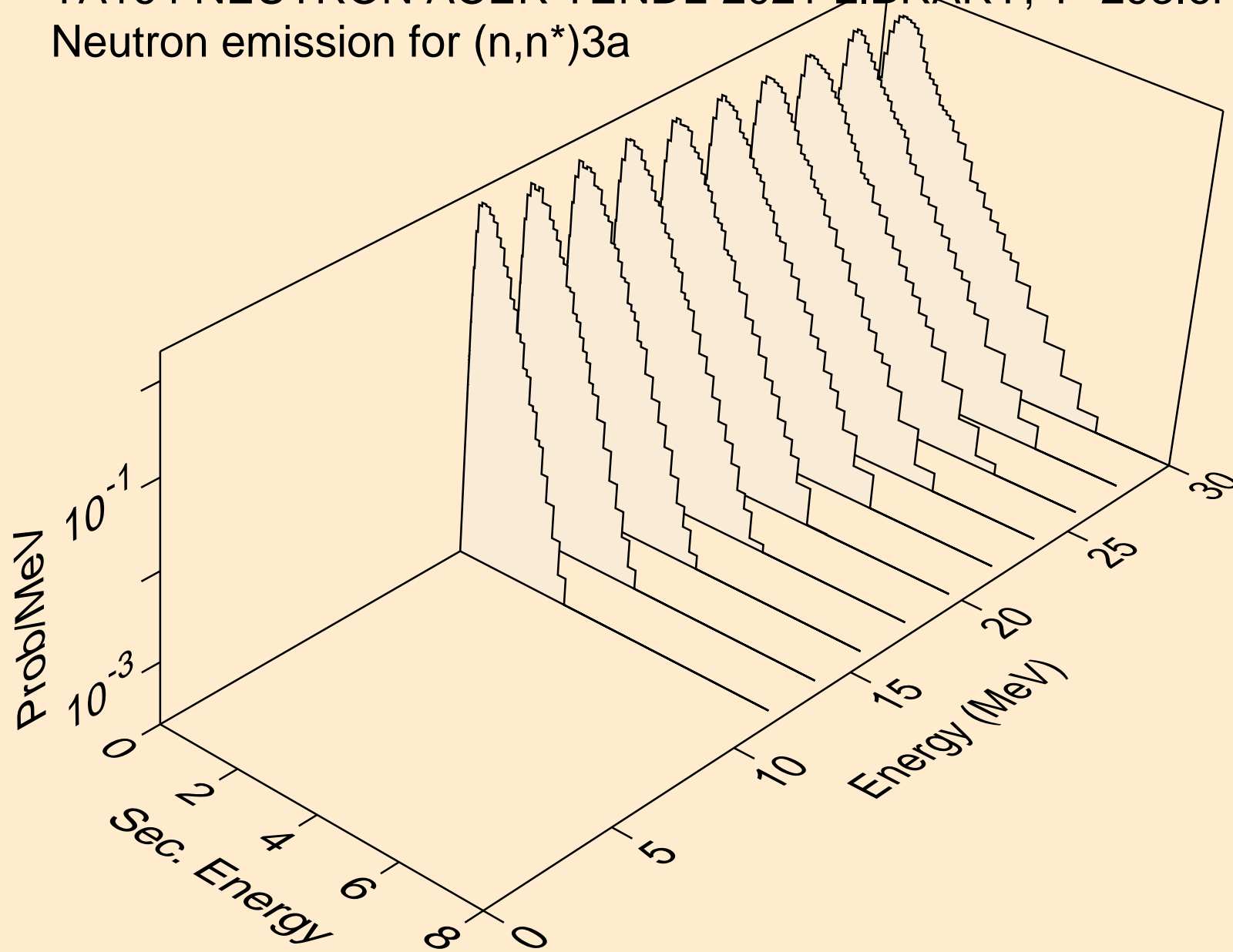

TA164 NEUTRON ACER TENDL-2021 LIBRARY; T=293.6K  
Neutron emission for (n,2n)a

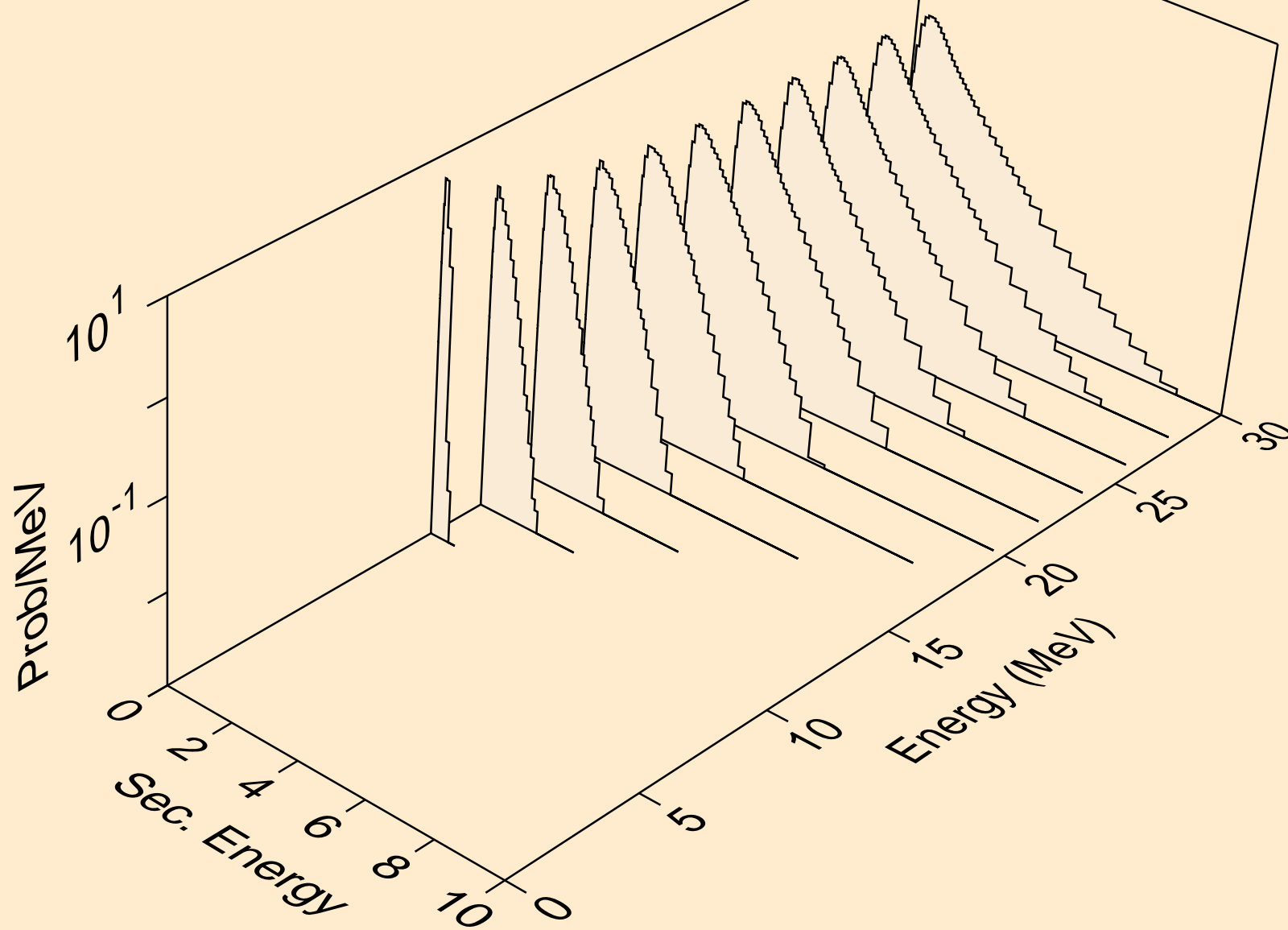

TA164 NEUTRON ACER TENDL-2021 LIBRARY; T=293.6K  
Neutron emission for (n,3n)a

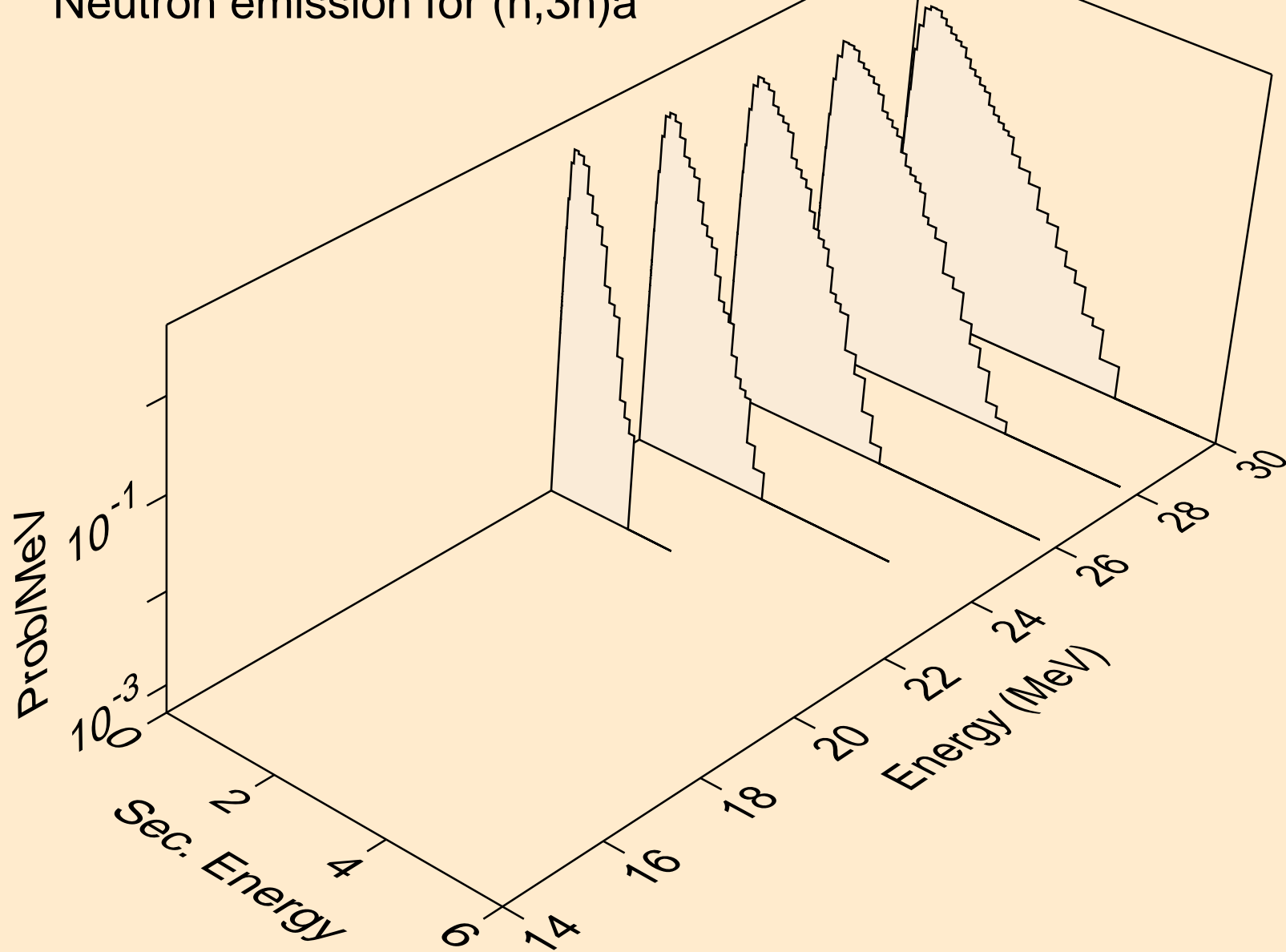

TA164 NEUTRON ACER TENDL-2021 LIBRARY; T=293.6K  
Neutron emission for (n,n\*)p

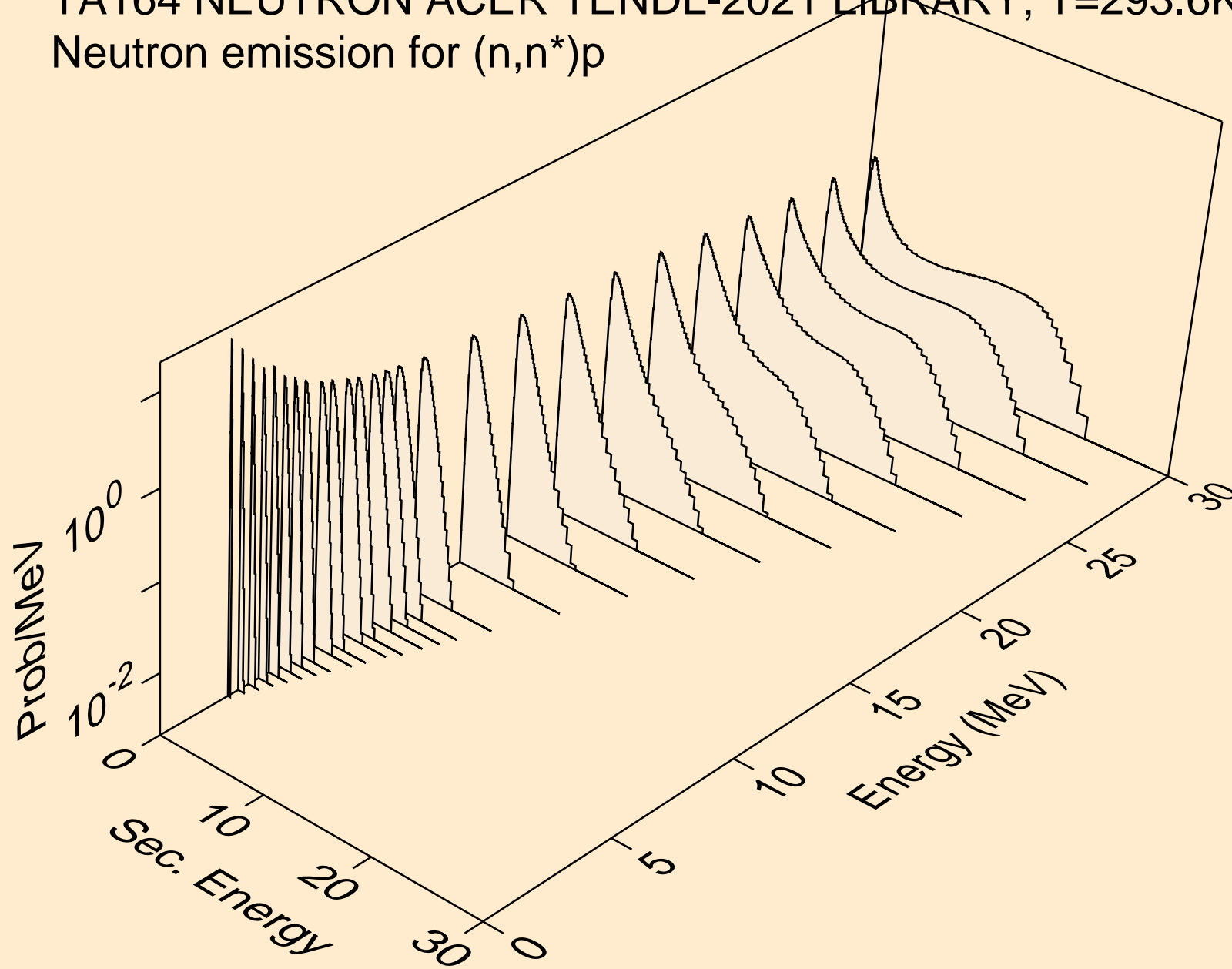

TA164 NEUTRON ACER TENDL-2021 LIBRARY; T=293.6K  
Neutron emission for (n,n\*)2a

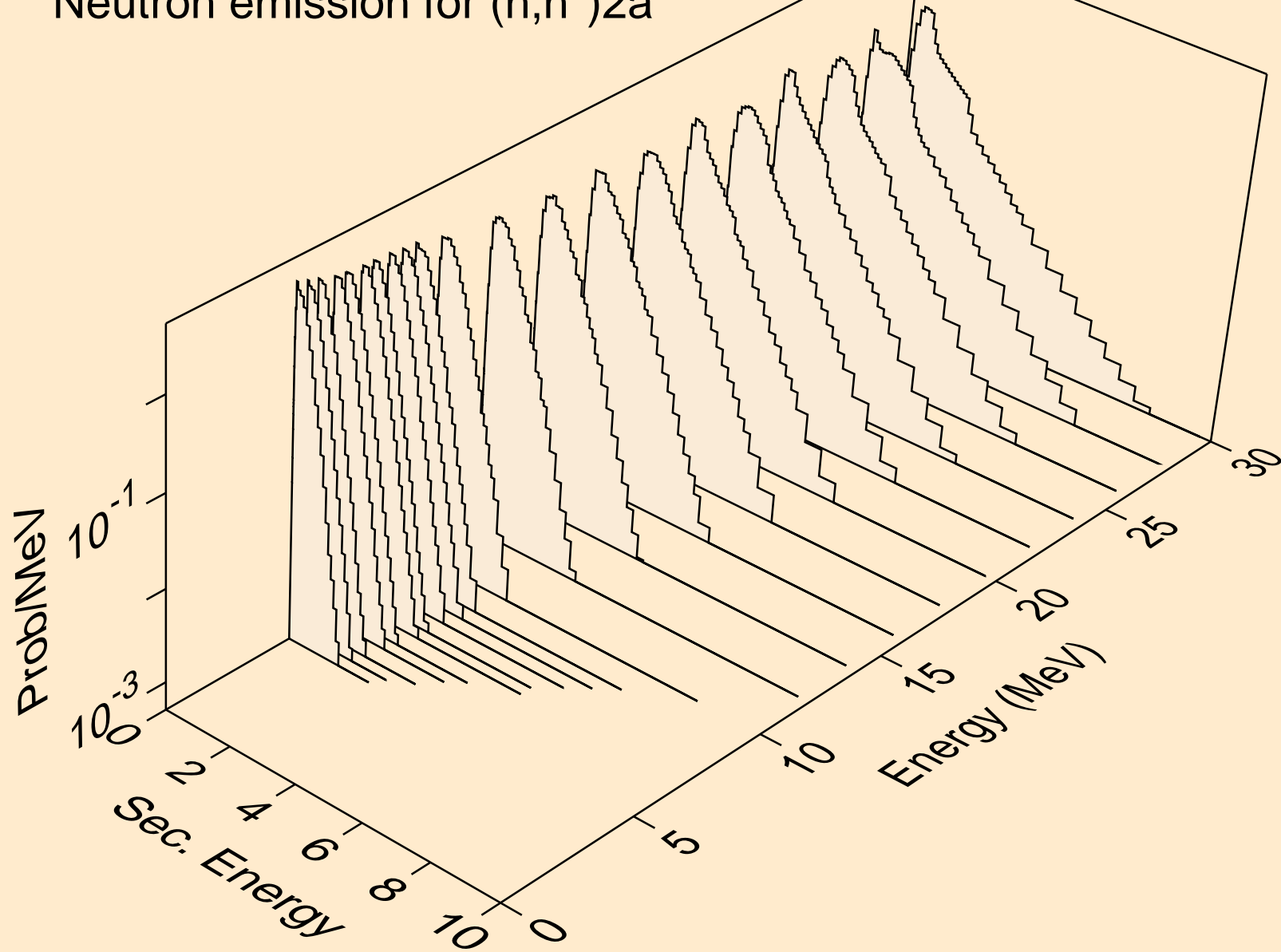



TA164 NEUTRON ACER TENDL-2021 LIBRARY; T=293.6K  
Neutron emission for (n,2n)2a

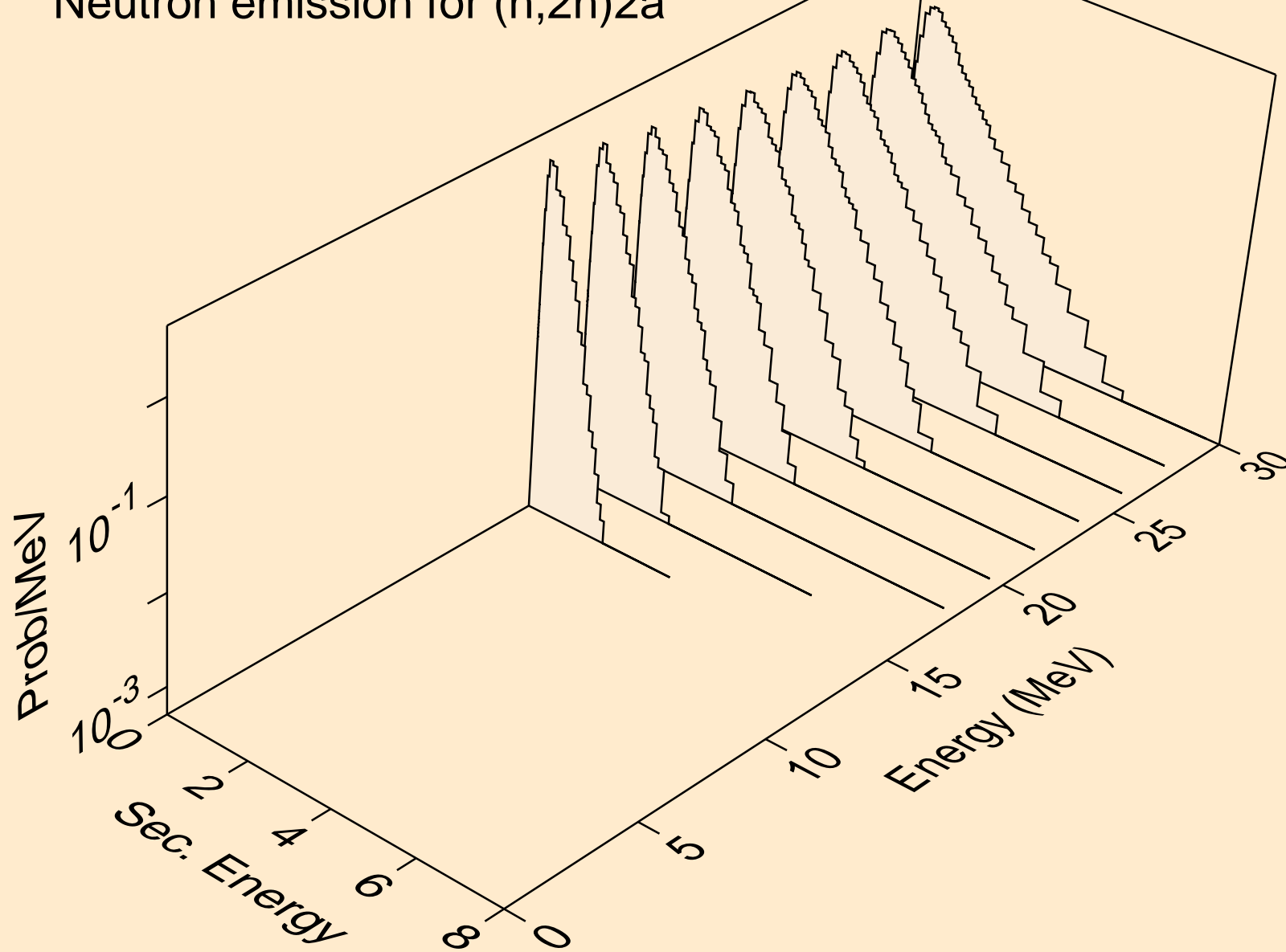

TA164 NEUTRON ACER TENDL-2021 LIBRARY; T=293.6K  
Neutron emission for (n,n\*)d

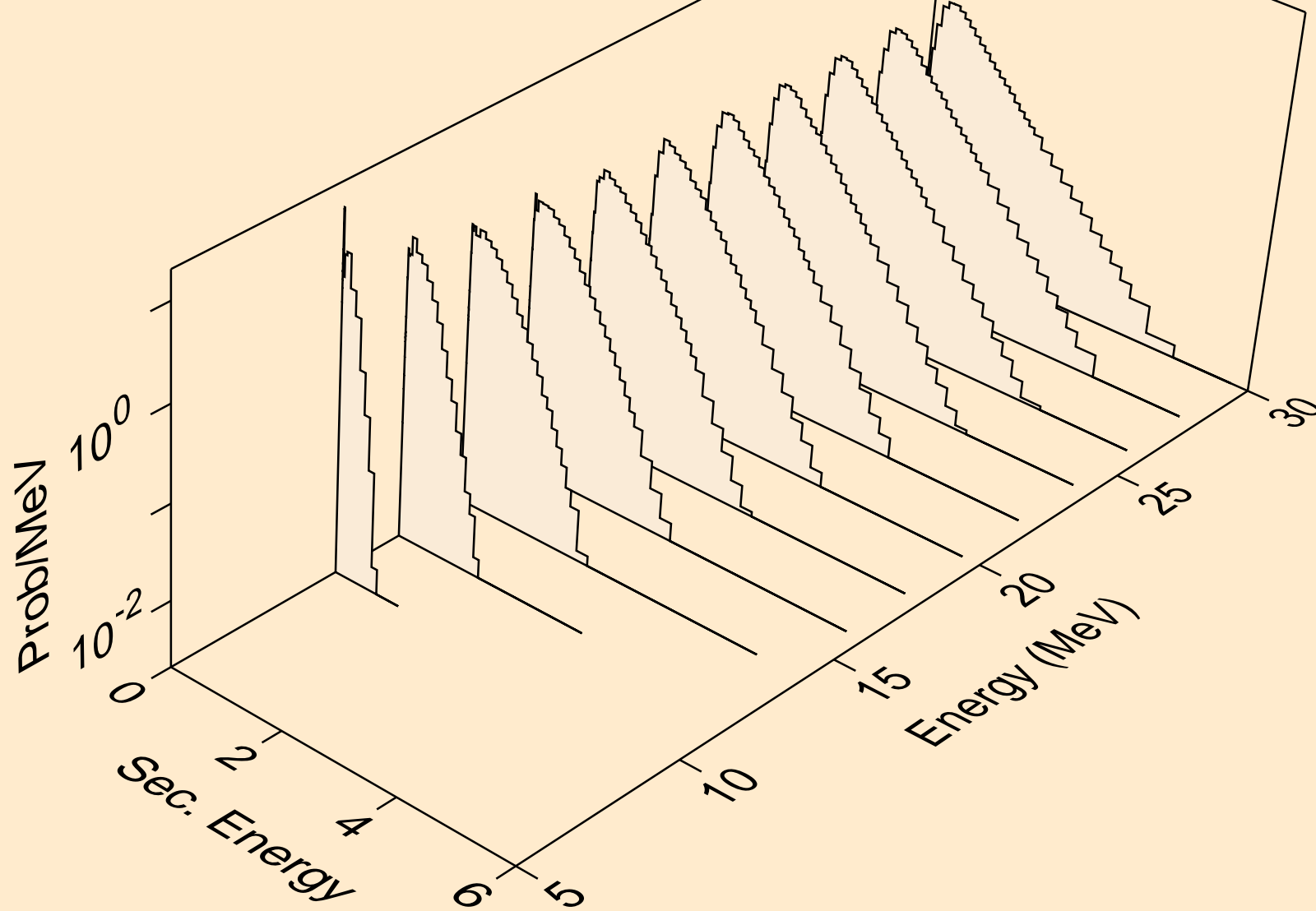

TA164 NEUTRON ACER TENDL-2021 LIBRARY; T=293.6K  
Neutron emission for (n,n\*)t

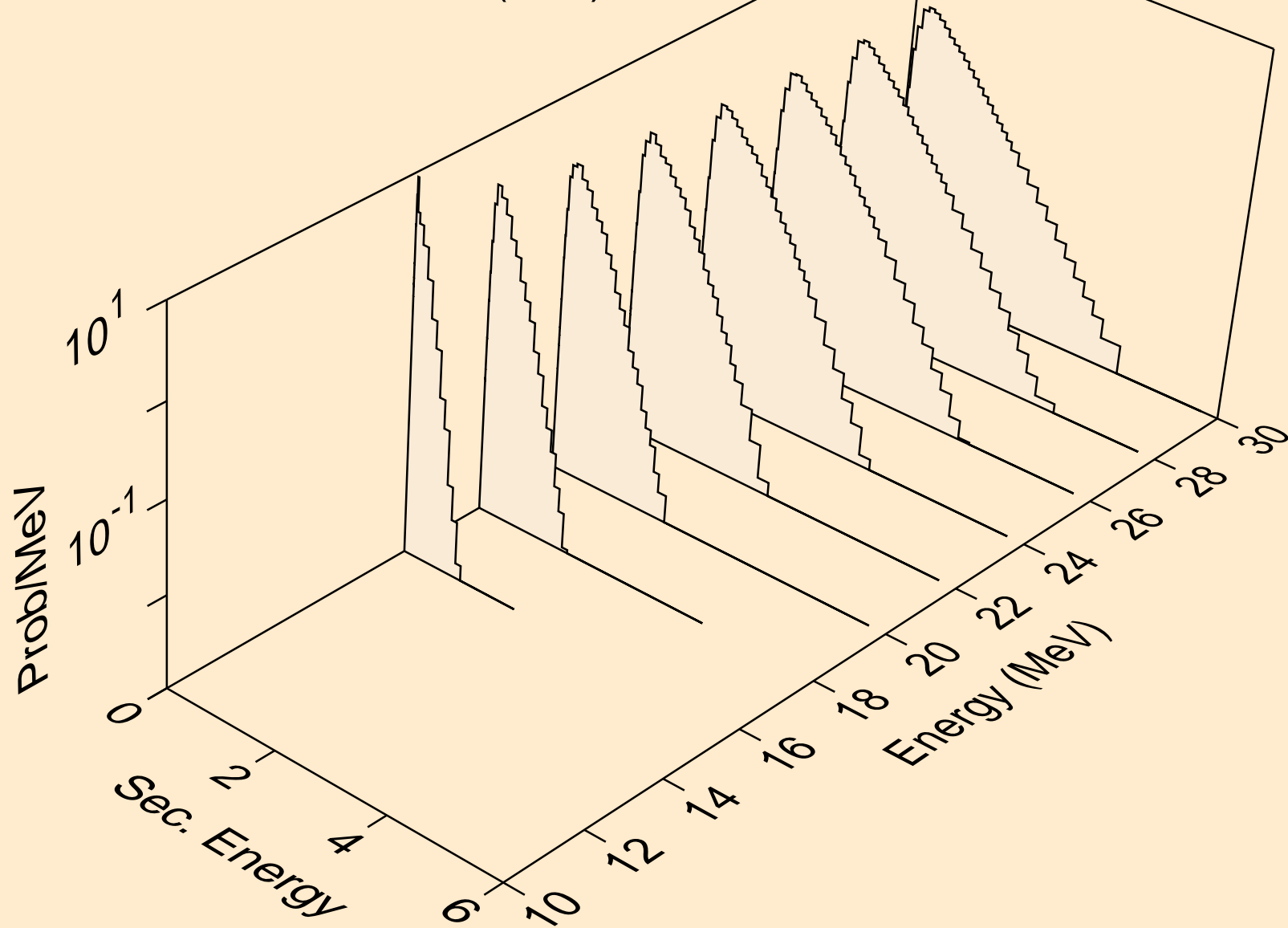

TA164 NEUTRON ACER TENDL-2021 LIBRARY; T=293.6K  
Neutron emission for (n,n\*)he3

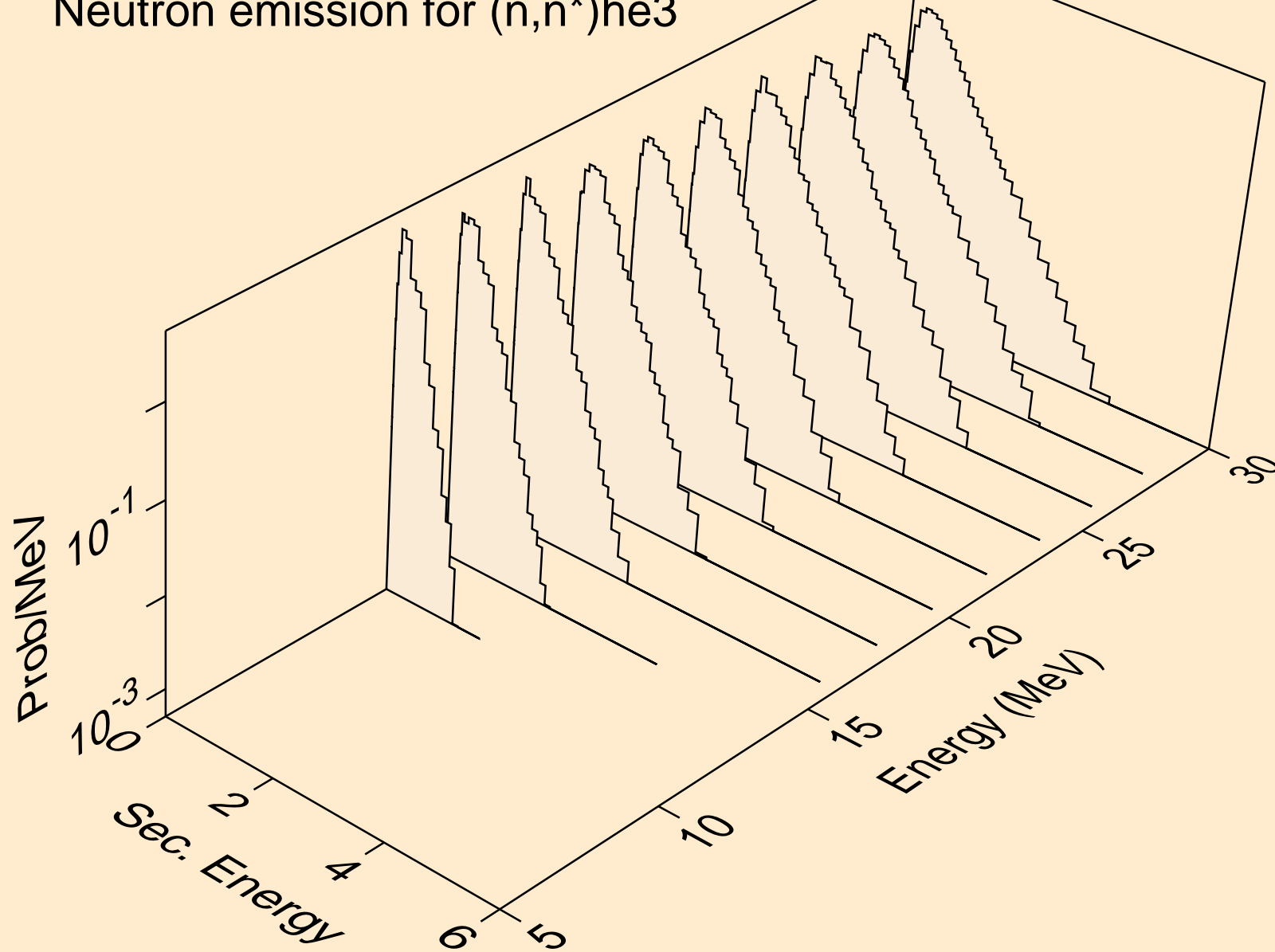

TA164 NEUTRON ACER TENDL-2021 LIBRARY; T=293.6K  
Neutron emission for (n,4n)

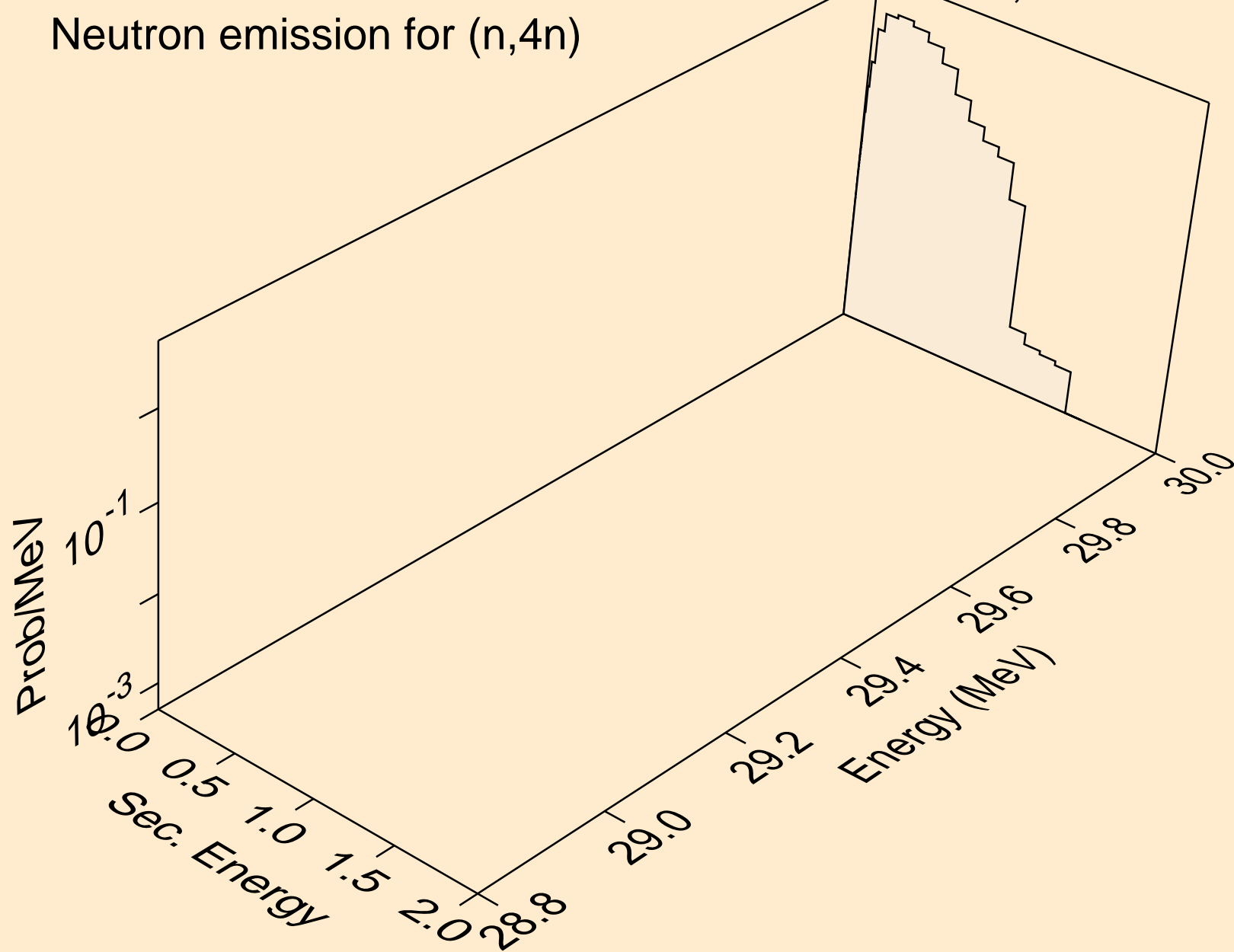

TA164 NEUTRON ACER TENDL-2021 LIBRARY; T=293.6K  
Neutron emission for (n,2np)

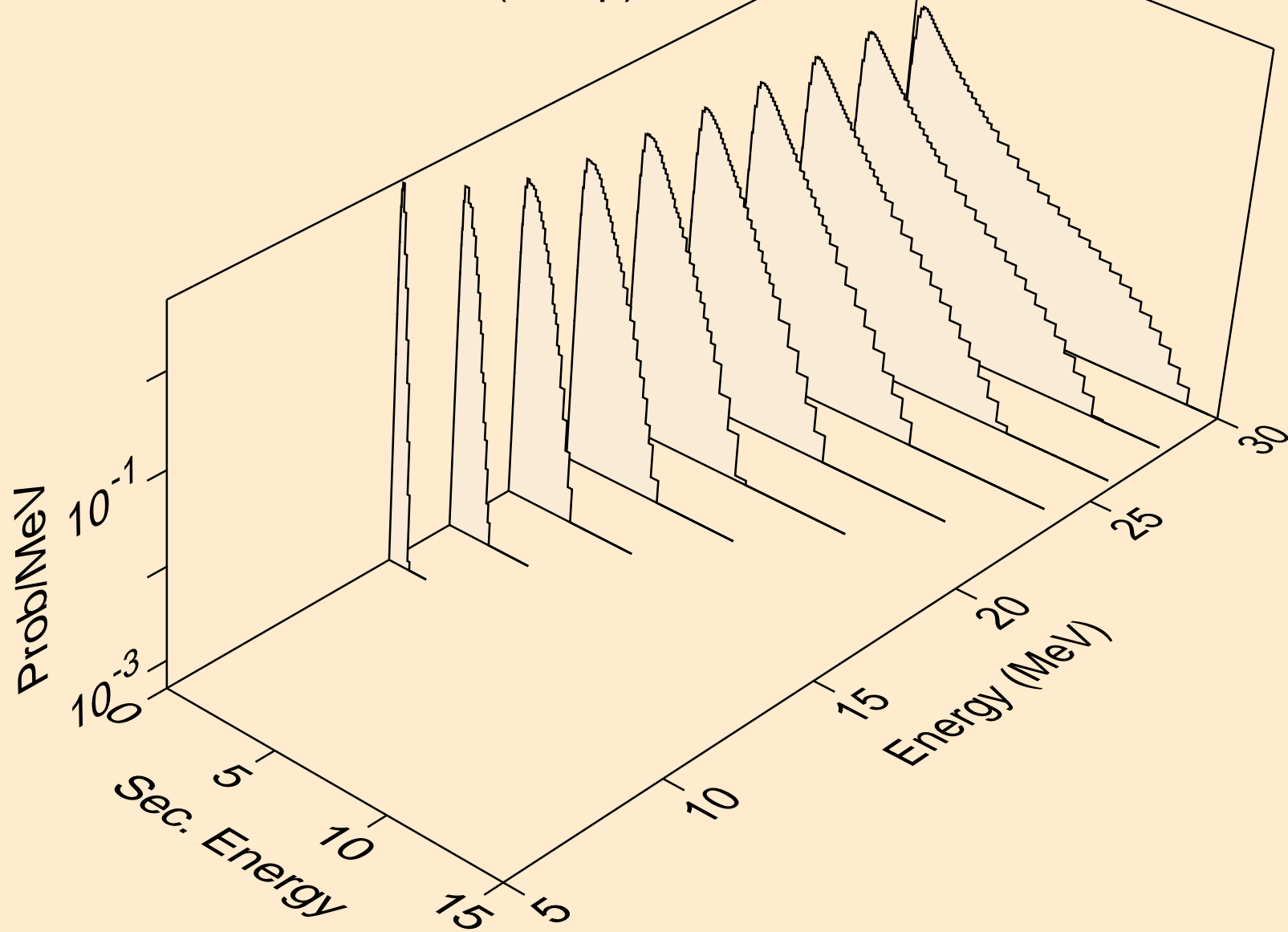

TA164 NEUTRON ACER TENDL-2021 LIBRARY; T=293.6K  
Neutron emission for (n,3np)

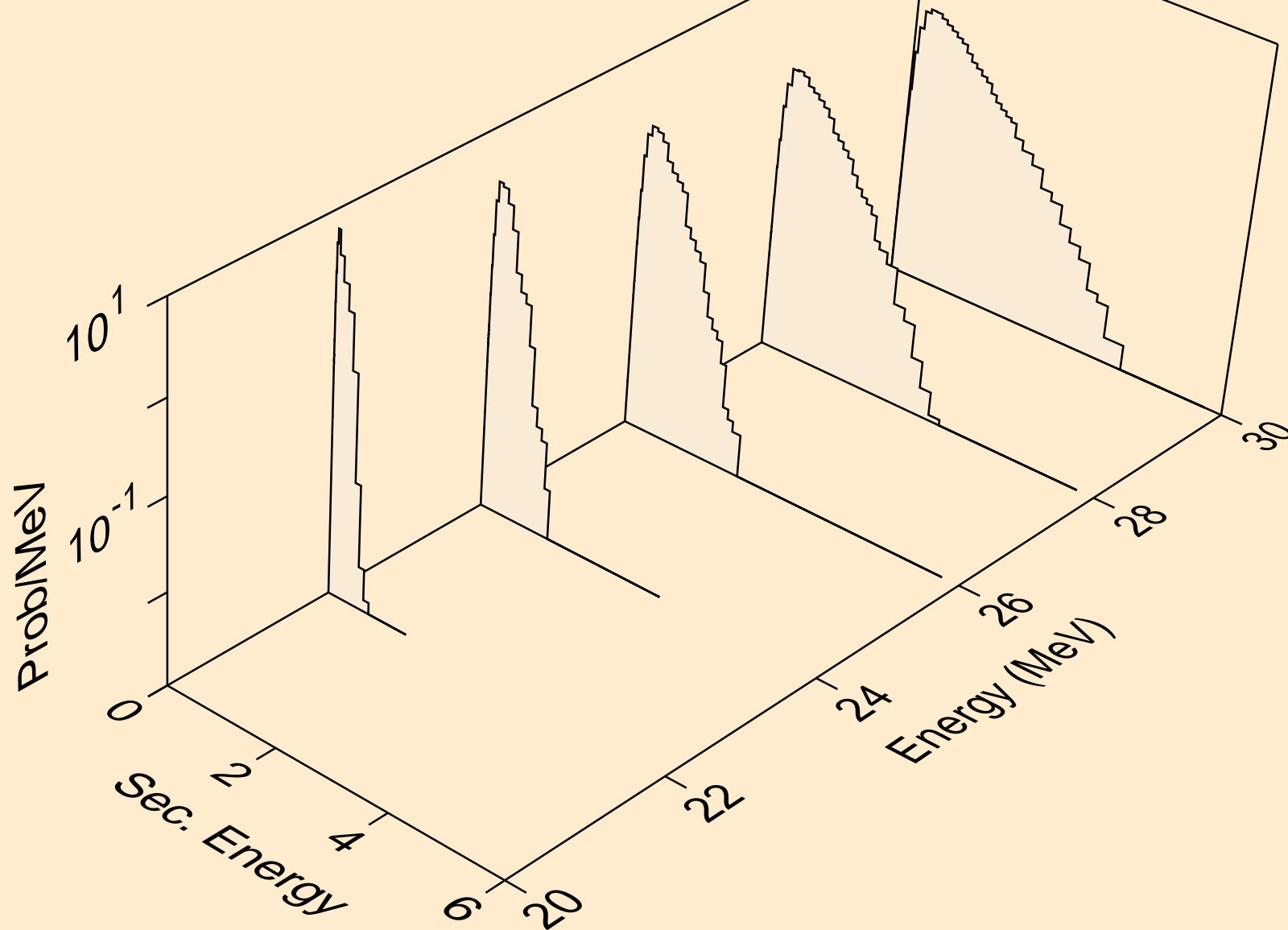

TA164 NEUTRON ACER TENDL-2021 LIBRARY; T=293.6K  
Neutron emission for (n,2np)

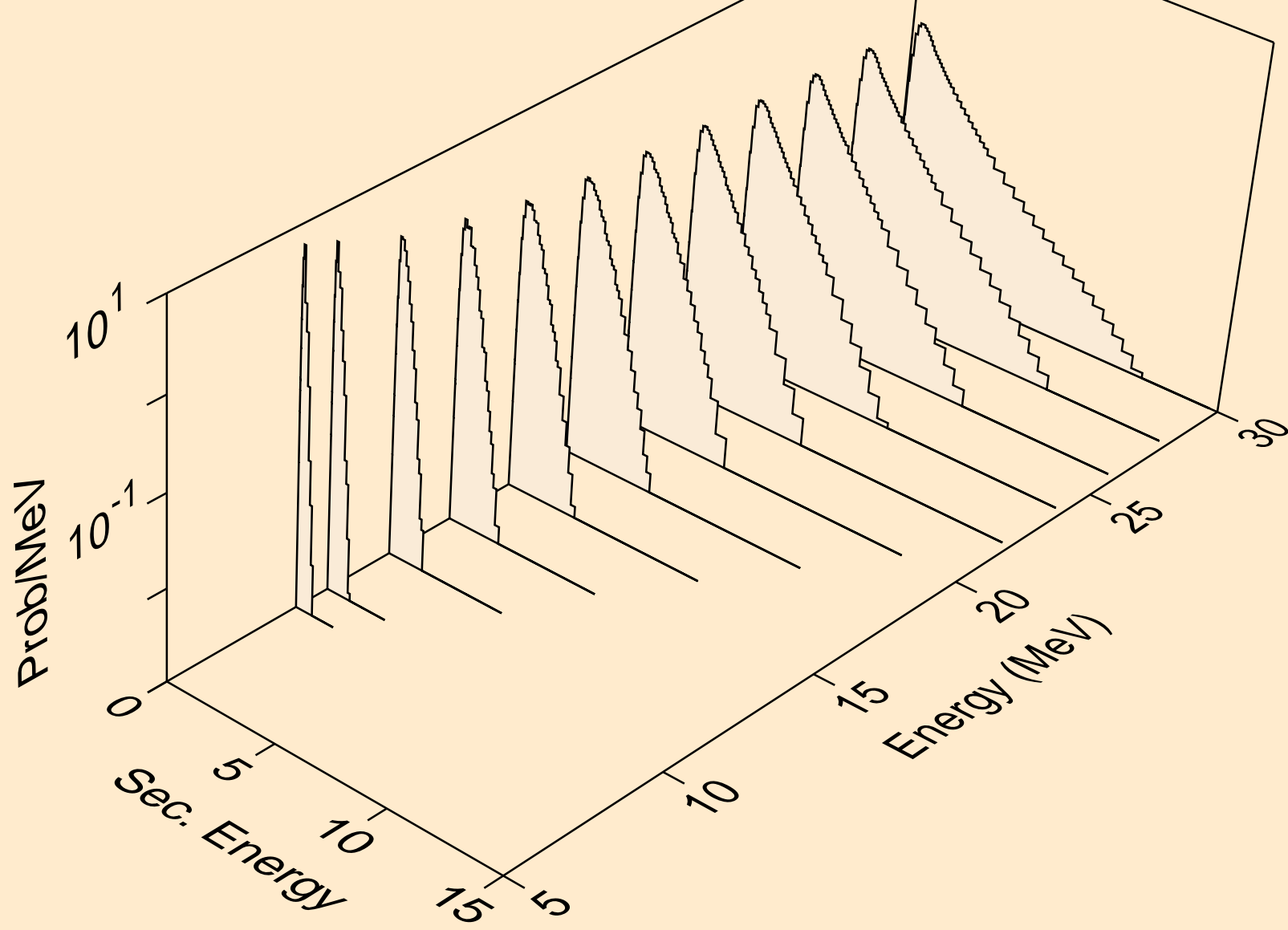



TA164 NEUTRON ACER TENDL-2021 LIBRARY; T=293.6K  
Neutron emission for (n,npa)

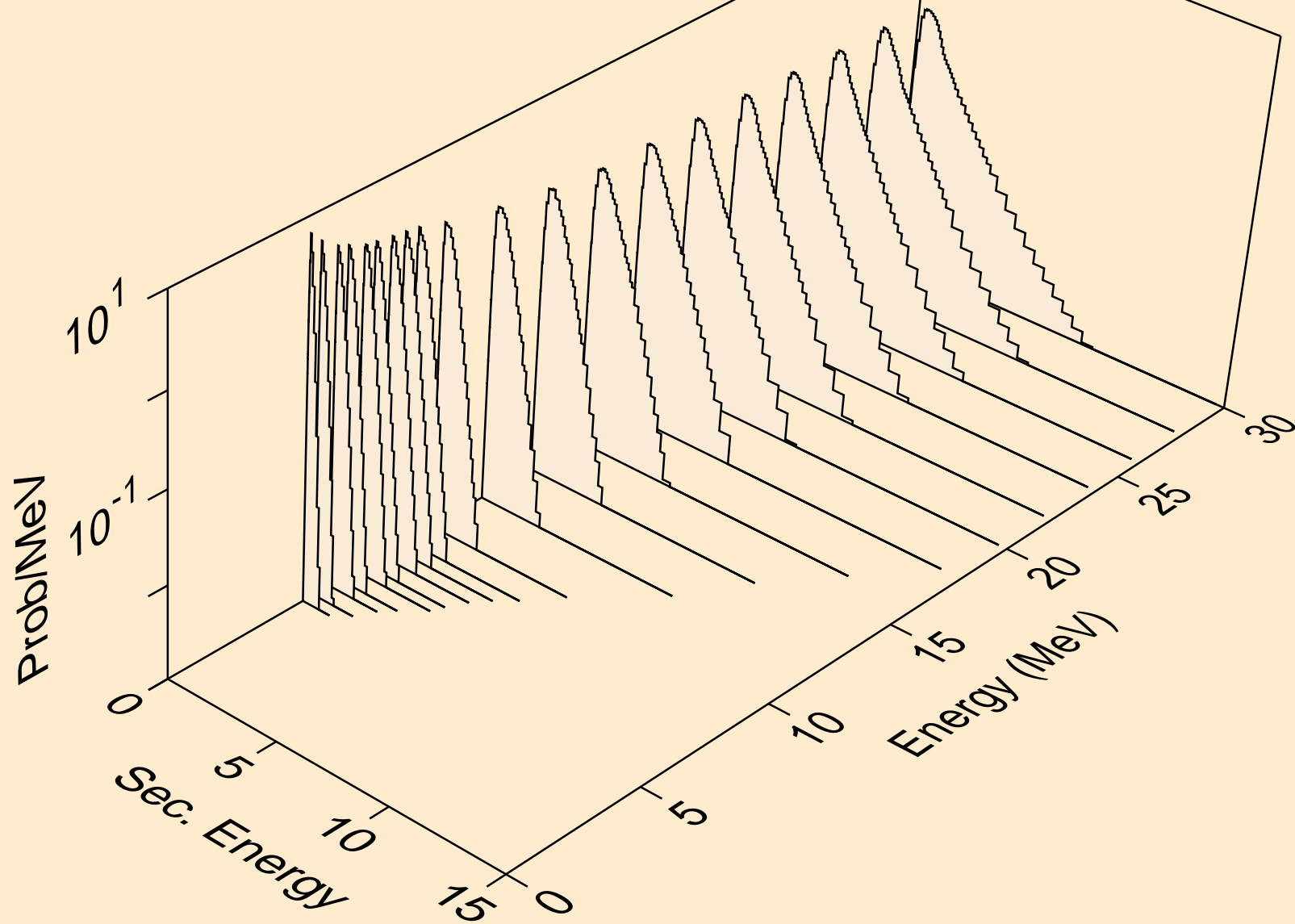

TA164 NEUTRON ACER TENDL-2021 LIBRARY; T=293.6K  
Neutron emission for (n,n\*c)

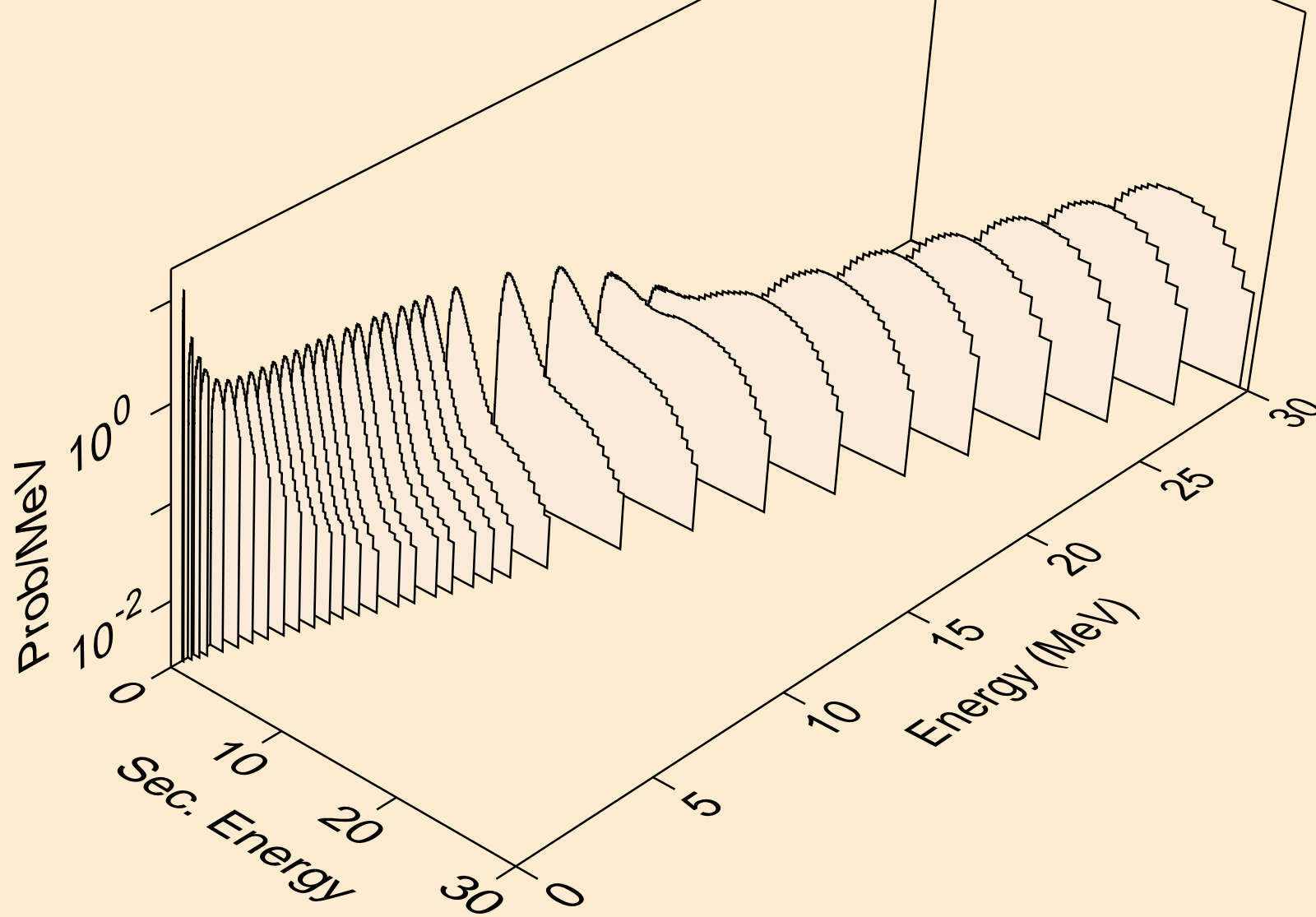

TA164 NEUTRON ACER TENDL-2021 LIBRARY; T=293.6K  
Photon emission for (n,x)

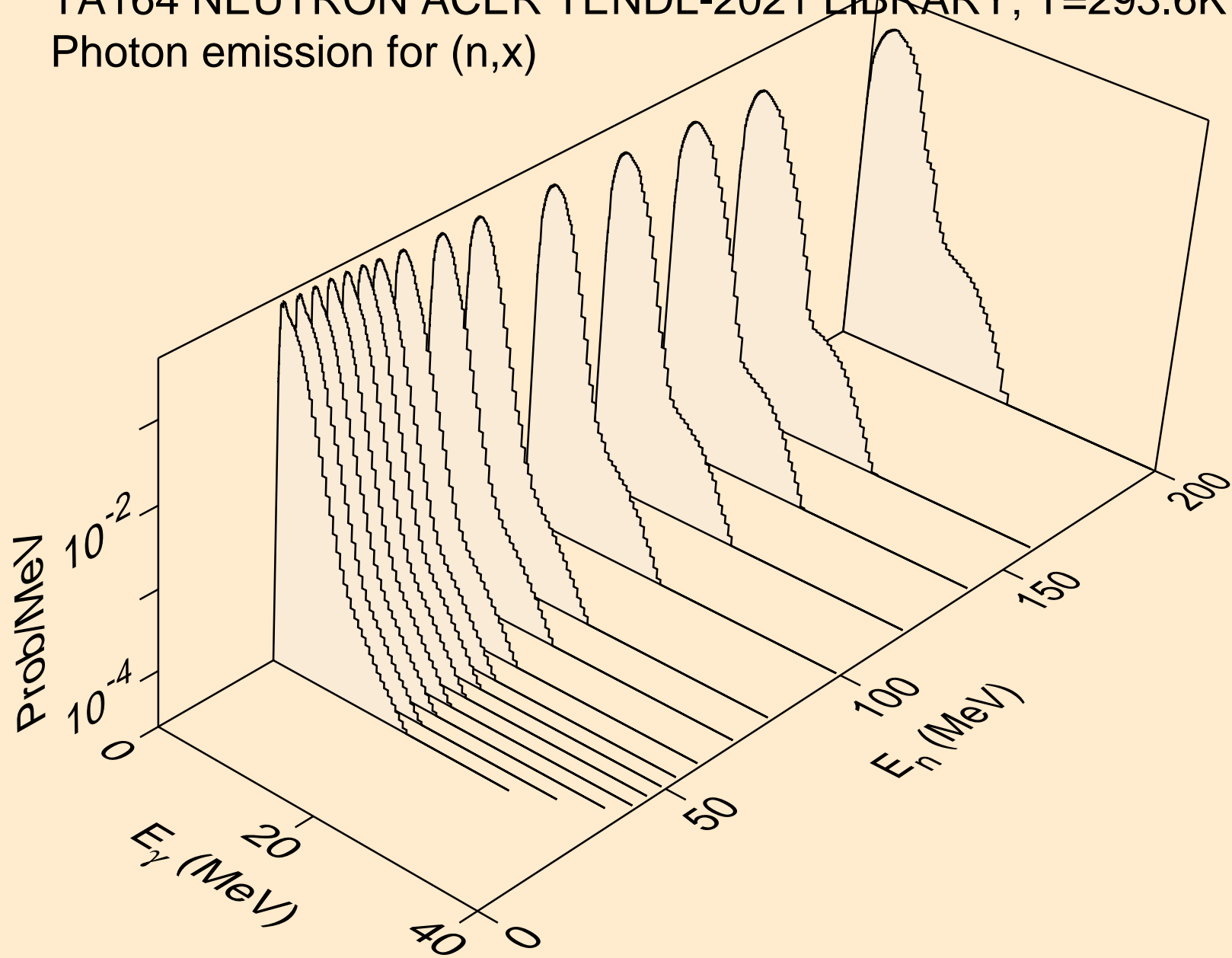

TA164 NEUTRON ACER TENDL-2021 LIBRARY; T=293.6K  
Photon emission for (n,2nd)

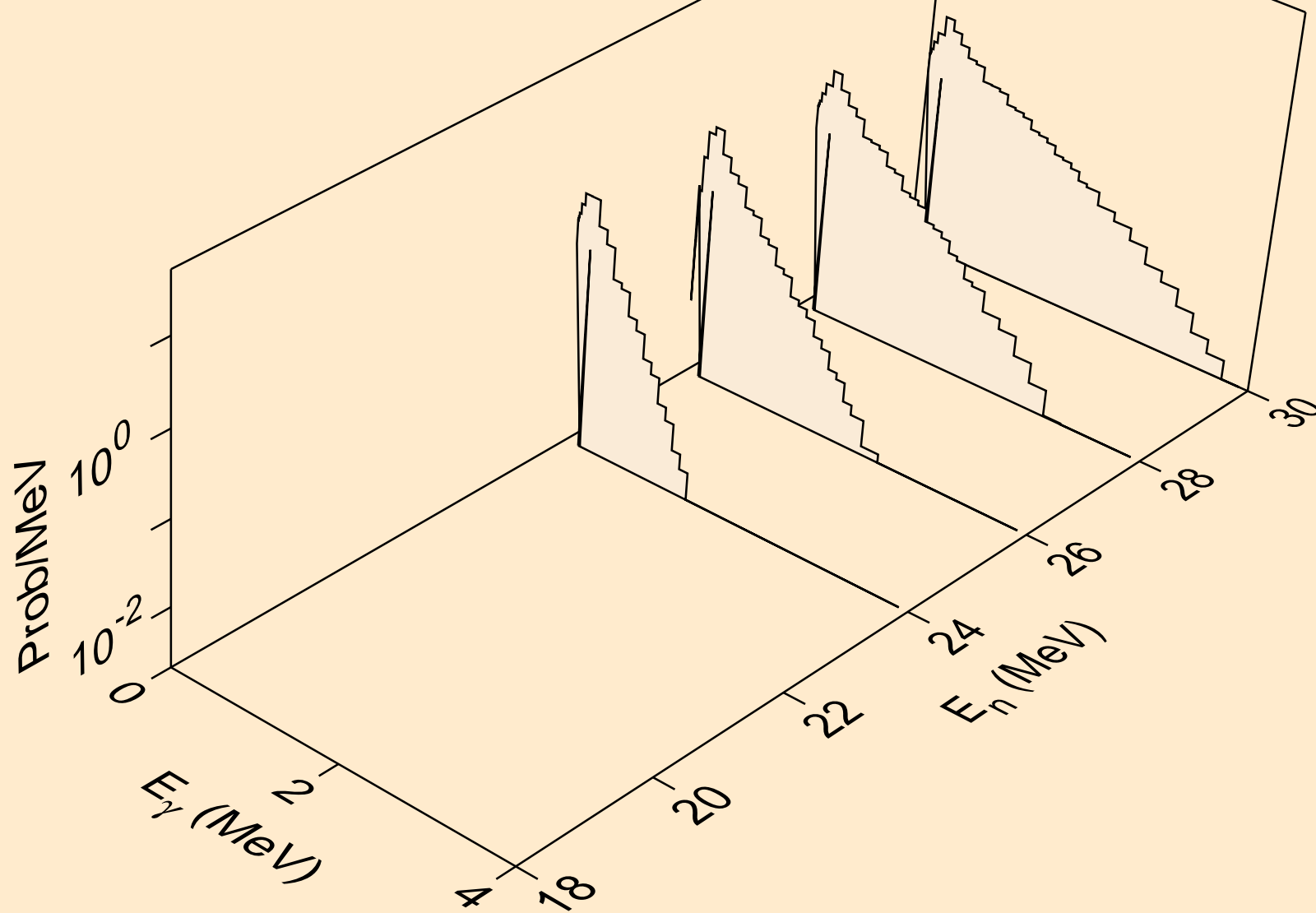

TA164 NEUTRON ACER TENDL-2021 LIBRARY; T=293.6K  
Photon emission for (n,2n)

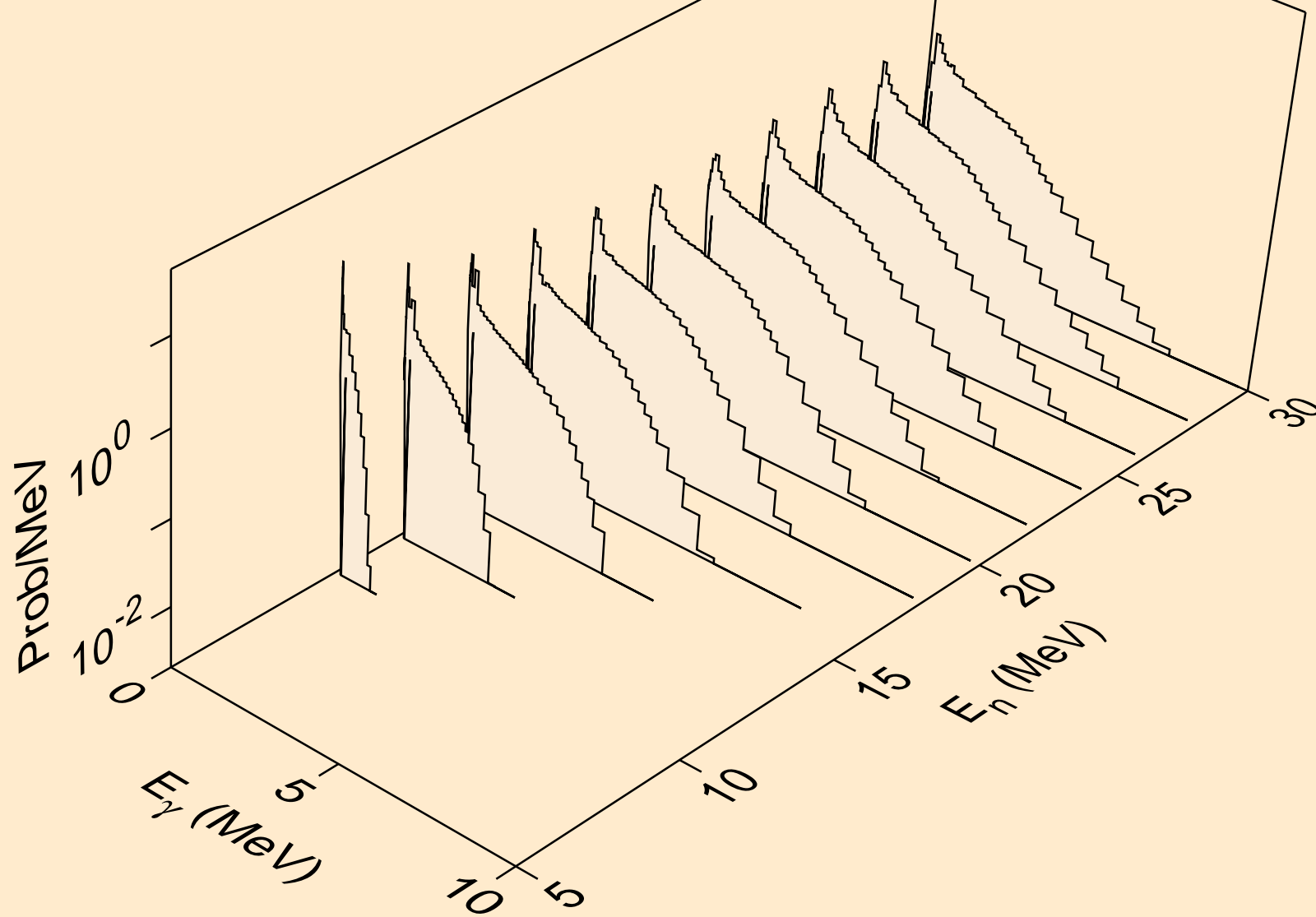

TA164 NEUTRON ACER TENDL-2021 LIBRARY; T=293.6K  
Photon emission for (n,3n)

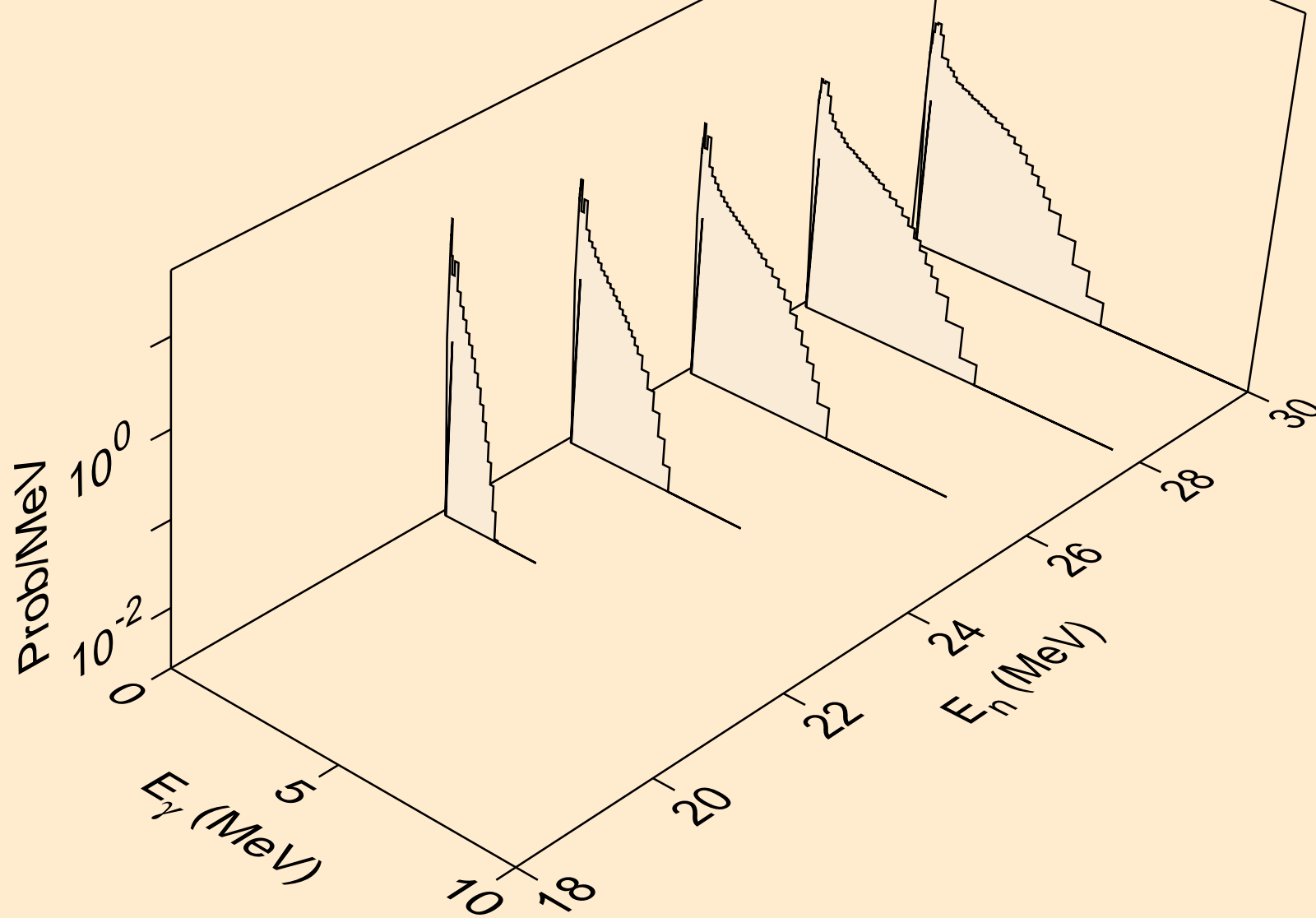

TA164 NEUTRON ACER TENDL-2021 LIBRARY; T=293.6K  
Photon emission for (n,n\*)a

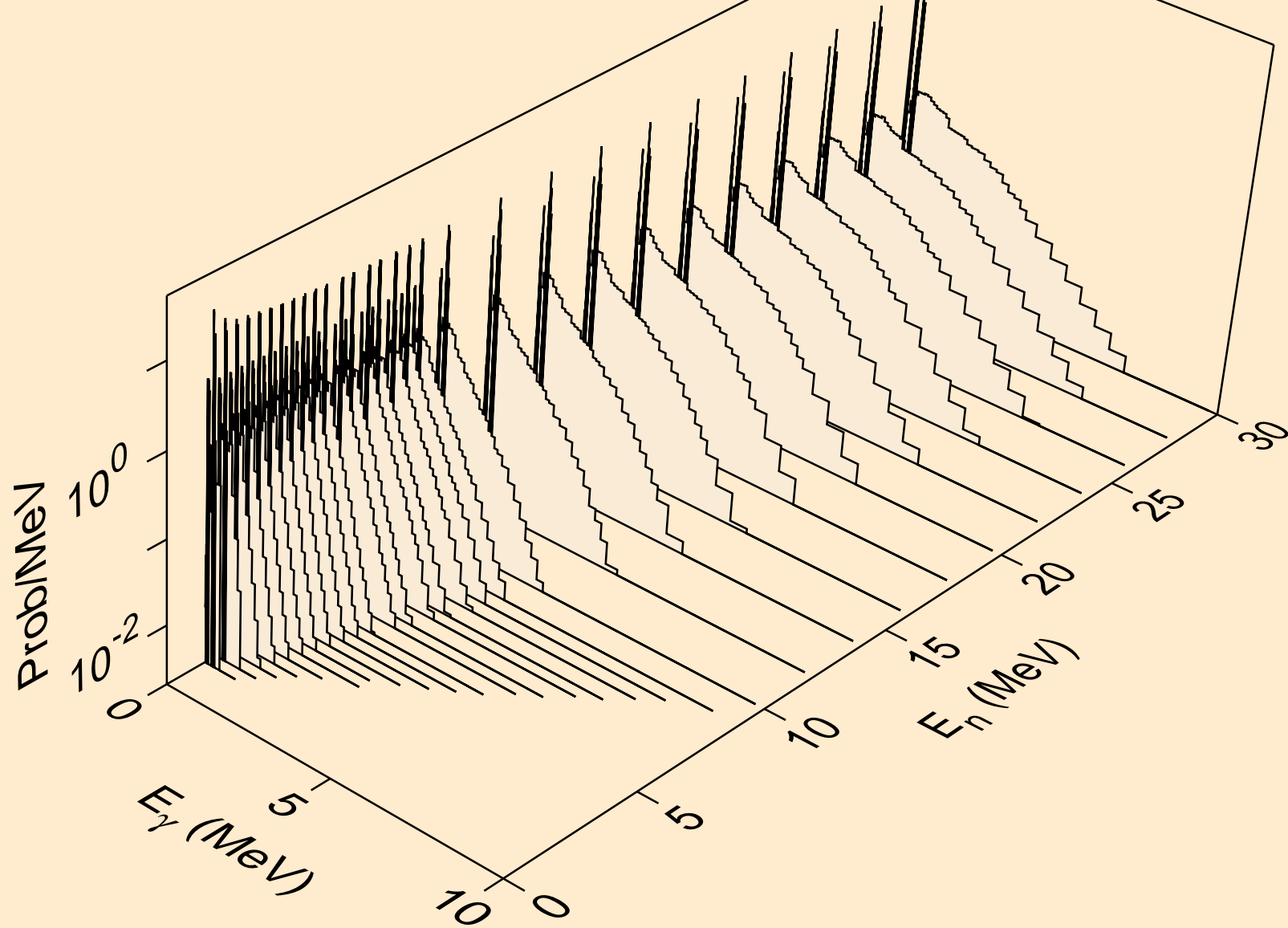

TA164 NEUTRON ACER TENDL-2021 LIBRARY; T=293.6K  
Photon emission for (n,n\*)3a

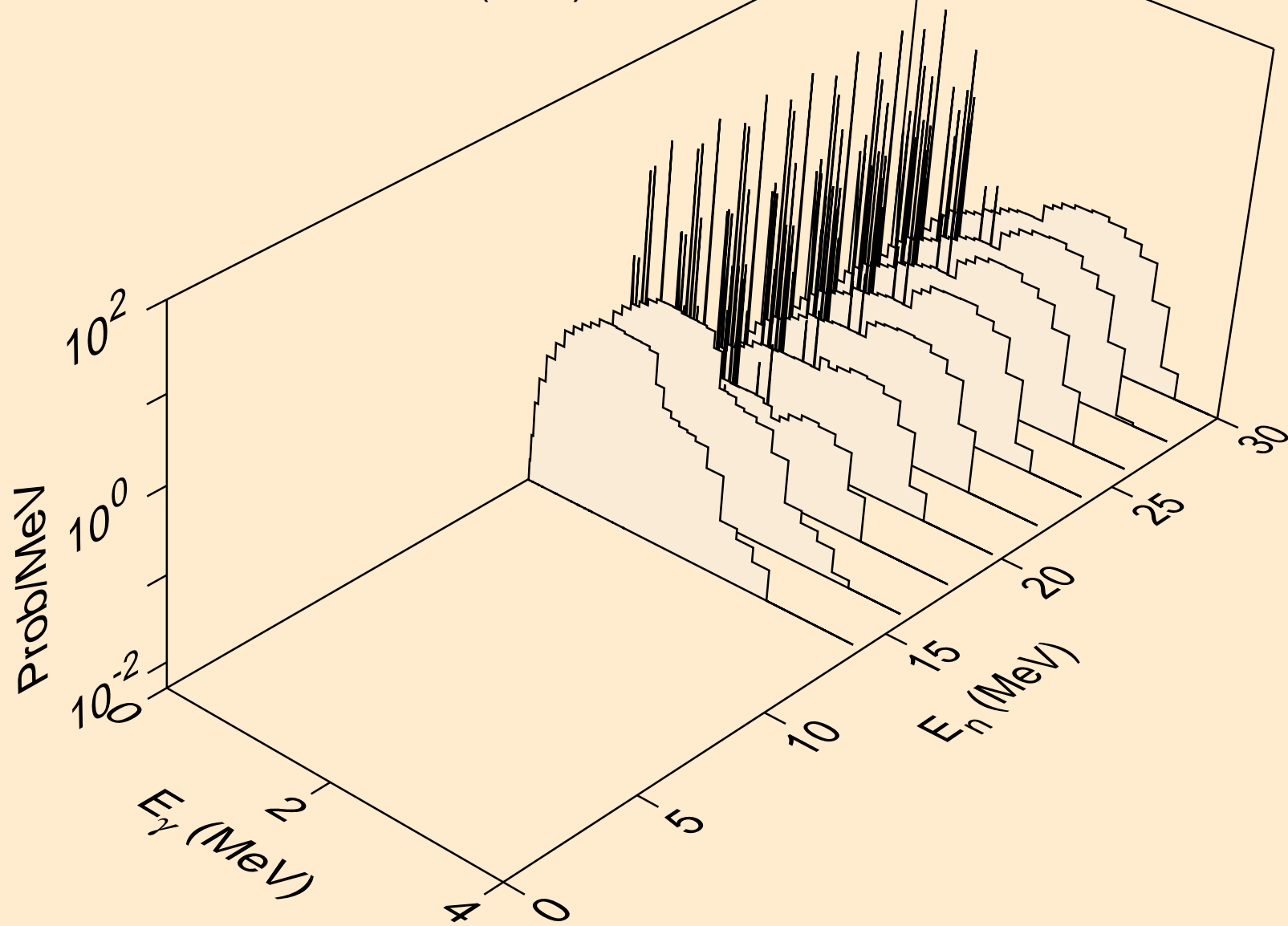



TA164 NEUTRON ACER TENDL-2021 LIBRARY; T=293.6K  
Photon emission for (n,2n)a

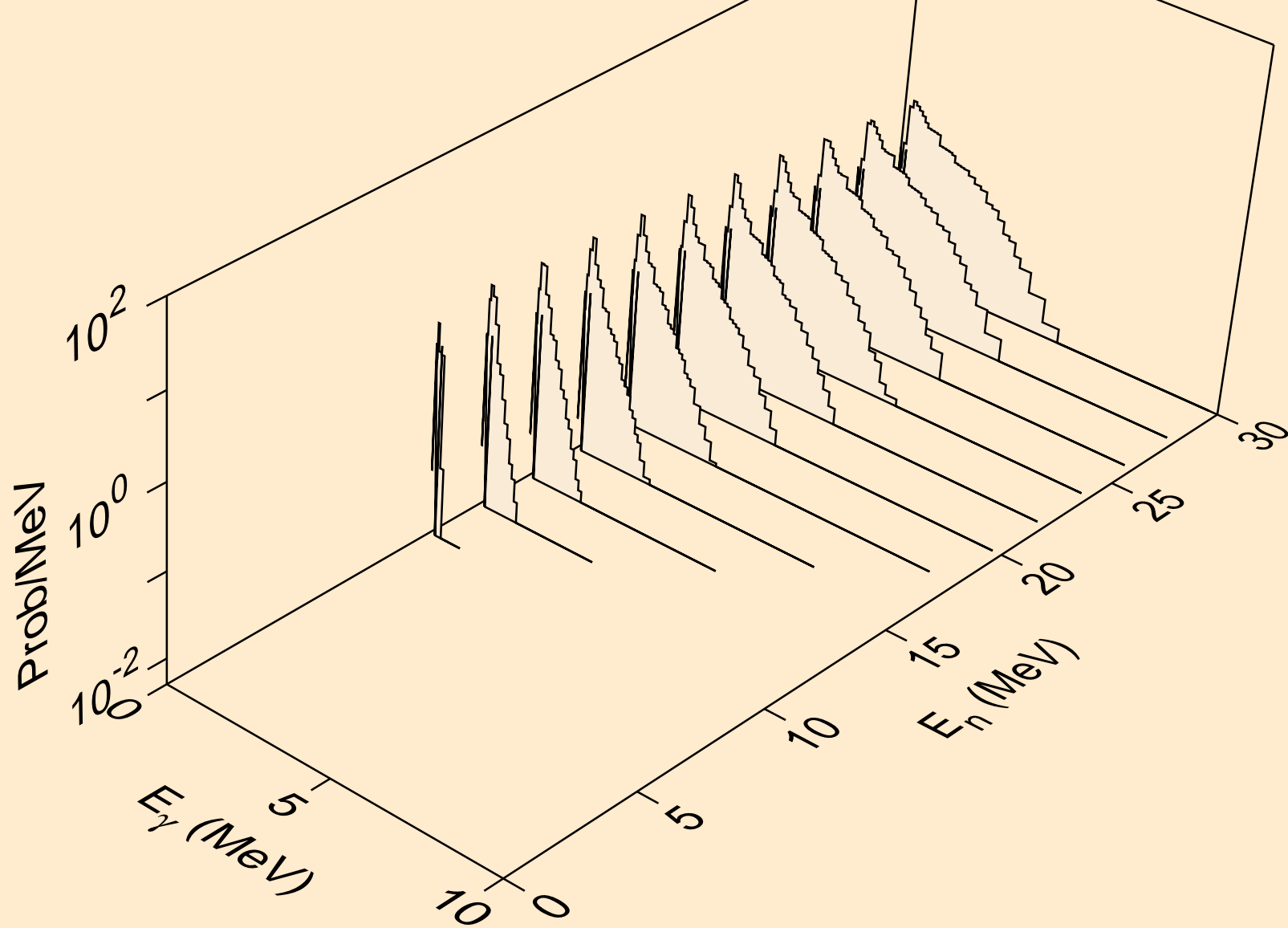

TA164 NEUTRON ACER TENDL-2021 LIBRARY; T=293.6K  
Photon emission for (n,3n)a

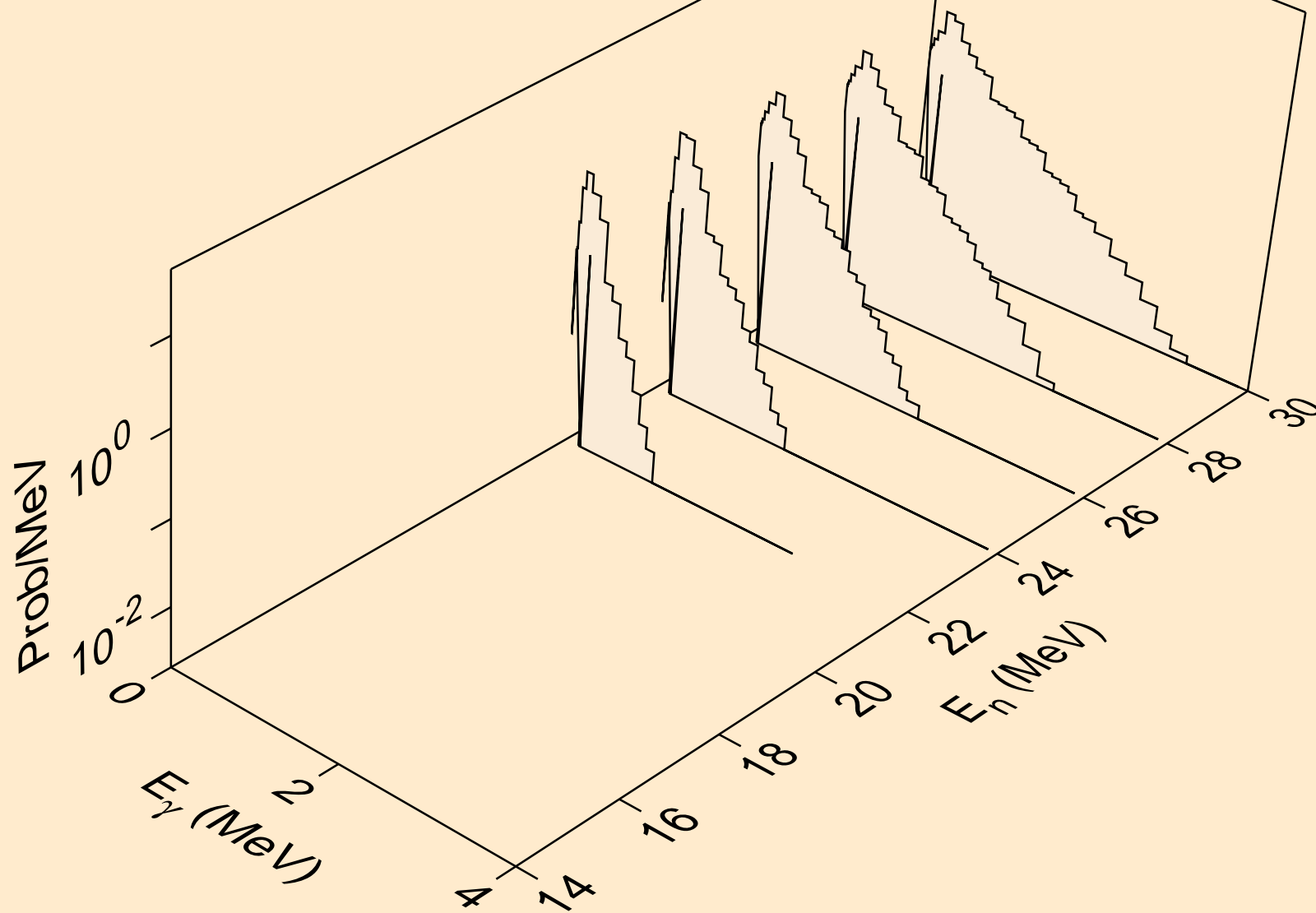

TA164 NEUTRON ACER TENDL-2021 LIBRARY; T=293.6K  
Photon emission for (n,n\*)p

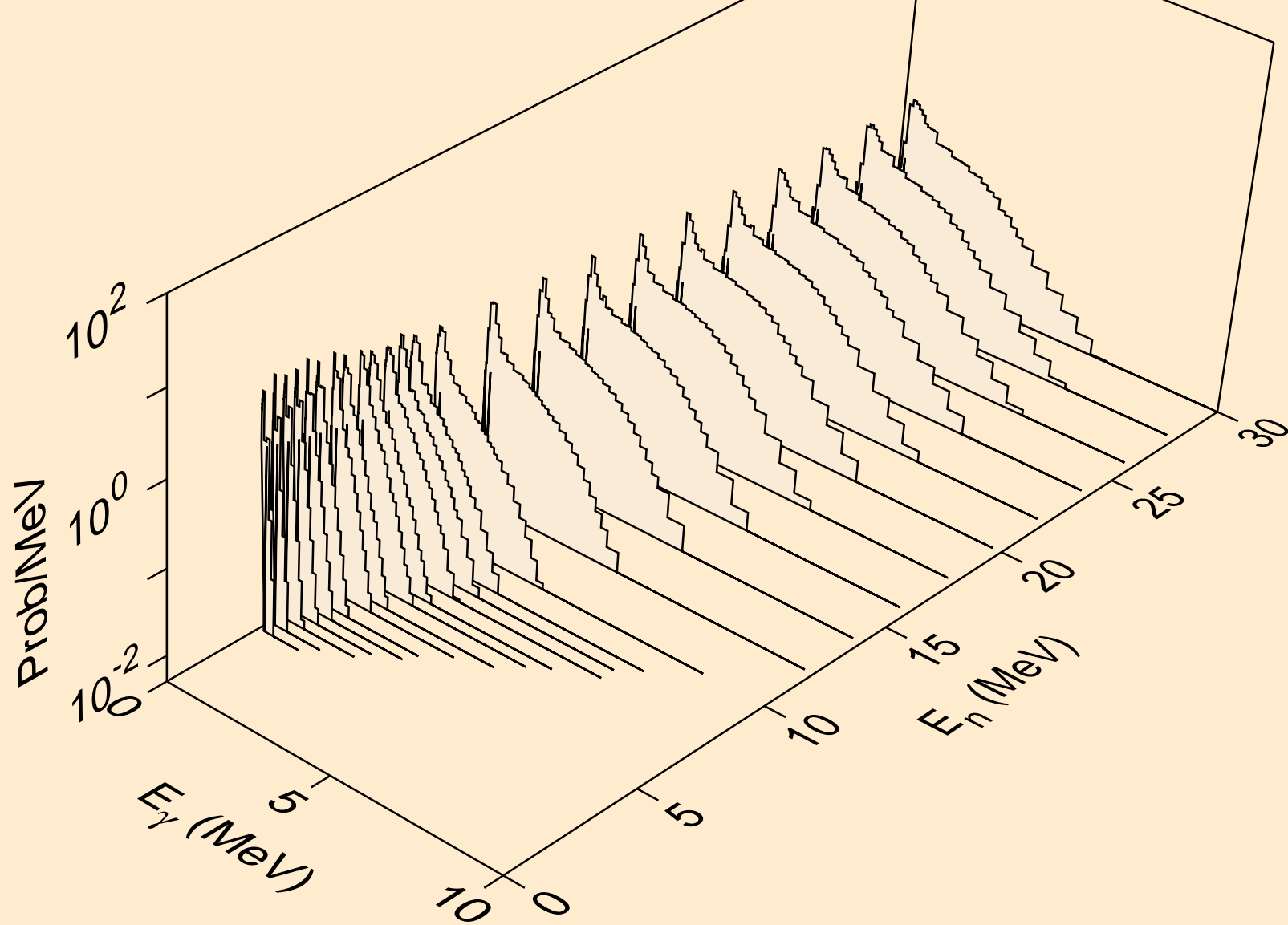

TA164 NEUTRON ACER TENDL-2021 LIBRARY; T=293.6K  
Photon emission for (n,n\*)2a

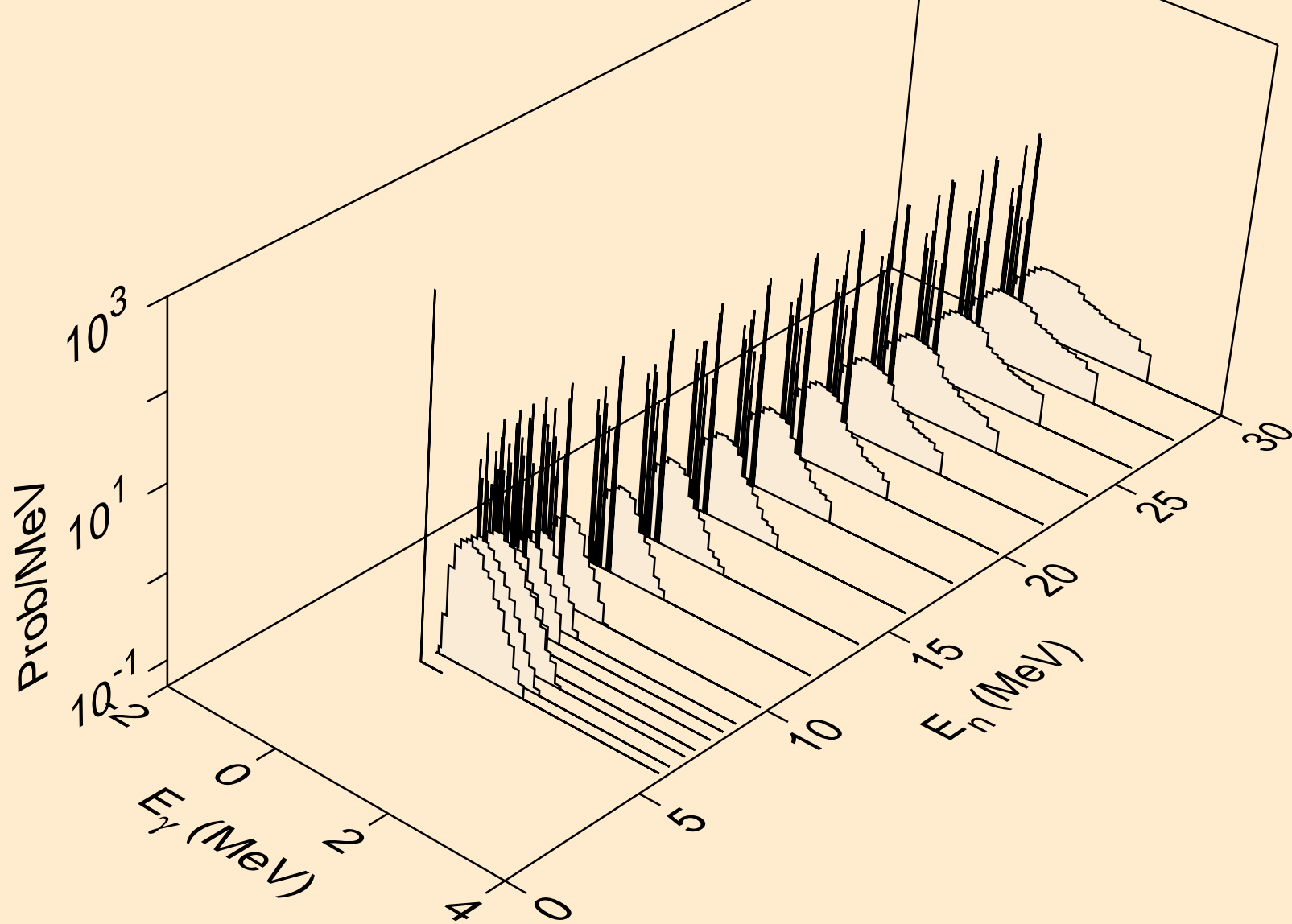

TA164 NEUTRON ACER TENDL-2021 LIBRARY; T=293.6K  
Photon emission for (n,2n)2a

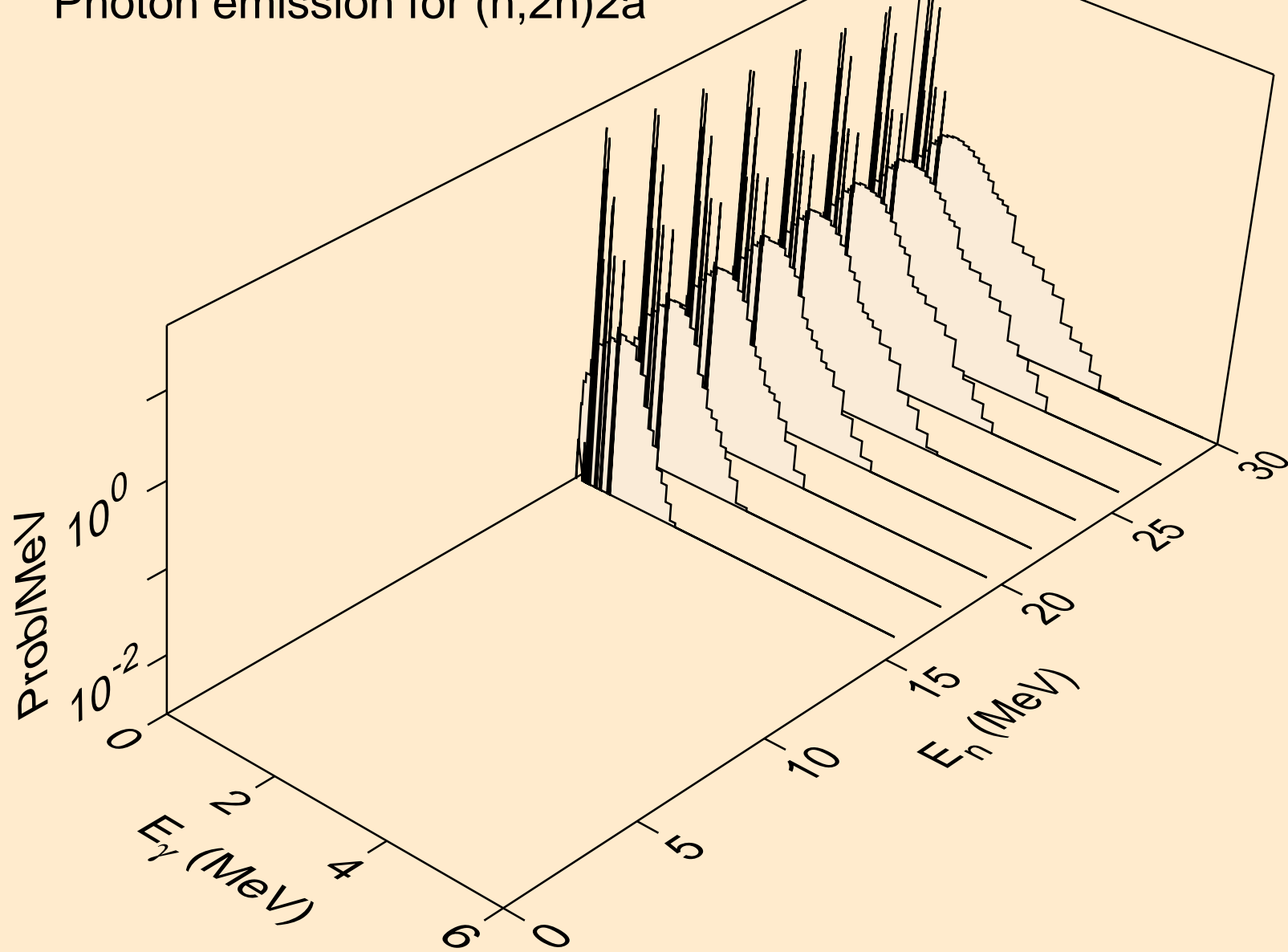

TA164 NEUTRON ACER TENDL-2021 LIBRARY; T=293.6K  
Photon emission for (n,n\*)d

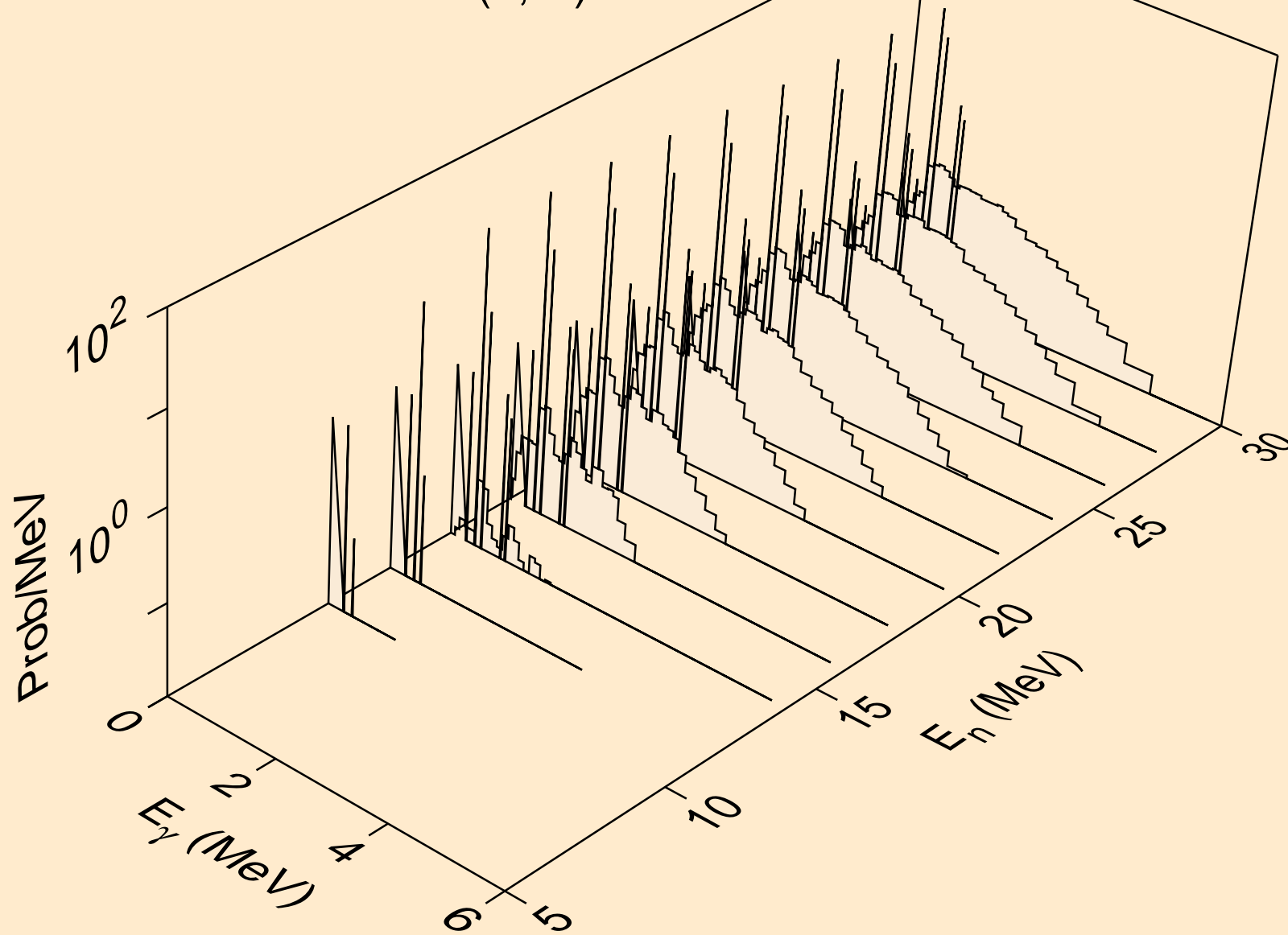

TA164 NEUTRON ACER TENDL-2021 LIBRARY; T=293.6K  
Photon emission for (n,n\*)t

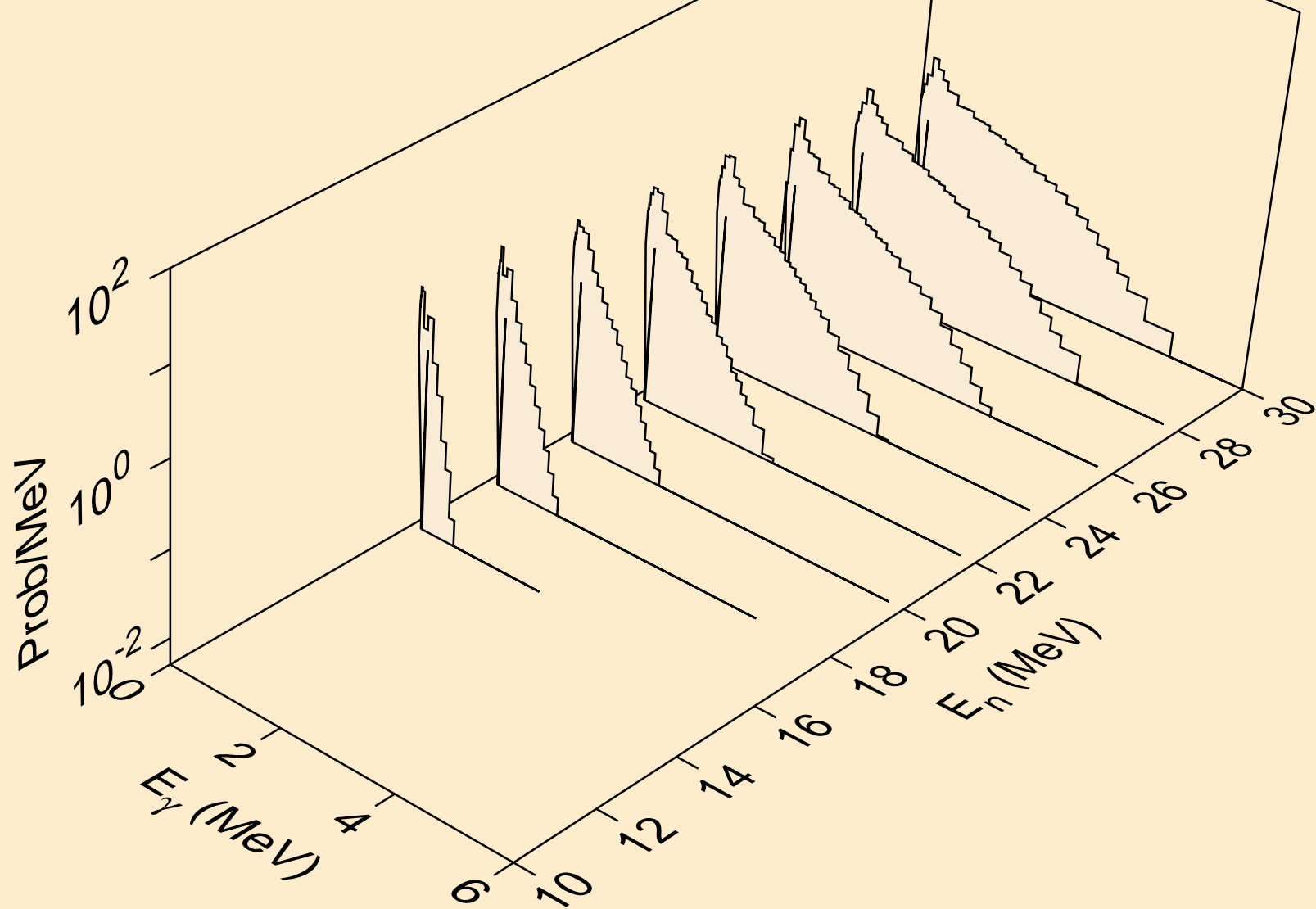

TA164 NEUTRON ACER TENDL-2021 LIBRARY; T=293.6K  
Photon emission for (n,n\*)he3

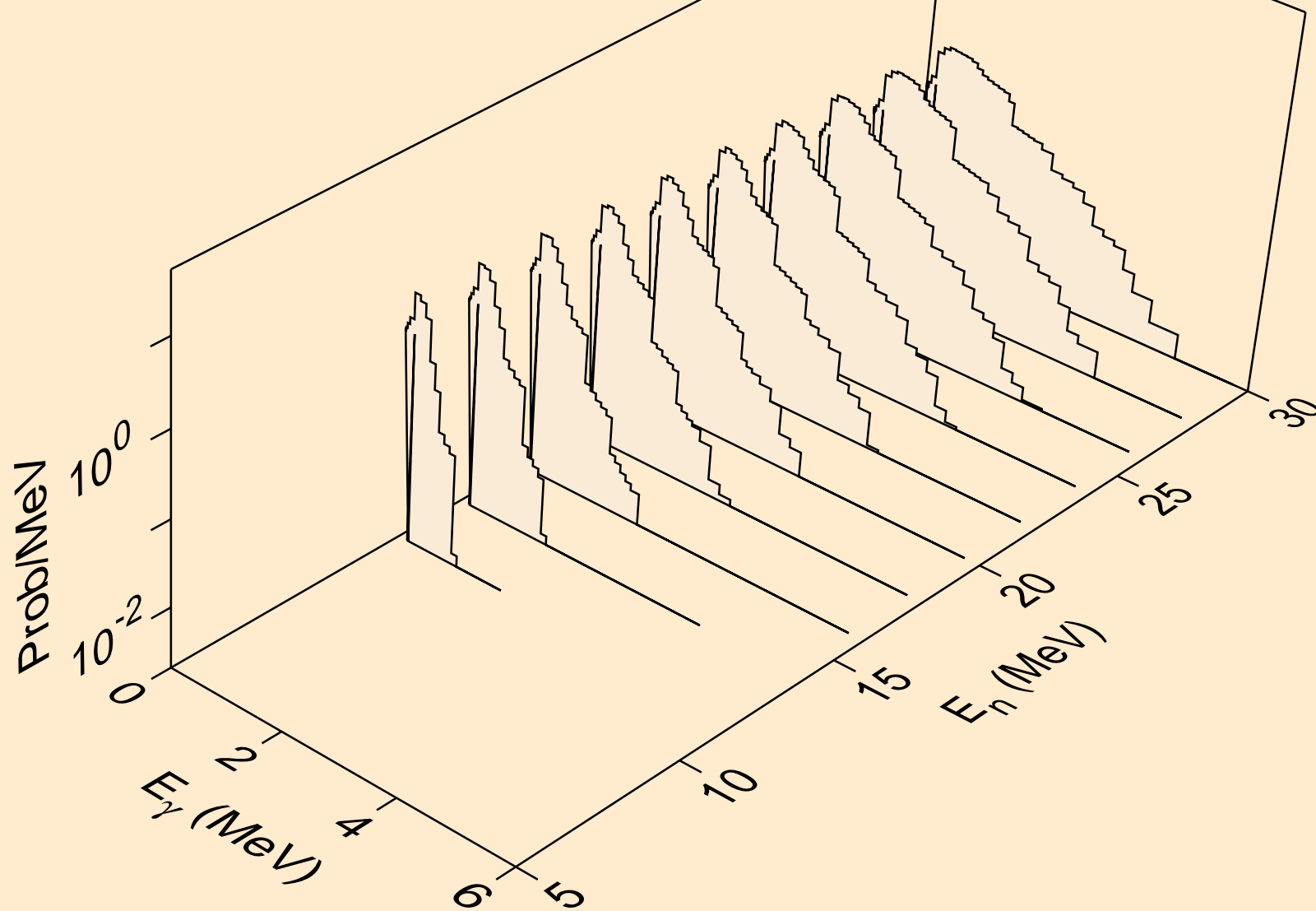



TA164 NEUTRON ACER TENDL-2021 LIBRARY; T=293.6K  
Photon emission for (n,4n)

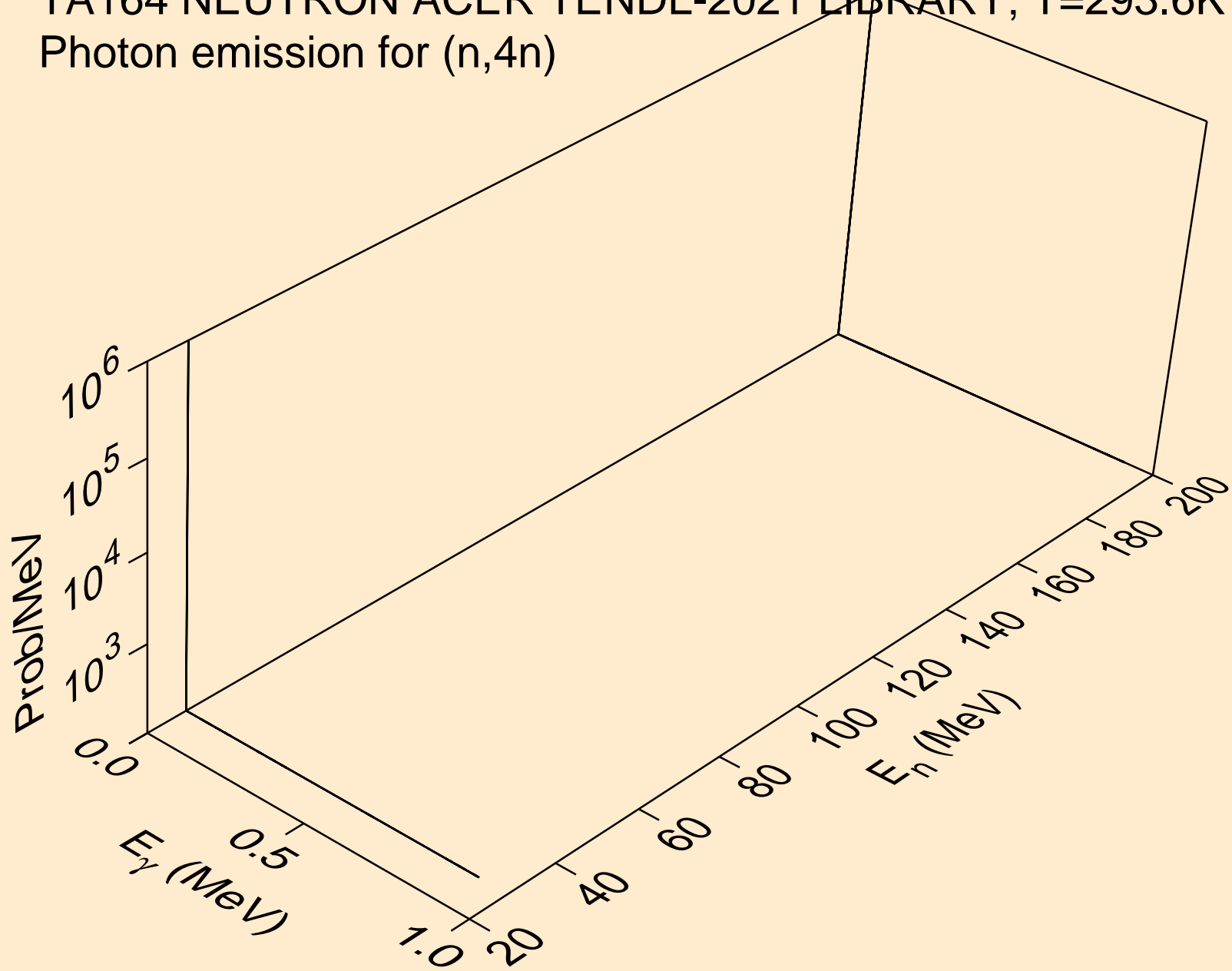

TA164 NEUTRON ACER TENDL-2021 LIBRARY; T=293.6K  
Photon emission for (n,2np)

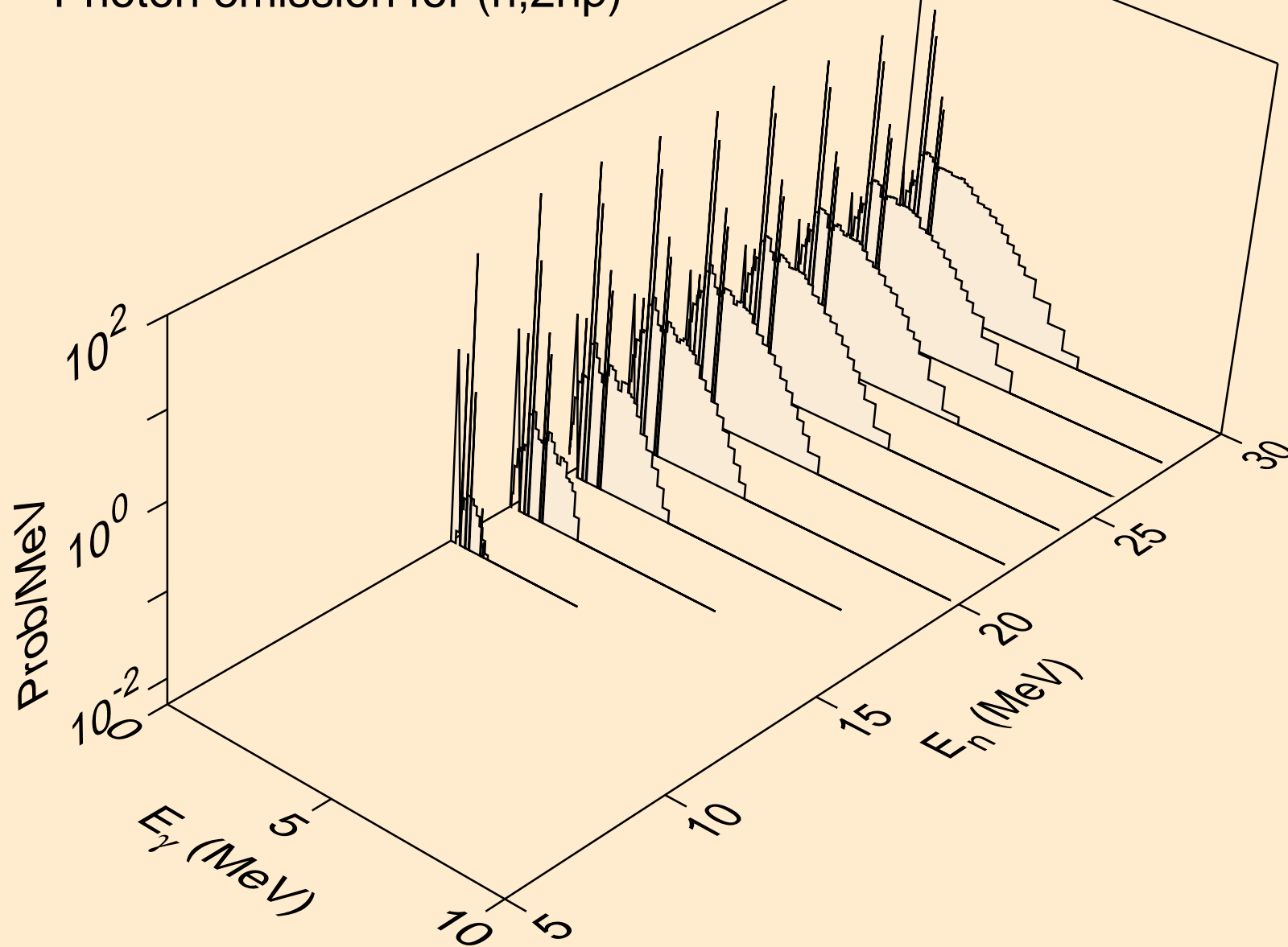

TA164 NEUTRON ACER TENDL-2021 LIBRARY; T=293.6K  
Photon emission for (n,3np)

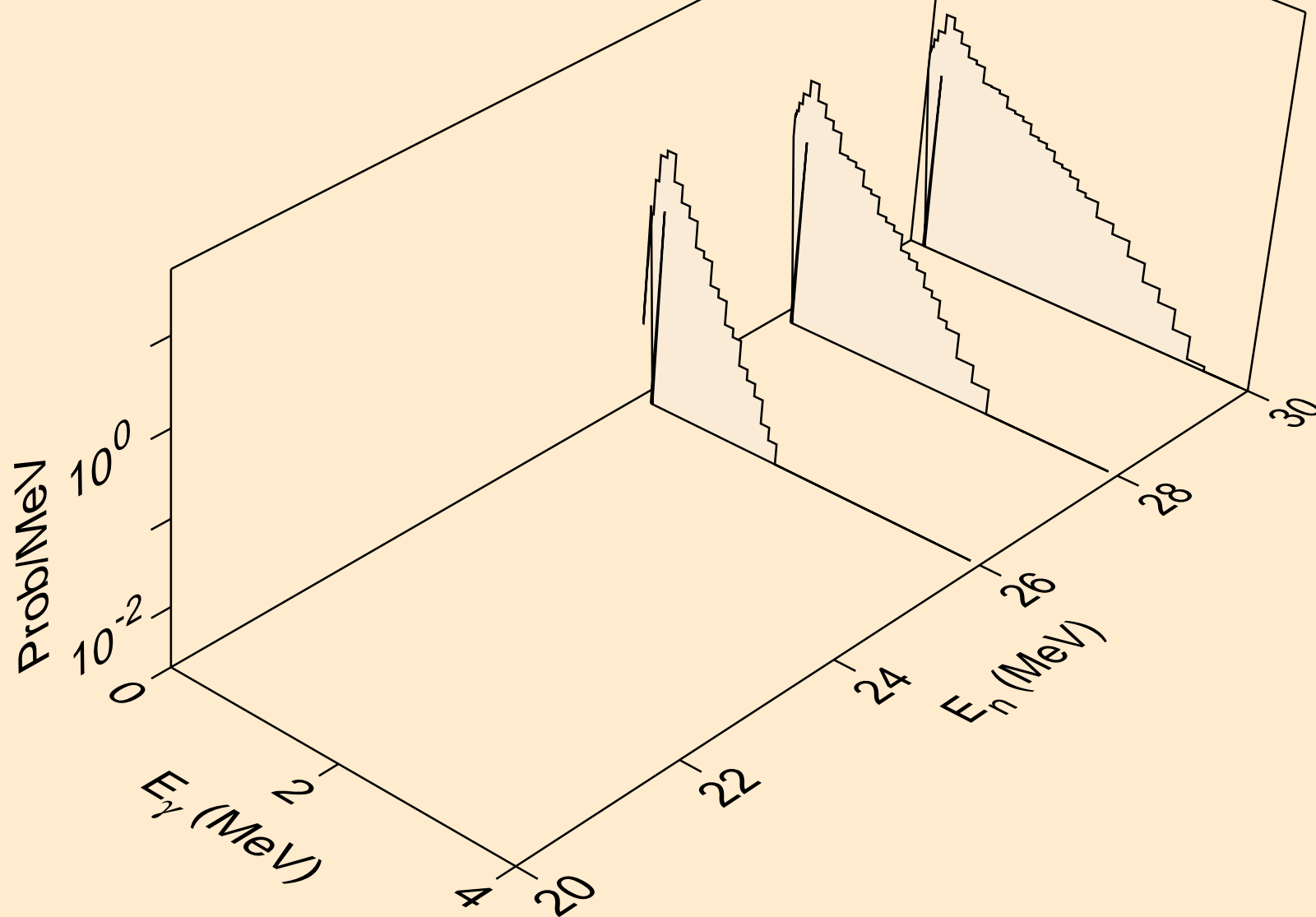

TA164 NEUTRON ACER TENDL-2021 LIBRARY; T=293.6K  
Photon emission for (n,2np)

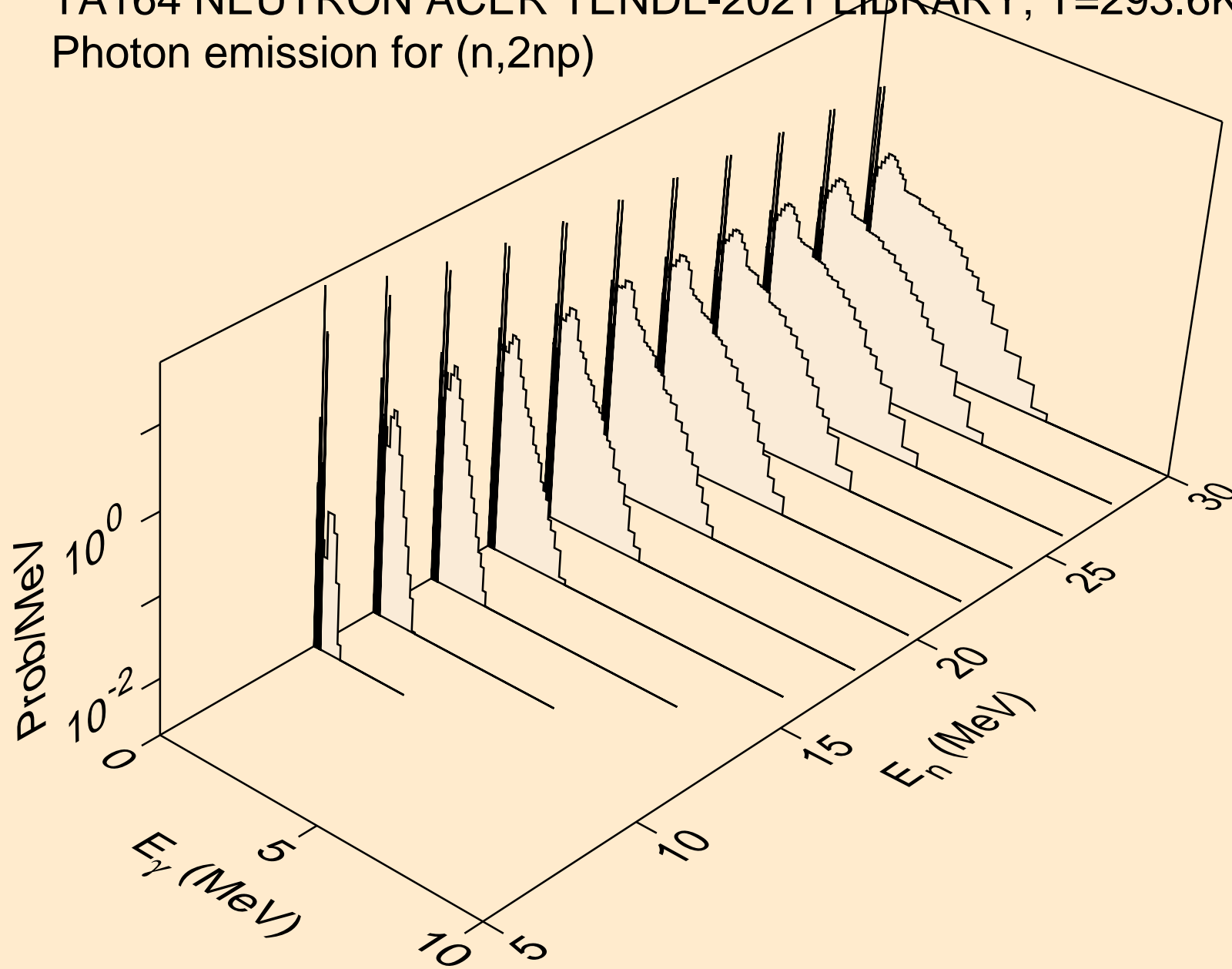

TA164 NEUTRON ACER TENDL-2021 LIBRARY; T=293.6K  
Photon emission for (n,npa)

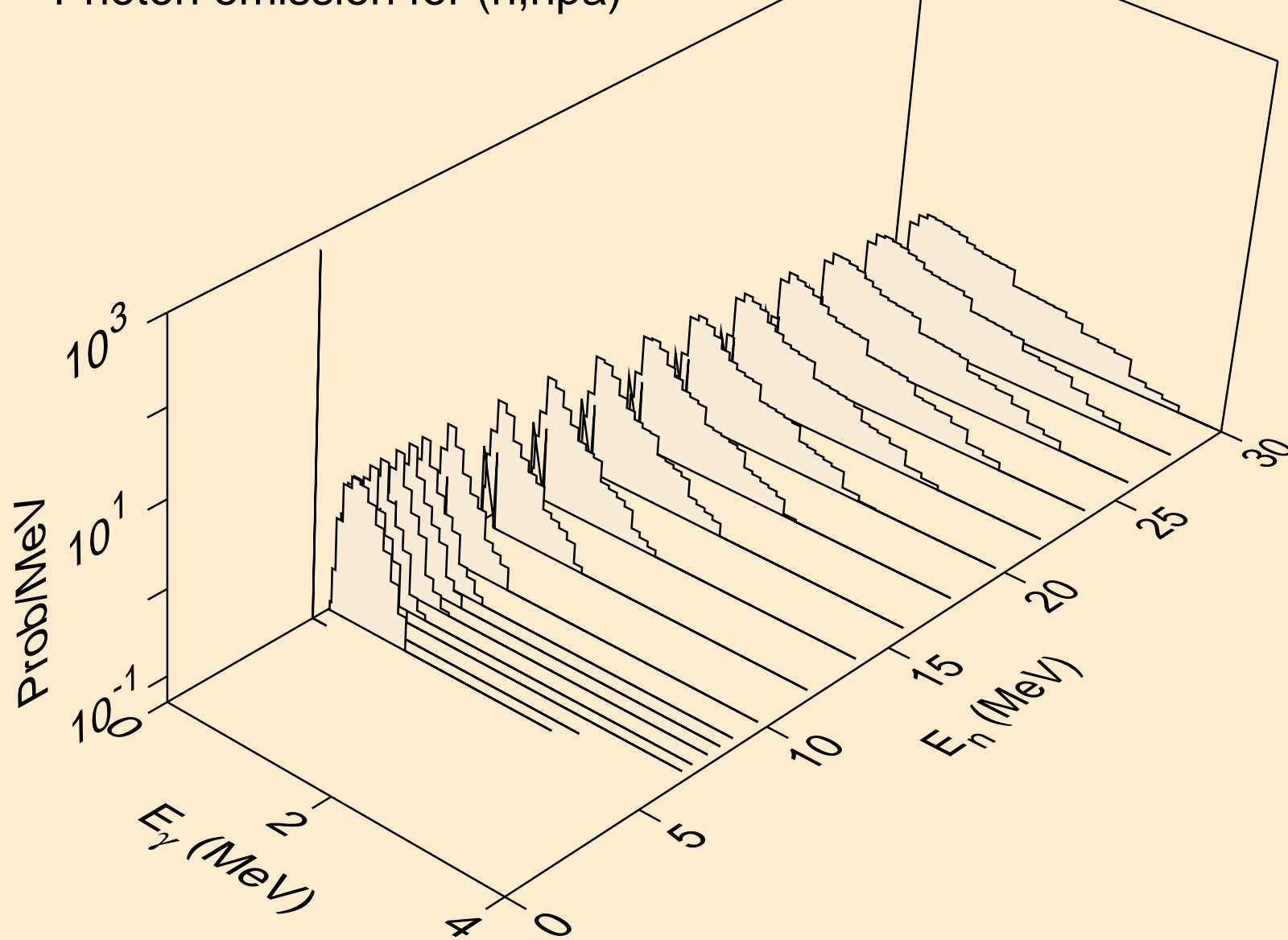

TA164 NEUTRON ACER TENDL-2021 LIBRARY; T=293.6K  
Photon emission for (n,n\*c)

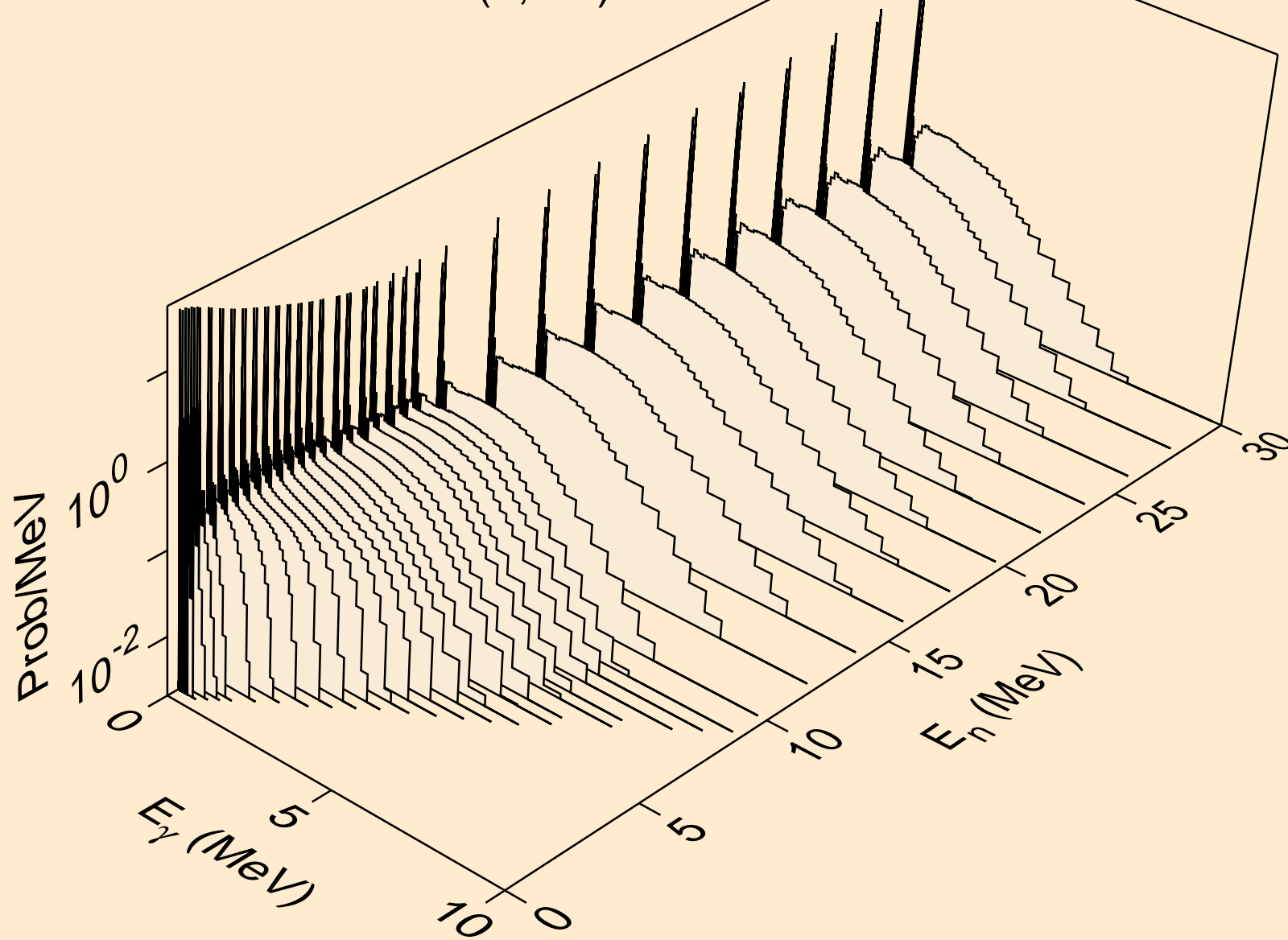

TA164 NEUTRON ACER TENDL-2021 LIBRARY; T=293.6K  
Photon emission for (n,gma)

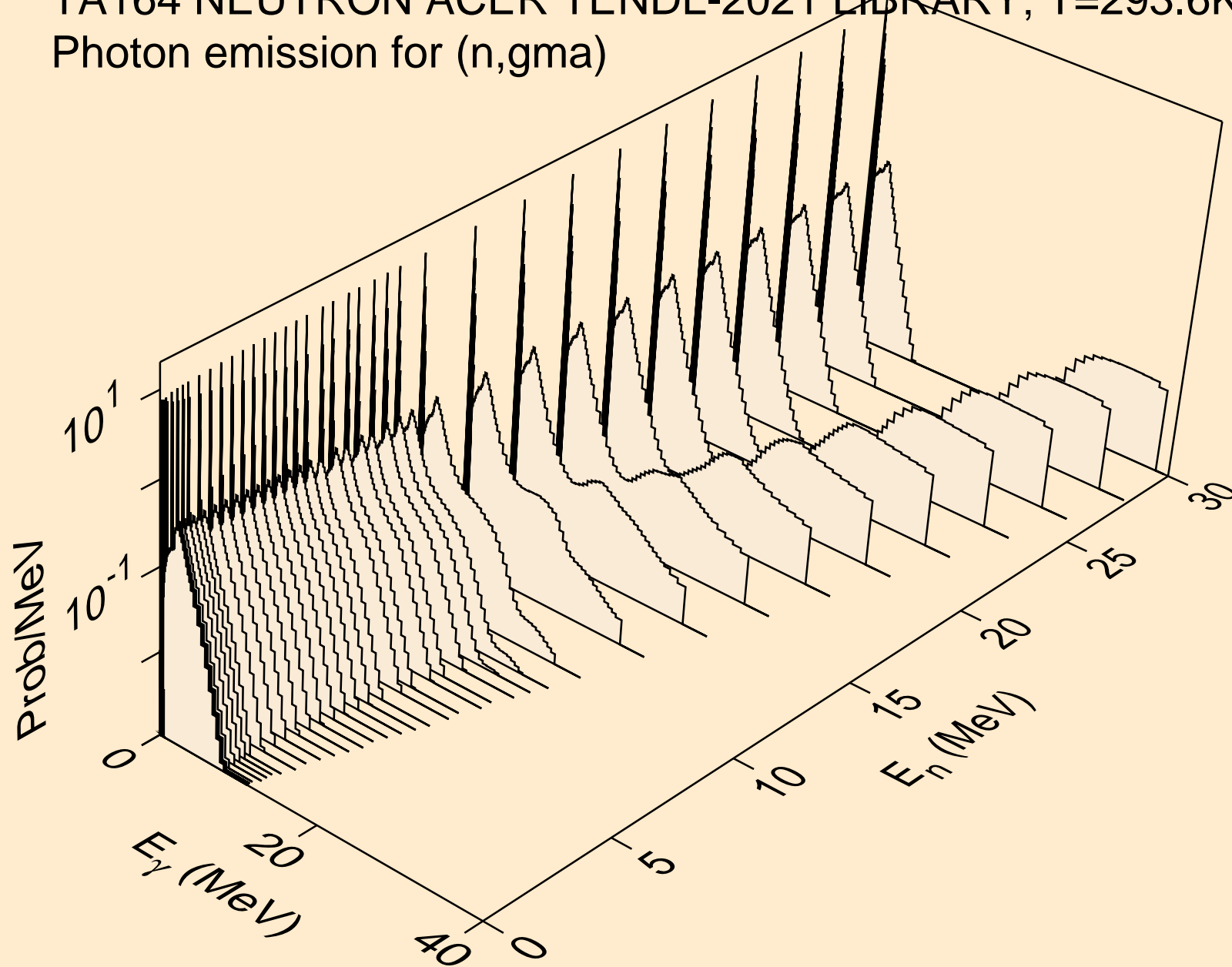

TA164 NEUTRON ACER TENDL-2021 LIBRARY; T=293.6K  
Photon emission for (n,p)

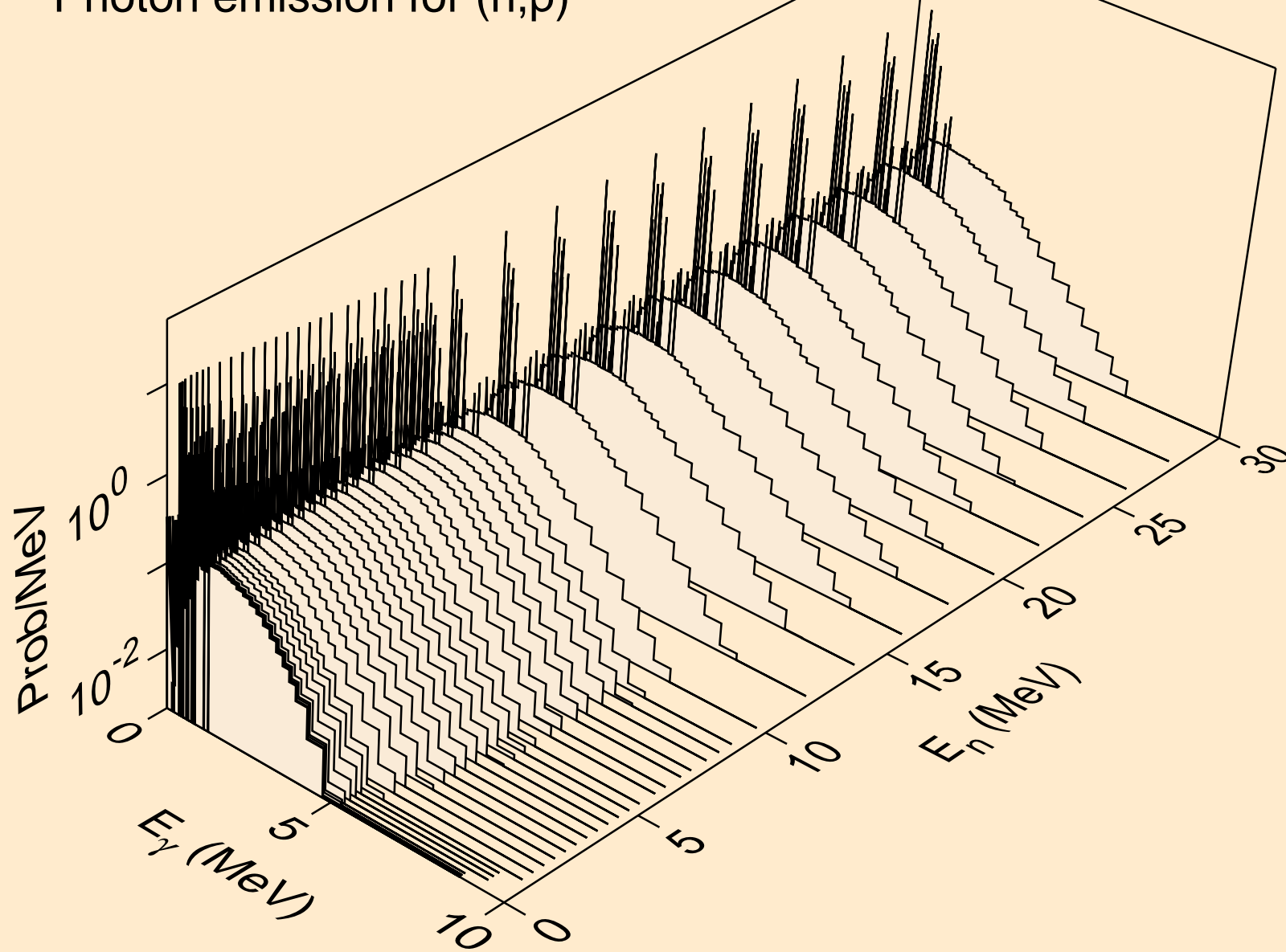



TA164 NEUTRON ACER TENDL-2021 LIBRARY; T=293.6K  
Photon emission for (n,d)

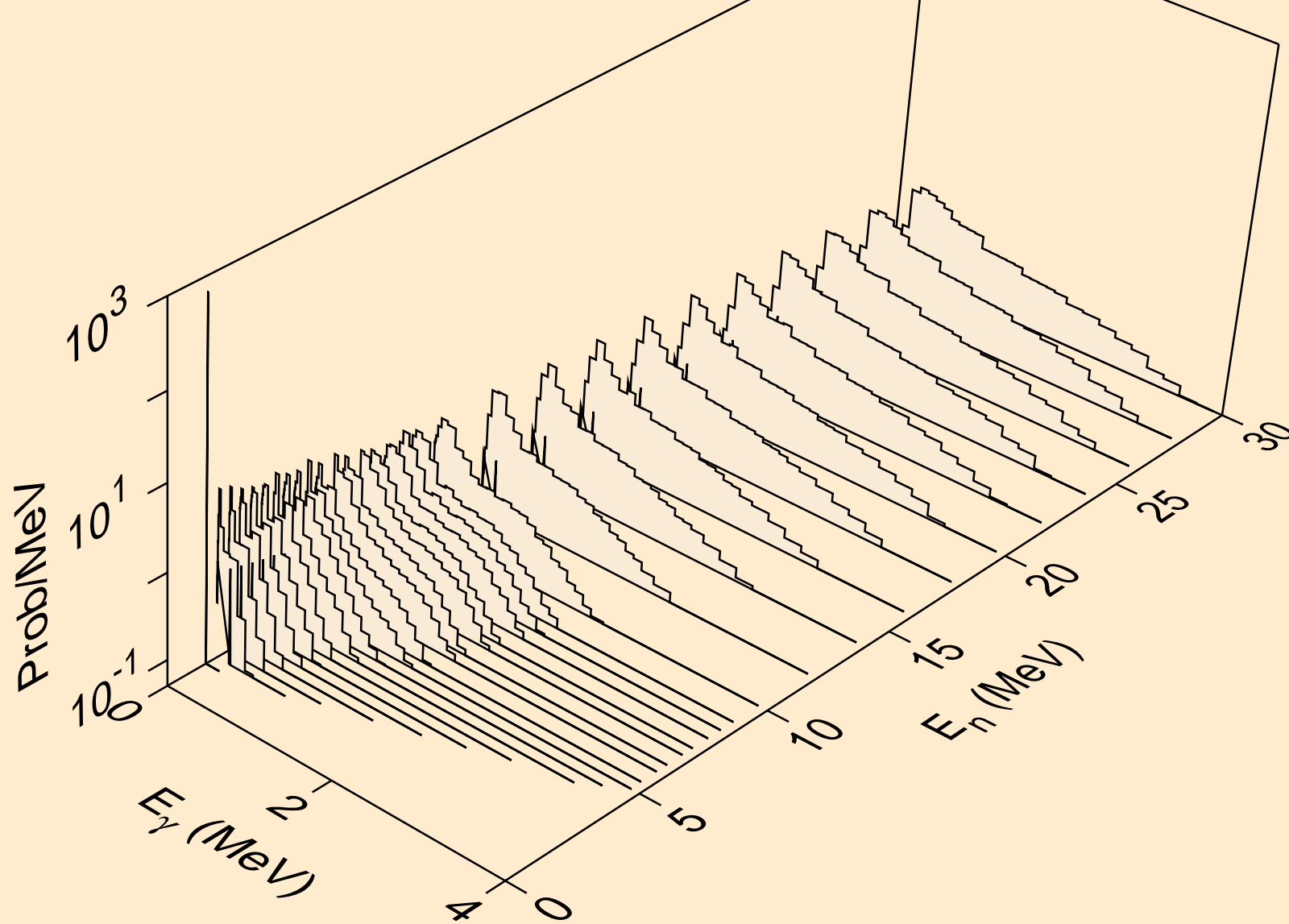

TA164 NEUTRON ACER TENDL-2021 LIBRARY; T=293.6K  
Photon emission for (n,t)

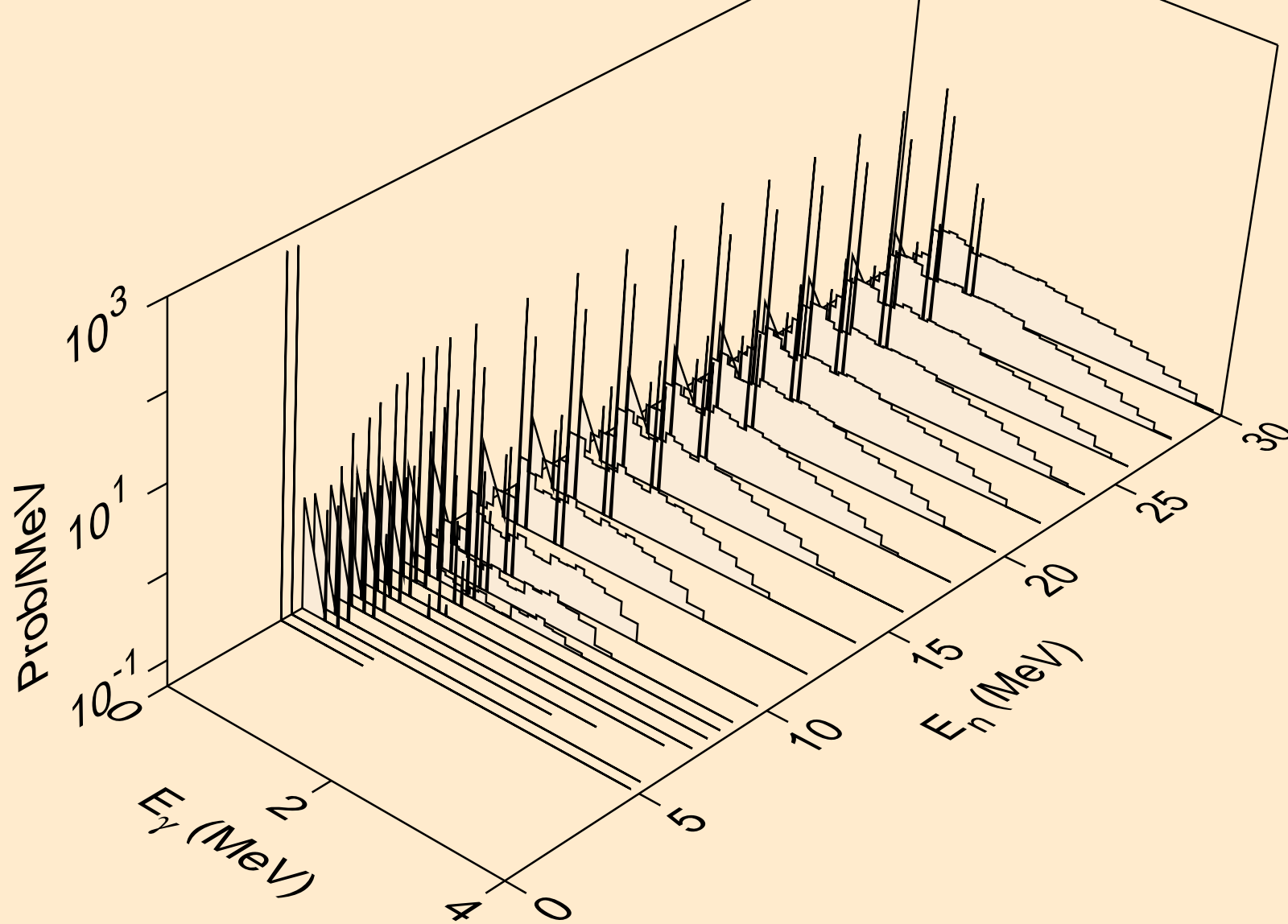

TA164 NEUTRON ACER TENDL-2021 LIBRARY; T=293.6K  
Photon emission for (n,he3)

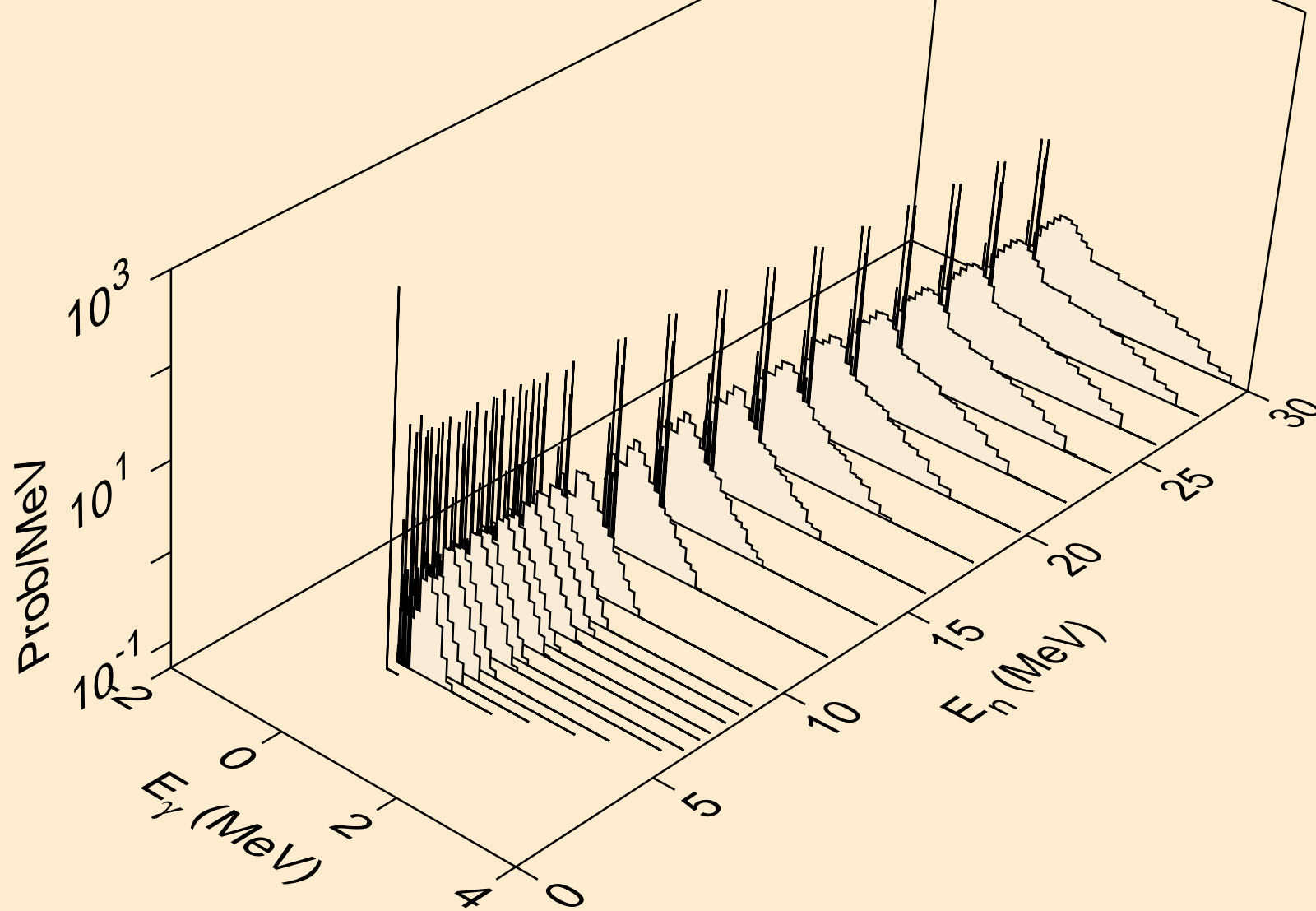

TA164 NEUTRON ACER TENDL-2021 LIBRARY; T=293.6K  
Photon emission for (n,a)

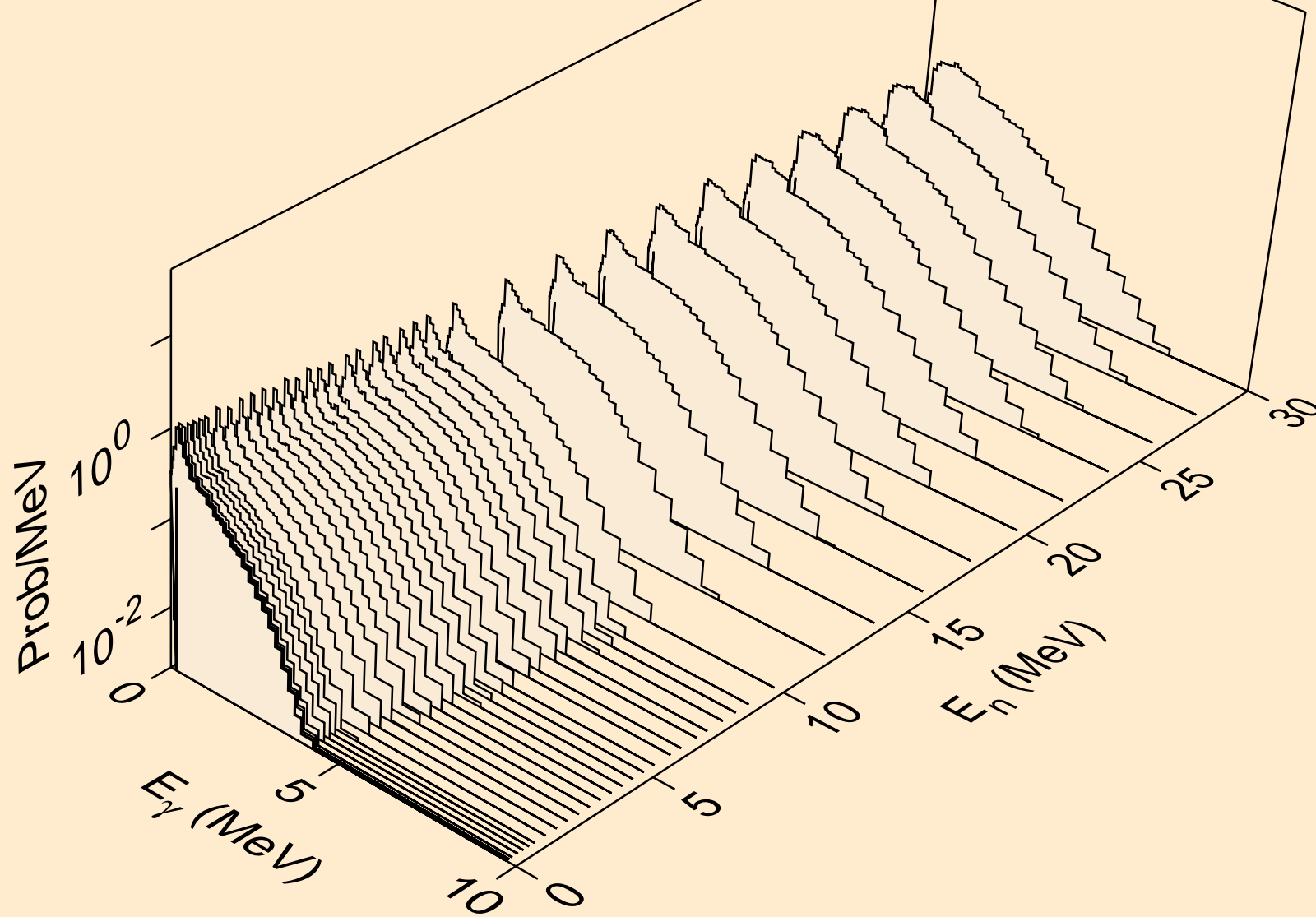

TA164 NEUTRON ACER TENDL-2021 LIBRARY; T=293.6K  
Photon emission for (n,2a)

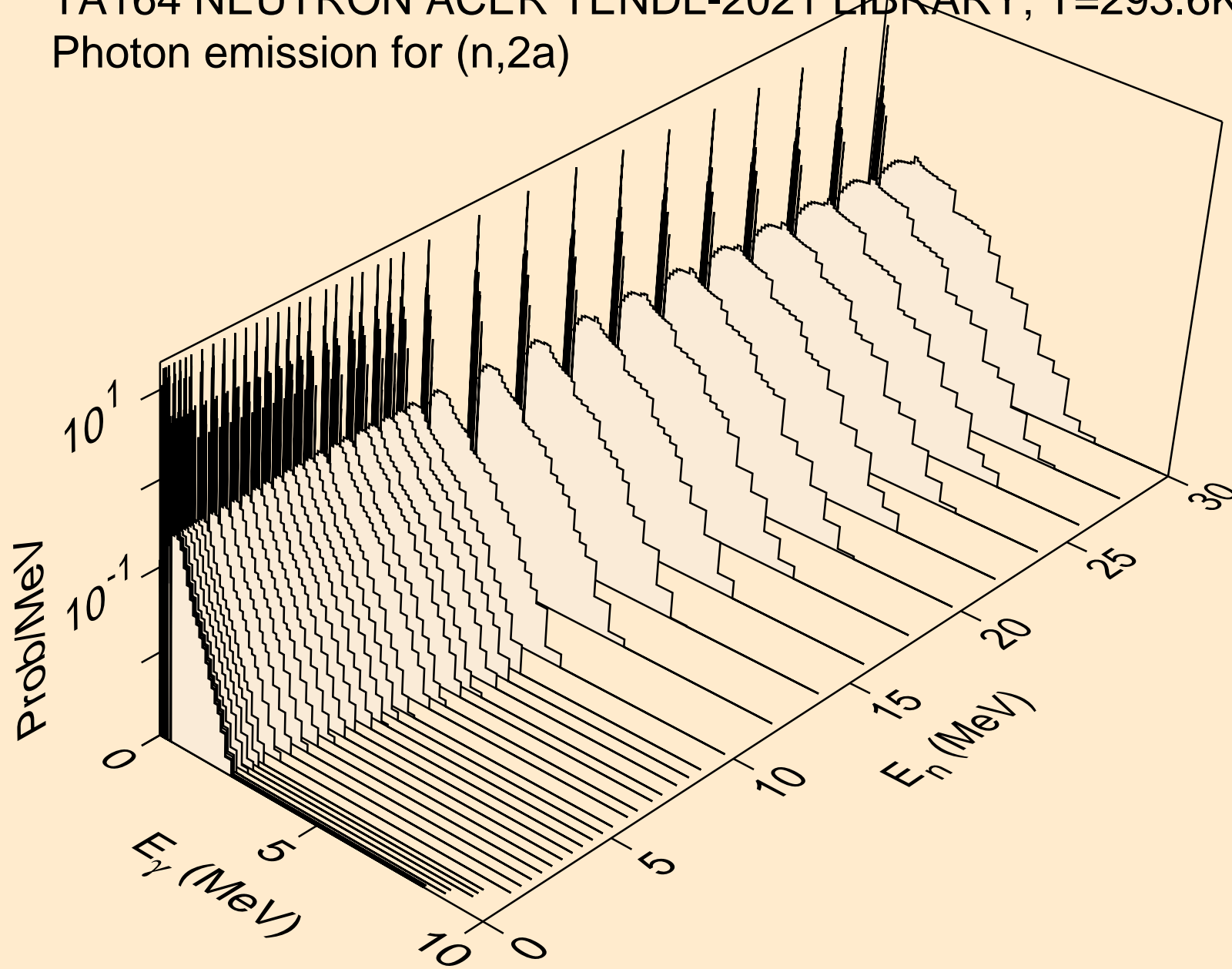

TA164 NEUTRON ACER TENDL-2021 LIBRARY; T=293.6K  
Photon emission for (n,3a)

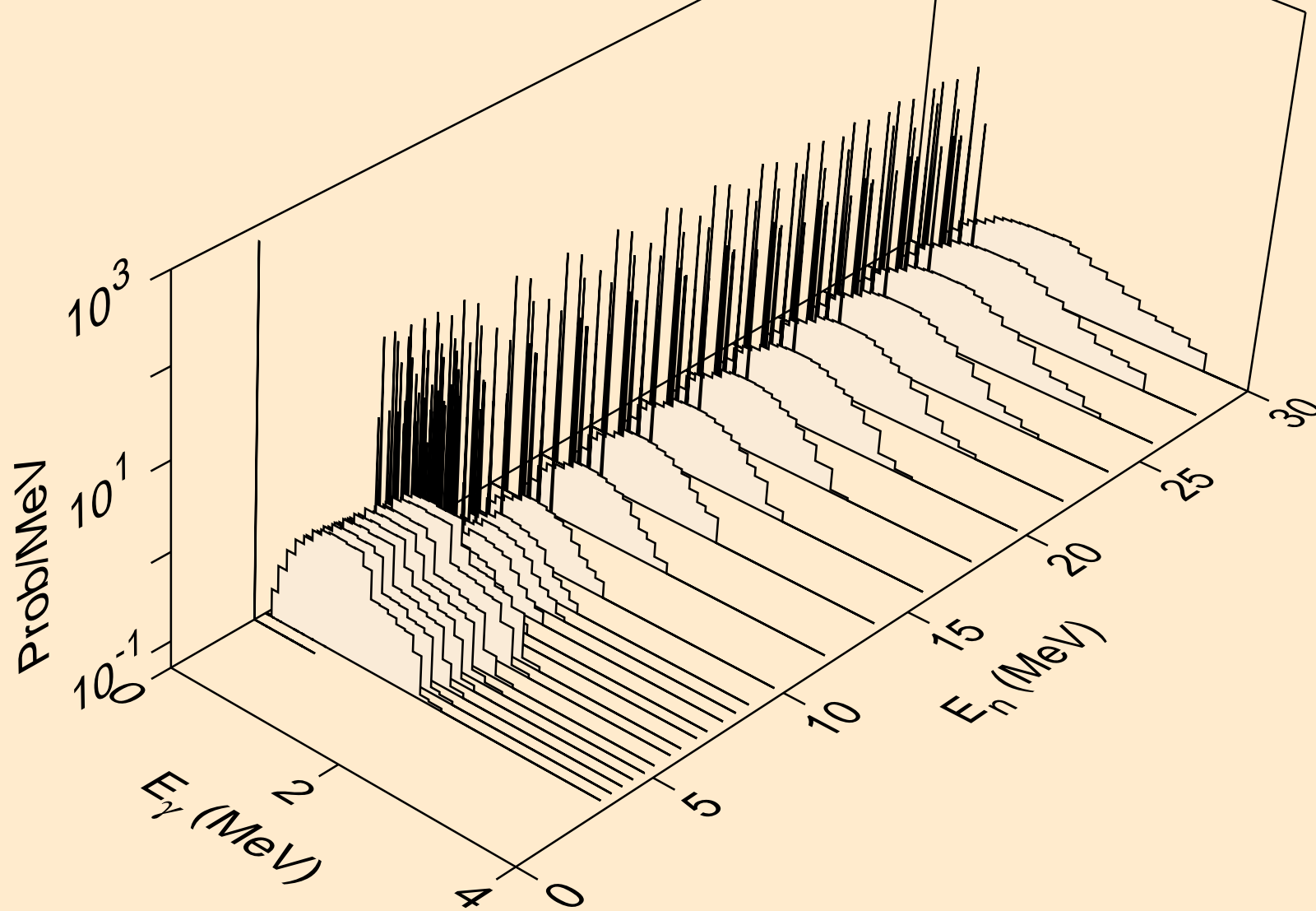

TA164 NEUTRON ACER TENDL-2021 LIBRARY; T=293.6K  
Photon emission for (n,2p)

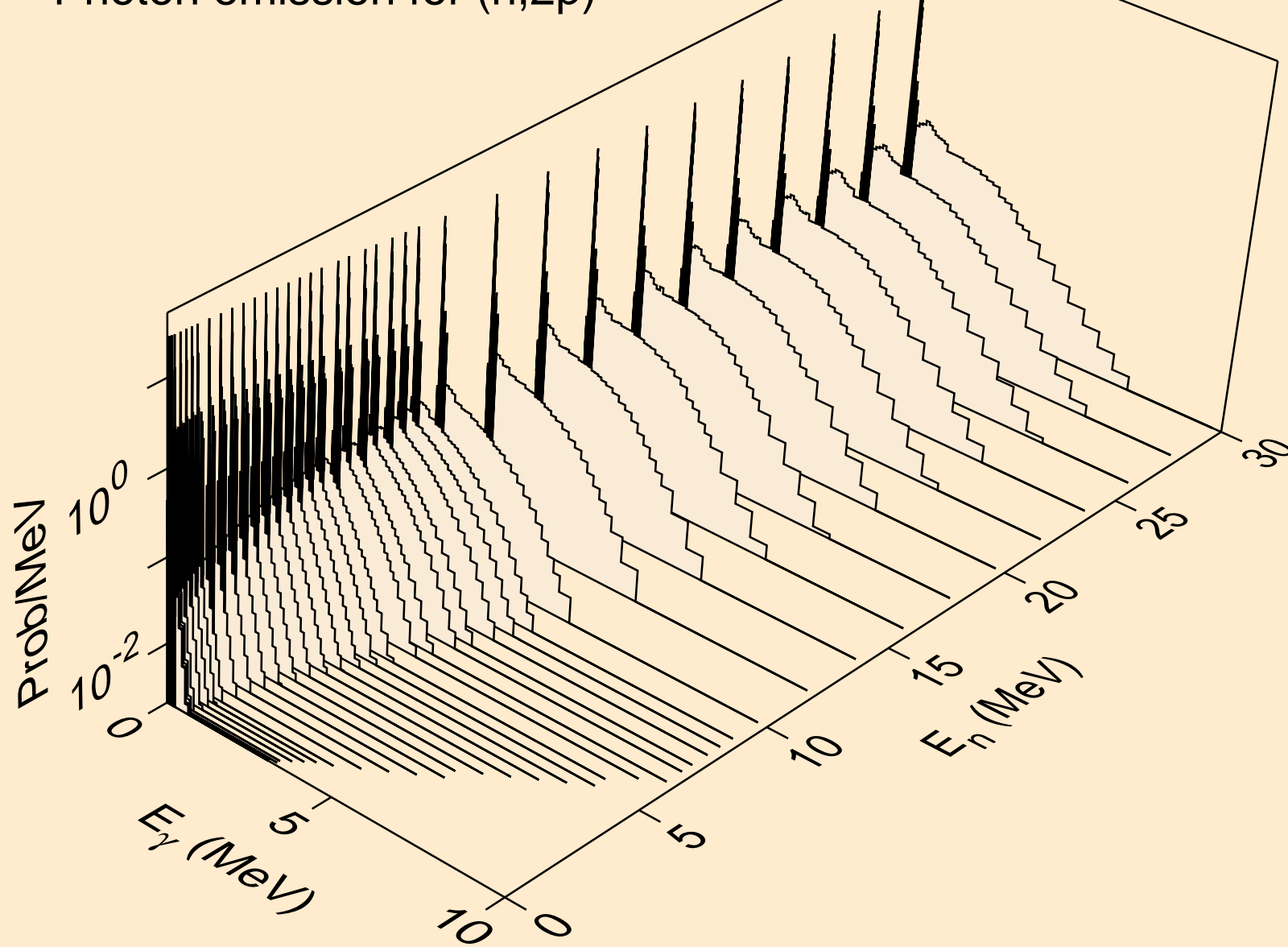

TA164 NEUTRON ACER TENDL-2021 LIBRARY; T=293.6K  
Photon emission for (n,p)

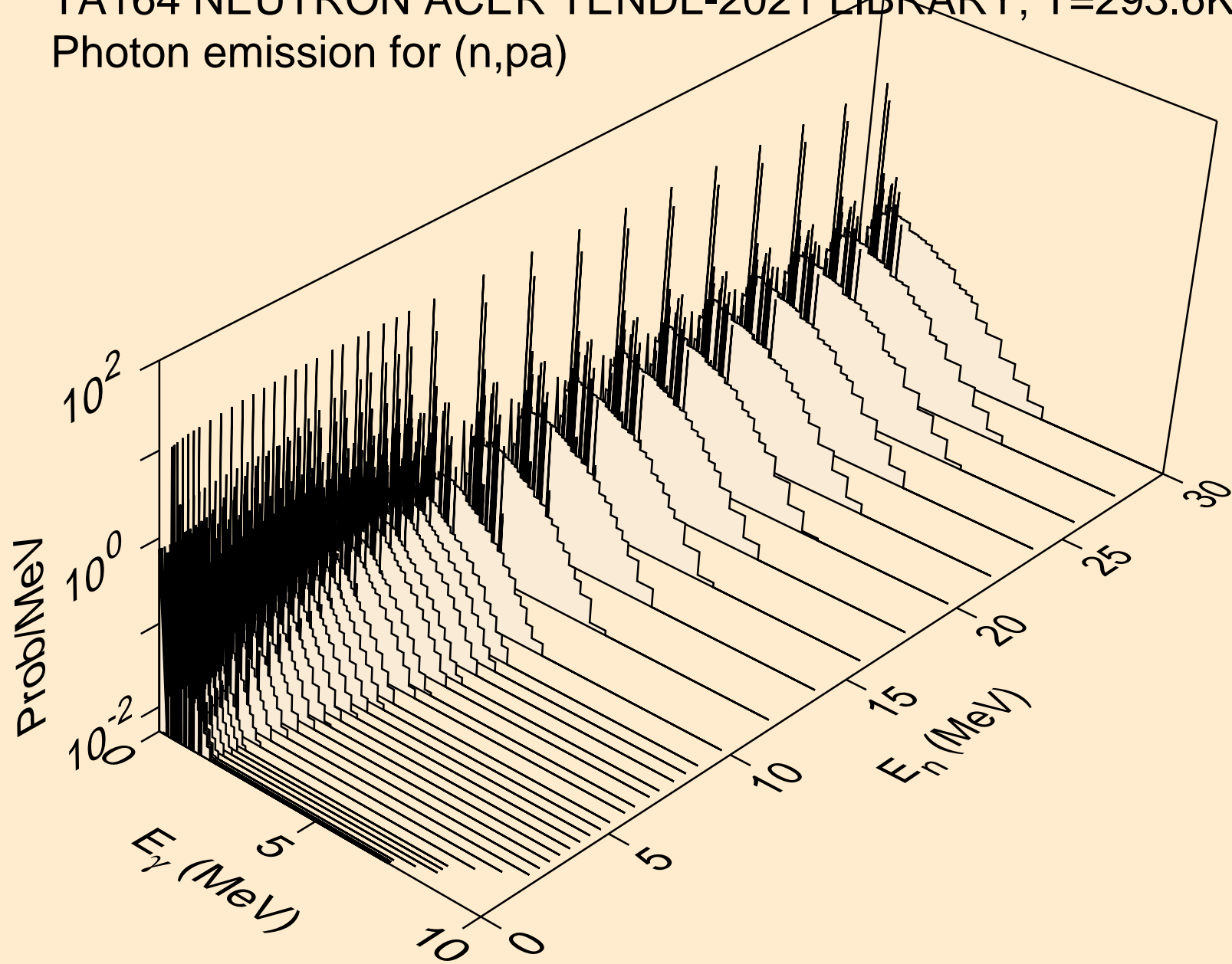



TA164 NEUTRON ACER TENDL-2021 LIBRARY; T=293.6K  
Photon emission for (n,t2a)

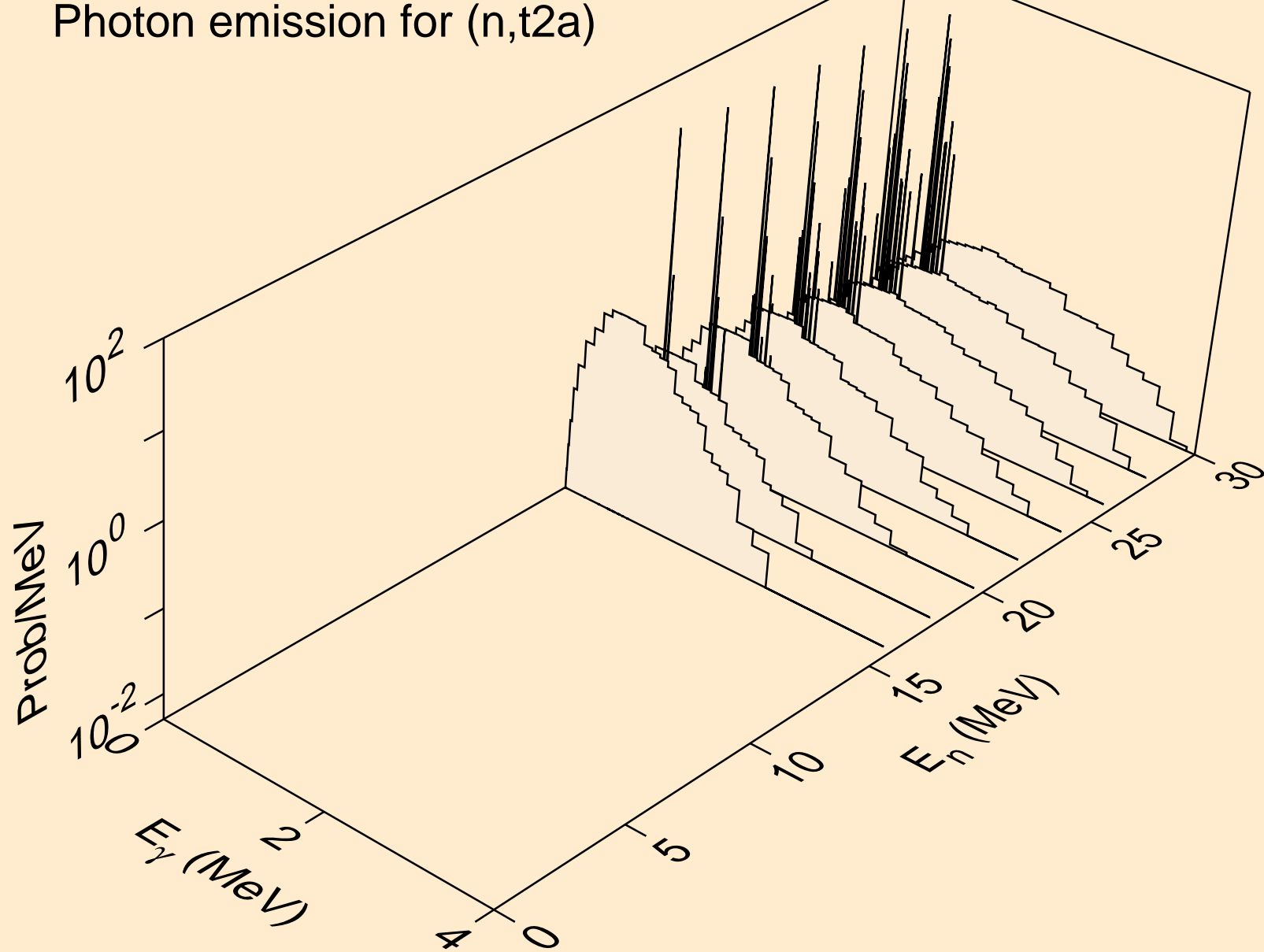

TA164 NEUTRON ACER TENDL-2021 LIBRARY; T=293.6K  
Photon emission for (n,d2a)

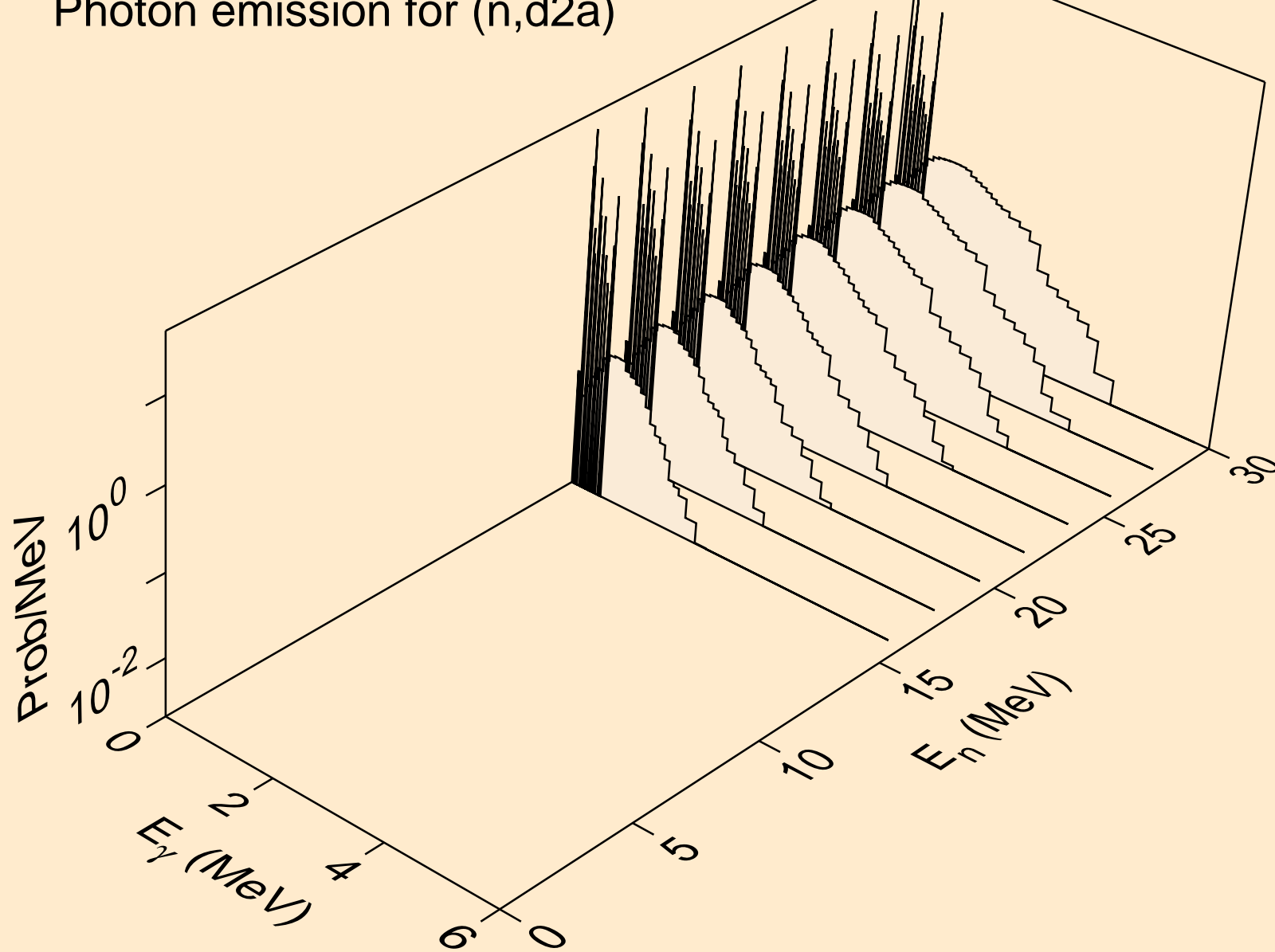

TA164 NEUTRON ACER TENDL-2021 LIBRARY; T=293.6K  
Photon emission for (n,pd)

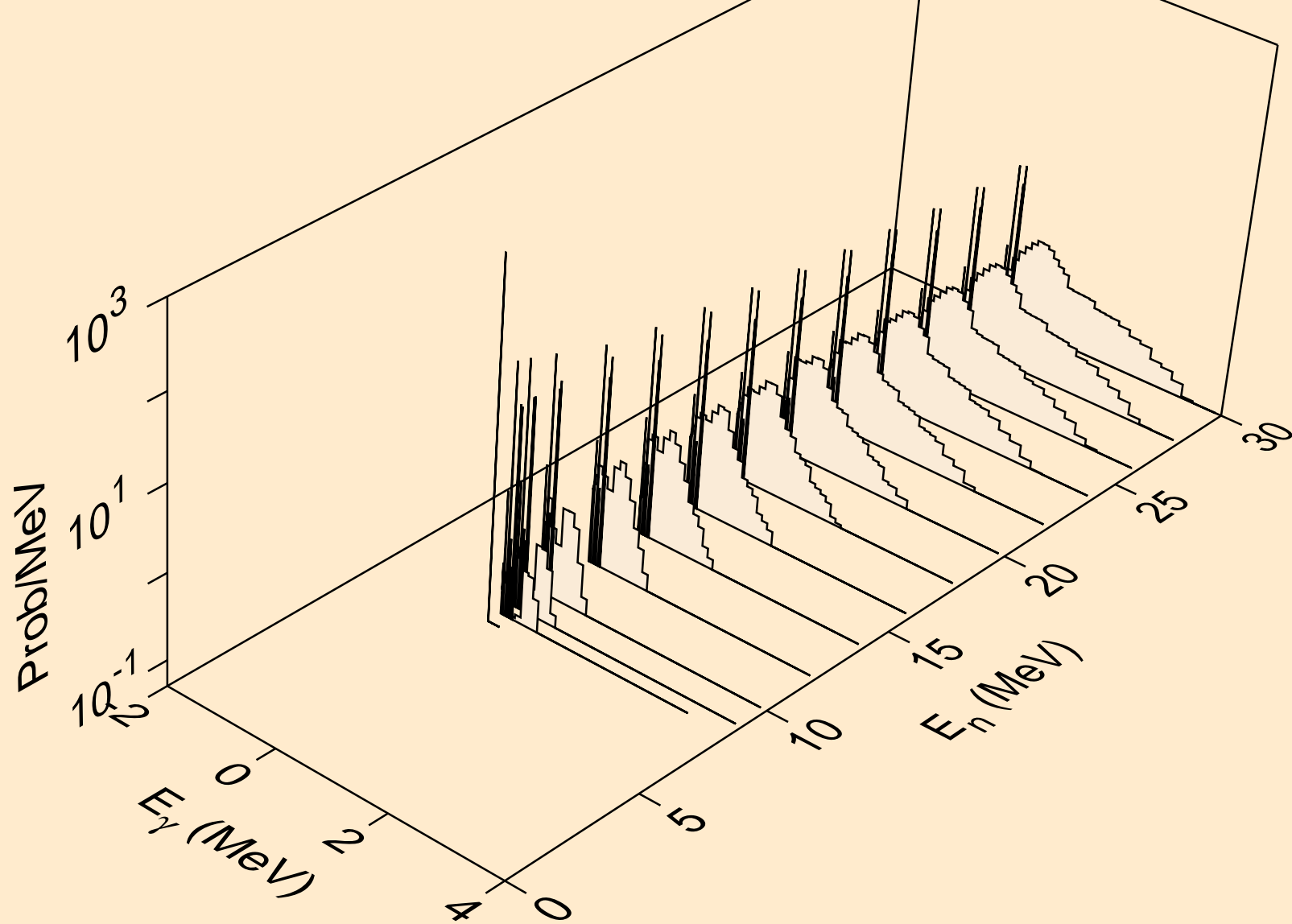

TA164 NEUTRON ACER TENDL-2021 LIBRARY; T=293.6K  
Photon emission for (n,pt)

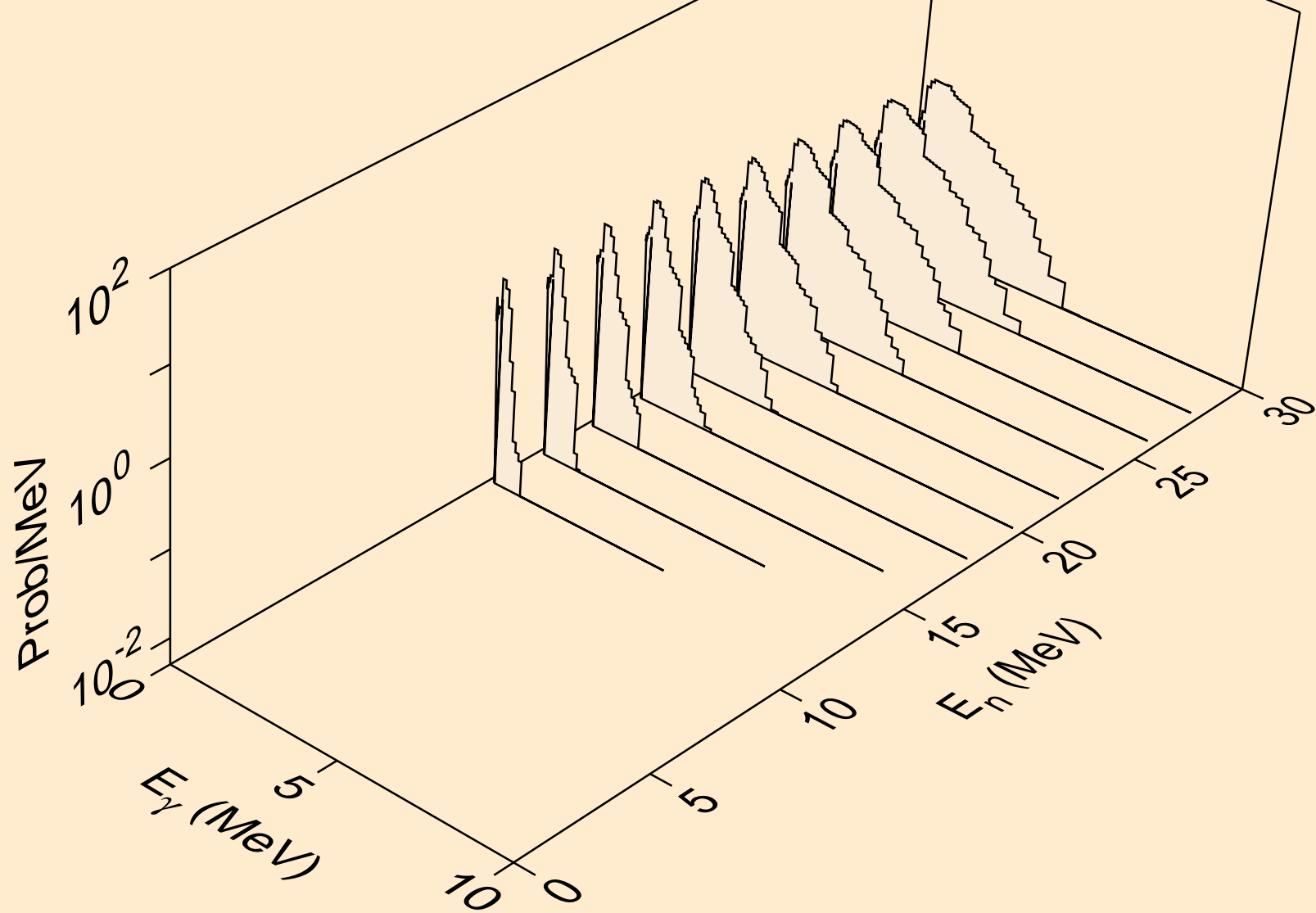

TA164 NEUTRON ACER TENDL-2021 LIBRARY; T=293.6K  
Photon emission for (n,da)

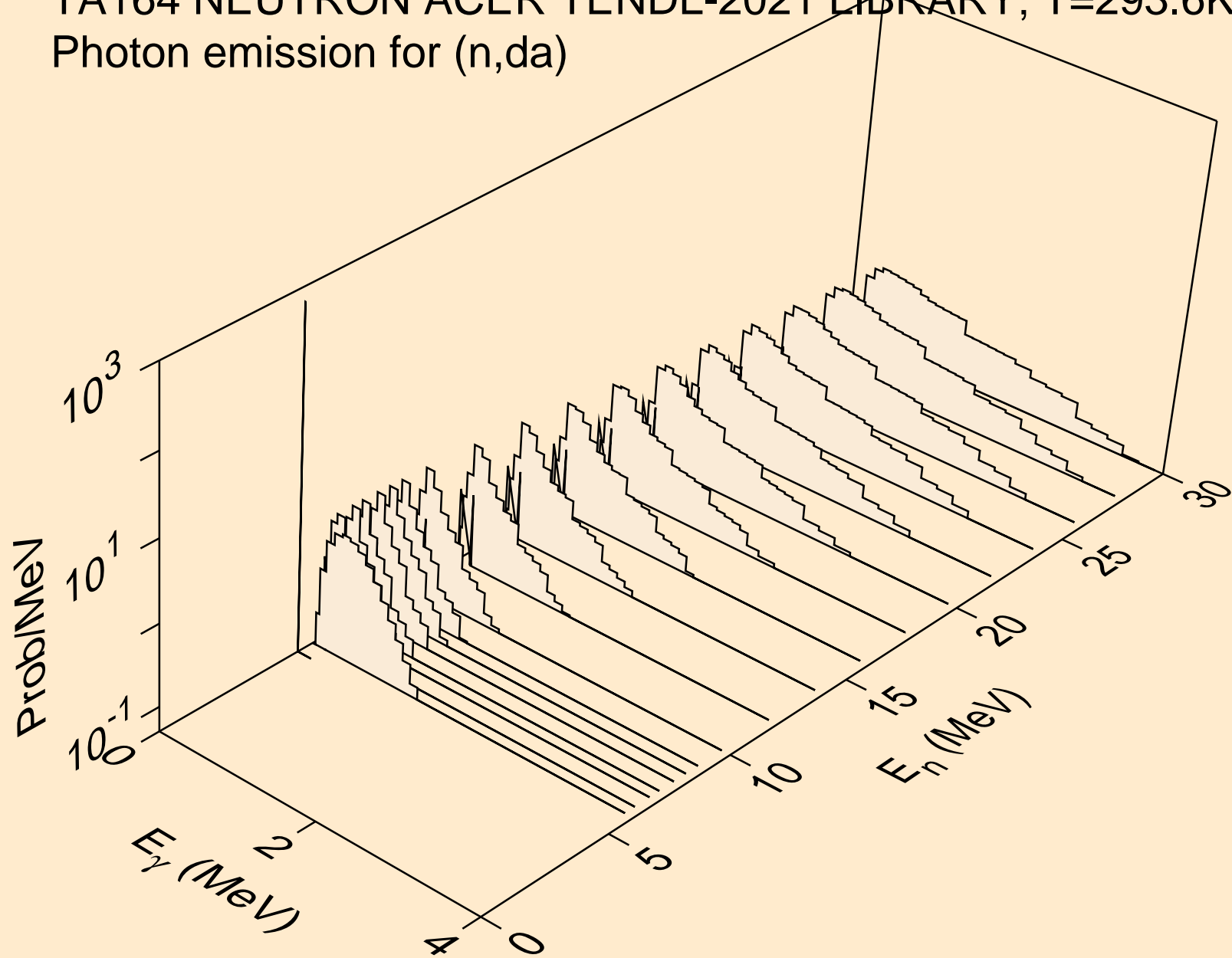

TA164 NEUTRON ACER TENDL-2021 LIBRARY; T=293.6K  
thermal capture photon spectrum

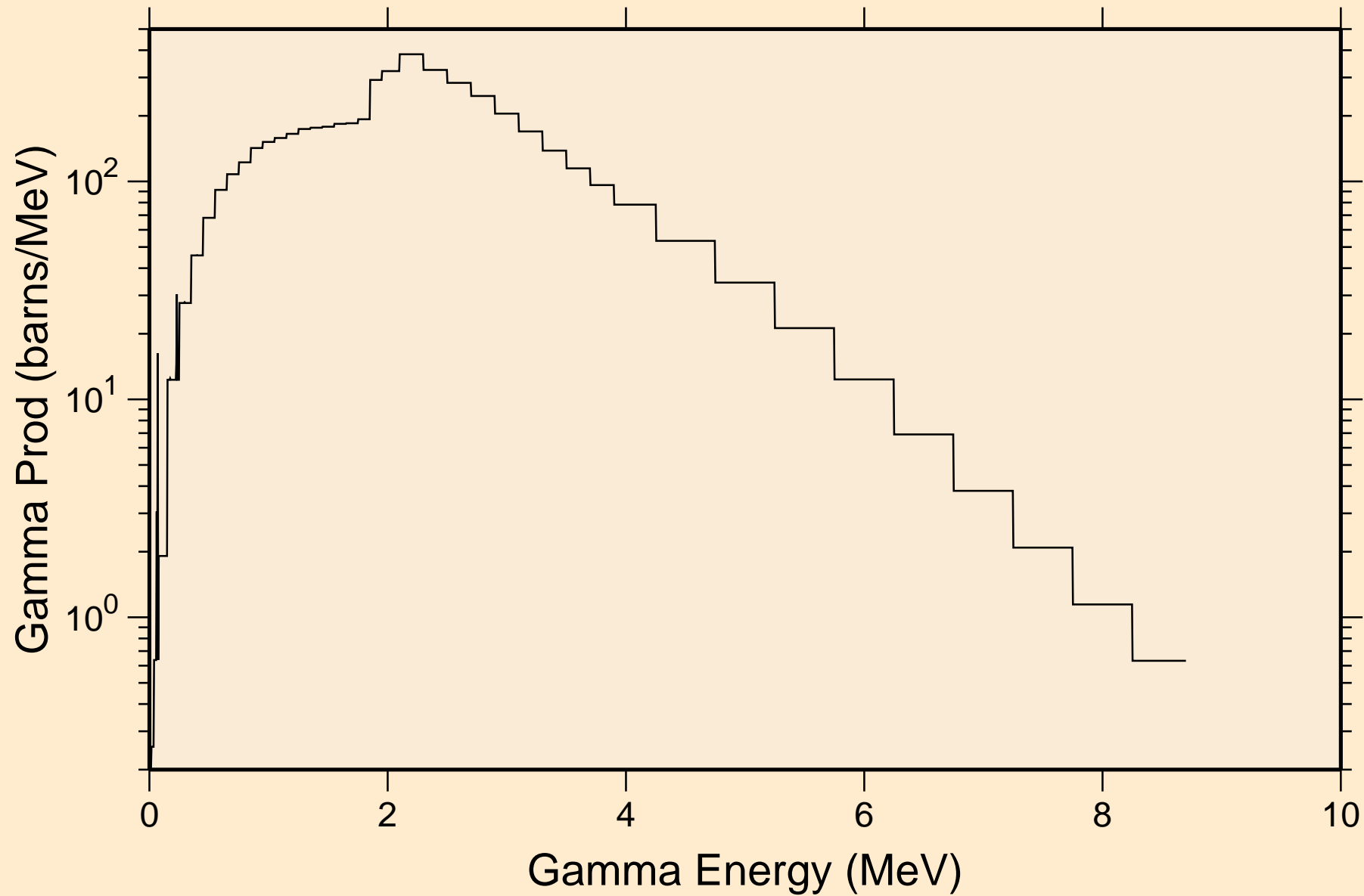

TA164 NEUTRON ACER TENDL-2021 LIBRARY; T=293.6K  
14 MeV photon spectrum

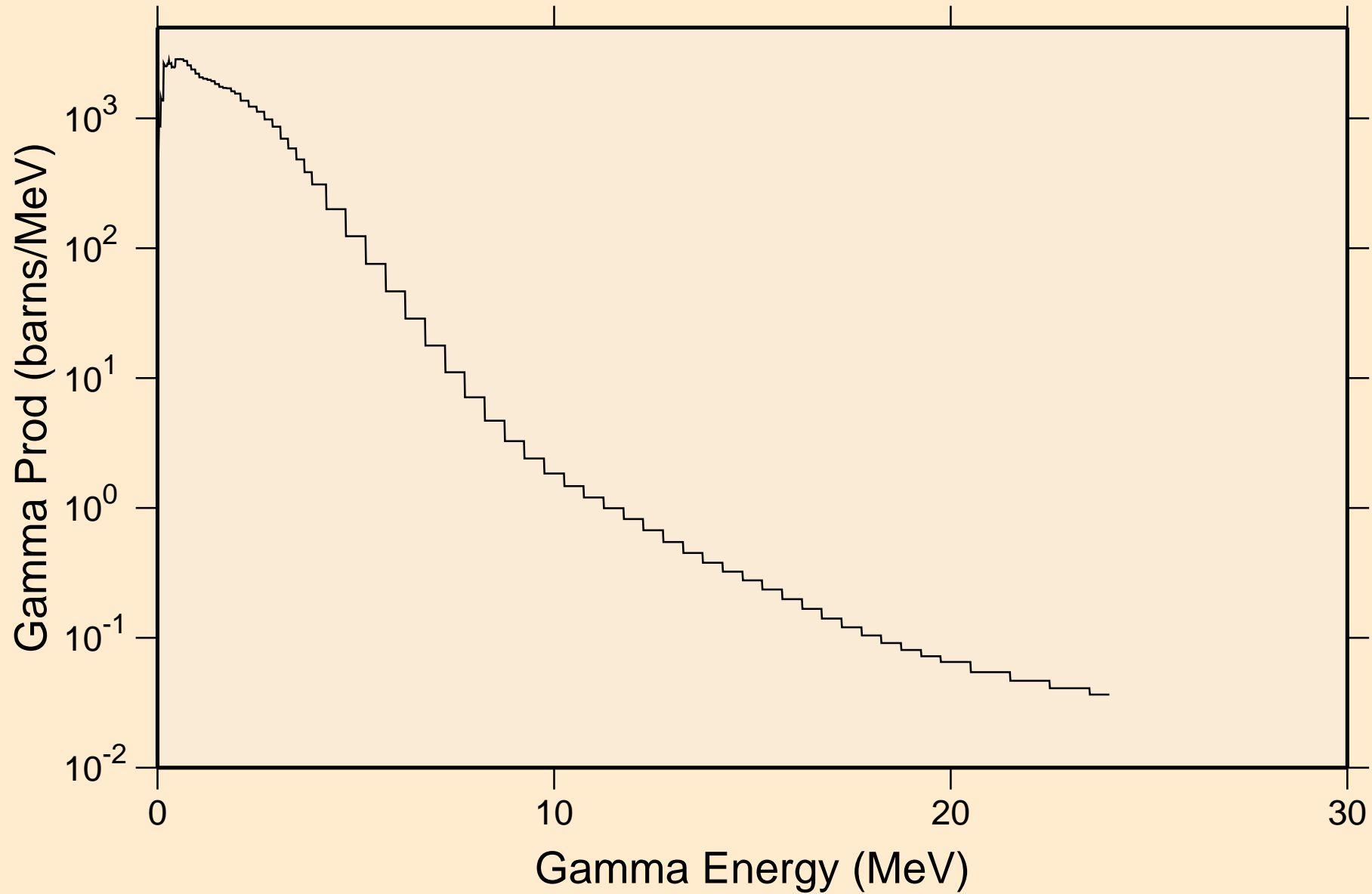

TA164 NEUTRON ACER TENDL-2021 LIBRARY; T=293.6K  
Particle heating contributions

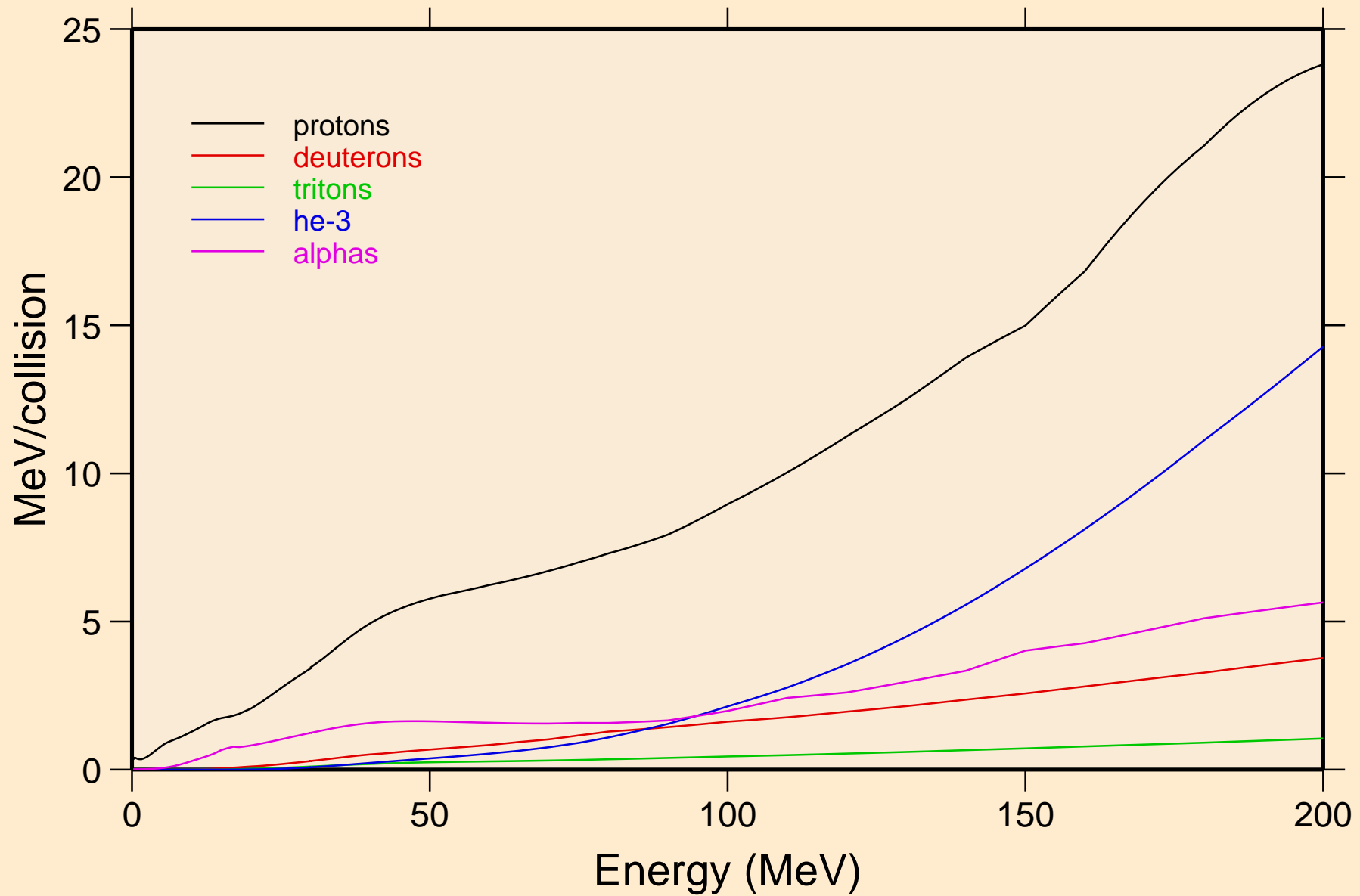



TA164 NEUTRON ACER TENDL-2021 LIBRARY; T=293.6K  
Recoil Heating

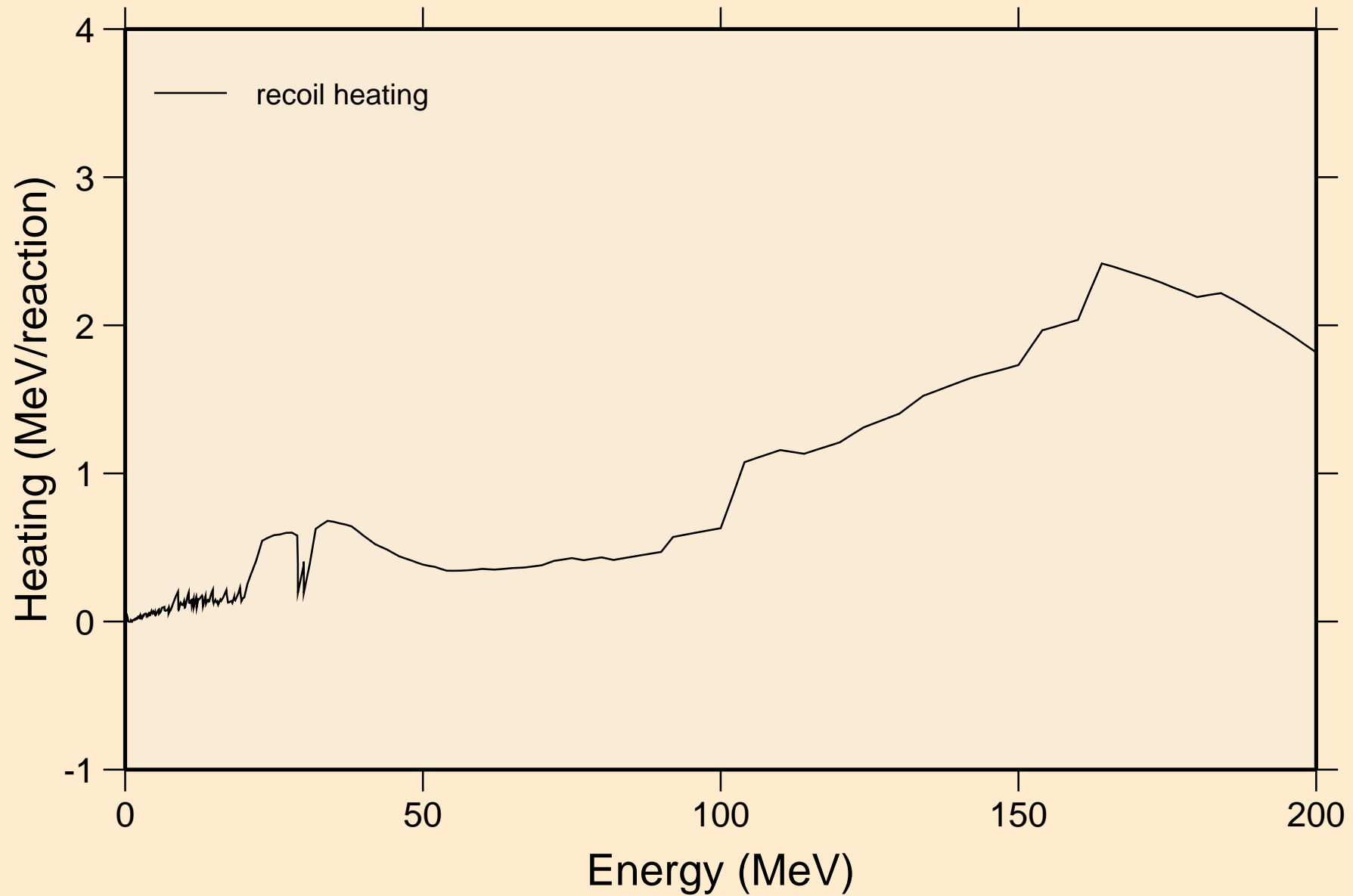

TA164 NEUTRON ACER TENDL-2021 LIBRARY; T=293.6K  
Particle production cross sections

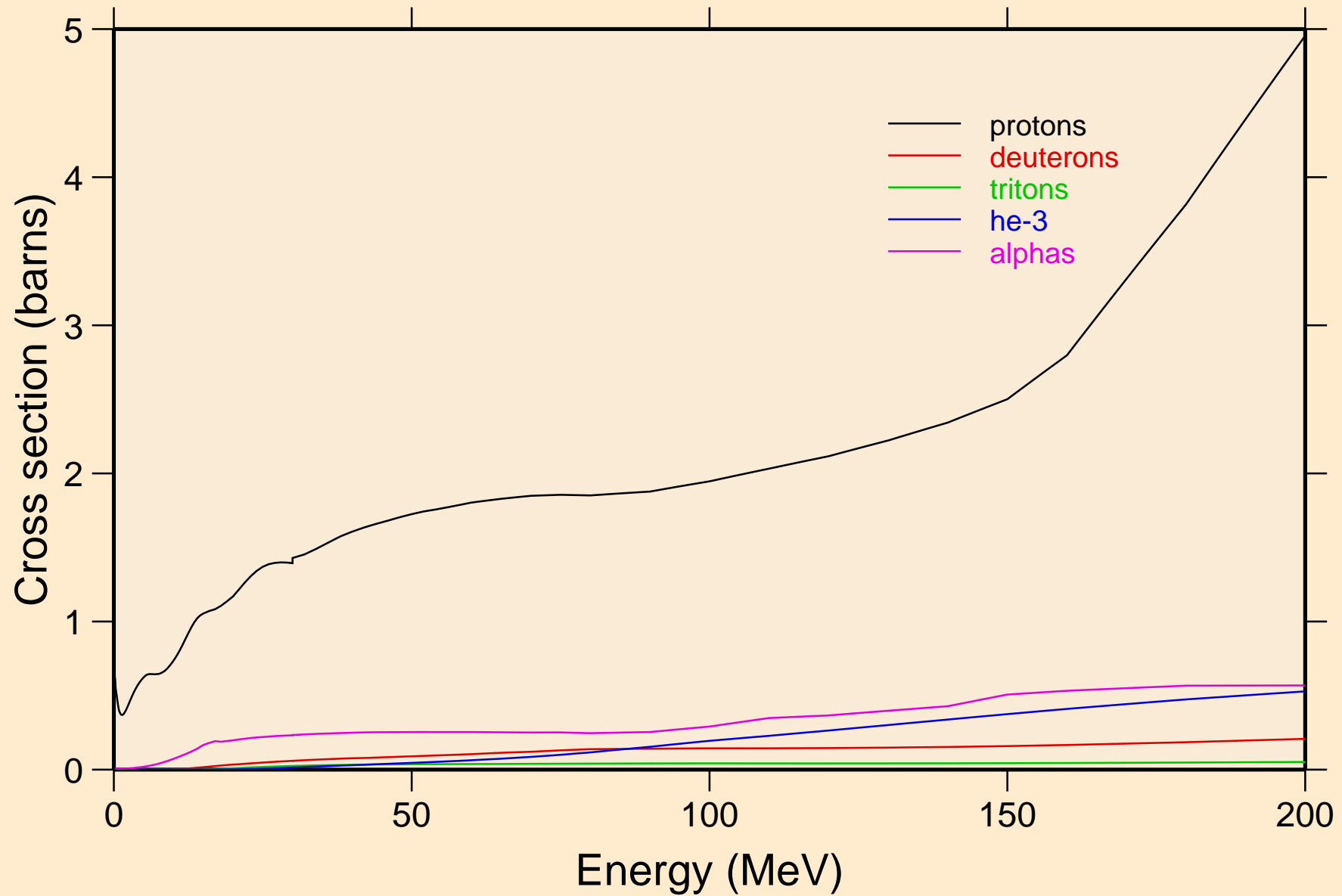

TA164 NEUTRON ACER TENDL-2021 LIBRARY; T=293.6K  
protons from (n,x)

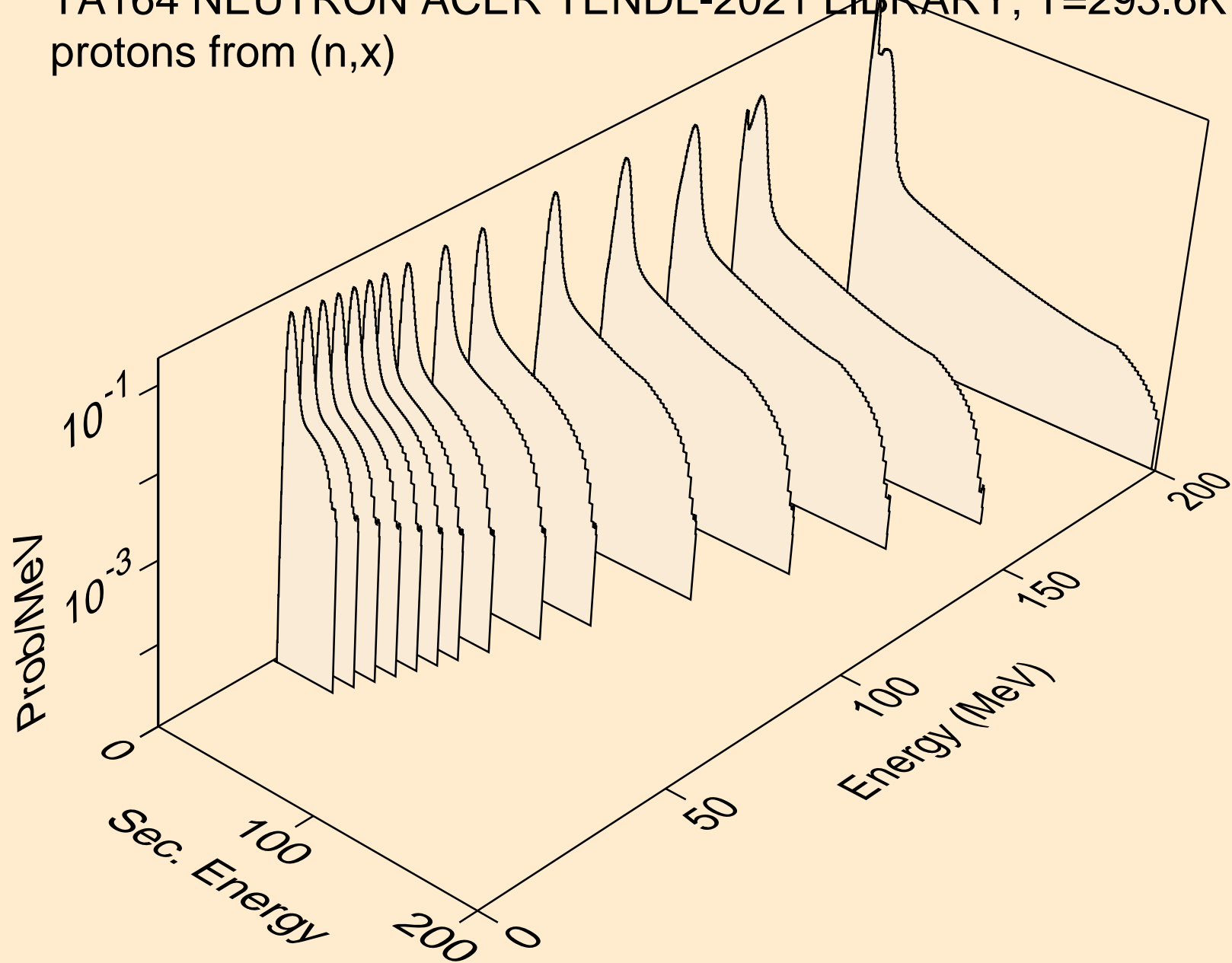

TA164 NEUTRON ACER TENDL-2021 LIBRARY; T=293.6K  
protons from (n,n\*)p

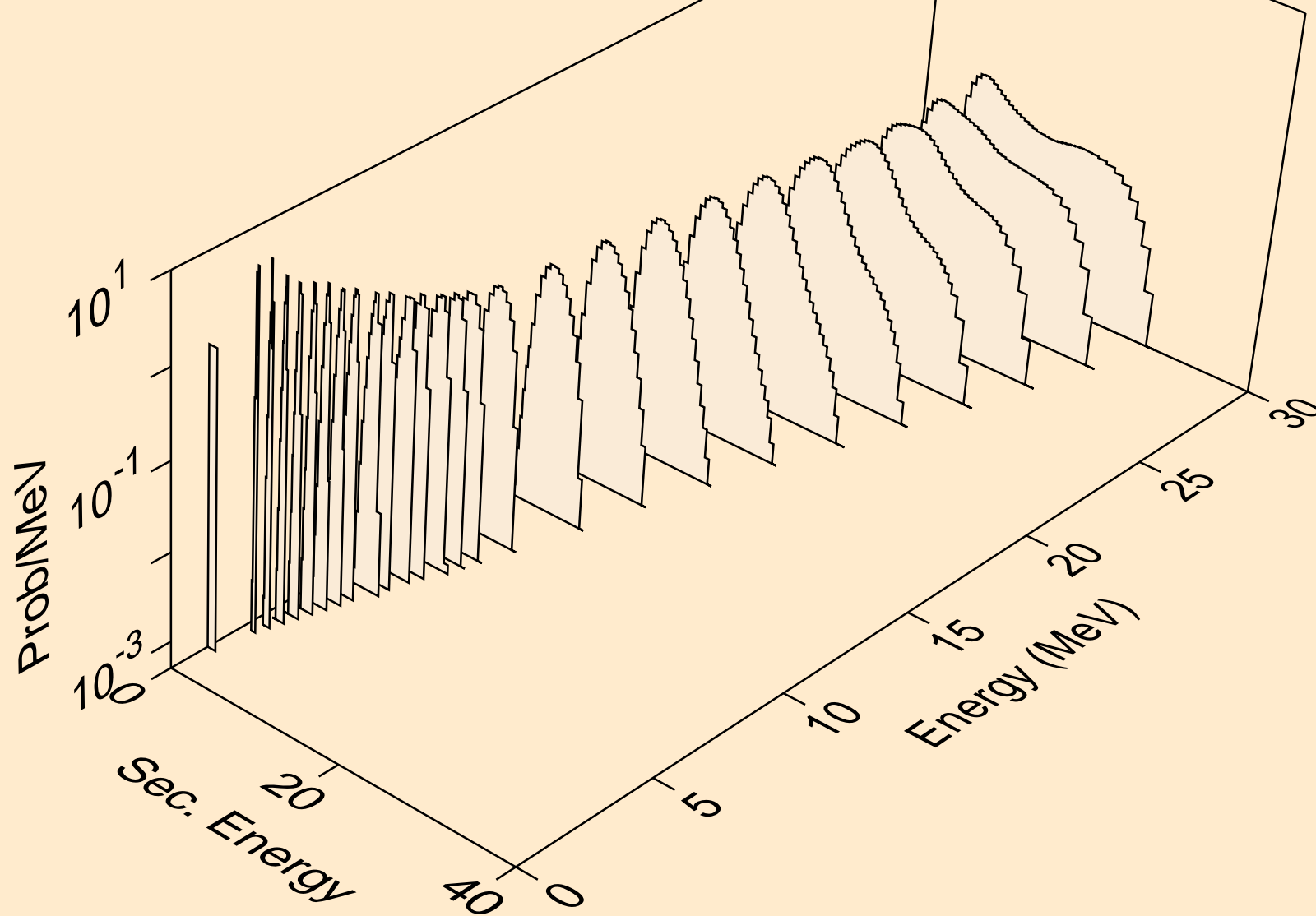

TA164 NEUTRON ACER TENDL-2021 LIBRARY; T=293.6K  
protons from (n,2np)

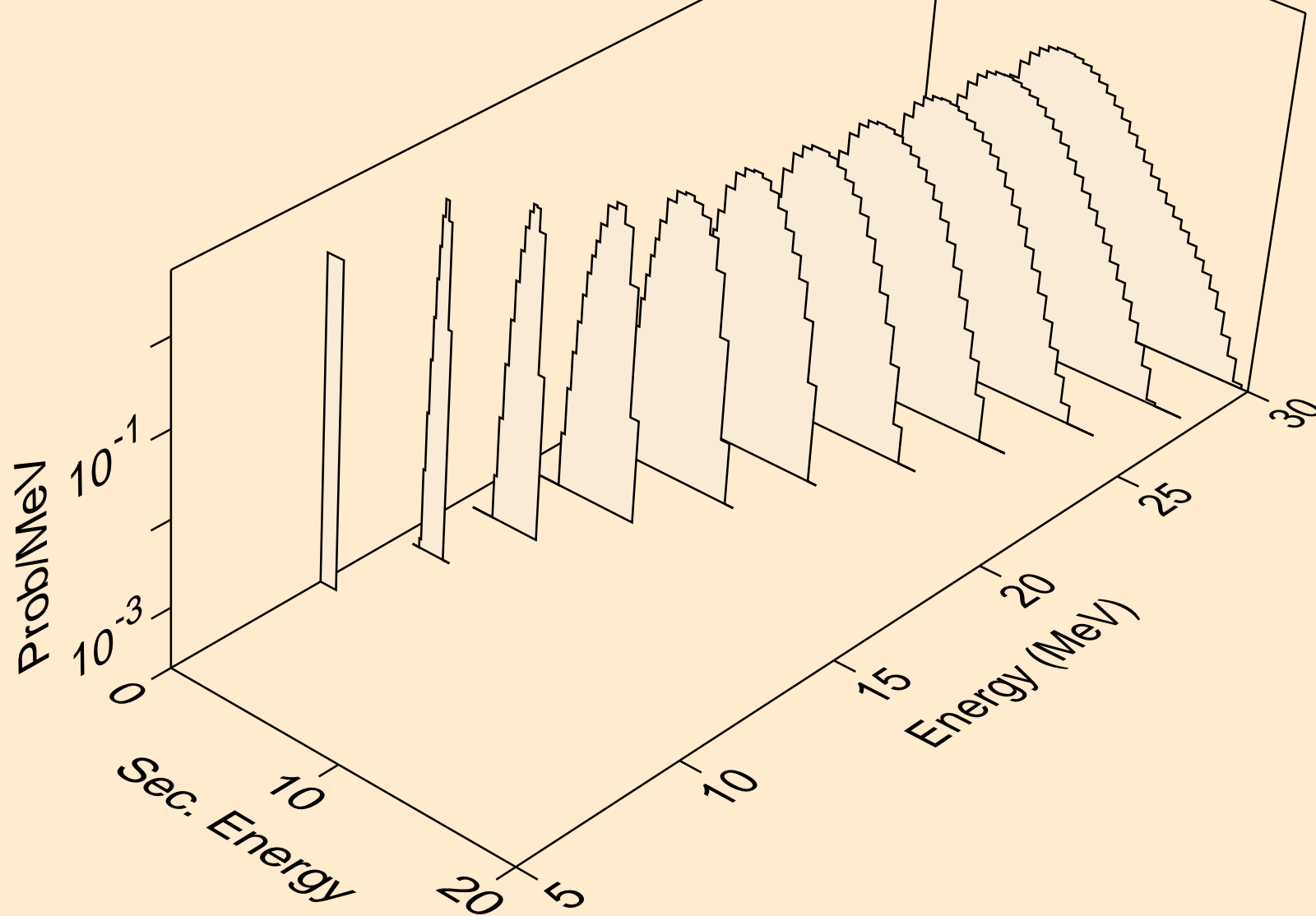

TA164 NEUTRON ACER TENDL-2021 LIBRARY; T=293.6K  
protons from (n,3np)

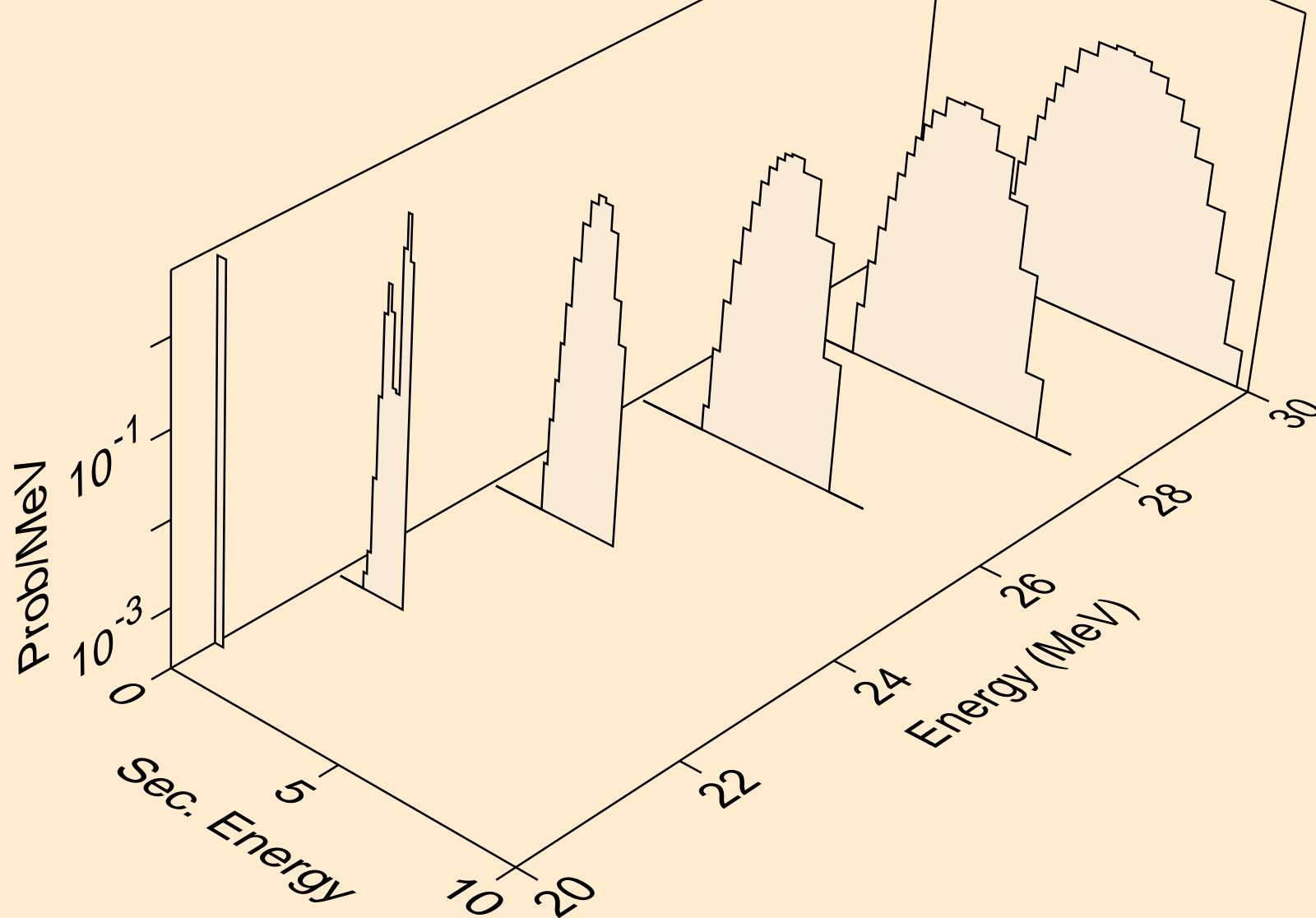

TA164 NEUTRON ACER TENDL-2021 LIBRARY; T=293.6K  
protons from (n,2np)

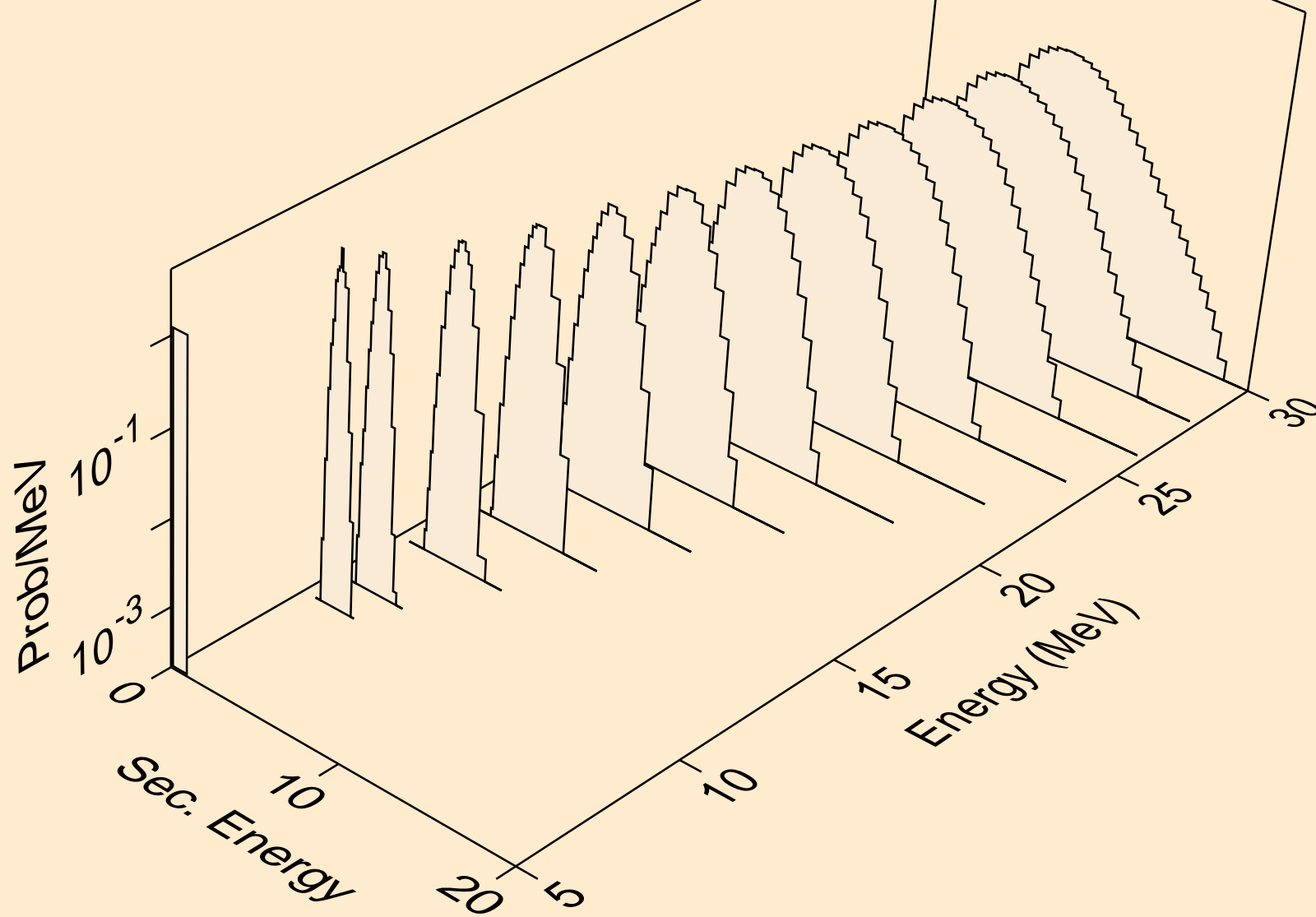

TA164 NEUTRON ACER TENDL-2021 LIBRARY; T=293.6K  
protons from (n,npa)

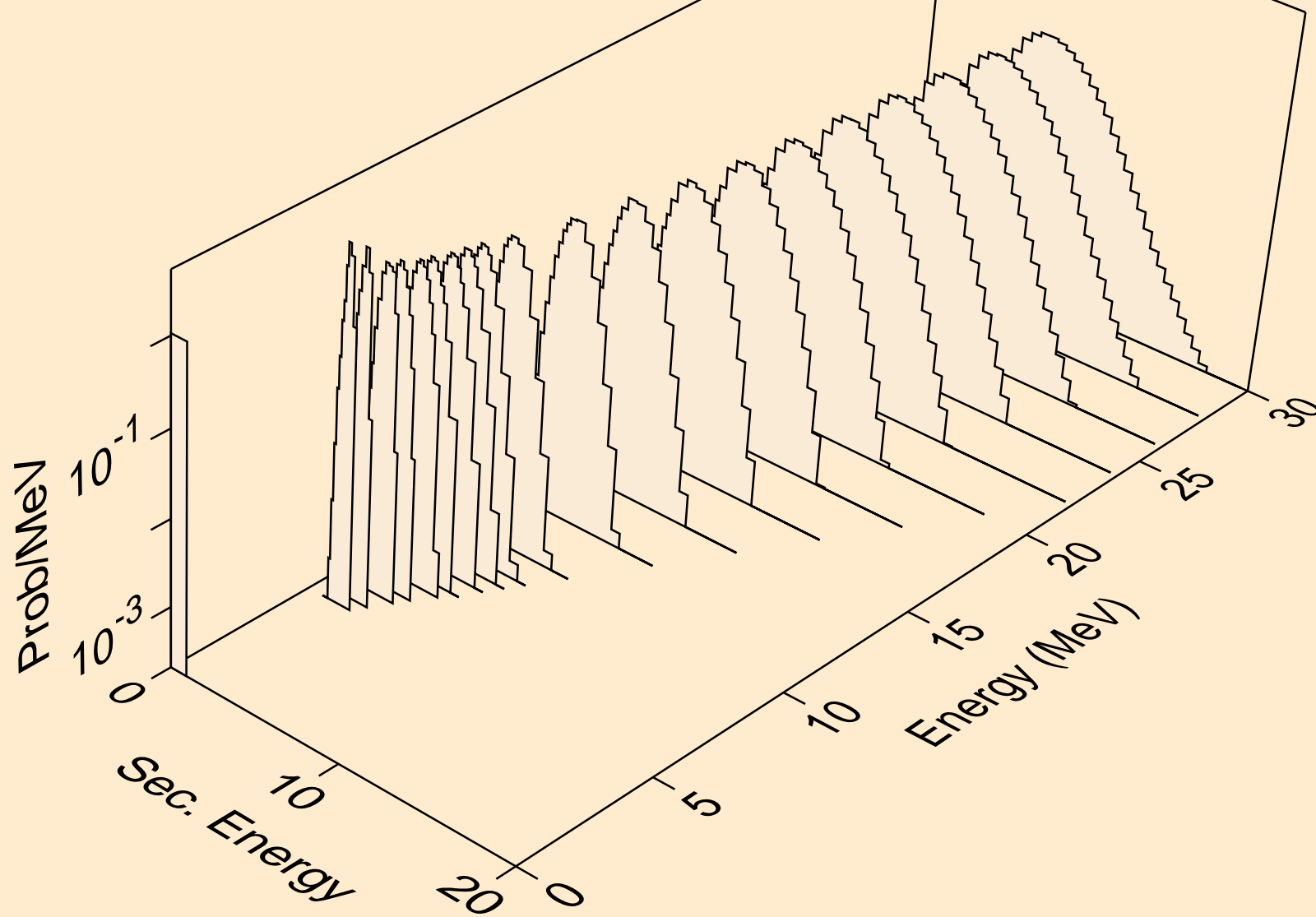



TA164 NEUTRON ACER TENDL-2021 LIBRARY; T=293.6K  
protons from (n,p)

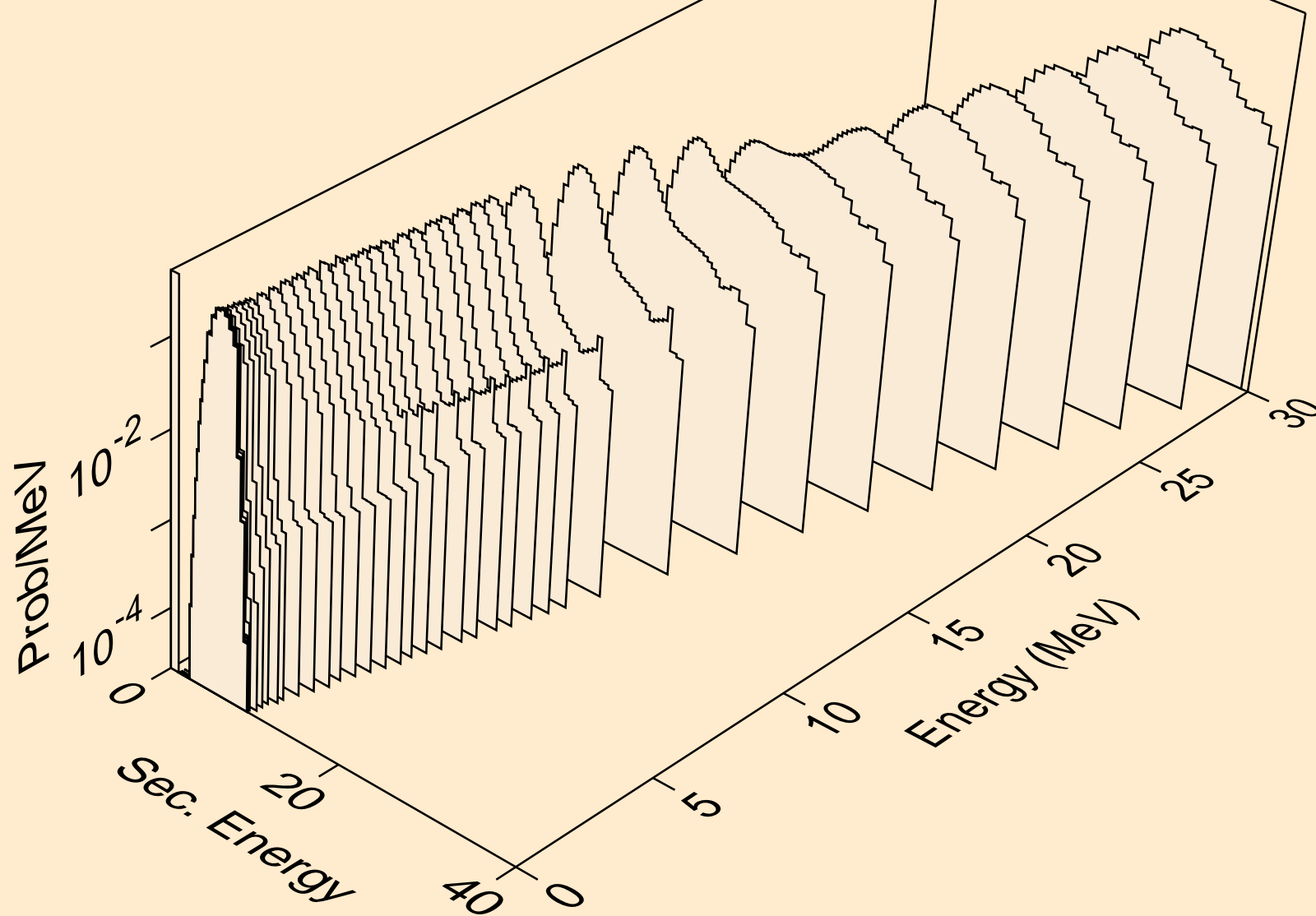

TA164 NEUTRON ACER TENDL-2021 LIBRARY; T=293.6K  
protons from (n,2p)

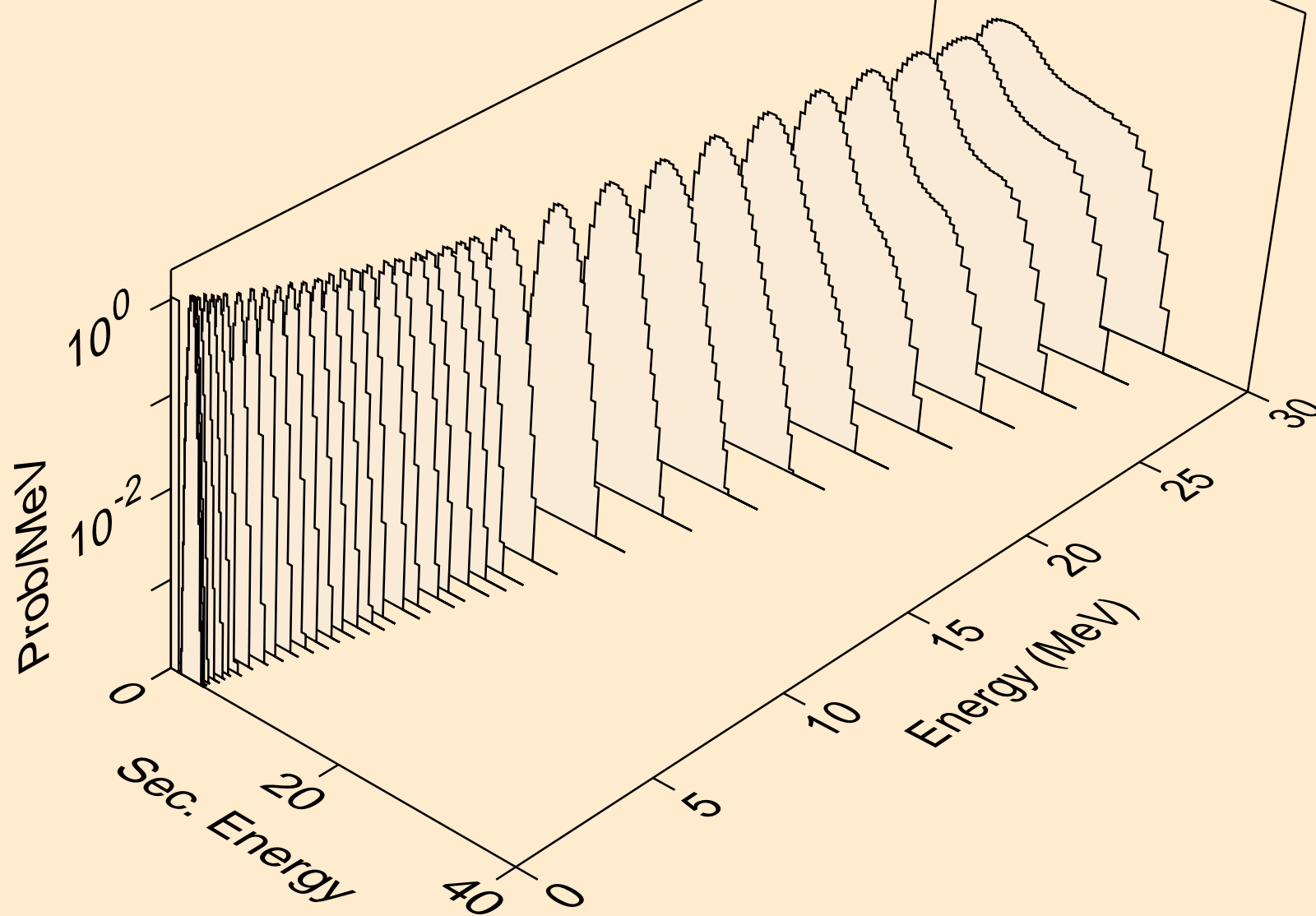

TA164 NEUTRON ACER TENDL-2021 LIBRARY; T=293.6K  
protons from (n,p)

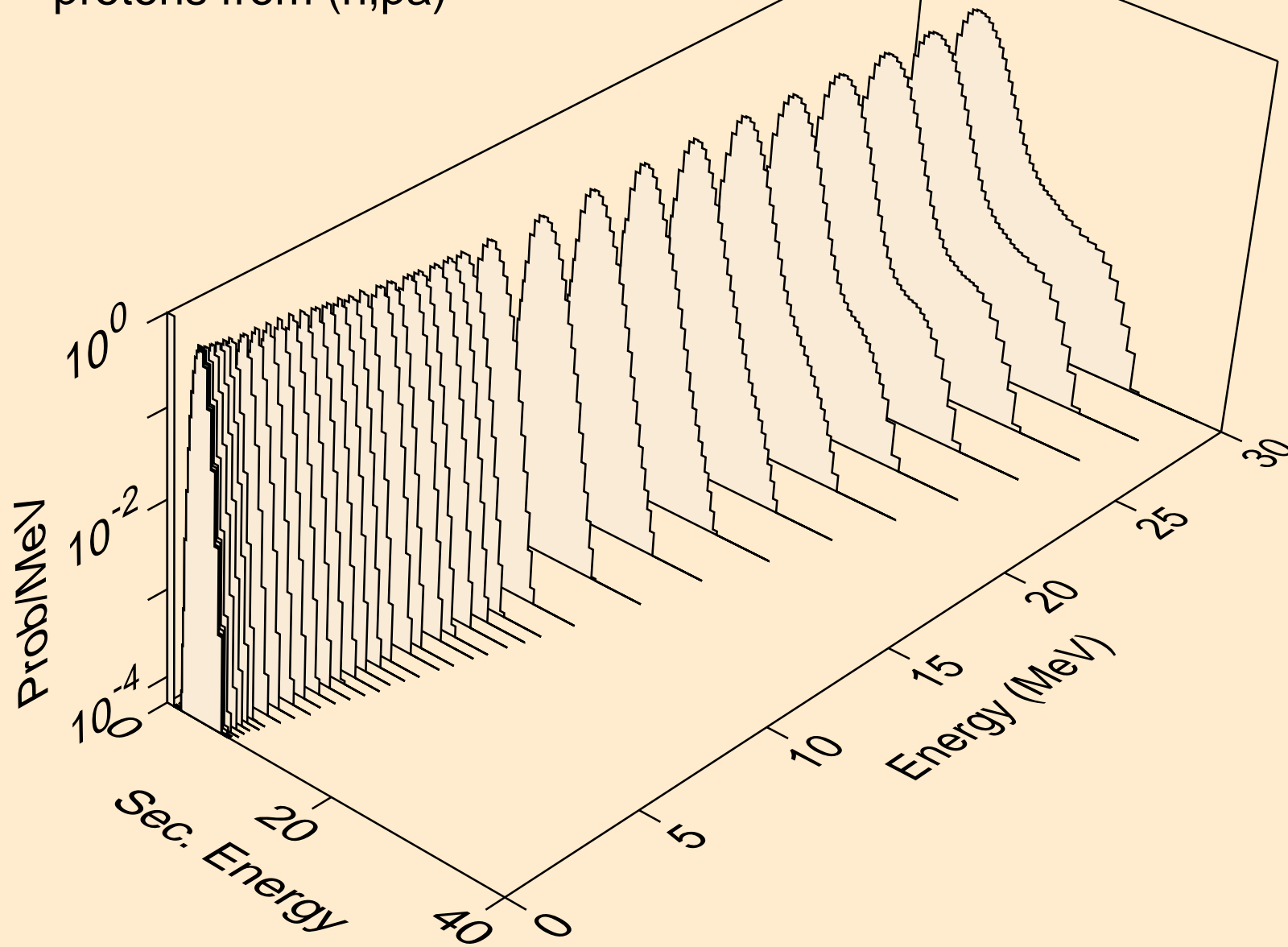

TA164 NEUTRON ACER TENDL-2021 LIBRARY; T=293.6K  
protons from (n,pd)

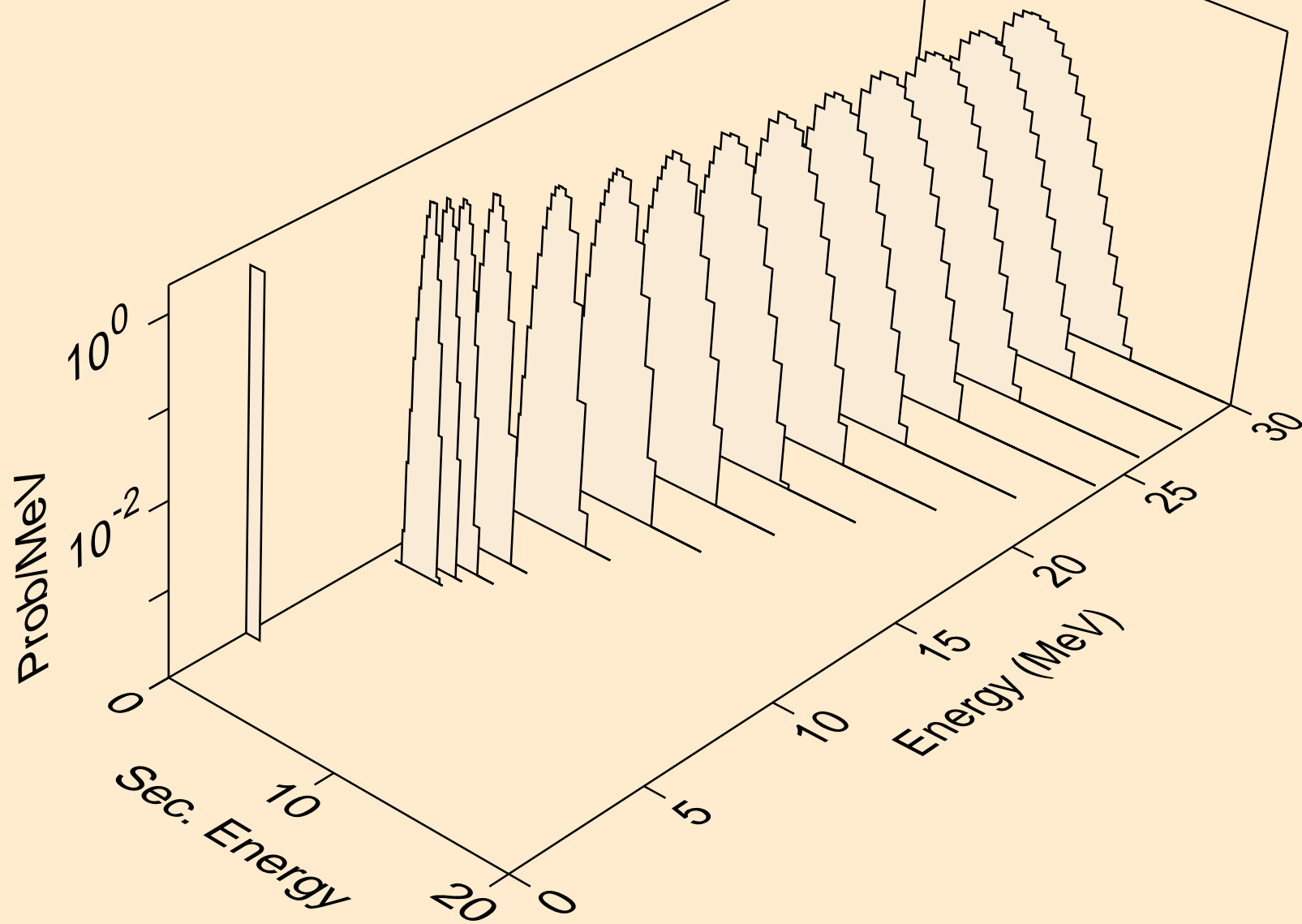

TA164 NEUTRON ACER TENDL-2021 LIBRARY; T=293.6K  
protons from (n,pt)

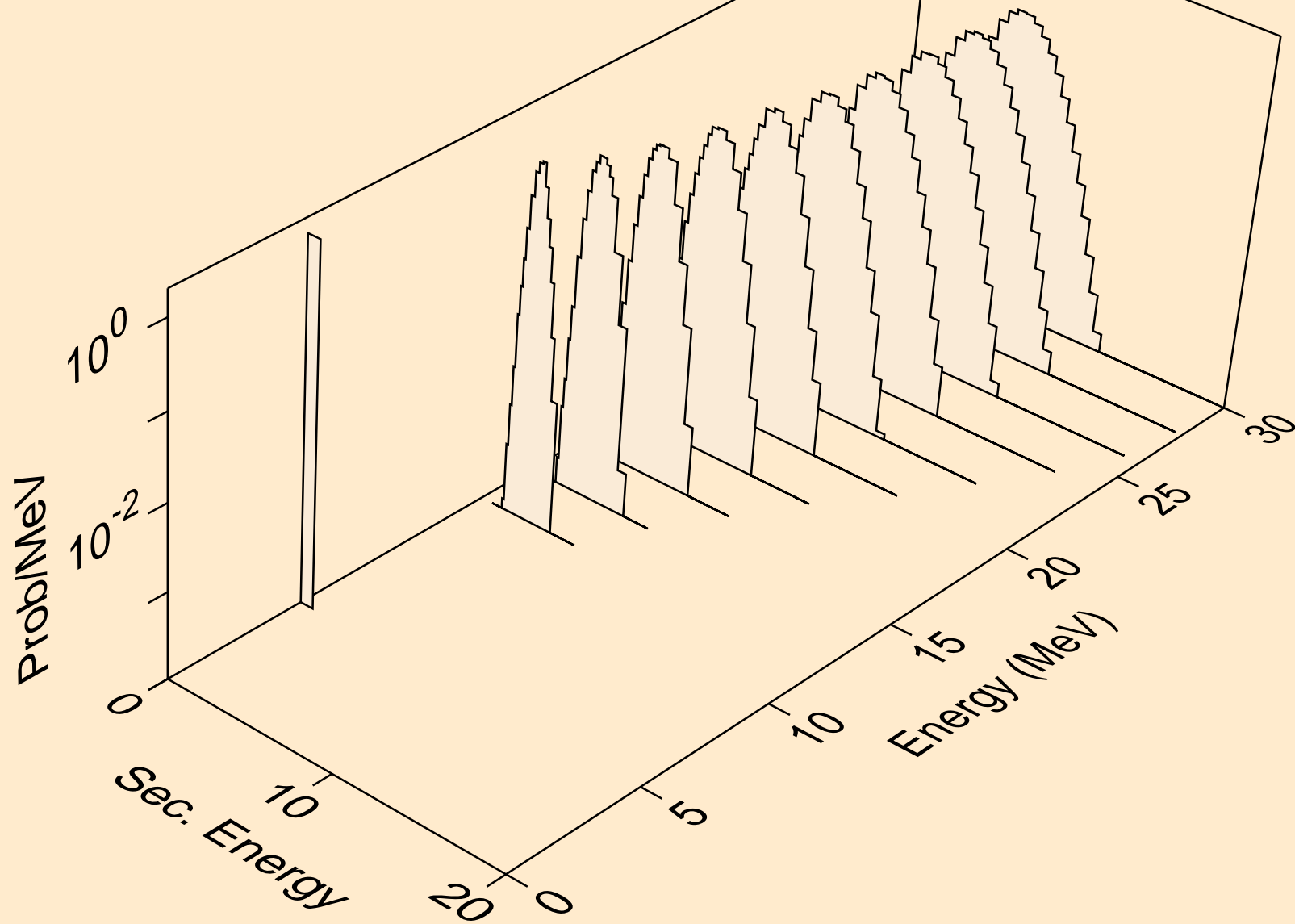

TA164 NEUTRON ACER TENDL-2021 LIBRARY; T=293.6K  
deuterons from (n,x)

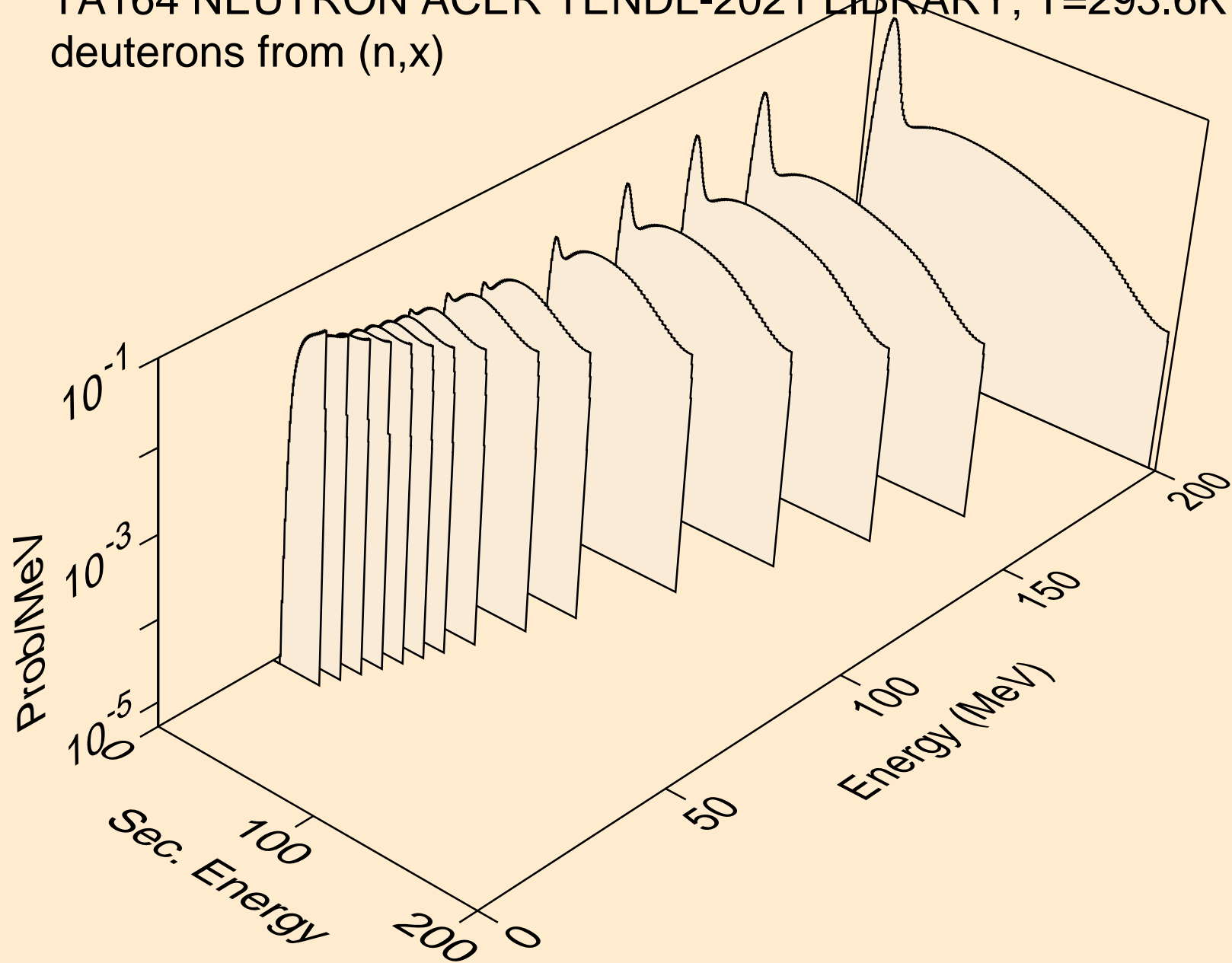

TA164 NEUTRON ACER TENDL-2021 LIBRARY; T=293.6K  
deuterons from (n,2nd)

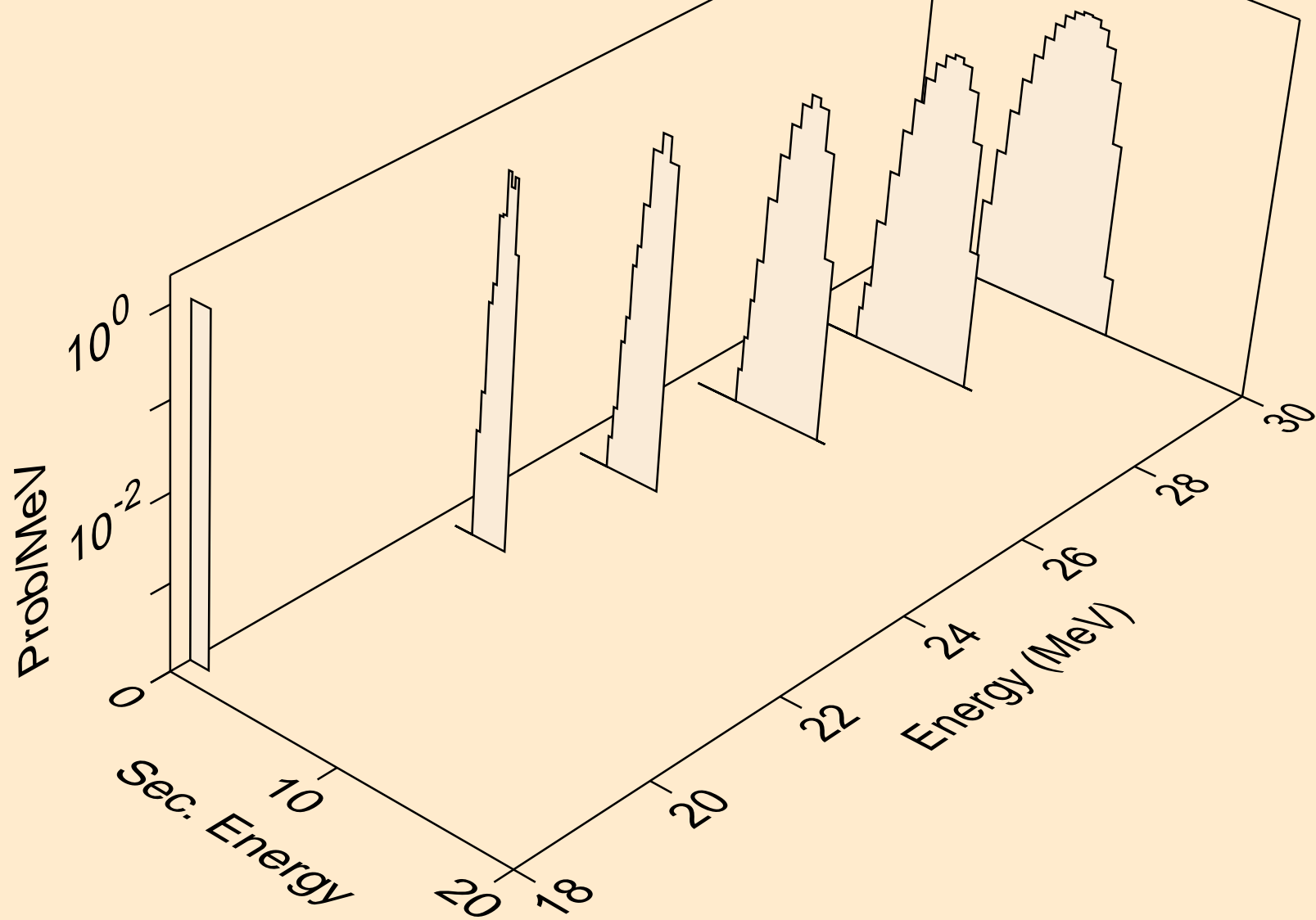

TA164 NEUTRON ACER TENDL-2021 LIBRARY; T=293.6K  
deuterons from (n,n\*)d

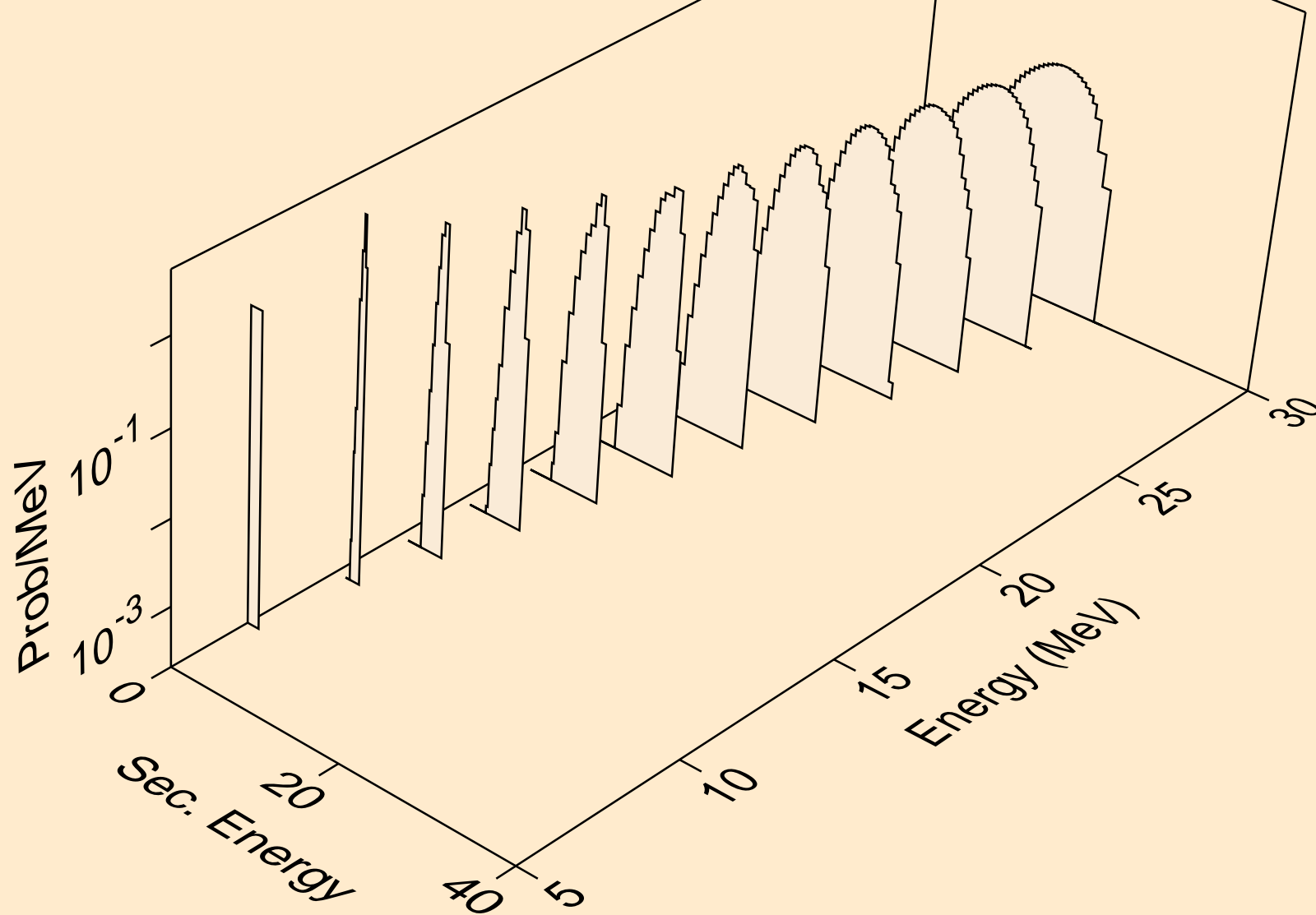



TA164 NEUTRON ACER TENDL-2021 LIBRARY; T=293.6K  
deuterons from (n,d)

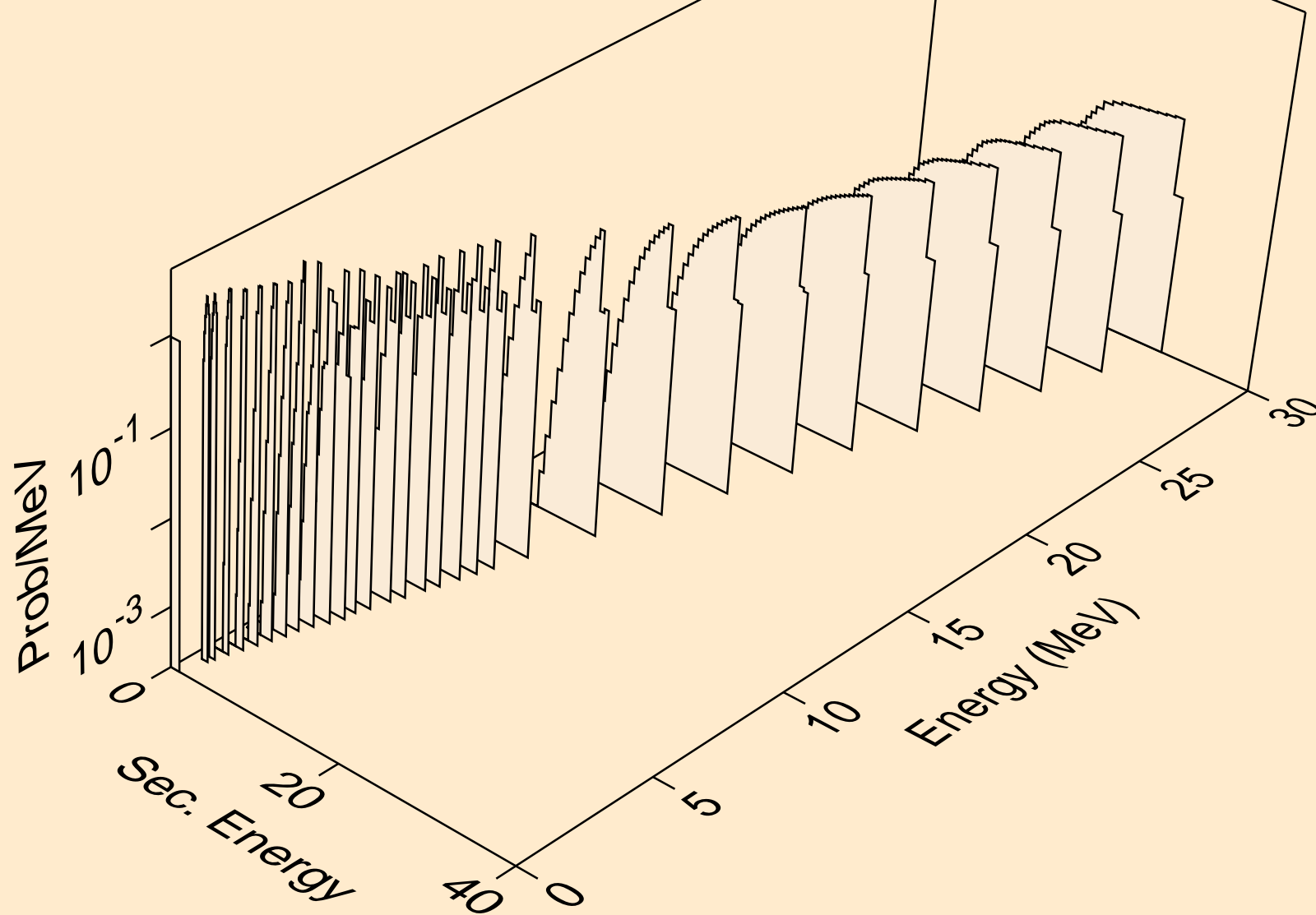

TA164 NEUTRON ACER TENDL-2021 LIBRARY; T=293.6K  
deuterons from (n,d2a)

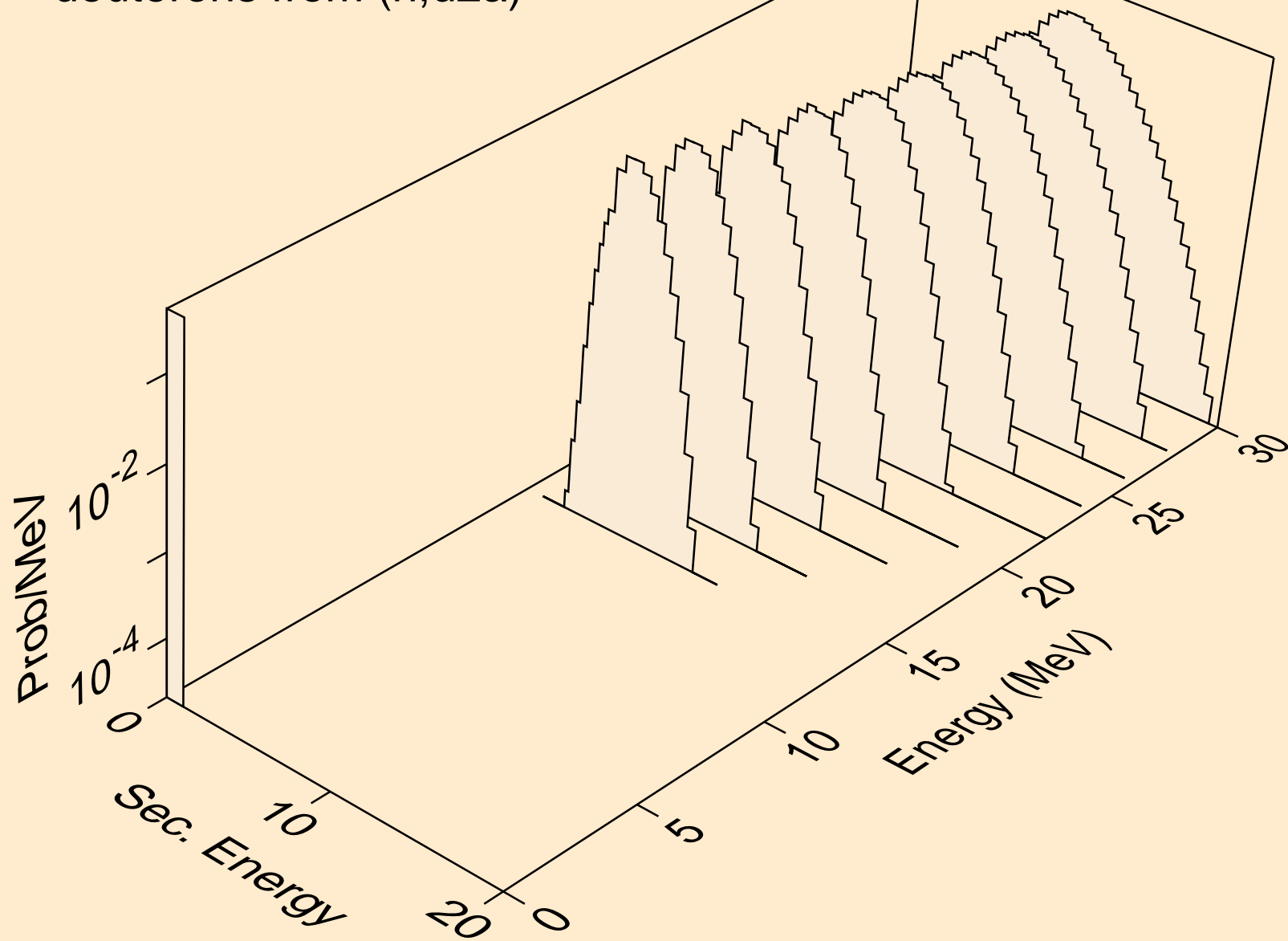

TA164 NEUTRON ACER TENDL-2021 LIBRARY; T=293.6K  
deuterons from (n,pd)

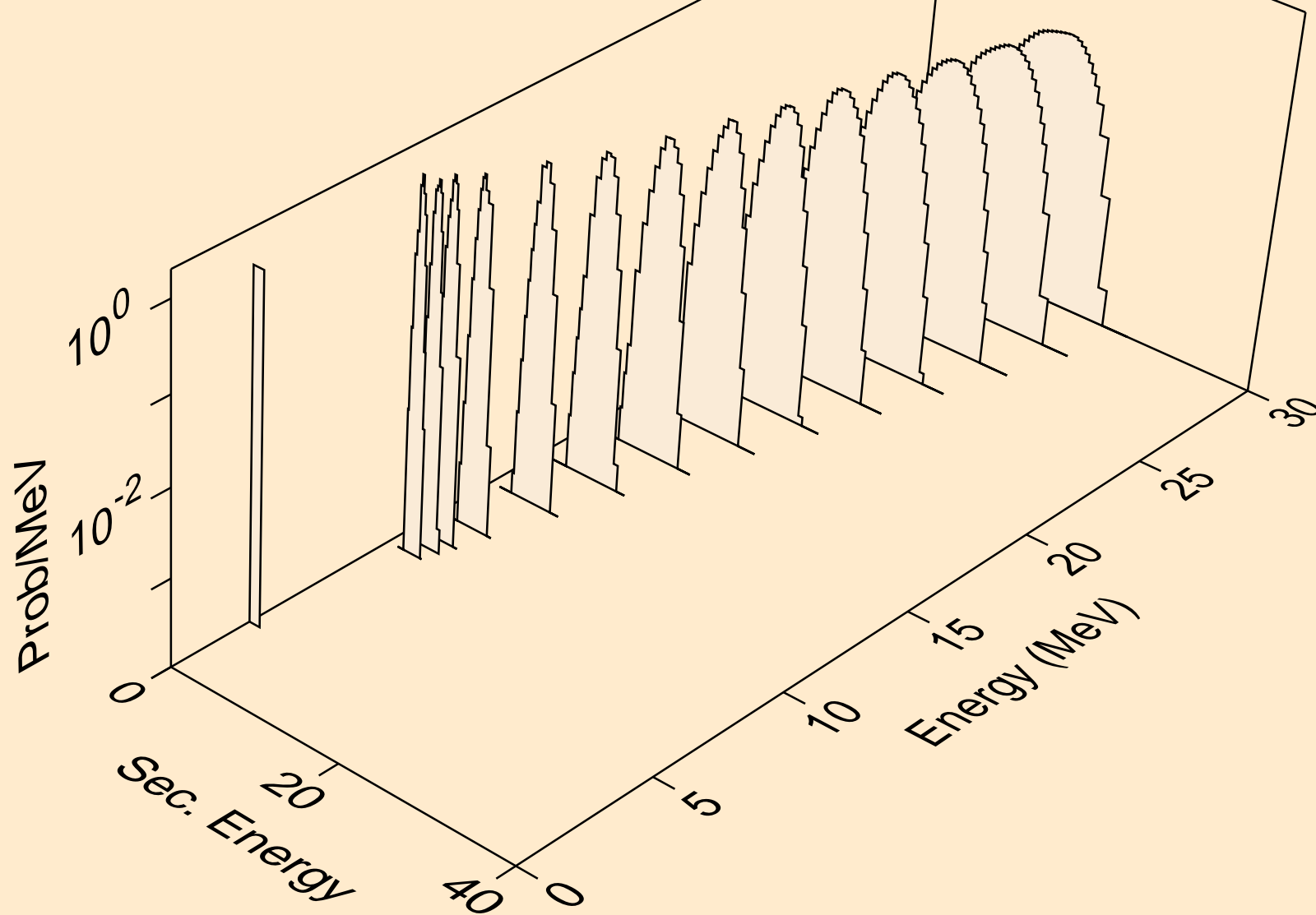

TA164 NEUTRON ACER TENDL-2021 LIBRARY; T=293.6K  
deuterons from (n,da)

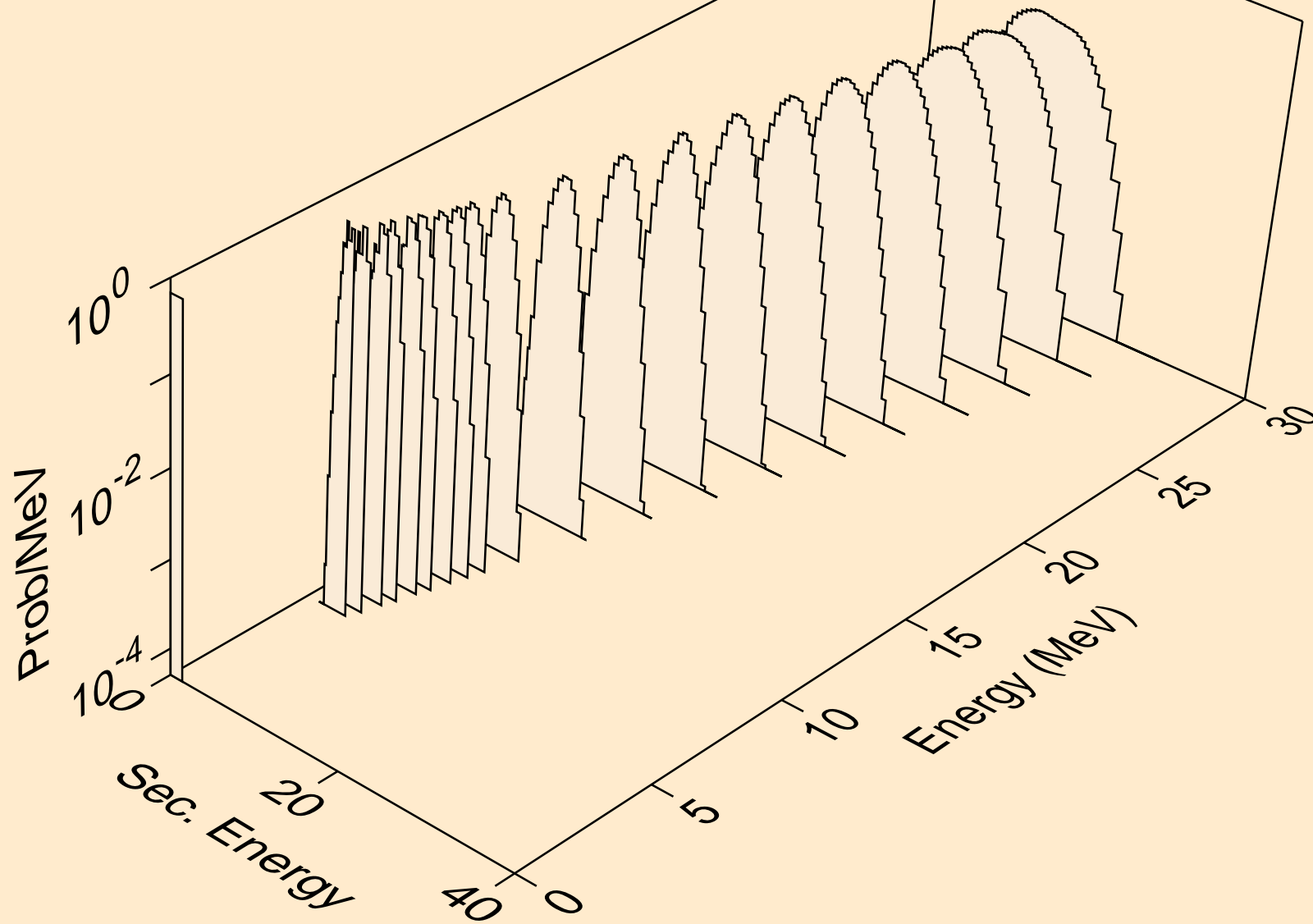

TA164 NEUTRON ACER TENDL-2021 LIBRARY; T=293.6K  
tritons from (n,x)

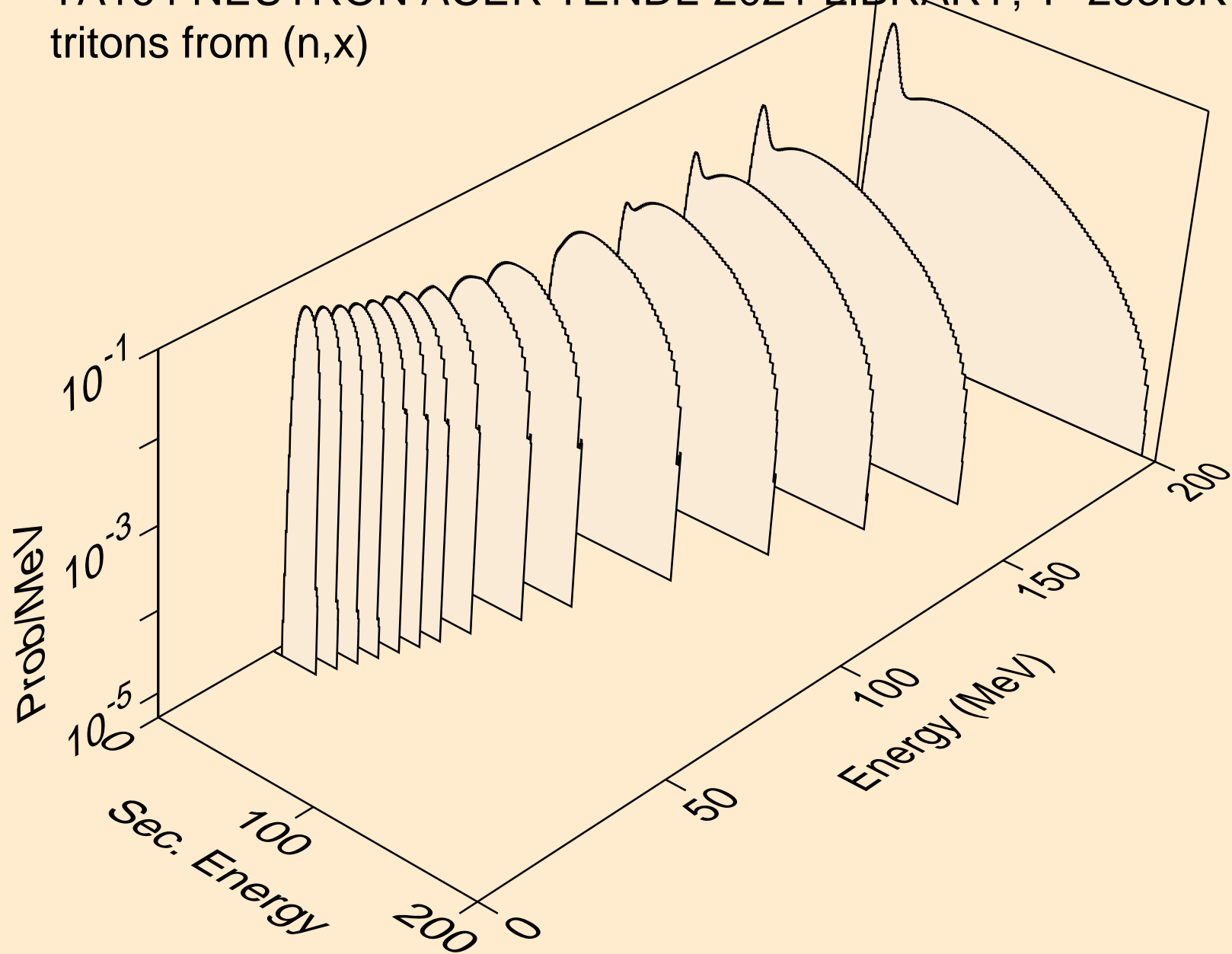

TA164 NEUTRON ACER TENDL-2021 LIBRARY; T=293.6K  
tritons from (n,n\*)t

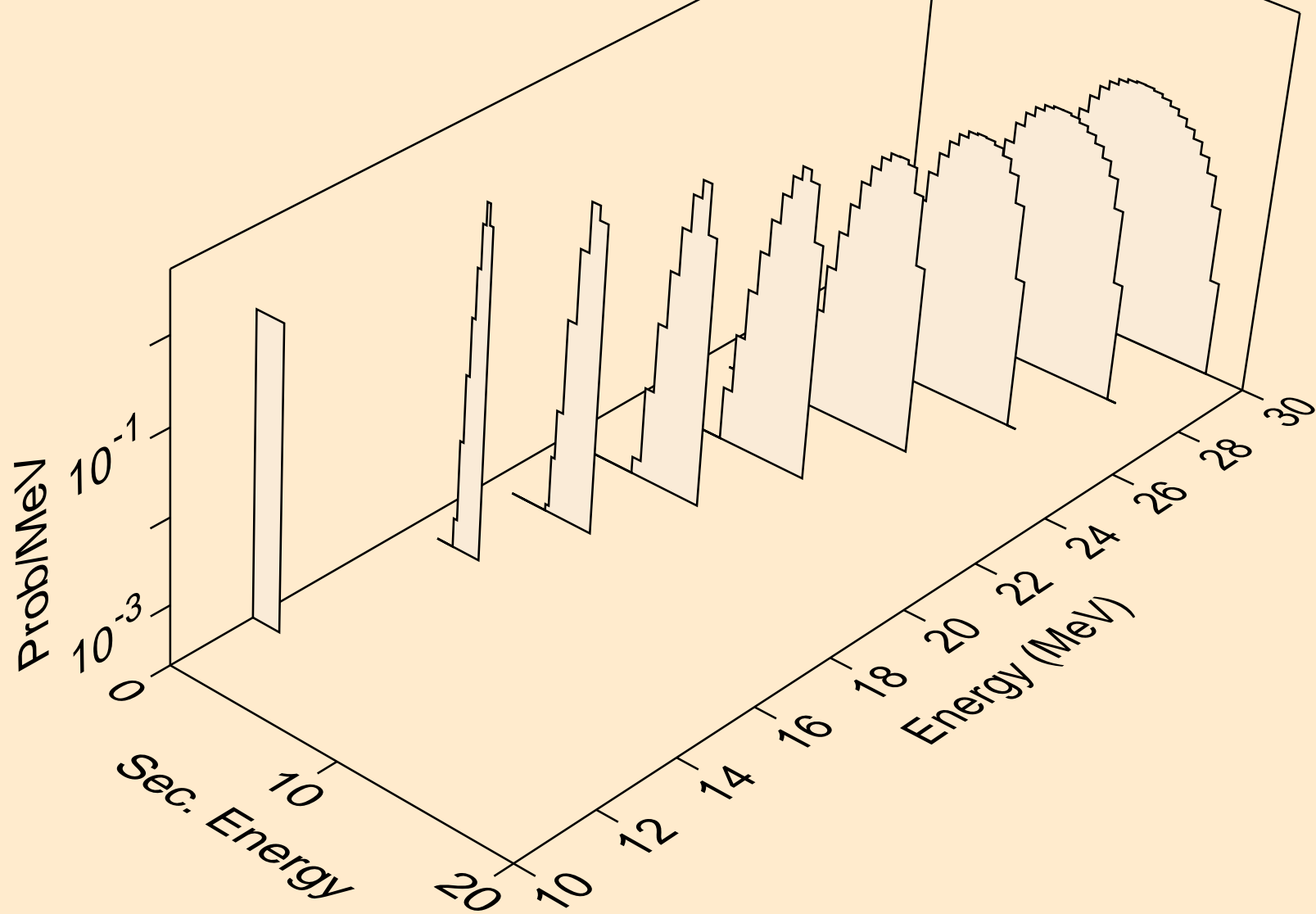

TA164 NEUTRON ACER TENDL-2021 LIBRARY; T=293.6K  
tritons from (n,t)

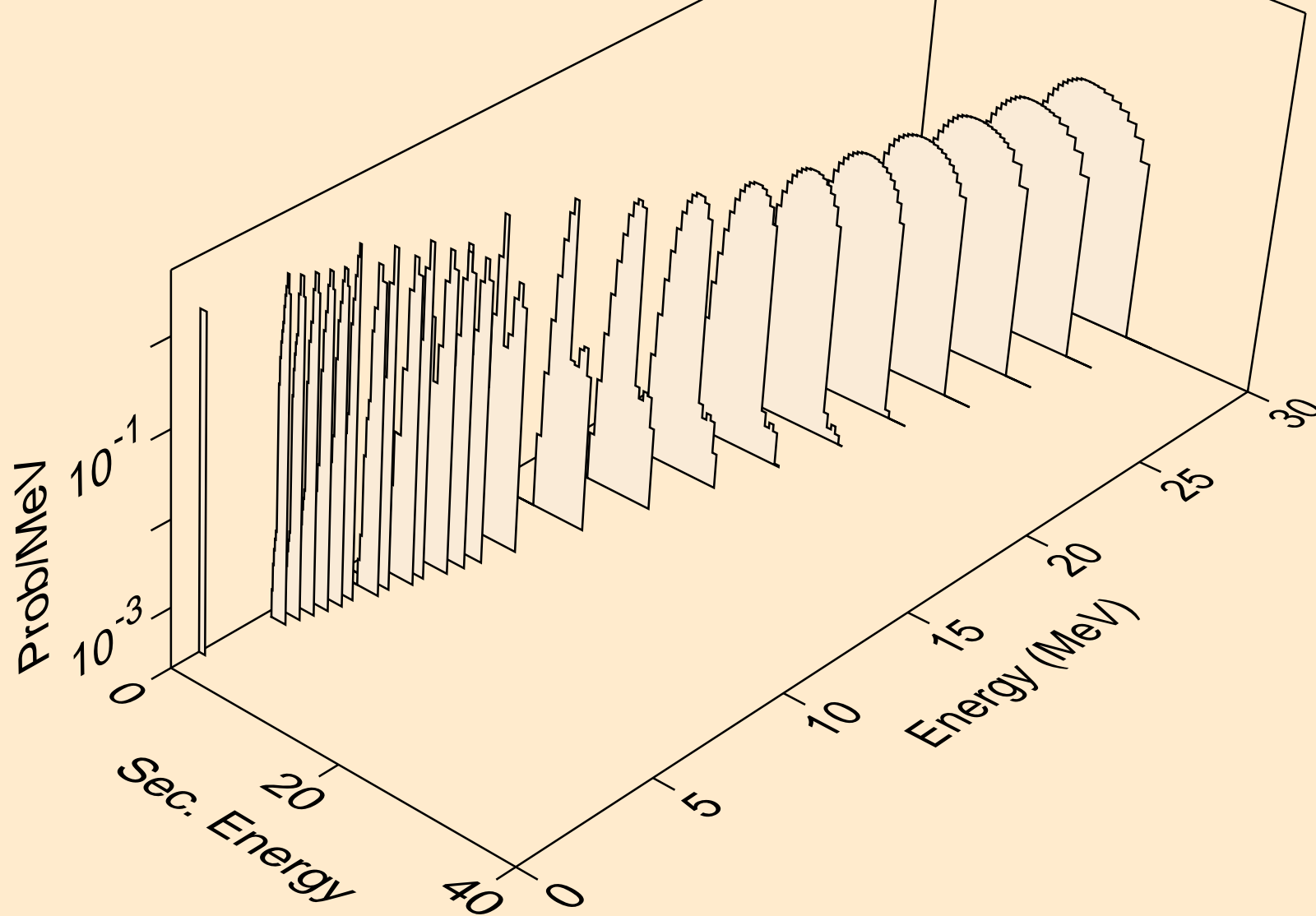

TA164 NEUTRON ACER TENDL-2021 LIBRARY; T=293.6K  
tritons from (n,t2a)

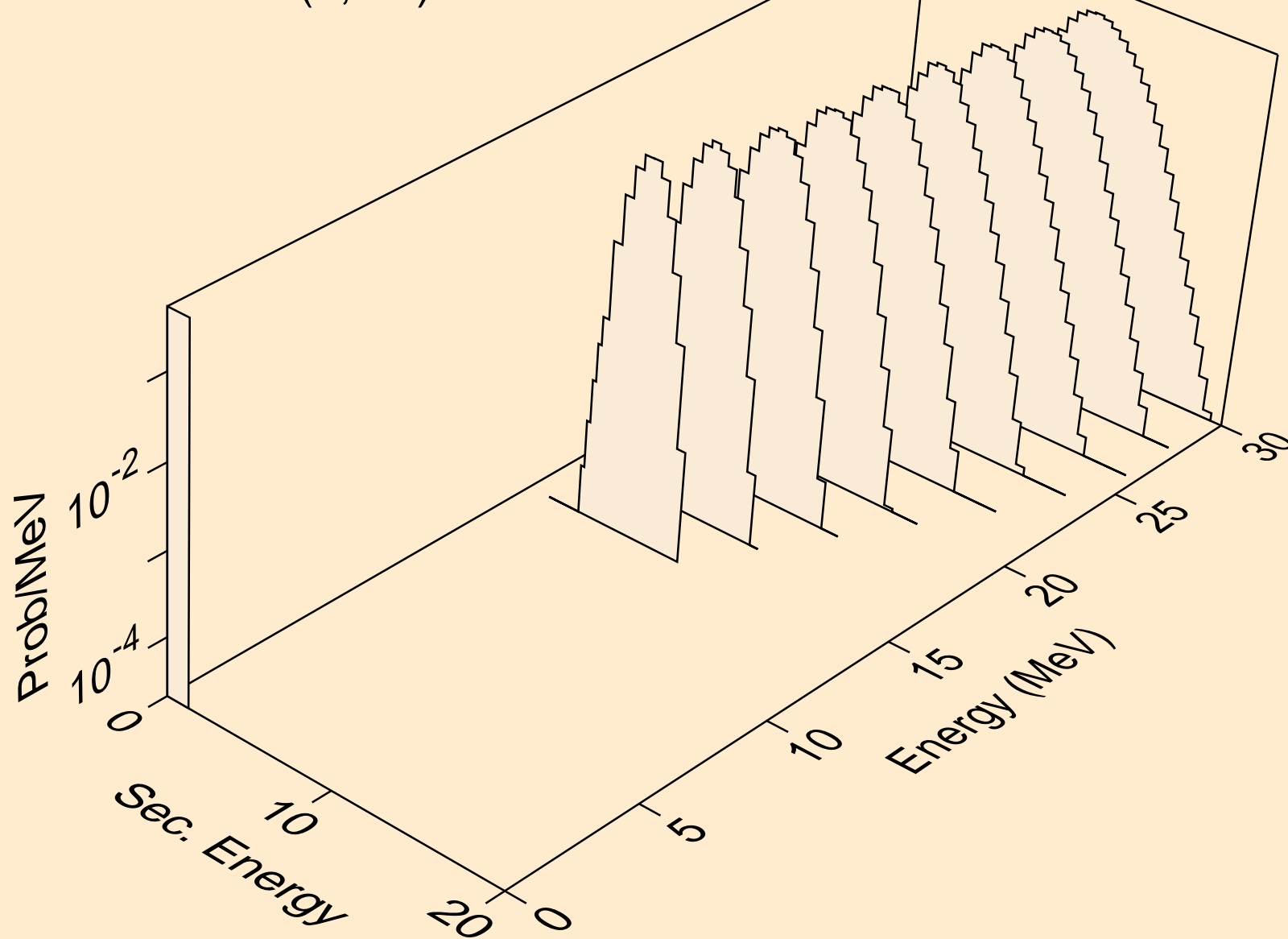



TA164 NEUTRON ACER TENDL-2021 LIBRARY; T=293.6K  
tritons from (n,pt)

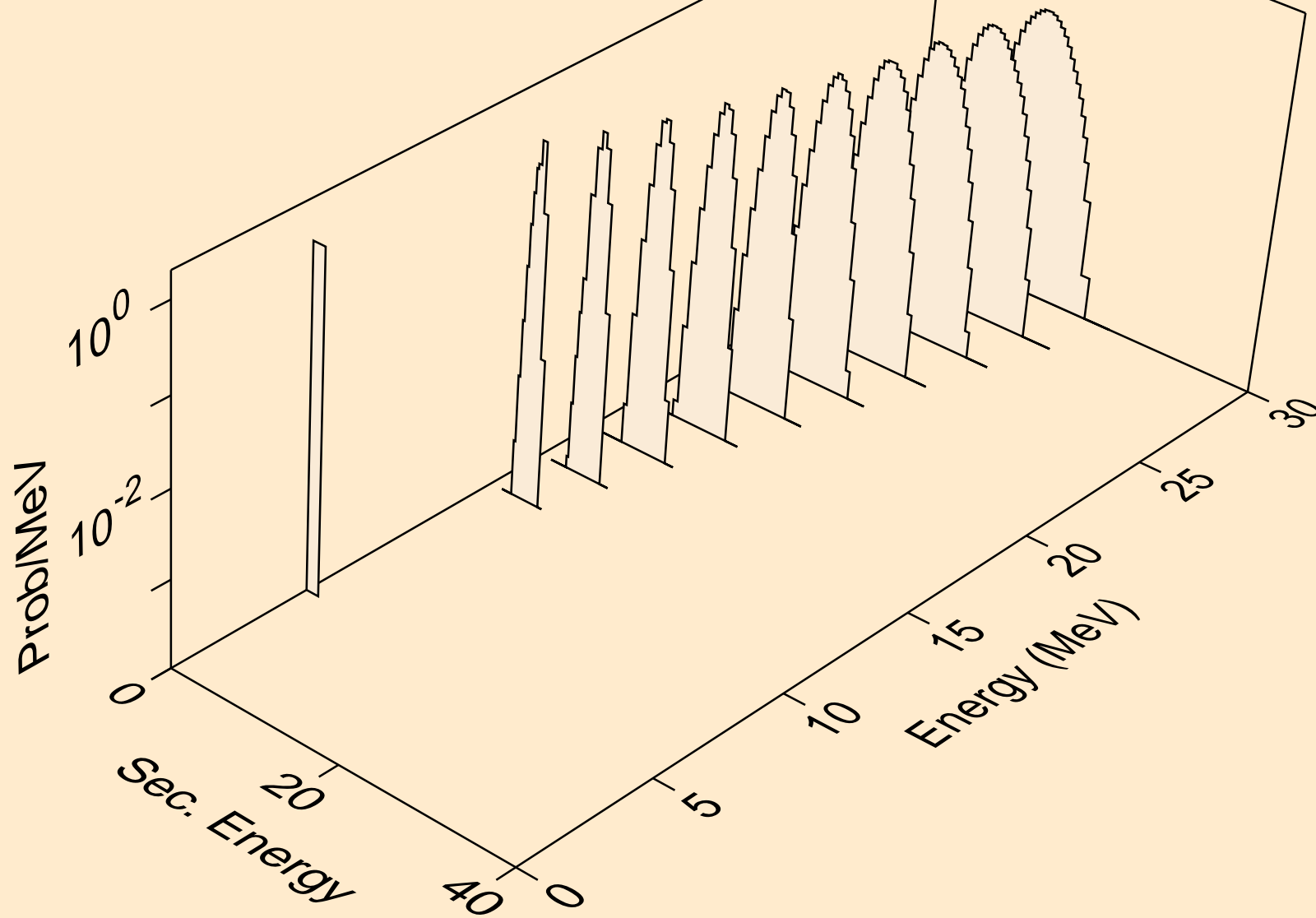

TA164 NEUTRON ACER TENDL-2021 LIBRARY; T=293.6K  
he3s from (n,x)

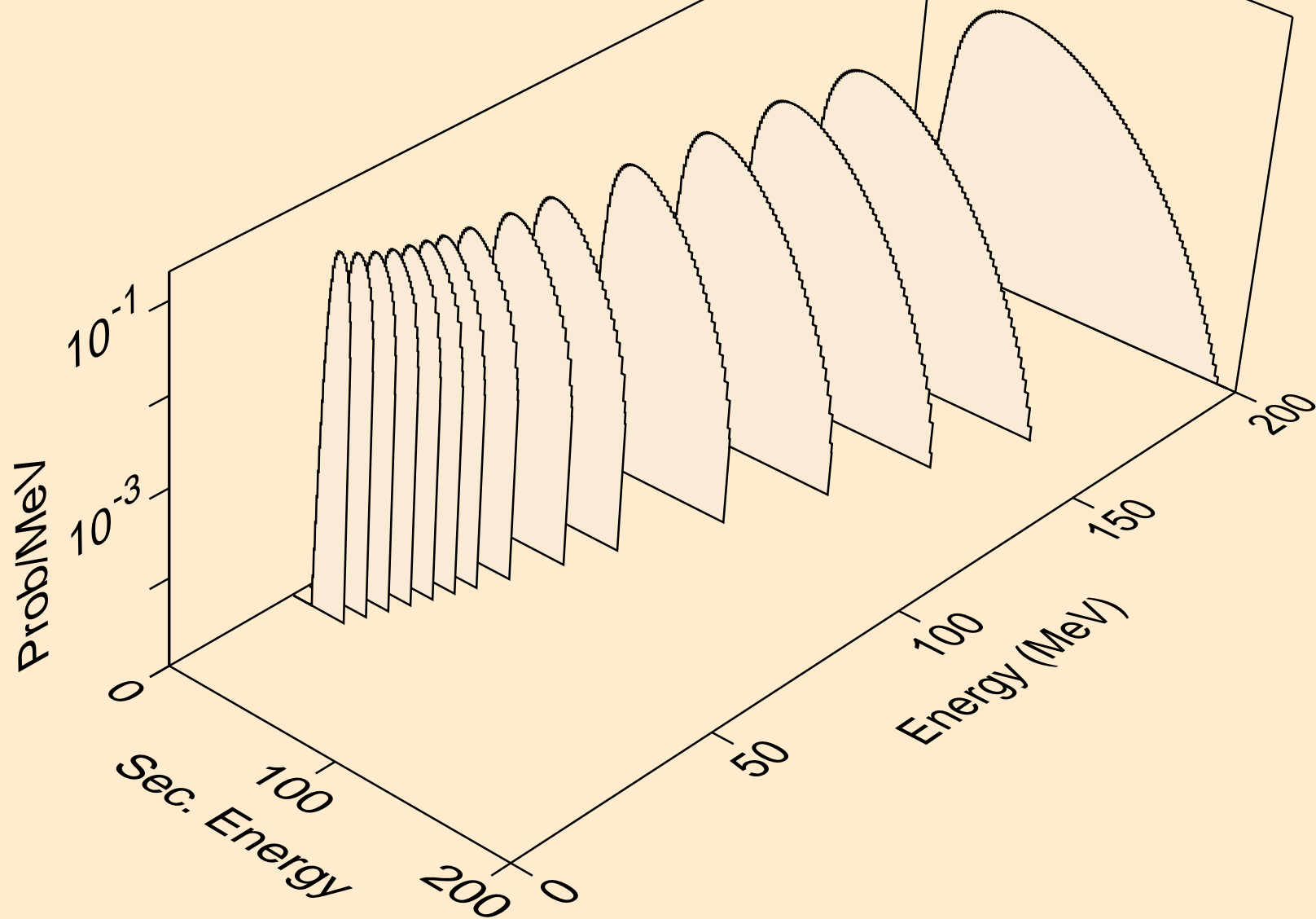

TA164 NEUTRON ACER TENDL-2021 LIBRARY; T=293.6K  
he3s from (n,n\*)he3

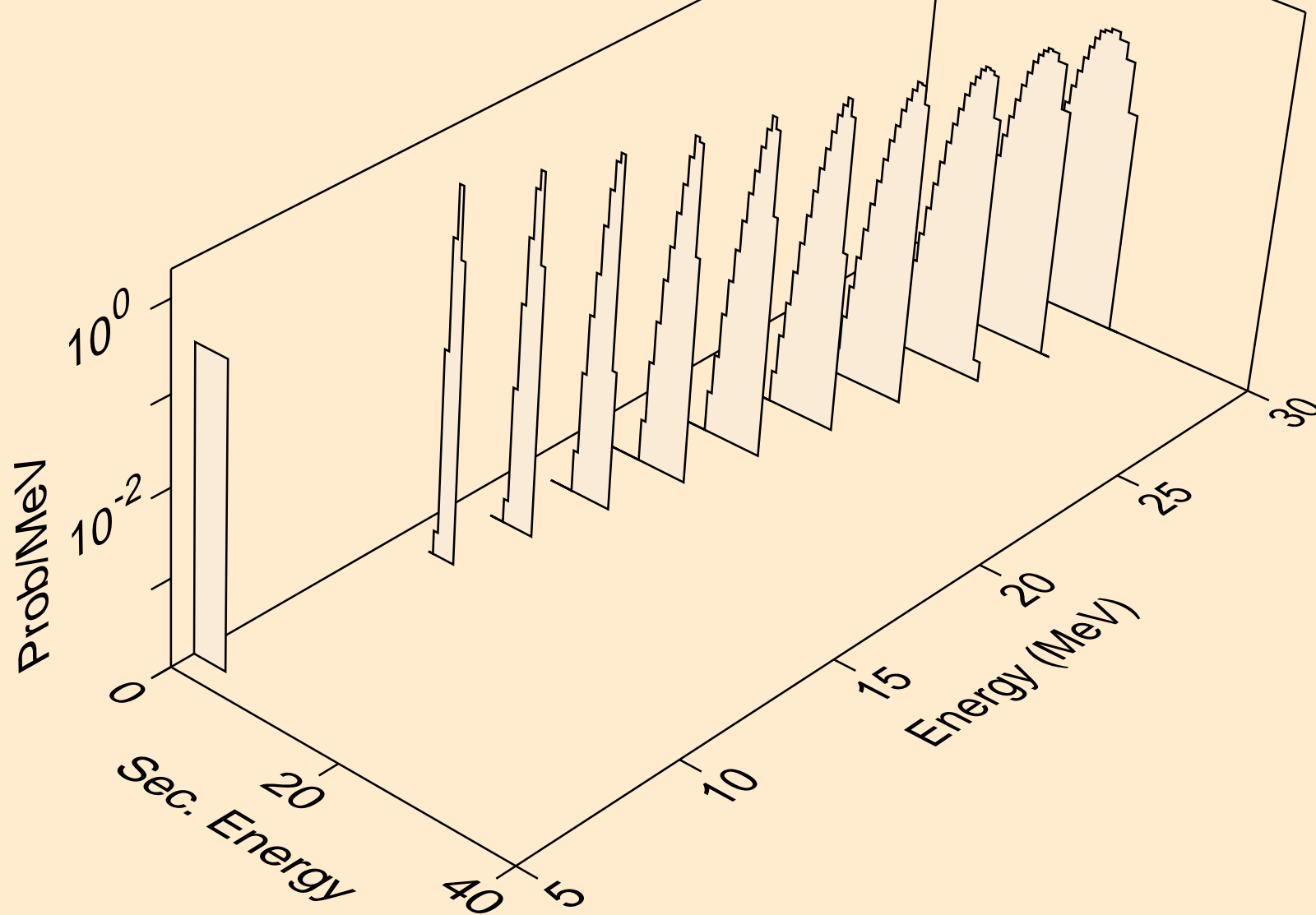

TA164 NEUTRON ACER TENDL-2021 LIBRARY; T=293.6K  
he3s from (n,he3)

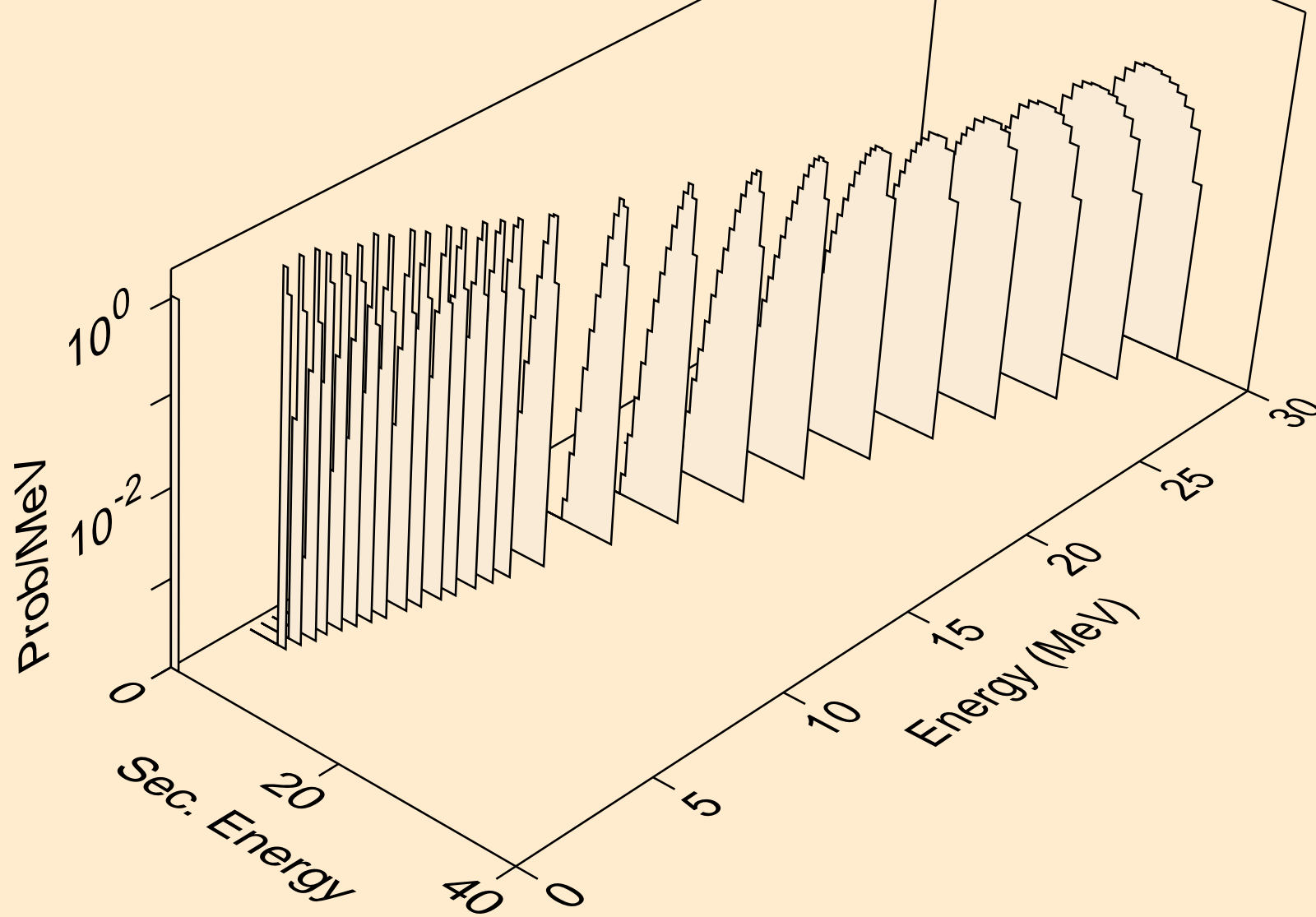

TA164 NEUTRON ACER TENDL-2021 LIBRARY; T=293.6K  
alphas from (n,x)

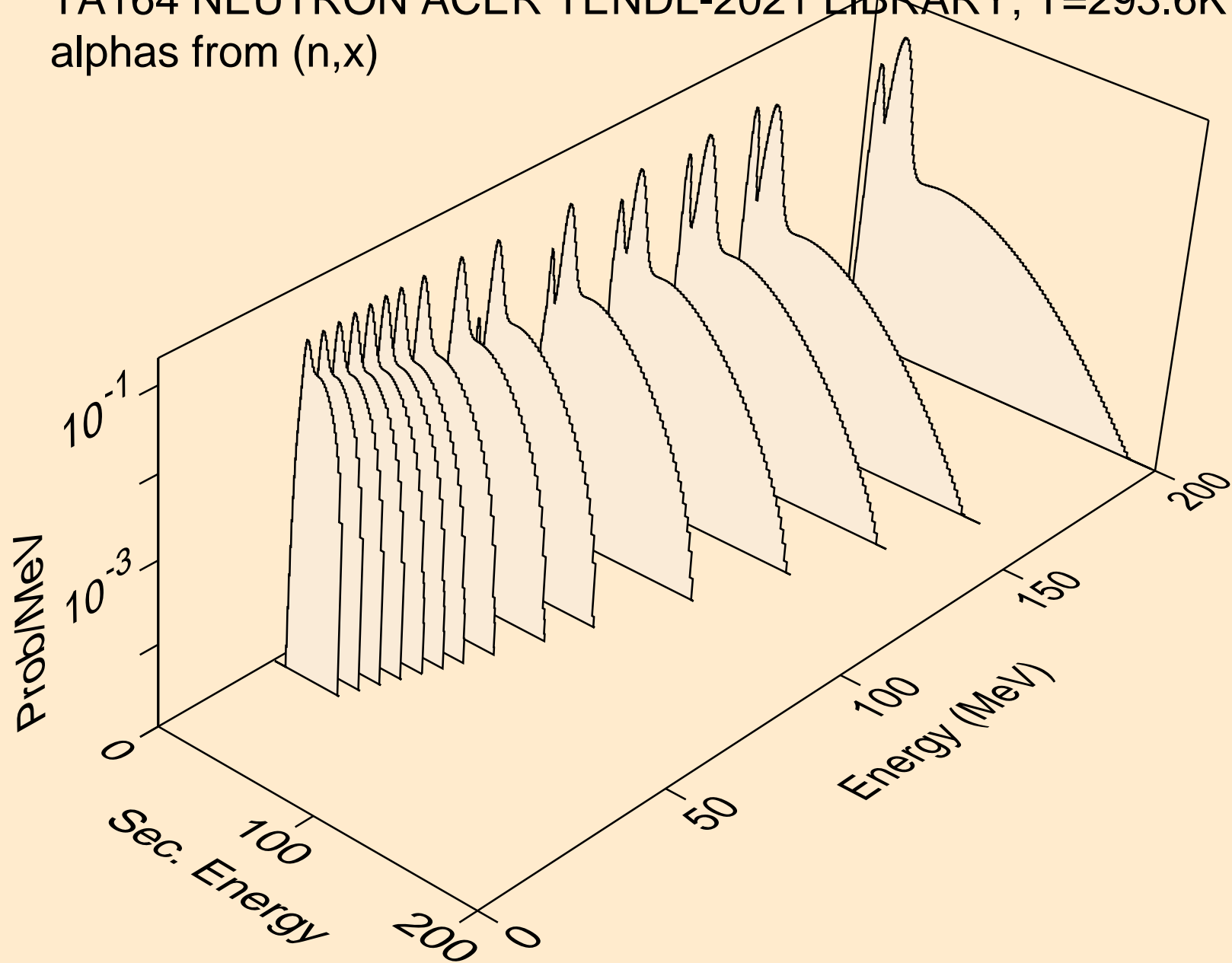

TA164 NEUTRON ACER TENDL-2021 LIBRARY; T=293.6K  
alphas from (n,n\*)a

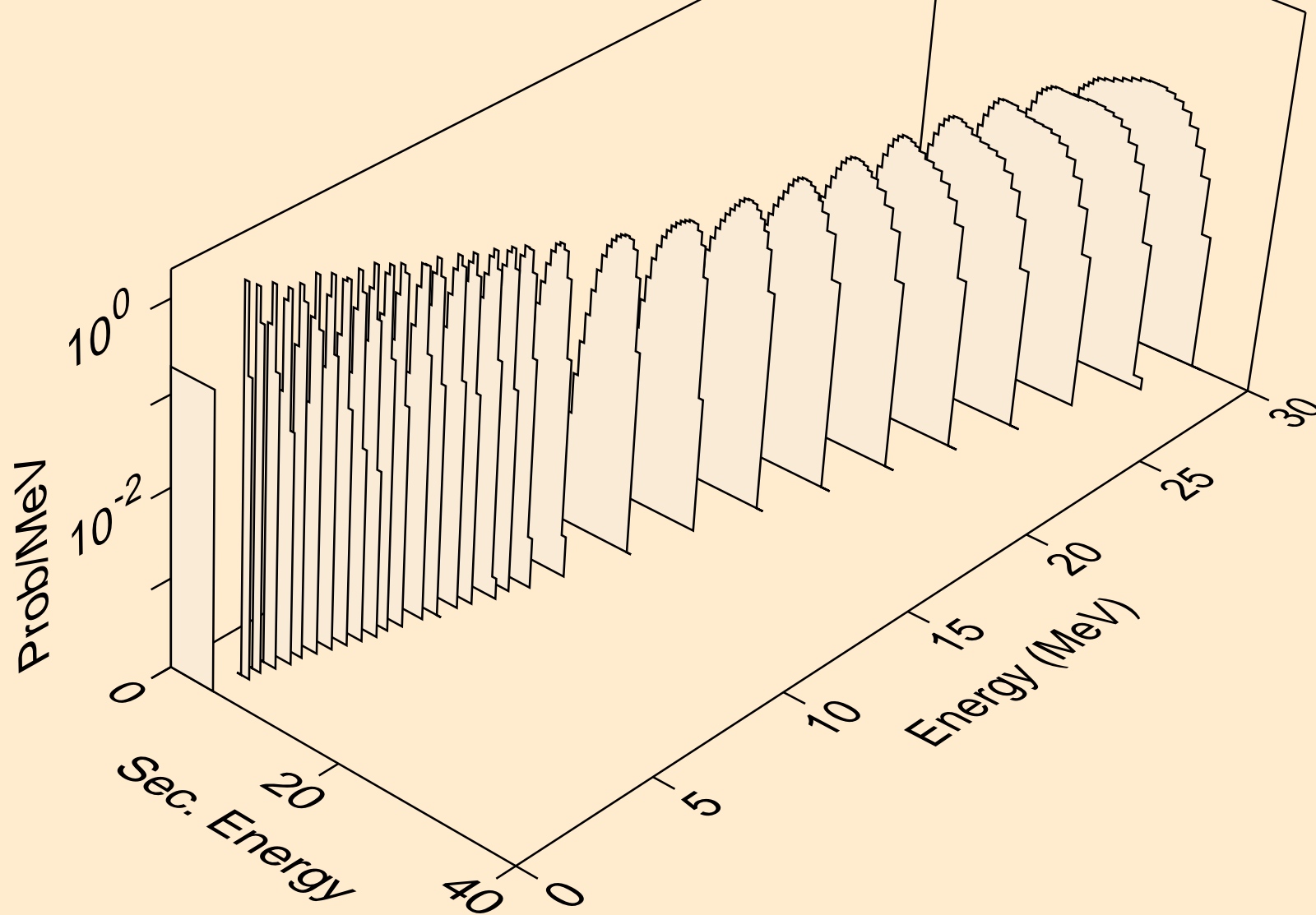

TA164 NEUTRON ACER TENDL-2021 LIBRARY; T=293.6K  
alphas from (n,n\*)3a

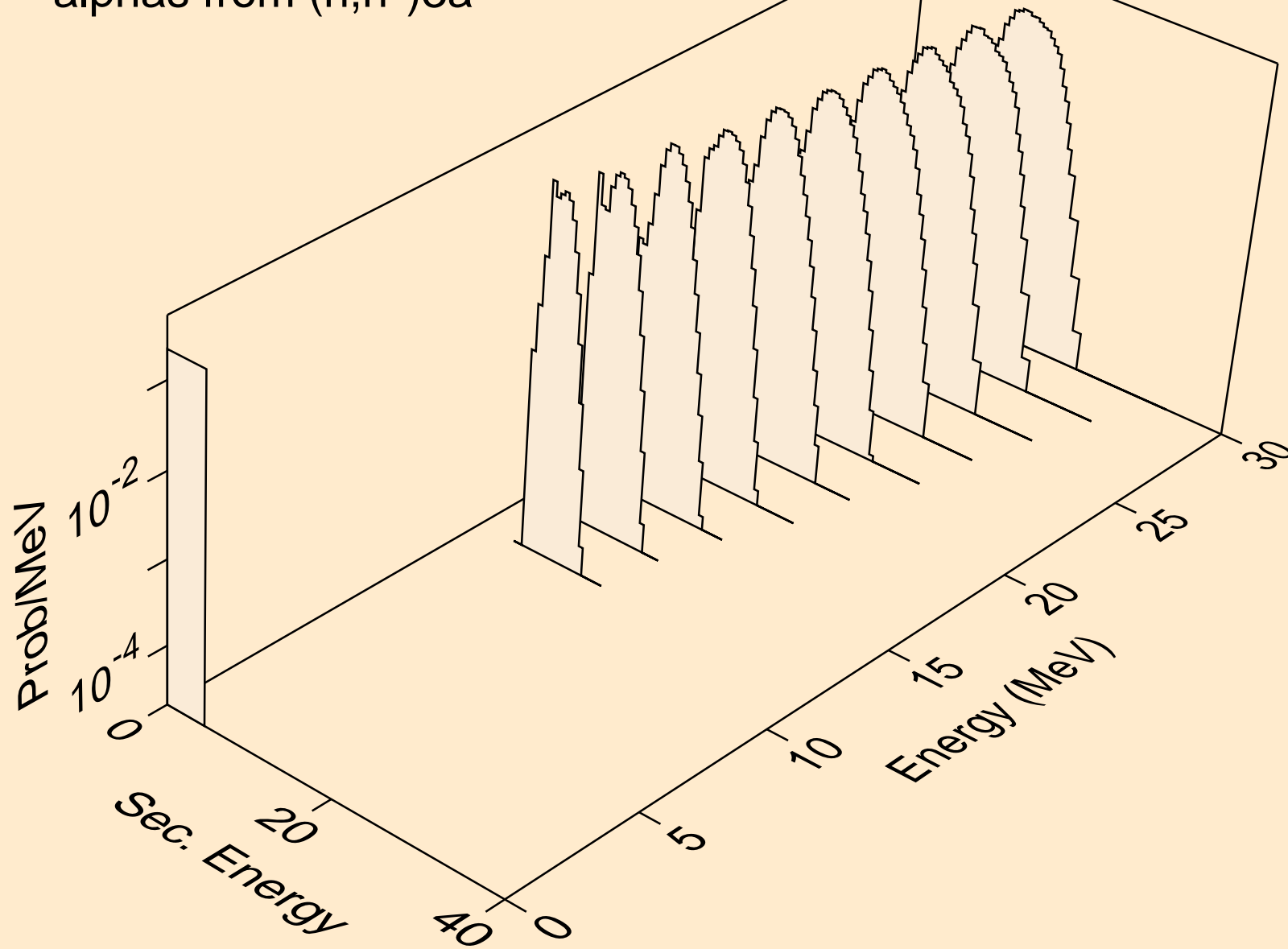

TA164 NEUTRON ACER TENDL-2021 LIBRARY; T=293.6K  
alphas from (n,2n)a

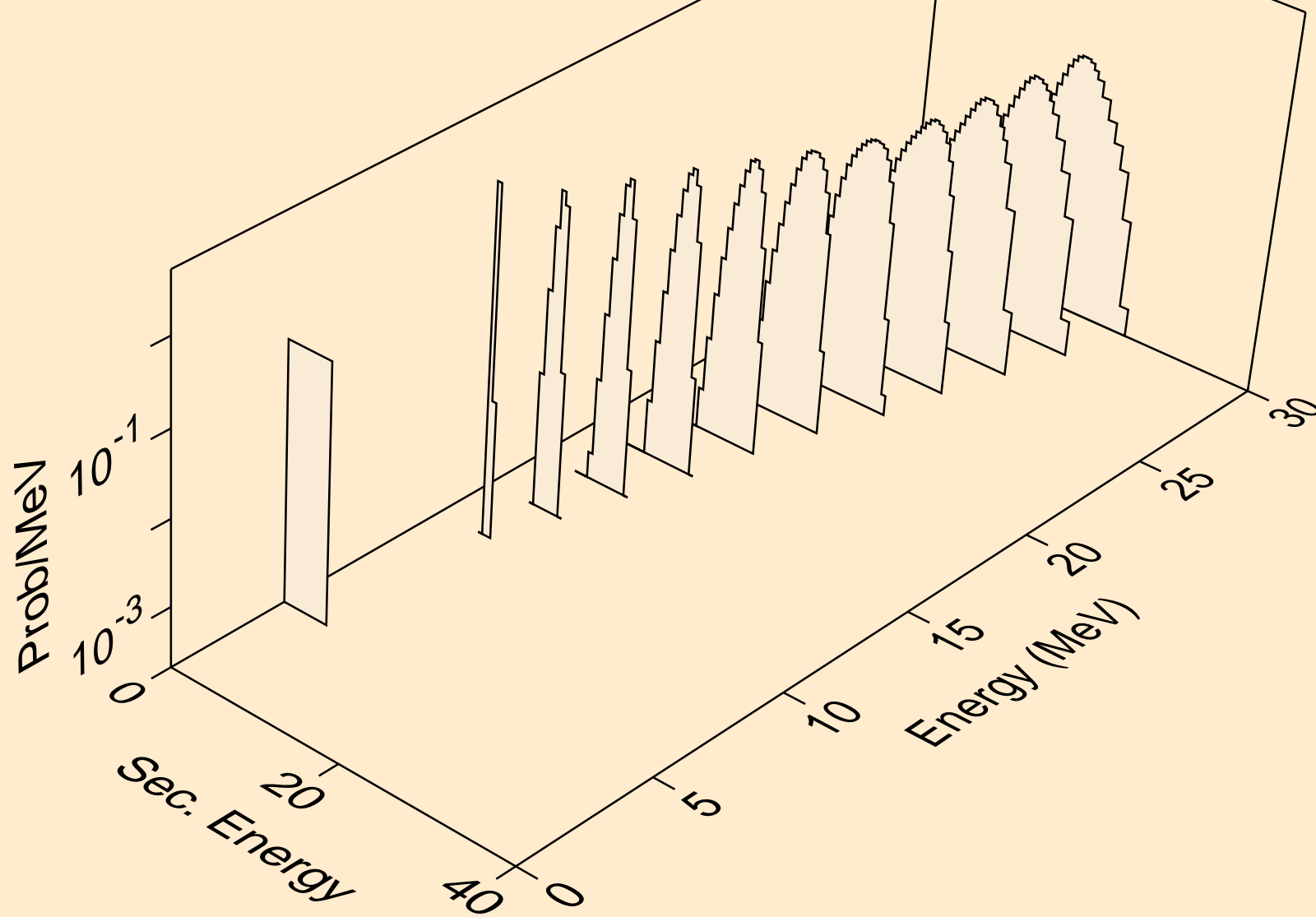



TA164 NEUTRON ACER TENDL-2021 LIBRARY; T=293.6K  
alphas from (n,3n)a

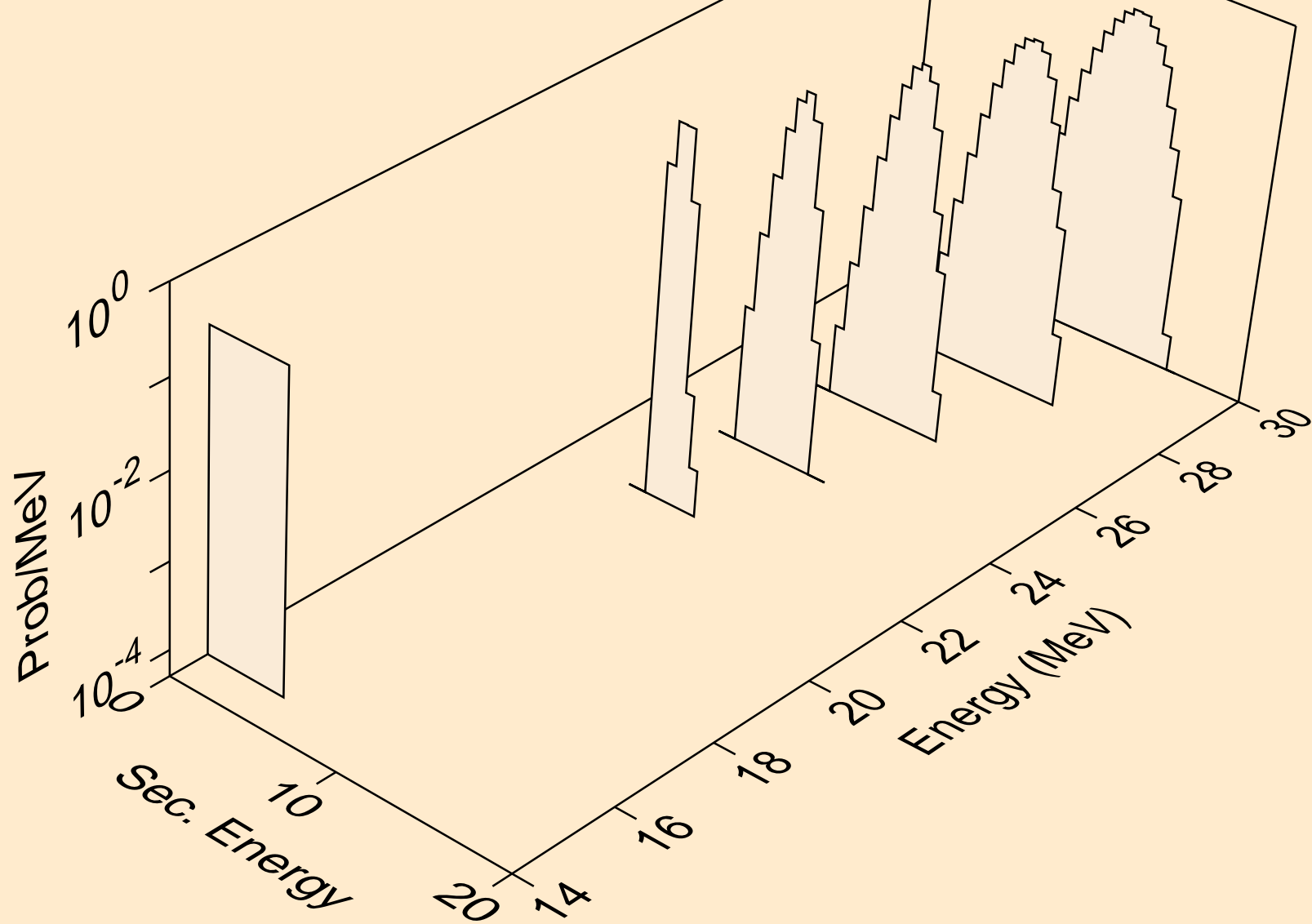

TA164 NEUTRON ACER TENDL-2021 LIBRARY; T=293.6K  
alphas from (n,n\*)2a

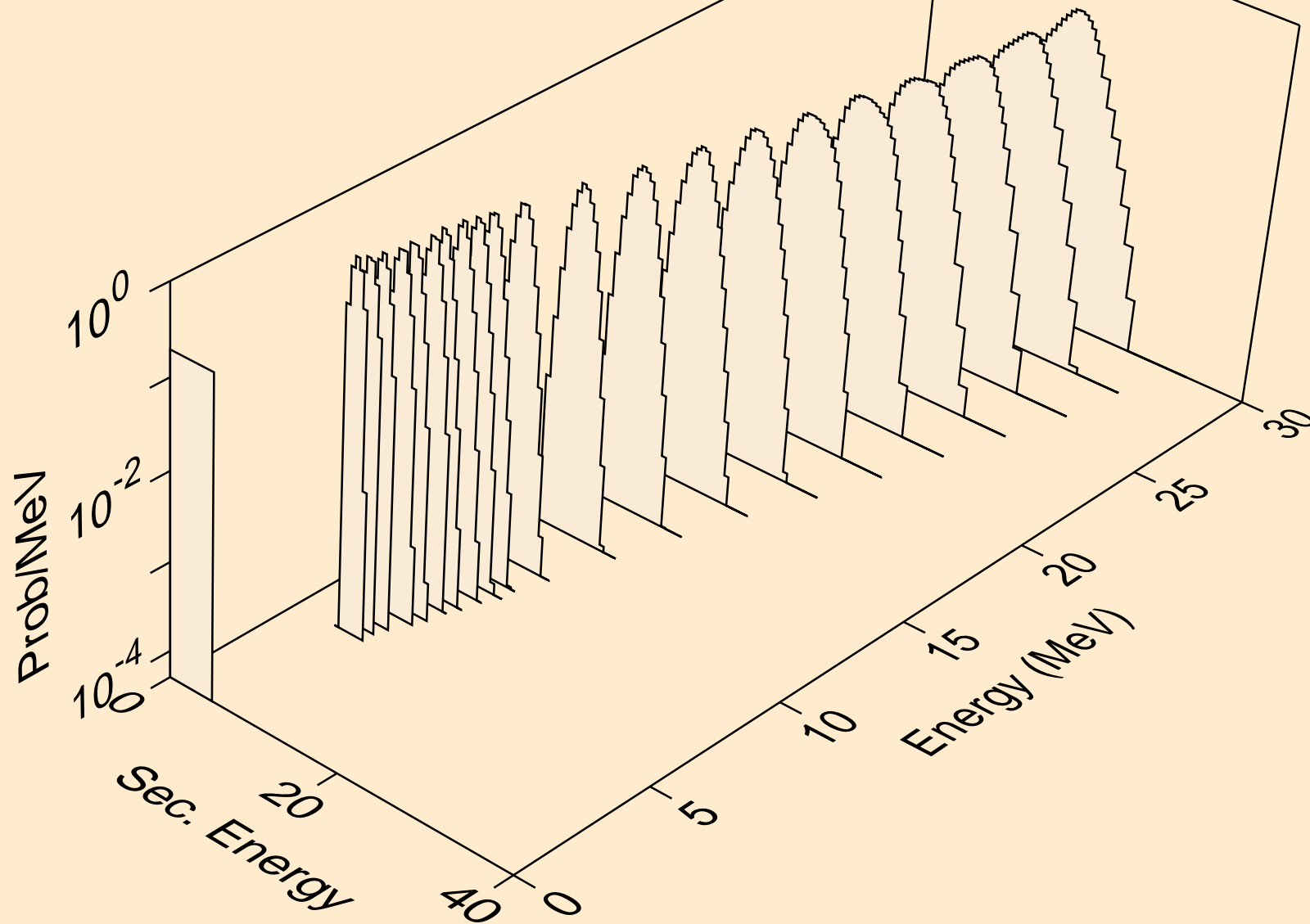

TA164 NEUTRON ACER TENDL-2021 LIBRARY; T=293.6K  
alphas from (n,2n)2a

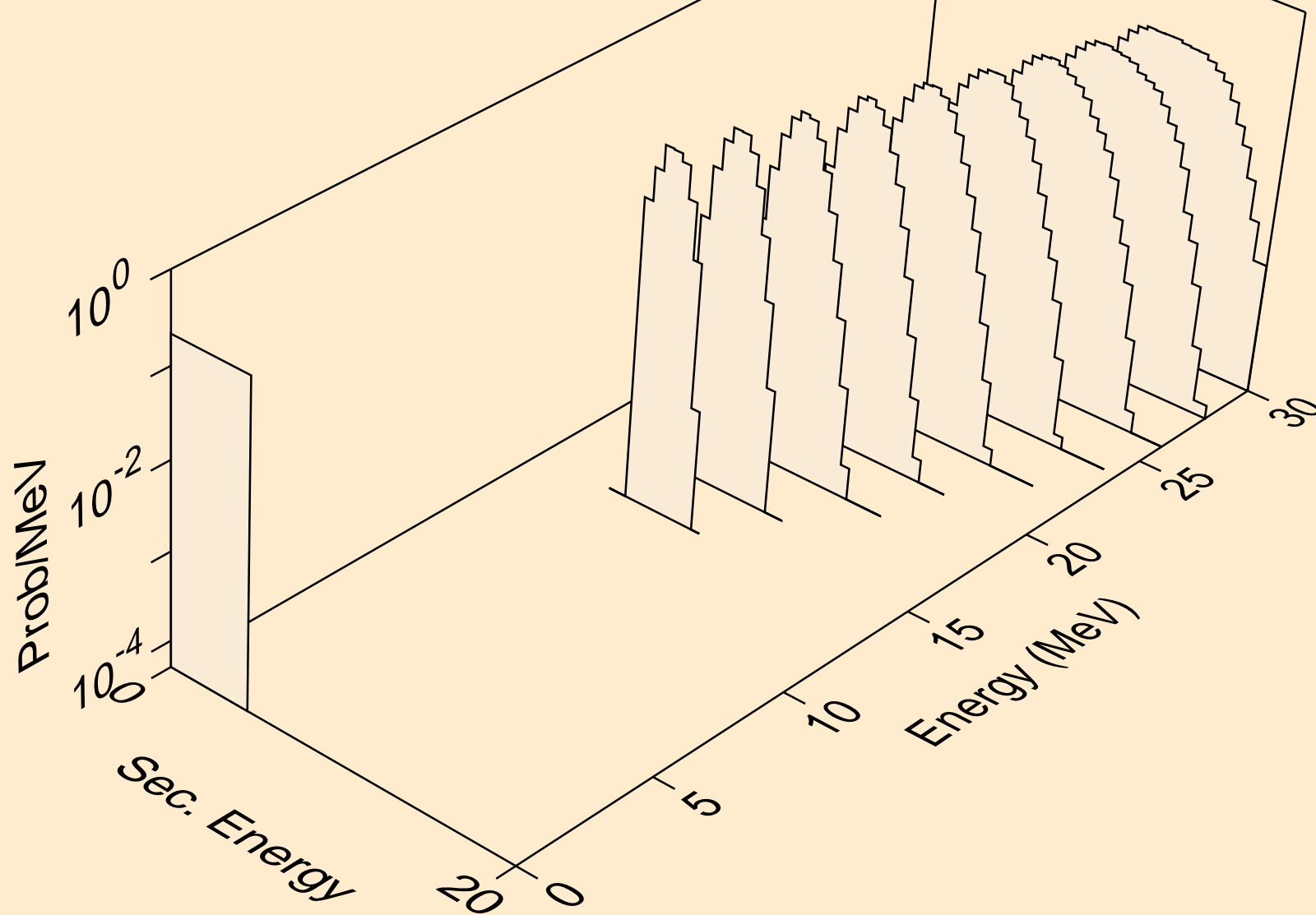

TA164 NEUTRON ACER TENDL-2021 LIBRARY; T=293.6K  
alphas from (n,npa)

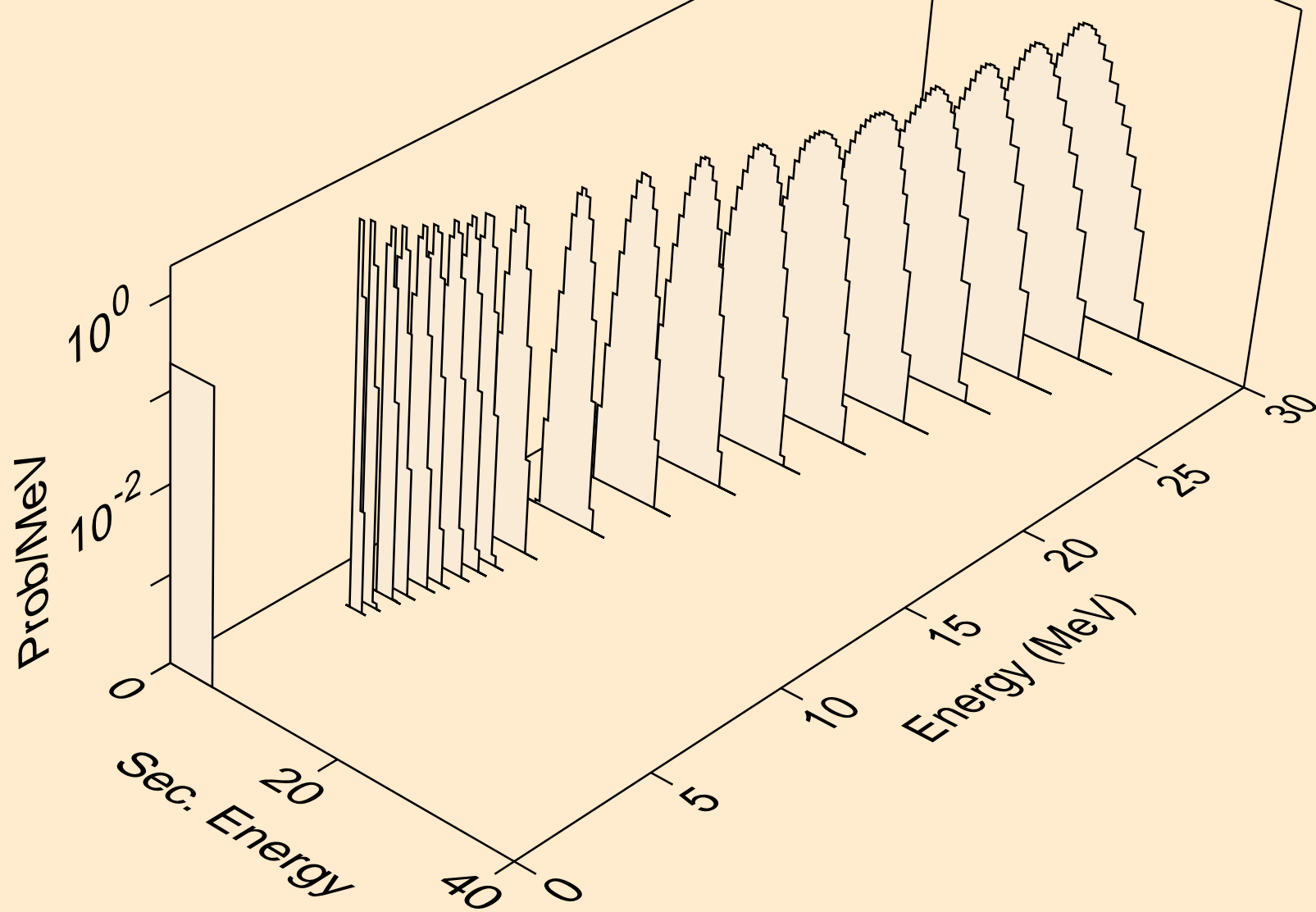

TA164 NEUTRON ACER TENDL-2021 LIBRARY; T=293.6K  
alphas from (n,a)

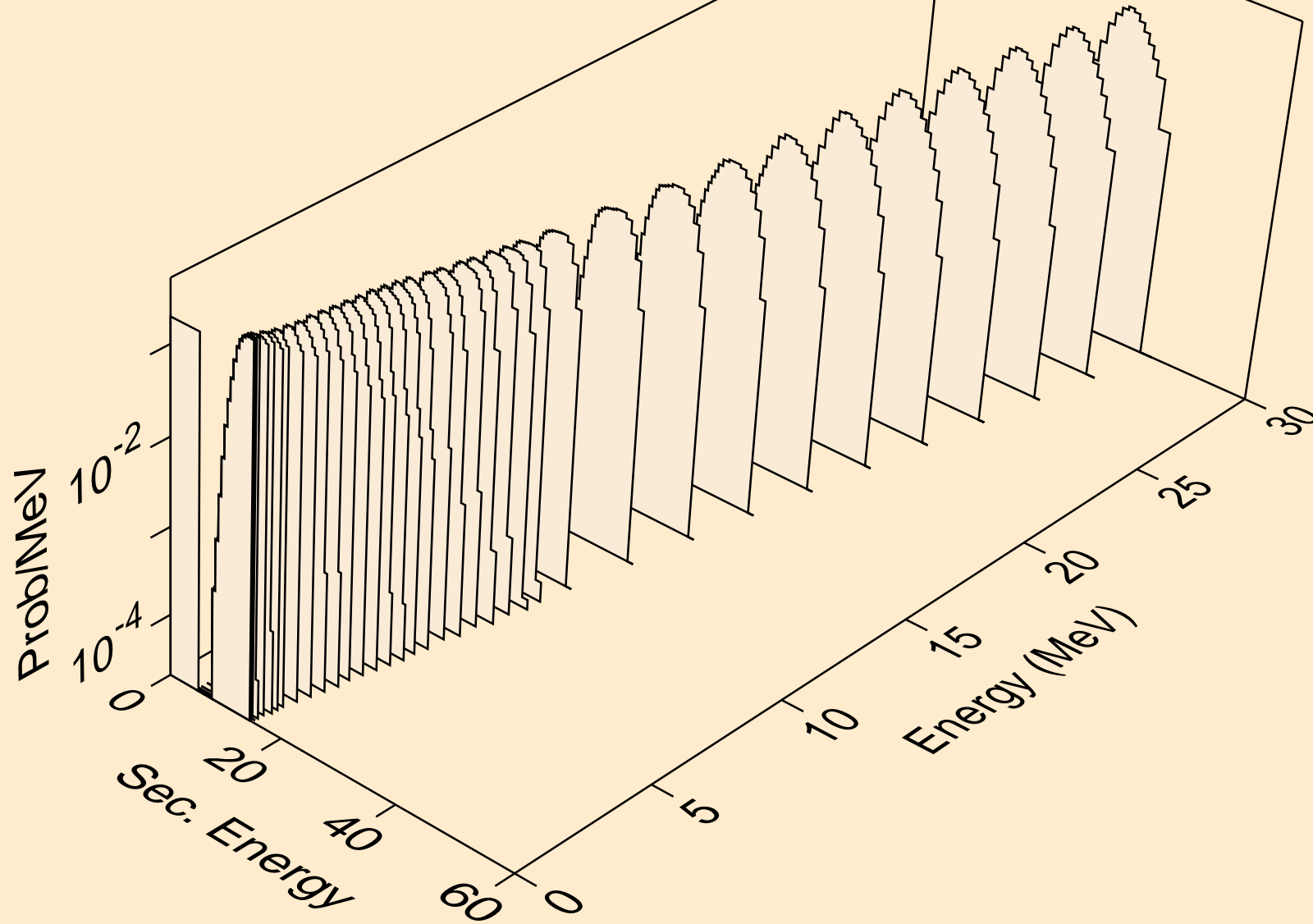

TA164 NEUTRON ACER TENDL-2021 LIBRARY; T=293.6K  
alphas from (n,2a)

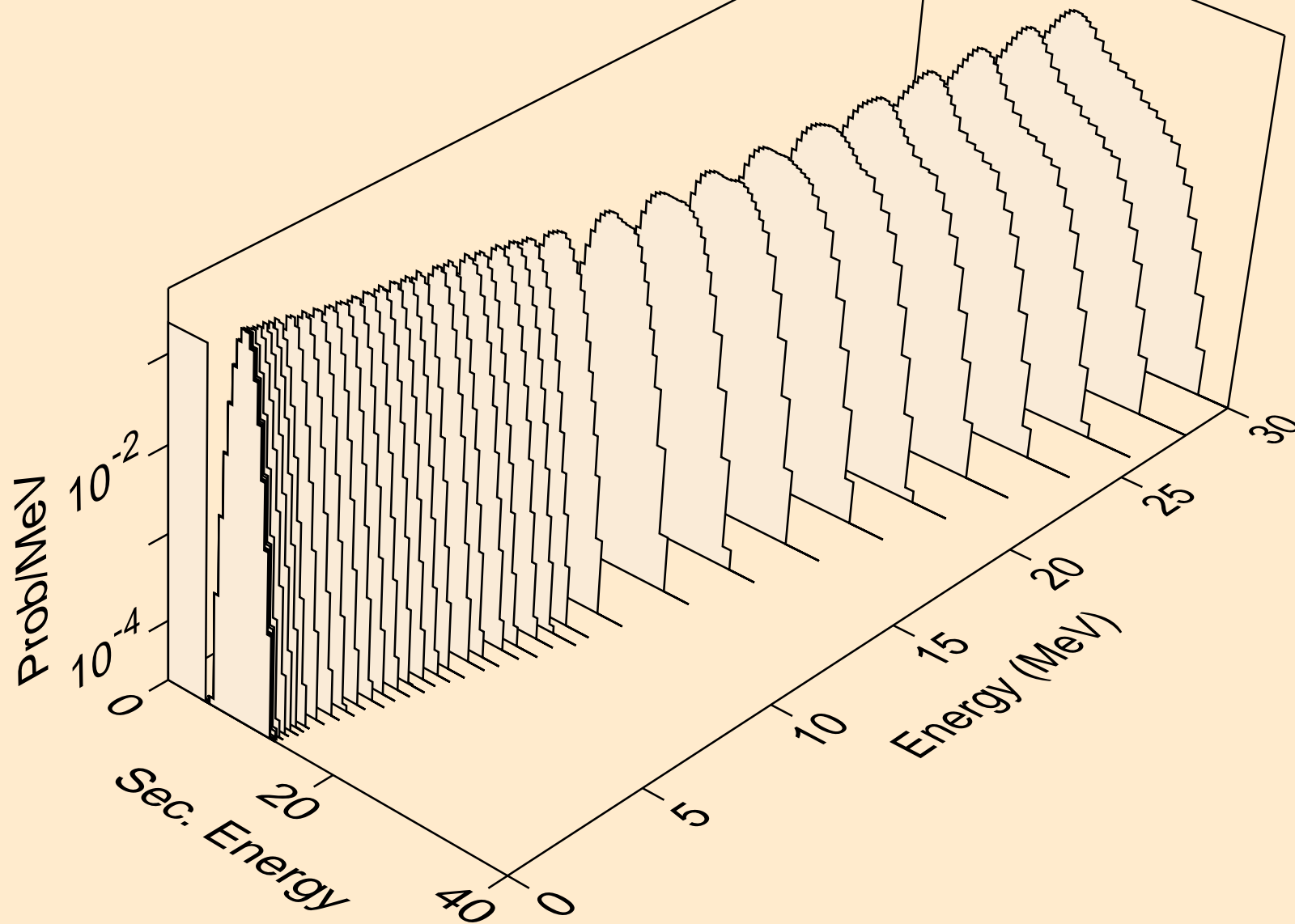

TA164 NEUTRON ACER TENDL-2021 LIBRARY; T=293.6K  
alphas from (n,3a)

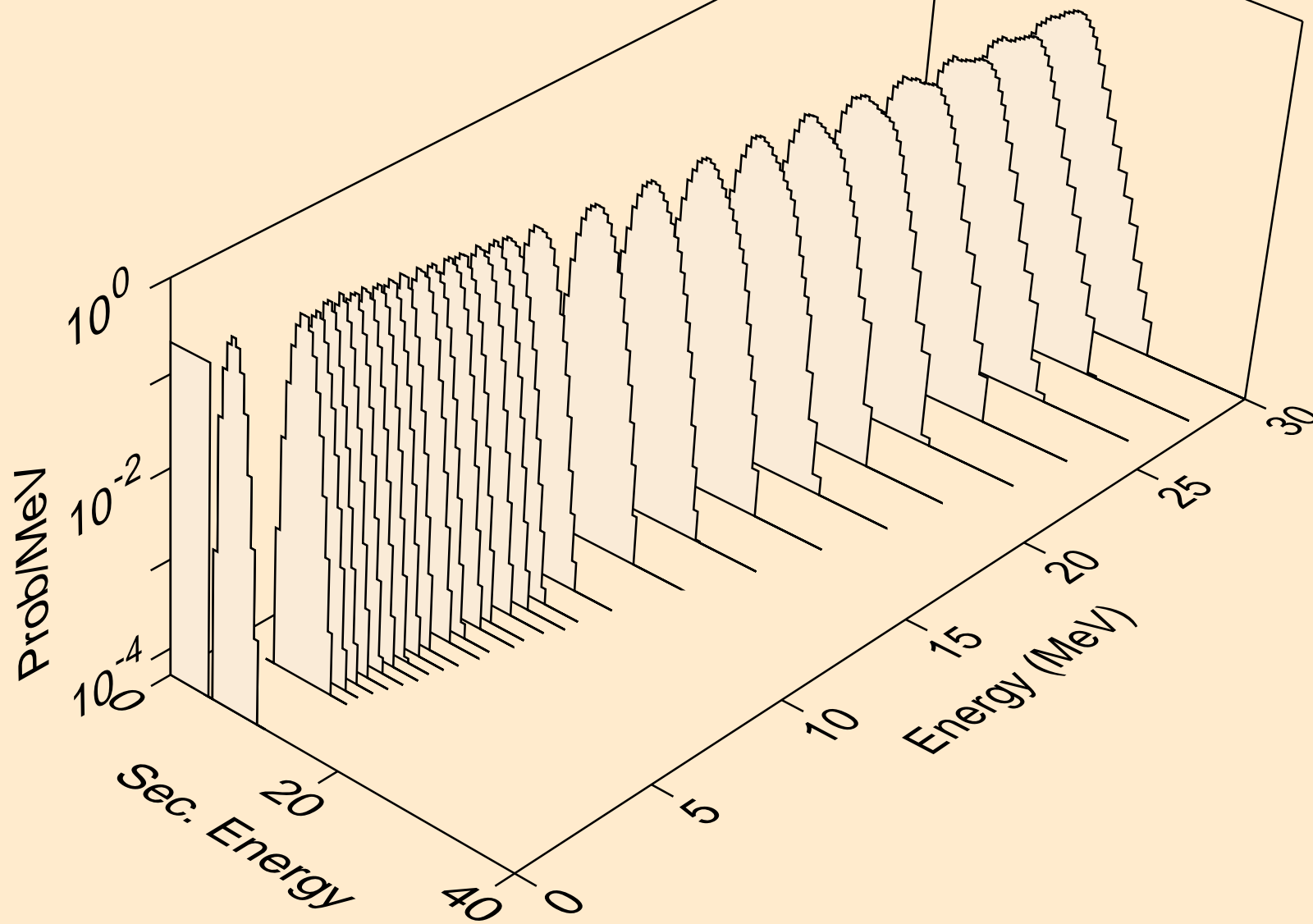

TA164 NEUTRON ACER TENDL-2021 LIBRARY; T=293.6K  
alphas from (n,pa)

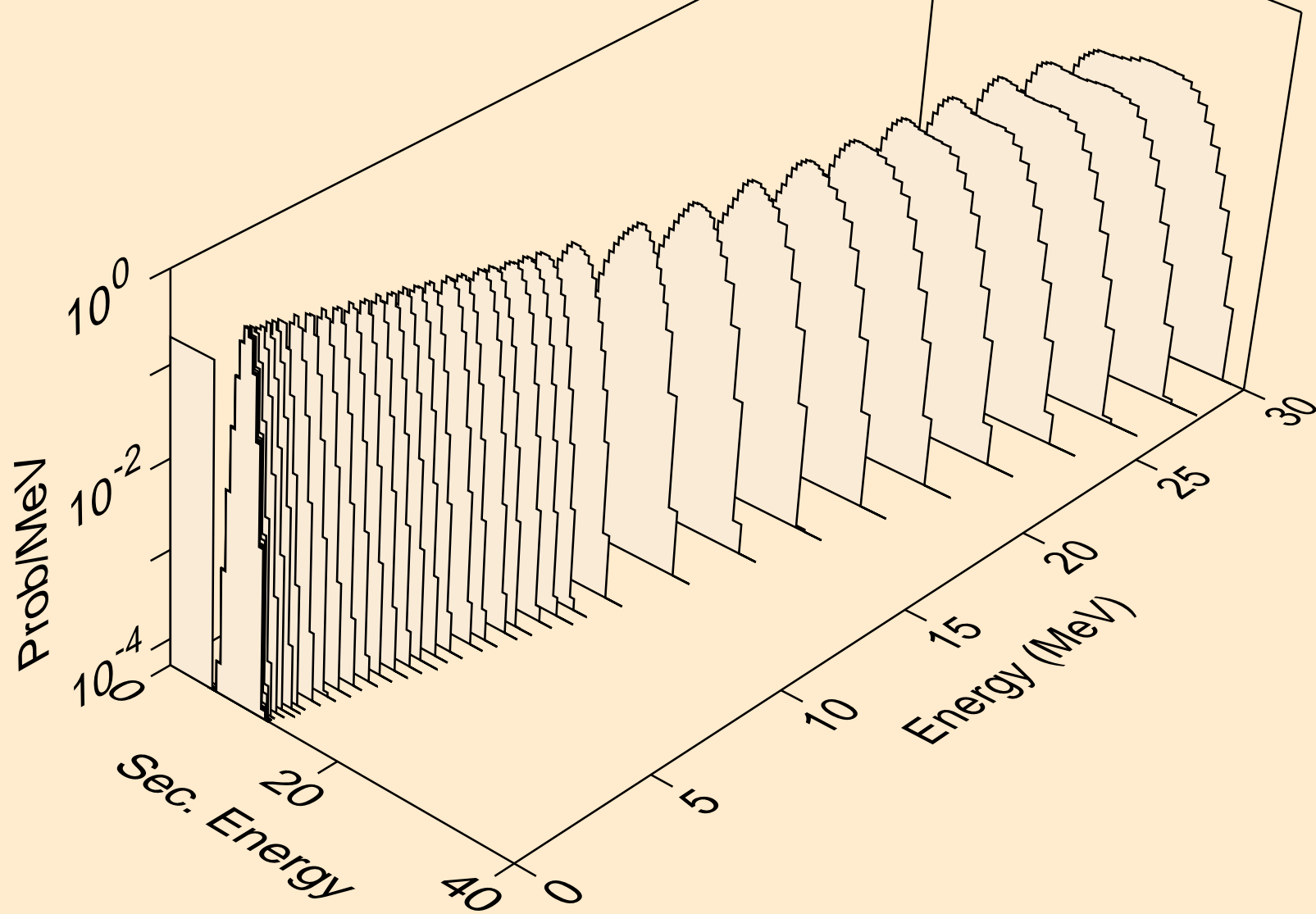



TA164 NEUTRON ACER TENDL-2021 LIBRARY; T=293.6K  
alphas from (n,t2a)

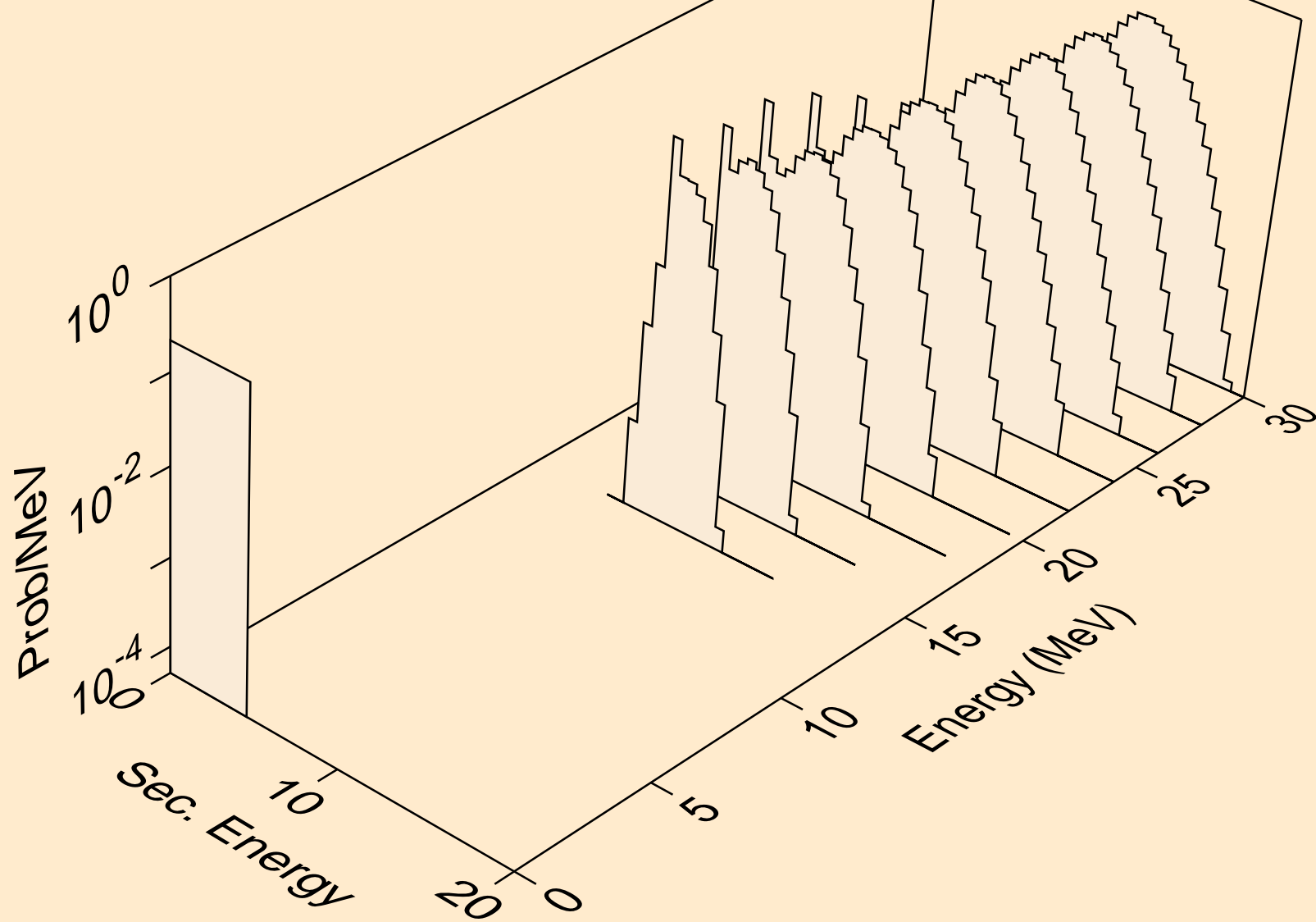

TA164 NEUTRON ACER TENDL-2021 LIBRARY; T=293.6K  
alphas from (n,d2a)

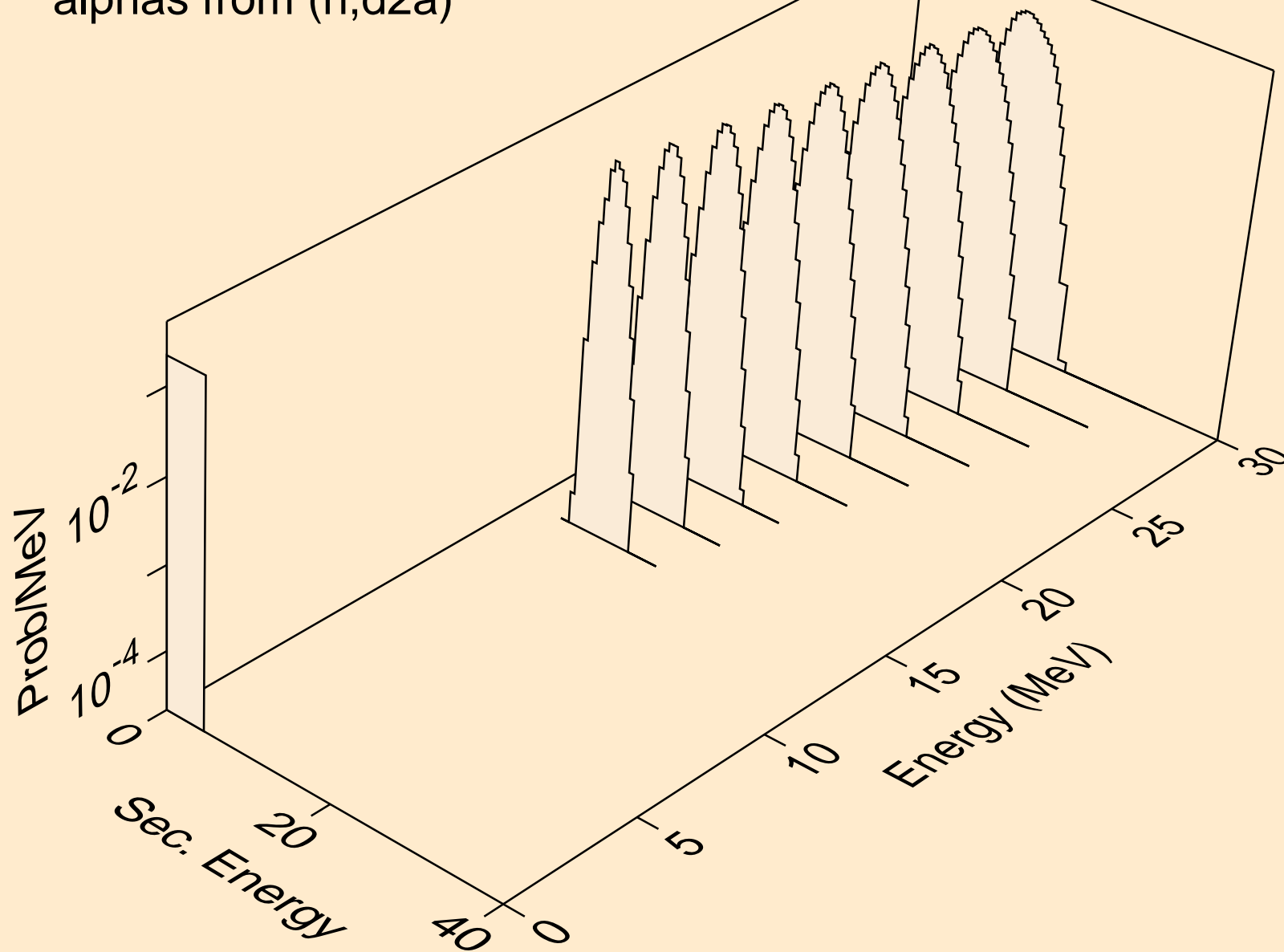

TA164 NEUTRON ACER TENDL-2021 LIBRARY; T=293.6K  
alphas from (n,da)

