

TA188 NEUTRON ACER TENDL-2021 LIBRARY; T=293.6K
Principal cross sections

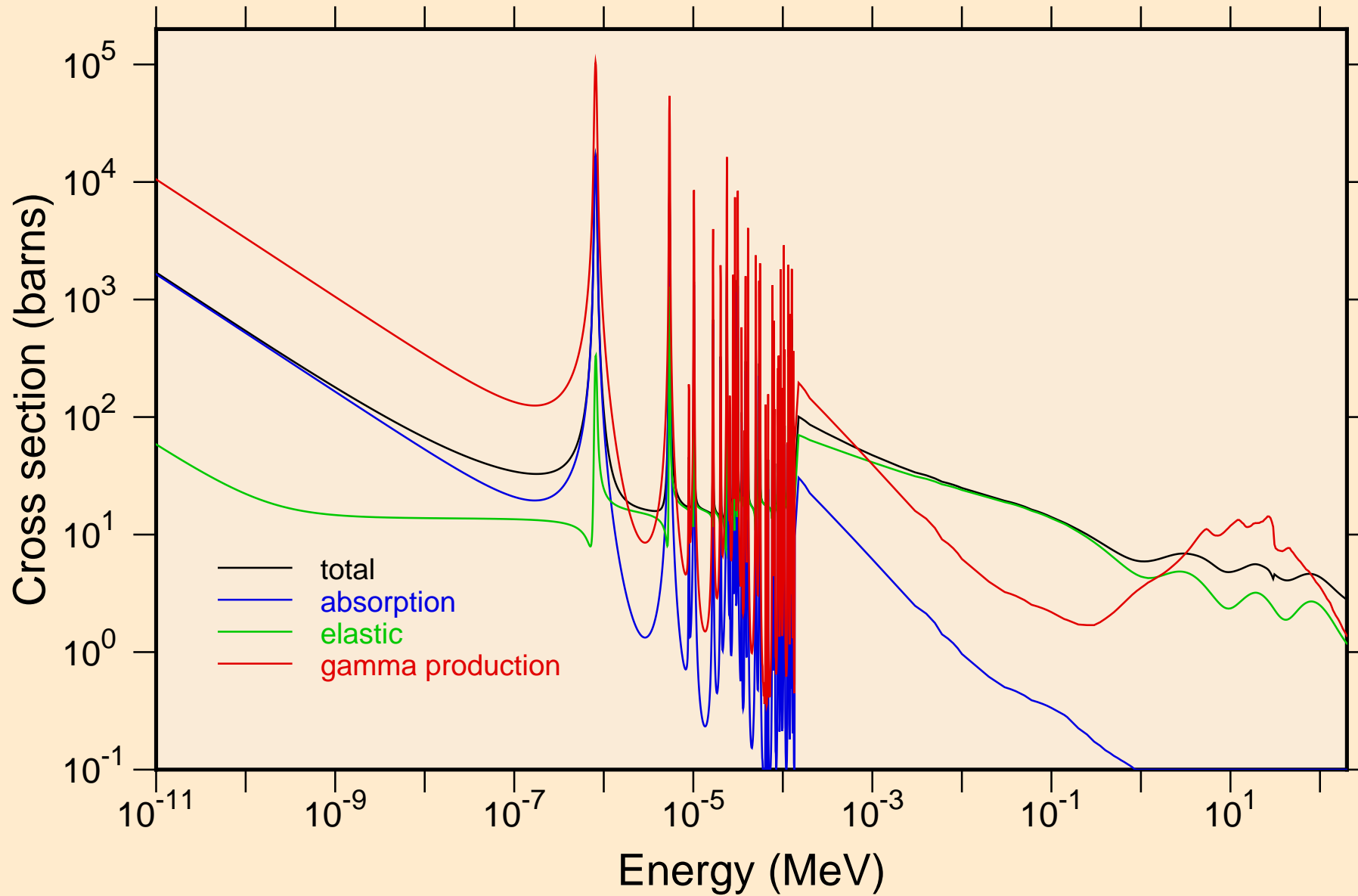

TA188 NEUTRON ACER TENDL-2021 LIBRARY; T=293.6K
resonance total cross section

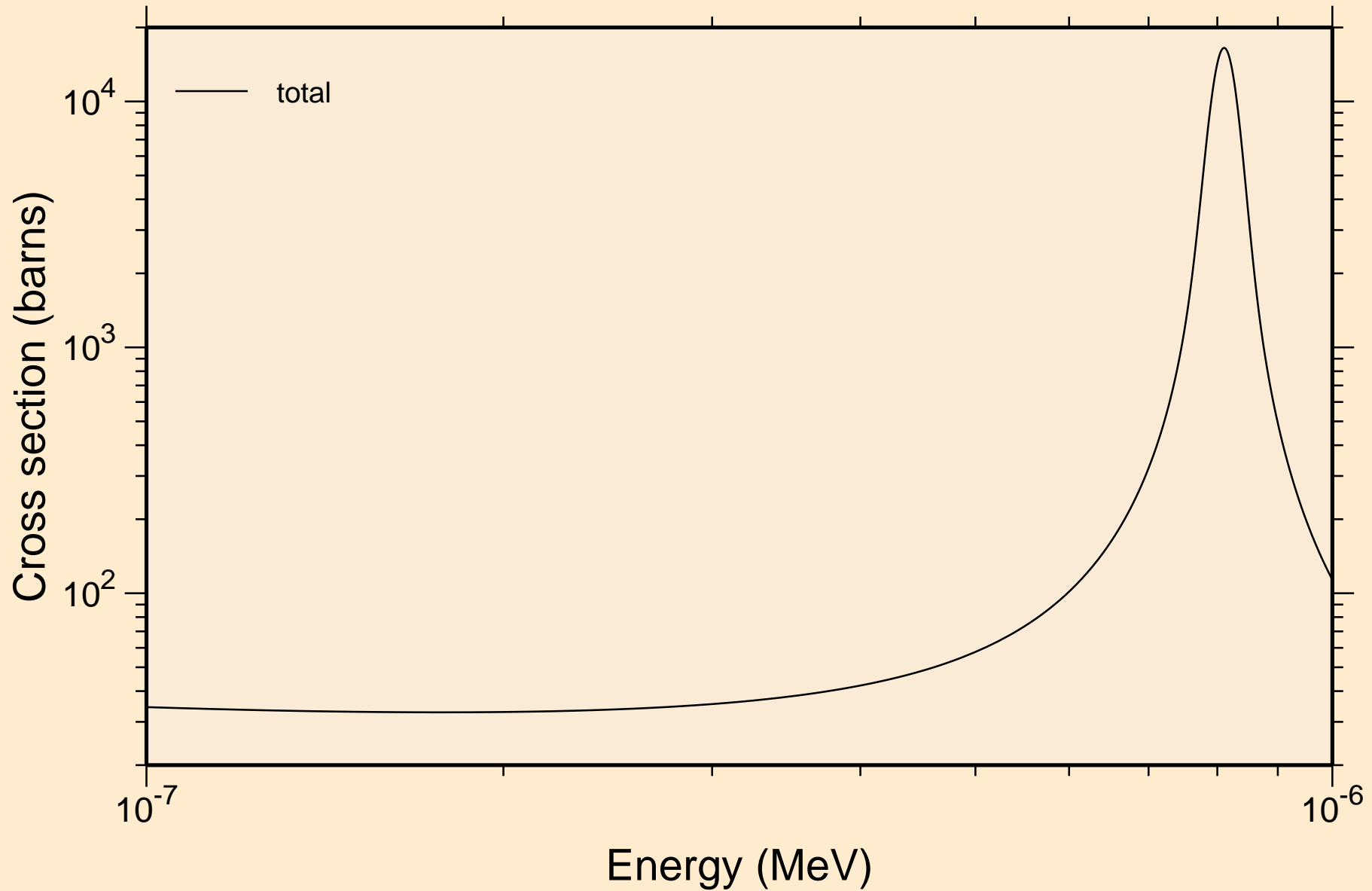

TA188 NEUTRON ACER TENDL-2021 LIBRARY; T=293.6K
resonance total cross section

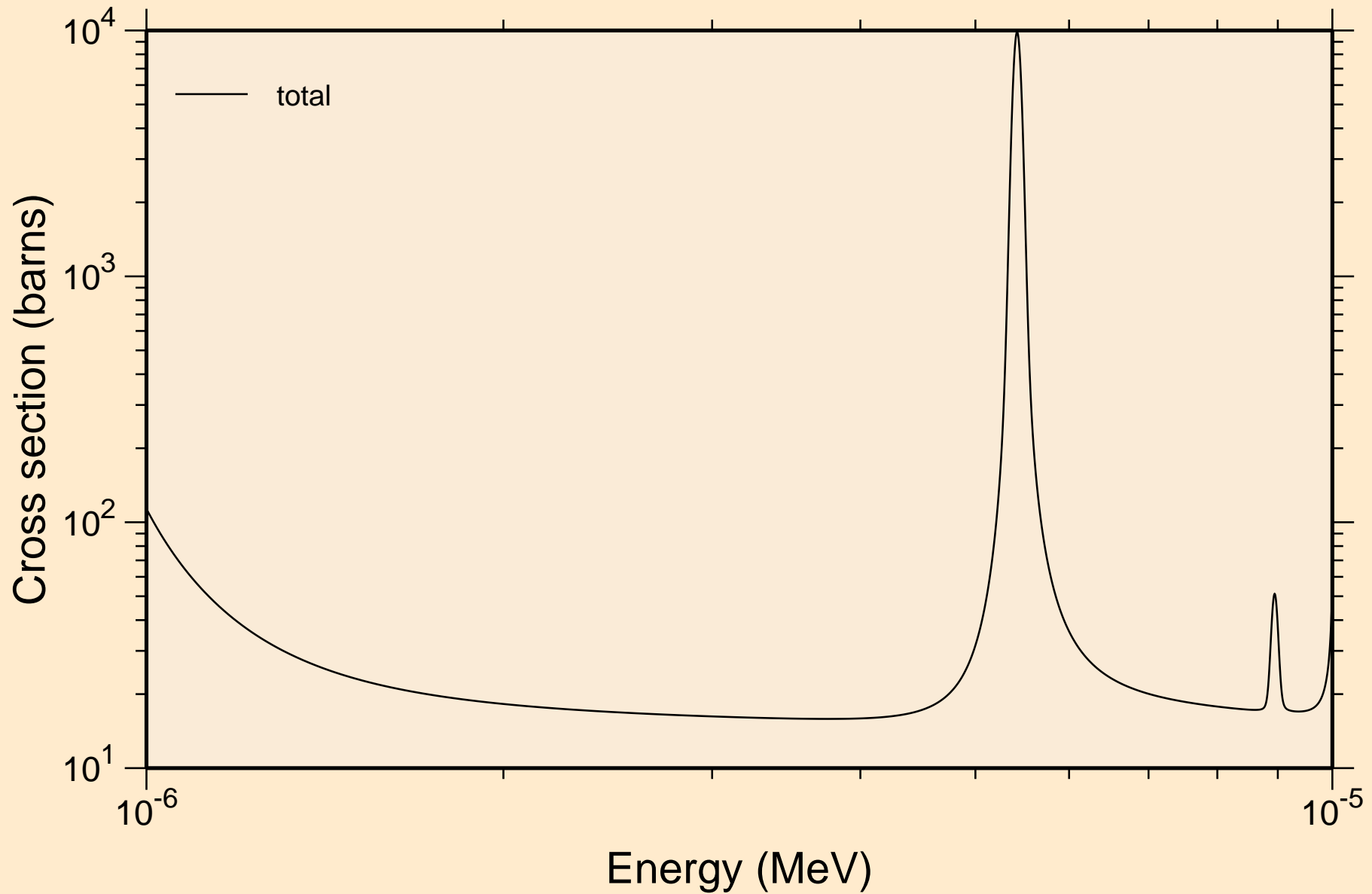

TA188 NEUTRON ACER TENDL-2021 LIBRARY; T=293.6K
resonance total cross section

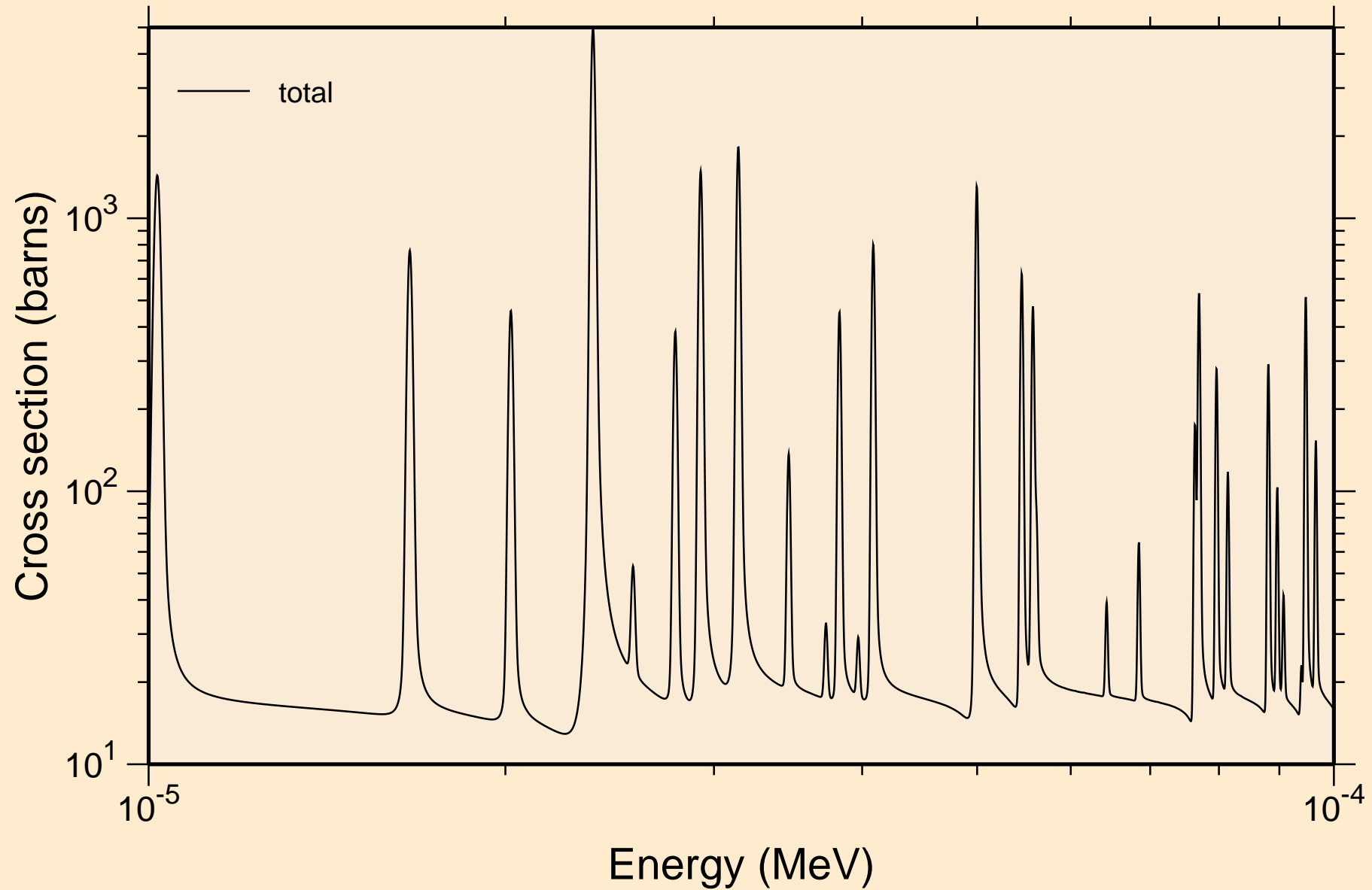

TA188 NEUTRON ACER TENDL-2021 LIBRARY; T=293.6K
resonance total cross section

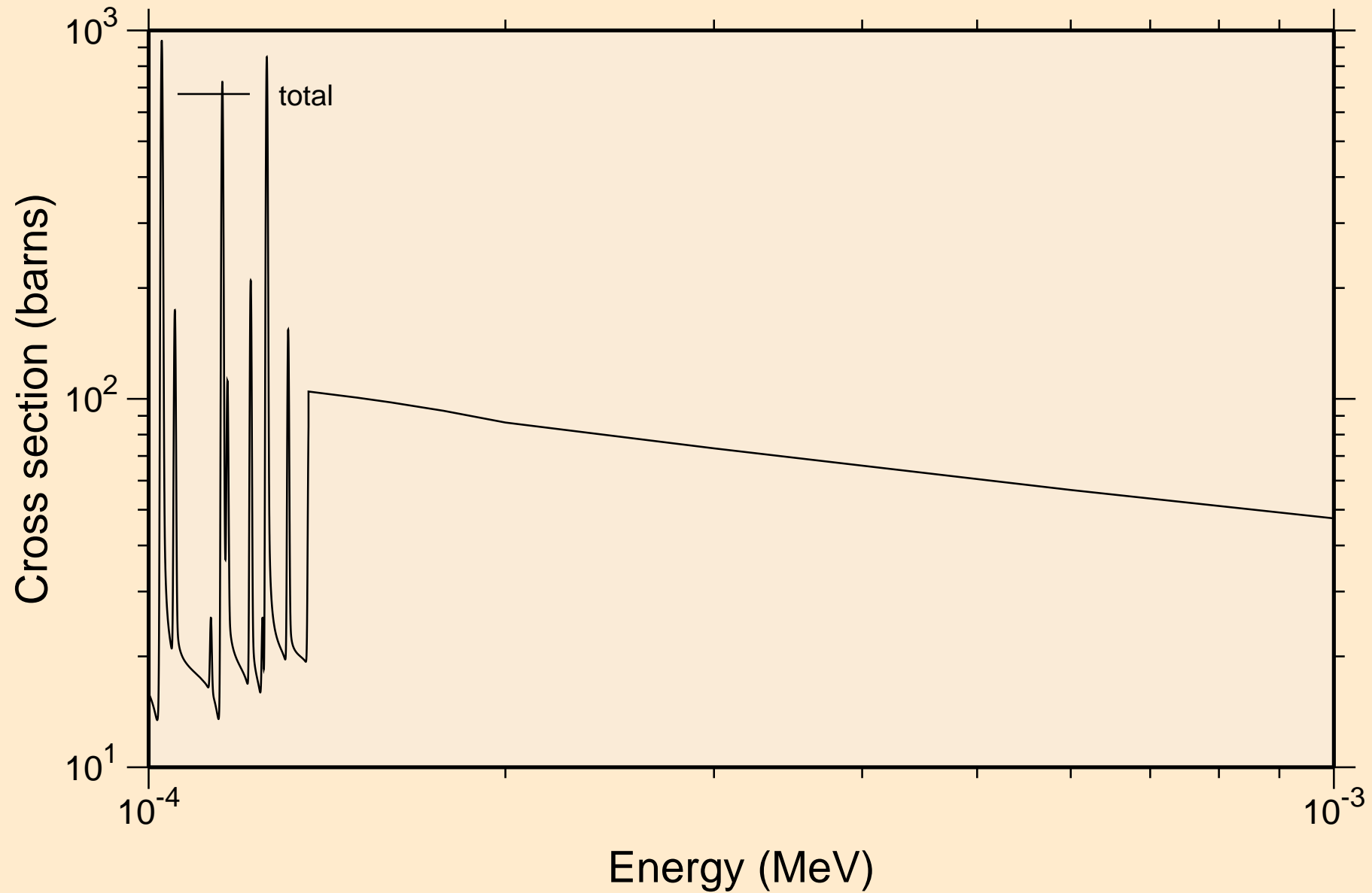

TA188 NEUTRON ACER TENDL-2021 LIBRARY; T=293.6K
resonance total cross section

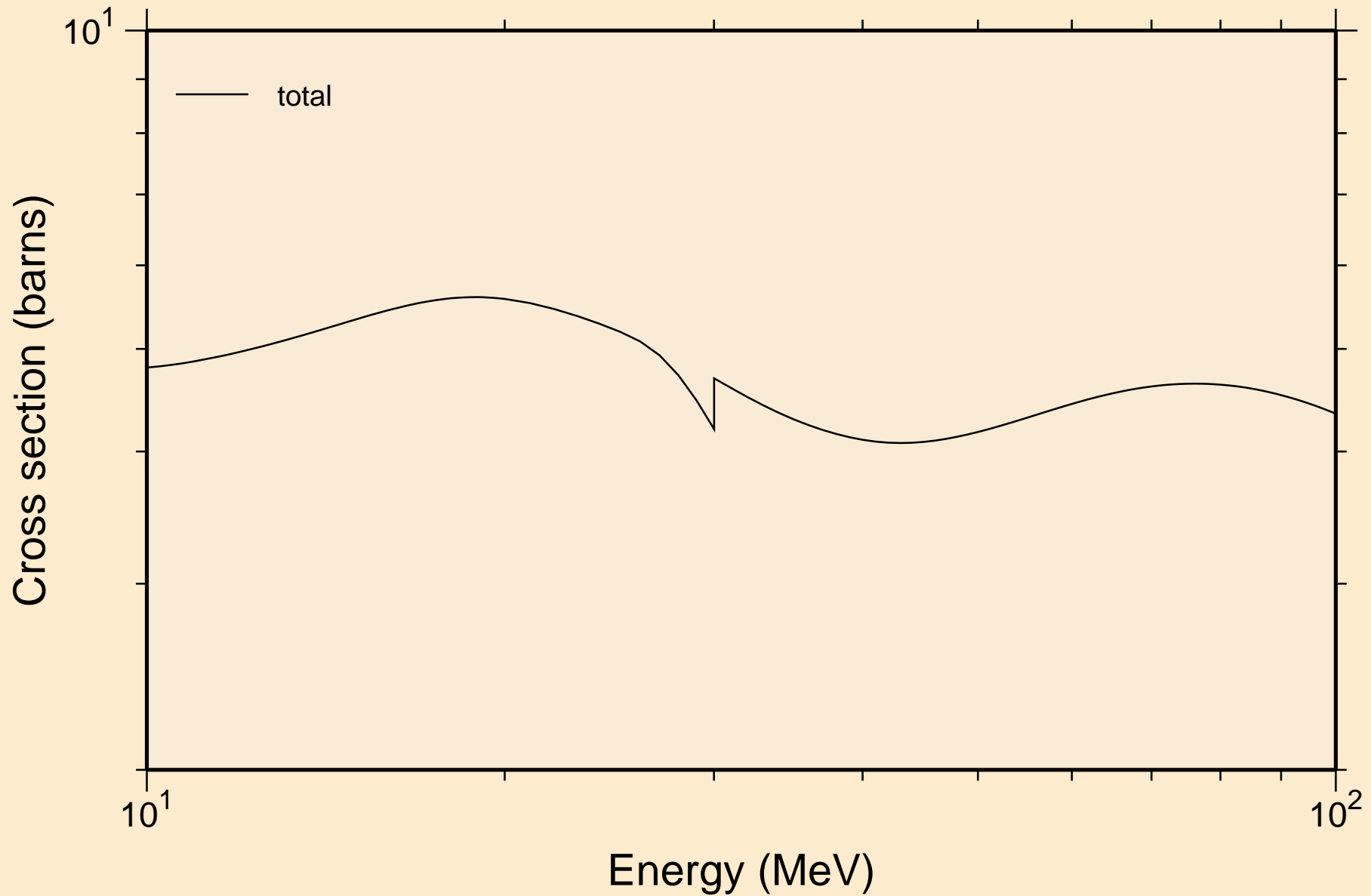

TA188 NEUTRON ACER TENDL-2021 LIBRARY; T=293.6K
resonance absorption cross sections

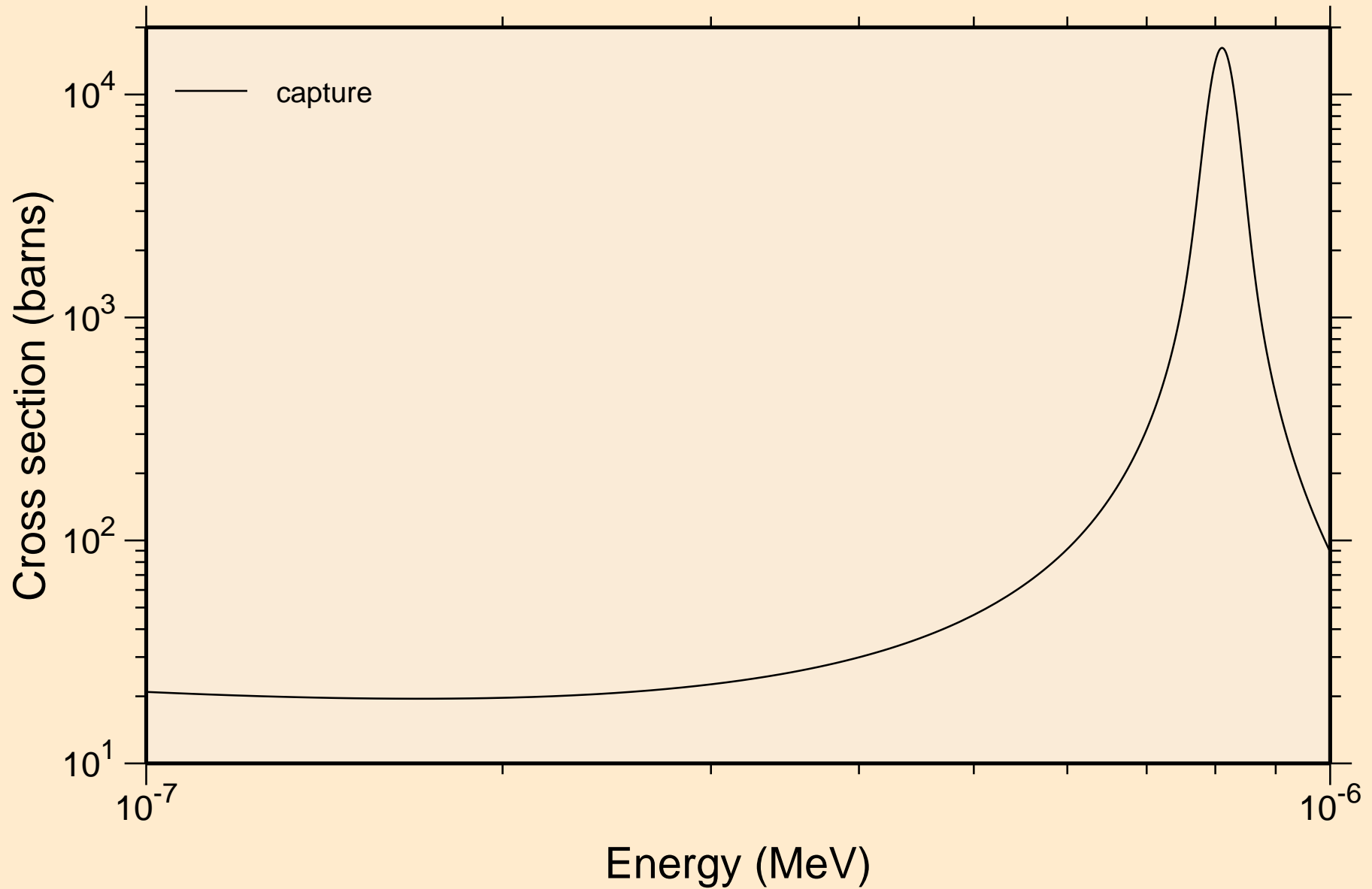

TA188 NEUTRON ACER TENDL-2021 LIBRARY; T=293.6K
resonance absorption cross sections

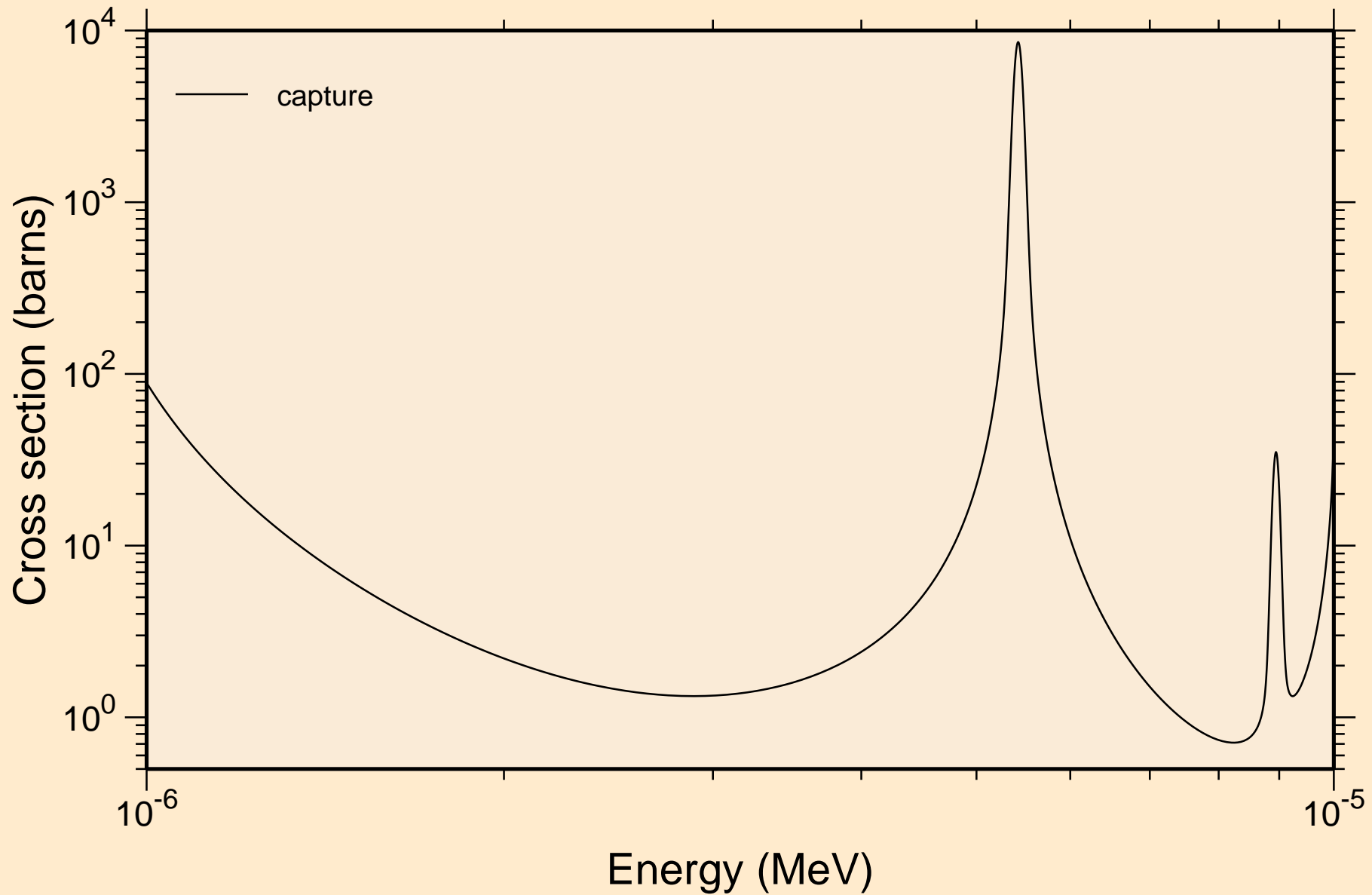

TA188 NEUTRON ACER TENDL-2021 LIBRARY; T=293.6K
resonance absorption cross sections

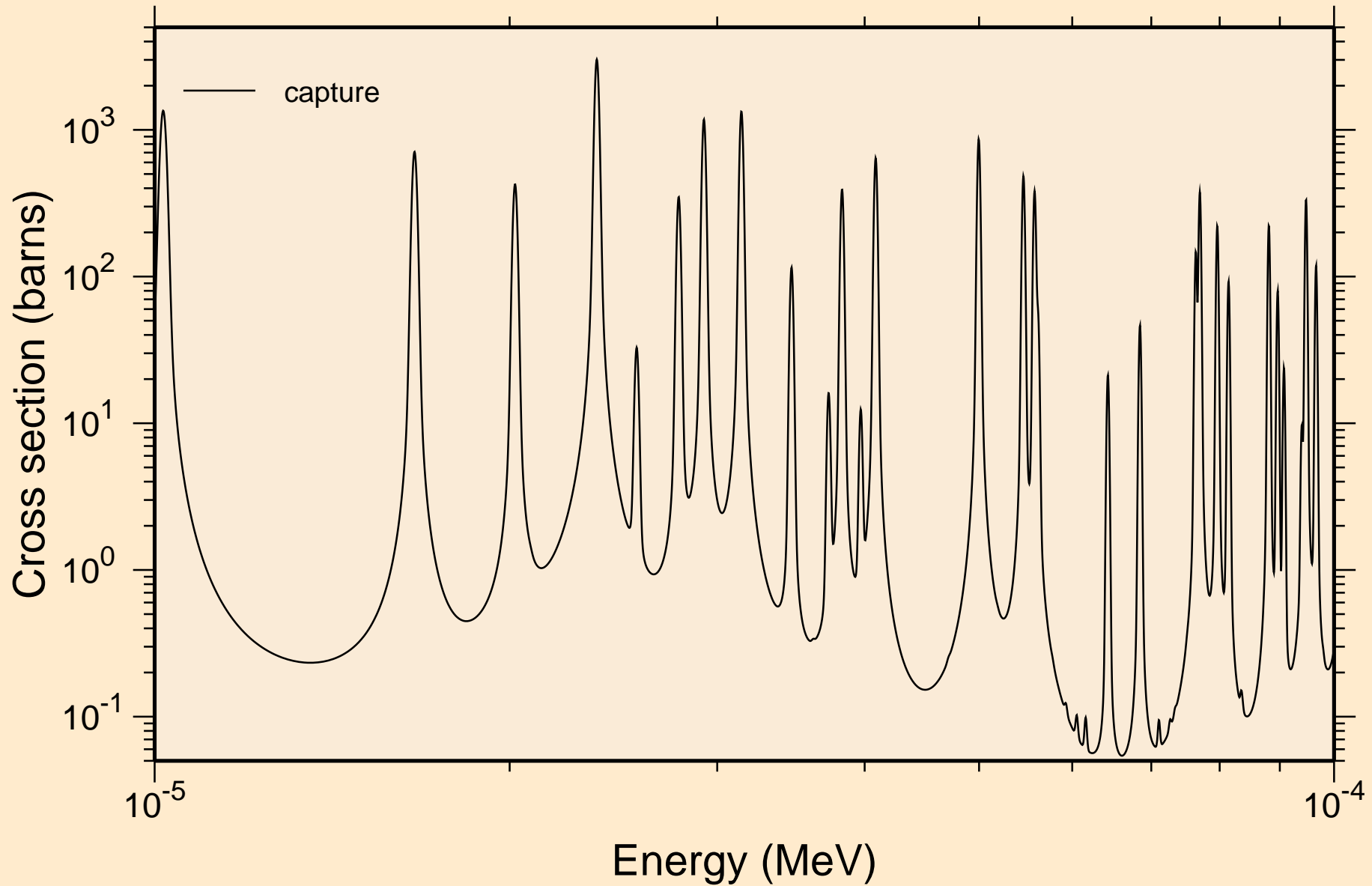

TA188 NEUTRON ACER TENDL-2021 LIBRARY; T=293.6K
resonance absorption cross sections

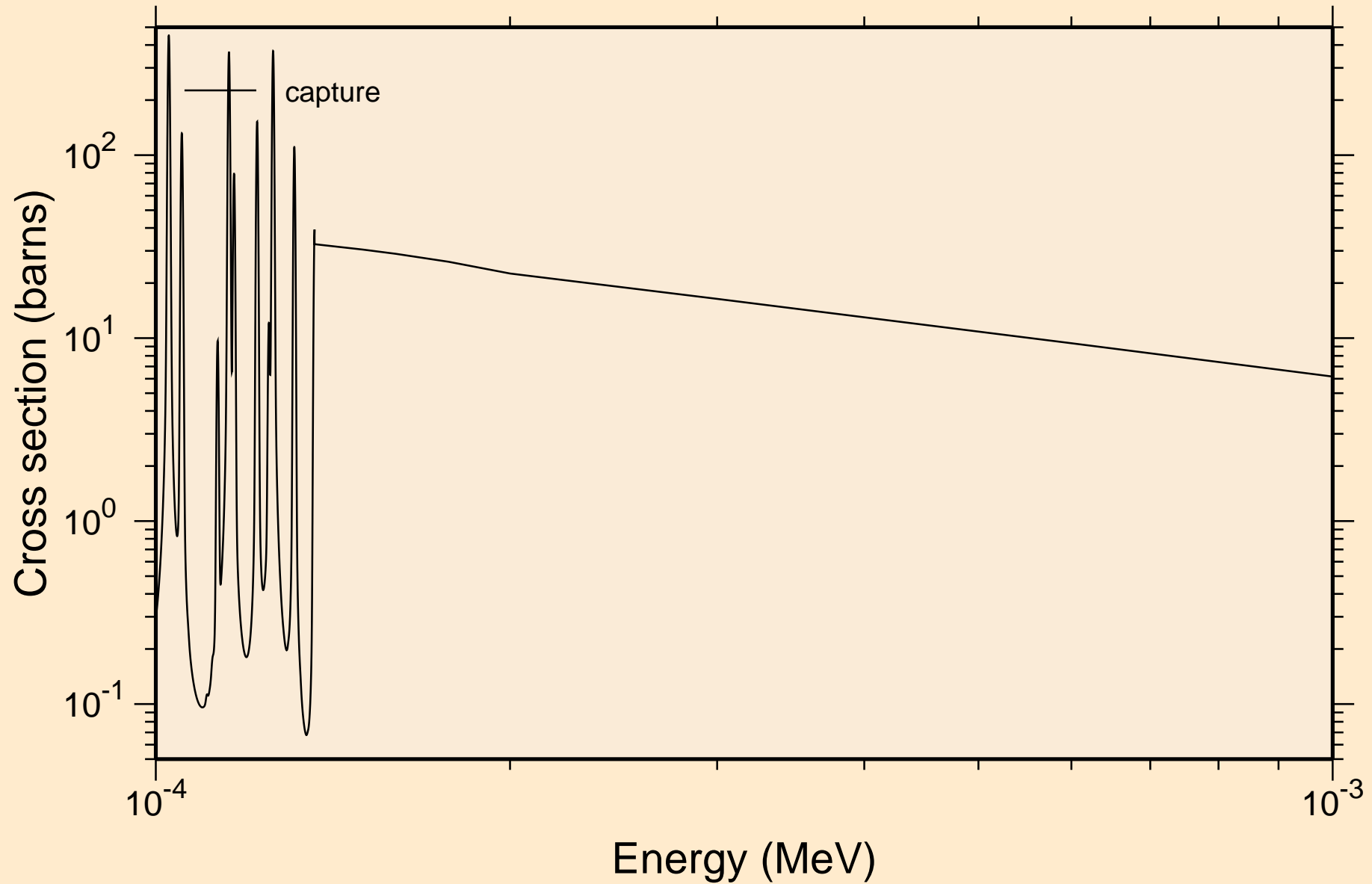

TA188 NEUTRON ACER TENDL-2021 LIBRARY; T=293.6K
resonance absorption cross sections

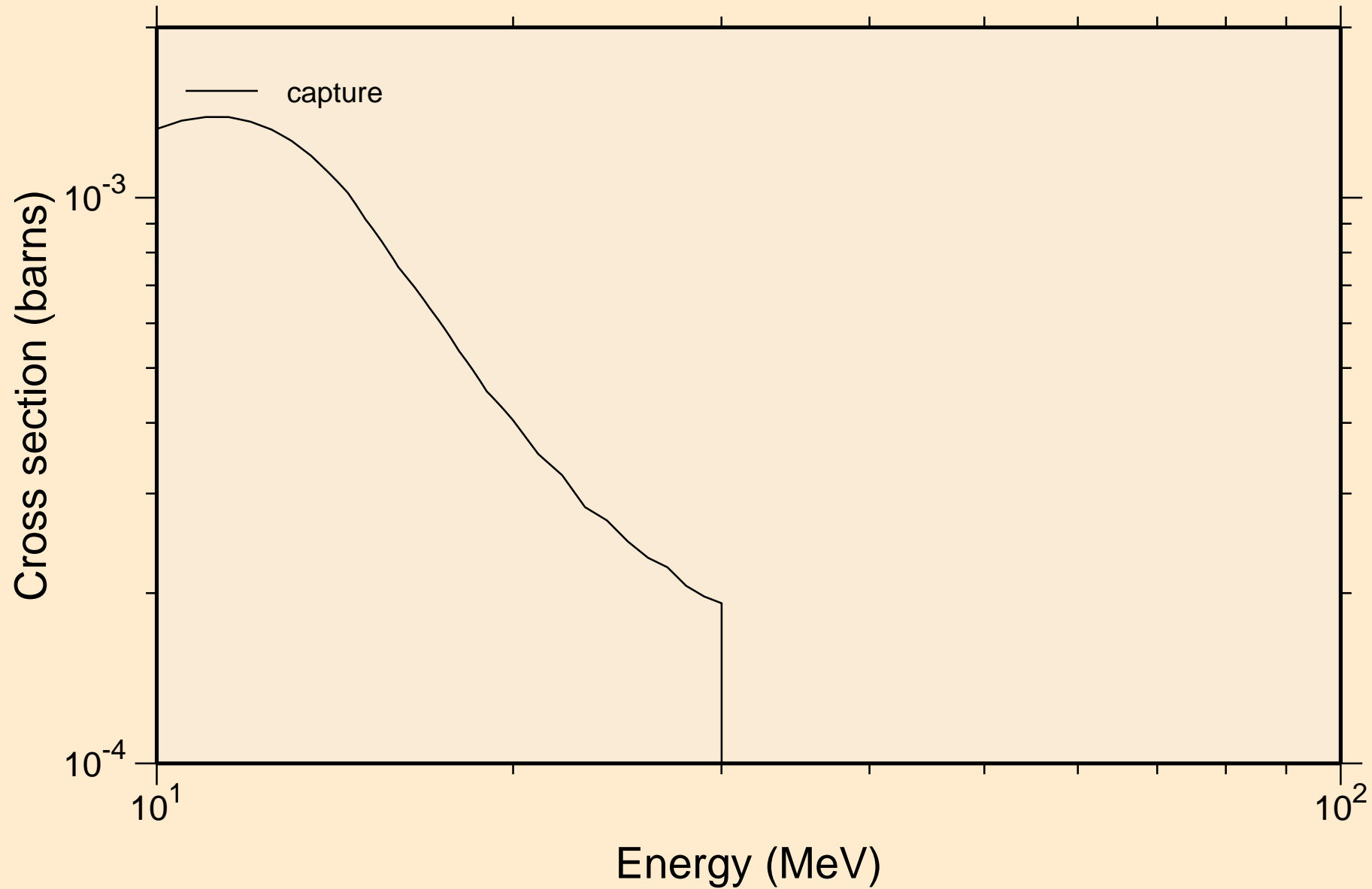

TA188 NEUTRON ACER TENDL-2021 LIBRARY; T=293.6K
Heating

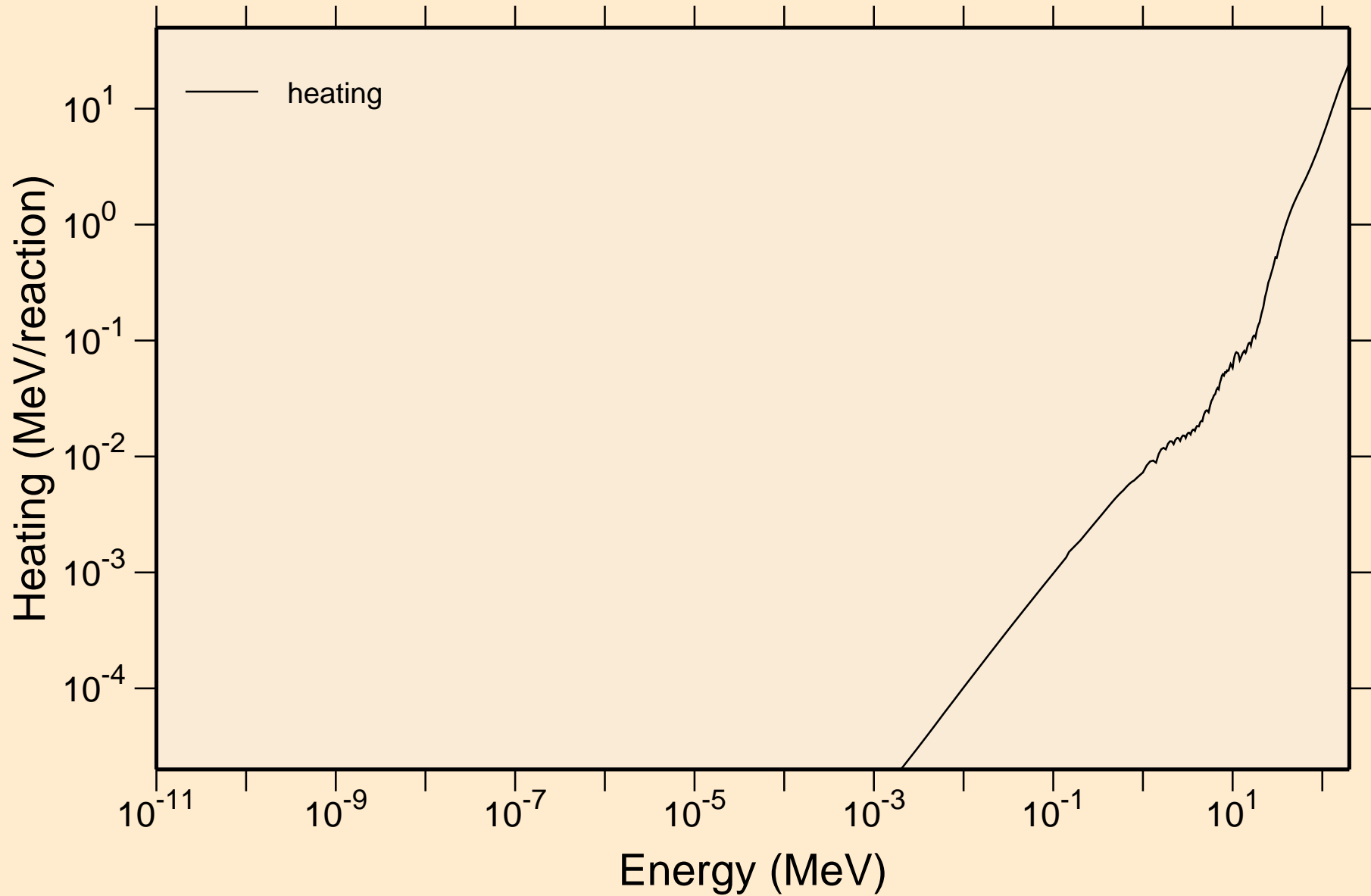

TA188 NEUTRON ACER TENDL-2021 LIBRARY; T=293.6K
Damage

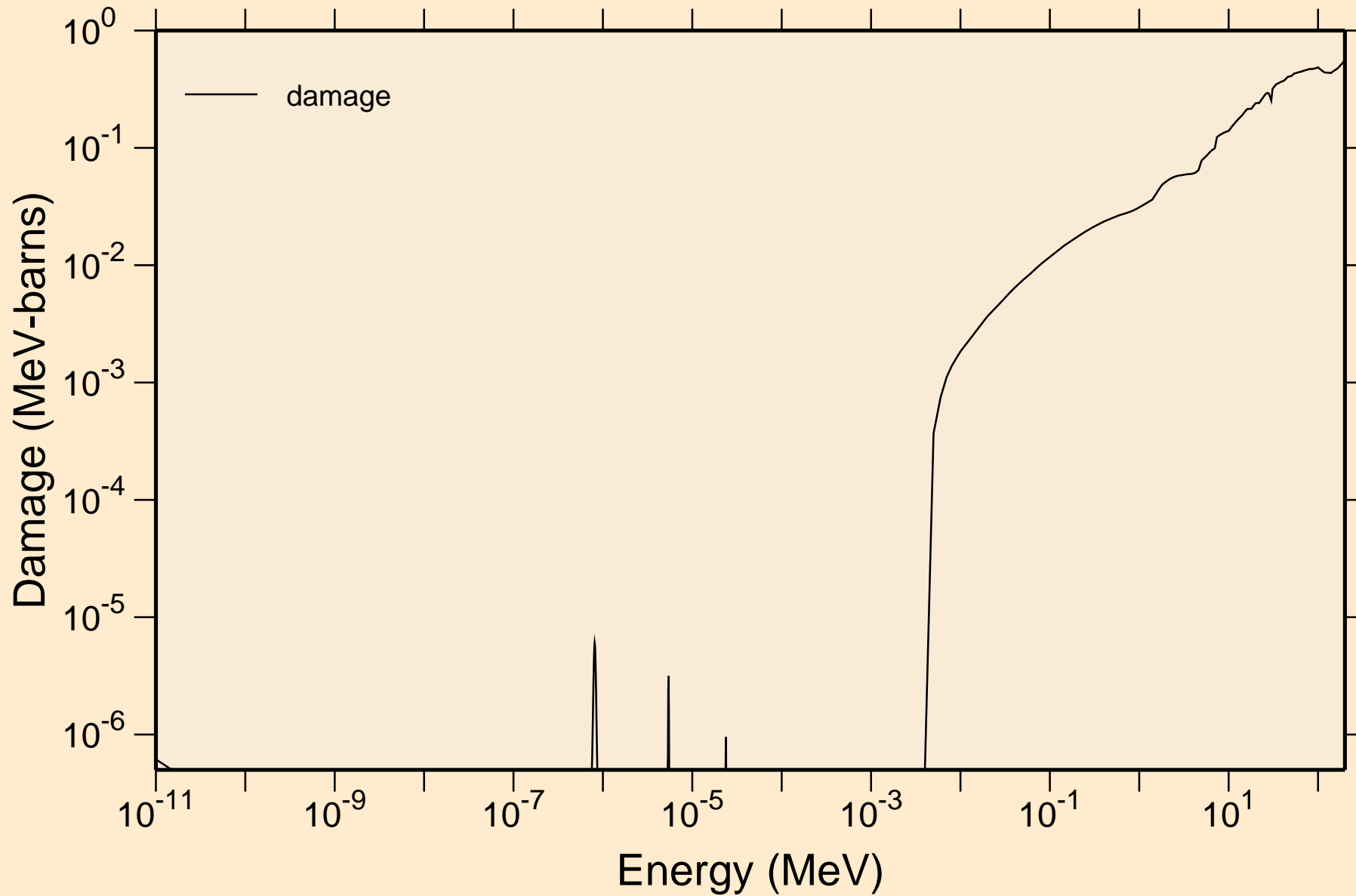

TA188 NEUTRON ACER TENDL-2021 LIBRARY; T=293.6K
Non-threshold reactions

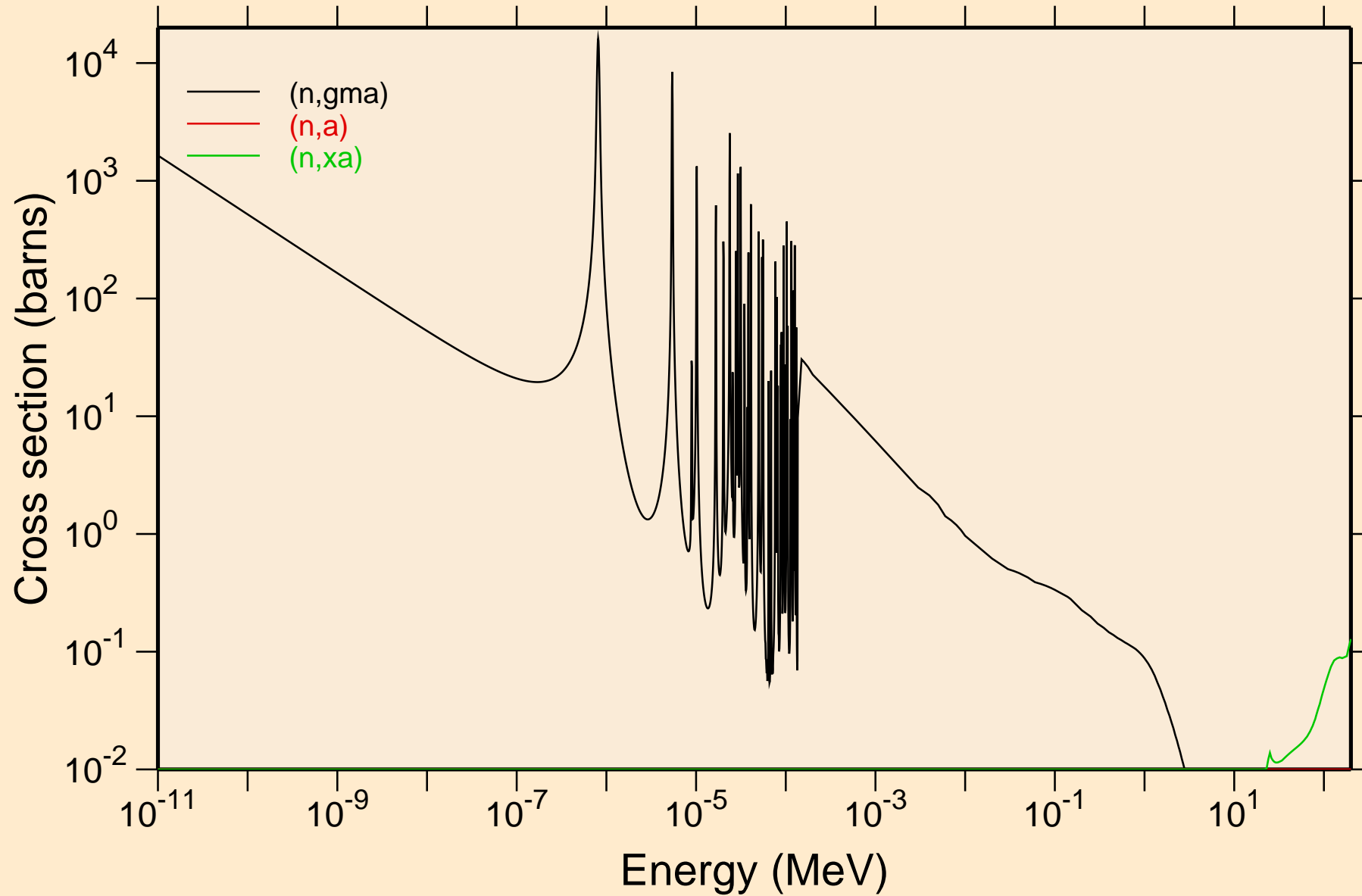

TA188 NEUTRON ACER TENDL-2021 LIBRARY; T=293.6K
Principal cross sections

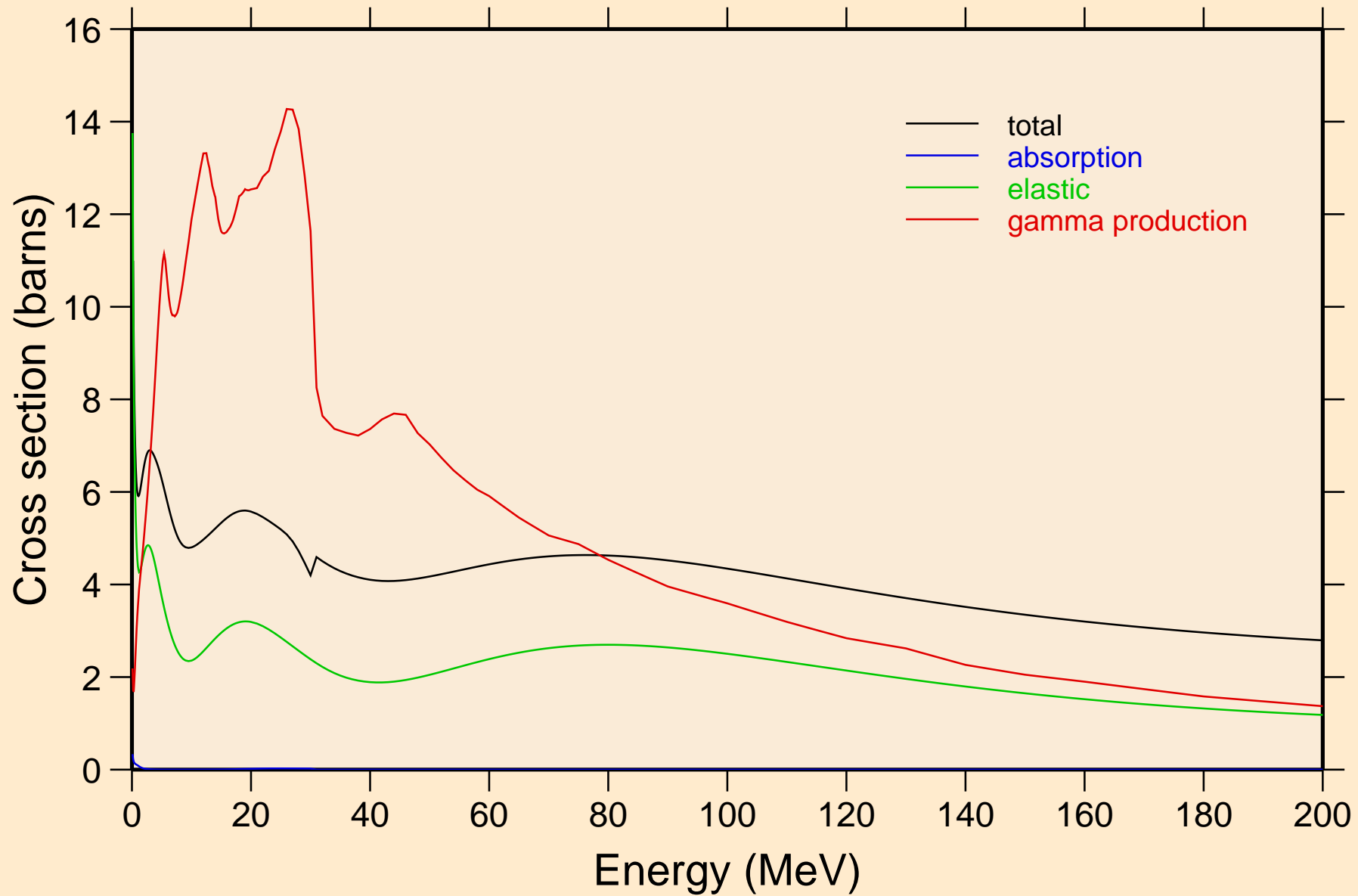

TA188 NEUTRON ACER TENDL-2021 LIBRARY; T=293.6K
Heating

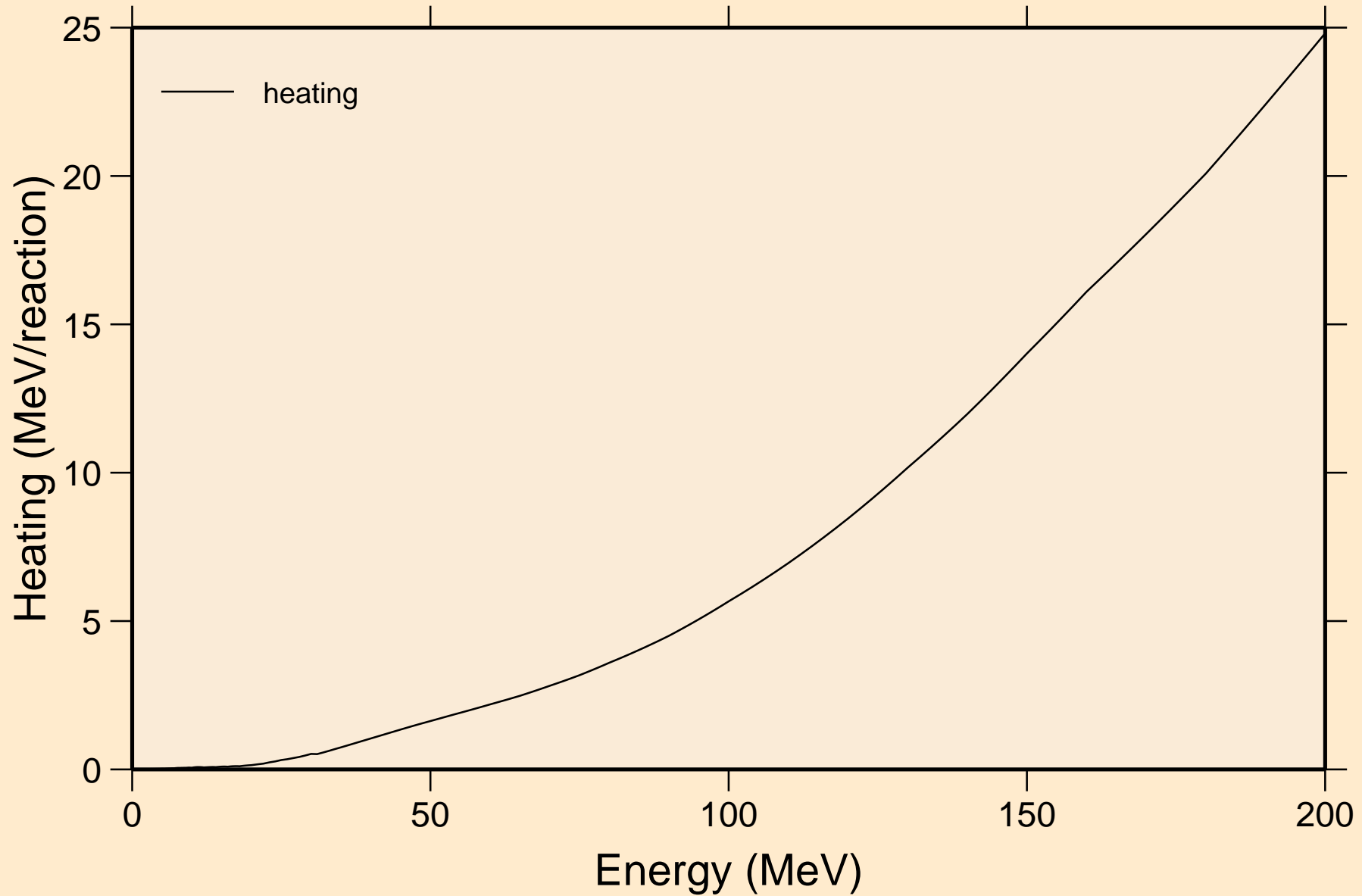

TA188 NEUTRON ACER TENDL-2021 LIBRARY; T=293.6K
Damage

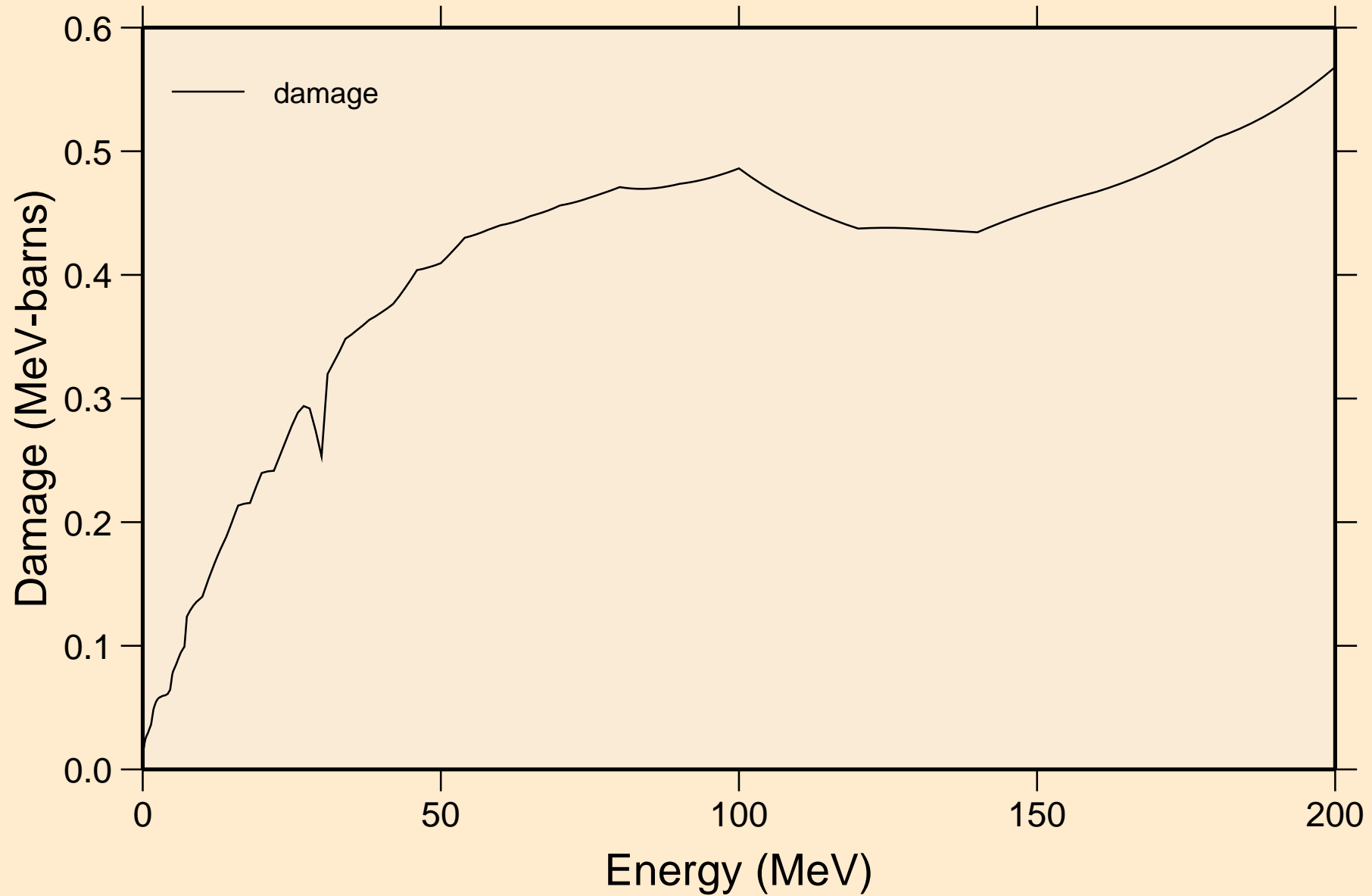

TA188 NEUTRON ACER TENDL-2021 LIBRARY; T=293.6K
Non-threshold reactions

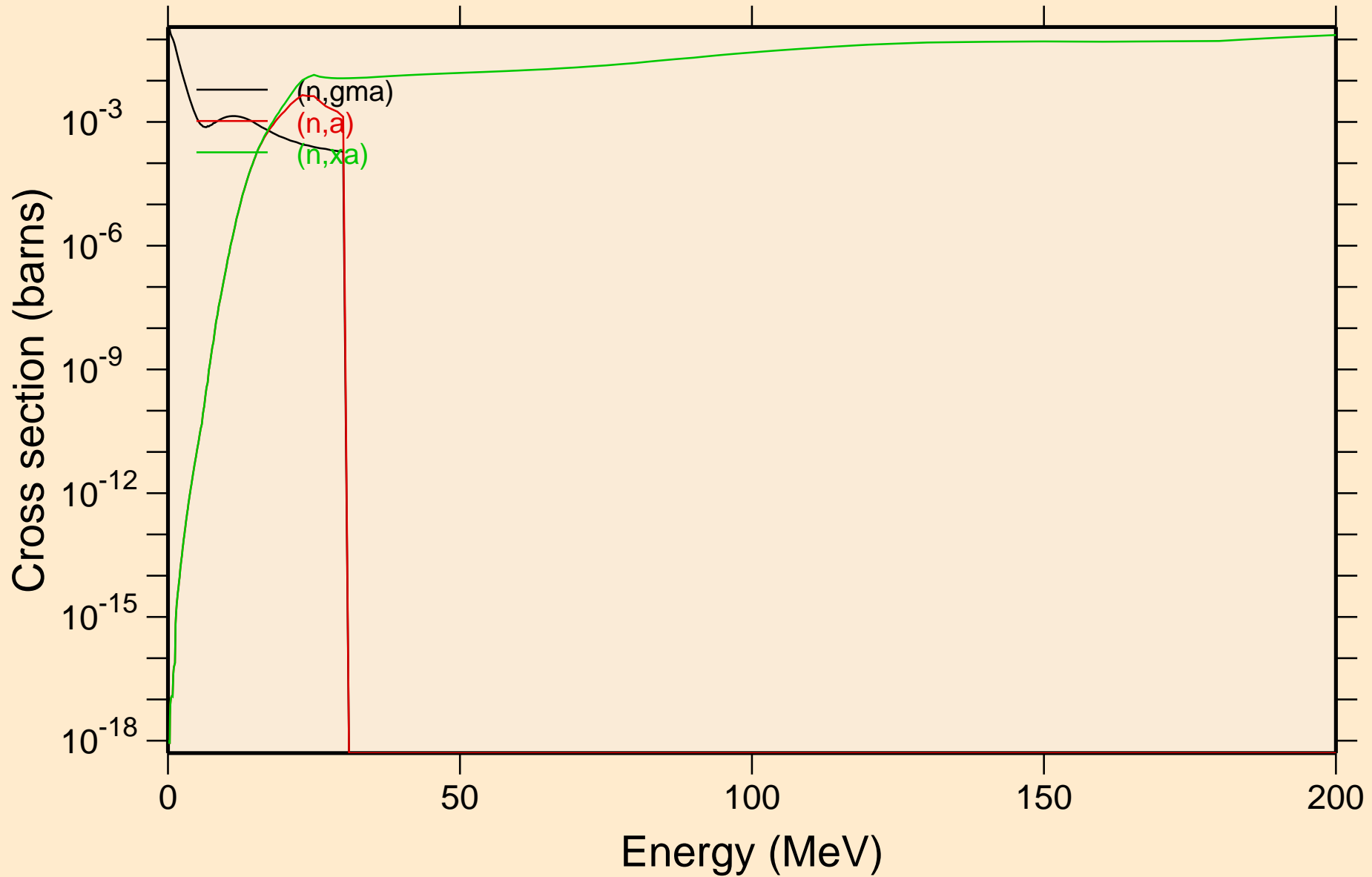

TA188 NEUTRON ACER TENDL-2021 LIBRARY; T=293.6K
Inelastic levels

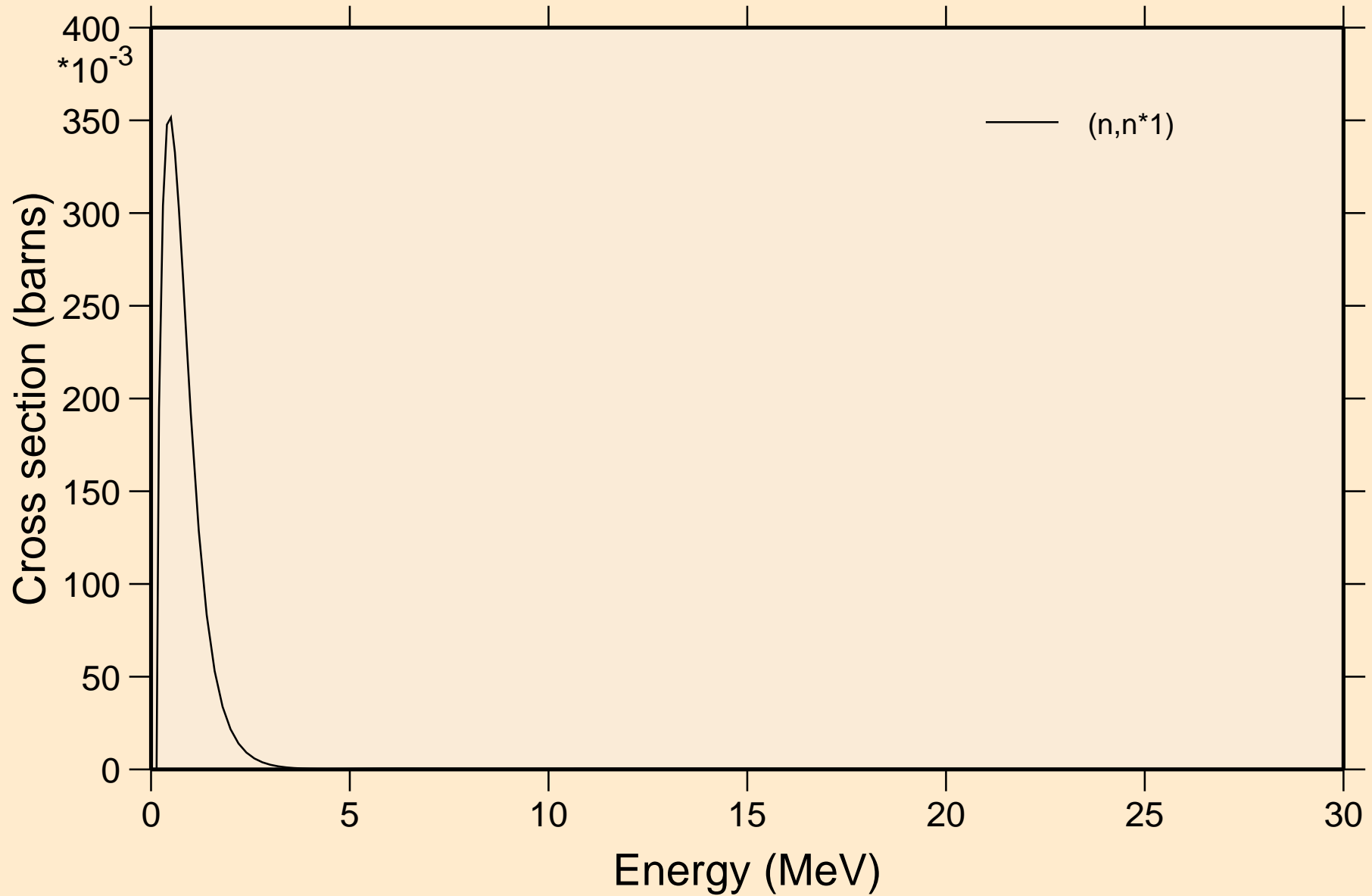

TA188 NEUTRON ACER TENDL-2021 LIBRARY; T=293.6K
Threshold reactions

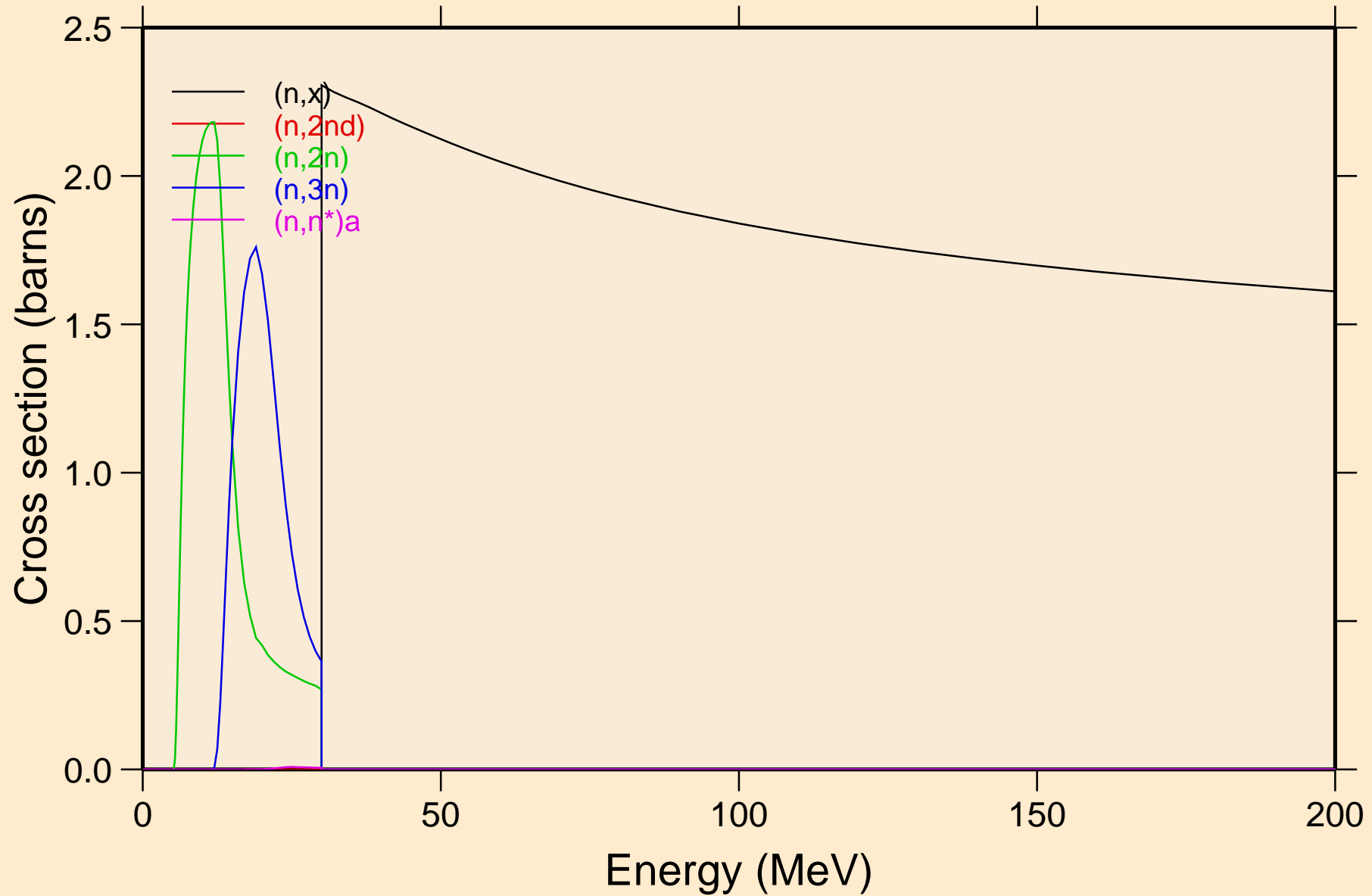

TA188 NEUTRON ACER TENDL-2021 LIBRARY; T=293.6K
Threshold reactions

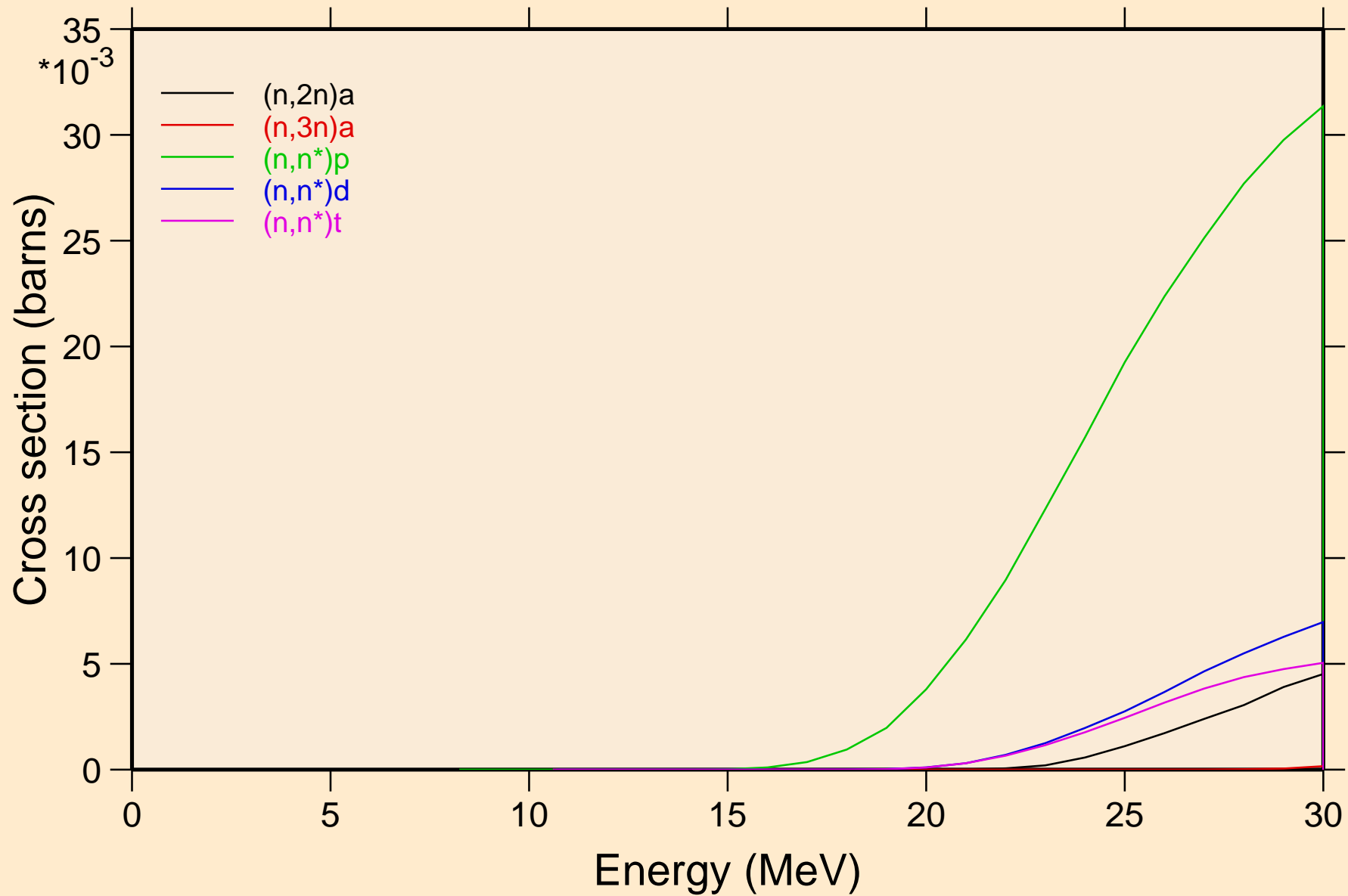

TA188 NEUTRON ACER TENDL-2021 LIBRARY; T=293.6K
Threshold reactions

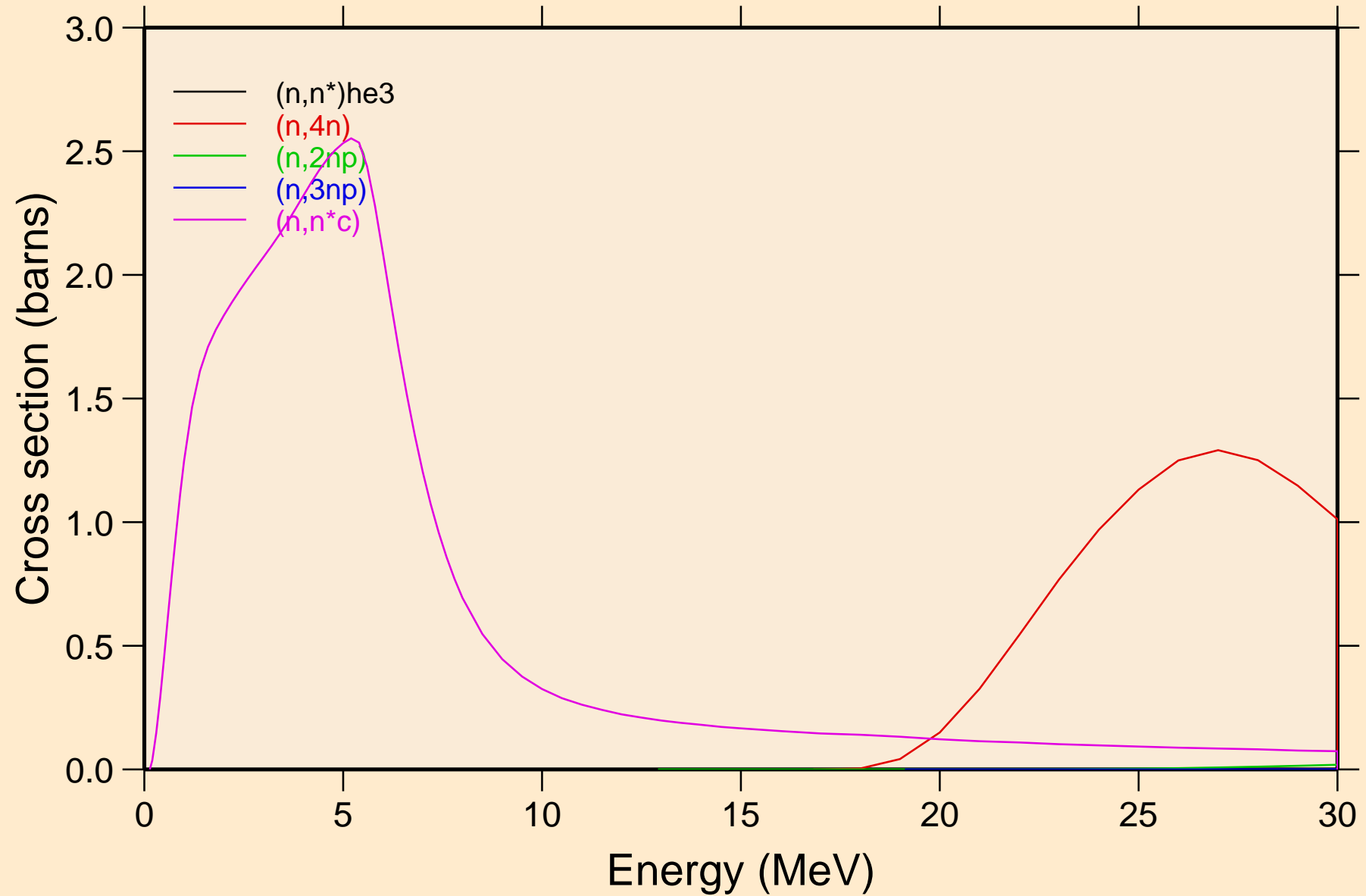

TA188 NEUTRON ACER TENDL-2021 LIBRARY; T=293.6K
Threshold reactions

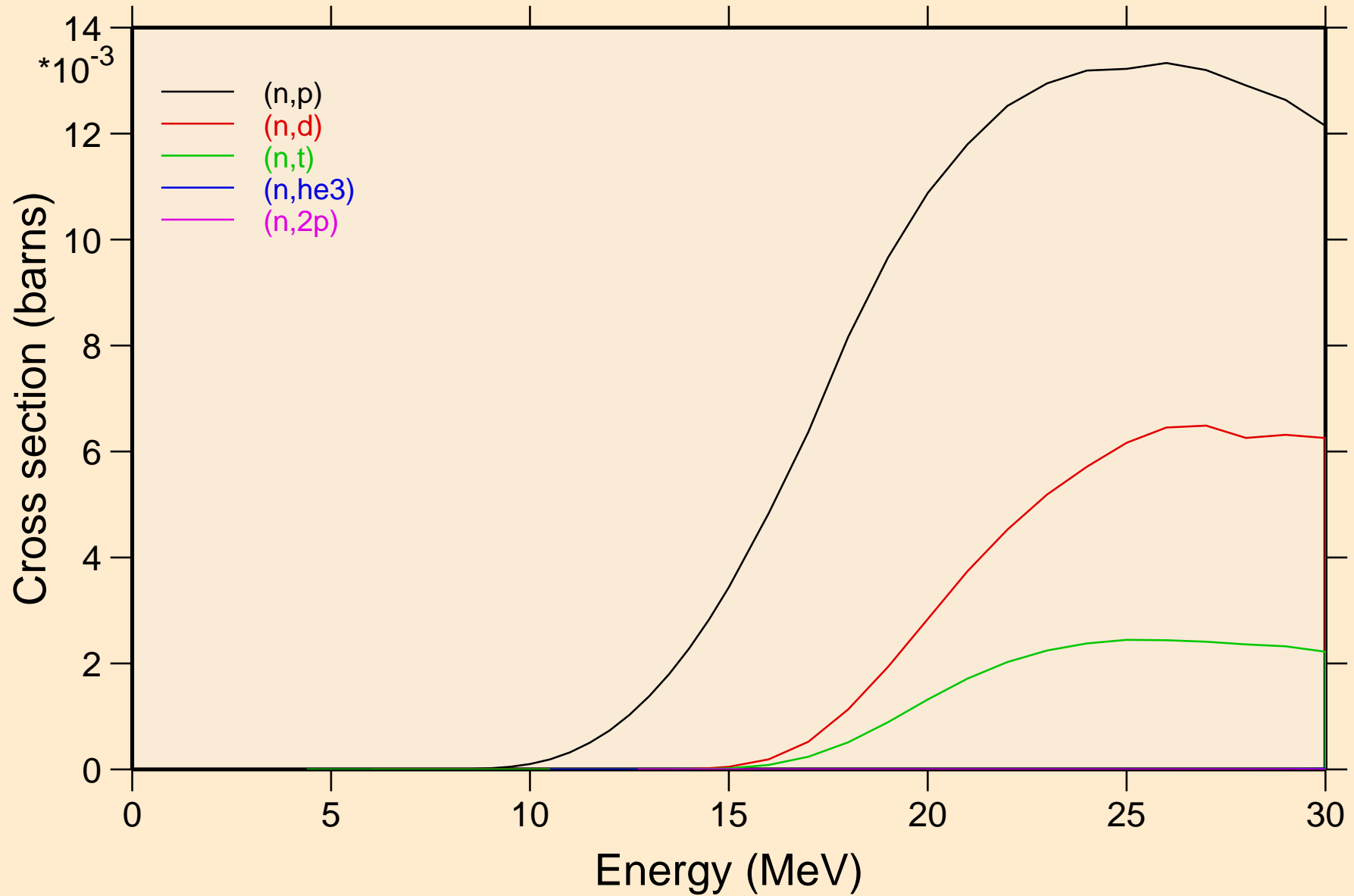

TA188 NEUTRON ACER TENDL-2021 LIBRARY; T=293.6K
Threshold reactions

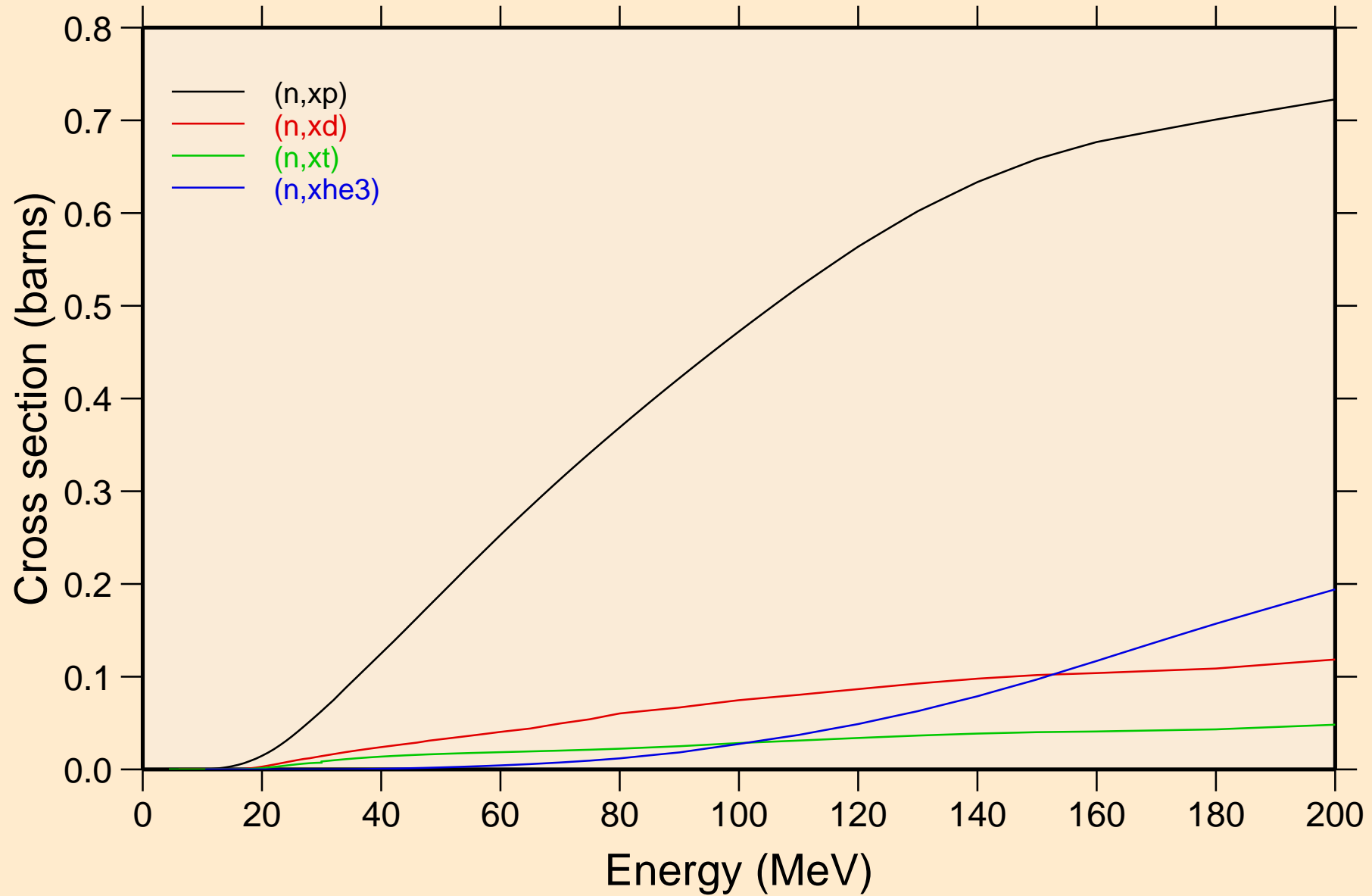

TA188 NEUTRON ACER TENDL-2021 LIBRARY; T=293.6K
angular distribution for elastic

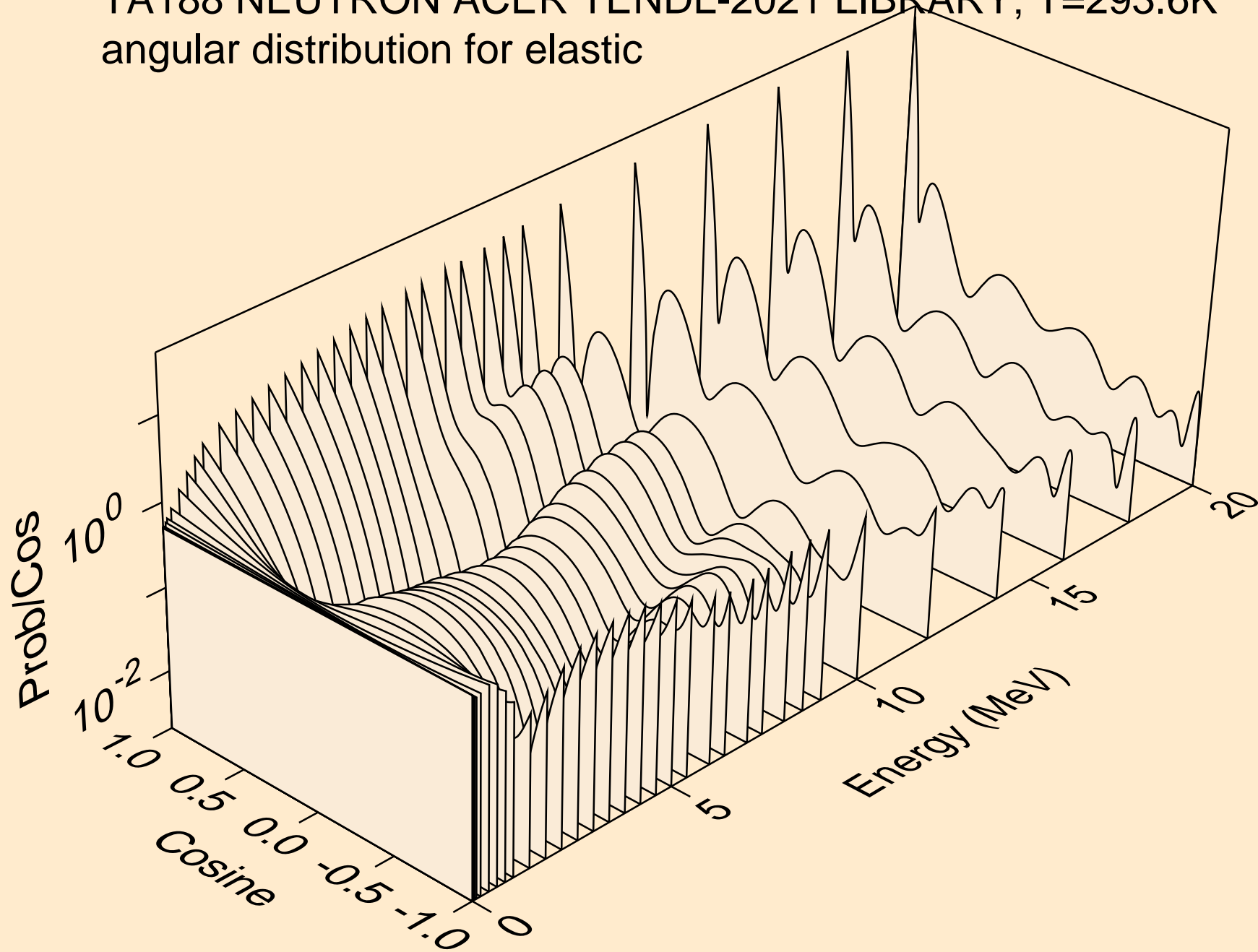

TA188 NEUTRON ACER TENDL-2021 LIBRARY; T=293.6K
angular distribution for elastic

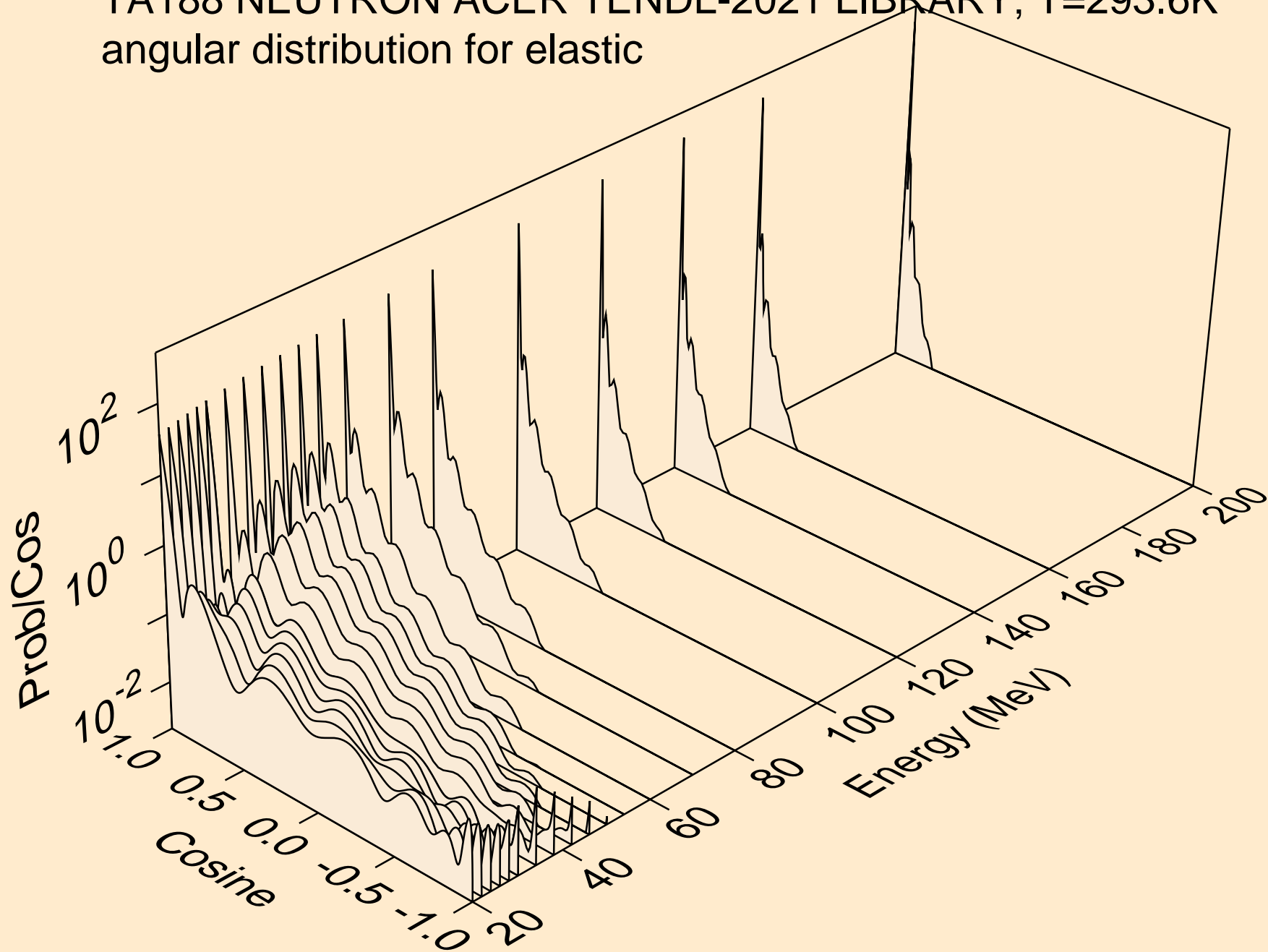

TA188 NEUTRON ACER TENDL-2021 LIBRARY; T=293.6K
angular distribution for (n,n*1)

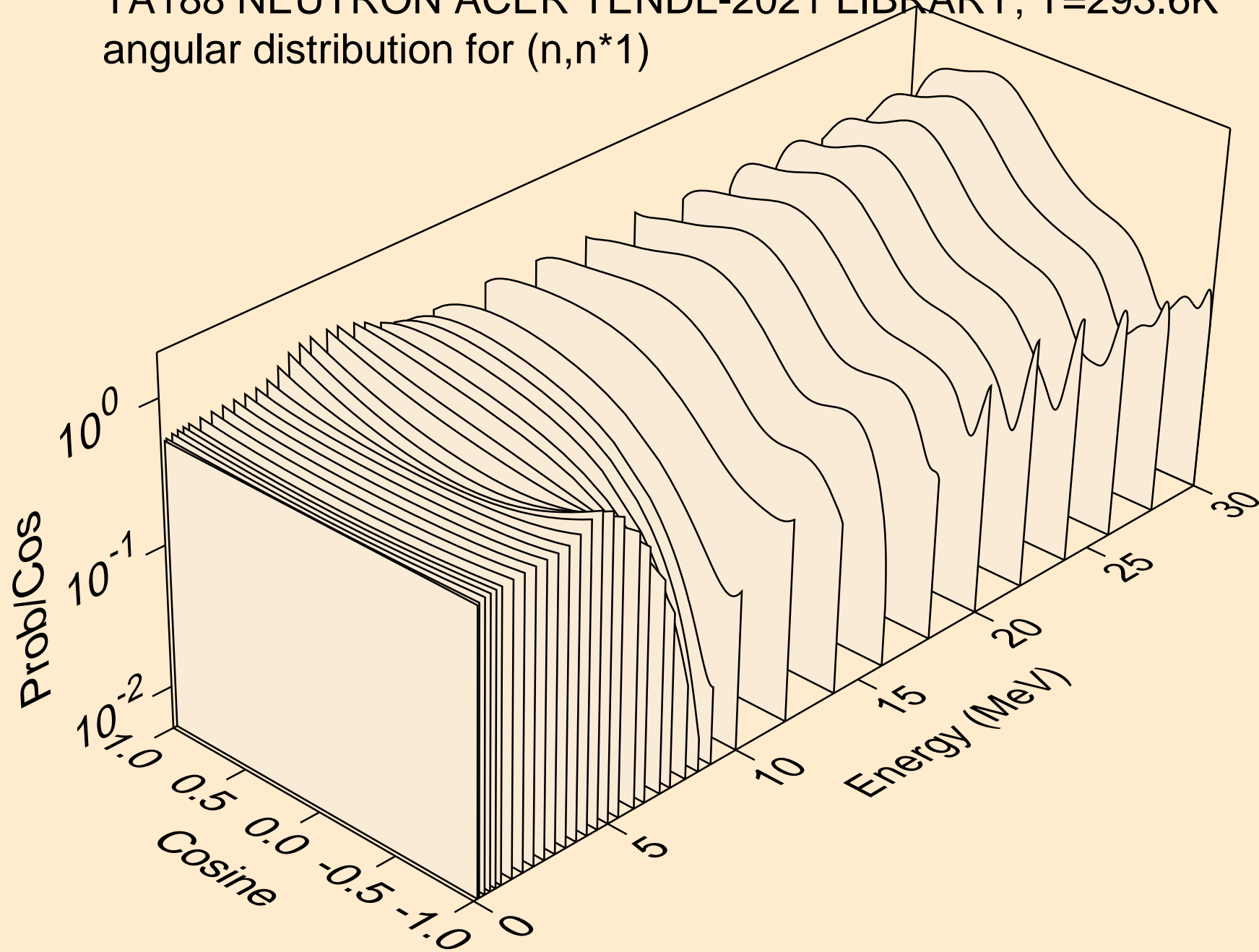

TA188 NEUTRON ACER TENDL-2021 LIBRARY; T=293.6K
Neutron emission for (n,x)

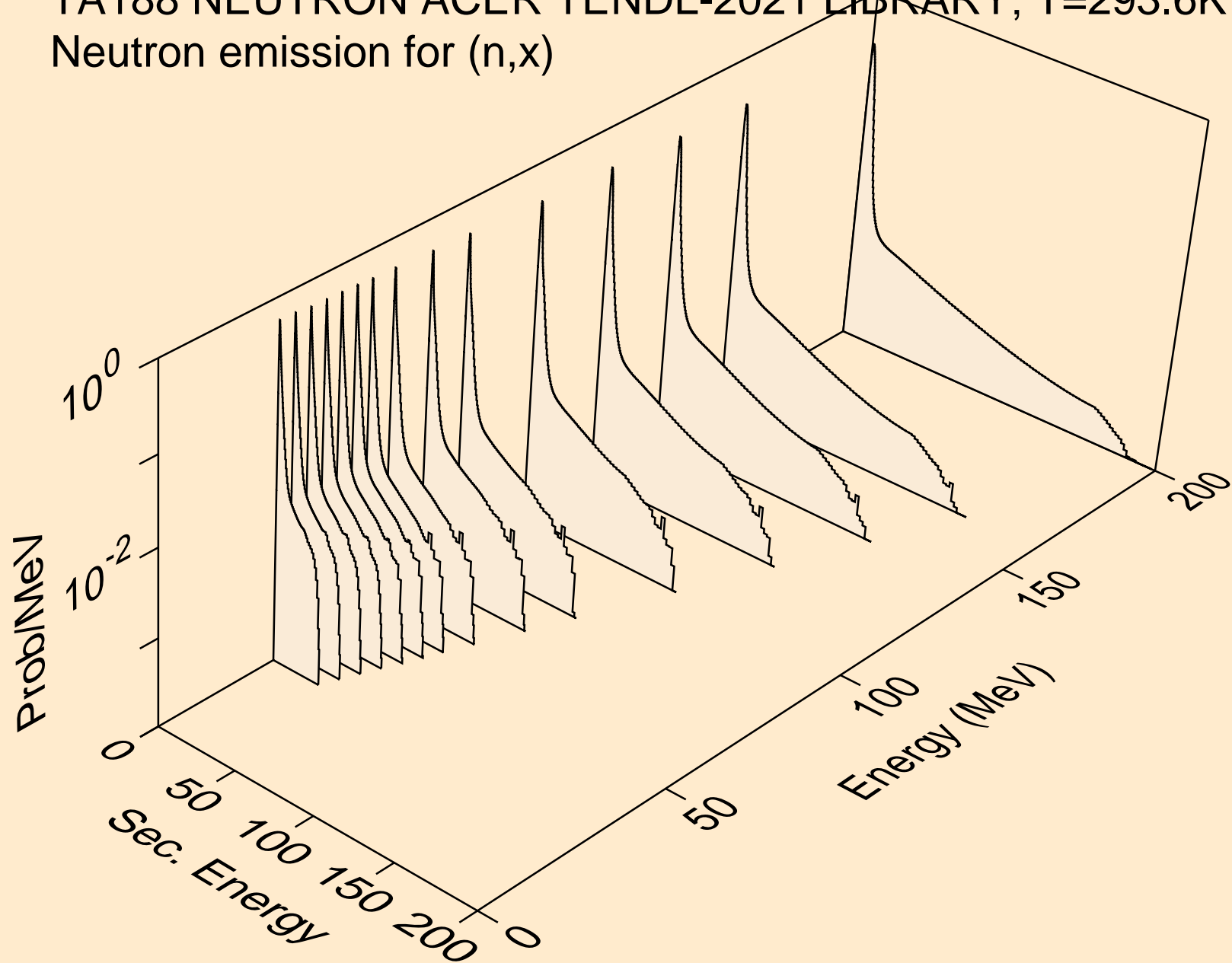

TA188 NEUTRON ACER TENDL-2021 LIBRARY; T=293.6K
Neutron emission for (n,2nd)

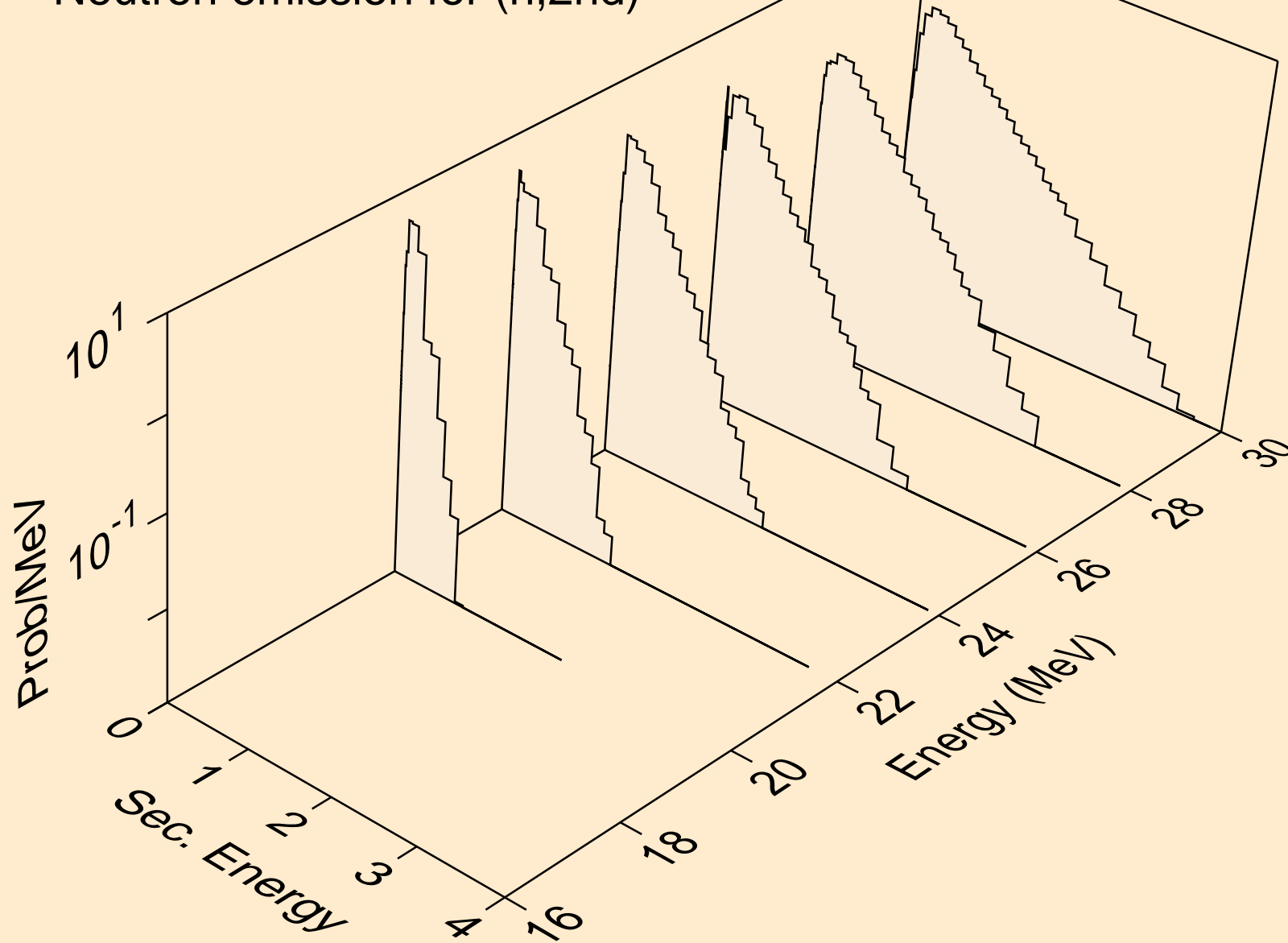

TA188 NEUTRON ACER TENDL-2021 LIBRARY; T=293.6K
Neutron emission for (n,2n)

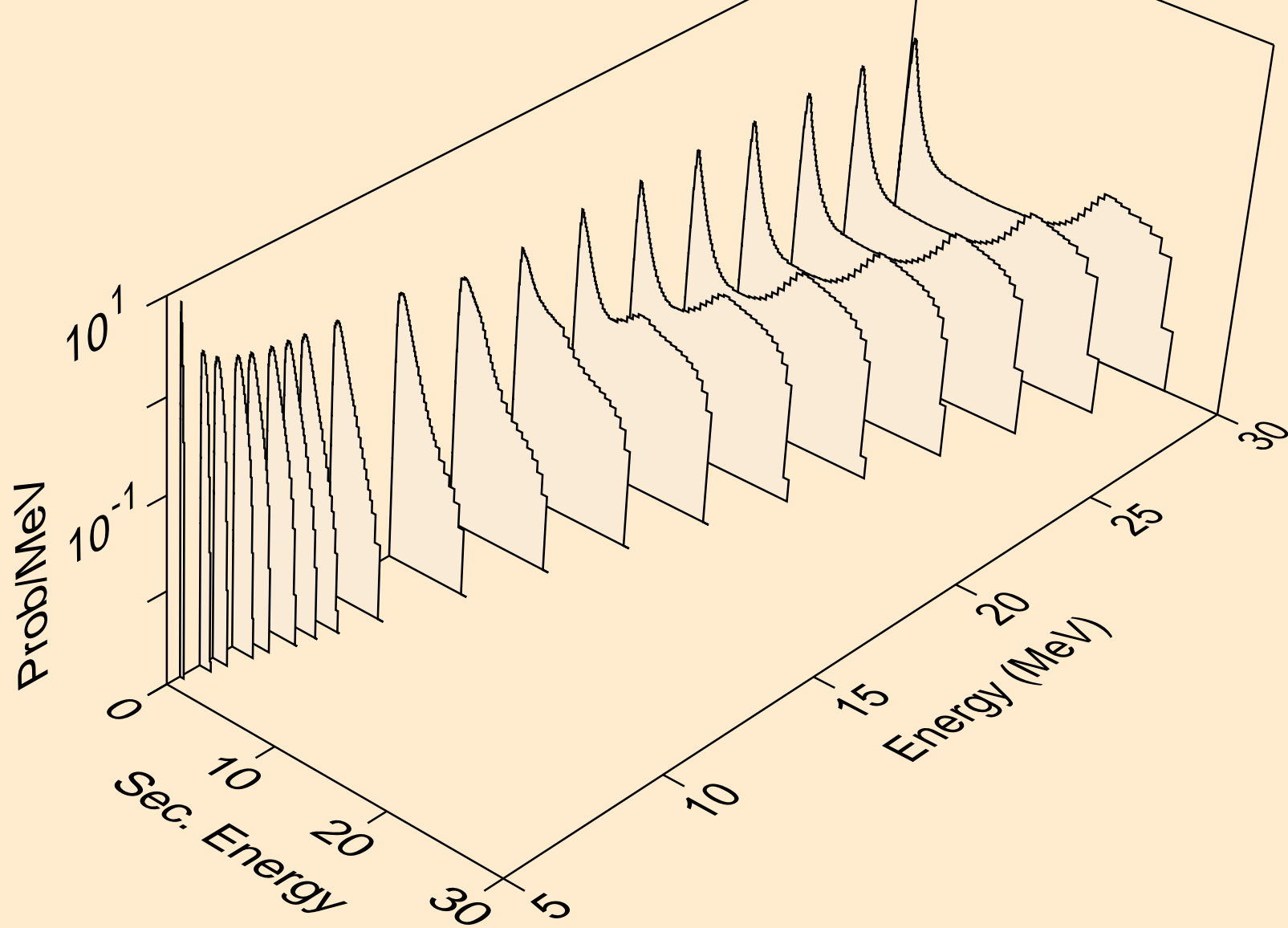

TA188 NEUTRON ACER TENDL-2021 LIBRARY; T=293.6K
Neutron emission for (n,3n)

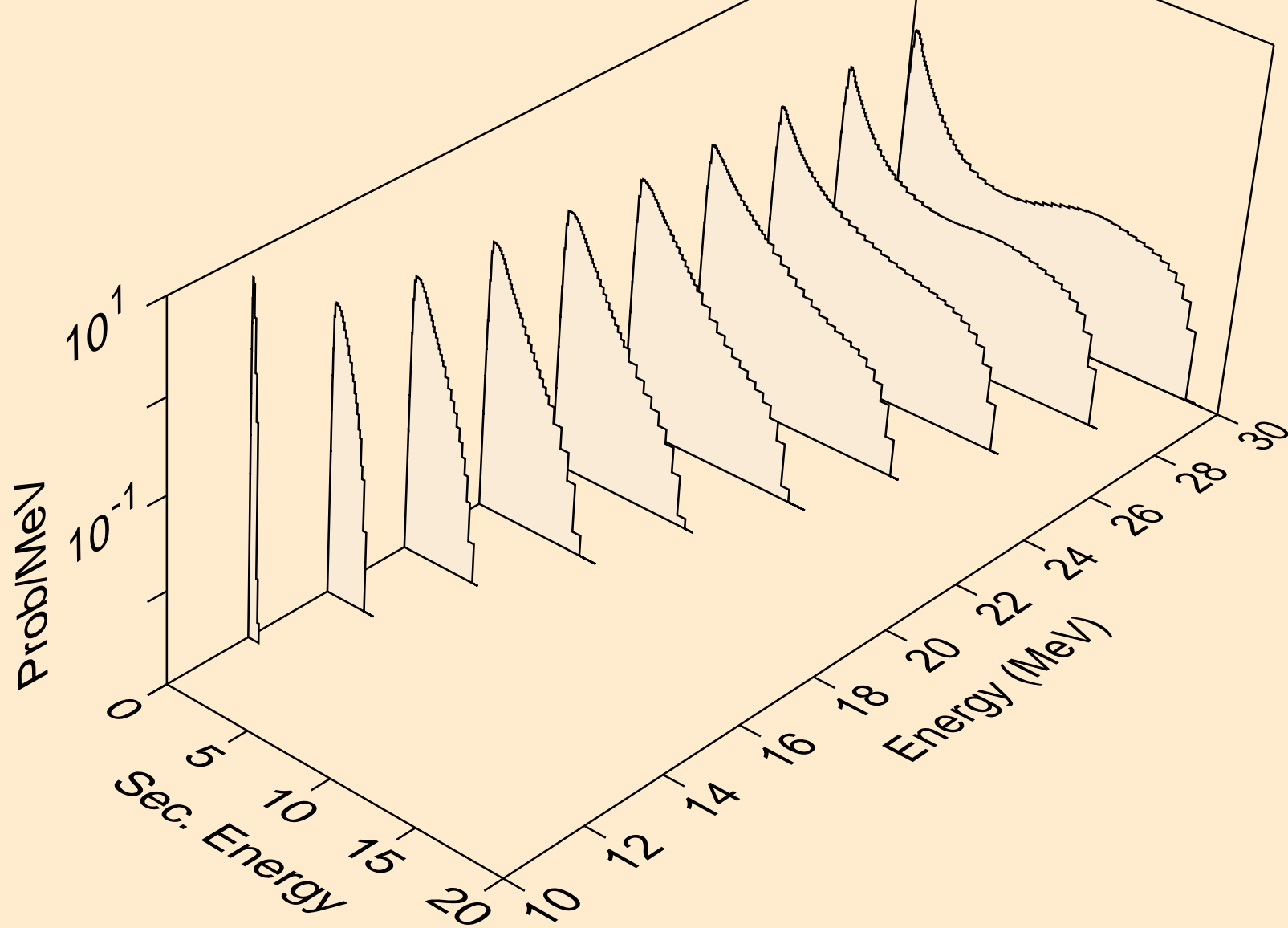

TA188 NEUTRON ACER TENDL-2021 LIBRARY; T=293.6K
Neutron emission for (n,n*)a

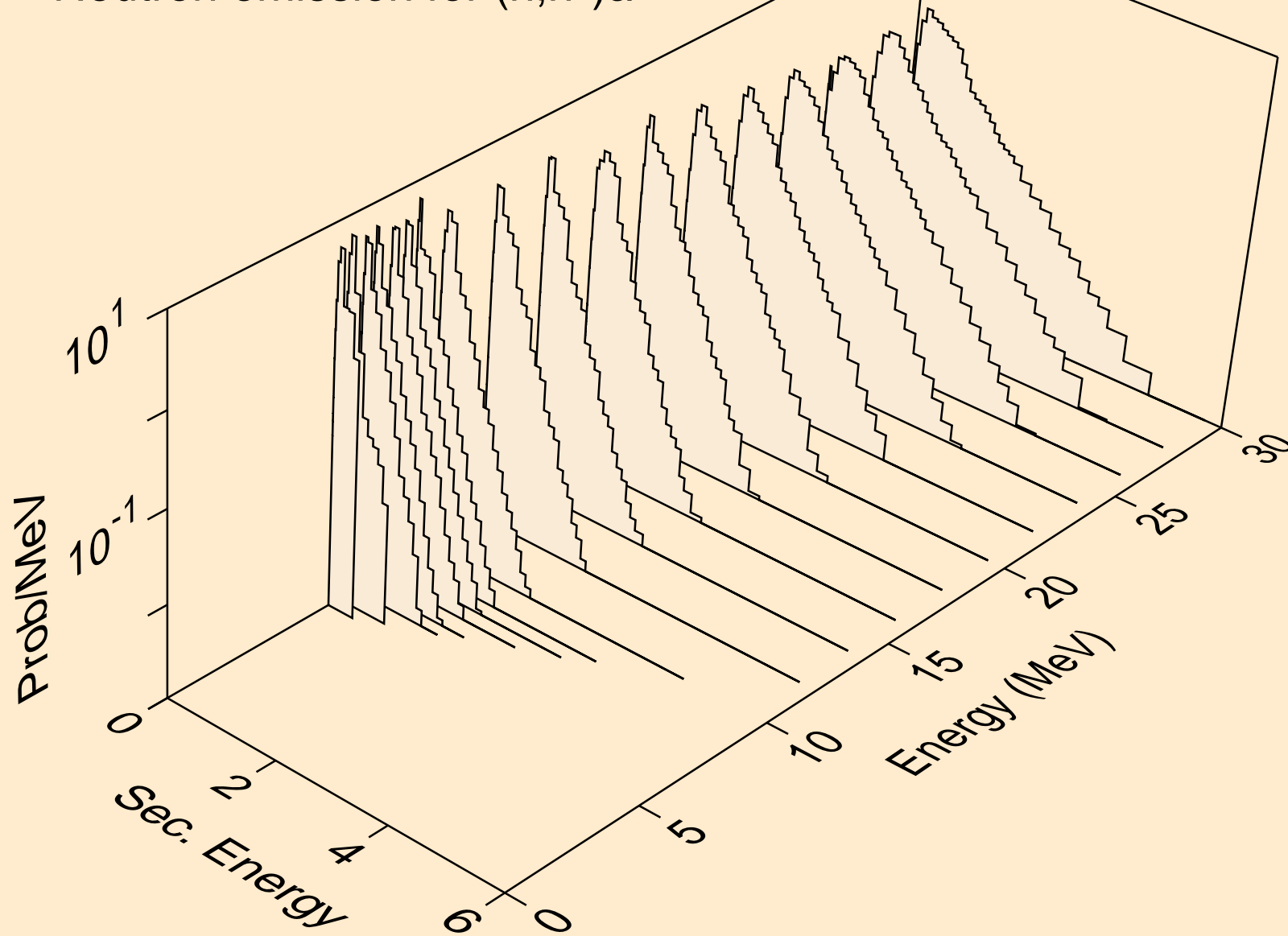

TA188 NEUTRON ACER TENDL-2021 LIBRARY; T=293.6K
Neutron emission for (n,2n)_a

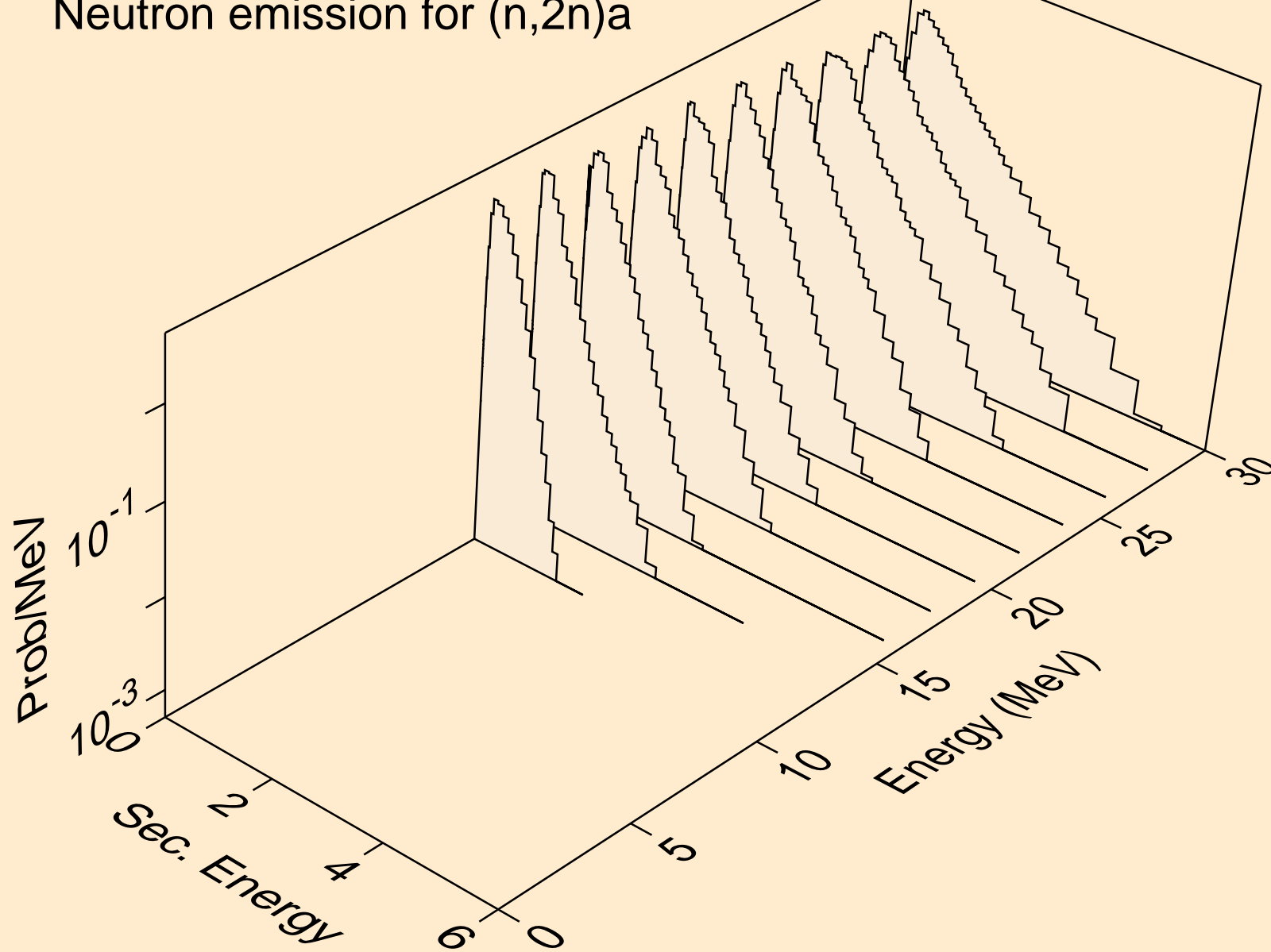

TA188 NEUTRON ACER TENDL-2021 LIBRARY; T=293.6K
Neutron emission for (n,3n)_a

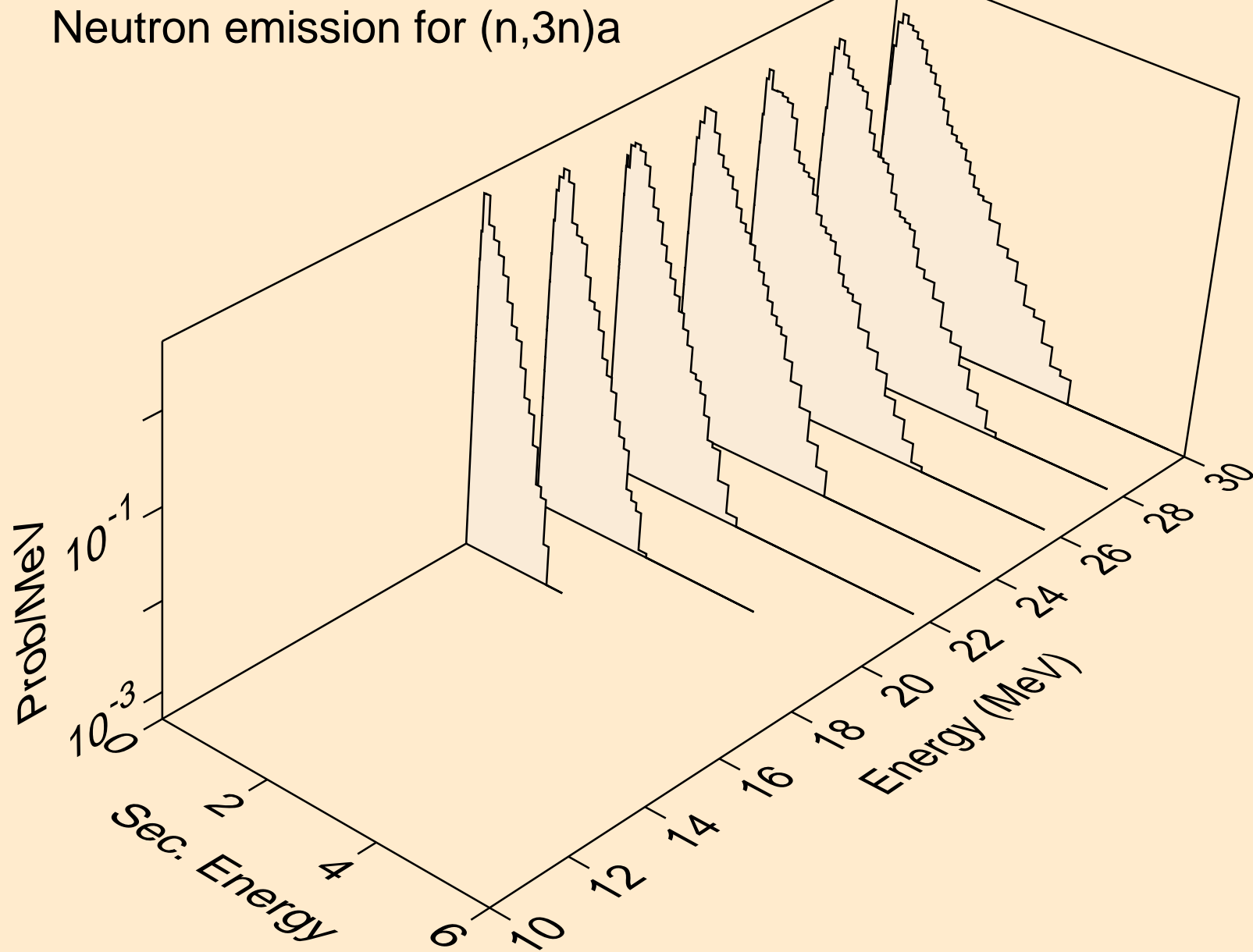

TA188 NEUTRON ACER TENDL-2021 LIBRARY; T=293.6K
Neutron emission for (n,n*)p

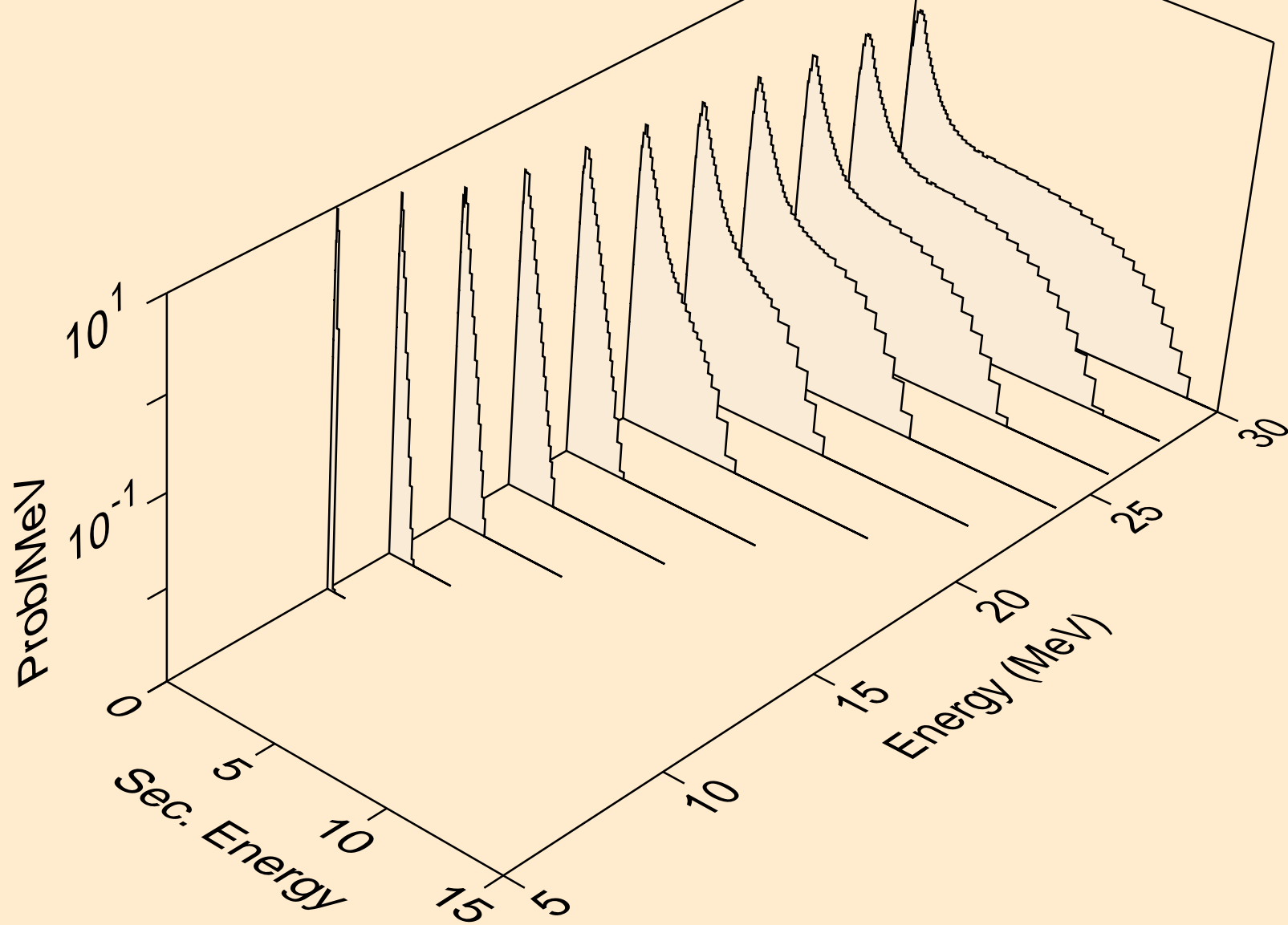

TA188 NEUTRON ACER TENDL-2021 LIBRARY; T=293.6K
Neutron emission for (n,n*)d

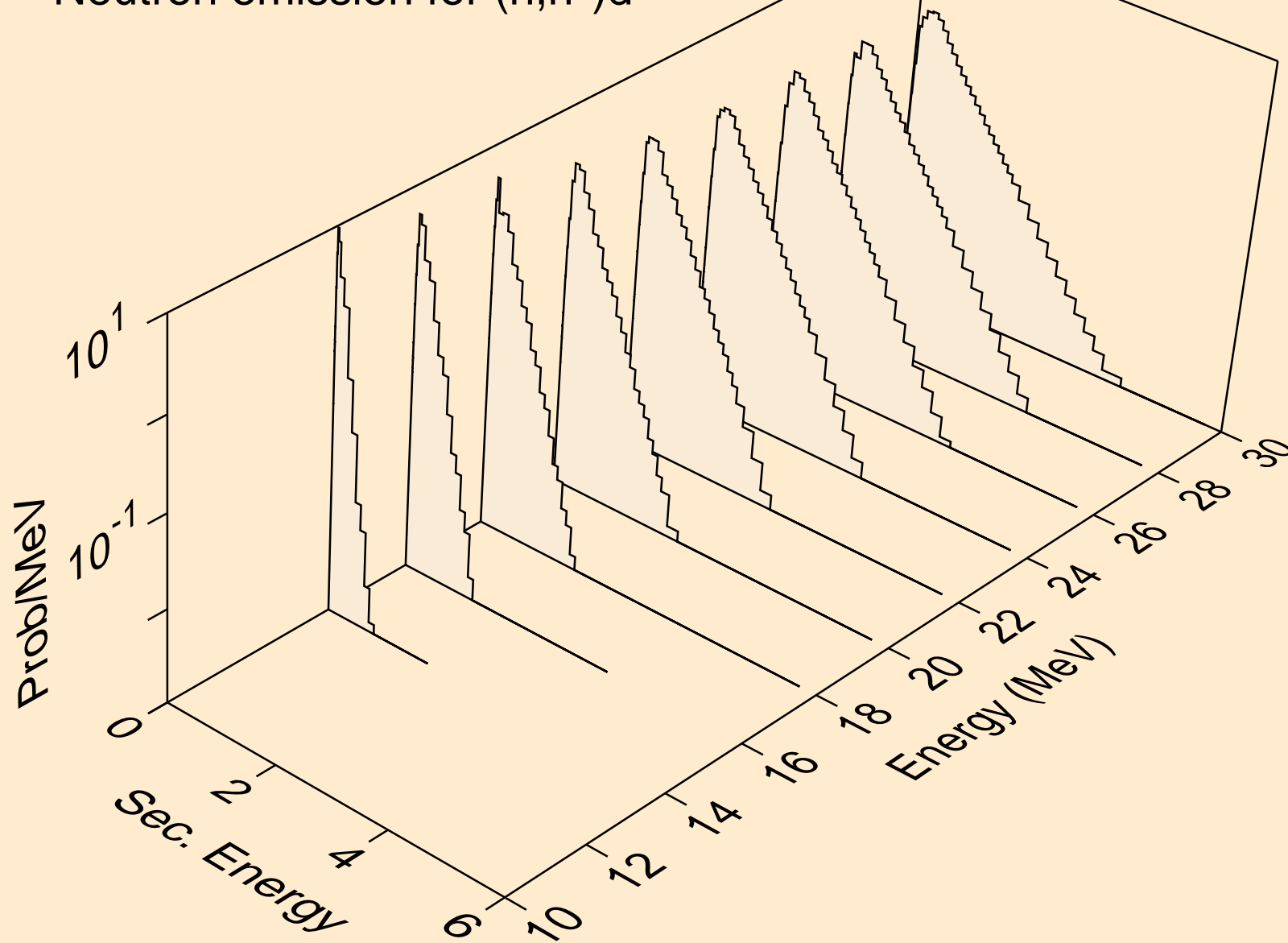

TA188 NEUTRON ACER TENDL-2021 LIBRARY; T=293.6K
Neutron emission for (n,n*)t

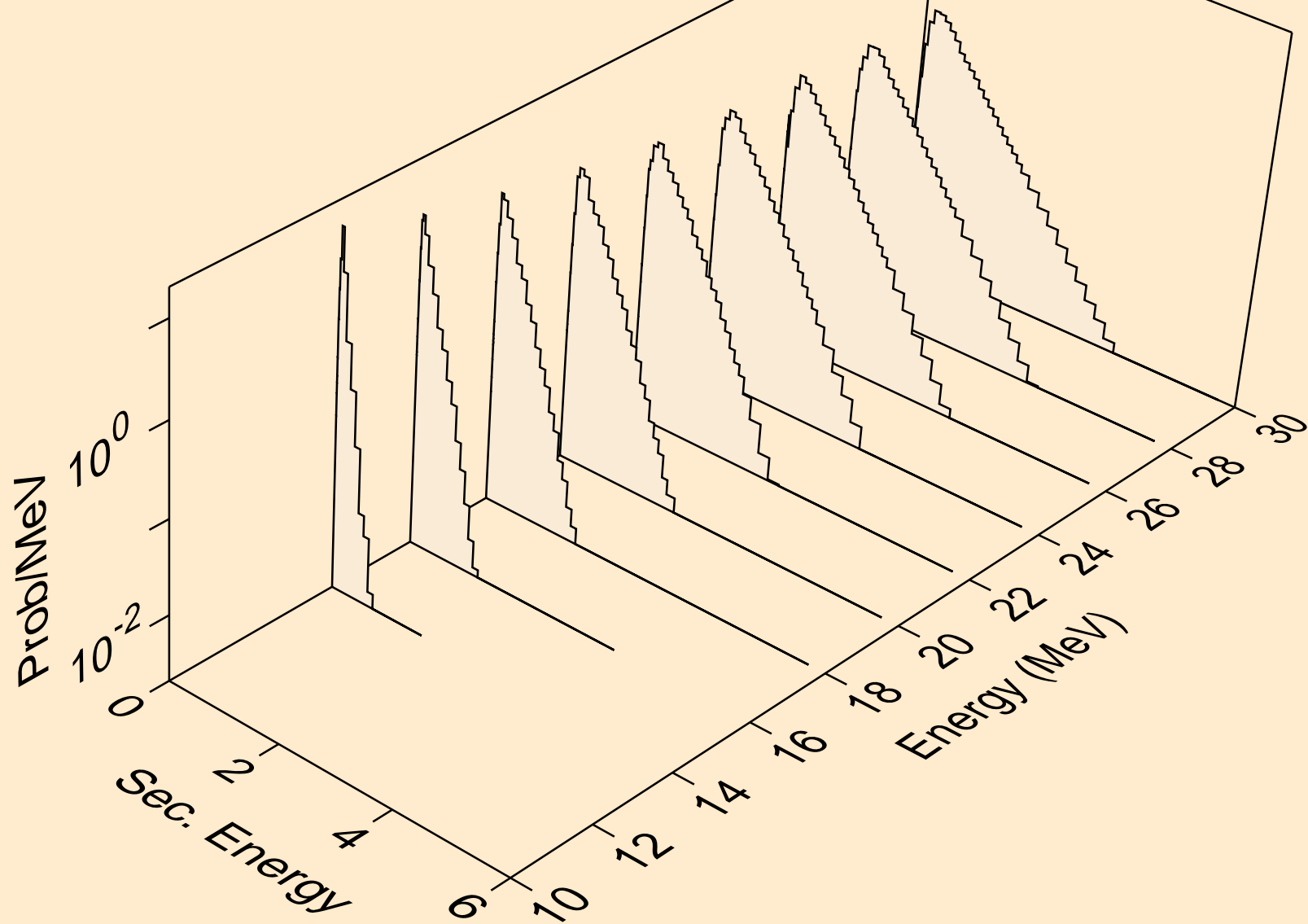

TA188 NEUTRON ACER TENDL-2021 LIBRARY; T=293.6K
Neutron emission for (n,n*)he3

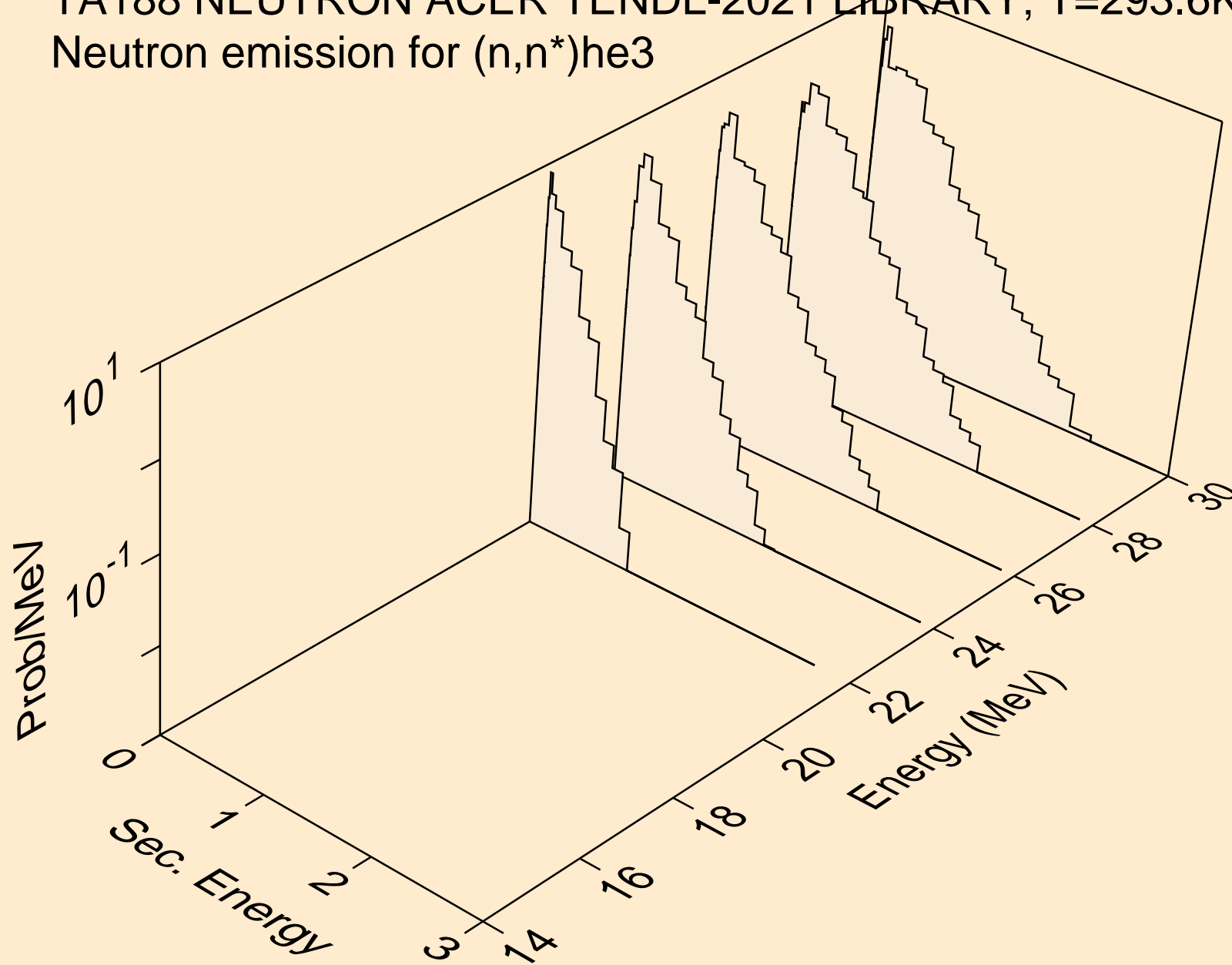

TA188 NEUTRON ACER TENDL-2021 LIBRARY; T=293.6K
Neutron emission for (n,4n)

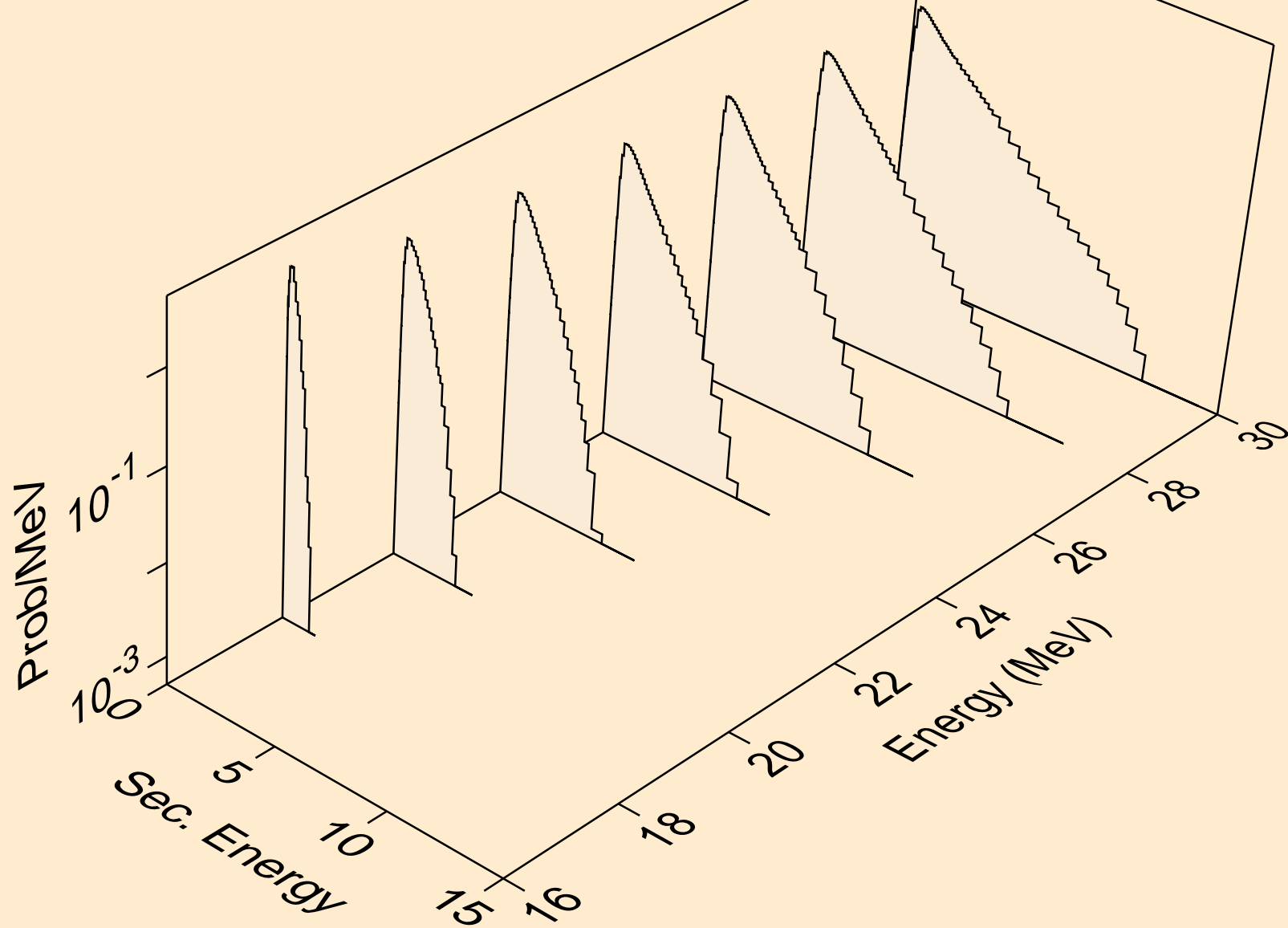

TA188 NEUTRON ACER TENDL-2021 LIBRARY; T=293.6K
Neutron emission for (n,2np)

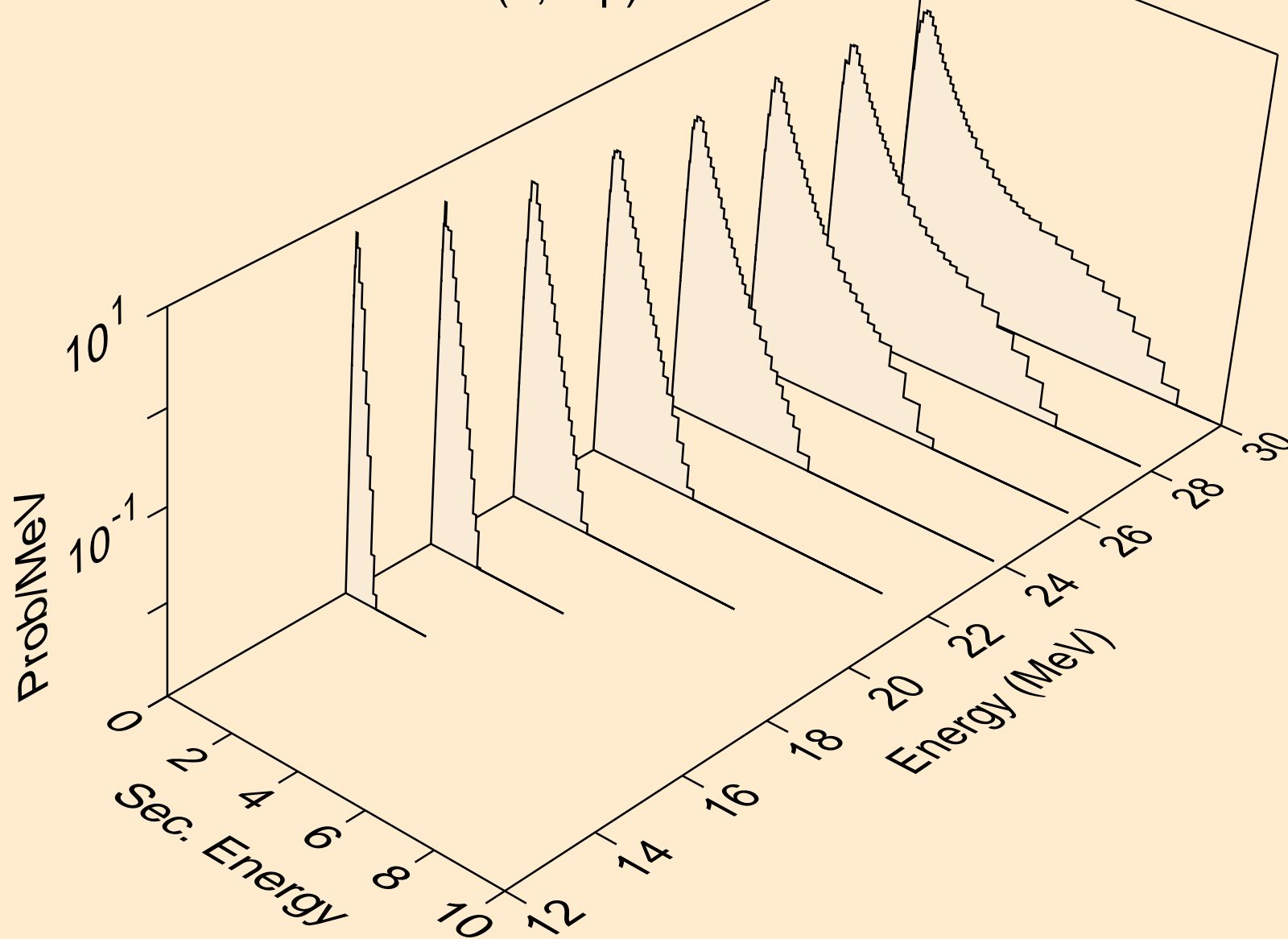

TA188 NEUTRON ACER TENDL-2021 LIBRARY; T=293.6K
Neutron emission for (n,3np)

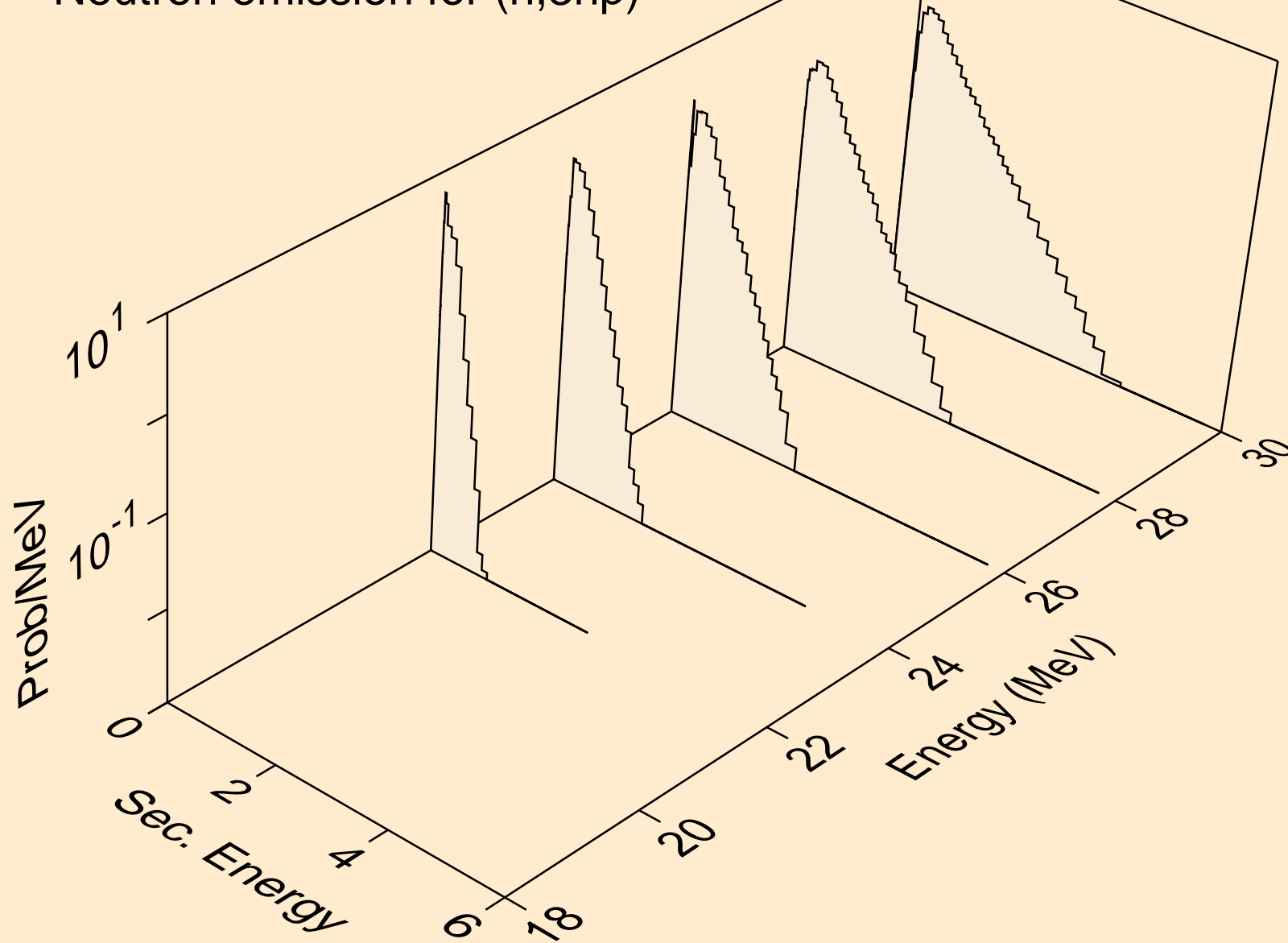

TA188 NEUTRON ACER TENDL-2021 LIBRARY; T=293.6K
Neutron emission for (n,n*c)

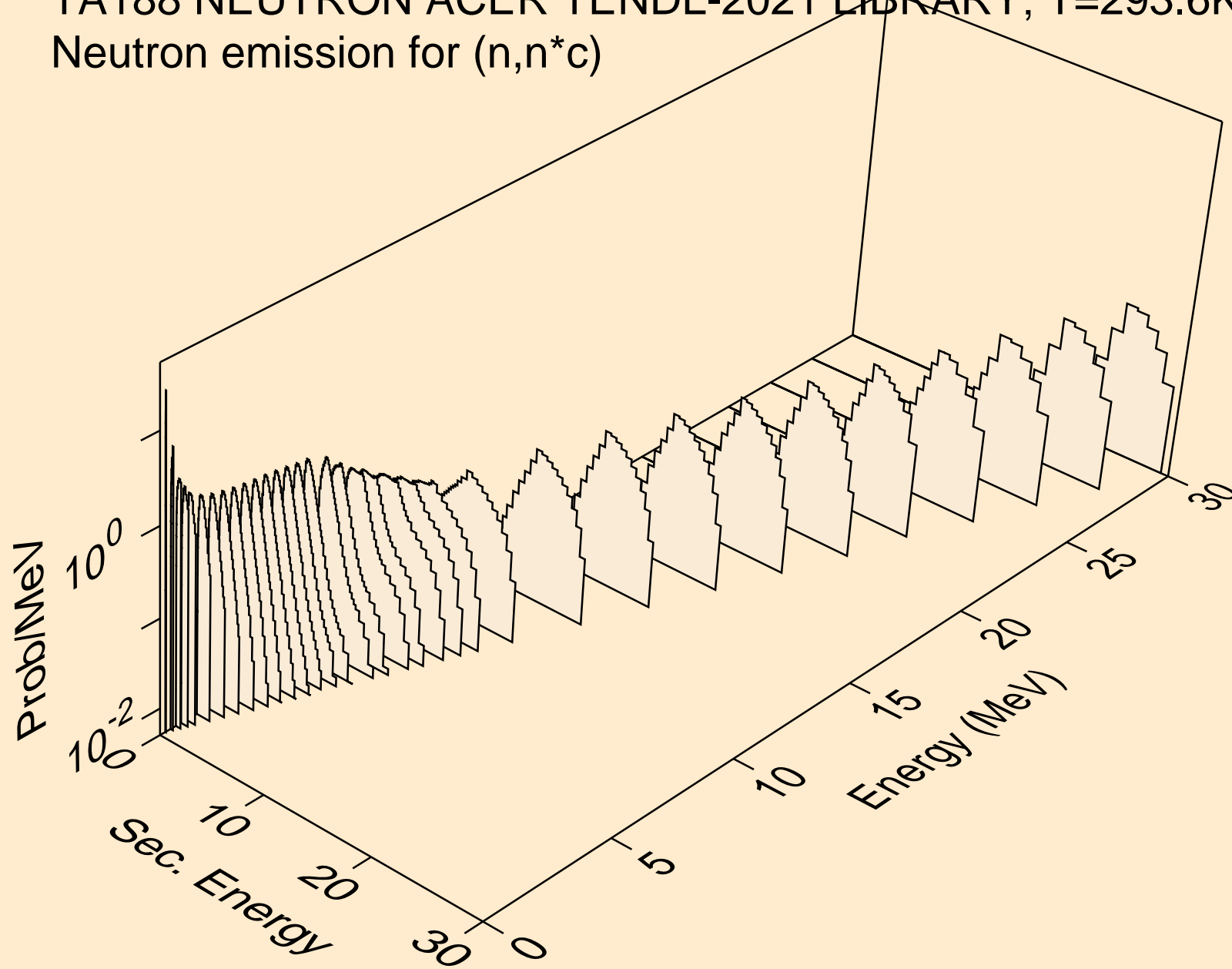

TA188 NEUTRON ACER TENDL-2021 LIBRARY; T=293.6K
Photon emission for (n,x)

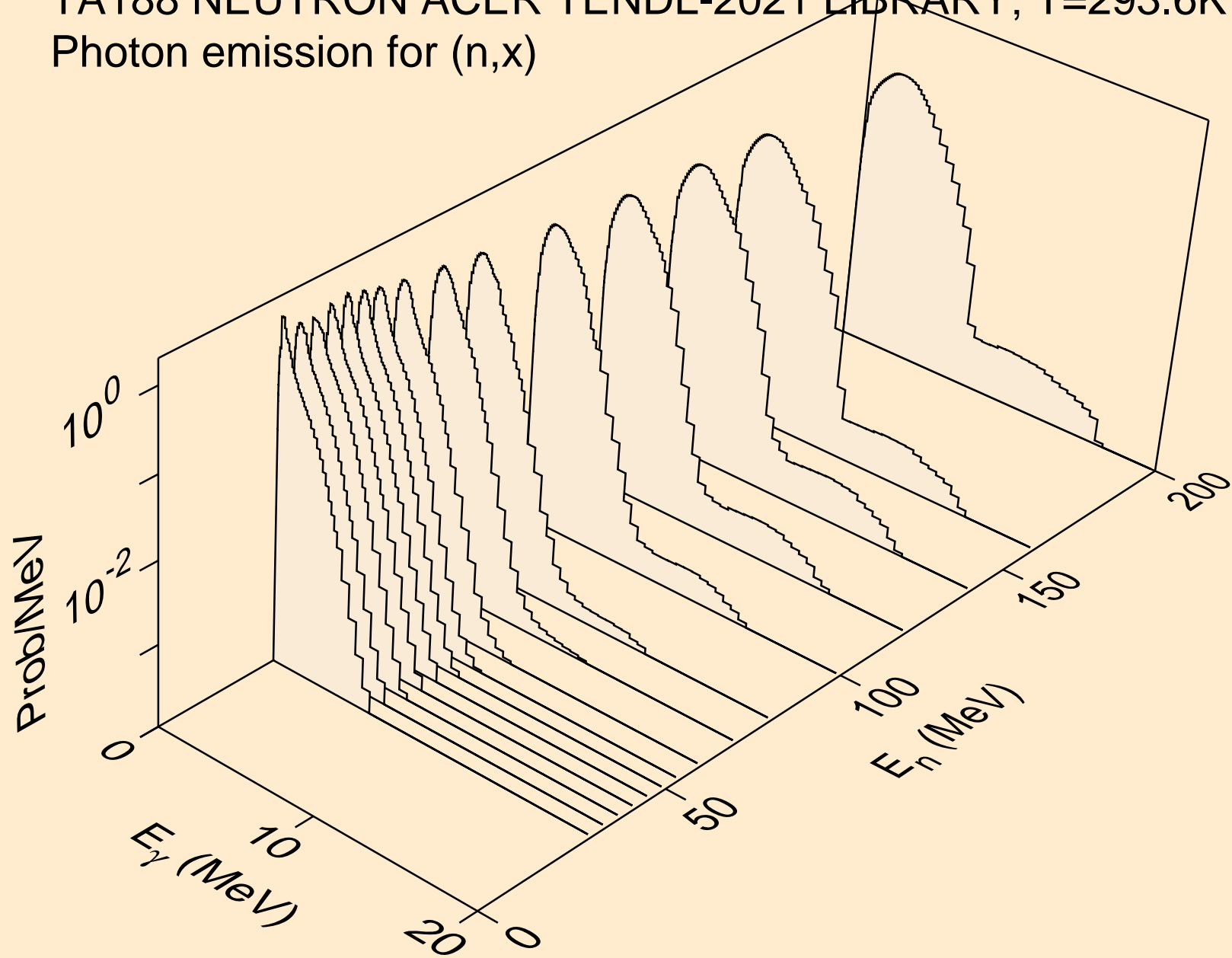

TA188 NEUTRON ACER TENDL-2021 LIBRARY; T=293.6K
Photon emission for (n,2nd)

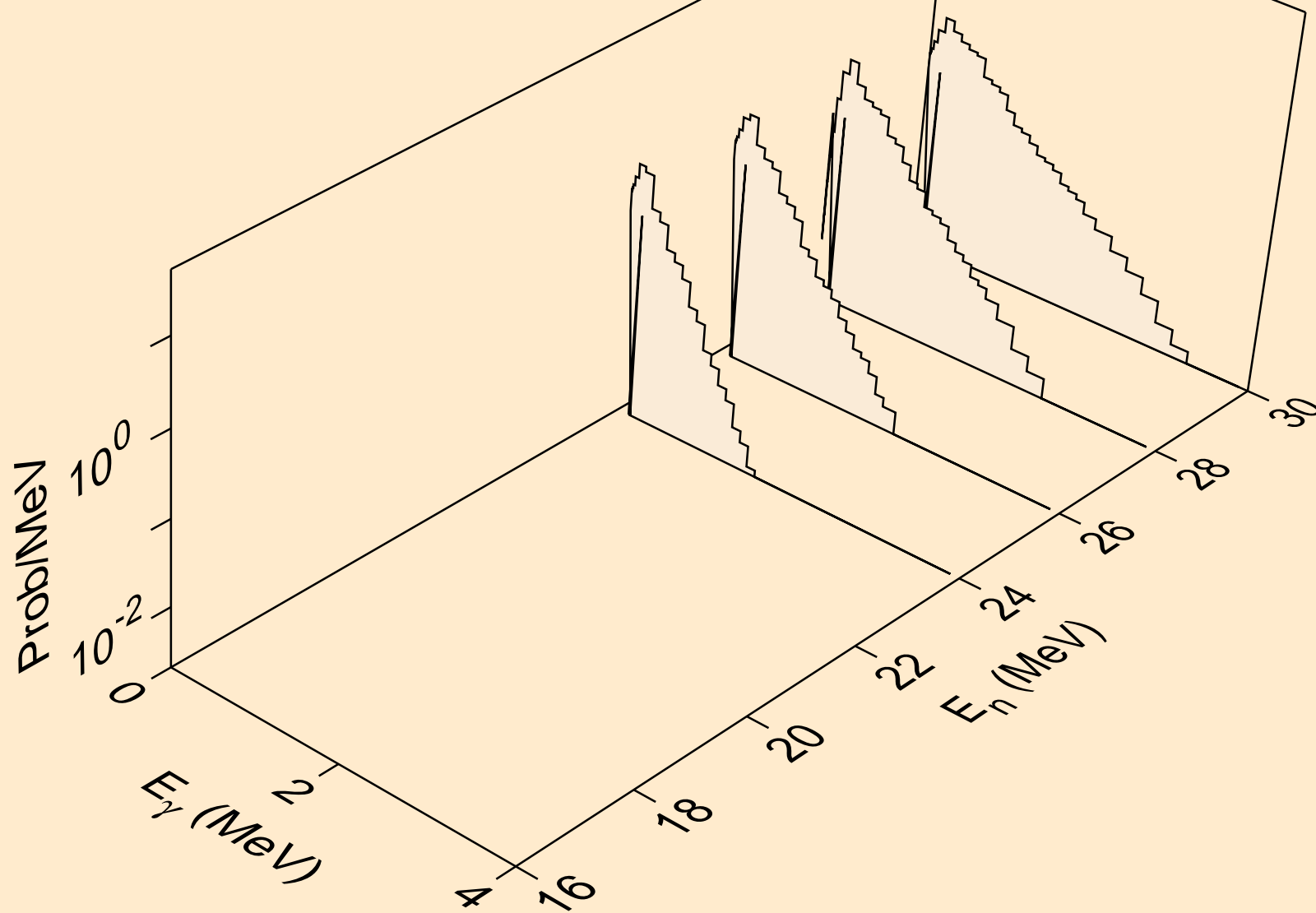

TA188 NEUTRON ACER TENDL-2021 LIBRARY; T=293.6K
Photon emission for (n,2n)

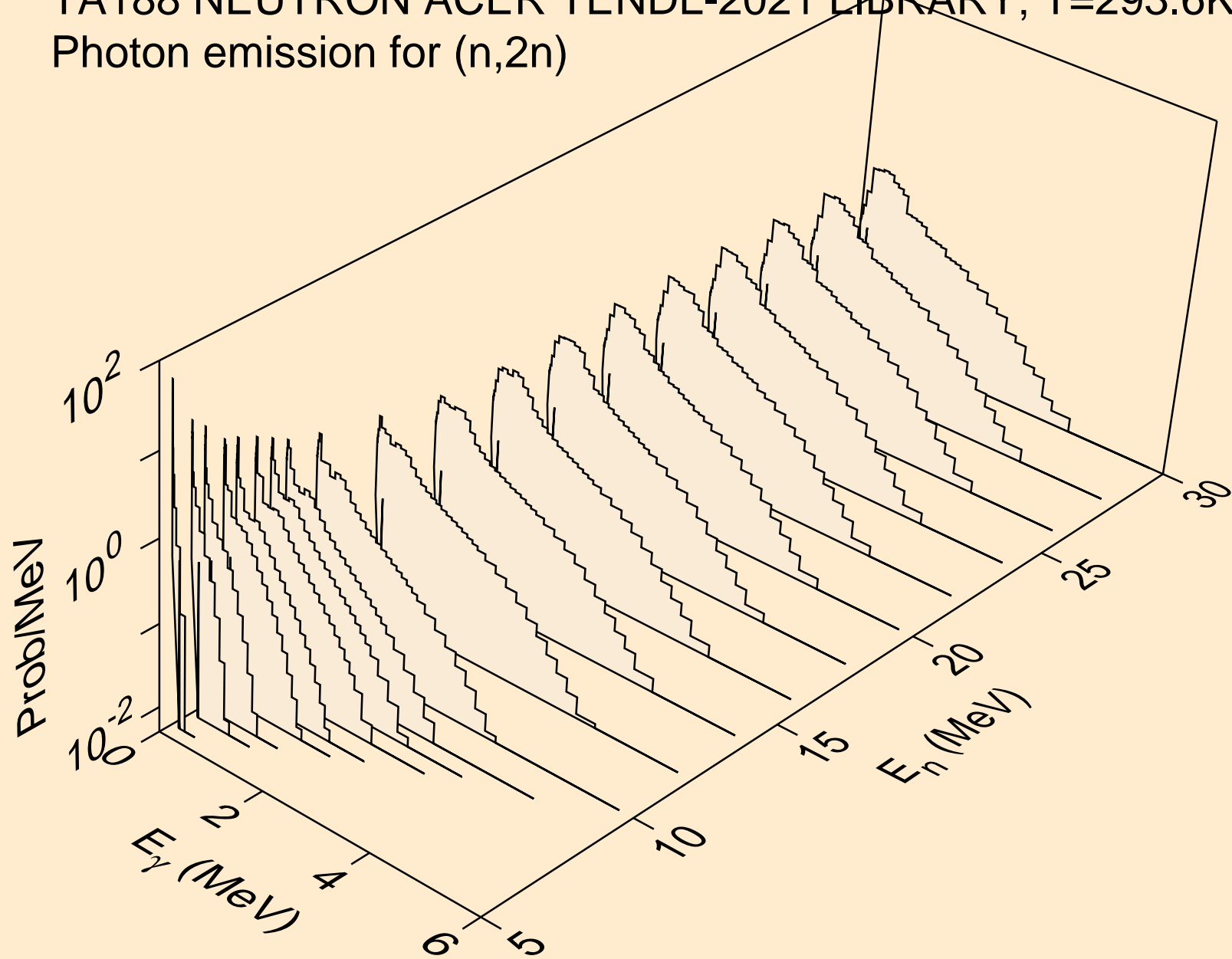

TA188 NEUTRON ACER TENDL-2021 LIBRARY; T=293.6K
Photon emission for (n,3n)

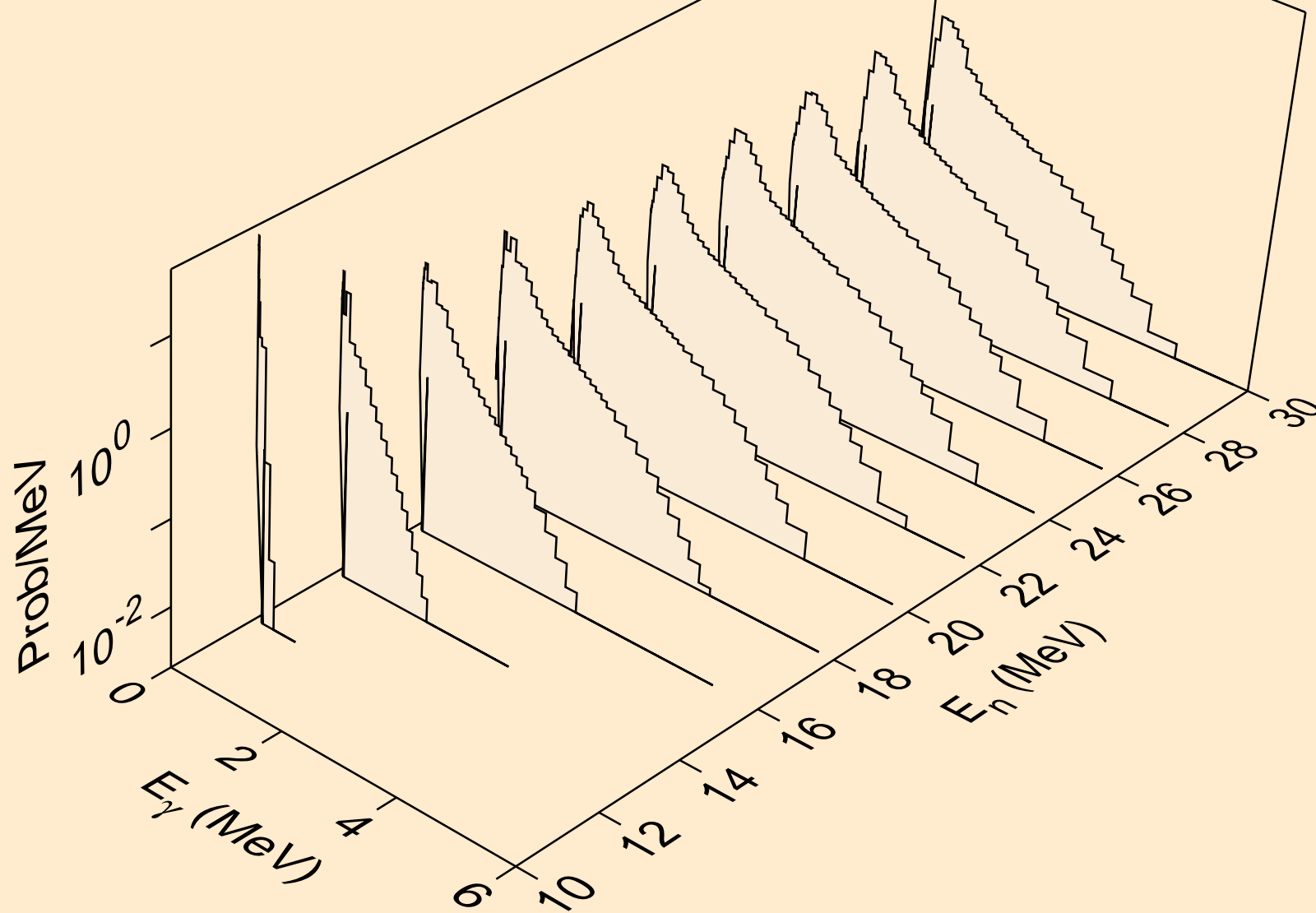

TA188 NEUTRON ACER TENDL-2021 LIBRARY; T=293.6K
Photon emission for (n,n*)a

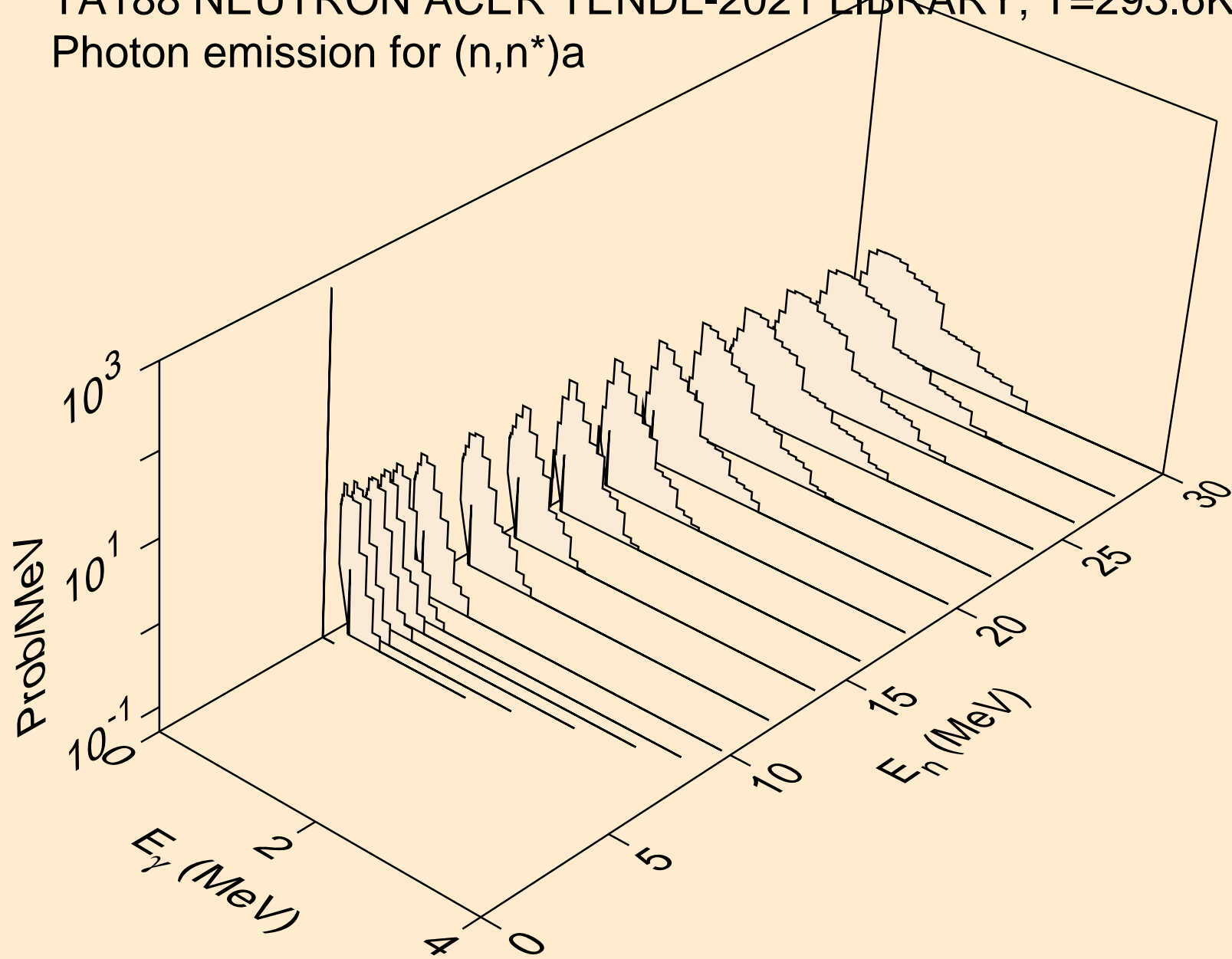

TA188 NEUTRON ACER TENDL-2021 LIBRARY; T=293.6K
Photon emission for (n,2n)a

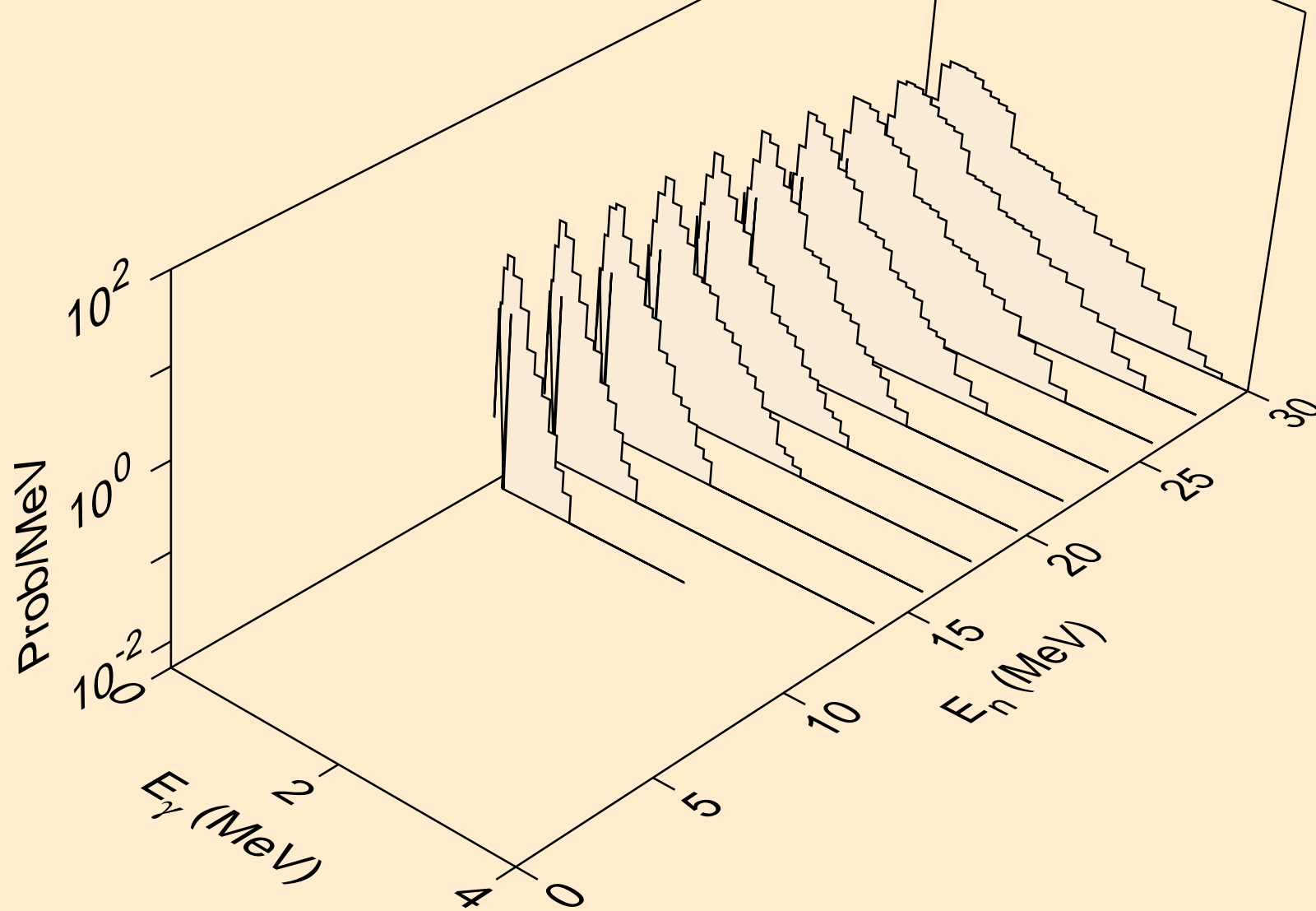

TA188 NEUTRON ACER TENDL-2021 LIBRARY; T=293.6K
Photon emission for (n,3n)a

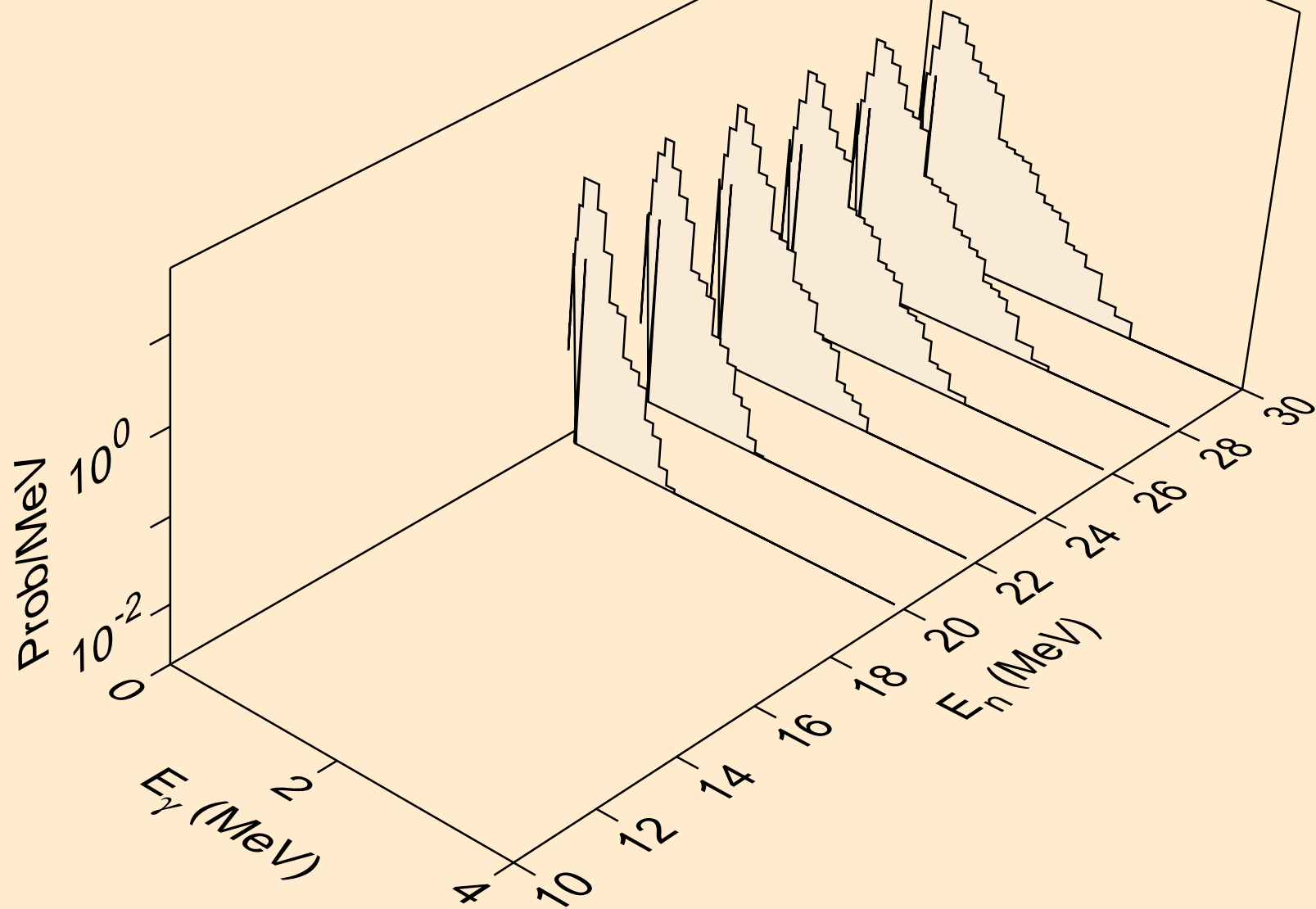

TA188 NEUTRON ACER TENDL-2021 LIBRARY; T=293.6K
Photon emission for (n,n*)p

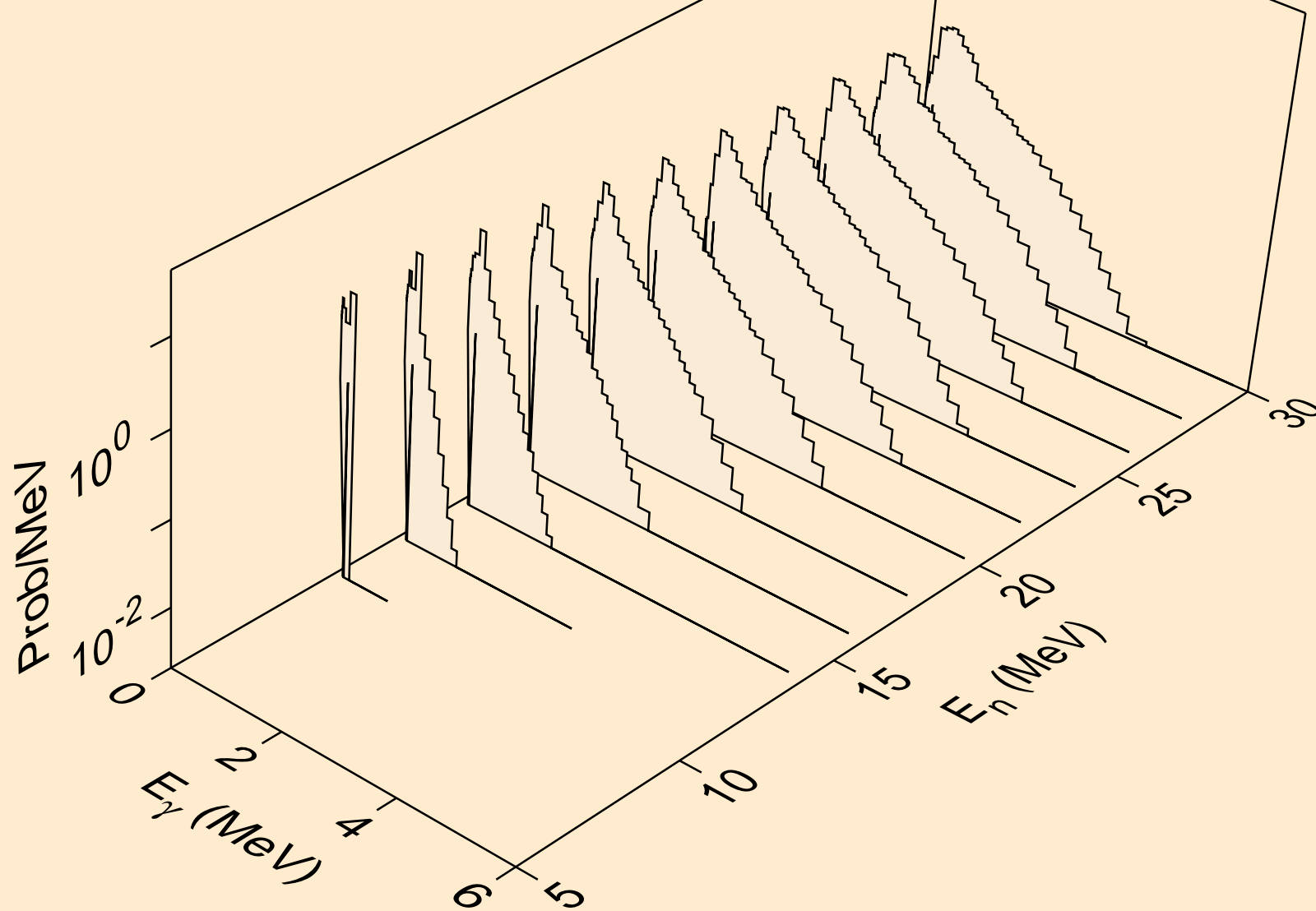

TA188 NEUTRON ACER TENDL-2021 LIBRARY; T=293.6K
Photon emission for (n,n*)d

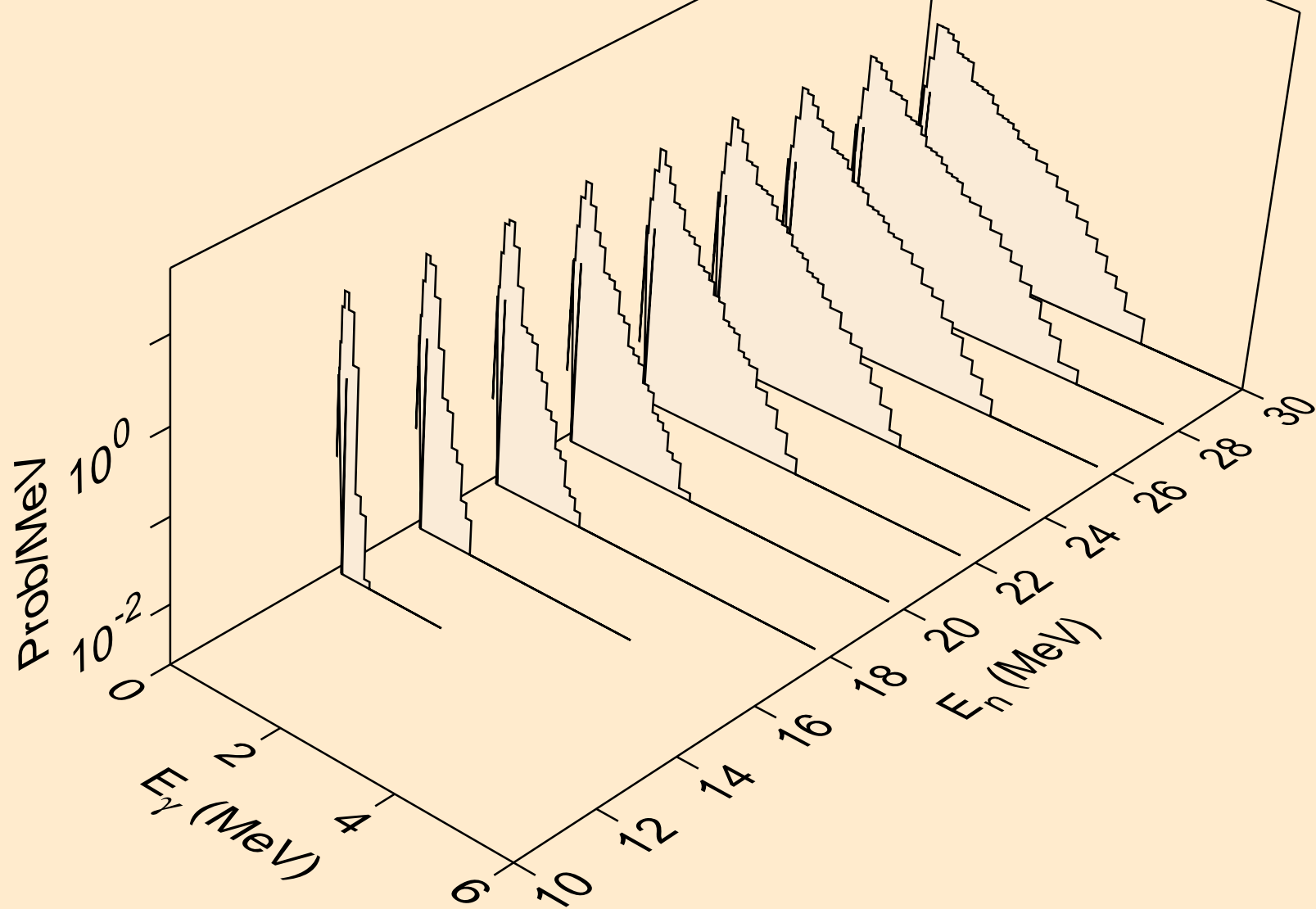

TA188 NEUTRON ACER TENDL-2021 LIBRARY; T=293.6K
Photon emission for (n,n*)t

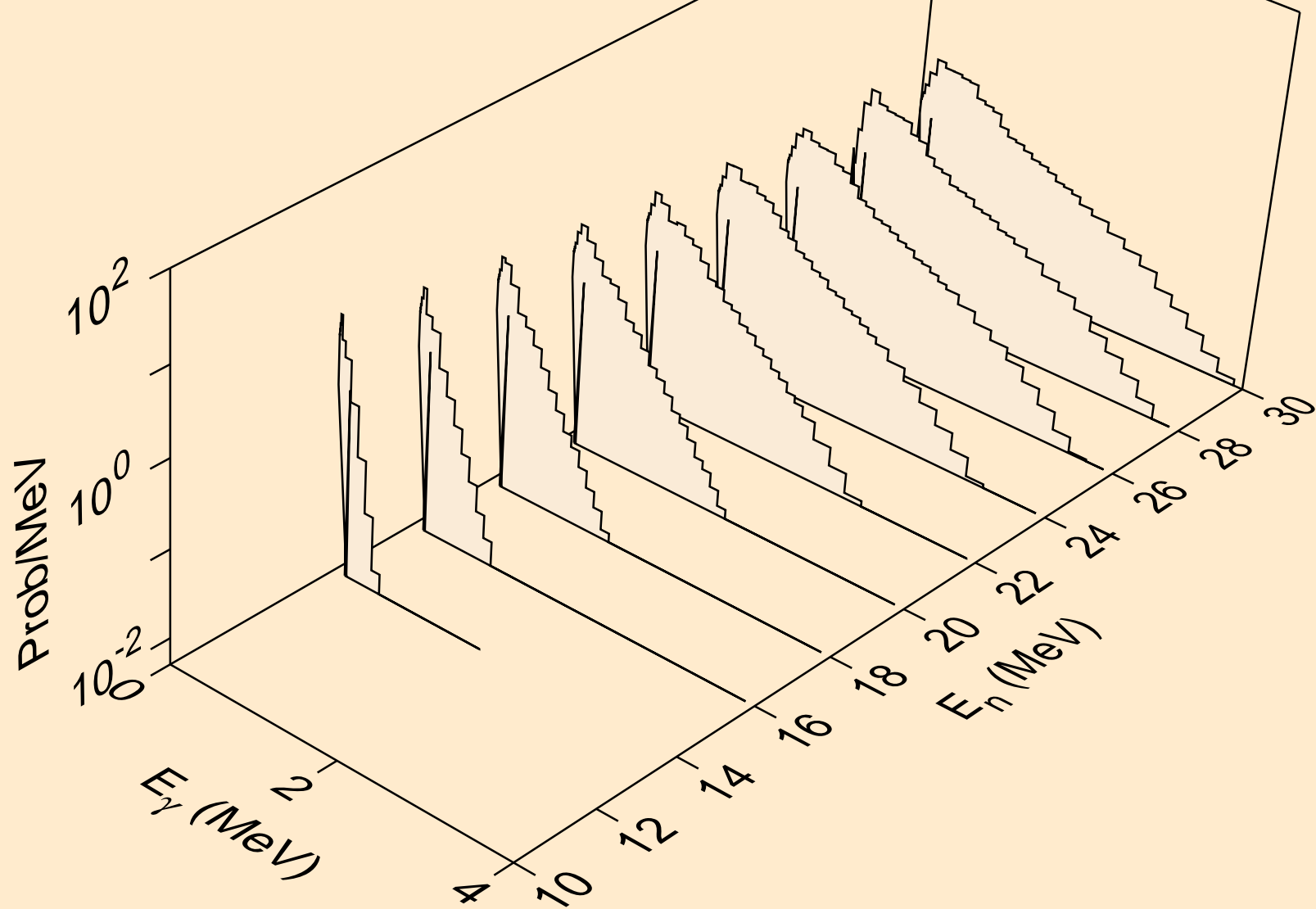

TA188 NEUTRON ACER TENDL-2021 LIBRARY; T=293.6K
Photon emission for (n,n*)he3

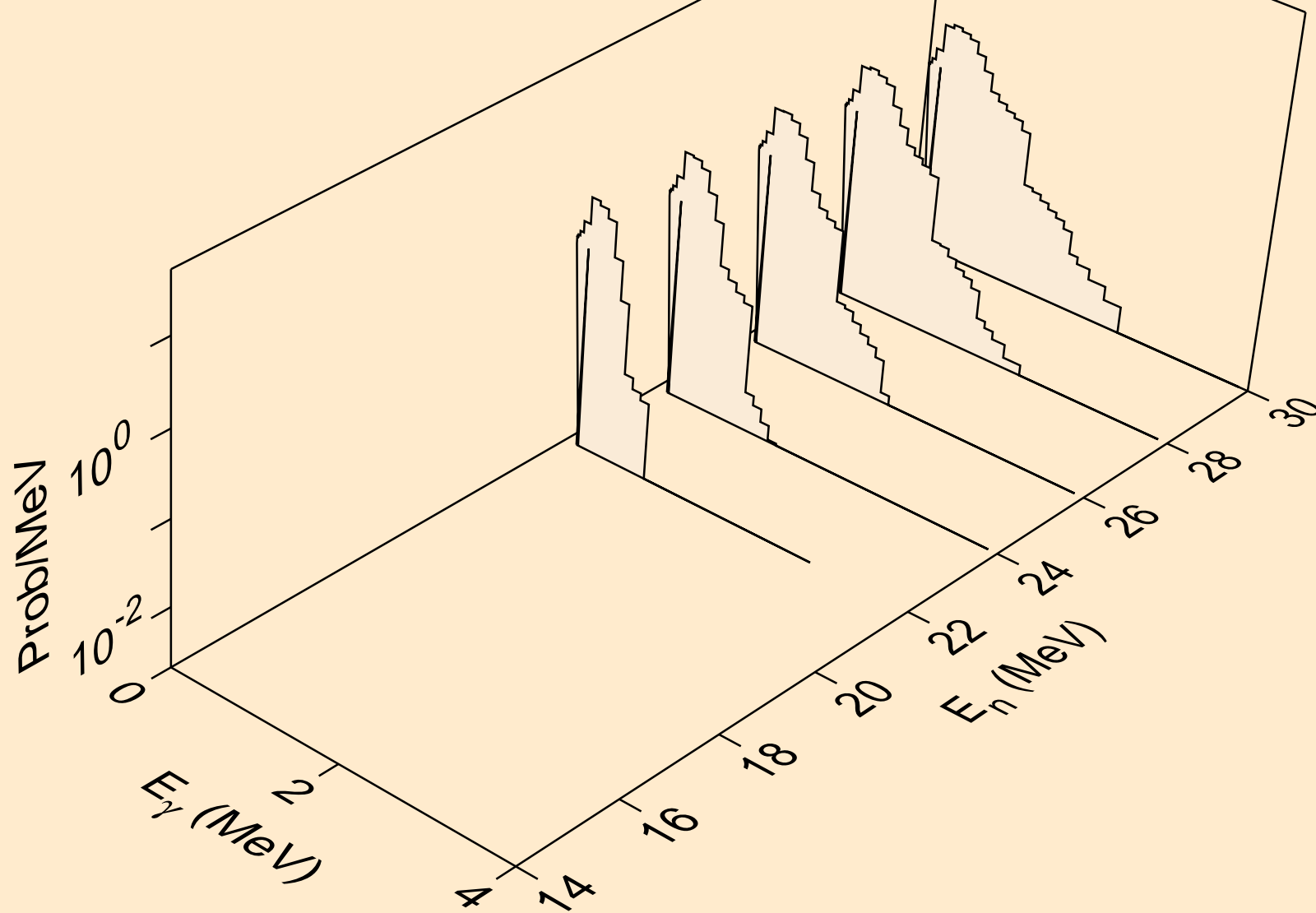

TA188 NEUTRON ACER TENDL-2021 LIBRARY; T=293.6K
Photon emission for (n,4n)

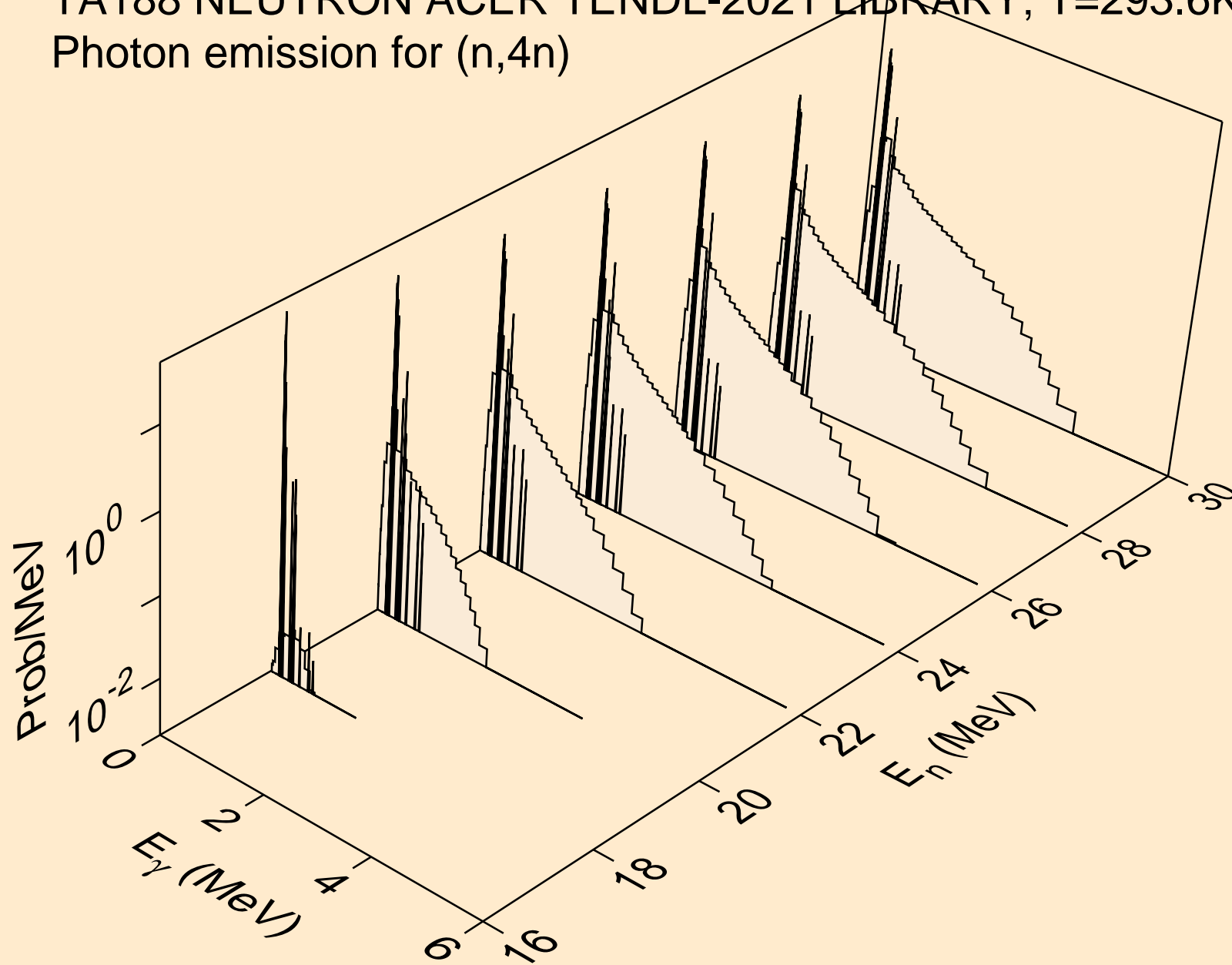

TA188 NEUTRON ACER TENDL-2021 LIBRARY; T=293.6K
Photon emission for (n,2np)

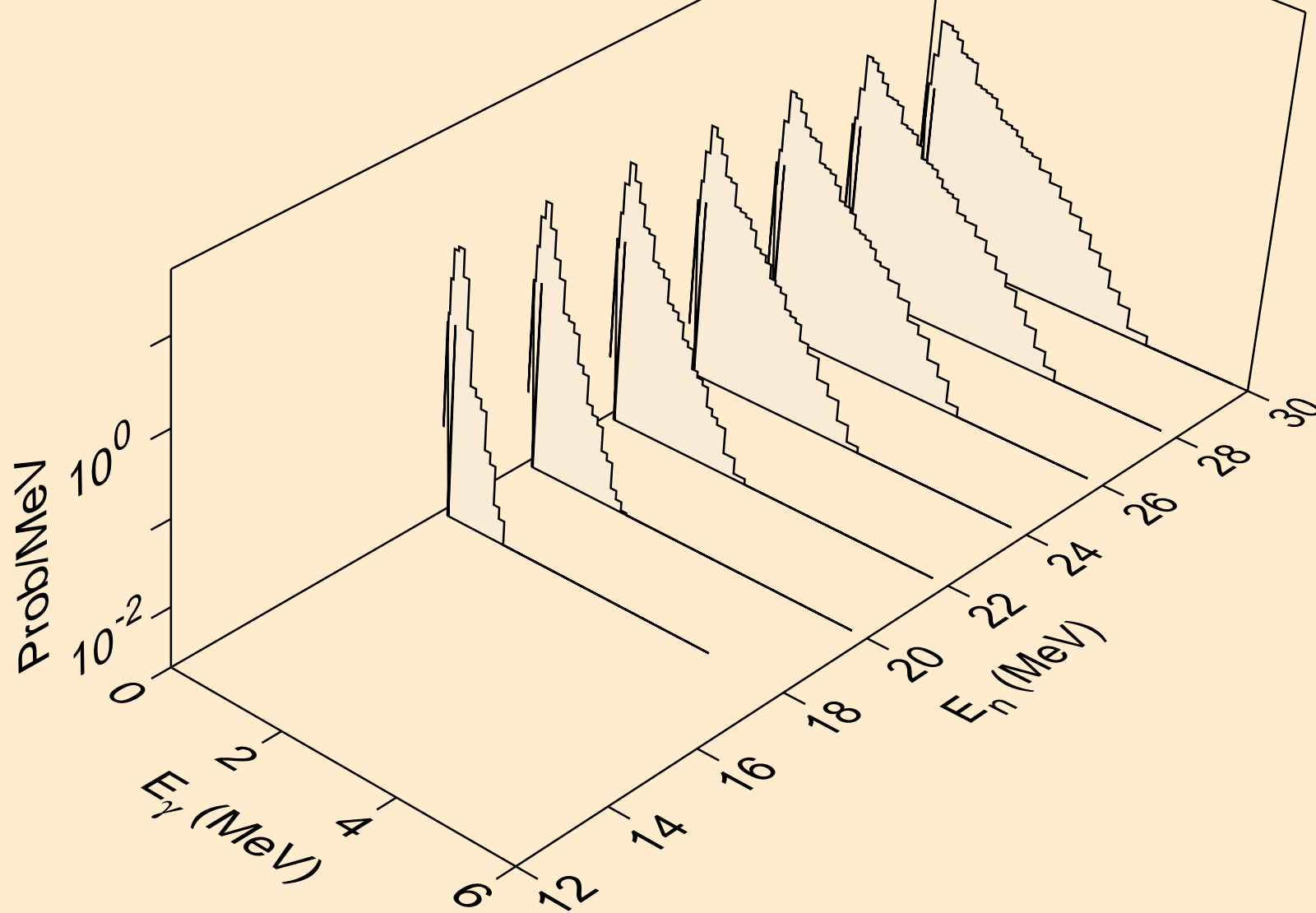

TA188 NEUTRON ACER TENDL-2021 LIBRARY; T=293.6K
Photon emission for (n,3np)

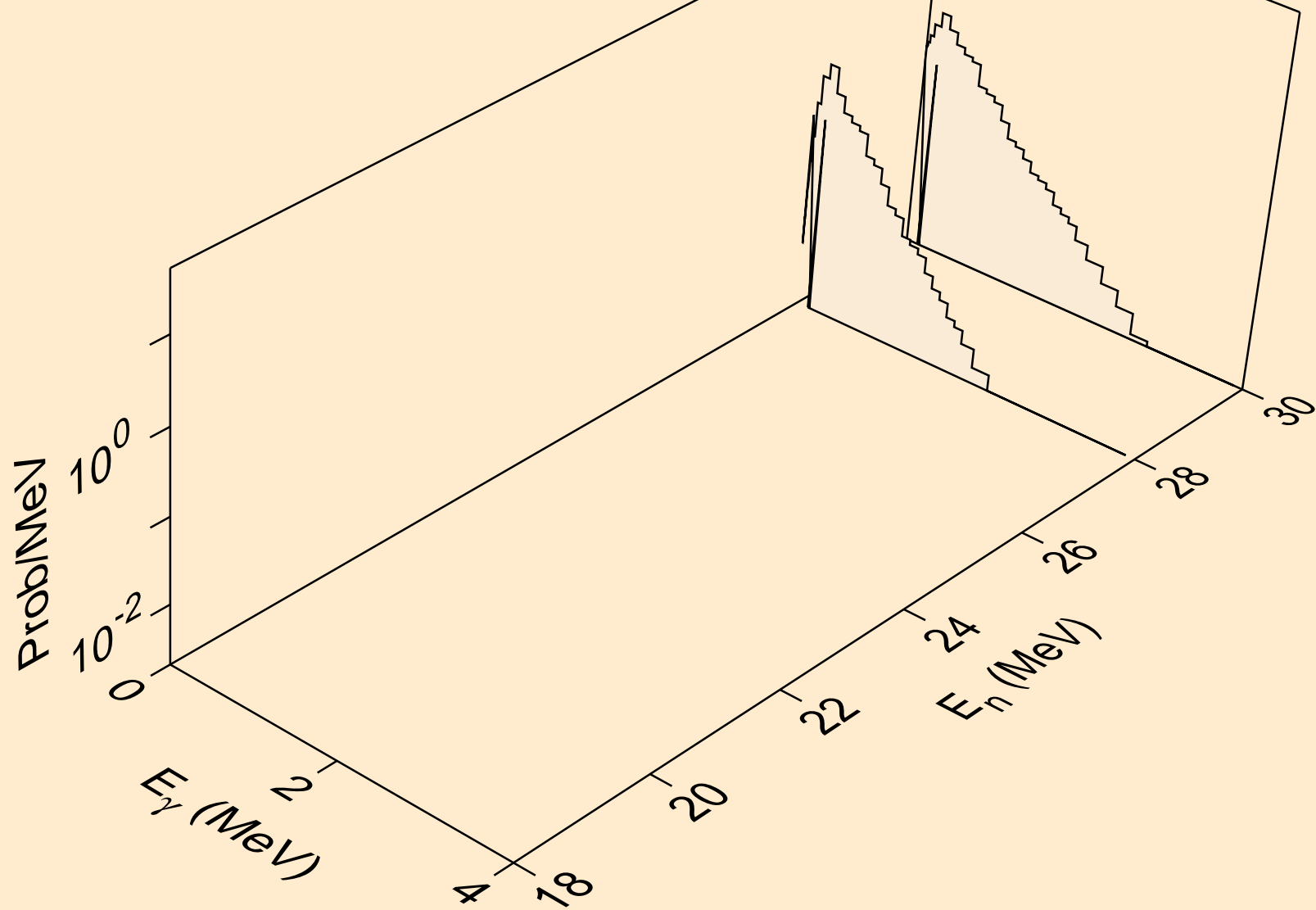

TA188 NEUTRON ACER TENDL-2021 LIBRARY; T=293.6K
Photon emission for (n,n*c)

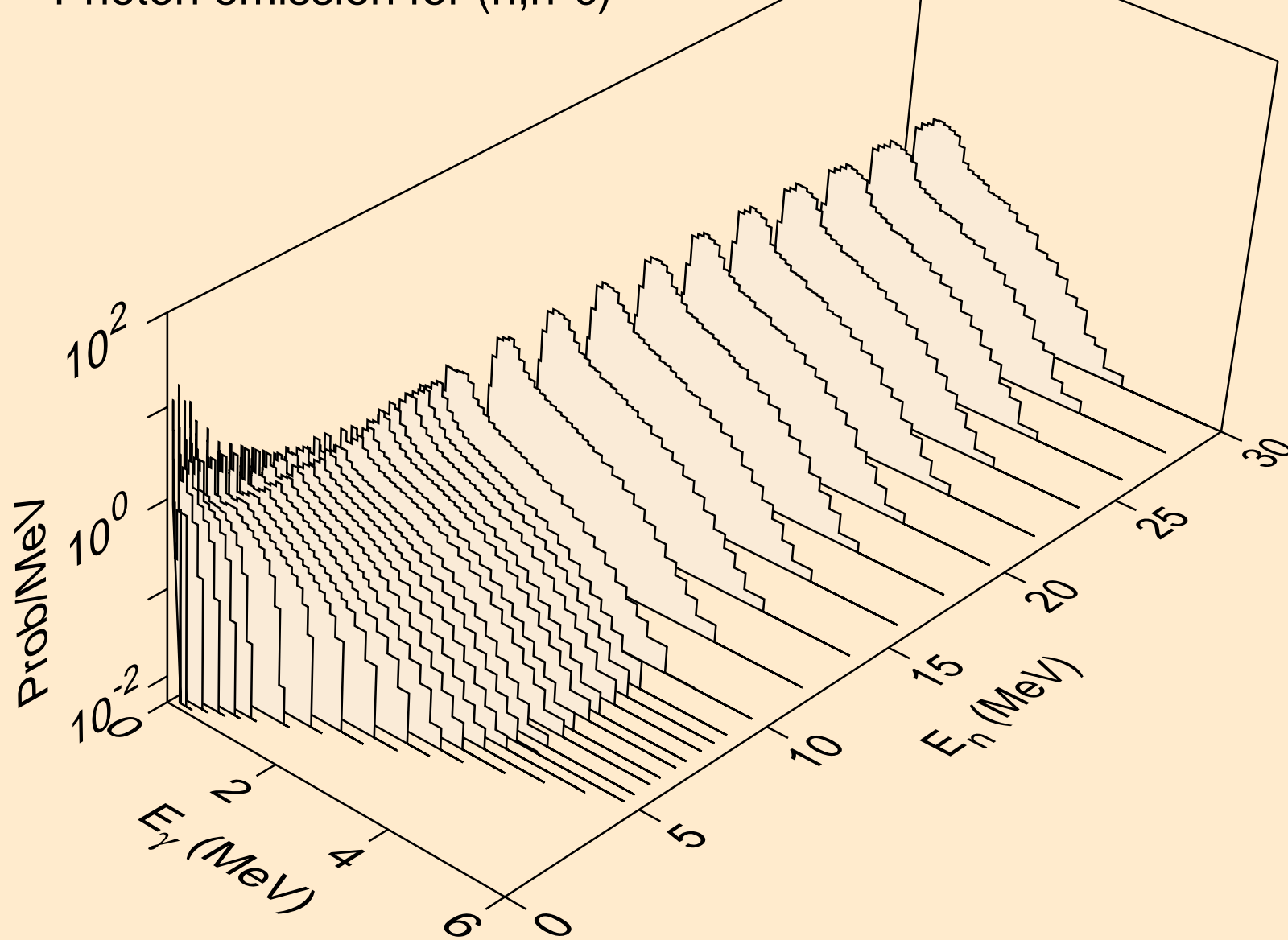

TA188 NEUTRON ACER TENDL-2021 LIBRARY; T=293.6K
Photon emission for (n,gma)

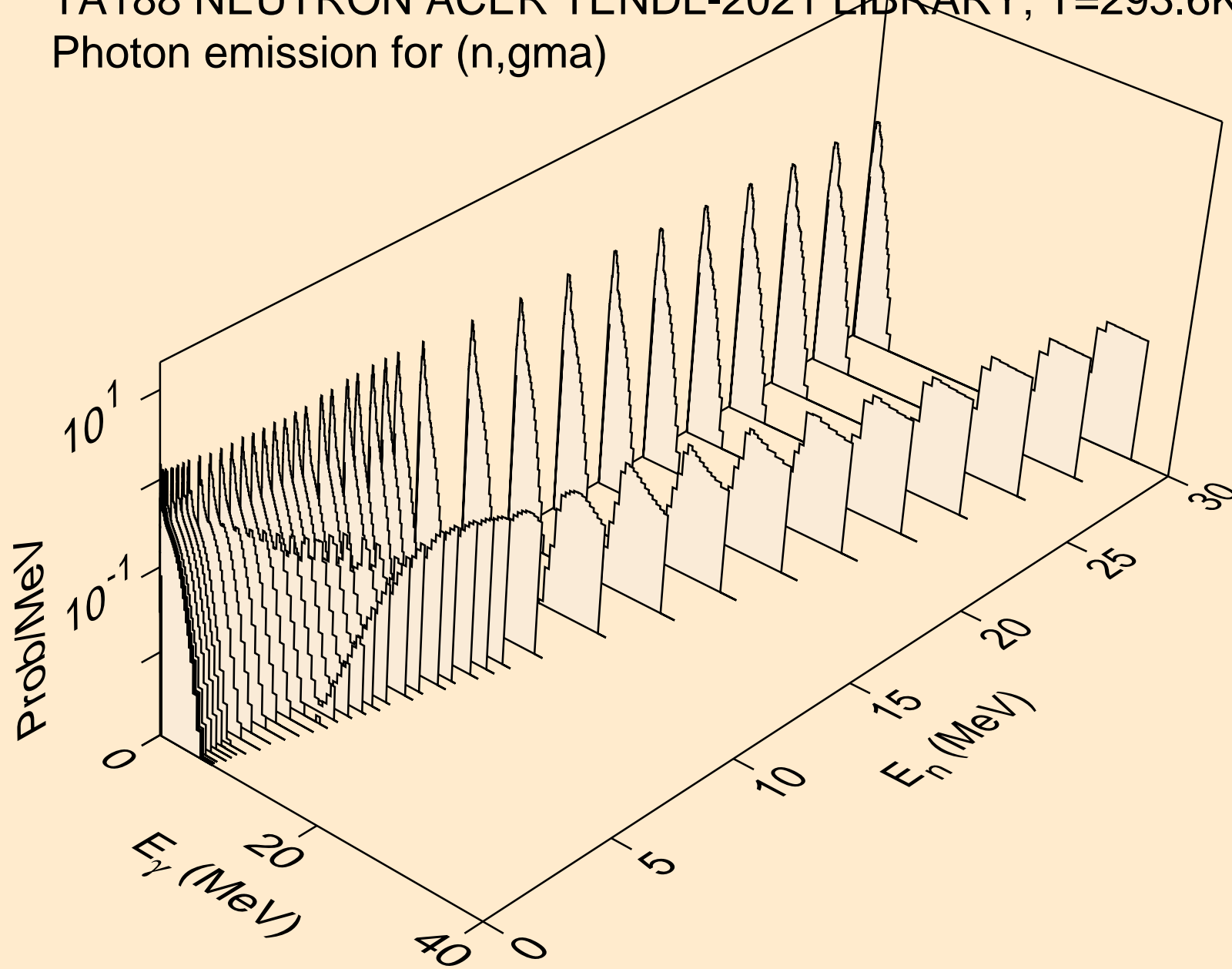

TA188 NEUTRON ACER TENDL-2021 LIBRARY; T=293.6K
Photon emission for (n,p)

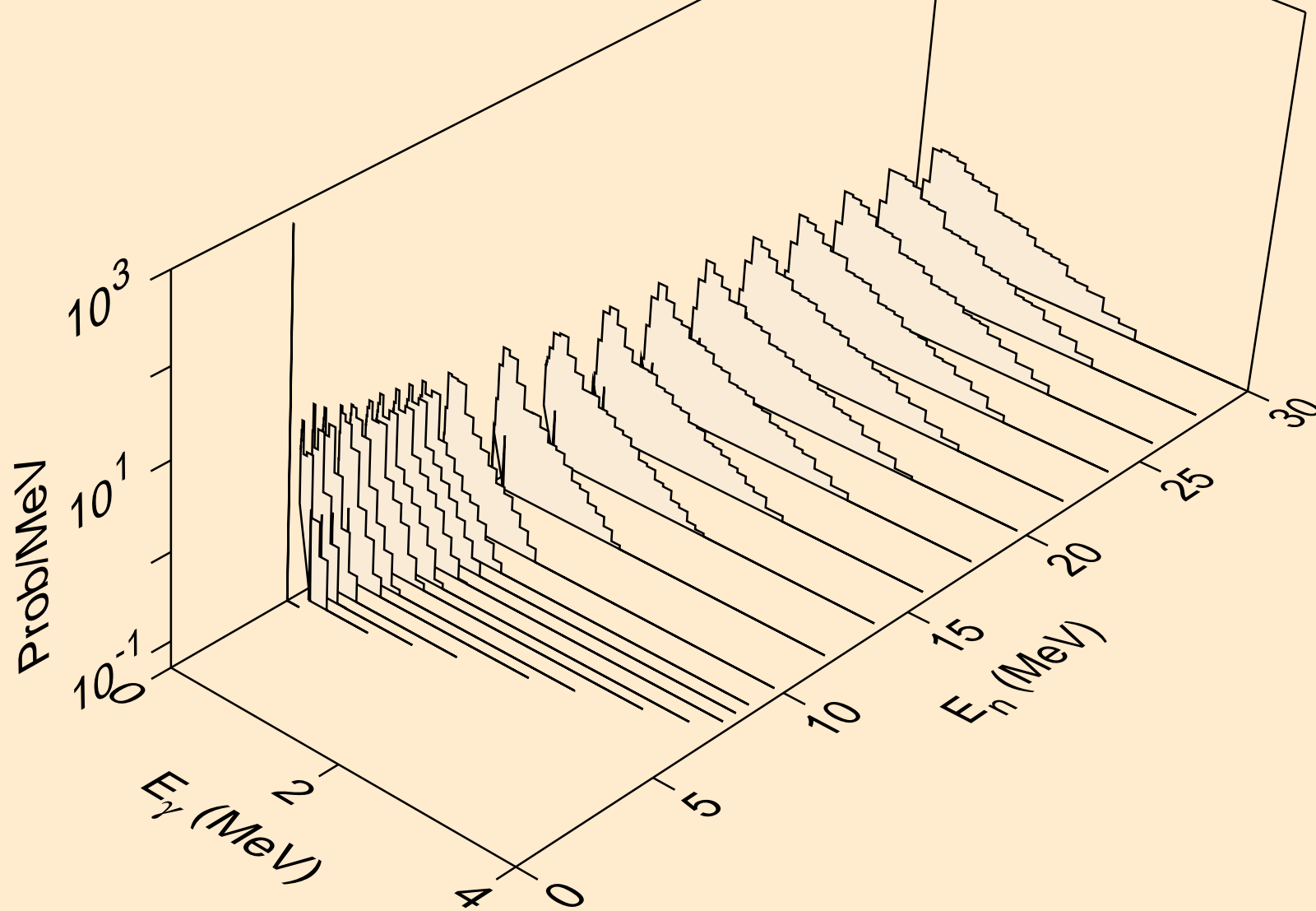

TA188 NEUTRON ACER TENDL-2021 LIBRARY; T=293.6K
Photon emission for (n,d)

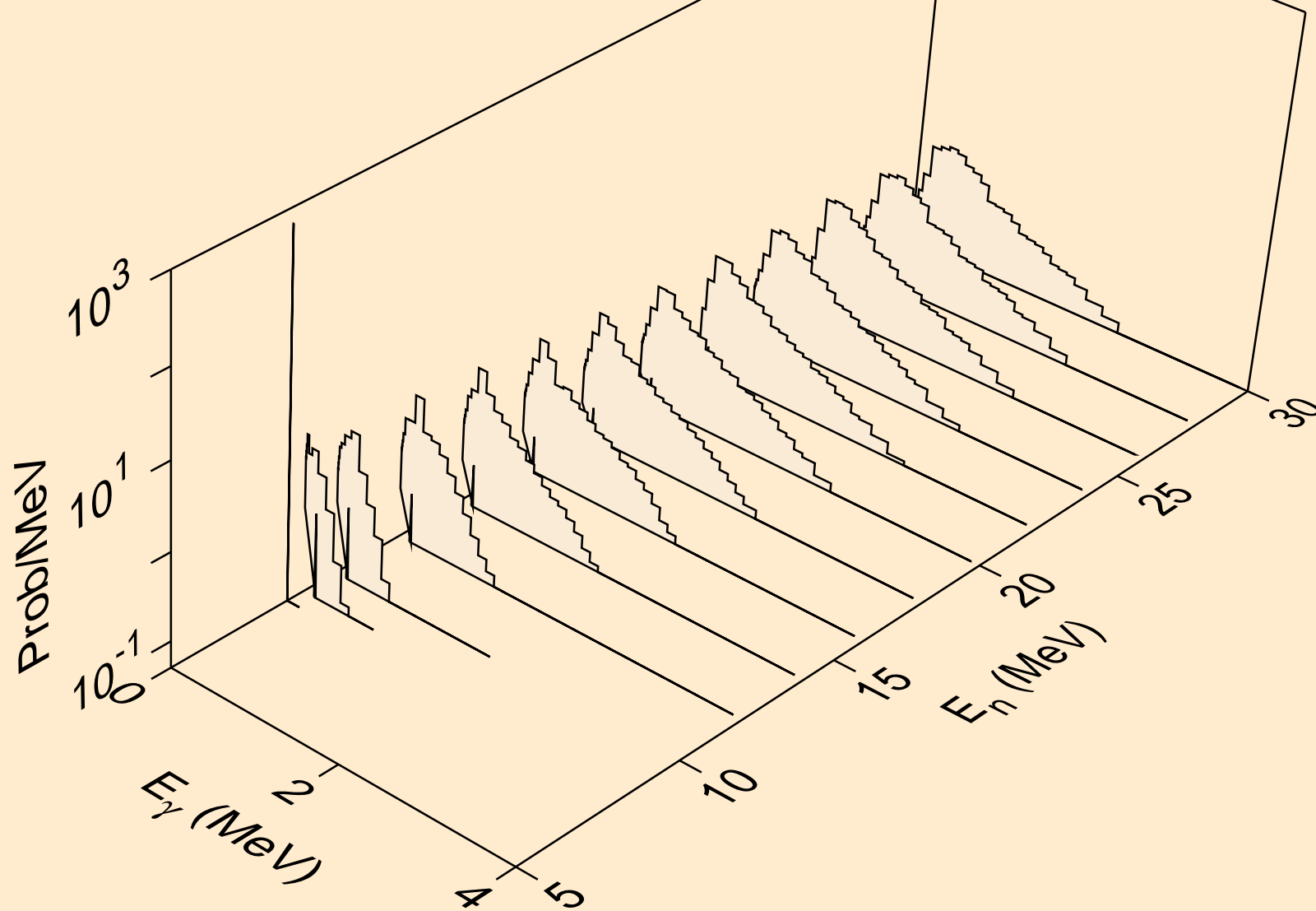

TA188 NEUTRON ACER TENDL-2021 LIBRARY; T=293.6K
Photon emission for (n,t)

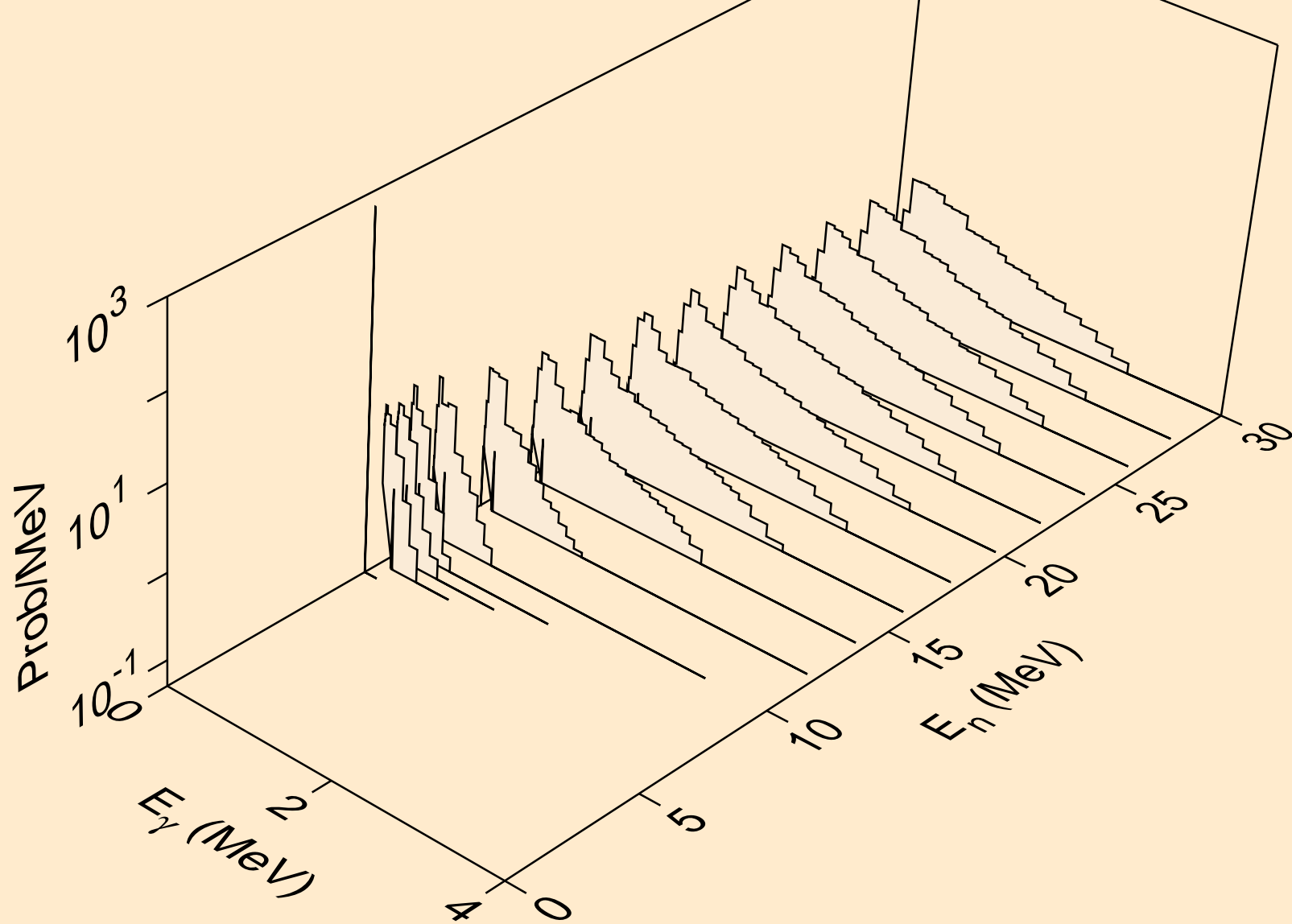

TA188 NEUTRON ACER TENDL-2021 LIBRARY; T=293.6K
Photon emission for (n,he3)

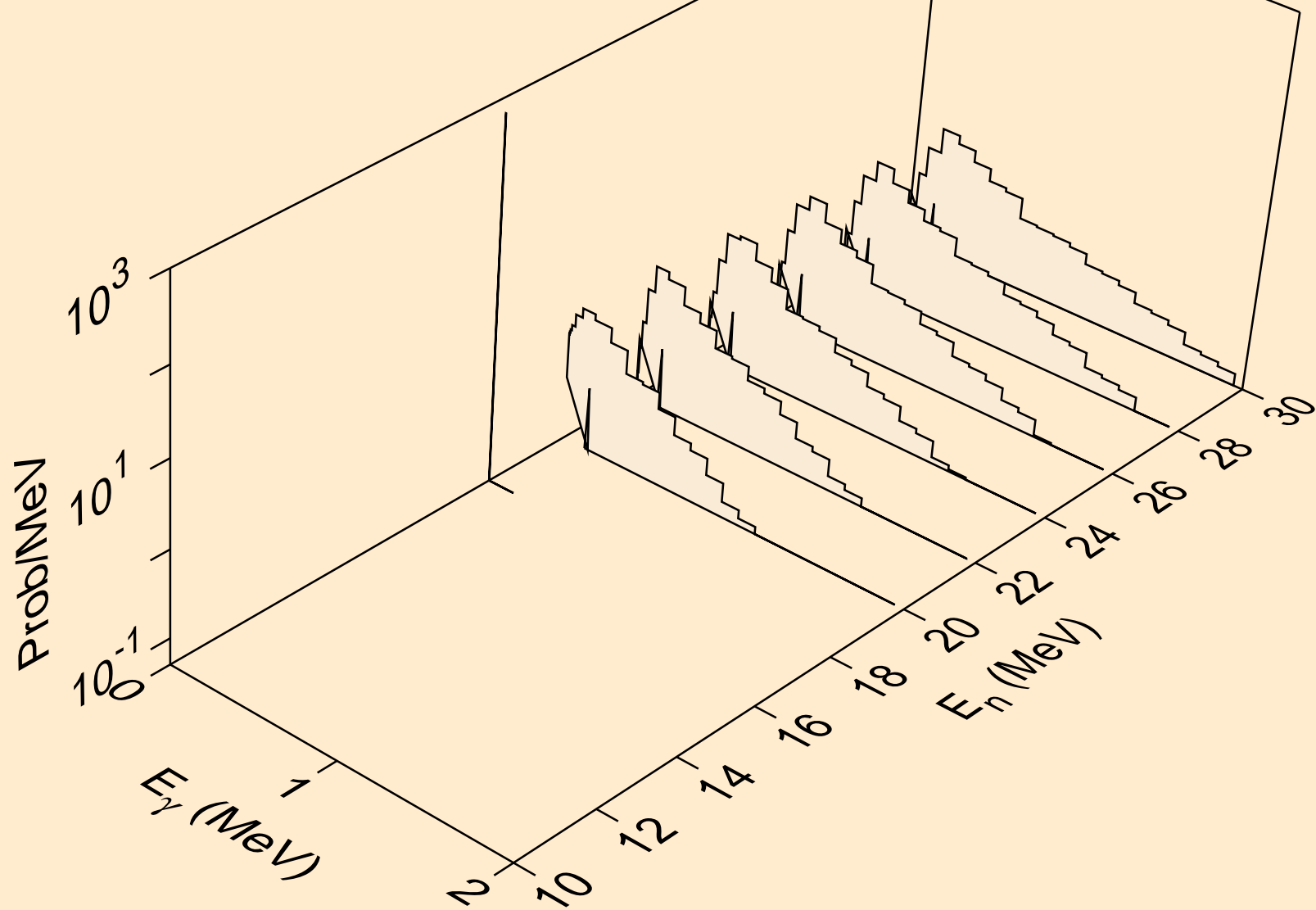

TA188 NEUTRON ACER TENDL-2021 LIBRARY; T=293.6K
Photon emission for (n,a)

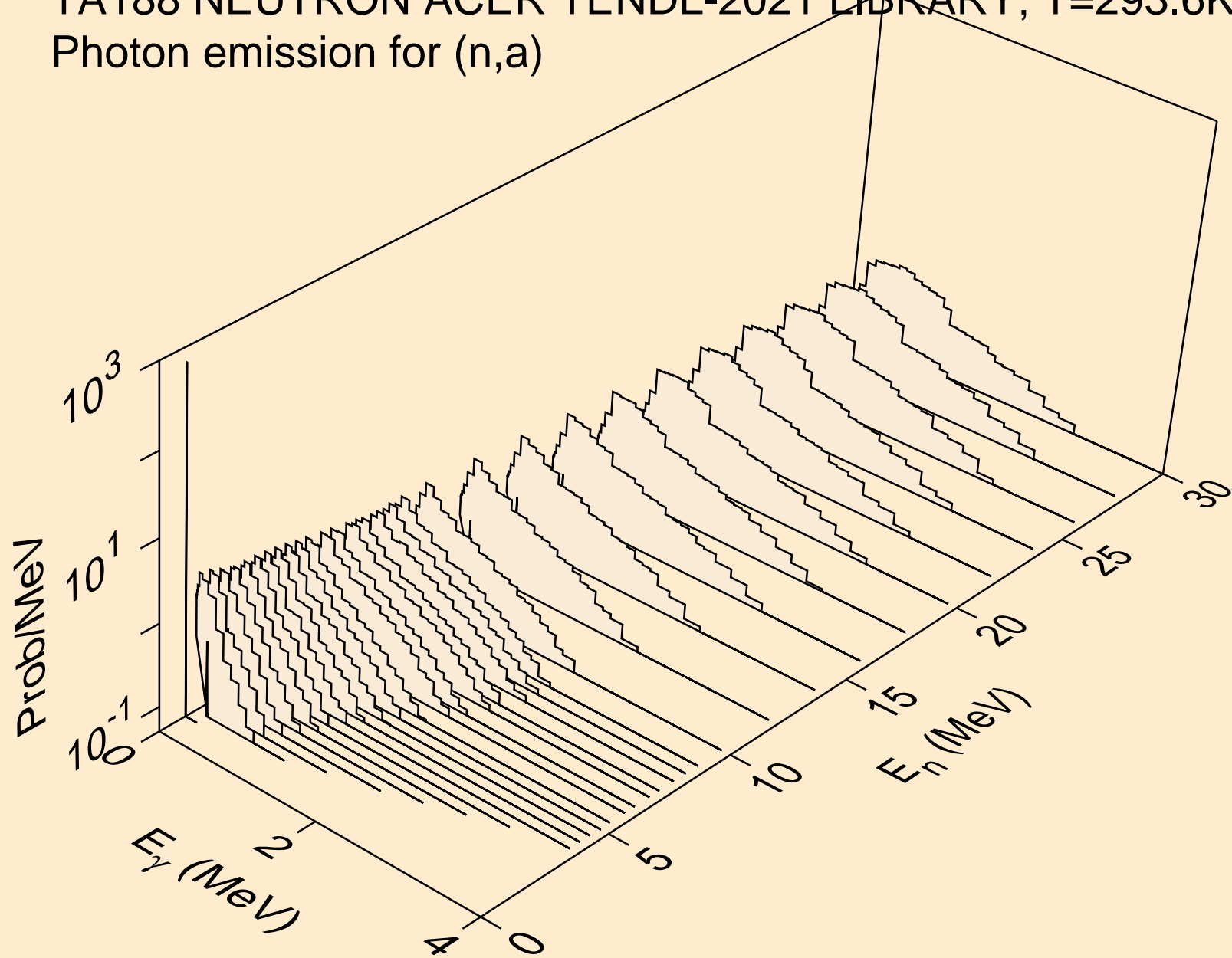

TA188 NEUTRON ACER TENDL-2021 LIBRARY; T=293.6K
Photon emission for (n,2p)

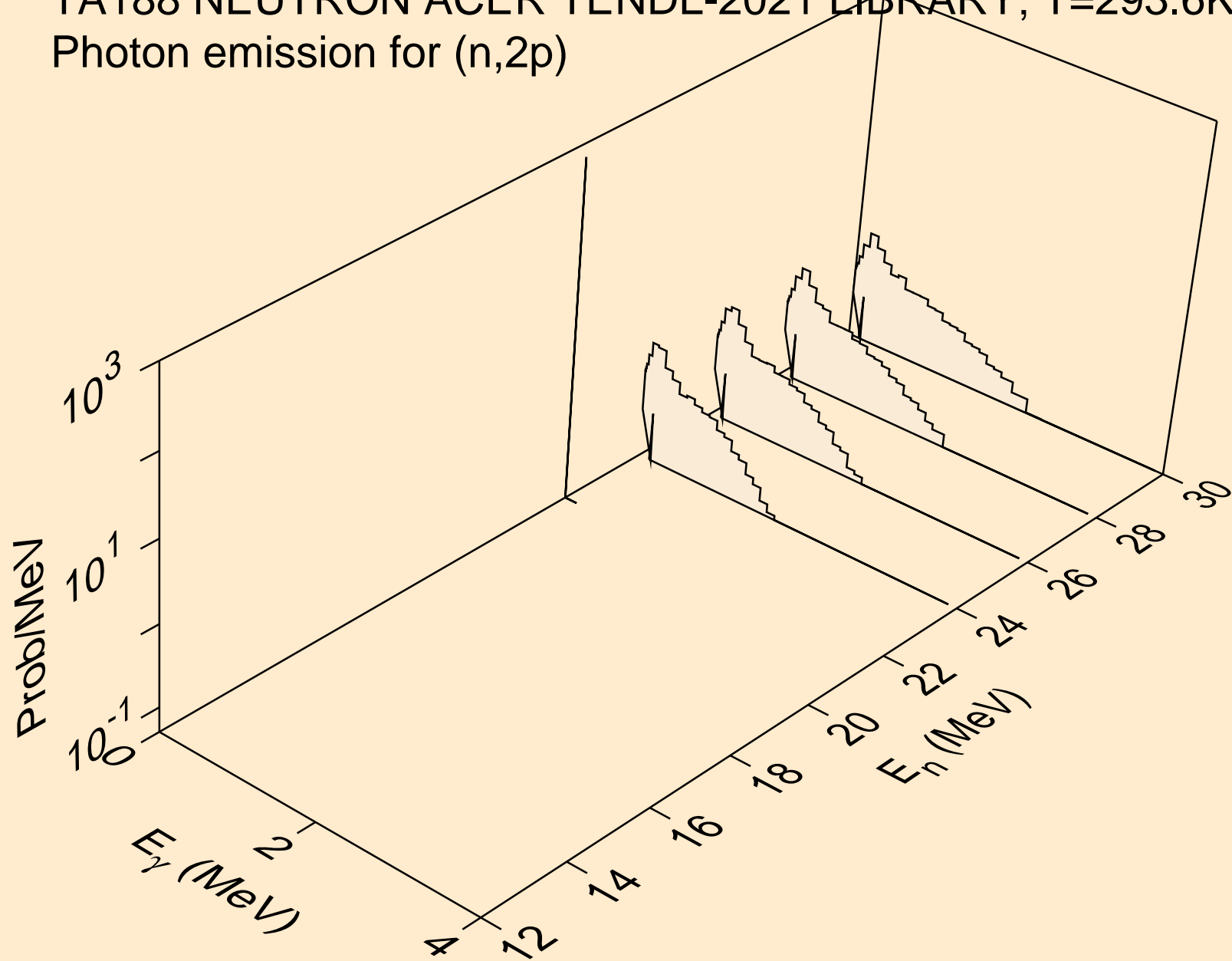

TA188 NEUTRON ACER TENDL-2021 LIBRARY; T=293.6K
thermal capture photon spectrum

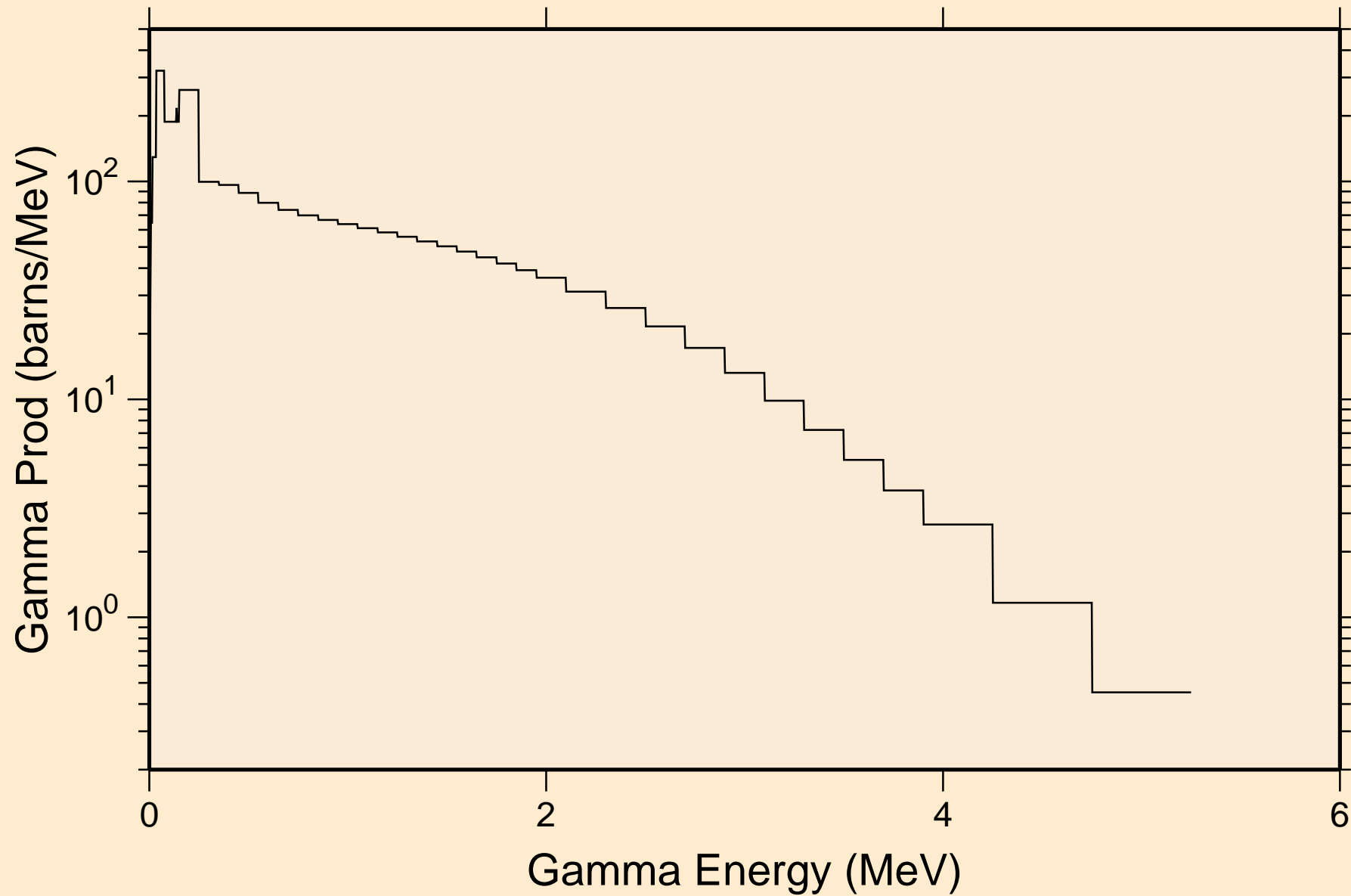

TA188 NEUTRON ACER TENDL-2021 LIBRARY; T=293.6K
14 MeV photon spectrum

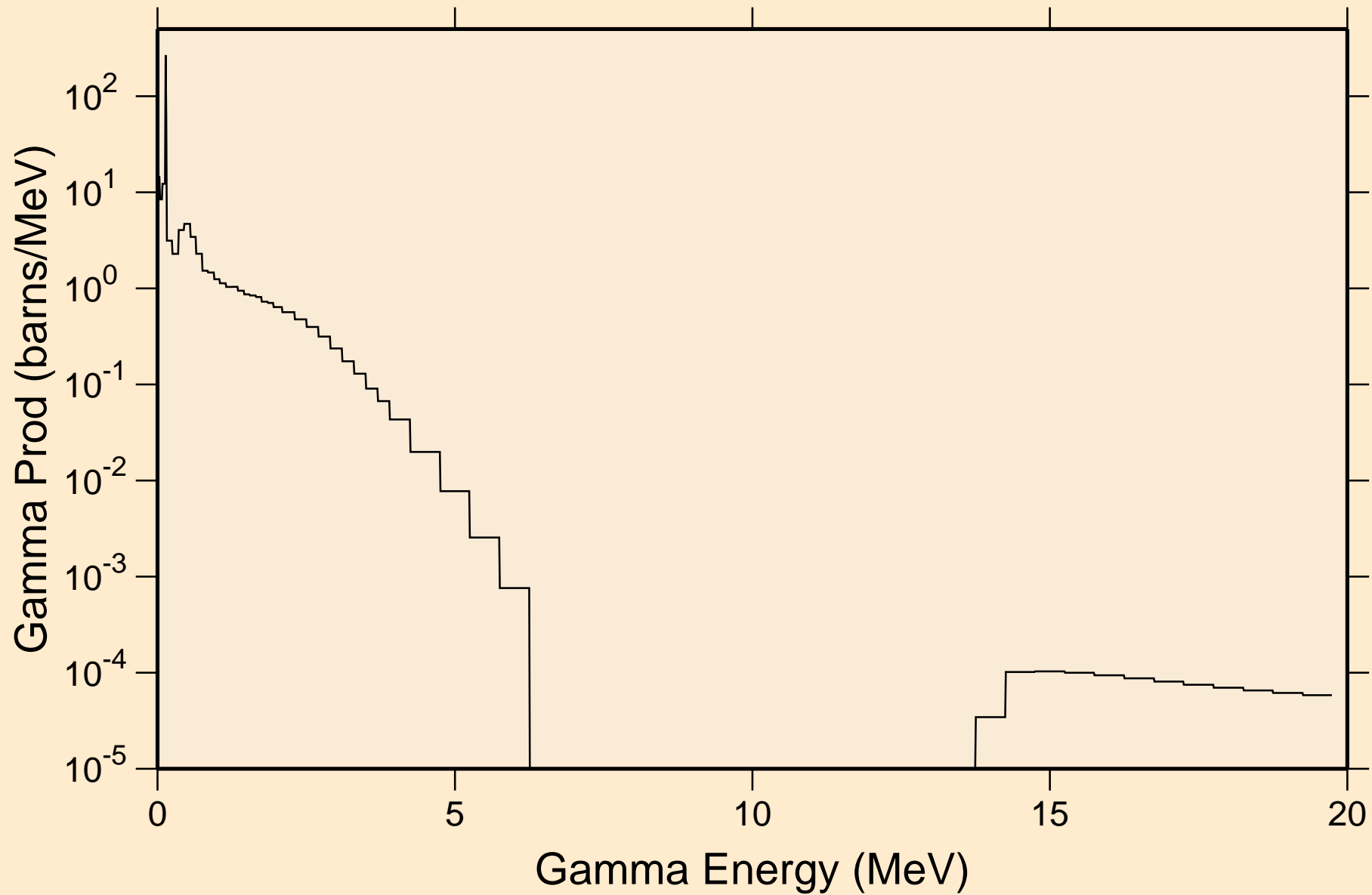

TA188 NEUTRON ACER TENDL-2021 LIBRARY; T=293.6K
Particle heating contributions

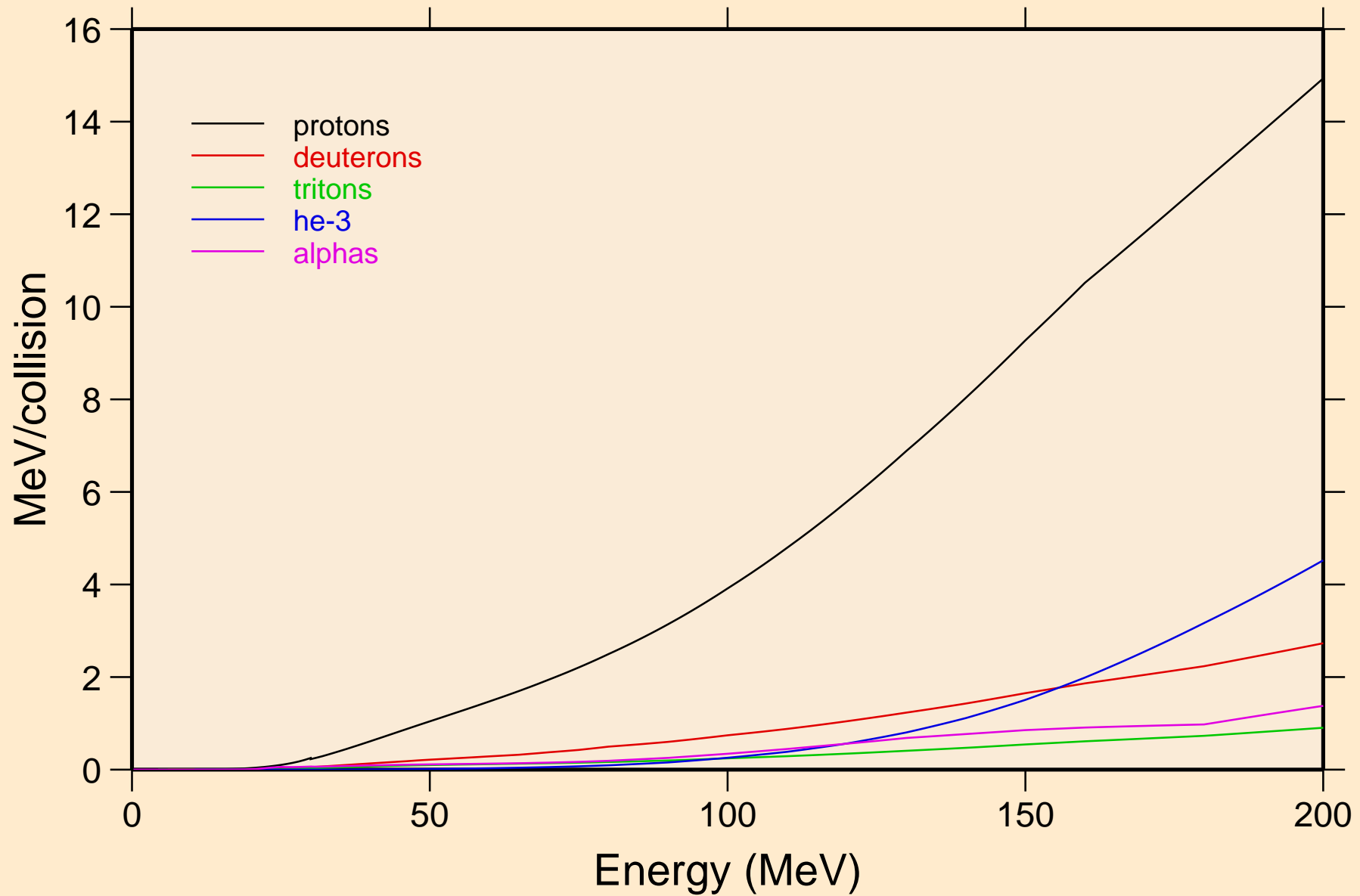

TA188 NEUTRON ACER TENDL-2021 LIBRARY; T=293.6K
Recoil Heating

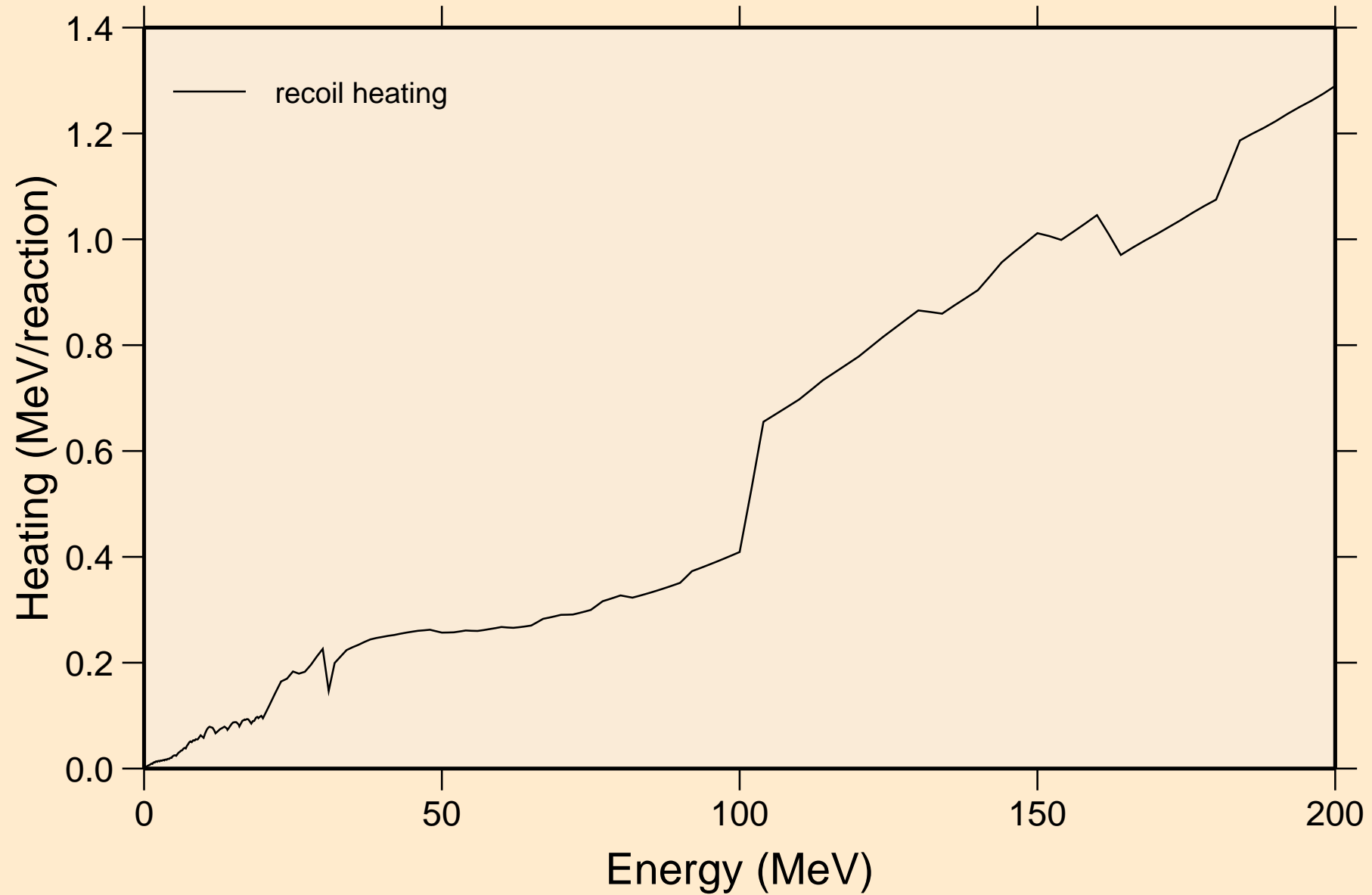

TA188 NEUTRON ACER TENDL-2021 LIBRARY; T=293.6K
Particle production cross sections

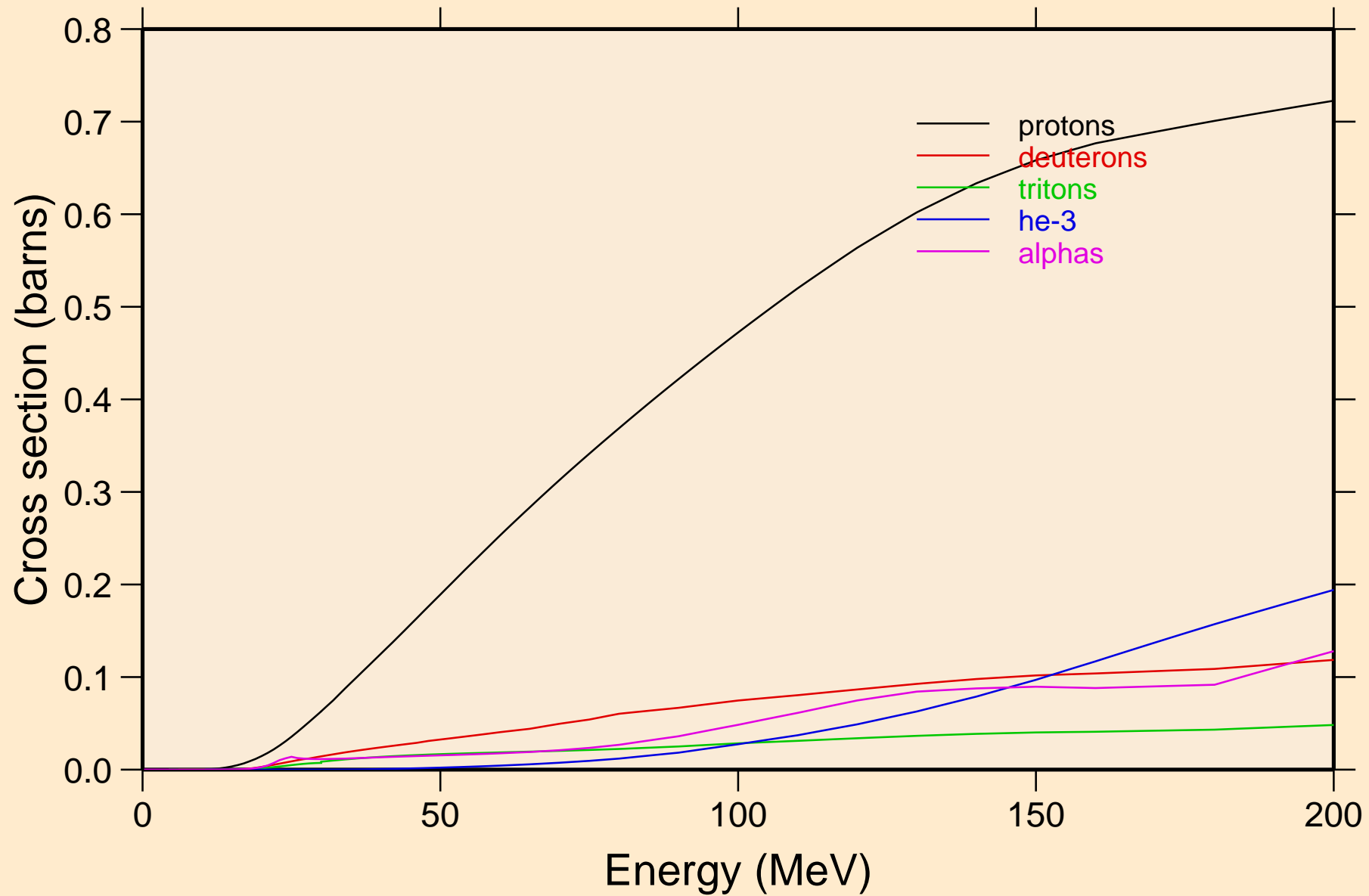

TA188 NEUTRON ACER TENDL-2021 LIBRARY; T=293.6K
protons from (n,x)

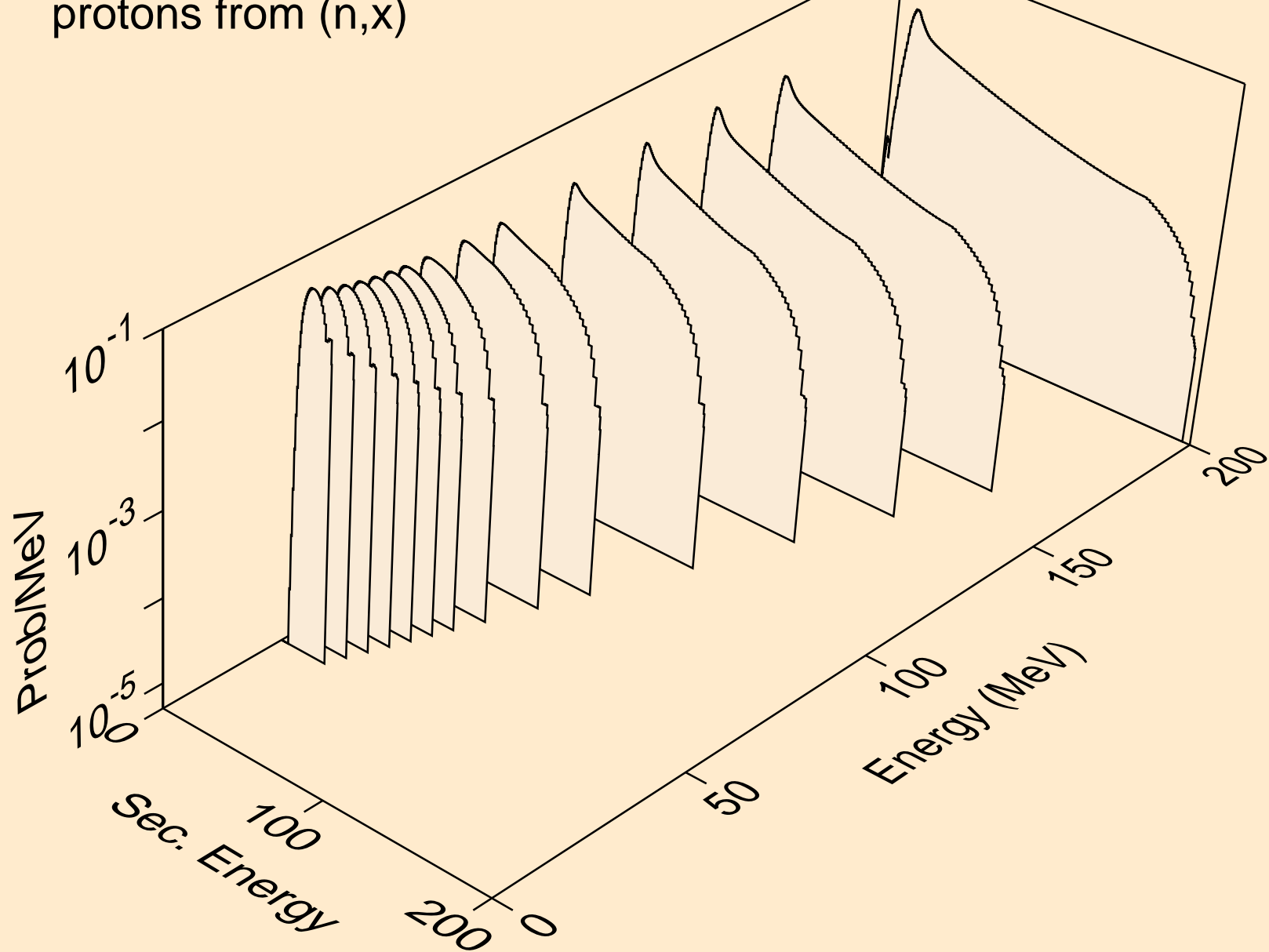

TA188 NEUTRON ACER TENDL-2021 LIBRARY; T=293.6K
protons from (n,n*)p

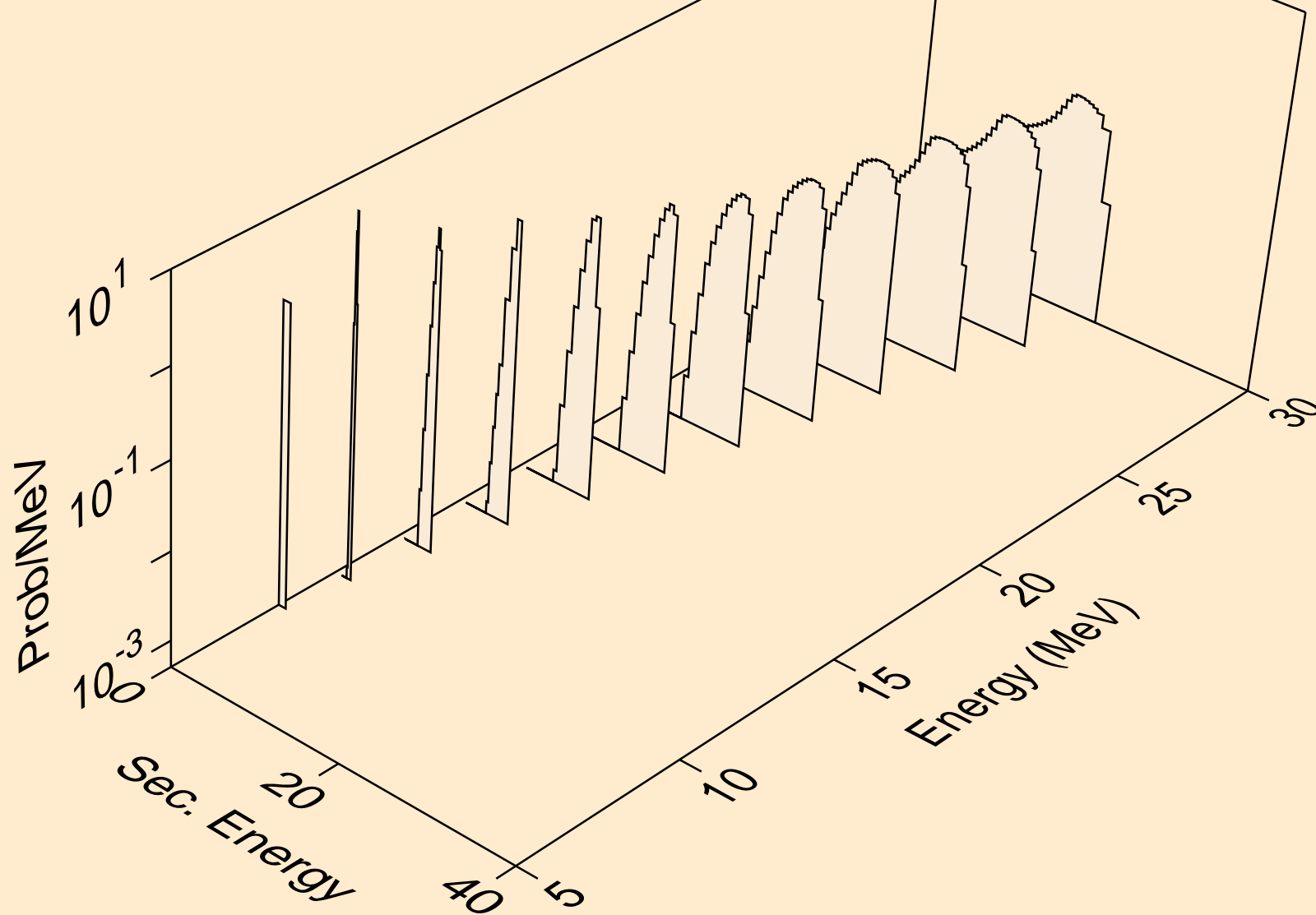

TA188 NEUTRON ACER TENDL-2021 LIBRARY; T=293.6K
protons from (n,2np)

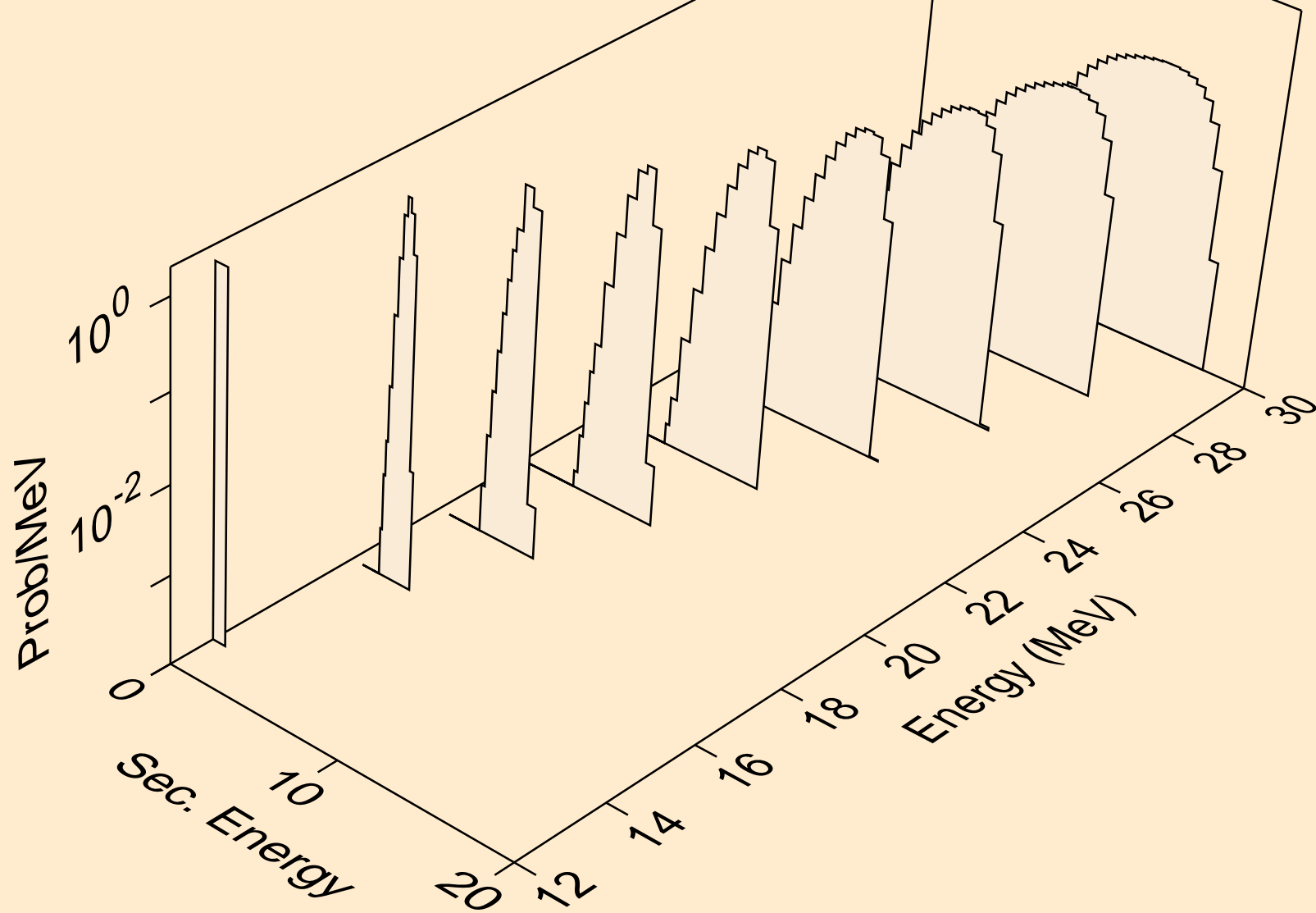

TA188 NEUTRON ACER TENDL-2021 LIBRARY; T=293.6K
protons from (n,3np)

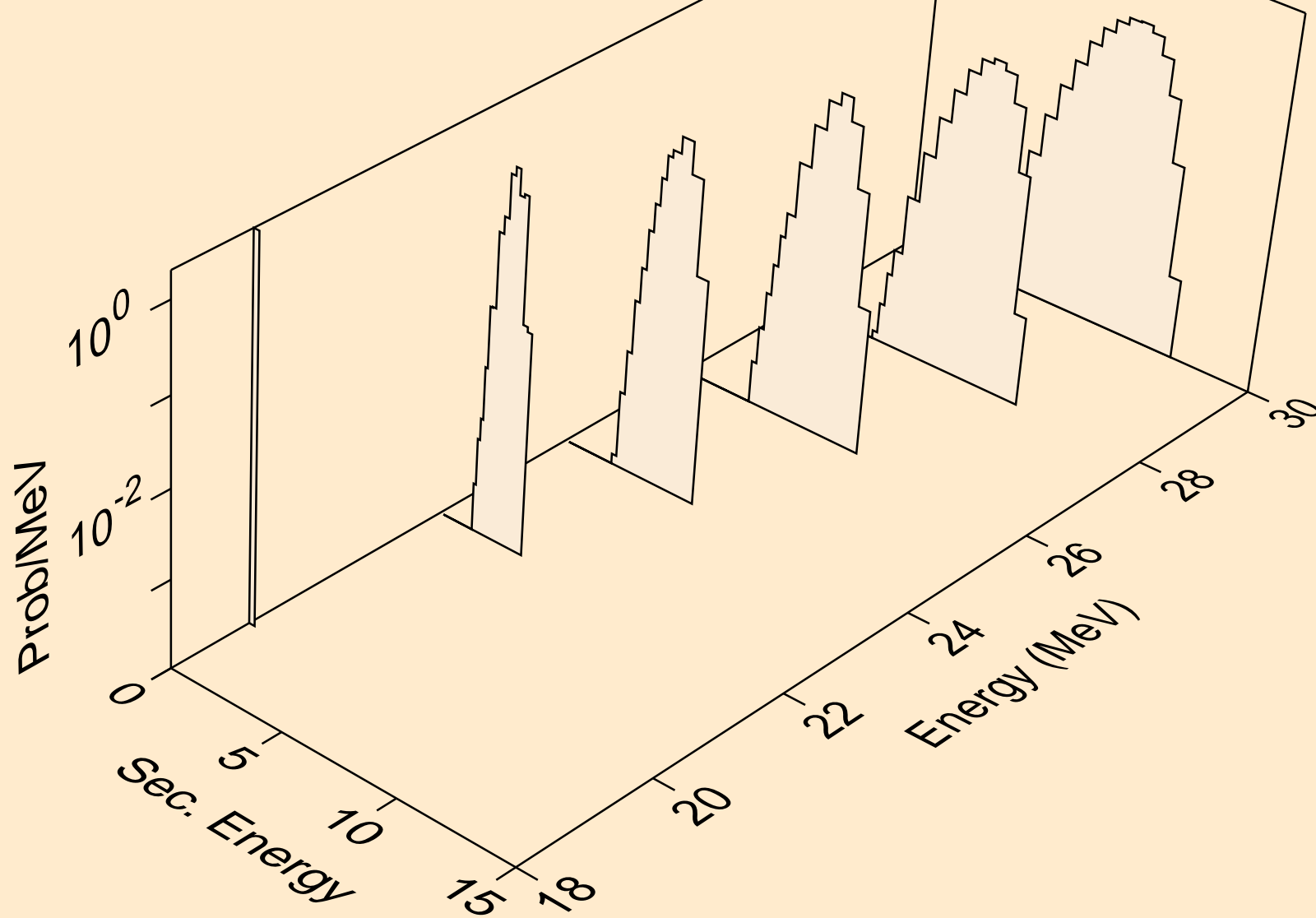

TA188 NEUTRON ACER TENDL-2021 LIBRARY; T=293.6K
protons from (n,p)

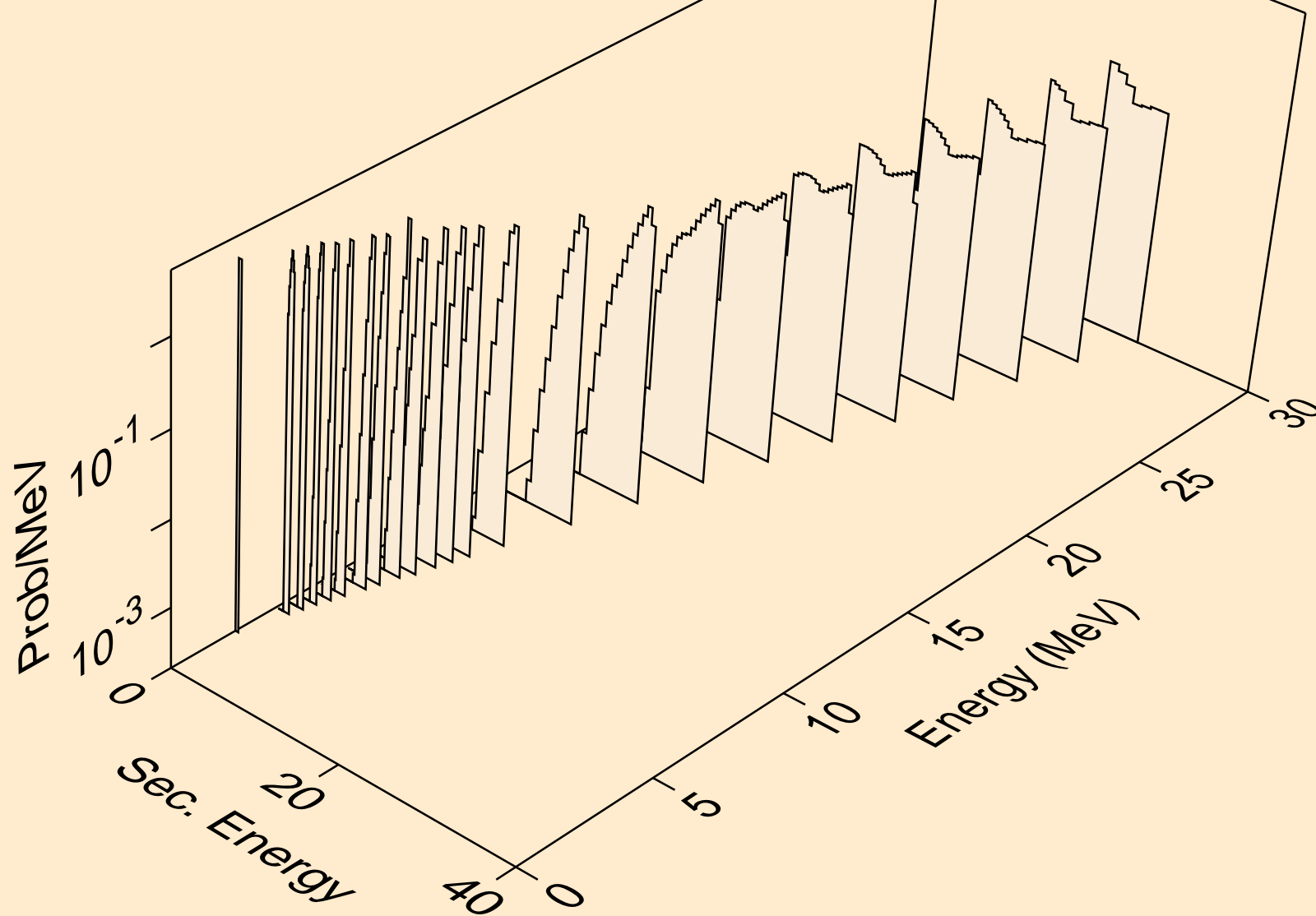

TA188 NEUTRON ACER TENDL-2021 LIBRARY; T=293.6K
protons from (n,2p)

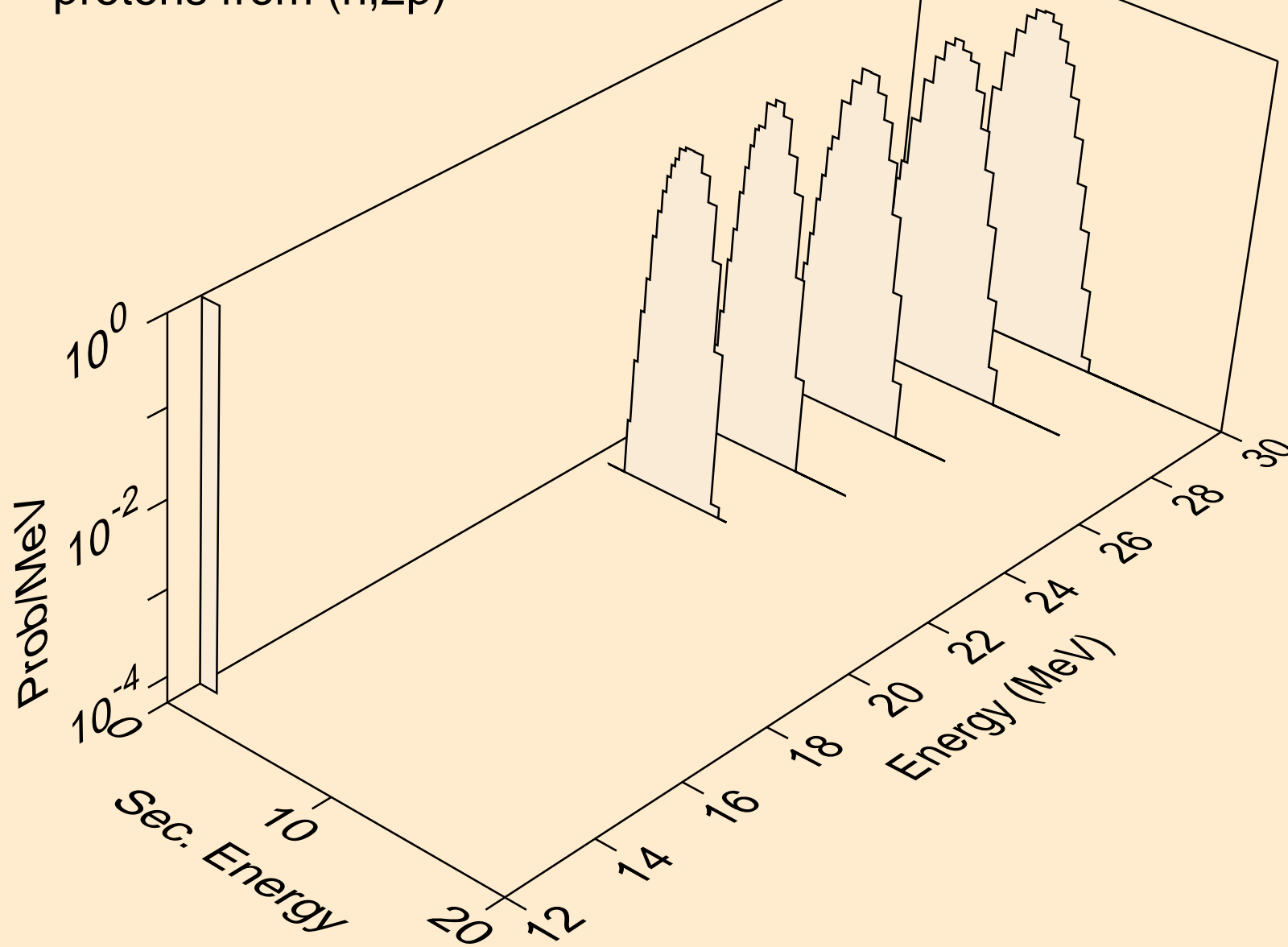

TA188 NEUTRON ACER TENDL-2021 LIBRARY; T=293.6K
deuterons from (n,x)

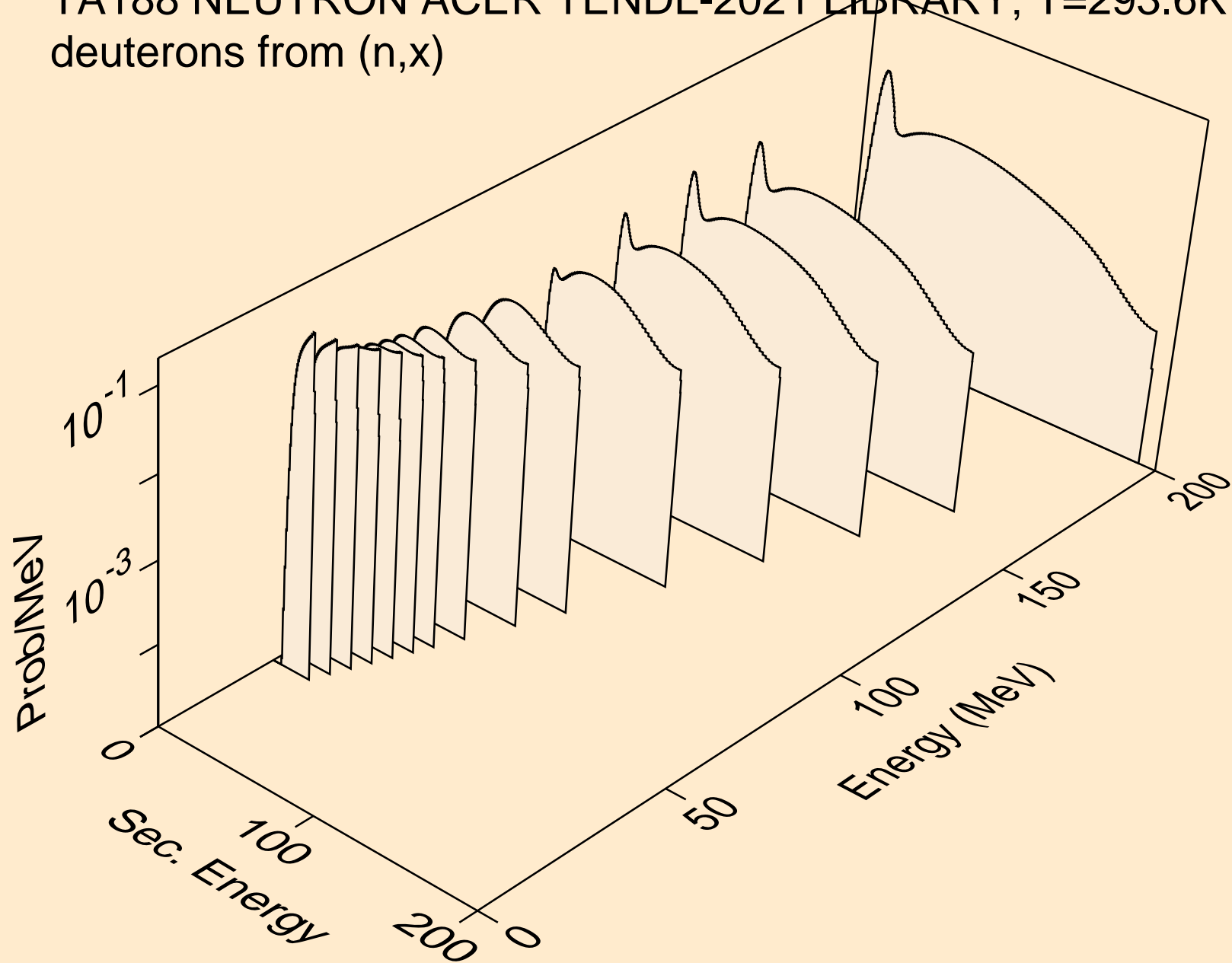

TA188 NEUTRON ACER TENDL-2021 LIBRARY; T=293.6K
deuterons from (n,2nd)

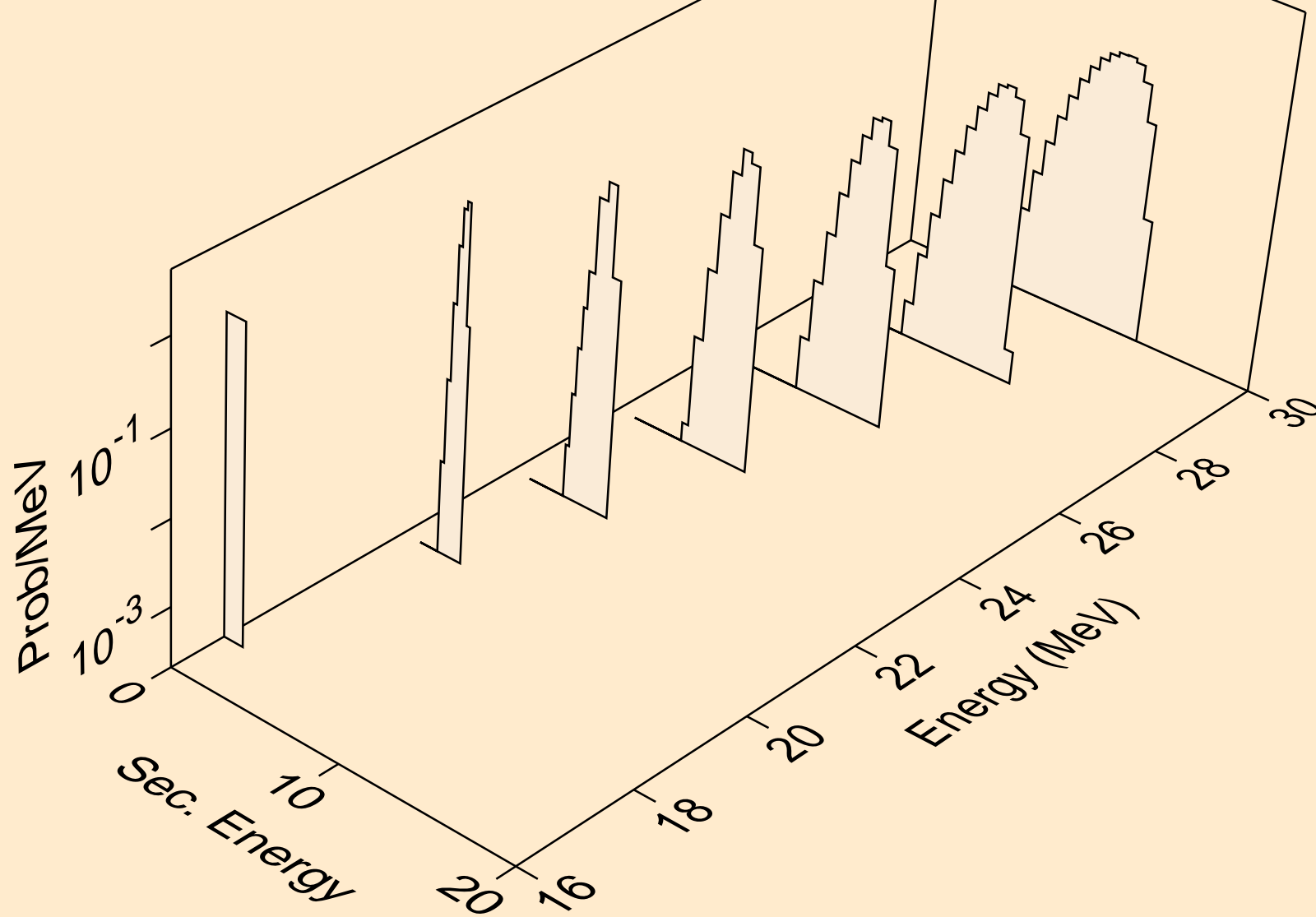

TA188 NEUTRON ACER TENDL-2021 LIBRARY; T=293.6K
deuterons from (n,n*)d

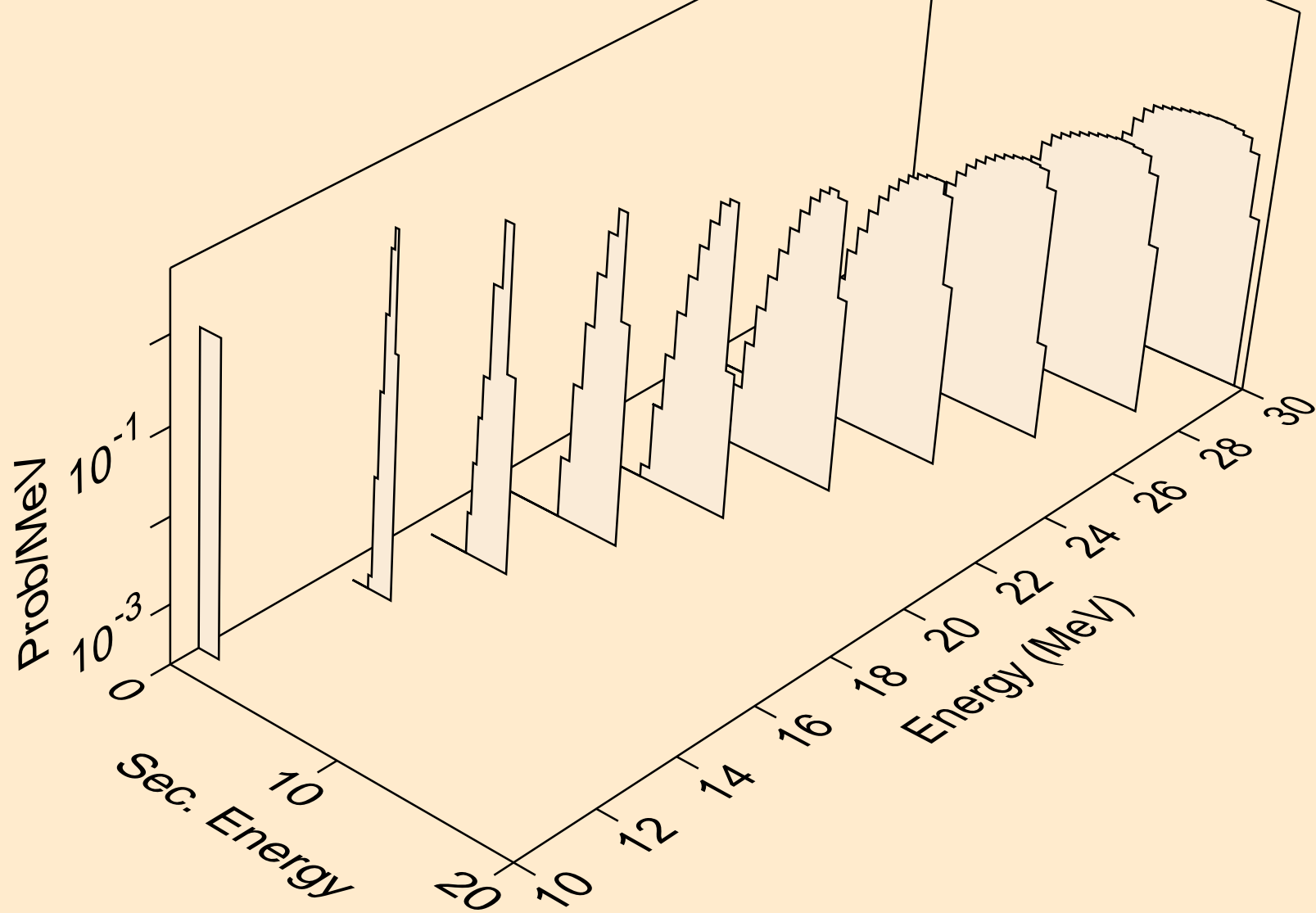

TA188 NEUTRON ACER TENDL-2021 LIBRARY; T=293.6K
deuterons from (n,d)

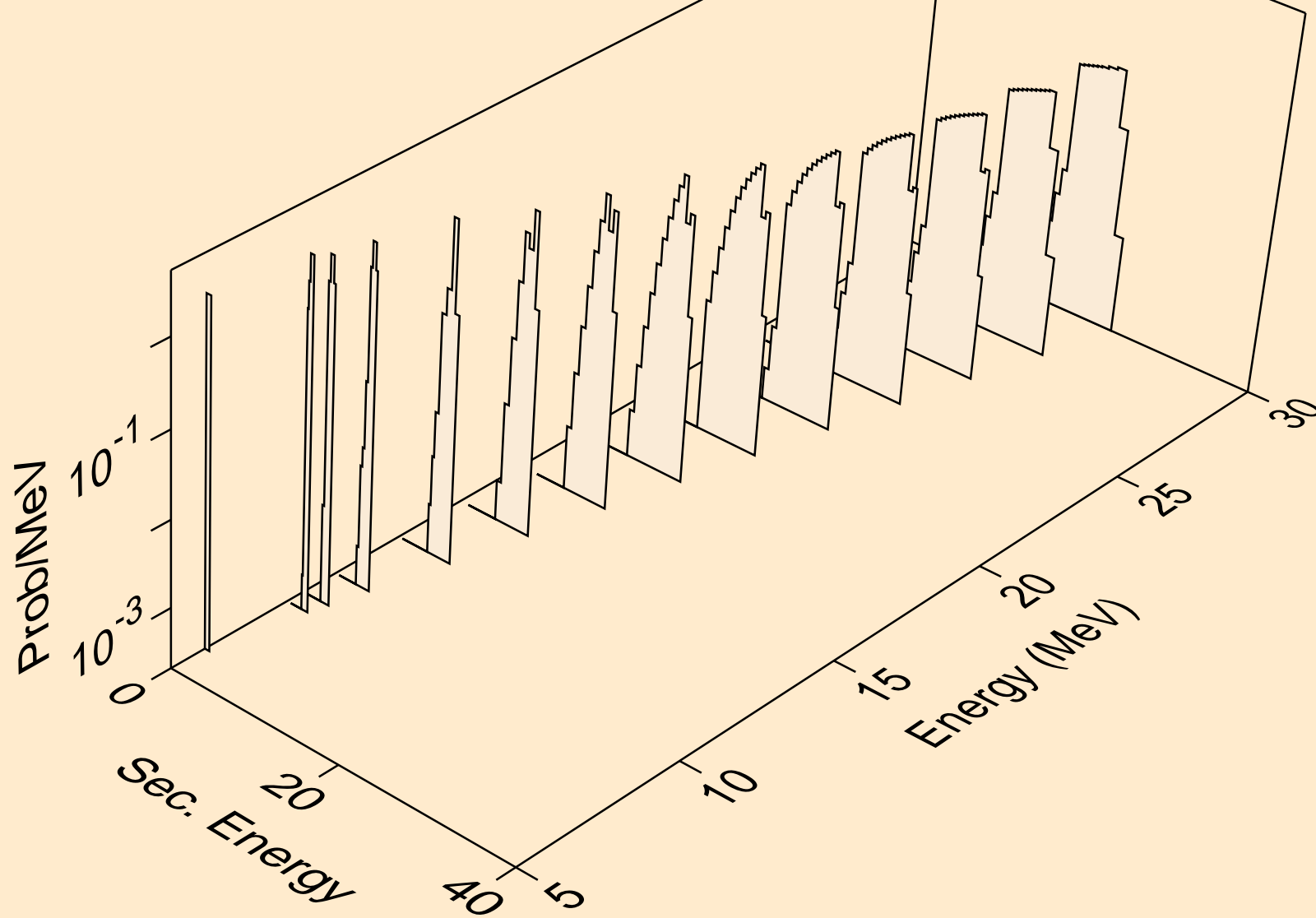

TA188 NEUTRON ACER TENDL-2021 LIBRARY; T=293.6K
tritons from (n,x)

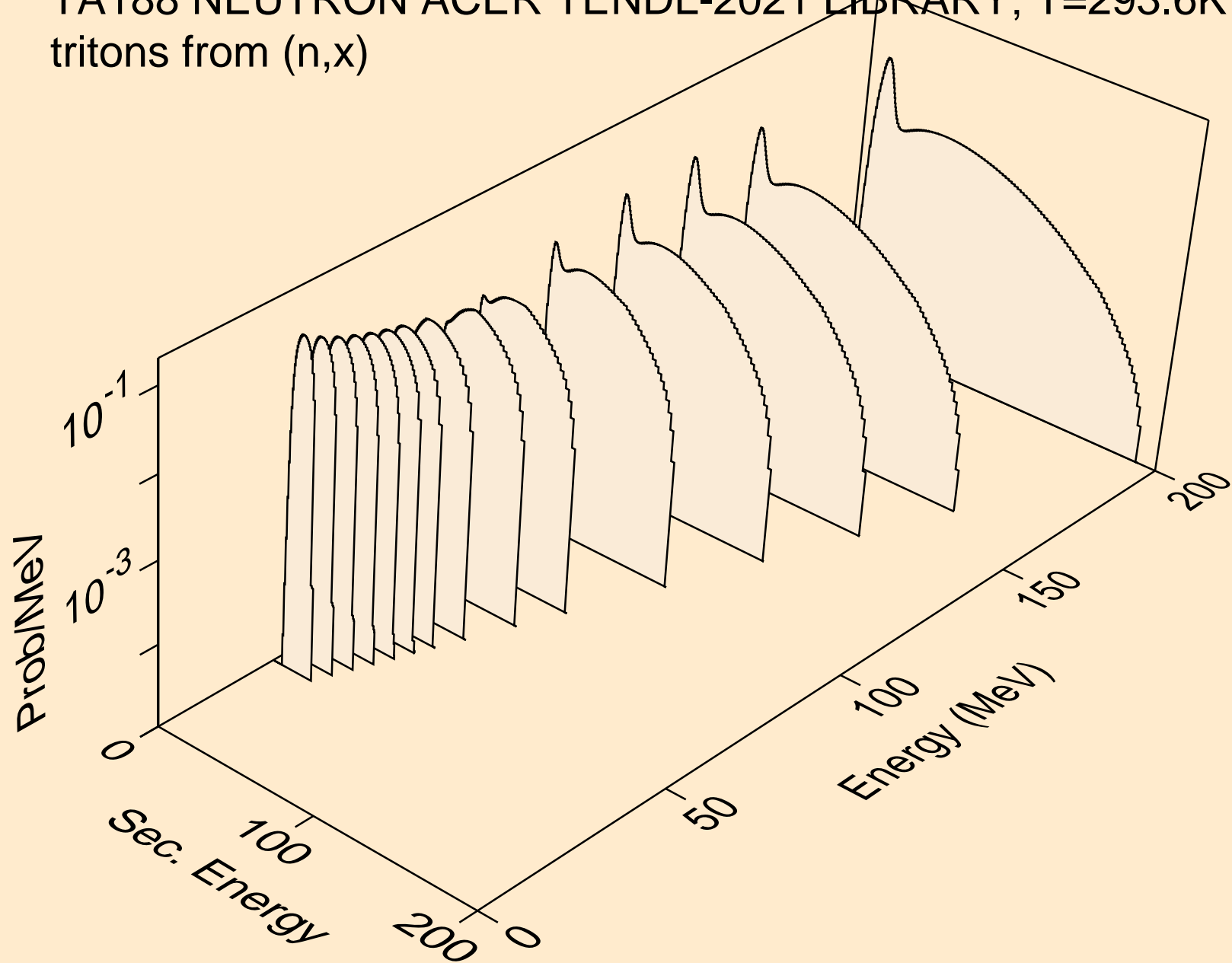

TA188 NEUTRON ACER TENDL-2021 LIBRARY; T=293.6K
tritons from (n,n*)t

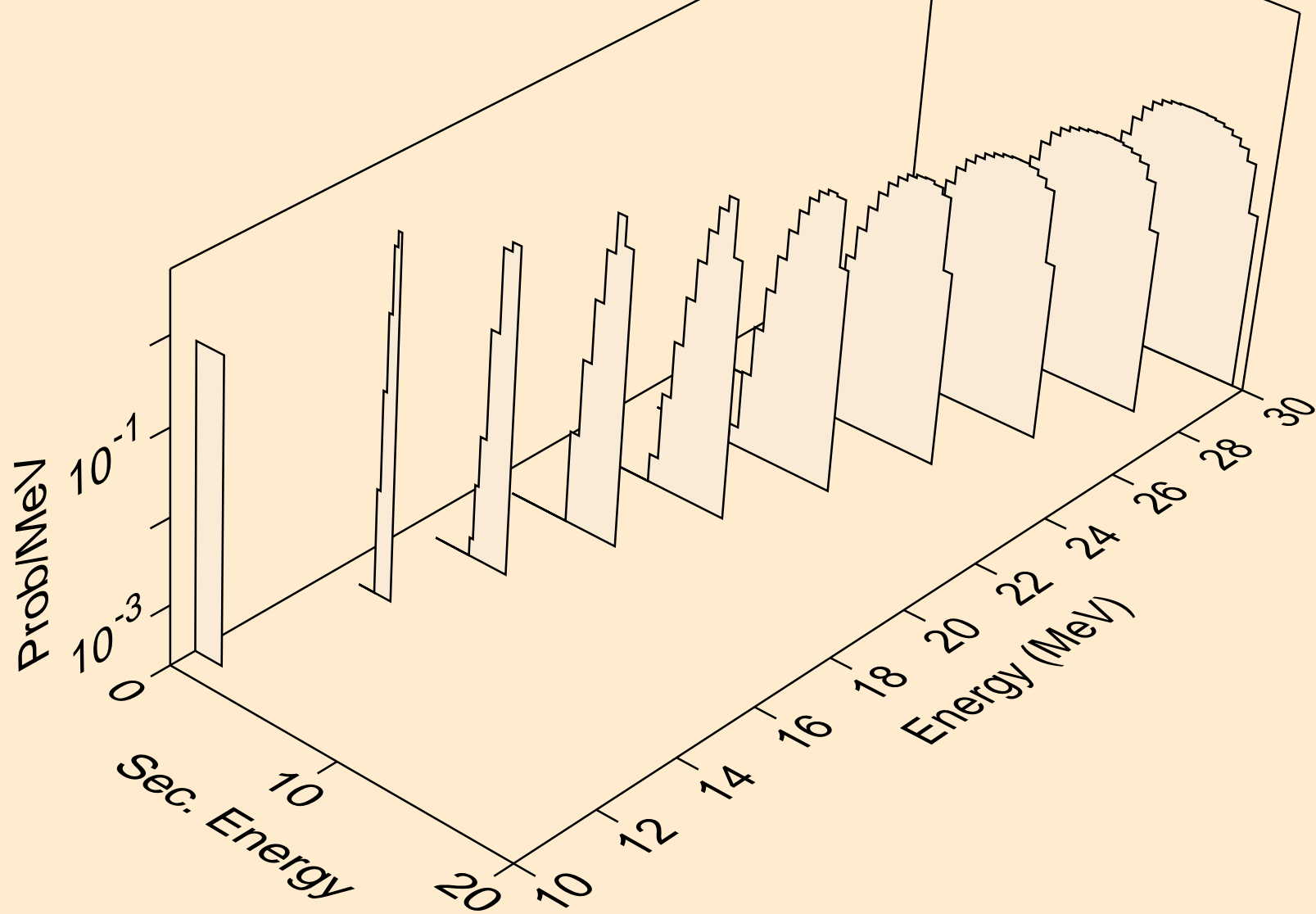

TA188 NEUTRON ACER TENDL-2021 LIBRARY; T=293.6K
tritons from (n,t)

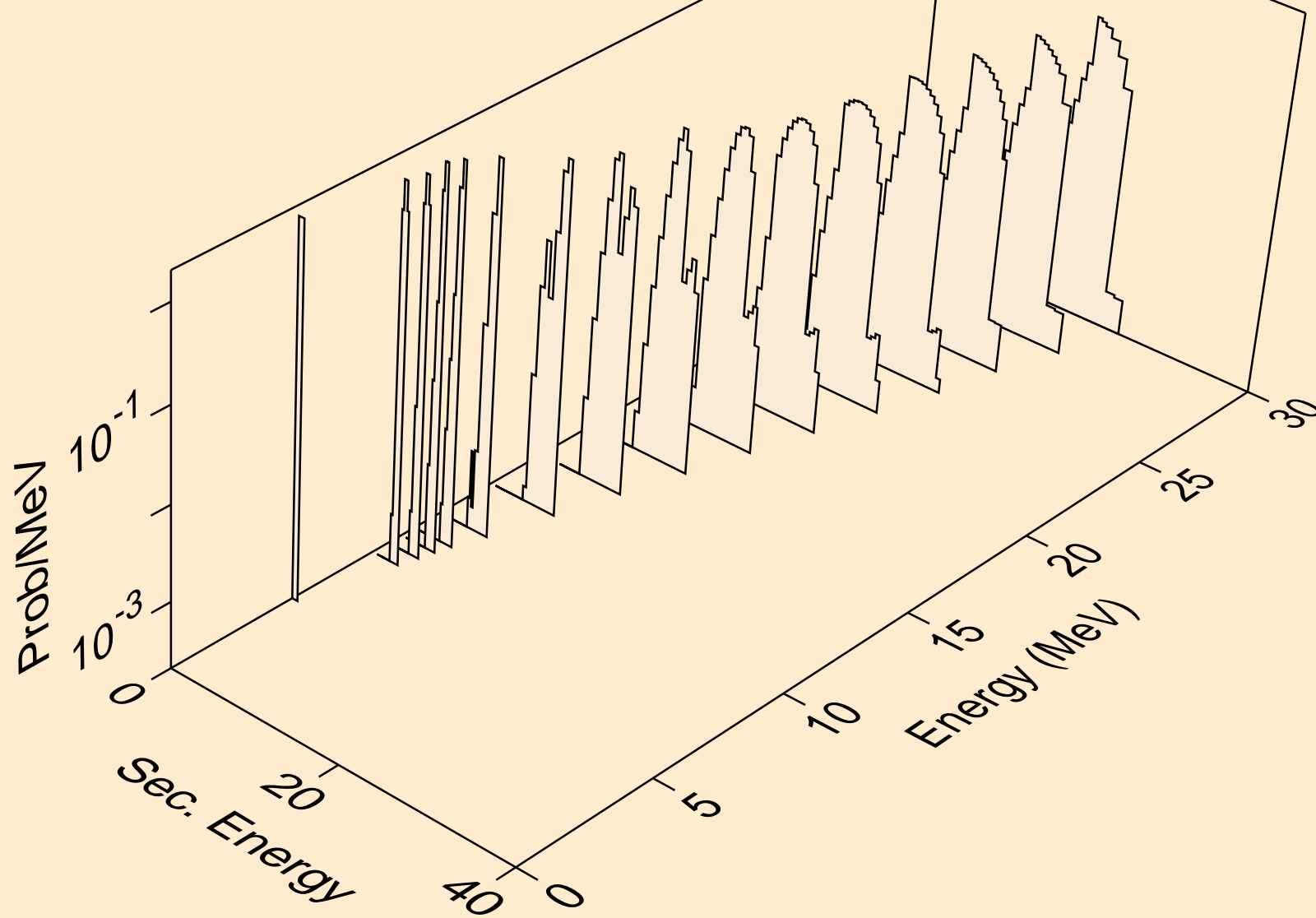

TA188 NEUTRON ACER TENDL-2021 LIBRARY; T=293.6K
he3s from (n,x)

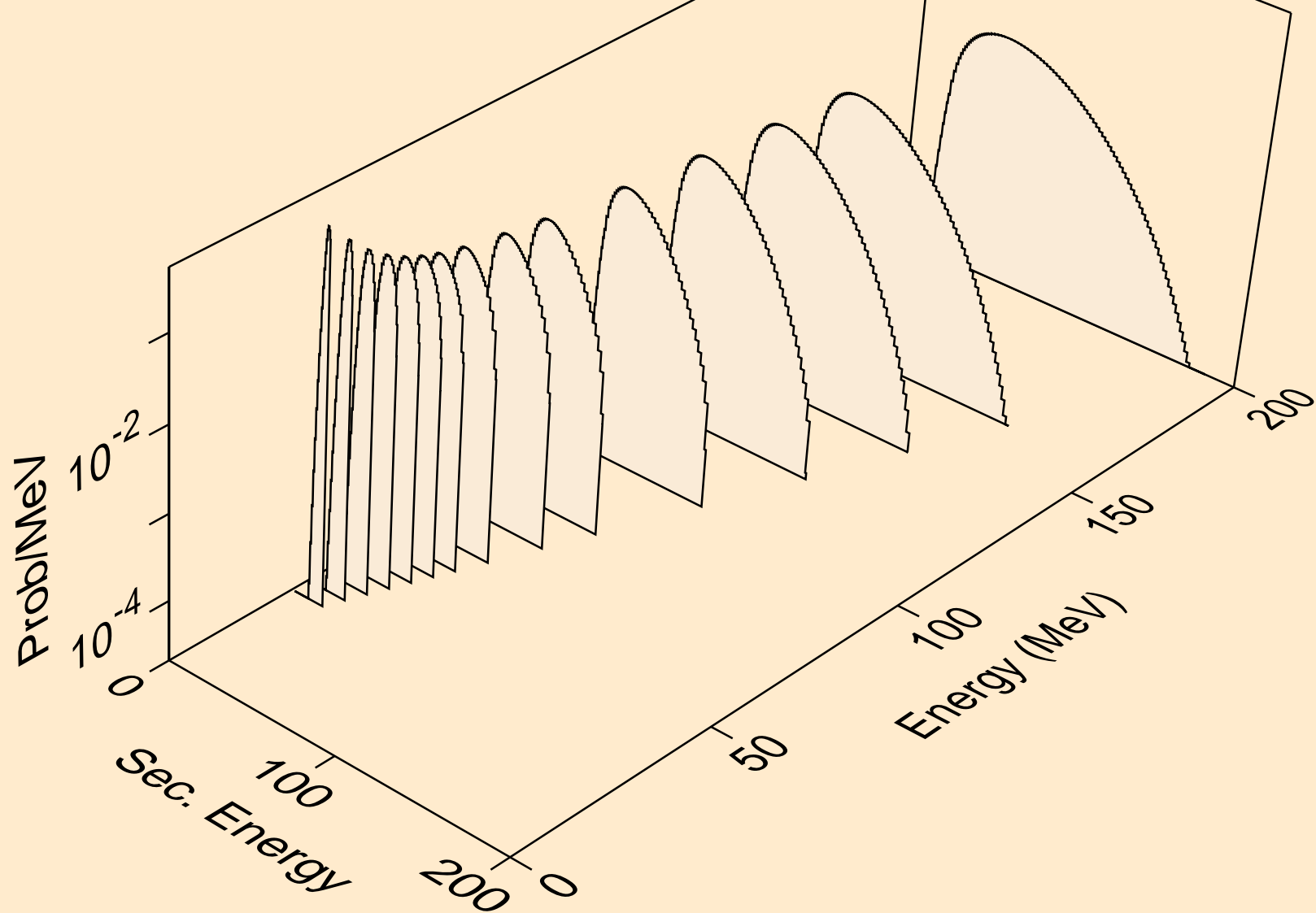

TA188 NEUTRON ACER TENDL-2021 LIBRARY; T=293.6K
he3s from (n,n*)he3

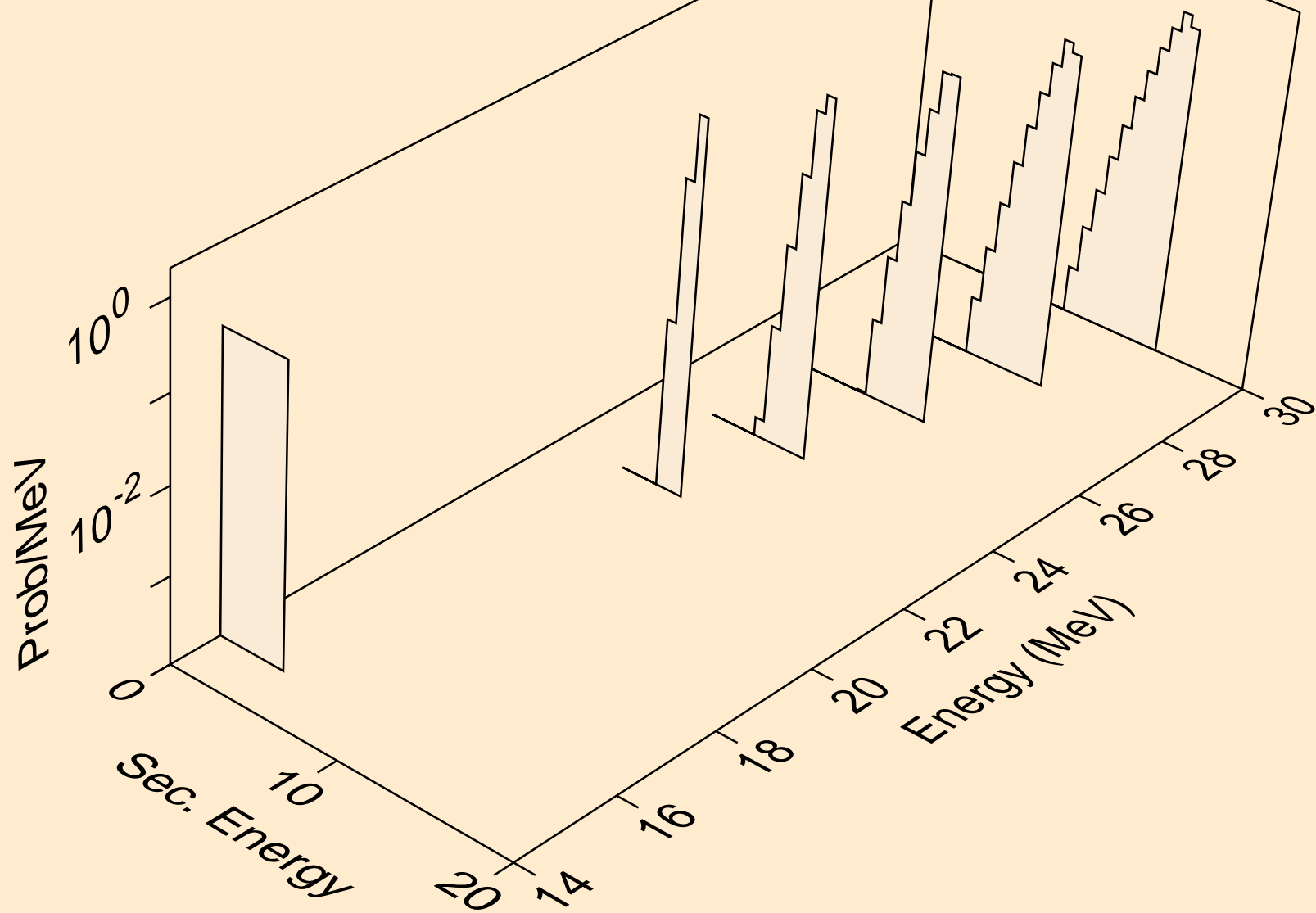

TA188 NEUTRON ACER TENDL-2021 LIBRARY; T=293.6K
he3s from (n,he3)

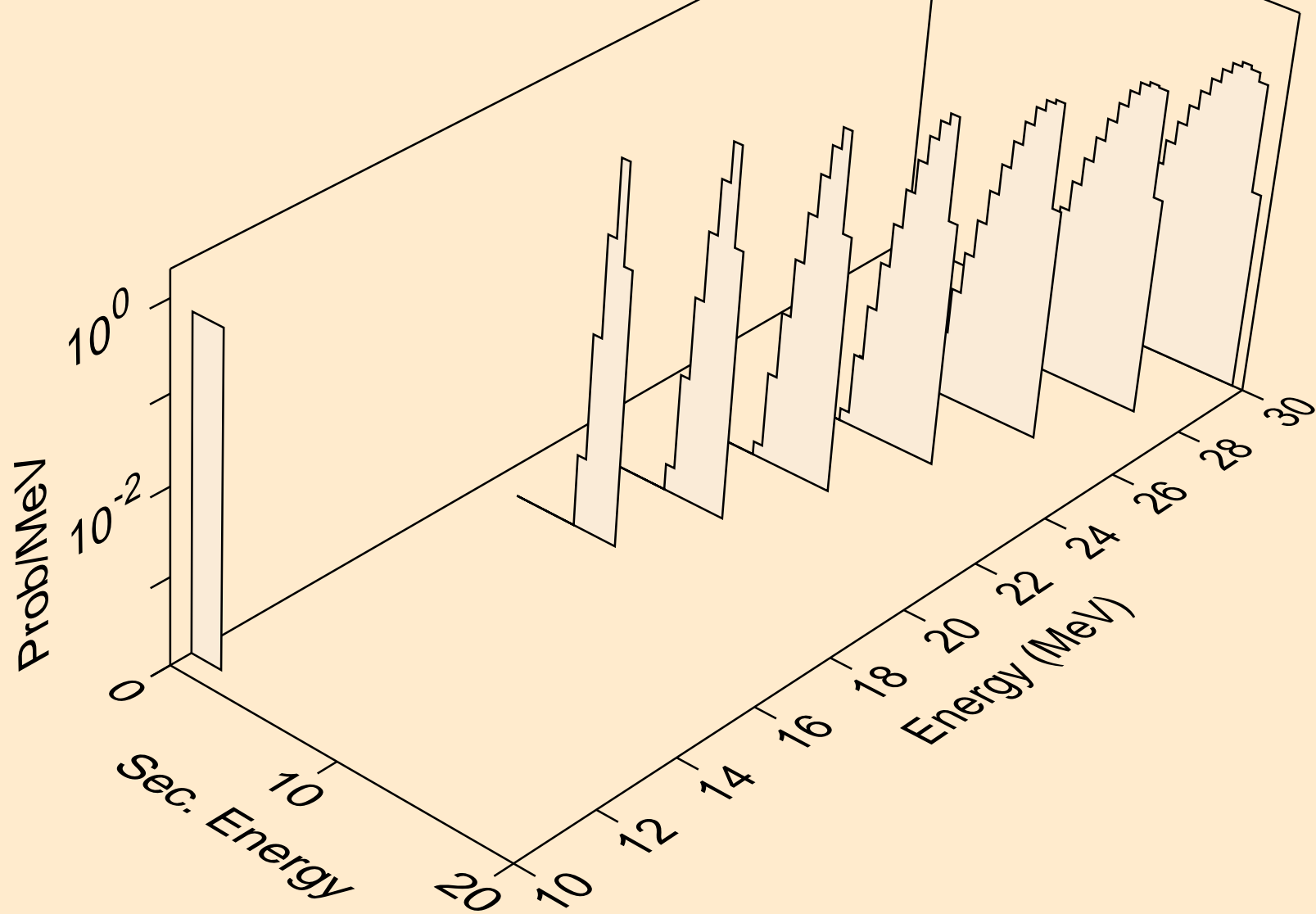

TA188 NEUTRON ACER TENDL-2021 LIBRARY; T=293.6K
alphas from (n,x)

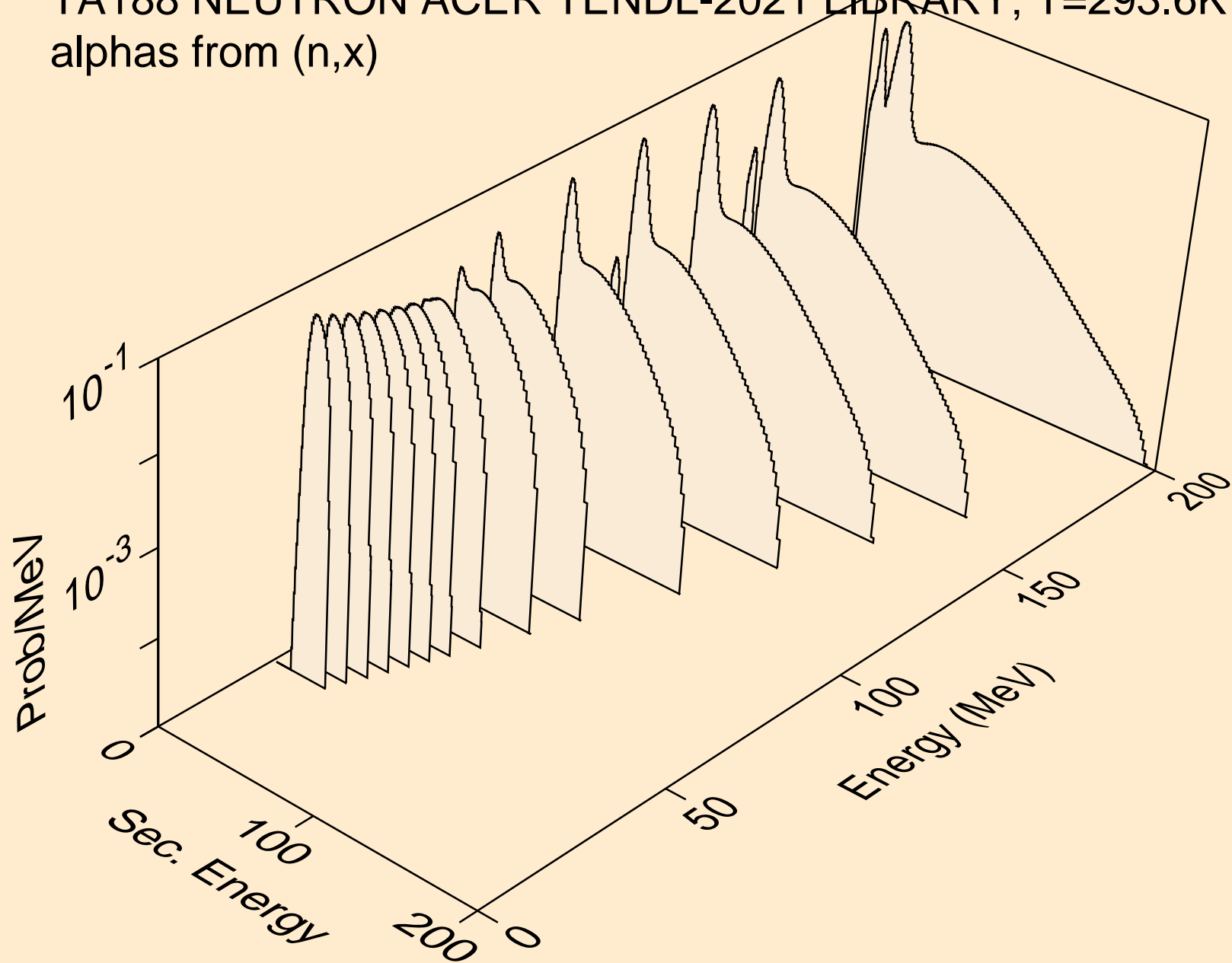

TA188 NEUTRON ACER TENDL-2021 LIBRARY; T=293.6K
alphas from (n,n*)a

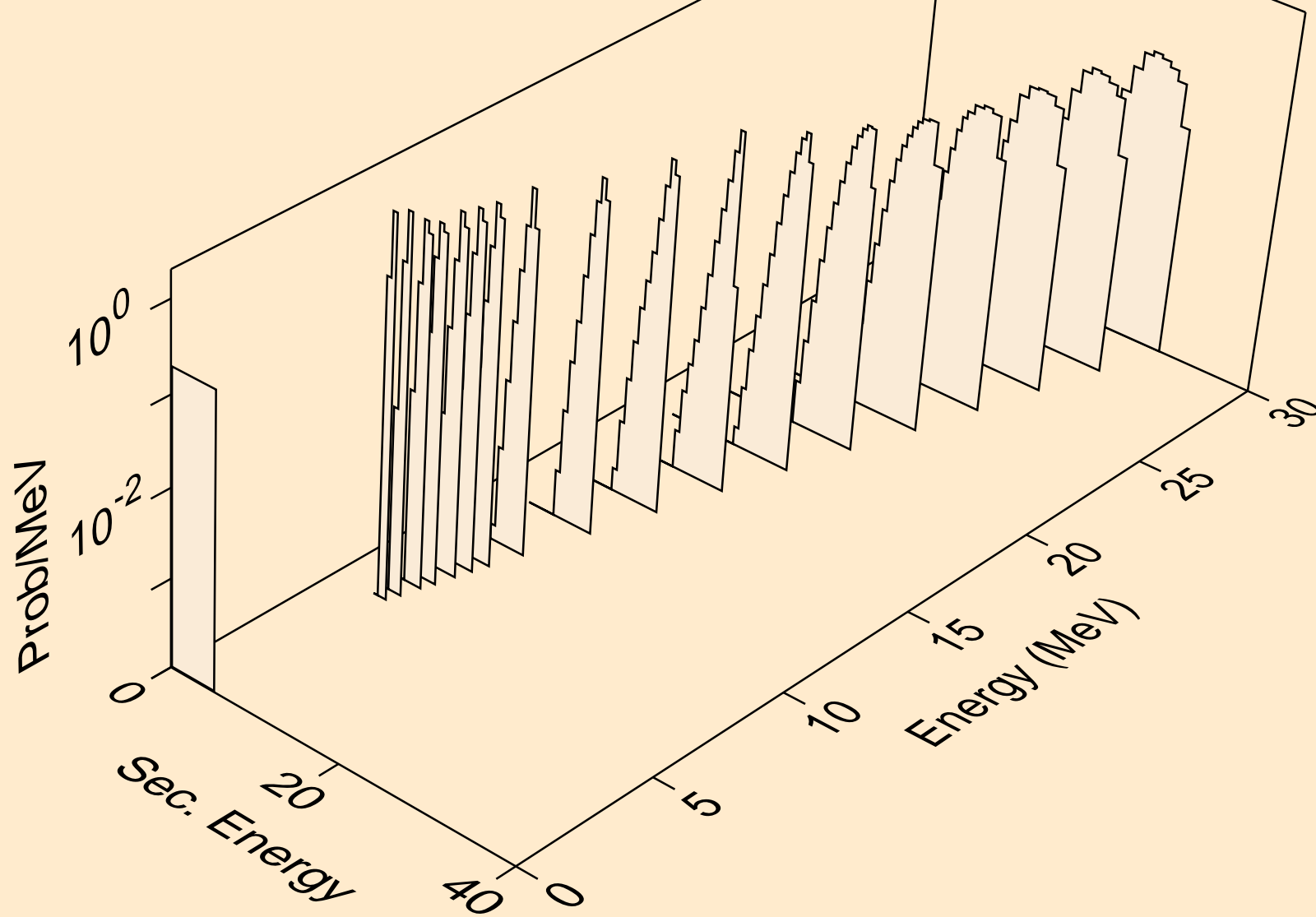

TA188 NEUTRON ACER TENDL-2021 LIBRARY; T=293.6K
alphas from (n,2n)a

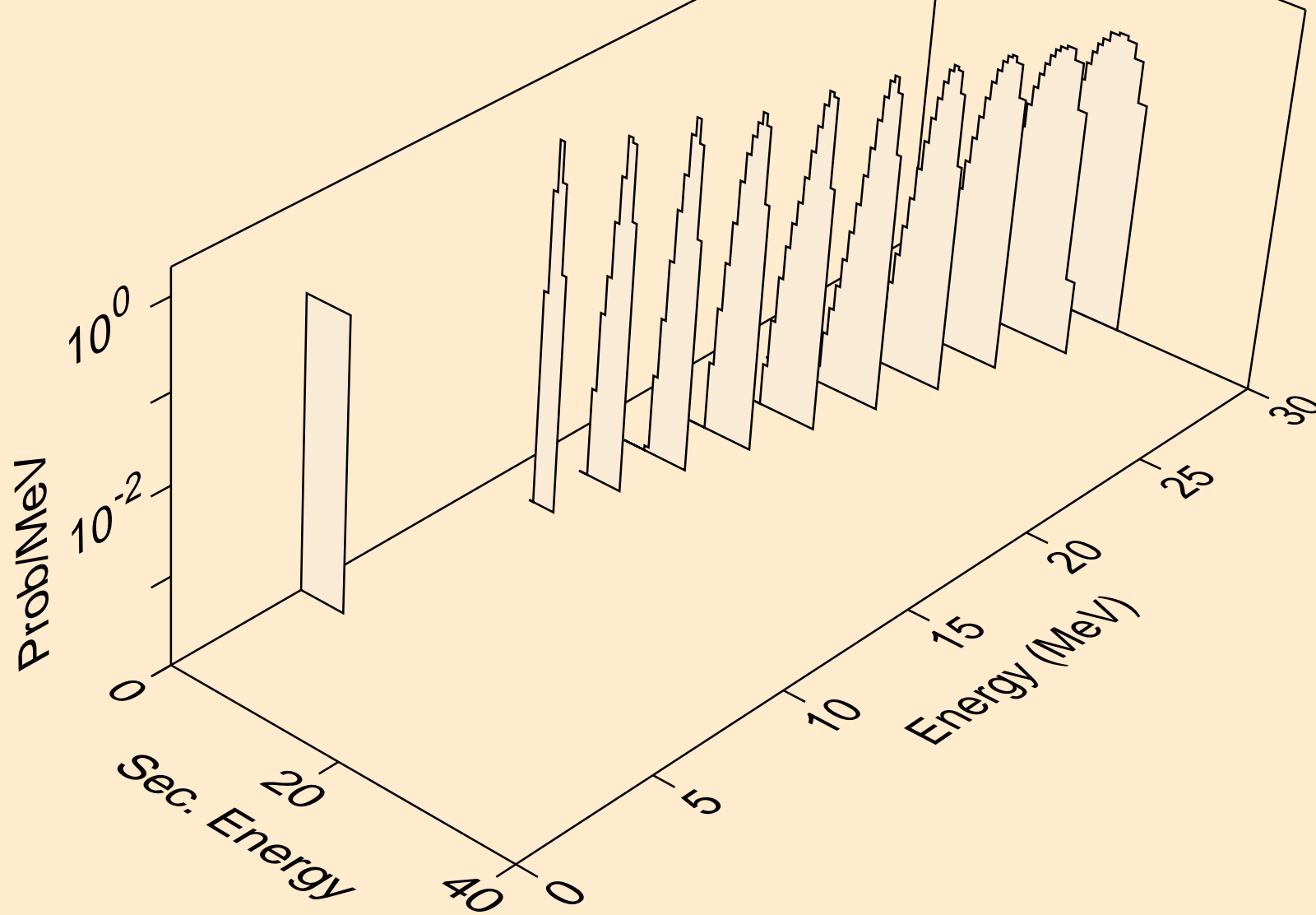

TA188 NEUTRON ACER TENDL-2021 LIBRARY; T=293.6K
alphas from (n,3n)a

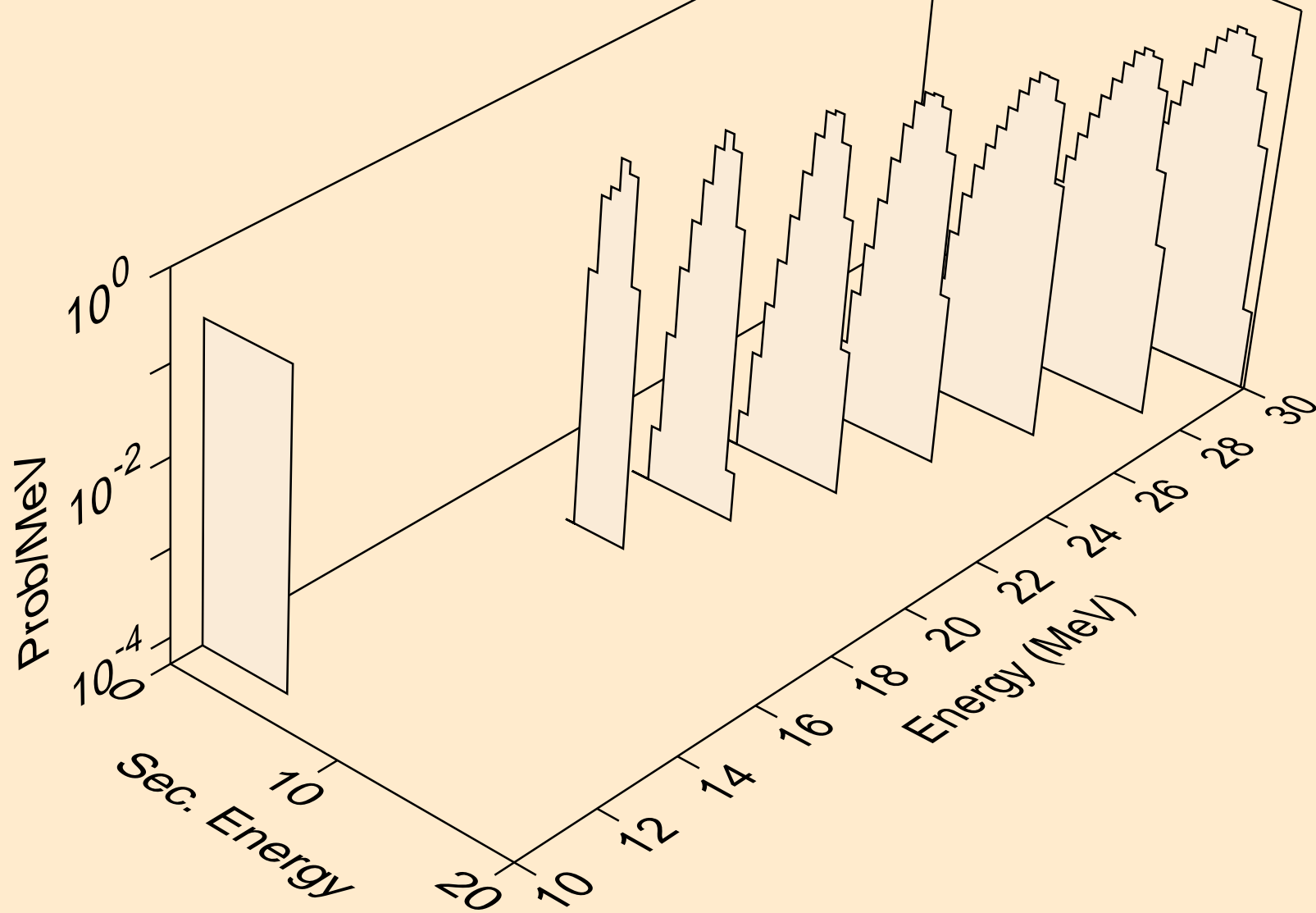

TA188 NEUTRON ACER TENDL-2021 LIBRARY; T=293.6K
alphas from (n,a)

