

TB154 NEUTRON ACER TENDL-2021 LIBRARY; T=293.6K
Principal cross sections

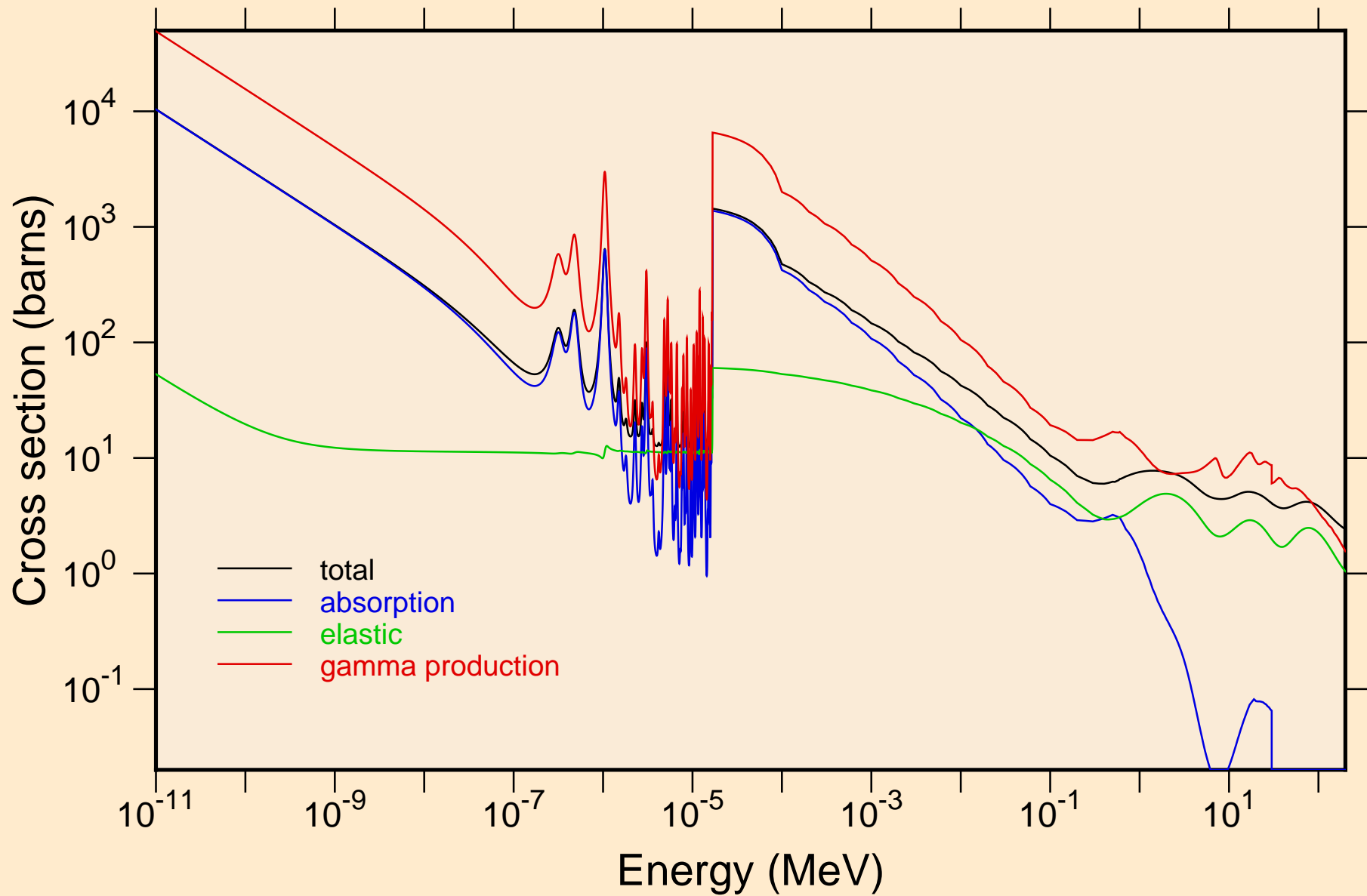

TB154 NEUTRON ACER TENDL-2021 LIBRARY; T=293.6K
resonance total cross section

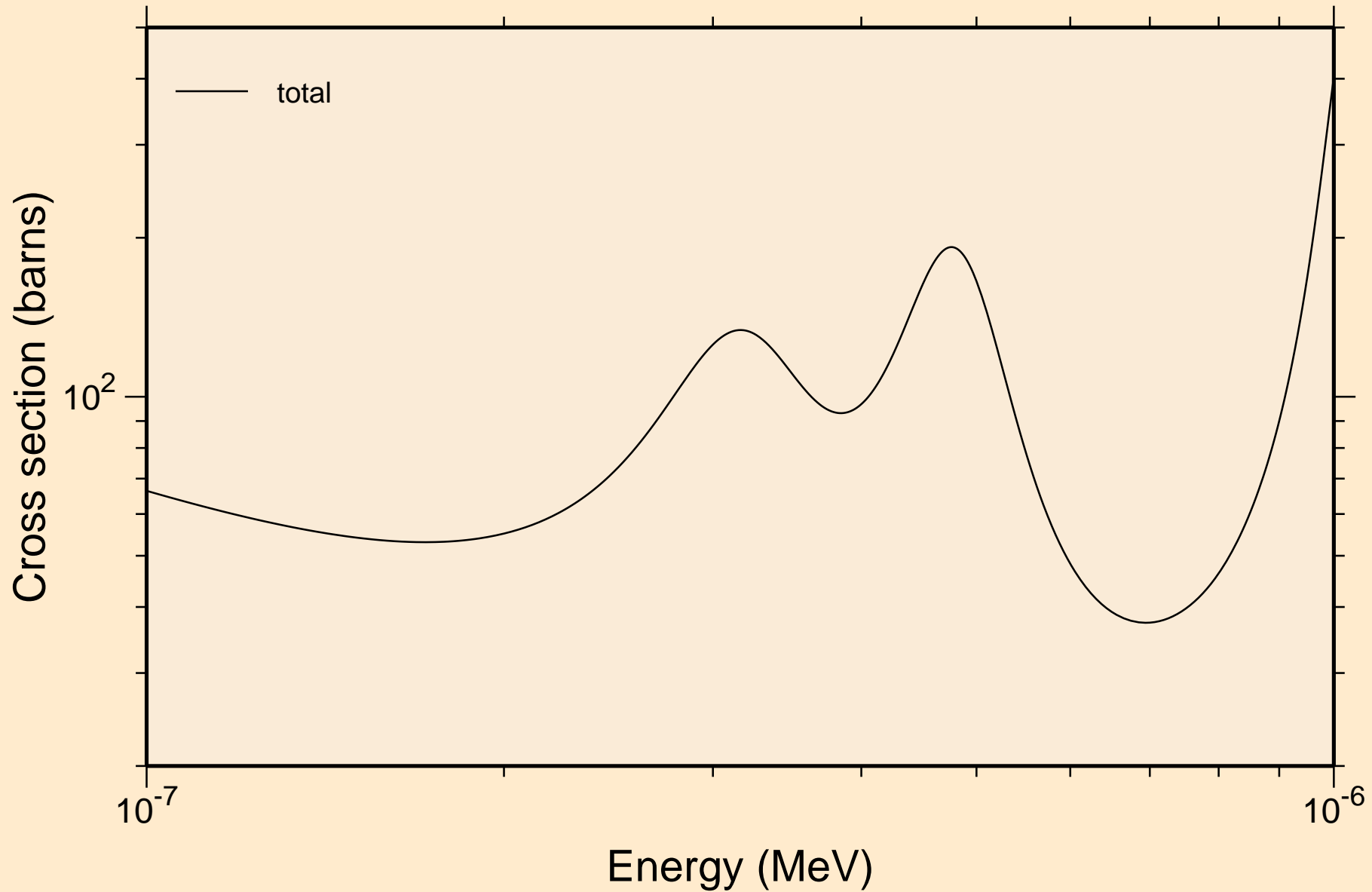

TB154 NEUTRON ACER TENDL-2021 LIBRARY; T=293.6K
resonance total cross section

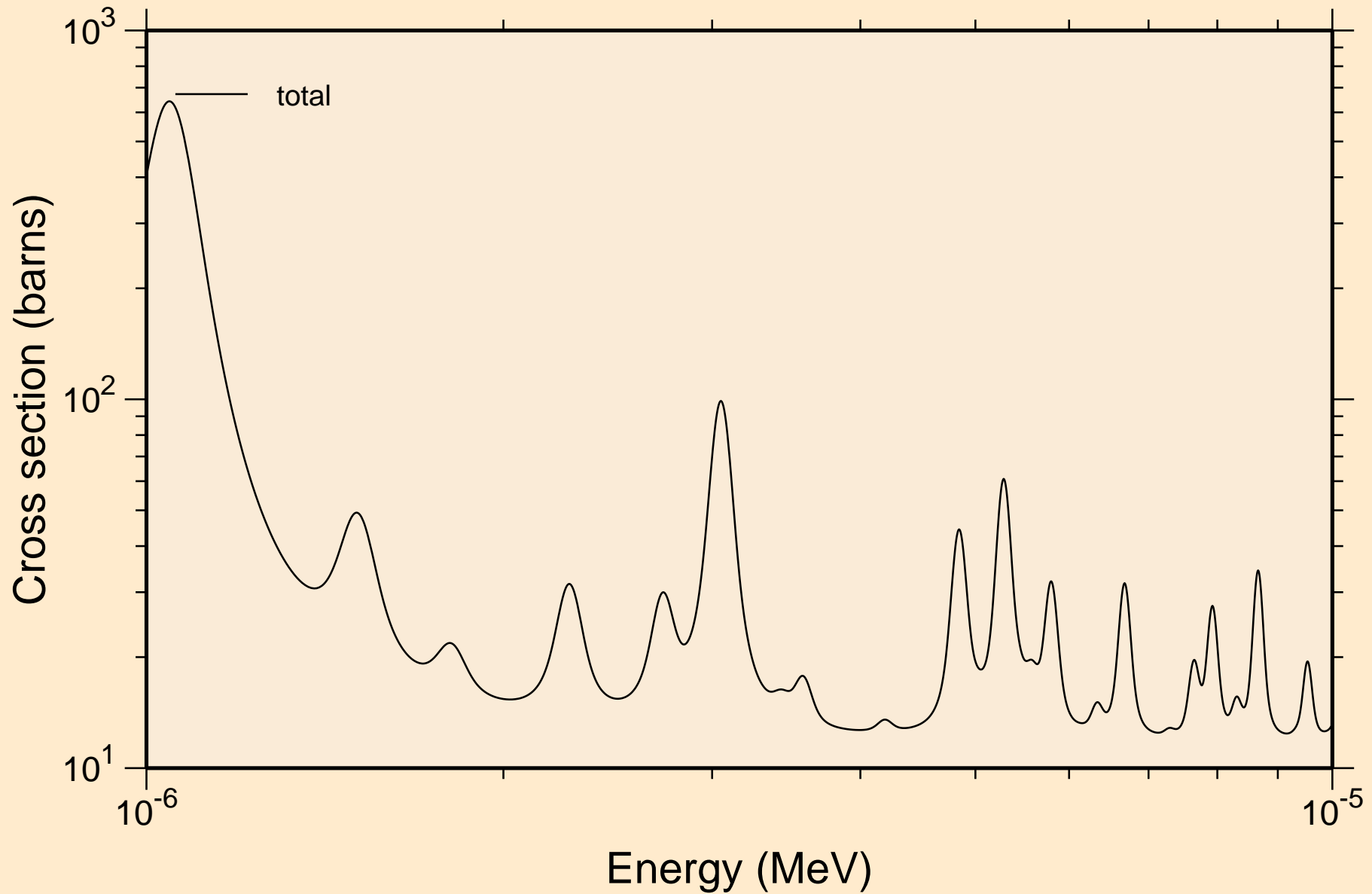

TB154 NEUTRON ACER TENDL-2021 LIBRARY; T=293.6K
resonance total cross section

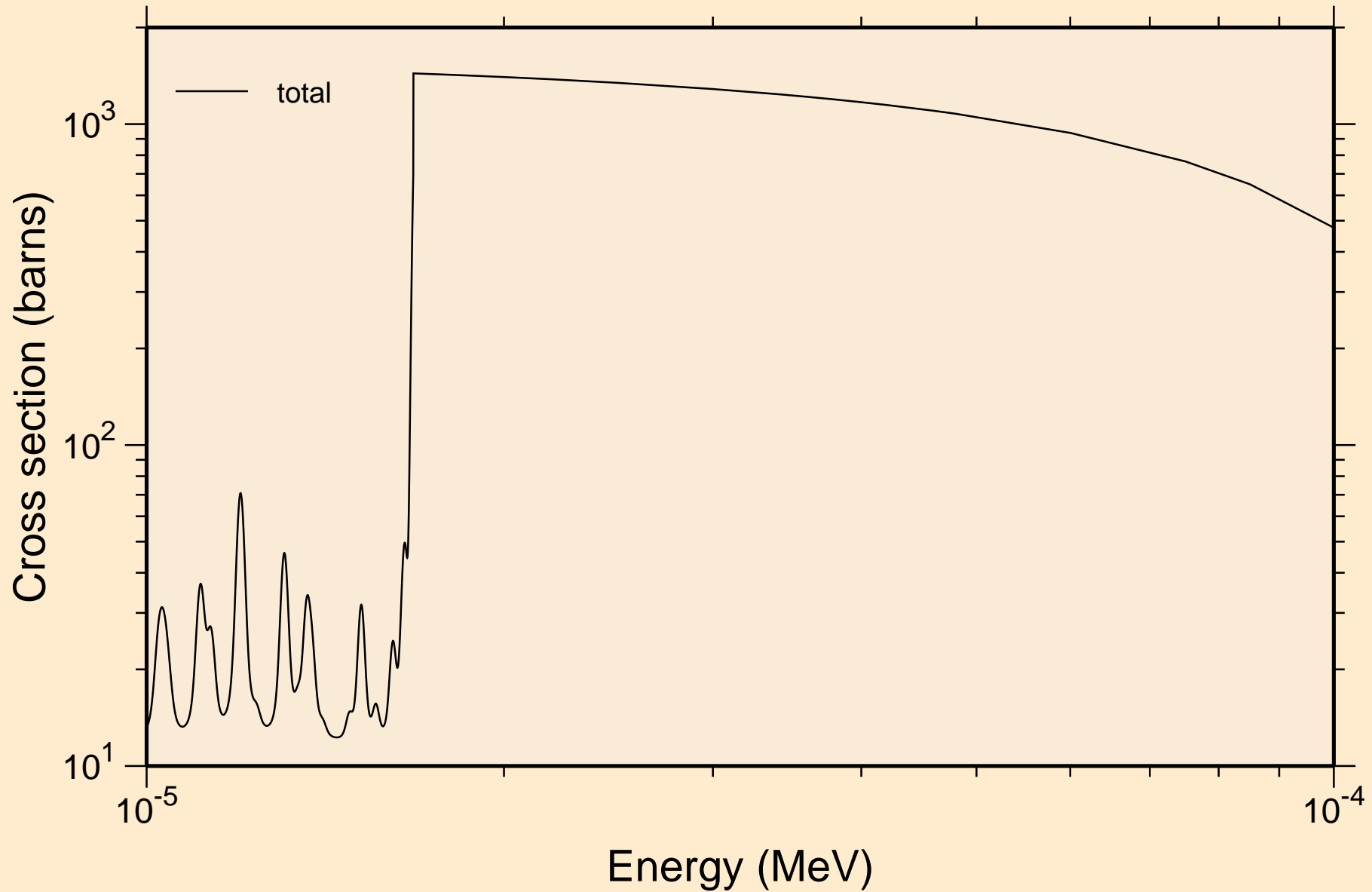

TB154 NEUTRON ACER TENDL-2021 LIBRARY; T=293.6K
resonance total cross section

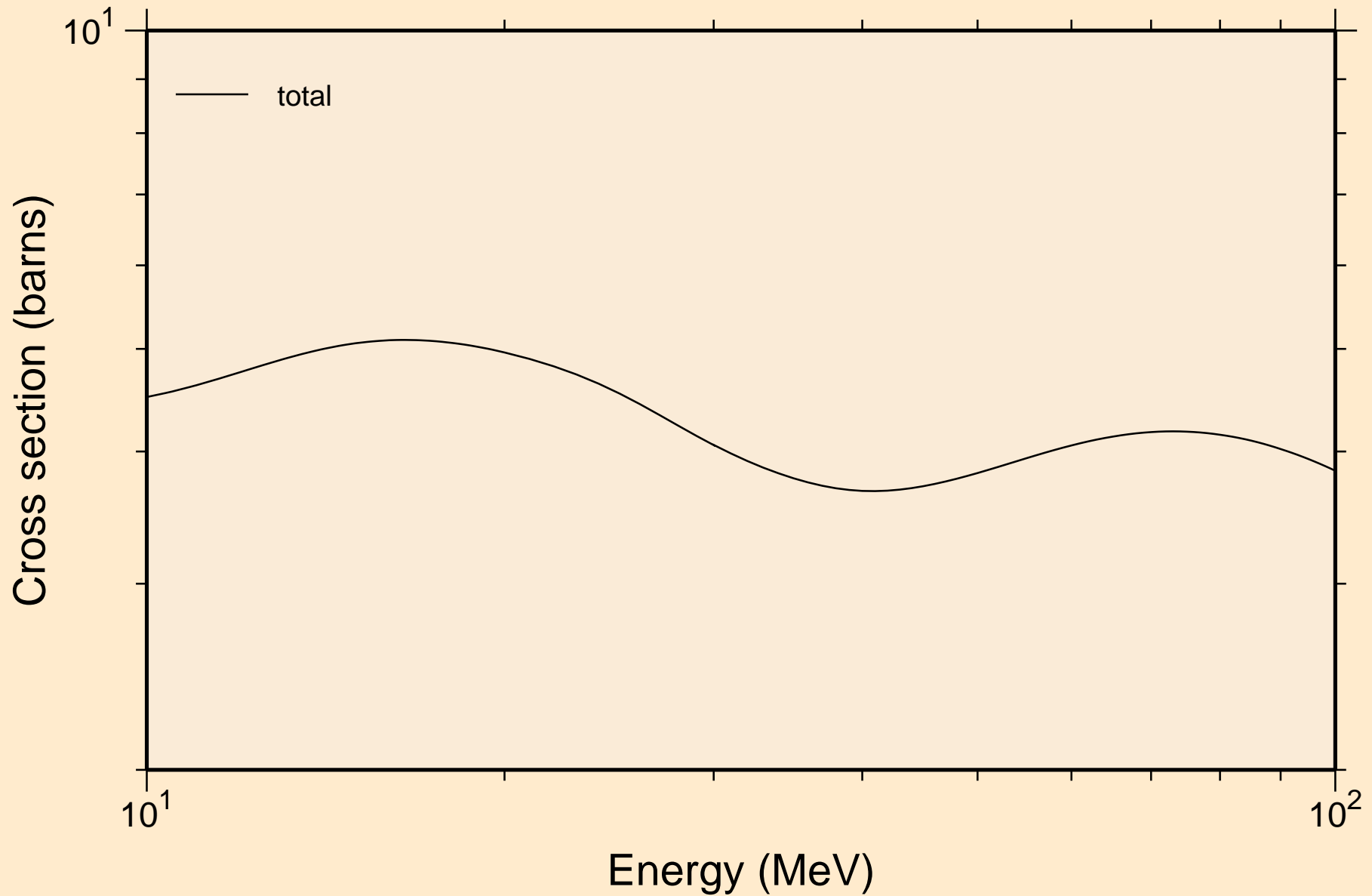

TB154 NEUTRON ACER TENDL-2021 LIBRARY; T=293.6K
resonance absorption cross sections

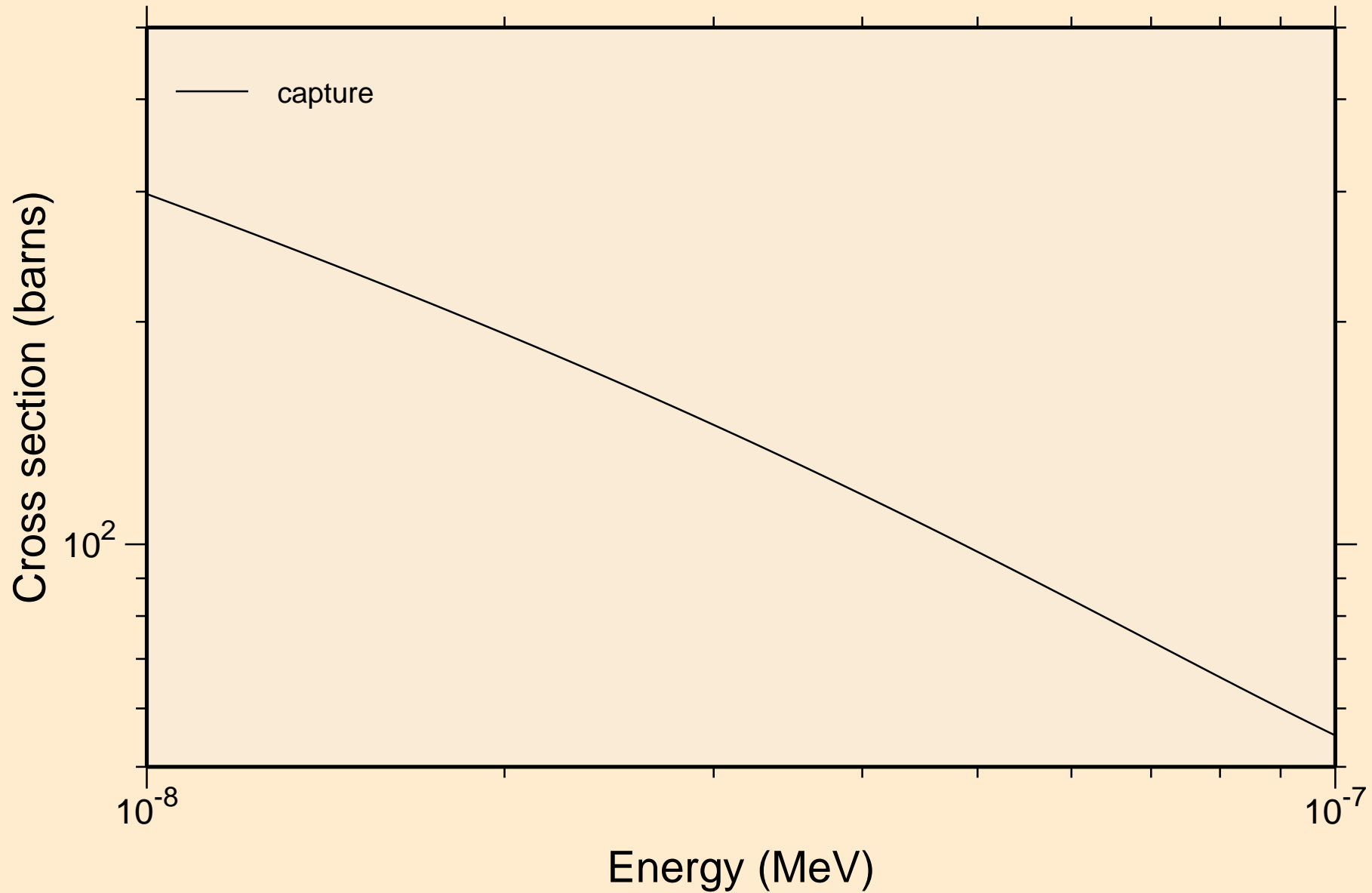

TB154 NEUTRON ACER TENDL-2021 LIBRARY; T=293.6K
resonance absorption cross sections

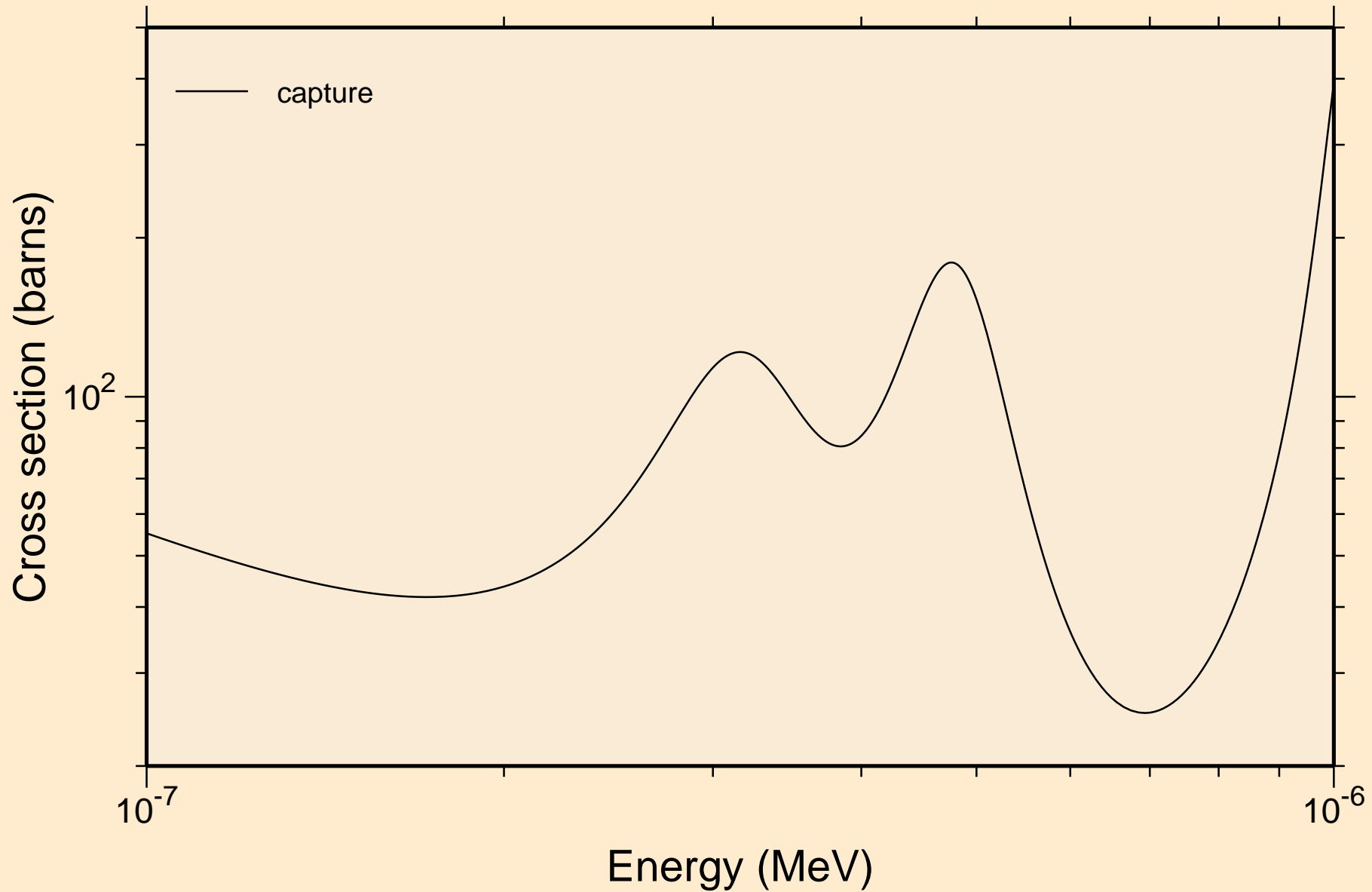

TB154 NEUTRON ACER TENDL-2021 LIBRARY; T=293.6K
resonance absorption cross sections

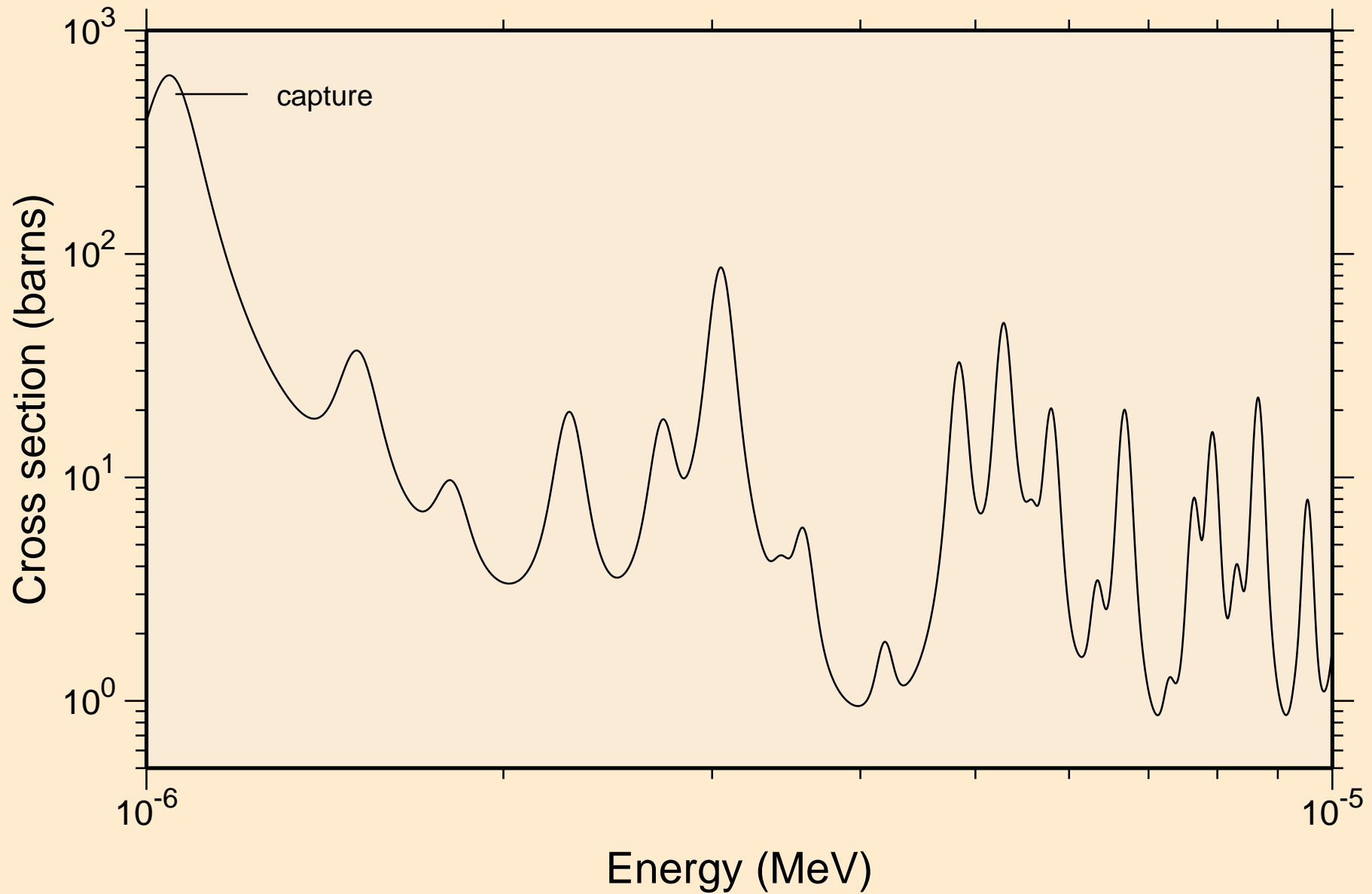

TB154 NEUTRON ACER TENDL-2021 LIBRARY; T=293.6K
resonance absorption cross sections

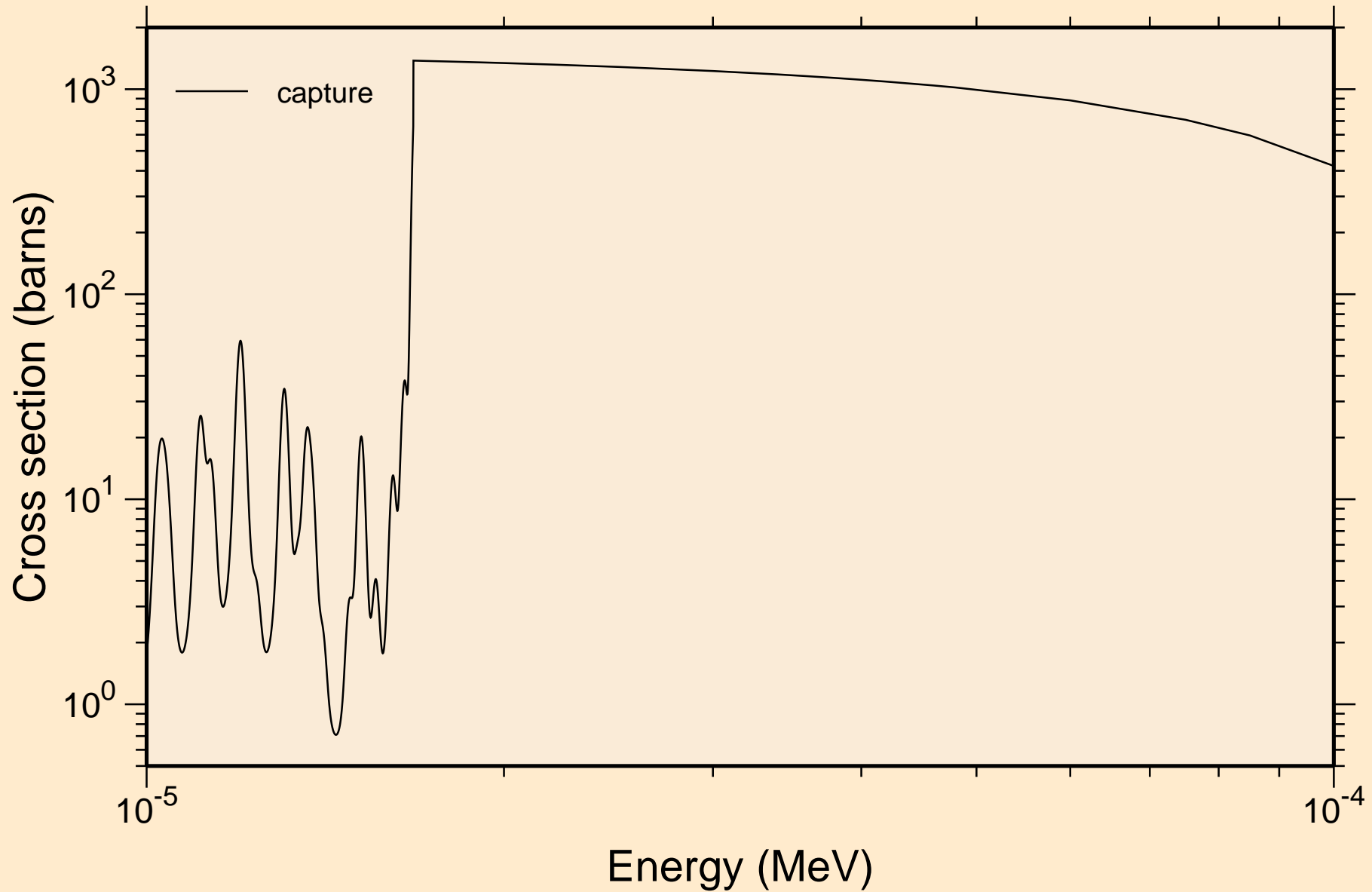

TB154 NEUTRON ACER TENDL-2021 LIBRARY; T=293.6K
resonance absorption cross sections

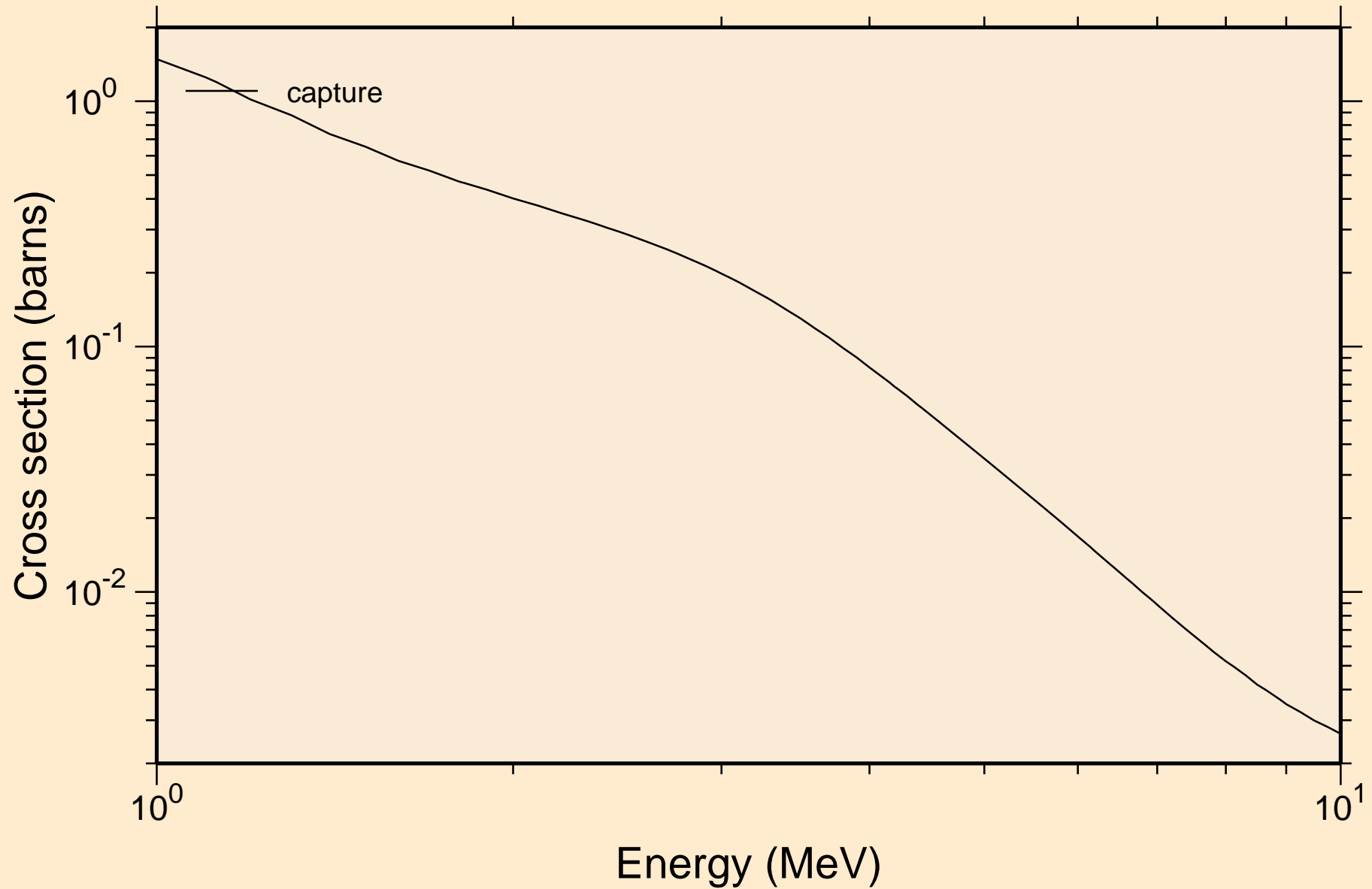

TB154 NEUTRON ACER TENDL-2021 LIBRARY; T=293.6K
Heating

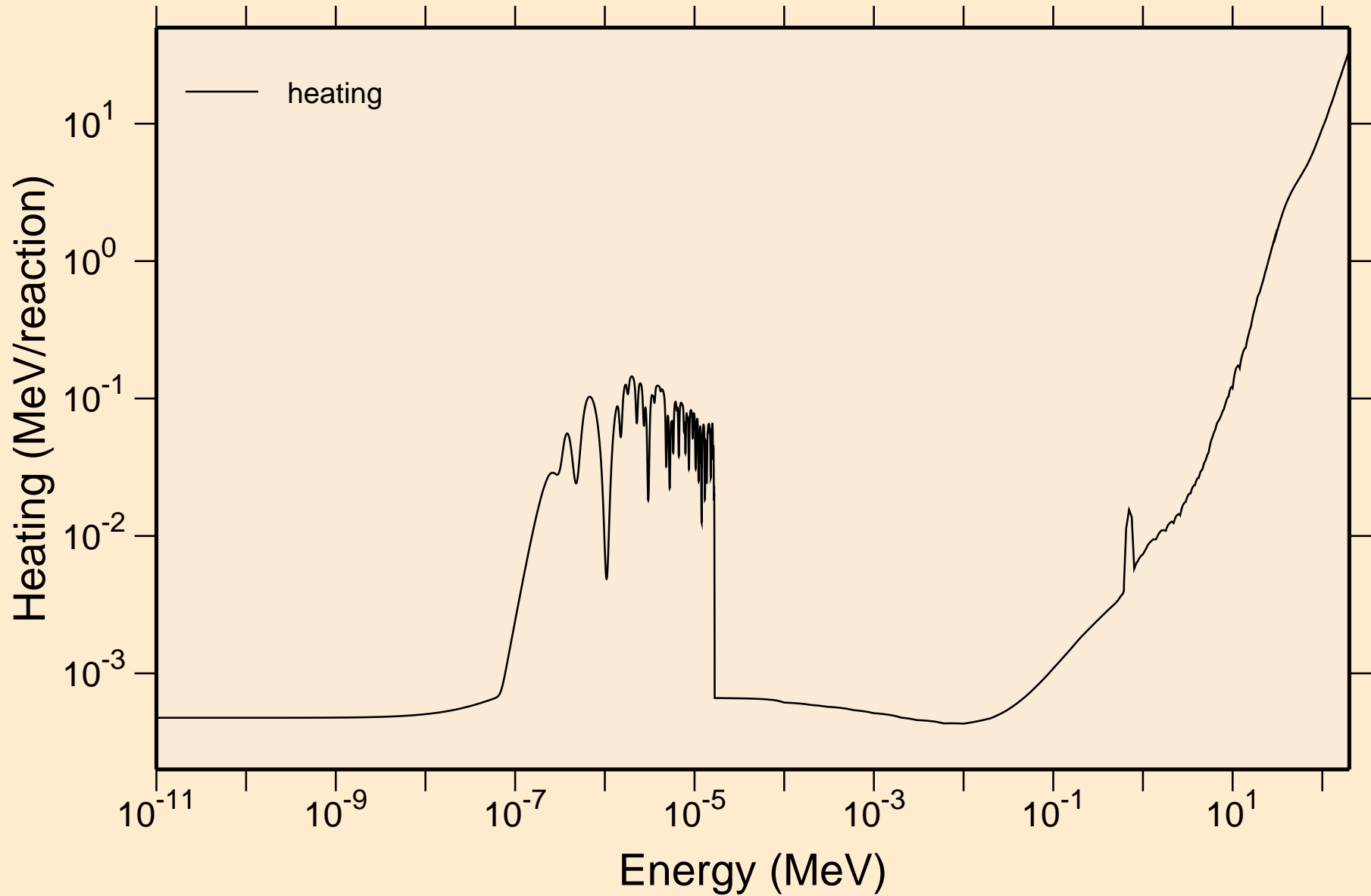

TB154 NEUTRON ACER TENDL-2021 LIBRARY; T=293.6K
Damage

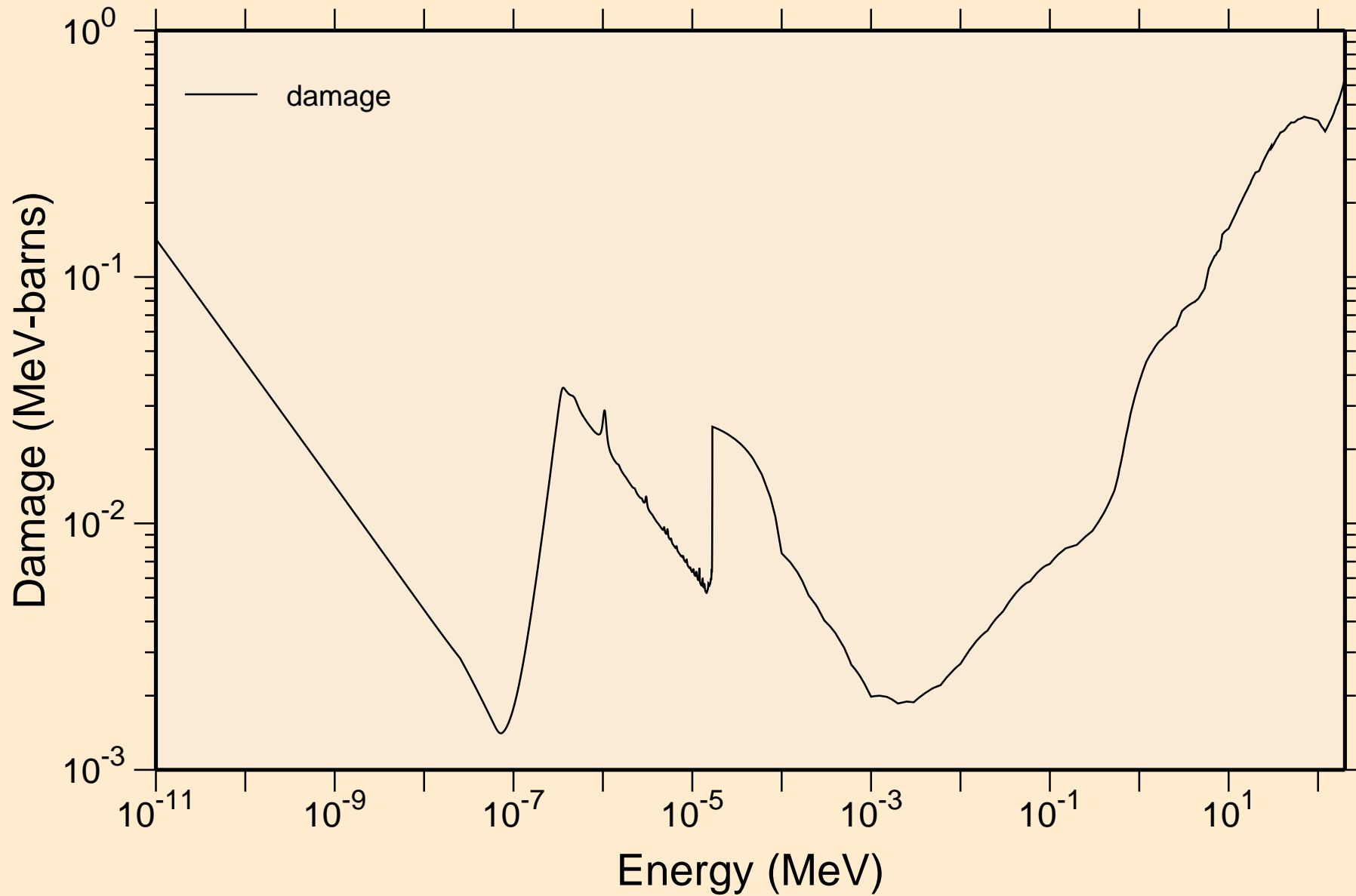

TB154 NEUTRON ACER TENDL-2021 LIBRARY; T=293.6K
Non-threshold reactions

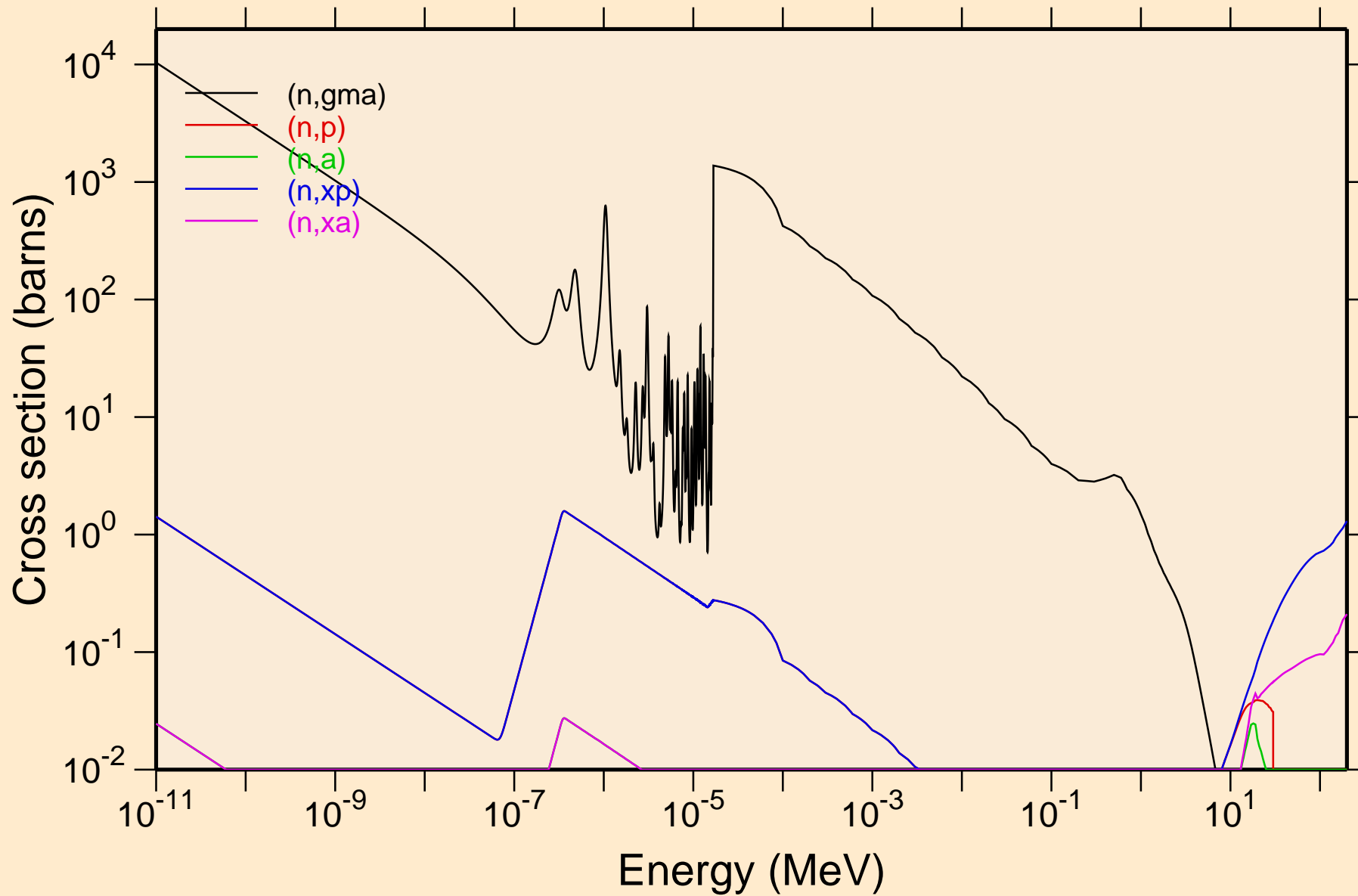

TB154 NEUTRON ACER TENDL-2021 LIBRARY; T=293.6K

Principal cross sections

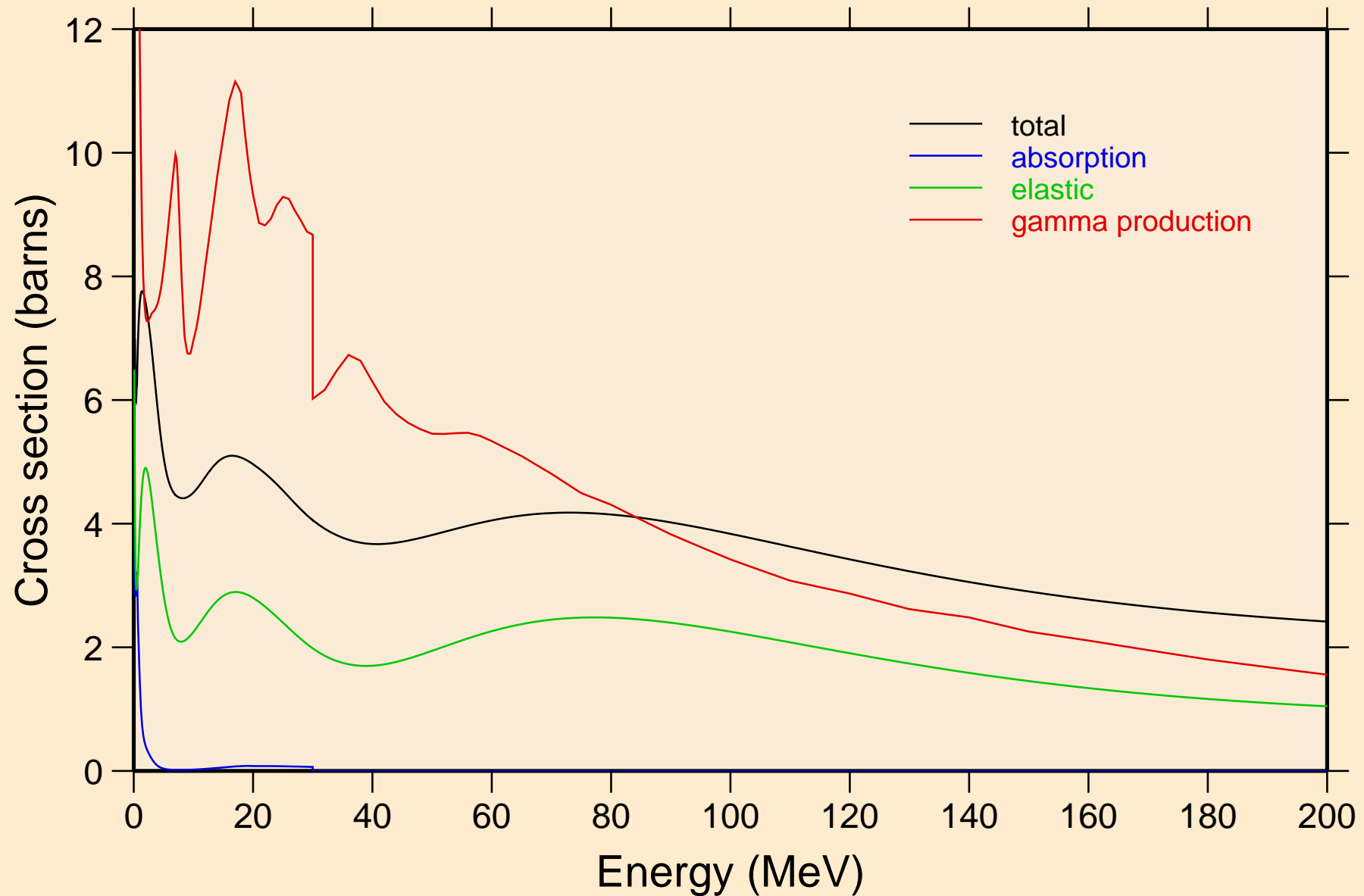

TB154 NEUTRON ACER TENDL-2021 LIBRARY; T=293.6K

Heating

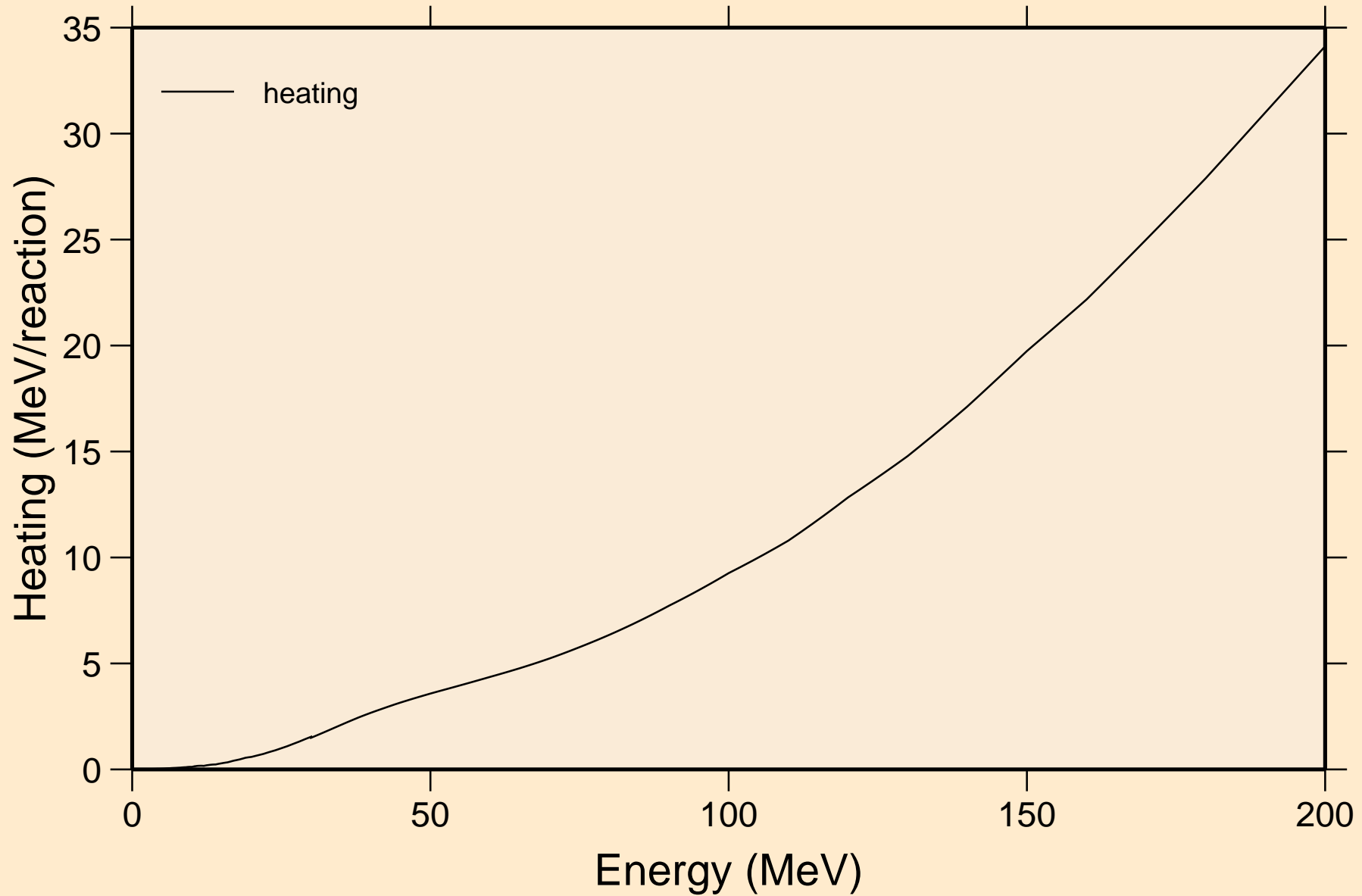

TB154 NEUTRON ACER TENDL-2021 LIBRARY; T=293.6K
Damage

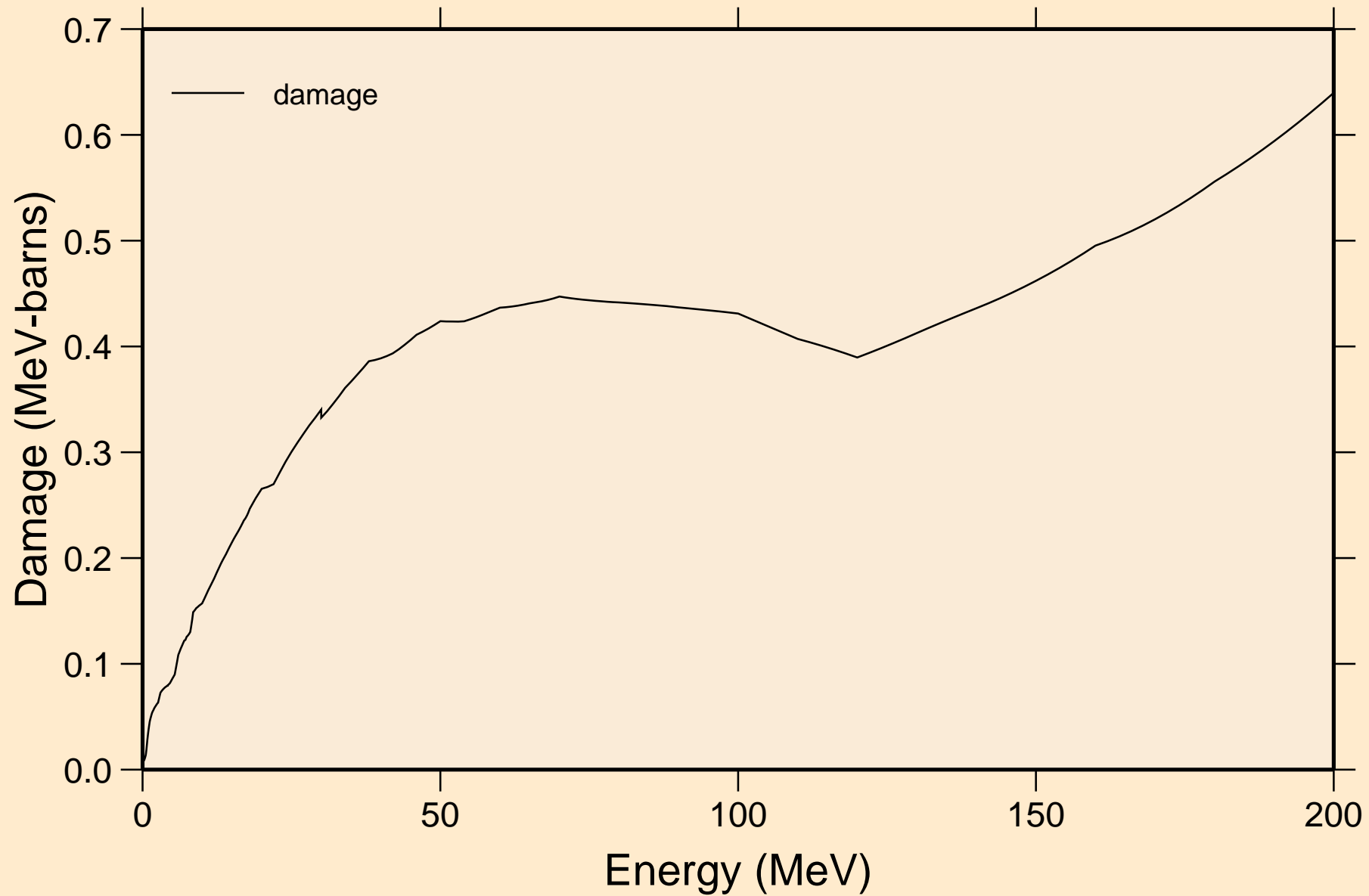

TB154 NEUTRON ACER TENDL-2021 LIBRARY; T=293.6K
Non-threshold reactions

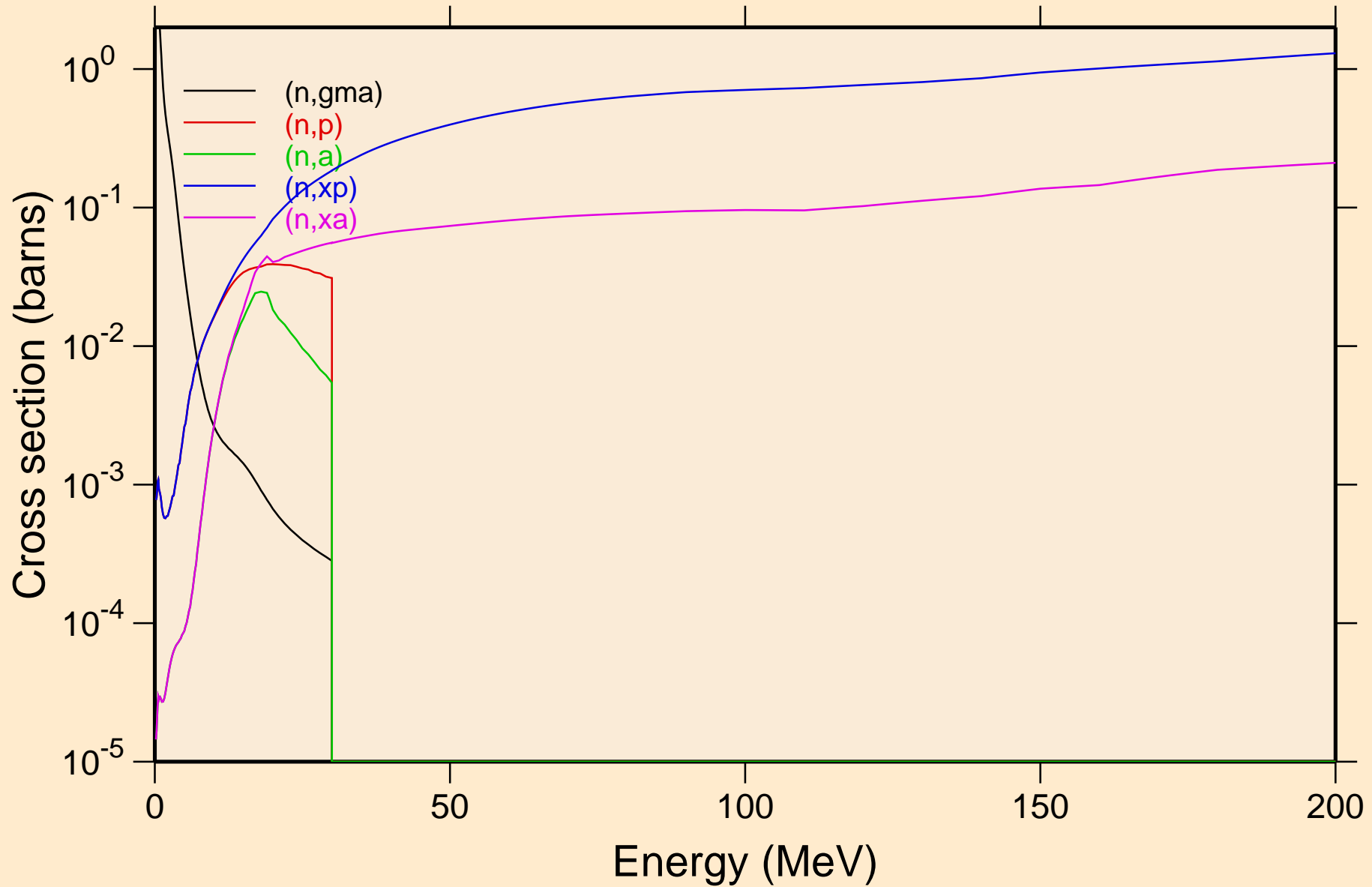

TB154 NEUTRON ACER TENDL-2021 LIBRARY; T=293.6K
Inelastic levels

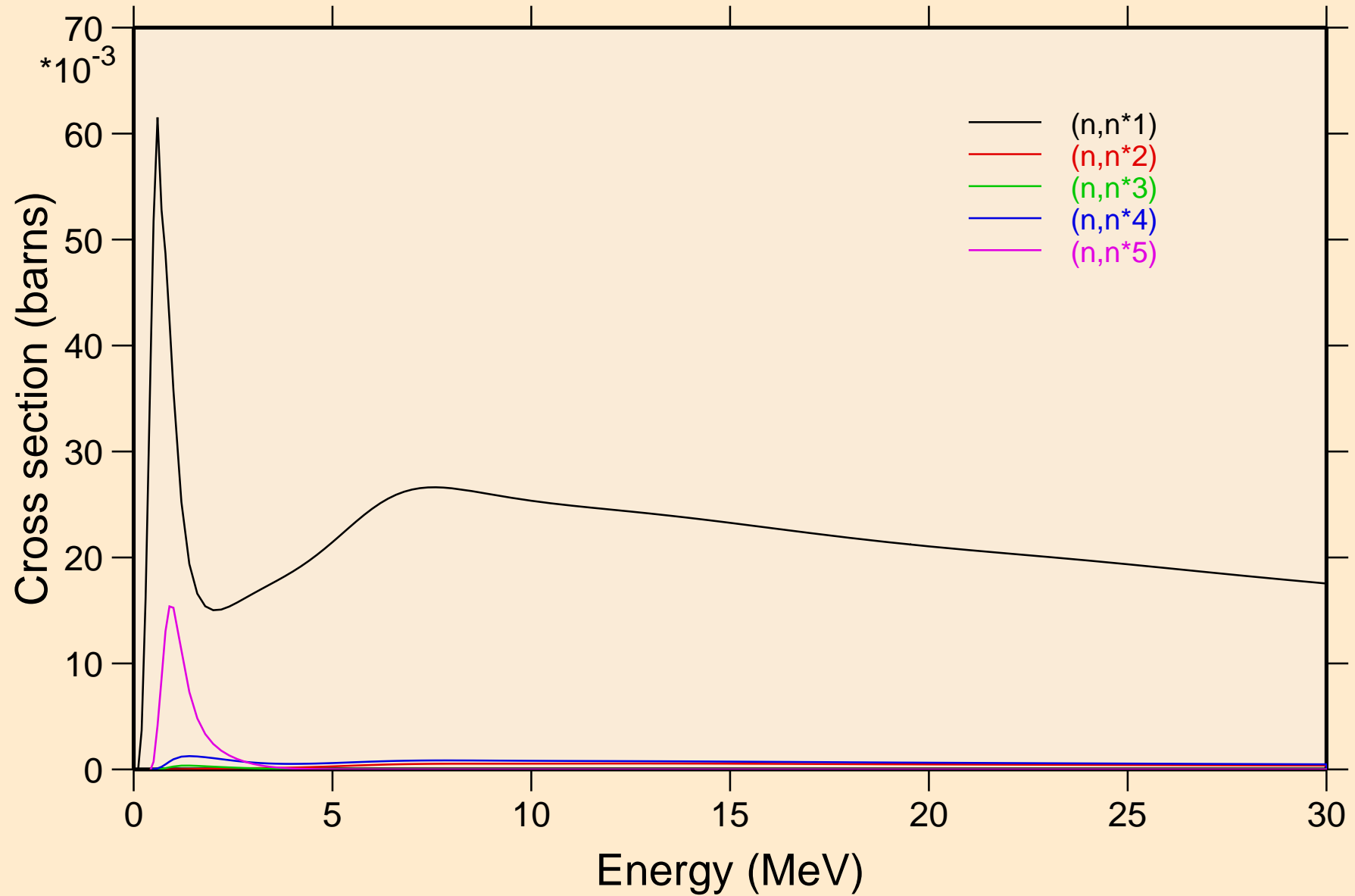

TB154 NEUTRON ACER TENDL-2021 LIBRARY; T=293.6K
Inelastic levels

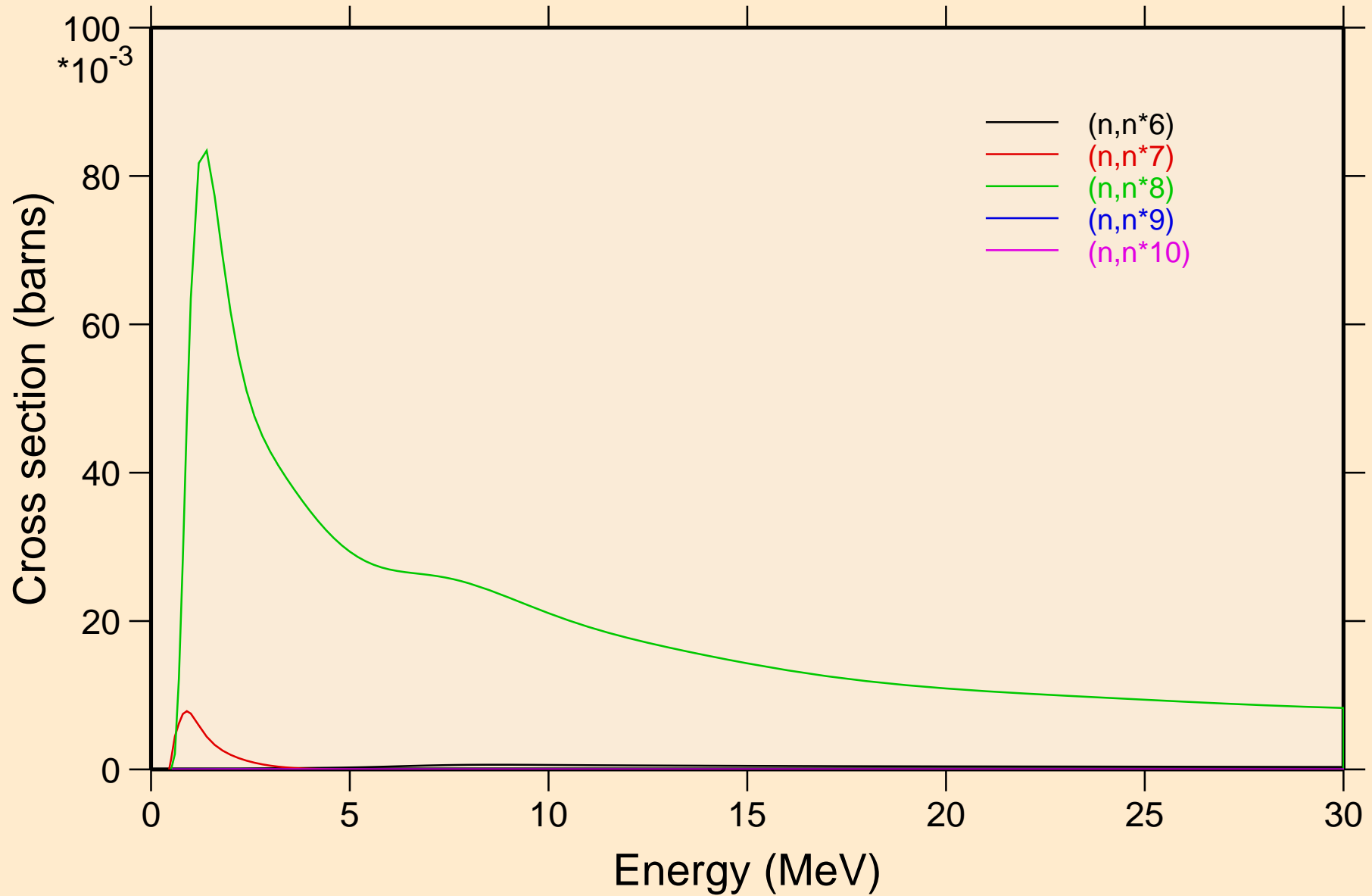

TB154 NEUTRON ACER TENDL-2021 LIBRARY; T=293.6K
Inelastic levels

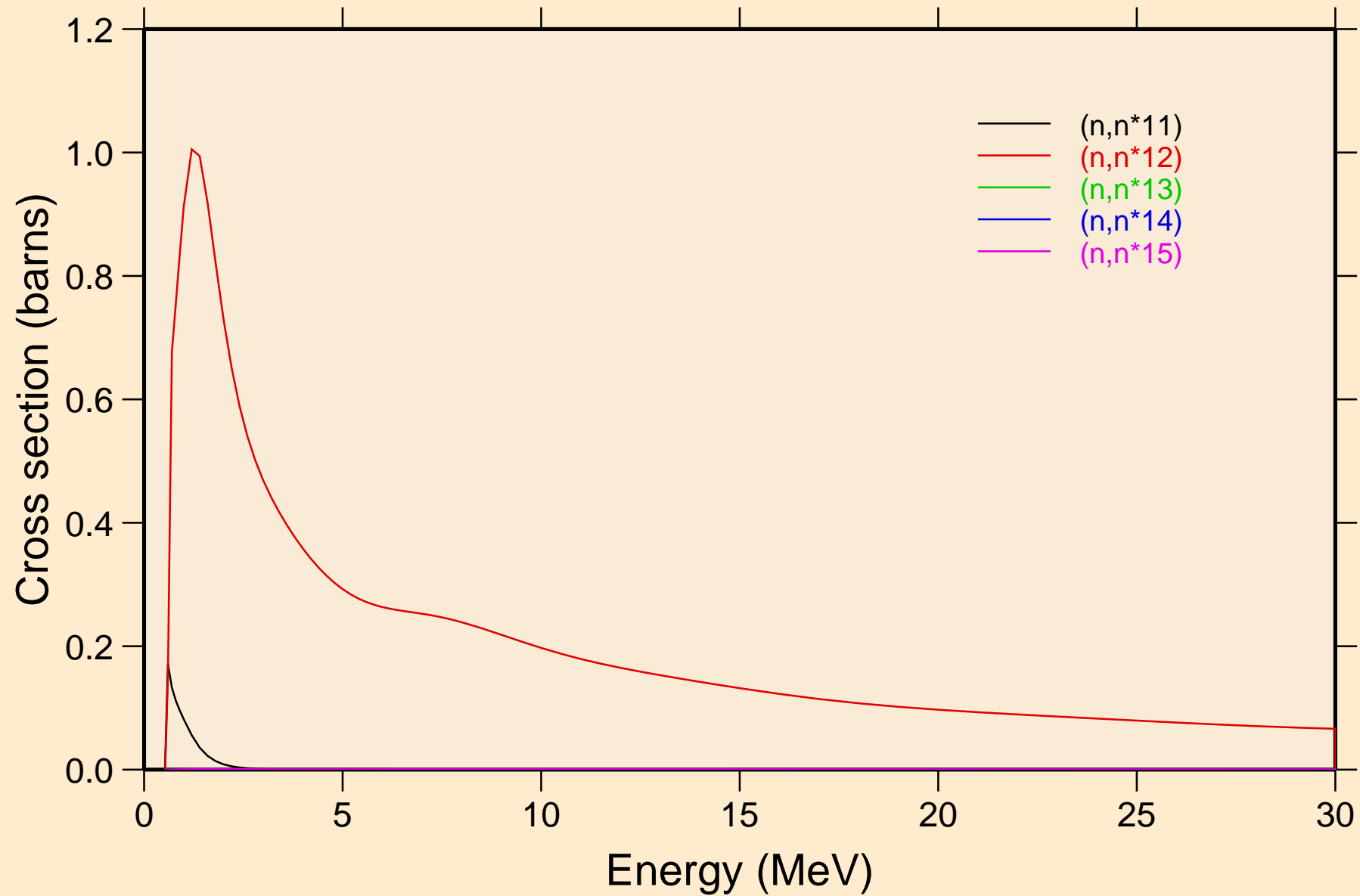

TB154 NEUTRON ACER TENDL-2021 LIBRARY; T=293.6K
Inelastic levels

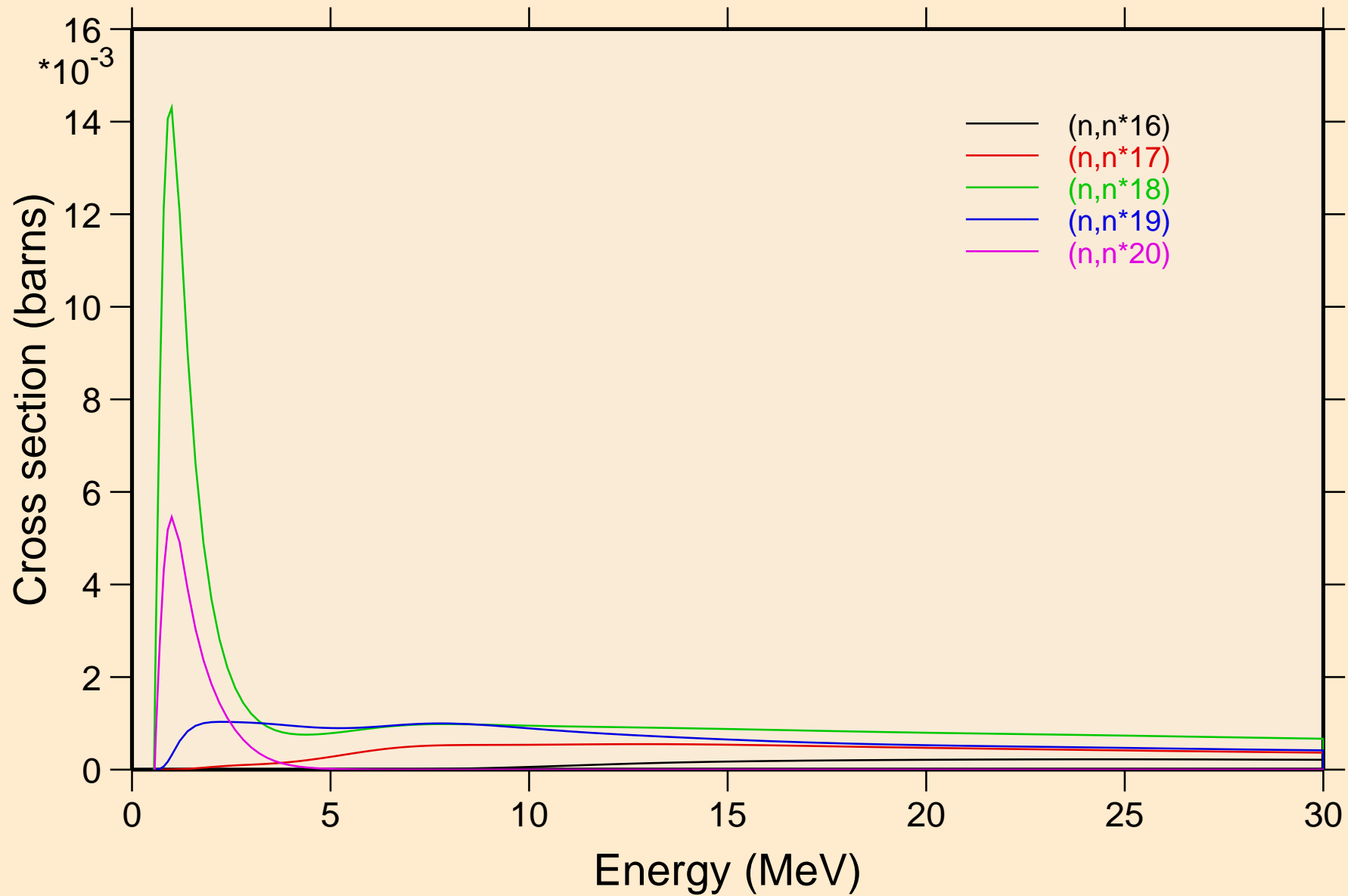

TB154 NEUTRON ACER TENDL-2021 LIBRARY; T=293.6K
Inelastic levels

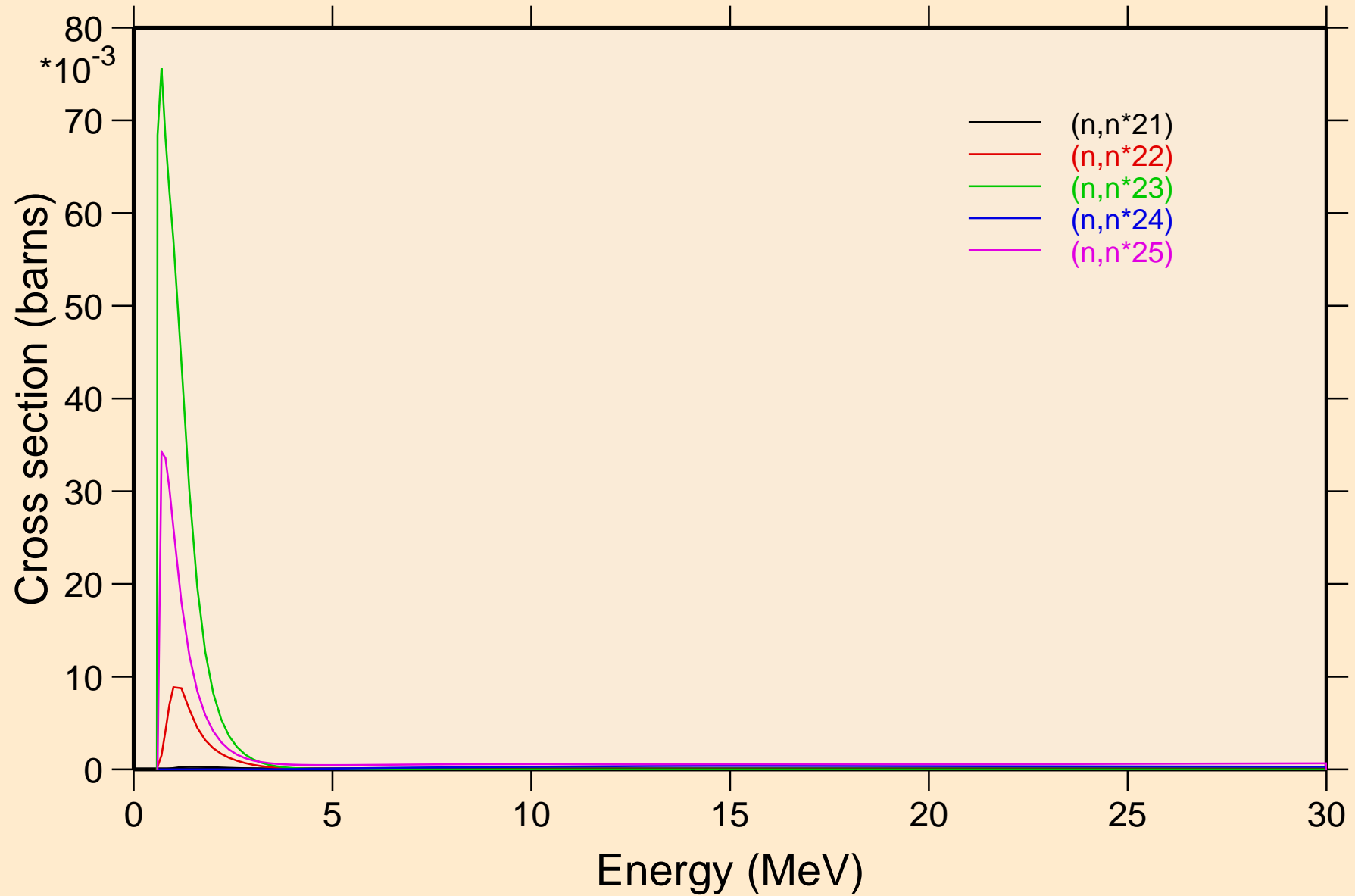

TB154 NEUTRON ACER TENDL-2021 LIBRARY; T=293.6K
Inelastic levels

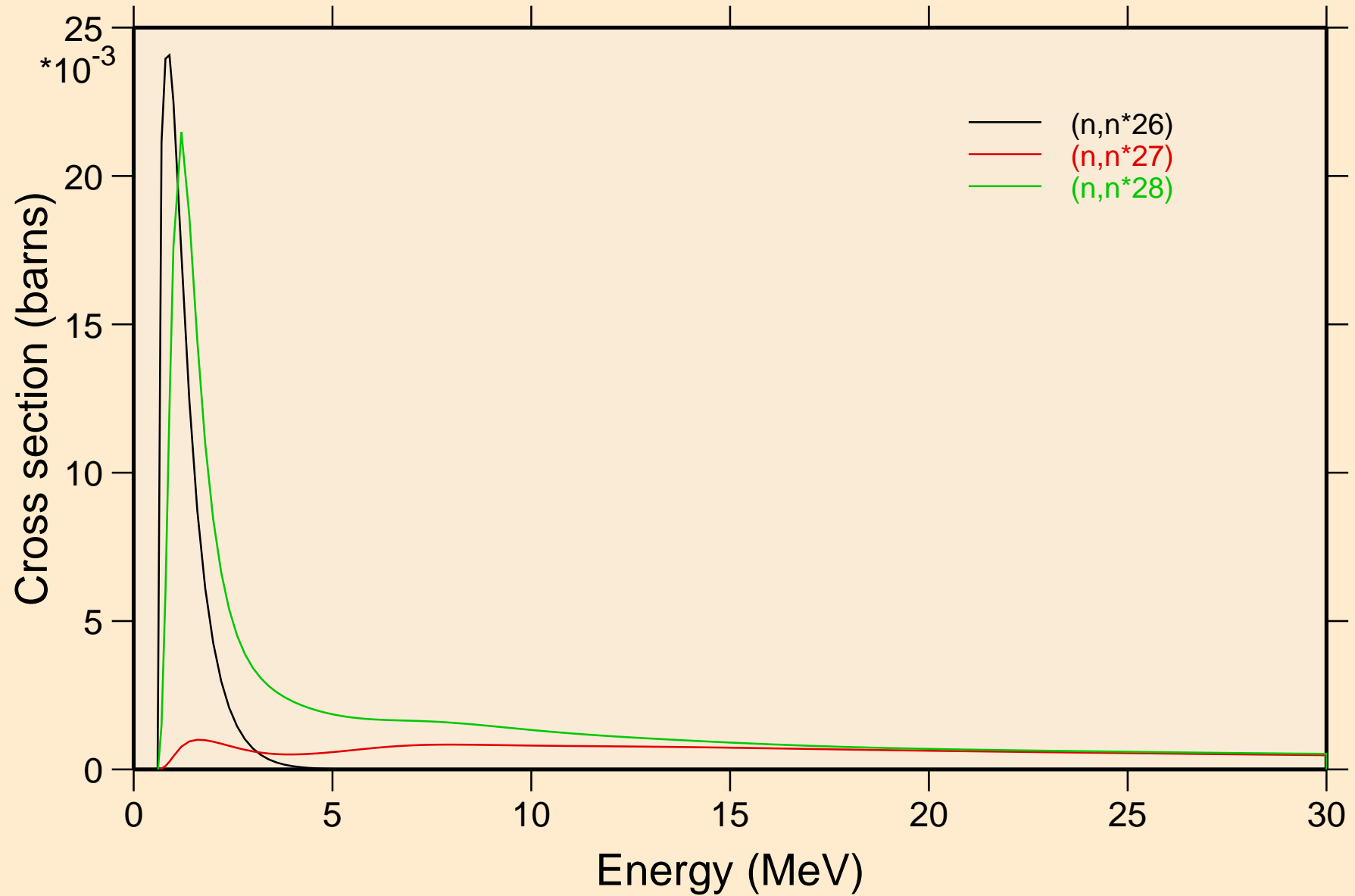

TB154 NEUTRON ACER TENDL-2021 LIBRARY; T=293.6K
Threshold reactions

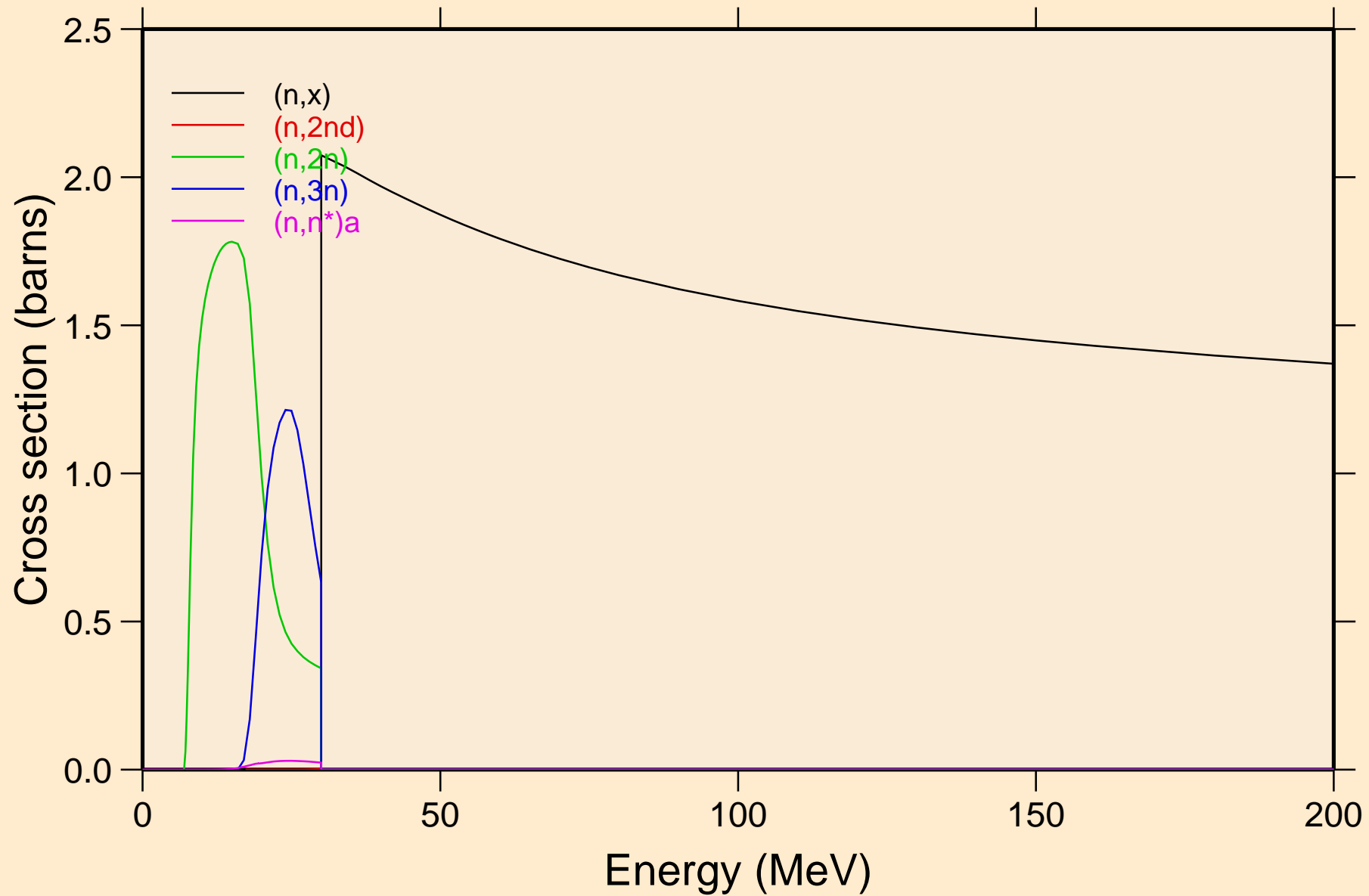

TB154 NEUTRON ACER TENDL-2021 LIBRARY; T=293.6K
Threshold reactions

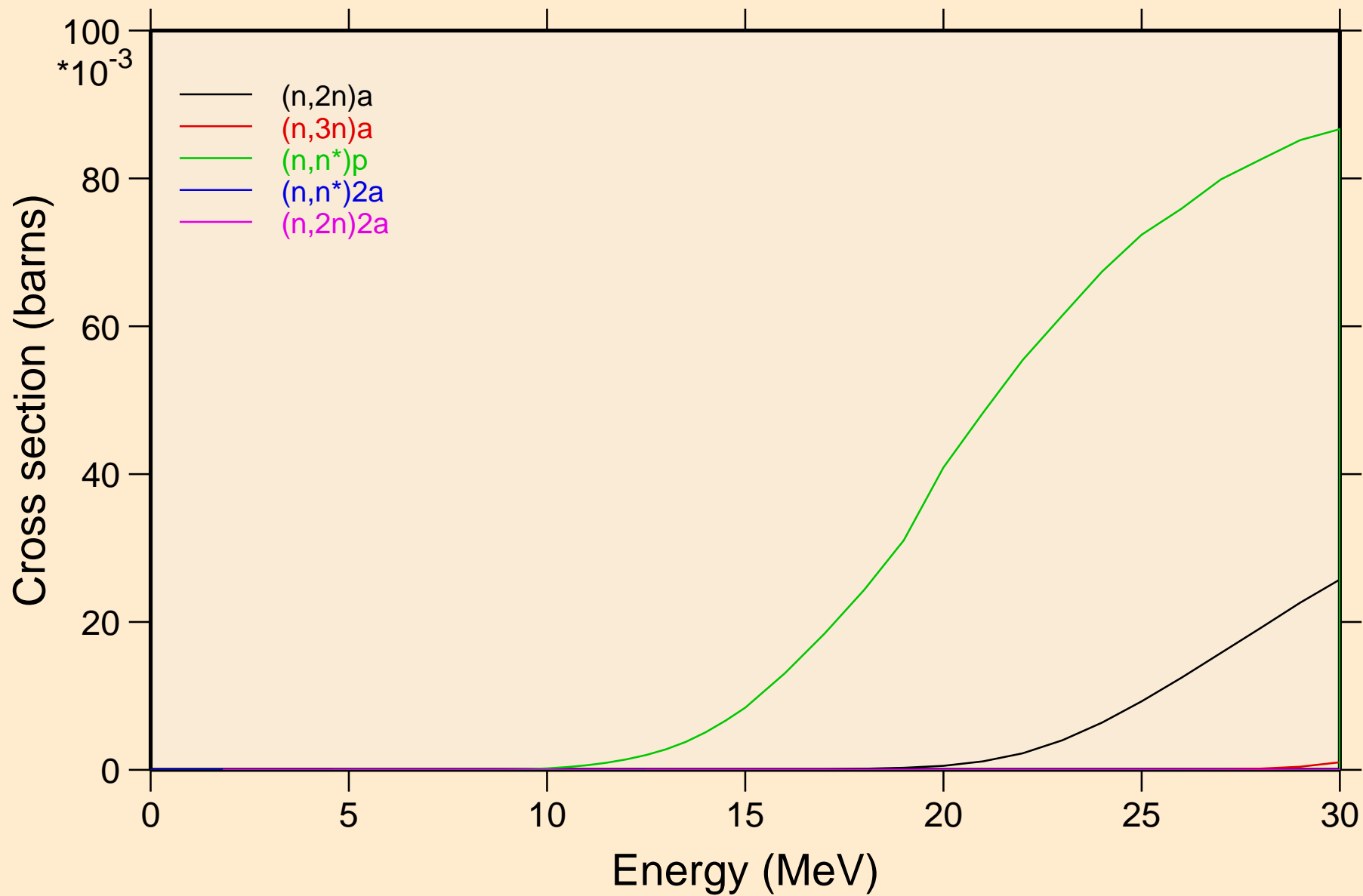

TB154 NEUTRON ACER TENDL-2021 LIBRARY; T=293.6K
Threshold reactions

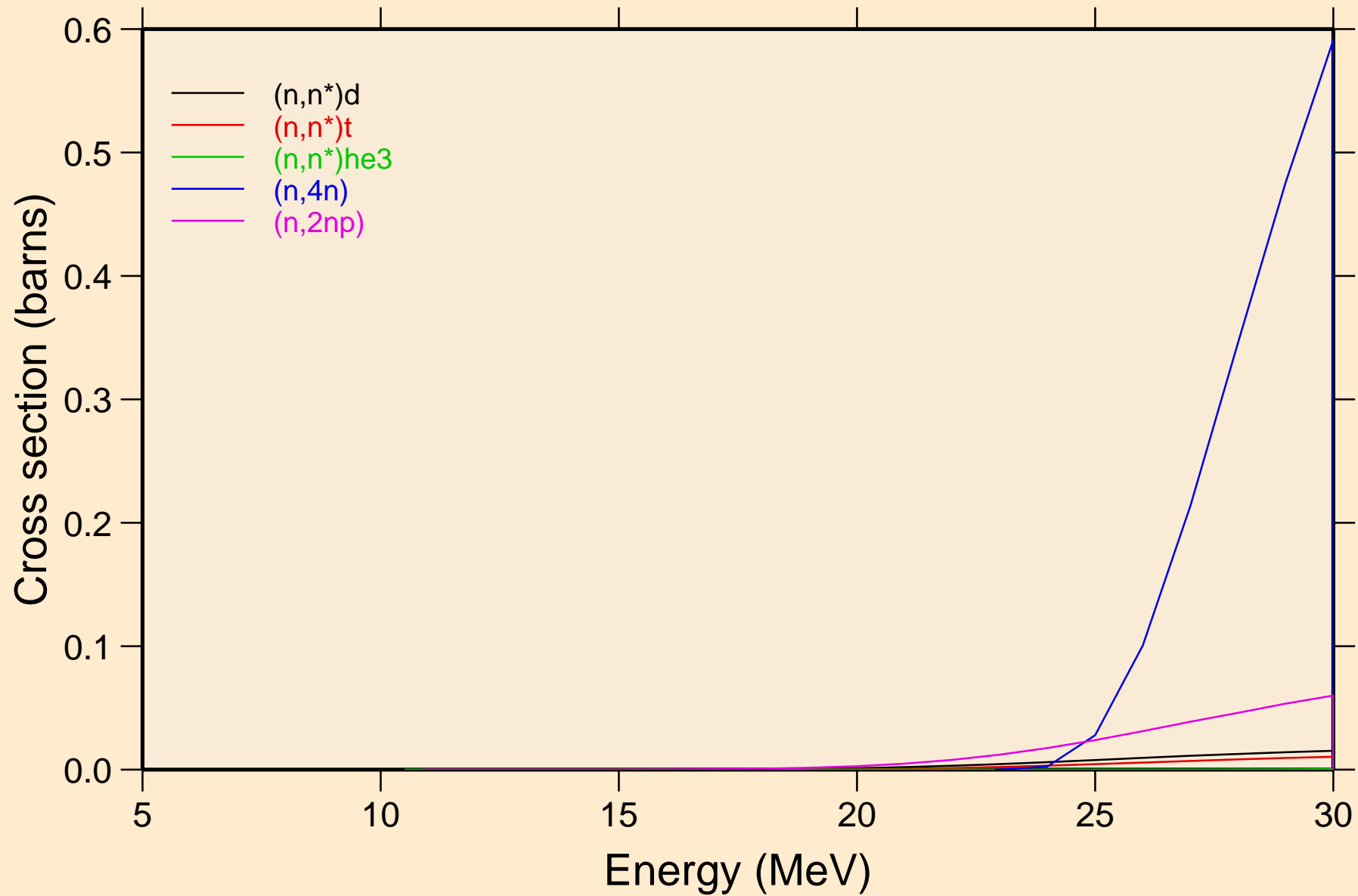

TB154 NEUTRON ACER TENDL-2021 LIBRARY; T=293.6K
Threshold reactions

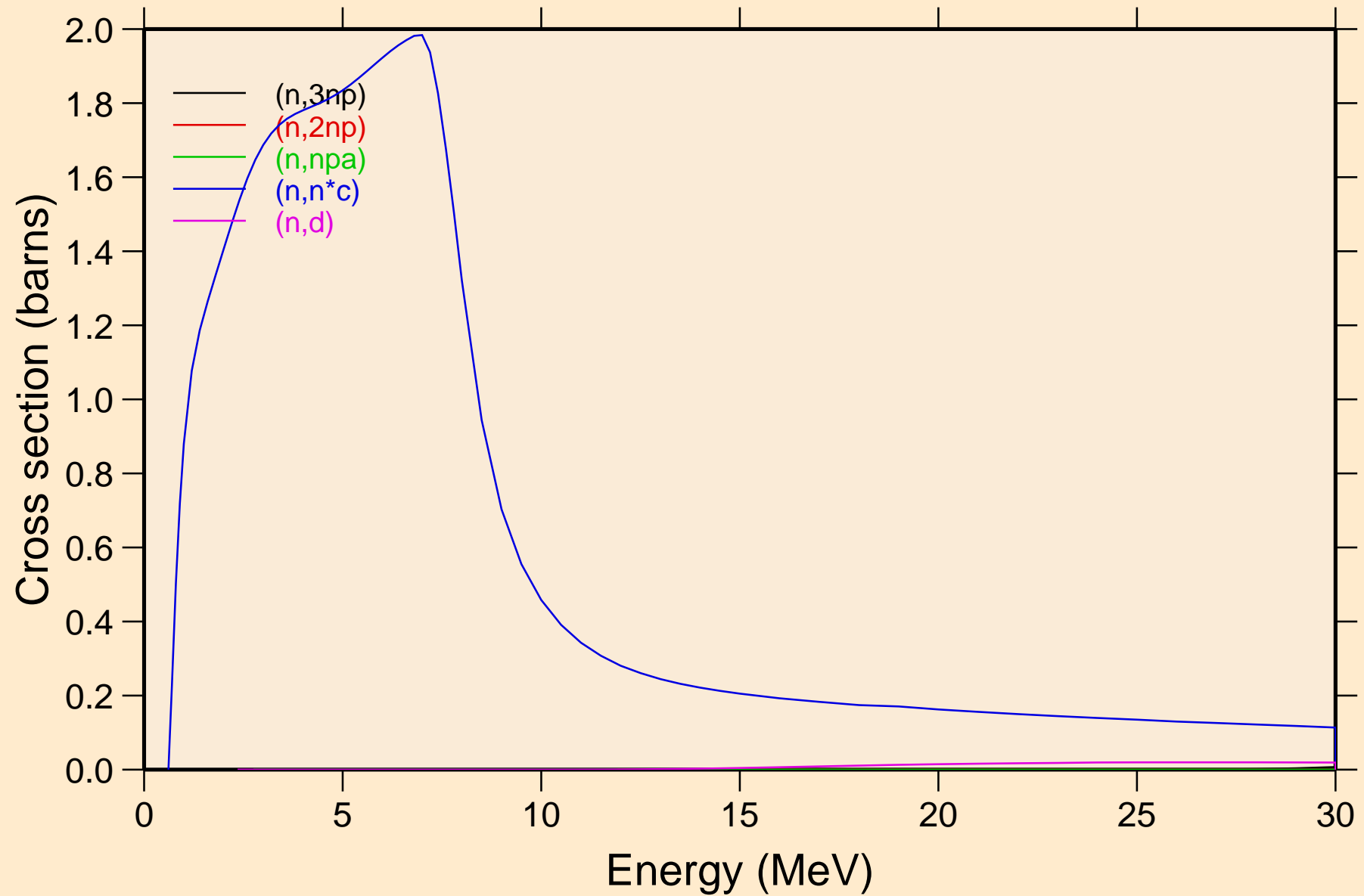

TB154 NEUTRON ACER TENDL-2021 LIBRARY; T=293.6K
Threshold reactions

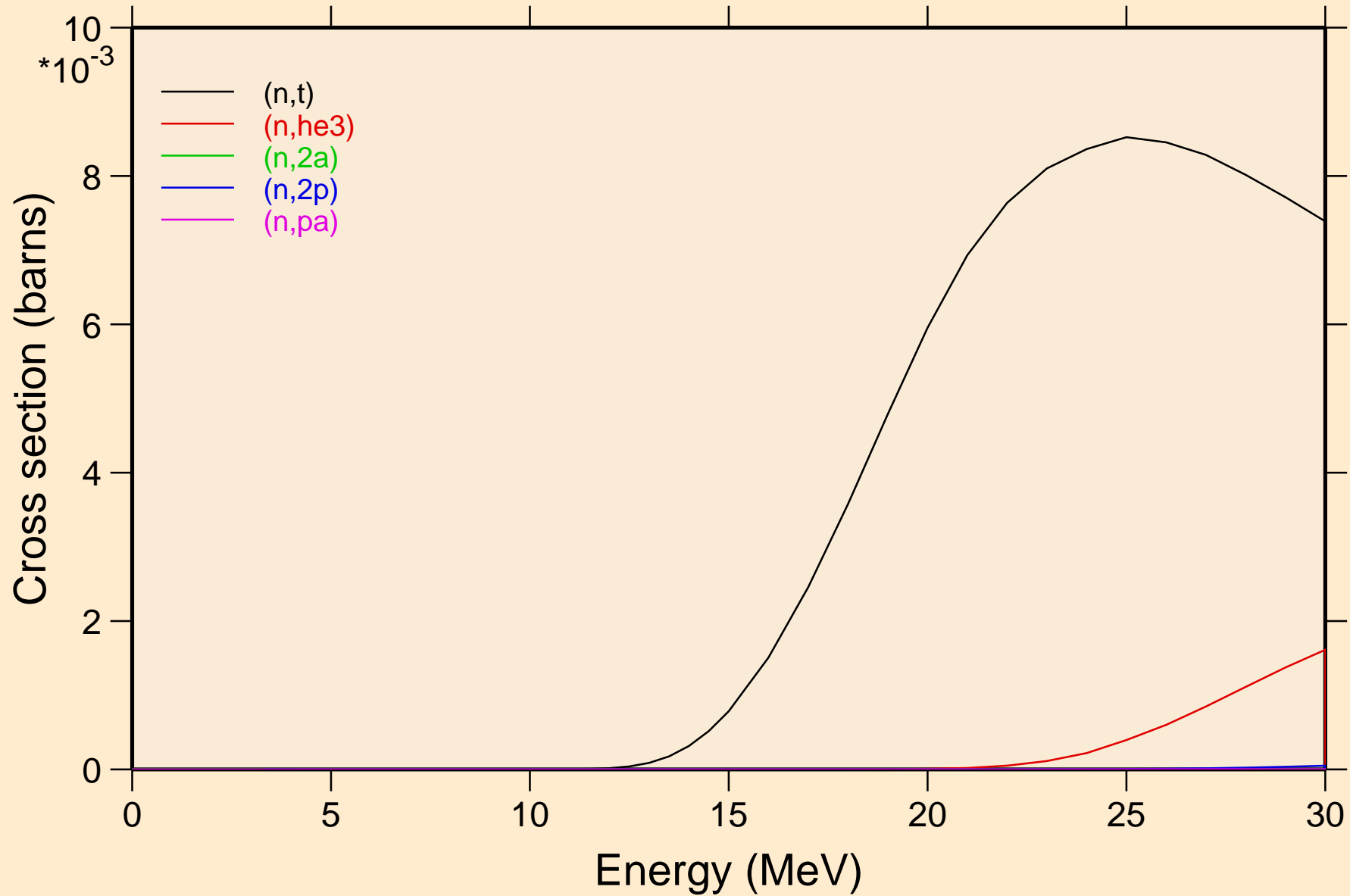

TB154 NEUTRON ACER TENDL-2021 LIBRARY; T=293.6K
Threshold reactions

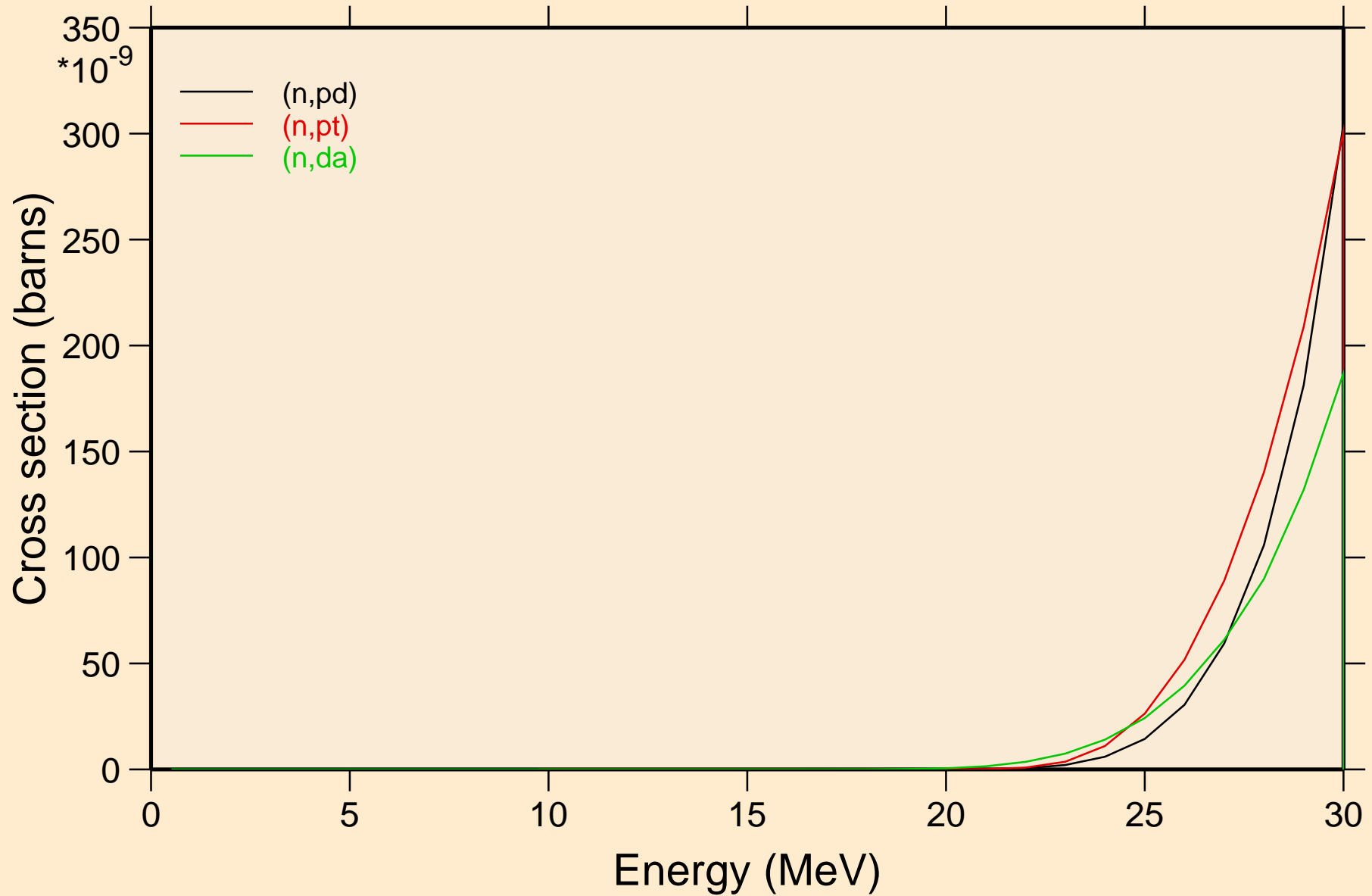

TB154 NEUTRON ACER TENDL-2021 LIBRARY; T=293.6K
Threshold reactions

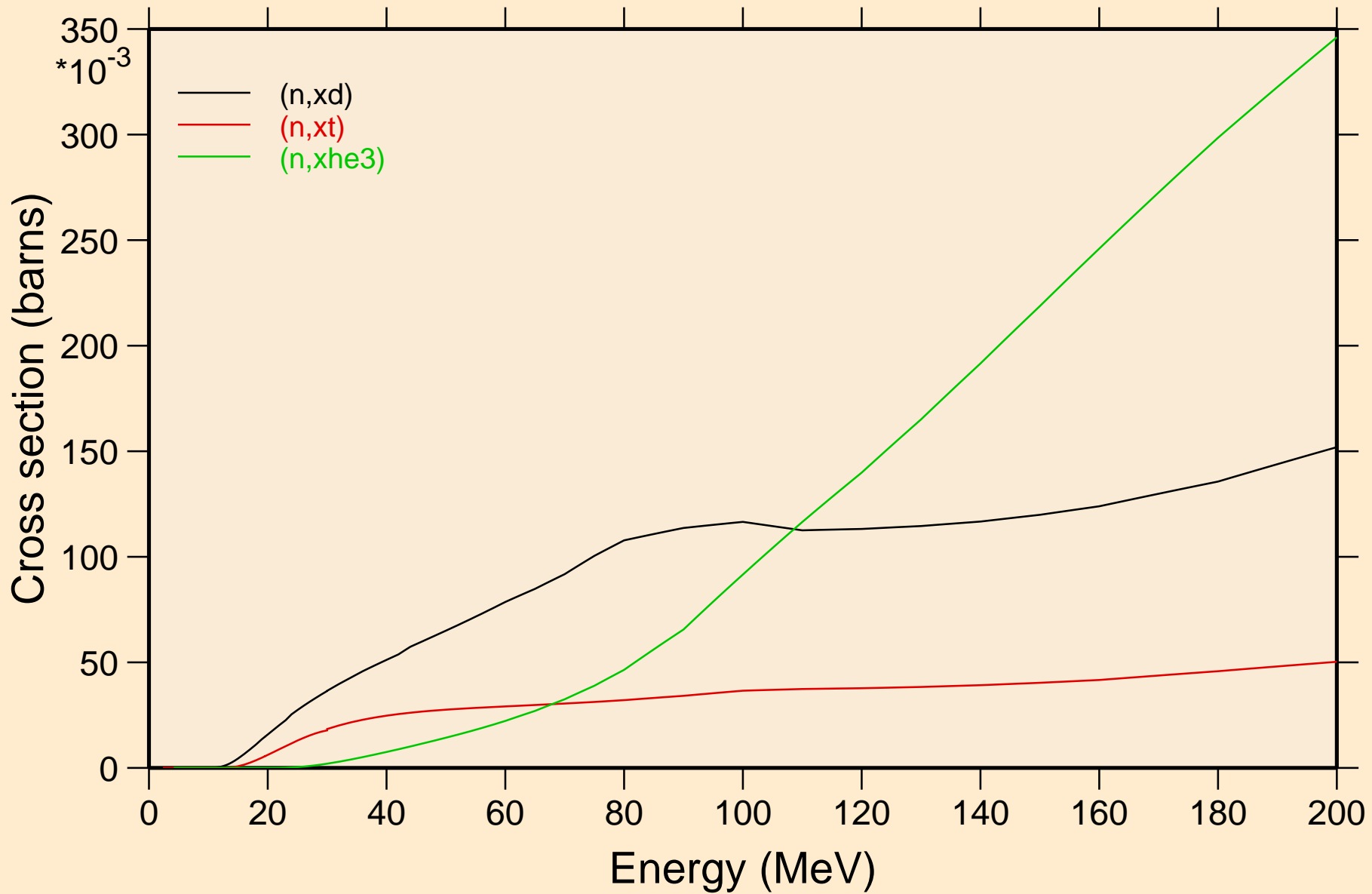

TB154 NEUTRON ACER TENDL-2021 LIBRARY; T=293.6K
angular distribution for elastic

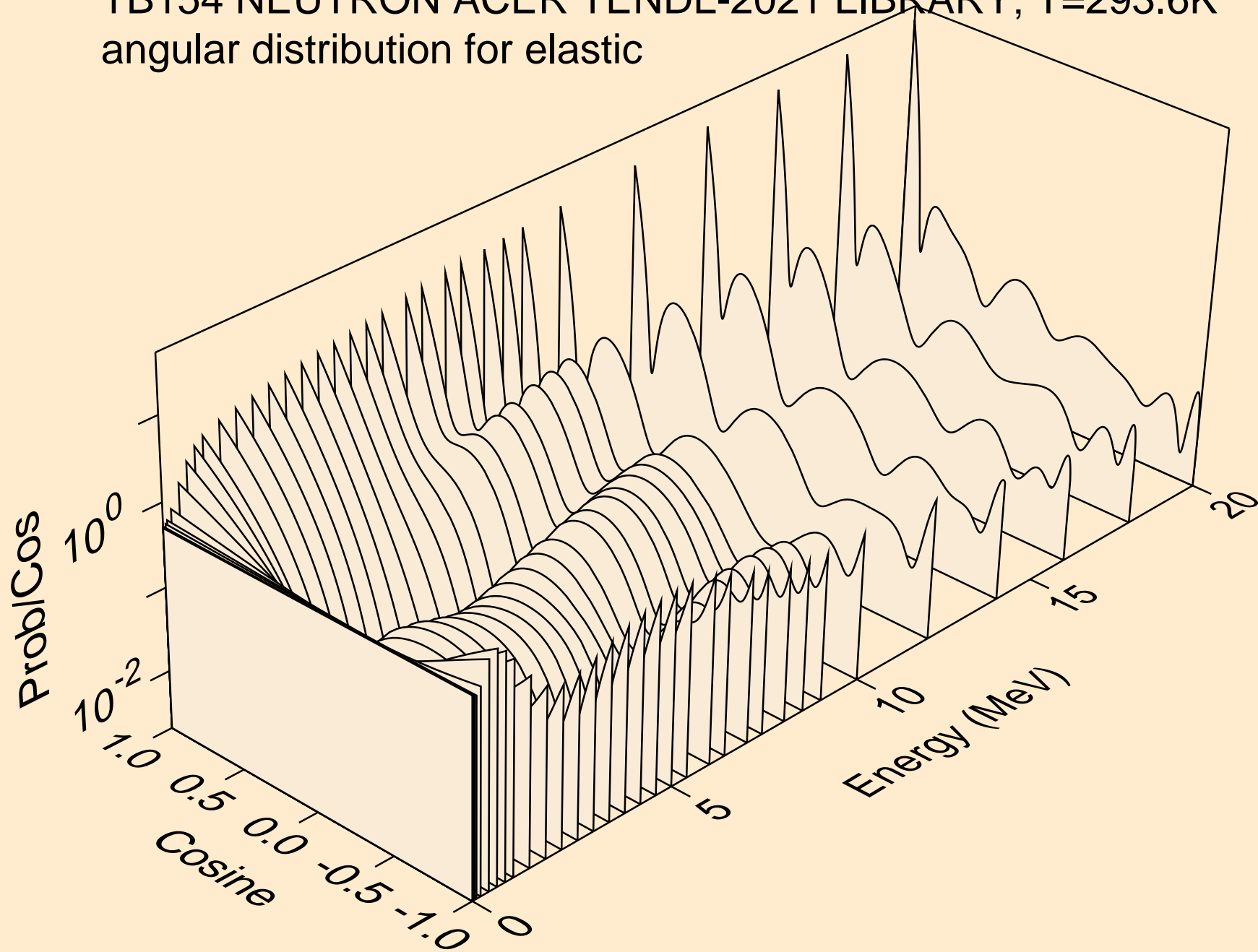

TB154 NEUTRON ACER TENDL-2021 LIBRARY; T=293.6K
angular distribution for elastic

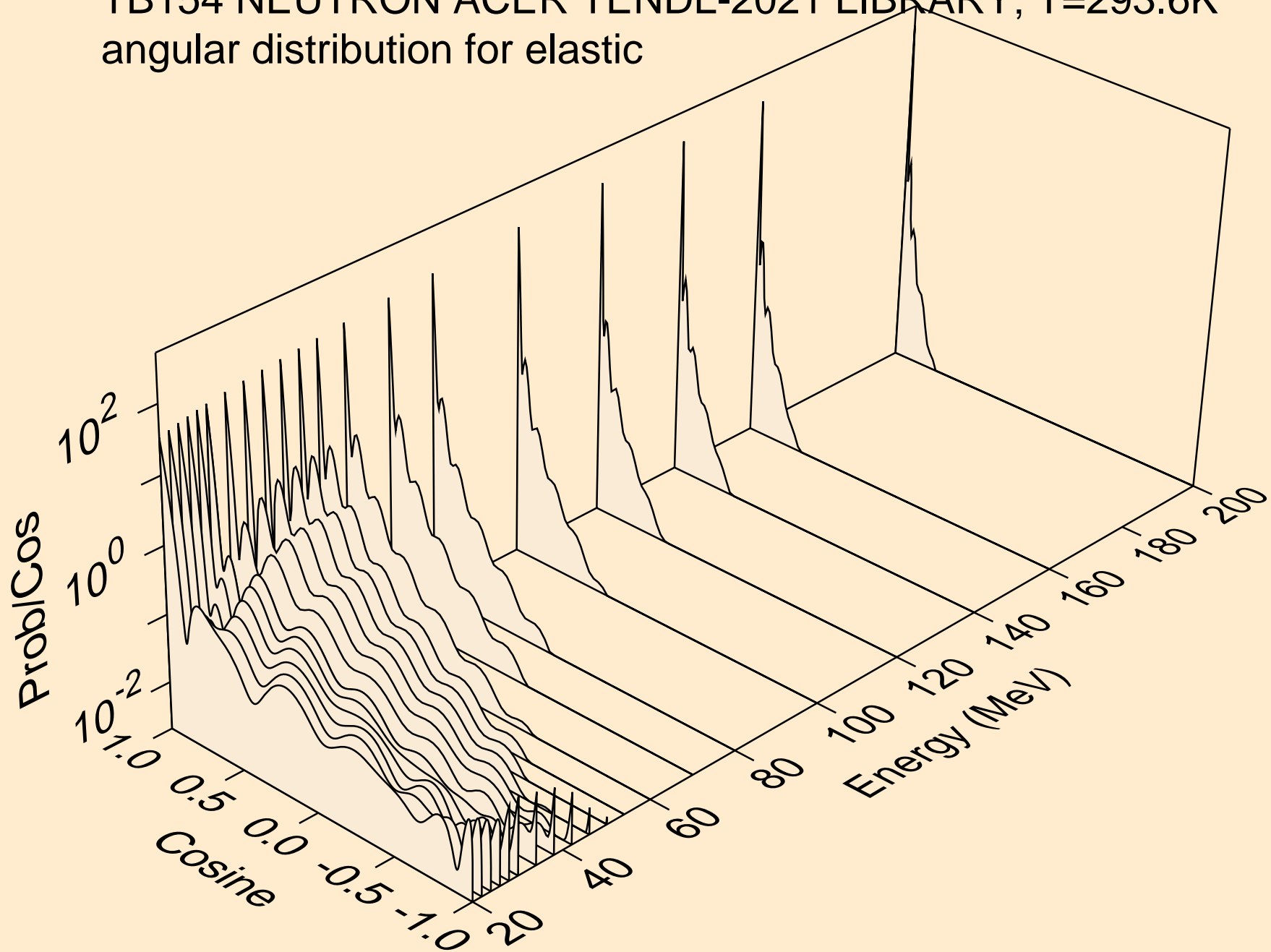

TB154 NEUTRON ACER TENDL-2021 LIBRARY; T=293.6K
angular distribution for (n,n*1)

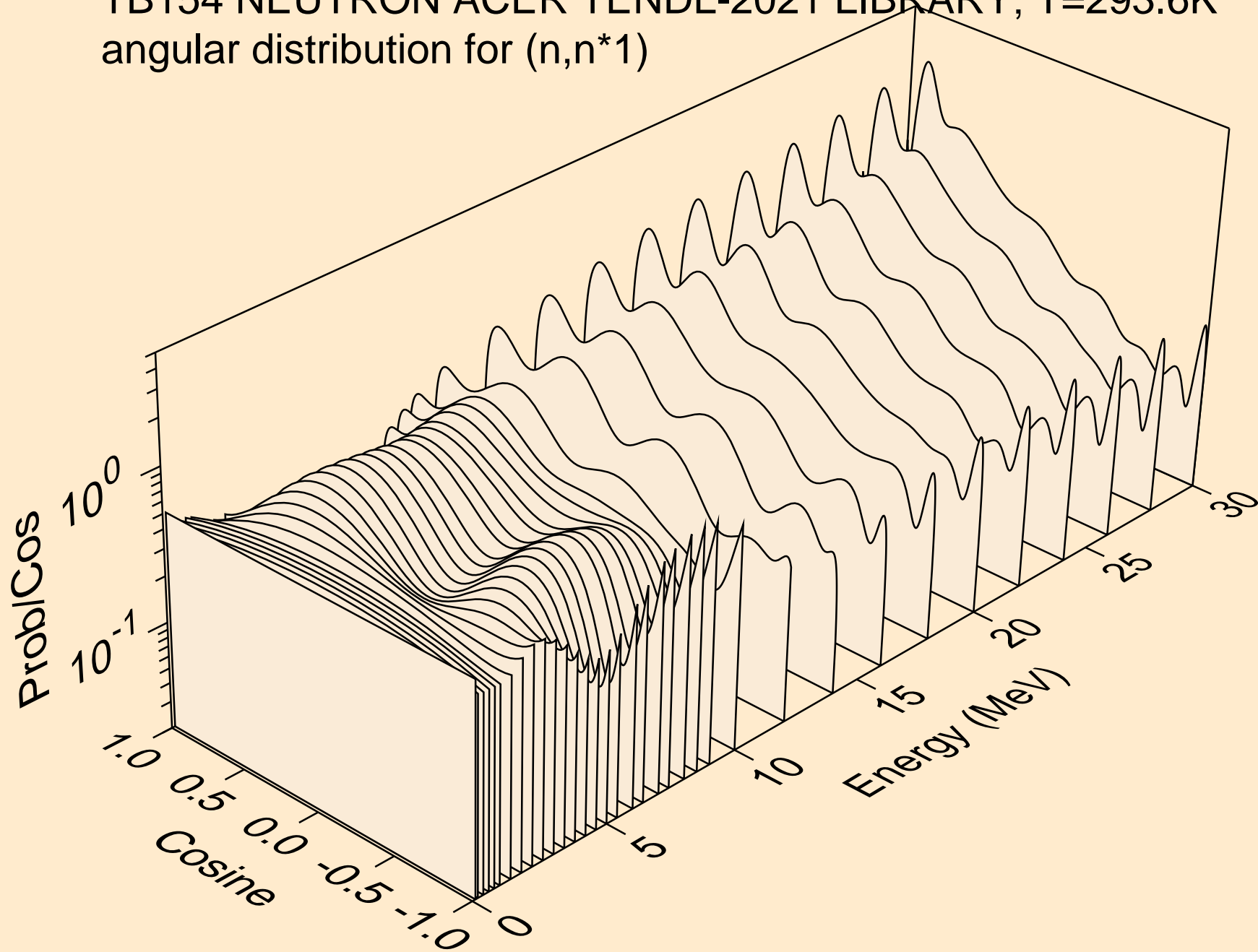

TB154 NEUTRON ACER TENDL-2021 LIBRARY; T=293.6K
angular distribution for (n,n*2)

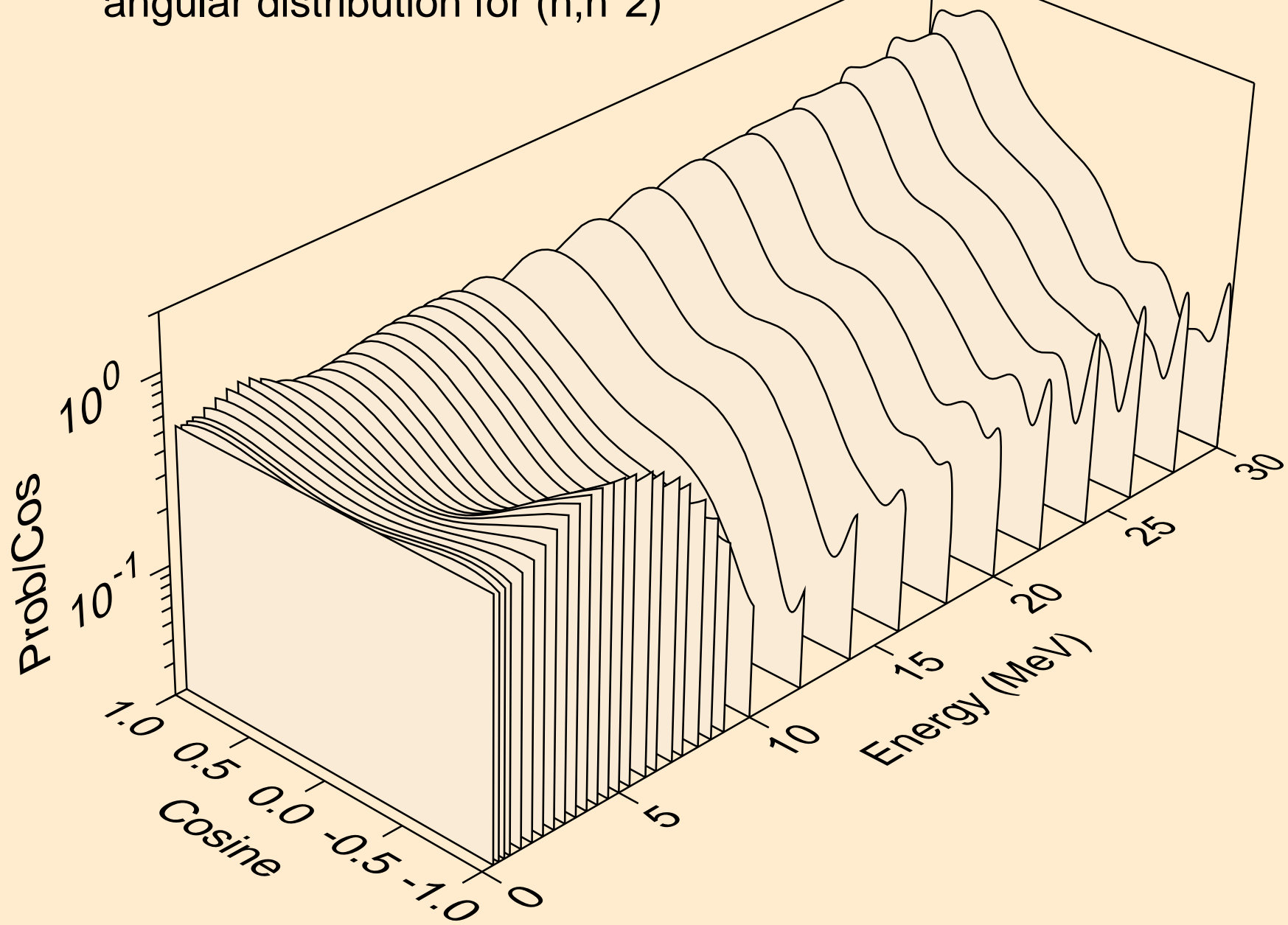

TB154 NEUTRON ACER TENDL-2021 LIBRARY; T=293.6K
angular distribution for (n,n*3)

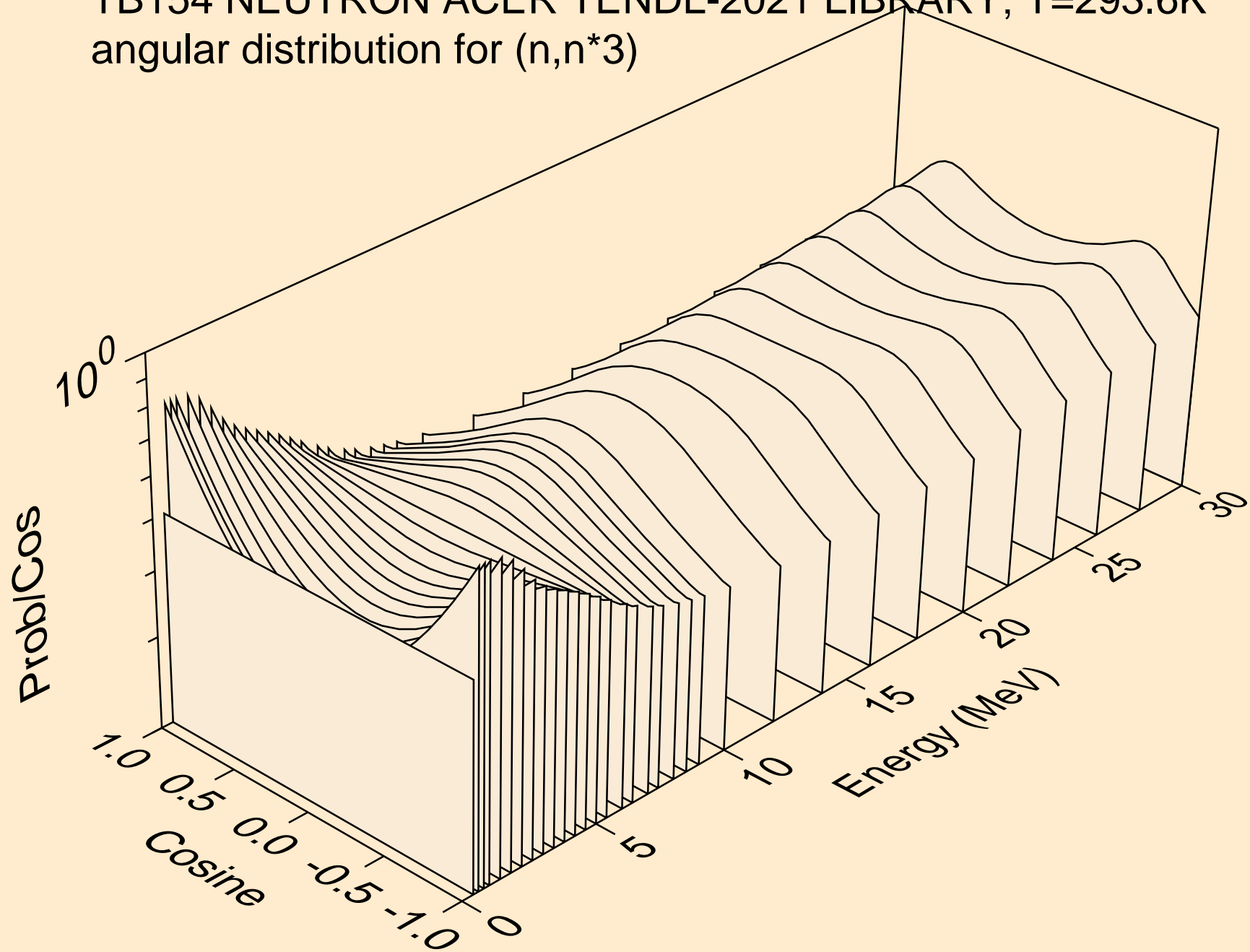

TB154 NEUTRON ACER TENDL-2021 LIBRARY; T=293.6K
angular distribution for (n,n*4)

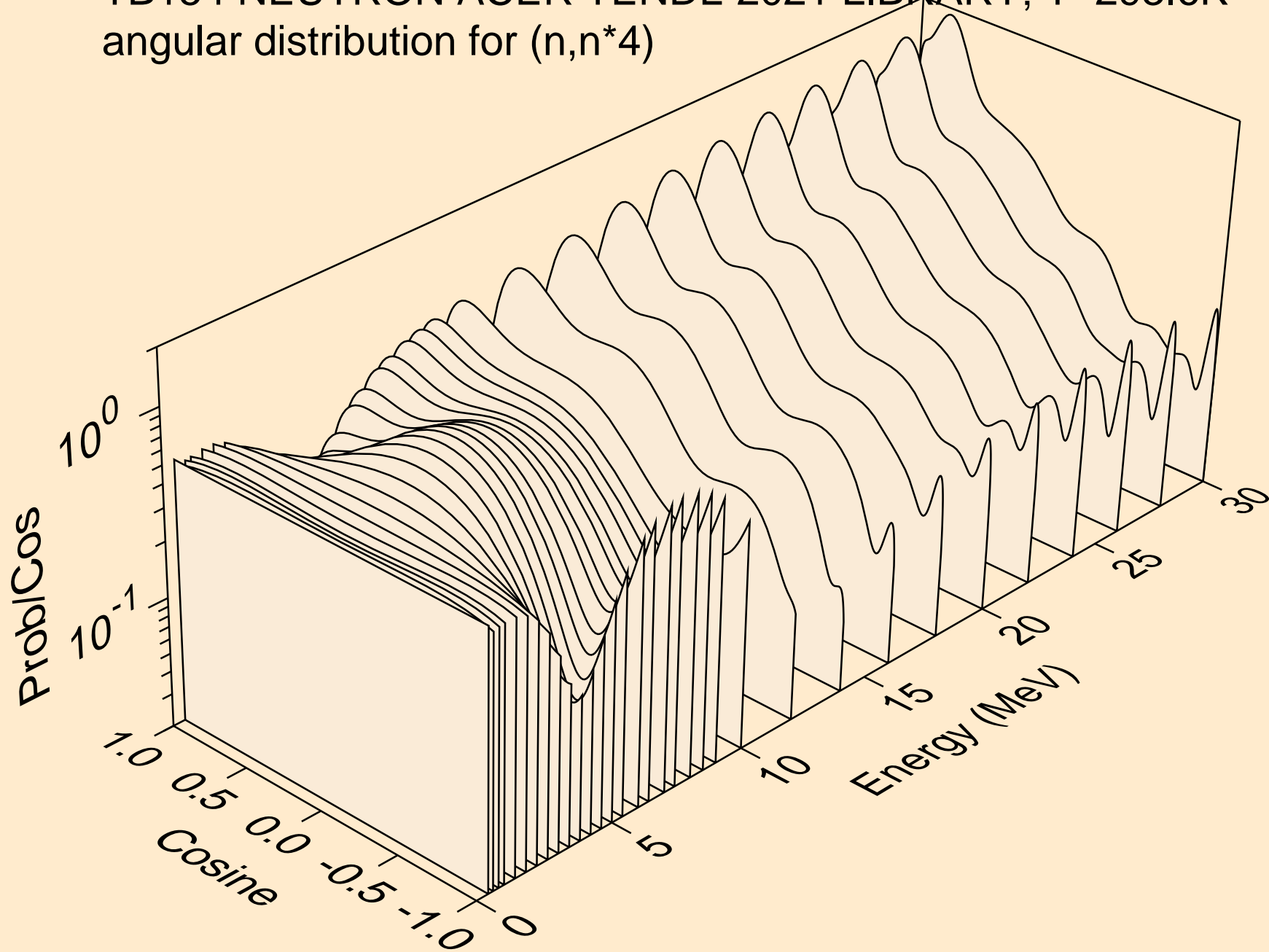

TB154 NEUTRON ACER TENDL-2021 LIBRARY; T=293.6K
angular distribution for (n,n*5)

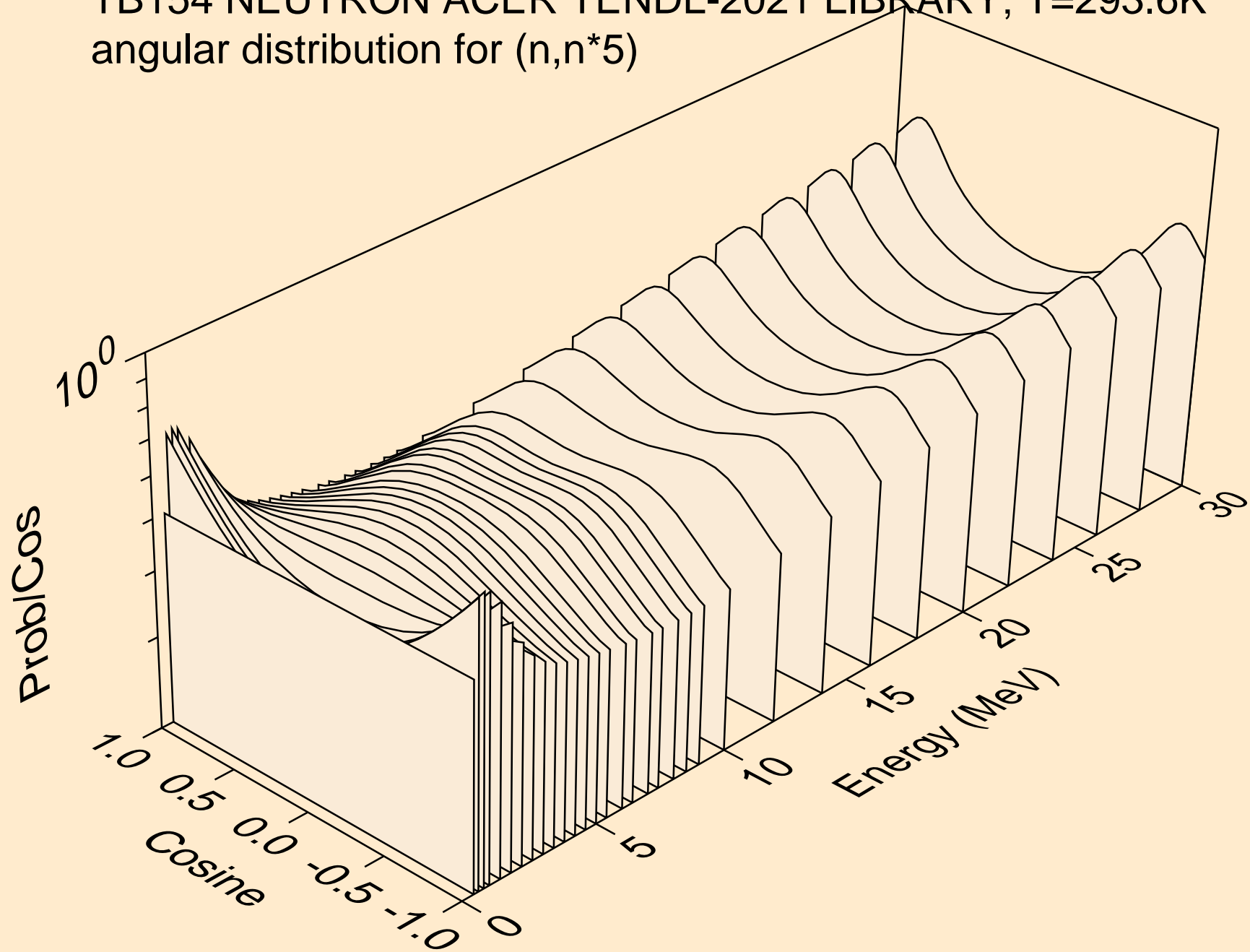

TB154 NEUTRON ACER TENDL-2021 LIBRARY; T=293.6K
angular distribution for (n,n*6)

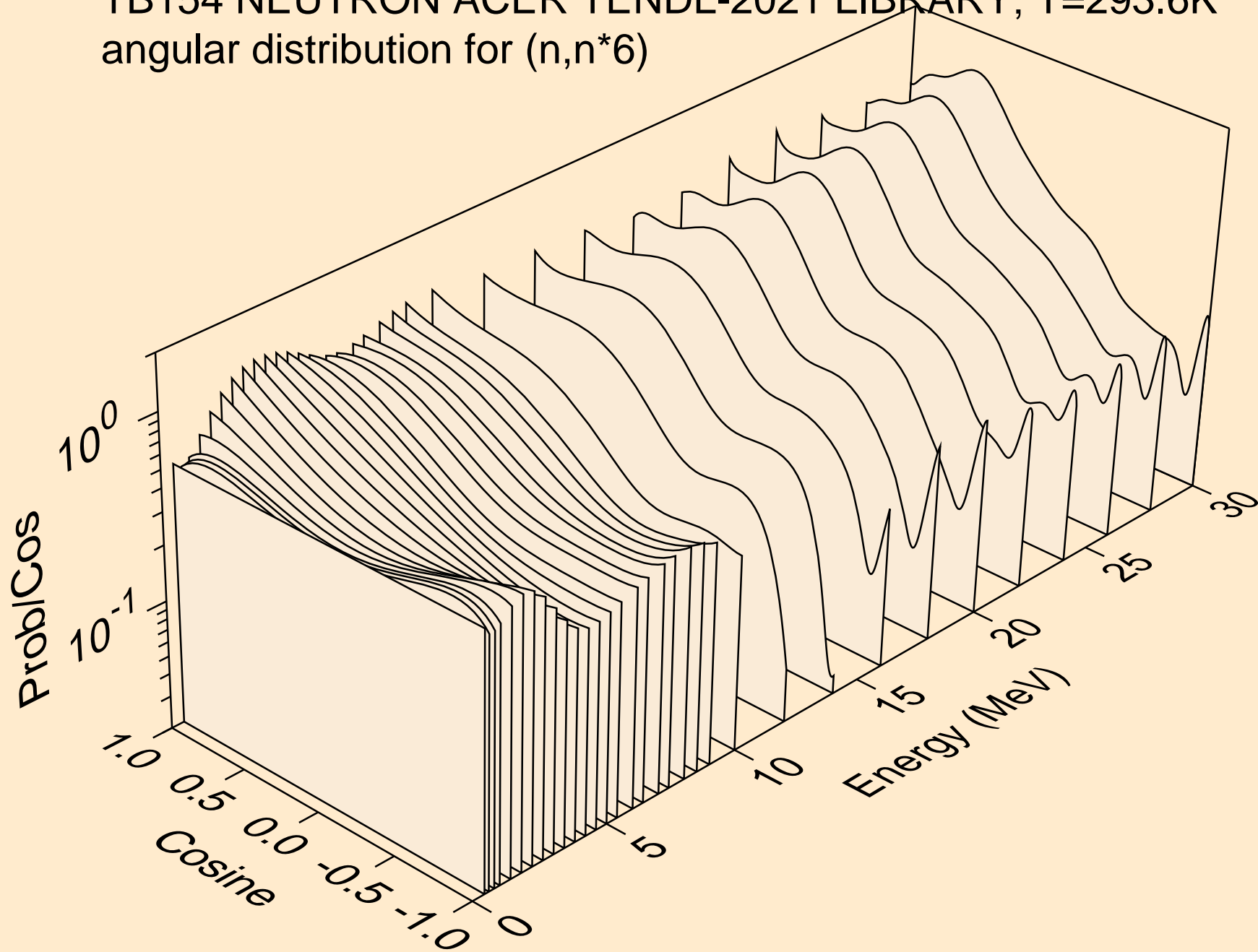

TB154 NEUTRON ACER TENDL-2021 LIBRARY; T=293.6K
angular distribution for (n,n*7)

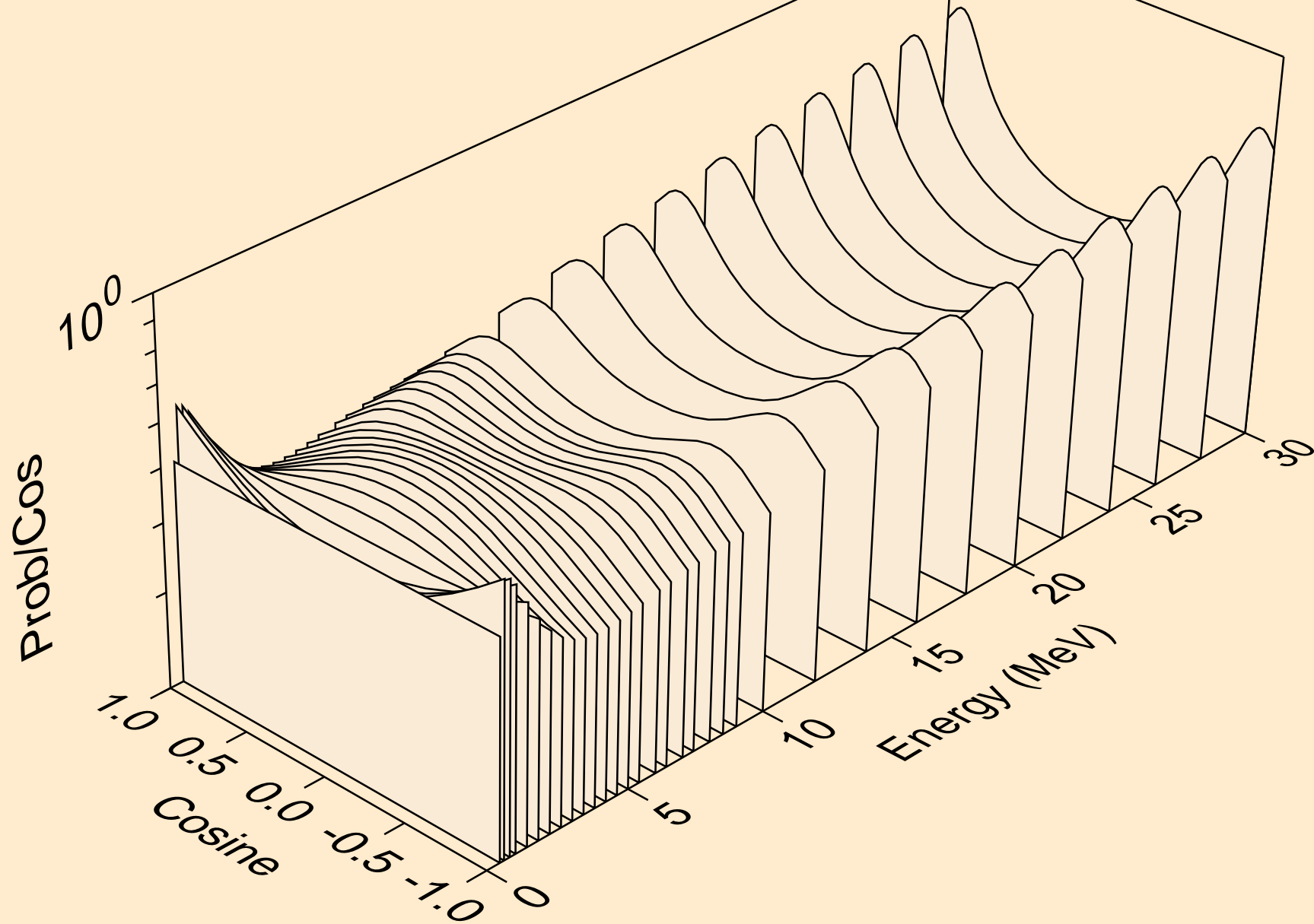

TB154 NEUTRON ACER TENDL-2021 LIBRARY; T=293.6K
angular distribution for (n,n*8)

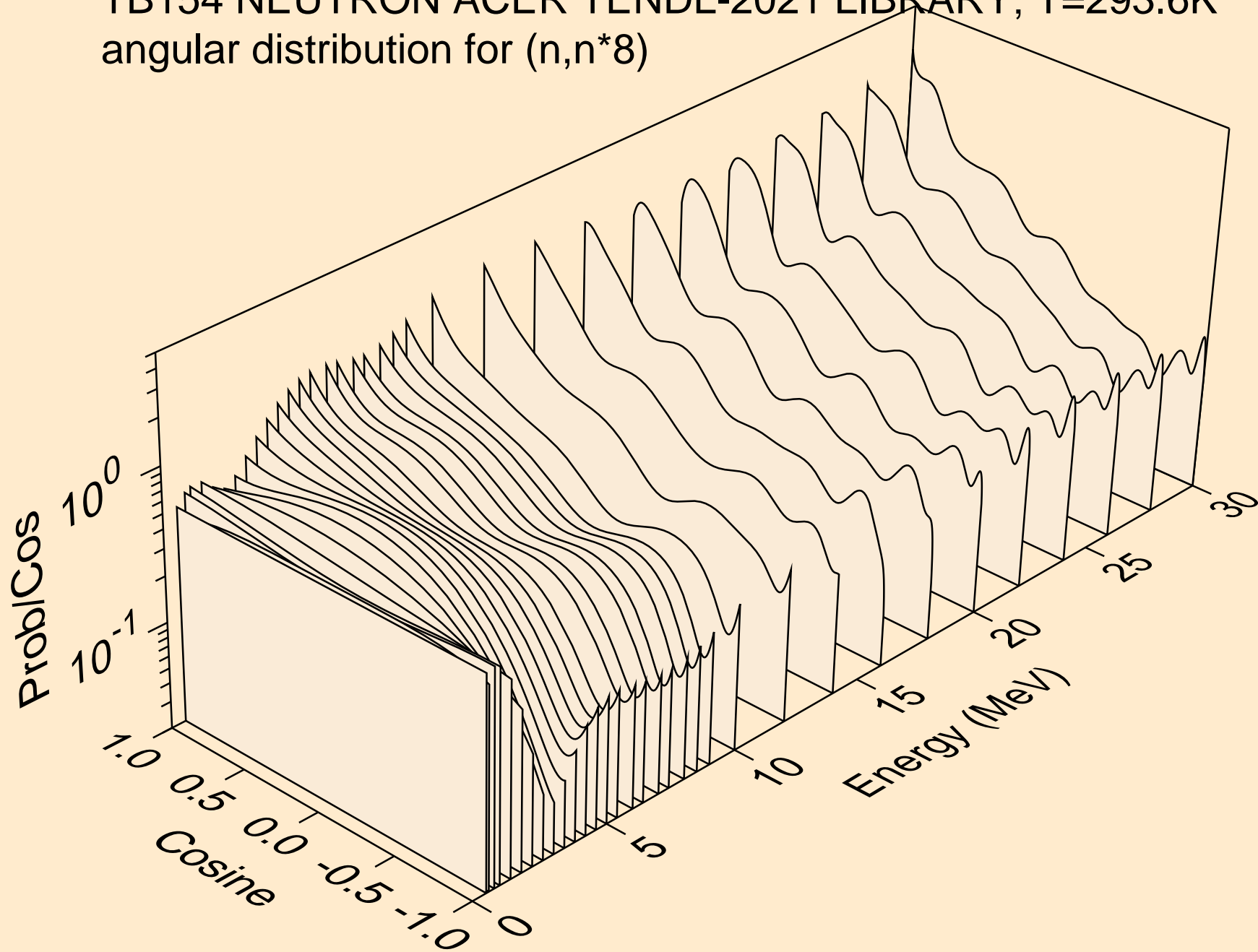

TB154 NEUTRON ACER TENDL-2021 LIBRARY; T=293.6K
angular distribution for (n,n*9)

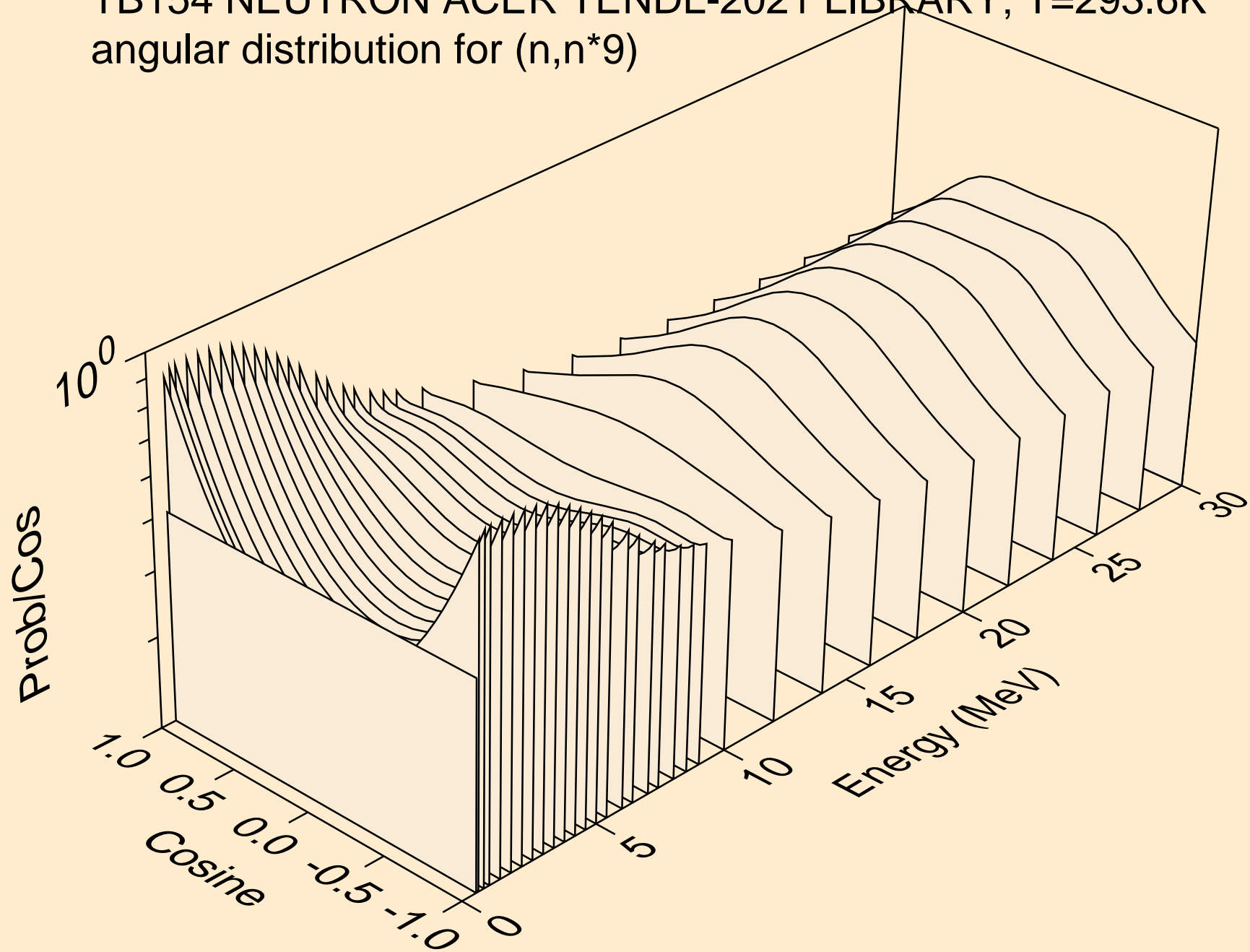

TB154 NEUTRON ACER TENDL-2021 LIBRARY; T=293.6K
angular distribution for (n,n*10)

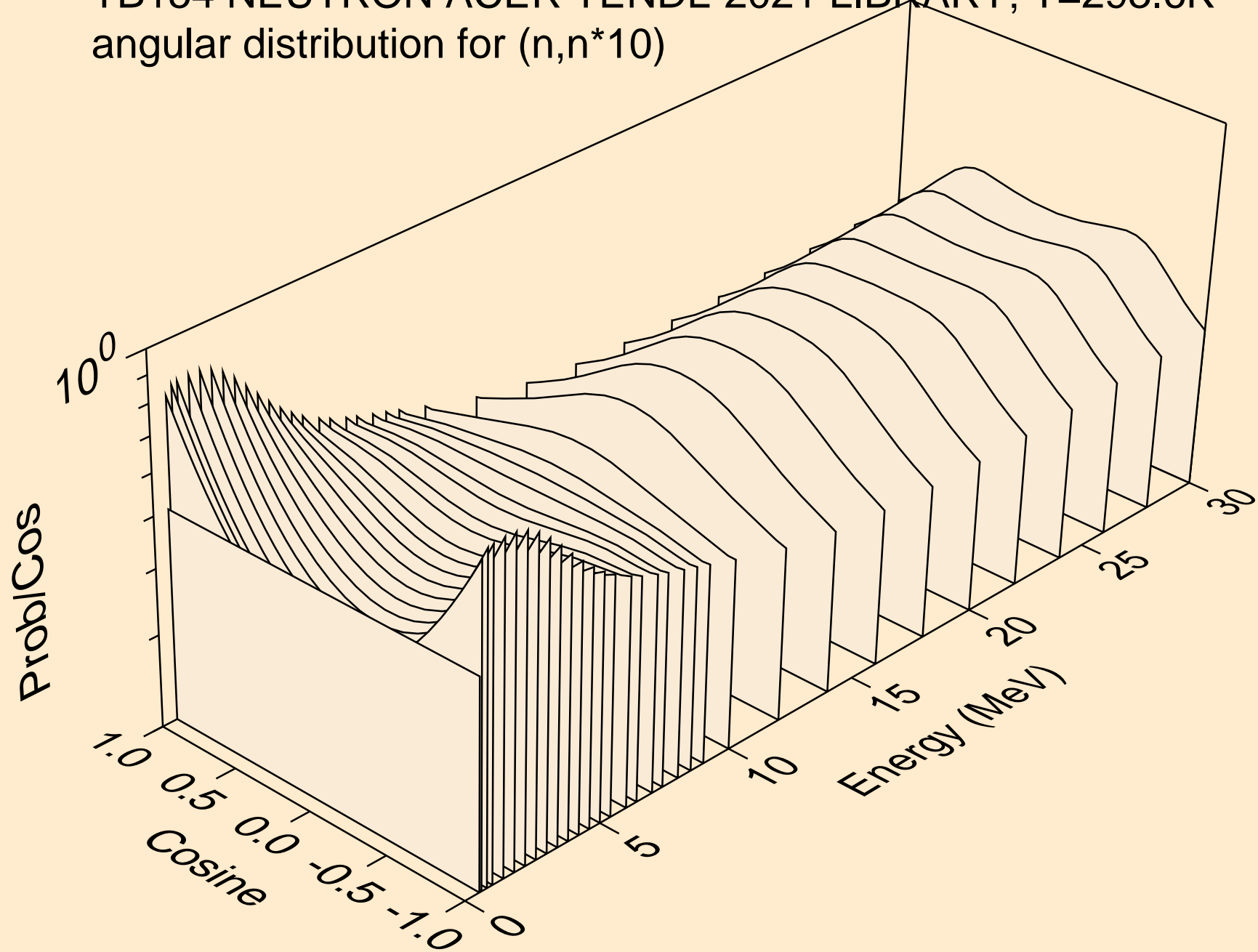

TB154 NEUTRON ACER TENDL-2021 LIBRARY; T=293.6K
angular distribution for (n,n*11)

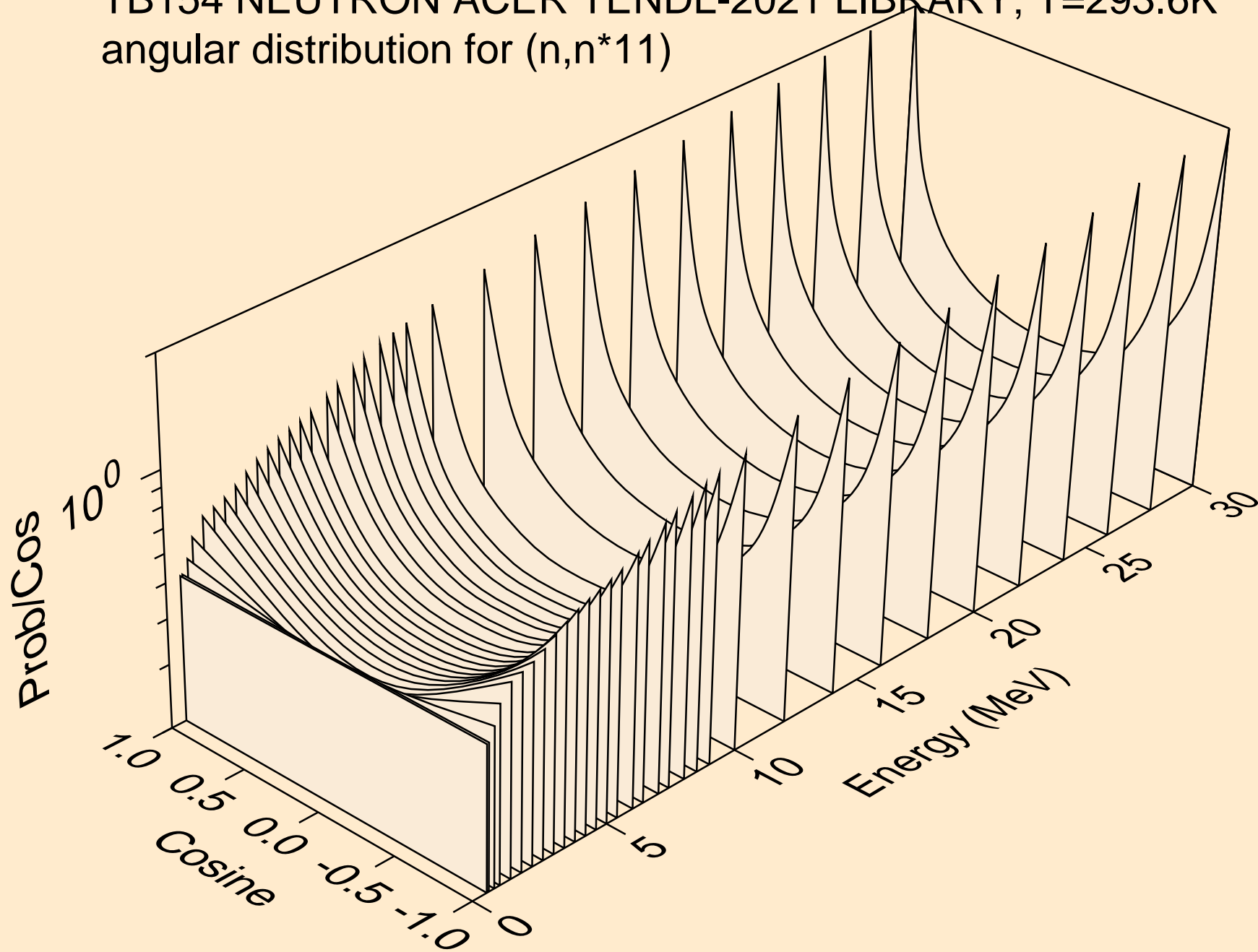

TB154 NEUTRON ACER TENDL-2021 LIBRARY; T=293.6K
angular distribution for (n,n*12)

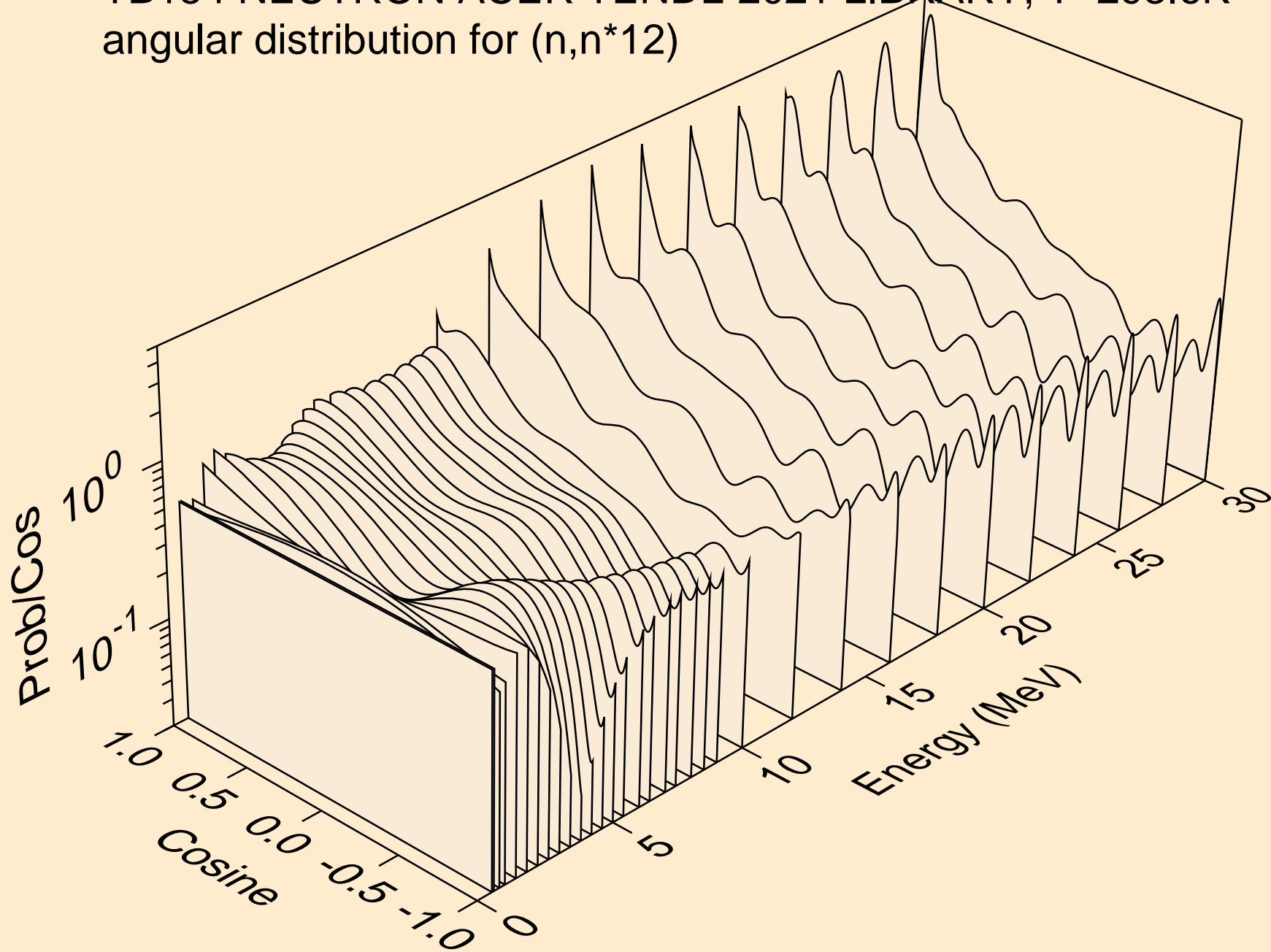

TB154 NEUTRON ACER TENDL-2021 LIBRARY; T=293.6K
angular distribution for (n,n*13)

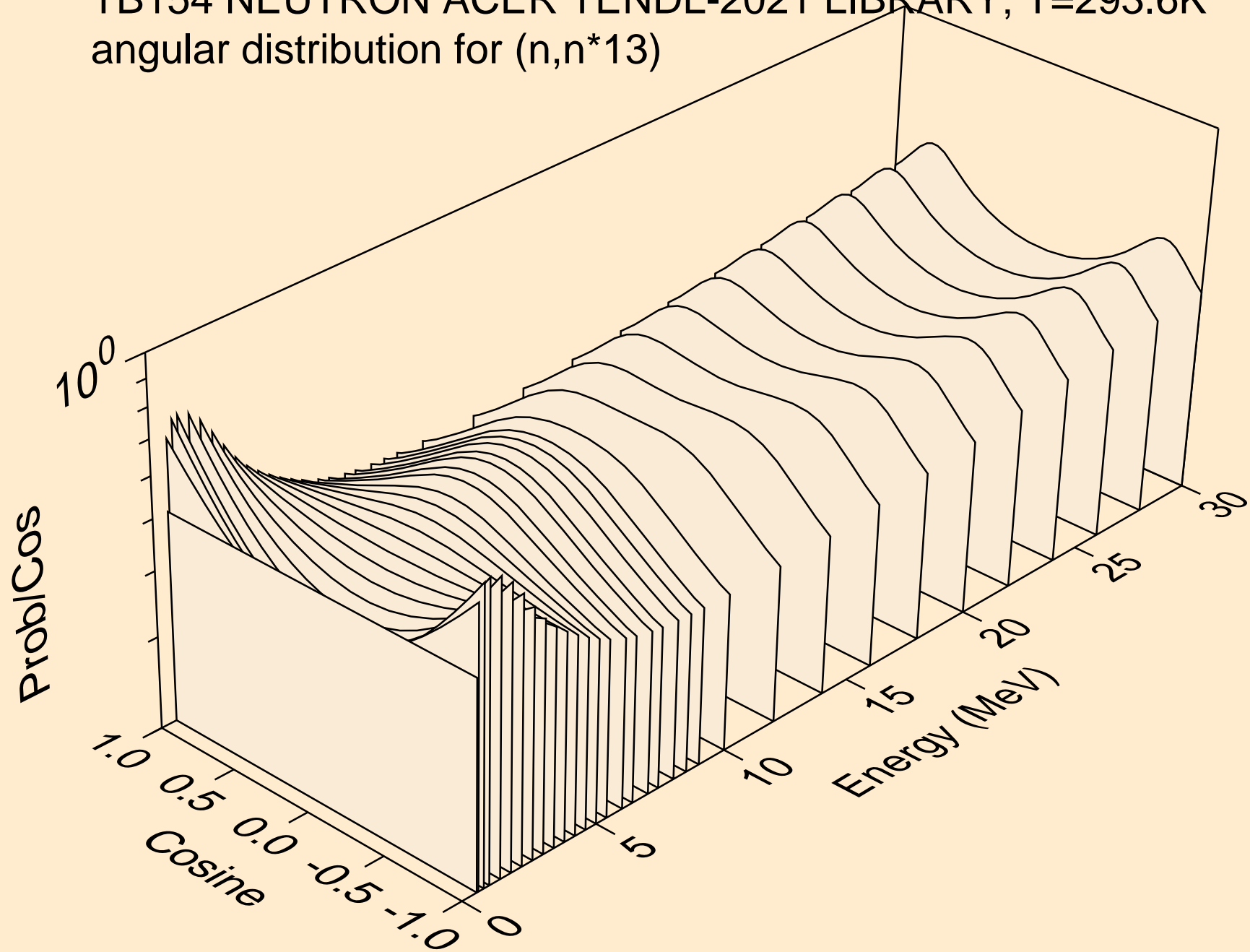

TB154 NEUTRON ACER TENDL-2021 LIBRARY; T=293.6K
angular distribution for (n,n*14)

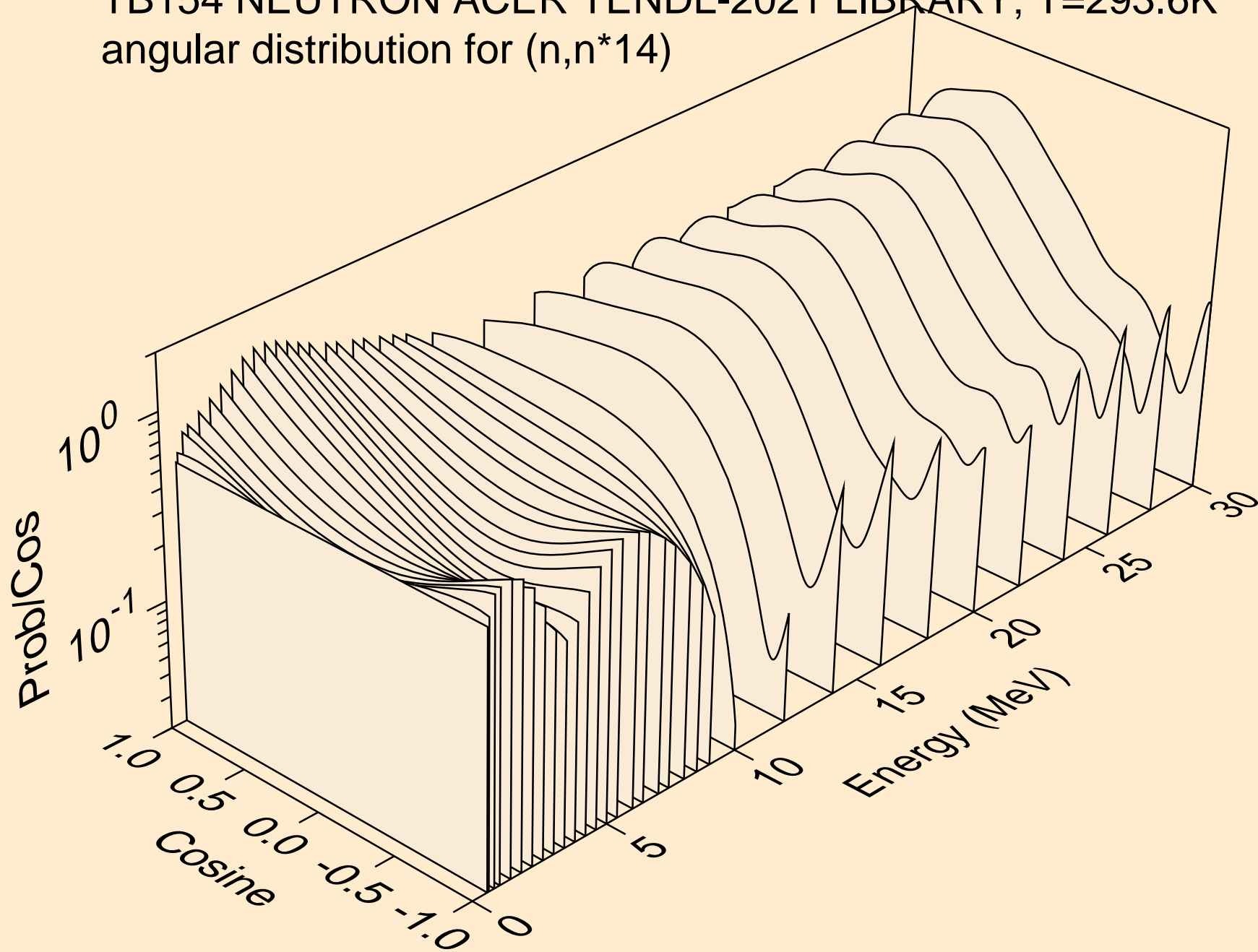

TB154 NEUTRON ACER TENDL-2021 LIBRARY; T=293.6K
angular distribution for (n,n*15)

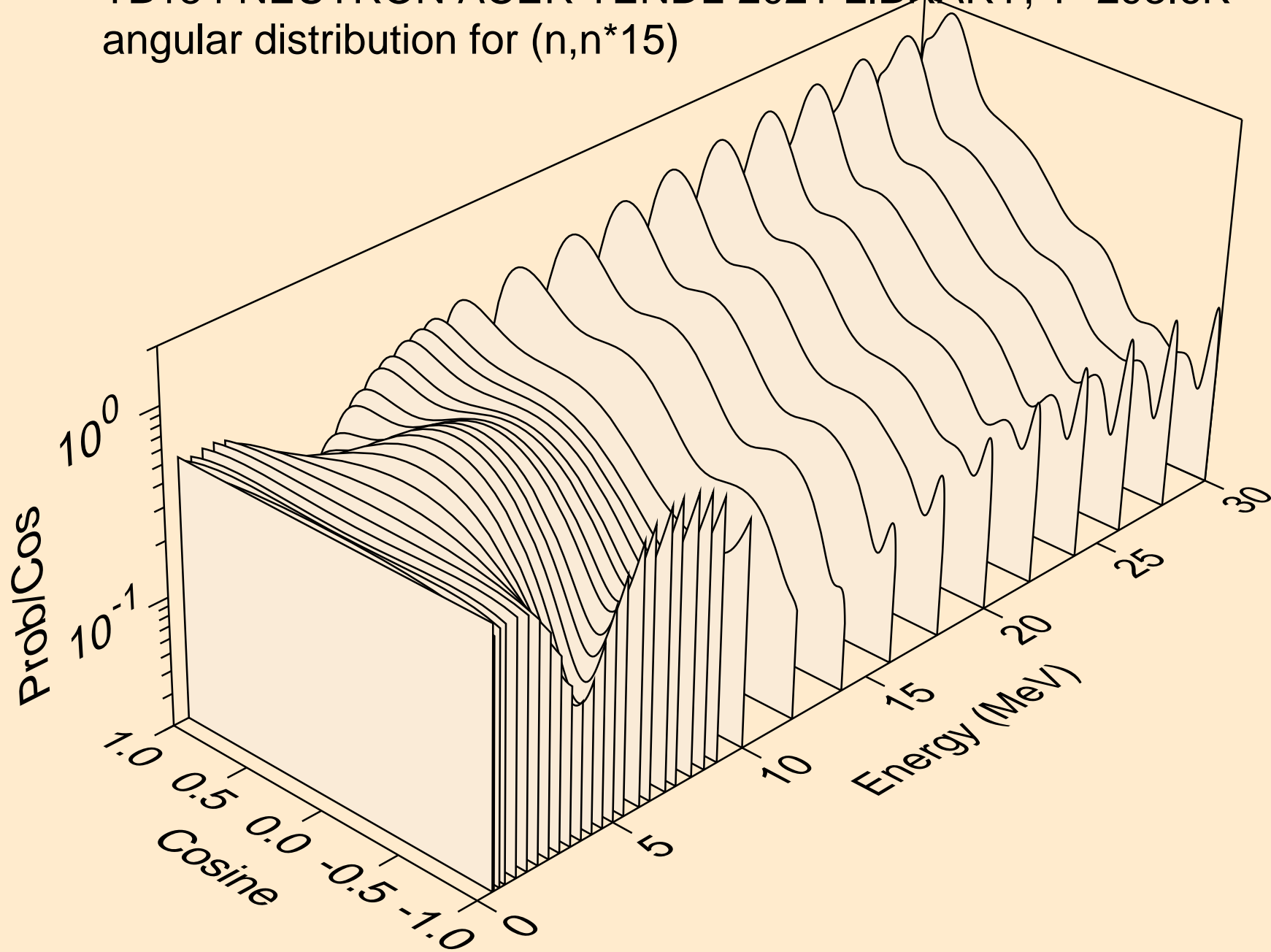

TB154 NEUTRON ACER TENDL-2021 LIBRARY; T=293.6K
angular distribution for (n,n*16)

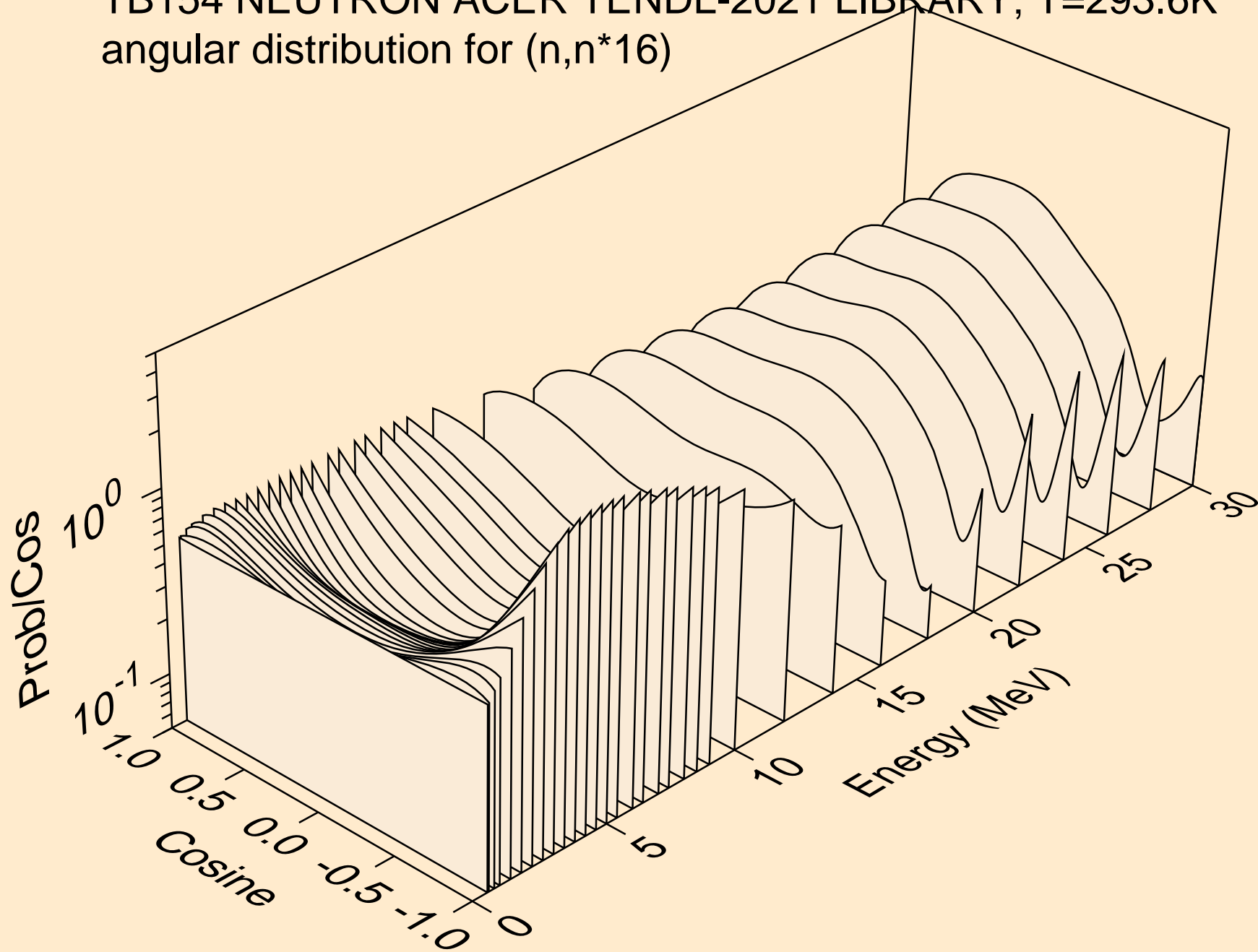

TB154 NEUTRON ACER TENDL-2021 LIBRARY; T=293.6K
angular distribution for (n,n*17)

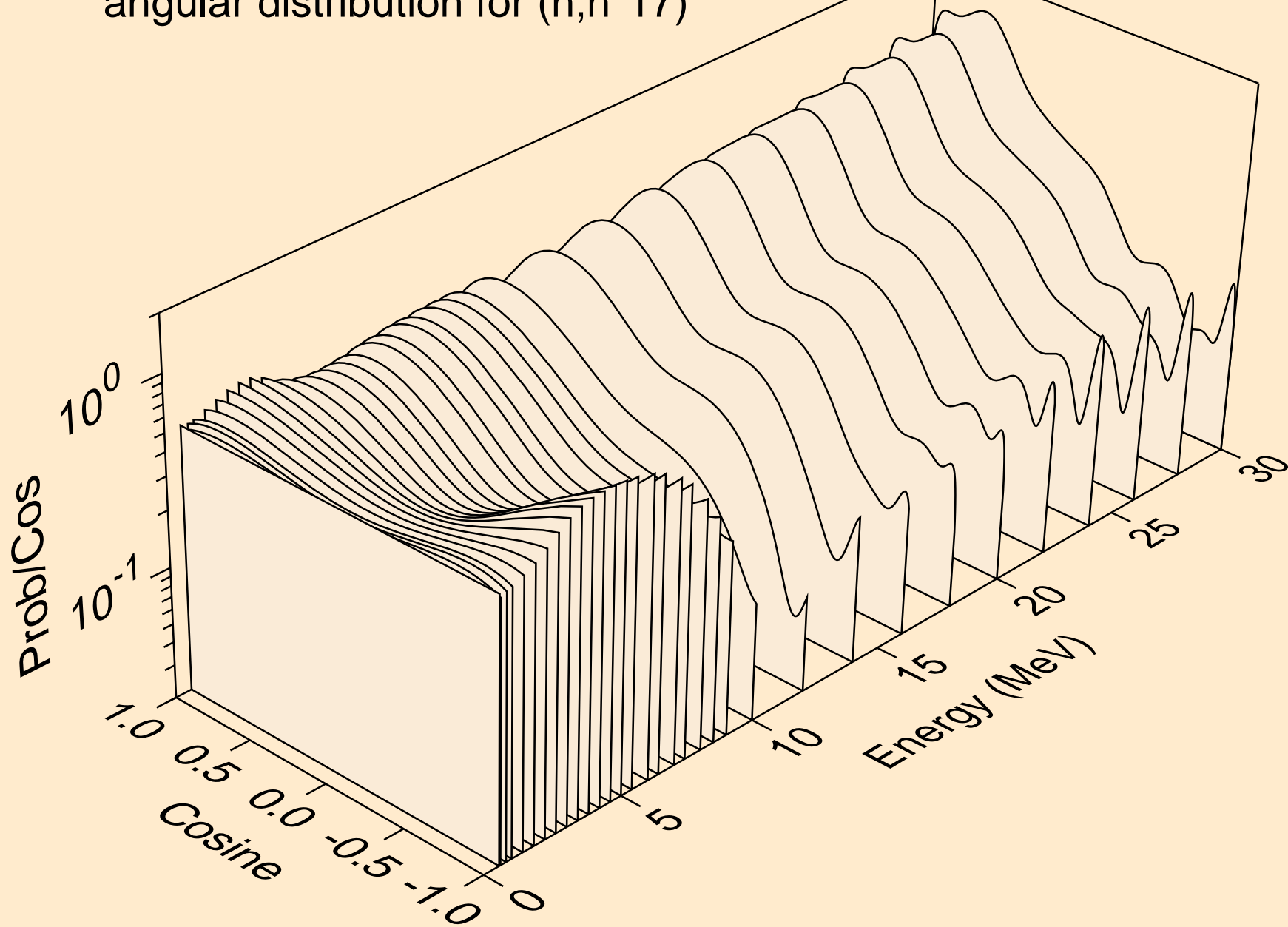

TB154 NEUTRON ACER TENDL-2021 LIBRARY; T=293.6K
angular distribution for (n,n*18)

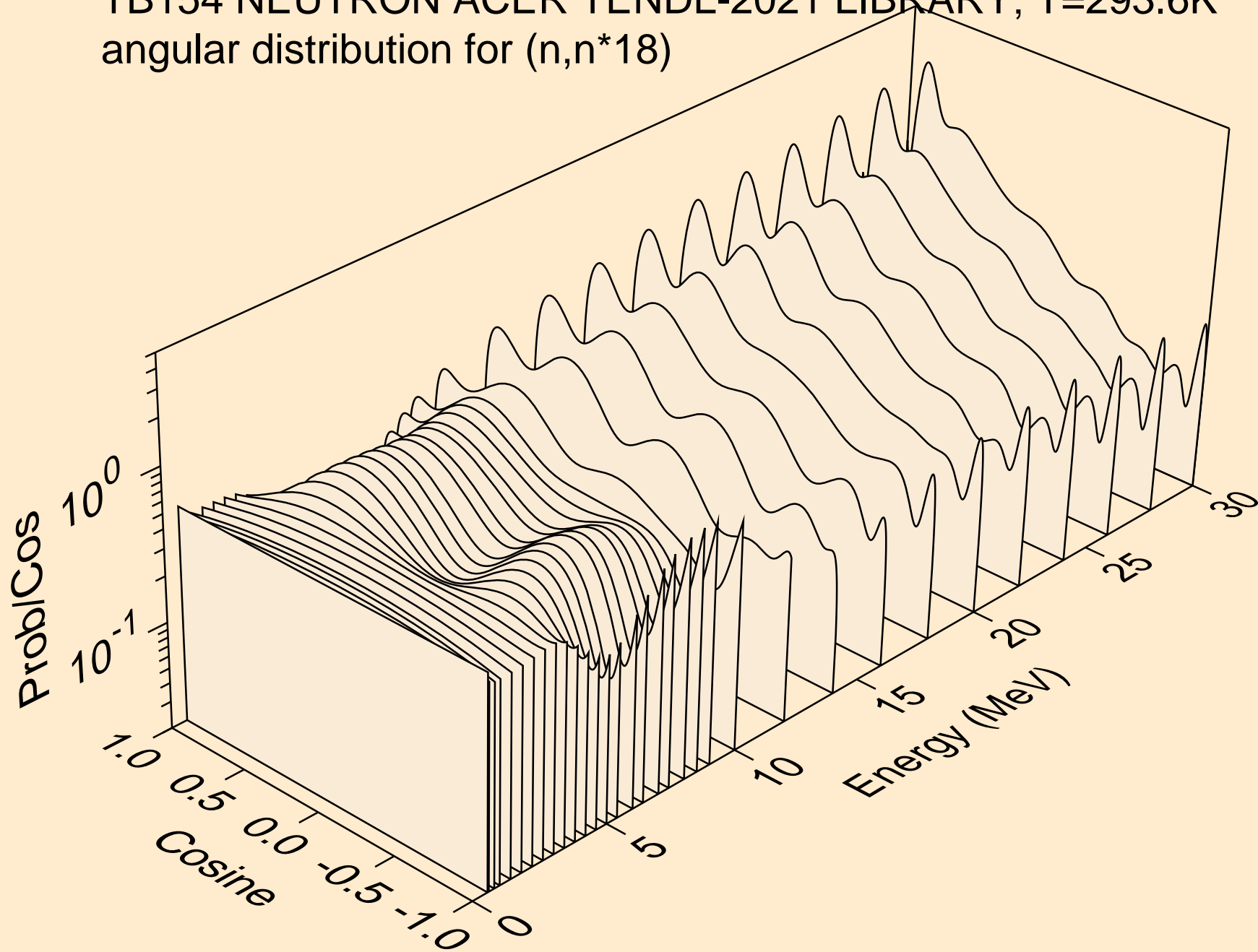

TB154 NEUTRON ACER TENDL-2021 LIBRARY; T=293.6K
angular distribution for (n,n*19)

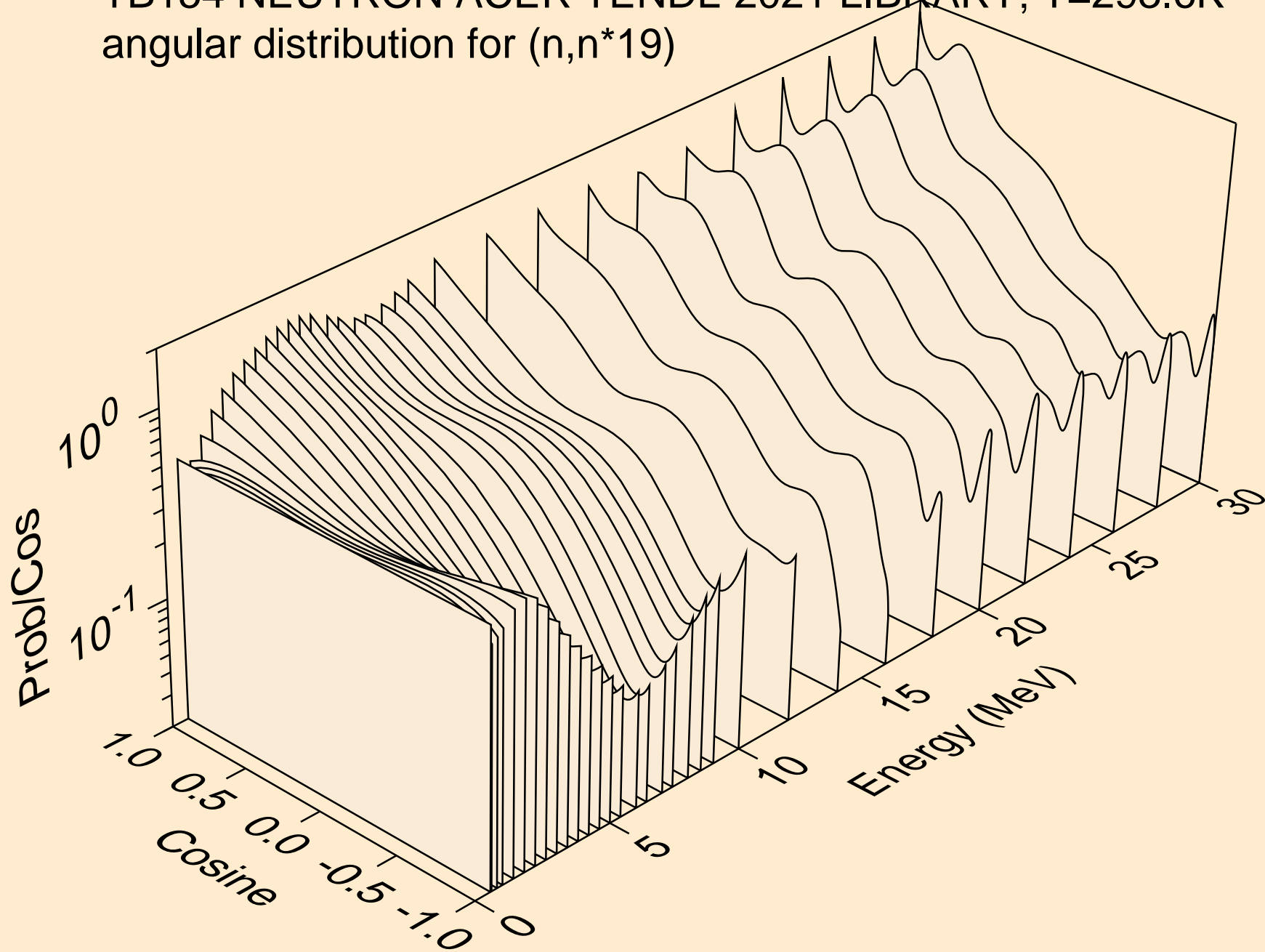

TB154 NEUTRON ACER TENDL-2021 LIBRARY; T=293.6K
angular distribution for (n,n*20)

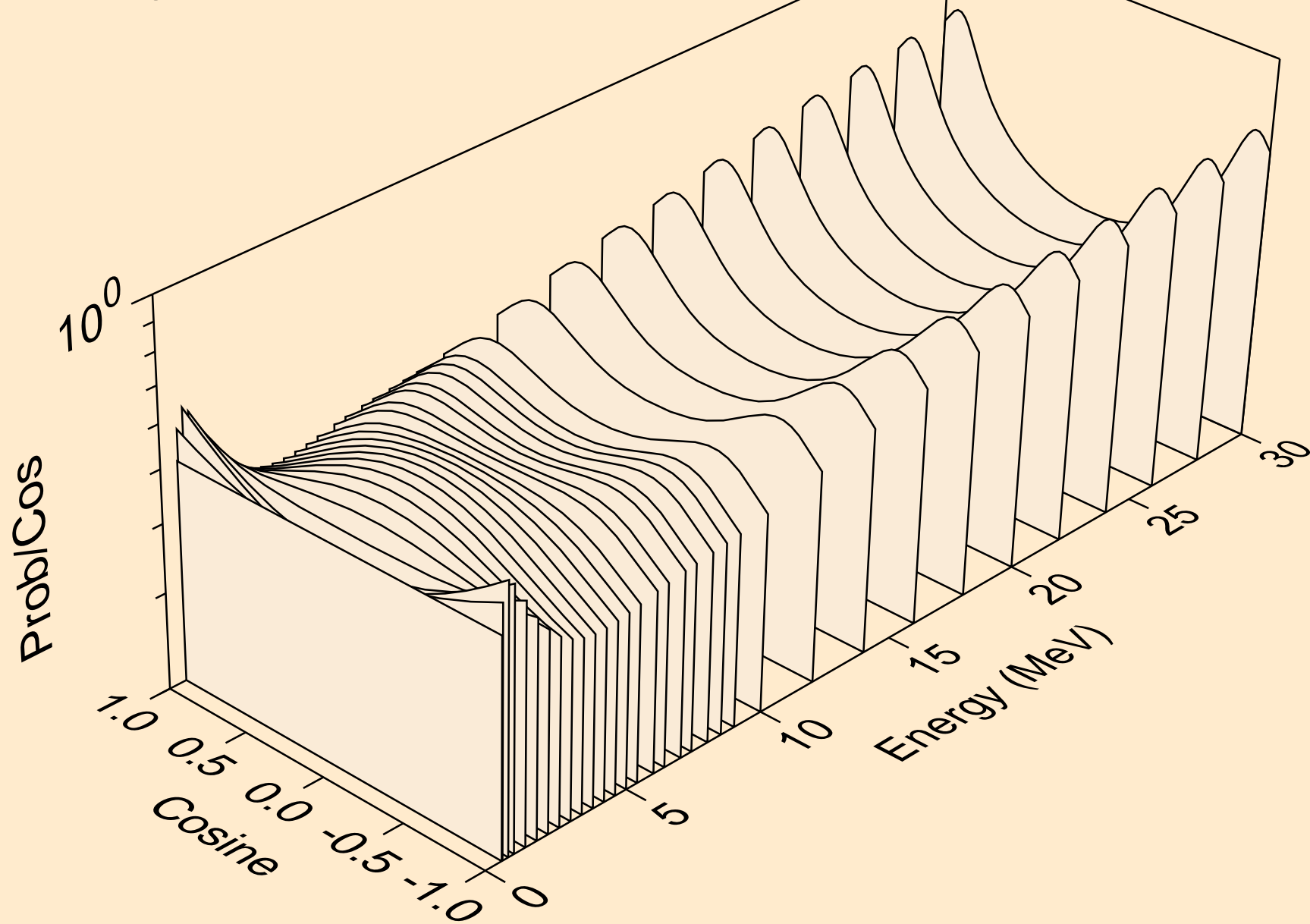

TB154 NEUTRON ACER TENDL-2021 LIBRARY; T=293.6K
angular distribution for (n,n*21)

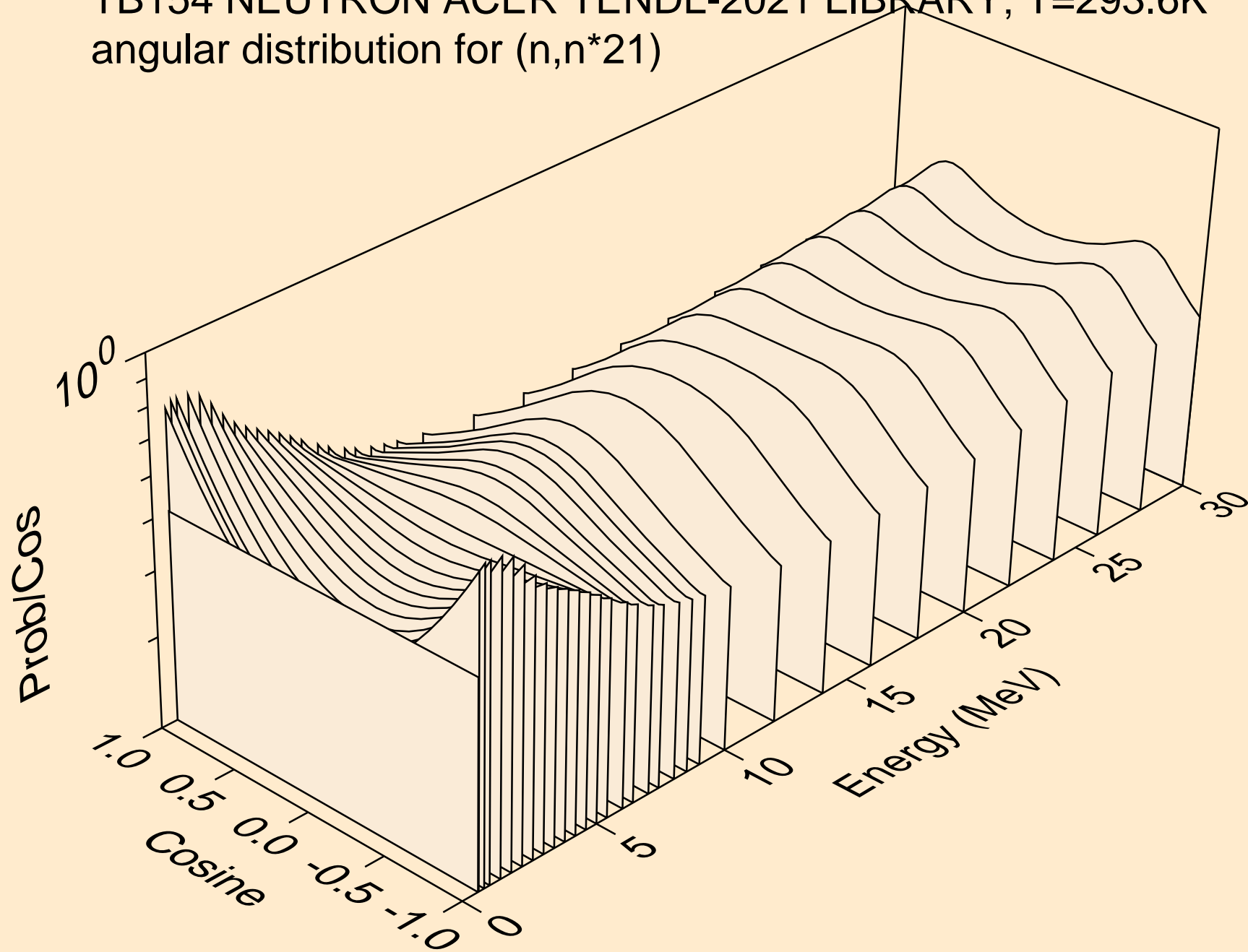

TB154 NEUTRON ACER TENDL-2021 LIBRARY; T=293.6K
angular distribution for (n,n*22)

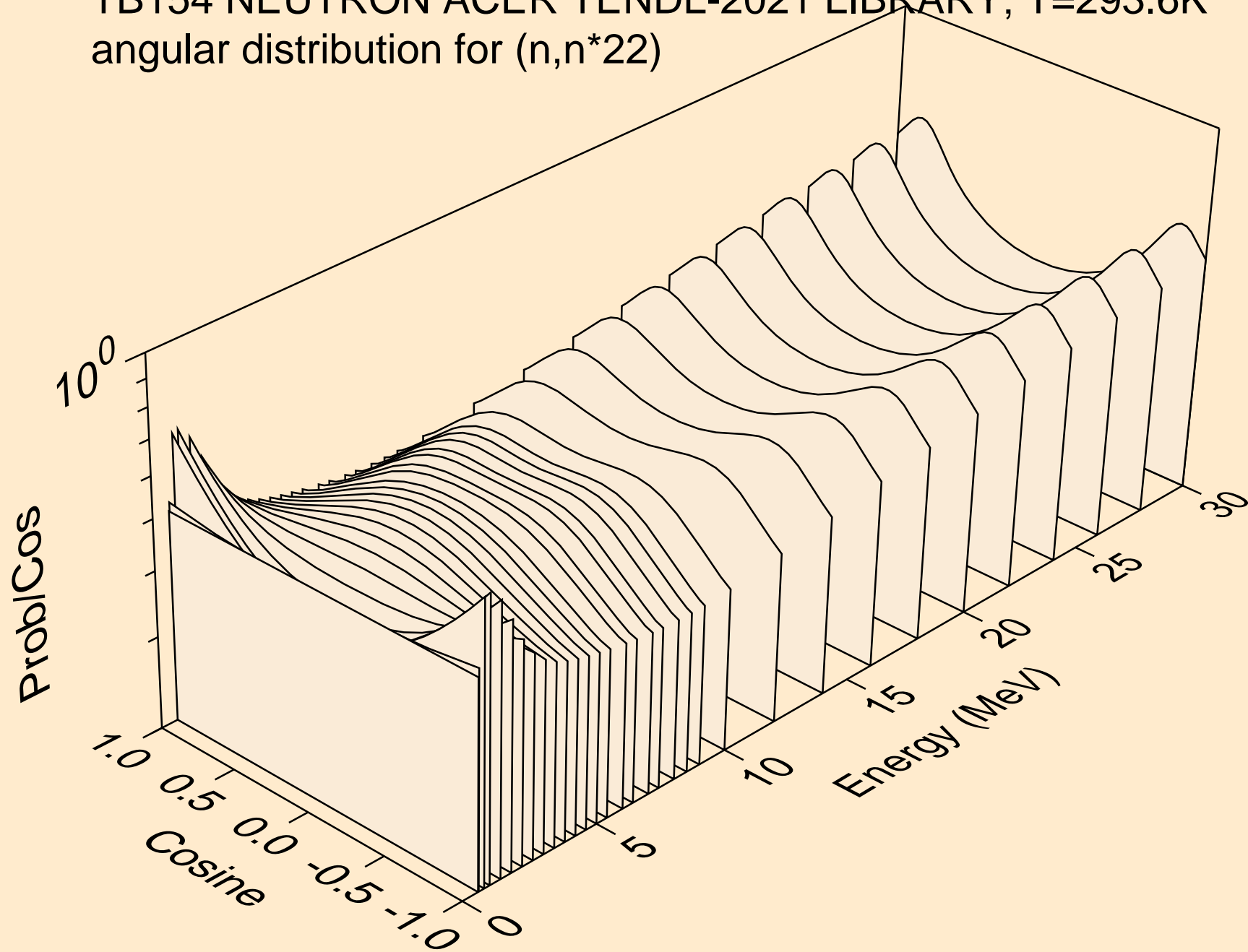

TB154 NEUTRON ACER TENDL-2021 LIBRARY; T=293.6K
angular distribution for (n,n*23)

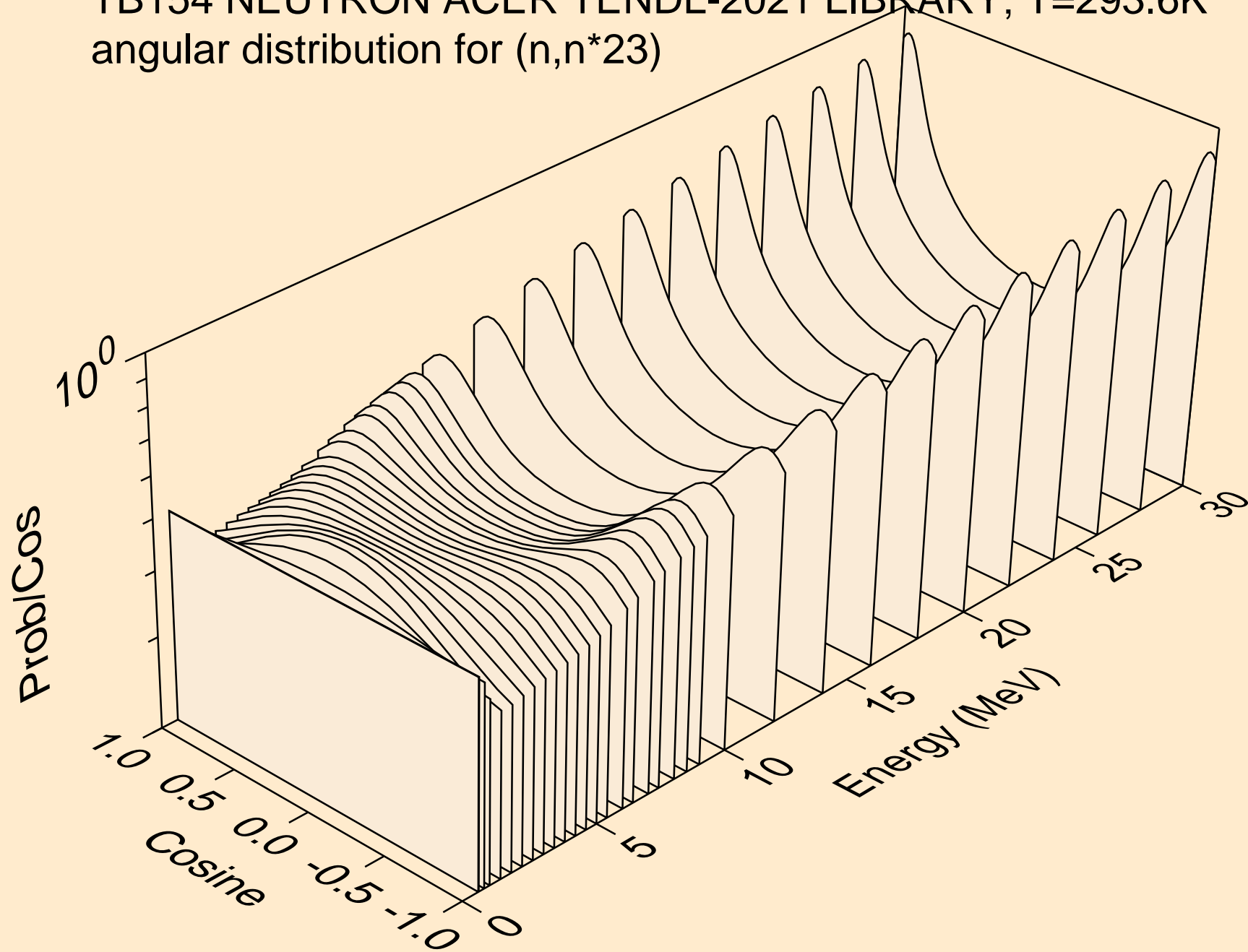

TB154 NEUTRON ACER TENDL-2021 LIBRARY; T=293.6K
angular distribution for (n,n*24)

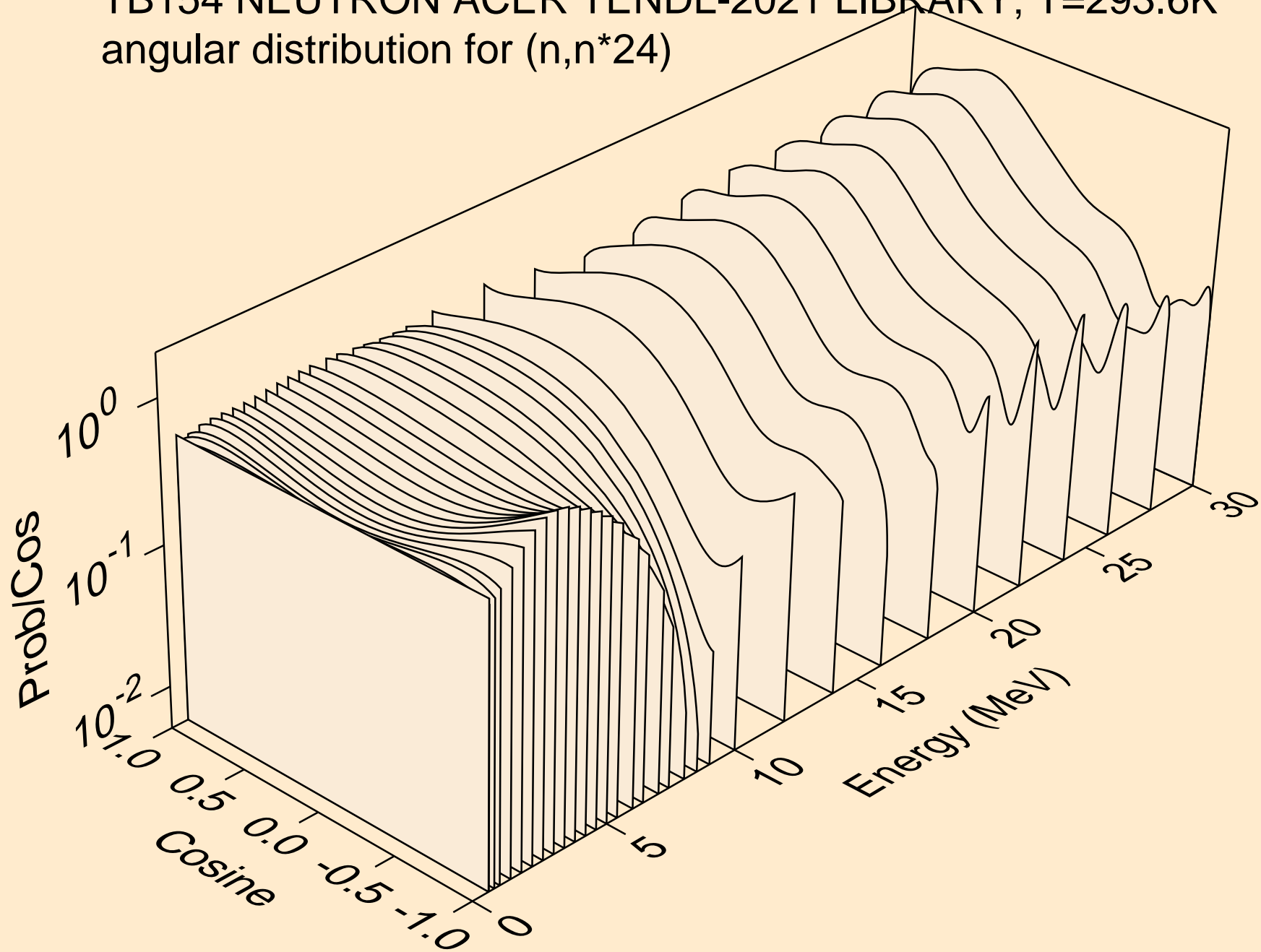

TB154 NEUTRON ACER TENDL-2021 LIBRARY; T=293.6K
angular distribution for (n,n*25)

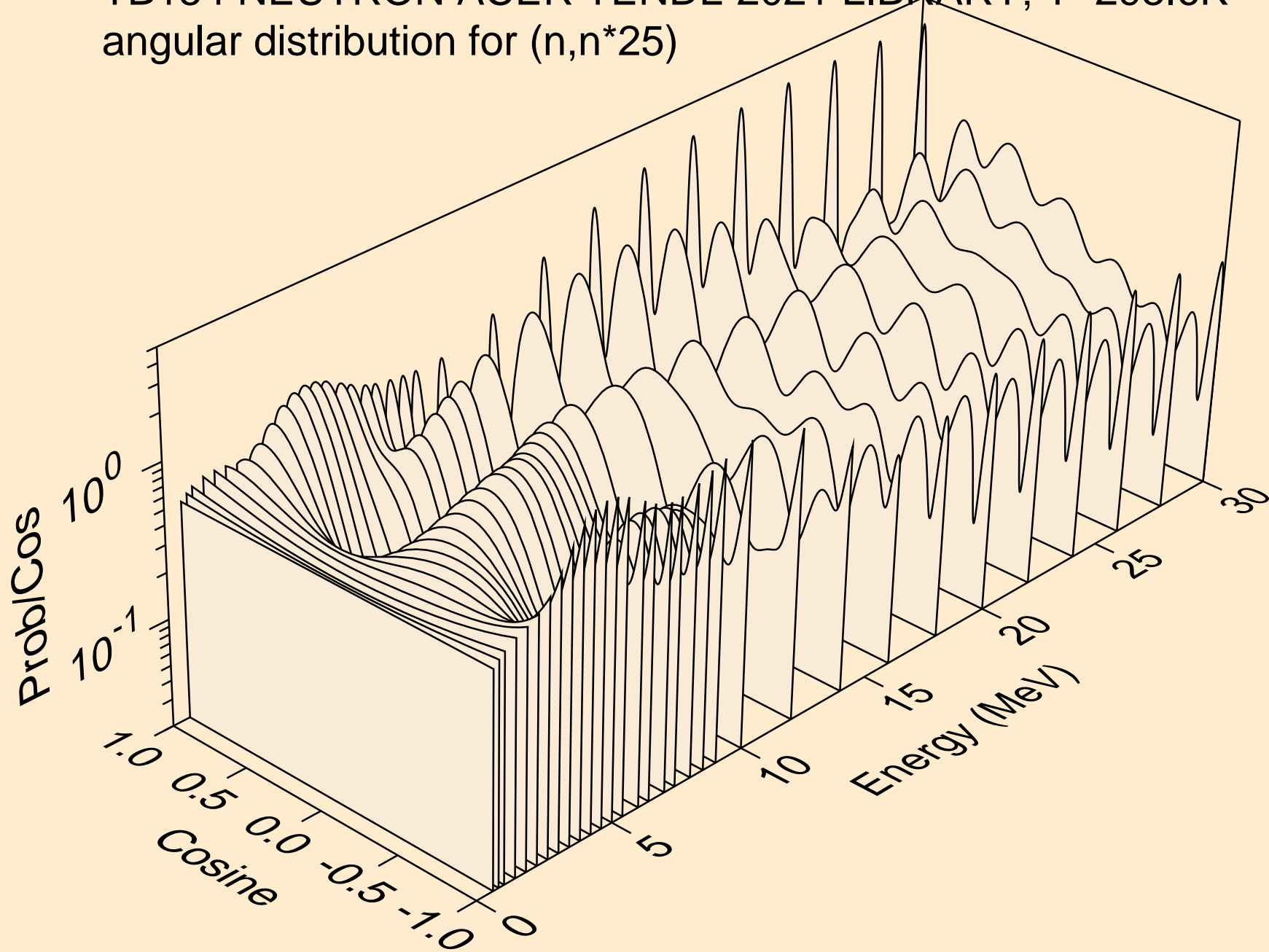

TB154 NEUTRON ACER TENDL-2021 LIBRARY; T=293.6K
angular distribution for (n,n*26)

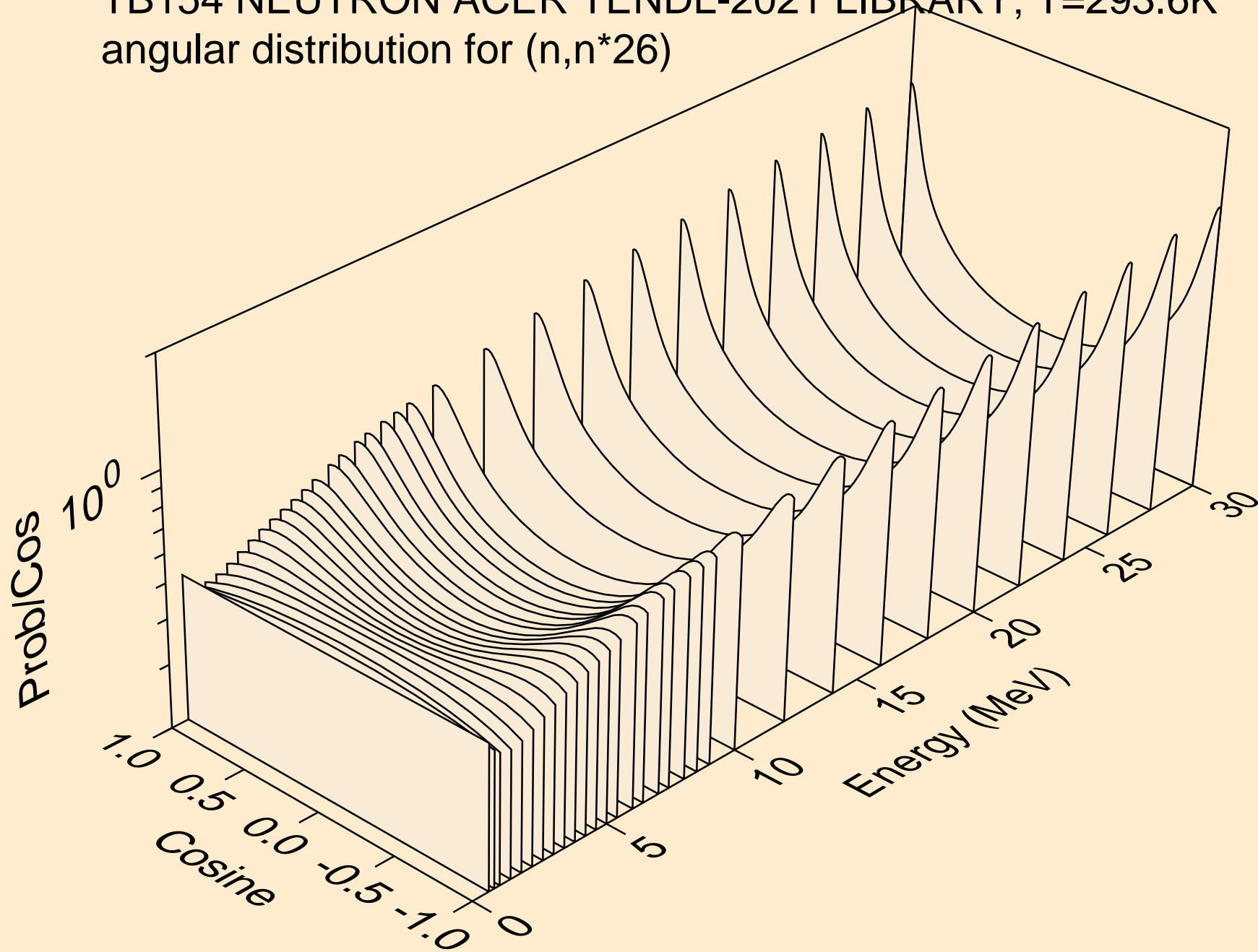

TB154 NEUTRON ACER TENDL-2021 LIBRARY; T=293.6K
angular distribution for (n,n*27)

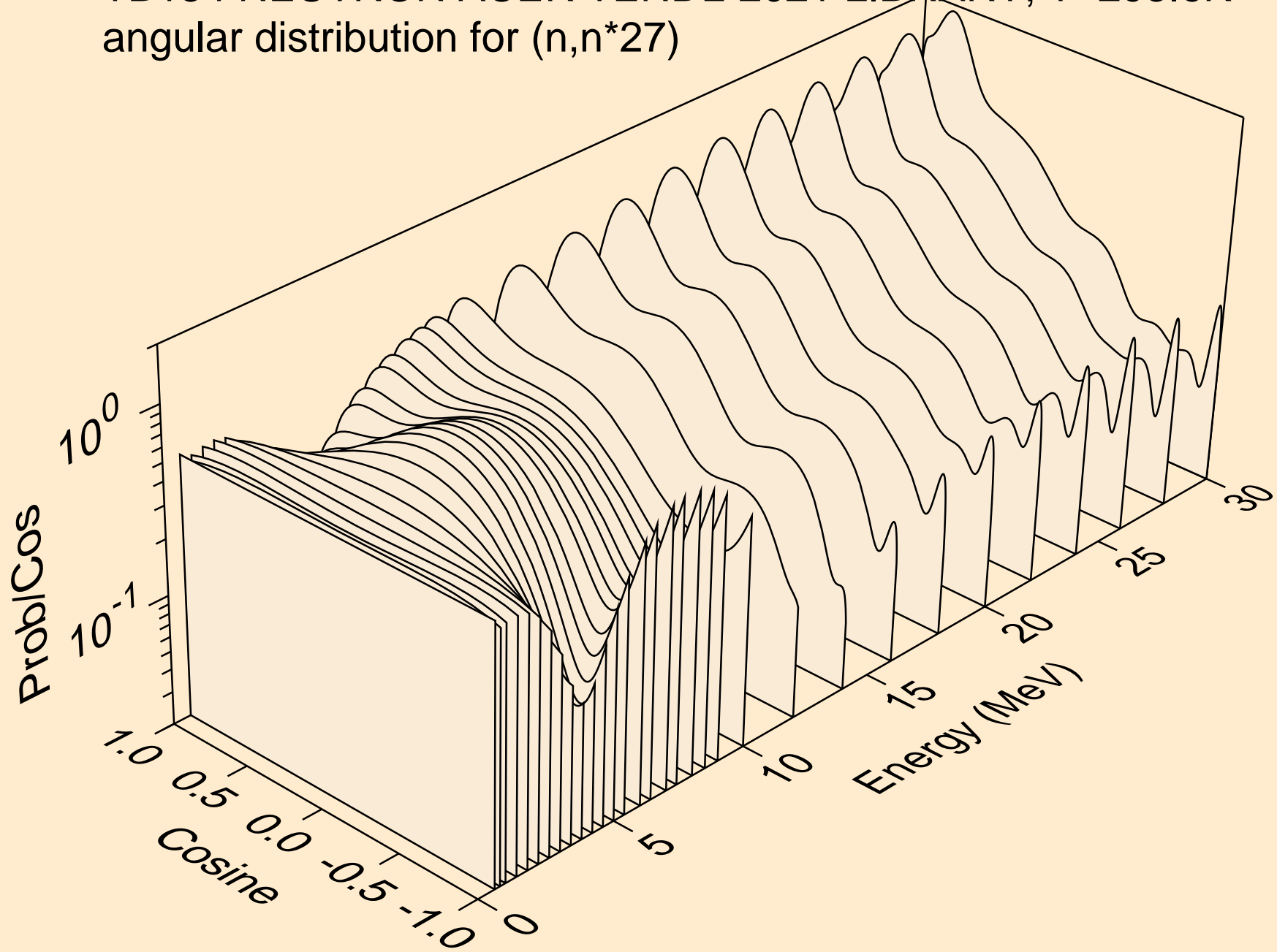

TB154 NEUTRON ACER TENDL-2021 LIBRARY; T=293.6K
angular distribution for (n,n*28)

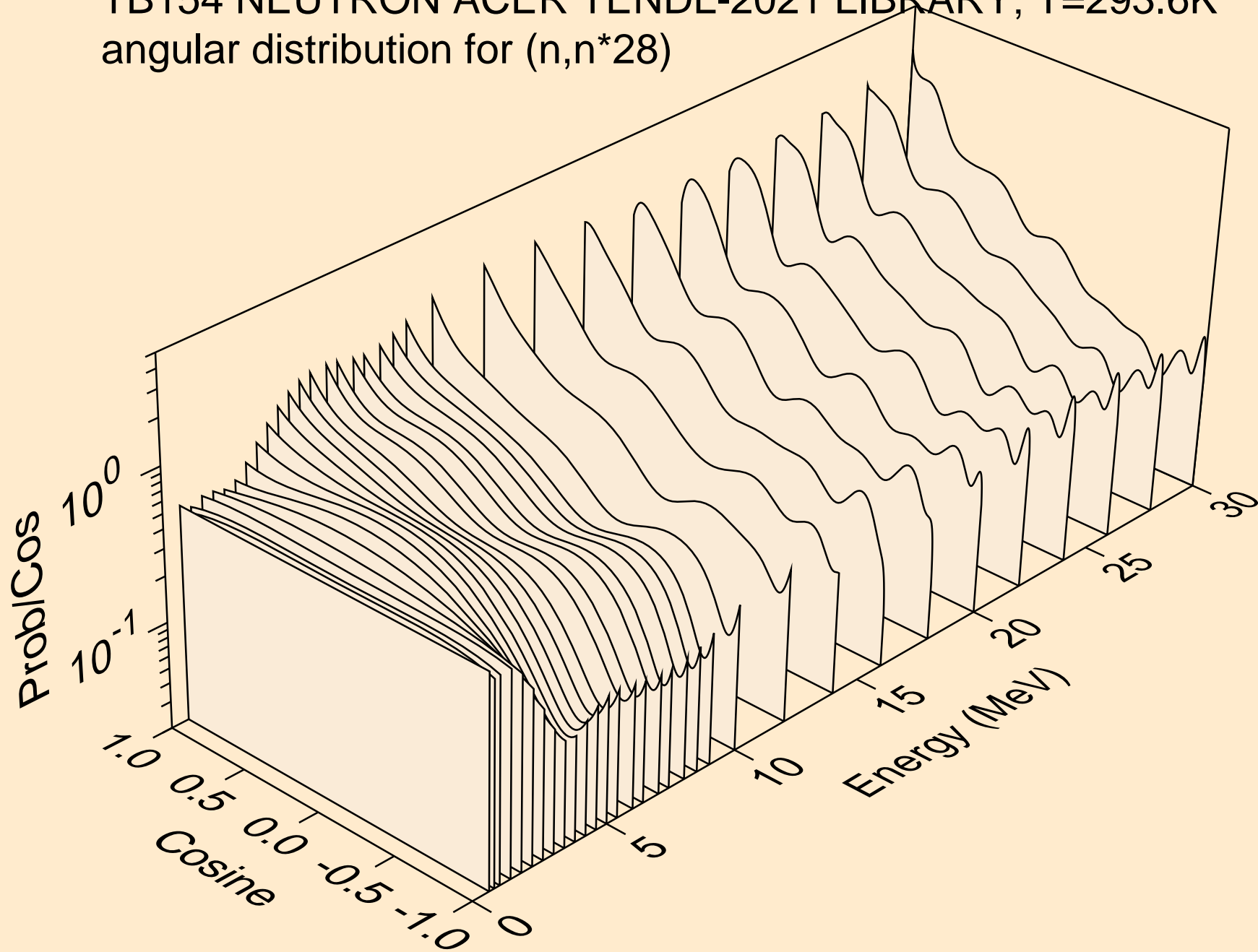

TB154 NEUTRON ACER TENDL-2021 LIBRARY; T=293.6K
Neutron emission for (n,x)

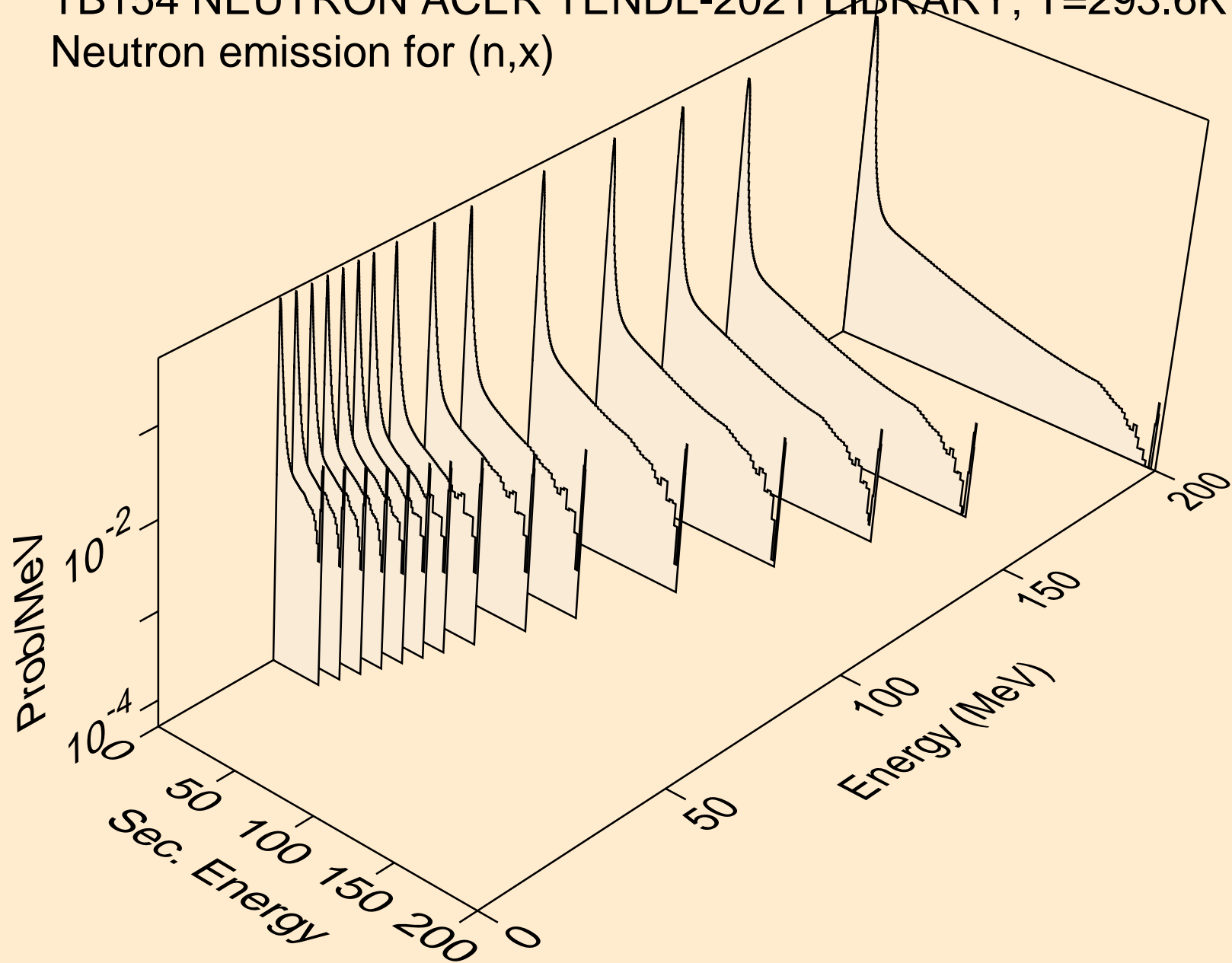

TB154 NEUTRON ACER TENDL-2021 LIBRARY; T=293.6K
Neutron emission for (n,2nd)

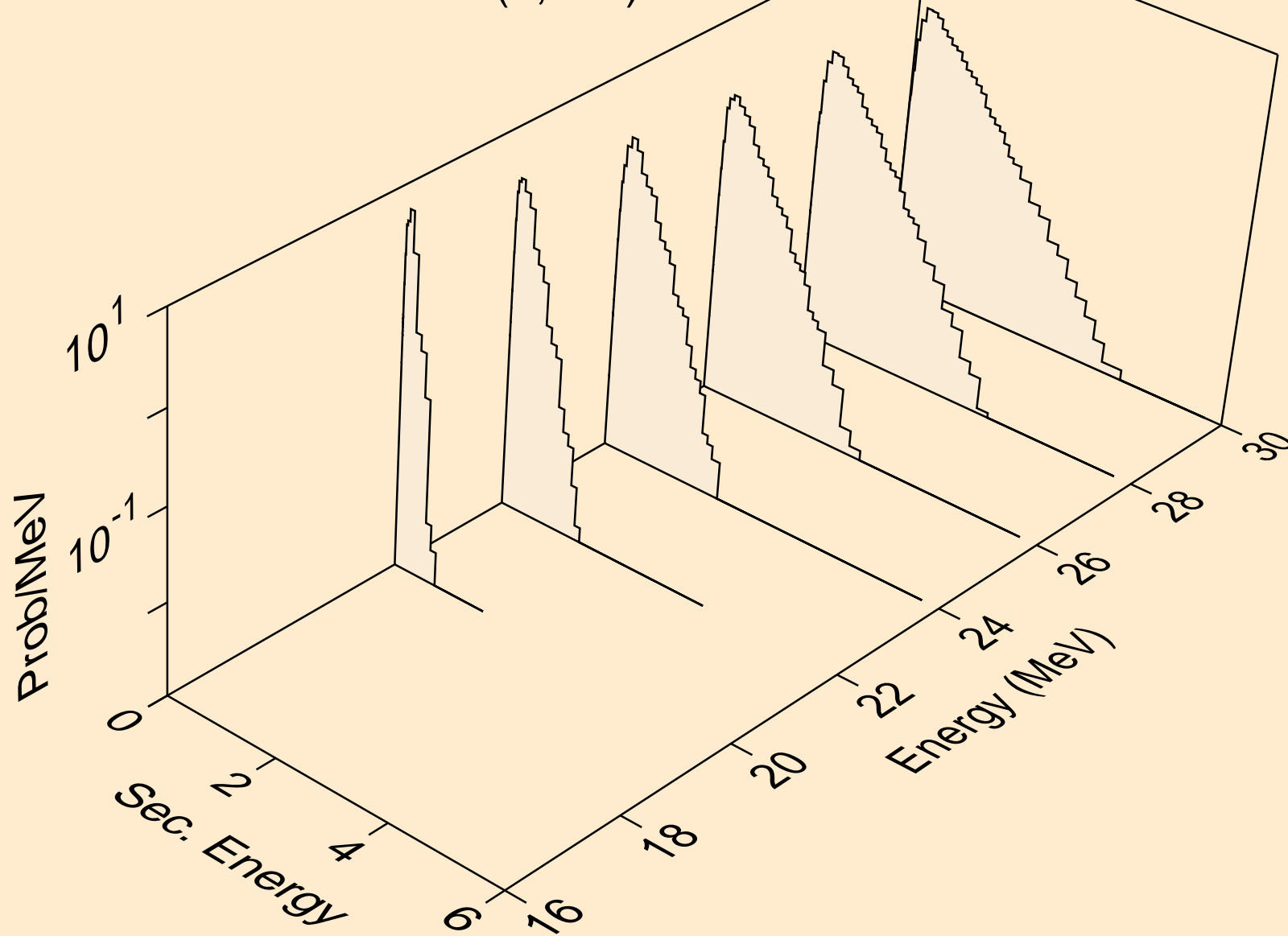

TB154 NEUTRON ACER TENDL-2021 LIBRARY; T=293.6K
Neutron emission for (n,2n)

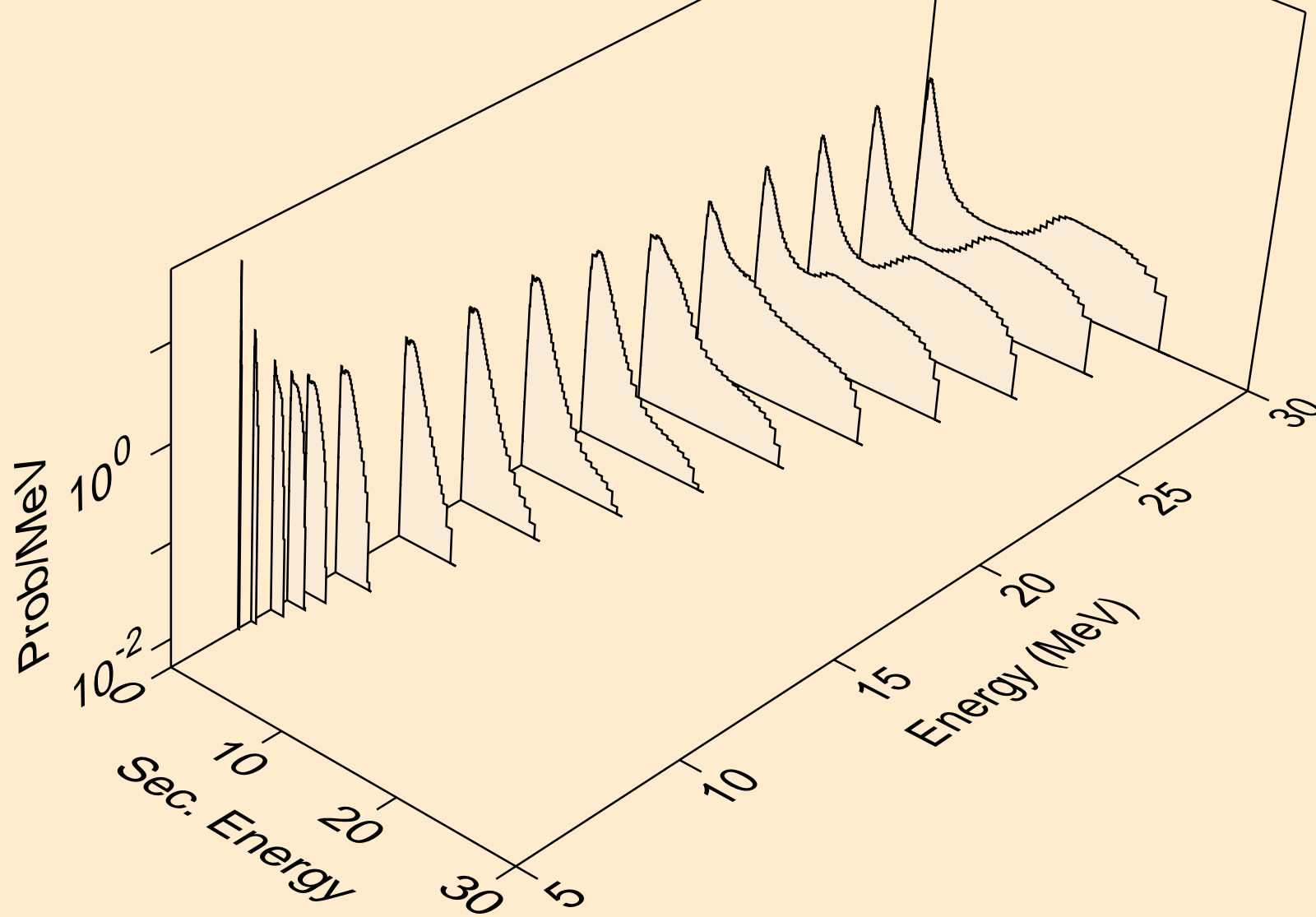

TB154 NEUTRON ACER TENDL-2021 LIBRARY; T=293.6K
Neutron emission for (n,3n)

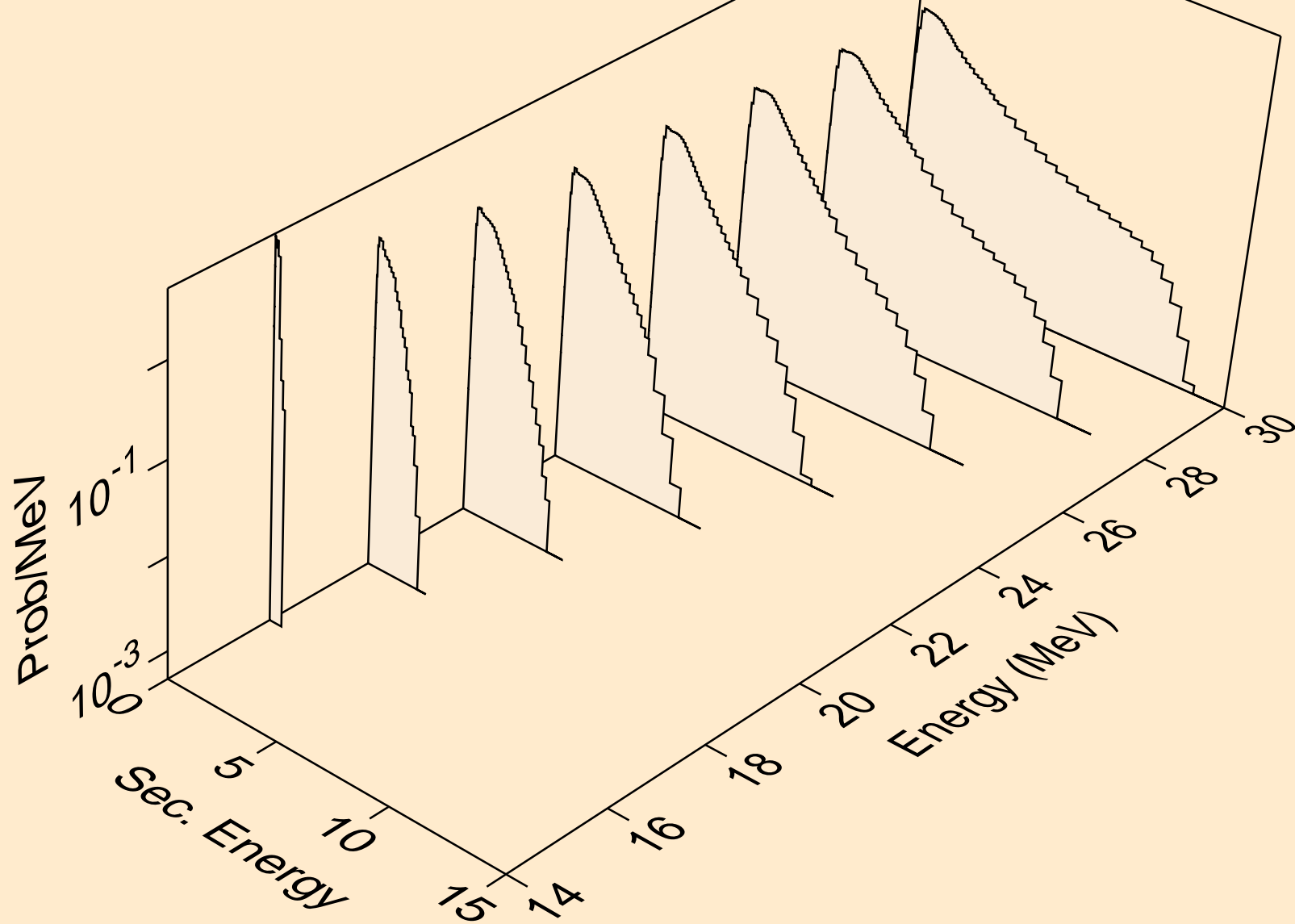

TB154 NEUTRON ACER TENDL-2021 LIBRARY; T=293.6K
Neutron emission for (n,n*)a

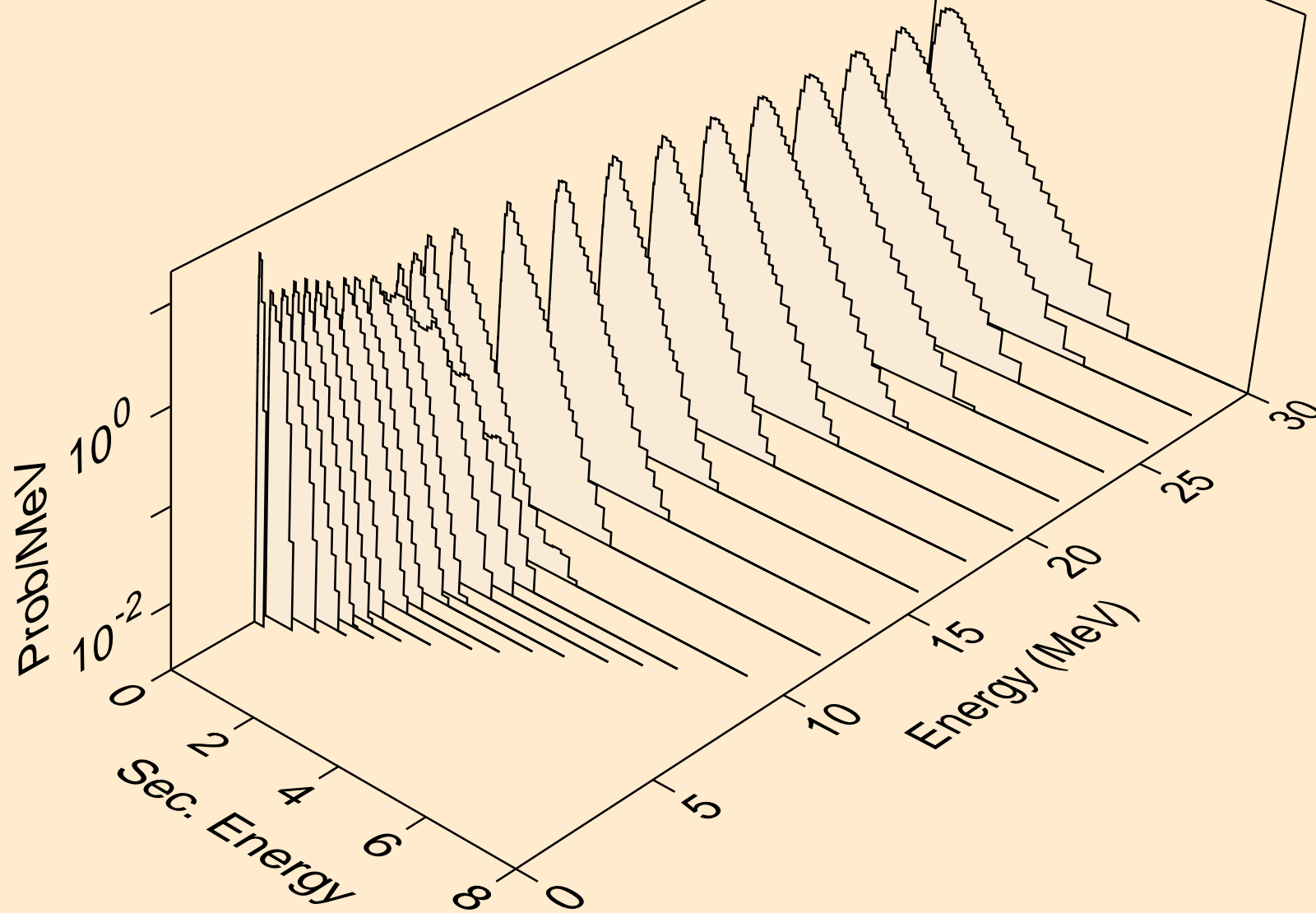

TB154 NEUTRON ACER TENDL-2021 LIBRARY; T=293.6K
Neutron emission for (n,2n)_a

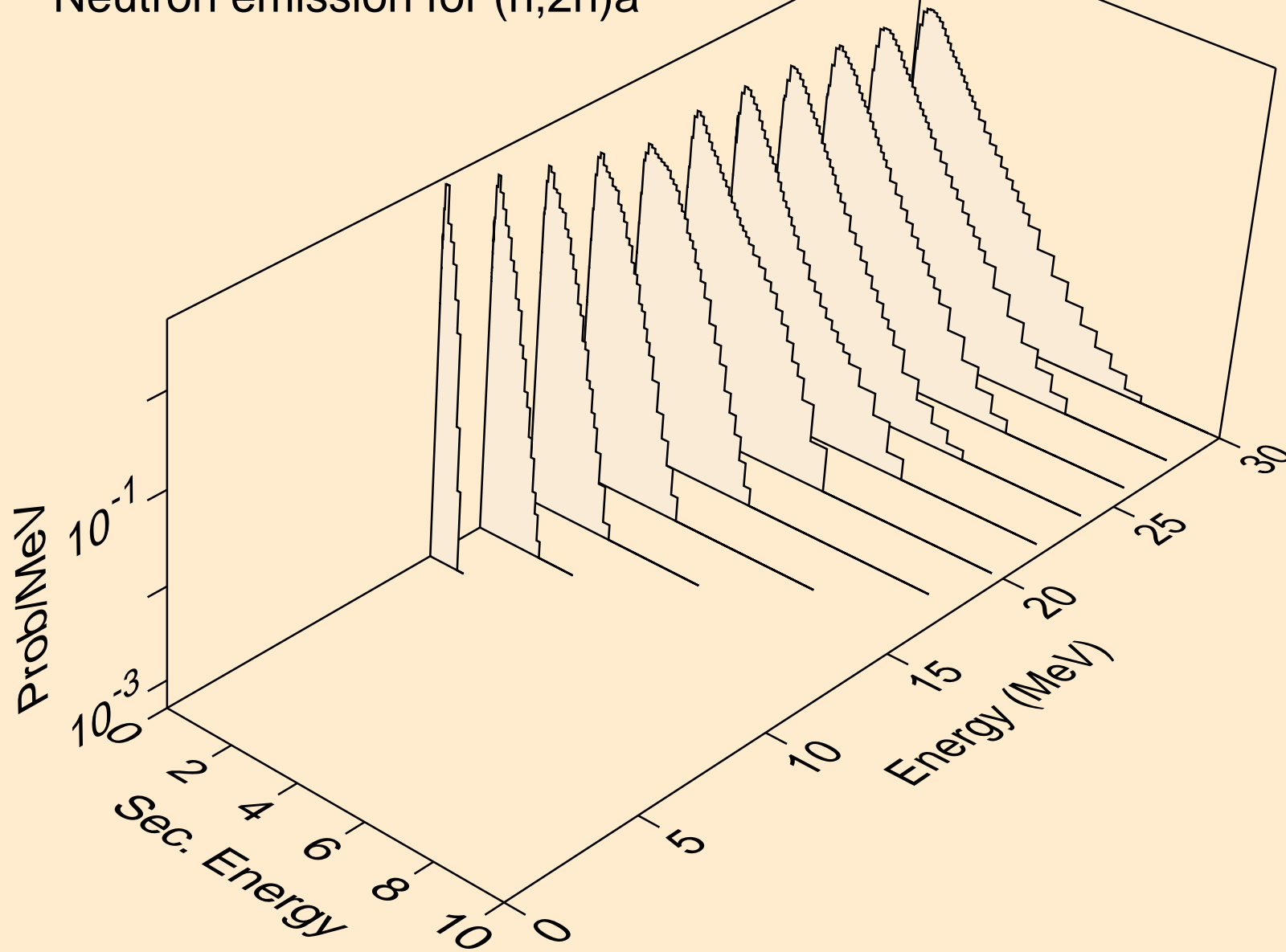

TB154 NEUTRON ACER TENDL-2021 LIBRARY; T=293.6K
Neutron emission for (n,3n)a

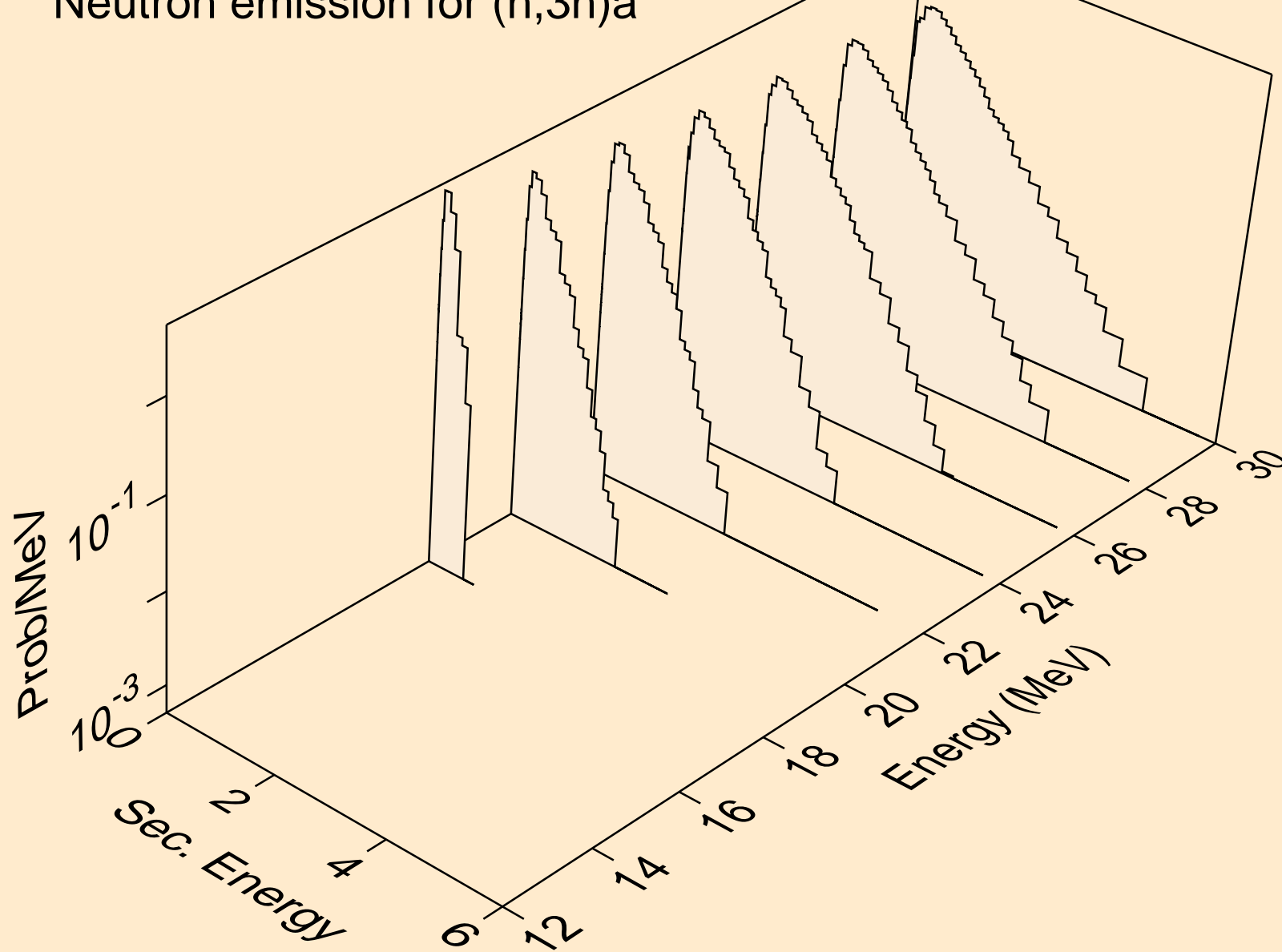

TB154 NEUTRON ACER TENDL-2021 LIBRARY; T=293.6K
Neutron emission for (n,n*)p

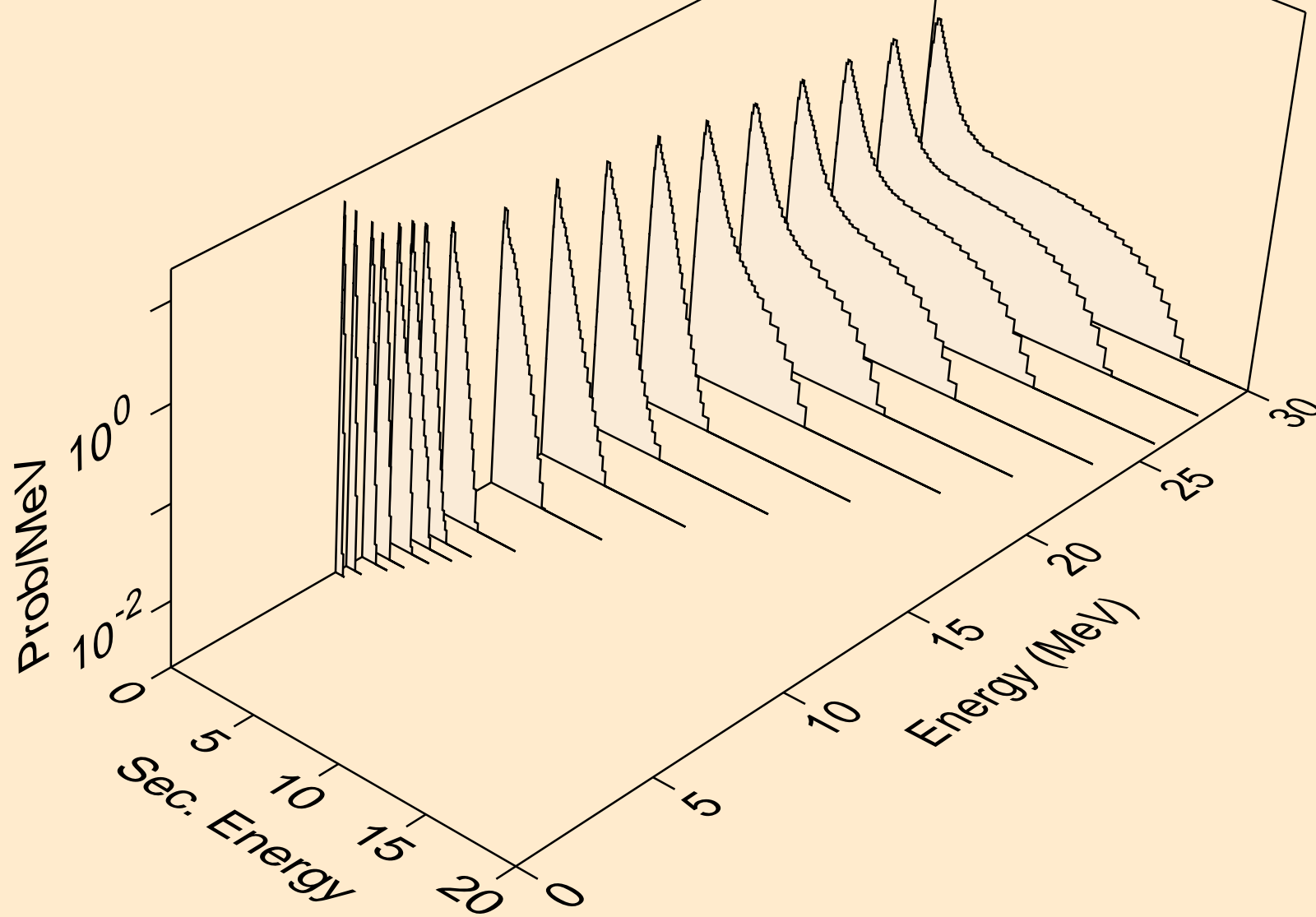

TB154 NEUTRON ACER TENDL-2021 LIBRARY; T=293.6K
Neutron emission for (n,n*)2a

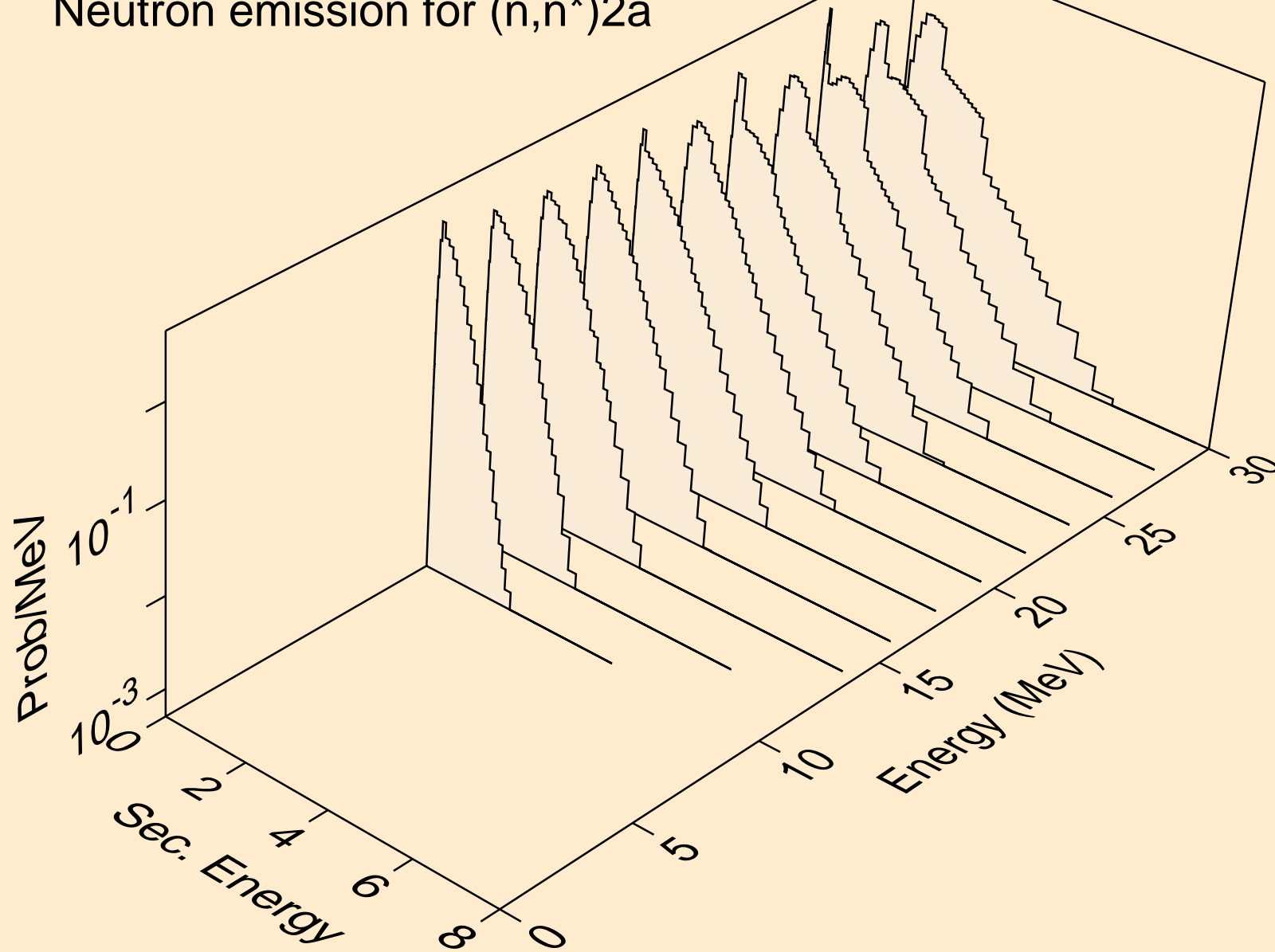

TB154 NEUTRON ACER TENDL-2021 LIBRARY; T=293.6K
Neutron emission for (n,2n)2a

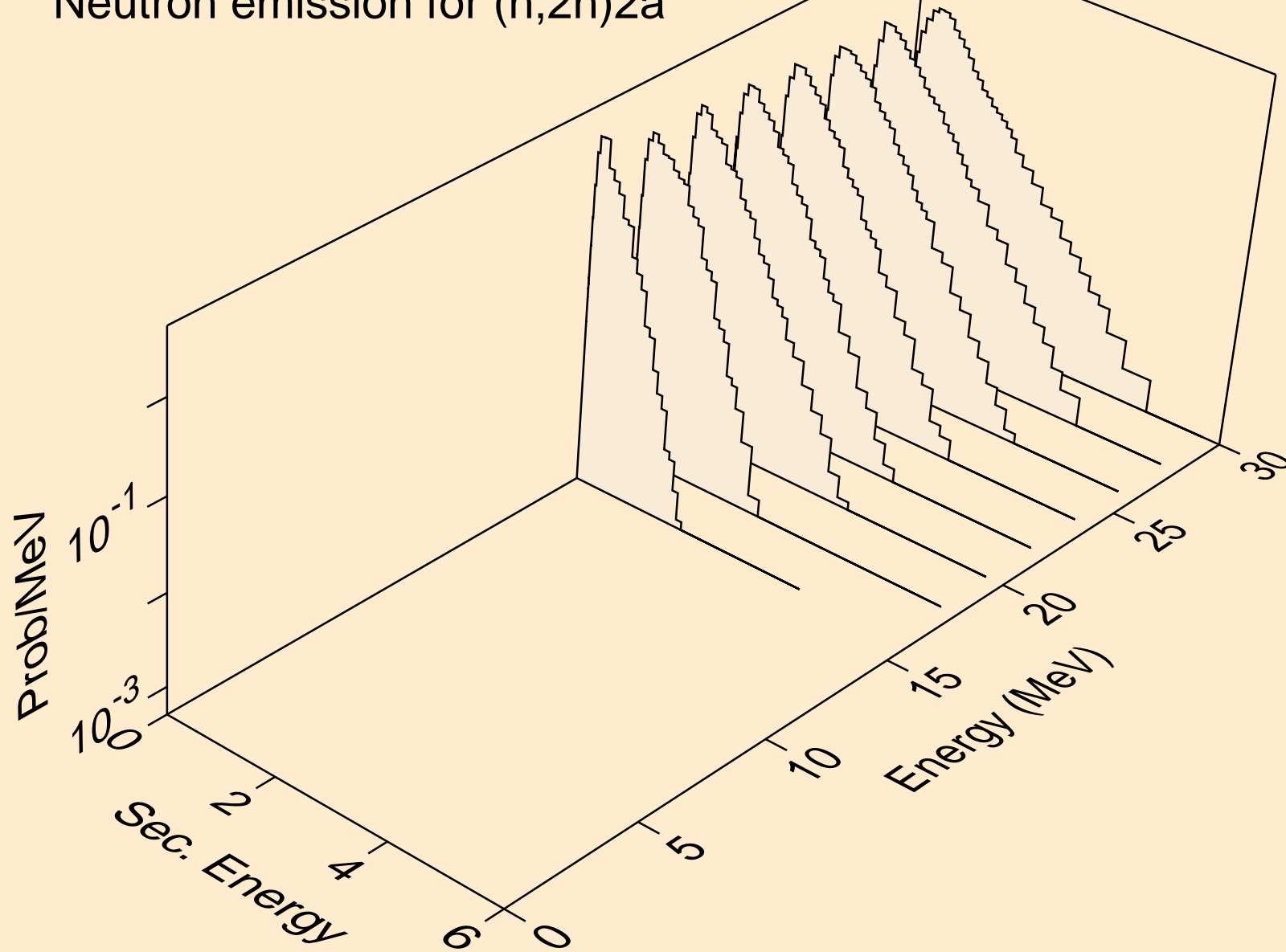

TB154 NEUTRON ACER TENDL-2021 LIBRARY; T=293.6K
Neutron emission for (n,n*)d

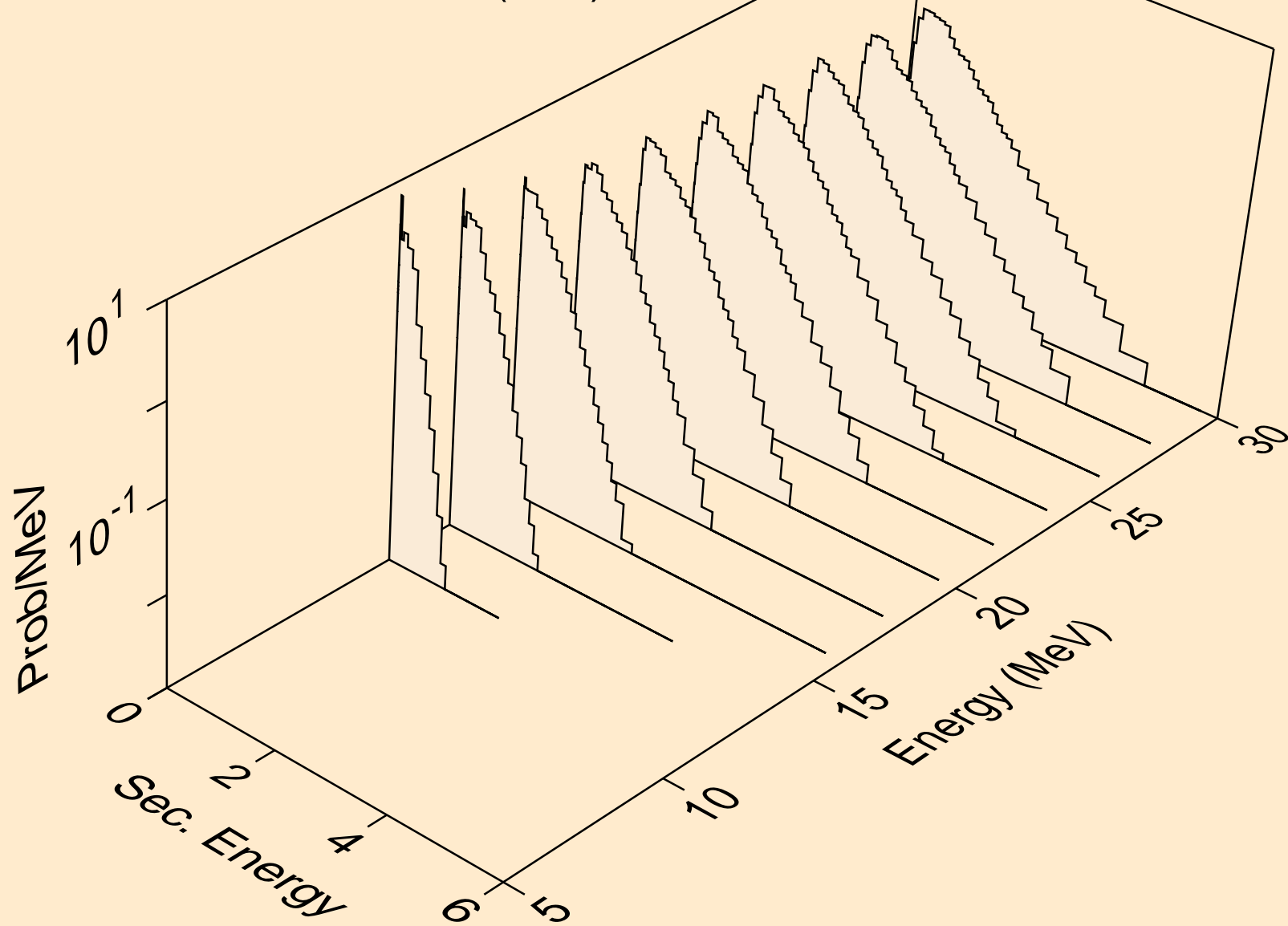

TB154 NEUTRON ACER TENDL-2021 LIBRARY; T=293.6K
Neutron emission for (n,n*)t

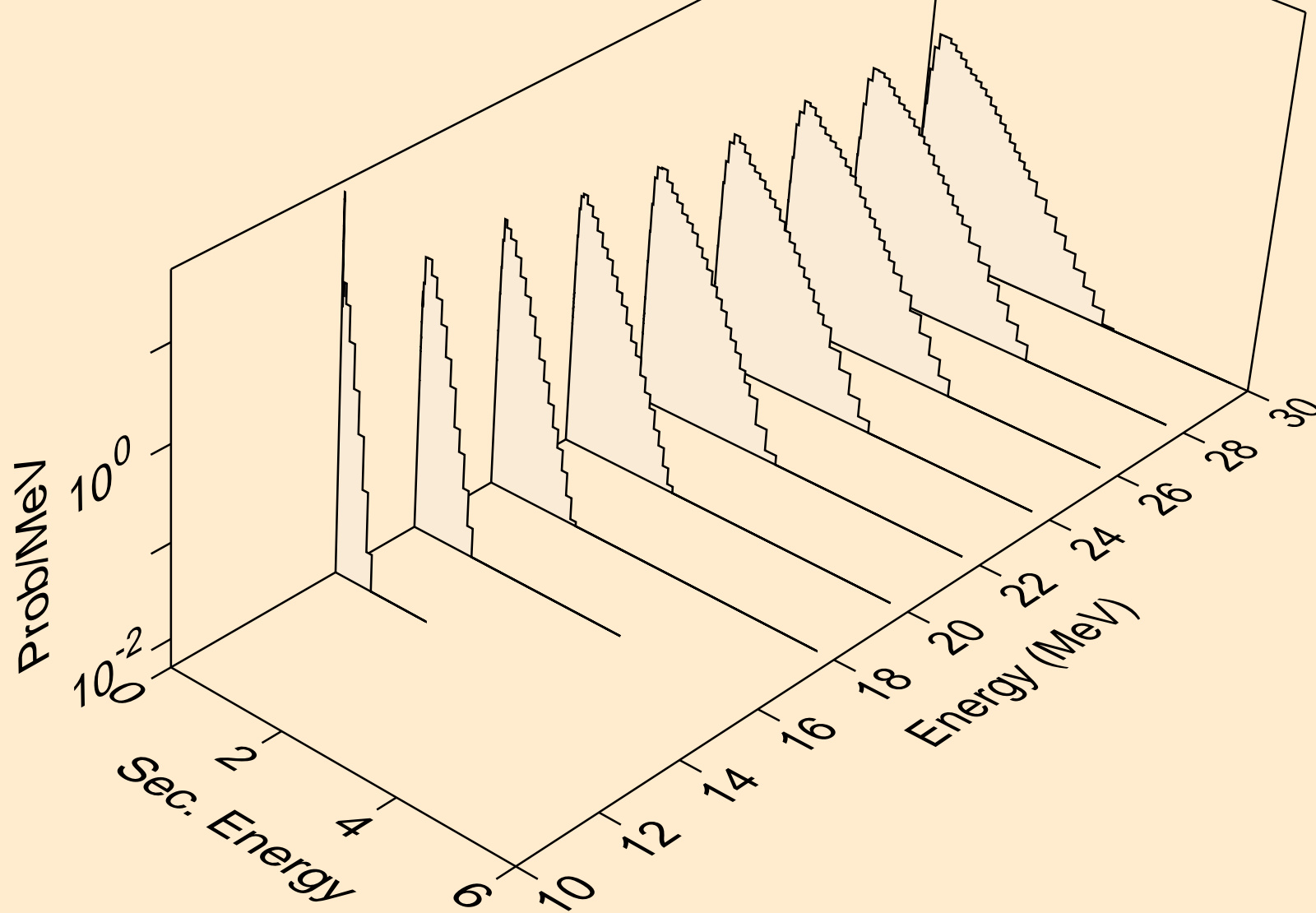

TB154 NEUTRON ACER TENDL-2021 LIBRARY; T=293.6K
Neutron emission for (n,n*)he3

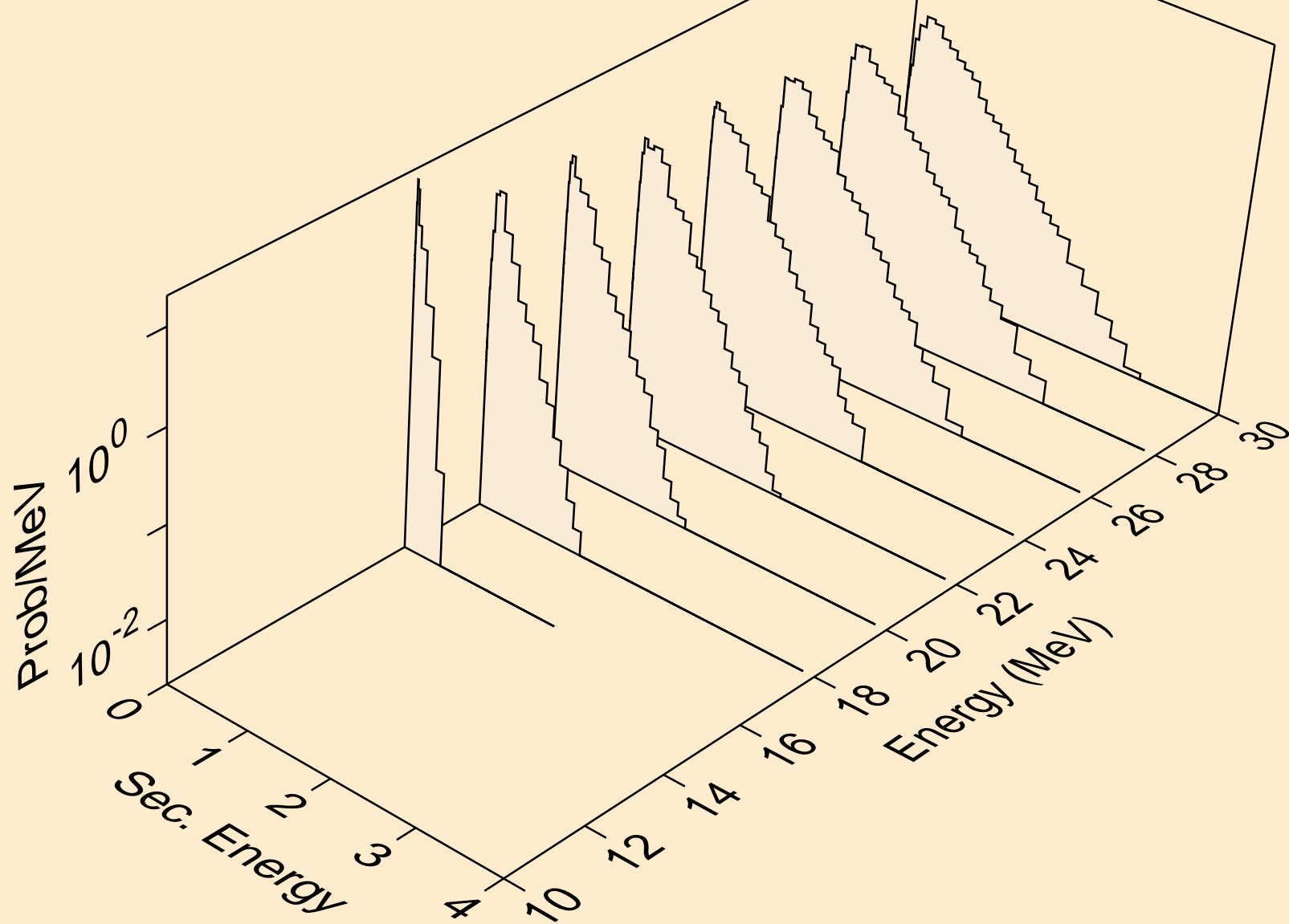

TB154 NEUTRON ACER TENDL-2021 LIBRARY; T=293.6K
Neutron emission for (n,4n)

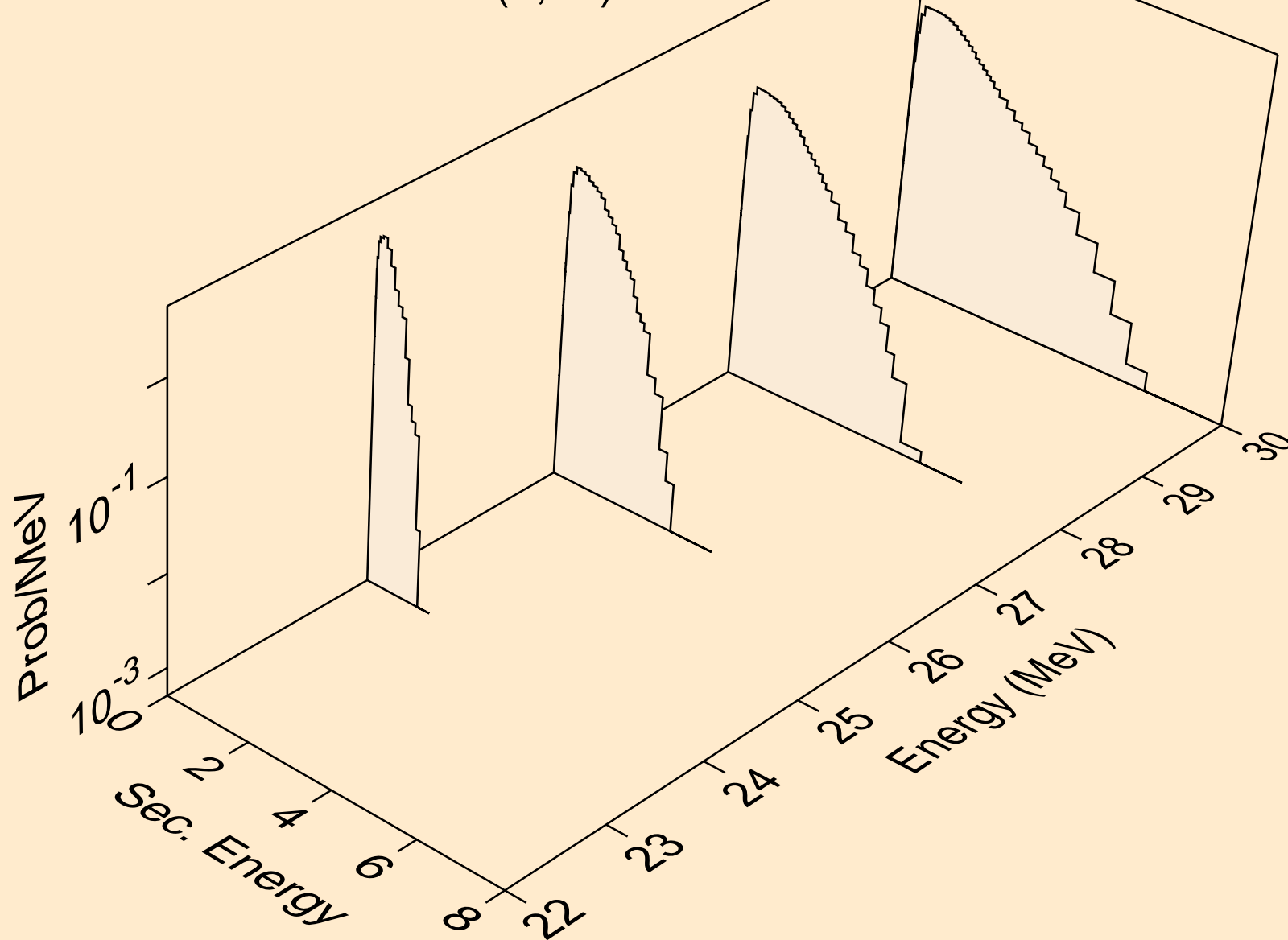

TB154 NEUTRON ACER TENDL-2021 LIBRARY; T=293.6K
Neutron emission for (n,2np)

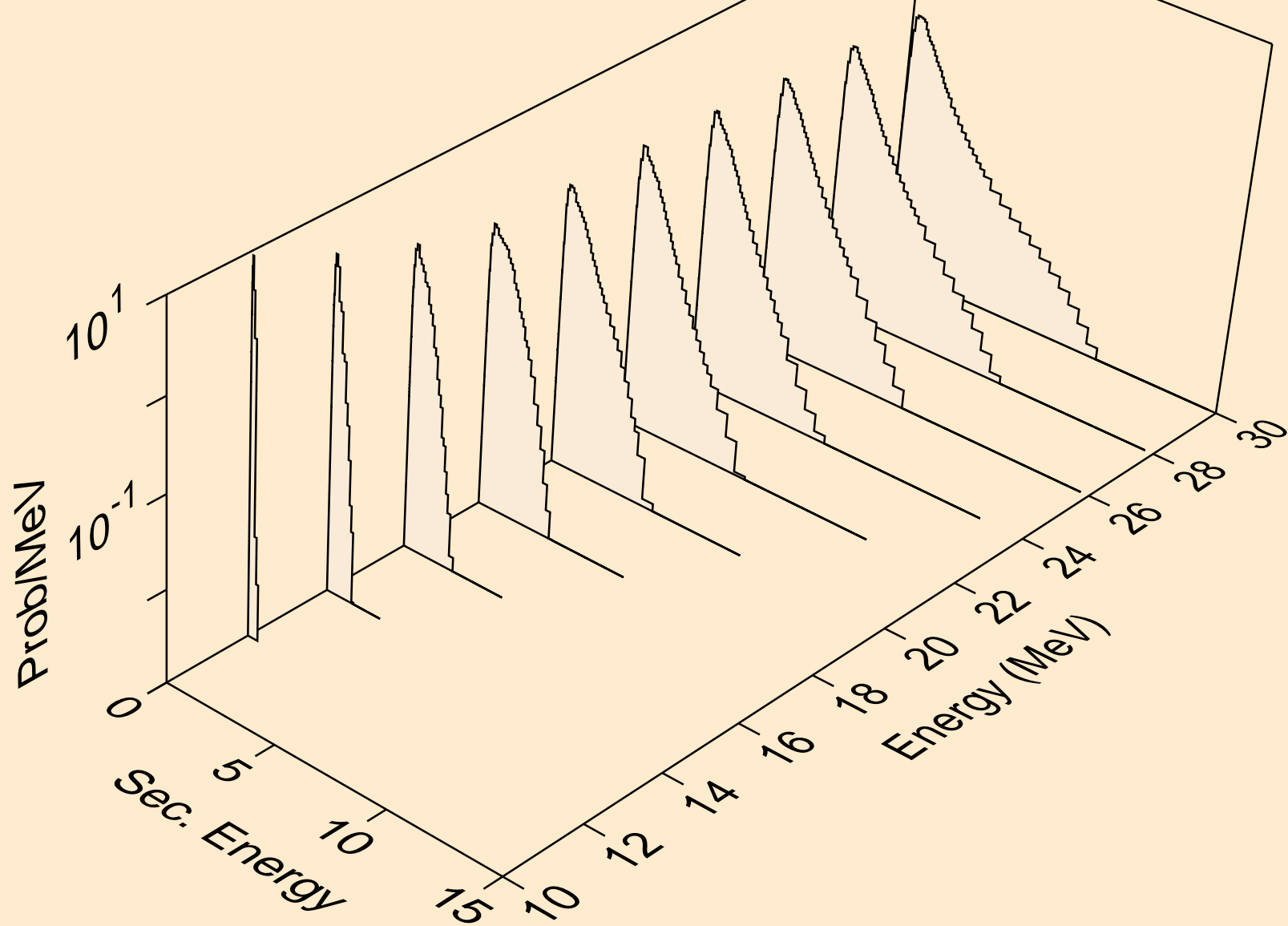

TB154 NEUTRON ACER TENDL-2021 LIBRARY; T=293.6K
Neutron emission for (n,3np)

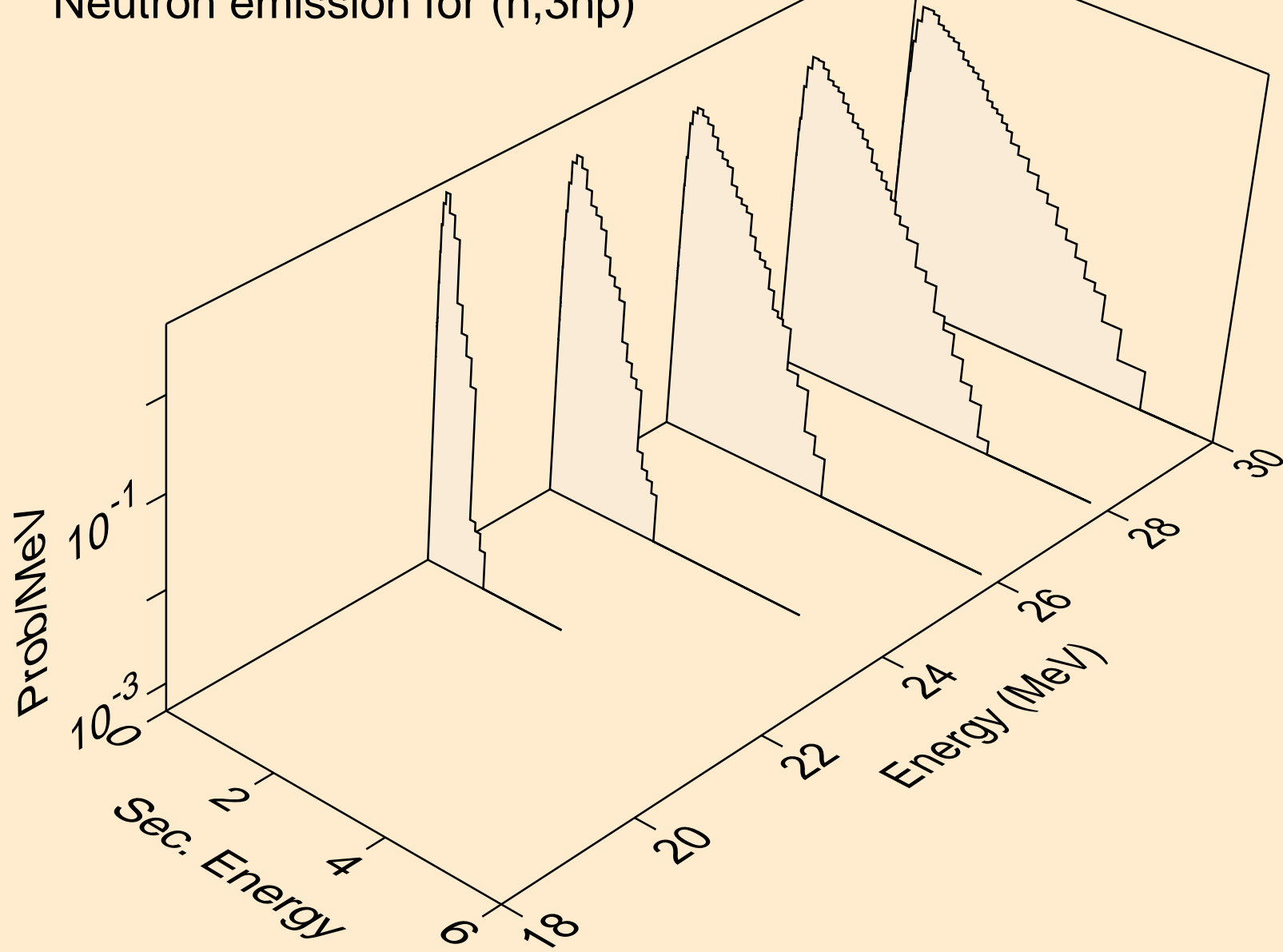

TB154 NEUTRON ACER TENDL-2021 LIBRARY; T=293.6K
Neutron emission for (n,2np)

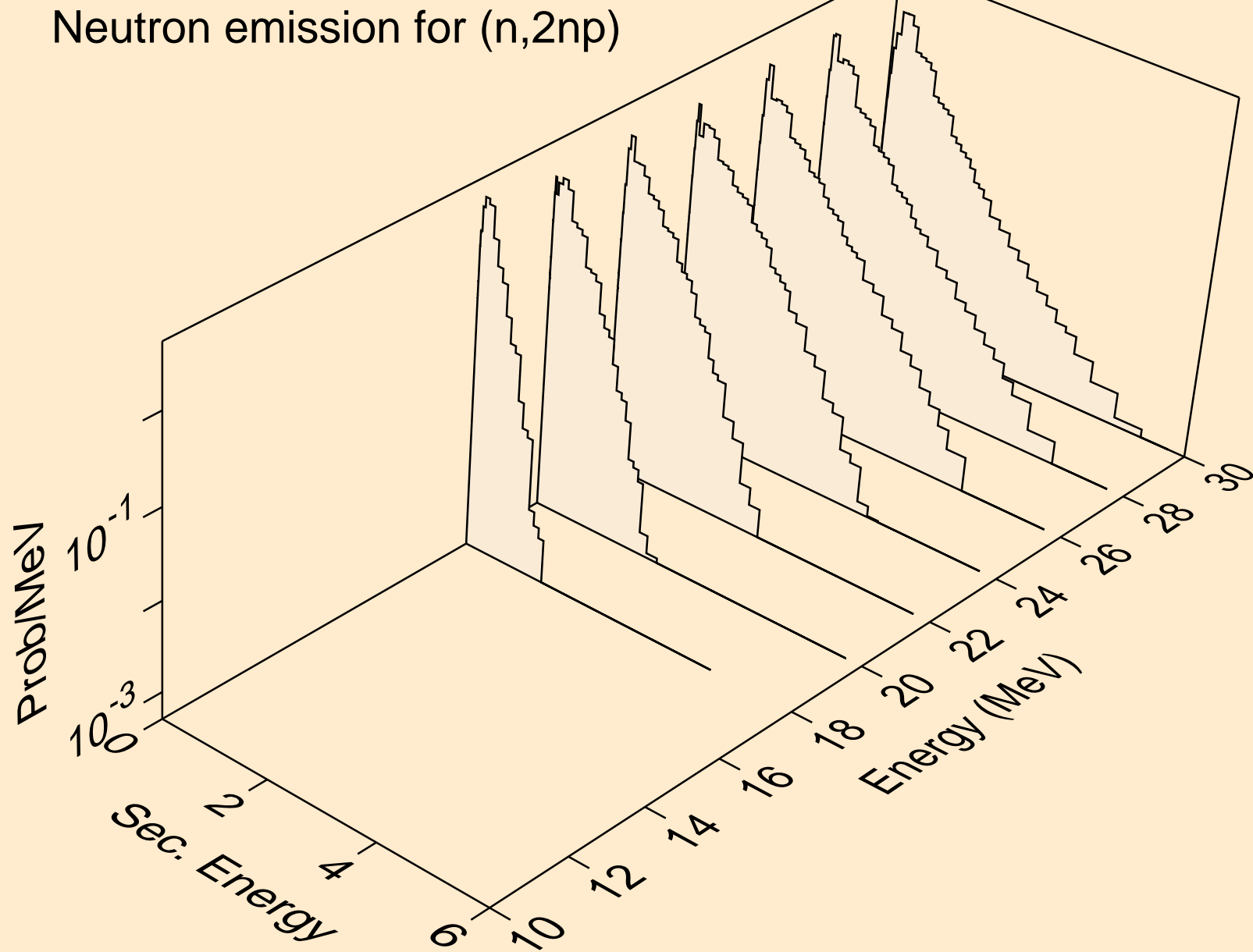

TB154 NEUTRON ACER TENDL-2021 LIBRARY; T=293.6K
Neutron emission for (n,npa)

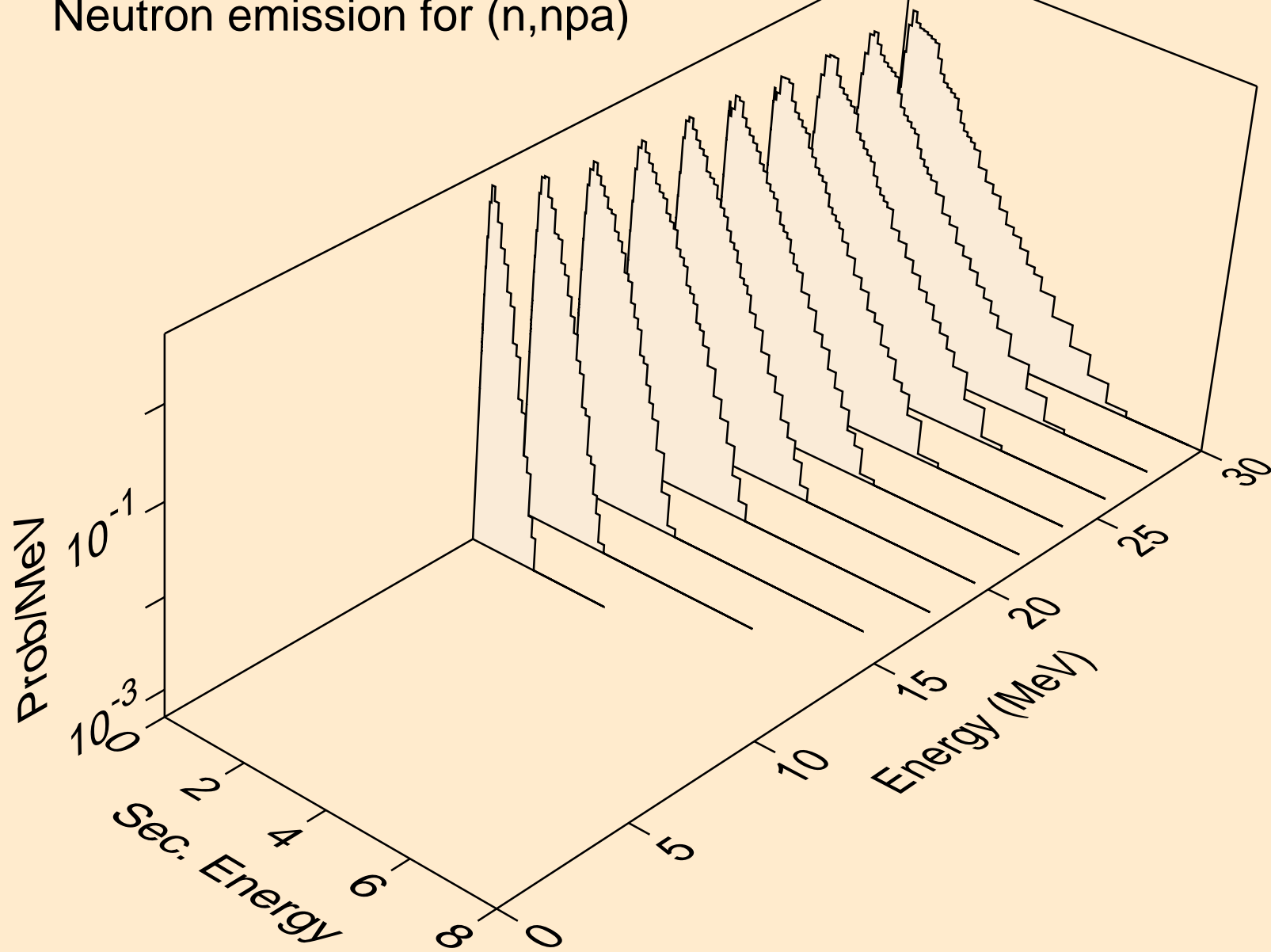

TB154 NEUTRON ACER TENDL-2021 LIBRARY; T=293.6K
Neutron emission for (n,n*c)

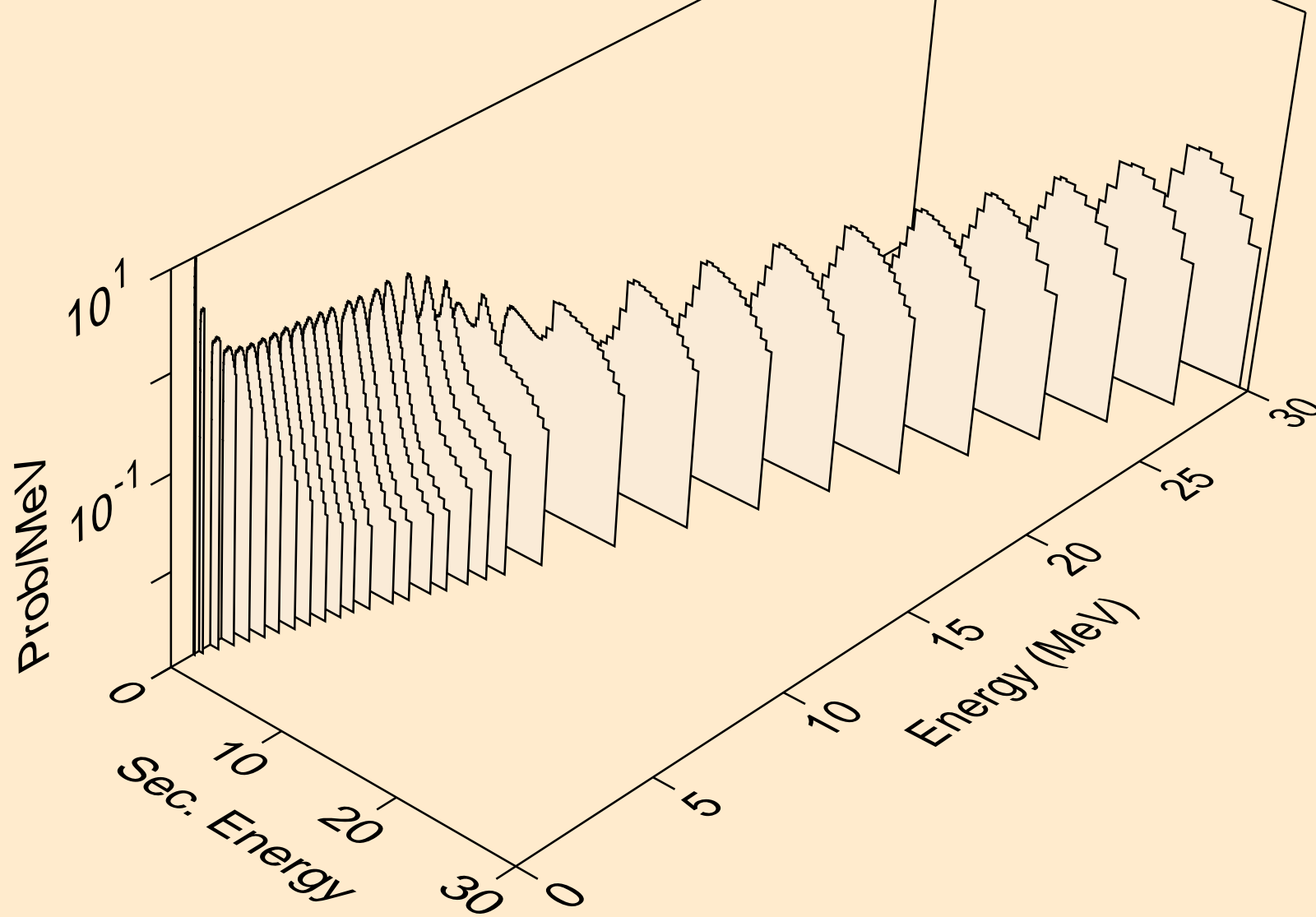

TB154 NEUTRON ACER TENDL-2021 LIBRARY; T=293.6K
Photon emission for (n,x)

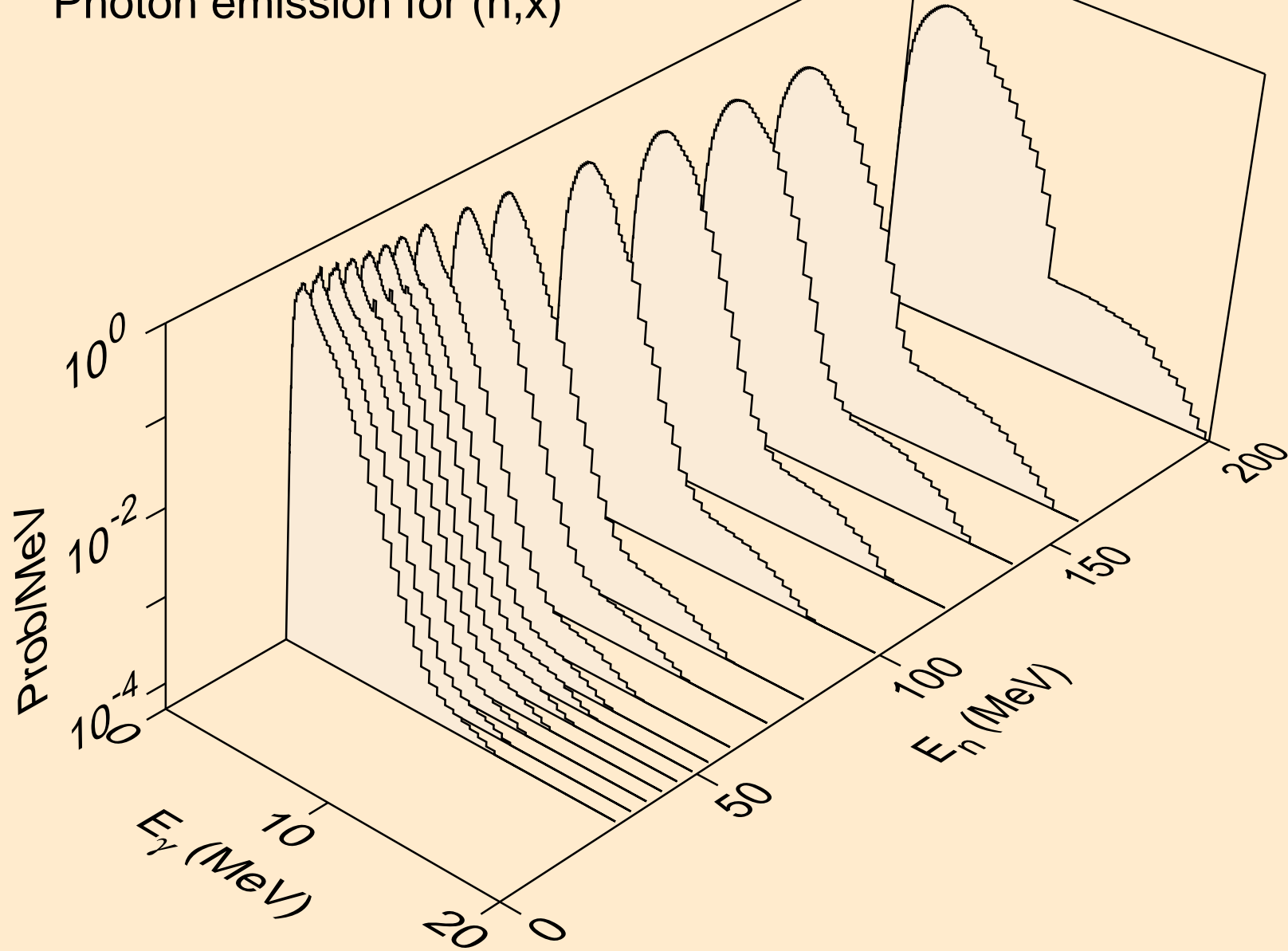

TB154 NEUTRON ACER TENDL-2021 LIBRARY; T=293.6K
Photon emission for (n,2nd)

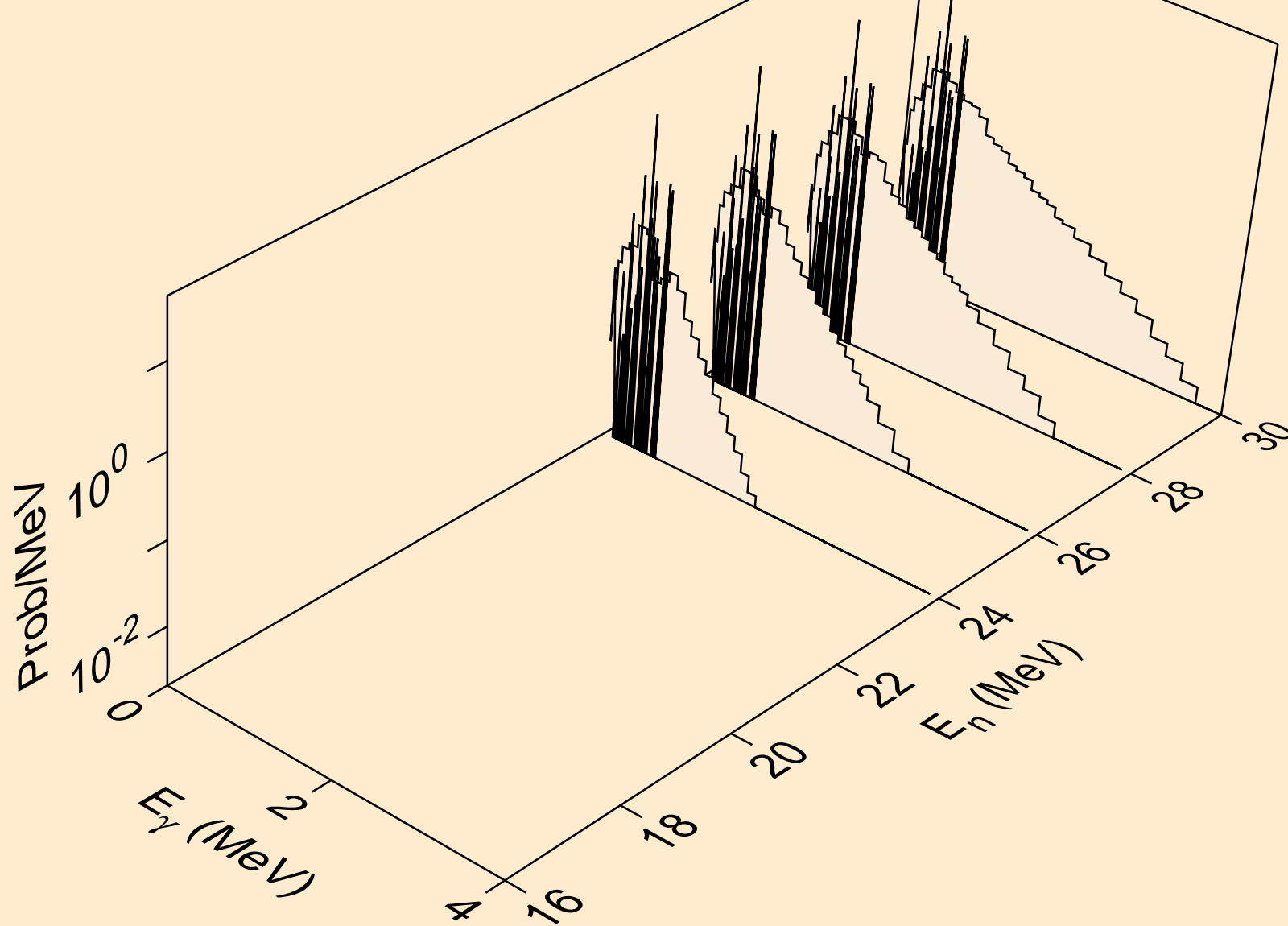

TB154 NEUTRON ACER TENDL-2021 LIBRARY; T=293.6K
Photon emission for (n,2n)

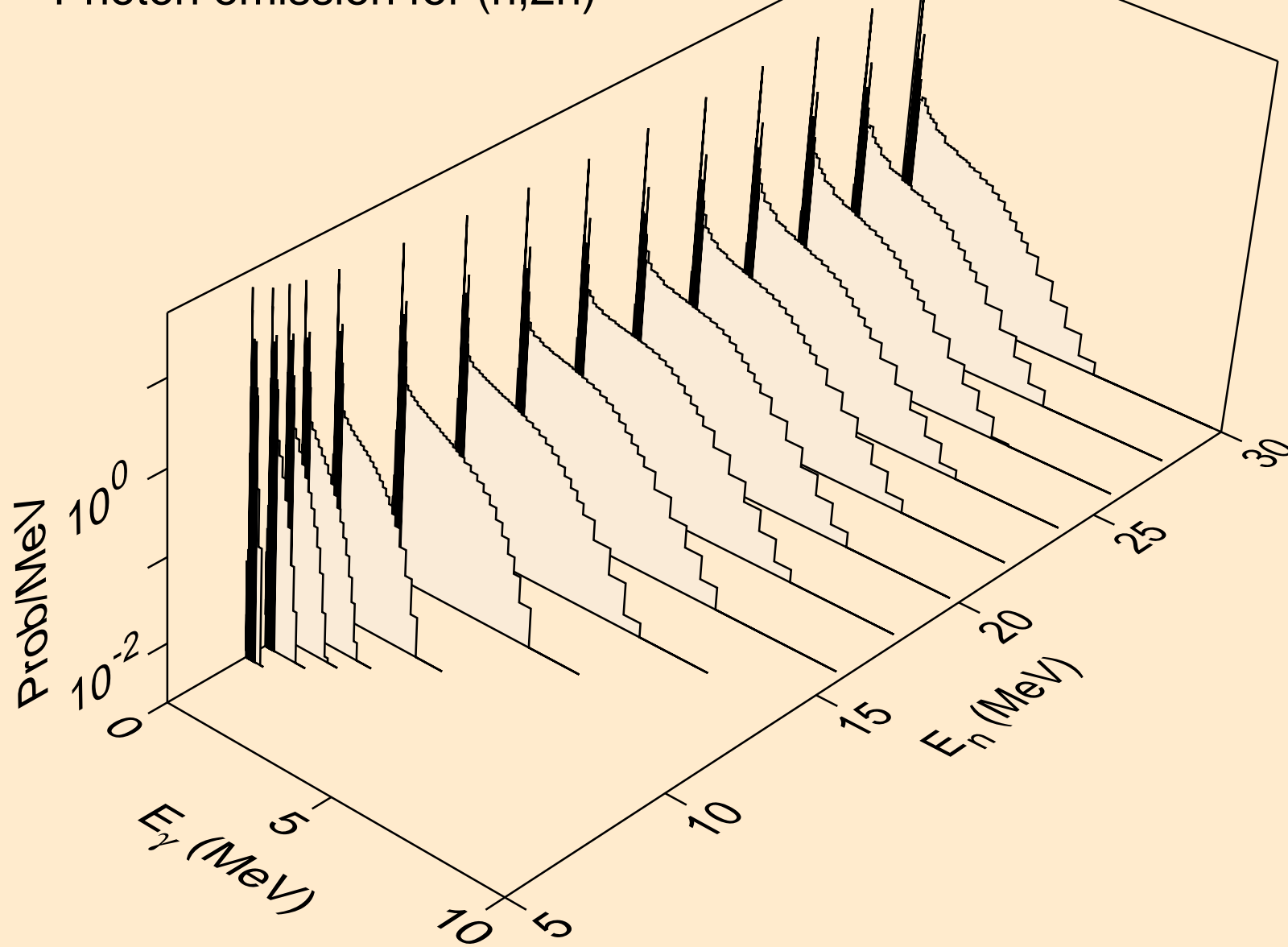

TB154 NEUTRON ACER TENDL-2021 LIBRARY; T=293.6K
Photon emission for (n,3n)

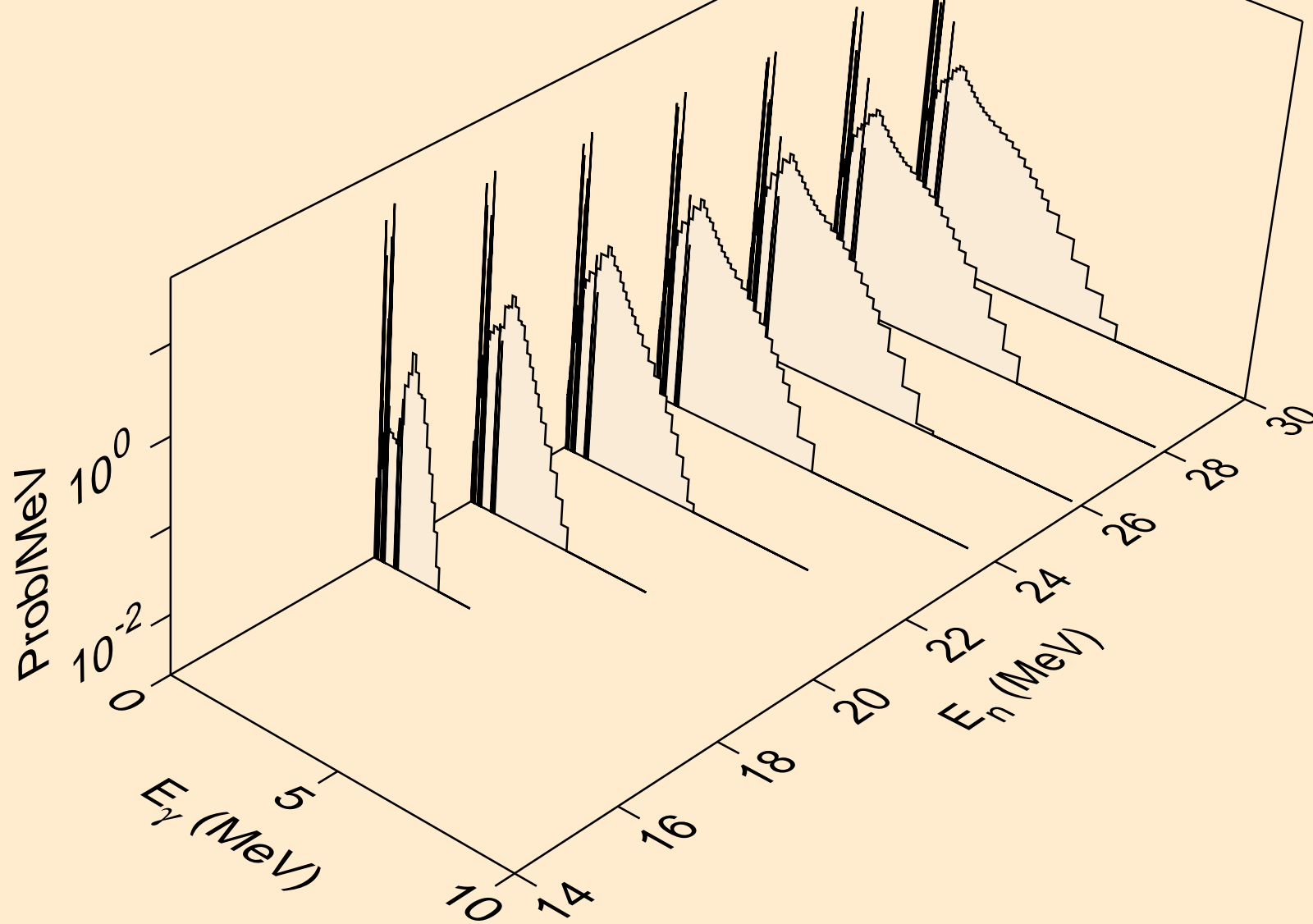

TB154 NEUTRON ACER TENDL-2021 LIBRARY; T=293.6K
Photon emission for (n,n*)a

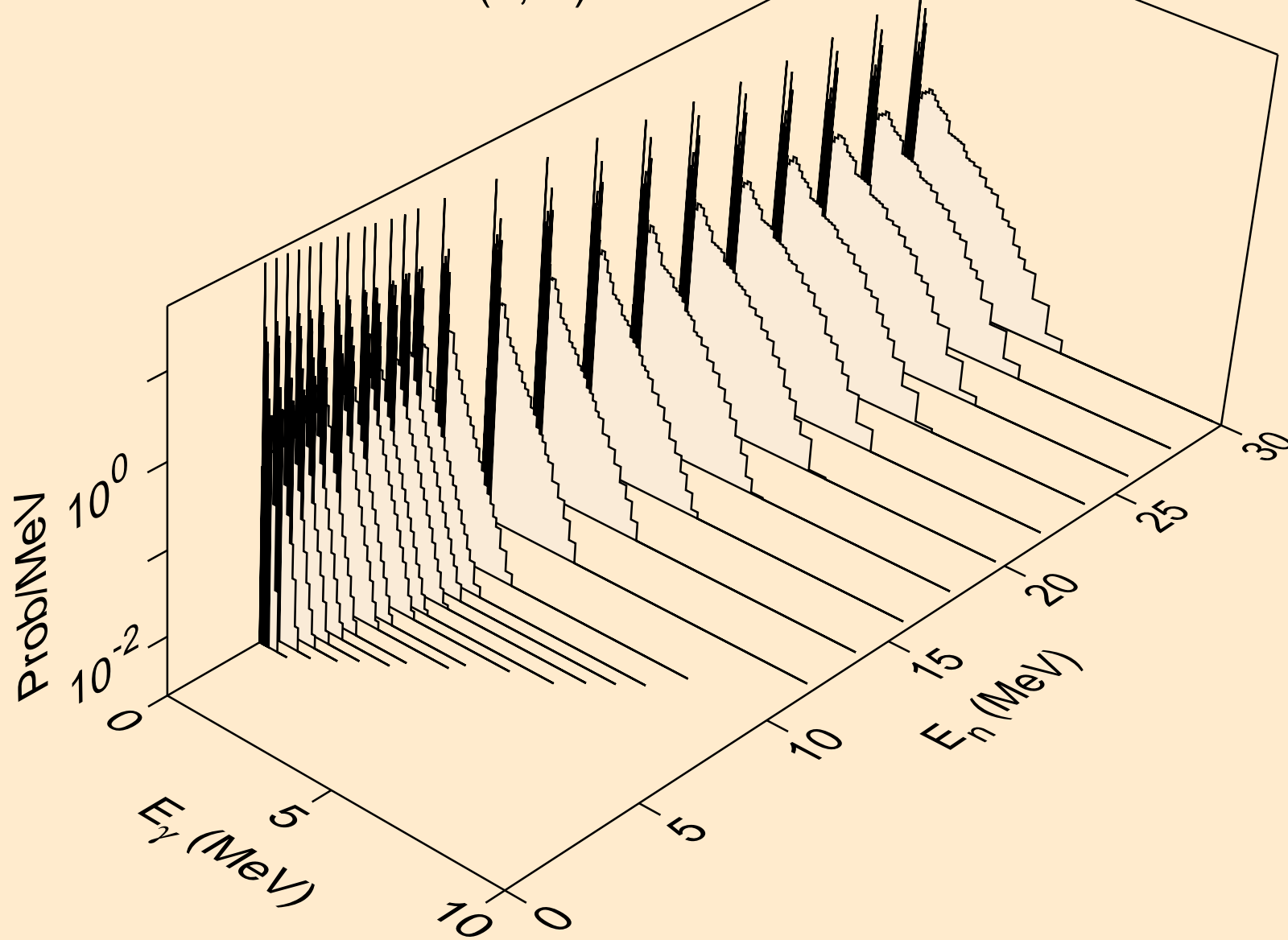

TB154 NEUTRON ACER TENDL-2021 LIBRARY; T=293.6K
Photon emission for (n,2n)a

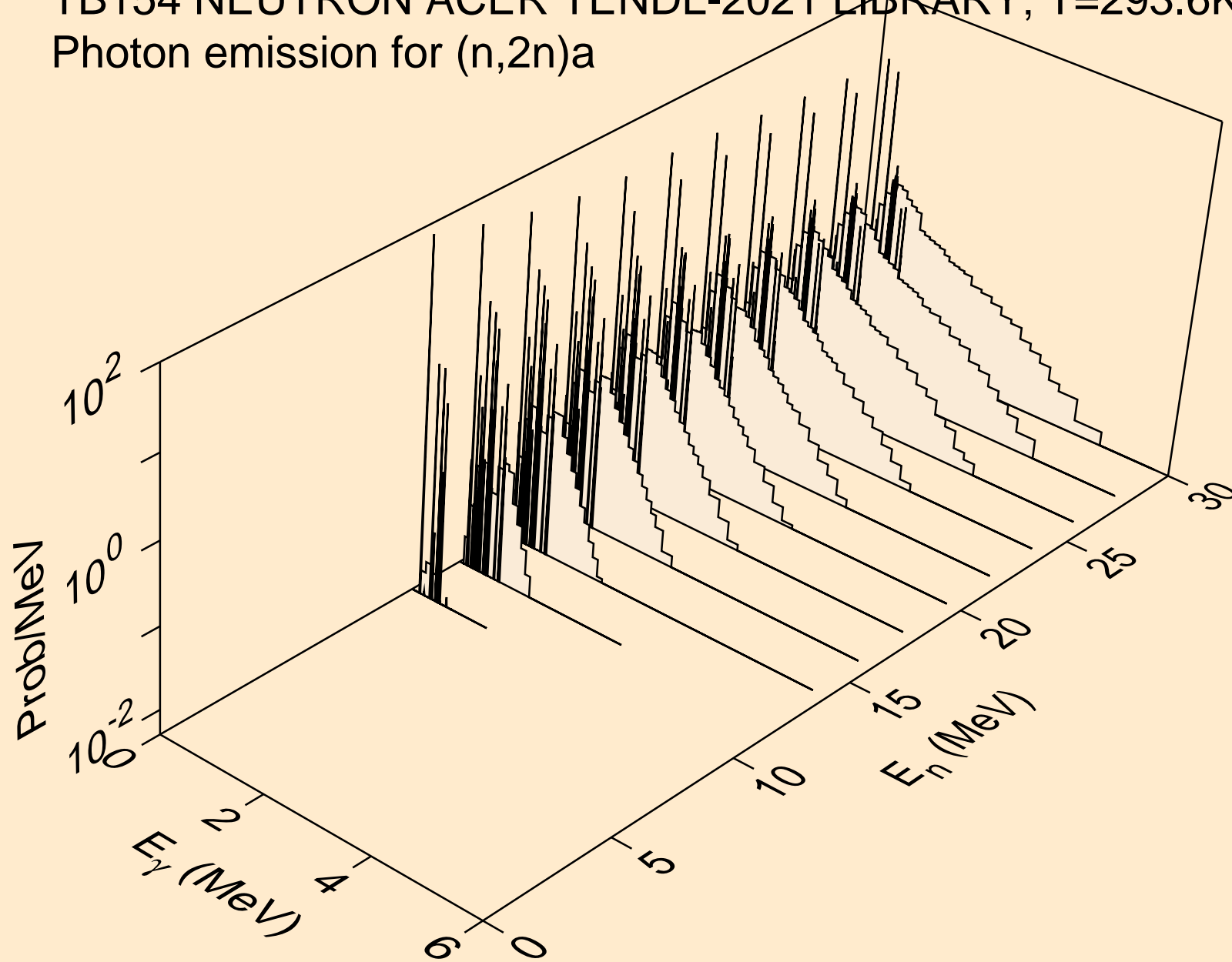

TB154 NEUTRON ACER TENDL-2021 LIBRARY; T=293.6K
Photon emission for (n,3n)a

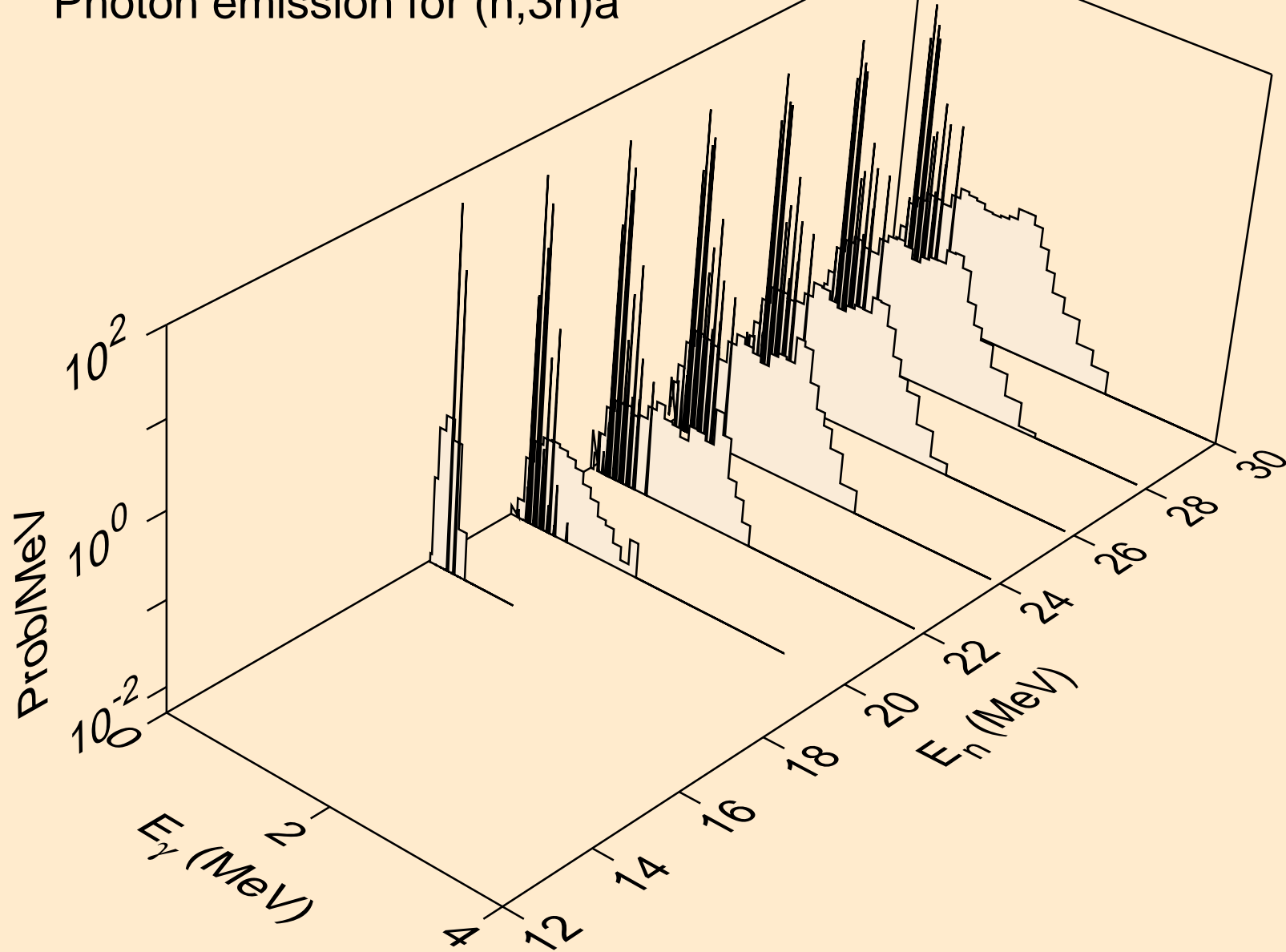

TB154 NEUTRON ACER TENDL-2021 LIBRARY; T=293.6K
Photon emission for (n,n*)p

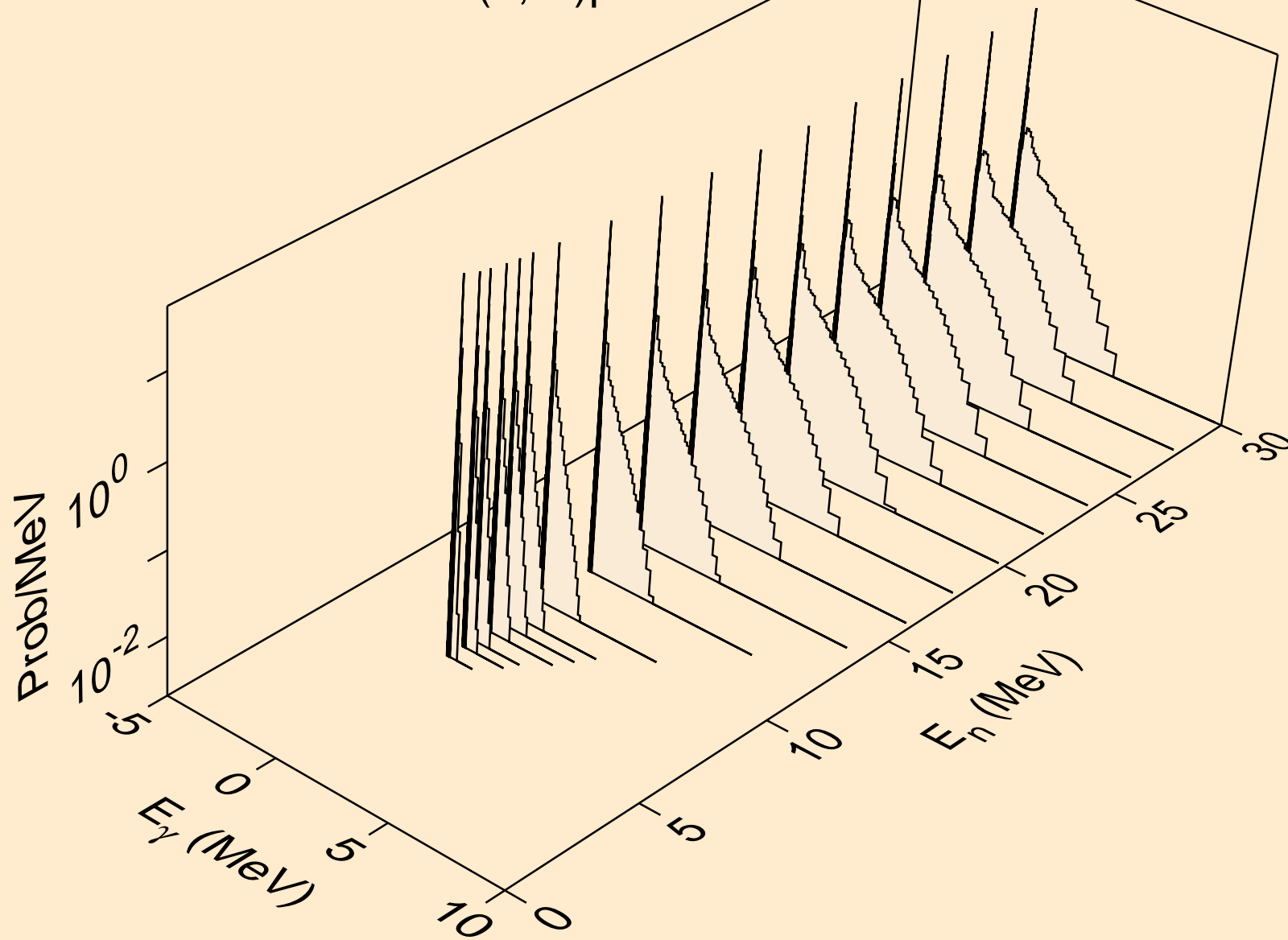

TB154 NEUTRON ACER TENDL-2021 LIBRARY; T=293.6K
Photon emission for (n,n*)2a

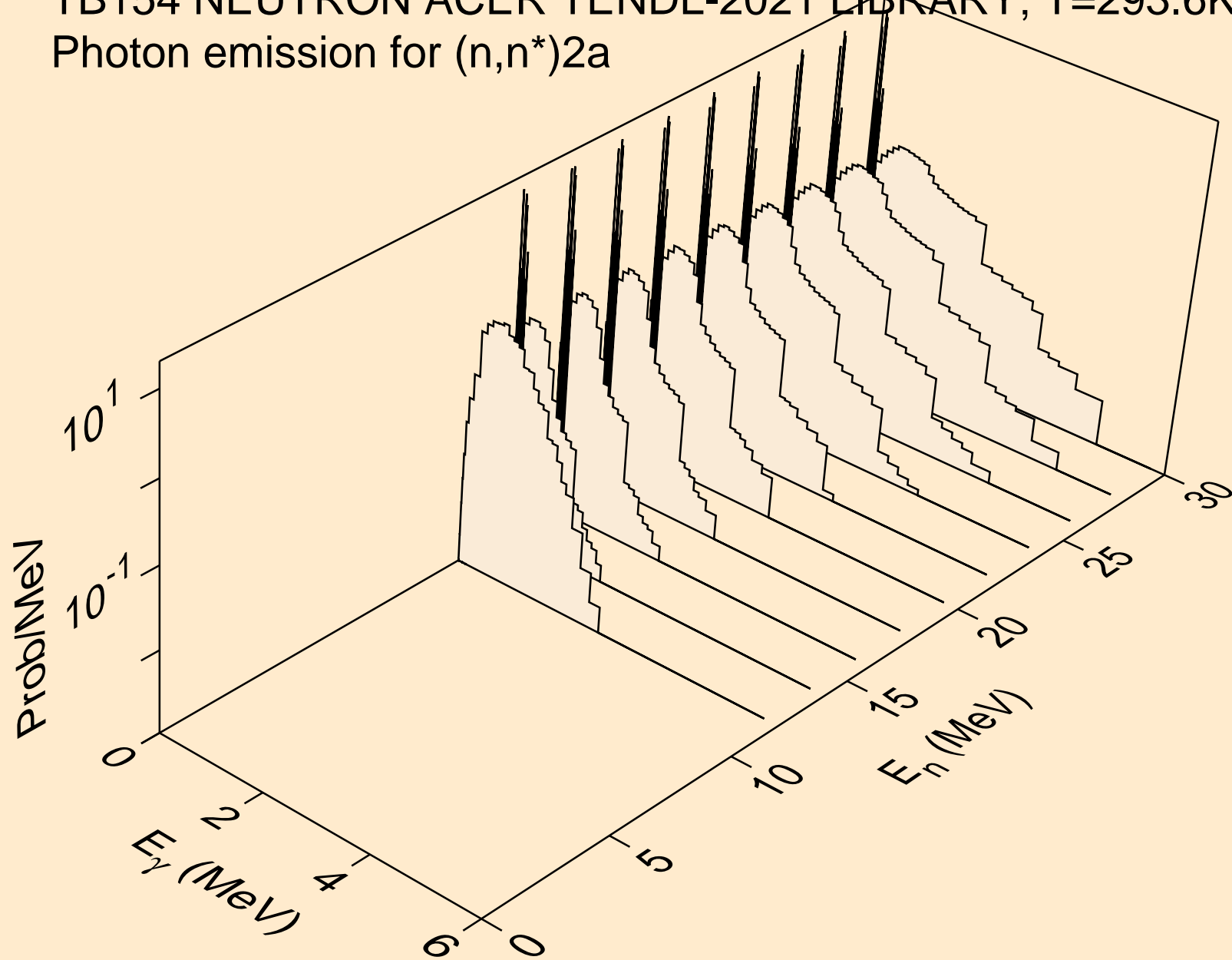

TB154 NEUTRON ACER TENDL-2021 LIBRARY; T=293.6K
Photon emission for (n,2n)2a

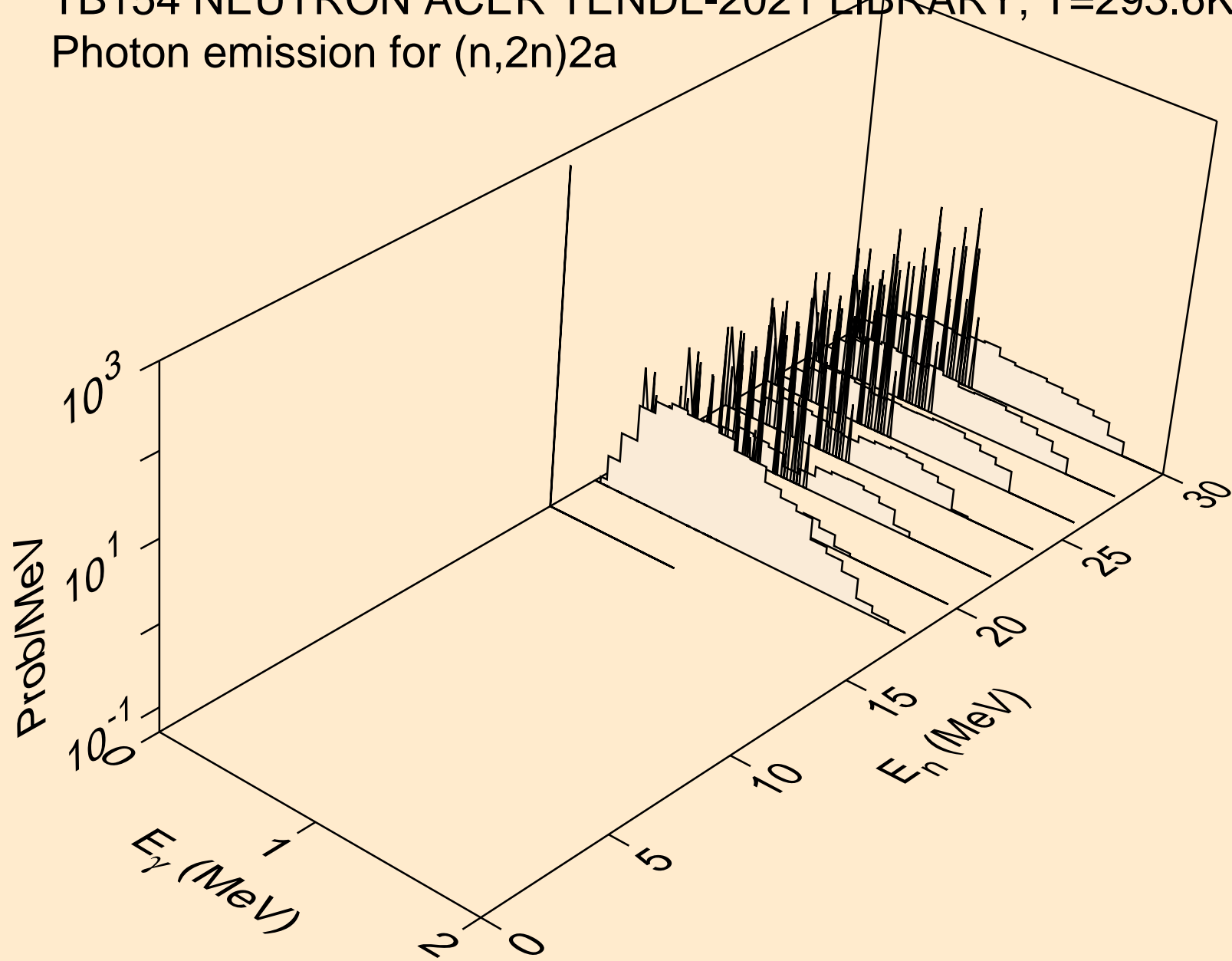

TB154 NEUTRON ACER TENDL-2021 LIBRARY; T=293.6K
Photon emission for (n,n*)d

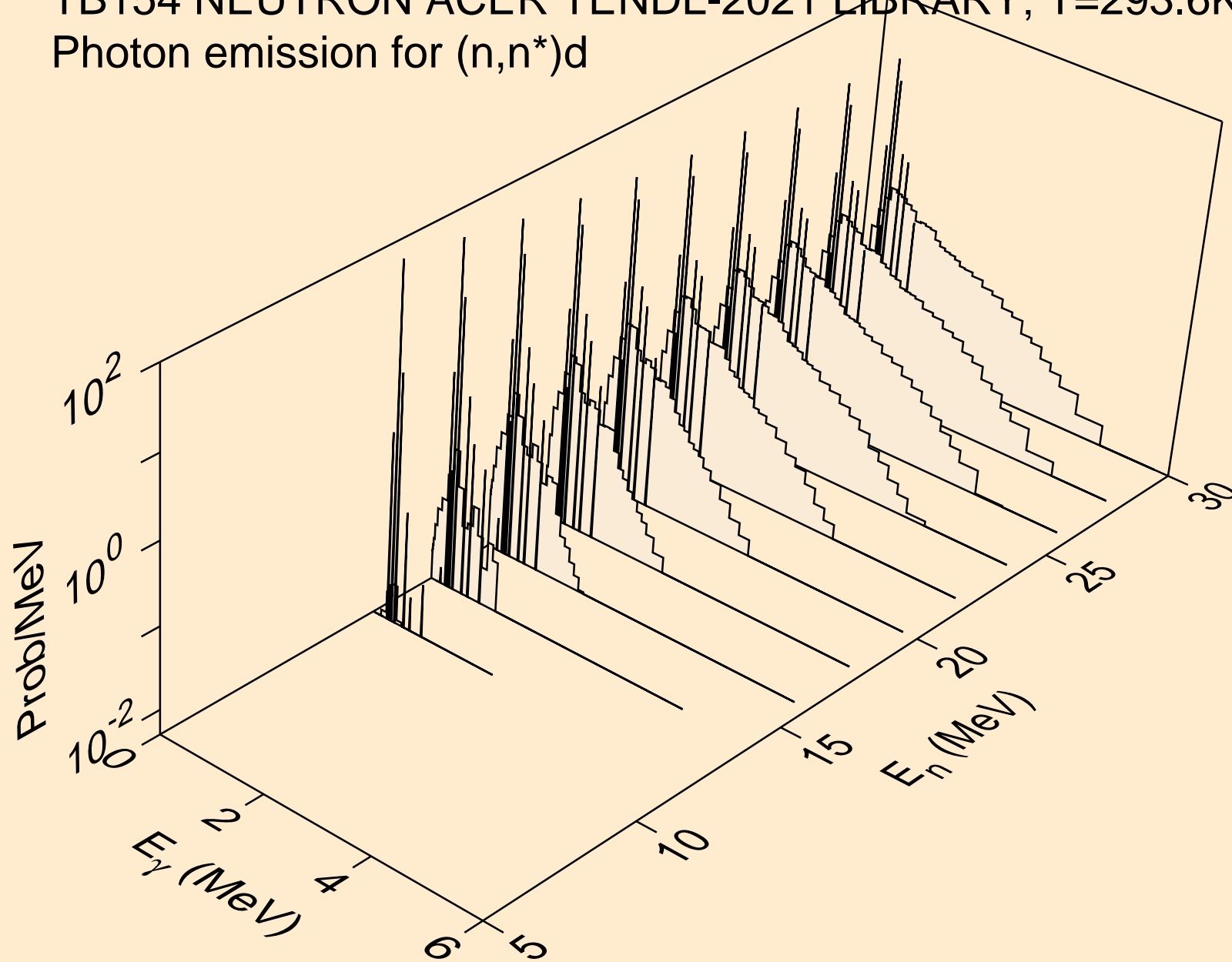

TB154 NEUTRON ACER TENDL-2021 LIBRARY; T=293.6K
Photon emission for (n,n*)t

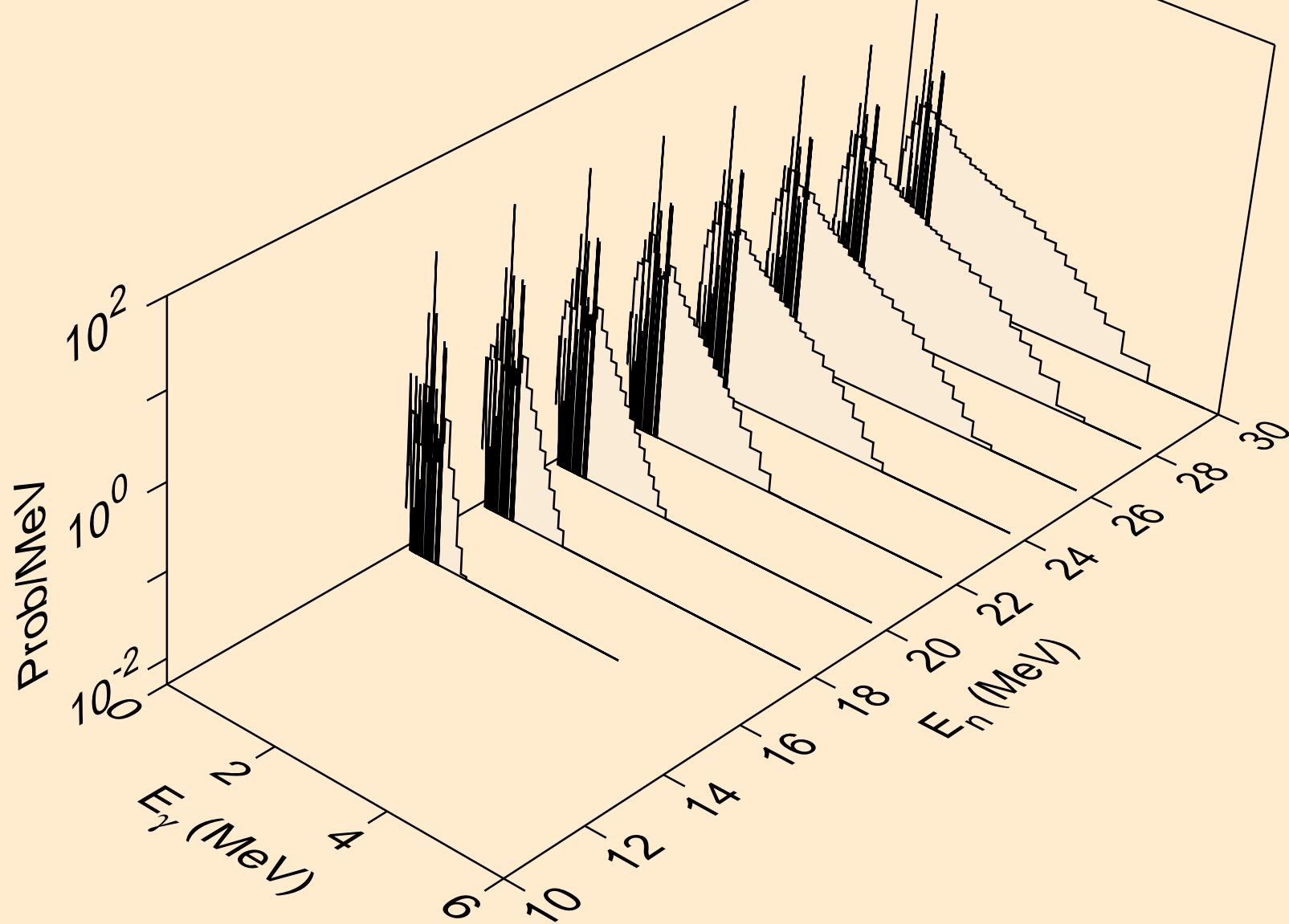

TB154 NEUTRON ACER TENDL-2021 LIBRARY; T=293.6K
Photon emission for (n,n*)he3

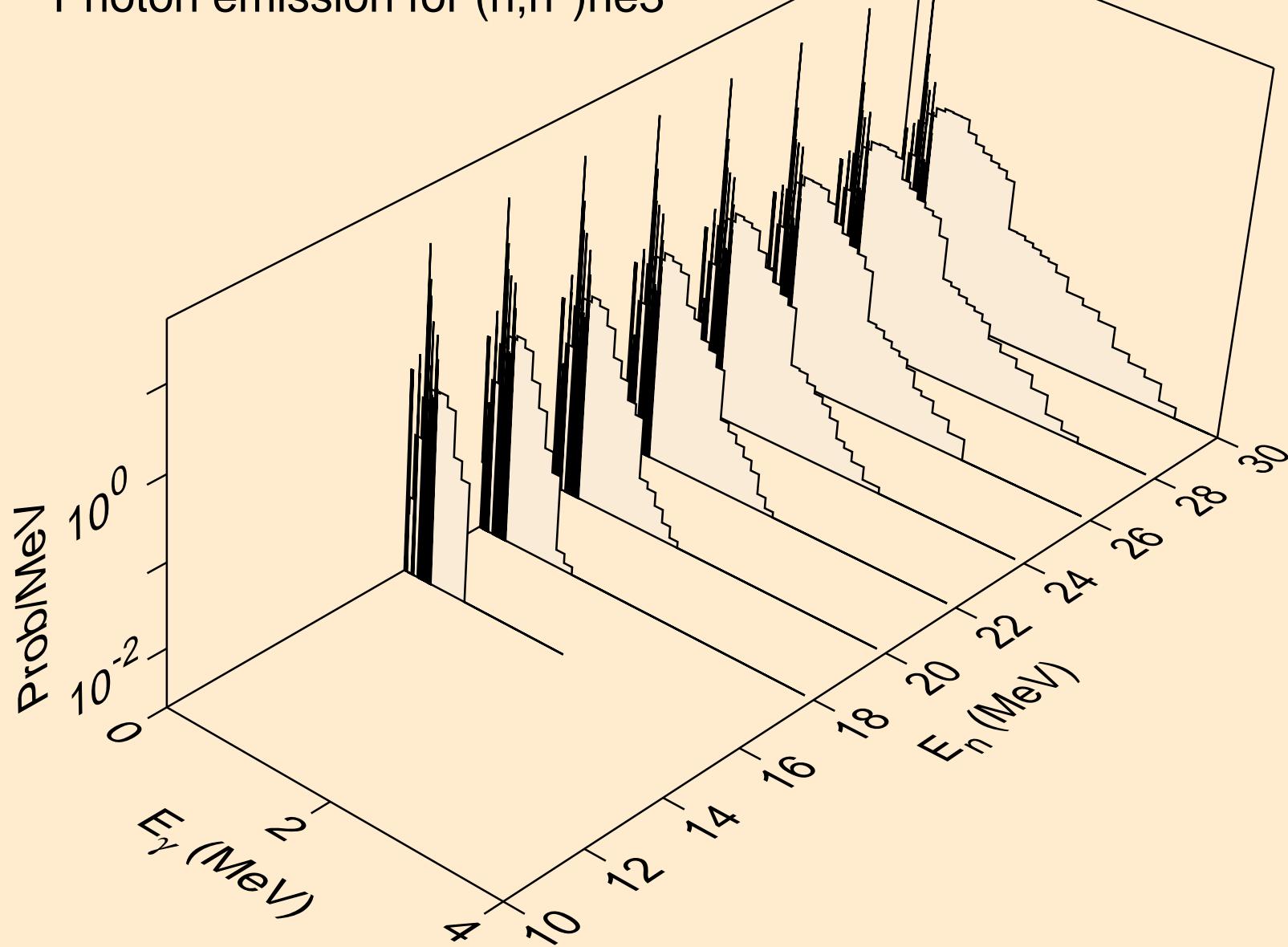

TB154 NEUTRON ACER TENDL-2021 LIBRARY; T=293.6K
Photon emission for (n,4n)

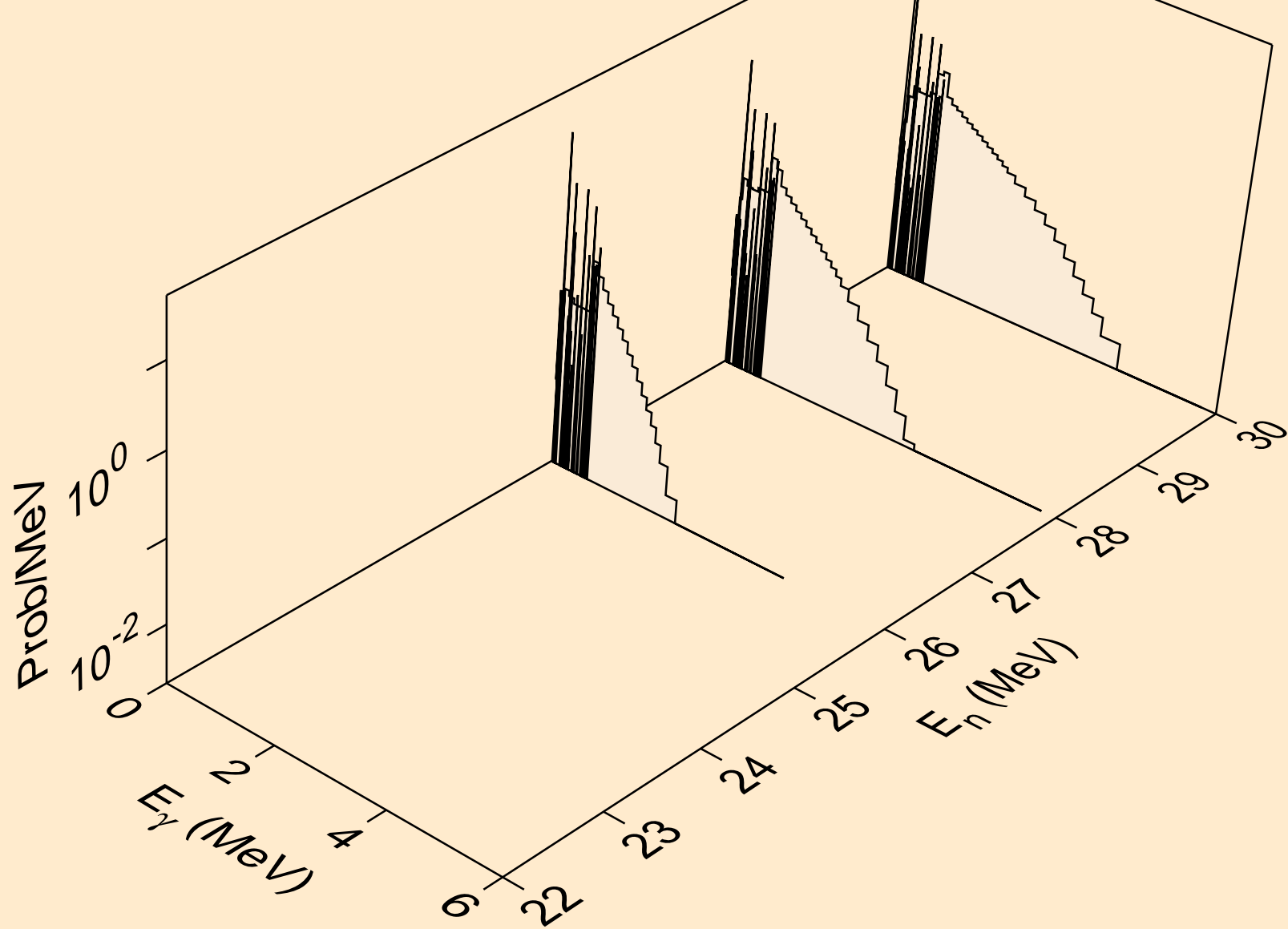

TB154 NEUTRON ACER TENDL-2021 LIBRARY; T=293.6K
Photon emission for (n,2np)

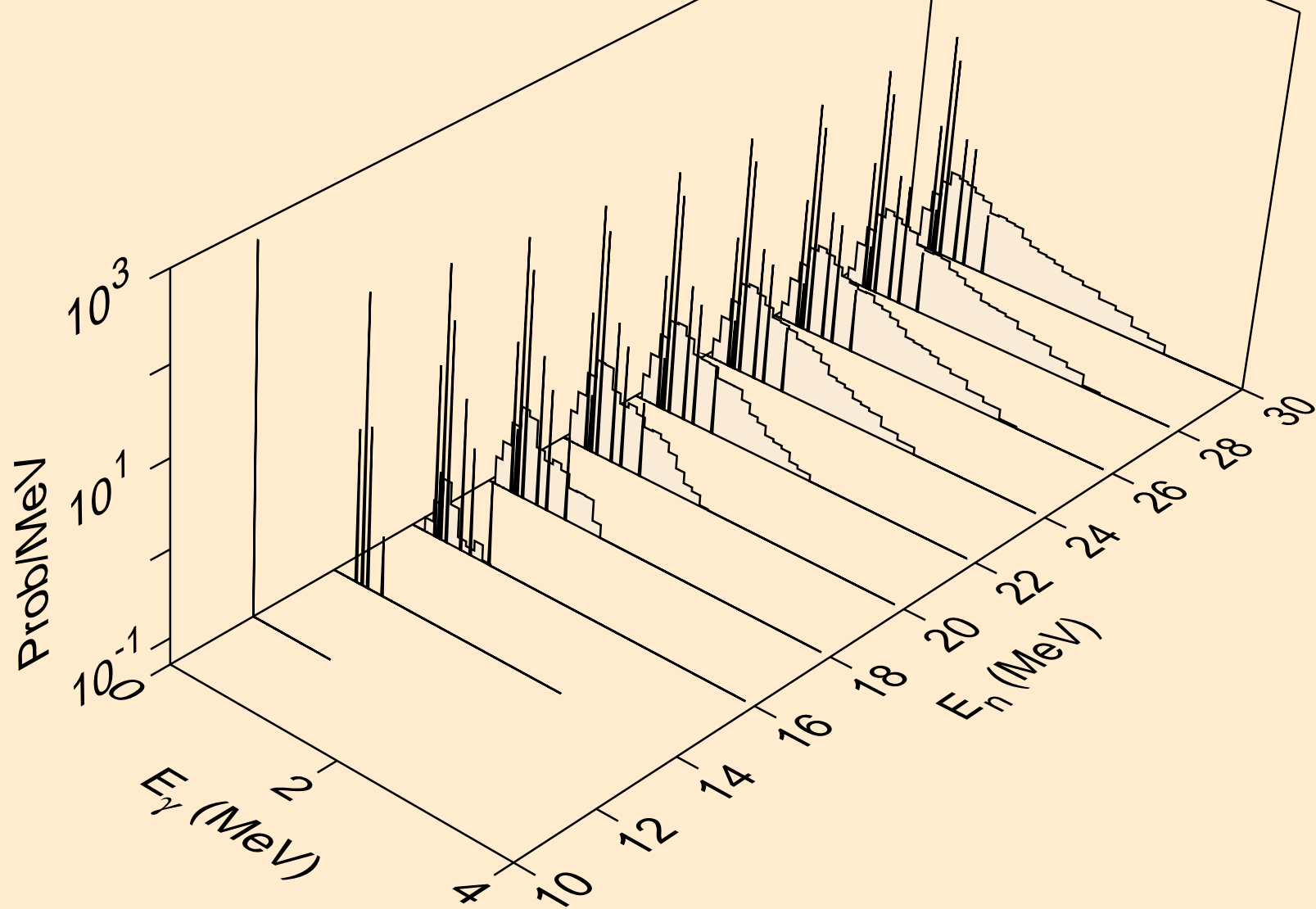

TB154 NEUTRON ACER TENDL-2021 LIBRARY; T=293.6K
Photon emission for (n,3np)

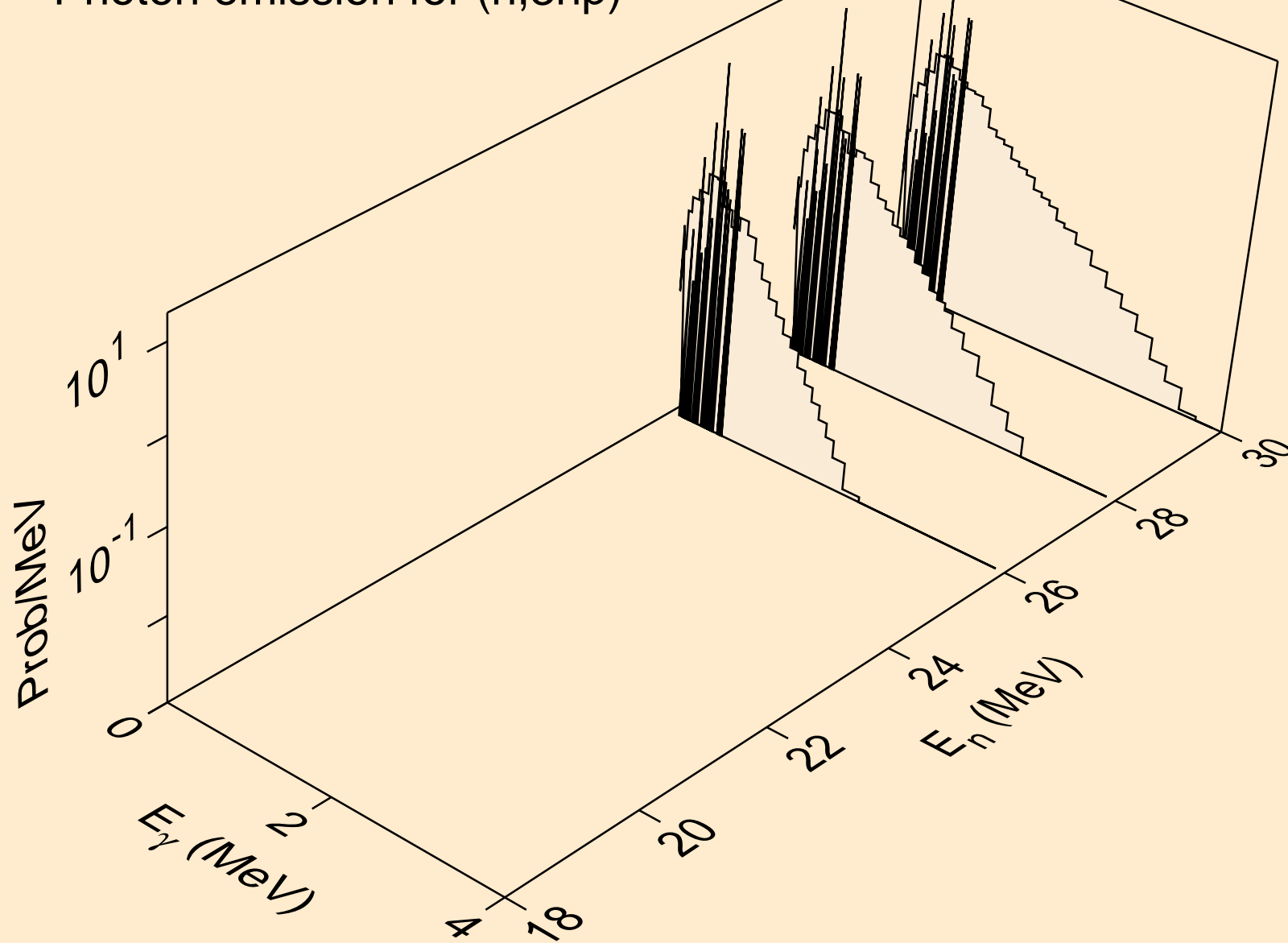

TB154 NEUTRON ACER TENDL-2021 LIBRARY; T=293.6K
Photon emission for (n,2np)

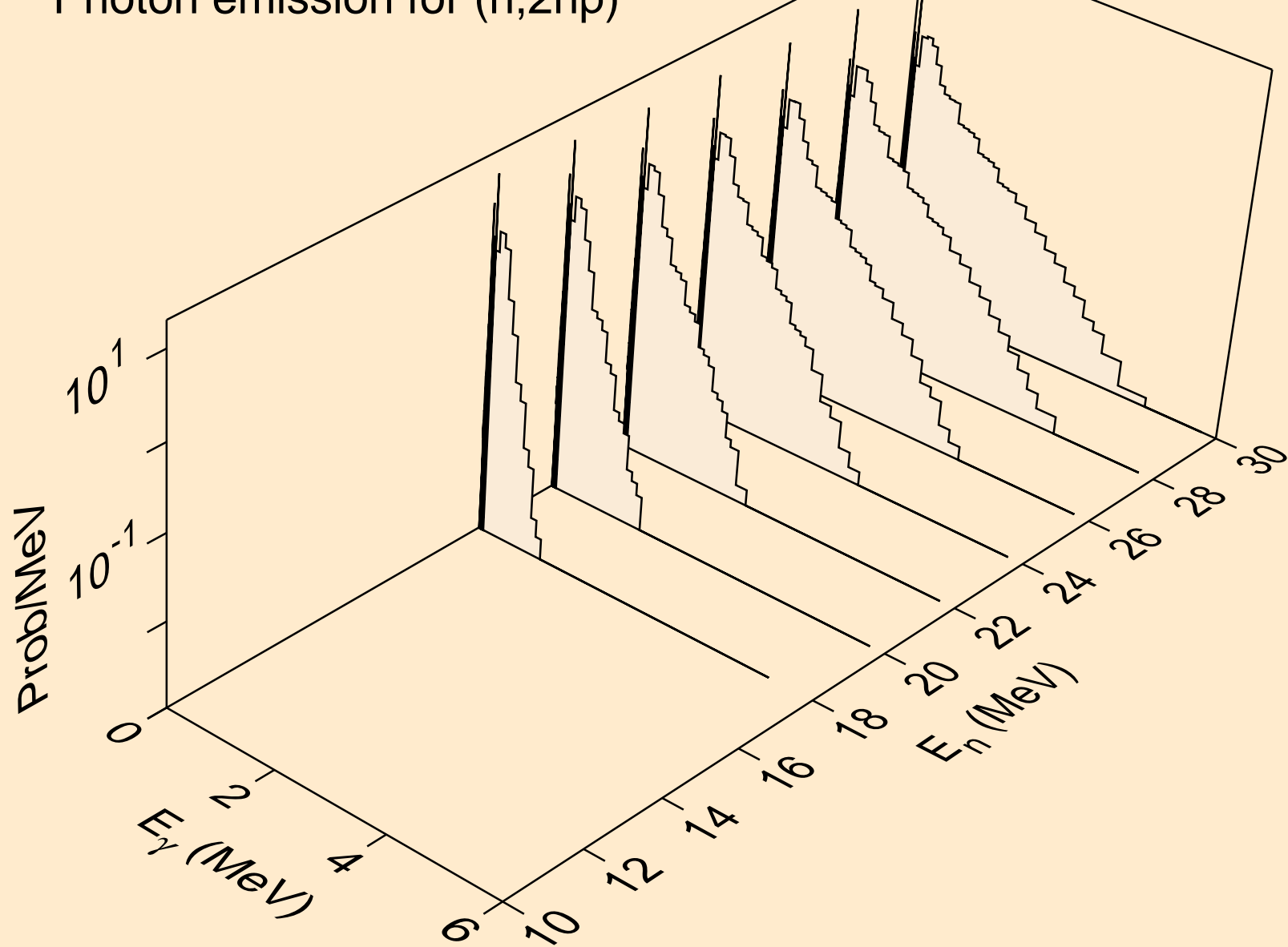

TB154 NEUTRON ACER TENDL-2021 LIBRARY; T=293.6K
Photon emission for (n,npa)

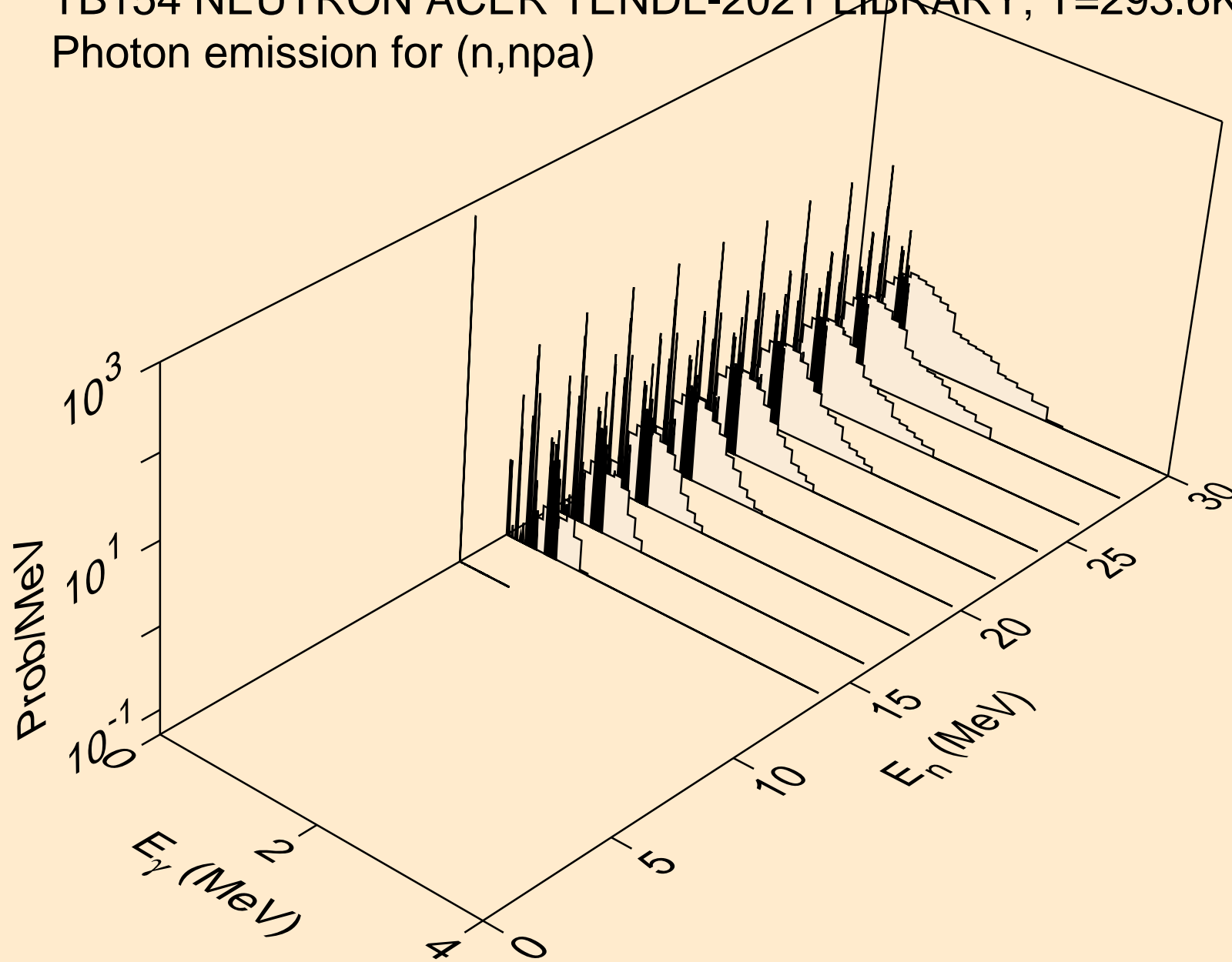

TB154 NEUTRON ACER TENDL-2021 LIBRARY; T=293.6K
Photon emission for (n,n*c)

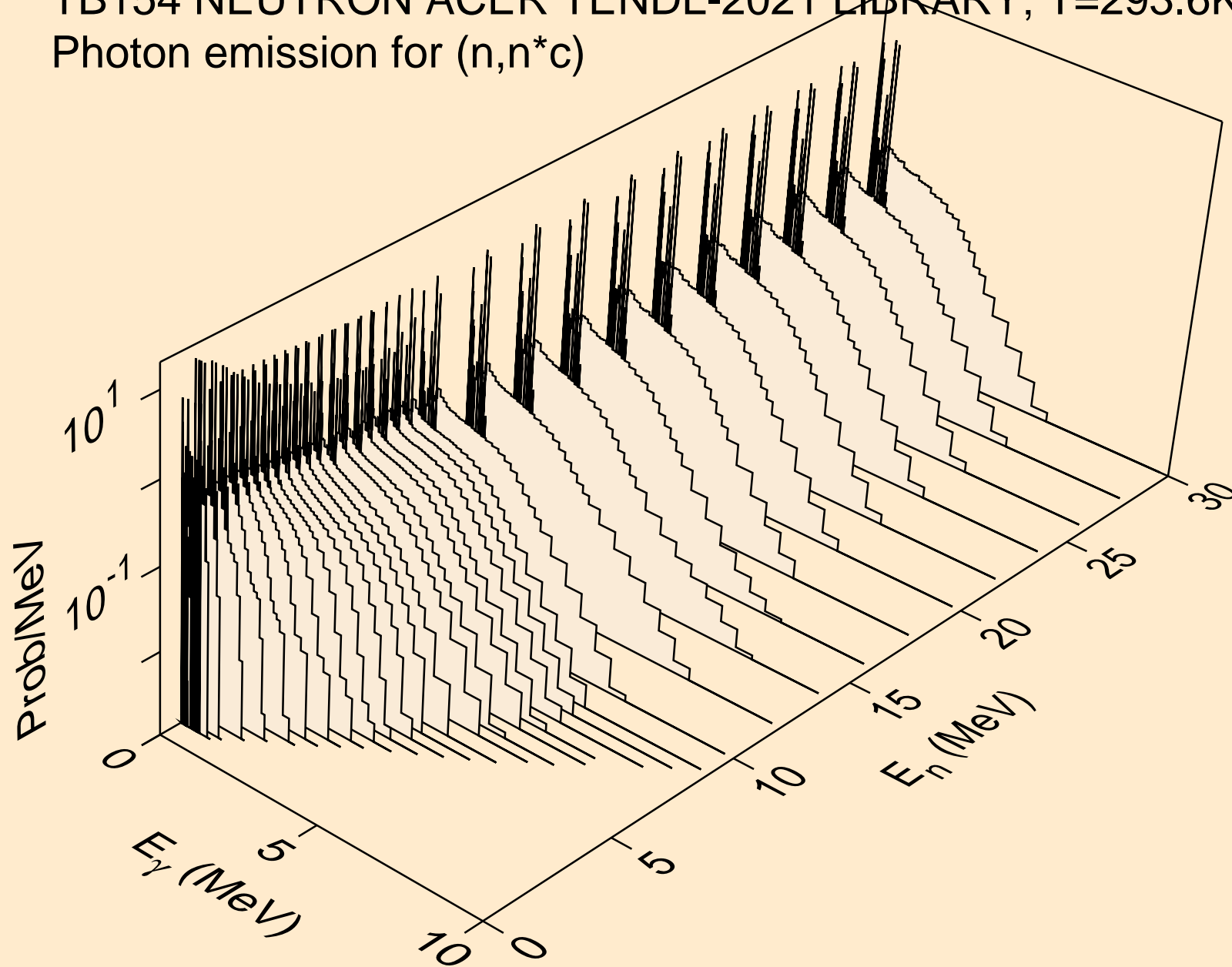

TB154 NEUTRON ACER TENDL-2021 LIBRARY; T=293.6K
Photon emission for (n,gma)

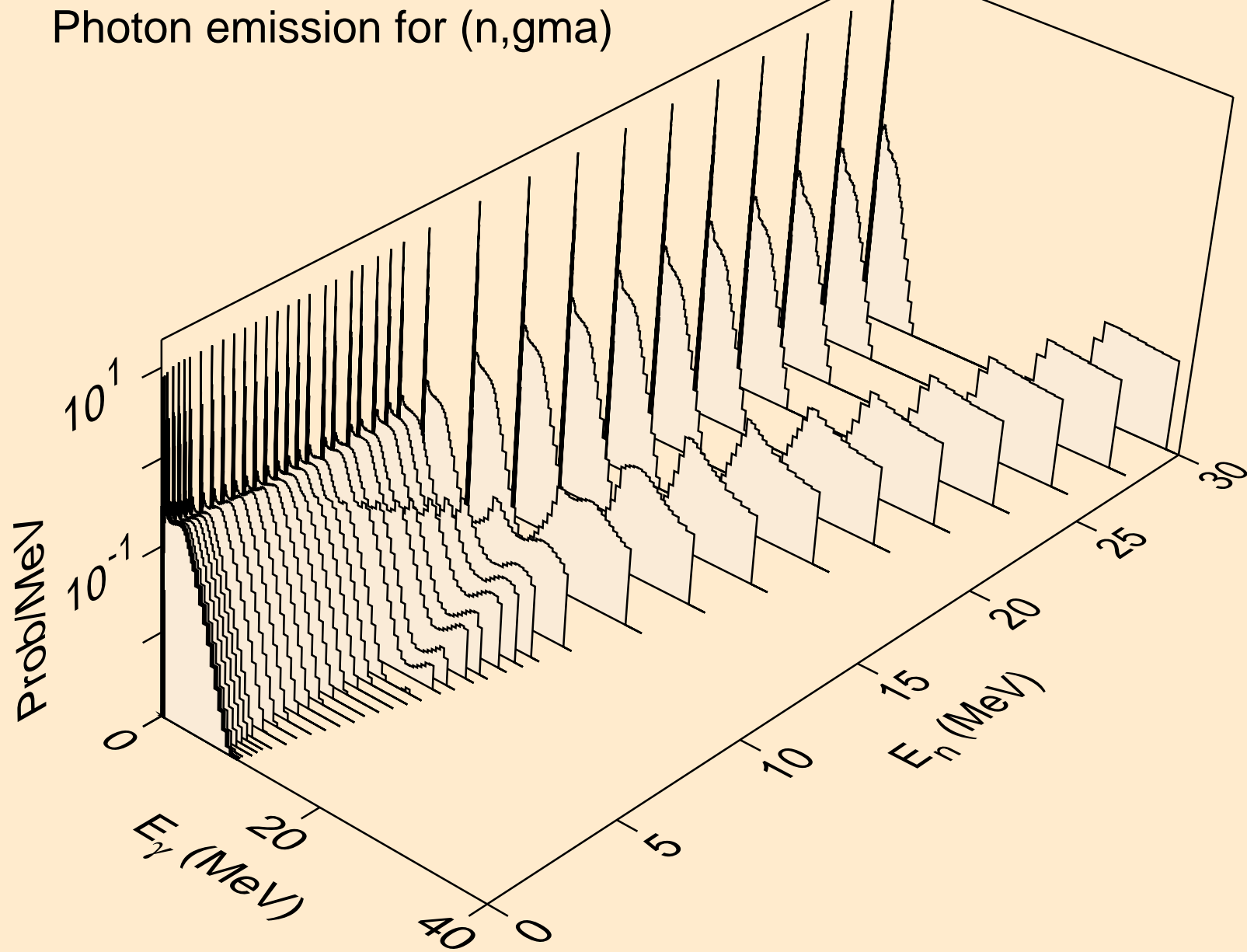

TB154 NEUTRON ACER TENDL-2021 LIBRARY; T=293.6K
Photon emission for (n,p)

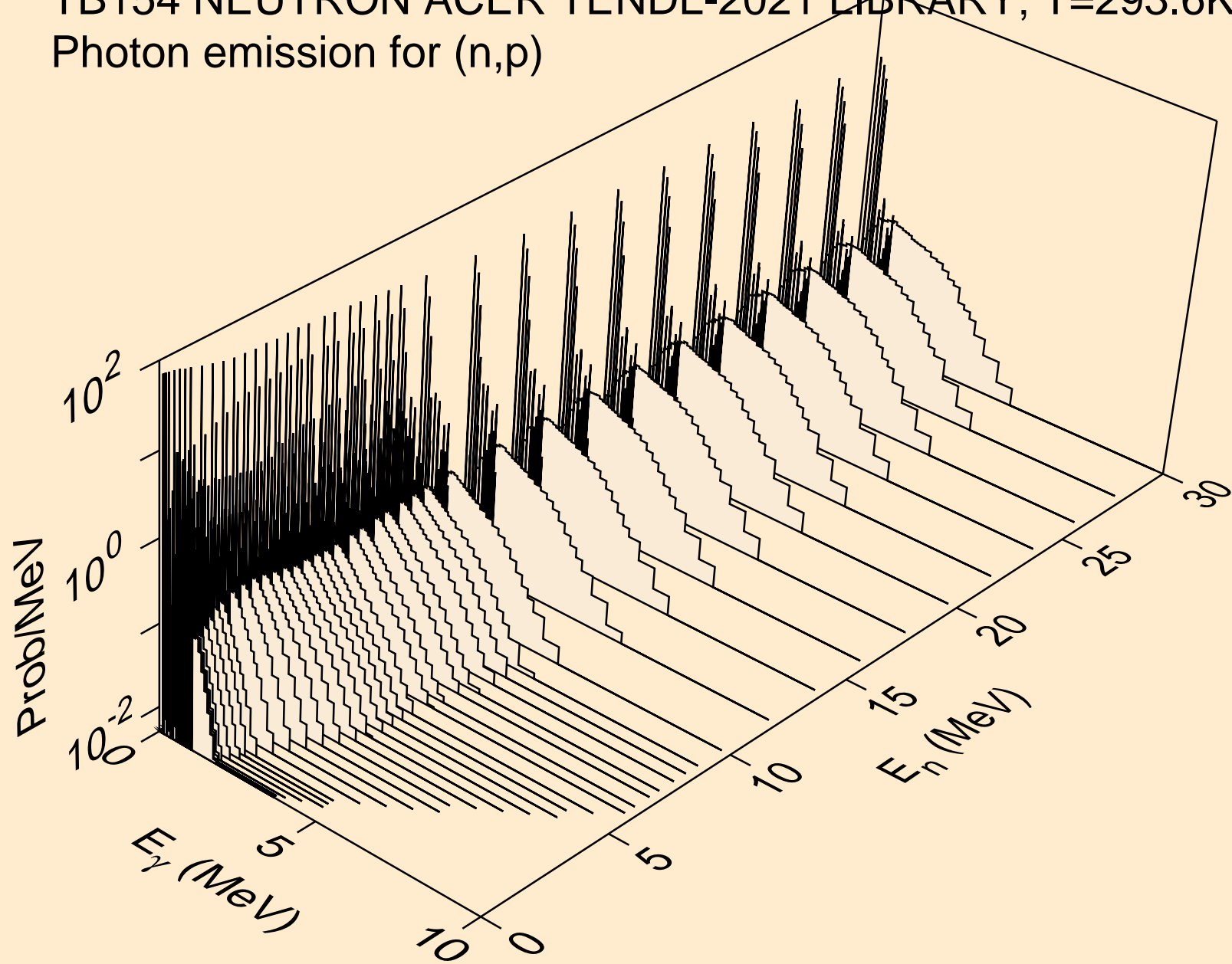

TB154 NEUTRON ACER TENDL-2021 LIBRARY; T=293.6K
Photon emission for (n,d)

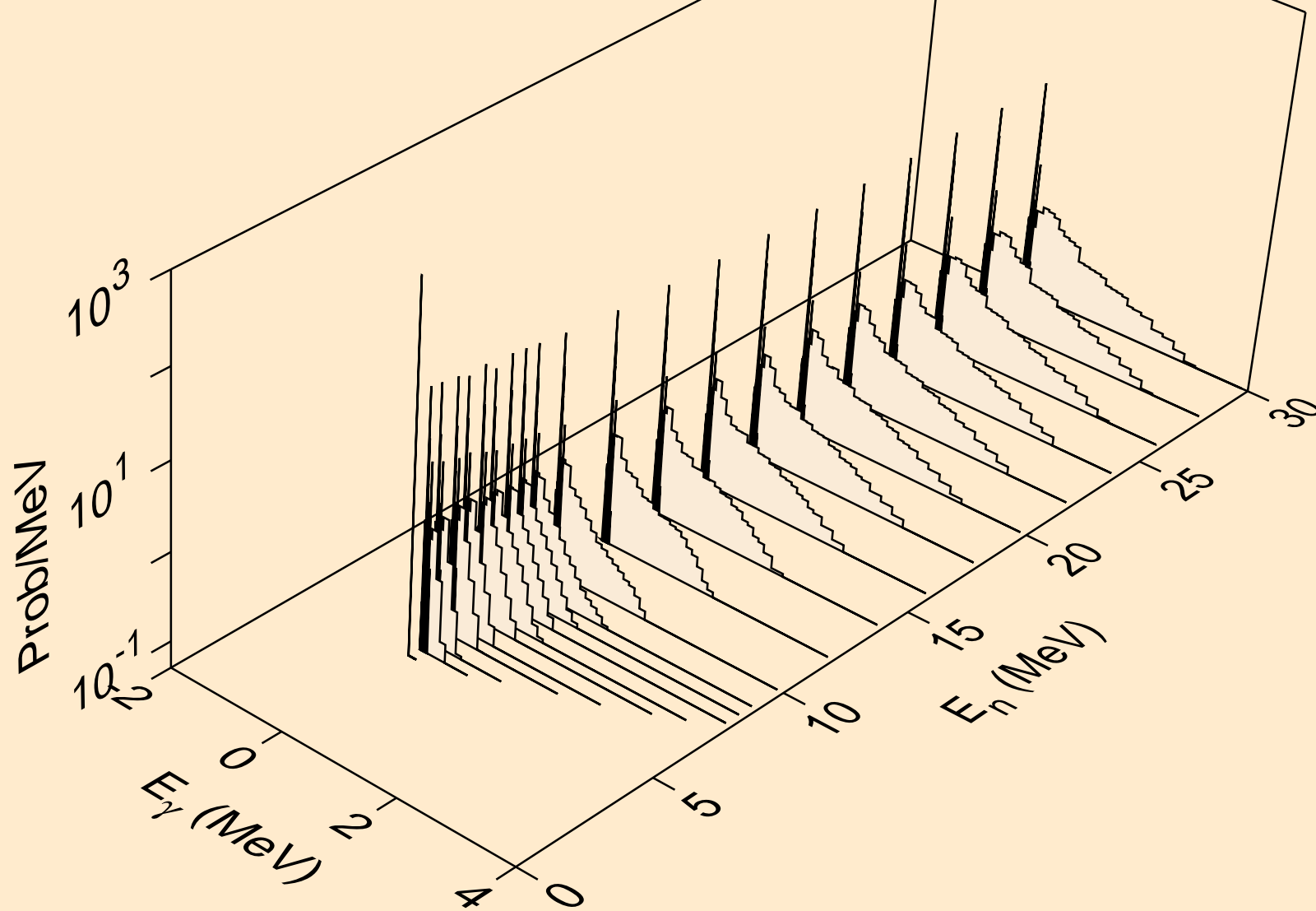

TB154 NEUTRON ACER TENDL-2021 LIBRARY; T=293.6K
Photon emission for (n,t)

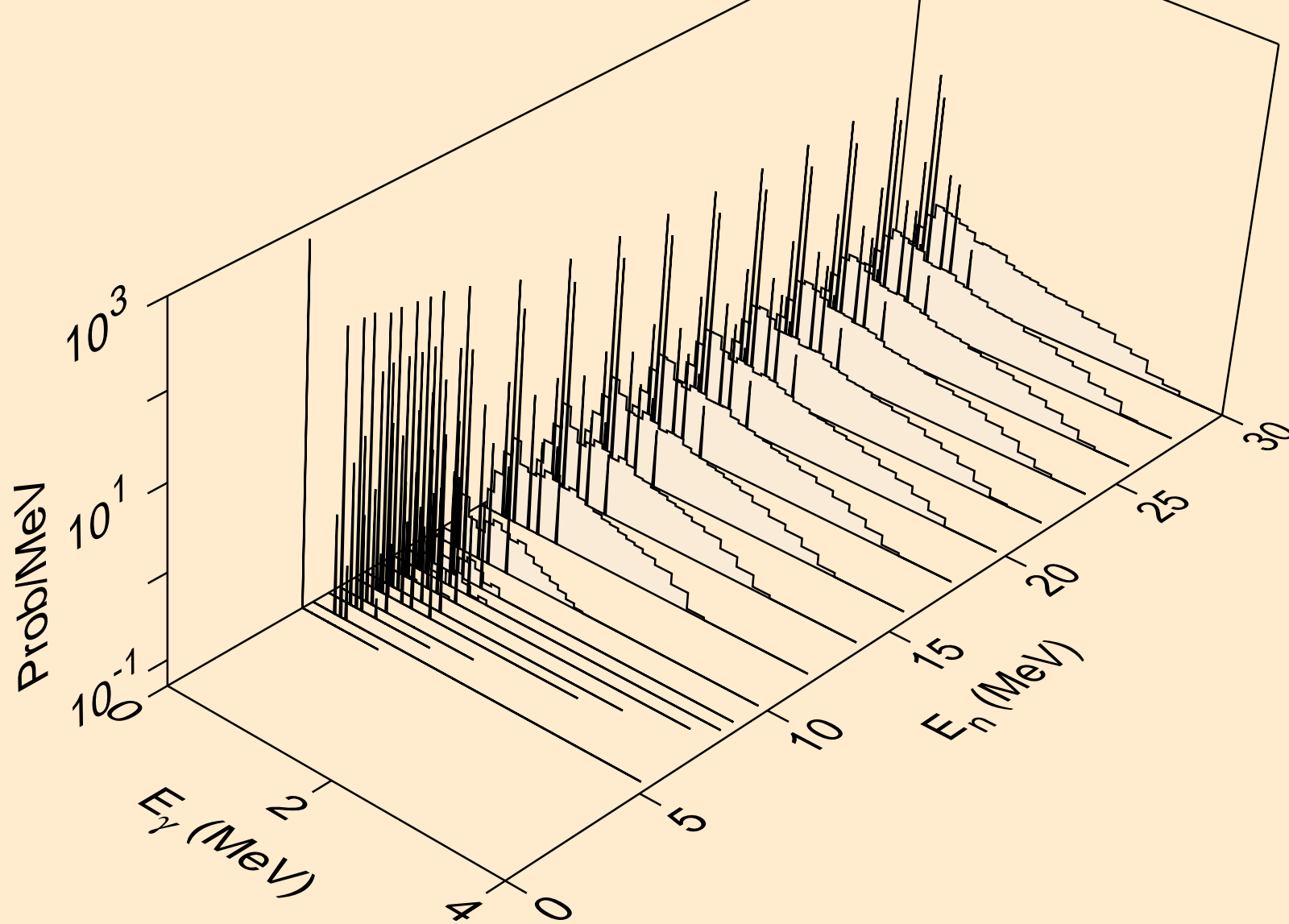

TB154 NEUTRON ACER TENDL-2021 LIBRARY; T=293.6K
Photon emission for (n,he3)

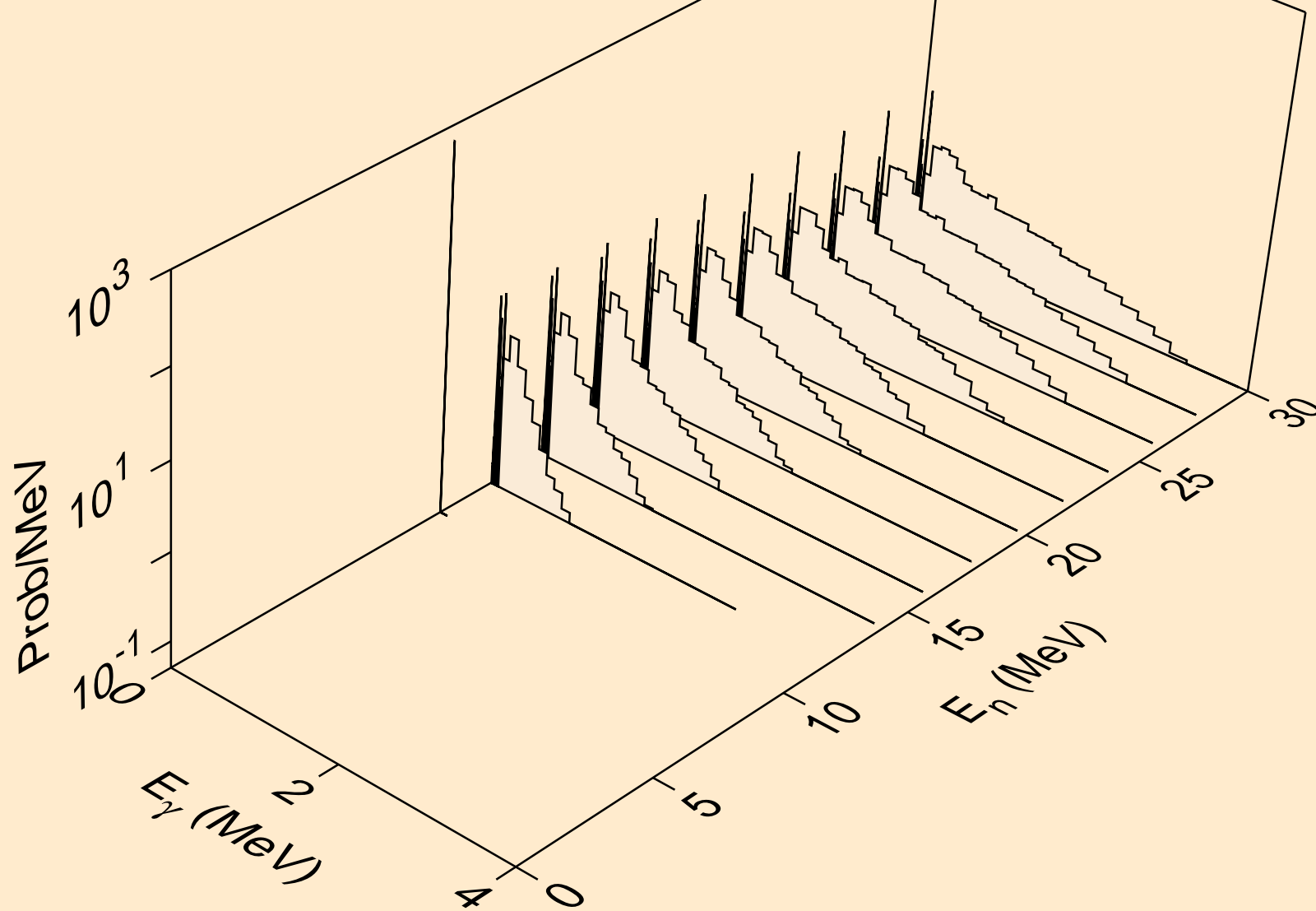

TB154 NEUTRON ACER TENDL-2021 LIBRARY; T=293.6K
Photon emission for (n,a)

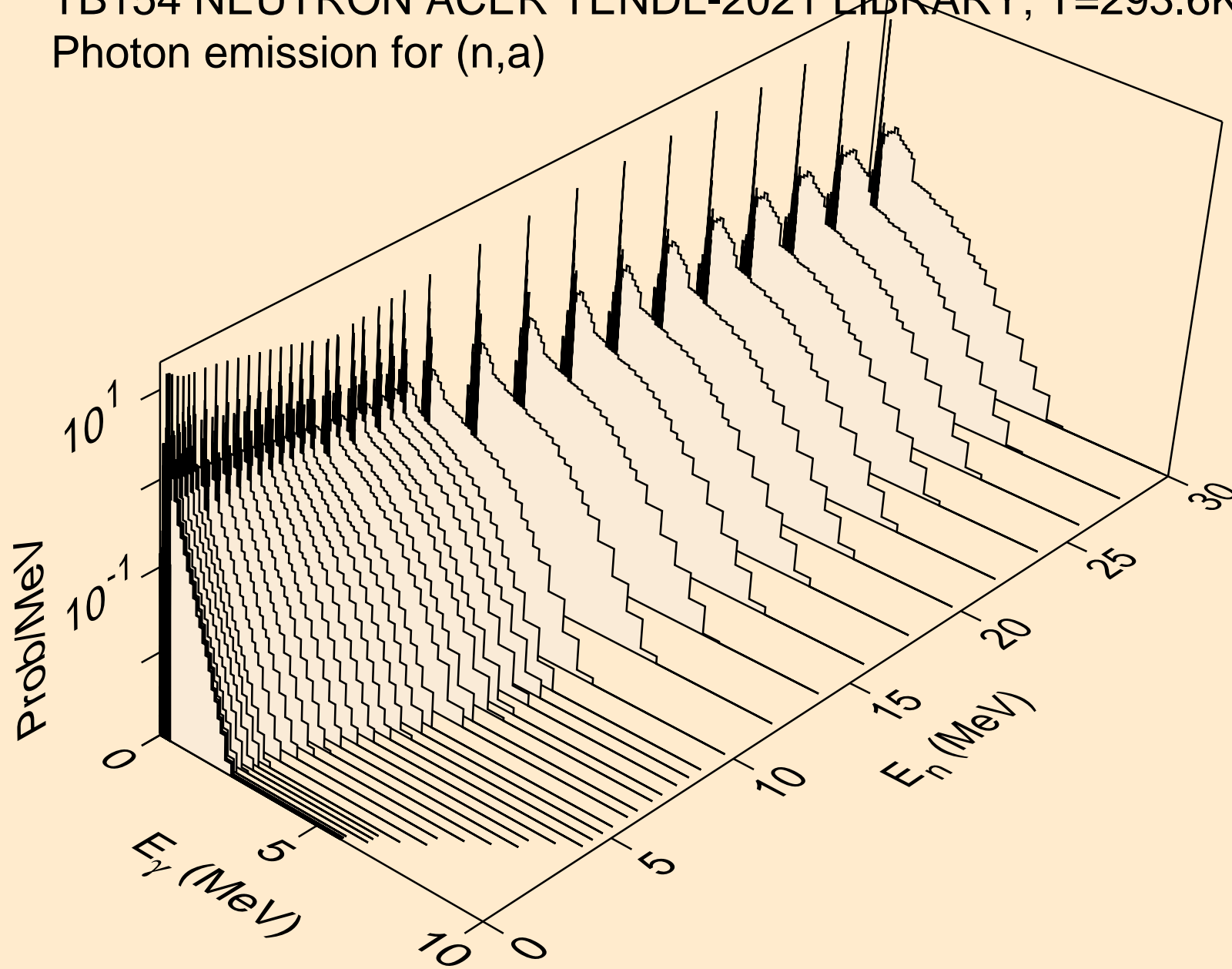

TB154 NEUTRON ACER TENDL-2021 LIBRARY; T=293.6K
Photon emission for (n,2a)

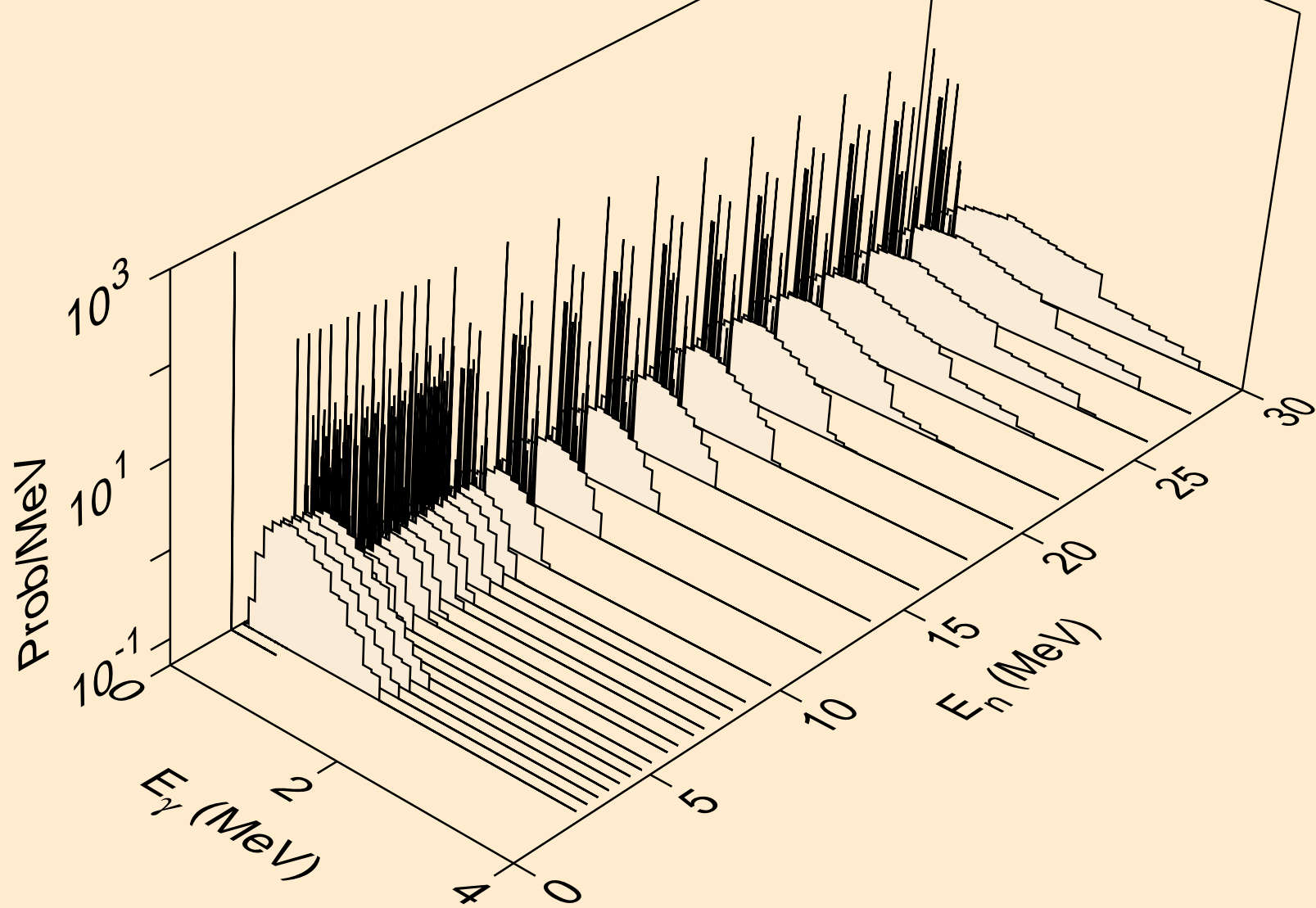

TB154 NEUTRON ACER TENDL-2021 LIBRARY; T=293.6K
Photon emission for (n,2p)

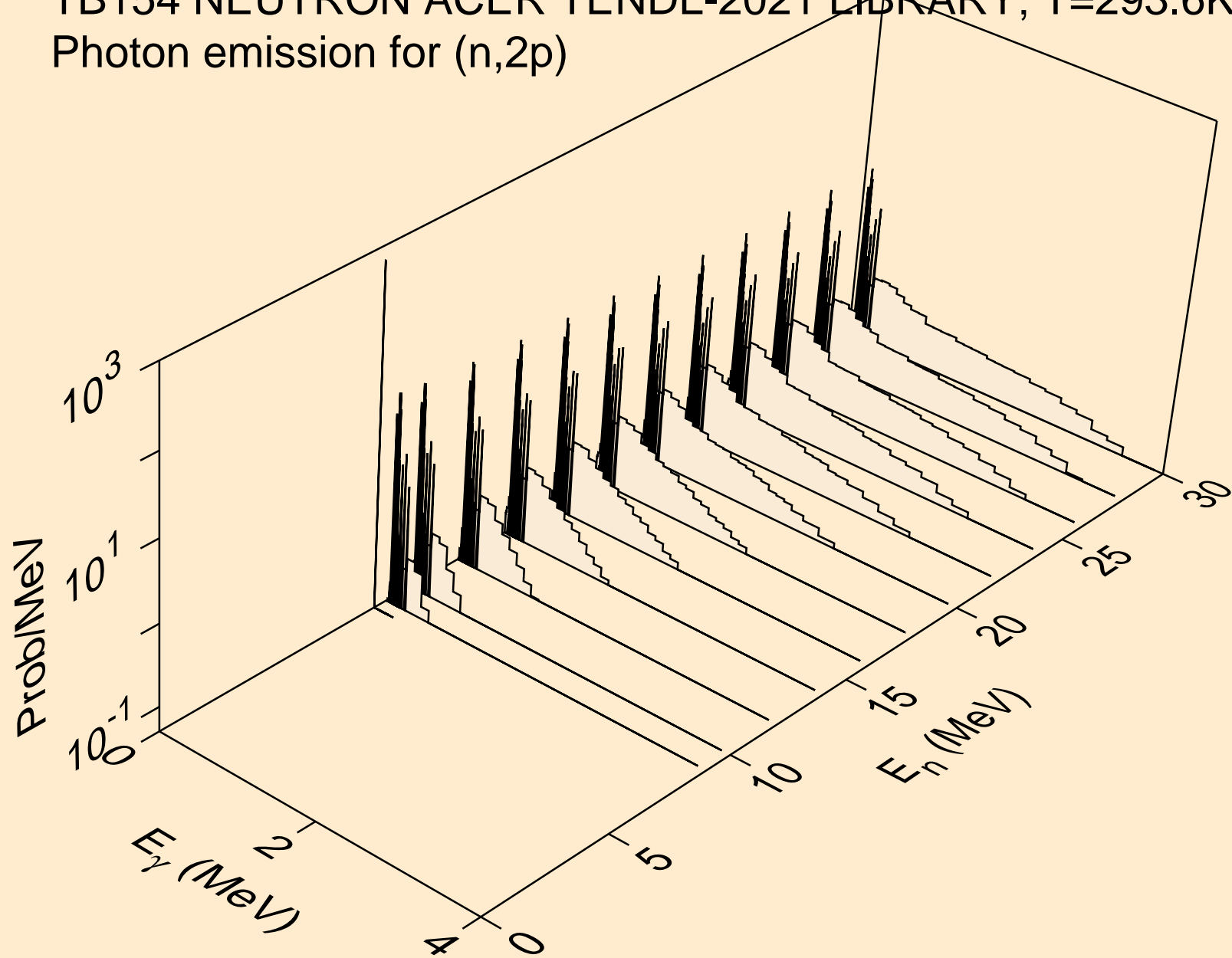

TB154 NEUTRON ACER TENDL-2021 LIBRARY; T=293.6K
Photon emission for (n,p α)

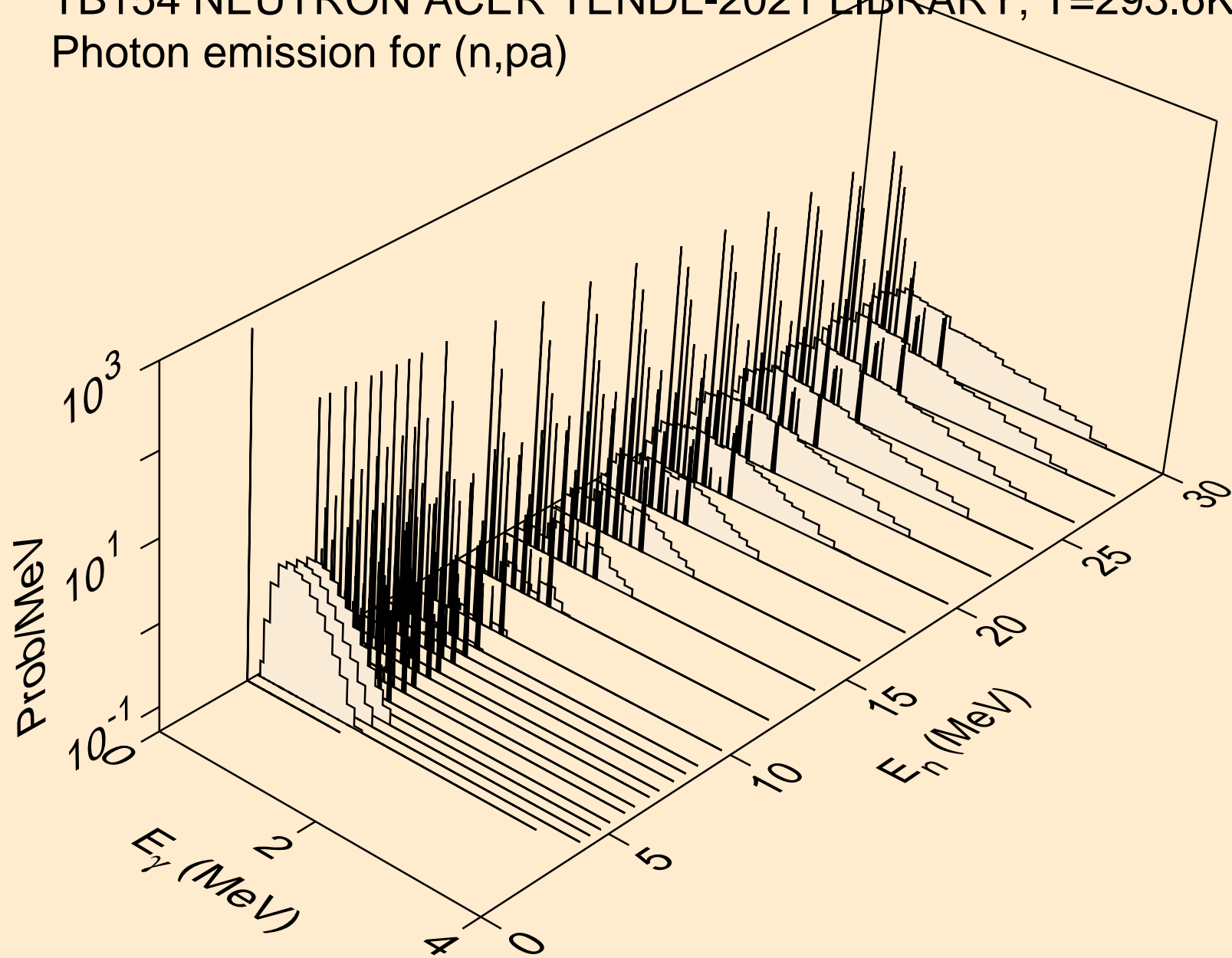

TB154 NEUTRON ACER TENDL-2021 LIBRARY; T=293.6K
Photon emission for (n,pd)

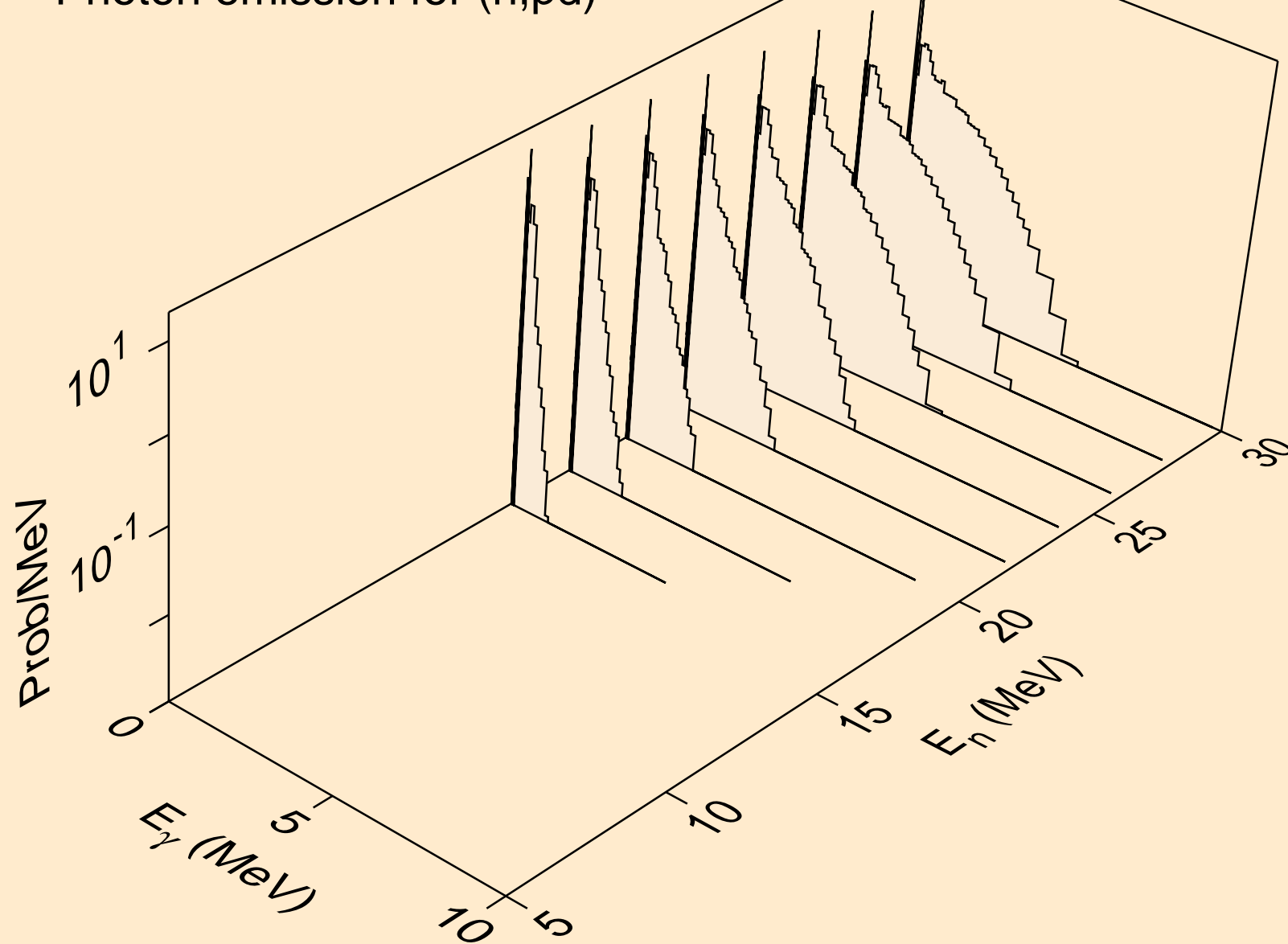

TB154 NEUTRON ACER TENDL-2021 LIBRARY; T=293.6K
Photon emission for (n,pt)

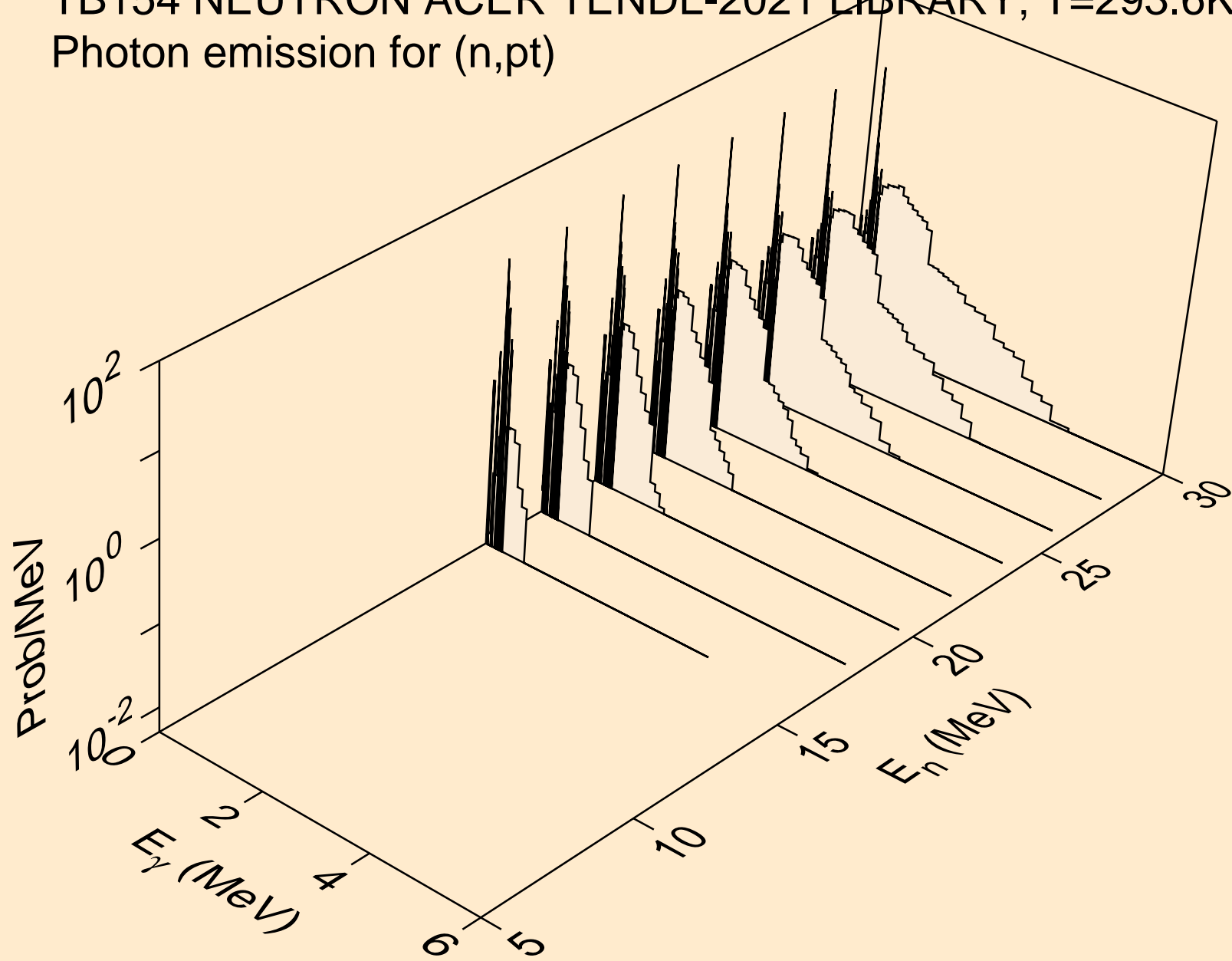

TB154 NEUTRON ACER TENDL-2021 LIBRARY; T=293.6K
Photon emission for (n,da)

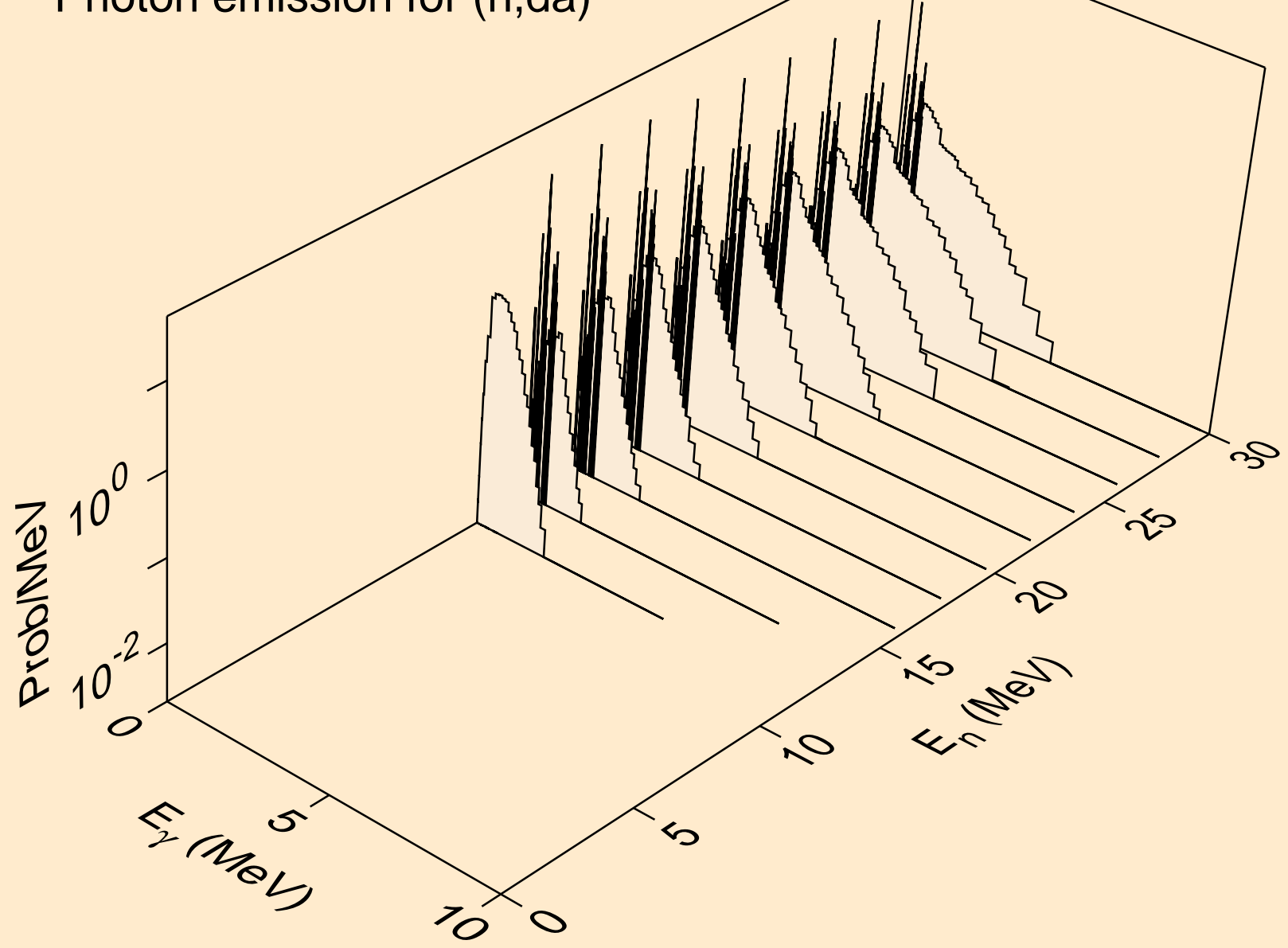

TB154 NEUTRON ACER TENDL-2021 LIBRARY; T=293.6K
thermal capture photon spectrum

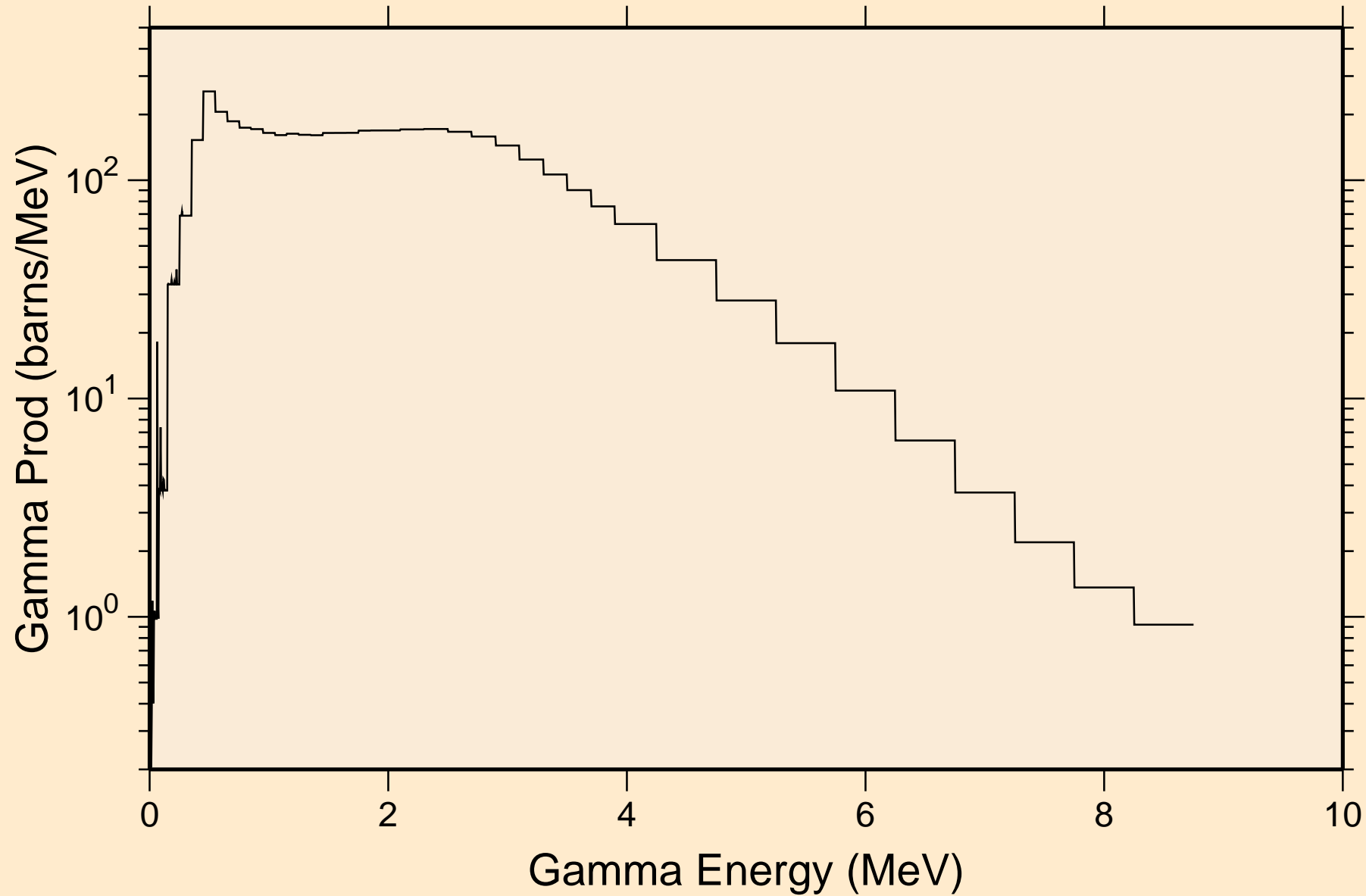

TB154 NEUTRON ACER TENDL-2021 LIBRARY; T=293.6K
14 MeV photon spectrum

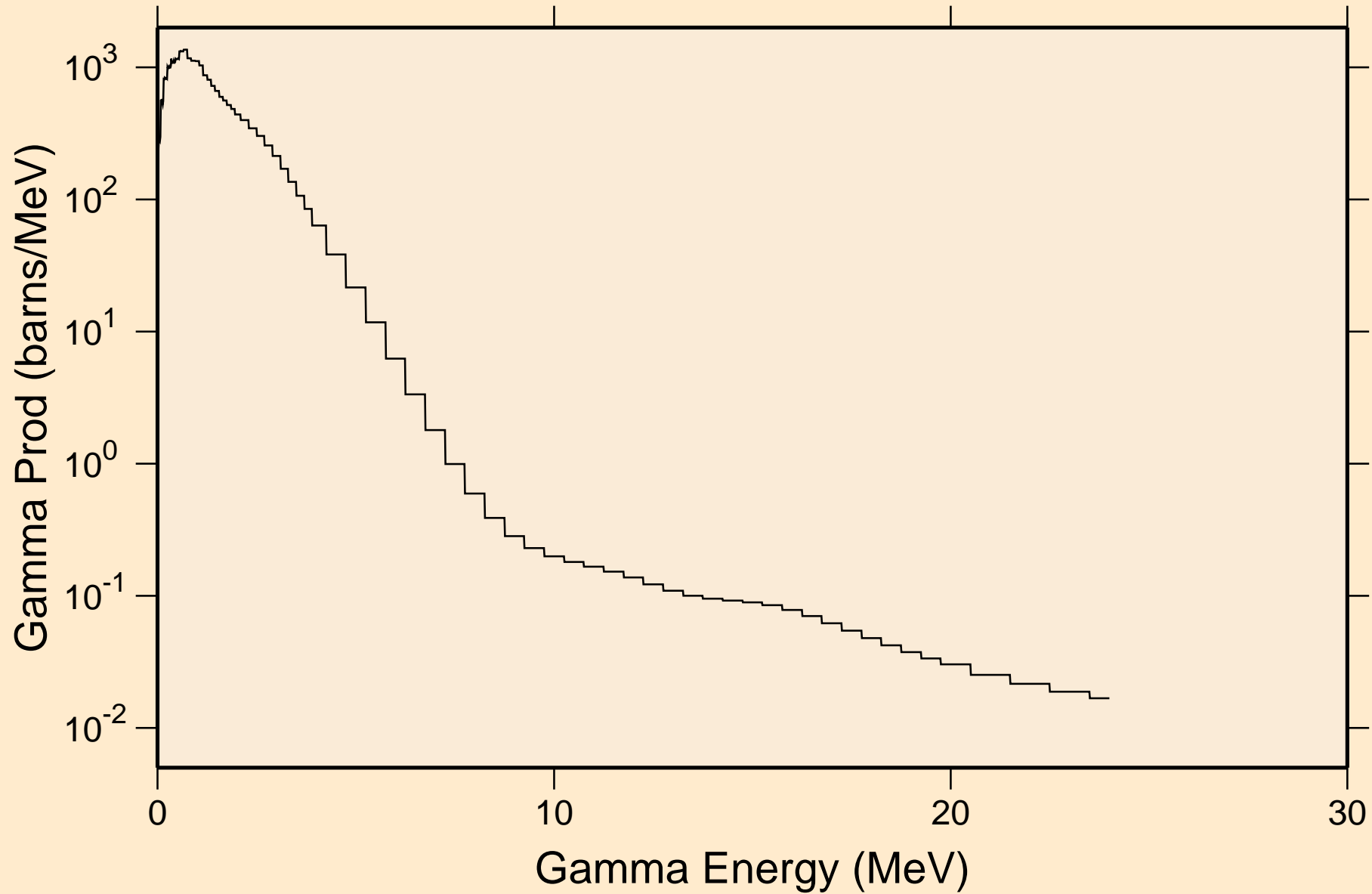

TB154 NEUTRON ACER TENDL-2021 LIBRARY; T=293.6K
Particle heating contributions

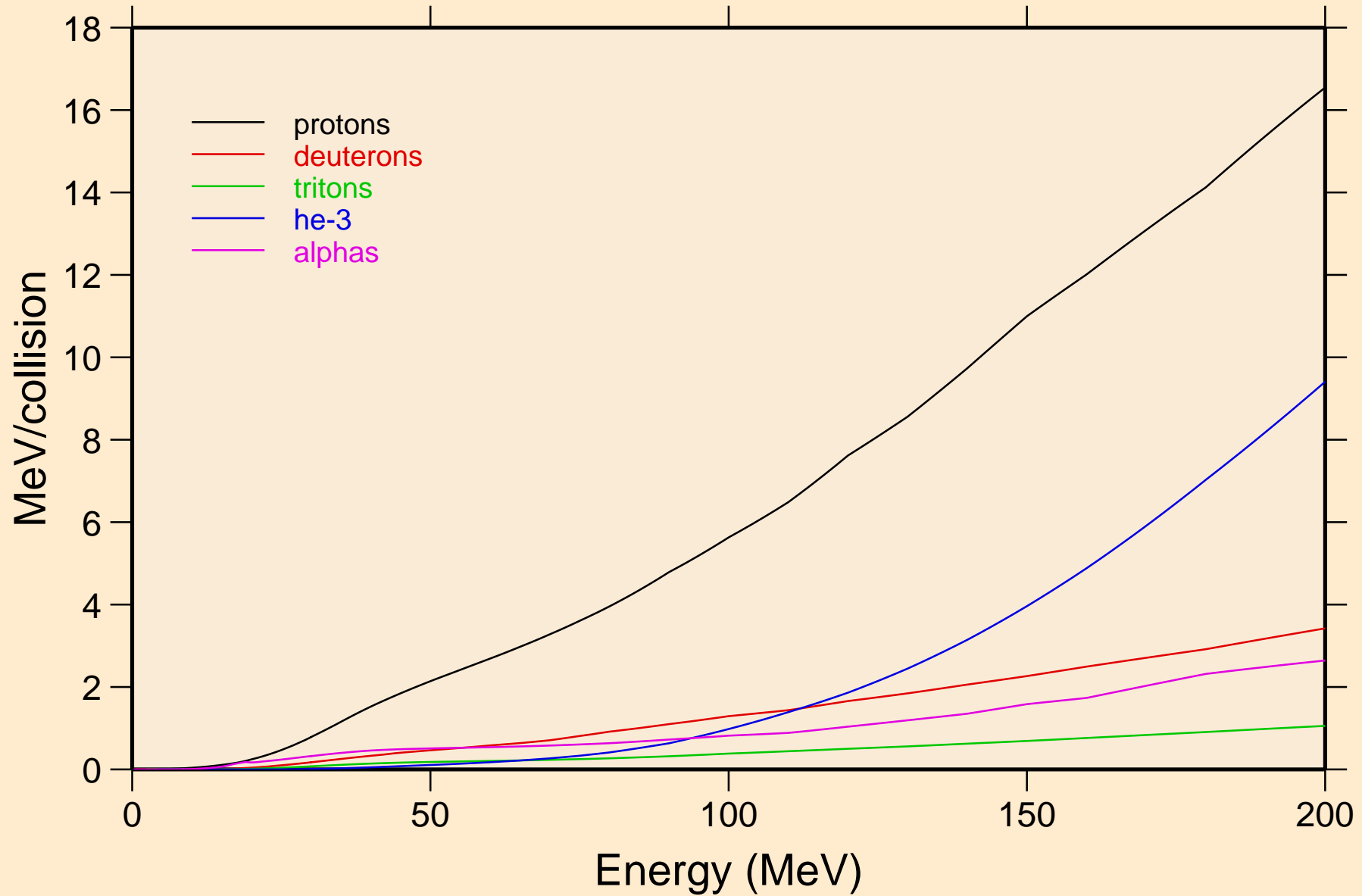

TB154 NEUTRON ACER TENDL-2021 LIBRARY; T=293.6K
Recoil Heating

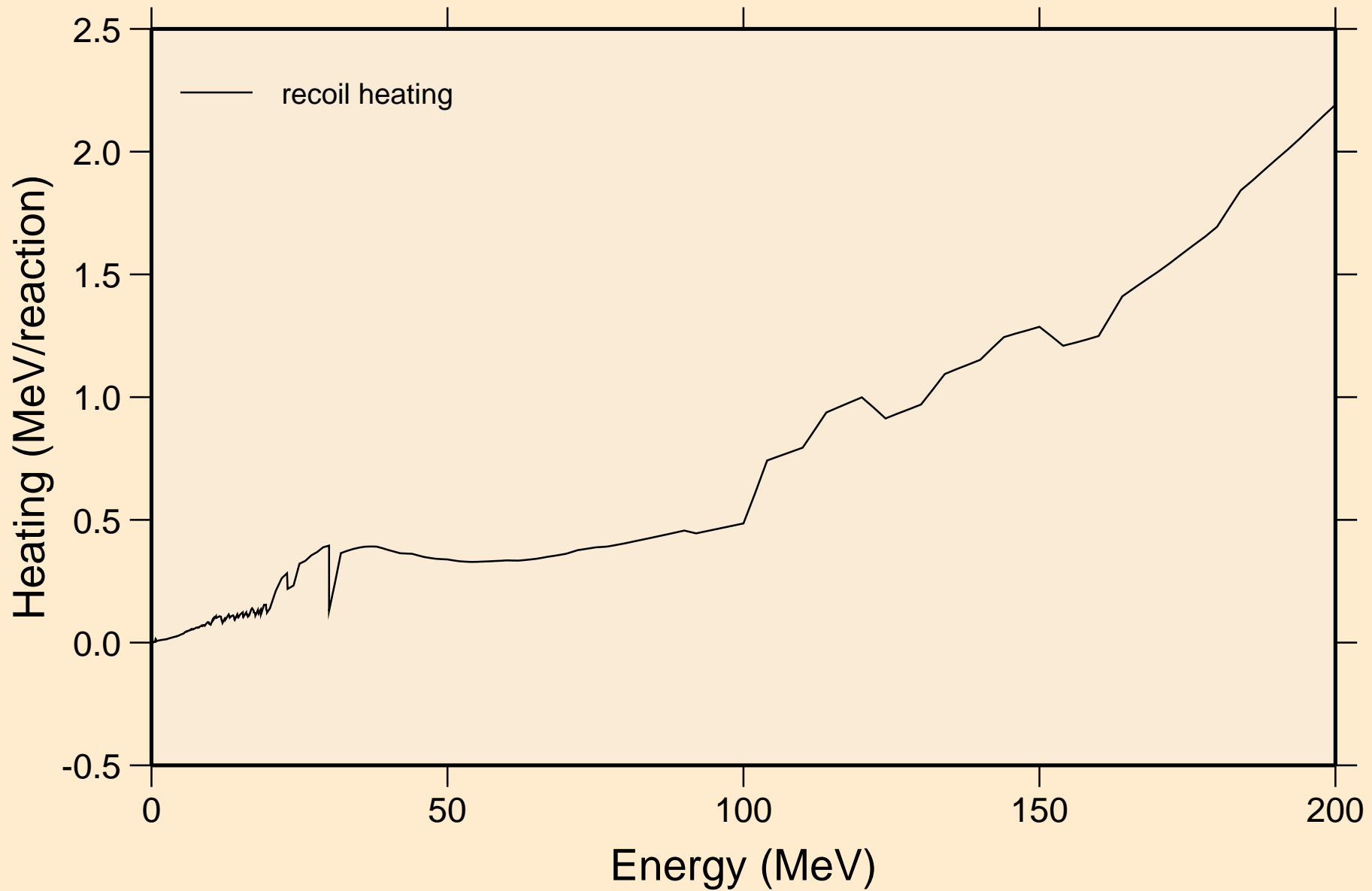

TB154 NEUTRON ACER TENDL-2021 LIBRARY; T=293.6K
Particle production cross sections

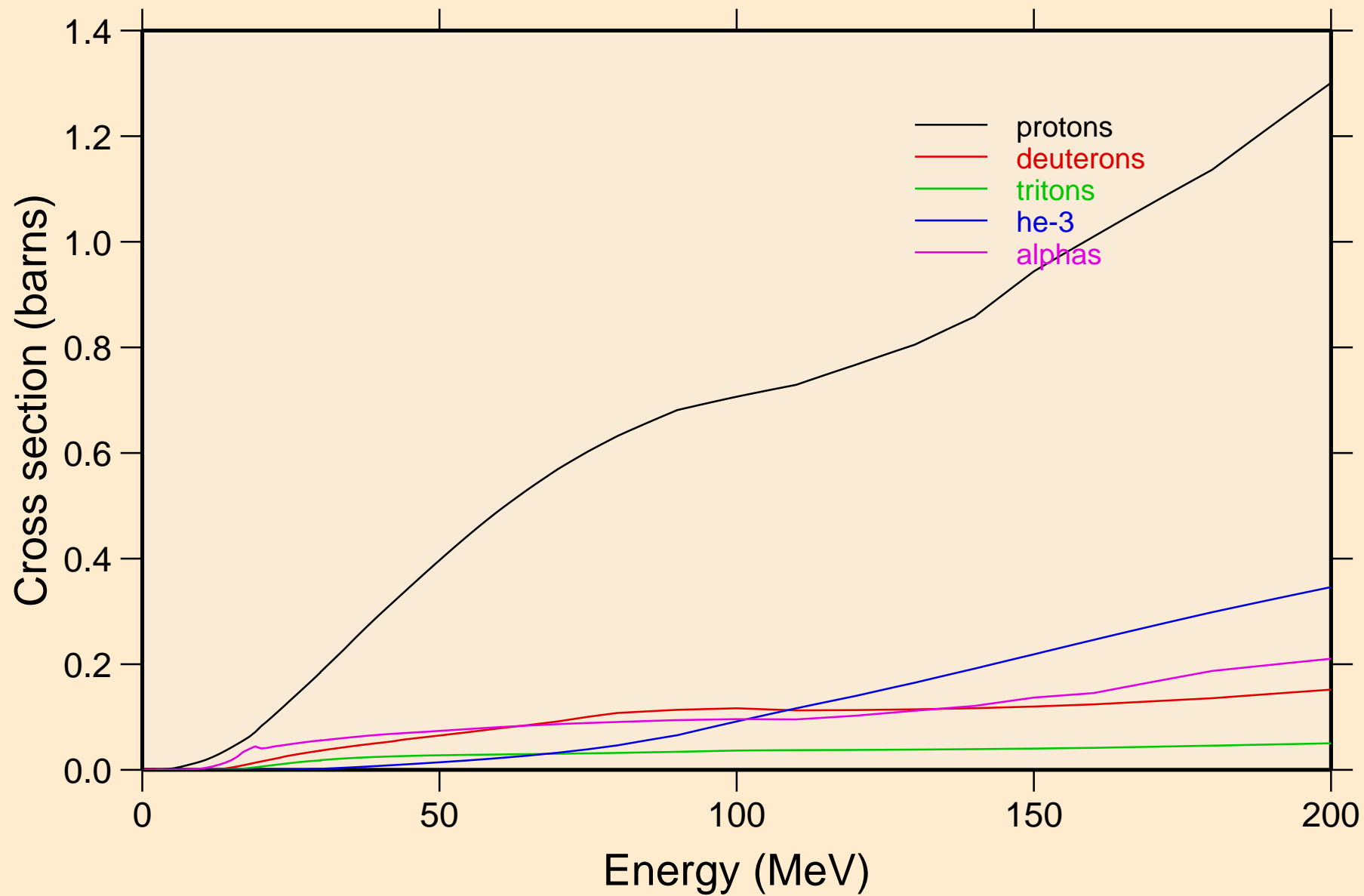

TB154 NEUTRON ACER TENDL-2021 LIBRARY; T=293.6K
protons from (n,x)

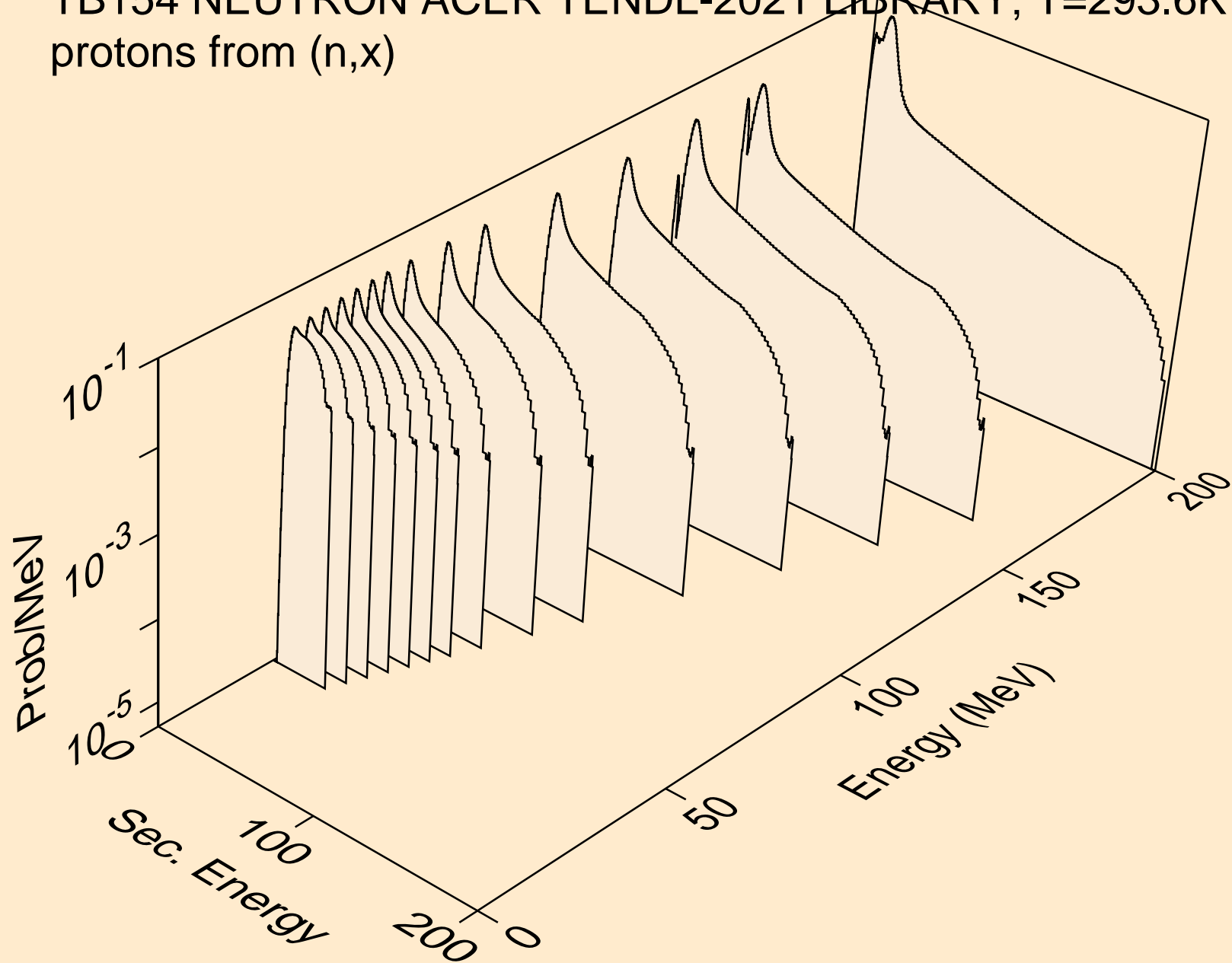

TB154 NEUTRON ACER TENDL-2021 LIBRARY; T=293.6K
protons from (n,n*)p

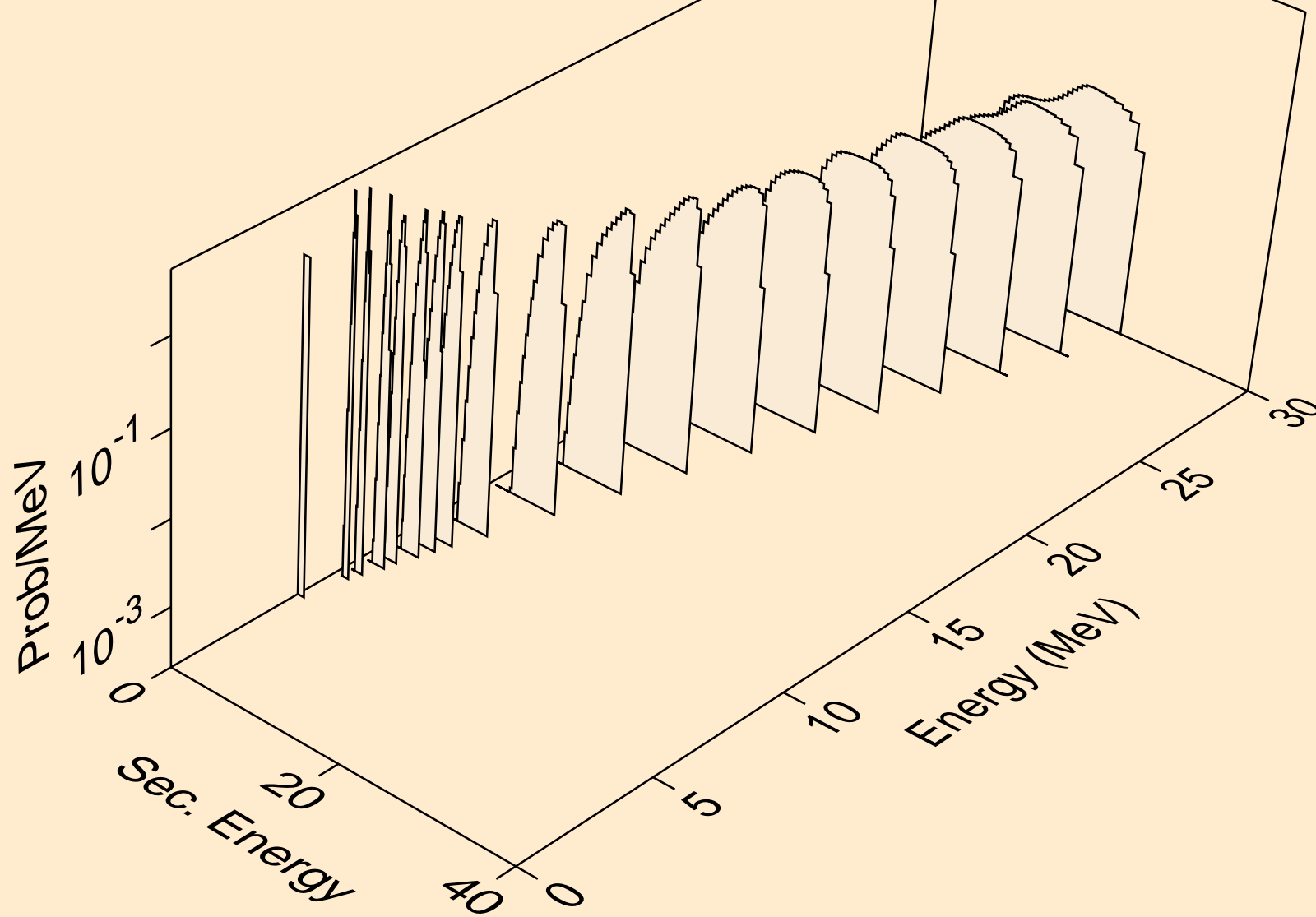

TB154 NEUTRON ACER TENDL-2021 LIBRARY; T=293.6K
protons from (n,2np)

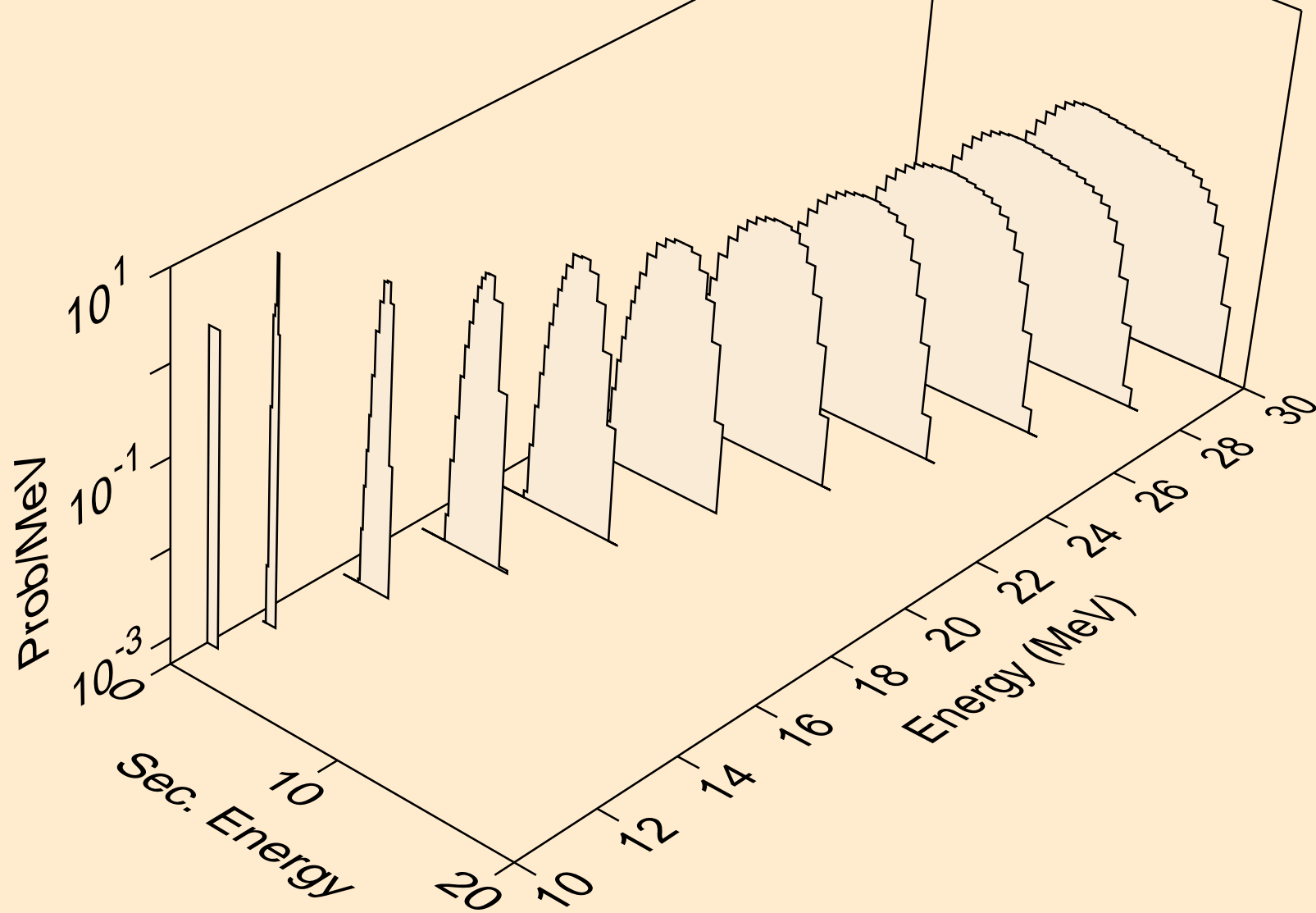

TB154 NEUTRON ACER TENDL-2021 LIBRARY; T=293.6K
protons from (n,3np)

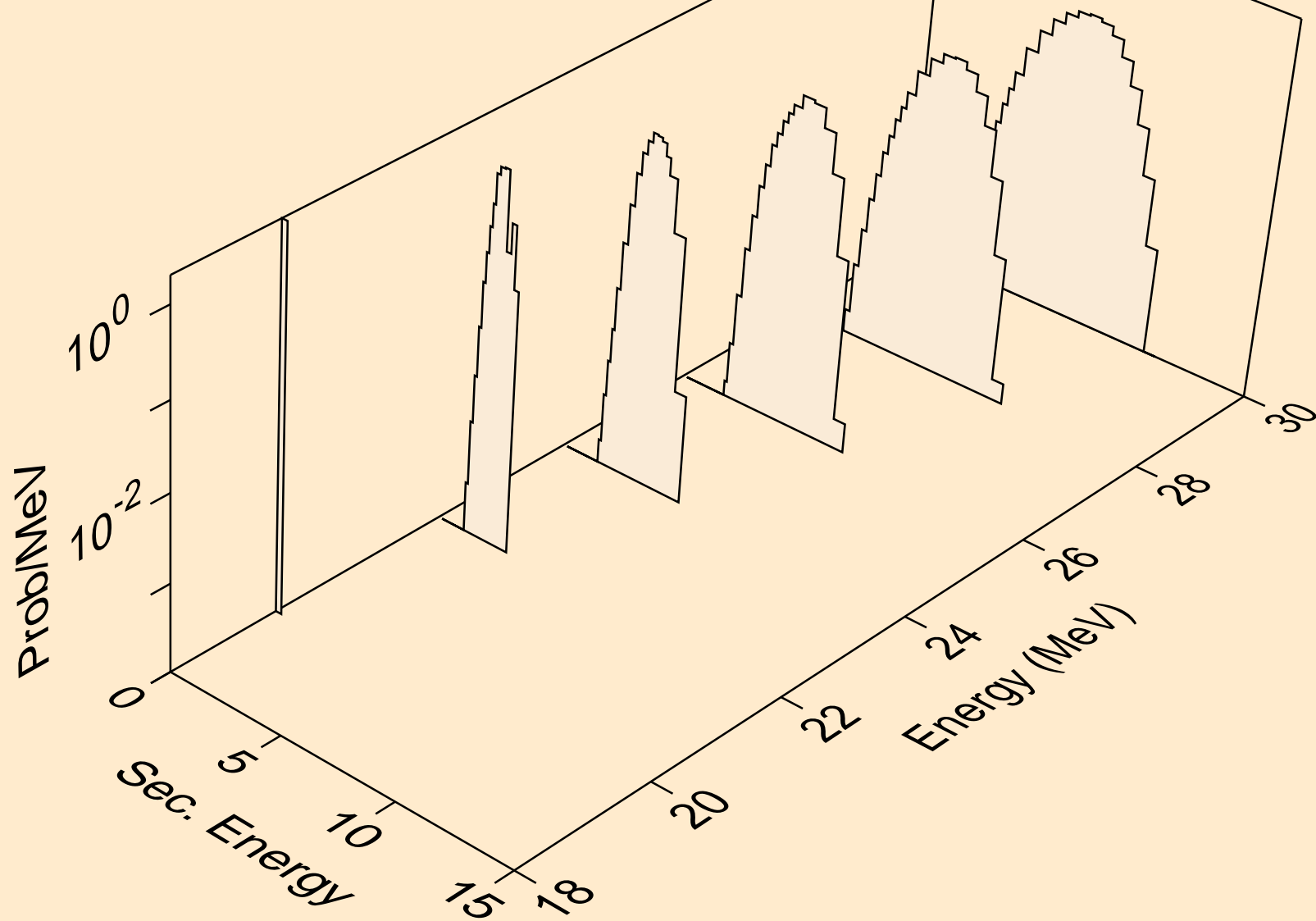

TB154 NEUTRON ACER TENDL-2021 LIBRARY; T=293.6K
protons from (n,2np)

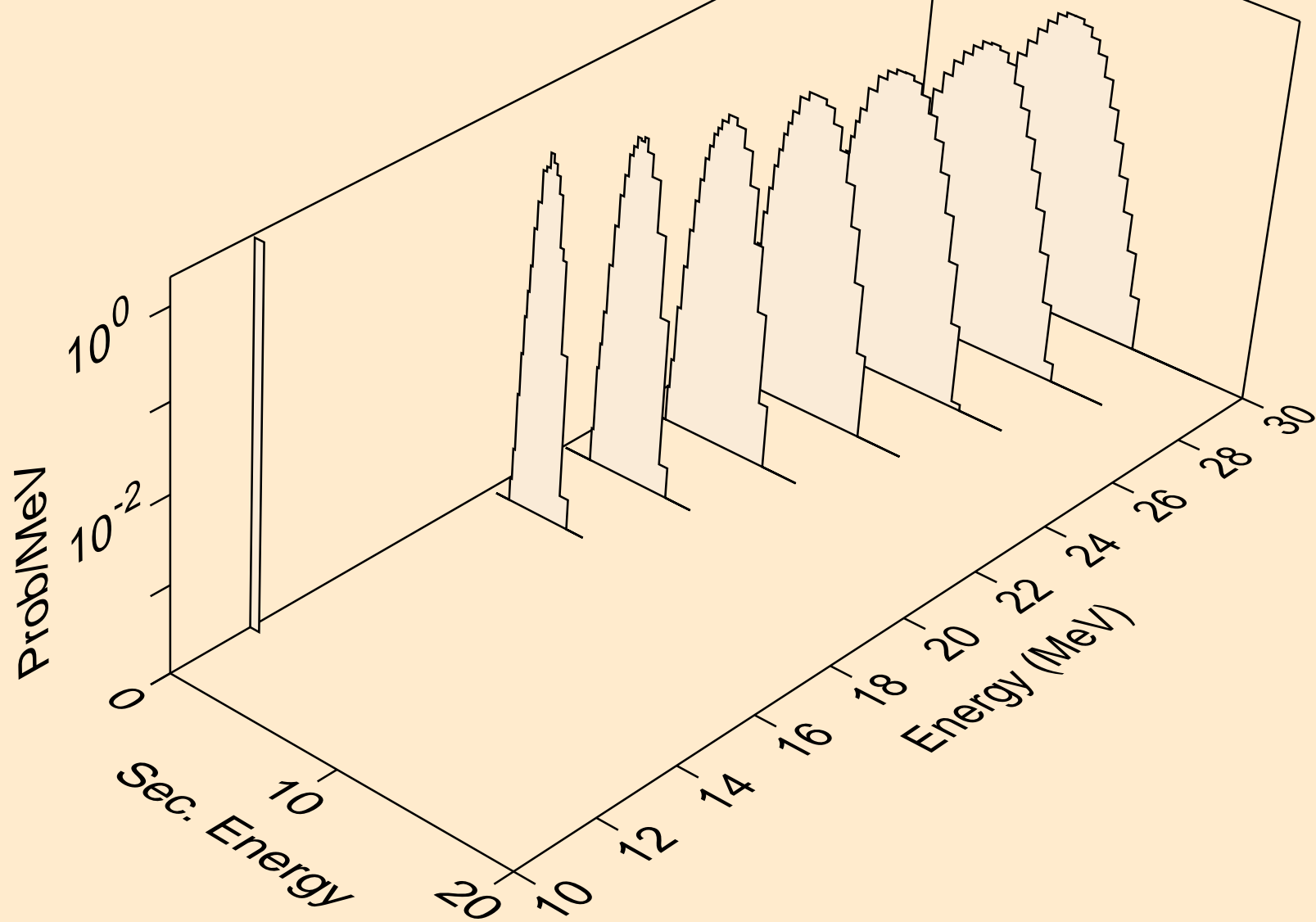

TB154 NEUTRON ACER TENDL-2021 LIBRARY; T=293.6K
protons from (n,npa)

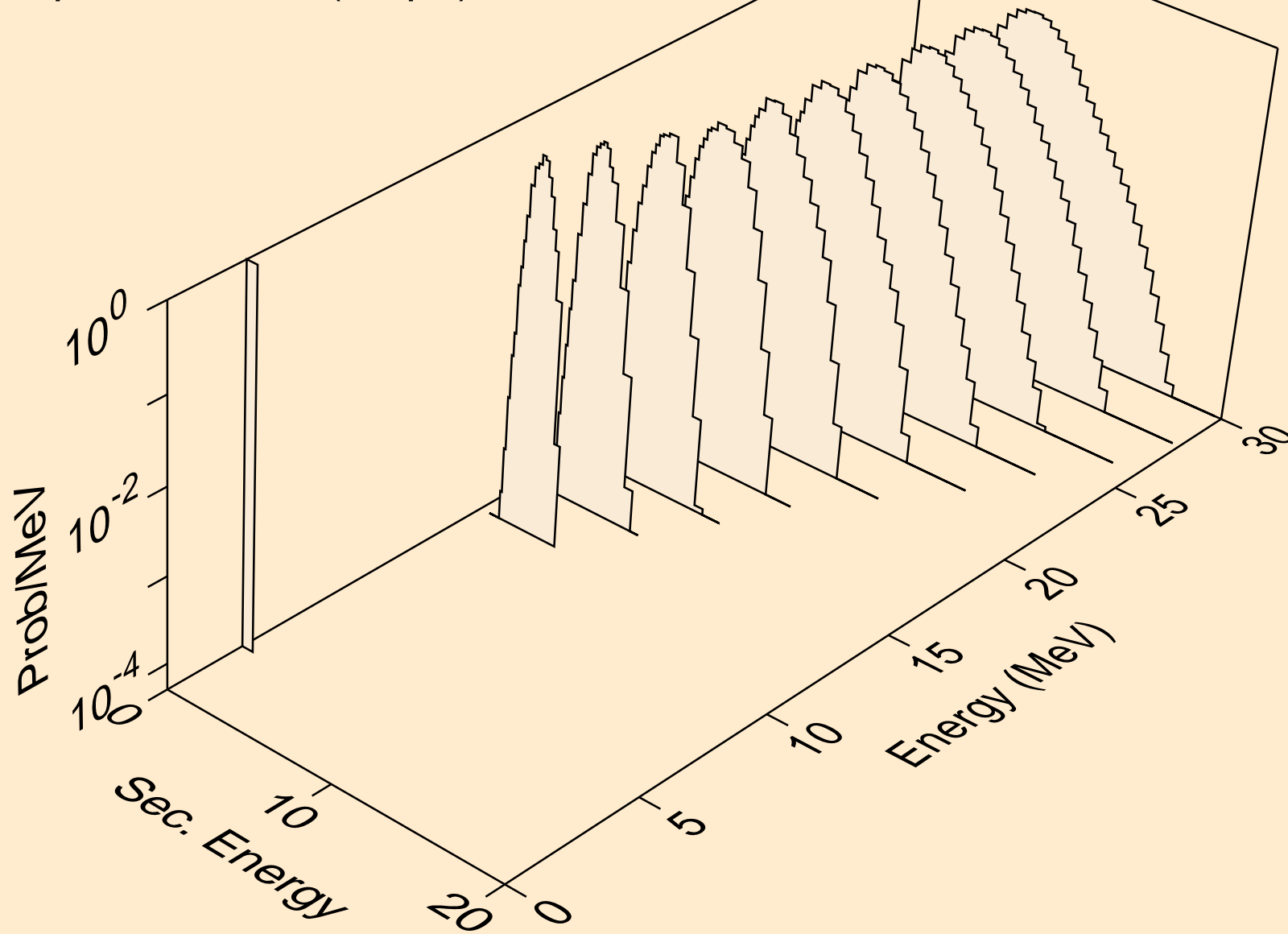

TB154 NEUTRON ACER TENDL-2021 LIBRARY; T=293.6K
protons from (n,p)

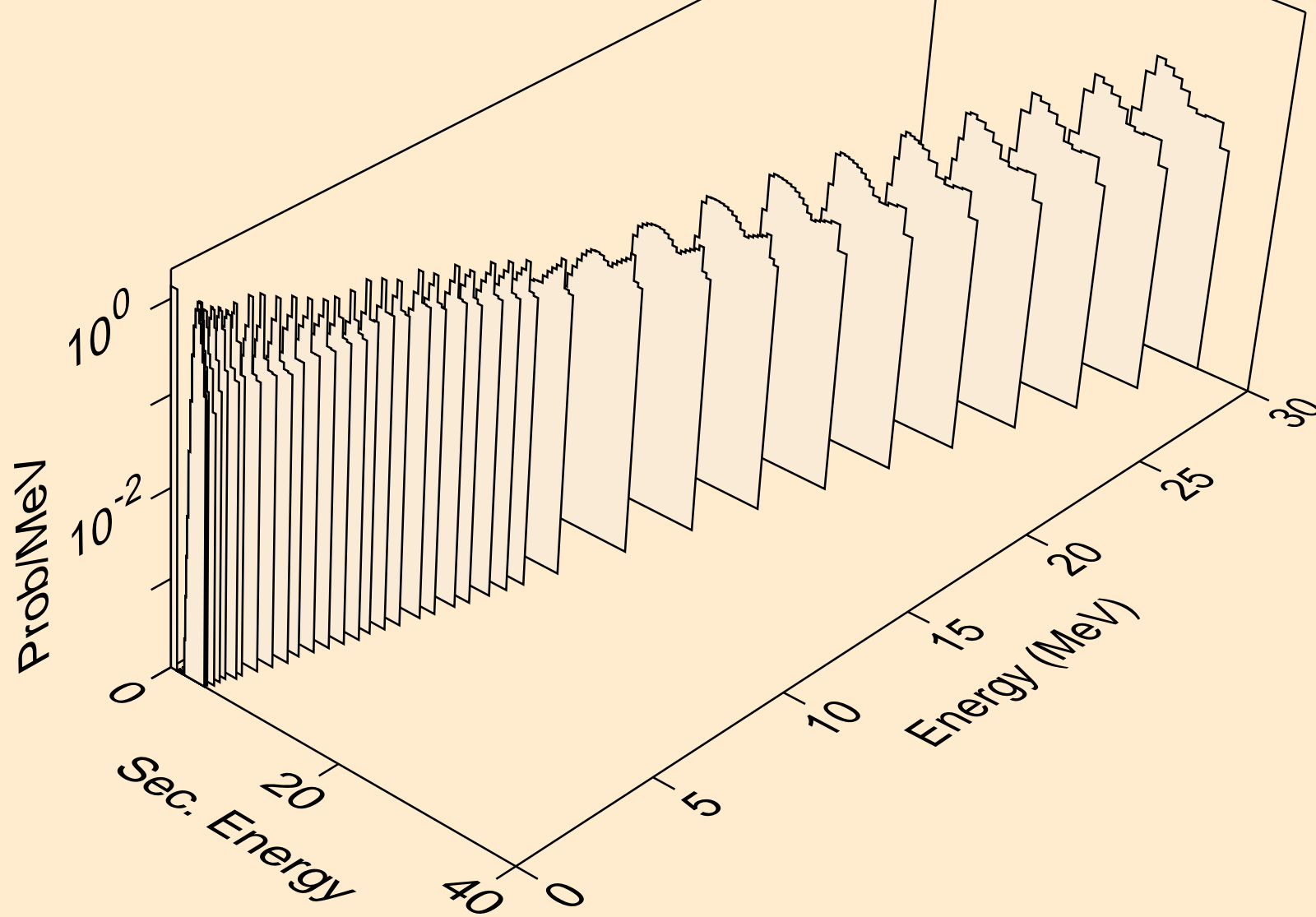

TB154 NEUTRON ACER TENDL-2021 LIBRARY; T=293.6K
protons from (n,2p)

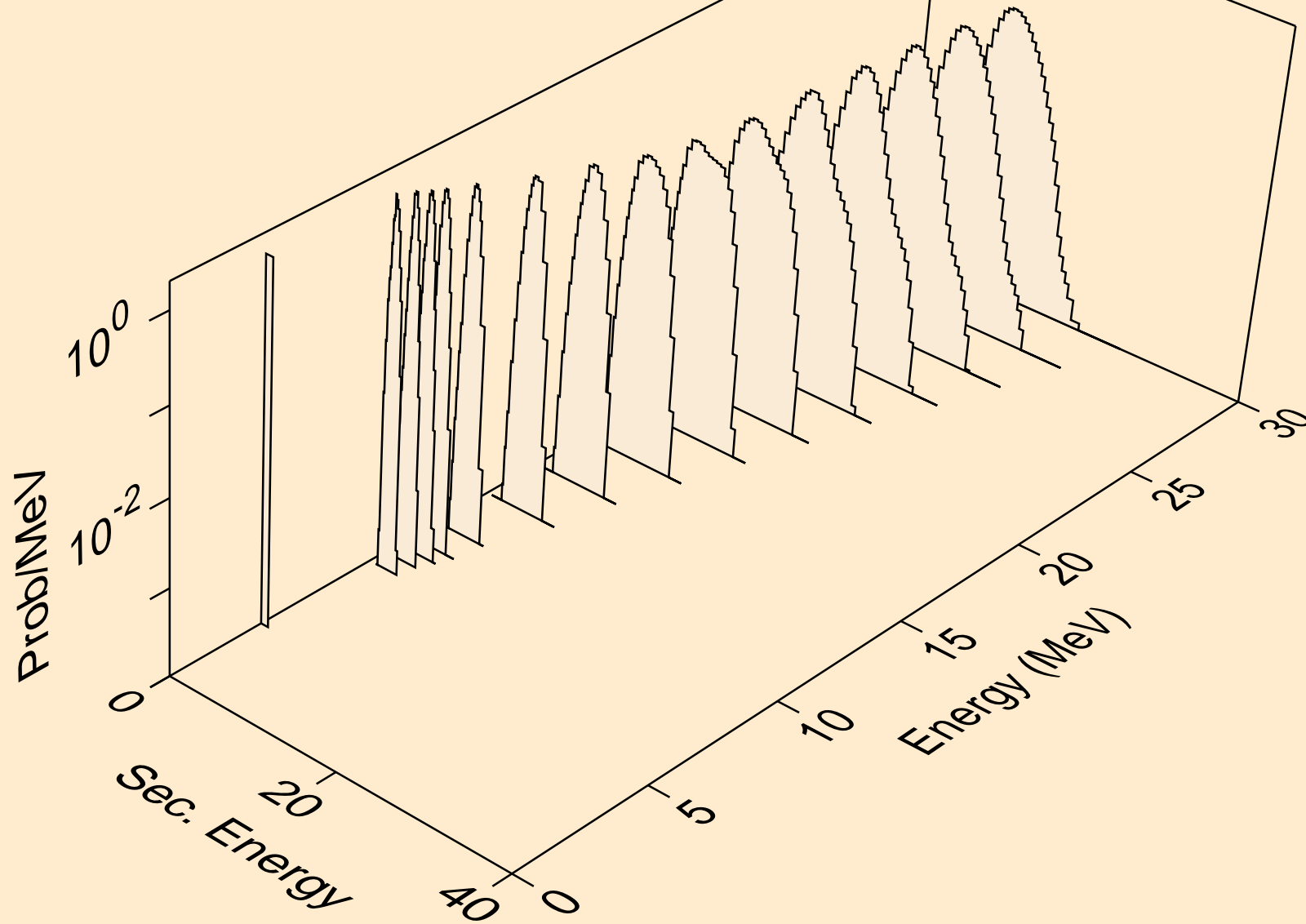

TB154 NEUTRON ACER TENDL-2021 LIBRARY; T=293.6K
protons from (n,p)

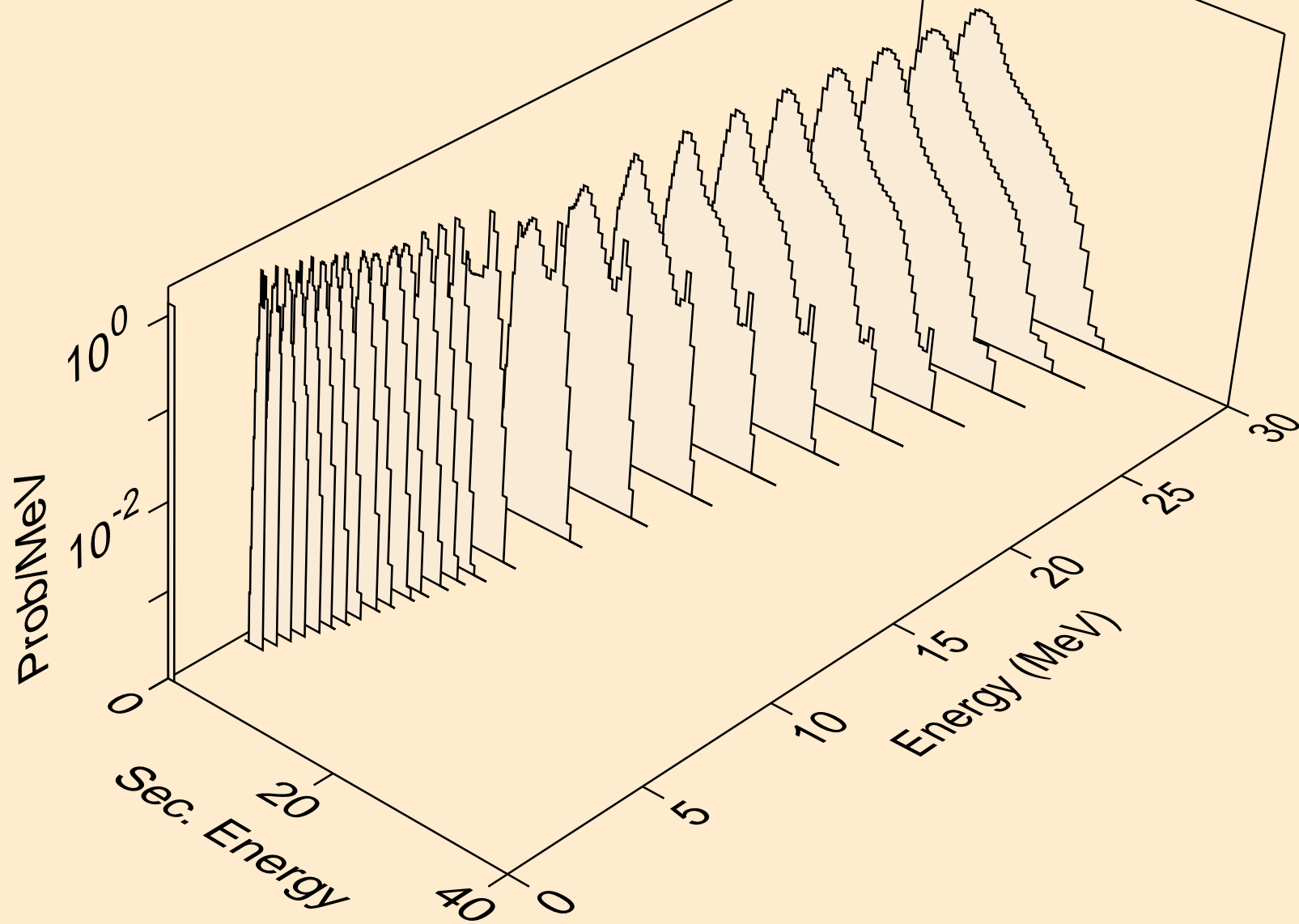

TB154 NEUTRON ACER TENDL-2021 LIBRARY; T=293.6K
protons from (n,pd)

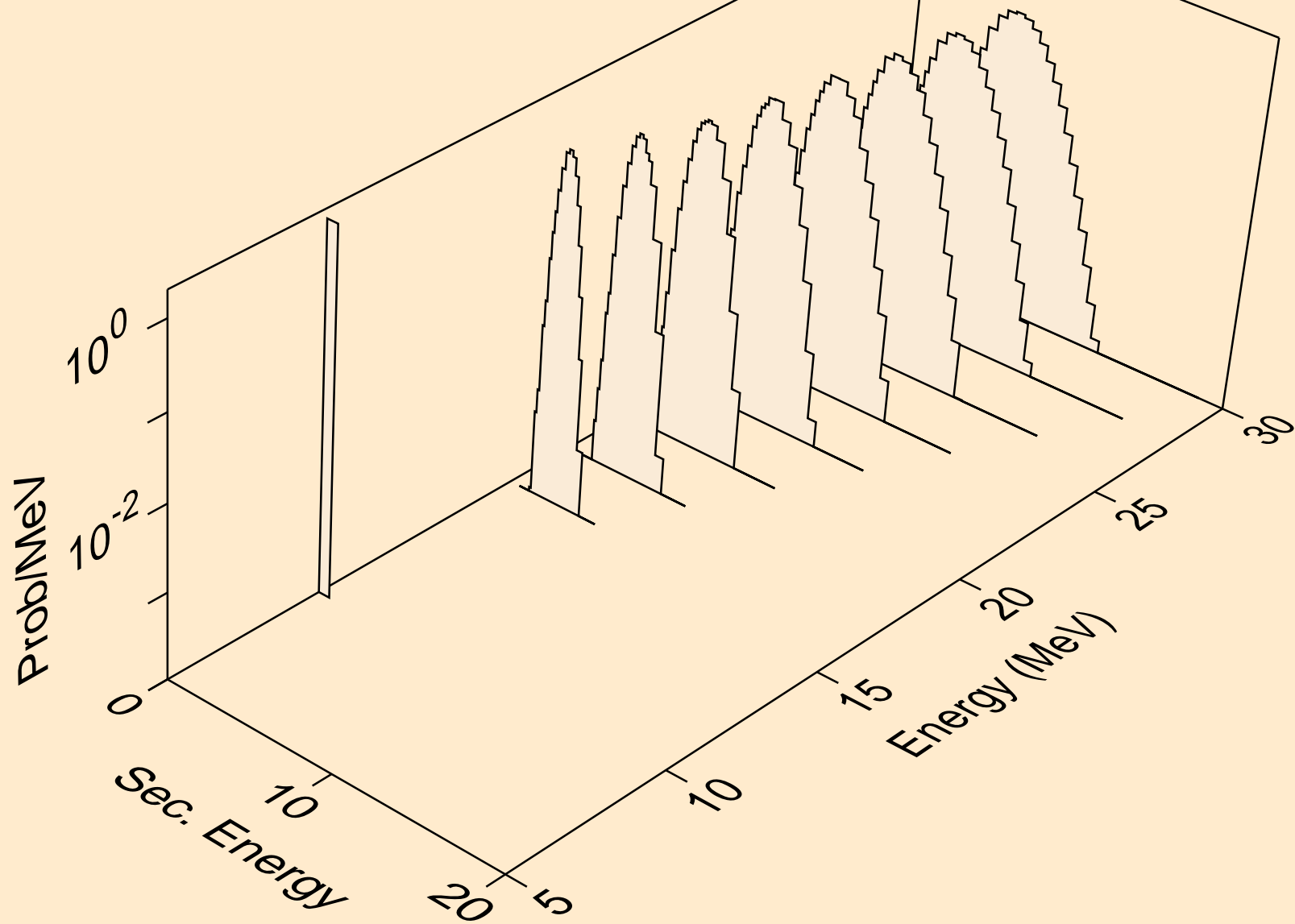

TB154 NEUTRON ACER TENDL-2021 LIBRARY; T=293.6K
protons from (n,pt)

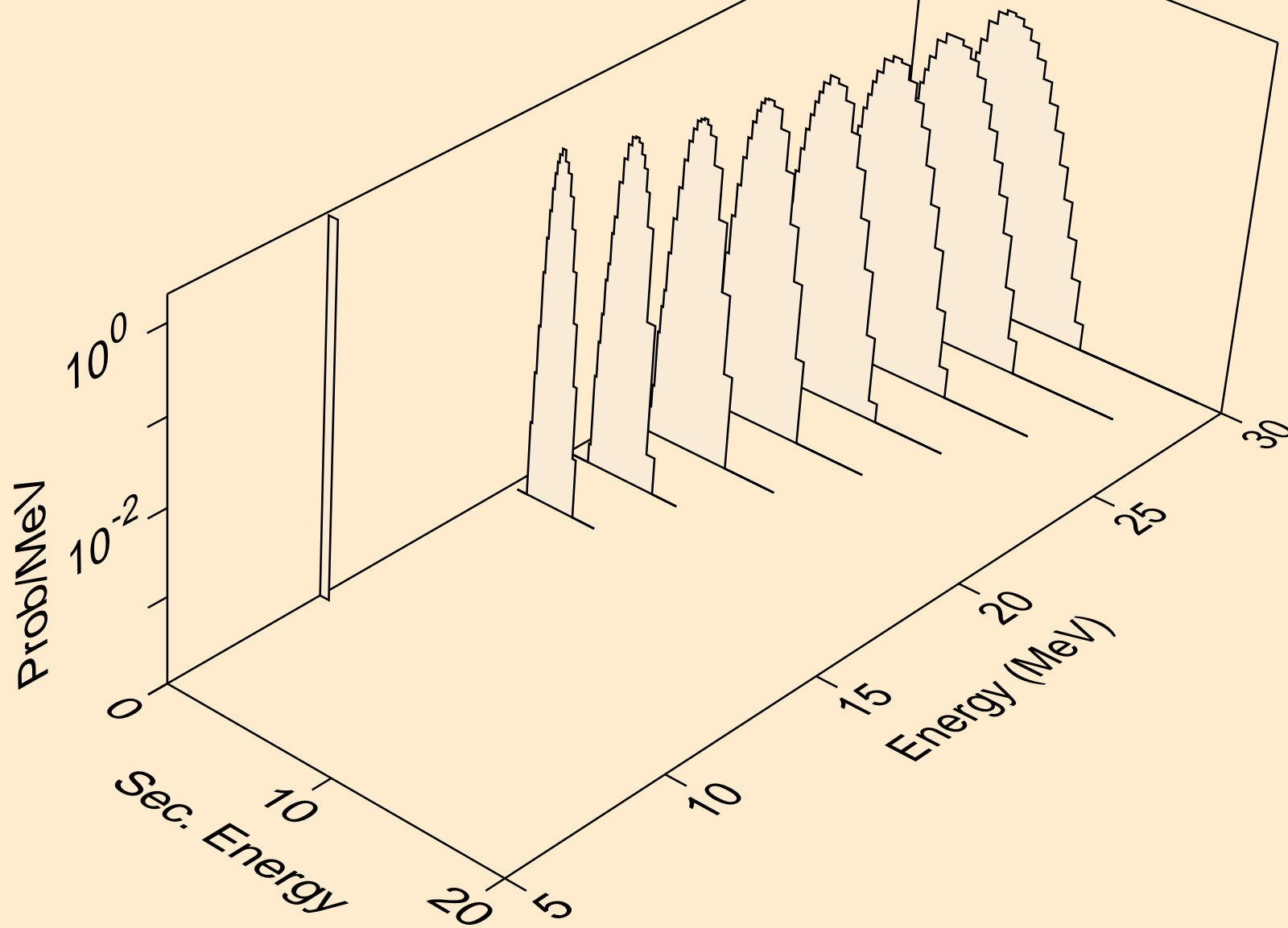

TB154 NEUTRON ACER TENDL-2021 LIBRARY; T=293.6K
deuterons from (n,x)

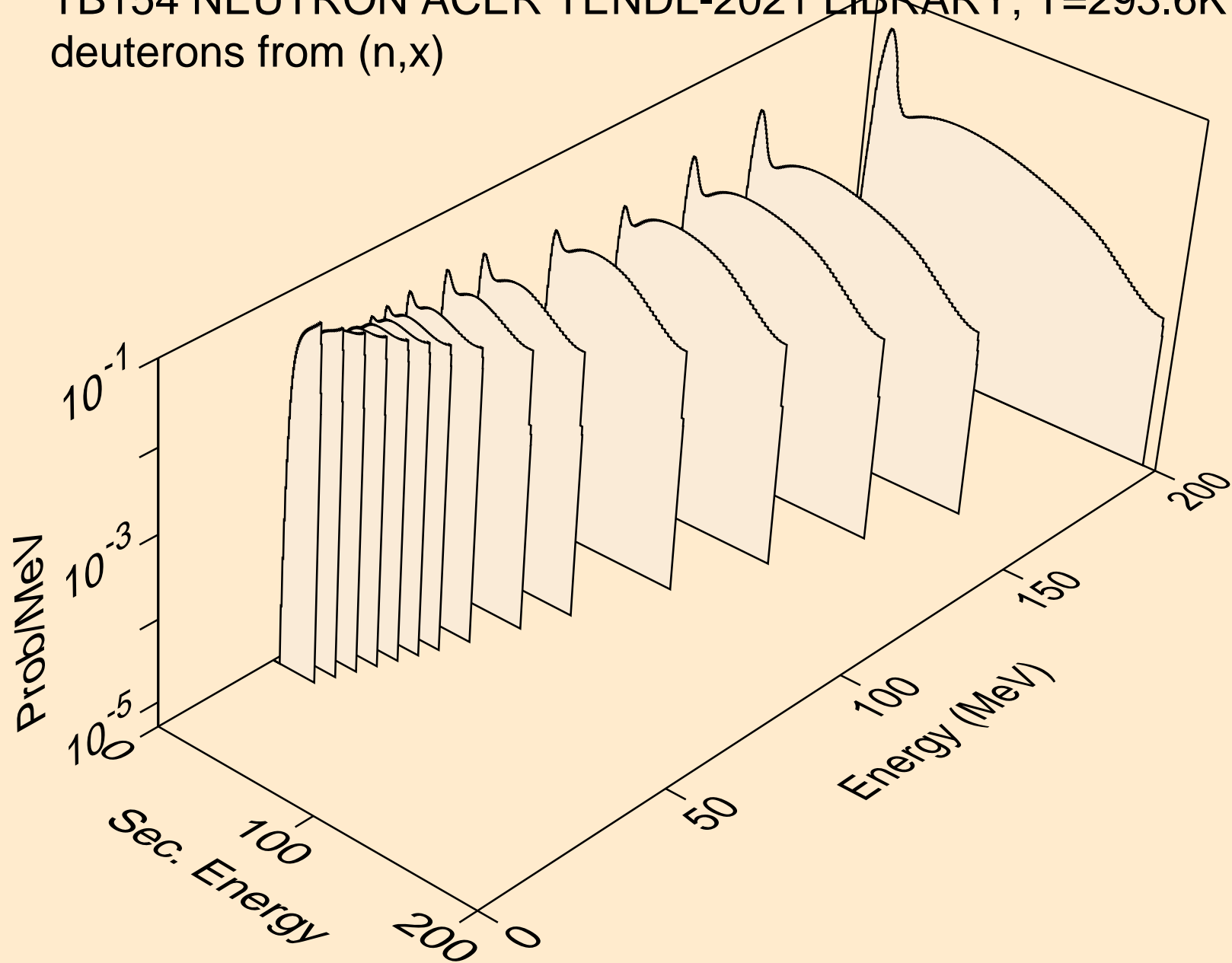

TB154 NEUTRON ACER TENDL-2021 LIBRARY; T=293.6K
deuterons from (n,2nd)

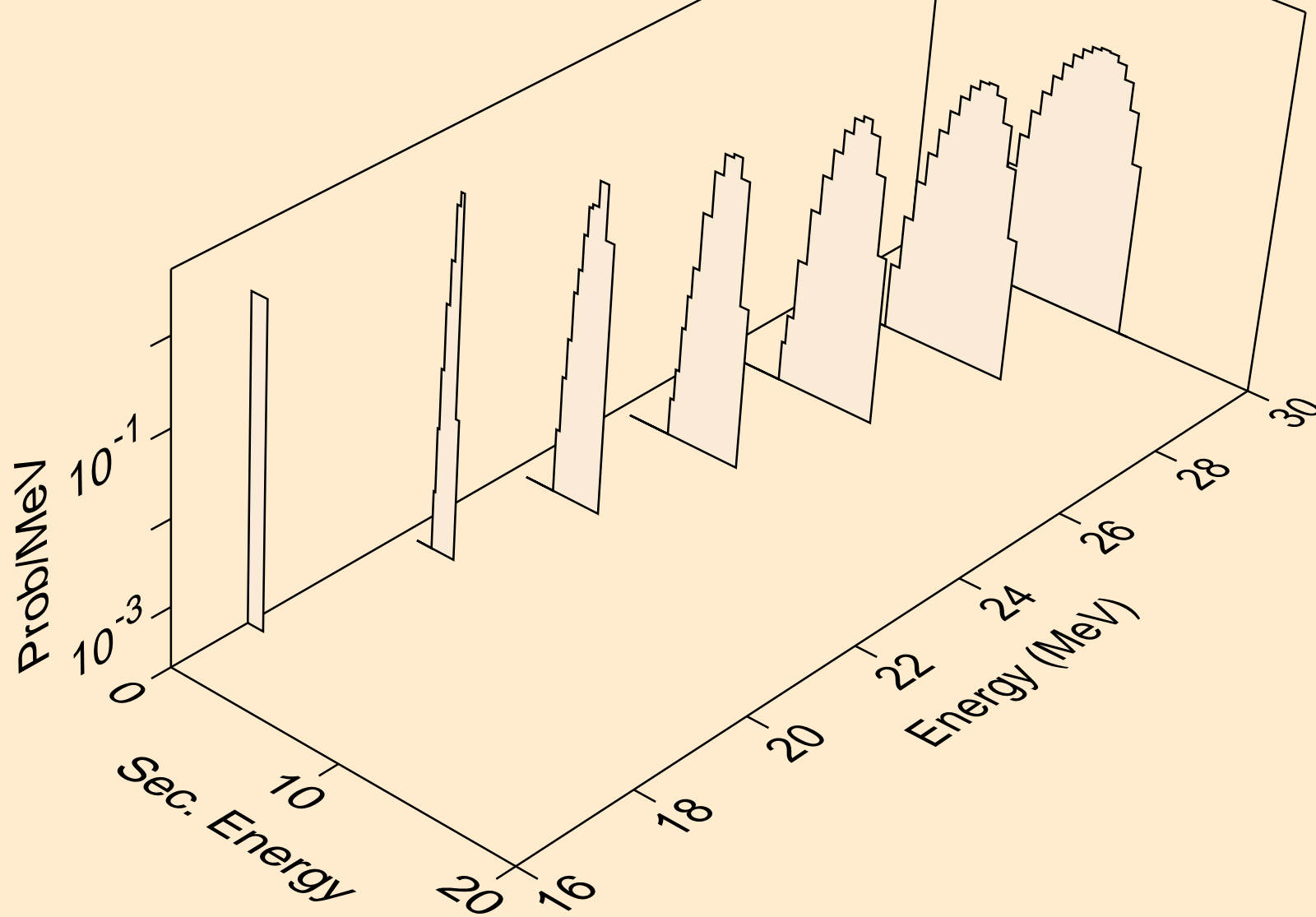

TB154 NEUTRON ACER TENDL-2021 LIBRARY; T=293.6K
deuterons from (n,n*)d

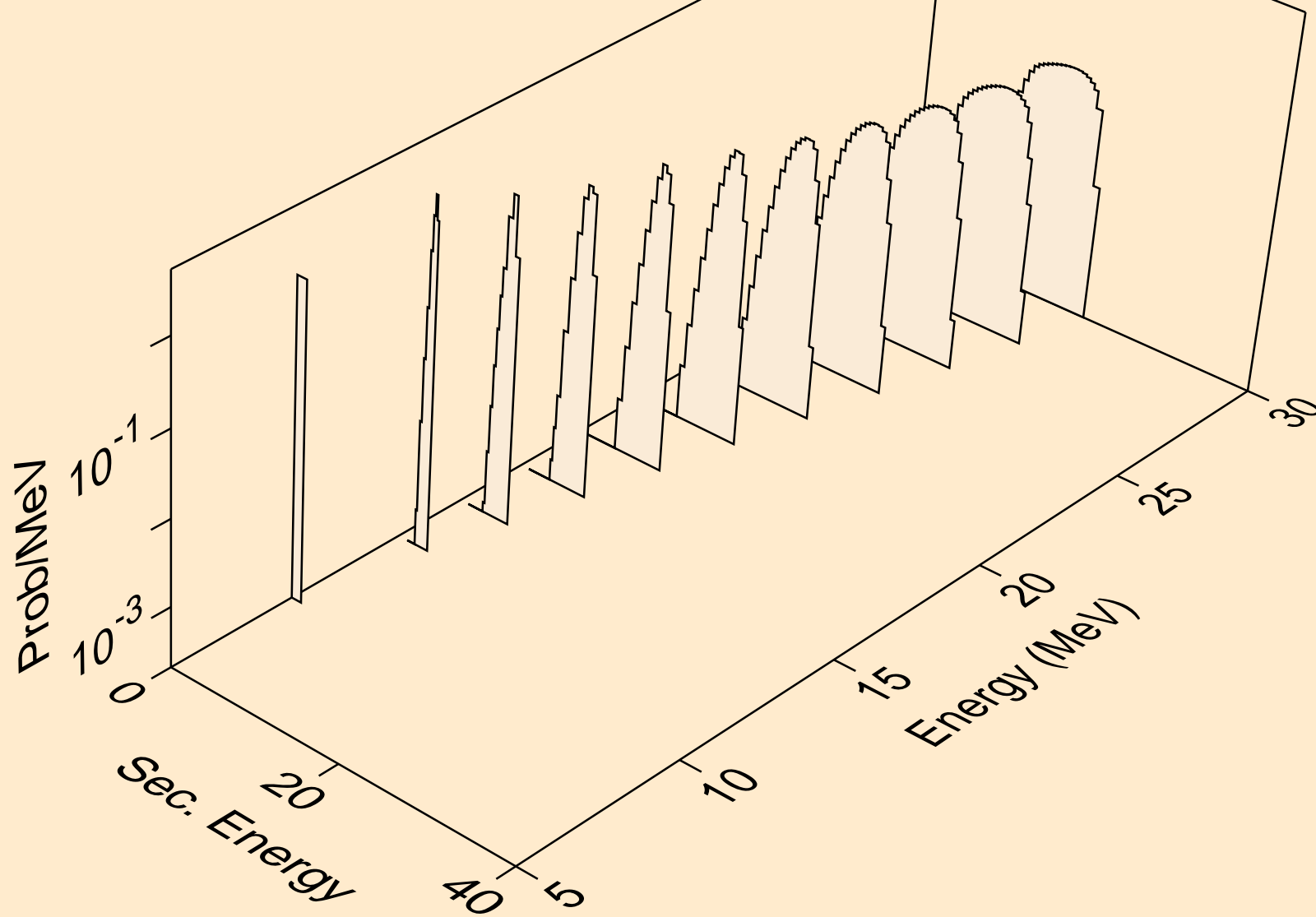

TB154 NEUTRON ACER TENDL-2021 LIBRARY; T=293.6K
deuterons from (n,d)

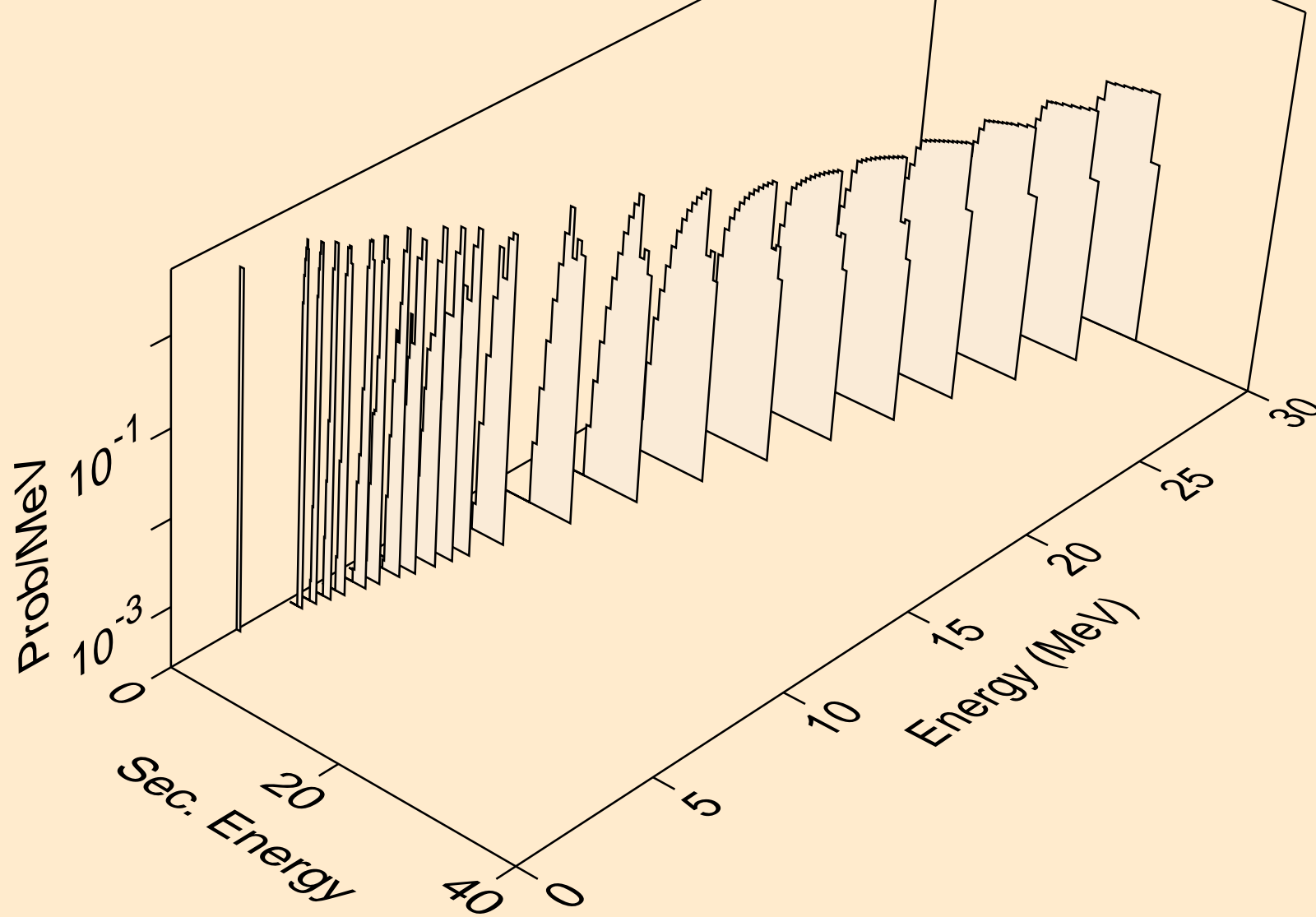

TB154 NEUTRON ACER TENDL-2021 LIBRARY; T=293.6K
deuterons from (n,pd)

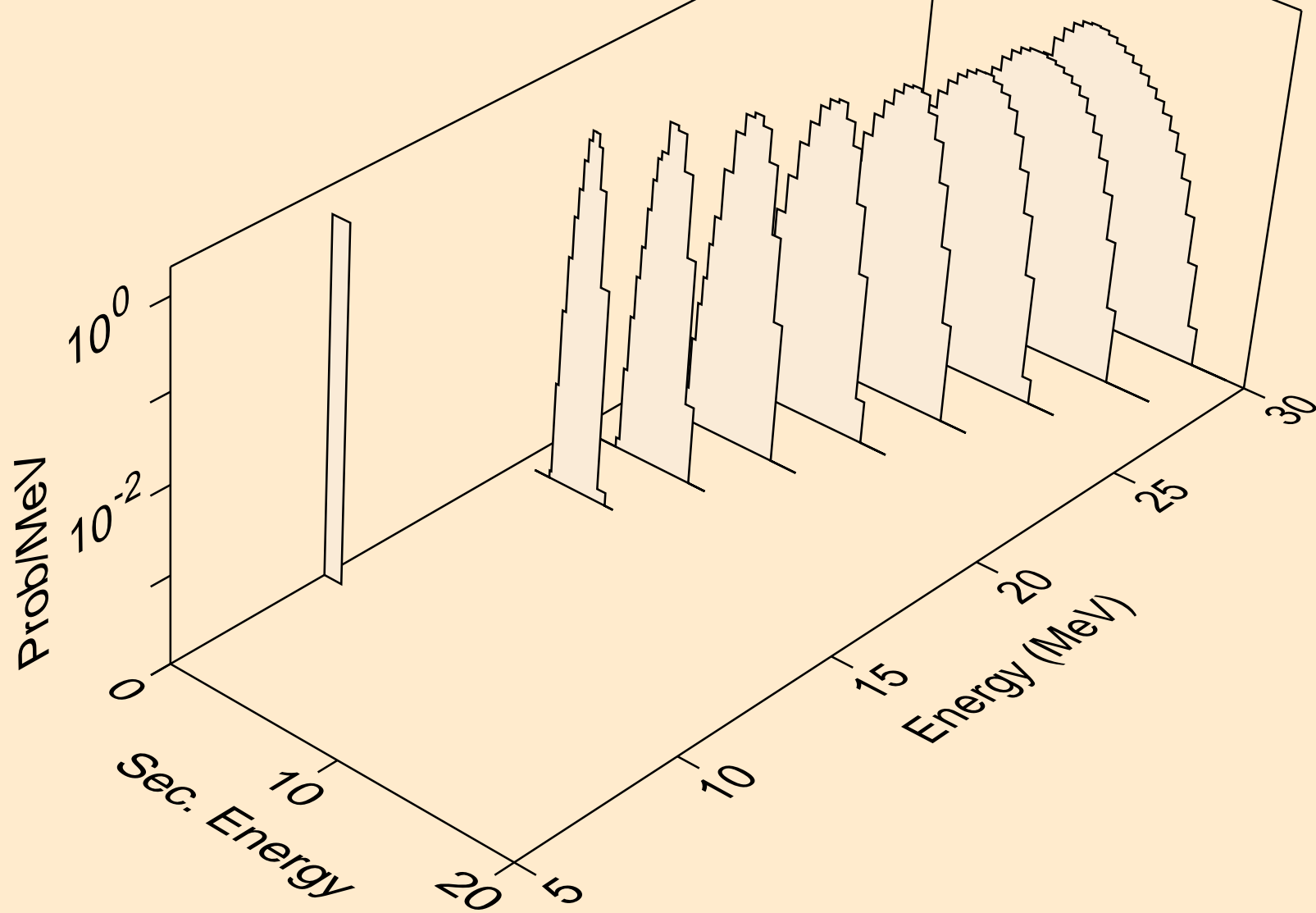

TB154 NEUTRON ACER TENDL-2021 LIBRARY; T=293.6K
deuterons from (n,da)

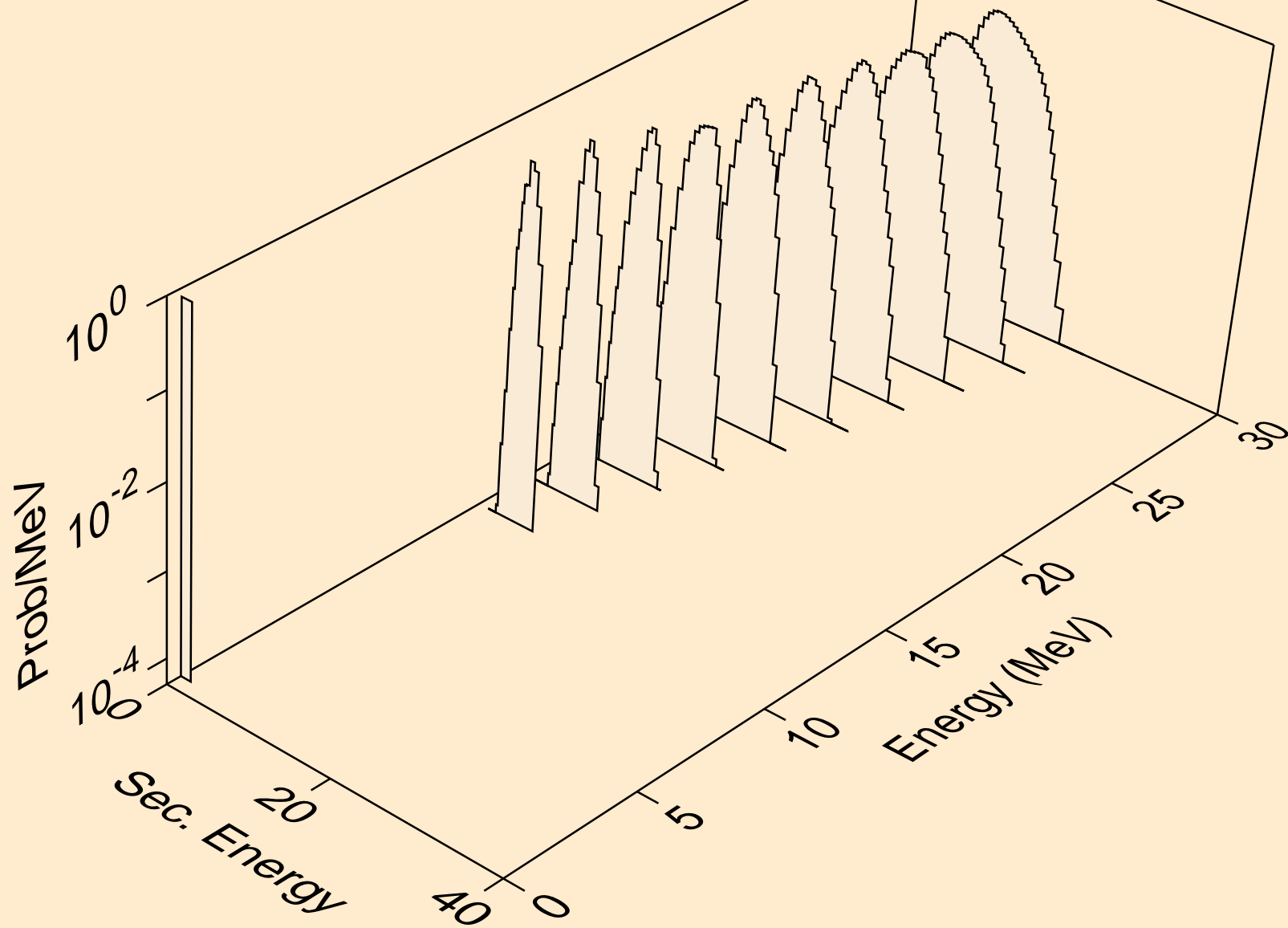

TB154 NEUTRON ACER TENDL-2021 LIBRARY; T=293.6K
tritons from (n,x)

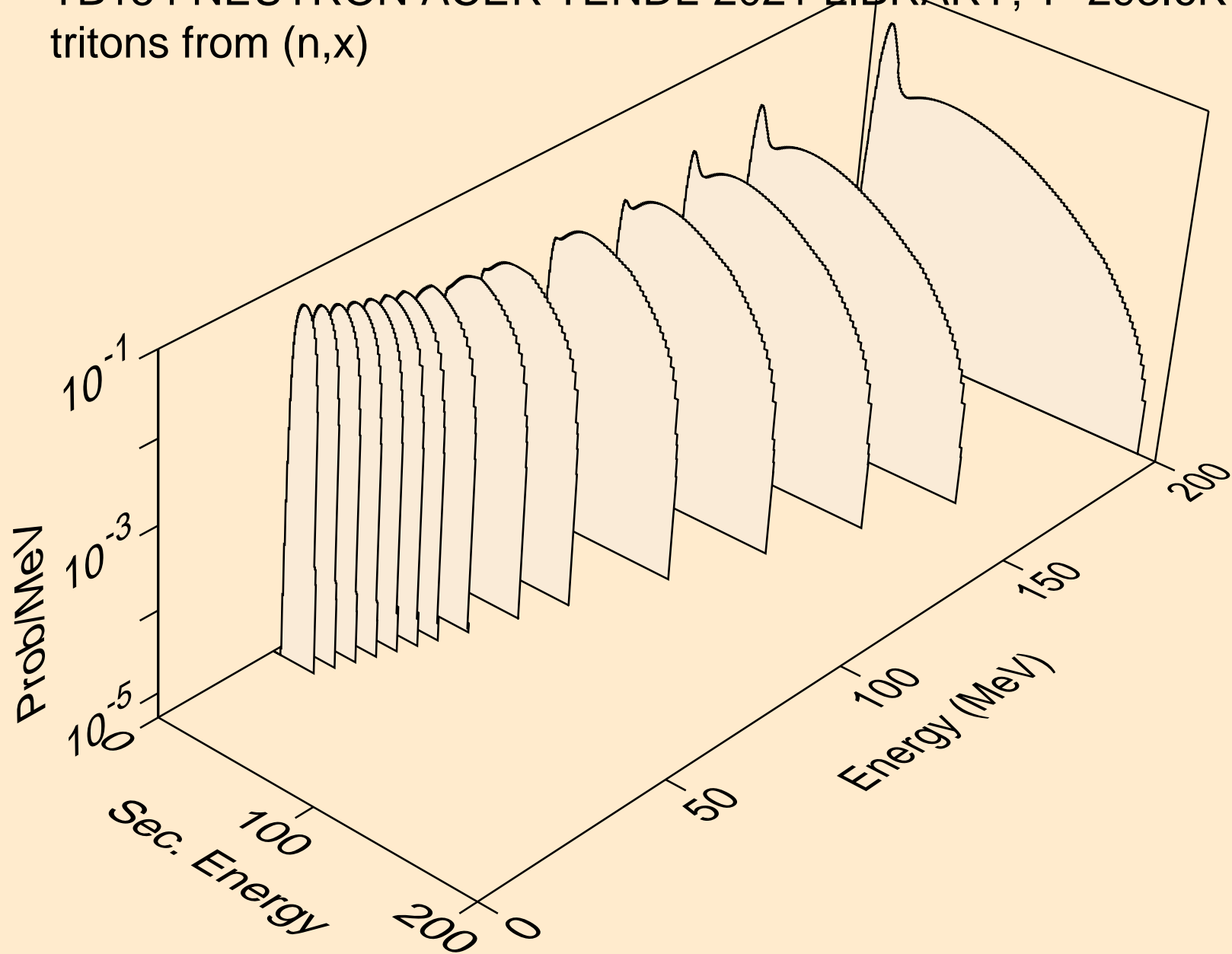

TB154 NEUTRON ACER TENDL-2021 LIBRARY; T=293.6K
tritons from (n,n*)t

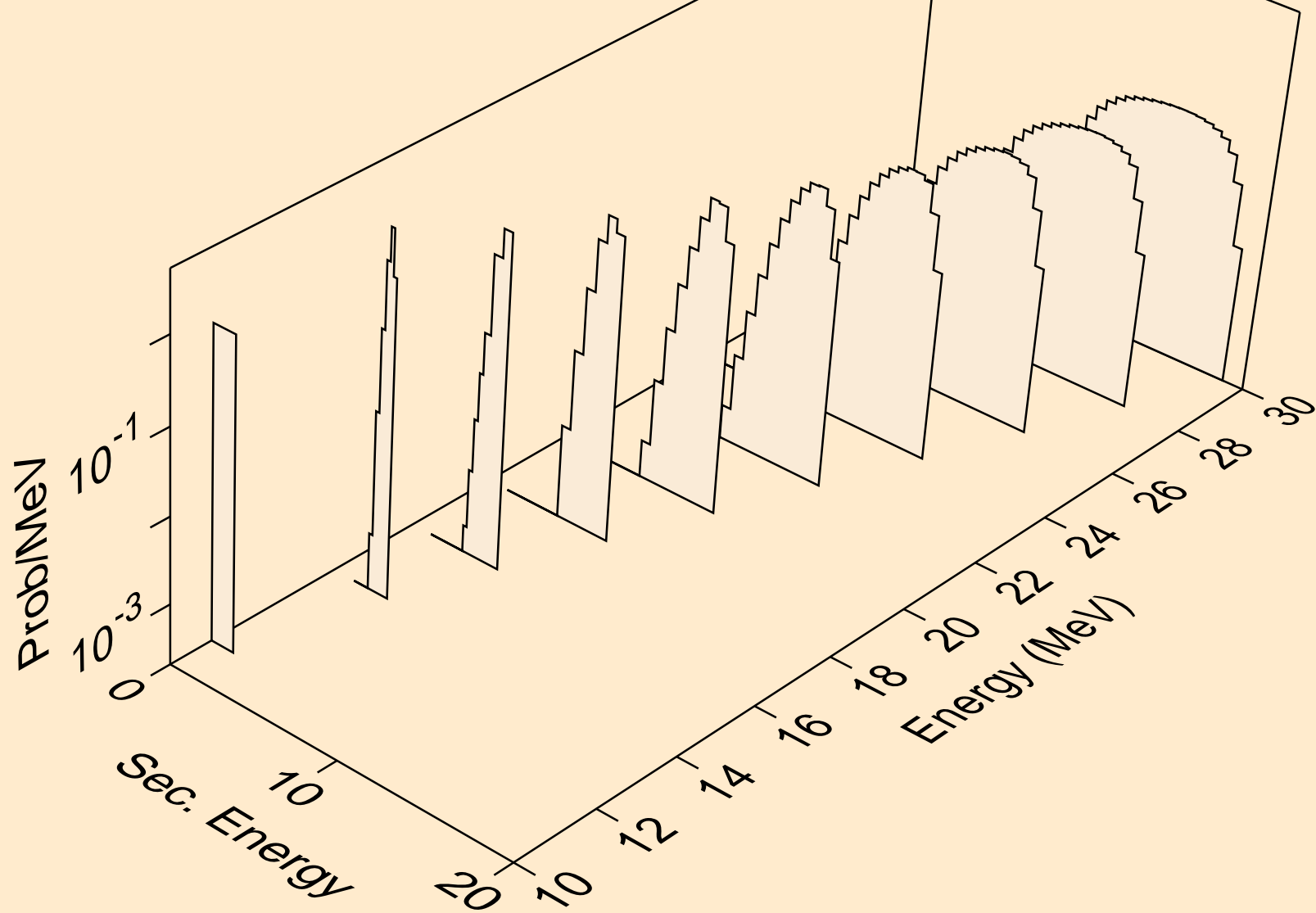

TB154 NEUTRON ACER TENDL-2021 LIBRARY; T=293.6K
tritons from (n,t)

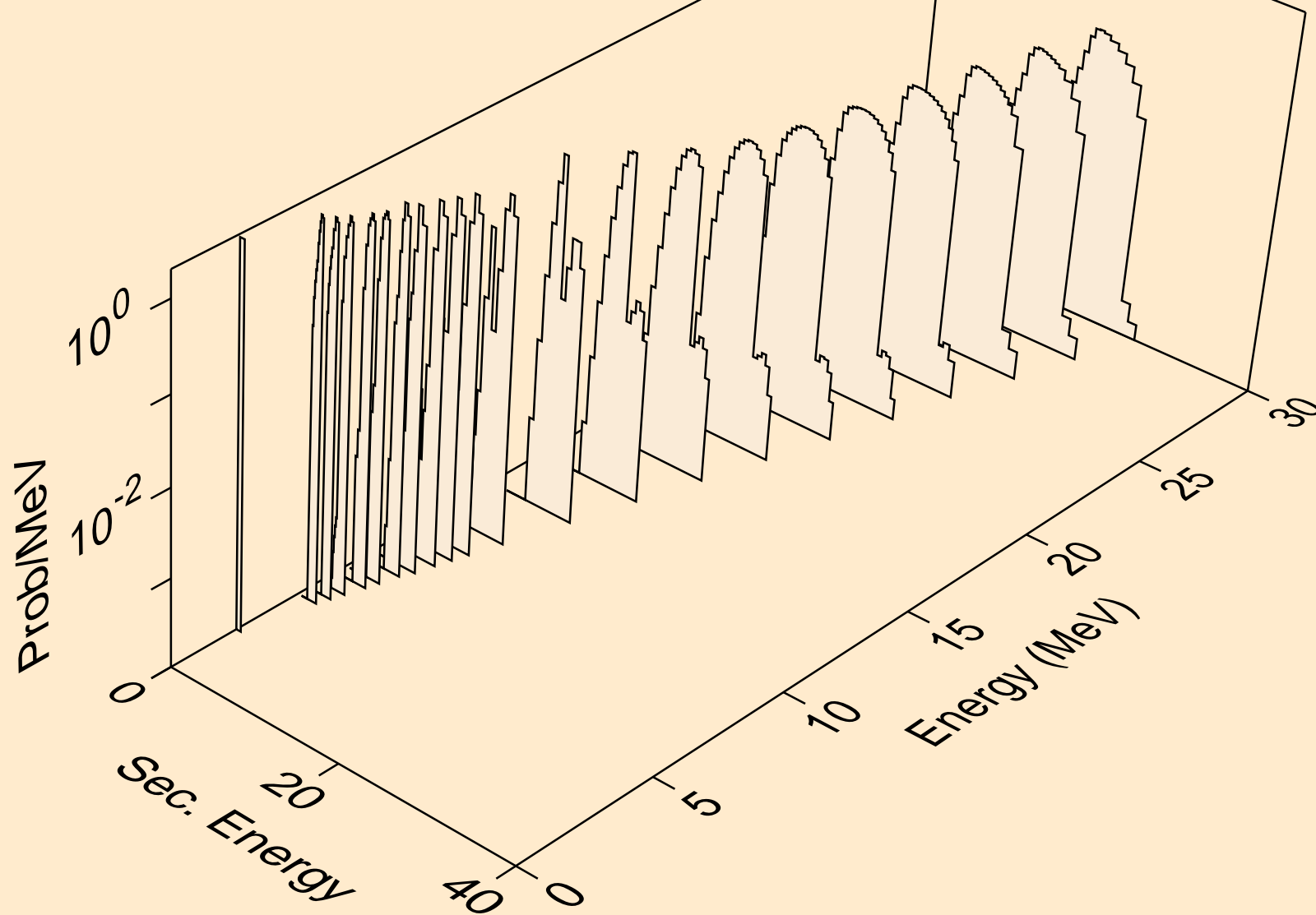

TB154 NEUTRON ACER TENDL-2021 LIBRARY; T=293.6K
tritons from (n,pt)

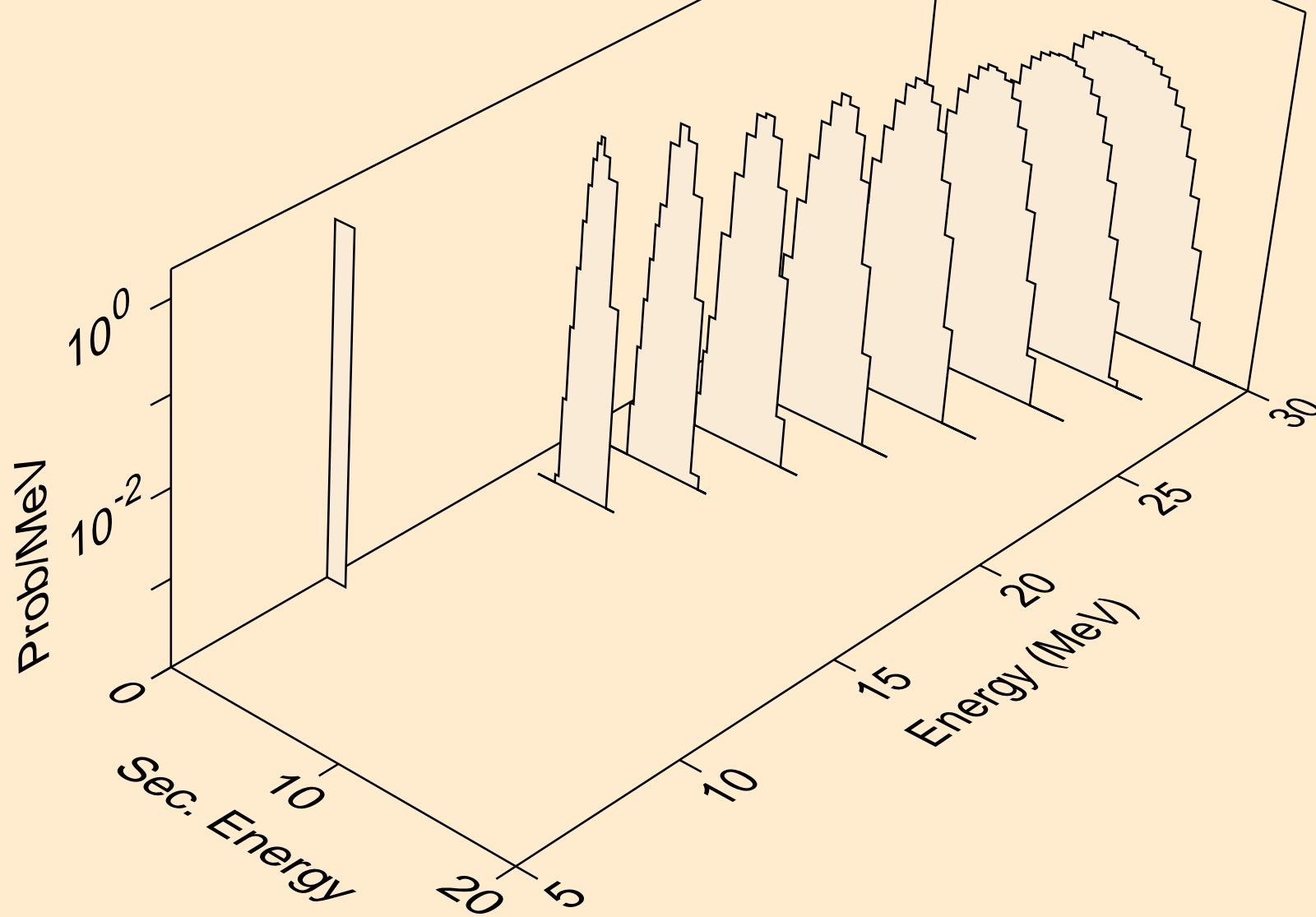

TB154 NEUTRON ACER TENDL-2021 LIBRARY; T=293.6K
he3s from (n,x)

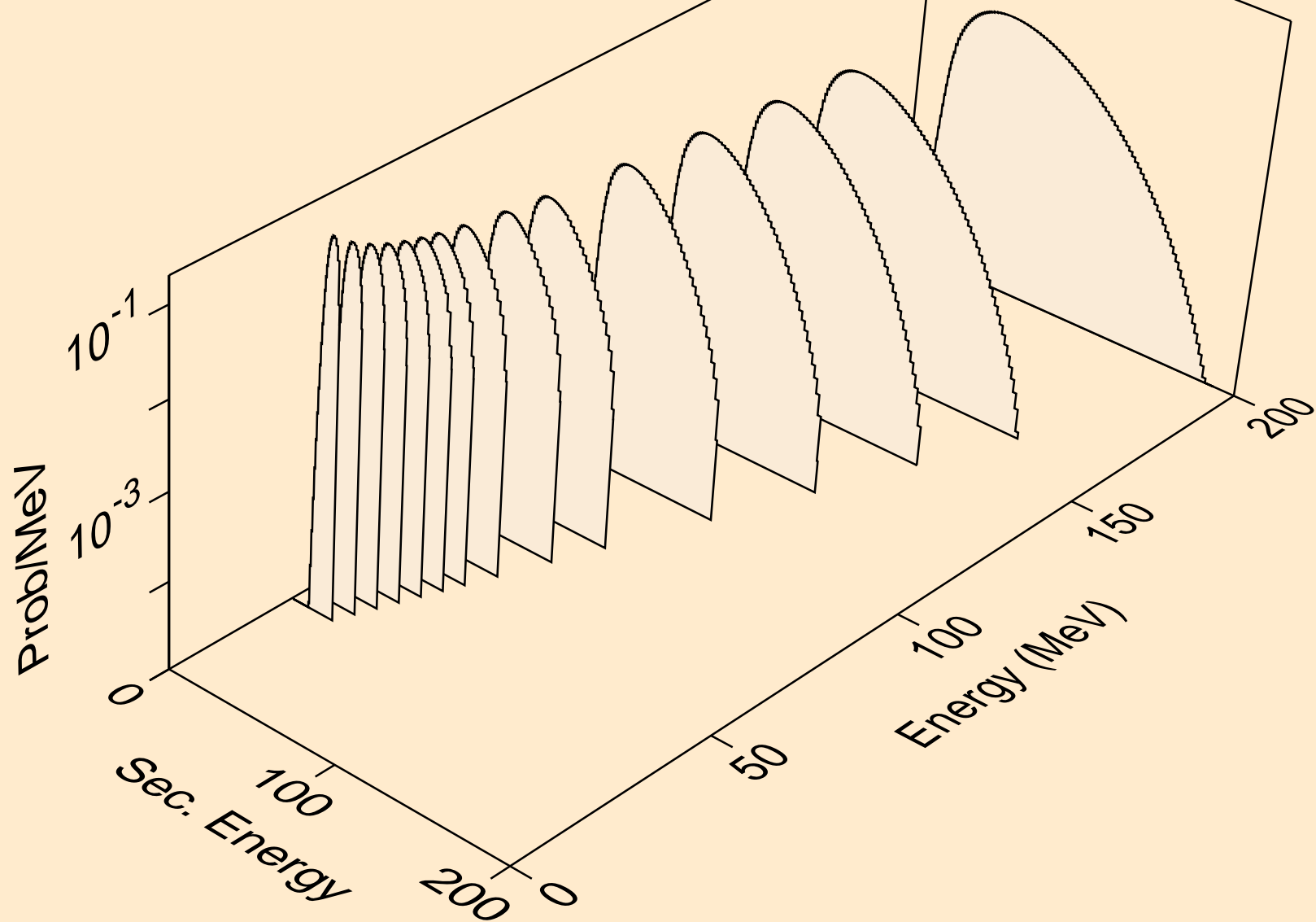

TB154 NEUTRON ACER TENDL-2021 LIBRARY; T=293.6K
he3s from (n,n*)he3

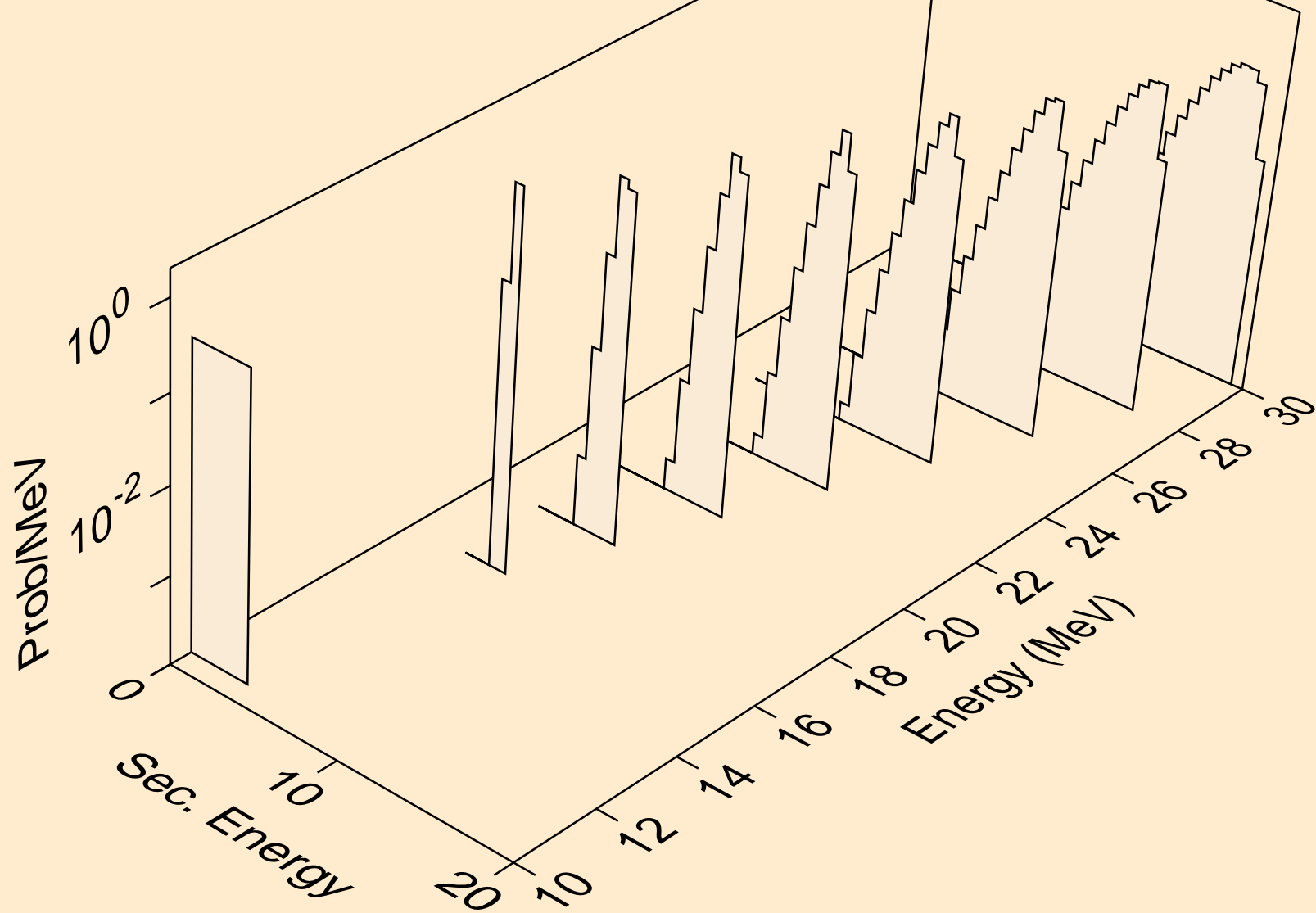

TB154 NEUTRON ACER TENDL-2021 LIBRARY; T=293.6K
alphas from (n,x)

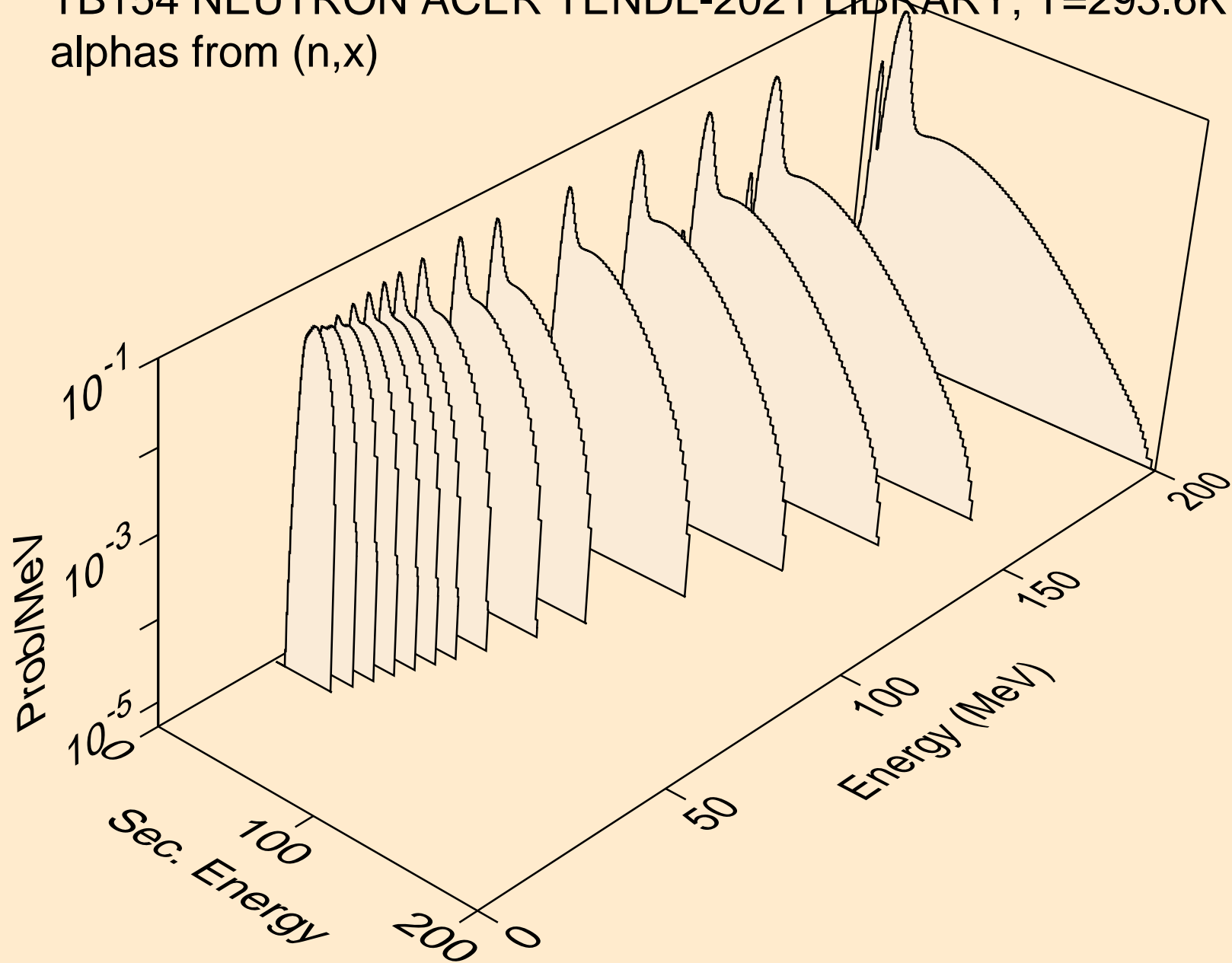

TB154 NEUTRON ACER TENDL-2021 LIBRARY; T=293.6K
alphas from (n,n*)a

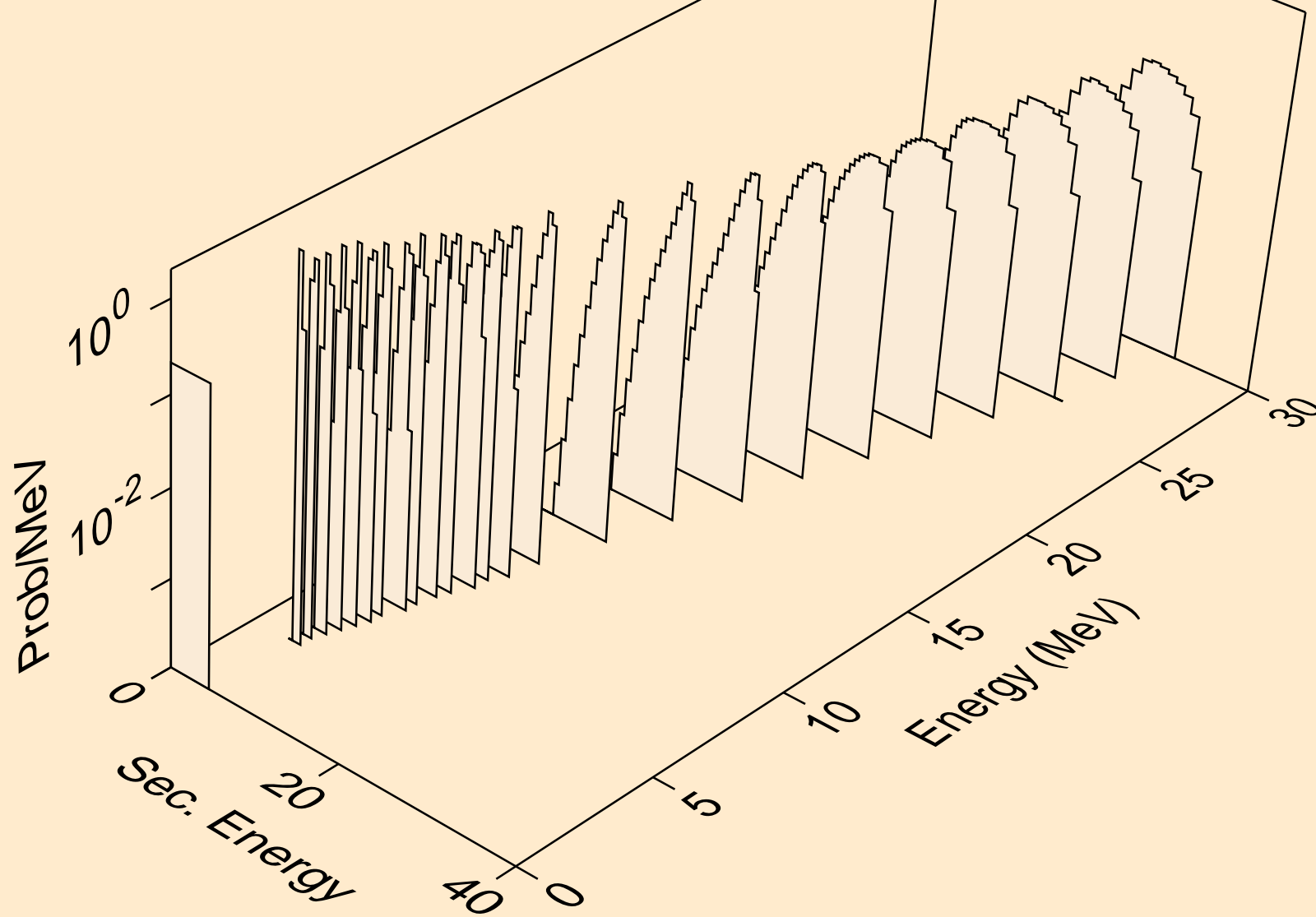

TB154 NEUTRON ACER TENDL-2021 LIBRARY; T=293.6K
alphas from (n,2n)a

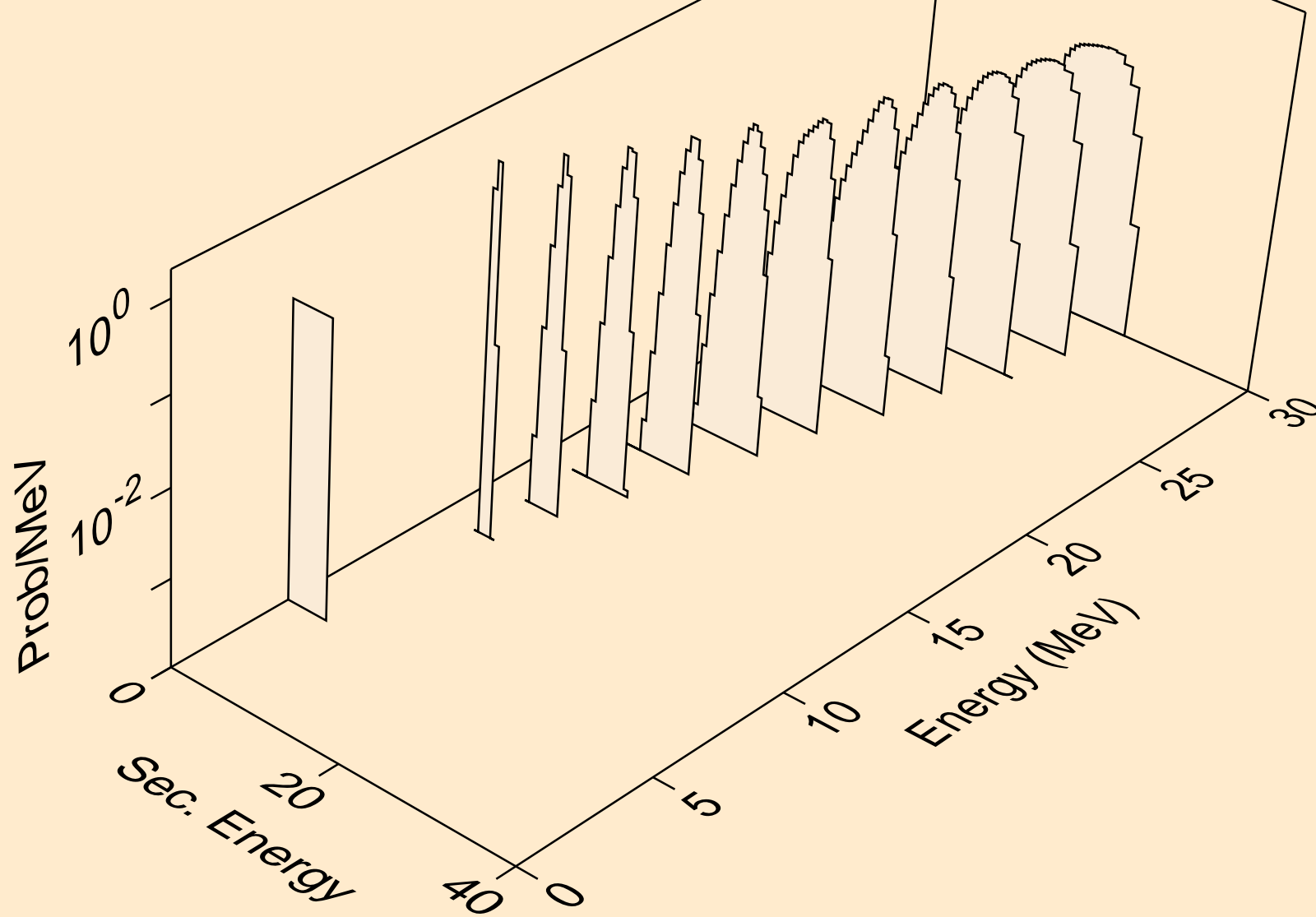

TB154 NEUTRON ACER TENDL-2021 LIBRARY; T=293.6K
alphas from (n,3n)a

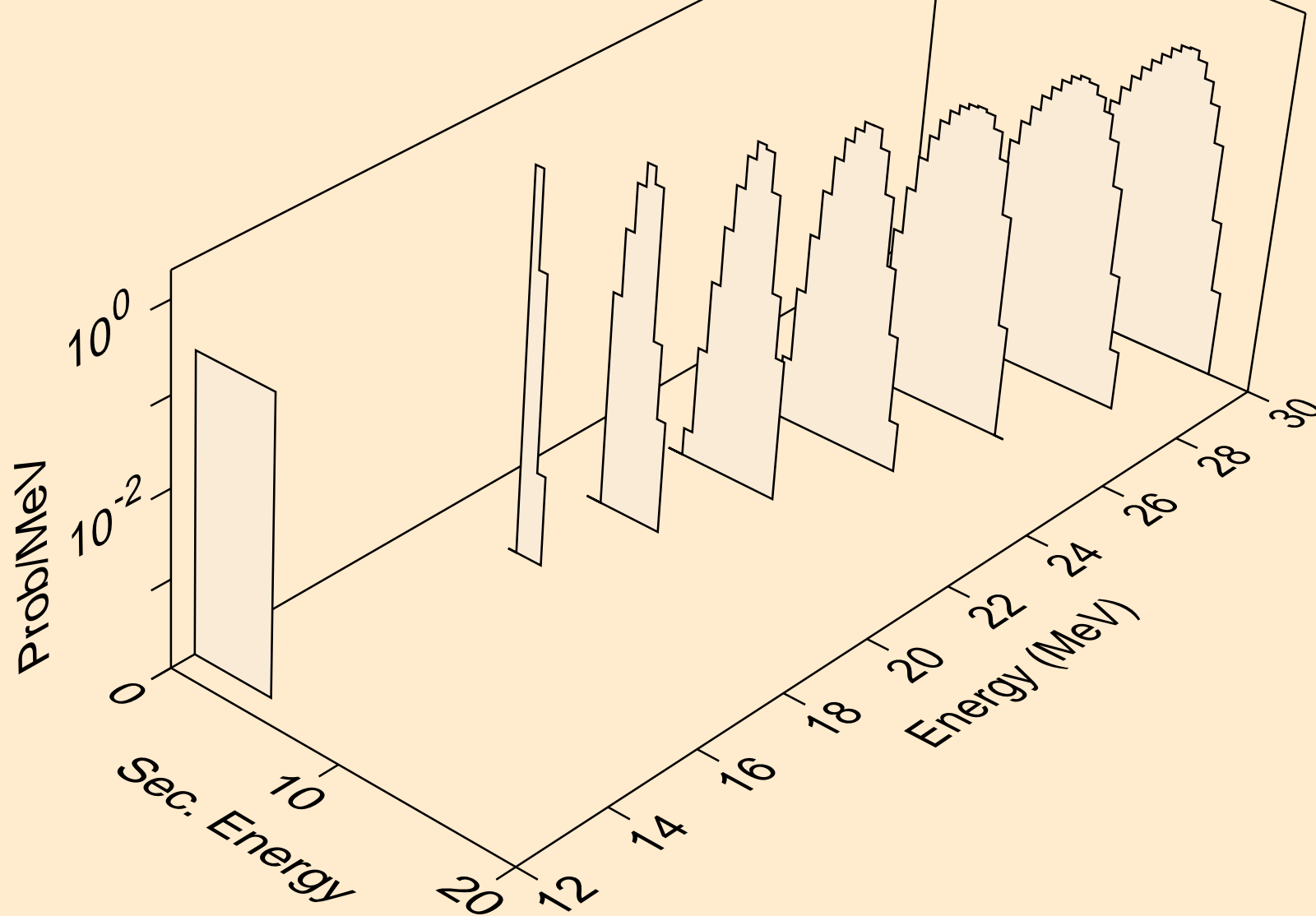

TB154 NEUTRON ACER TENDL-2021 LIBRARY; T=293.6K
alphas from (n,n*)2a

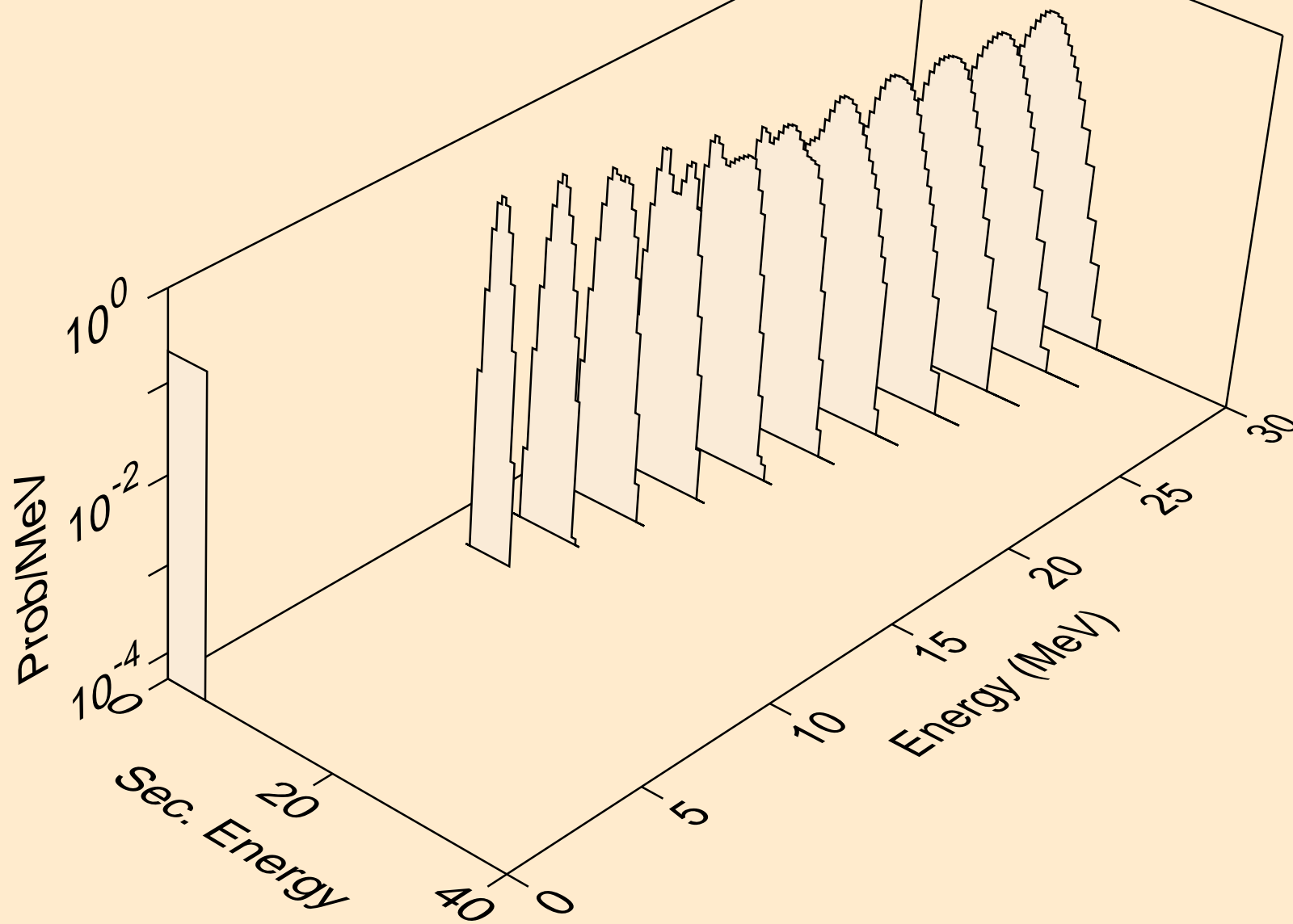

TB154 NEUTRON ACER TENDL-2021 LIBRARY; T=293.6K
alphas from (n,2n)2a

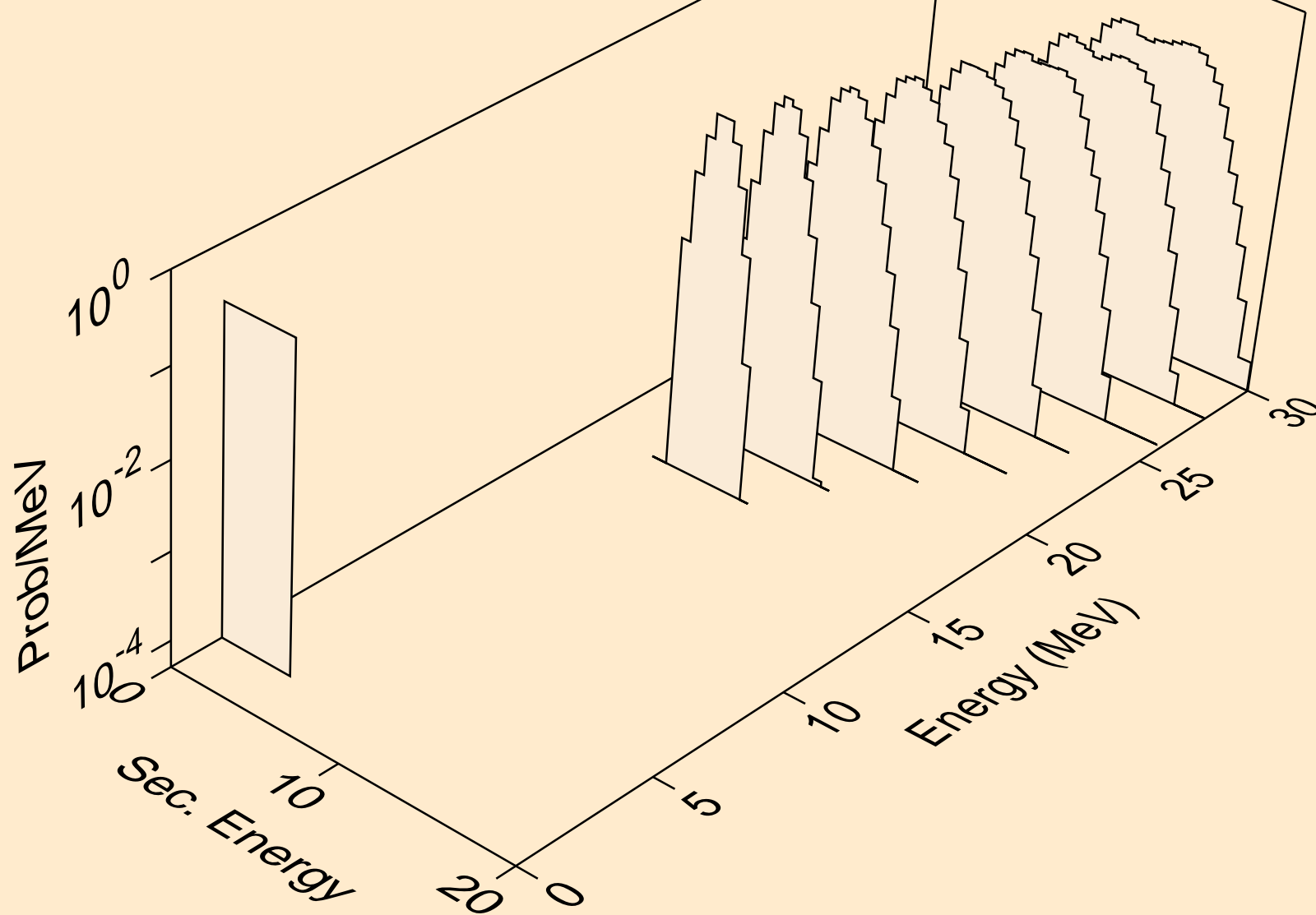

TB154 NEUTRON ACER TENDL-2021 LIBRARY; T=293.6K
alphas from (n,npa)

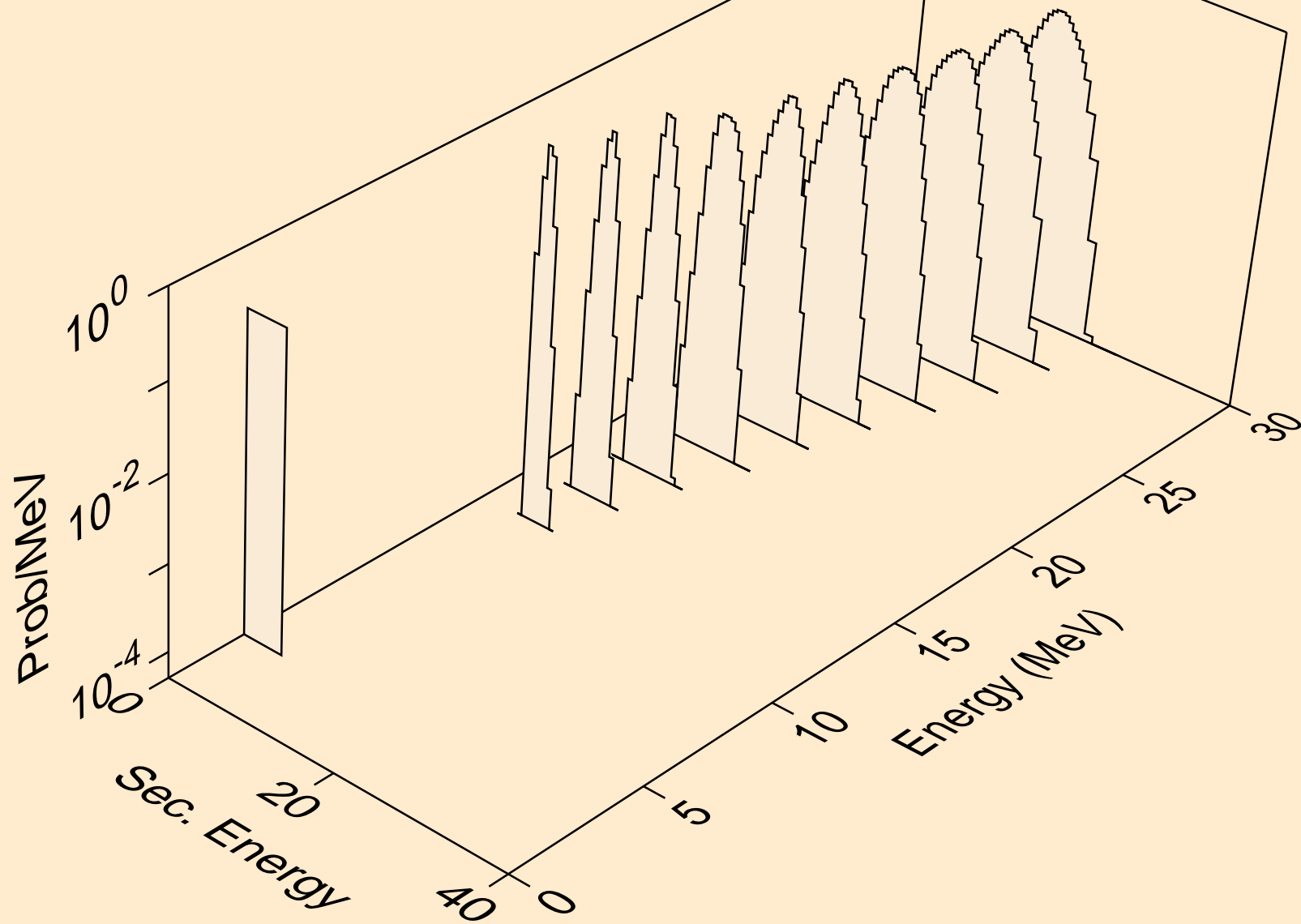

TB154 NEUTRON ACER TENDL-2021 LIBRARY; T=293.6K
alphas from (n,a)

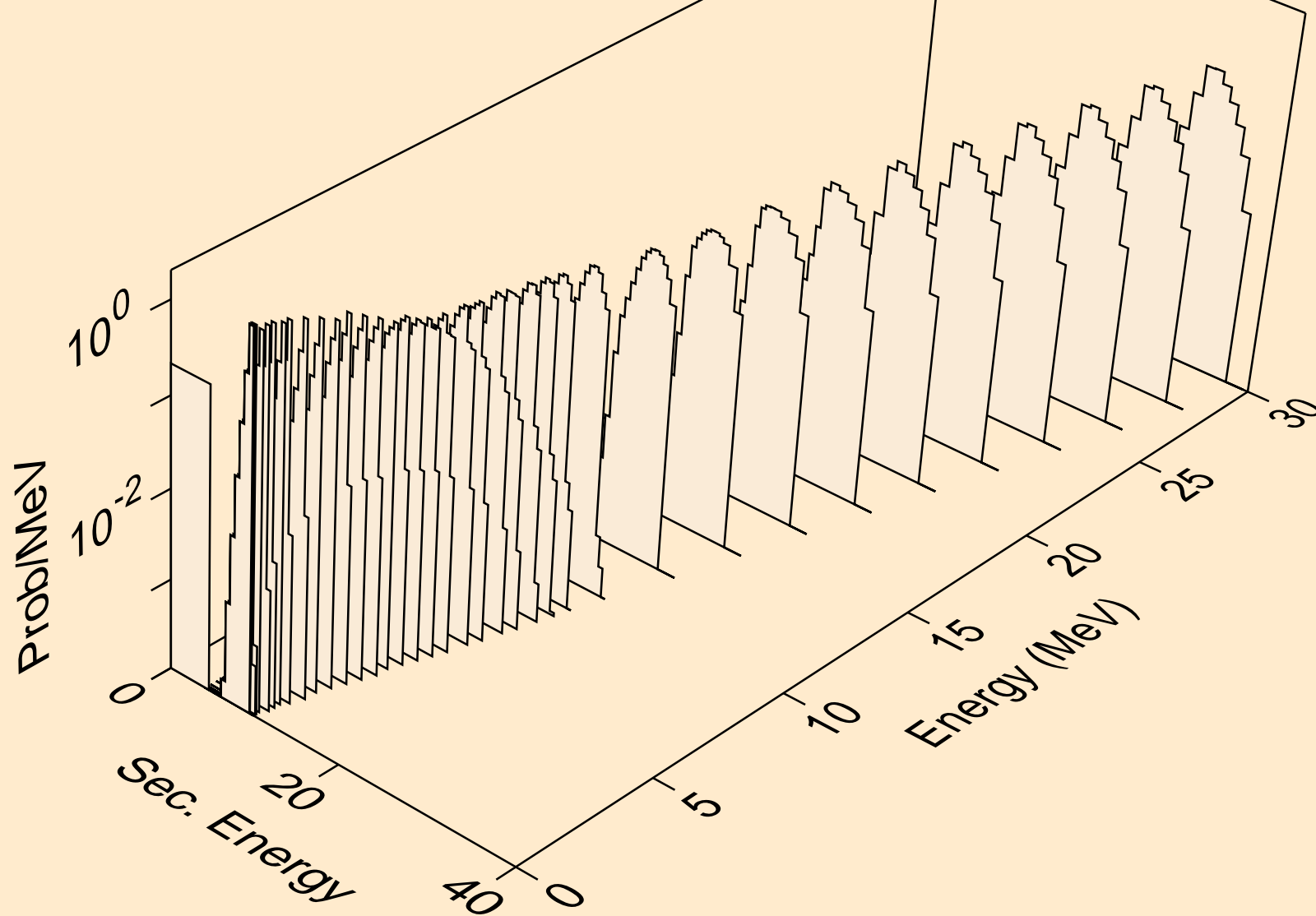

TB154 NEUTRON ACER TENDL-2021 LIBRARY; T=293.6K
alphas from (n,2a)

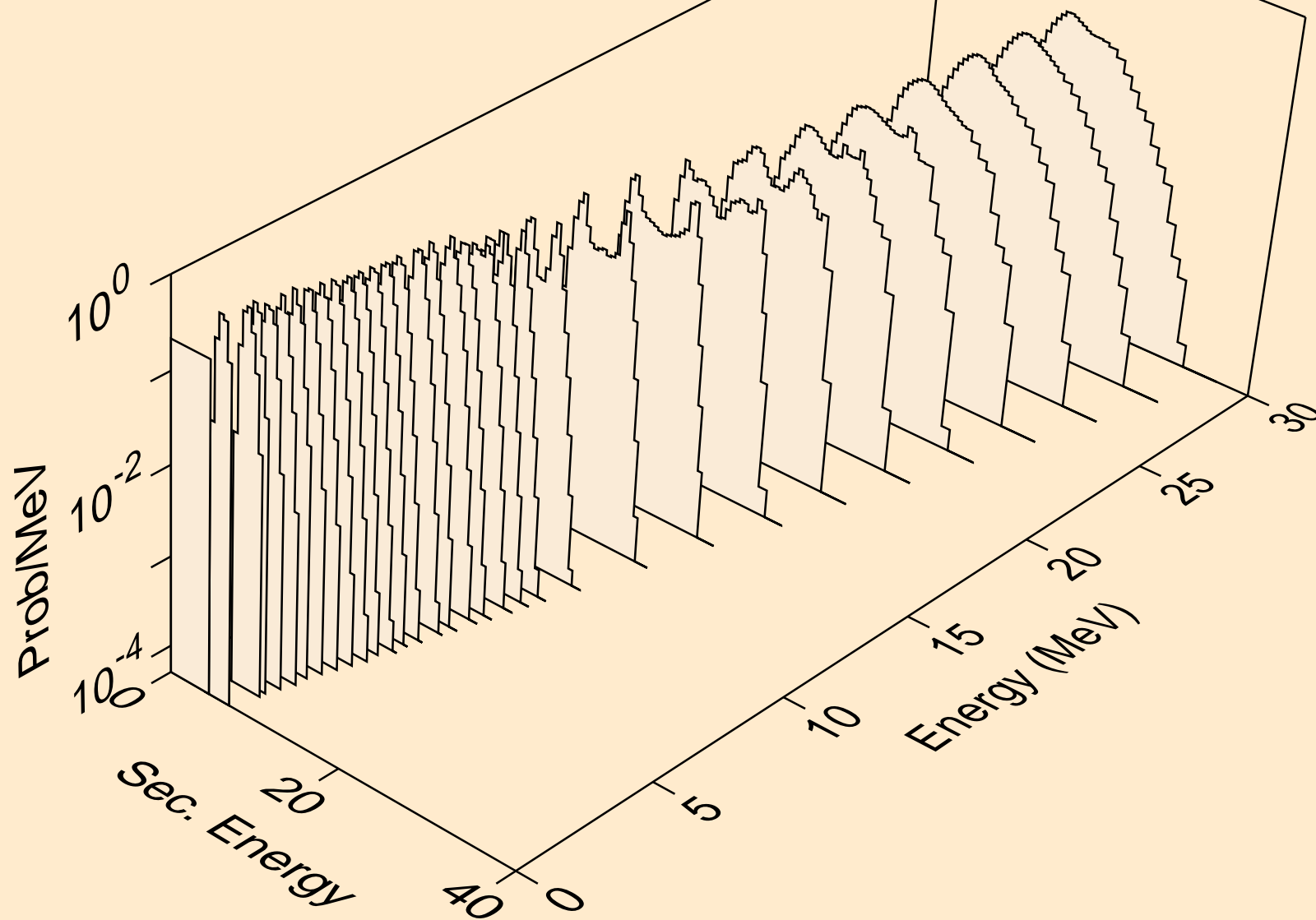

TB154 NEUTRON ACER TENDL-2021 LIBRARY; T=293.6K
alphas from (n,pa)

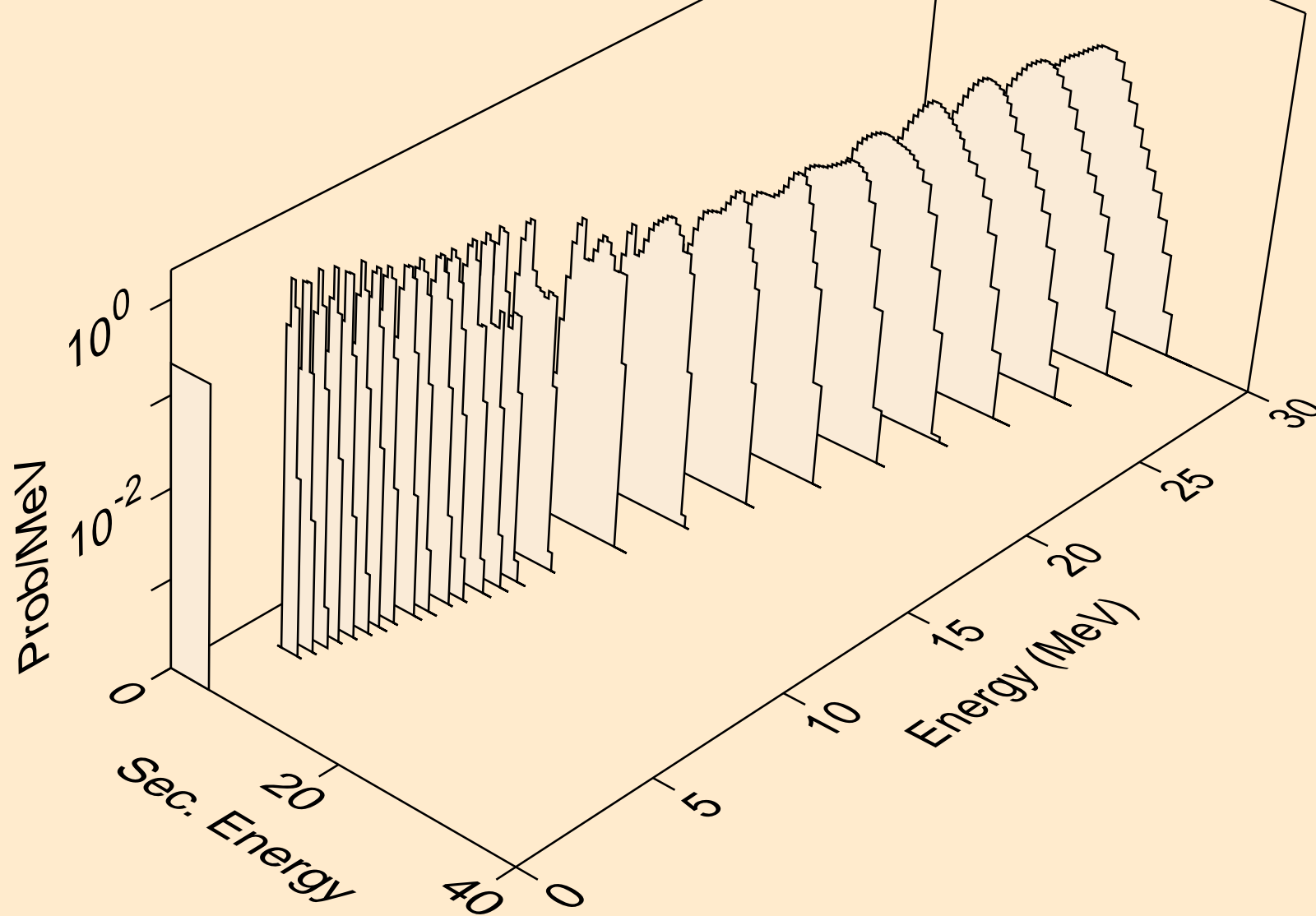

TB154 NEUTRON ACER TENDL-2021 LIBRARY; T=293.6K
alphas from (n,da)

