

TB160 NEUTRON ACER TENDL-2021 LIBRARY; T=293.6K  
Principal cross sections

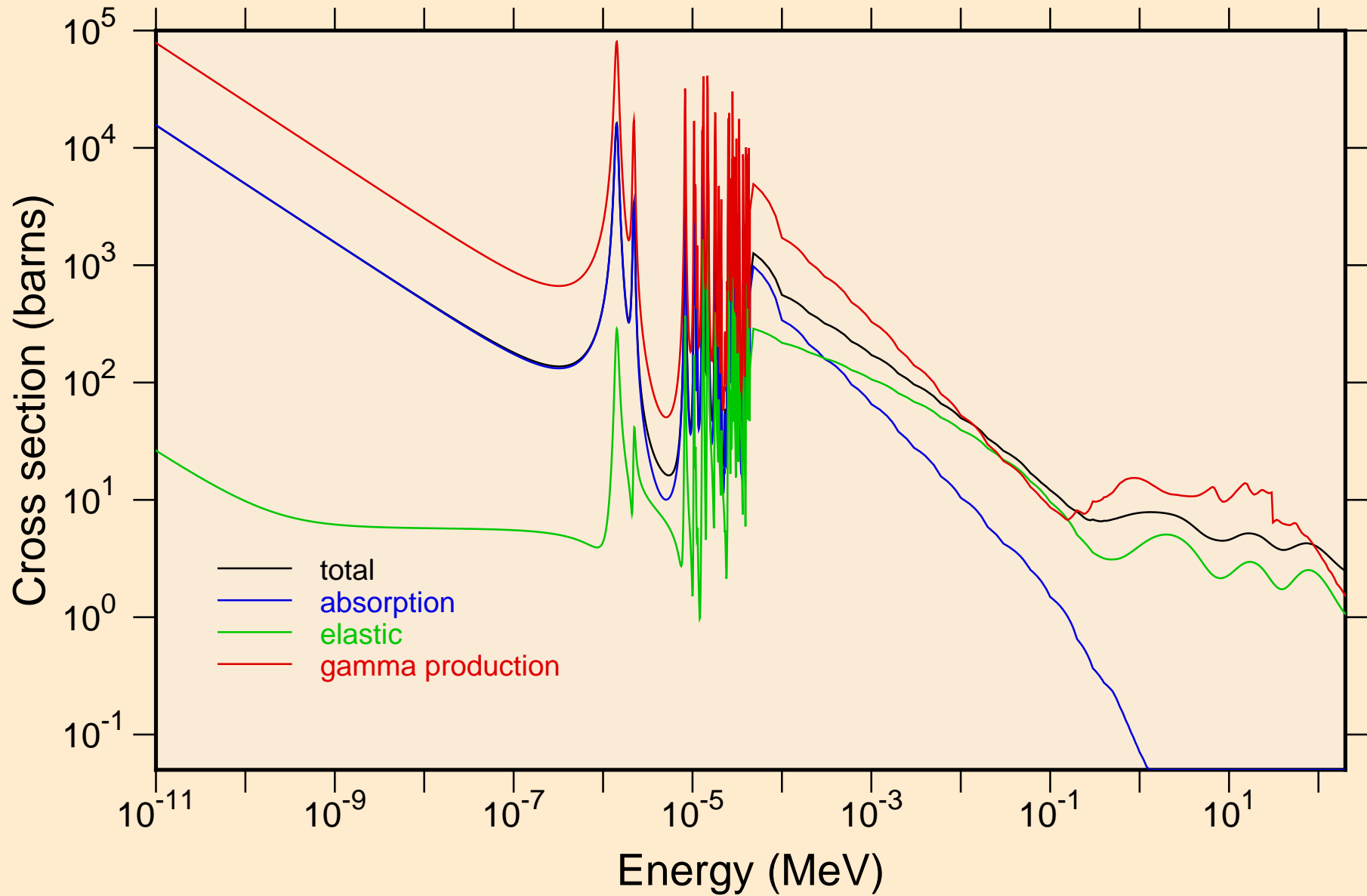

TB160 NEUTRON ACER TENDL-2021 LIBRARY; T=293.6K  
resonance total cross section

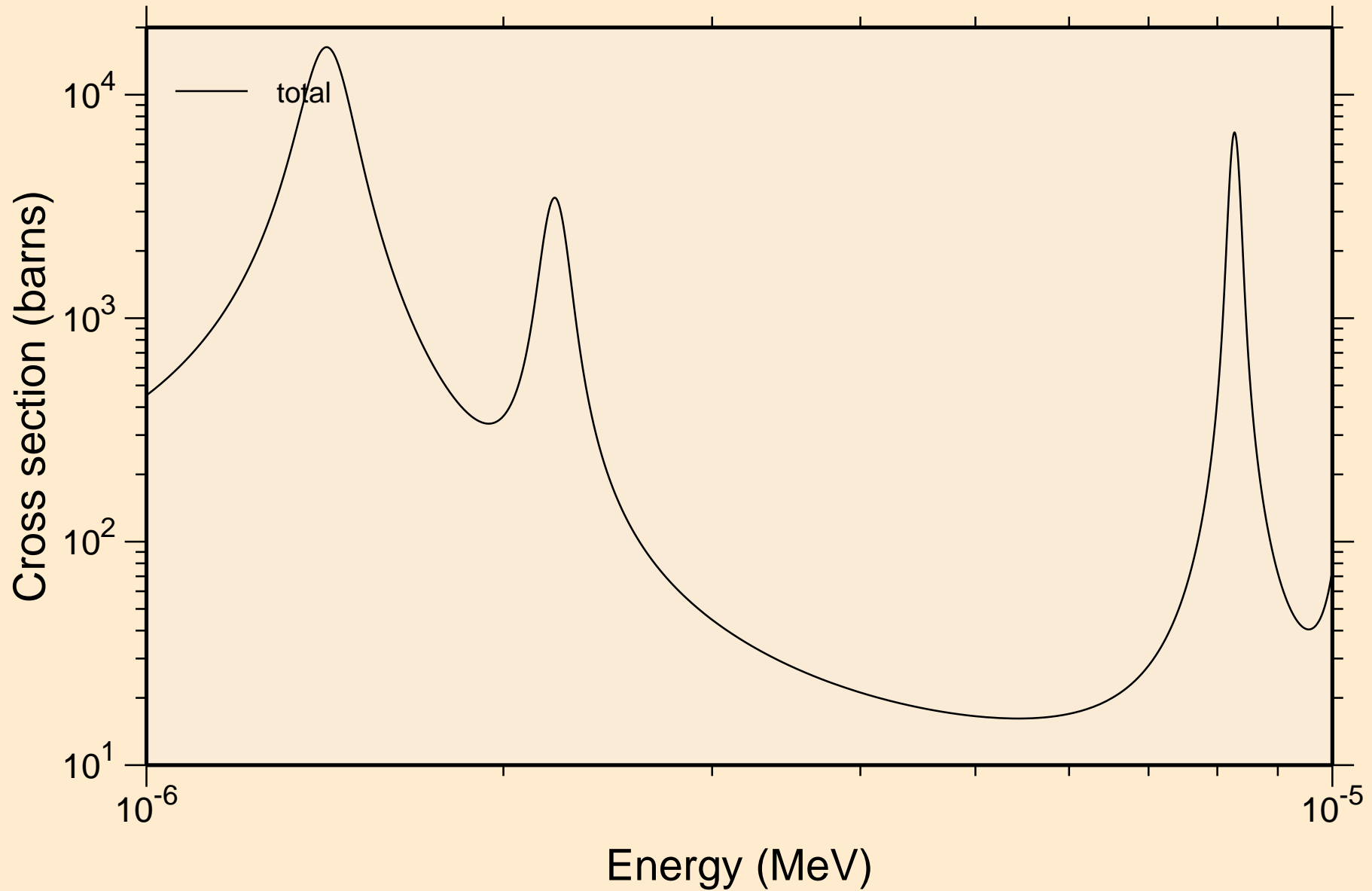

TB160 NEUTRON ACER TENDL-2021 LIBRARY; T=293.6K  
resonance total cross section

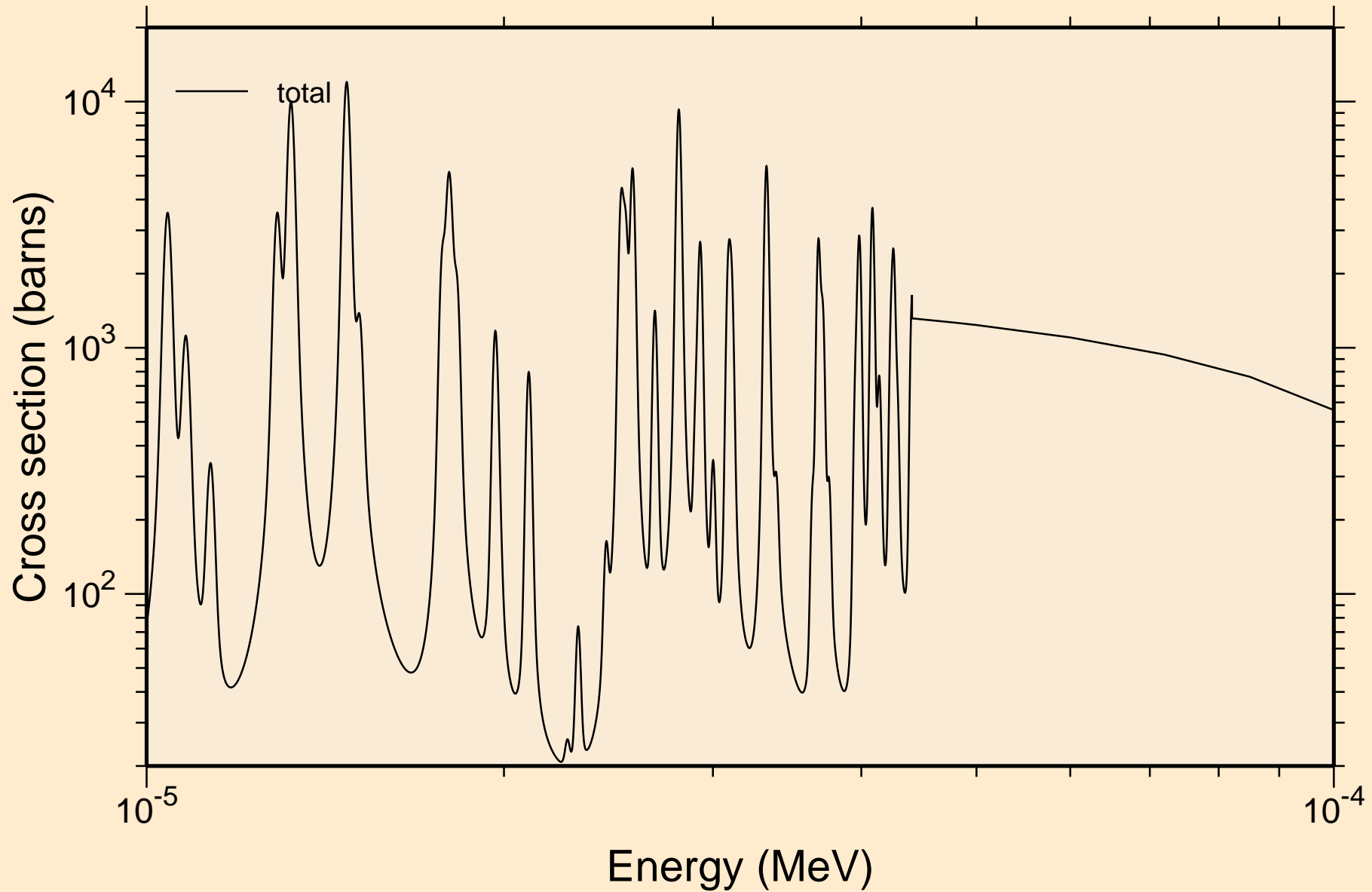

TB160 NEUTRON ACER TENDL-2021 LIBRARY; T=293.6K  
resonance total cross section

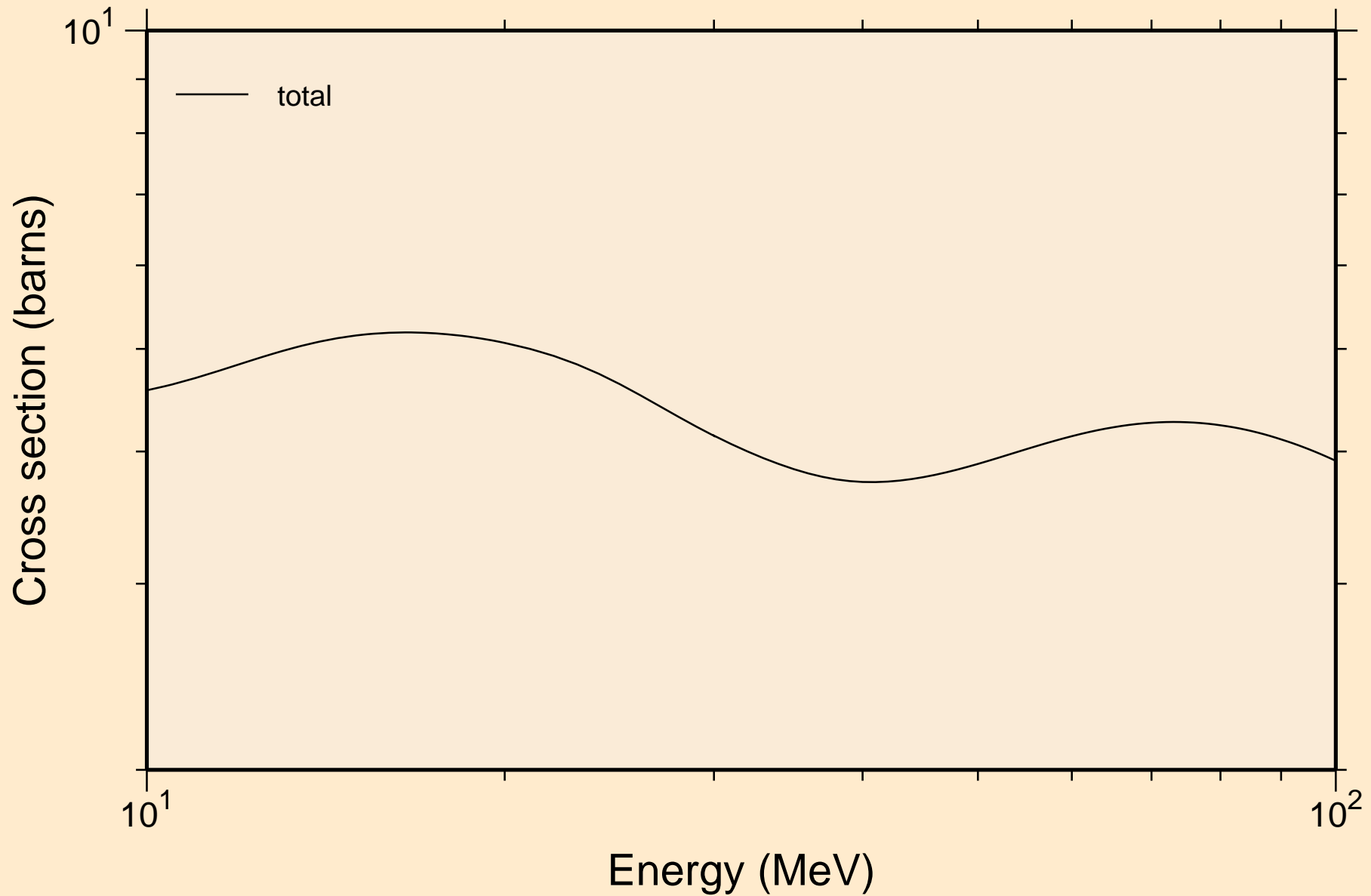

TB160 NEUTRON ACER TENDL-2021 LIBRARY; T=293.6K  
resonance absorption cross sections

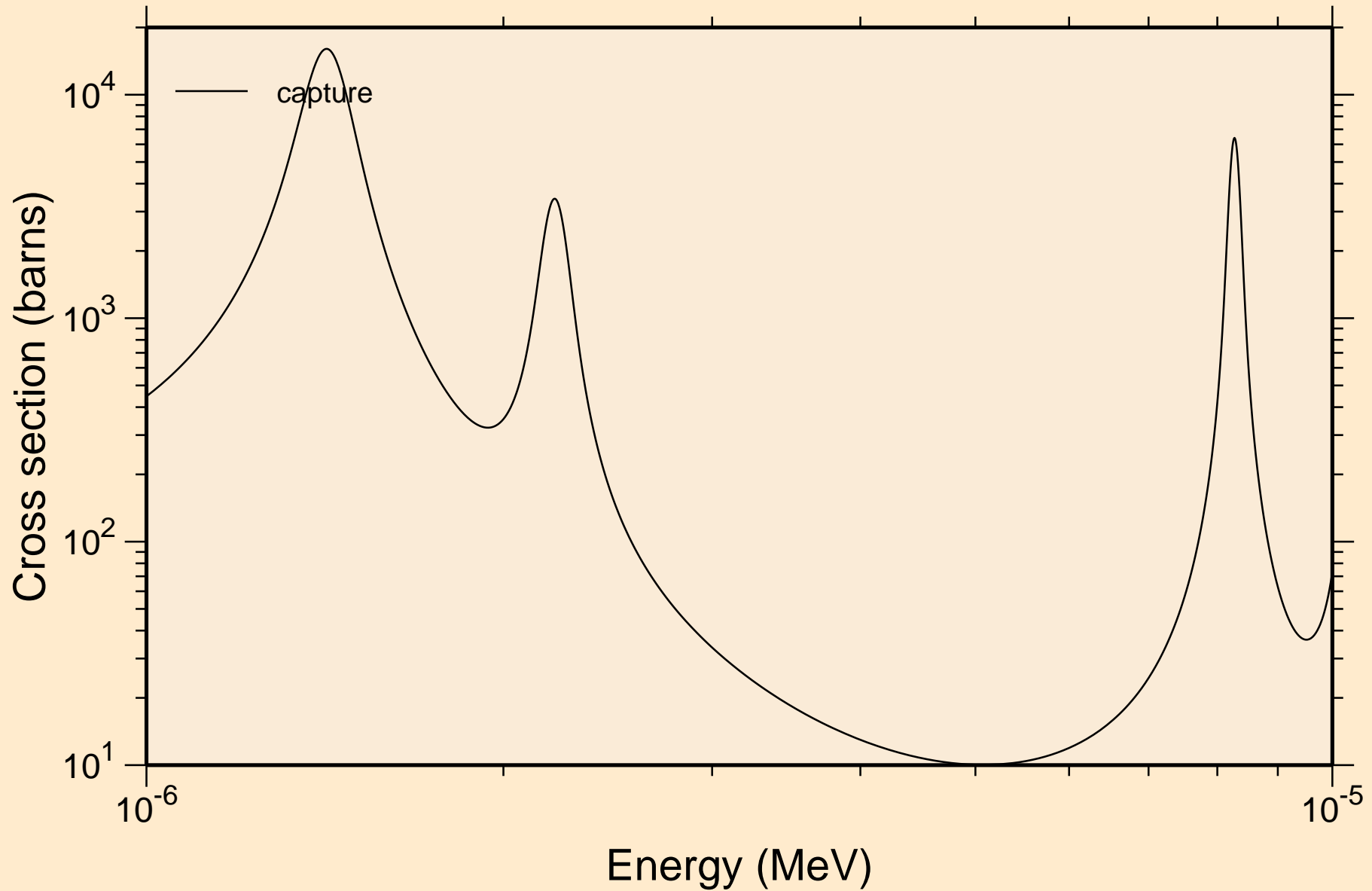

TB160 NEUTRON ACER TENDL-2021 LIBRARY; T=293.6K  
resonance absorption cross sections

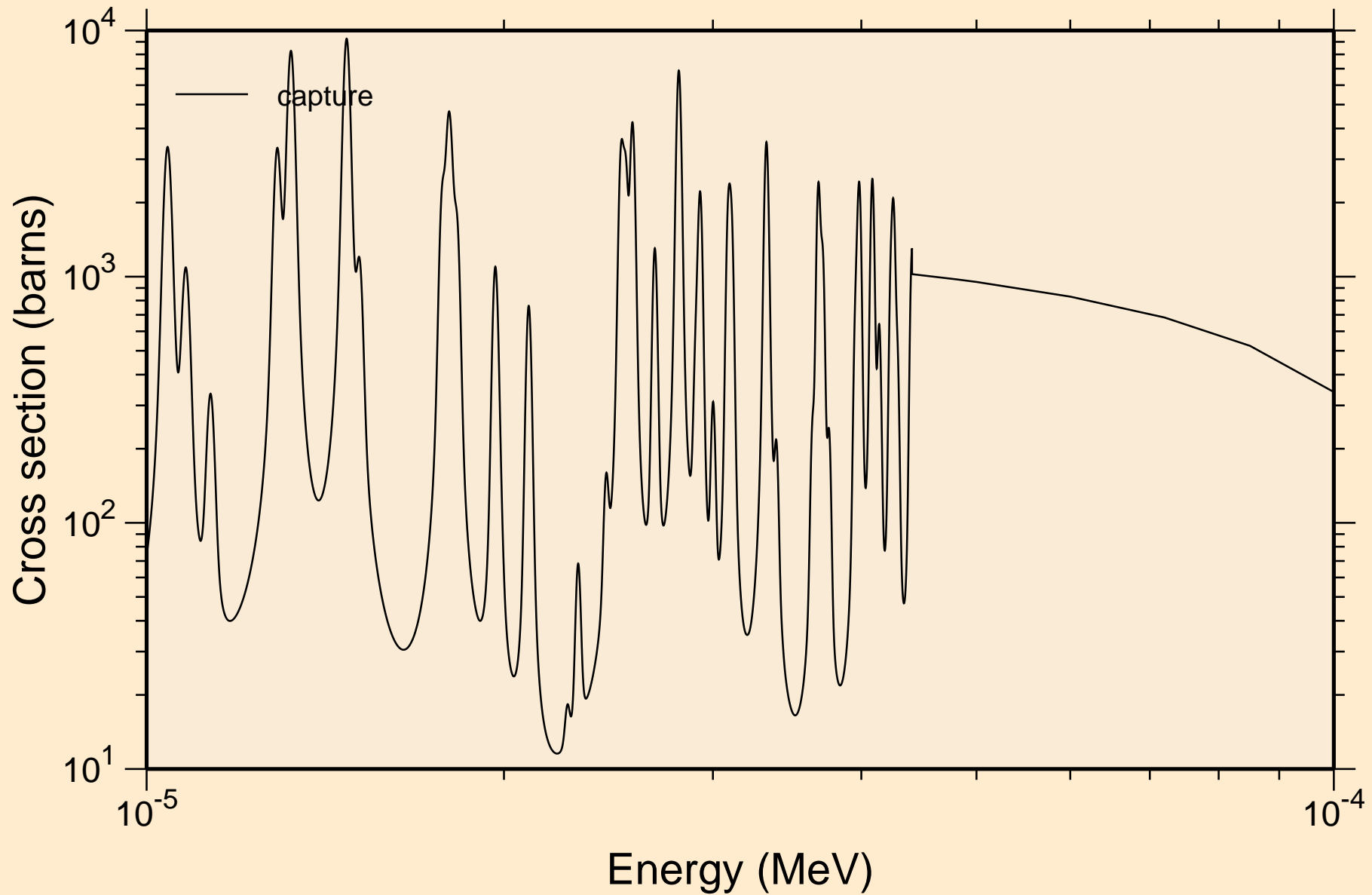

TB160 NEUTRON ACER TENDL-2021 LIBRARY; T=293.6K  
resonance absorption cross sections

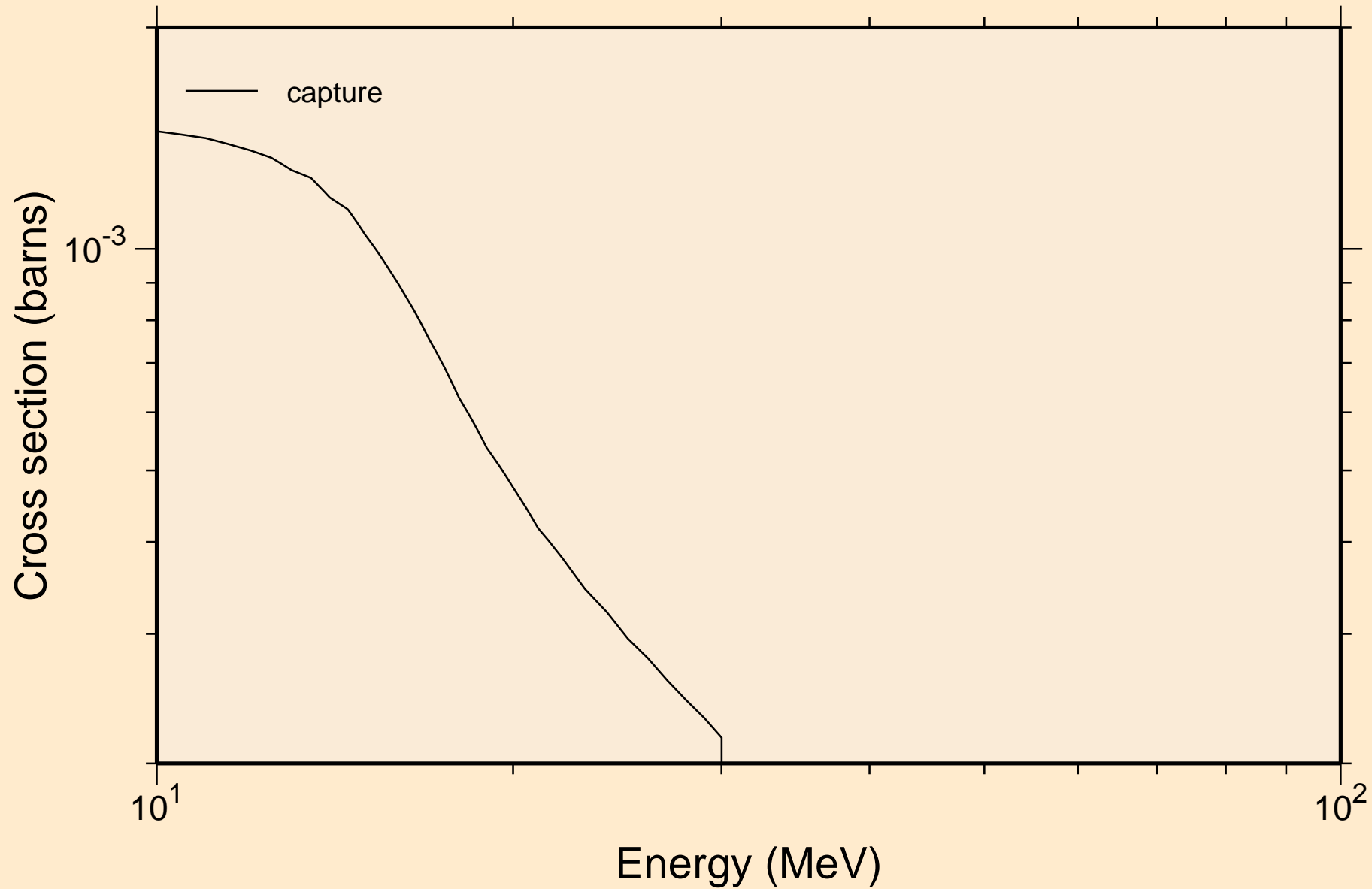

TB160 NEUTRON ACER TENDL-2021 LIBRARY; T=293.6K  
Heating

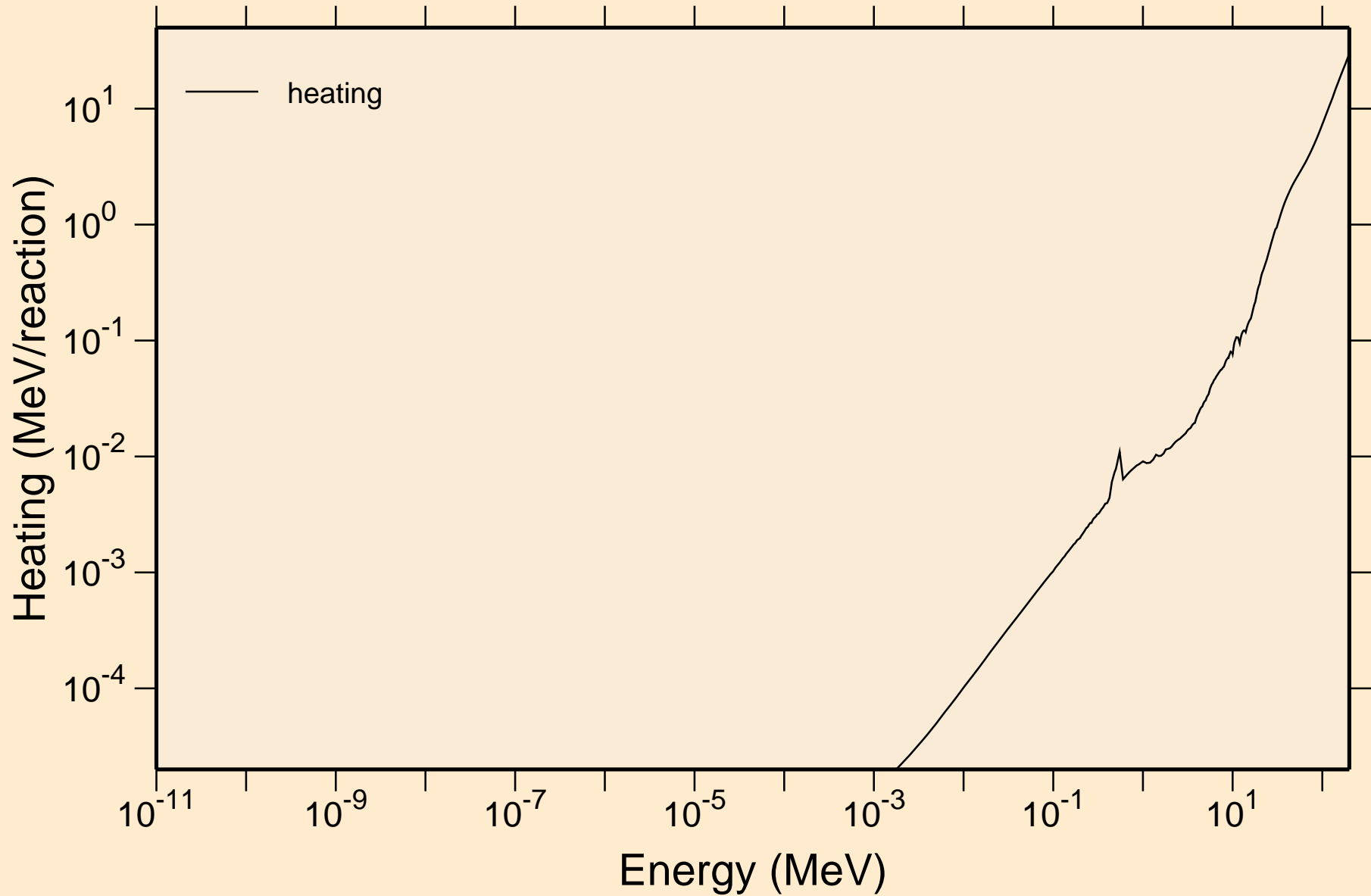



TB160 NEUTRON ACER TENDL-2021 LIBRARY; T=293.6K  
Damage

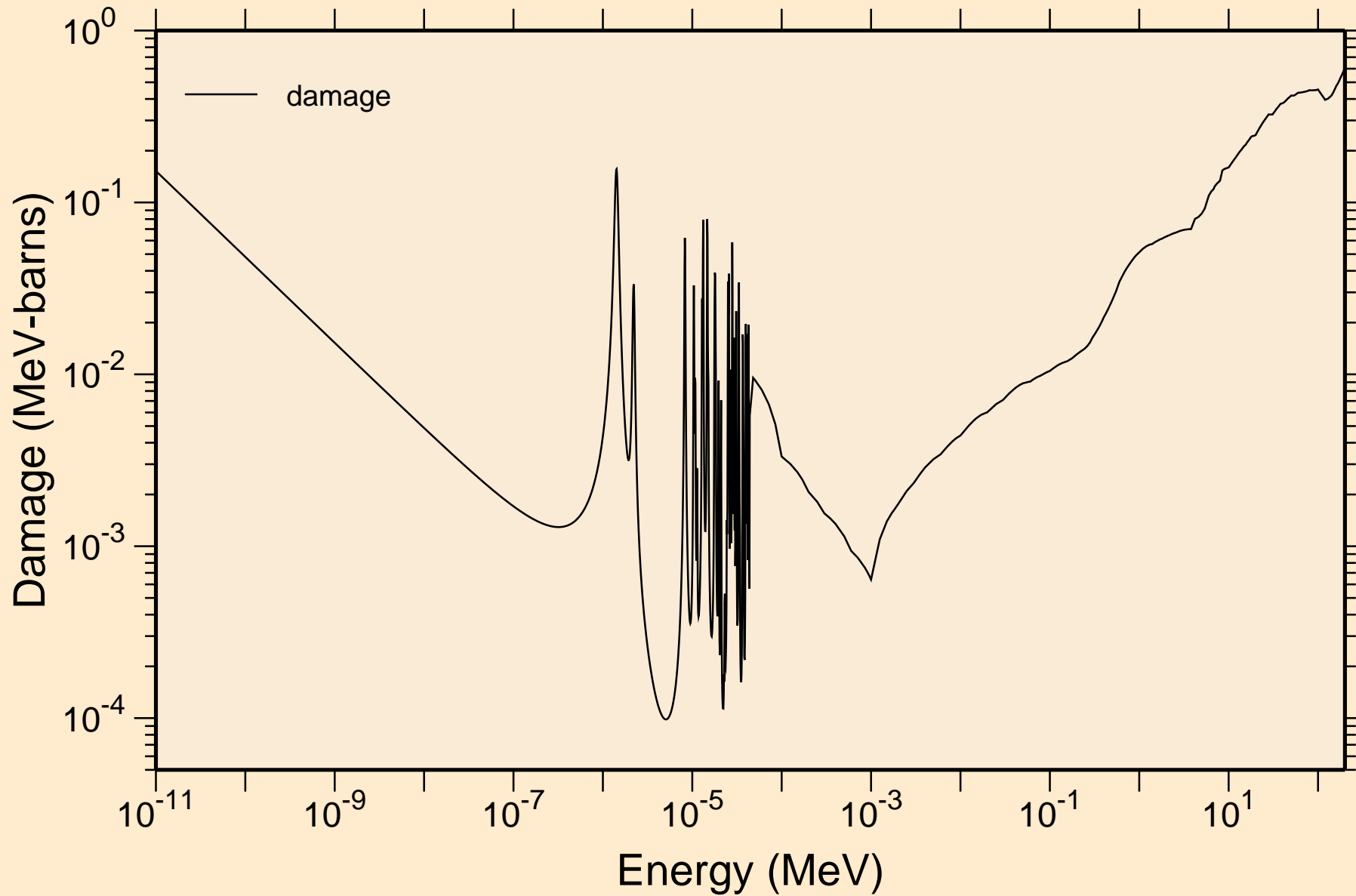

TB160 NEUTRON ACER TENDL-2021 LIBRARY; T=293.6K  
Non-threshold reactions

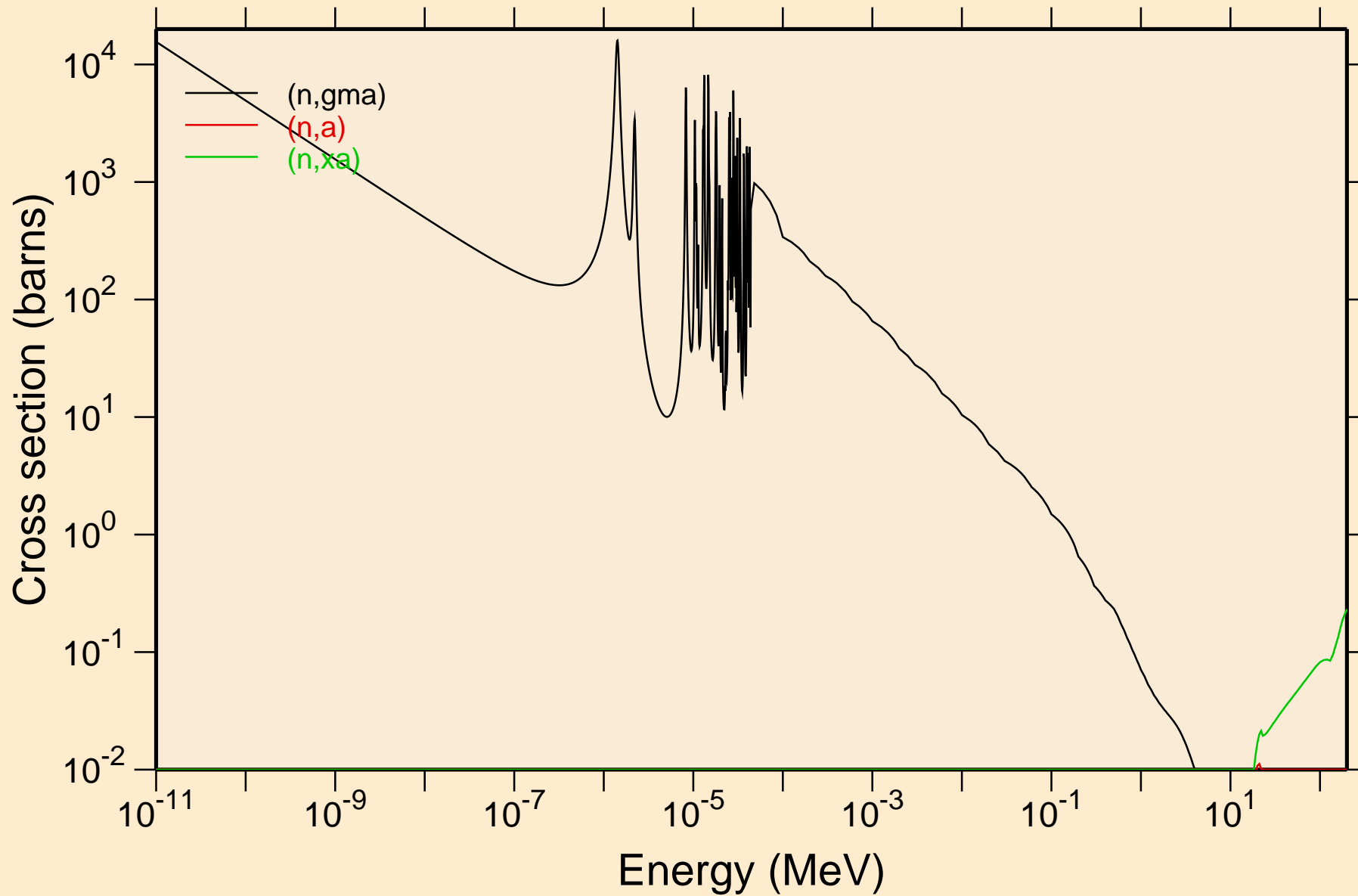

TB160 NEUTRON ACER TENDL-2021 LIBRARY; T=293.6K  
Principal cross sections

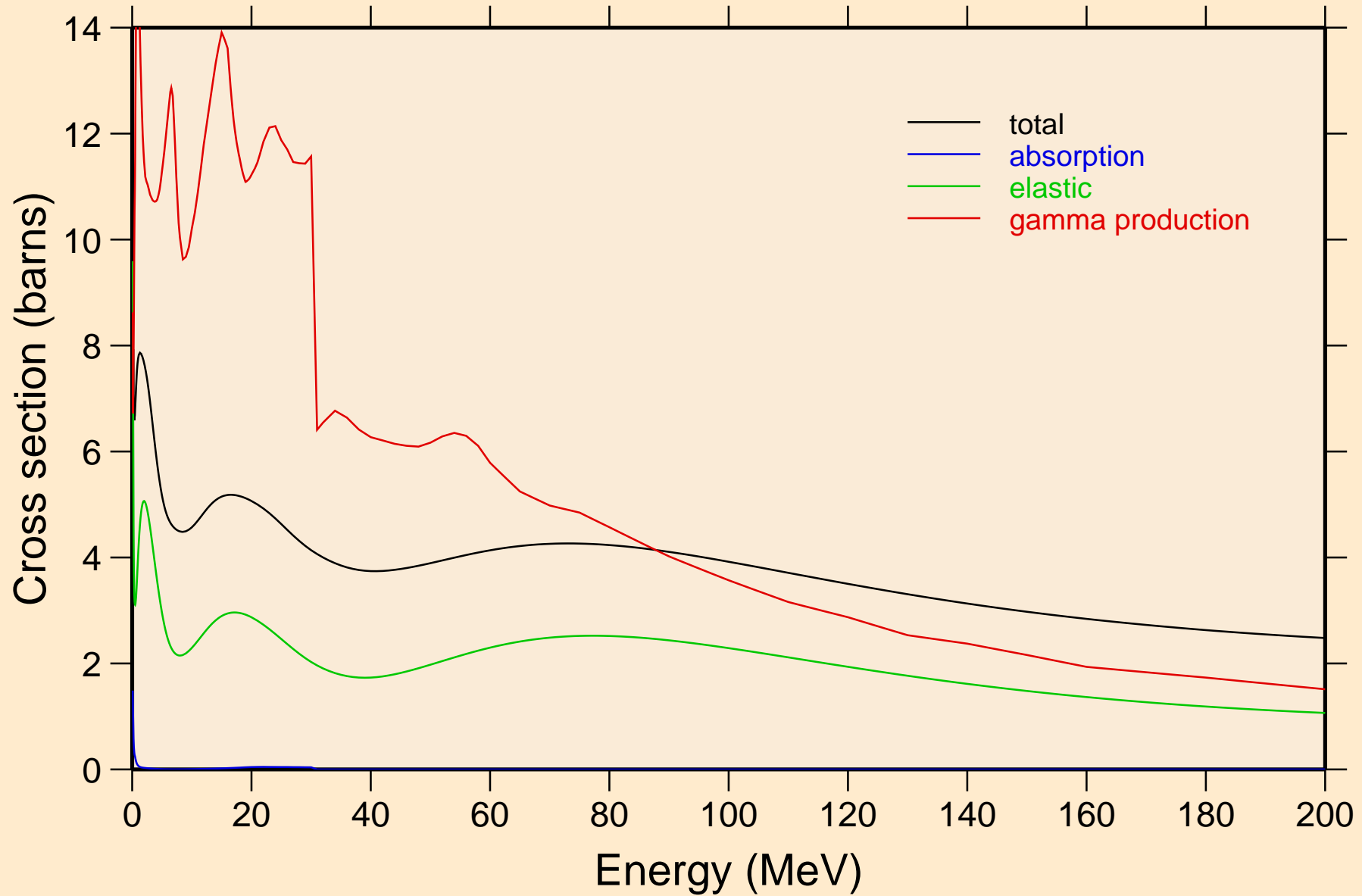

TB160 NEUTRON ACER TENDL-2021 LIBRARY; T=293.6K  
Heating

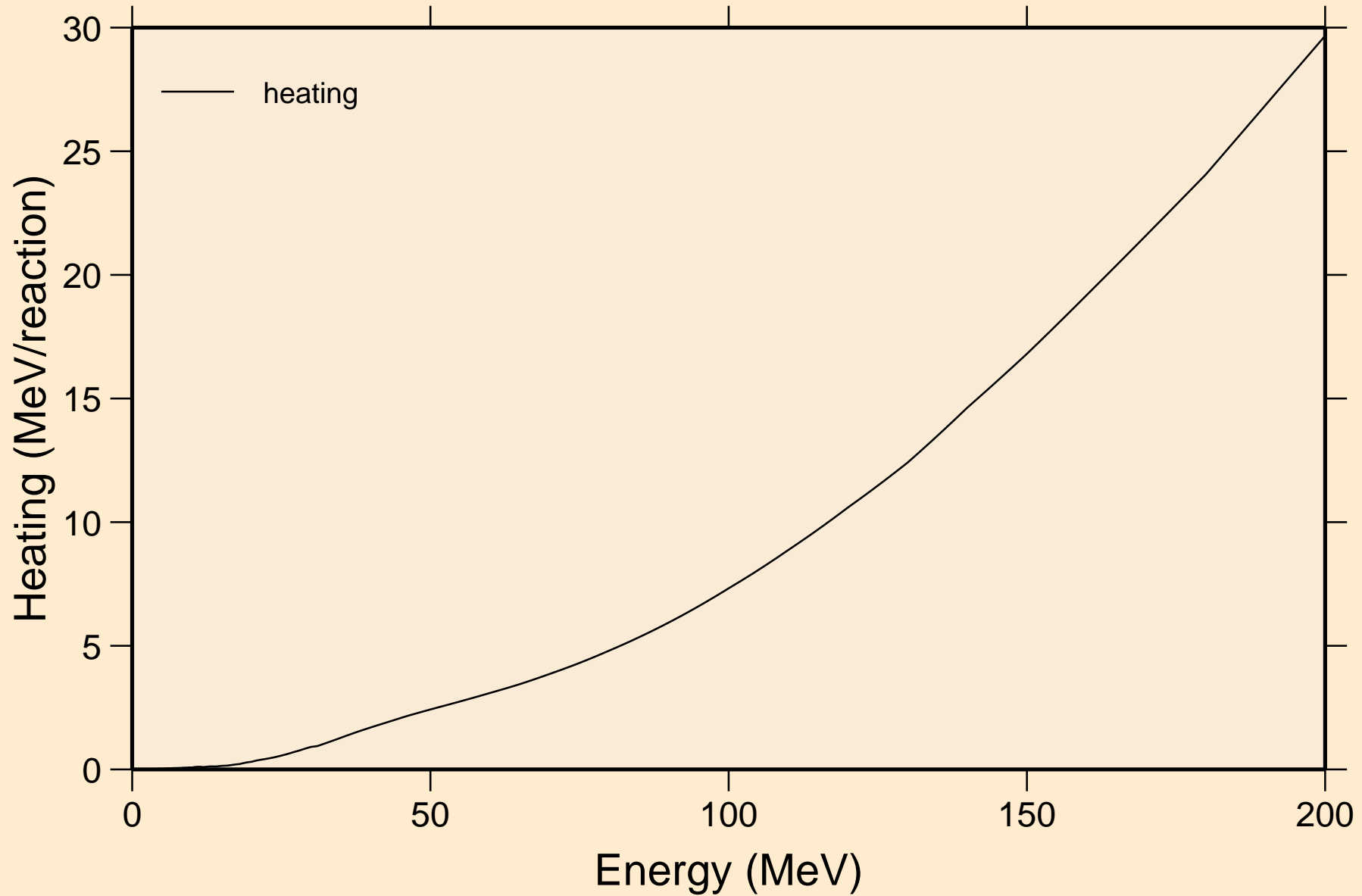

TB160 NEUTRON ACER TENDL-2021 LIBRARY; T=293.6K  
Damage

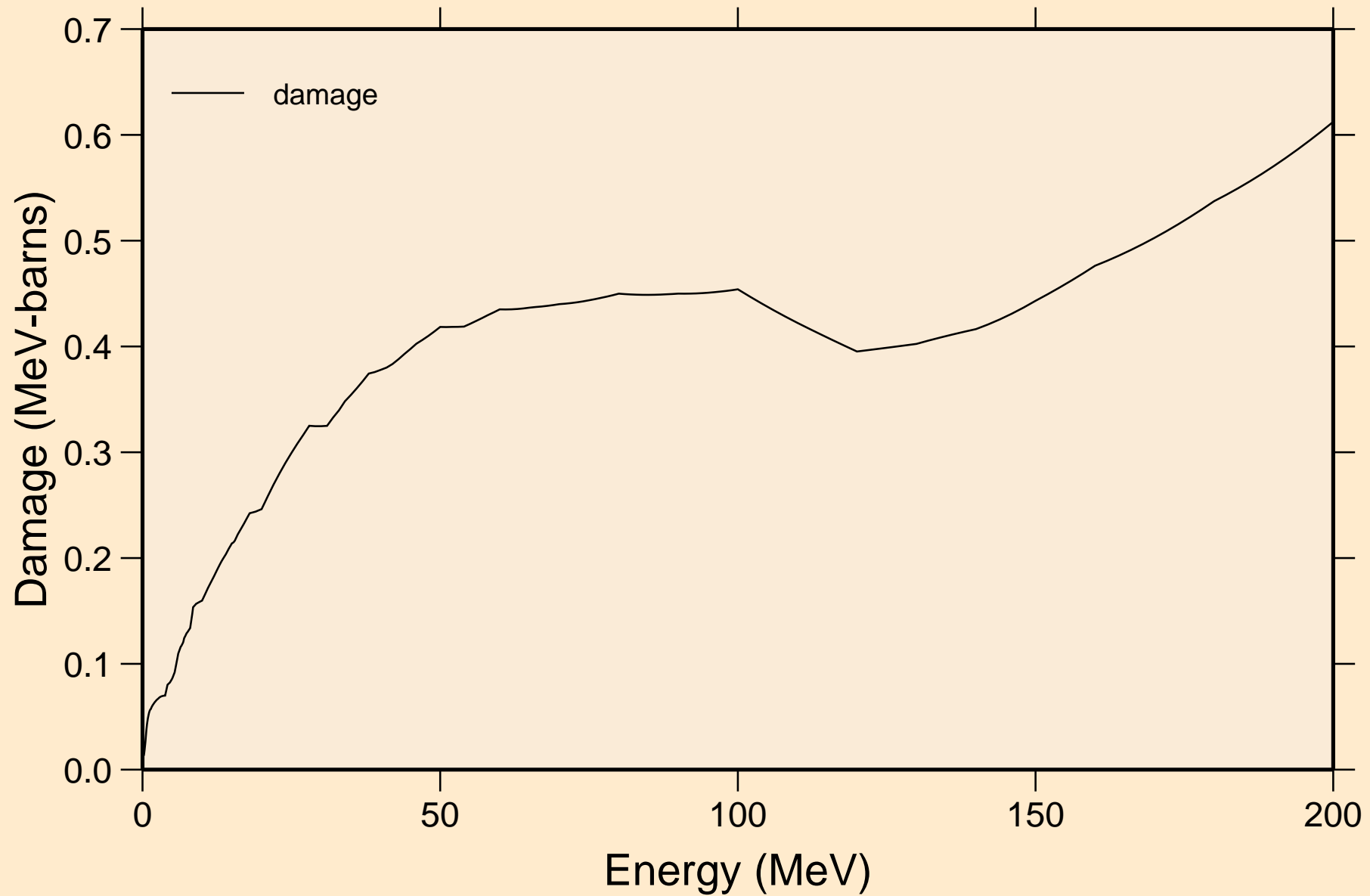

TB160 NEUTRON ACER TENDL-2021 LIBRARY; T=293.6K  
Non-threshold reactions

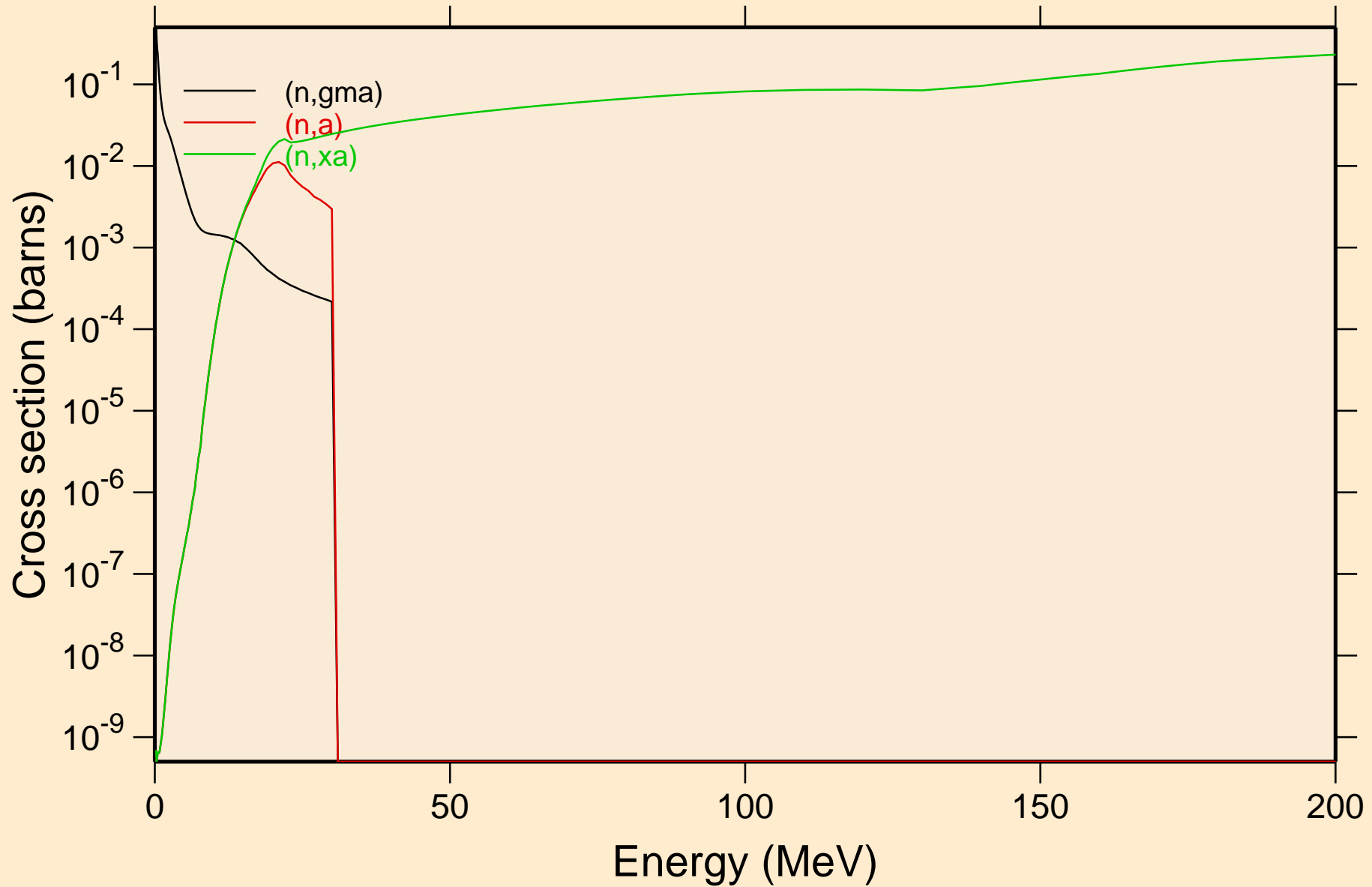

TB160 NEUTRON ACER TENDL-2021 LIBRARY; T=293.6K  
Inelastic levels

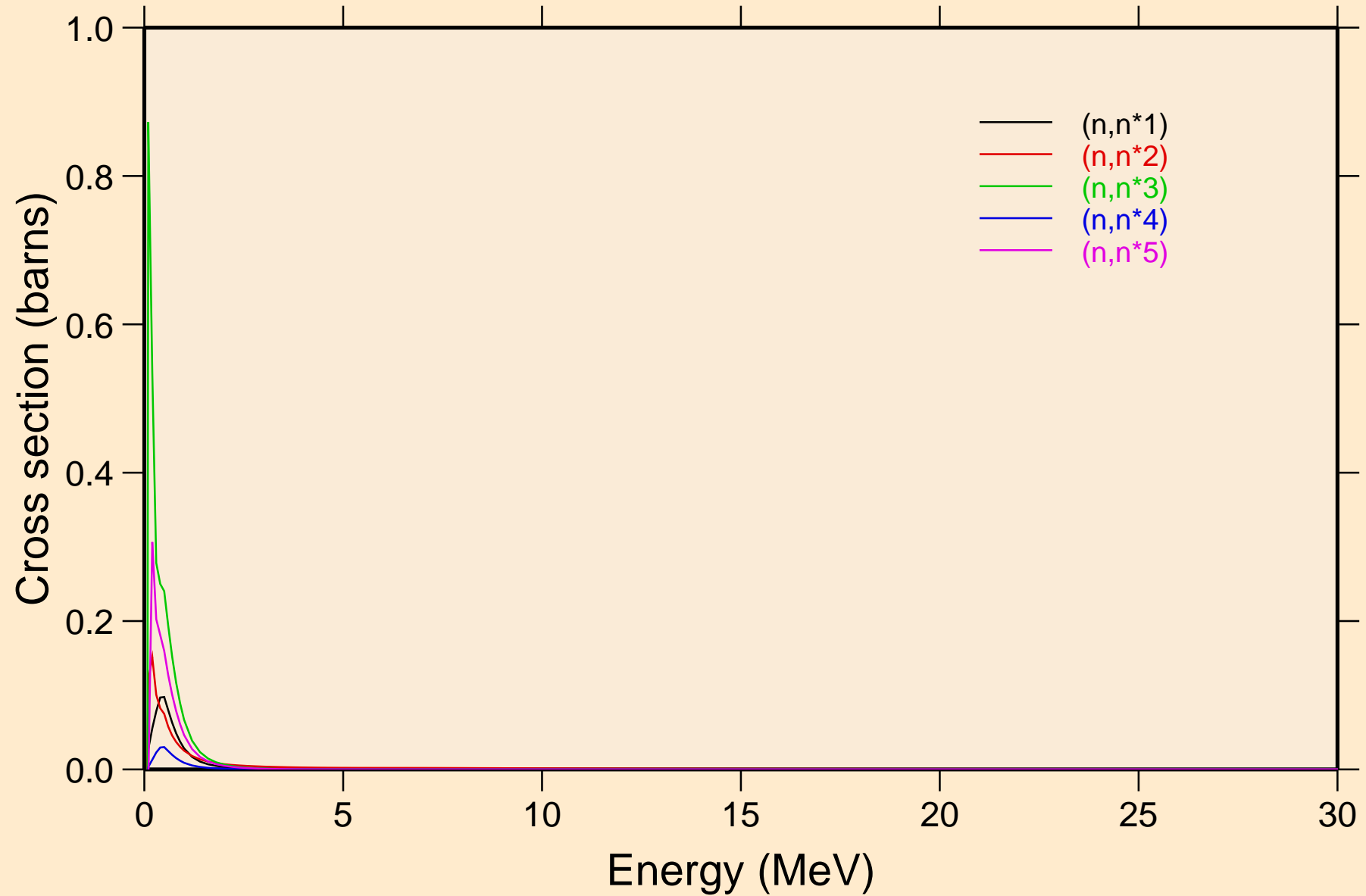

TB160 NEUTRON ACER TENDL-2021 LIBRARY; T=293.6K  
Inelastic levels

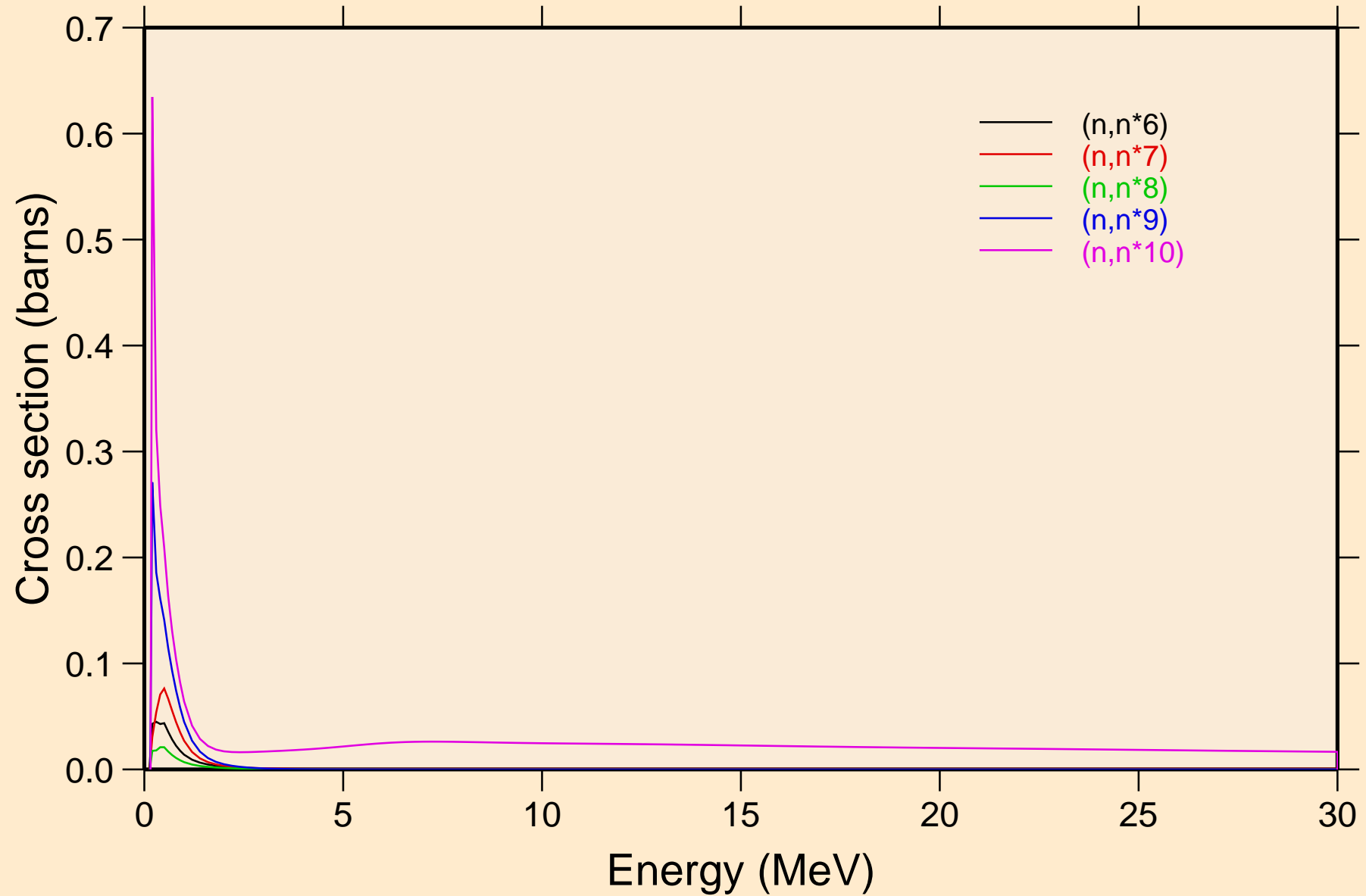



TB160 NEUTRON ACER TENDL-2021 LIBRARY; T=293.6K  
Inelastic levels

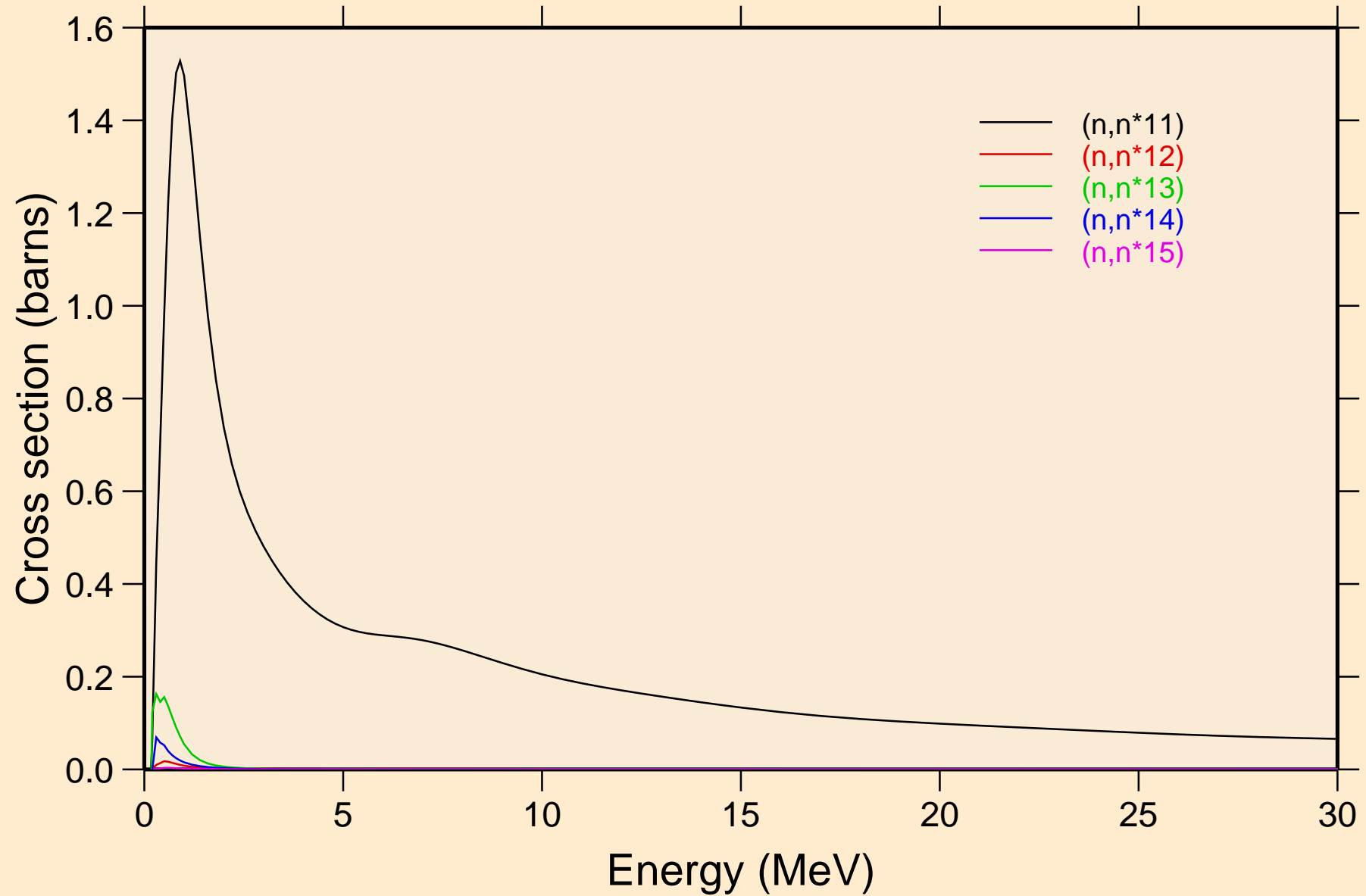

TB160 NEUTRON ACER TENDL-2021 LIBRARY; T=293.6K  
Inelastic levels

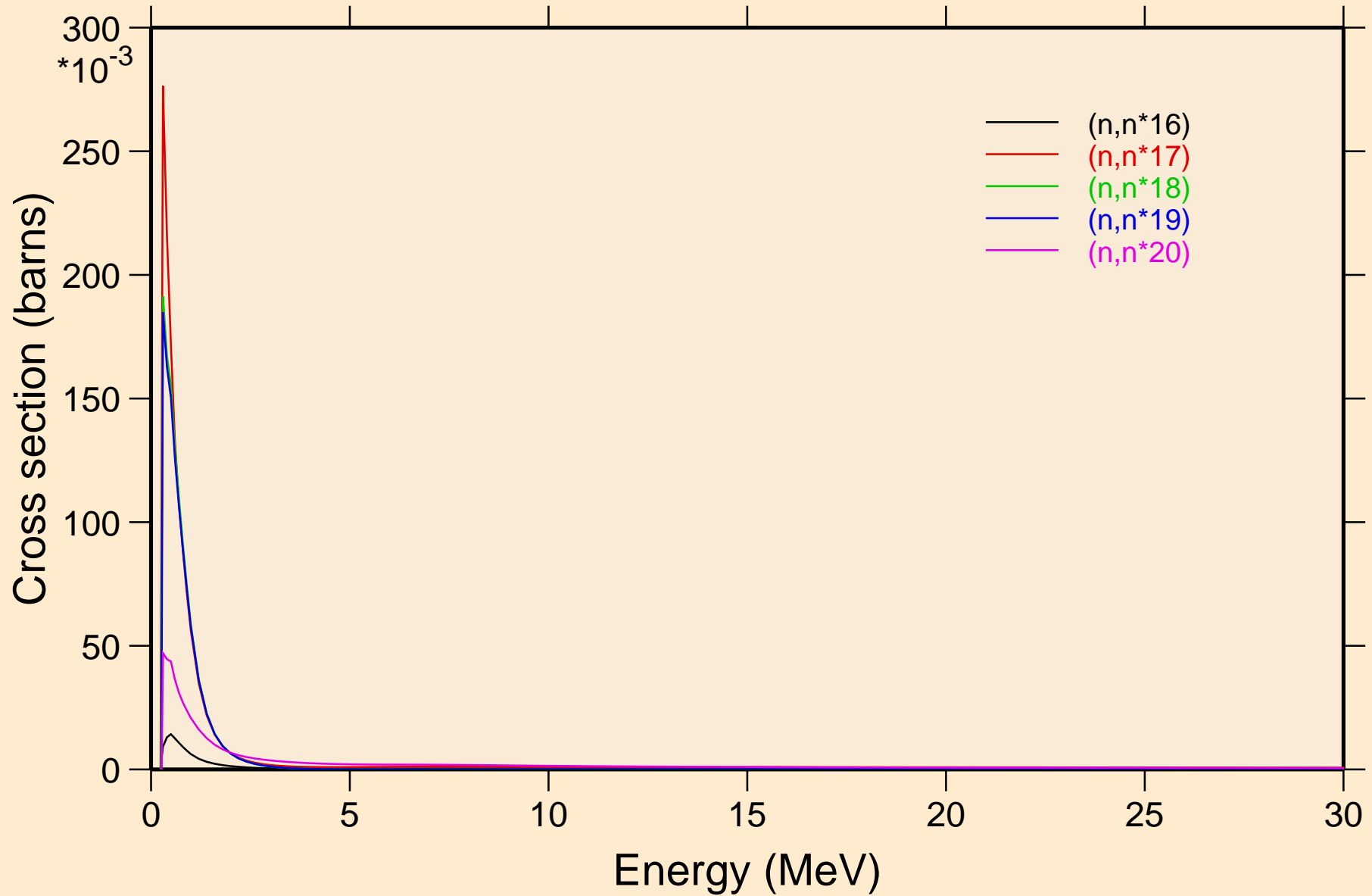

TB160 NEUTRON ACER TENDL-2021 LIBRARY; T=293.6K  
Inelastic levels

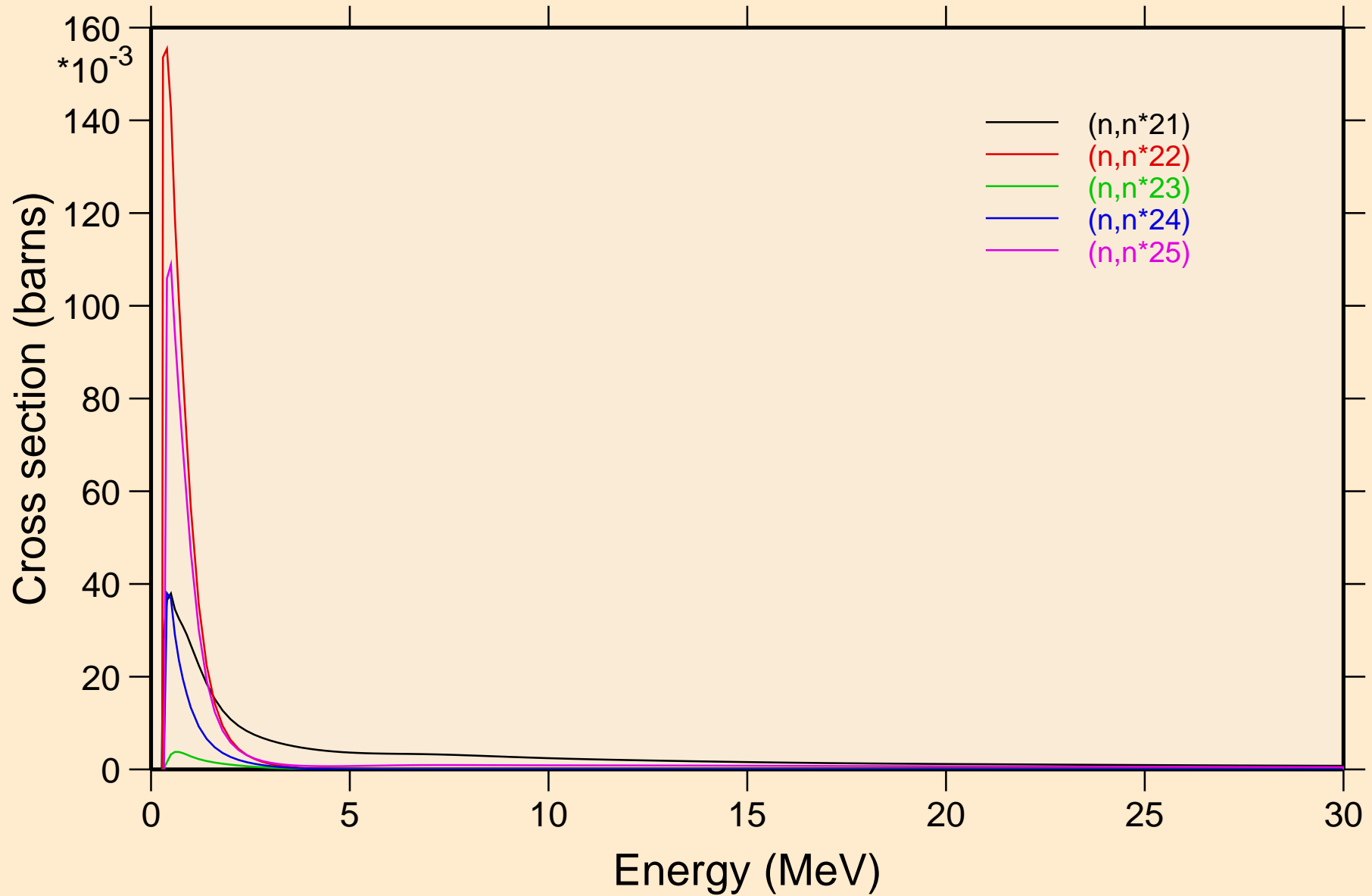

TB160 NEUTRON ACER TENDL-2021 LIBRARY; T=293.6K  
Inelastic levels

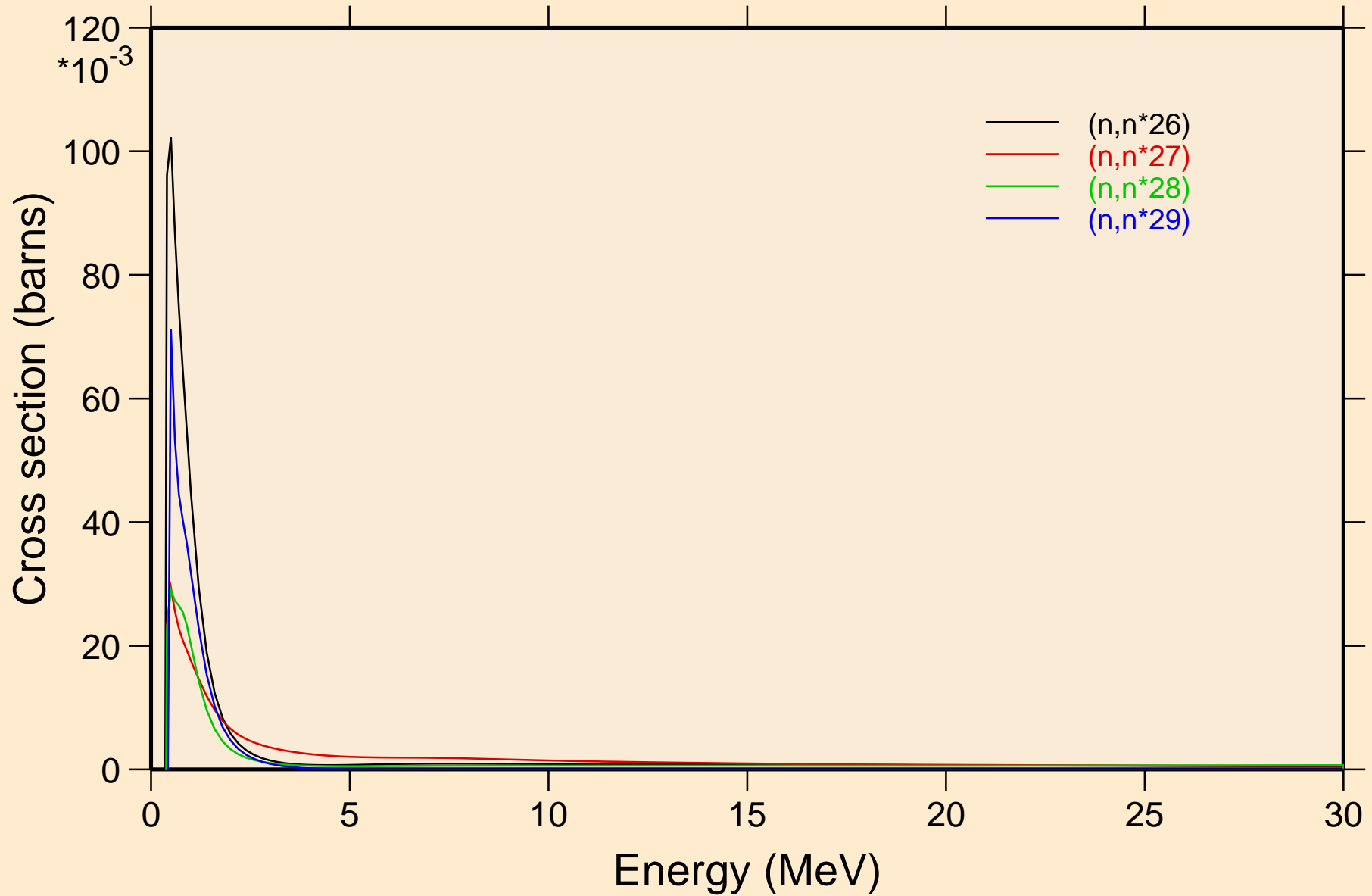

TB160 NEUTRON ACER TENDL-2021 LIBRARY; T=293.6K  
Threshold reactions

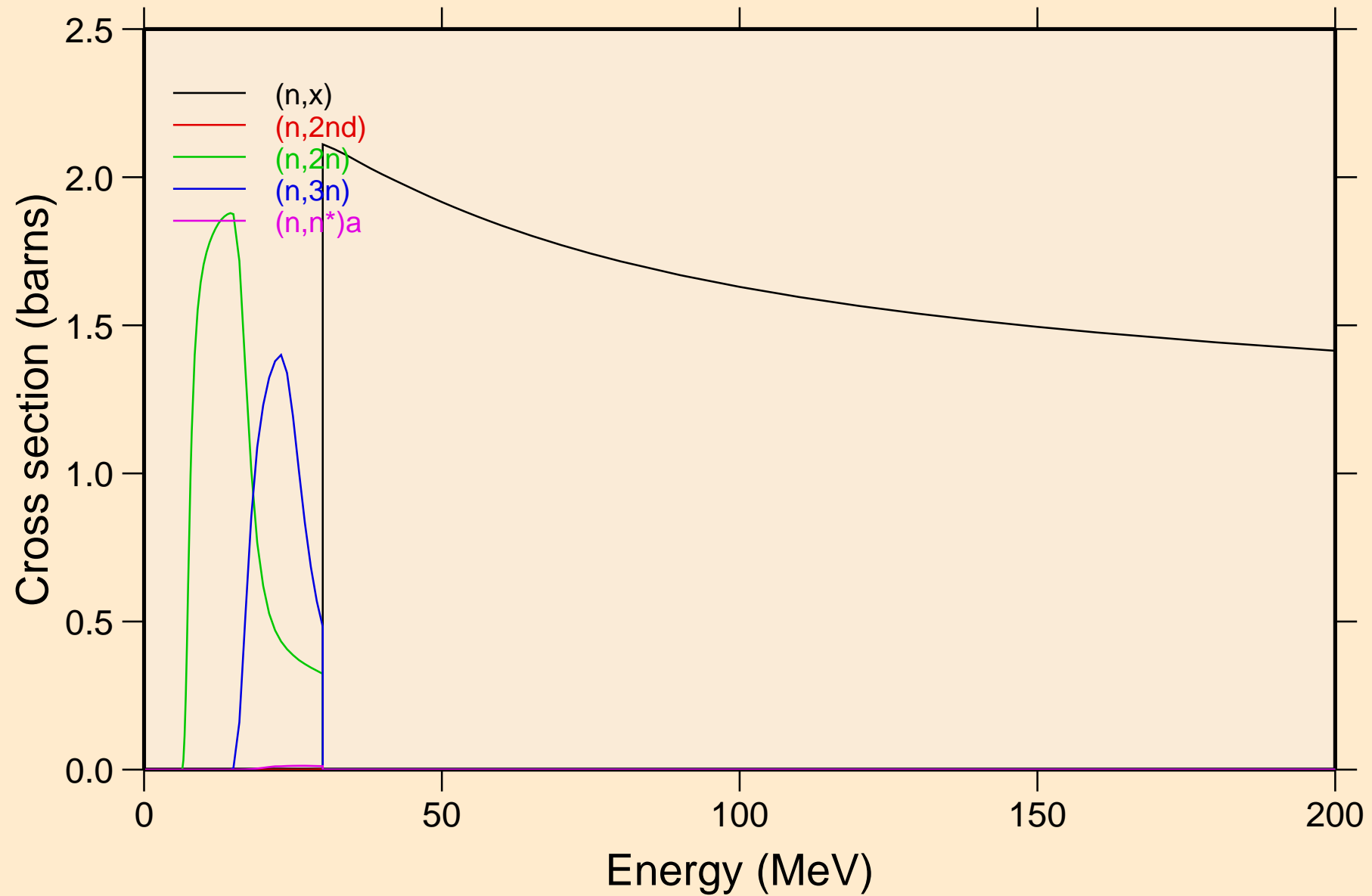

TB160 NEUTRON ACER TENDL-2021 LIBRARY; T=293.6K  
Threshold reactions

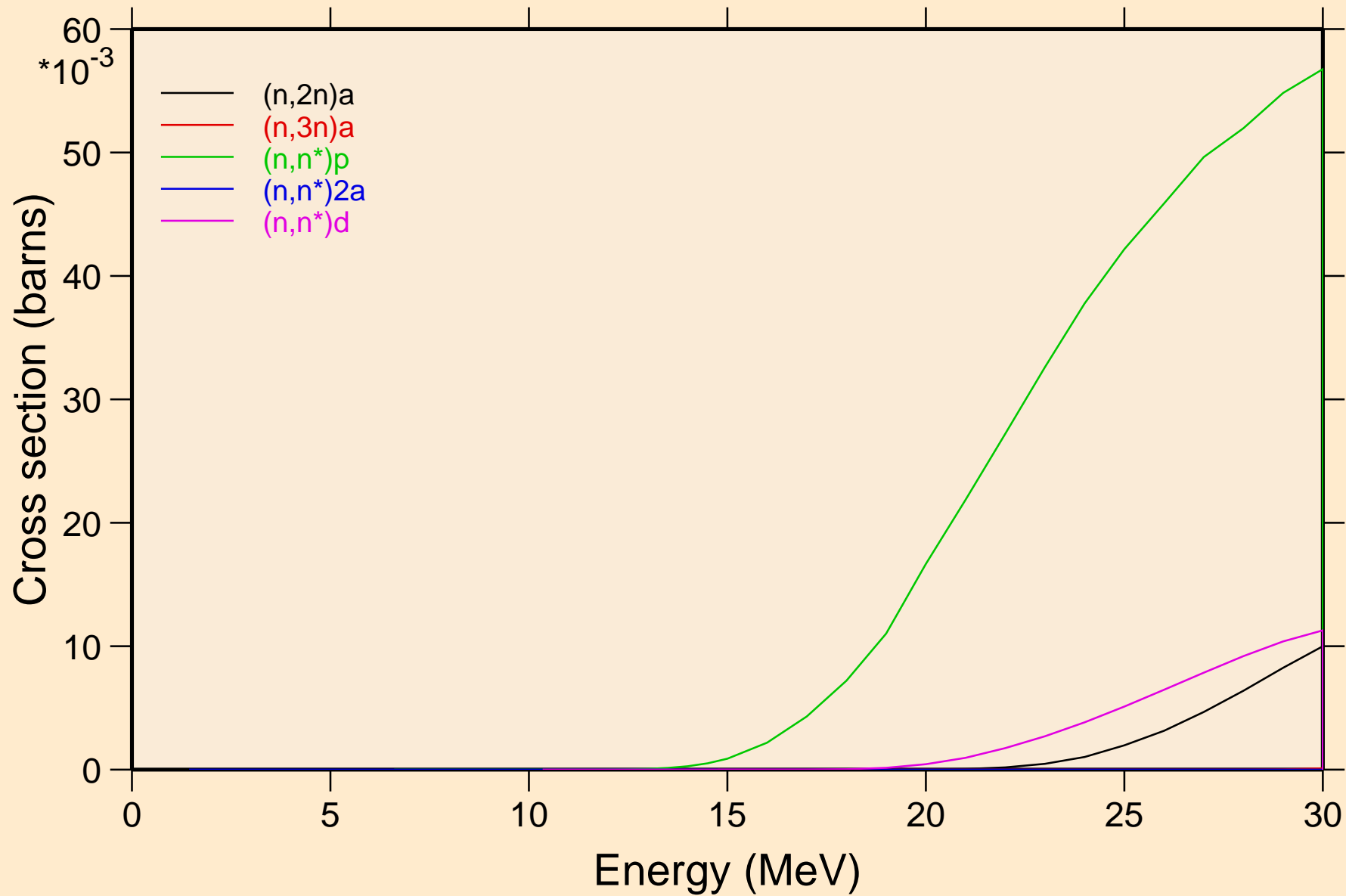

TB160 NEUTRON ACER TENDL-2021 LIBRARY; T=293.6K  
Threshold reactions

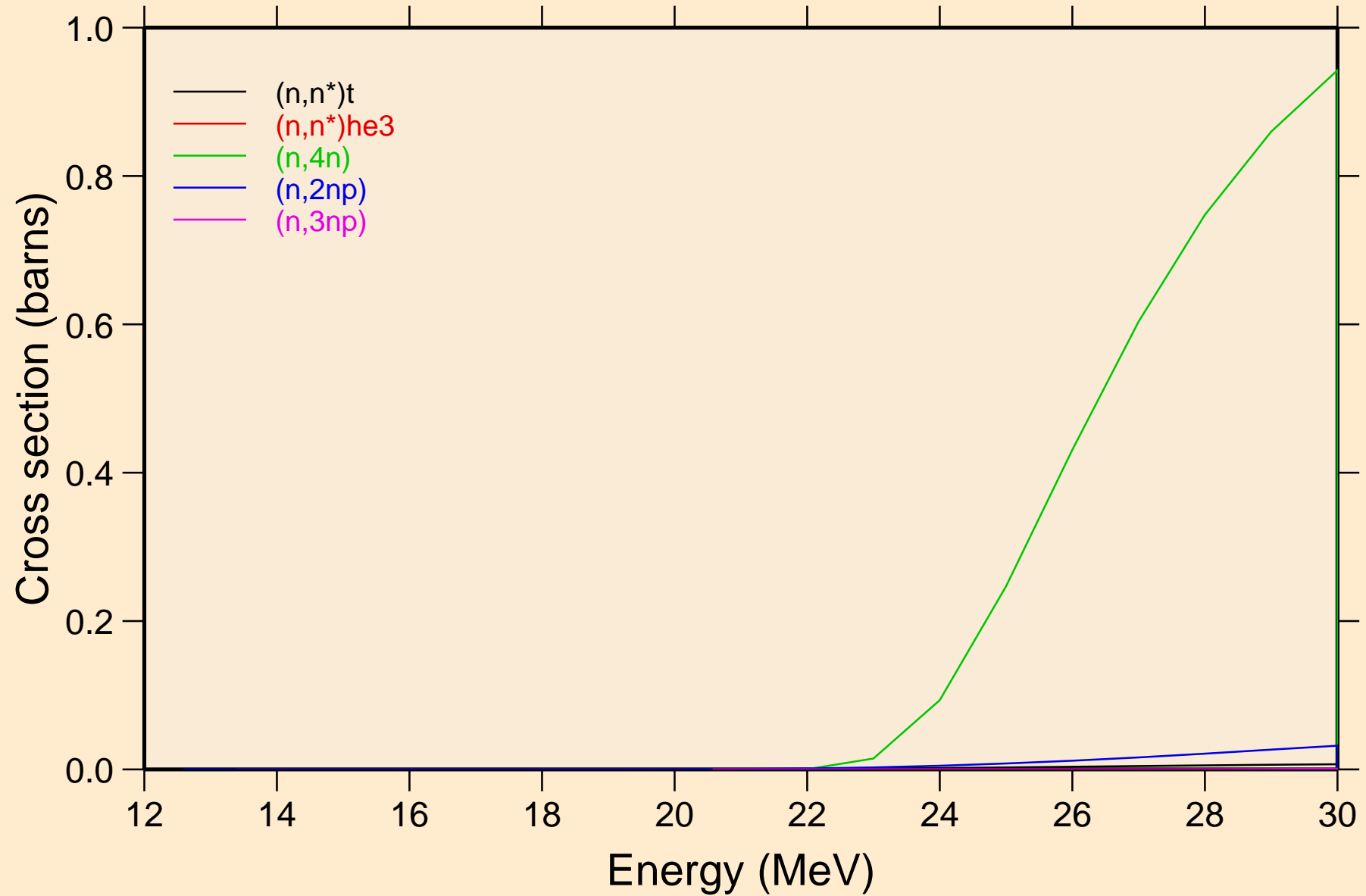

TB160 NEUTRON ACER TENDL-2021 LIBRARY; T=293.6K  
Threshold reactions

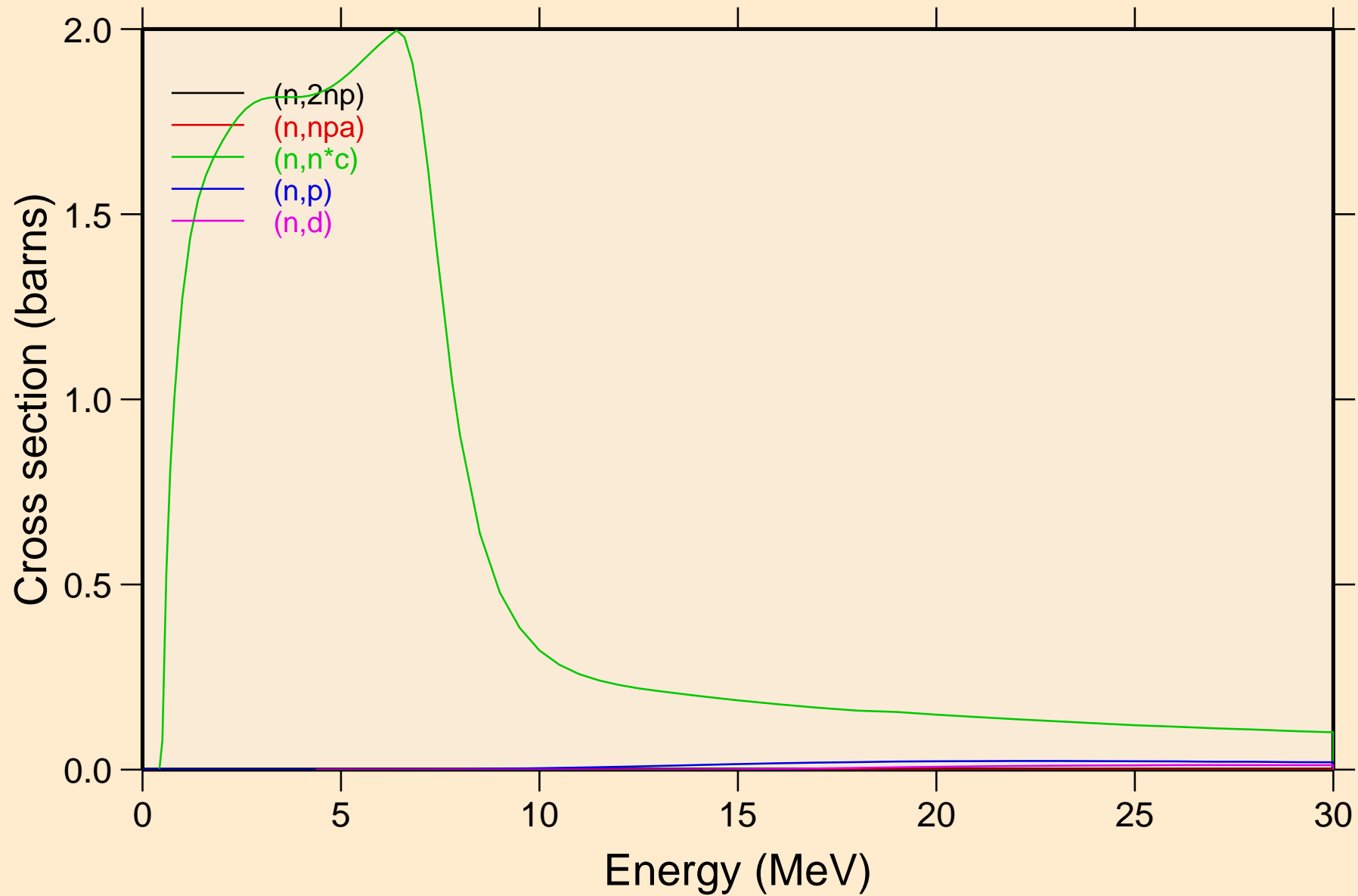



TB160 NEUTRON ACER TENDL-2021 LIBRARY; T=293.6K  
Threshold reactions

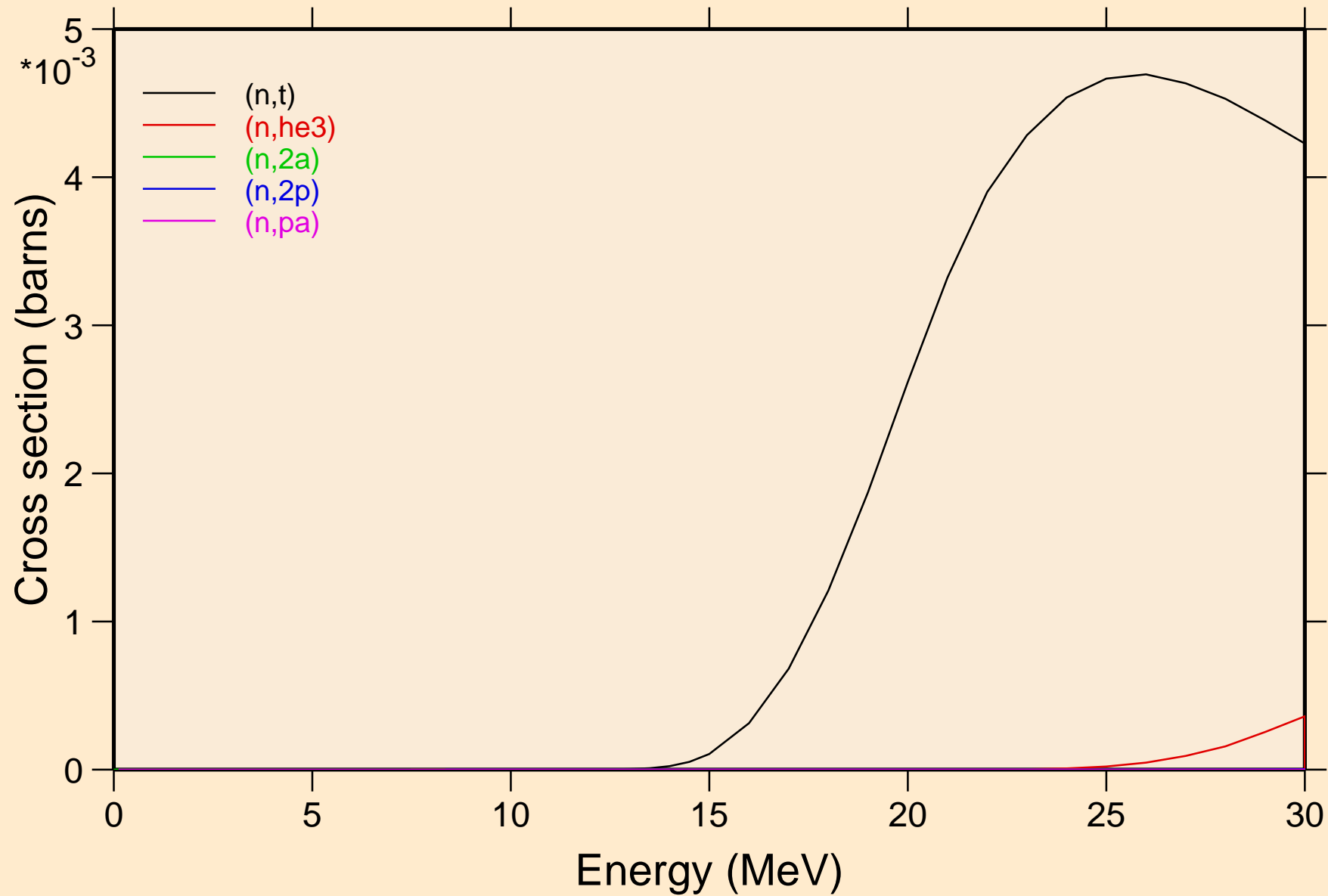

TB160 NEUTRON ACER TENDL-2021 LIBRARY; T=293.6K  
Threshold reactions

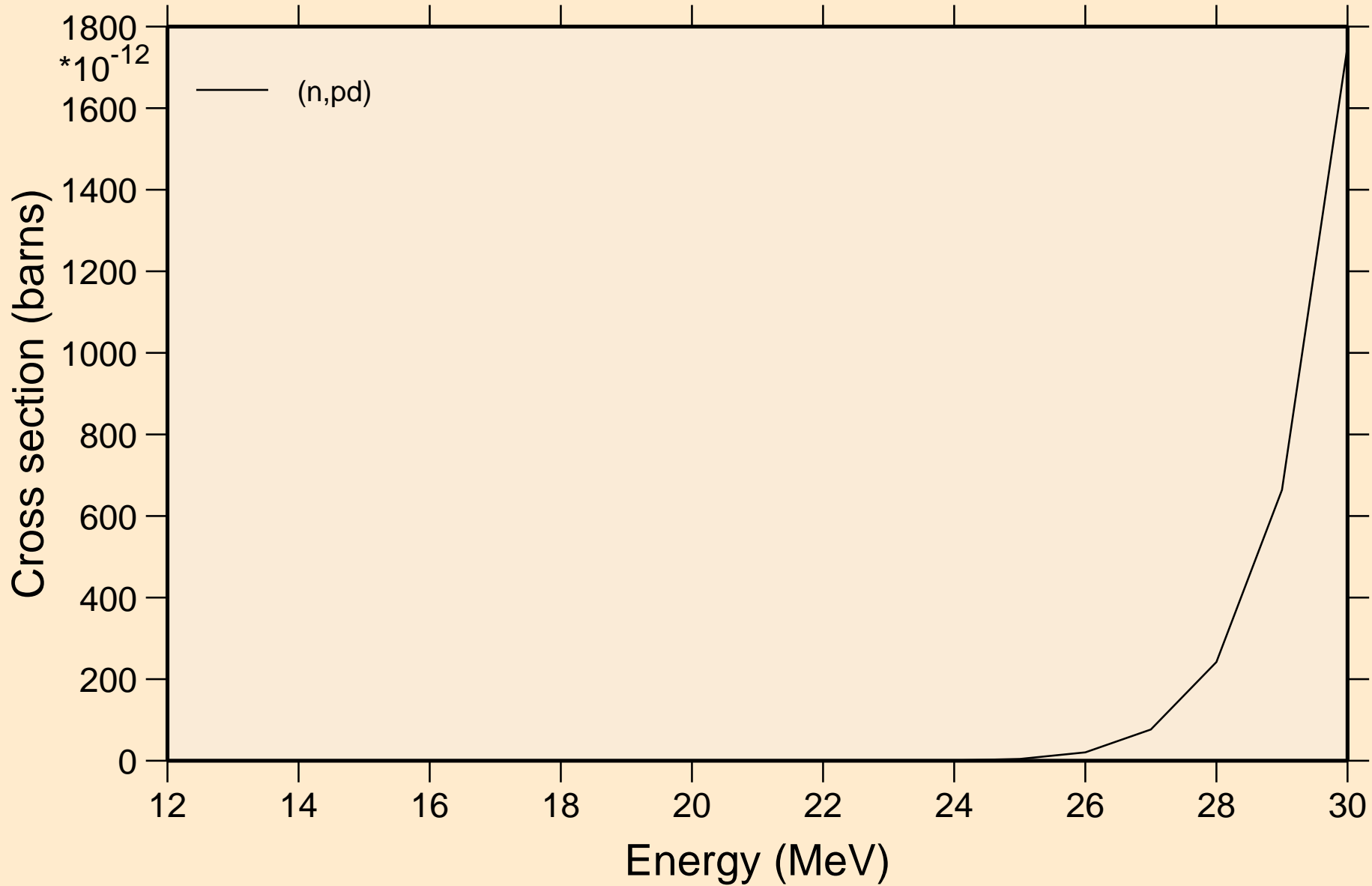

TB160 NEUTRON ACER TENDL-2021 LIBRARY; T=293.6K  
Threshold reactions

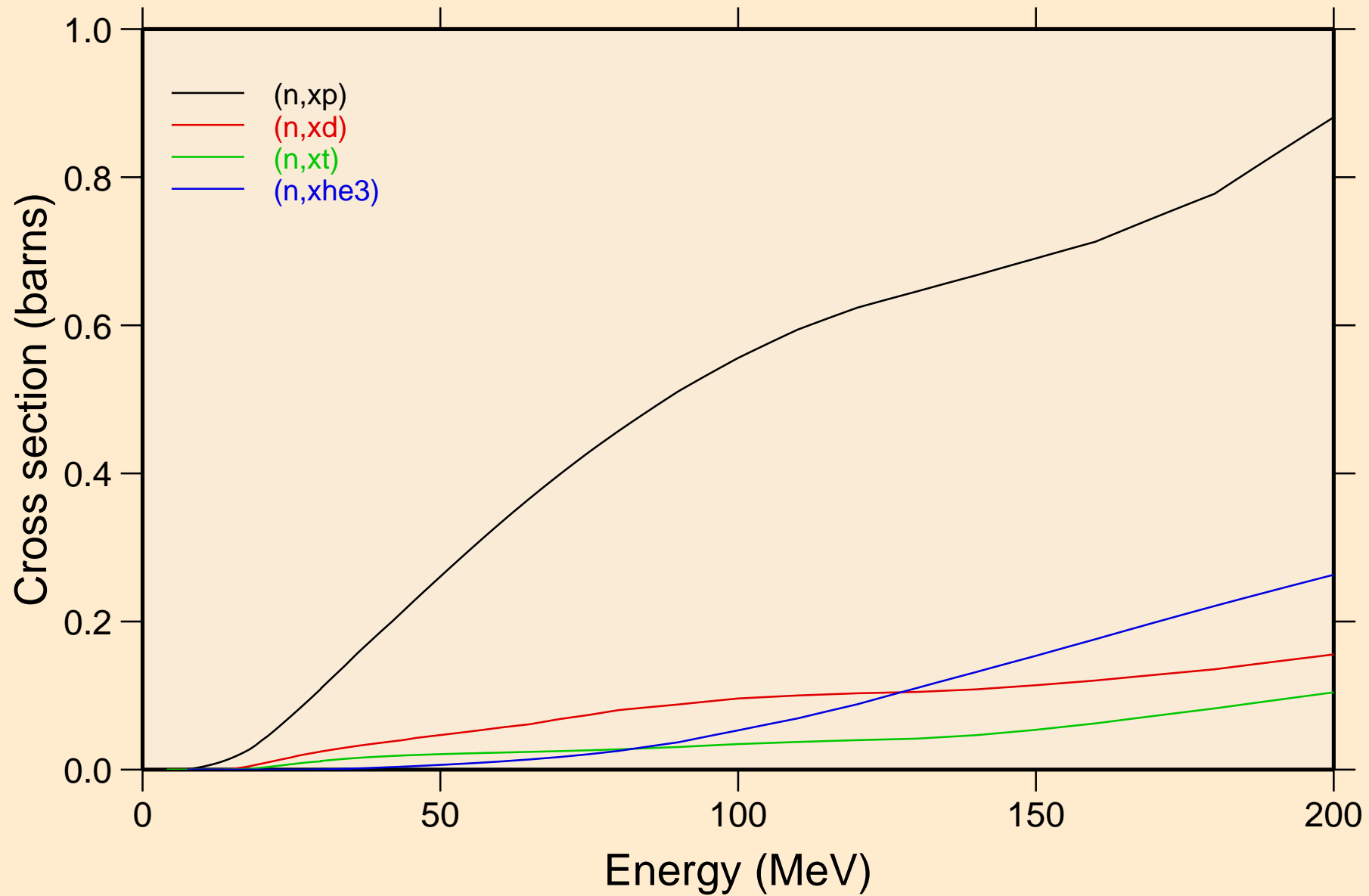

TB160 NEUTRON ACER TENDL-2021 LIBRARY; T=293.6K  
angular distribution for elastic

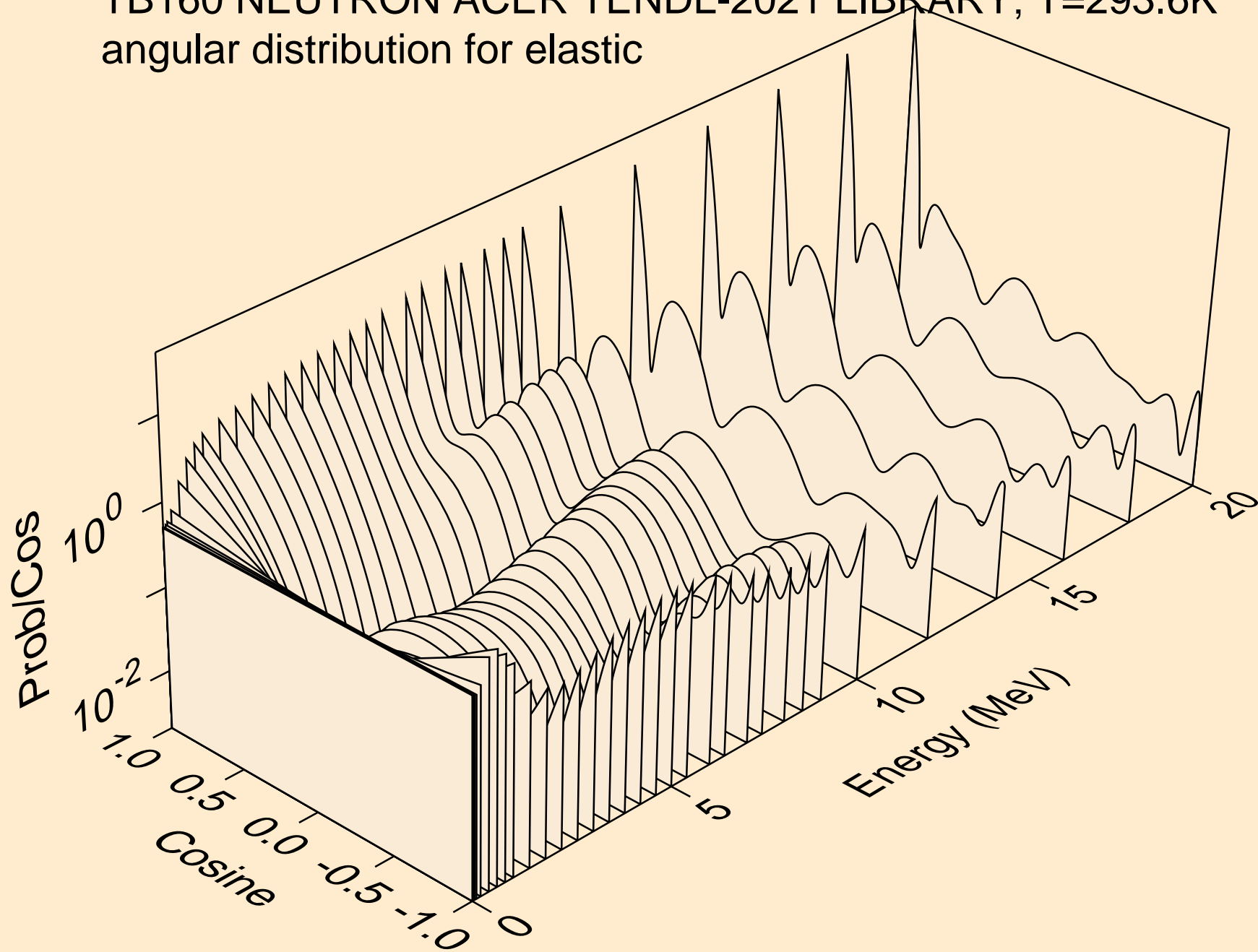

TB160 NEUTRON ACER TENDL-2021 LIBRARY; T=293.6K  
angular distribution for elastic

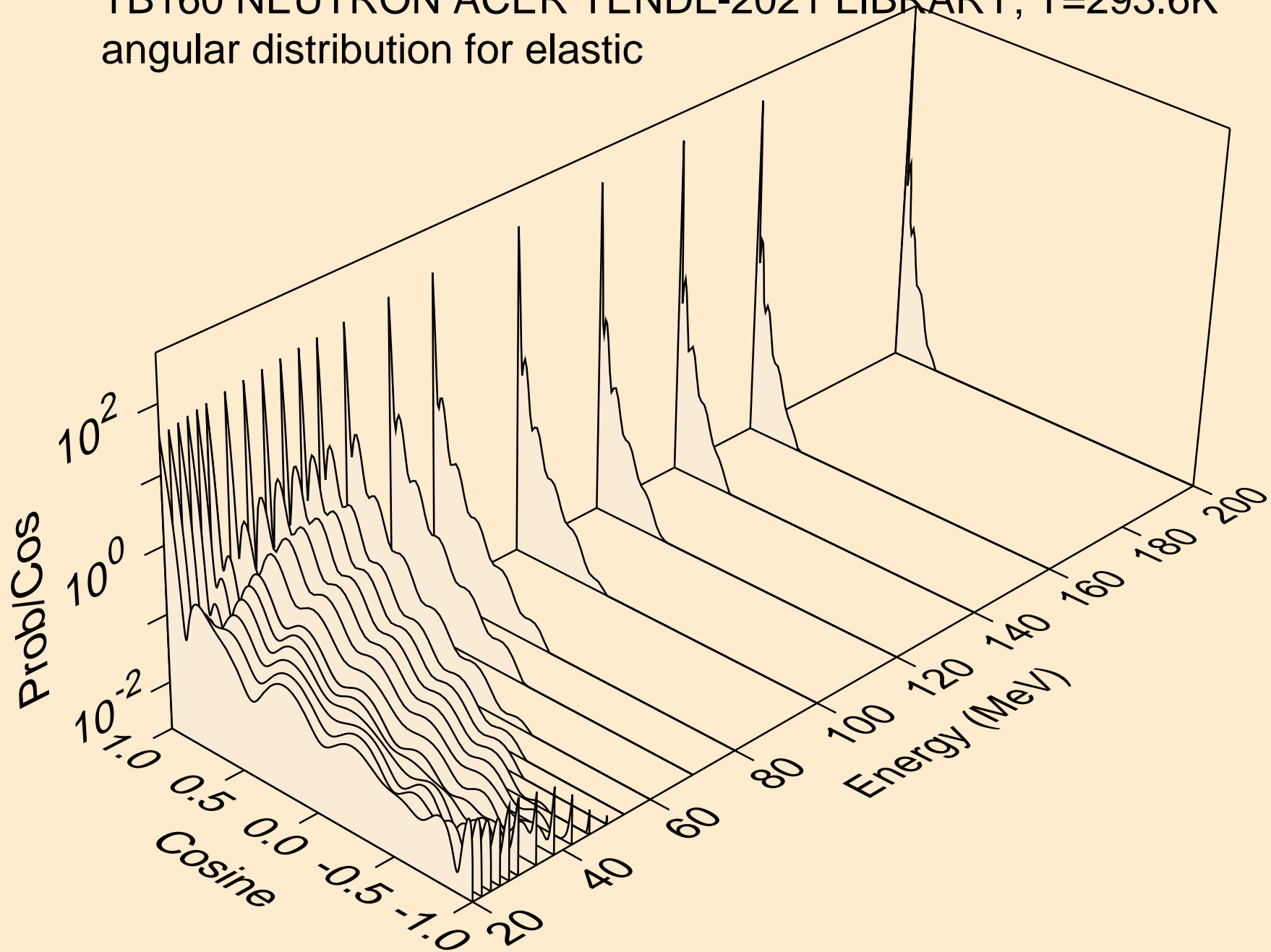

TB160 NEUTRON ACER TENDL-2021 LIBRARY; T=293.6K  
angular distribution for (n,n\*1)

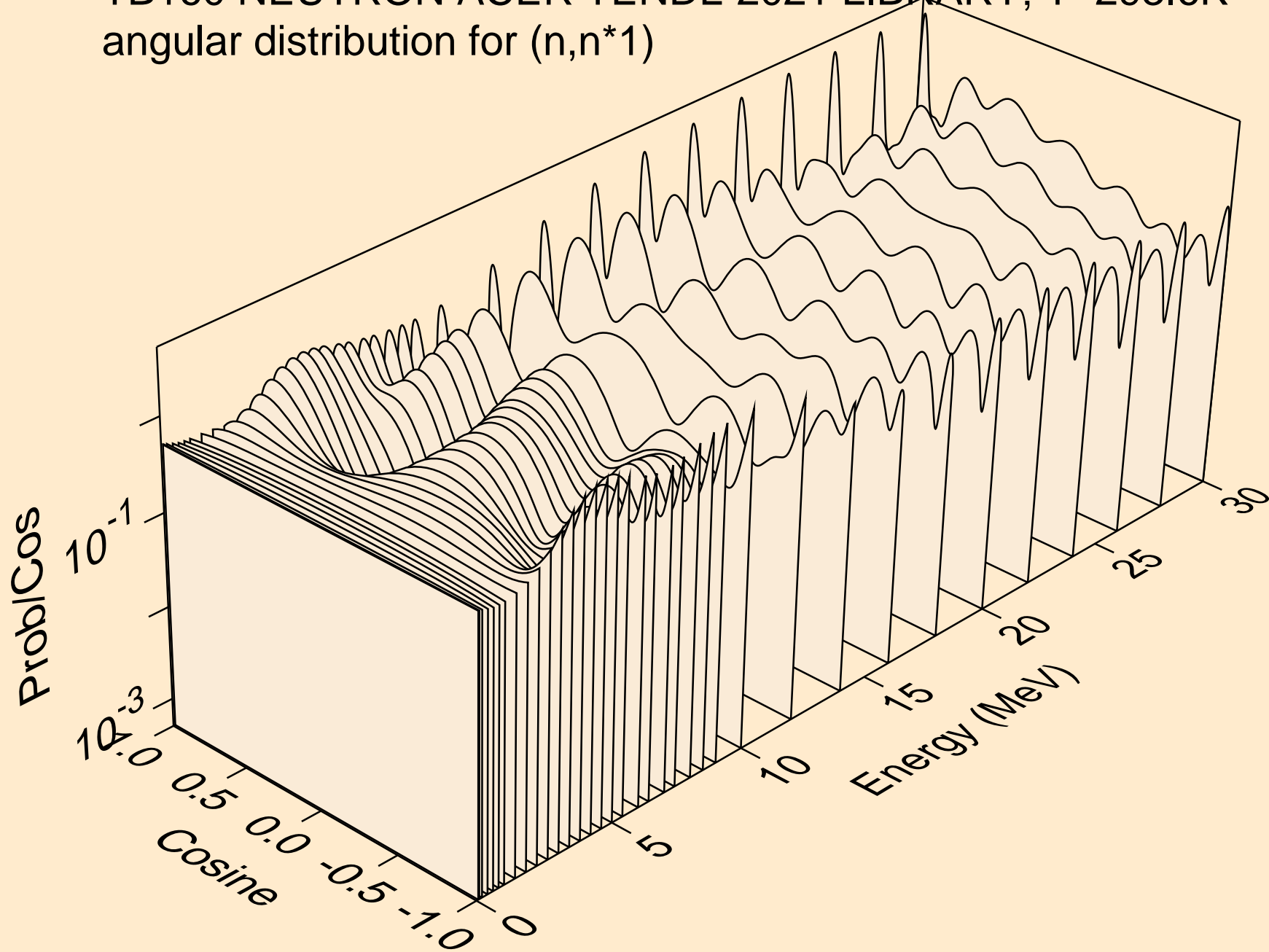

TB160 NEUTRON ACER TENDL-2021 LIBRARY; T=293.6K  
angular distribution for (n,n\*2)

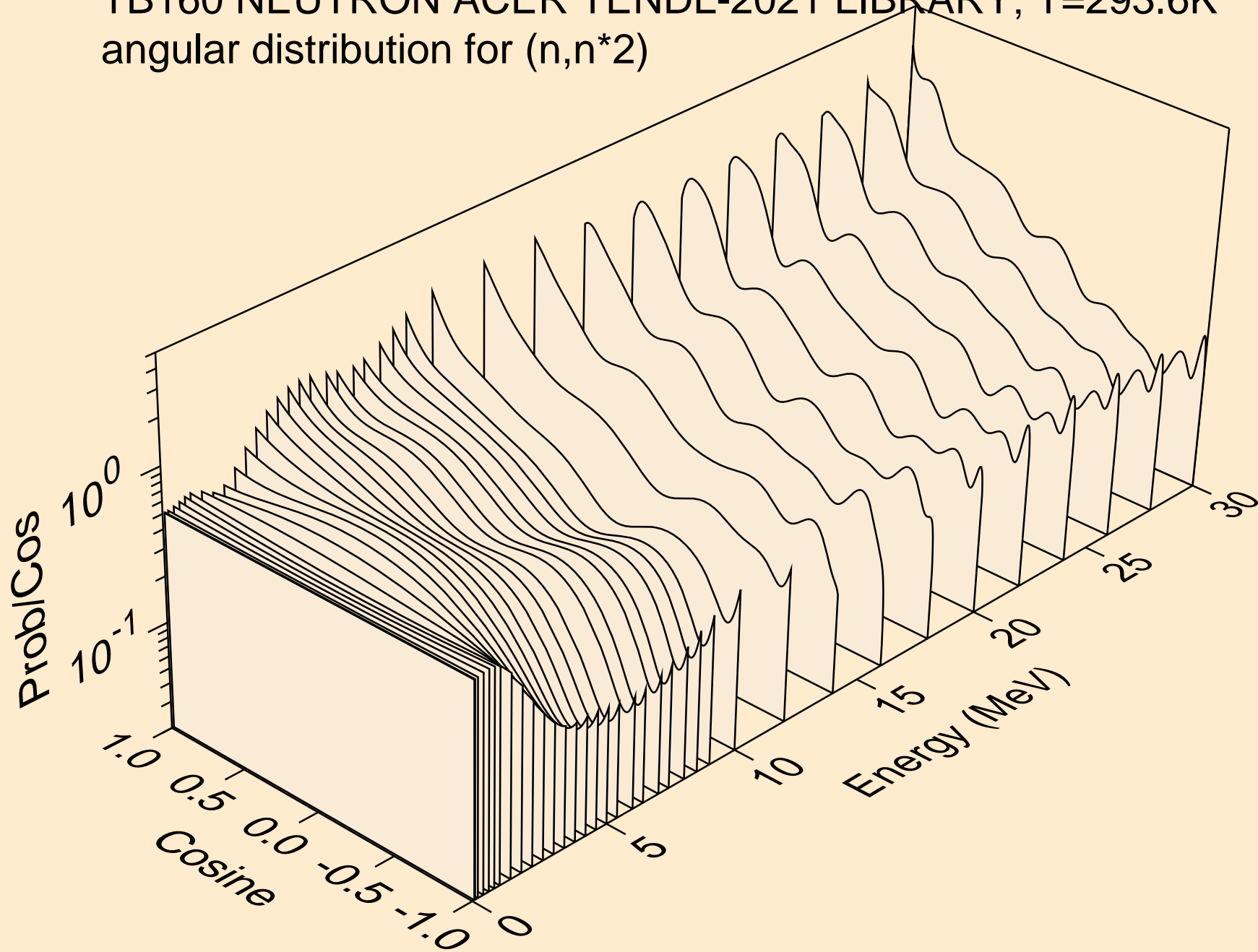

TB160 NEUTRON ACER TENDL-2021 LIBRARY; T=293.6K  
angular distribution for (n,n\*3)

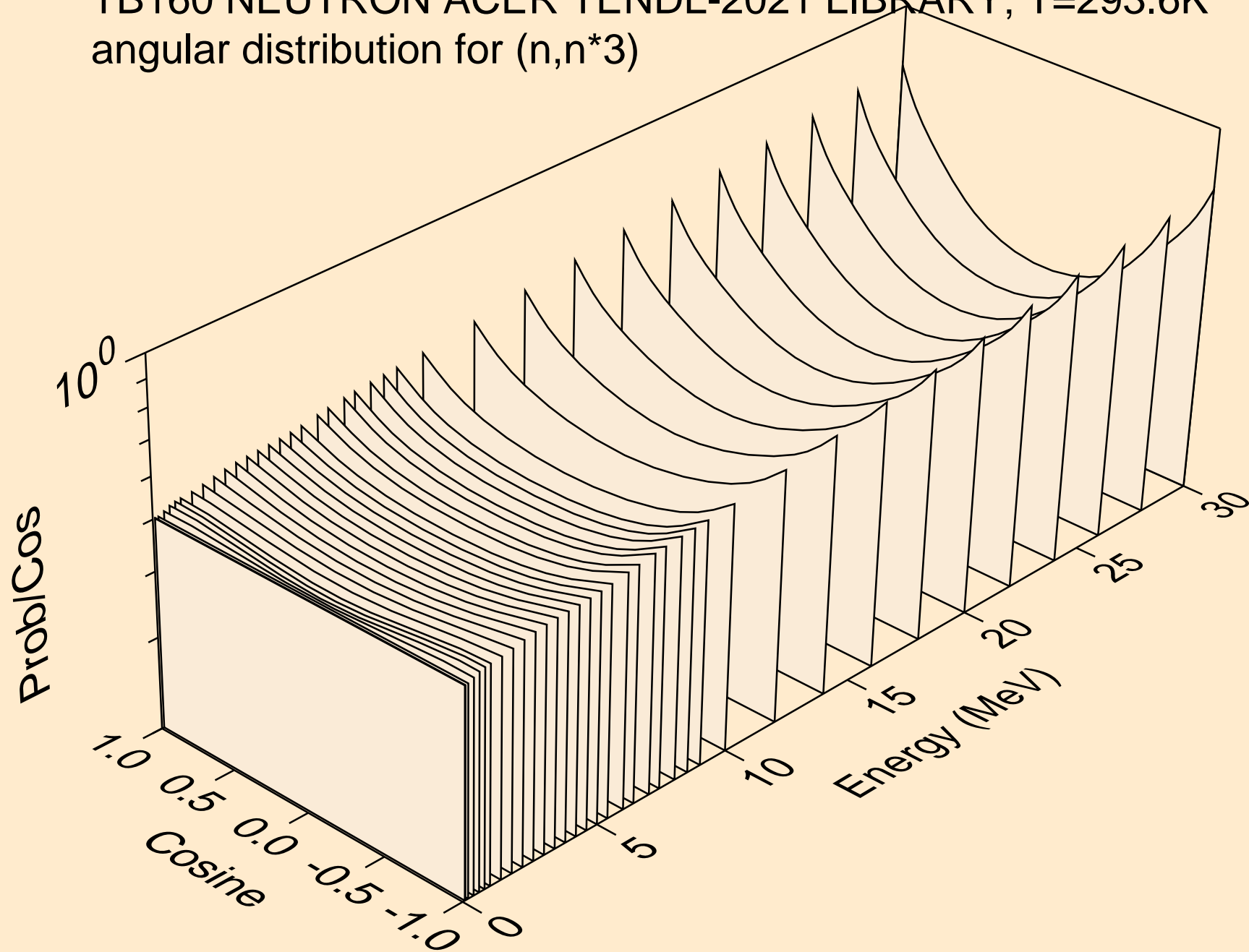



TB160 NEUTRON ACER TENDL-2021 LIBRARY; T=293.6K  
angular distribution for (n,n\*4)

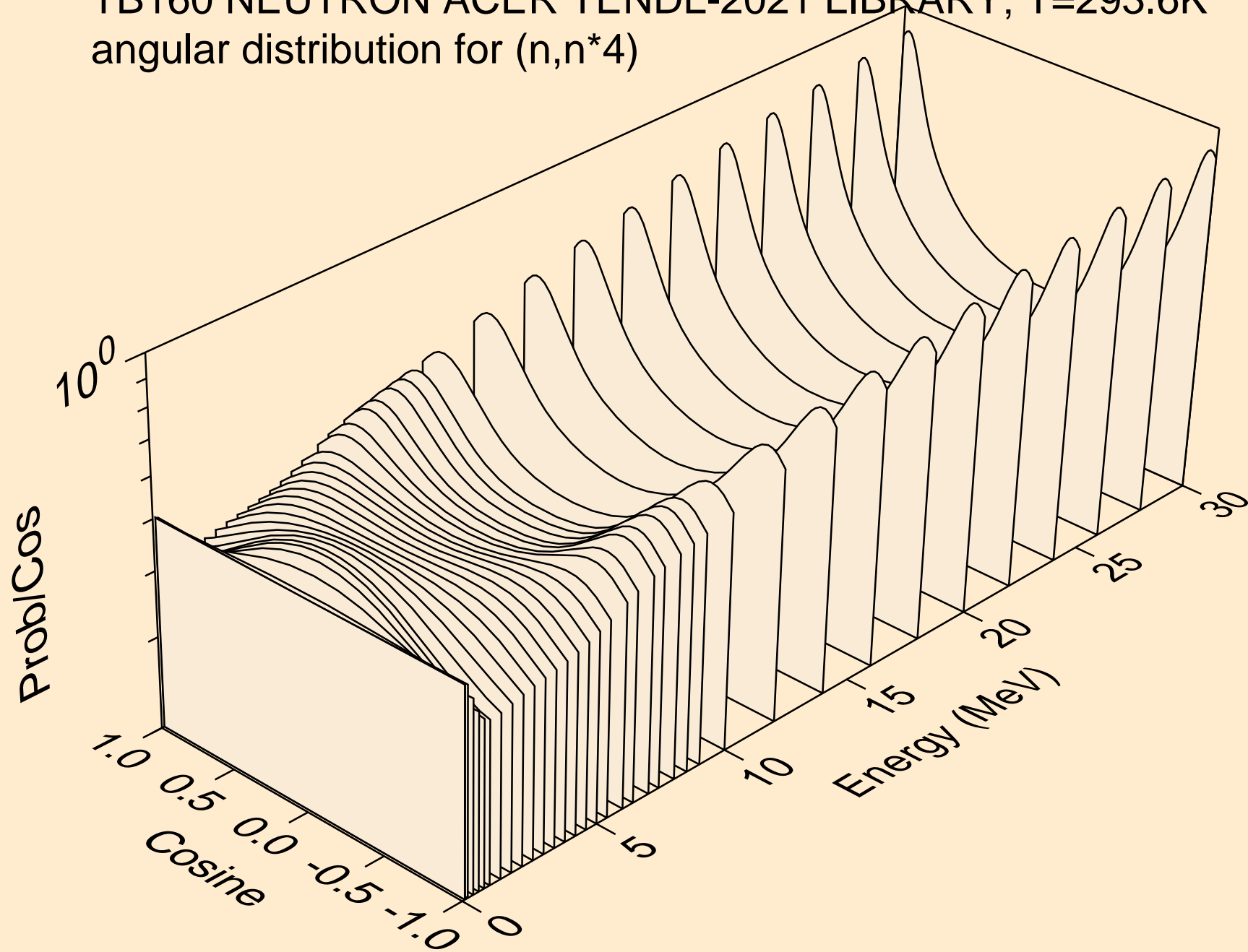

TB160 NEUTRON ACER TENDL-2021 LIBRARY; T=293.6K  
angular distribution for (n,n\*5)

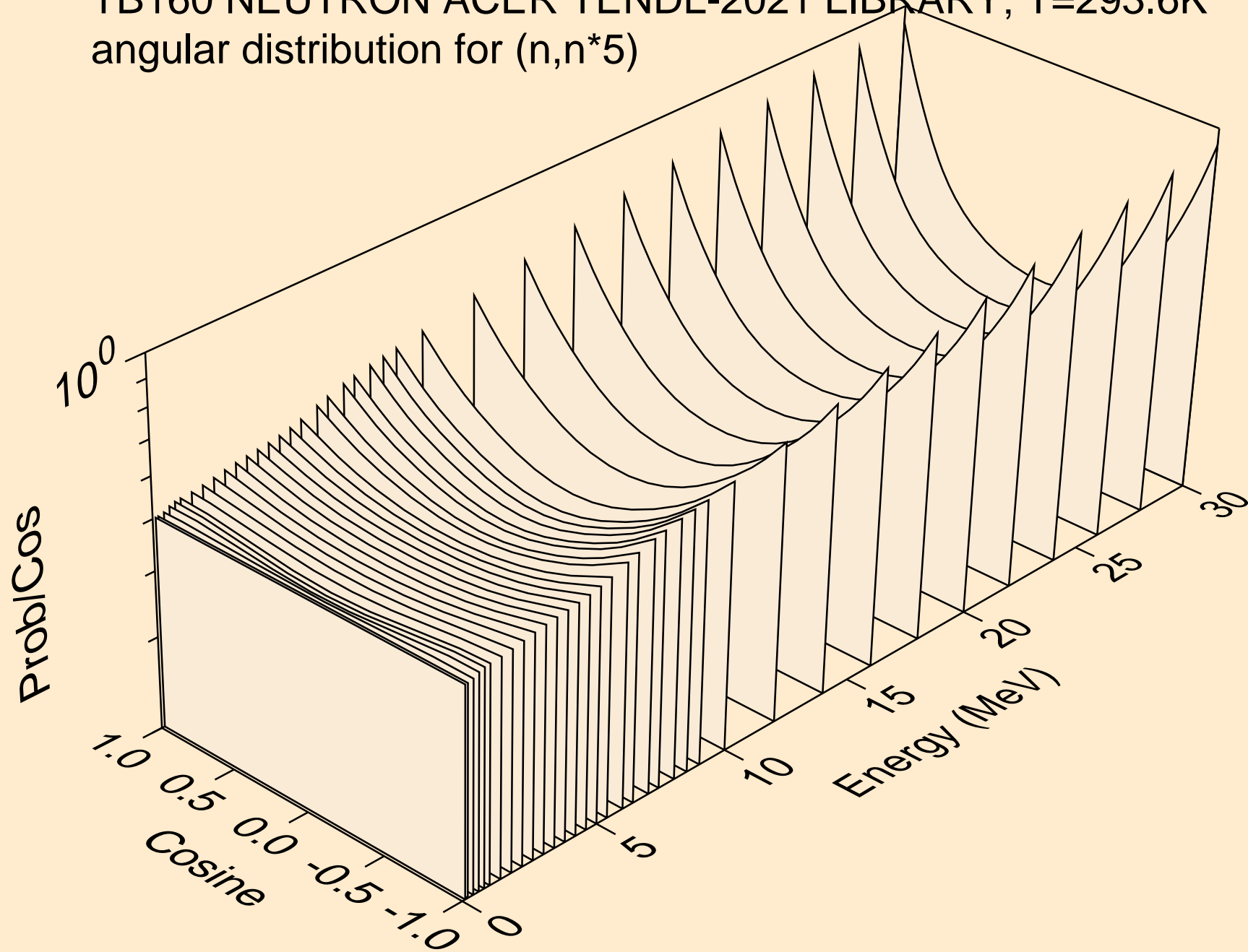

TB160 NEUTRON ACER TENDL-2021 LIBRARY; T=293.6K  
angular distribution for (n,n\*6)

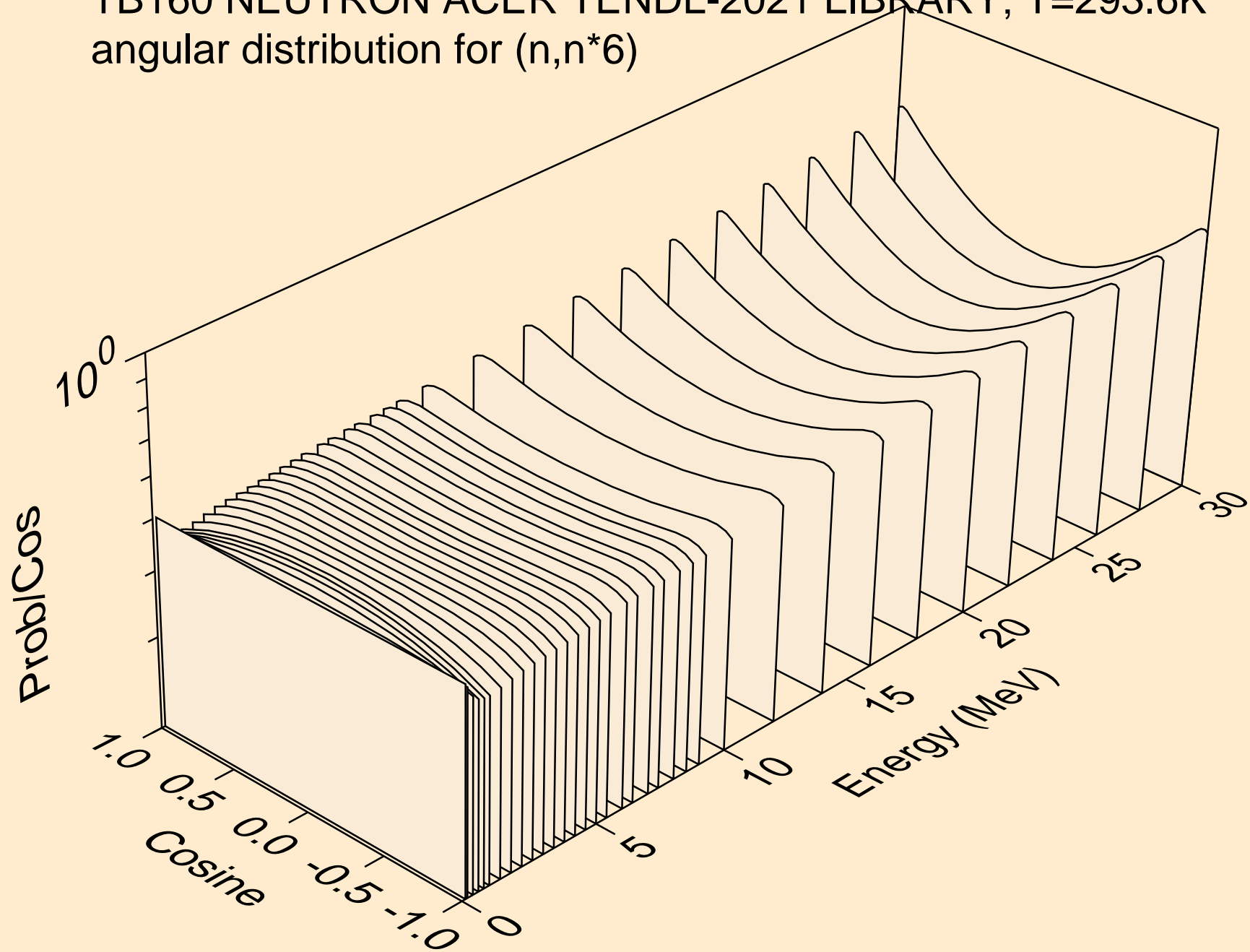

TB160 NEUTRON ACER TENDL-2021 LIBRARY; T=293.6K  
angular distribution for (n,n\*7)

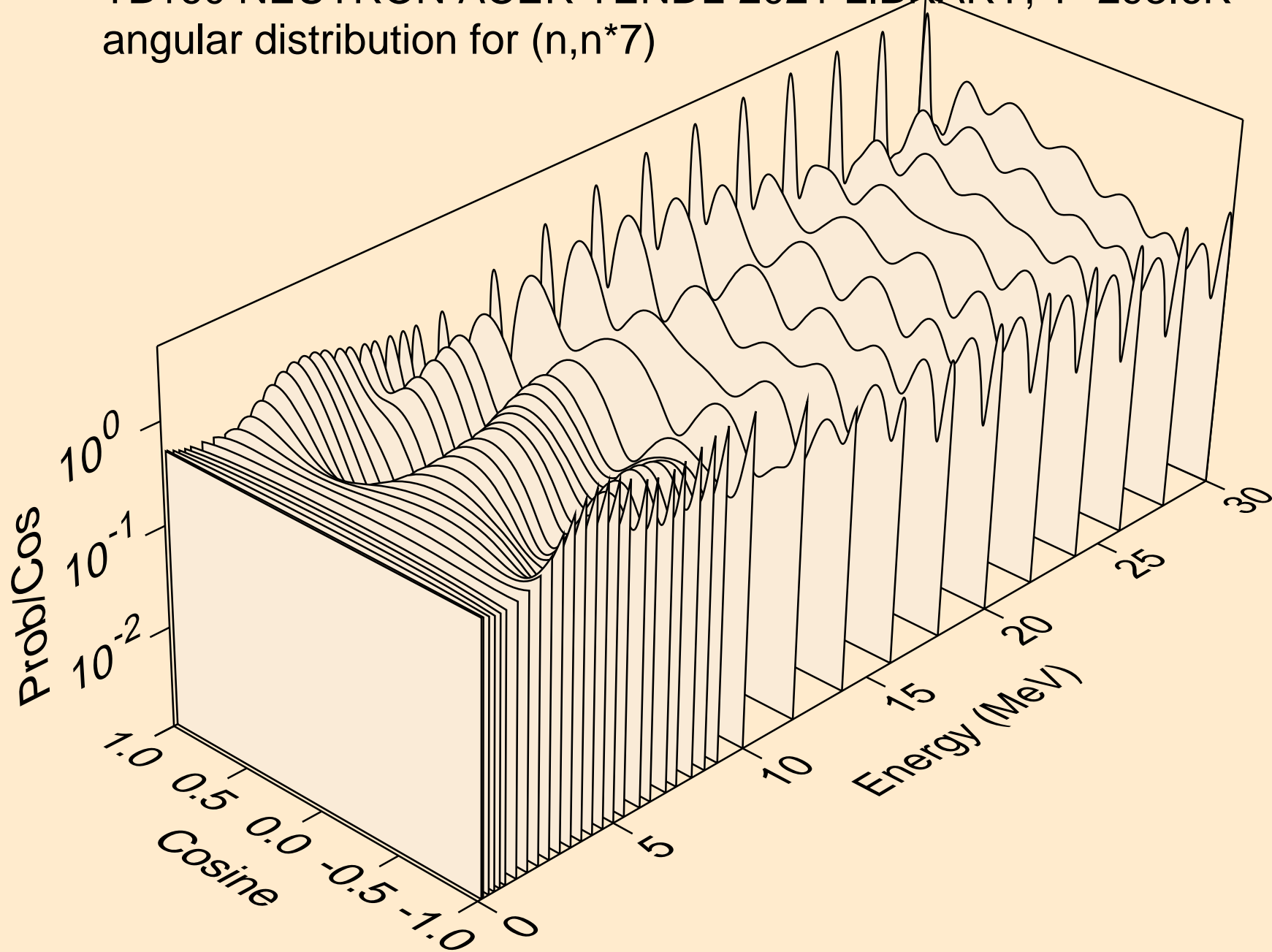

TB160 NEUTRON ACER TENDL-2021 LIBRARY; T=293.6K  
angular distribution for (n,n\*8)

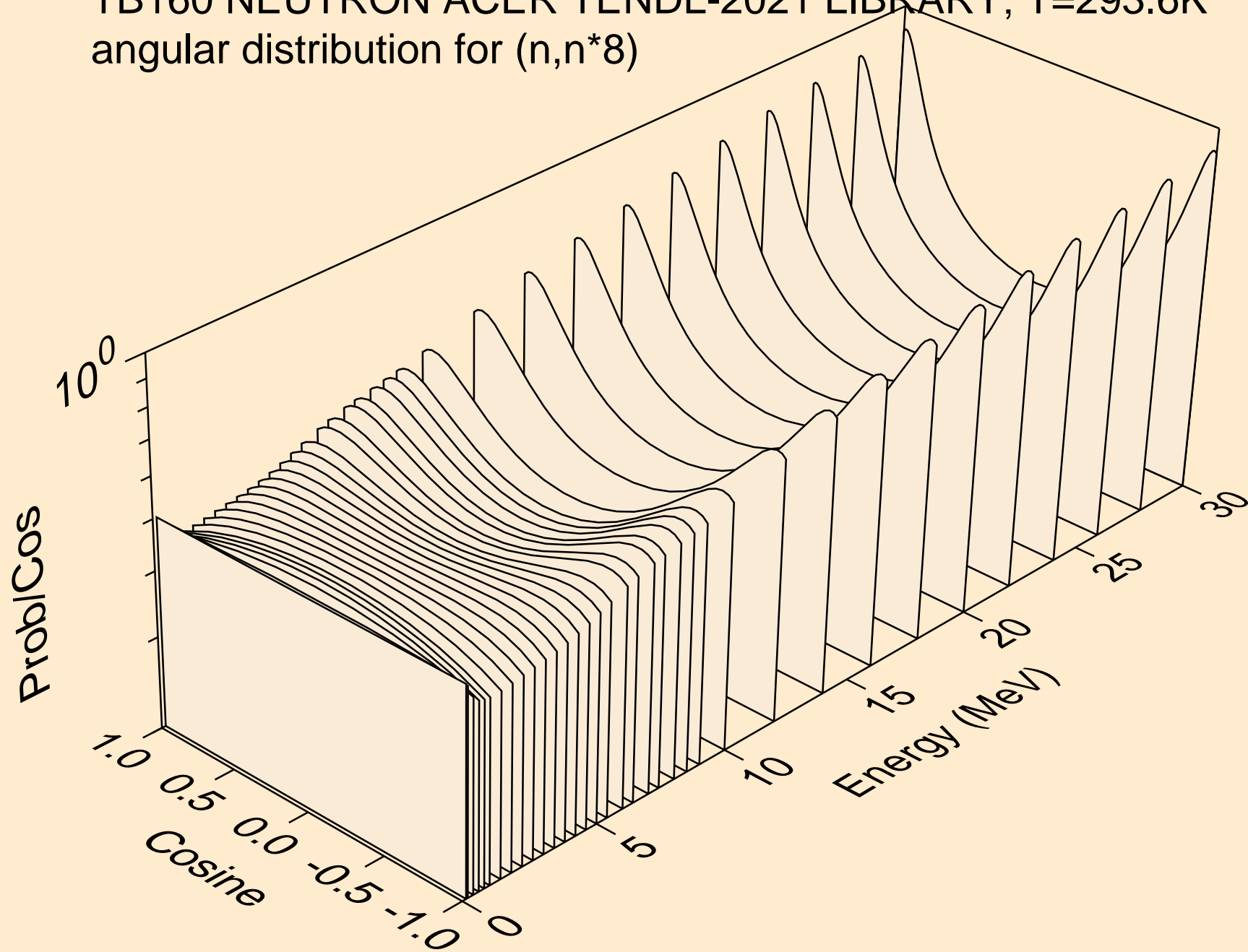

TB160 NEUTRON ACER TENDL-2021 LIBRARY; T=293.6K  
angular distribution for (n,n\*9)

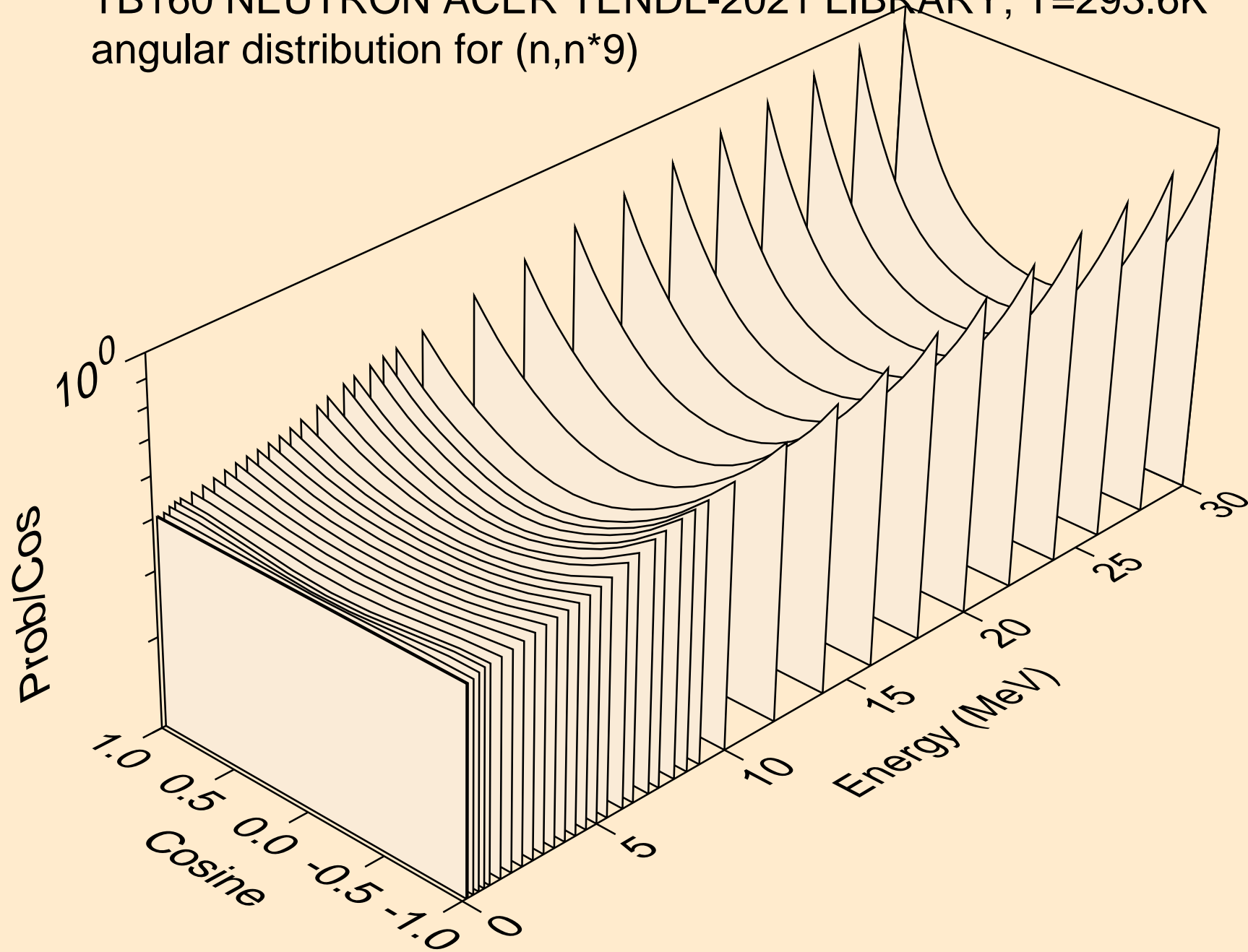

TB160 NEUTRON ACER TENDL-2021 LIBRARY; T=293.6K  
angular distribution for (n,n\*10)

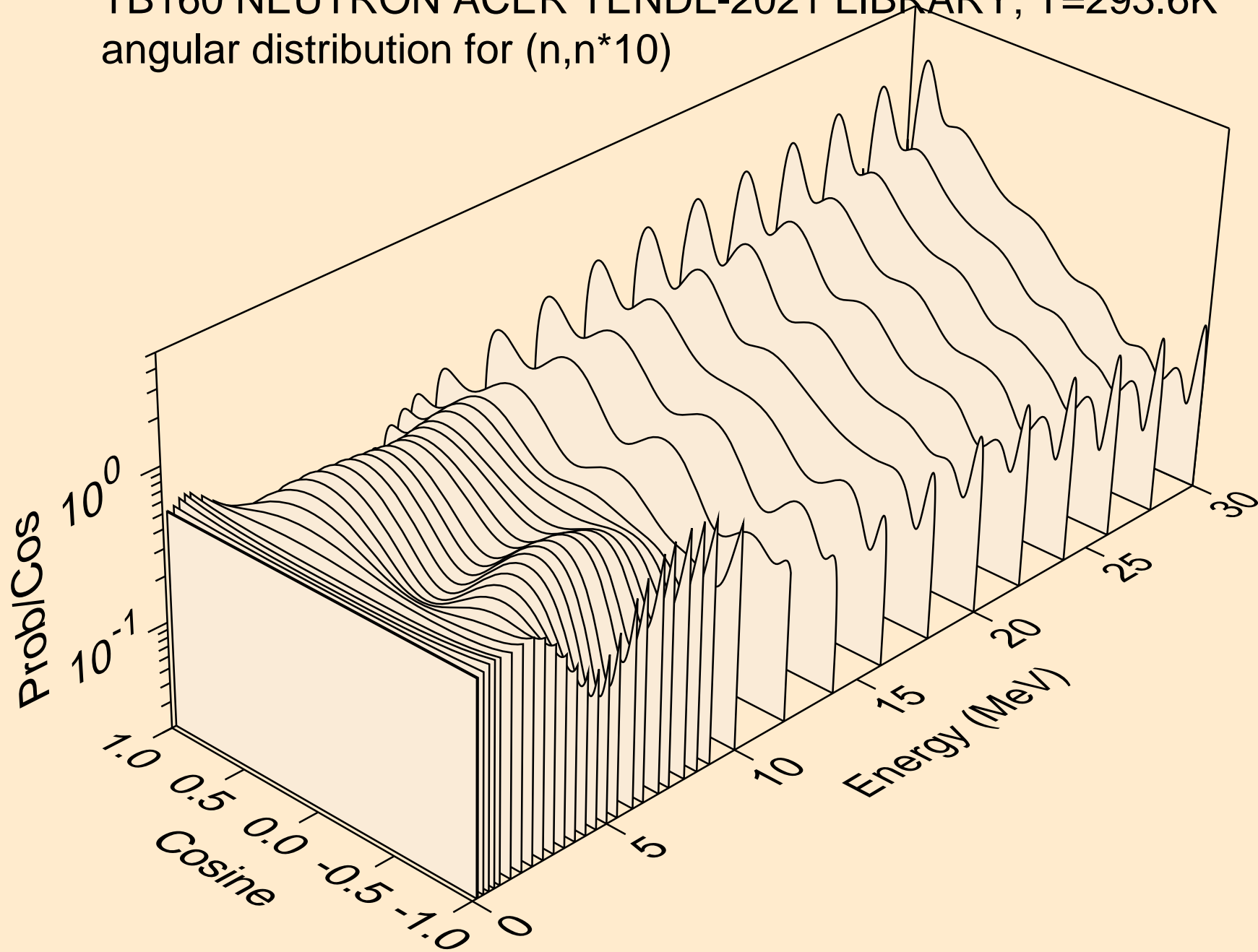



TB160 NEUTRON ACER TENDL-2021 LIBRARY; T=293.6K  
angular distribution for (n,n\*11)

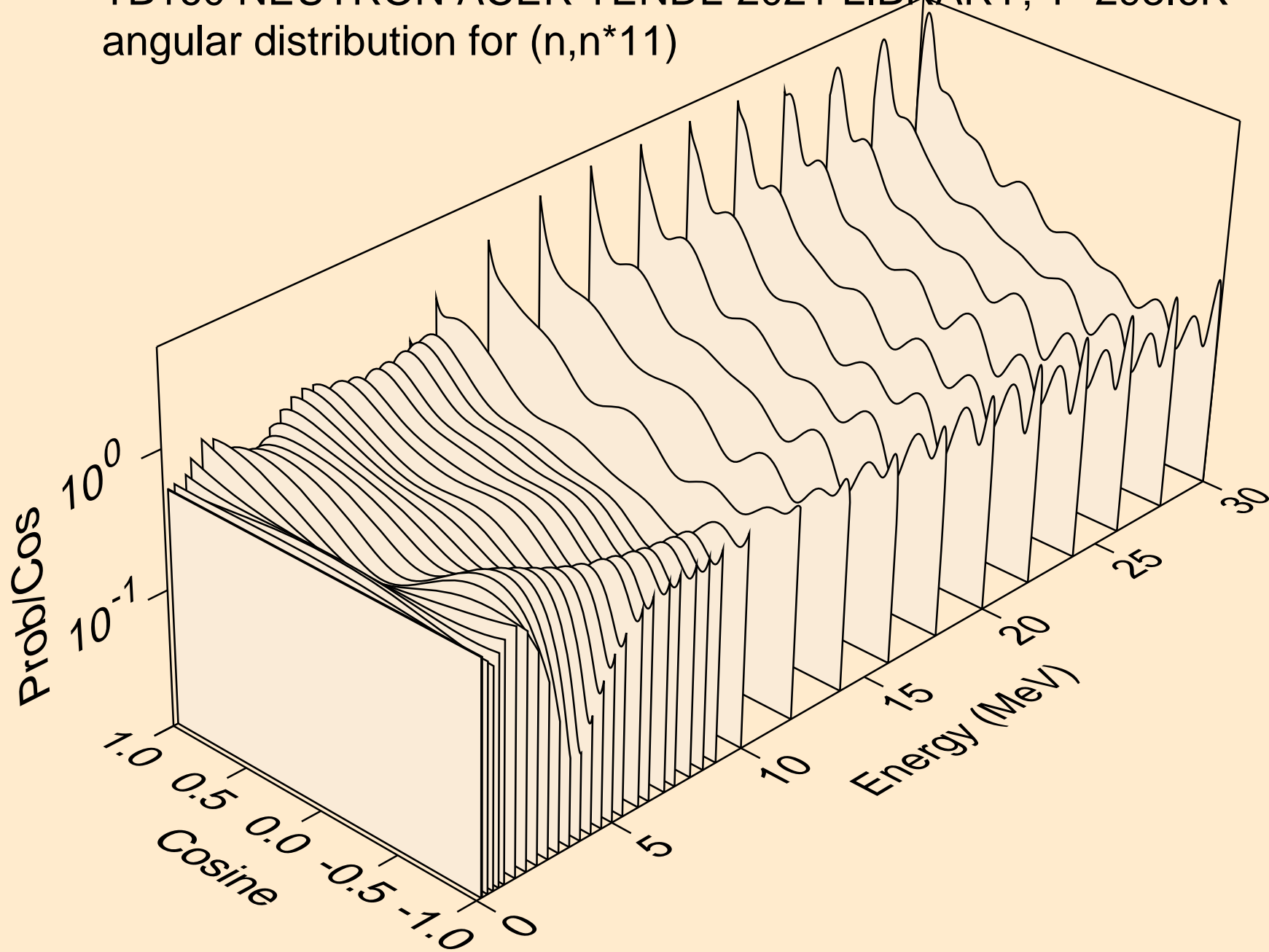



TB160 NEUTRON ACER TENDL-2021 LIBRARY; T=293.6K  
angular distribution for (n,n\*12)

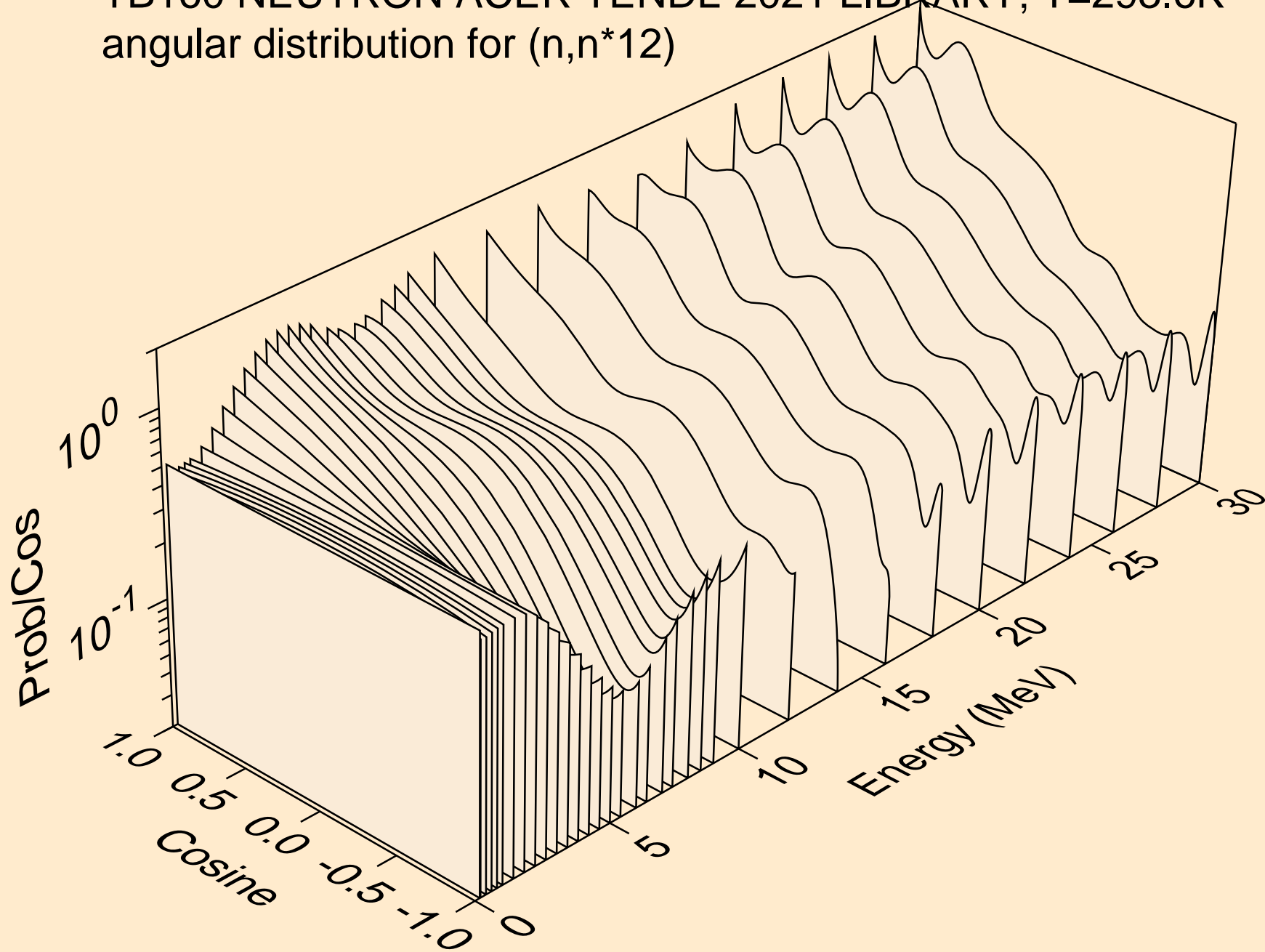

TB160 NEUTRON ACER TENDL-2021 LIBRARY; T=293.6K  
angular distribution for (n,n\*13)

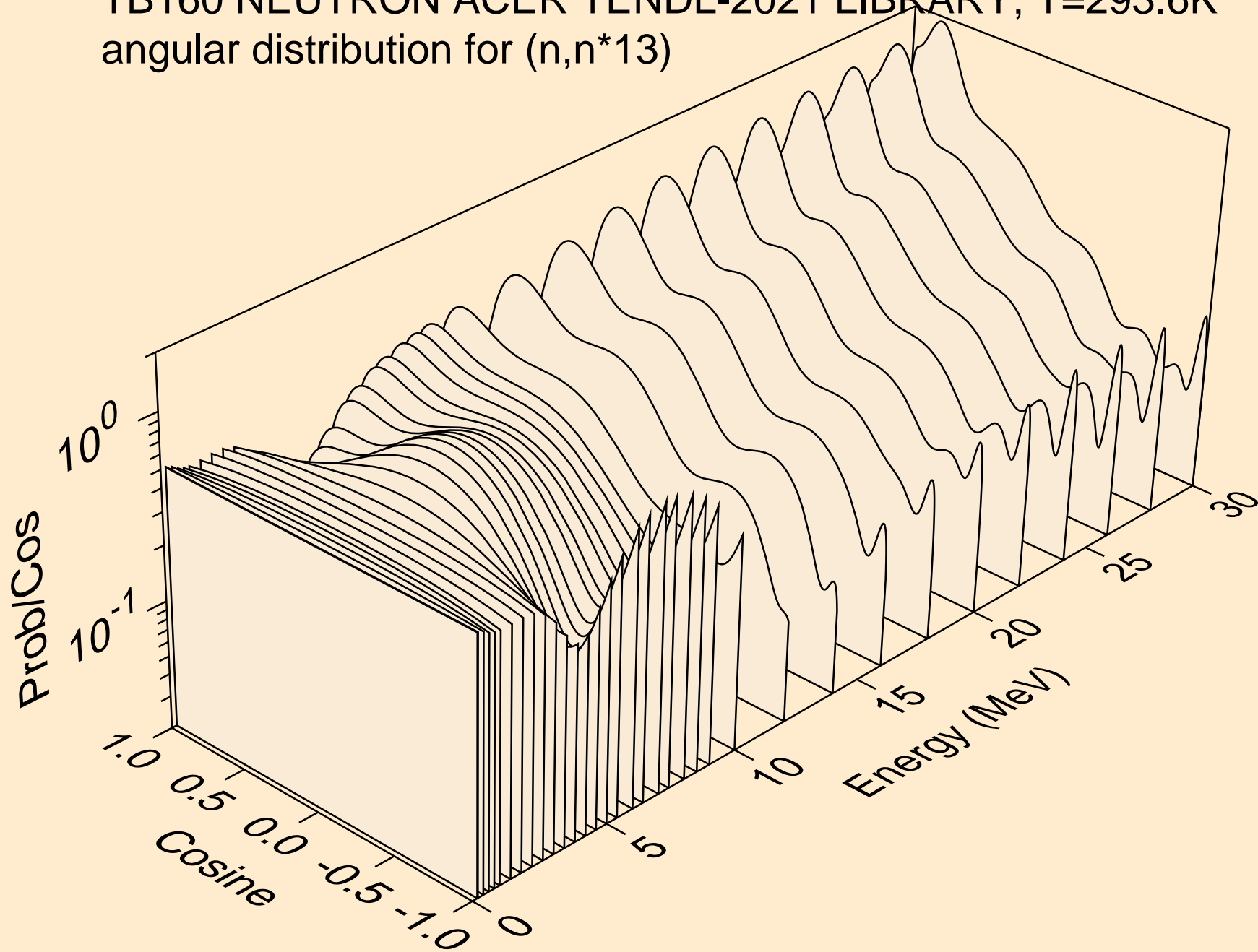

TB160 NEUTRON ACER TENDL-2021 LIBRARY; T=293.6K  
angular distribution for (n,n\*14)

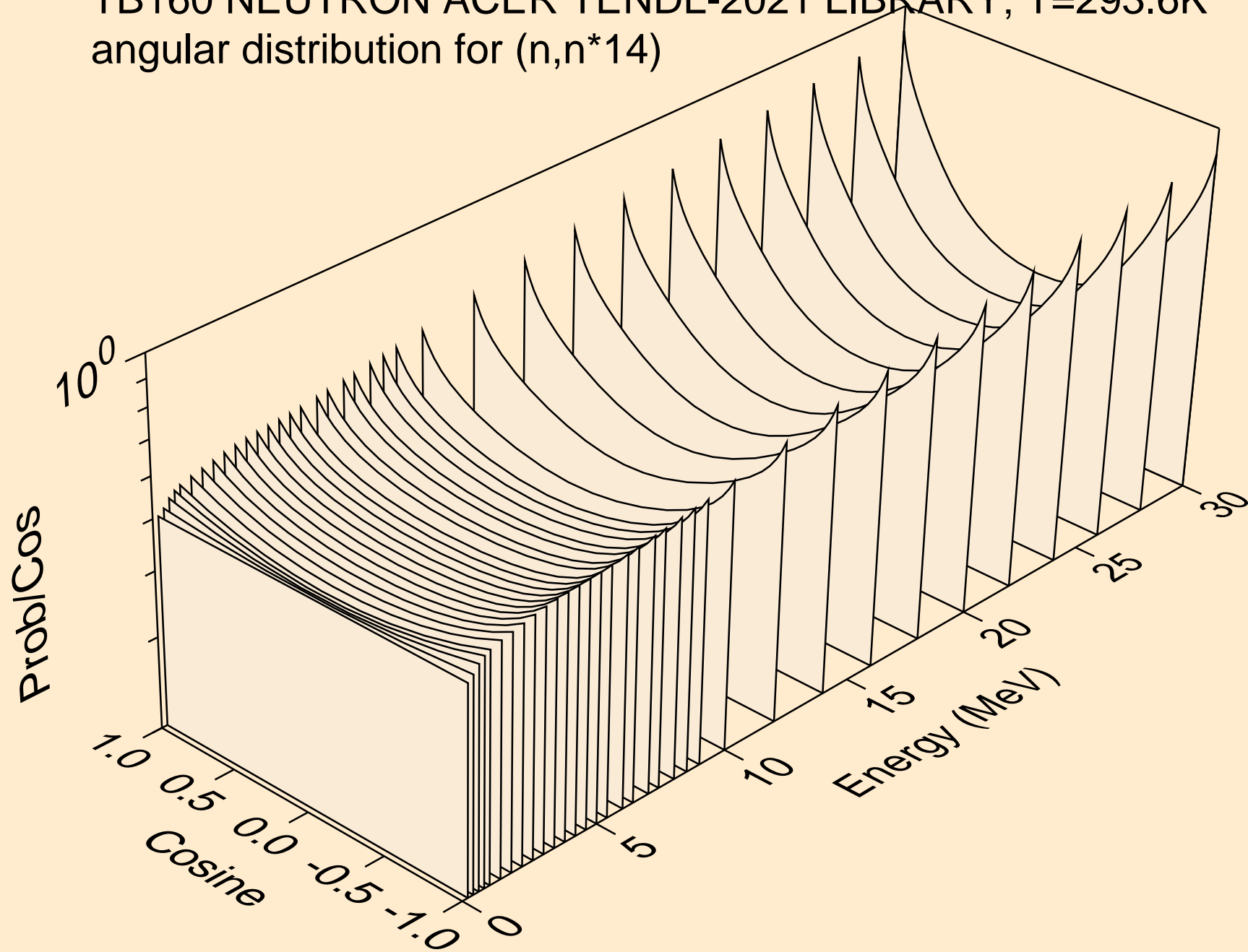

TB160 NEUTRON ACER TENDL-2021 LIBRARY; T=293.6K  
angular distribution for (n,n\*15)

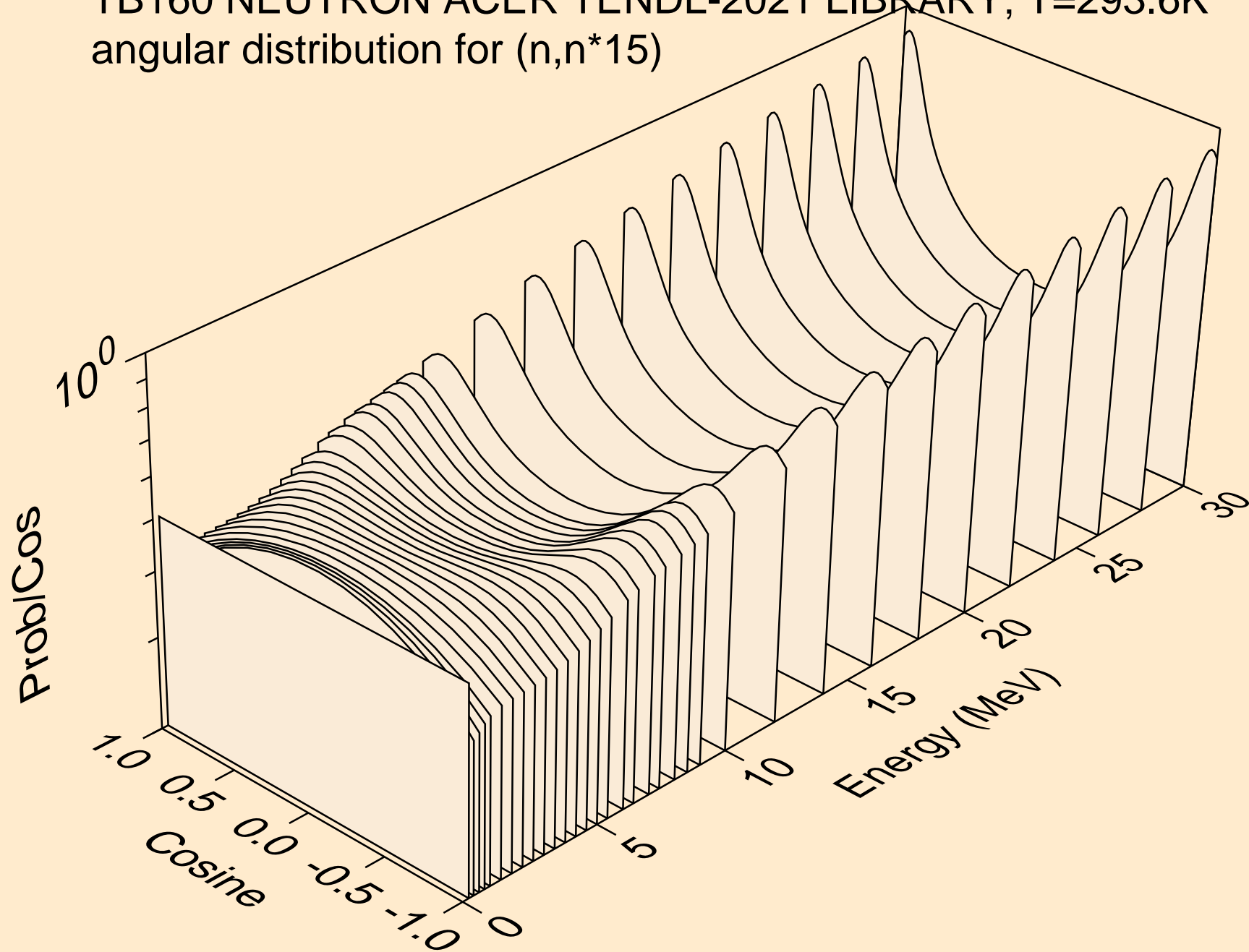

TB160 NEUTRON ACER TENDL-2021 LIBRARY; T=293.6K  
angular distribution for (n,n\*16)

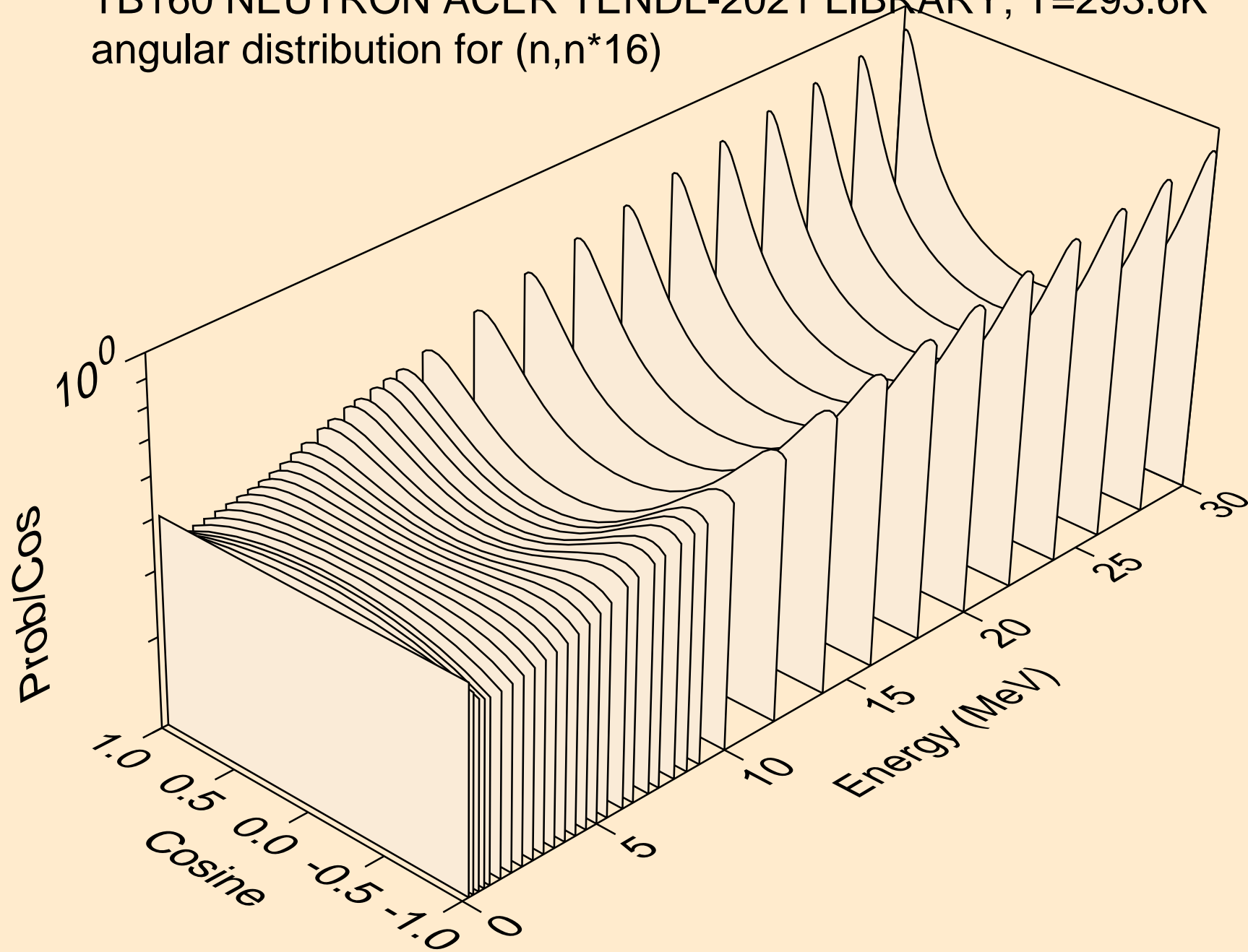

TB160 NEUTRON ACER TENDL-2021 LIBRARY; T=293.6K  
angular distribution for (n,n\*17)

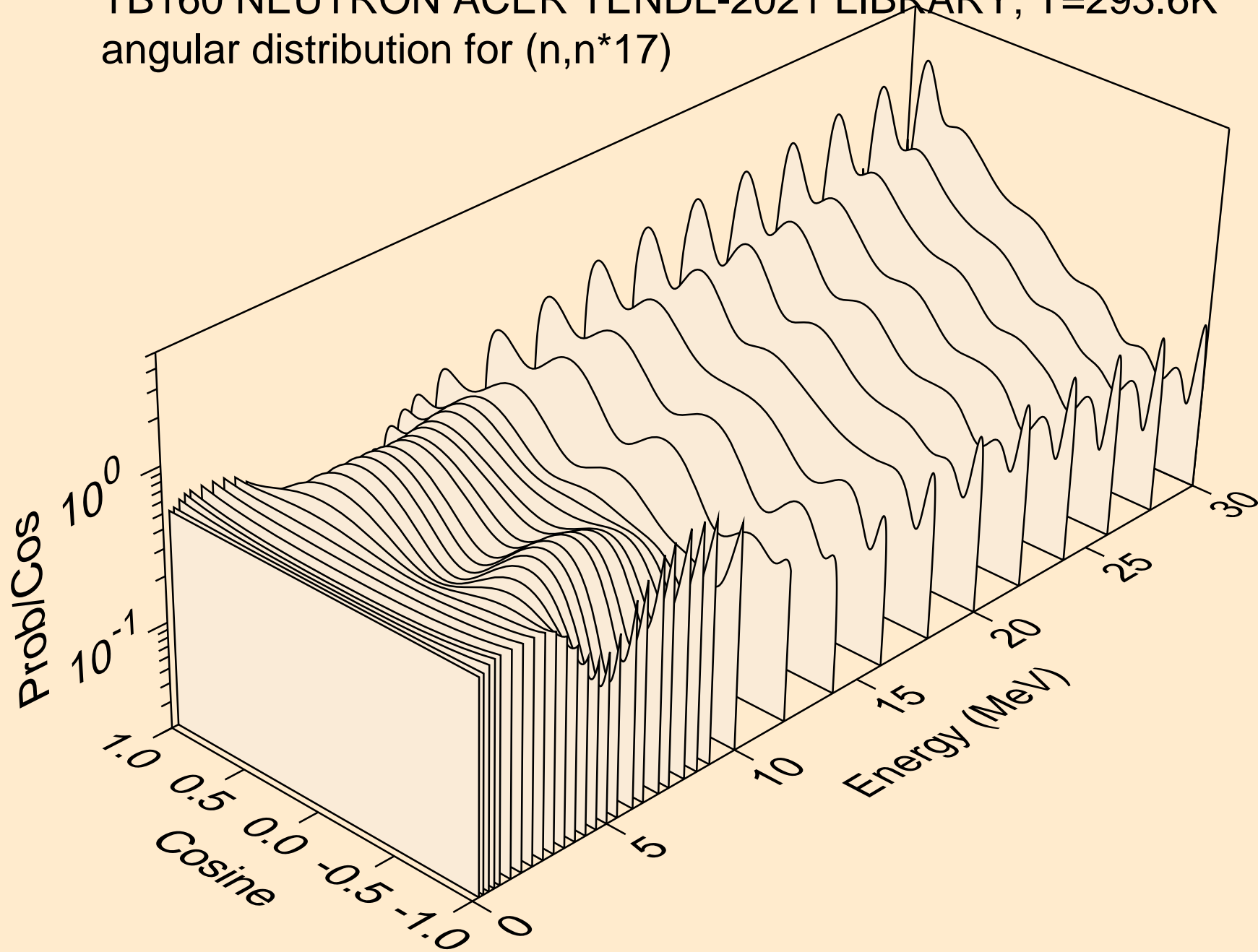

TB160 NEUTRON ACER TENDL-2021 LIBRARY; T=293.6K  
angular distribution for (n,n\*18)

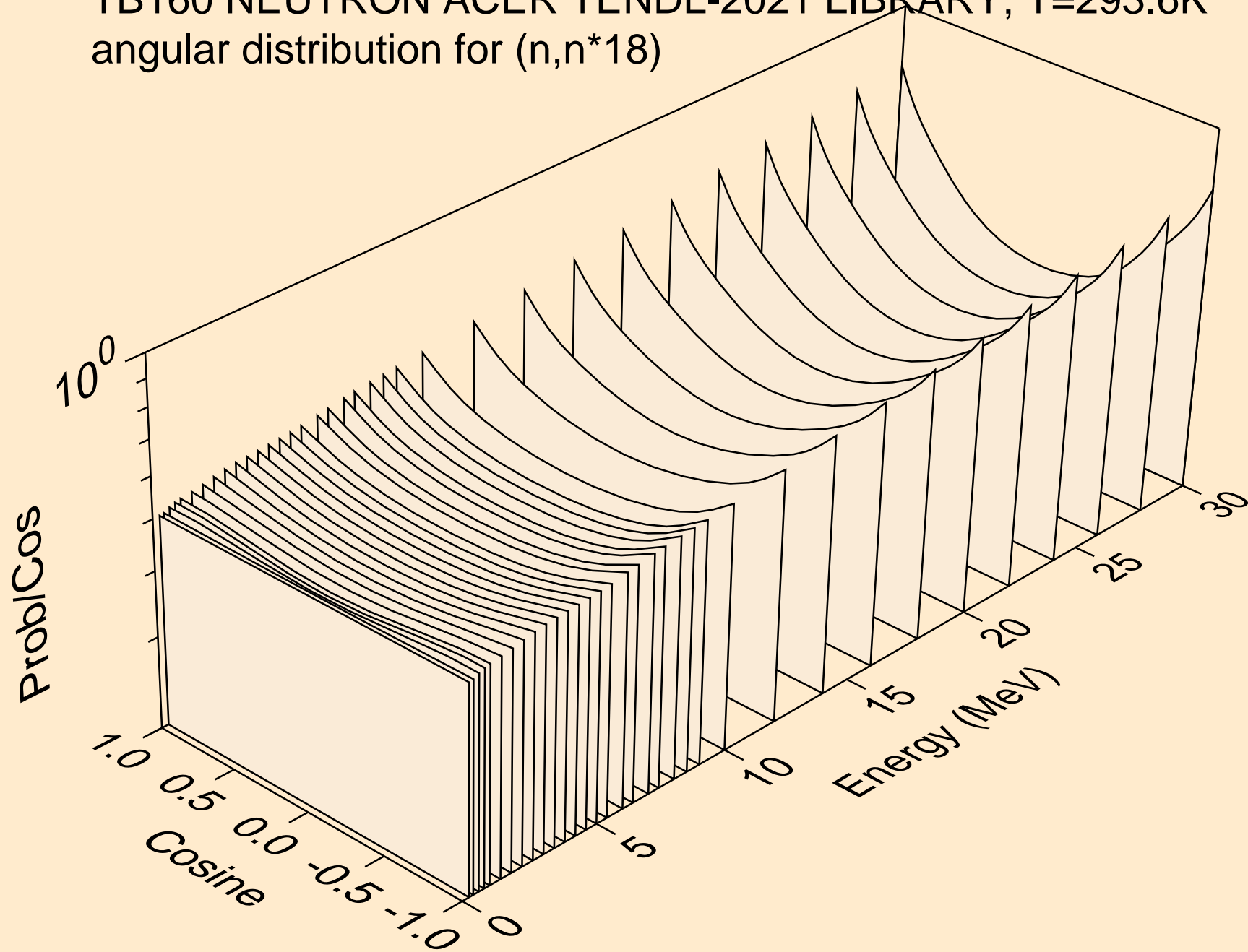

TB160 NEUTRON ACER TENDL-2021 LIBRARY; T=293.6K  
angular distribution for (n,n\*19)

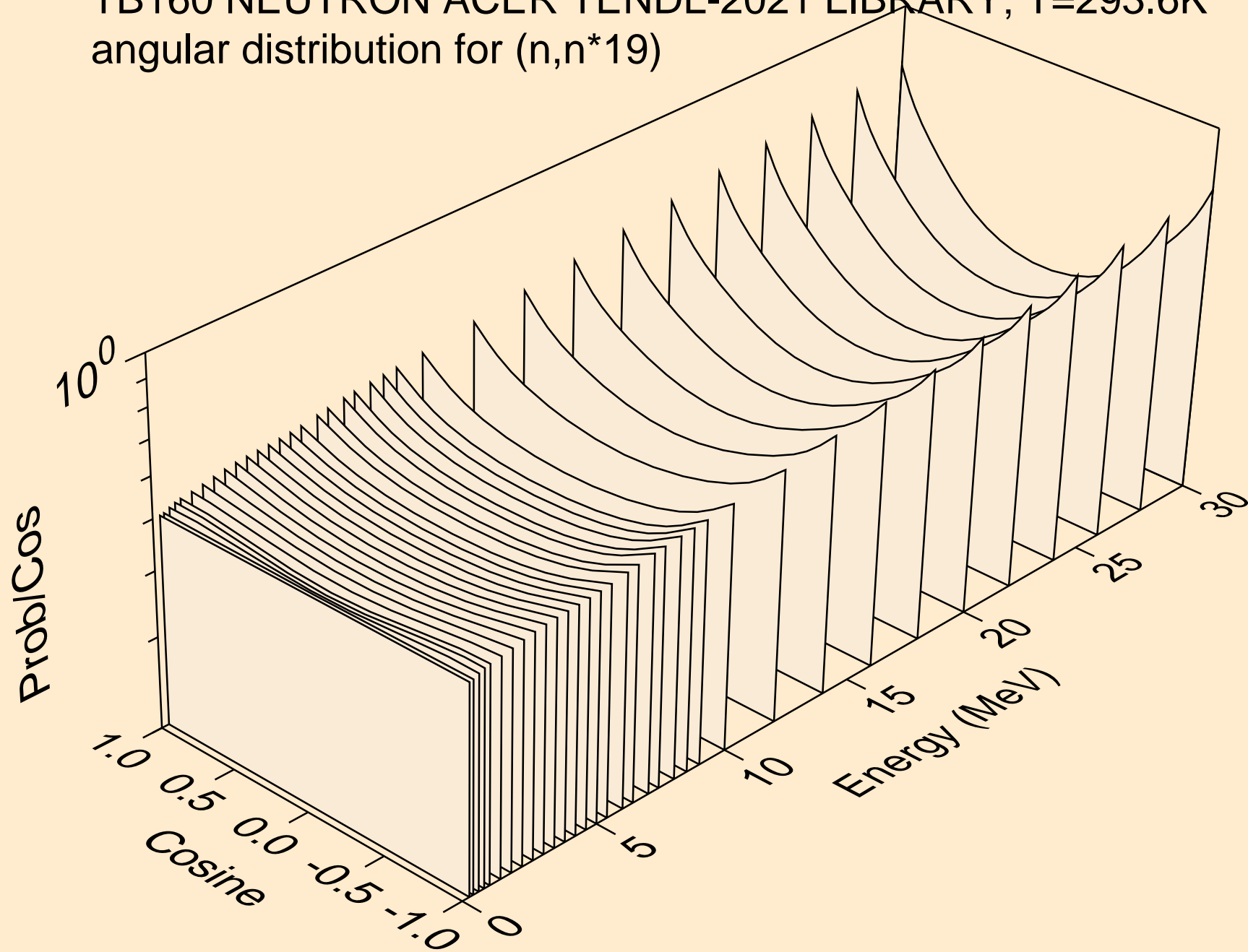



TB160 NEUTRON ACER TENDL-2021 LIBRARY; T=293.6K  
angular distribution for (n,n\*20)

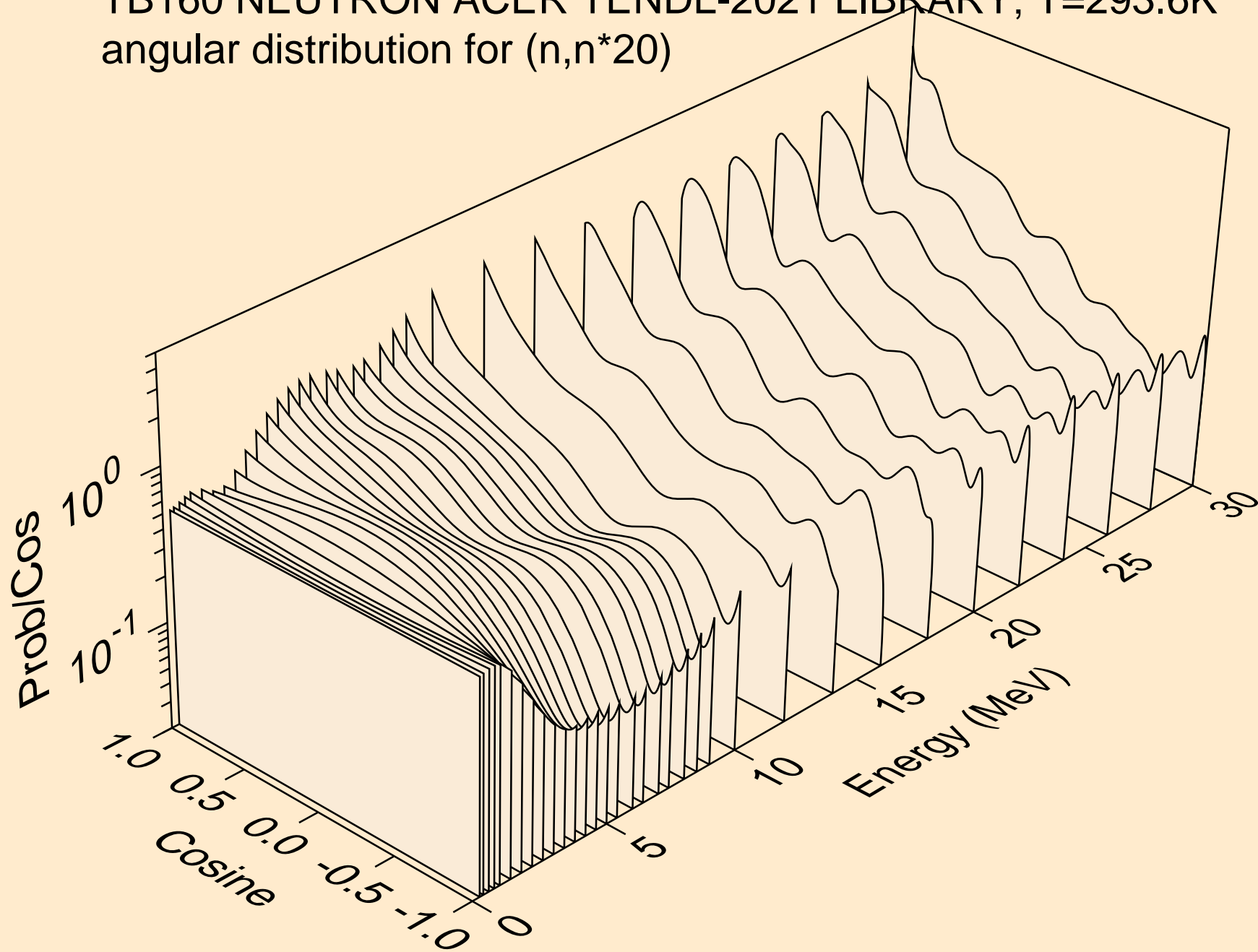

TB160 NEUTRON ACER TENDL-2021 LIBRARY; T=293.6K  
angular distribution for (n,n\*21)

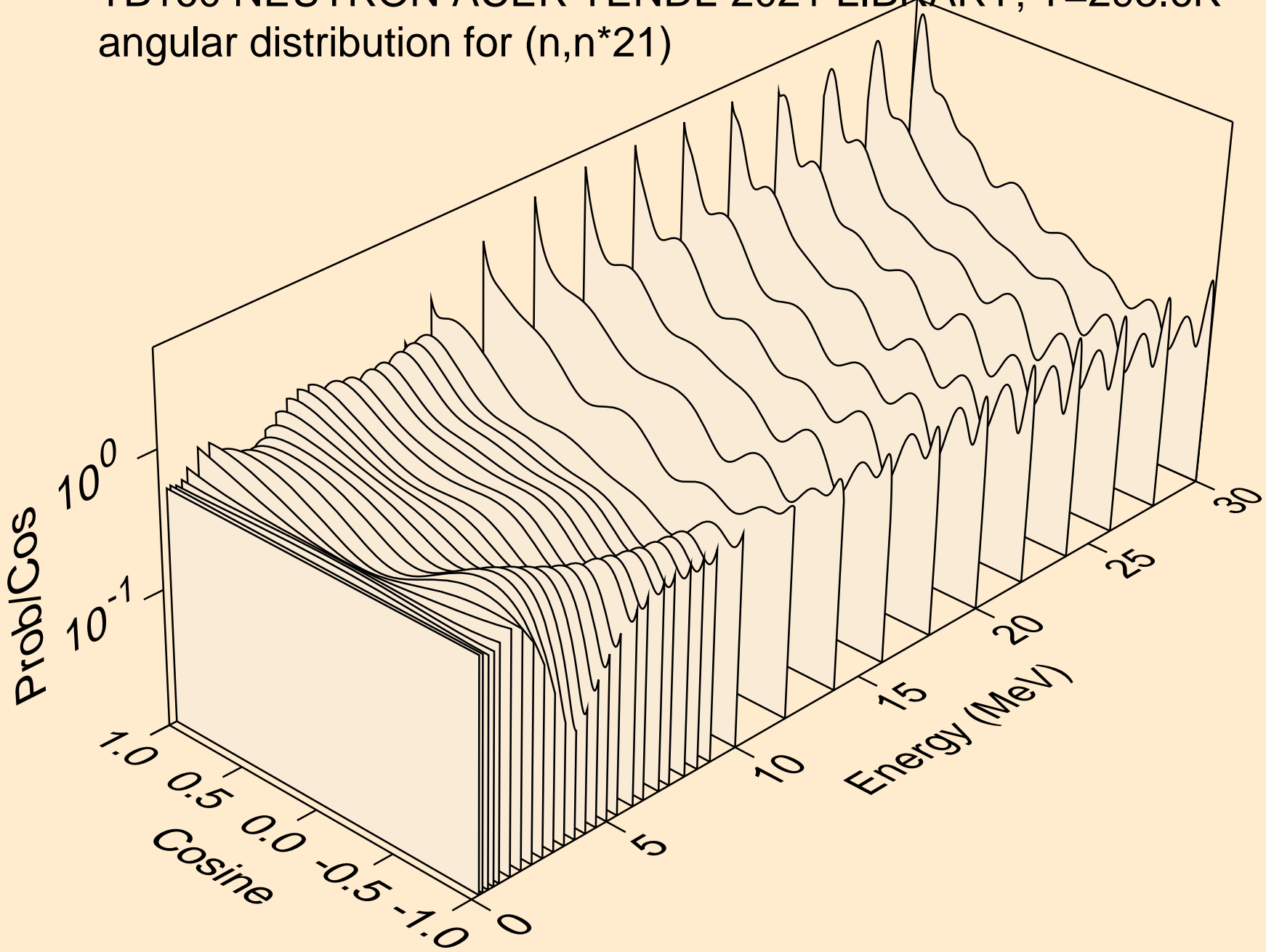

TB160 NEUTRON ACER TENDL-2021 LIBRARY; T=293.6K  
angular distribution for (n,n\*22)

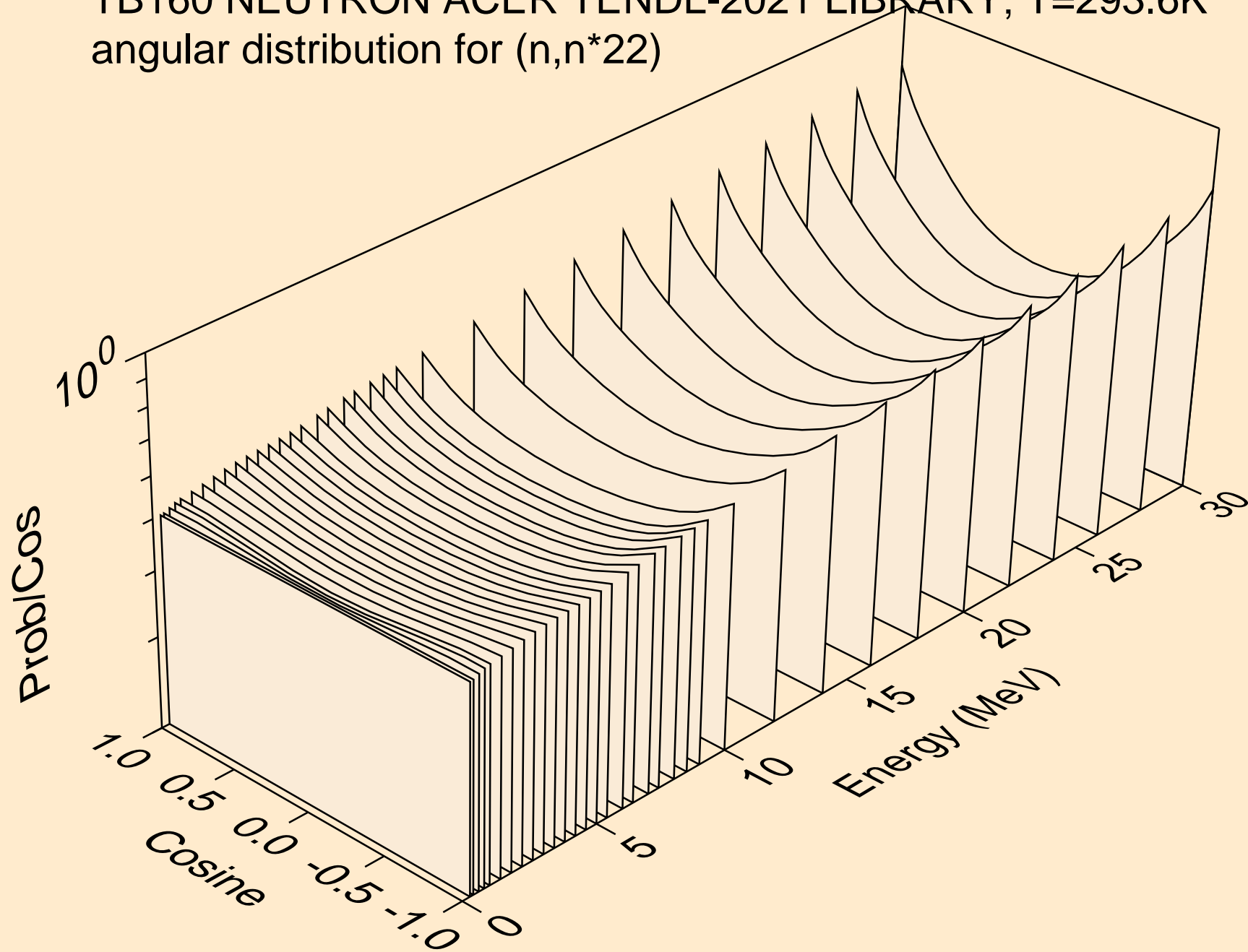

TB160 NEUTRON ACER TENDL-2021 LIBRARY; T=293.6K  
angular distribution for (n,n\*23)

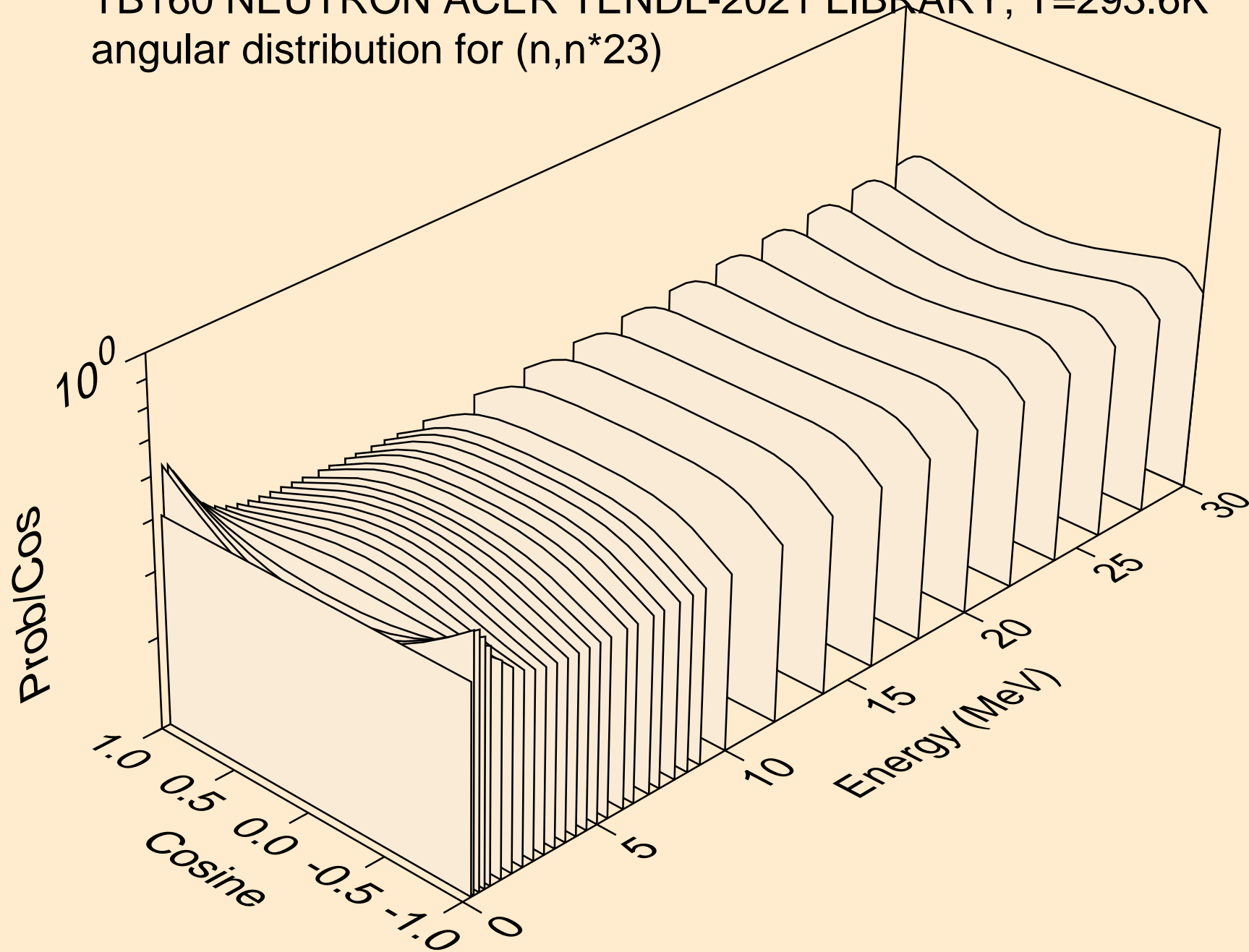

TB160 NEUTRON ACER TENDL-2021 LIBRARY; T=293.6K  
angular distribution for (n,n\*24)

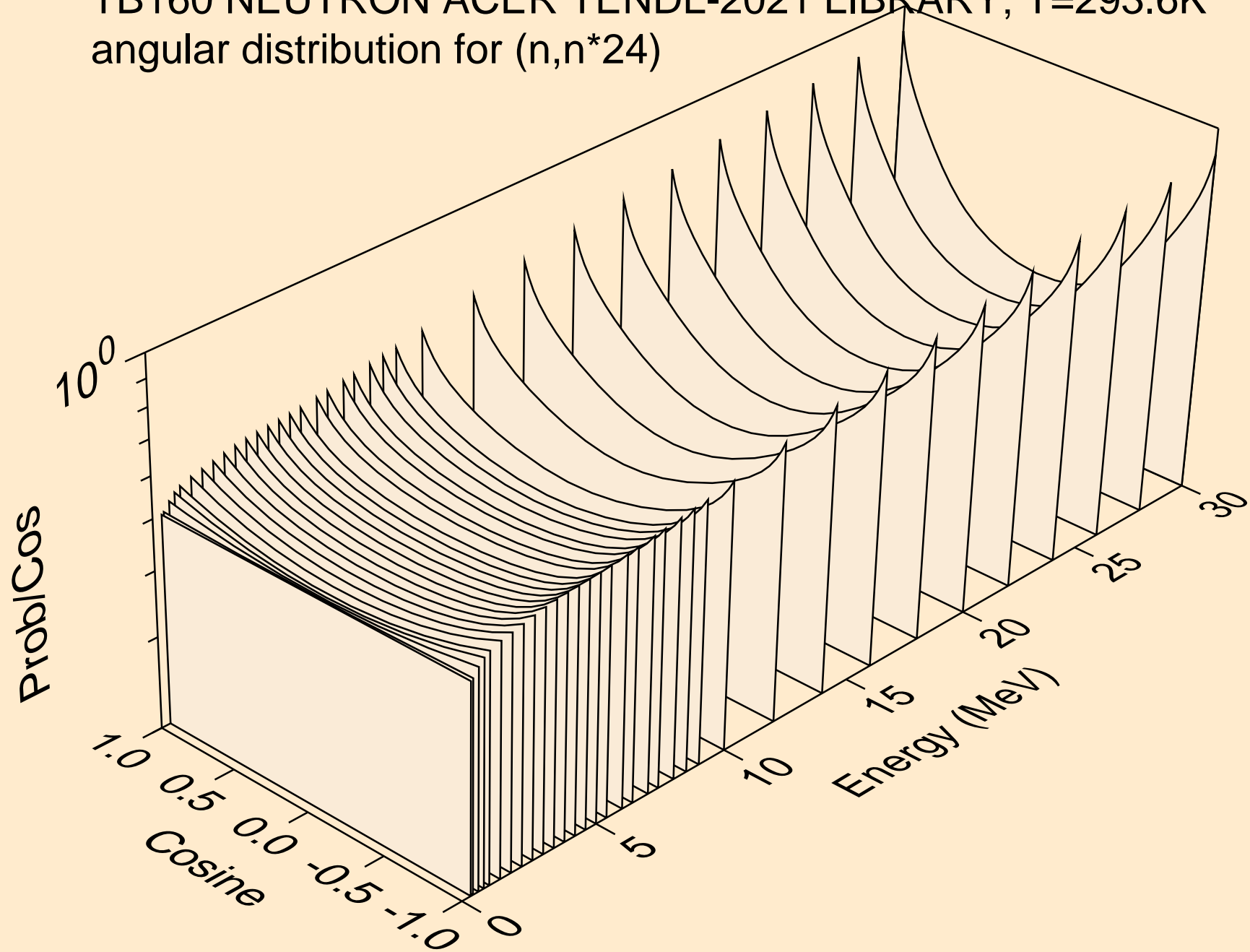

TB160 NEUTRON ACER TENDL-2021 LIBRARY; T=293.6K  
angular distribution for (n,n\*25)

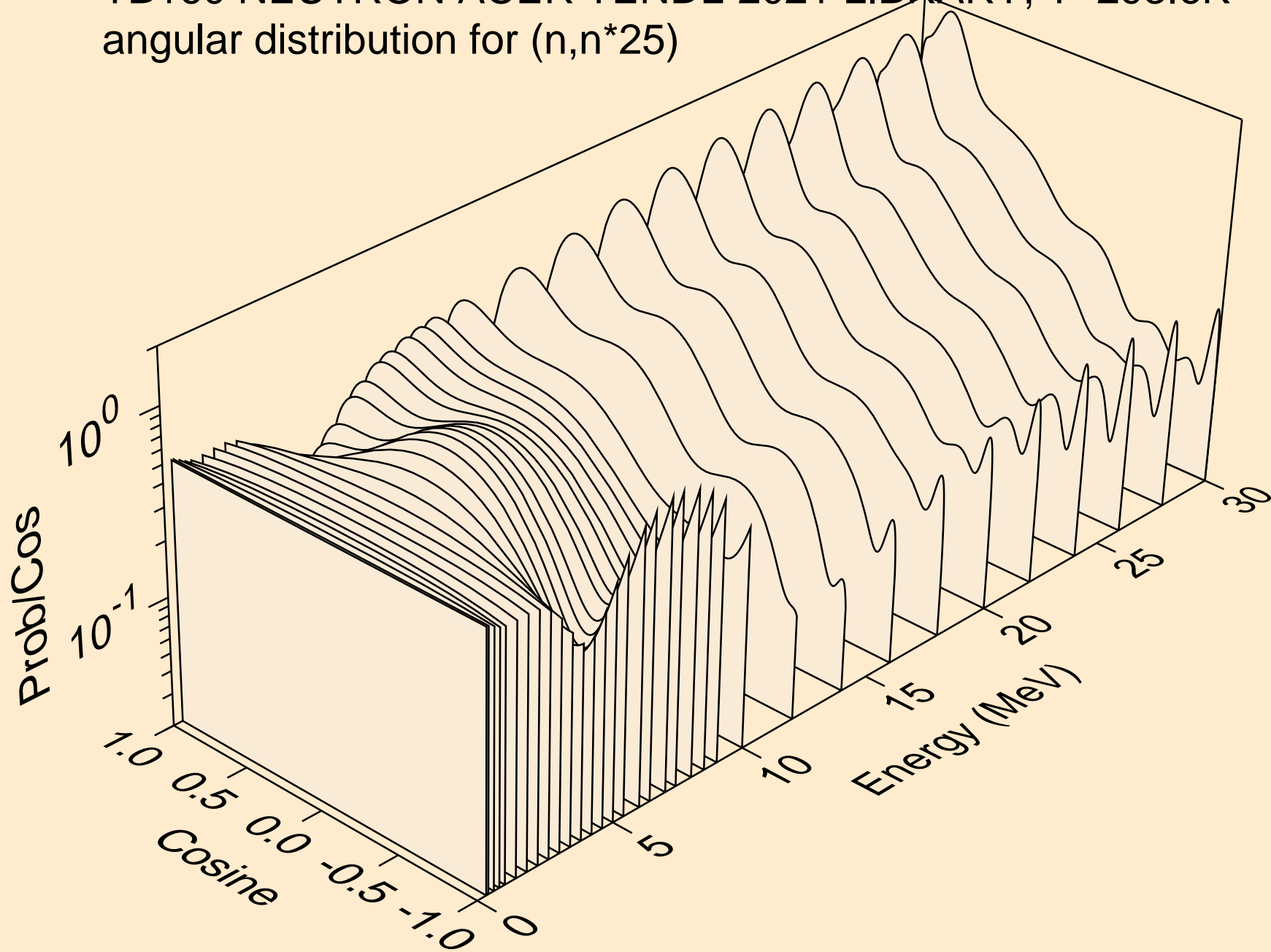

TB160 NEUTRON ACER TENDL-2021 LIBRARY; T=293.6K  
angular distribution for (n,n\*26)

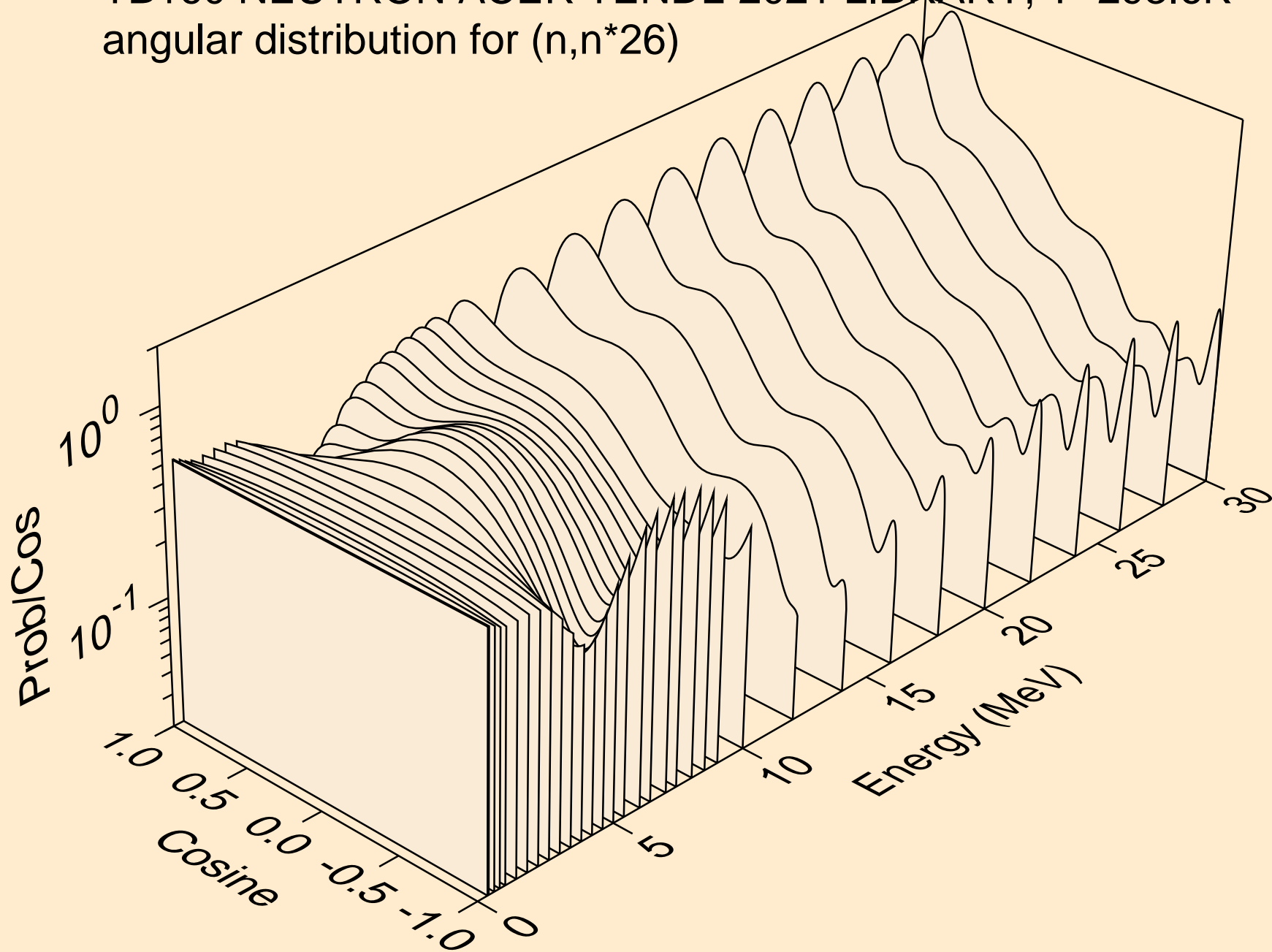



TB160 NEUTRON ACER TENDL-2021 LIBRARY; T=293.6K  
angular distribution for (n,n\*27)

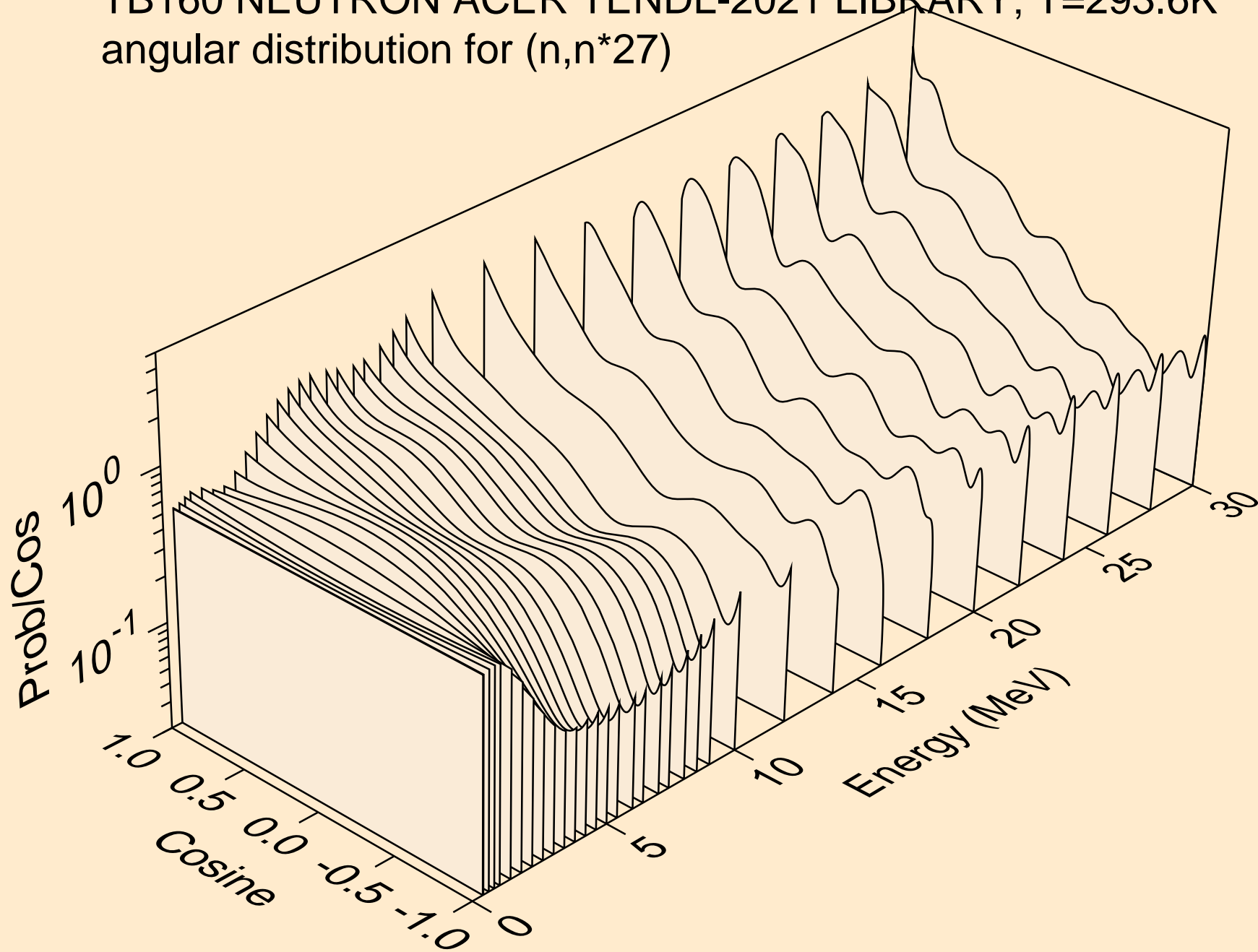



TB160 NEUTRON ACER TENDL-2021 LIBRARY; T=293.6K  
angular distribution for (n,n\*28)

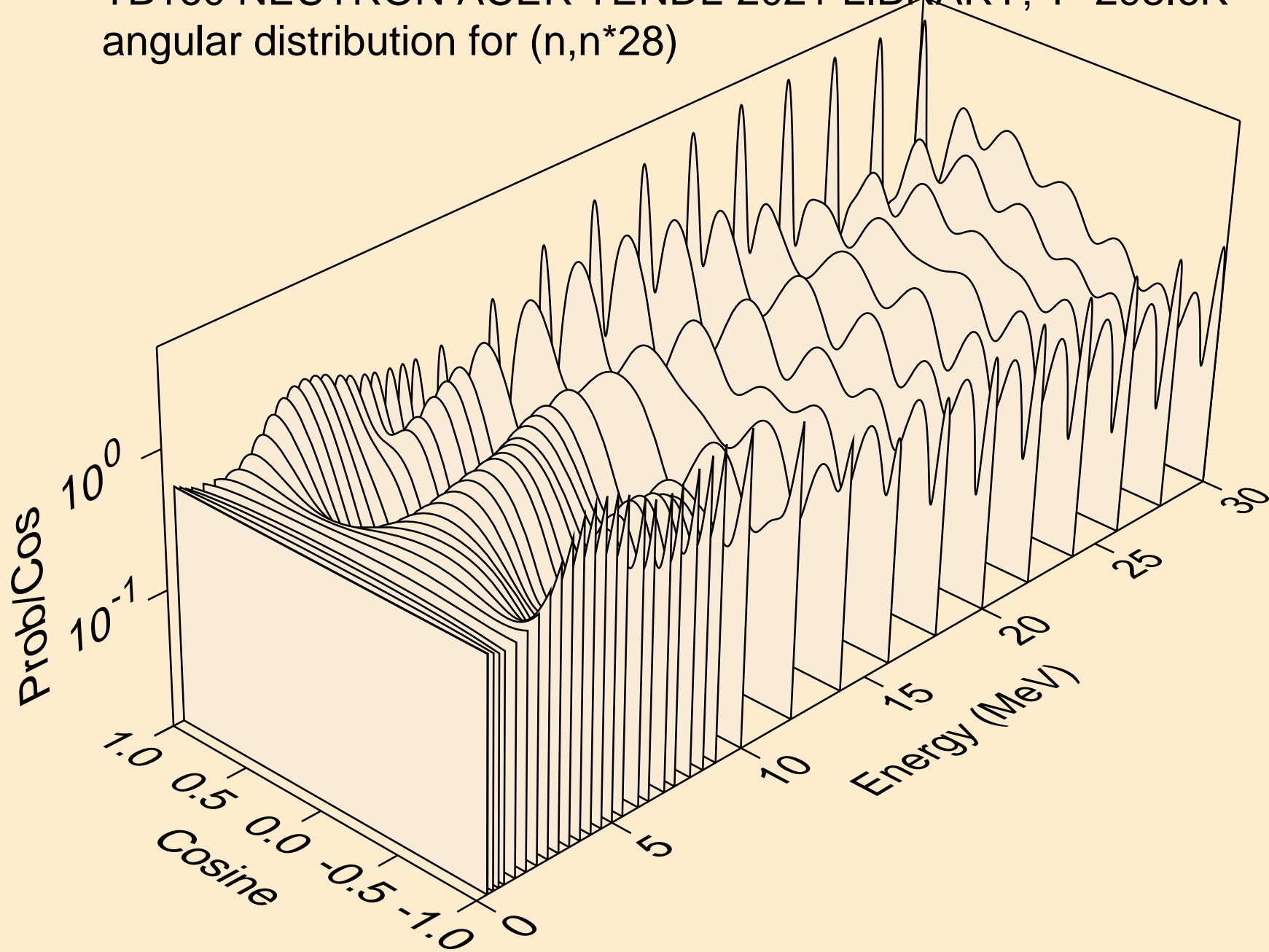

TB160 NEUTRON ACER TENDL-2021 LIBRARY; T=293.6K  
angular distribution for (n,n\*29)

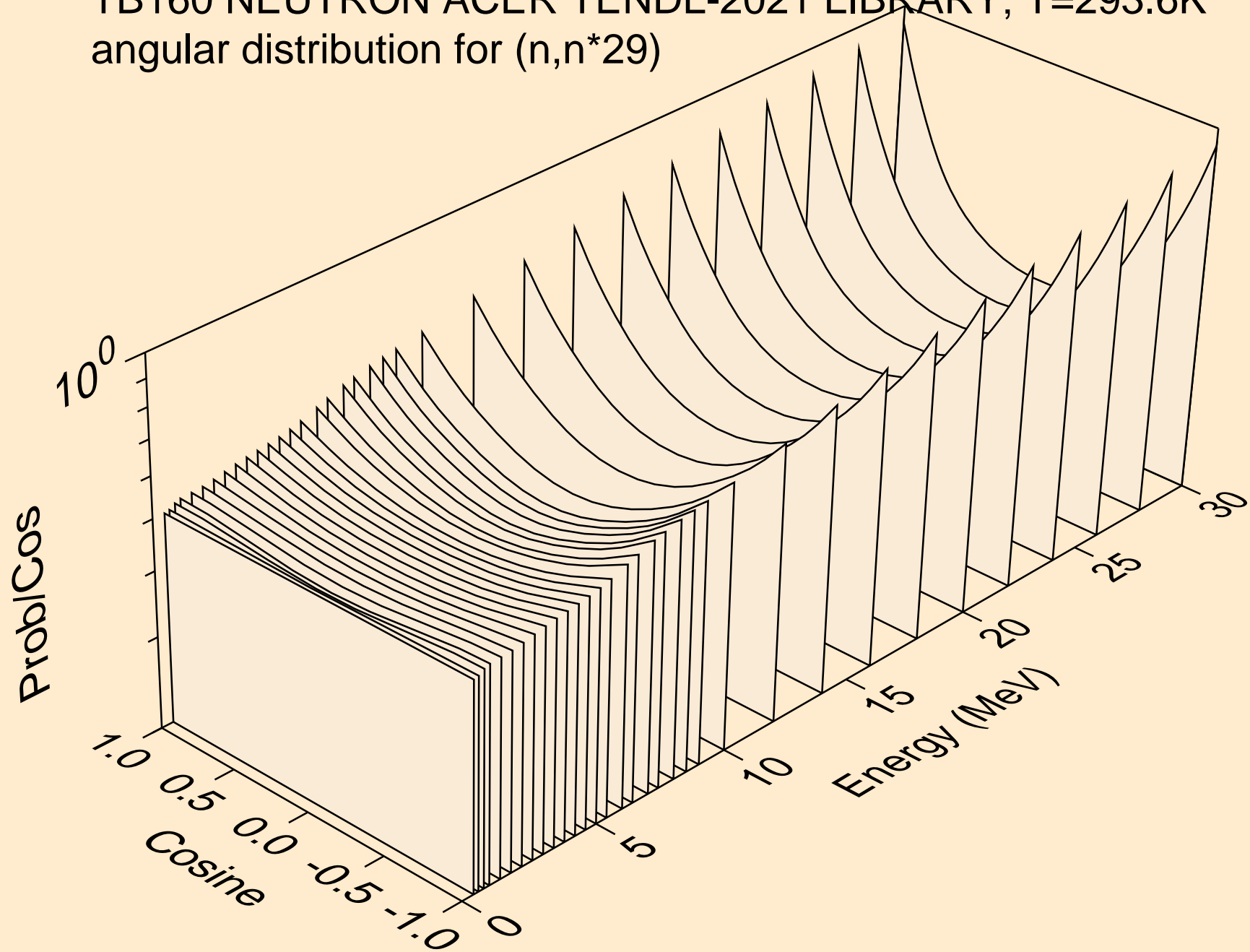

TB160 NEUTRON ACER TENDL-2021 LIBRARY; T=293.6K  
Neutron emission for (n,x)

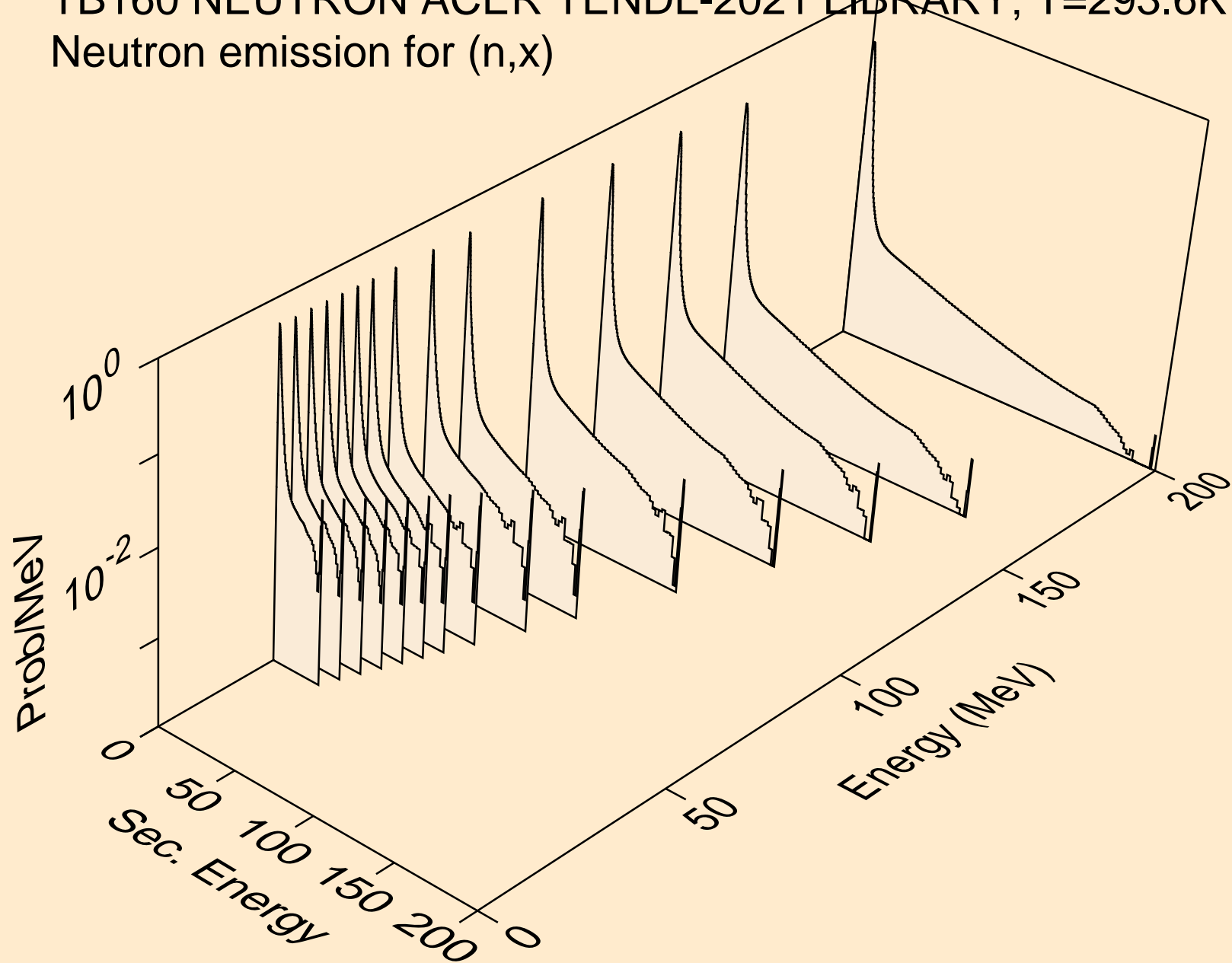

TB160 NEUTRON ACER TENDL-2021 LIBRARY; T=293.6K  
Neutron emission for (n,2nd)

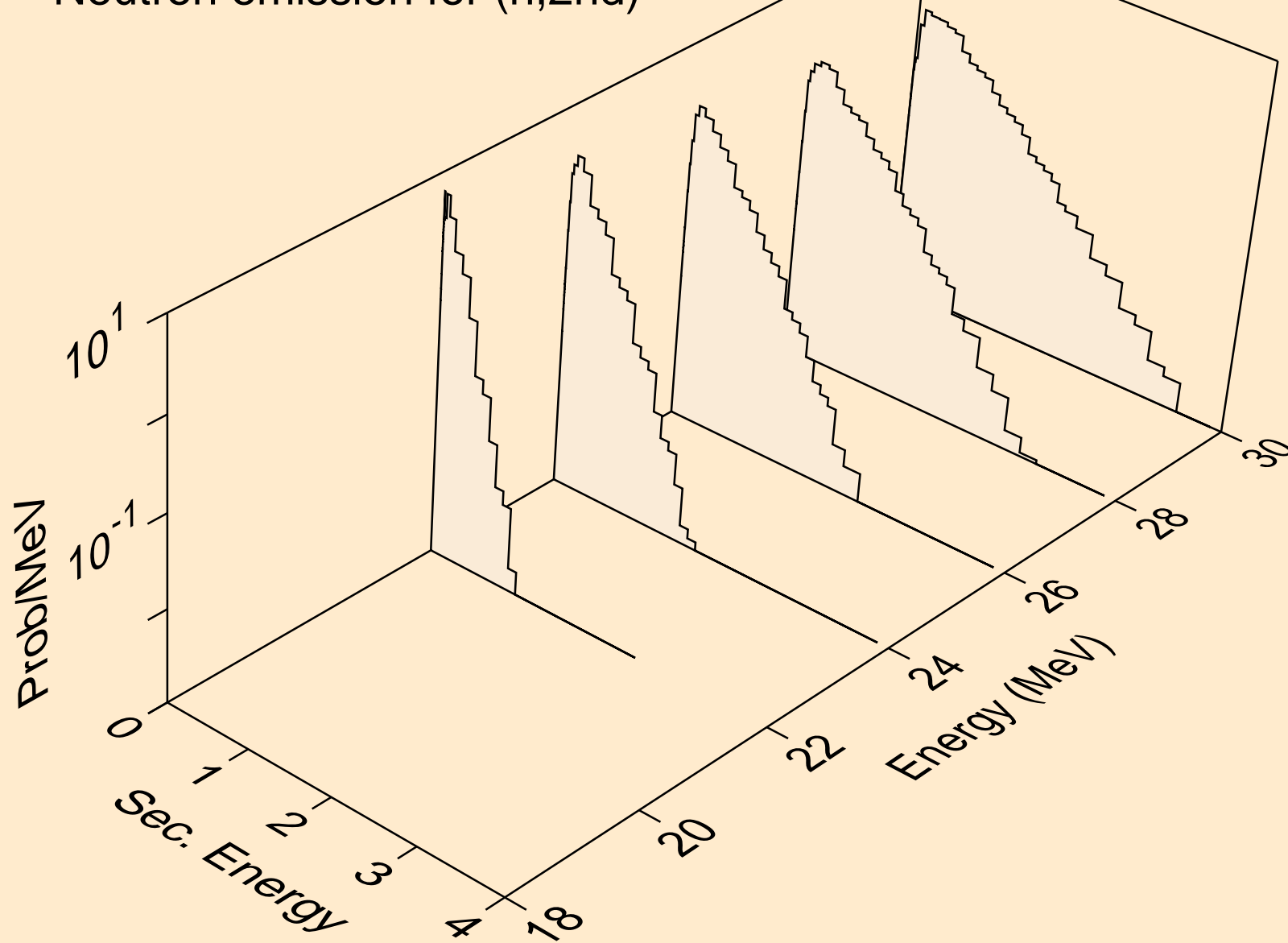

TB160 NEUTRON ACER TENDL-2021 LIBRARY; T=293.6K  
Neutron emission for (n,2n)

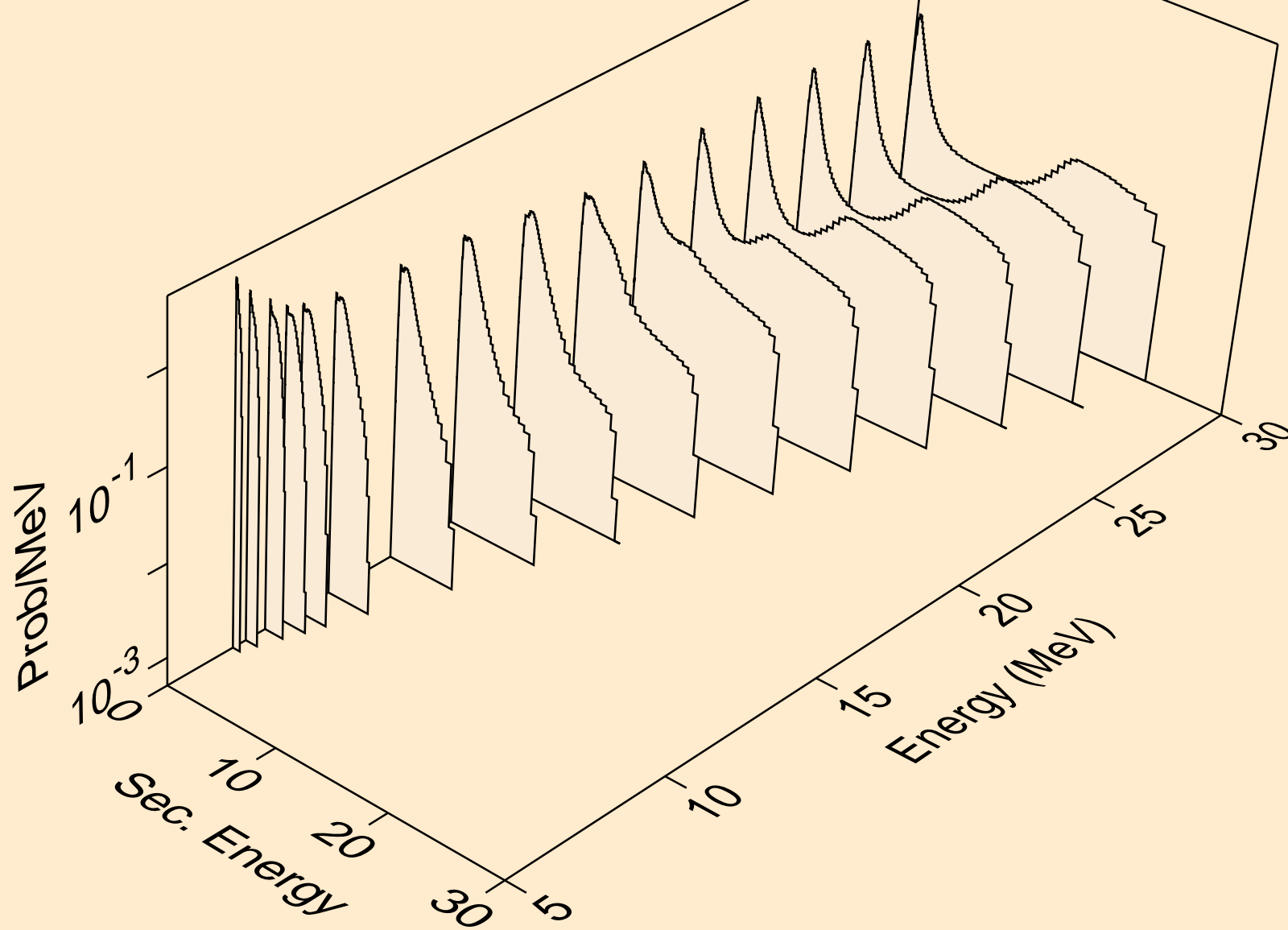

TB160 NEUTRON ACER TENDL-2021 LIBRARY; T=293.6K  
Neutron emission for (n,3n)

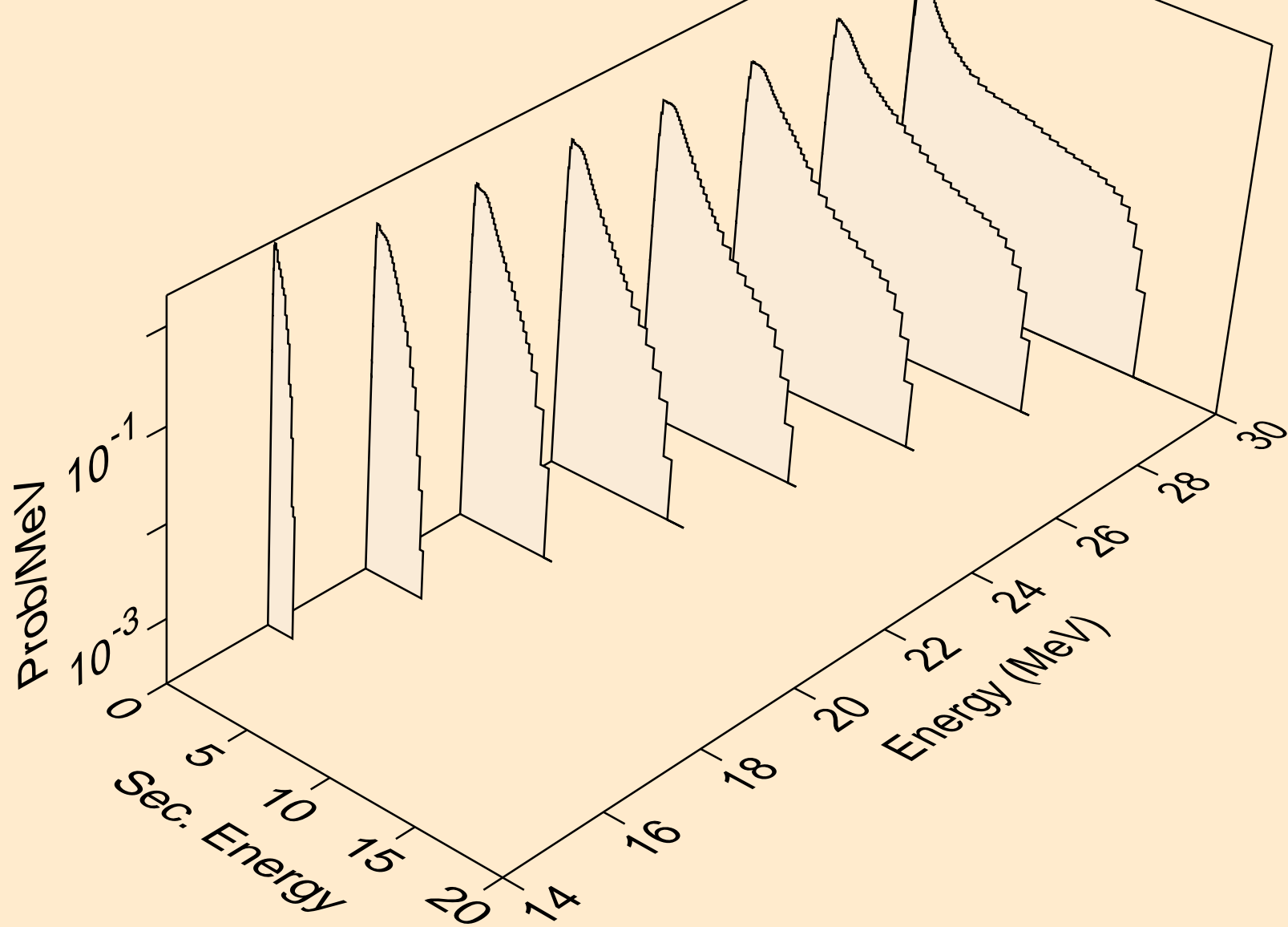

TB160 NEUTRON ACER TENDL-2021 LIBRARY; T=293.6K  
Neutron emission for (n,n\*)a

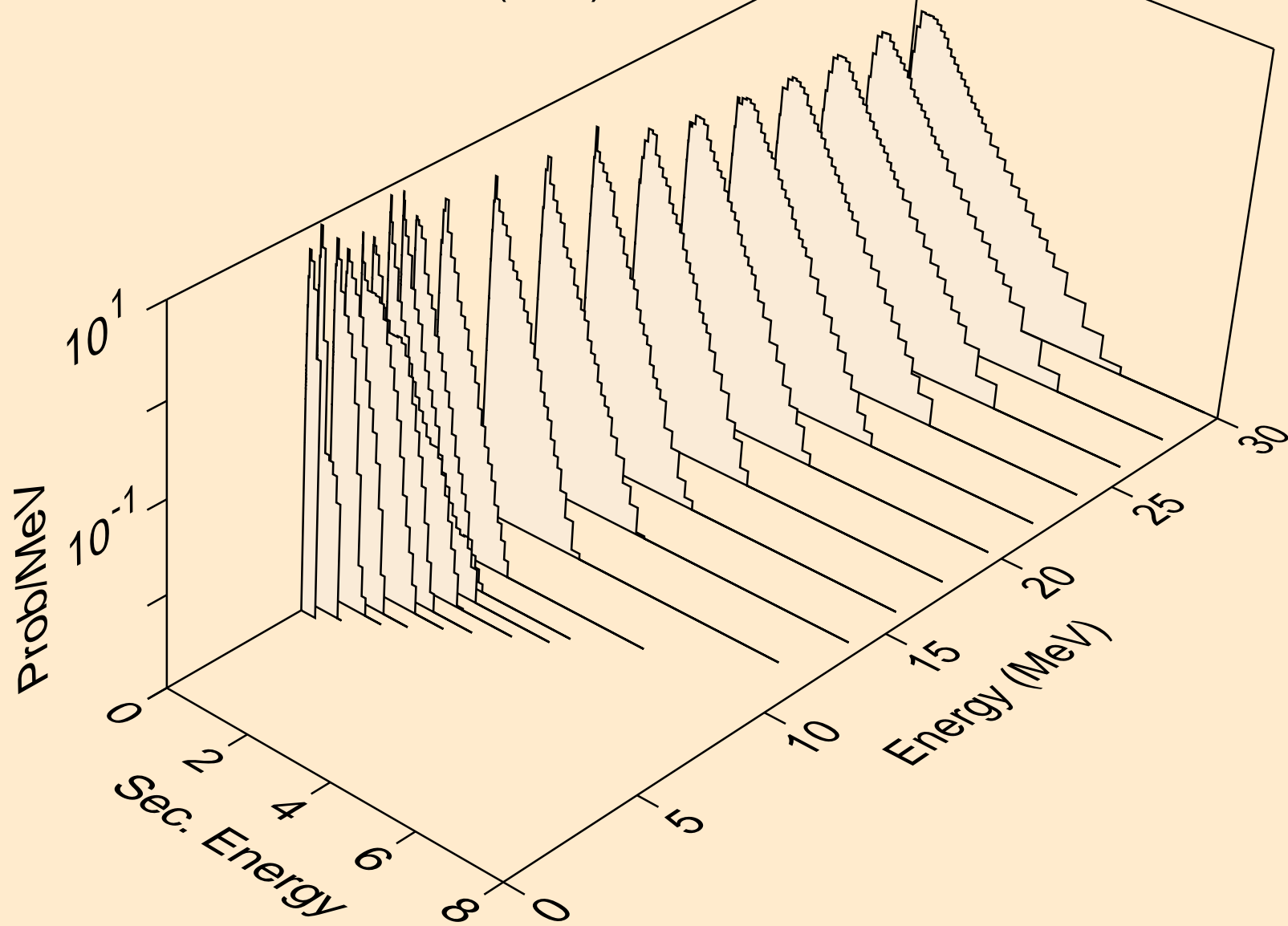

TB160 NEUTRON ACER TENDL-2021 LIBRARY; T=293.6K  
Neutron emission for (n,2n)<sub>a</sub>

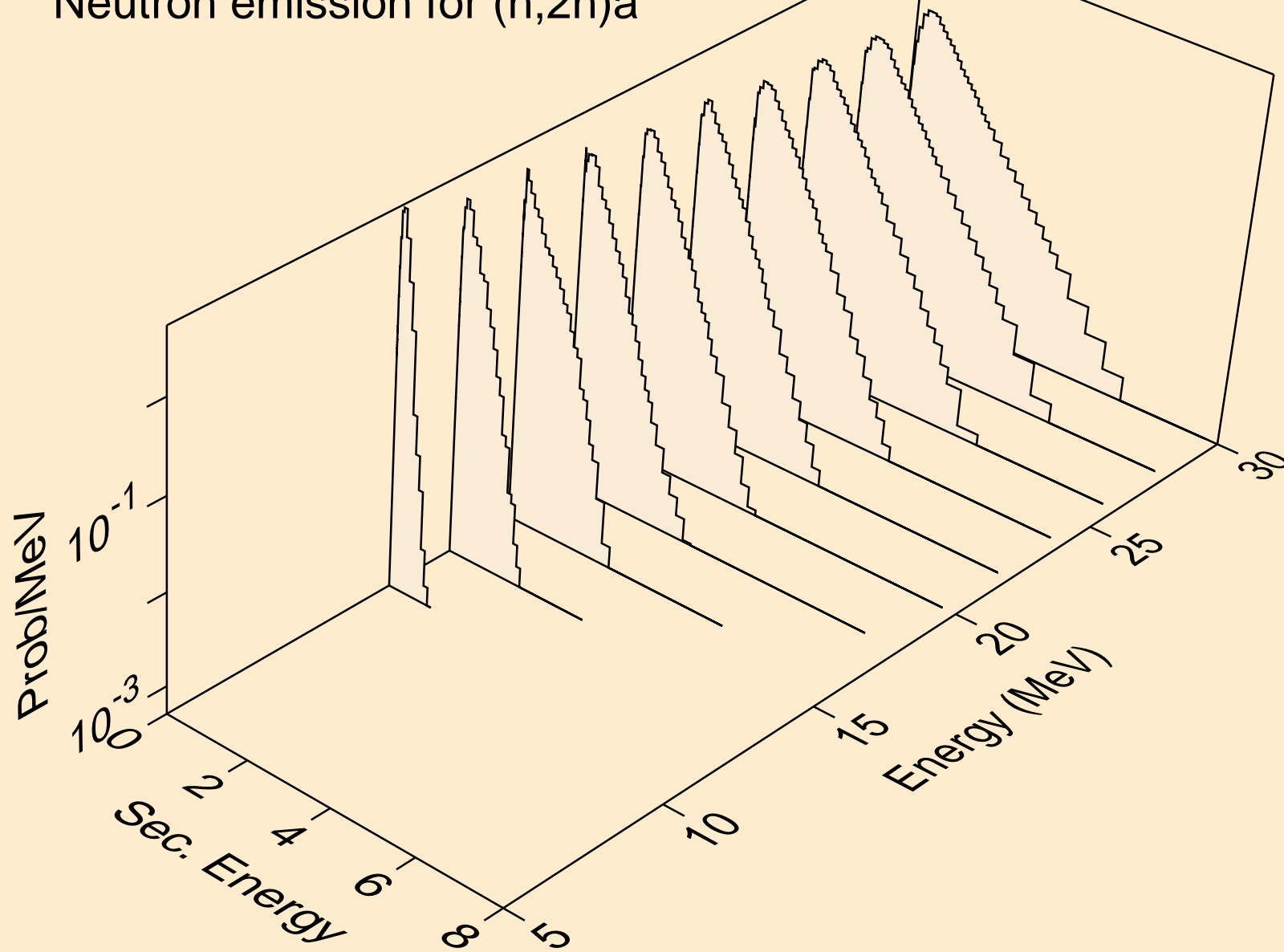



TB160 NEUTRON ACER TENDL-2021 LIBRARY; T=293.6K  
Neutron emission for (n,3n)a

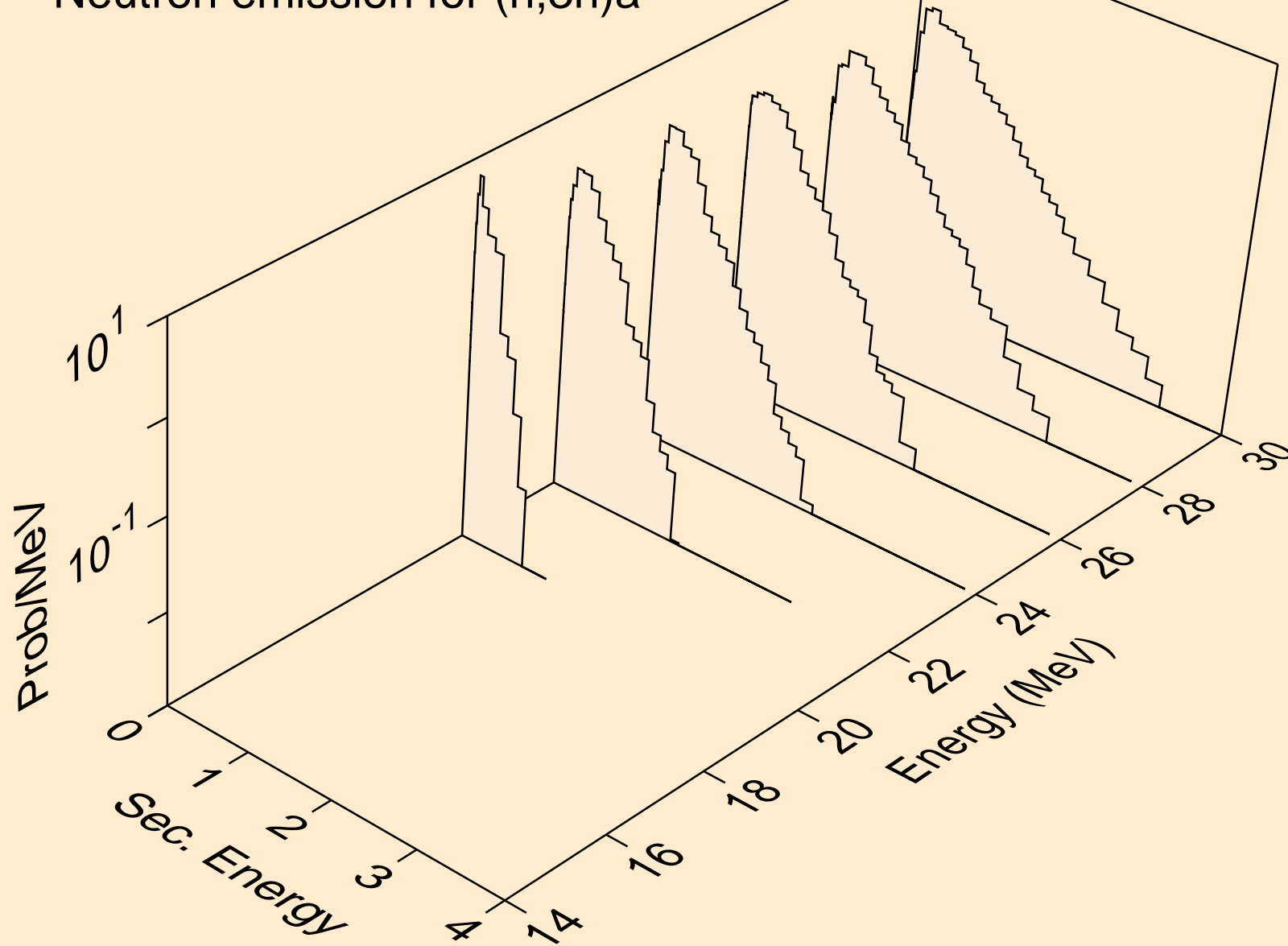

TB160 NEUTRON ACER TENDL-2021 LIBRARY; T=293.6K  
Neutron emission for (n,n\*)p

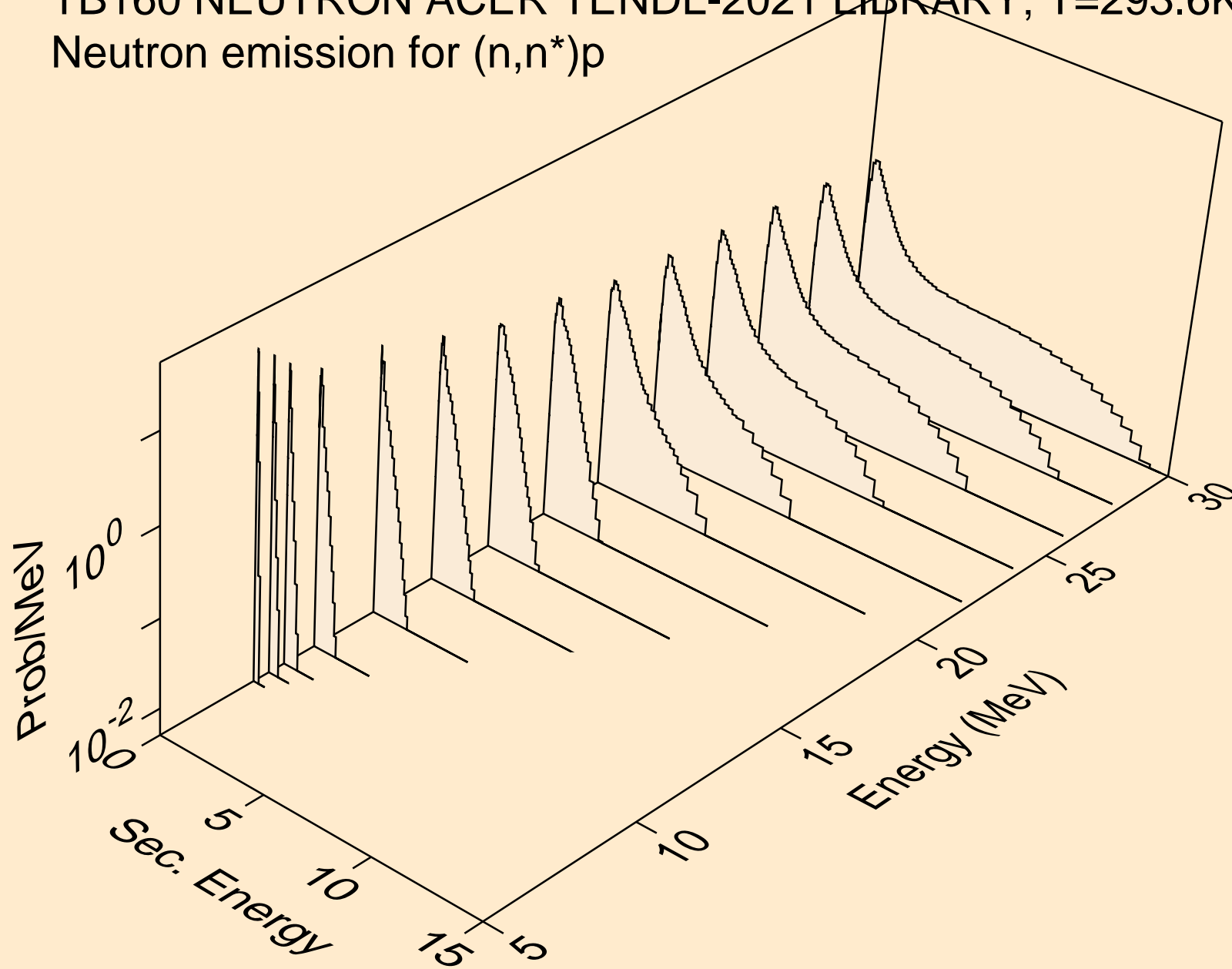

TB160 NEUTRON ACER TENDL-2021 LIBRARY; T=293.6K  
Neutron emission for (n,n\*)2a

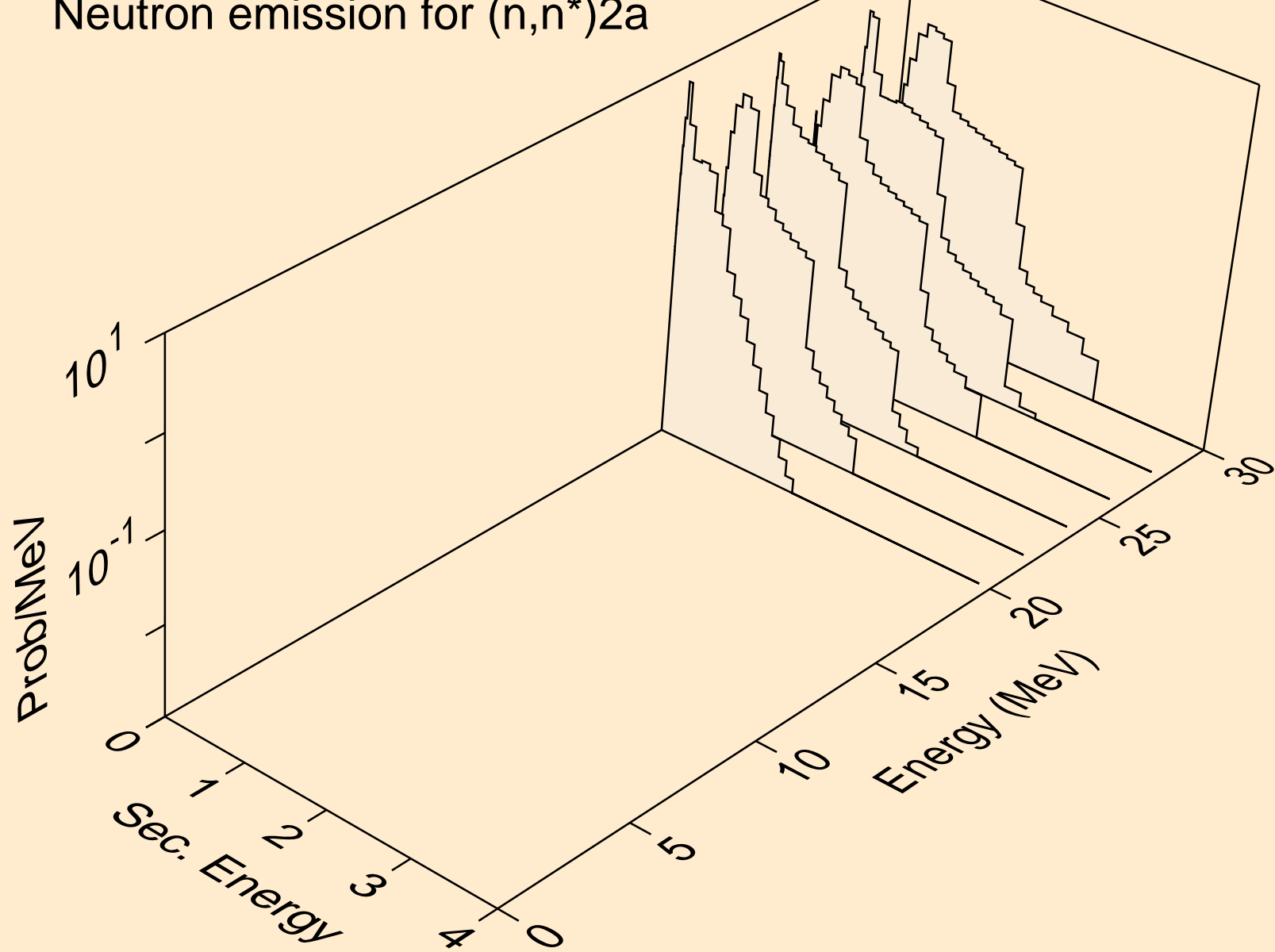

TB160 NEUTRON ACER TENDL-2021 LIBRARY; T=293.6K  
Neutron emission for (n,n\*)d

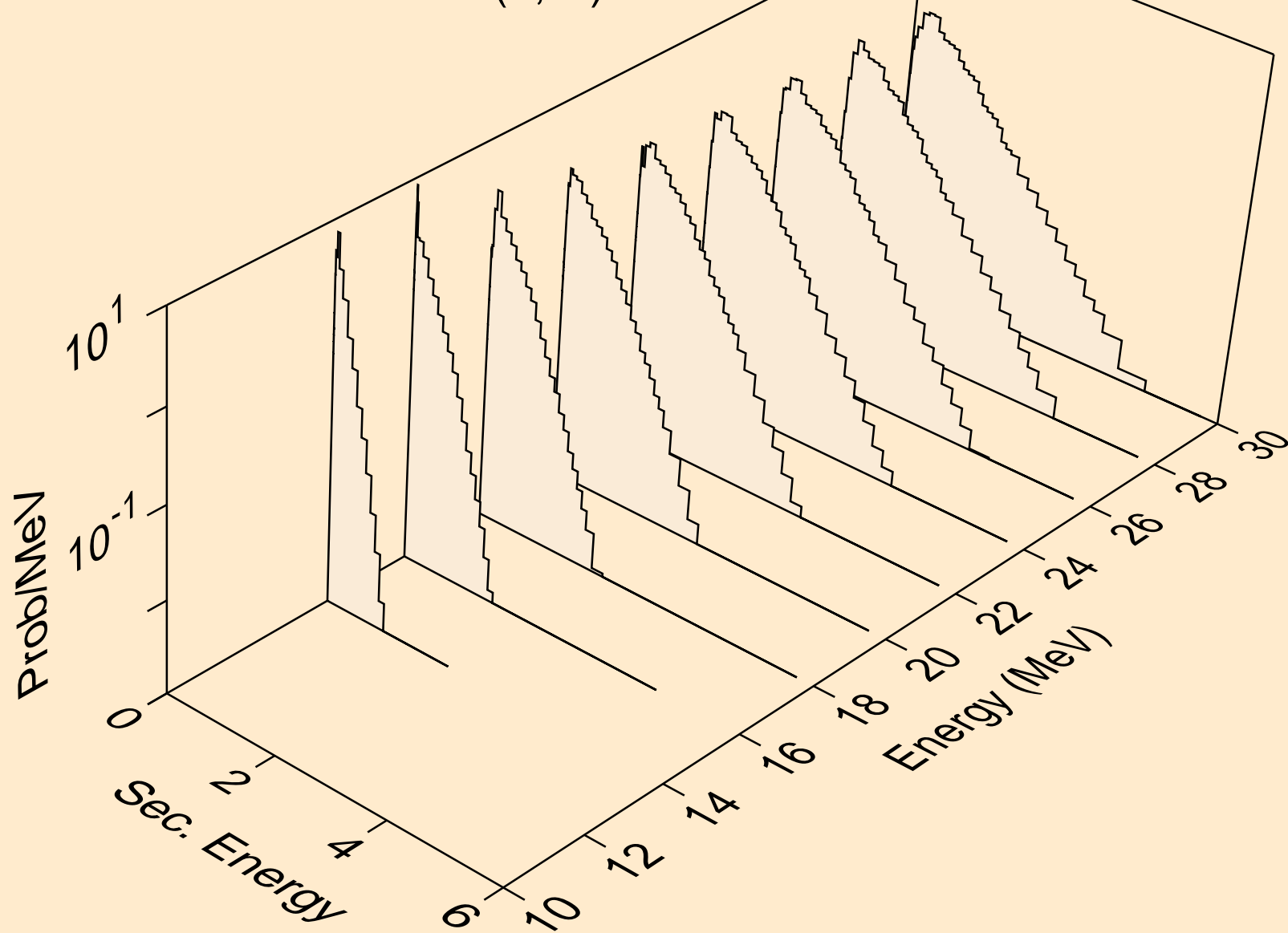

TB160 NEUTRON ACER TENDL-2021 LIBRARY; T=293.6K  
Neutron emission for (n,n\*)t

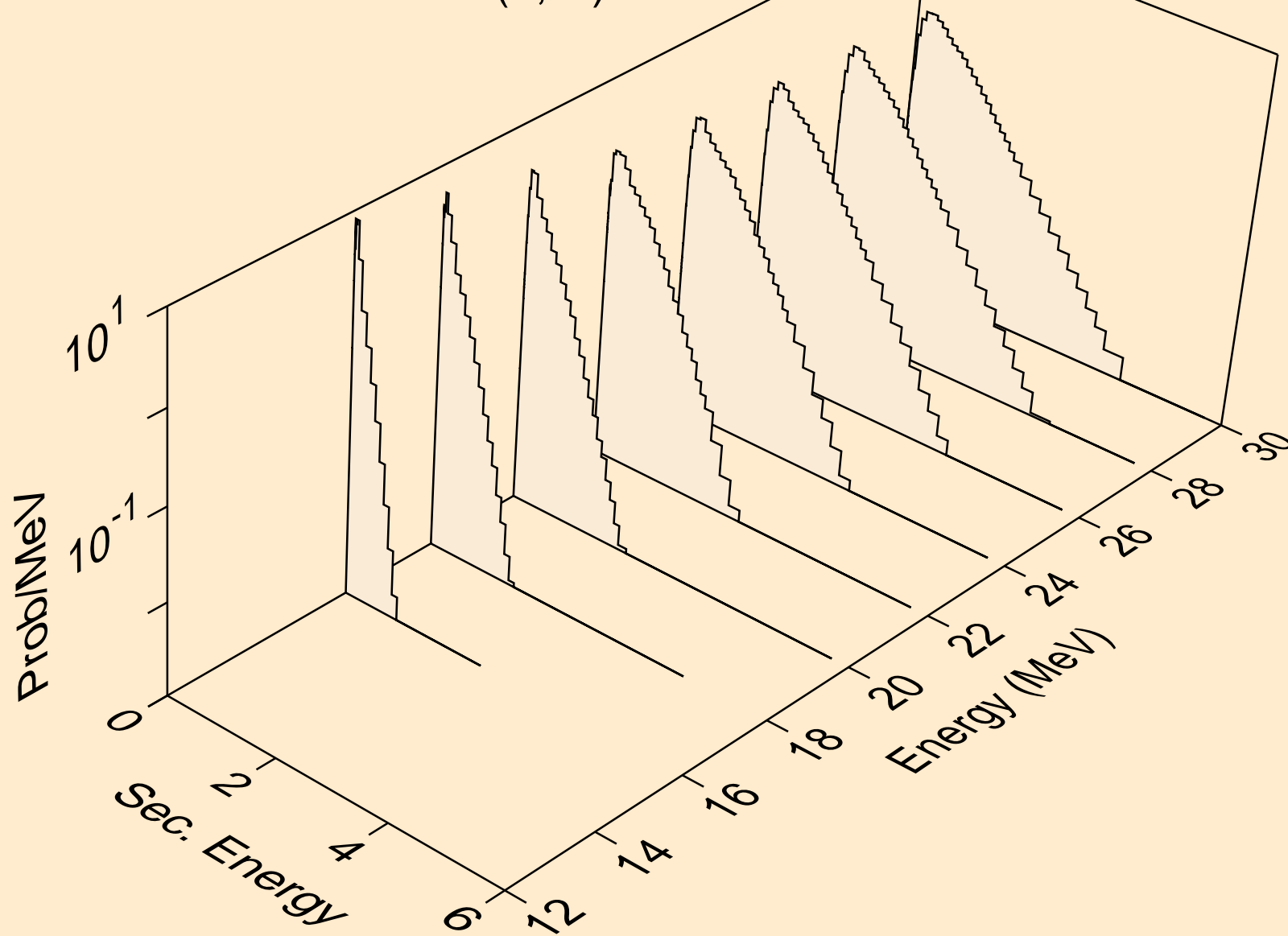

TB160 NEUTRON ACER TENDL-2021 LIBRARY; T=293.6K  
Neutron emission for (n,n\*)he3

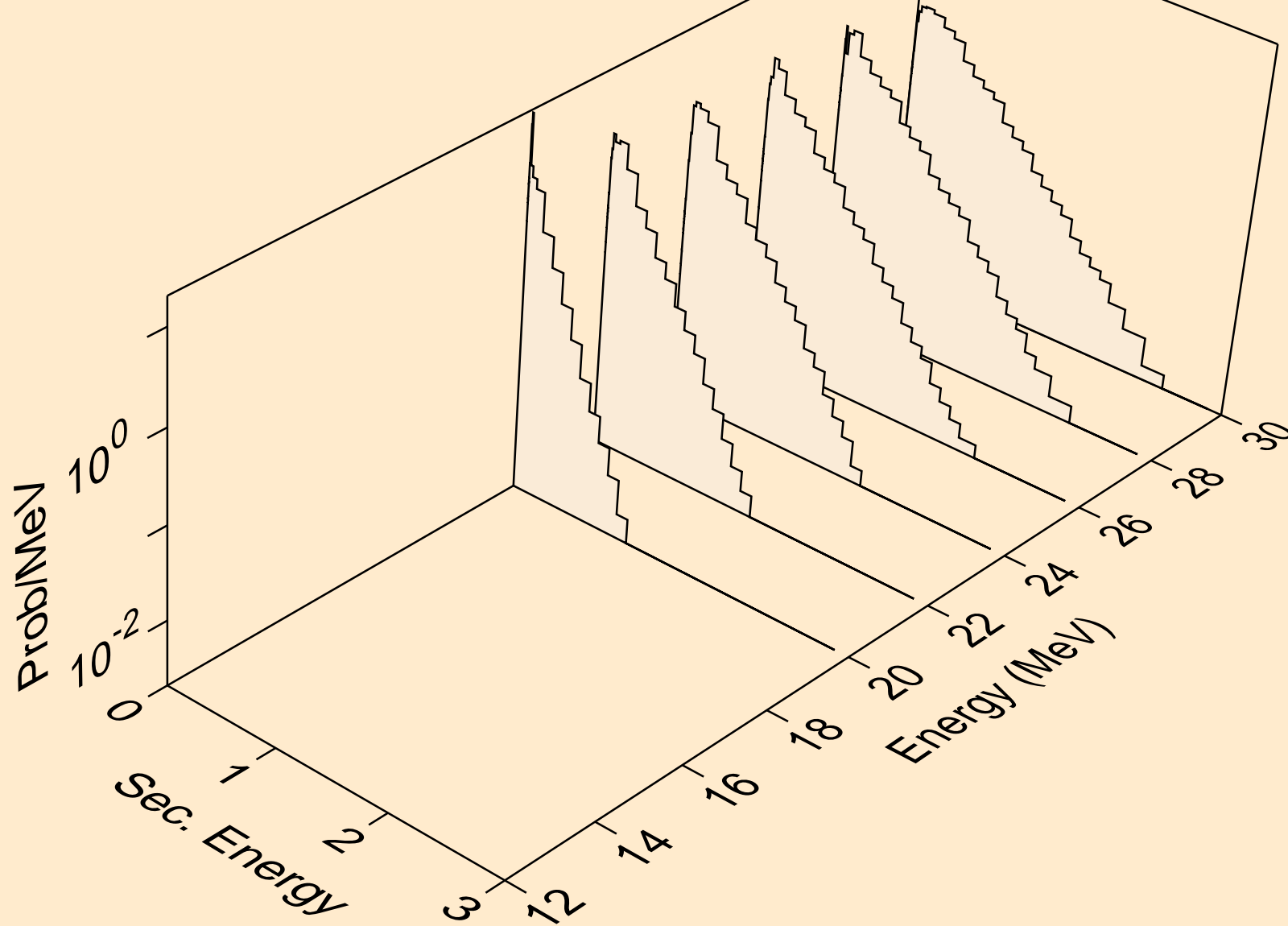

TB160 NEUTRON ACER TENDL-2021 LIBRARY; T=293.6K  
Neutron emission for (n,4n)

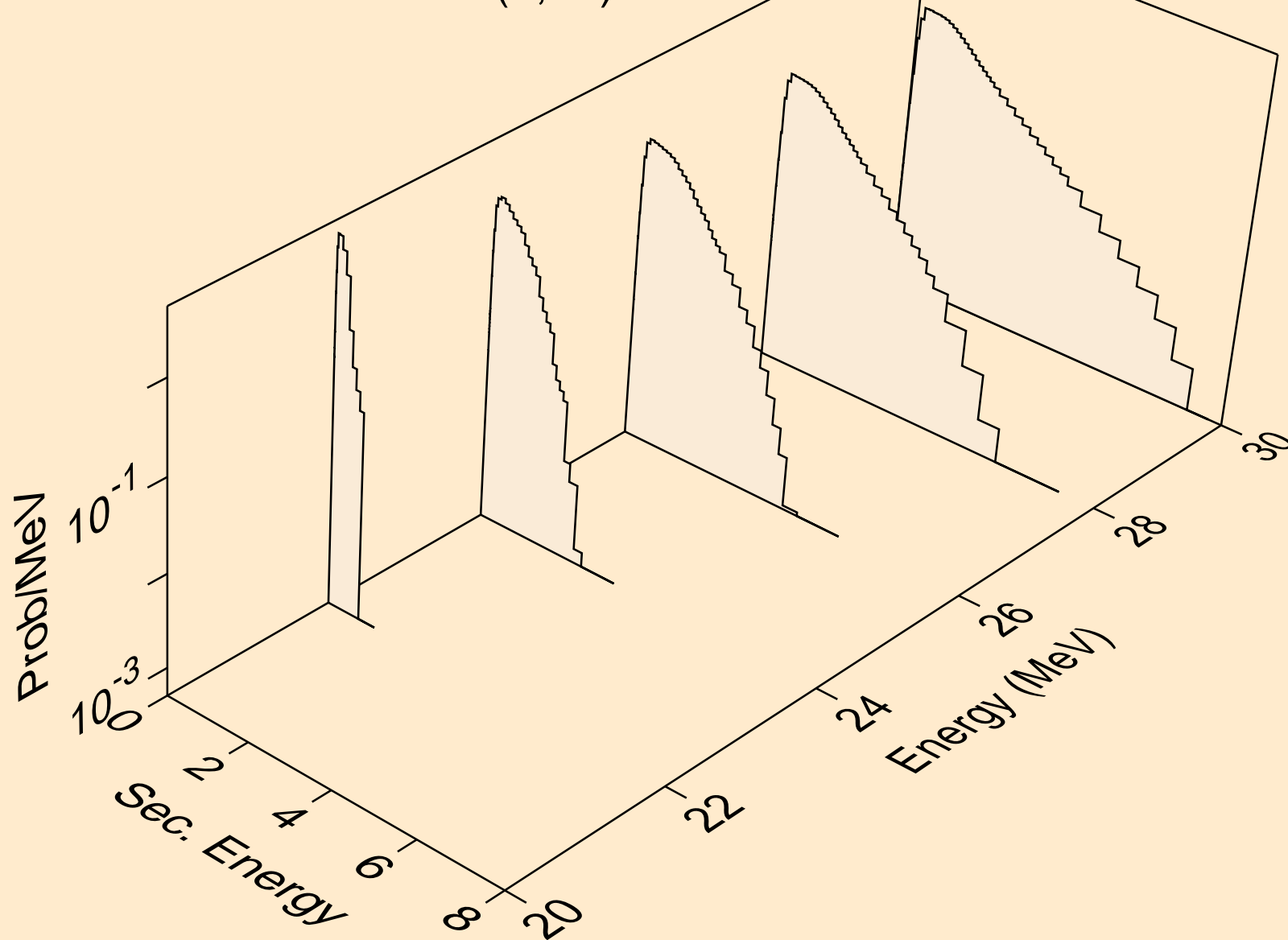

TB160 NEUTRON ACER TENDL-2021 LIBRARY; T=293.6K  
Neutron emission for (n,2np)

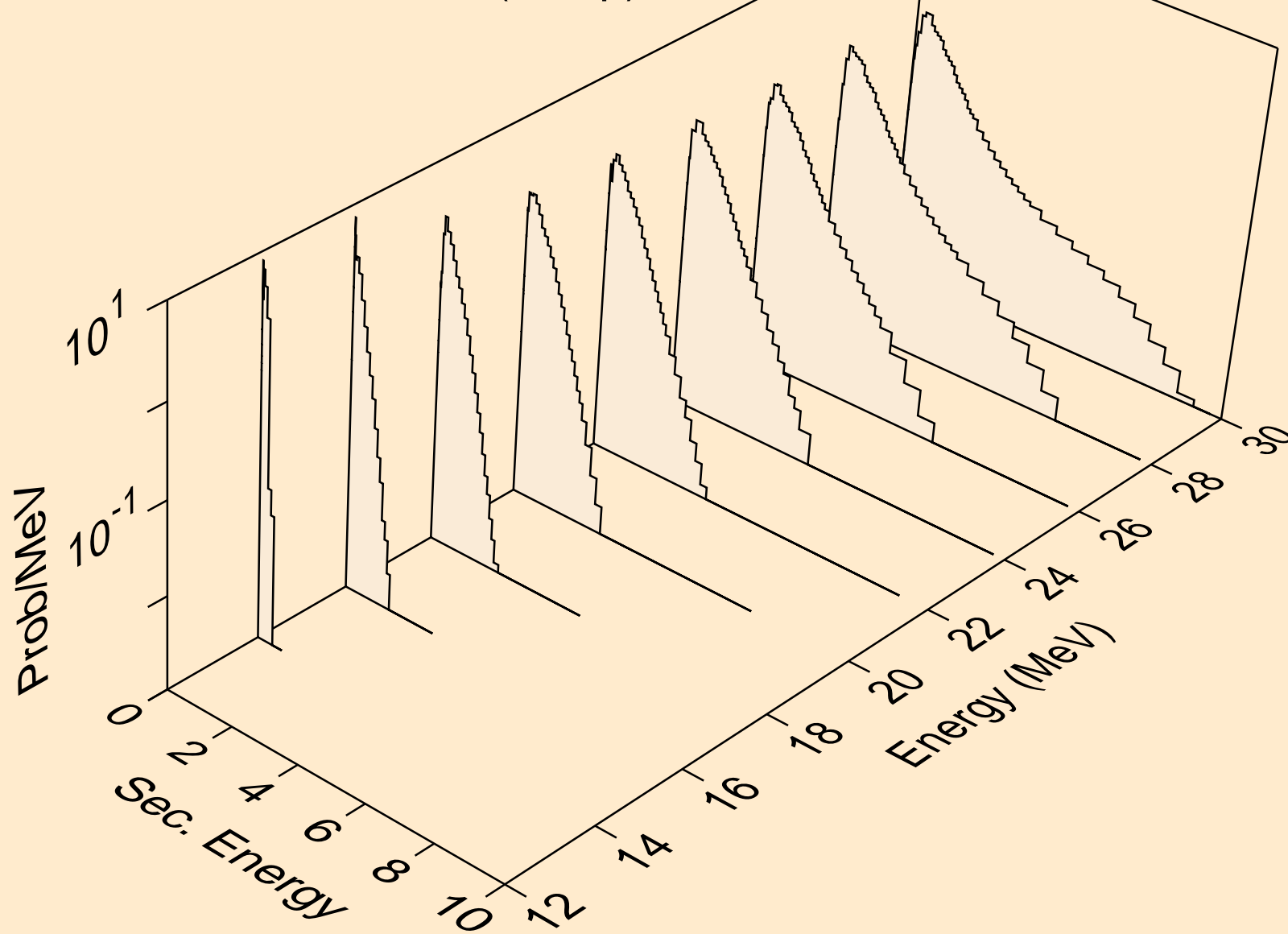



TB160 NEUTRON ACER TENDL-2021 LIBRARY; T=293.6K  
Neutron emission for (n,3np)

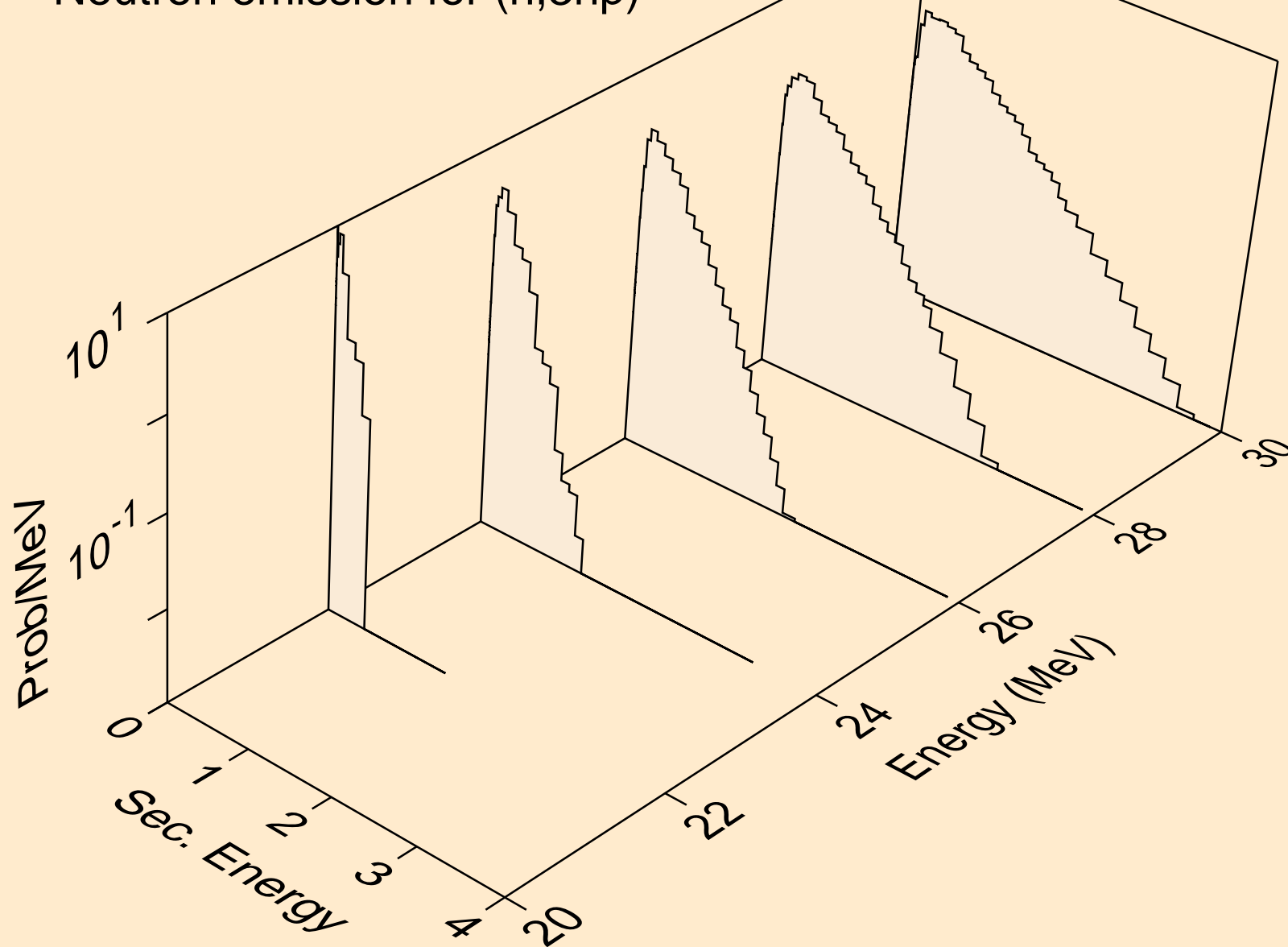

TB160 NEUTRON ACER TENDL-2021 LIBRARY; T=293.6K  
Neutron emission for (n,2np)

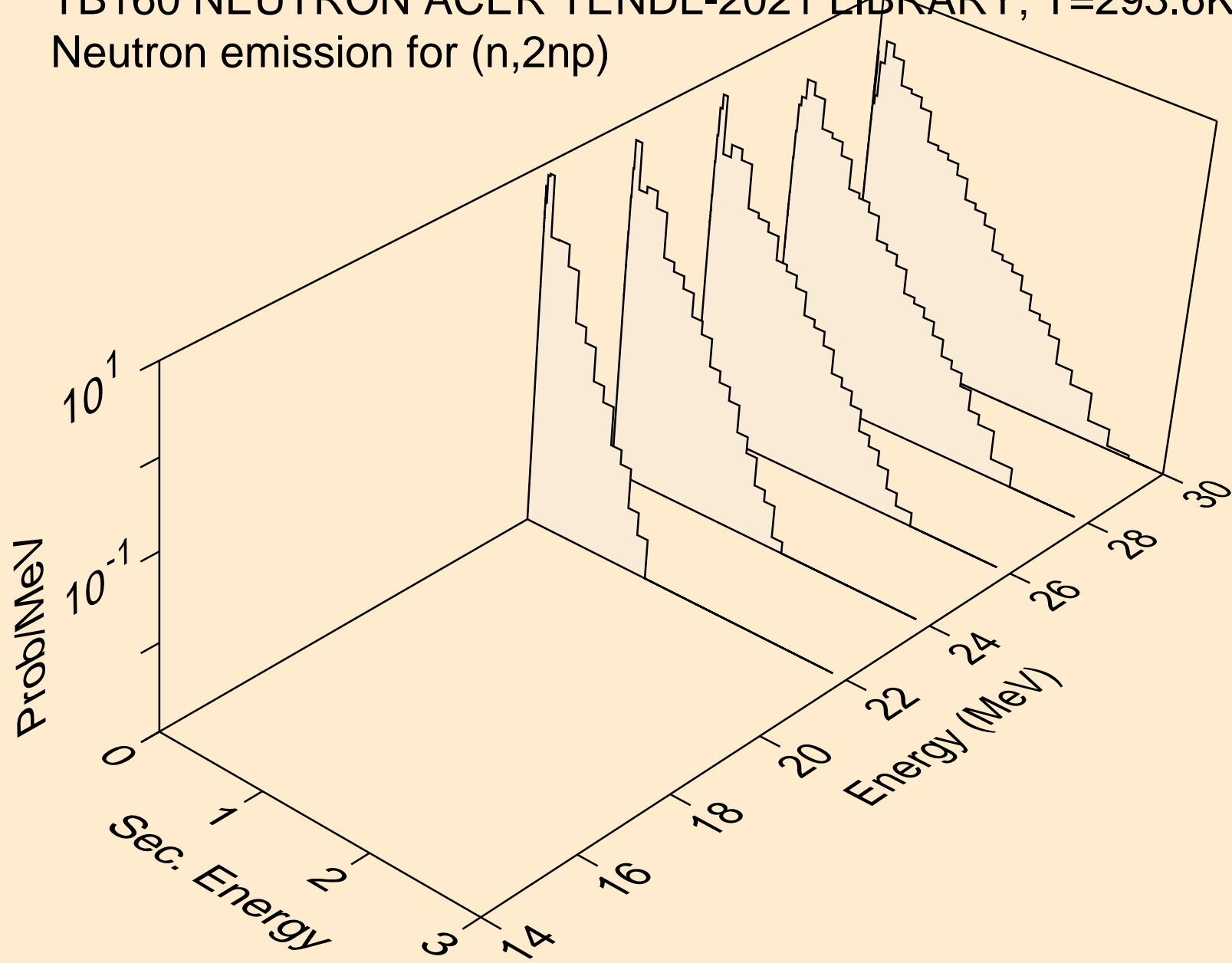

TB160 NEUTRON ACER TENDL-2021 LIBRARY; T=293.6K  
Neutron emission for (n,npa)

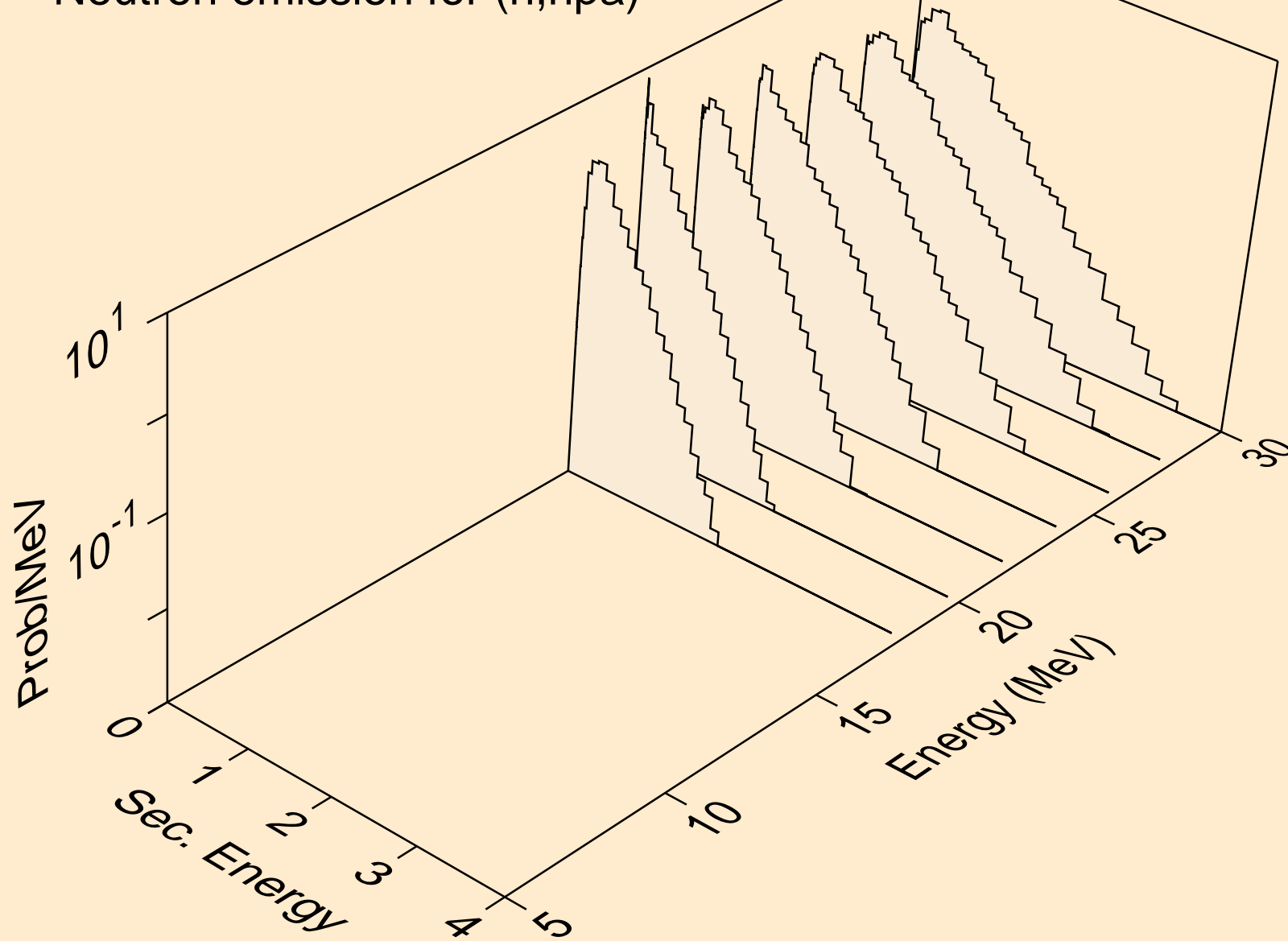

TB160 NEUTRON ACER TENDL-2021 LIBRARY; T=293.6K  
Neutron emission for (n,n\*c)

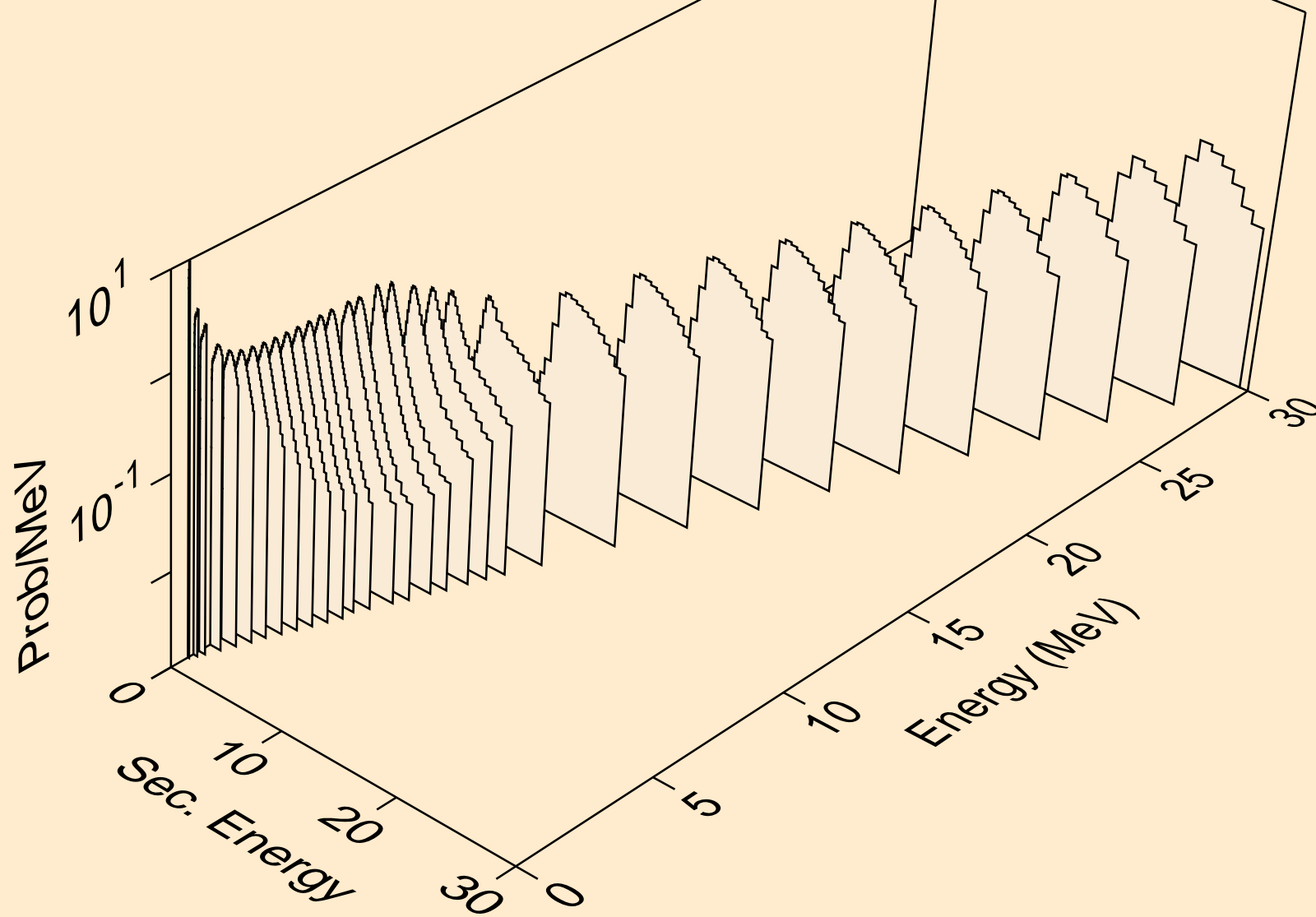

TB160 NEUTRON ACER TENDL-2021 LIBRARY; T=293.6K  
Photon emission for (n,x)

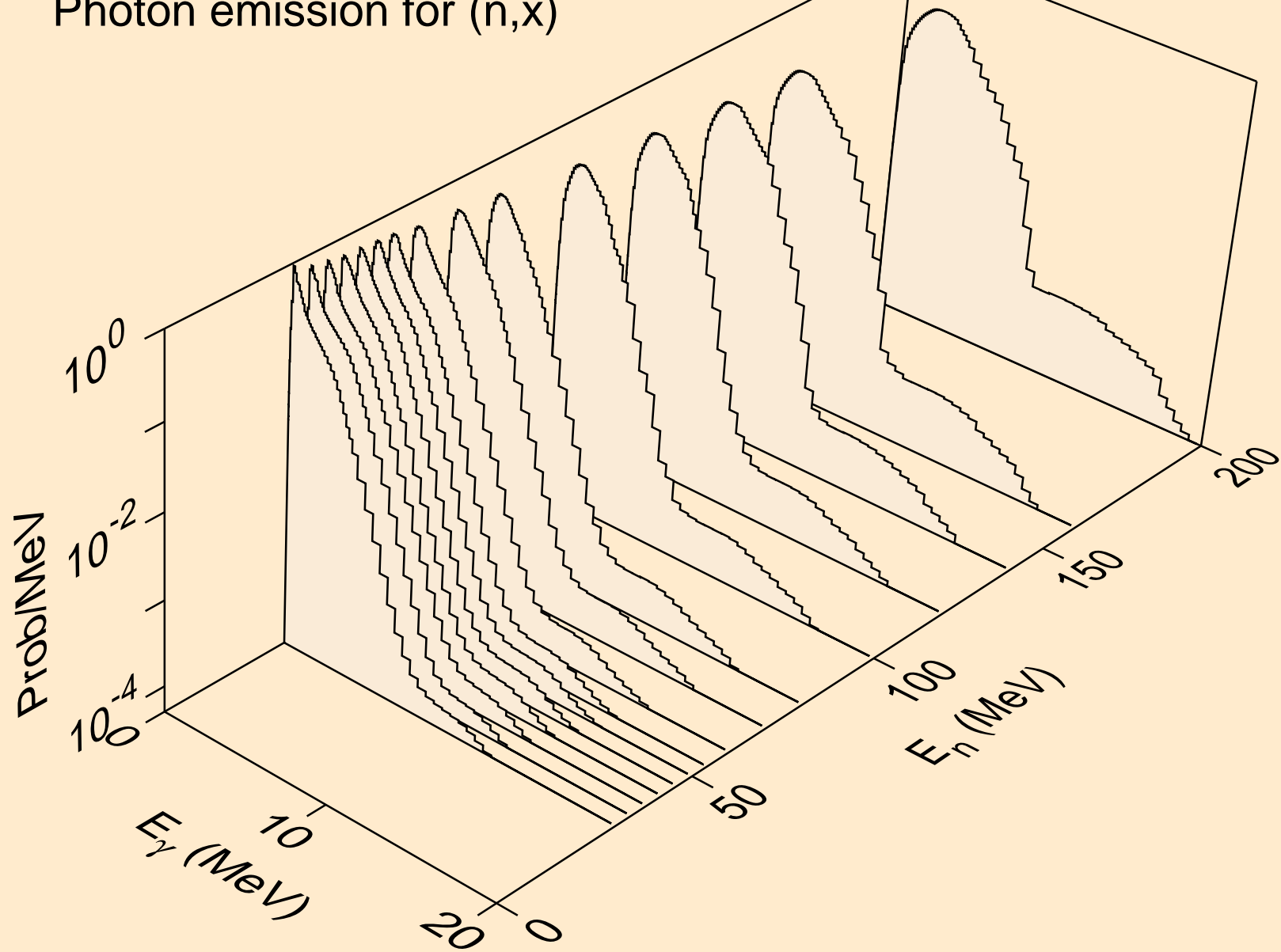

TB160 NEUTRON ACER TENDL-2021 LIBRARY; T=293.6K  
Photon emission for (n,2nd)

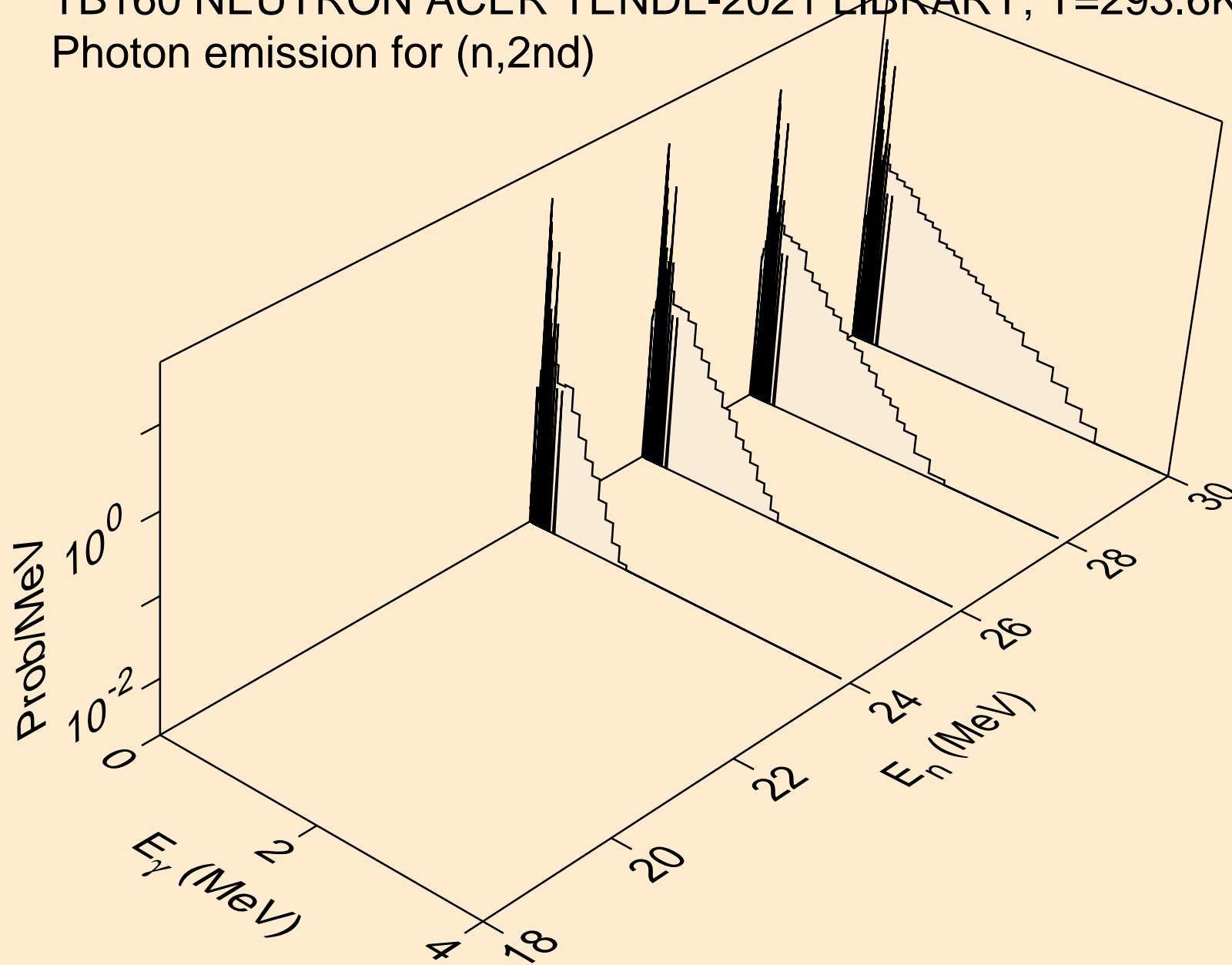

TB160 NEUTRON ACER TENDL-2021 LIBRARY; T=293.6K  
Photon emission for (n,2n)

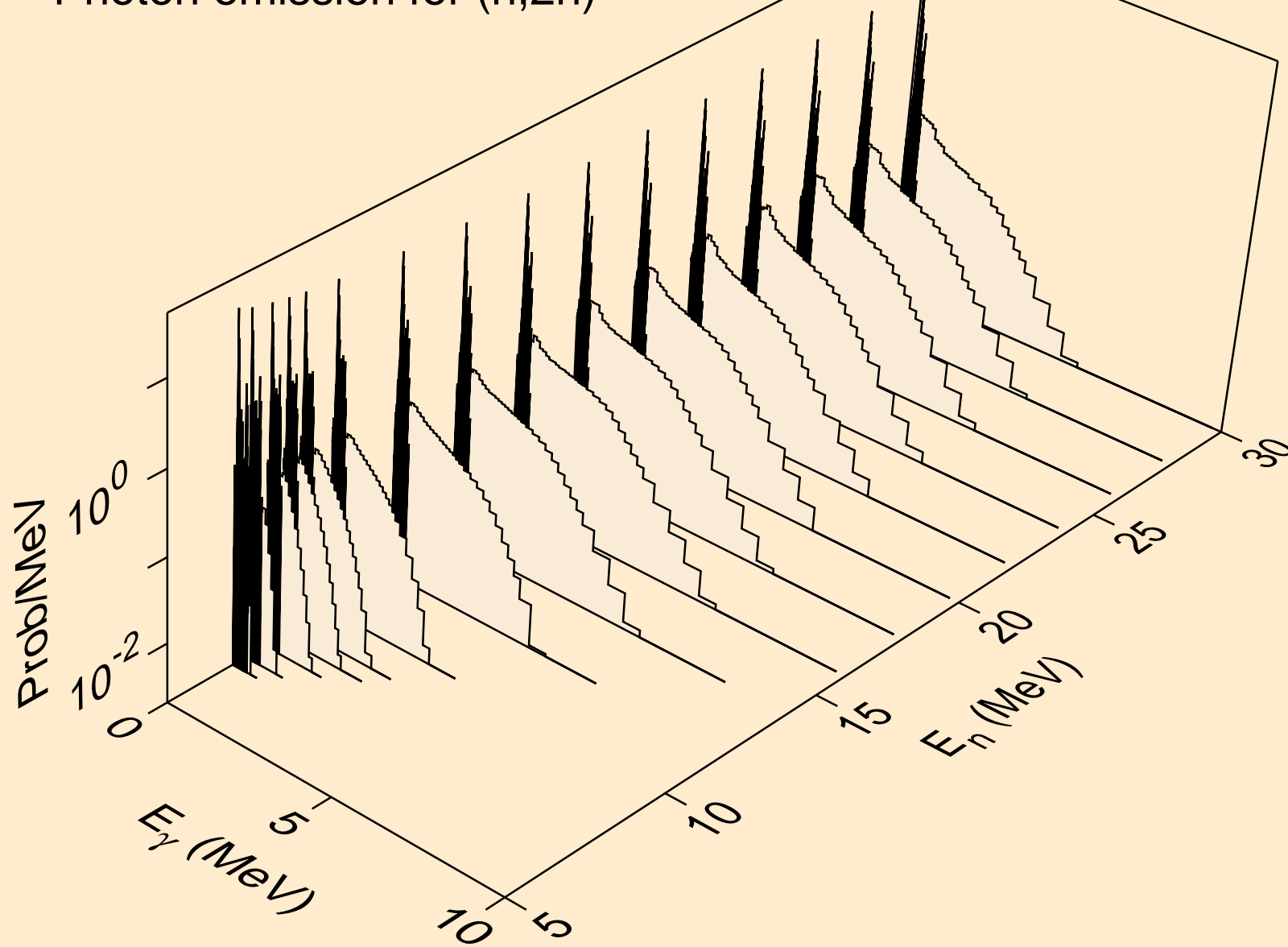

TB160 NEUTRON ACER TENDL-2021 LIBRARY; T=293.6K  
Photon emission for (n,3n)

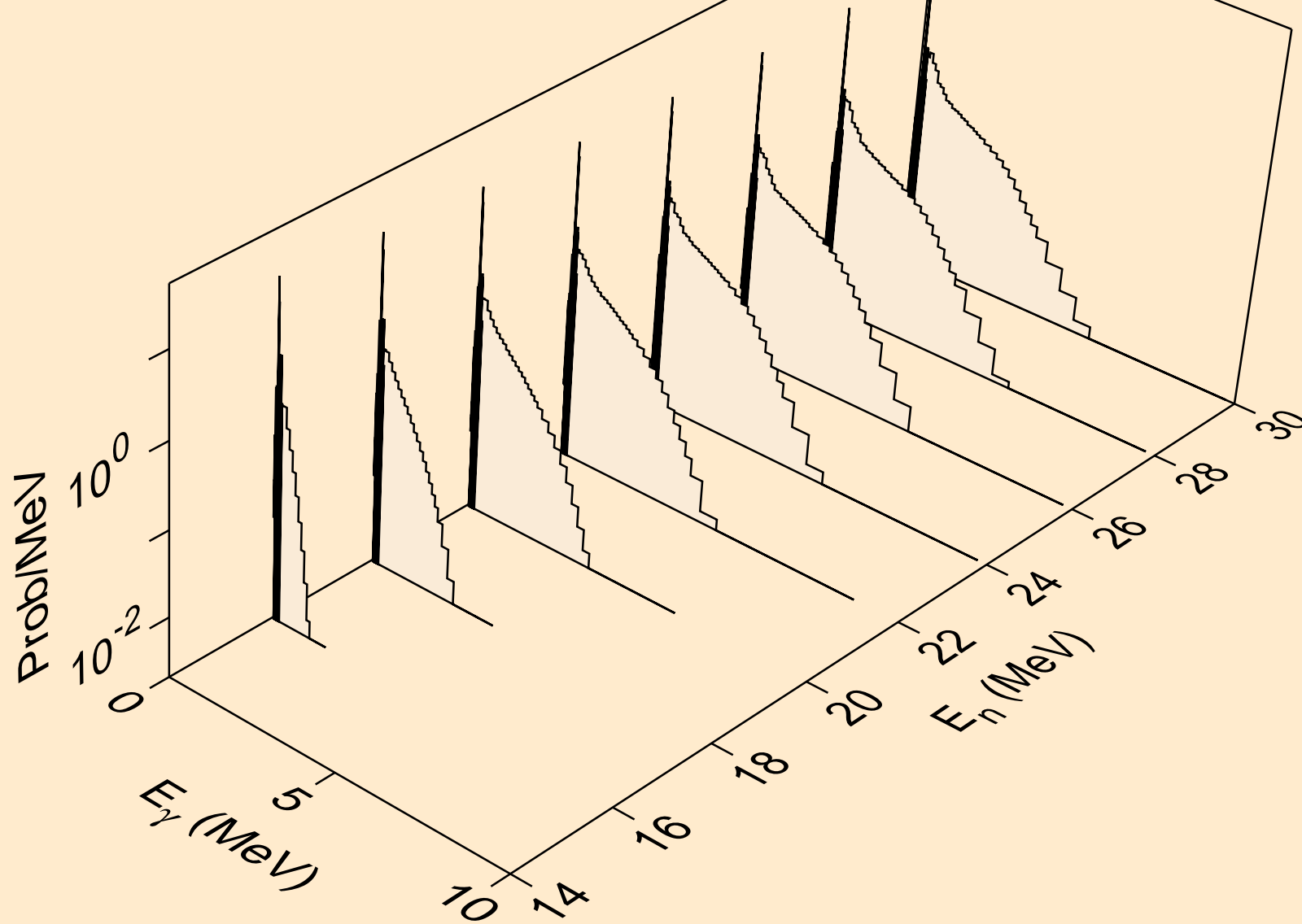



TB160 NEUTRON ACER TENDL-2021 LIBRARY; T=293.6K  
Photon emission for (n,n\*)a

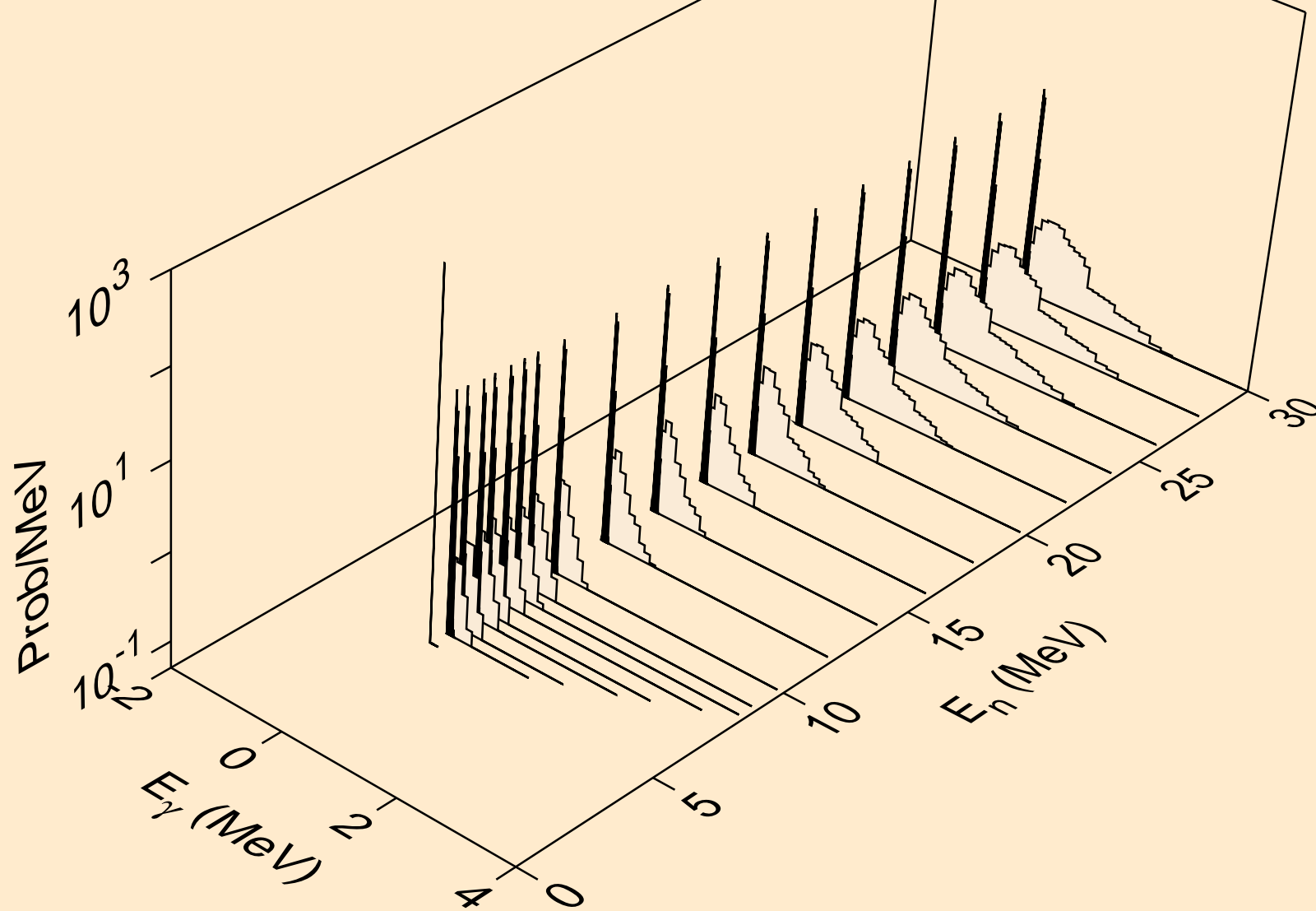

TB160 NEUTRON ACER TENDL-2021 LIBRARY; T=293.6K  
Photon emission for (n,2n)a

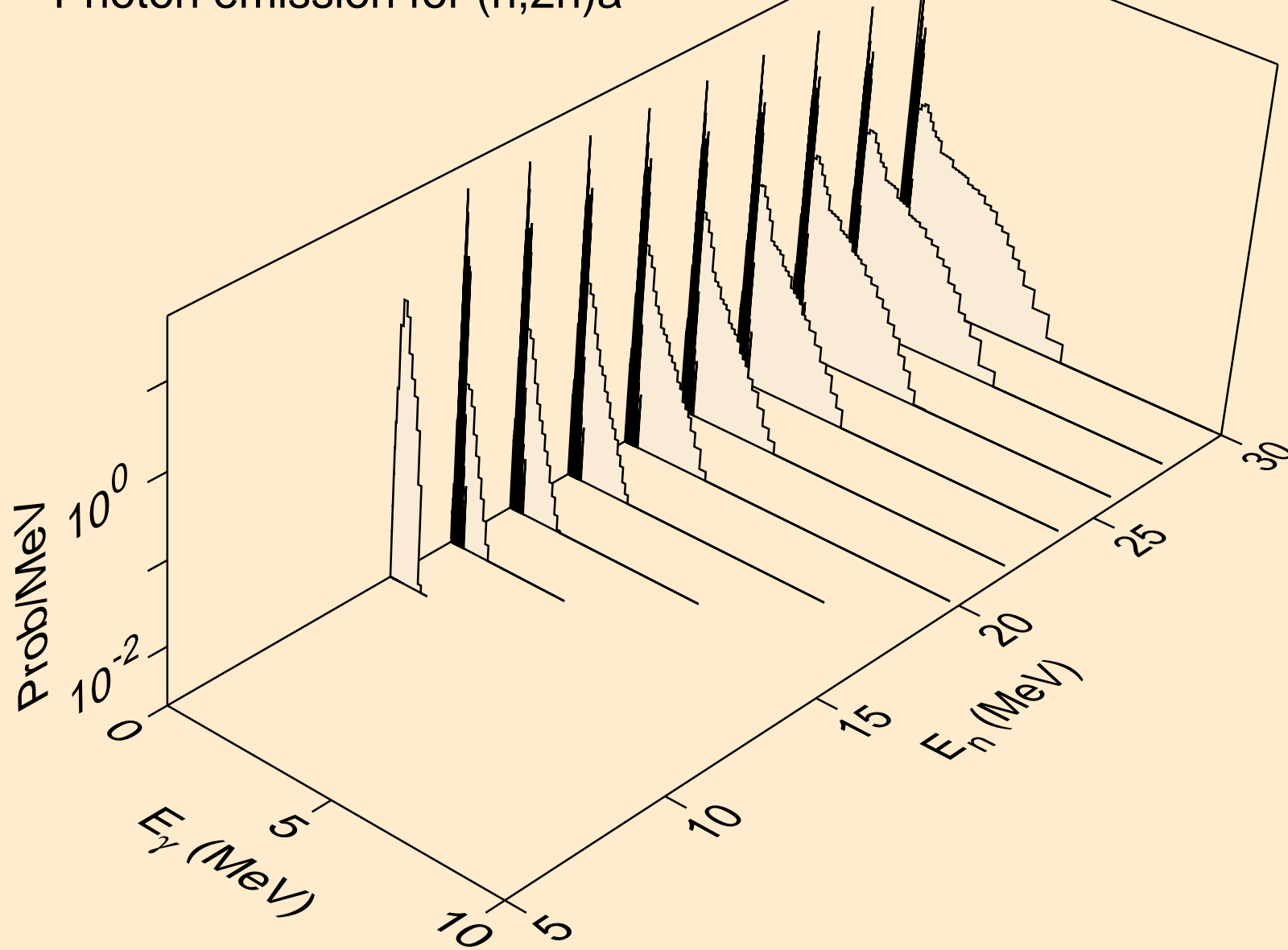

TB160 NEUTRON ACER TENDL-2021 LIBRARY; T=293.6K  
Photon emission for (n,3n)a

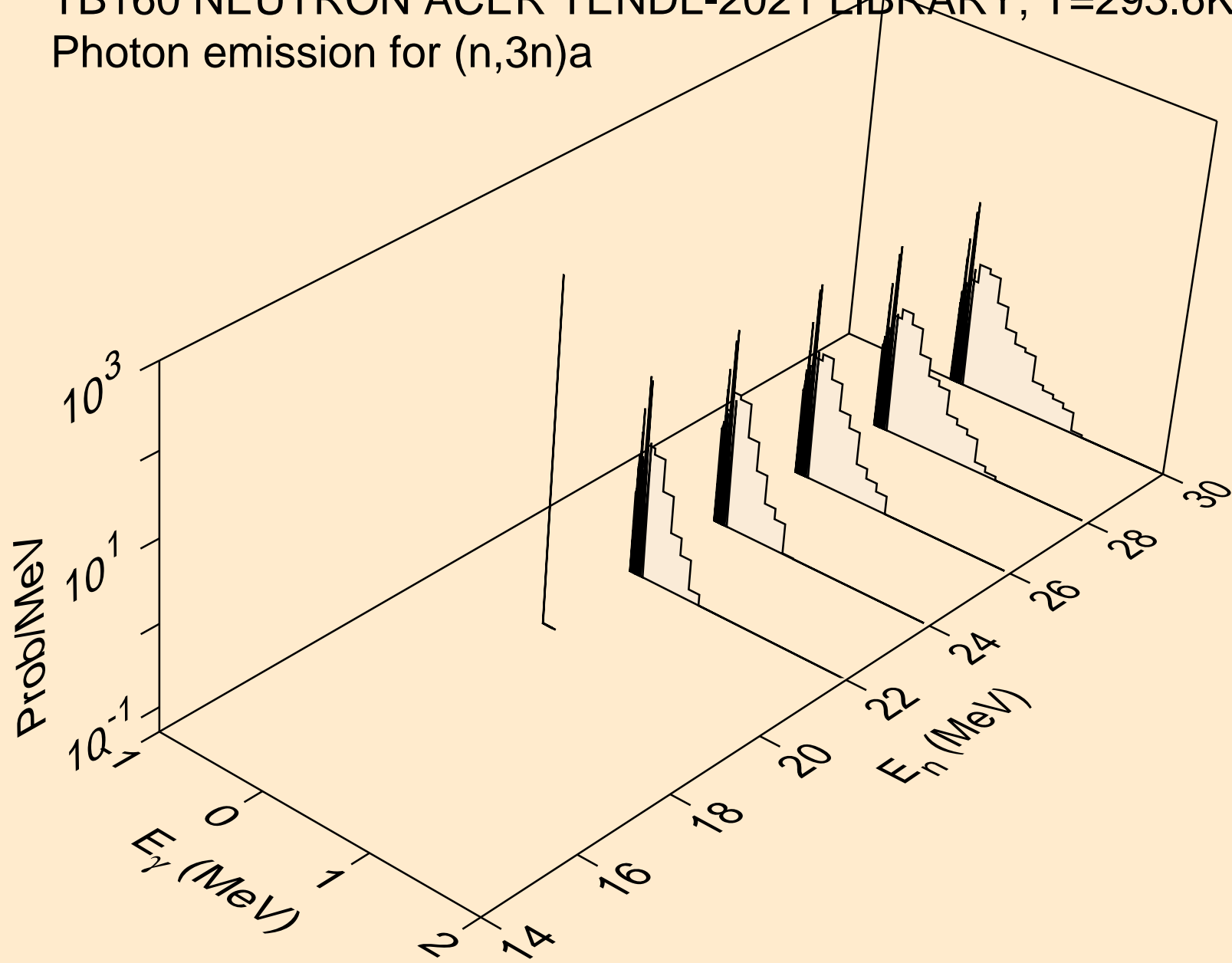

TB160 NEUTRON ACER TENDL-2021 LIBRARY; T=293.6K  
Photon emission for (n,n\*)p

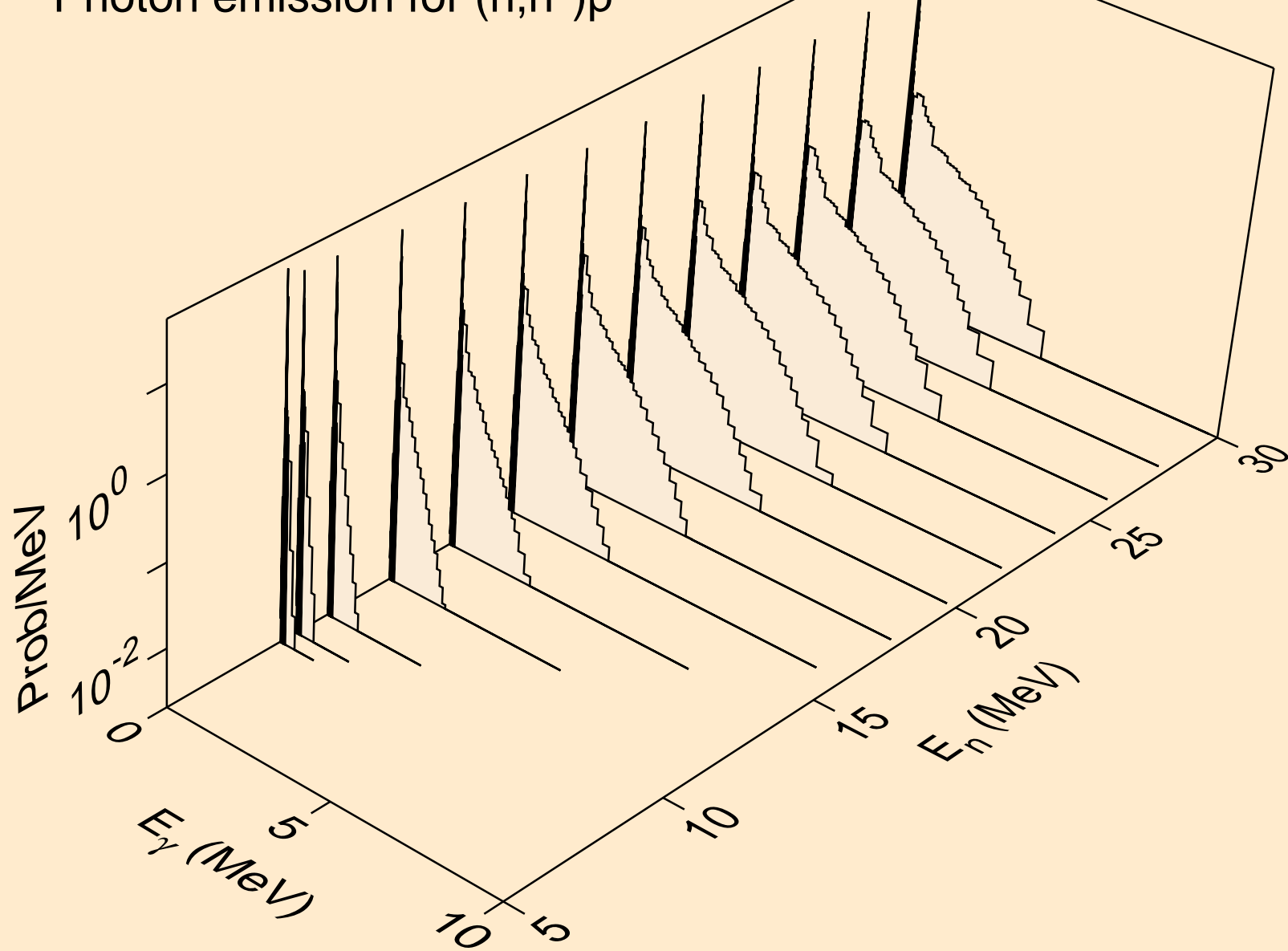

TB160 NEUTRON ACER TENDL-2021 LIBRARY; T=293.6K  
Photon emission for (n,n\*)2a

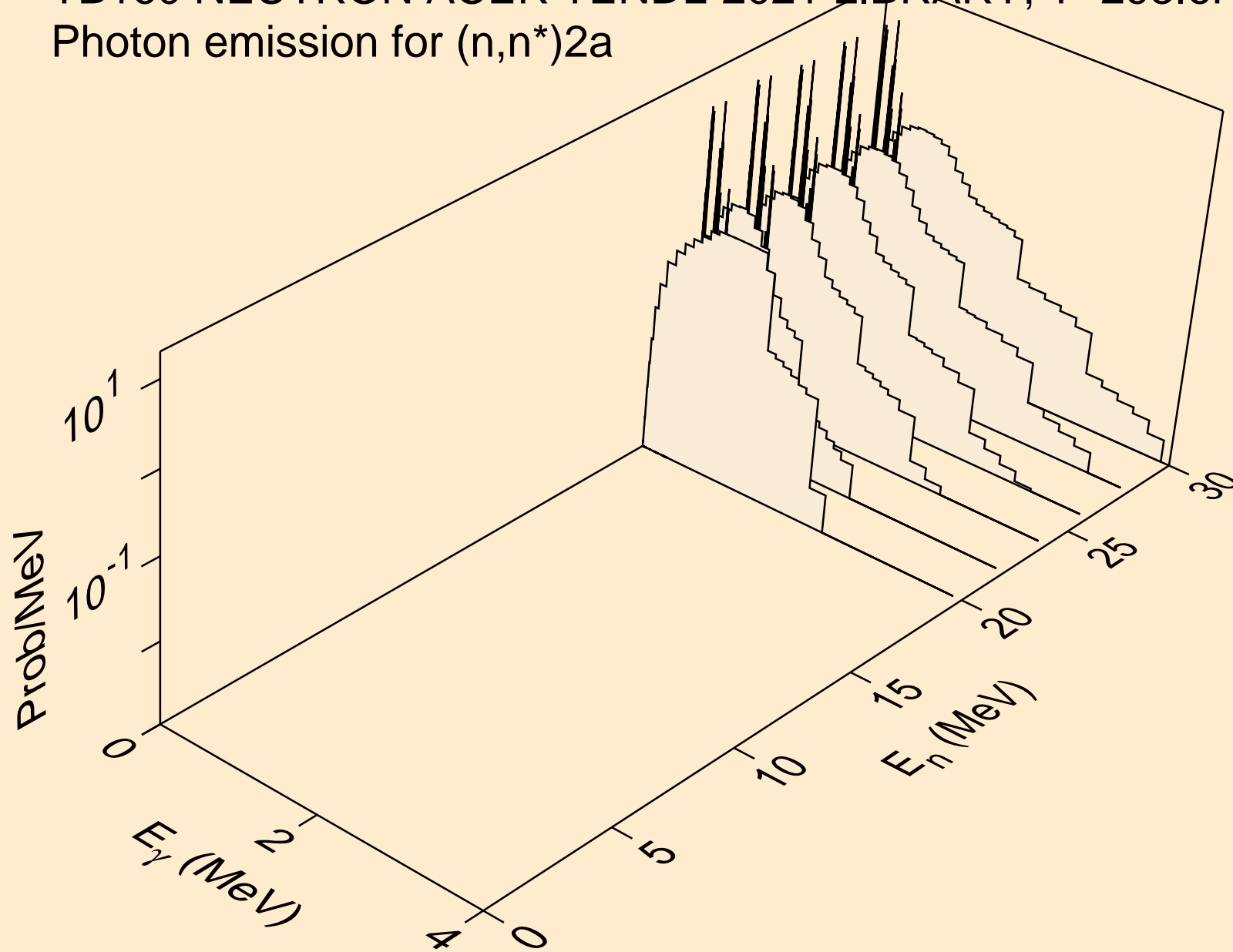

TB160 NEUTRON ACER TENDL-2021 LIBRARY; T=293.6K  
Photon emission for (n,n\*)d

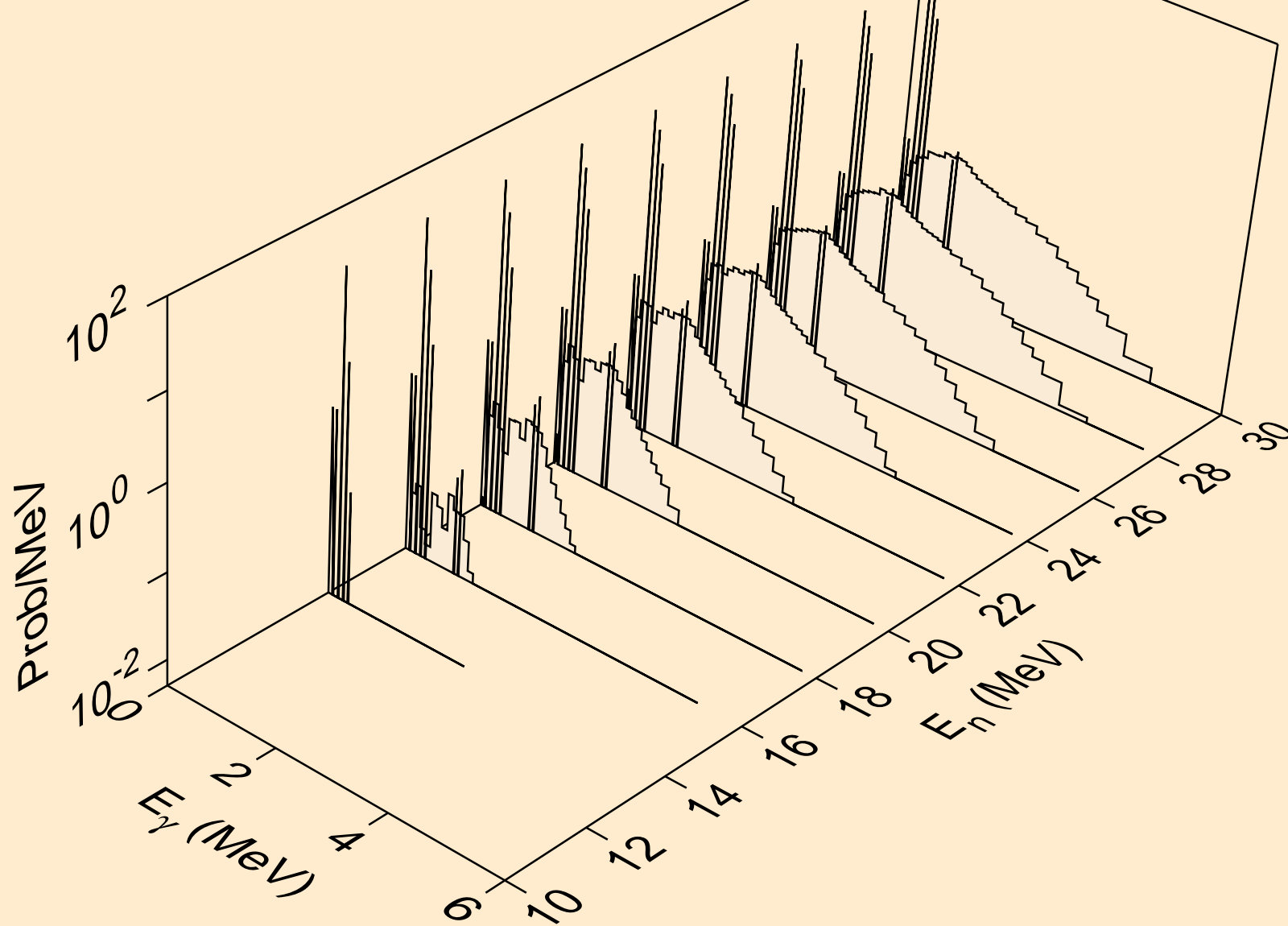

TB160 NEUTRON ACER TENDL-2021 LIBRARY; T=293.6K  
Photon emission for (n,n\*)t

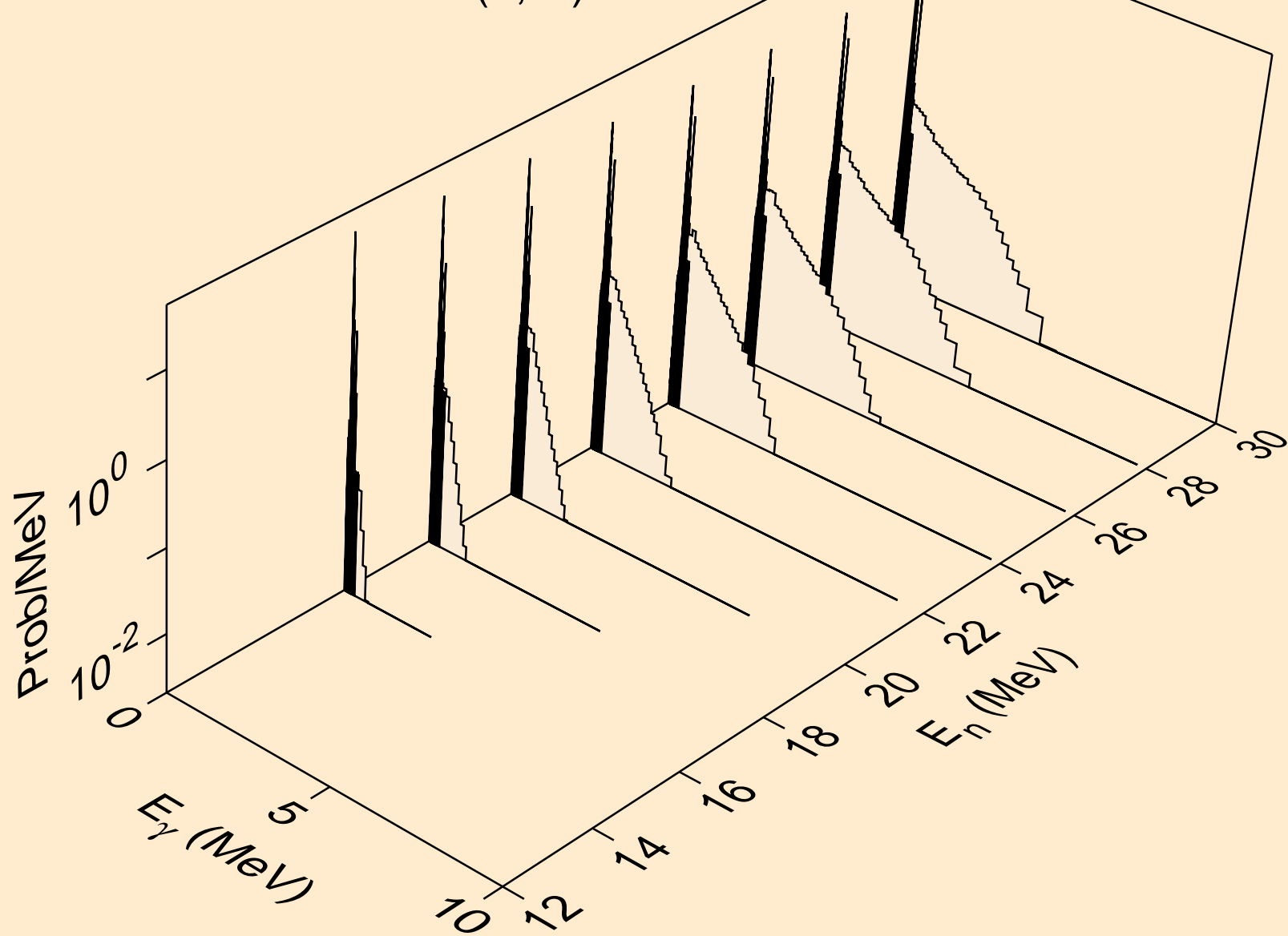

TB160 NEUTRON ACER TENDL-2021 LIBRARY; T=293.6K  
Photon emission for (n,n\*)he3

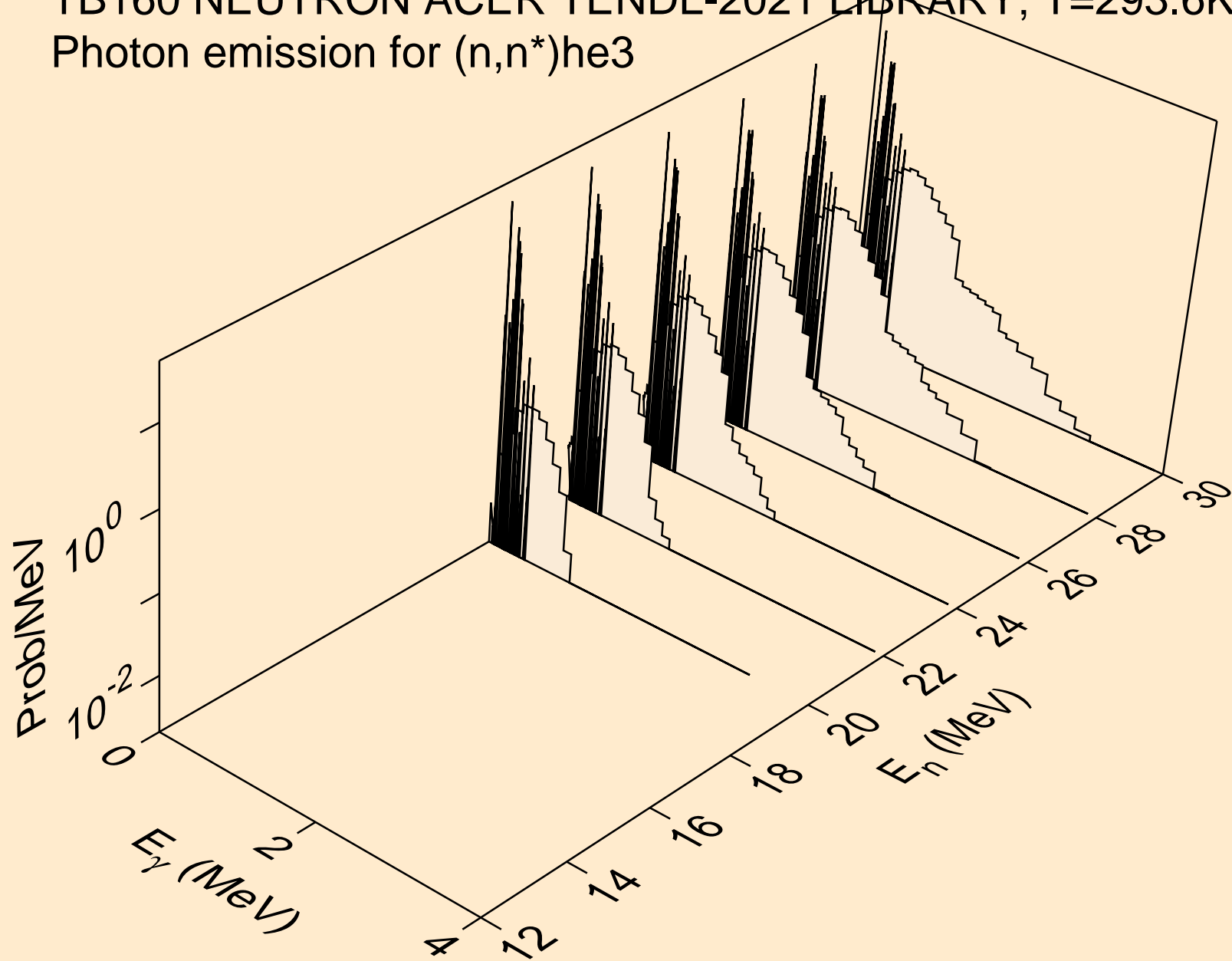



TB160 NEUTRON ACER TENDL-2021 LIBRARY; T=293.6K  
Photon emission for (n,4n)

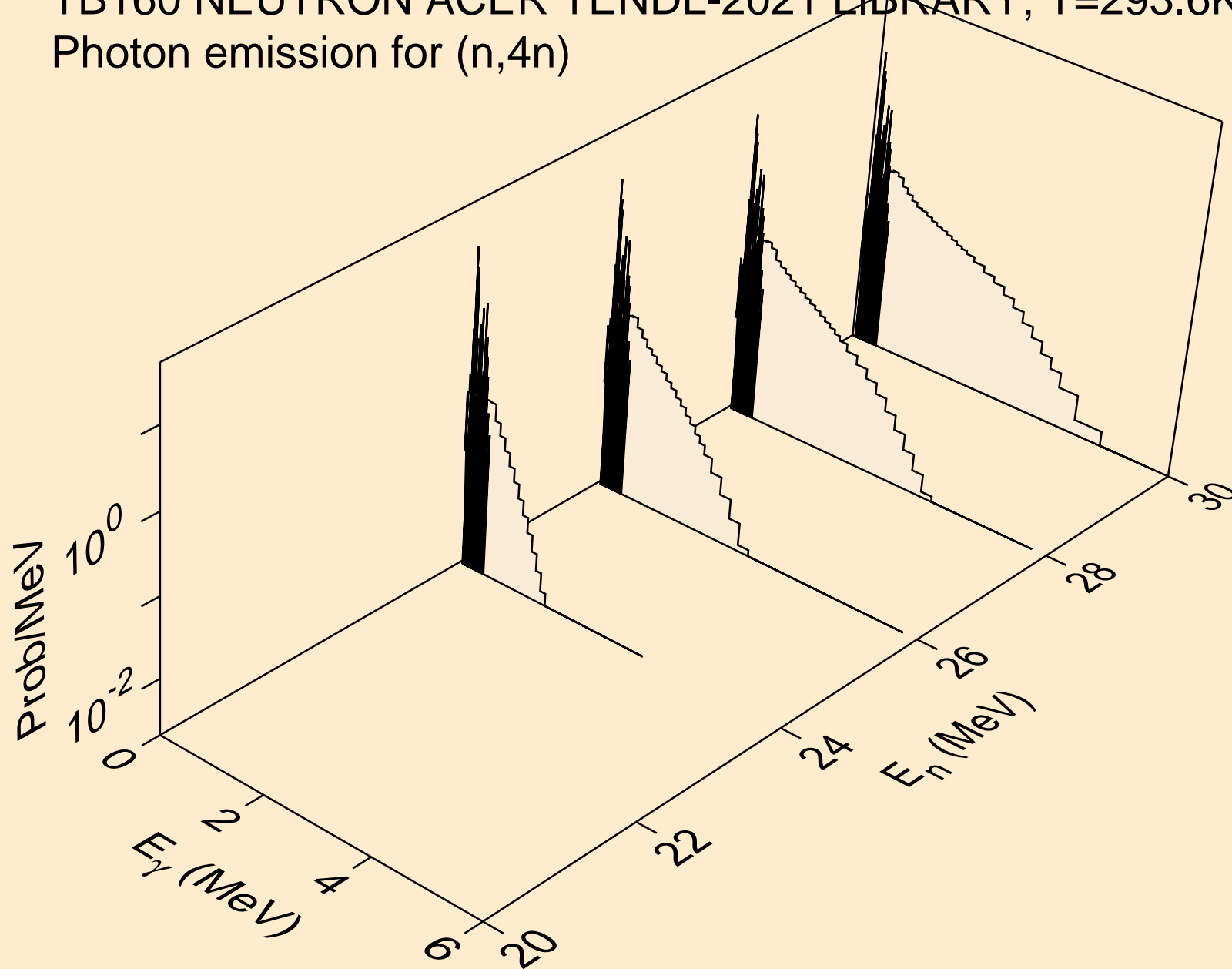

TB160 NEUTRON ACER TENDL-2021 LIBRARY; T=293.6K  
Photon emission for (n,2np)

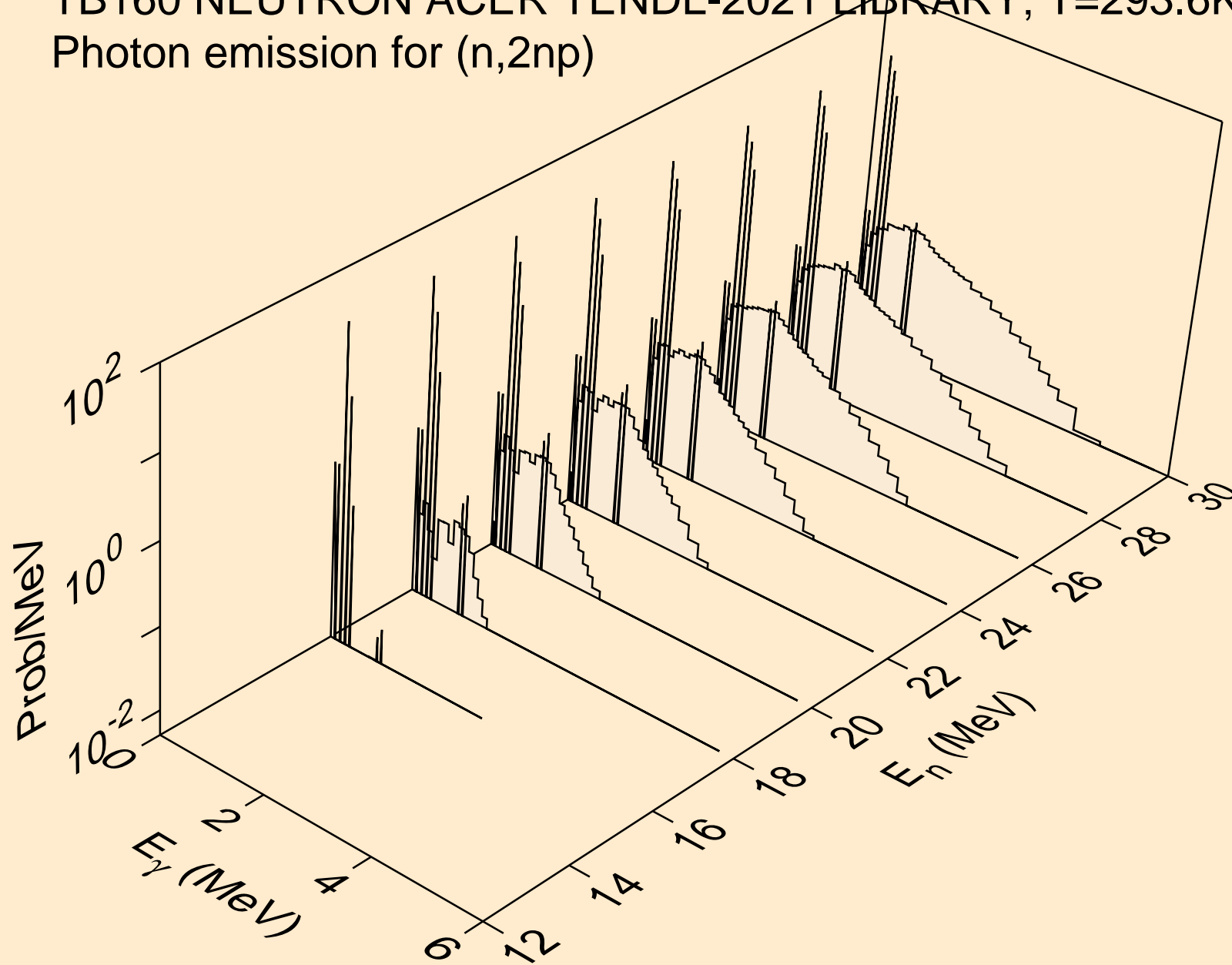

TB160 NEUTRON ACER TENDL-2021 LIBRARY; T=293.6K  
Photon emission for (n,3np)

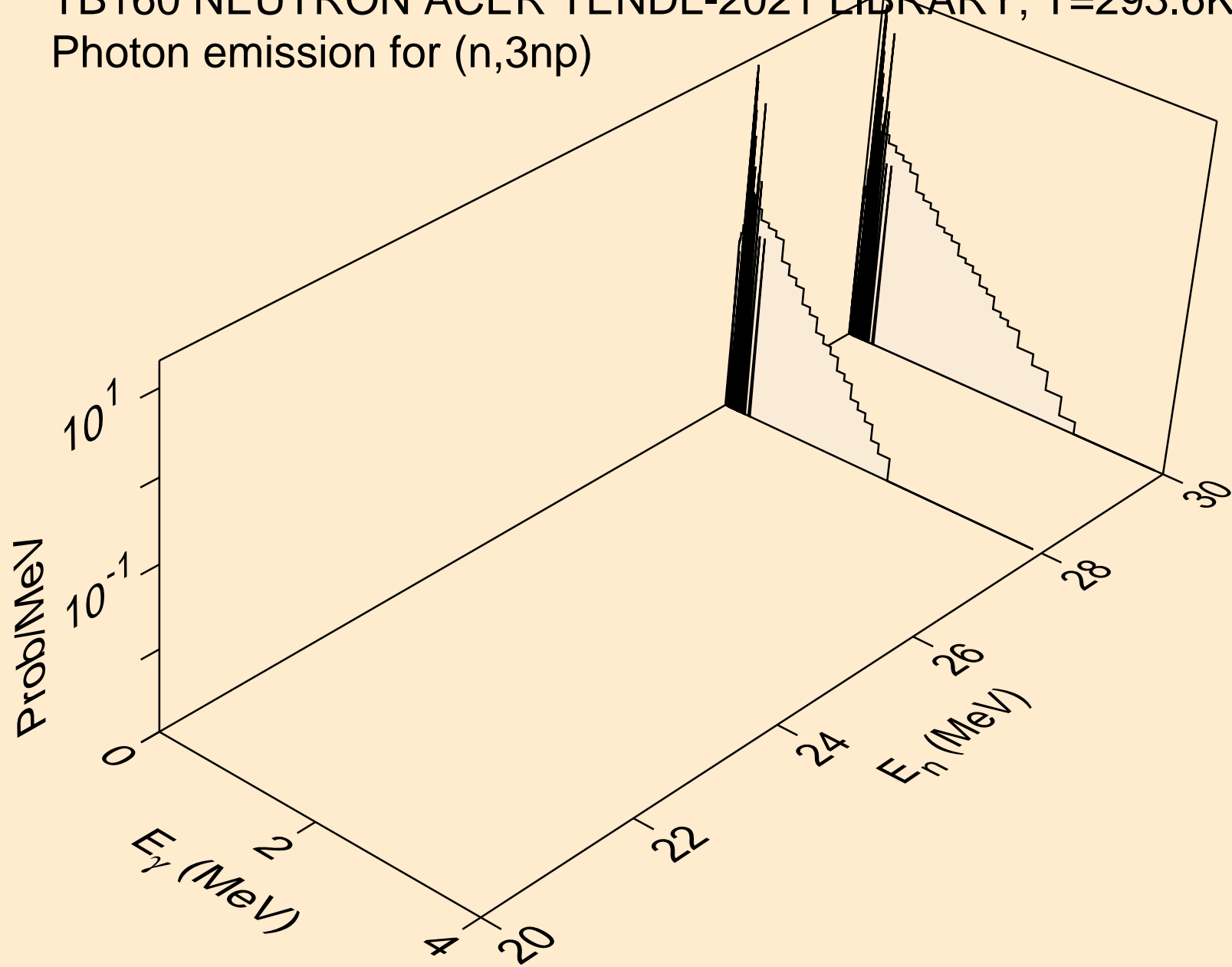

TB160 NEUTRON ACER TENDL-2021 LIBRARY; T=293.6K  
Photon emission for (n,2np)

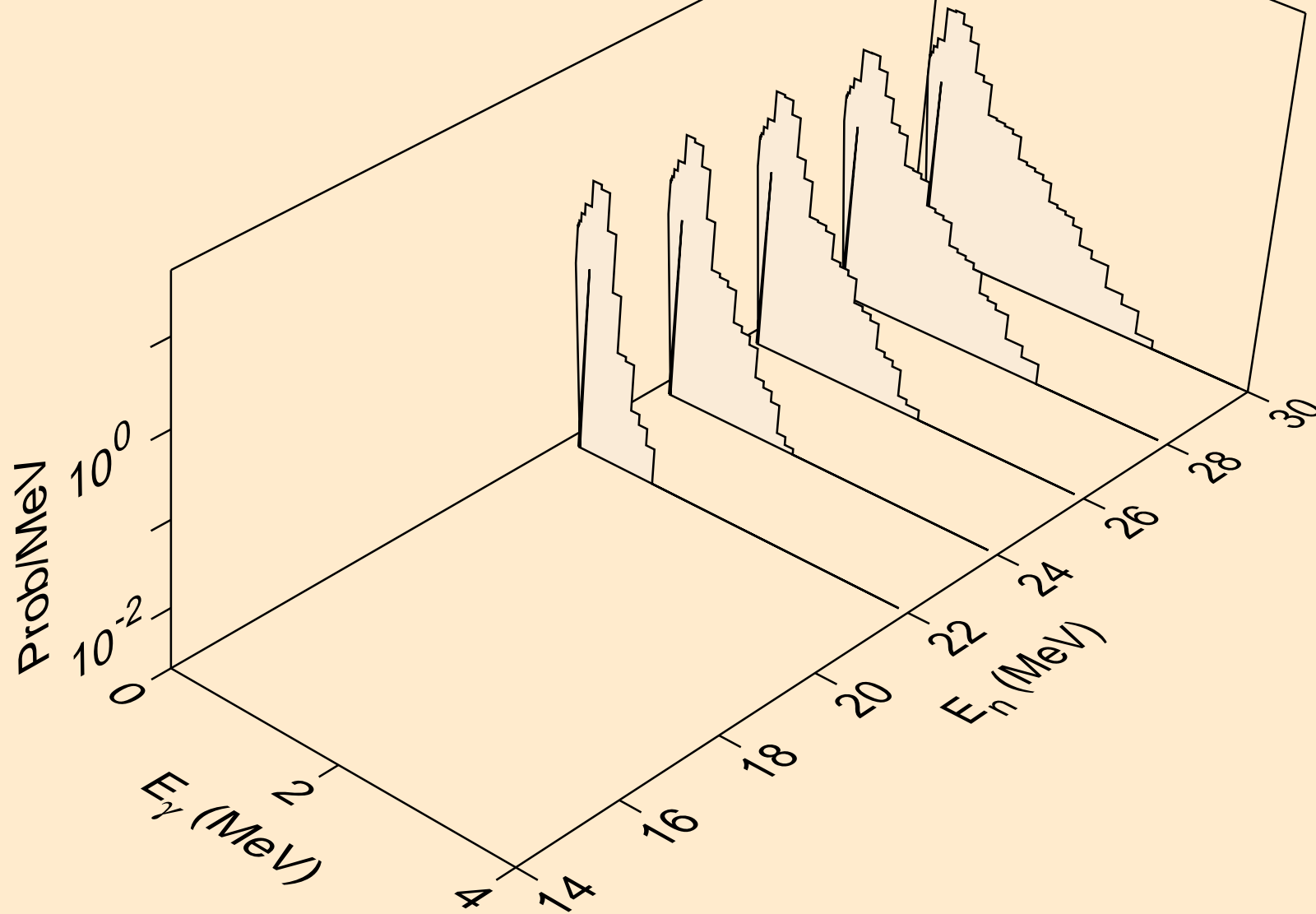

TB160 NEUTRON ACER TENDL-2021 LIBRARY; T=293.6K  
Photon emission for (n,npa)

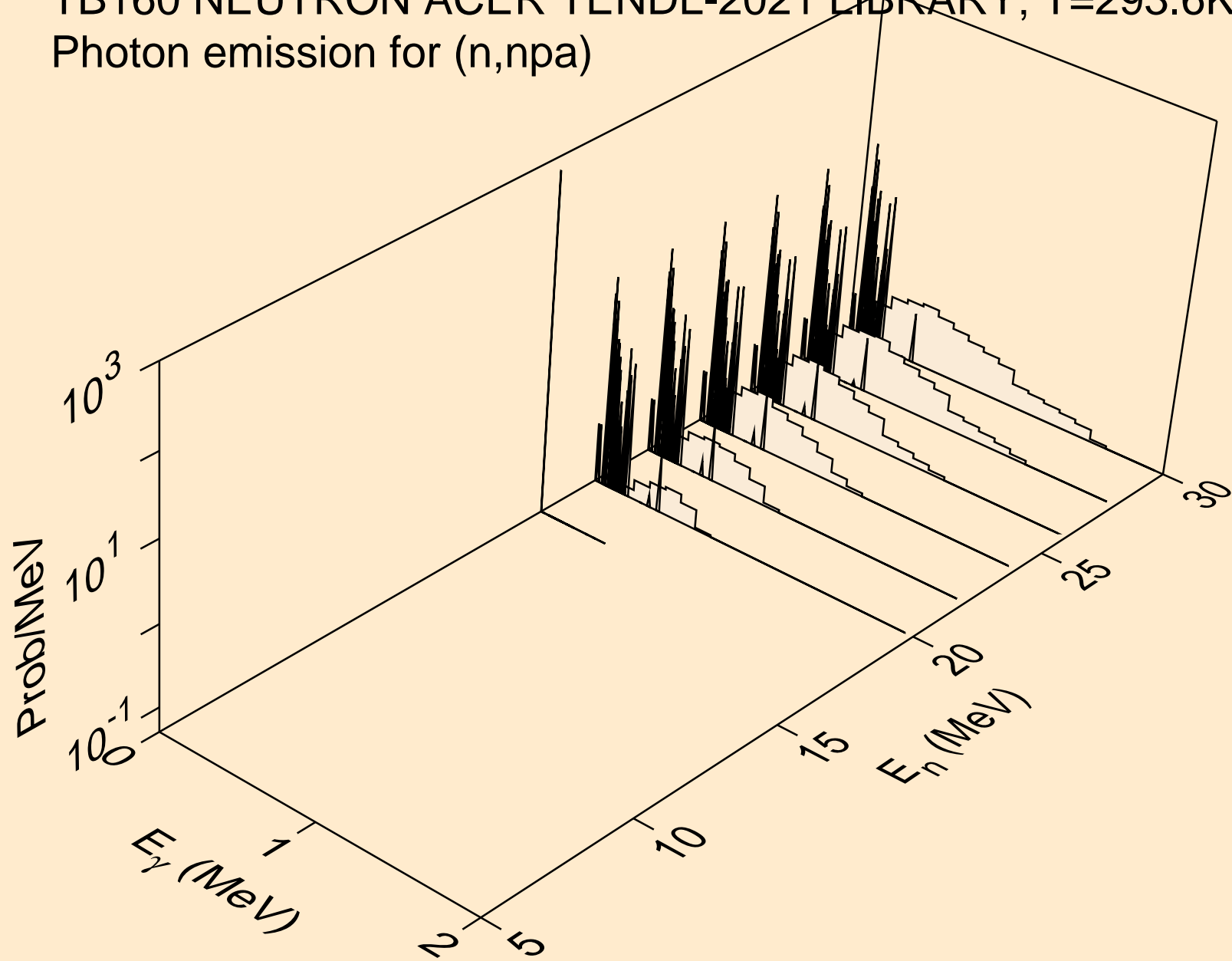

TB160 NEUTRON ACER TENDL-2021 LIBRARY; T=293.6K  
Photon emission for (n,n\*c)

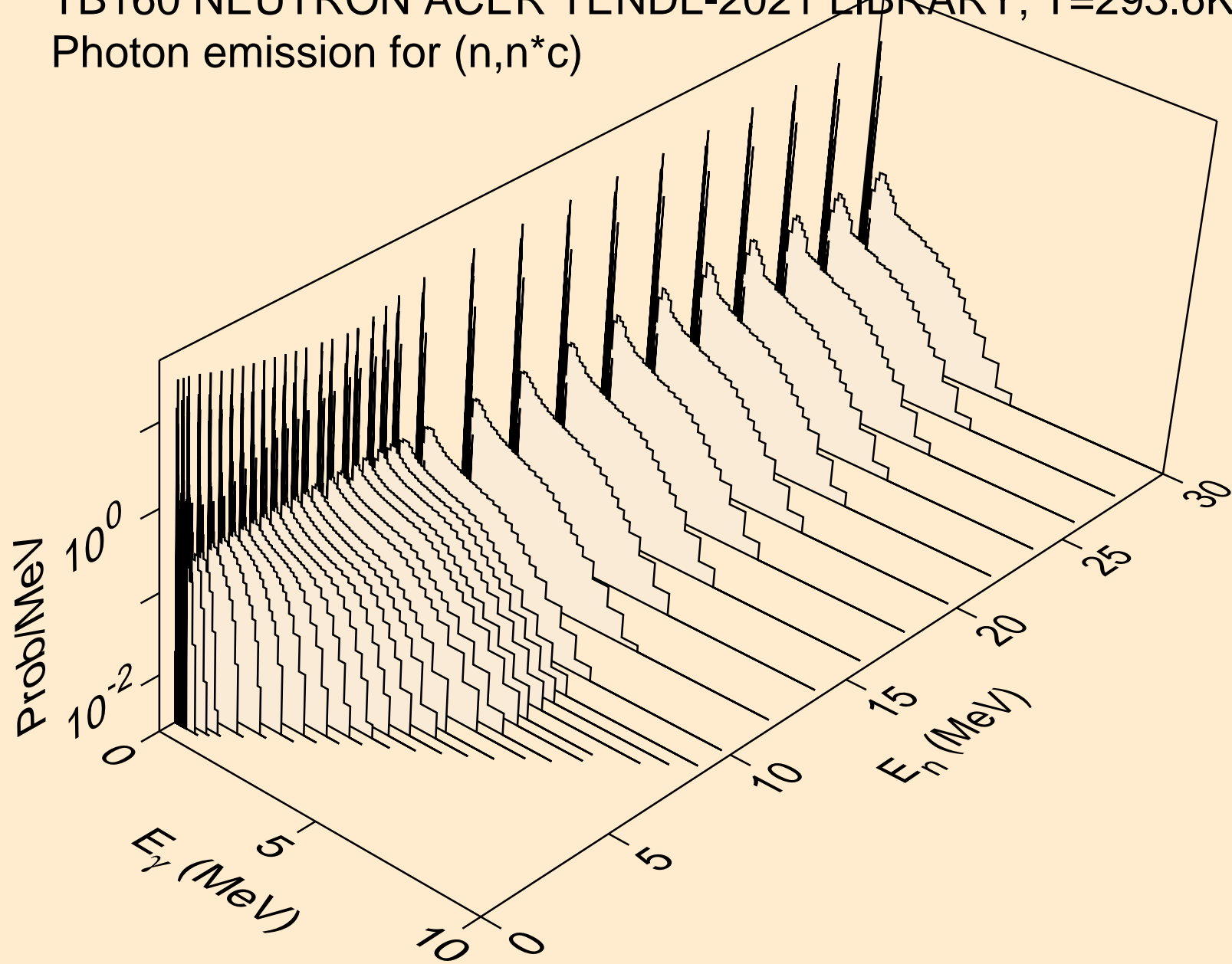

TB160 NEUTRON ACER TENDL-2021 LIBRARY; T=293.6K  
Photon emission for (n,gma)

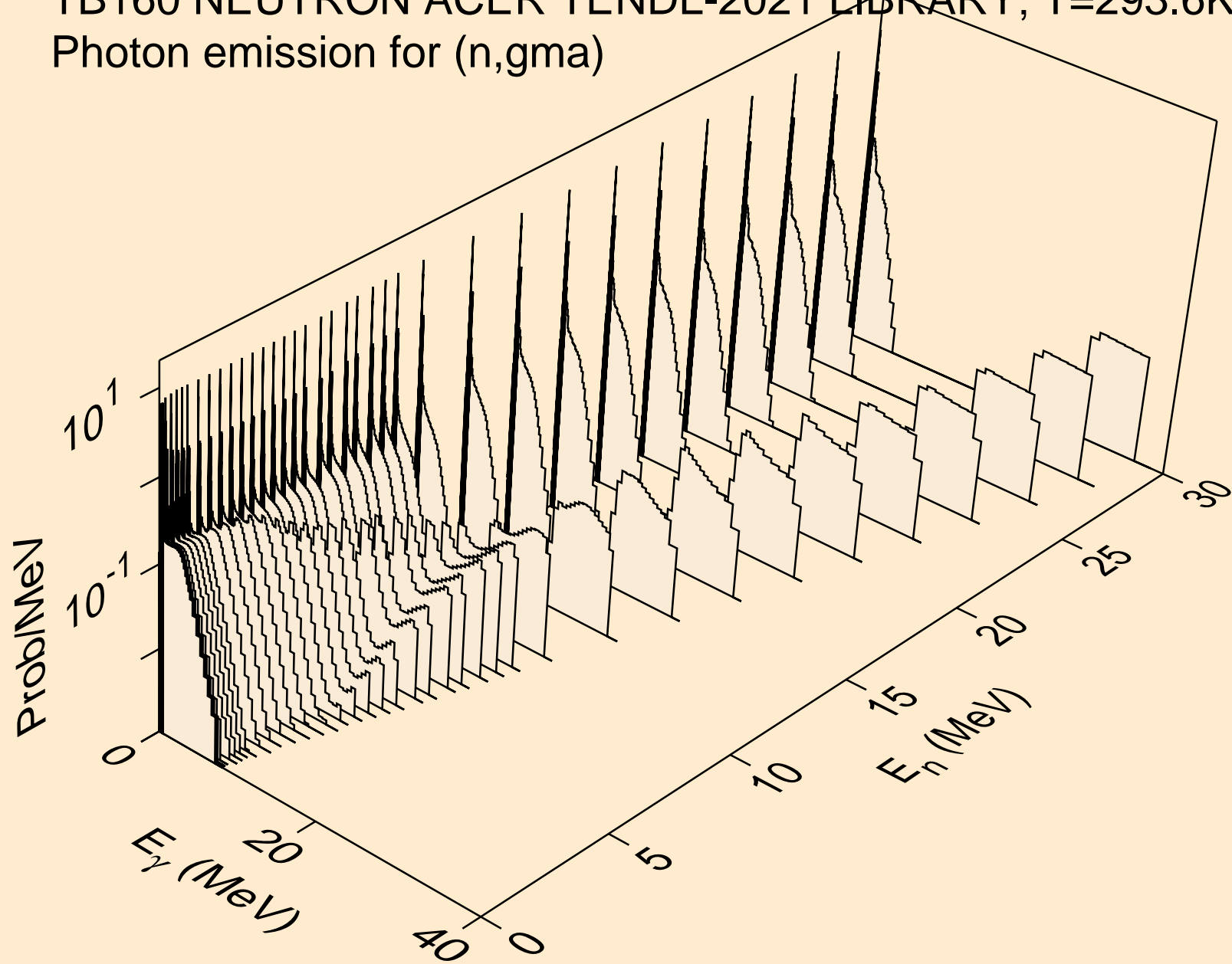

TB160 NEUTRON ACER TENDL-2021 LIBRARY; T=293.6K  
Photon emission for (n,p)

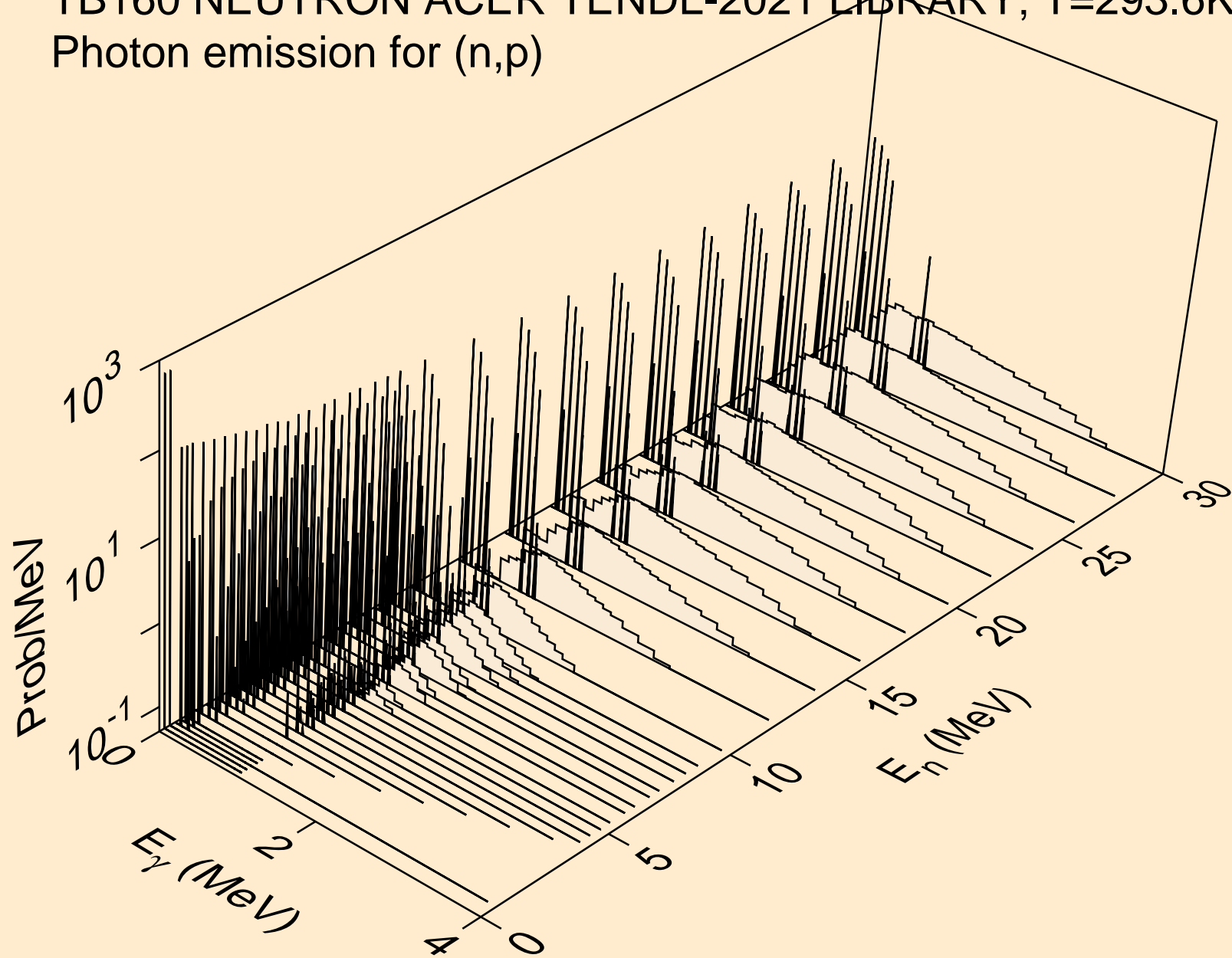



TB160 NEUTRON ACER TENDL-2021 LIBRARY; T=293.6K  
Photon emission for (n,d)

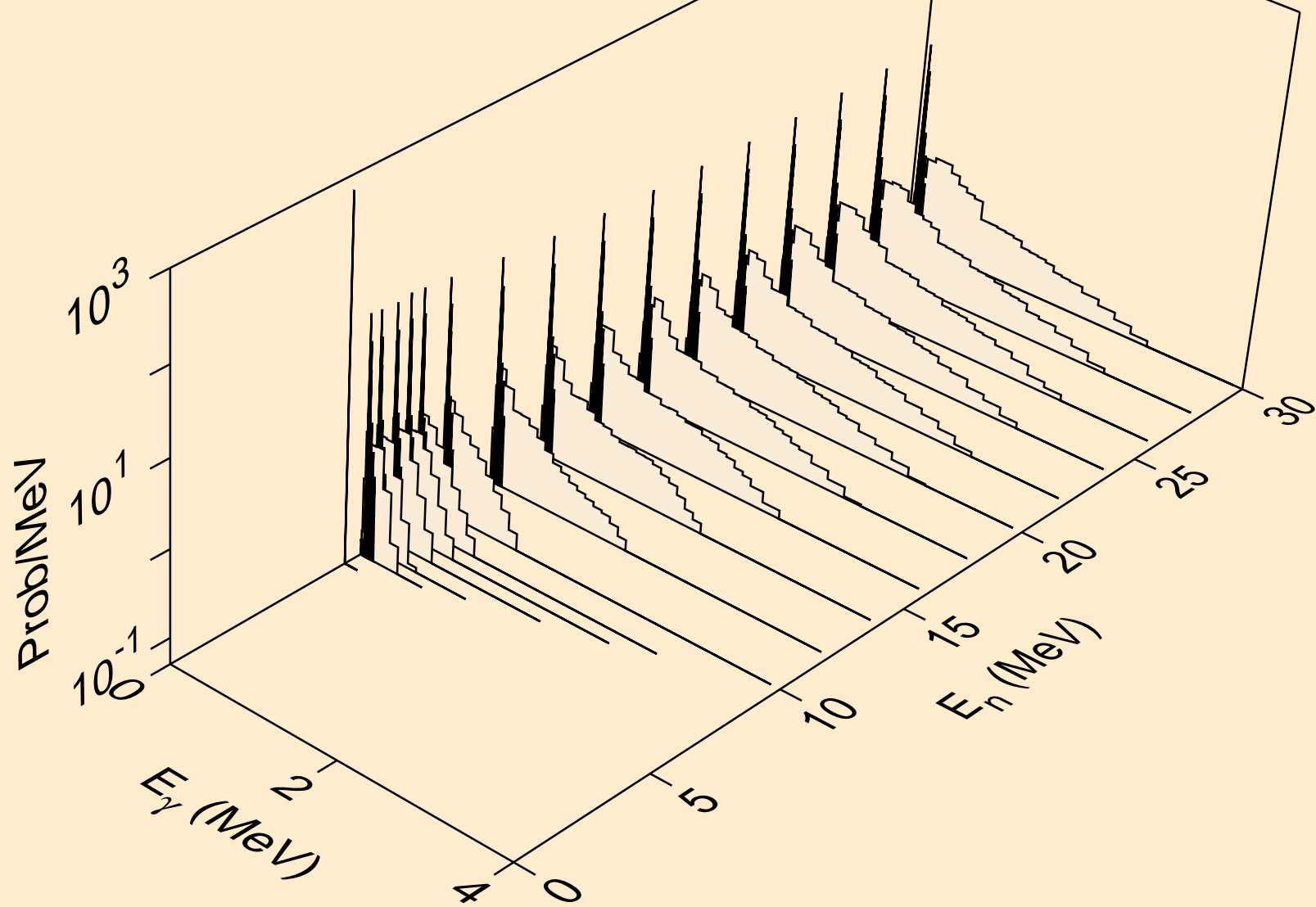

TB160 NEUTRON ACER TENDL-2021 LIBRARY; T=293.6K  
Photon emission for (n,t)

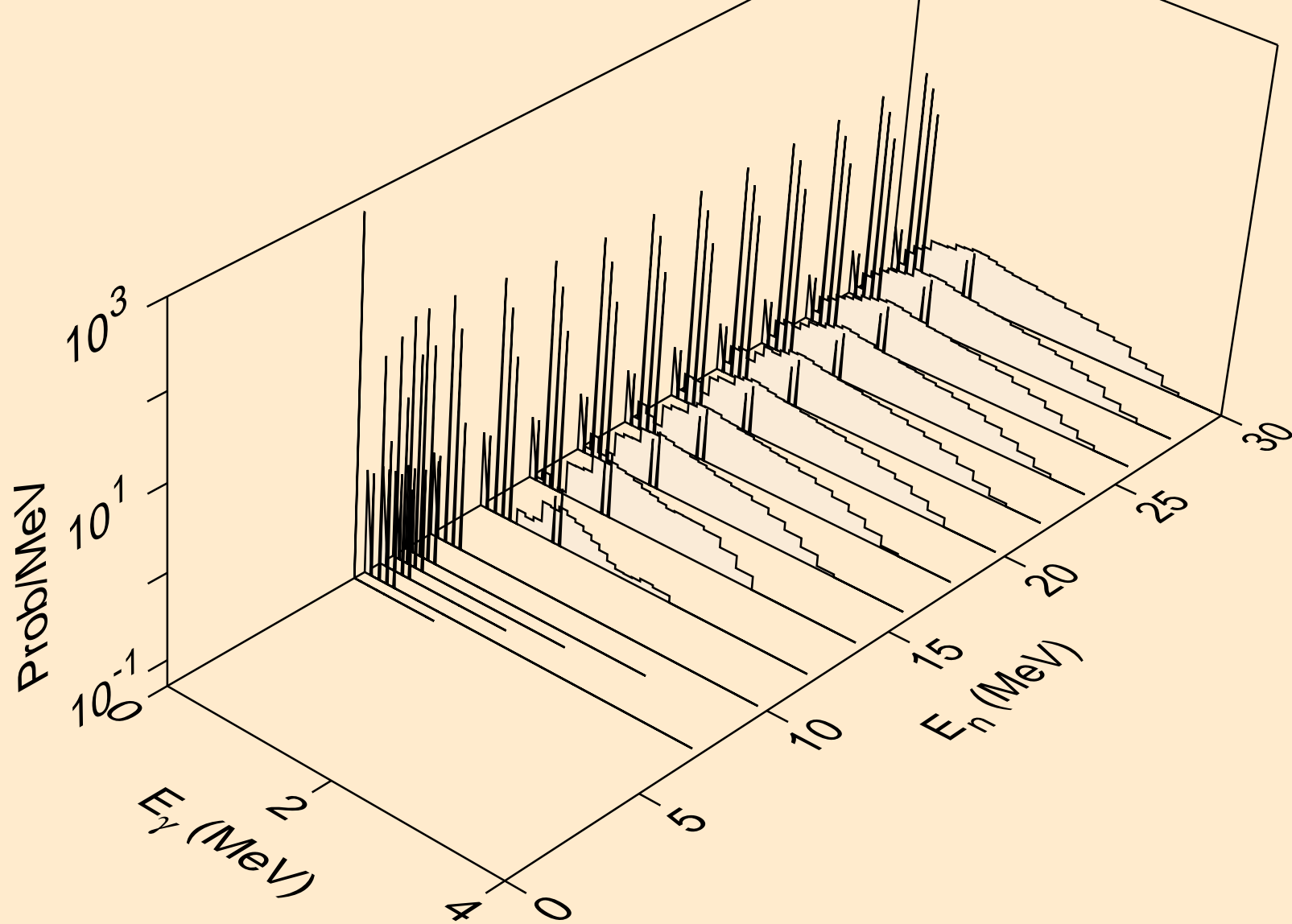

TB160 NEUTRON ACER TENDL-2021 LIBRARY; T=293.6K  
Photon emission for (n,he3)

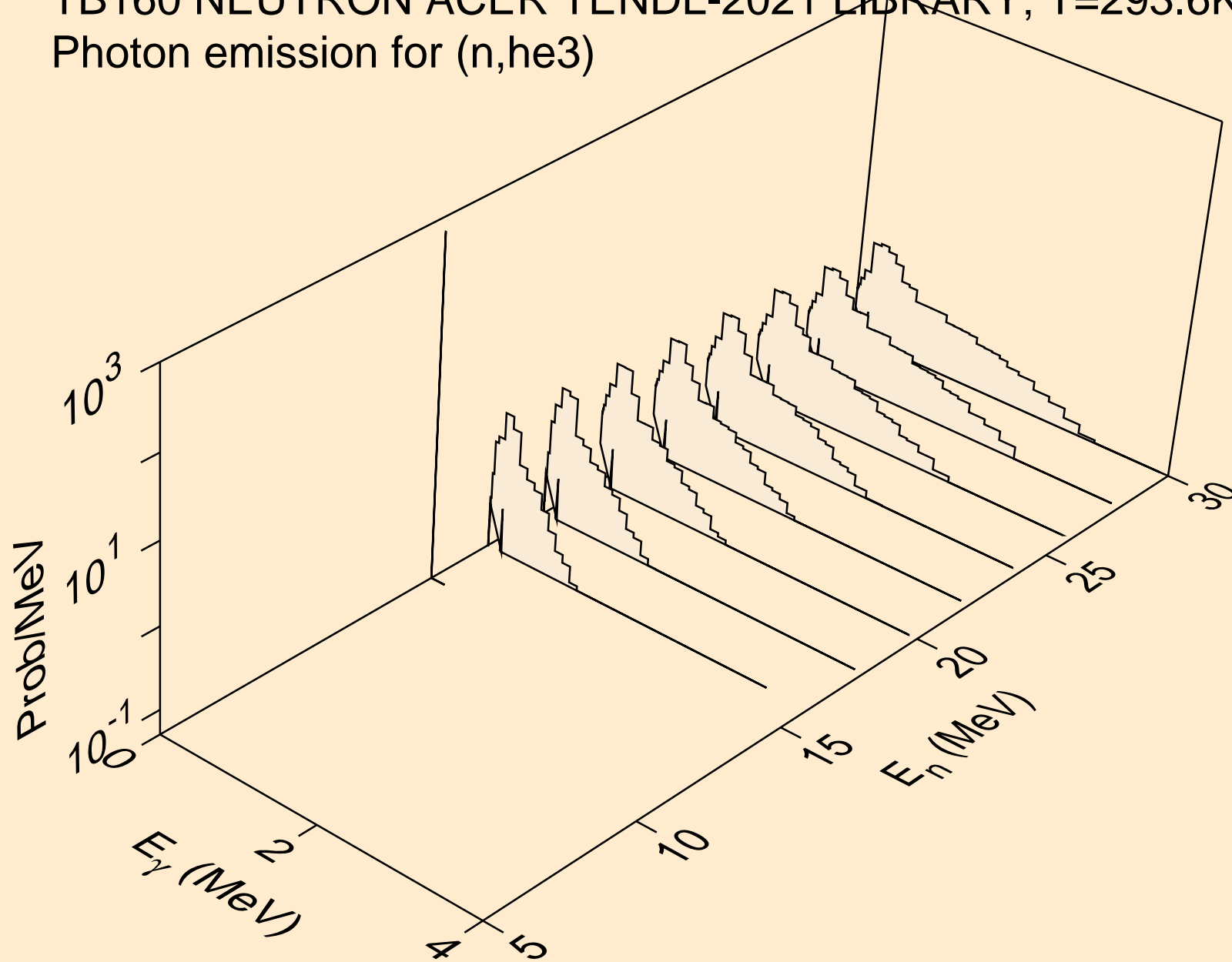

TB160 NEUTRON ACER TENDL-2021 LIBRARY; T=293.6K  
Photon emission for (n,a)

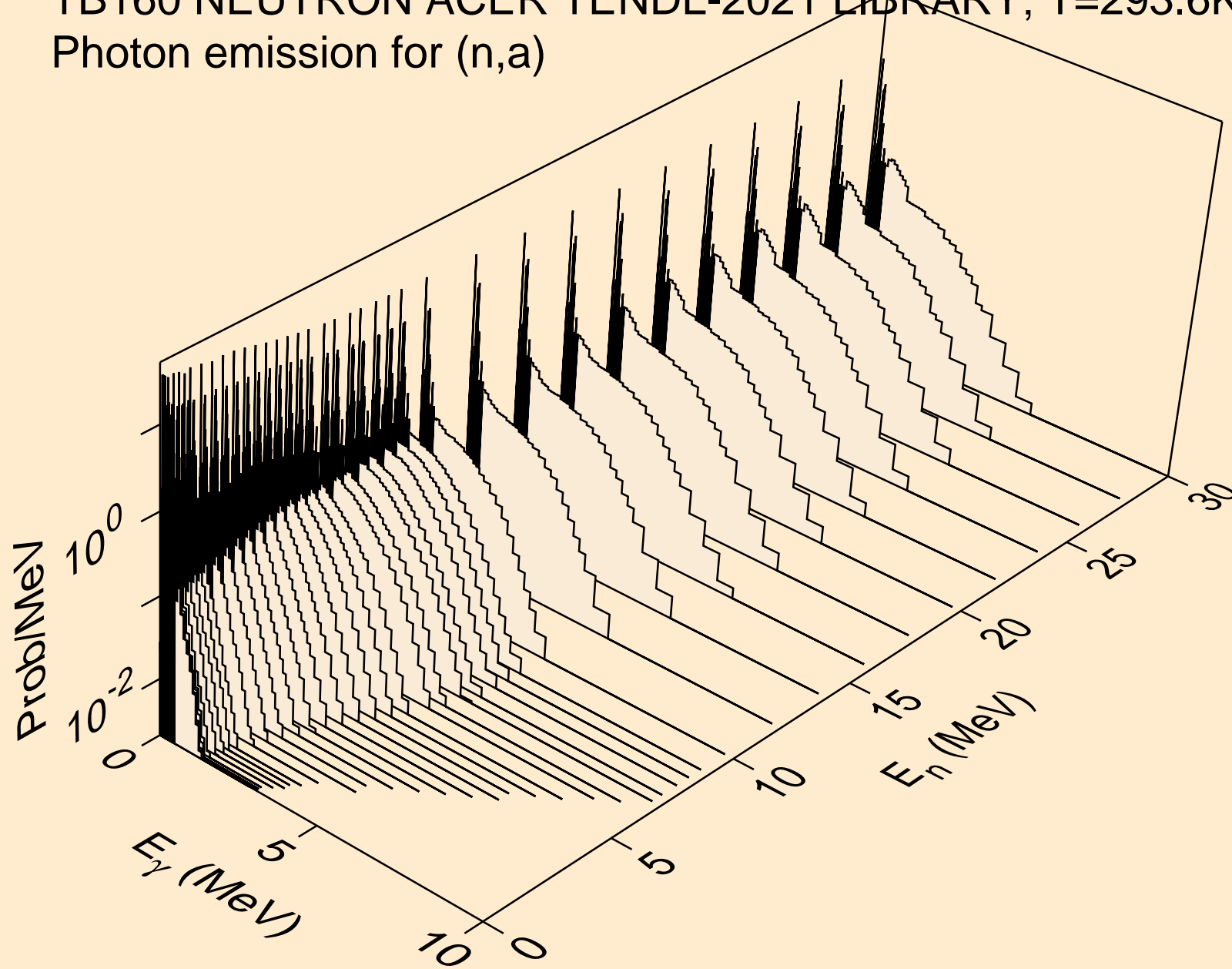

TB160 NEUTRON ACER TENDL-2021 LIBRARY; T=293.6K  
Photon emission for (n,2a)

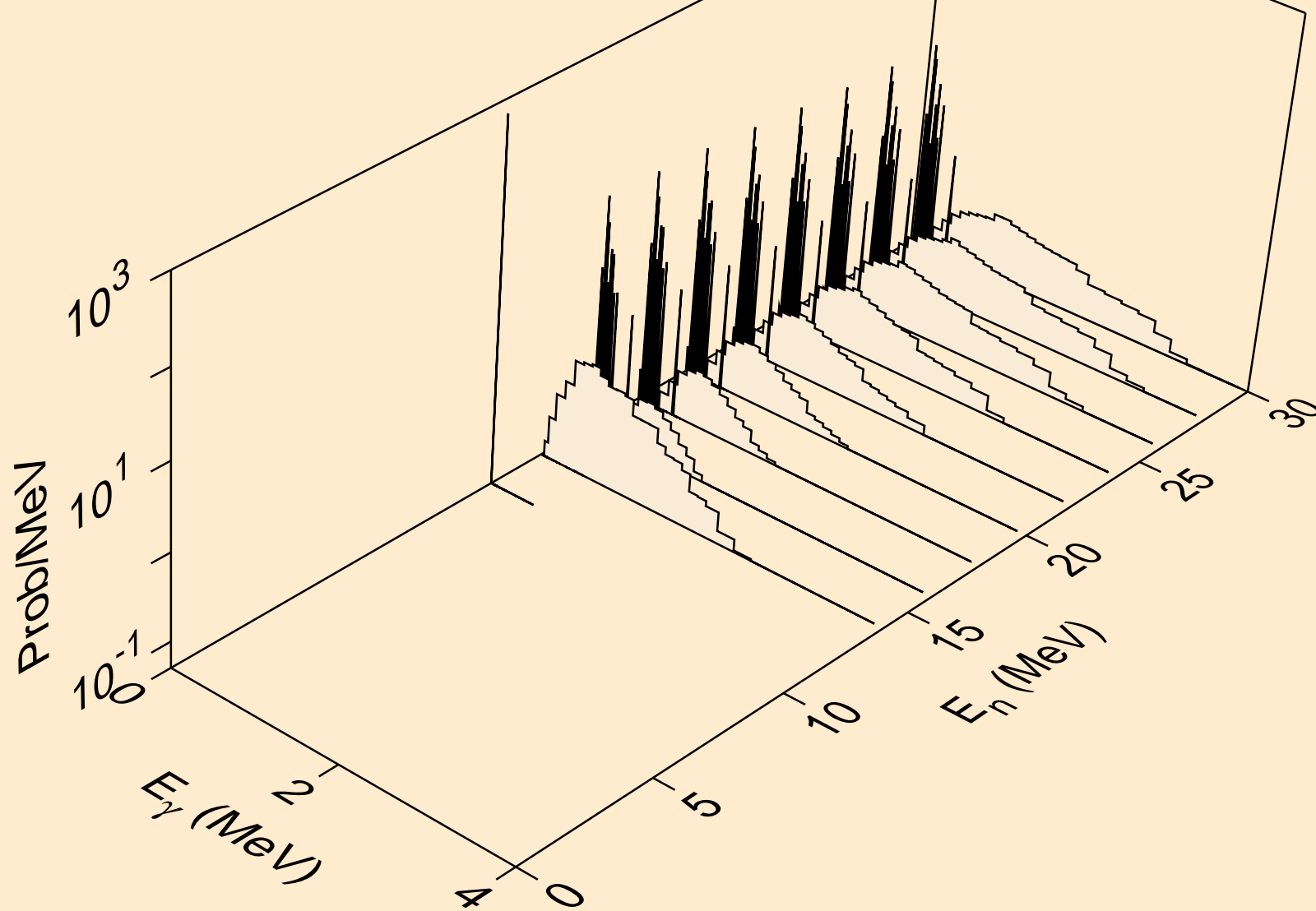

TB160 NEUTRON ACER TENDL-2021 LIBRARY; T=293.6K  
Photon emission for (n,2p)

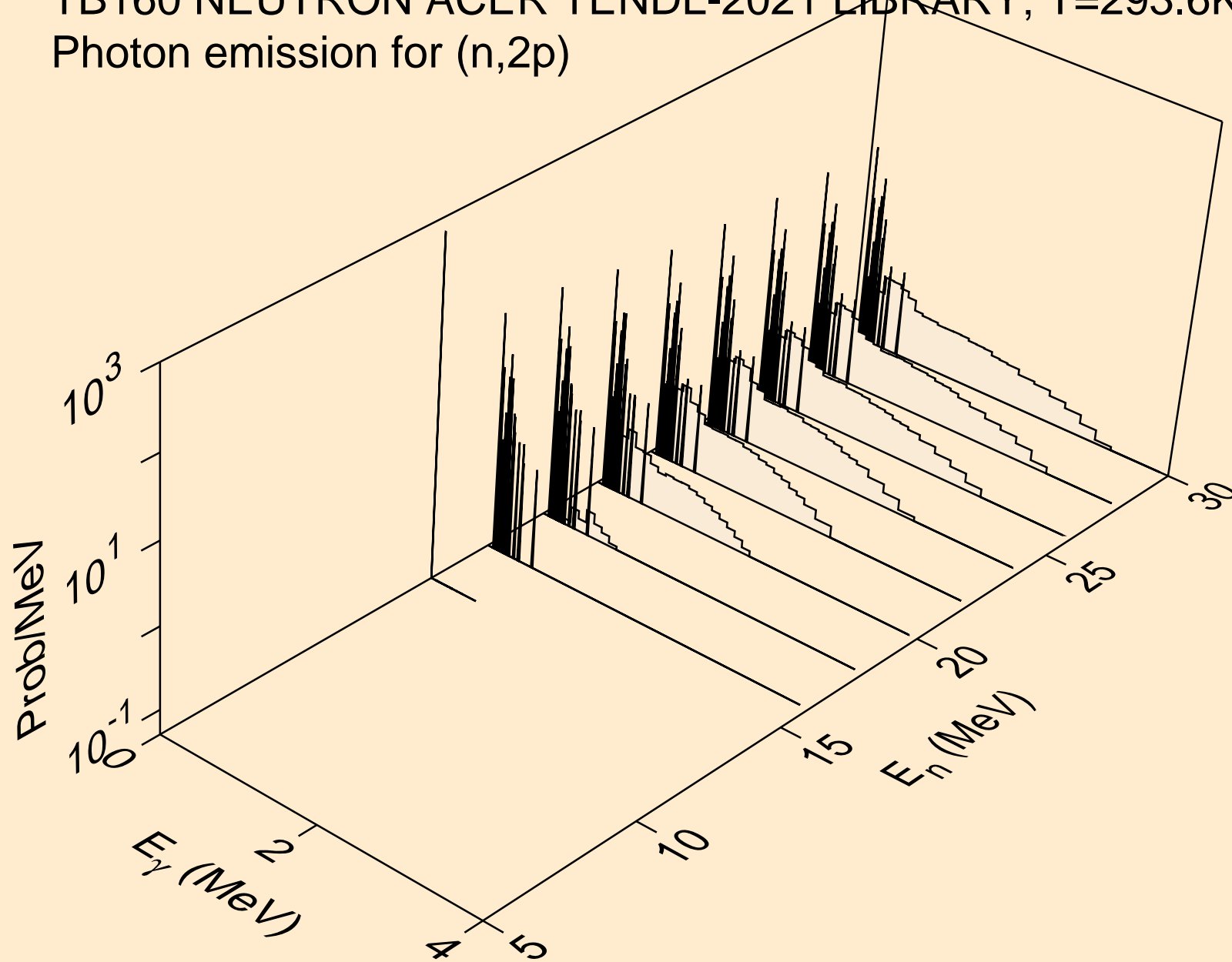

TB160 NEUTRON ACER TENDL-2021 LIBRARY; T=293.6K  
Photon emission for (n,p)

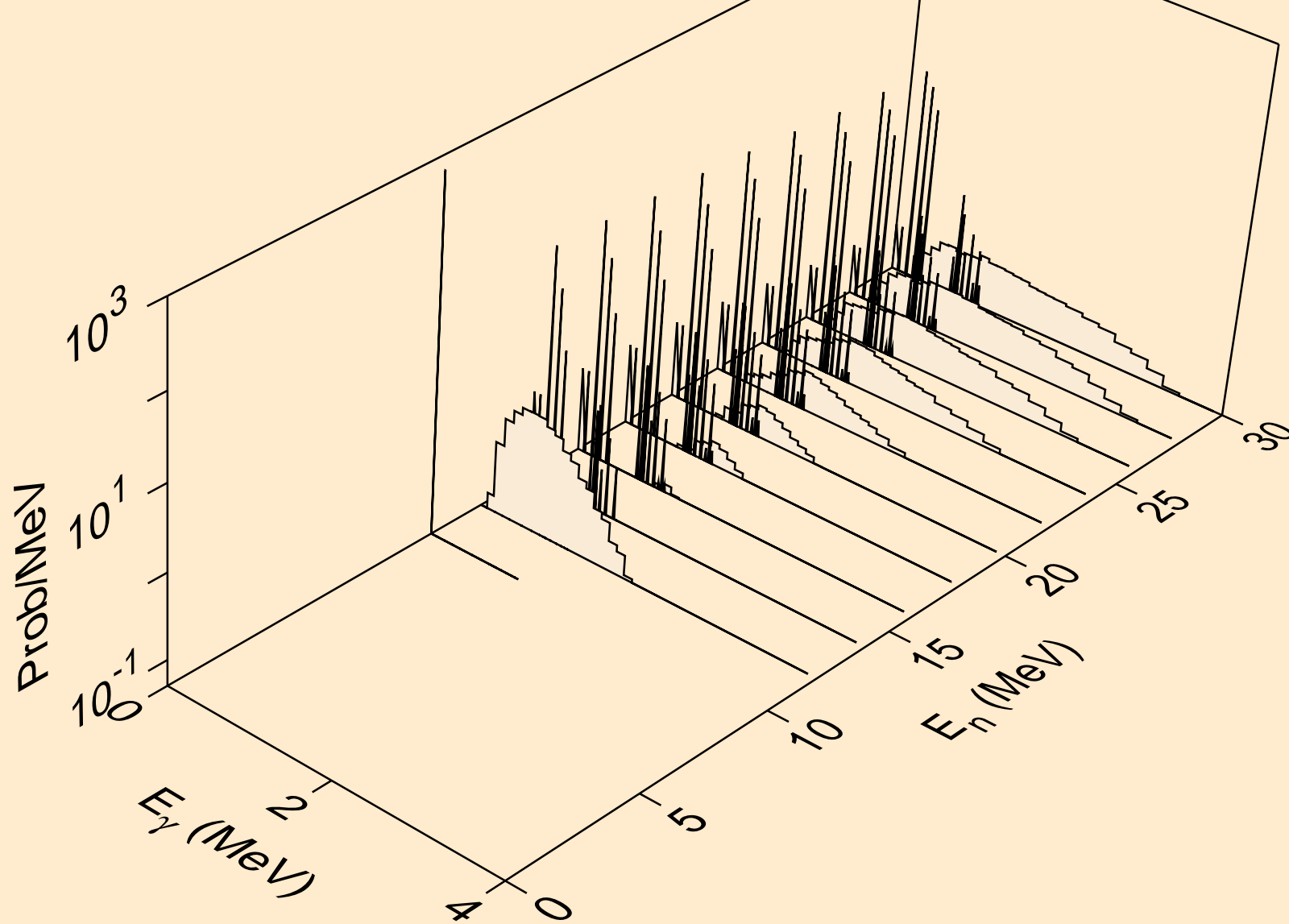

TB160 NEUTRON ACER TENDL-2021 LIBRARY; T=293.6K  
Photon emission for (n,pd)

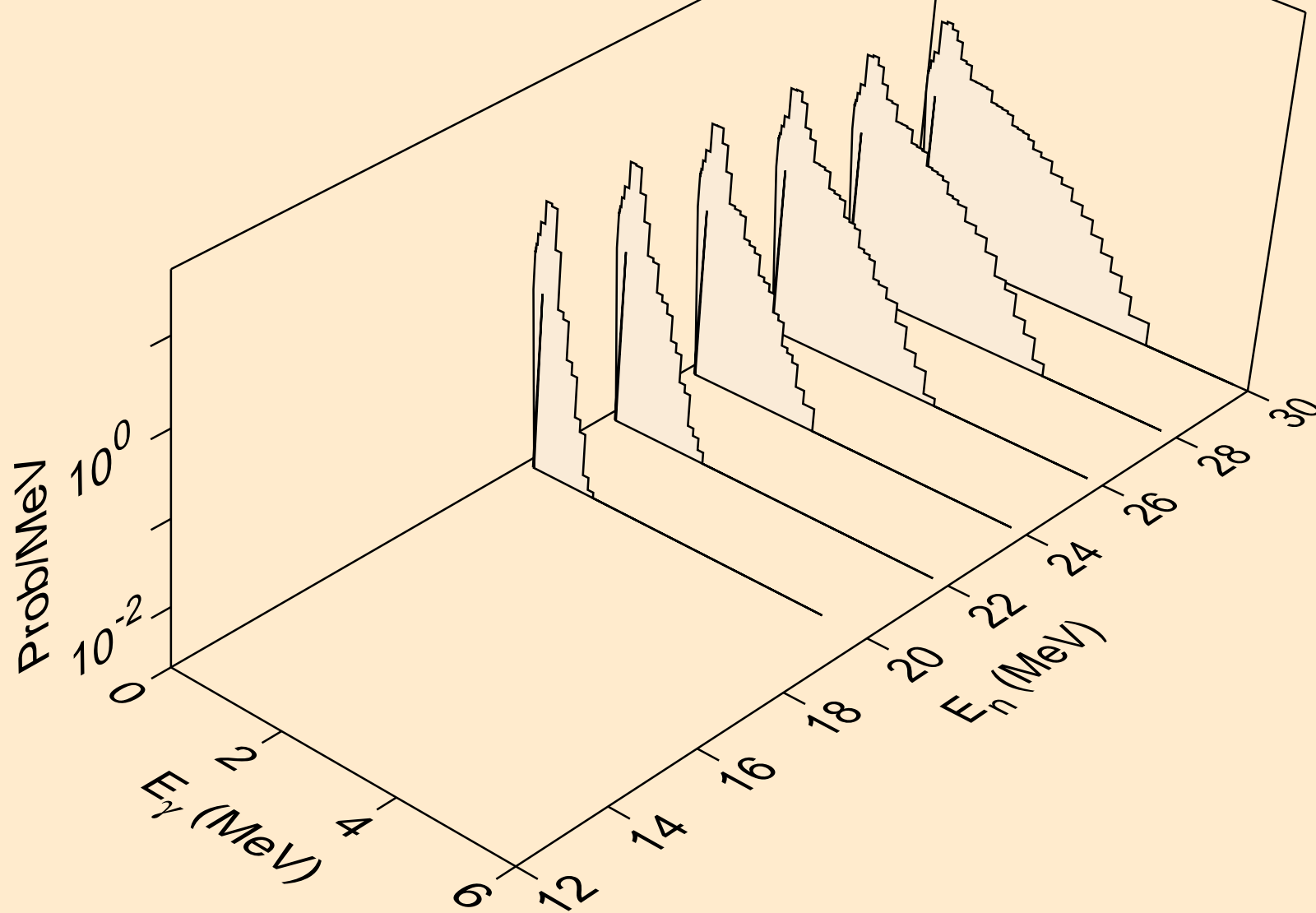



TB160 NEUTRON ACER TENDL-2021 LIBRARY; T=293.6K  
thermal capture photon spectrum

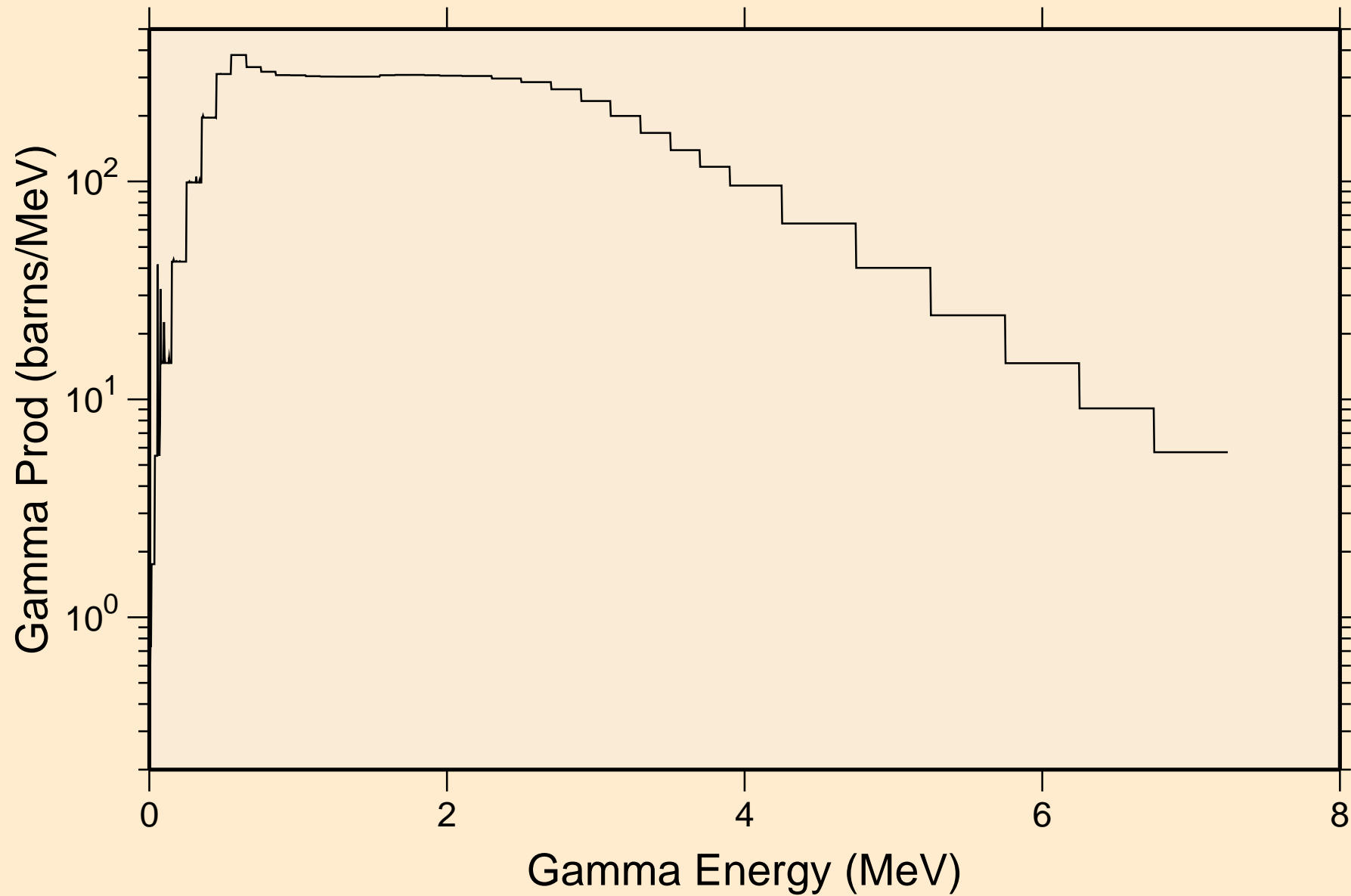

TB160 NEUTRON ACER TENDL-2021 LIBRARY; T=293.6K  
14 MeV photon spectrum

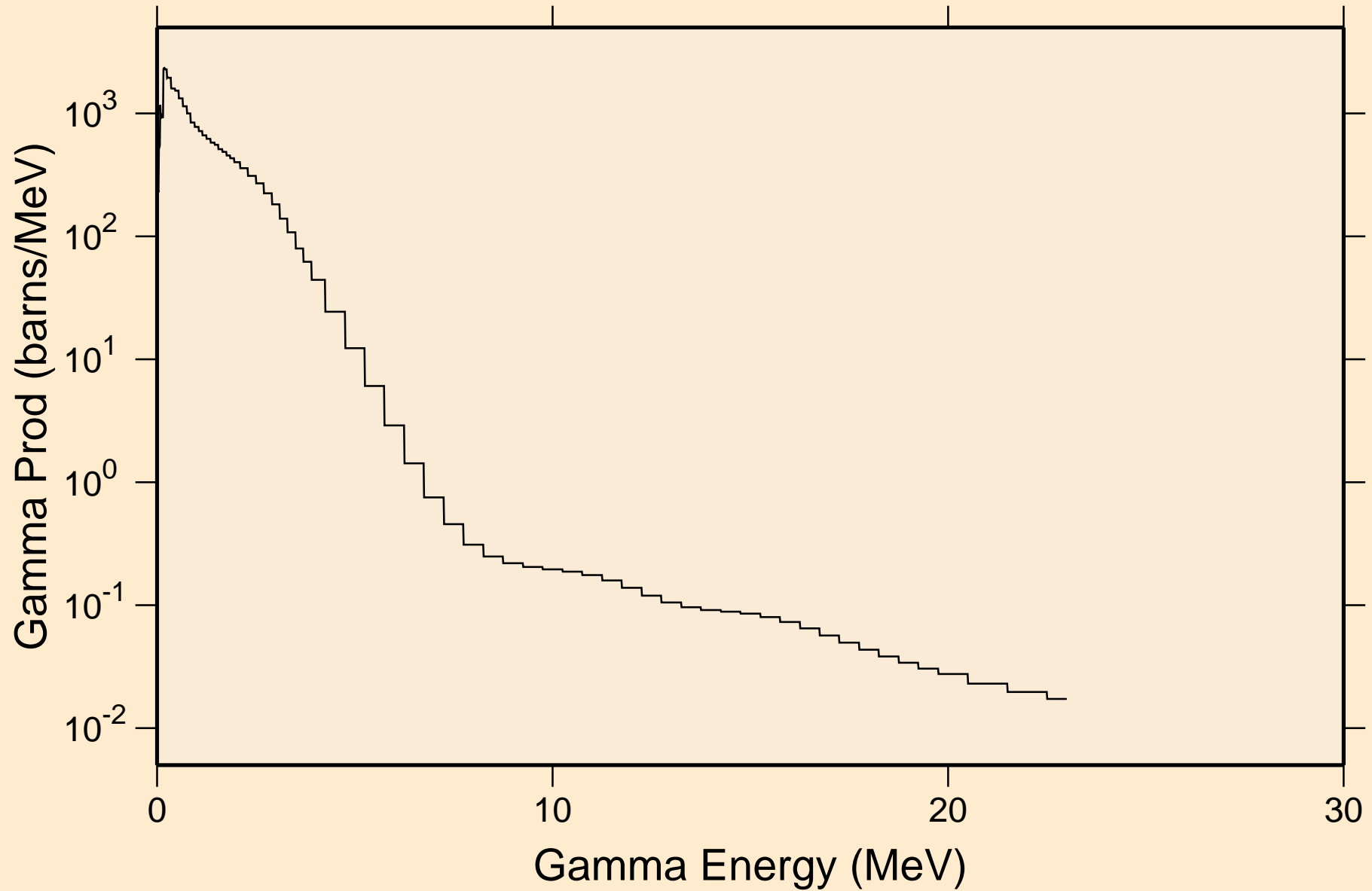

TB160 NEUTRON ACER TENDL-2021 LIBRARY; T=293.6K  
Particle heating contributions

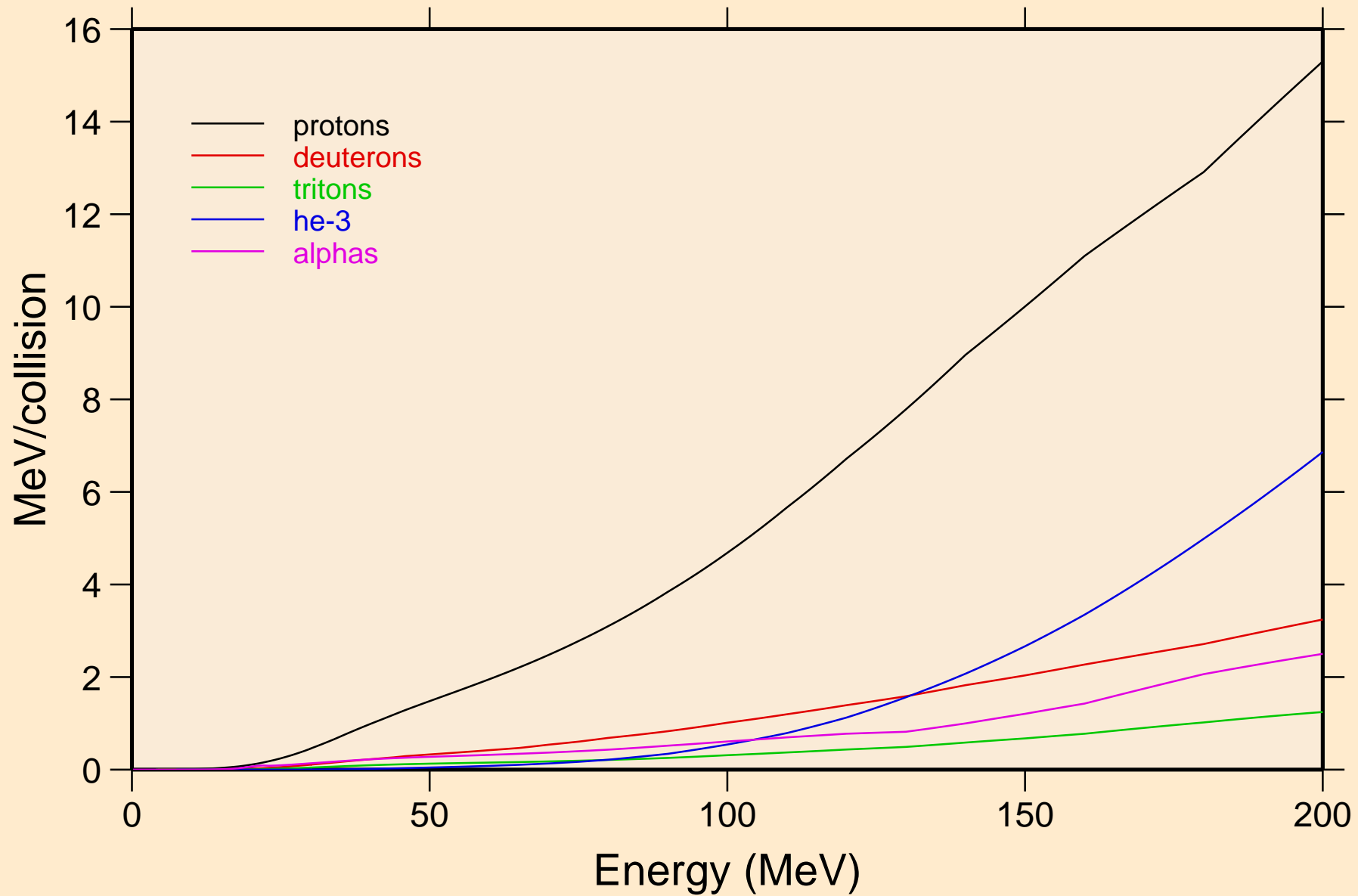

TB160 NEUTRON ACER TENDL-2021 LIBRARY; T=293.6K  
Recoil Heating

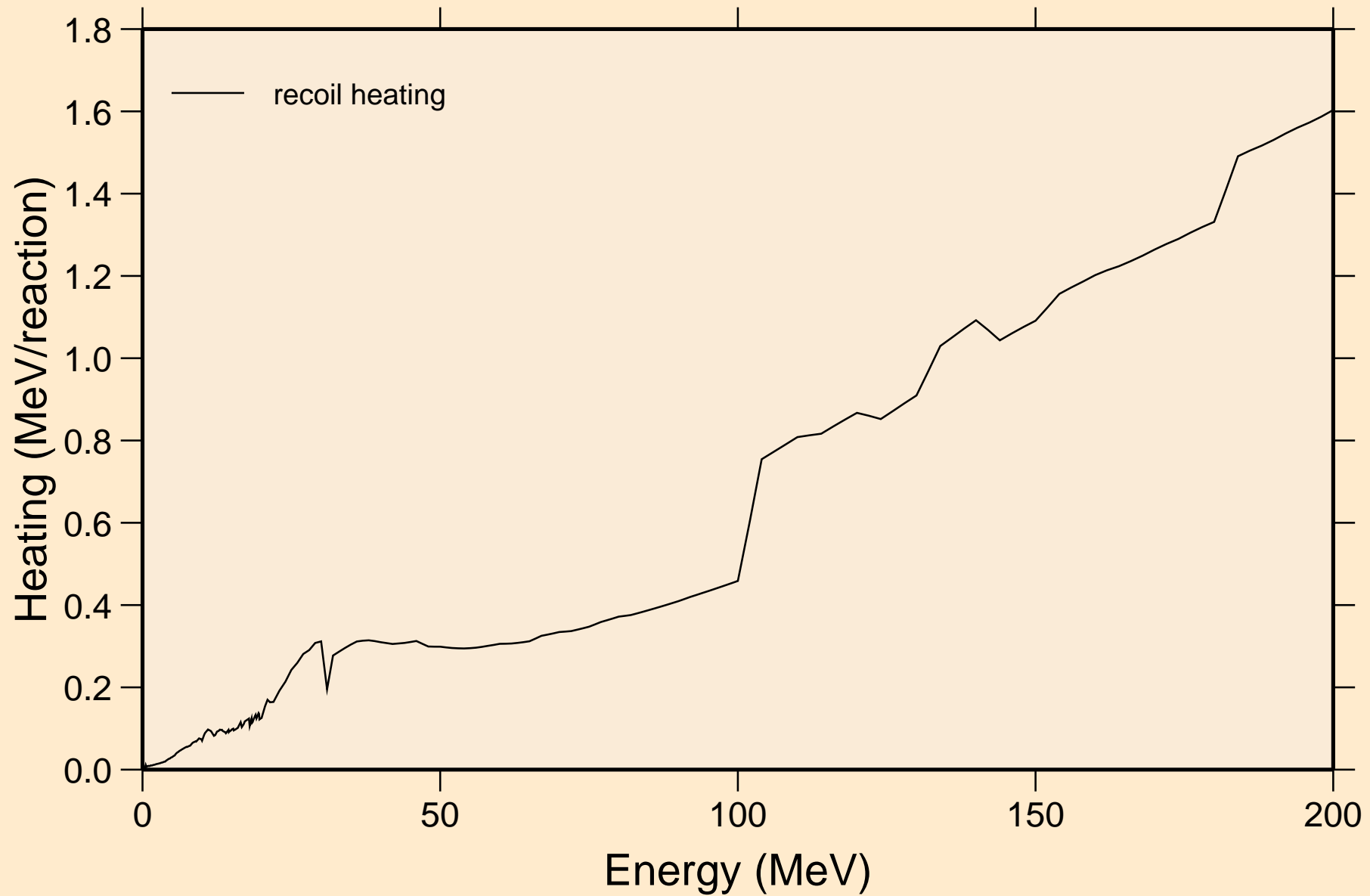

TB160 NEUTRON ACER TENDL-2021 LIBRARY; T=293.6K  
Particle production cross sections

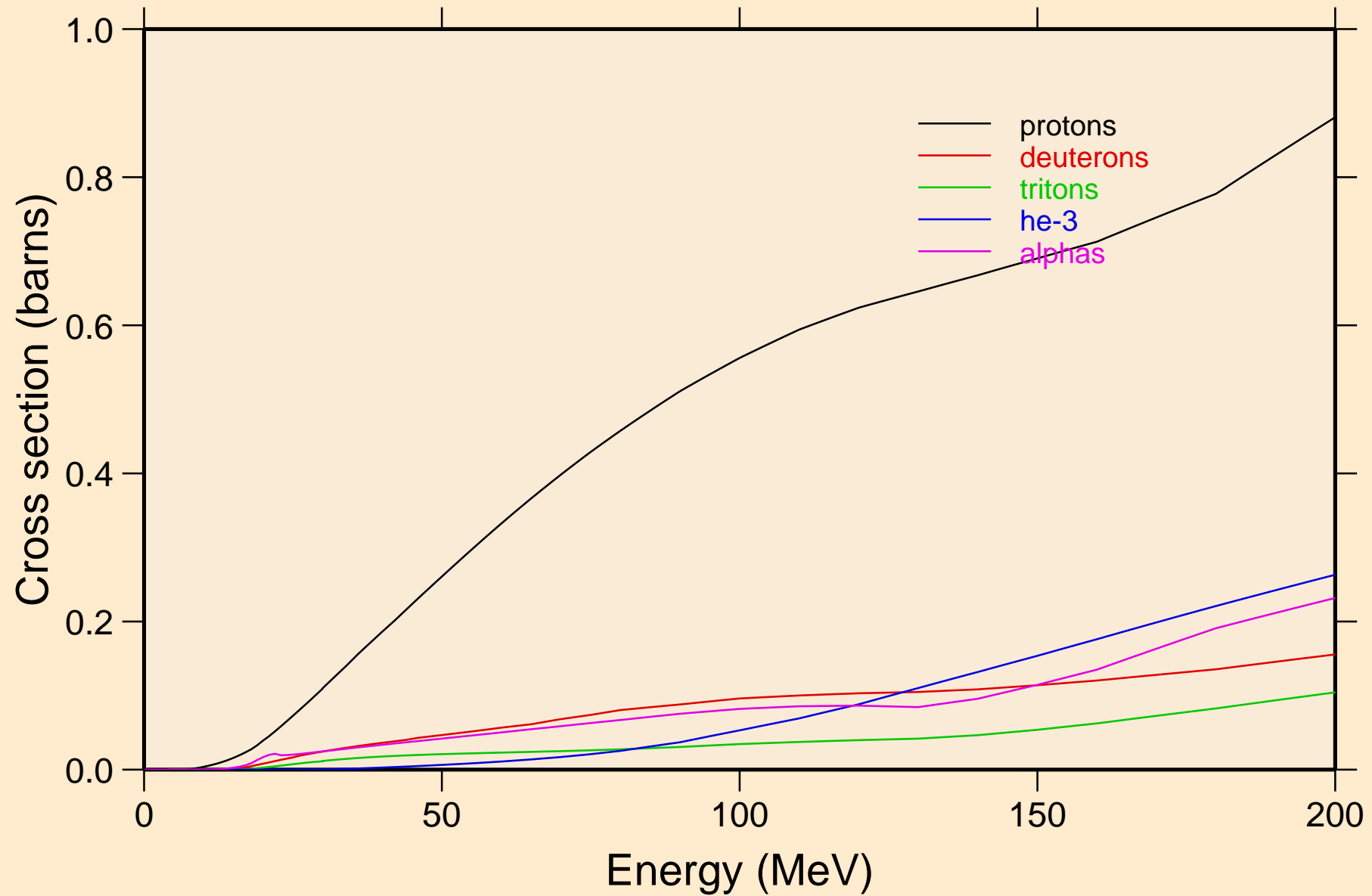

TB160 NEUTRON ACER TENDL-2021 LIBRARY; T=293.6K  
protons from (n,x)

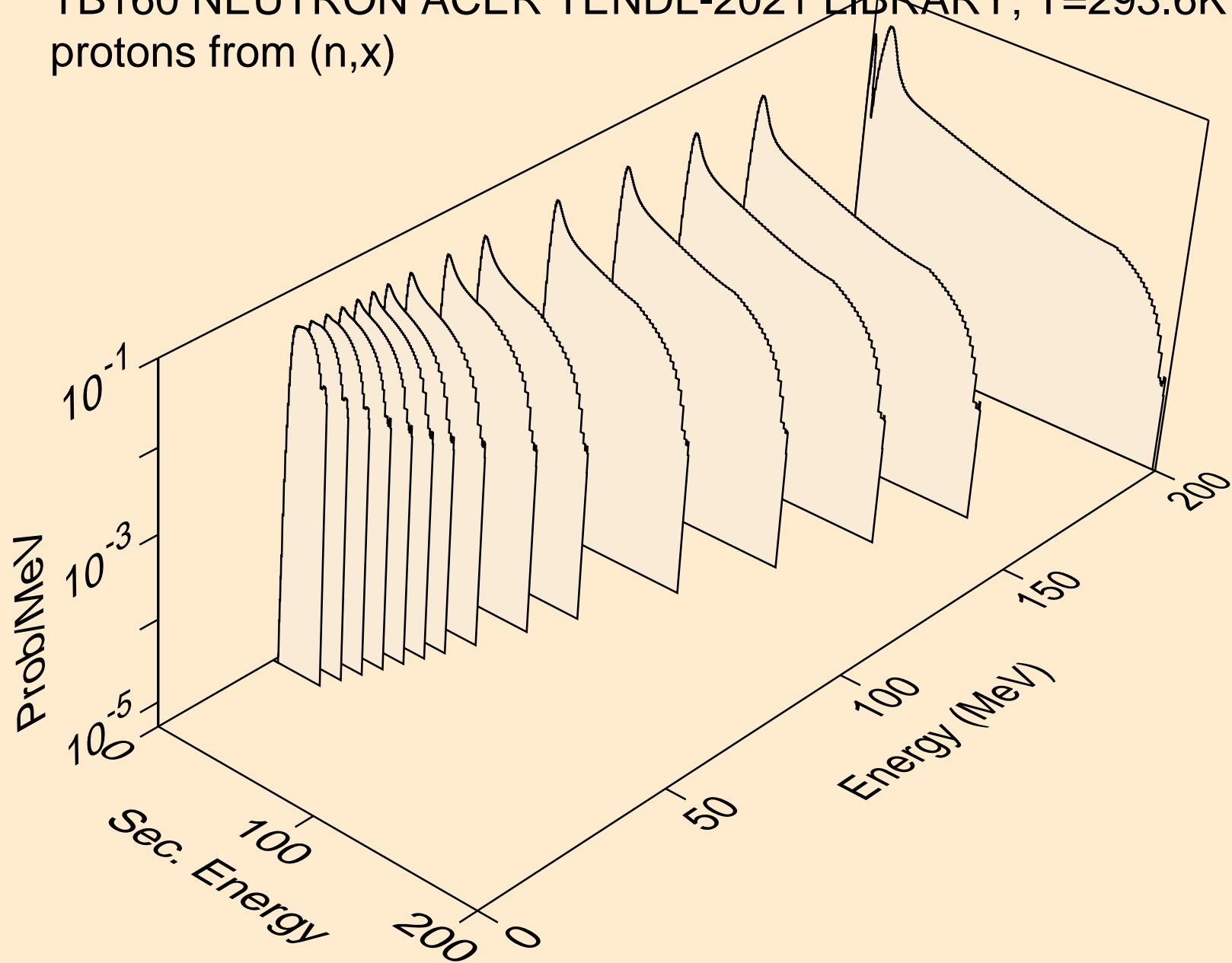

TB160 NEUTRON ACER TENDL-2021 LIBRARY; T=293.6K  
protons from (n,n\*)p

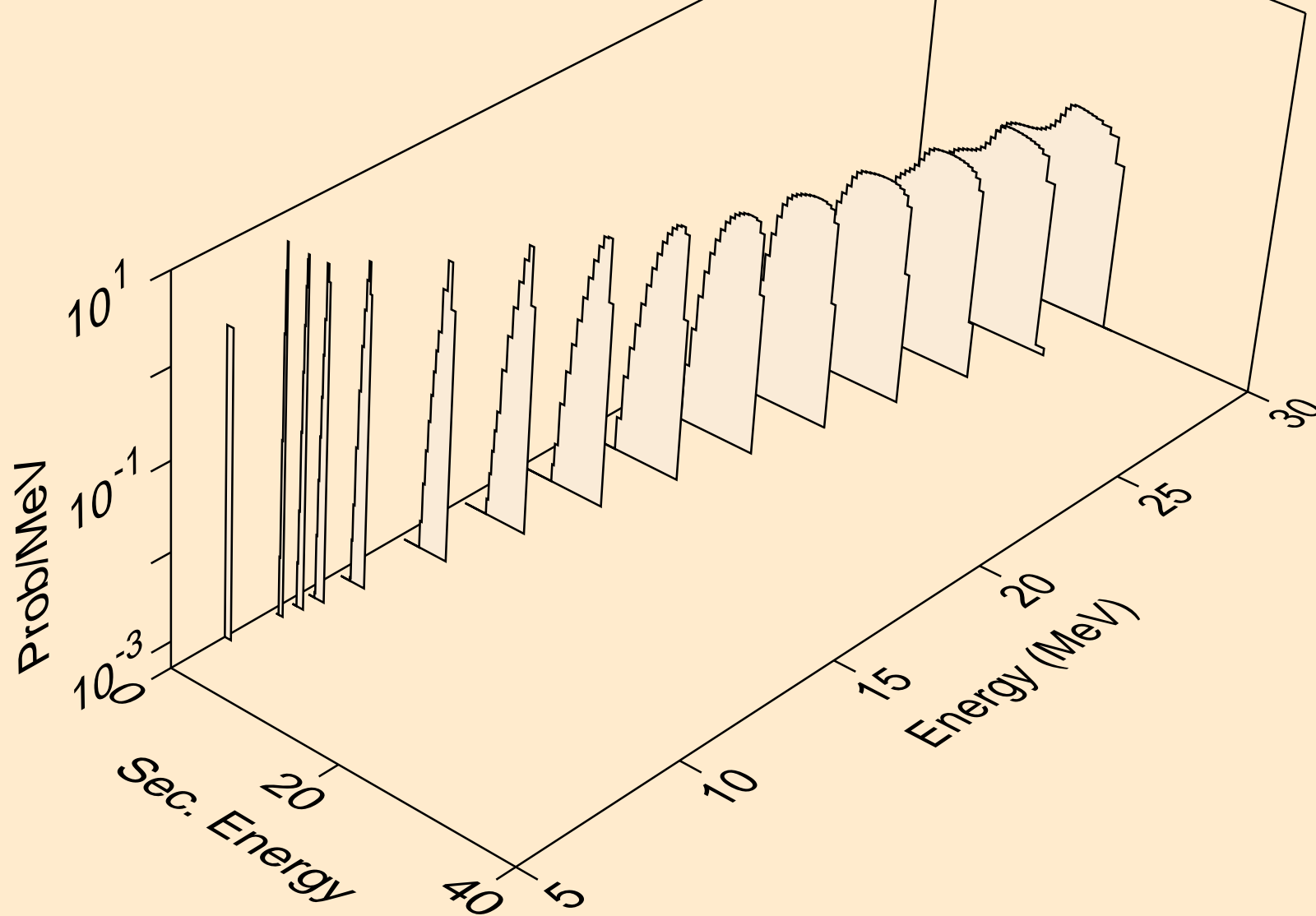

TB160 NEUTRON ACER TENDL-2021 LIBRARY; T=293.6K  
protons from (n,2np)

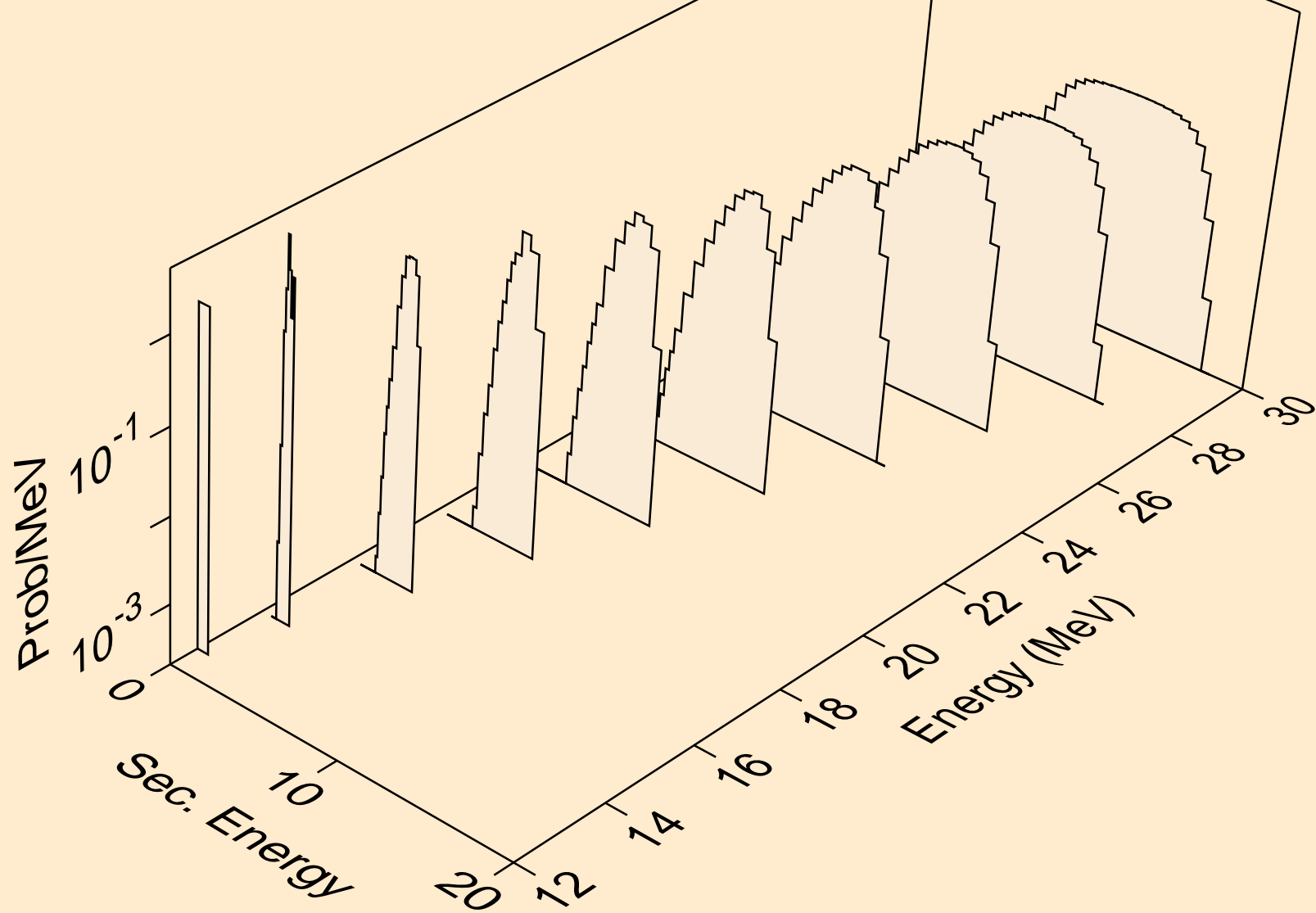



TB160 NEUTRON ACER TENDL-2021 LIBRARY; T=293.6K  
protons from (n,3np)

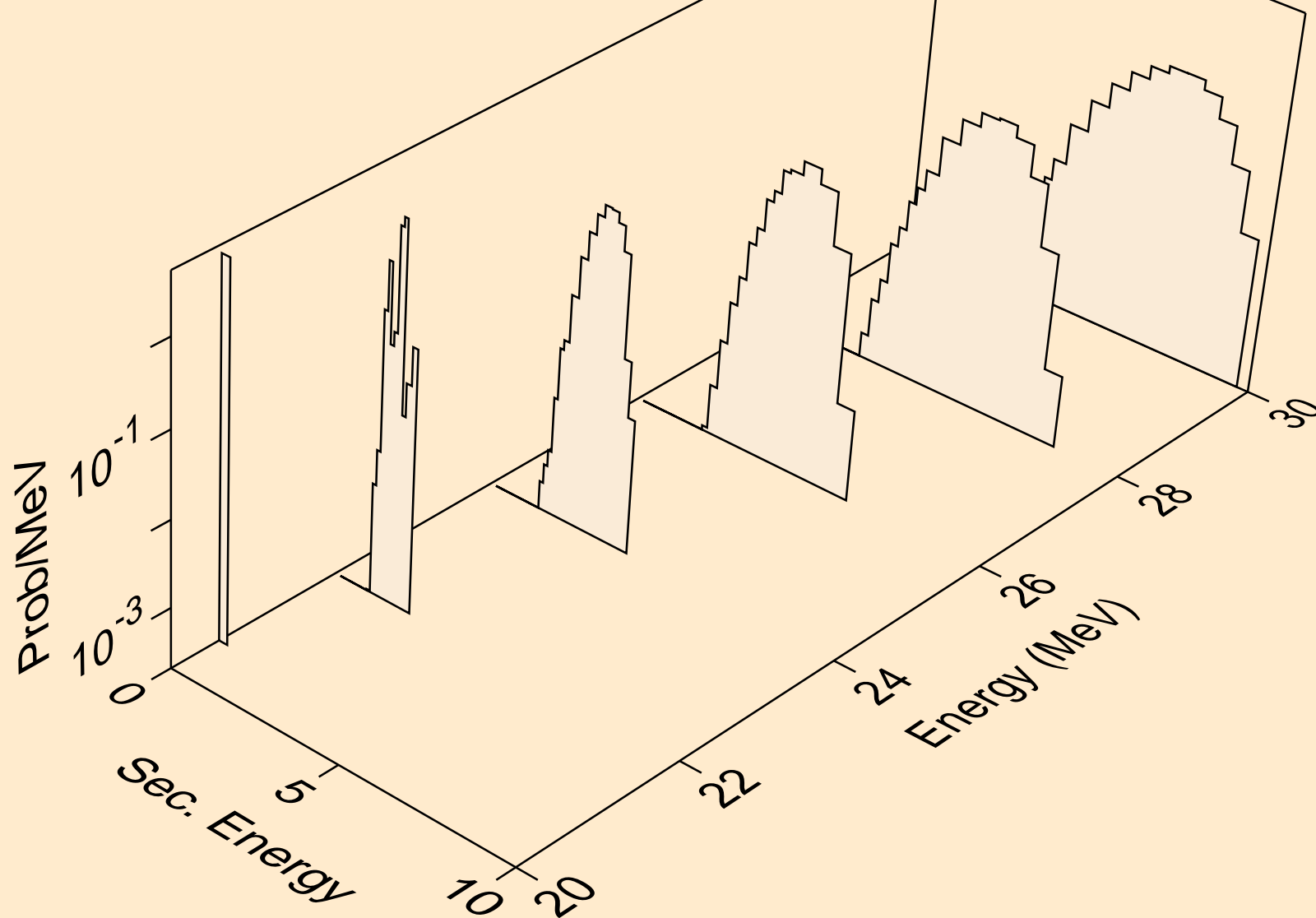

TB160 NEUTRON ACER TENDL-2021 LIBRARY; T=293.6K  
protons from (n,2np)

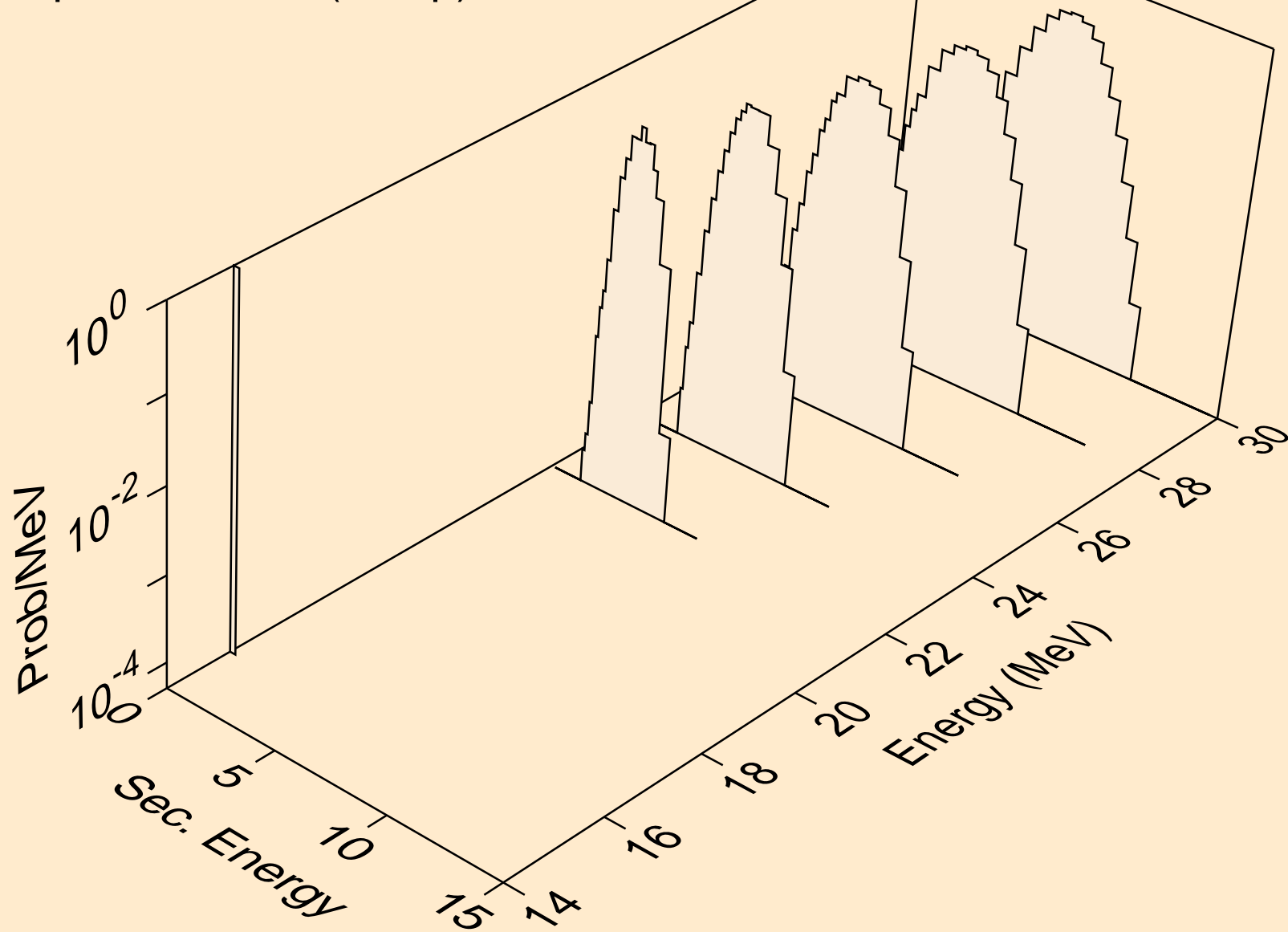

TB160 NEUTRON ACER TENDL-2021 LIBRARY; T=293.6K  
protons from (n,npa)

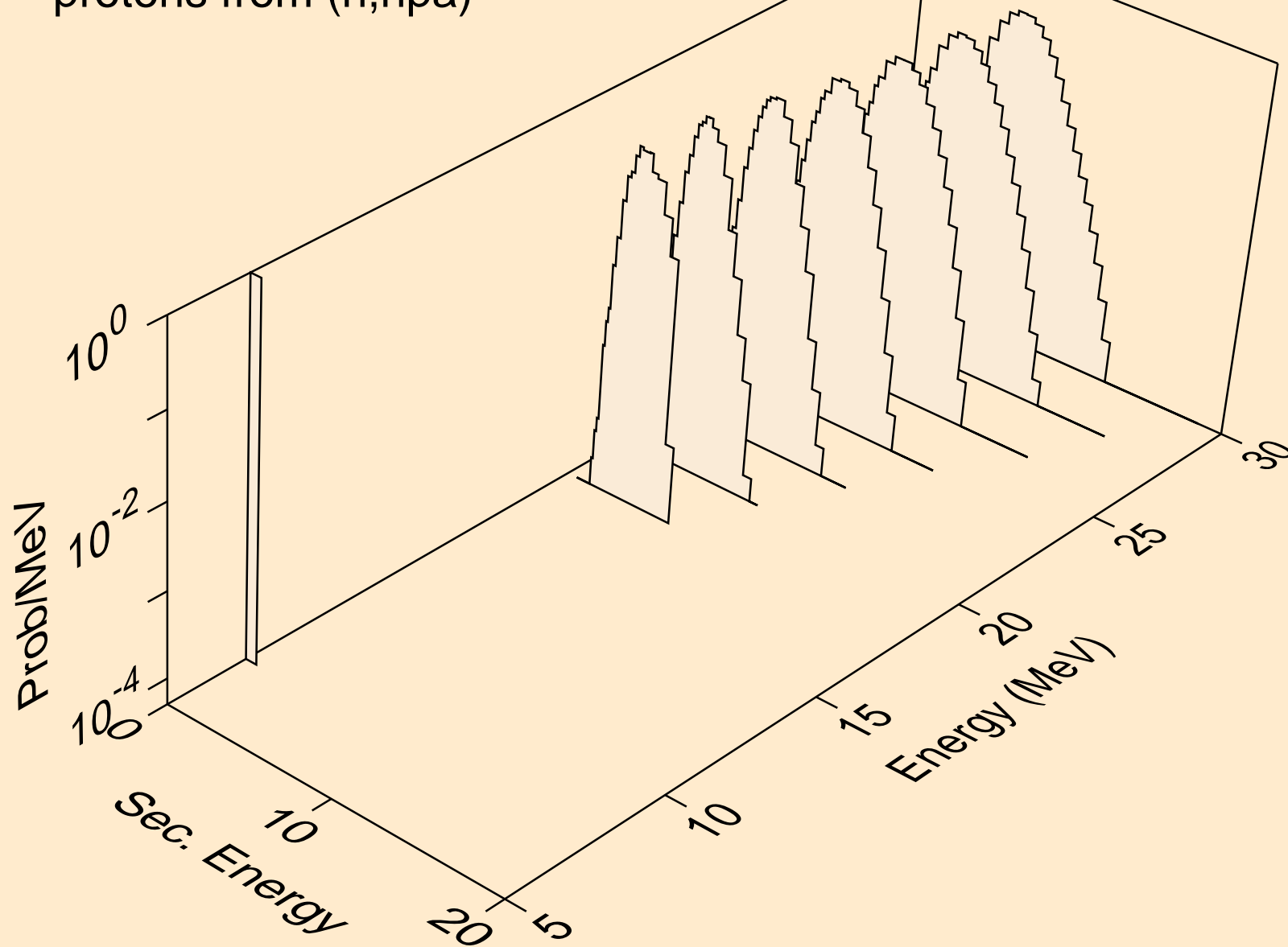

TB160 NEUTRON ACER TENDL-2021 LIBRARY; T=293.6K  
protons from (n,p)

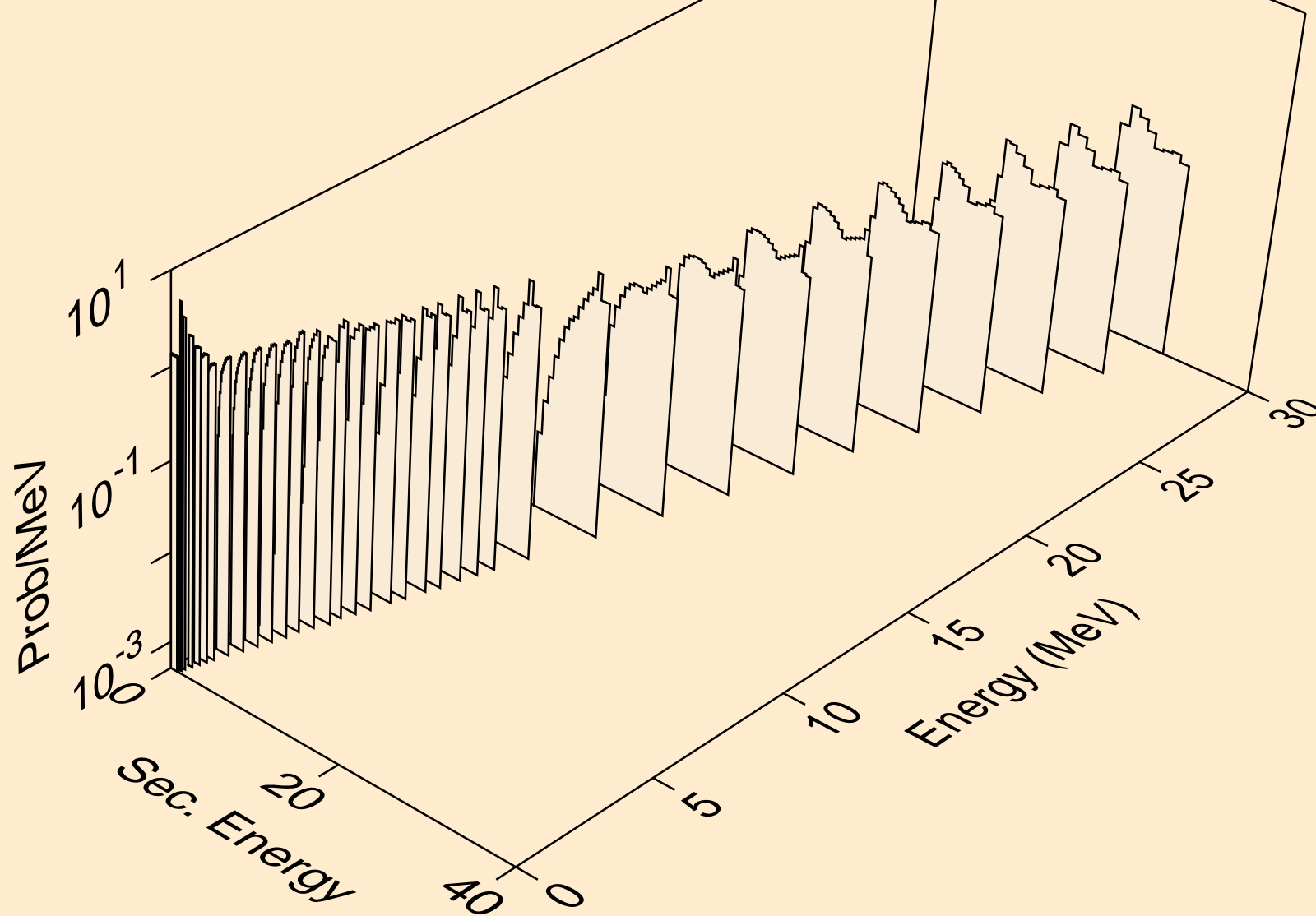

TB160 NEUTRON ACER TENDL-2021 LIBRARY; T=293.6K  
protons from (n,2p)

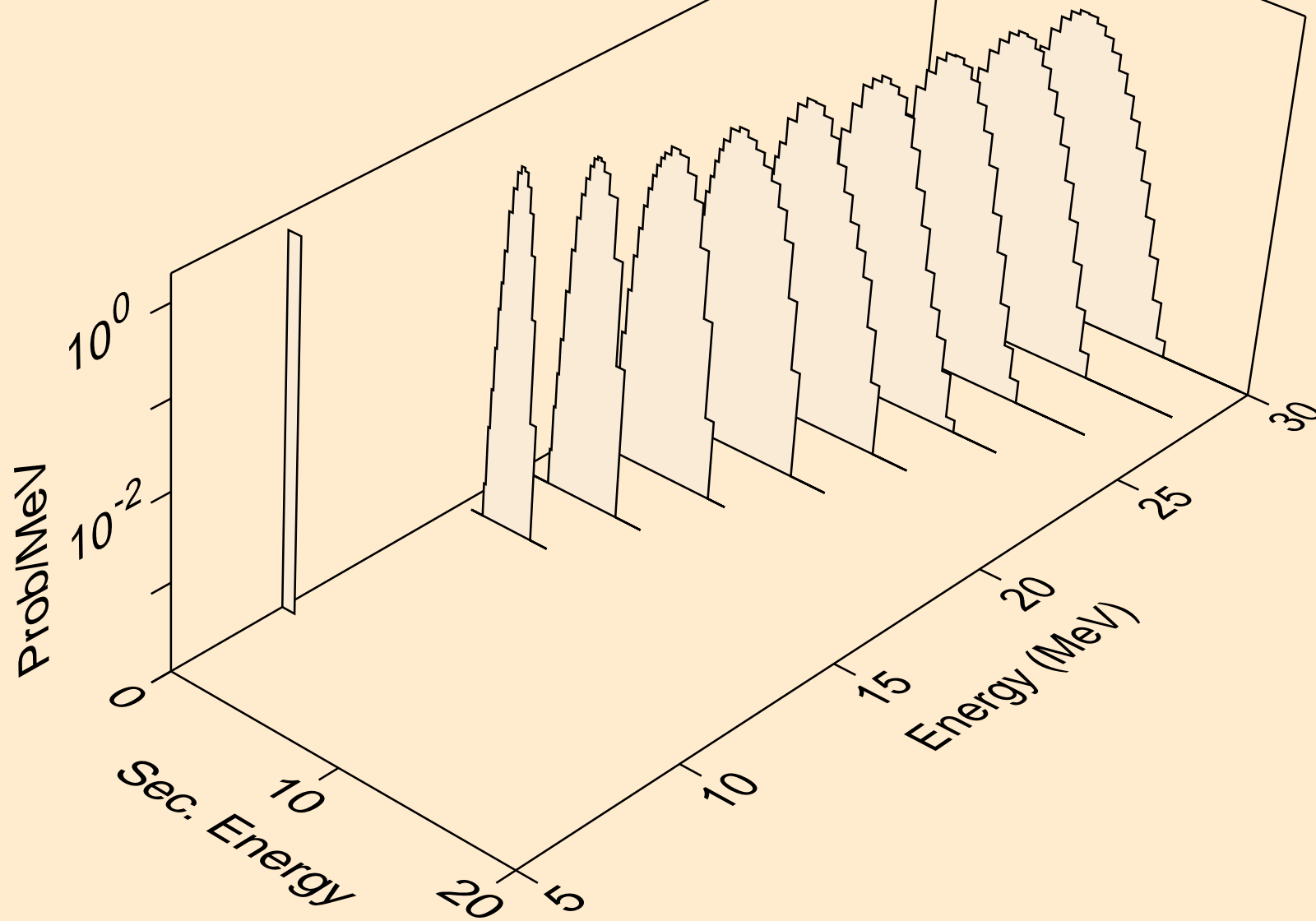

TB160 NEUTRON ACER TENDL-2021 LIBRARY; T=293.6K  
protons from (n,p)

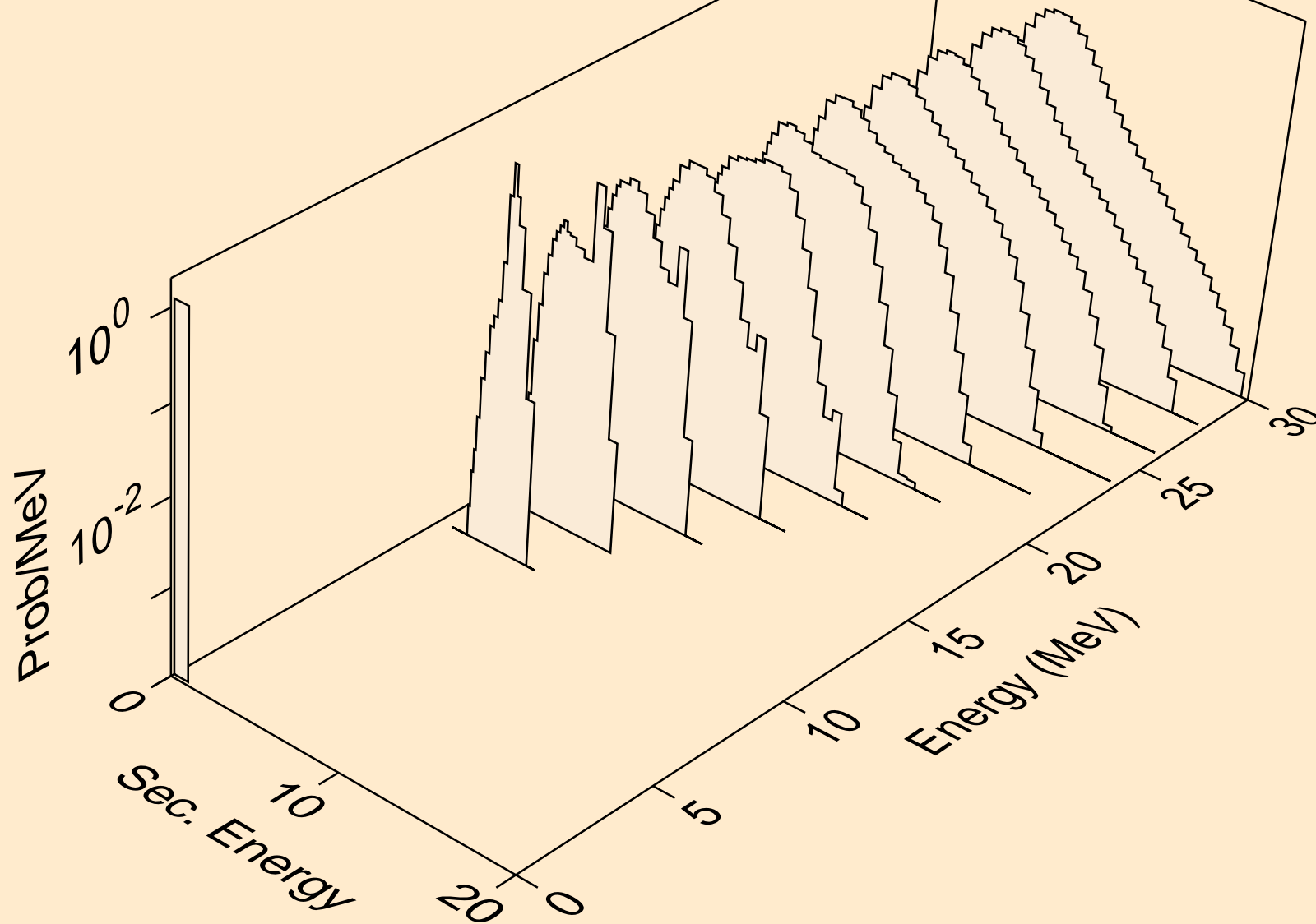

TB160 NEUTRON ACER TENDL-2021 LIBRARY; T=293.6K  
protons from (n,pd)

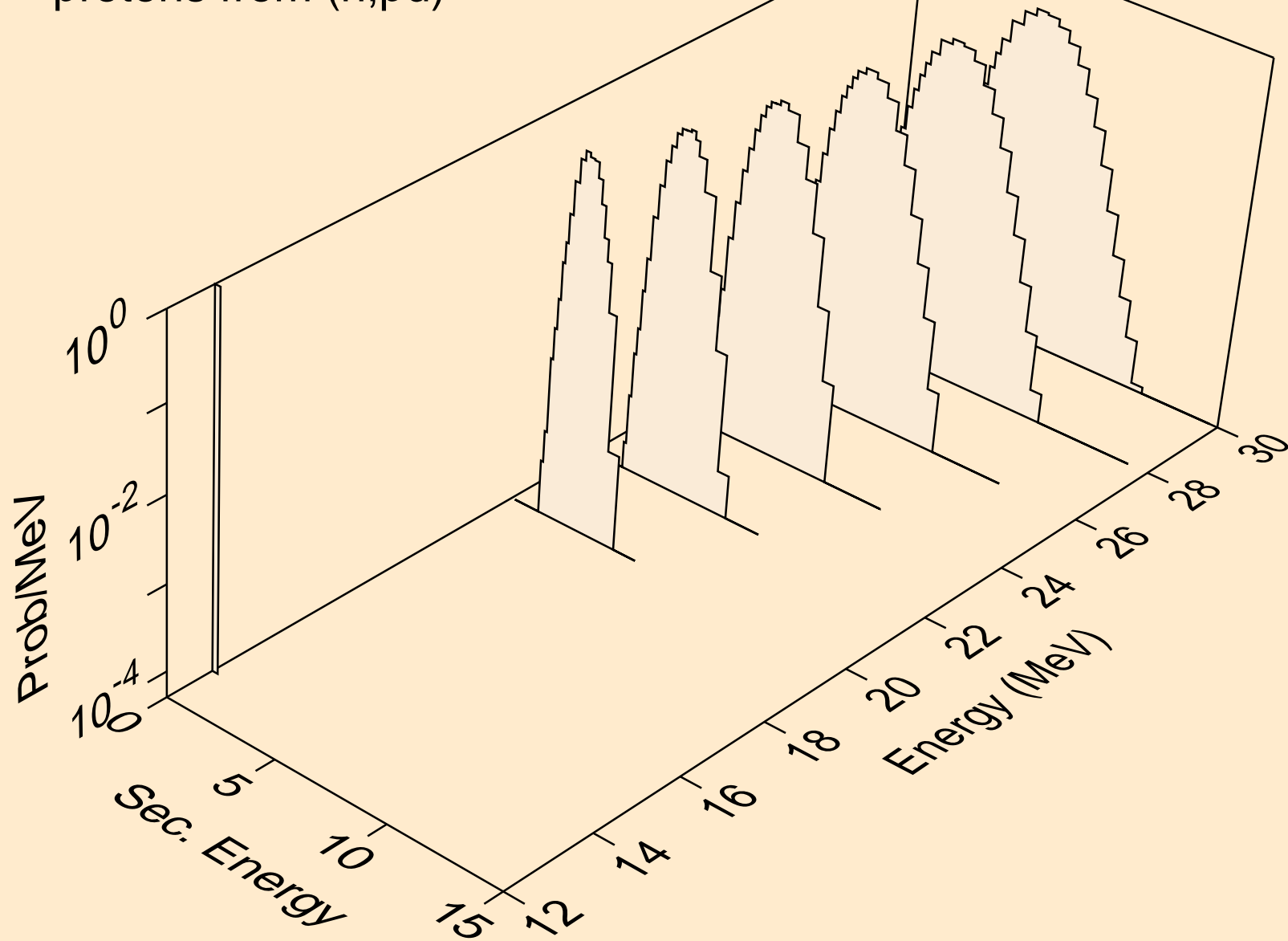

TB160 NEUTRON ACER TENDL-2021 LIBRARY; T=293.6K  
deuterons from (n,x)

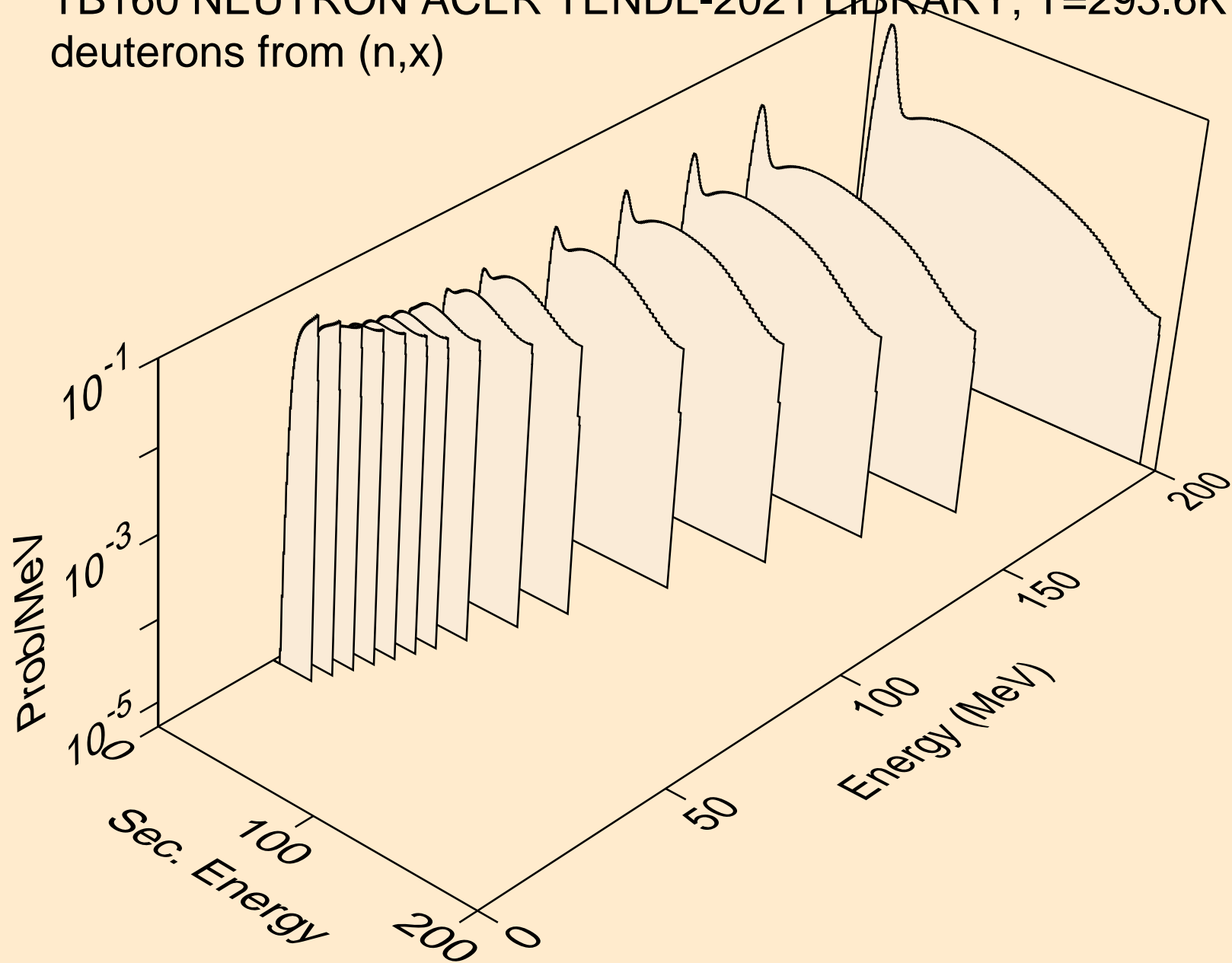



TB160 NEUTRON ACER TENDL-2021 LIBRARY; T=293.6K  
deuterons from (n,2nd)

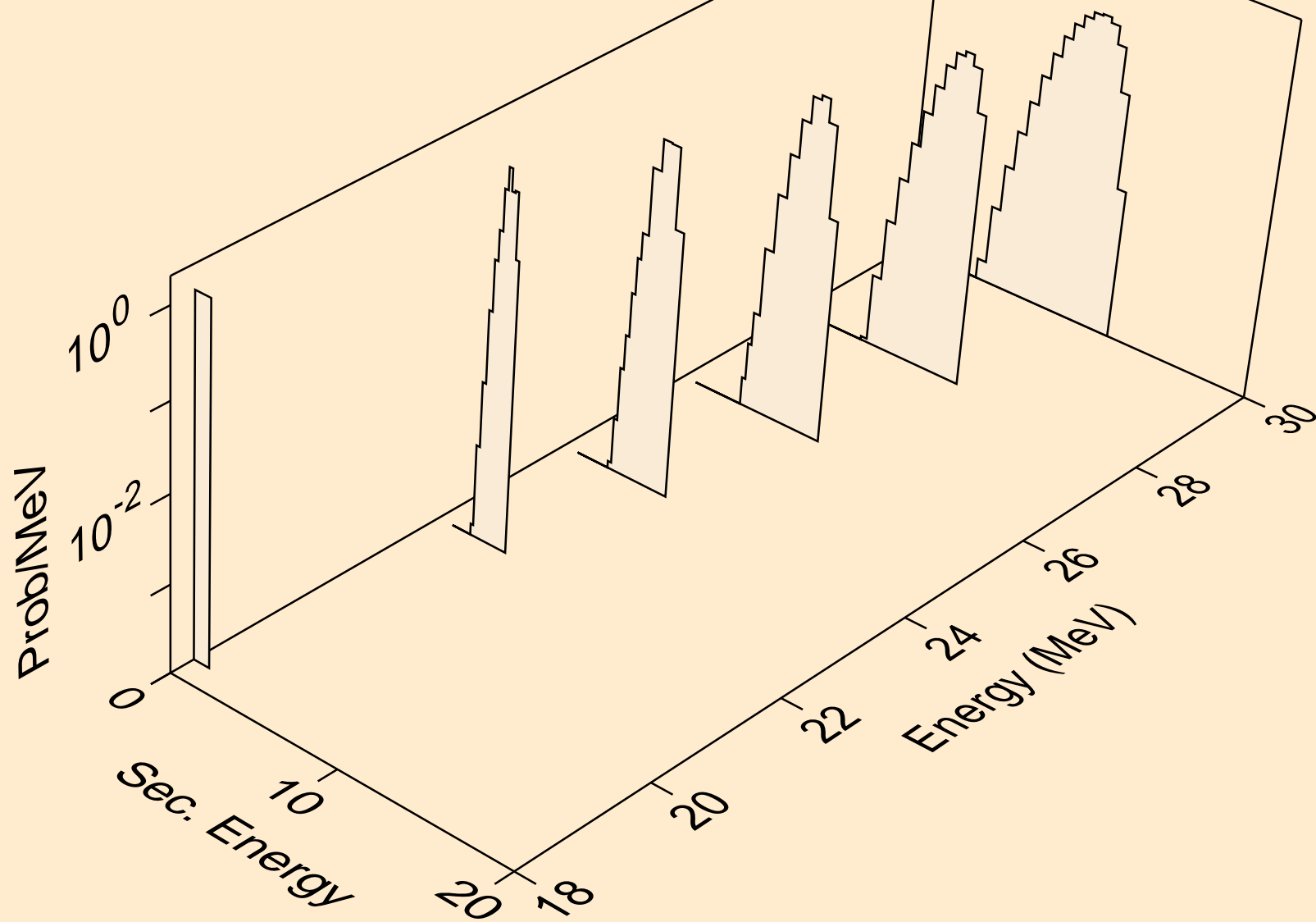

TB160 NEUTRON ACER TENDL-2021 LIBRARY; T=293.6K  
deuterons from (n,n\*)d

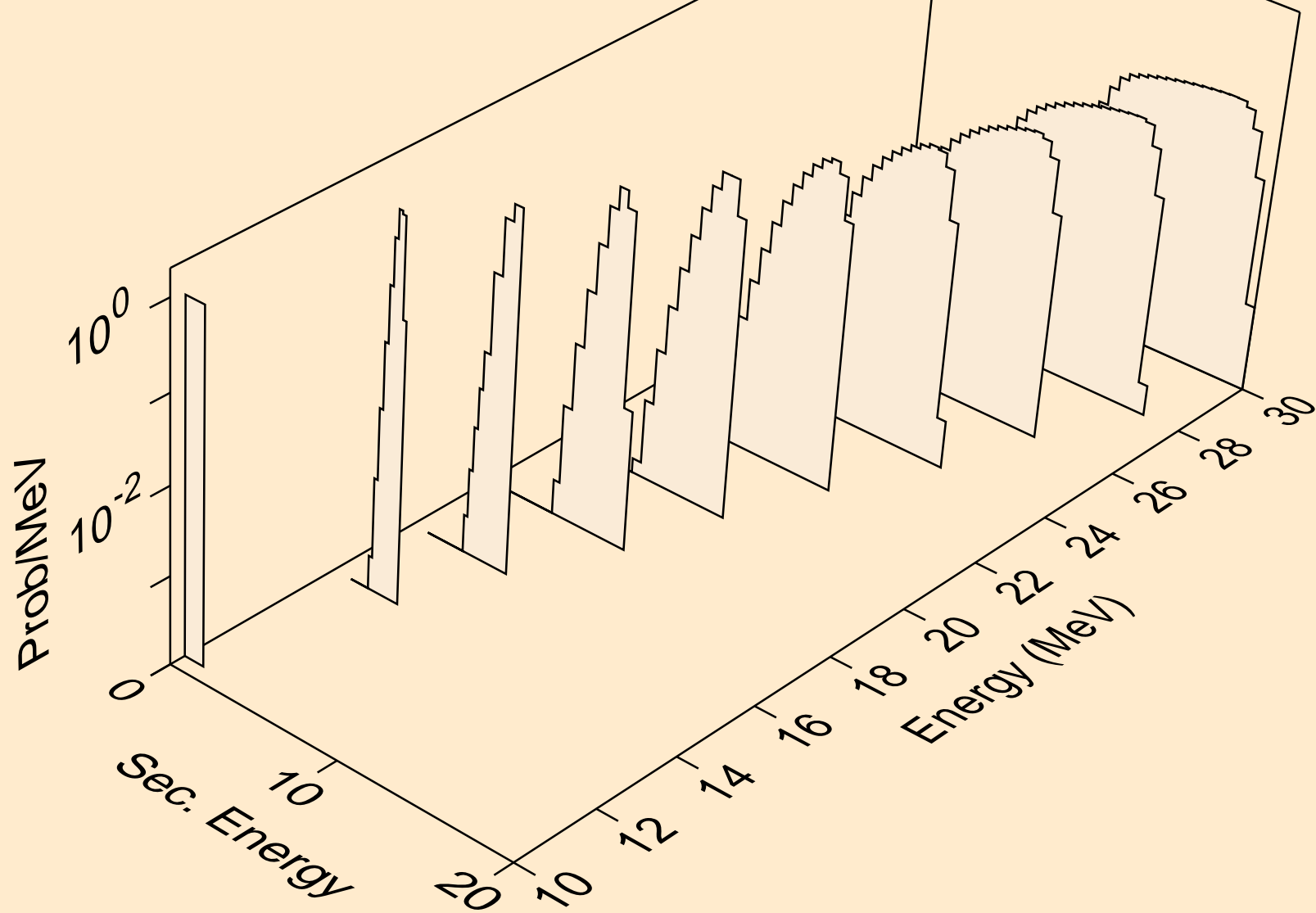

TB160 NEUTRON ACER TENDL-2021 LIBRARY; T=293.6K  
deuterons from (n,d)

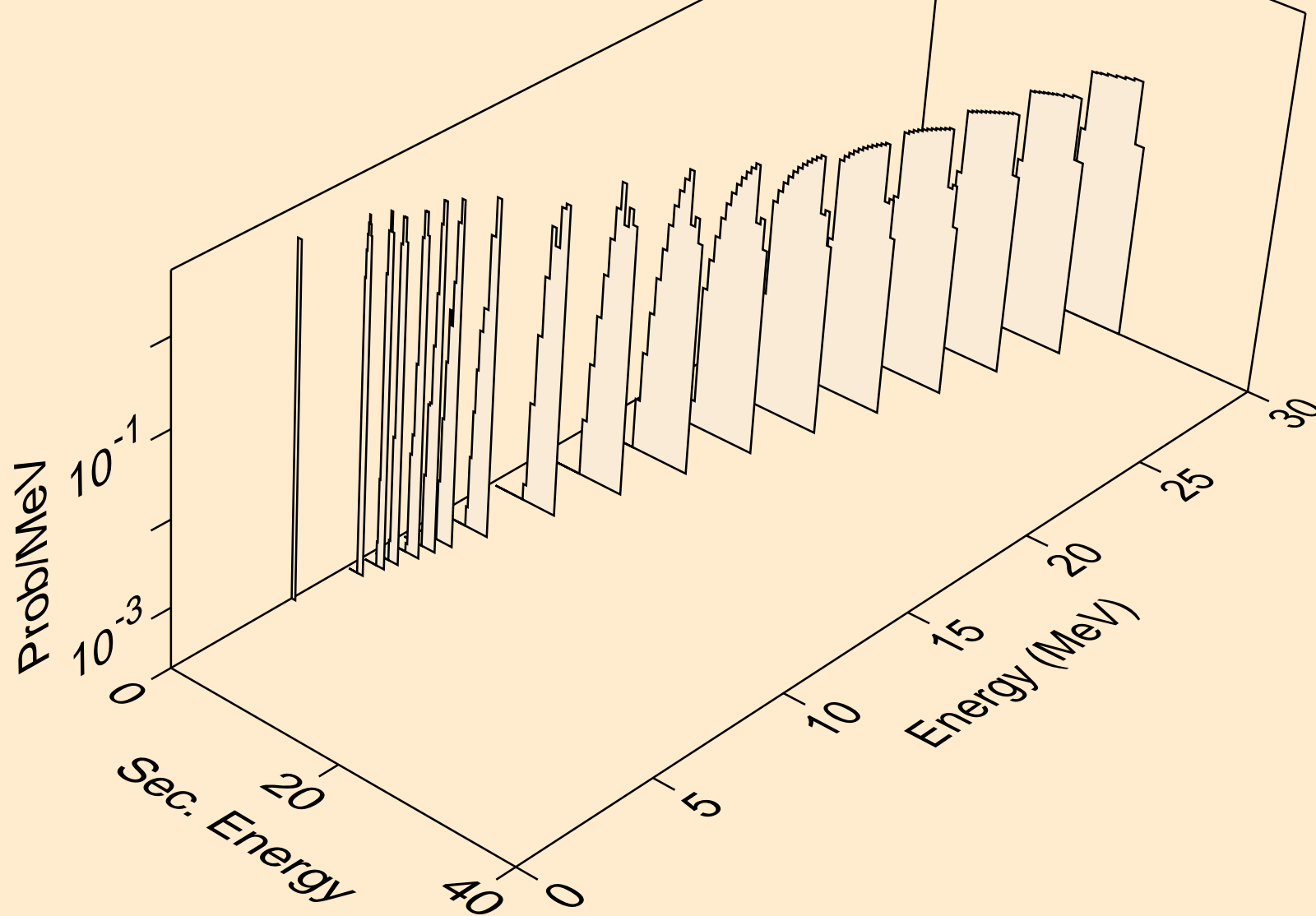

TB160 NEUTRON ACER TENDL-2021 LIBRARY; T=293.6K  
deuterons from (n,pd)

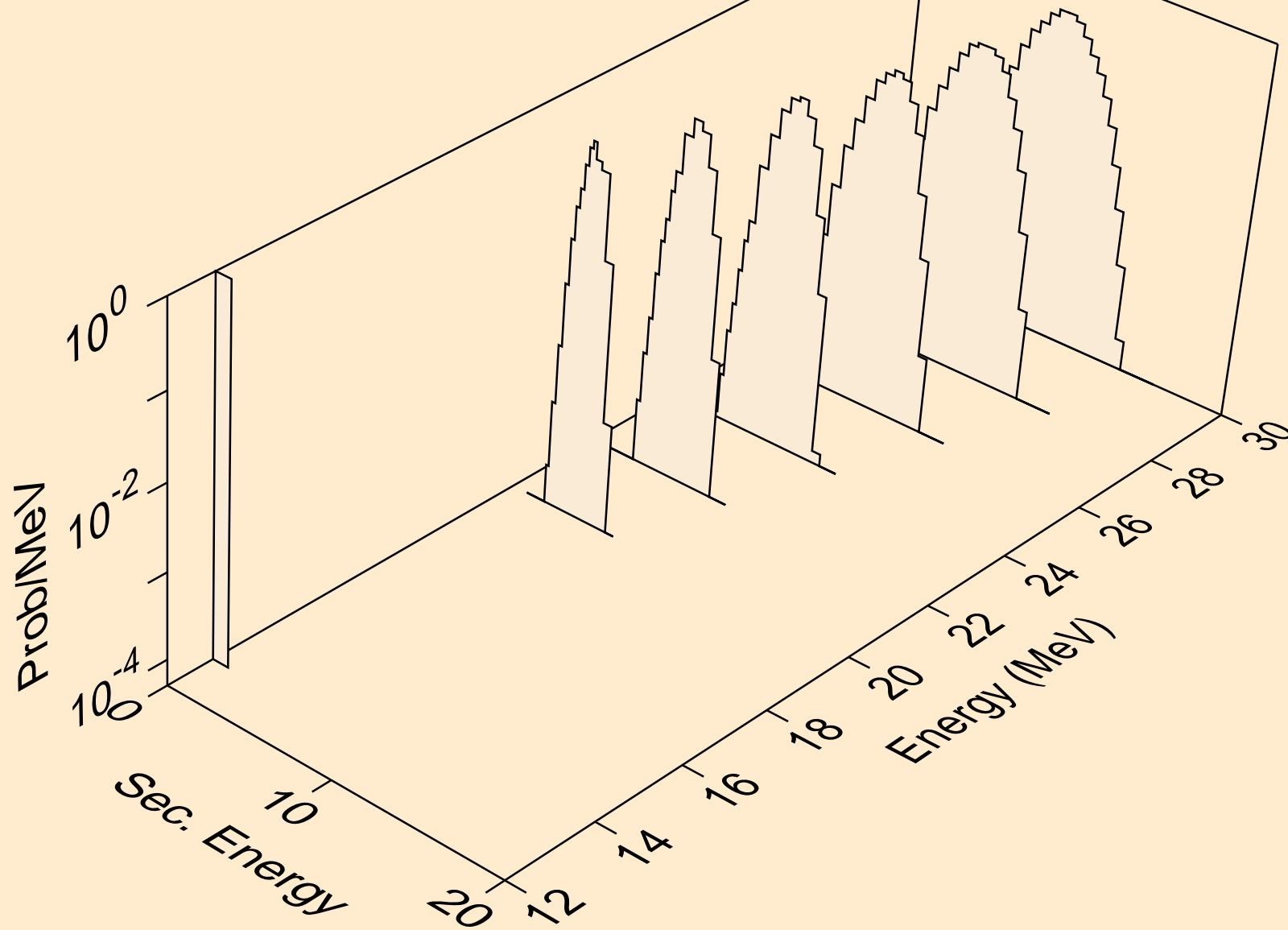

TB160 NEUTRON ACER TENDL-2021 LIBRARY; T=293.6K  
tritons from (n,x)

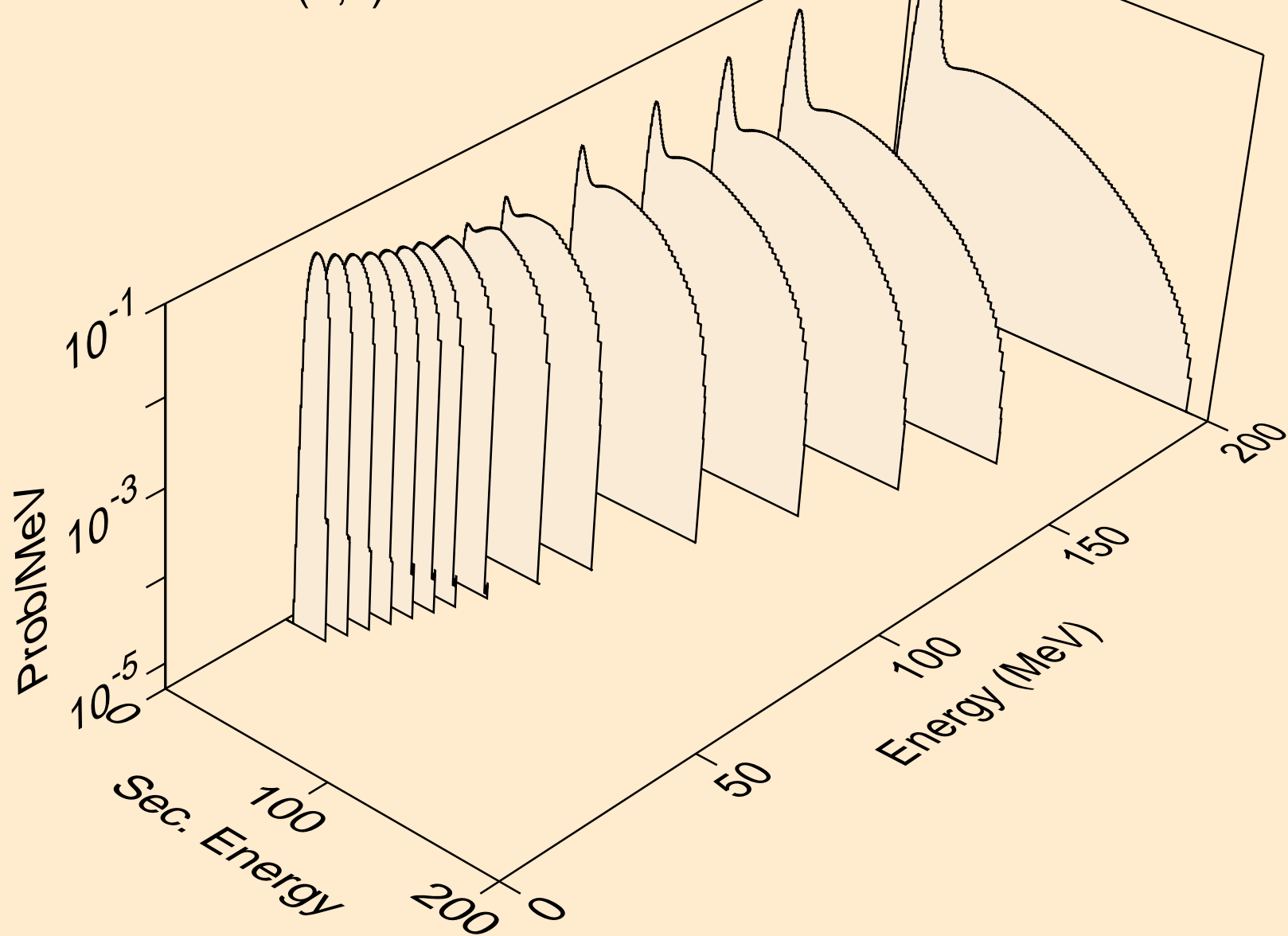

TB160 NEUTRON ACER TENDL-2021 LIBRARY; T=293.6K  
tritons from (n,n\*)t

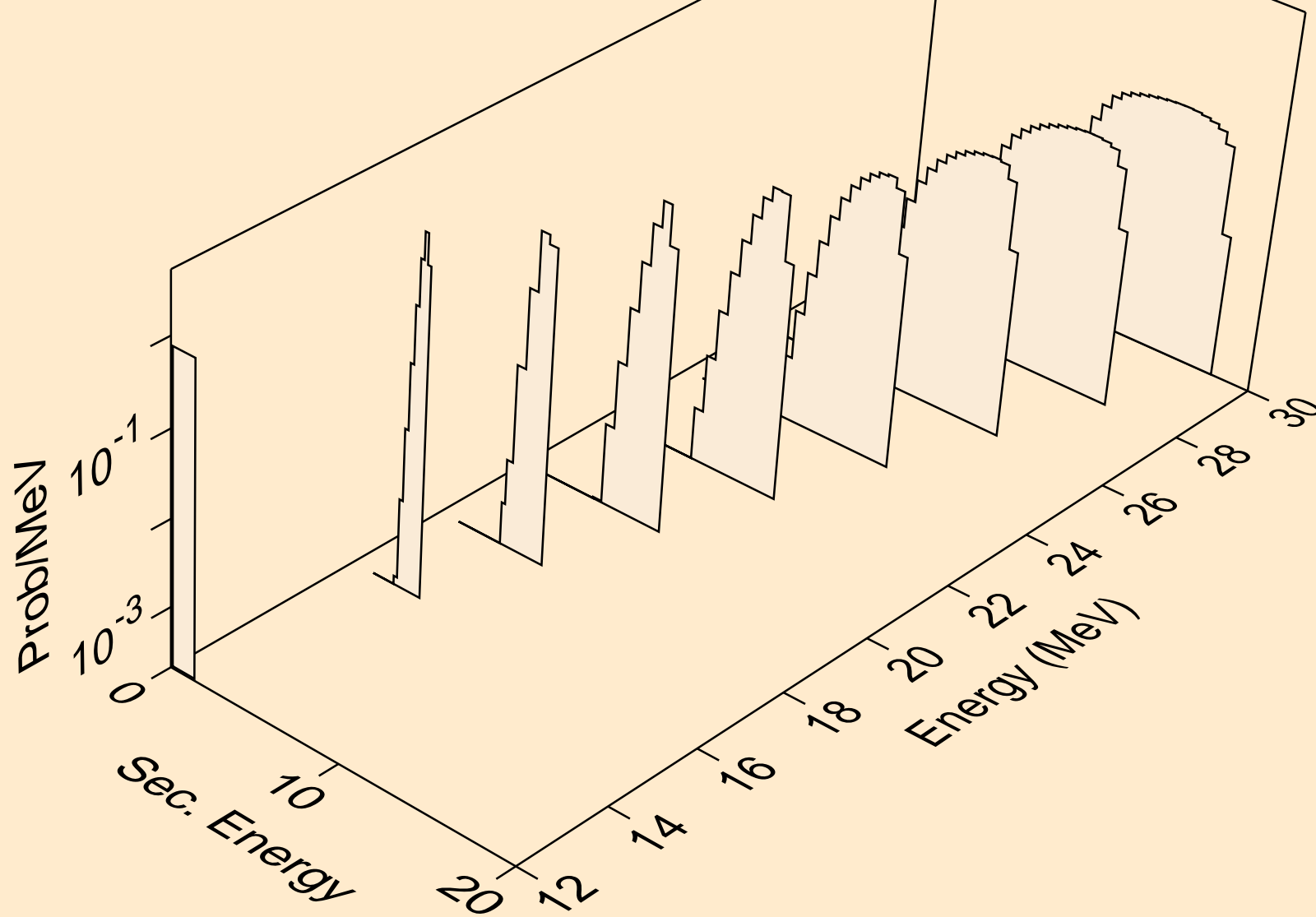

TB160 NEUTRON ACER TENDL-2021 LIBRARY; T=293.6K  
tritons from (n,t)

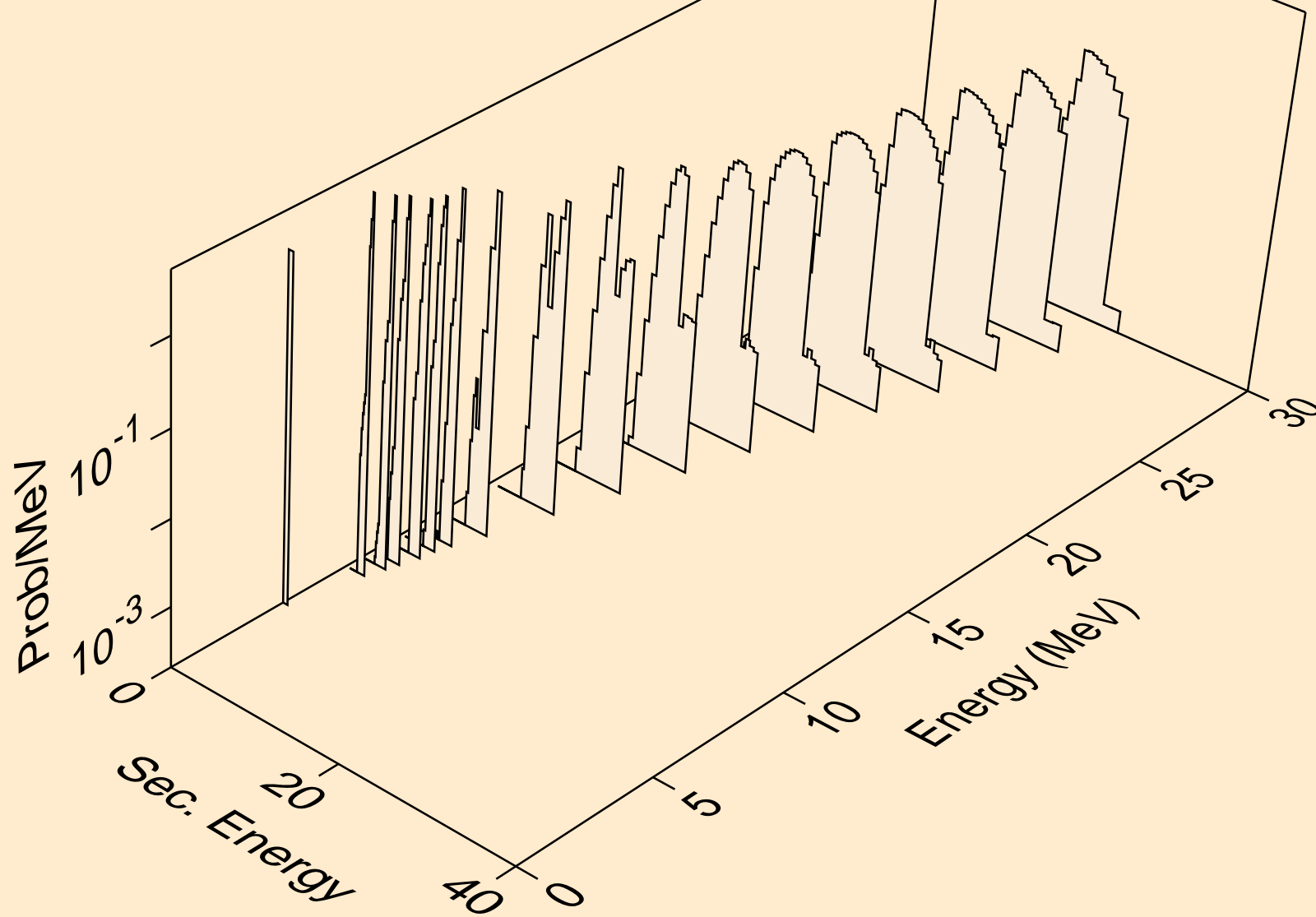

TB160 NEUTRON ACER TENDL-2021 LIBRARY; T=293.6K  
he3s from (n,x)

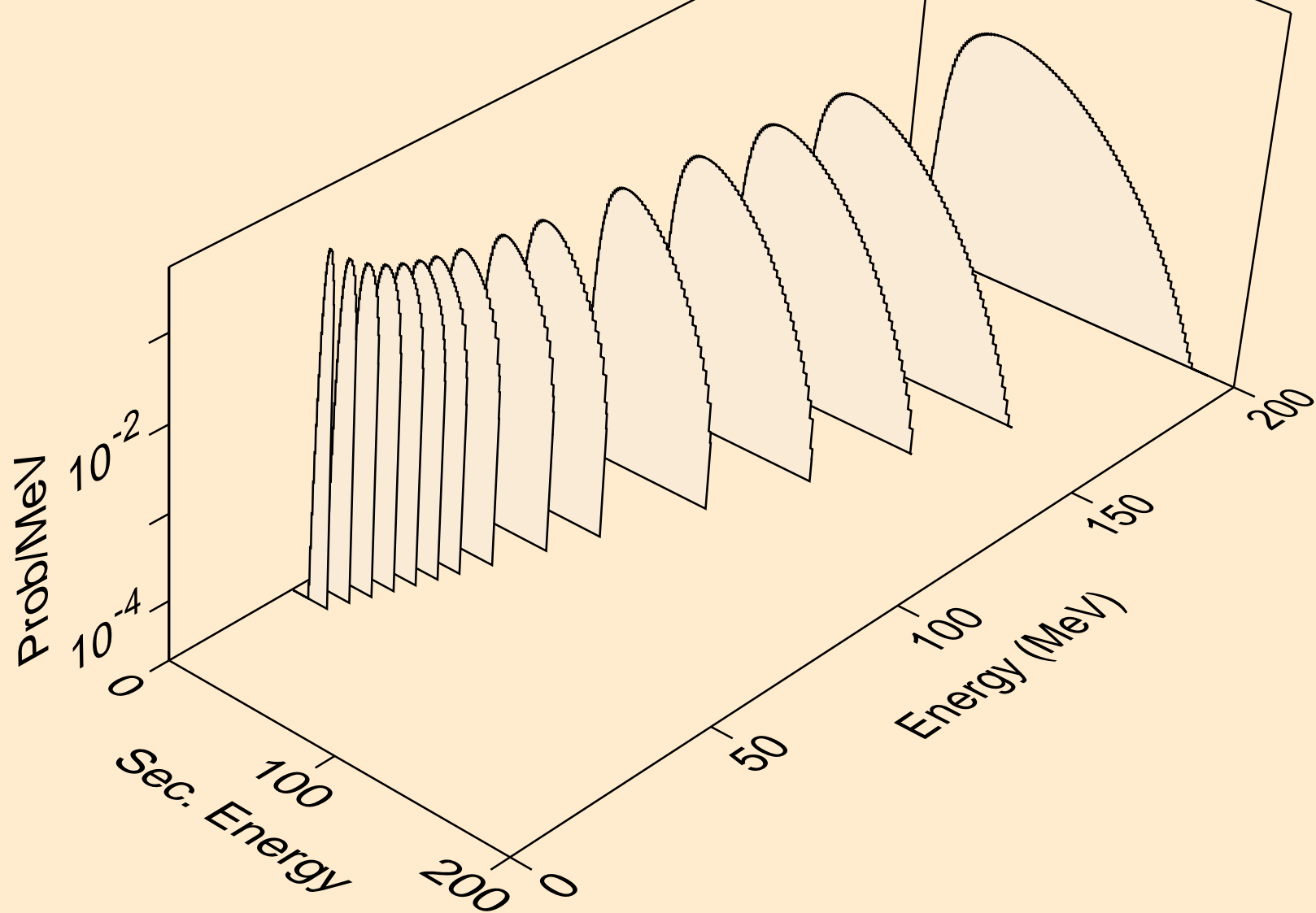



TB160 NEUTRON ACER TENDL-2021 LIBRARY; T=293.6K  
he3s from (n,n\*)he3

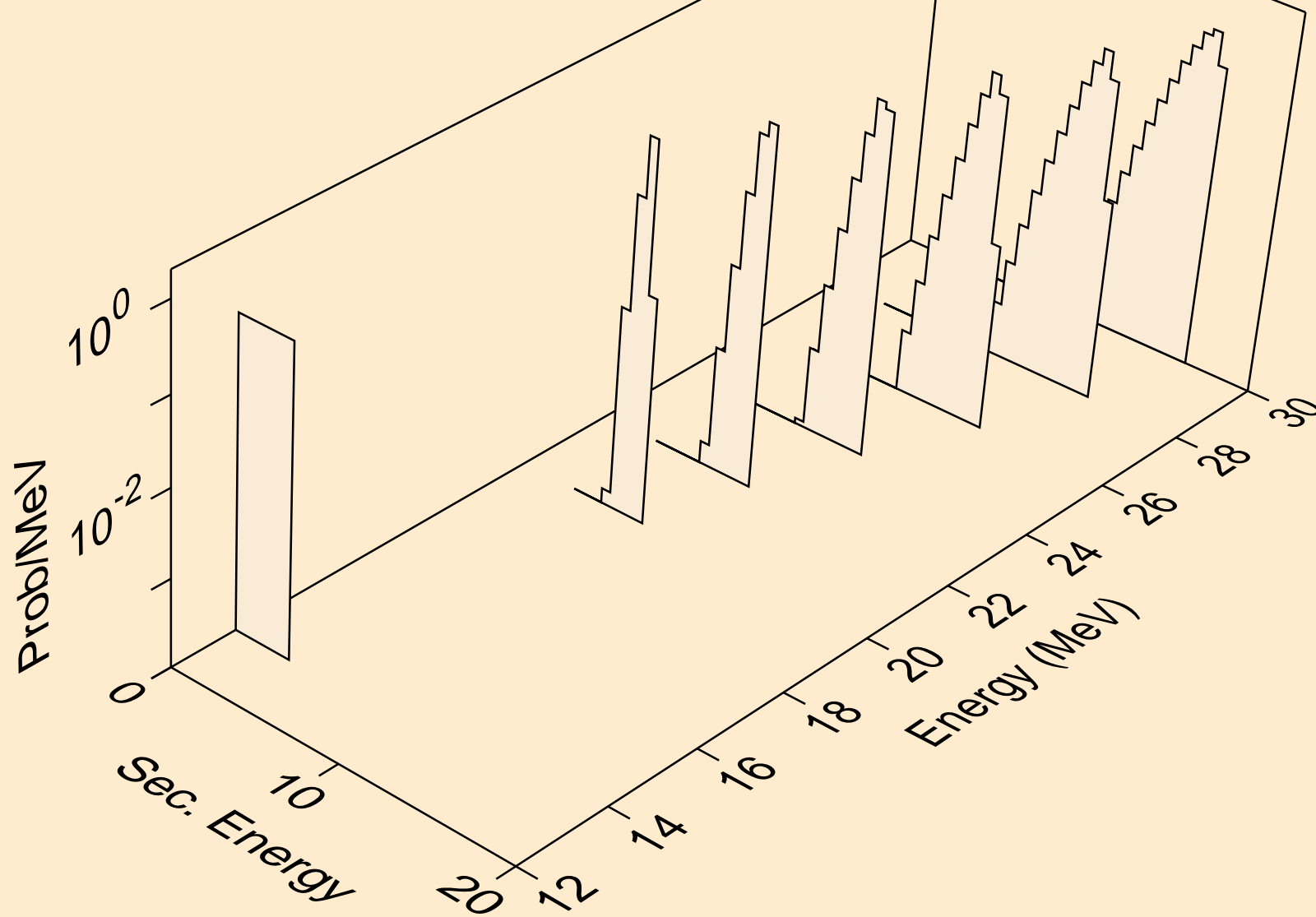

TB160 NEUTRON ACER TENDL-2021 LIBRARY; T=293.6K  
he3s from (n,he3)

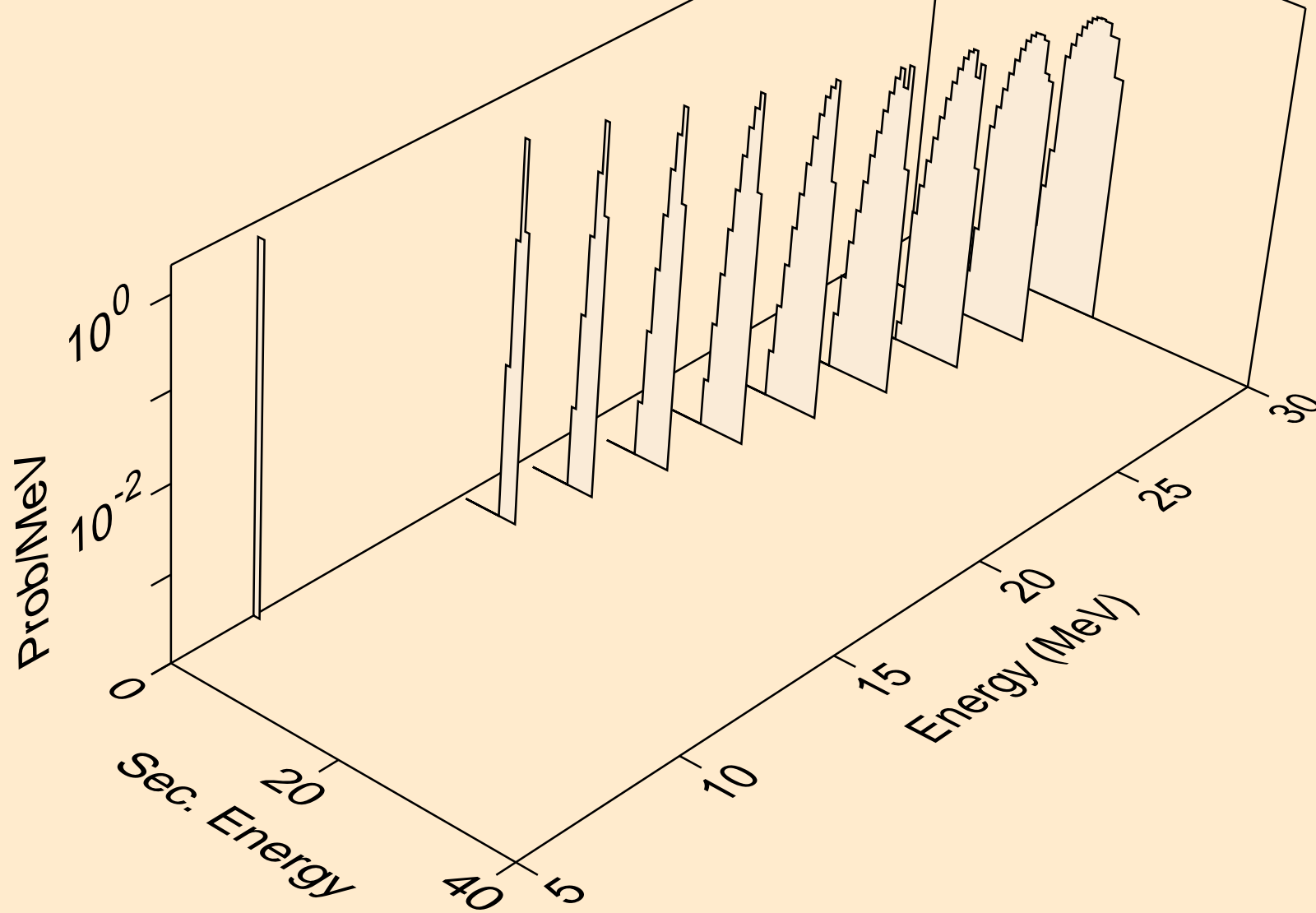

TB160 NEUTRON ACER TENDL-2021 LIBRARY; T=293.6K  
alphas from (n,x)

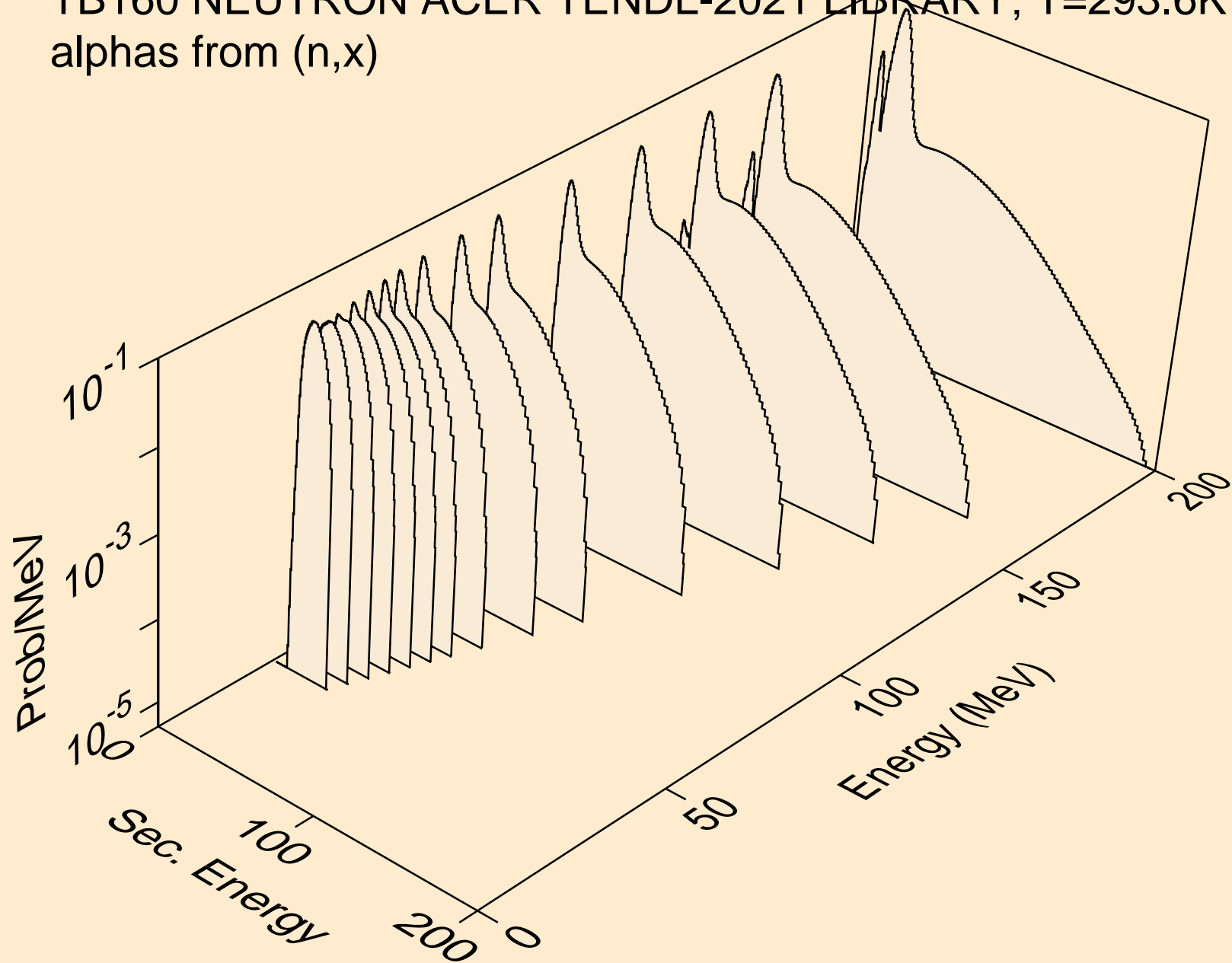

TB160 NEUTRON ACER TENDL-2021 LIBRARY; T=293.6K  
alphas from (n,n\*)a

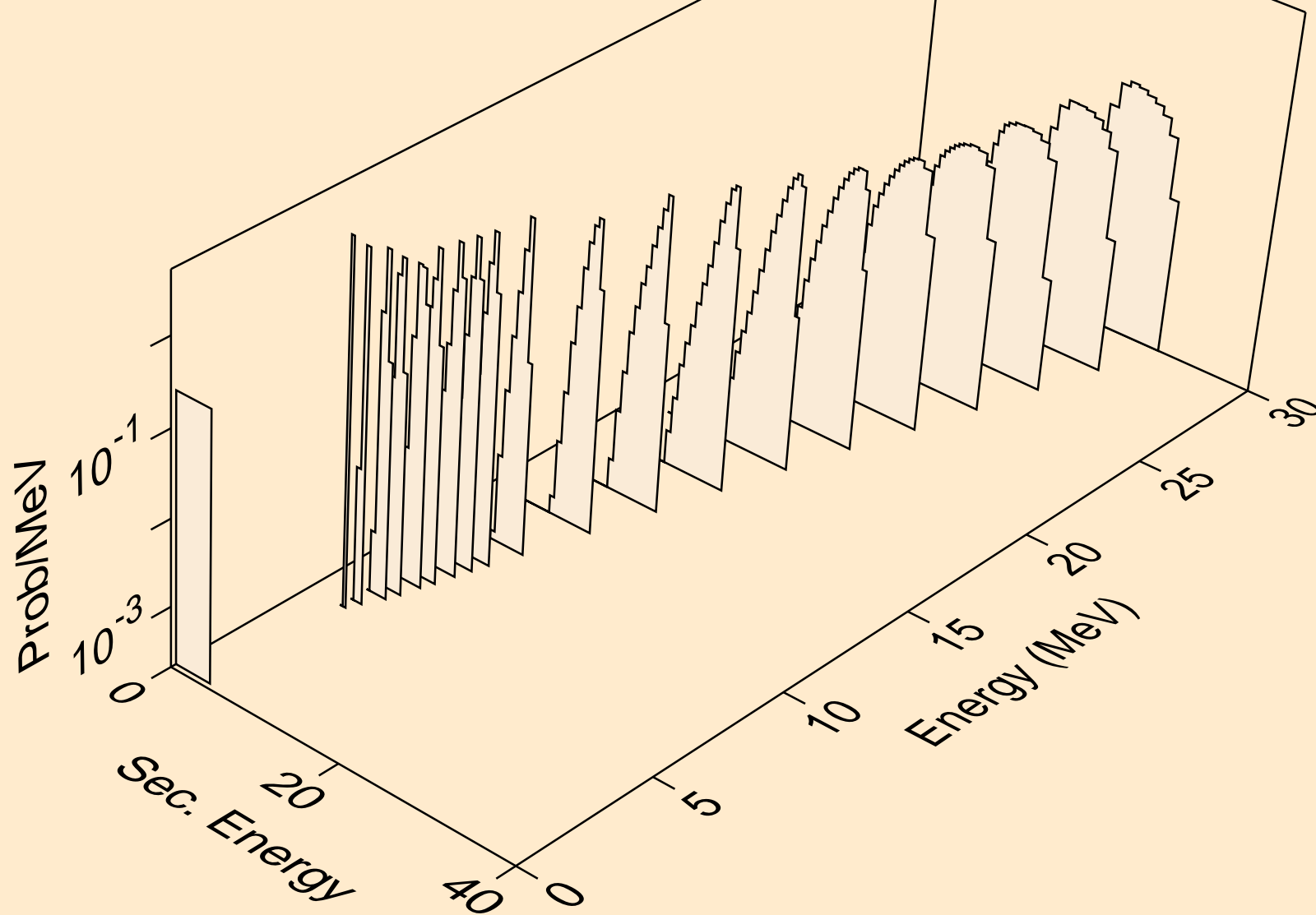

TB160 NEUTRON ACER TENDL-2021 LIBRARY; T=293.6K  
alphas from (n,2n)a

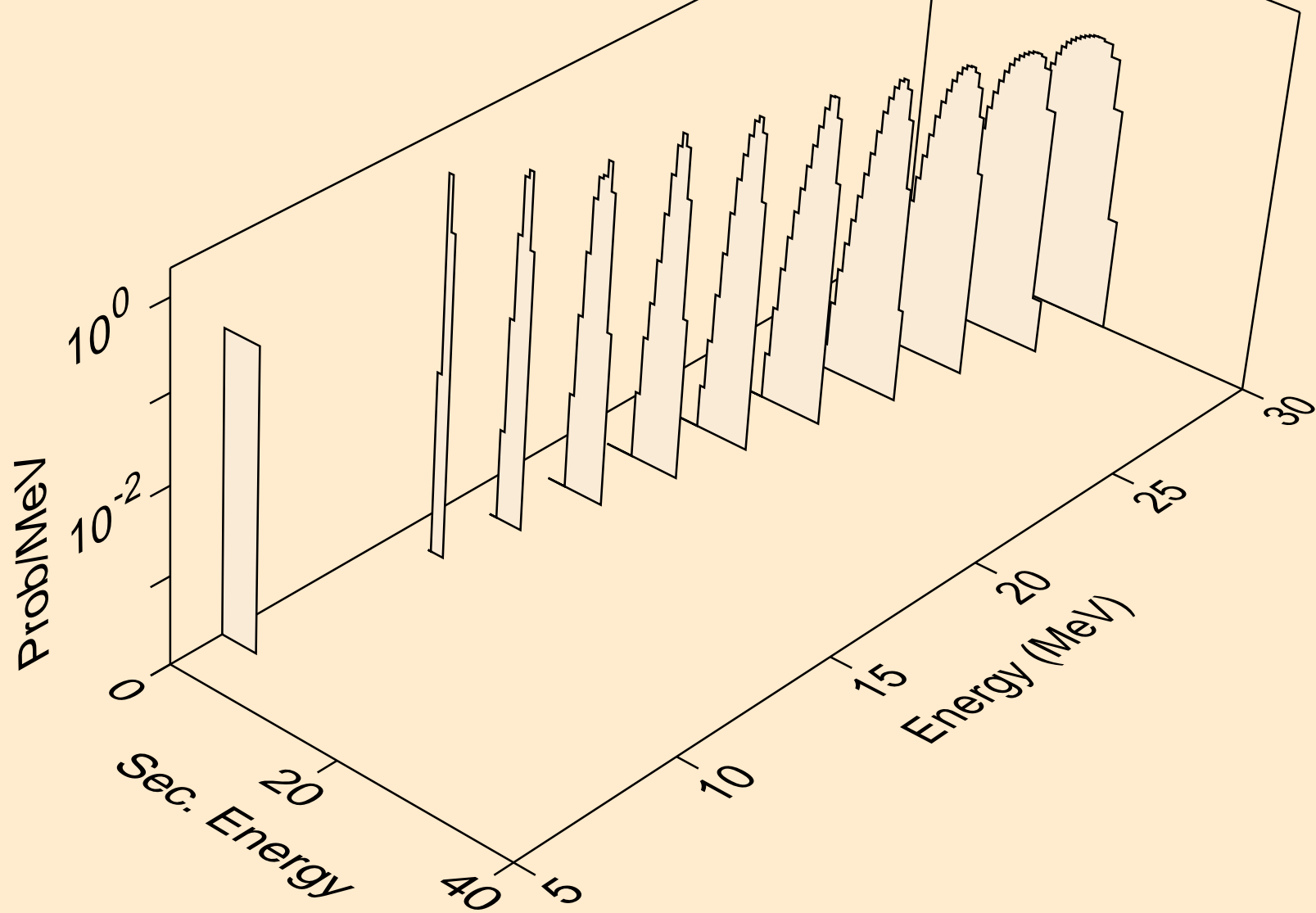

TB160 NEUTRON ACER TENDL-2021 LIBRARY; T=293.6K  
alphas from (n,3n)a

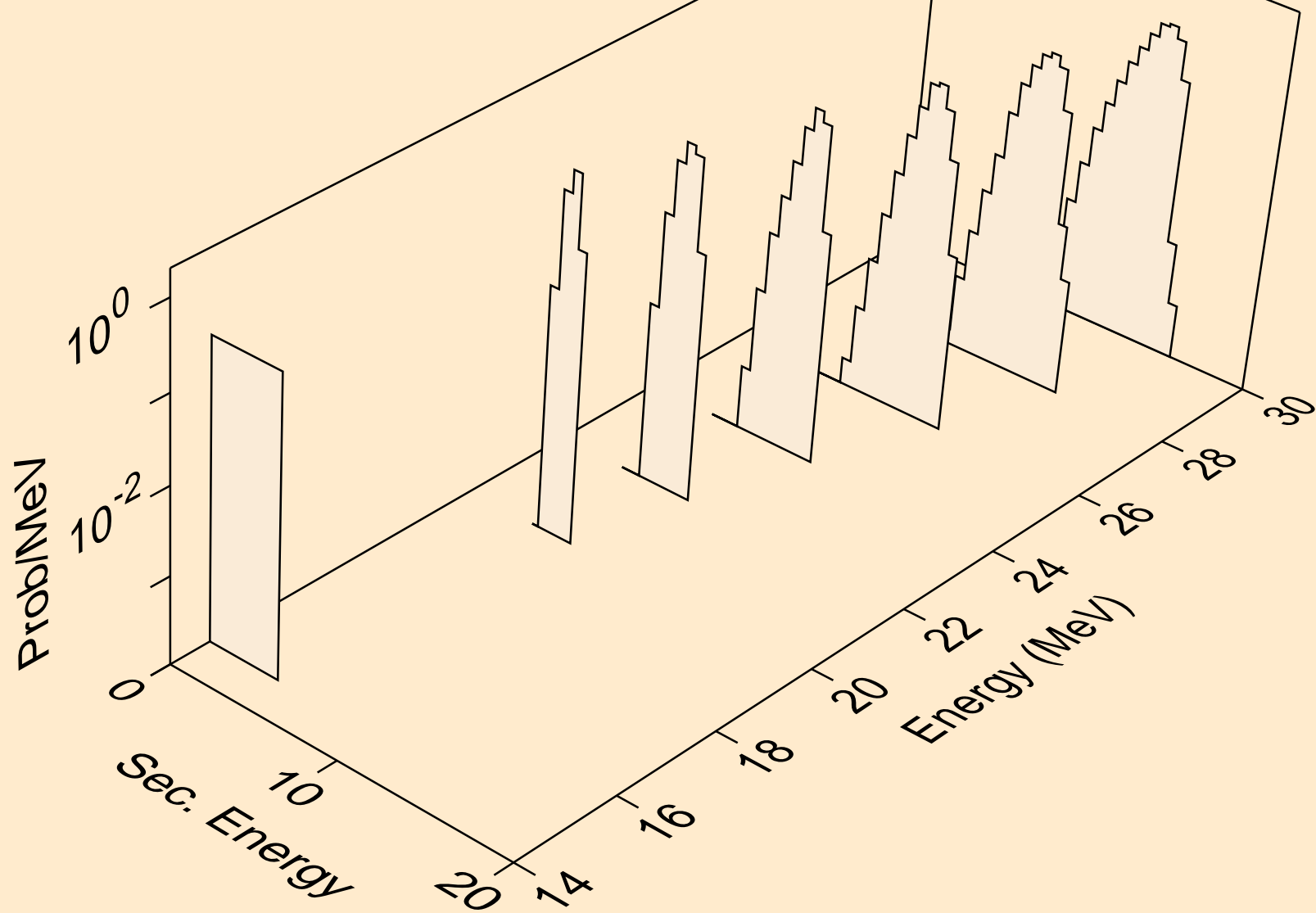

TB160 NEUTRON ACER TENDL-2021 LIBRARY; T=293.6K  
alphas from (n,n\*)2a

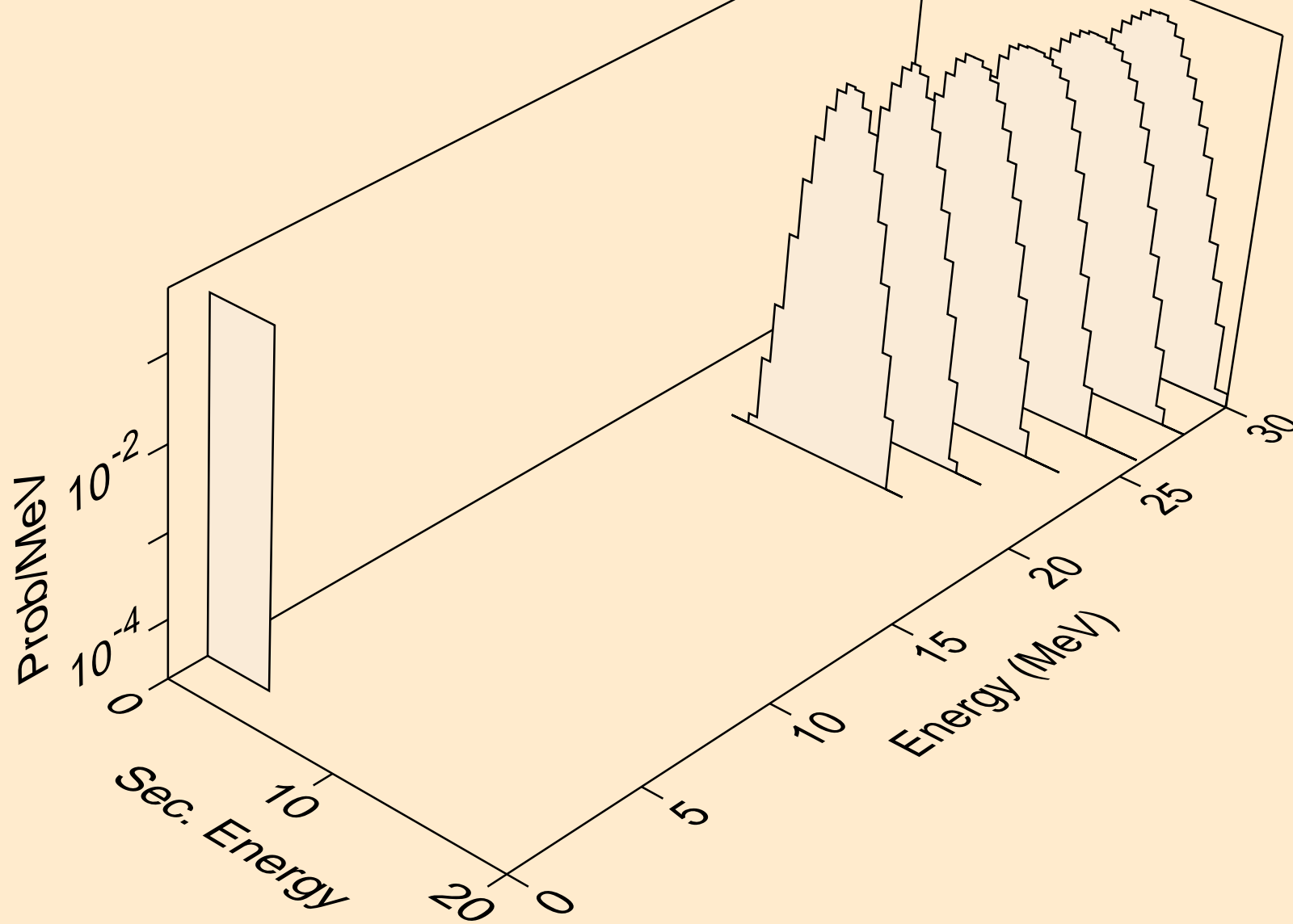

TB160 NEUTRON ACER TENDL-2021 LIBRARY; T=293.6K  
alphas from (n,npa)

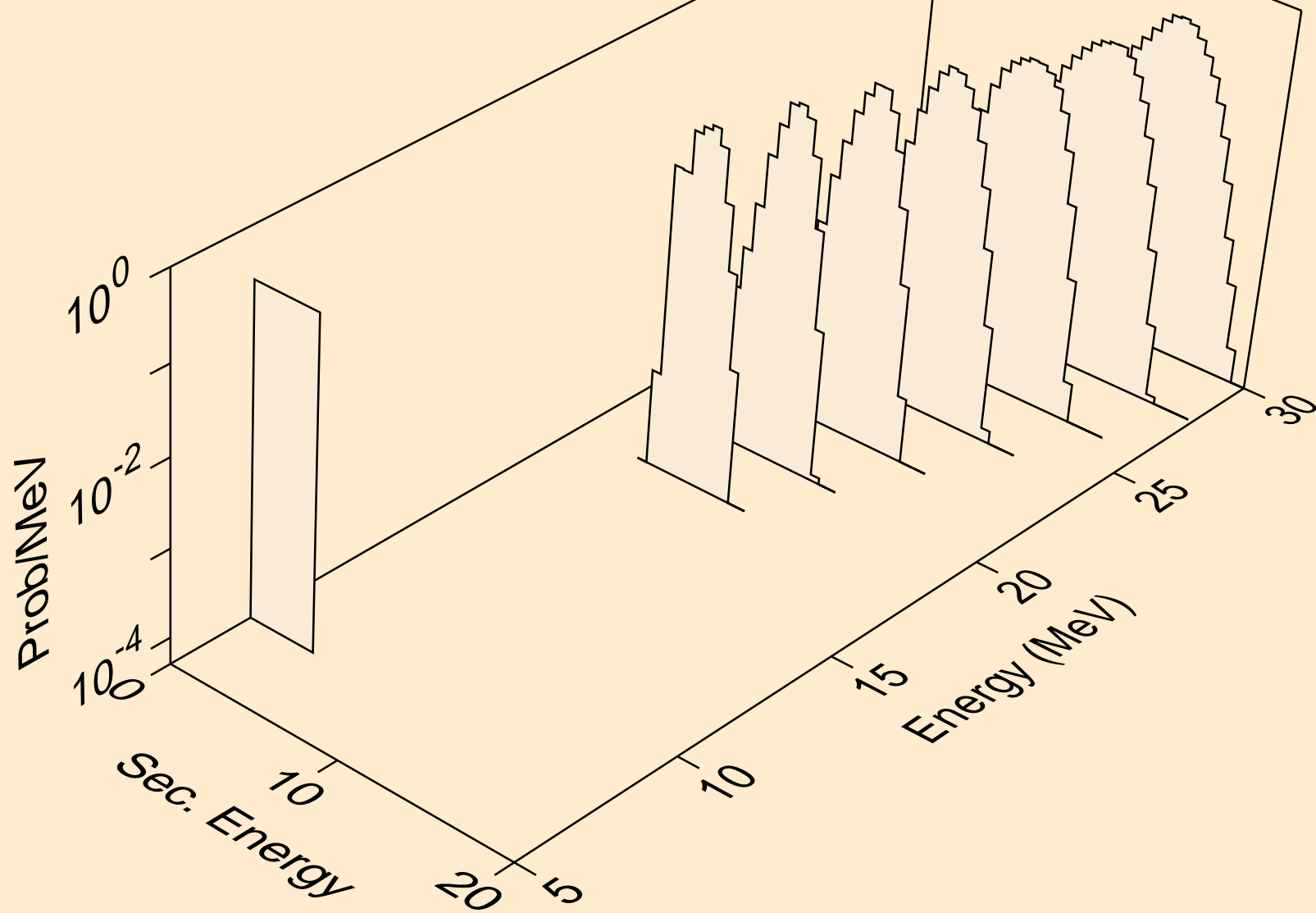



TB160 NEUTRON ACER TENDL-2021 LIBRARY; T=293.6K  
alphas from (n,a)

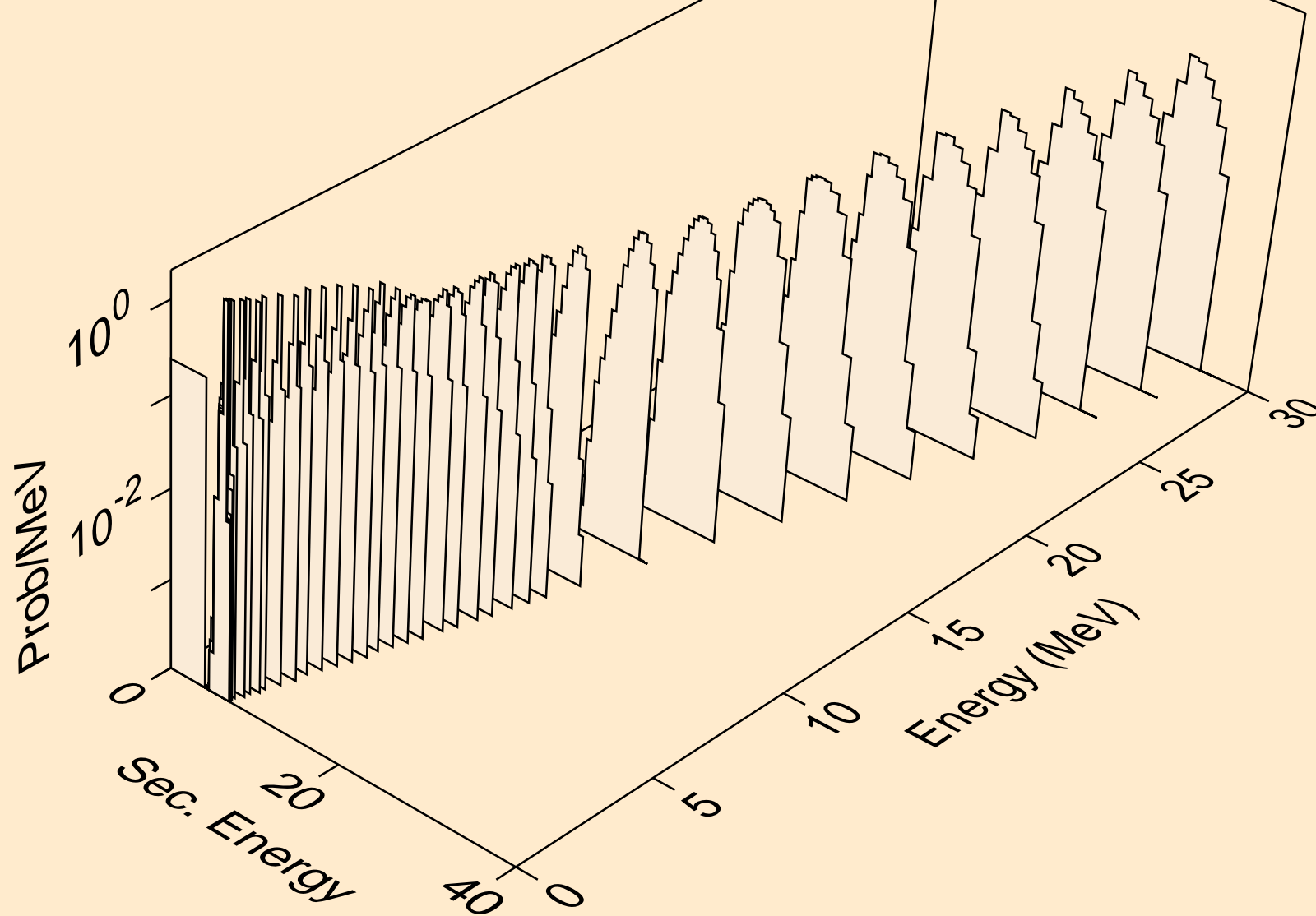

TB160 NEUTRON ACER TENDL-2021 LIBRARY; T=293.6K  
alphas from (n,2a)

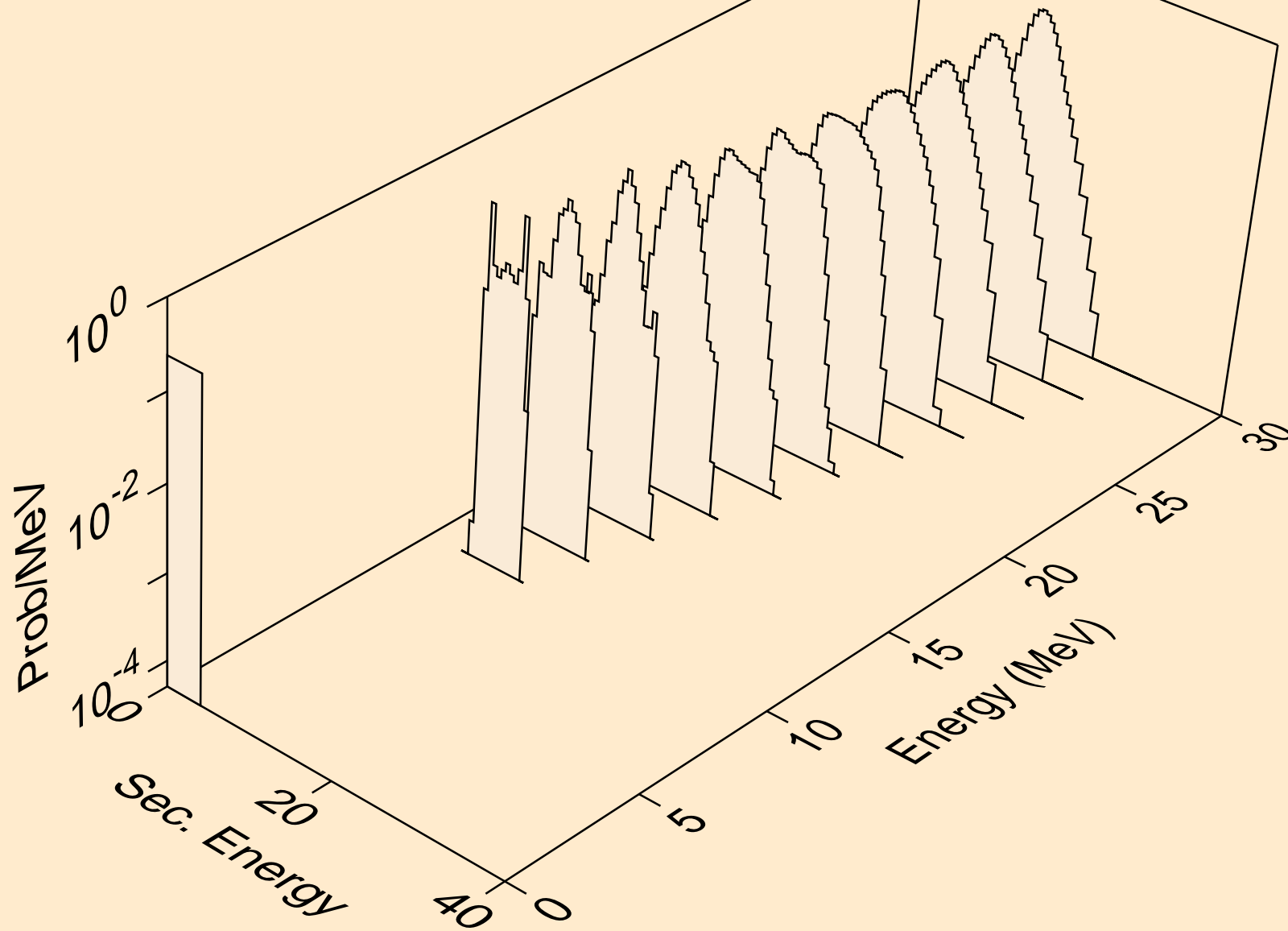

TB160 NEUTRON ACER TENDL-2021 LIBRARY; T=293.6K  
alphas from (n,pa)

