

TB170 NEUTRON ACER TENDL-2021 LIBRARY; T=293.6K
Principal cross sections

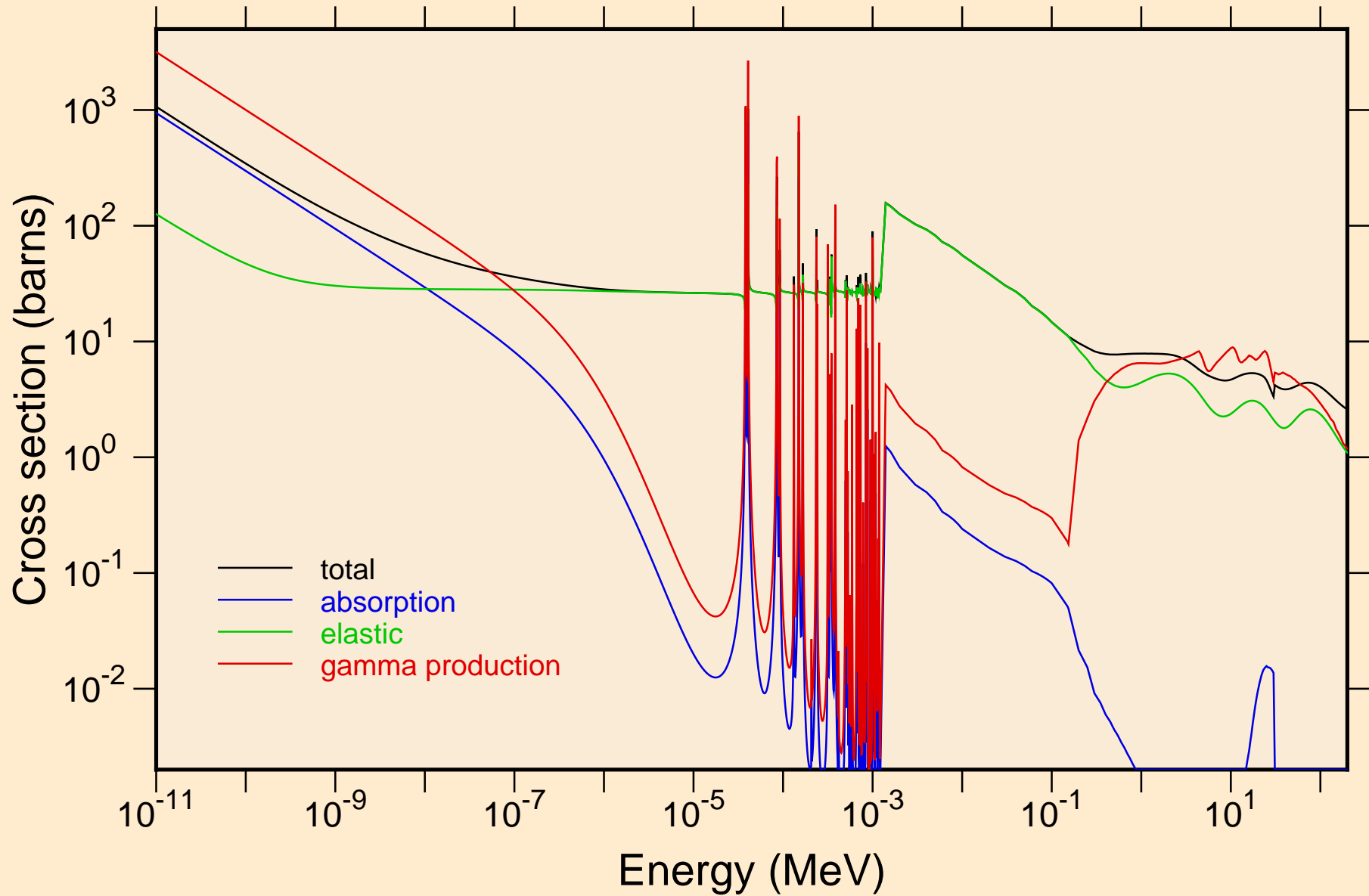

TB170 NEUTRON ACER TENDL-2021 LIBRARY; T=293.6K
resonance total cross section

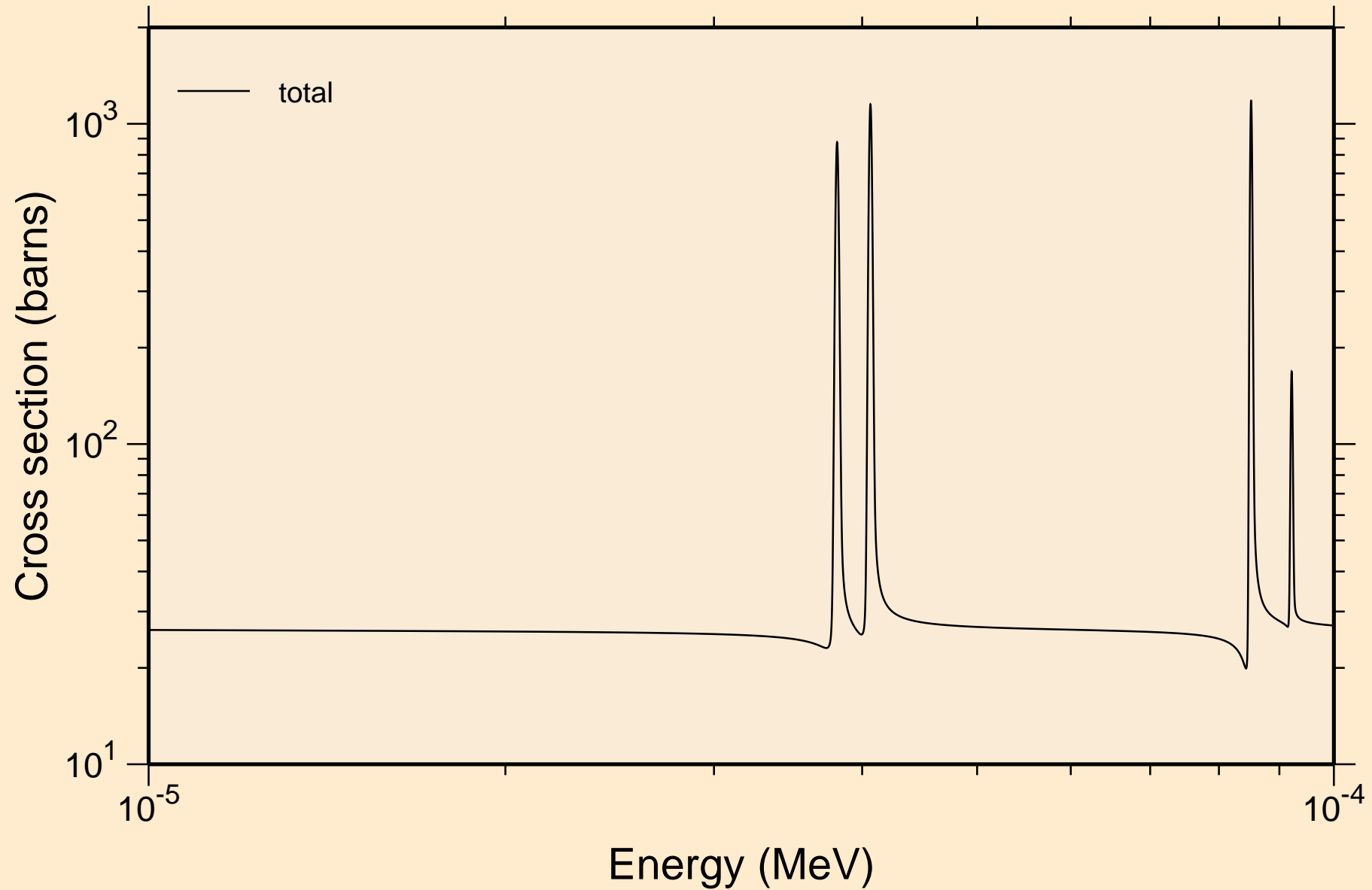

TB170 NEUTRON ACER TENDL-2021 LIBRARY; T=293.6K
resonance total cross section

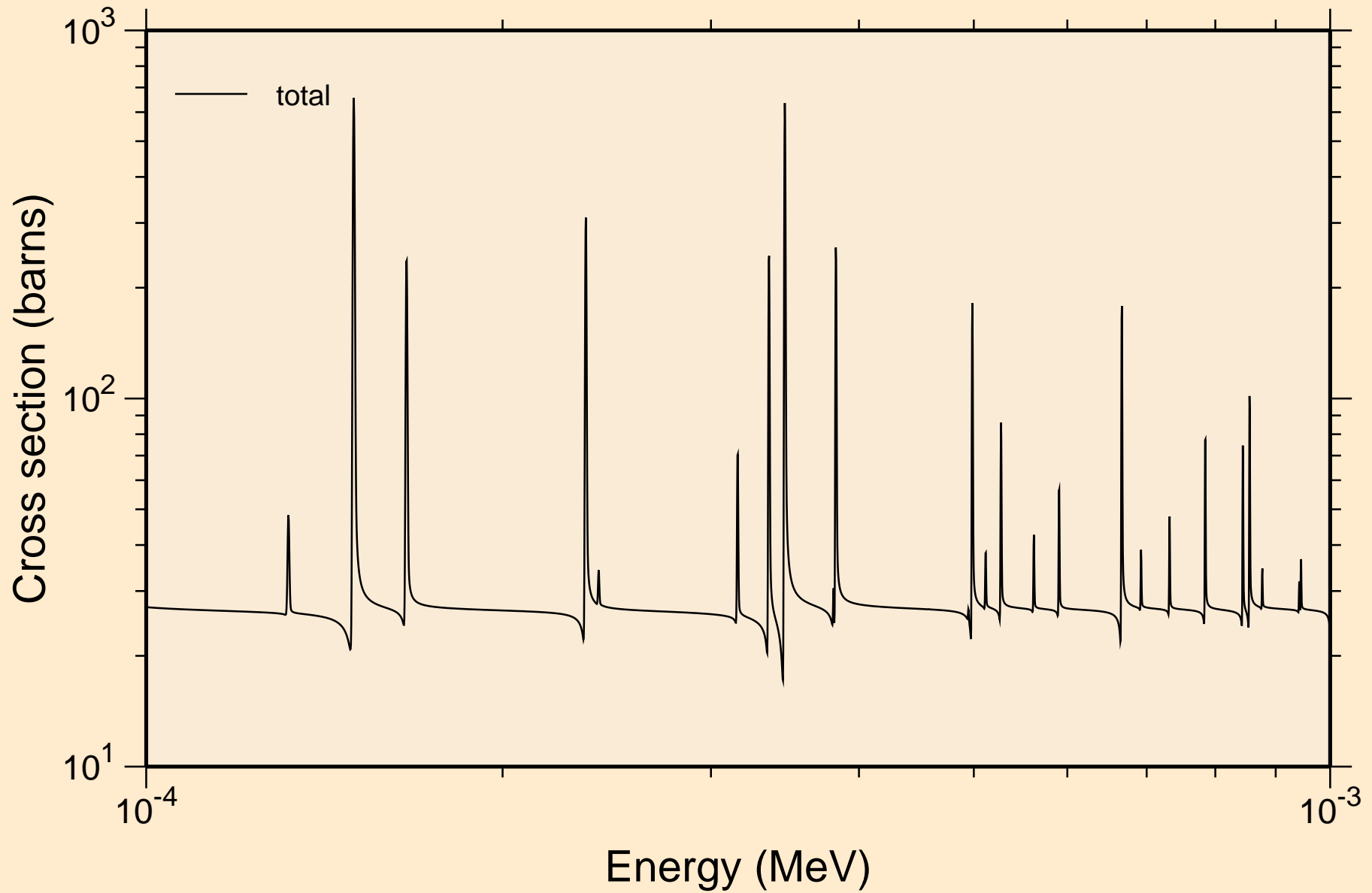

TB170 NEUTRON ACER TENDL-2021 LIBRARY; T=293.6K
resonance total cross section

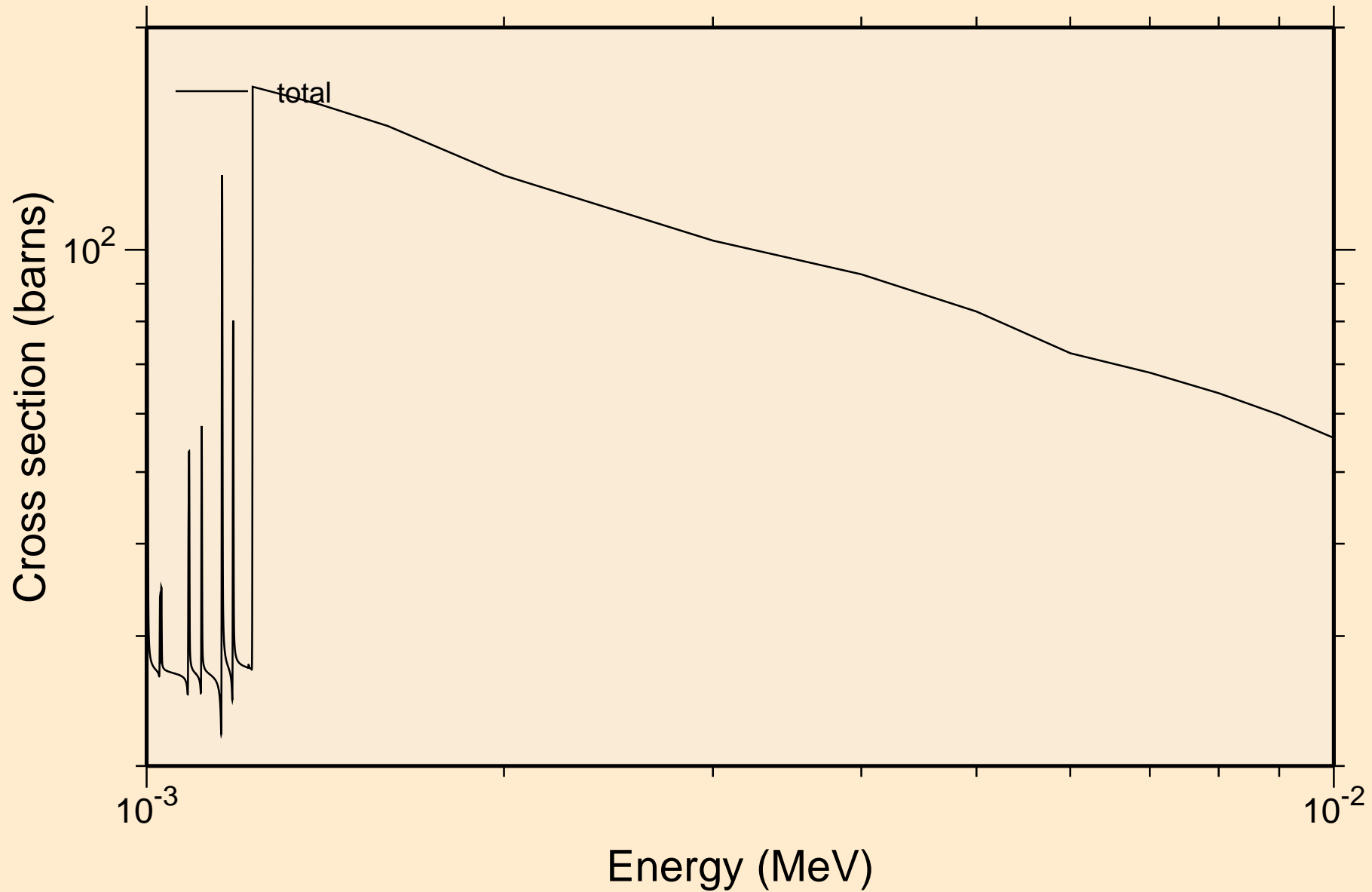

TB170 NEUTRON ACER TENDL-2021 LIBRARY; T=293.6K
resonance total cross section

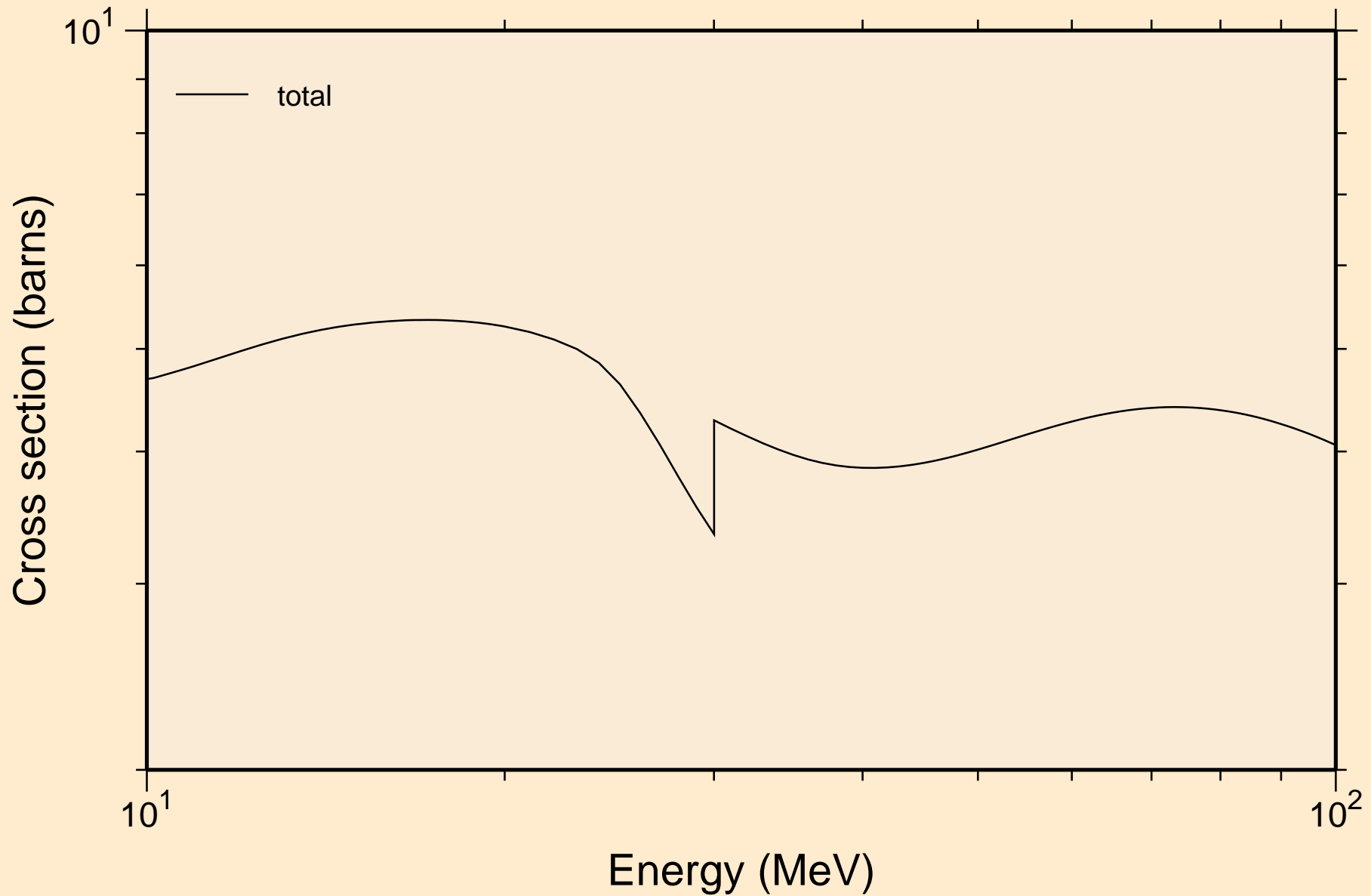

TB170 NEUTRON ACER TENDL-2021 LIBRARY; T=293.6K
resonance absorption cross sections

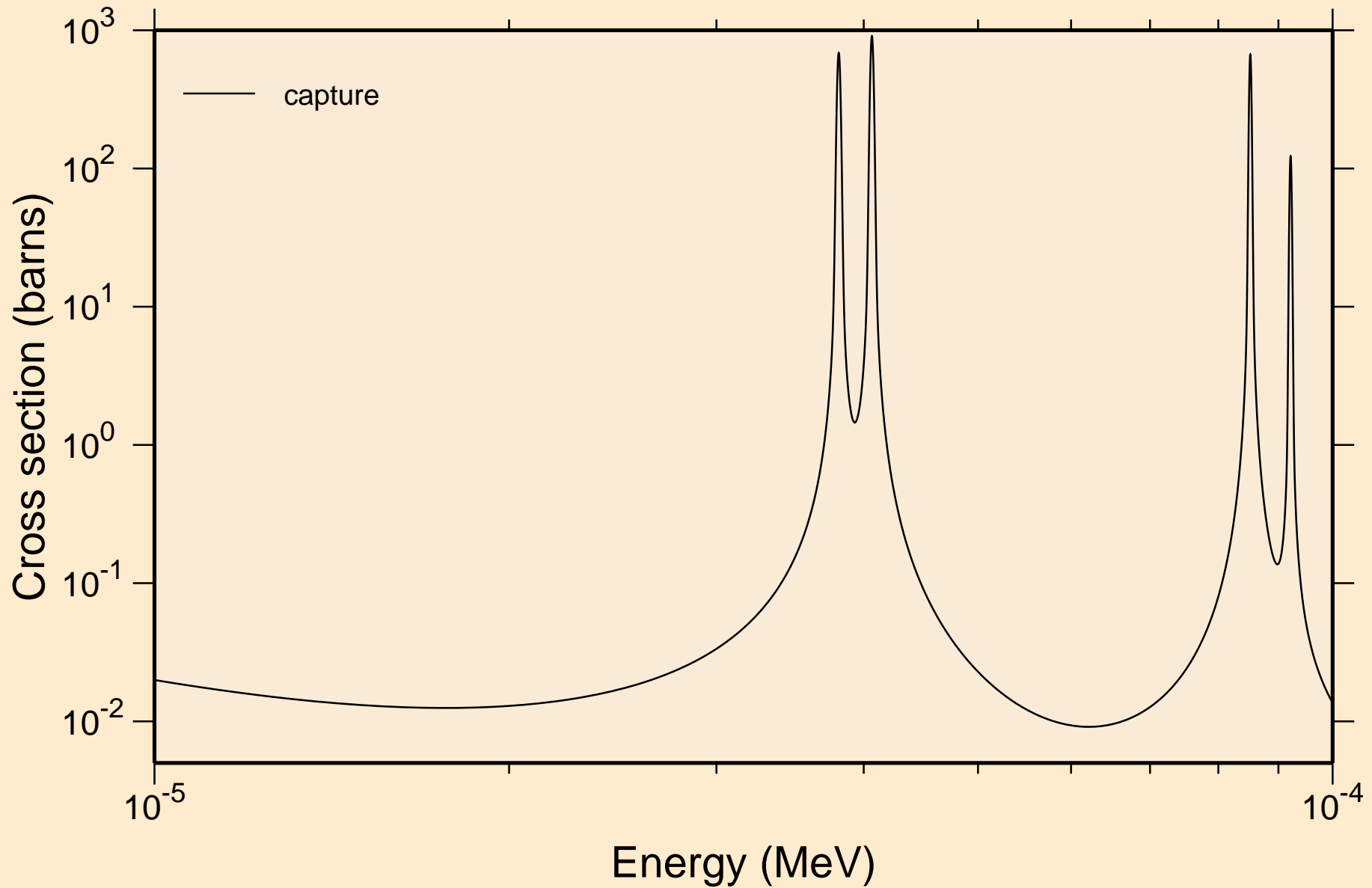

TB170 NEUTRON ACER TENDL-2021 LIBRARY; T=293.6K
resonance absorption cross sections

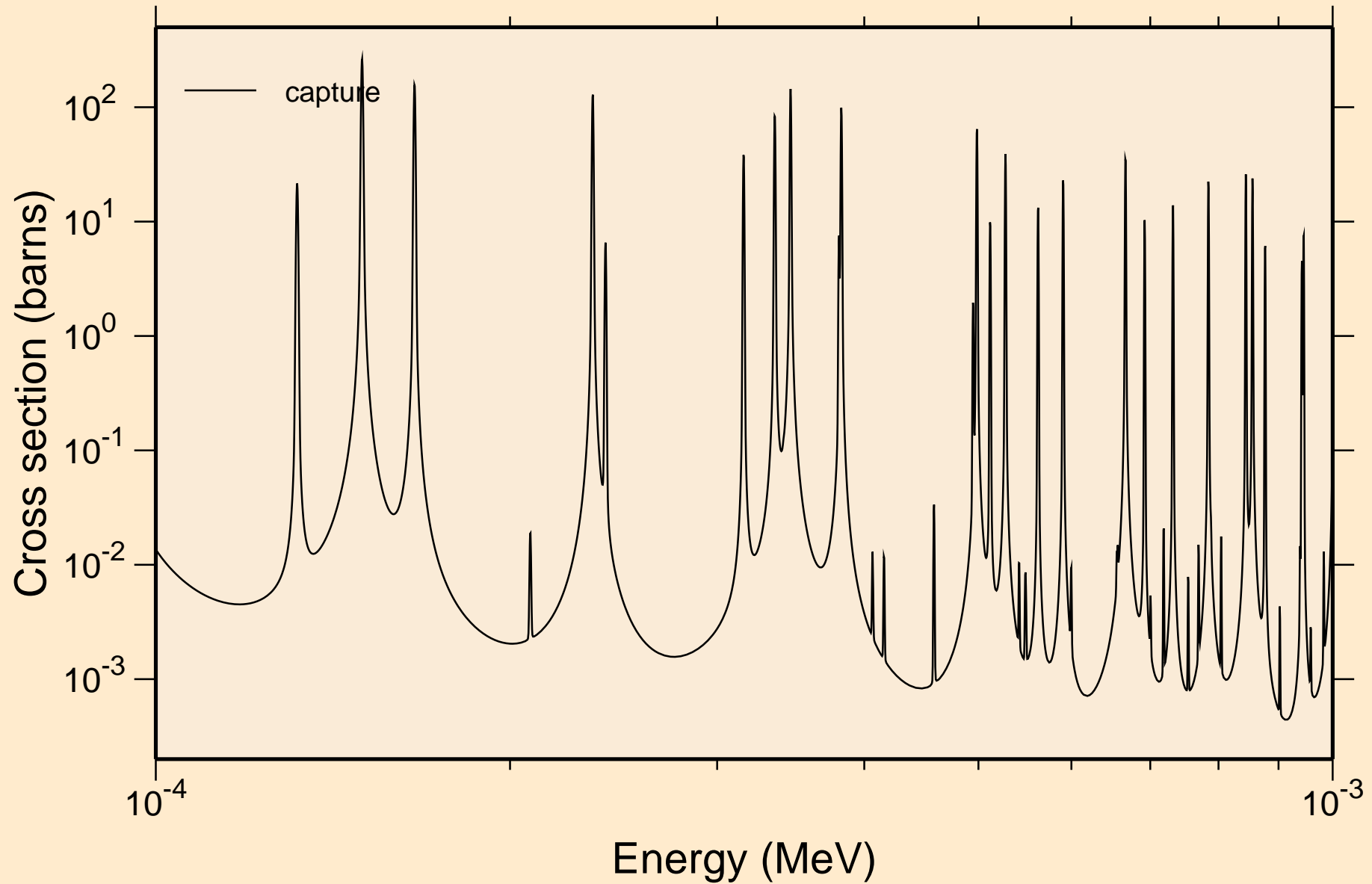

TB170 NEUTRON ACER TENDL-2021 LIBRARY; T=293.6K
resonance absorption cross sections

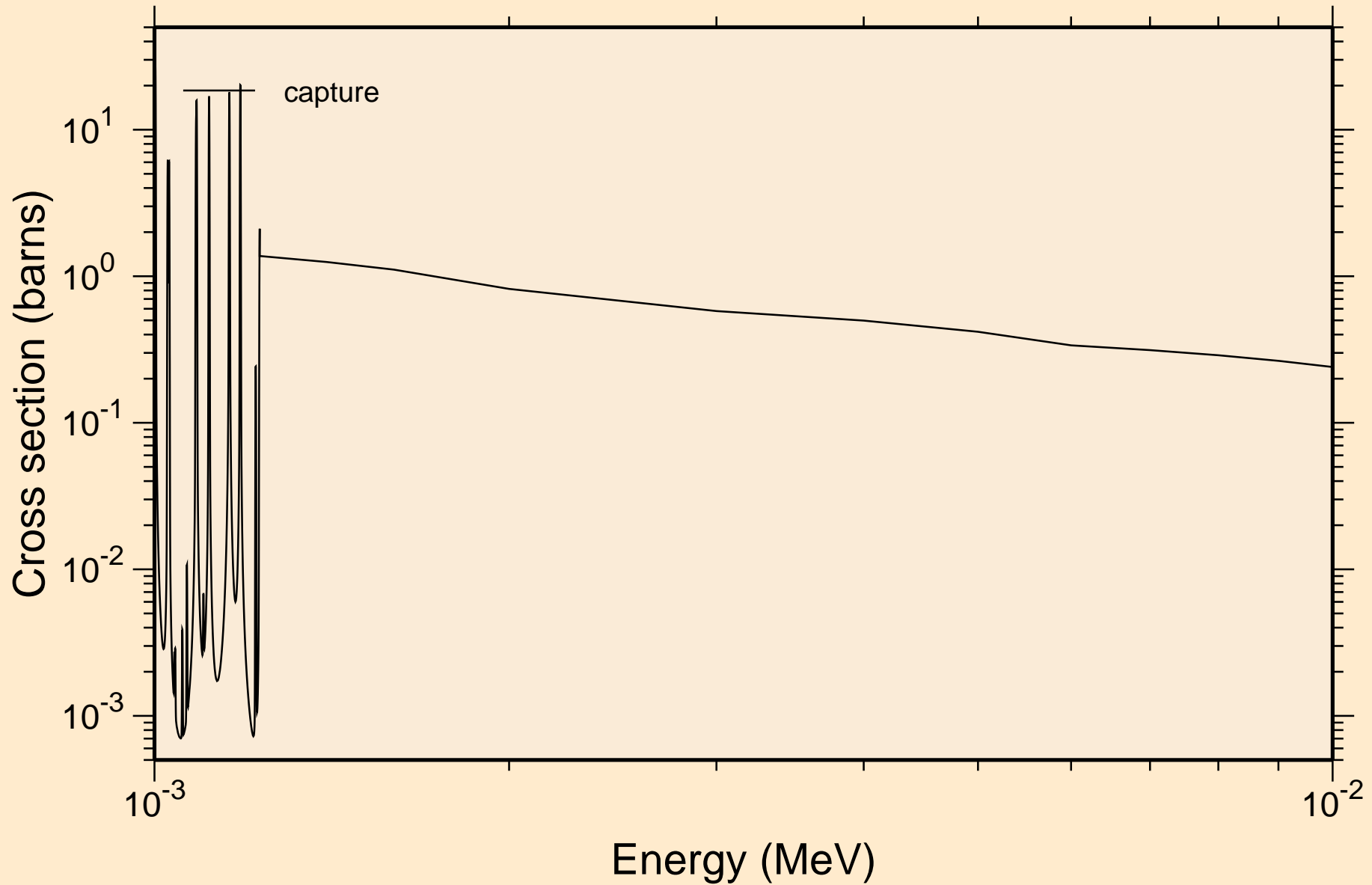

TB170 NEUTRON ACER TENDL-2021 LIBRARY; T=293.6K
resonance absorption cross sections

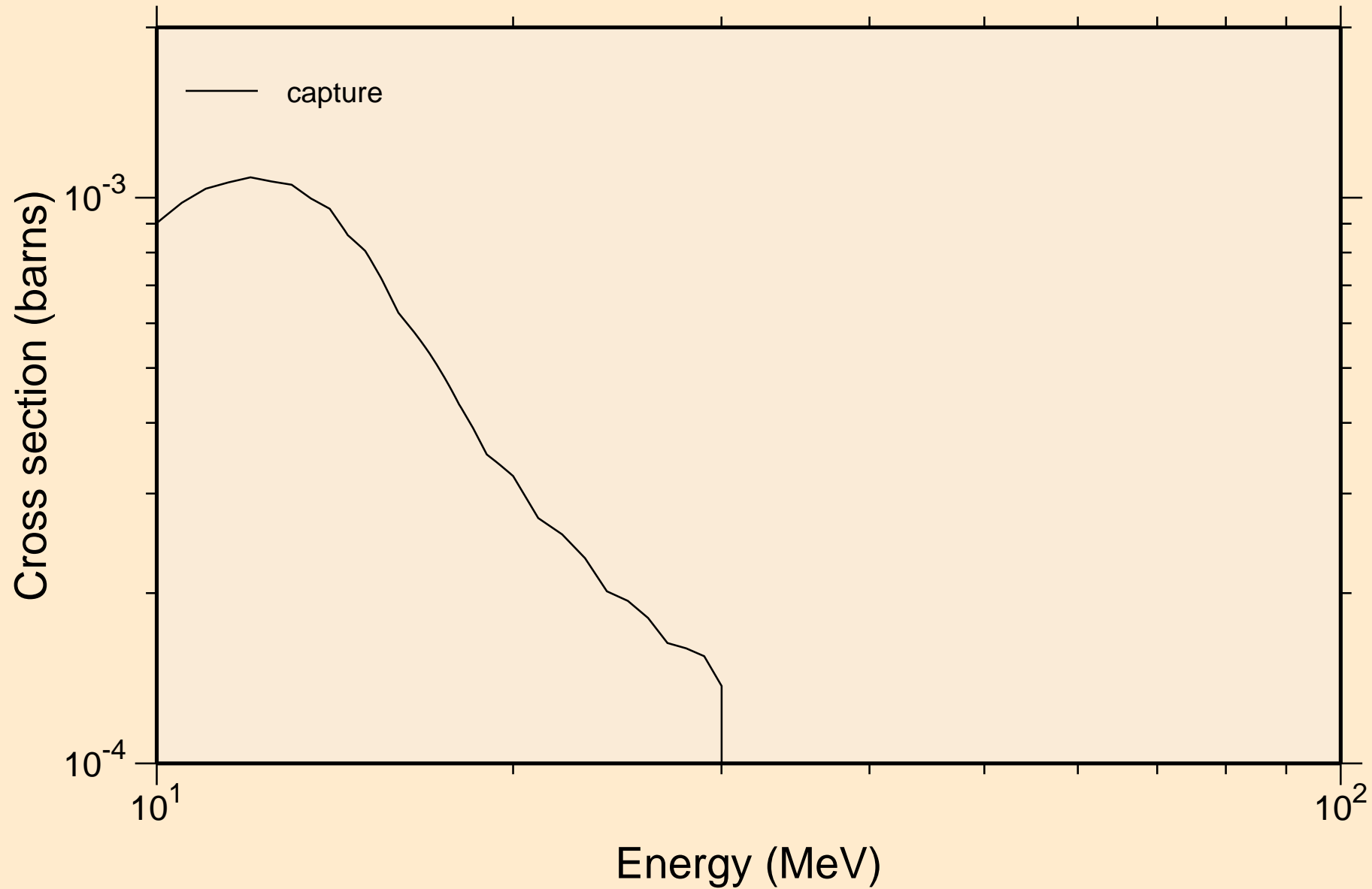

TB170 NEUTRON ACER TENDL-2021 LIBRARY; T=293.6K
Heating

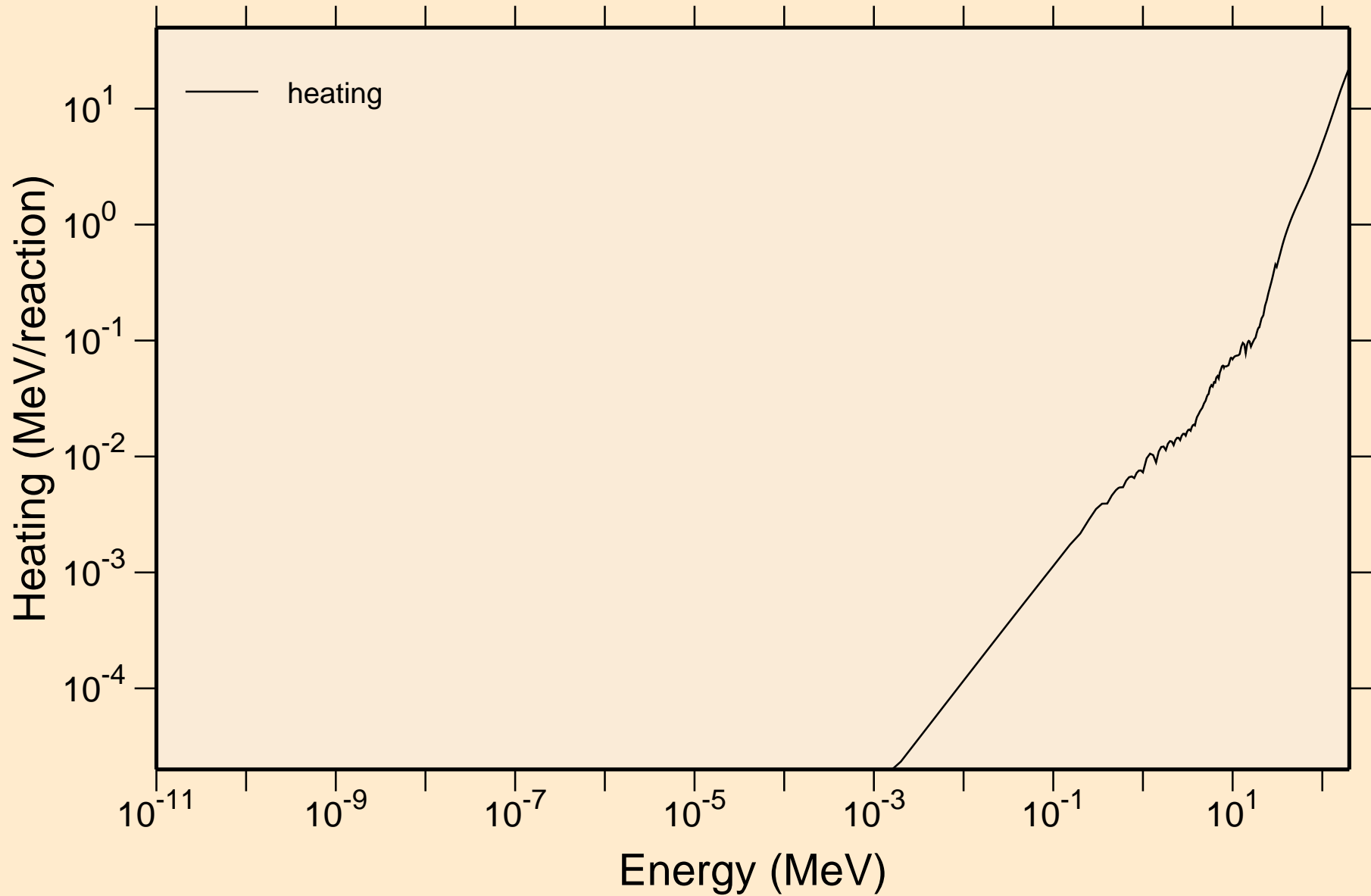

TB170 NEUTRON ACER TENDL-2021 LIBRARY; T=293.6K
Damage

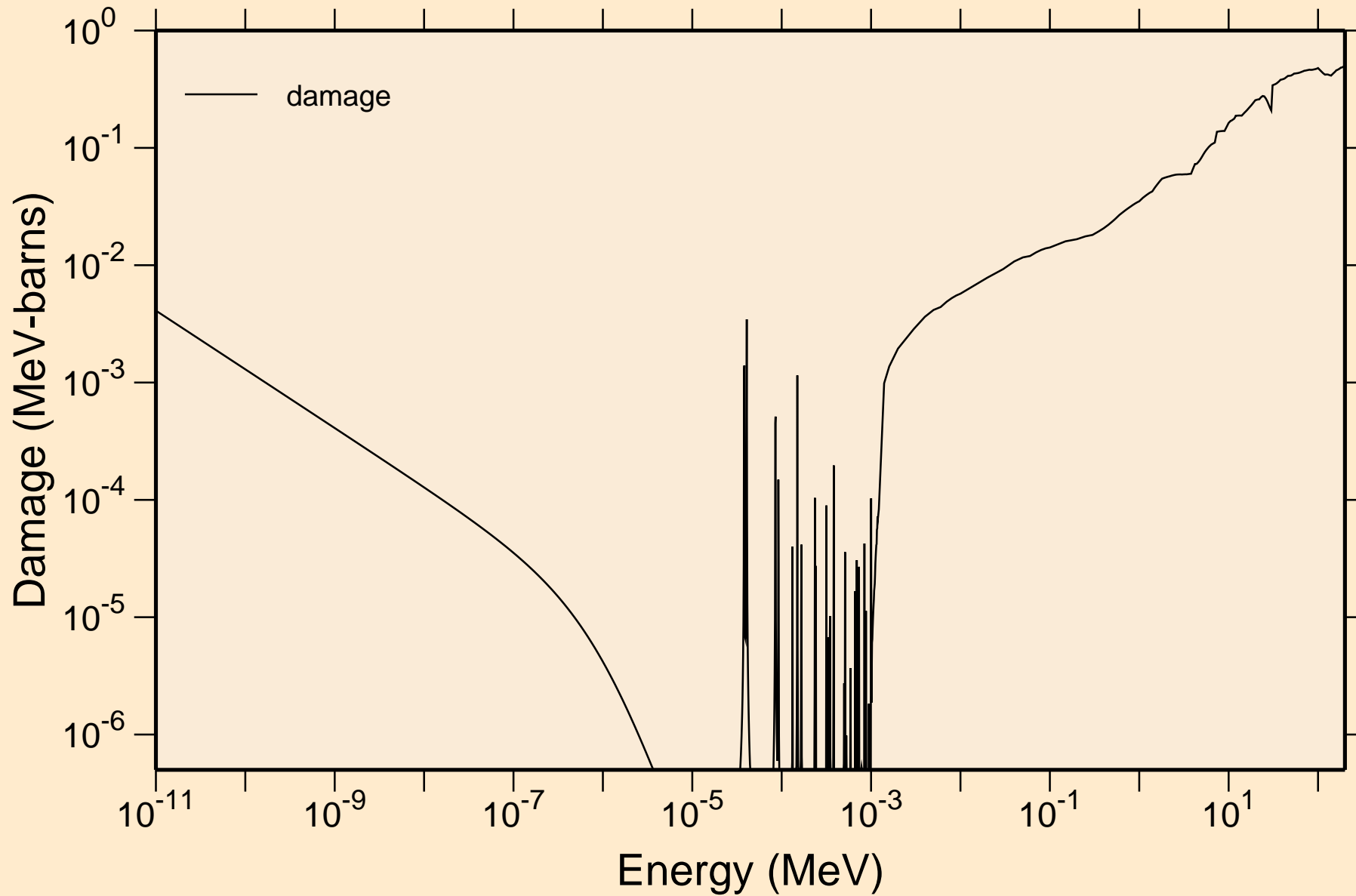

TB170 NEUTRON ACER TENDL-2021 LIBRARY; T=293.6K
Non-threshold reactions

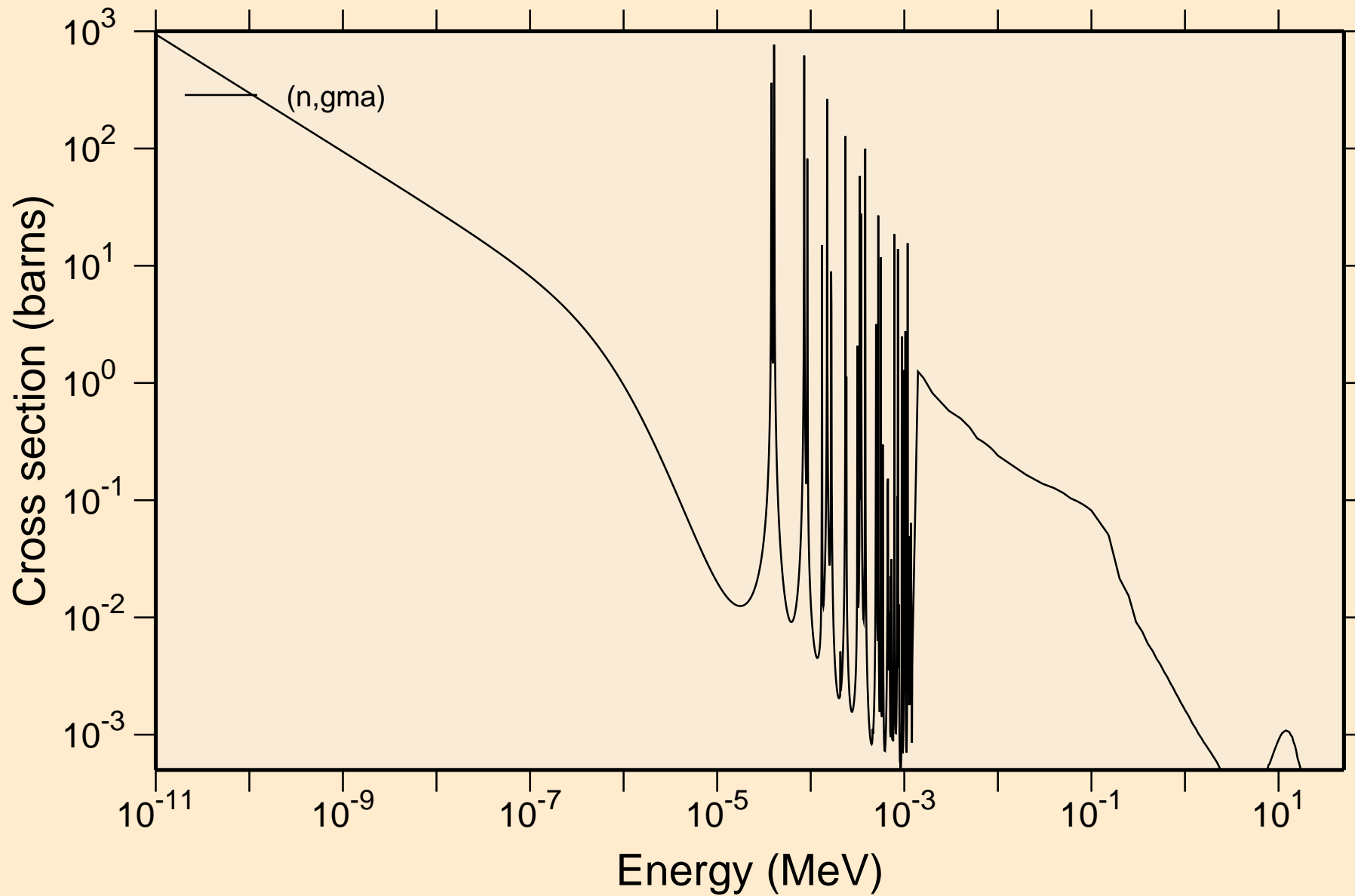

TB170 NEUTRON ACER TENDL-2021 LIBRARY; T=293.6K
Principal cross sections

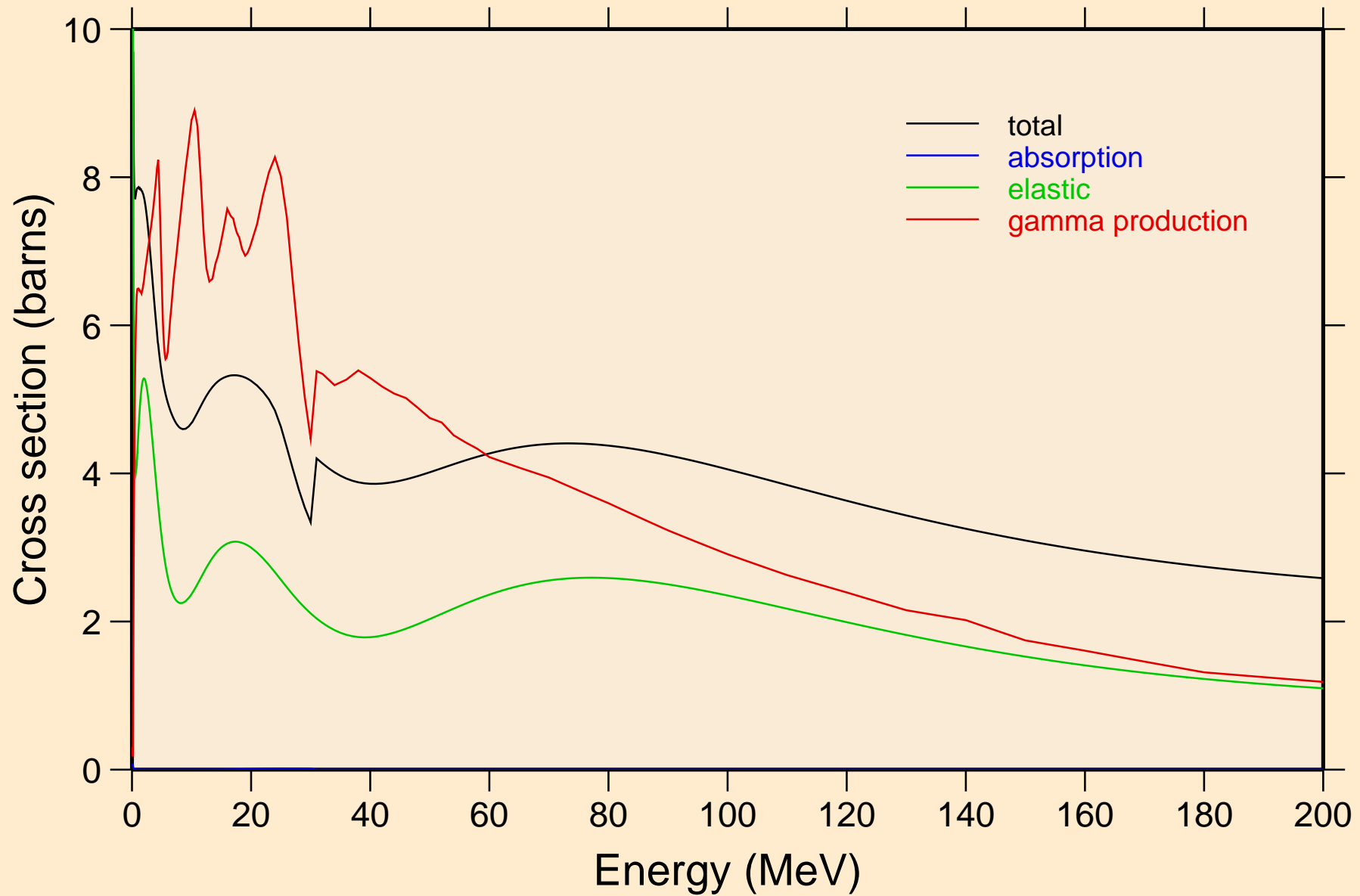

TB170 NEUTRON ACER TENDL-2021 LIBRARY; T=293.6K

Heating

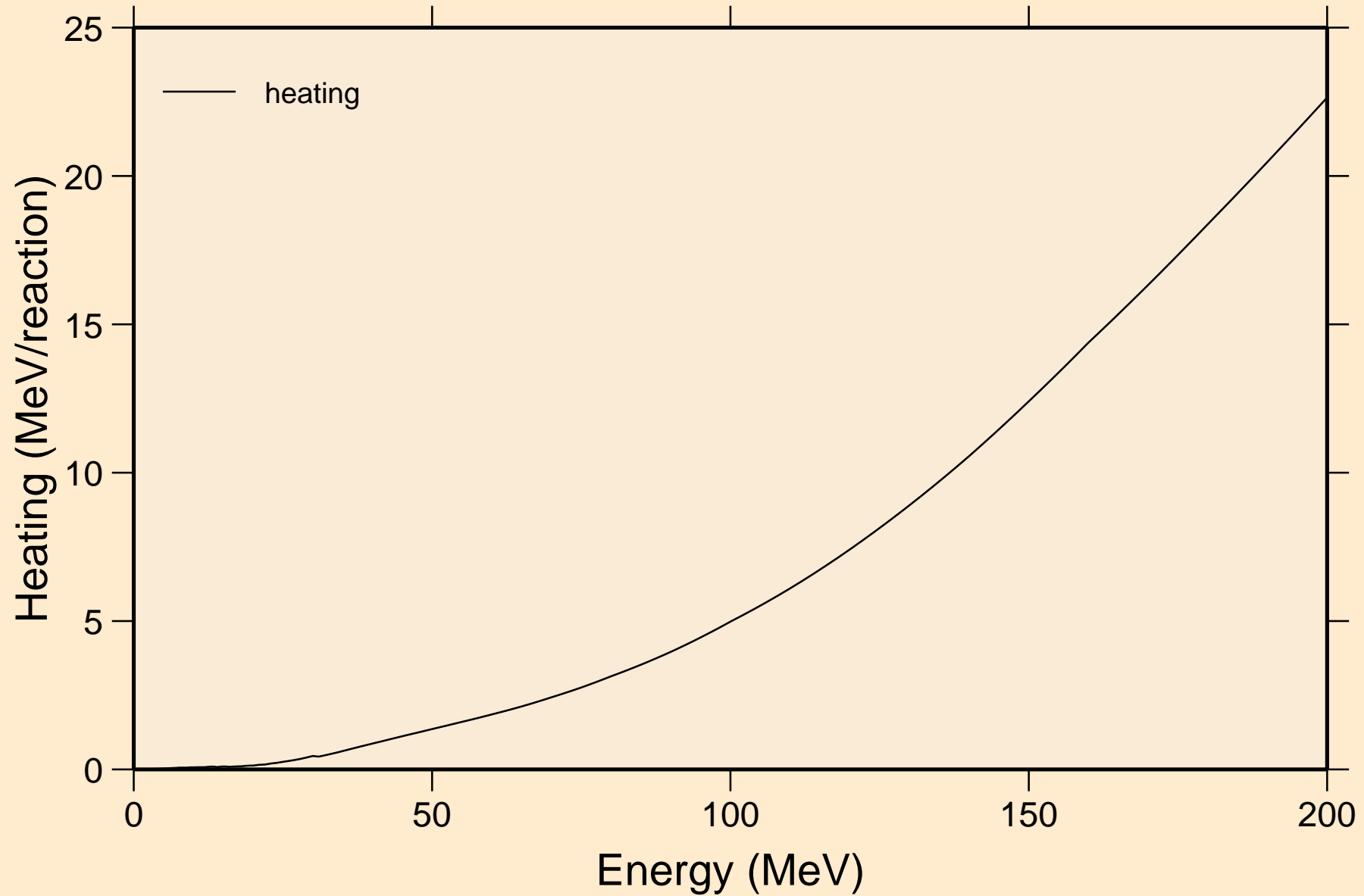

TB170 NEUTRON ACER TENDL-2021 LIBRARY; T=293.6K
Damage

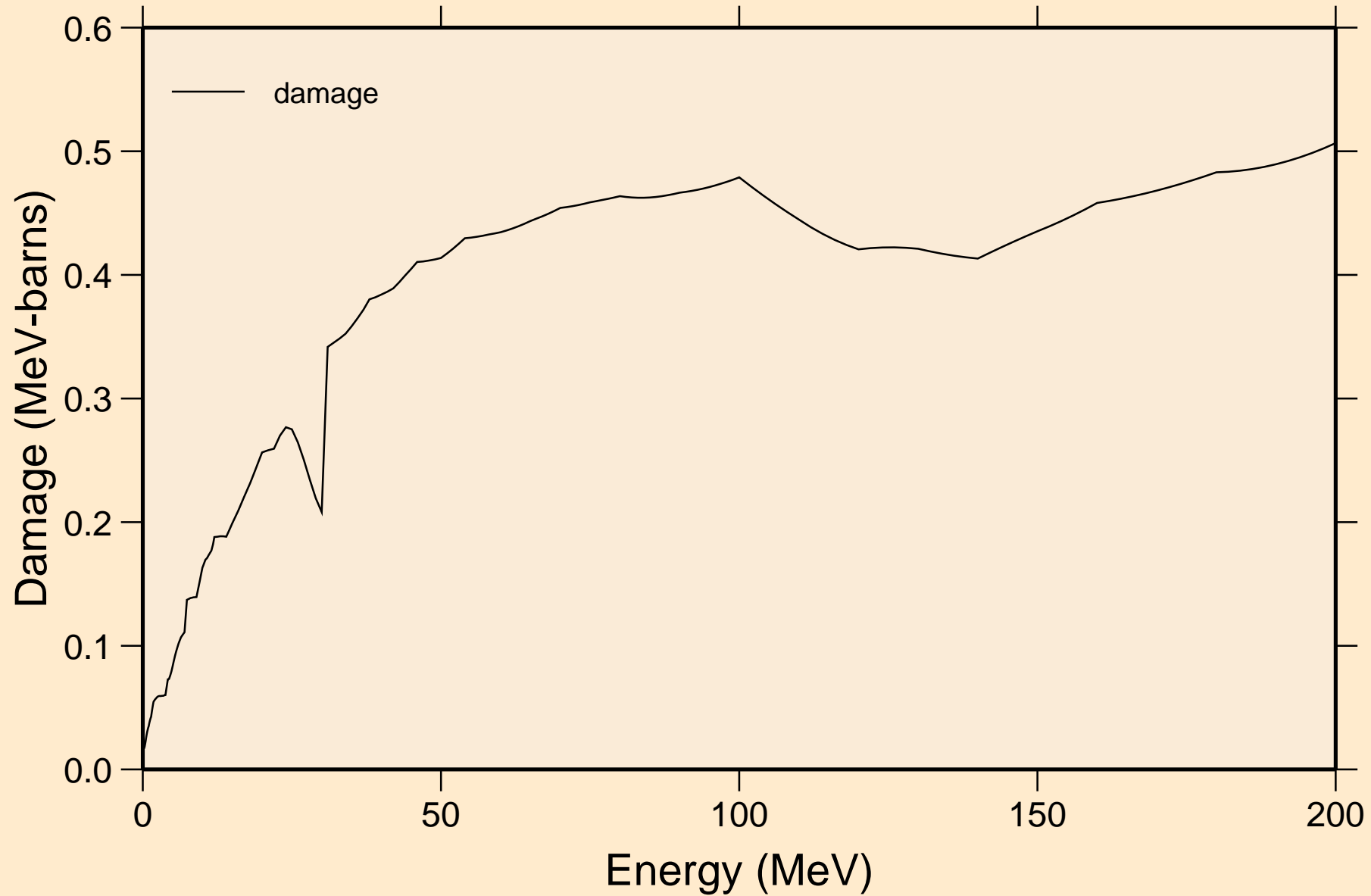

TB170 NEUTRON ACER TENDL-2021 LIBRARY; T=293.6K
Non-threshold reactions

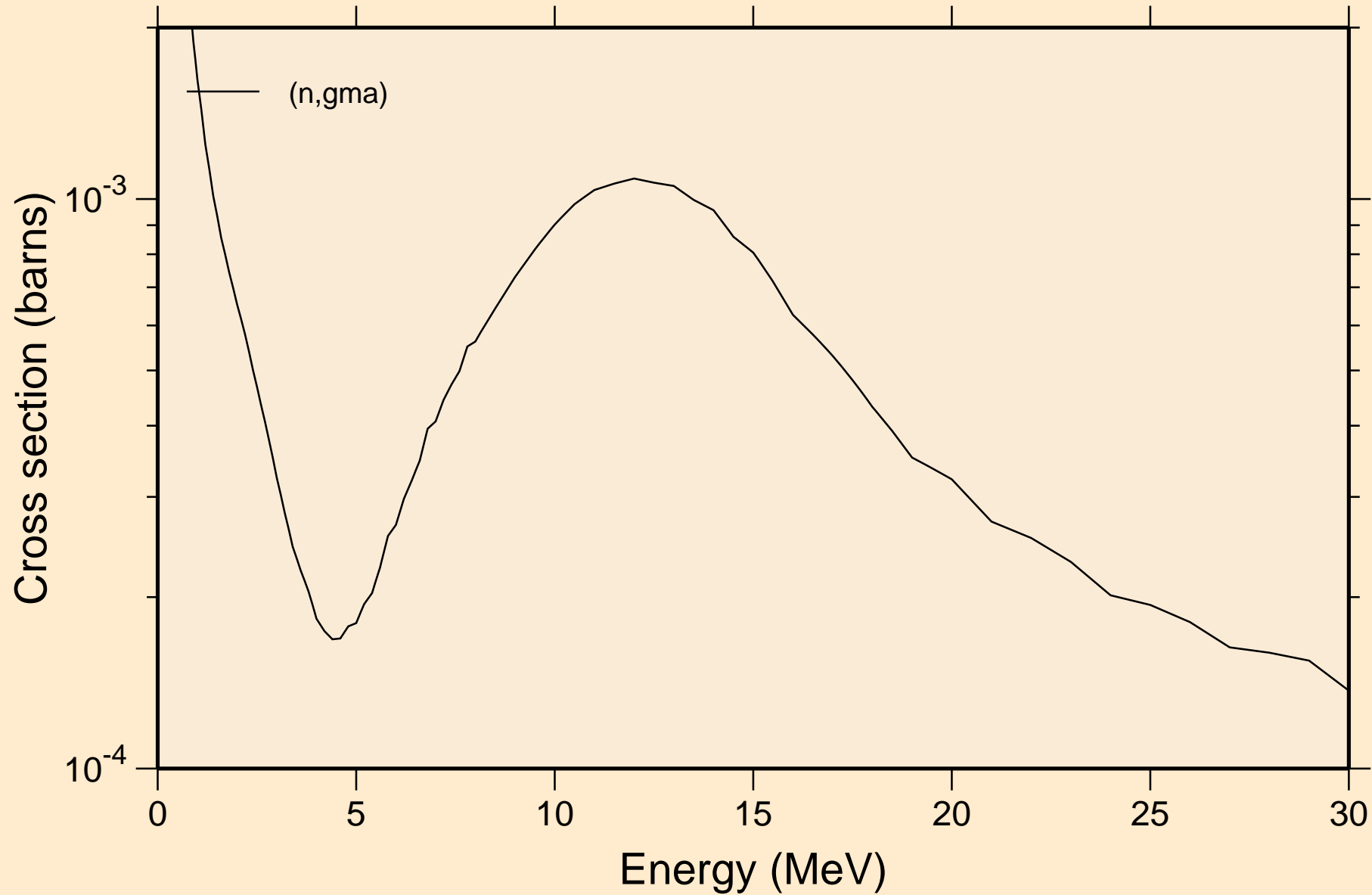

TB170 NEUTRON ACER TENDL-2021 LIBRARY; T=293.6K
Inelastic levels

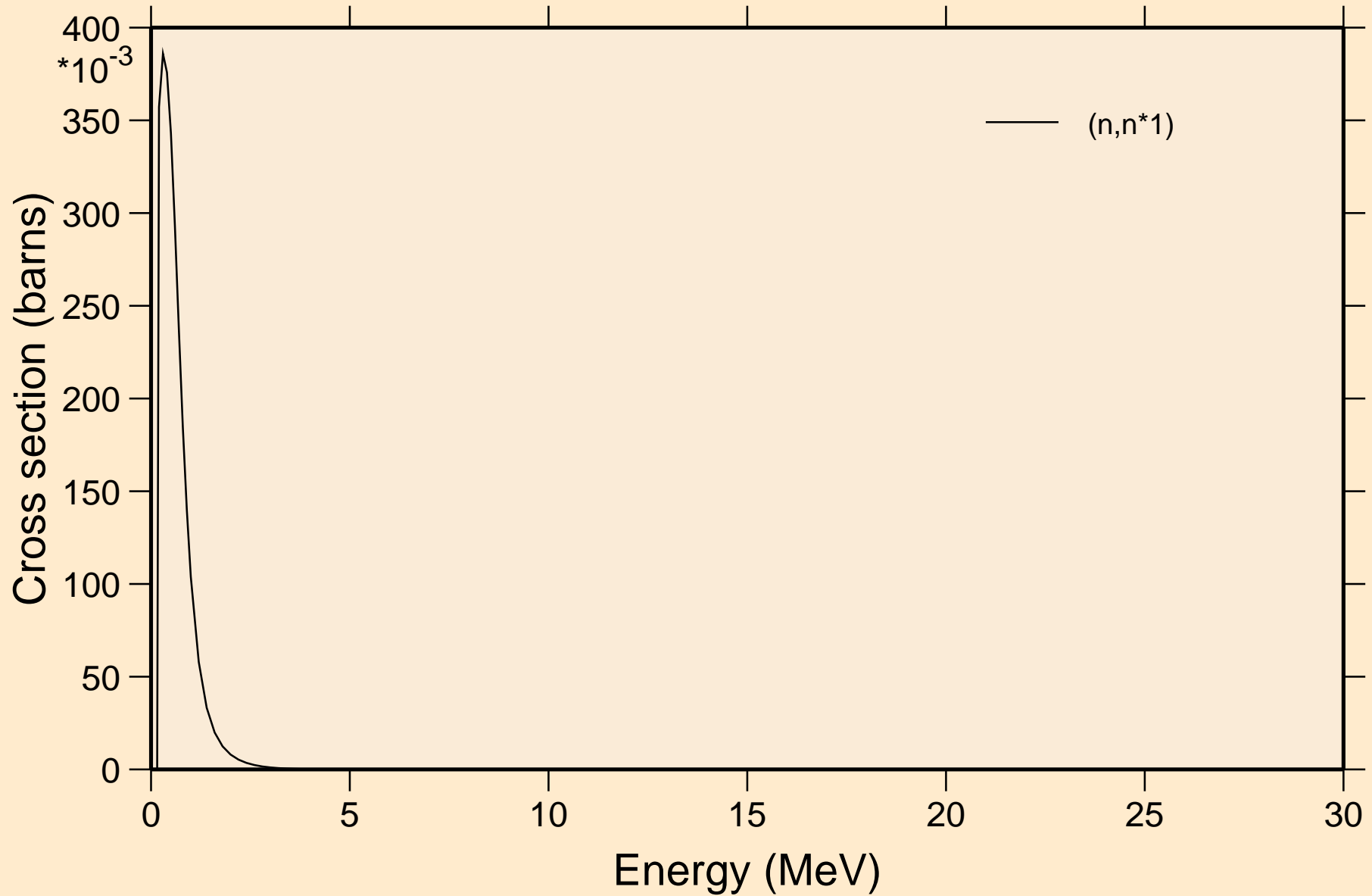

TB170 NEUTRON ACER TENDL-2021 LIBRARY; T=293.6K
Threshold reactions

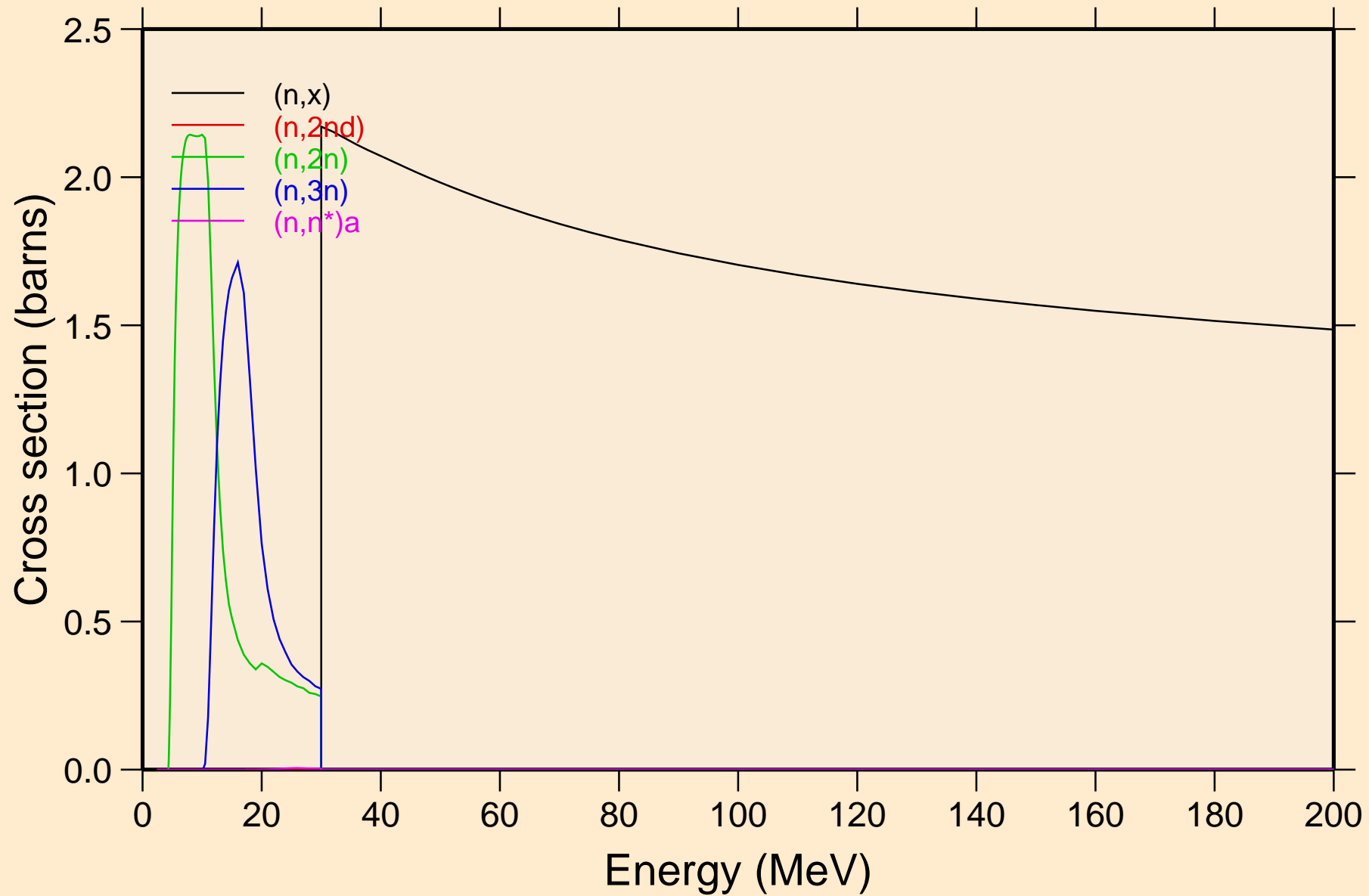

TB170 NEUTRON ACER TENDL-2021 LIBRARY; T=293.6K
Threshold reactions

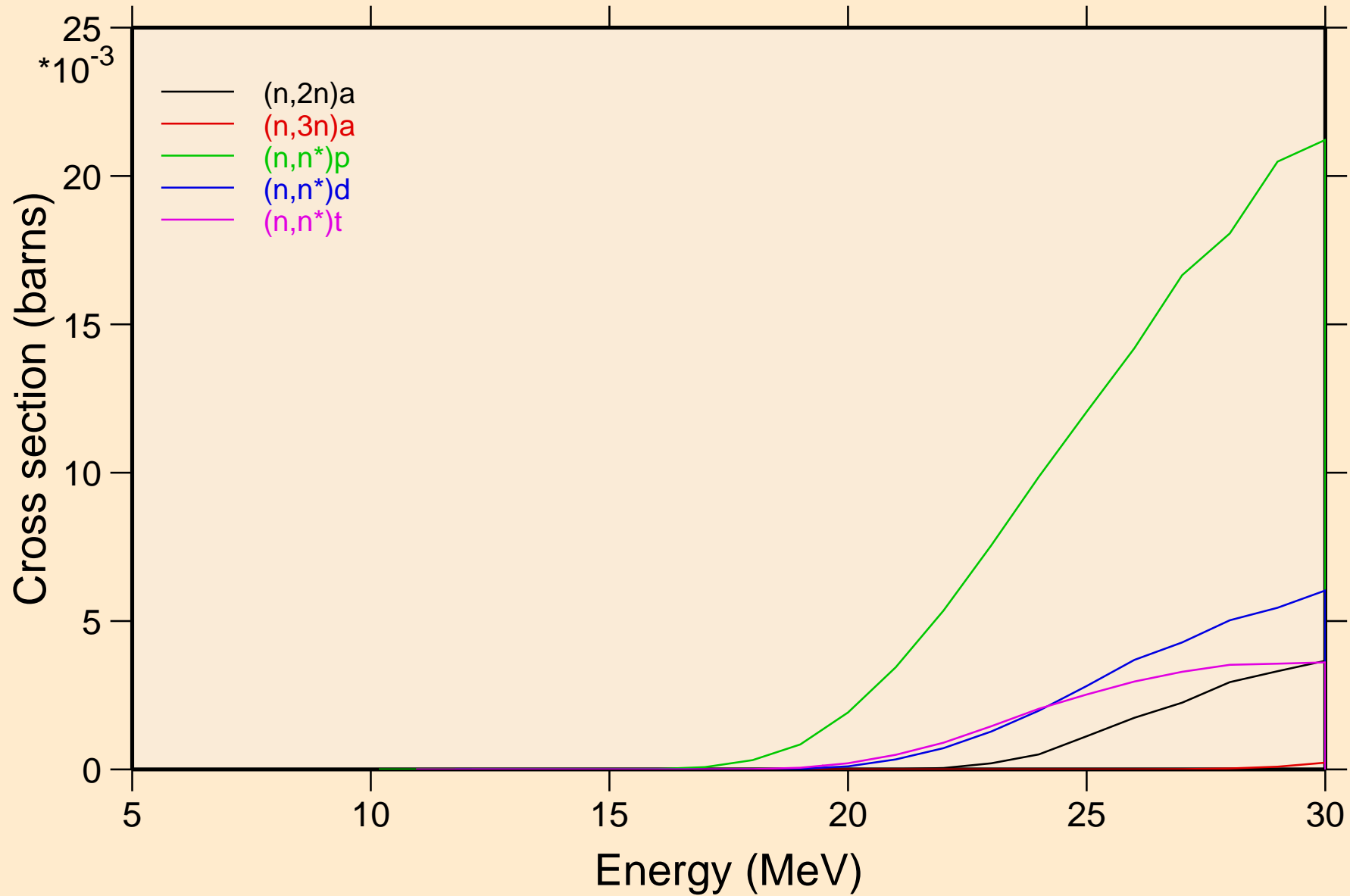

TB170 NEUTRON ACER TENDL-2021 LIBRARY; T=293.6K
Threshold reactions

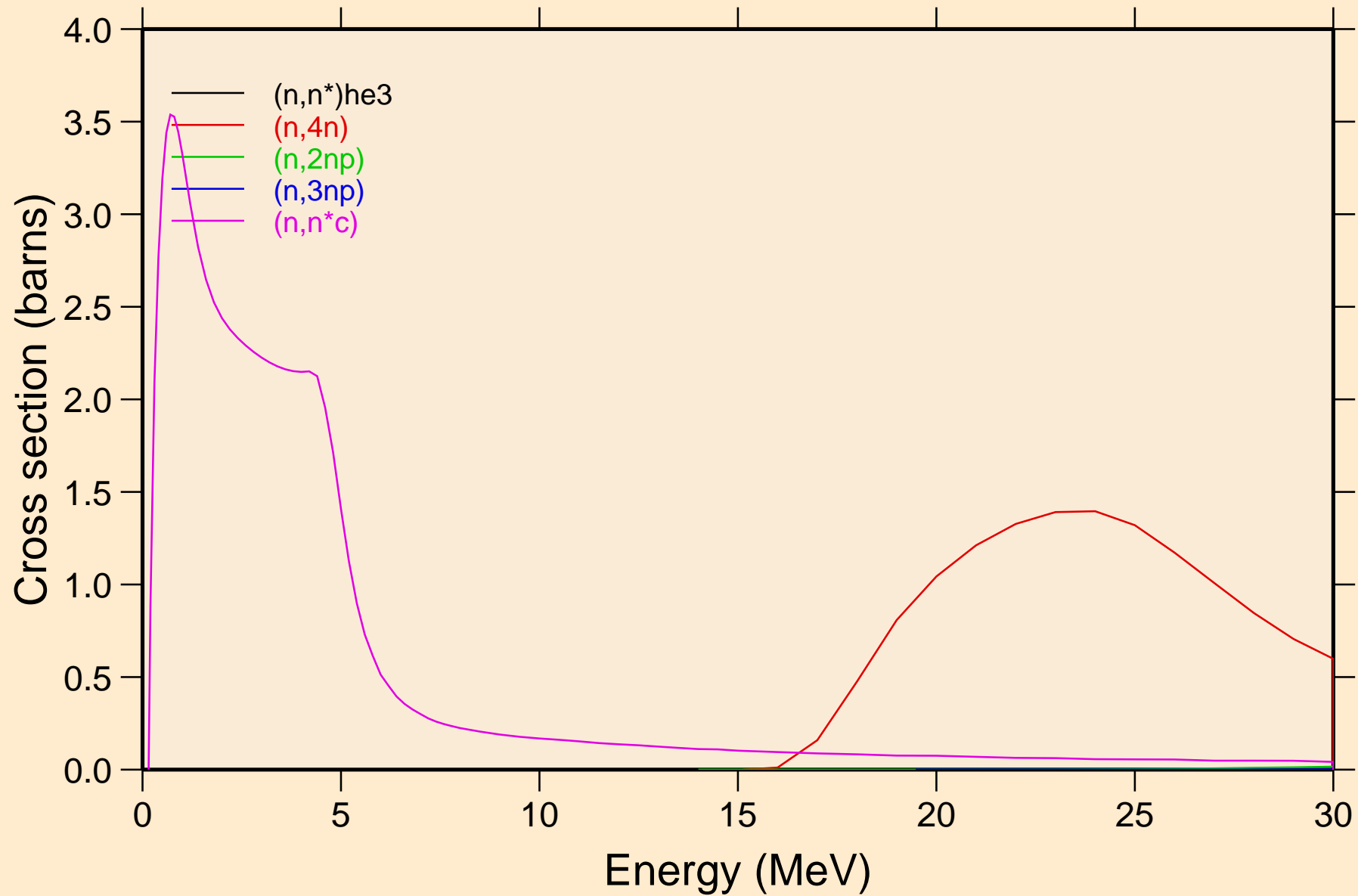

TB170 NEUTRON ACER TENDL-2021 LIBRARY; T=293.6K
Threshold reactions

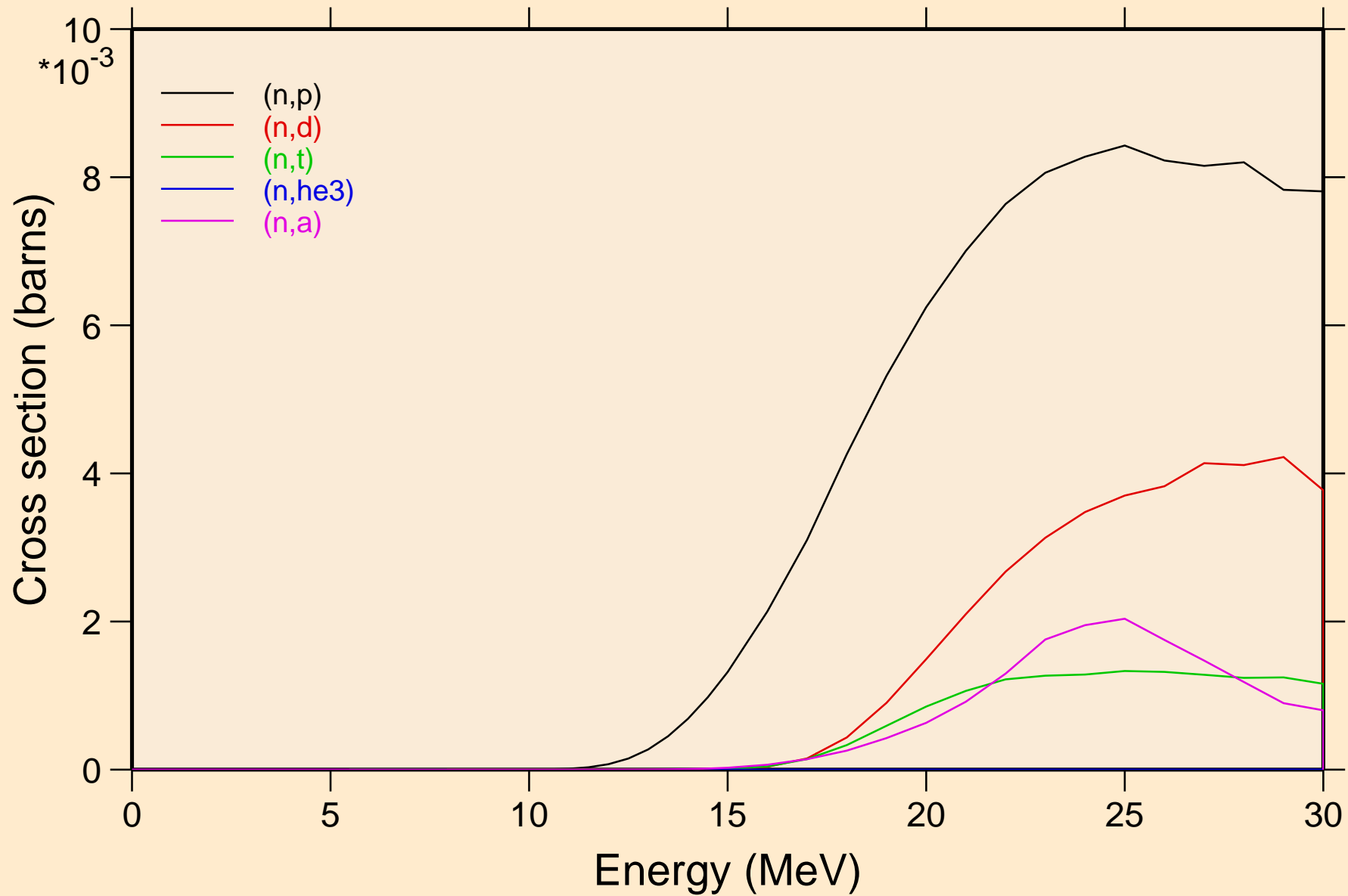

TB170 NEUTRON ACER TENDL-2021 LIBRARY; T=293.6K
Threshold reactions

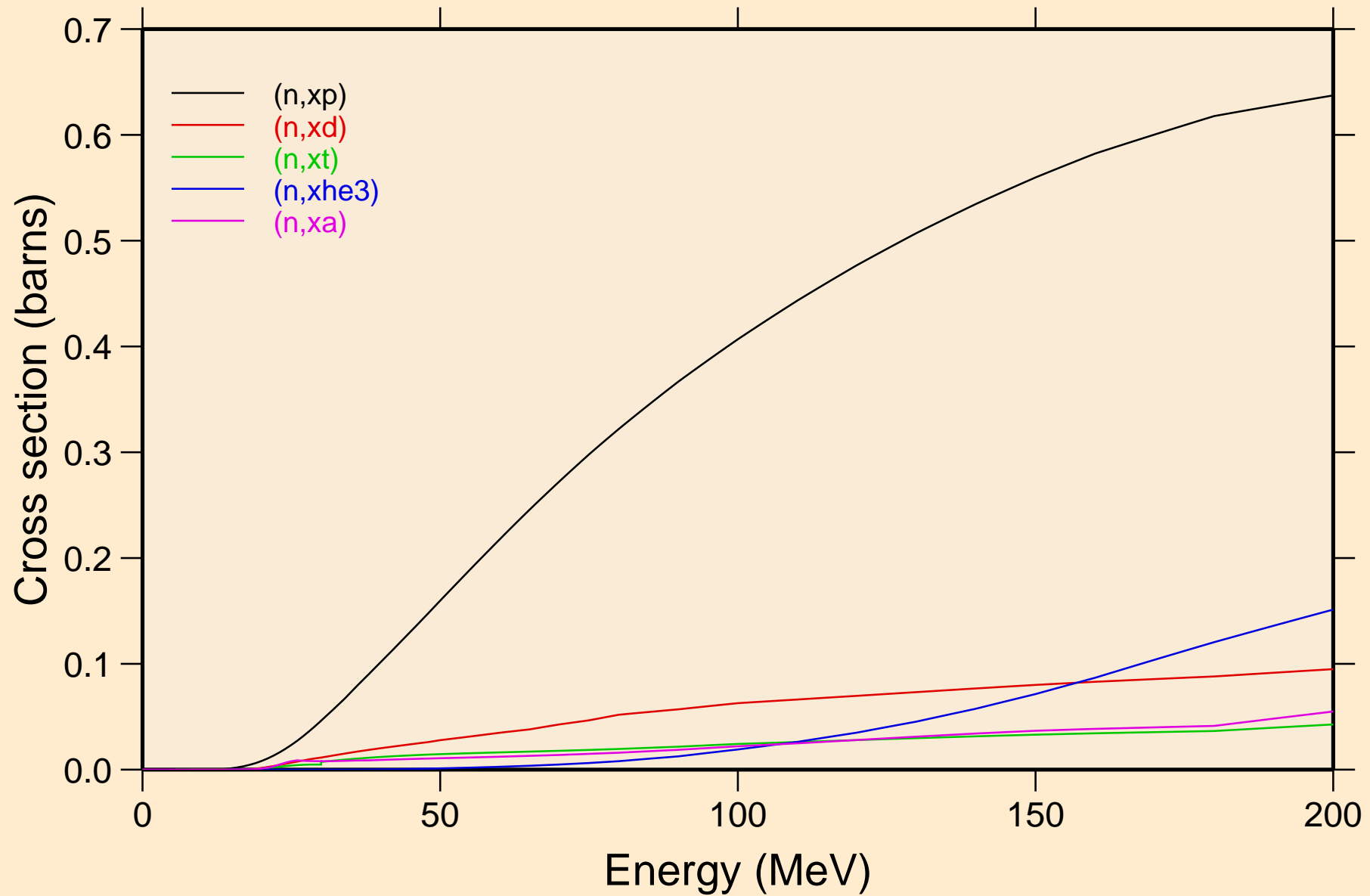

TB170 NEUTRON ACER TENDL-2021 LIBRARY; T=293.6K
angular distribution for elastic

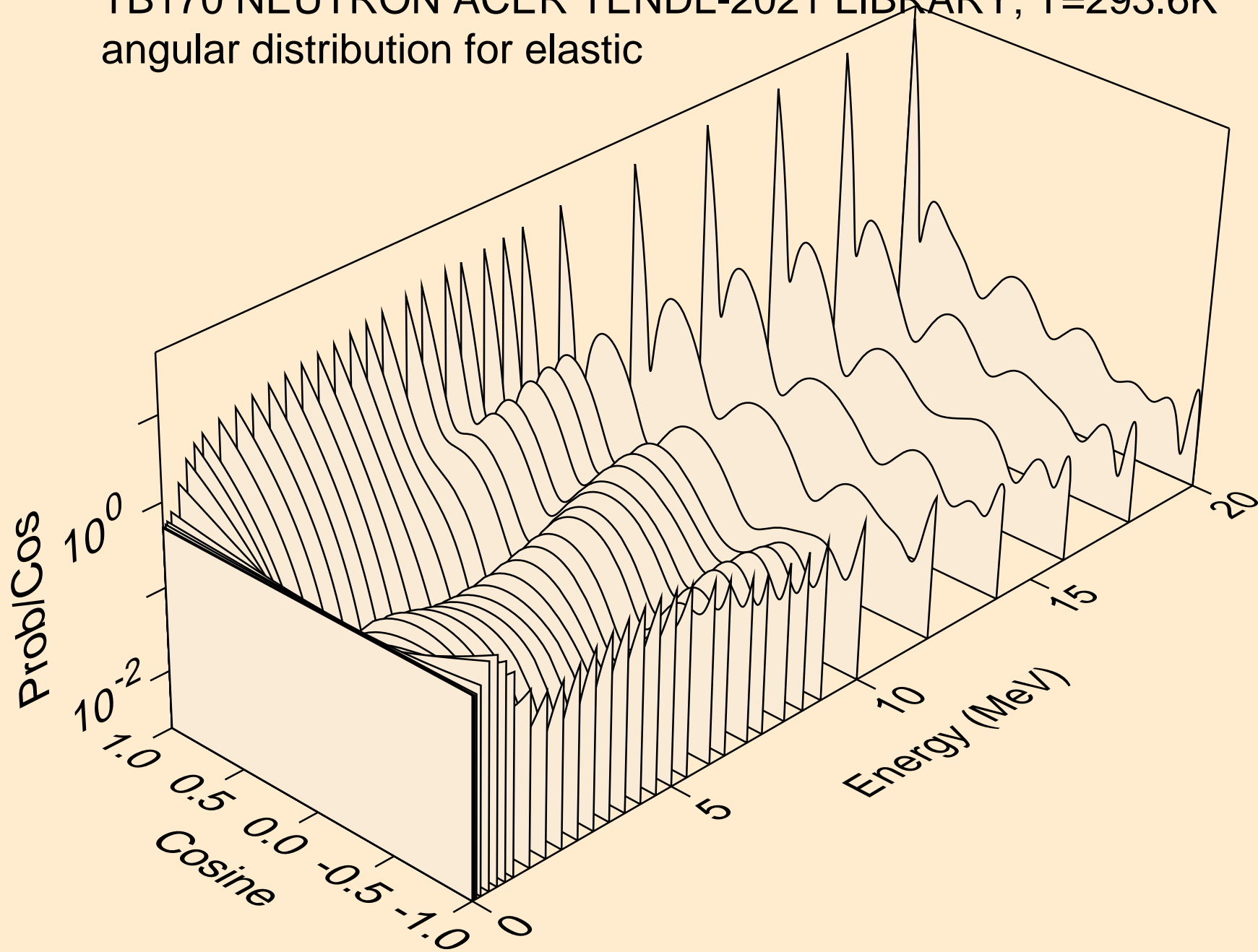

TB170 NEUTRON ACER TENDL-2021 LIBRARY; T=293.6K
angular distribution for elastic

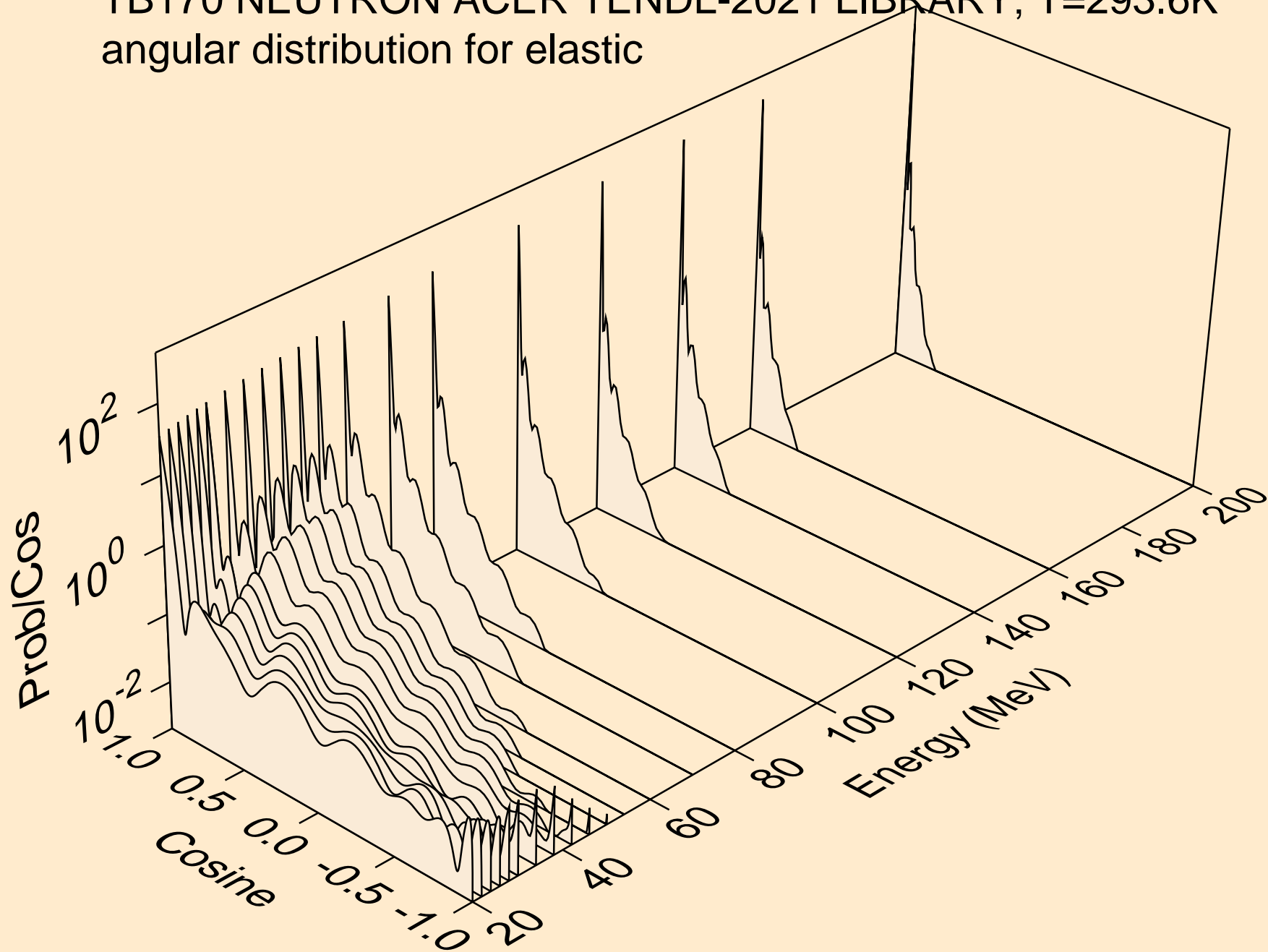

TB170 NEUTRON ACER TENDL-2021 LIBRARY; T=293.6K
angular distribution for (n,n*1)

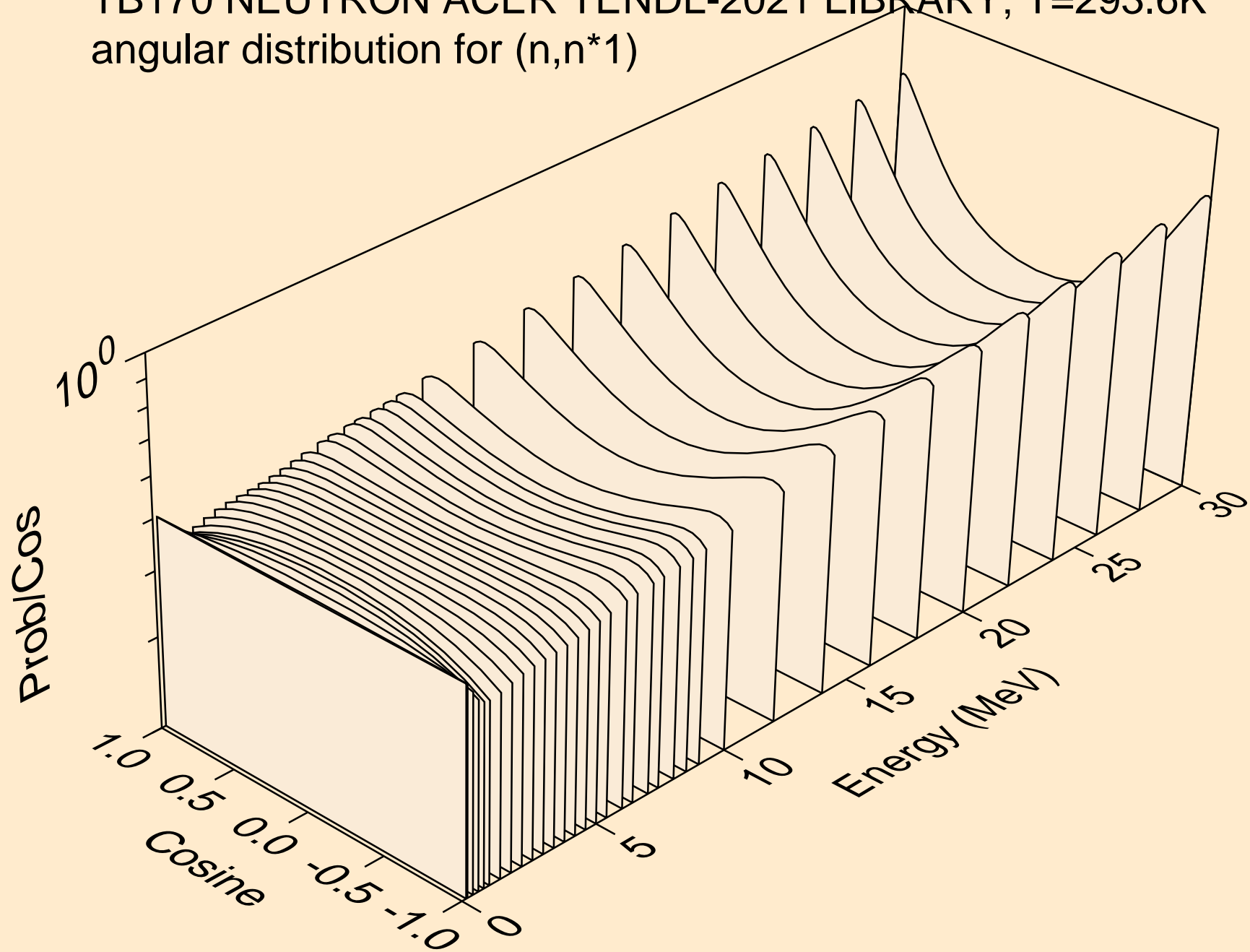

TB170 NEUTRON ACER TENDL-2021 LIBRARY; T=293.6K
Neutron emission for (n,x)

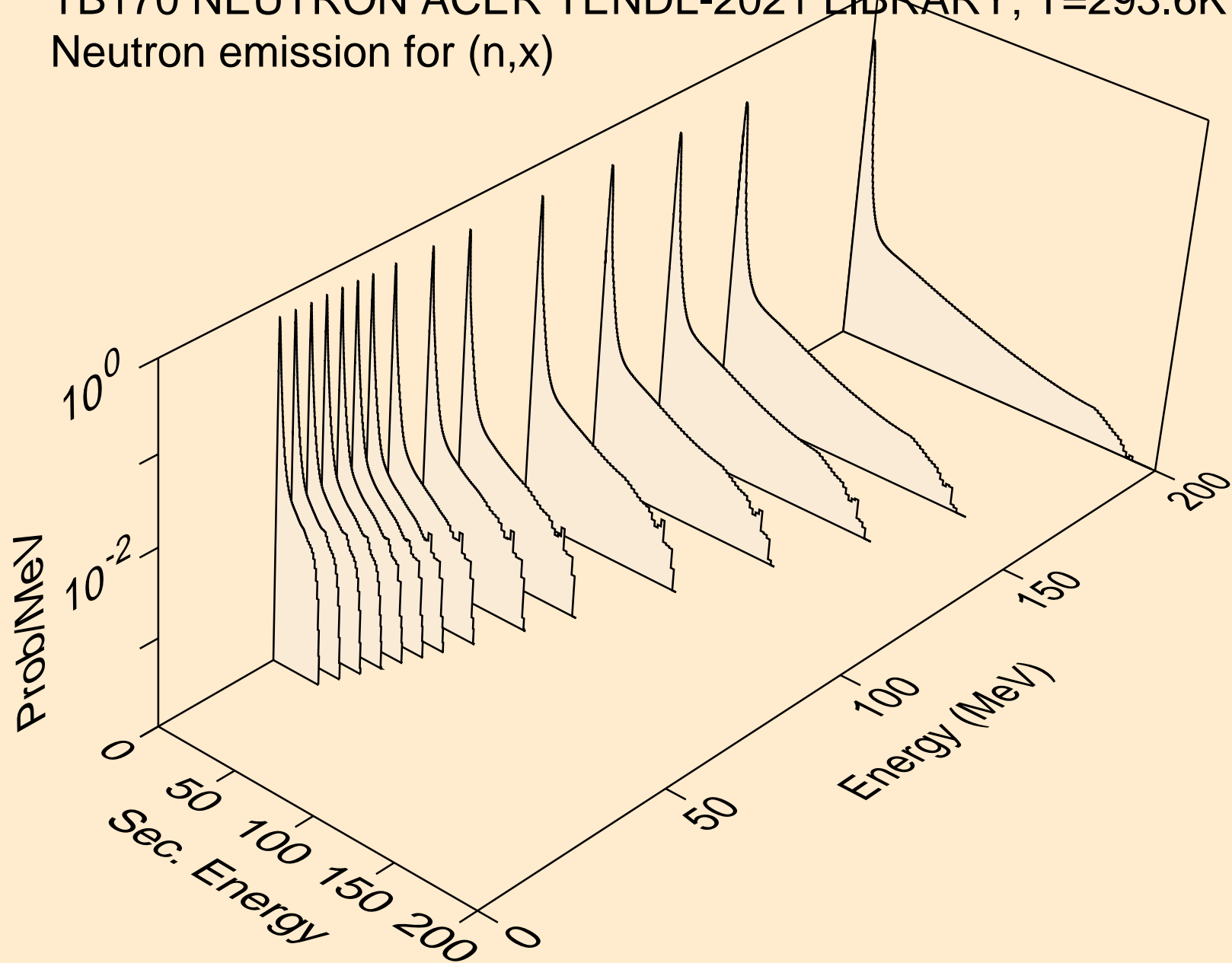

TB170 NEUTRON ACER TENDL-2021 LIBRARY; T=293.6K
Neutron emission for (n,2nd)

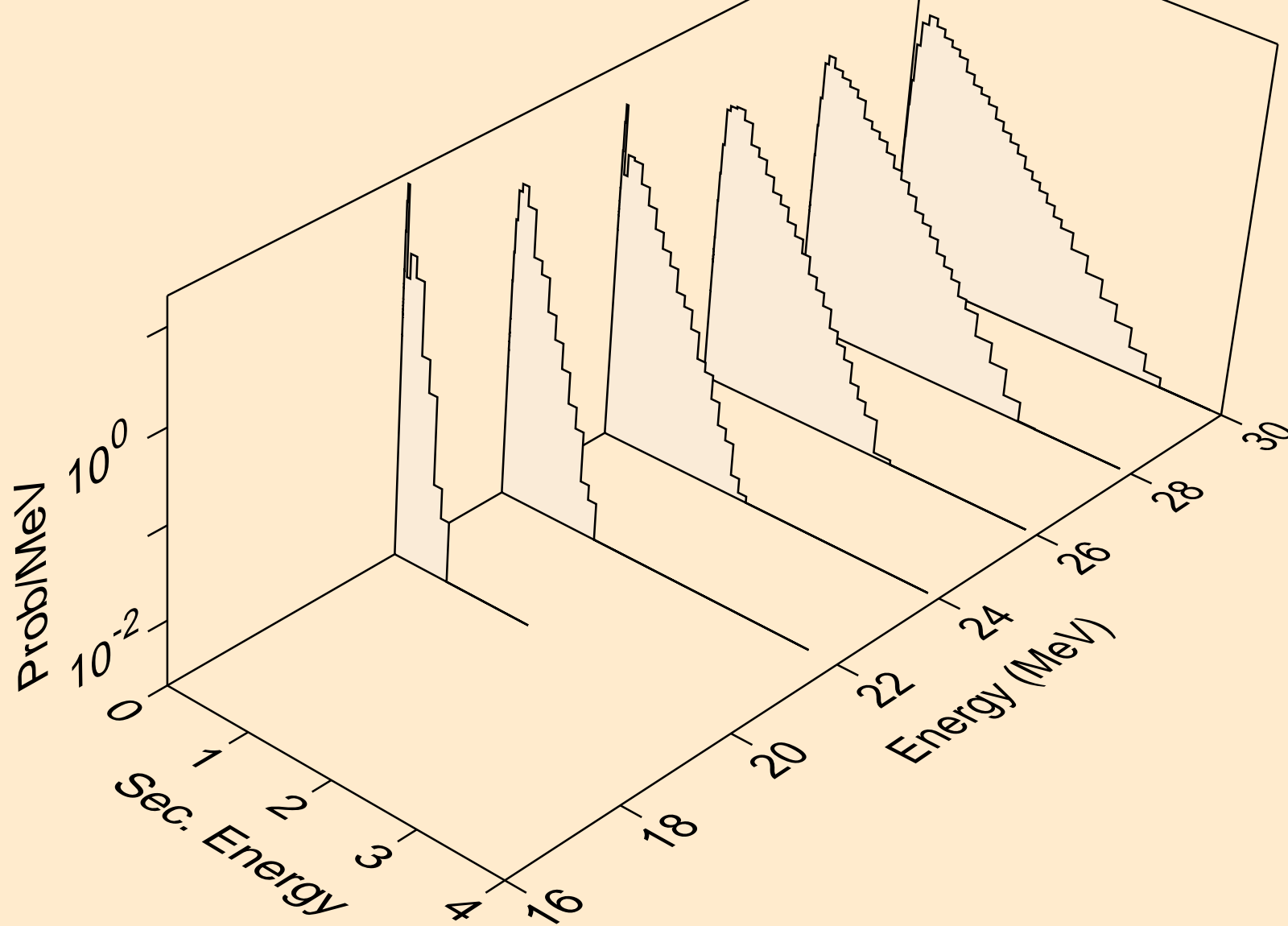

TB170 NEUTRON ACER TENDL-2021 LIBRARY; T=293.6K
Neutron emission for (n,2n)

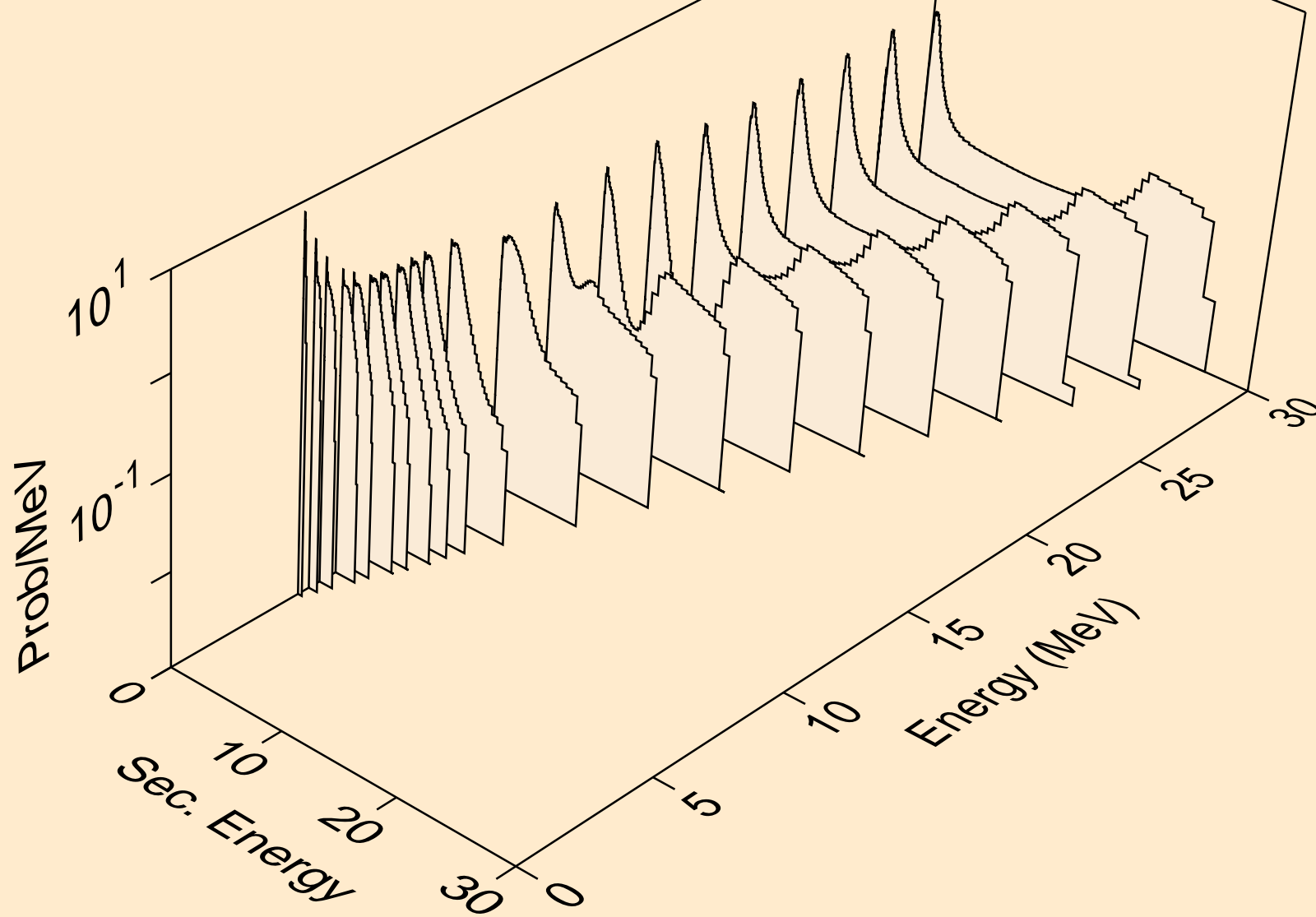

TB170 NEUTRON ACER TENDL-2021 LIBRARY; T=293.6K
Neutron emission for (n,3n)

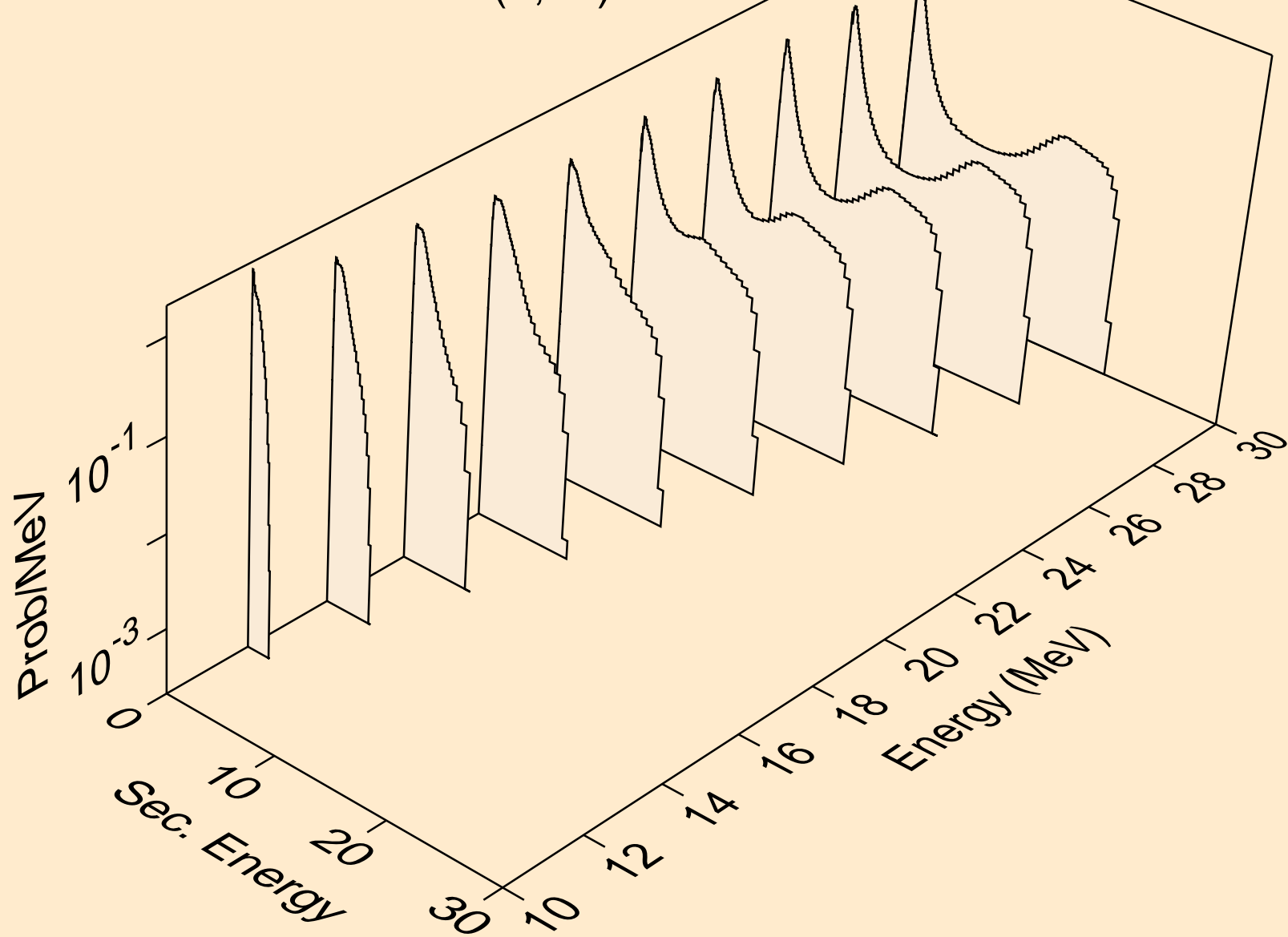

TB170 NEUTRON ACER TENDL-2021 LIBRARY; T=293.6K
Neutron emission for (n,n*)a

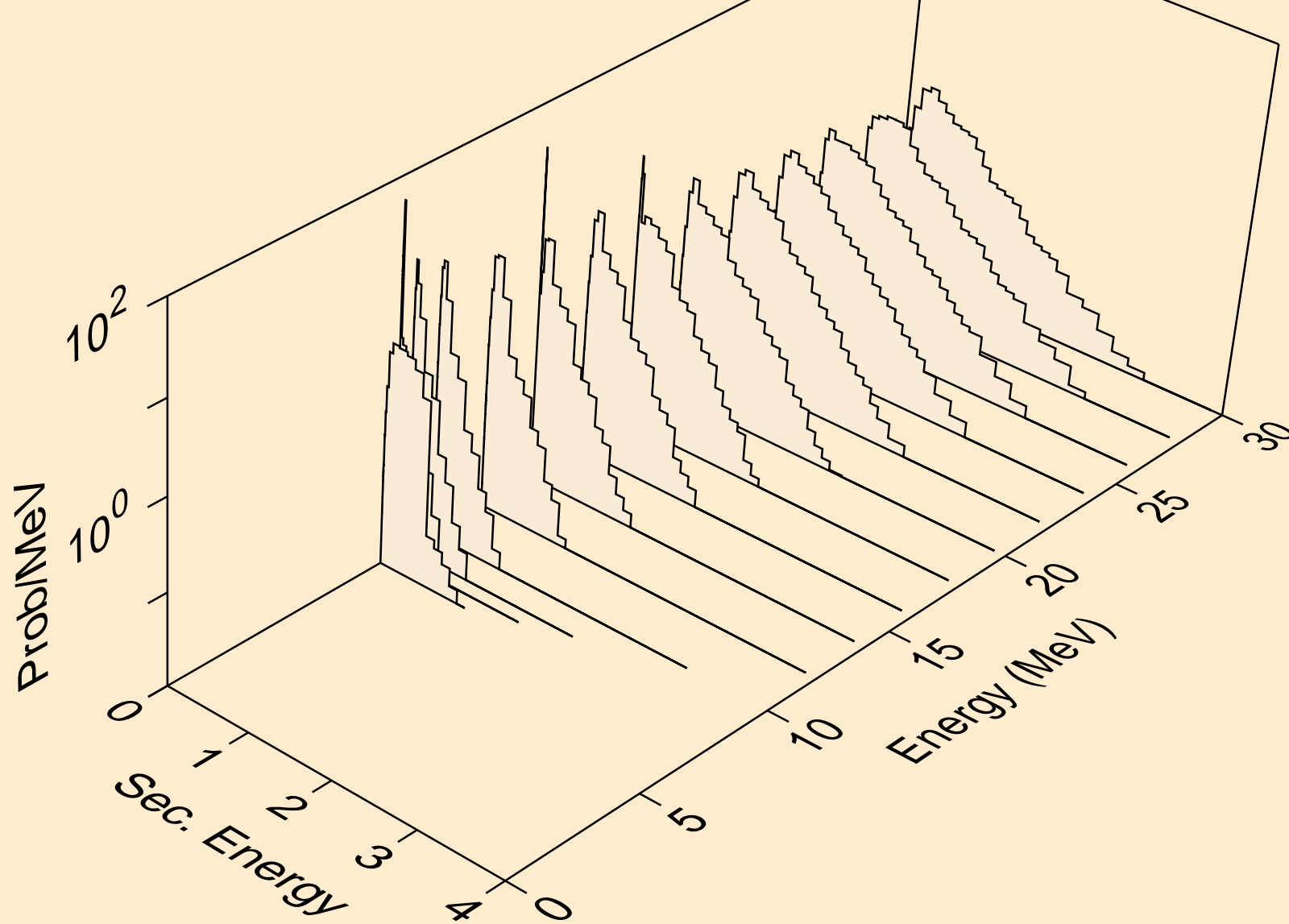

TB170 NEUTRON ACER TENDL-2021 LIBRARY; T=293.6K
Neutron emission for (n,2n)_a

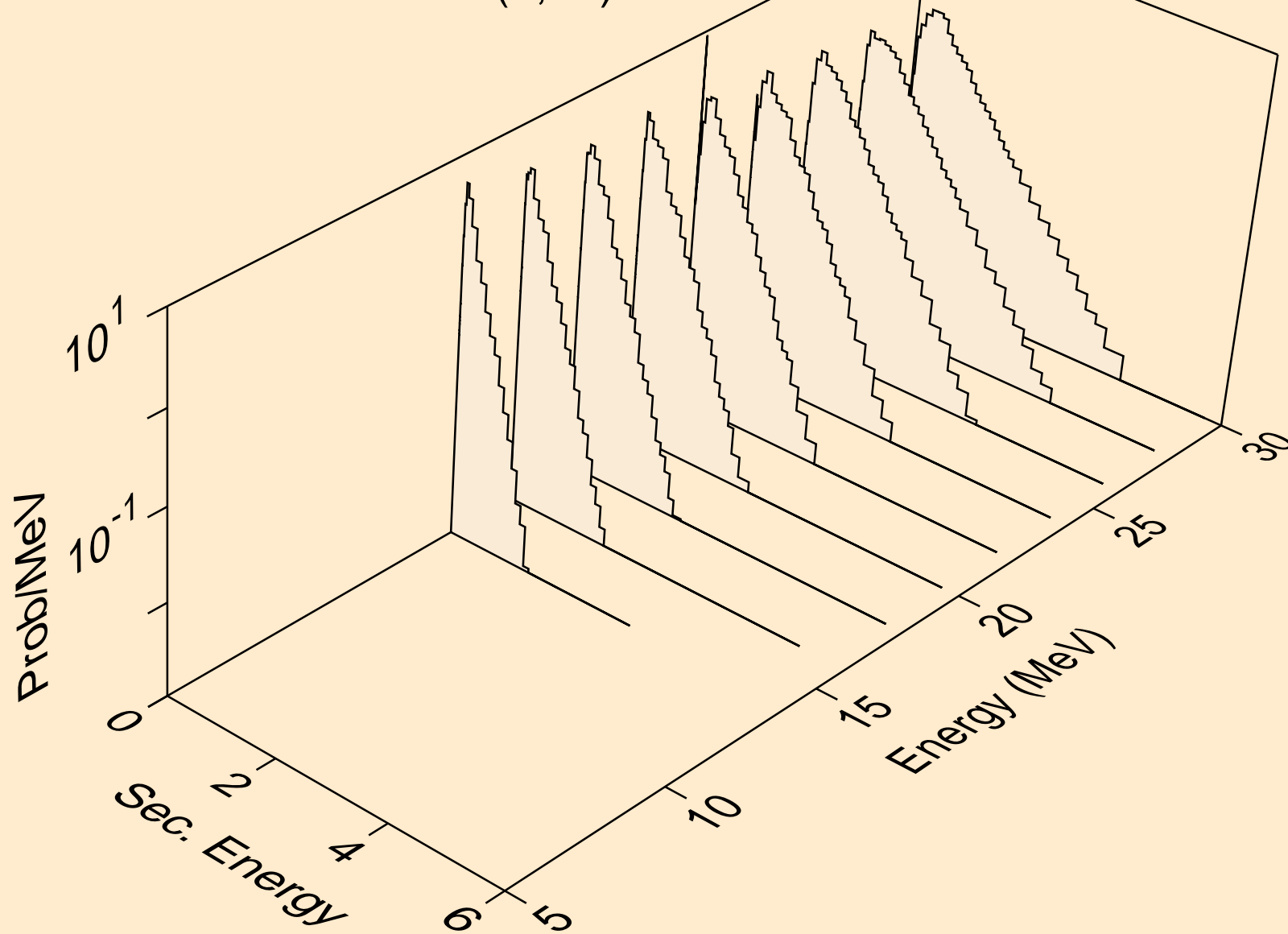

TB170 NEUTRON ACER TENDL-2021 LIBRARY; T=293.6K
Neutron emission for (n,3n)a

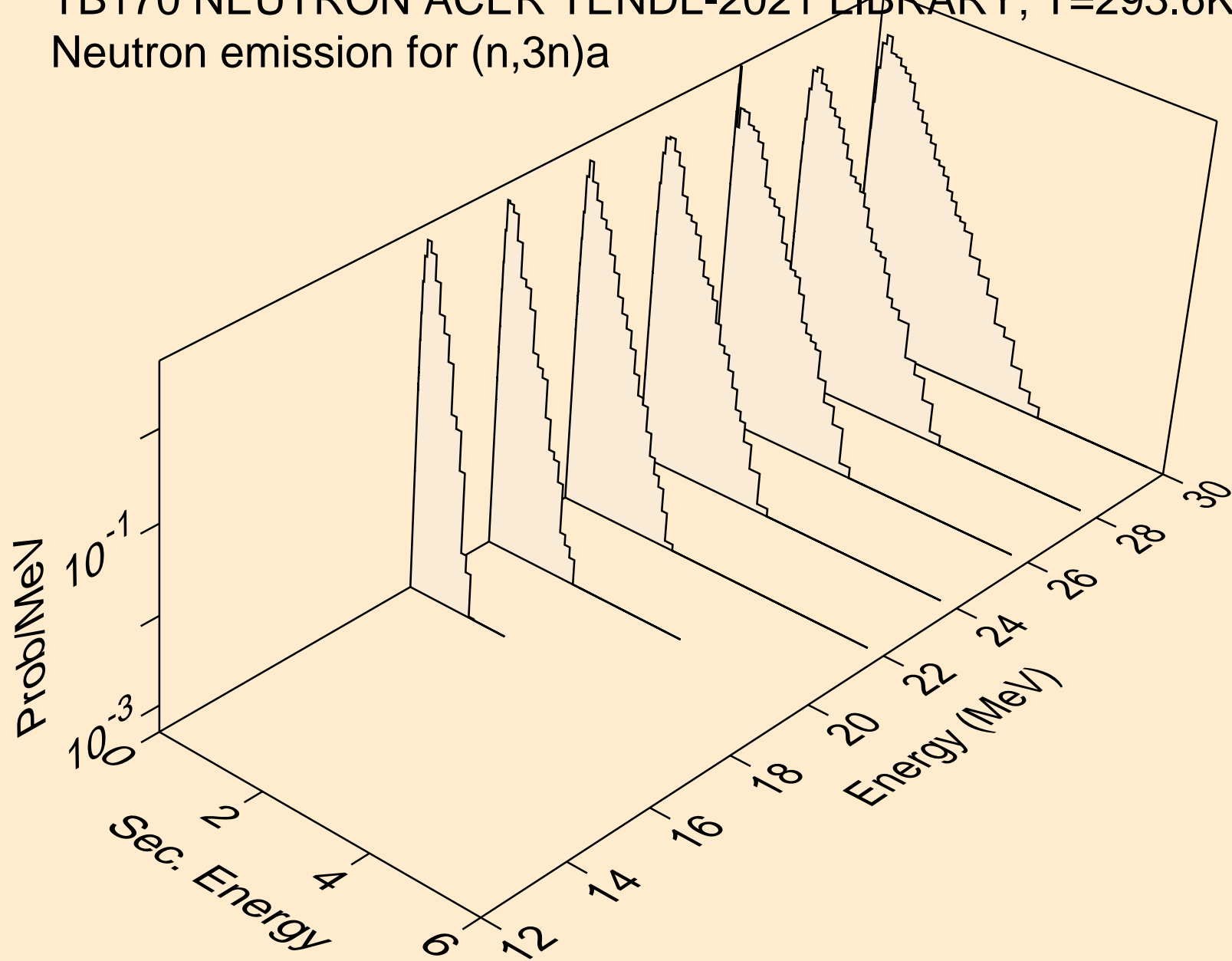

TB170 NEUTRON ACER TENDL-2021 LIBRARY; T=293.6K
Neutron emission for (n,n*)p

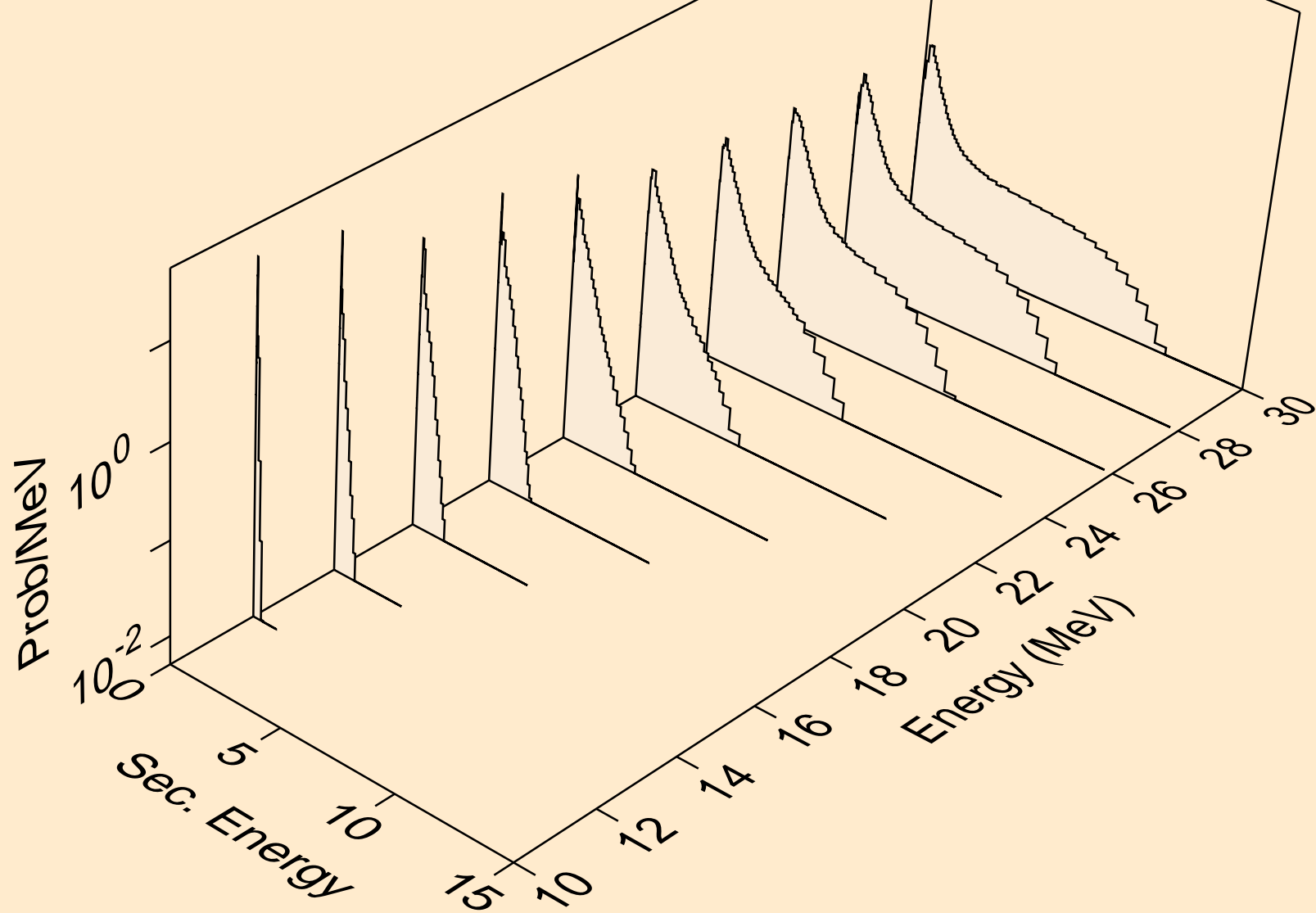

TB170 NEUTRON ACER TENDL-2021 LIBRARY; T=293.6K
Neutron emission for (n,n*)d

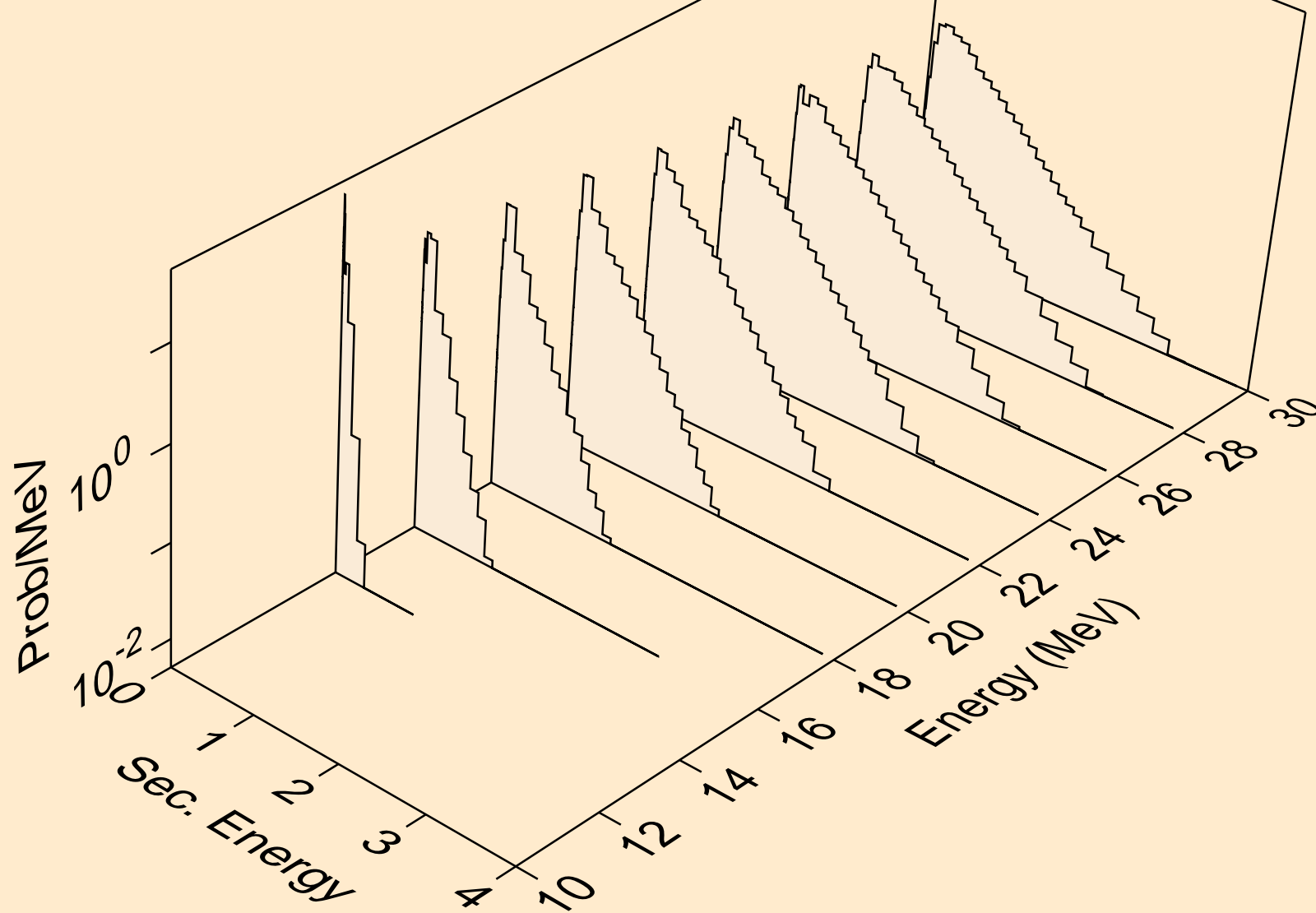

TB170 NEUTRON ACER TENDL-2021 LIBRARY; T=293.6K
Neutron emission for (n,n*)t

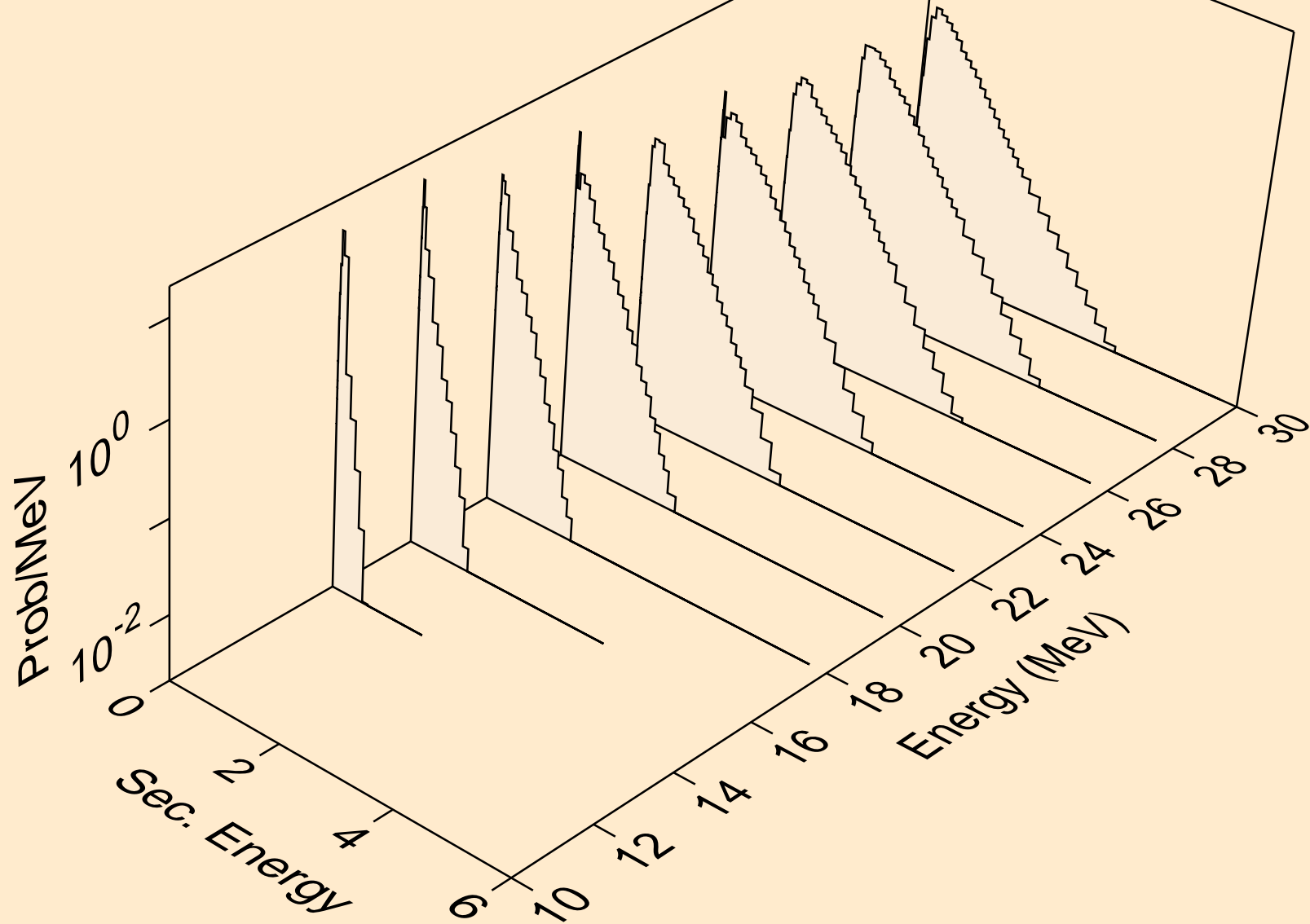

TB170 NEUTRON ACER TENDL-2021 LIBRARY; T=293.6K
Neutron emission for (n,n*)he3

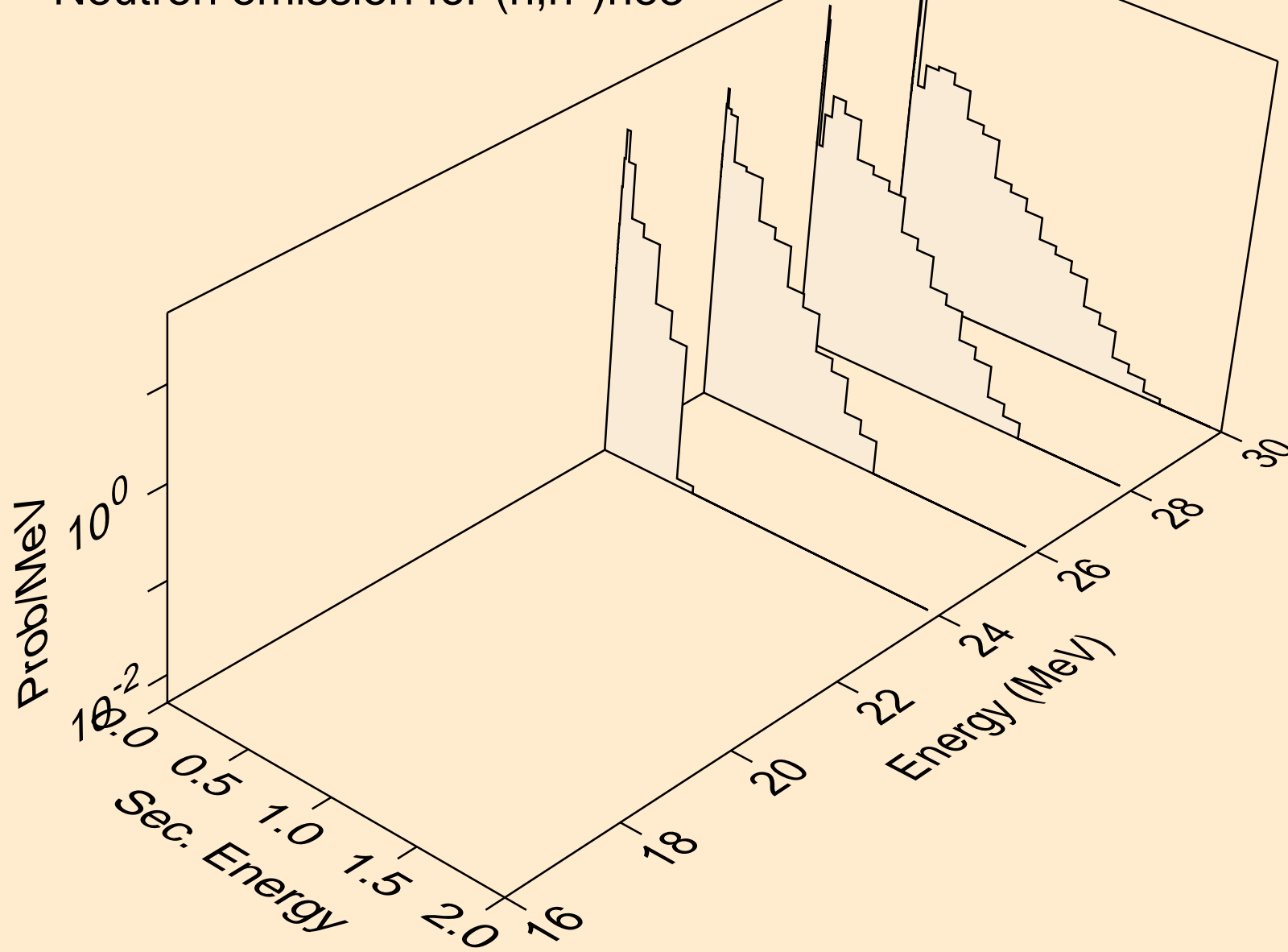

TB170 NEUTRON ACER TENDL-2021 LIBRARY; T=293.6K
Neutron emission for (n,4n)

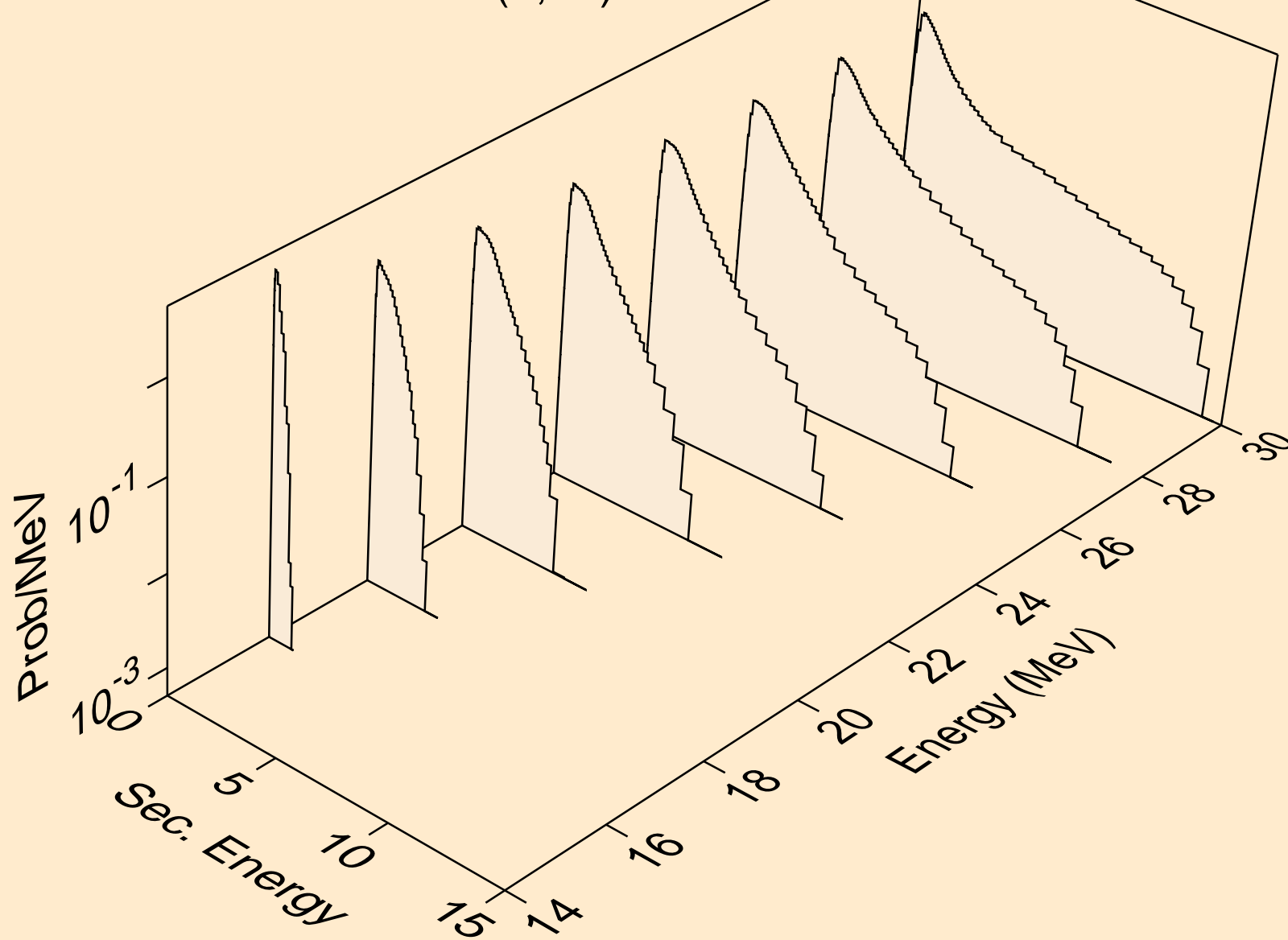

TB170 NEUTRON ACER TENDL-2021 LIBRARY; T=293.6K
Neutron emission for (n,2np)

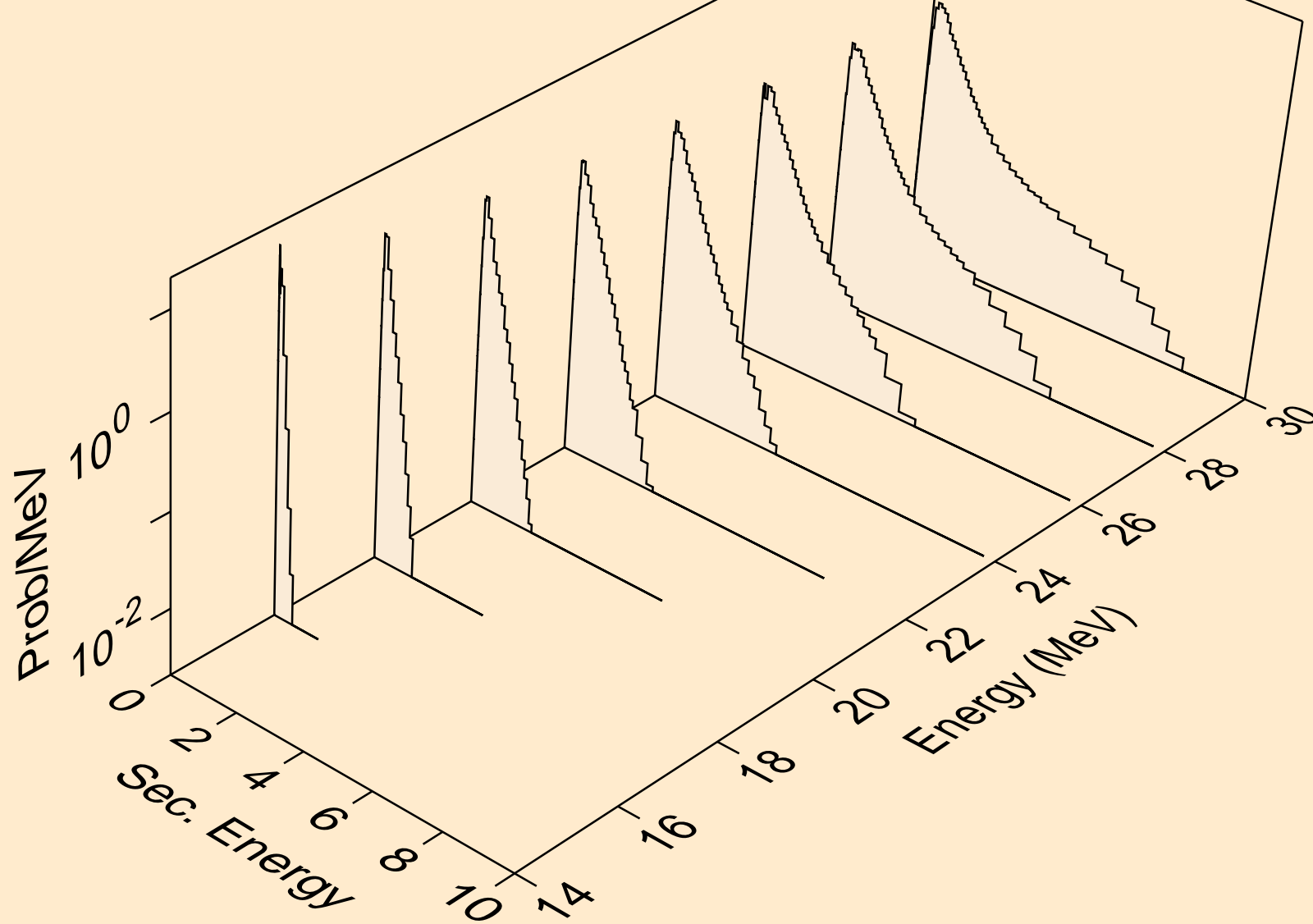

TB170 NEUTRON ACER TENDL-2021 LIBRARY; T=293.6K
Neutron emission for (n,3np)

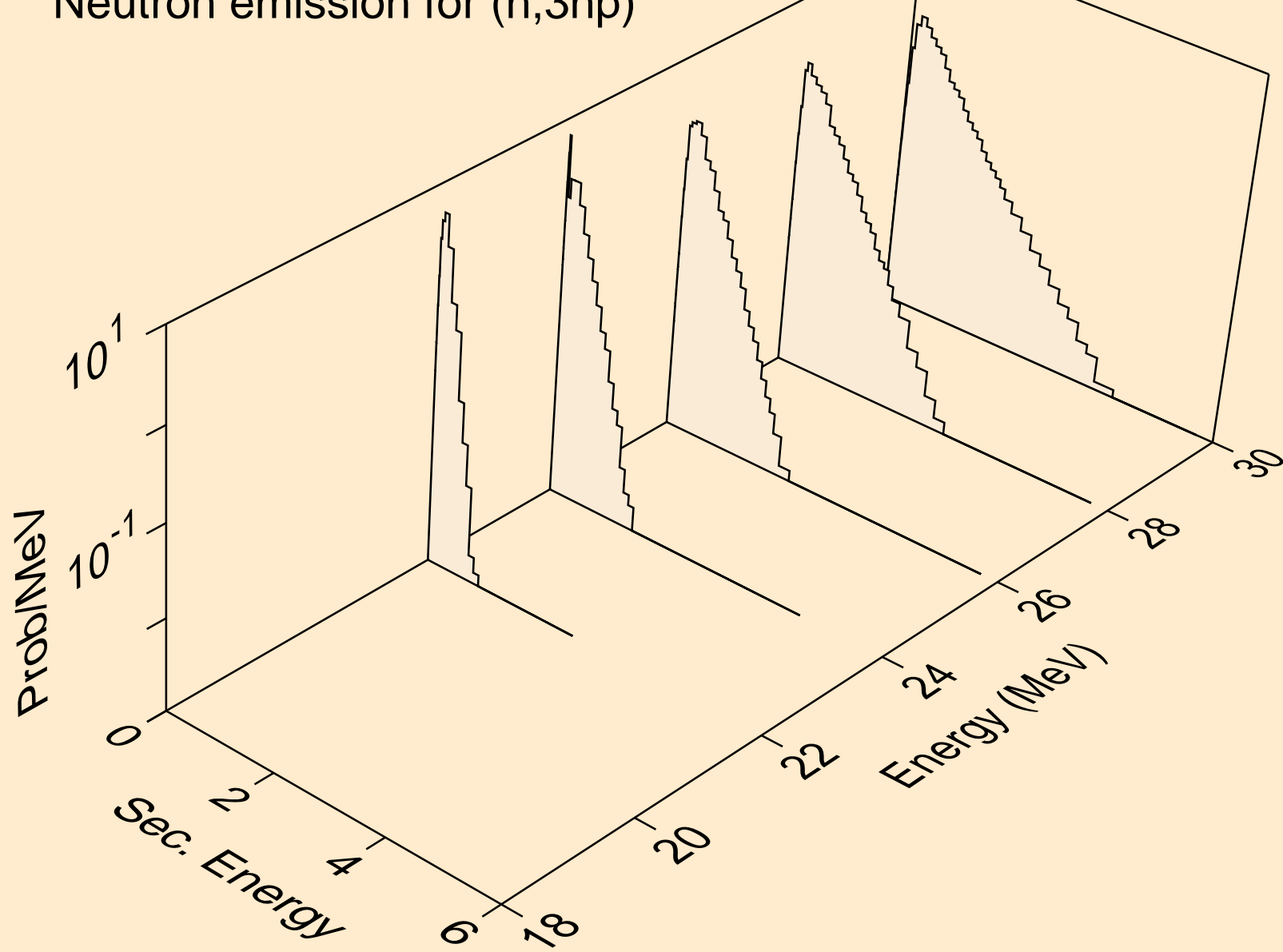

TB170 NEUTRON ACER TENDL-2021 LIBRARY; T=293.6K
Neutron emission for (n,n*c)

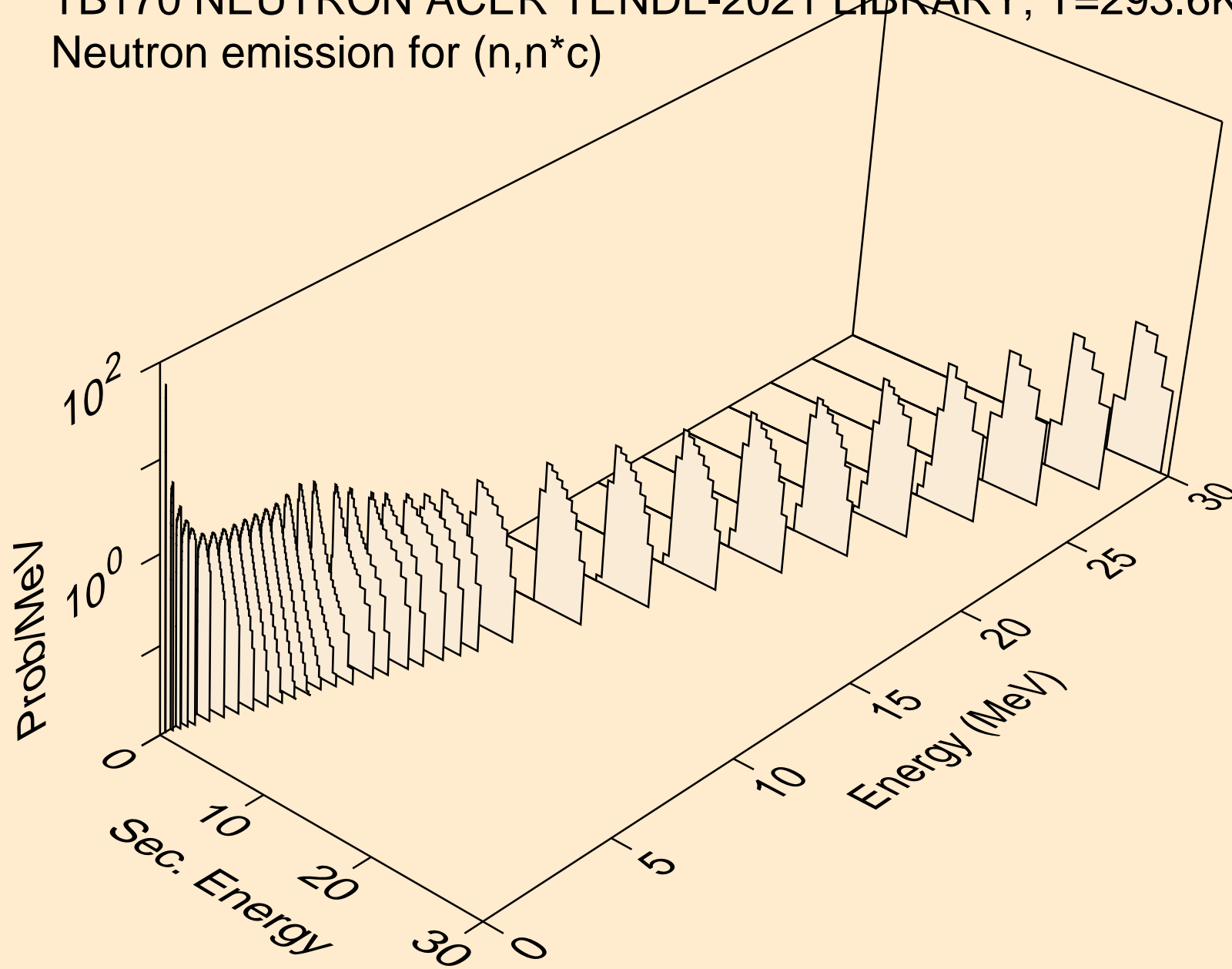

TB170 NEUTRON ACER TENDL-2021 LIBRARY; T=293.6K
Photon emission for (n,x)

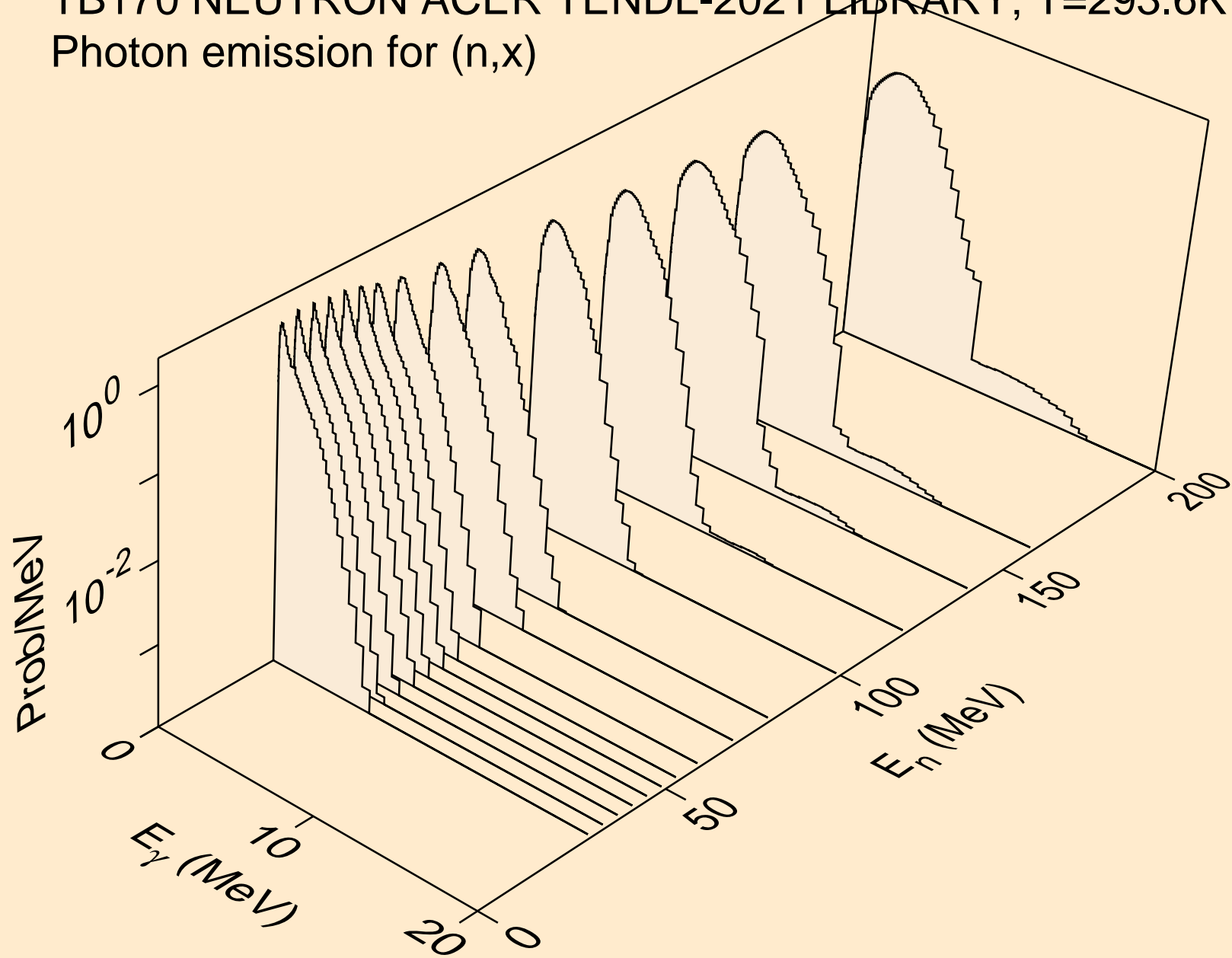

TB170 NEUTRON ACER TENDL-2021 LIBRARY; T=293.6K
Photon emission for (n,2nd)

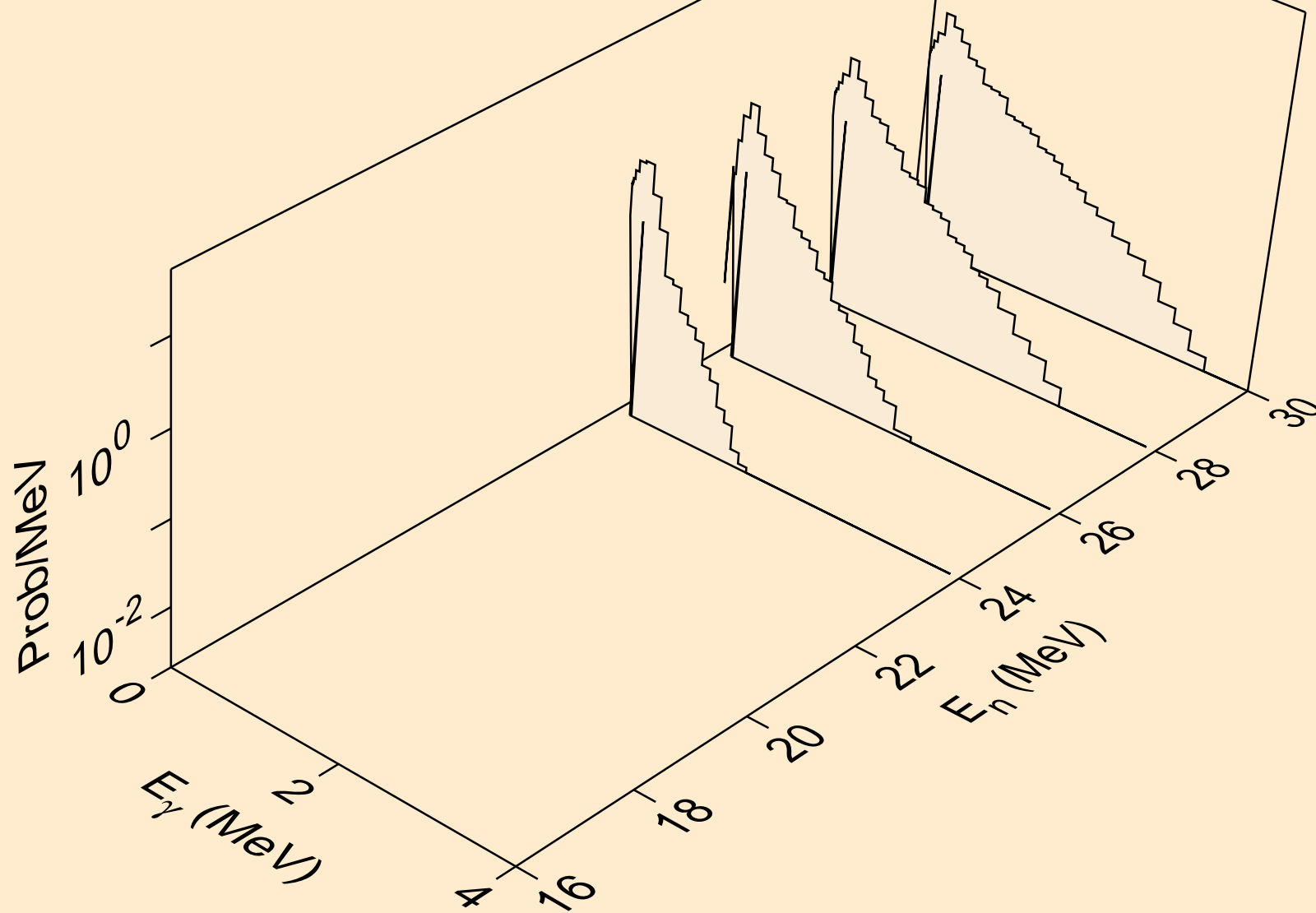

TB170 NEUTRON ACER TENDL-2021 LIBRARY; T=293.6K
Photon emission for (n,2n)

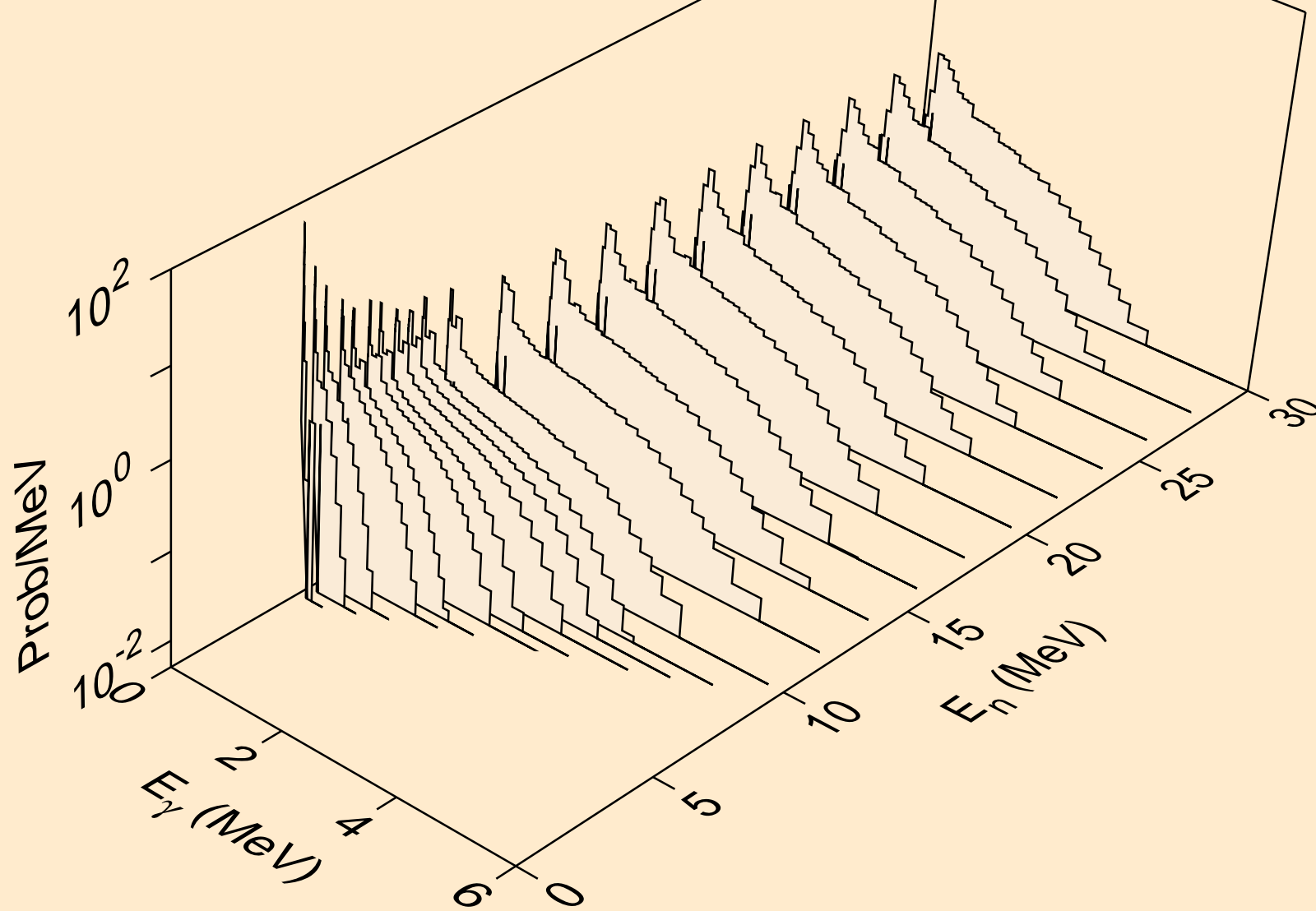

TB170 NEUTRON ACER TENDL-2021 LIBRARY; T=293.6K
Photon emission for (n,3n)

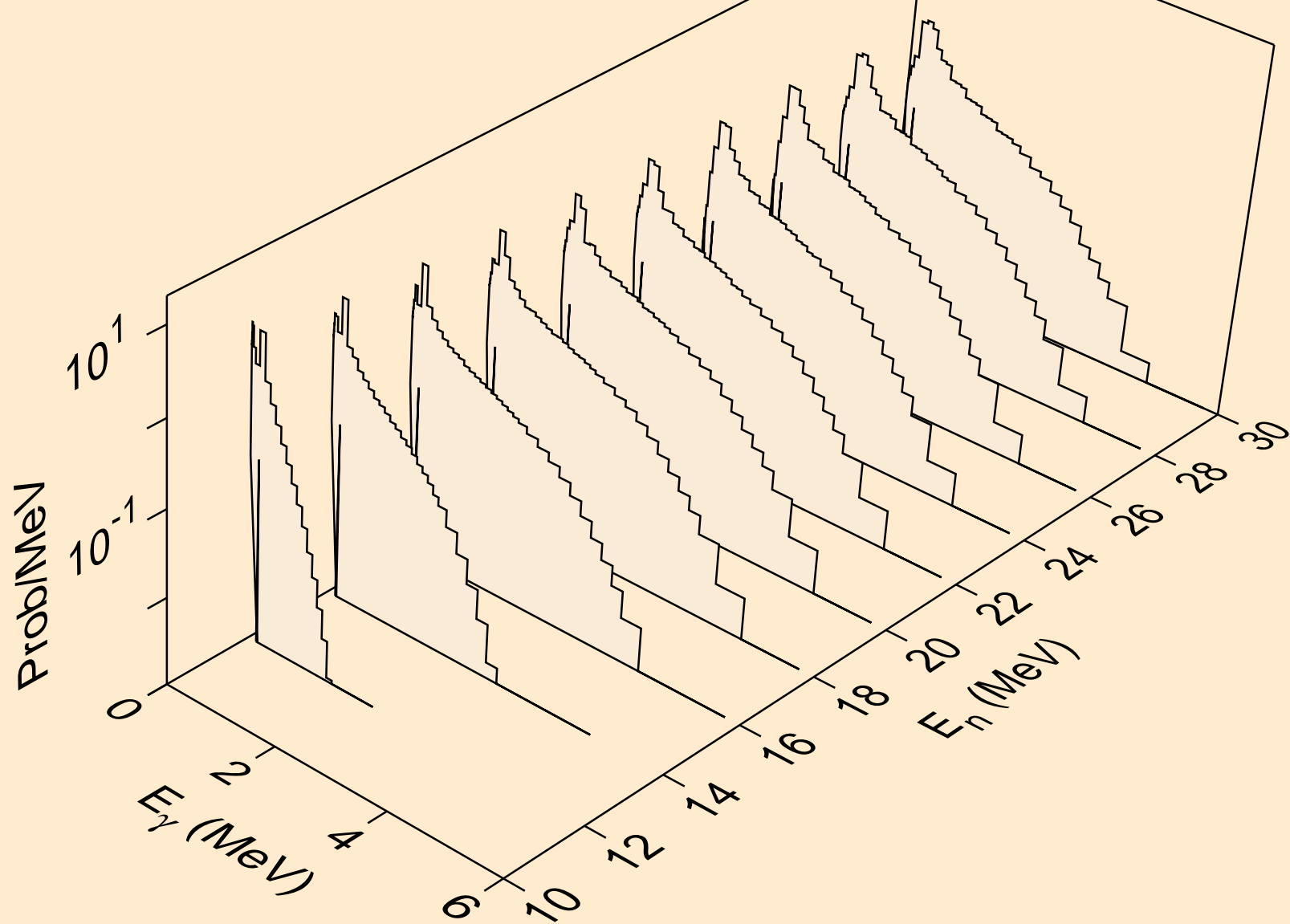

TB170 NEUTRON ACER TENDL-2021 LIBRARY; T=293.6K
Photon emission for (n,n*)a

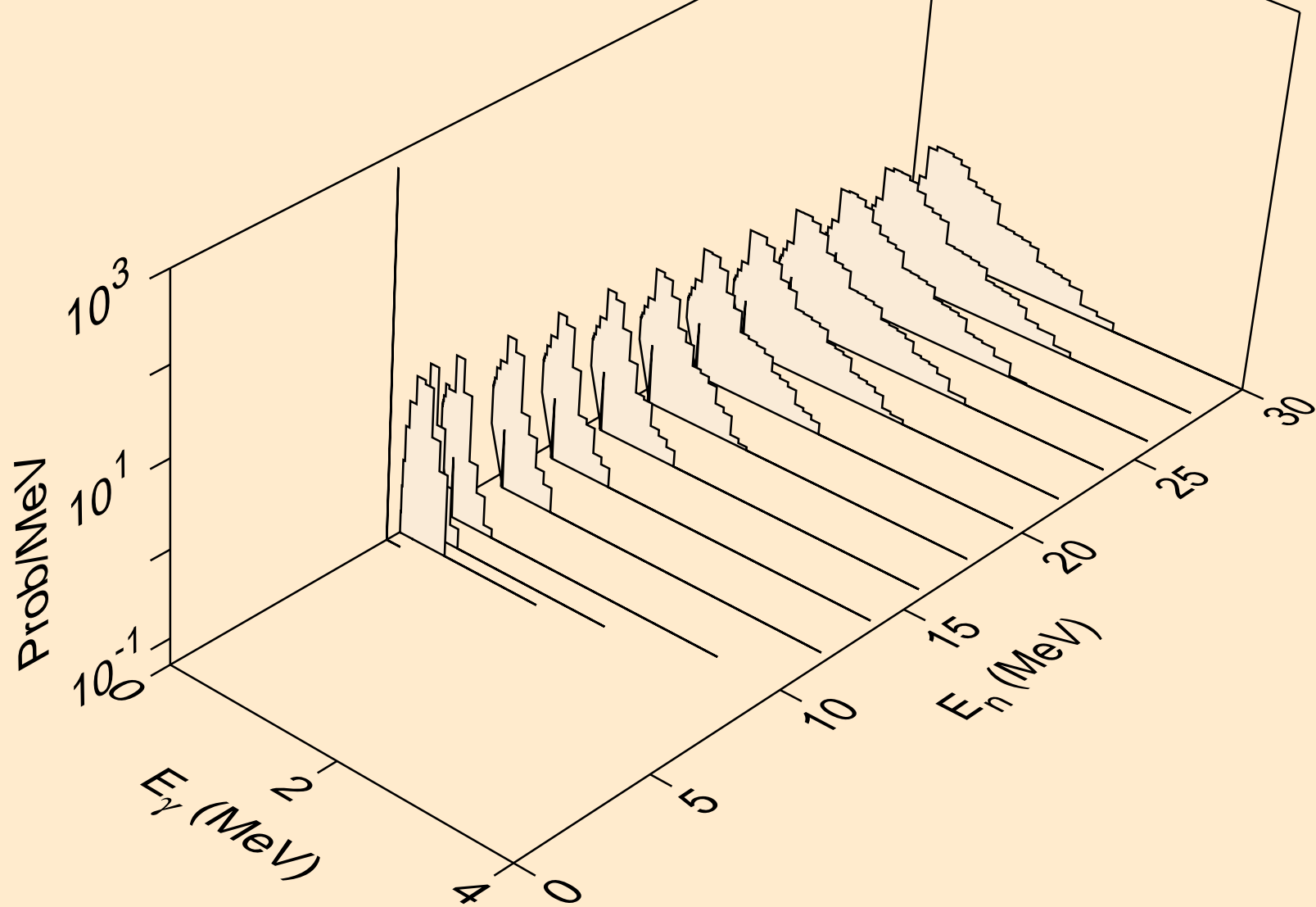

TB170 NEUTRON ACER TENDL-2021 LIBRARY; T=293.6K
Photon emission for (n,2n)a

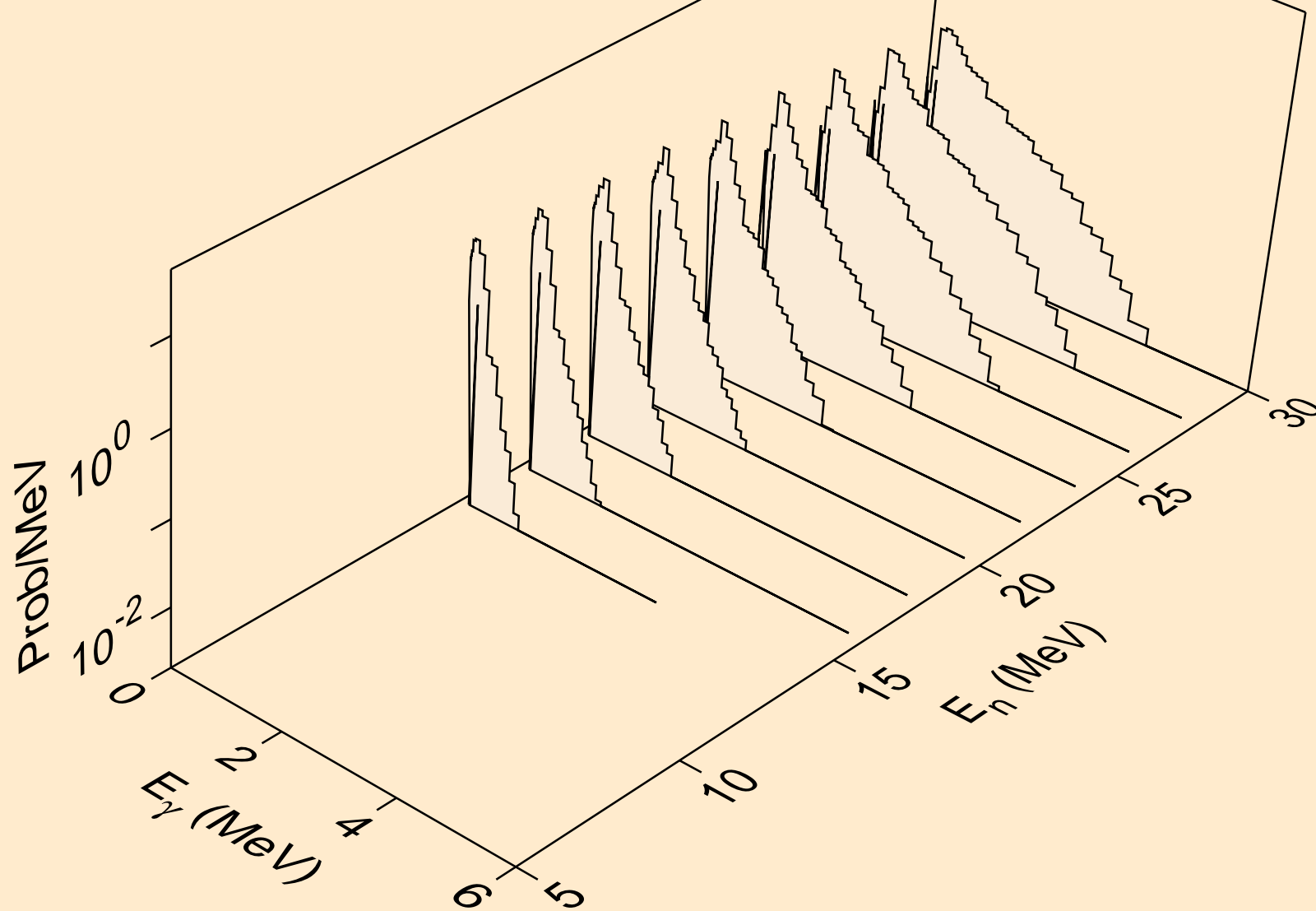

TB170 NEUTRON ACER TENDL-2021 LIBRARY; T=293.6K
Photon emission for (n,3n)a

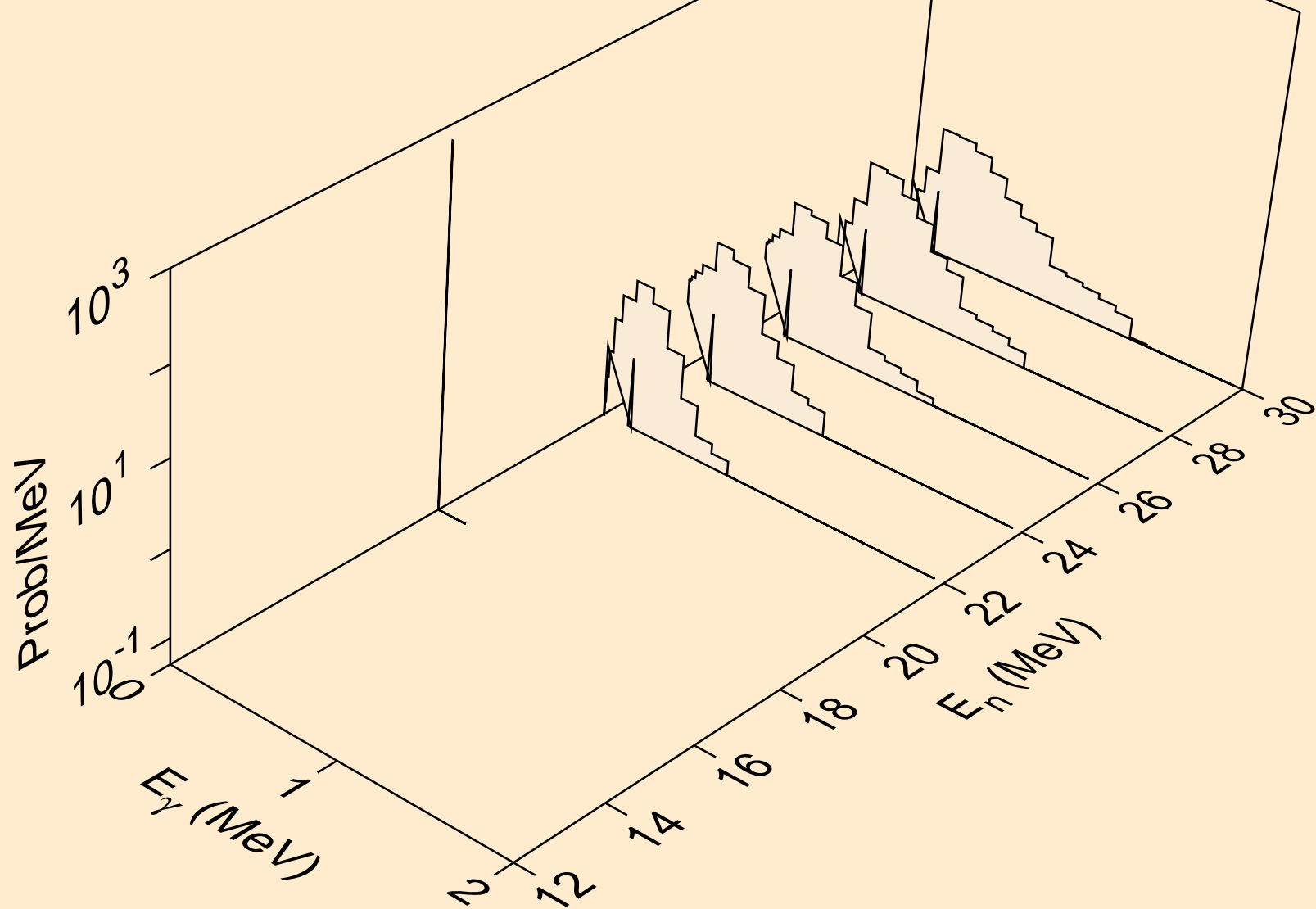

TB170 NEUTRON ACER TENDL-2021 LIBRARY; T=293.6K
Photon emission for (n,n*)p

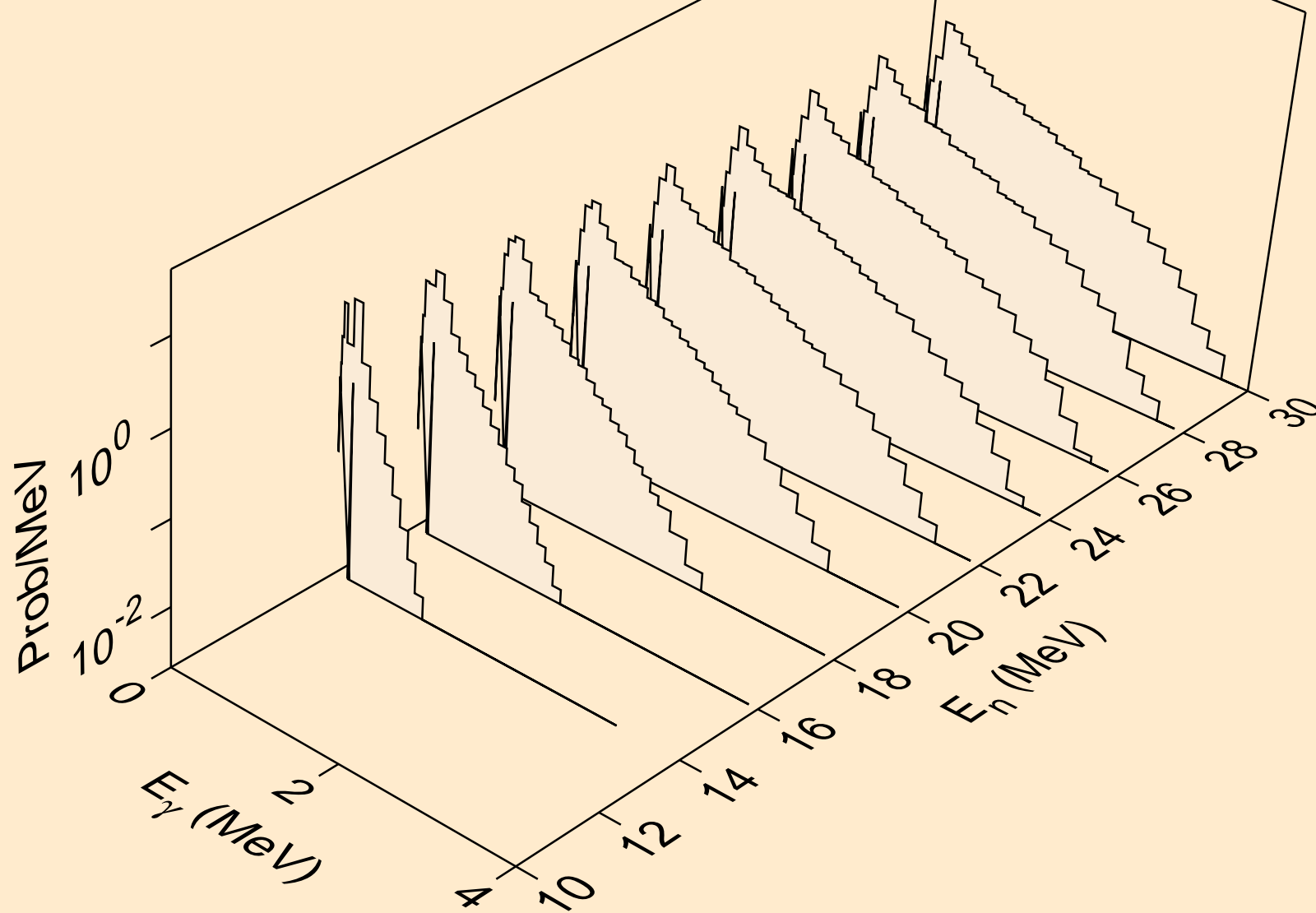

TB170 NEUTRON ACER TENDL-2021 LIBRARY; T=293.6K
Photon emission for (n,n*)d

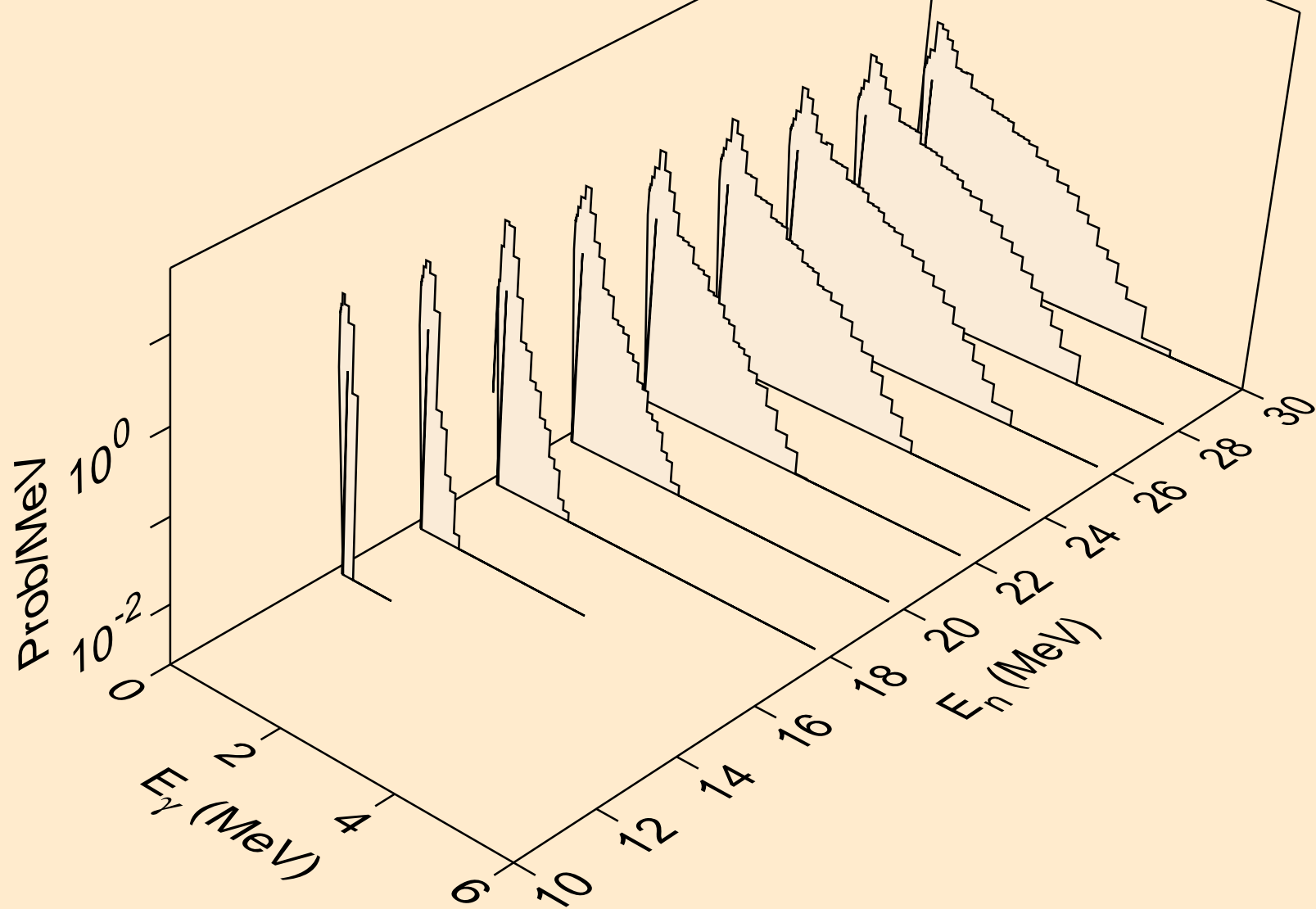

TB170 NEUTRON ACER TENDL-2021 LIBRARY; T=293.6K
Photon emission for (n,n*)t

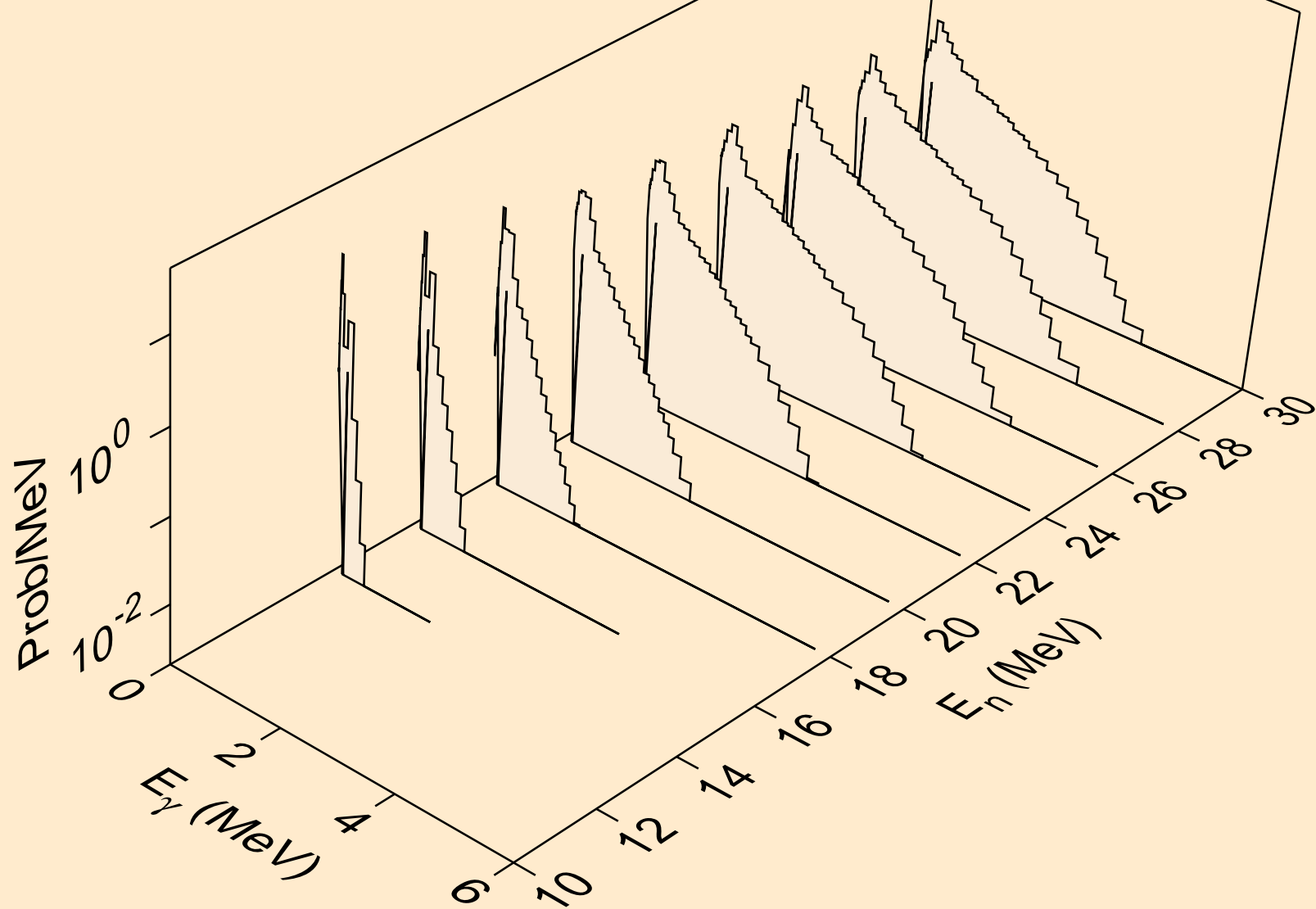

TB170 NEUTRON ACER TENDL-2021 LIBRARY; T=293.6K
Photon emission for (n,n*)he3

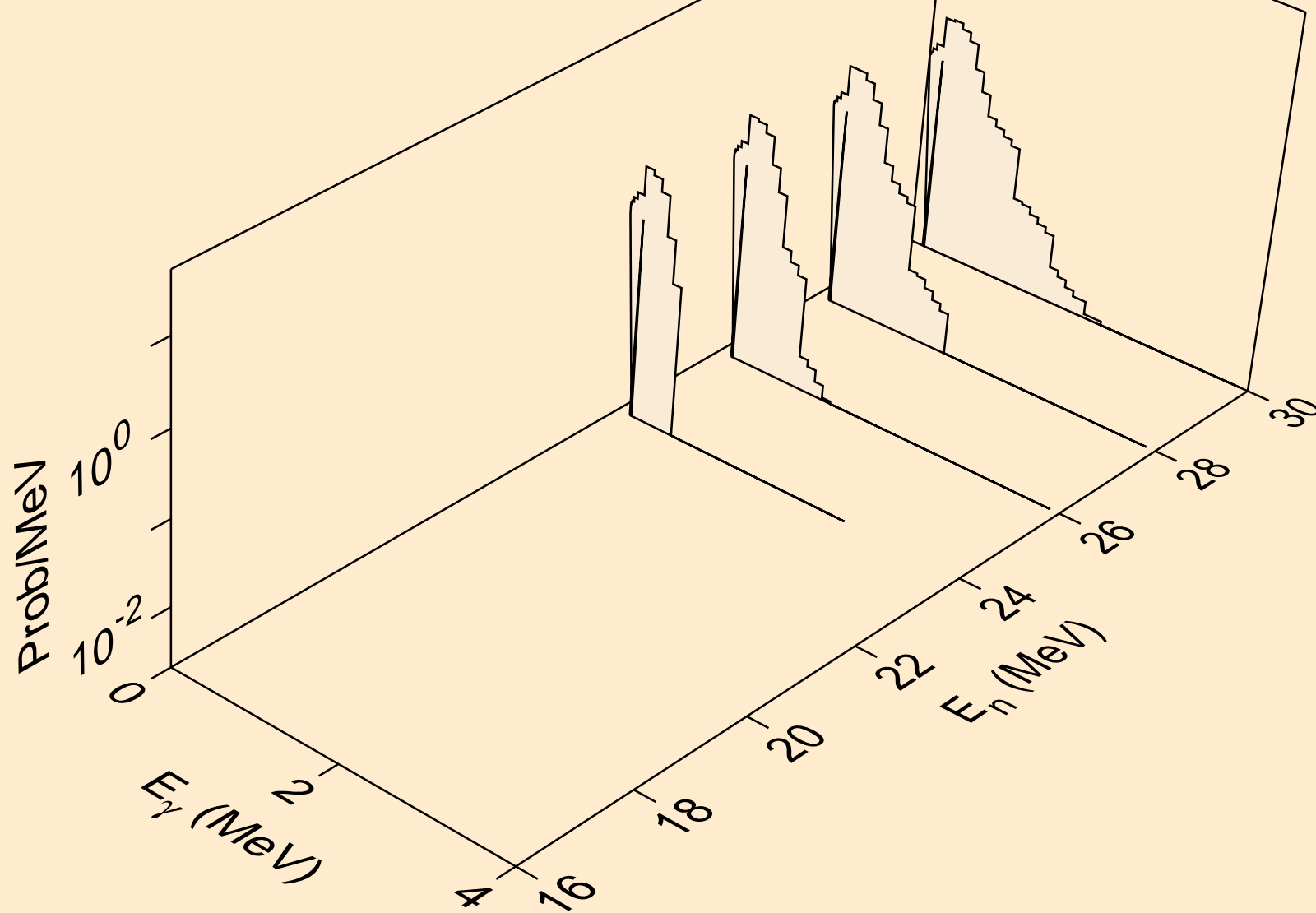

TB170 NEUTRON ACER TENDL-2021 LIBRARY; T=293.6K
Photon emission for (n,4n)

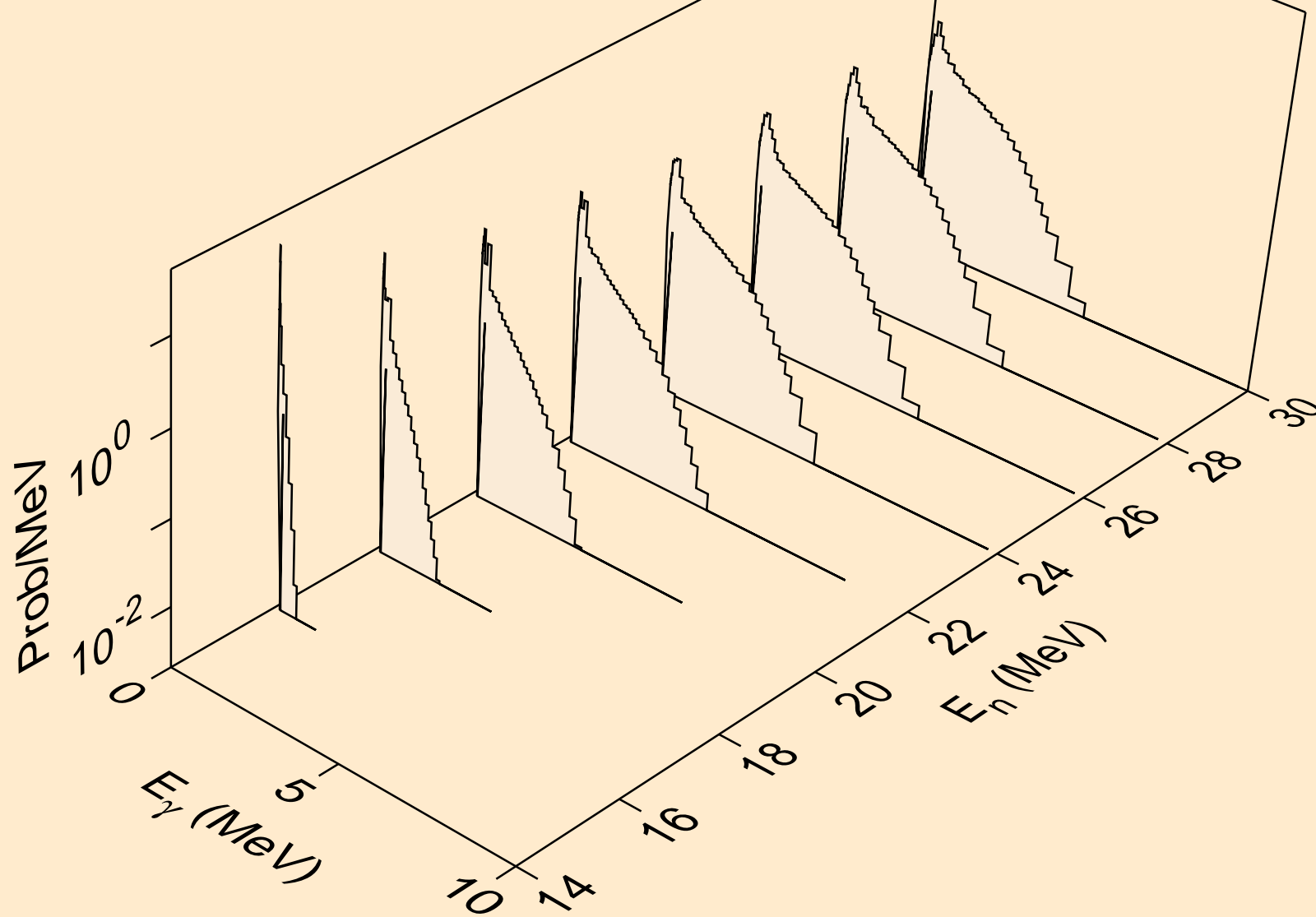

TB170 NEUTRON ACER TENDL-2021 LIBRARY; T=293.6K
Photon emission for (n,2np)

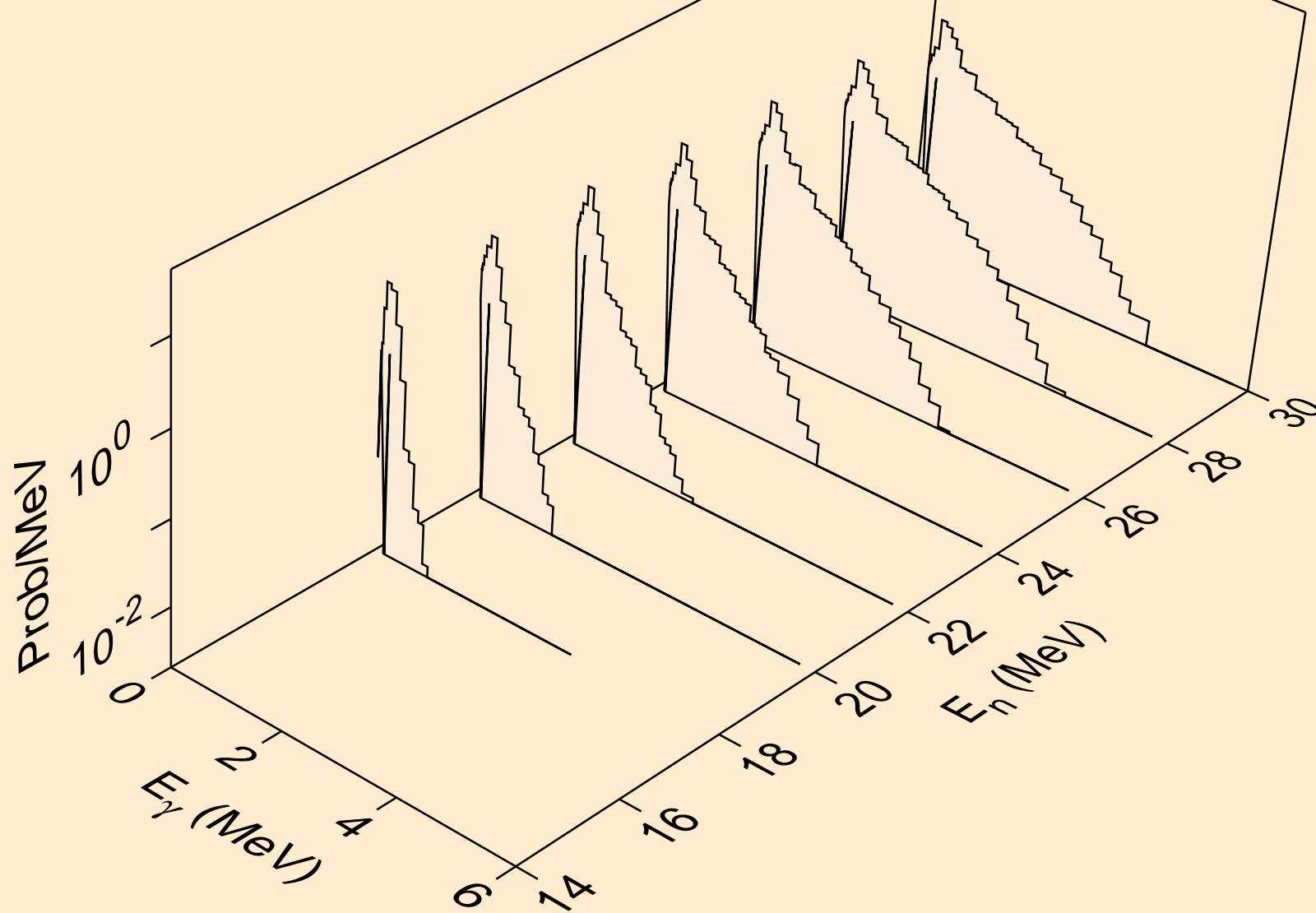

TB170 NEUTRON ACER TENDL-2021 LIBRARY; T=293.6K
Photon emission for (n,3np)

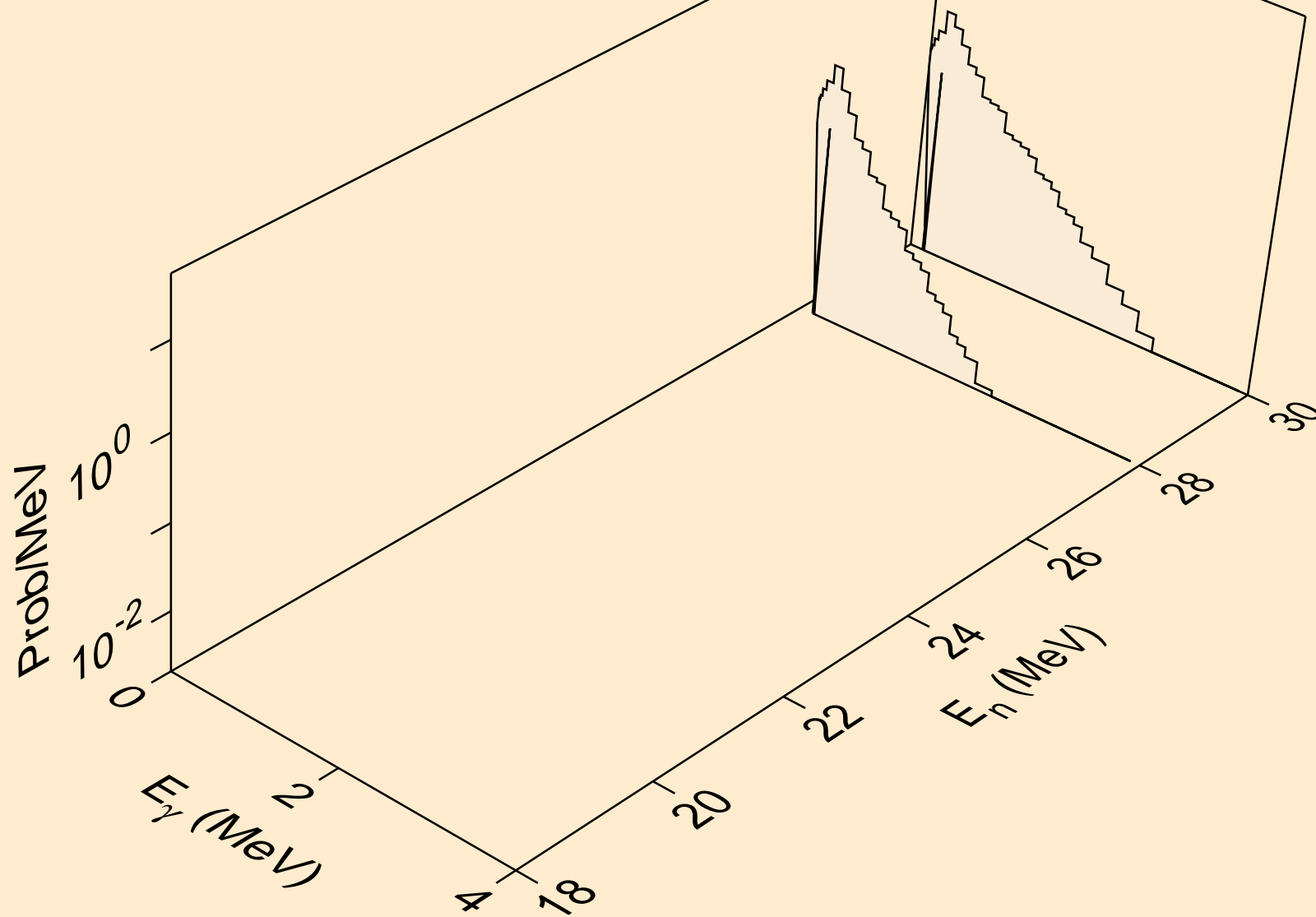

TB170 NEUTRON ACER TENDL-2021 LIBRARY; T=293.6K
Photon emission for (n,n*c)

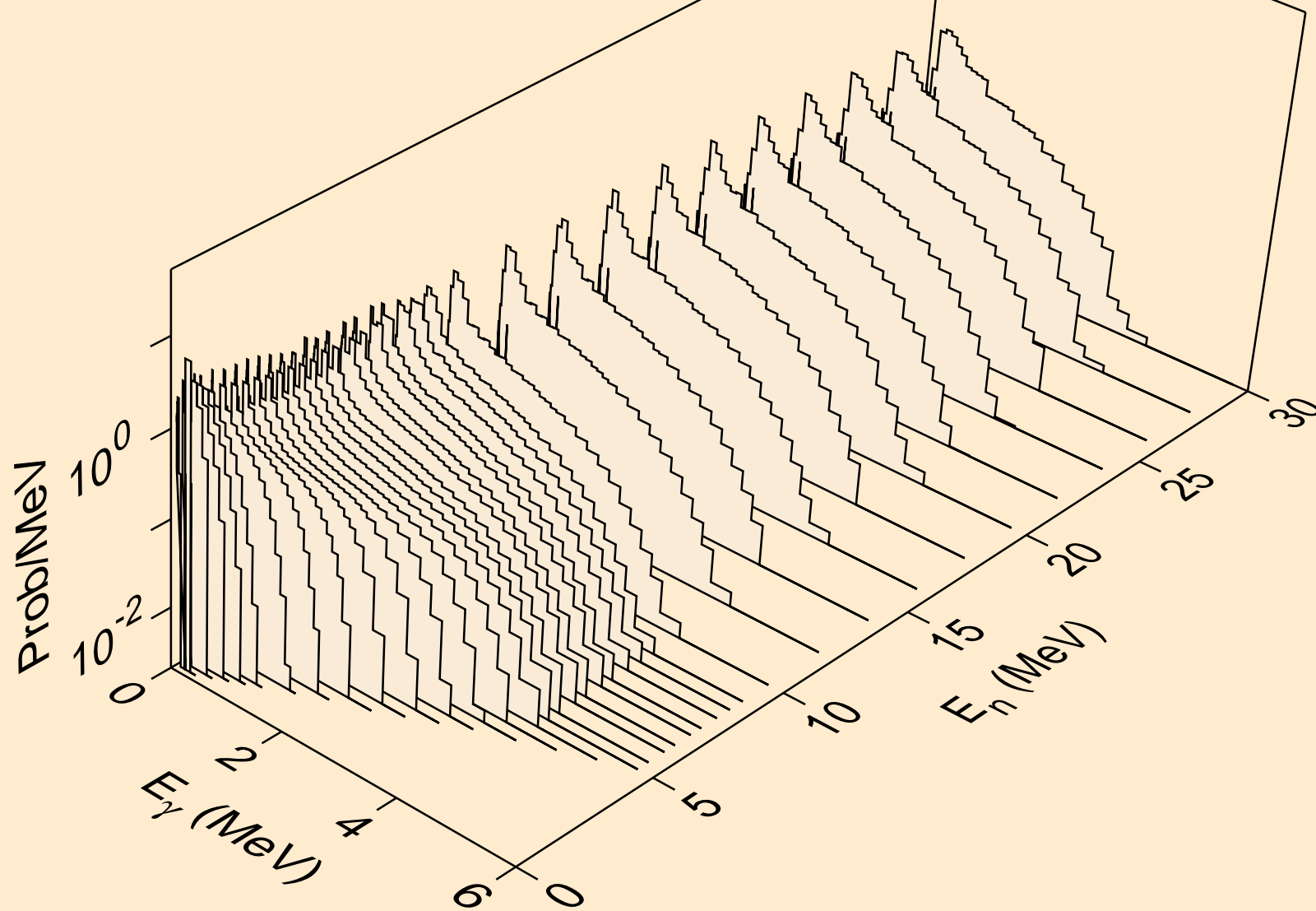

TB170 NEUTRON ACER TENDL-2021 LIBRARY; T=293.6K
Photon emission for (n,gma)

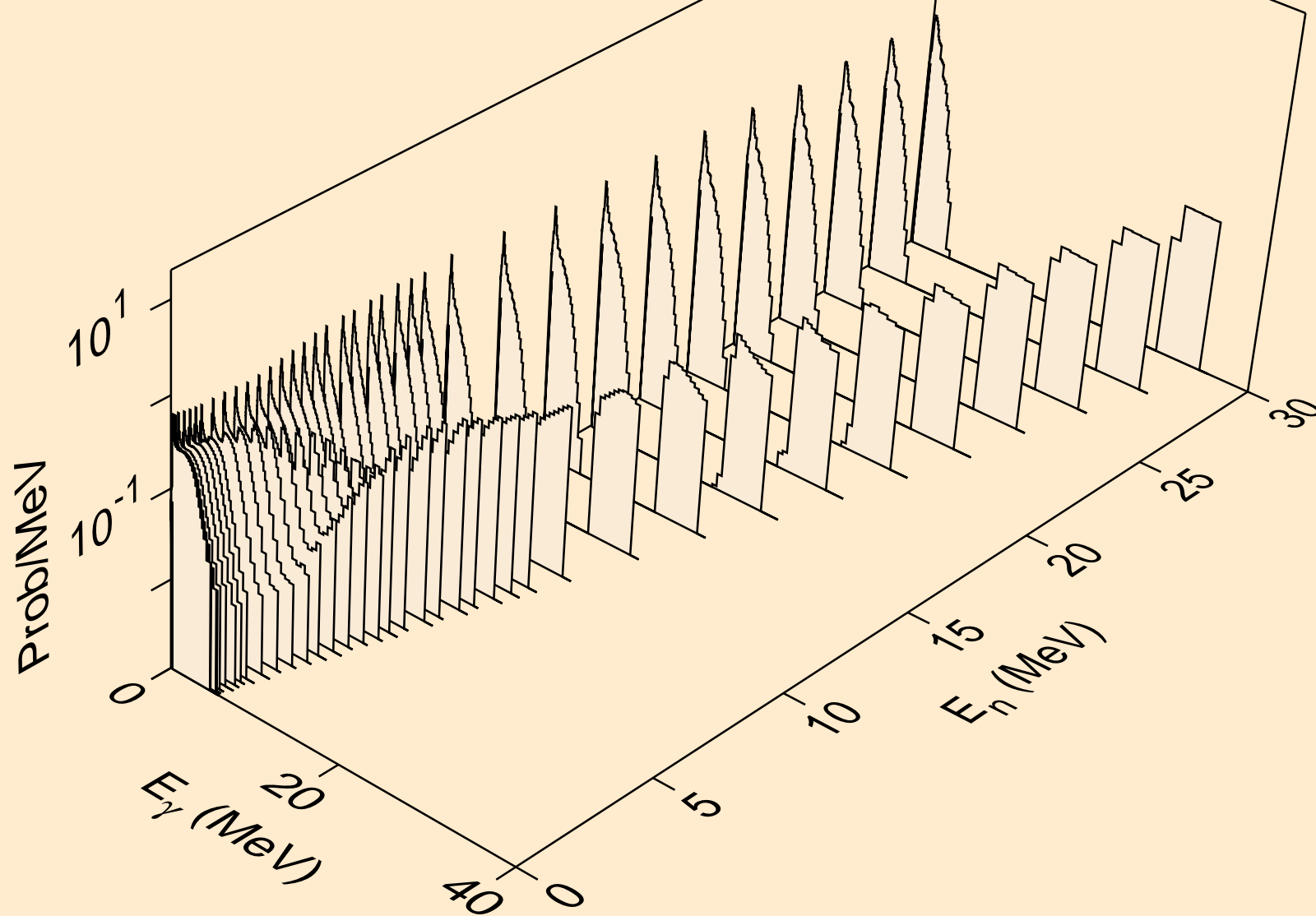

TB170 NEUTRON ACER TENDL-2021 LIBRARY; T=293.6K
Photon emission for (n,p)

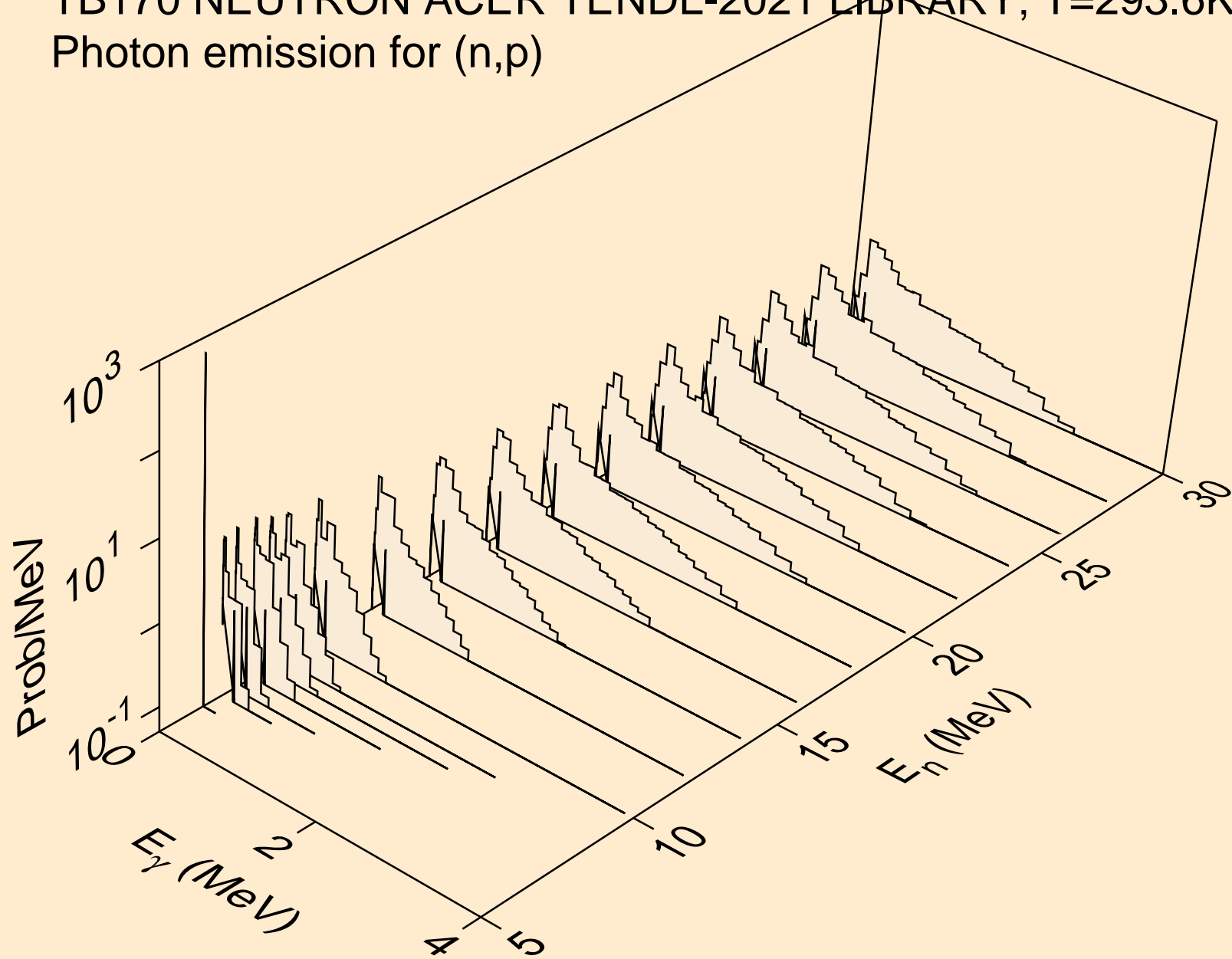

TB170 NEUTRON ACER TENDL-2021 LIBRARY; T=293.6K
Photon emission for (n,d)

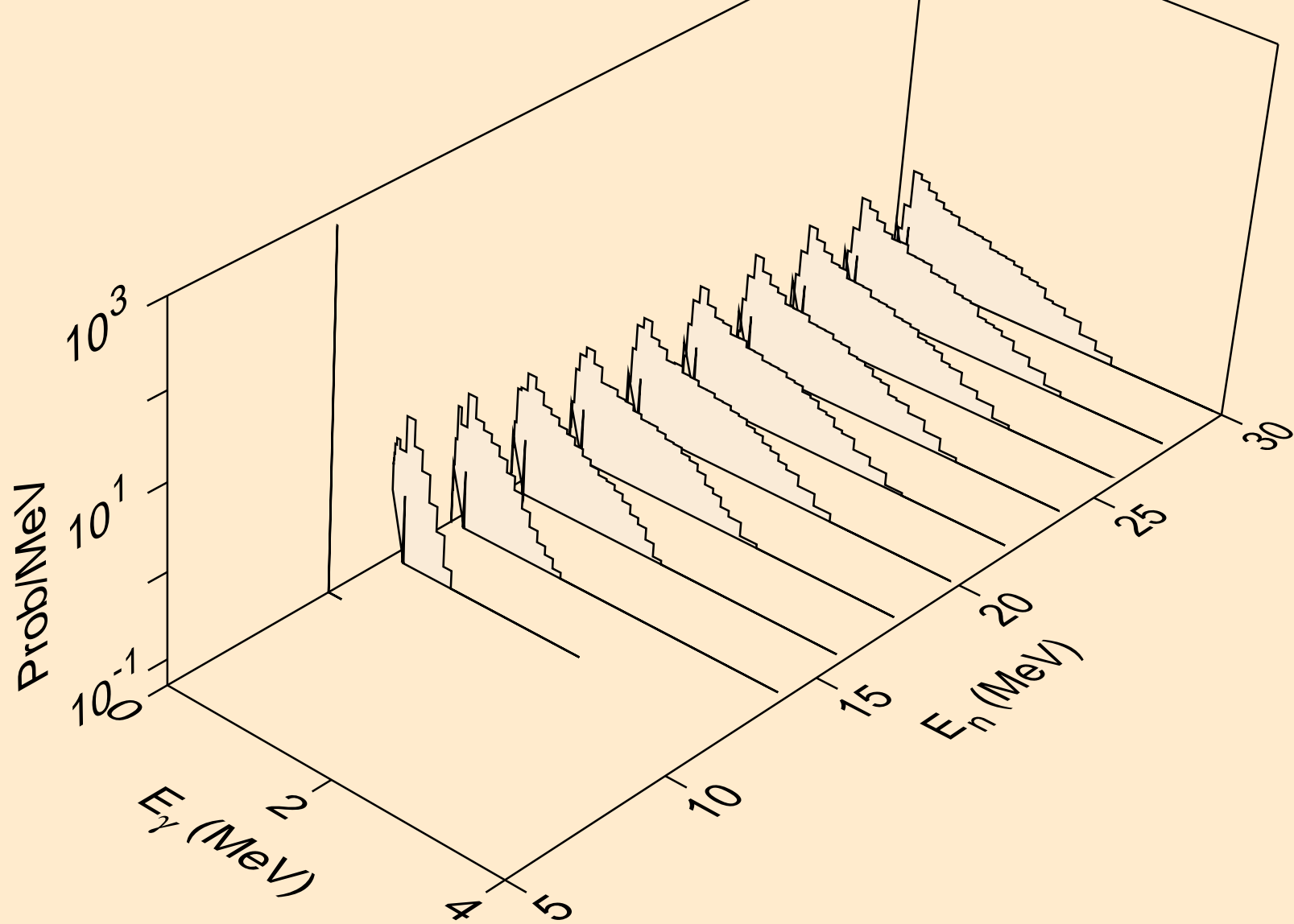

TB170 NEUTRON ACER TENDL-2021 LIBRARY; T=293.6K
Photon emission for (n,t)

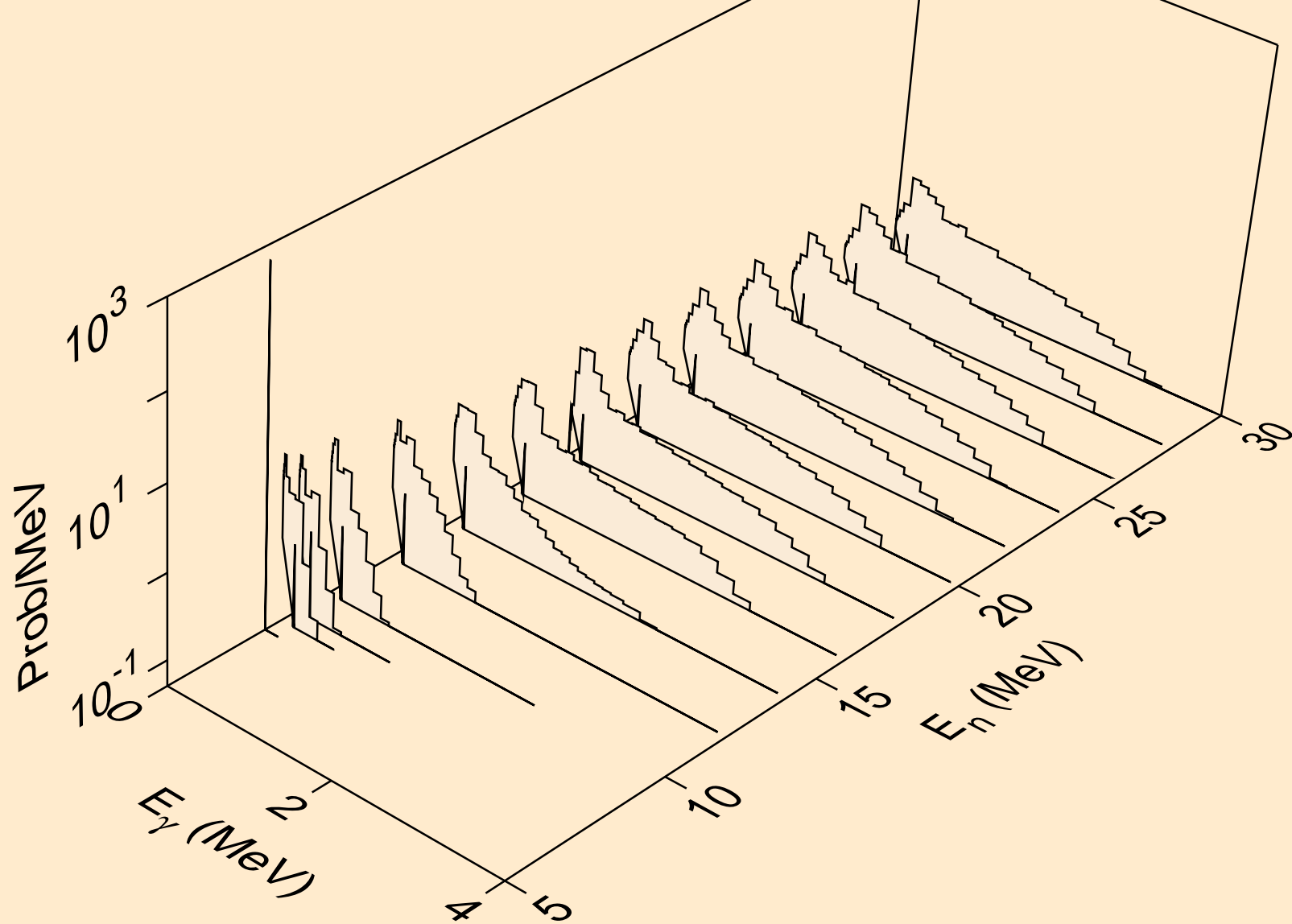

TB170 NEUTRON ACER TENDL-2021 LIBRARY; T=293.6K
Photon emission for (n,he3)

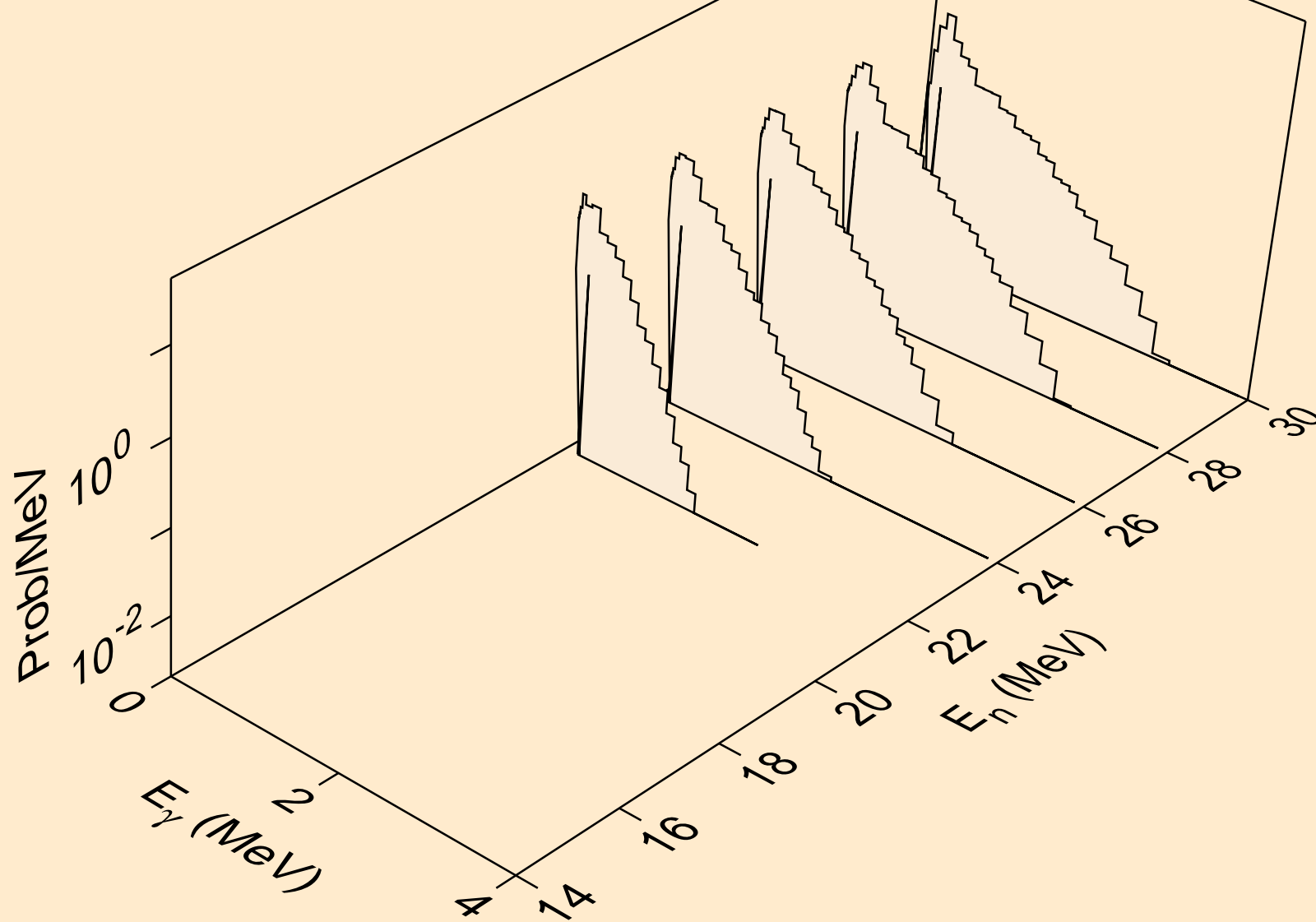

TB170 NEUTRON ACER TENDL-2021 LIBRARY; T=293.6K
Photon emission for (n,a)

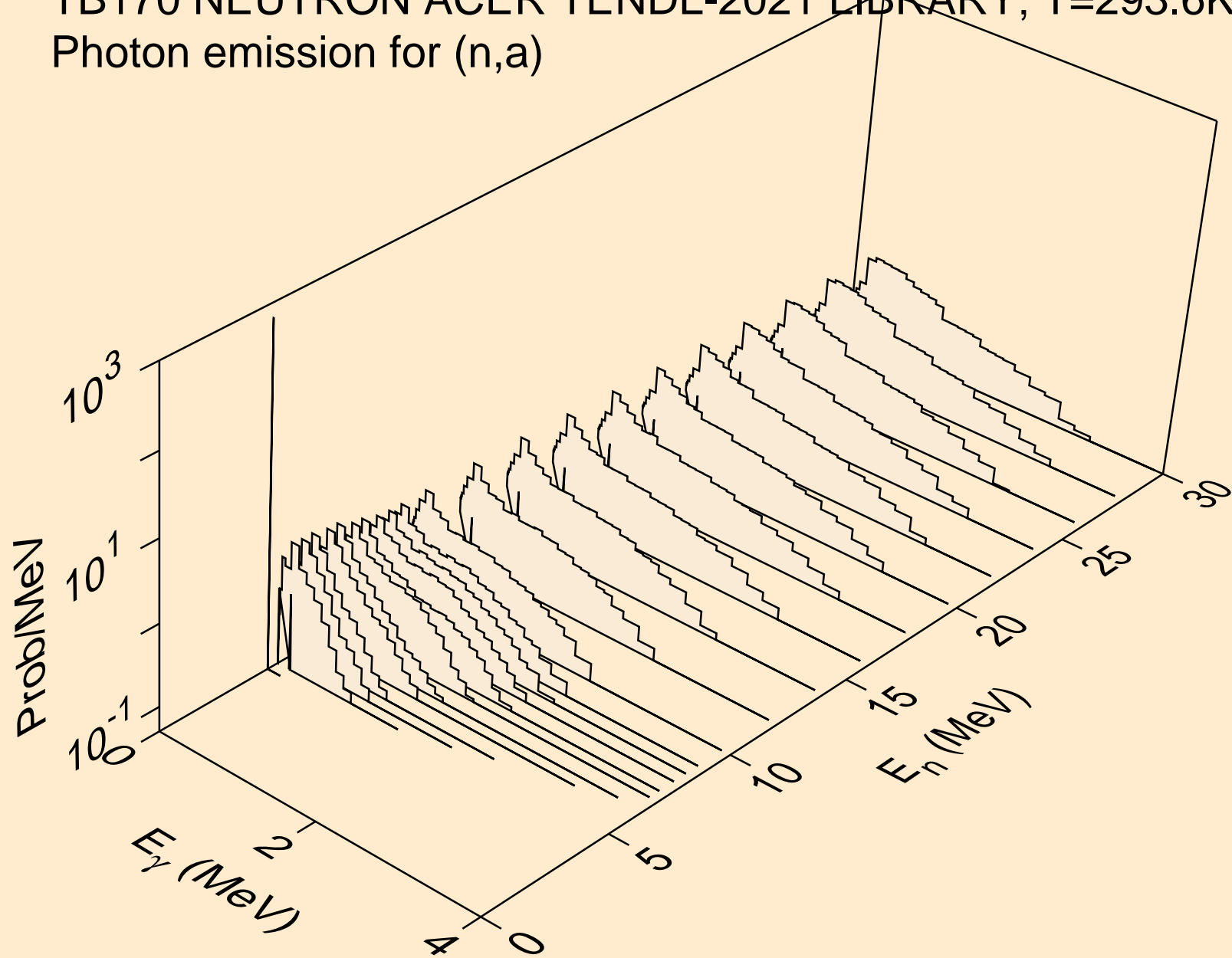

TB170 NEUTRON ACER TENDL-2021 LIBRARY; T=293.6K
thermal capture photon spectrum

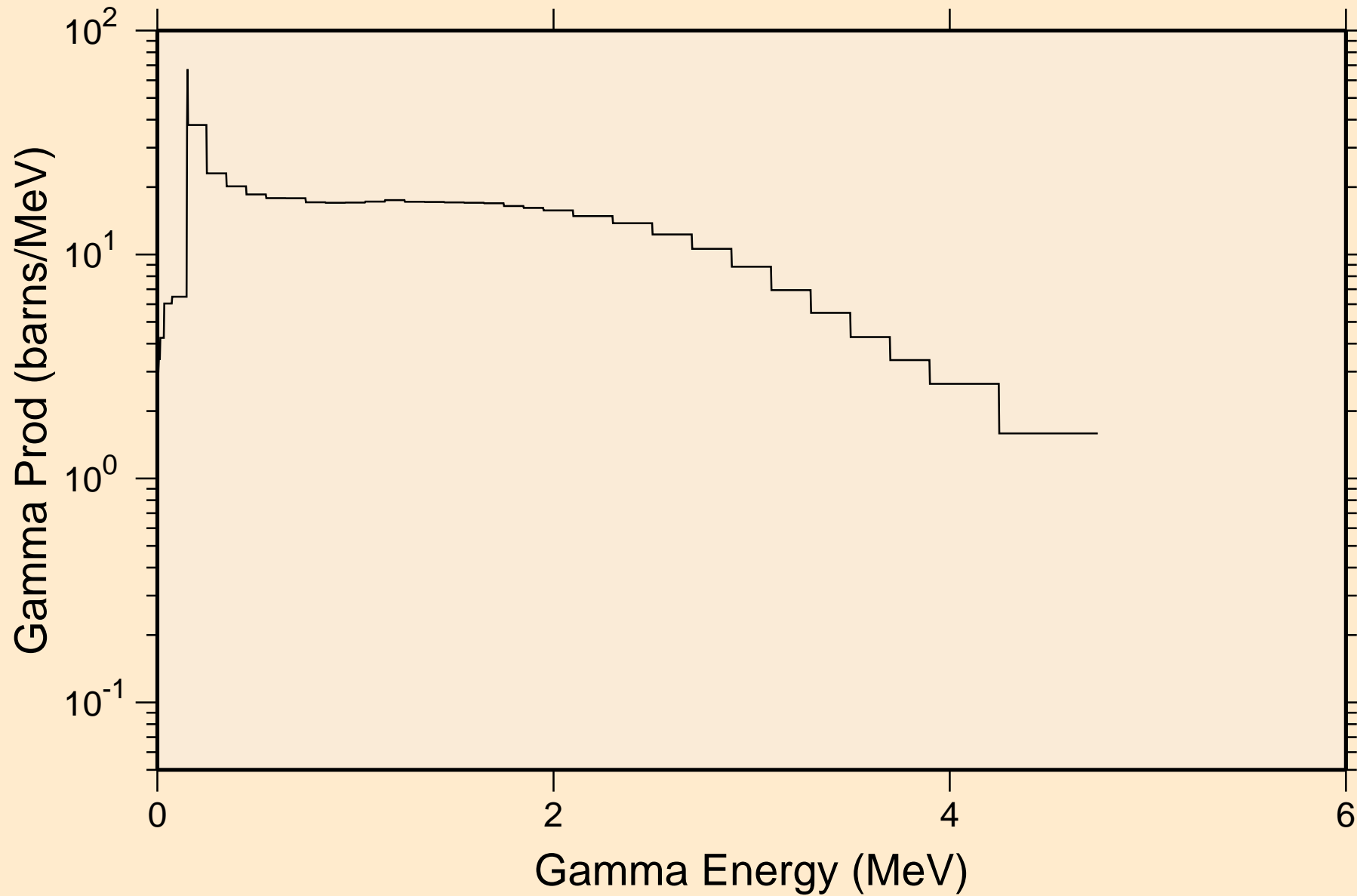

TB170 NEUTRON ACER TENDL-2021 LIBRARY; T=293.6K
14 MeV photon spectrum

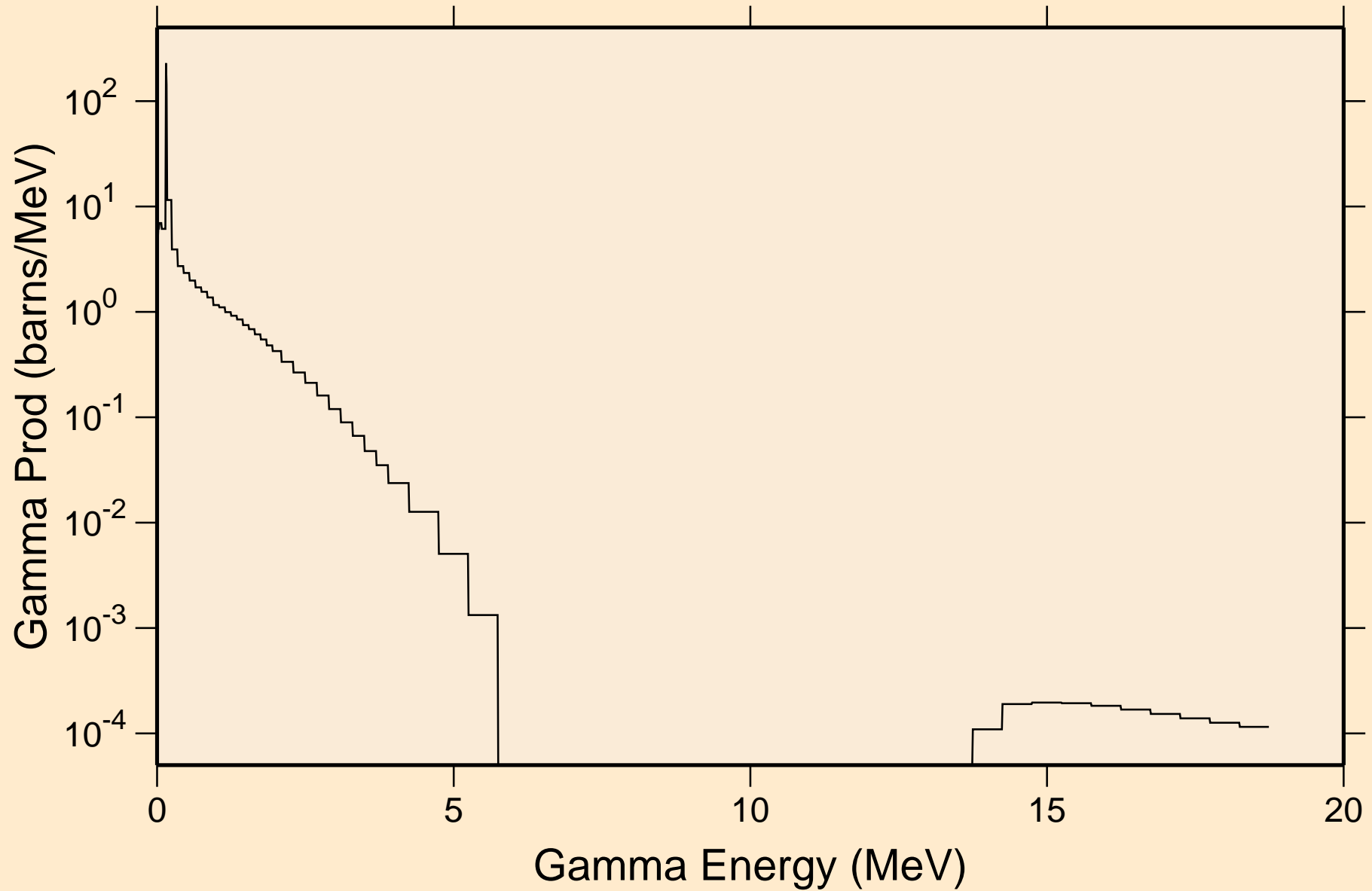

TB170 NEUTRON ACER TENDL-2021 LIBRARY; T=293.6K
Particle heating contributions

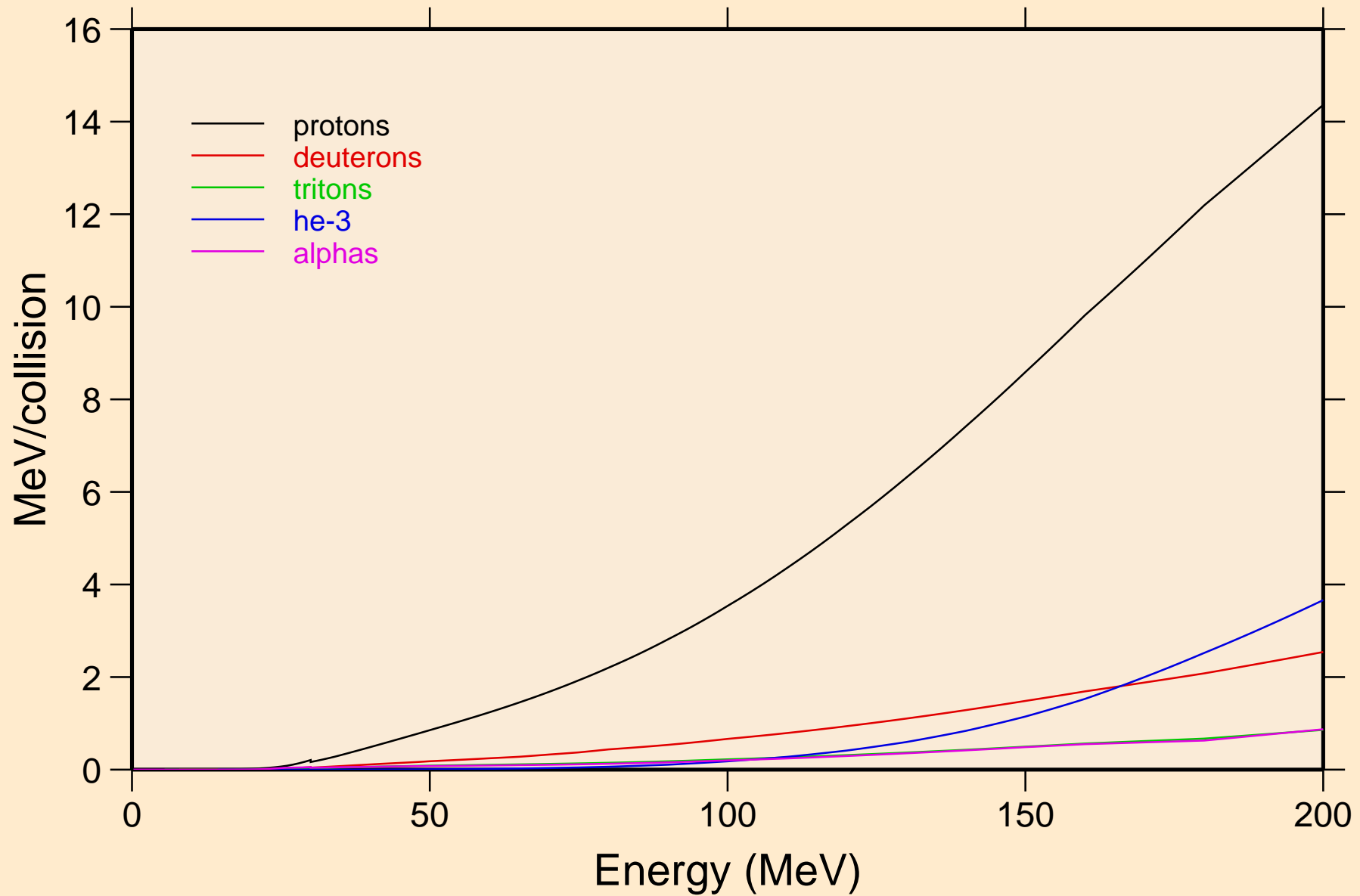

TB170 NEUTRON ACER TENDL-2021 LIBRARY; T=293.6K
Recoil Heating

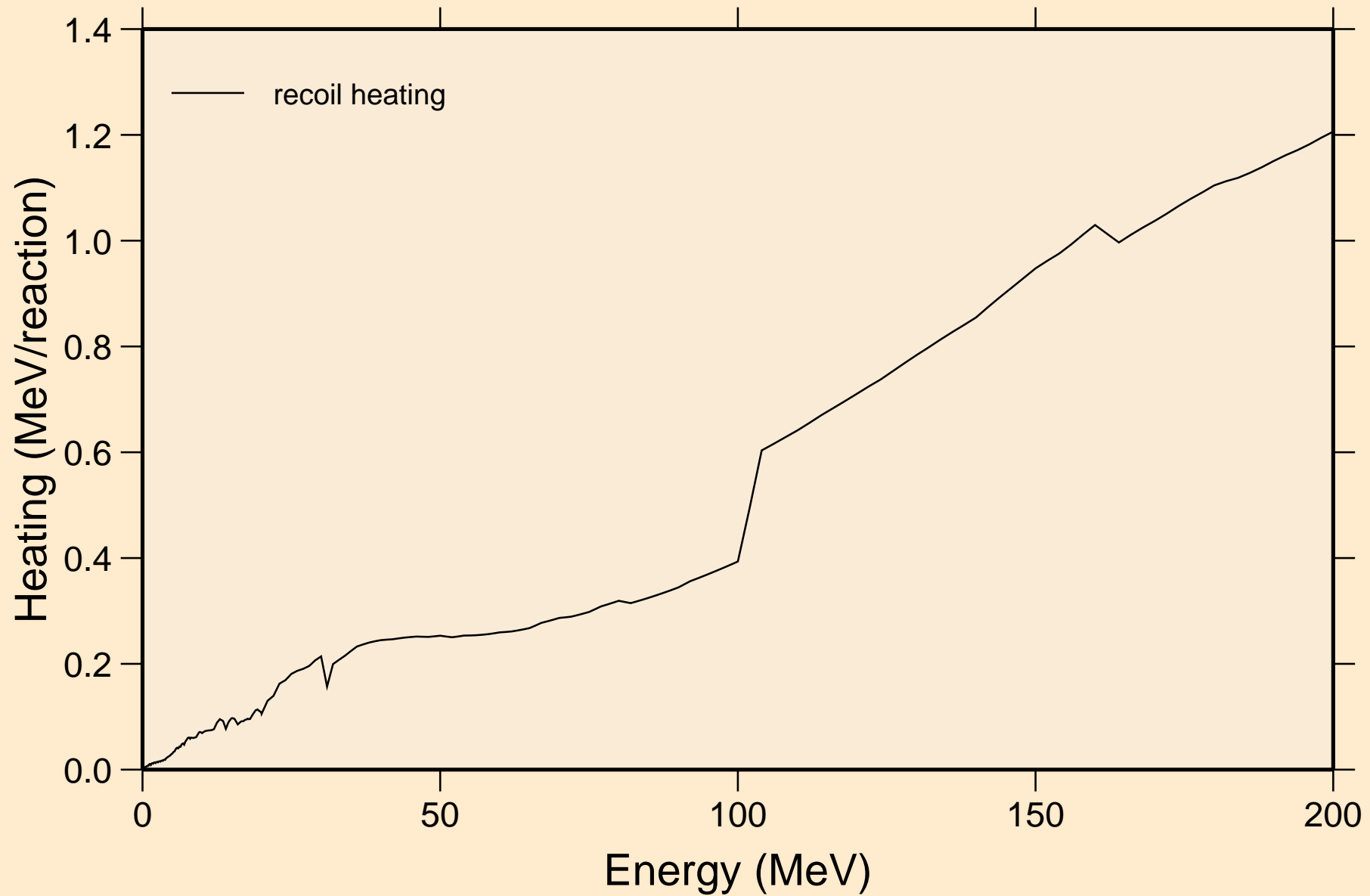

TB170 NEUTRON ACER TENDL-2021 LIBRARY; T=293.6K
Particle production cross sections

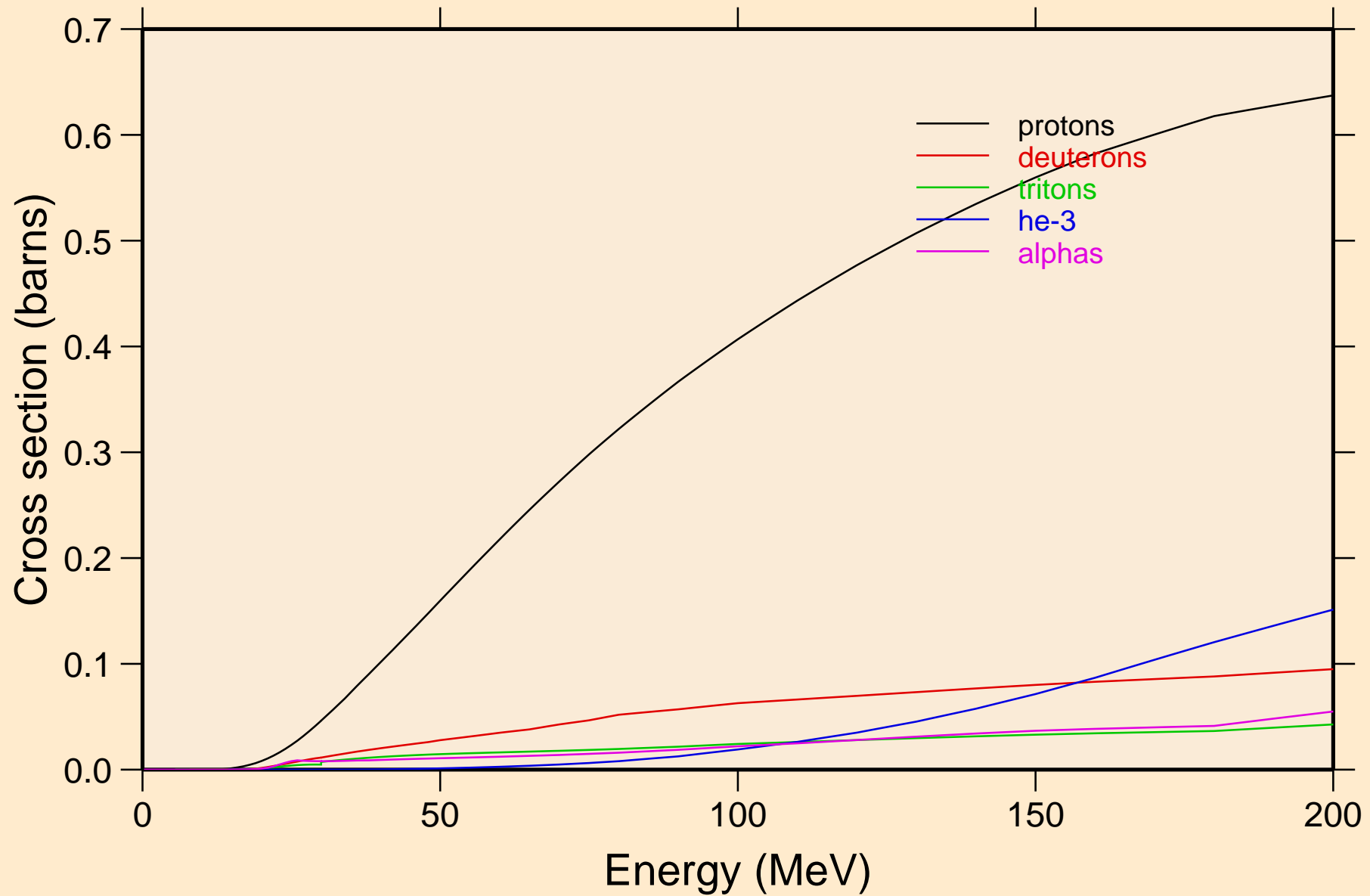

TB170 NEUTRON ACER TENDL-2021 LIBRARY; T=293.6K
protons from (n,x)

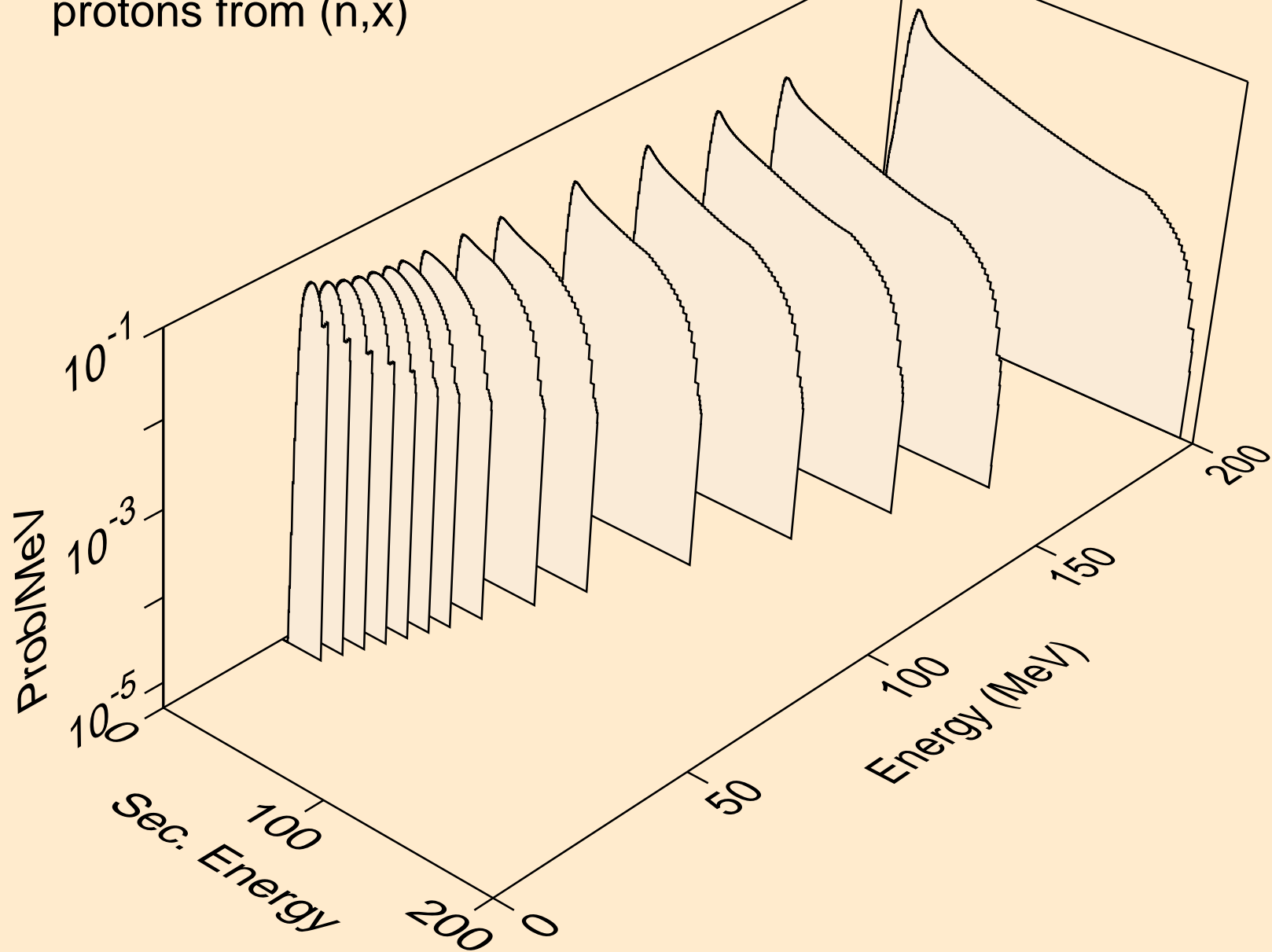

TB170 NEUTRON ACER TENDL-2021 LIBRARY; T=293.6K
protons from (n,n*)p

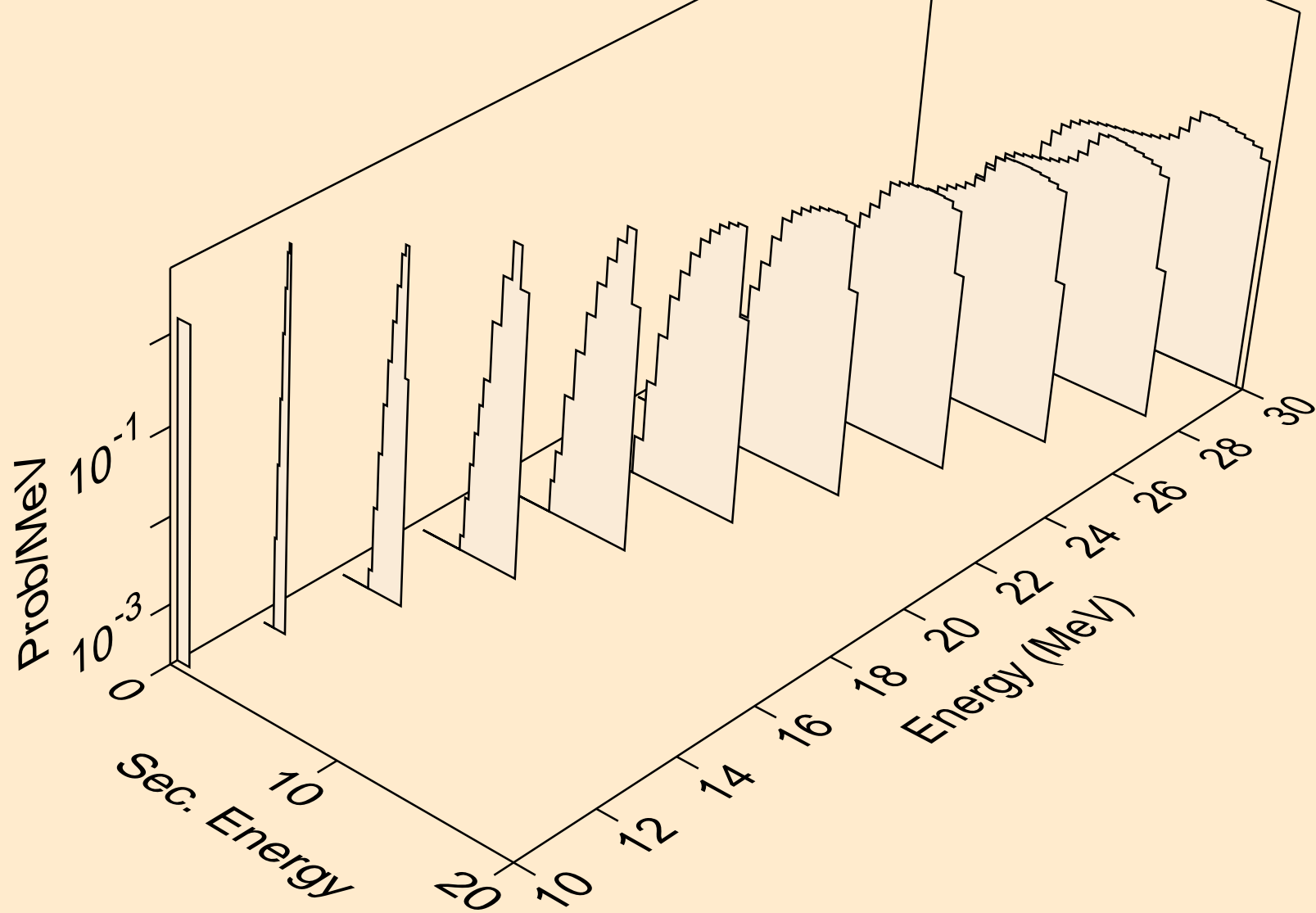

TB170 NEUTRON ACER TENDL-2021 LIBRARY; T=293.6K
protons from (n,2np)

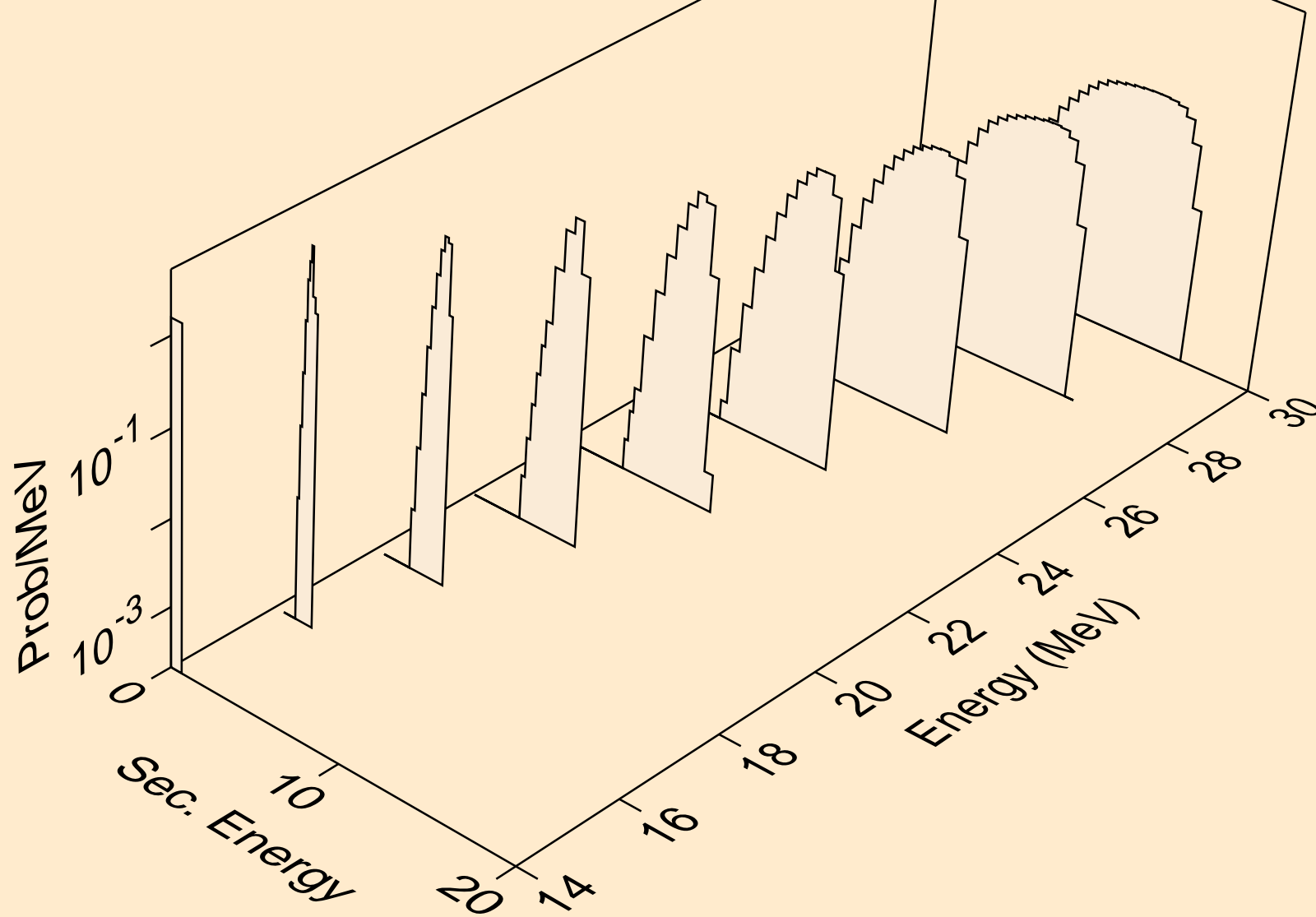

TB170 NEUTRON ACER TENDL-2021 LIBRARY; T=293.6K
protons from (n,3np)

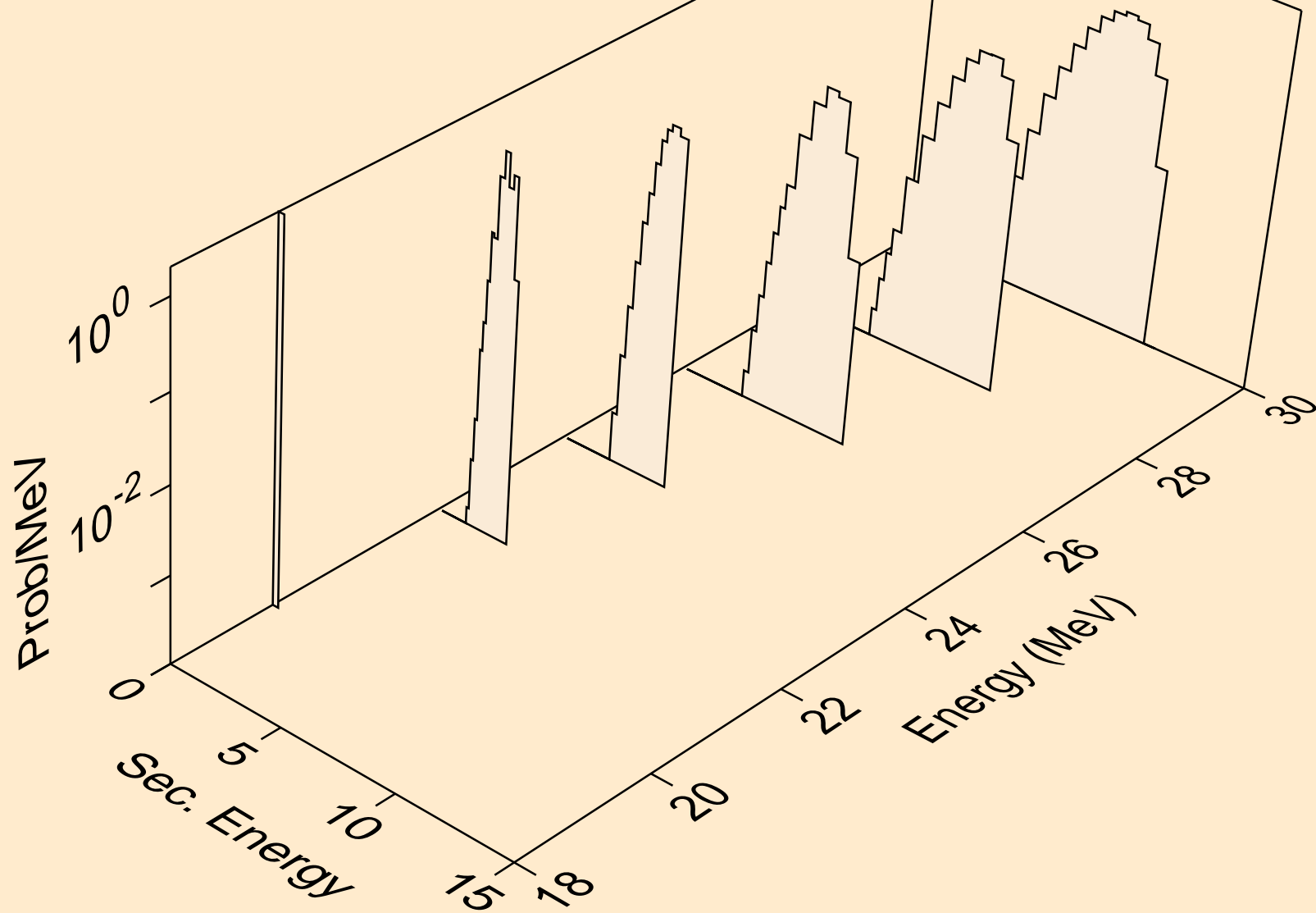

TB170 NEUTRON ACER TENDL-2021 LIBRARY; T=293.6K
protons from (n,p)

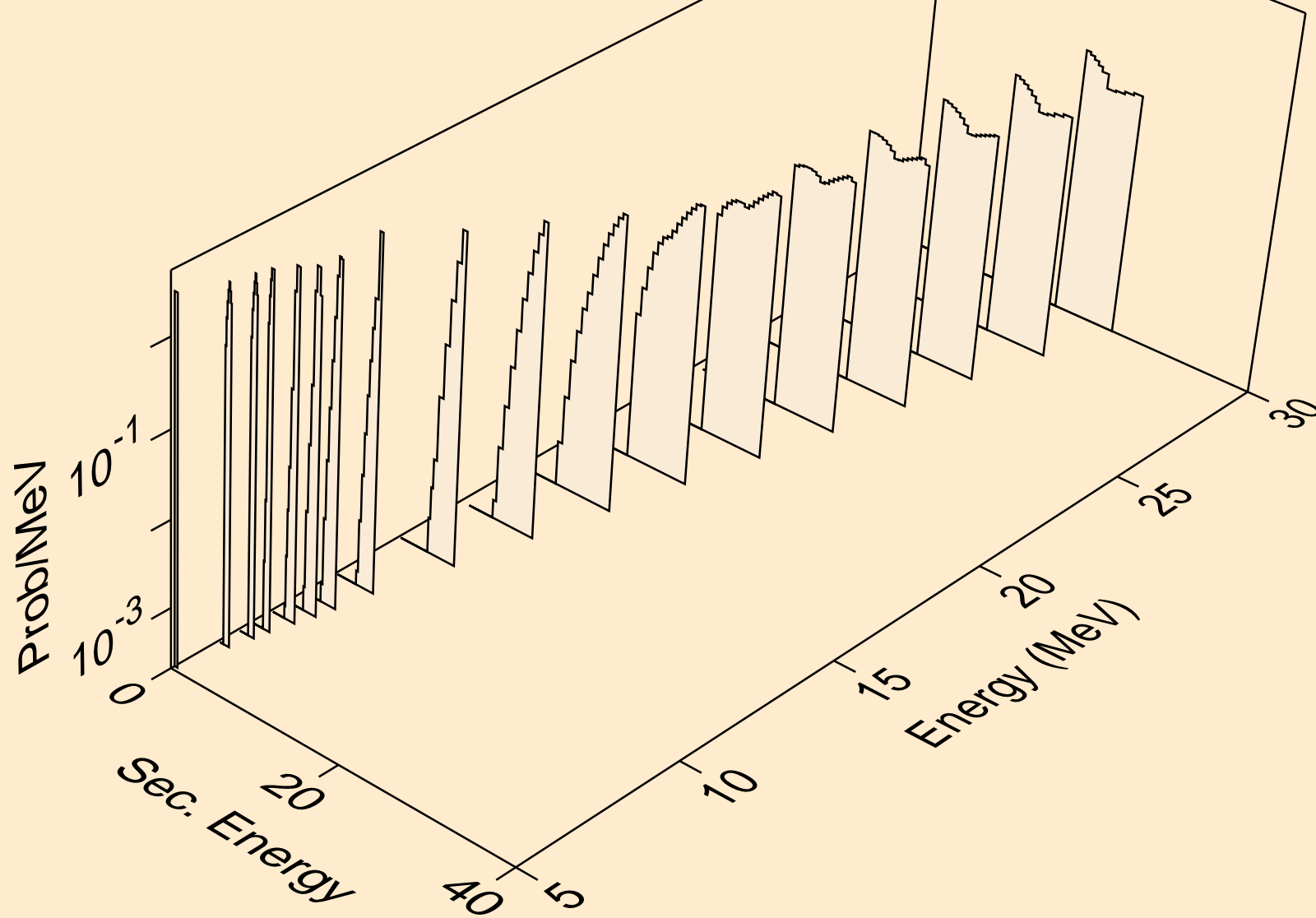

TB170 NEUTRON ACER TENDL-2021 LIBRARY; T=293.6K
deuterons from (n,x)

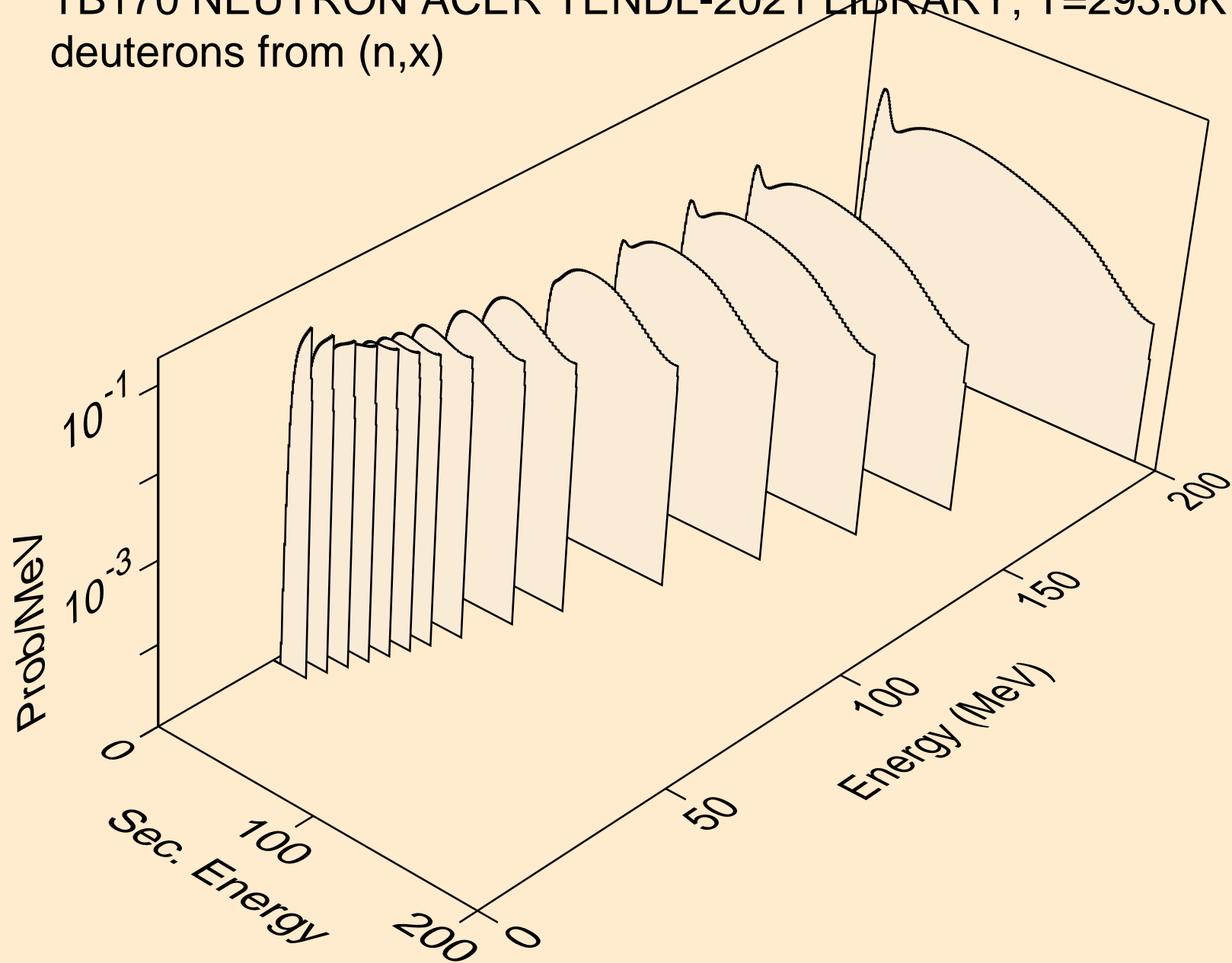

TB170 NEUTRON ACER TENDL-2021 LIBRARY; T=293.6K
deuterons from (n,2nd)

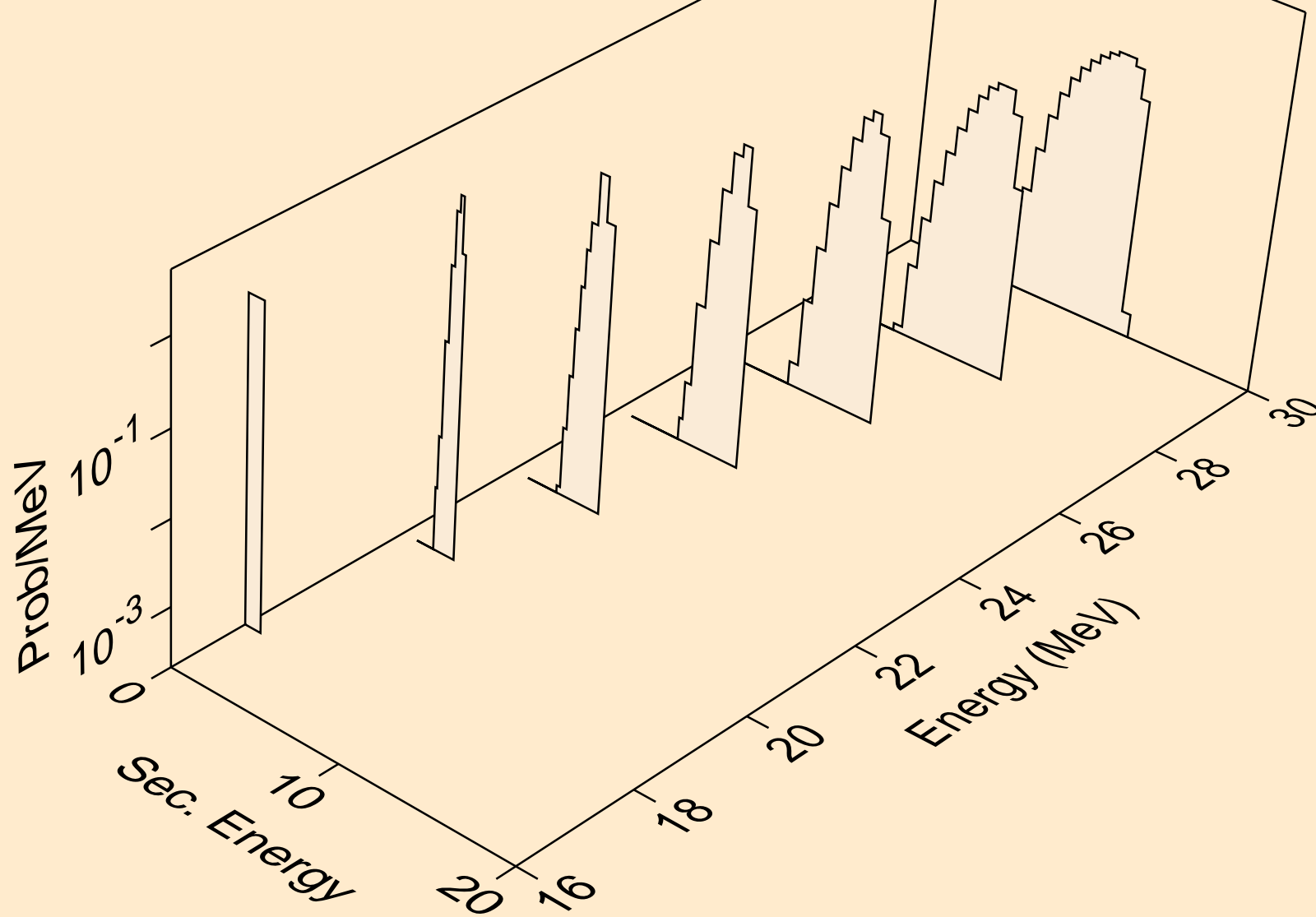

TB170 NEUTRON ACER TENDL-2021 LIBRARY; T=293.6K
deuterons from (n,n*)d

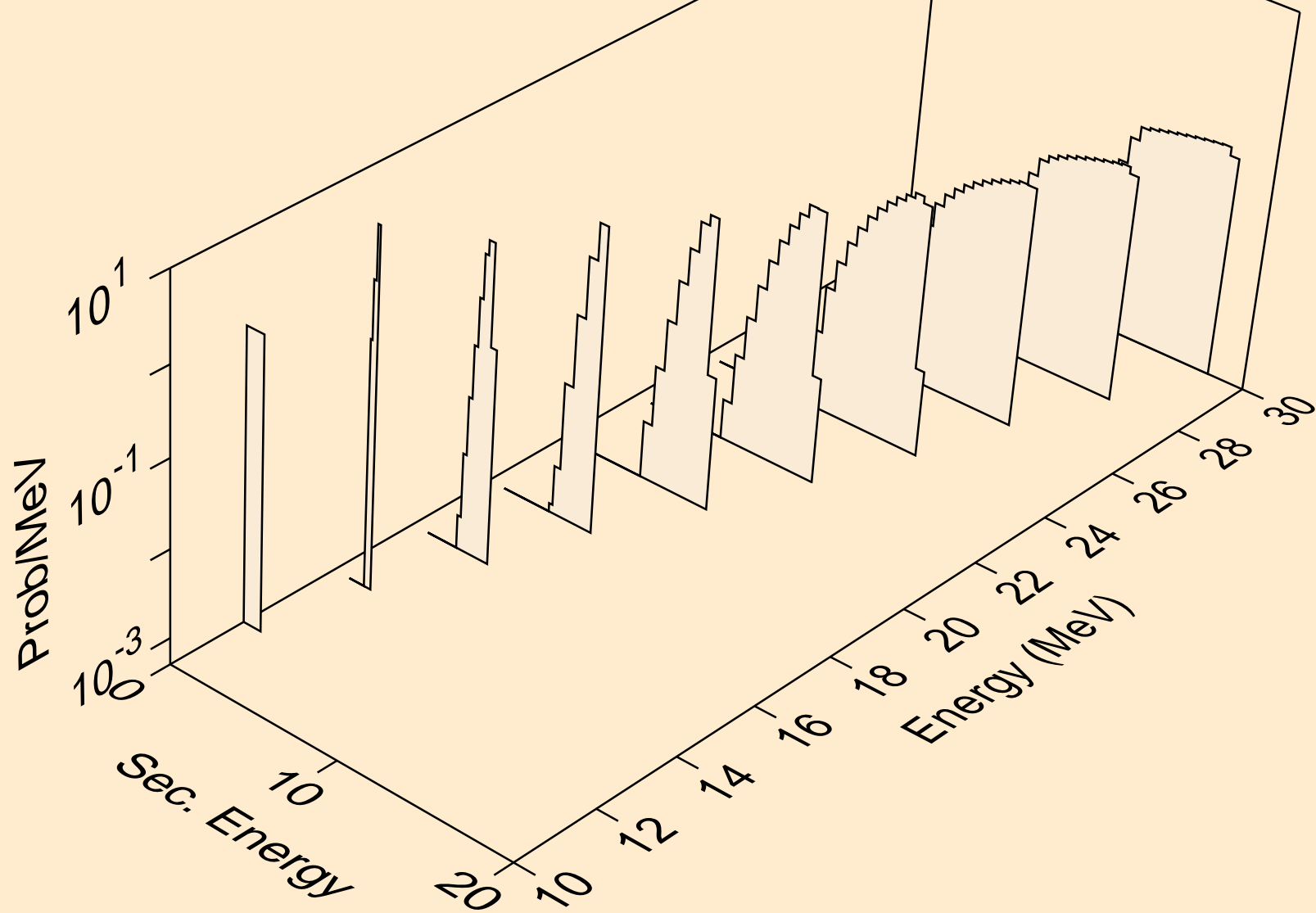

TB170 NEUTRON ACER TENDL-2021 LIBRARY; T=293.6K
deuterons from (n,d)

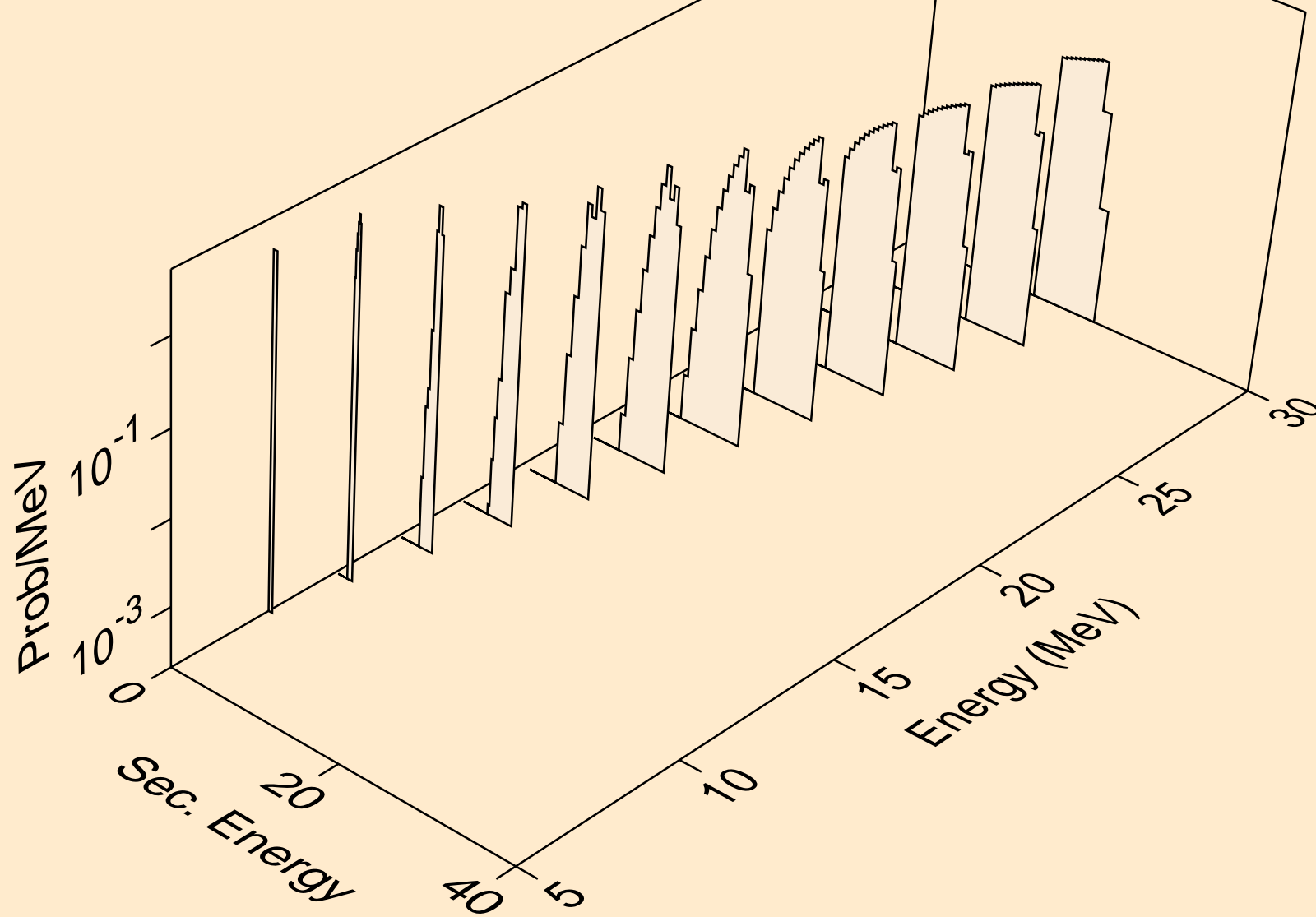

TB170 NEUTRON ACER TENDL-2021 LIBRARY; T=293.6K
tritons from (n,x)

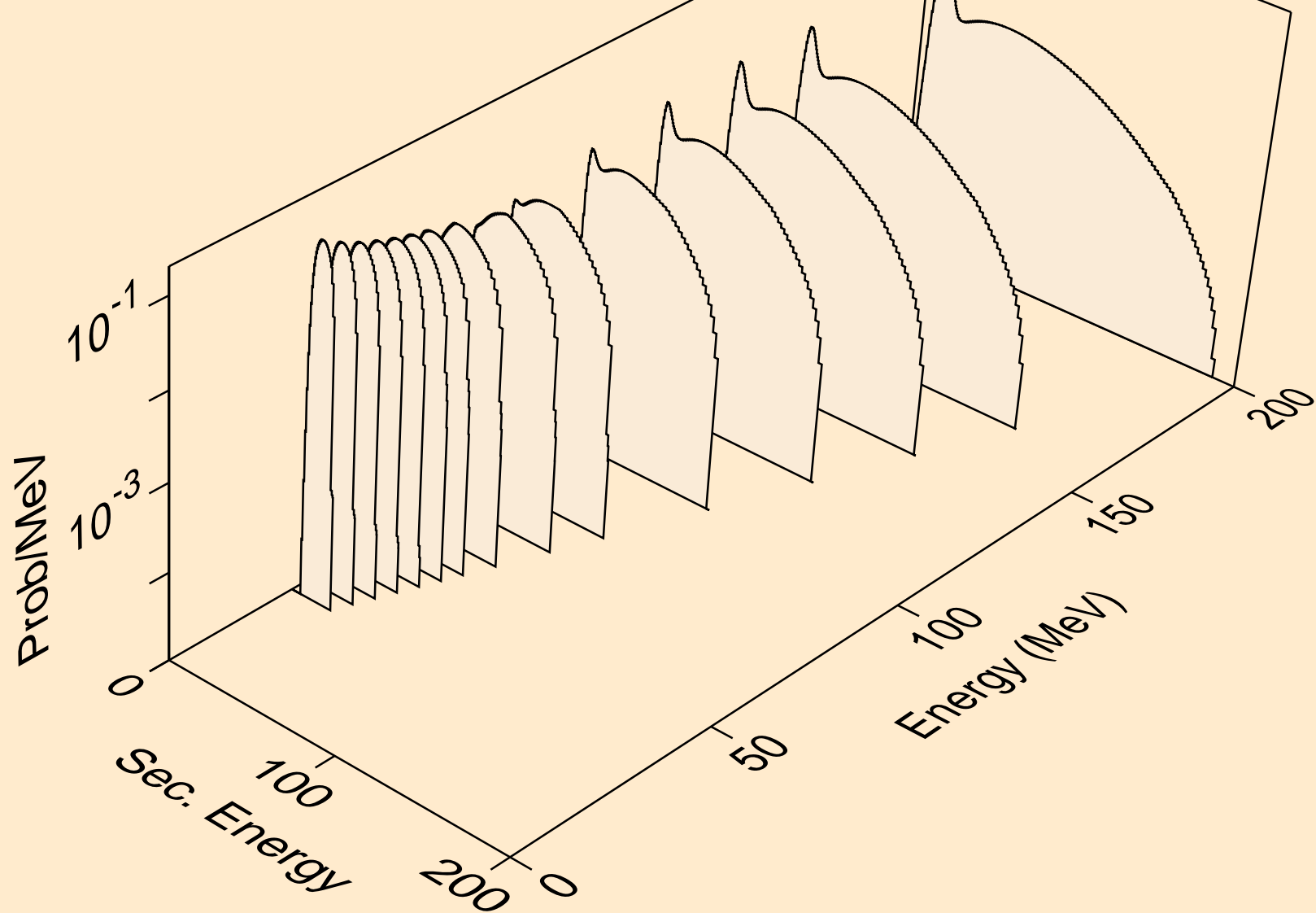

TB170 NEUTRON ACER TENDL-2021 LIBRARY; T=293.6K
tritons from (n,n*)t

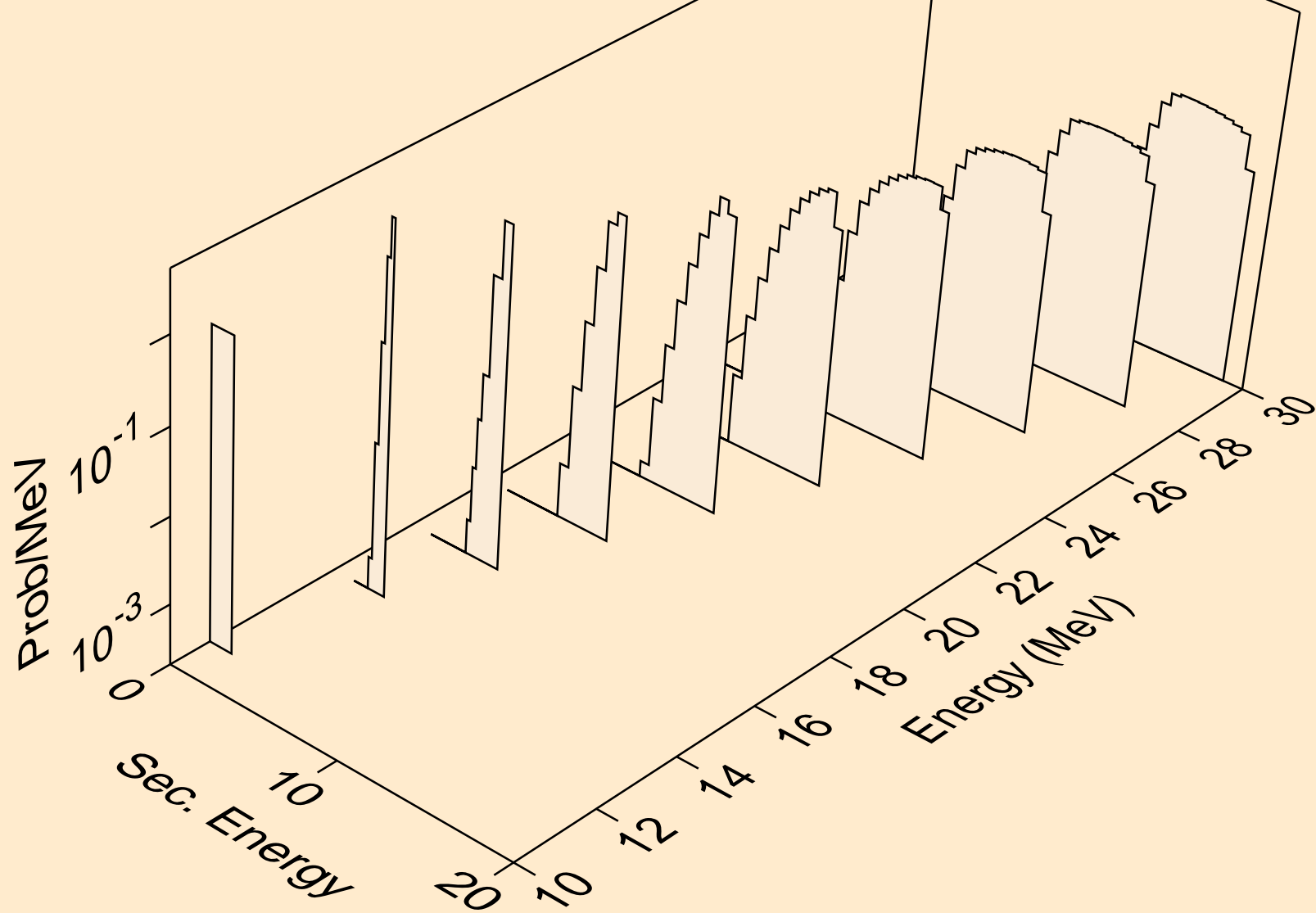

TB170 NEUTRON ACER TENDL-2021 LIBRARY; T=293.6K
tritons from (n,t)

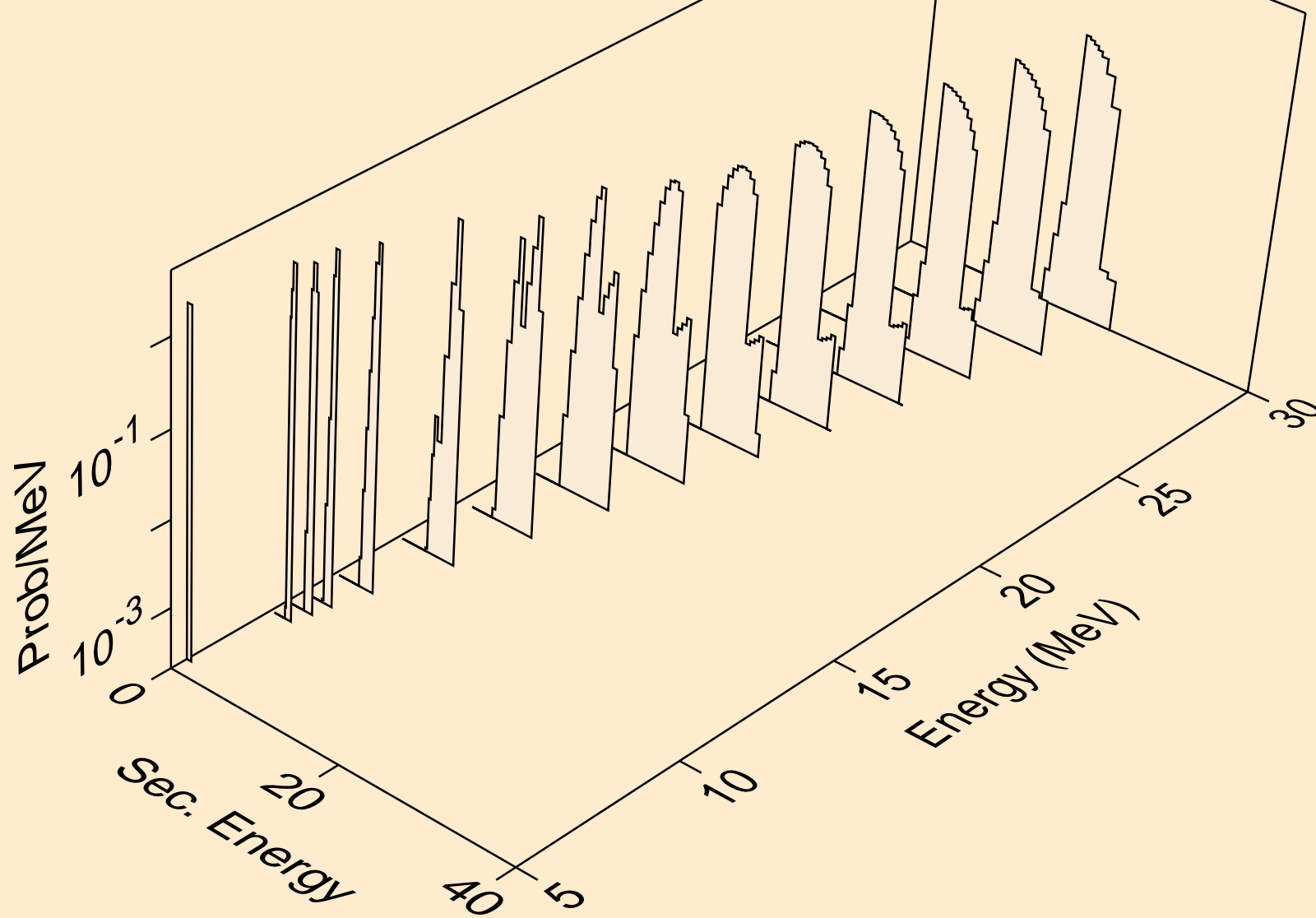

TB170 NEUTRON ACER TENDL-2021 LIBRARY; T=293.6K
he3s from (n,x)

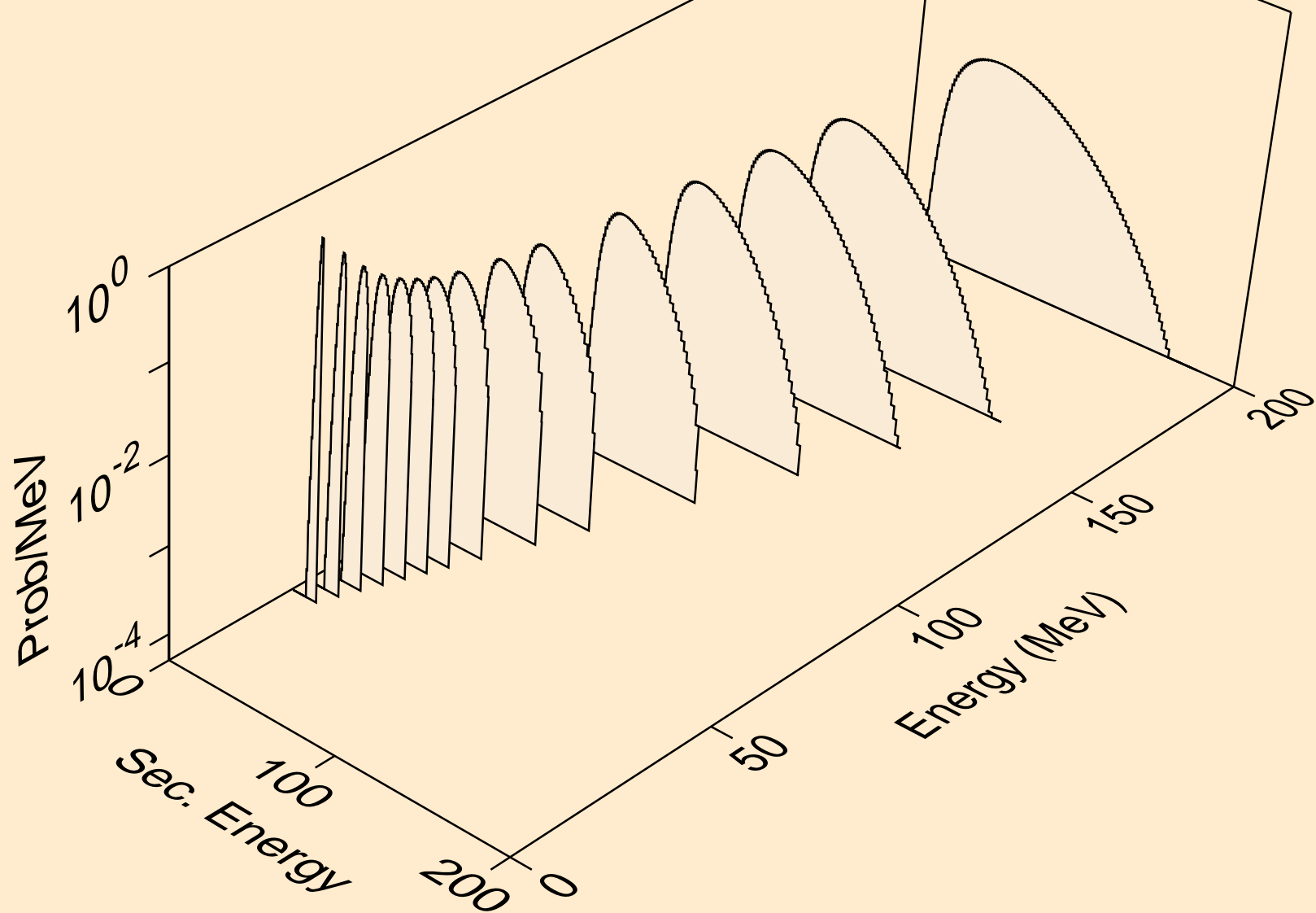

TB170 NEUTRON ACER TENDL-2021 LIBRARY; T=293.6K
he3s from (n,n*)he3

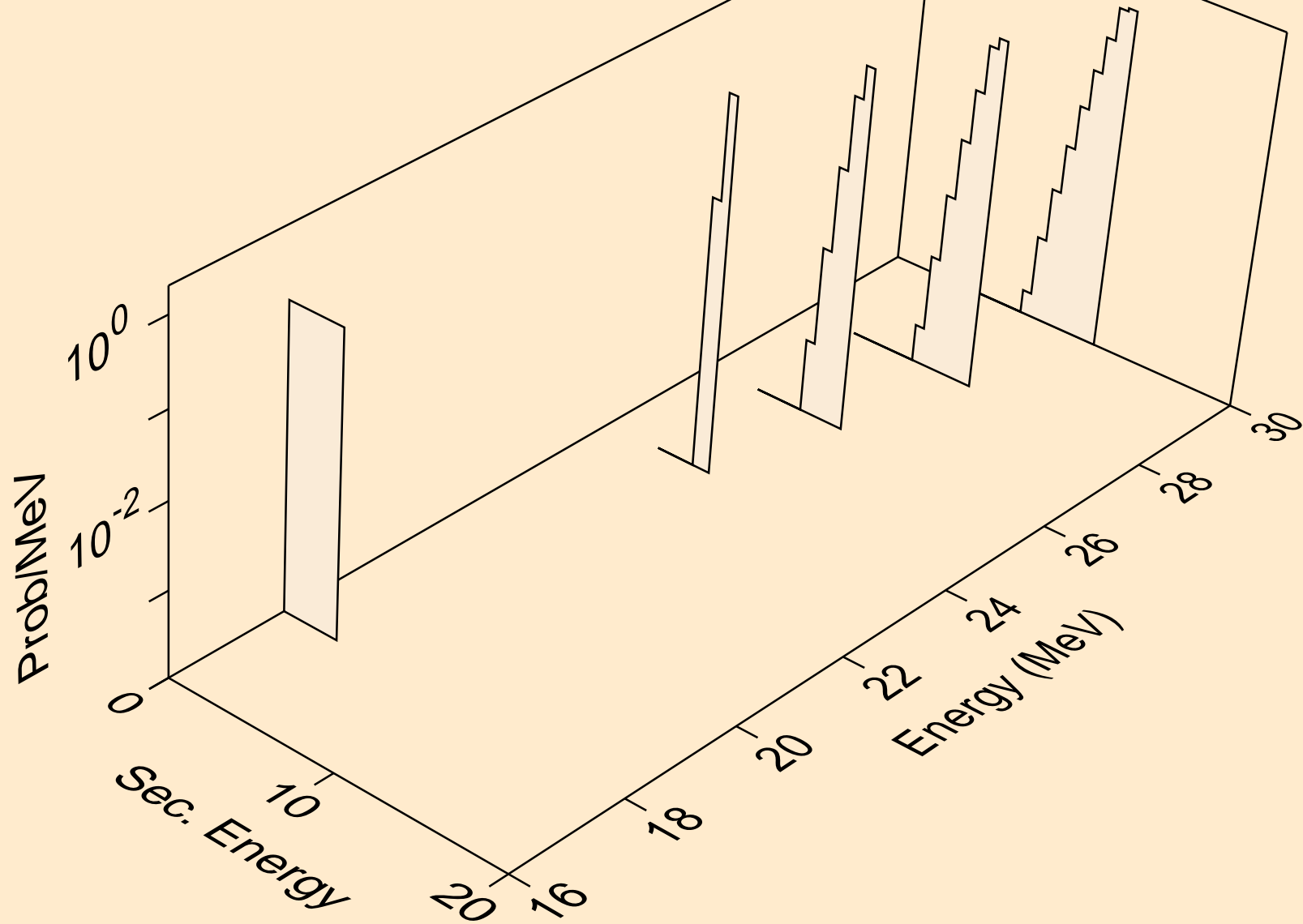

TB170 NEUTRON ACER TENDL-2021 LIBRARY; T=293.6K
he3s from (n,he3)

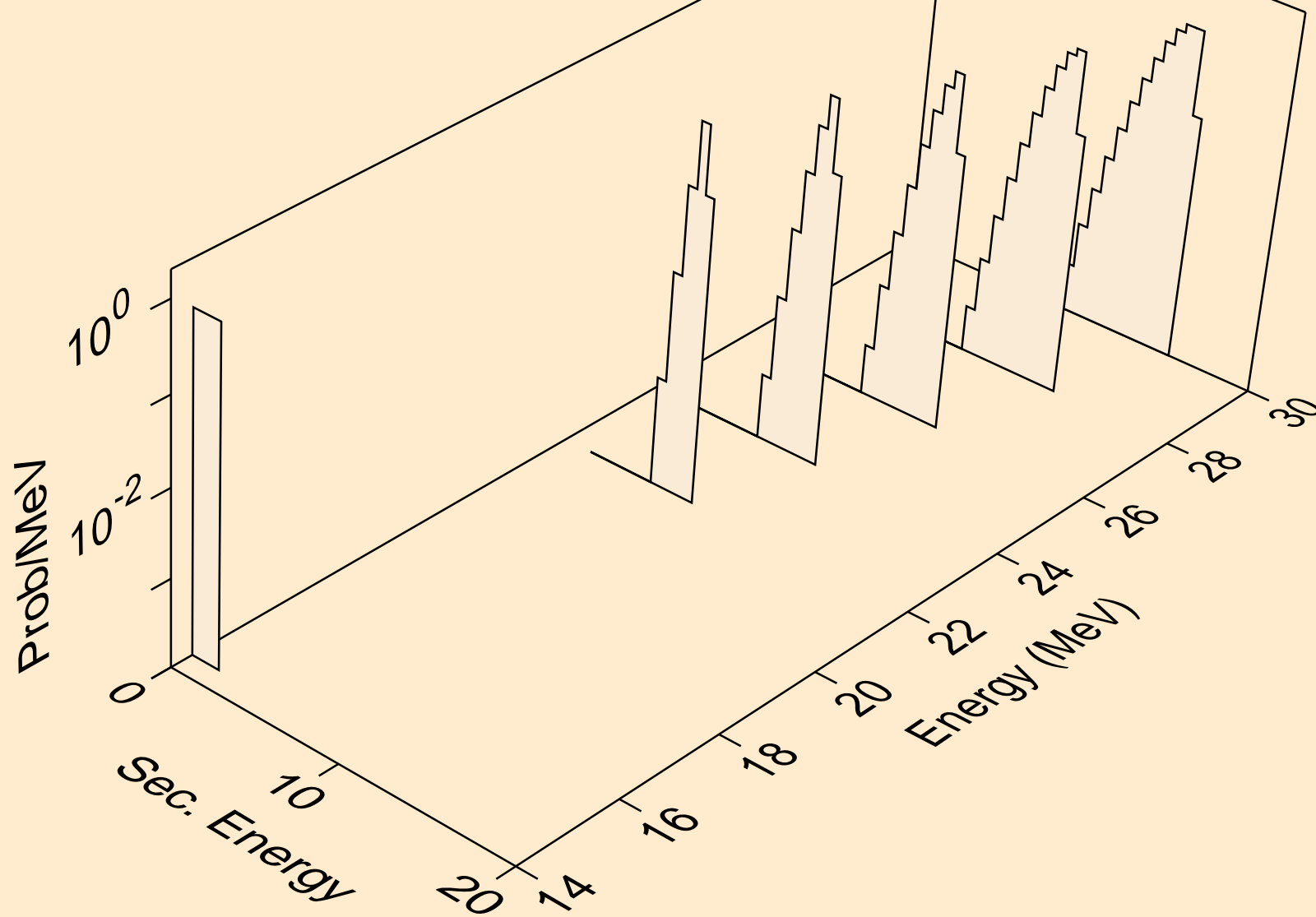

TB170 NEUTRON ACER TENDL-2021 LIBRARY; T=293.6K
alphas from (n,x)

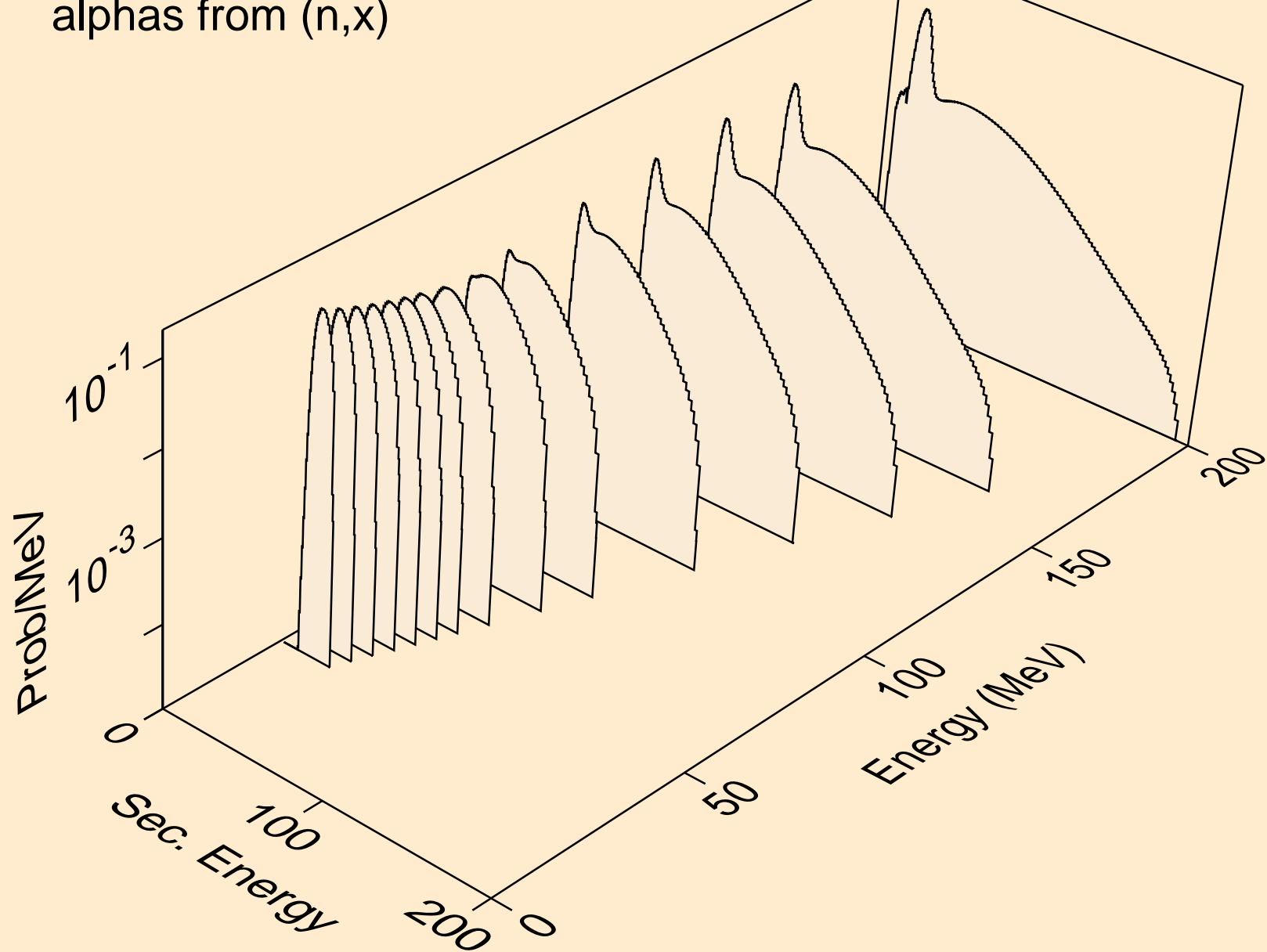

TB170 NEUTRON ACER TENDL-2021 LIBRARY; T=293.6K
alphas from (n,n*)a

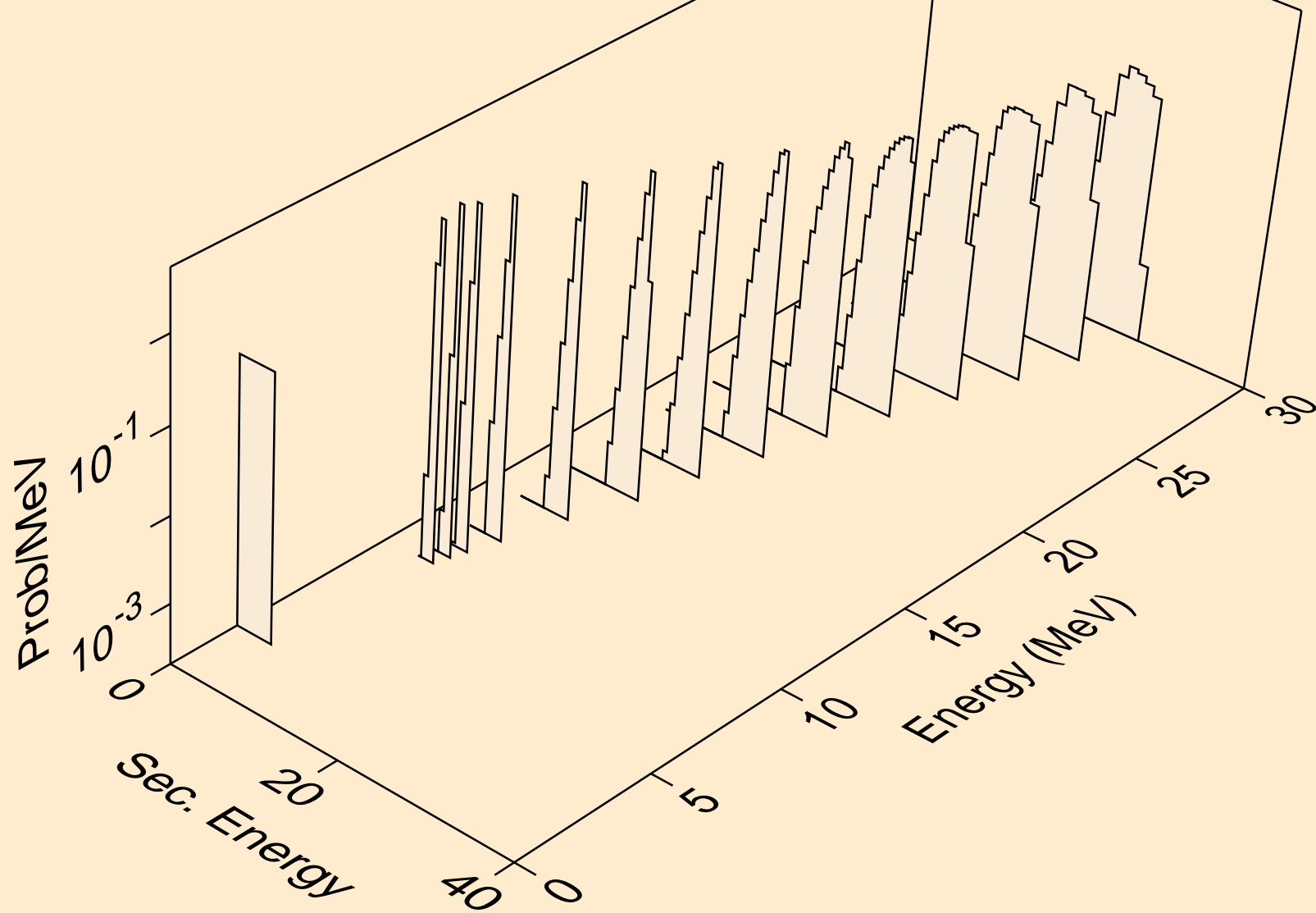

TB170 NEUTRON ACER TENDL-2021 LIBRARY; T=293.6K
alphas from (n,2n)a

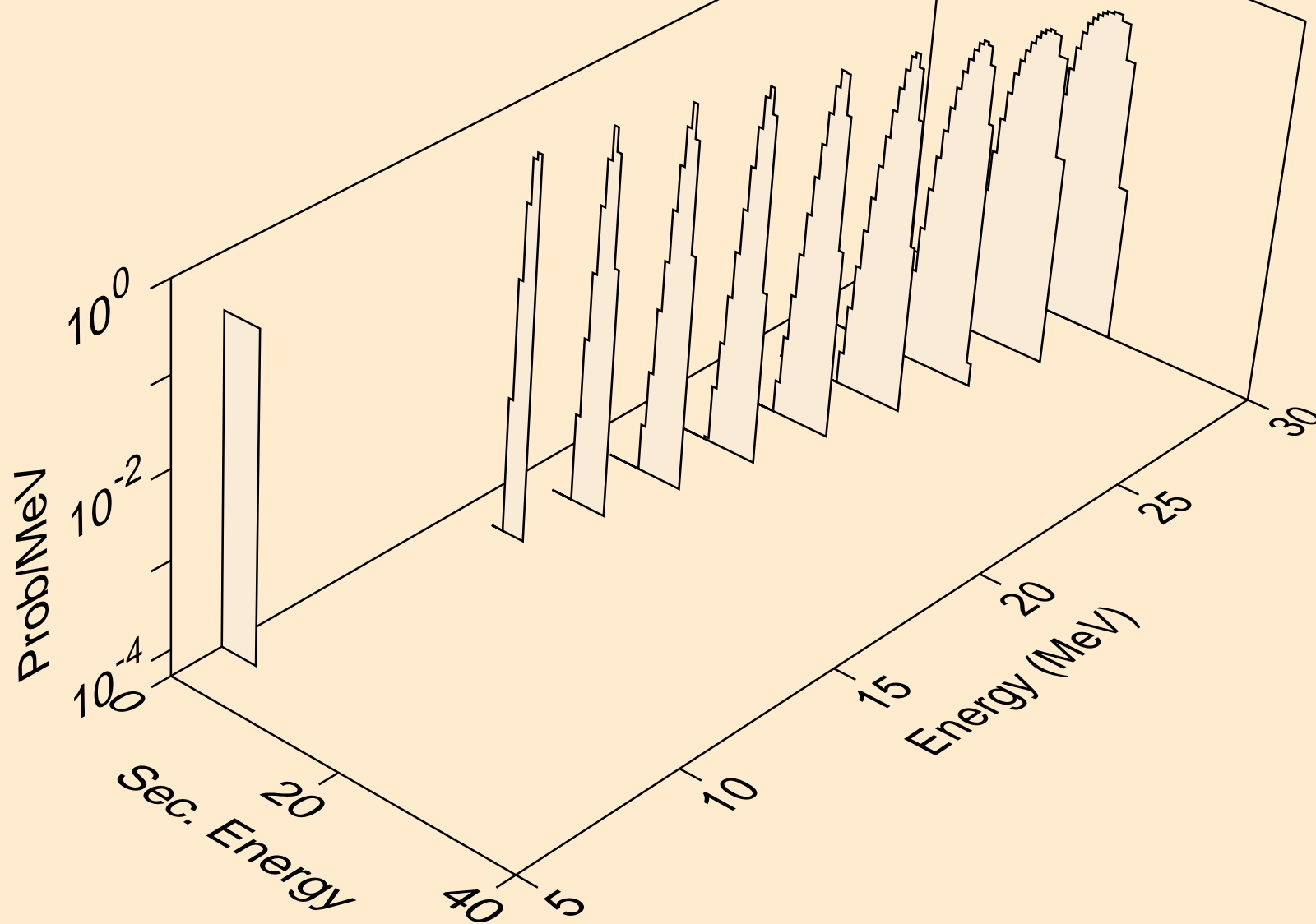

TB170 NEUTRON ACER TENDL-2021 LIBRARY; T=293.6K
alphas from (n,3n)a

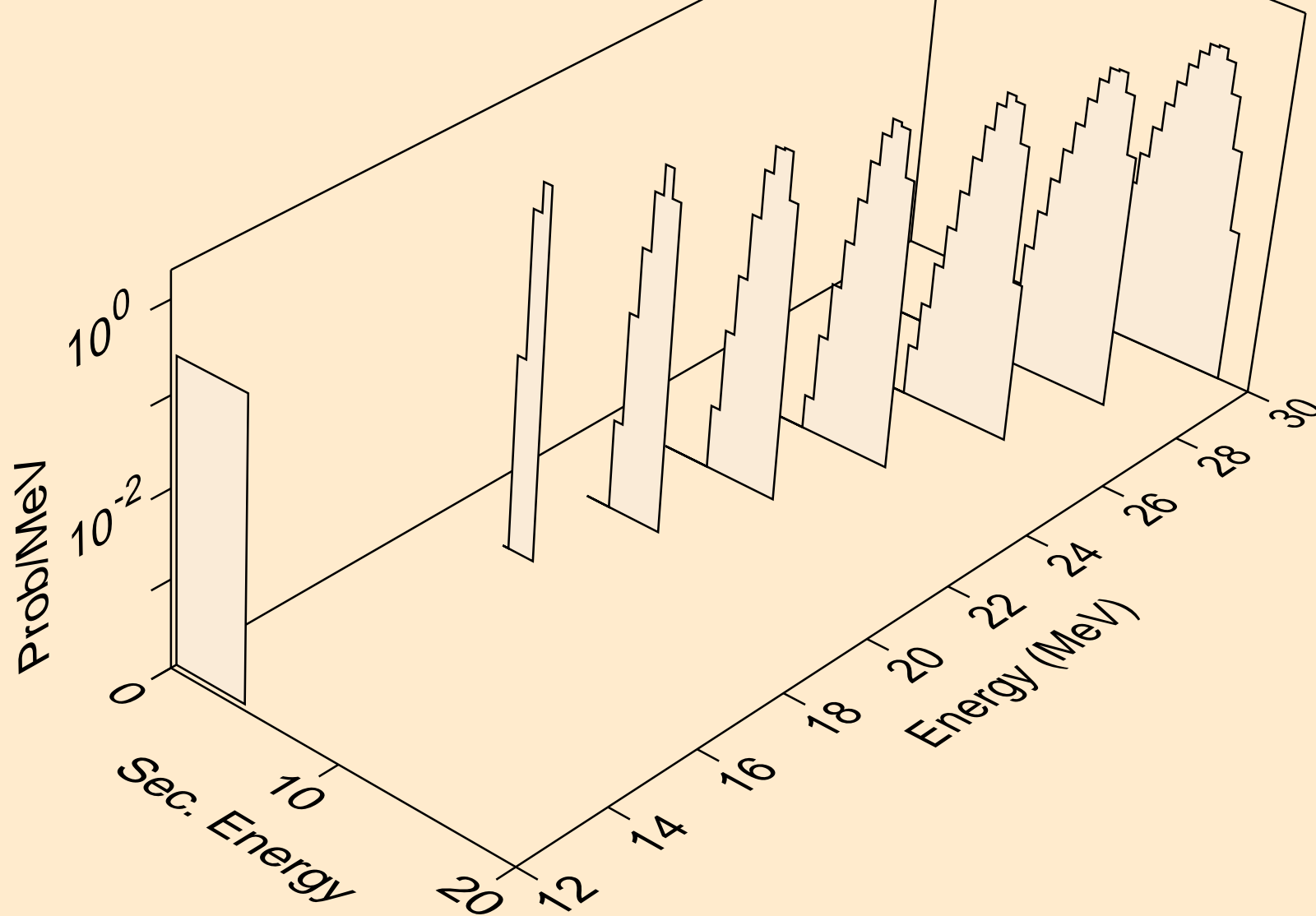

TB170 NEUTRON ACER TENDL-2021 LIBRARY; T=293.6K
alphas from (n,a)

