

TC088M NEUTRON ACER TENDL-2021 LIBRARY; T=293.6K
Principal cross sections

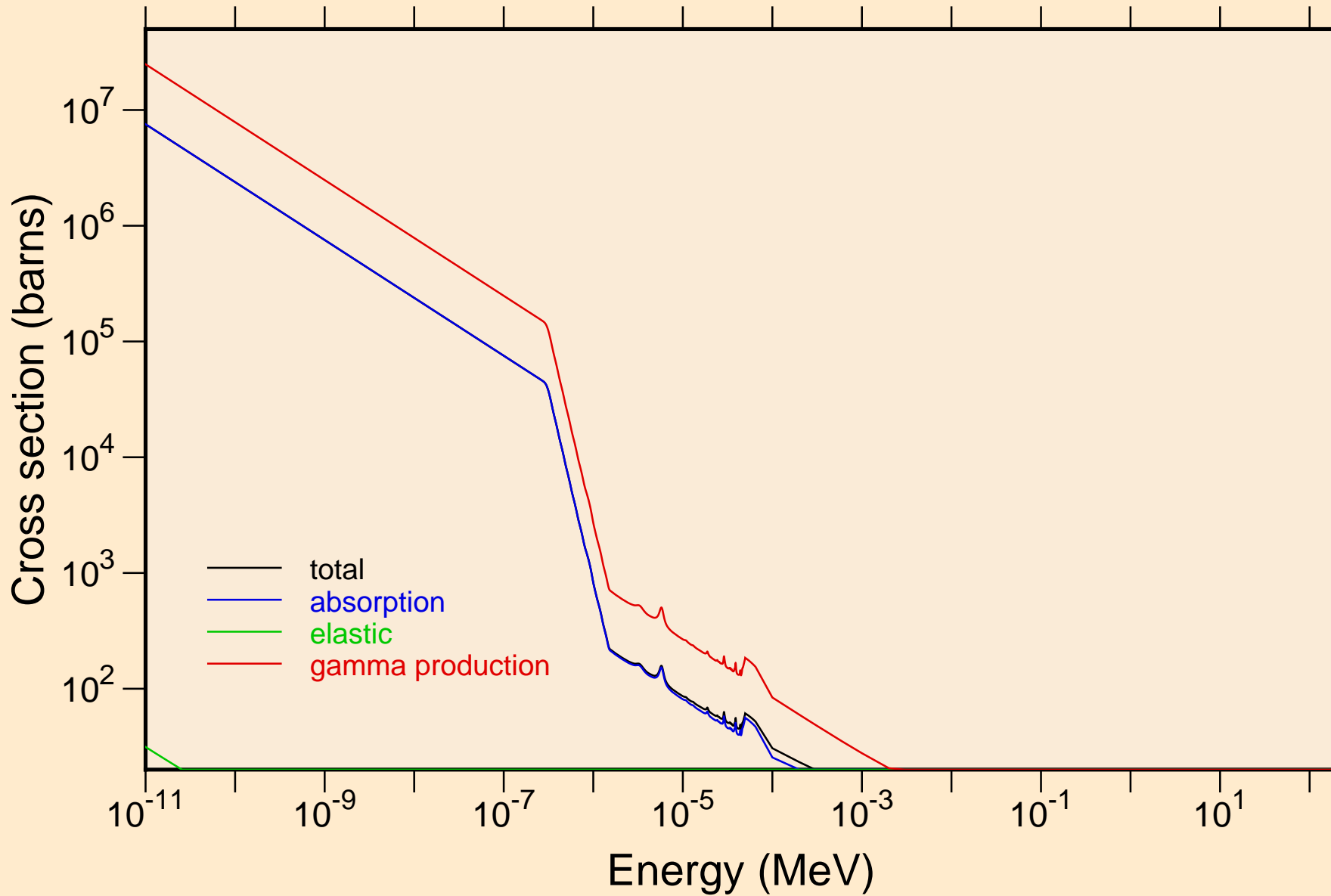

TC088M NEUTRON ACER TENDL-2021 LIBRARY; T=293.6K
resonance total cross section

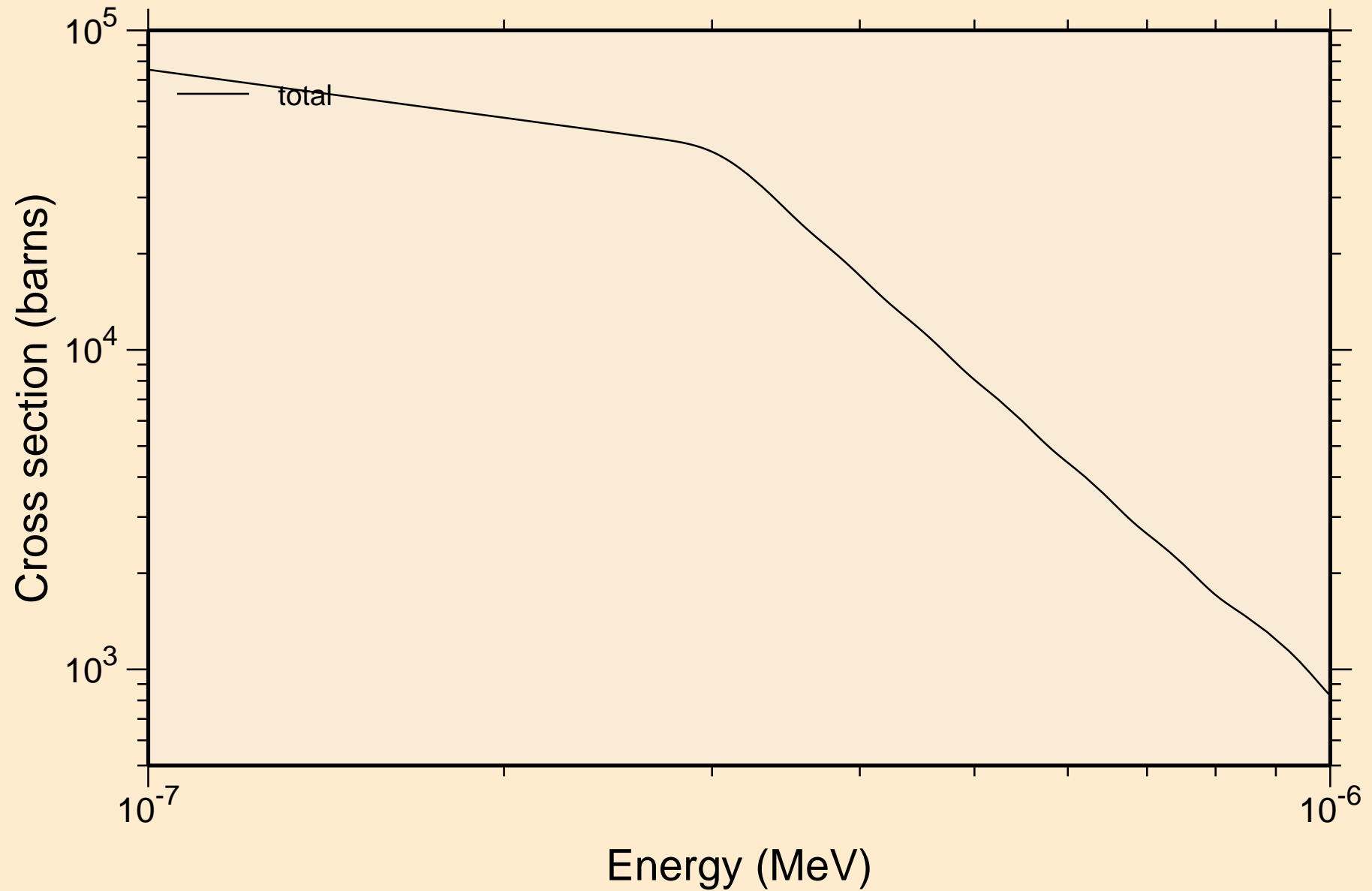

TC088M NEUTRON ACER TENDL-2021 LIBRARY; T=293.6K
resonance total cross section

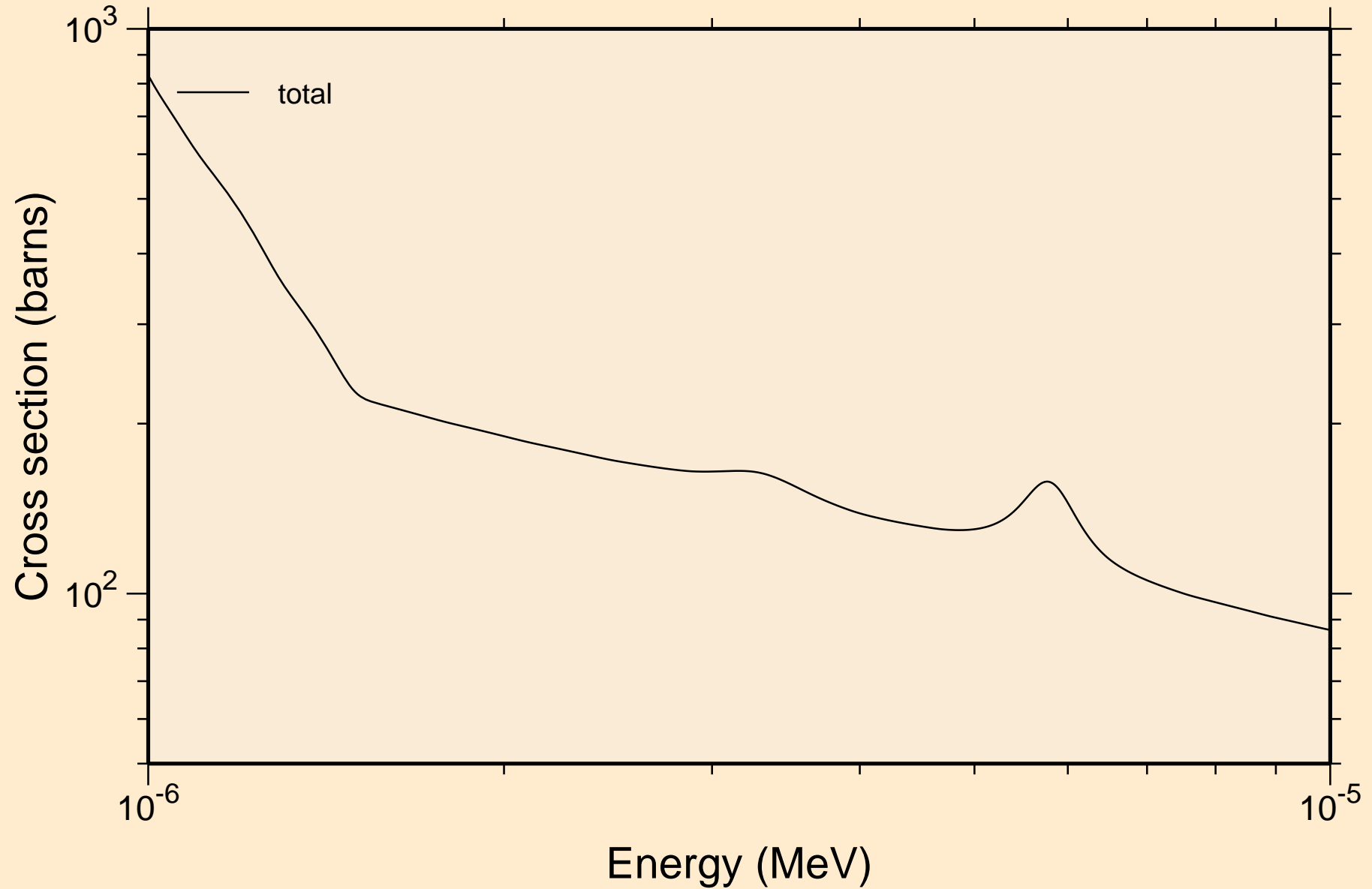

TC088M NEUTRON ACER TENDL-2021 LIBRARY; T=293.6K
resonance total cross section

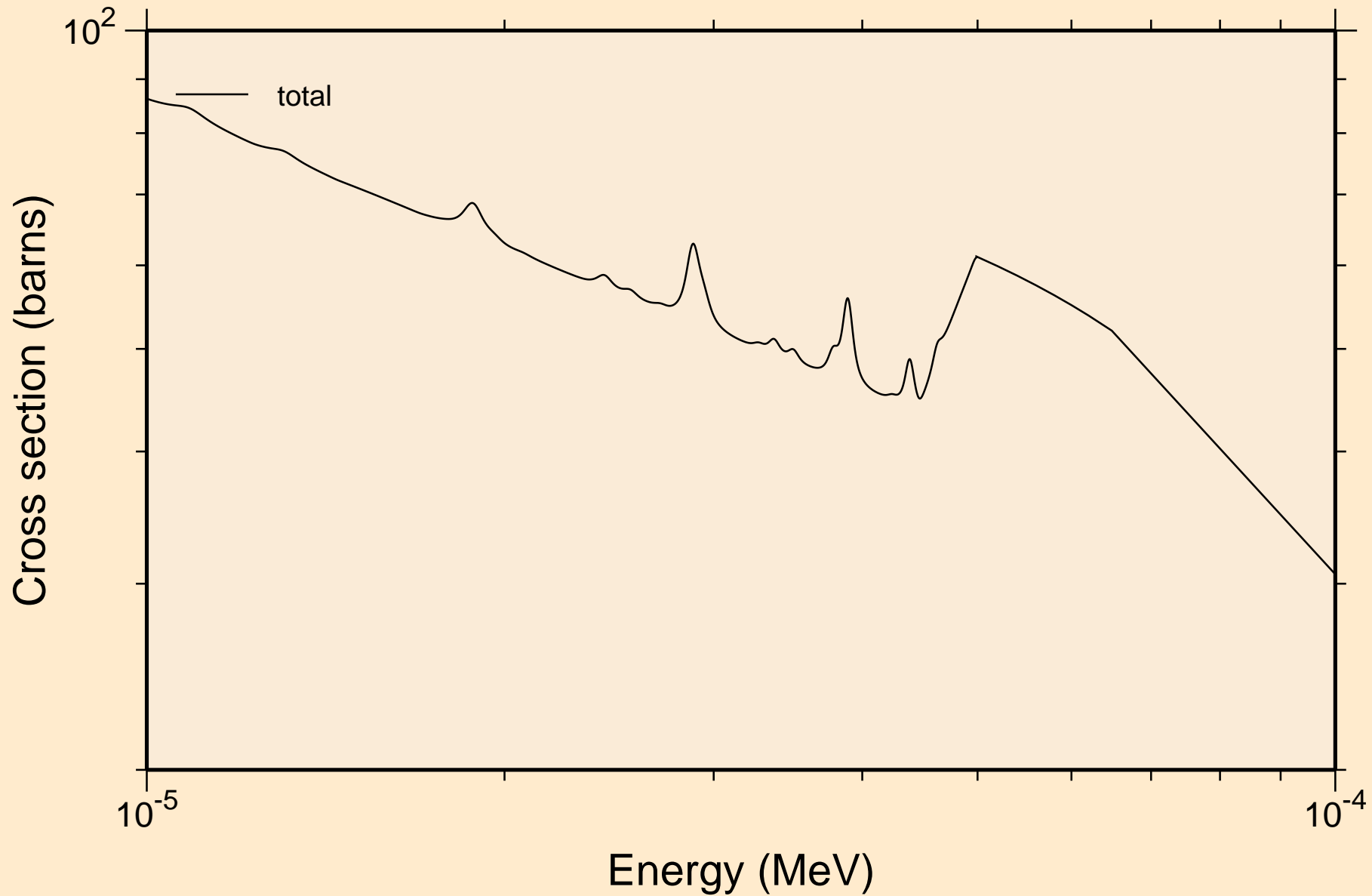

T̄C088M NEUTRON ACER TENDL-2021 LIBRARY; T=293.6K
resonance total cross section

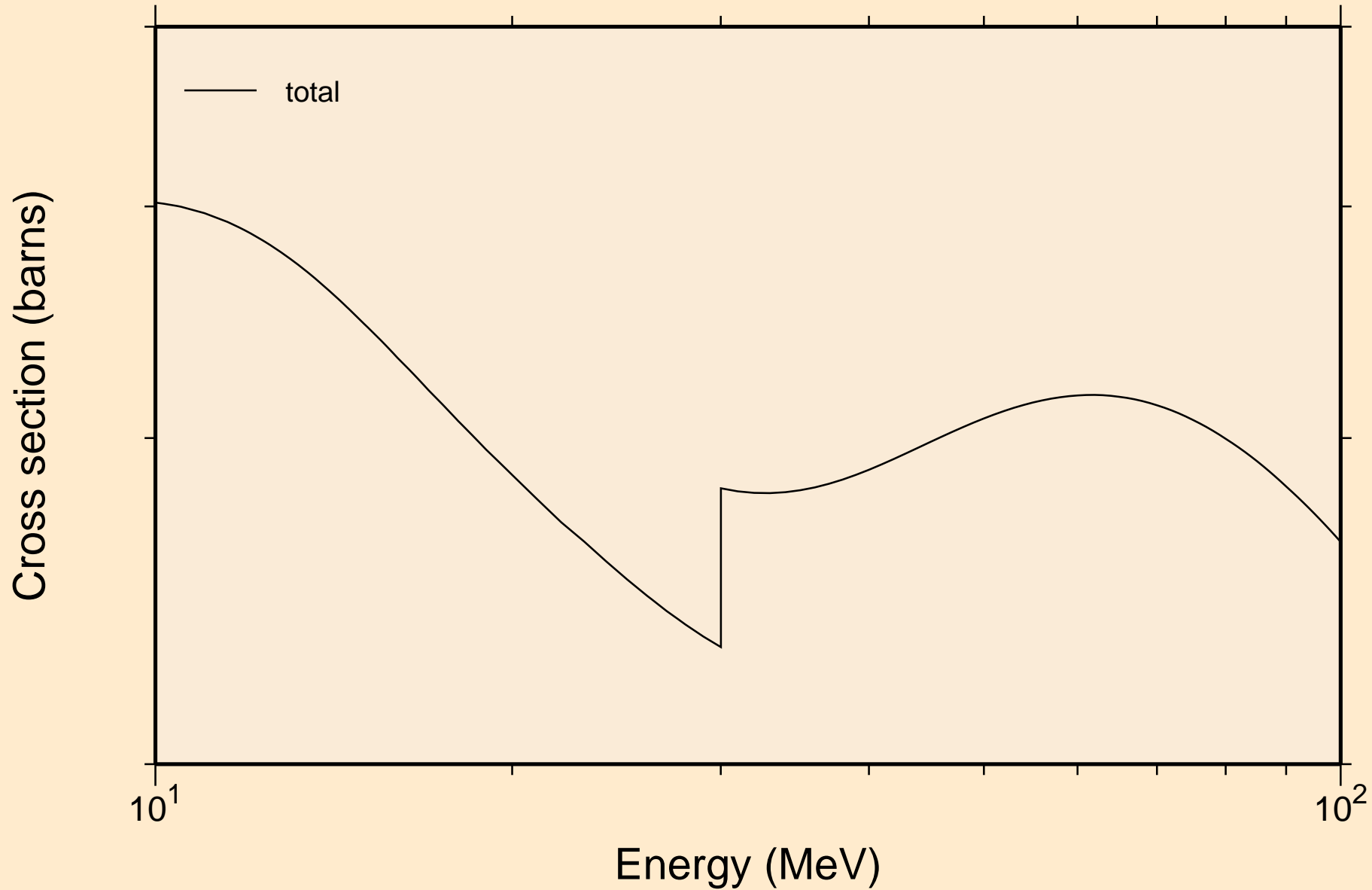

TC088M NEUTRON ACER TENDL-2021 LIBRARY; T=293.6K
resonance absorption cross sections

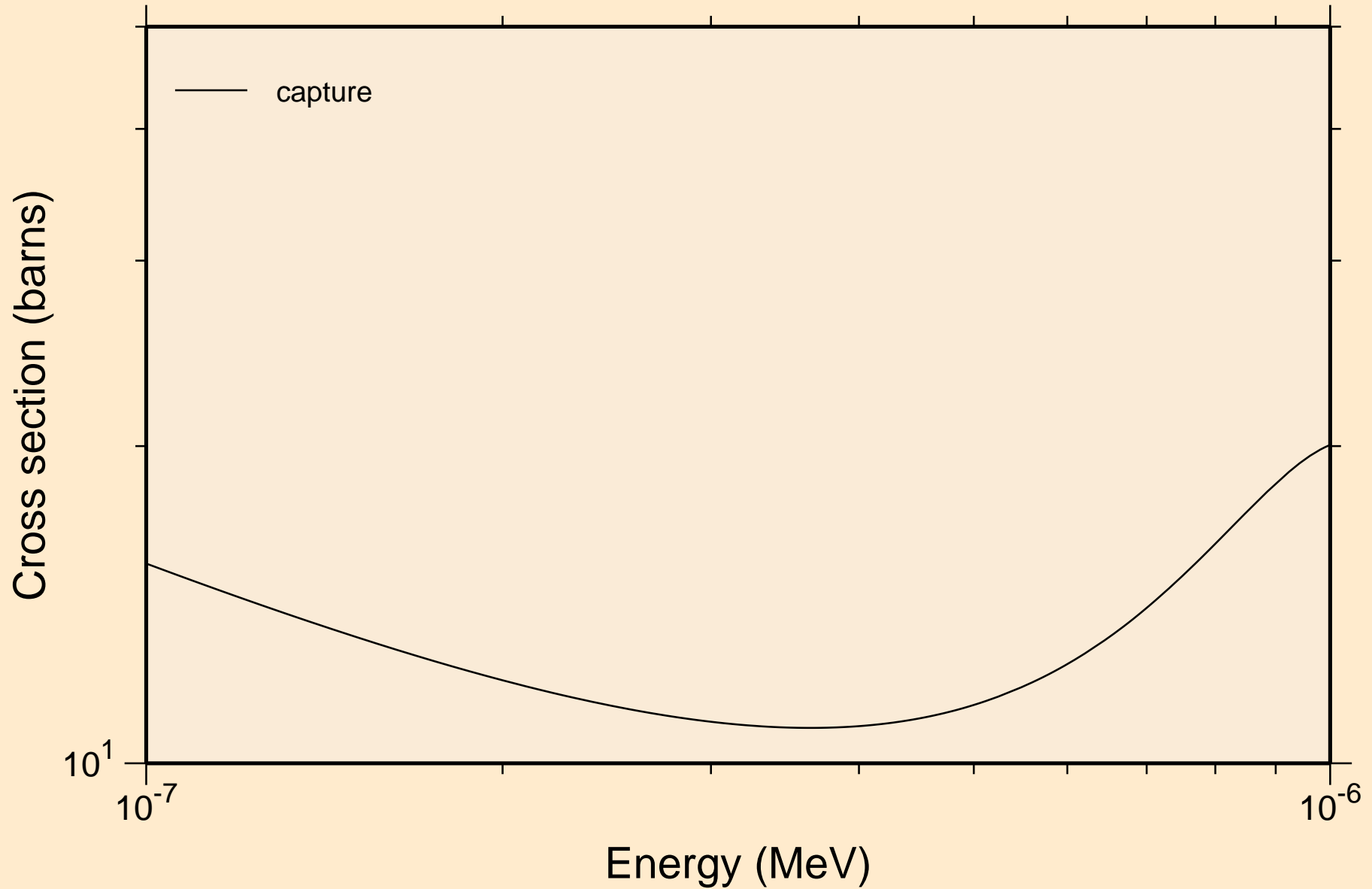

TC088M NEUTRON ACER TENDL-2021 LIBRARY; T=293.6K
resonance absorption cross sections

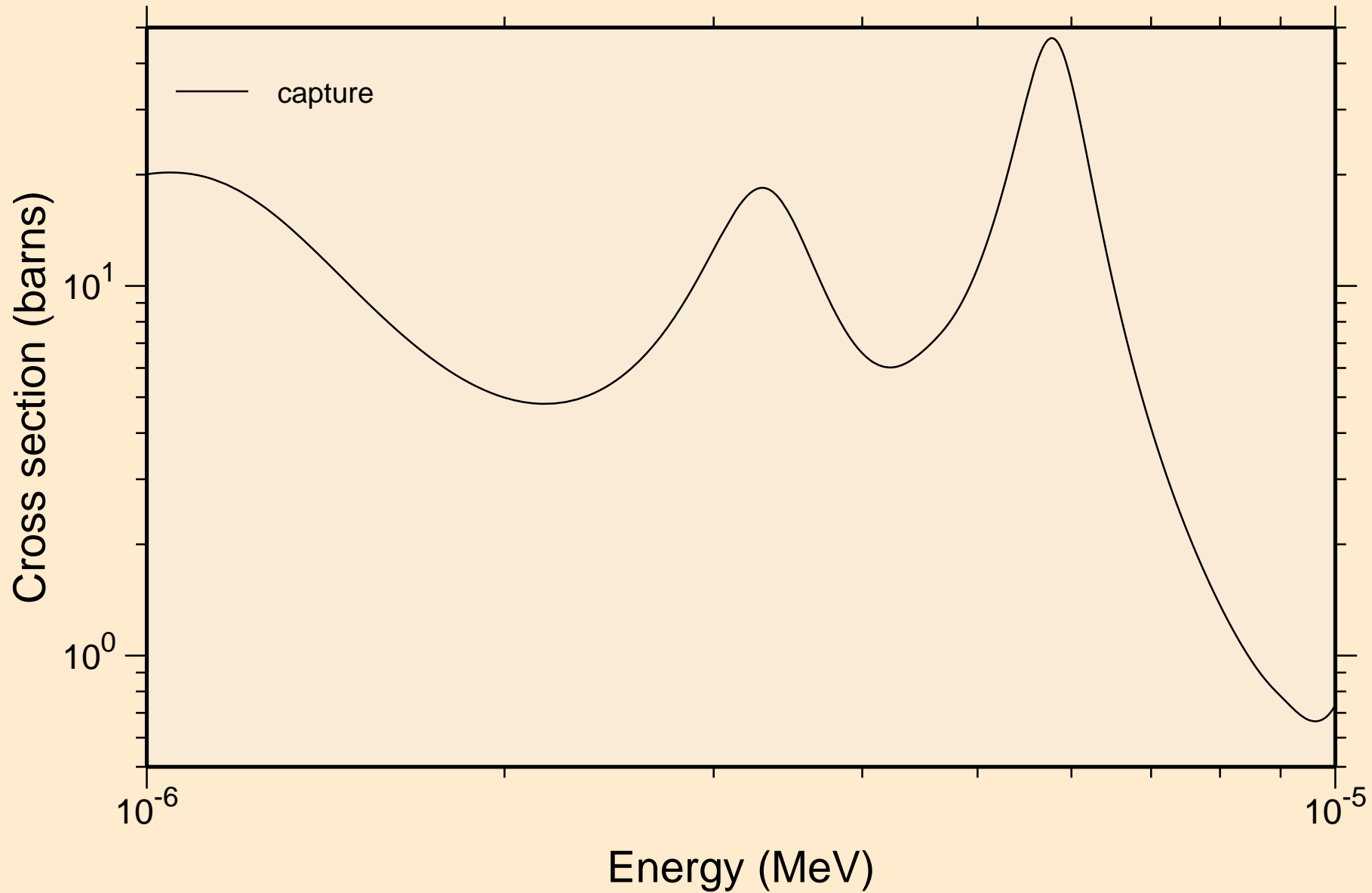

TC088M NEUTRON ACER TENDL-2021 LIBRARY; T=293.6K
resonance absorption cross sections

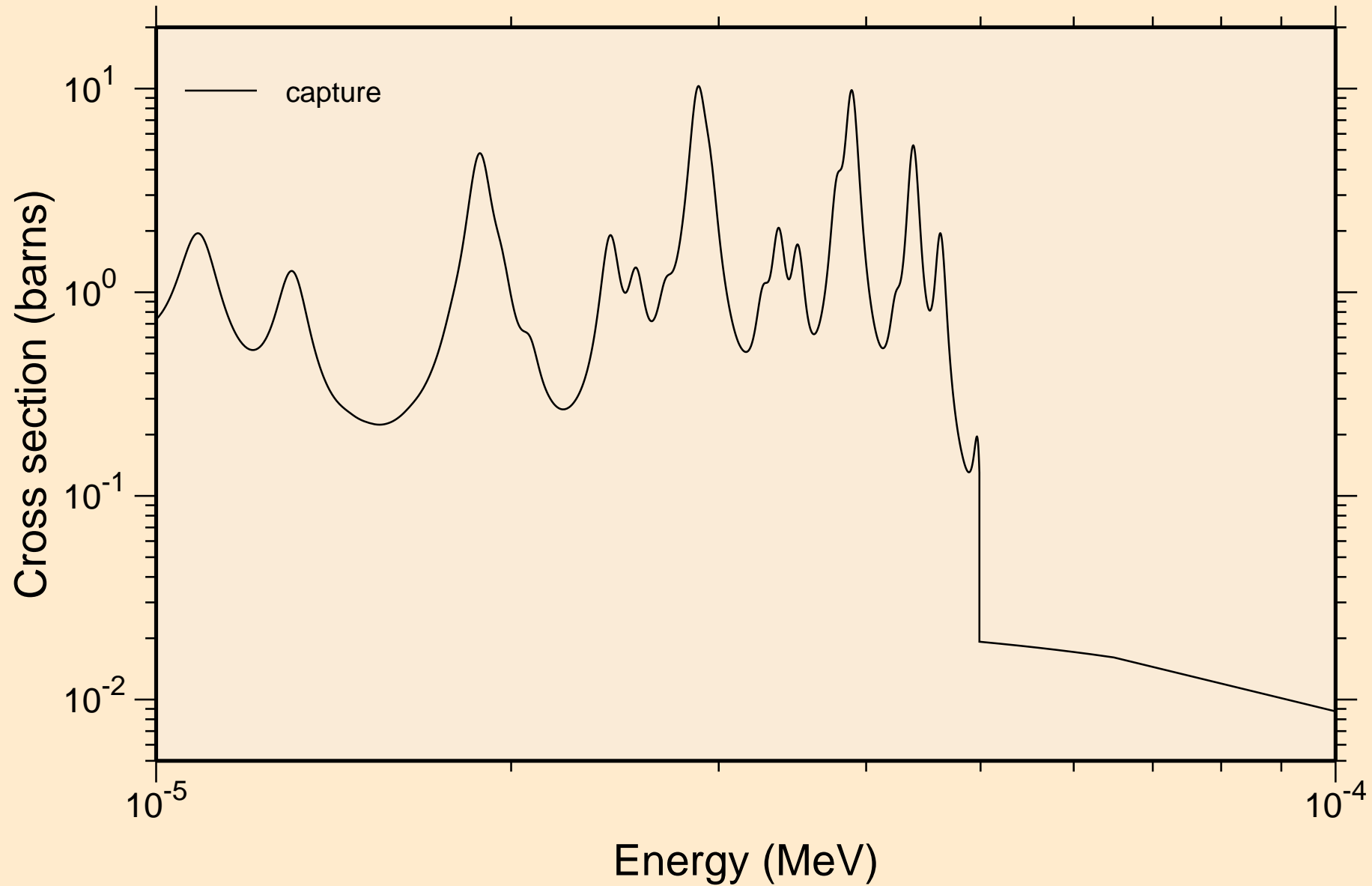

TC088M NEUTRON ACER TENDL-2021 LIBRARY; T=293.6K
resonance absorption cross sections

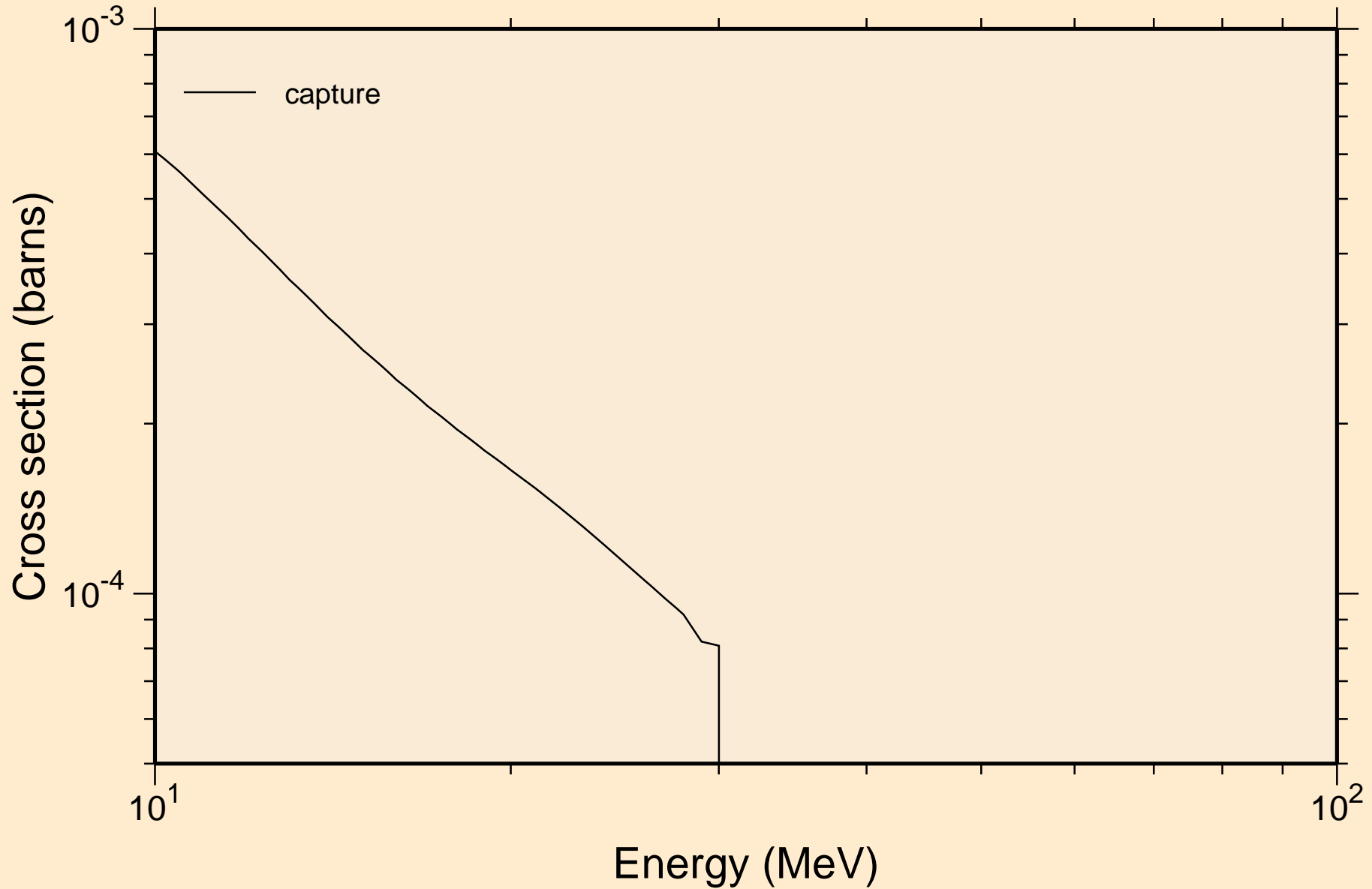

TC088M NEUTRON ACER TENDL-2021 LIBRARY; T=293.6K
Heating

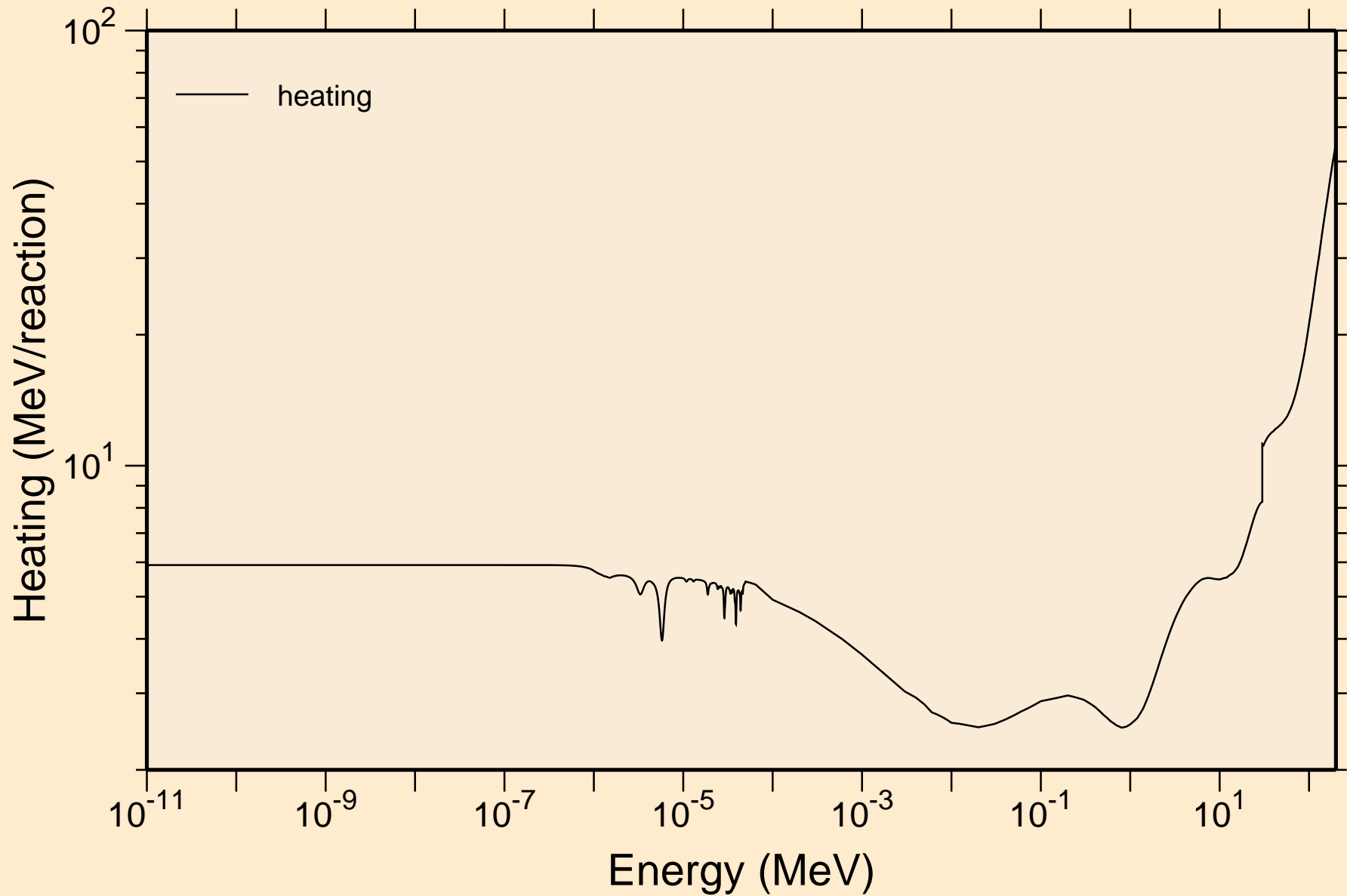

TC088M NEUTRON ACER TENDL-2021 LIBRARY; T=293.6K
Damage

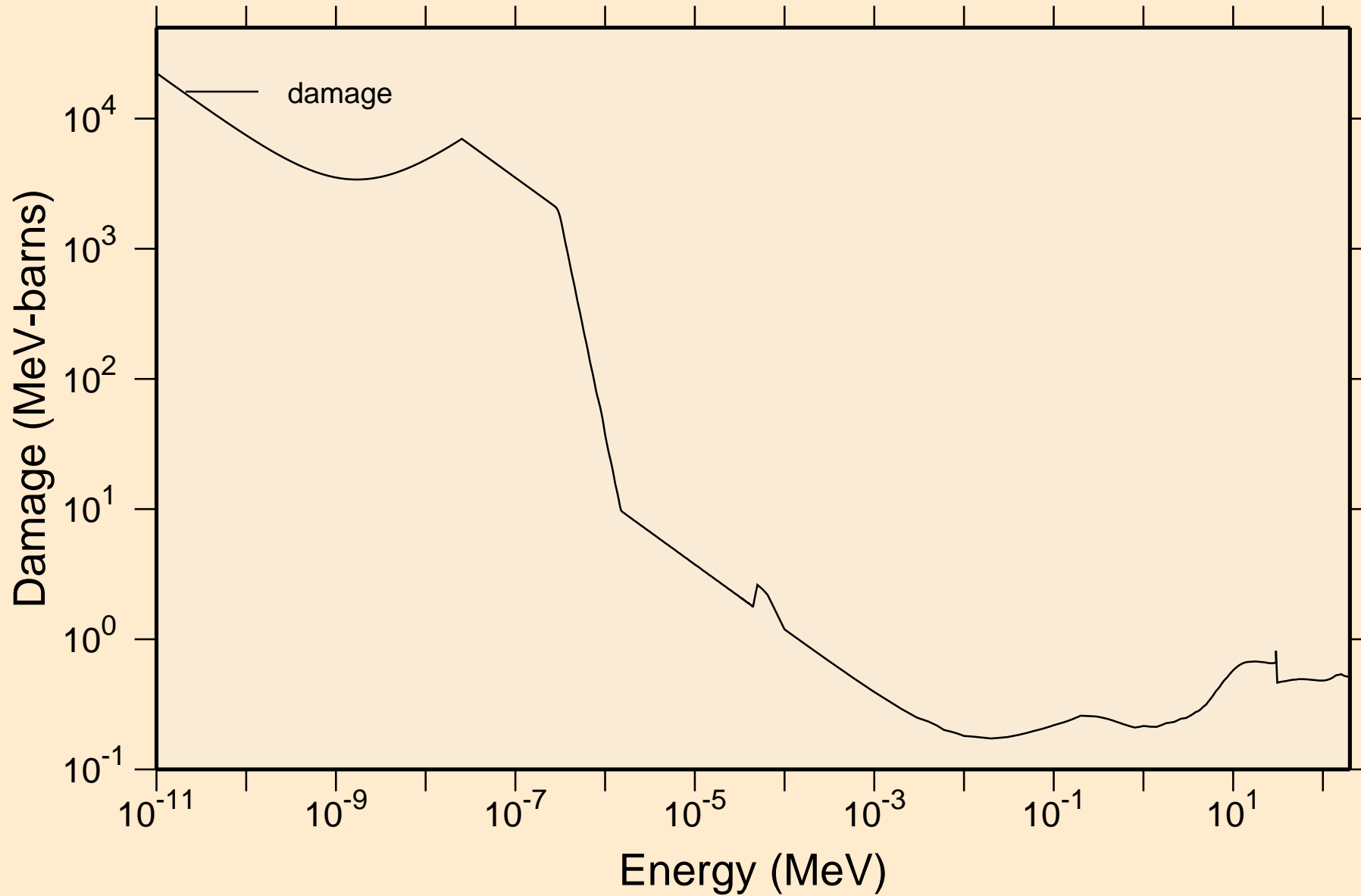

TC088M NEUTRON ACER TENDL-2021 LIBRARY; T=293.6K
Non-threshold reactions

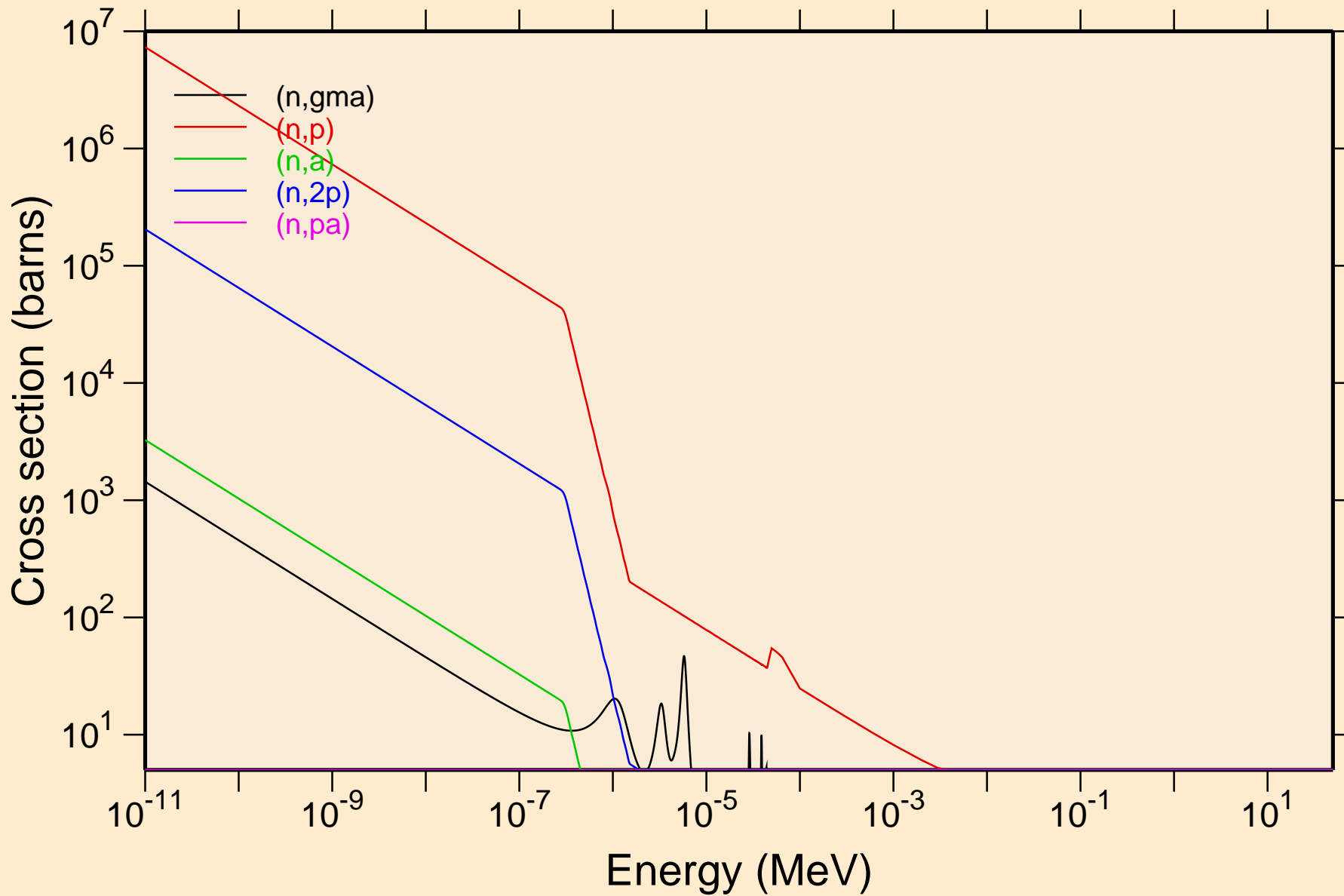

TC088M NEUTRON ACER TENDL-2021 LIBRARY; T=293.6K
Non-threshold reactions

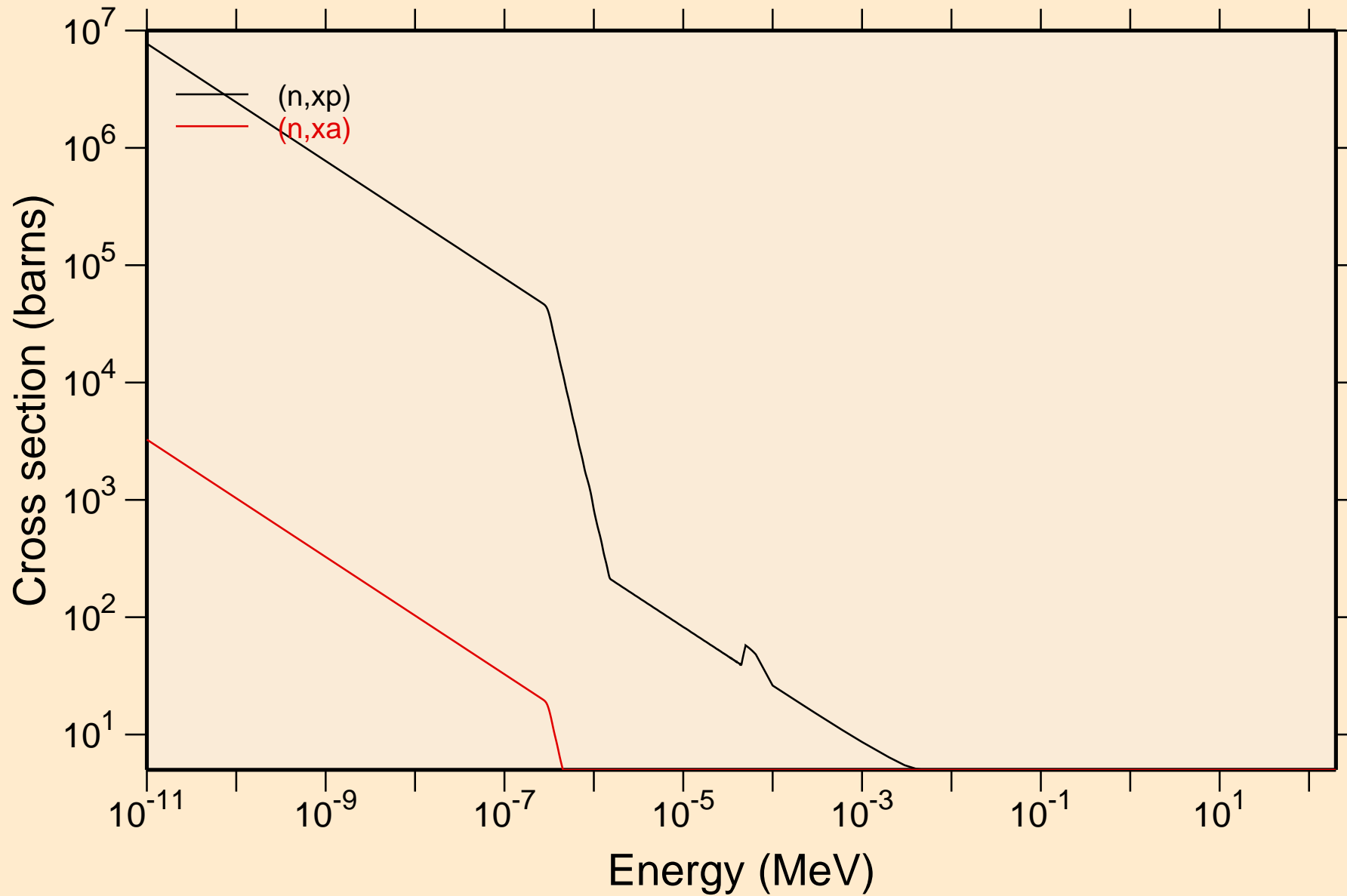

TC088M NEUTRON ACER TENDL-2021 LIBRARY; T=293.6K
Principal cross sections

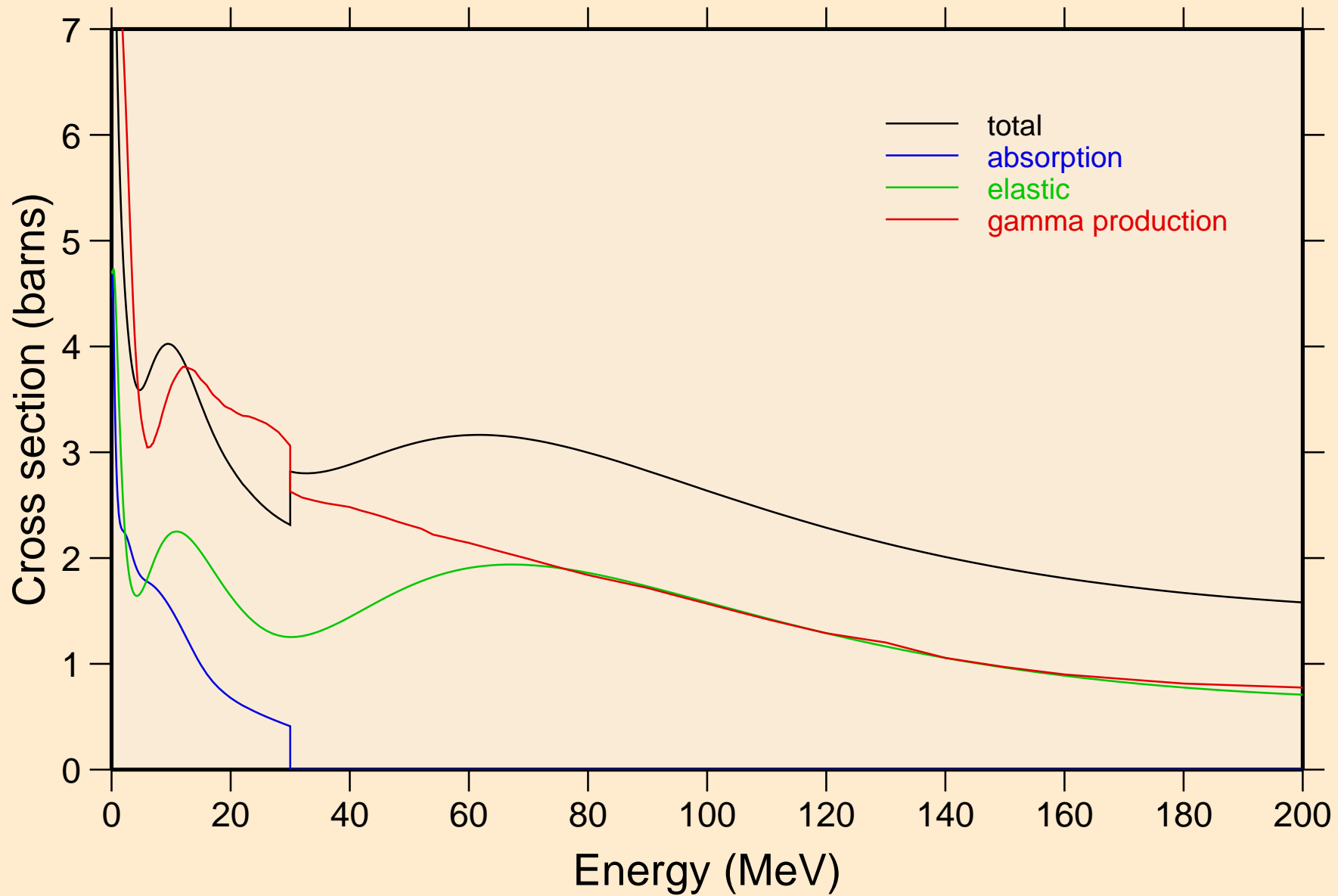

TC088M NEUTRON ACER TENDL-2021 LIBRARY; T=293.6K
Heating

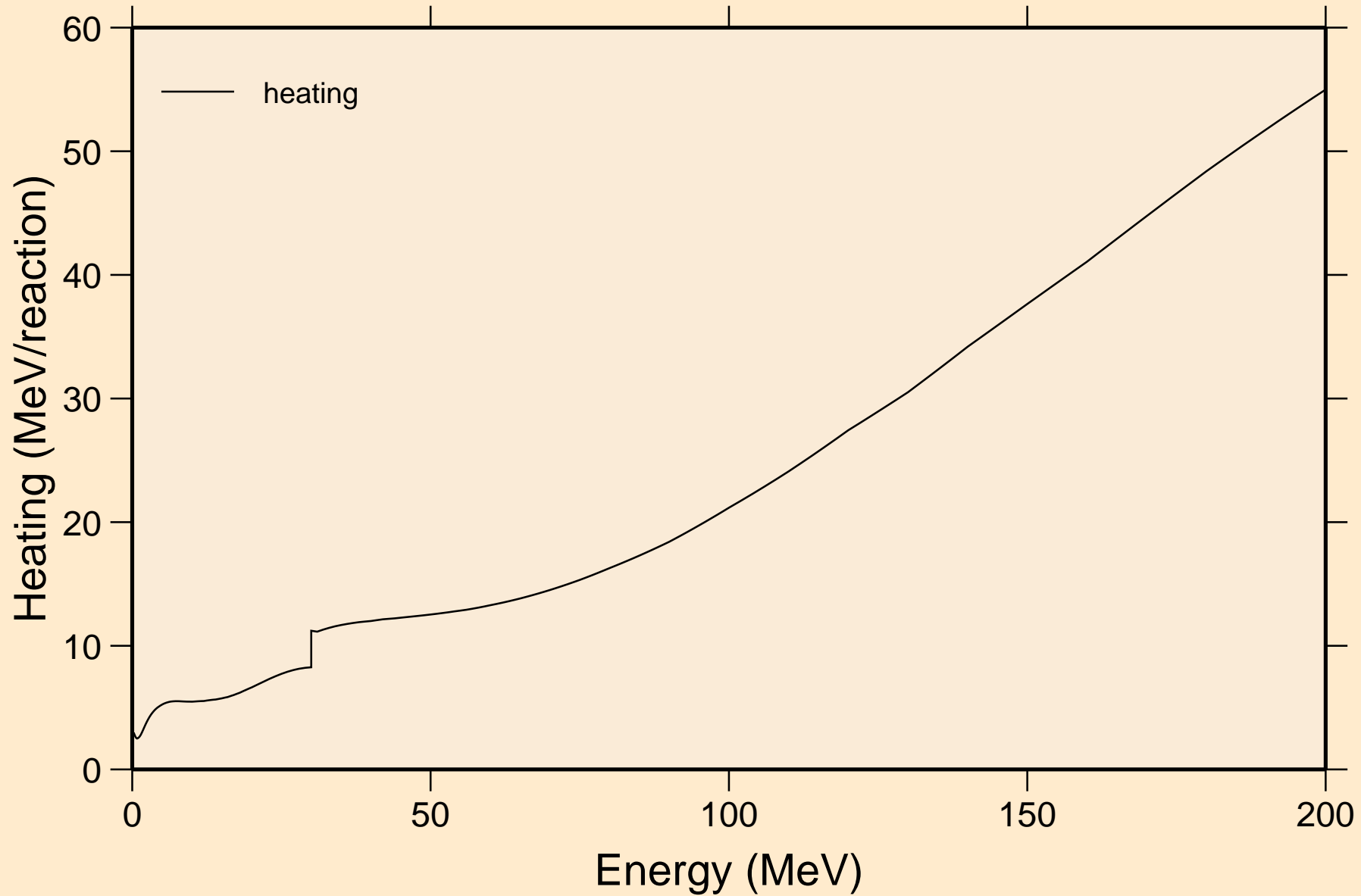

TC088M NEUTRON ACER TENDL-2021 LIBRARY; T=293.6K
Damage

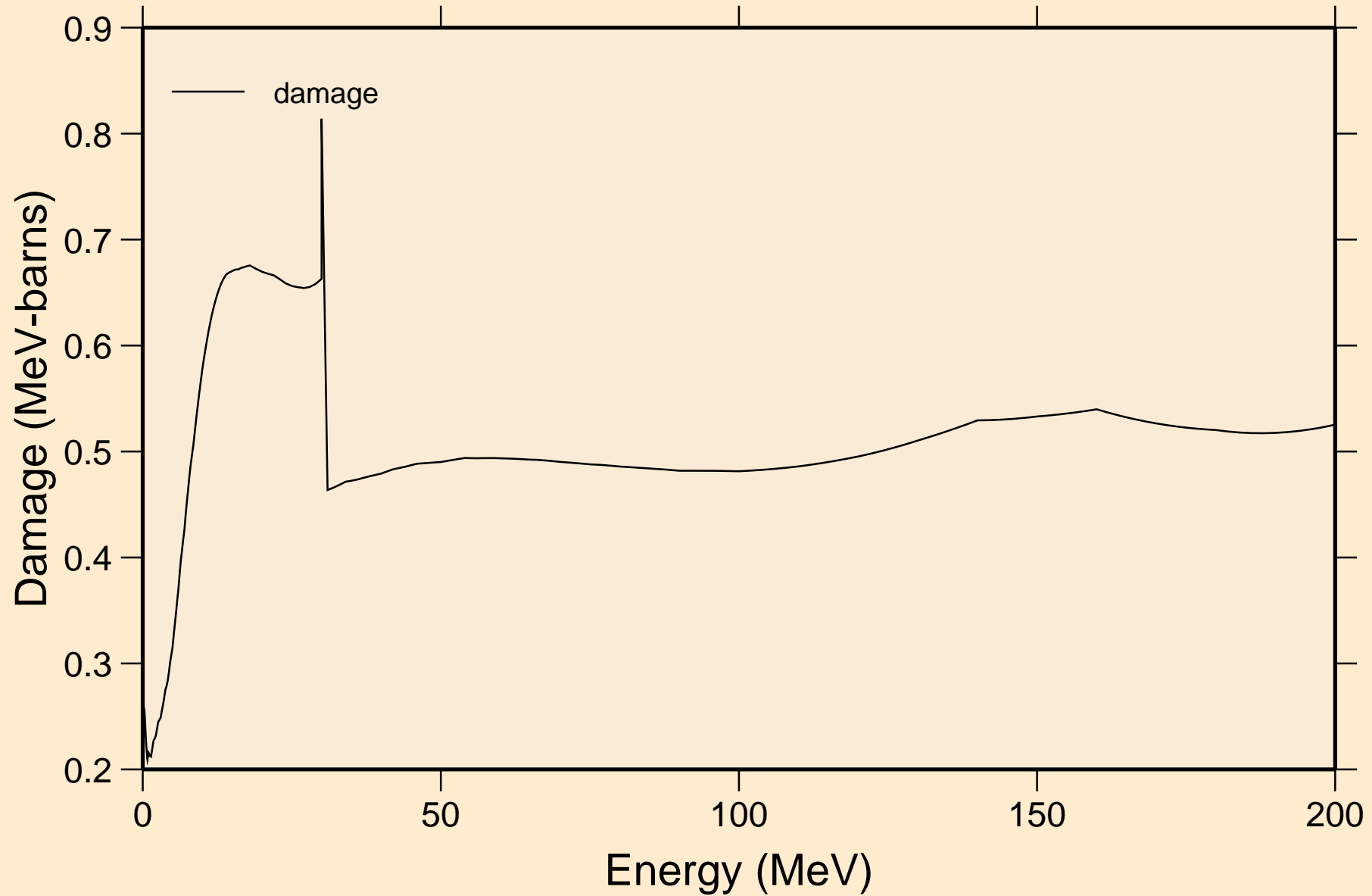

TC088M NEUTRON ACER TENDL-2021 LIBRARY; T=293.6K
Non-threshold reactions

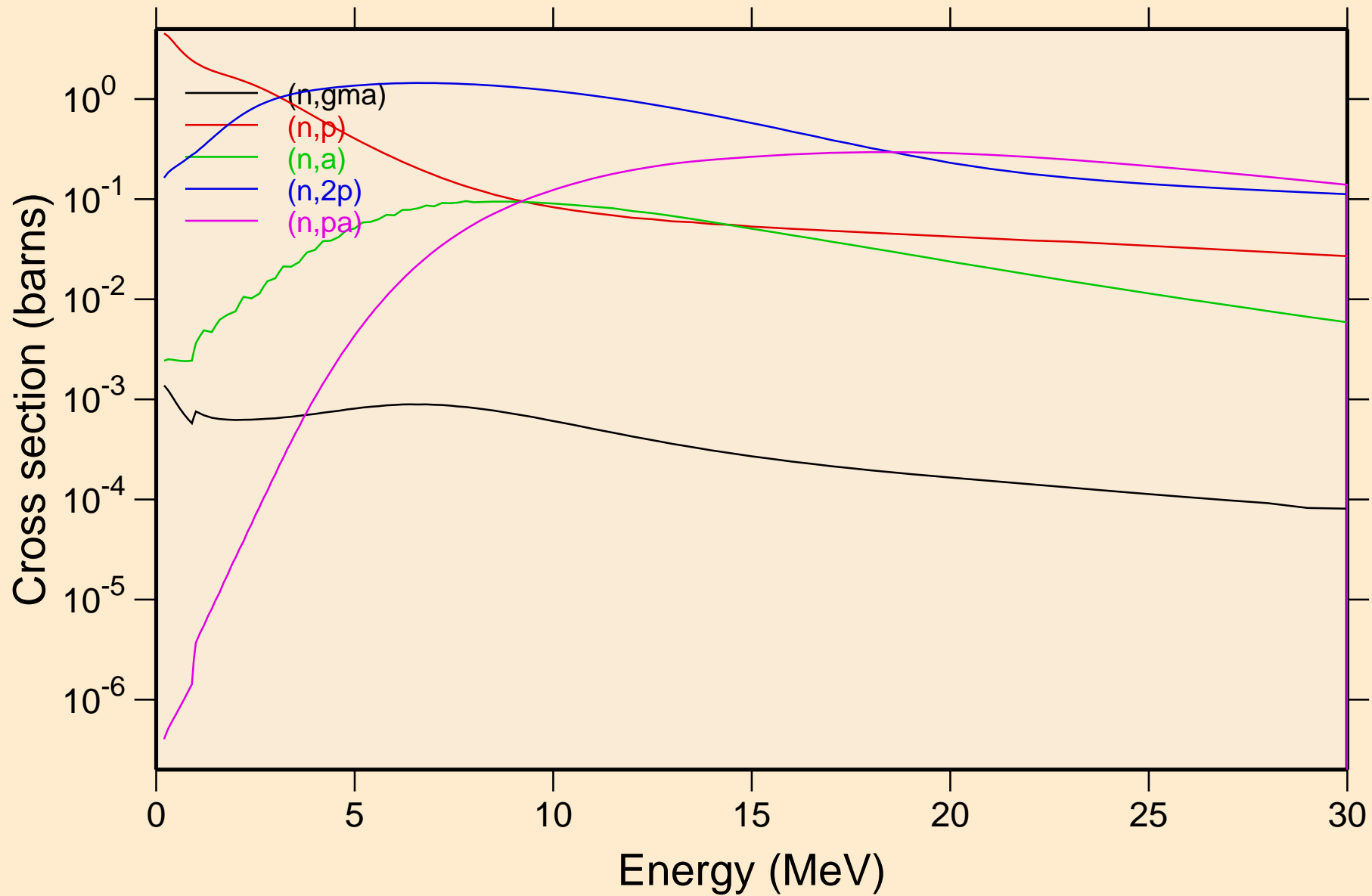

TC088M NEUTRON ACER TENDL-2021 LIBRARY; T=293.6K
Non-threshold reactions

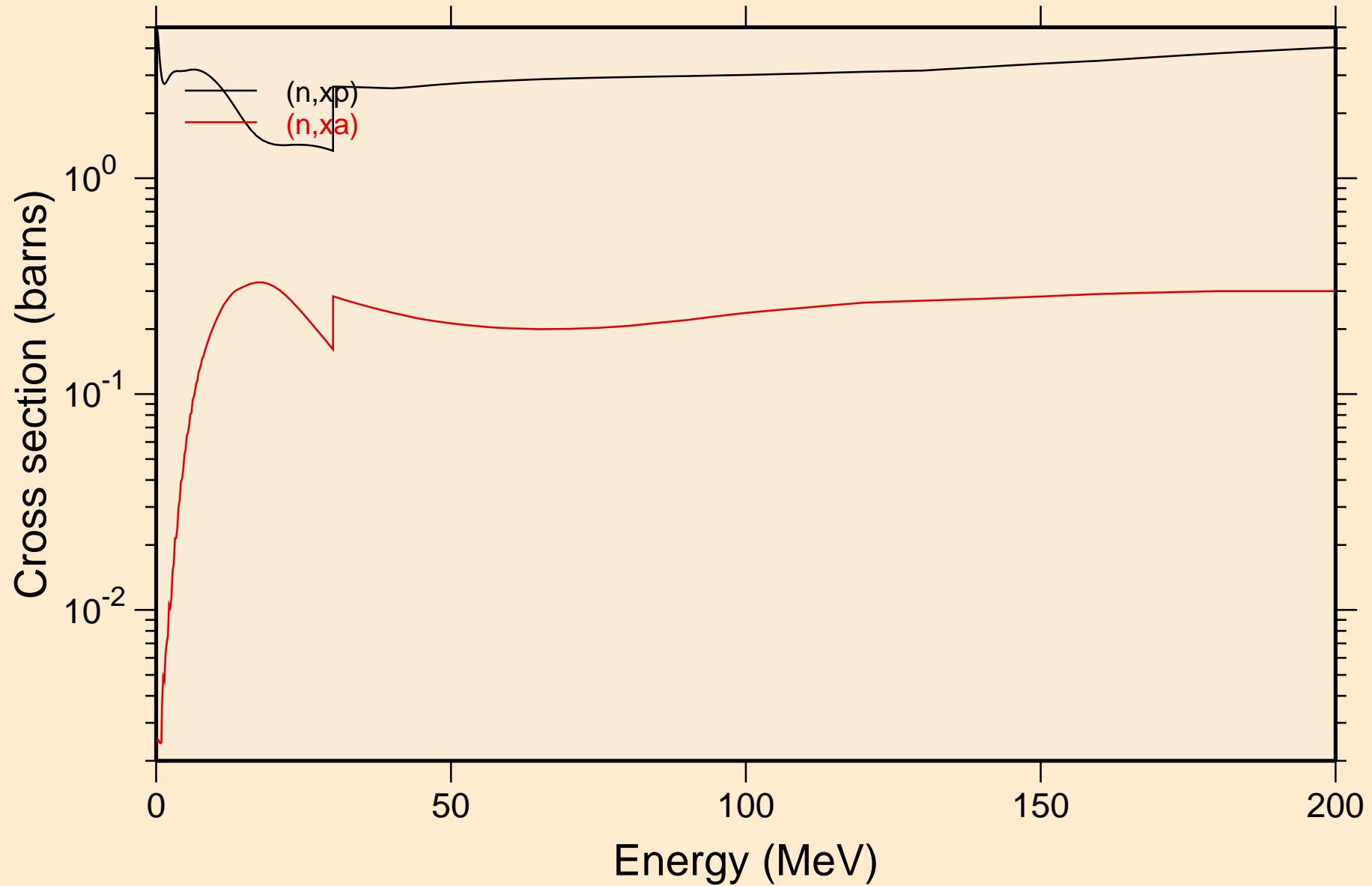

TC088M NEUTRON ACER TENDL-2021 LIBRARY; T=293.6K
Inelastic levels

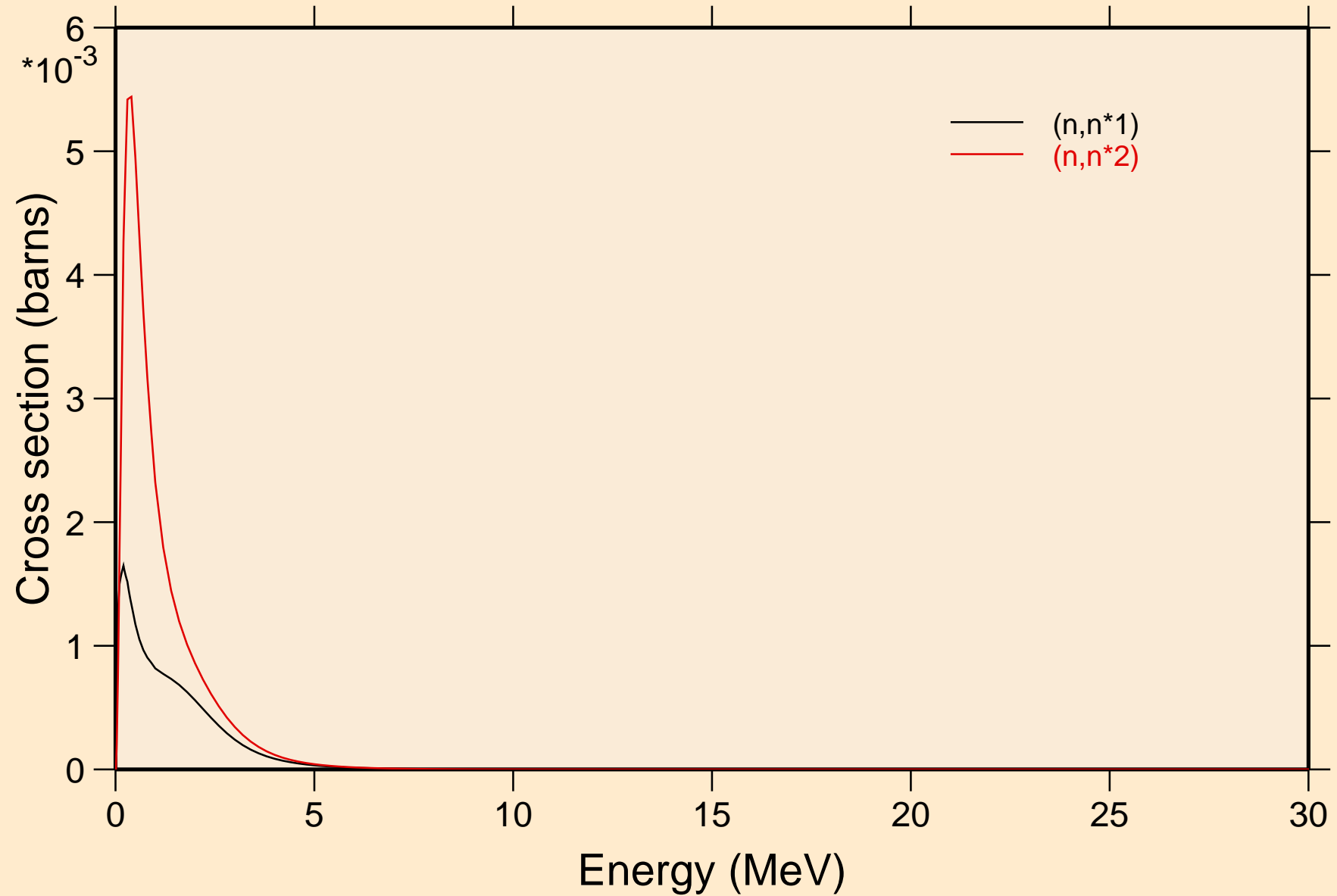

TC088M NEUTRON ACER TENDL-2021 LIBRARY; T=293.6K
Threshold reactions

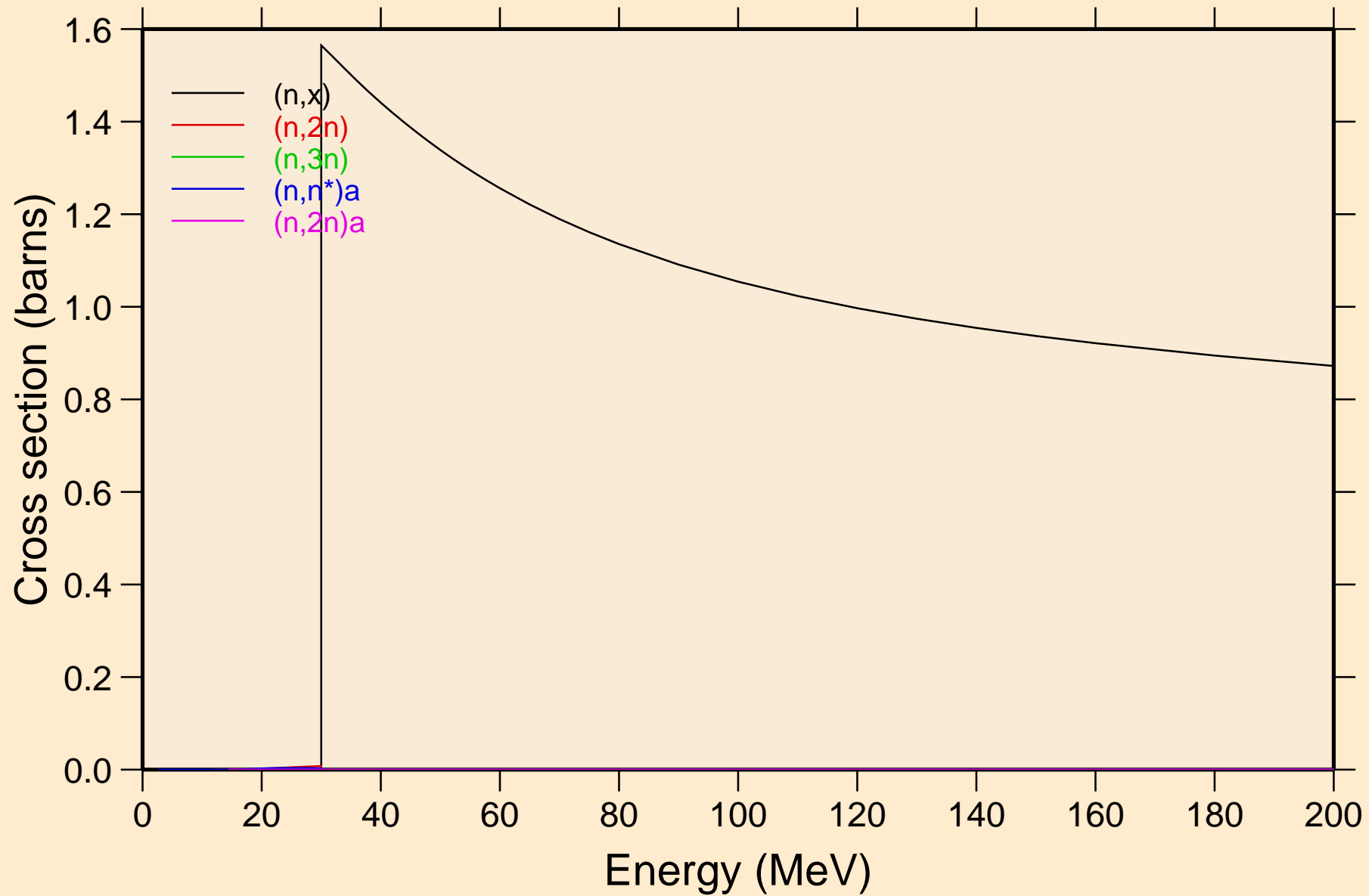

TC088M NEUTRON ACER TENDL-2021 LIBRARY; T=293.6K
Threshold reactions

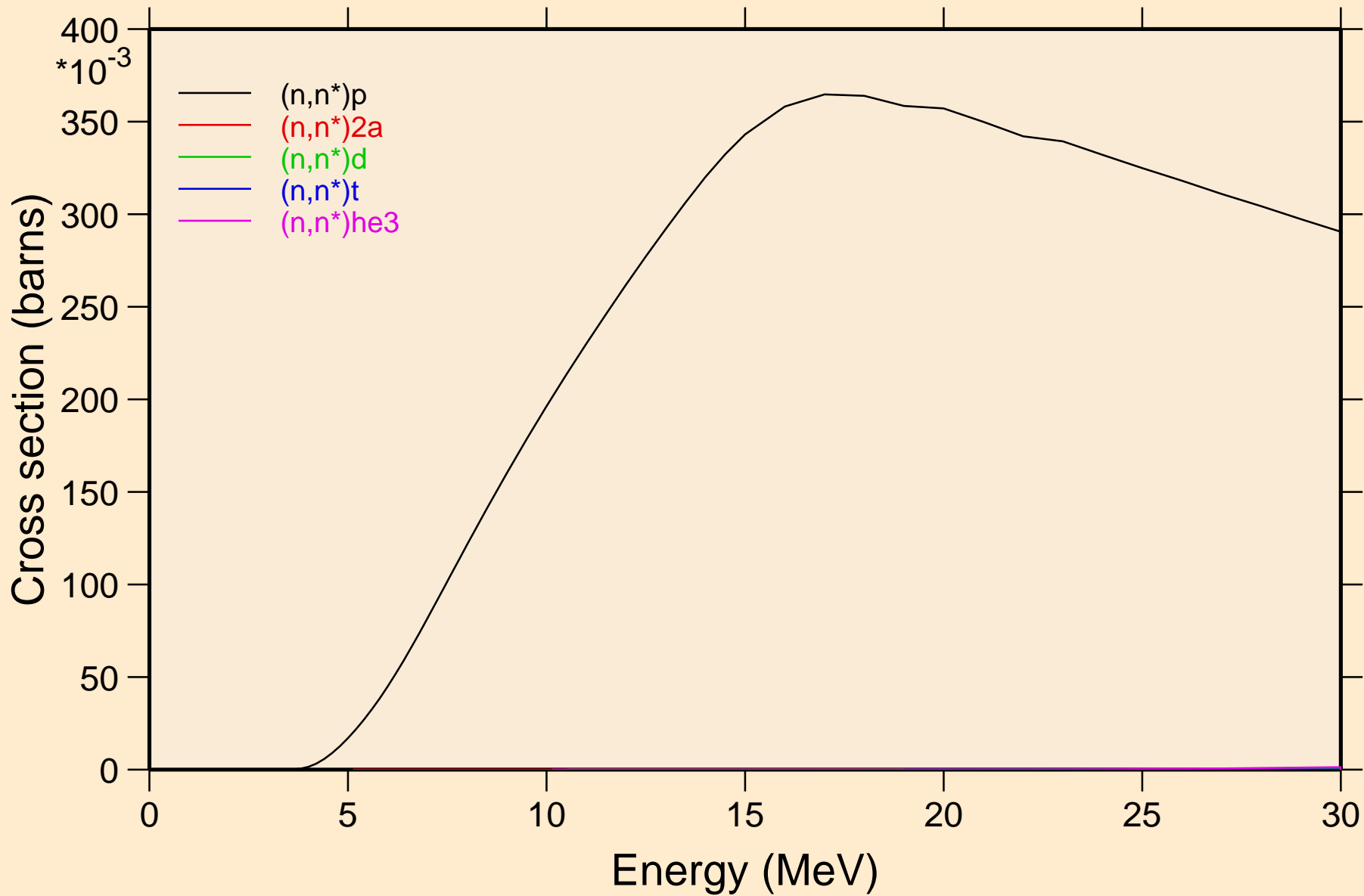

TC088M NEUTRON ACER TENDL-2021 LIBRARY; T=293.6K
Threshold reactions

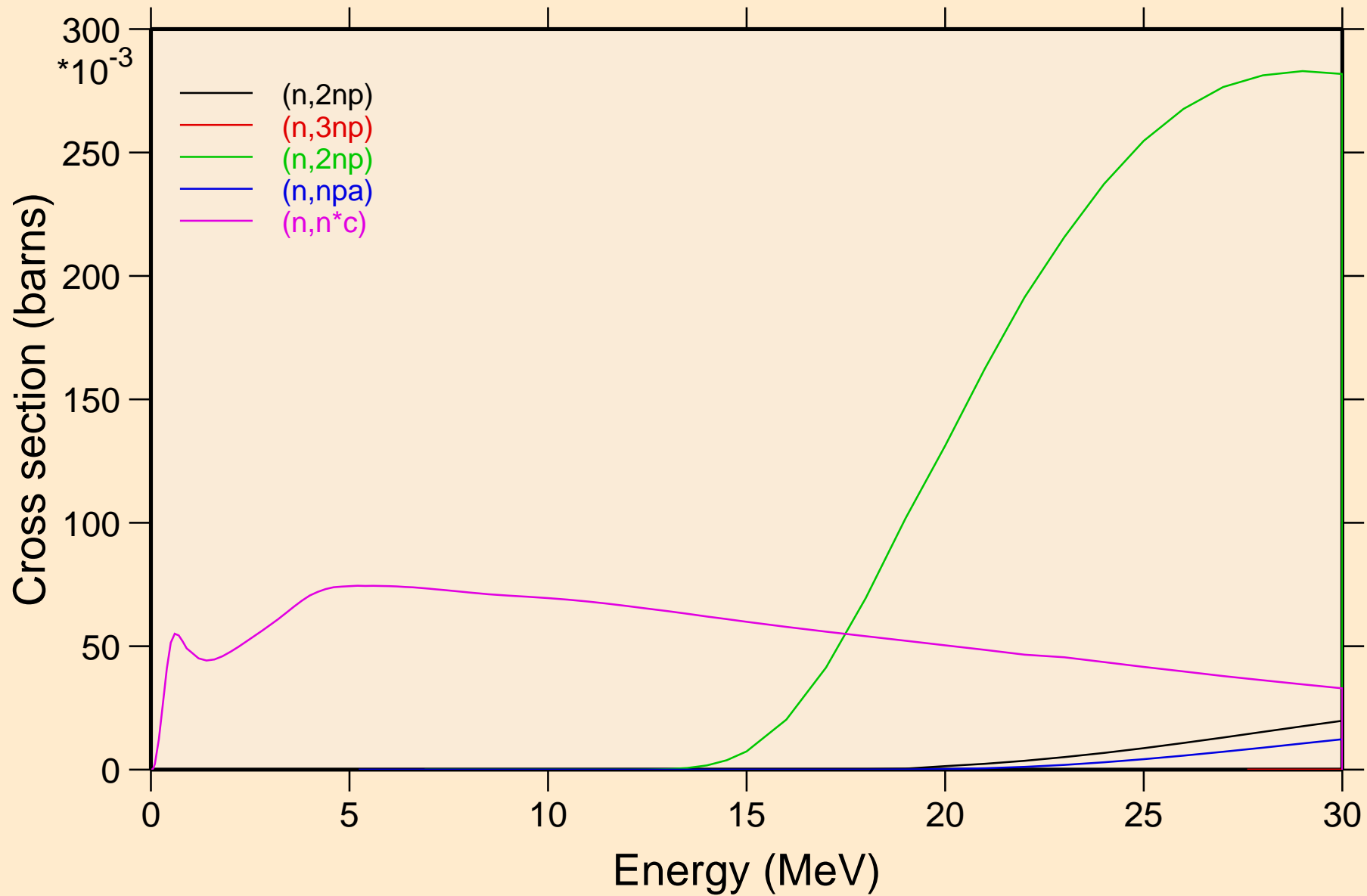

TC088M NEUTRON ACER TENDL-2021 LIBRARY; T=293.6K
Threshold reactions

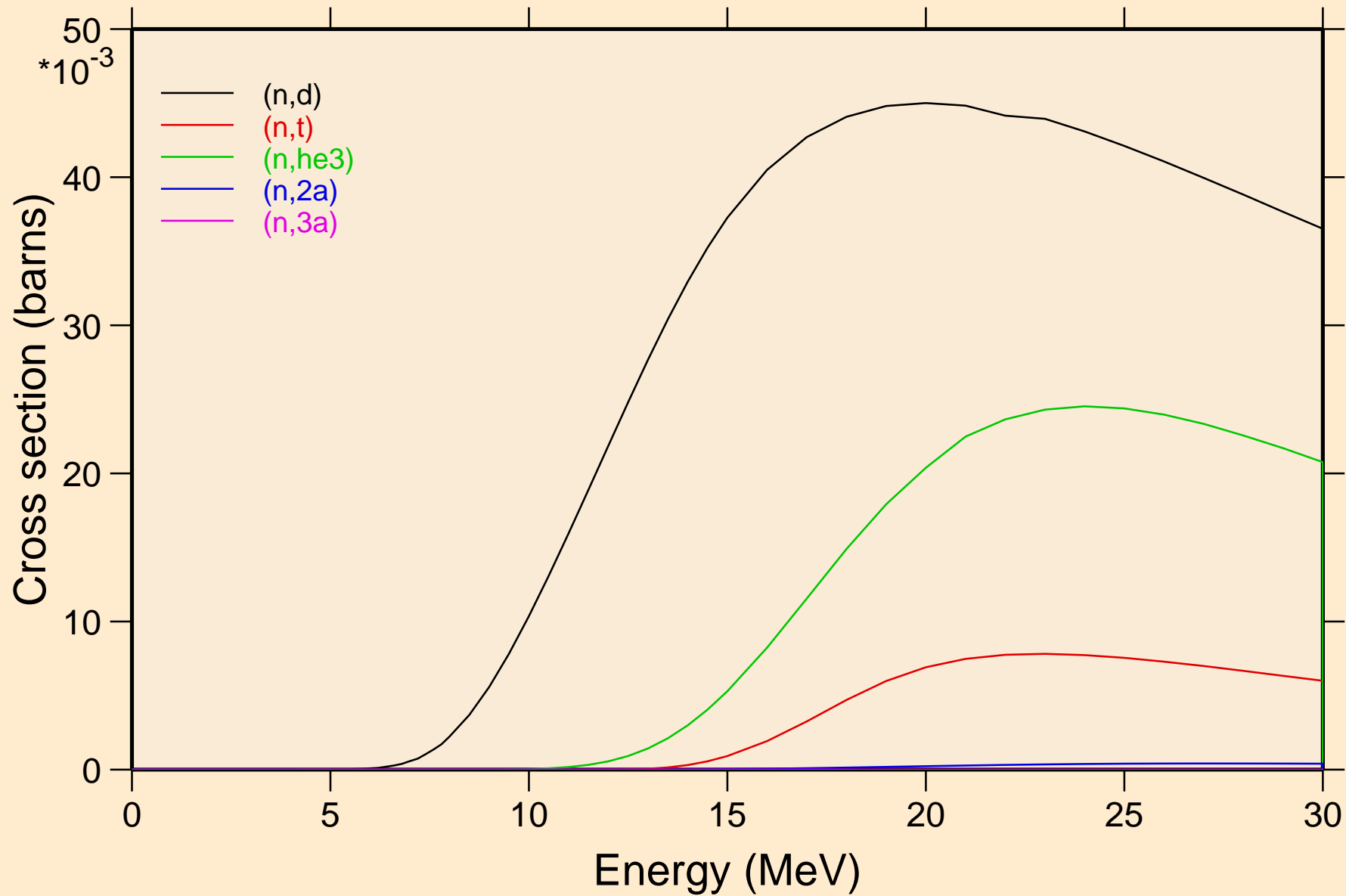

TC088M NEUTRON ACER TENDL-2021 LIBRARY; T=293.6K
Threshold reactions

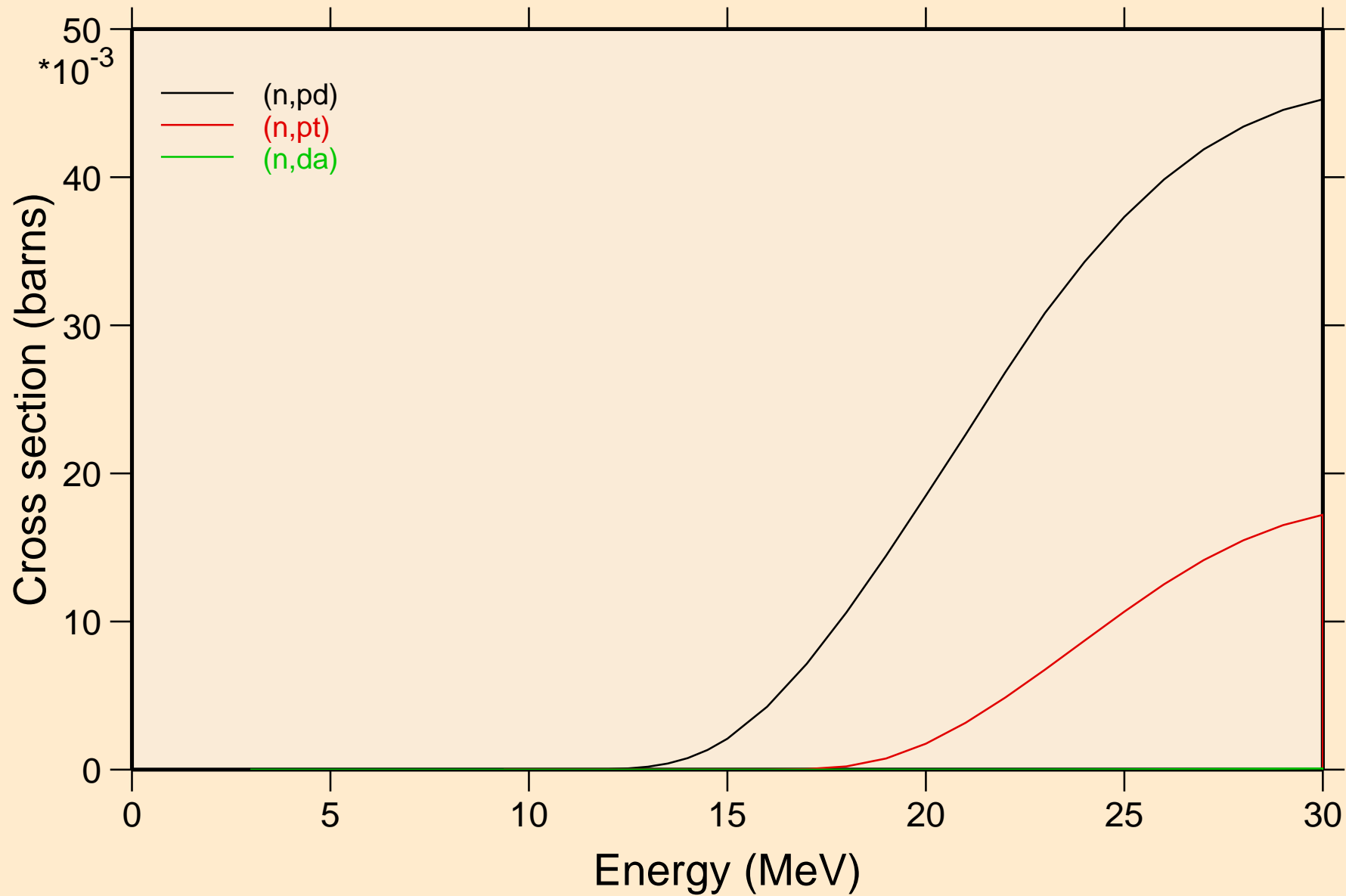

TC088M NEUTRON ACER TENDL-2021 LIBRARY; T=293.6K
Threshold reactions

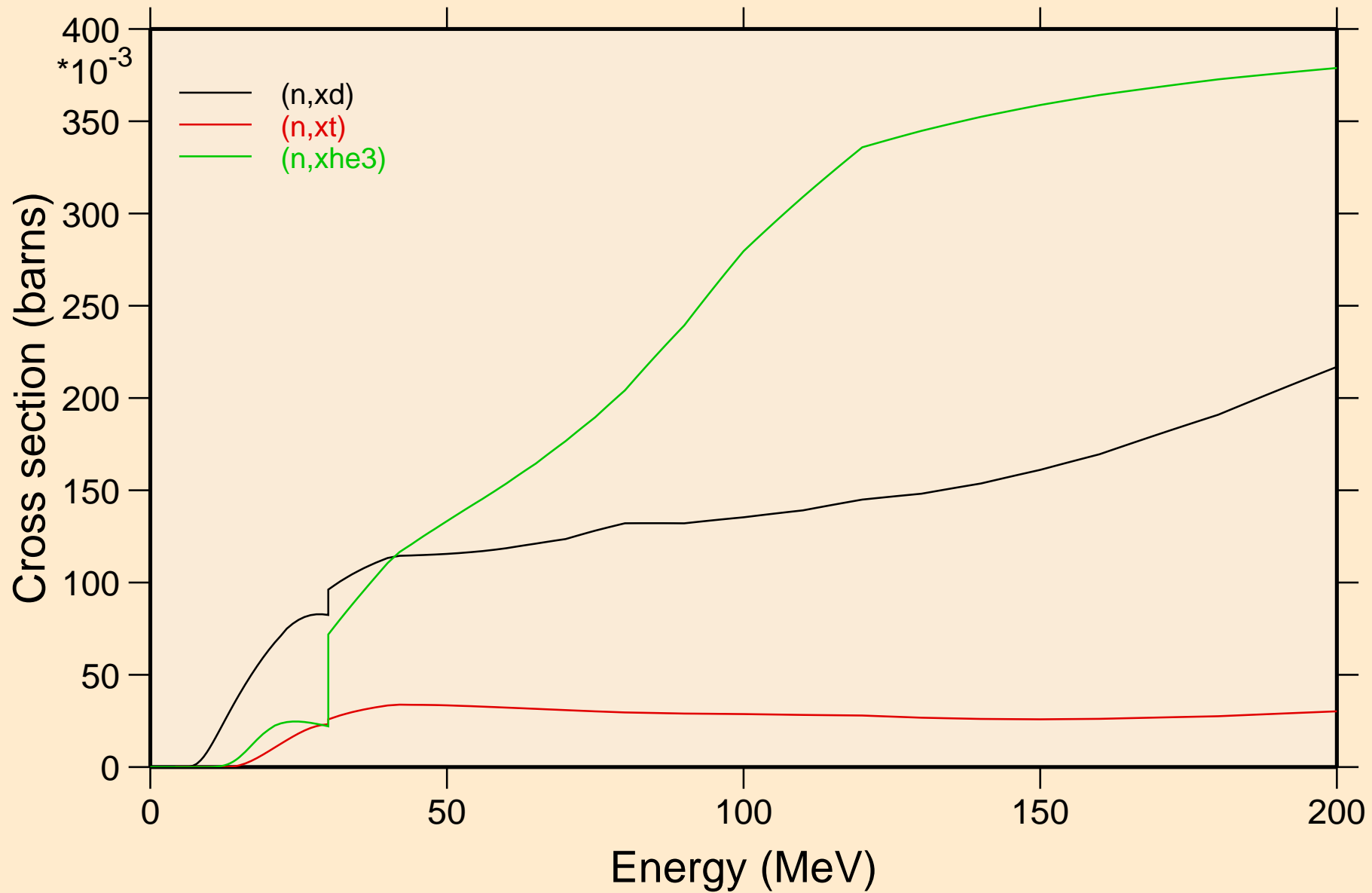

TC088M NEUTRON ACER TENDL-2021 LIBRARY; T=293.6K
angular distribution for elastic

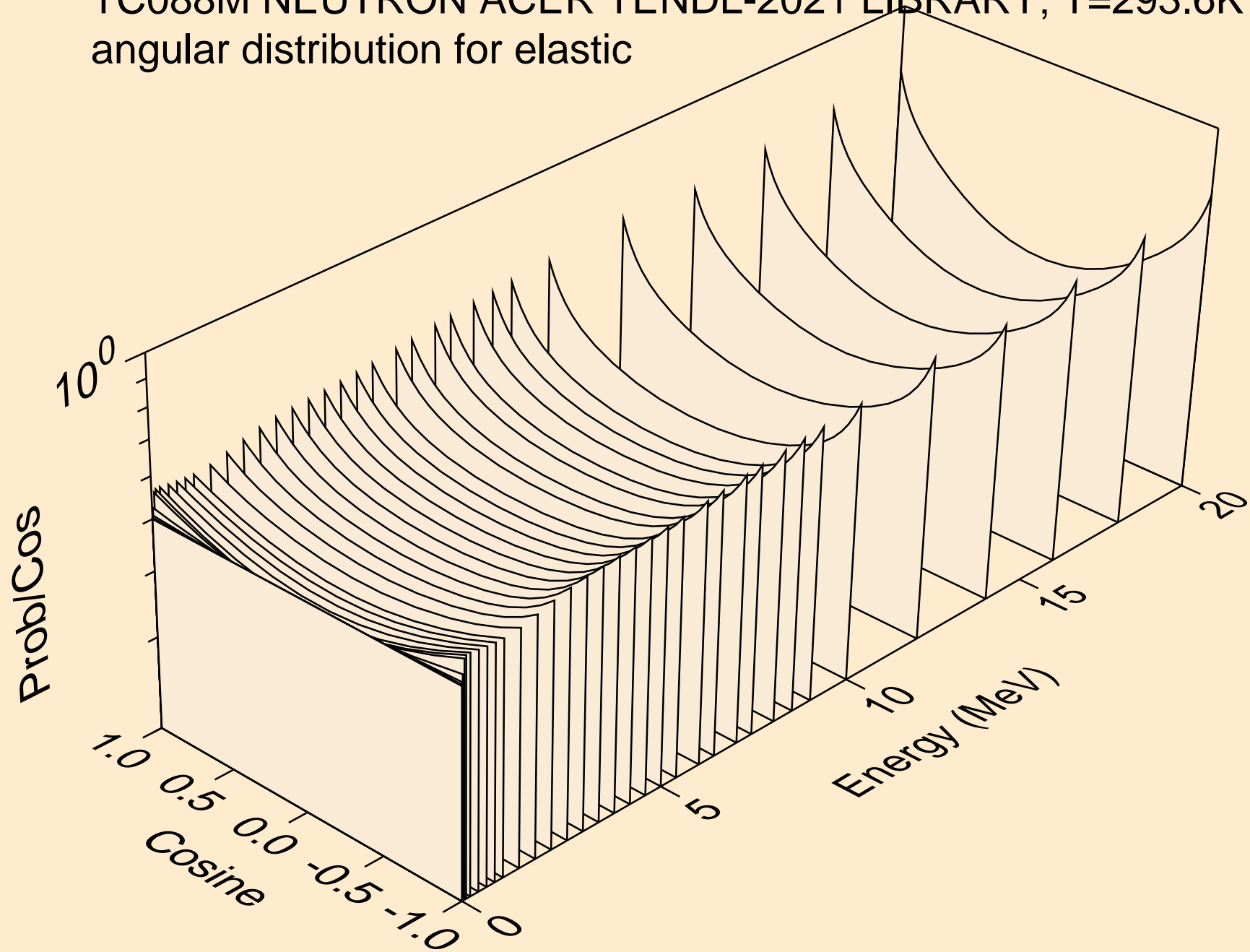

TC088M NEUTRON ACER TENDL-2021 LIBRARY; T=293.6K
angular distribution for elastic

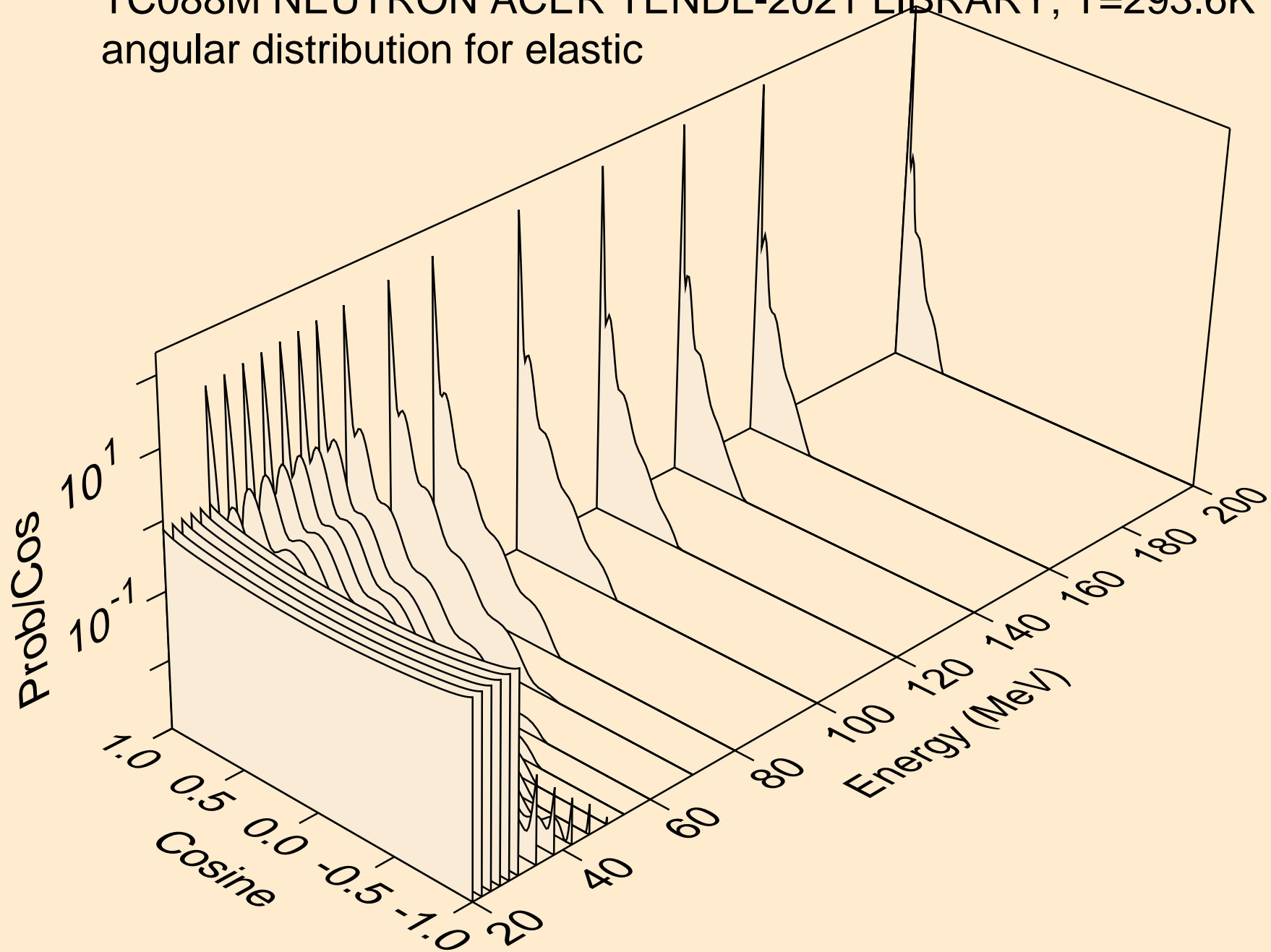

TC088M NEUTRON ACER TENDL-2021 LIBRARY; T=293.6K
angular distribution for (n,n*1)

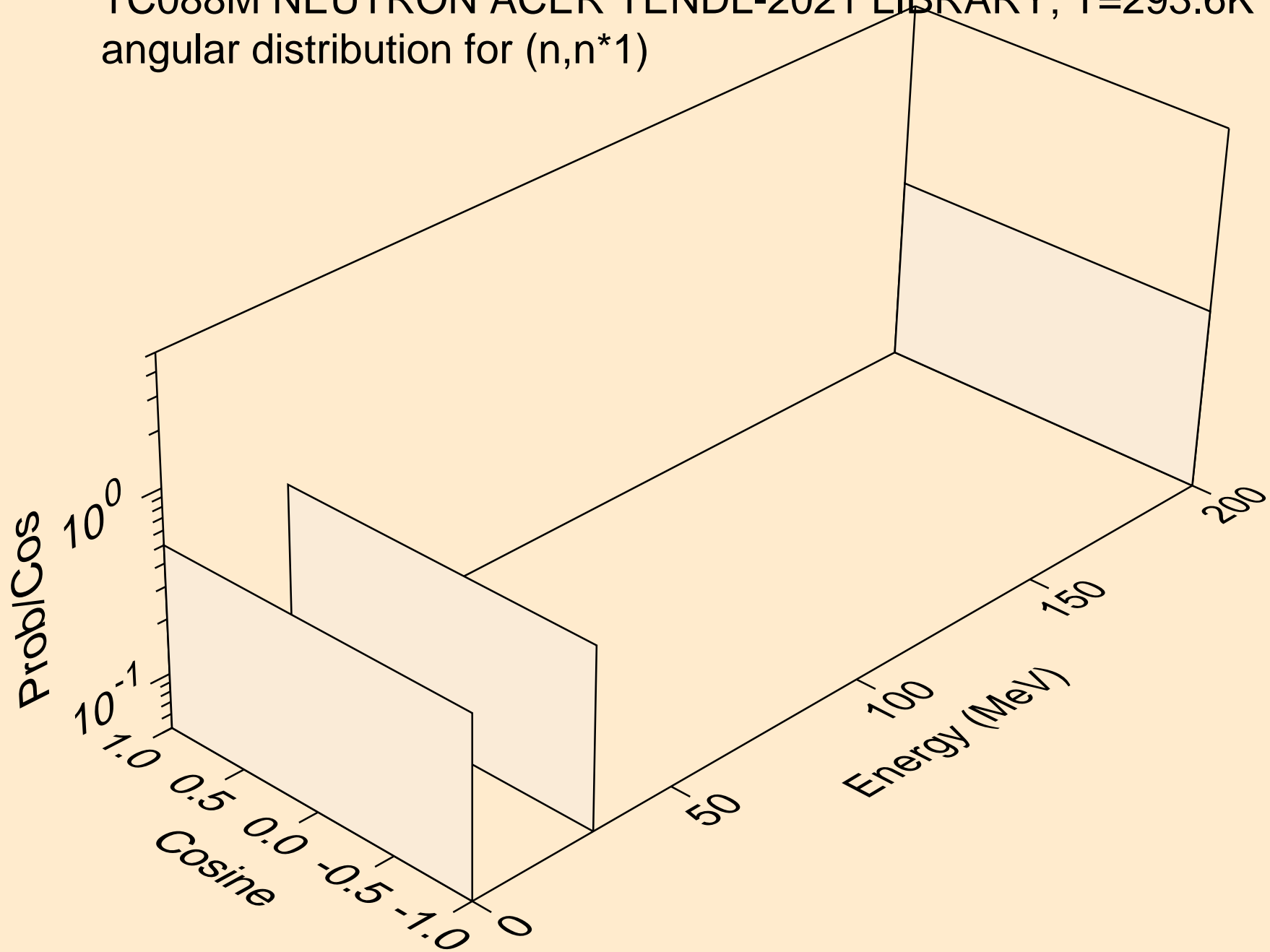

TC088M NEUTRON ACER TENDL-2021 LIBRARY; T=293.6K
angular distribution for (n,n*2)

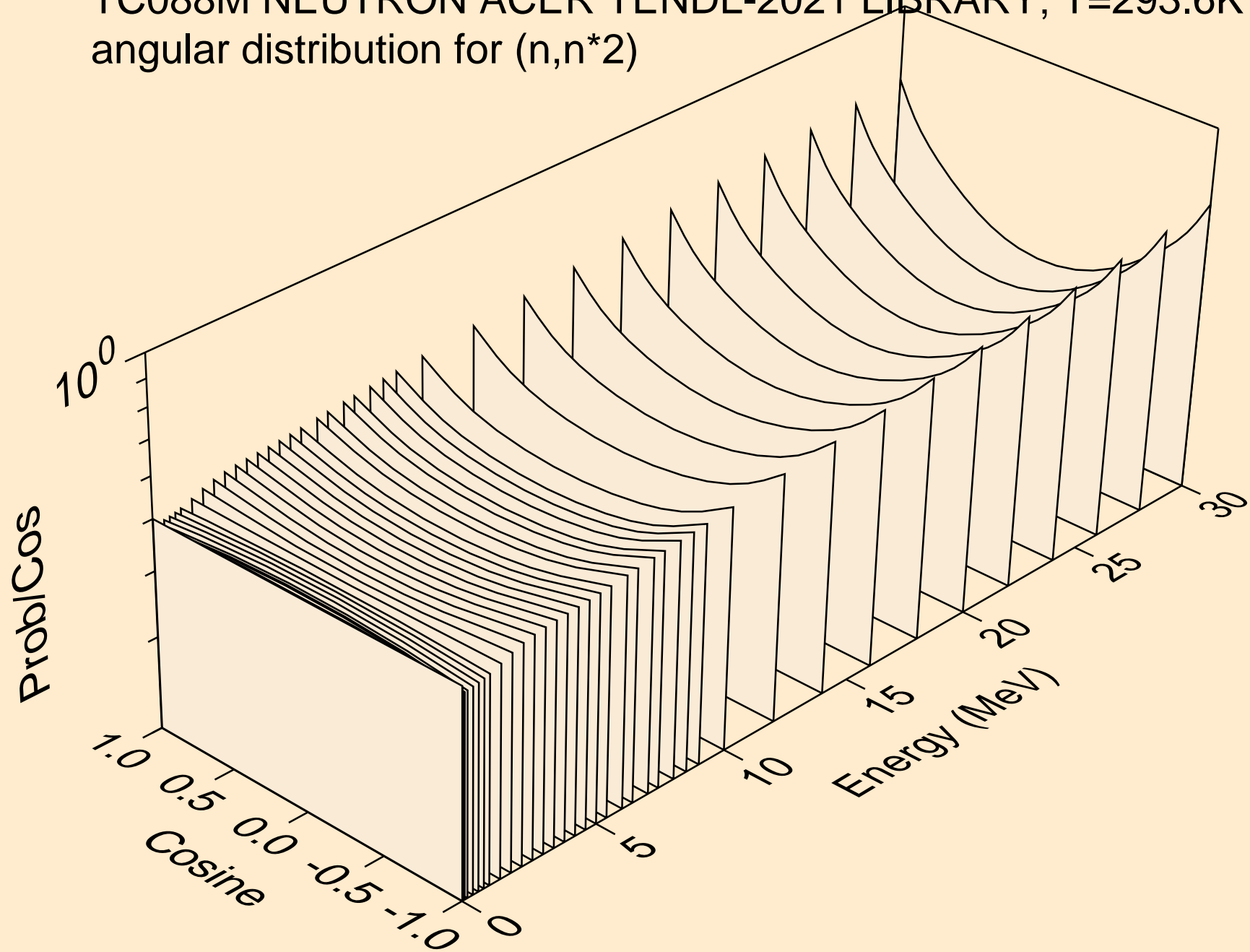

TC088M NEUTRON ACER TENDL-2021 LIBRARY; T=293.6K
Neutron emission for (n,x)

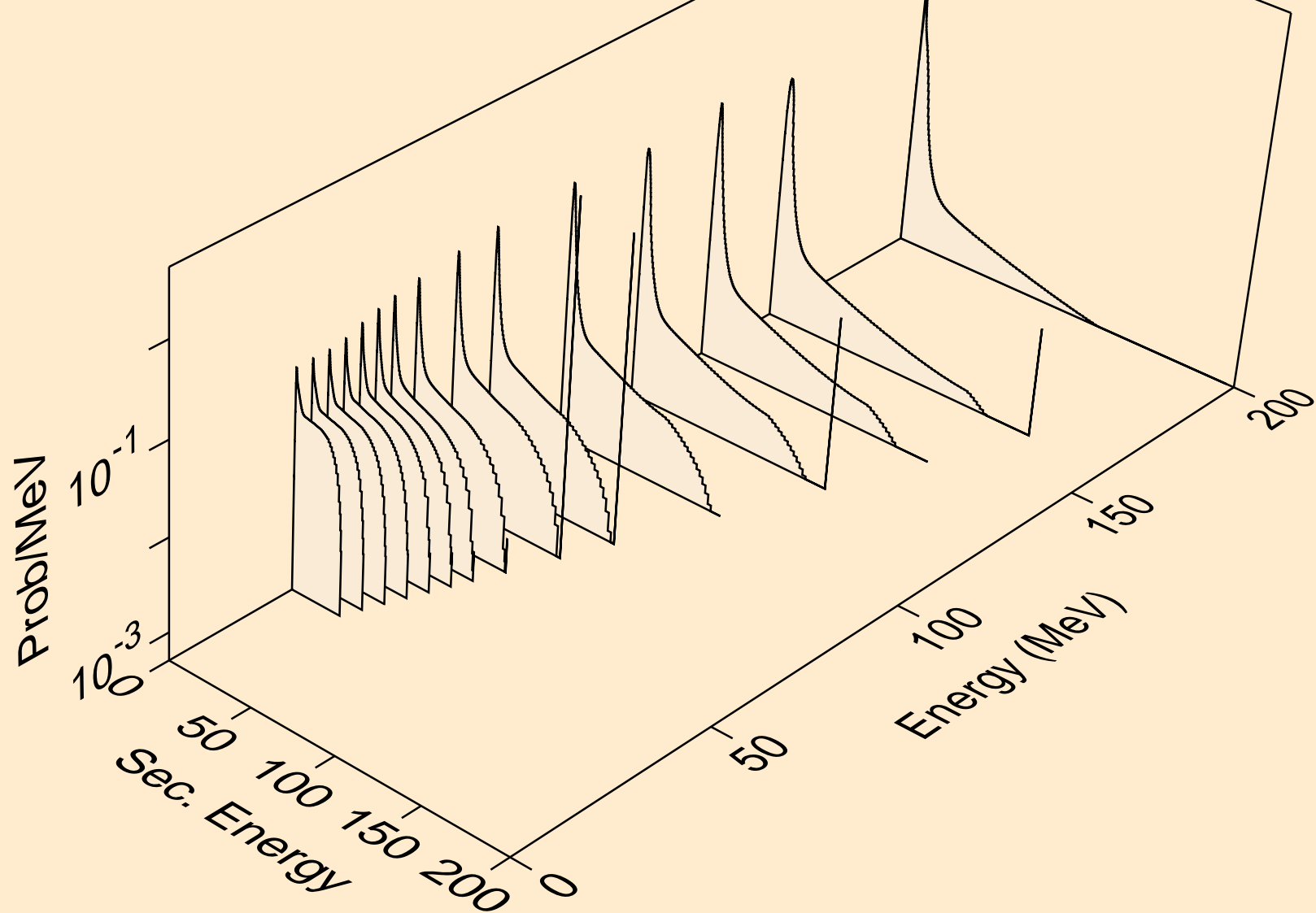

TC088M NEUTRON ACER TENDL-2021 LIBRARY; T=293.6K
Neutron emission for (n,2n)

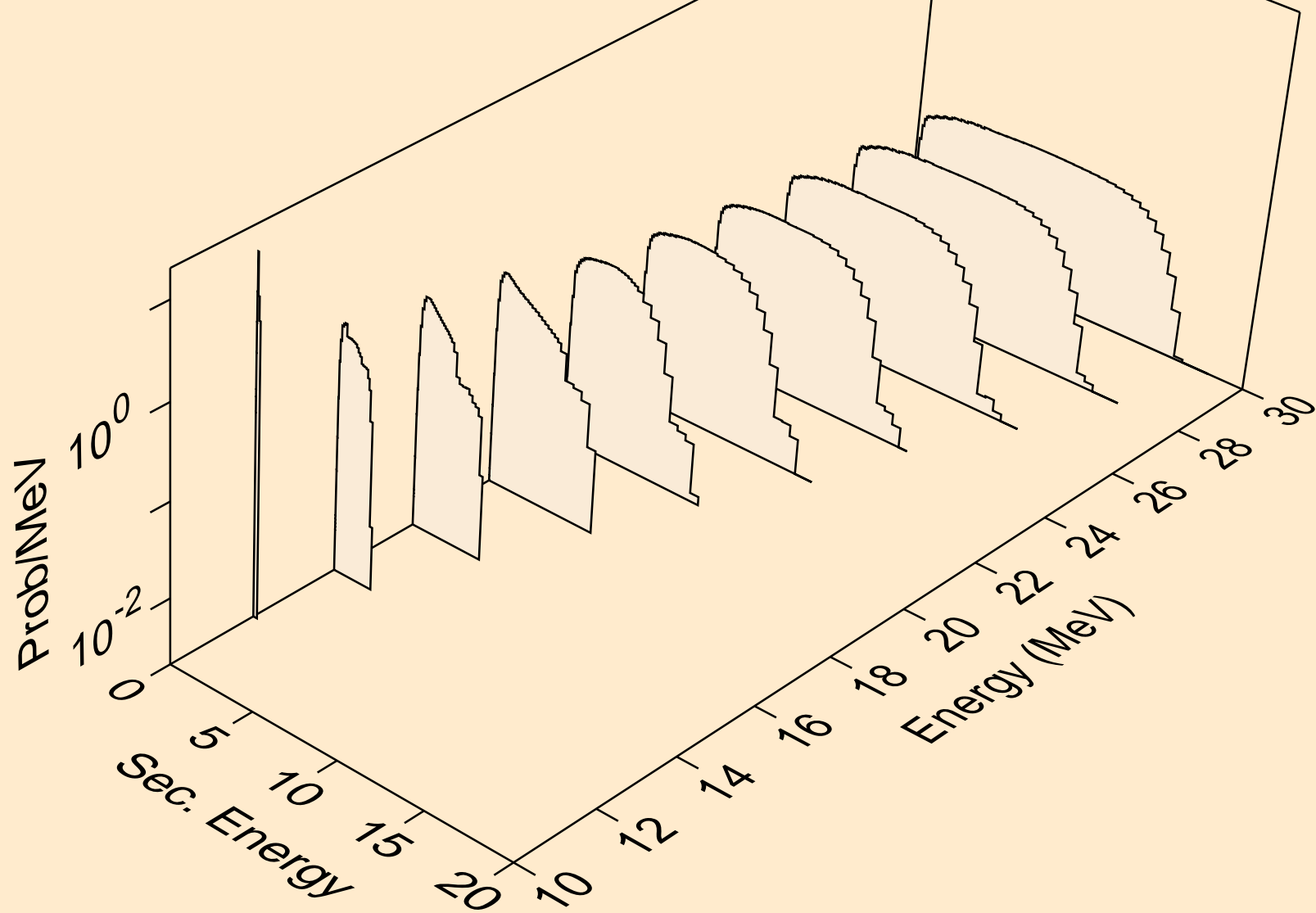

TC088M NEUTRON ACER TENDL-2021 LIBRARY; T=293.6K
Neutron emission for (n,3n)

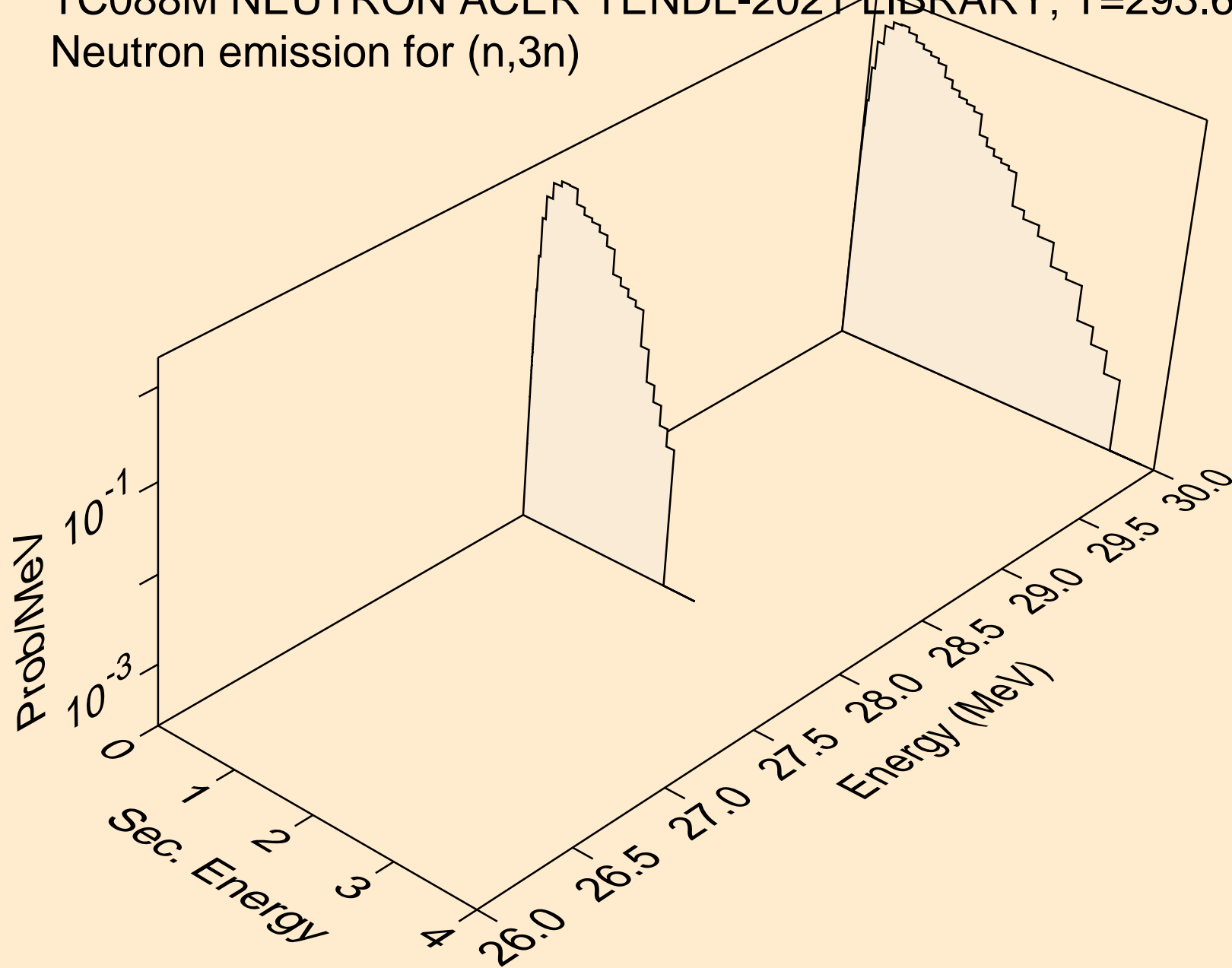

TC088M NEUTRON ACER TENDL-2021 LIBRARY; T=293.6K
Neutron emission for (n,n*)a

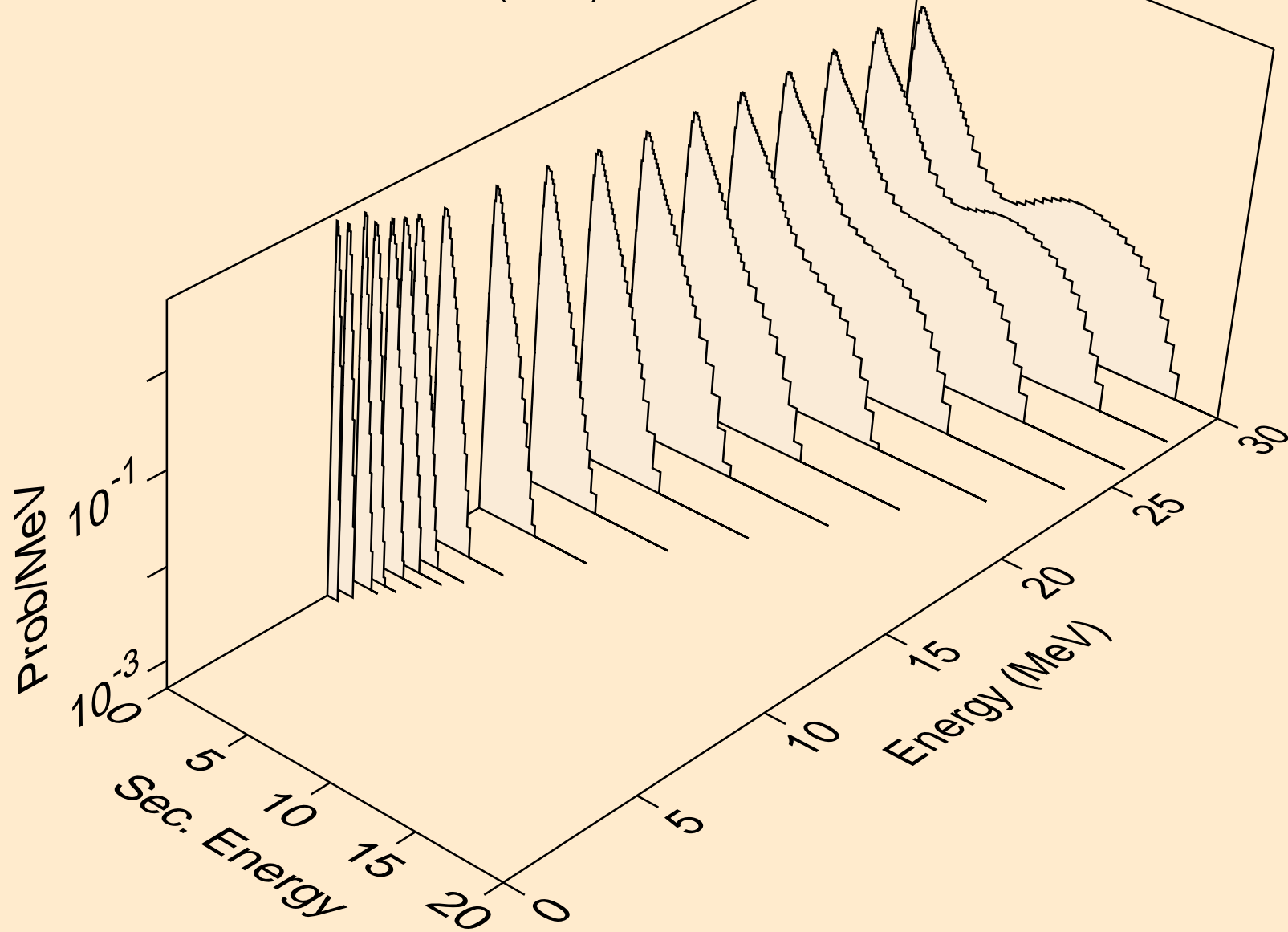

TC088M NEUTRON ACER TENDL-2021 LIBRARY; T=293.6K
Neutron emission for (n,2n)_a

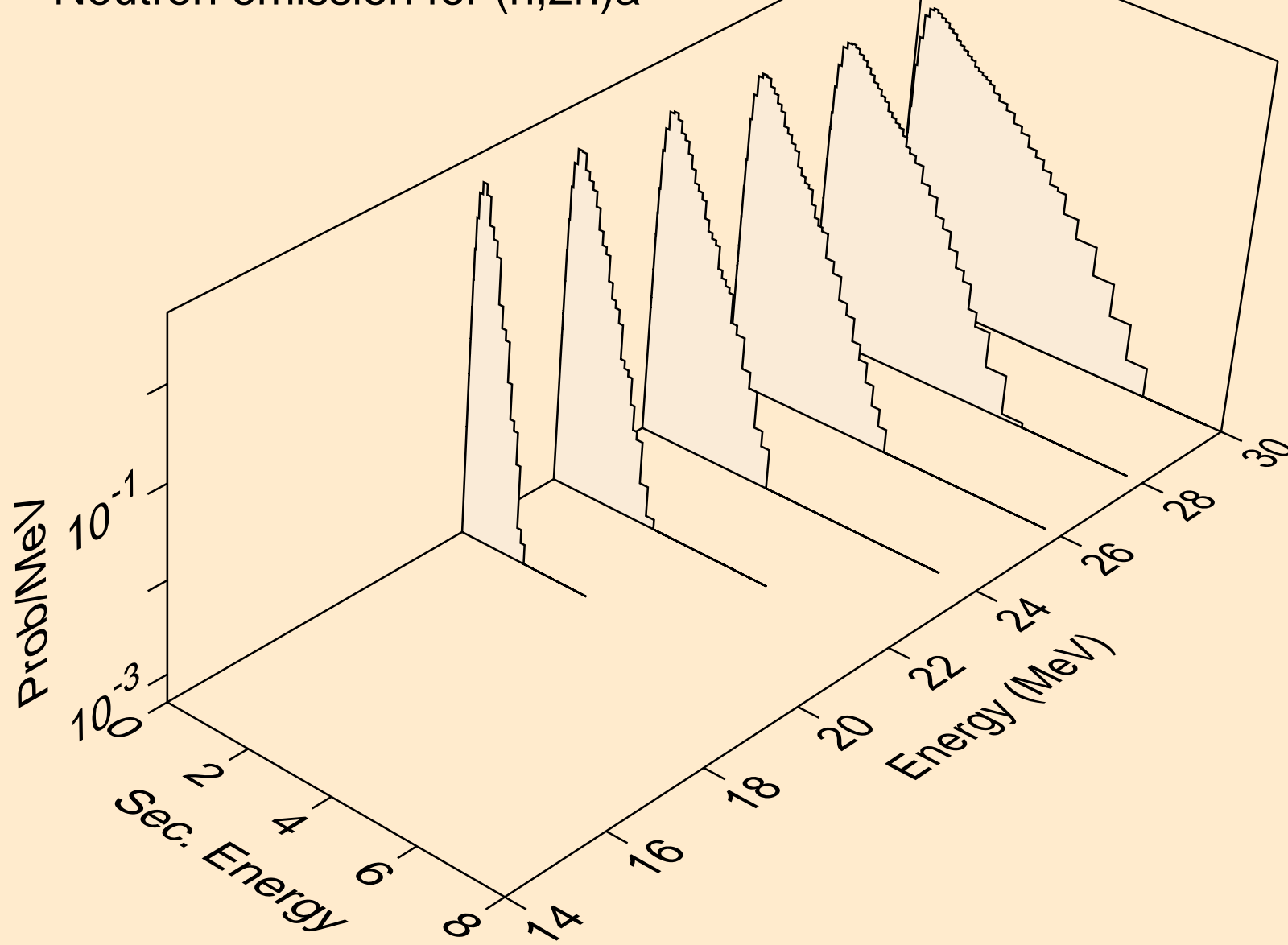

TC088M NEUTRON ACER TENDL-2021 LIBRARY; T=293.6K
Neutron emission for (n,n*)p

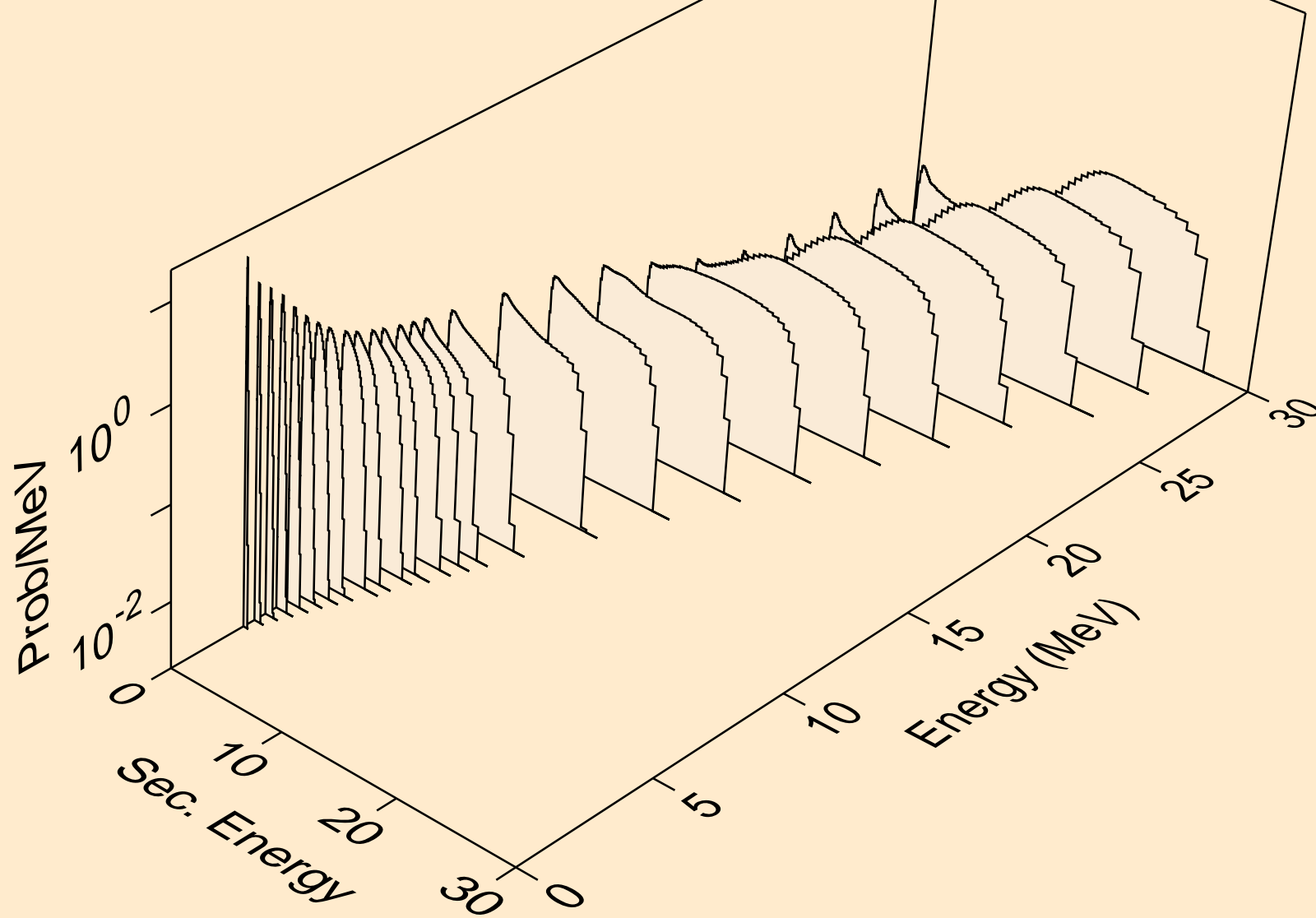

TC088M NEUTRON ACER TENDL-2021 LIBRARY; T=293.6K
Neutron emission for (n,n*)2a

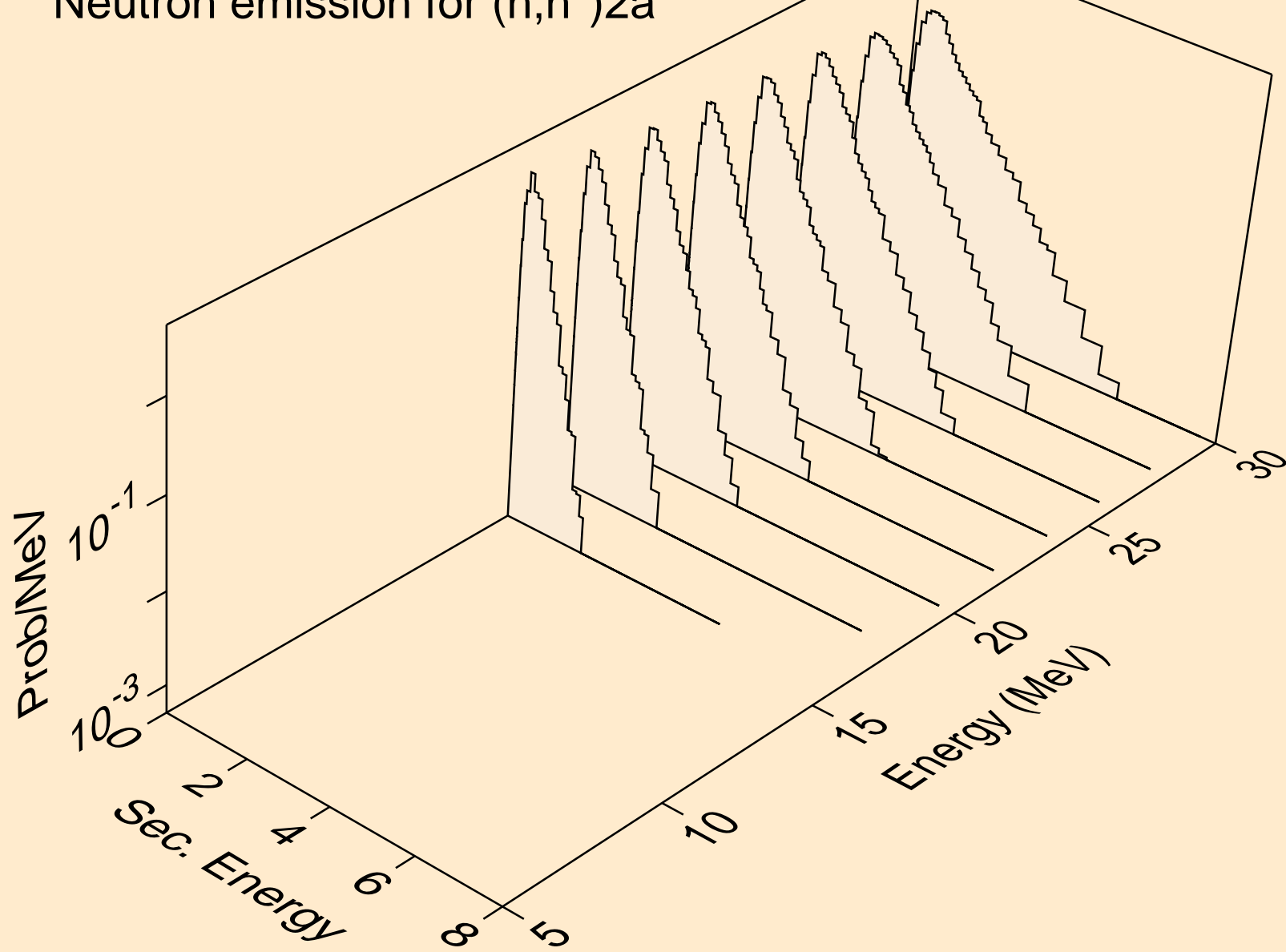

TC088M NEUTRON ACER TENDL-2021 LIBRARY; T=293.6K
Neutron emission for (n,n*)d

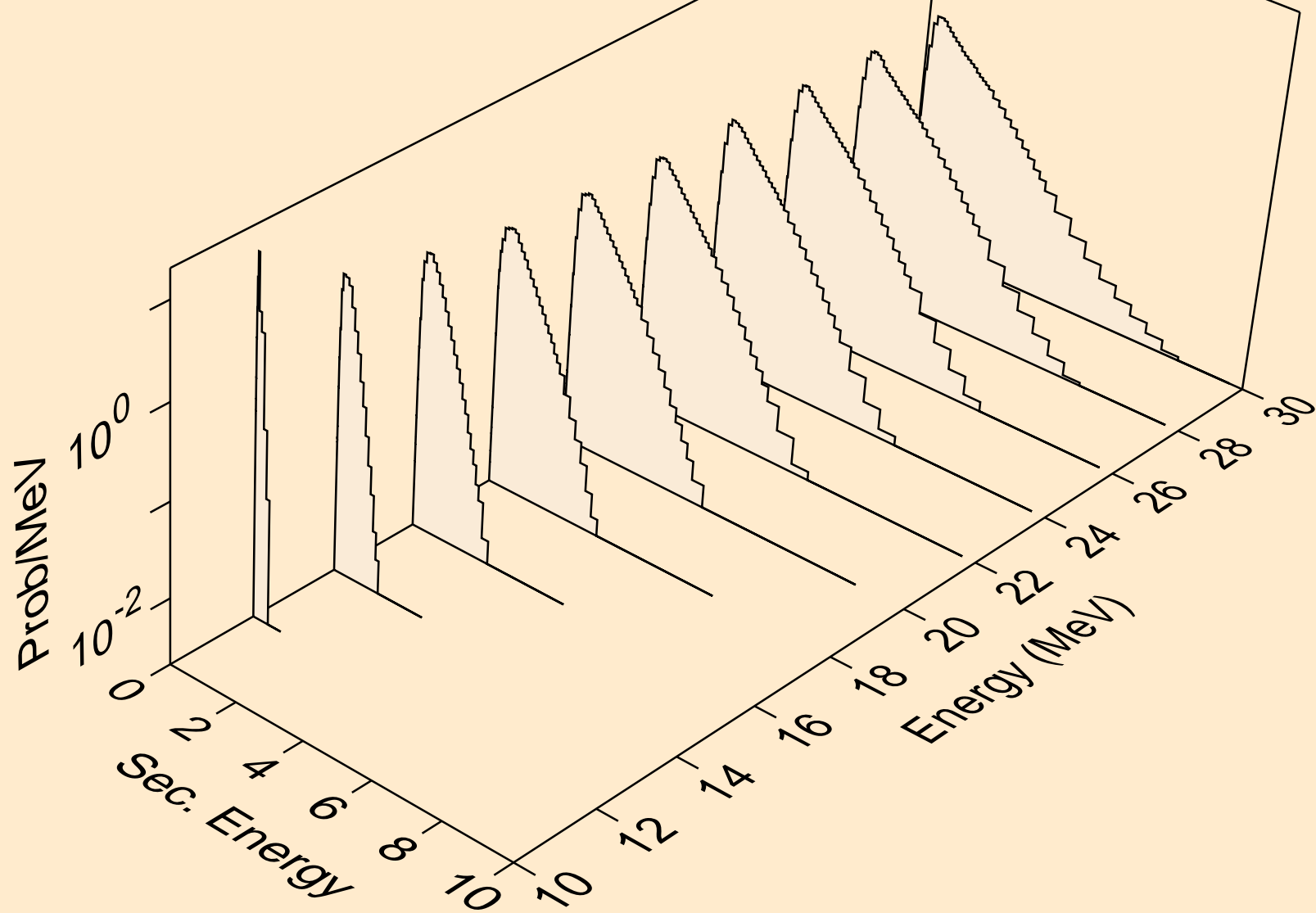

TC088M NEUTRON ACER TENDL-2021 LIBRARY; T=293.6K
Neutron emission for (n,n*)t

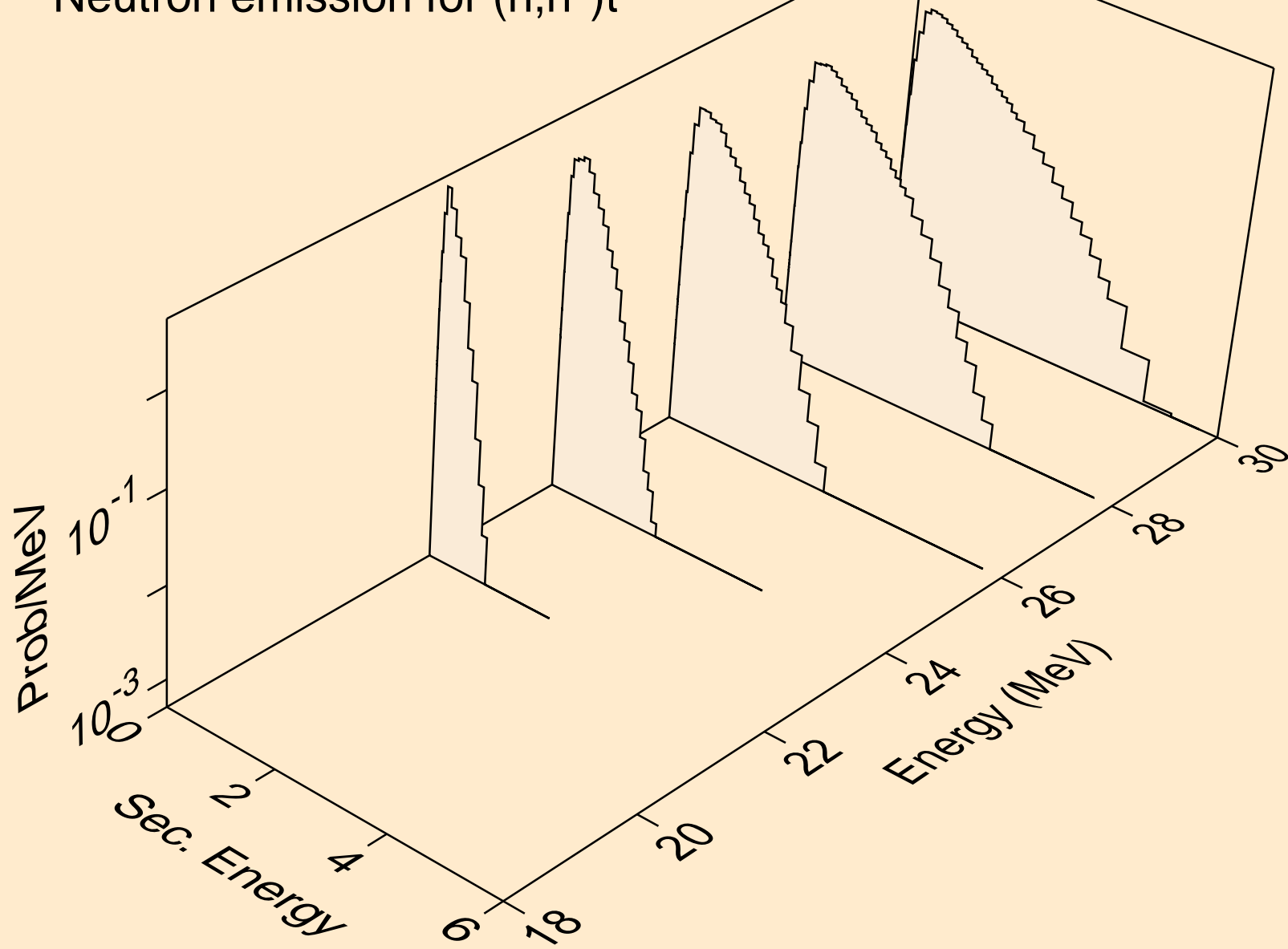

TC088M NEUTRON ACER TENDL-2021 LIBRARY; T=293.6K
Neutron emission for (n,n*)he3

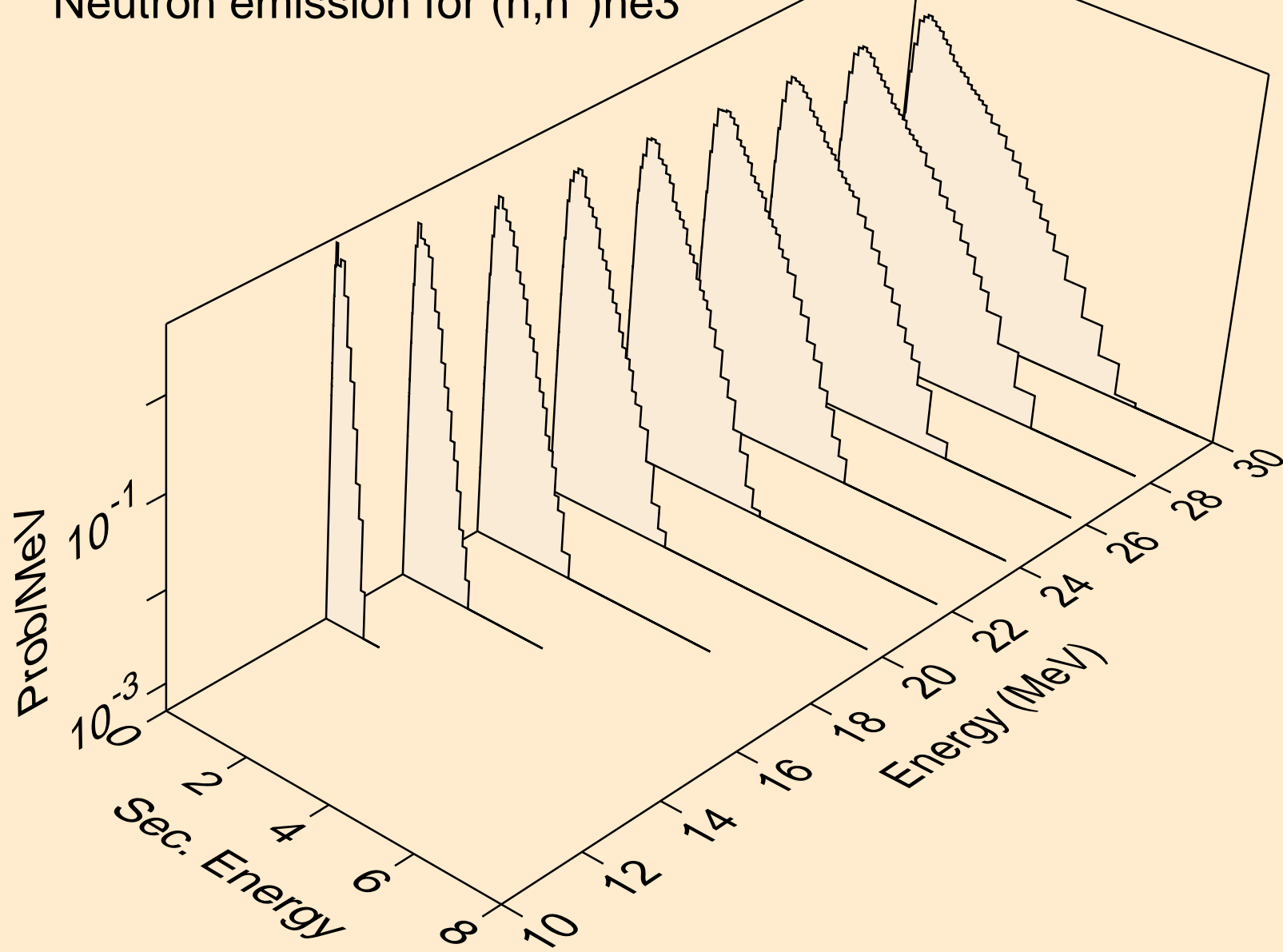

TC088M NEUTRON ACER TENDL-2021 LIBRARY; T=293.6K
Neutron emission for (n,2np)

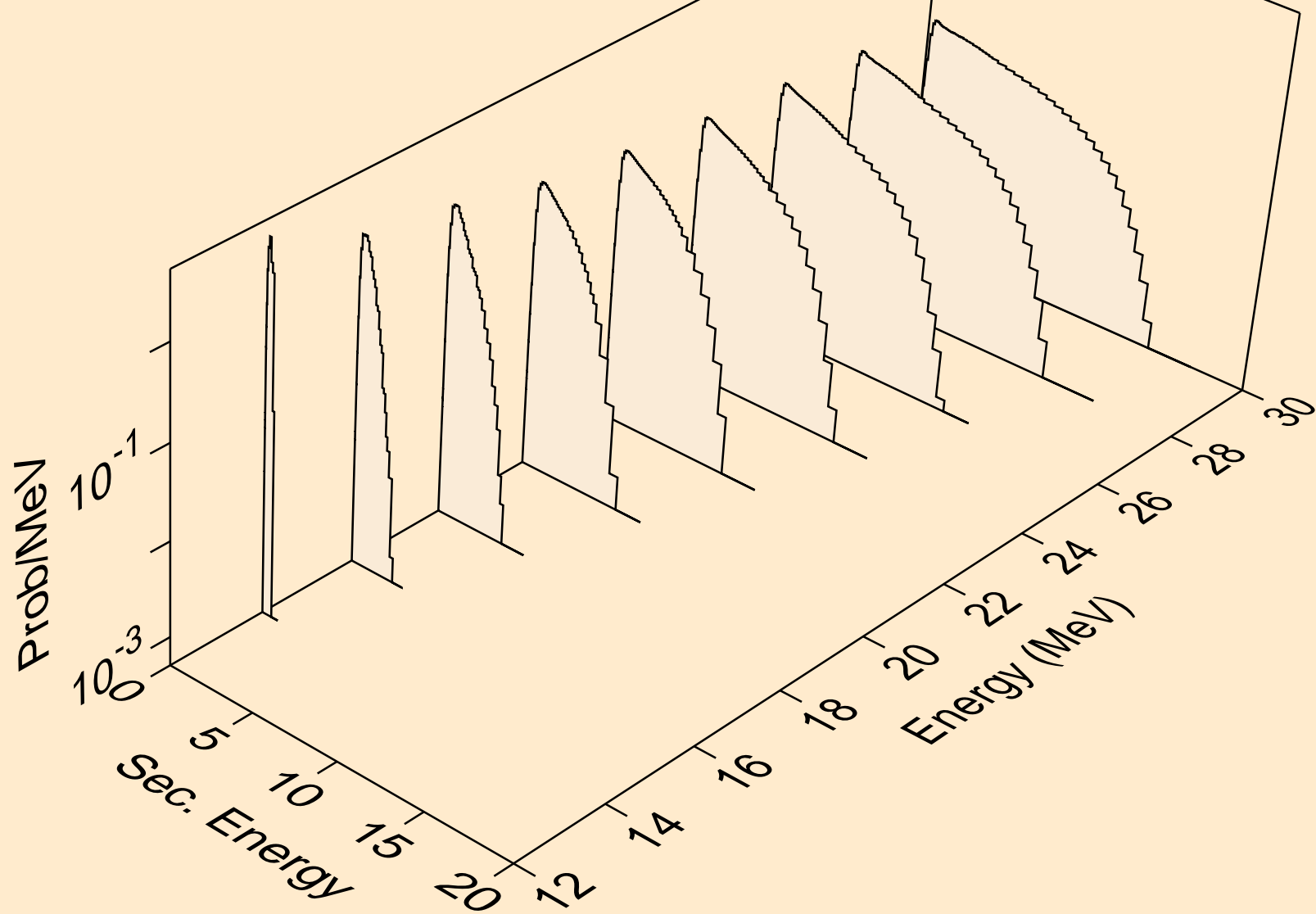

TC088M NEUTRON ACER TENDL-2021 LIBRARY; T=293.6K
Neutron emission for (n,3np)

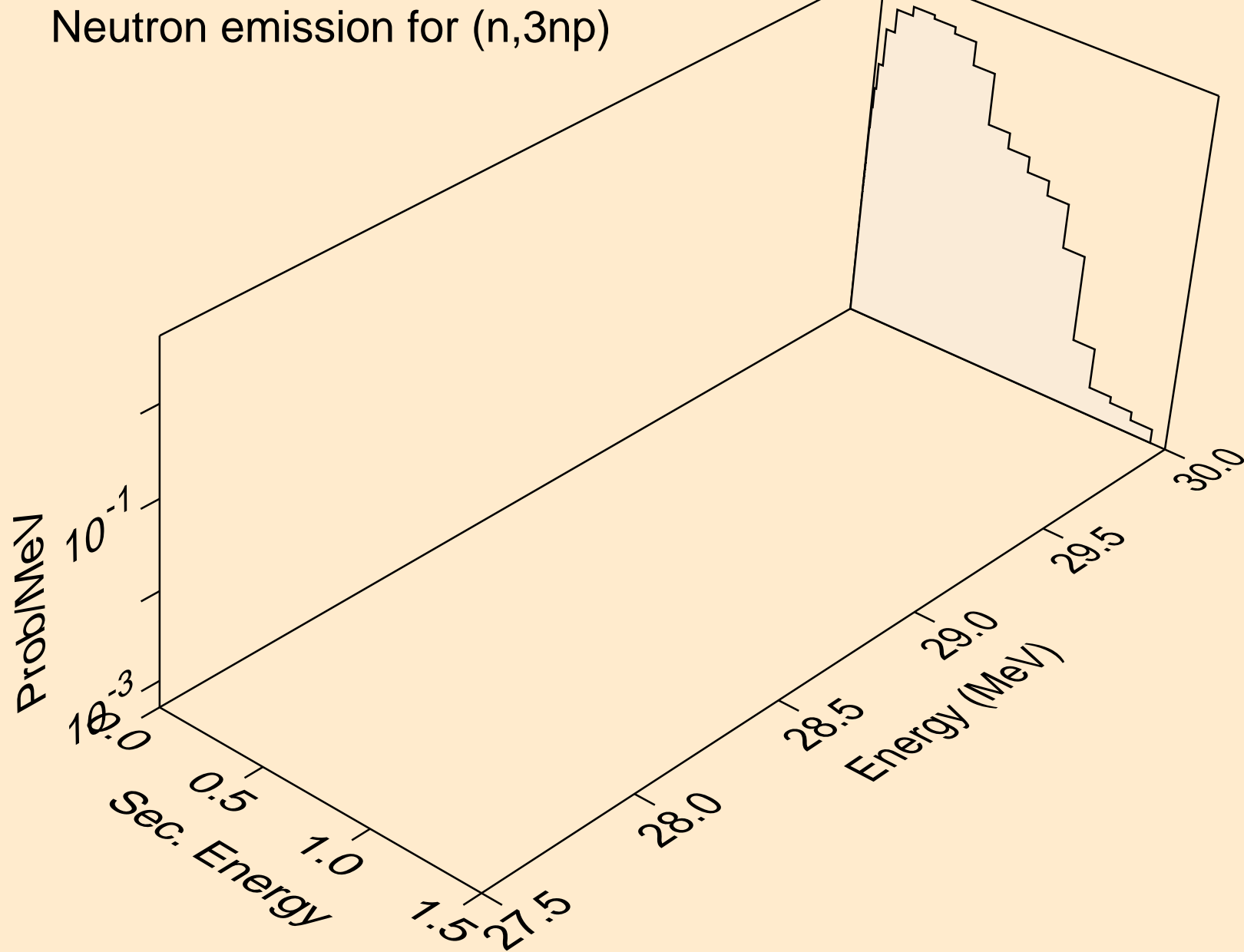

TC088M NEUTRON ACER TENDL-2021 LIBRARY; T=293.6K
Neutron emission for (n,2np)

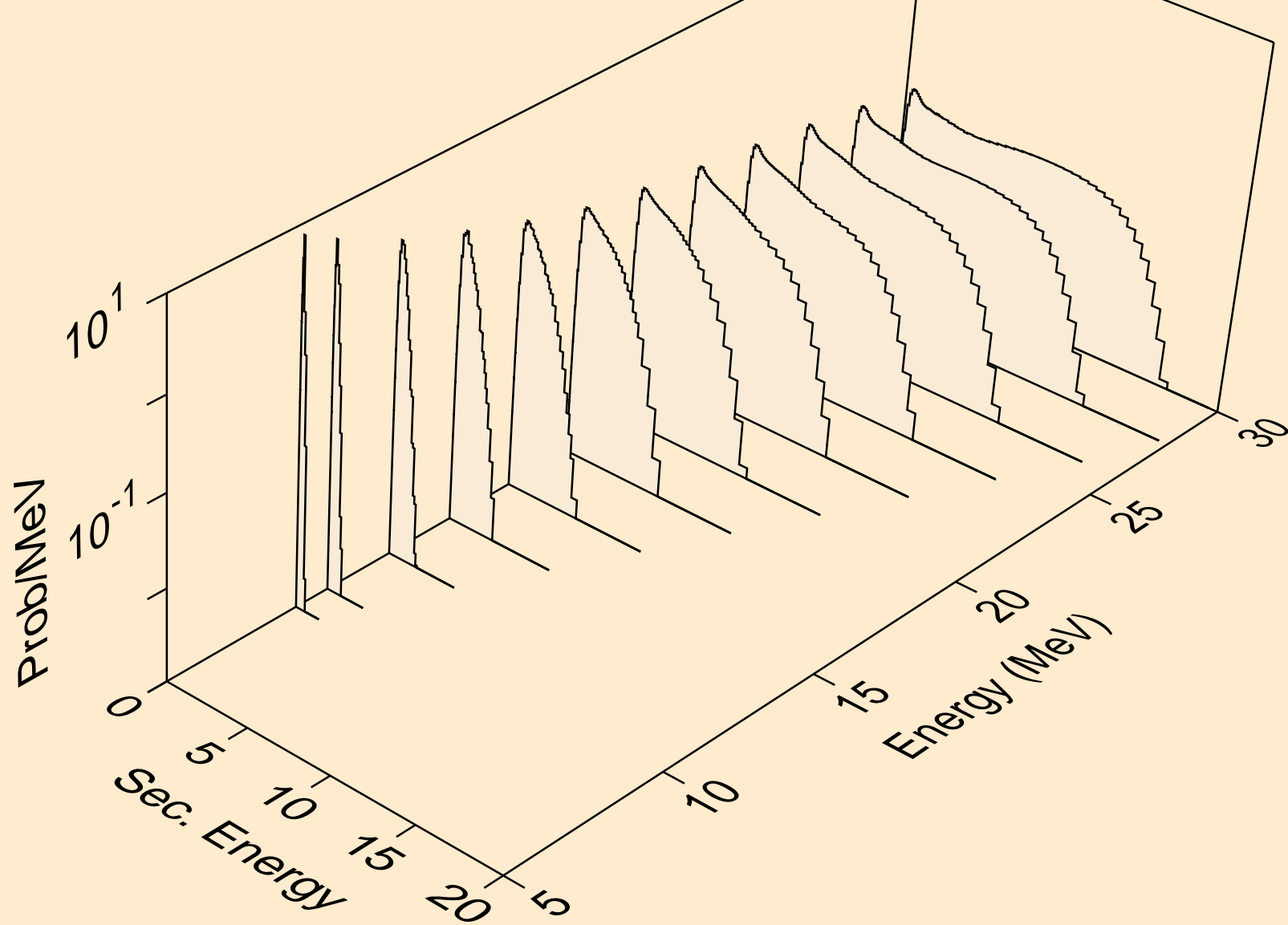

TC088M NEUTRON ACER TENDL-2021 LIBRARY; T=293.6K
Neutron emission for (n,npa)

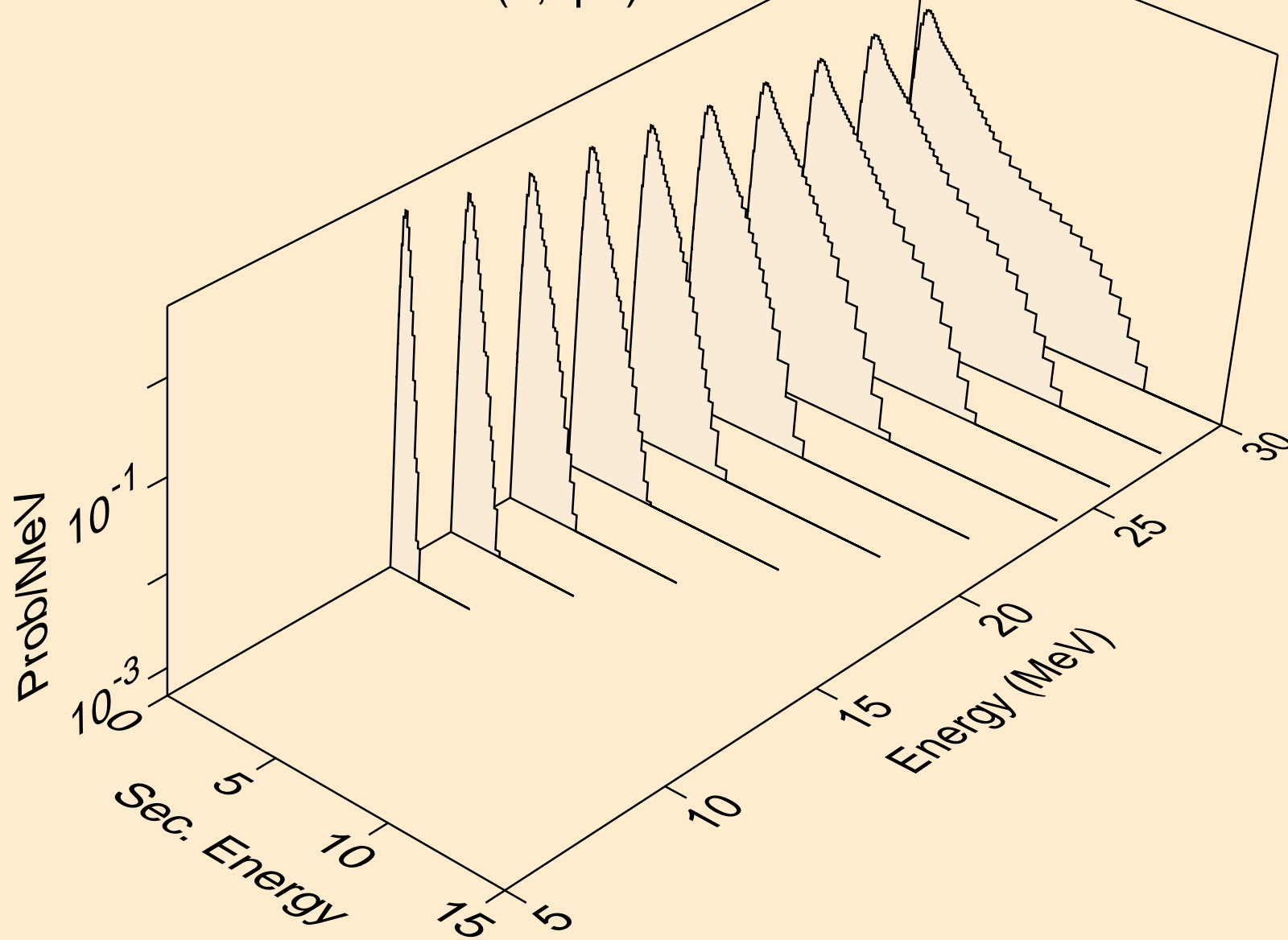

TC088M NEUTRON ACER TENDL-2021 LIBRARY; T=293.6K
Neutron emission for (n,n*c)

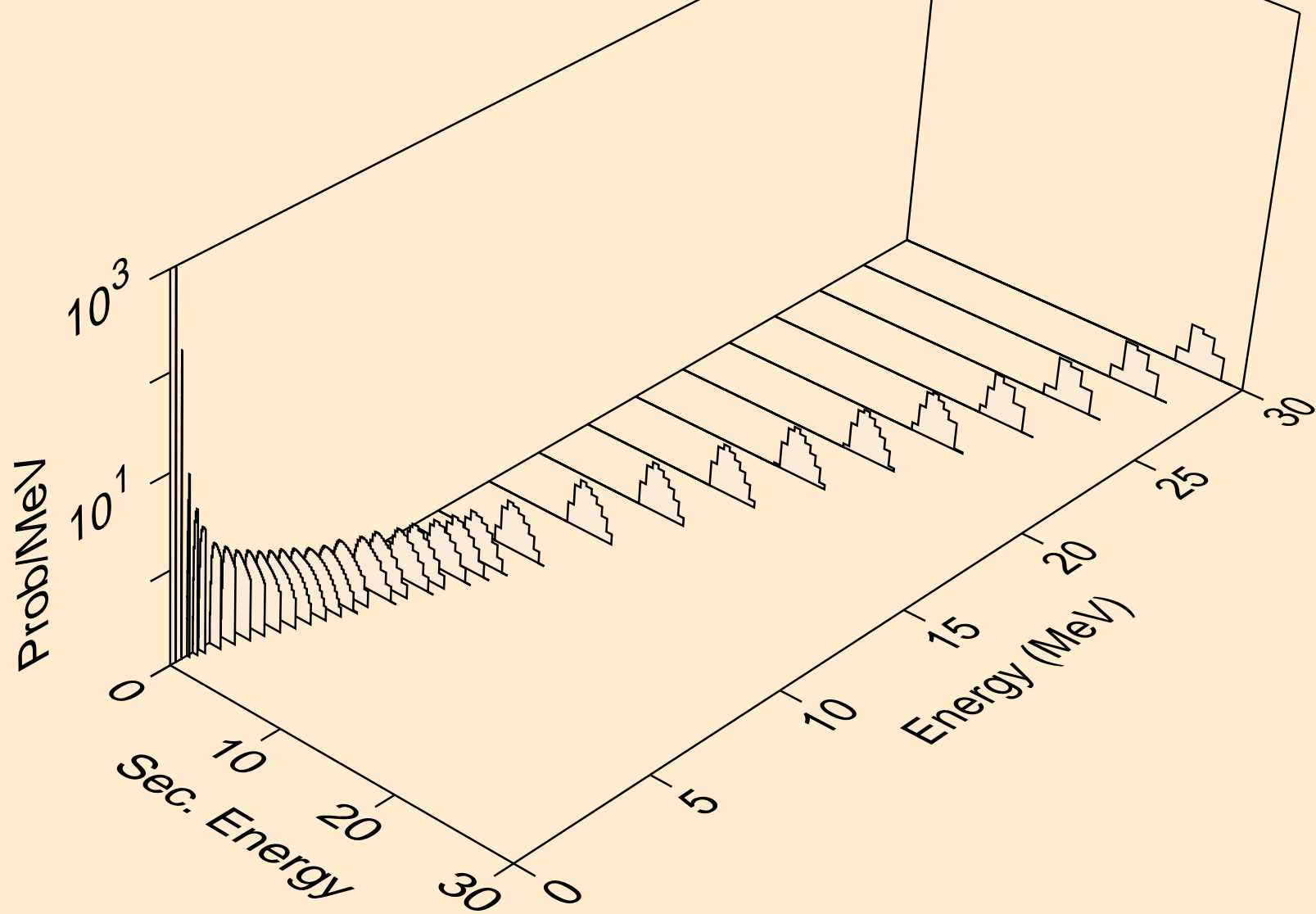

TC088M NEUTRON ACER TENDL-2021 LIBRARY; T=293.6K
Photon emission for (n,x)

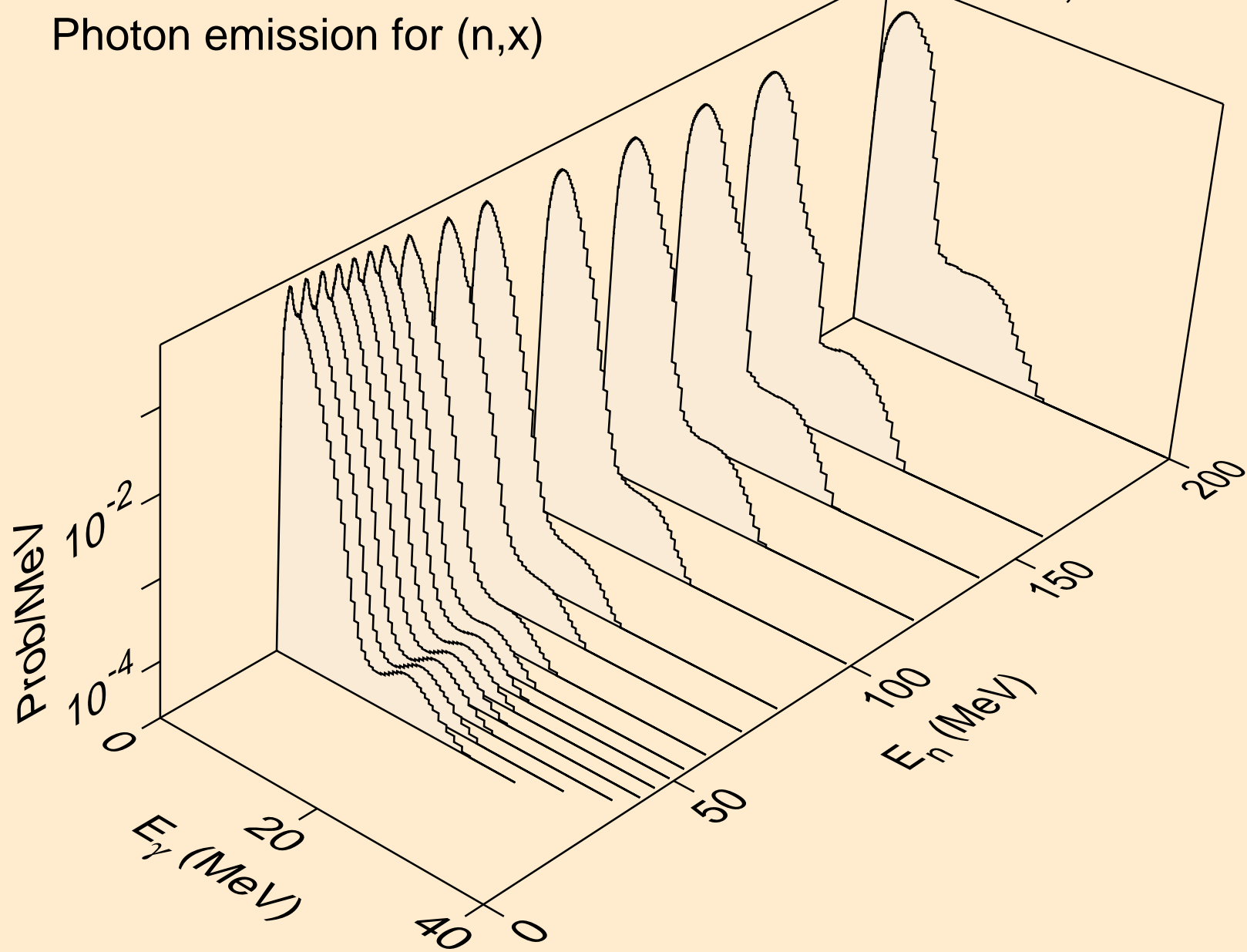

TC088M NEUTRON ACER TENDL-2021 LIBRARY; T=293.6K
Photon emission for (n,2n)

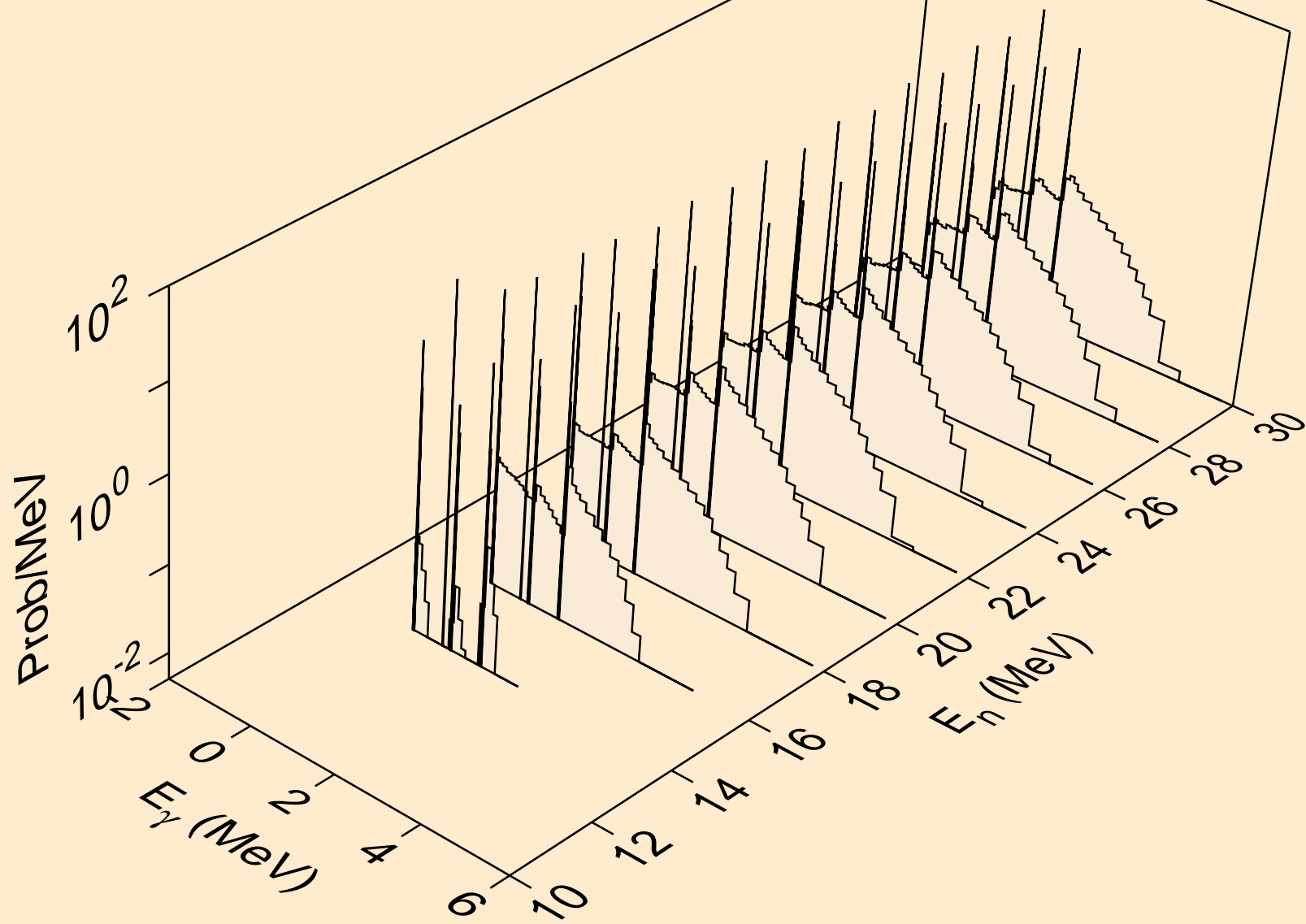

TC088M NEUTRON ACER TENDL-2021 LIBRARY; T=293.6K
Photon emission for (n,3n)

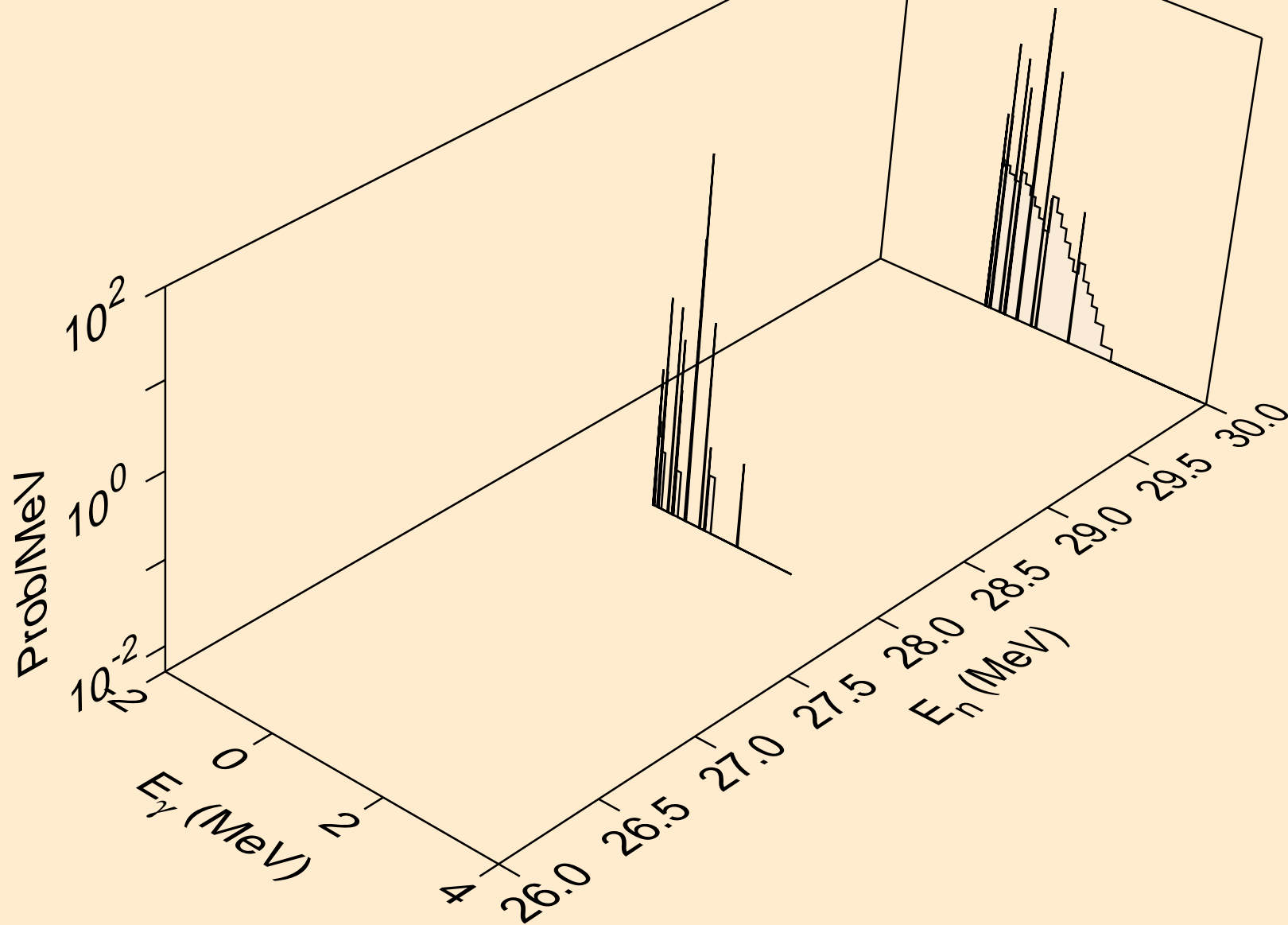

TC088M NEUTRON ACER TENDL-2021 LIBRARY; T=293.6K
Photon emission for (n,n*)a

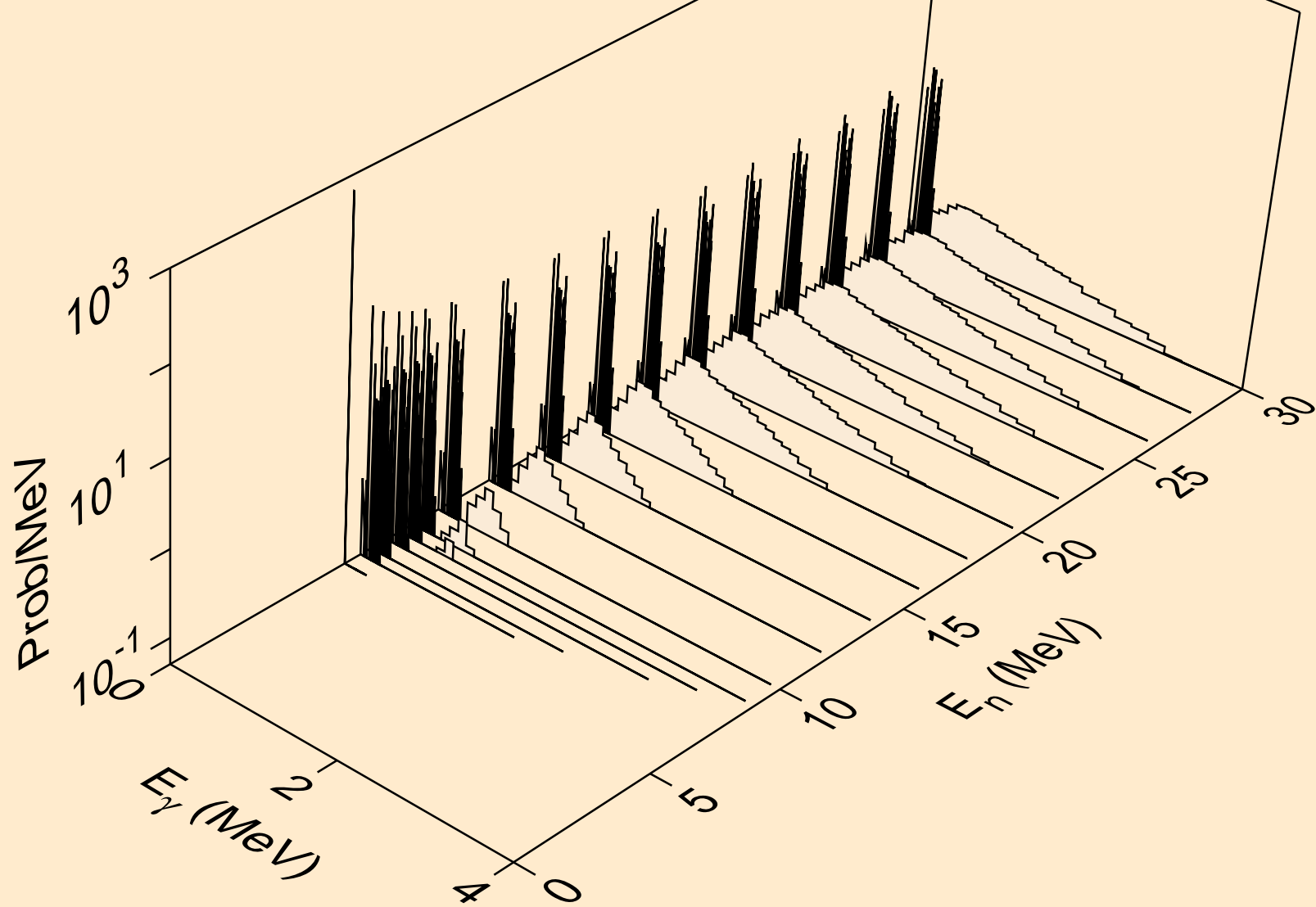

TC088M NEUTRON ACER TENDL-2021 LIBRARY; T=293.6K
Photon emission for (n,2n)a

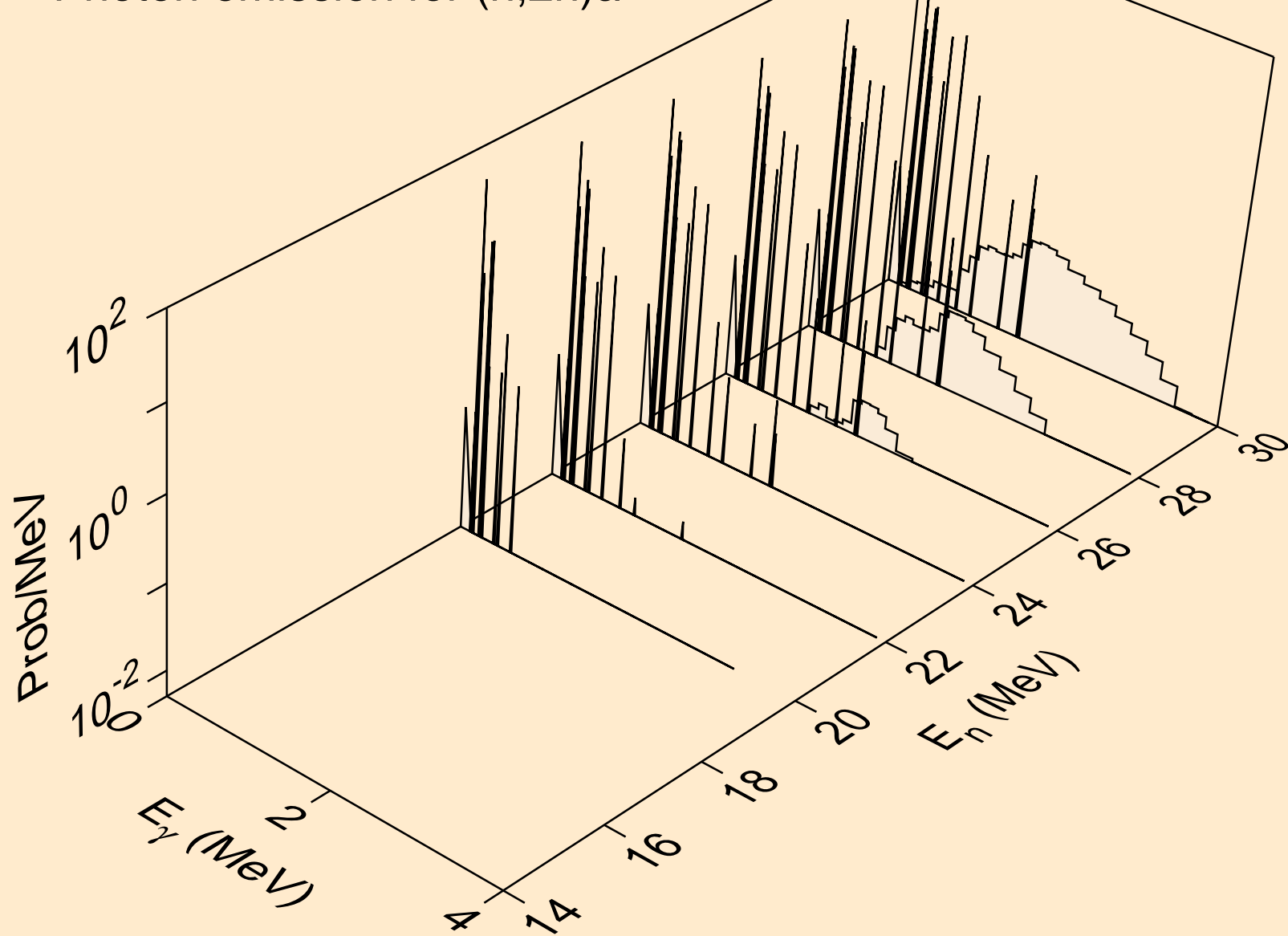

TC088M NEUTRON ACER TENDL-2021 LIBRARY; T=293.6K
Photon emission for (n,n*)p

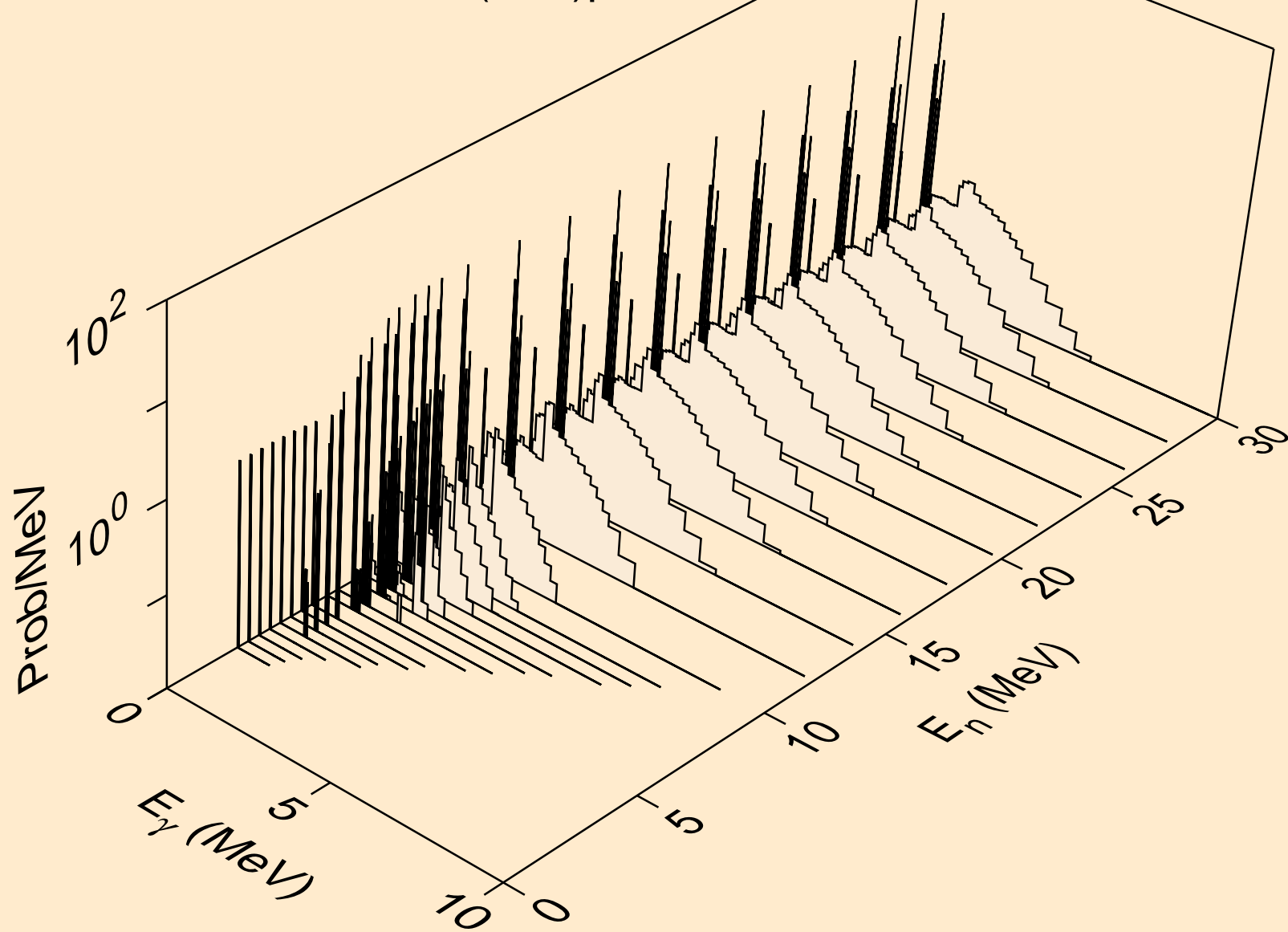

TC088M NEUTRON ACER TENDL-2021 LIBRARY; T=293.6K
Photon emission for (n,n*)2a

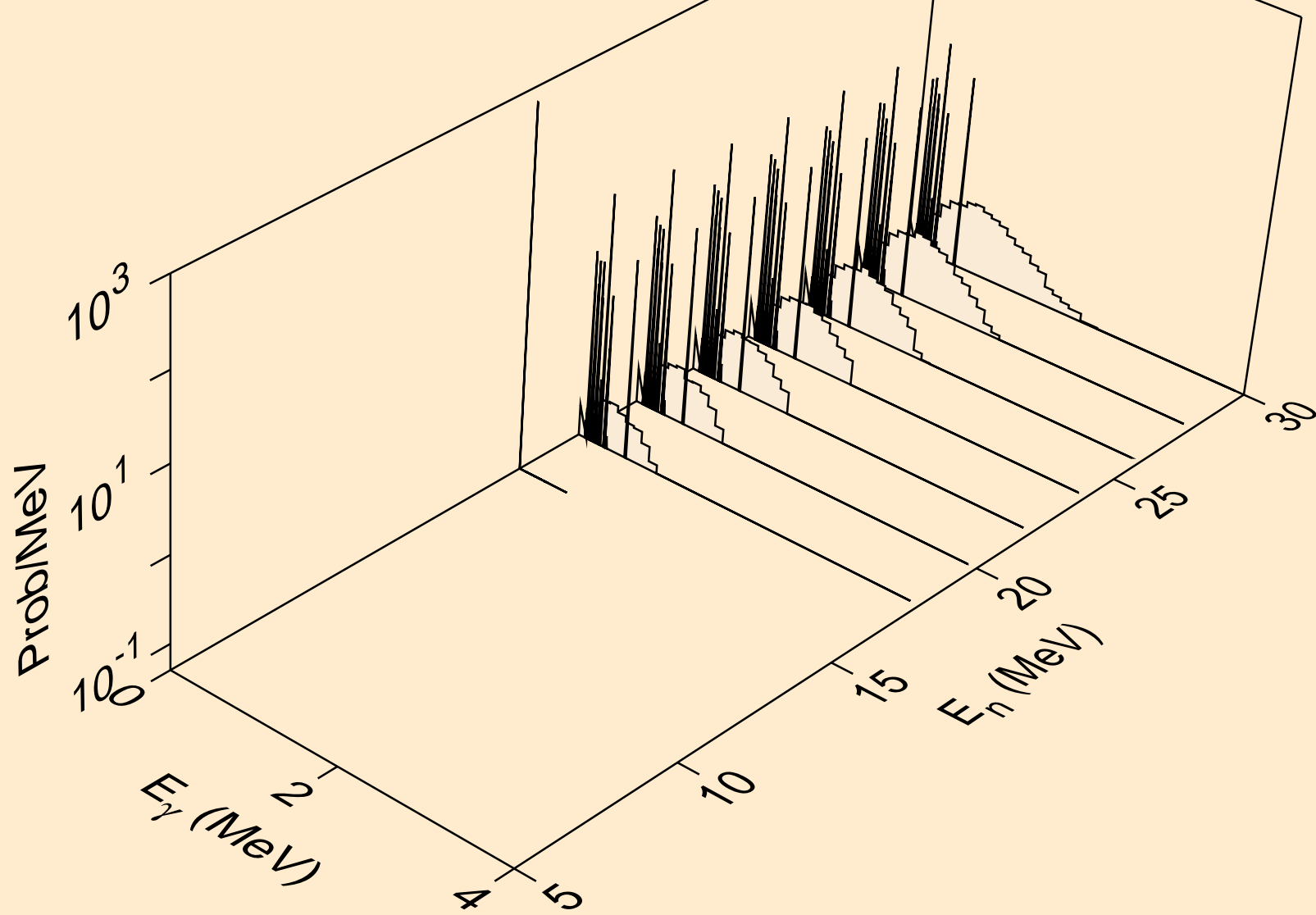

TC088M NEUTRON ACER TENDL-2021 LIBRARY; T=293.6K
Photon emission for (n,n*)d

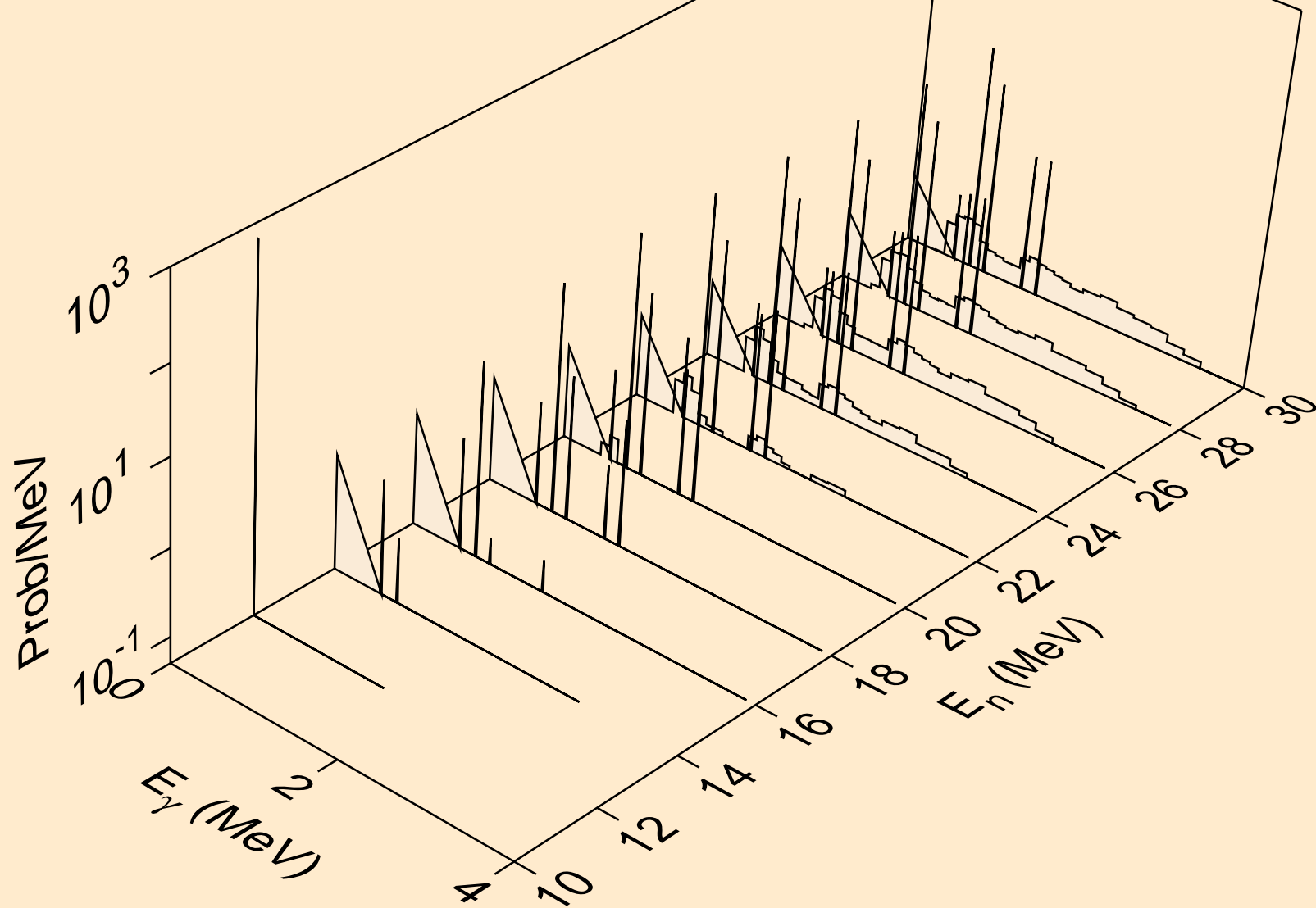

TC088M NEUTRON ACER TENDL-2021 LIBRARY; T=293.6K
Photon emission for (n,n*)t

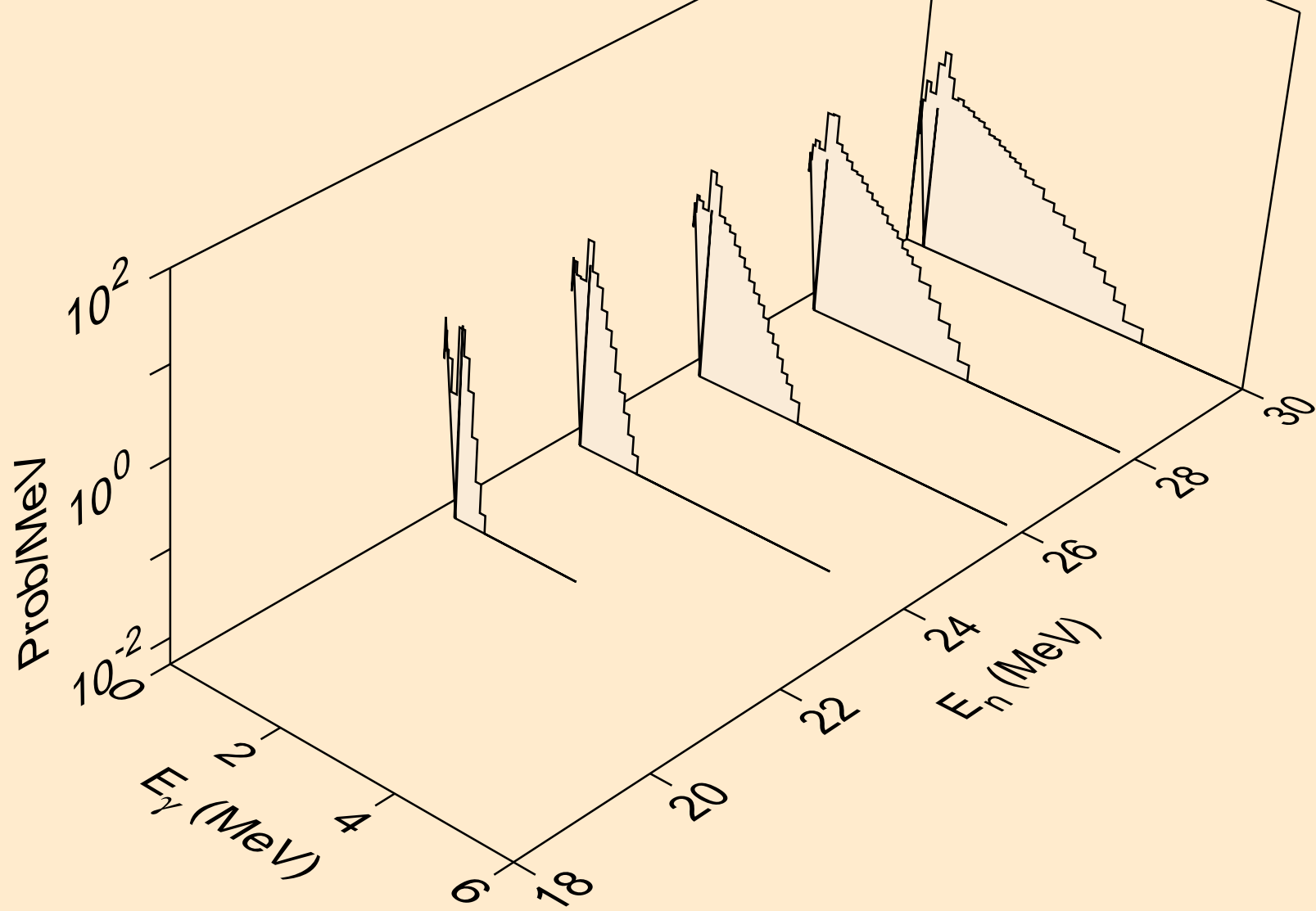

TC088M NEUTRON ACER TENDL-2021 LIBRARY; T=293.6K
Photon emission for (n,n*)he3

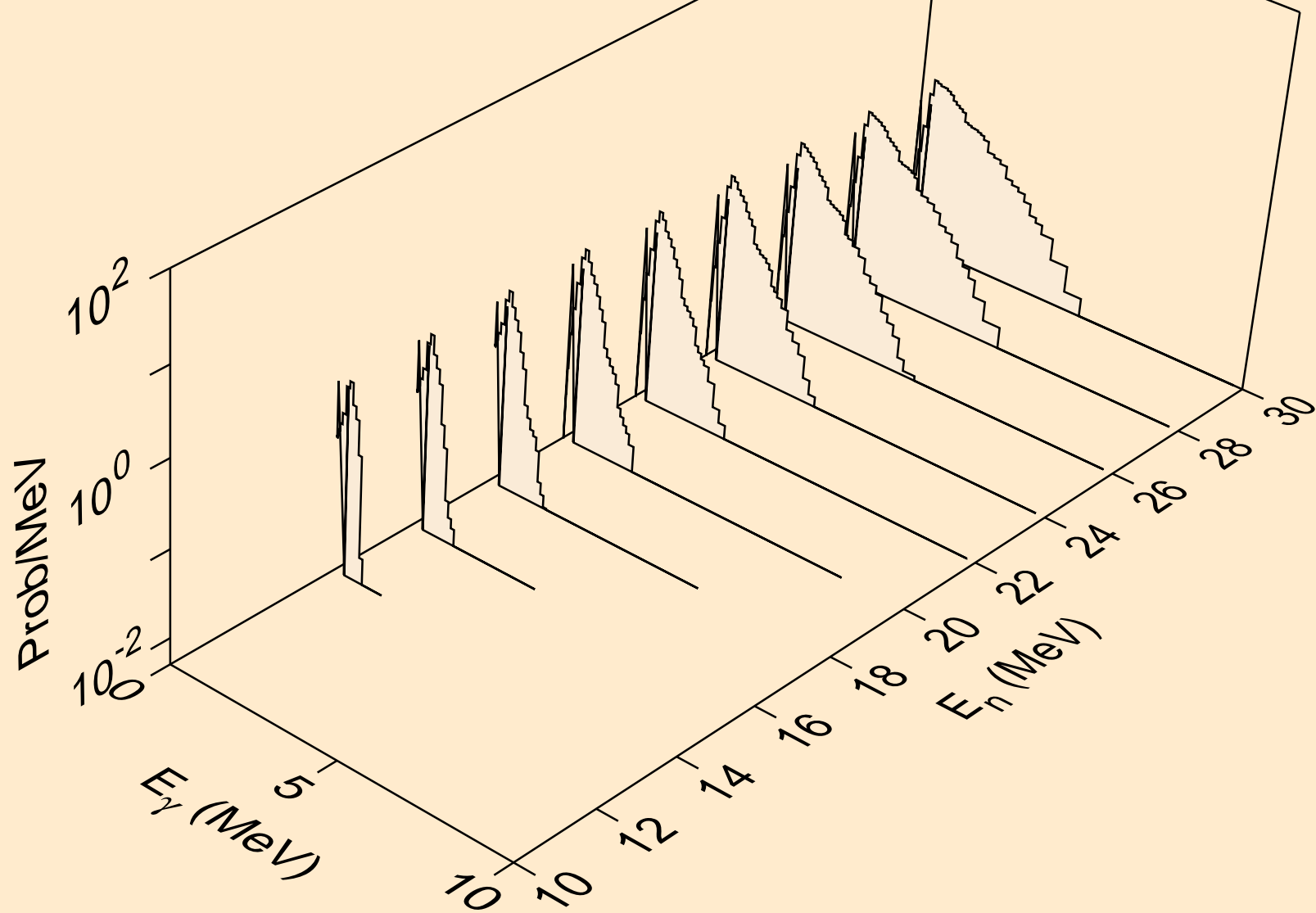

TC088M NEUTRON ACER TENDL-2021 LIBRARY; T=293.6K
Photon emission for (n,2np)

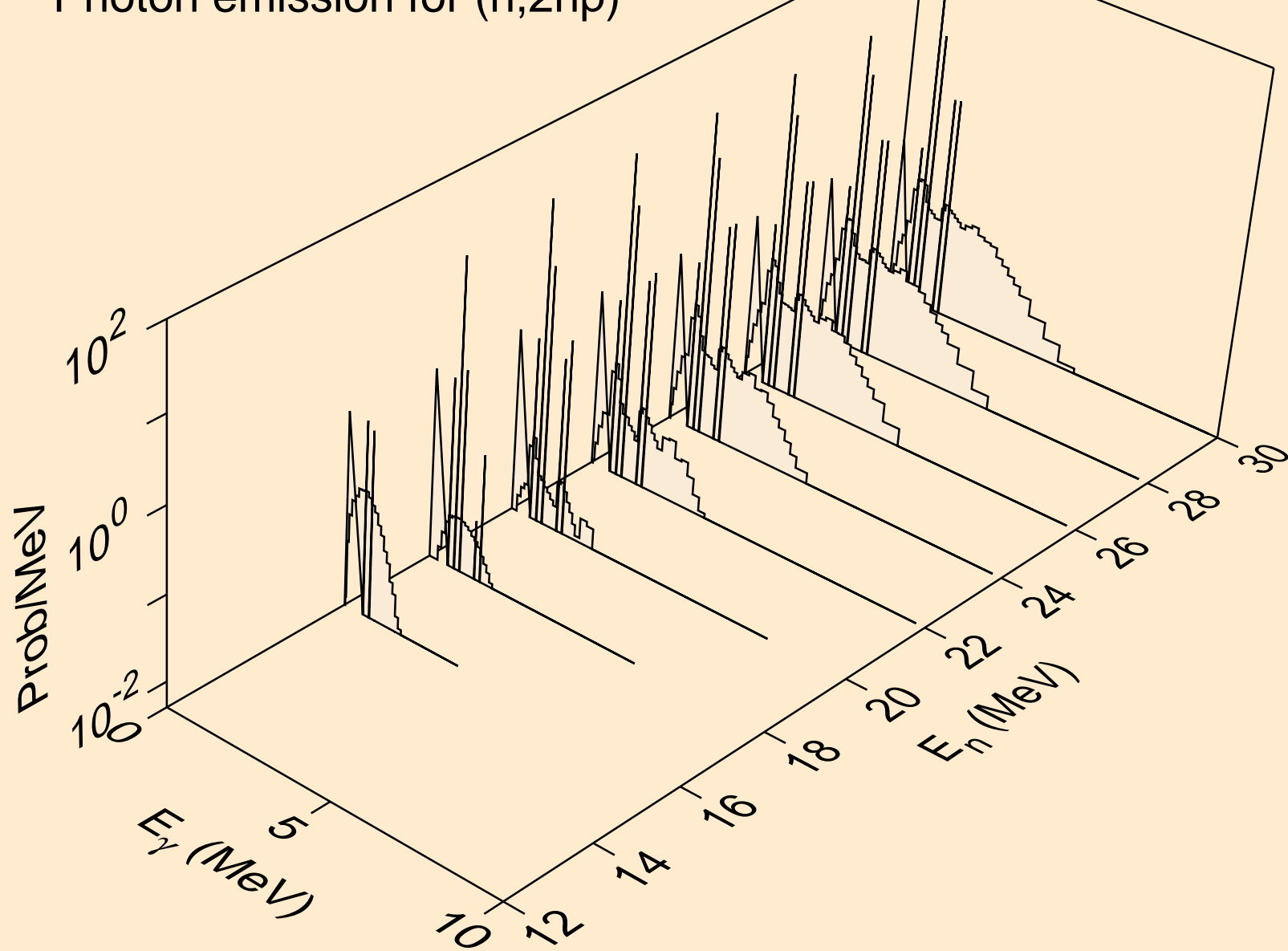

TC088M NEUTRON ACER TENDL-2021 LIBRARY; T=293.6K
Photon emission for (n,3np)

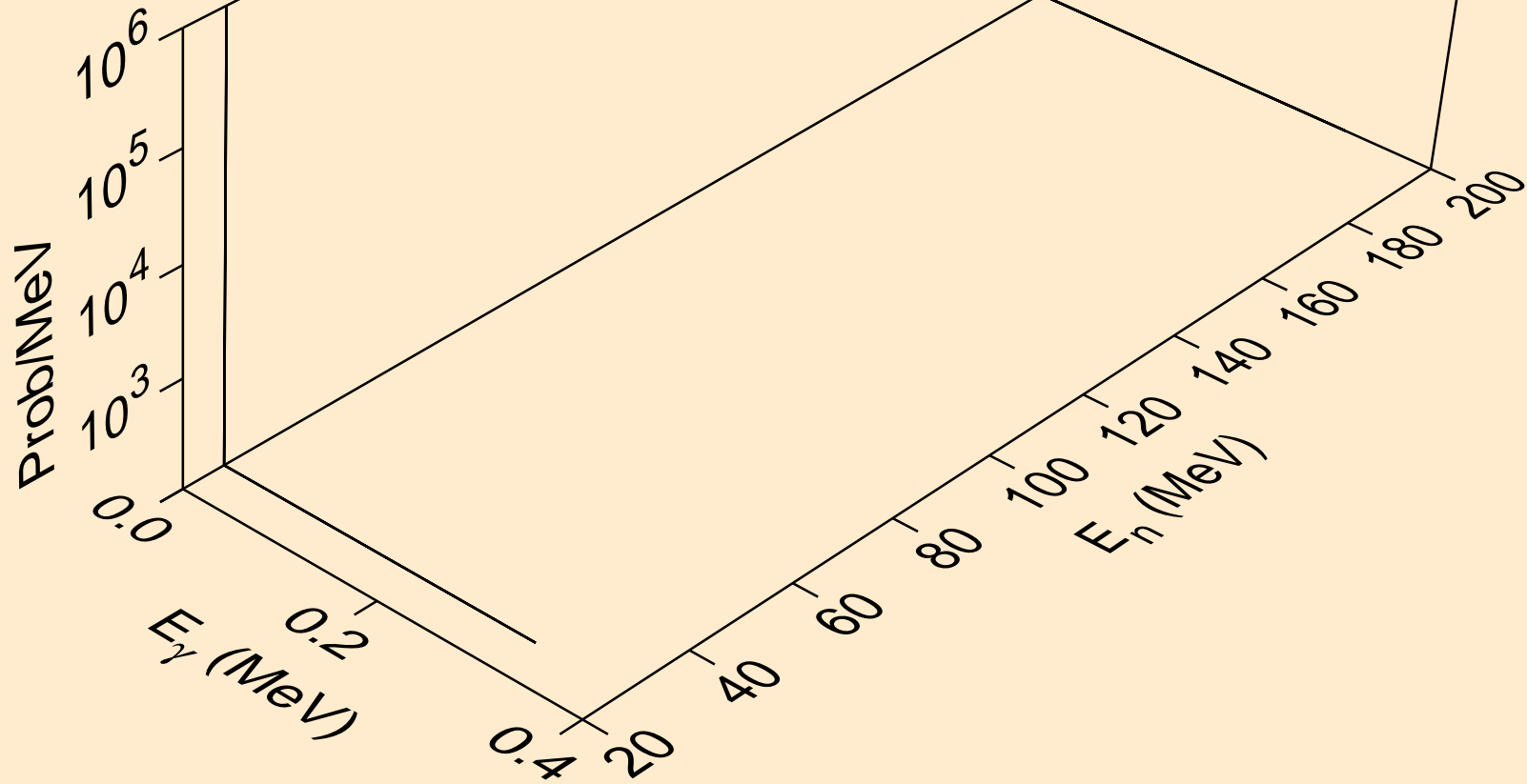

TC088M NEUTRON ACER TENDL-2021 LIBRARY; T=293.6K
Photon emission for (n,2np)

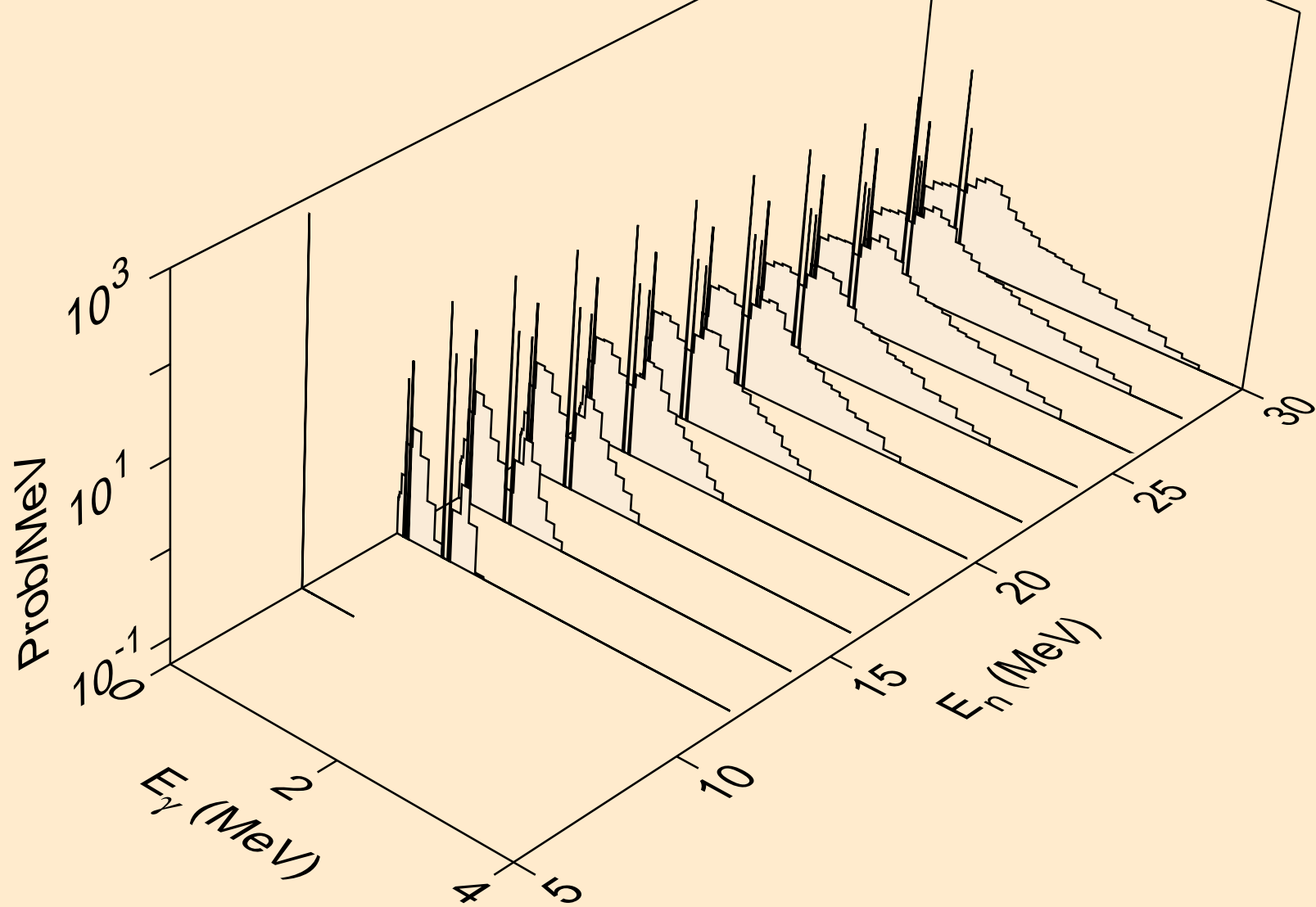

TC088M NEUTRON ACER TENDL-2021 LIBRARY; T=293.6K
Photon emission for (n,npa)

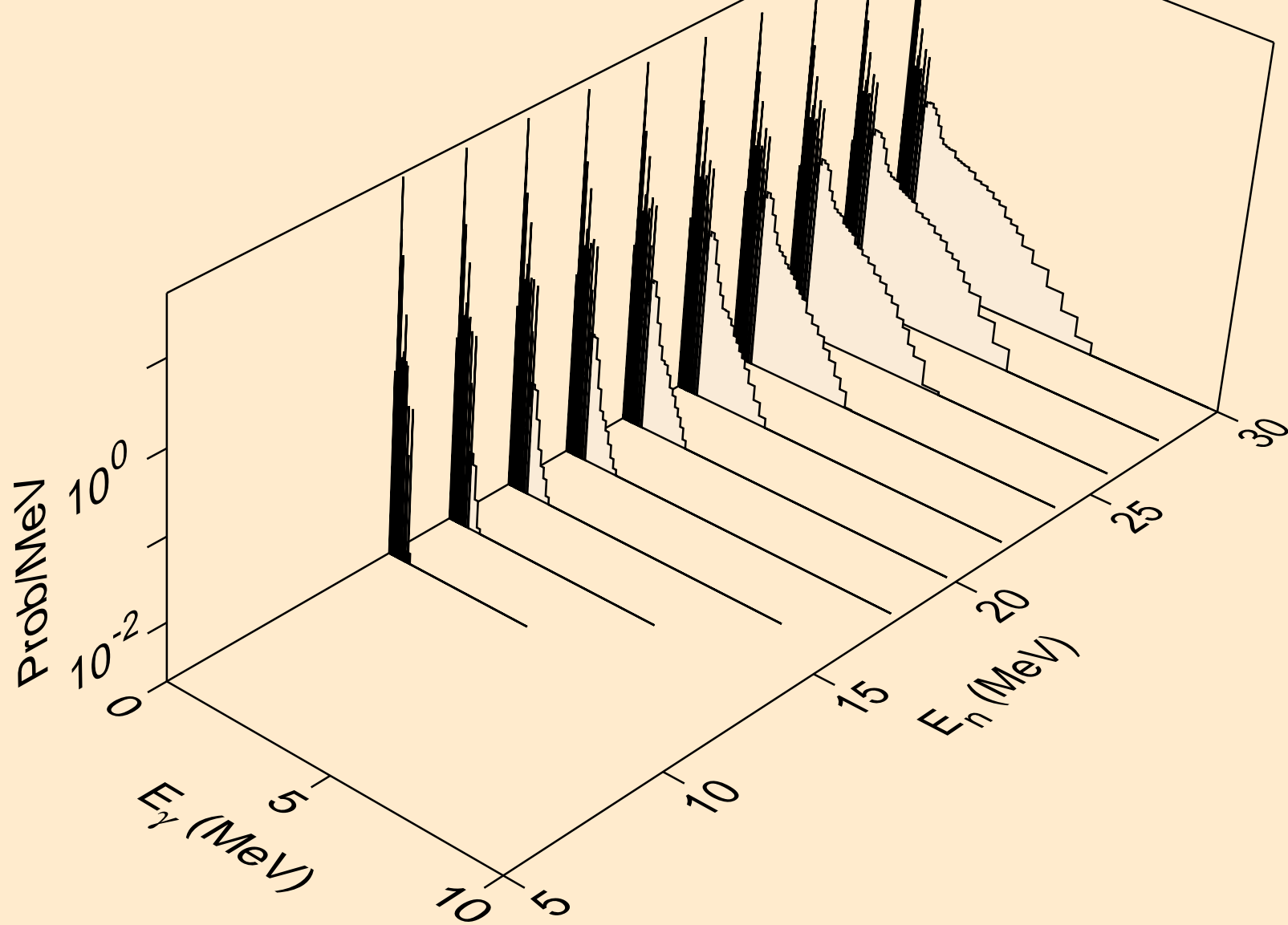

TC088M NEUTRON ACER TENDL-2021 LIBRARY; T=293.6K
Photon emission for (n,n*2)

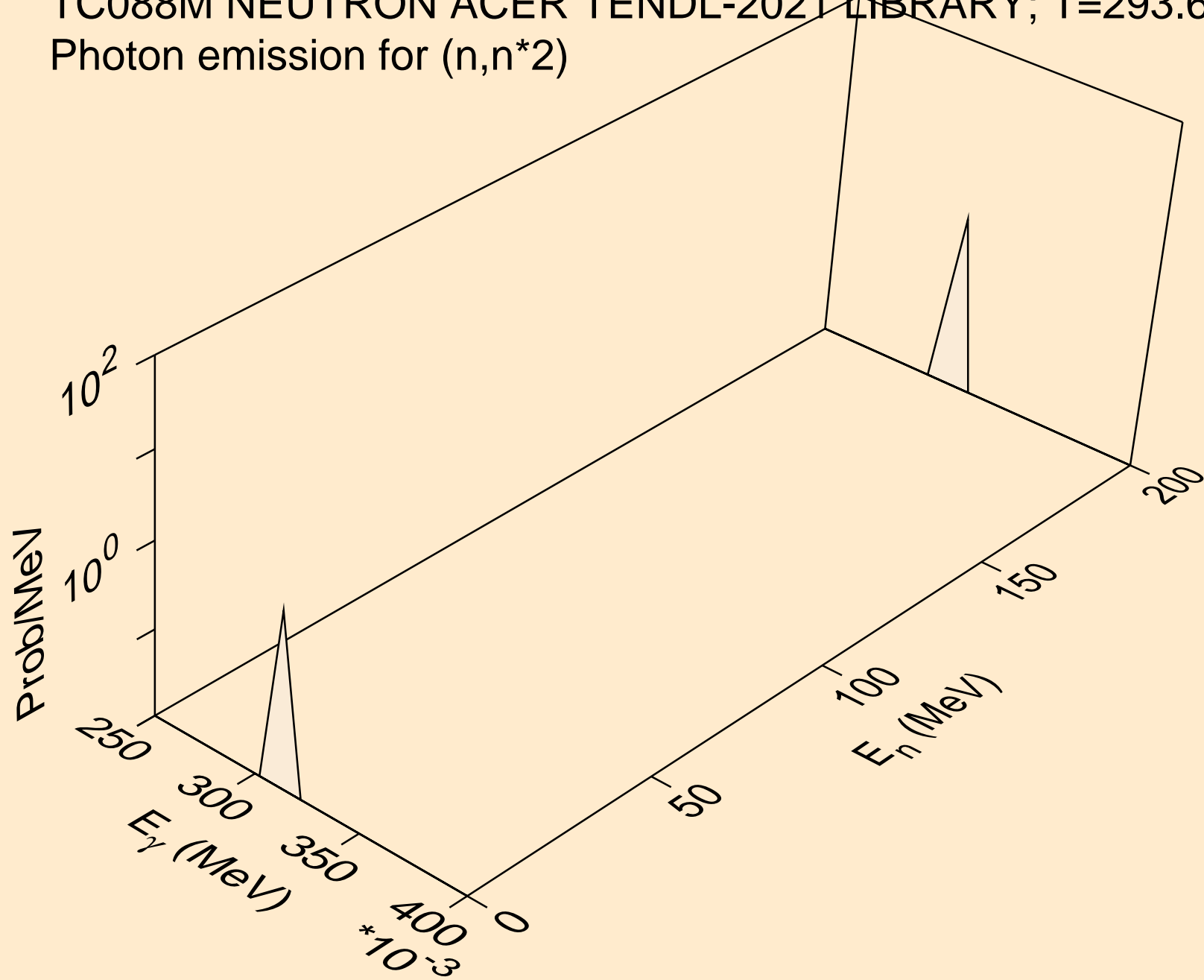

TC088M NEUTRON ACER TENDL-2021 LIBRARY; T=293.6K
Photon emission for (n,n*c)

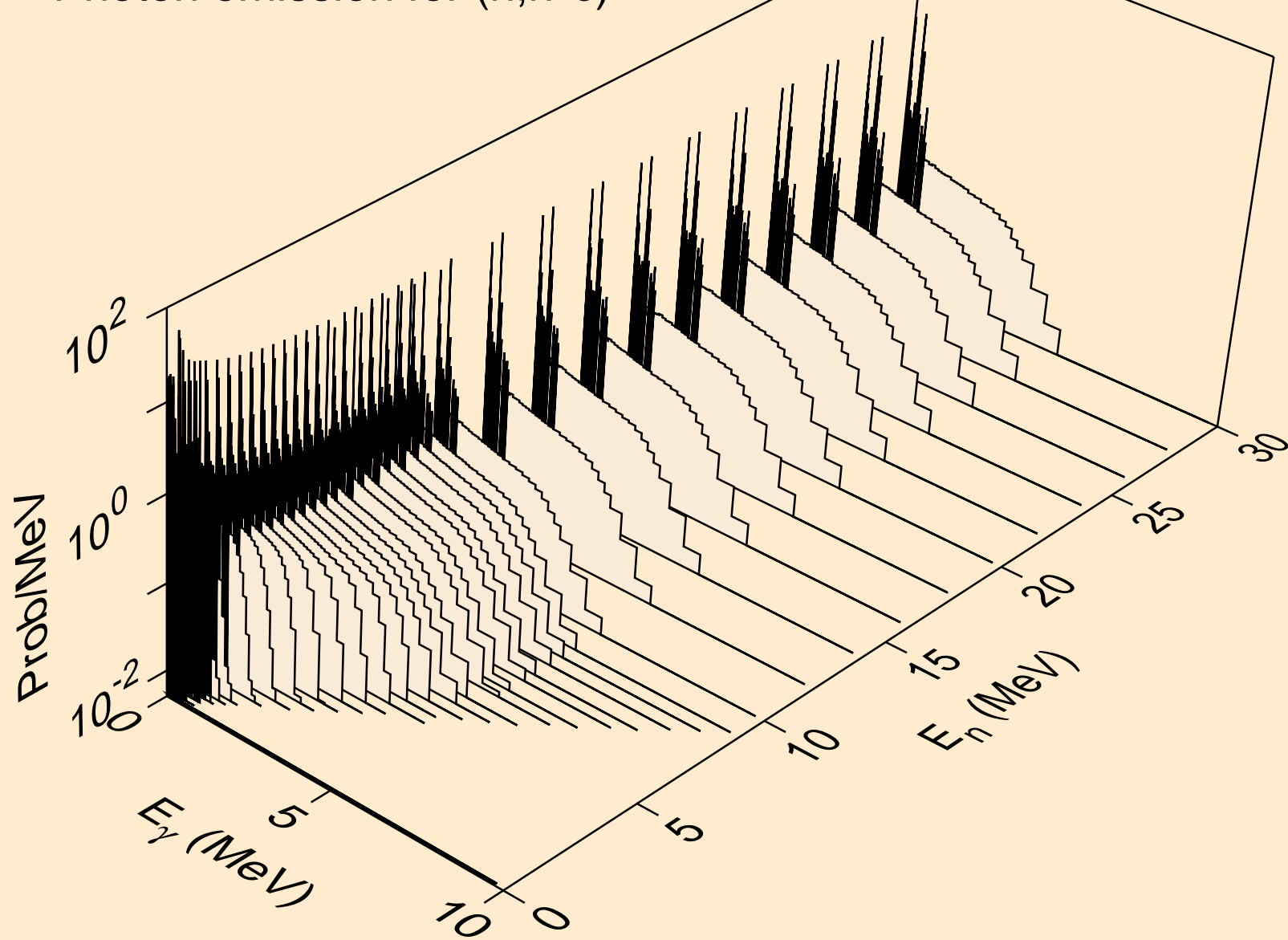

TC088M NEUTRON ACER TENDL-2021 LIBRARY; T=293.6K
Photon emission for (n,gma)

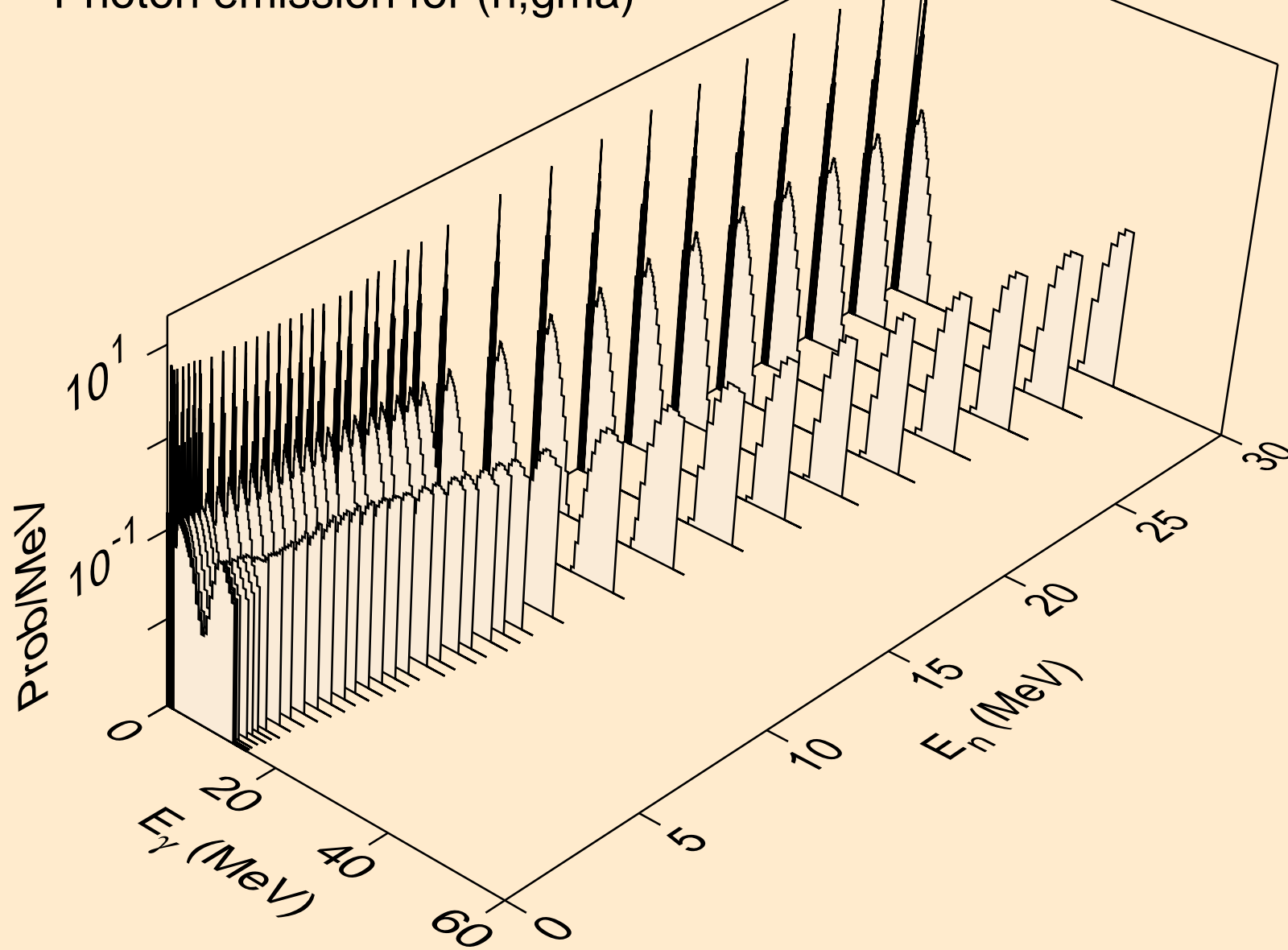

TC088M NEUTRON ACER TENDL-2021 LIBRARY; T=293.6K
Photon emission for (n,p)

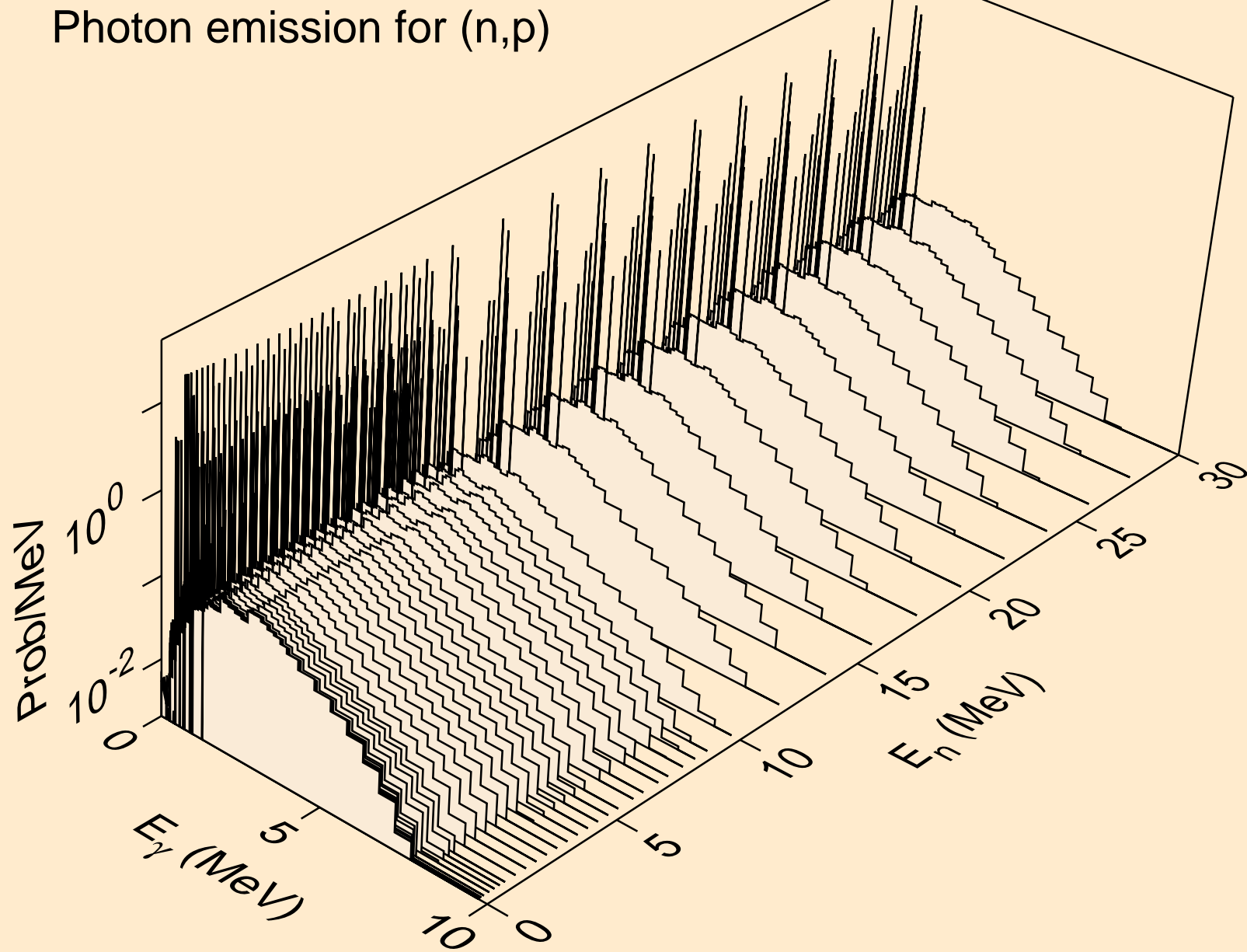

TC088M NEUTRON ACER TENDL-2021 LIBRARY; T=293.6K
Photon emission for (n,d)

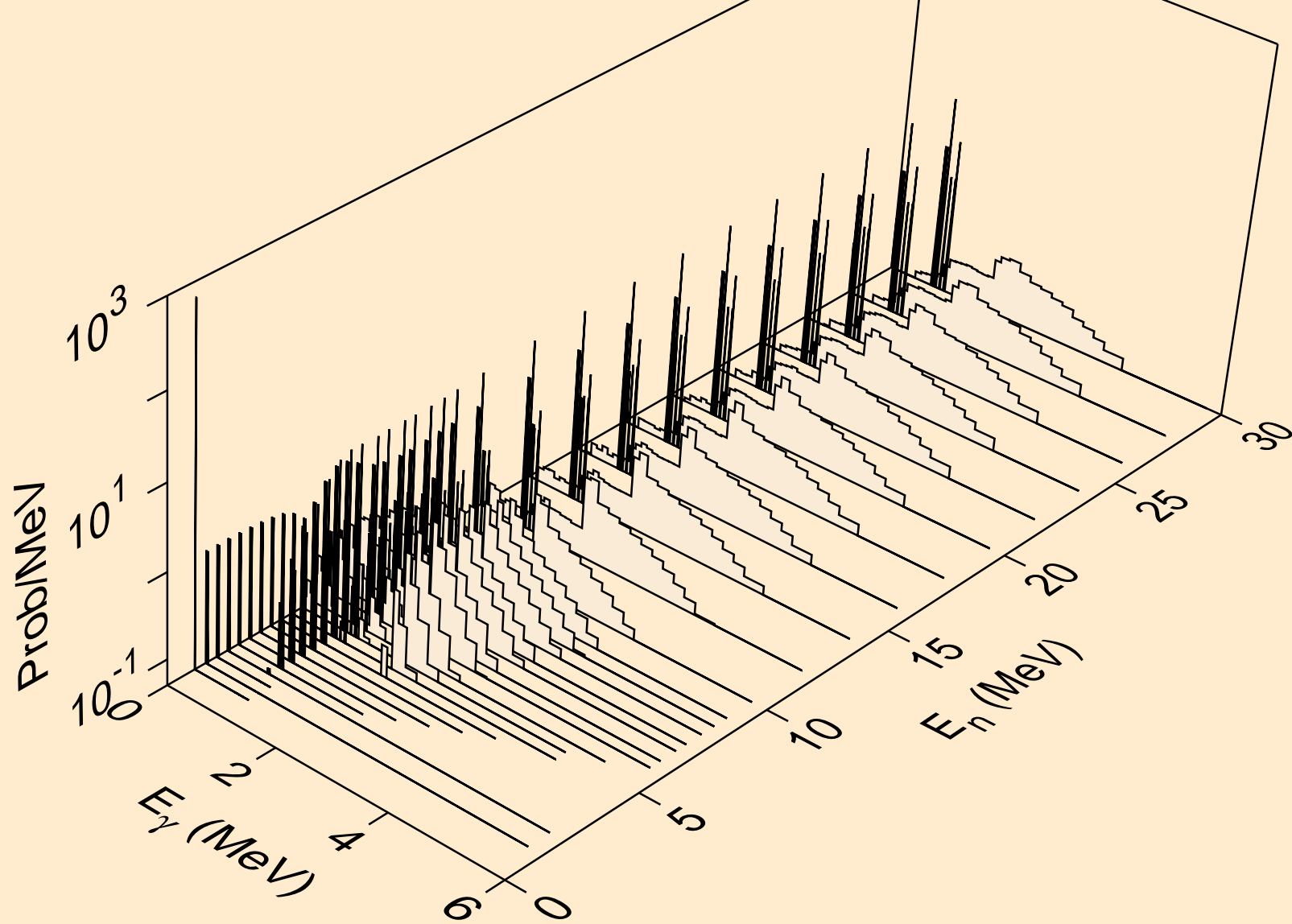

TC088M NEUTRON ACER TENDL-2021 LIBRARY; T=293.6K
Photon emission for (n,t)

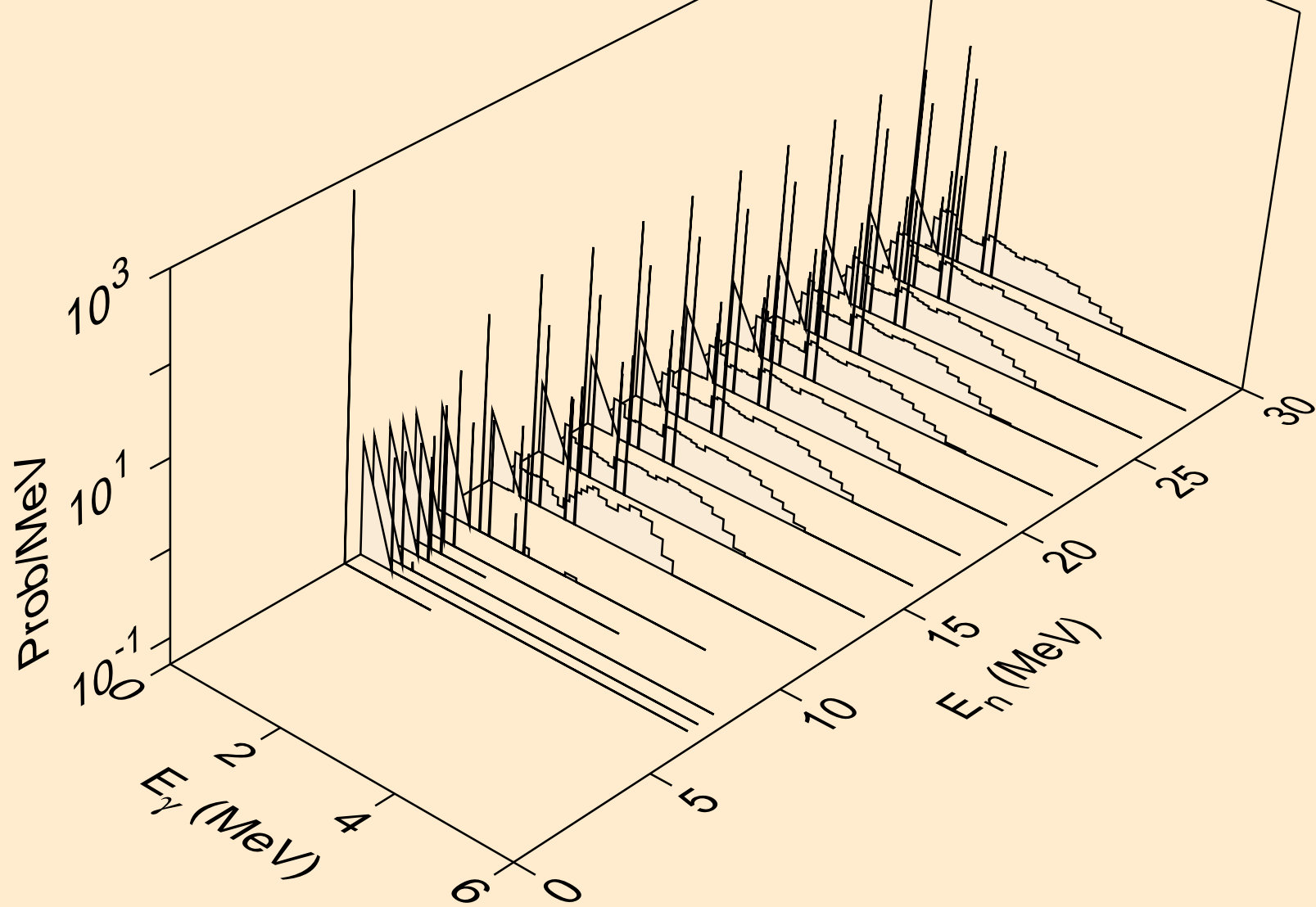

TC088M NEUTRON ACER TENDL-2021 LIBRARY; T=293.6K
Photon emission for (n,he3)

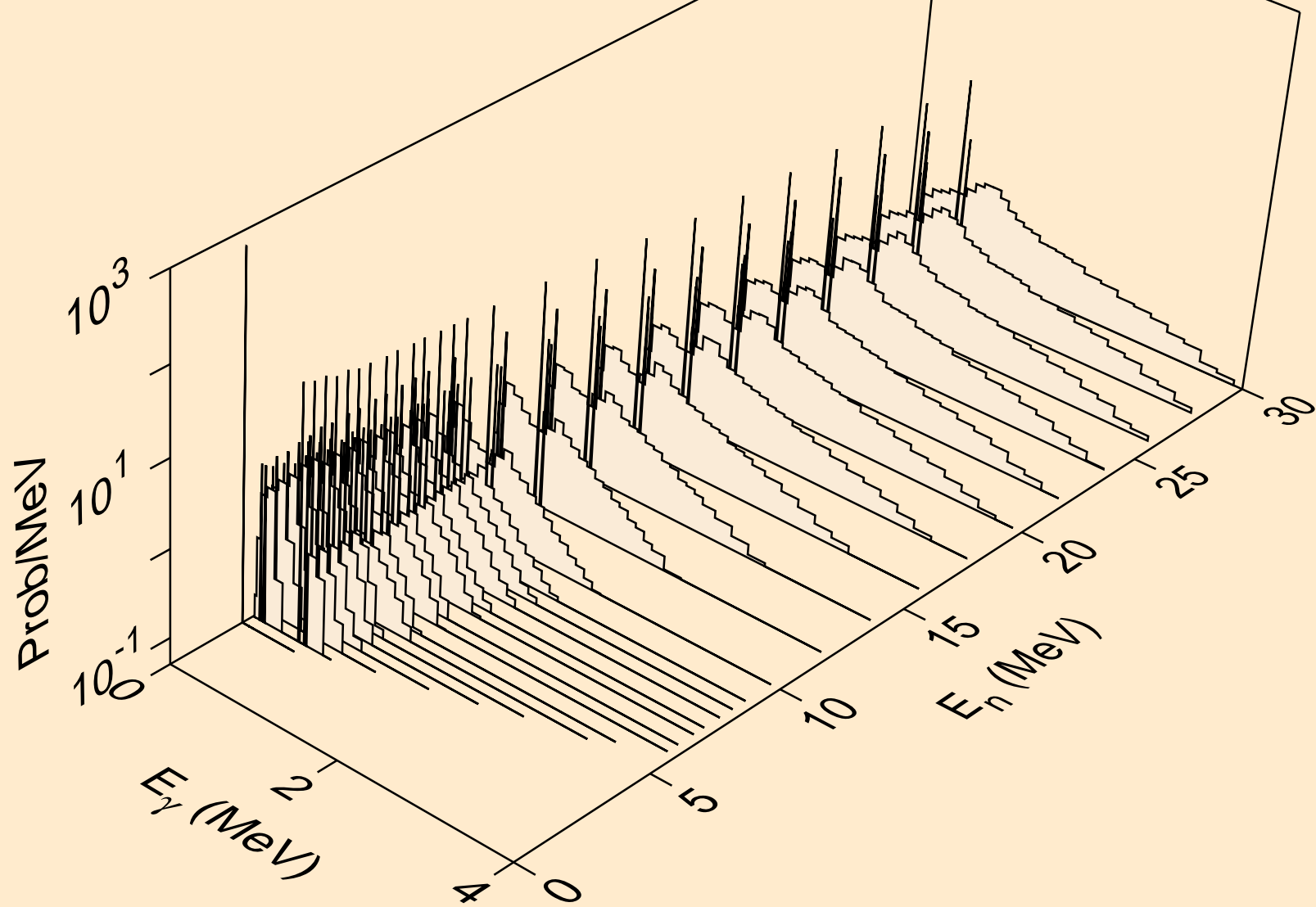

TC088M NEUTRON ACER TENDL-2021 LIBRARY; T=293.6K
Photon emission for (n,a)

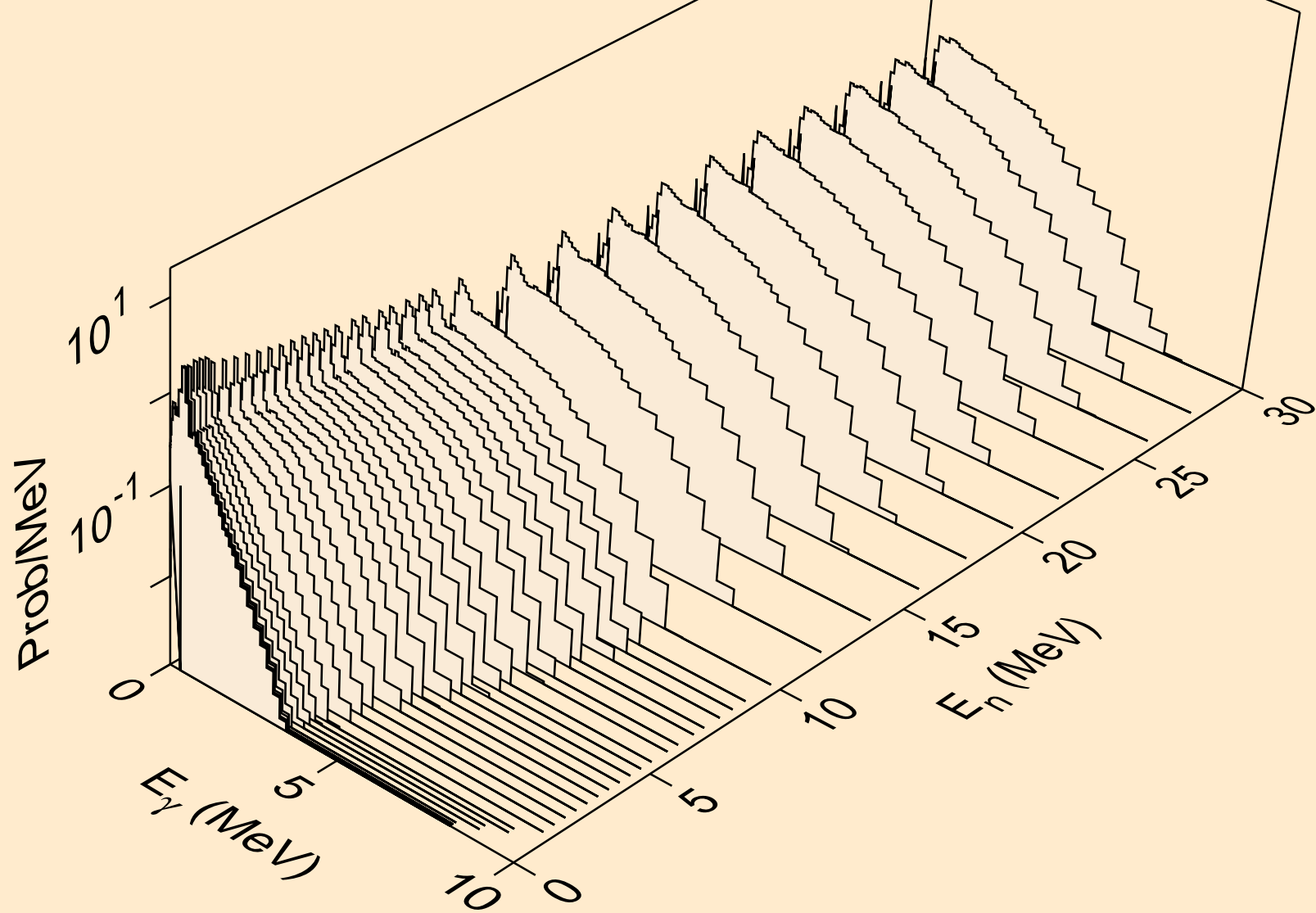

TC088M NEUTRON ACER TENDL-2021 LIBRARY; T=293.6K
Photon emission for (n,2a)

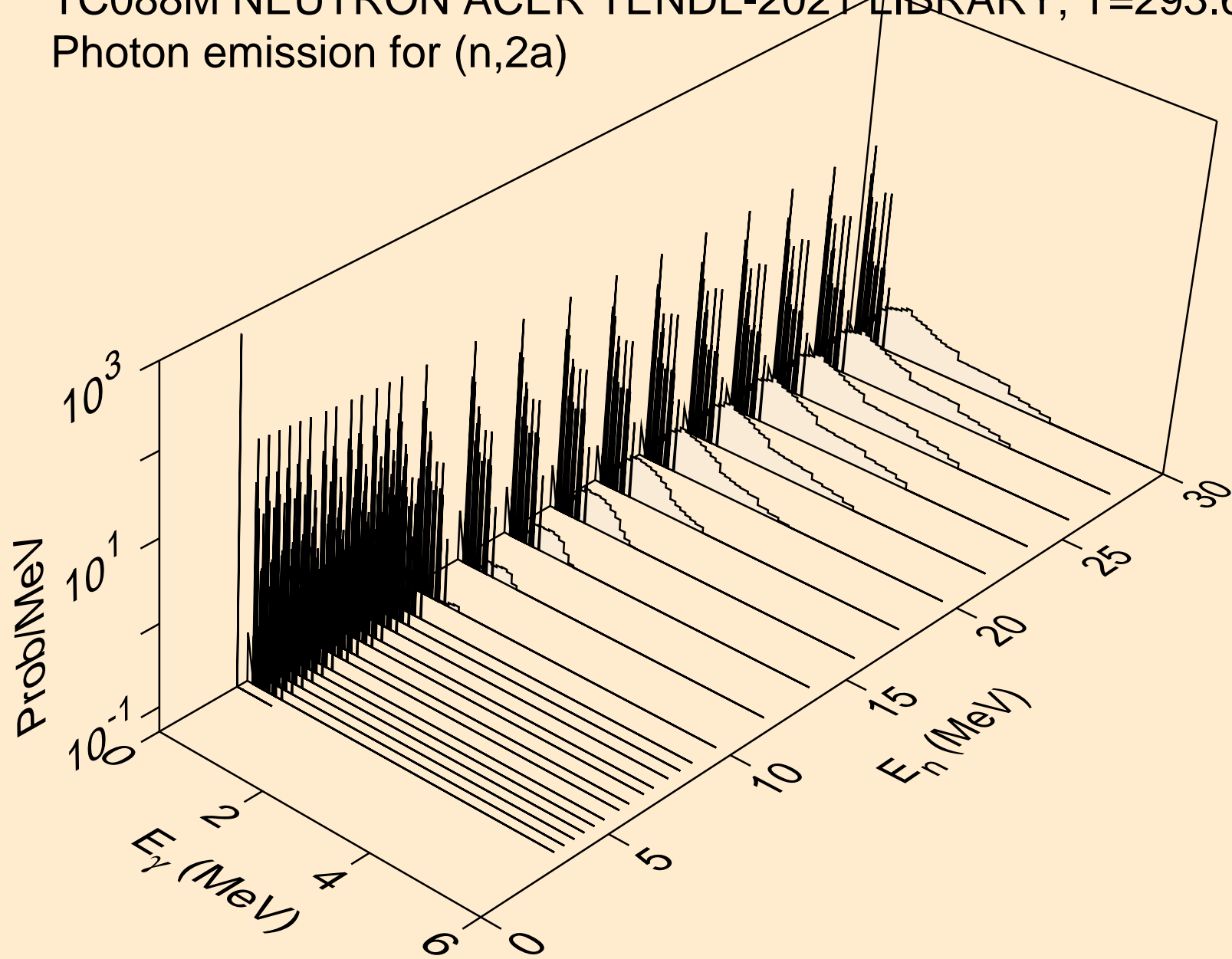

TC088M NEUTRON ACER TENDL-2021 LIBRARY; T=293.6K
Photon emission for (n,3a)

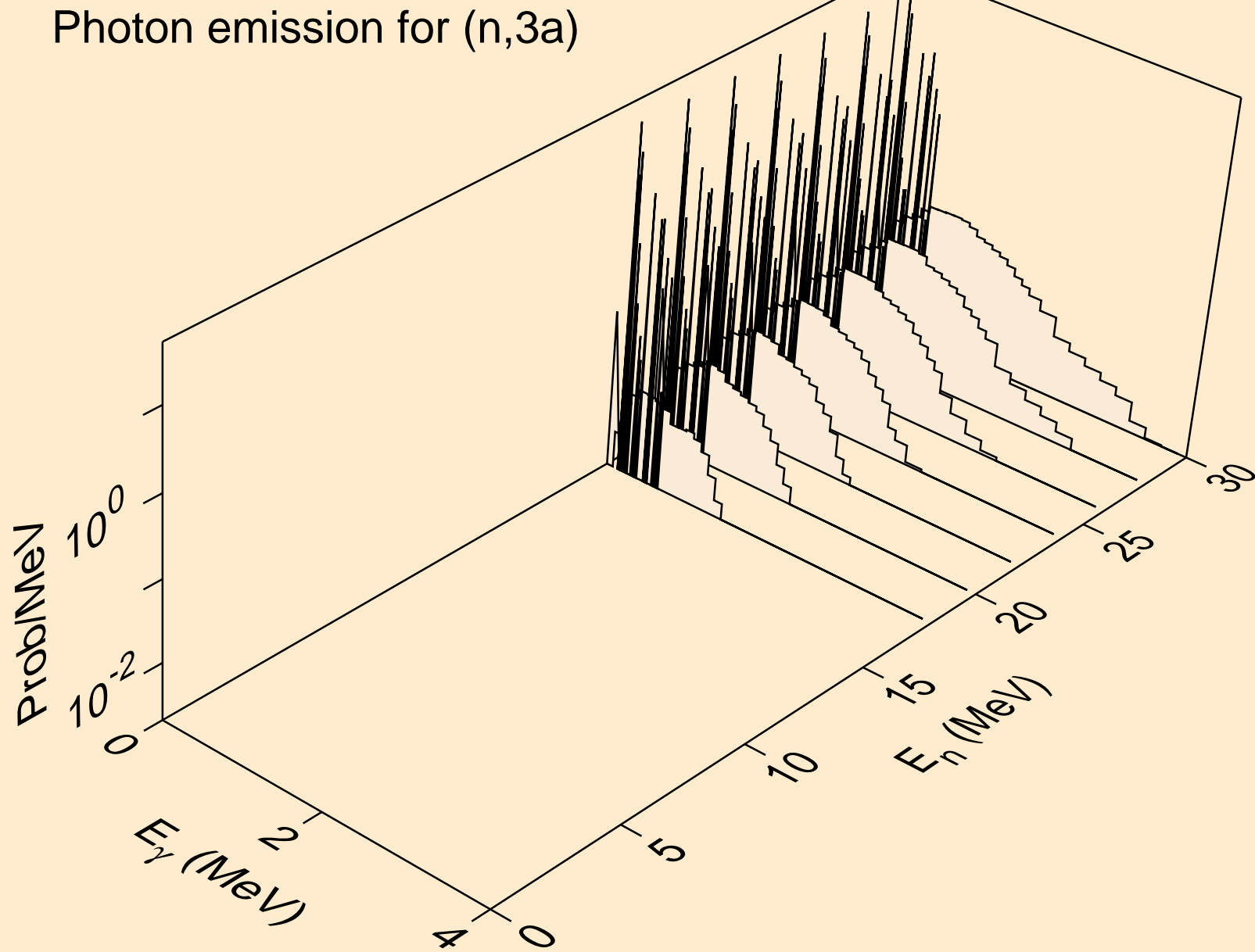

TC088M NEUTRON ACER TENDL-2021 LIBRARY; T=293.6K
Photon emission for (n,2p)

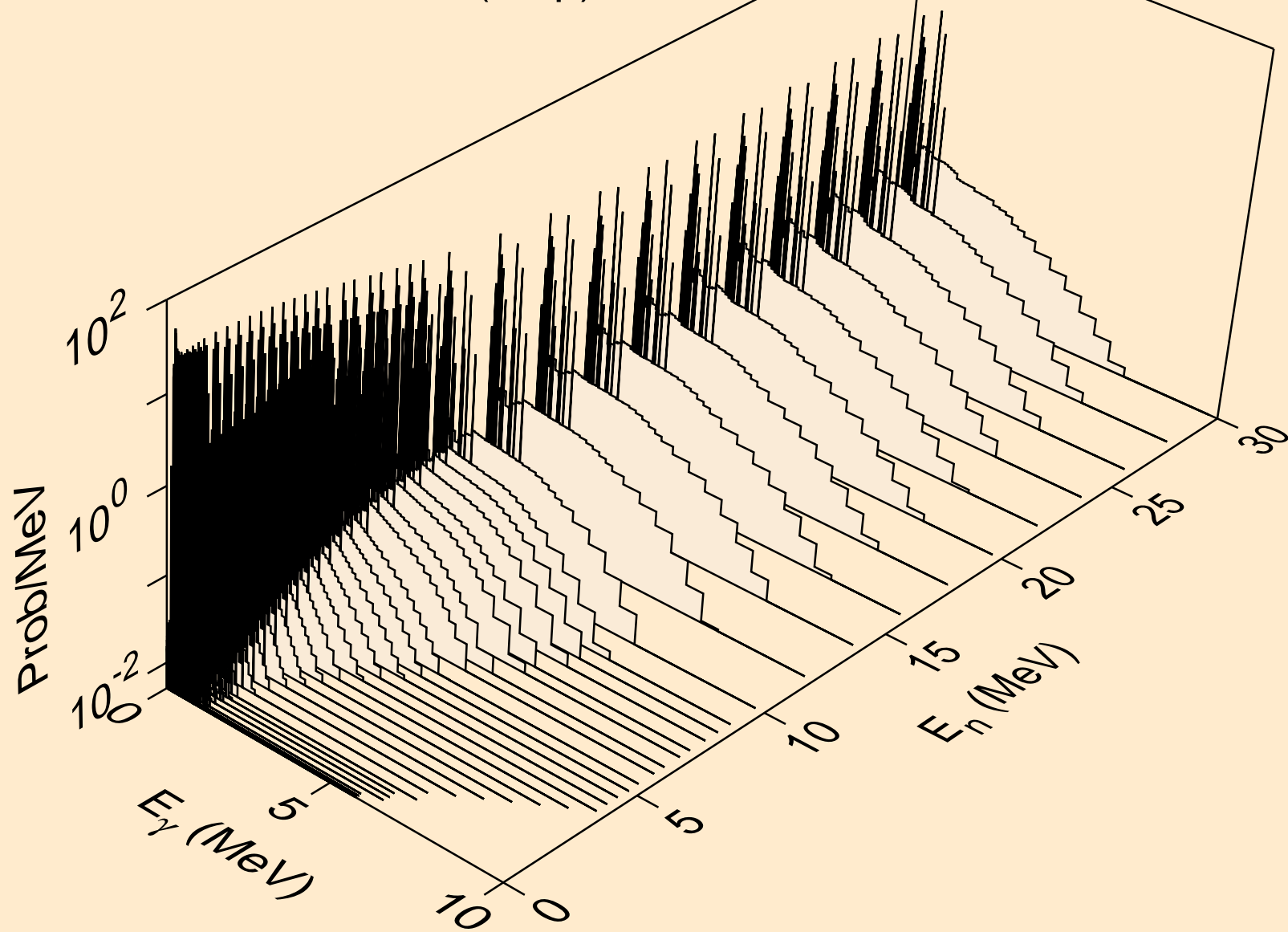

TC088M NEUTRON ACER TENDL-2021 LIBRARY; T=293.6K
Photon emission for (n,p α)

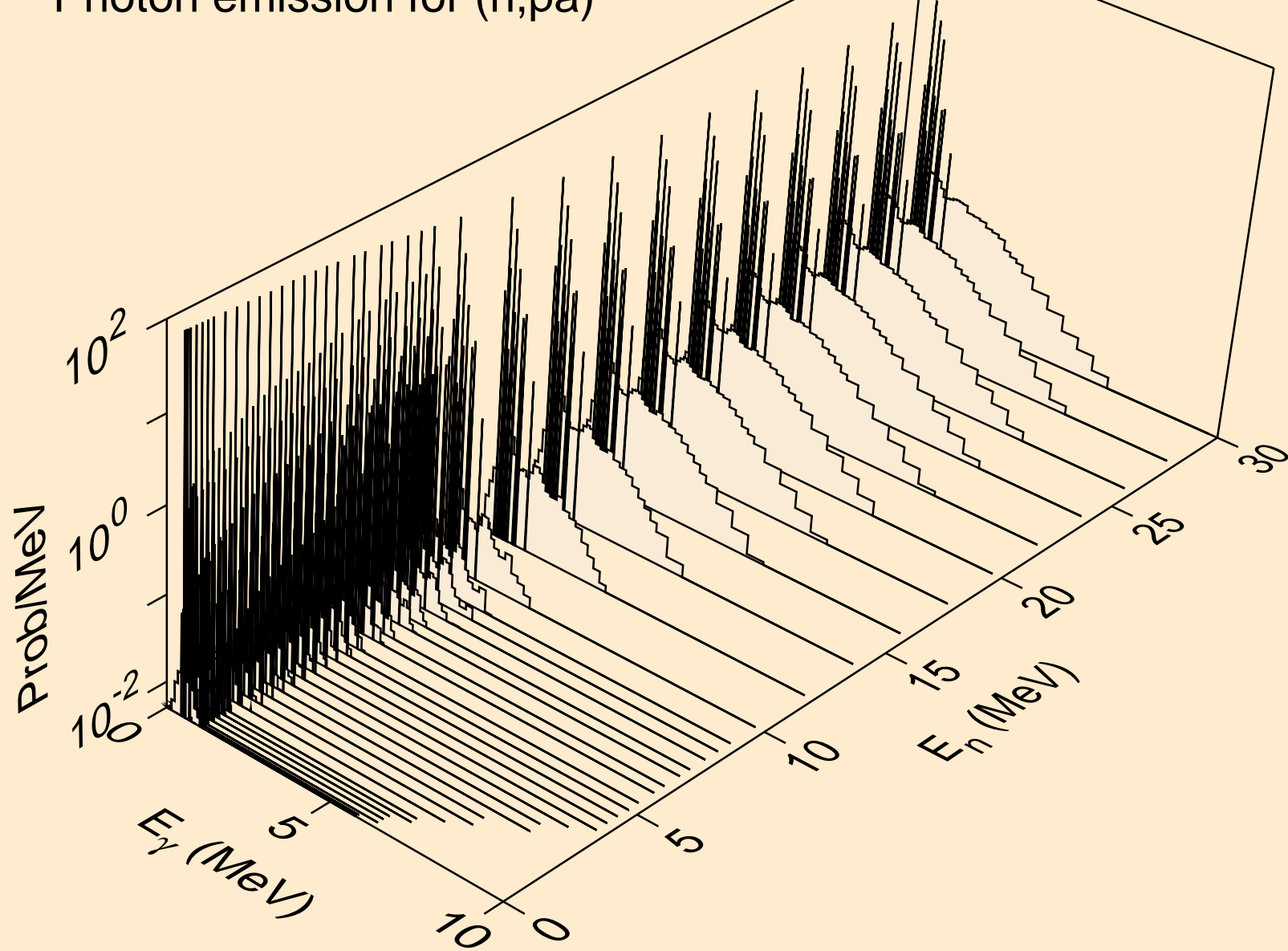

TC088M NEUTRON ACER TENDL-2021 LIBRARY; T=293.6K
Photon emission for (n,pd)

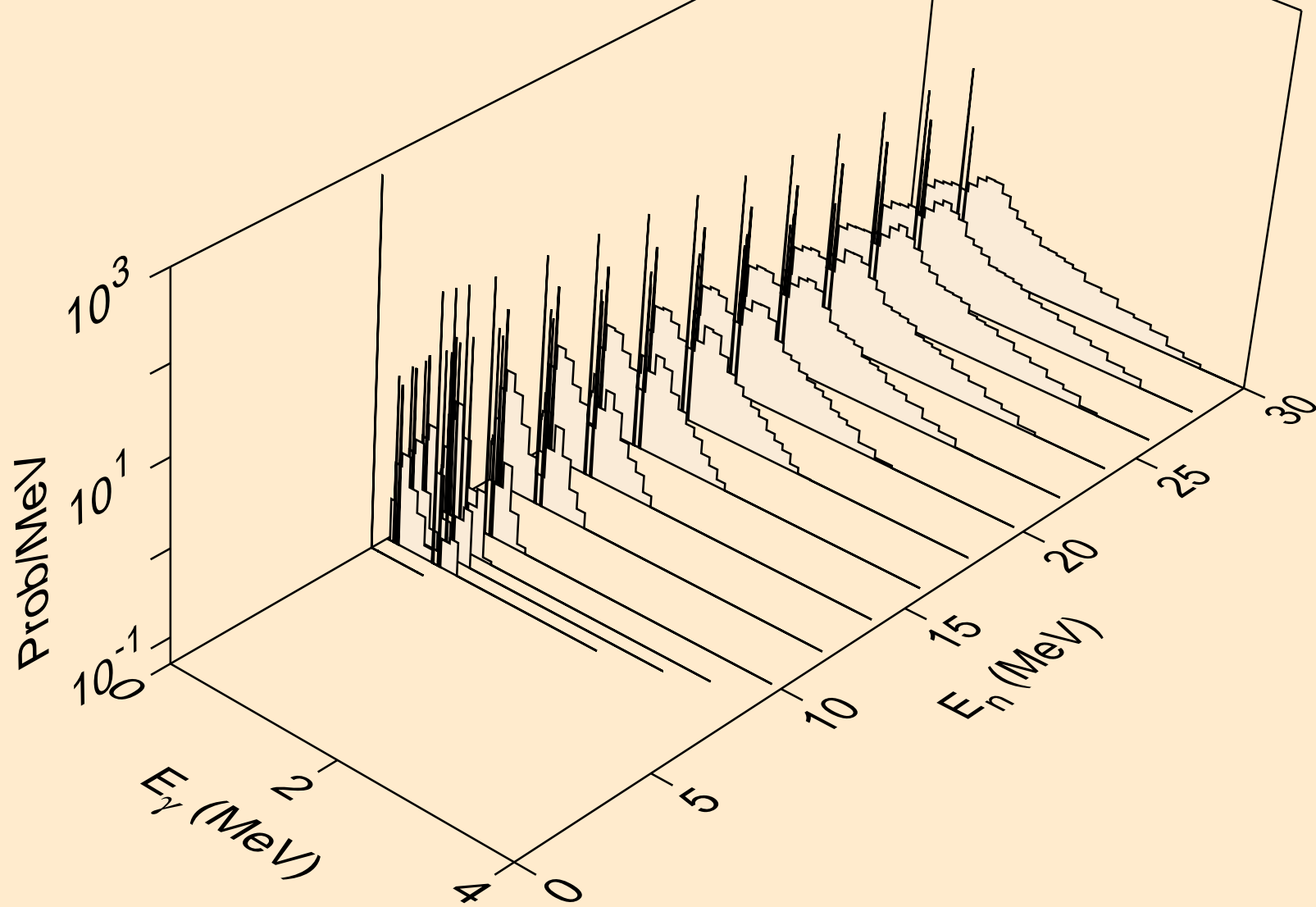

TC088M NEUTRON ACER TENDL-2021 LIBRARY; T=293.6K
Photon emission for (n,pt)

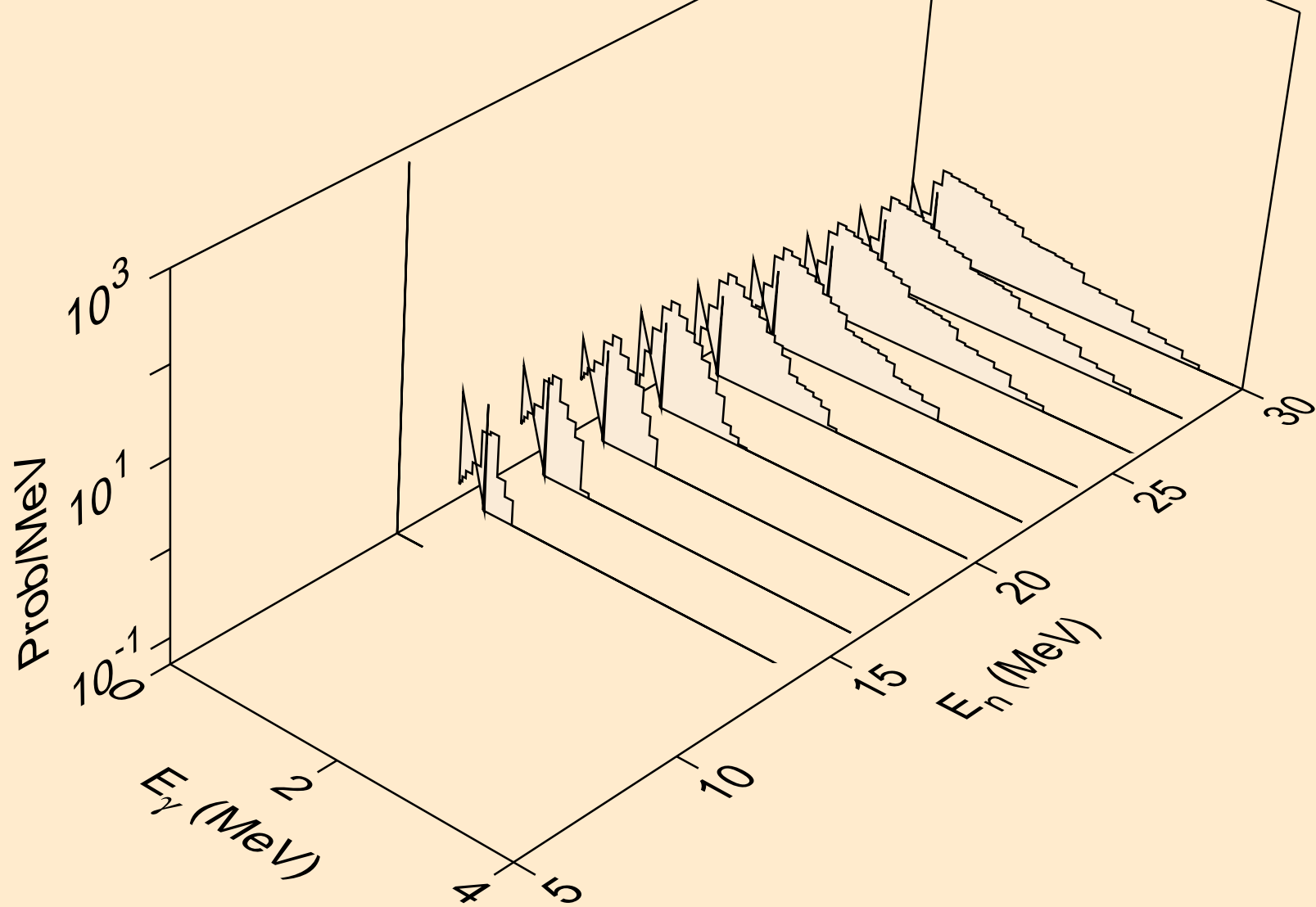

TC088M NEUTRON ACER TENDL-2021 LIBRARY; T=293.6K
Photon emission for (n,da)

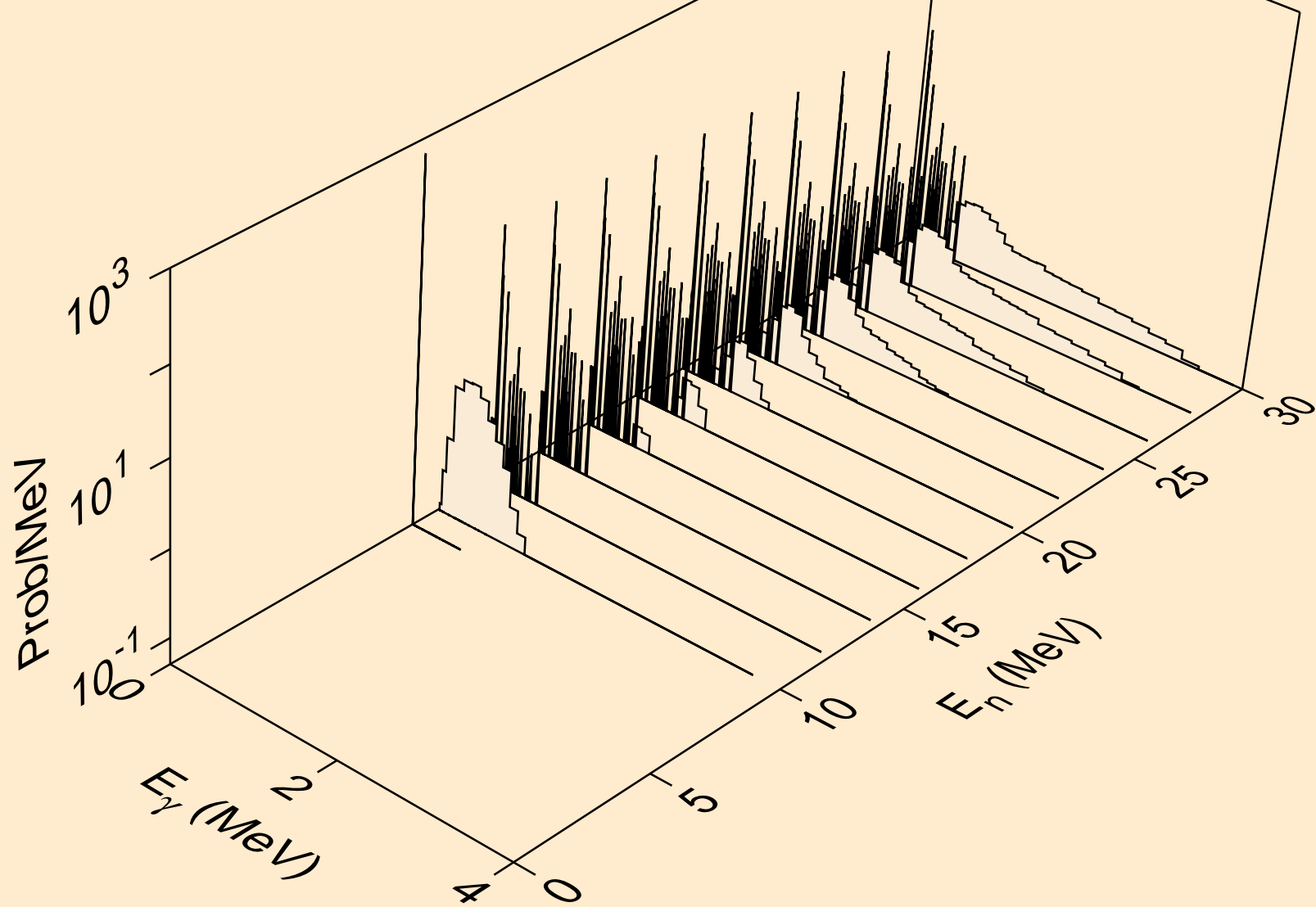

TC088M NEUTRON ACER TENDL-2021 LIBRARY; T=293.6K
thermal capture photon spectrum

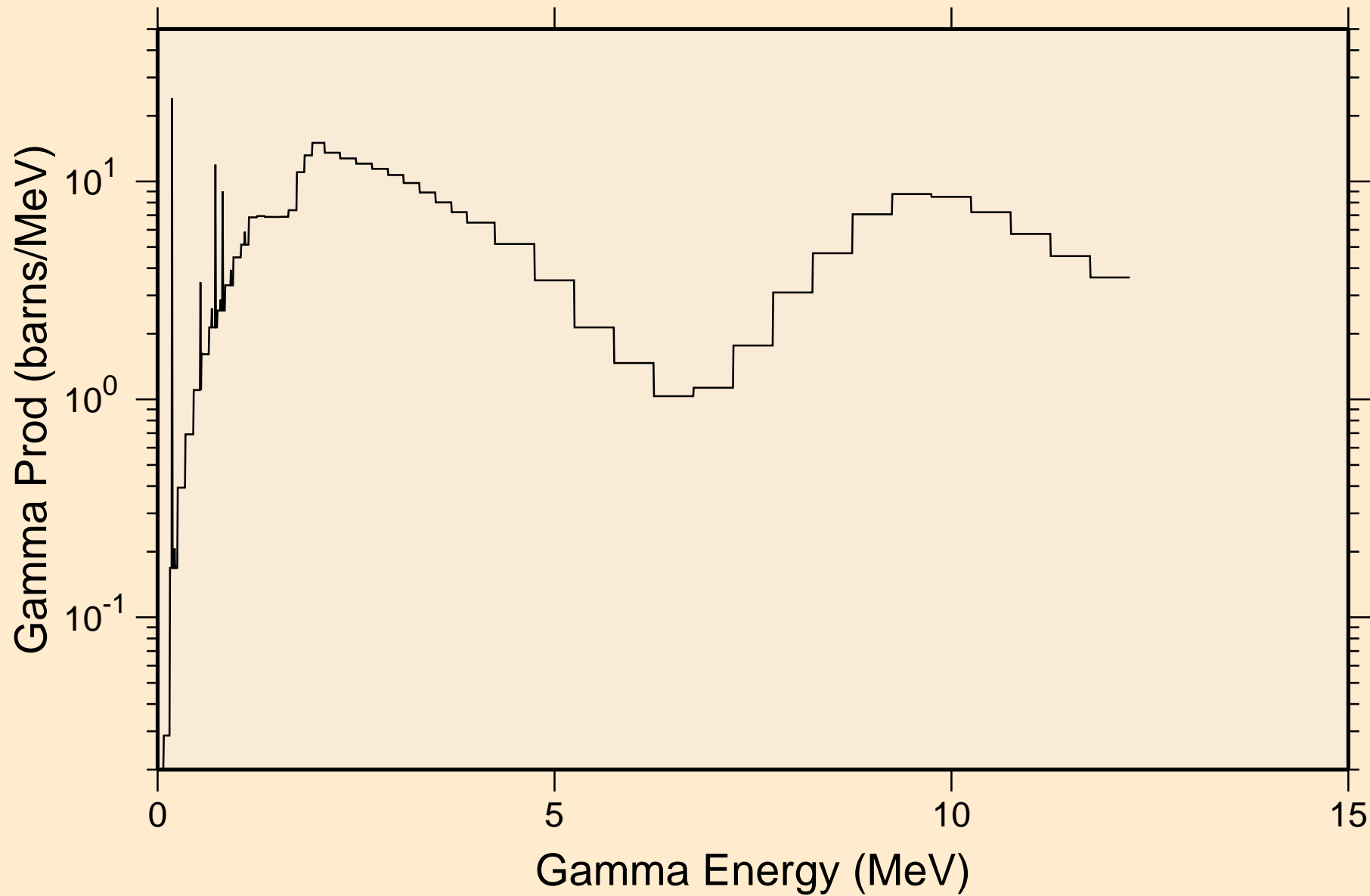

TC088M NEUTRON ACER TENDL-2021 LIBRARY; T=293.6K
14 MeV photon spectrum

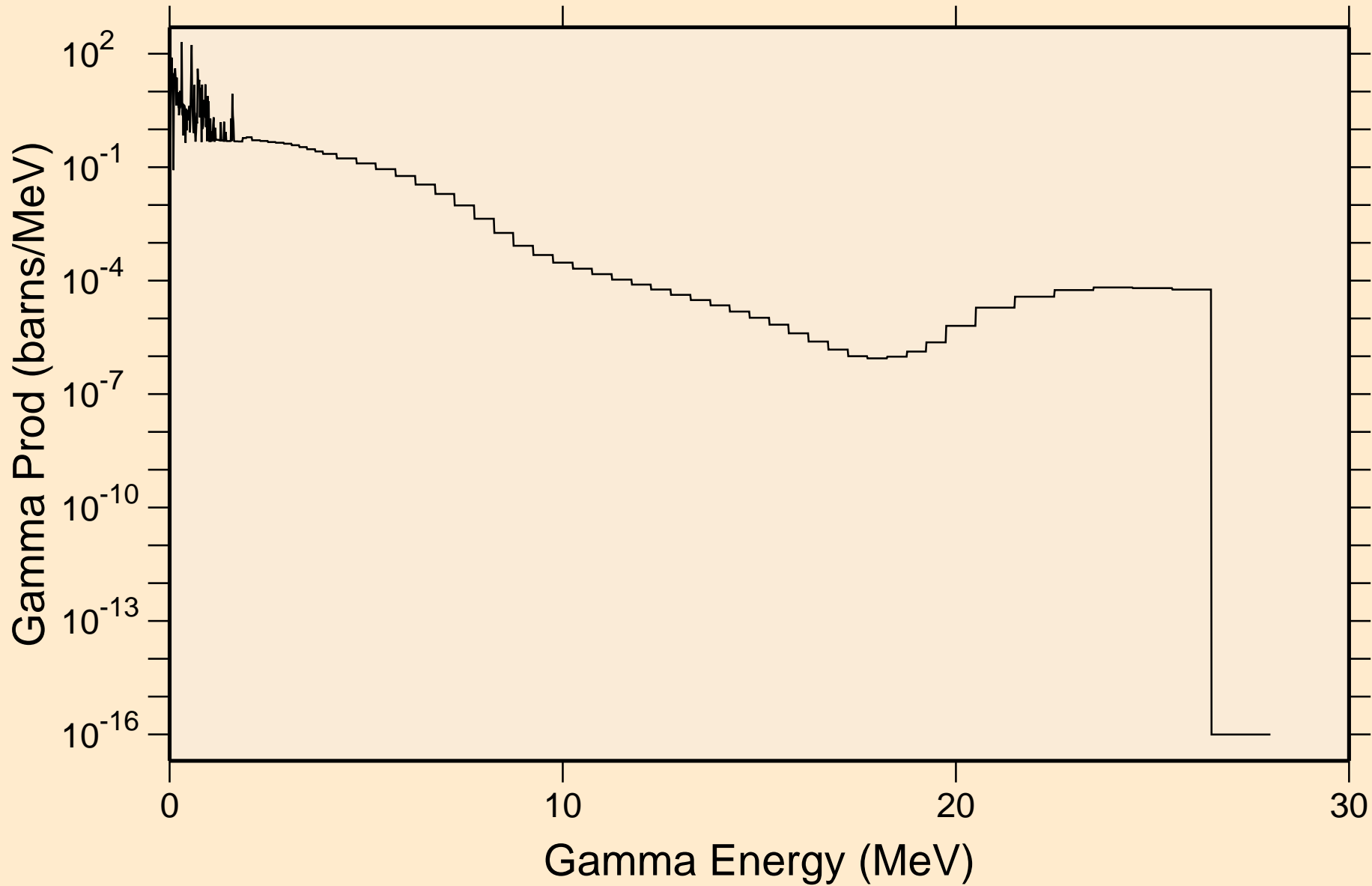

TC088M NEUTRON ACER TENDL-2021 LIBRARY; T=293.6K
Particle heating contributions

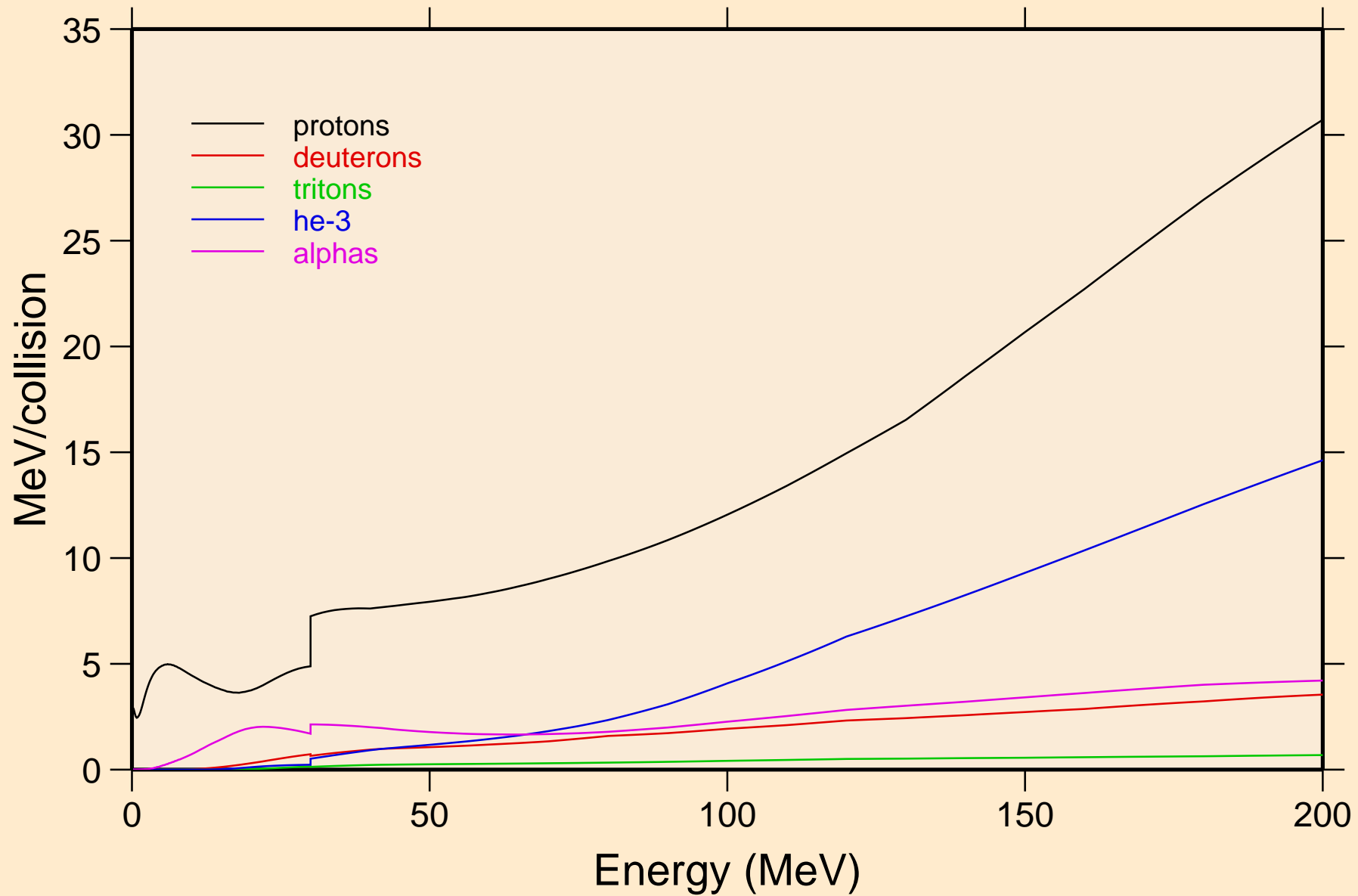

TC088M NEUTRON ACER TENDL-2021 LIBRARY; T=293.6K
Recoil Heating

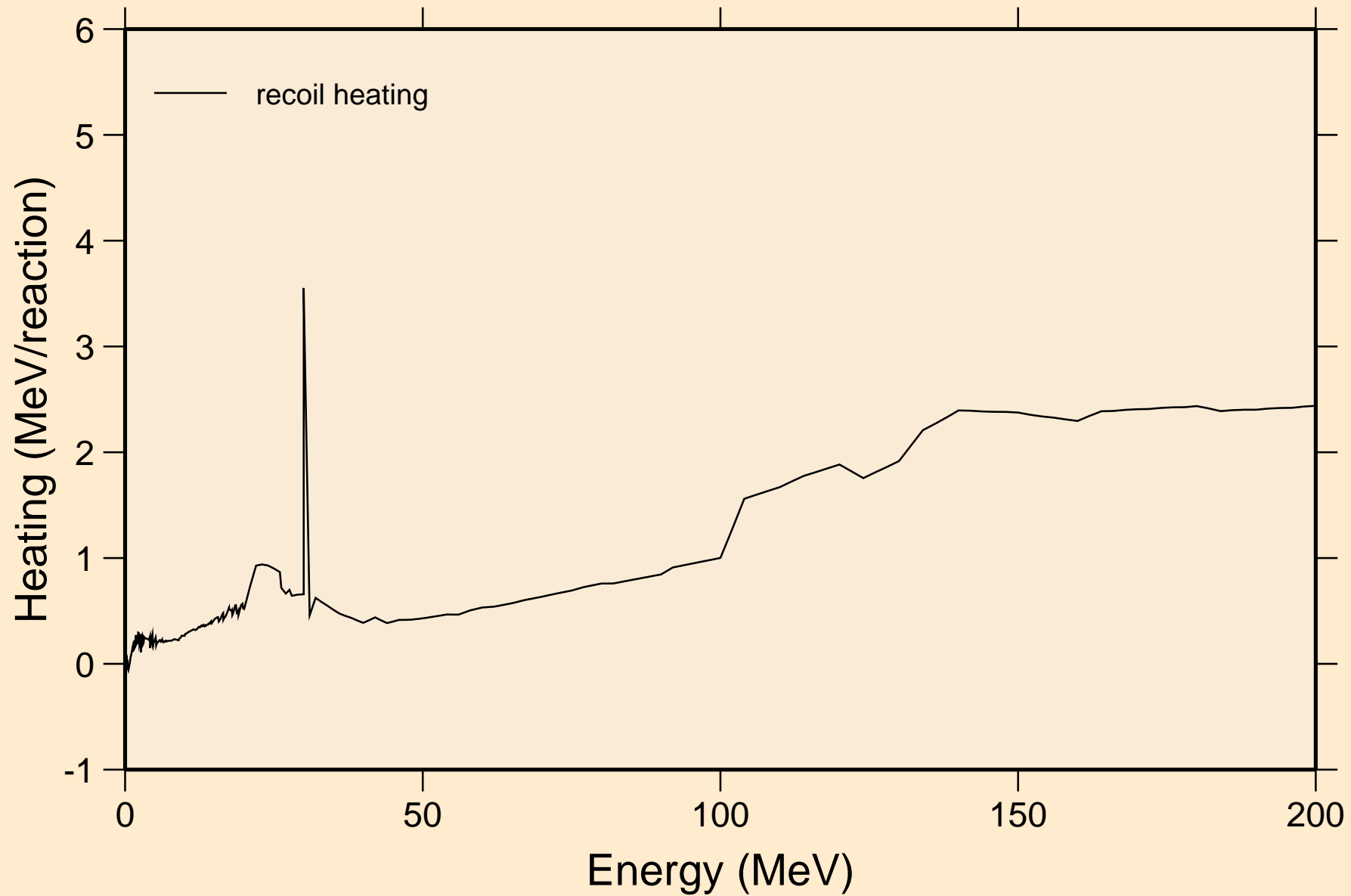

TC088M NEUTRON ACER TENDL-2021 LIBRARY; T=293.6K
Particle production cross sections

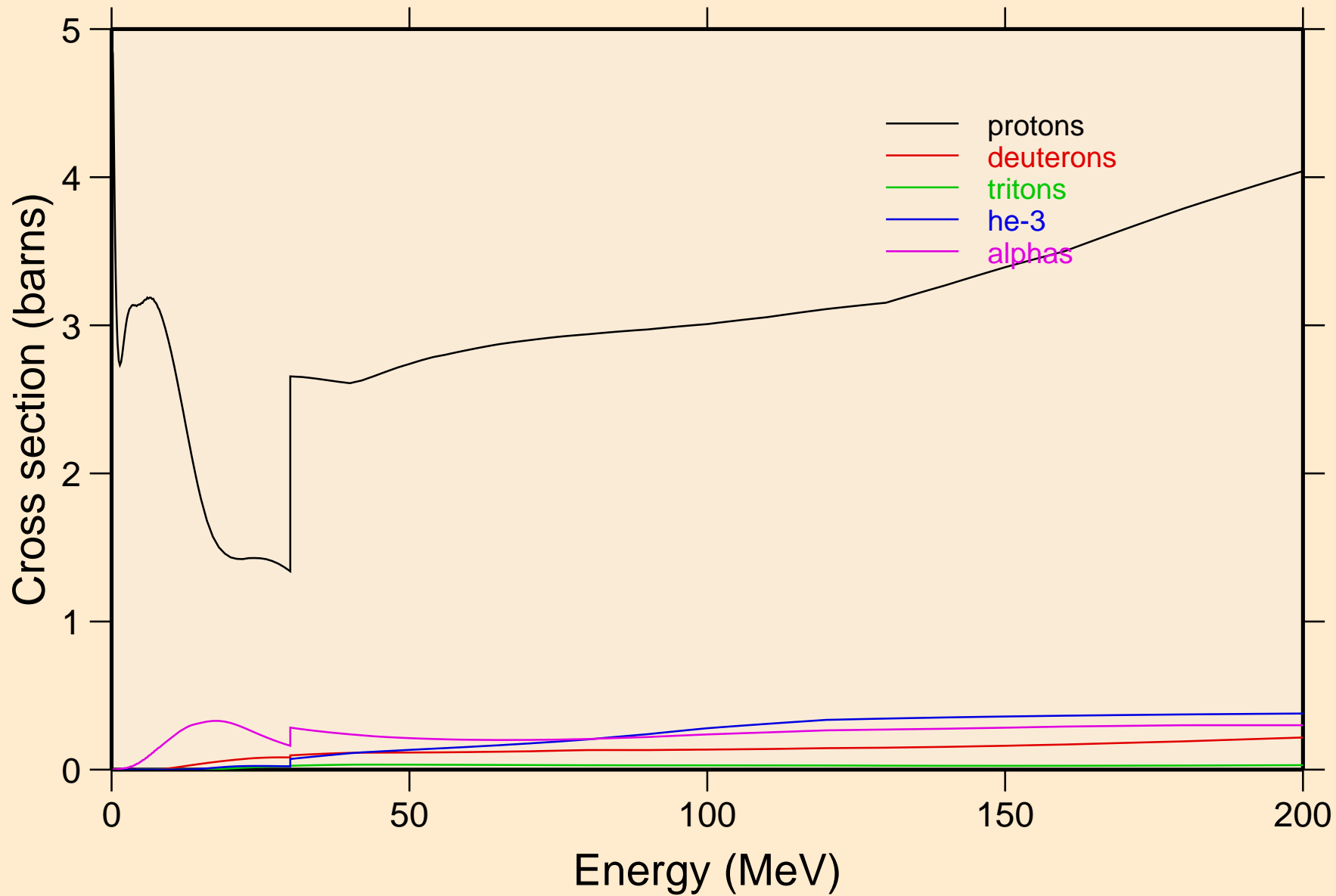

TC088M NEUTRON ACER TENDL-2021 LIBRARY; T=293.6K
protons from (n,x)

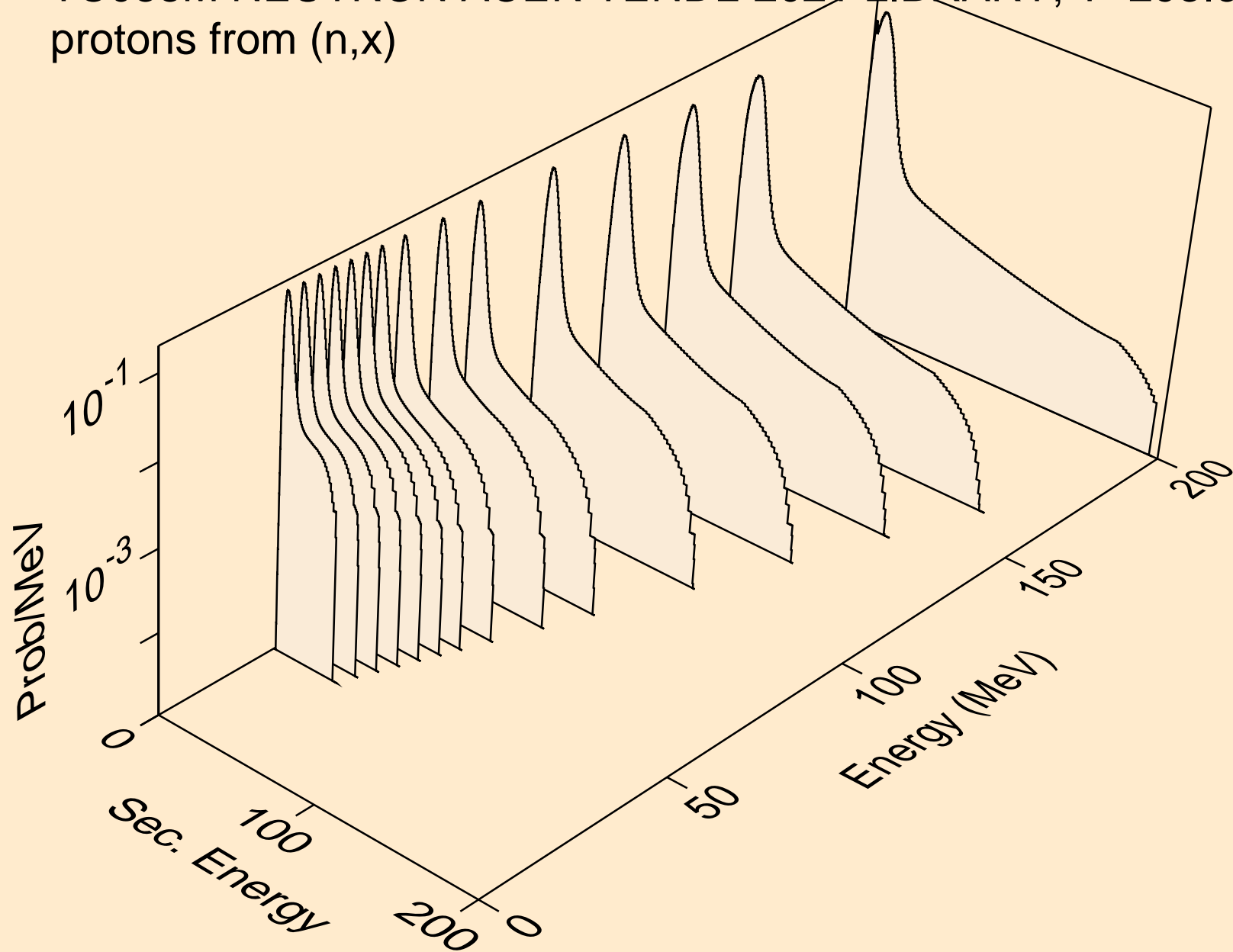

TC088M NEUTRON ACER TENDL-2021 LIBRARY; T=293.6K
protons from (n,n*)p

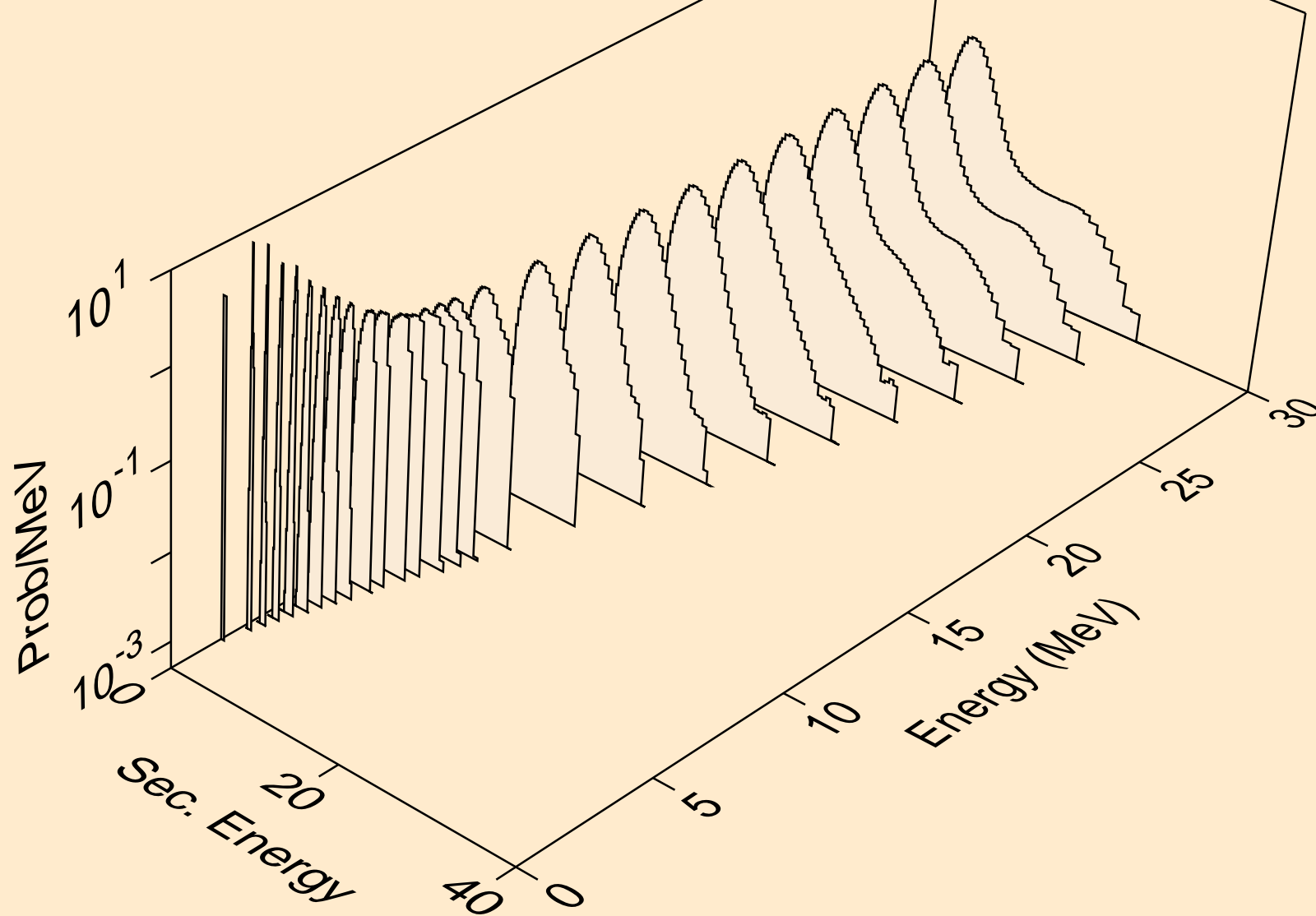

TC088M NEUTRON ACER TENDL-2021 LIBRARY; T=293.6K
protons from (n,2np)

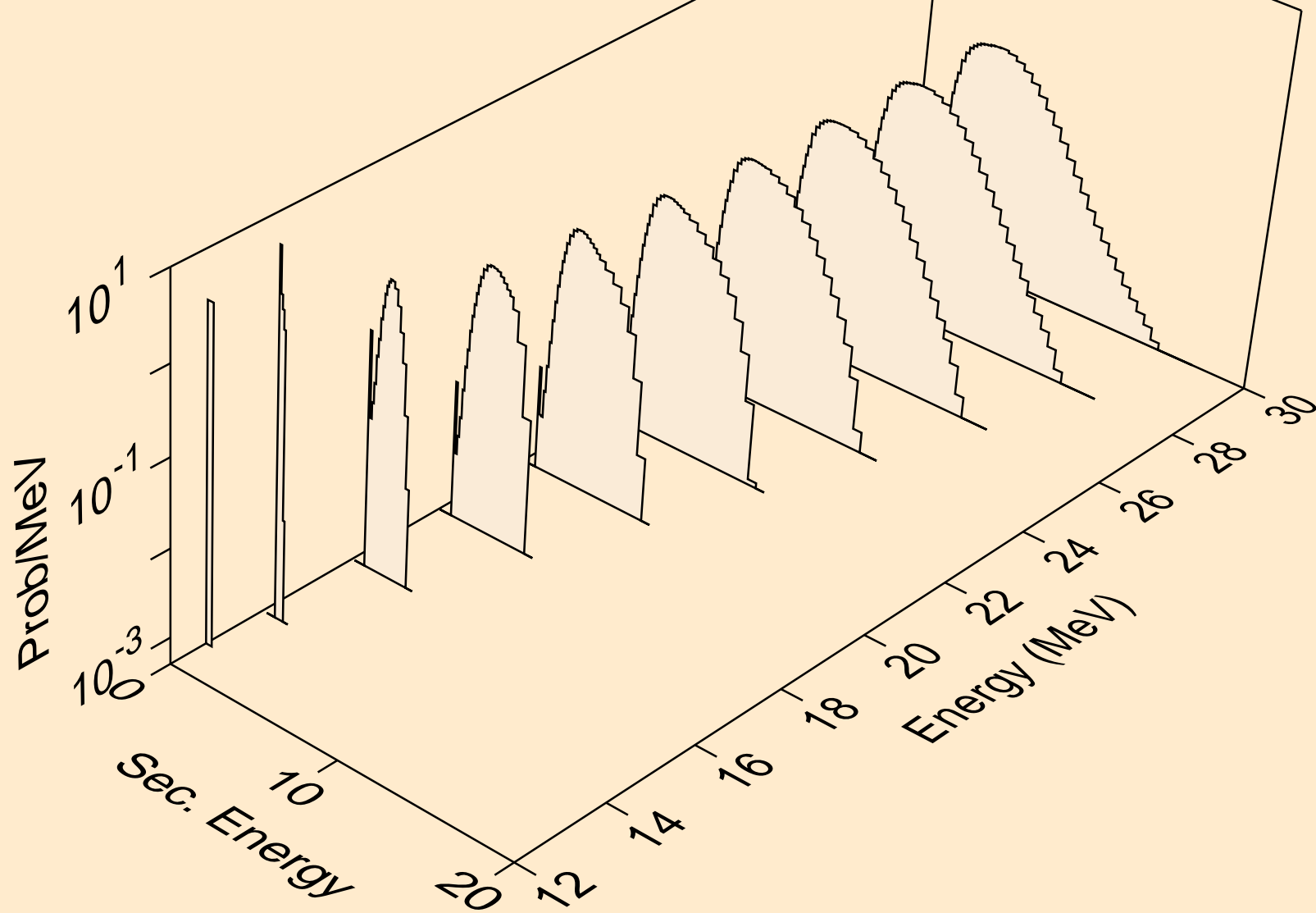

TC088M NEUTRON ACER TENDL-2021 LIBRARY; T=293.6K
protons from (n,3np)

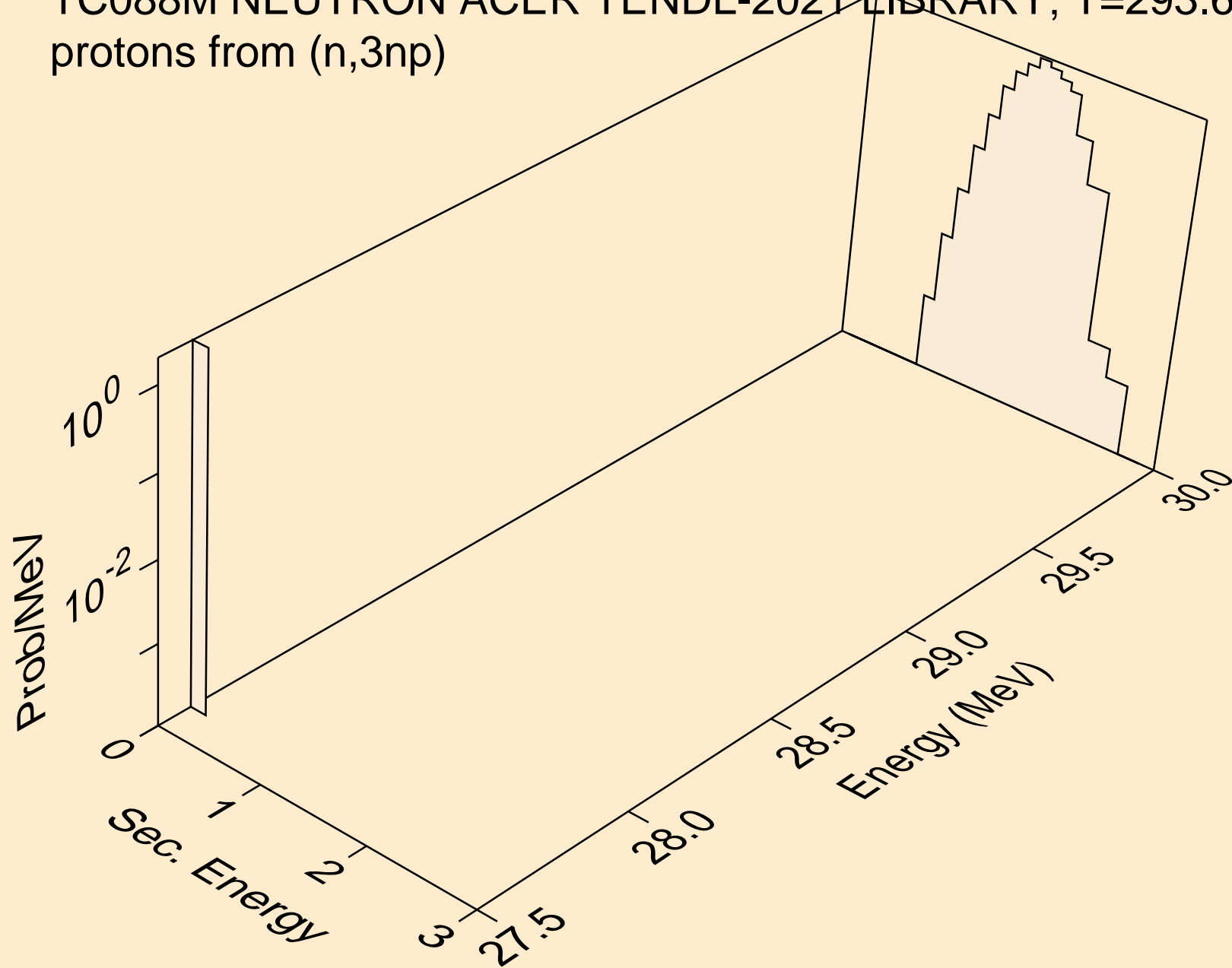

TC088M NEUTRON ACER TENDL-2021 LIBRARY; T=293.6K
protons from (n,2np)

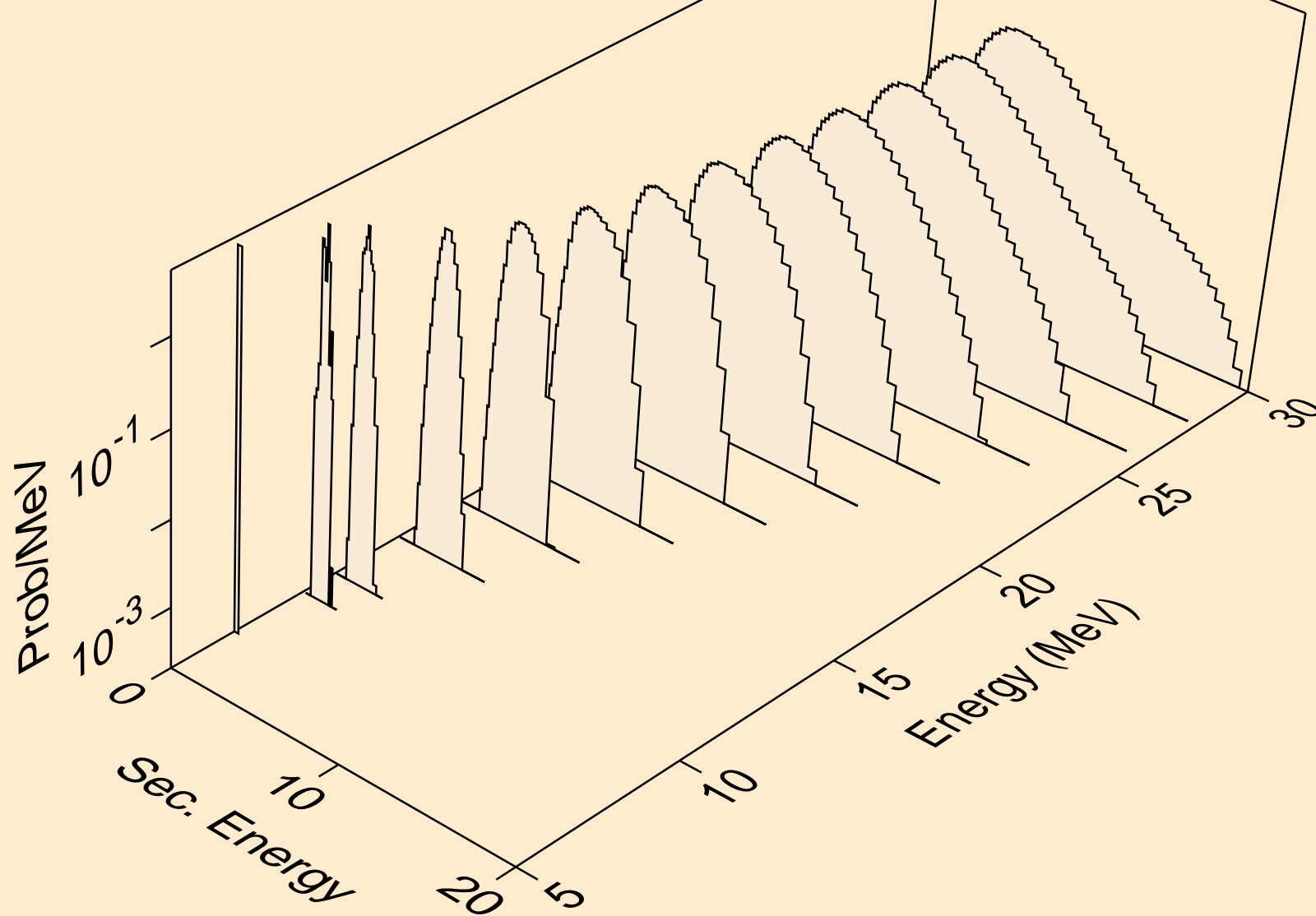

TC088M NEUTRON ACER TENDL-2021 LIBRARY; T=293.6K
protons from (n,npa)

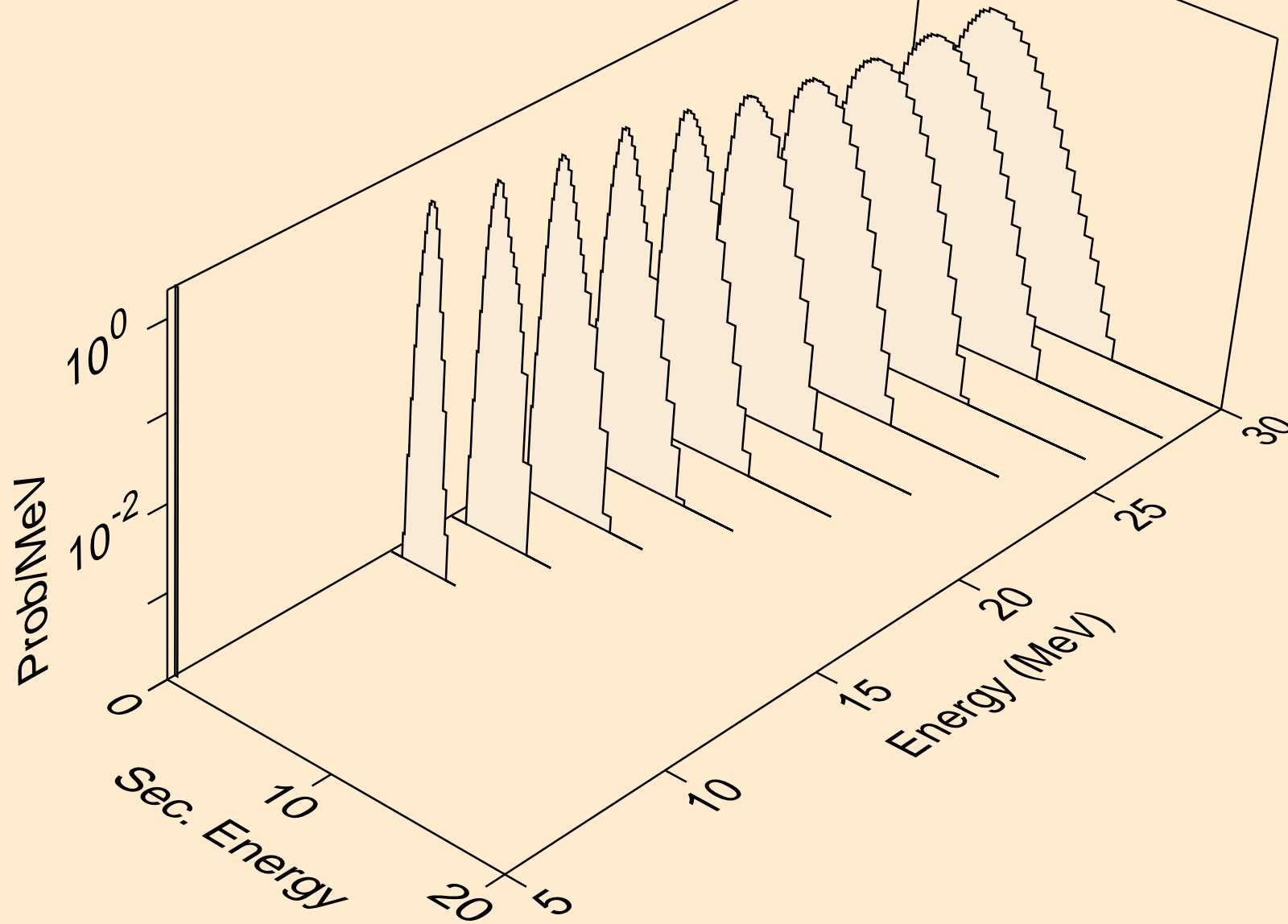

TC088M NEUTRON ACER TENDL-2021 LIBRARY; T=293.6K
protons from (n,p)

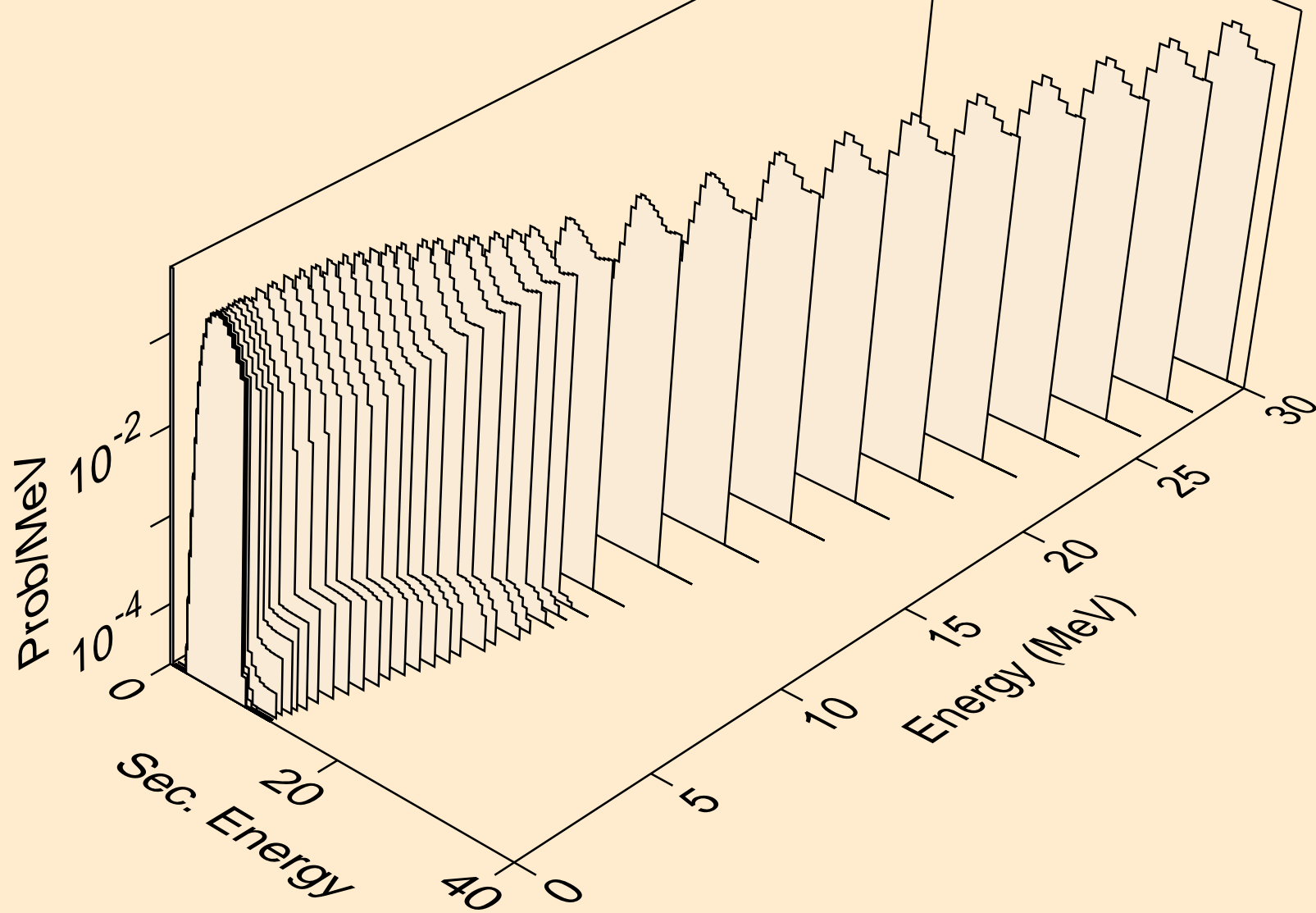

TC088M NEUTRON ACER TENDL-2021 LIBRARY; T=293.6K
protons from (n,2p)

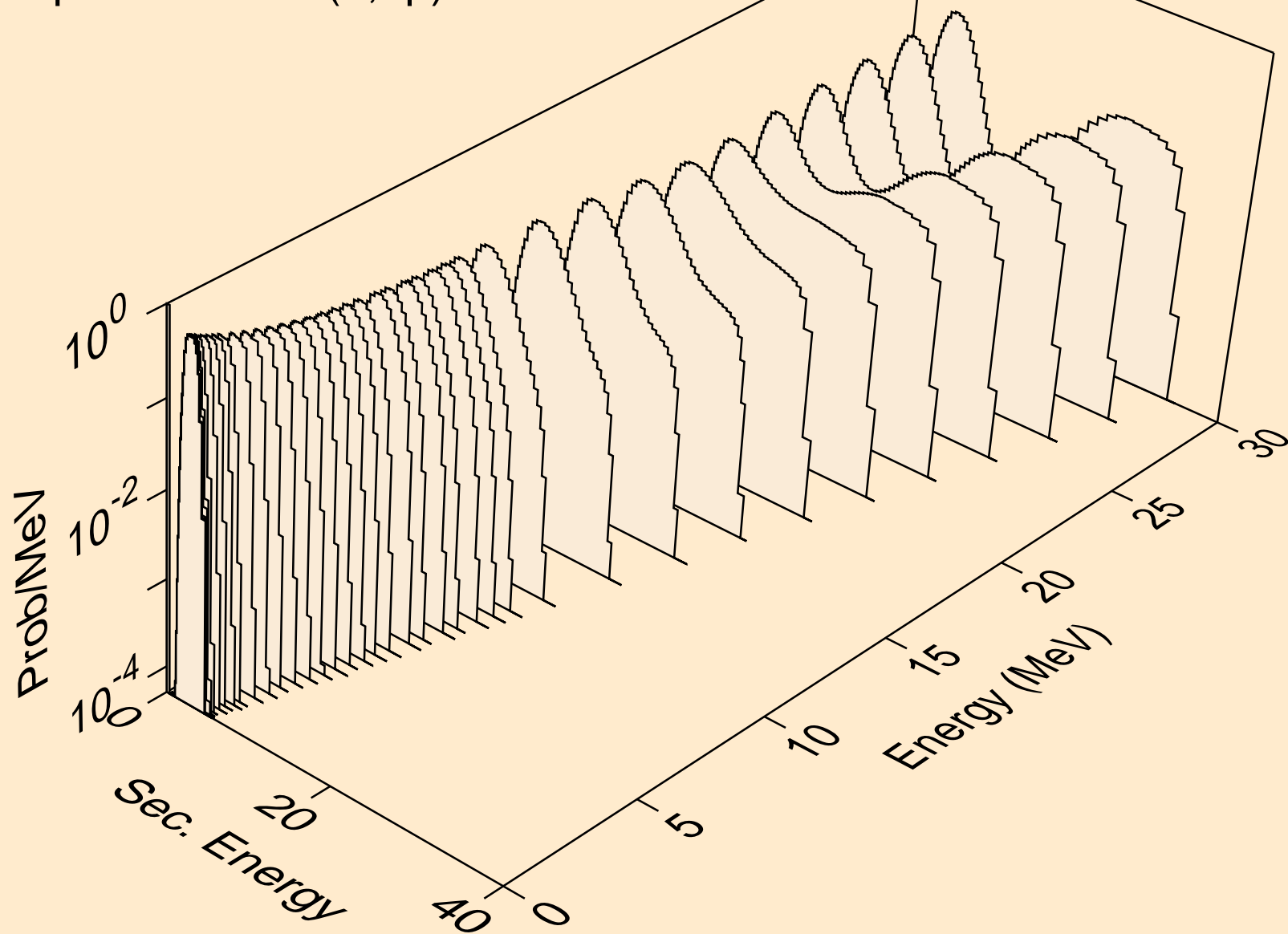

TC088M NEUTRON ACER TENDL-2021 LIBRARY; T=293.6K
protons from (n,p)

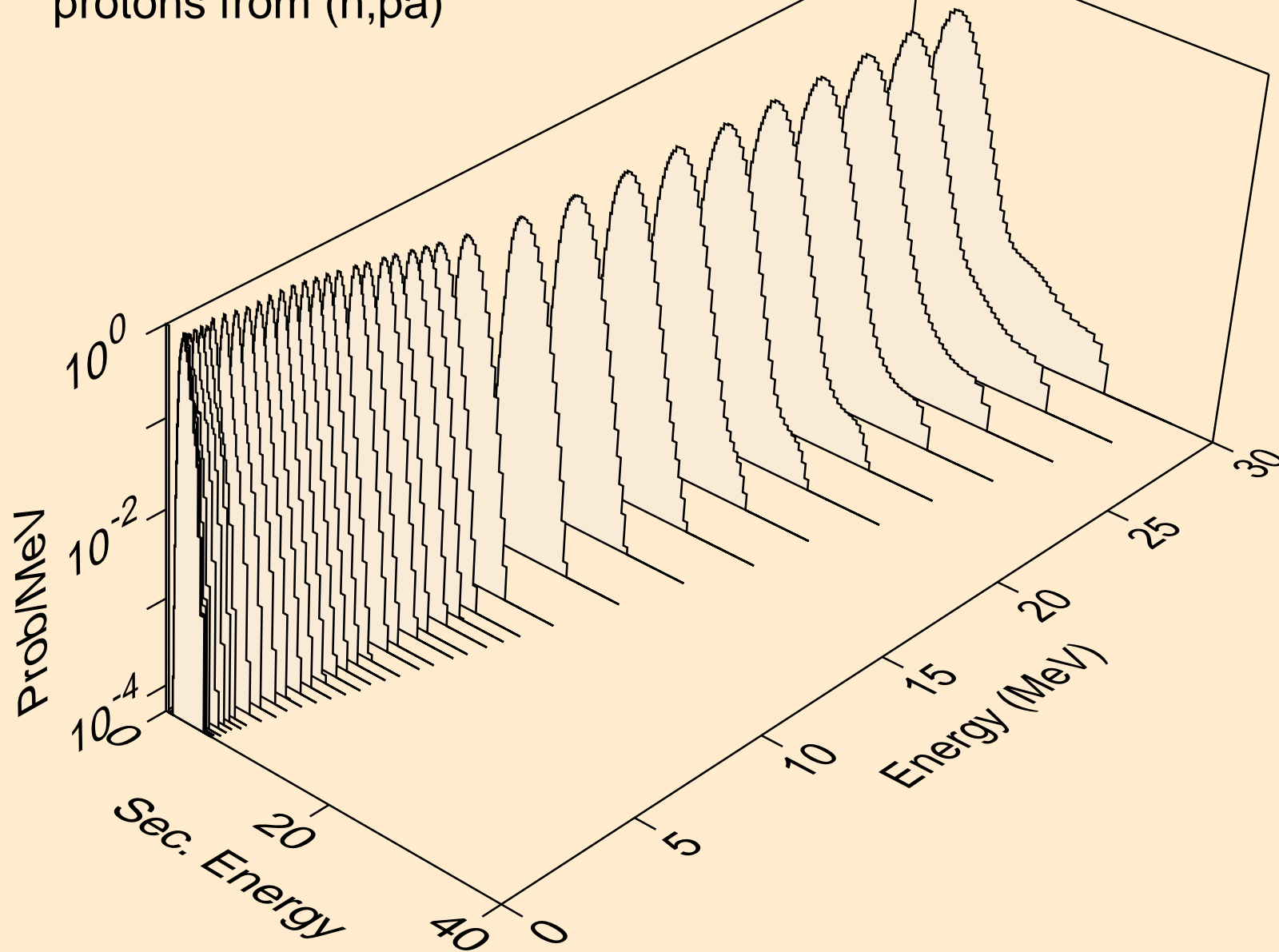

TC088M NEUTRON ACER TENDL-2021 LIBRARY; T=293.6K
protons from (n,pd)

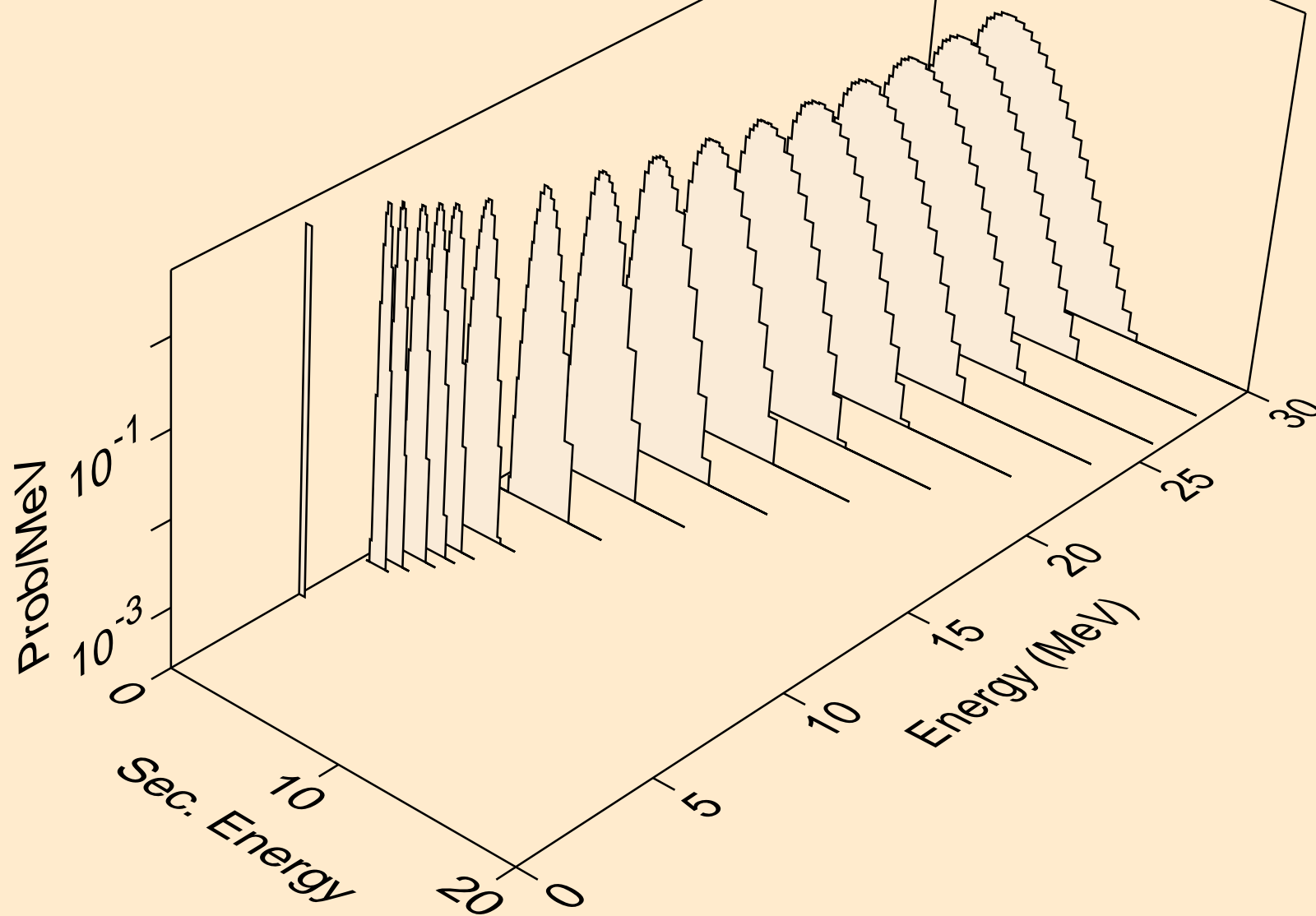

TC088M NEUTRON ACER TENDL-2021 LIBRARY; T=293.6K
protons from (n,pt)

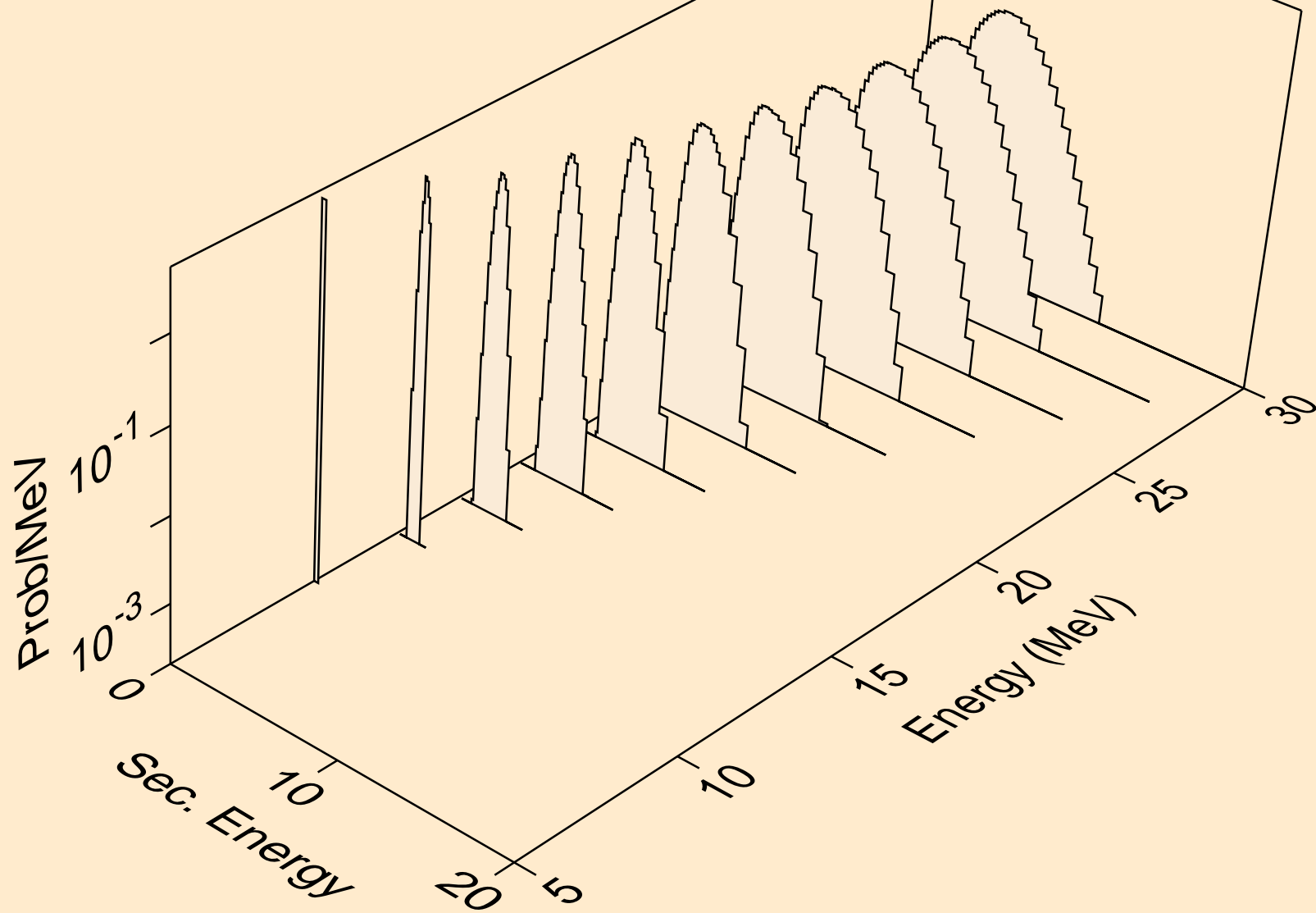

TC088M NEUTRON ACER TENDL-2021 LIBRARY; T=293.6K
deuterons from (n,x)

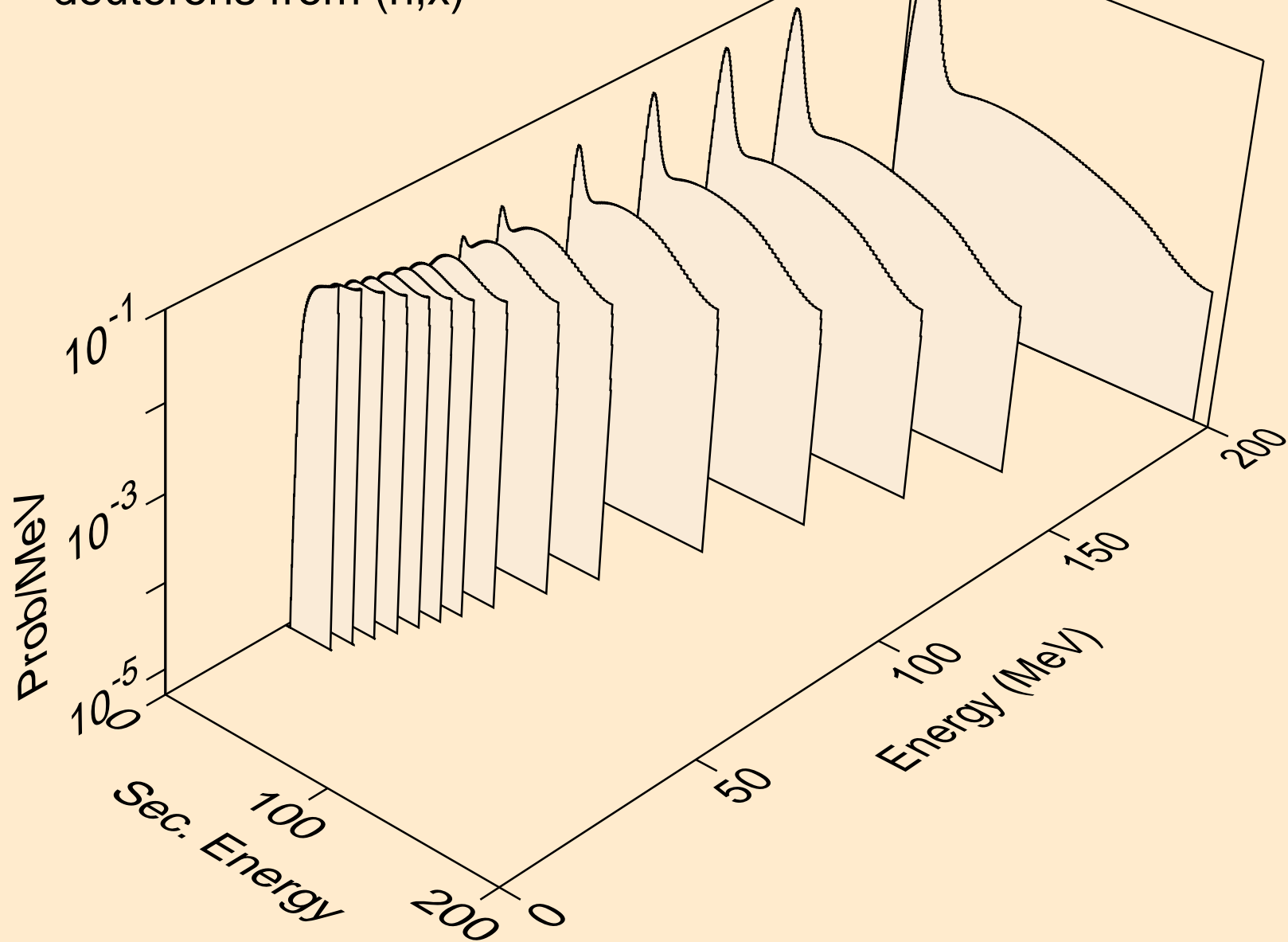

TC088M NEUTRON ACER TENDL-2021 LIBRARY; T=293.6K
deuterons from (n,n*)d

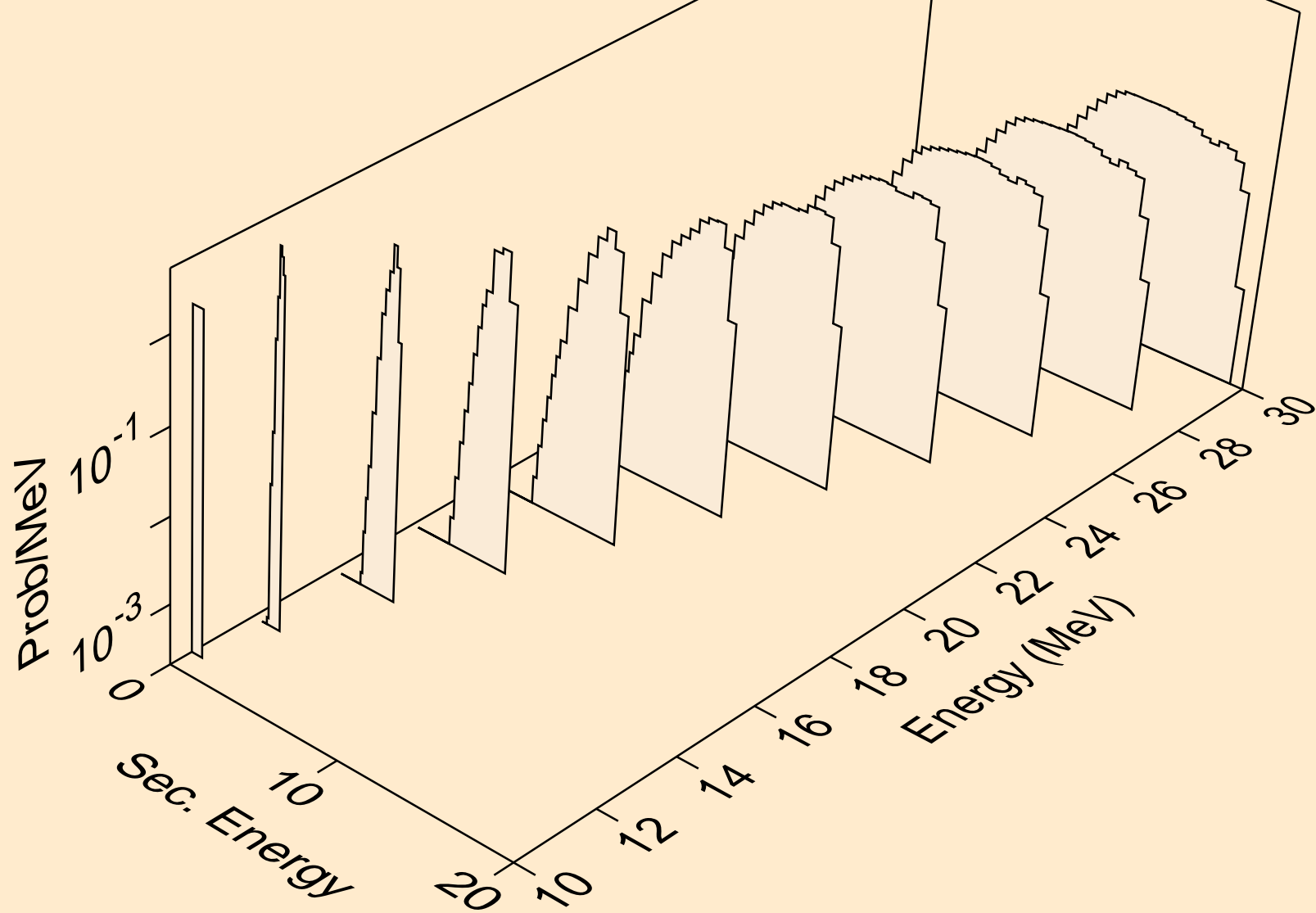

TC088M NEUTRON ACER TENDL-2021 LIBRARY; T=293.6K
deuterons from (n,d)

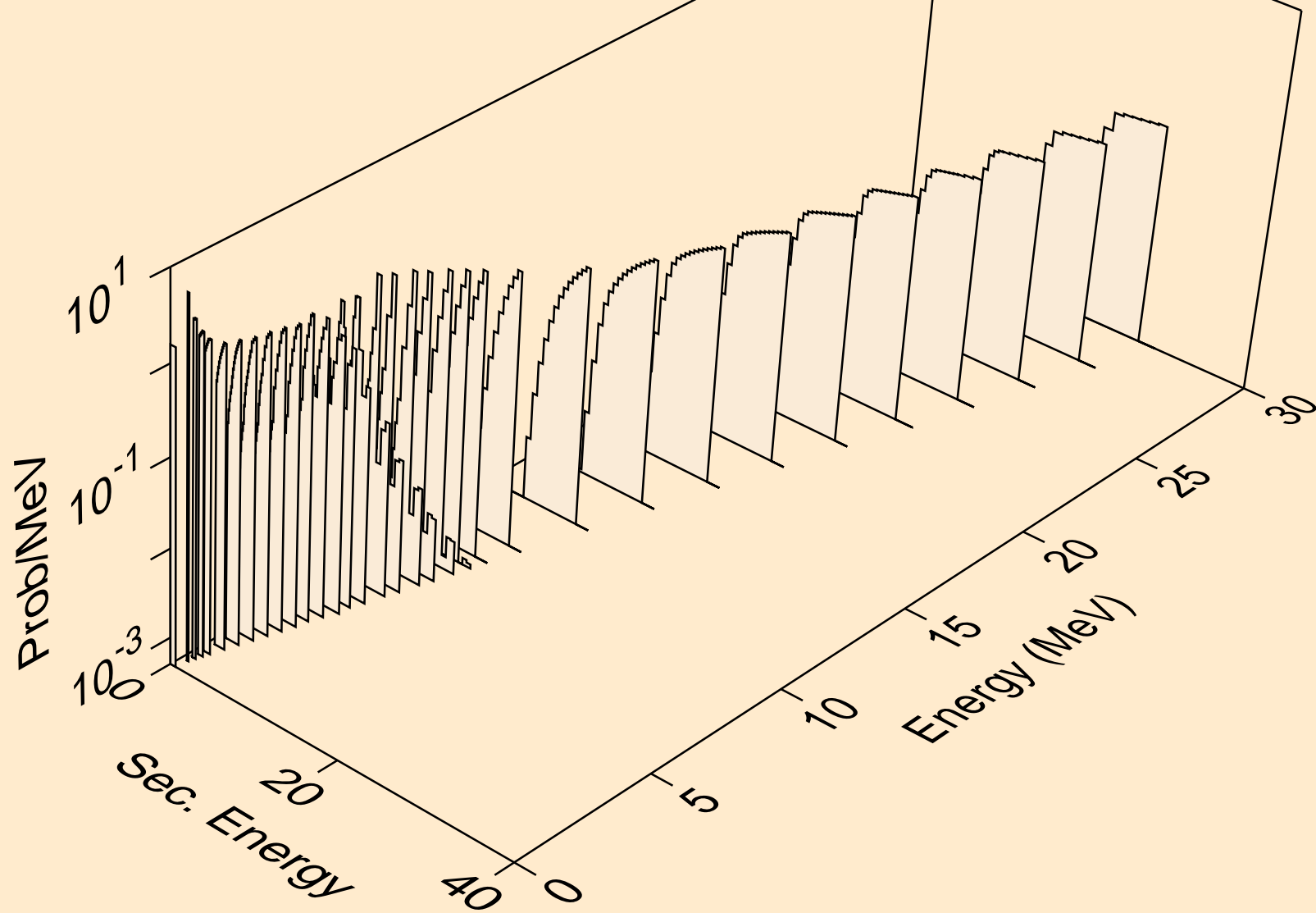

TC088M NEUTRON ACER TENDL-2021 LIBRARY; T=293.6K
deuterons from (n,pd)

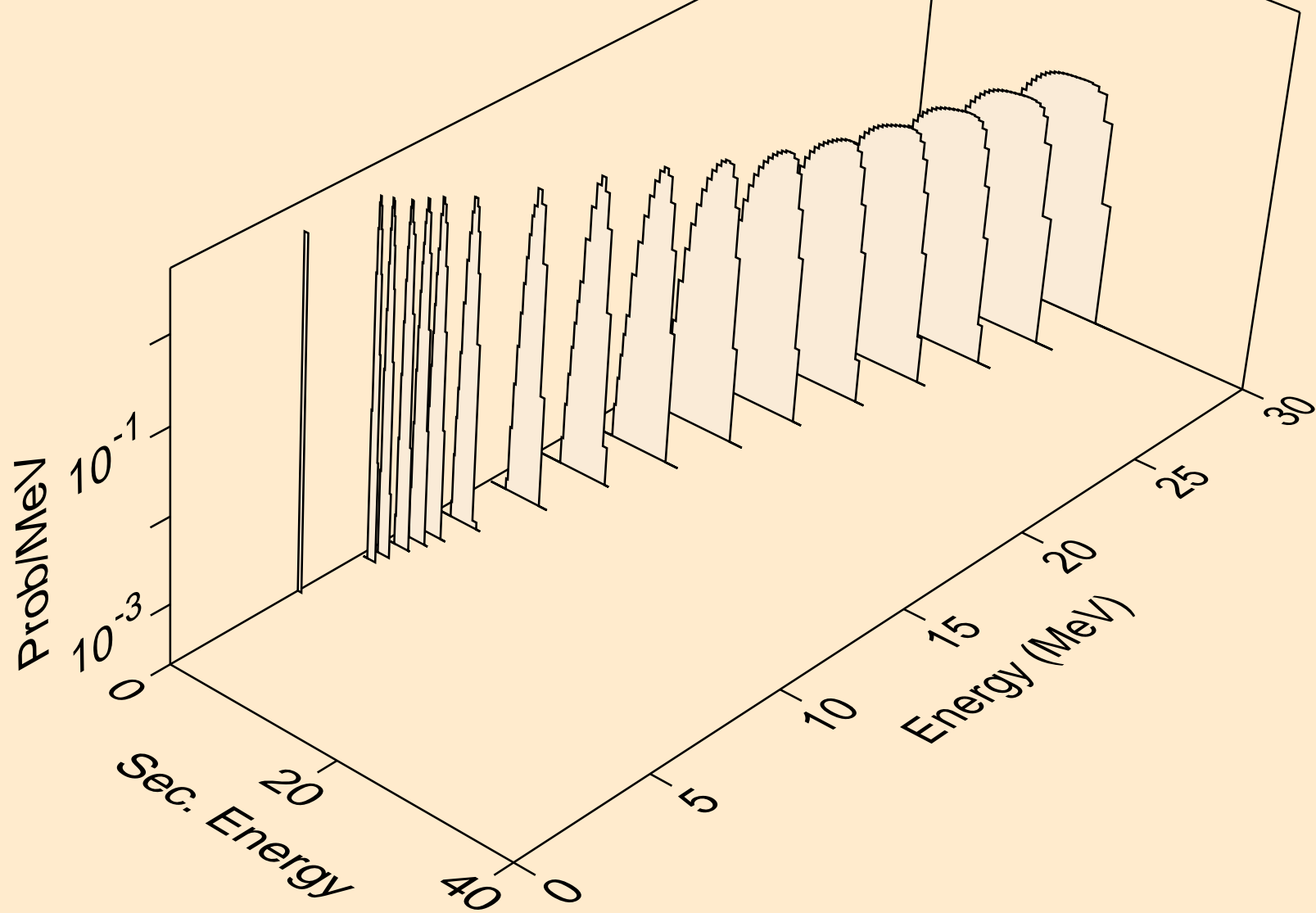

TC088M NEUTRON ACER TENDL-2021 LIBRARY; T=293.6K
deuterons from (n,da)

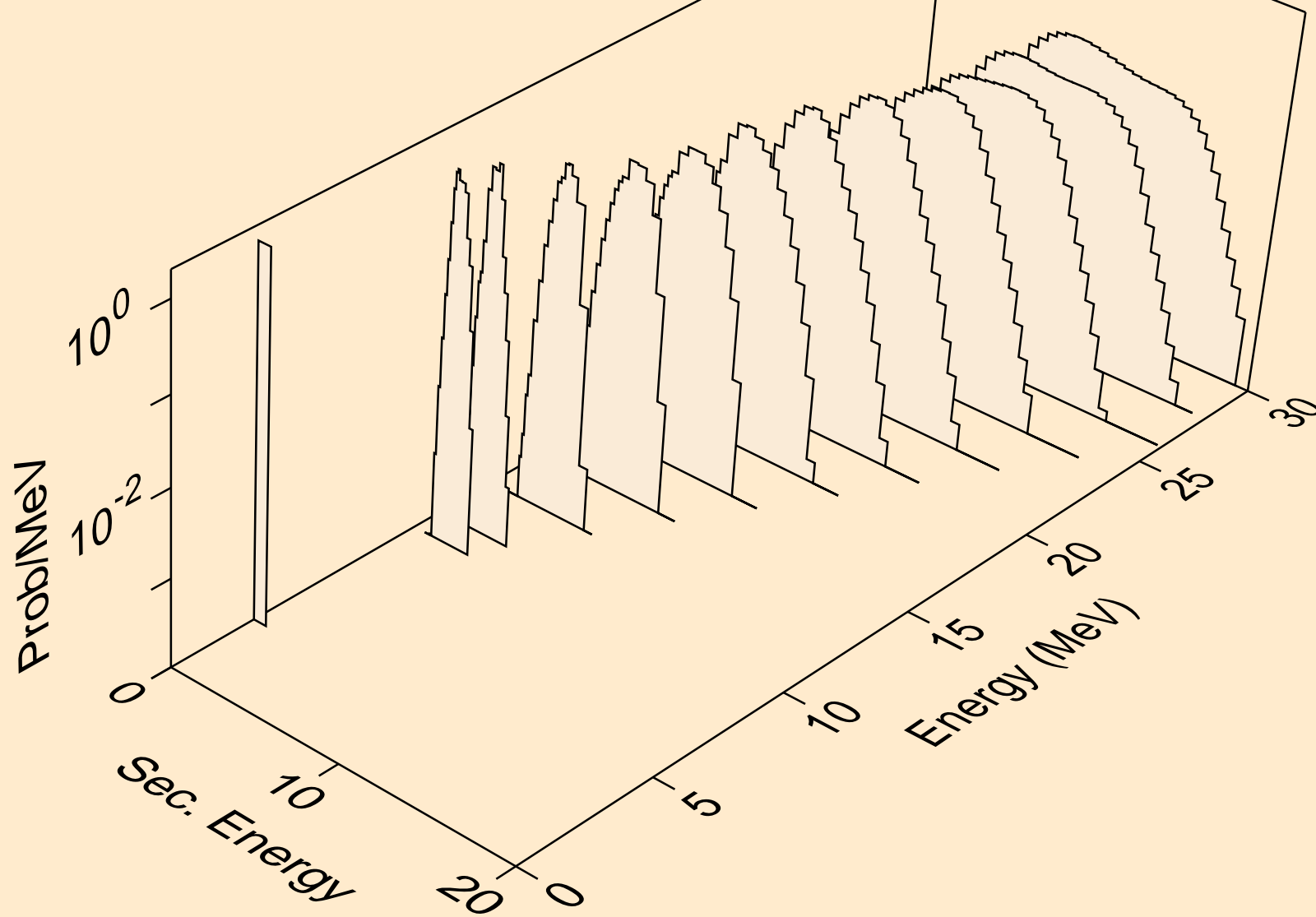

TC088M NEUTRON ACER TENDL-2021 LIBRARY; T=293.6K
tritons from (n,x)

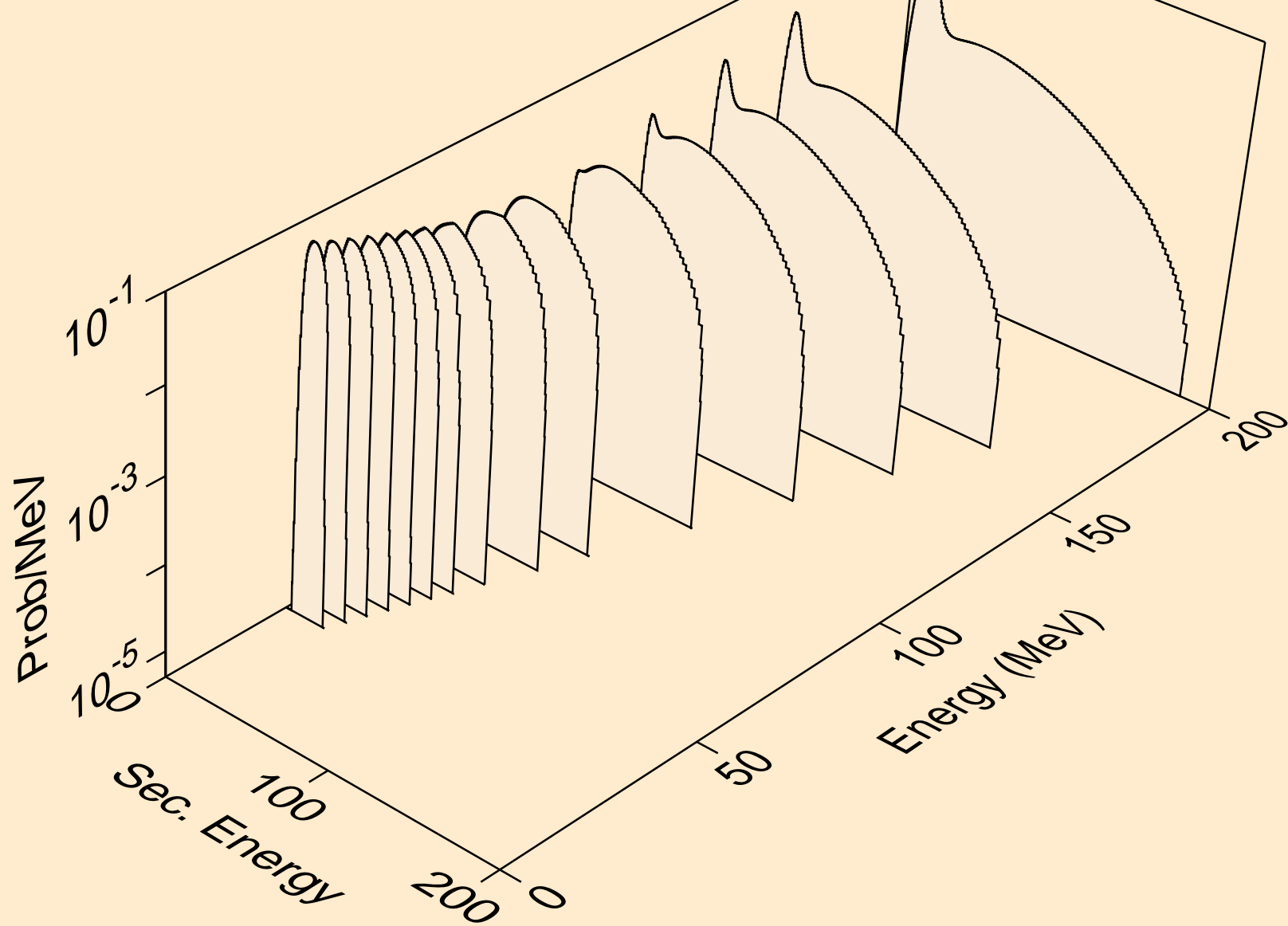

TC088M NEUTRON ACER TENDL-2021 LIBRARY; T=293.6K
tritons from (n,n*)t

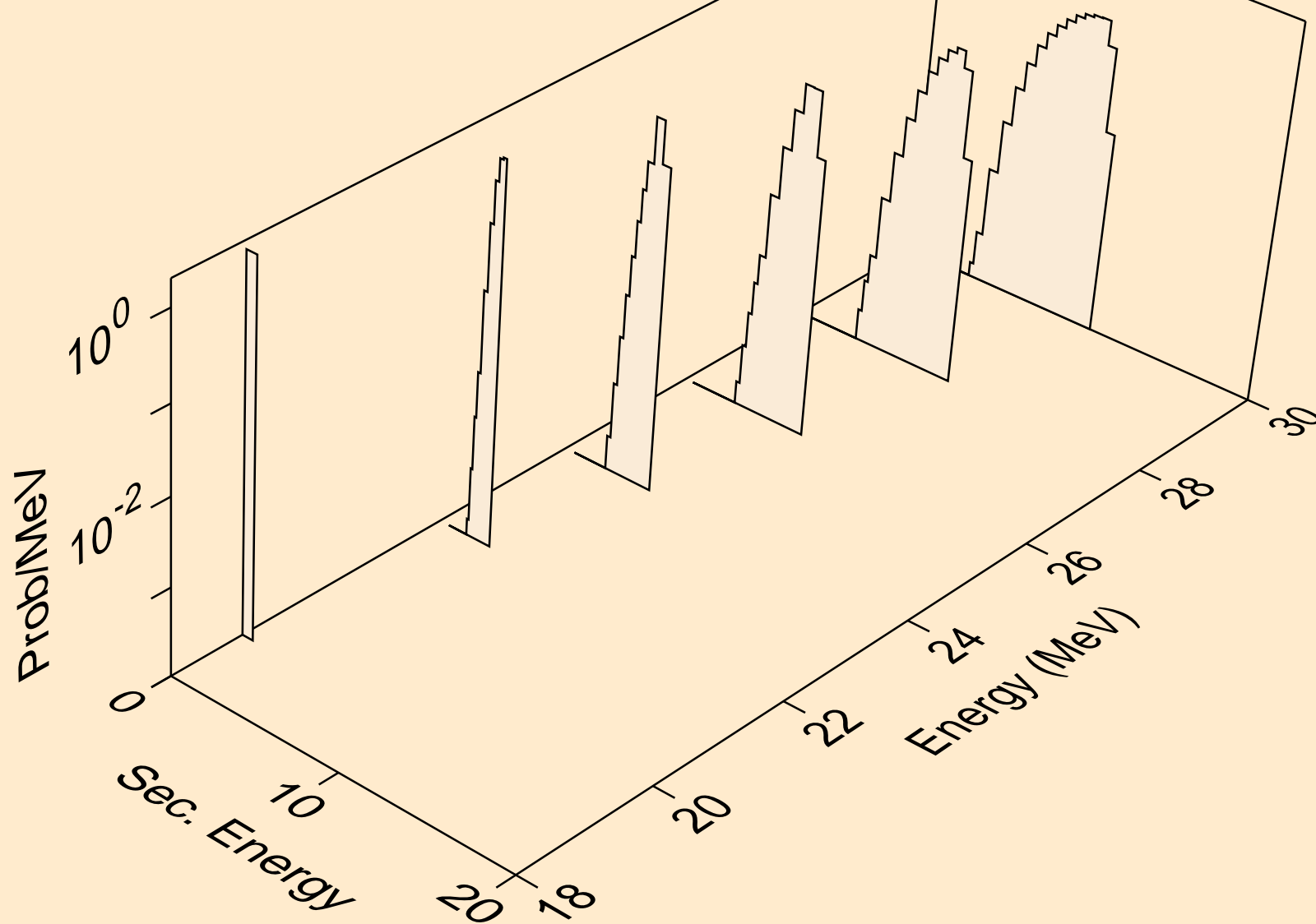

TC088M NEUTRON ACER TENDL-2021 LIBRARY; T=293.6K
tritons from (n,t)

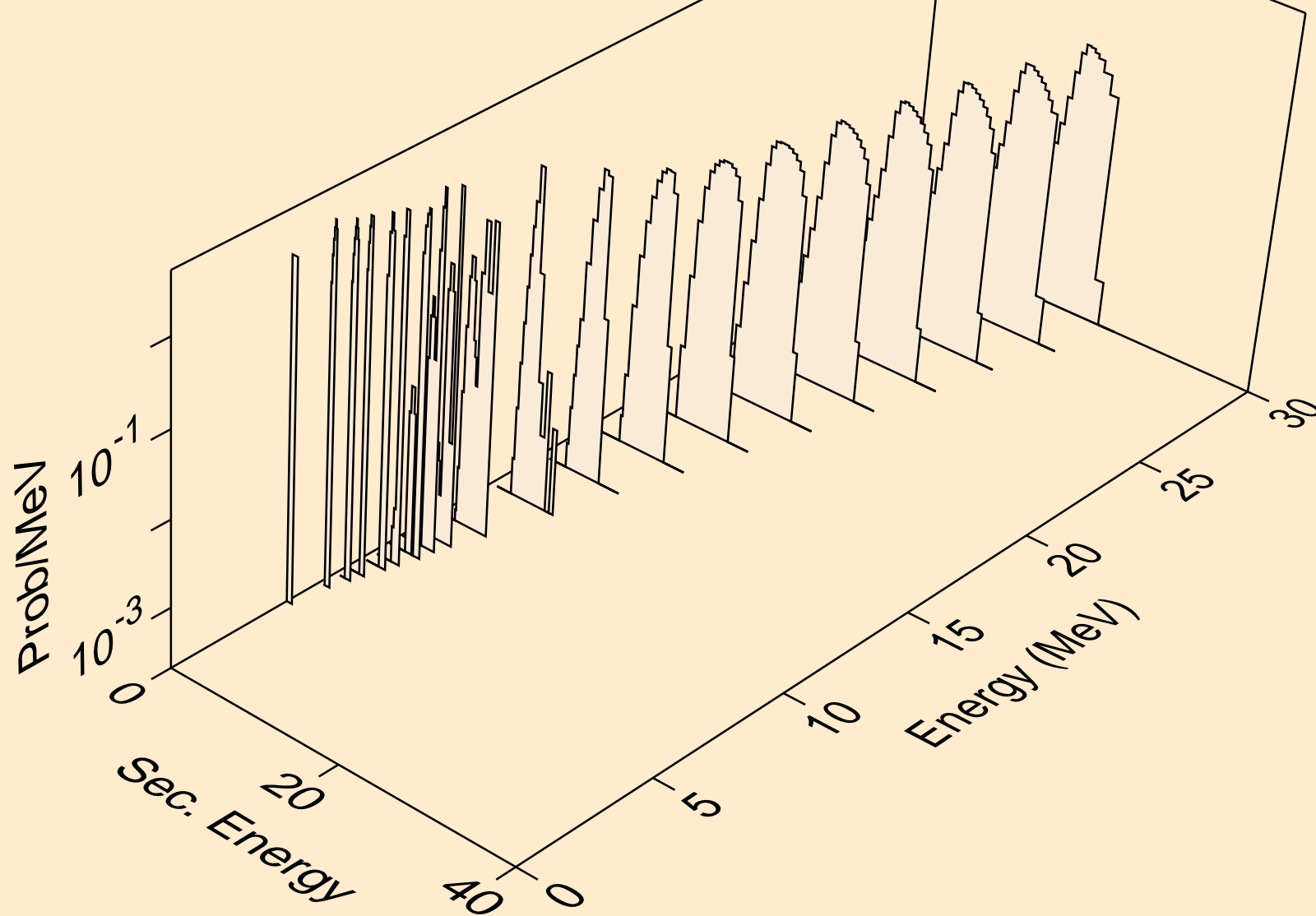

TC088M NEUTRON ACER TENDL-2021 LIBRARY; T=293.6K
tritons from (n,pt)

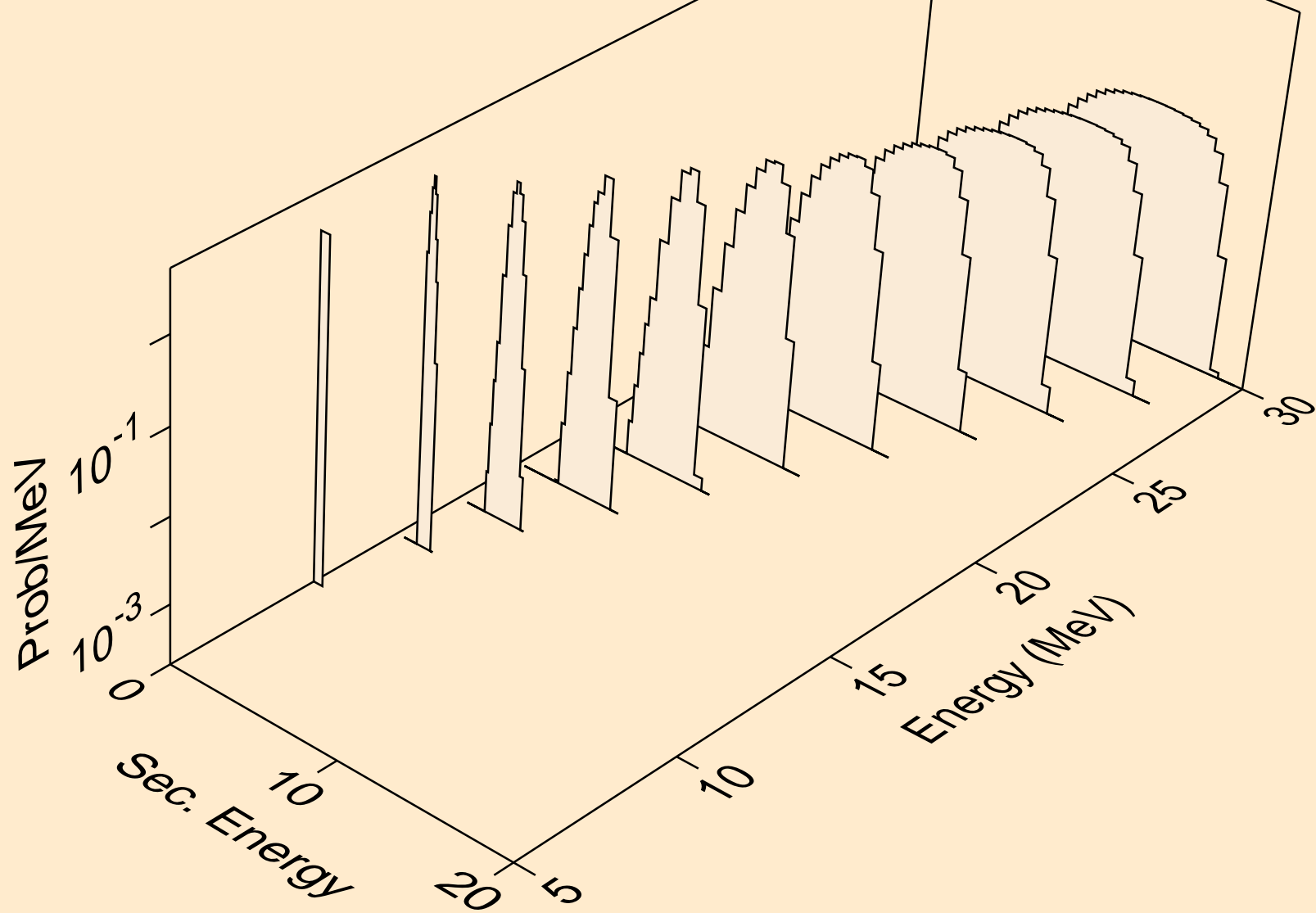

TC088M NEUTRON ACER TENDL-2021 LIBRARY; T=293.6K
he3s from (n,x)

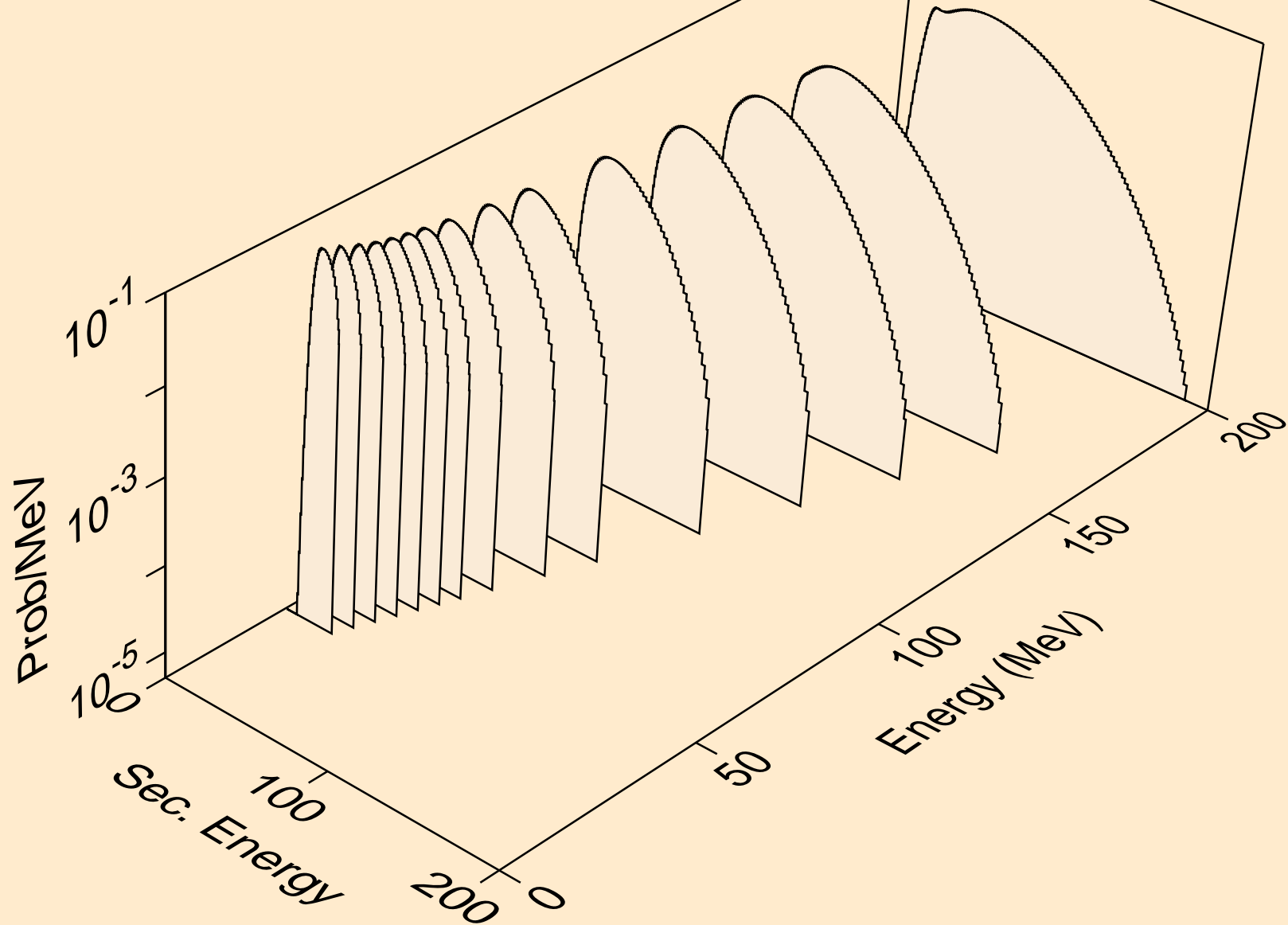

TC088M NEUTRON ACER TENDL-2021 LIBRARY; T=293.6K
he3s from (n,n*)he3

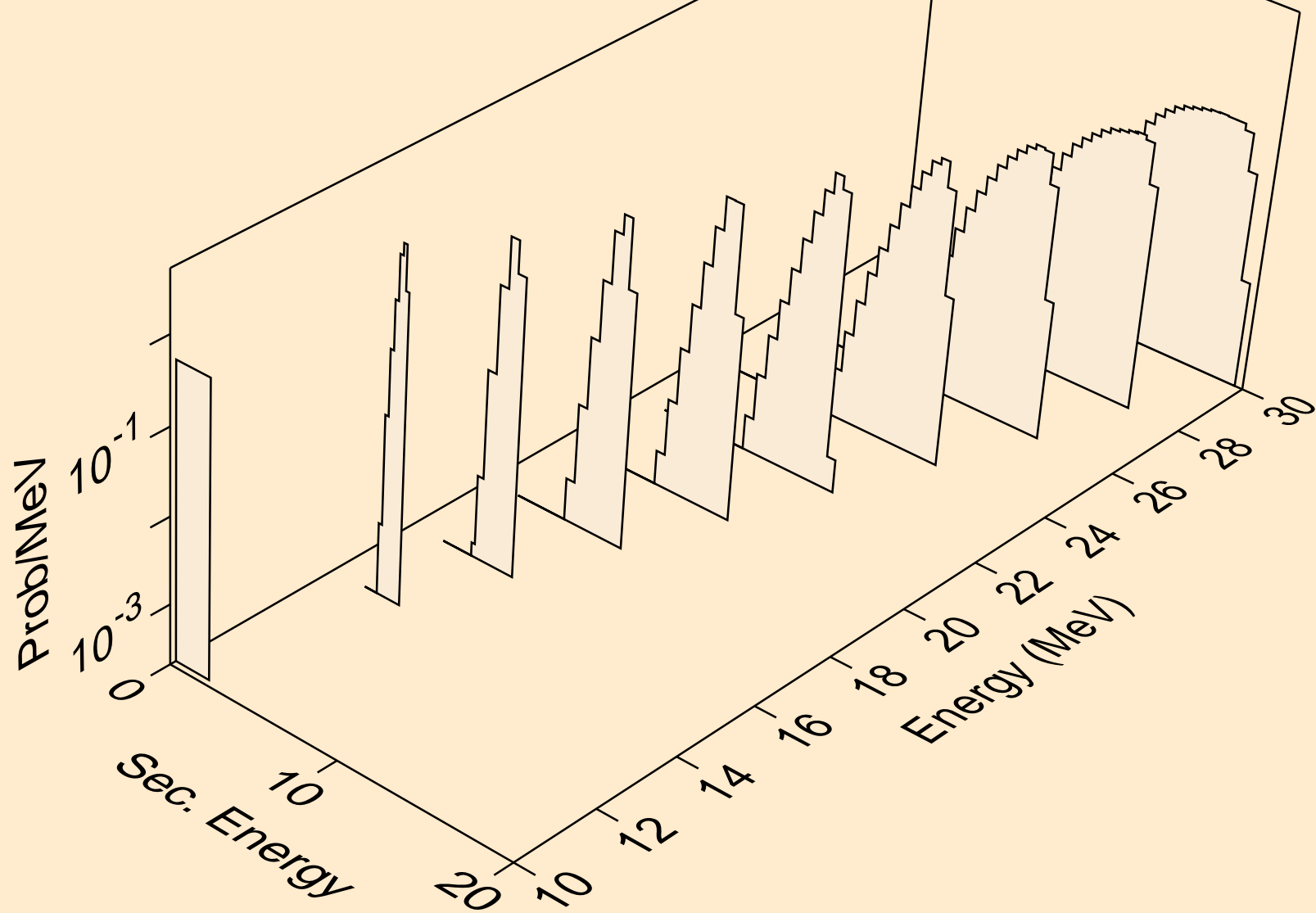

TC088M NEUTRON ACER TENDL-2021 LIBRARY; T=293.6K
he3s from (n,he3)

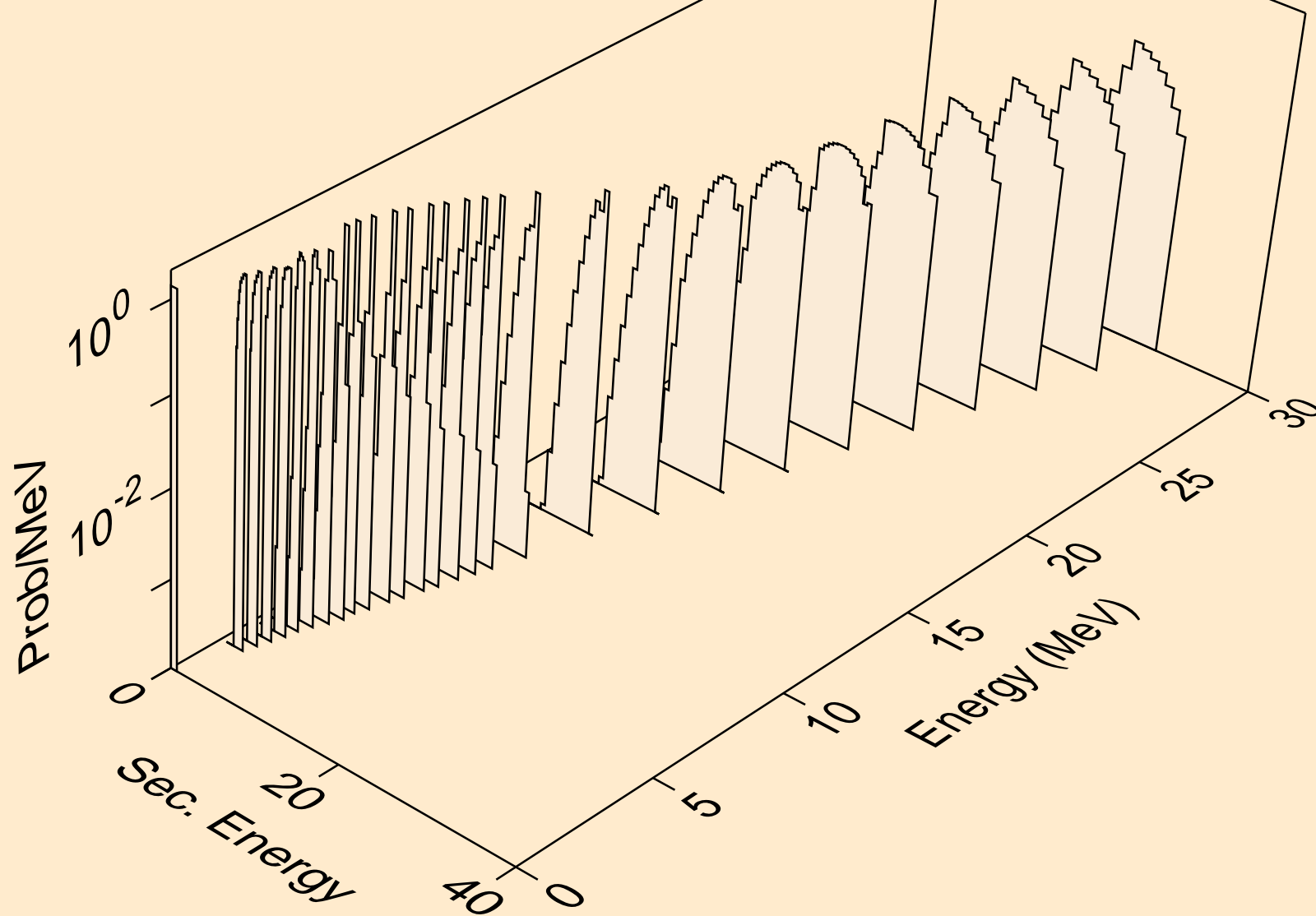

TC088M NEUTRON ACER TENDL-2021 LIBRARY; T=293.6K
alphas from (n,x)

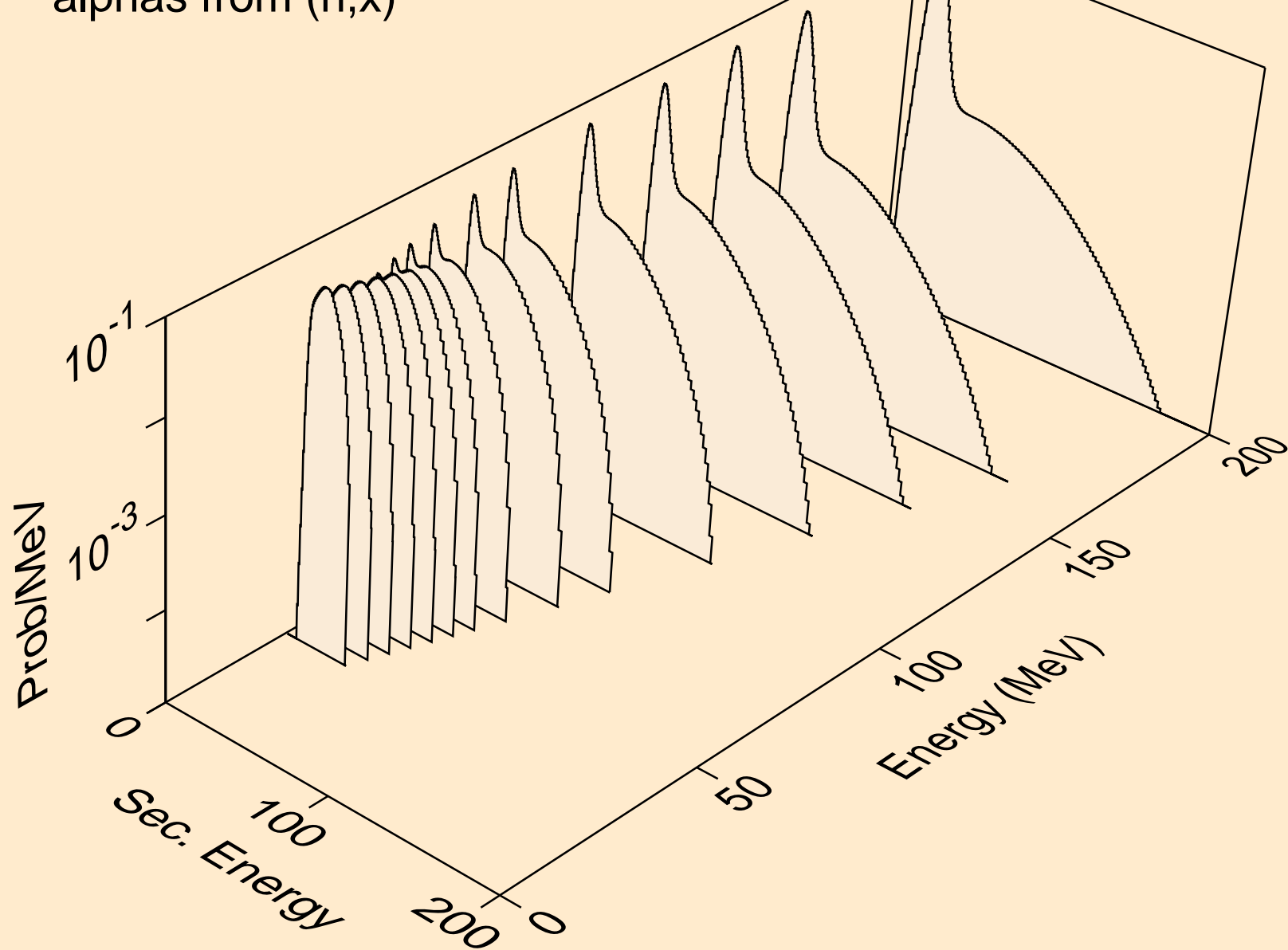

TC088M NEUTRON ACER TENDL-2021 LIBRARY; T=293.6K
alphas from (n,n*)a

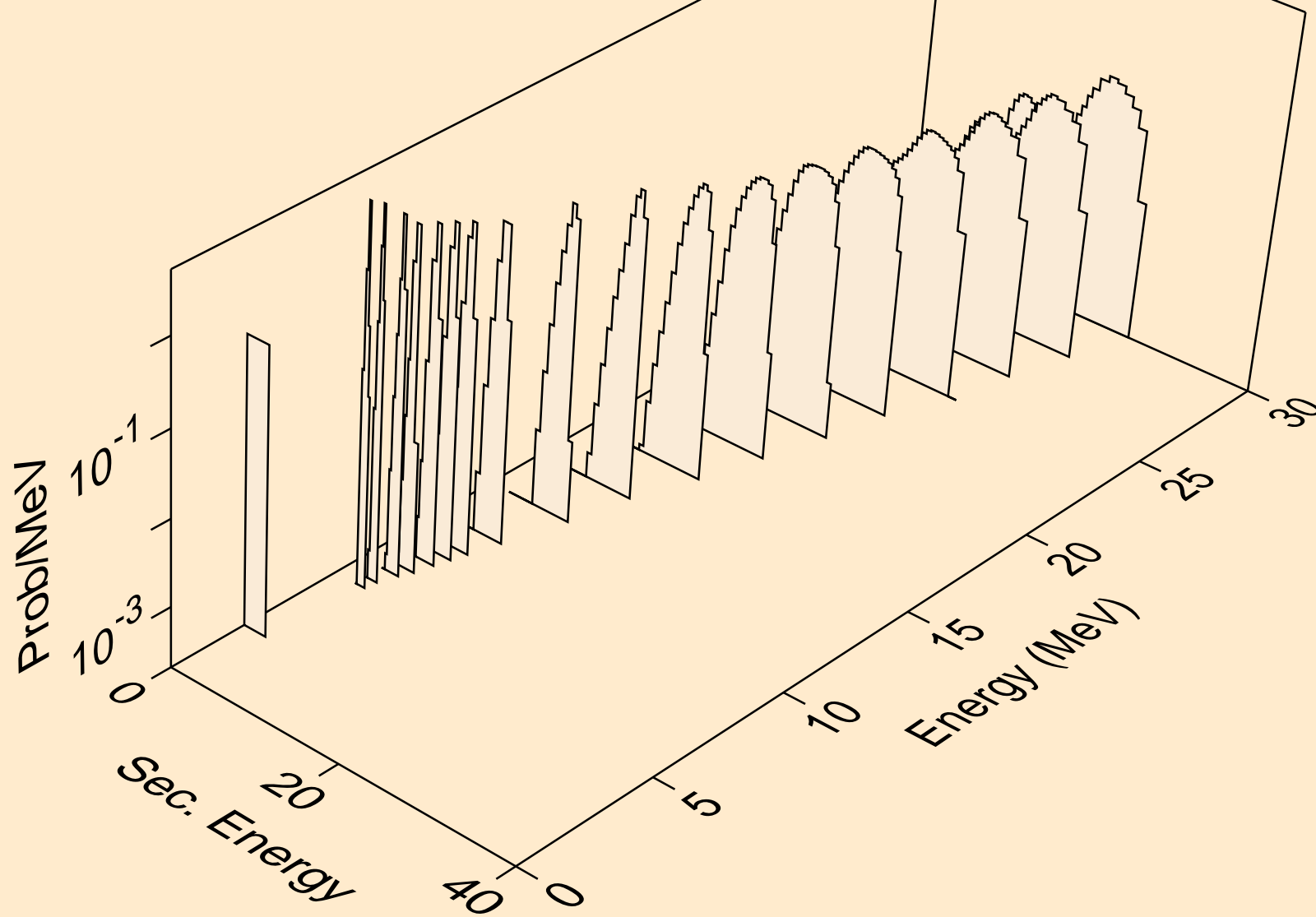

TC088M NEUTRON ACER TENDL-2021 LIBRARY; T=293.6K
alphas from (n,2n)a

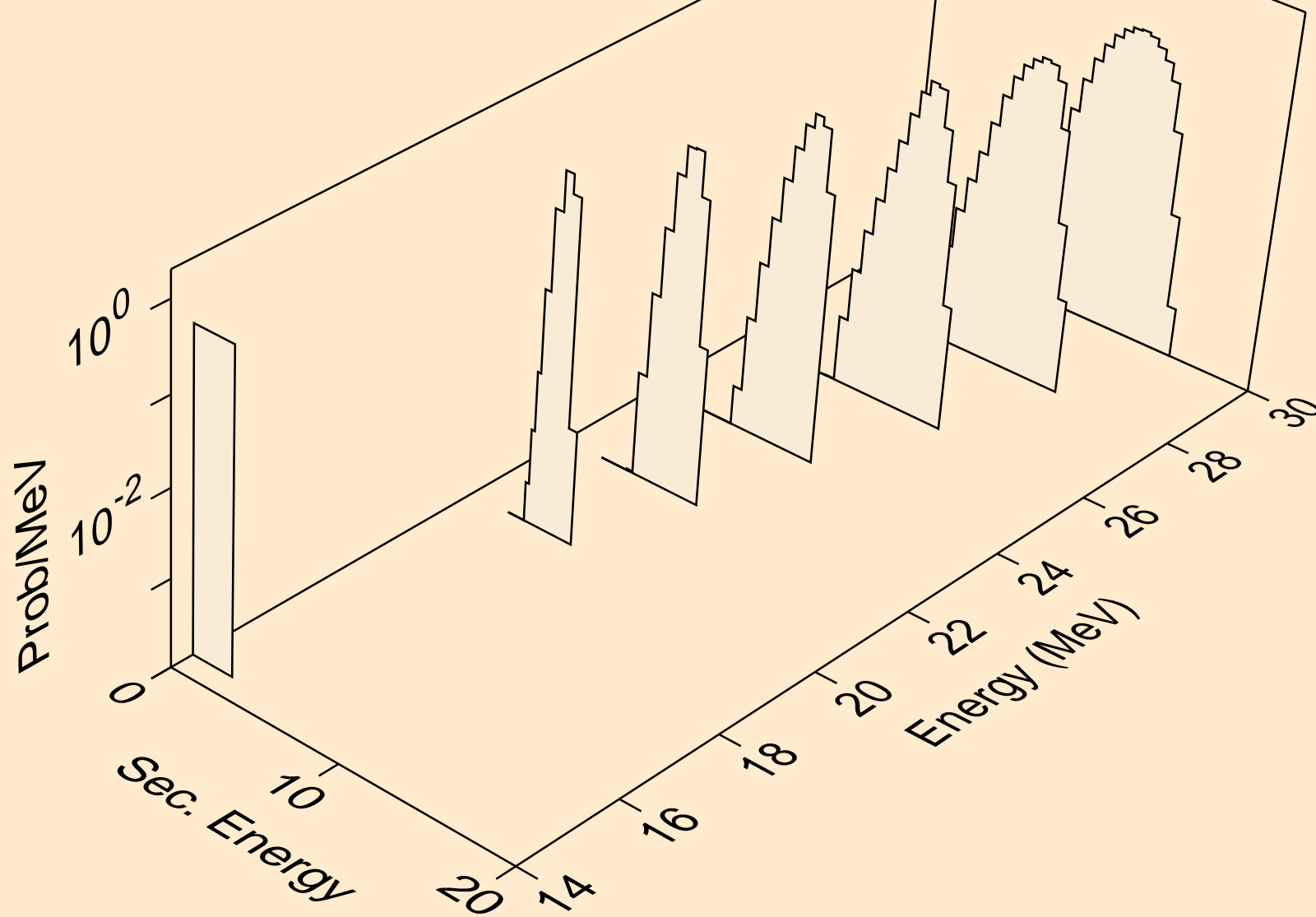

TC088M NEUTRON ACER TENDL-2021 LIBRARY; T=293.6K
alphas from (n,n*)2a

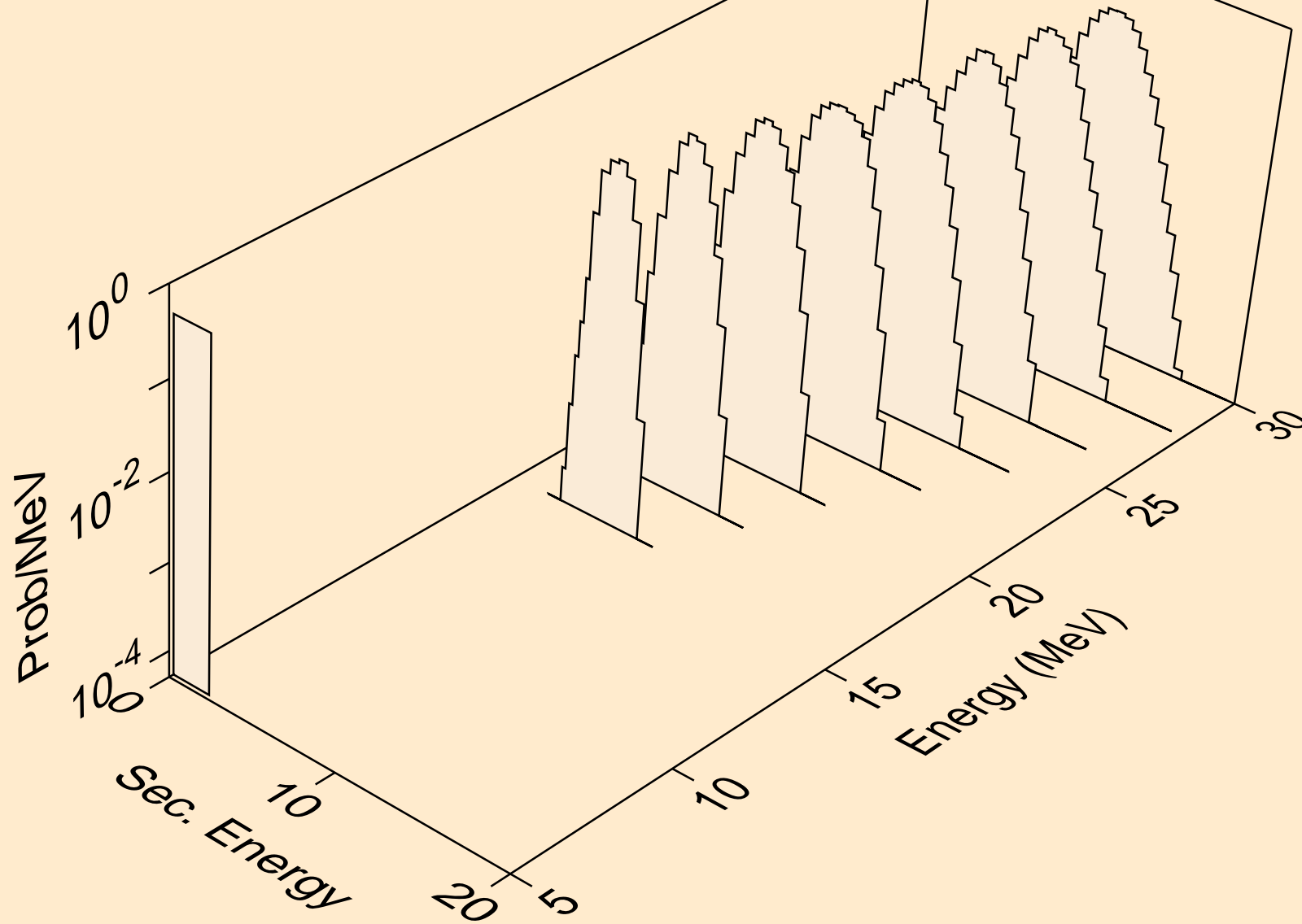

TC088M NEUTRON ACER TENDL-2021 LIBRARY; T=293.6K
alphas from (n,npa)

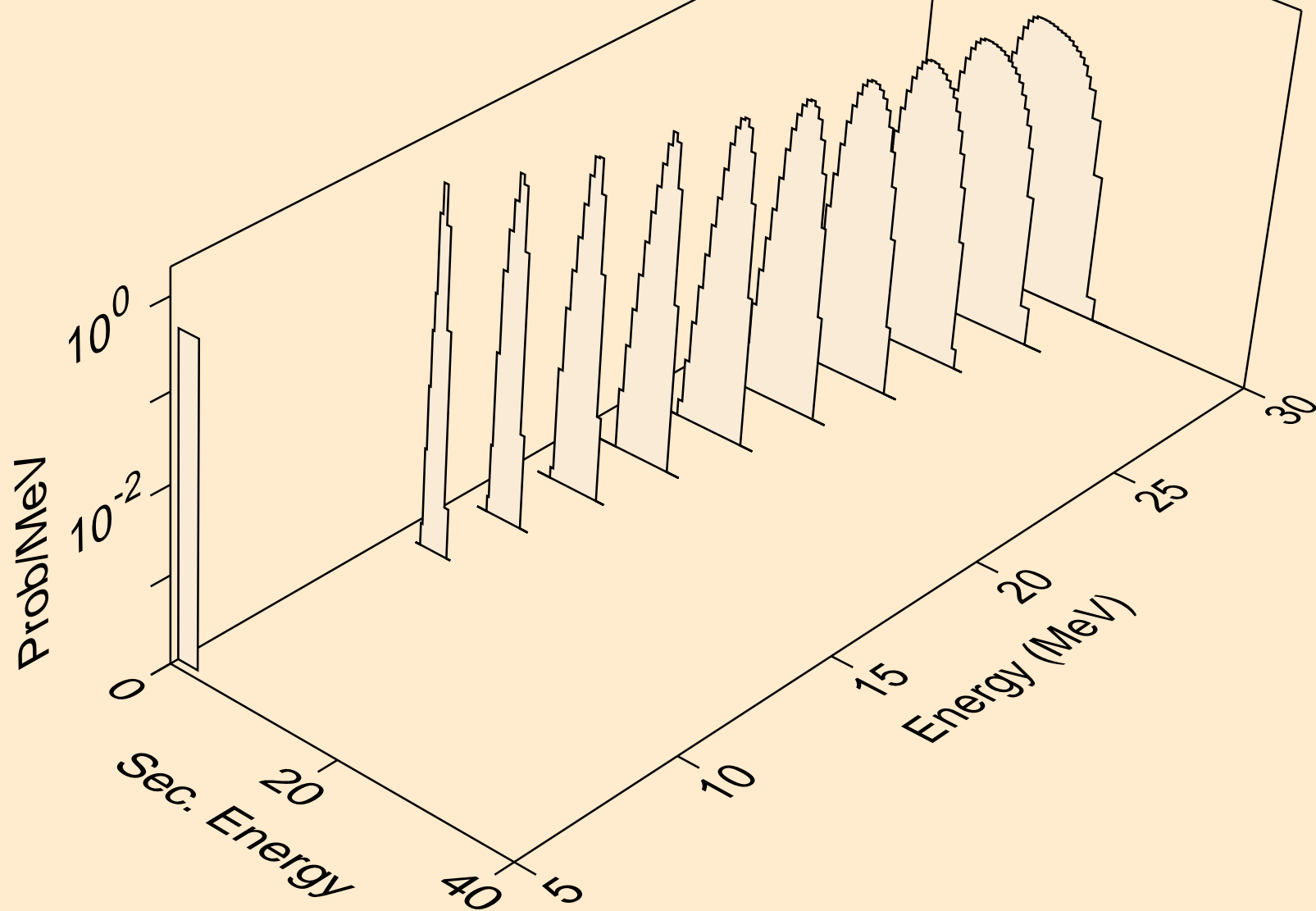

TC088M NEUTRON ACER TENDL-2021 LIBRARY; T=293.6K
alphas from (n,a)

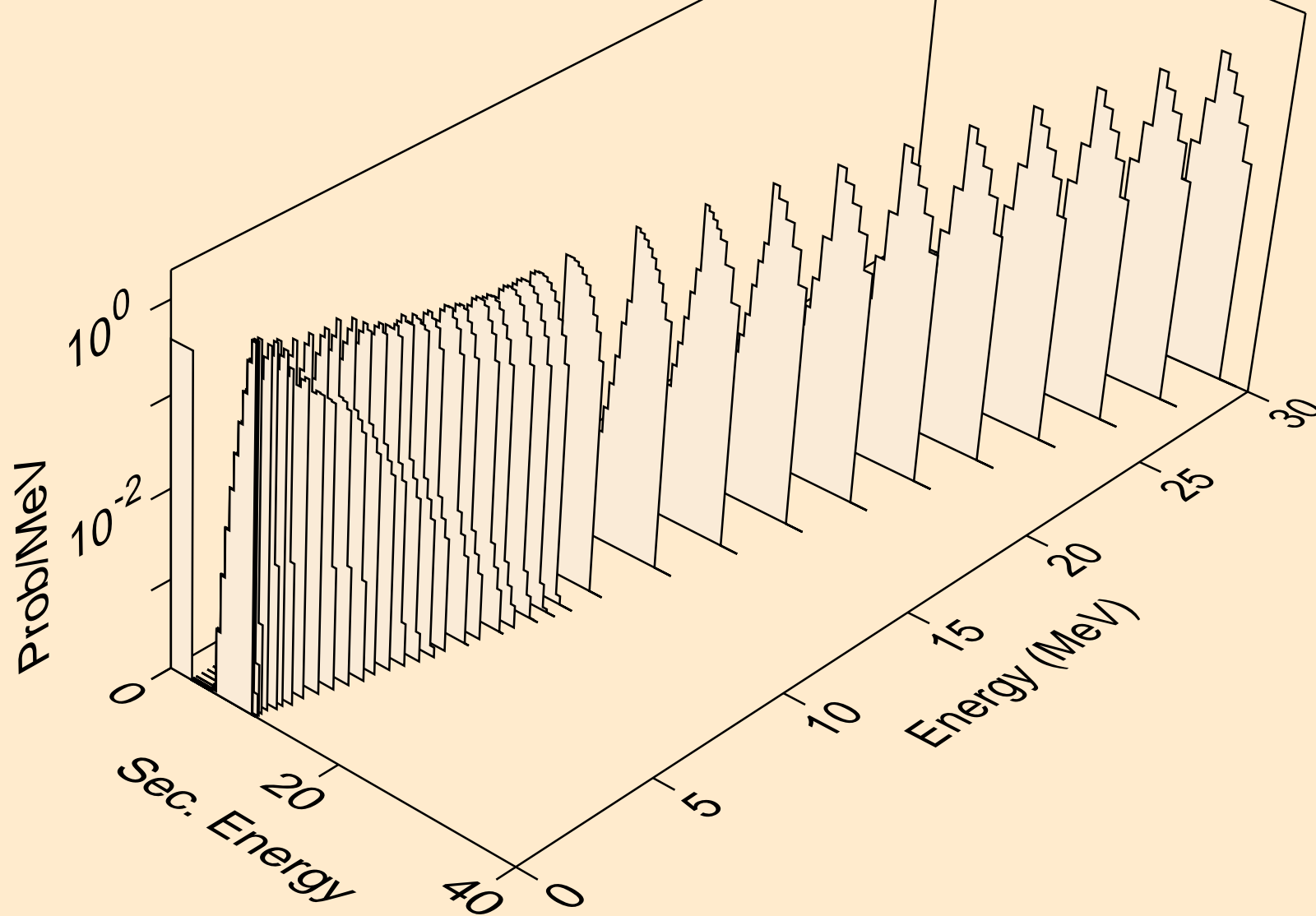

TC088M NEUTRON ACER TENDL-2021 LIBRARY; T=293.6K
alphas from (n,2a)

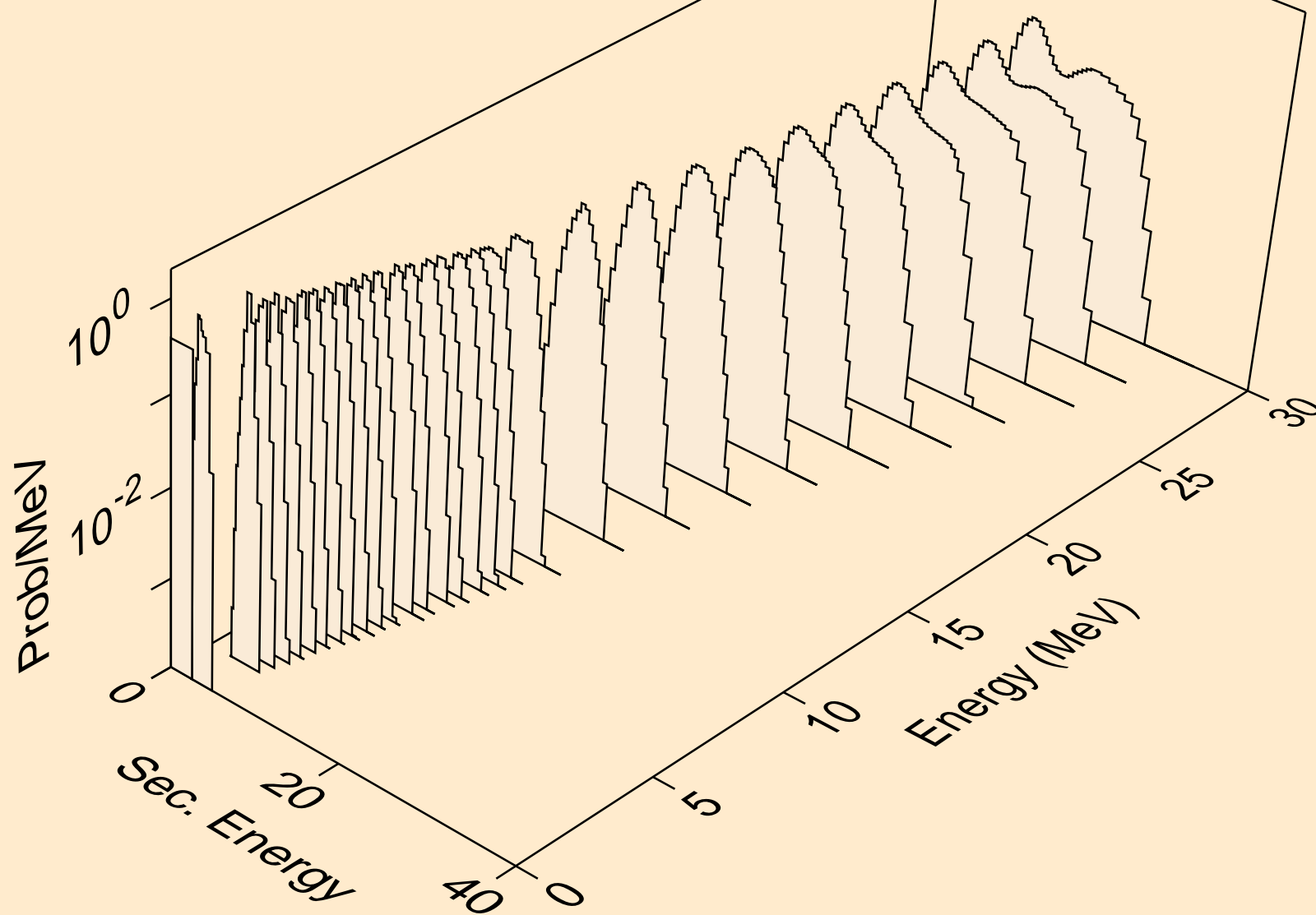

TC088M NEUTRON ACER TENDL-2021 LIBRARY; T=293.6K
alphas from (n,3a)

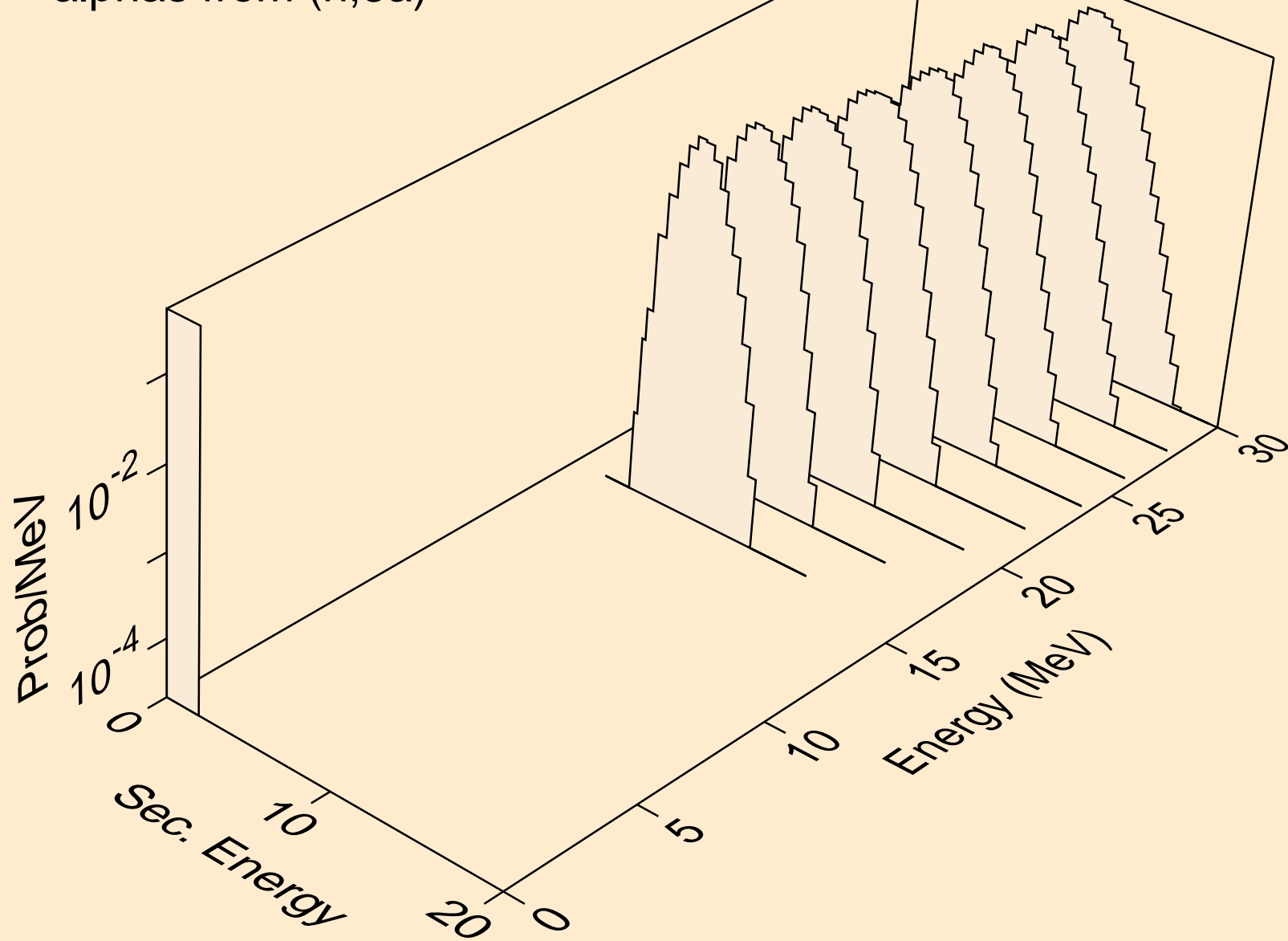

TC088M NEUTRON ACER TENDL-2021 LIBRARY; T=293.6K
alphas from (n,pa)

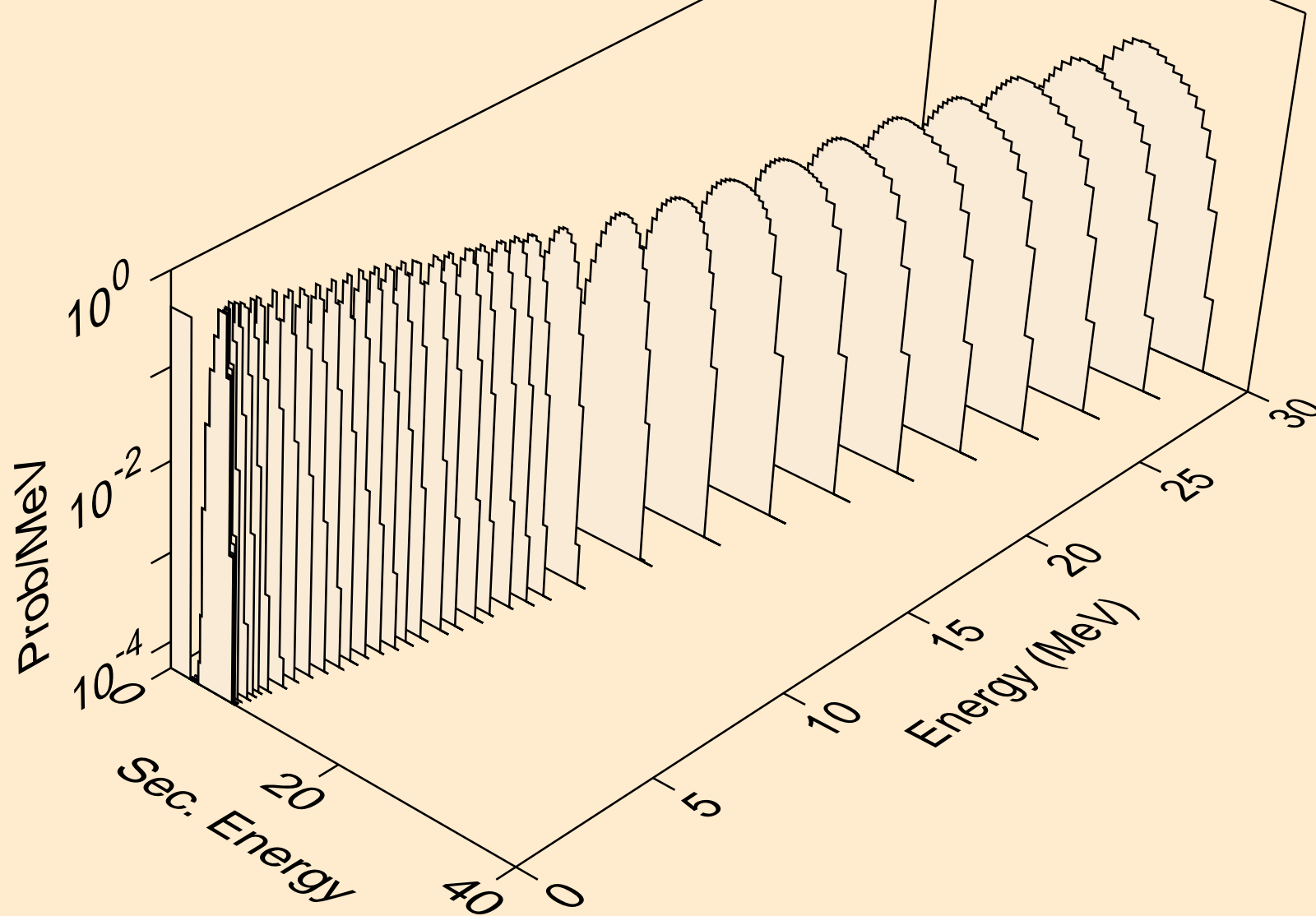

TC088M NEUTRON ACER TENDL-2021 LIBRARY; T=293.6K
alphas from (n,da)

