

TC095 NEUTRON ACER TENDL-2021 LIBRARY; T=293.6K
Principal cross sections

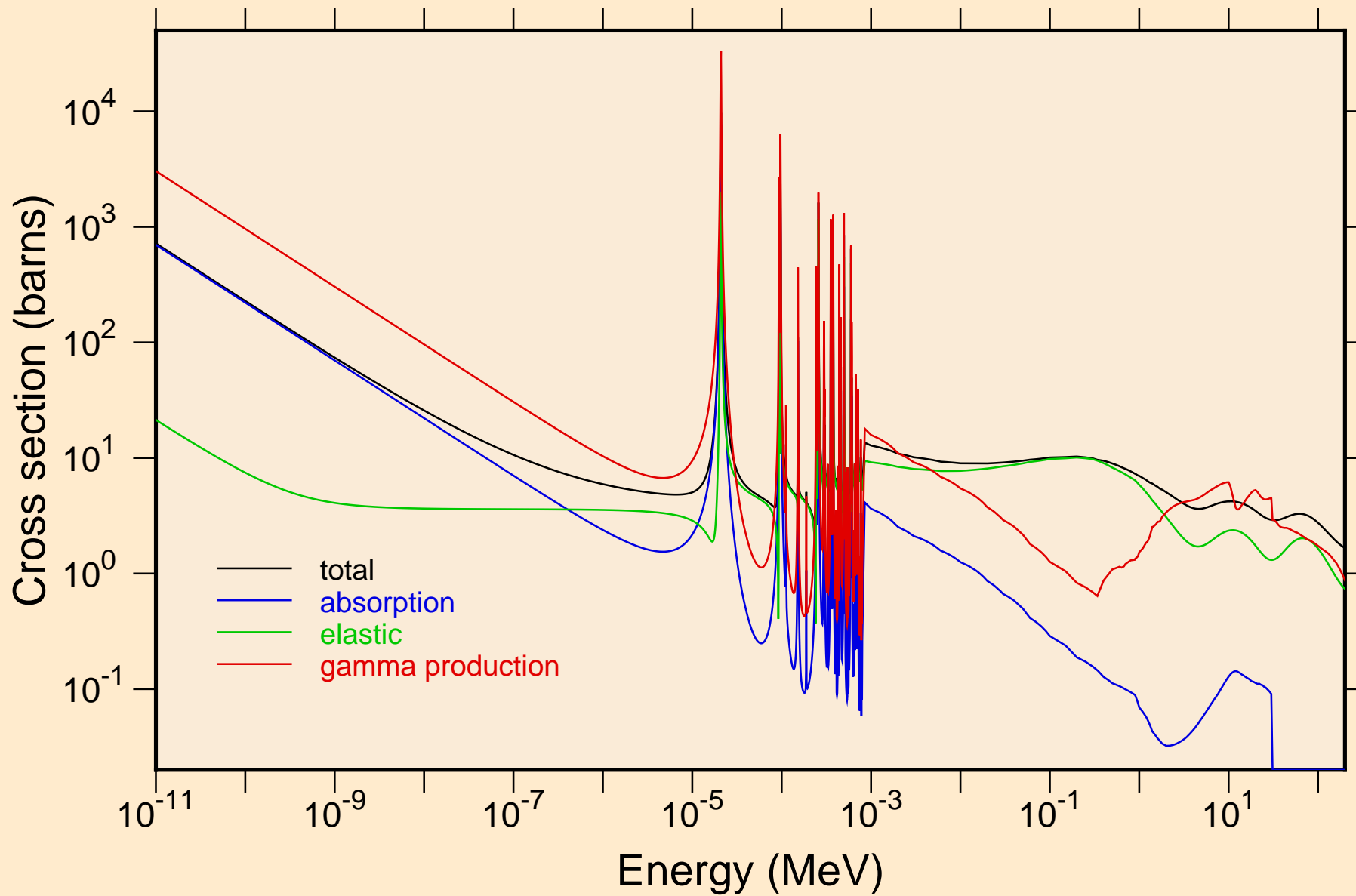

TC095 NEUTRON ACER TENDL-2021 LIBRARY; T=293.6K
resonance total cross section

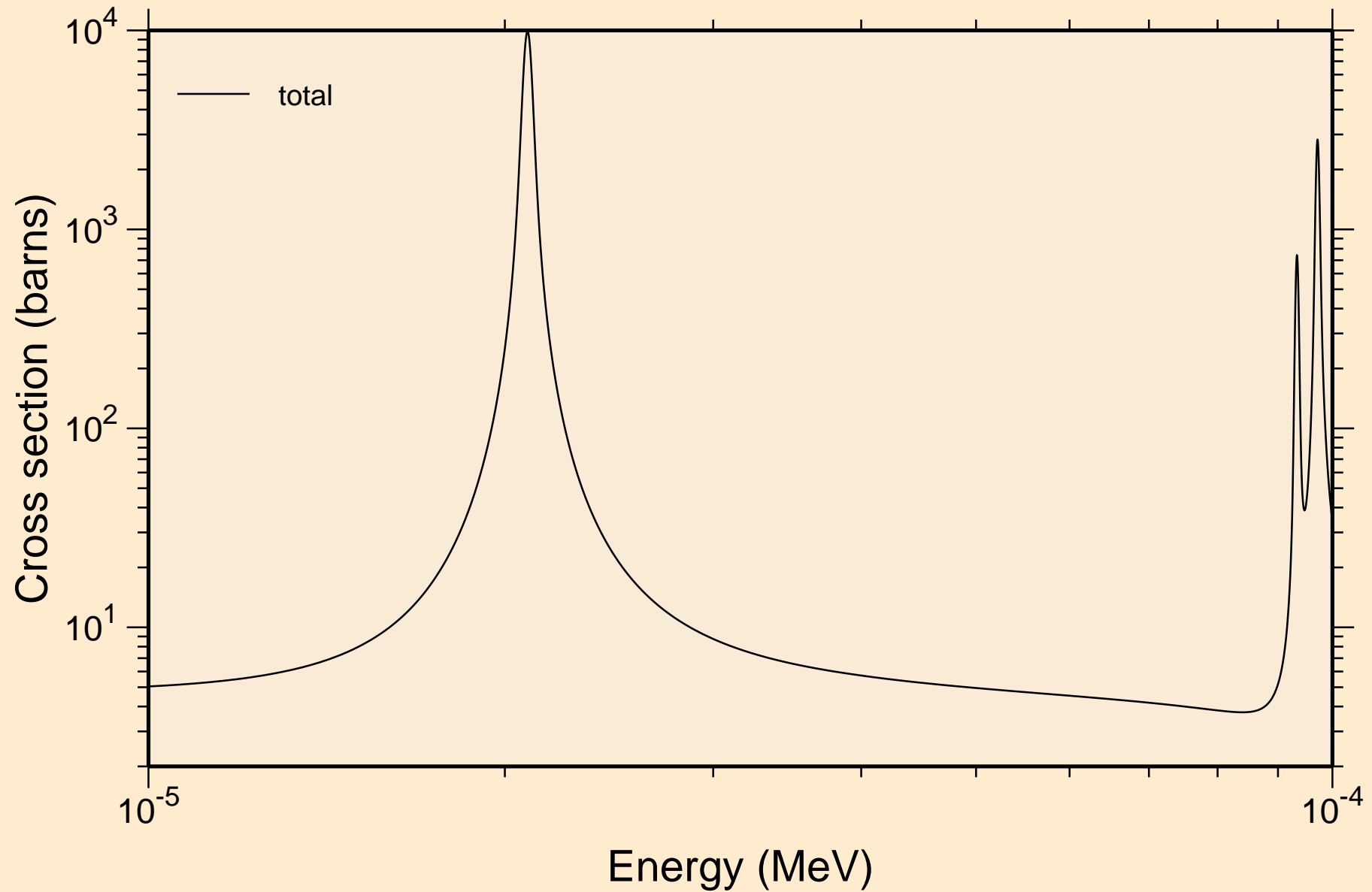

TC095 NEUTRON ACER TENDL-2021 LIBRARY; T=293.6K
resonance total cross section

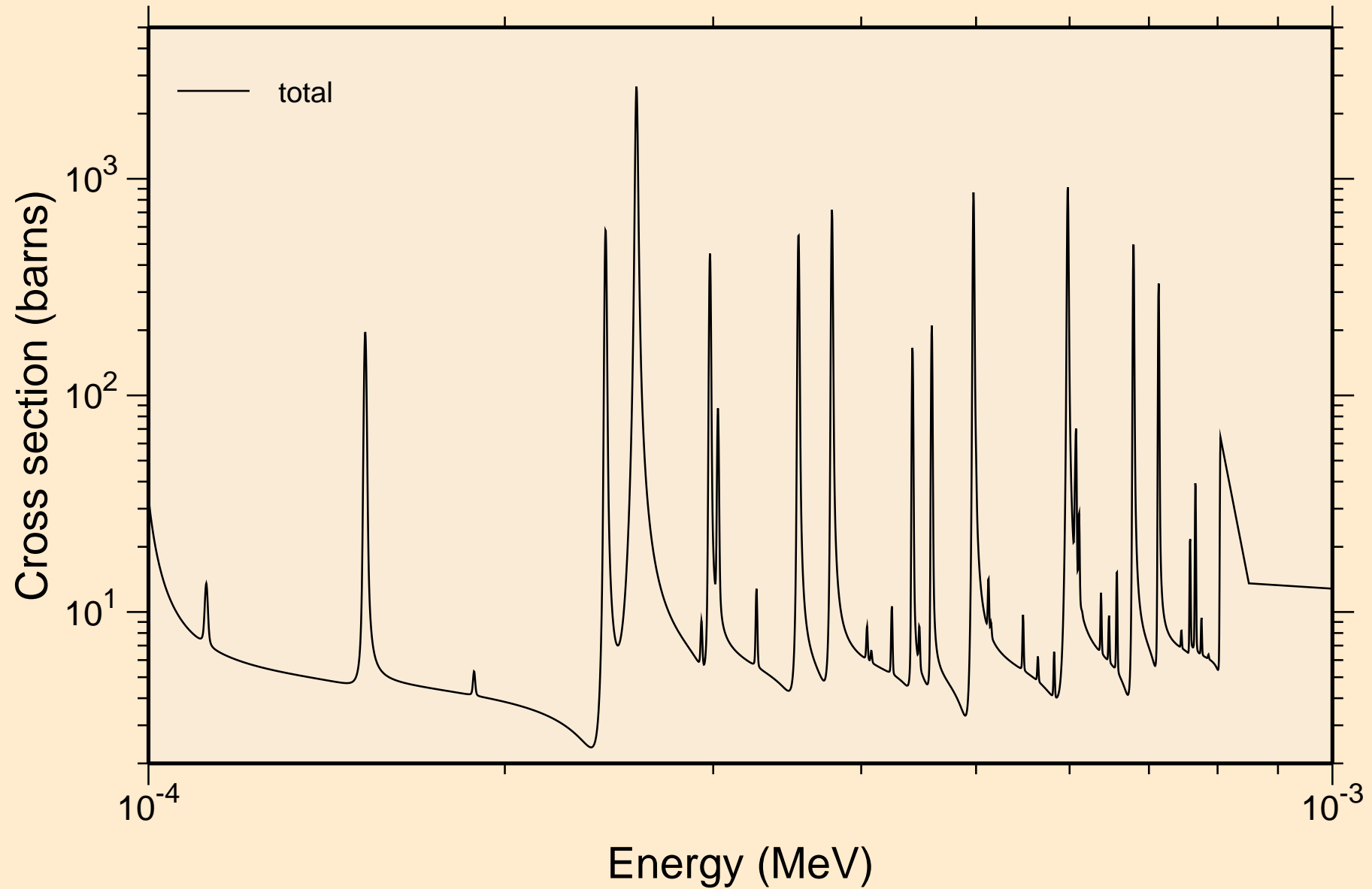

TC095 NEUTRON ACER TENDL-2021 LIBRARY; T=293.6K
resonance total cross section

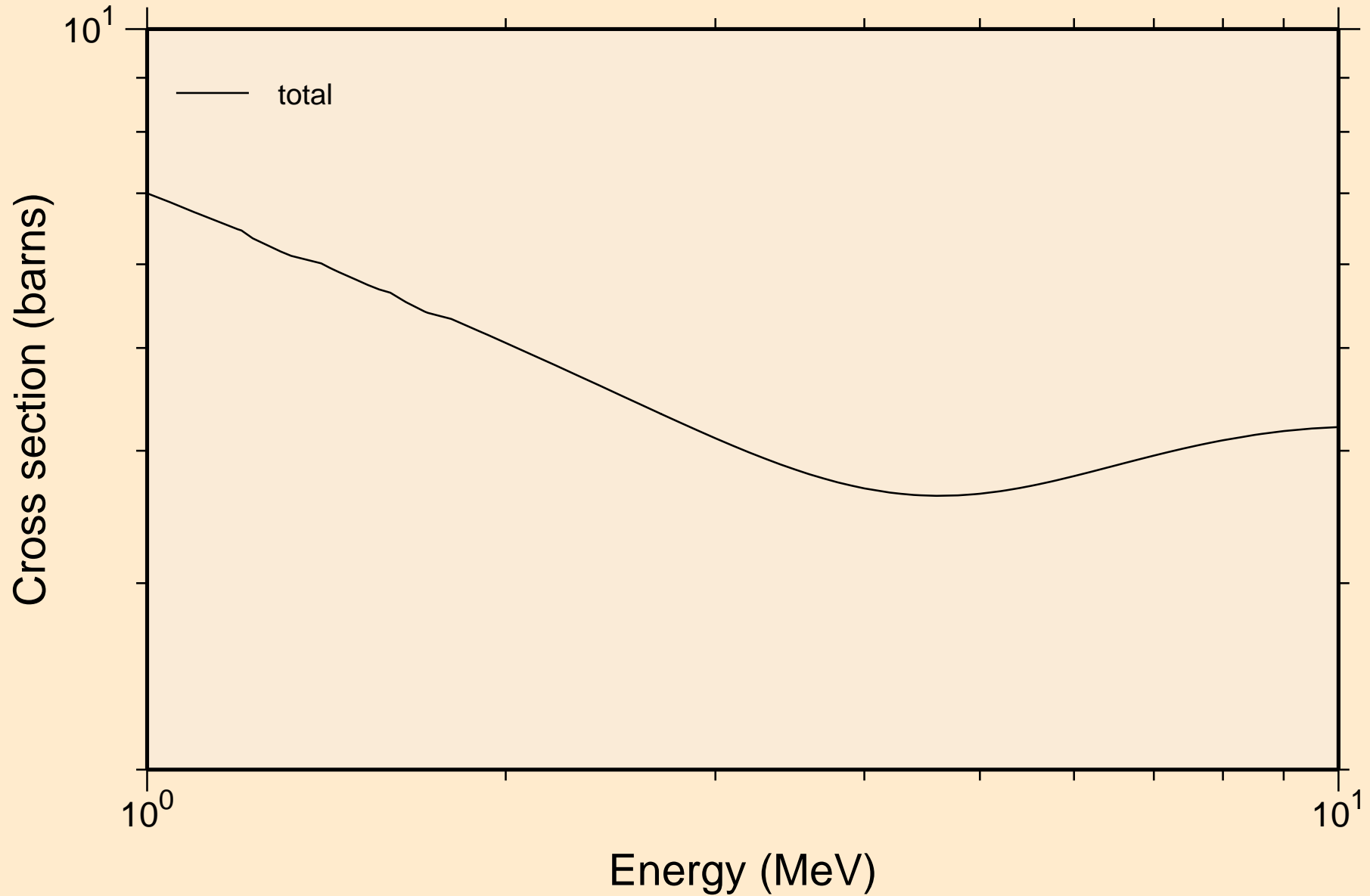

TC095 NEUTRON ACER TENDL-2021 LIBRARY; T=293.6K
resonance absorption cross sections

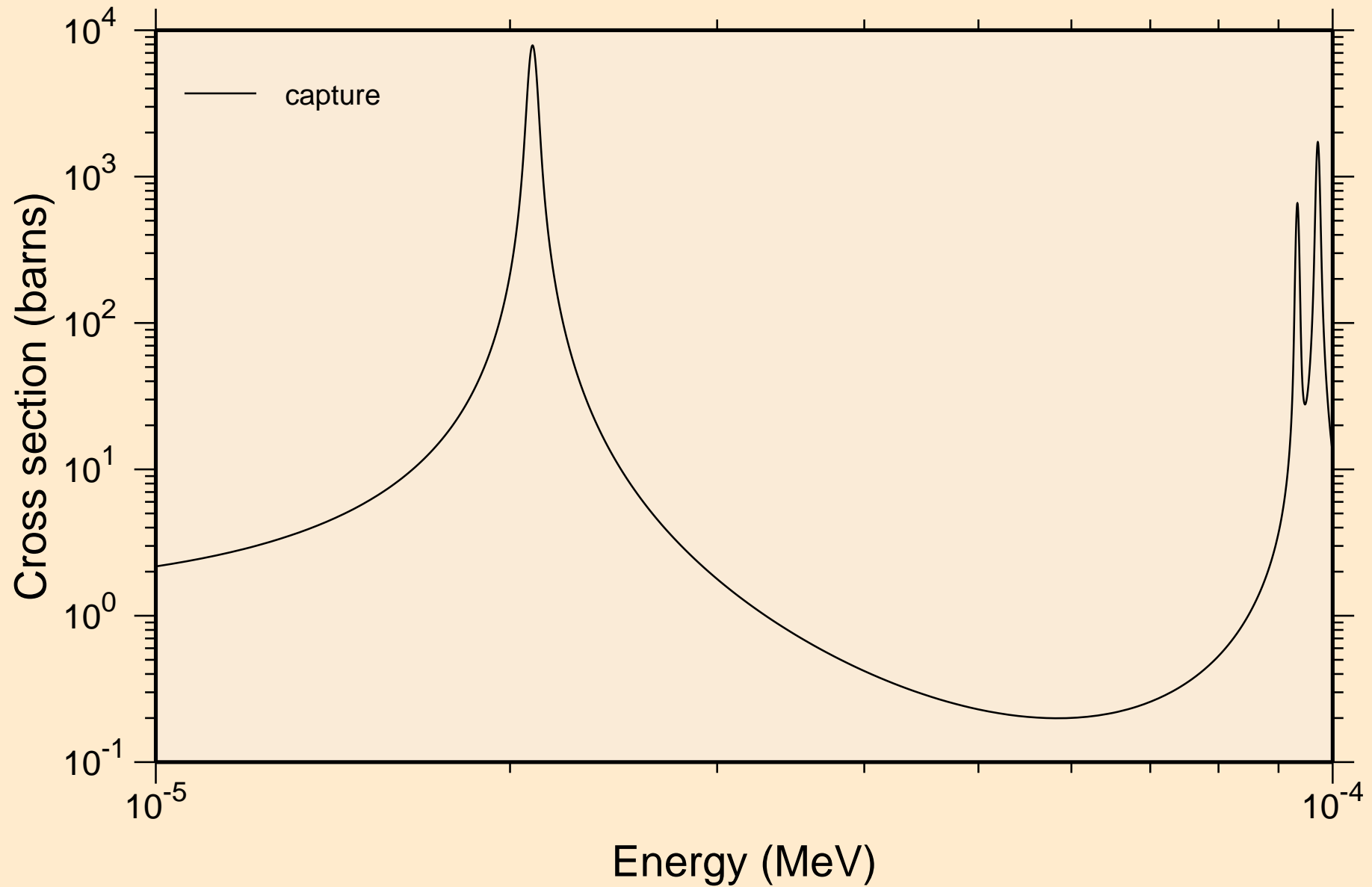

TC095 NEUTRON ACER TENDL-2021 LIBRARY; T=293.6K
resonance absorption cross sections

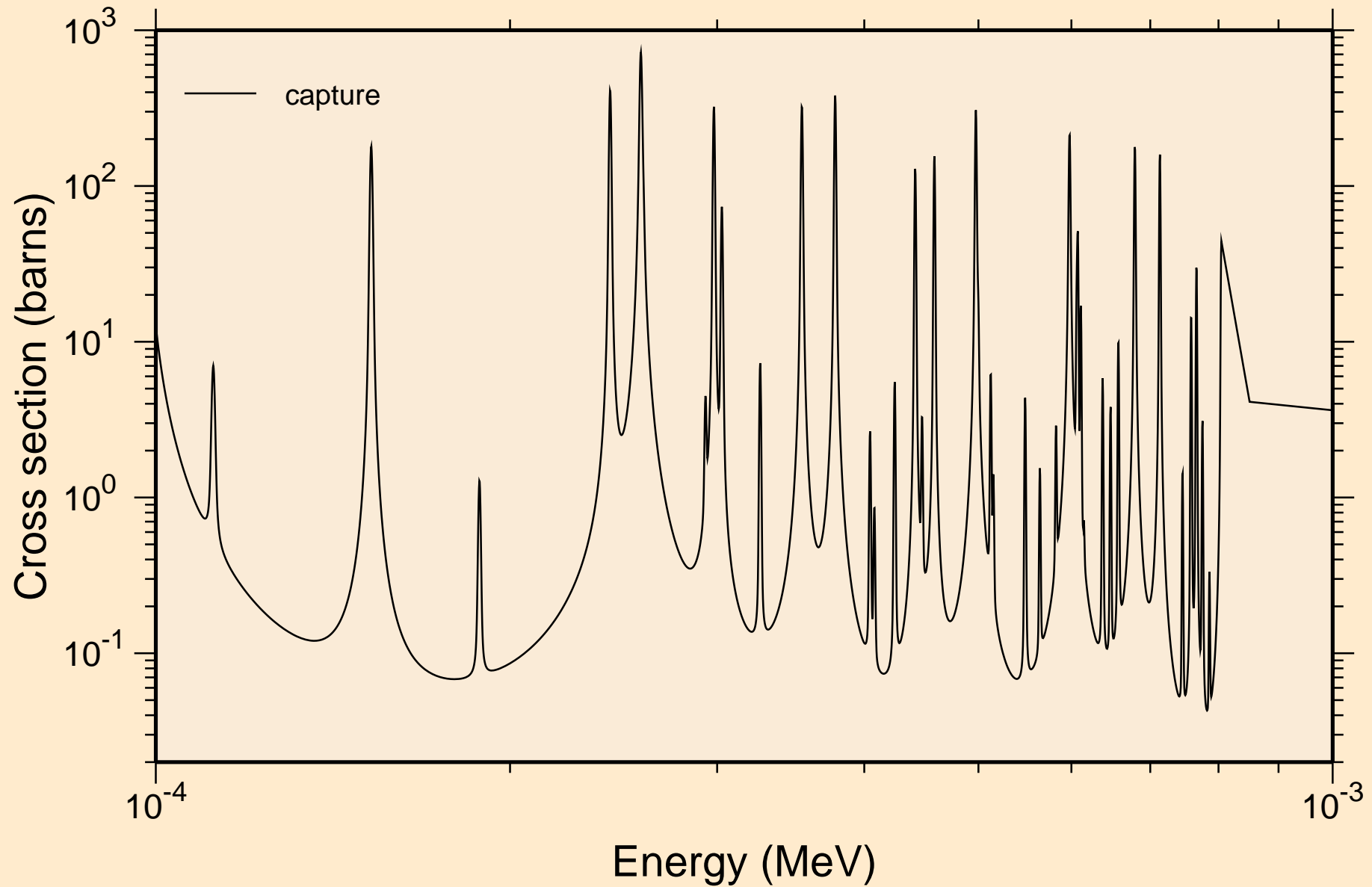

TC095 NEUTRON ACER TENDL-2021 LIBRARY; T=293.6K
resonance absorption cross sections

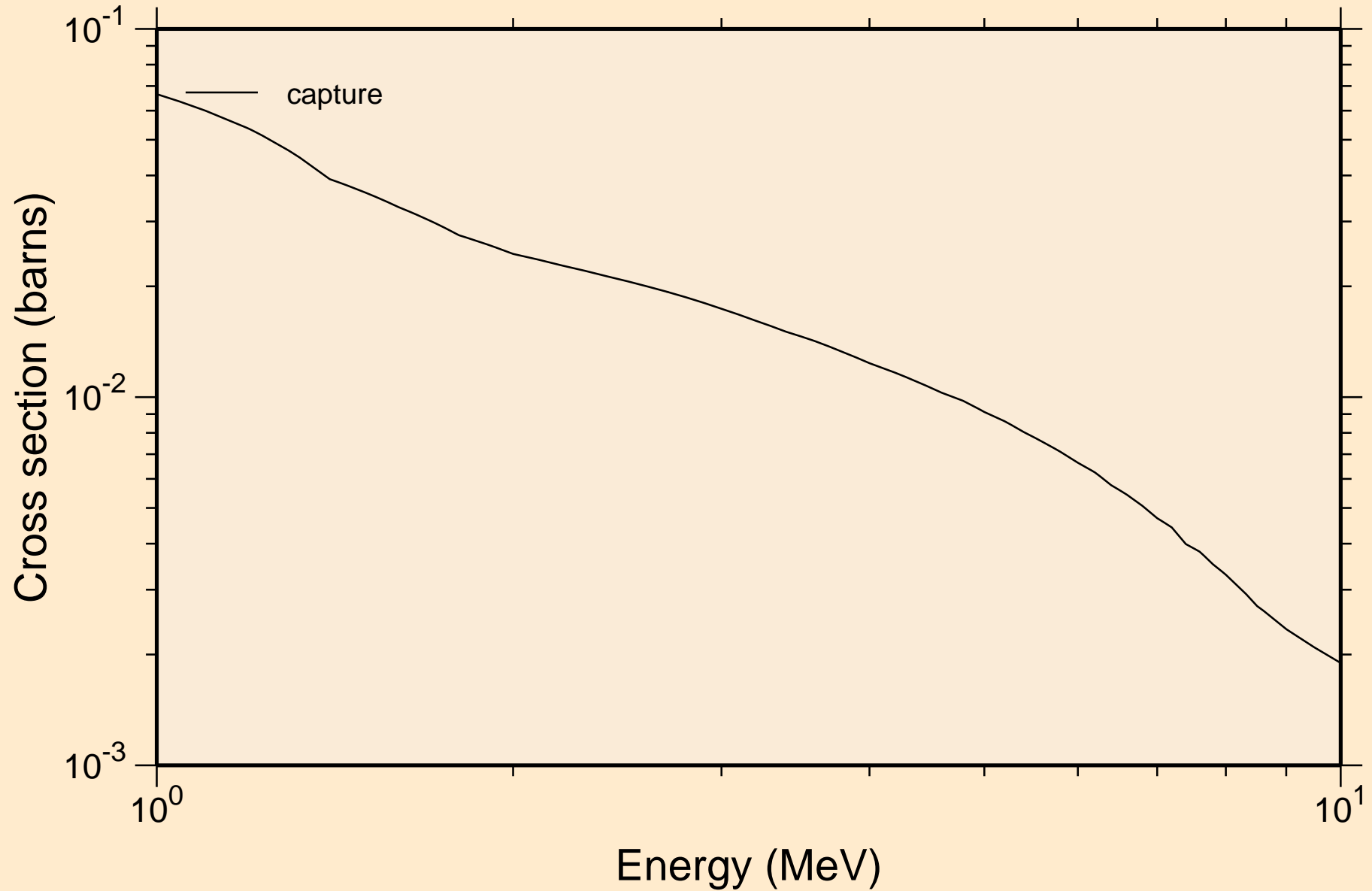

TC095 NEUTRON ACER TENDL-2021 LIBRARY; T=293.6K
Heating

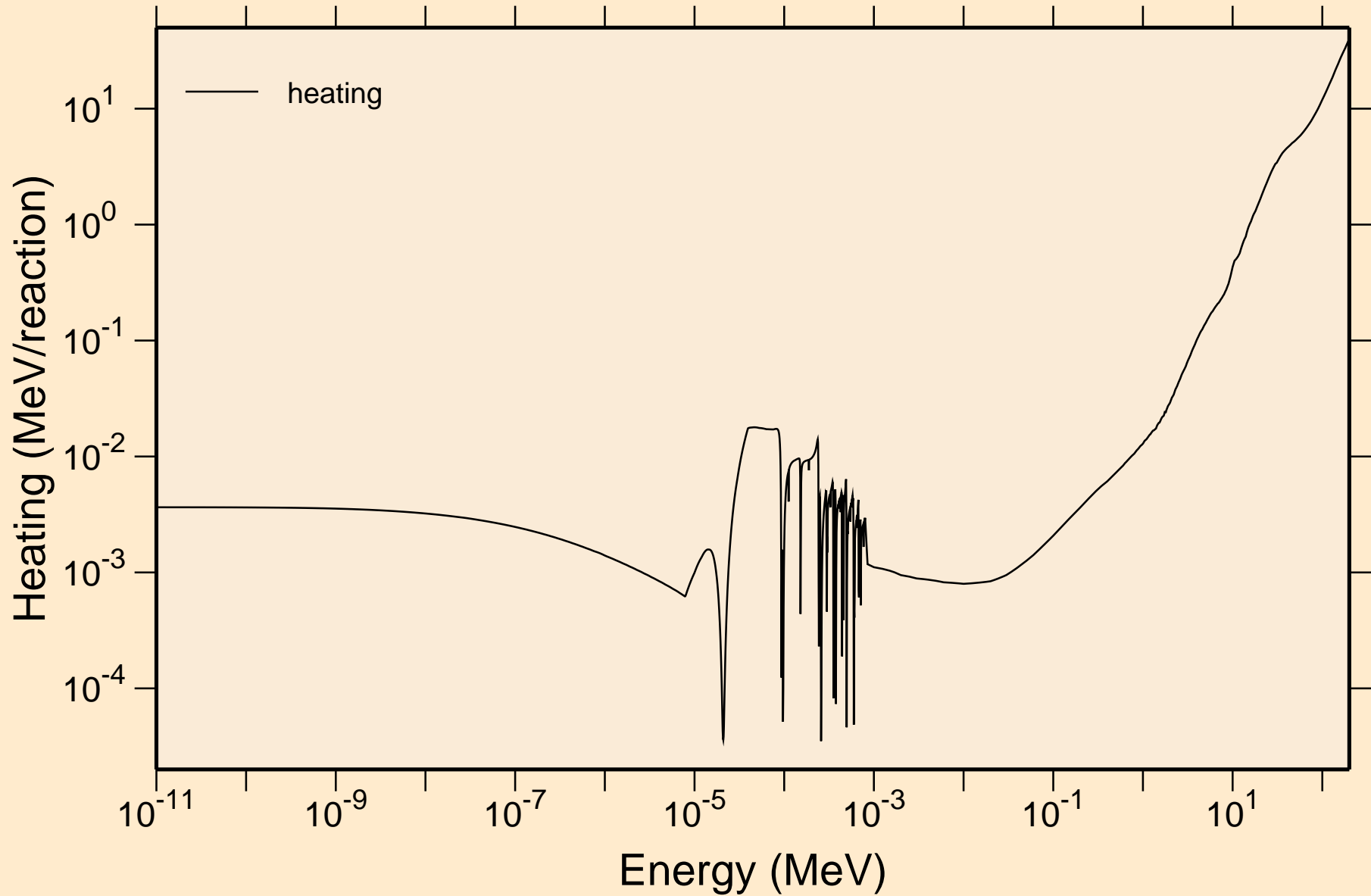

TC095 NEUTRON ACER TENDL-2021 LIBRARY; T=293.6K
Damage

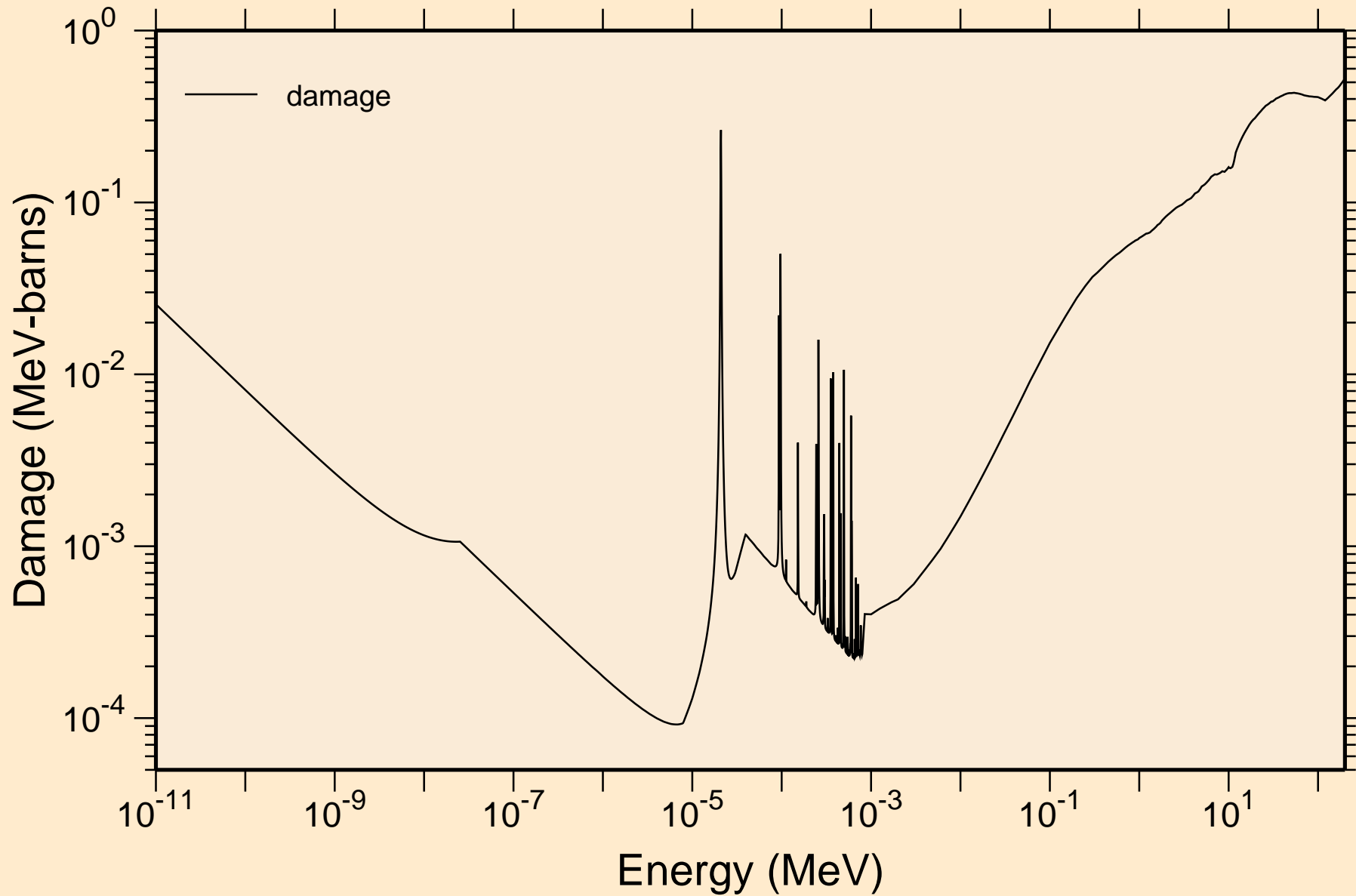

TC095 NEUTRON ACER TENDL-2021 LIBRARY; T=293.6K
Non-threshold reactions

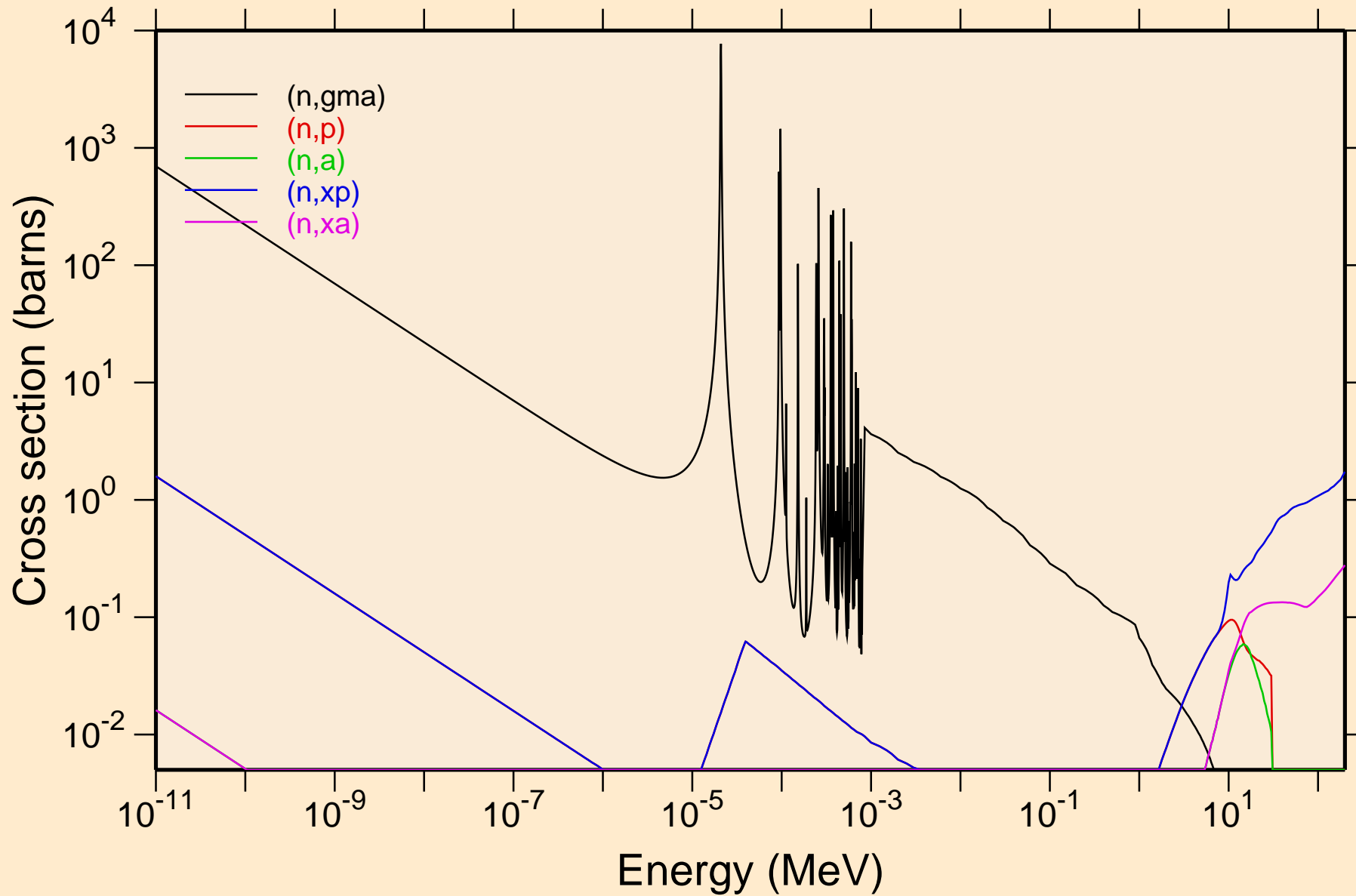

TC095 NEUTRON ACER TENDL-2021 LIBRARY; T=293.6K
Principal cross sections

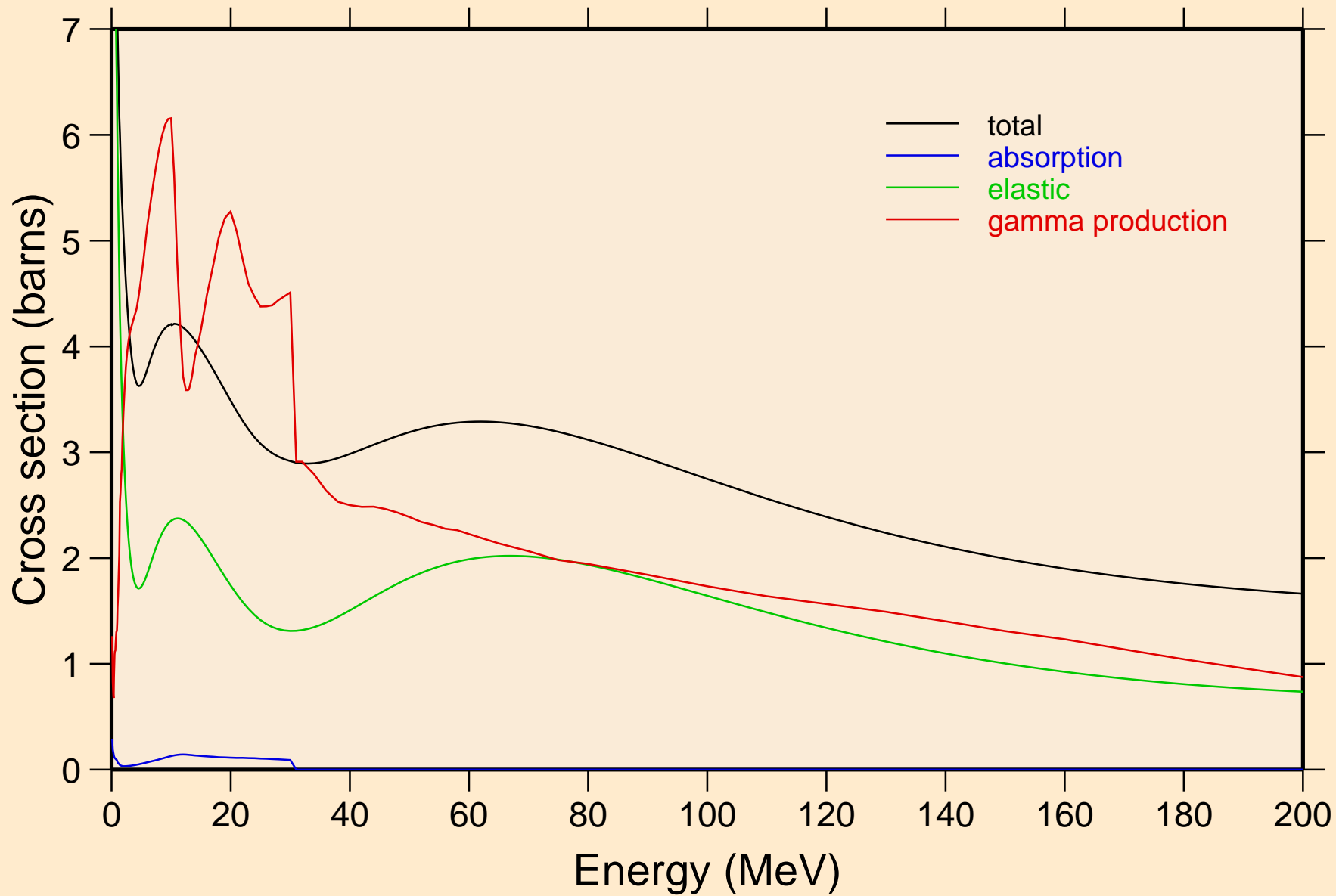

TC095 NEUTRON ACER TENDL-2021 LIBRARY; T=293.6K

Heating

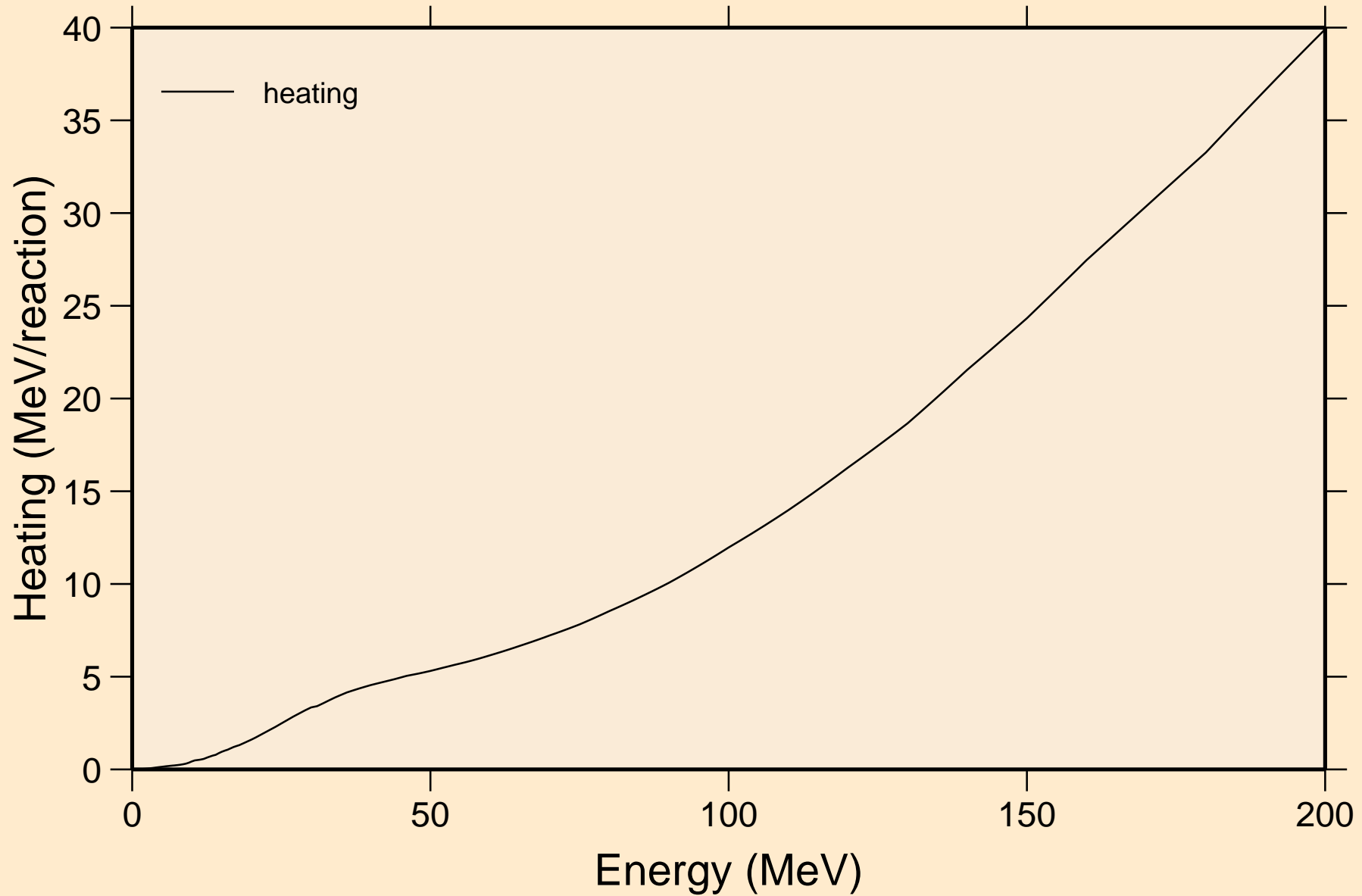

TC095 NEUTRON ACER TENDL-2021 LIBRARY; T=293.6K
Damage

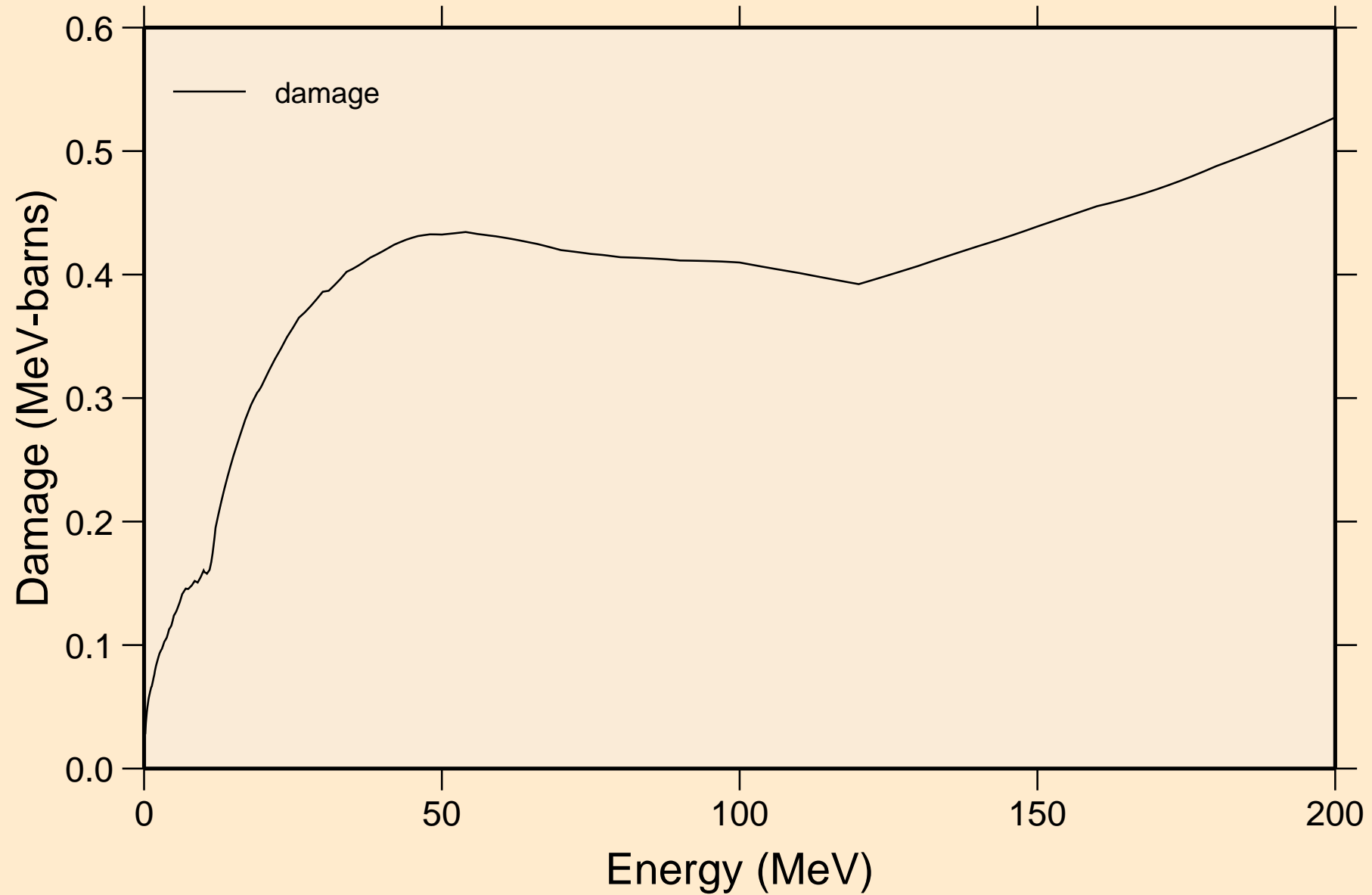

TC095 NEUTRON ACER TENDL-2021 LIBRARY; T=293.6K
Non-threshold reactions

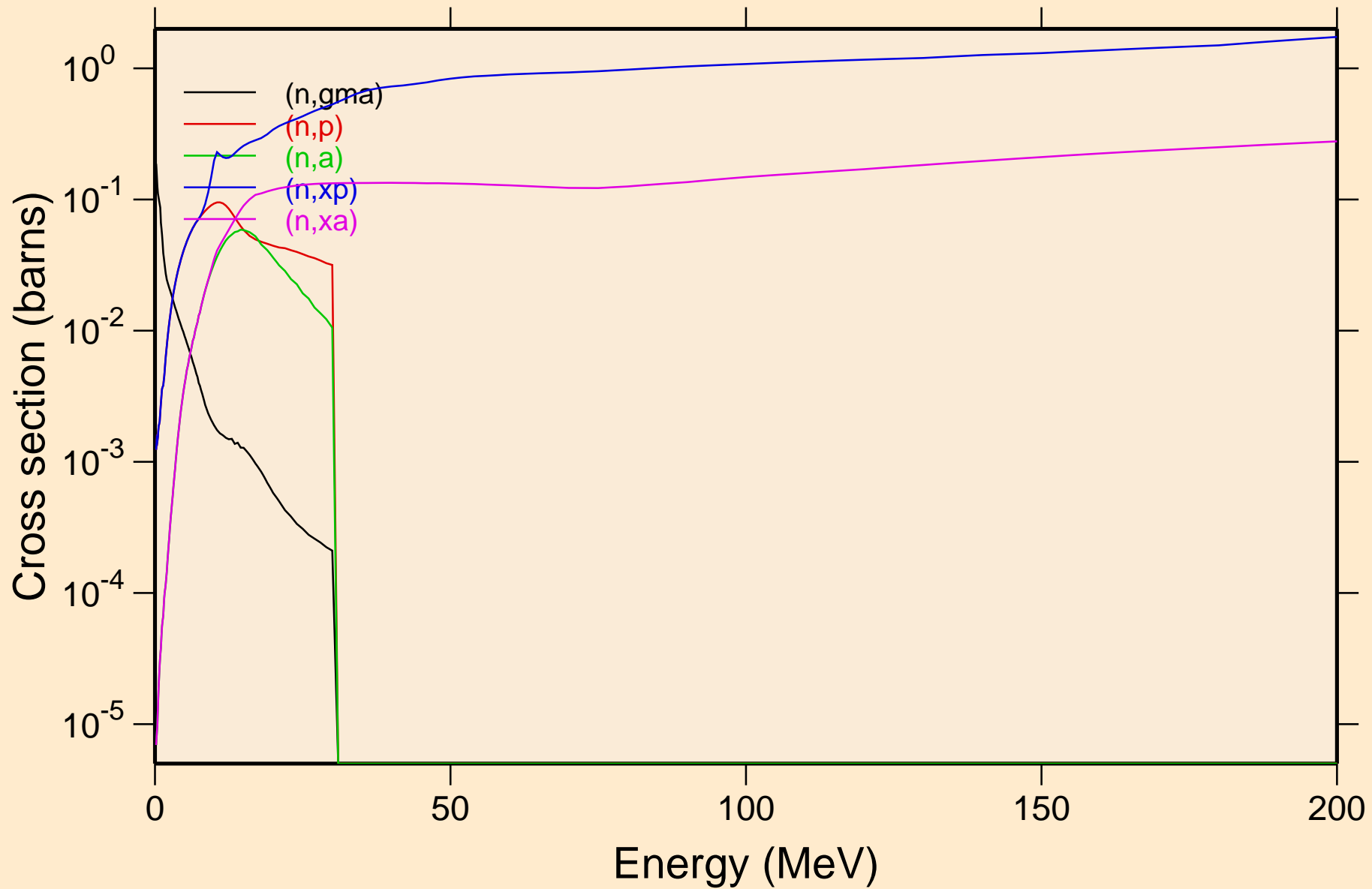

TC095 NEUTRON ACER TENDL-2021 LIBRARY; T=293.6K
Inelastic levels

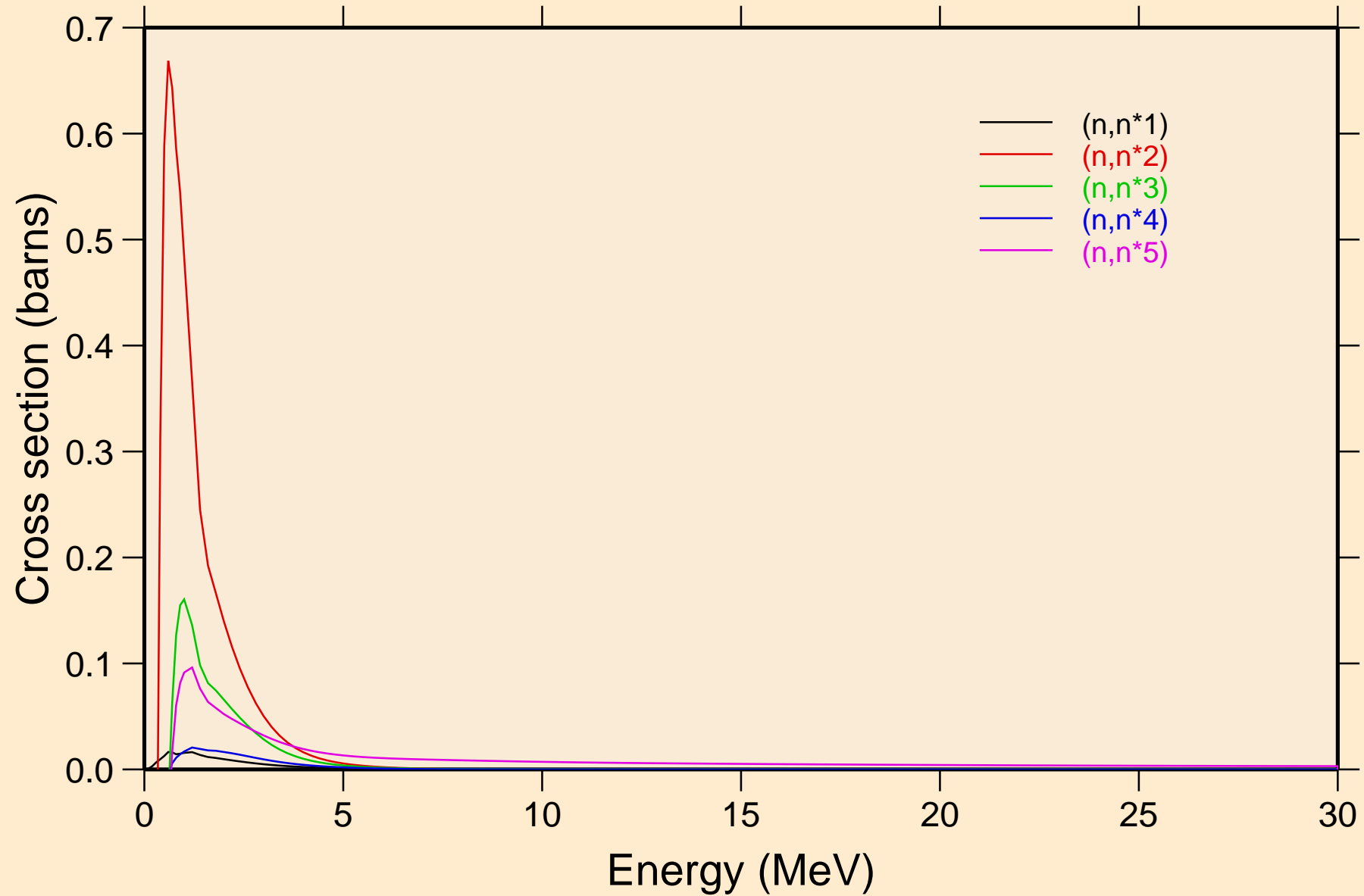

TC095 NEUTRON ACER TENDL-2021 LIBRARY; T=293.6K
Inelastic levels

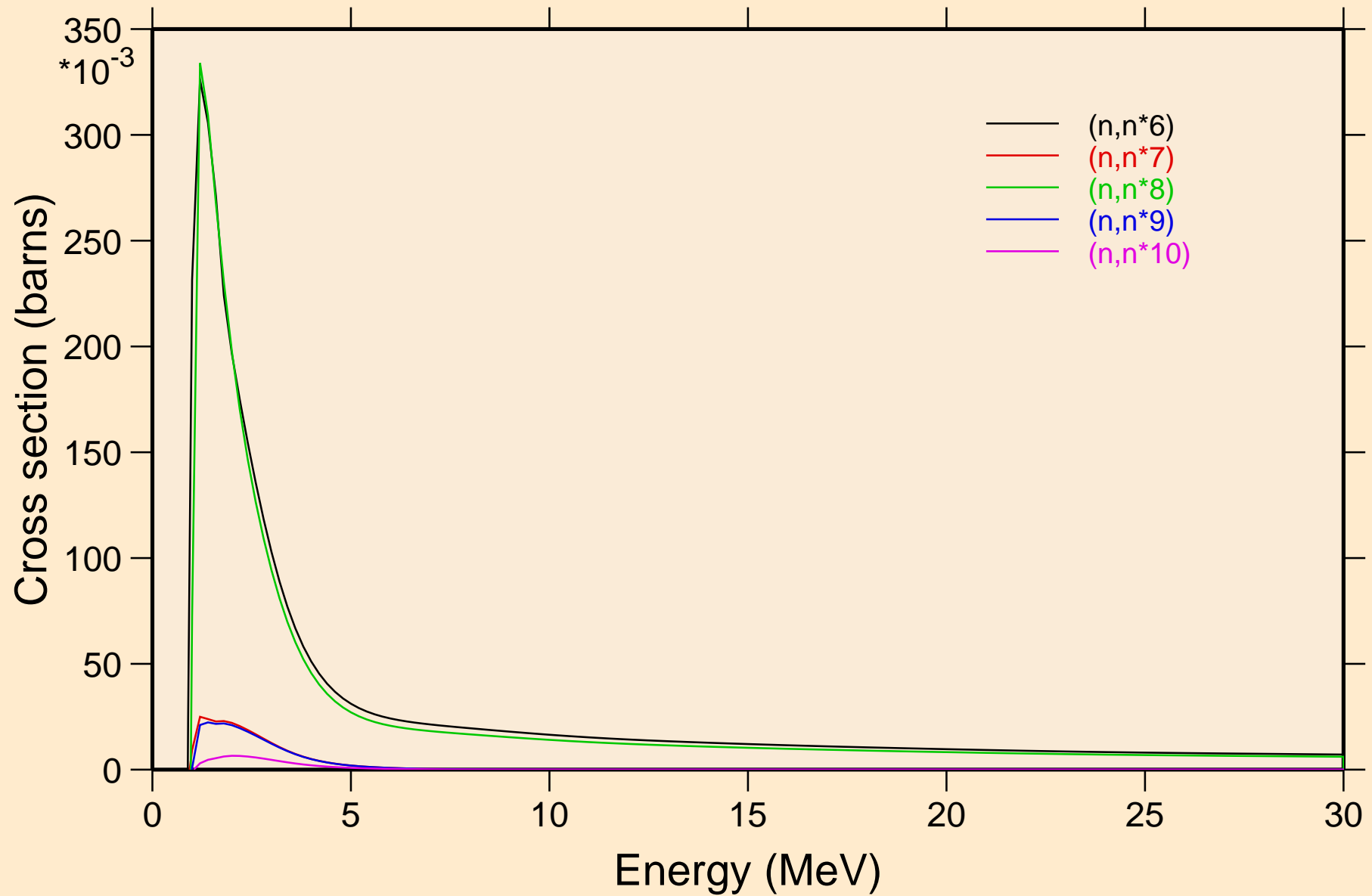

TC095 NEUTRON ACER TENDL-2021 LIBRARY; T=293.6K
Inelastic levels

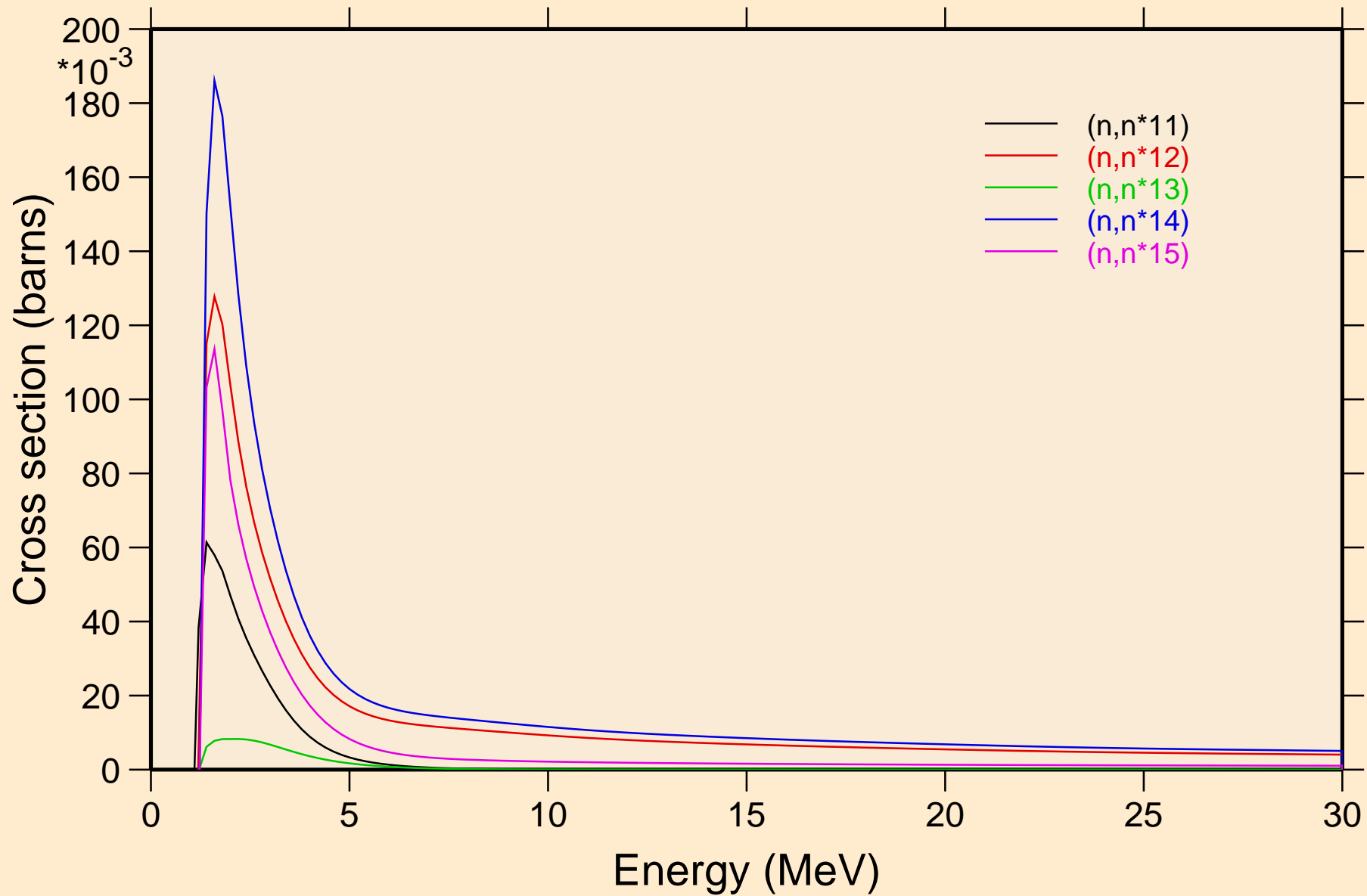

TC095 NEUTRON ACER TENDL-2021 LIBRARY; T=293.6K
Inelastic levels

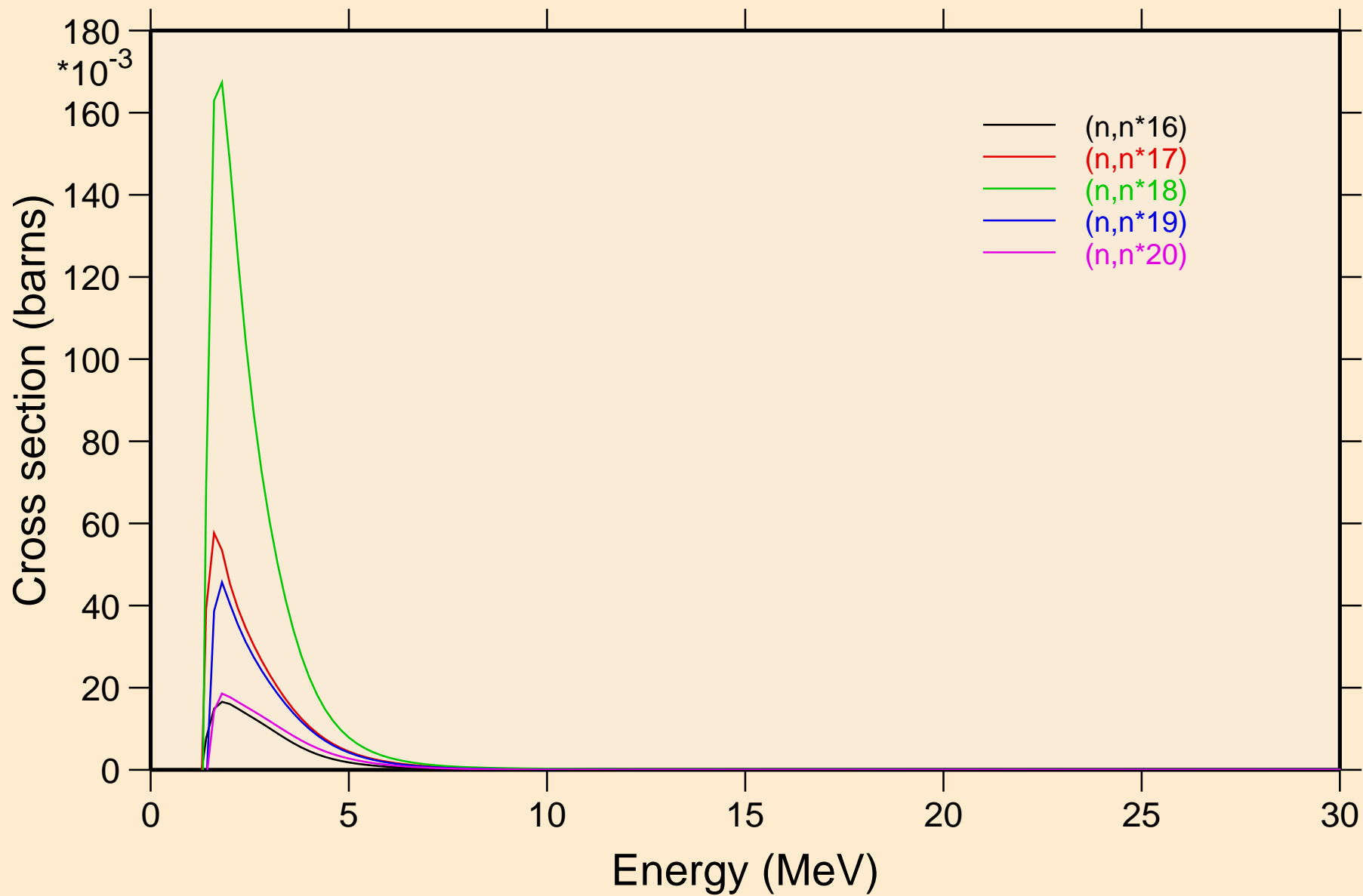

TC095 NEUTRON ACER TENDL-2021 LIBRARY; T=293.6K
Inelastic levels

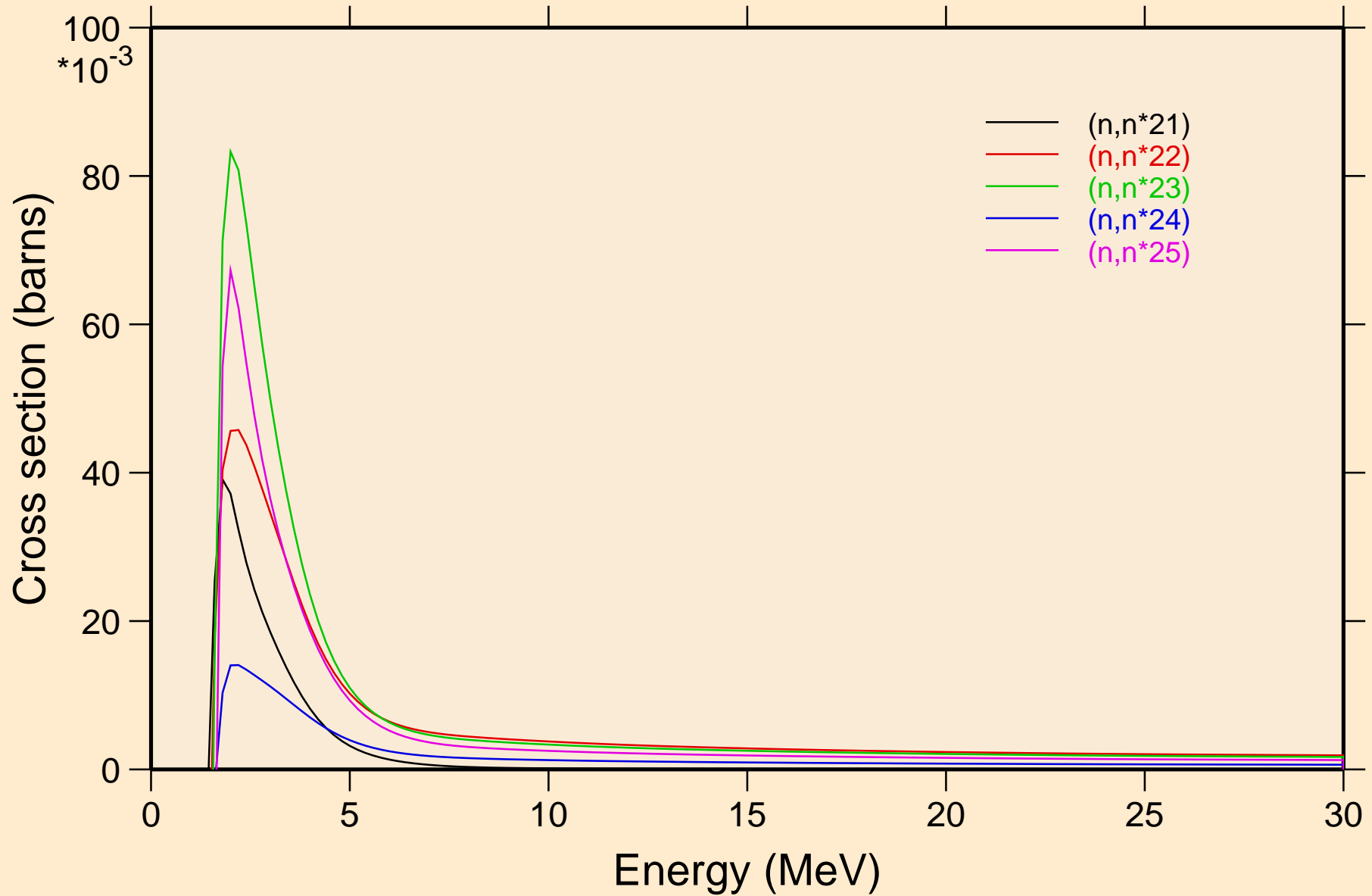

TC095 NEUTRON ACER TENDL-2021 LIBRARY; T=293.6K
Inelastic levels

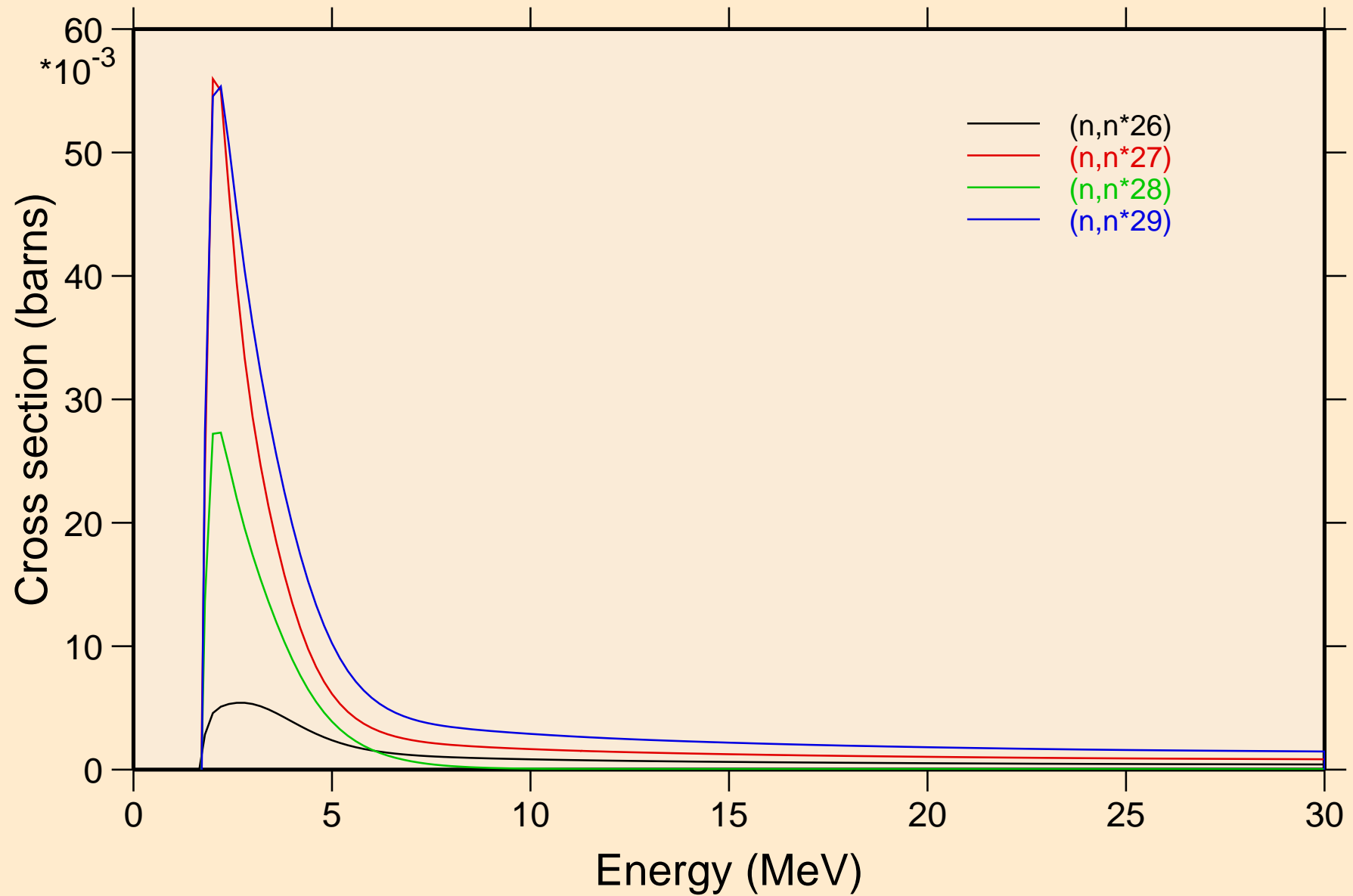

TC095 NEUTRON ACER TENDL-2021 LIBRARY; T=293.6K
Threshold reactions

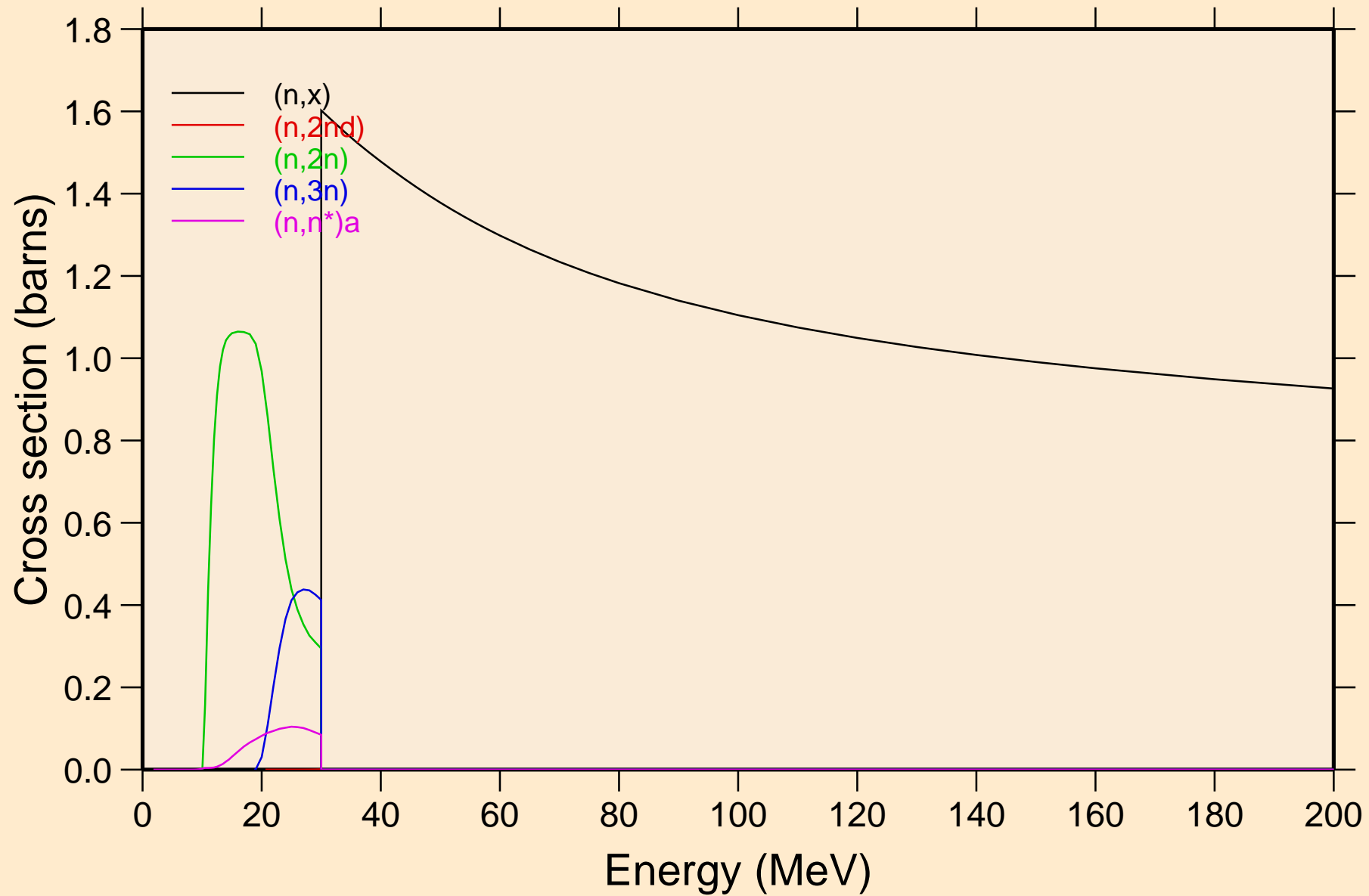

TC095 NEUTRON ACER TENDL-2021 LIBRARY; T=293.6K
Threshold reactions

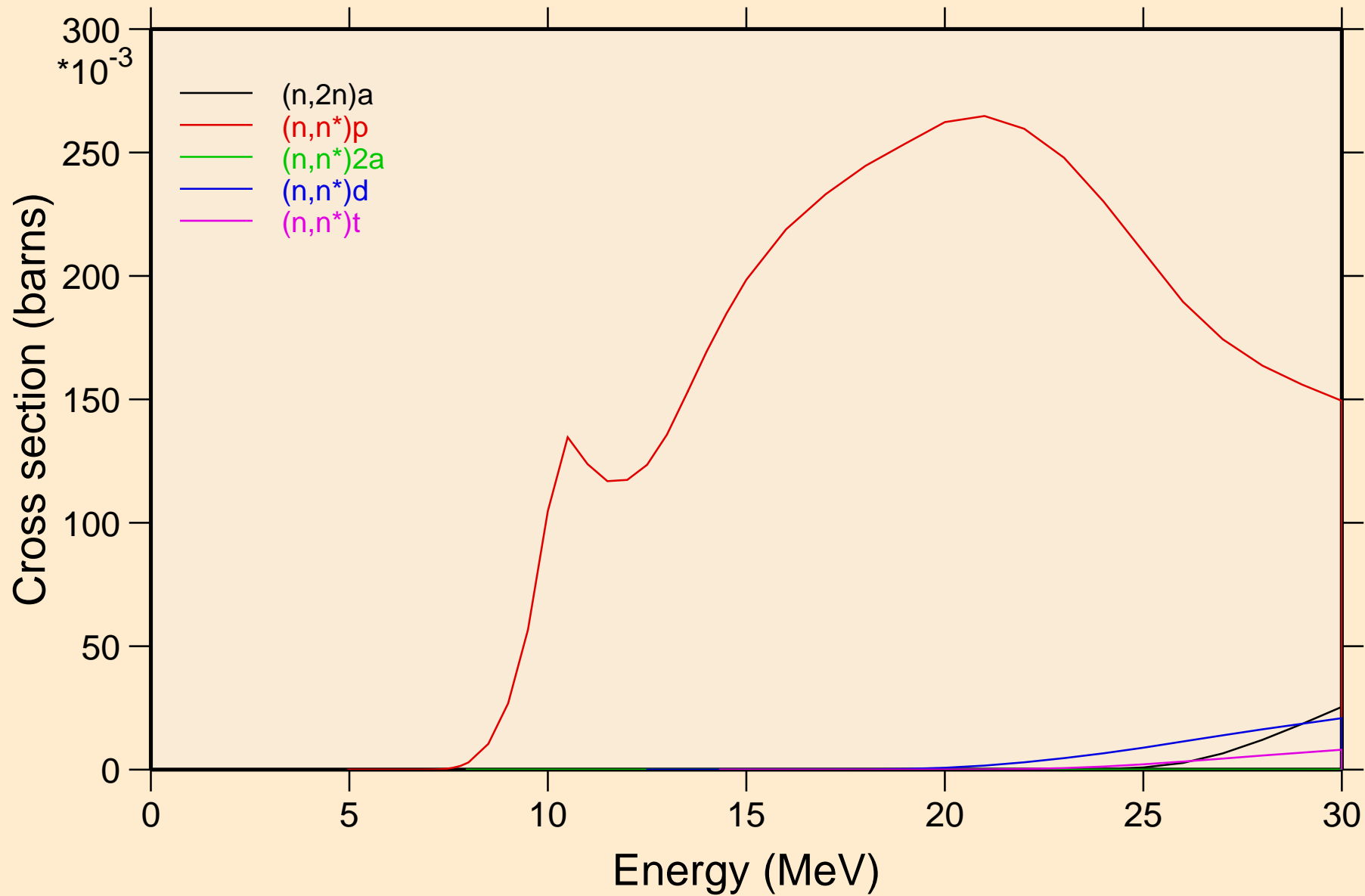

TC095 NEUTRON ACER TENDL-2021 LIBRARY; T=293.6K
Threshold reactions

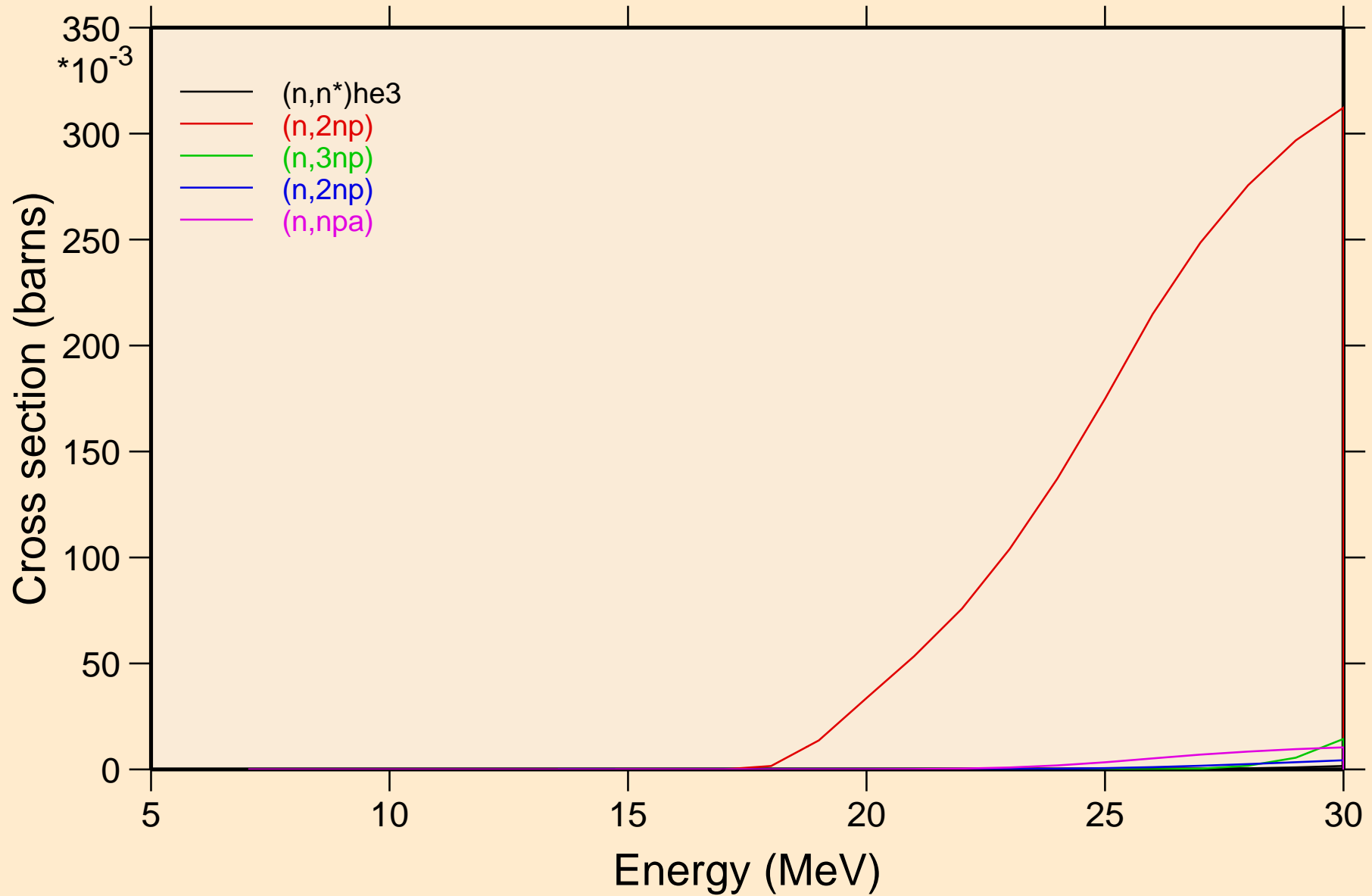

TC095 NEUTRON ACER TENDL-2021 LIBRARY; T=293.6K
Threshold reactions

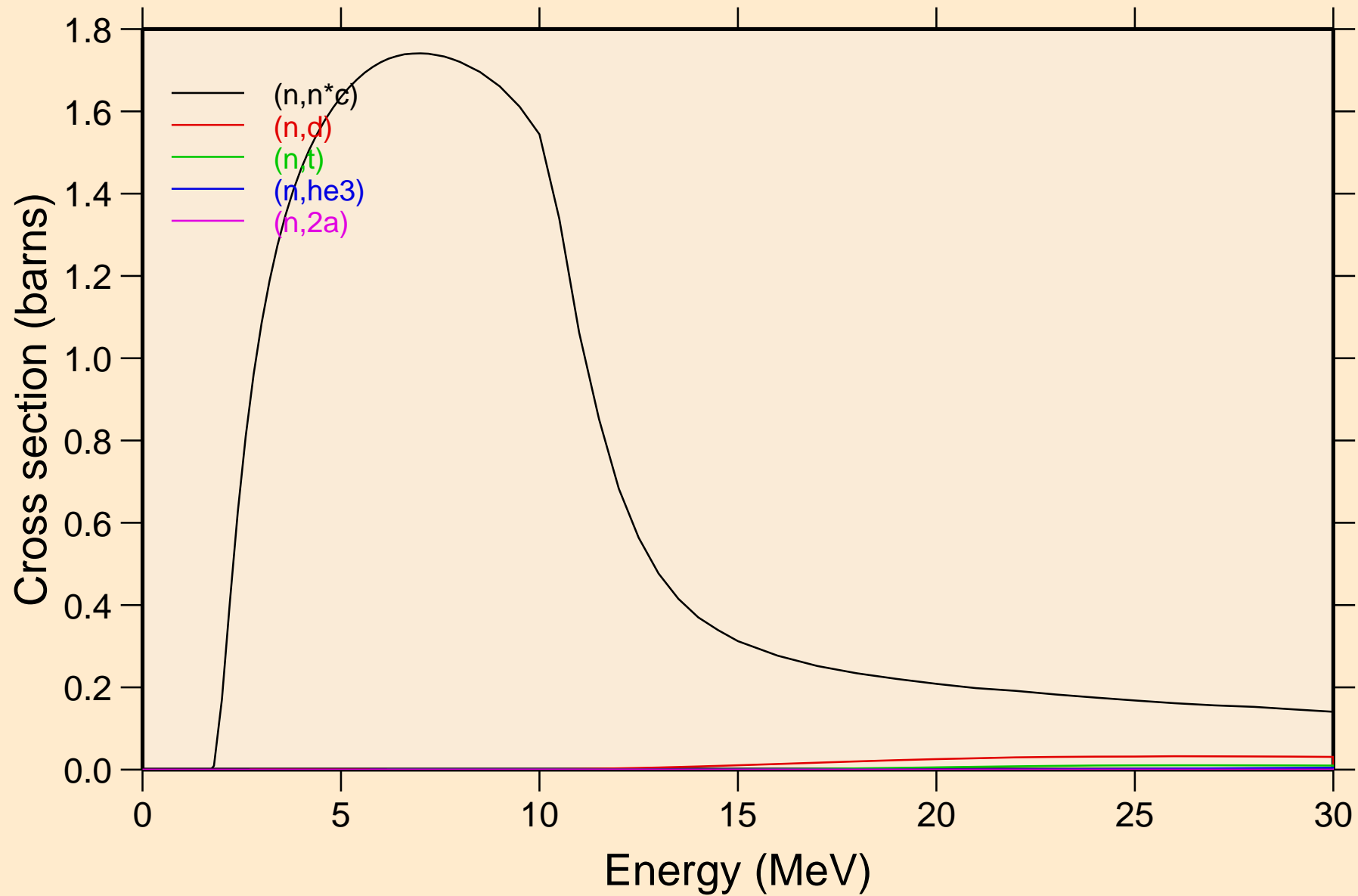

TC095 NEUTRON ACER TENDL-2021 LIBRARY; T=293.6K
Threshold reactions

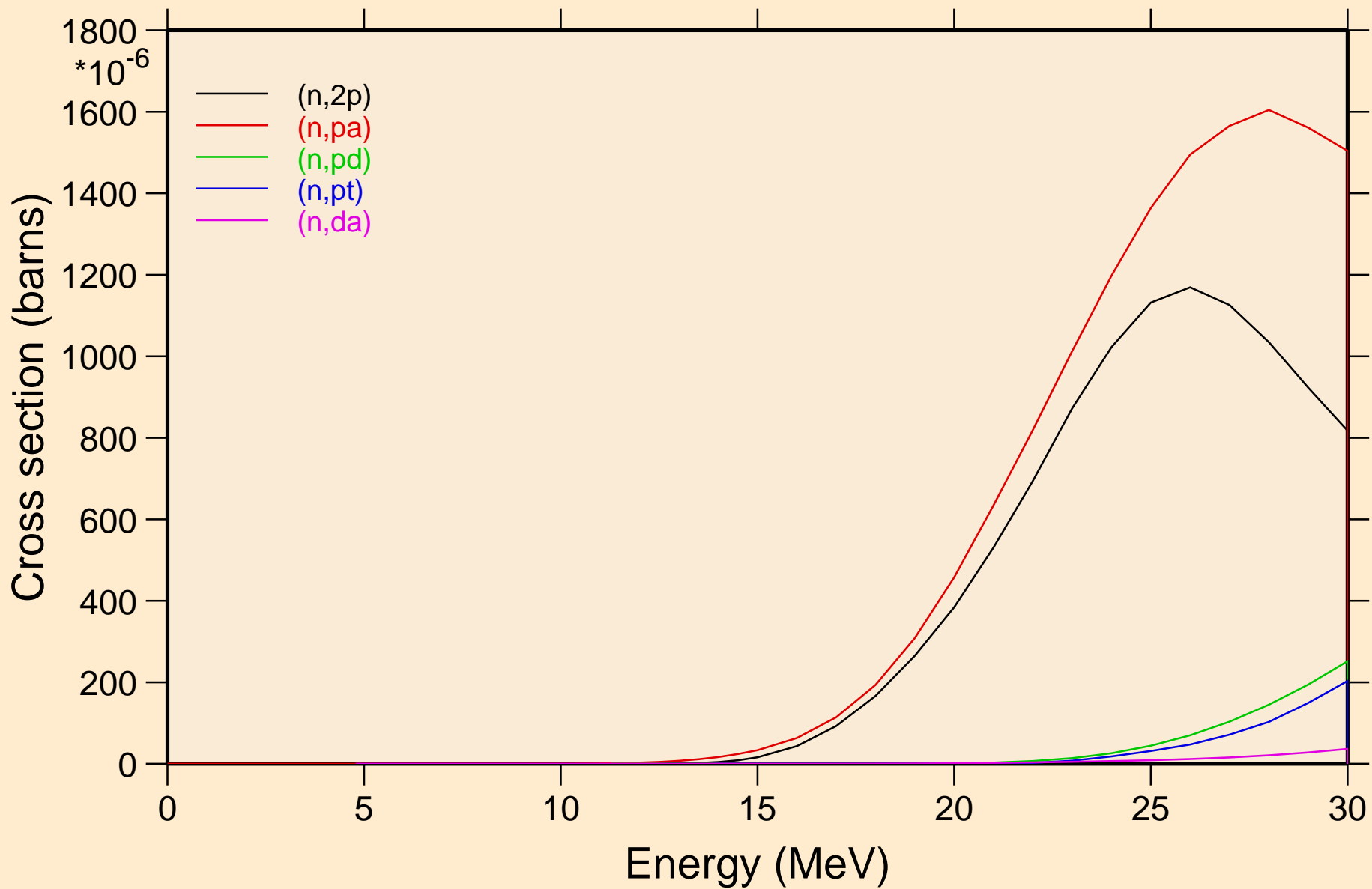

TC095 NEUTRON ACER TENDL-2021 LIBRARY; T=293.6K
Threshold reactions

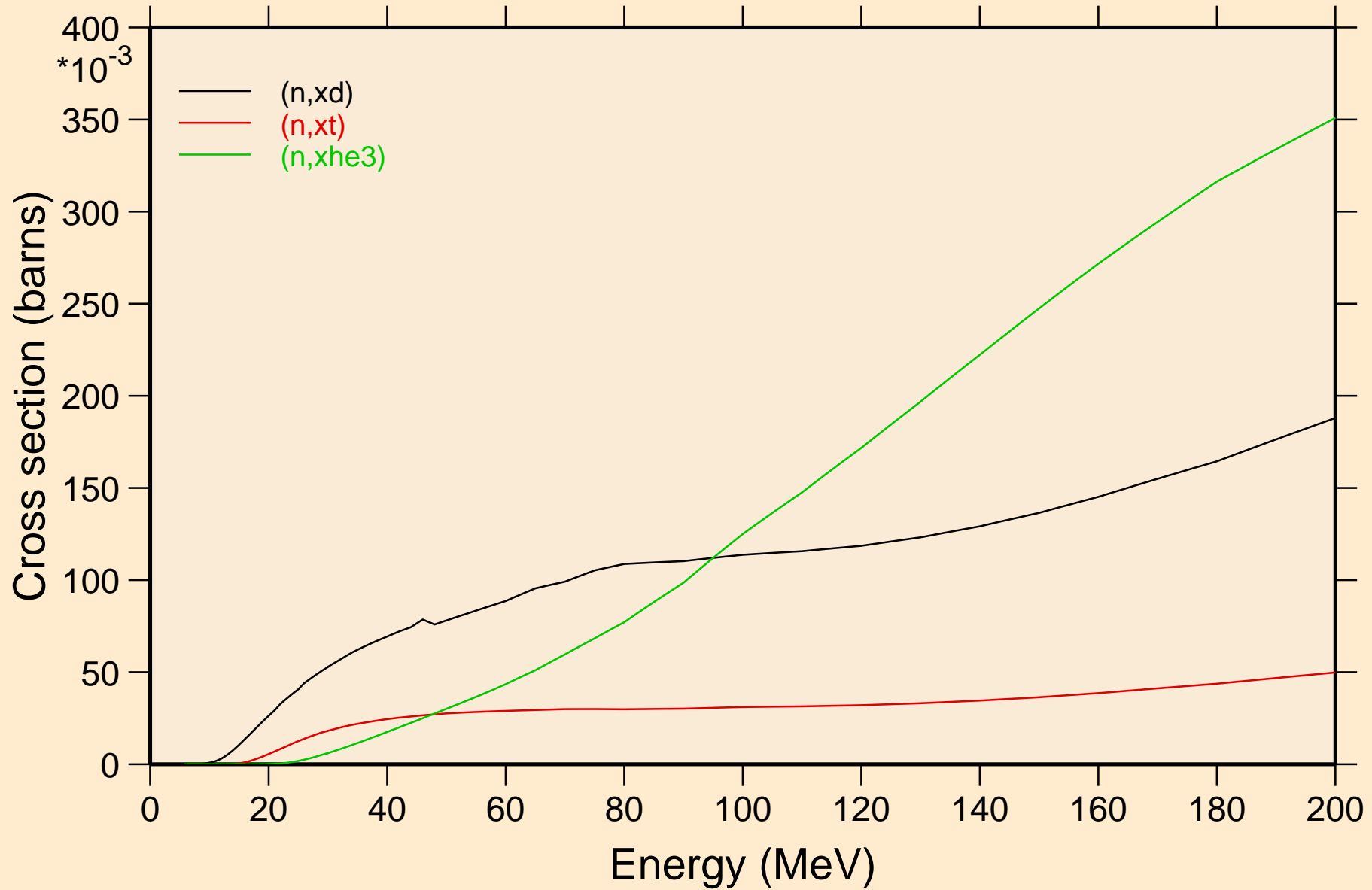

TC095 NEUTRON ACER TENDL-2021 LIBRARY; T=293.6K
angular distribution for elastic

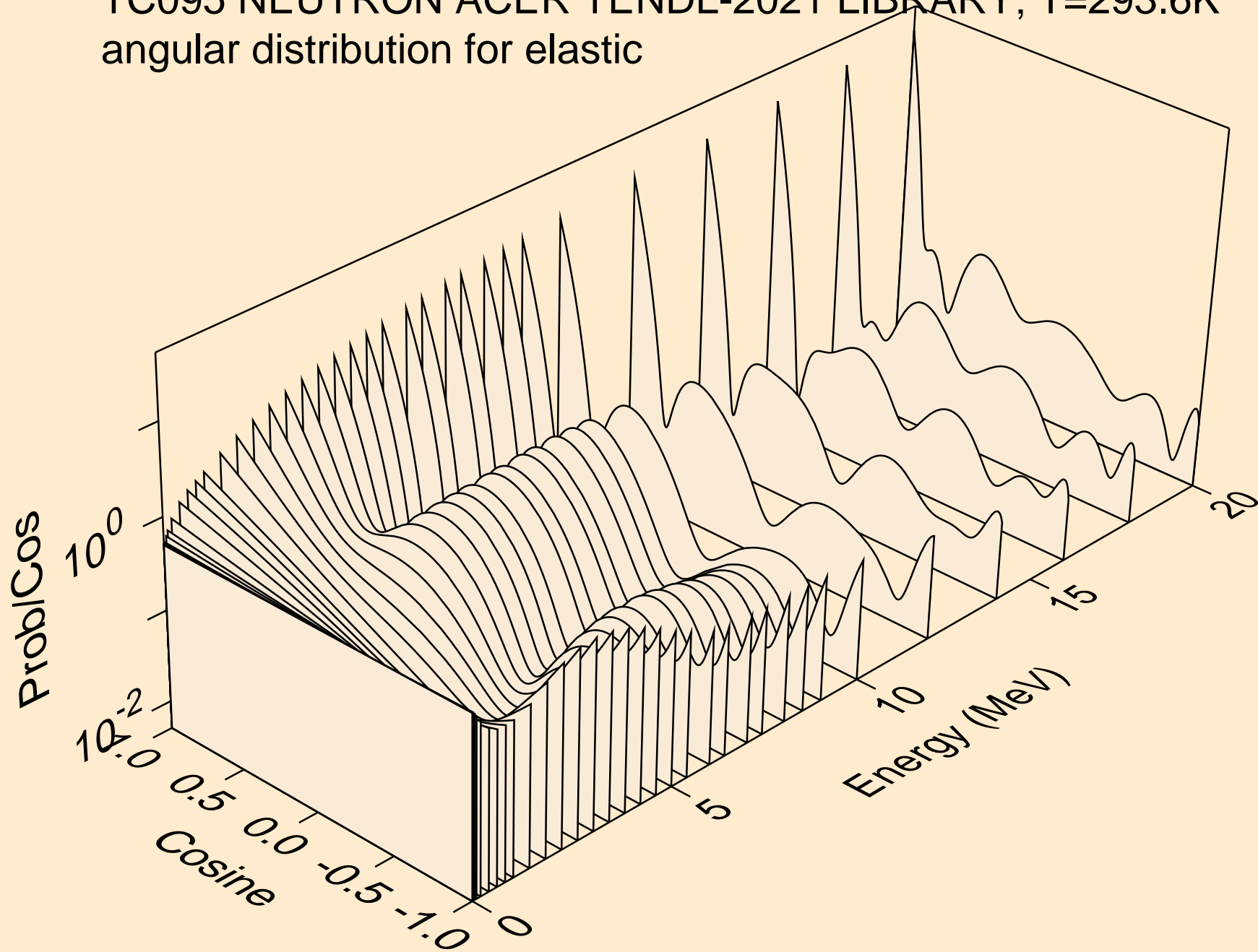

TC095 NEUTRON ACER TENDL-2021 LIBRARY; T=293.6K
angular distribution for elastic

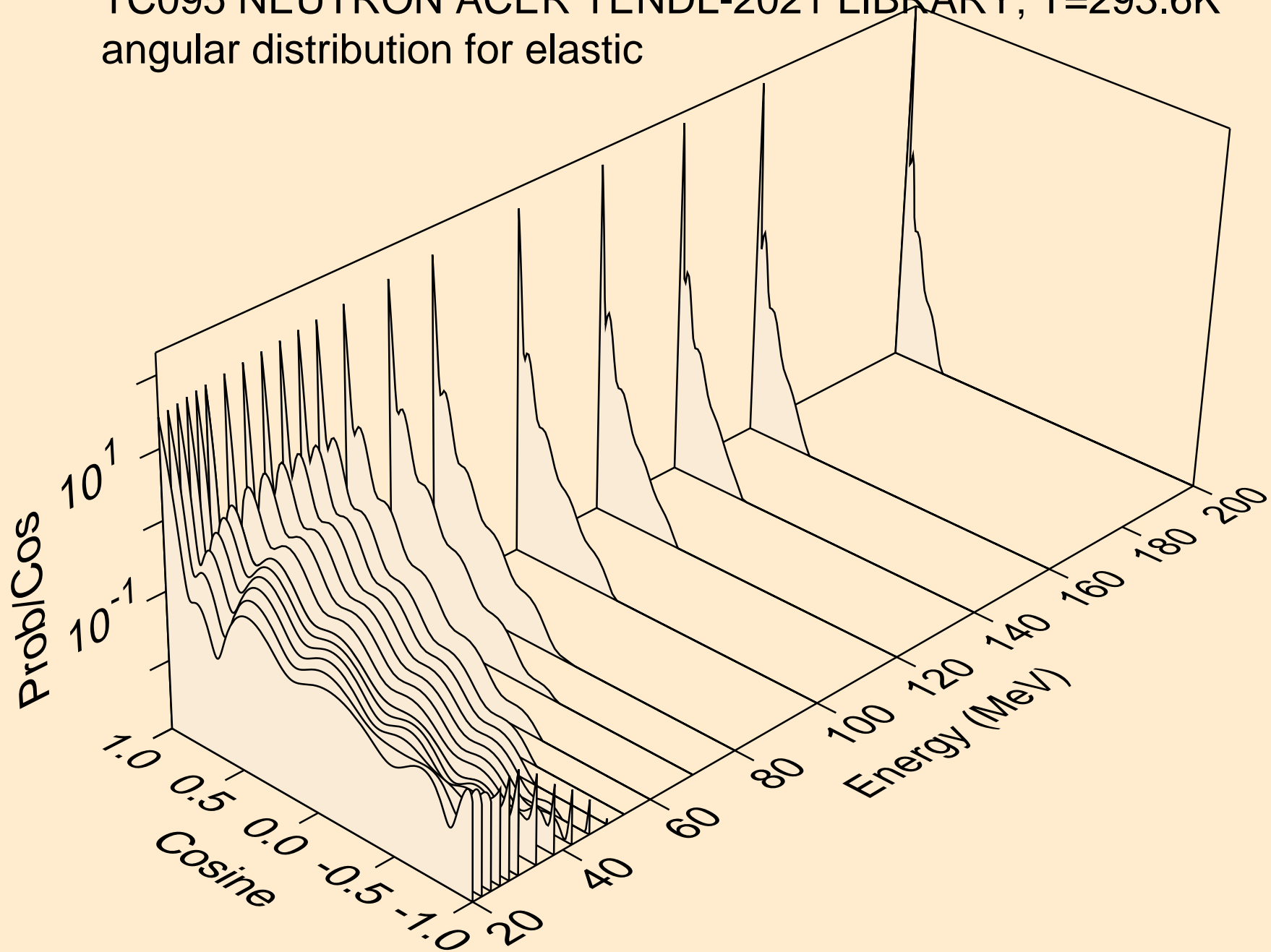

TC095 NEUTRON ACER TENDL-2021 LIBRARY; T=293.6K
angular distribution for (n,n*1)

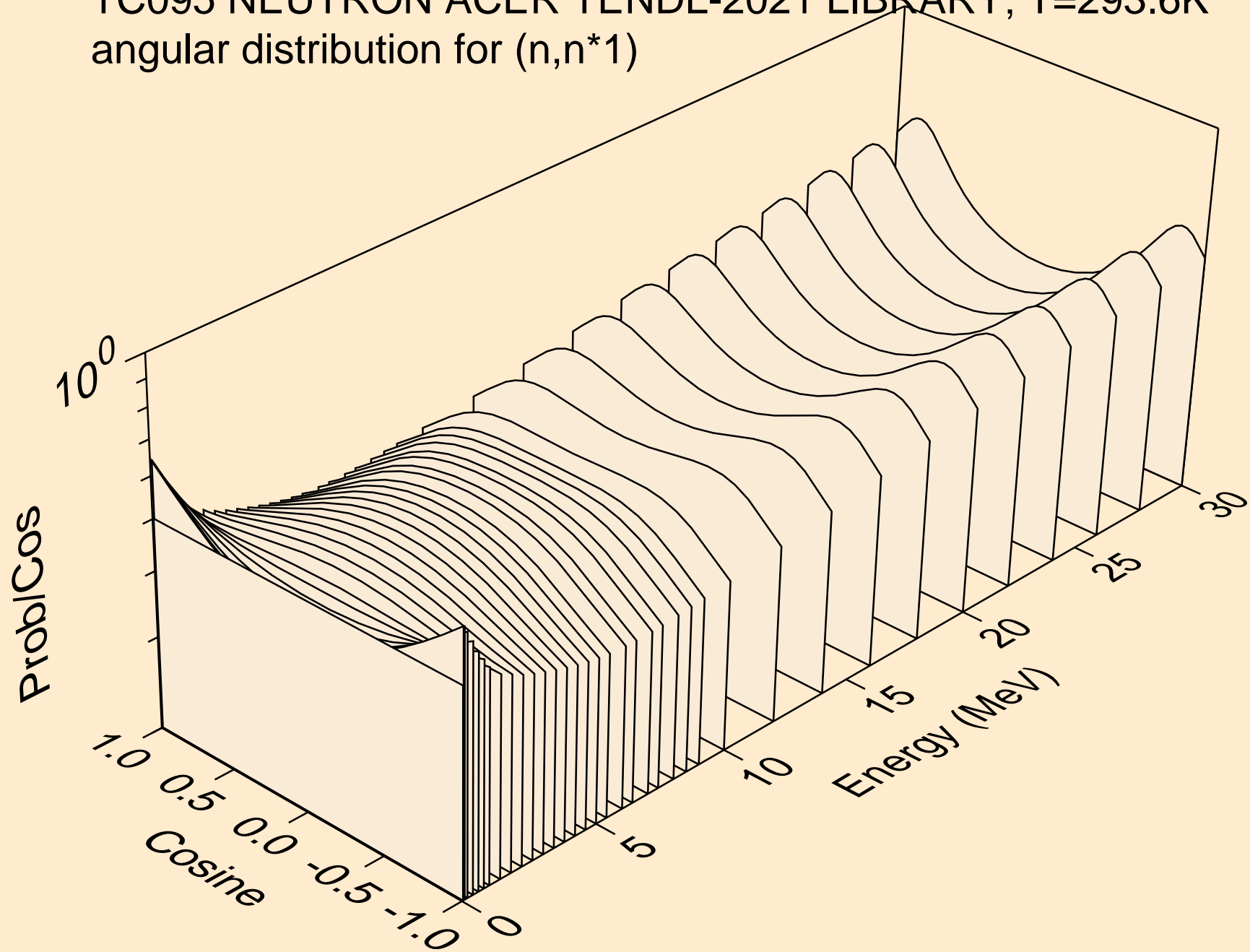

TC095 NEUTRON ACER TENDL-2021 LIBRARY; T=293.6K
angular distribution for (n,n*2)

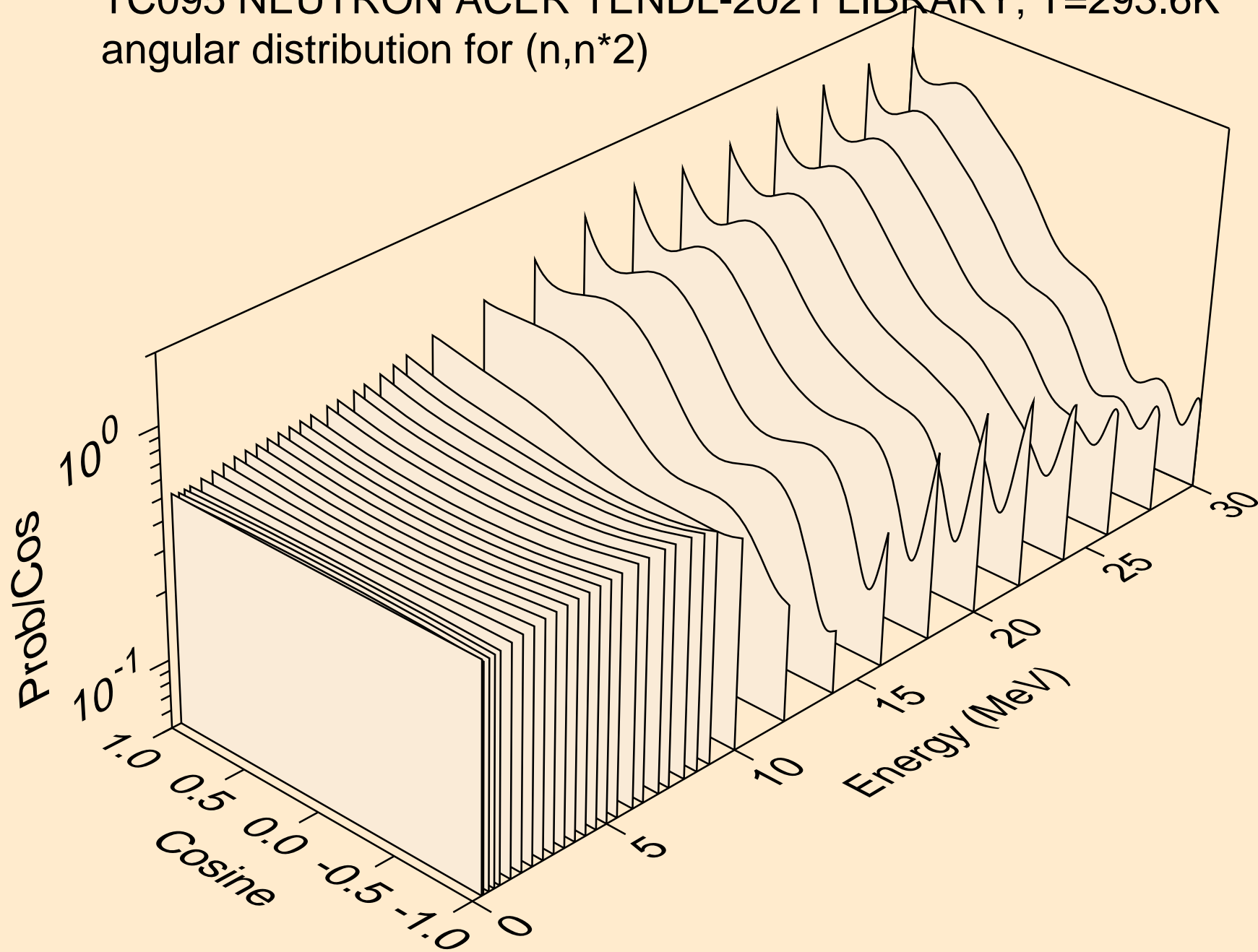

TC095 NEUTRON ACER TENDL-2021 LIBRARY; T=293.6K
angular distribution for (n,n*3)

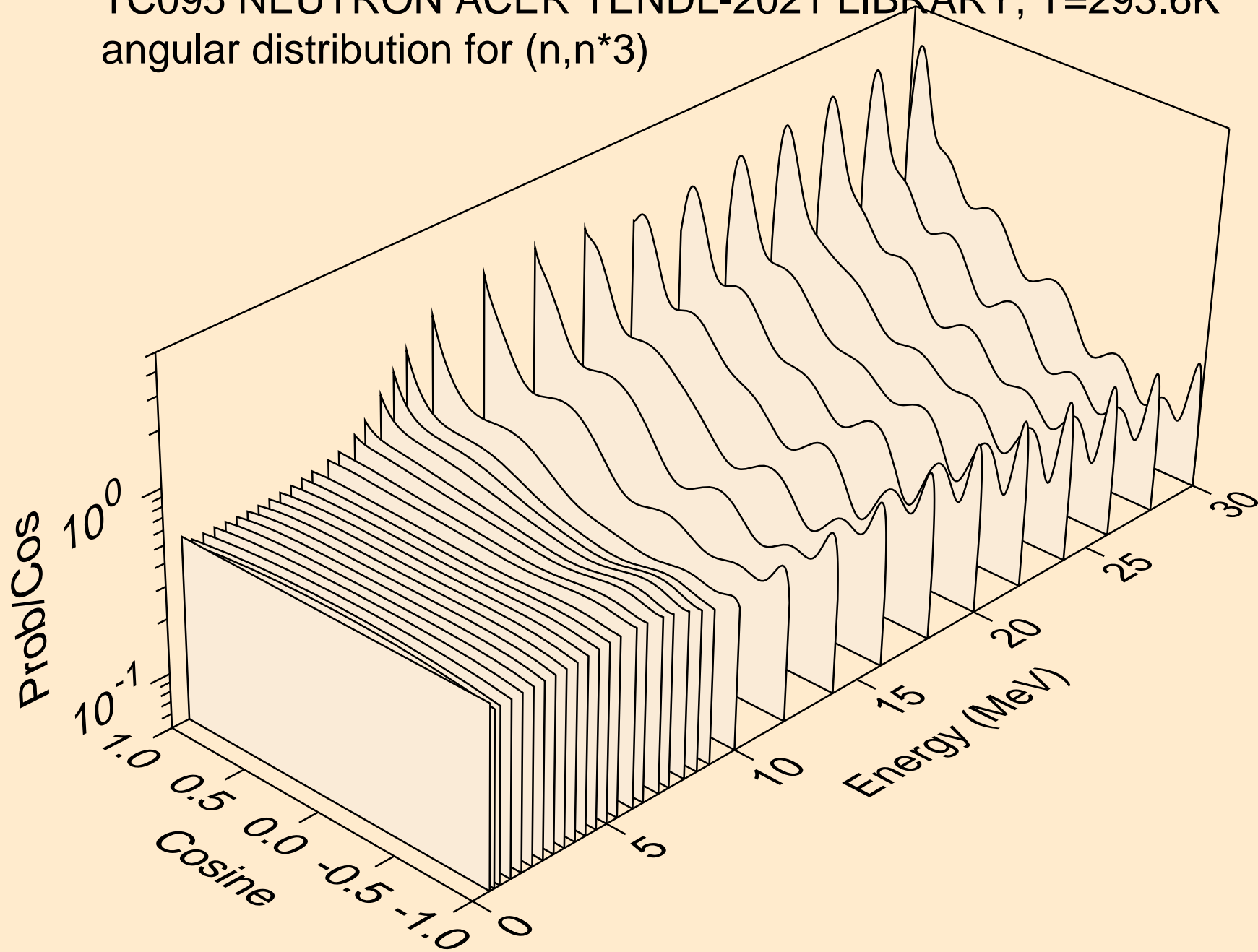

TC095 NEUTRON ACER TENDL-2021 LIBRARY; T=293.6K
angular distribution for (n,n*4)

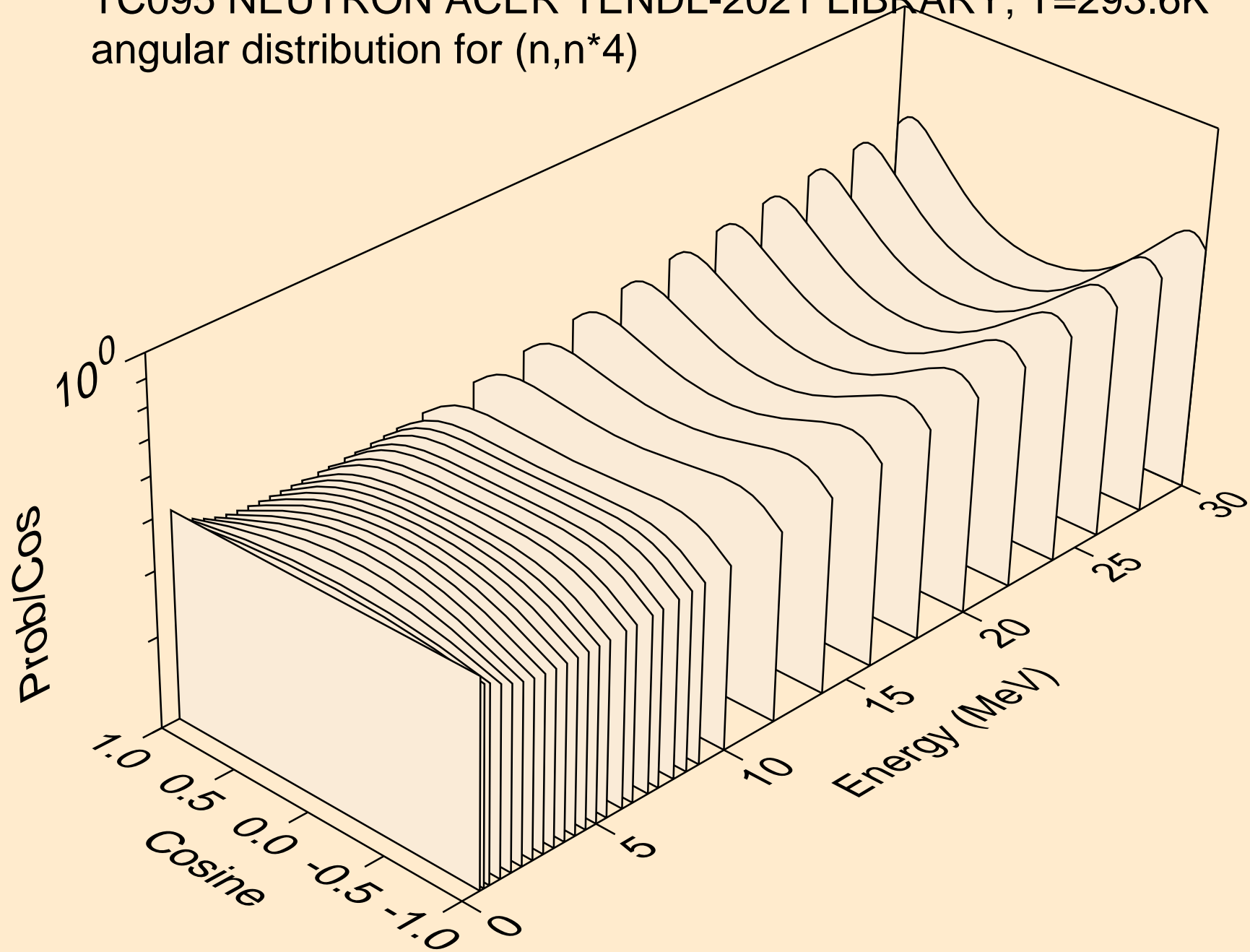

TC095 NEUTRON ACER TENDL-2021 LIBRARY; T=293.6K
angular distribution for (n,n*5)

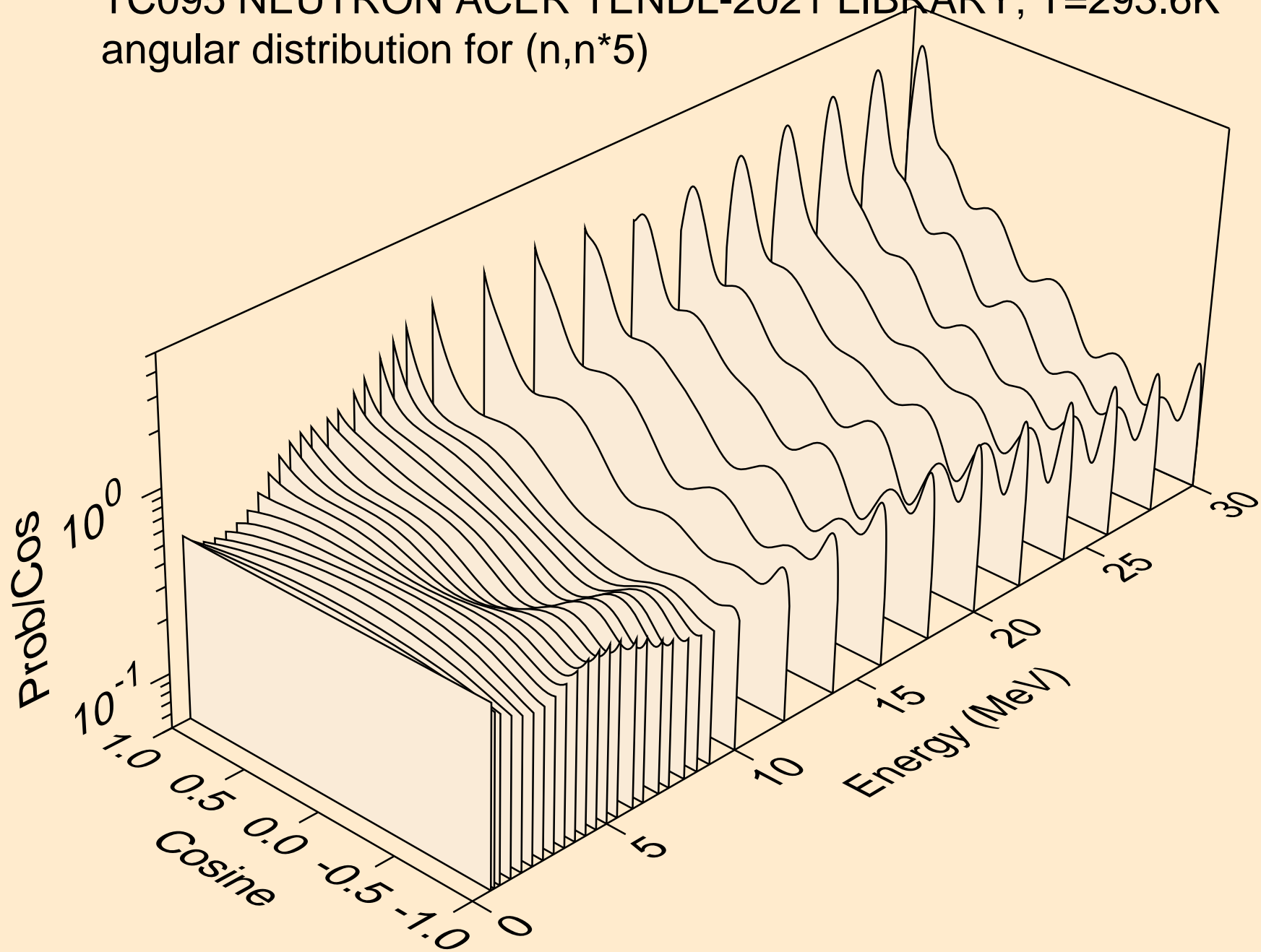

TC095 NEUTRON ACER TENDL-2021 LIBRARY; T=293.6K
angular distribution for (n,n*6)

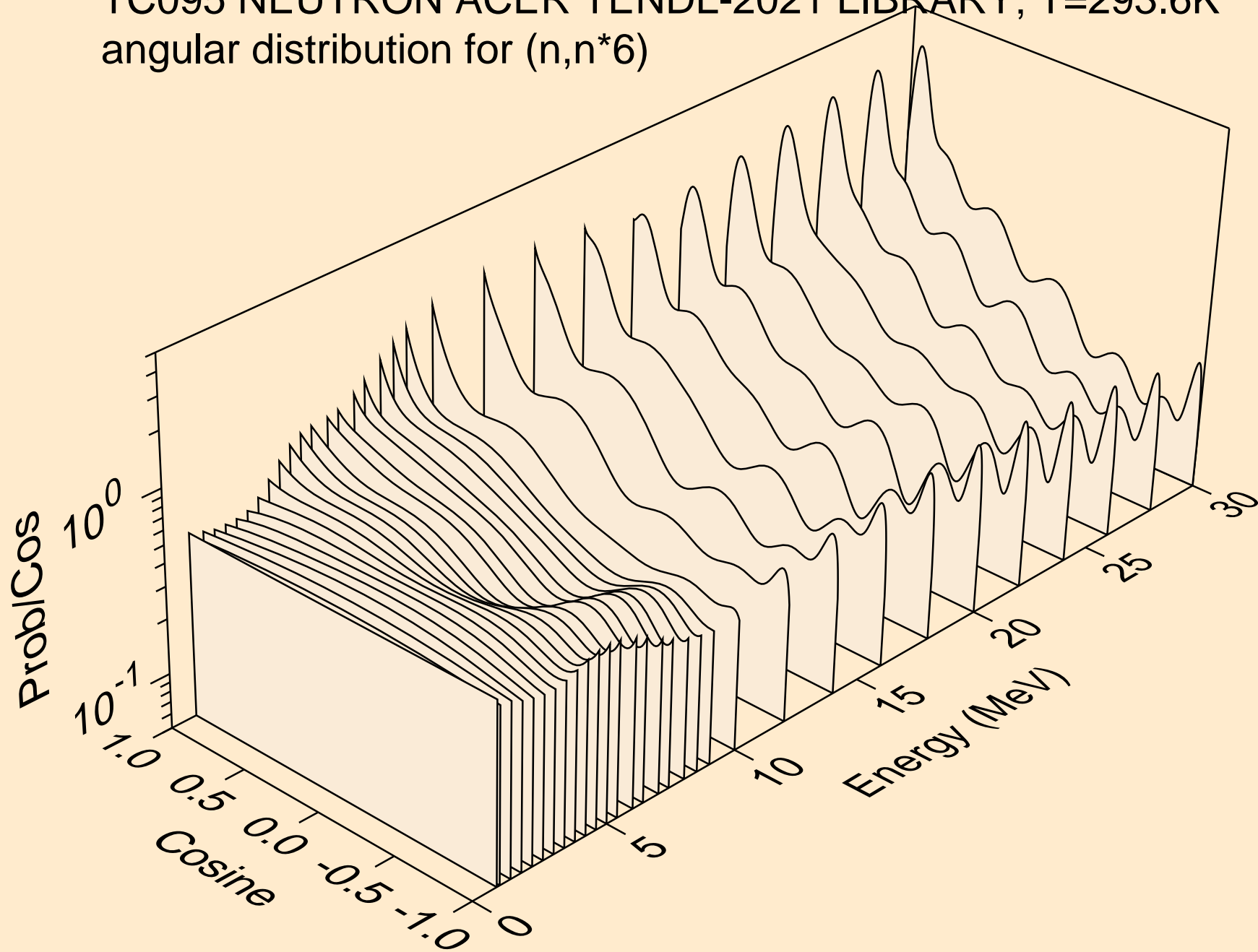

TC095 NEUTRON ACER TENDL-2021 LIBRARY; T=293.6K
angular distribution for (n,n*7)

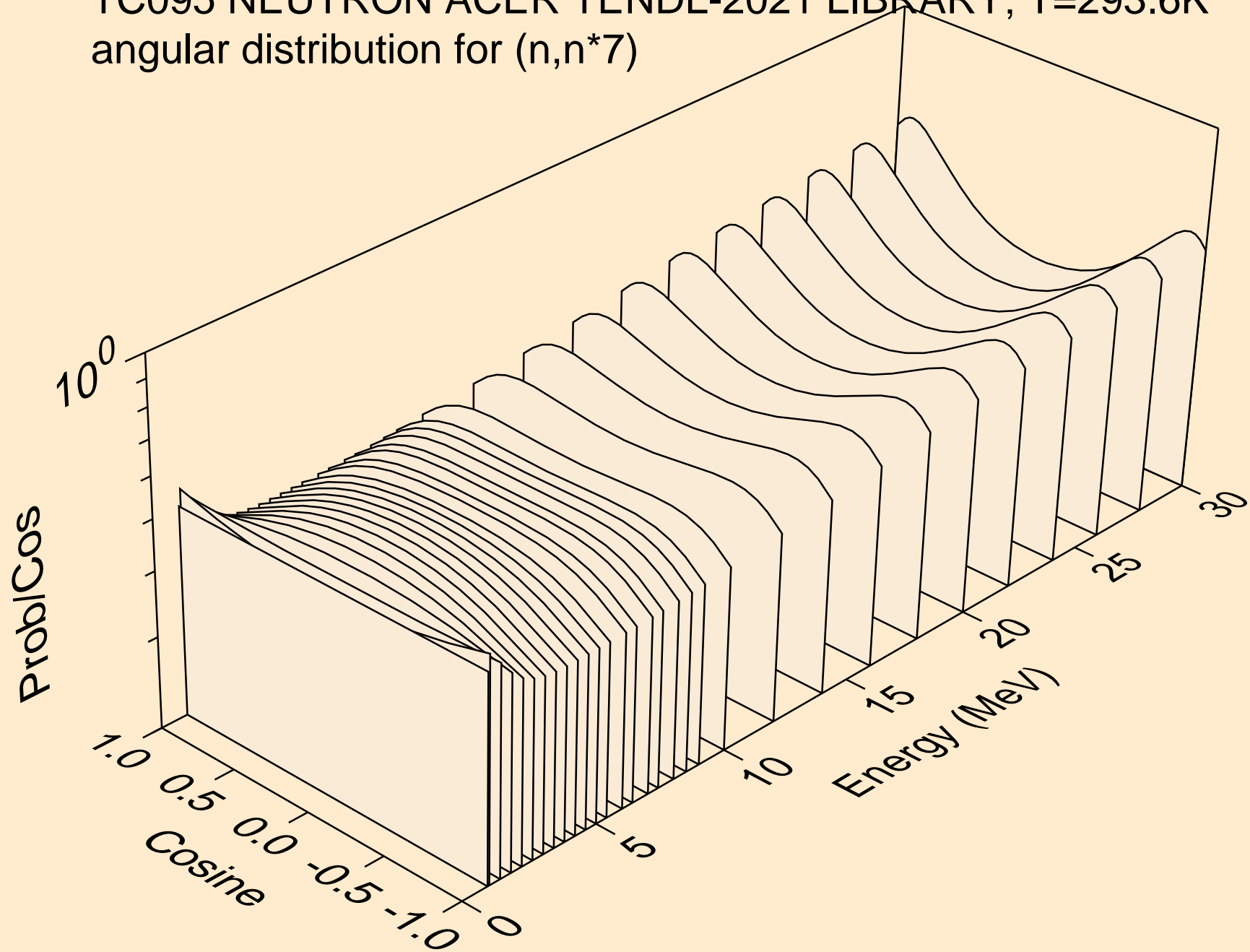

TC095 NEUTRON ACER TENDL-2021 LIBRARY; T=293.6K
angular distribution for (n,n*8)

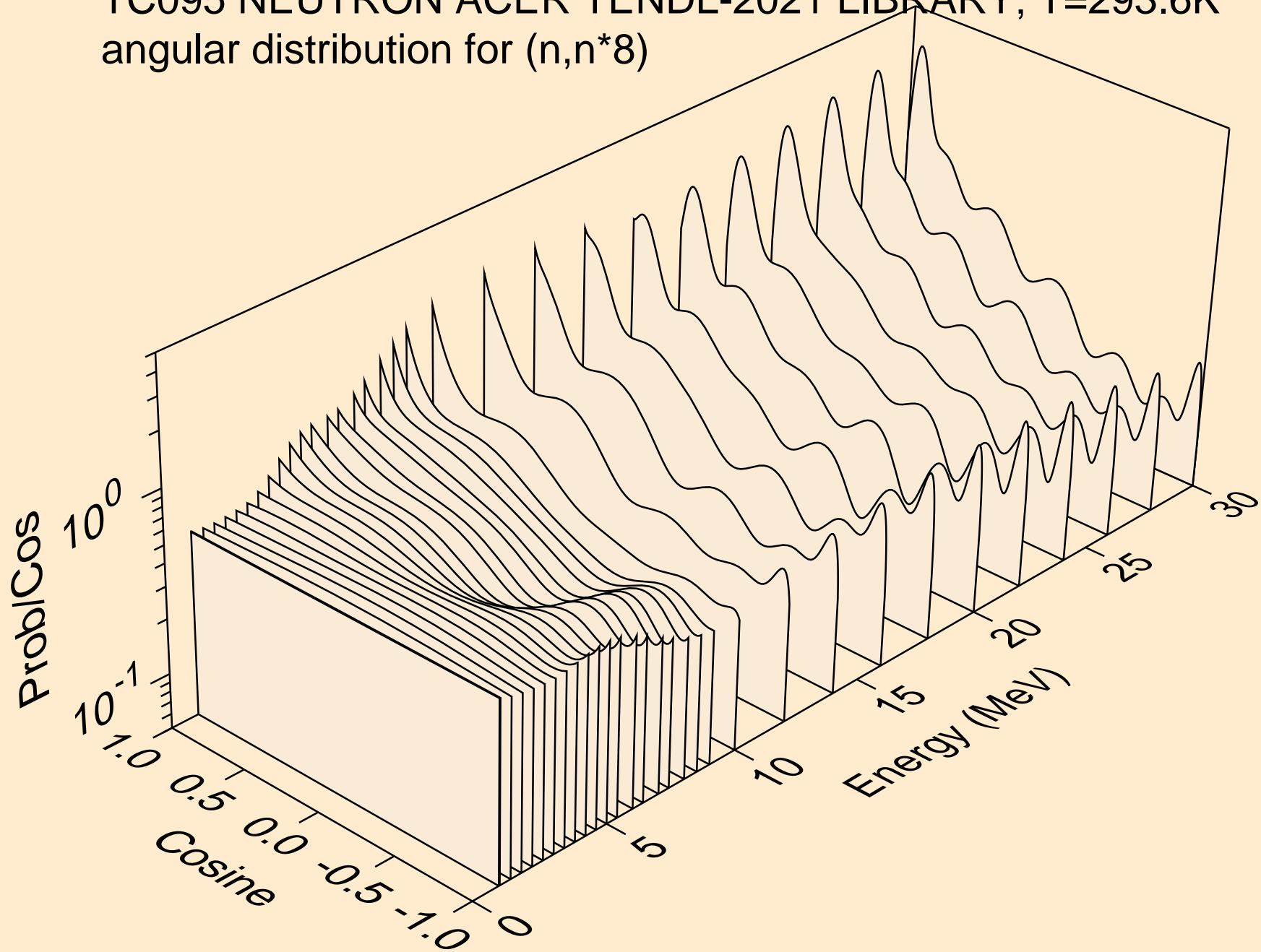

TC095 NEUTRON ACER TENDL-2021 LIBRARY; T=293.6K
angular distribution for (n,n*9)

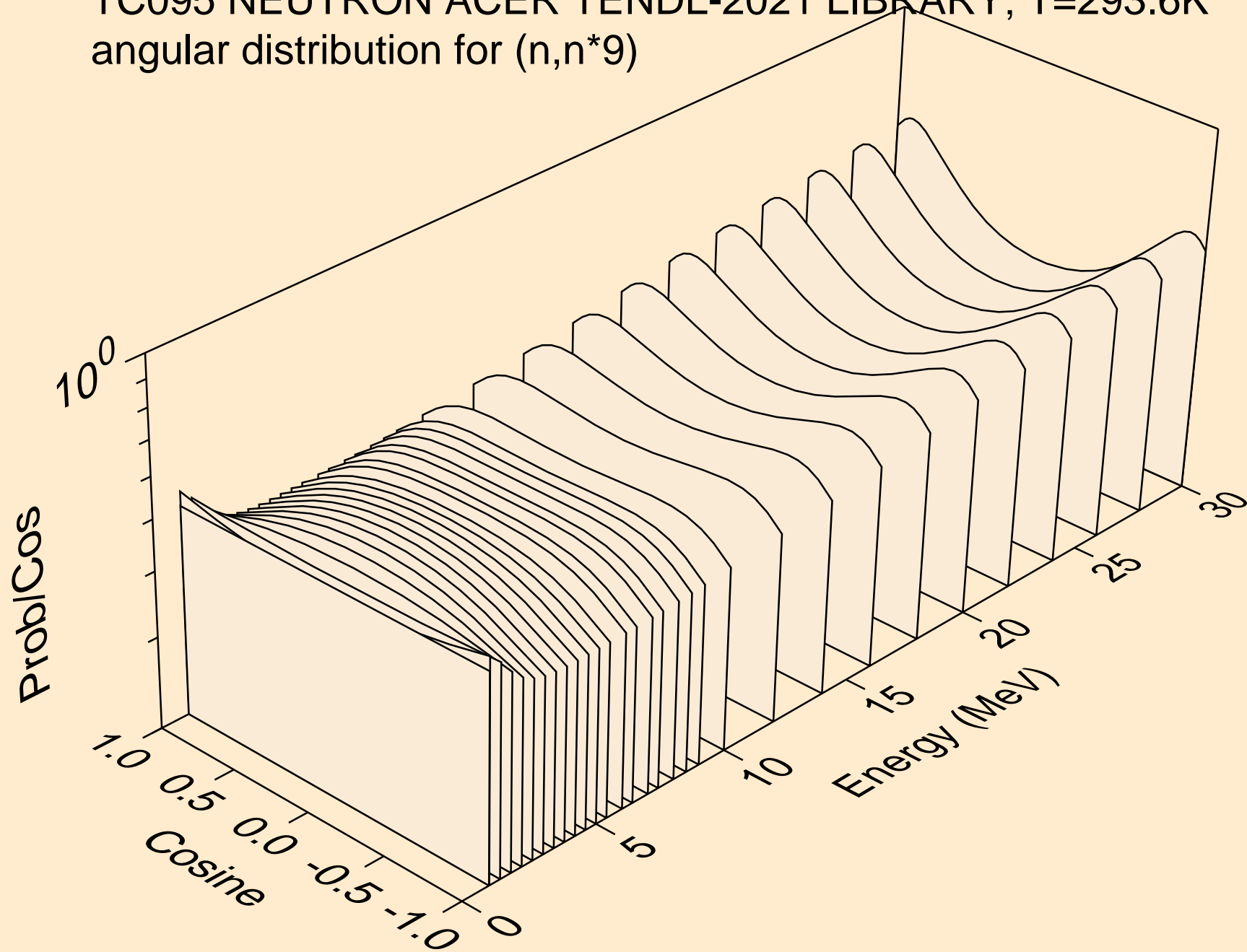

TC095 NEUTRON ACER TENDL-2021 LIBRARY; T=293.6K
angular distribution for (n,n*10)

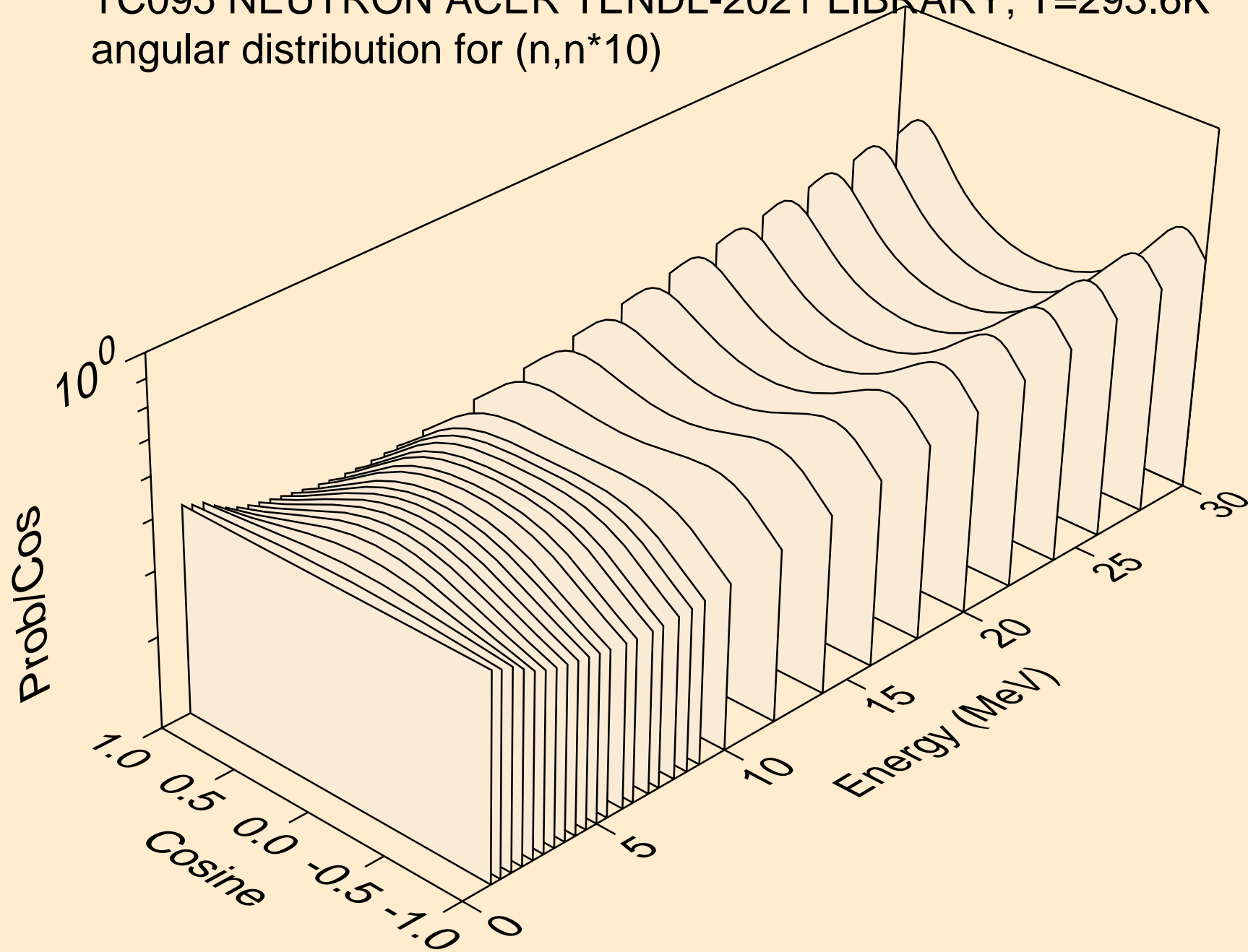

TC095 NEUTRON ACER TENDL-2021 LIBRARY; T=293.6K
angular distribution for (n,n*11)

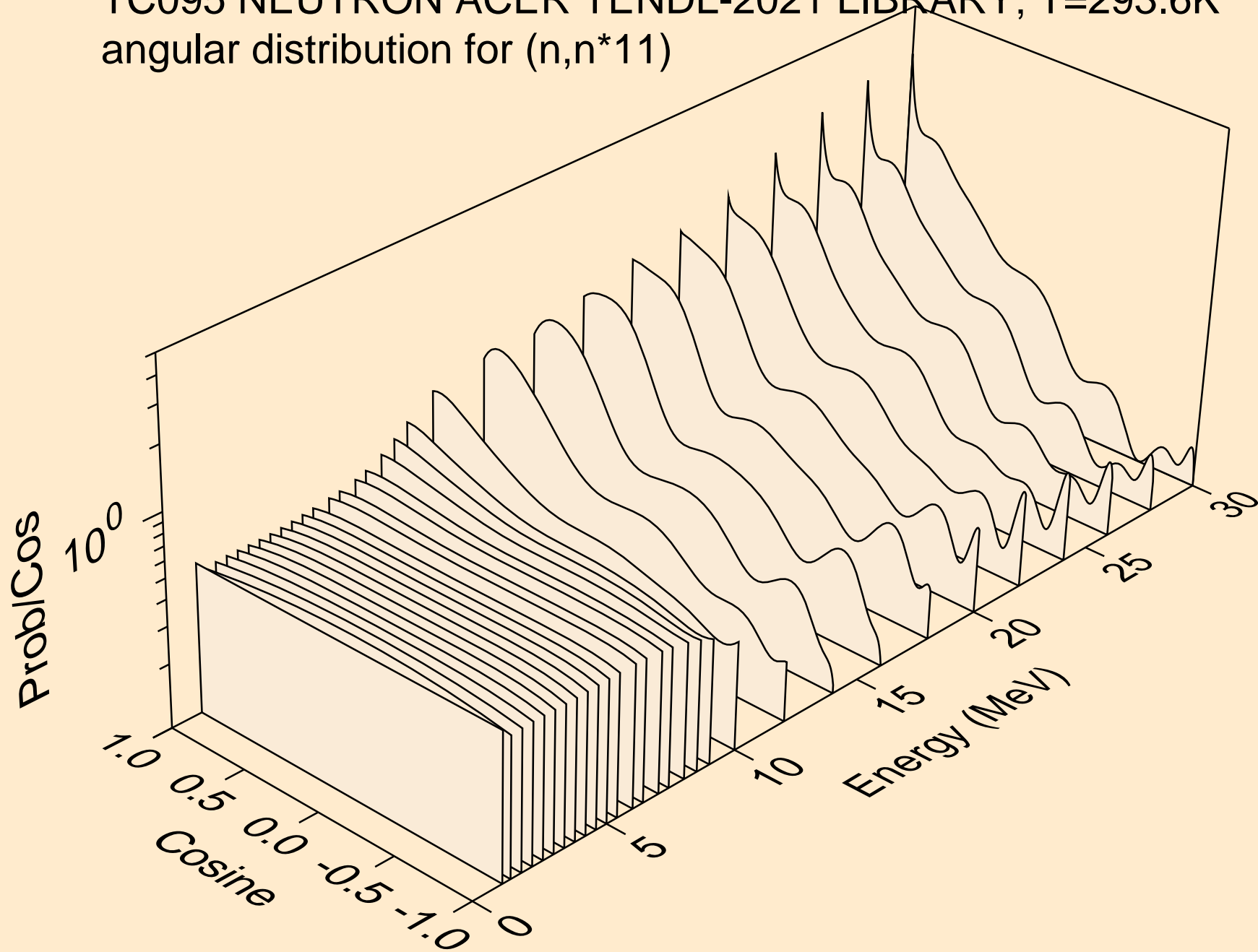

TC095 NEUTRON ACER TENDL-2021 LIBRARY; T=293.6K
angular distribution for (n,n*12)

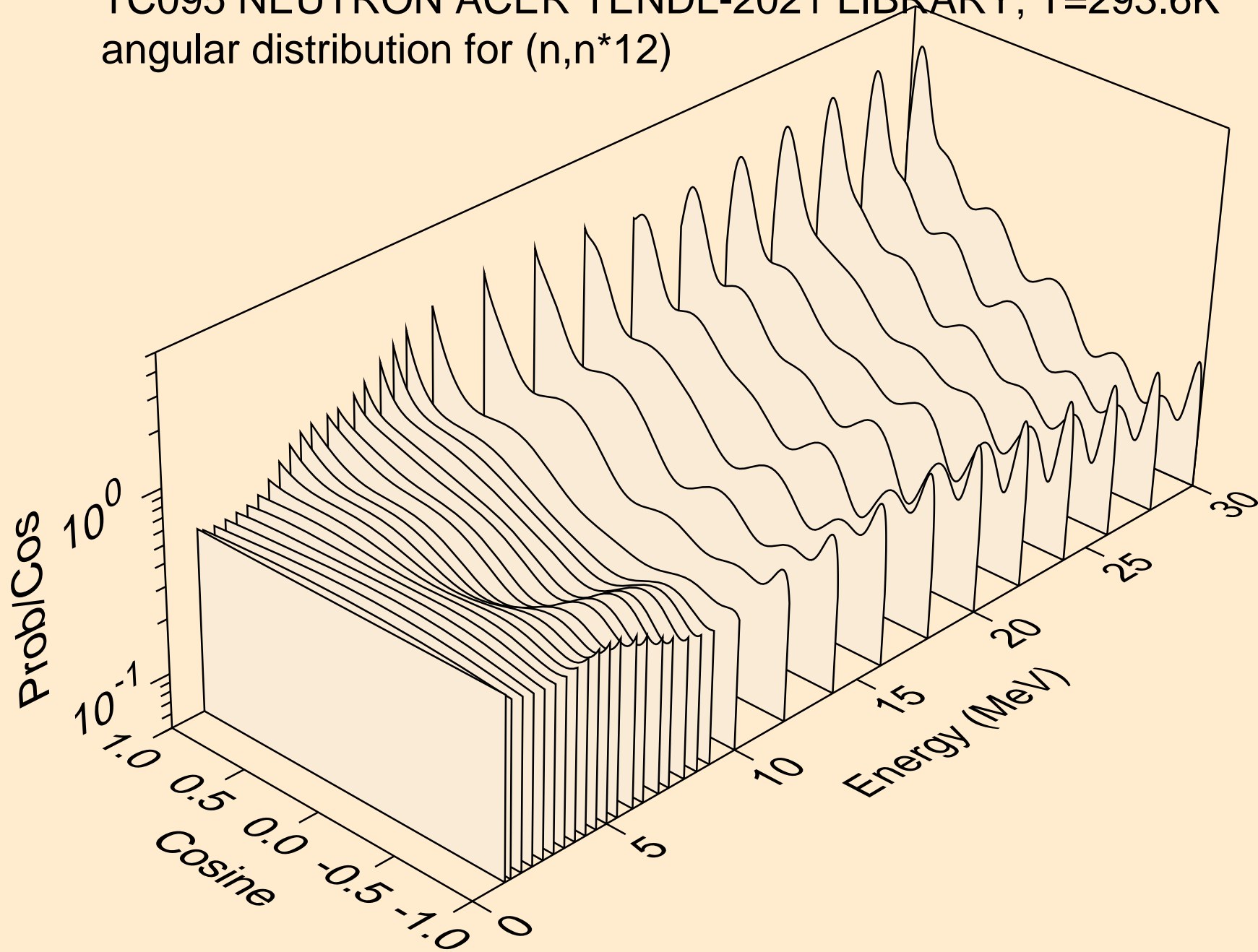

TC095 NEUTRON ACER TENDL-2021 LIBRARY; T=293.6K
angular distribution for (n,n*13)

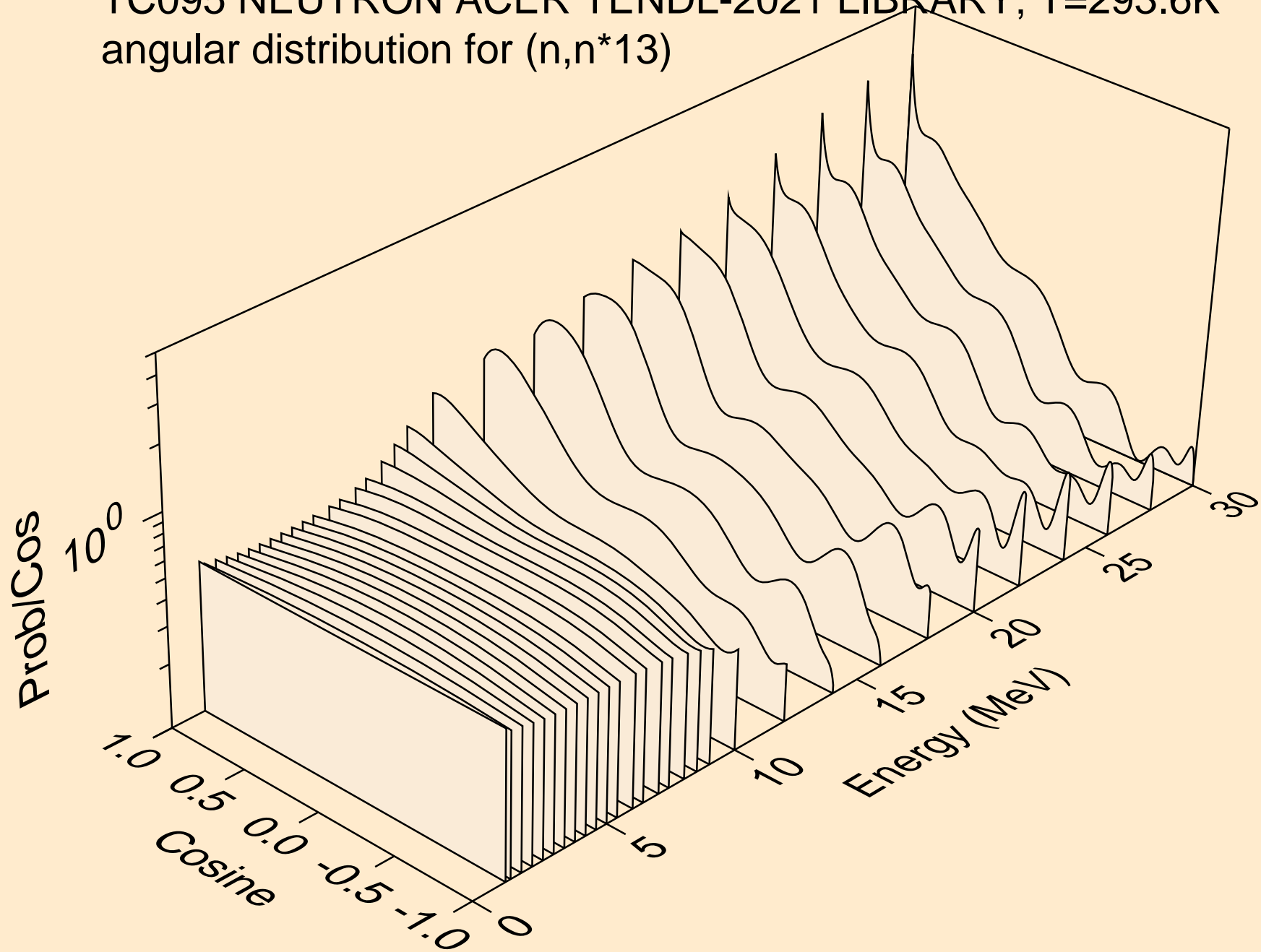

TC095 NEUTRON ACER TENDL-2021 LIBRARY; T=293.6K
angular distribution for (n,n*14)

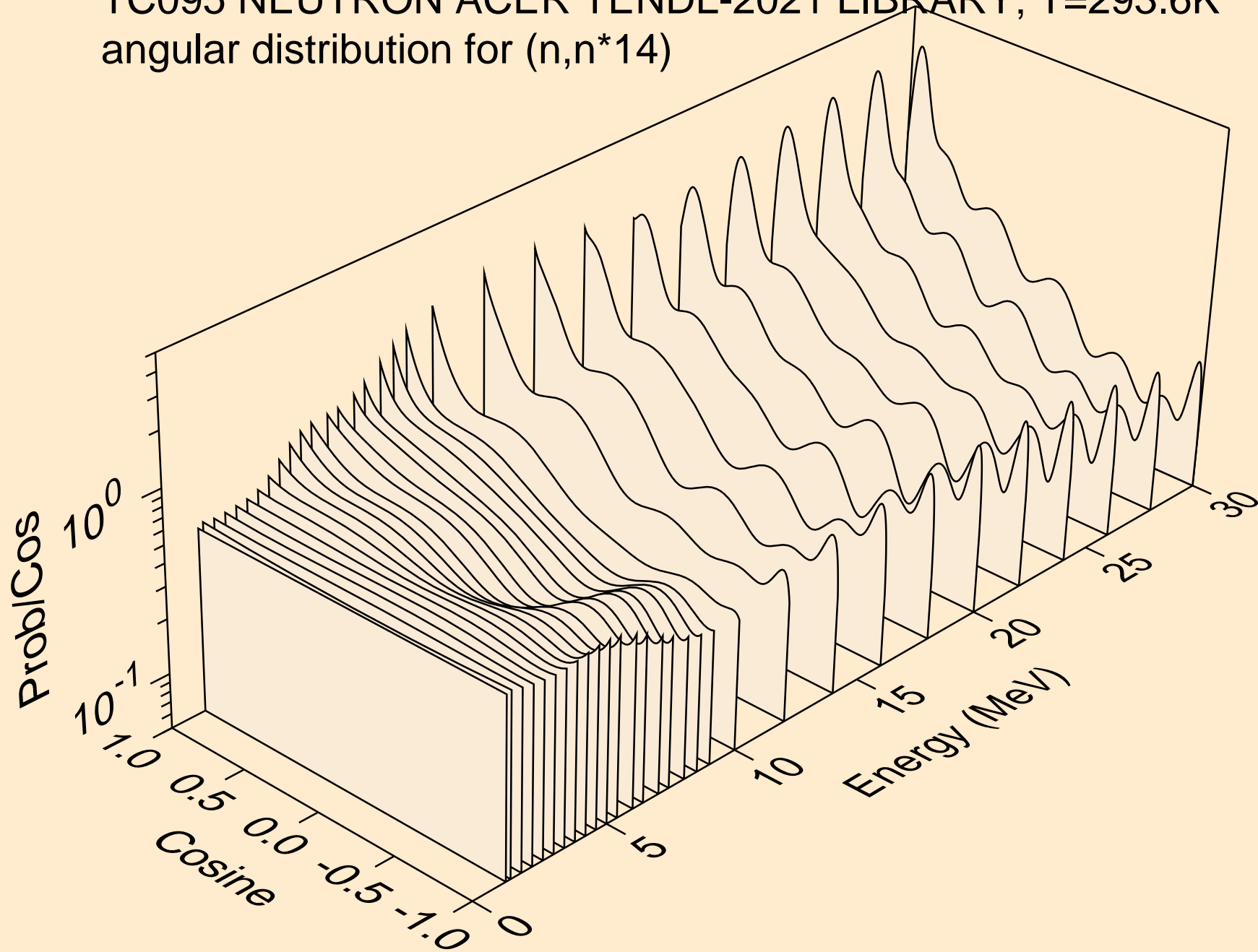

TC095 NEUTRON ACER TENDL-2021 LIBRARY; T=293.6K
angular distribution for (n,n*15)

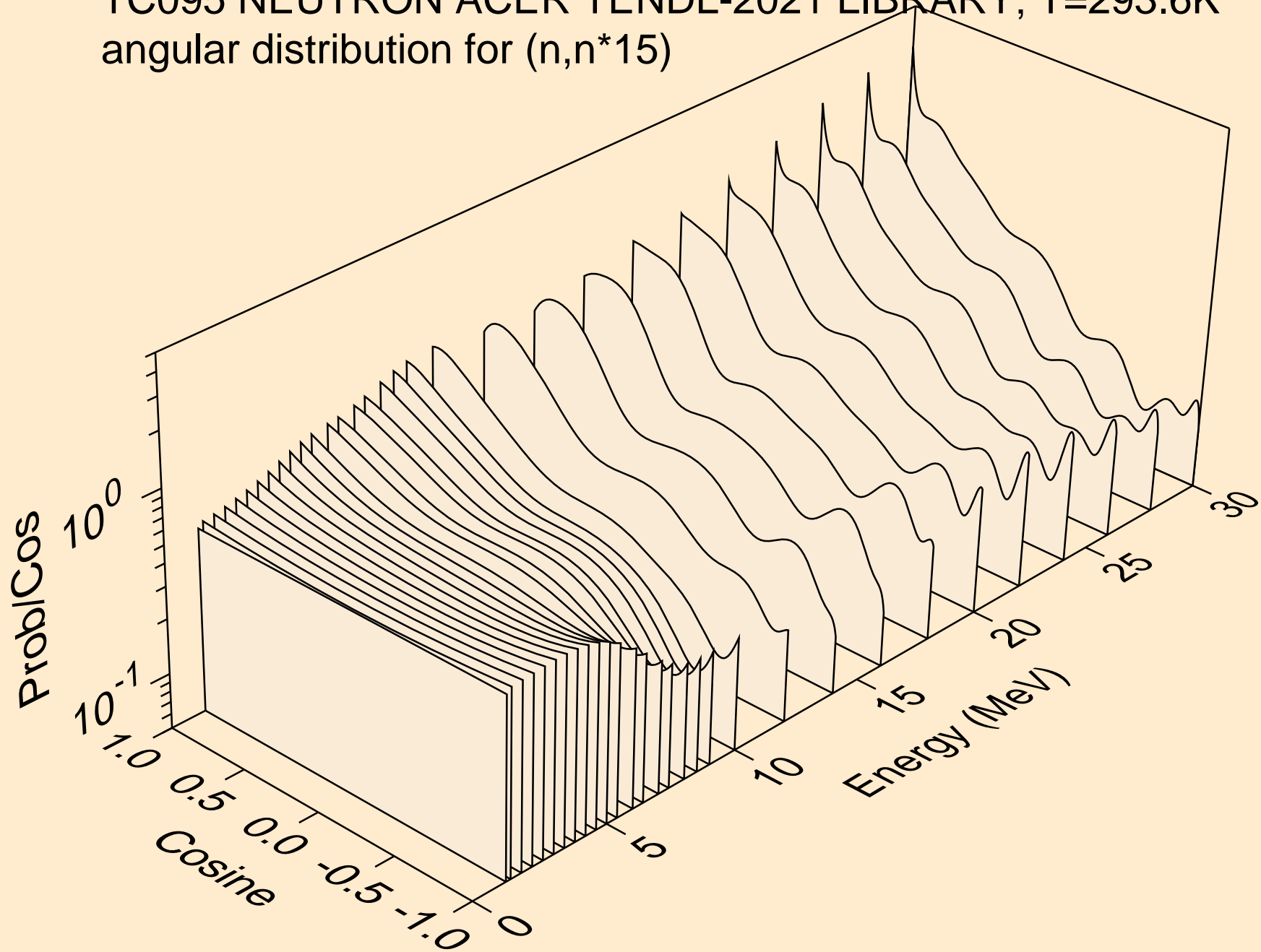

TC095 NEUTRON ACER TENDL-2021 LIBRARY; T=293.6K
angular distribution for (n,n*16)

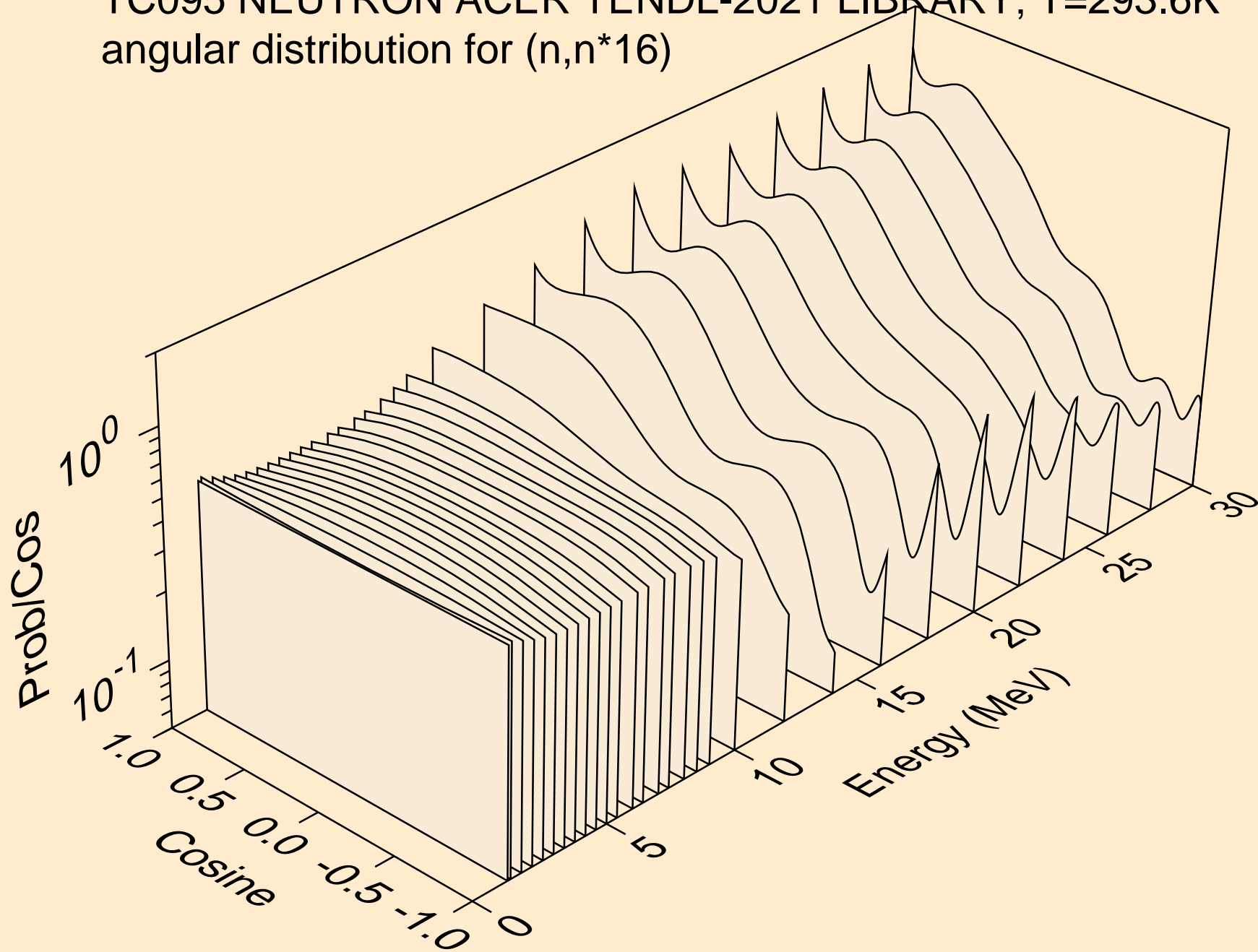

TC095 NEUTRON ACER TENDL-2021 LIBRARY; T=293.6K
angular distribution for (n,n*17)

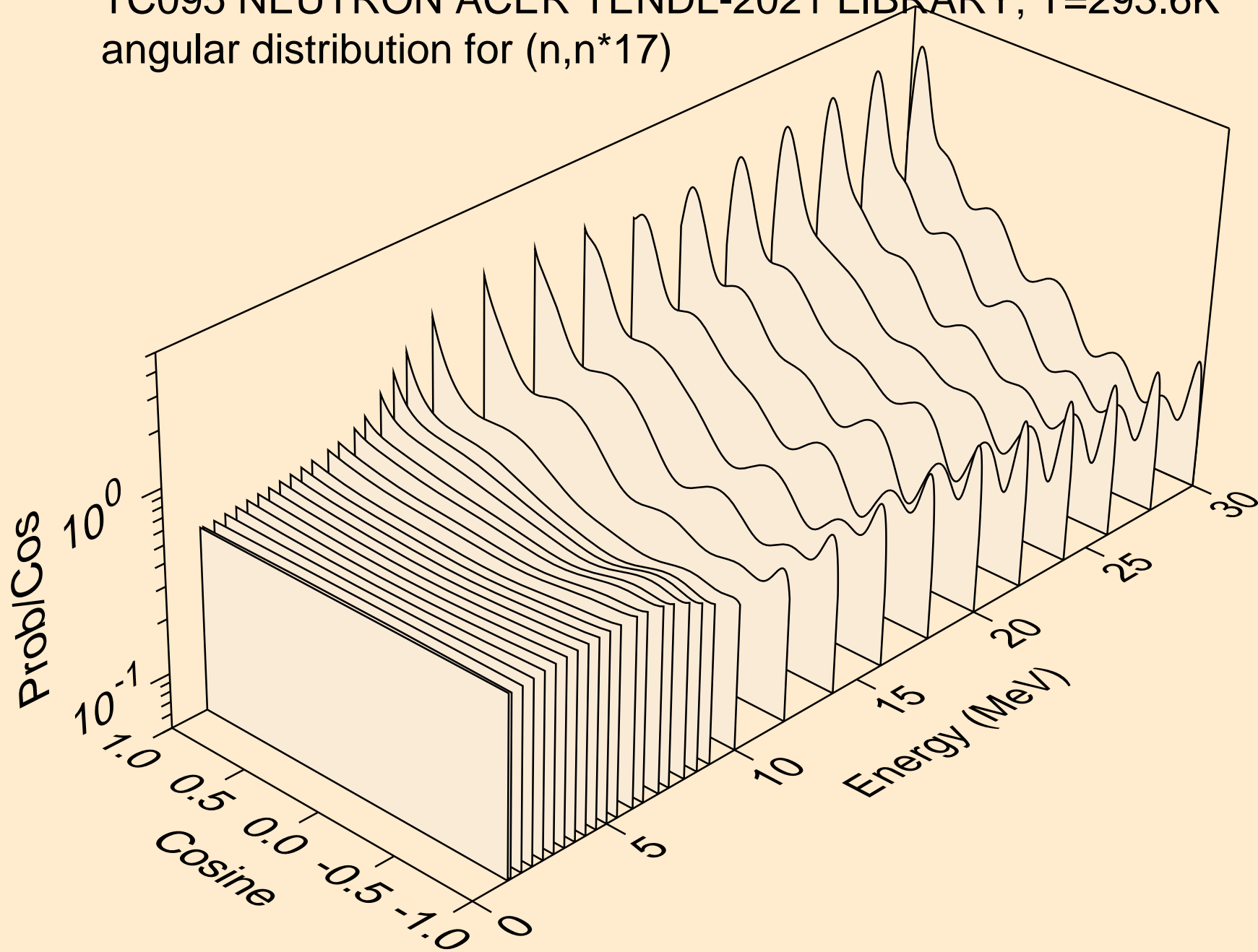

TC095 NEUTRON ACER TENDL-2021 LIBRARY; T=293.6K
angular distribution for (n,n*18)

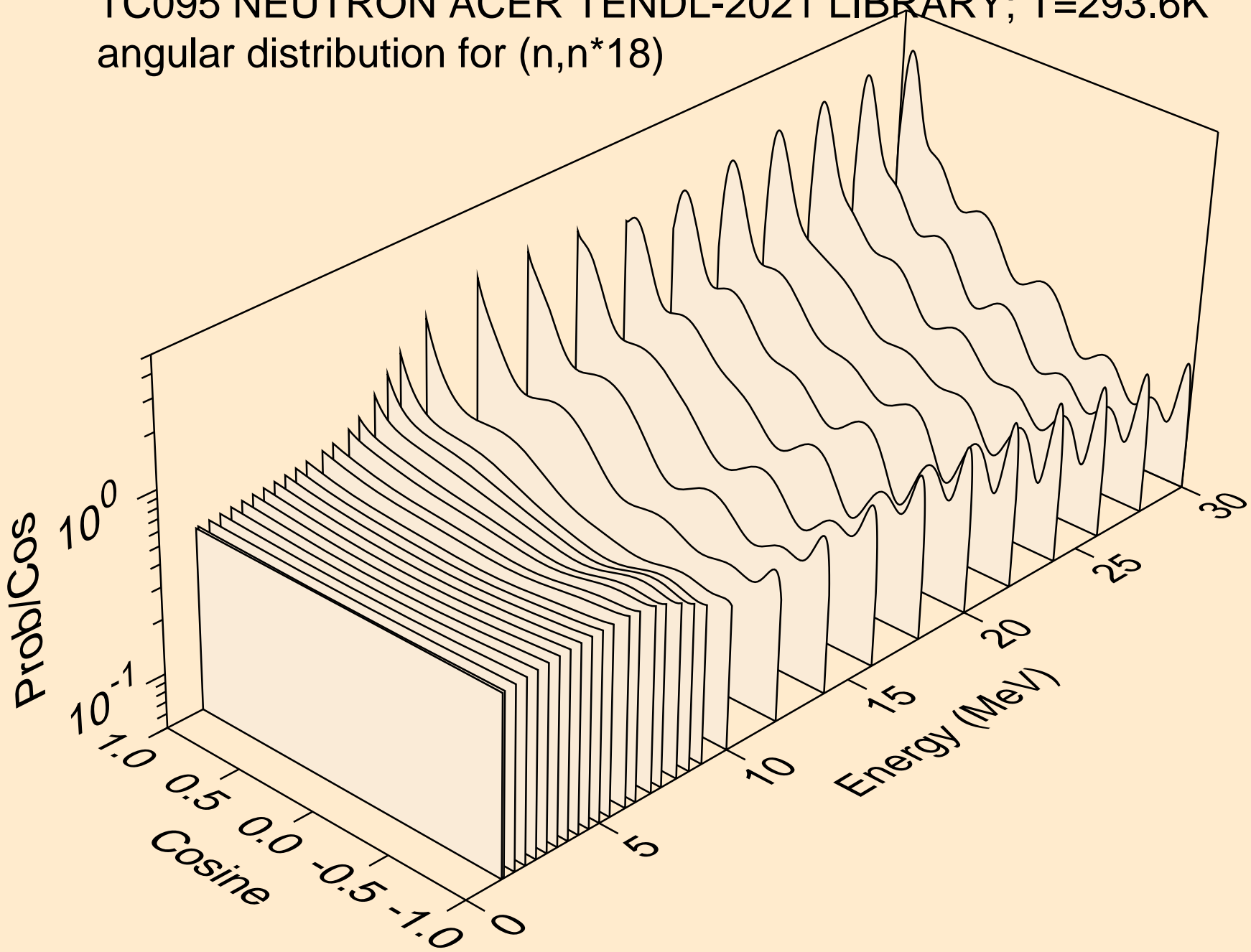

TC095 NEUTRON ACER TENDL-2021 LIBRARY; T=293.6K
angular distribution for (n,n*19)

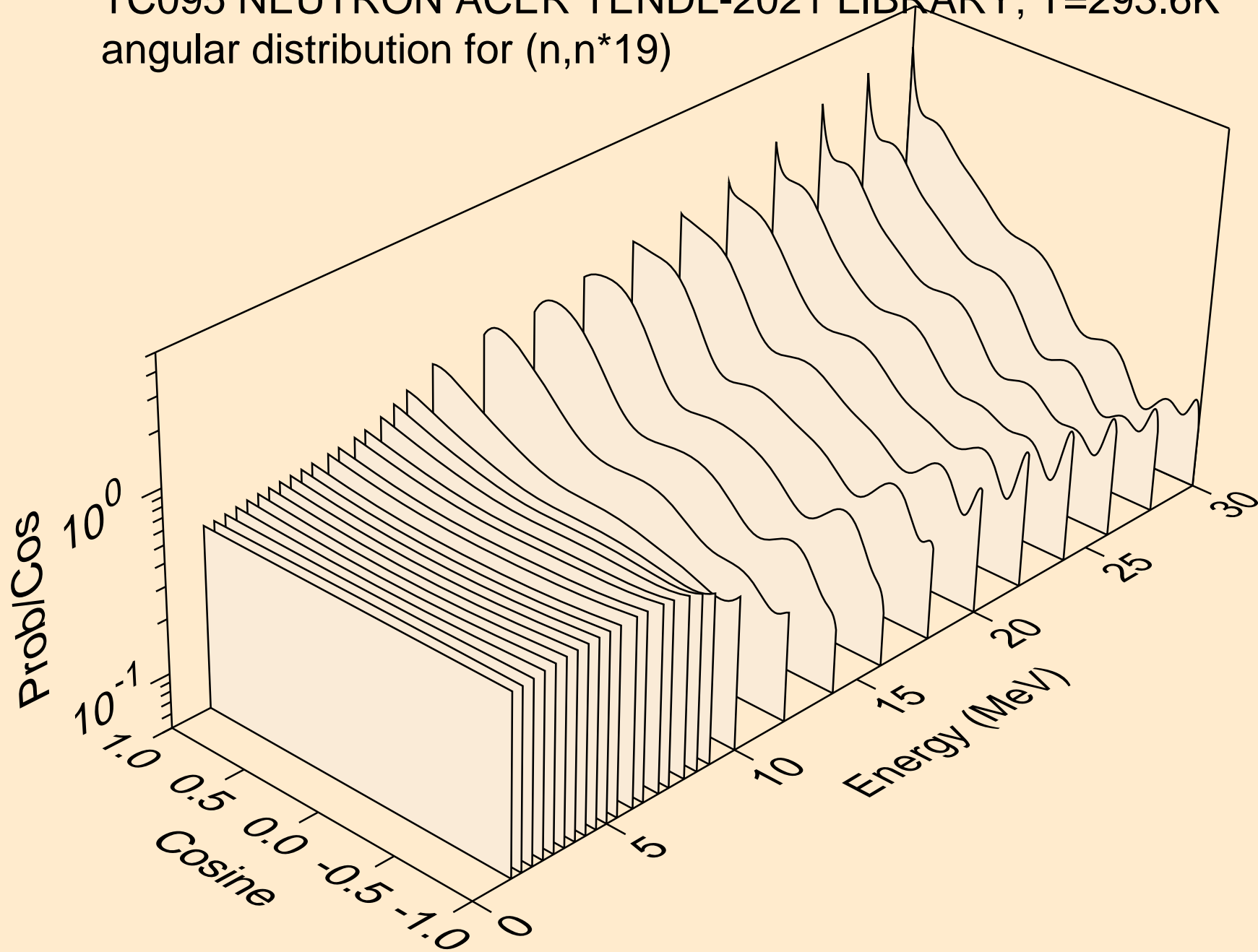

TC095 NEUTRON ACER TENDL-2021 LIBRARY; T=293.6K
angular distribution for (n,n*20)

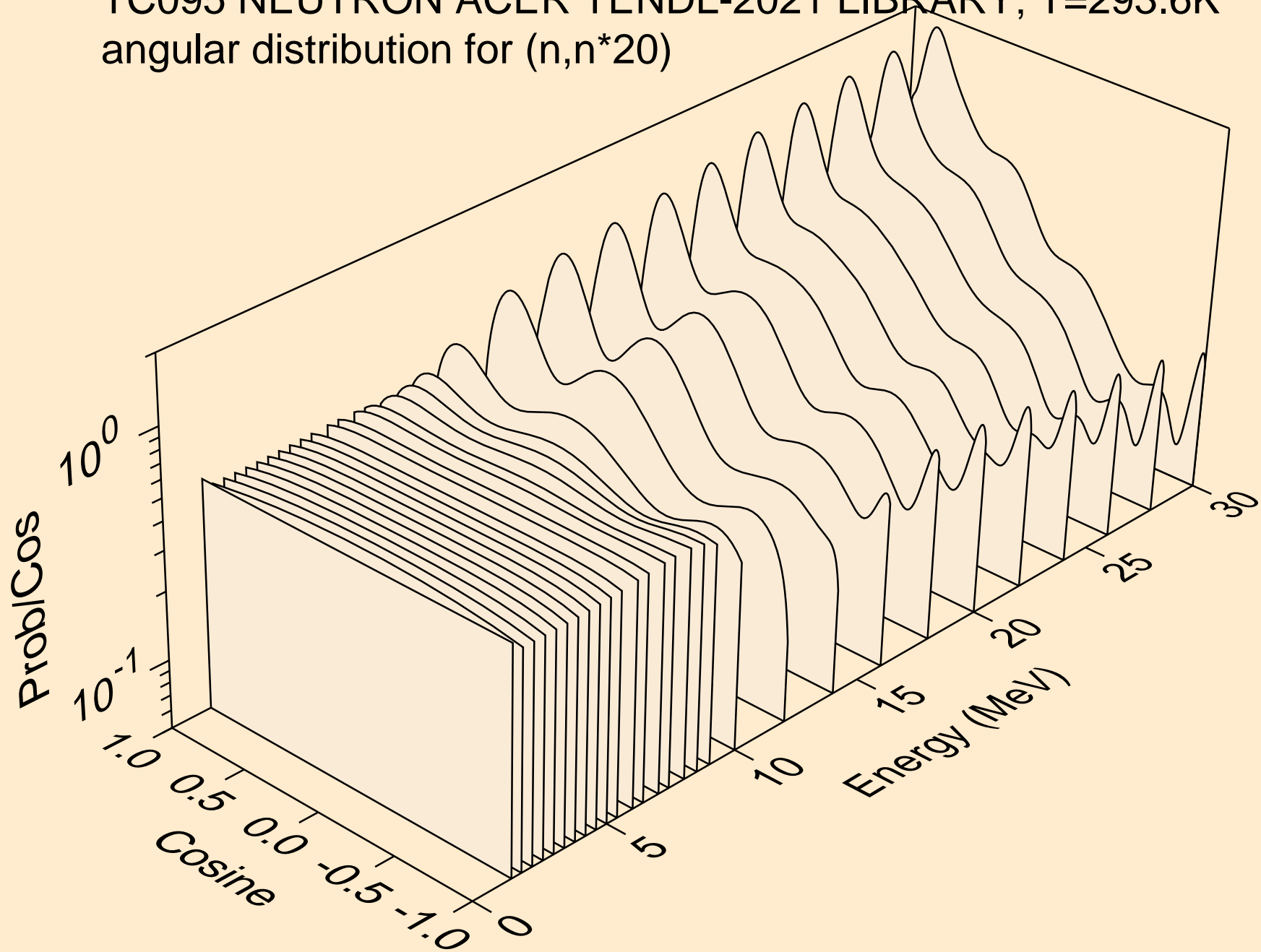

TC095 NEUTRON ACER TENDL-2021 LIBRARY; T=293.6K
angular distribution for (n,n*21)

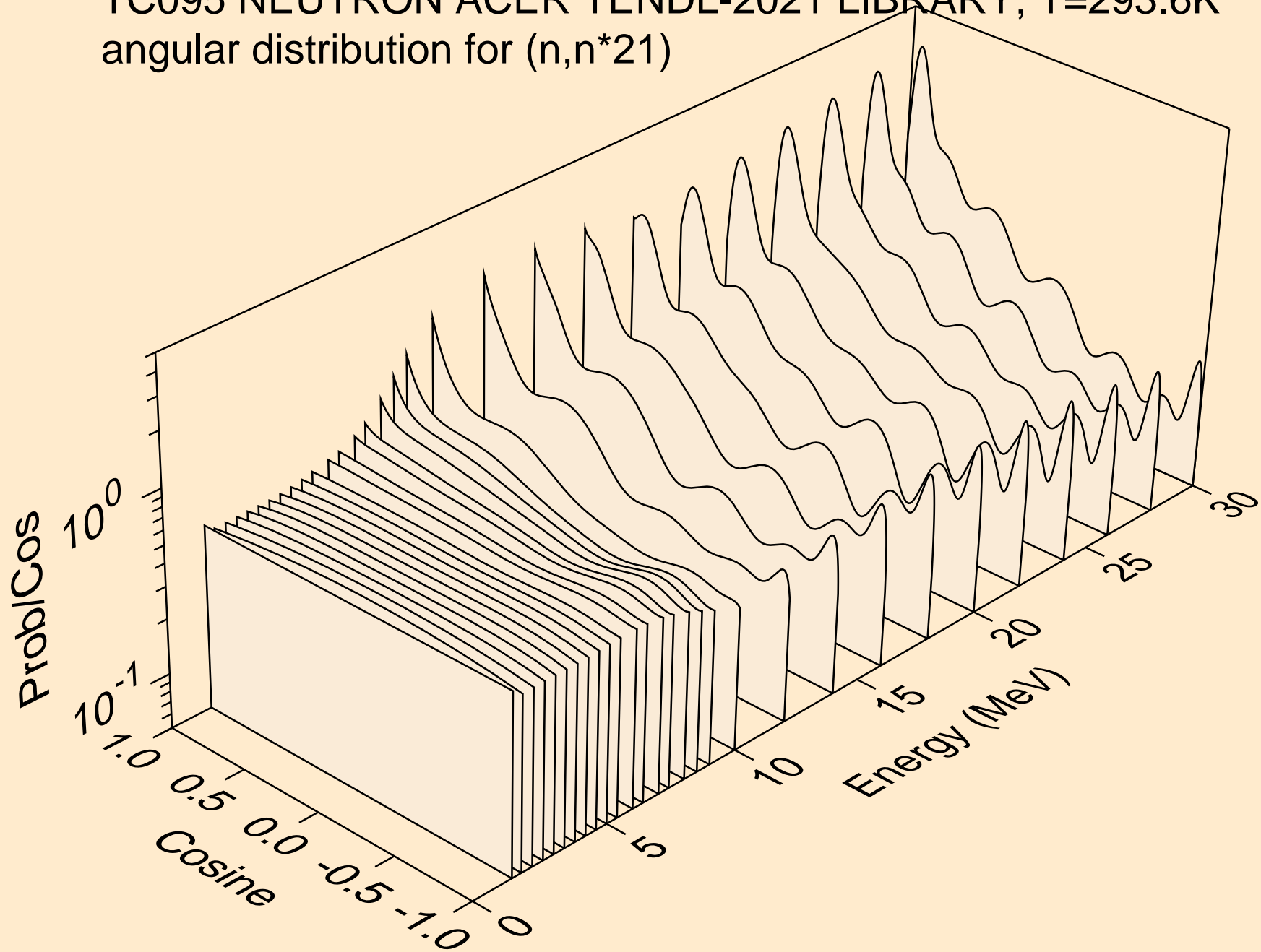

TC095 NEUTRON ACER TENDL-2021 LIBRARY; T=293.6K
angular distribution for (n,n*22)

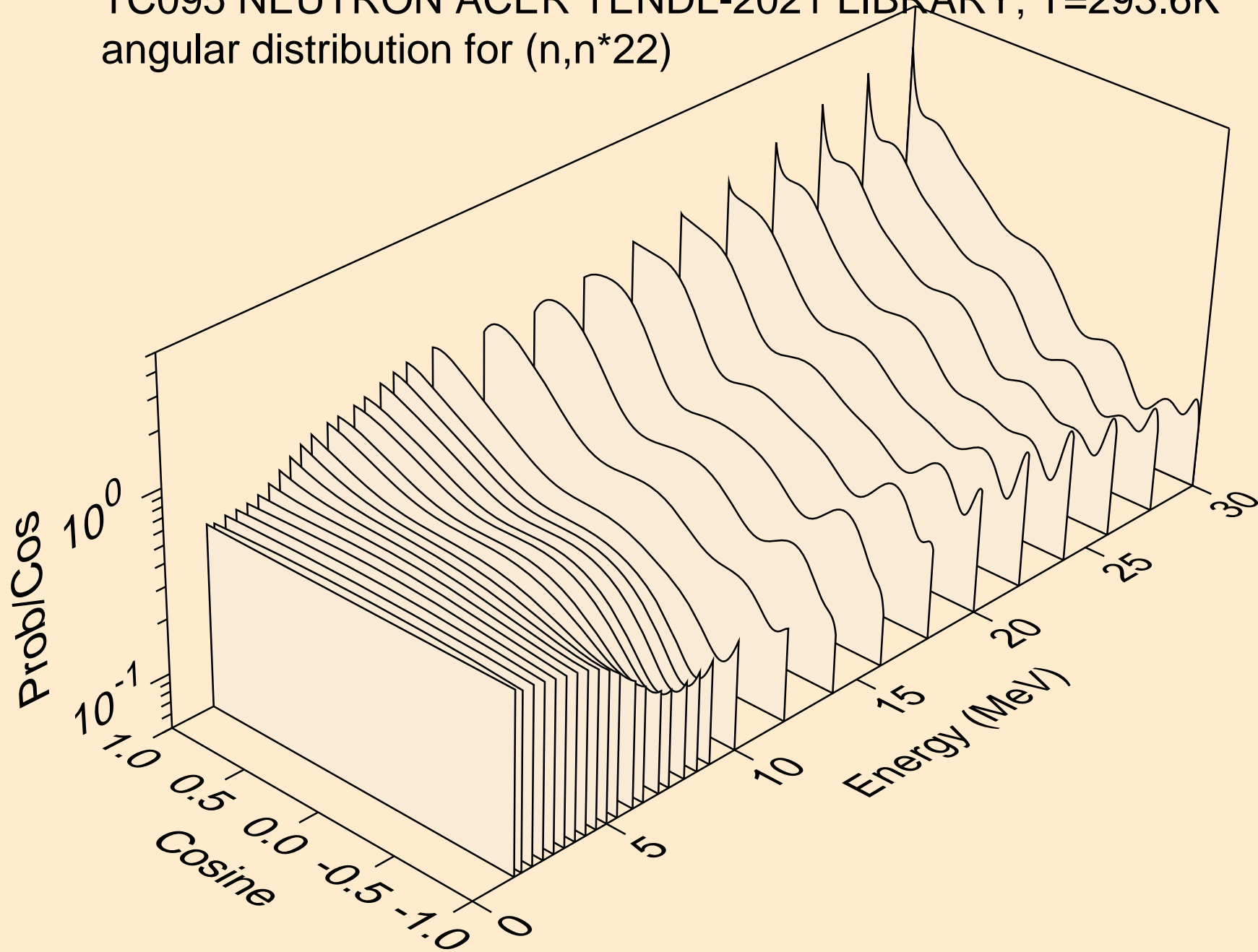

TC095 NEUTRON ACER TENDL-2021 LIBRARY; T=293.6K
angular distribution for (n,n*23)

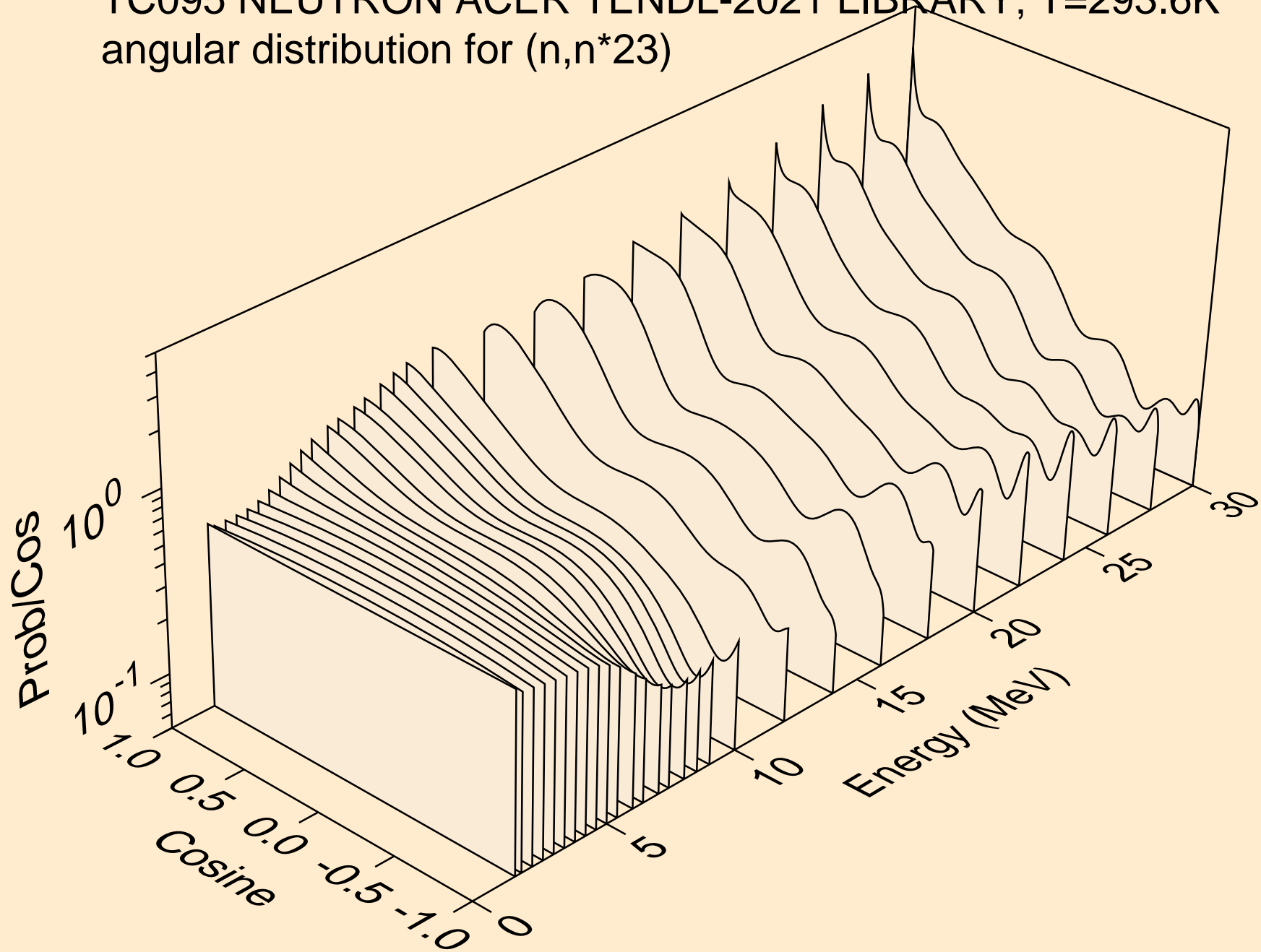

TC095 NEUTRON ACER TENDL-2021 LIBRARY; T=293.6K
angular distribution for (n,n*24)

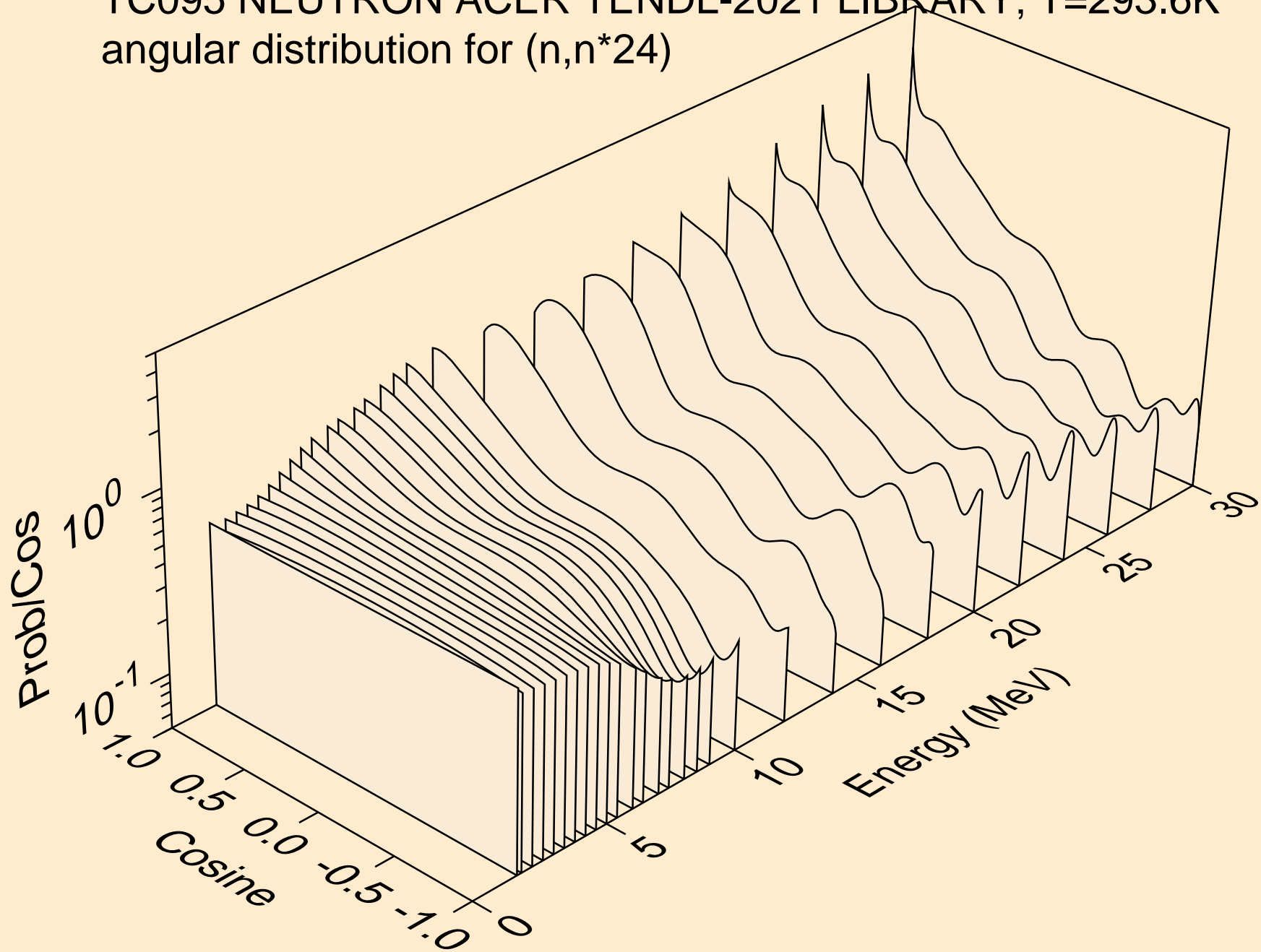

TC095 NEUTRON ACER TENDL-2021 LIBRARY; T=293.6K
angular distribution for (n,n*25)

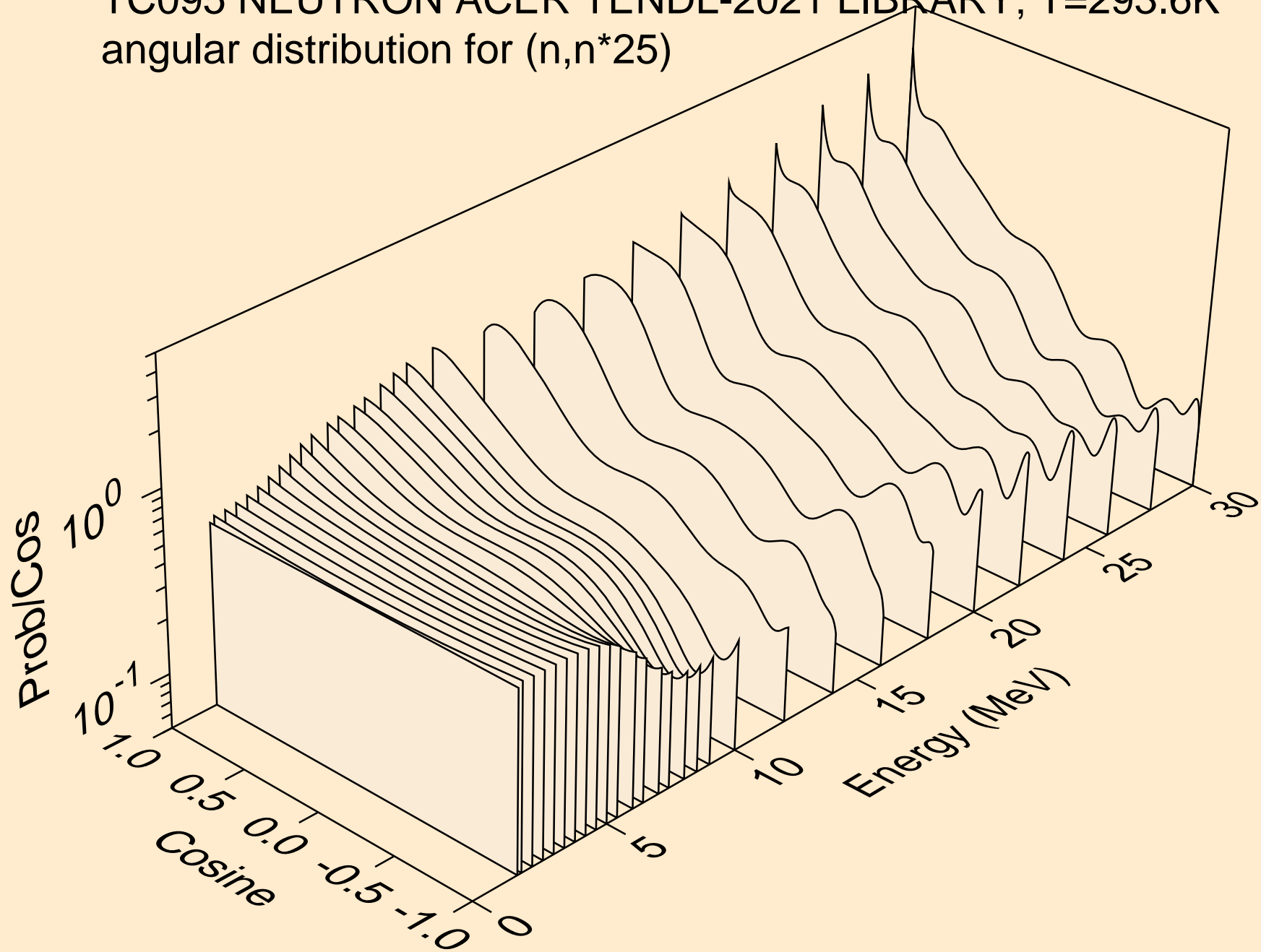

TC095 NEUTRON ACER TENDL-2021 LIBRARY; T=293.6K
angular distribution for (n,n*26)

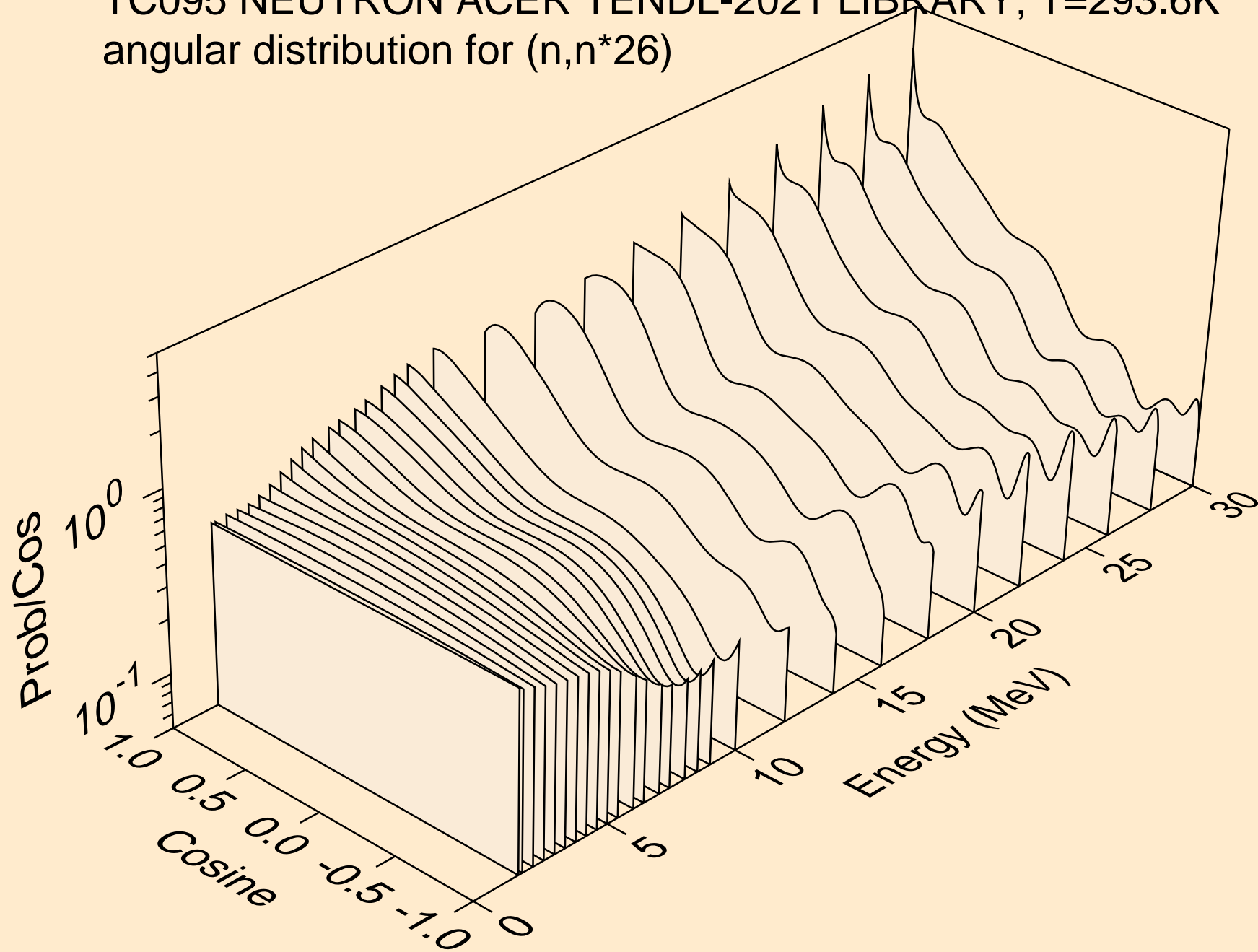

TC095 NEUTRON ACER TENDL-2021 LIBRARY; T=293.6K
angular distribution for (n,n*27)

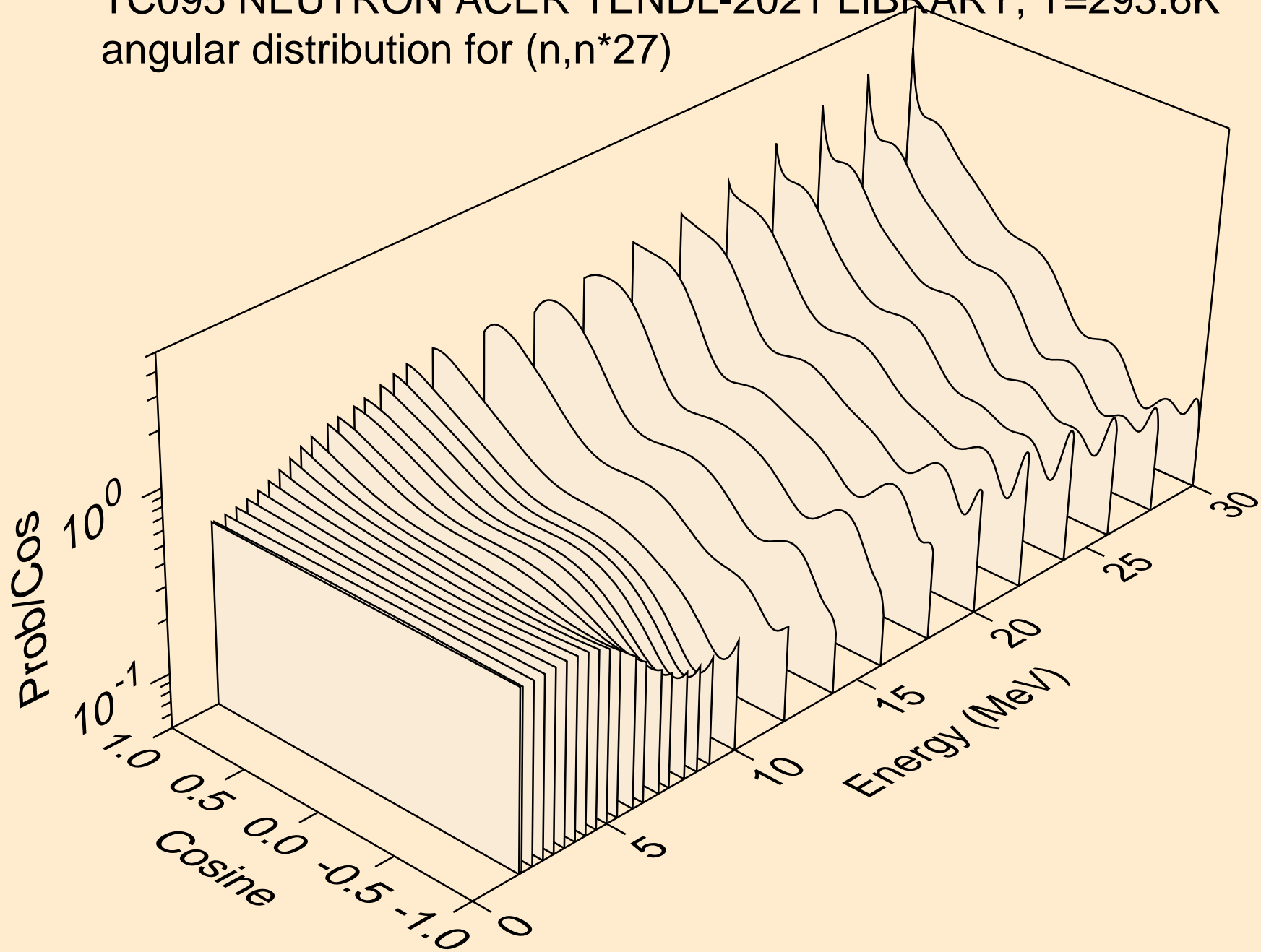

TC095 NEUTRON ACER TENDL-2021 LIBRARY; T=293.6K
angular distribution for (n,n*28)

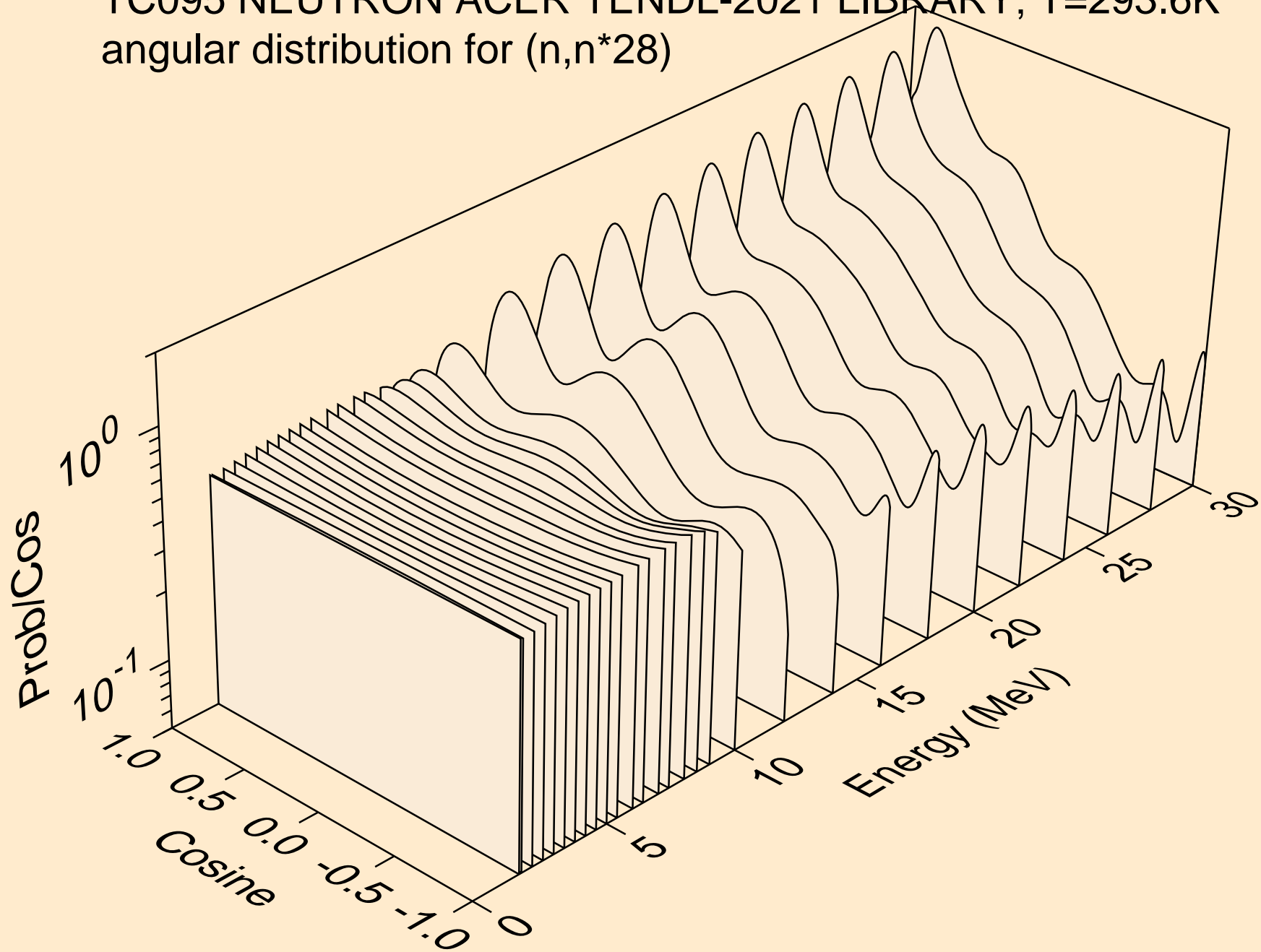

TC095 NEUTRON ACER TENDL-2021 LIBRARY; T=293.6K
angular distribution for (n,n*29)

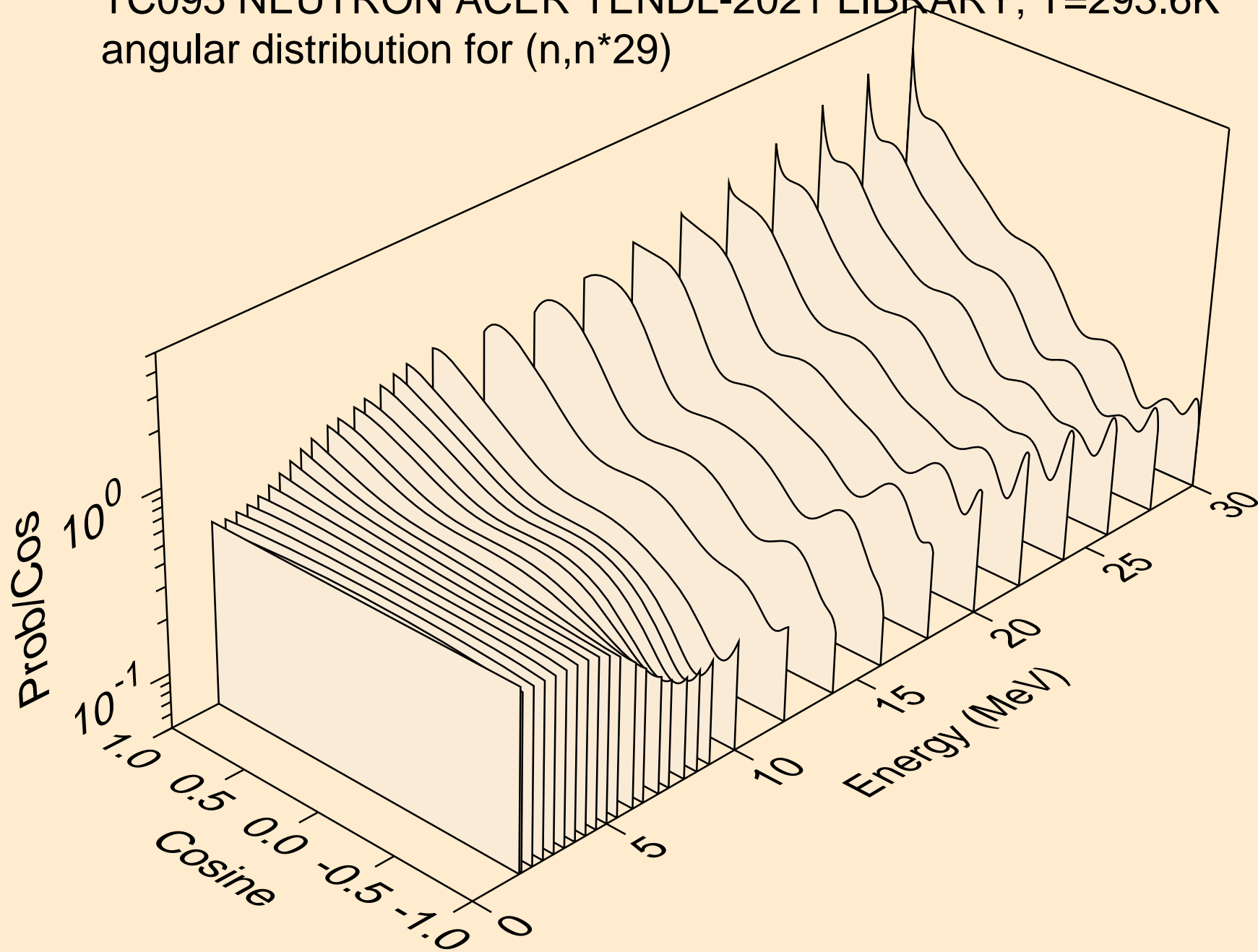

TC095 NEUTRON ACER TENDL-2021 LIBRARY; T=293.6K
Neutron emission for (n,x)

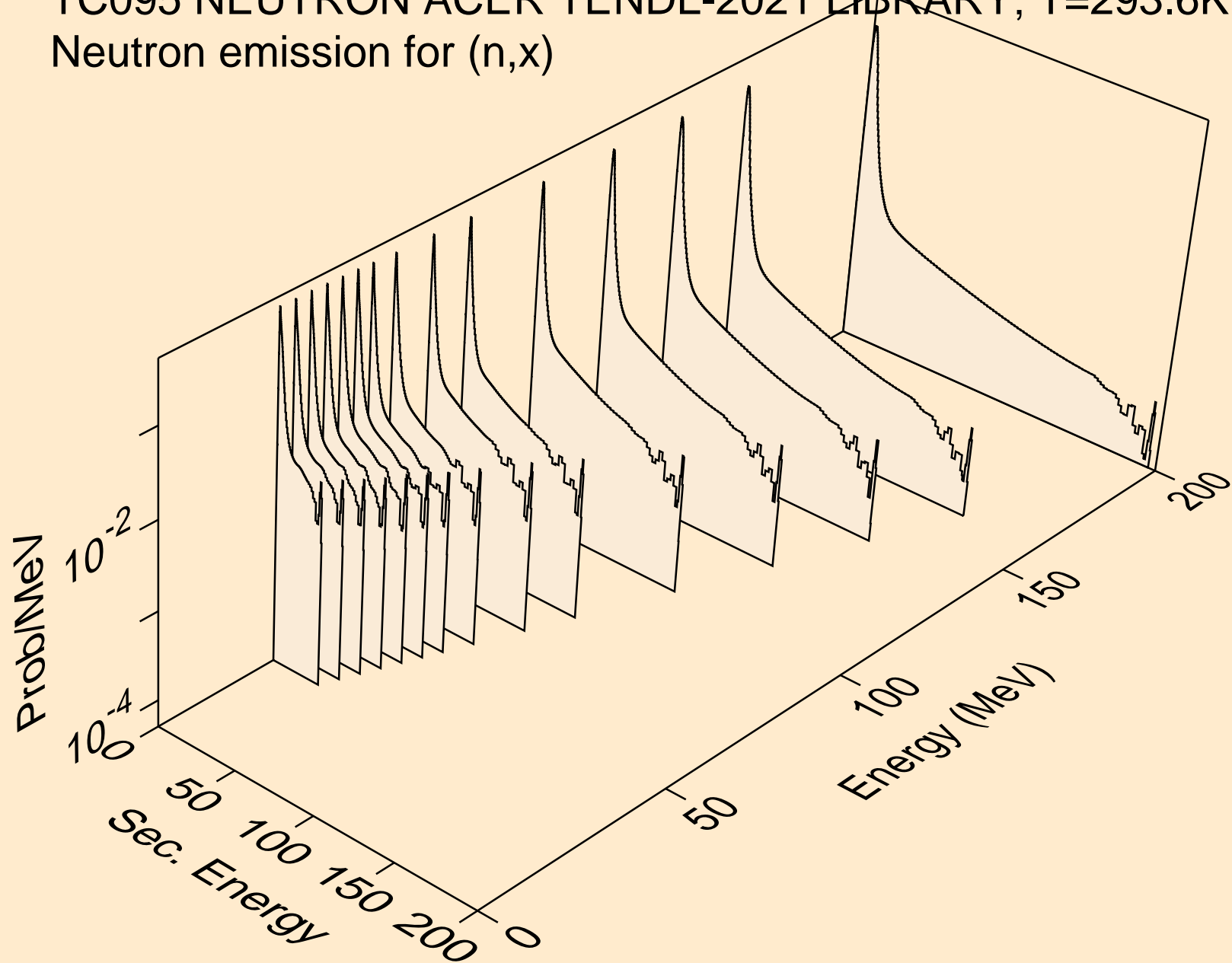

TC095 NEUTRON ACER TENDL-2021 LIBRARY; T=293.6K
Neutron emission for (n,2nd)

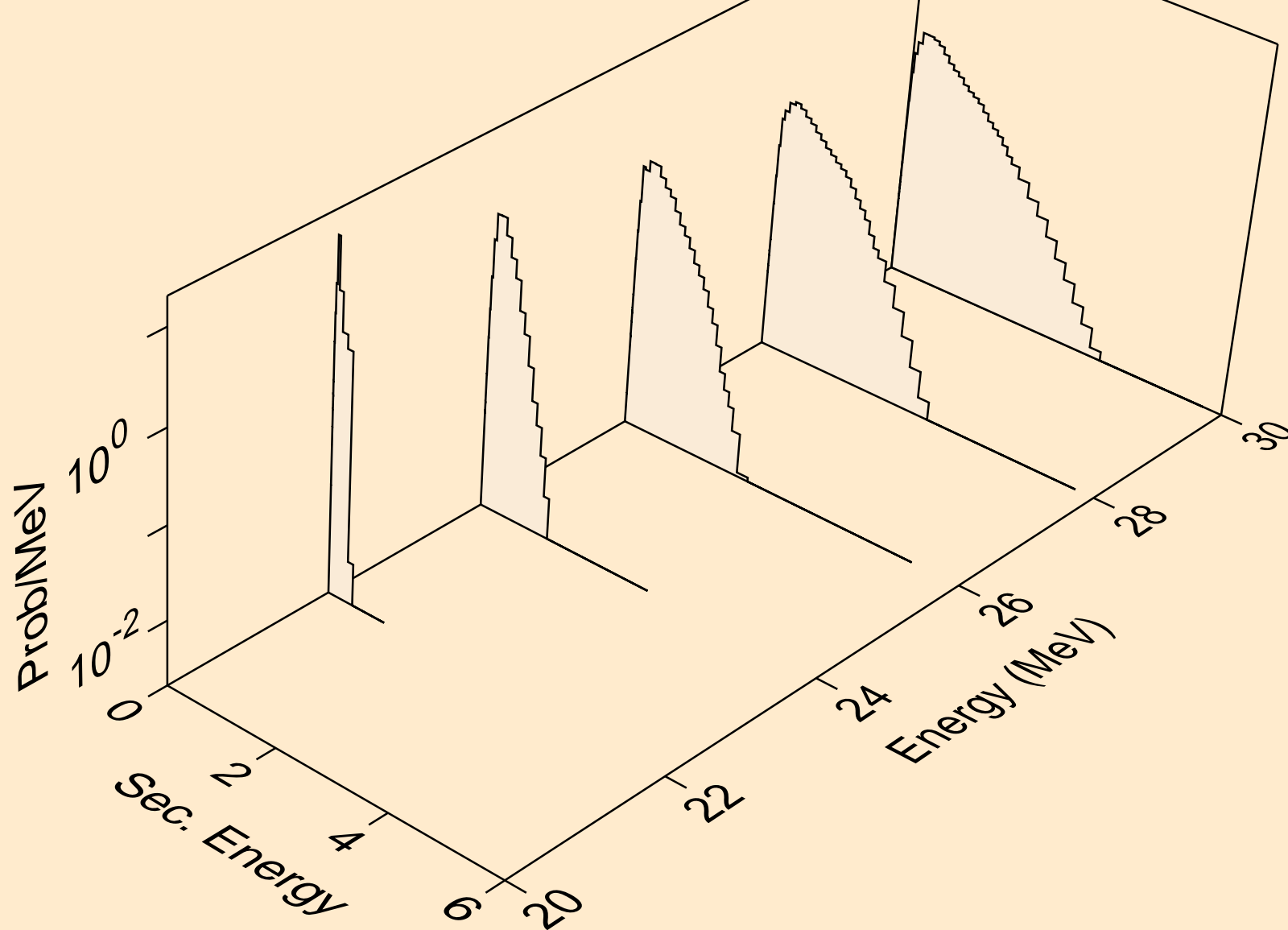

TC095 NEUTRON ACER TENDL-2021 LIBRARY; T=293.6K
Neutron emission for (n,2n)

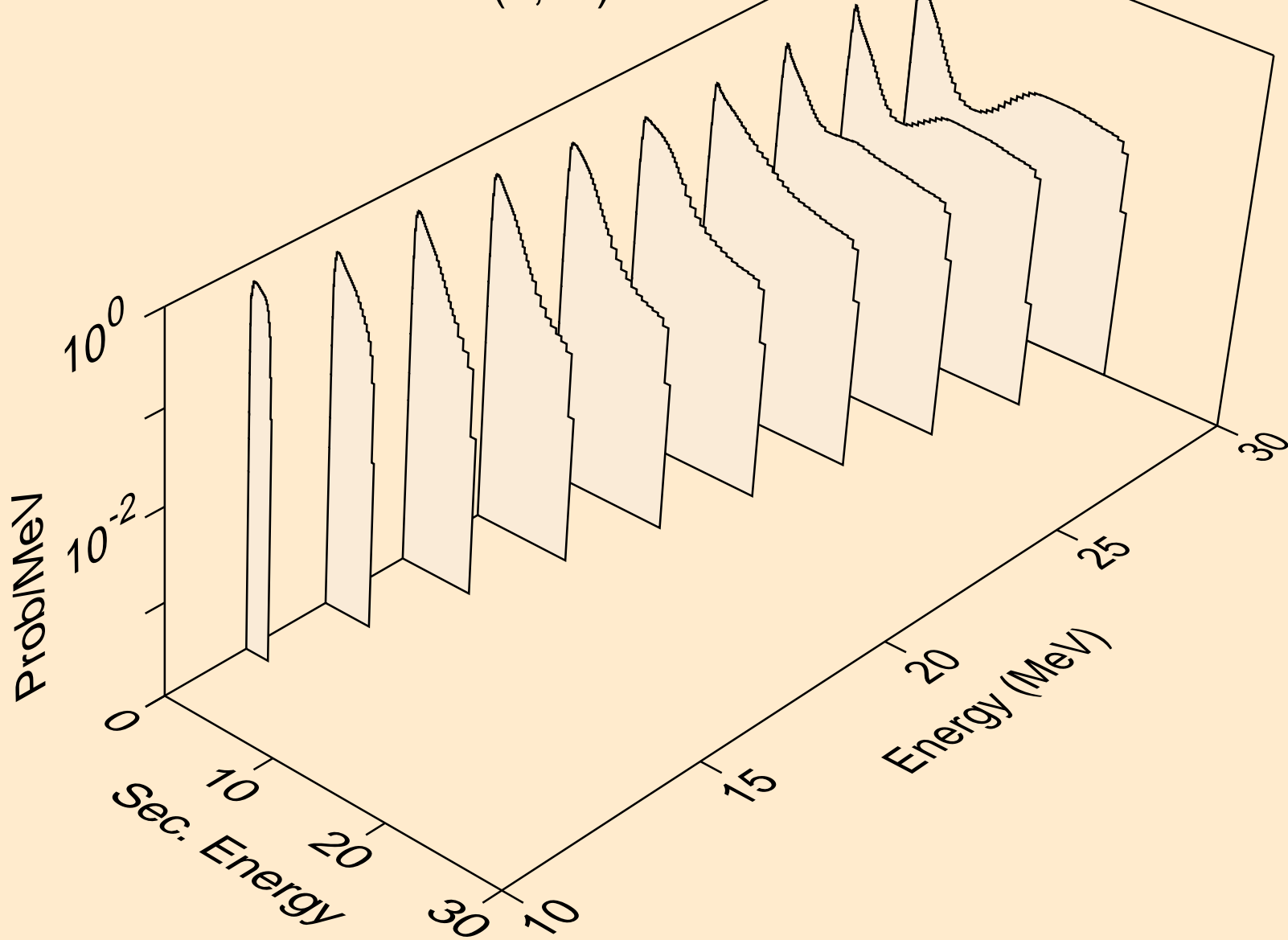

TC095 NEUTRON ACER TENDL-2021 LIBRARY; T=293.6K
Neutron emission for (n,3n)

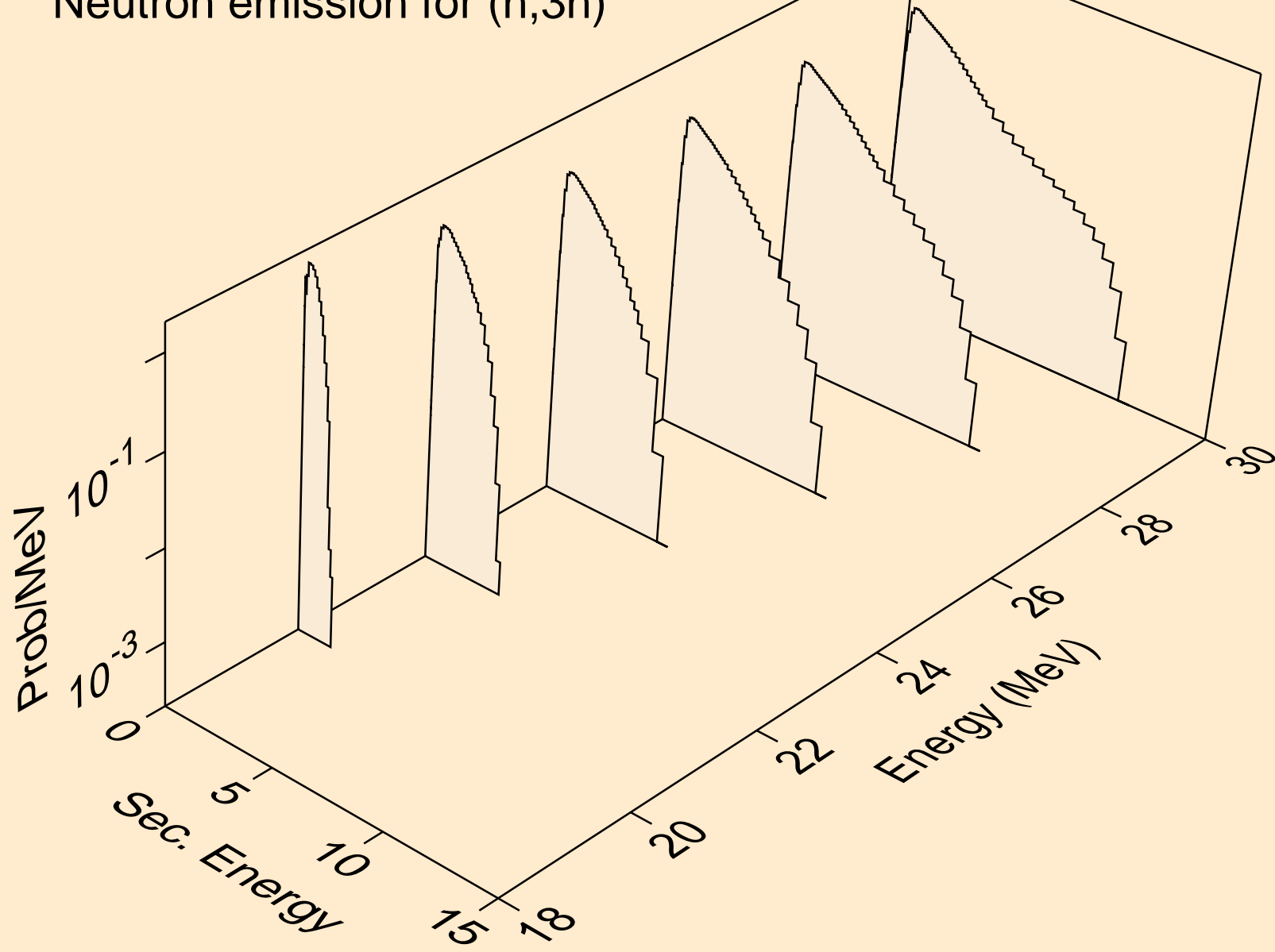

TC095 NEUTRON ACER TENDL-2021 LIBRARY; T=293.6K
Neutron emission for (n,n*)a

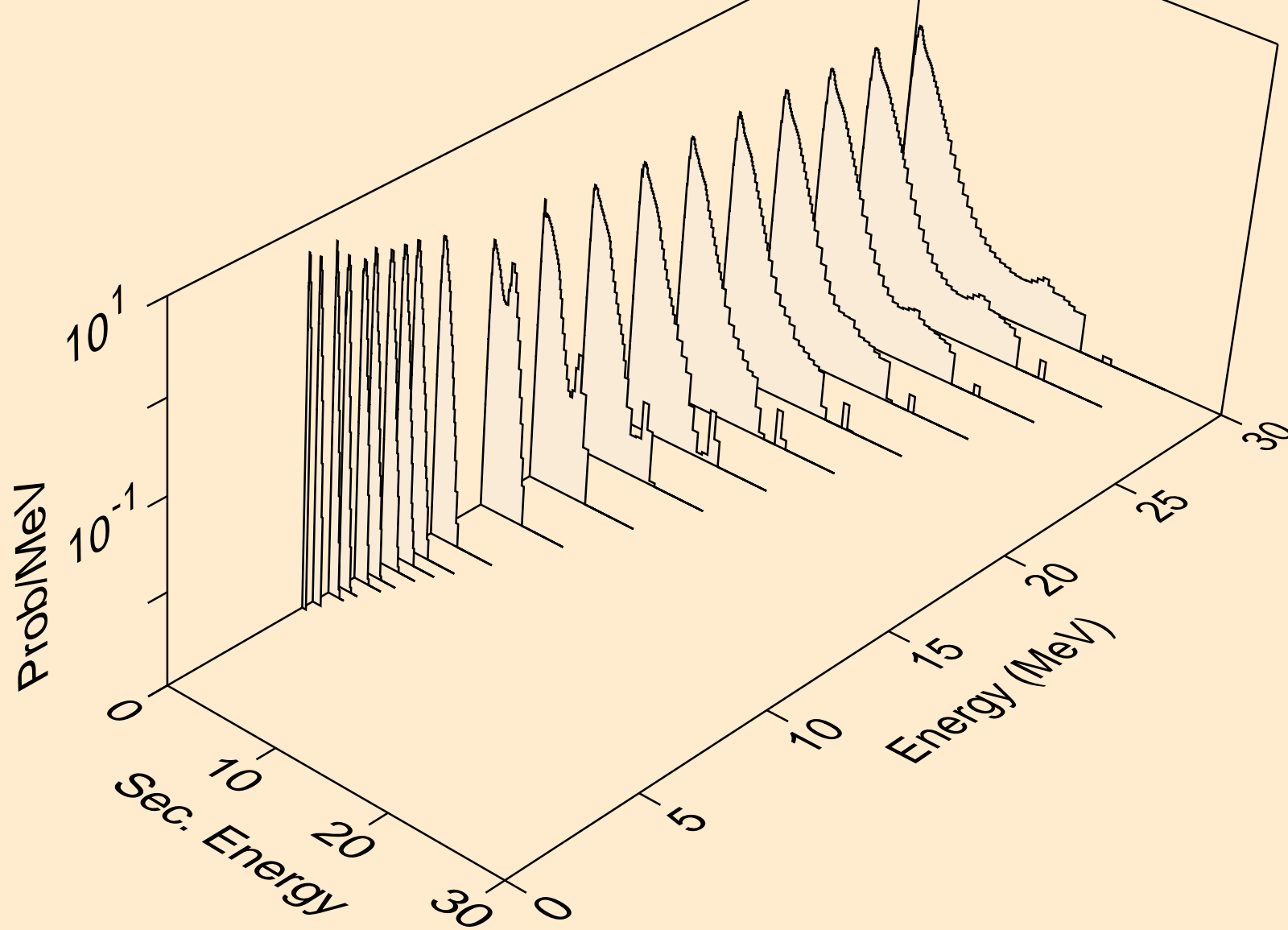

TC095 NEUTRON ACER TENDL-2021 LIBRARY; T=293.6K
Neutron emission for (n,2n)_a

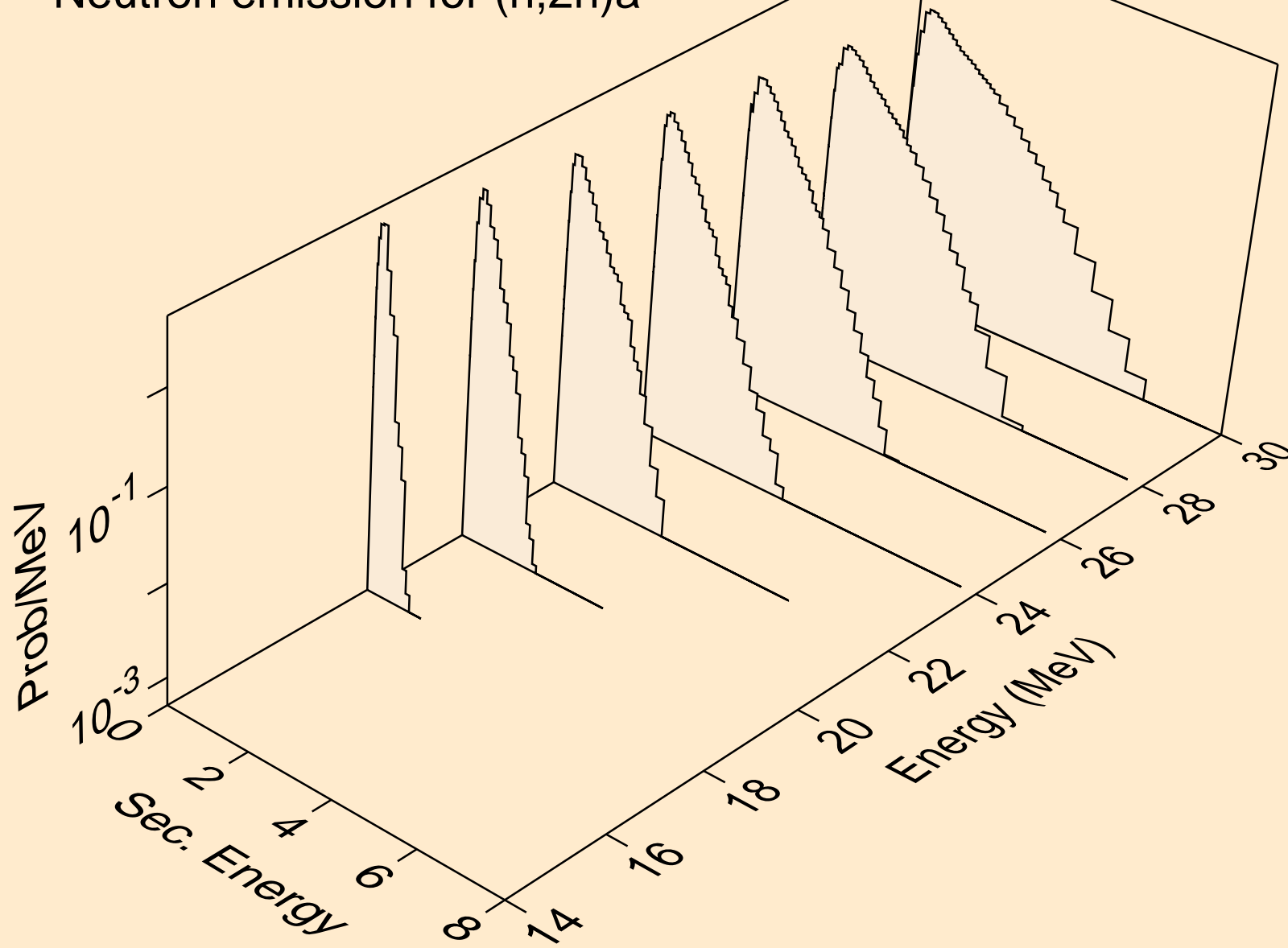

TC095 NEUTRON ACER TENDL-2021 LIBRARY; T=293.6K
Neutron emission for (n,n*)p

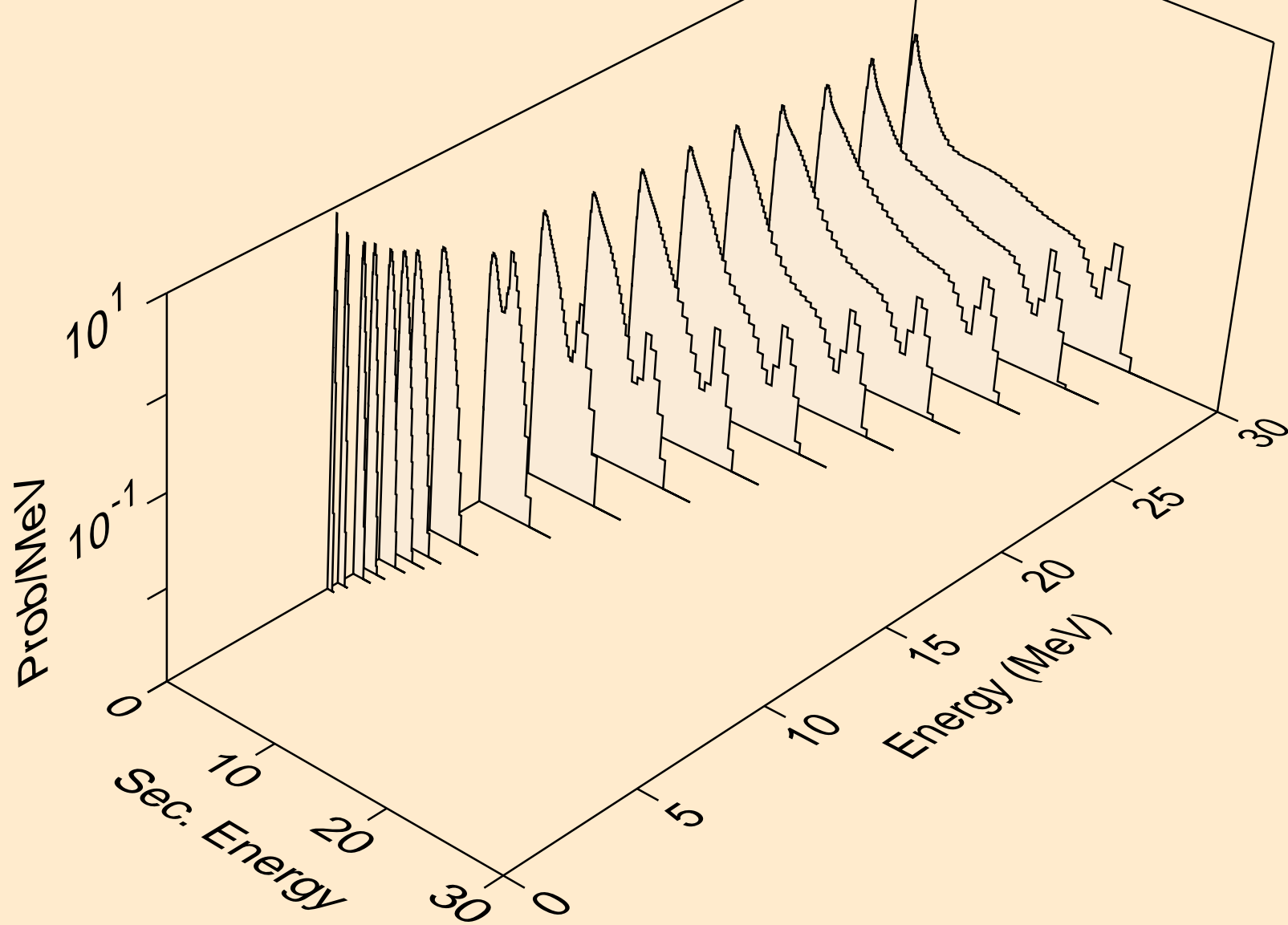

TC095 NEUTRON ACER TENDL-2021 LIBRARY; T=293.6K
Neutron emission for (n,n*)2a

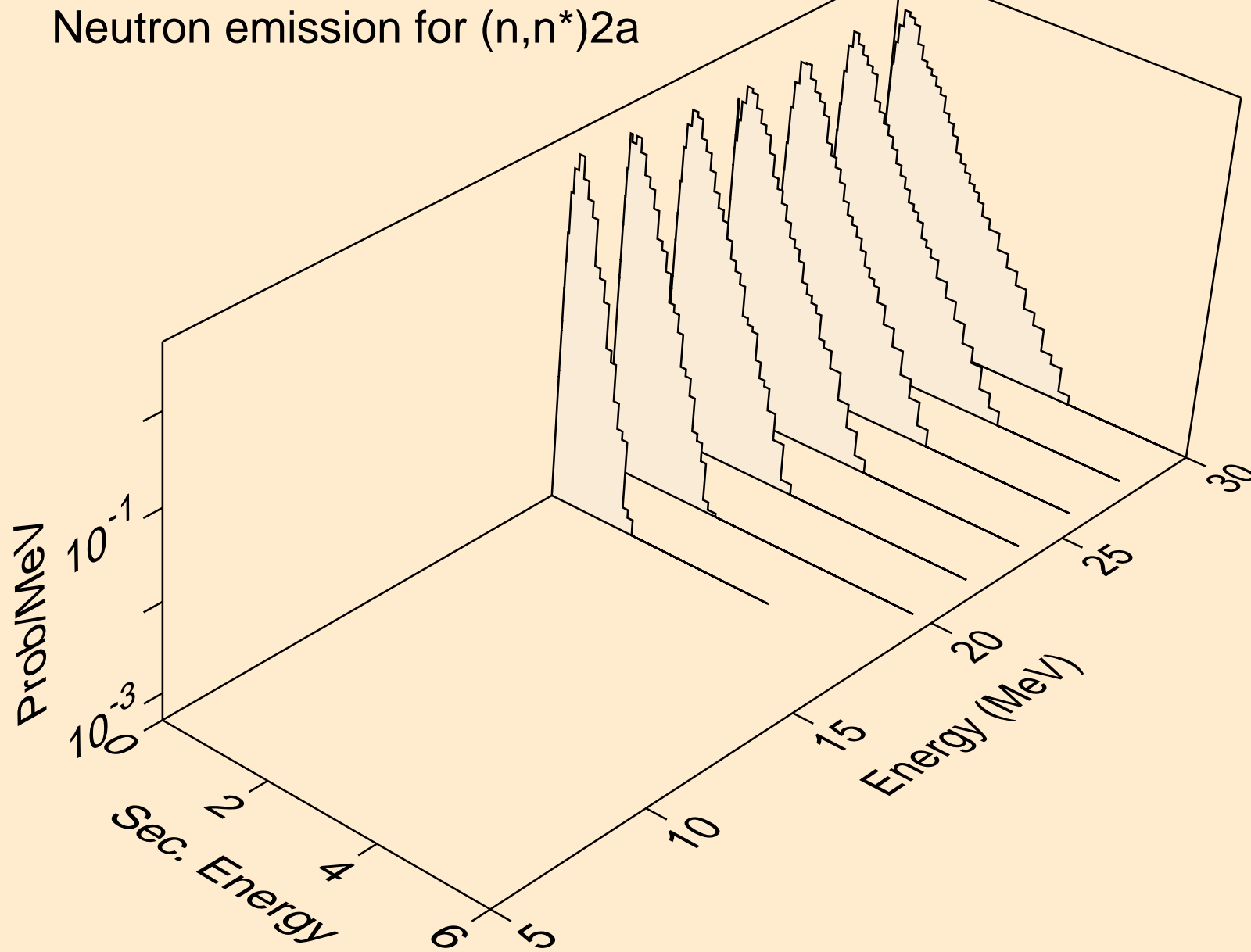

TC095 NEUTRON ACER TENDL-2021 LIBRARY; T=293.6K
Neutron emission for (n,n*)d

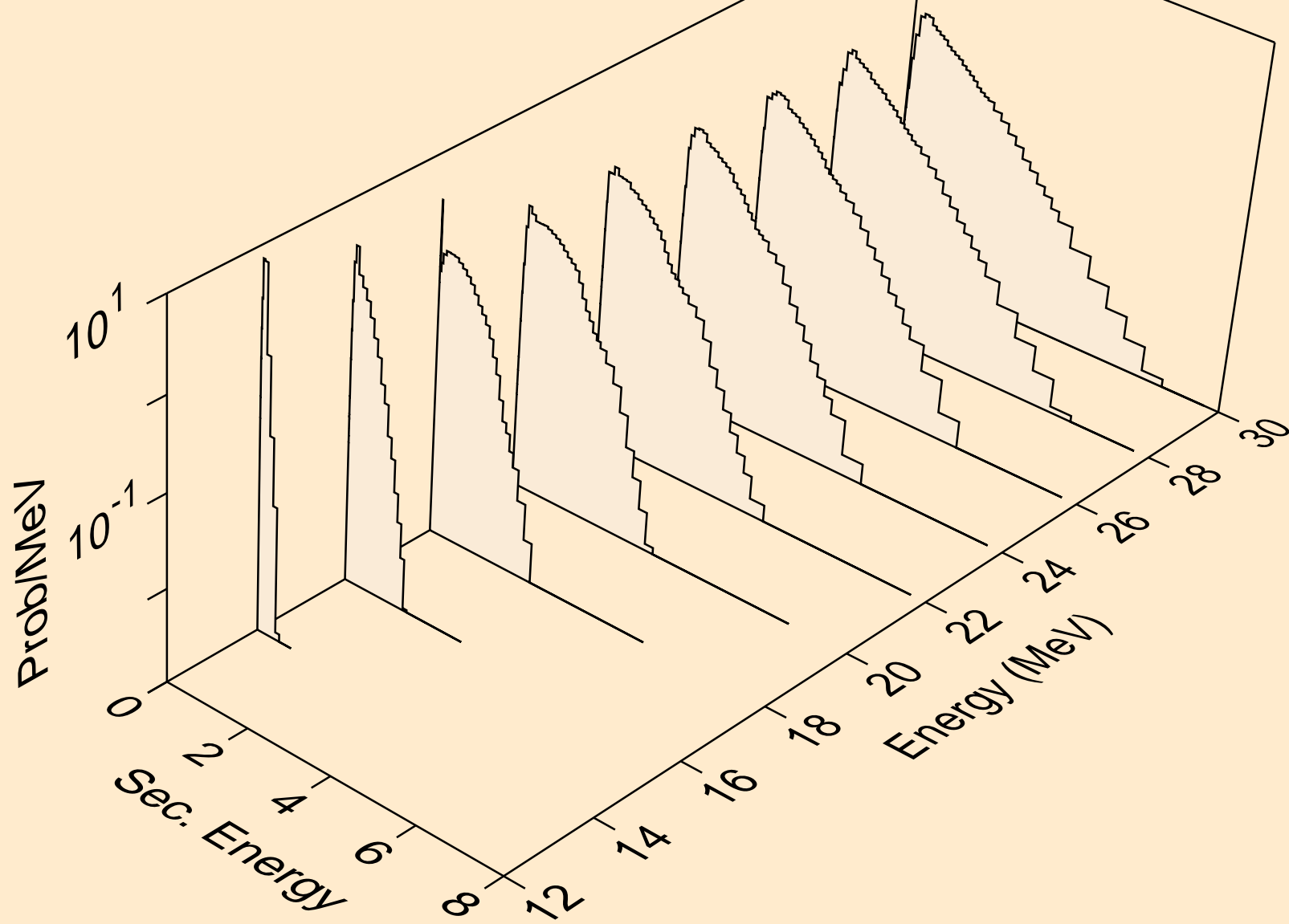

TC095 NEUTRON ACER TENDL-2021 LIBRARY; T=293.6K
Neutron emission for (n,n*)t

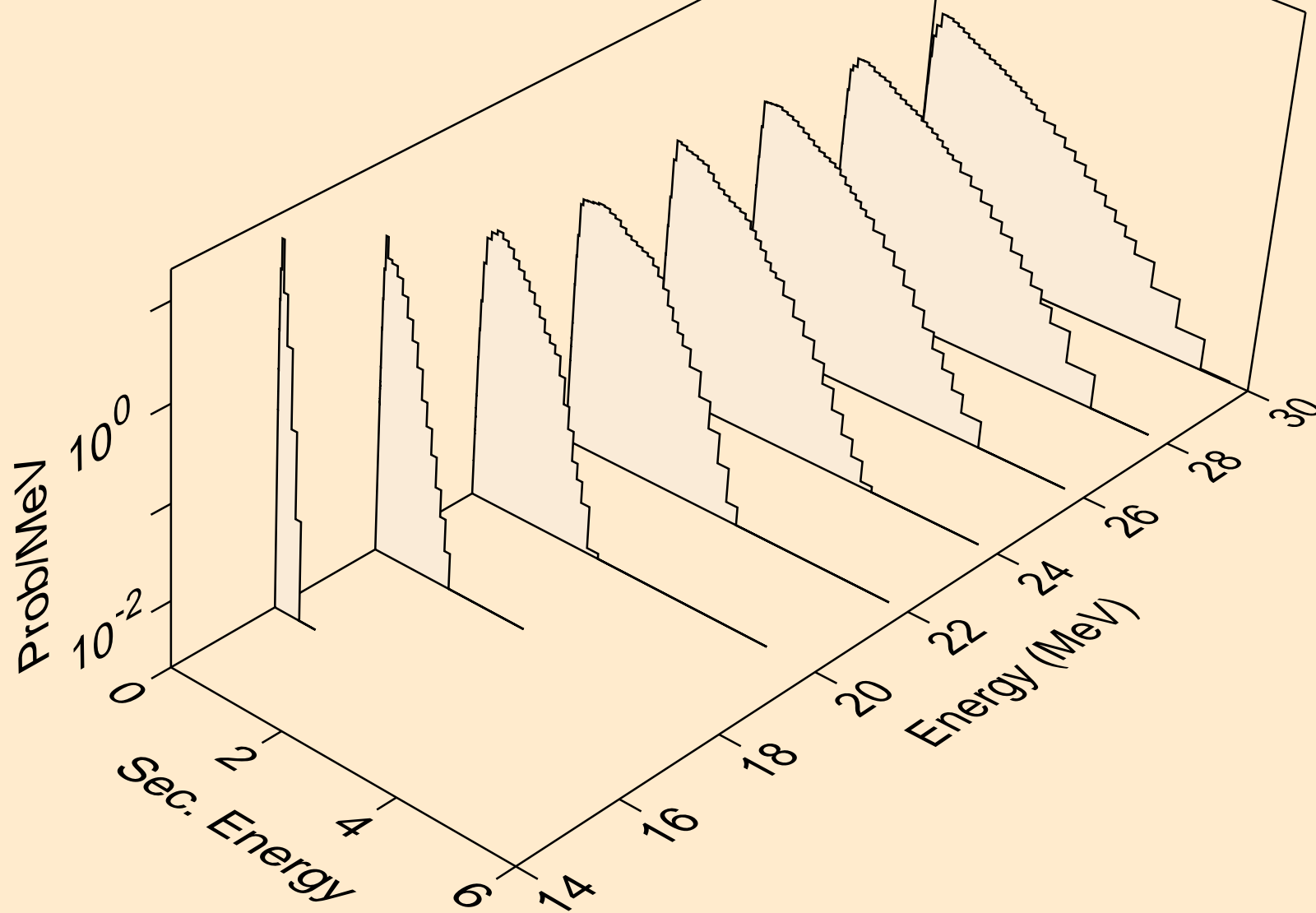

TC095 NEUTRON ACER TENDL-2021 LIBRARY; T=293.6K
Neutron emission for (n,n*)he3

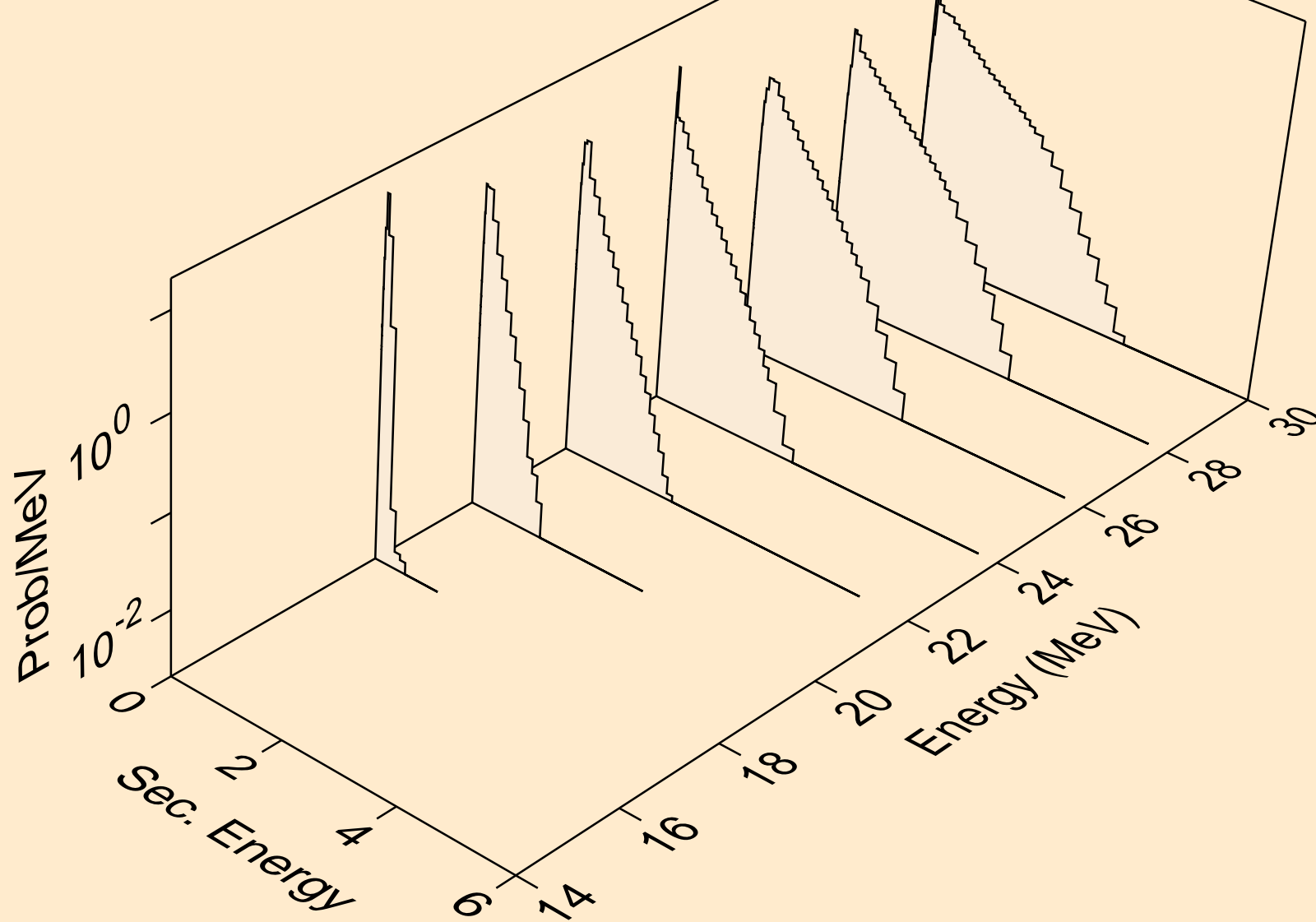

TC095 NEUTRON ACER TENDL-2021 LIBRARY; T=293.6K
Neutron emission for (n,2np)

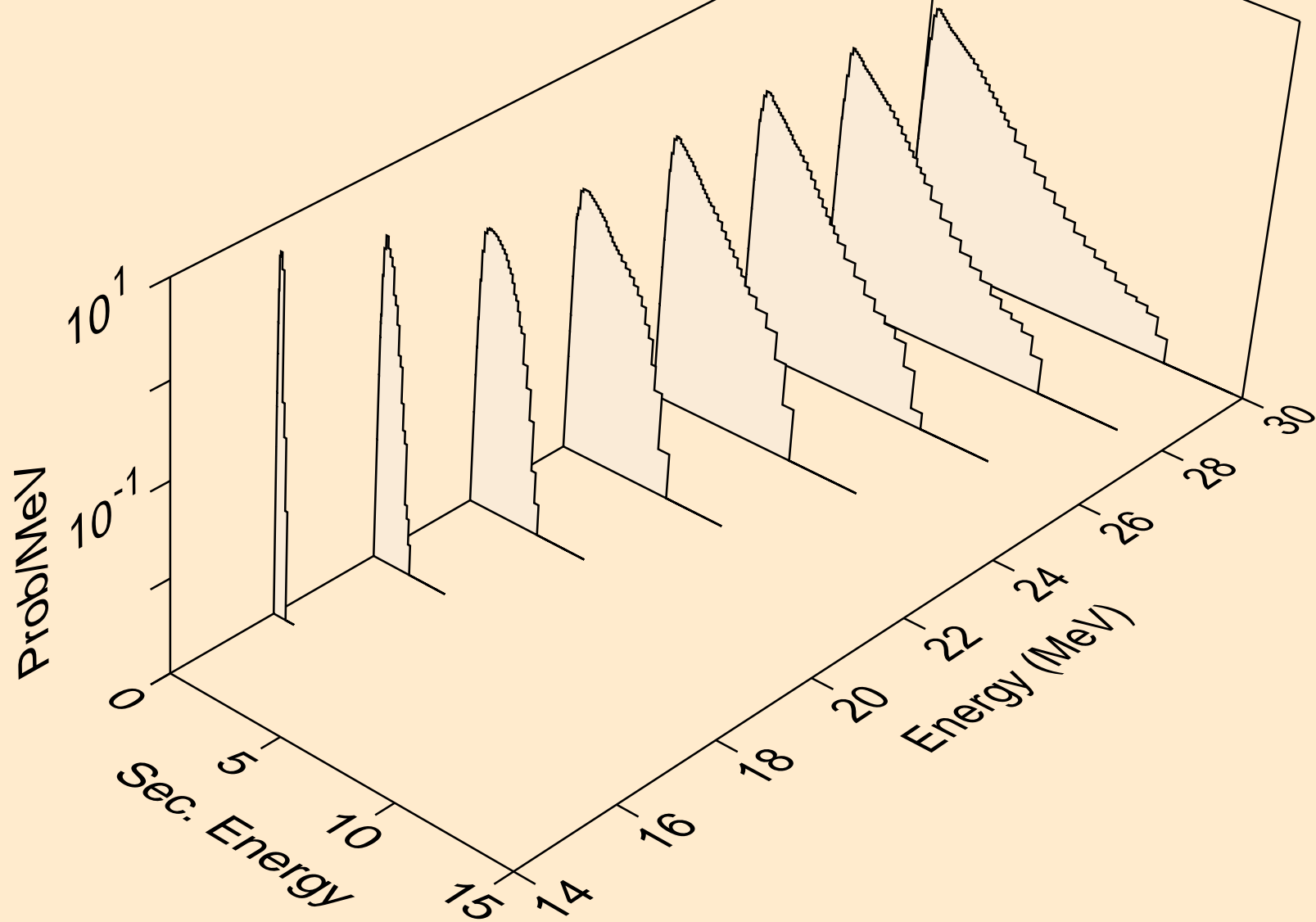

TC095 NEUTRON ACER TENDL-2021 LIBRARY; T=293.6K
Neutron emission for (n,3np)

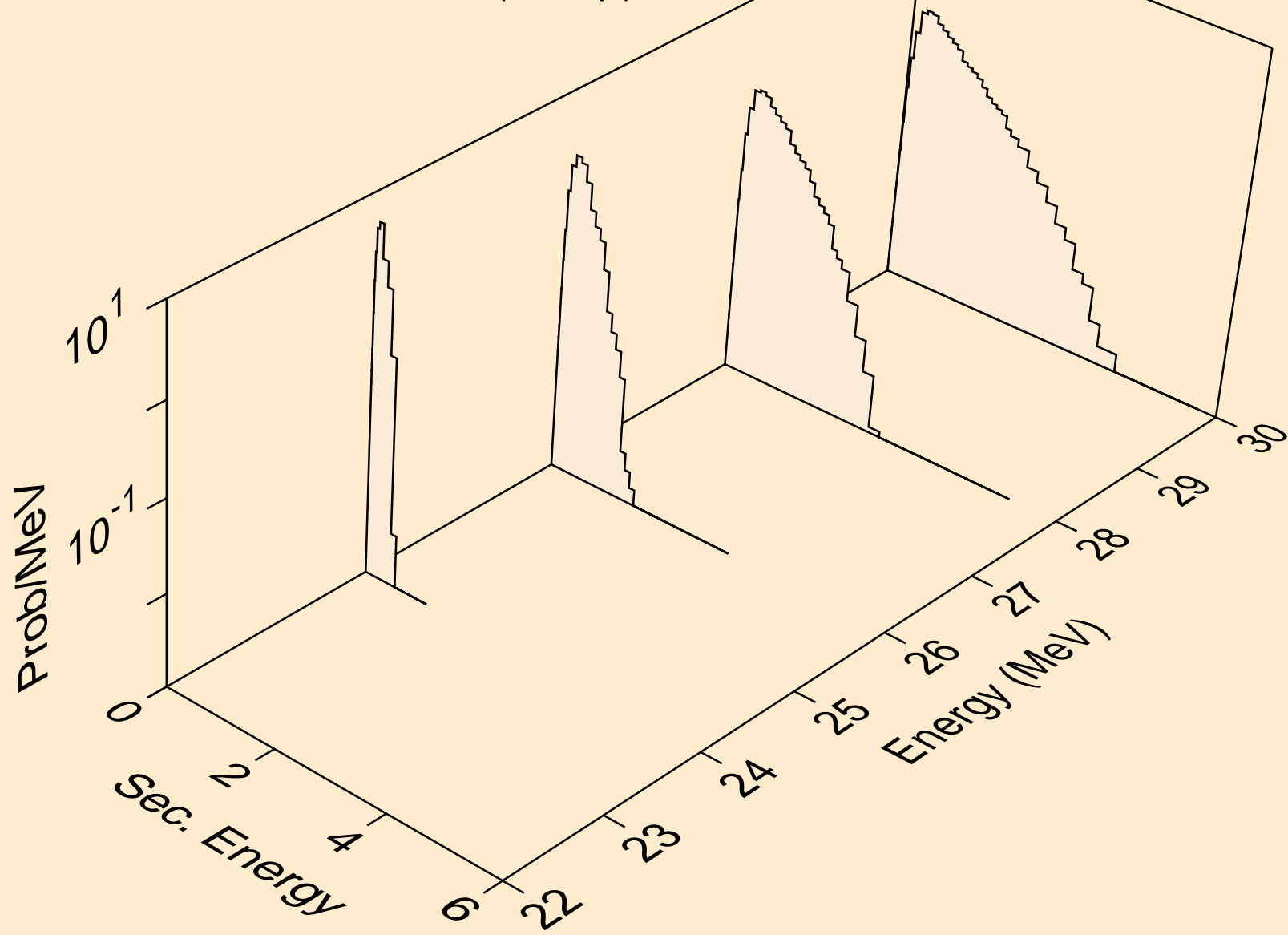

TC095 NEUTRON ACER TENDL-2021 LIBRARY; T=293.6K
Neutron emission for (n,2np)

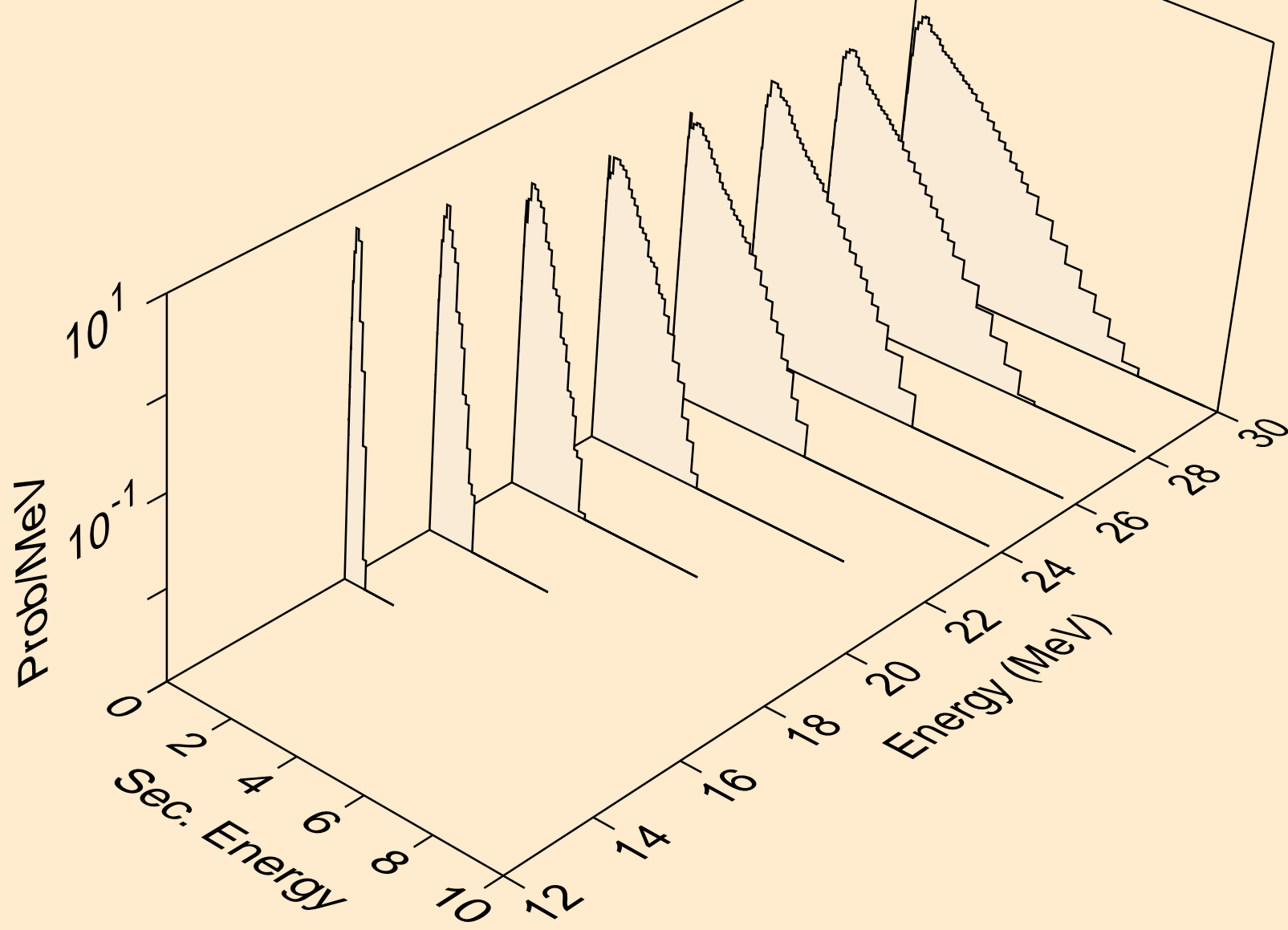

TC095 NEUTRON ACER TENDL-2021 LIBRARY; T=293.6K
Neutron emission for (n,npa)

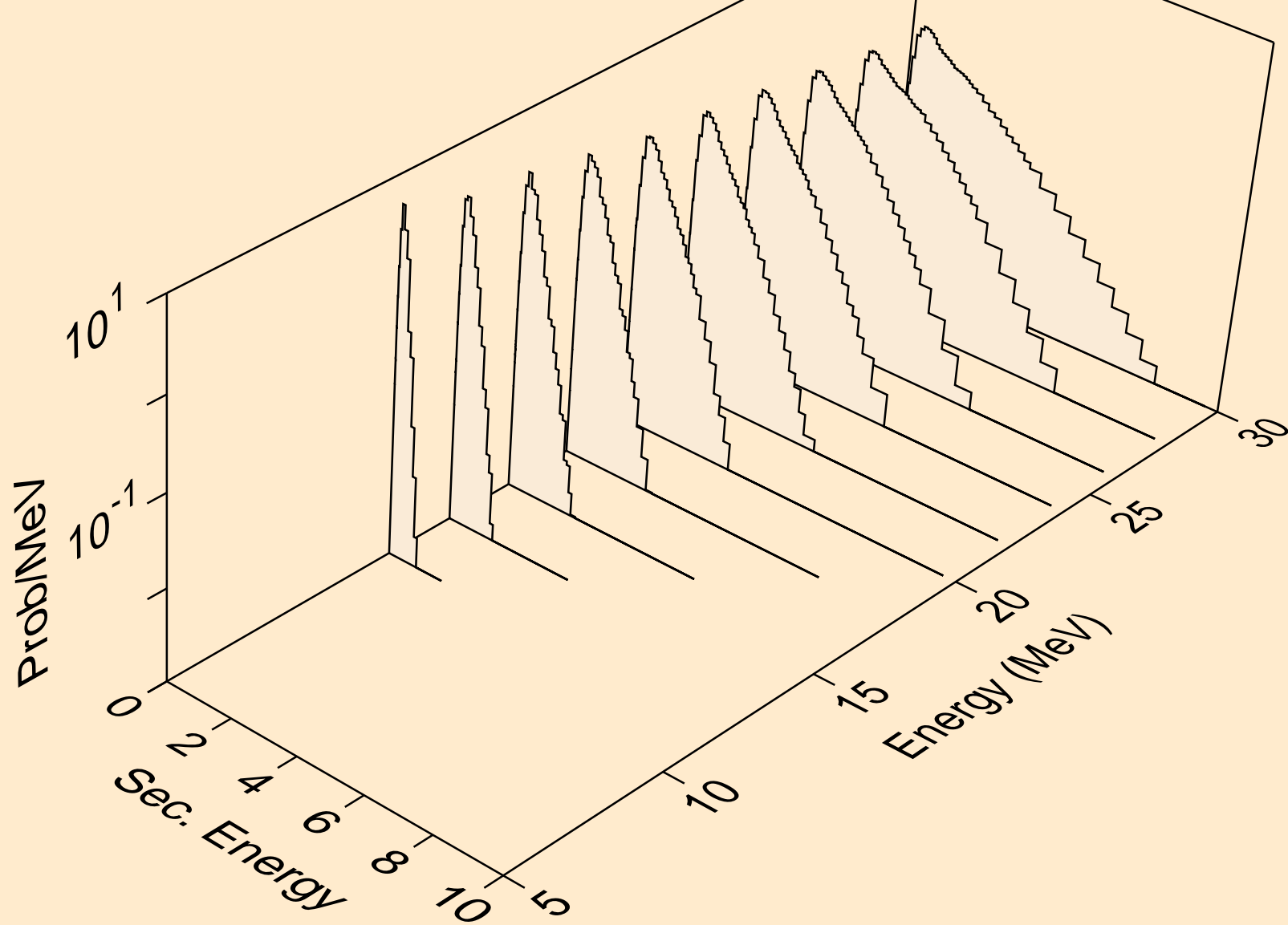

TC095 NEUTRON ACER TENDL-2021 LIBRARY; T=293.6K
Neutron emission for (n,n*c)

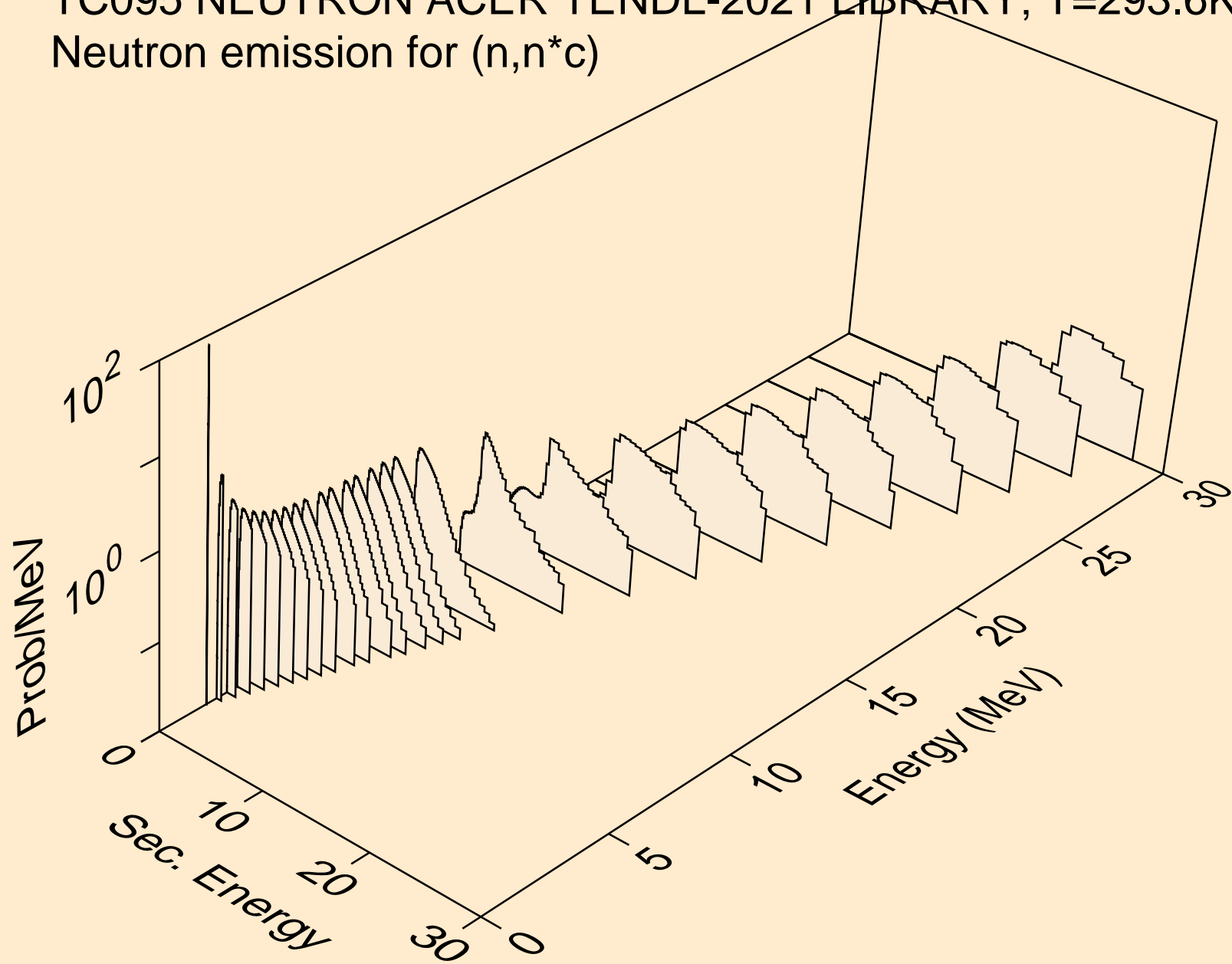

TC095 NEUTRON ACER TENDL-2021 LIBRARY; T=293.6K
Photon emission for (n,x)

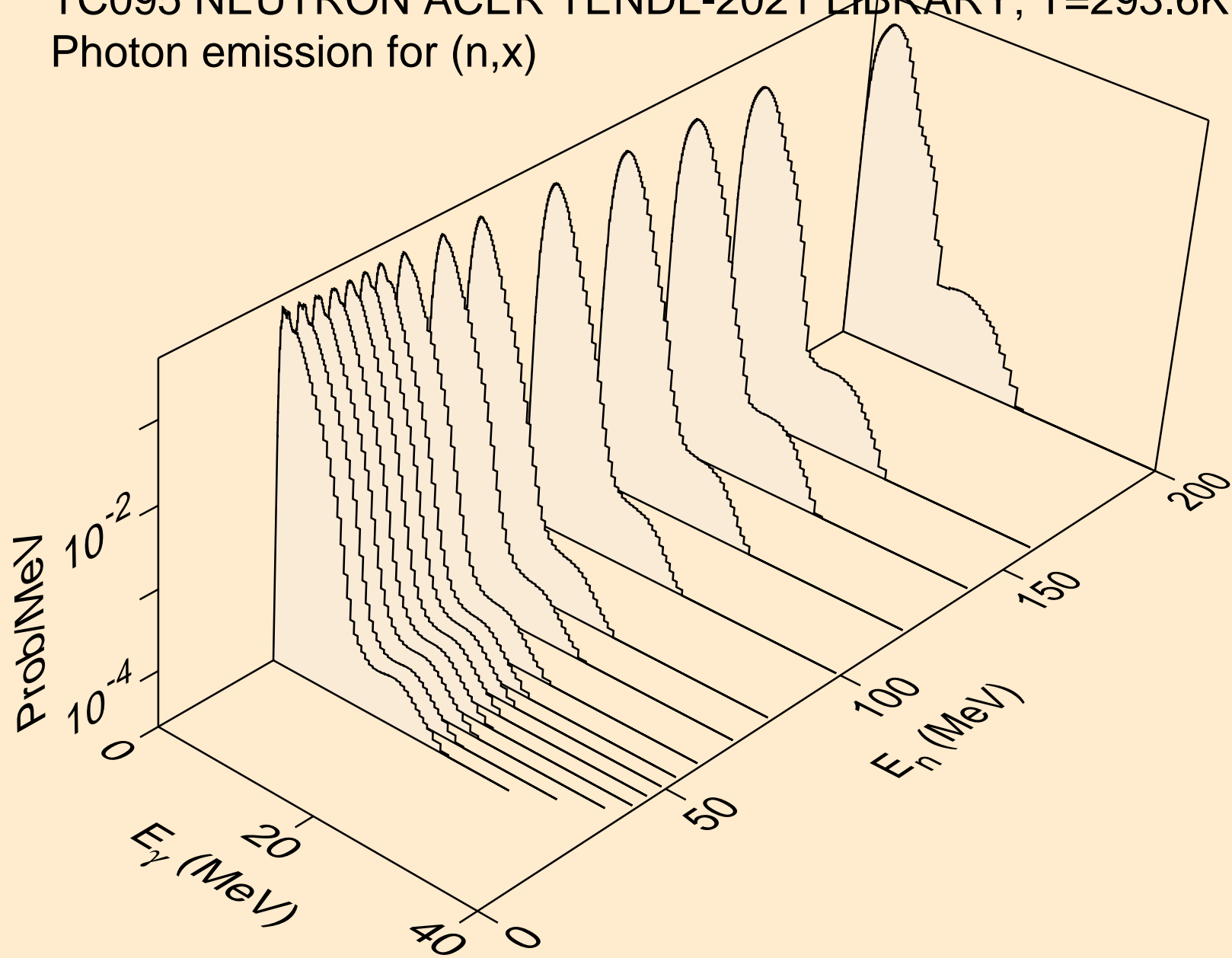

TC095 NEUTRON ACER TENDL-2021 LIBRARY; T=293.6K
Photon emission for (n,2nd)

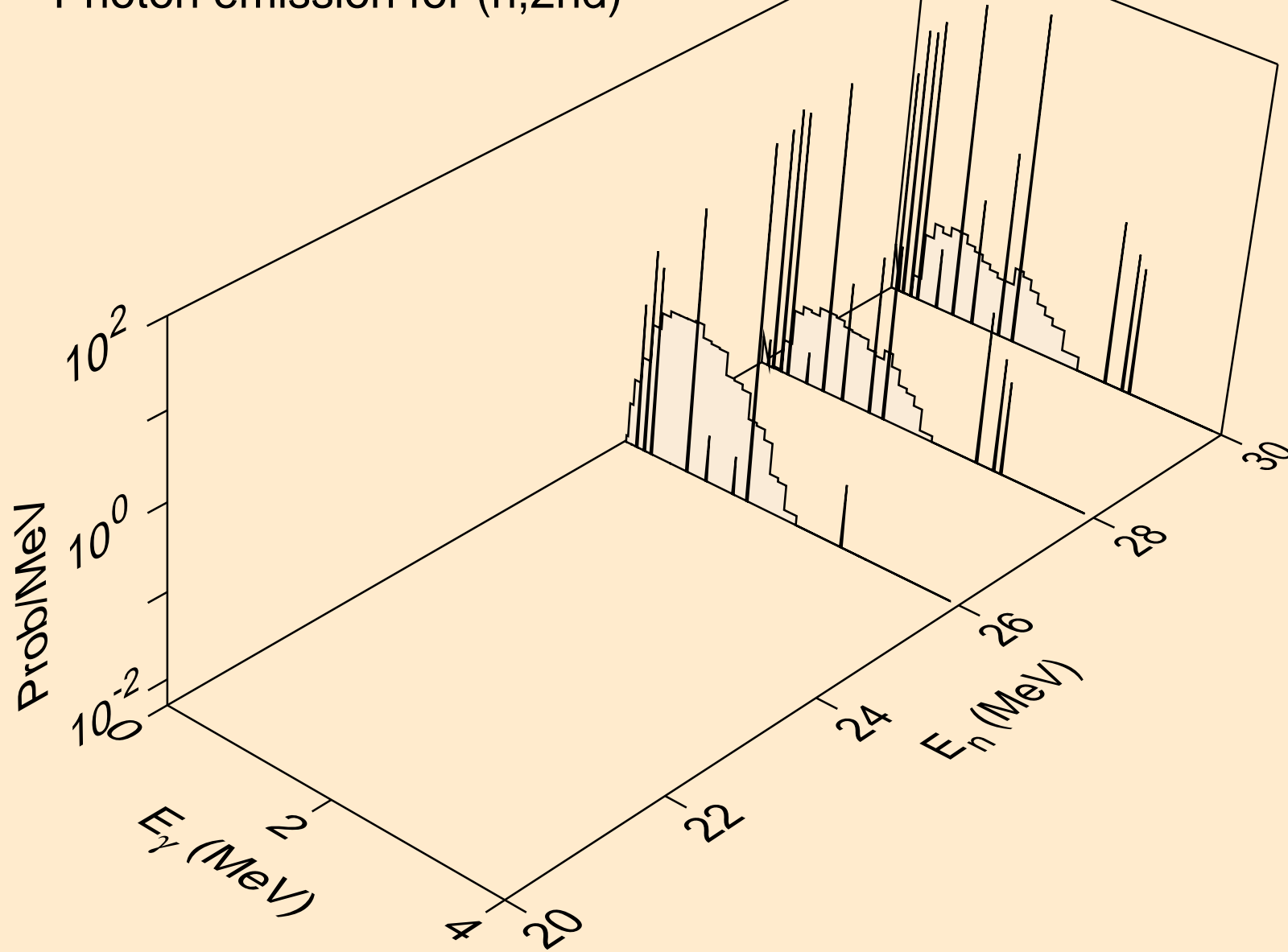

TC095 NEUTRON ACER TENDL-2021 LIBRARY; T=293.6K
Photon emission for (n,2n)

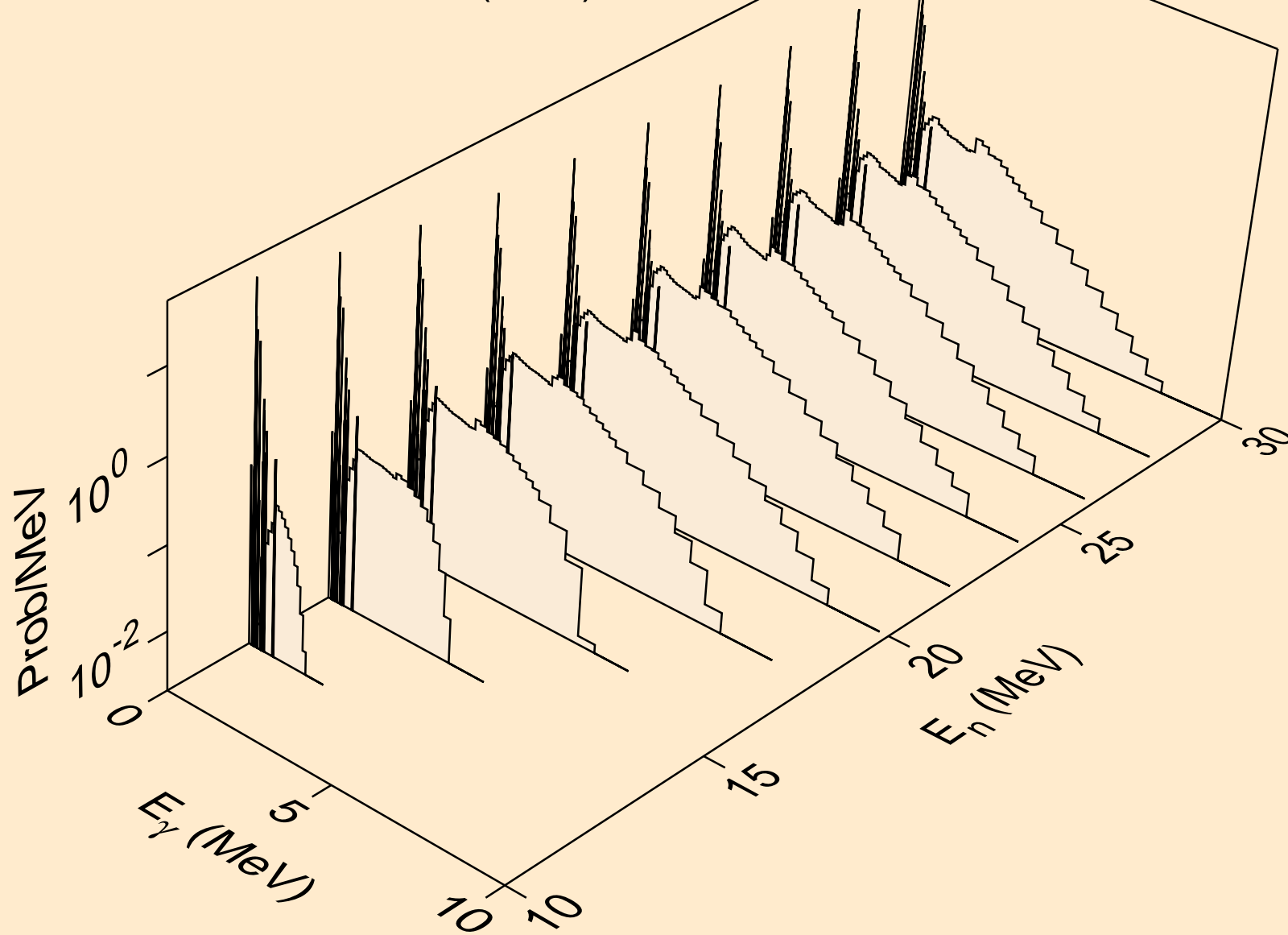

TC095 NEUTRON ACER TENDL-2021 LIBRARY; T=293.6K
Photon emission for (n,3n)

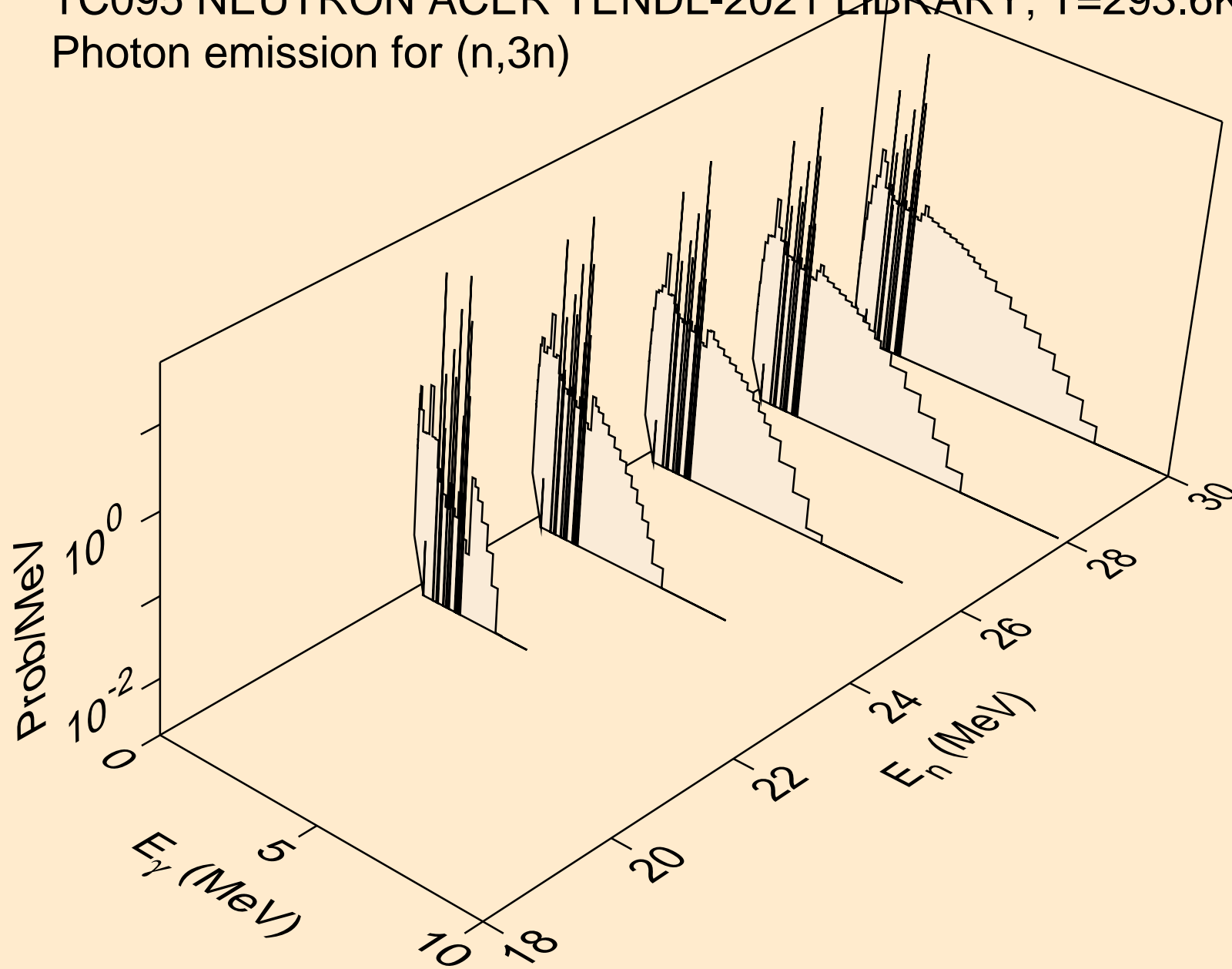

TC095 NEUTRON ACER TENDL-2021 LIBRARY; T=293.6K
Photon emission for (n,n*)a

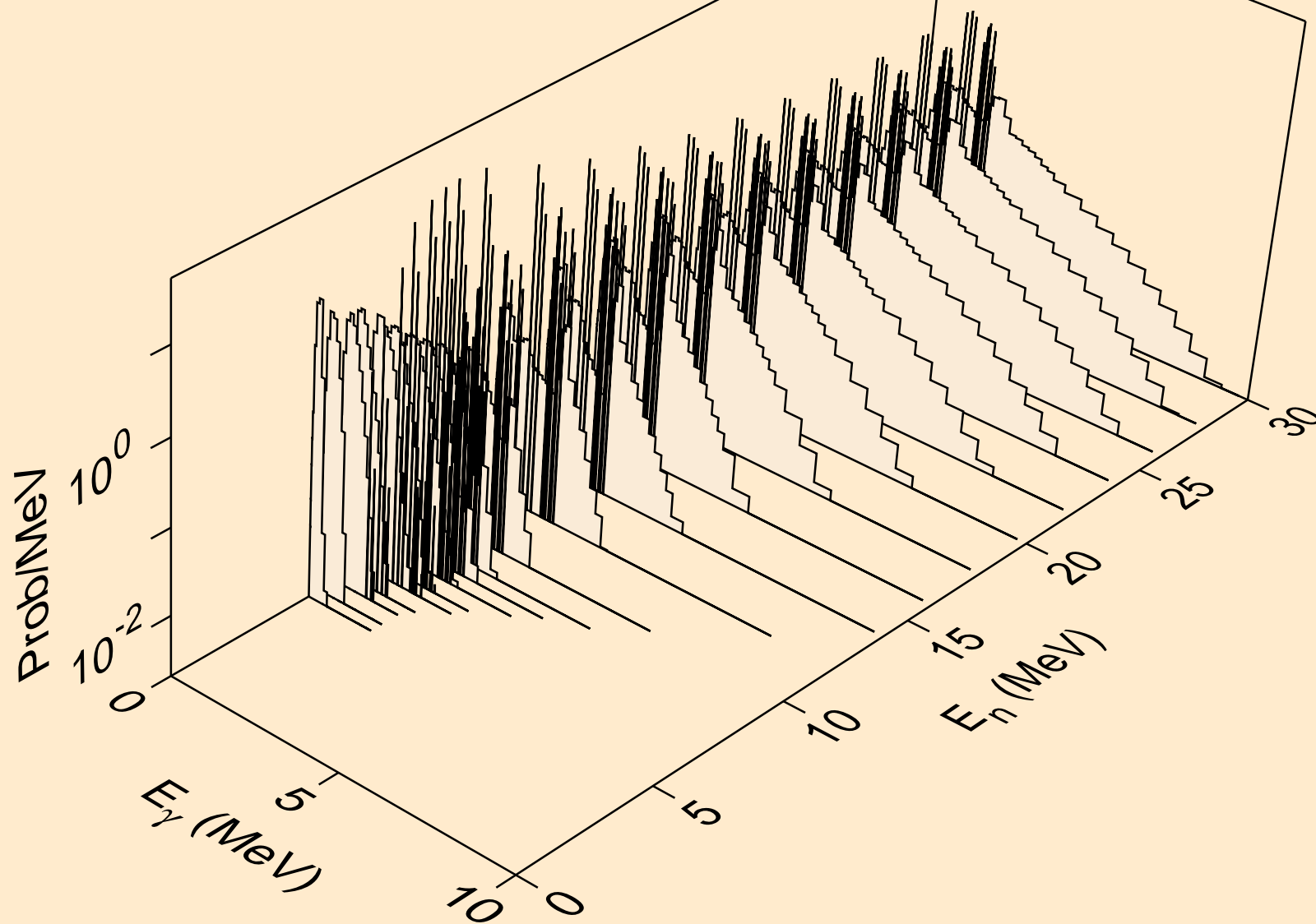

TC095 NEUTRON ACER TENDL-2021 LIBRARY; T=293.6K
Photon emission for (n,2n)a

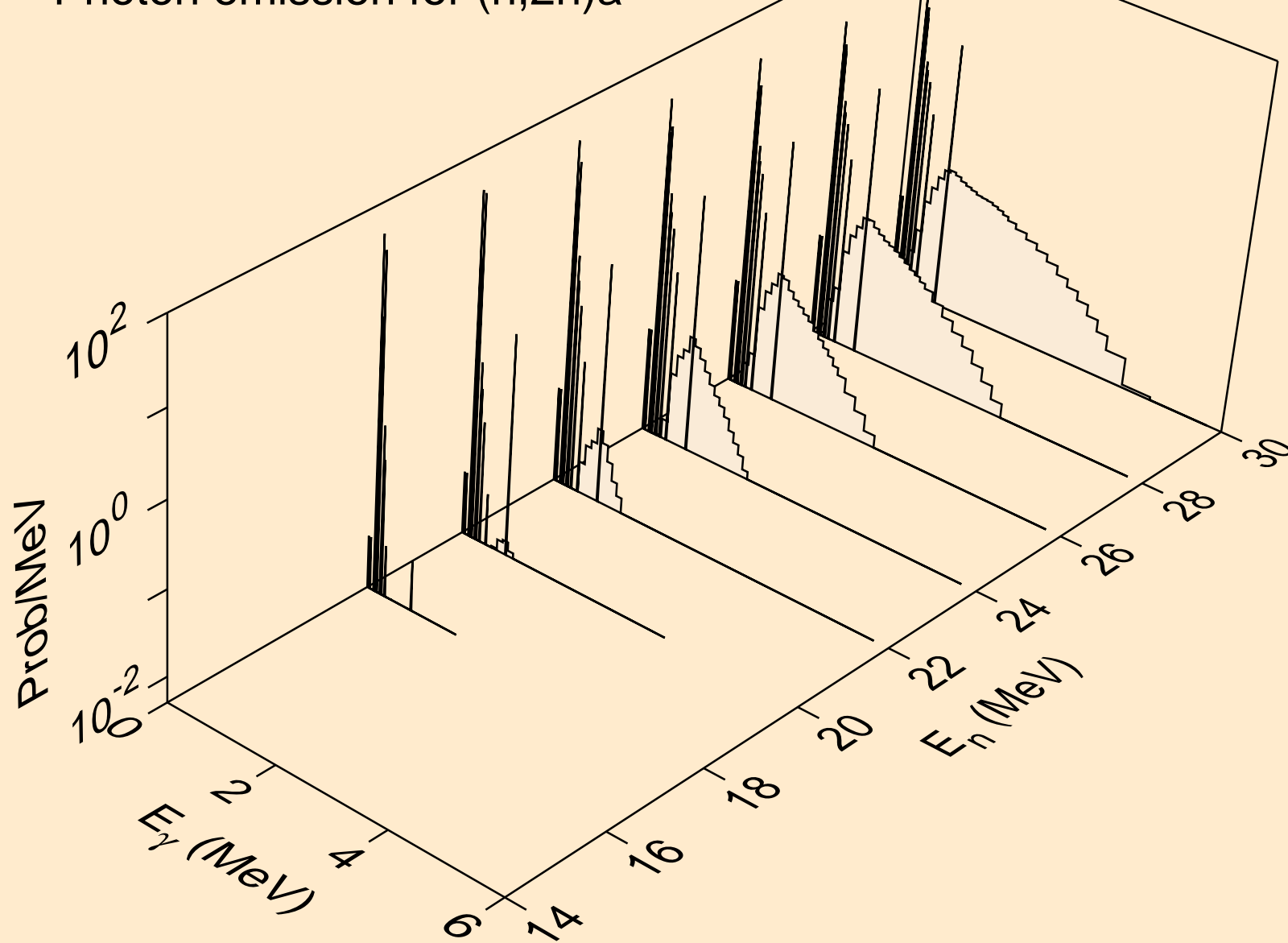

TC095 NEUTRON ACER TENDL-2021 LIBRARY; T=293.6K
Photon emission for (n,n*)p

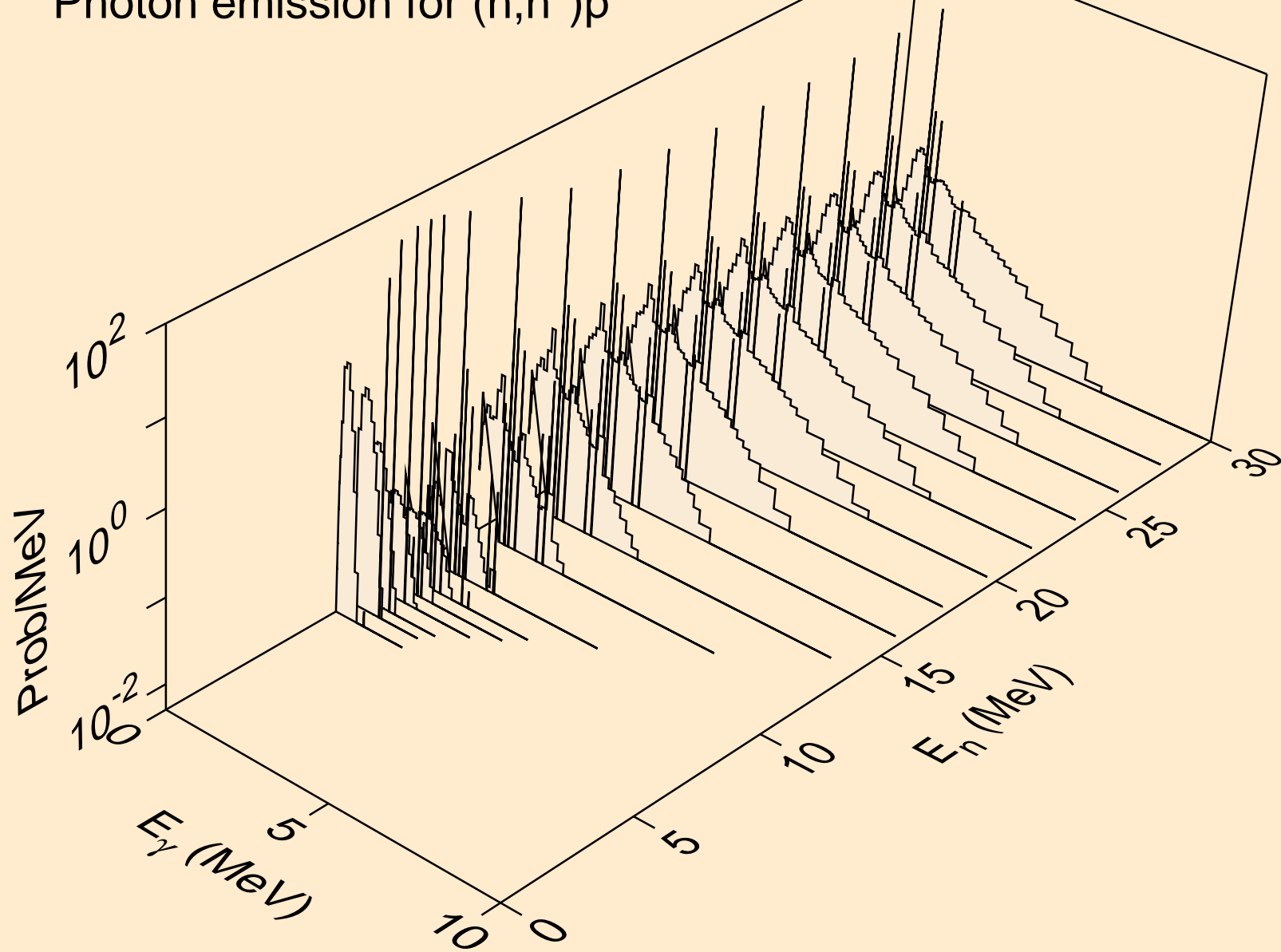

TC095 NEUTRON ACER TENDL-2021 LIBRARY; T=293.6K
Photon emission for (n,n*)2a

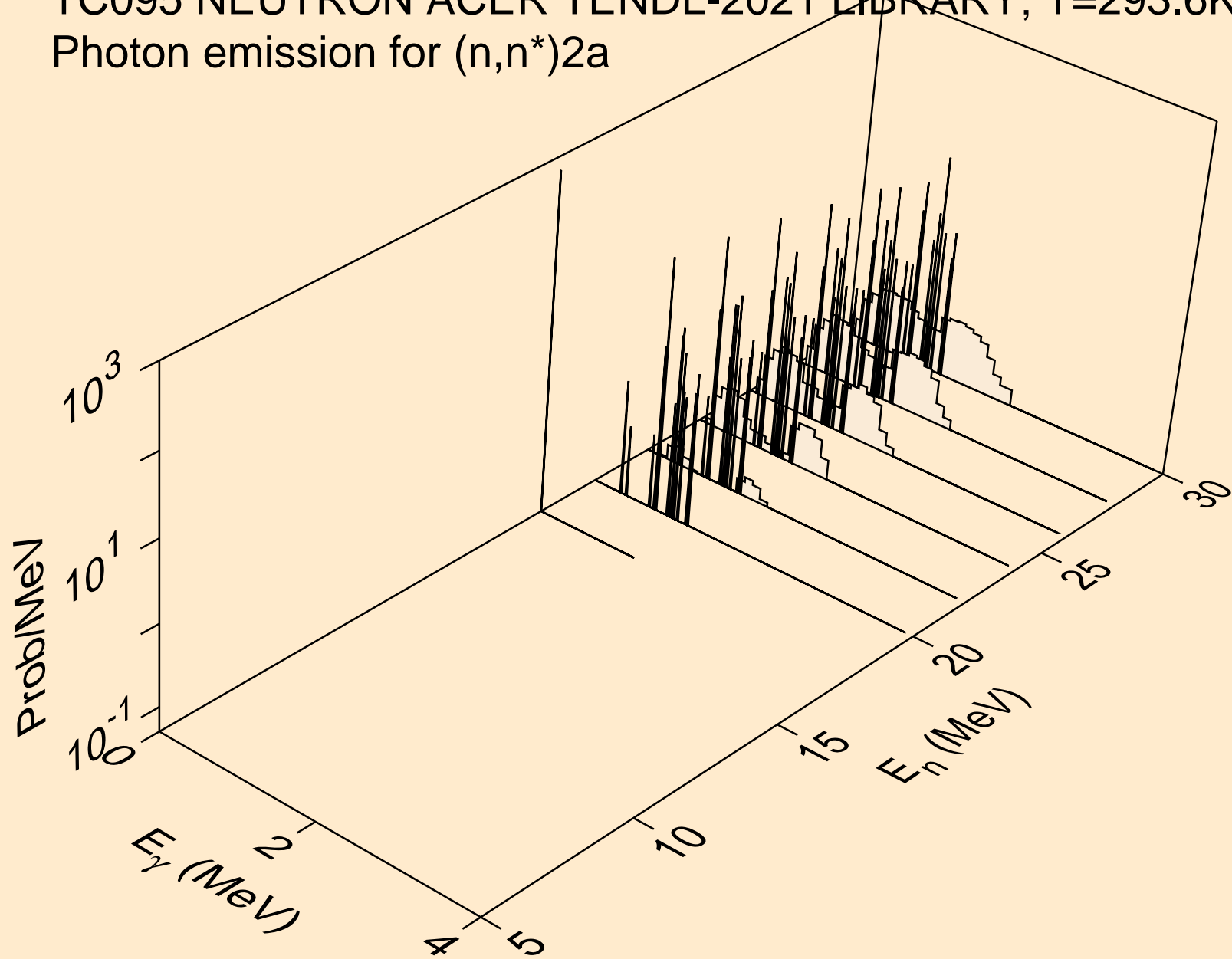

TC095 NEUTRON ACER TENDL-2021 LIBRARY; T=293.6K
Photon emission for (n,n*)d

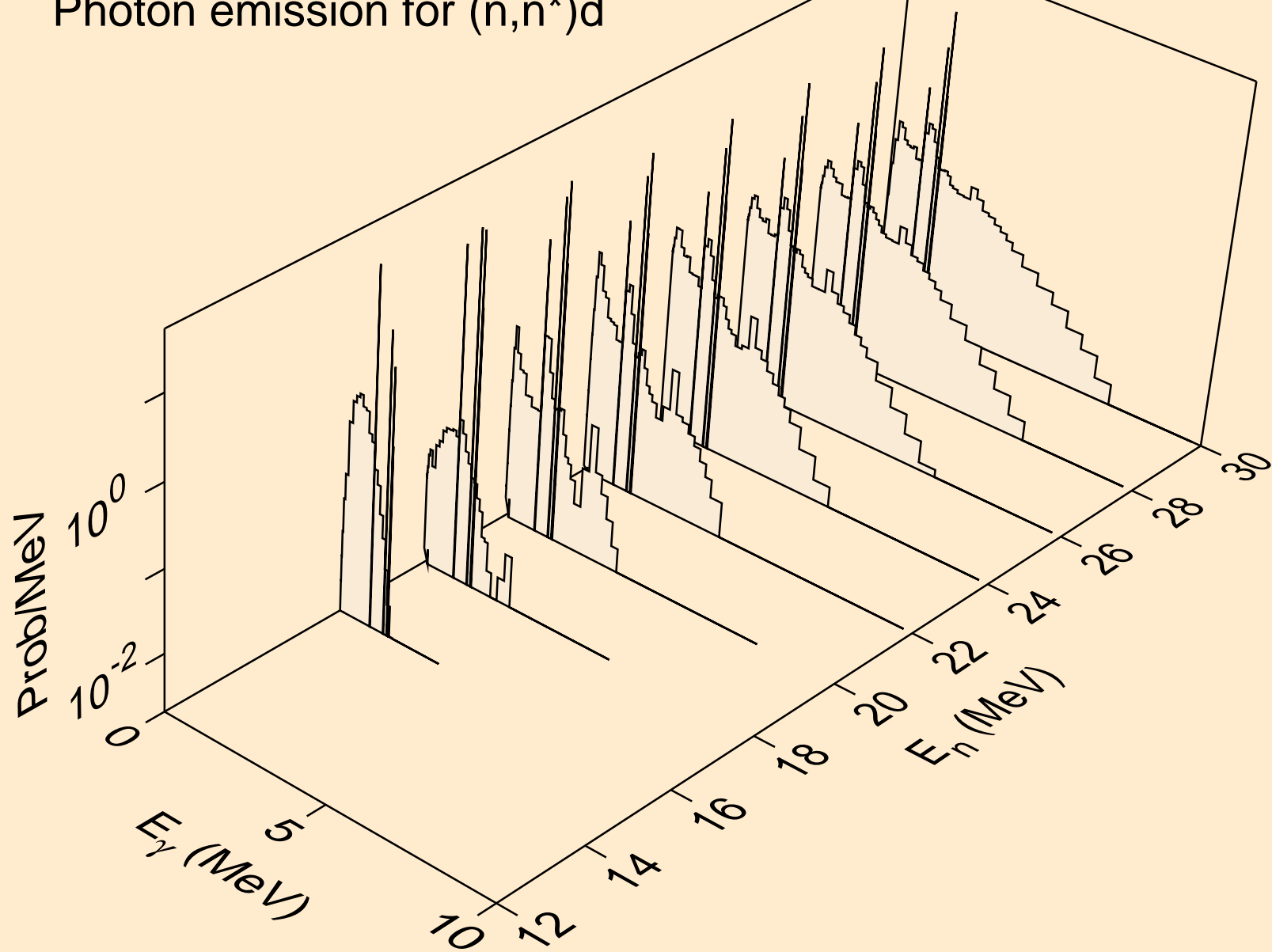

TC095 NEUTRON ACER TENDL-2021 LIBRARY; T=293.6K
Photon emission for (n,n*)t

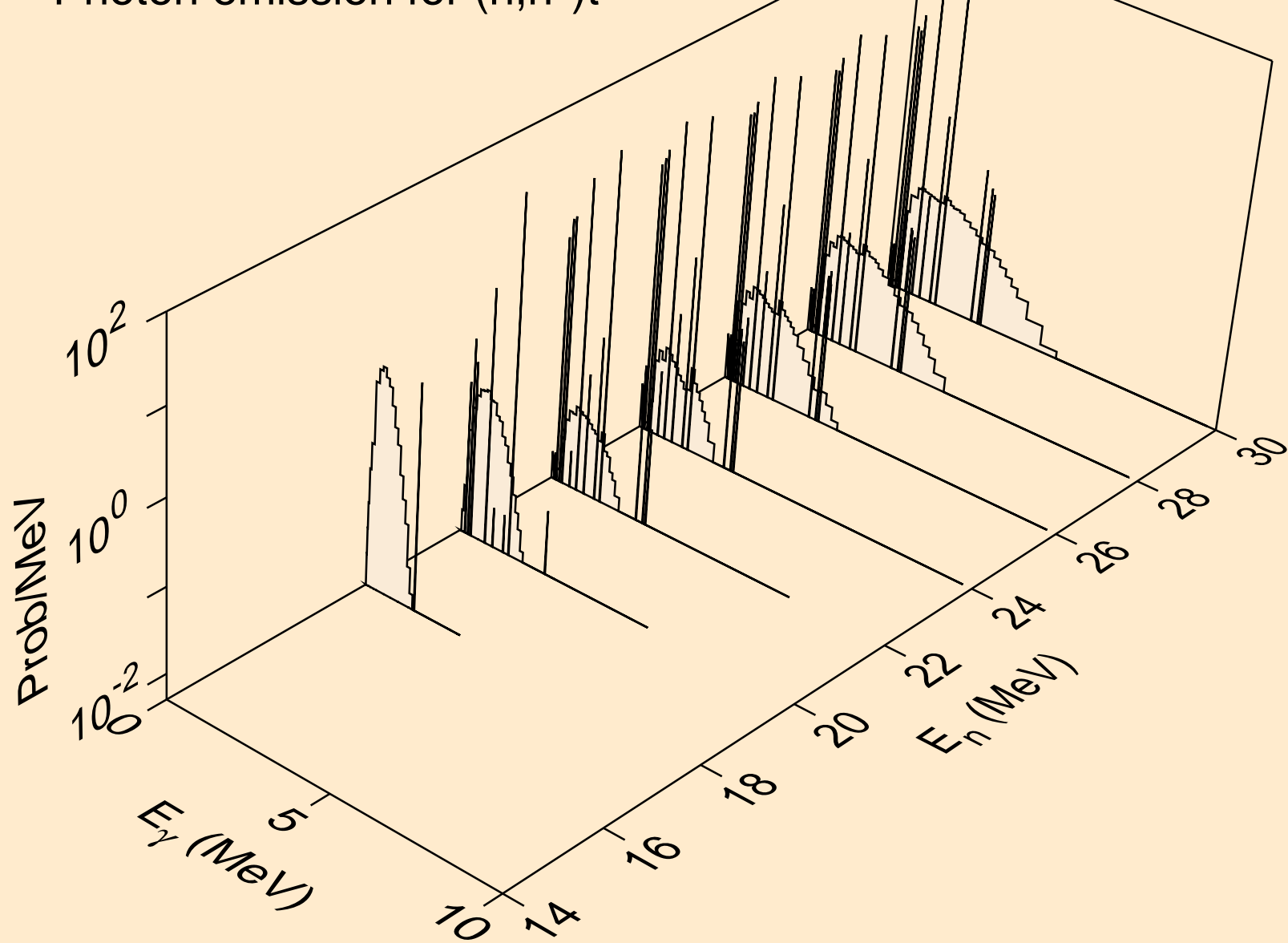

TC095 NEUTRON ACER TENDL-2021 LIBRARY; T=293.6K
Photon emission for (n,n*)he3

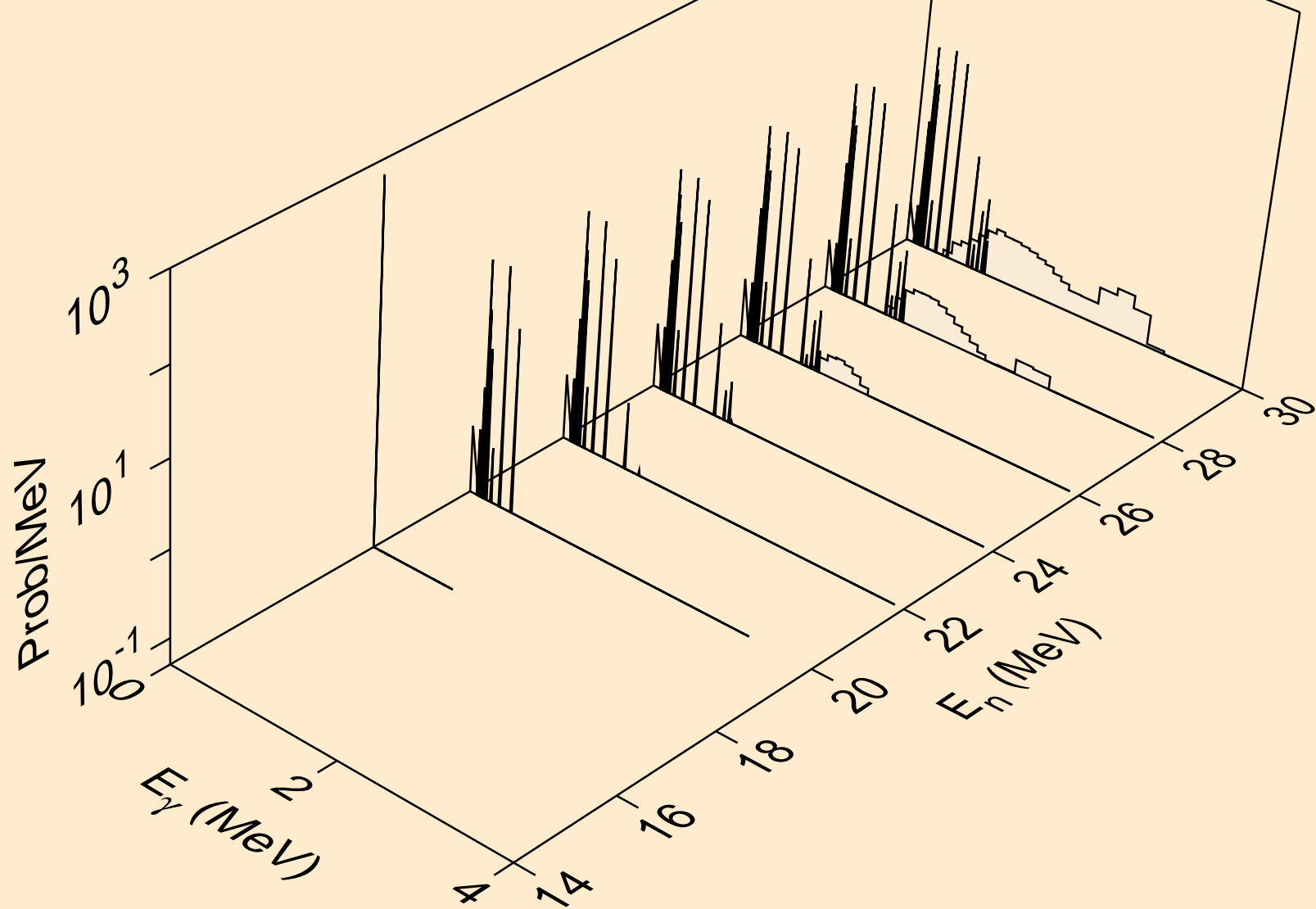

TC095 NEUTRON ACER TENDL-2021 LIBRARY; T=293.6K
Photon emission for (n,2np)

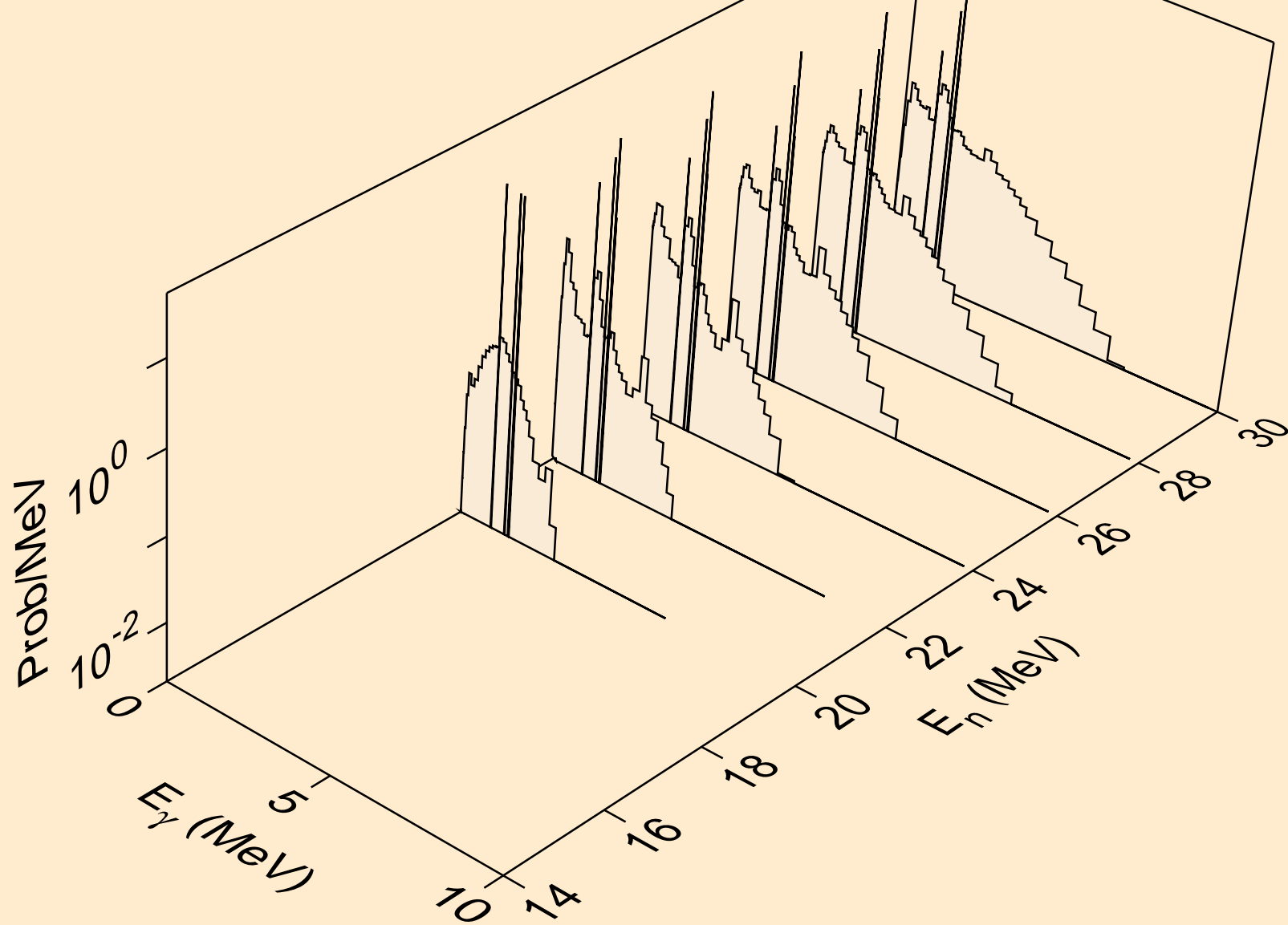

TC095 NEUTRON ACER TENDL-2021 LIBRARY; T=293.6K
Photon emission for (n,3np)

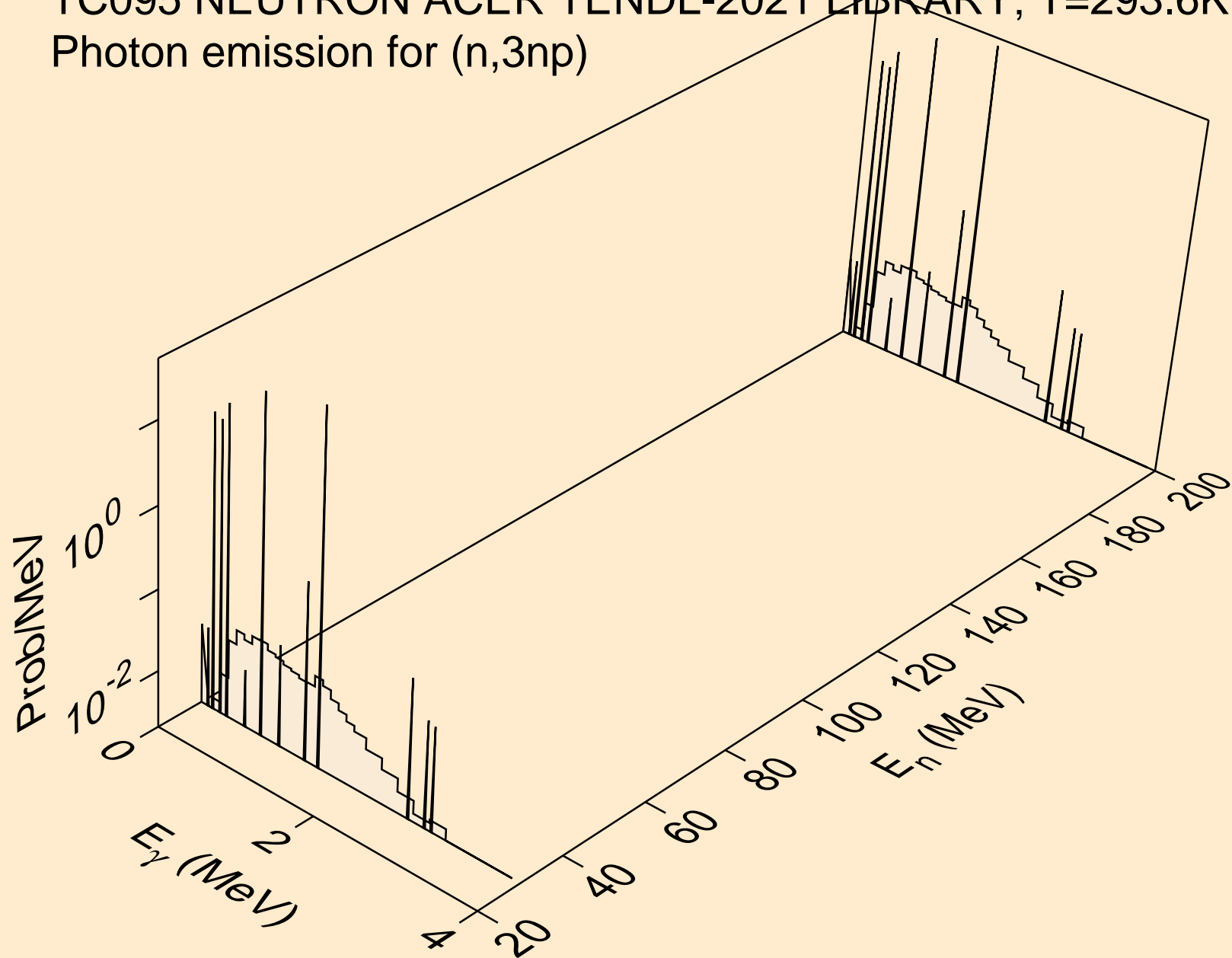

TC095 NEUTRON ACER TENDL-2021 LIBRARY; T=293.6K
Photon emission for (n,2np)

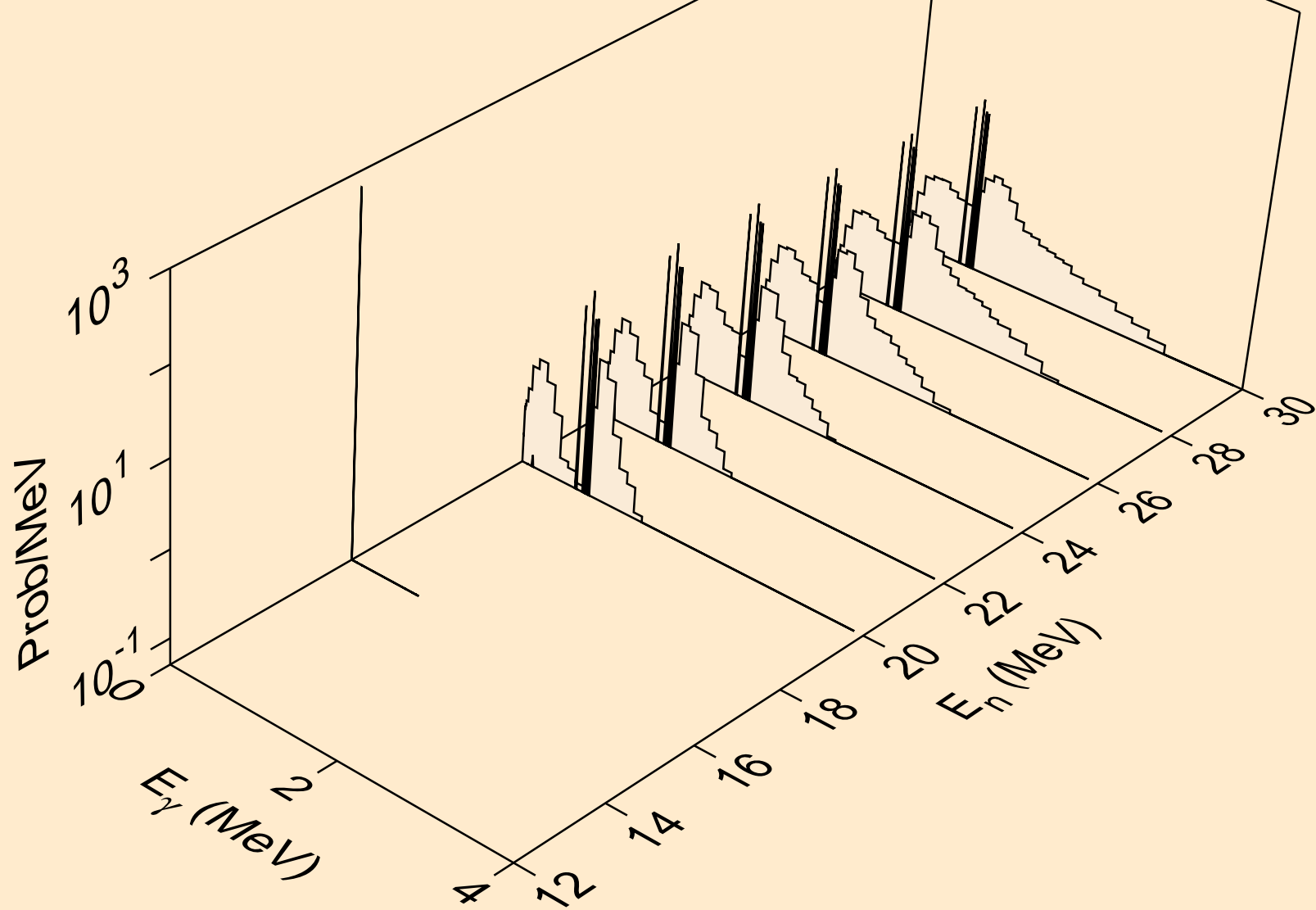

TC095 NEUTRON ACER TENDL-2021 LIBRARY; T=293.6K
Photon emission for (n,npa)

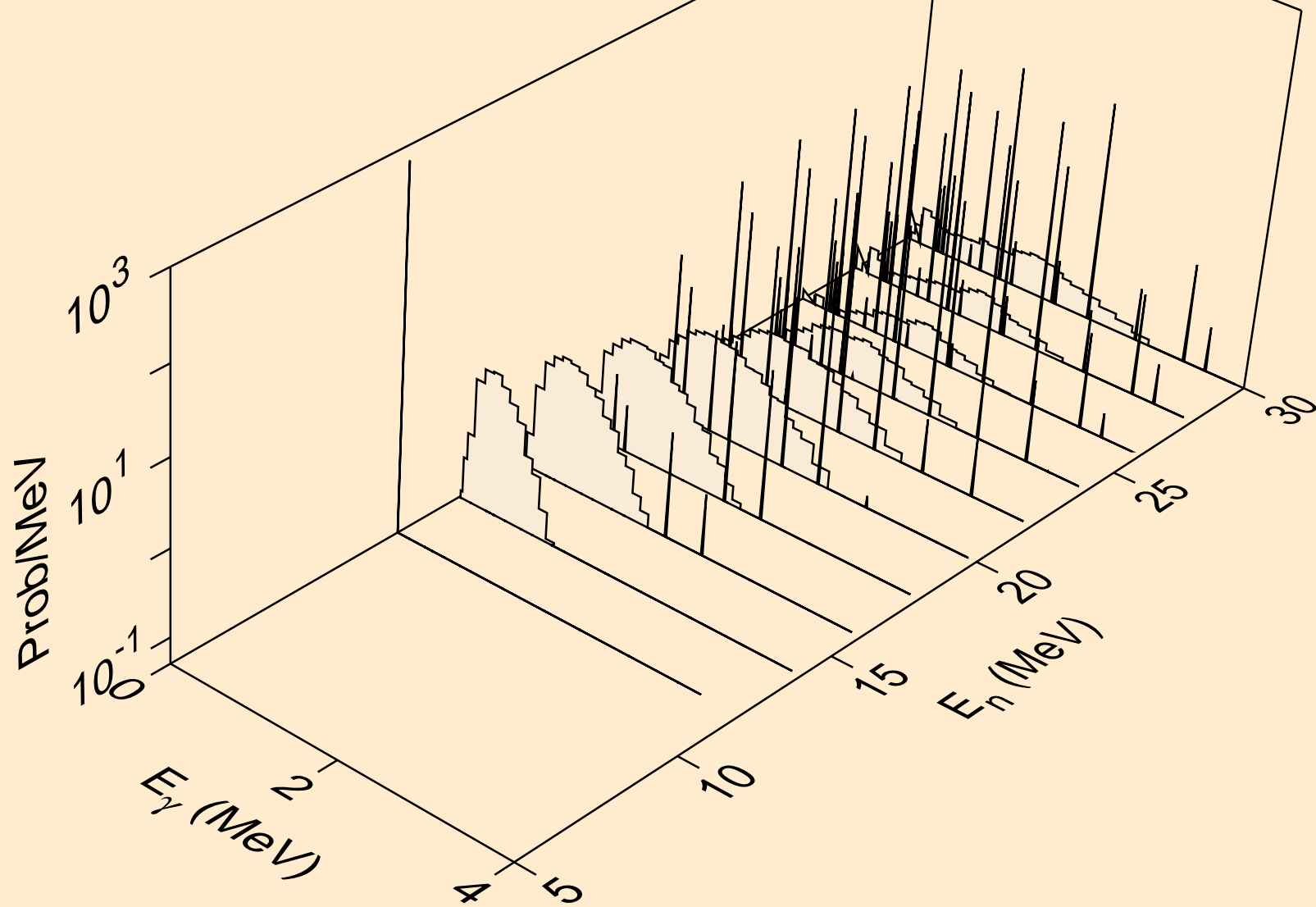

TC095 NEUTRON ACER TENDL-2021 LIBRARY; T=293.6K
Photon emission for (n,n*c)

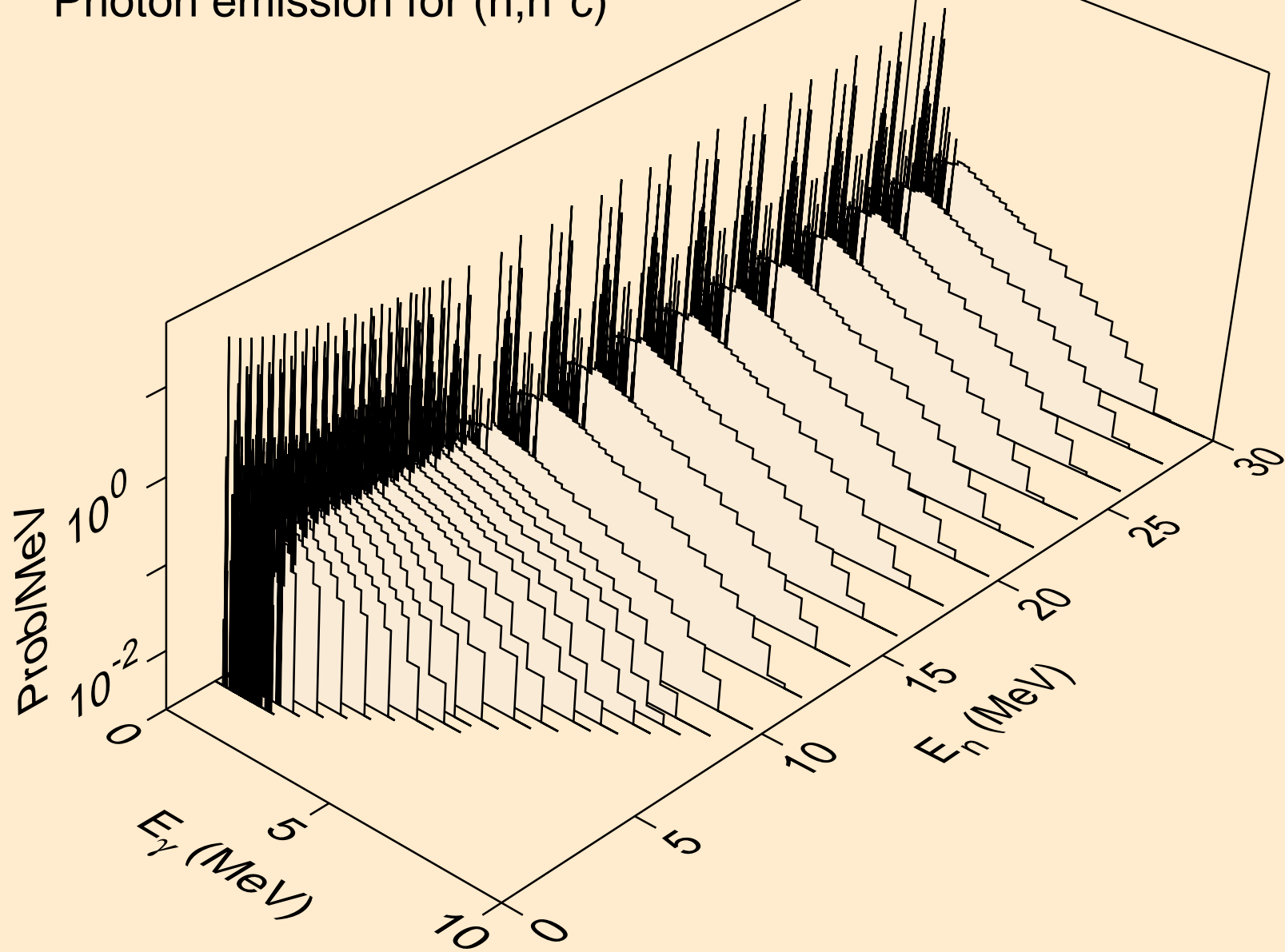

TC095 NEUTRON ACER TENDL-2021 LIBRARY; T=293.6K
Photon emission for (n,gma)

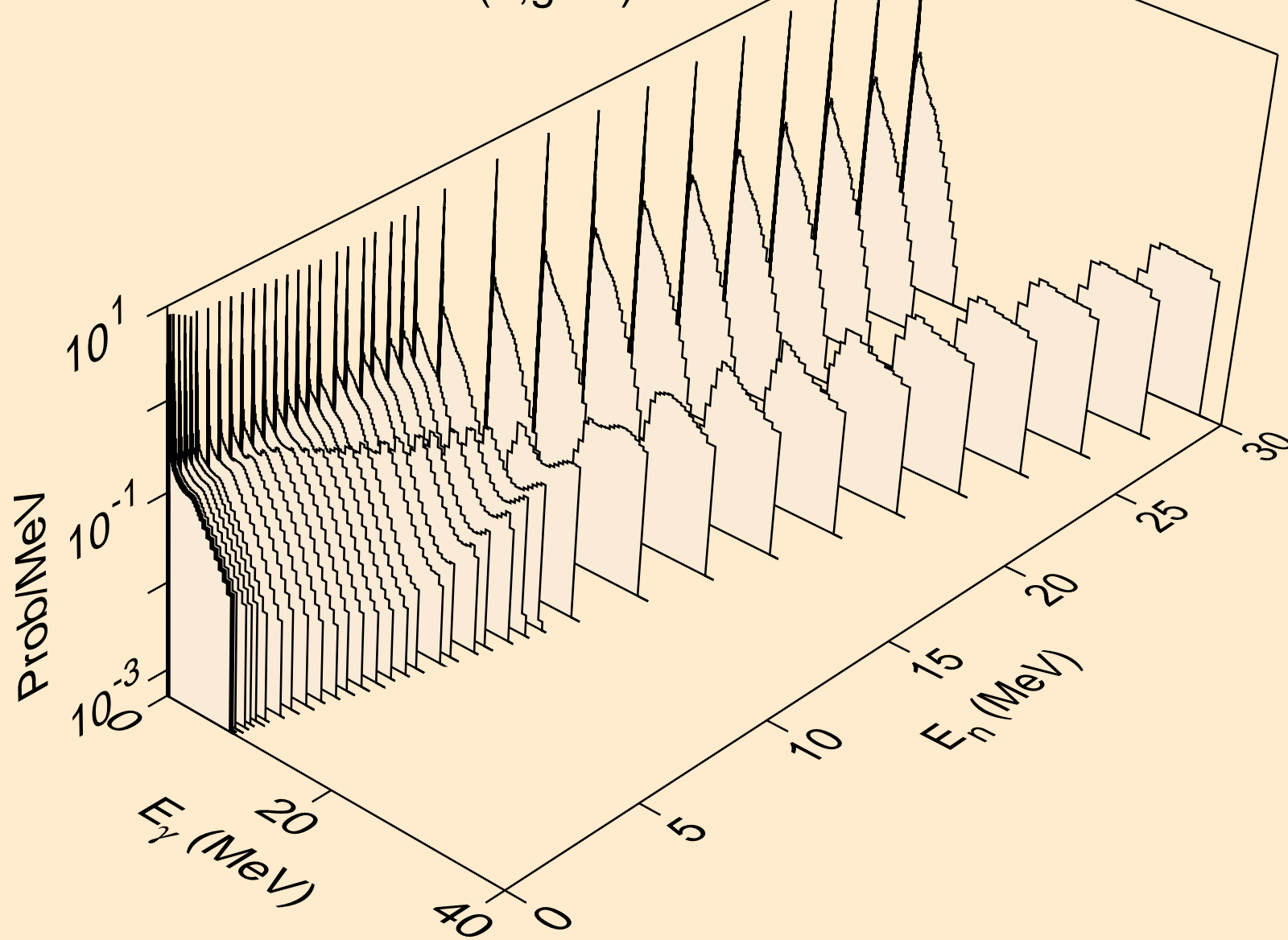

TC095 NEUTRON ACER TENDL-2021 LIBRARY; T=293.6K
Photon emission for (n,p)

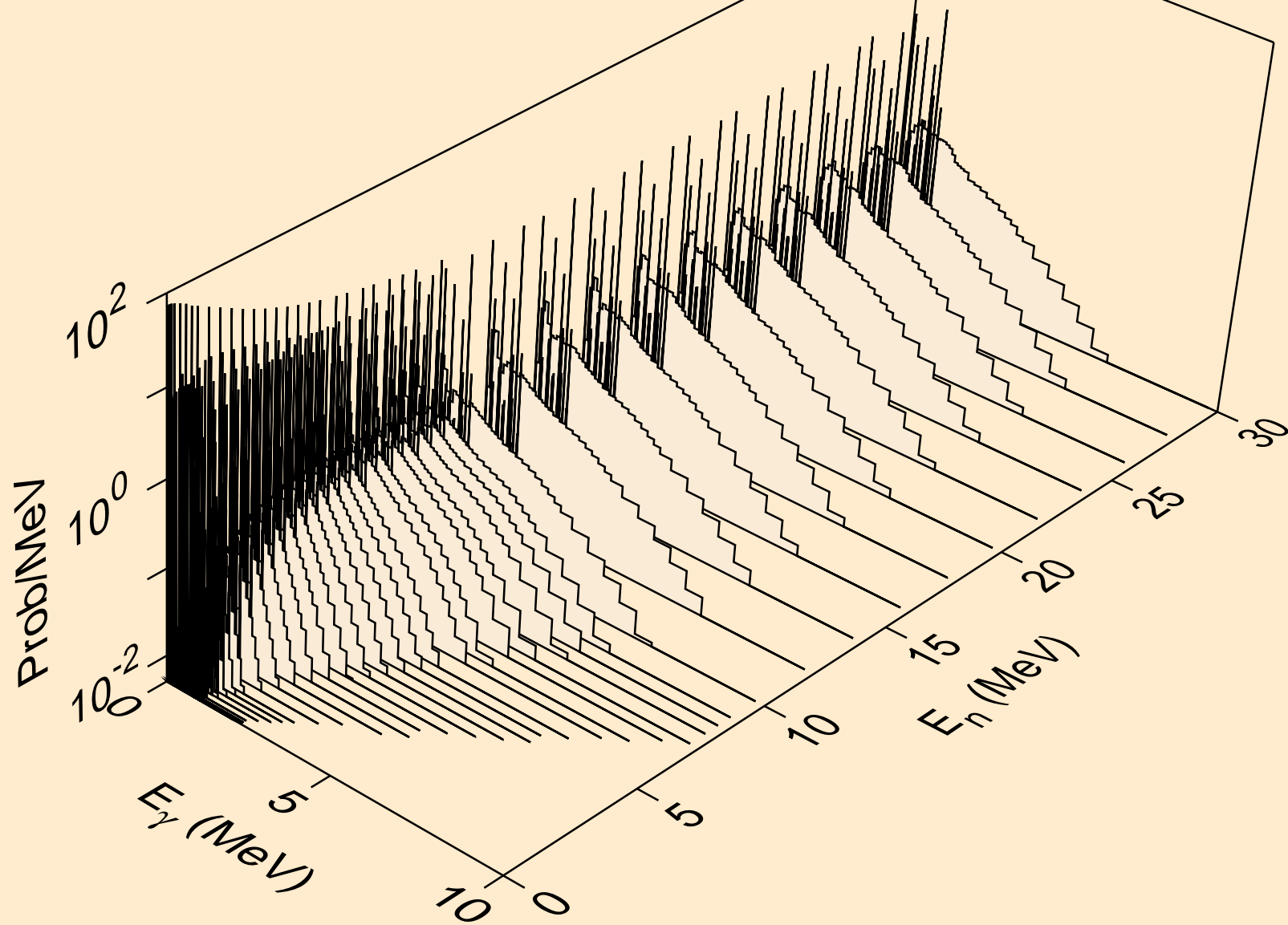

TC095 NEUTRON ACER TENDL-2021 LIBRARY; T=293.6K
Photon emission for (n,d)

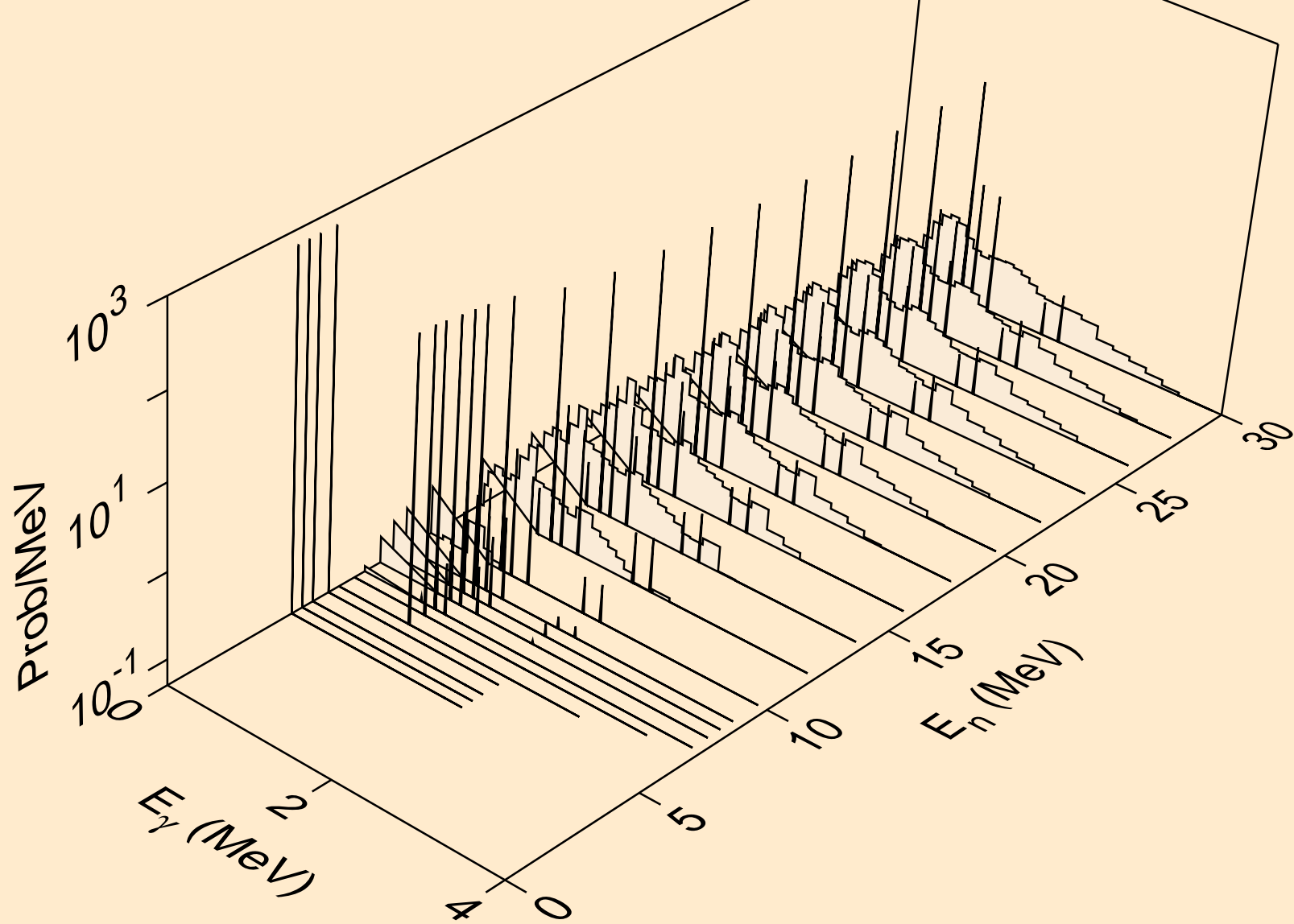

TC095 NEUTRON ACER TENDL-2021 LIBRARY; T=293.6K
Photon emission for (n,t)

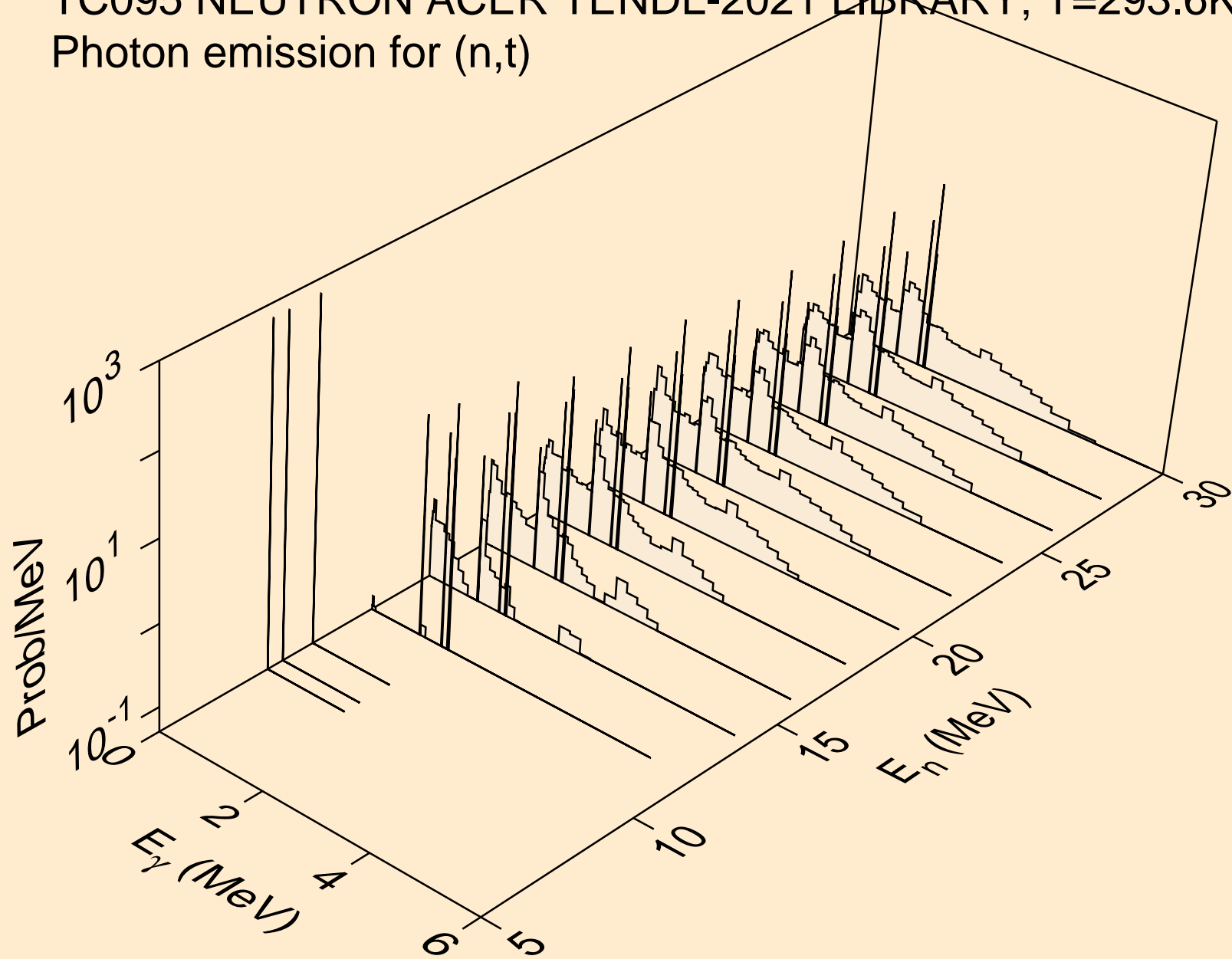

TC095 NEUTRON ACER TENDL-2021 LIBRARY; T=293.6K
Photon emission for (n,he3)

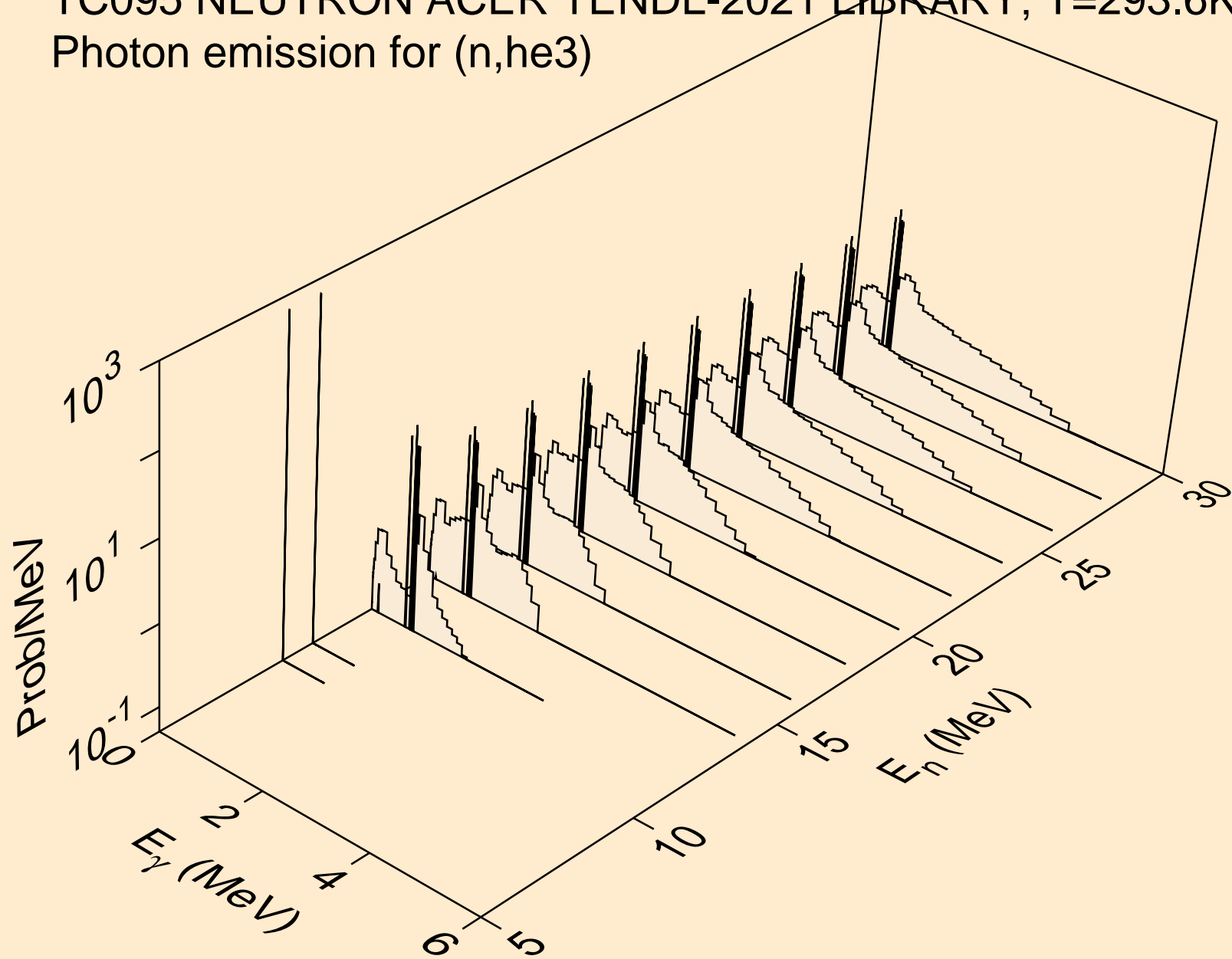

TC095 NEUTRON ACER TENDL-2021 LIBRARY; T=293.6K
Photon emission for (n,a)

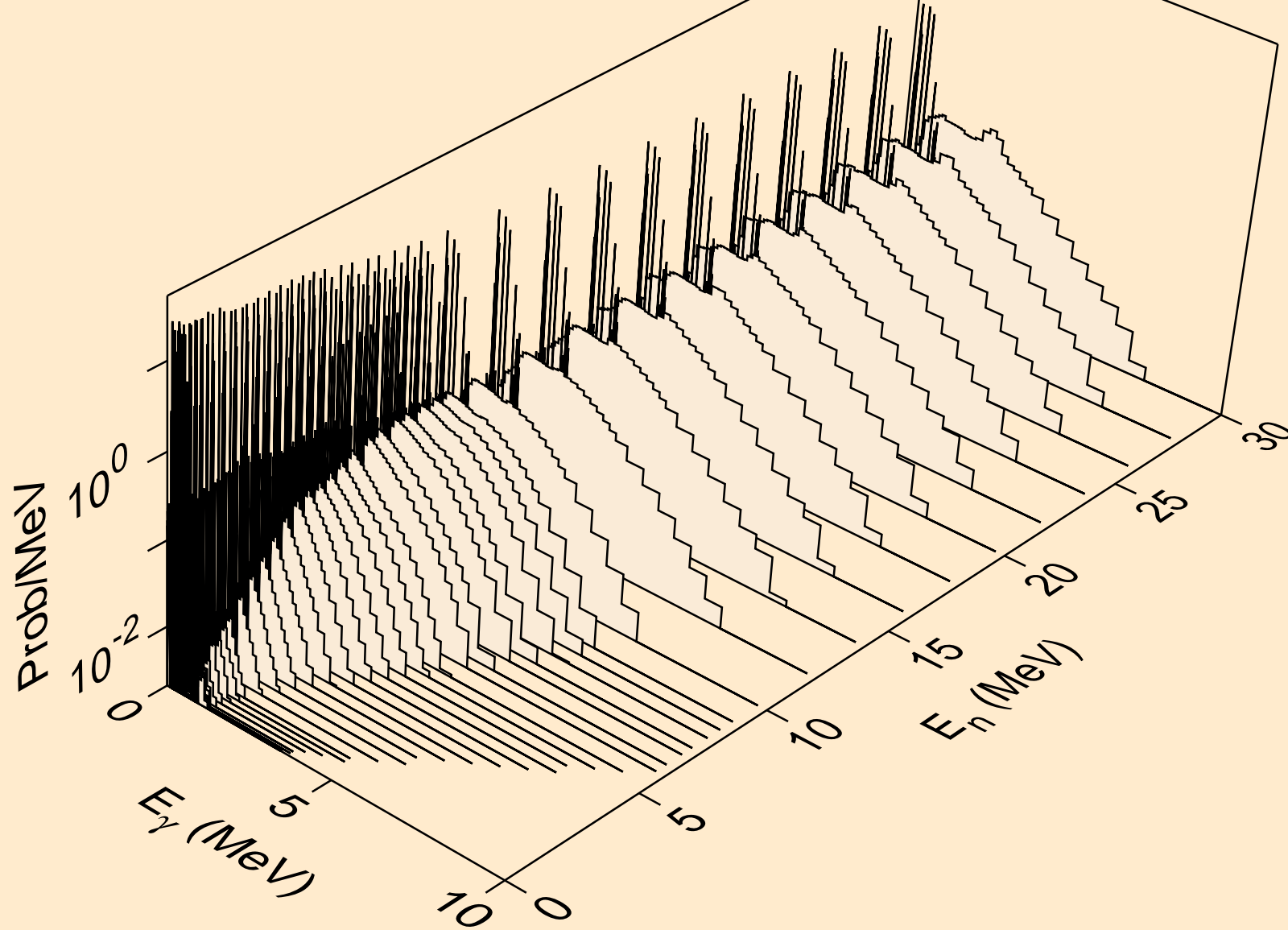

TC095 NEUTRON ACER TENDL-2021 LIBRARY; T=293.6K
Photon emission for (n,2a)

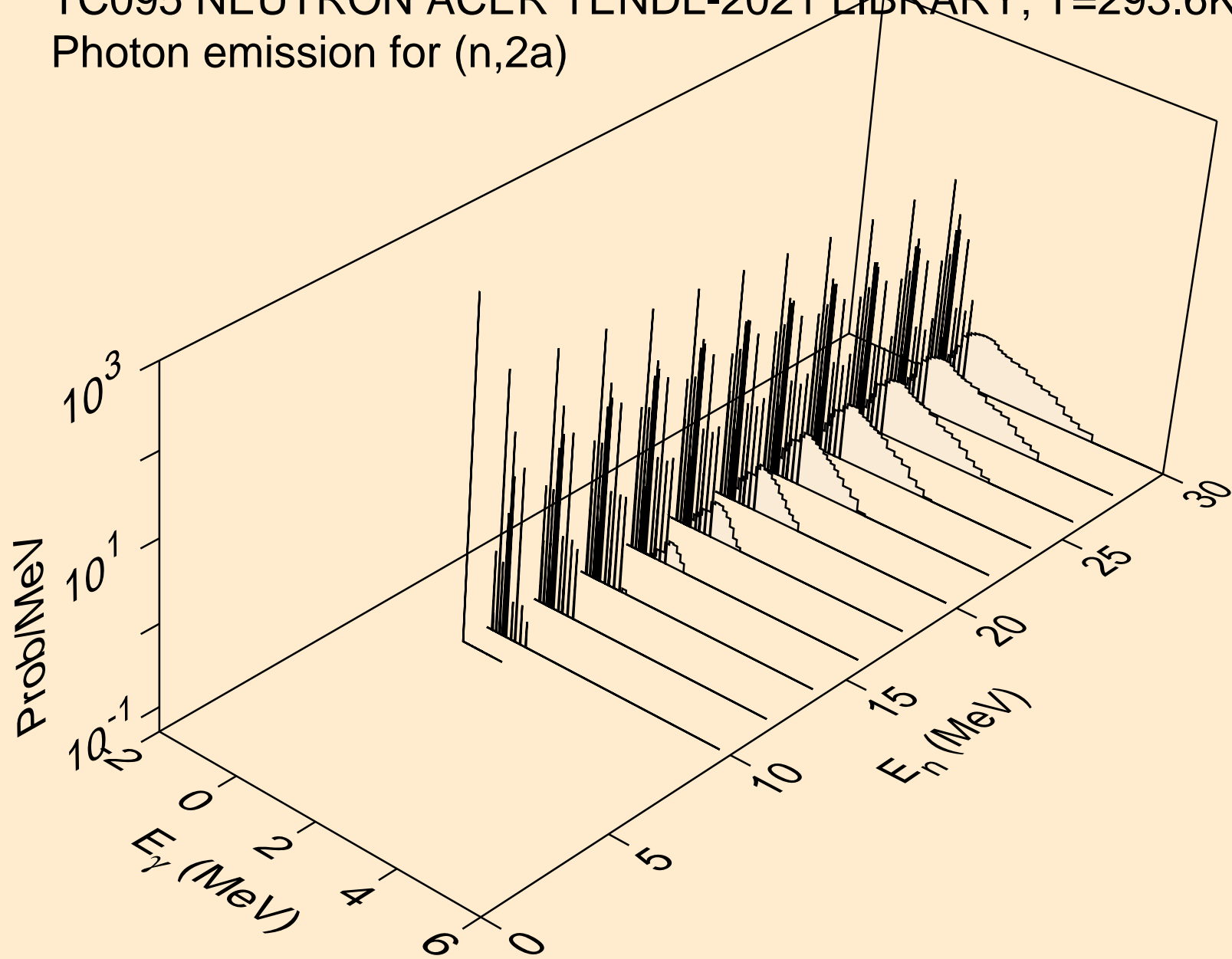

TC095 NEUTRON ACER TENDL-2021 LIBRARY; T=293.6K
Photon emission for (n,2p)

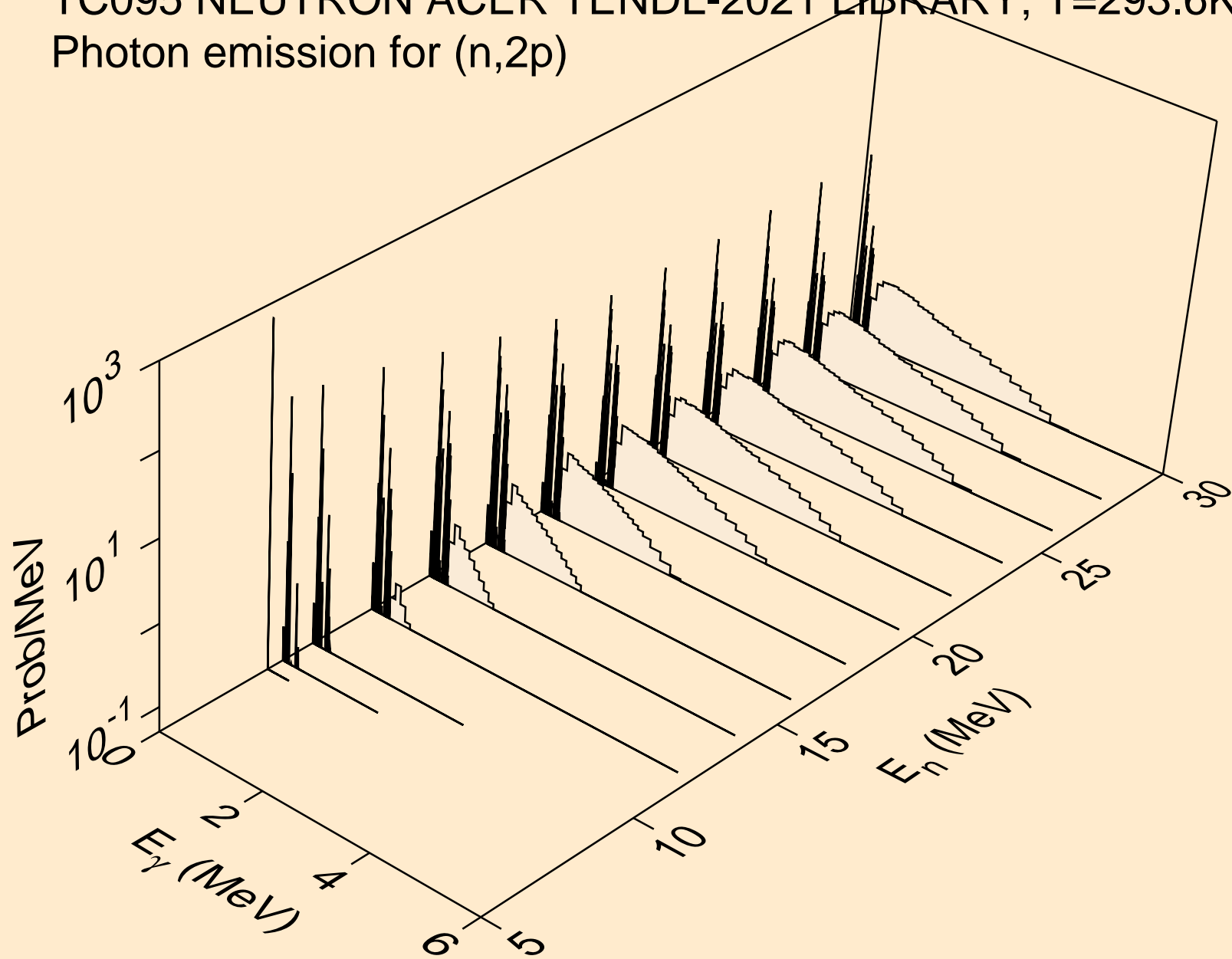

TC095 NEUTRON ACER TENDL-2021 LIBRARY; T=293.6K
Photon emission for (n,p)

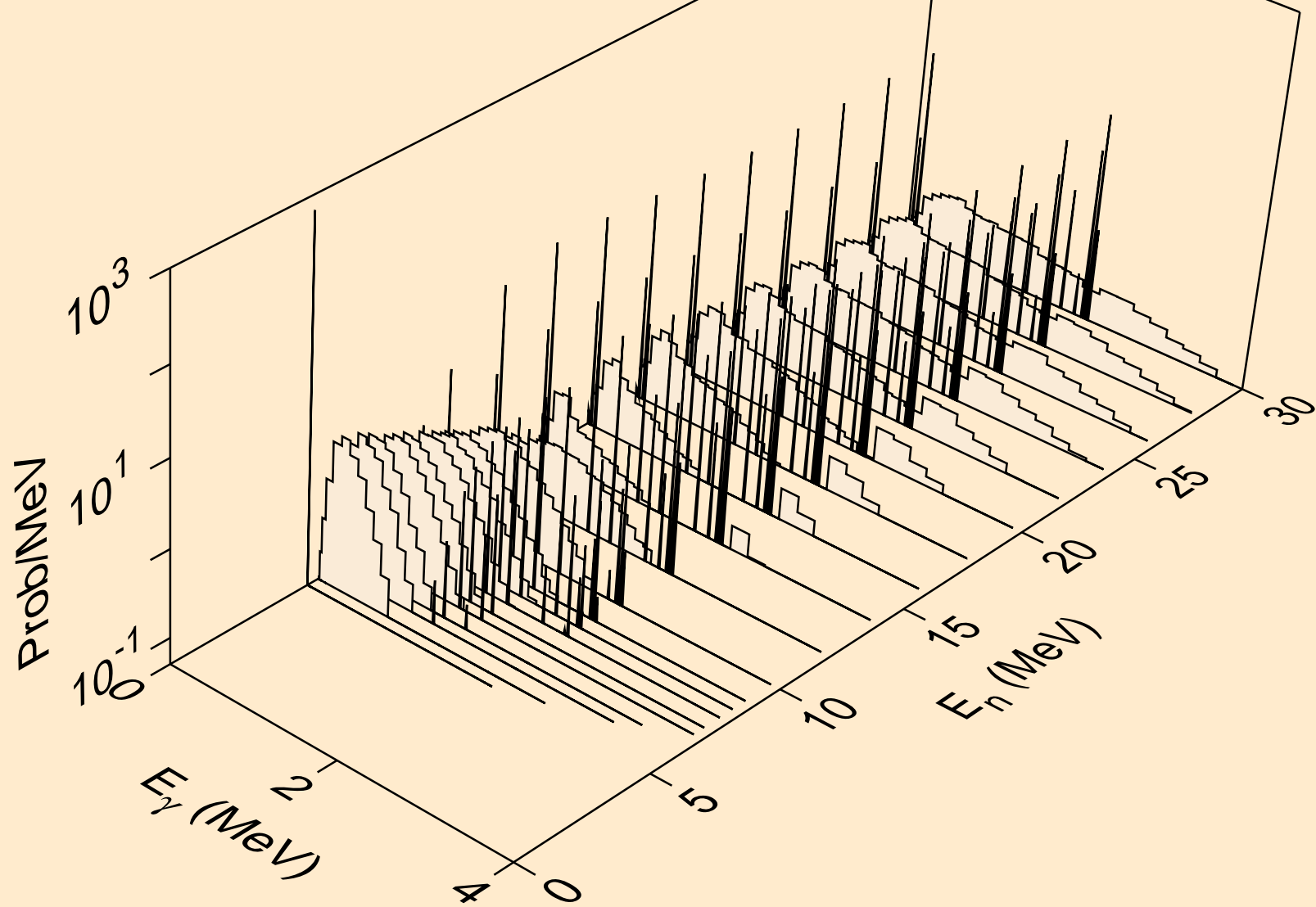

TC095 NEUTRON ACER TENDL-2021 LIBRARY; T=293.6K
Photon emission for (n,pd)

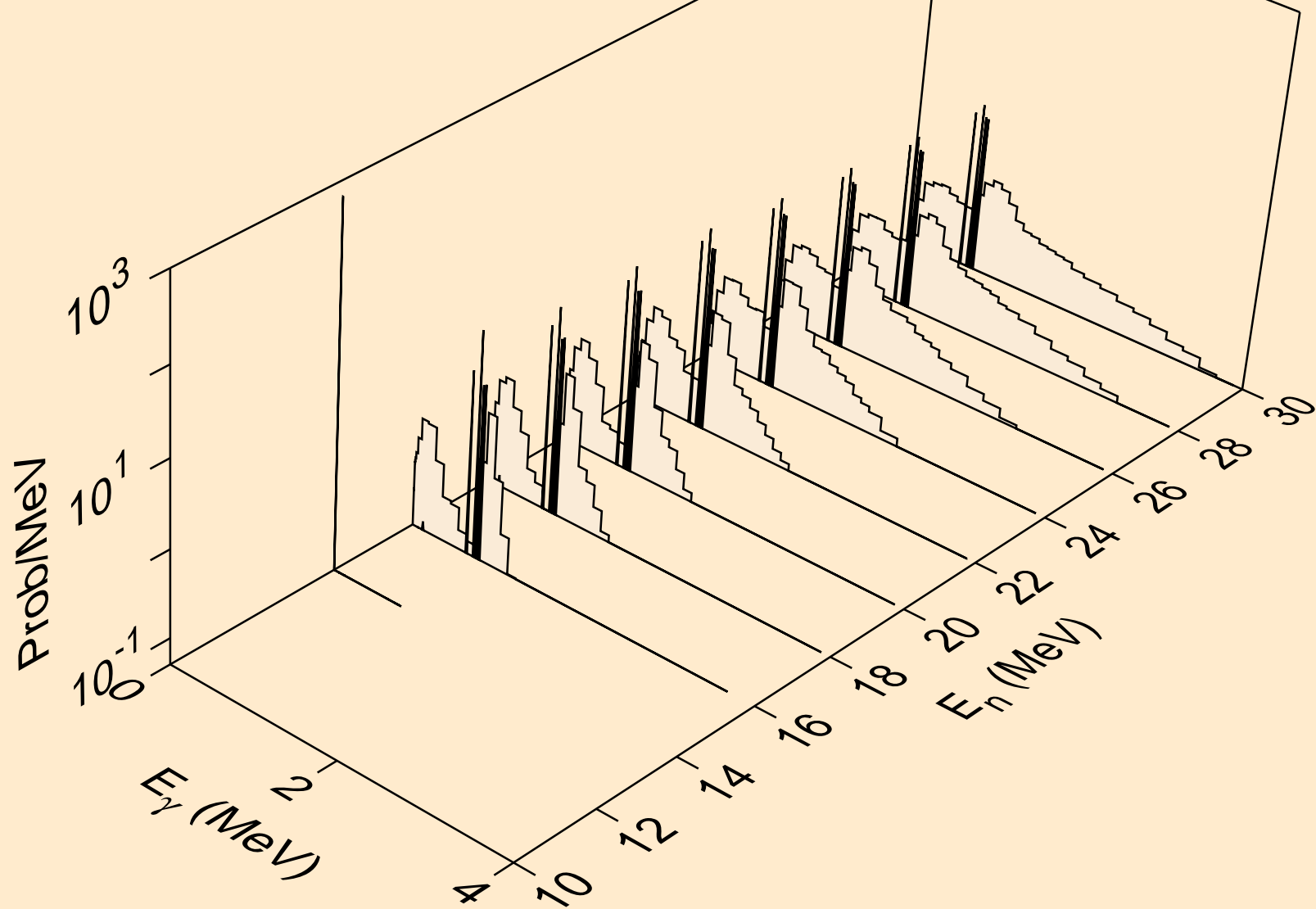

TC095 NEUTRON ACER TENDL-2021 LIBRARY; T=293.6K
Photon emission for (n,pt)

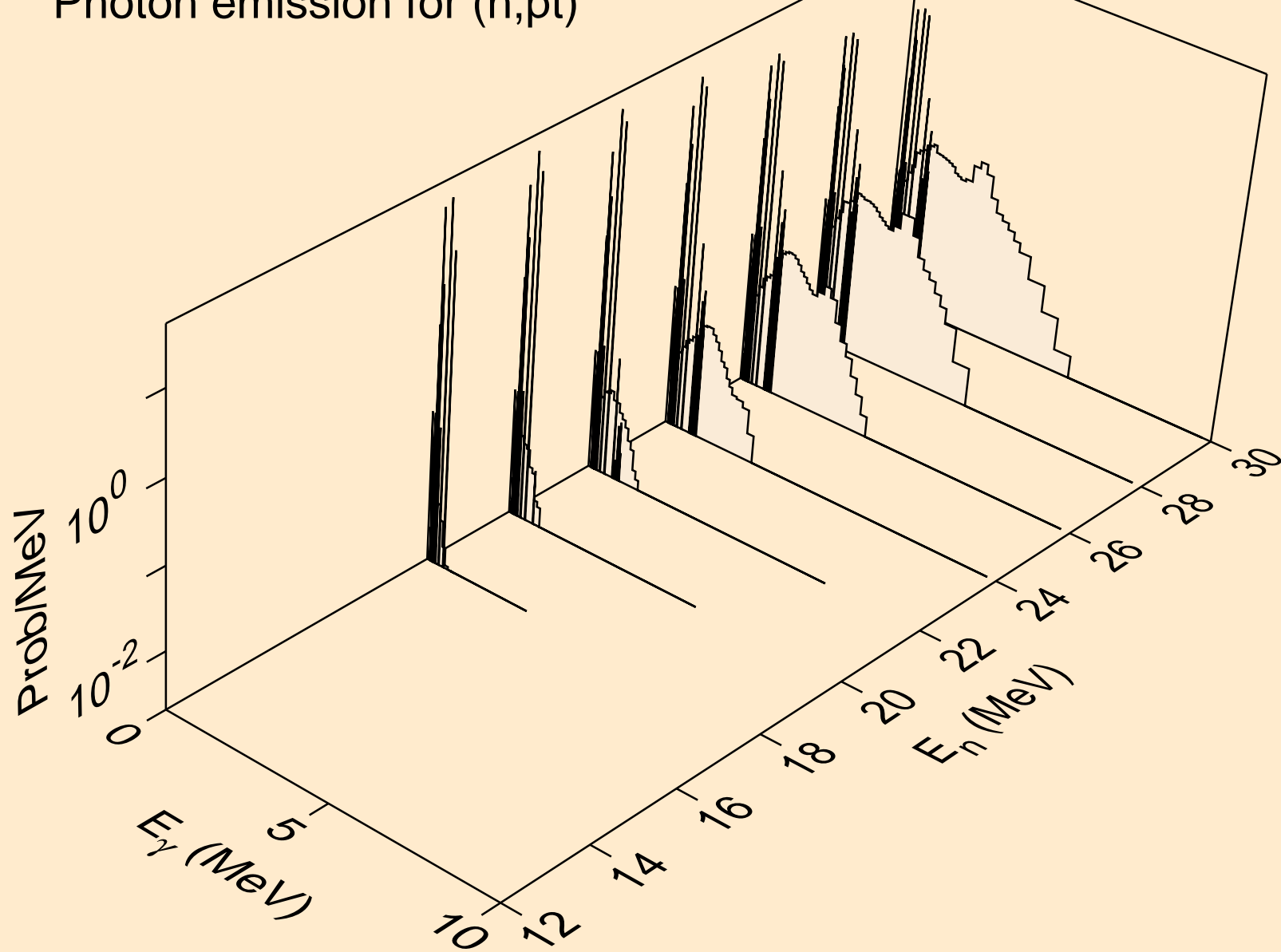

TC095 NEUTRON ACER TENDL-2021 LIBRARY; T=293.6K
Photon emission for (n,da)

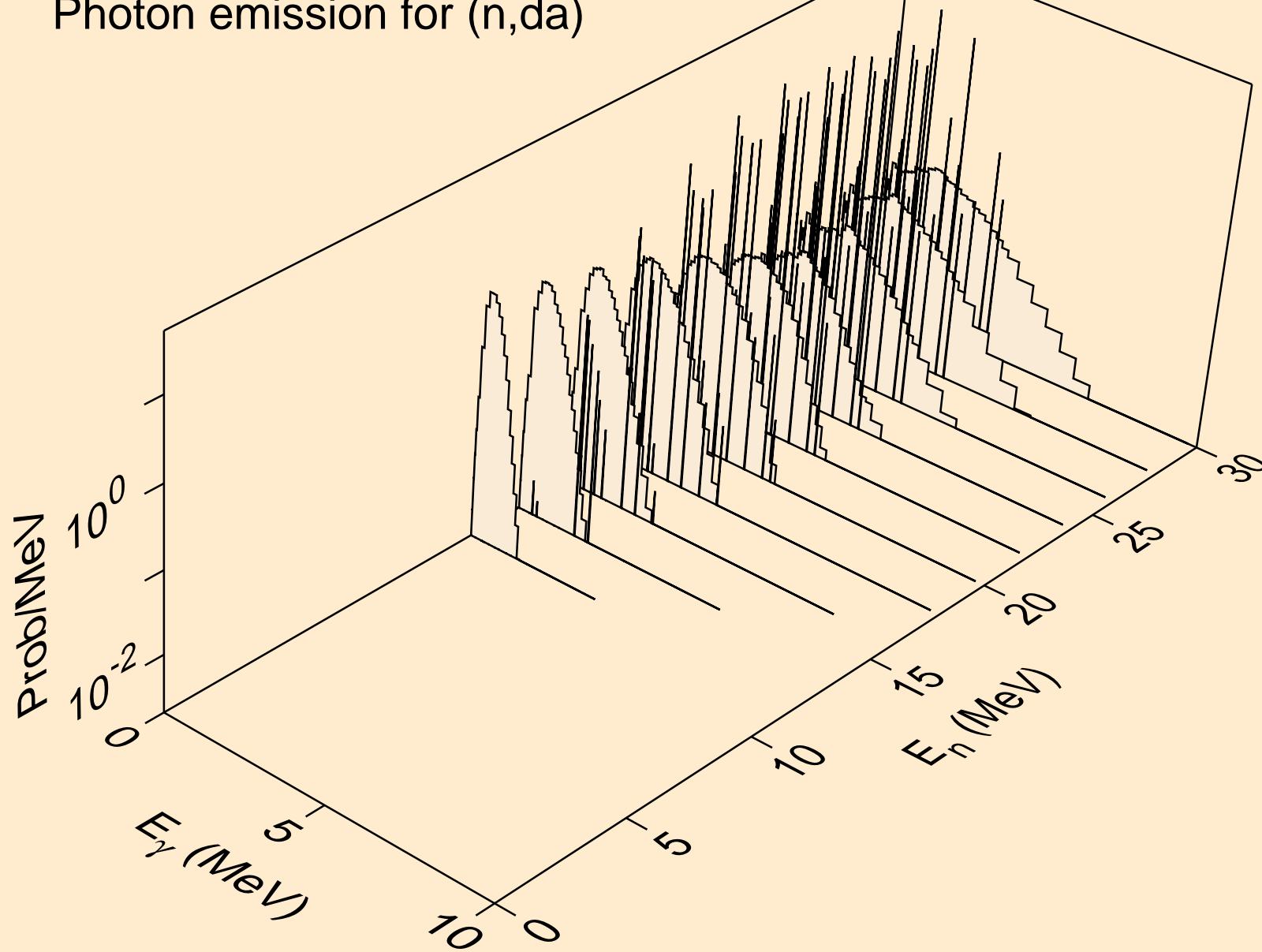

TC095 NEUTRON ACER TENDL-2021 LIBRARY; T=293.6K
thermal capture photon spectrum

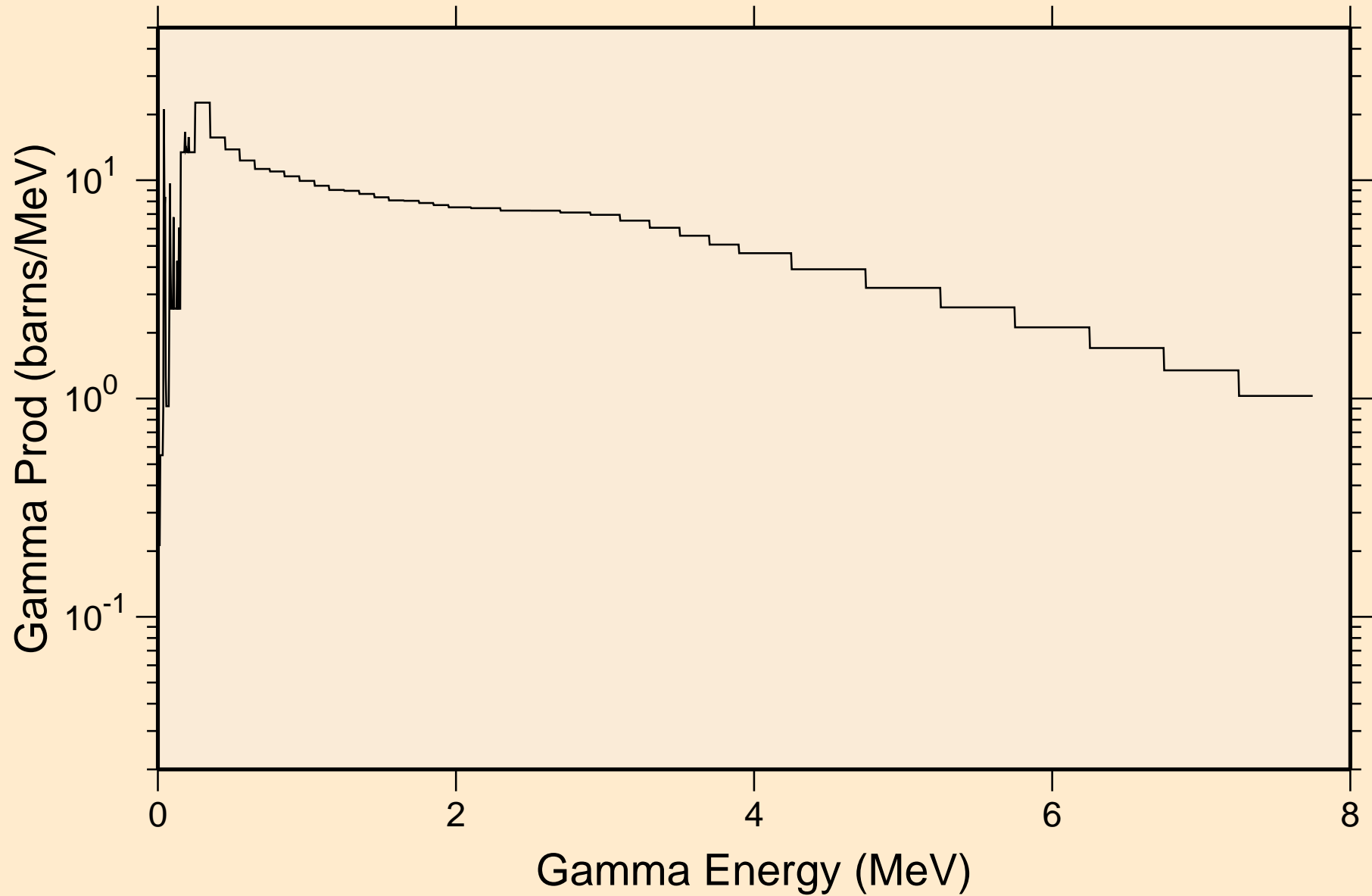

TC095 NEUTRON ACER TENDL-2021 LIBRARY; T=293.6K
14 MeV photon spectrum

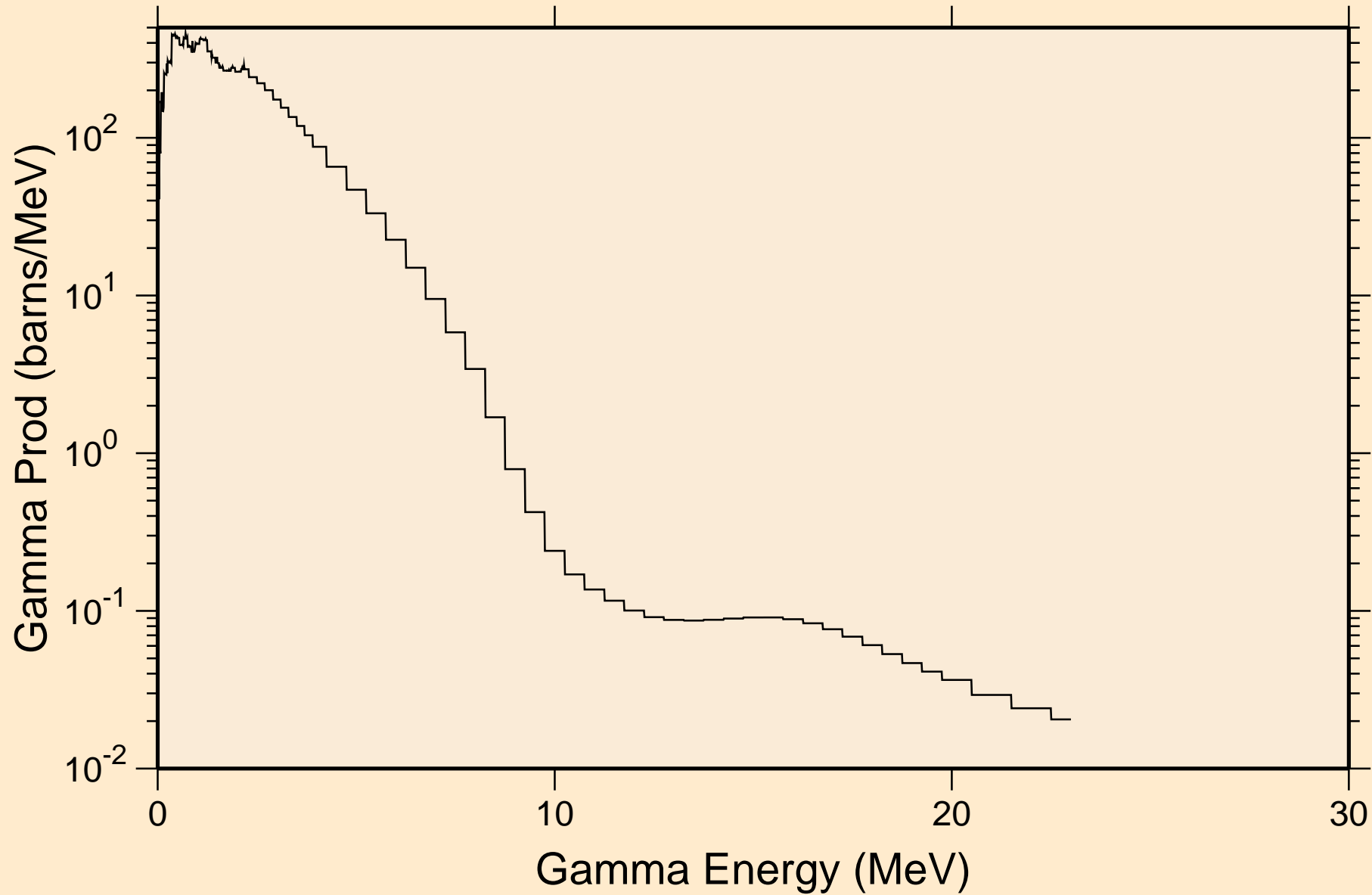

TC095 NEUTRON ACER TENDL-2021 LIBRARY; T=293.6K
Particle heating contributions

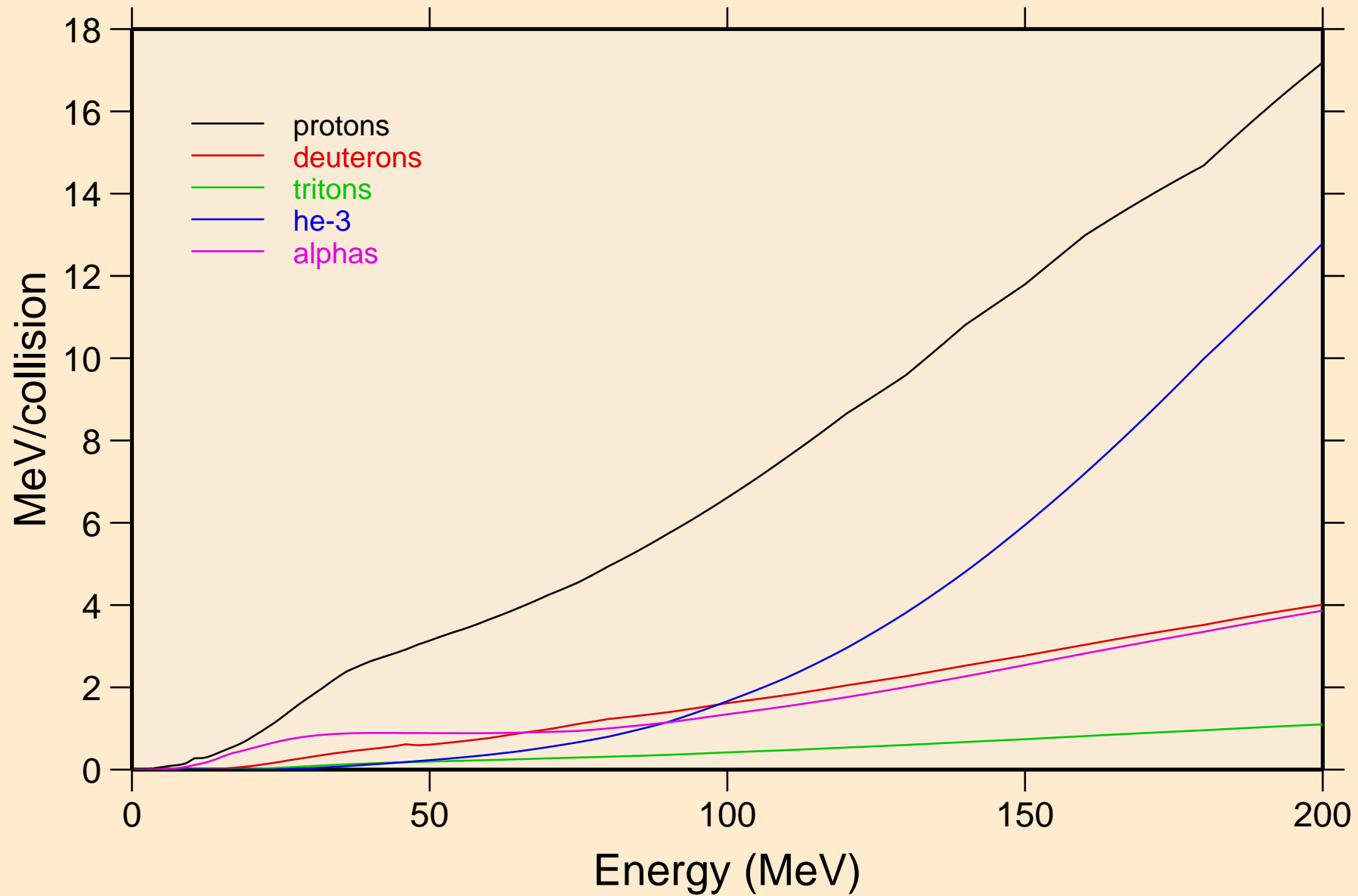

TC095 NEUTRON ACER TENDL-2021 LIBRARY; T=293.6K
Recoil Heating

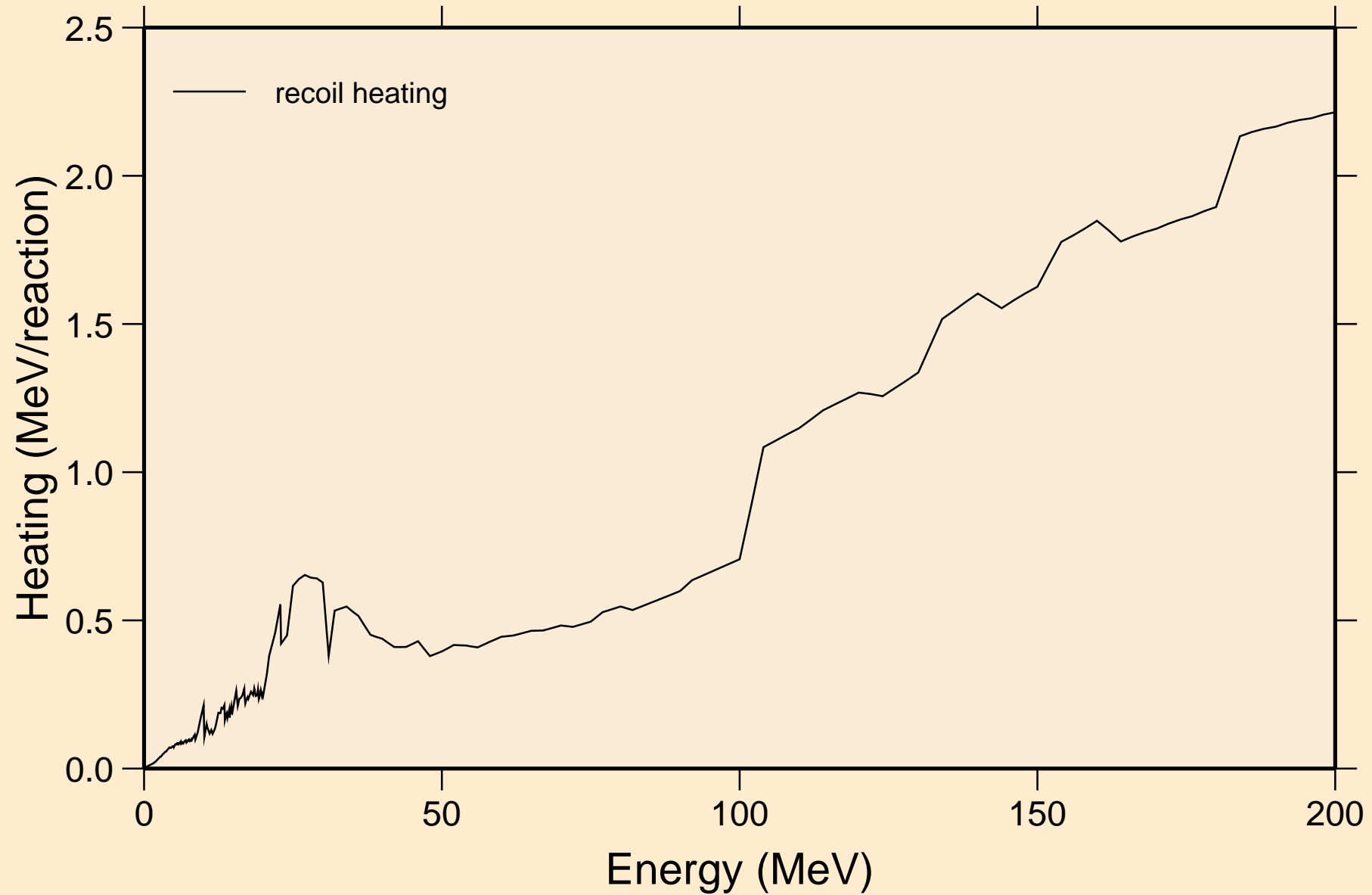

TC095 NEUTRON ACER TENDL-2021 LIBRARY; T=293.6K
Particle production cross sections

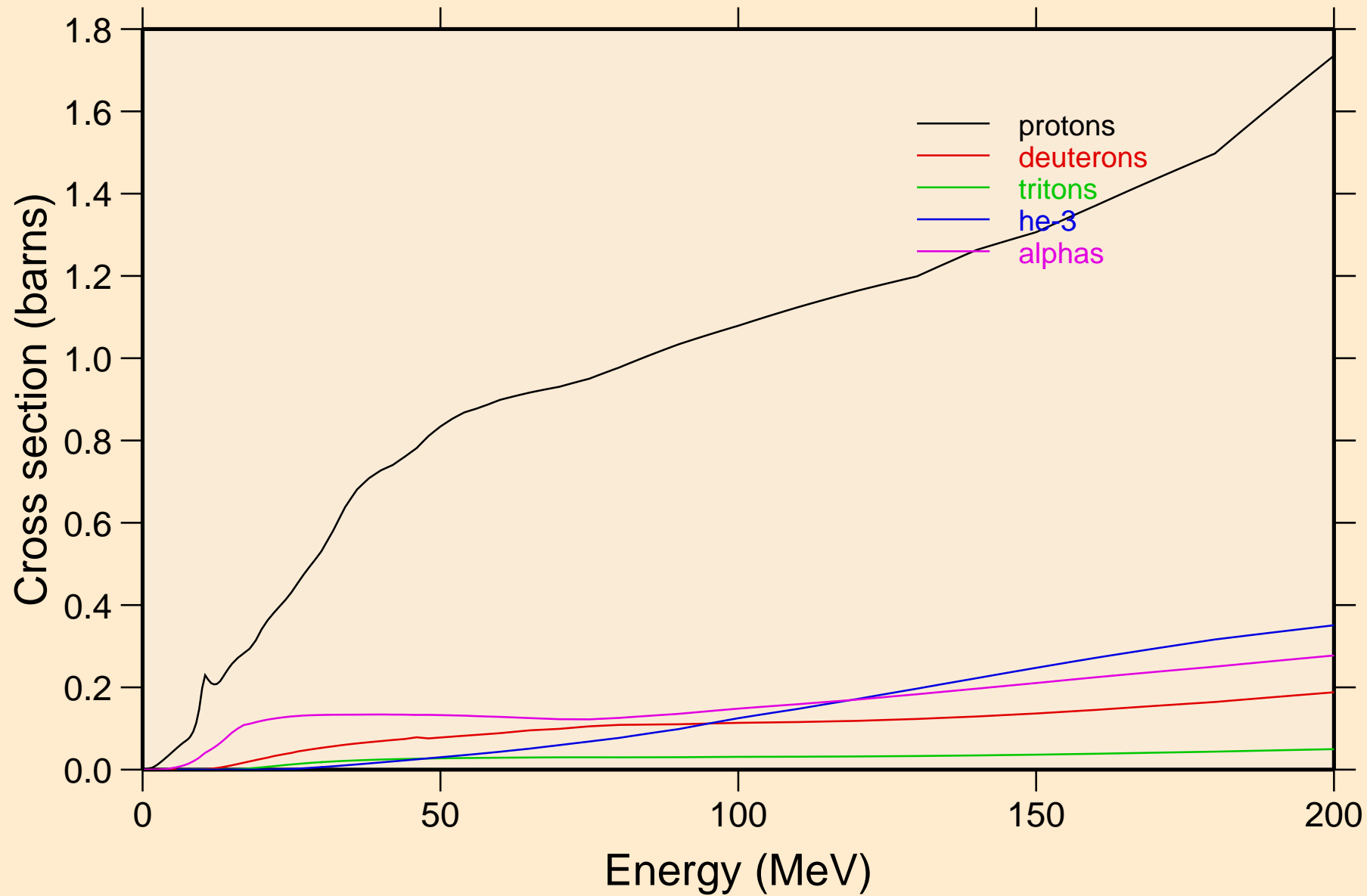

TC095 NEUTRON ACER TENDL-2021 LIBRARY; T=293.6K
protons from (n,x)

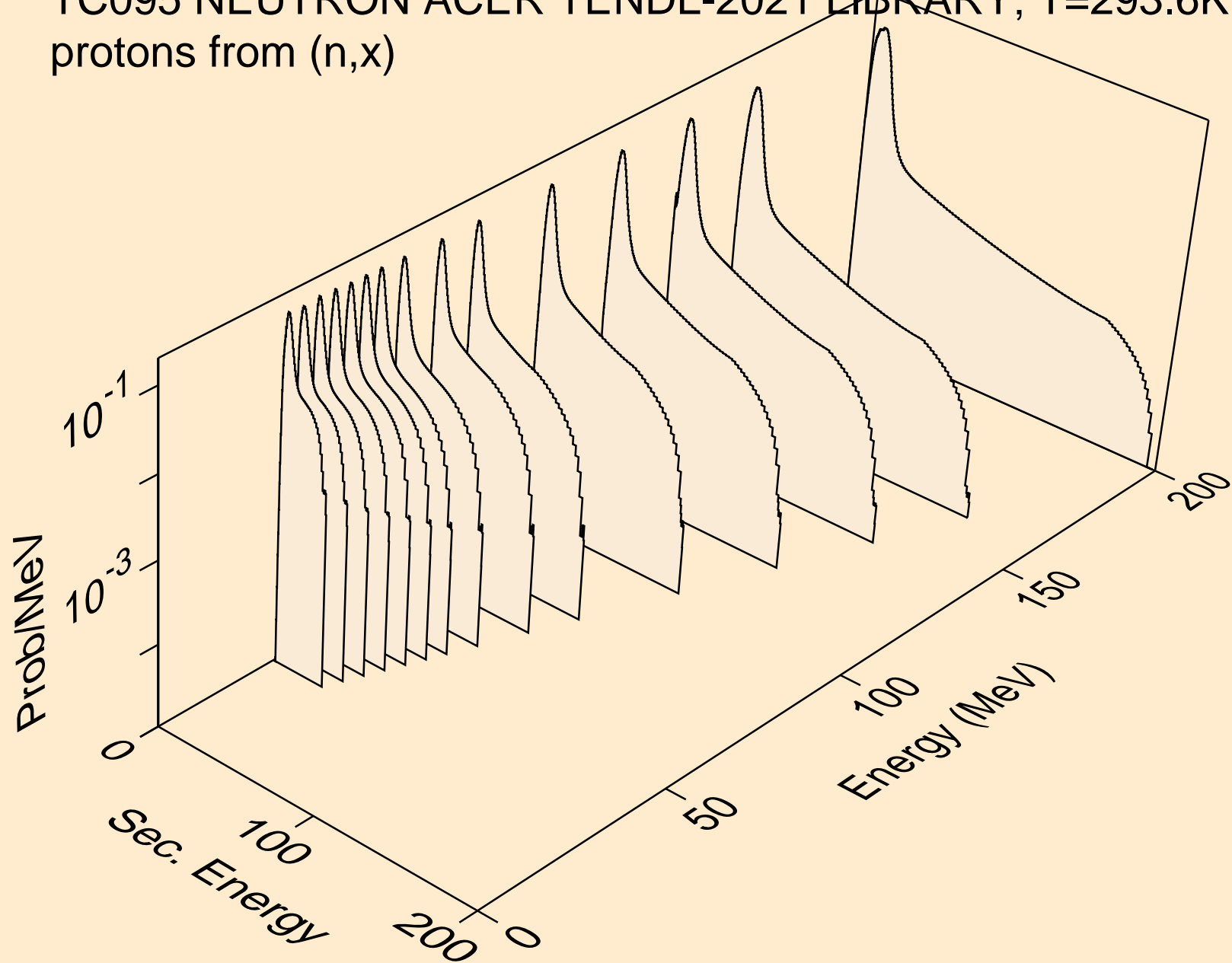

TC095 NEUTRON ACER TENDL-2021 LIBRARY; T=293.6K
protons from (n,n*)p

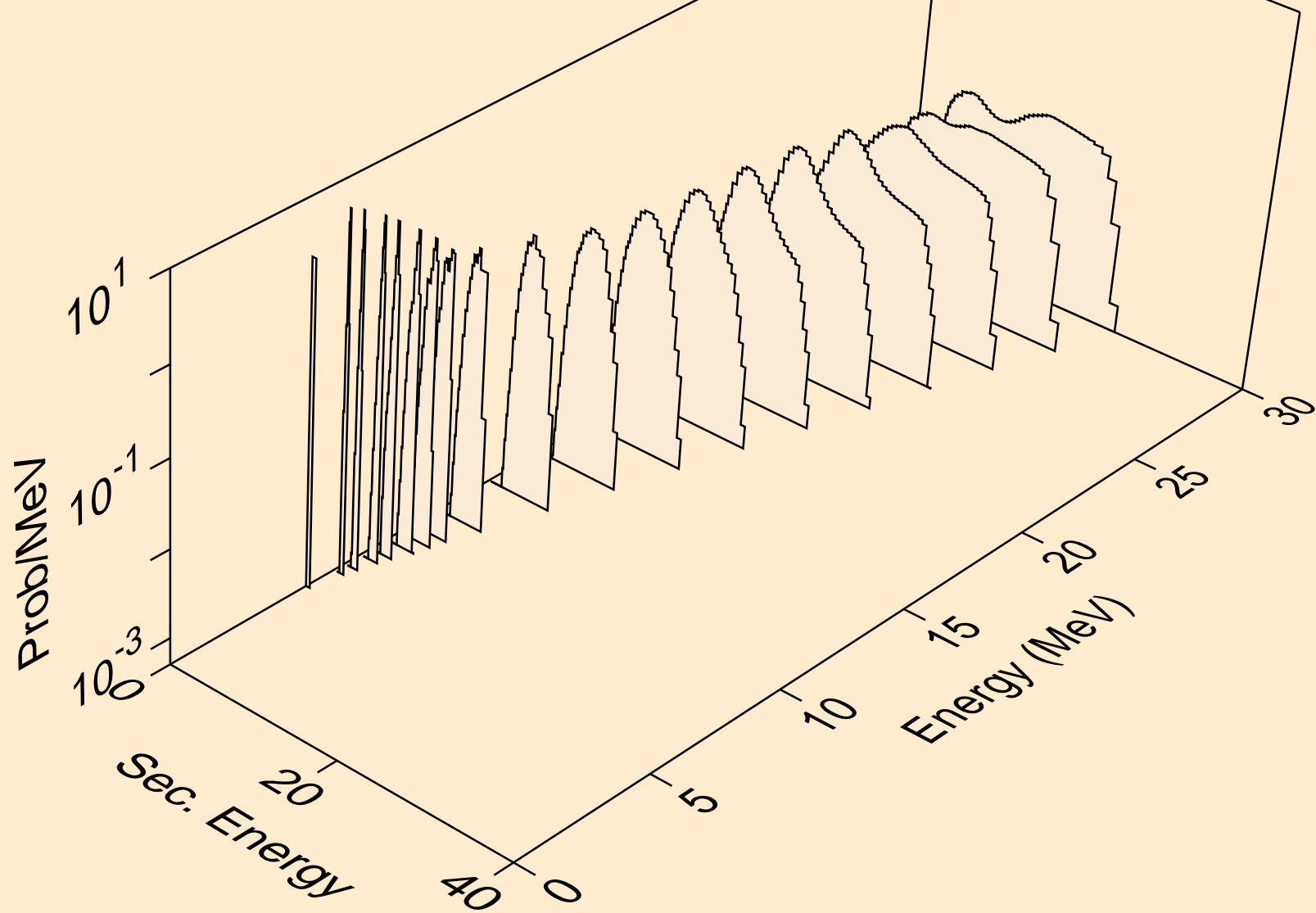

TC095 NEUTRON ACER TENDL-2021 LIBRARY; T=293.6K
protons from (n,2np)

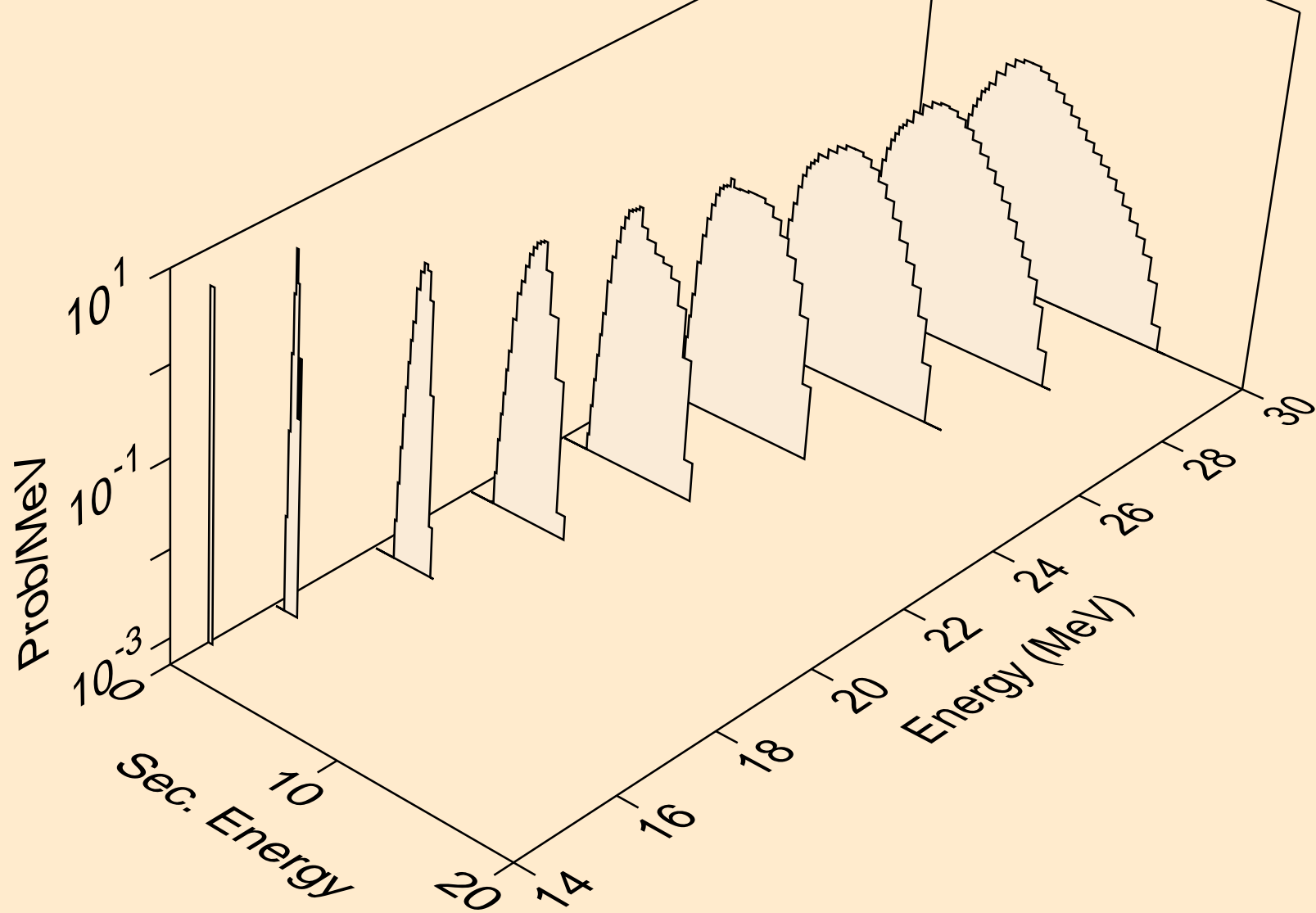

TC095 NEUTRON ACER TENDL-2021 LIBRARY; T=293.6K
protons from (n,3np)

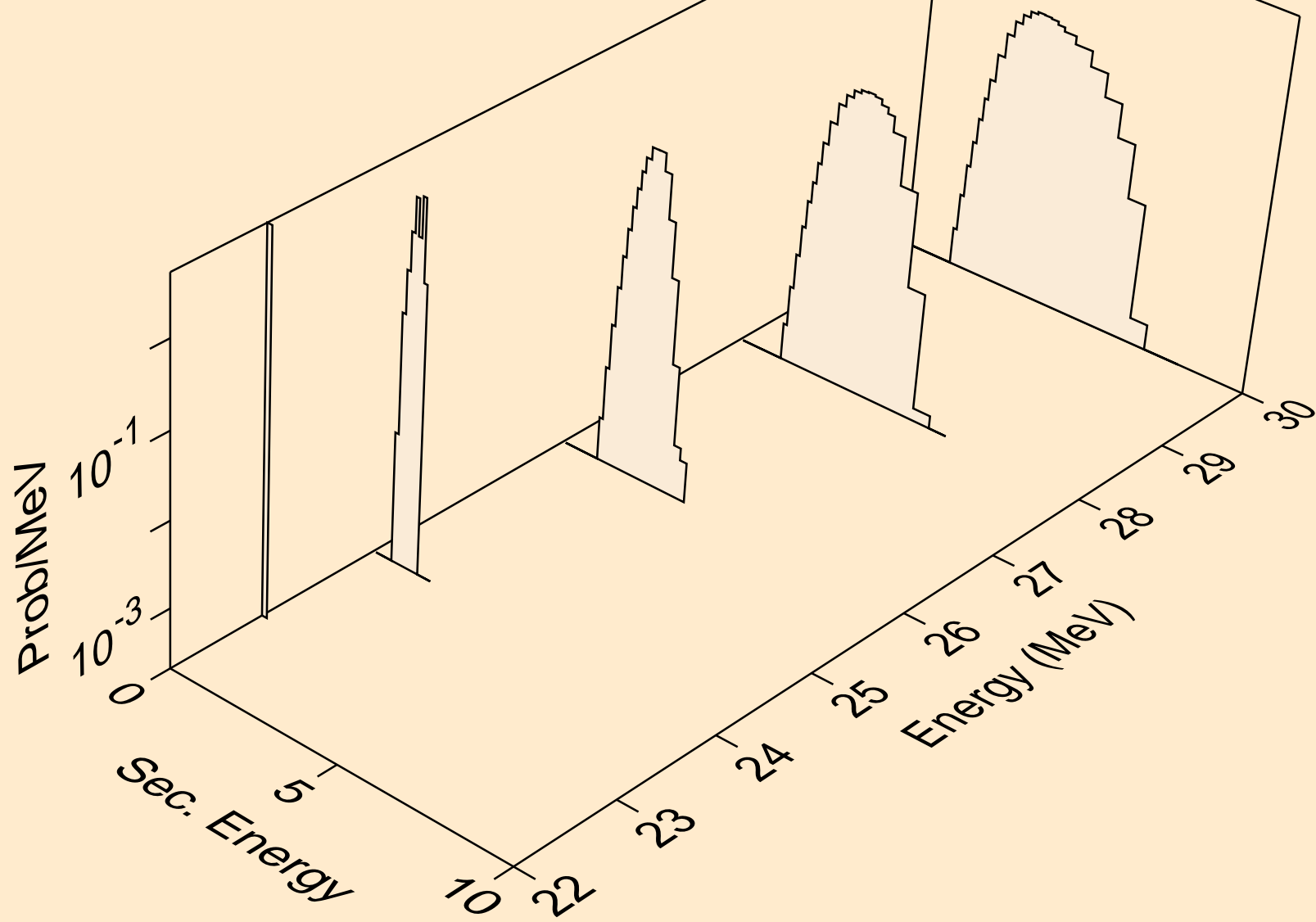

TC095 NEUTRON ACER TENDL-2021 LIBRARY; T=293.6K
protons from (n,2np)

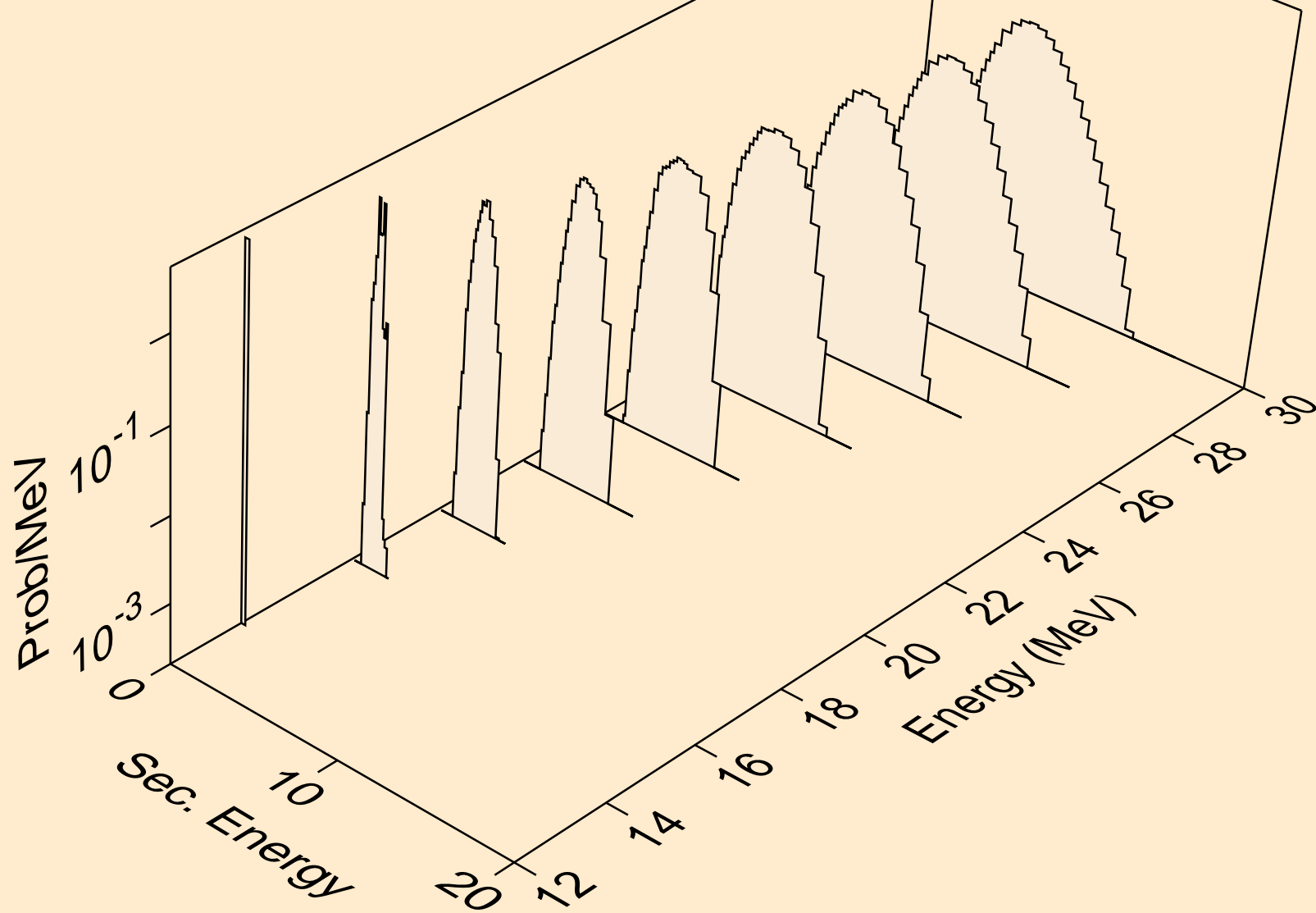

TC095 NEUTRON ACER TENDL-2021 LIBRARY; T=293.6K
protons from (n,npa)

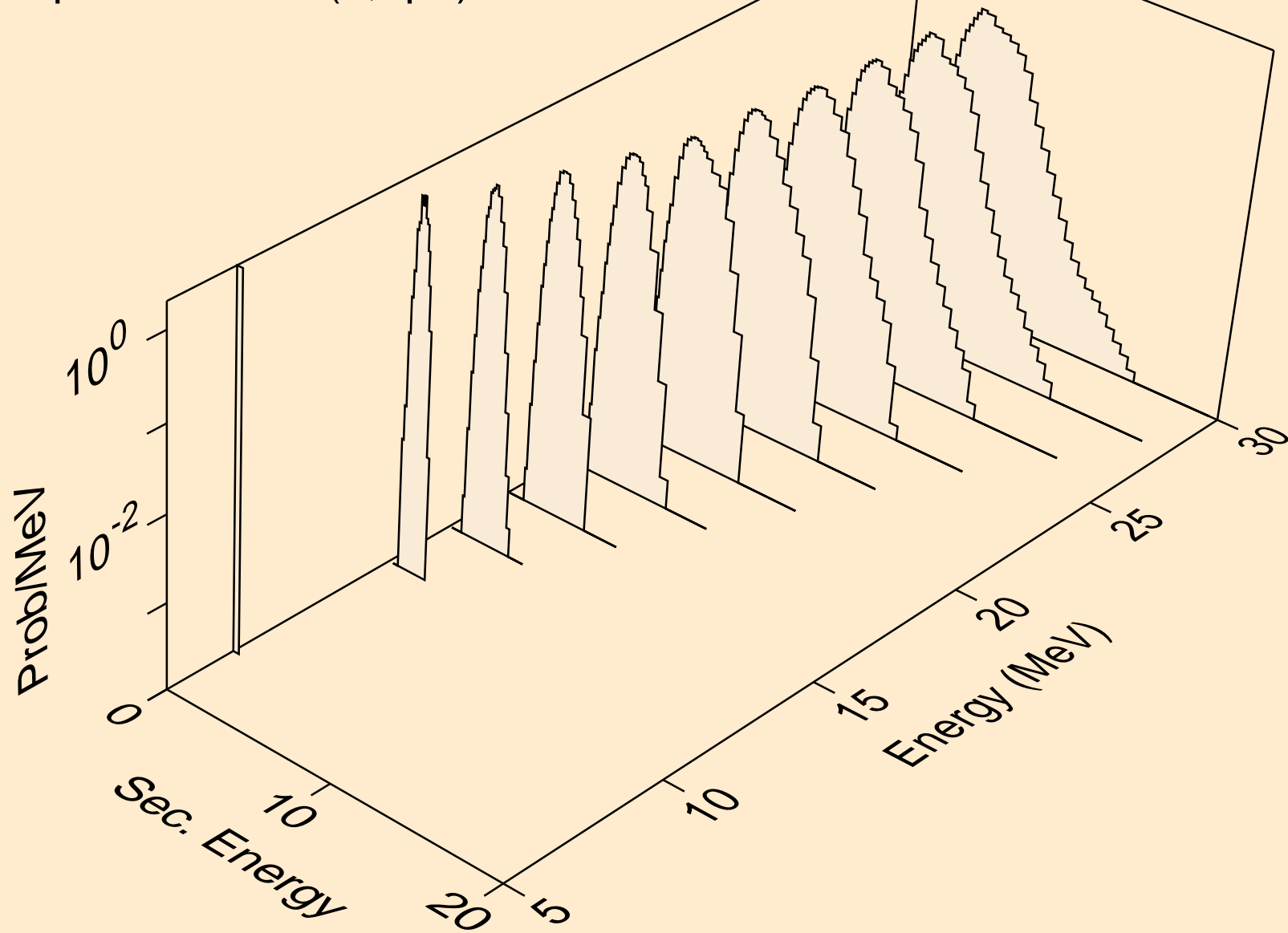

TC095 NEUTRON ACER TENDL-2021 LIBRARY; T=293.6K
protons from (n,p)

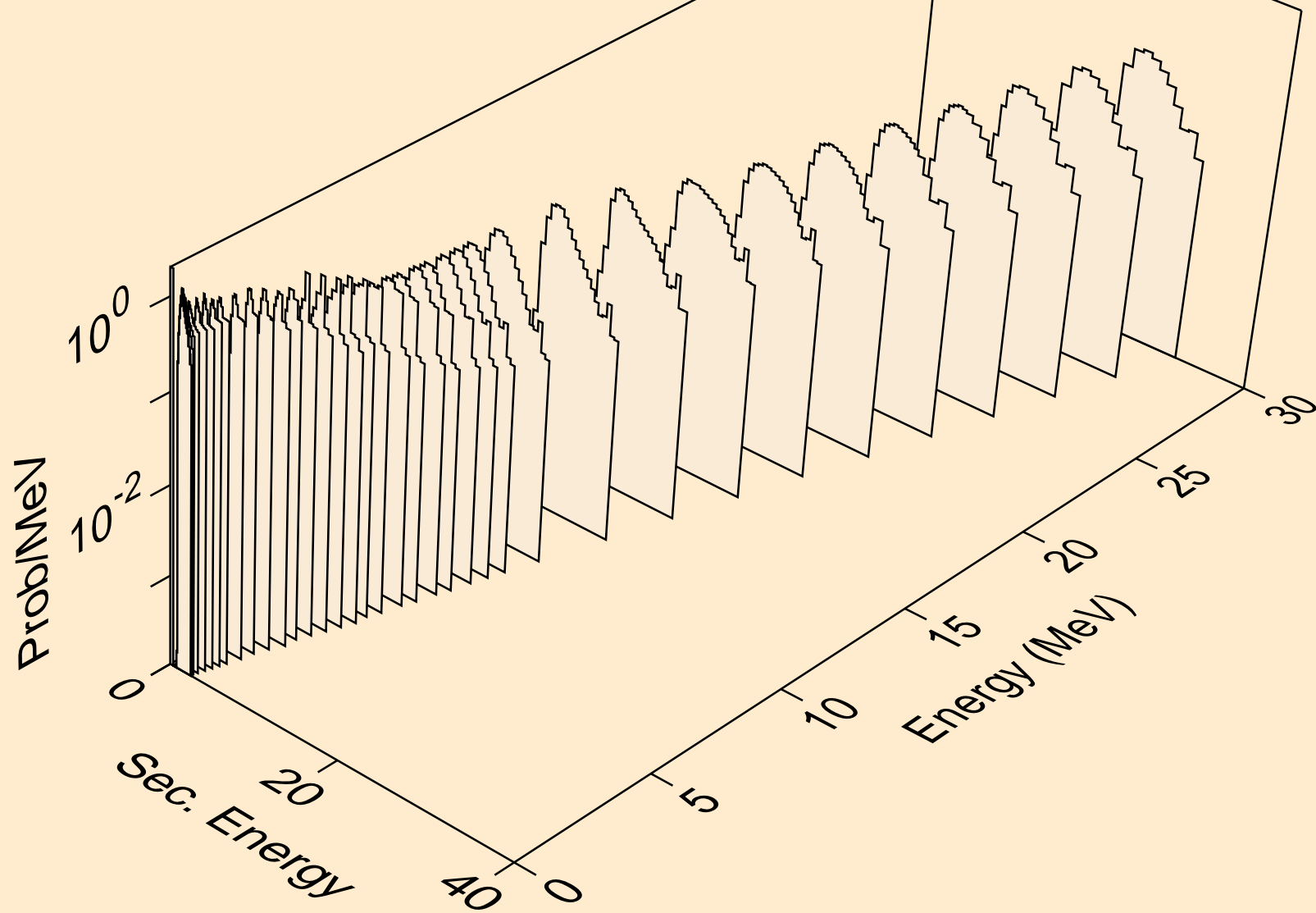

TC095 NEUTRON ACER TENDL-2021 LIBRARY; T=293.6K
protons from (n,2p)

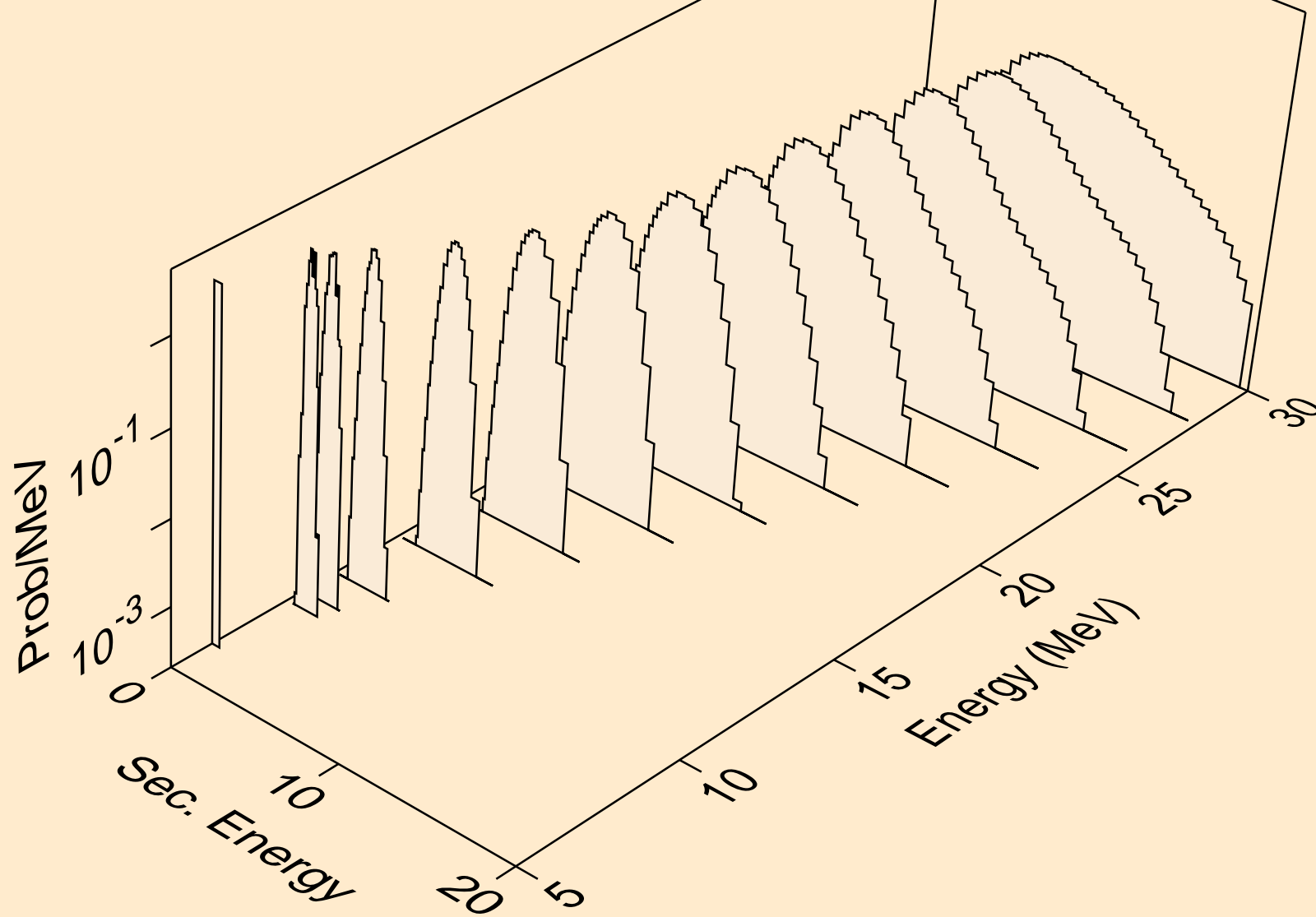

TC095 NEUTRON ACER TENDL-2021 LIBRARY; T=293.6K
protons from (n,p)

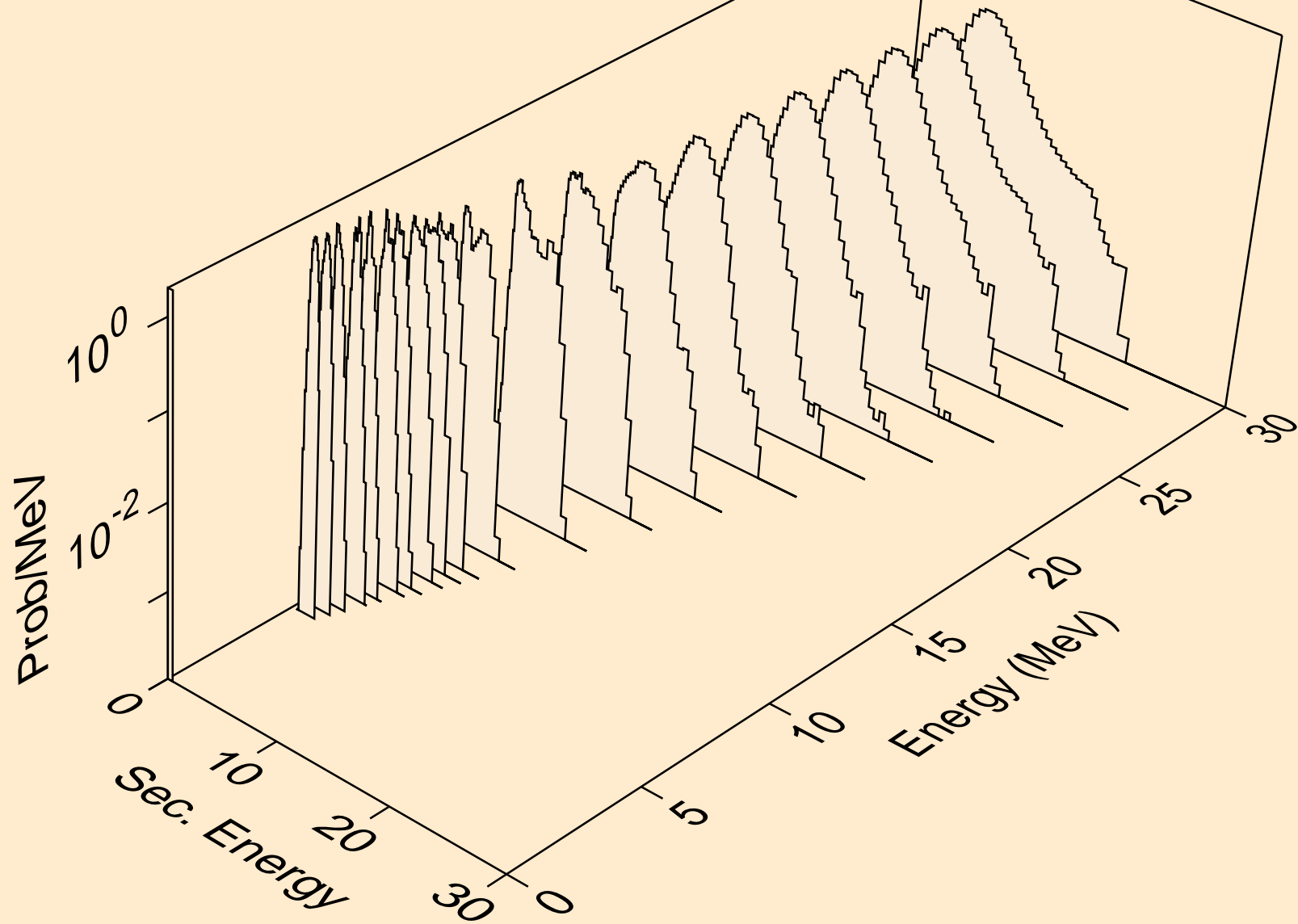

TC095 NEUTRON ACER TENDL-2021 LIBRARY; T=293.6K
protons from (n,pd)

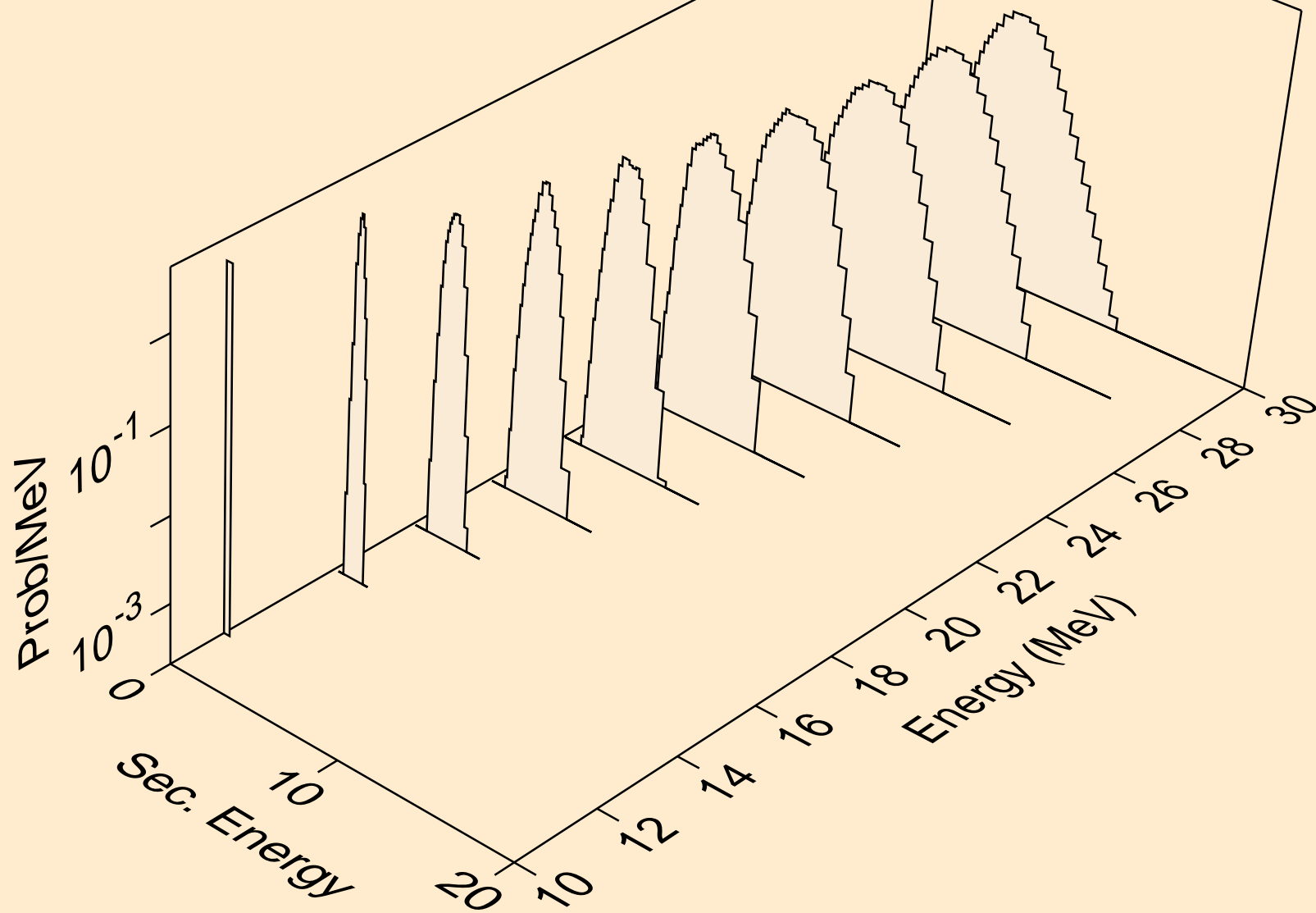

TC095 NEUTRON ACER TENDL-2021 LIBRARY; T=293.6K
protons from (n,pt)

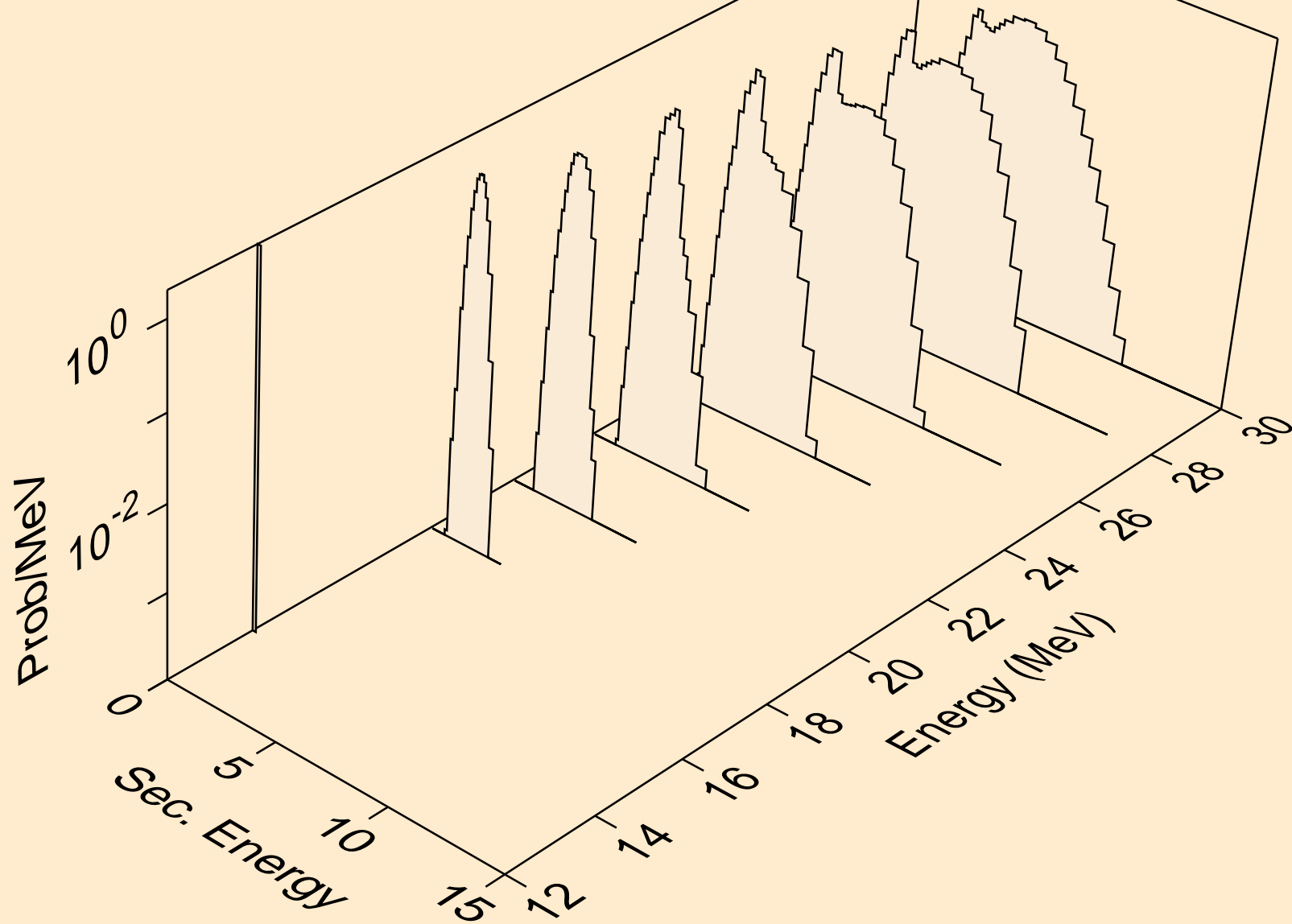

TC095 NEUTRON ACER TENDL-2021 LIBRARY; T=293.6K
deuterons from (n,x)

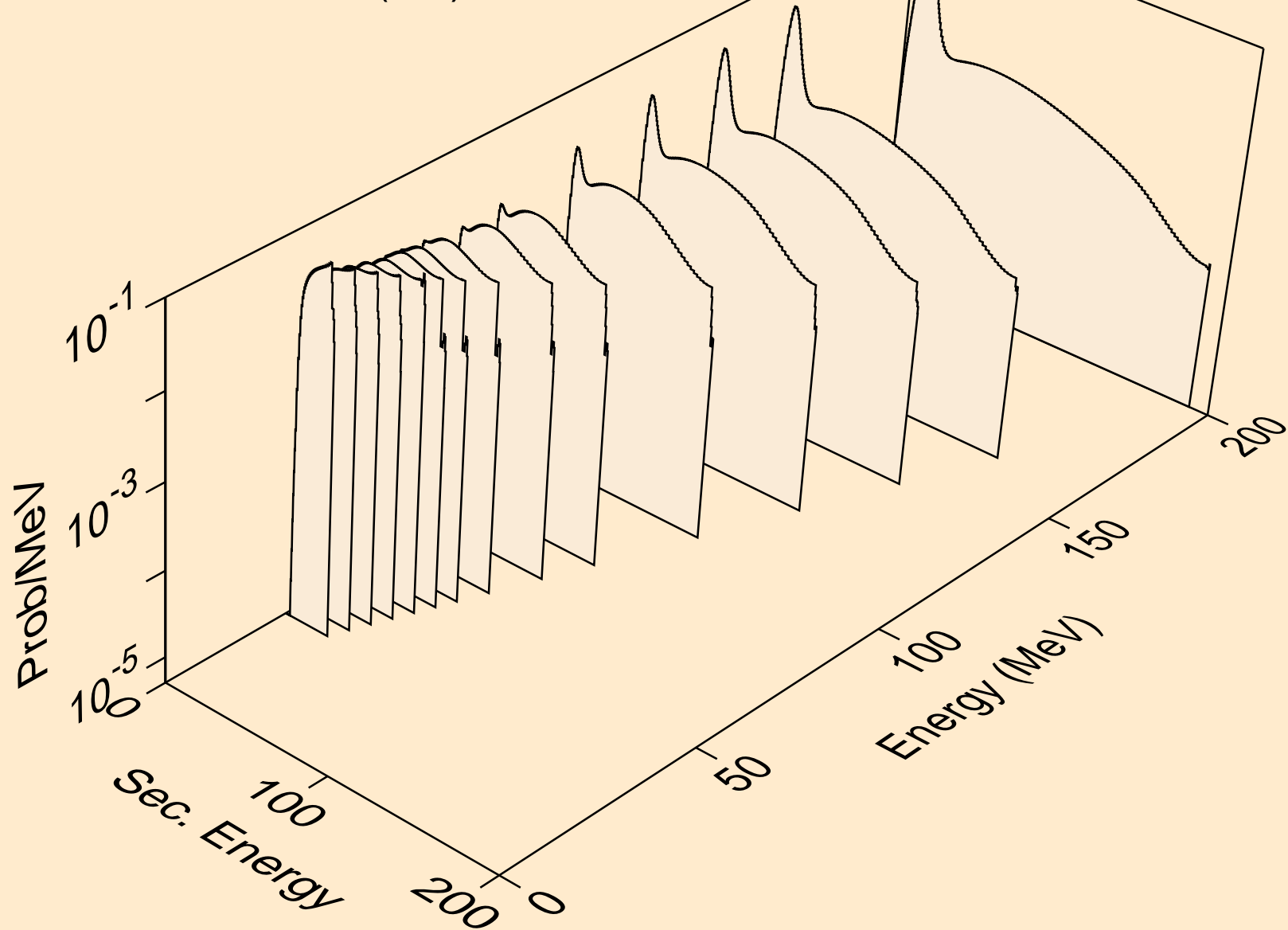

TC095 NEUTRON ACER TENDL-2021 LIBRARY; T=293.6K
deuterons from (n,2nd)

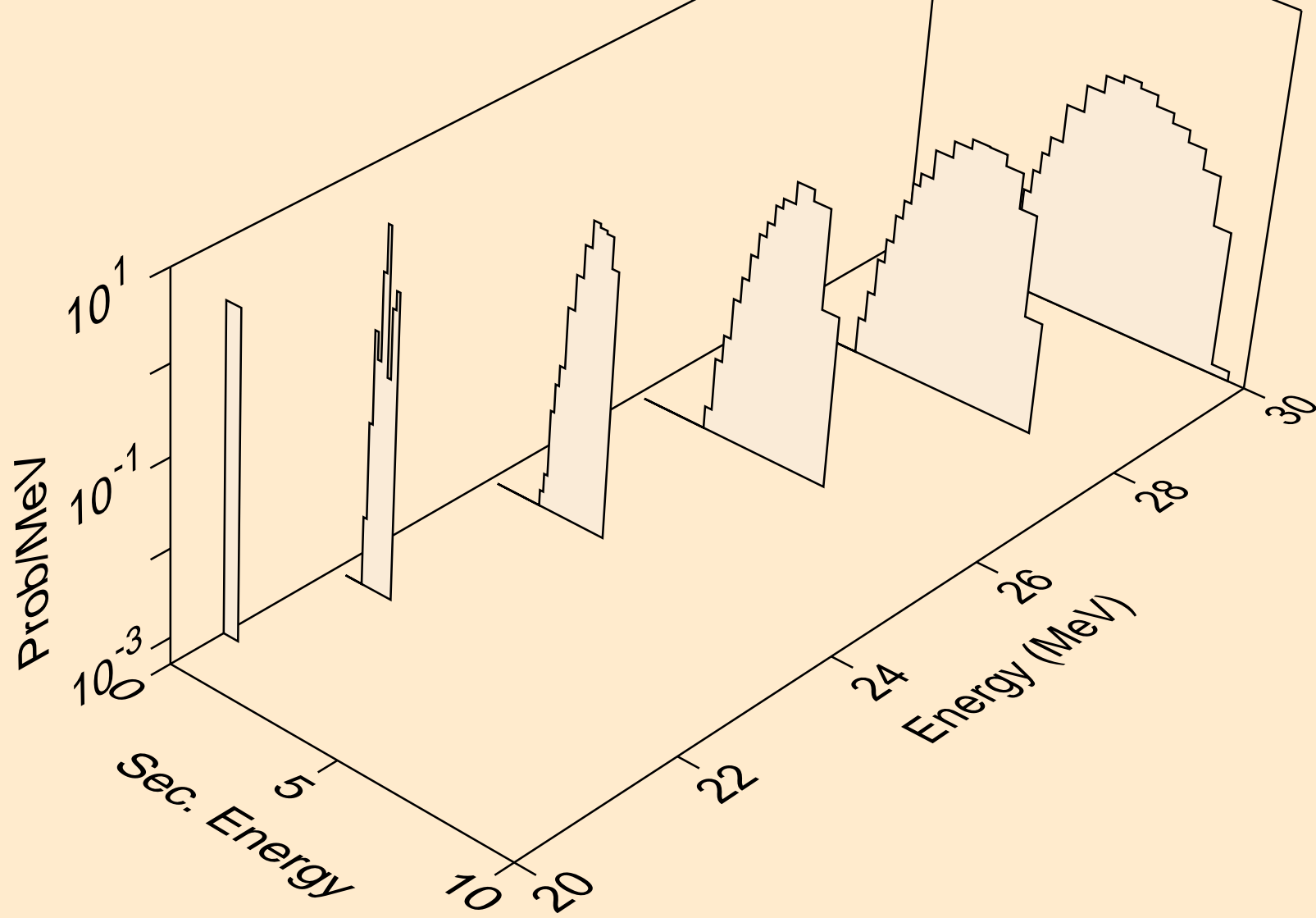

TC095 NEUTRON ACER TENDL-2021 LIBRARY; T=293.6K
deuterons from (n,n*)d

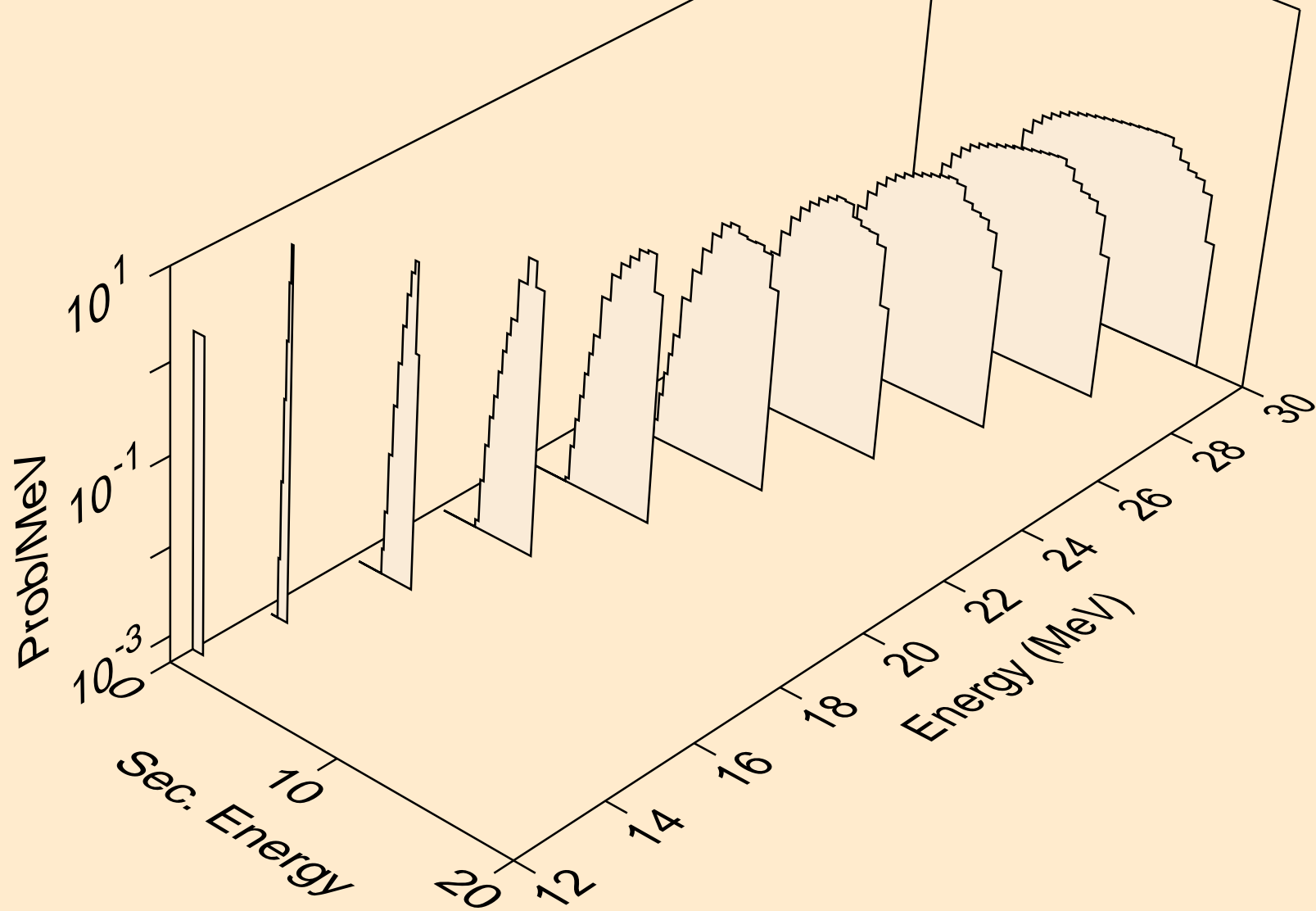

TC095 NEUTRON ACER TENDL-2021 LIBRARY; T=293.6K
deuterons from (n,d)

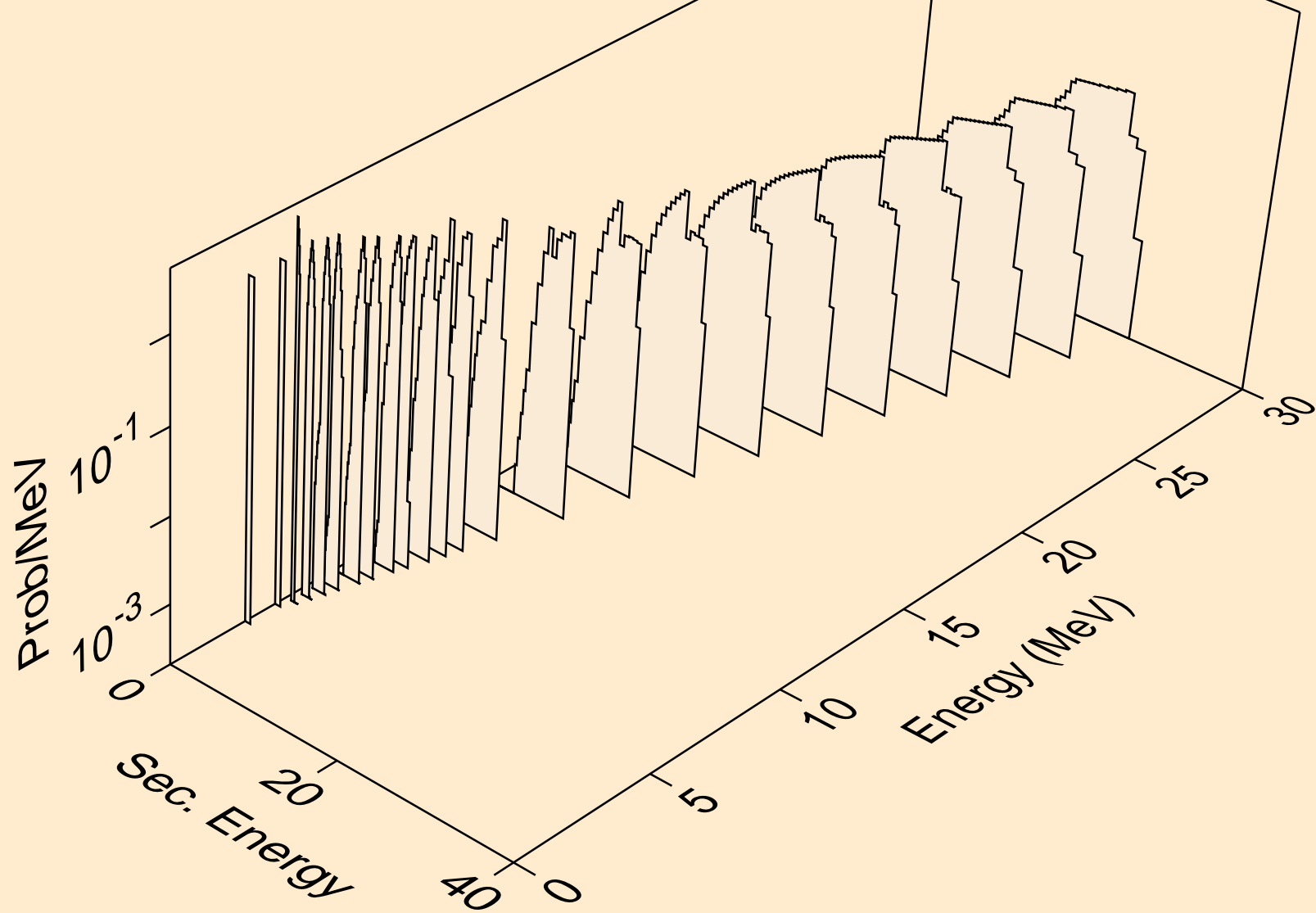

TC095 NEUTRON ACER TENDL-2021 LIBRARY; T=293.6K
deuterons from (n,pd)

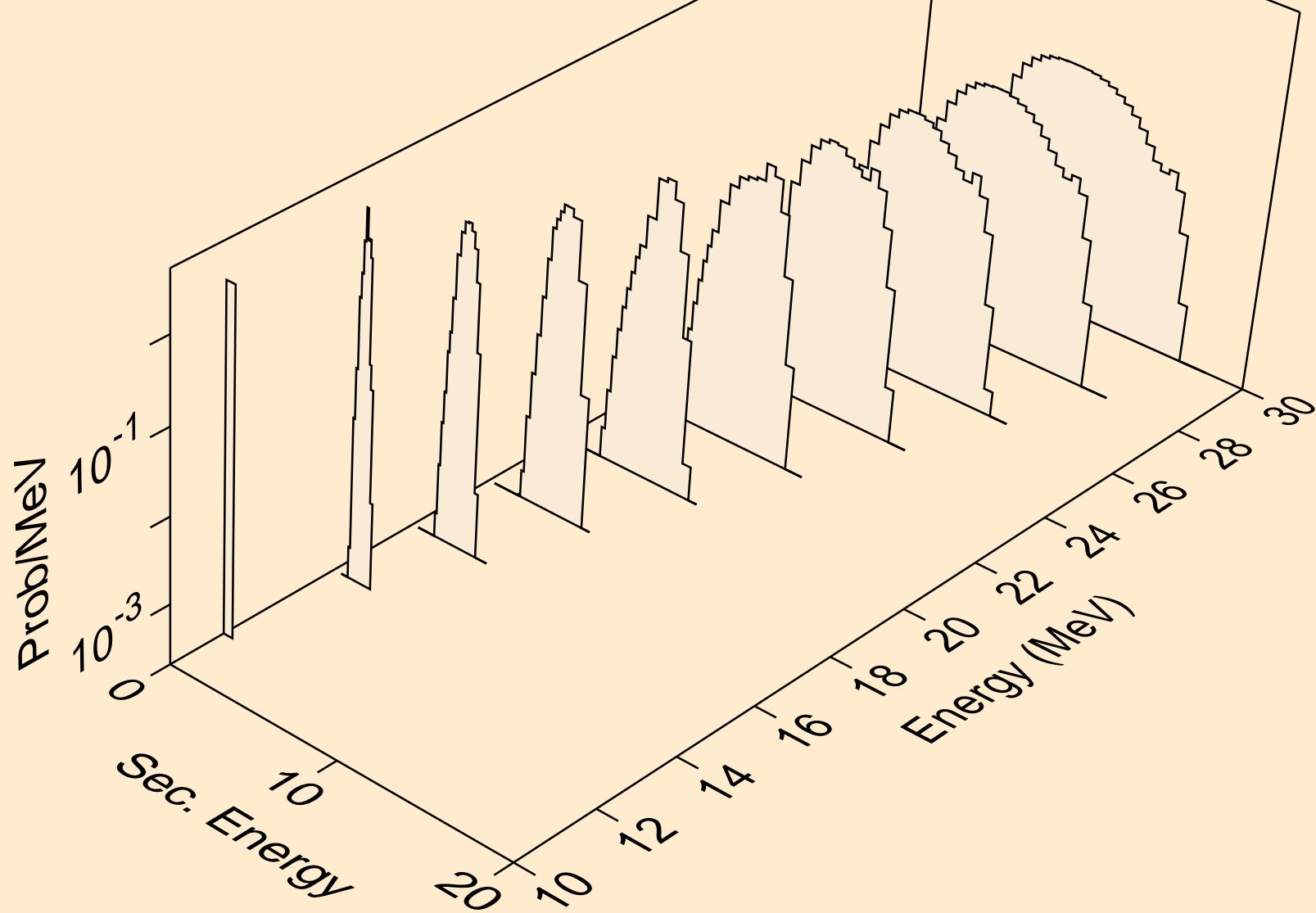

TC095 NEUTRON ACER TENDL-2021 LIBRARY; T=293.6K
deuterons from (n,da)

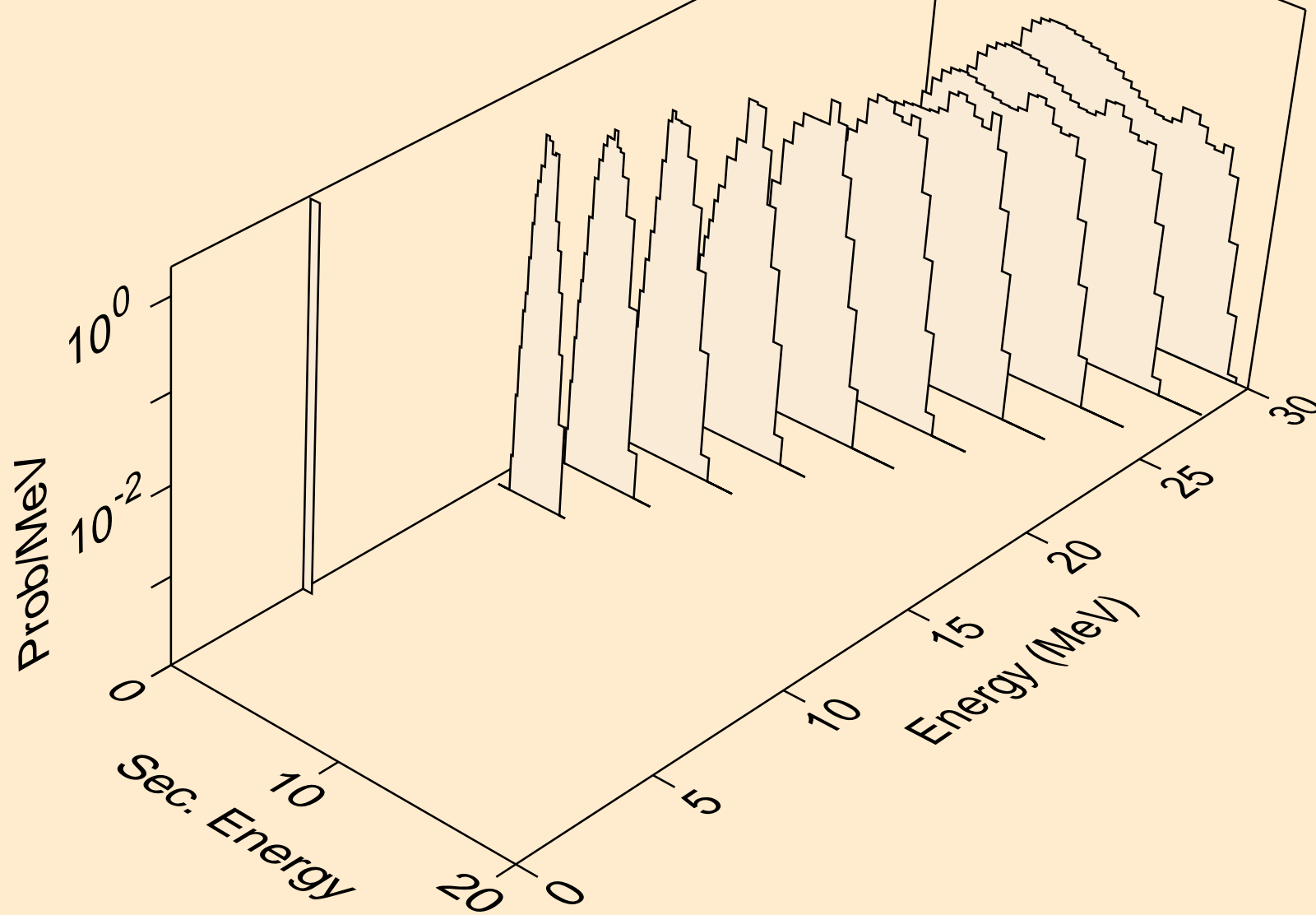

TC095 NEUTRON ACER TENDL-2021 LIBRARY; T=293.6K
tritons from (n,x)

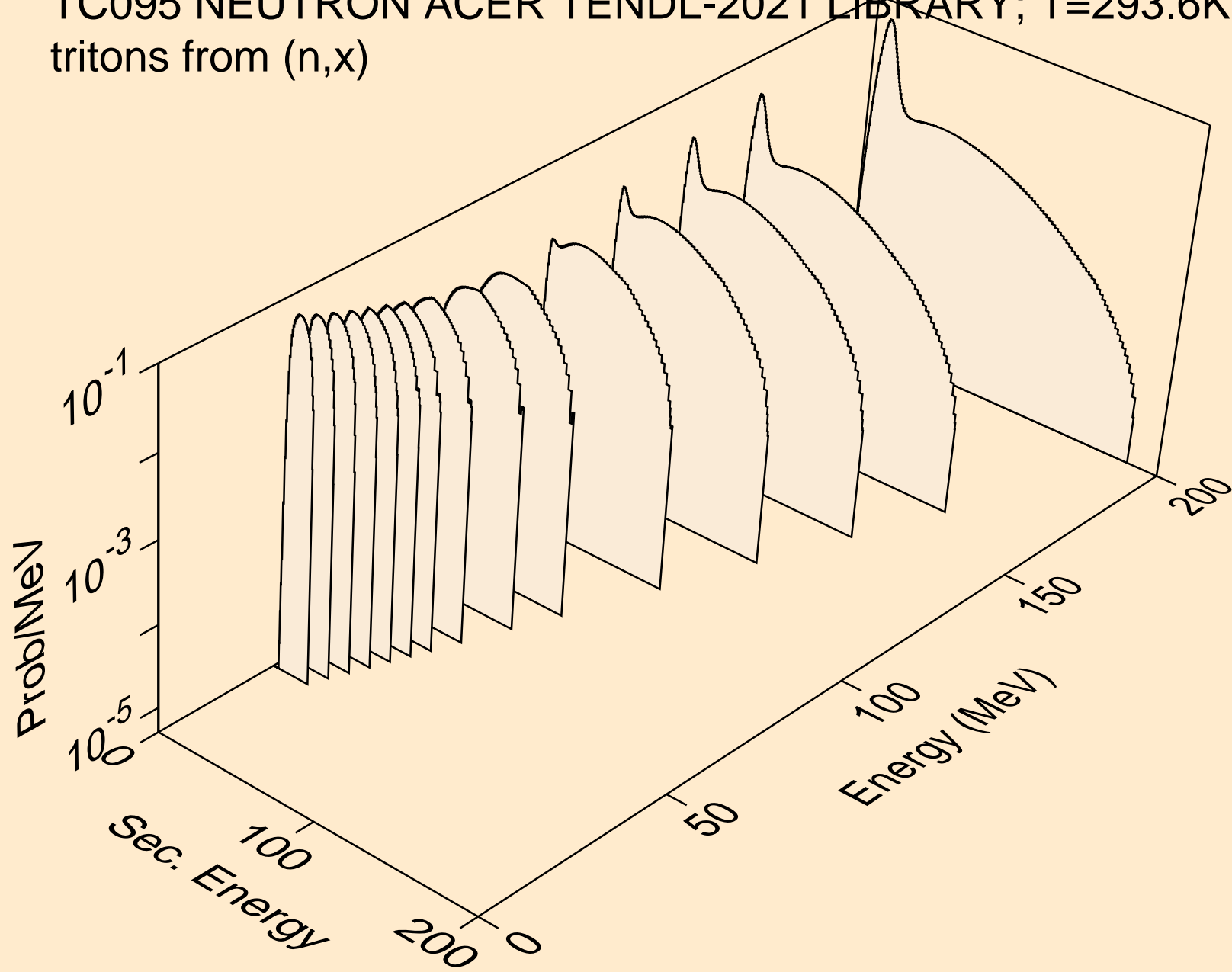

TC095 NEUTRON ACER TENDL-2021 LIBRARY; T=293.6K
tritons from (n,n*)t

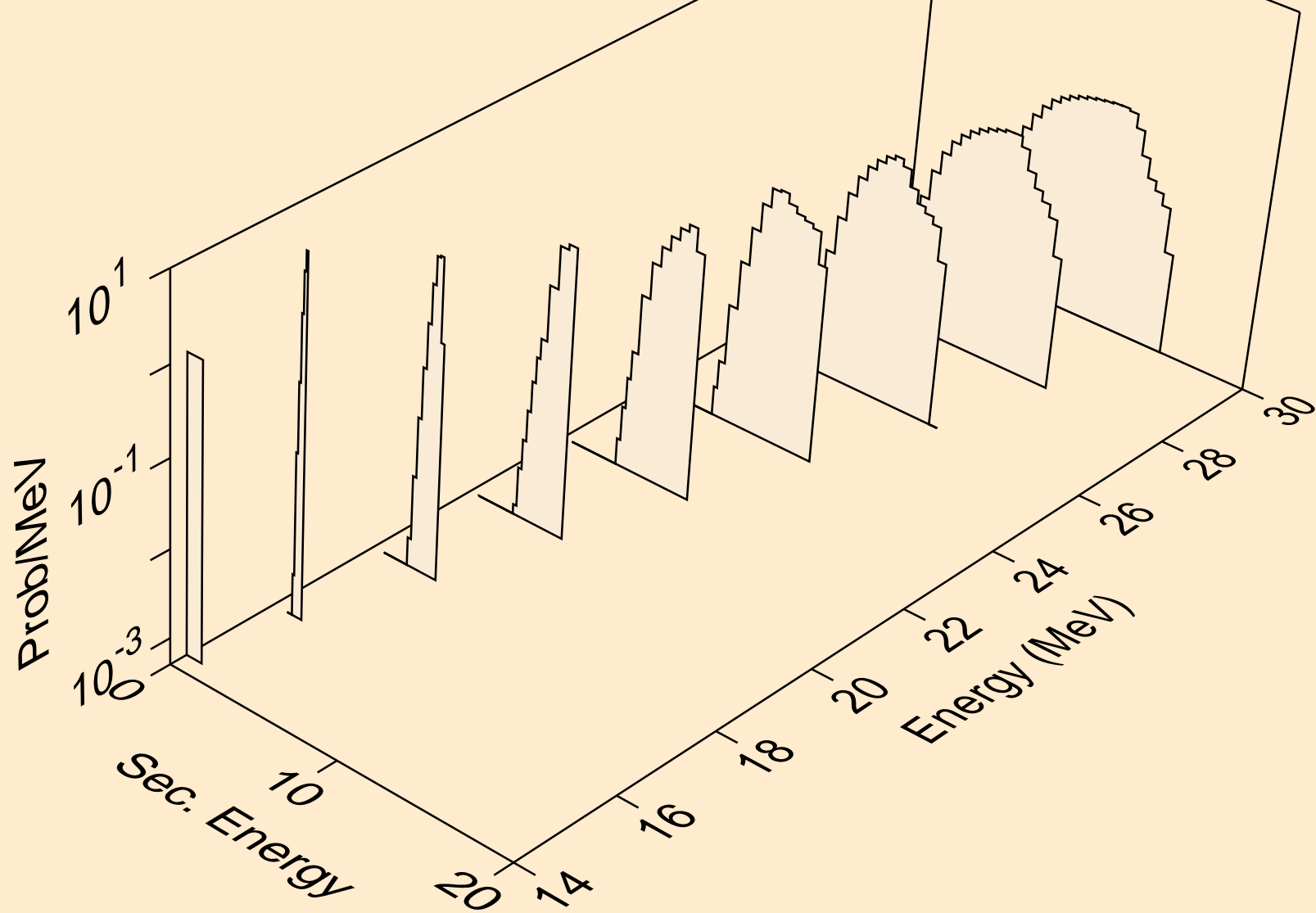

TC095 NEUTRON ACER TENDL-2021 LIBRARY; T=293.6K
tritons from (n,t)

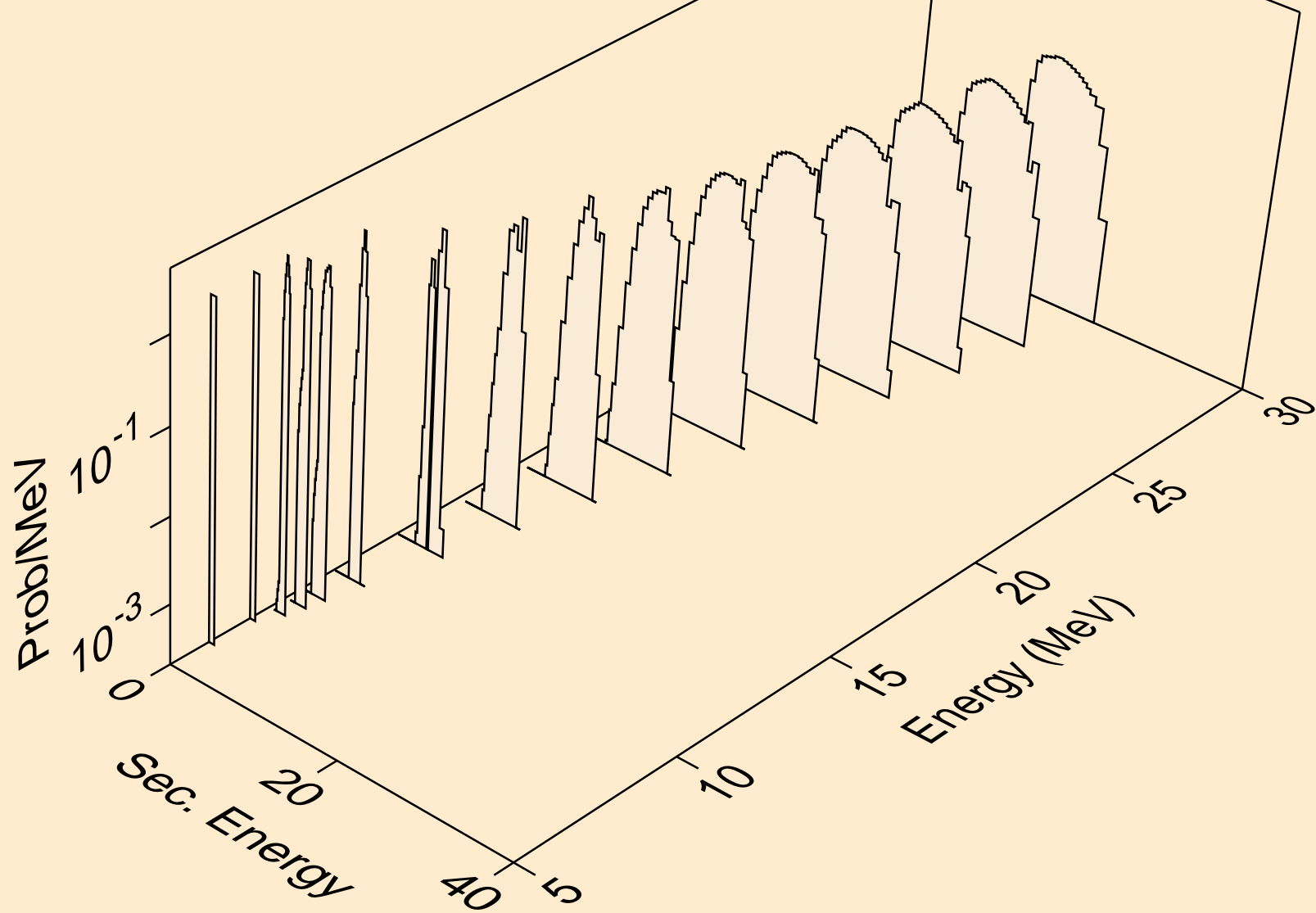

TC095 NEUTRON ACER TENDL-2021 LIBRARY; T=293.6K
tritons from (n,pt)

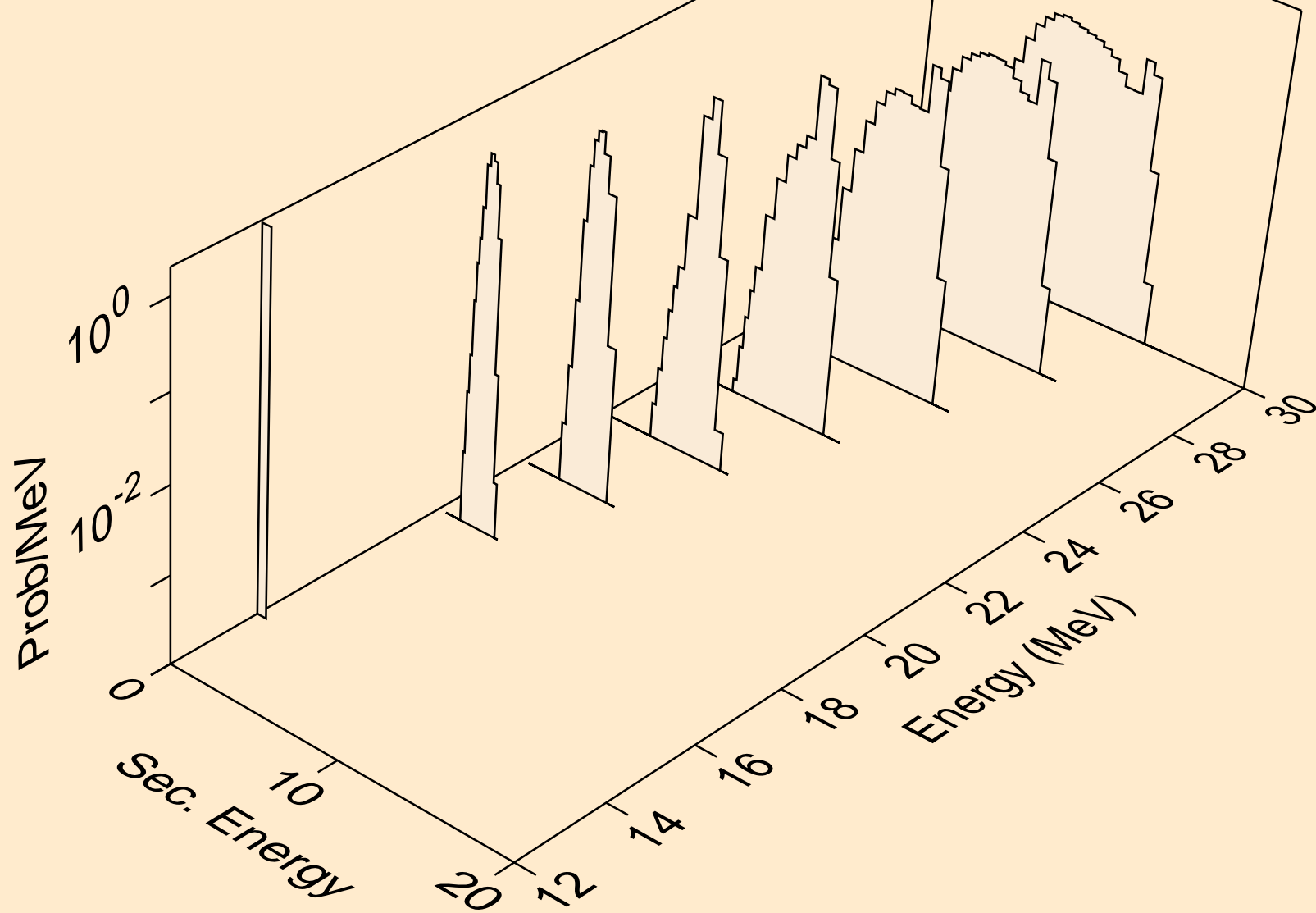

TC095 NEUTRON ACER TENDL-2021 LIBRARY; T=293.6K
he3s from (n,x)

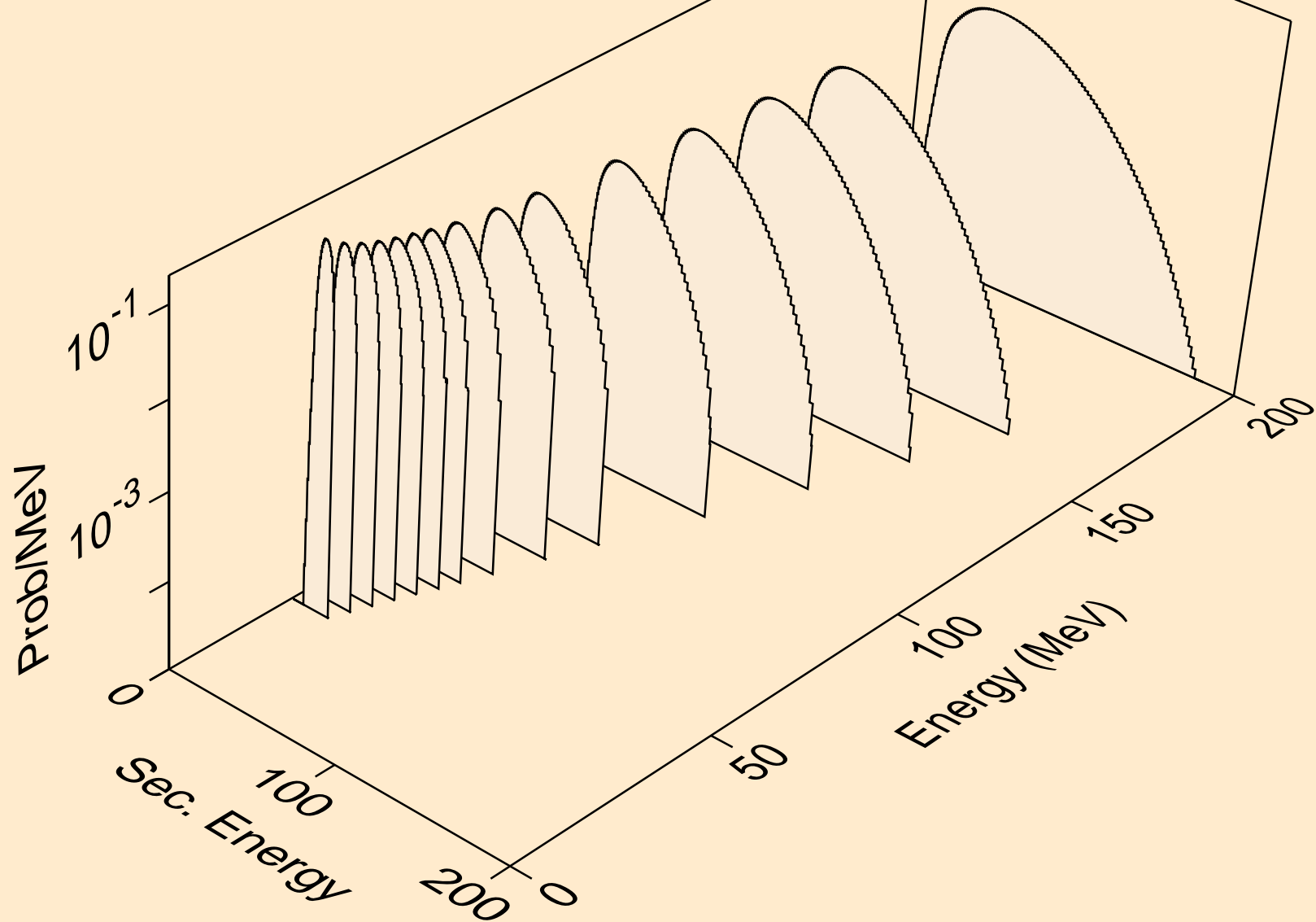

TC095 NEUTRON ACER TENDL-2021 LIBRARY; T=293.6K
he3s from (n,n*)he3

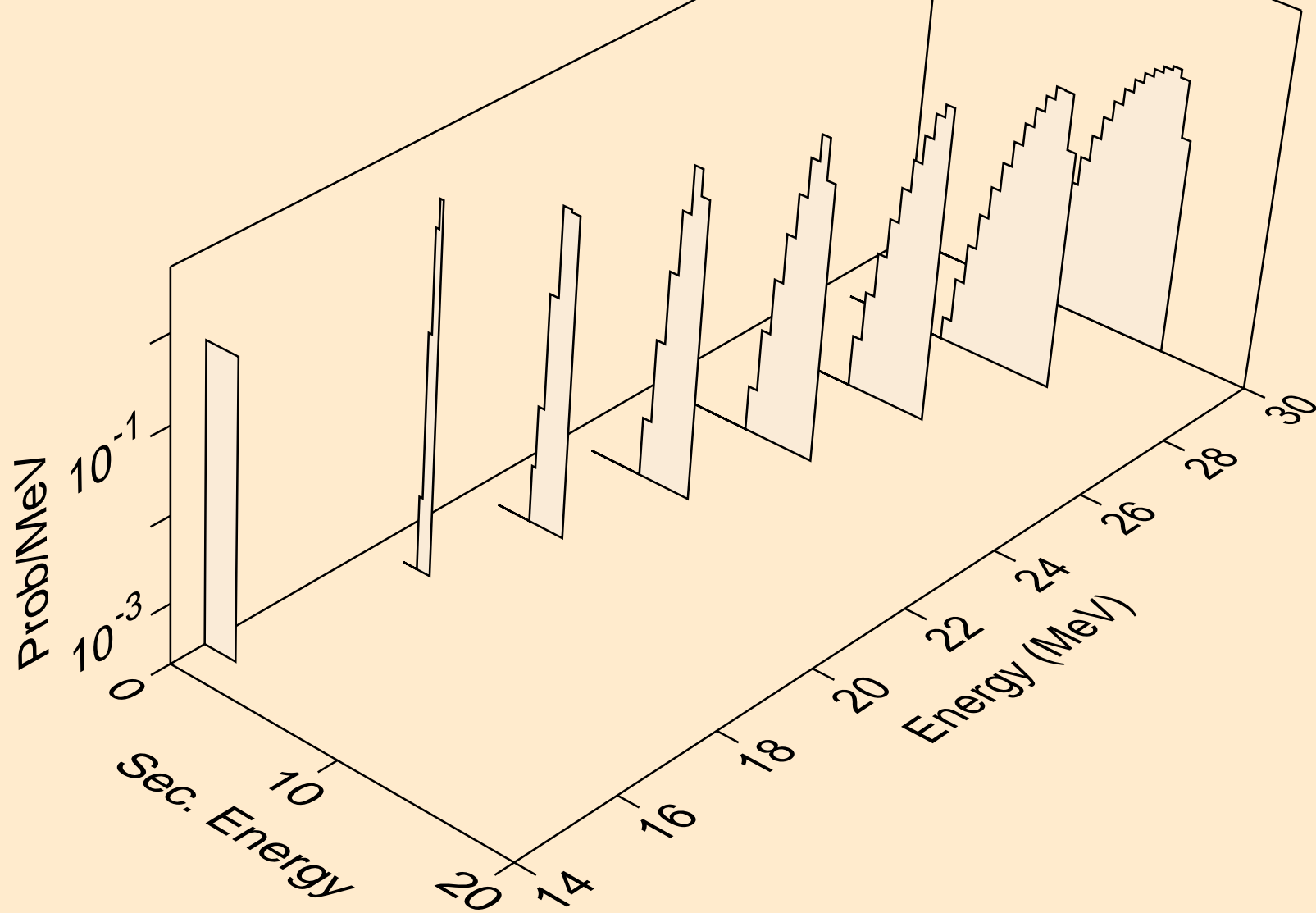

TC095 NEUTRON ACER TENDL-2021 LIBRARY; T=293.6K
he3s from (n,he3)

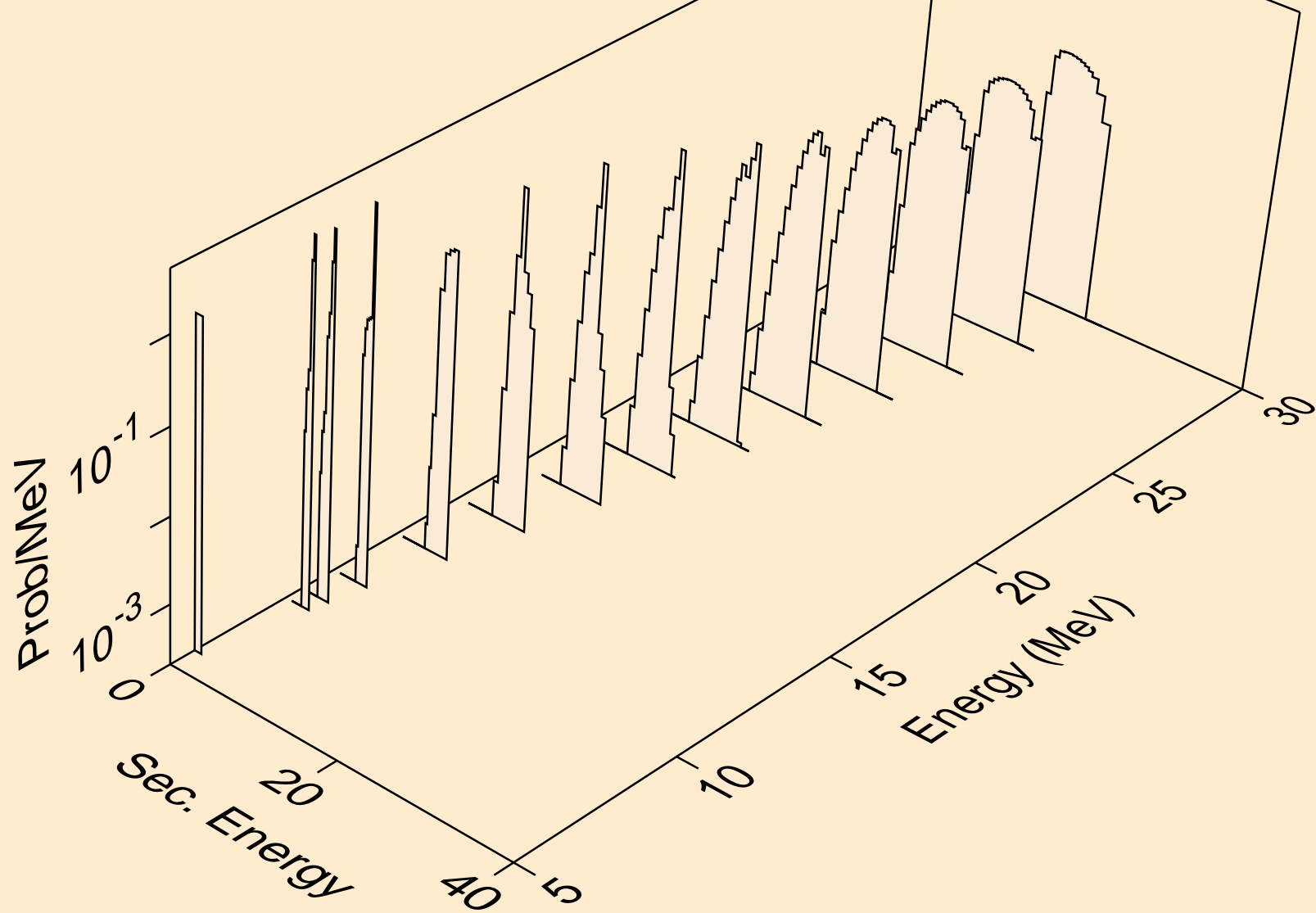

TC095 NEUTRON ACER TENDL-2021 LIBRARY; T=293.6K
alphas from (n,x)

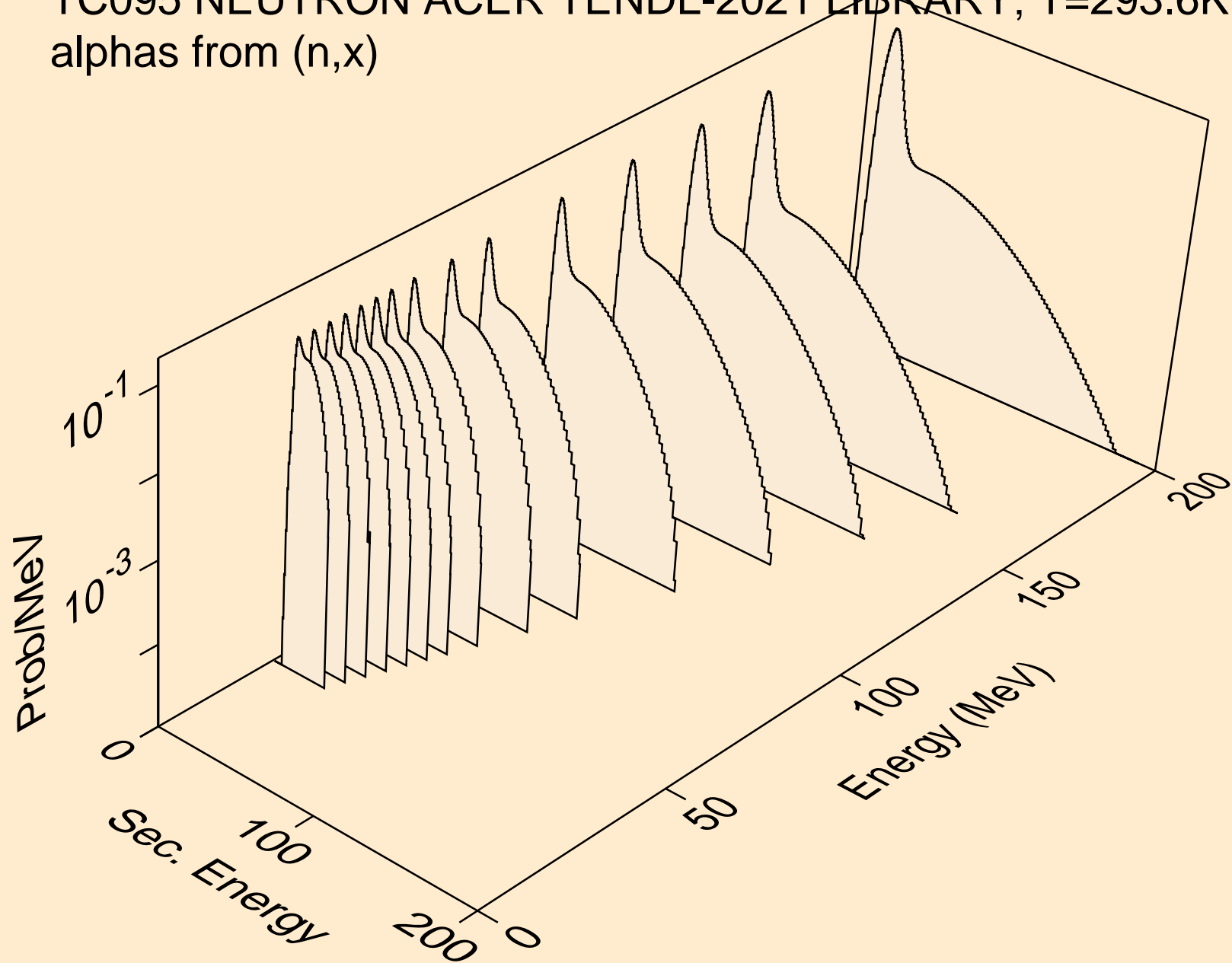

TC095 NEUTRON ACER TENDL-2021 LIBRARY; T=293.6K
alphas from (n,n*)a

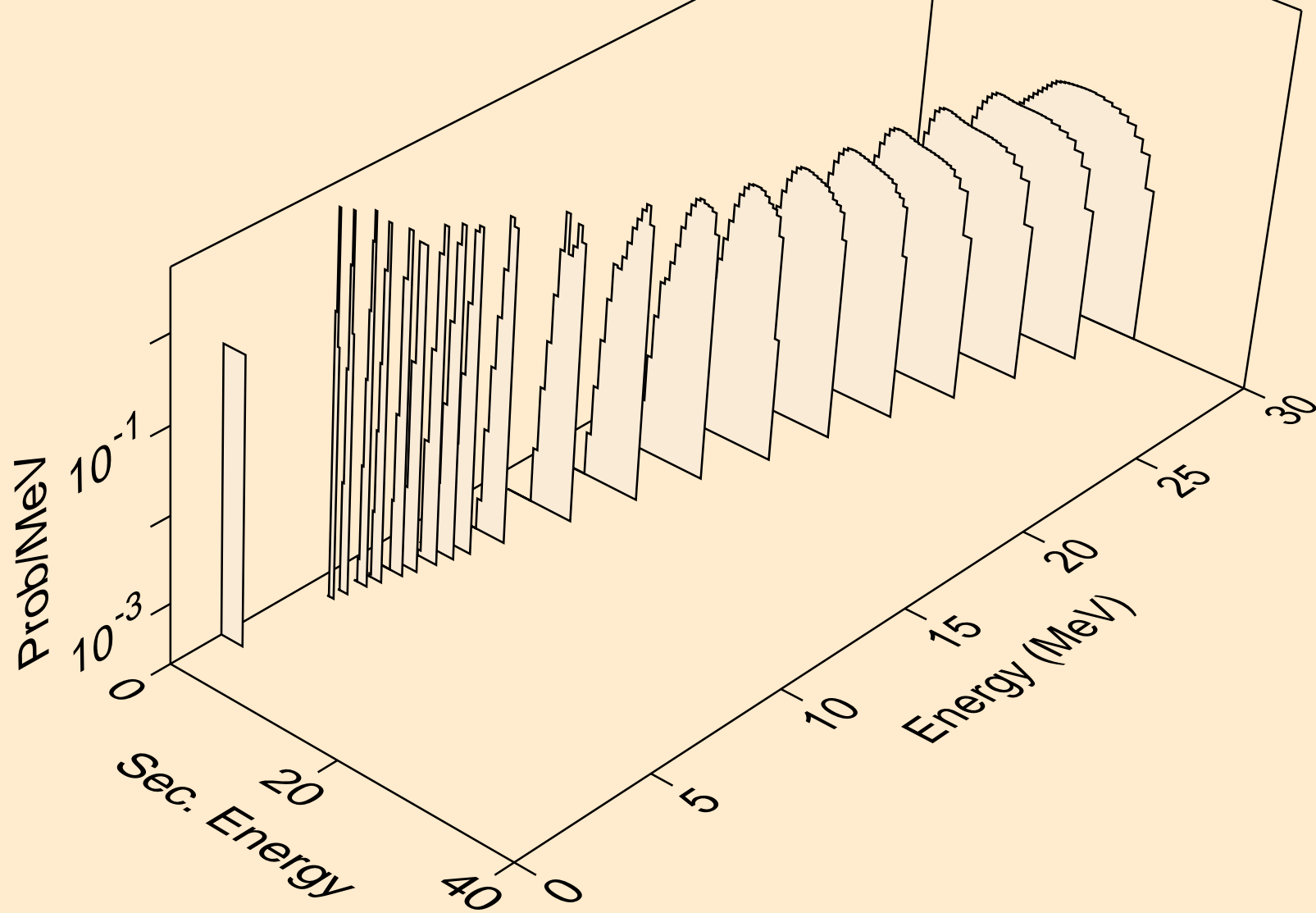

TC095 NEUTRON ACER TENDL-2021 LIBRARY; T=293.6K
alphas from (n,2n)a

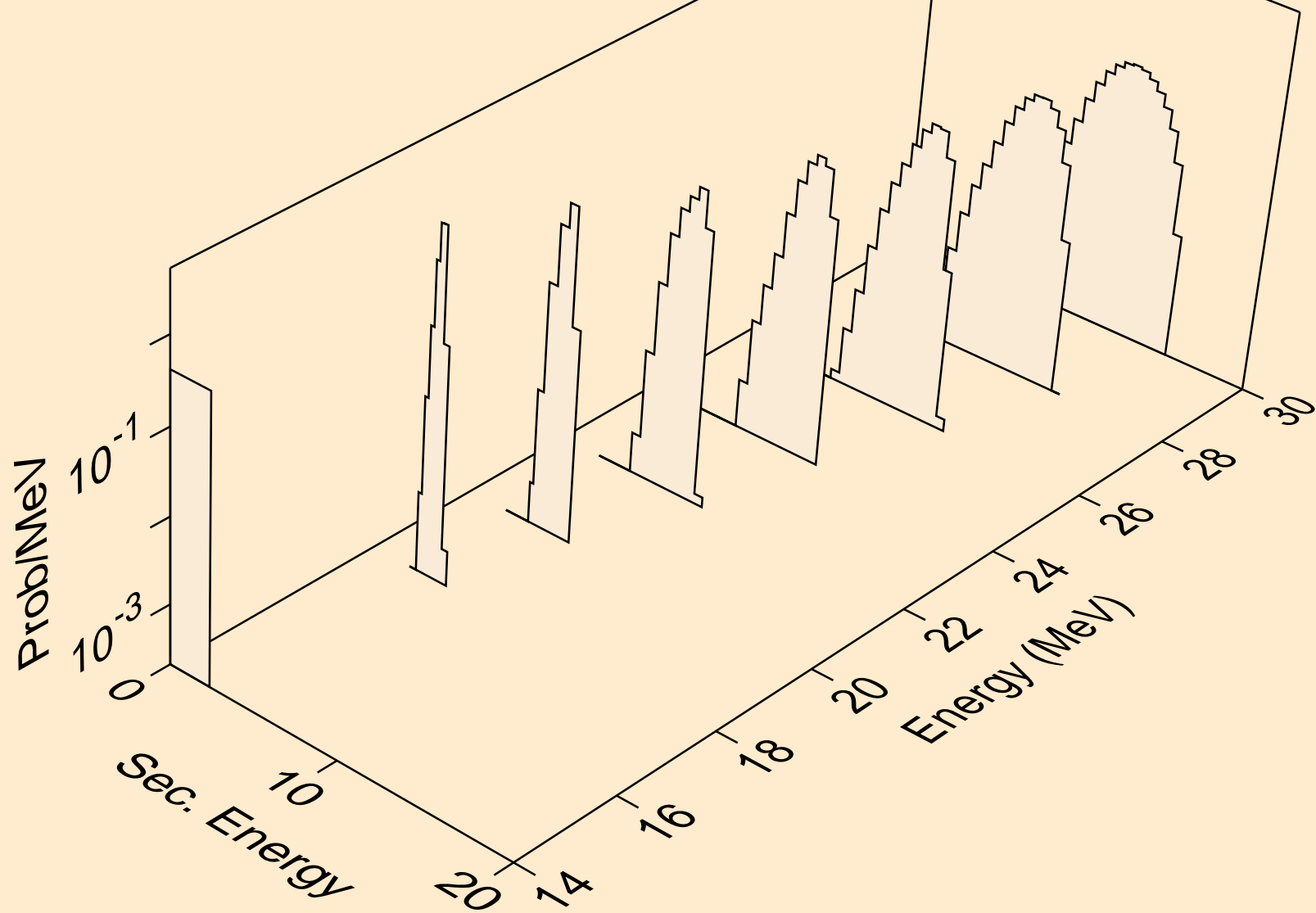

TC095 NEUTRON ACER TENDL-2021 LIBRARY; T=293.6K
alphas from (n,n*)2a

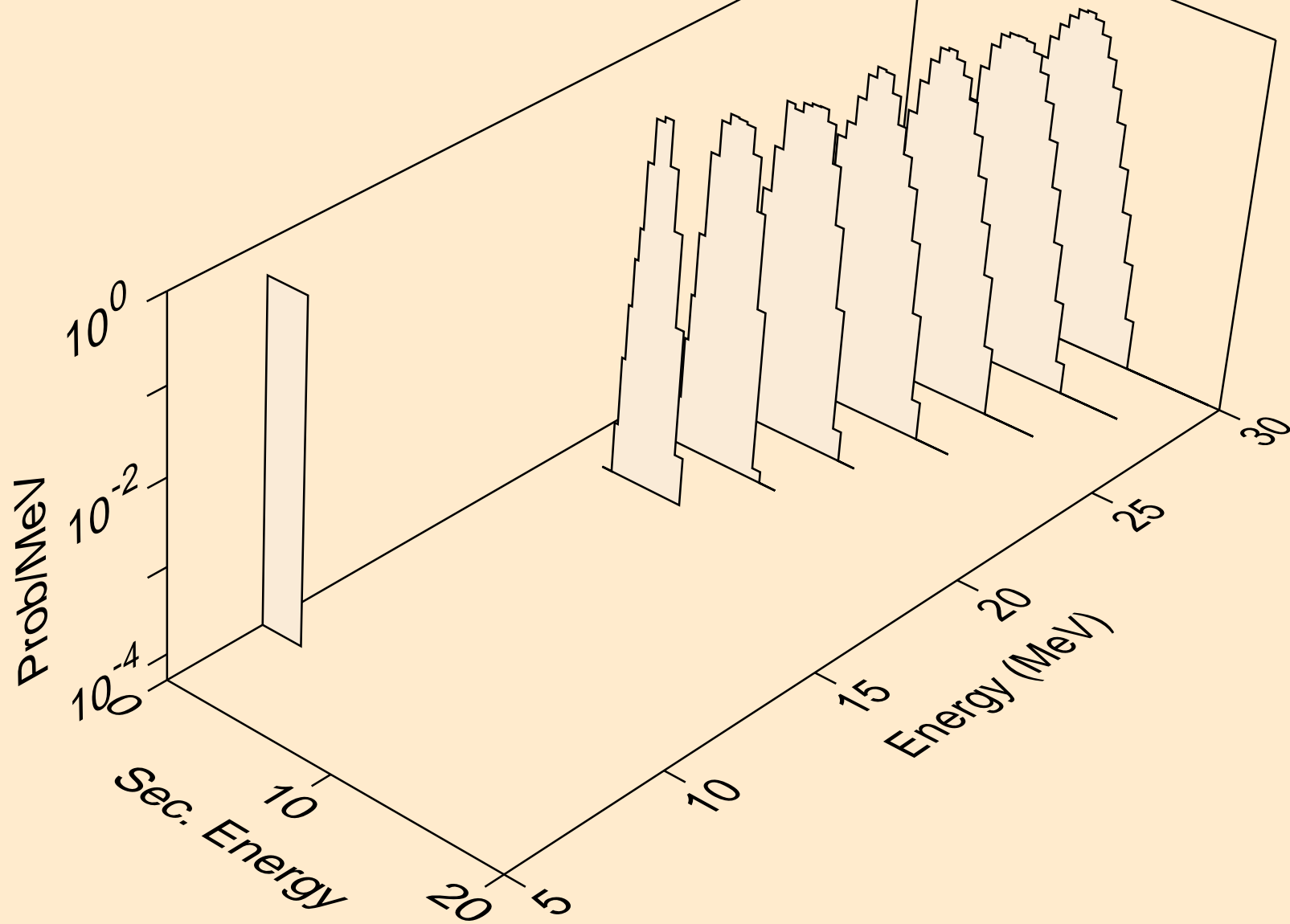

TC095 NEUTRON ACER TENDL-2021 LIBRARY; T=293.6K
alphas from (n,npa)

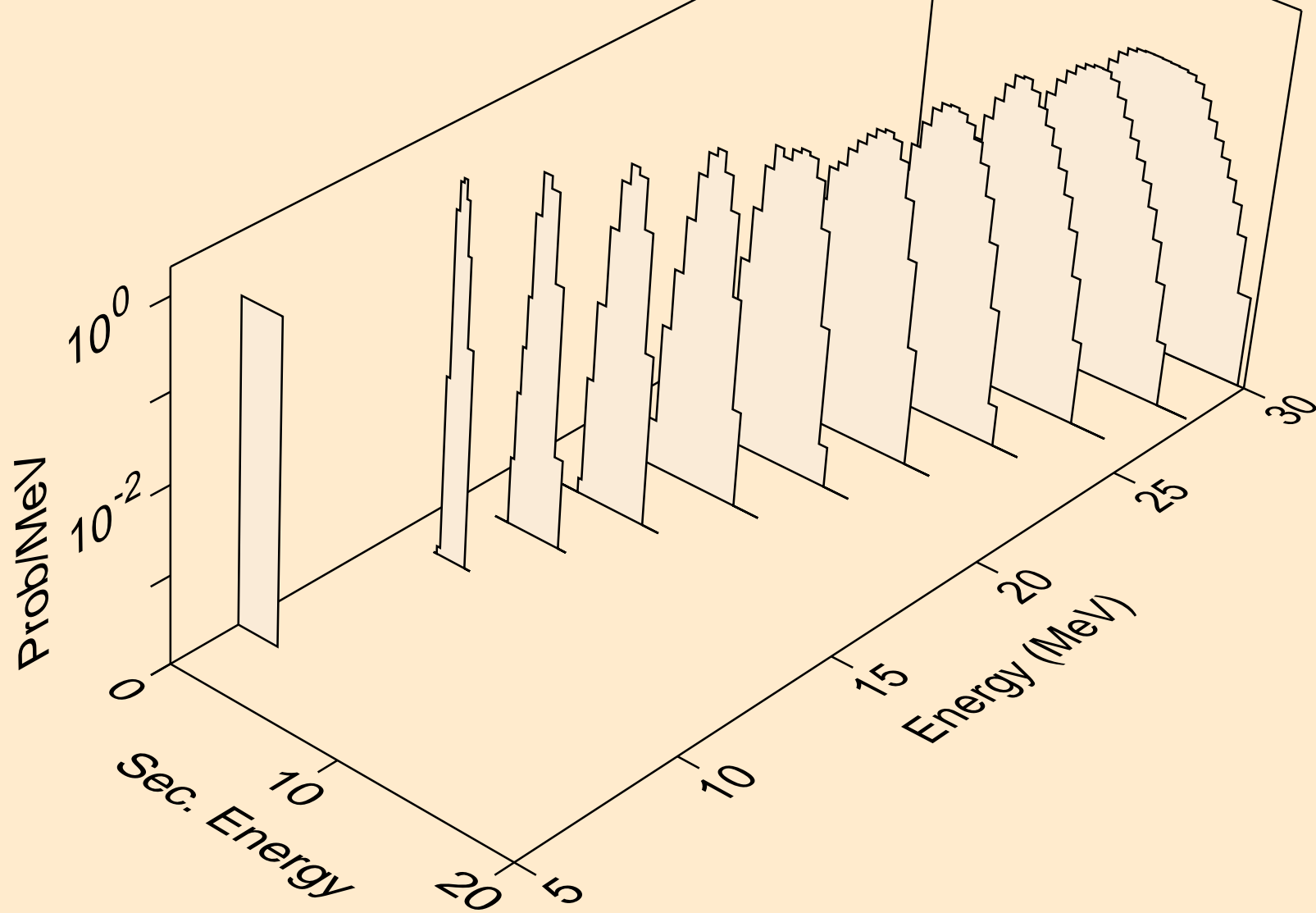

TC095 NEUTRON ACER TENDL-2021 LIBRARY; T=293.6K
alphas from (n,a)

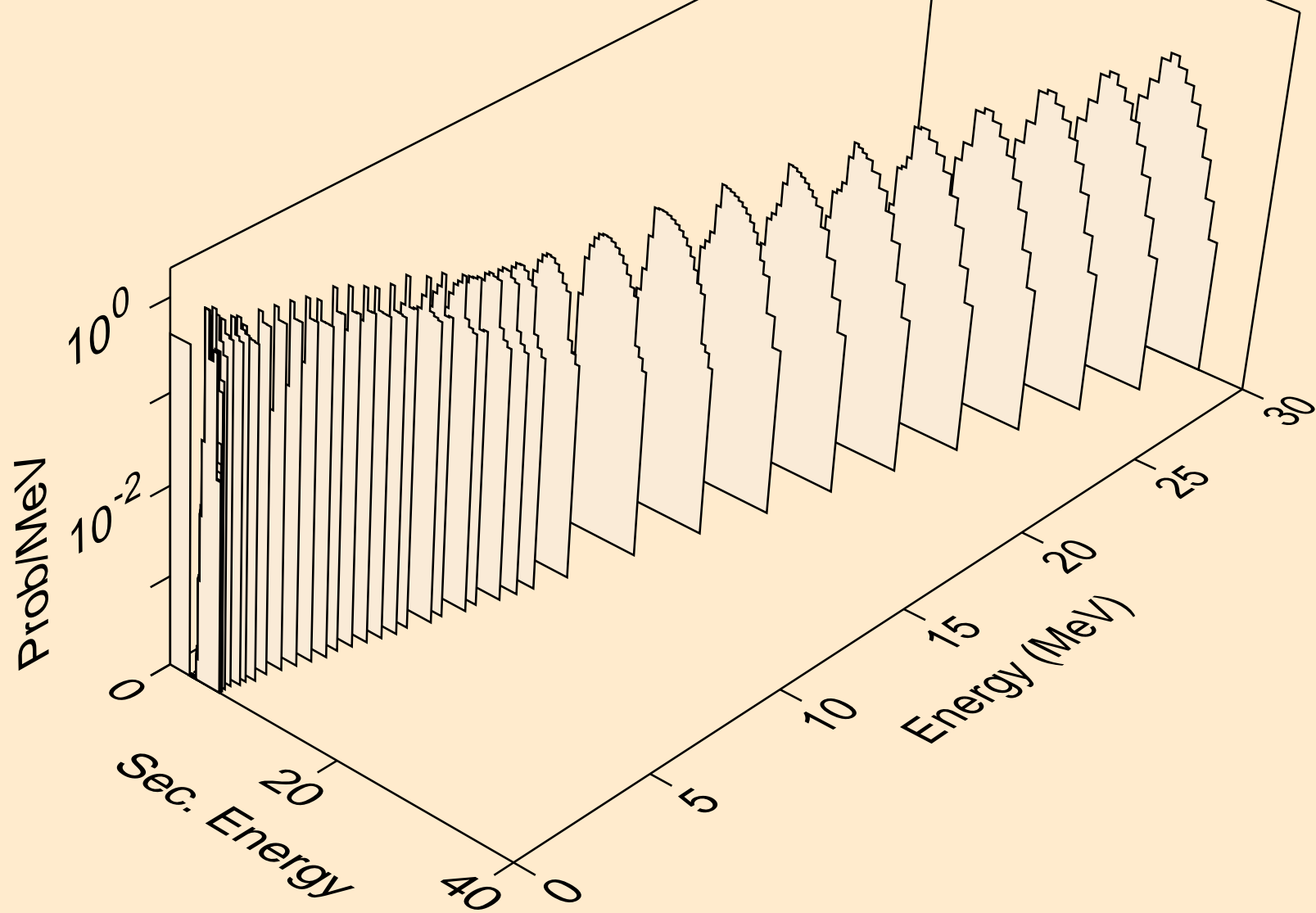

TC095 NEUTRON ACER TENDL-2021 LIBRARY; T=293.6K
alphas from (n,2a)

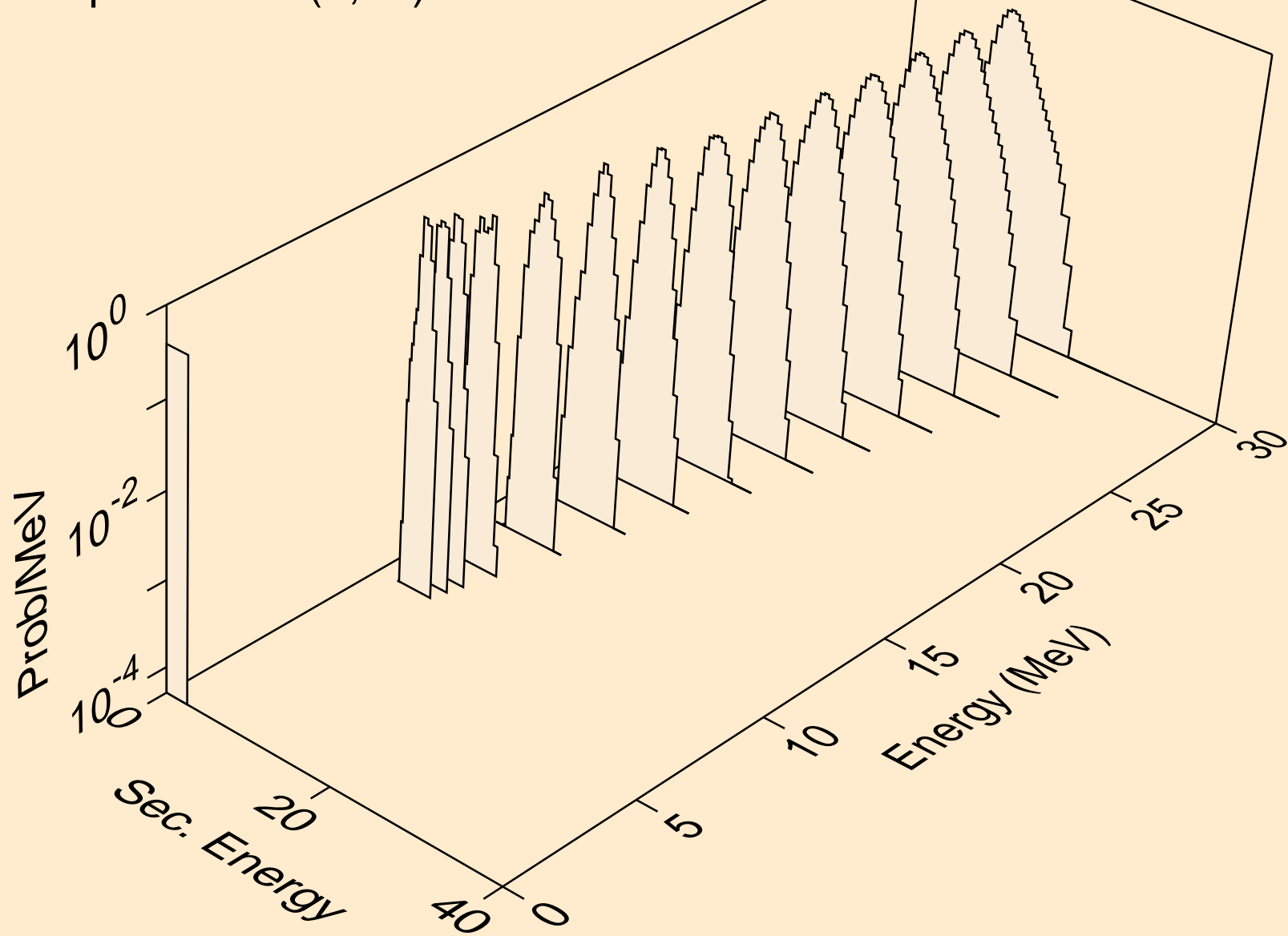

TC095 NEUTRON ACER TENDL-2021 LIBRARY; T=293.6K
alphas from (n,pa)

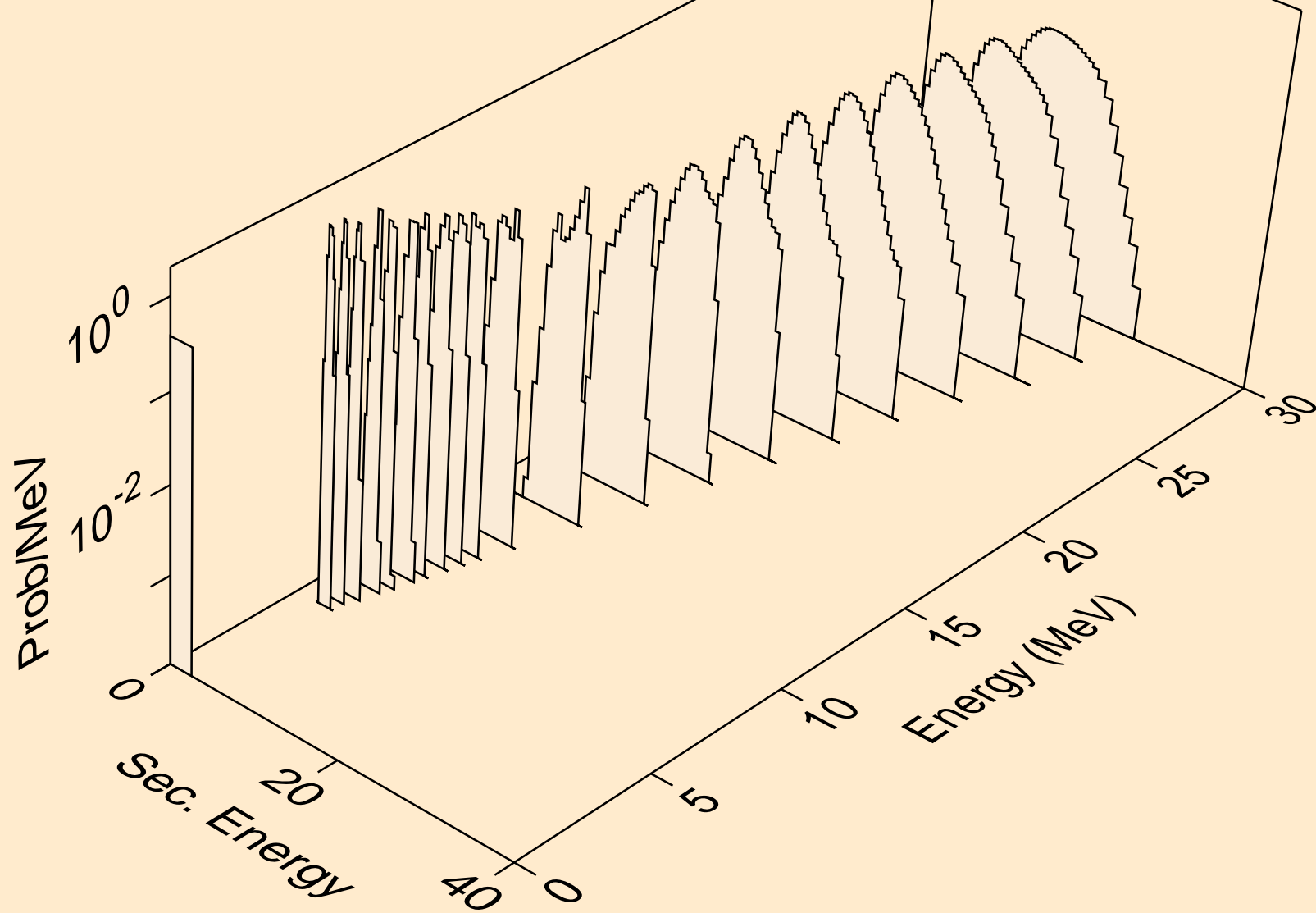

TC095 NEUTRON ACER TENDL-2021 LIBRARY; T=293.6K
alphas from (n,da)

