

TC101 NEUTRON ACER TENDL-2021 LIBRARY; T=293.6K

Principal cross sections

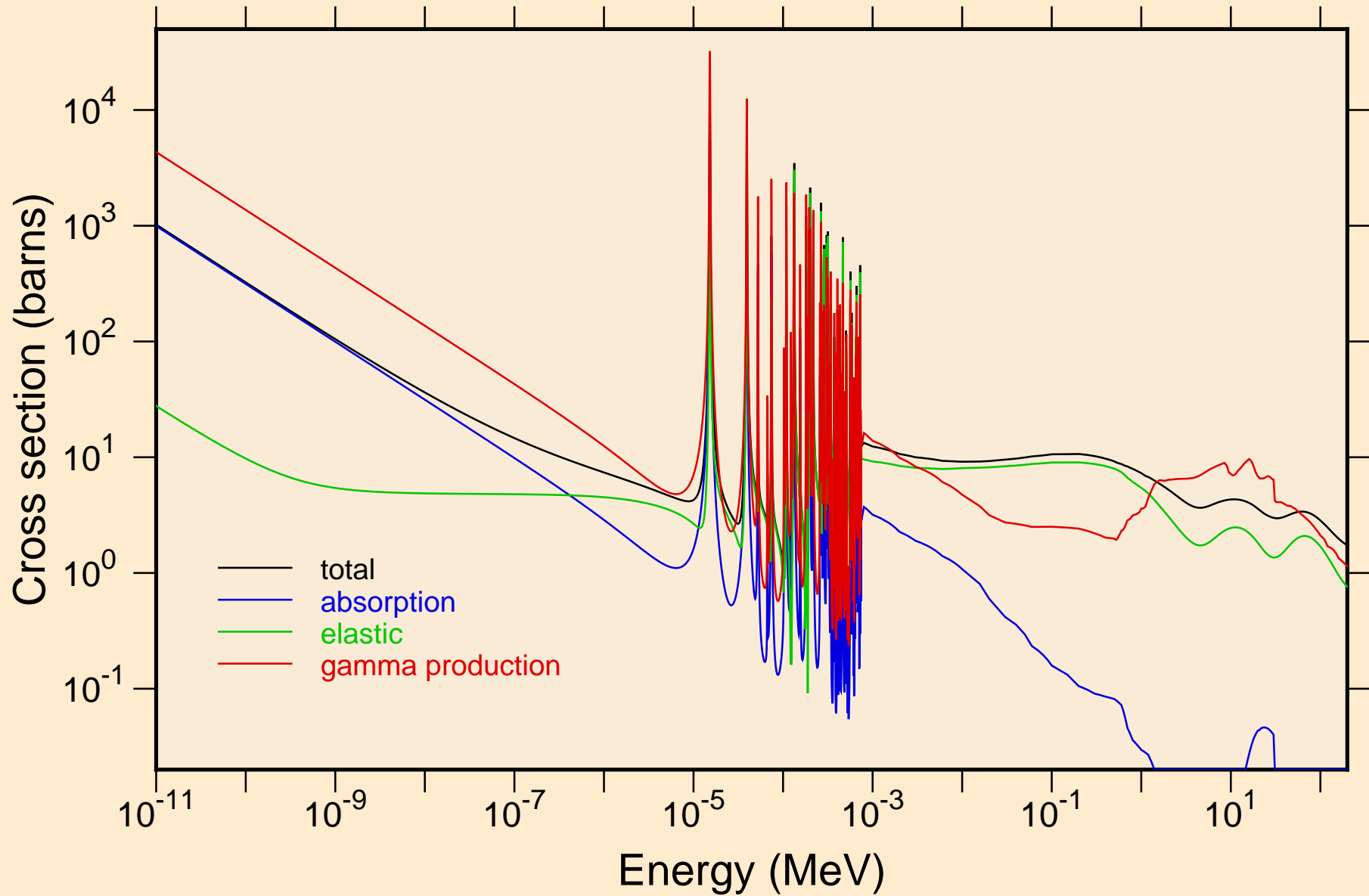

TC101 NEUTRON ACER TENDL-2021 LIBRARY; T=293.6K
resonance total cross section

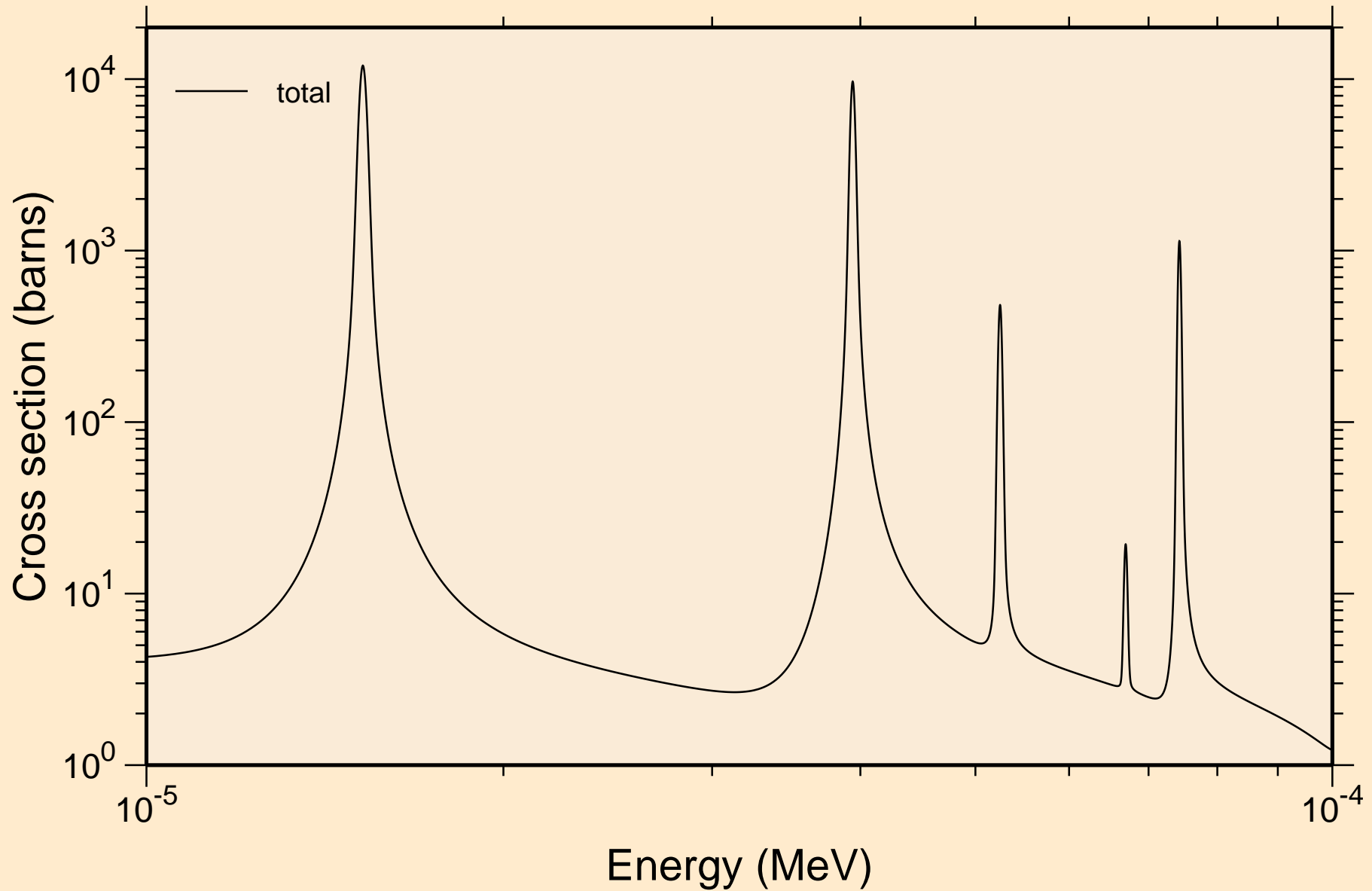

TC101 NEUTRON ACER TENDL-2021 LIBRARY; T=293.6K
resonance total cross section

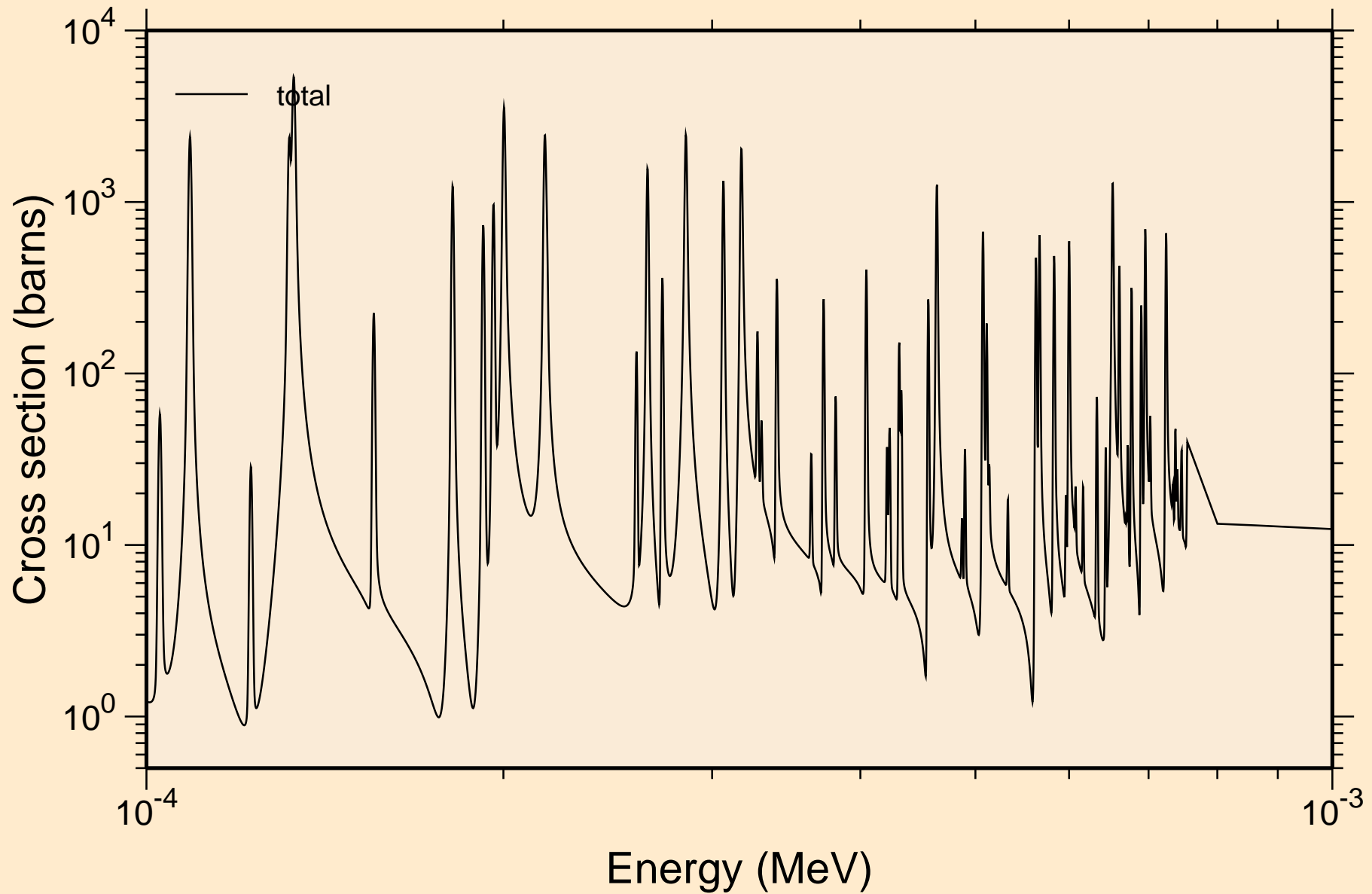

T̄C101 NEUTRON ACER TENDL-2021 LIBRARY; T=293.6K
resonance total cross section

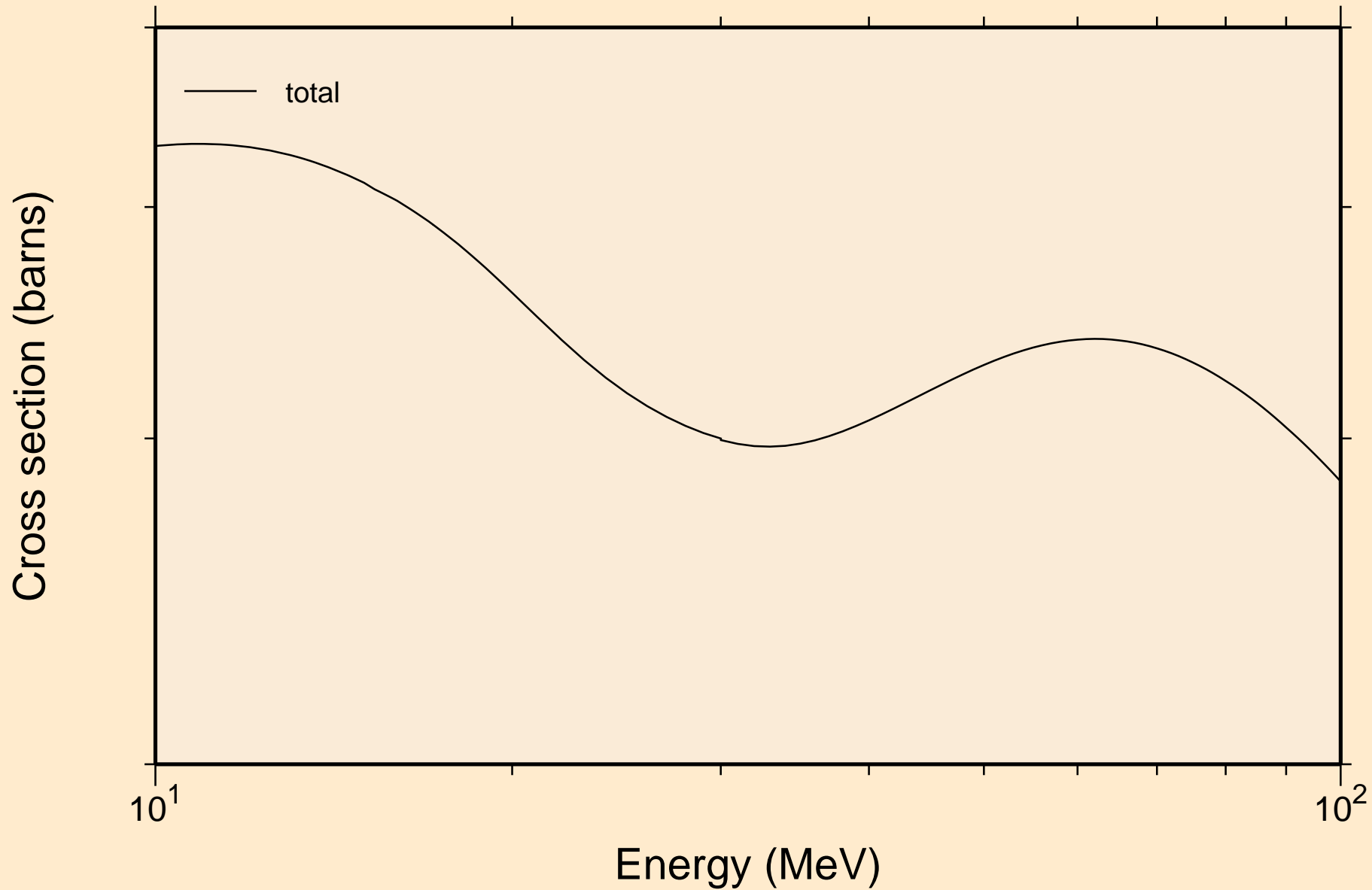

TC101 NEUTRON ACER TENDL-2021 LIBRARY; T=293.6K
resonance absorption cross sections

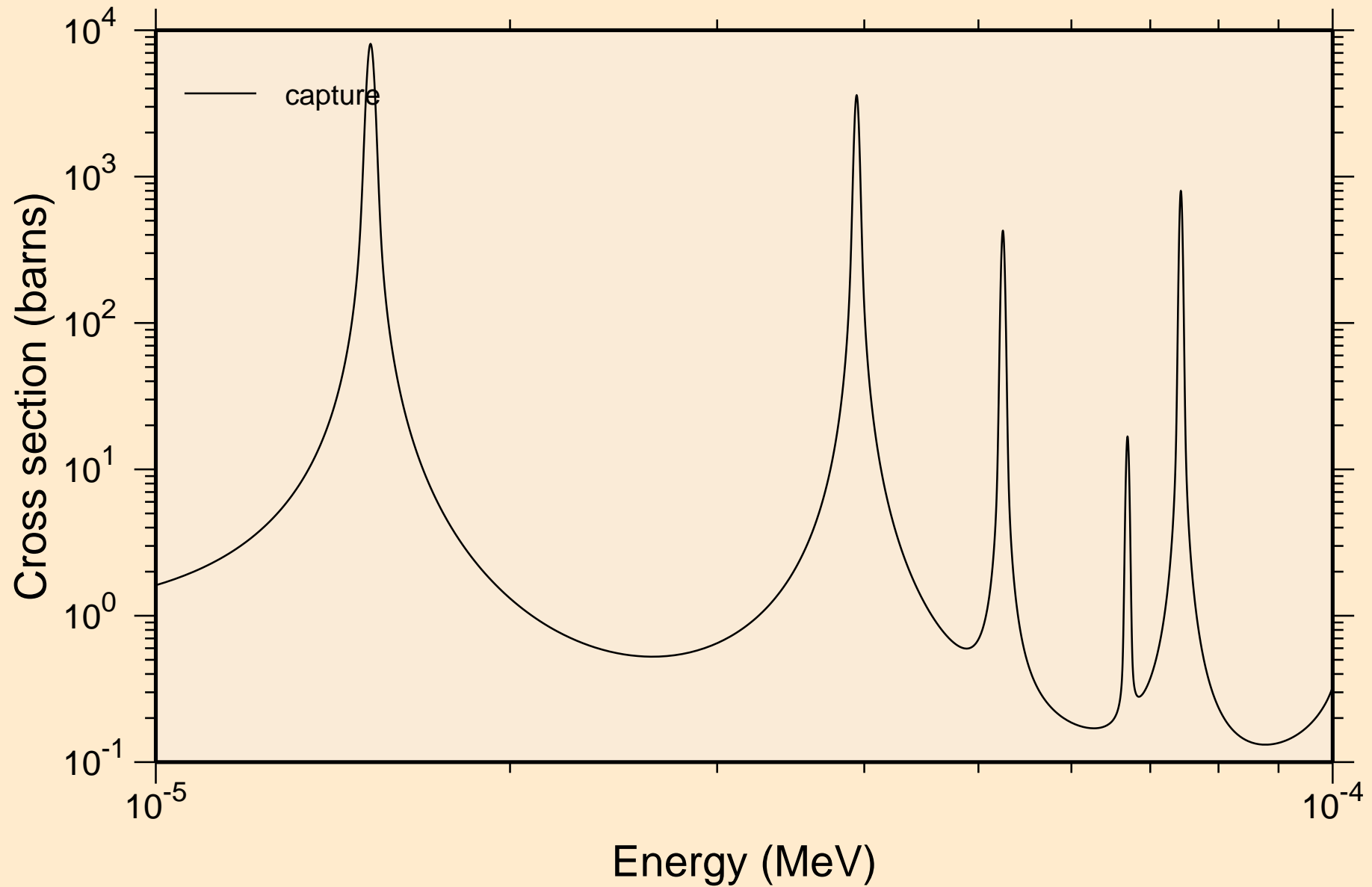

TC101 NEUTRON ACER TENDL-2021 LIBRARY; T=293.6K
resonance absorption cross sections

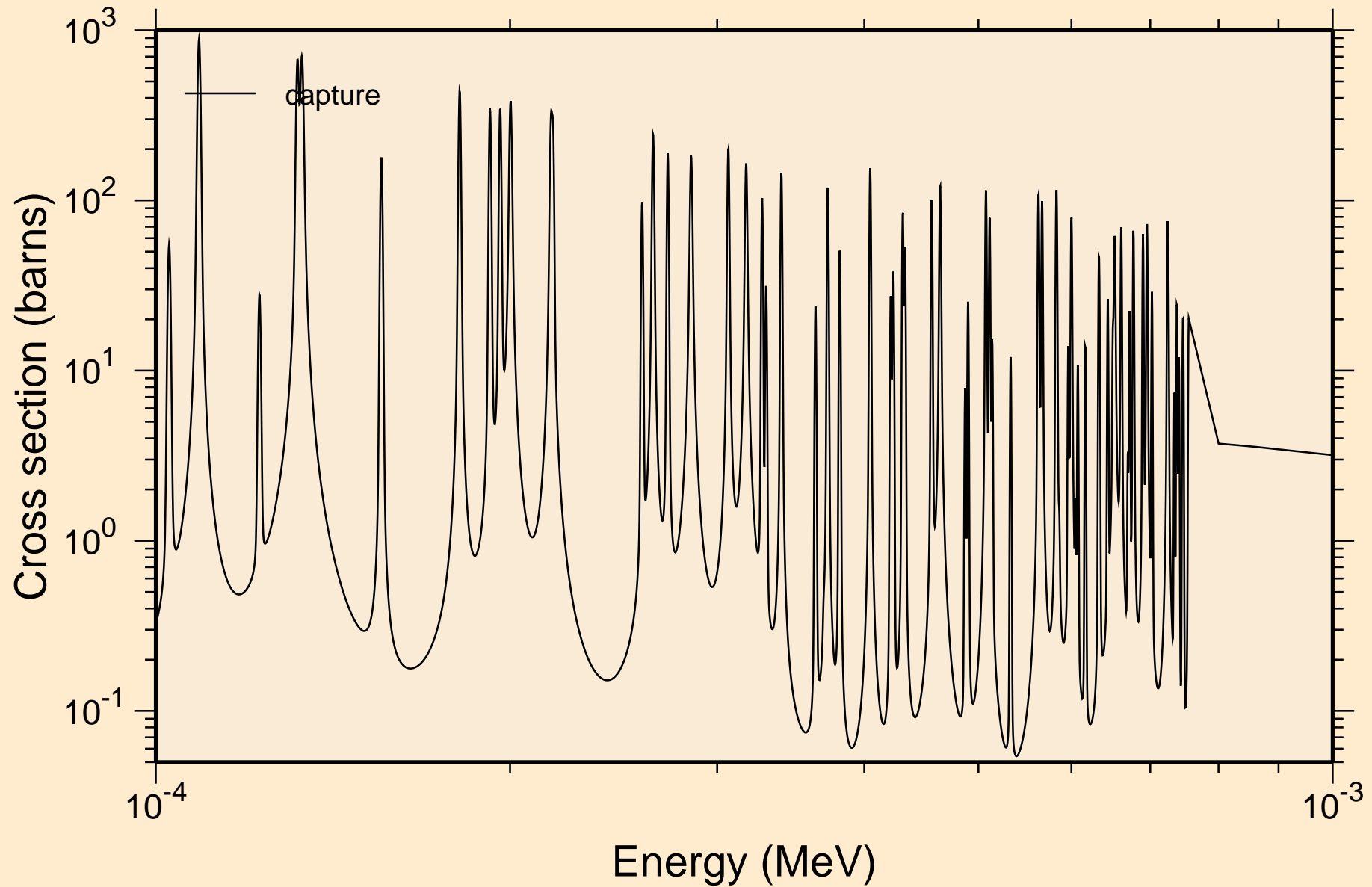

TC101 NEUTRON ACER TENDL-2021 LIBRARY; T=293.6K
resonance absorption cross sections

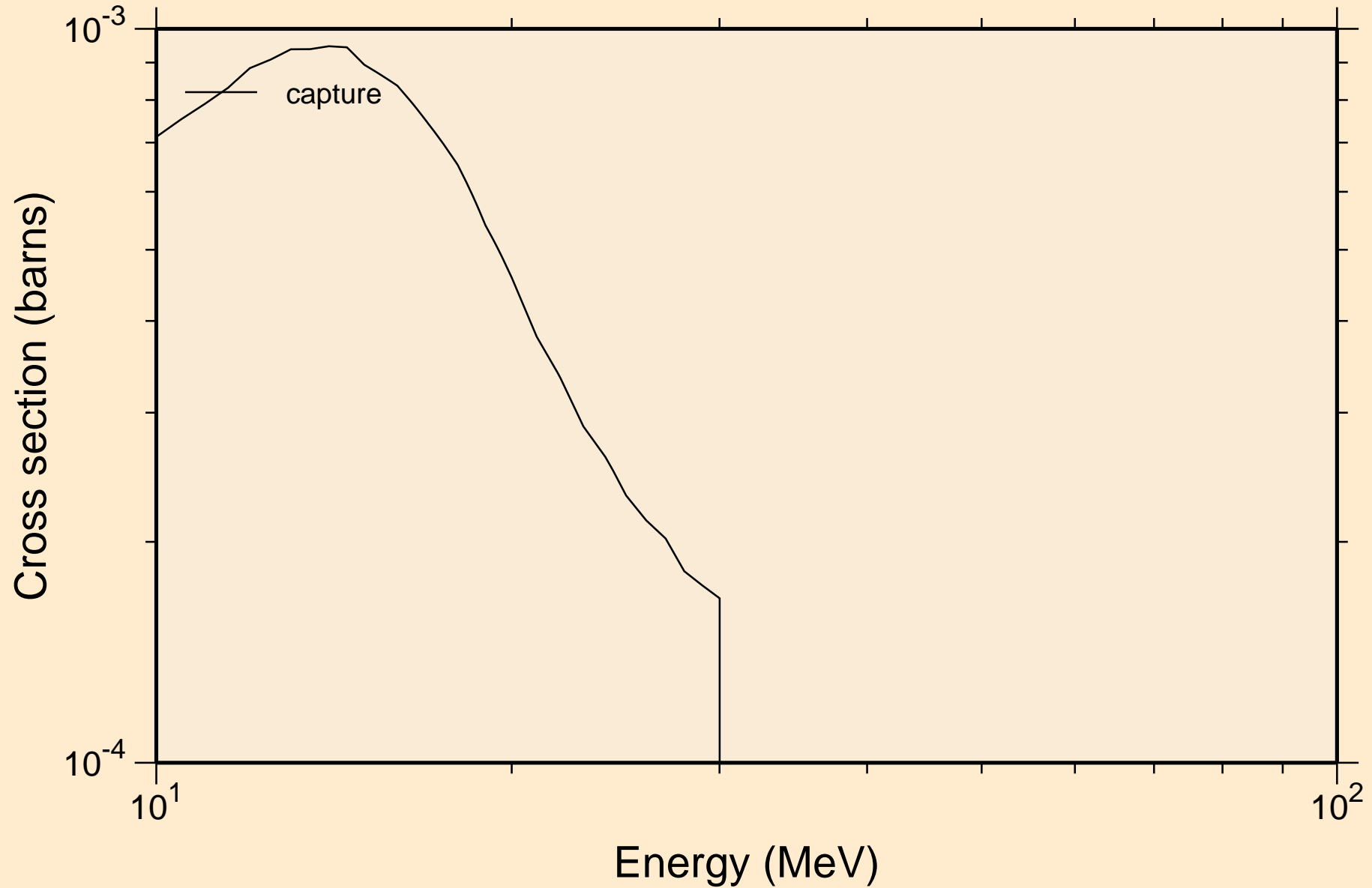

TC101 NEUTRON ACER TENDL-2021 LIBRARY; T=293.6K
Heating

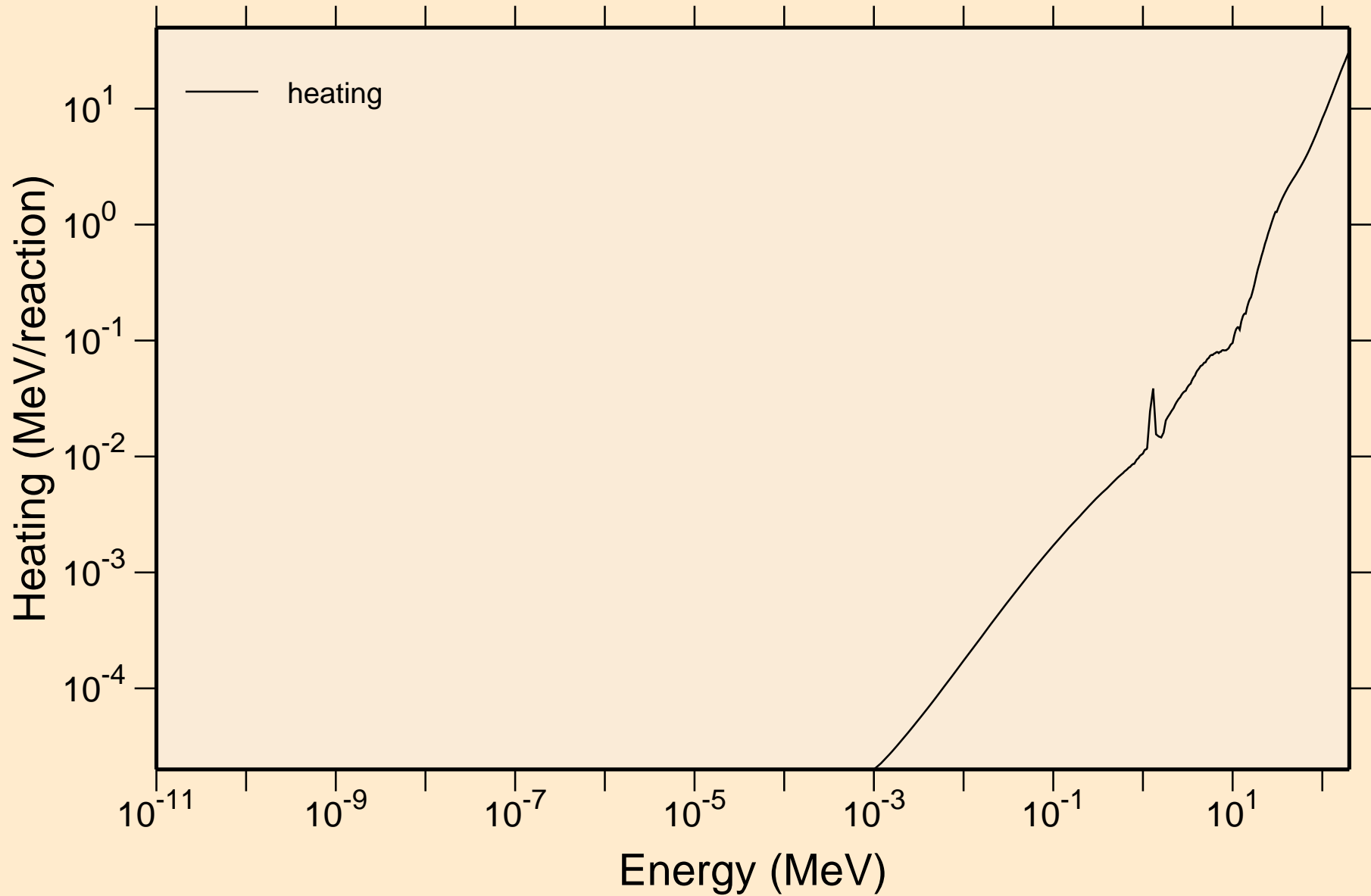

TC101 NEUTRON ACER TENDL-2021 LIBRARY; T=293.6K
Damage

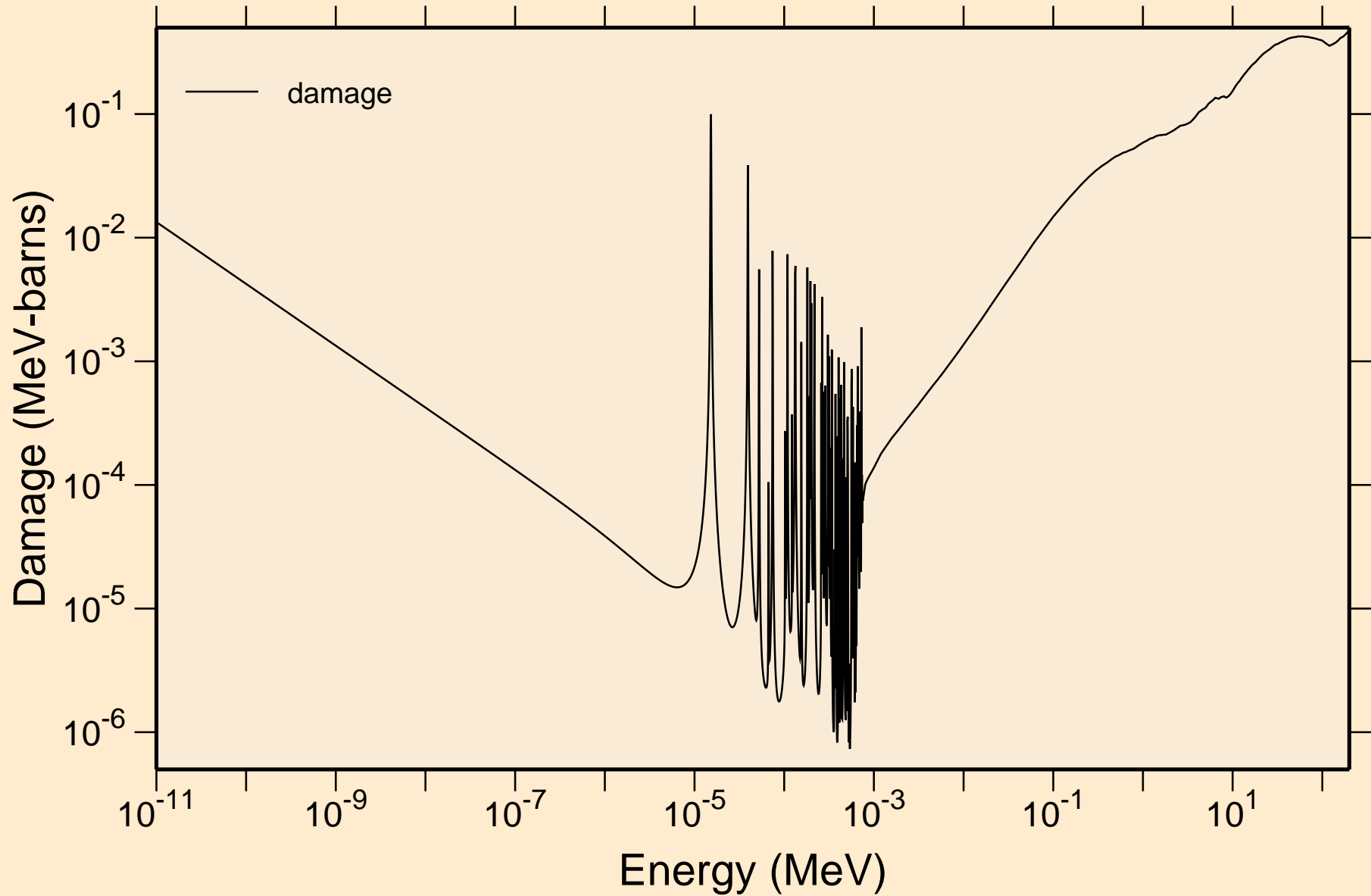

TC101 NEUTRON ACER TENDL-2021 LIBRARY; T=293.6K
Non-threshold reactions

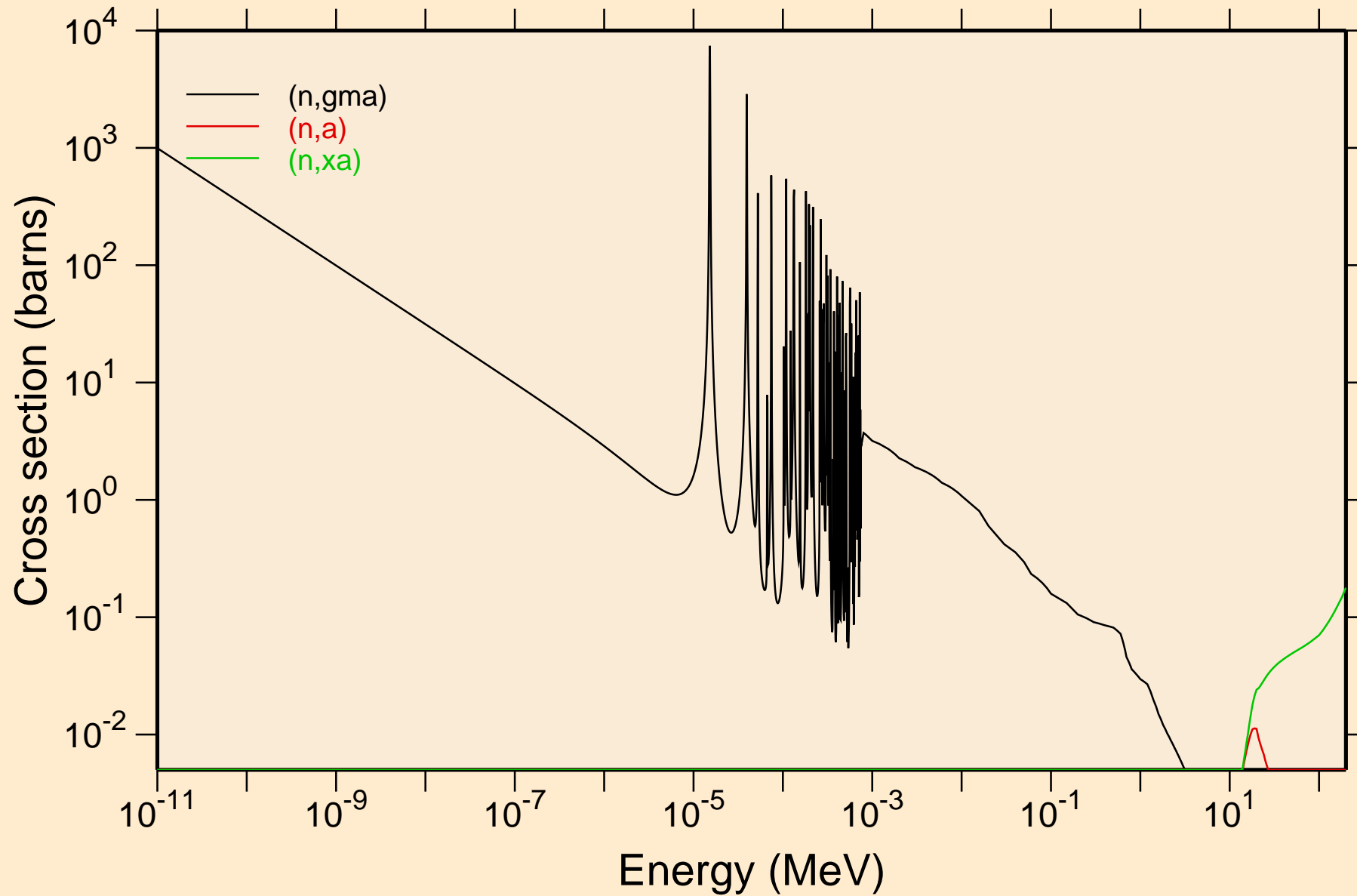

TC101 NEUTRON ACER TENDL-2021 LIBRARY; T=293.6K
Principal cross sections

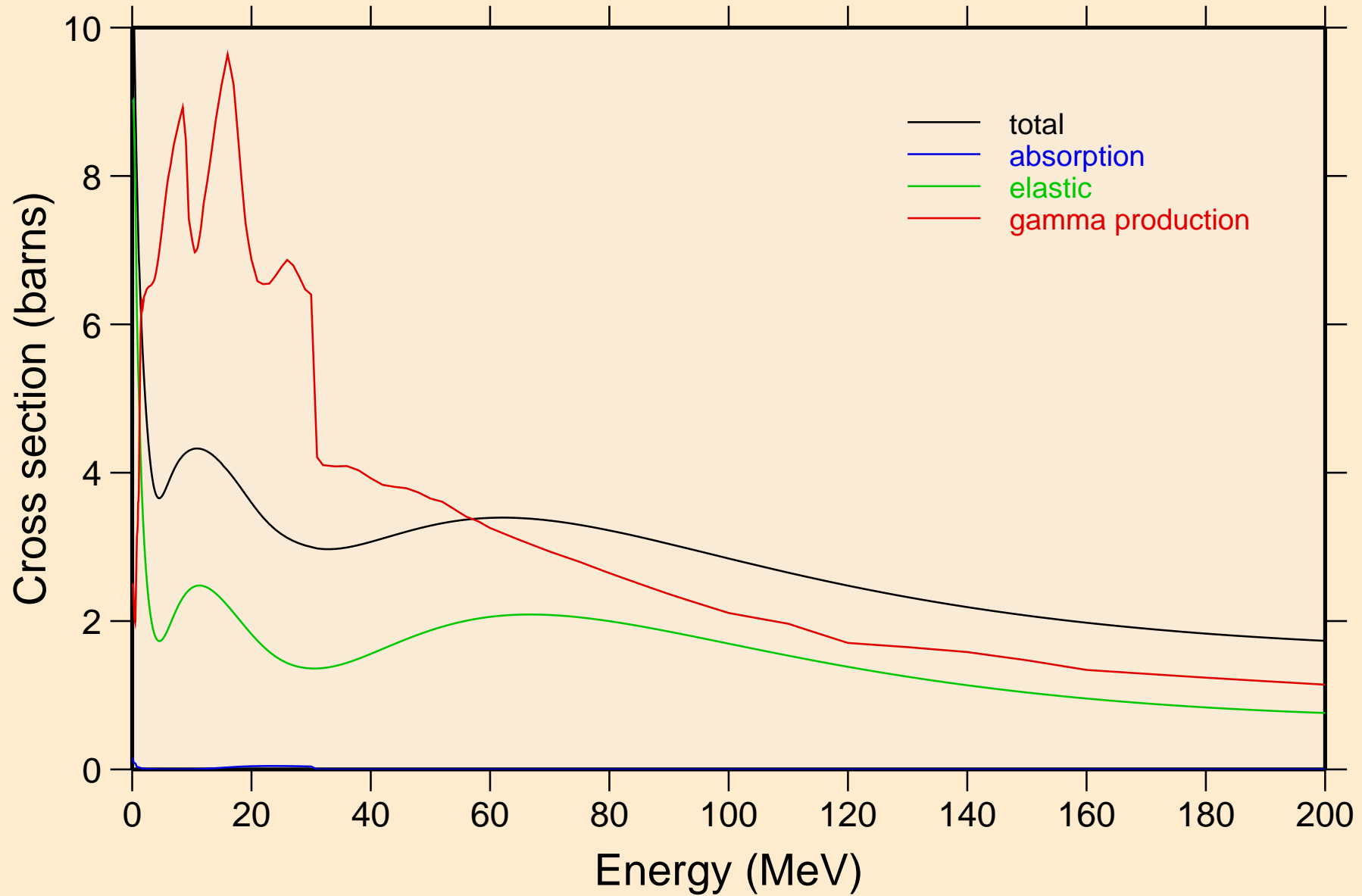

TC101 NEUTRON ACER TENDL-2021 LIBRARY; T=293.6K
Heating

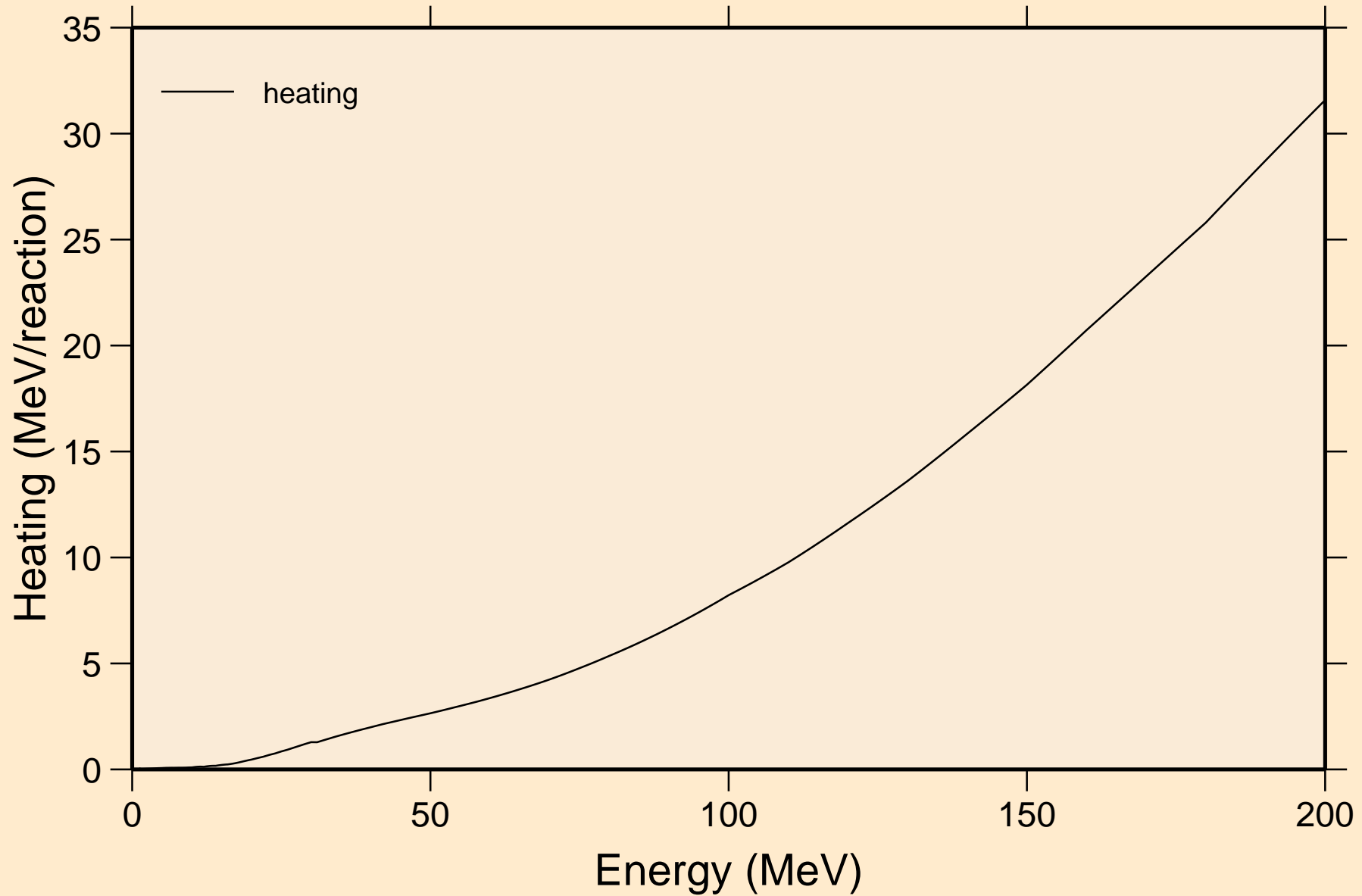

TC101 NEUTRON ACER TENDL-2021 LIBRARY; T=293.6K
Damage

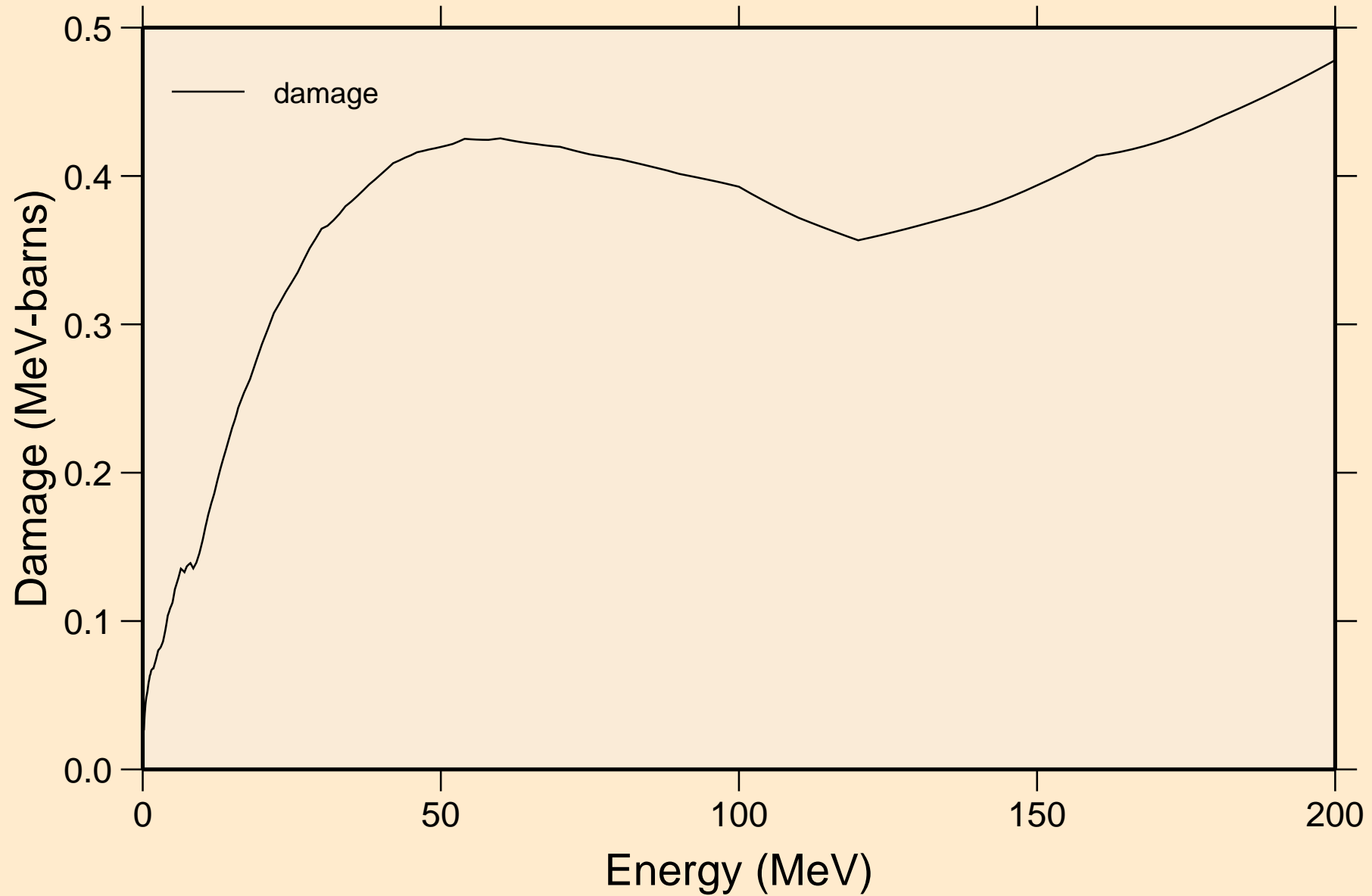

TC101 NEUTRON ACER TENDL-2021 LIBRARY; T=293.6K
Non-threshold reactions

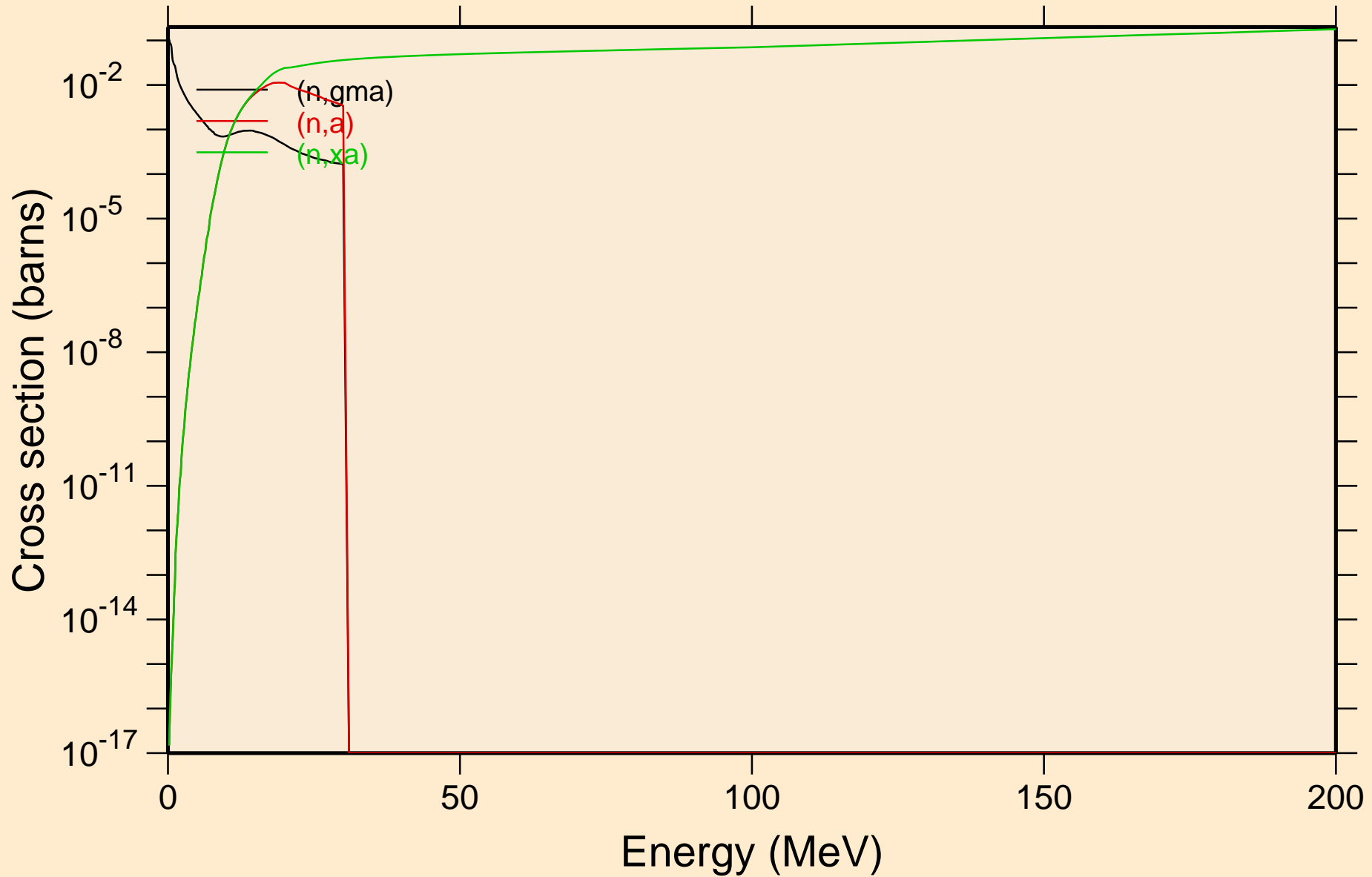

TC101 NEUTRON ACER TENDL-2021 LIBRARY; T=293.6K
Inelastic levels

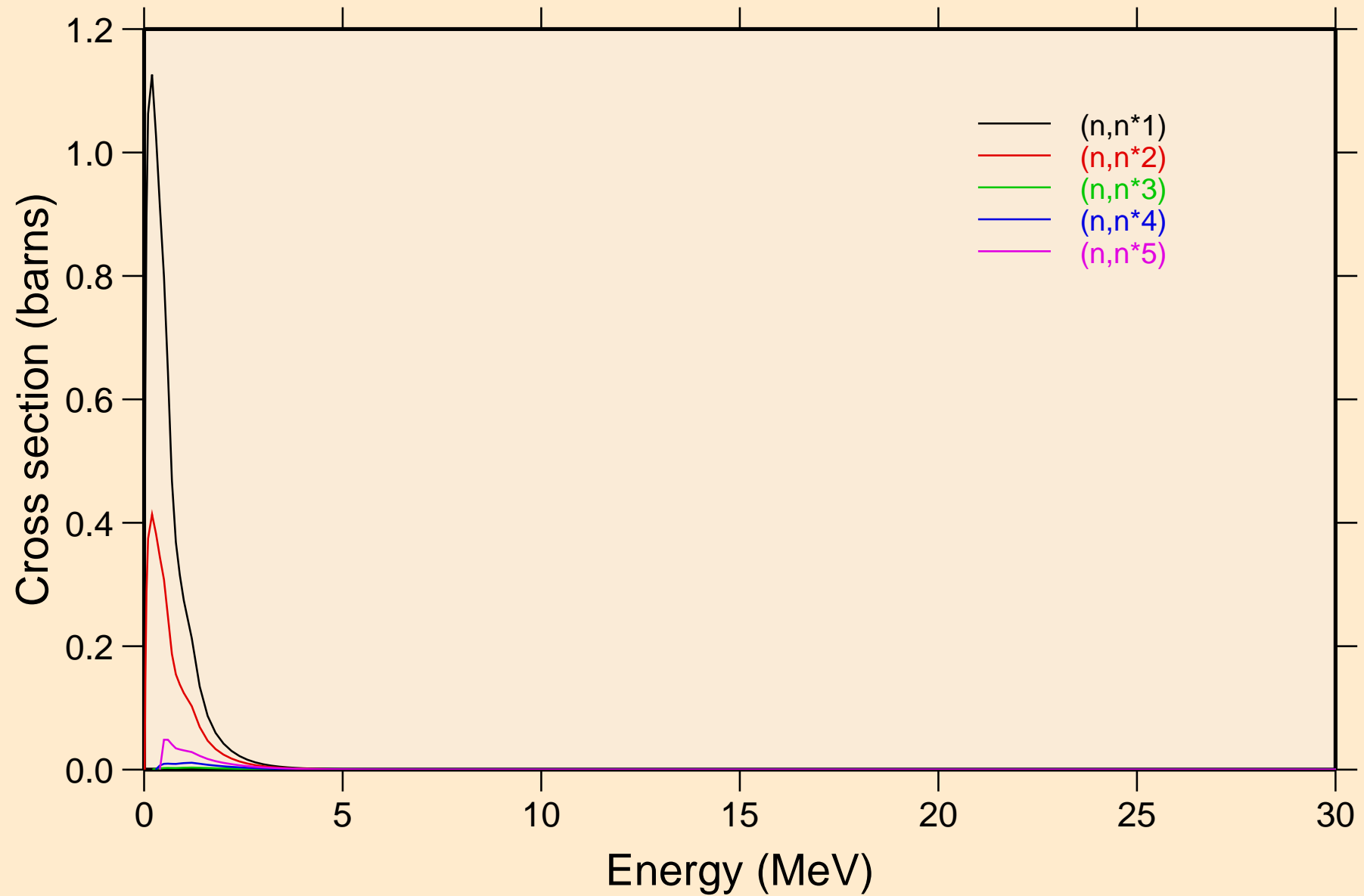

TC101 NEUTRON ACER TENDL-2021 LIBRARY; T=293.6K
Inelastic levels

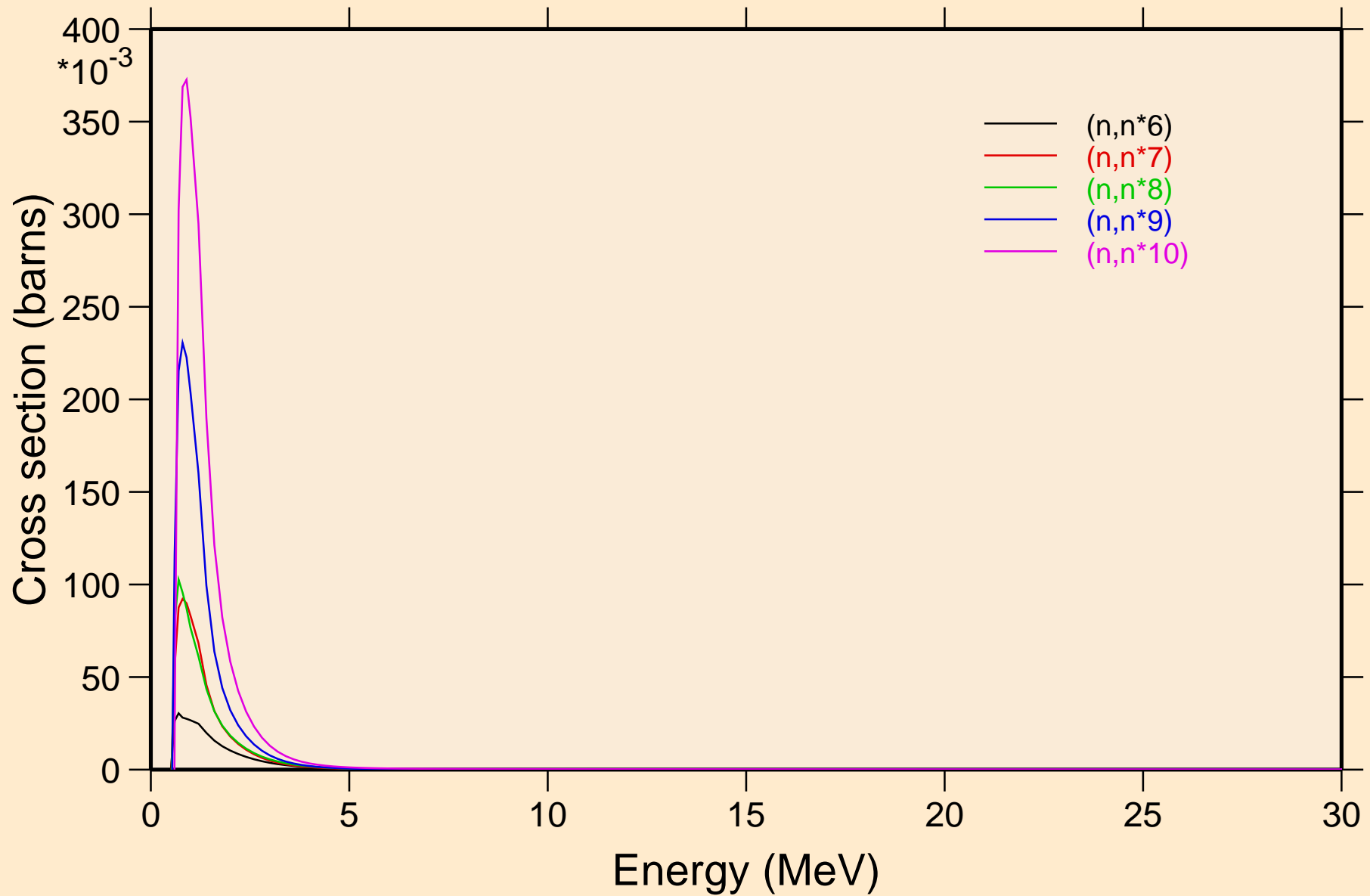

TC101 NEUTRON ACER TENDL-2021 LIBRARY; T=293.6K
Inelastic levels

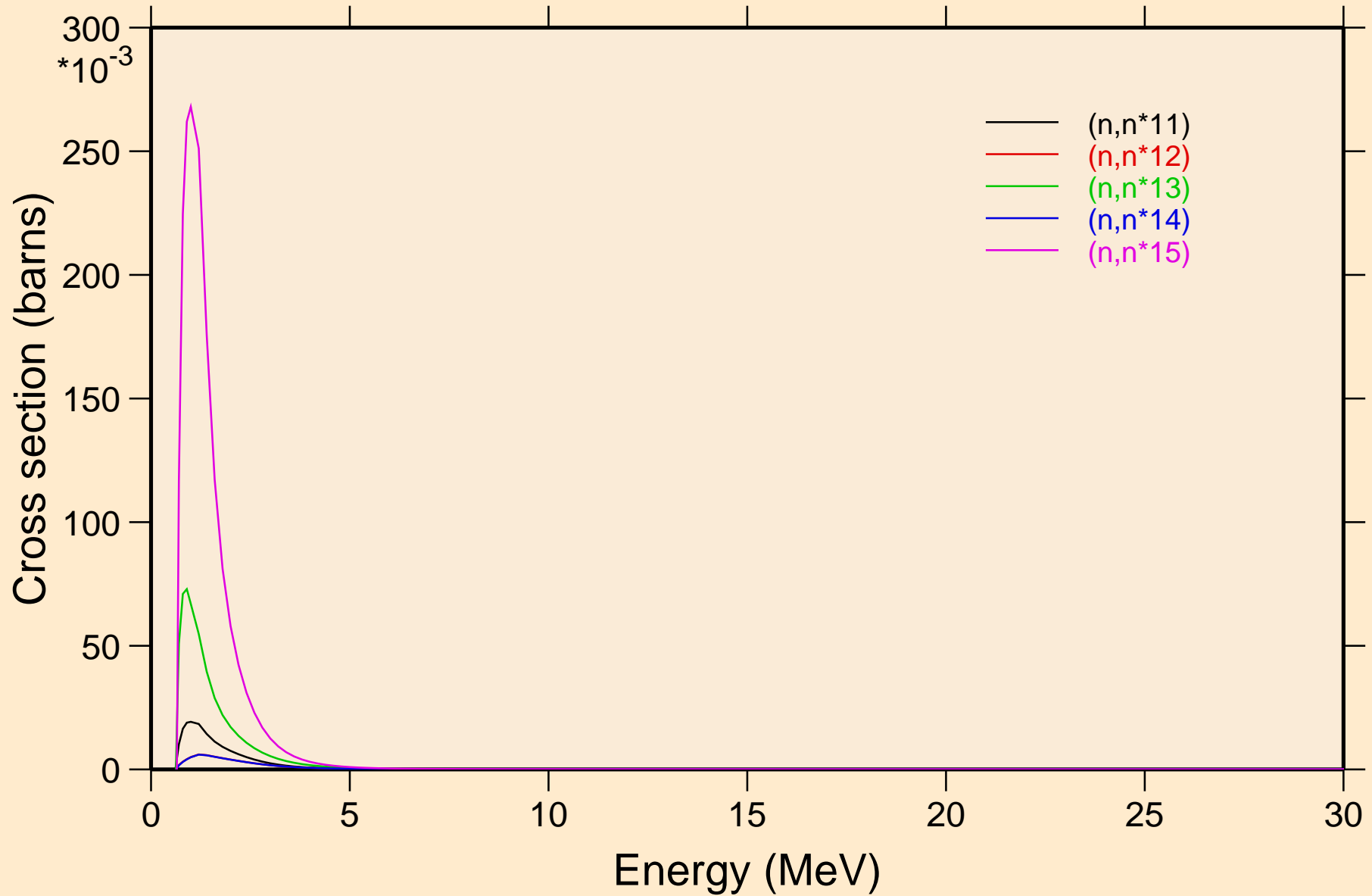

TC101 NEUTRON ACER TENDL-2021 LIBRARY; T=293.6K
Inelastic levels

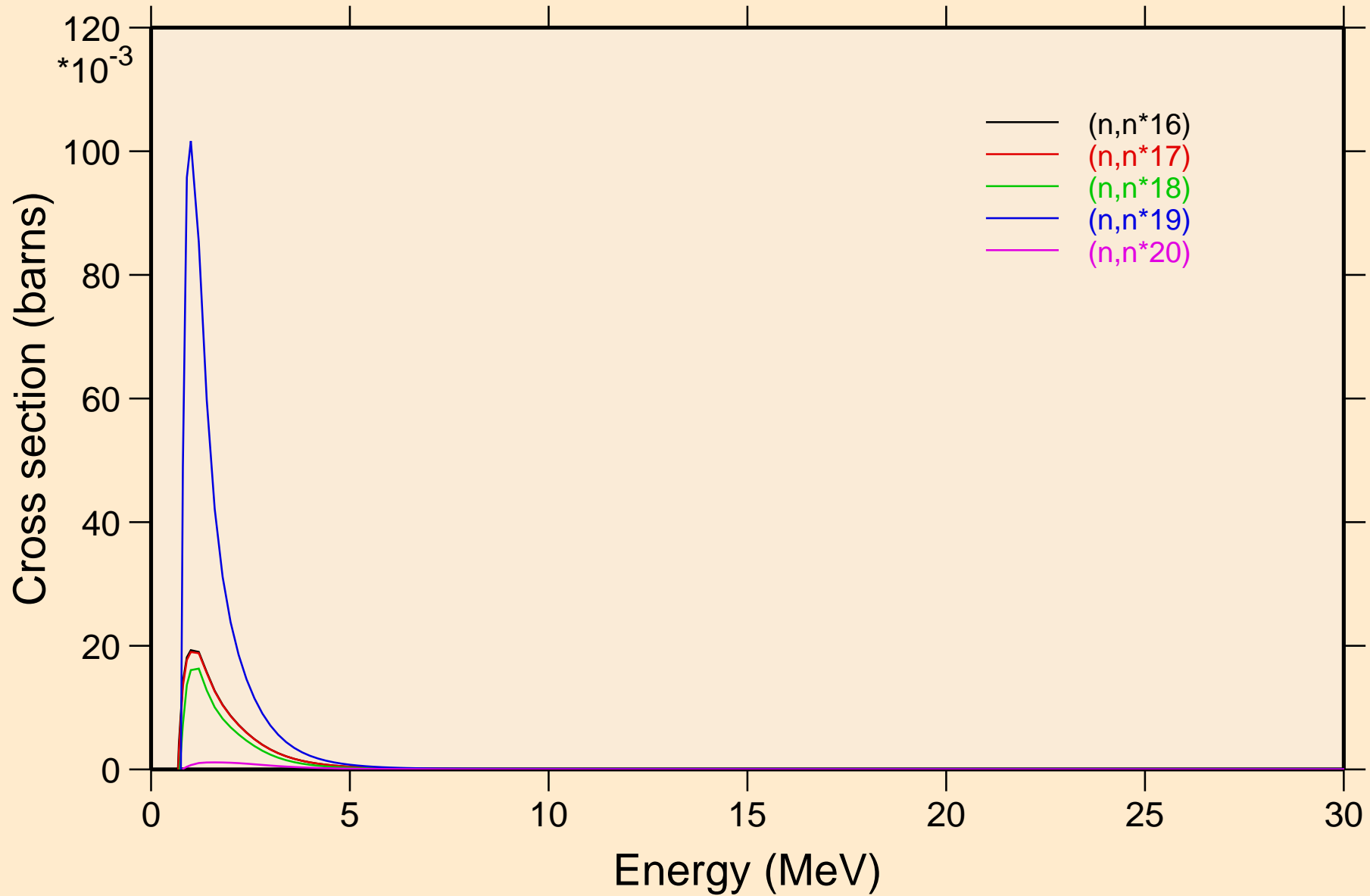

TC101 NEUTRON ACER TENDL-2021 LIBRARY; T=293.6K
Inelastic levels

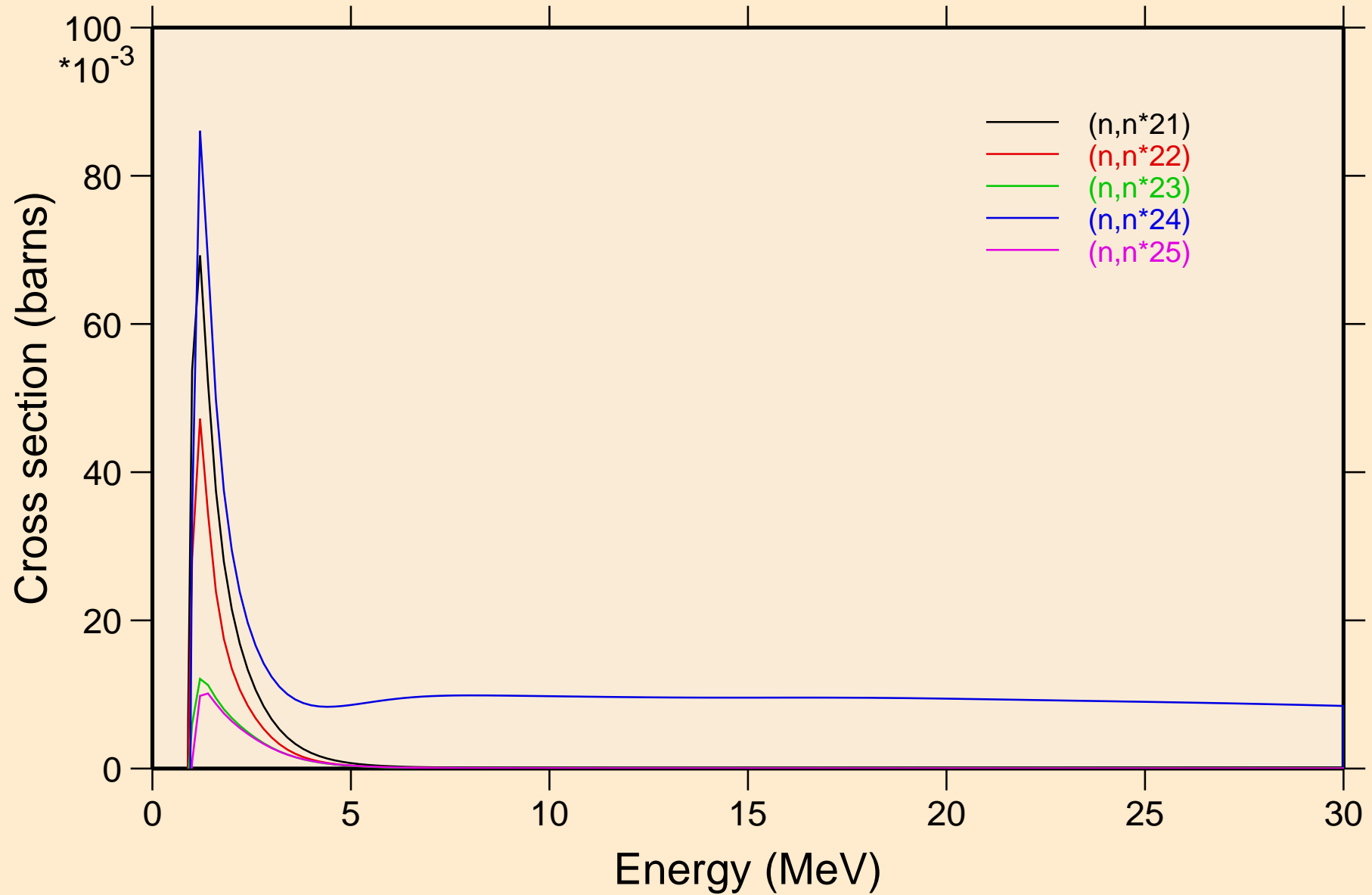

TC101 NEUTRON ACER TENDL-2021 LIBRARY; T=293.6K
Inelastic levels

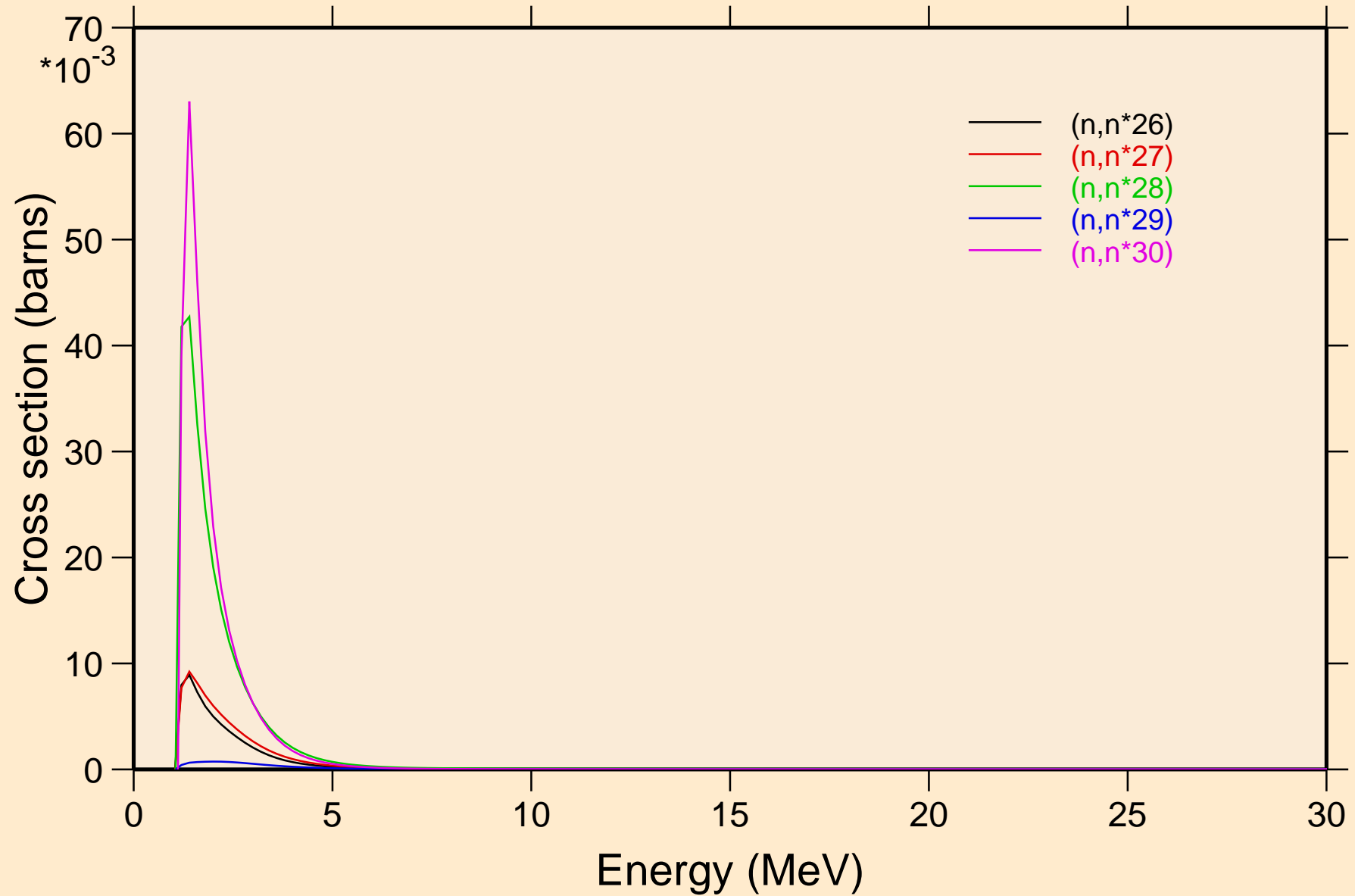

TC101 NEUTRON ACER TENDL-2021 LIBRARY; T=293.6K
Threshold reactions

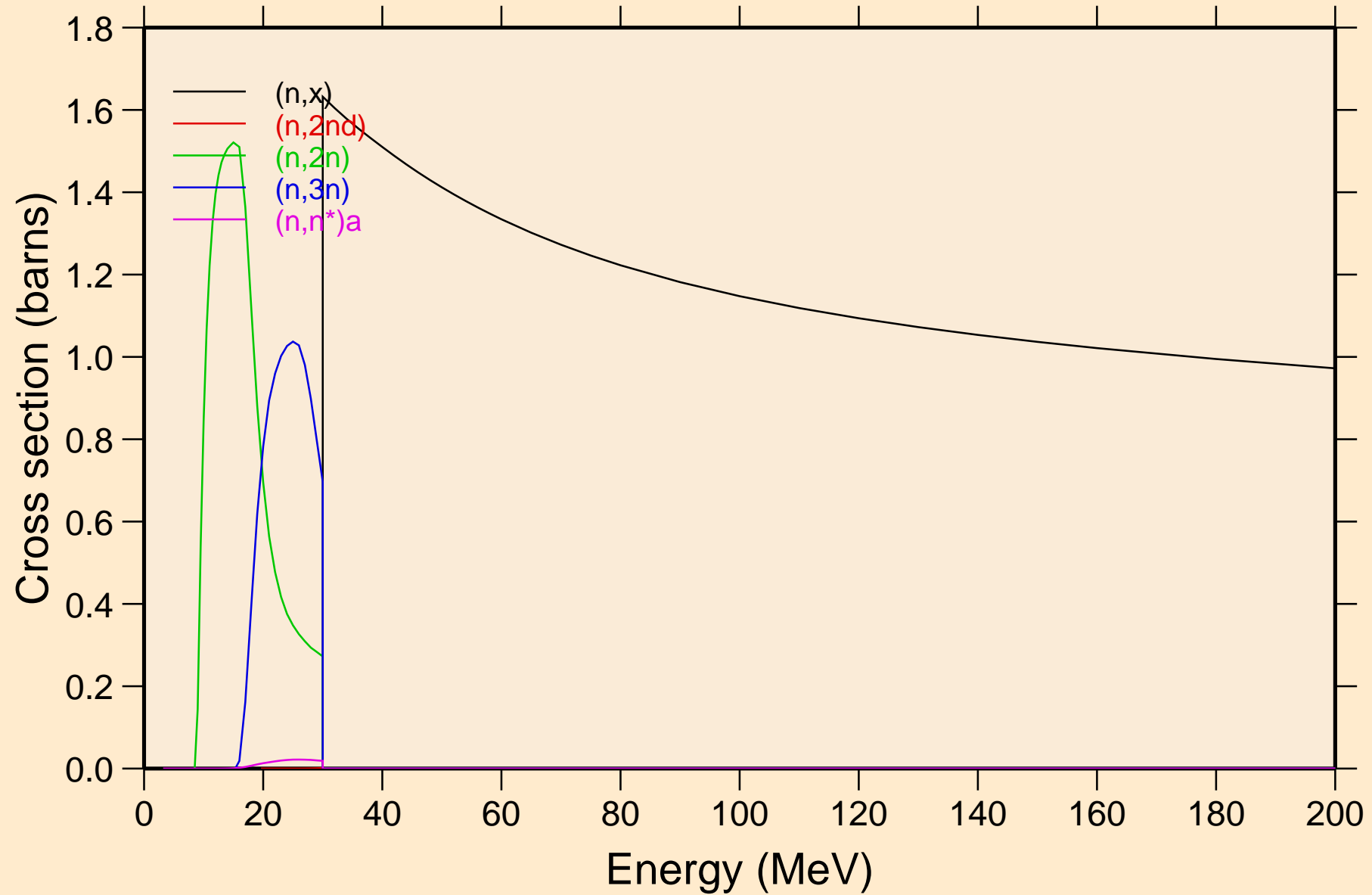

TC101 NEUTRON ACER TENDL-2021 LIBRARY; T=293.6K
Threshold reactions

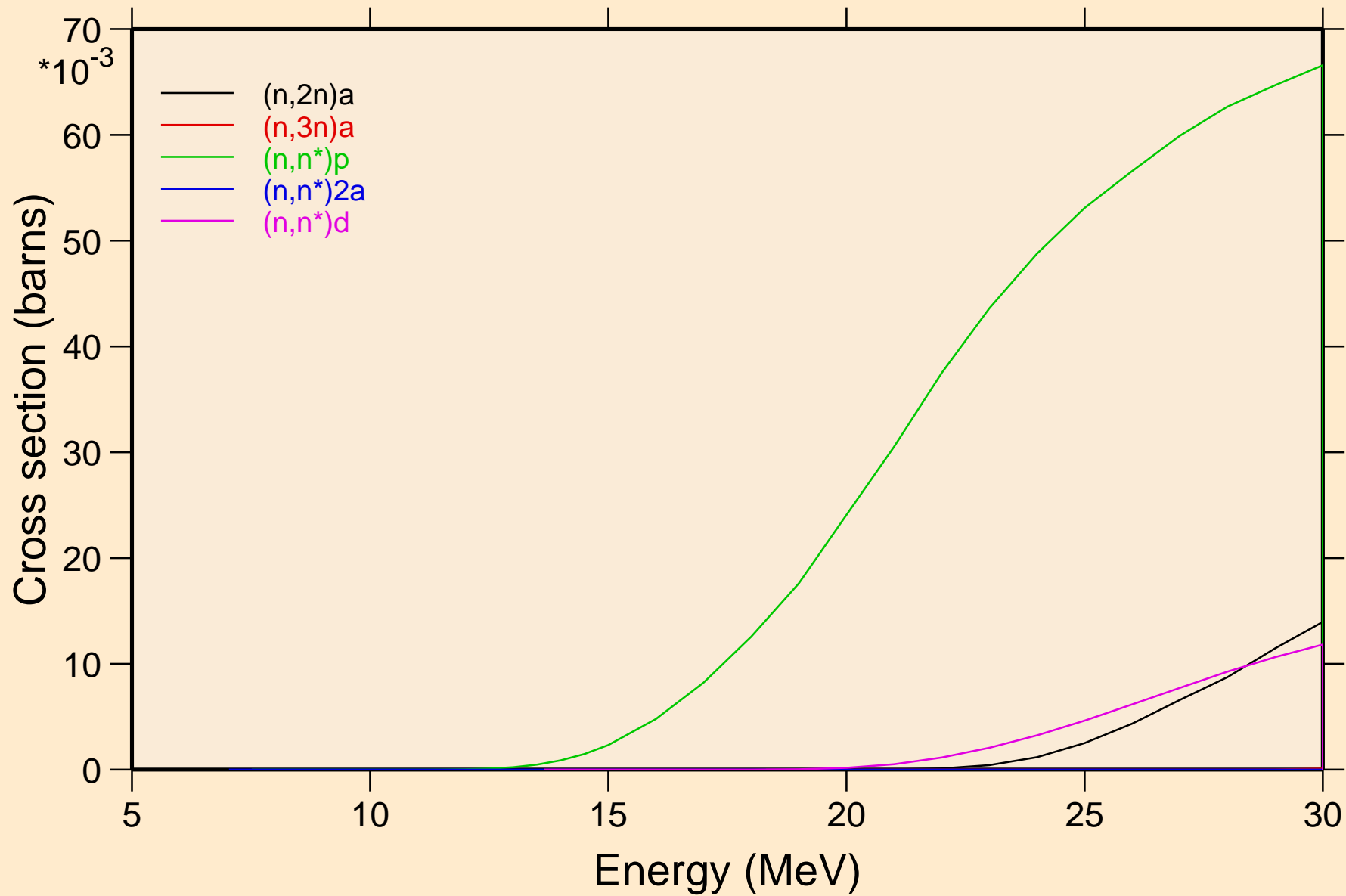

TC101 NEUTRON ACER TENDL-2021 LIBRARY; T=293.6K
Threshold reactions

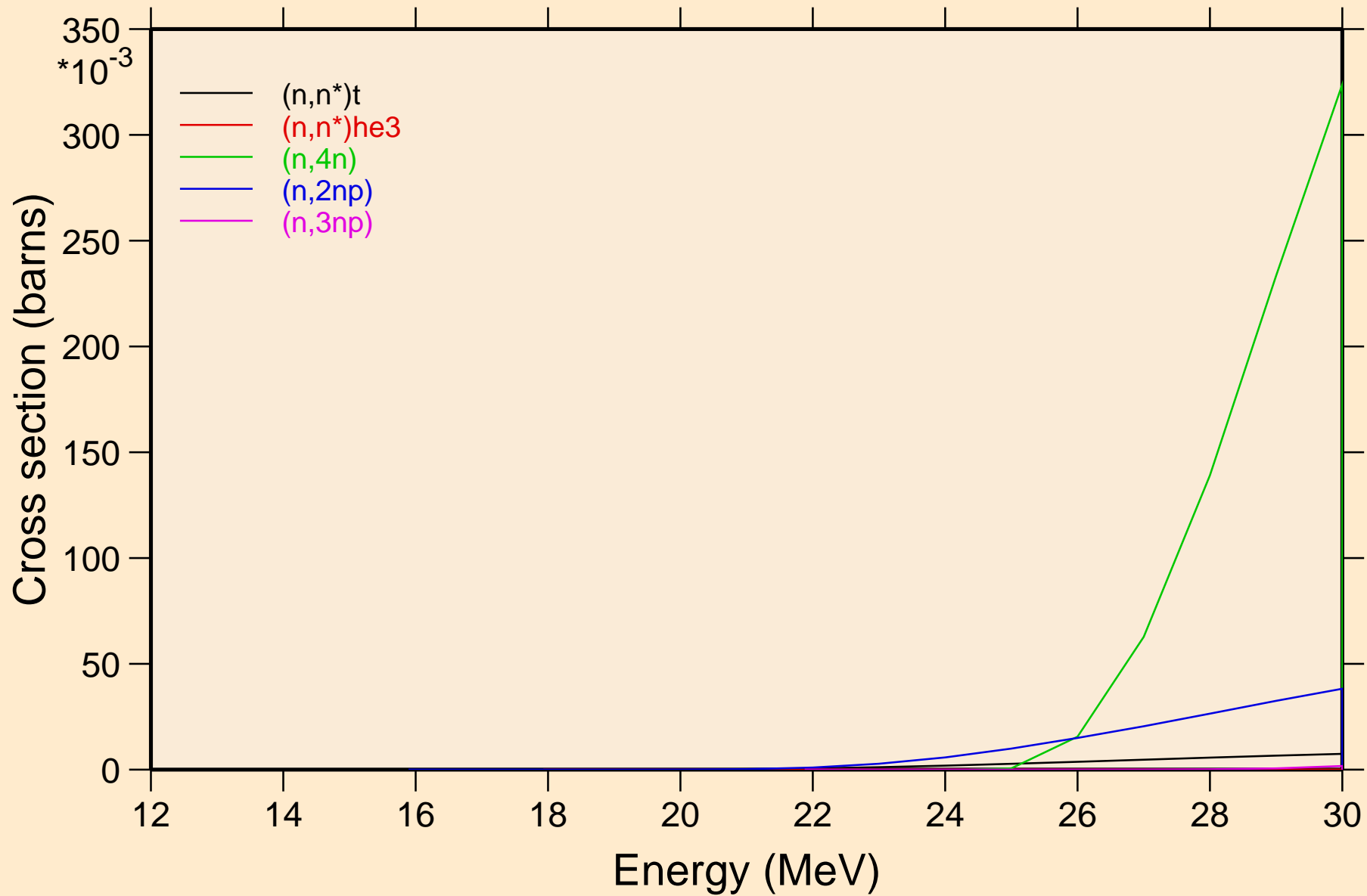

TC101 NEUTRON ACER TENDL-2021 LIBRARY; T=293.6K
Threshold reactions

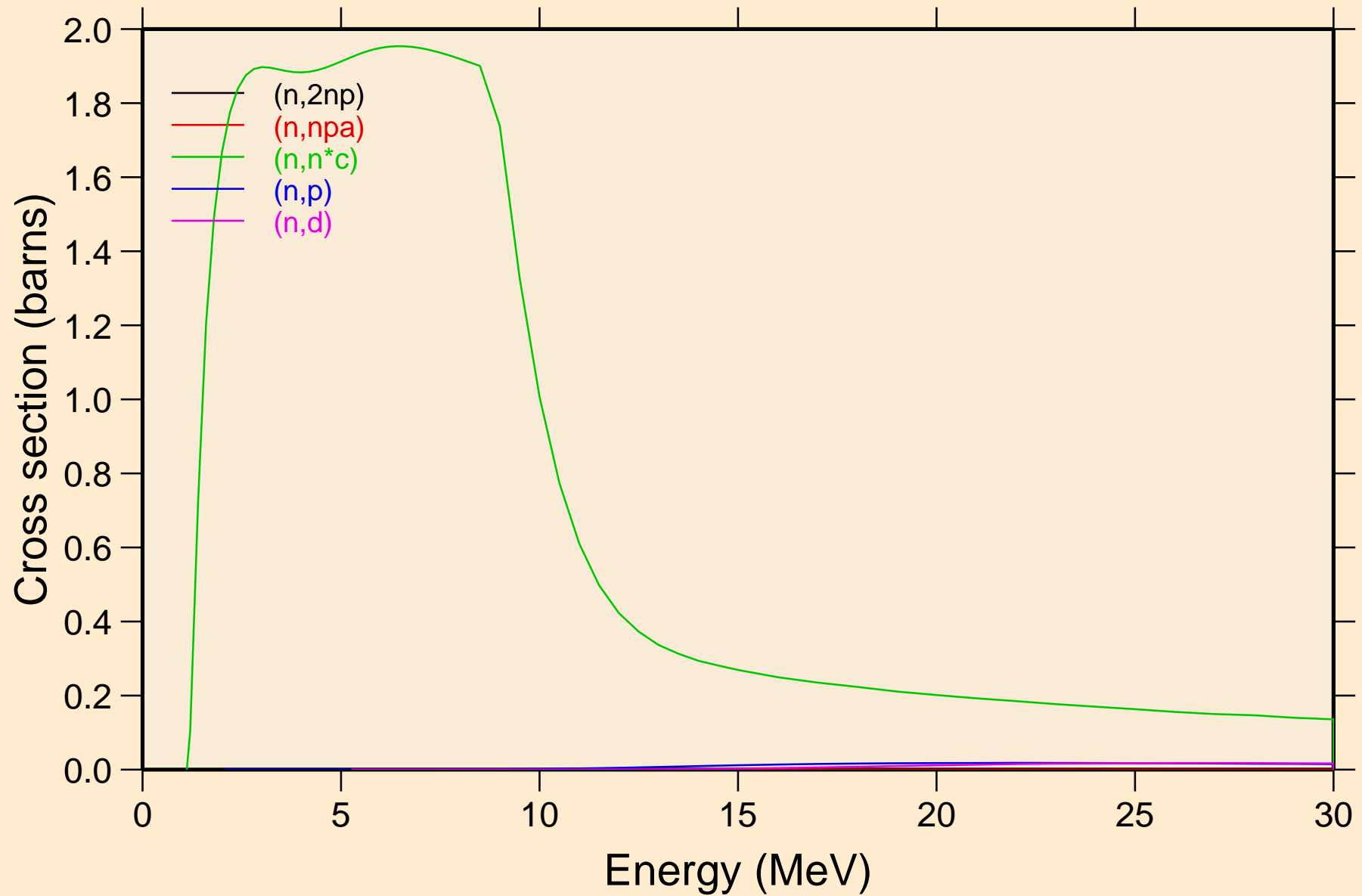

TC101 NEUTRON ACER TENDL-2021 LIBRARY; T=293.6K
Threshold reactions

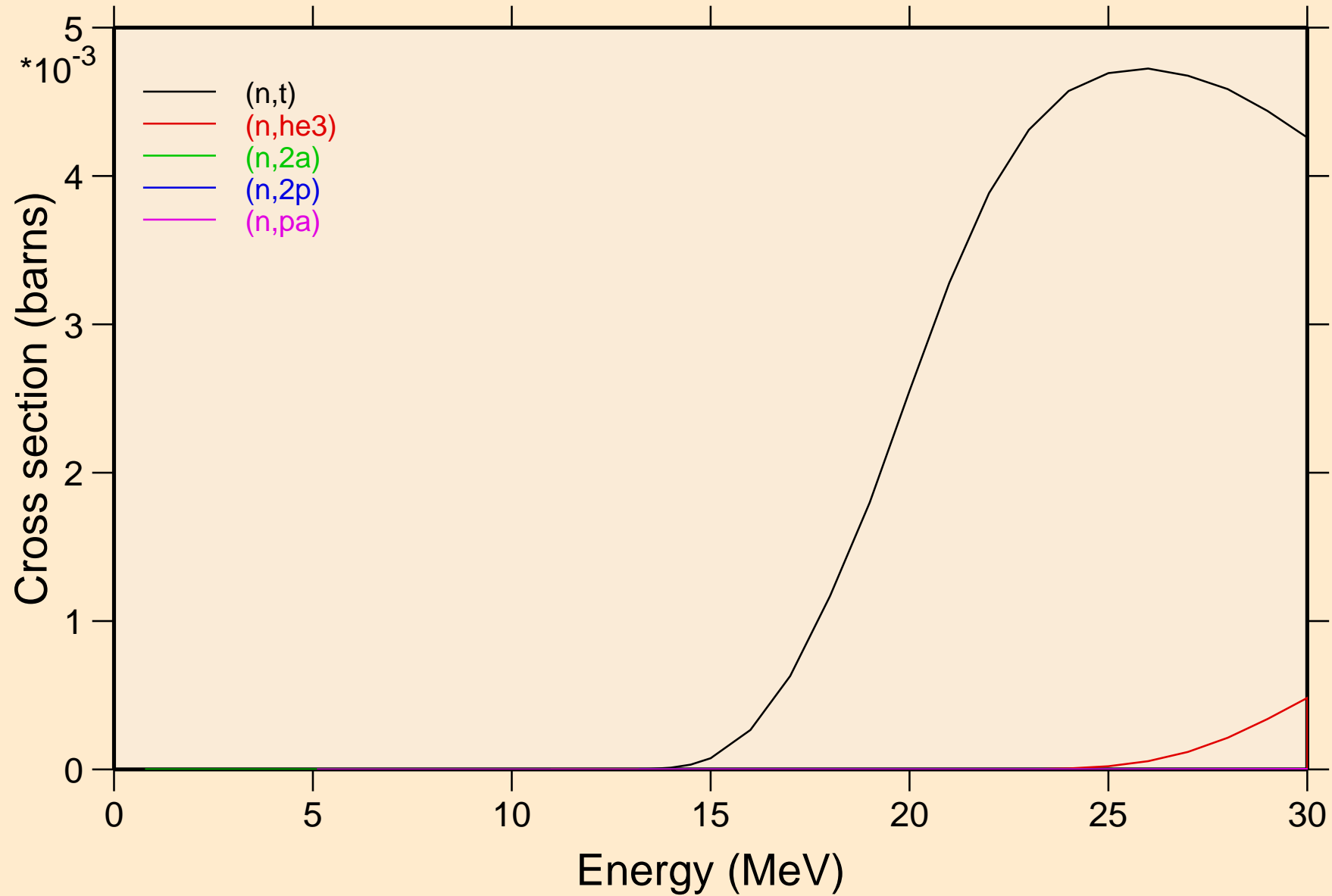

TC101 NEUTRON ACER TENDL-2021 LIBRARY; T=293.6K
Threshold reactions

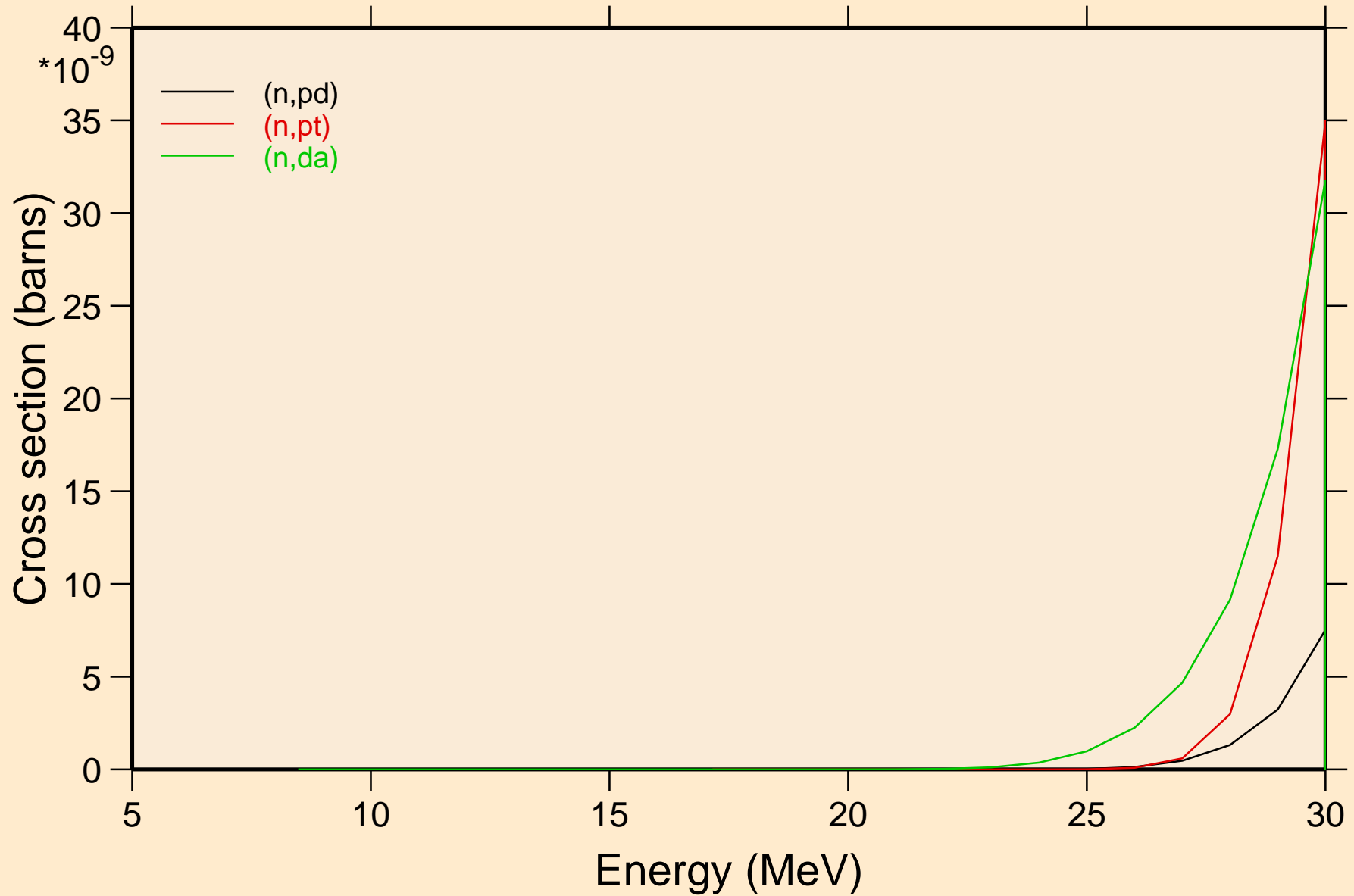

TC101 NEUTRON ACER TENDL-2021 LIBRARY; T=293.6K
Threshold reactions

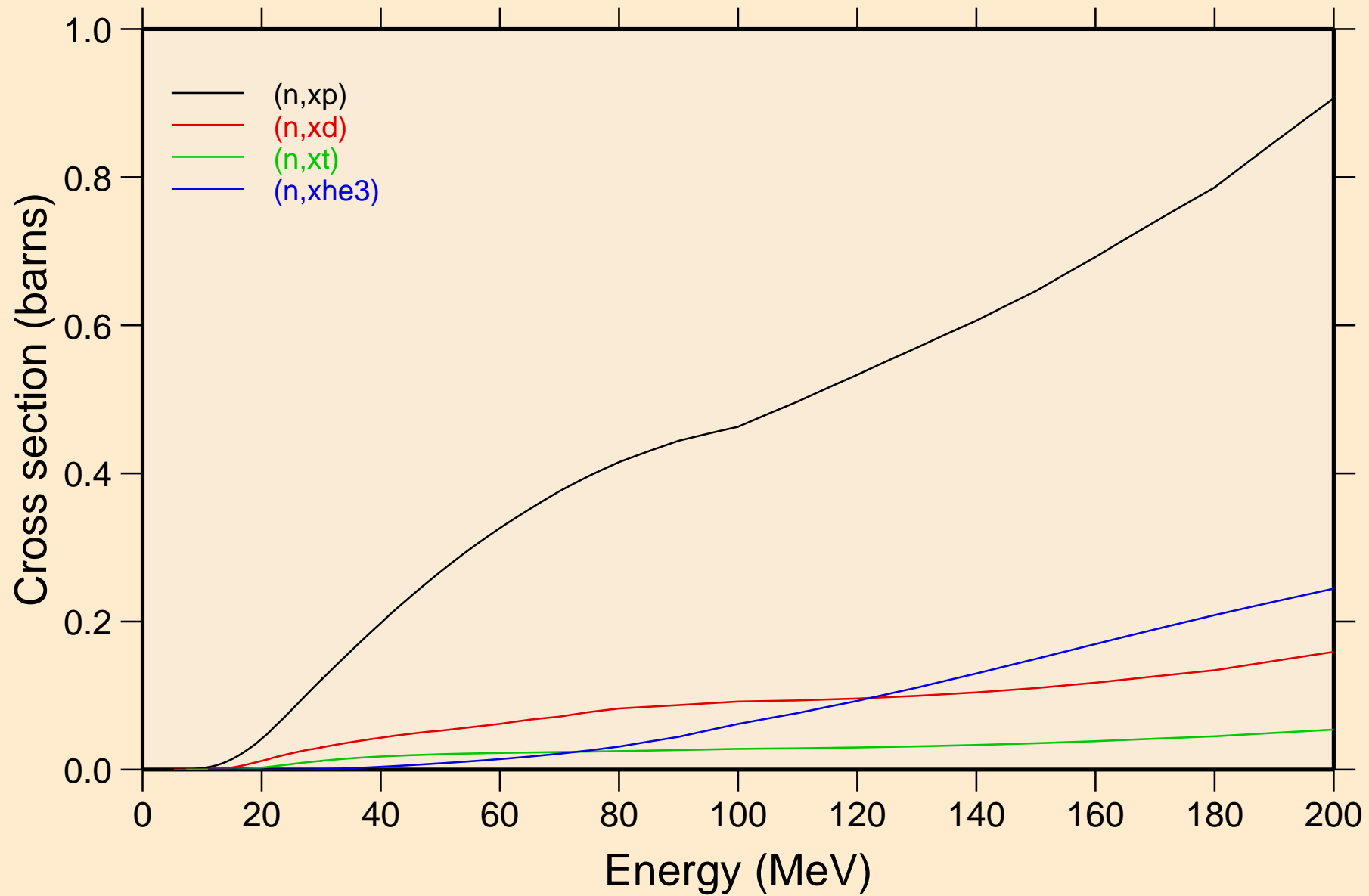

TC101 NEUTRON ACER TENDL-2021 LIBRARY; T=293.6K
angular distribution for elastic

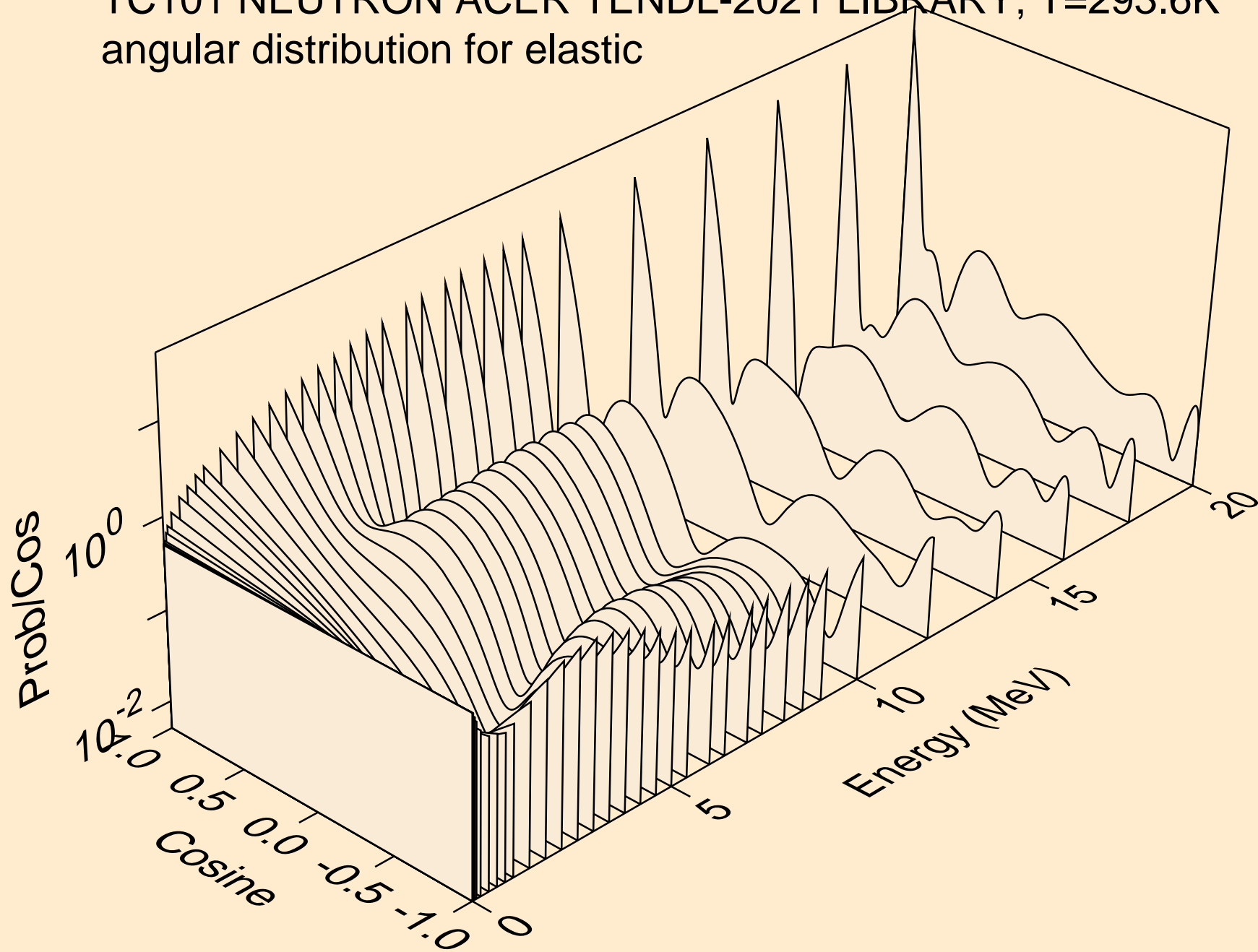

TC101 NEUTRON ACER TENDL-2021 LIBRARY; T=293.6K
angular distribution for elastic

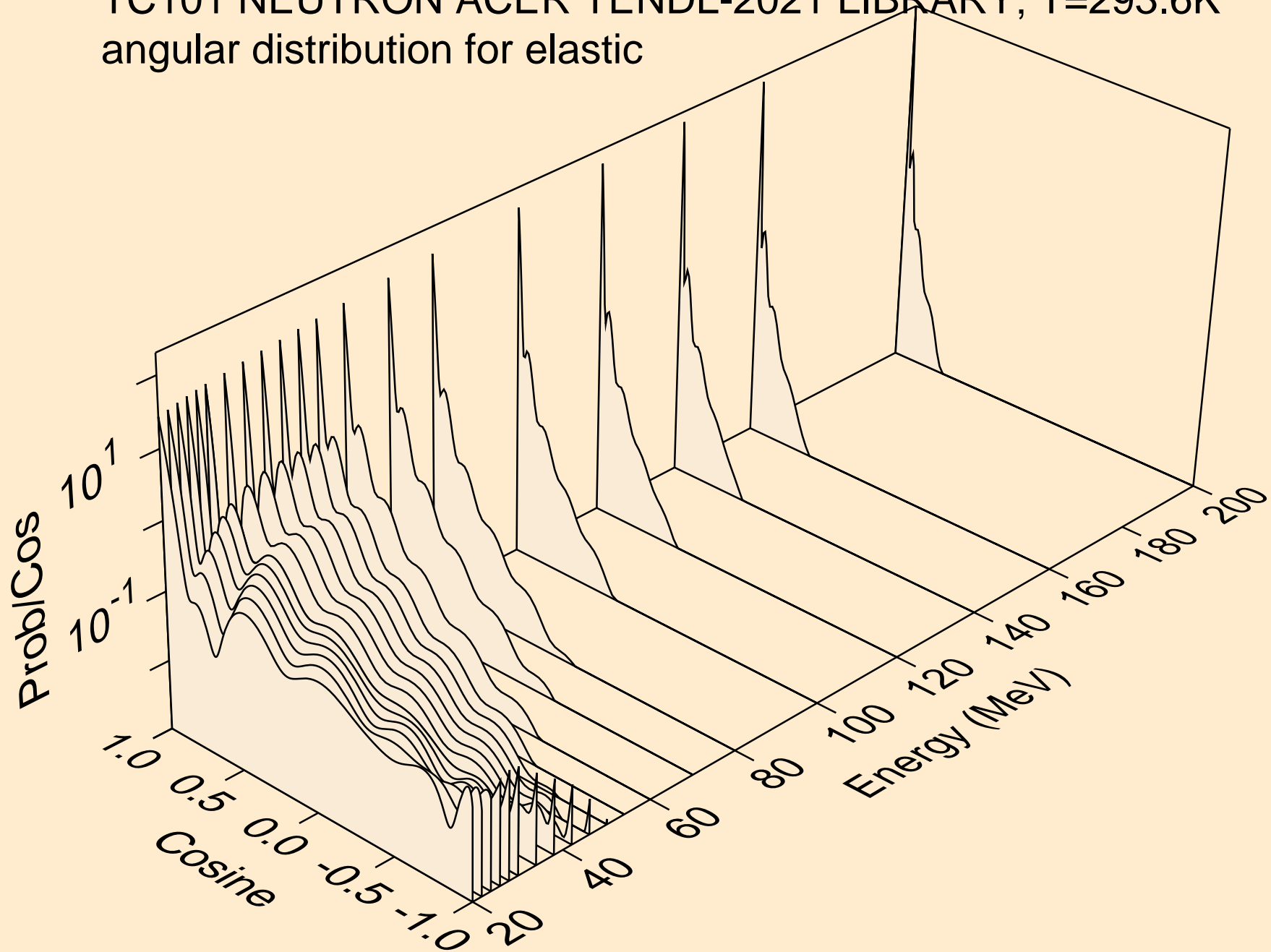

TC101 NEUTRON ACER TENDL-2021 LIBRARY; T=293.6K
angular distribution for (n,n*1)

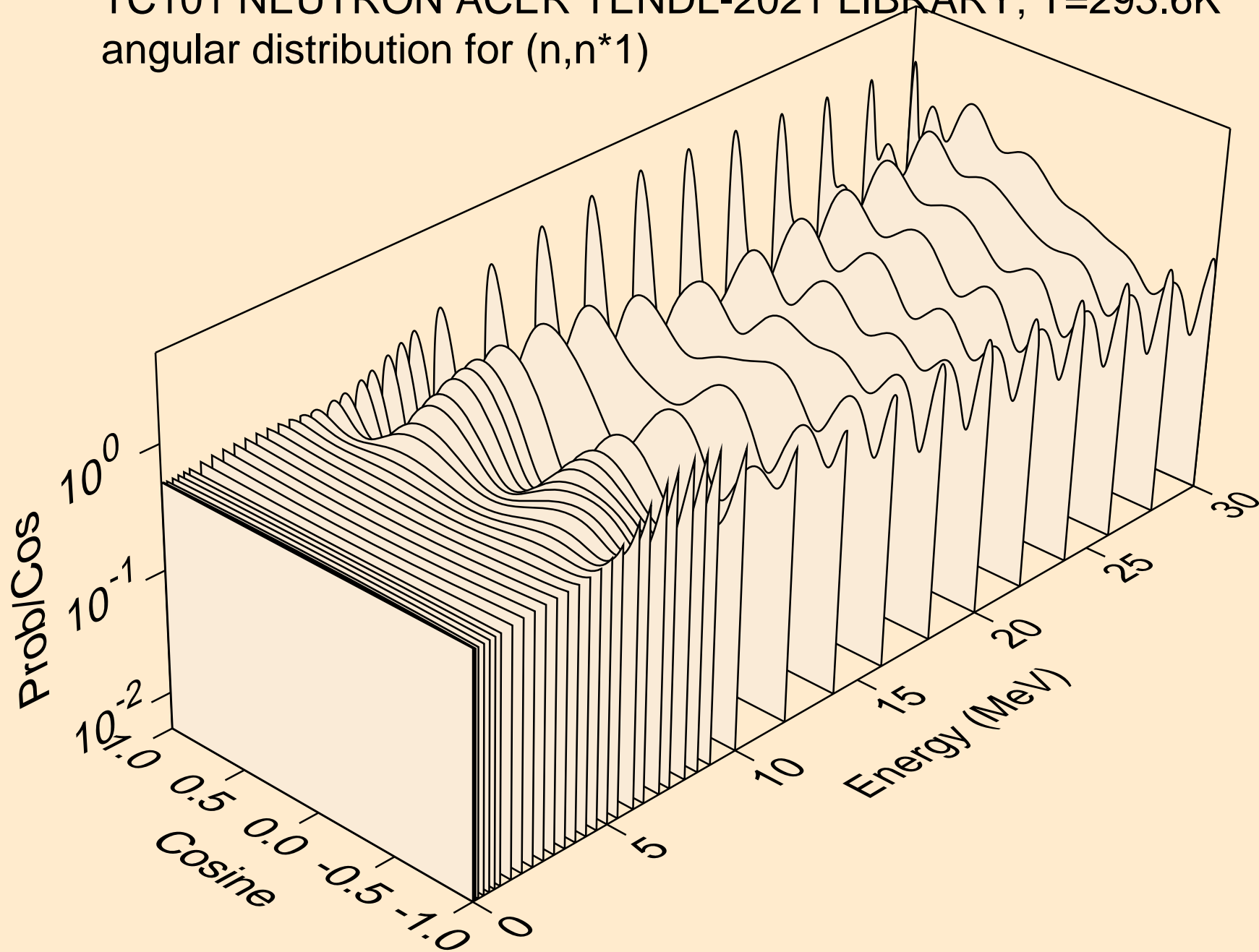

TC101 NEUTRON ACER TENDL-2021 LIBRARY; T=293.6K
angular distribution for (n,n*2)

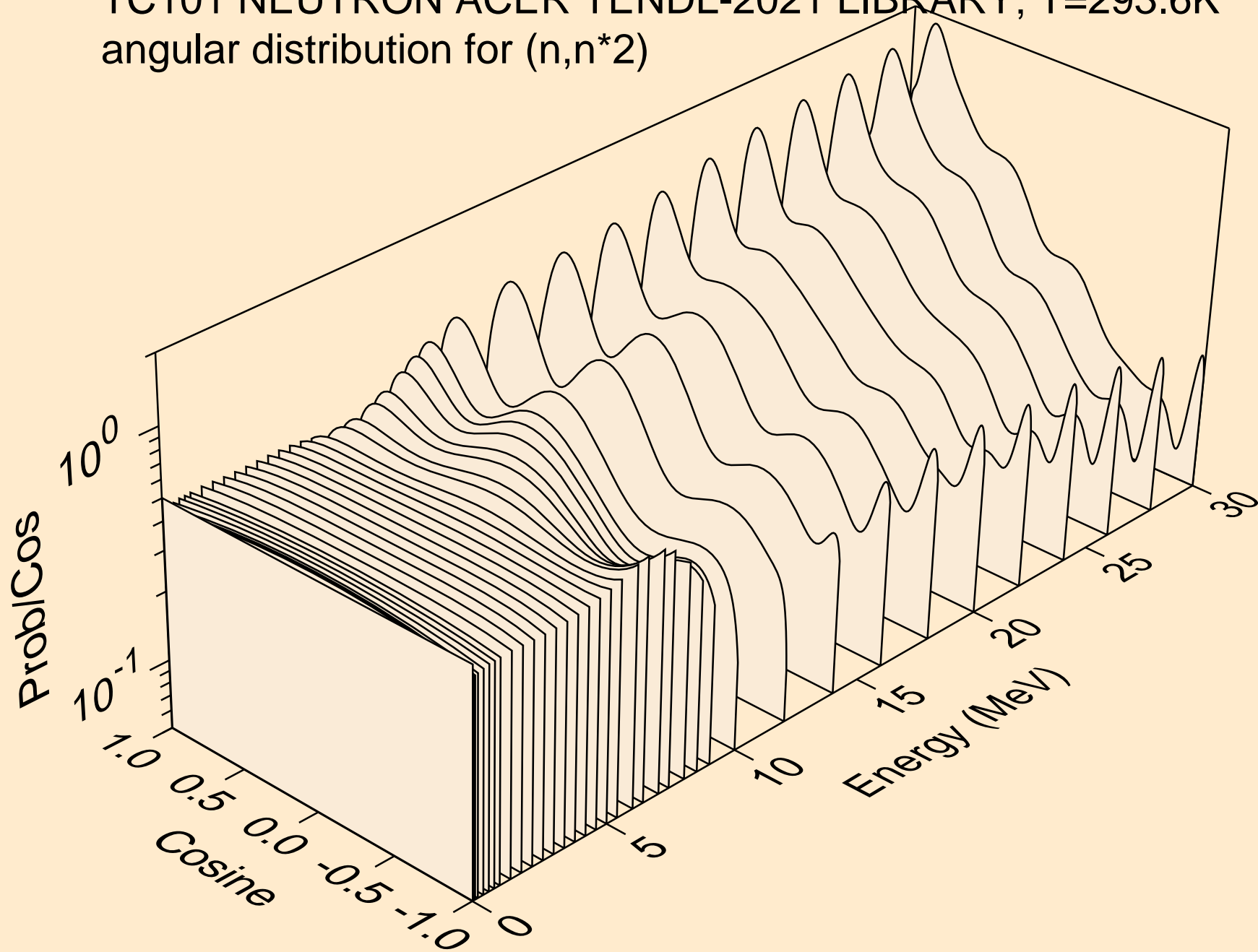

TC101 NEUTRON ACER TENDL-2021 LIBRARY; T=293.6K
angular distribution for (n,n*3)

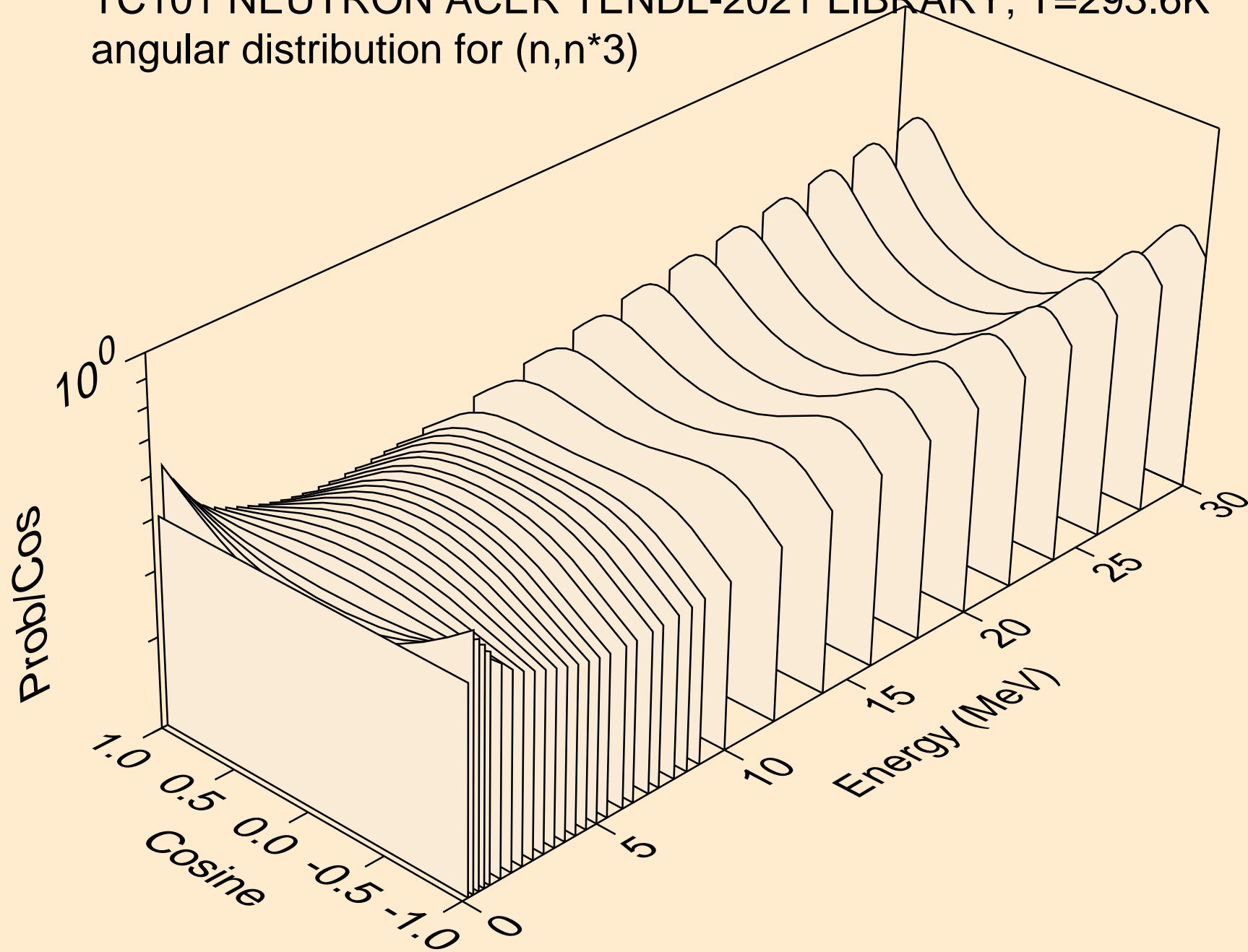

TC101 NEUTRON ACER TENDL-2021 LIBRARY; T=293.6K
angular distribution for (n,n*4)

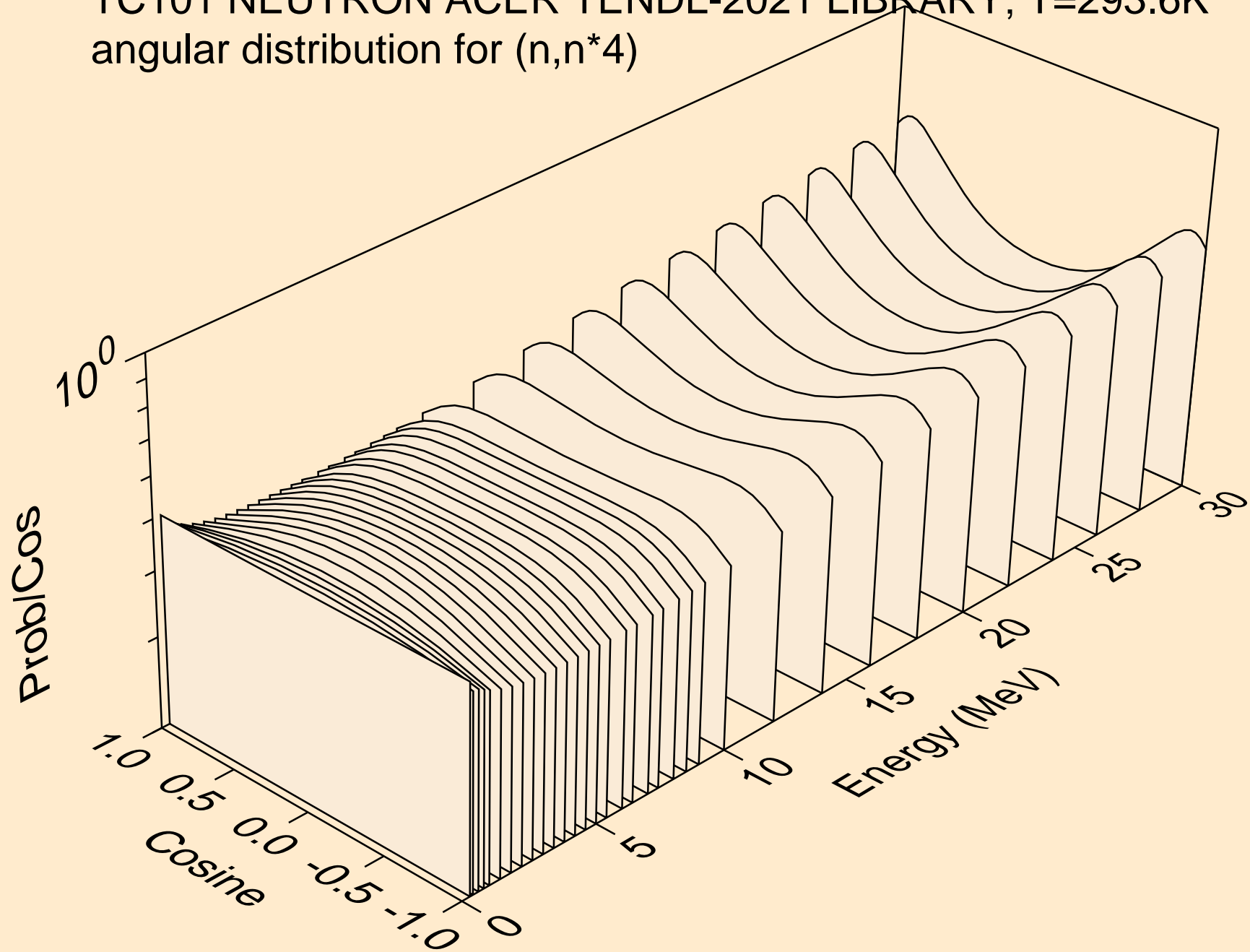

TC101 NEUTRON ACER TENDL-2021 LIBRARY; T=293.6K
angular distribution for (n,n*5)

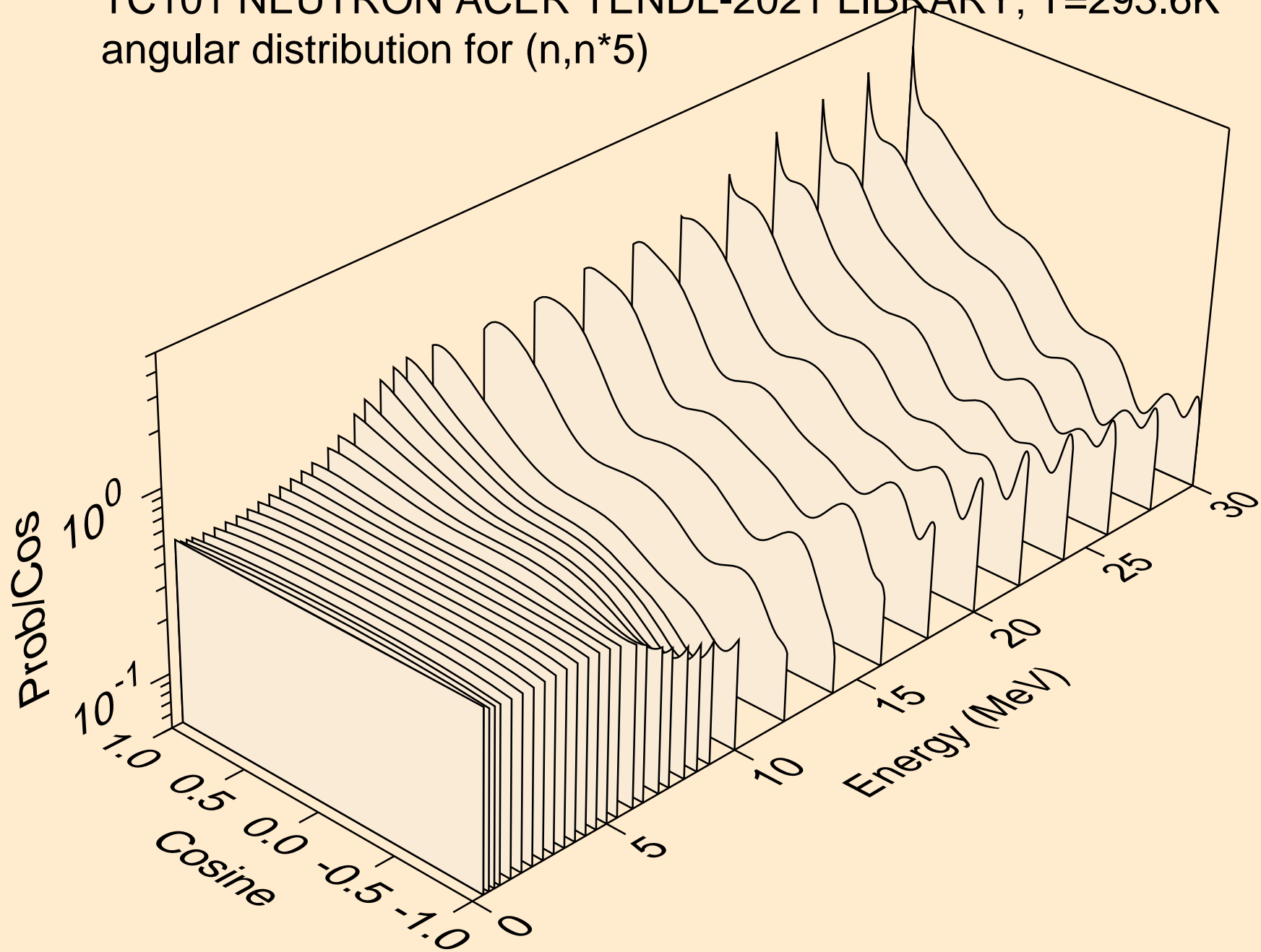

TC101 NEUTRON ACER TENDL-2021 LIBRARY; T=293.6K
angular distribution for (n,n*6)

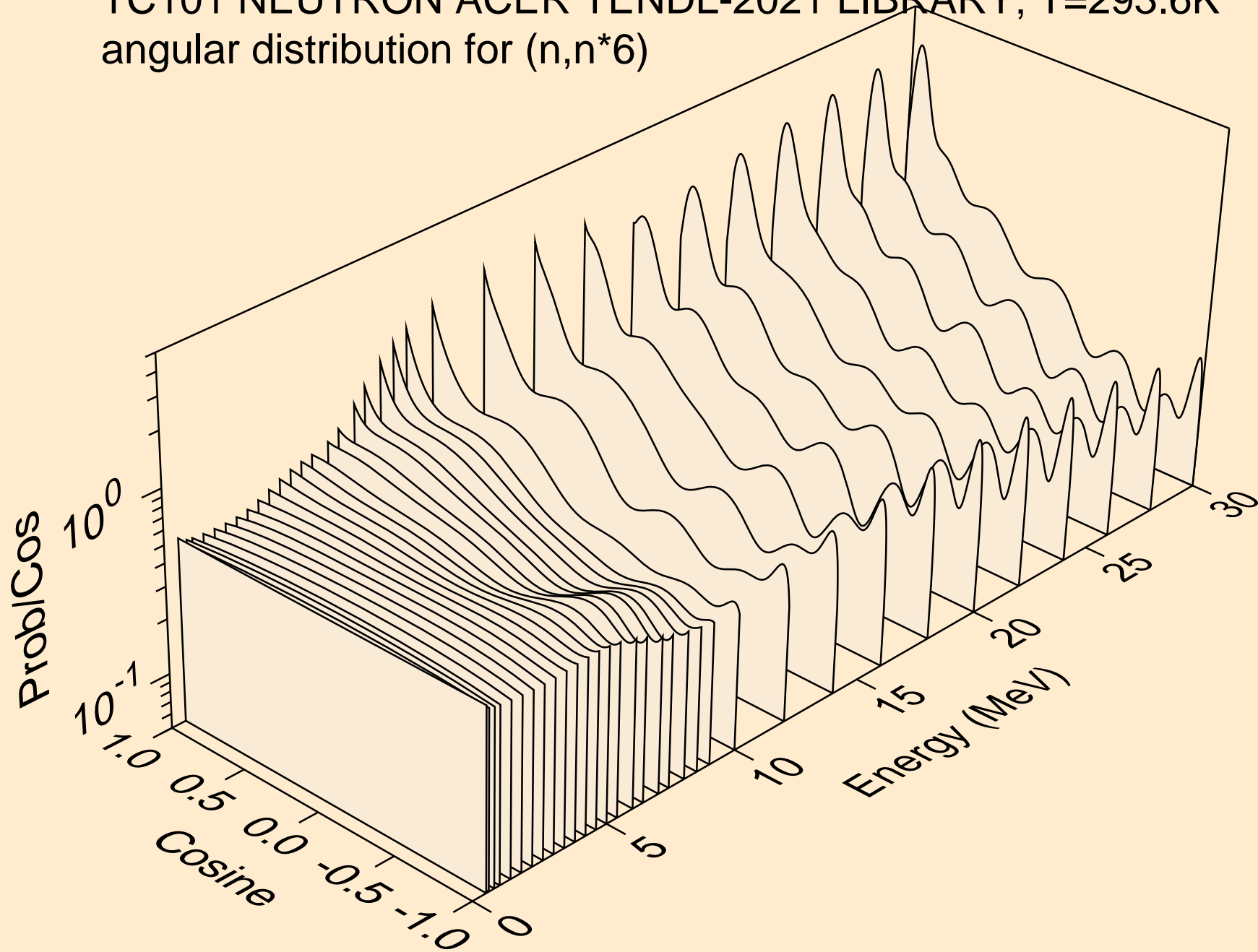

TC101 NEUTRON ACER TENDL-2021 LIBRARY; T=293.6K
angular distribution for (n,n*7)

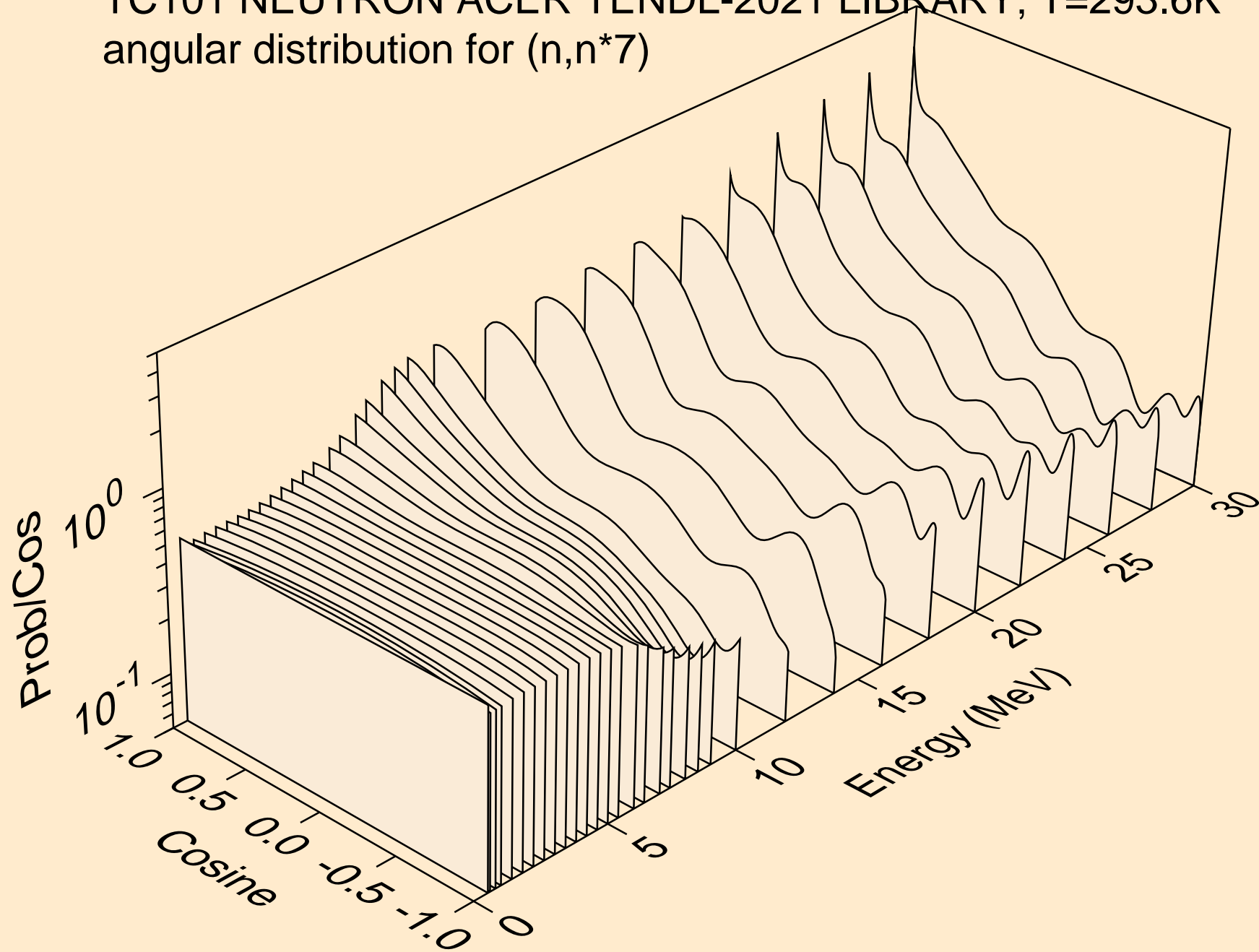

TC101 NEUTRON ACER TENDL-2021 LIBRARY; T=293.6K
angular distribution for (n,n*8)

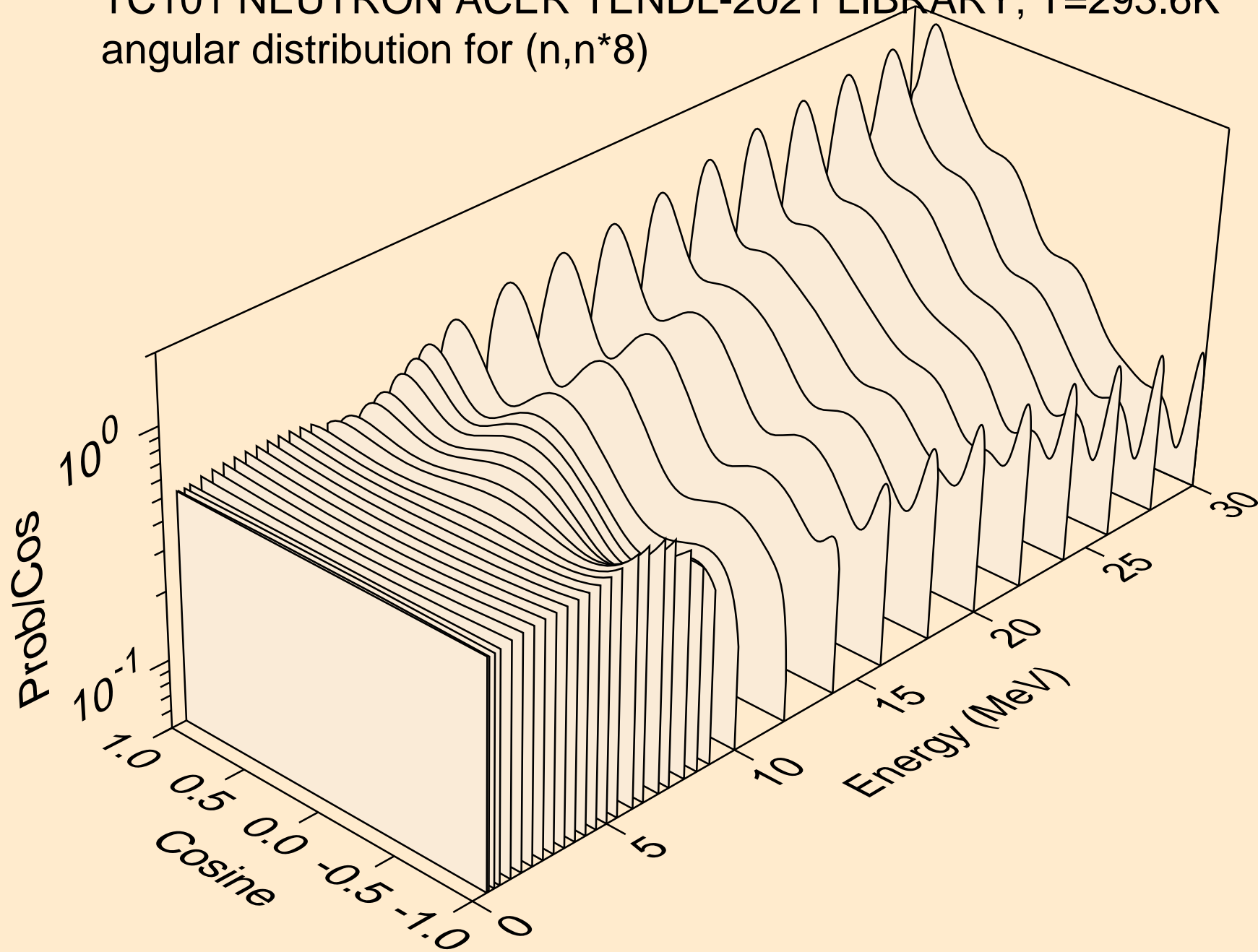

TC101 NEUTRON ACER TENDL-2021 LIBRARY; T=293.6K
angular distribution for (n,n*9)

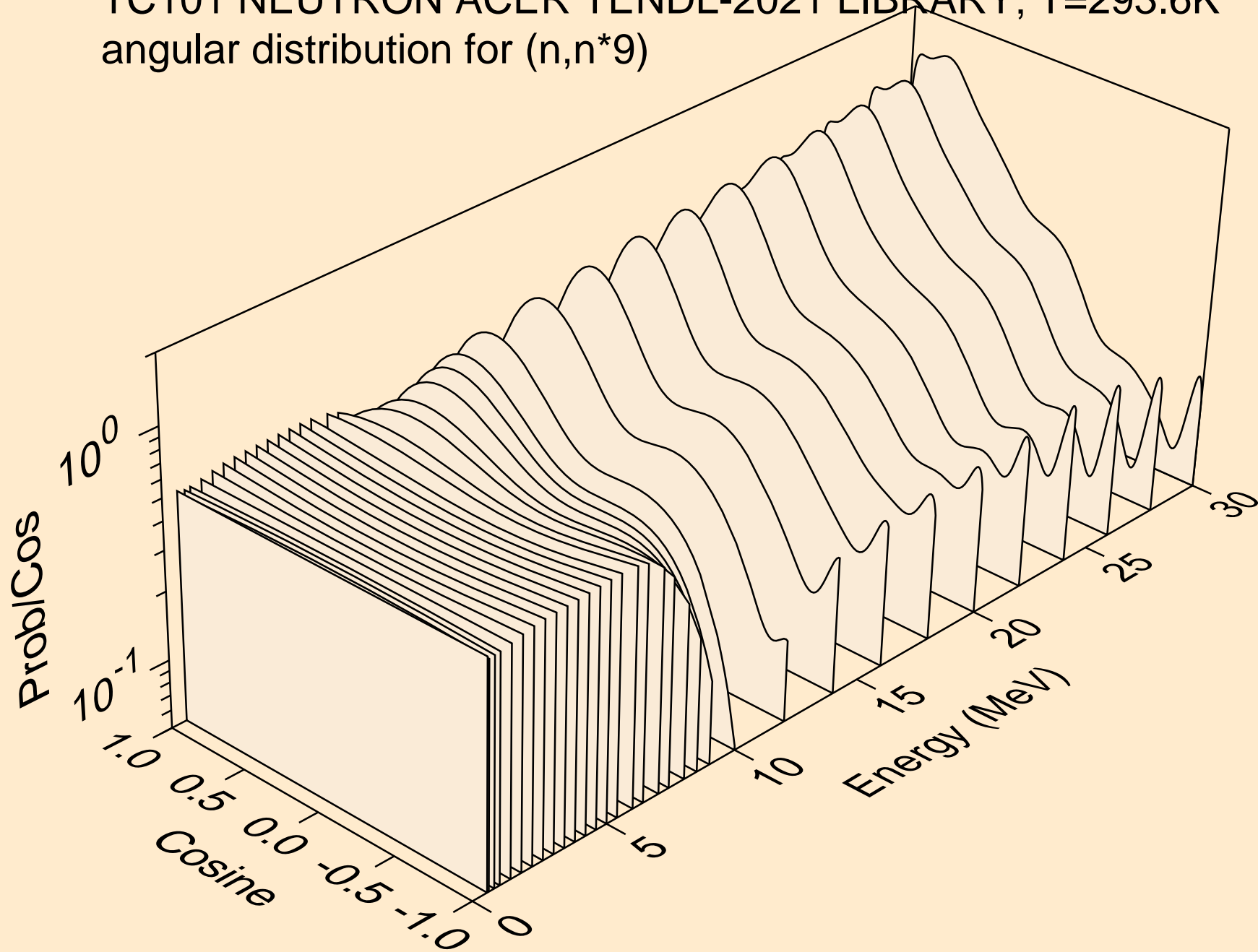

TC101 NEUTRON ACER TENDL-2021 LIBRARY; T=293.6K
angular distribution for (n,n*10)

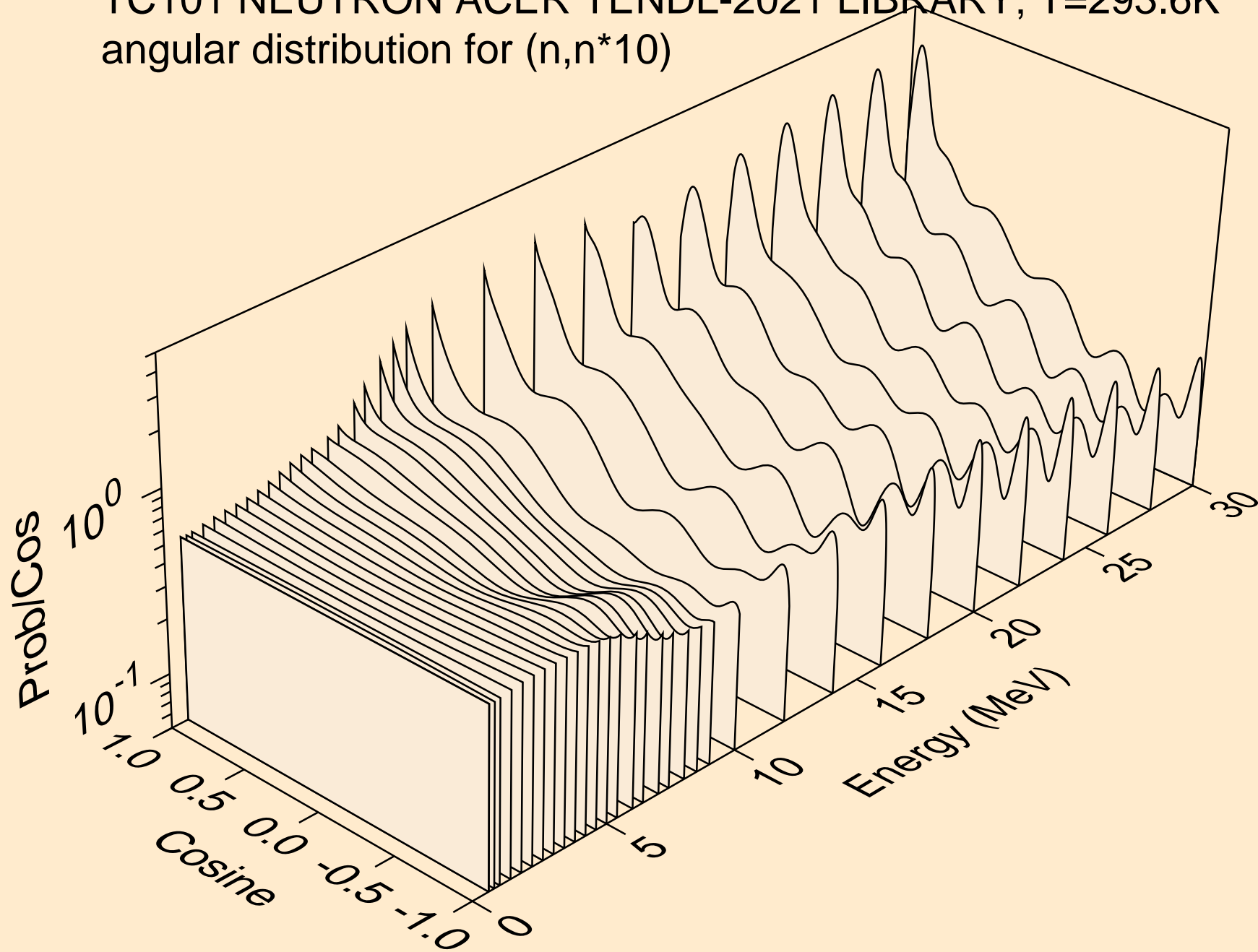

TC101 NEUTRON ACER TENDL-2021 LIBRARY; T=293.6K
angular distribution for (n,n*11)

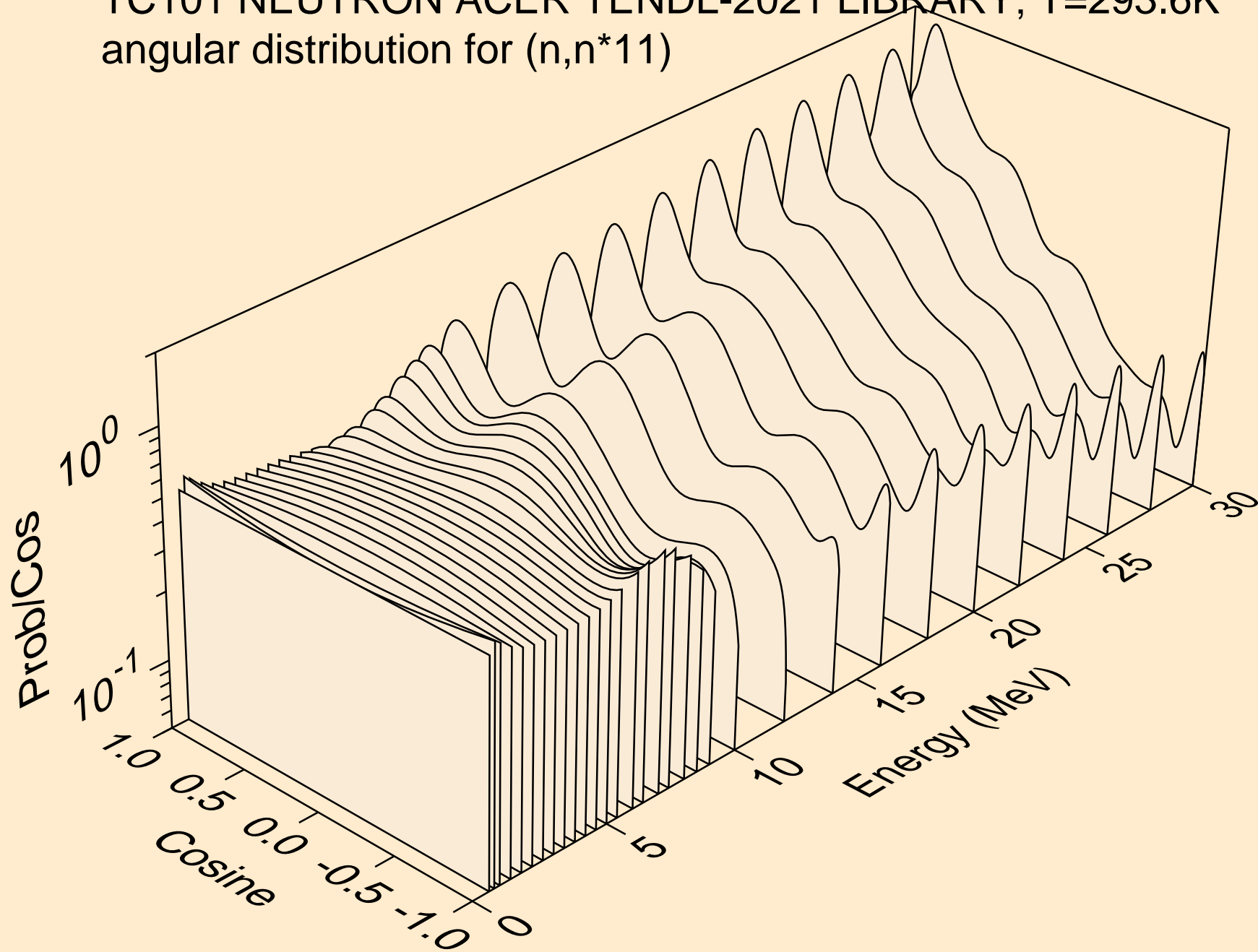

TC101 NEUTRON ACER TENDL-2021 LIBRARY; T=293.6K
angular distribution for (n,n*12)

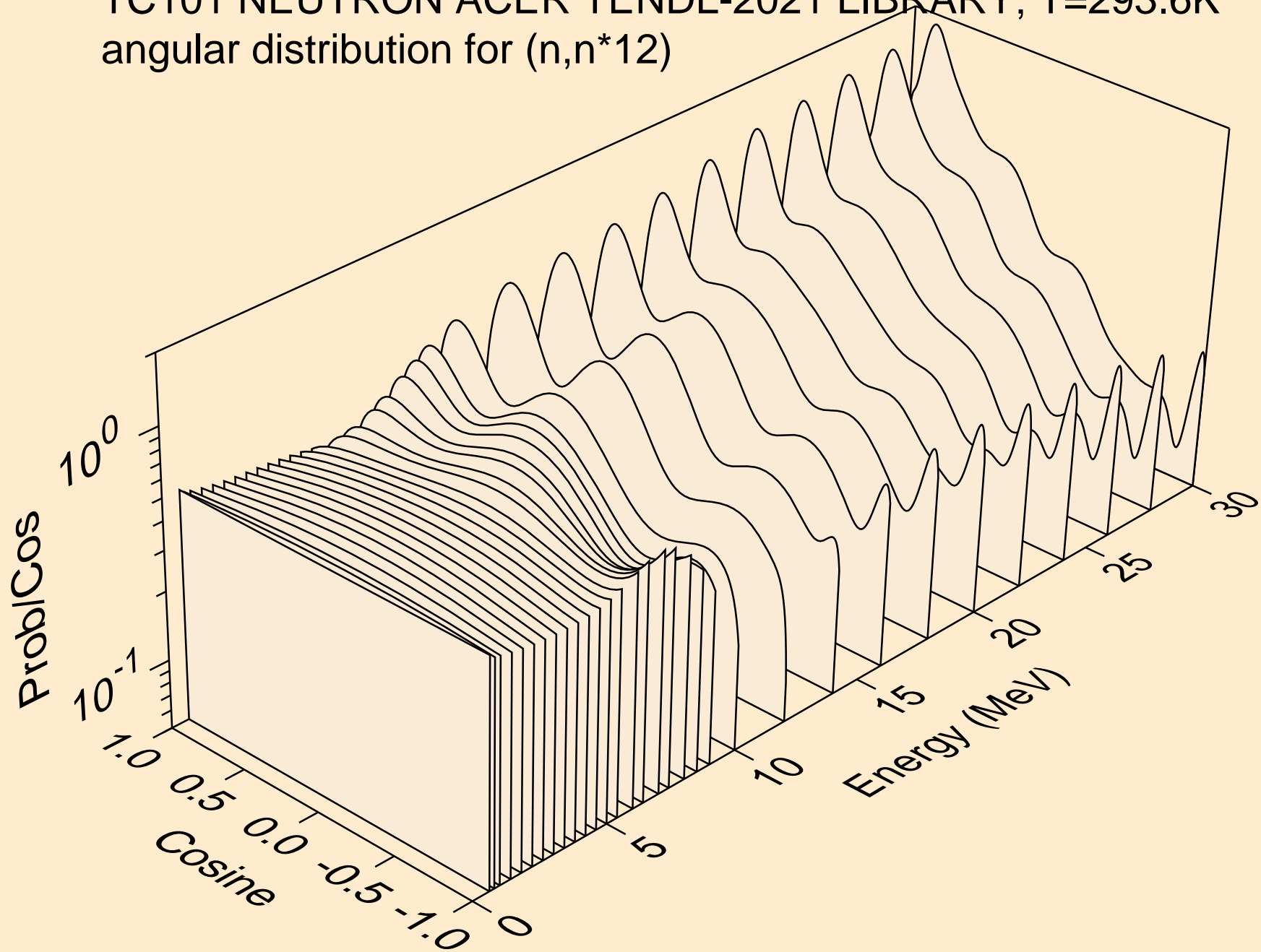

TC101 NEUTRON ACER TENDL-2021 LIBRARY; T=293.6K
angular distribution for (n,n*13)

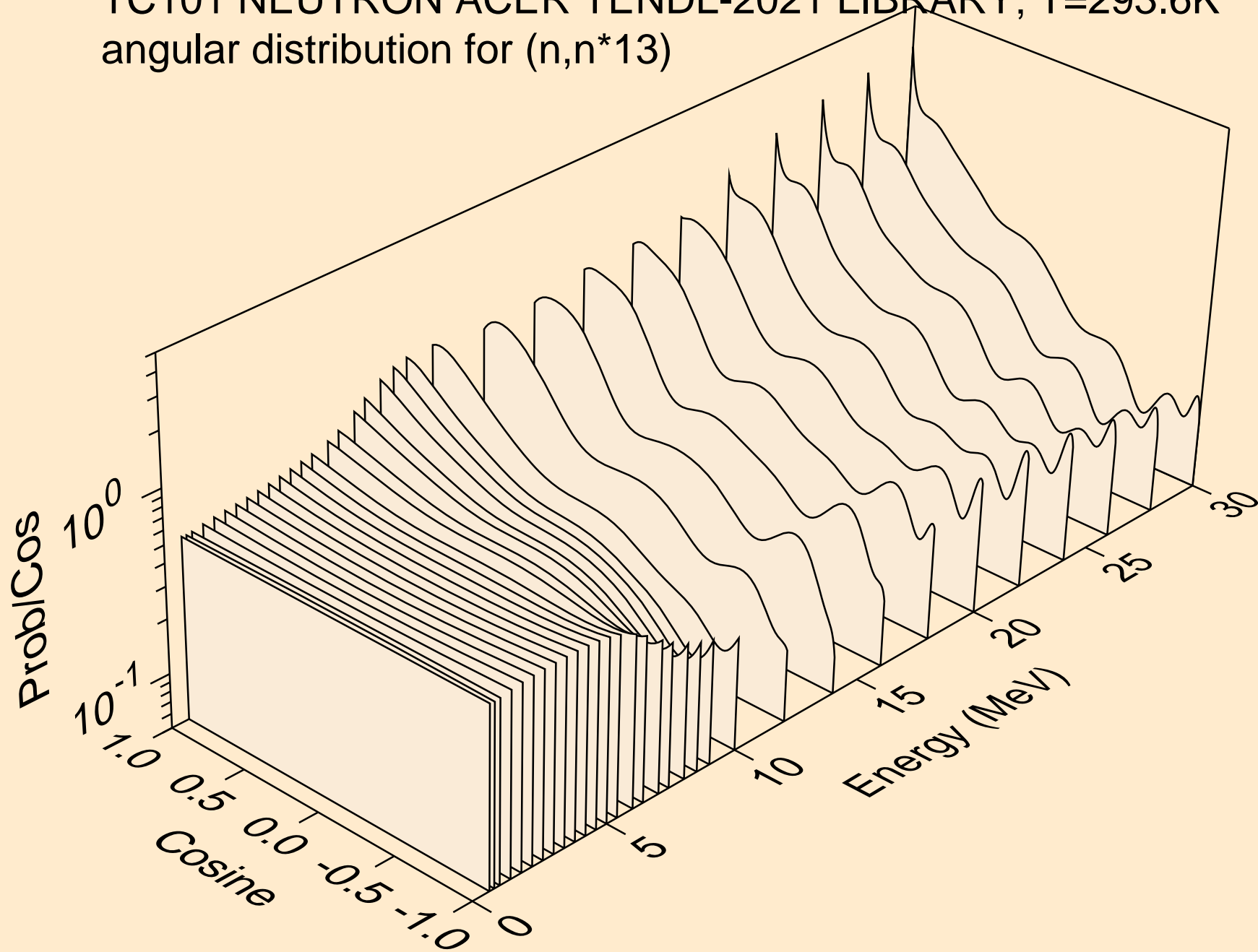

TC101 NEUTRON ACER TENDL-2021 LIBRARY; T=293.6K
angular distribution for (n,n*14)

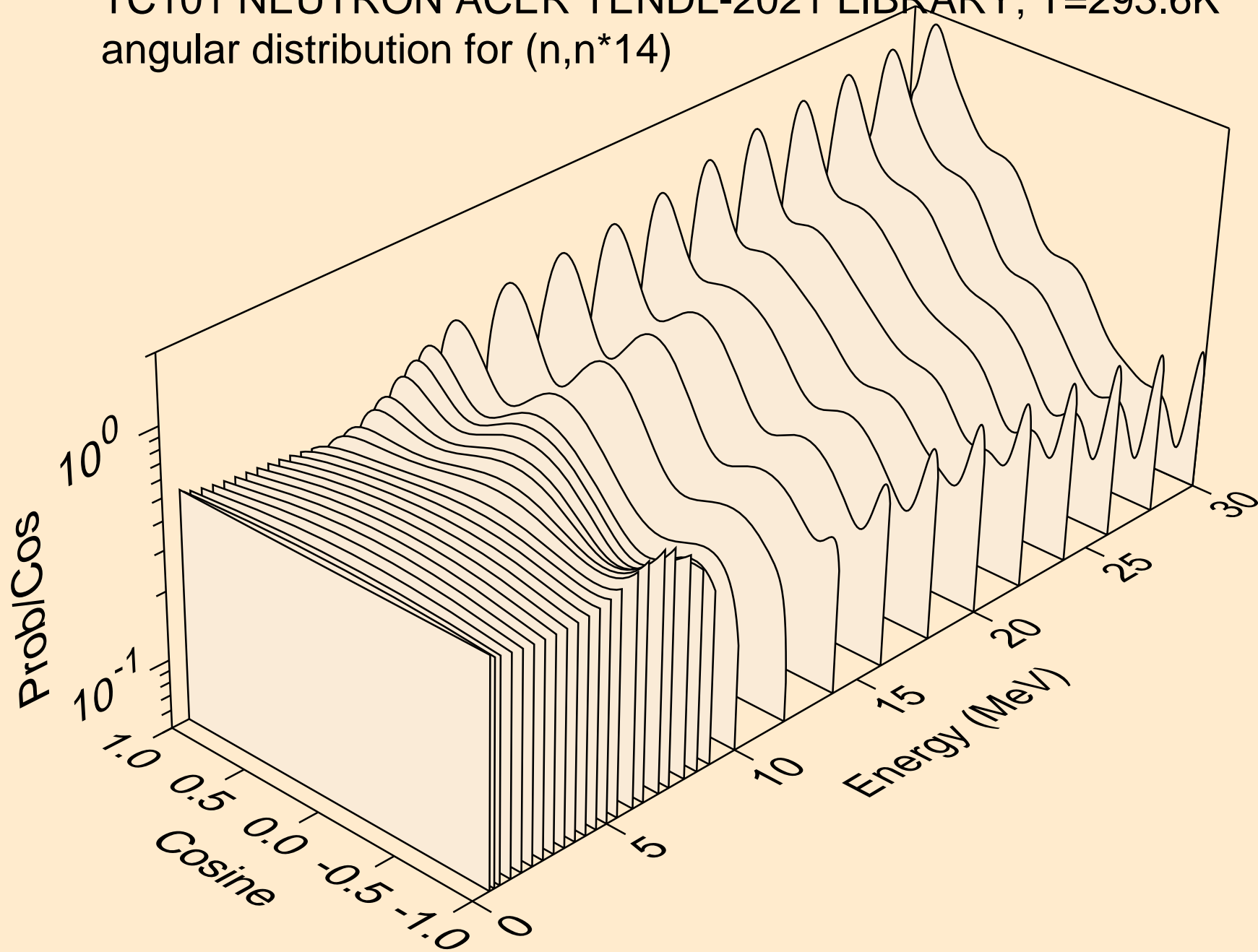

TC101 NEUTRON ACER TENDL-2021 LIBRARY; T=293.6K
angular distribution for (n,n*15)

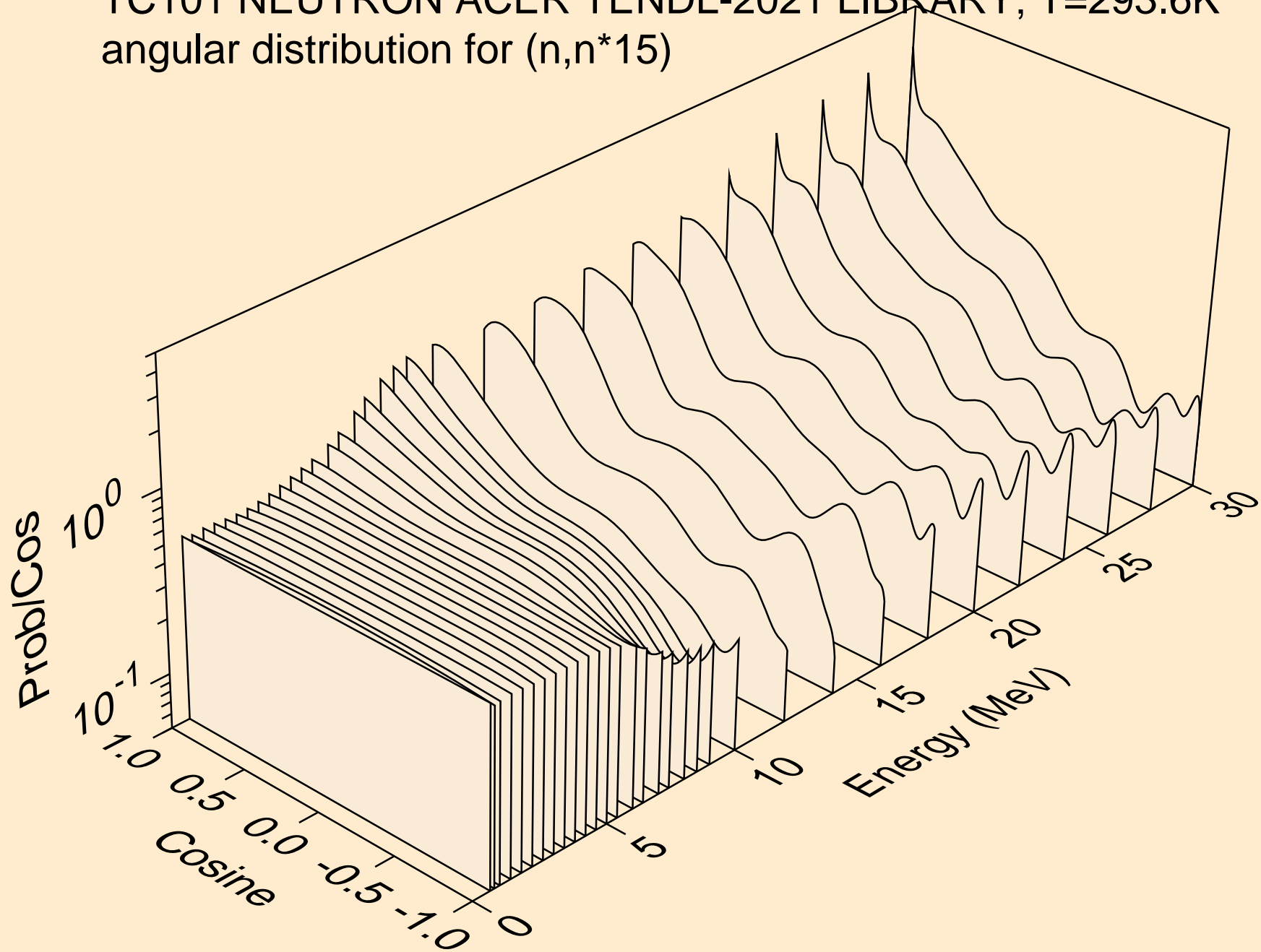

TC101 NEUTRON ACER TENDL-2021 LIBRARY; T=293.6K
angular distribution for (n,n*16)

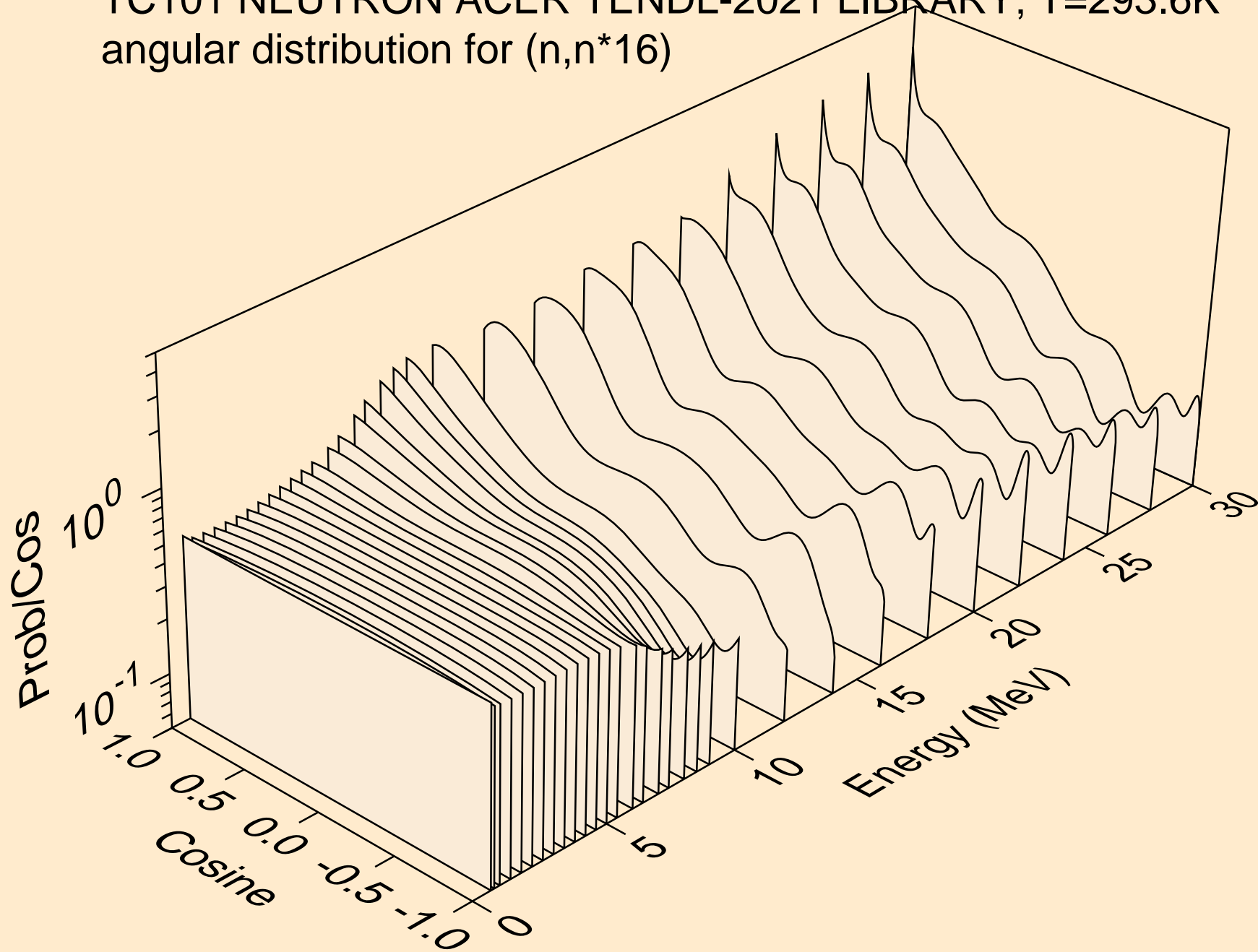

TC101 NEUTRON ACER TENDL-2021 LIBRARY; T=293.6K
angular distribution for (n,n*17)

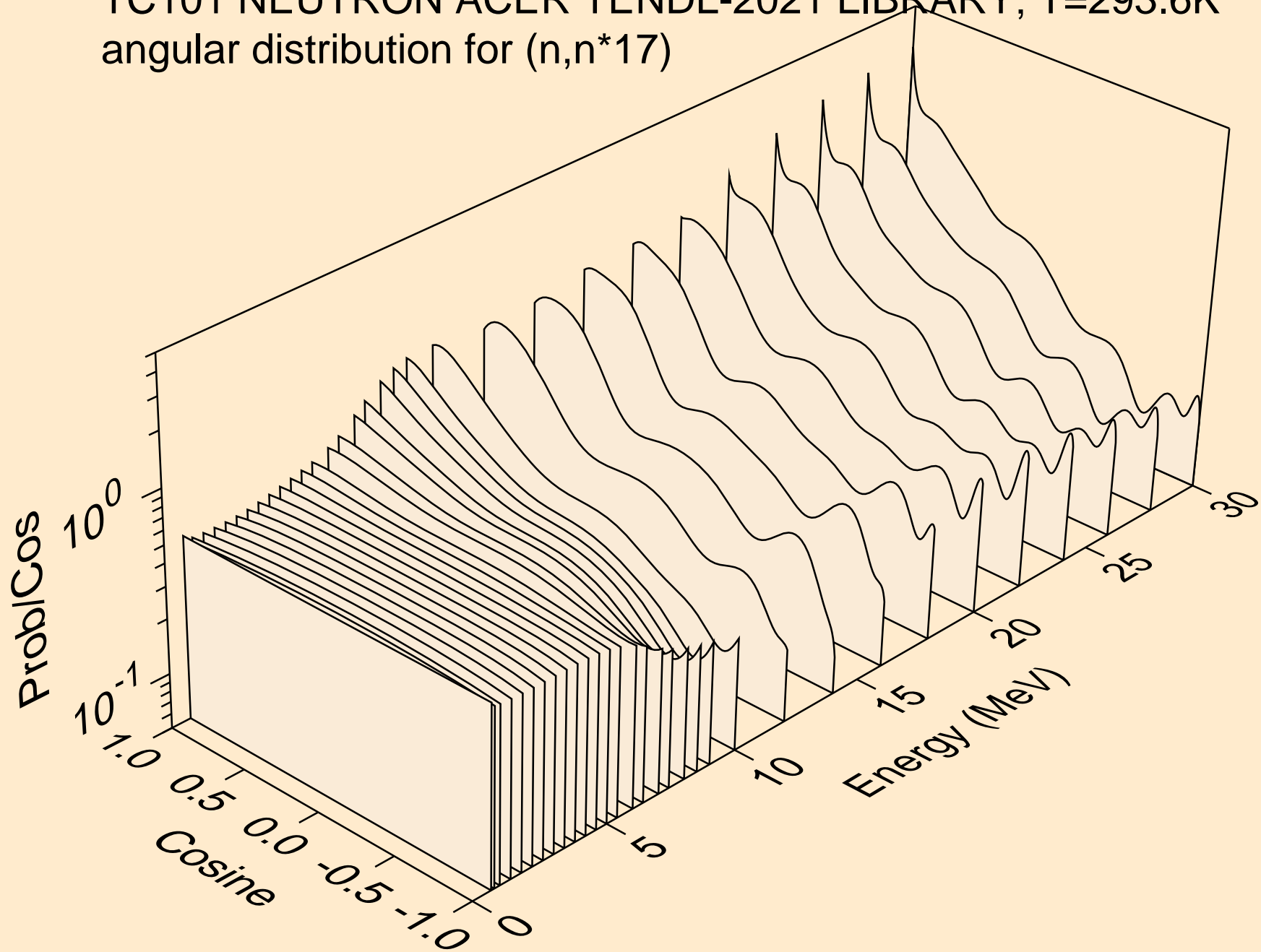

TC101 NEUTRON ACER TENDL-2021 LIBRARY; T=293.6K
angular distribution for (n,n*18)

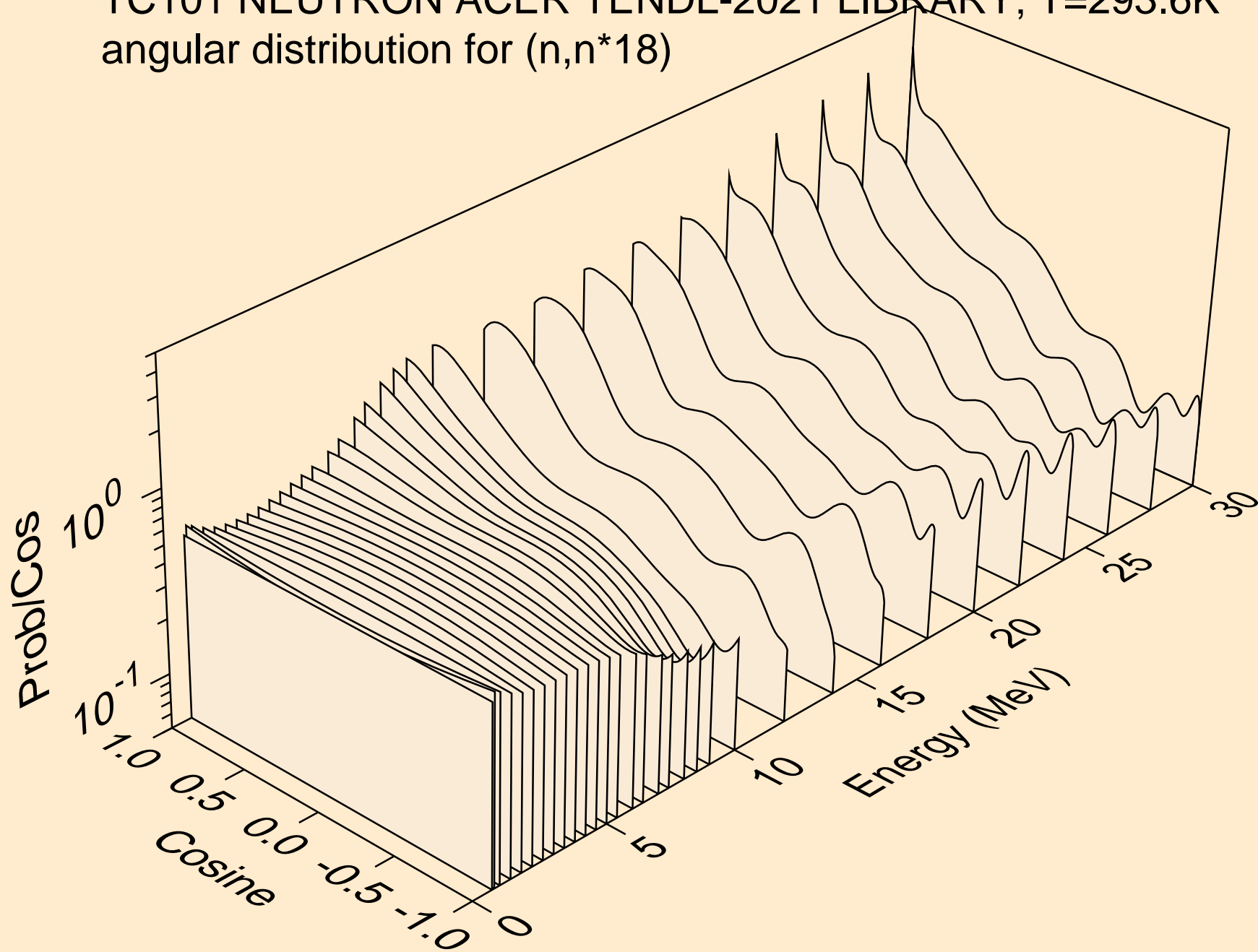

TC101 NEUTRON ACER TENDL-2021 LIBRARY; T=293.6K
angular distribution for (n,n*19)

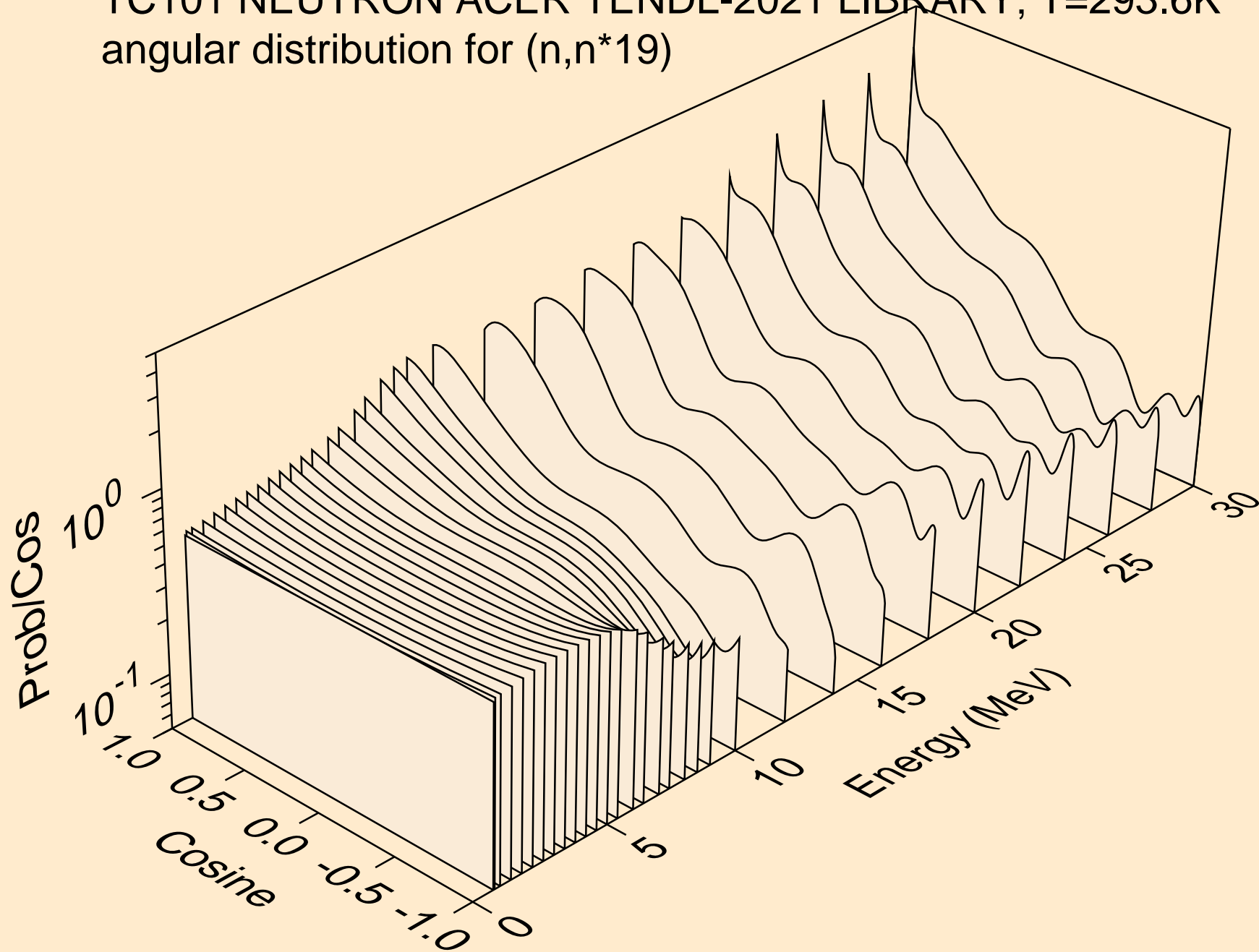

TC101 NEUTRON ACER TENDL-2021 LIBRARY; T=293.6K
angular distribution for (n,n*20)

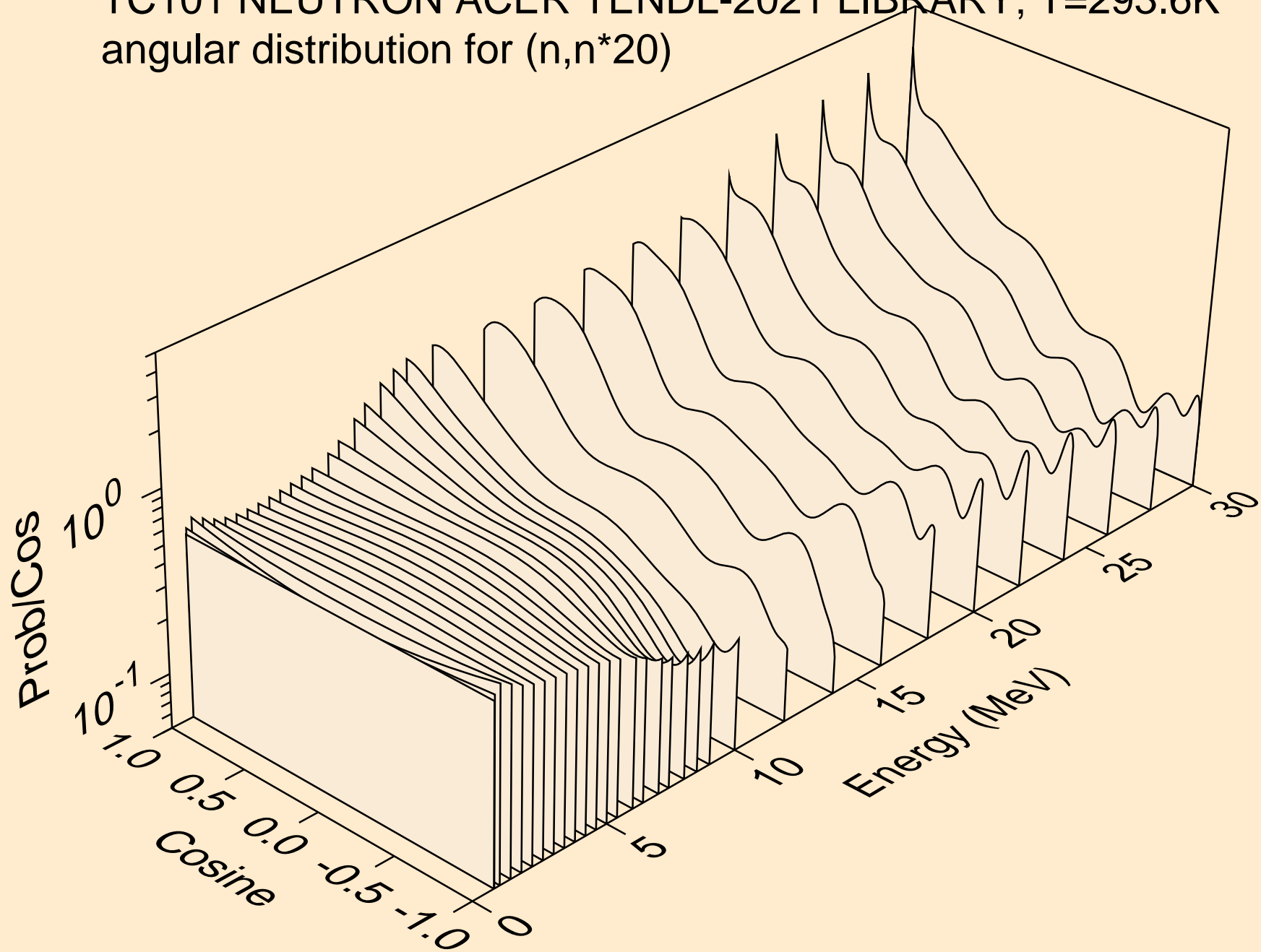

TC101 NEUTRON ACER TENDL-2021 LIBRARY; T=293.6K
angular distribution for (n,n*21)

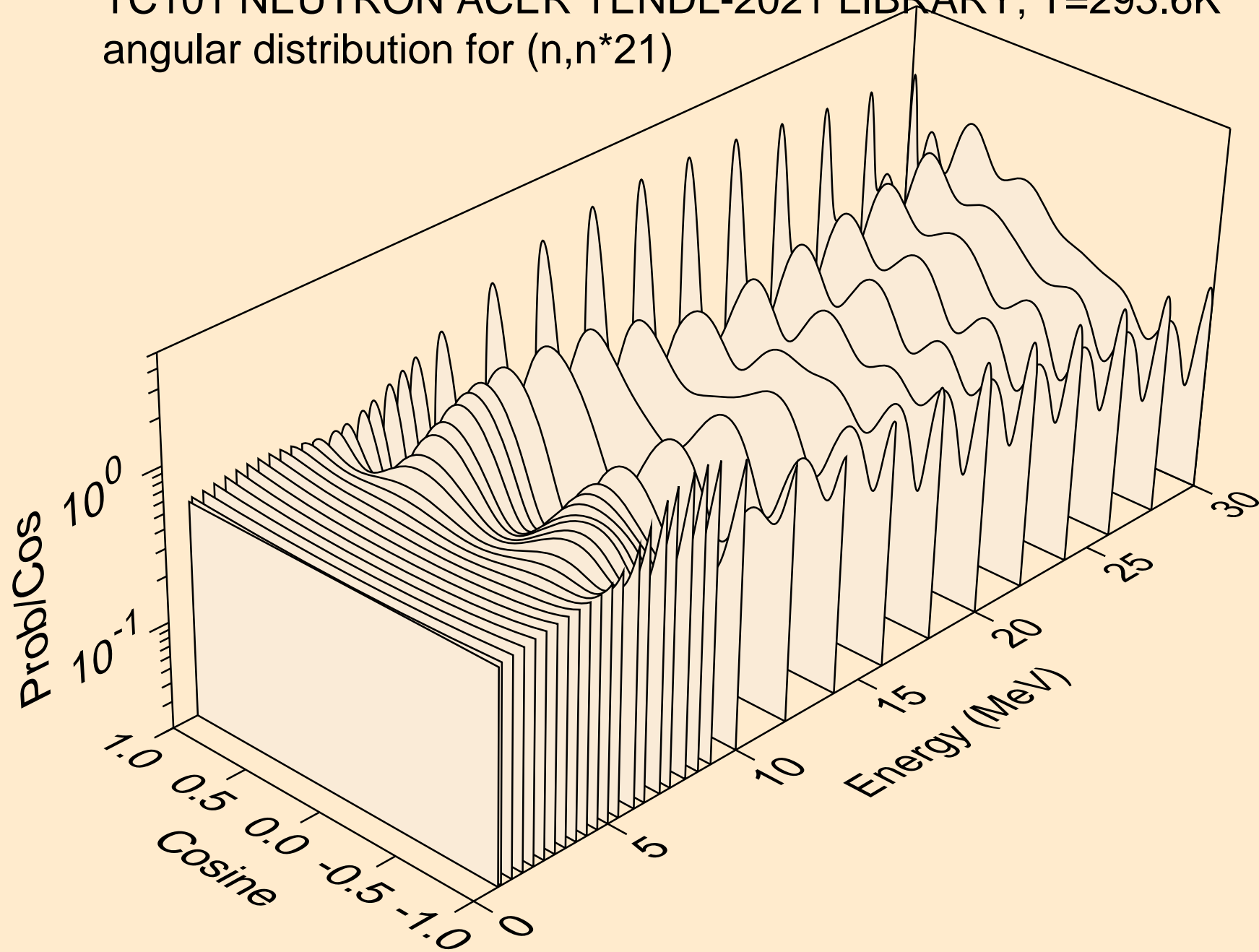

TC101 NEUTRON ACER TENDL-2021 LIBRARY; T=293.6K
angular distribution for (n,n*22)

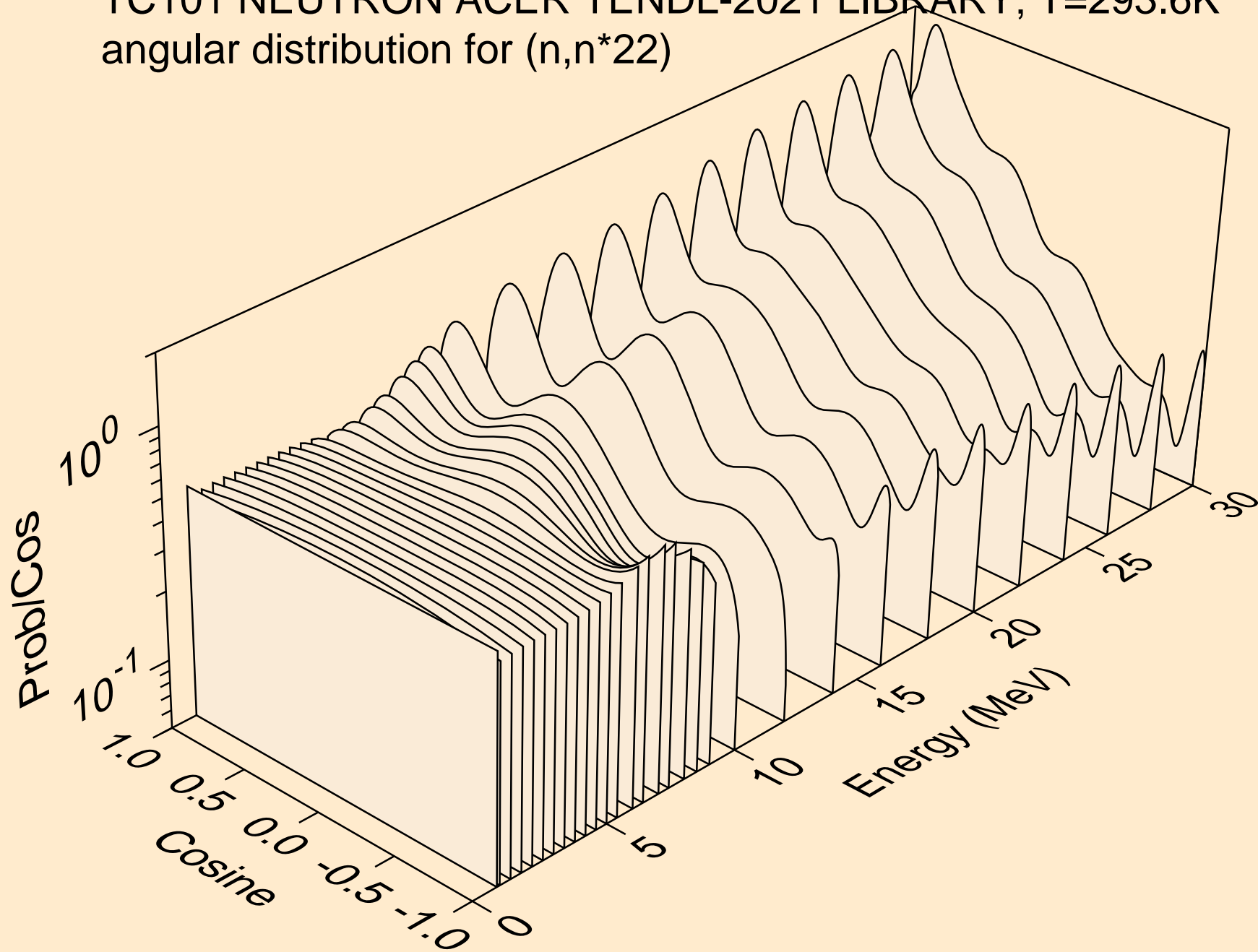

TC101 NEUTRON ACER TENDL-2021 LIBRARY; T=293.6K
angular distribution for (n,n*23)

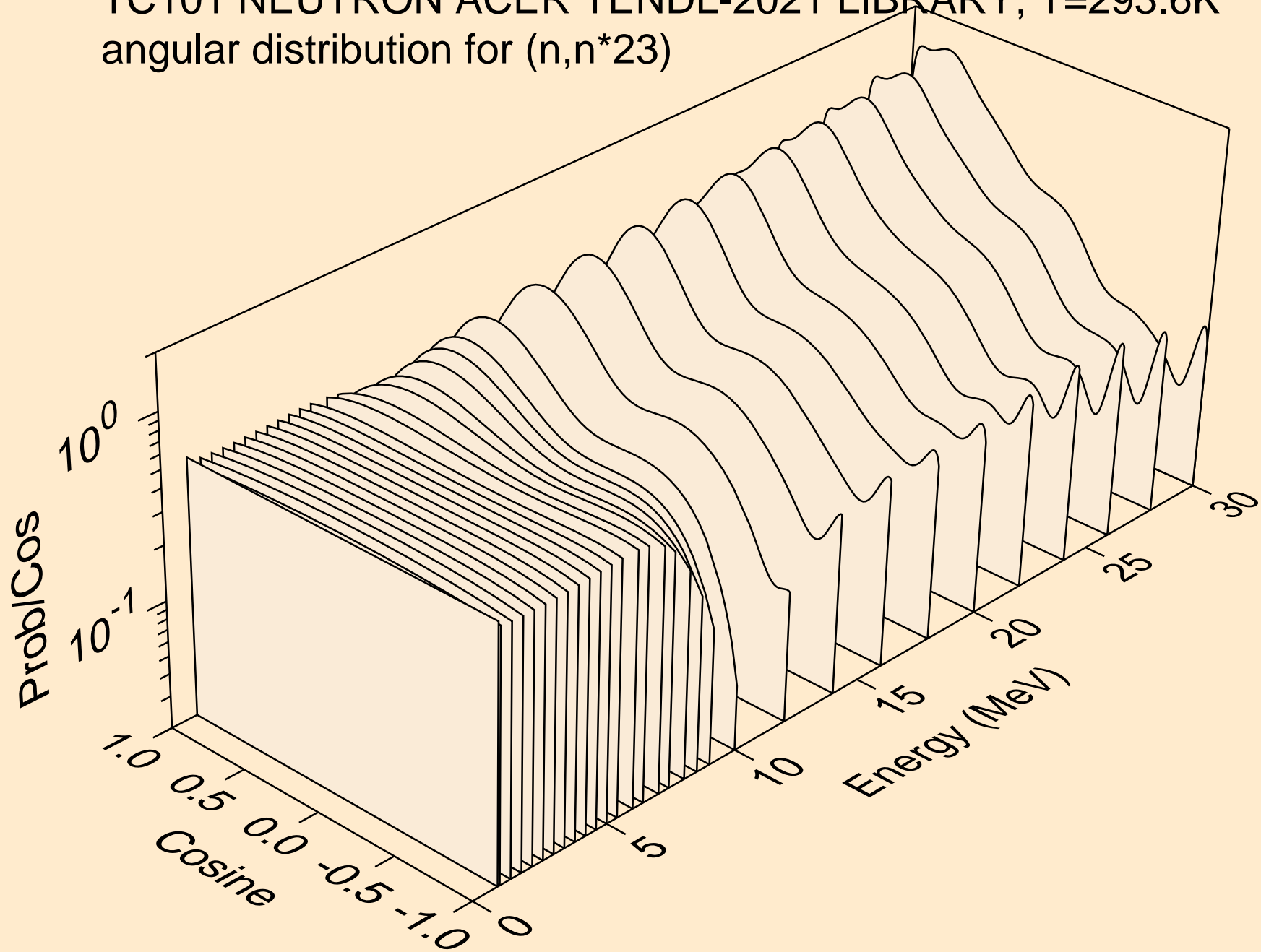

TC101 NEUTRON ACER TENDL-2021 LIBRARY; T=293.6K
angular distribution for (n,n*24)

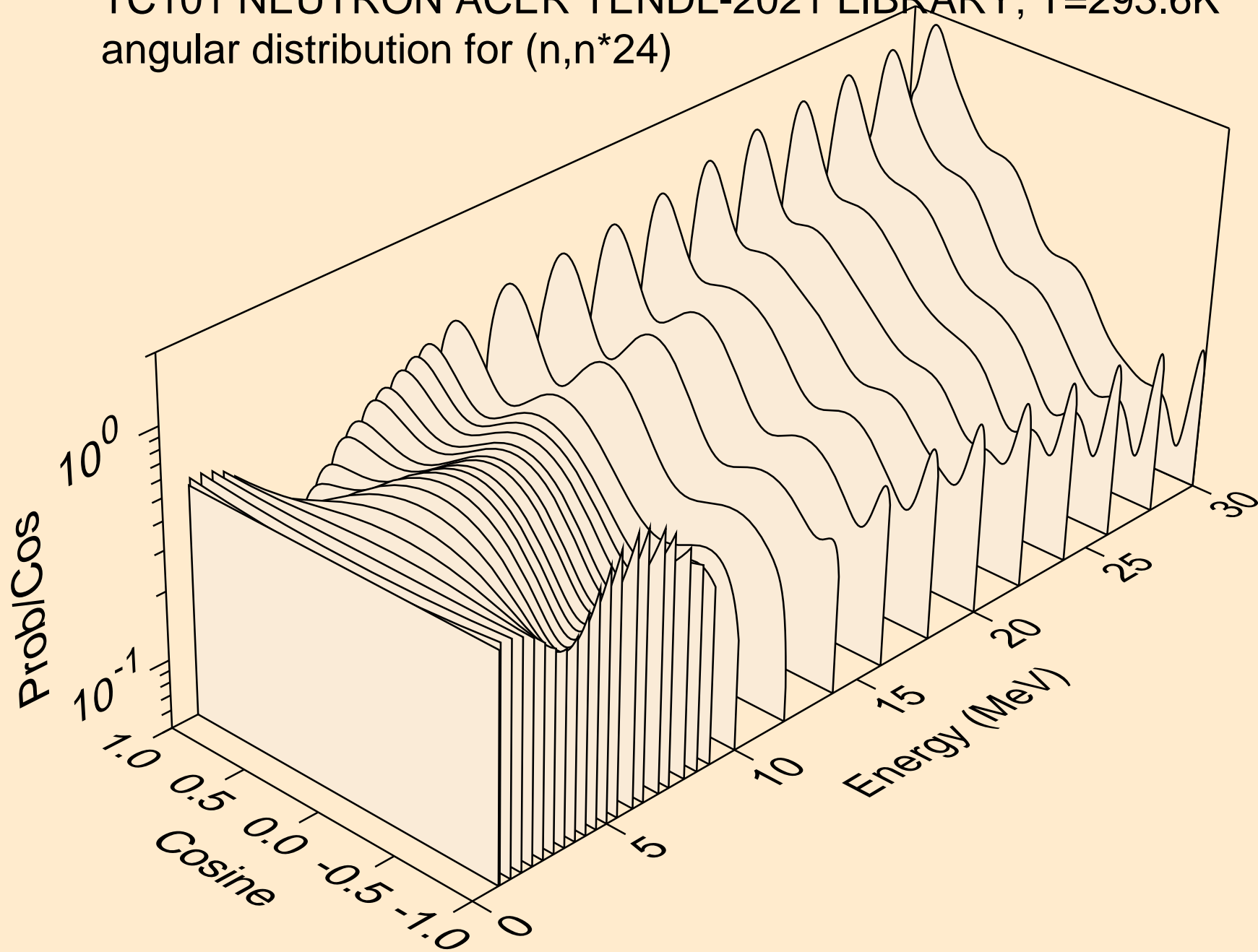

TC101 NEUTRON ACER TENDL-2021 LIBRARY; T=293.6K
angular distribution for (n,n*25)

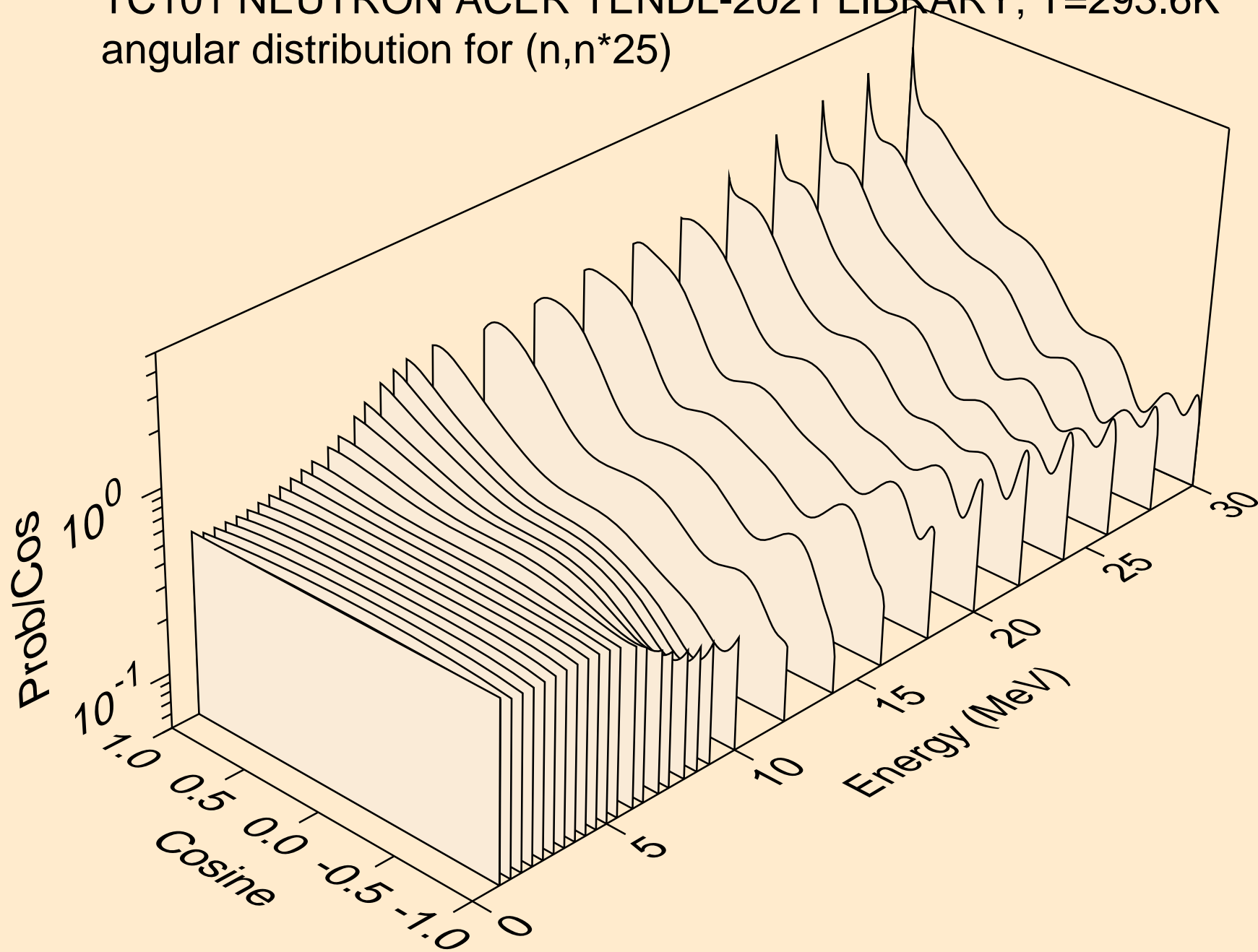

TC101 NEUTRON ACER TENDL-2021 LIBRARY; T=293.6K
angular distribution for (n,n*26)

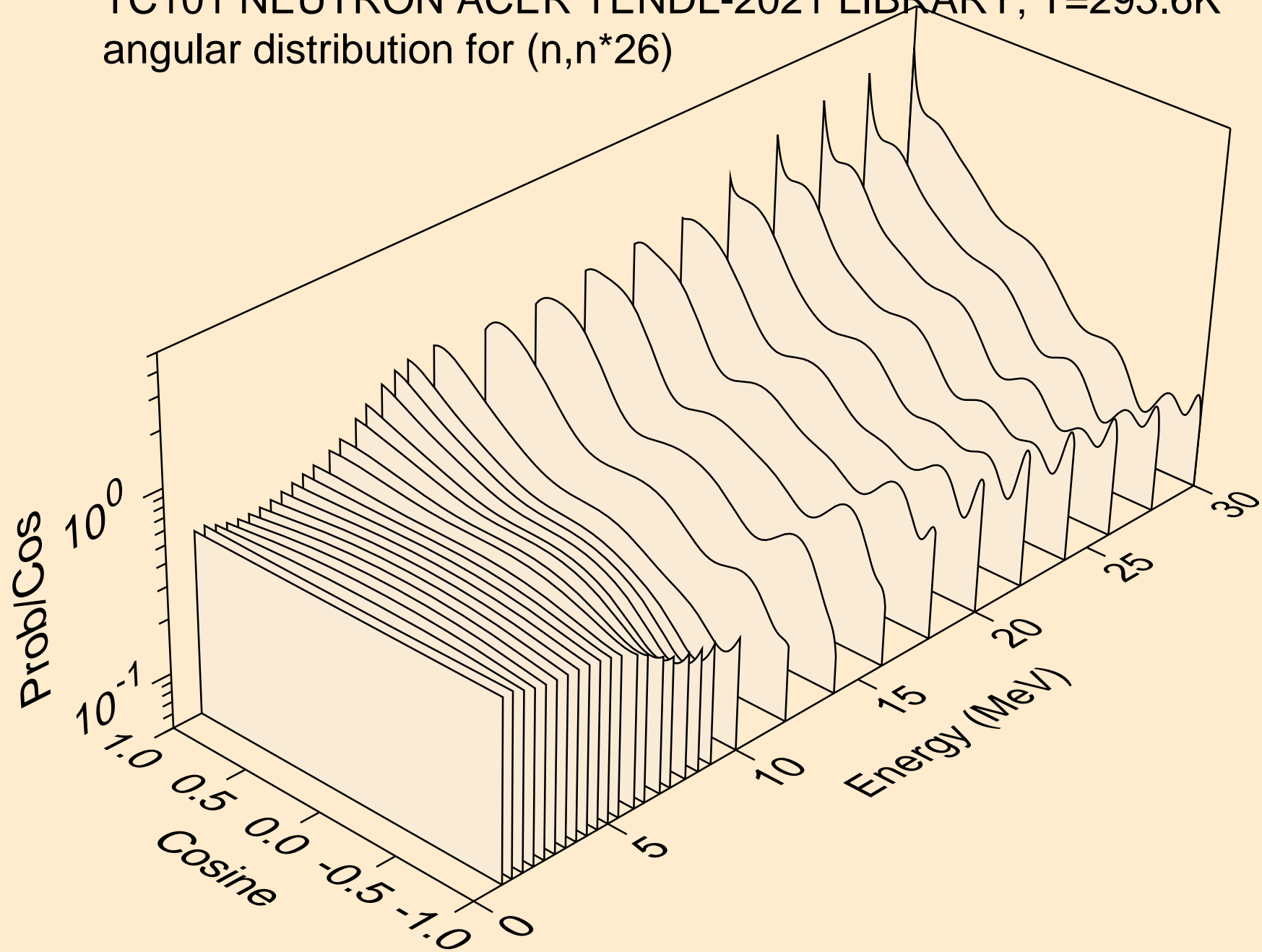

TC101 NEUTRON ACER TENDL-2021 LIBRARY; T=293.6K
angular distribution for (n,n*27)

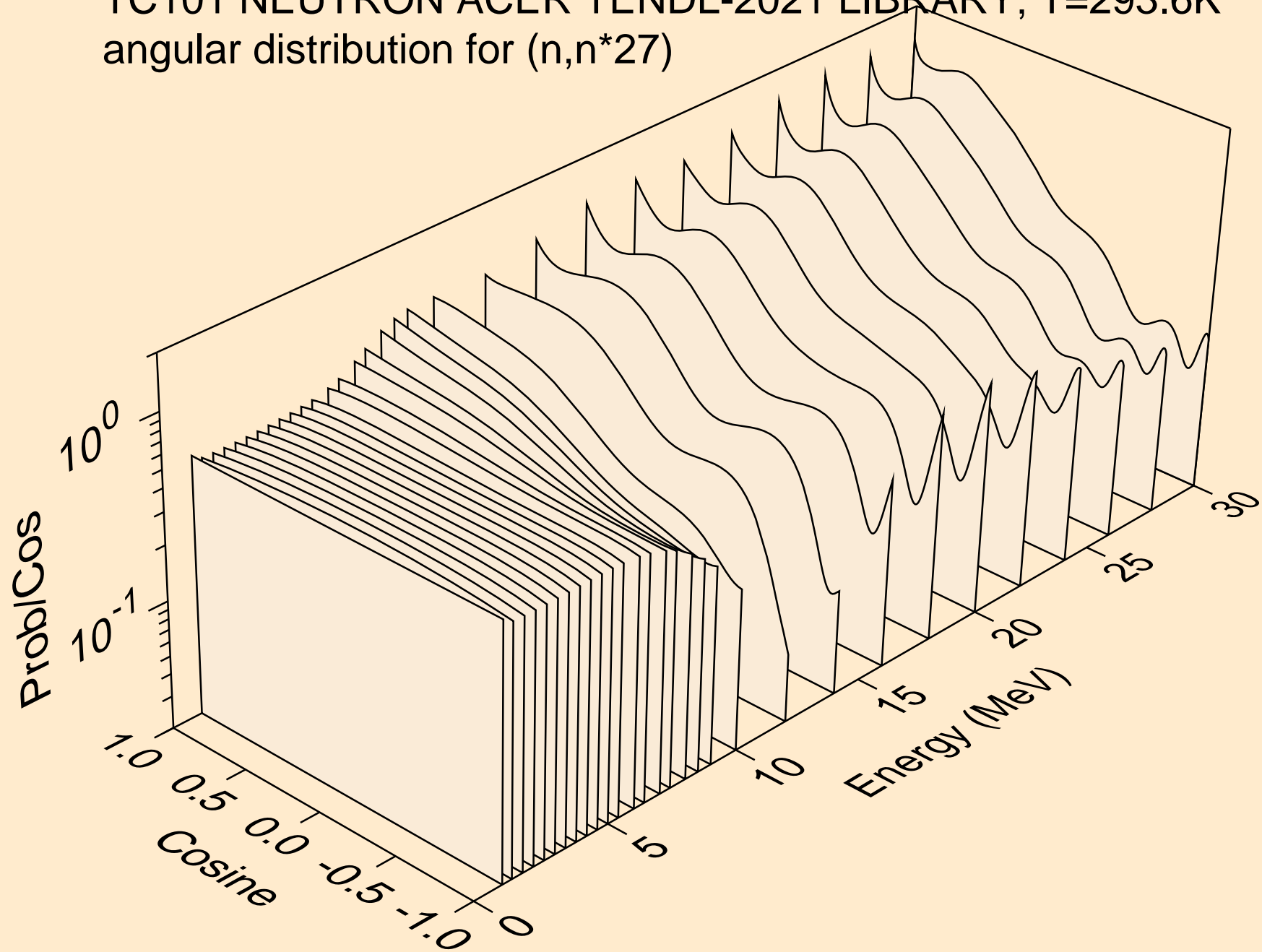

TC101 NEUTRON ACER TENDL-2021 LIBRARY; T=293.6K
angular distribution for (n,n*28)

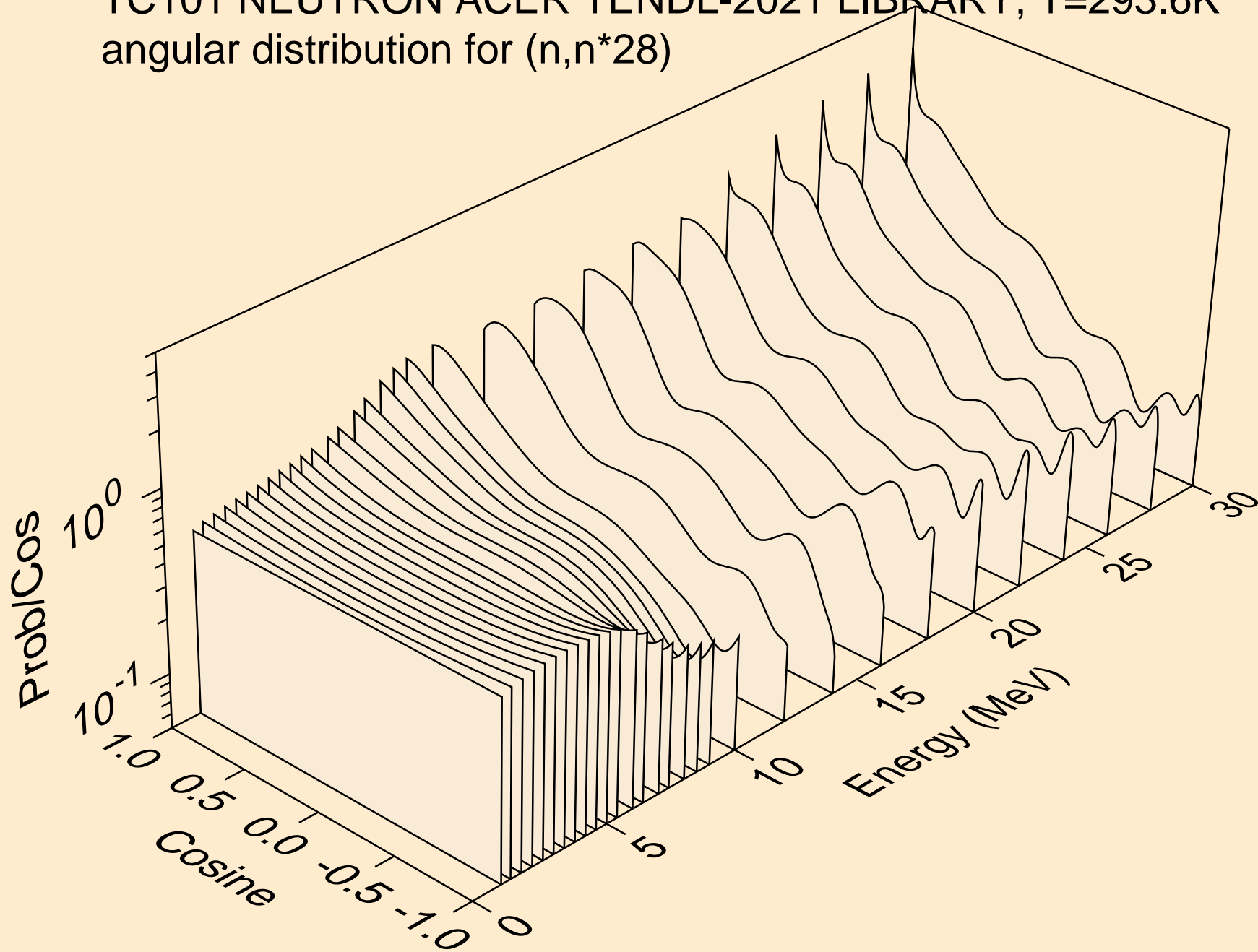

TC101 NEUTRON ACER TENDL-2021 LIBRARY; T=293.6K
angular distribution for (n,n*29)

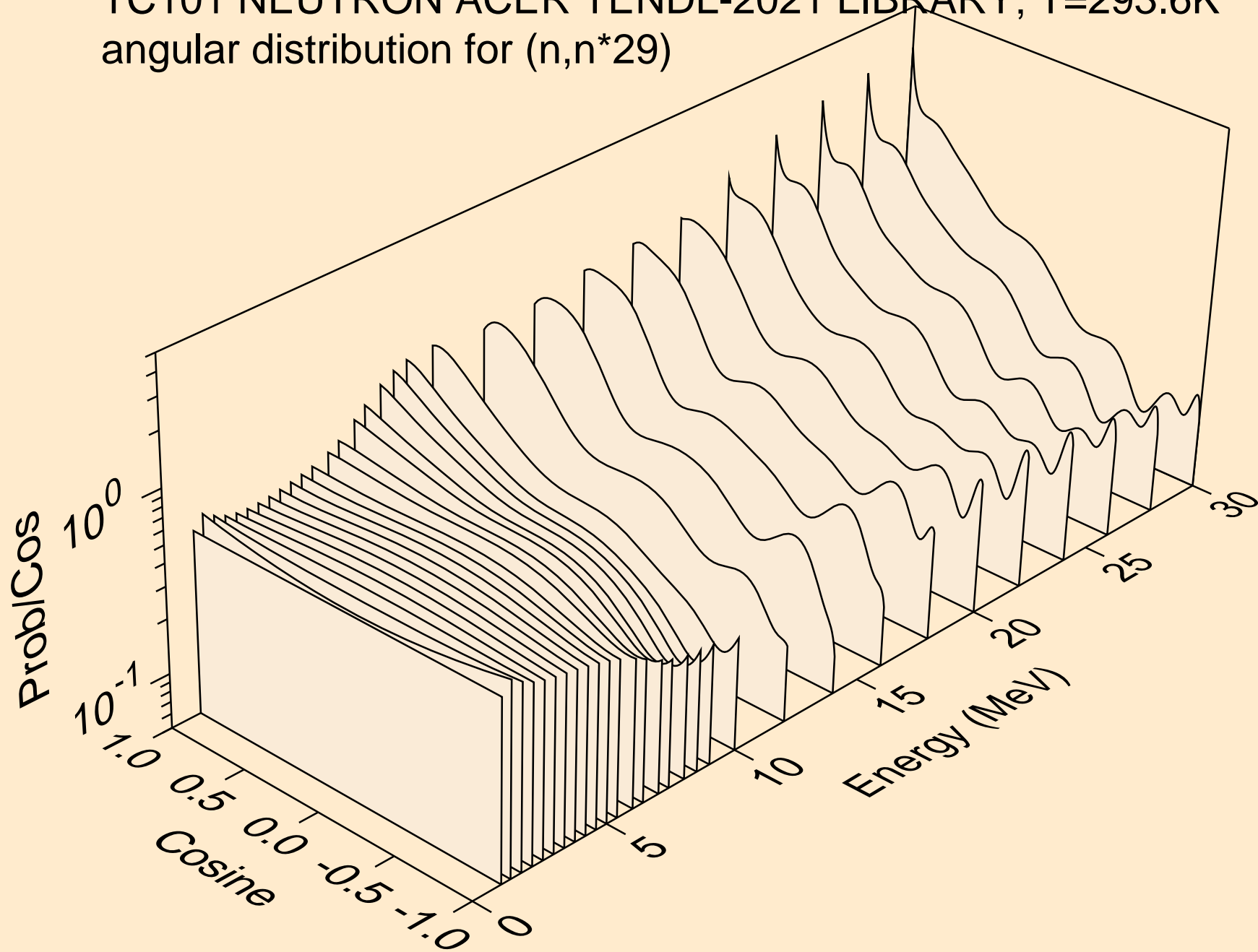

TC101 NEUTRON ACER TENDL-2021 LIBRARY; T=293.6K
angular distribution for (n,n*30)

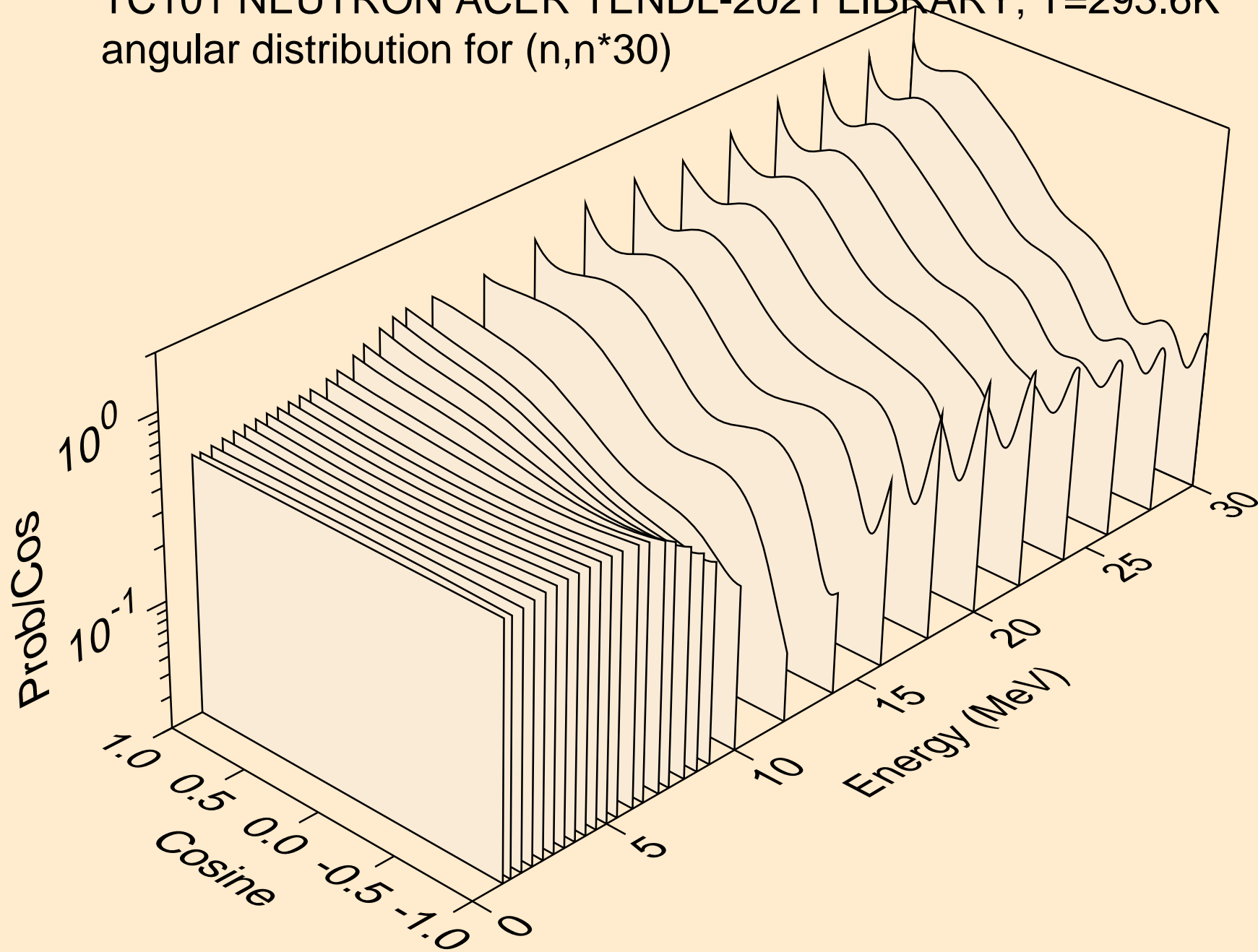

TC101 NEUTRON ACER TENDL-2021 LIBRARY; T=293.6K
Neutron emission for (n,x)

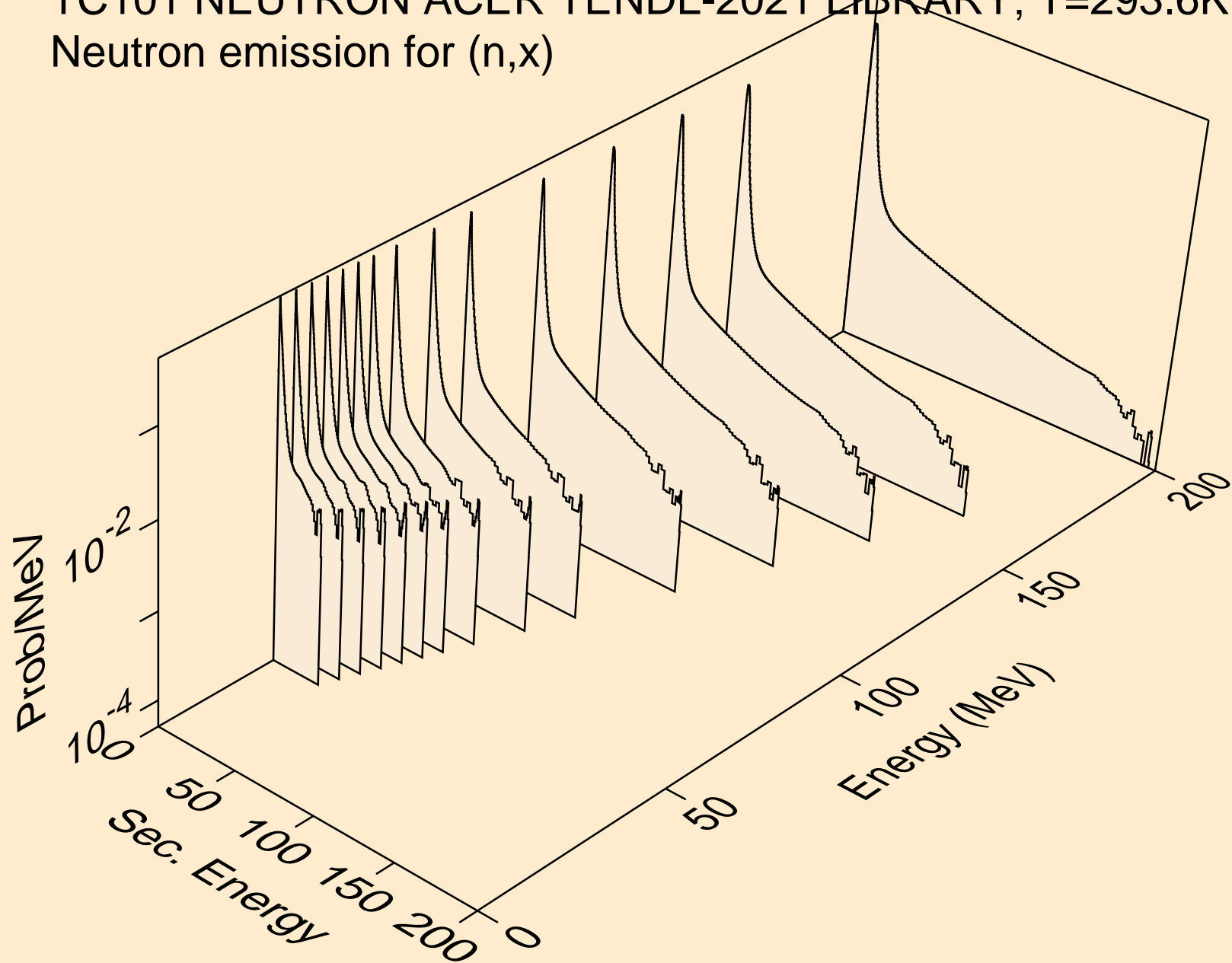

TC101 NEUTRON ACER TENDL-2021 LIBRARY; T=293.6K
Neutron emission for (n,2nd)

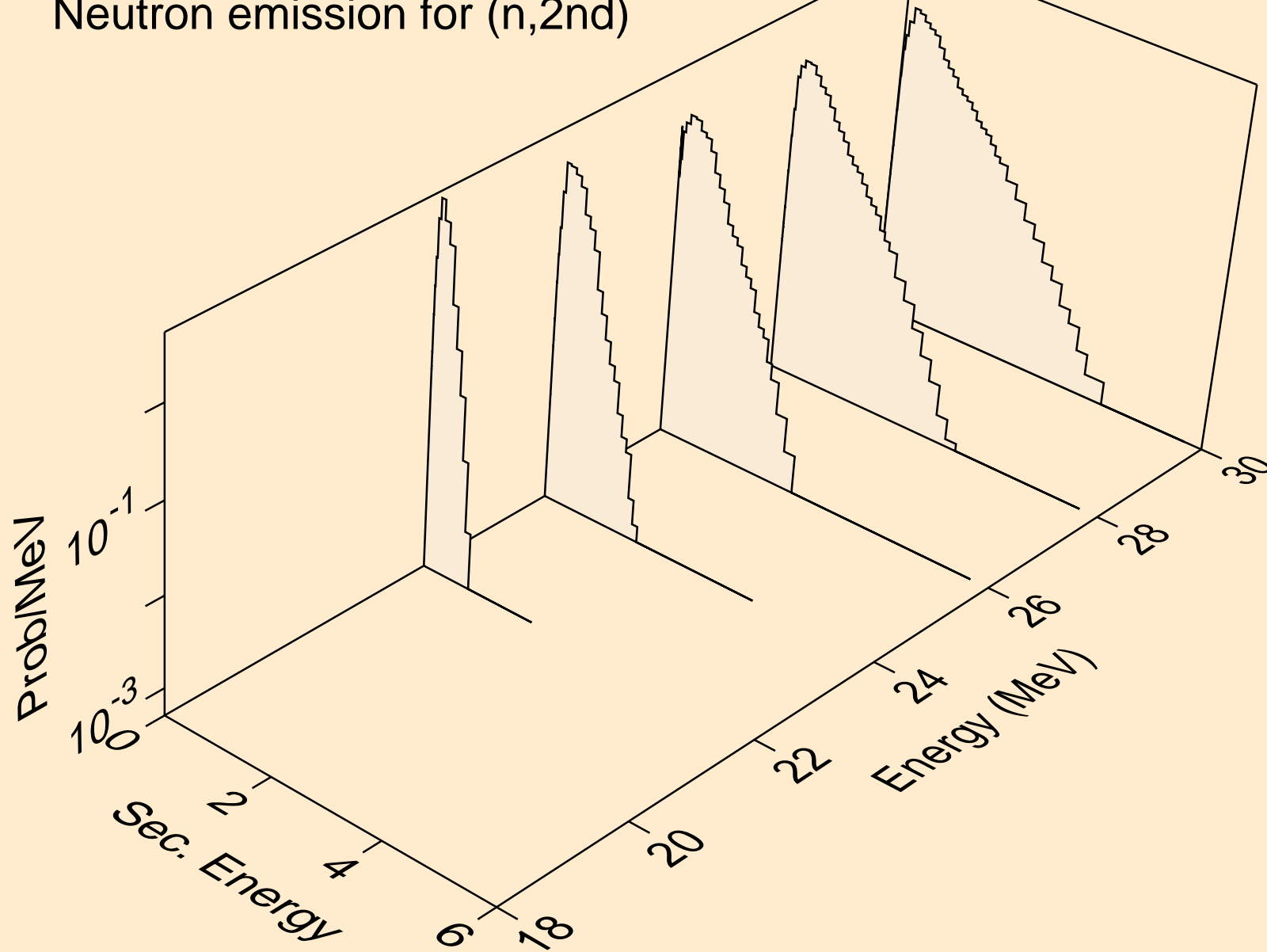

TC101 NEUTRON ACER TENDL-2021 LIBRARY; T=293.6K
Neutron emission for (n,2n)

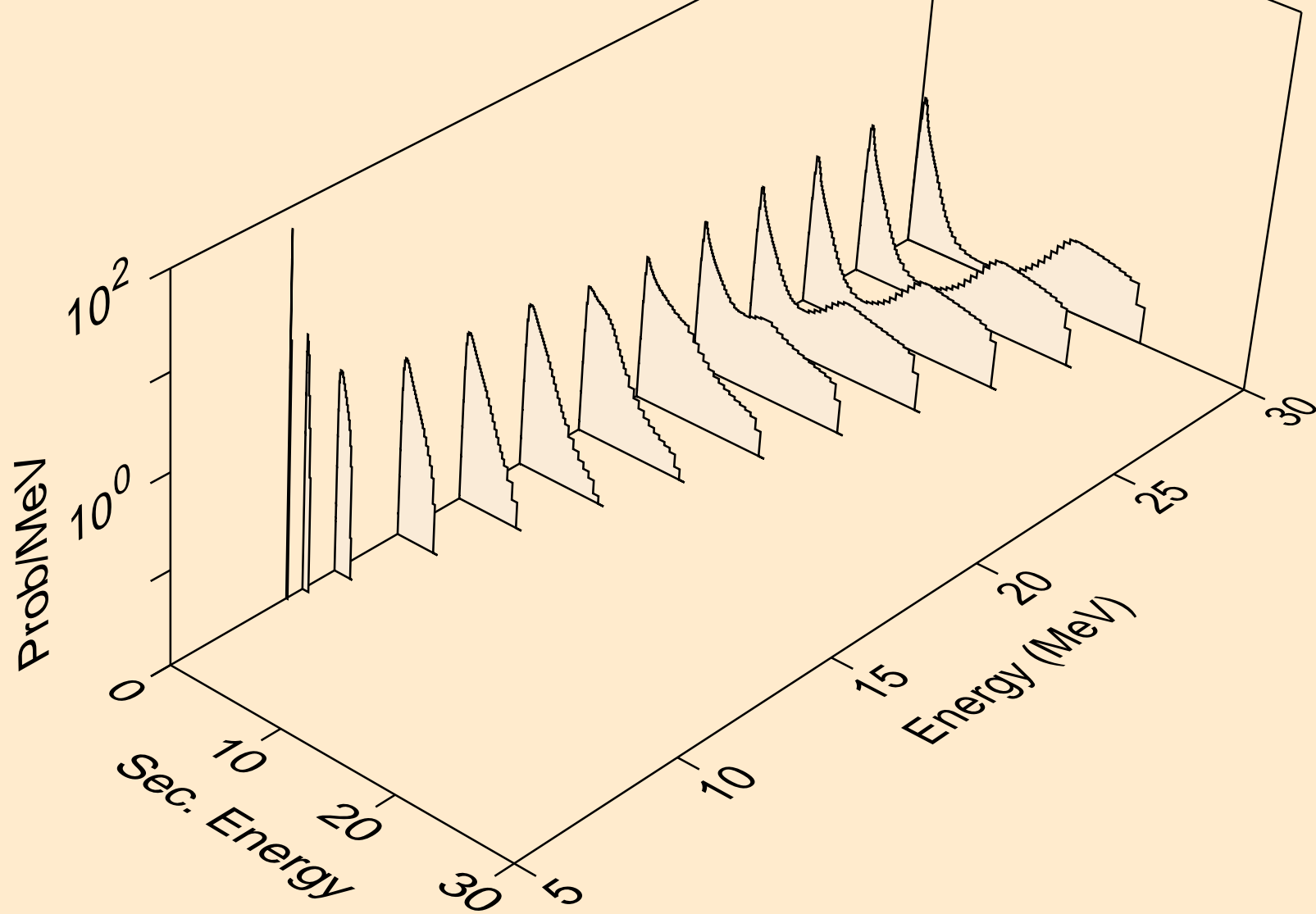

TC101 NEUTRON ACER TENDL-2021 LIBRARY; T=293.6K
Neutron emission for (n,3n)

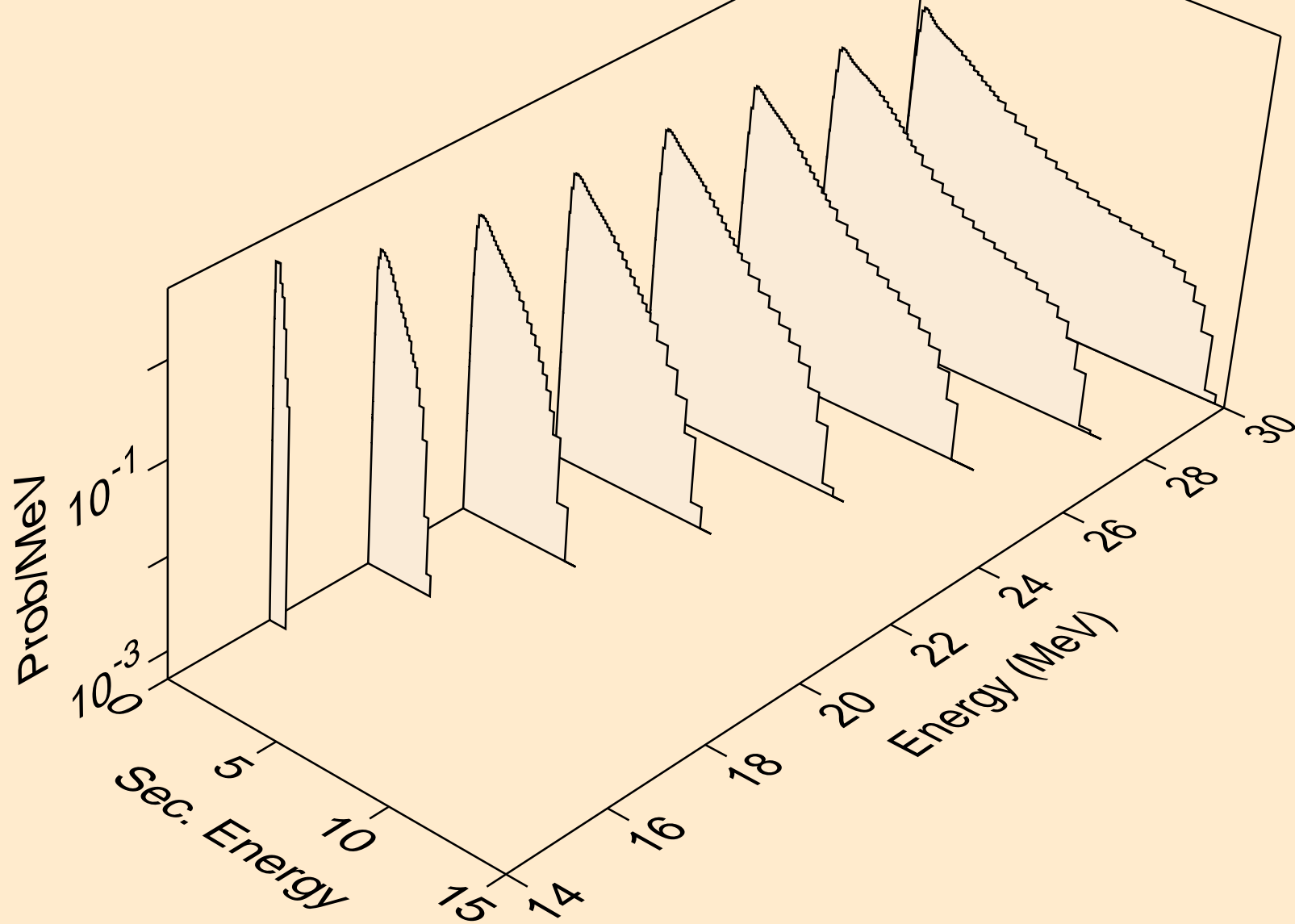

TC101 NEUTRON ACER TENDL-2021 LIBRARY; T=293.6K
Neutron emission for (n,n*)a

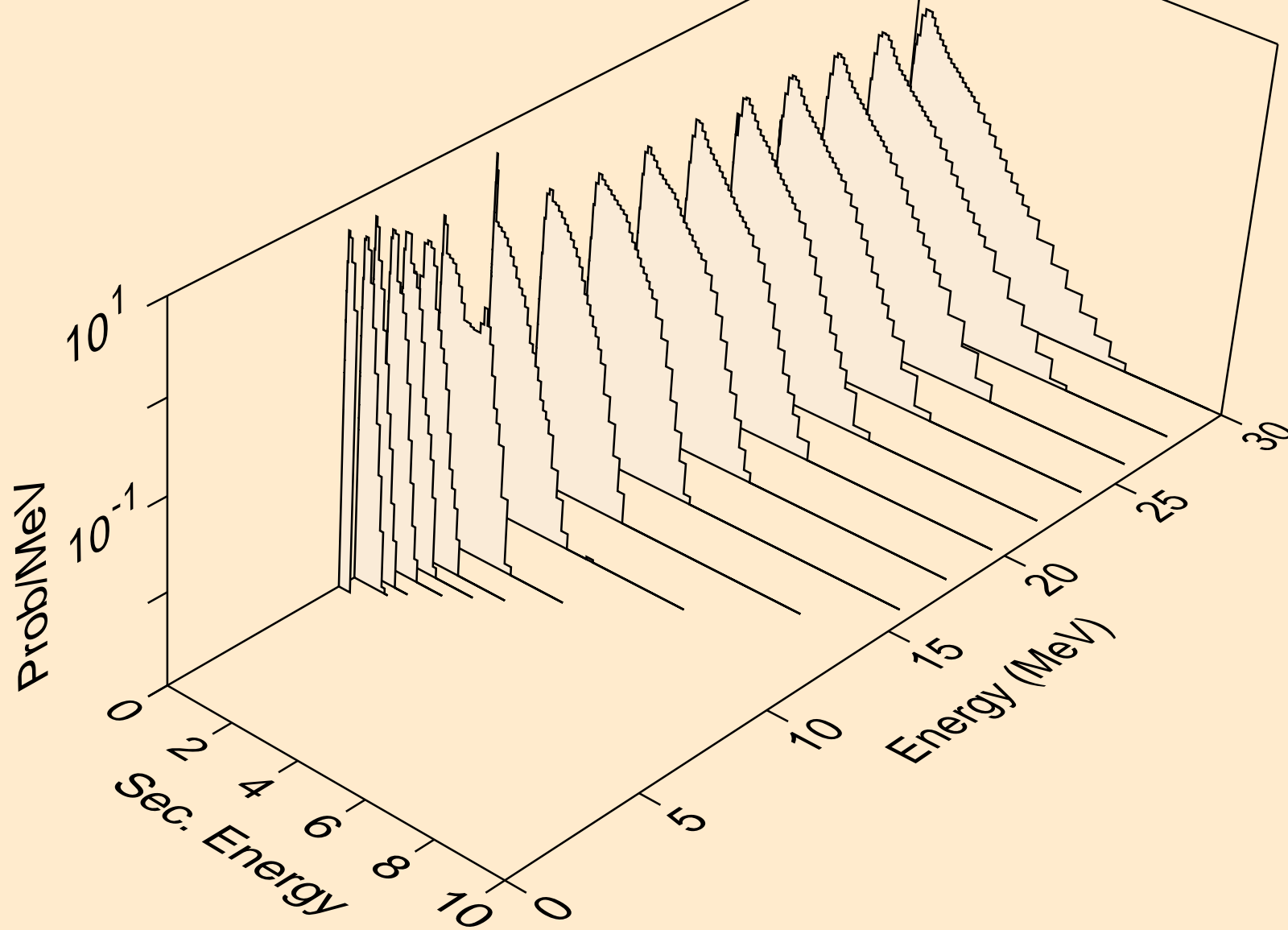

TC101 NEUTRON ACER TENDL-2021 LIBRARY; T=293.6K
Neutron emission for (n,2n)_a

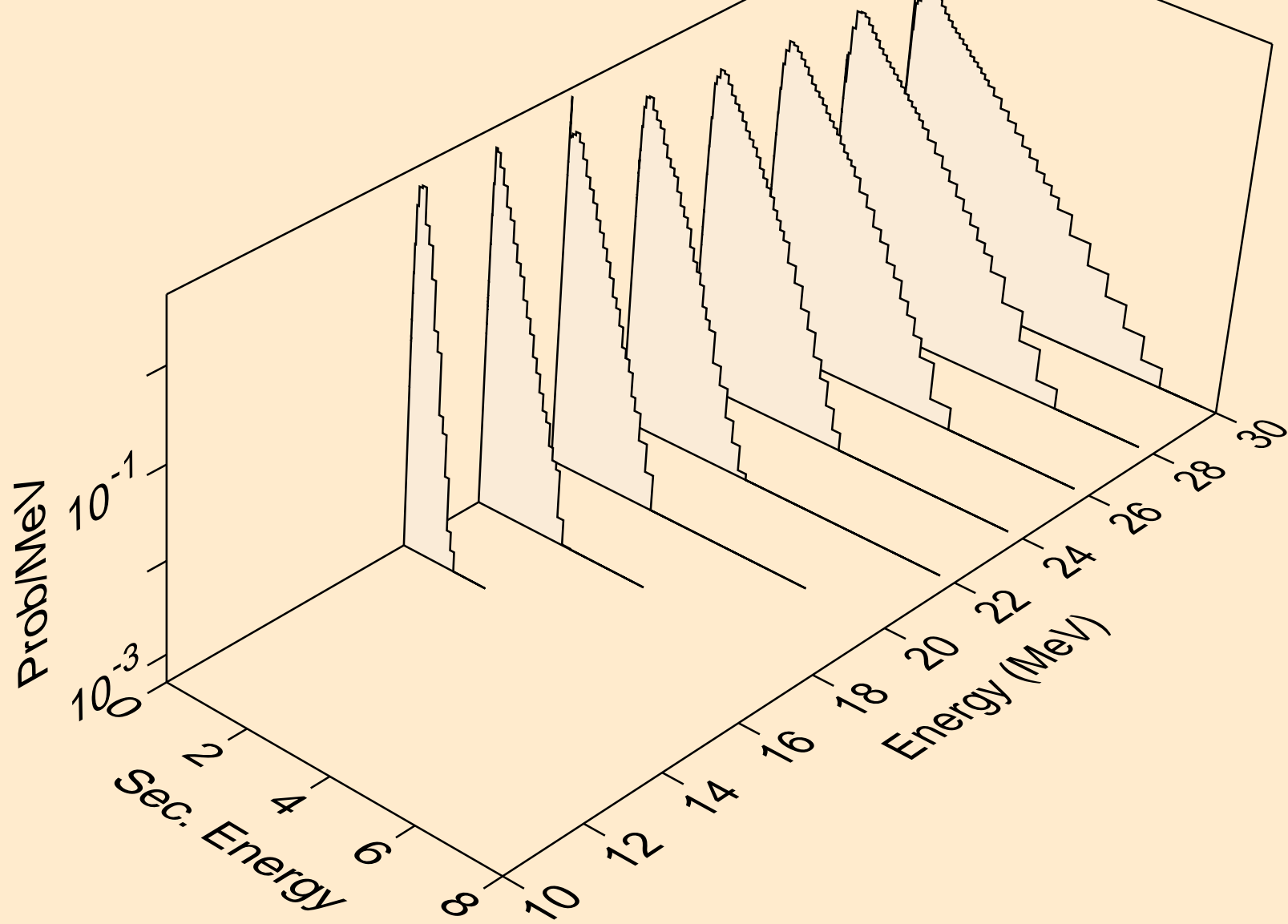

TC101 NEUTRON ACER TENDL-2021 LIBRARY; T=293.6K
Neutron emission for (n,3n)a

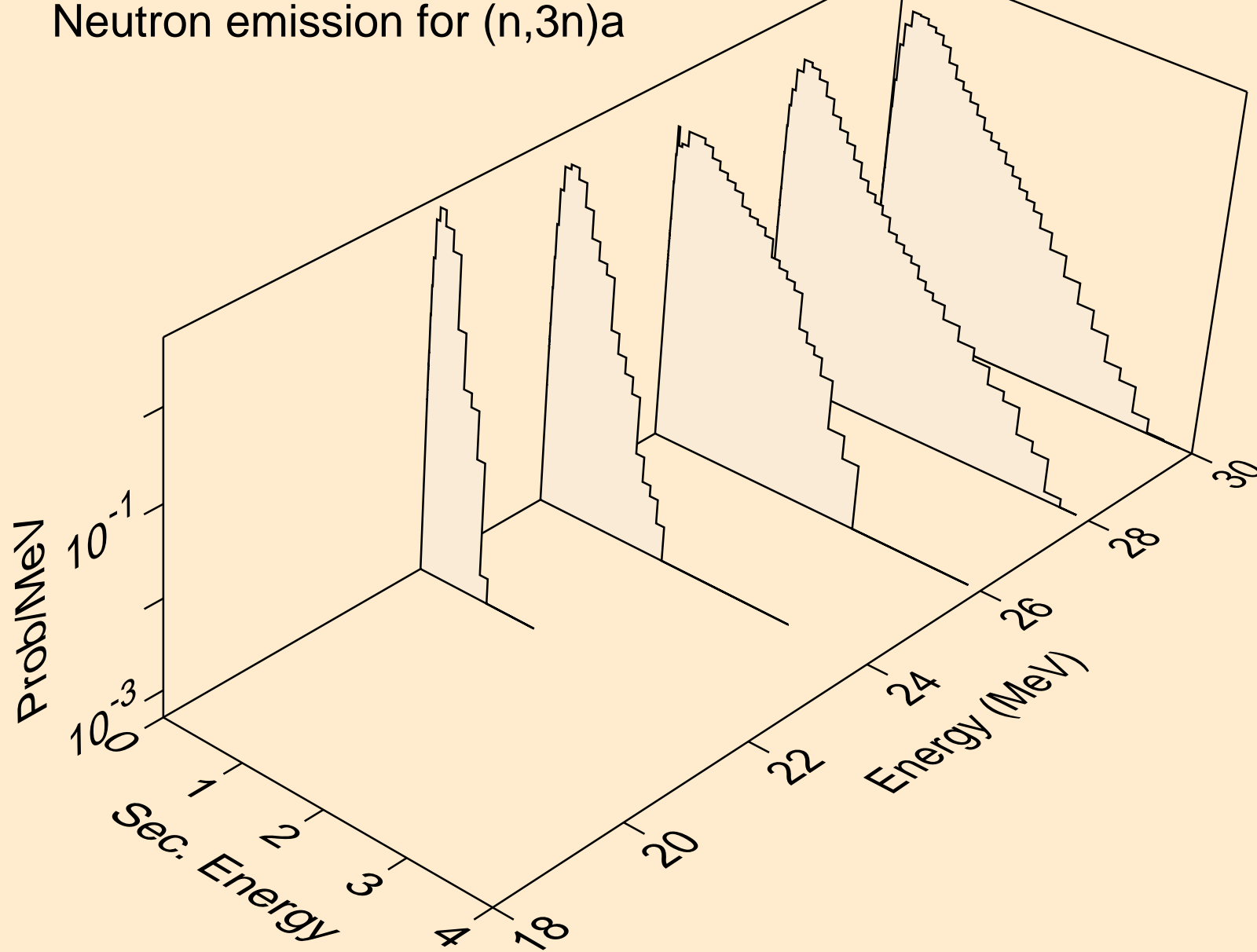

TC101 NEUTRON ACER TENDL-2021 LIBRARY; T=293.6K
Neutron emission for (n,n*)p

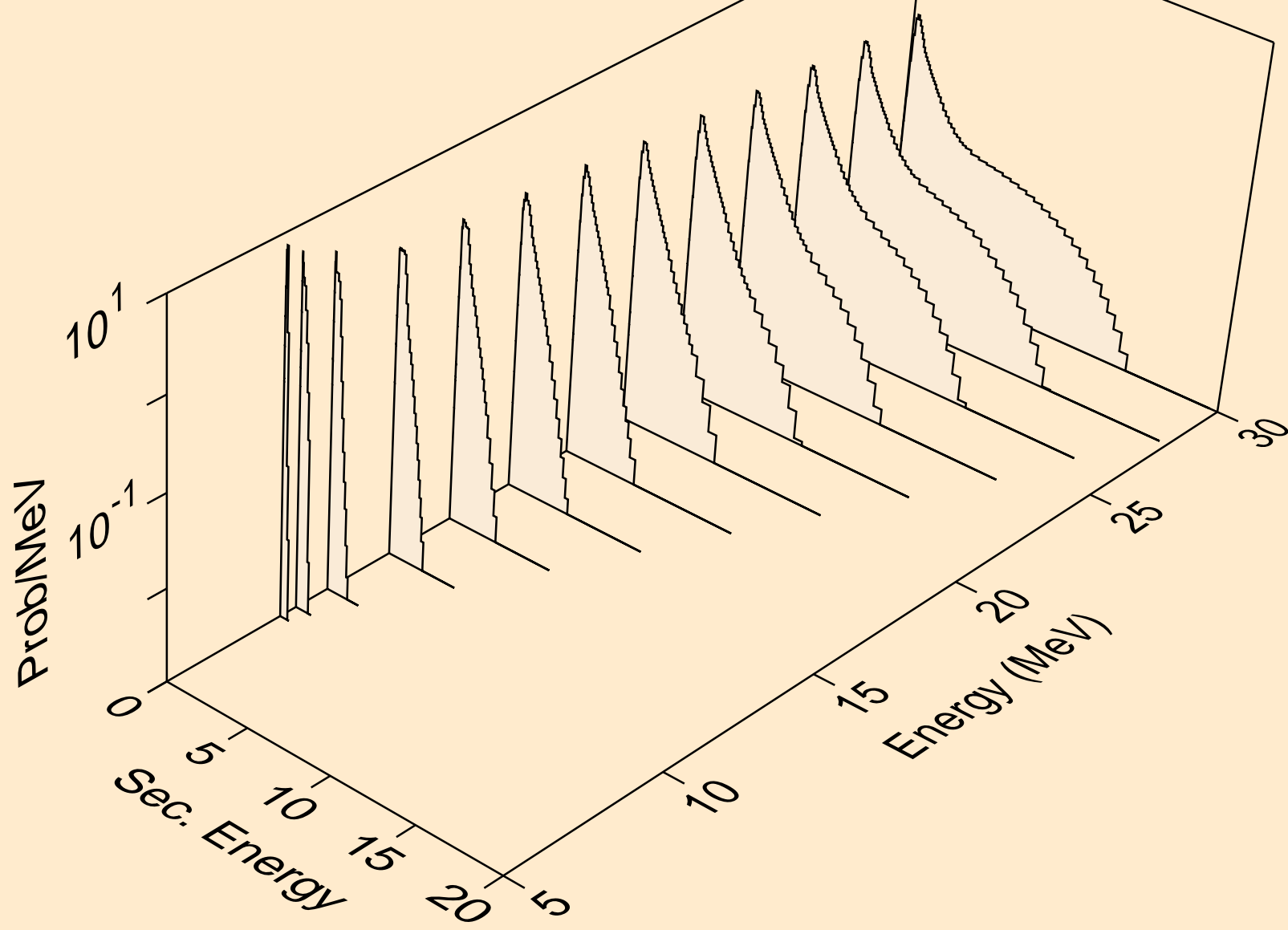

TC101 NEUTRON ACER TENDL-2021 LIBRARY; T=293.6K
Neutron emission for (n,n*)2a

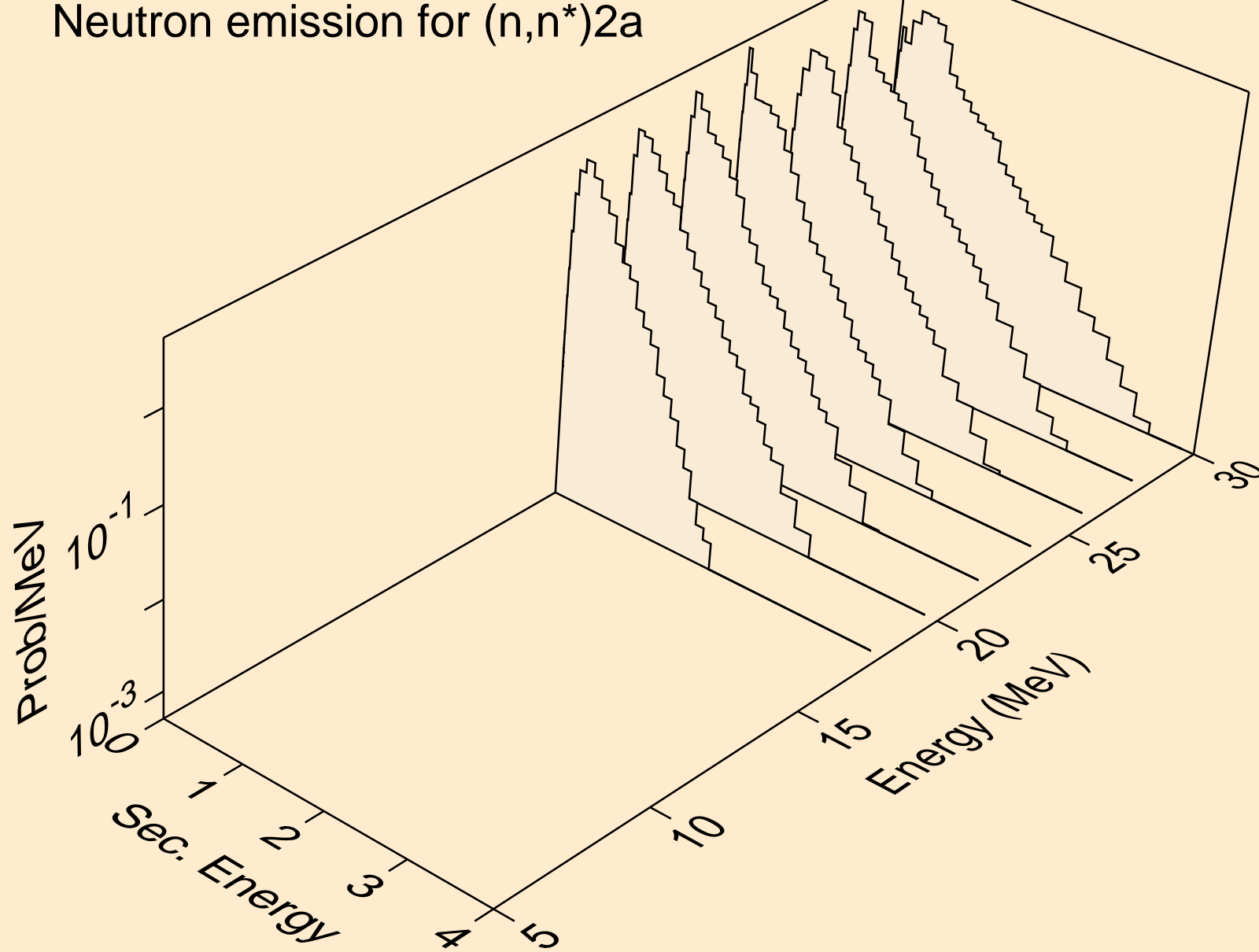

TC101 NEUTRON ACER TENDL-2021 LIBRARY; T=293.6K
Neutron emission for (n,n*)d

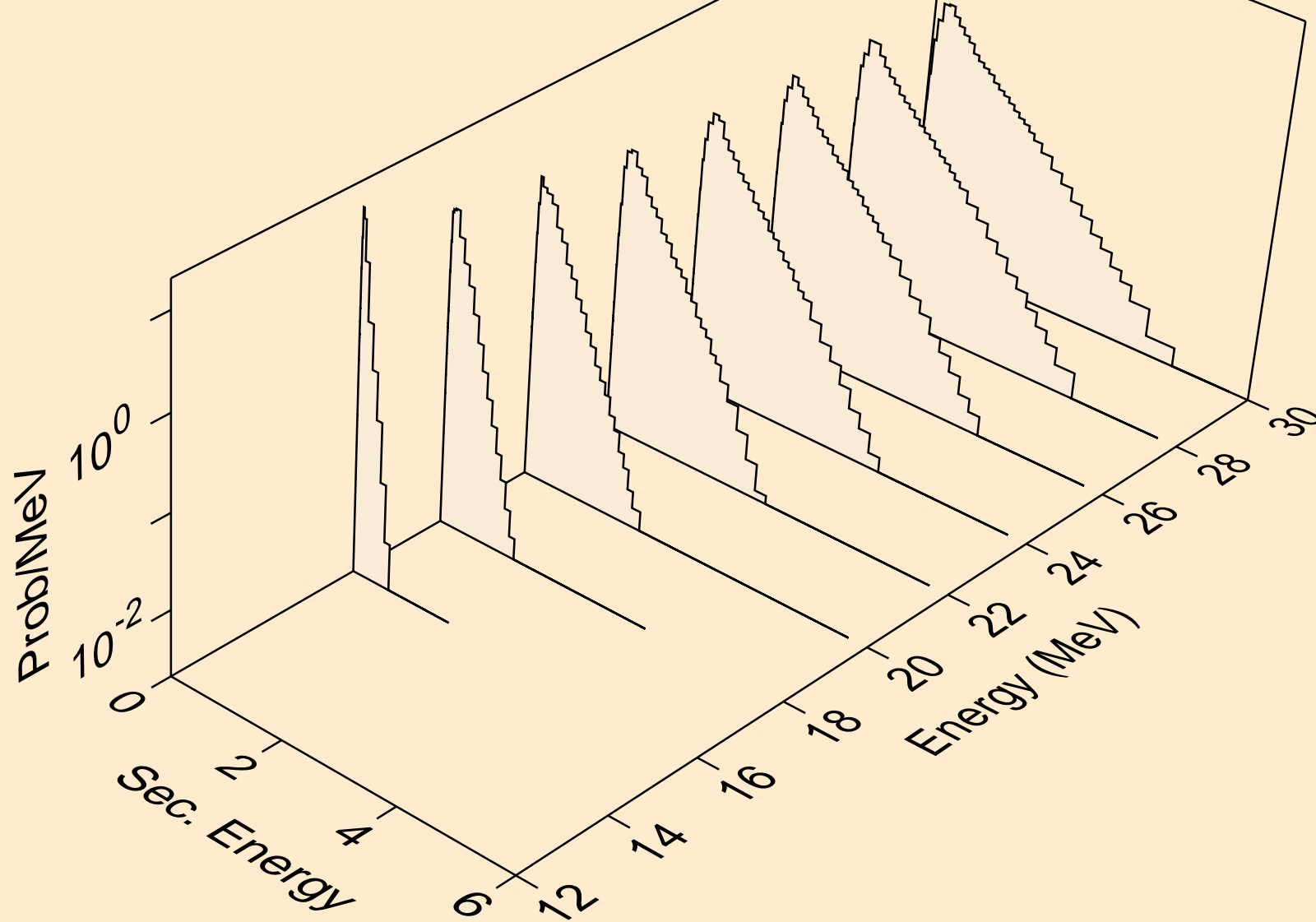

TC101 NEUTRON ACER TENDL-2021 LIBRARY; T=293.6K
Neutron emission for (n,n*)t

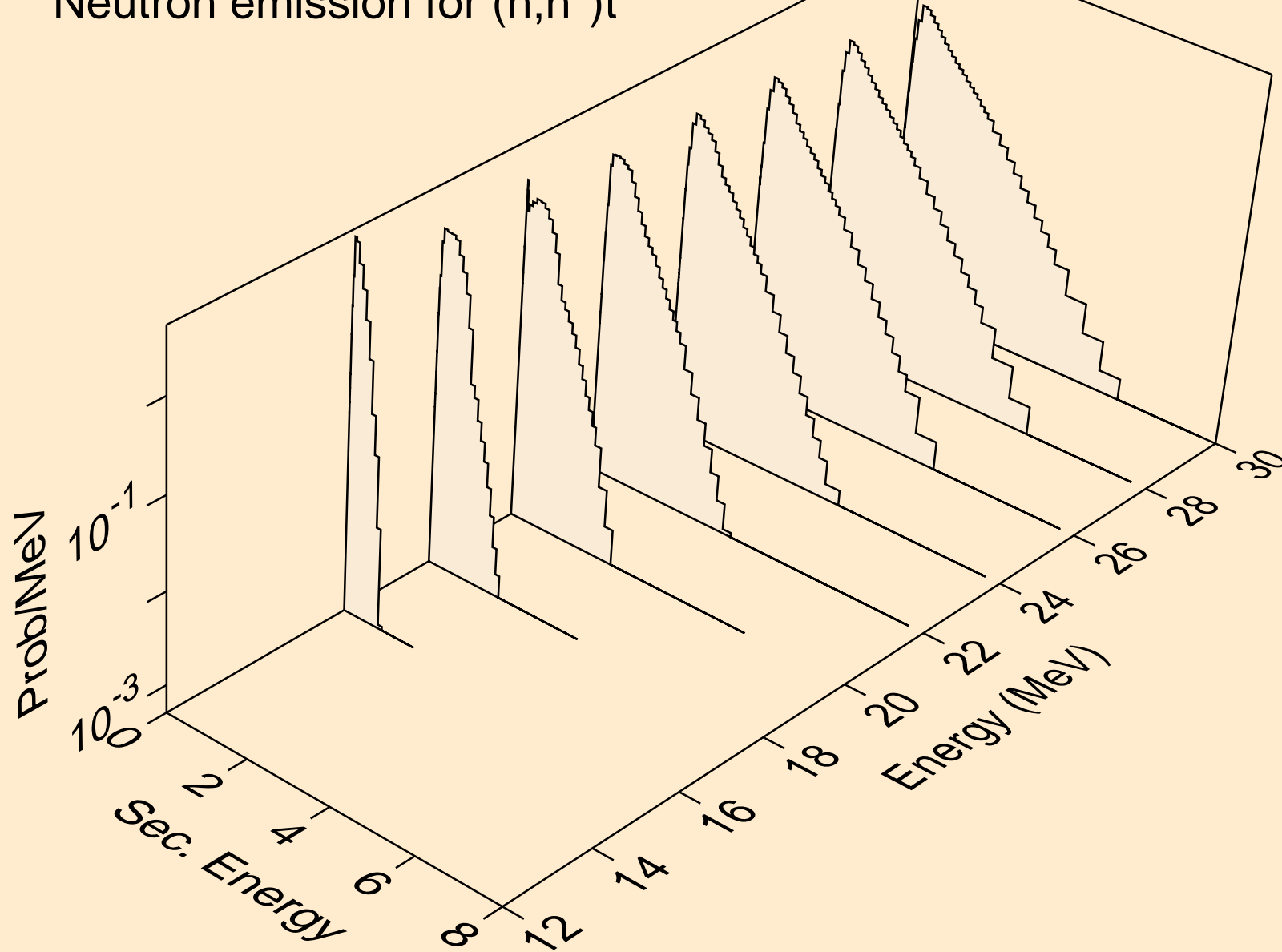

TC101 NEUTRON ACER TENDL-2021 LIBRARY; T=293.6K
Neutron emission for (n,n*)he3

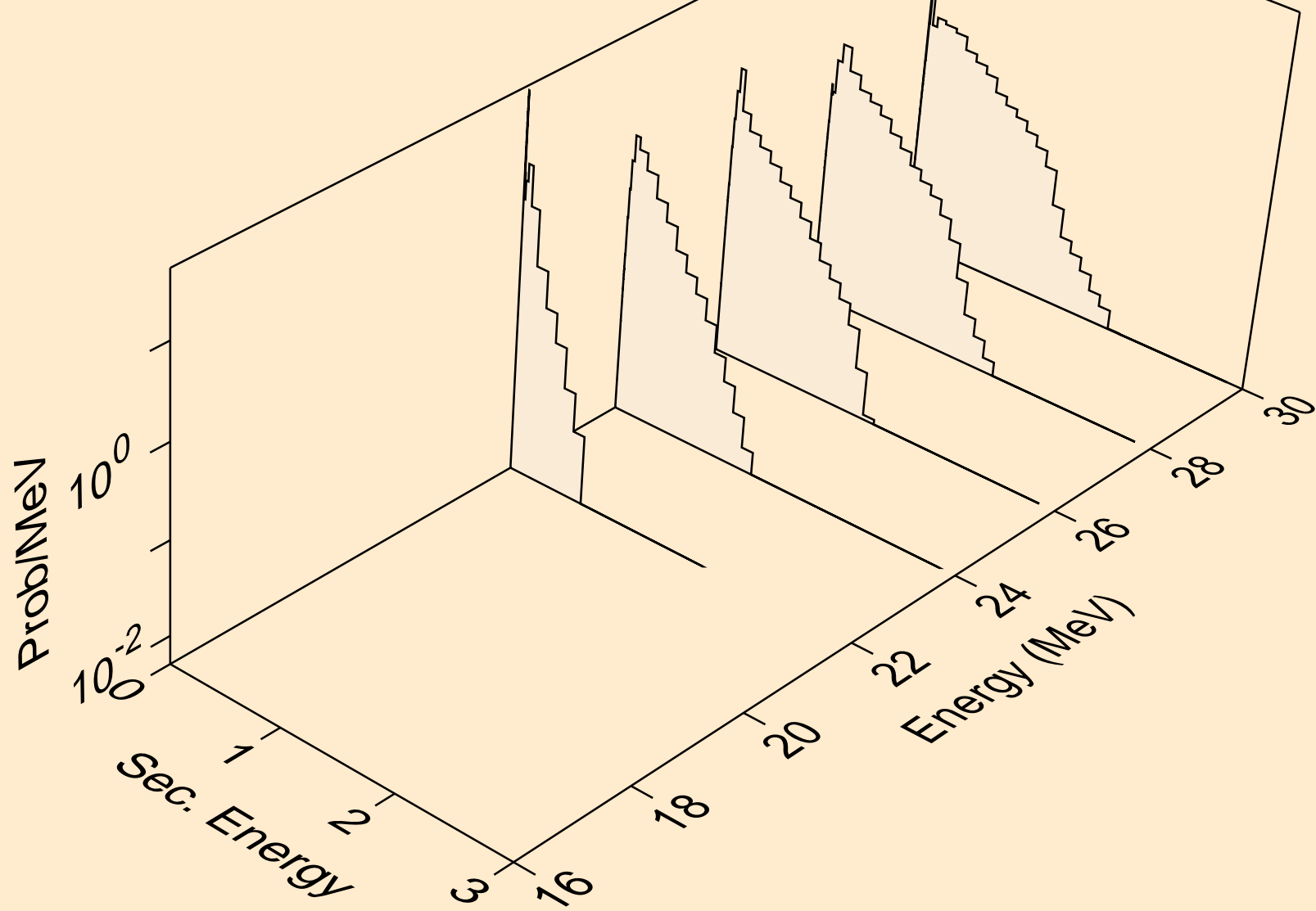

TC101 NEUTRON ACER TENDL-2021 LIBRARY; T=293.6K
Neutron emission for (n,4n)

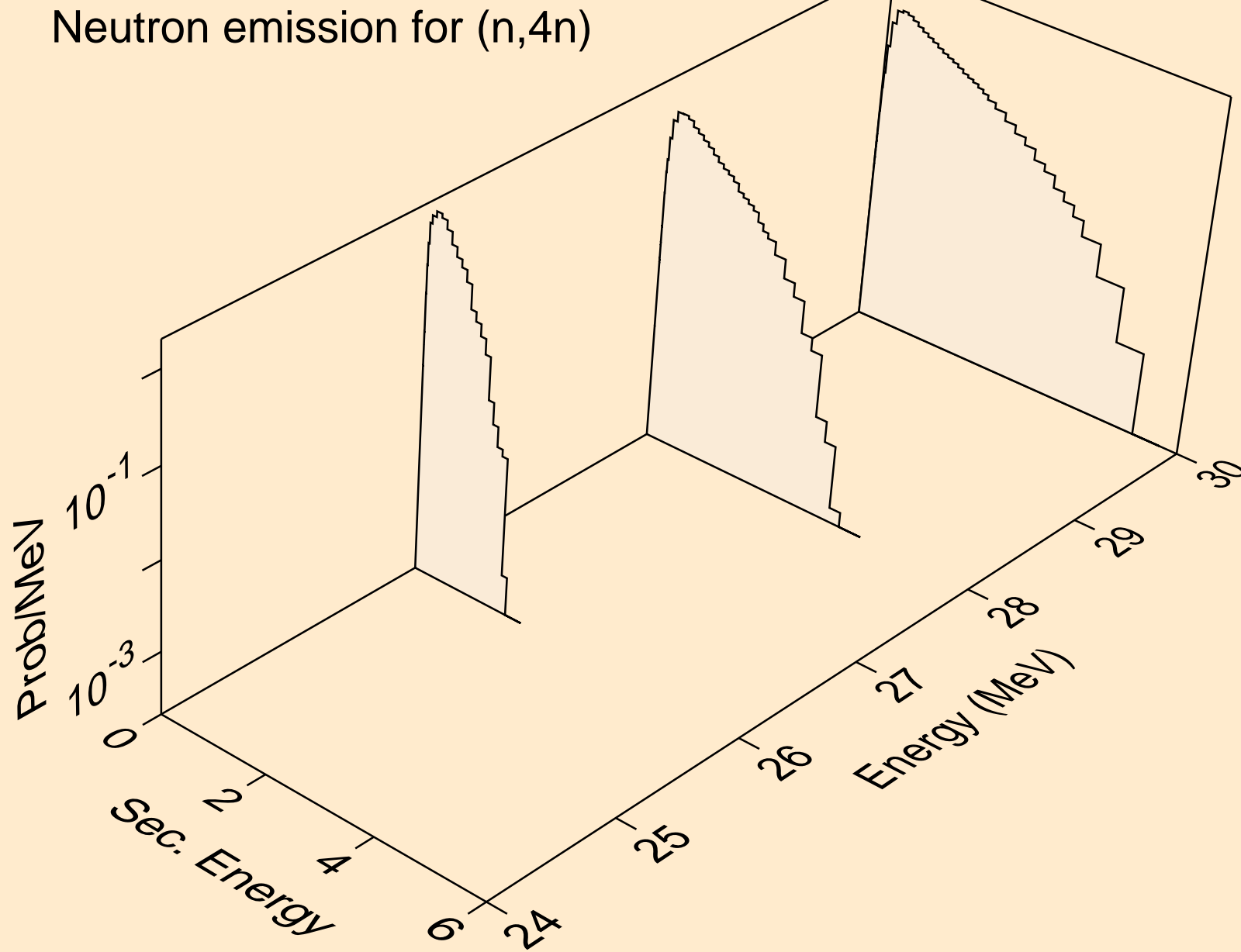

TC101 NEUTRON ACER TENDL-2021 LIBRARY; T=293.6K
Neutron emission for (n,2np)

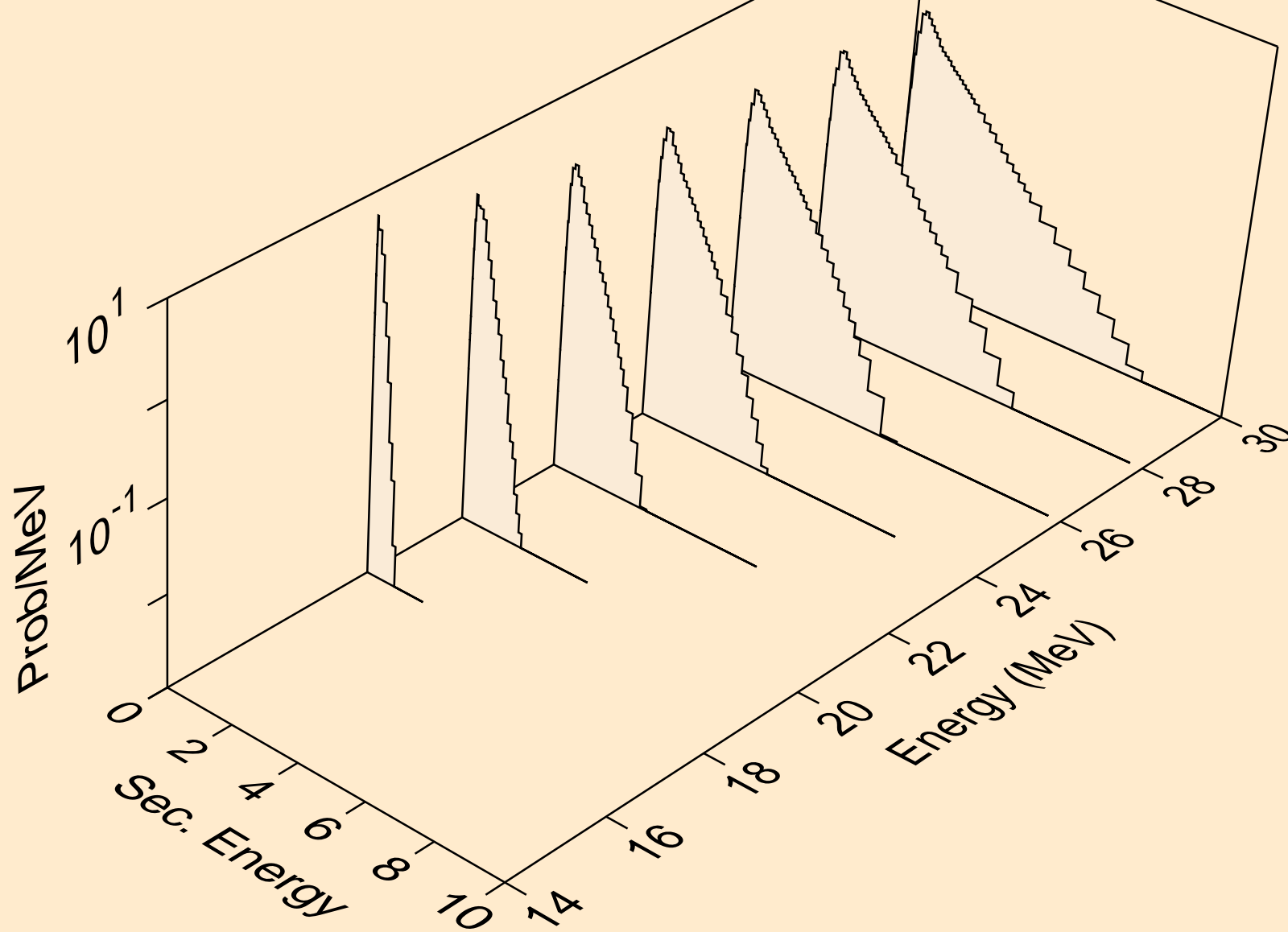

TC101 NEUTRON ACER TENDL-2021 LIBRARY; T=293.6K
Neutron emission for (n,3np)

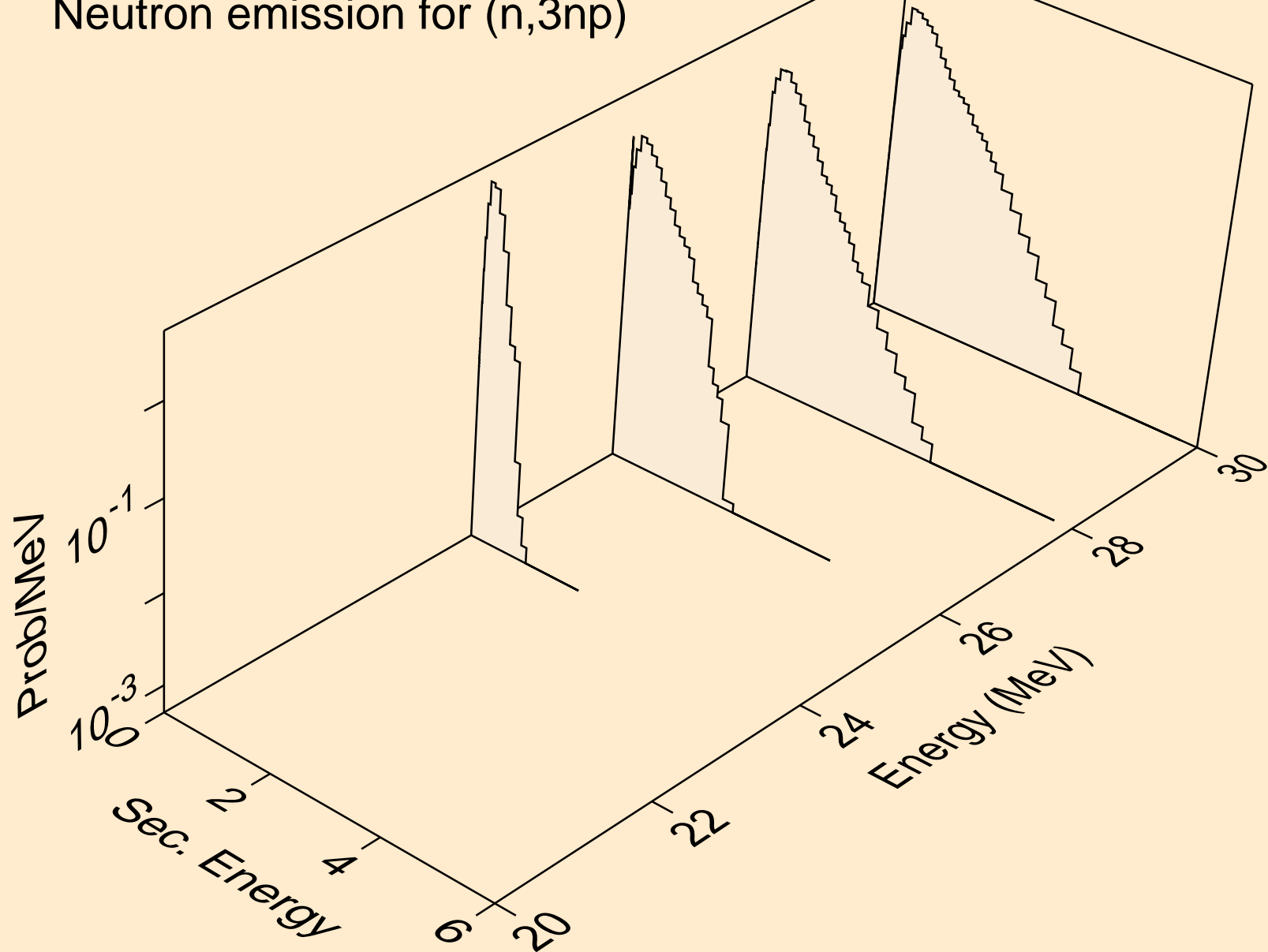

TC101 NEUTRON ACER TENDL-2021 LIBRARY; T=293.6K
Neutron emission for (n,2np)

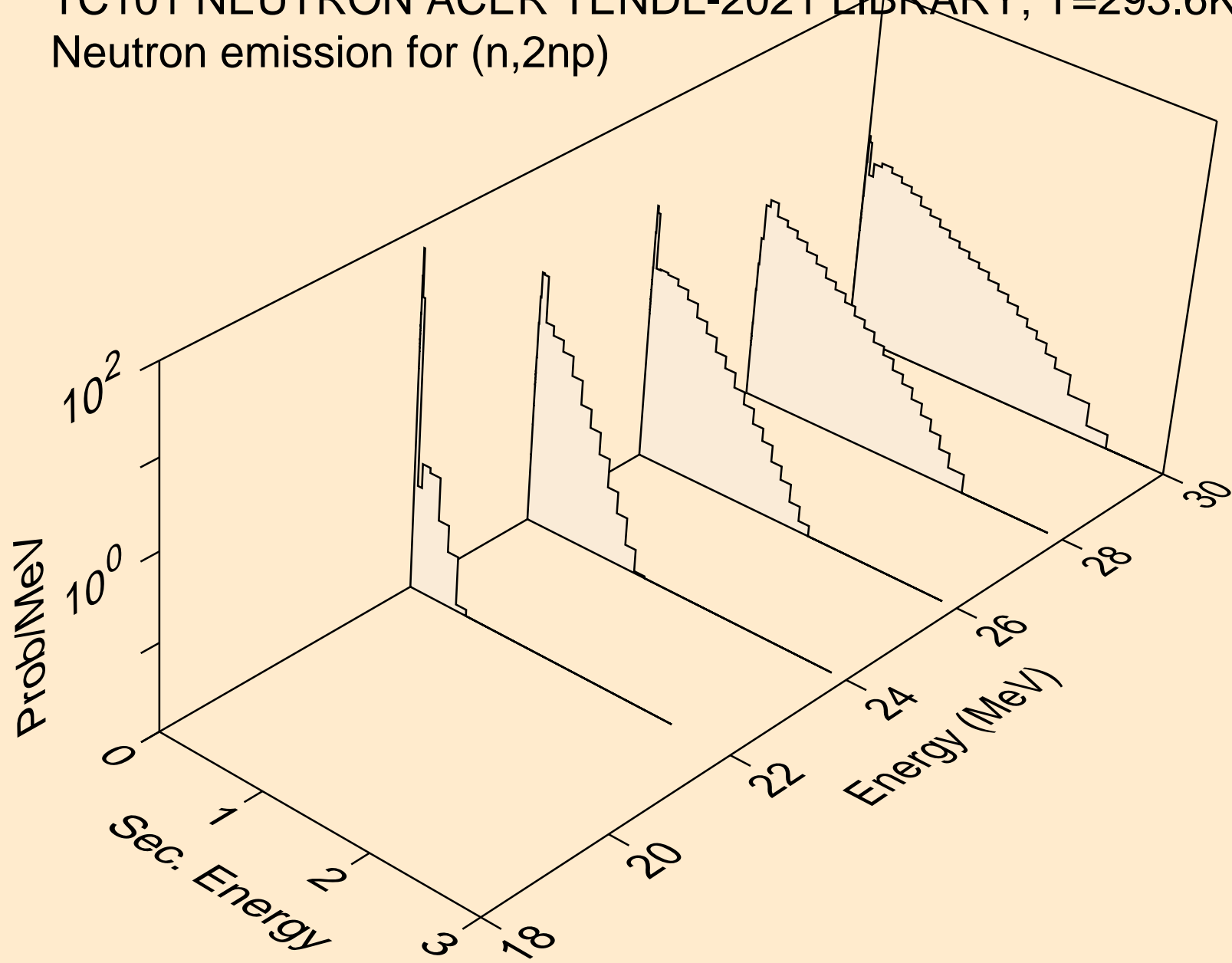

TC101 NEUTRON ACER TENDL-2021 LIBRARY; T=293.6K
Neutron emission for (n,npa)

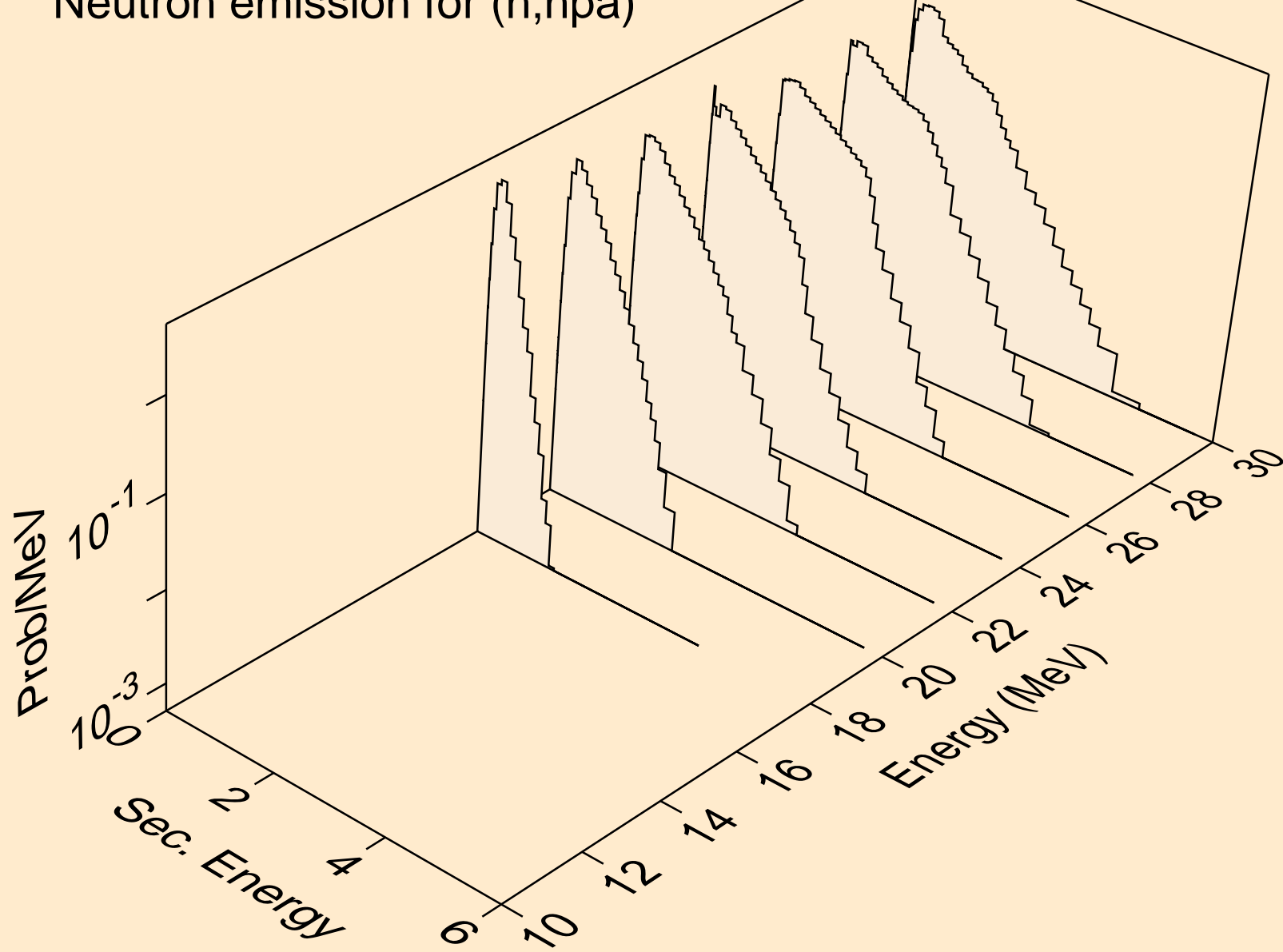

TC101 NEUTRON ACER TENDL-2021 LIBRARY; T=293.6K
Neutron emission for (n,n*c)

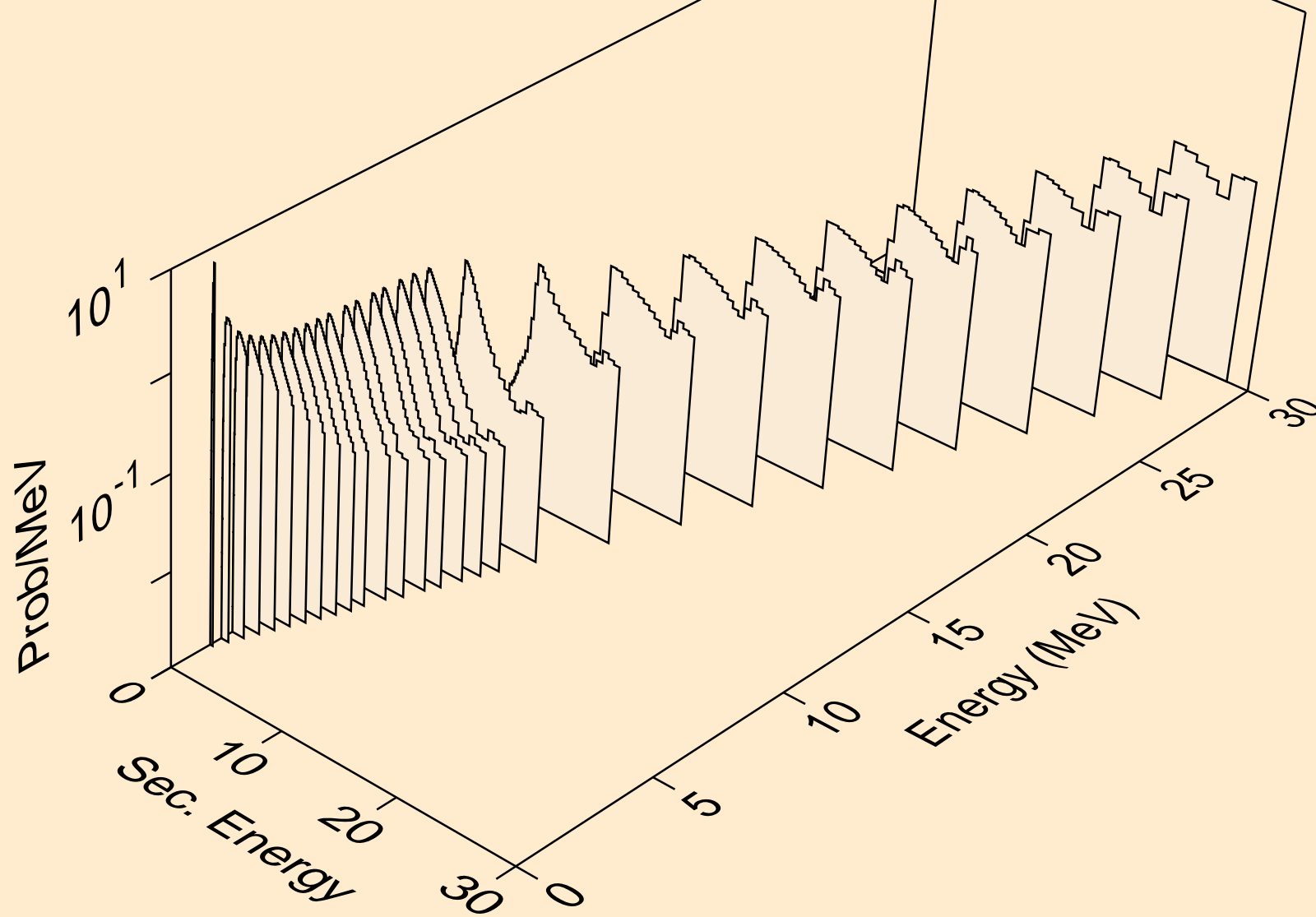

TC101 NEUTRON ACER TENDL-2021 LIBRARY; T=293.6K
Photon emission for (n,x)

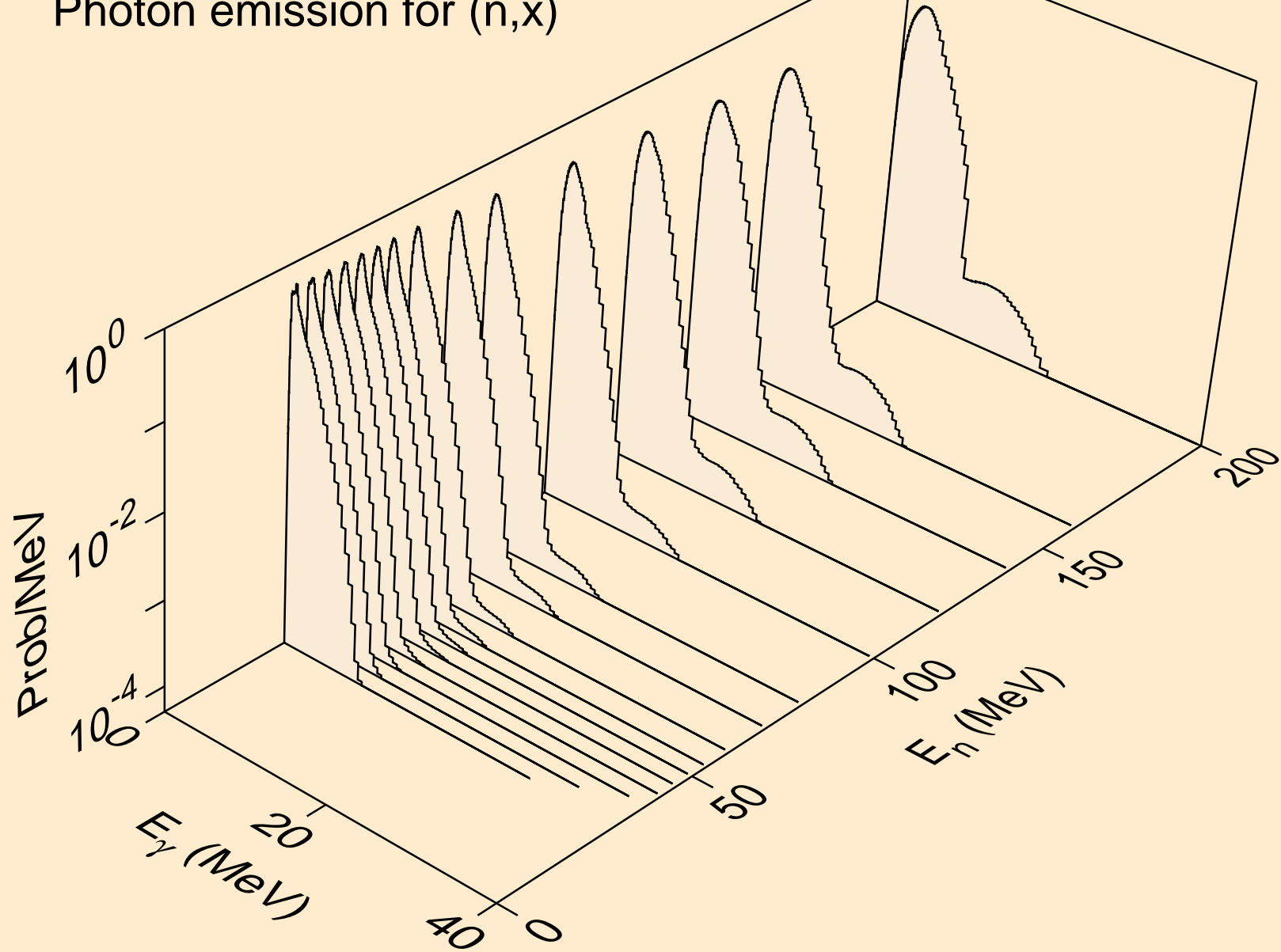

TC101 NEUTRON ACER TENDL-2021 LIBRARY; T=293.6K
Photon emission for (n,2nd)

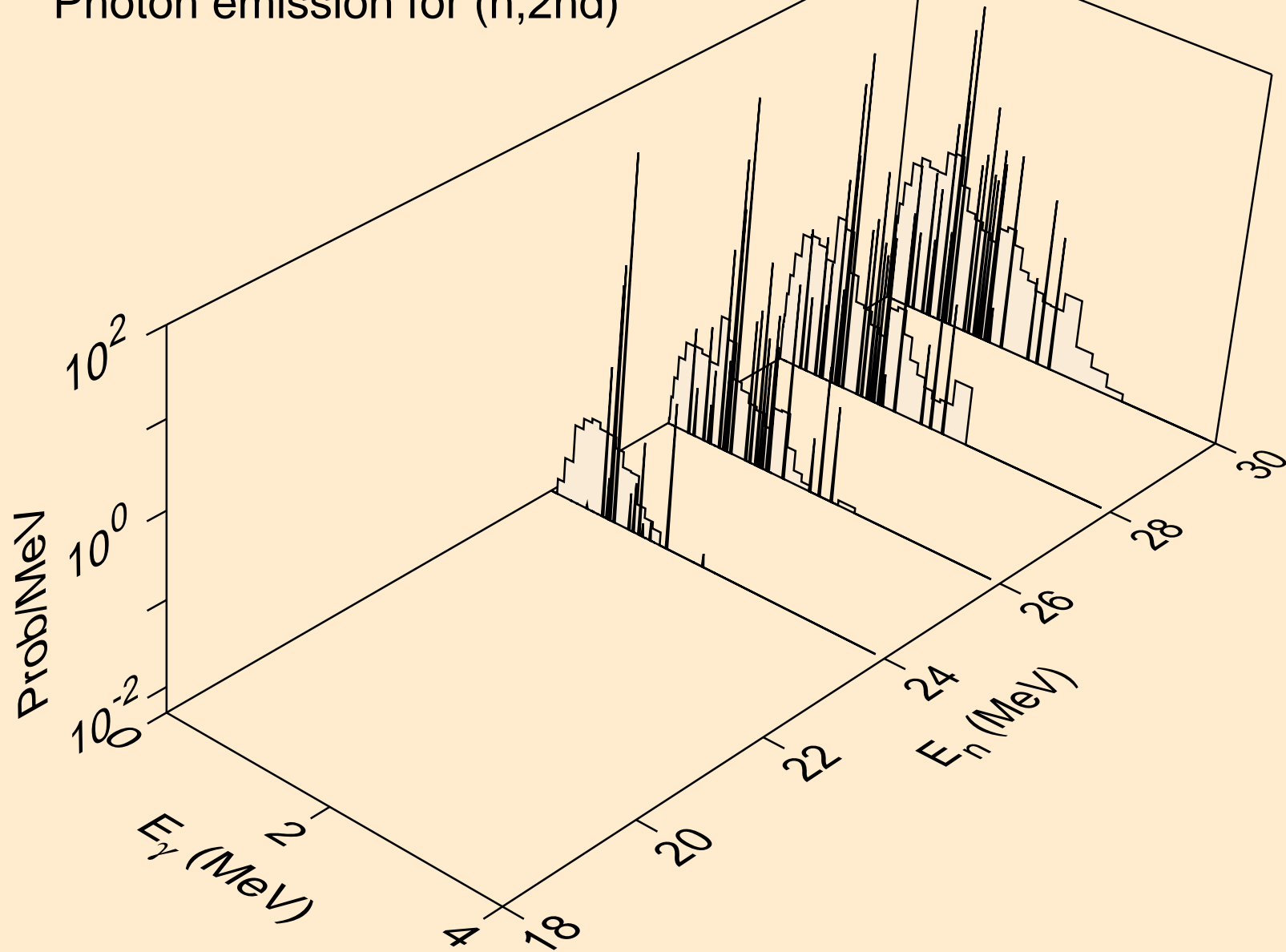

TC101 NEUTRON ACER TENDL-2021 LIBRARY; T=293.6K
Photon emission for (n,2n)

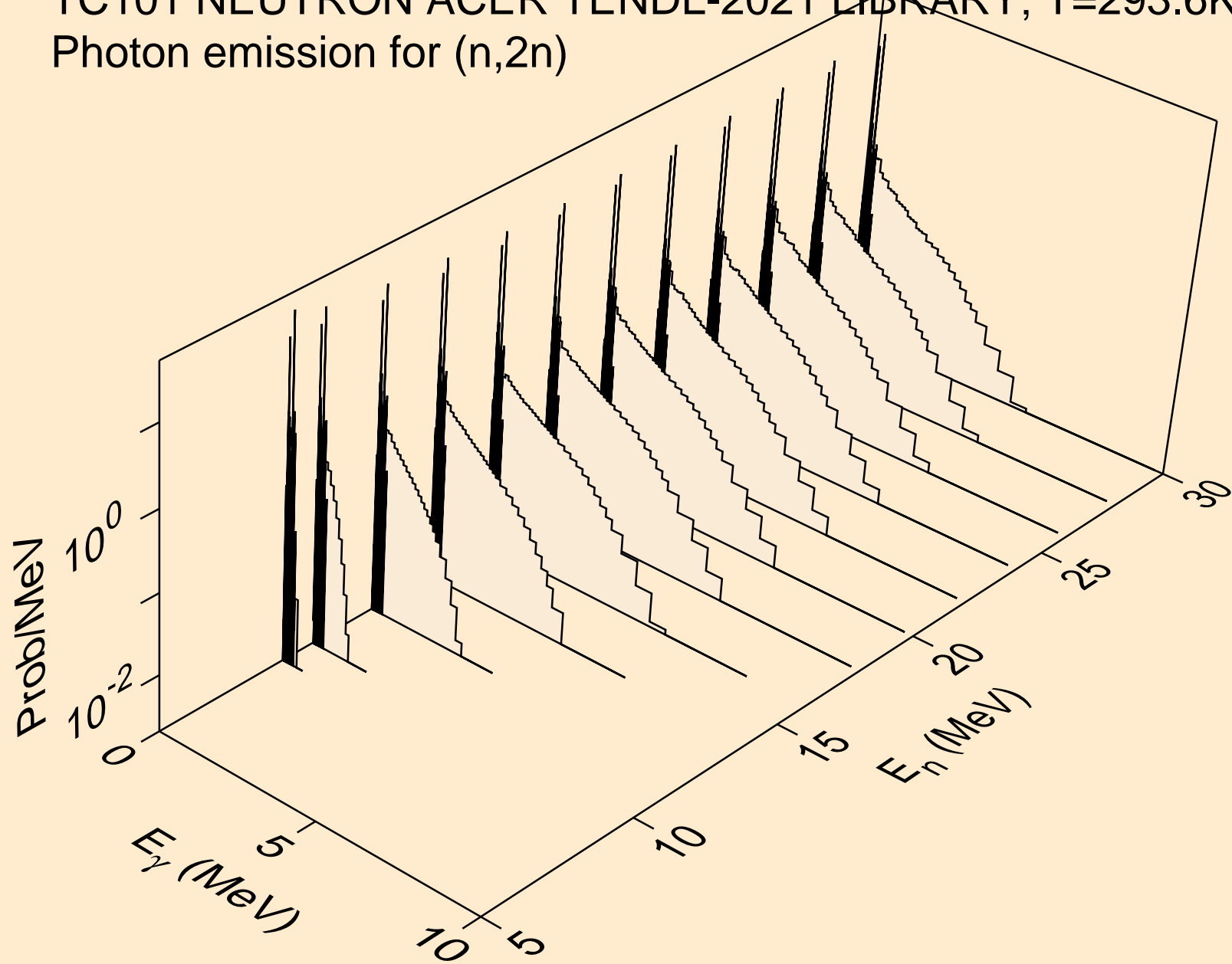

TC101 NEUTRON ACER TENDL-2021 LIBRARY; T=293.6K
Photon emission for (n,3n)

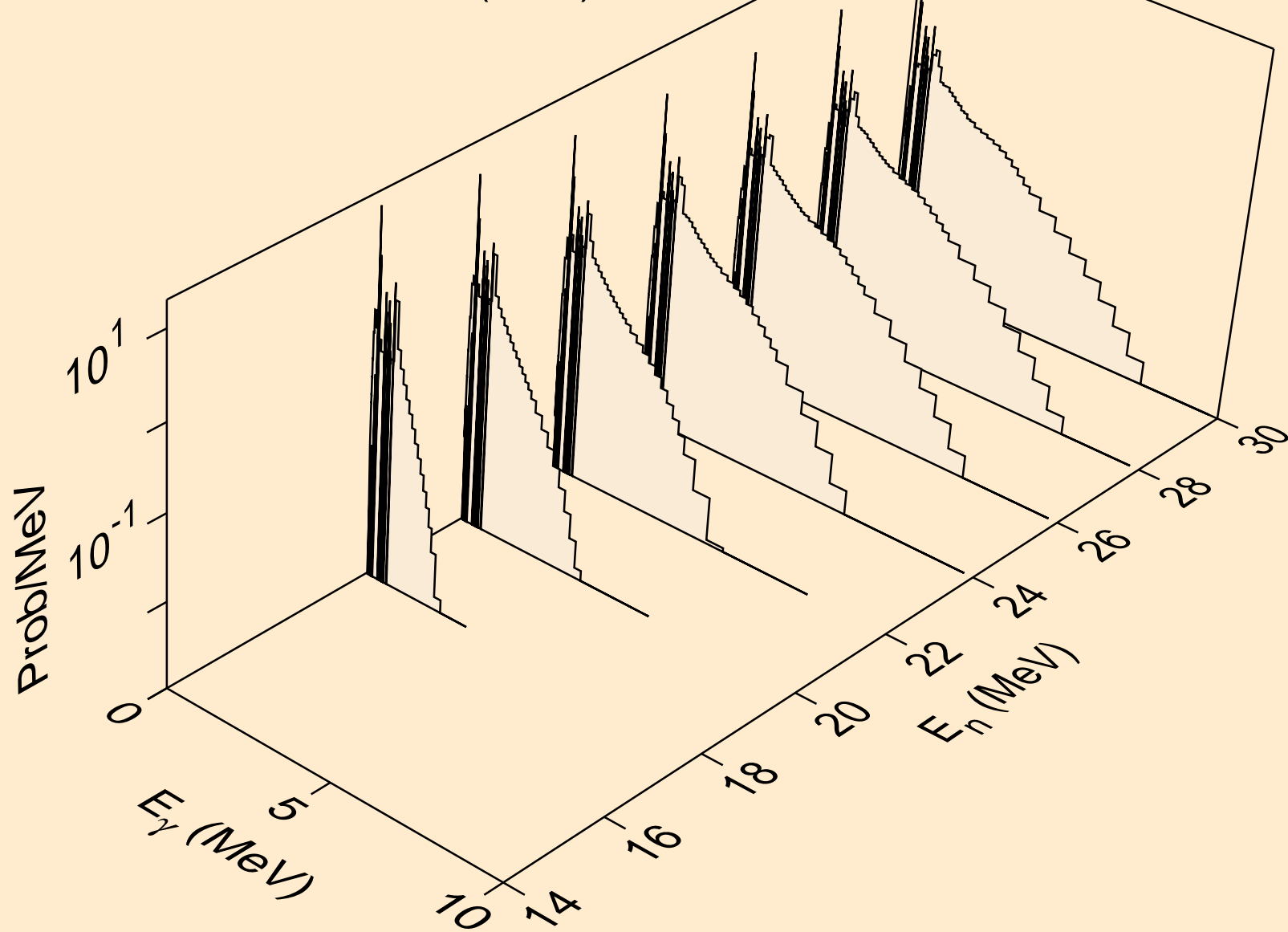

TC101 NEUTRON ACER TENDL-2021 LIBRARY; T=293.6K
Photon emission for (n,n*)a

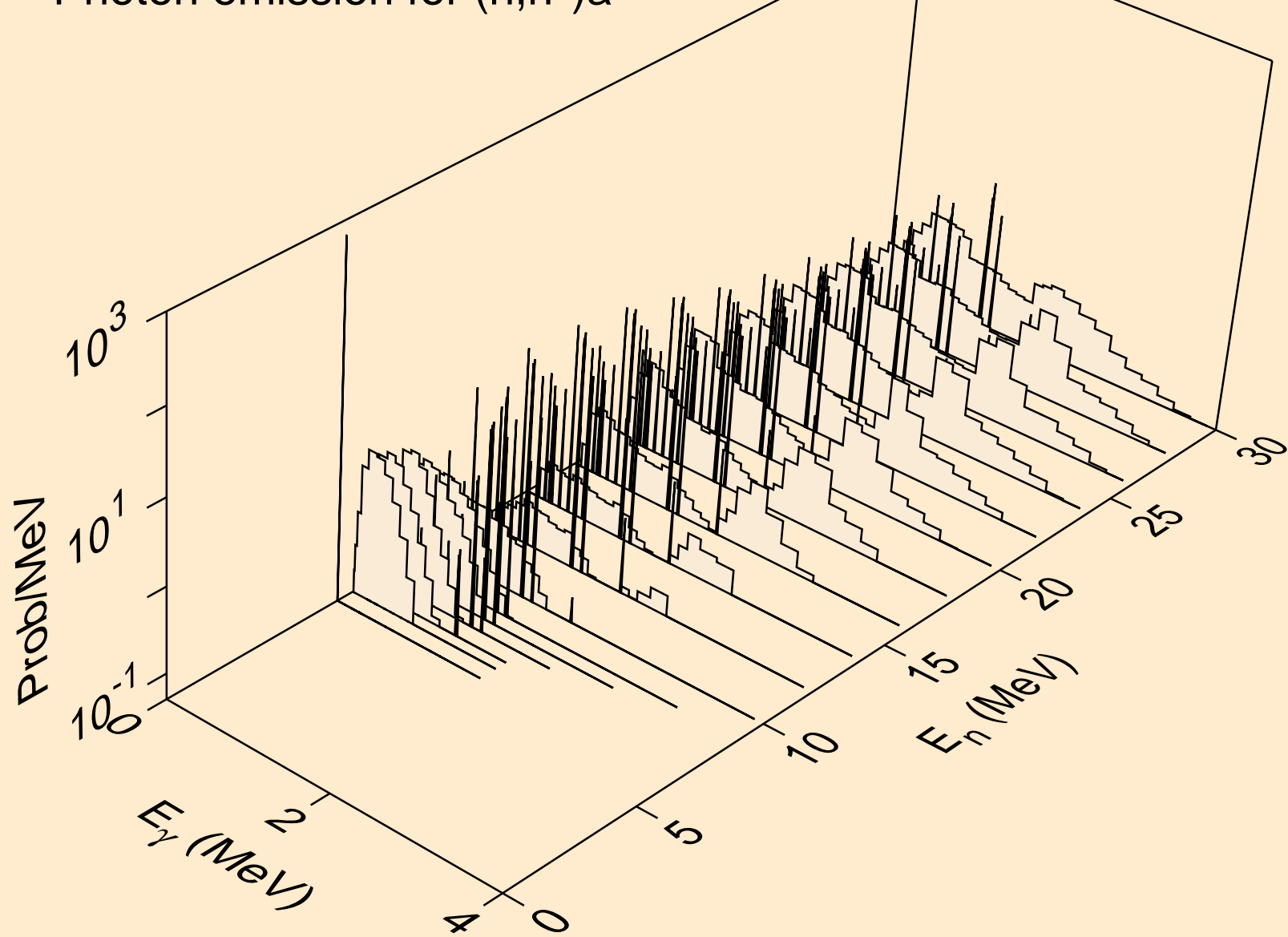

TC101 NEUTRON ACER TENDL-2021 LIBRARY; T=293.6K
Photon emission for (n,2n)a

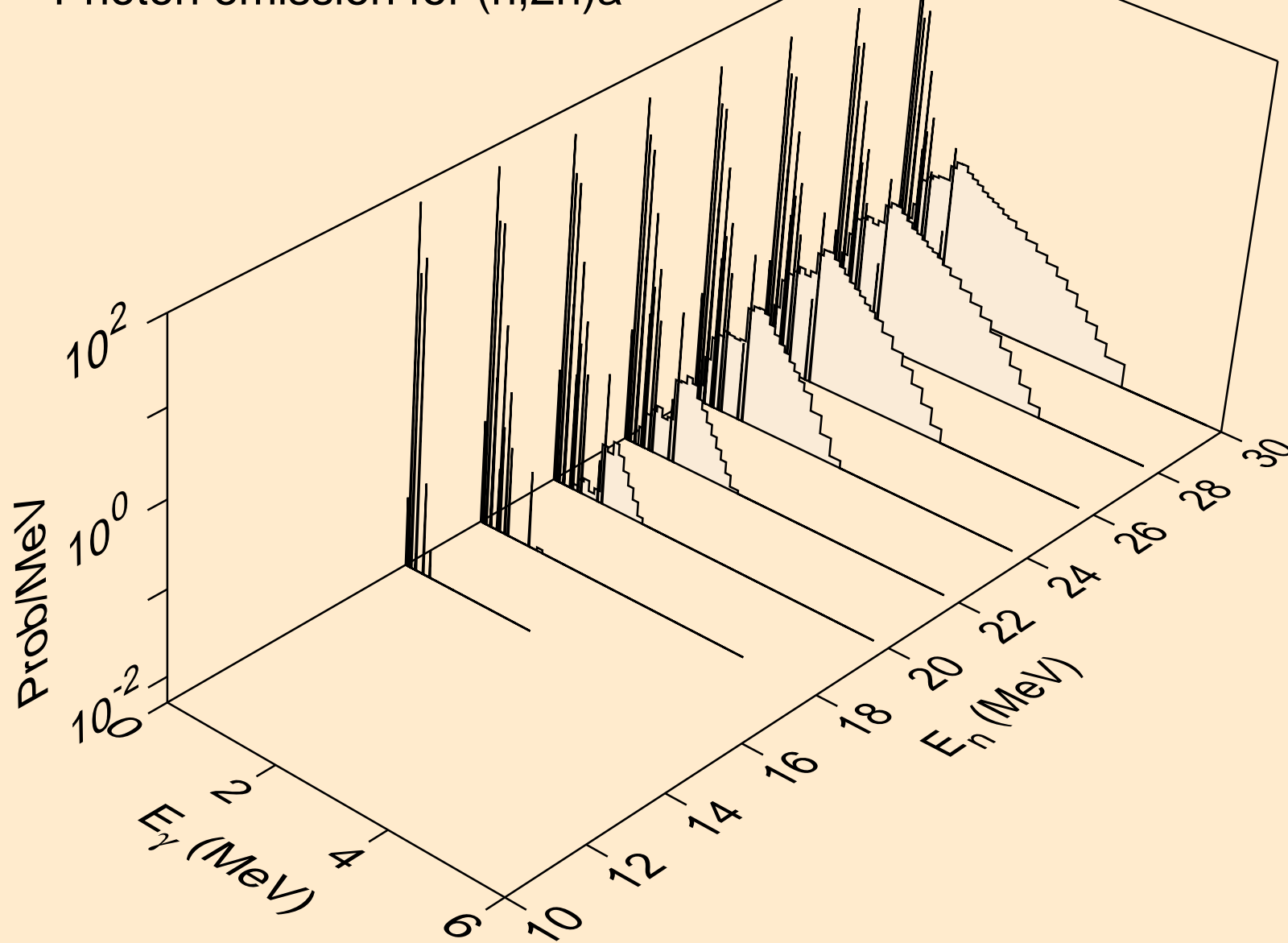

TC101 NEUTRON ACER TENDL-2021 LIBRARY; T=293.6K
Photon emission for (n,3n)a

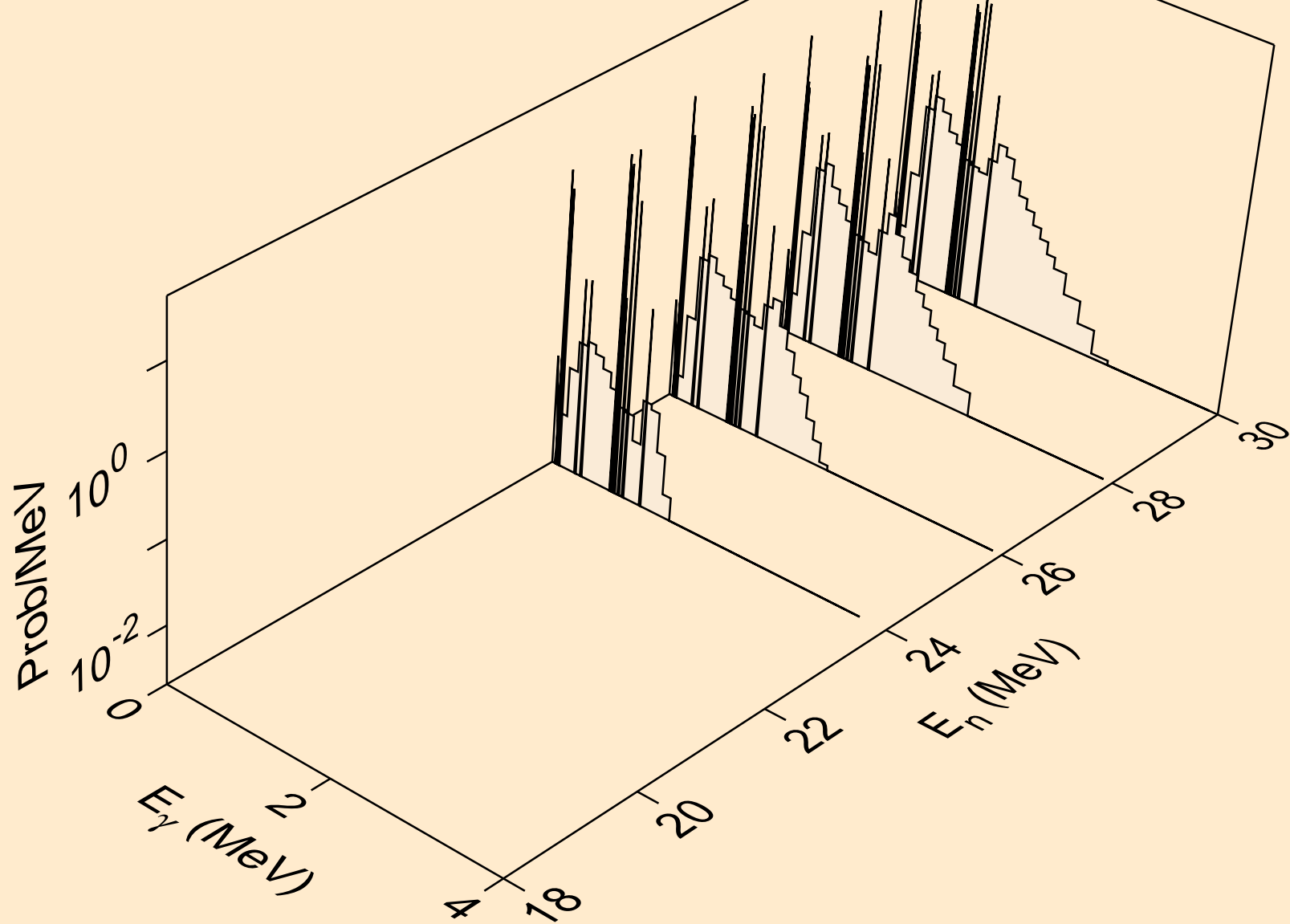

TC101 NEUTRON ACER TENDL-2021 LIBRARY; T=293.6K
Photon emission for (n,n*)p

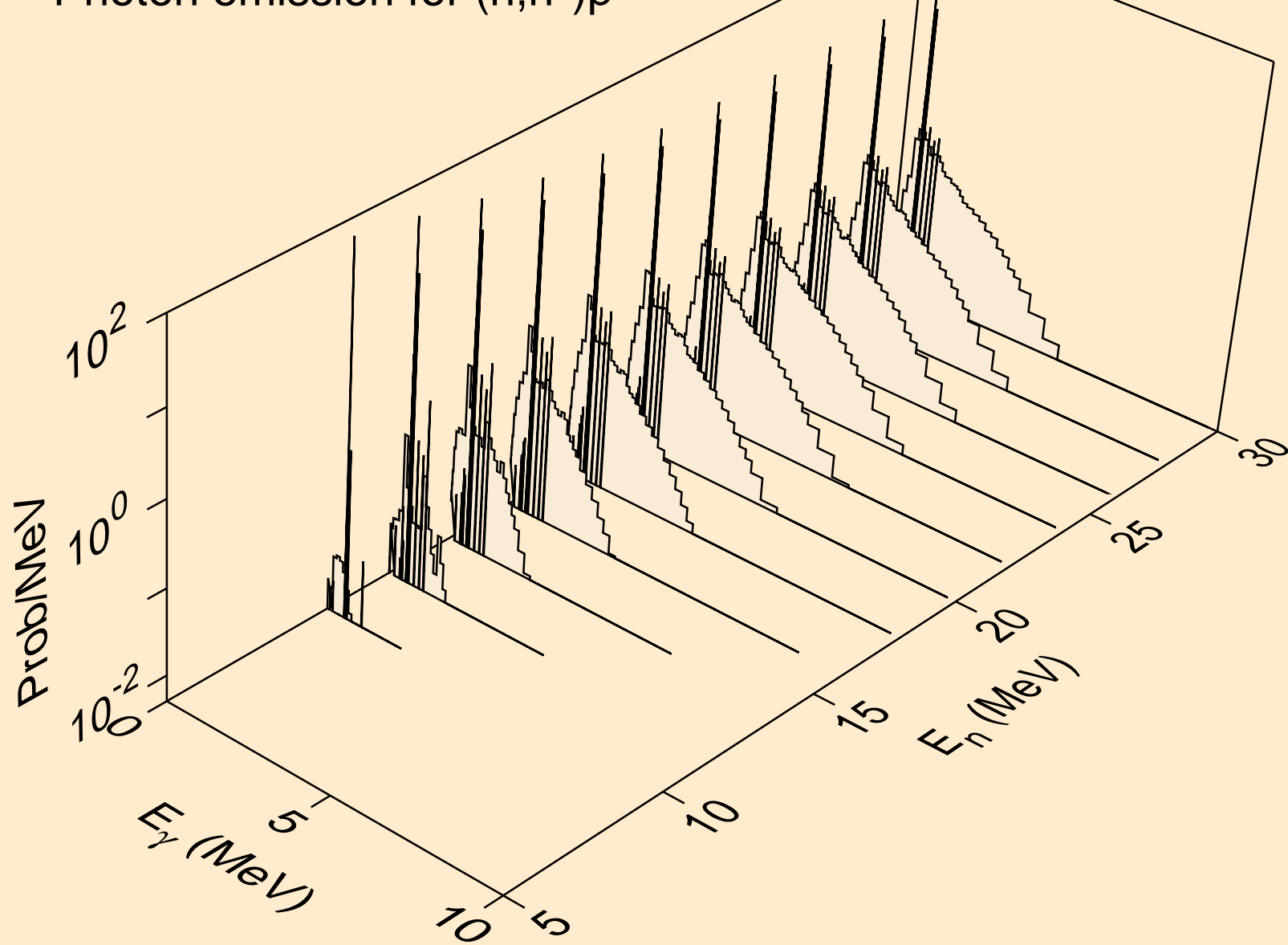

TC101 NEUTRON ACER TENDL-2021 LIBRARY; T=293.6K
Photon emission for (n,n*)2a

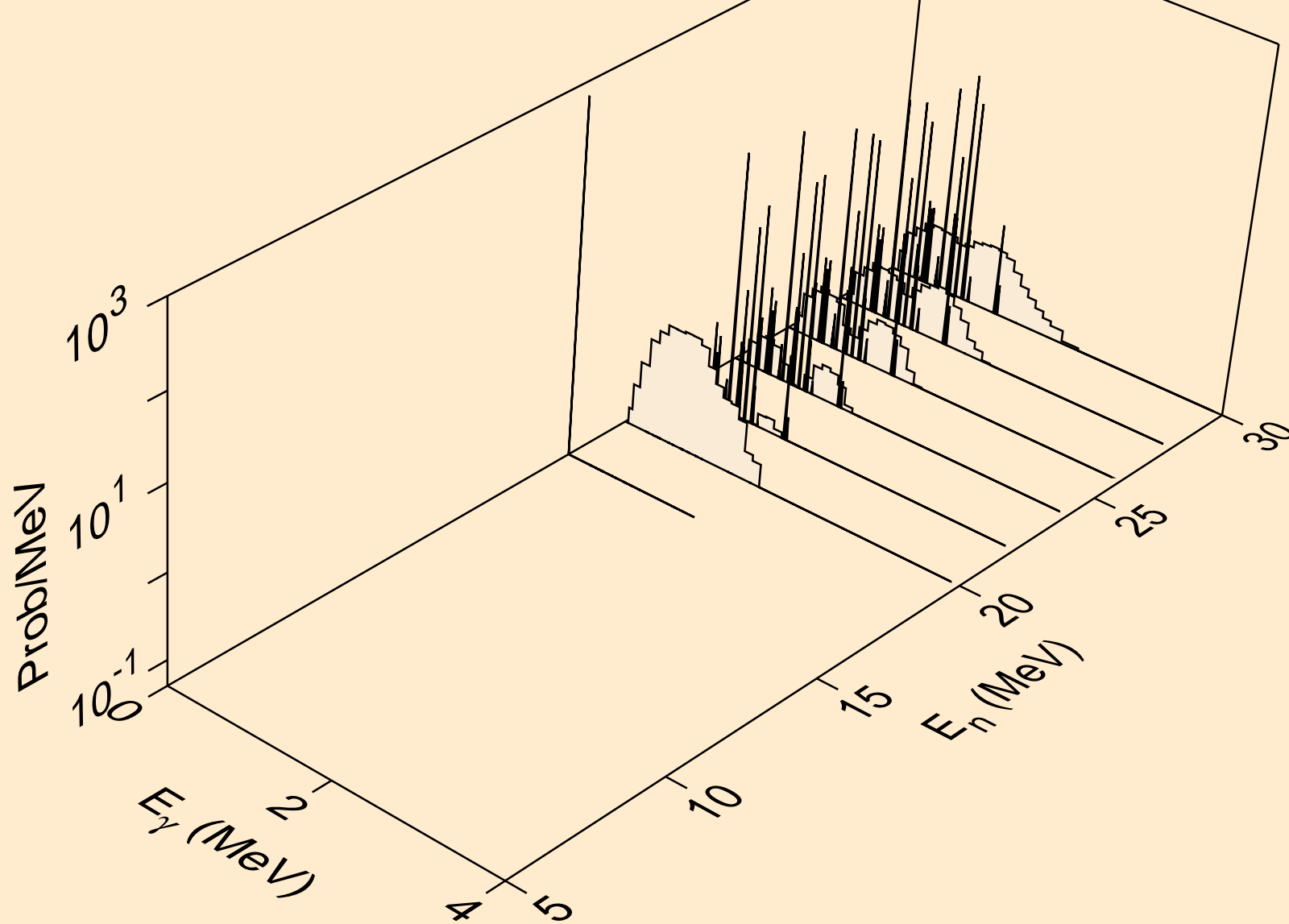

TC101 NEUTRON ACER TENDL-2021 LIBRARY; T=293.6K
Photon emission for (n,n*)d

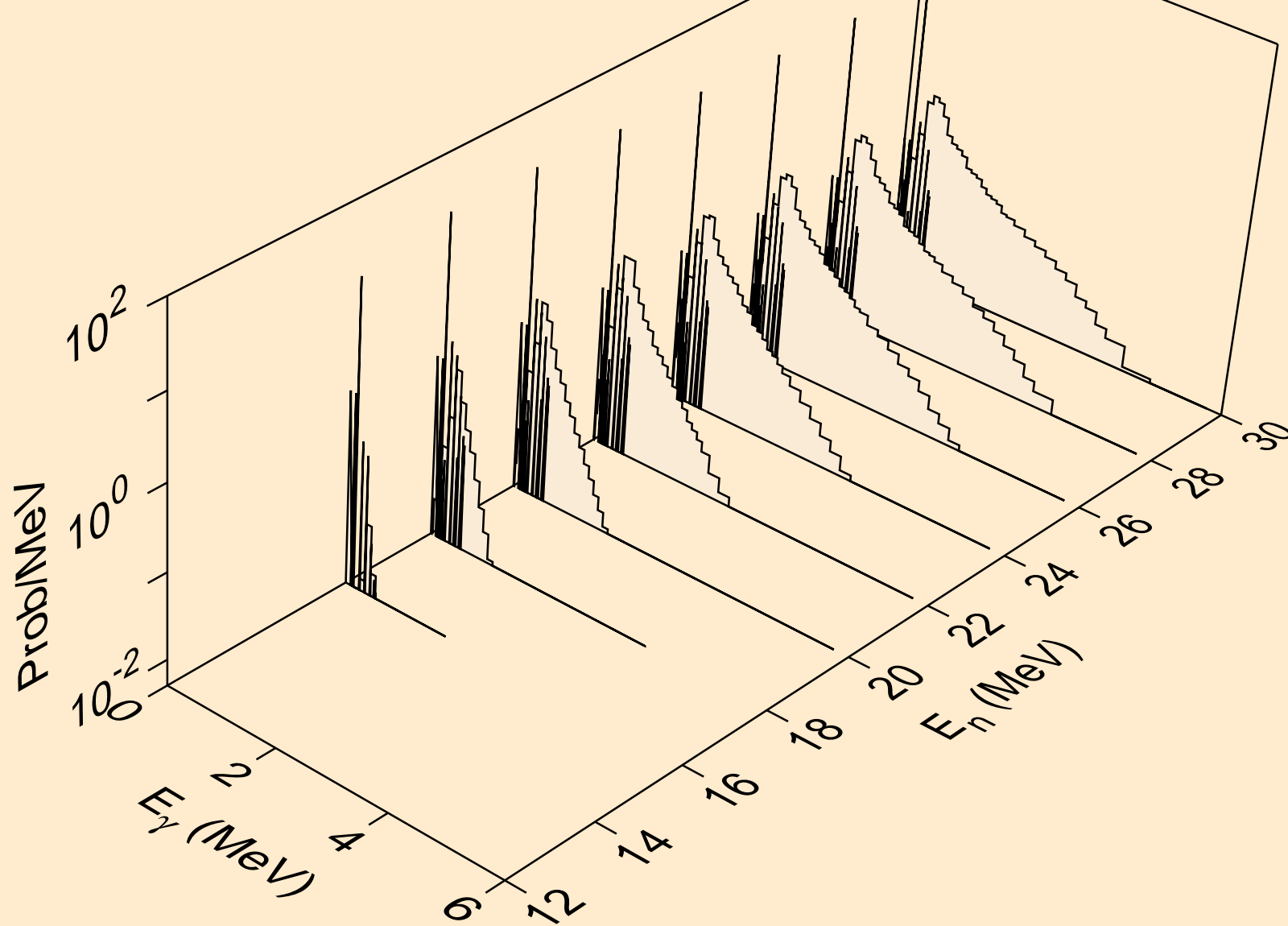

TC101 NEUTRON ACER TENDL-2021 LIBRARY; T=293.6K
Photon emission for (n,n*)t

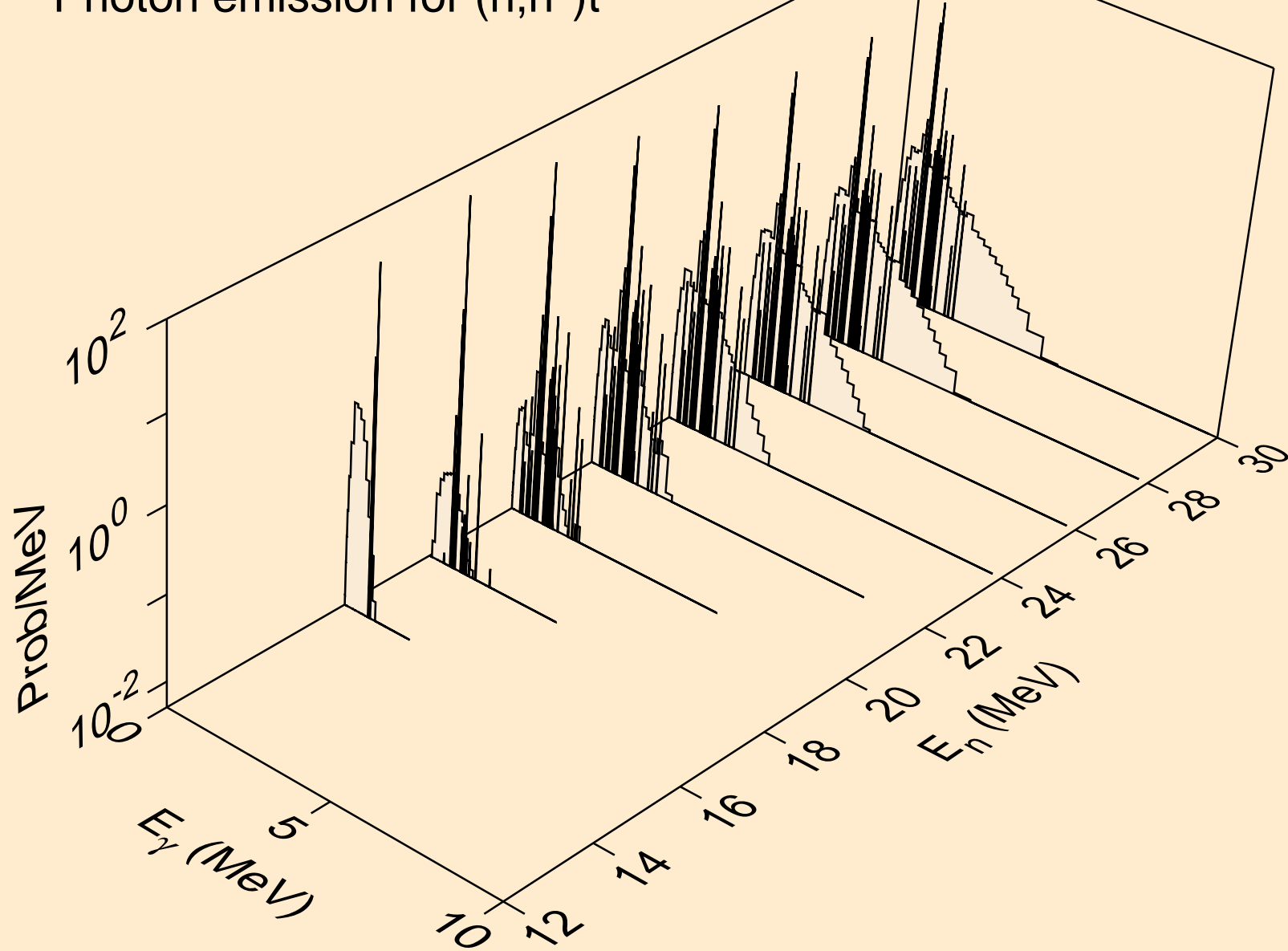

TC101 NEUTRON ACER TENDL-2021 LIBRARY; T=293.6K
Photon emission for (n,n*)he3

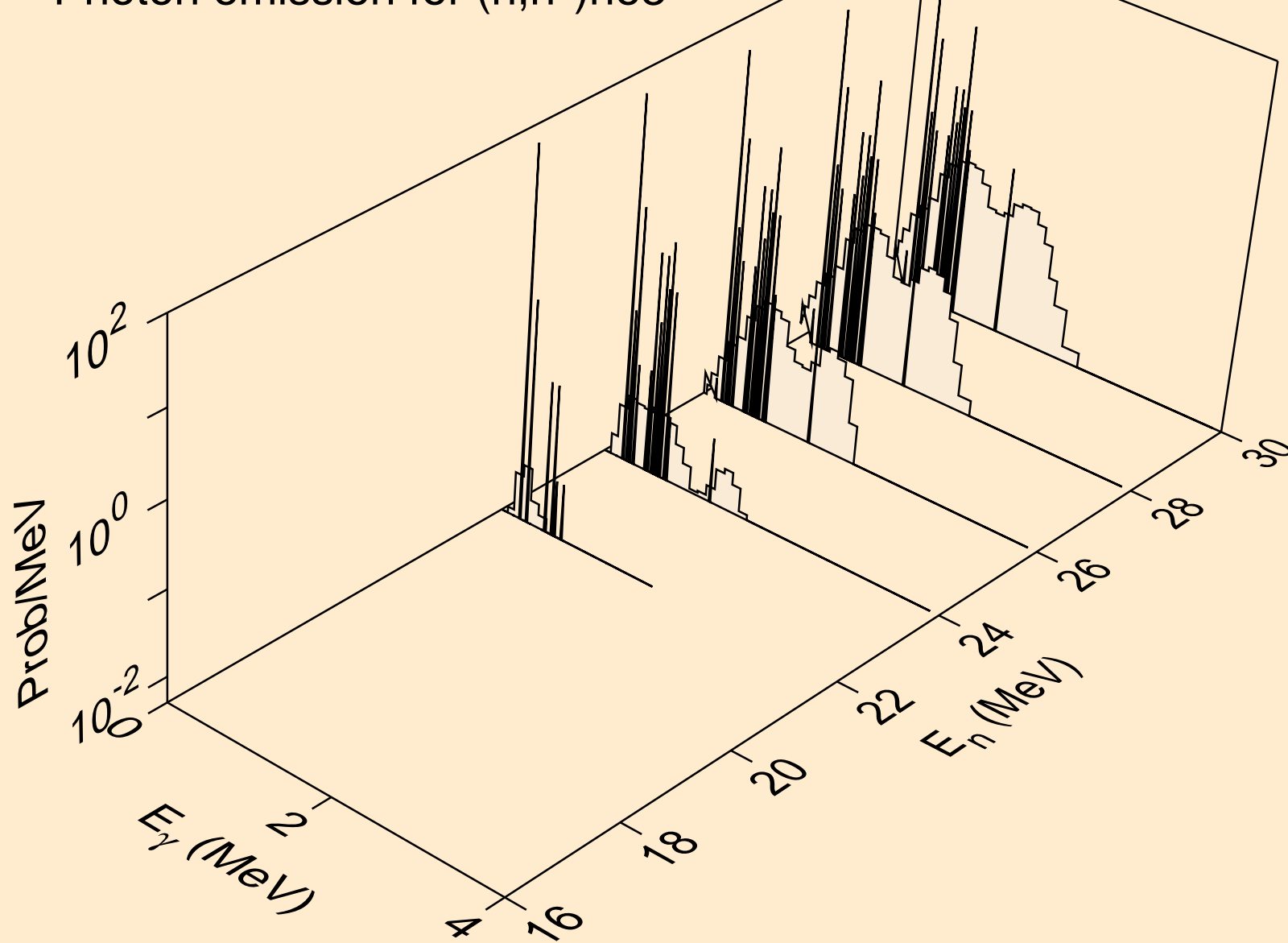

TC101 NEUTRON ACER TENDL-2021 LIBRARY; T=293.6K
Photon emission for (n,4n)

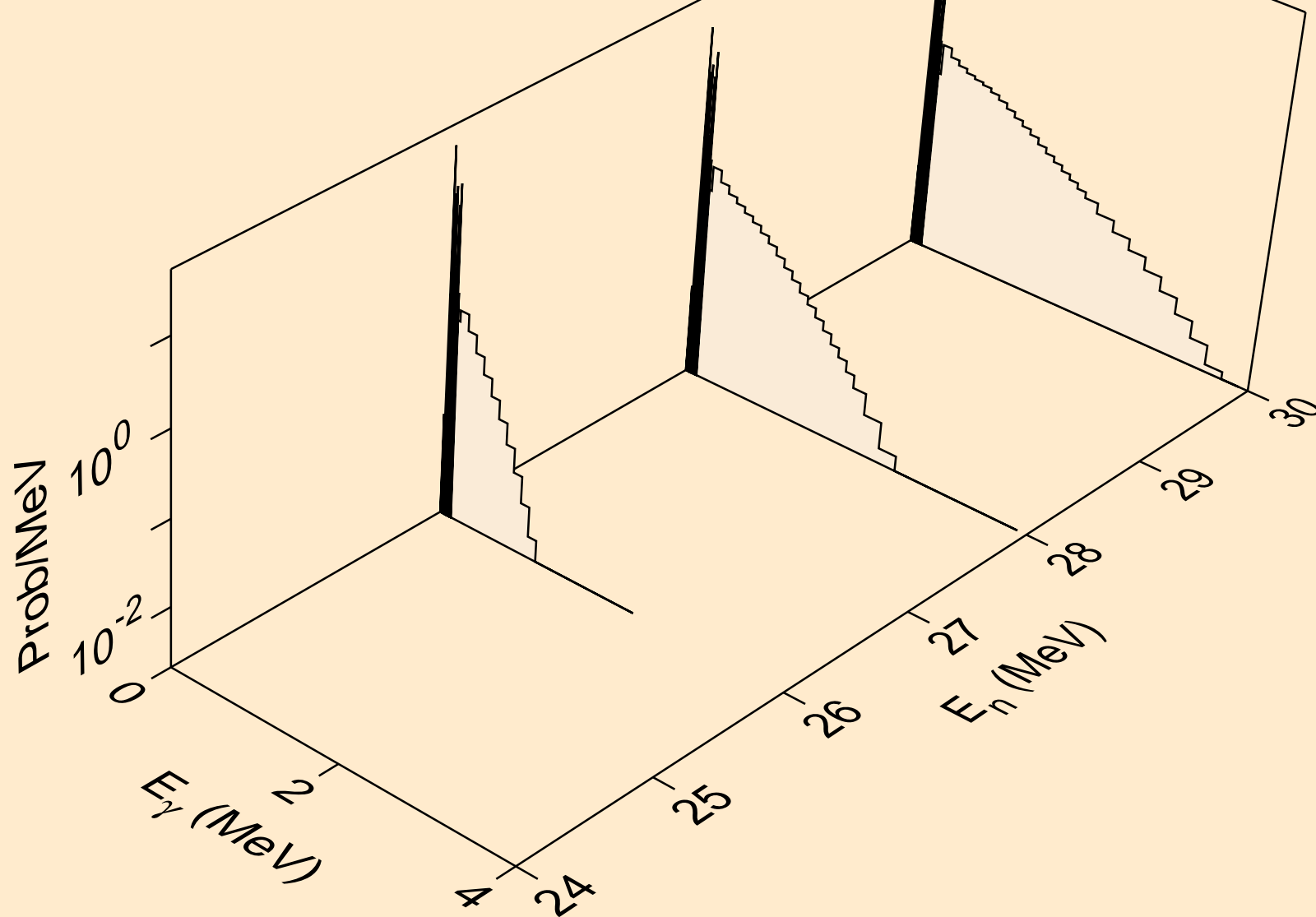

TC101 NEUTRON ACER TENDL-2021 LIBRARY; T=293.6K
Photon emission for (n,2np)

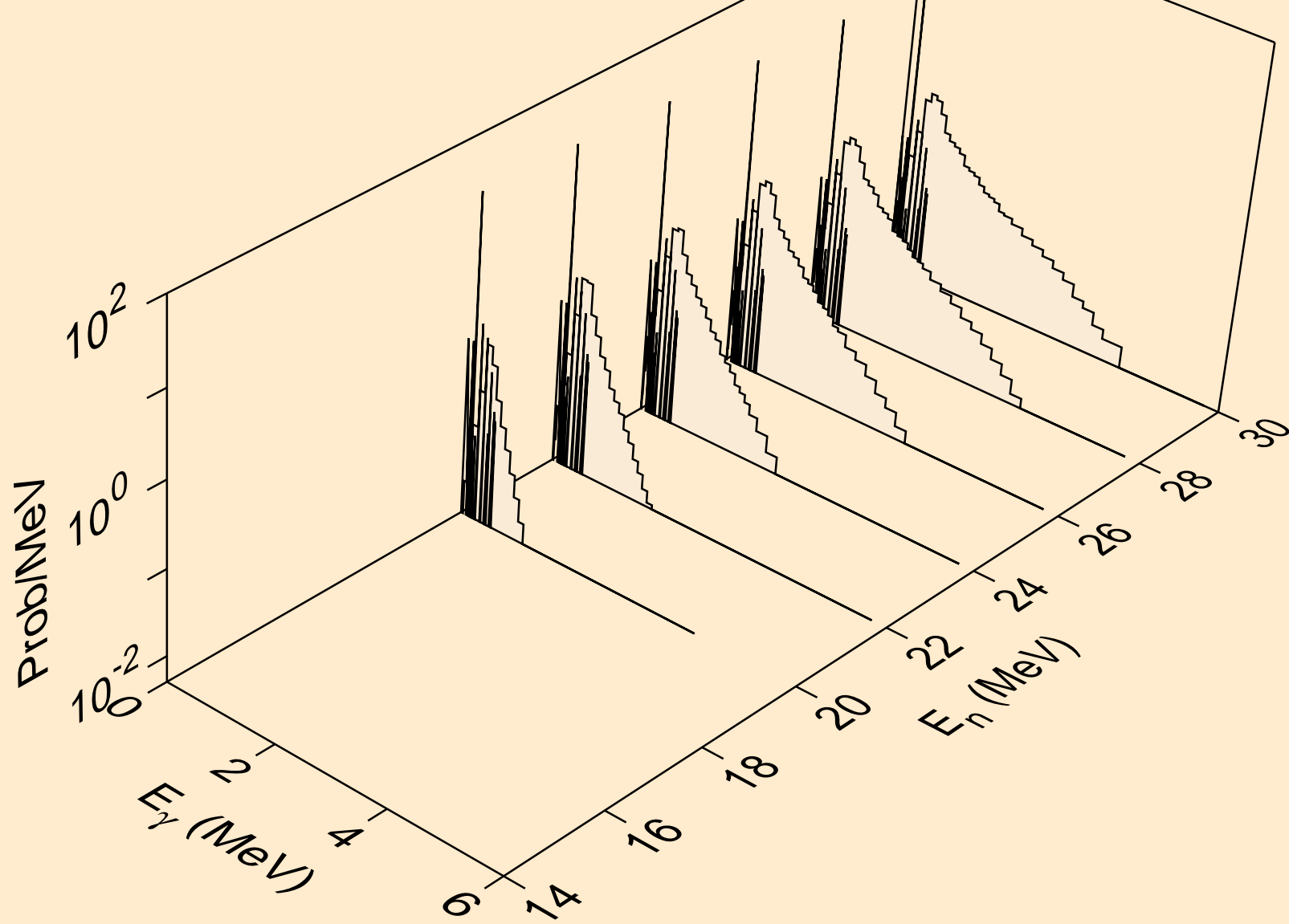

TC101 NEUTRON ACER TENDL-2021 LIBRARY; T=293.6K
Photon emission for (n,3np)

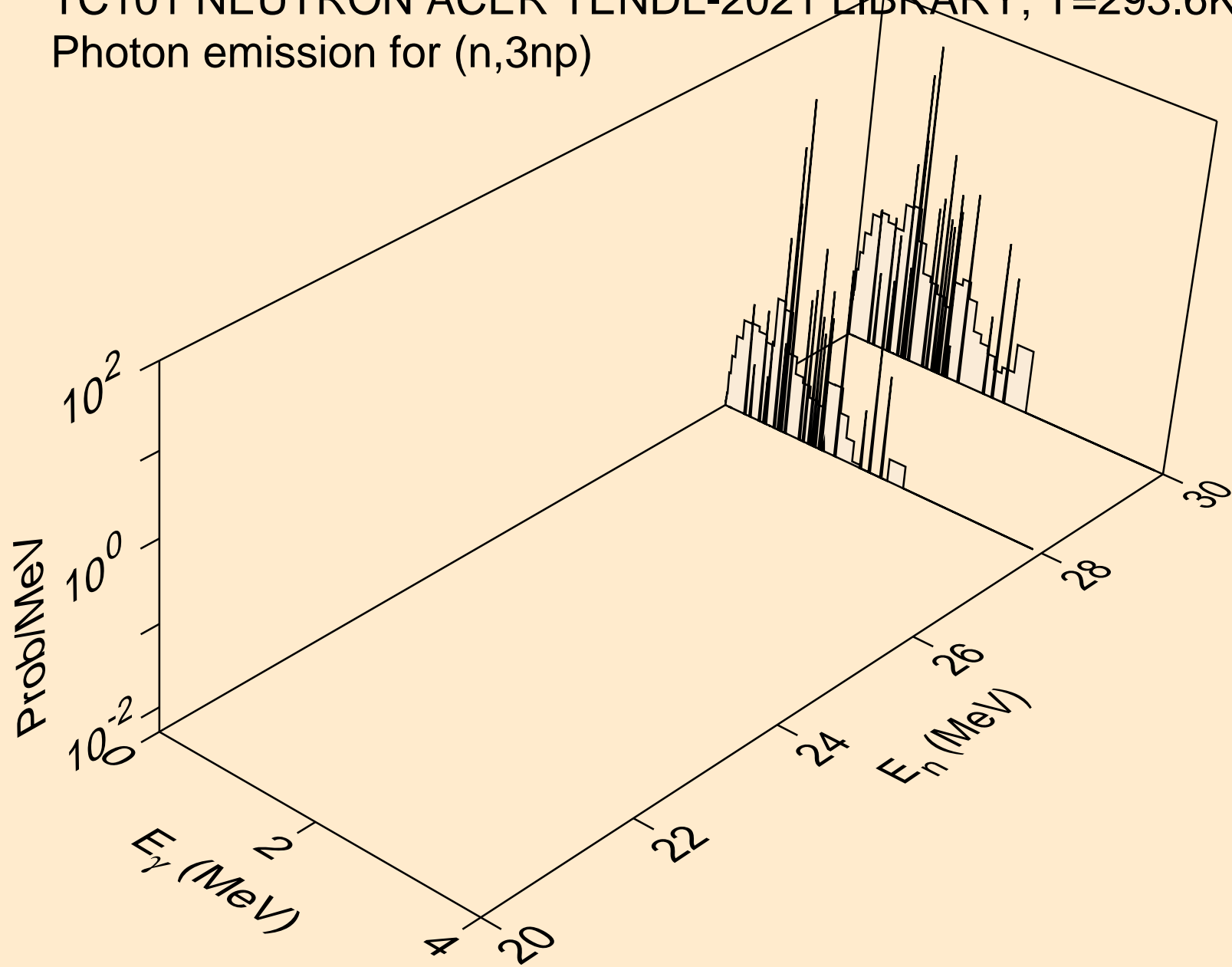

TC101 NEUTRON ACER TENDL-2021 LIBRARY; T=293.6K
Photon emission for (n,2np)

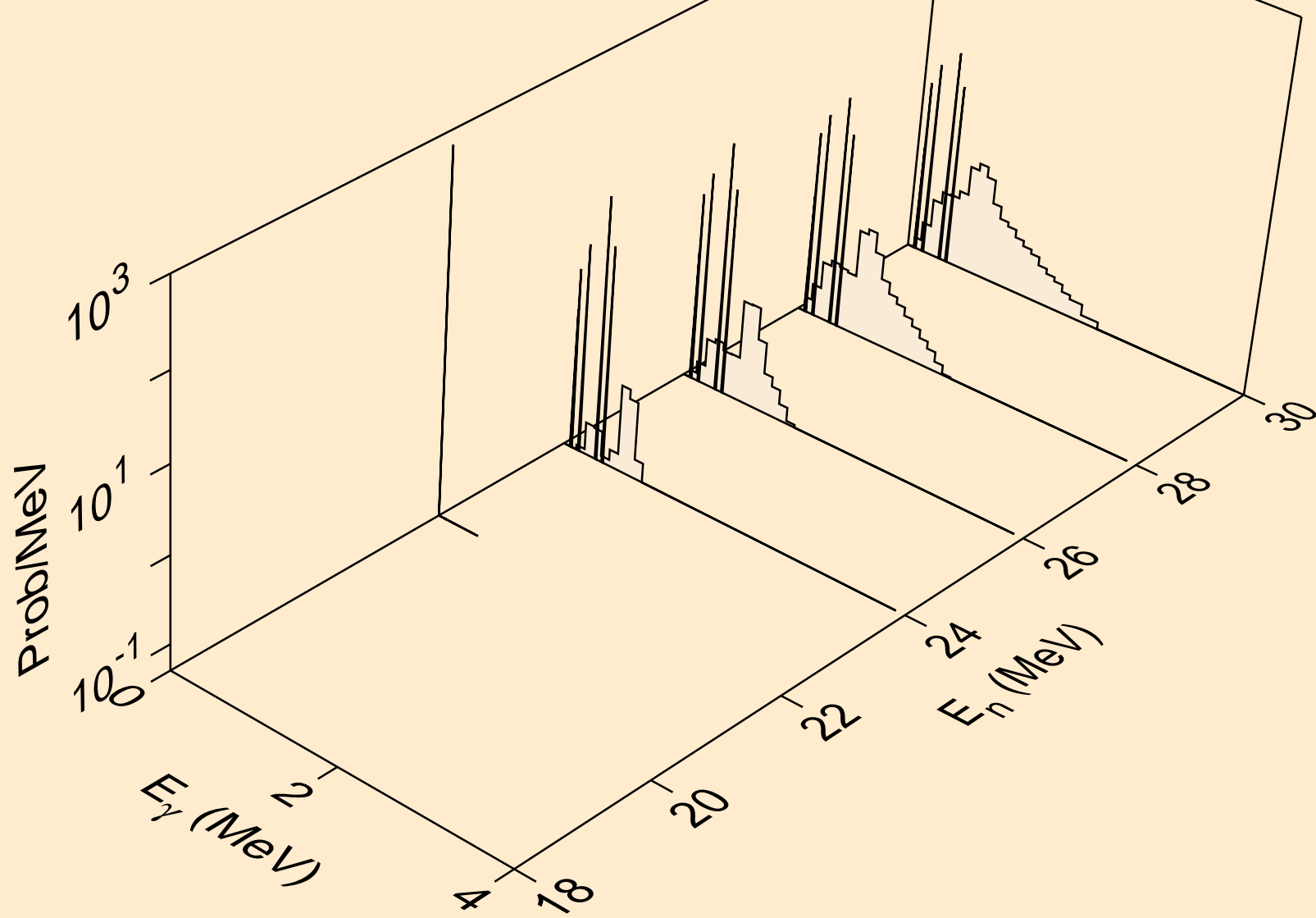

TC101 NEUTRON ACER TENDL-2021 LIBRARY; T=293.6K
Photon emission for (n,npa)

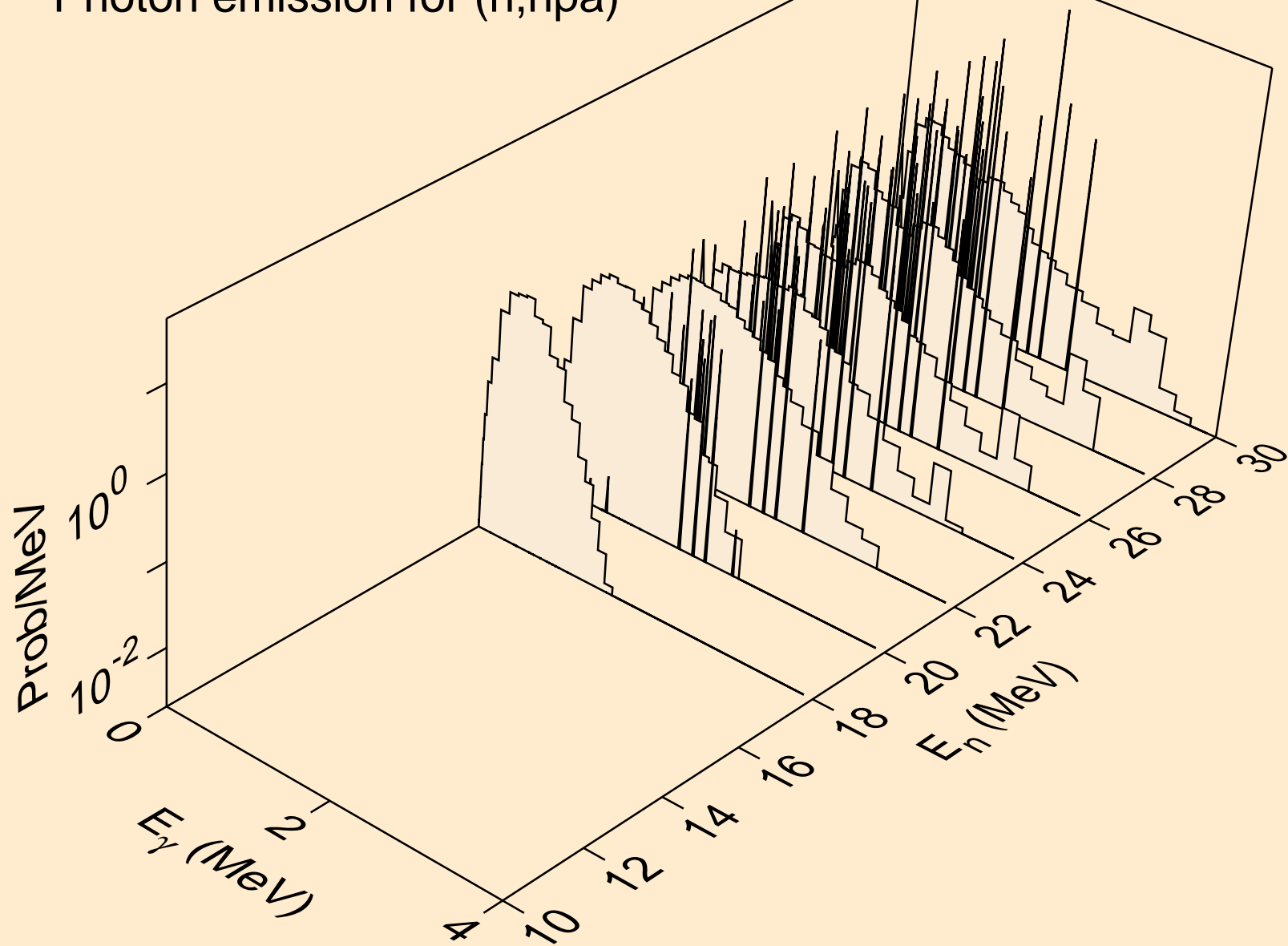

TC101 NEUTRON ACER TENDL-2021 LIBRARY; T=293.6K
Photon emission for (n,n*c)

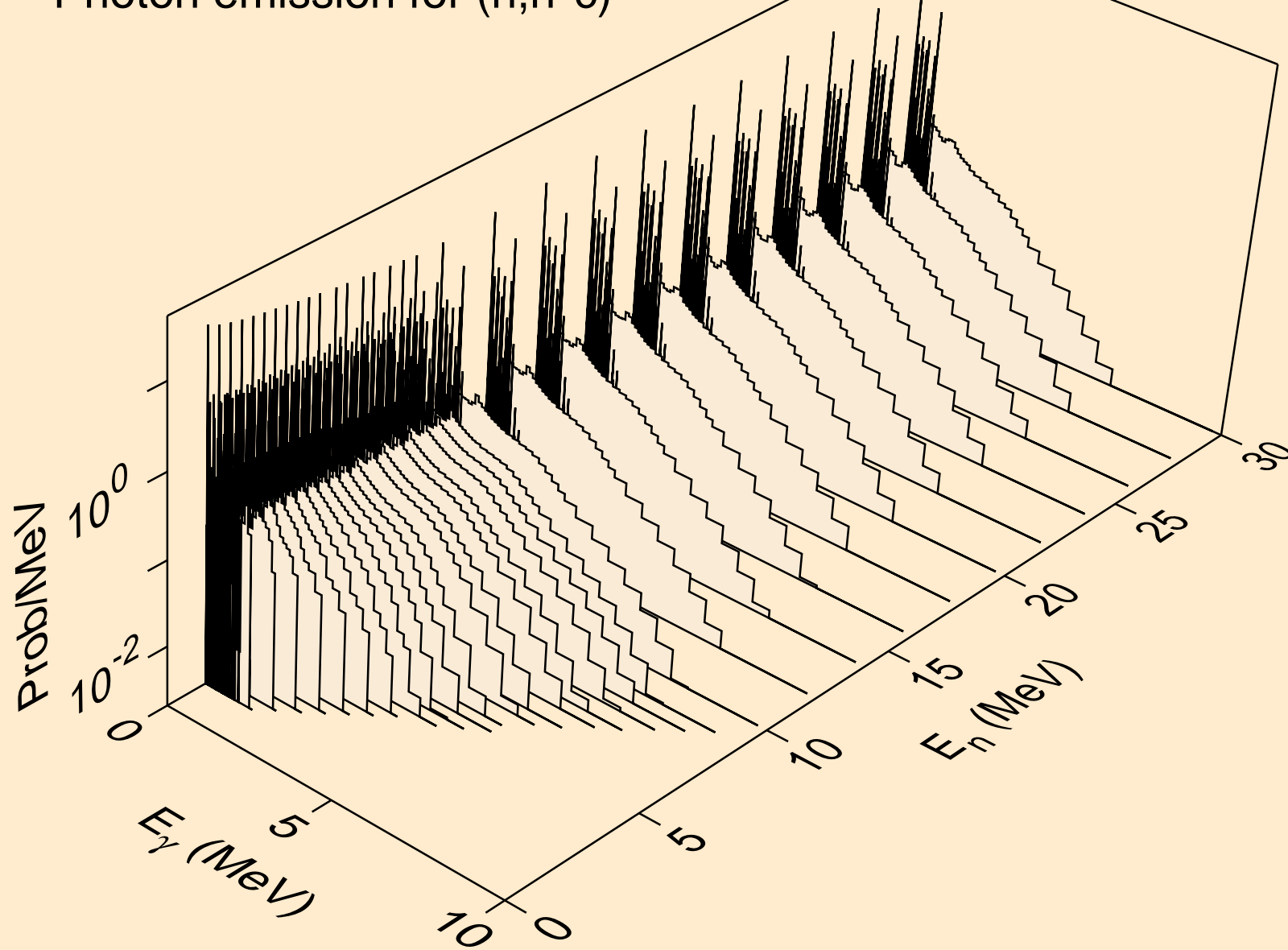

TC101 NEUTRON ACER TENDL-2021 LIBRARY; T=293.6K
Photon emission for (n,gma)

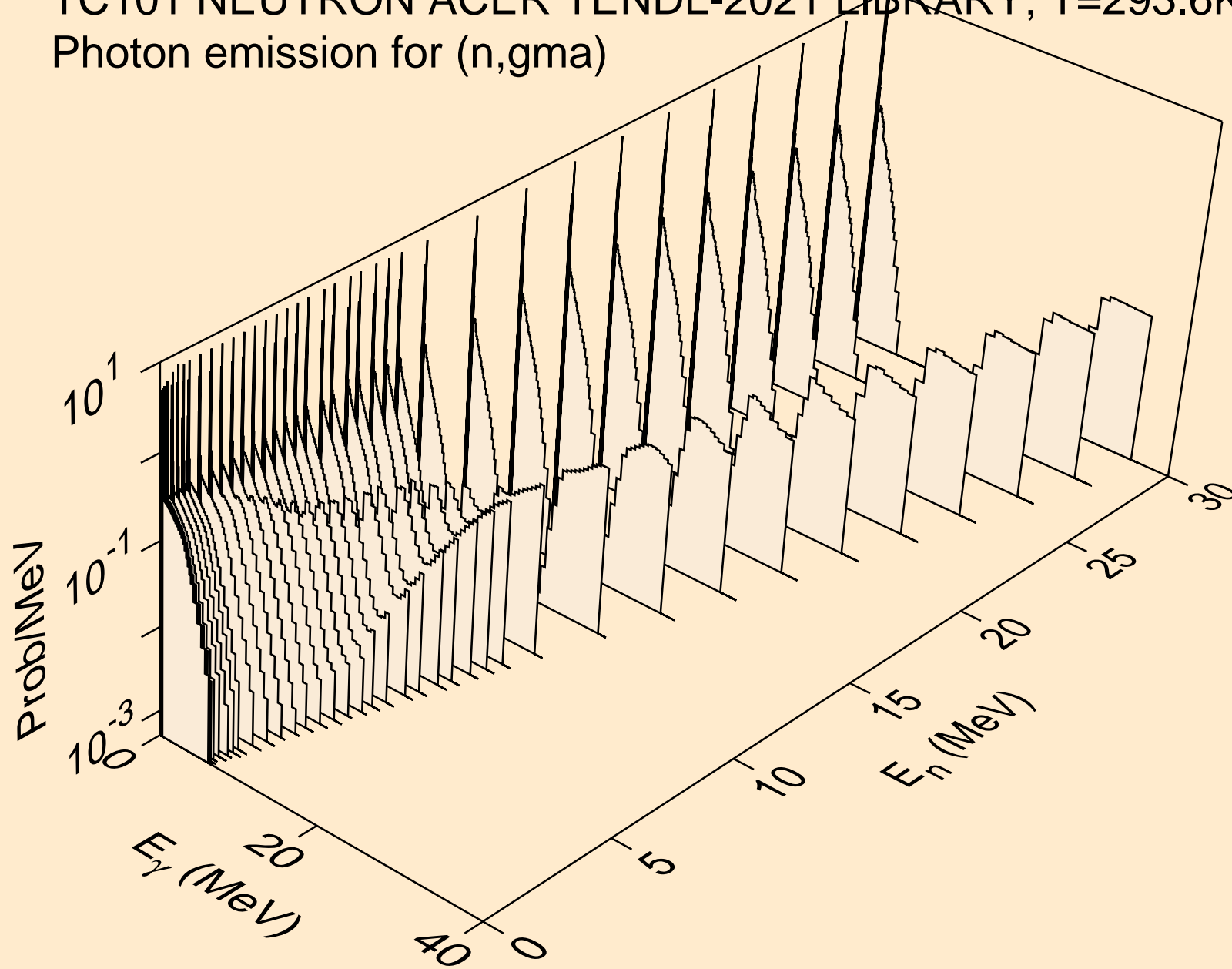

TC101 NEUTRON ACER TENDL-2021 LIBRARY; T=293.6K
Photon emission for (n,p)

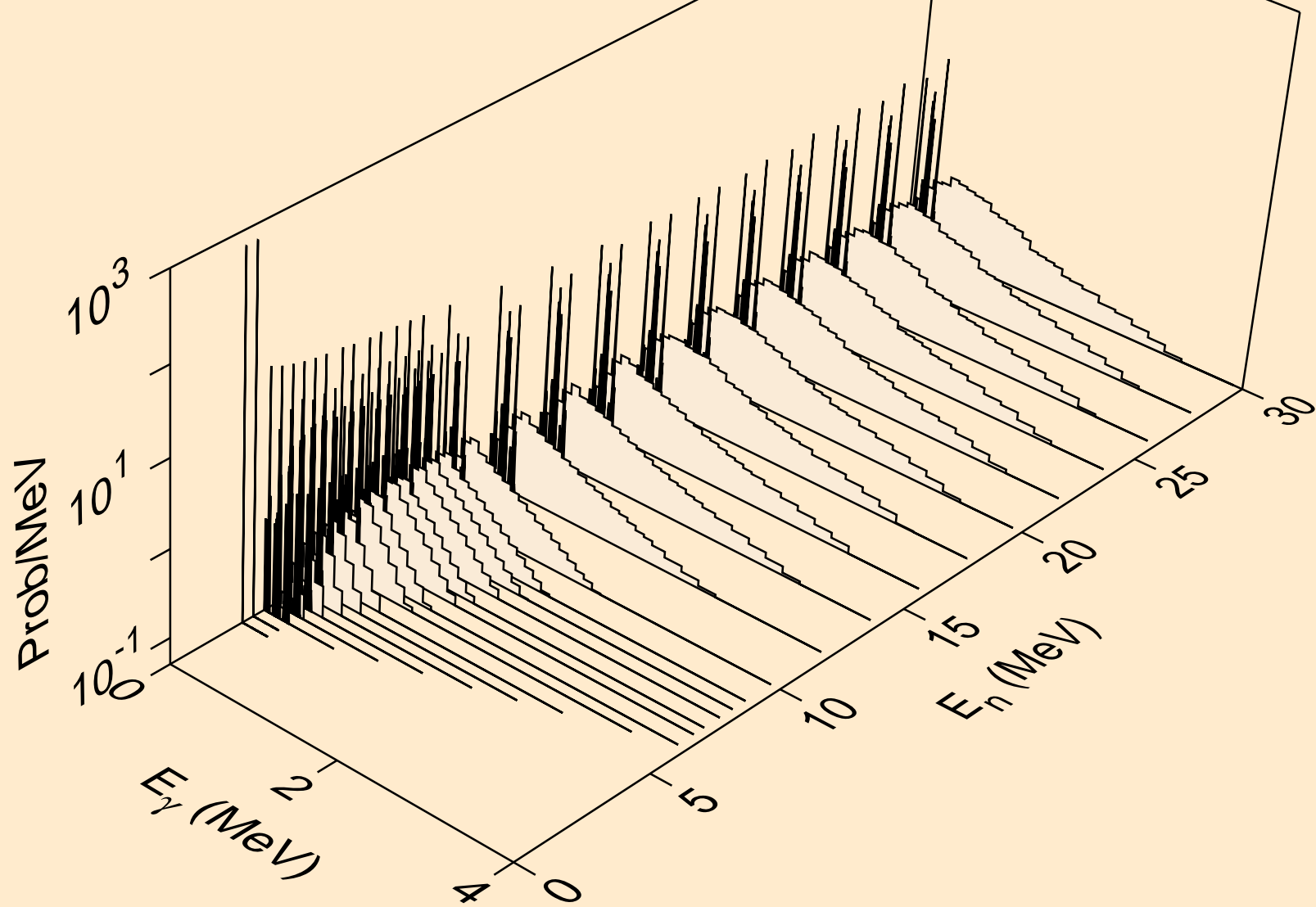

TC101 NEUTRON ACER TENDL-2021 LIBRARY; T=293.6K
Photon emission for (n,d)

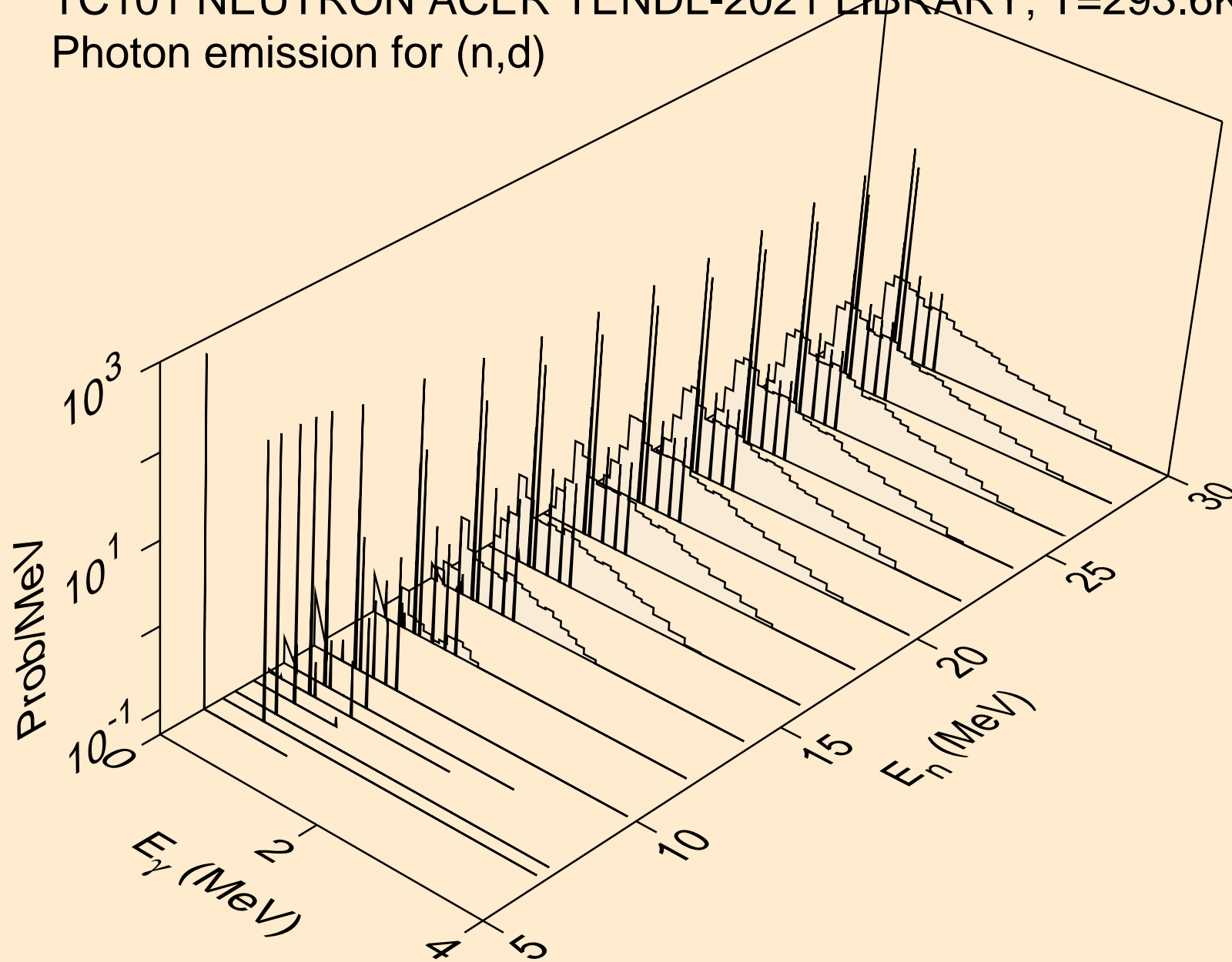

TC101 NEUTRON ACER TENDL-2021 LIBRARY; T=293.6K
Photon emission for (n,t)

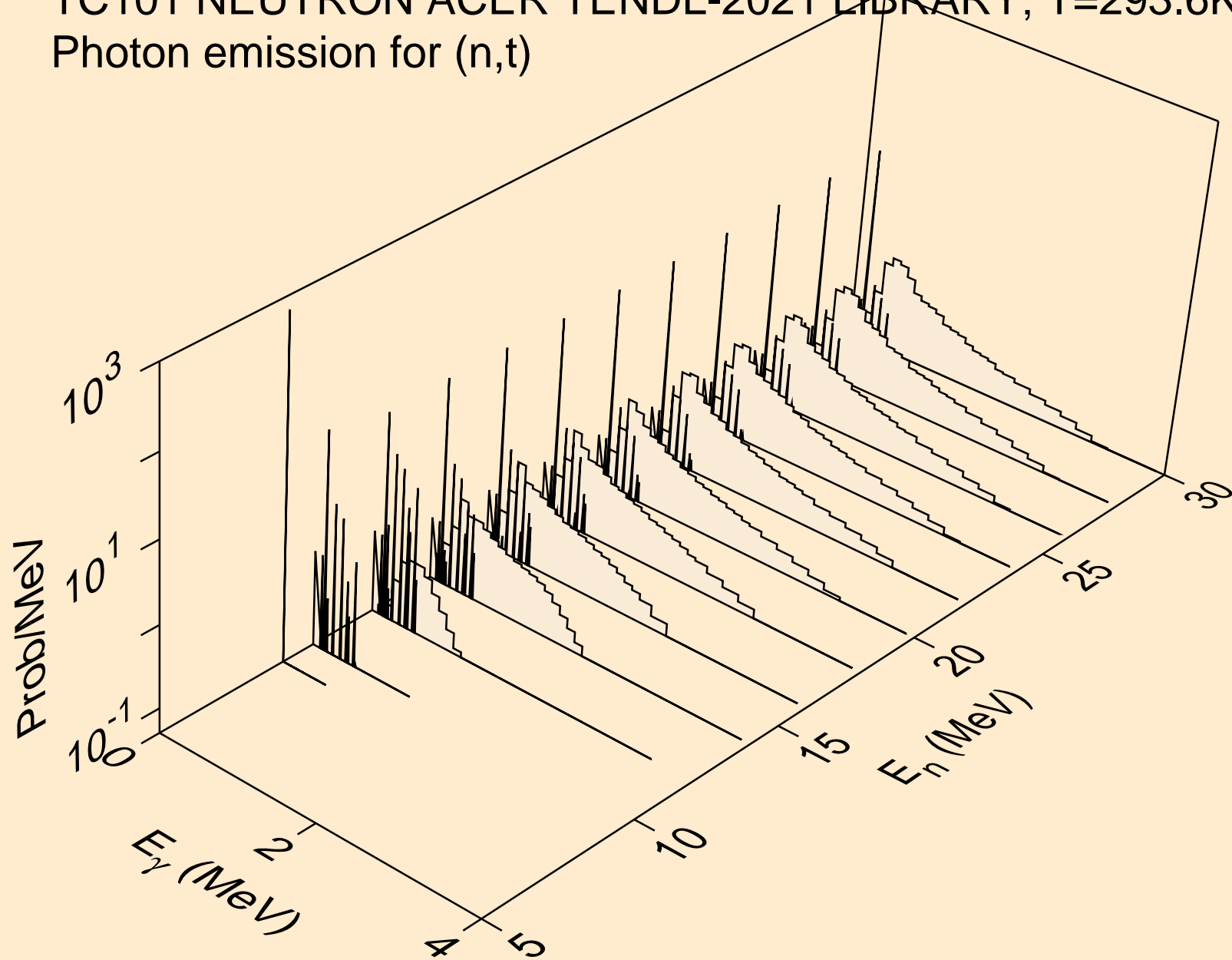

TC101 NEUTRON ACER TENDL-2021 LIBRARY; T=293.6K
Photon emission for (n,he3)

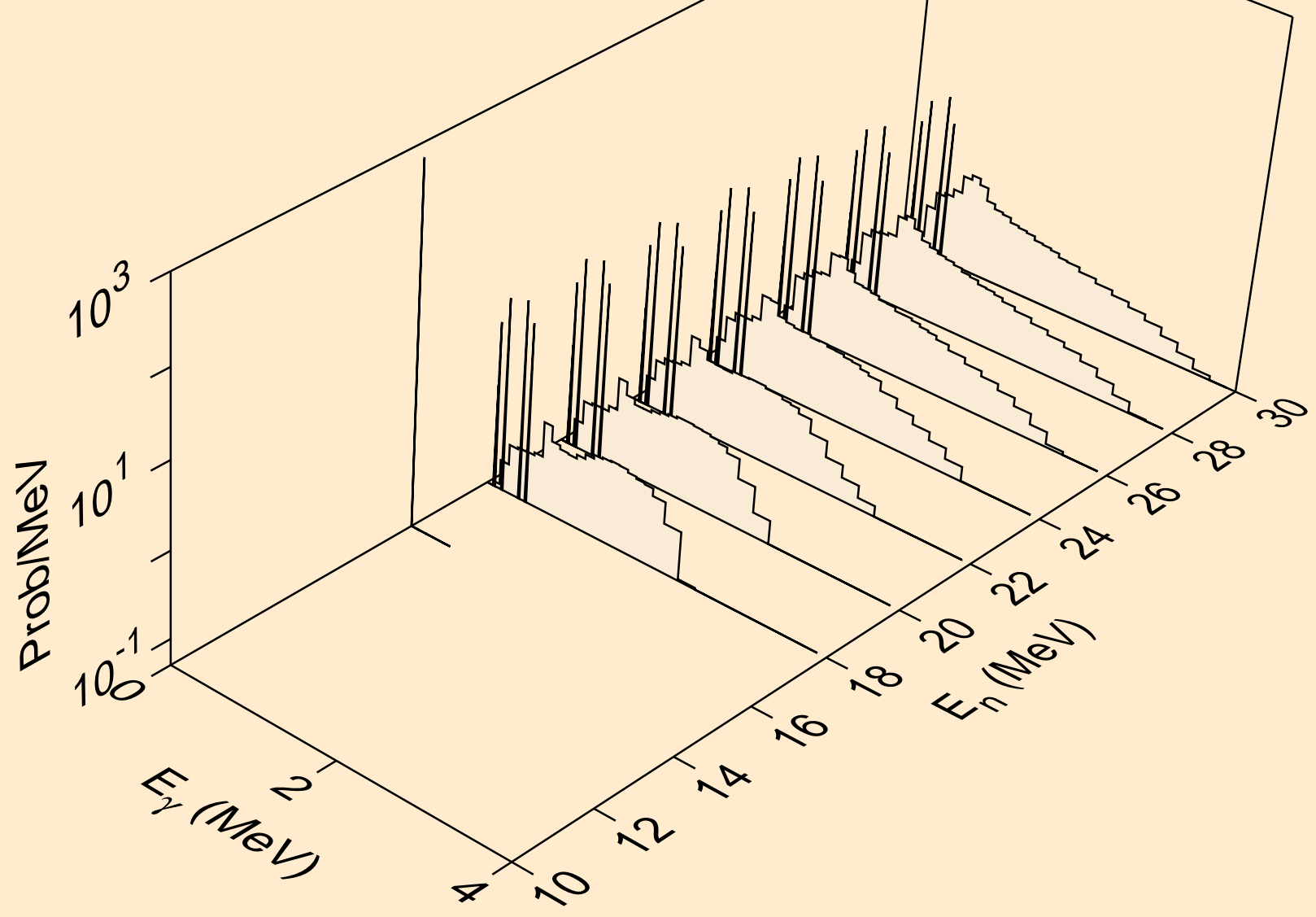

TC101 NEUTRON ACER TENDL-2021 LIBRARY; T=293.6K
Photon emission for (n,a)

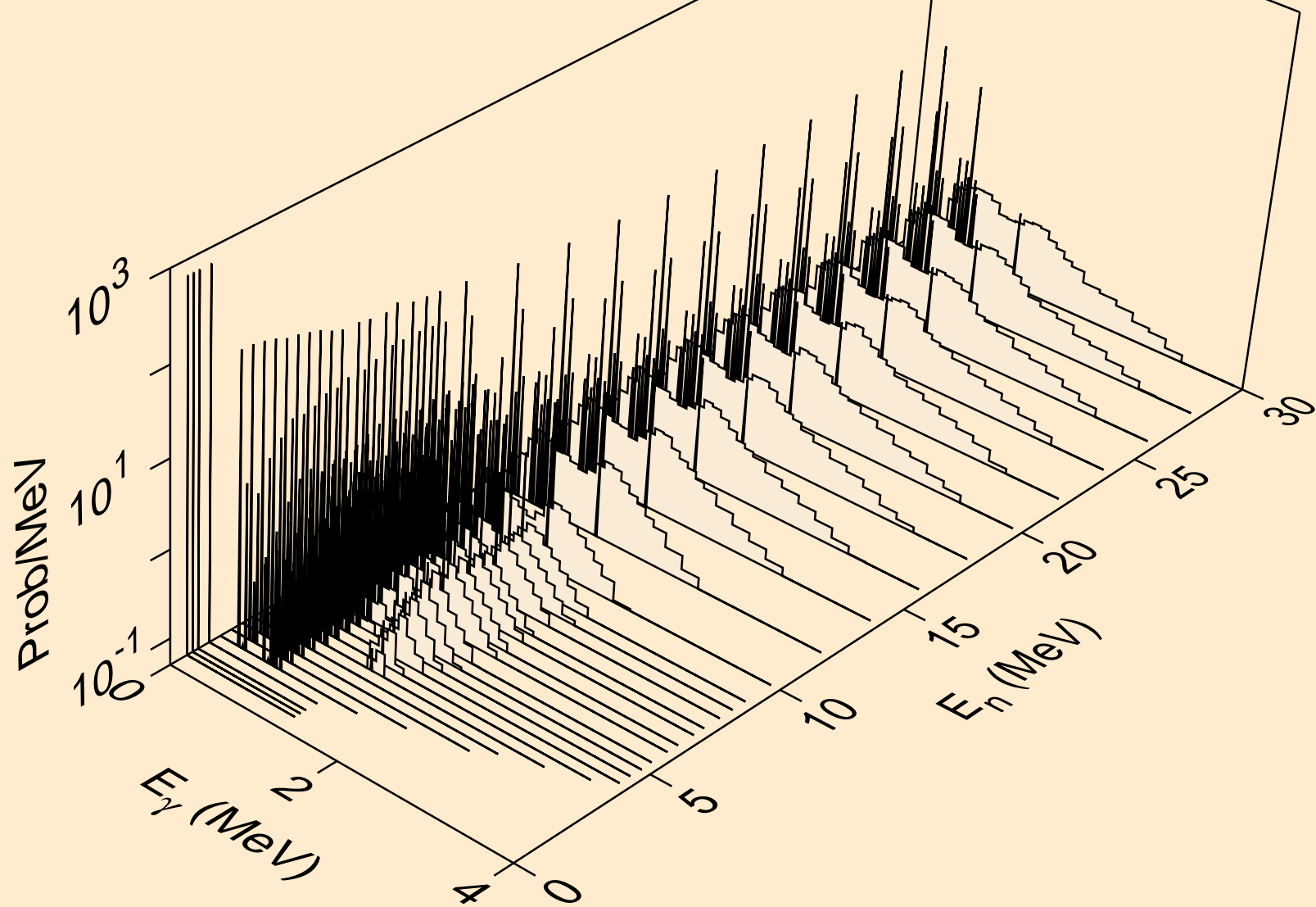

TC101 NEUTRON ACER TENDL-2021 LIBRARY; T=293.6K
Photon emission for (n,2a)

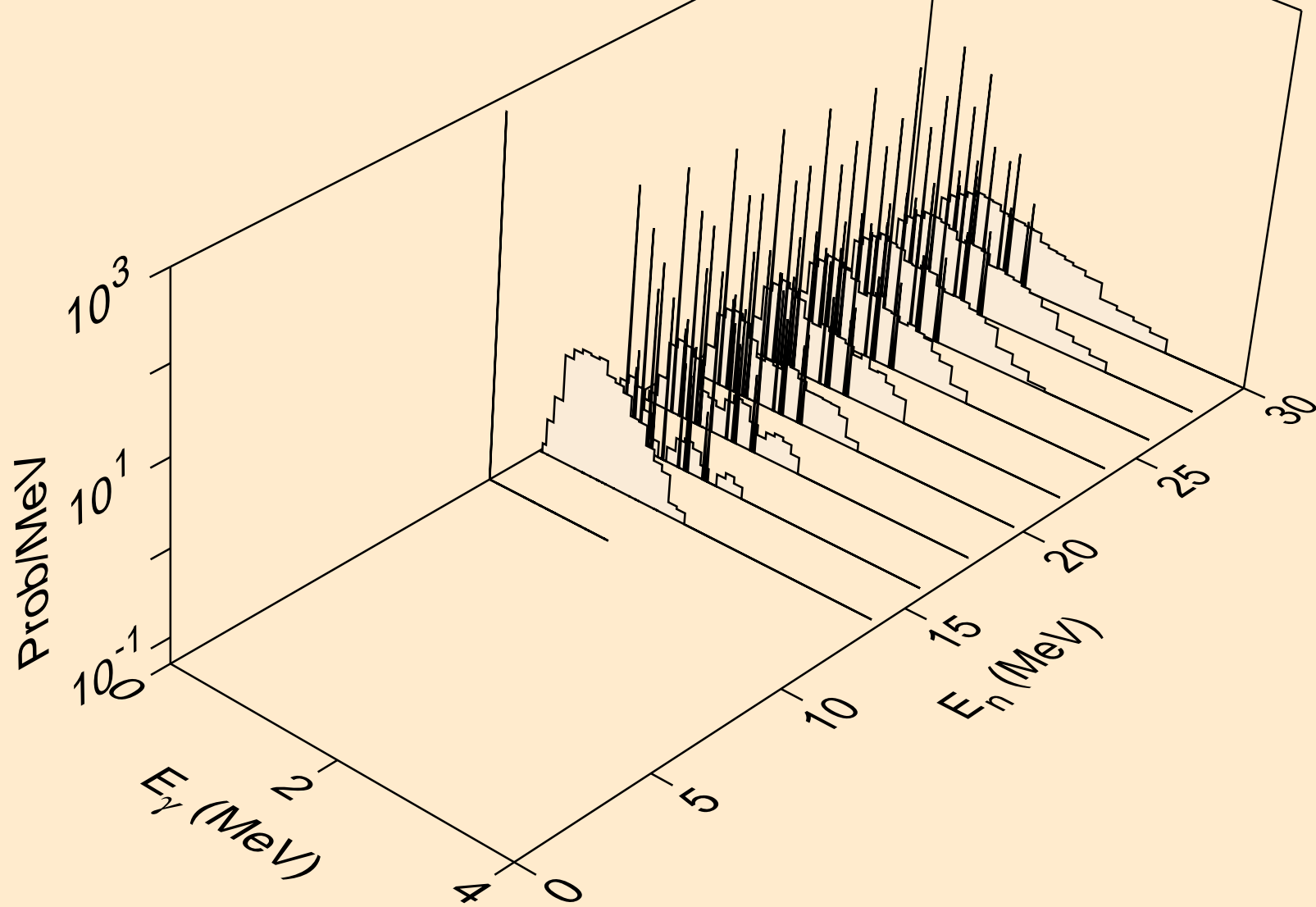

TC101 NEUTRON ACER TENDL-2021 LIBRARY; T=293.6K
Photon emission for (n,2p)

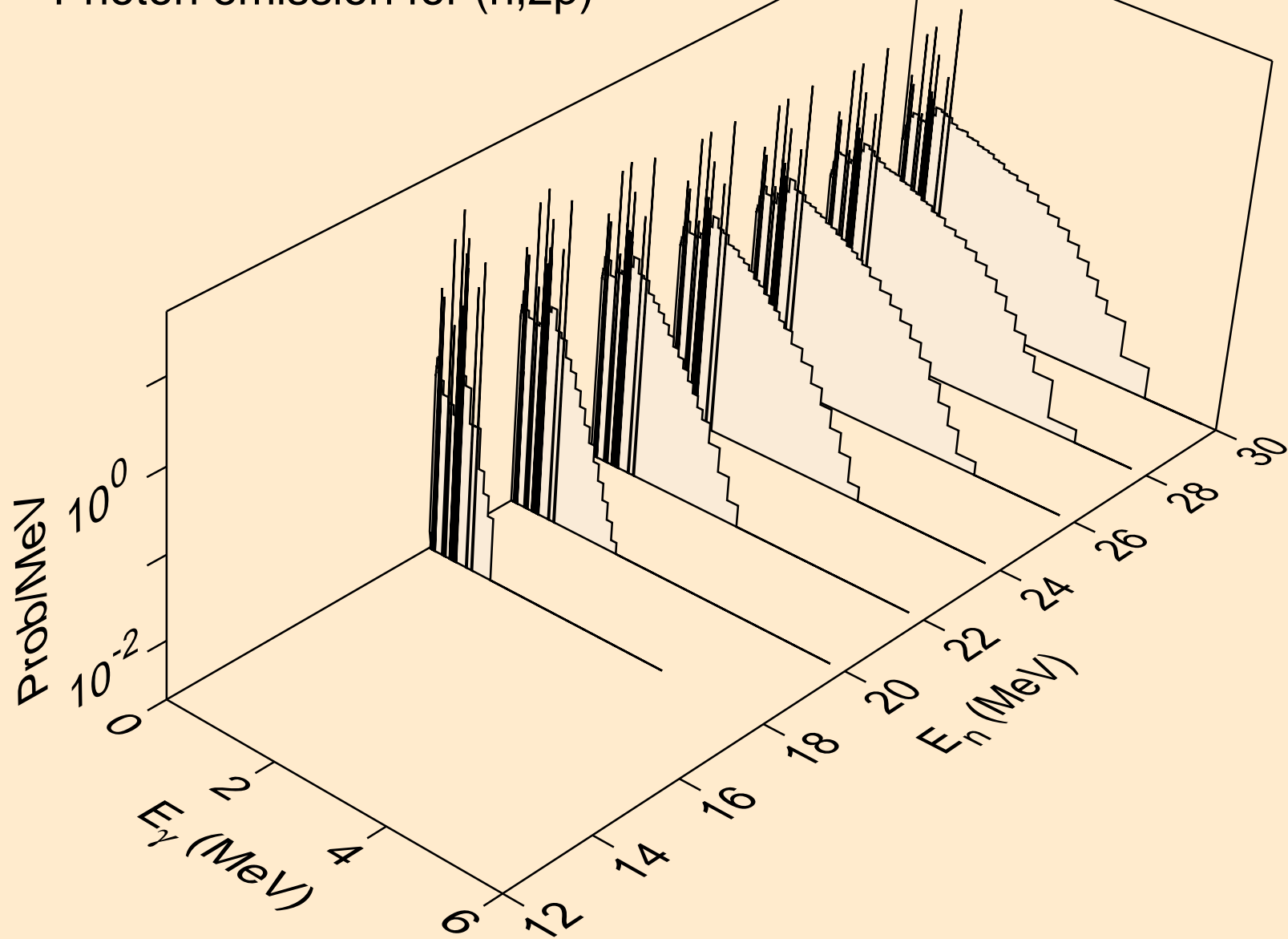

TC101 NEUTRON ACER TENDL-2021 LIBRARY; T=293.6K
Photon emission for (n,p α)

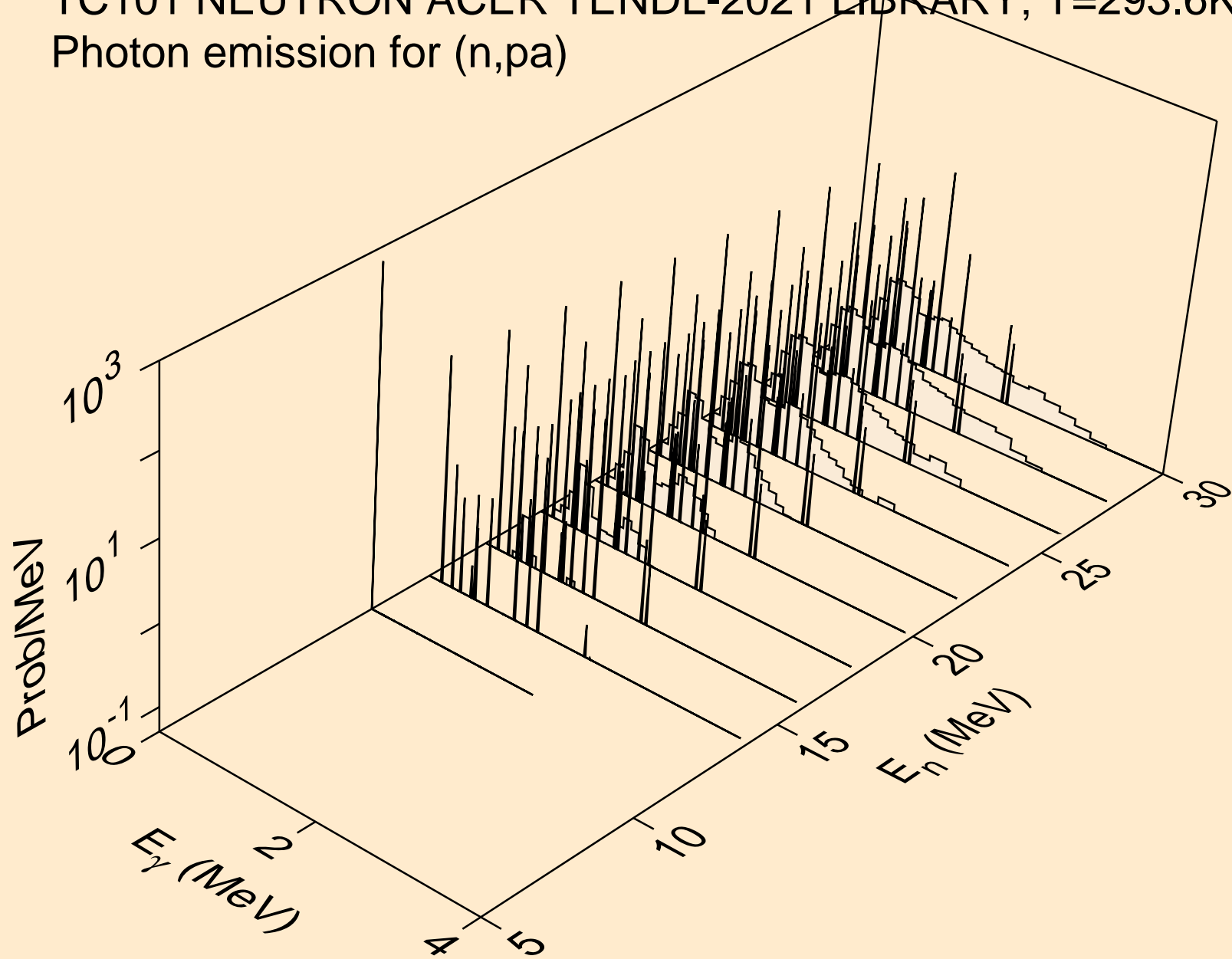

TC101 NEUTRON ACER TENDL-2021 LIBRARY; T=293.6K
Photon emission for (n,pd)

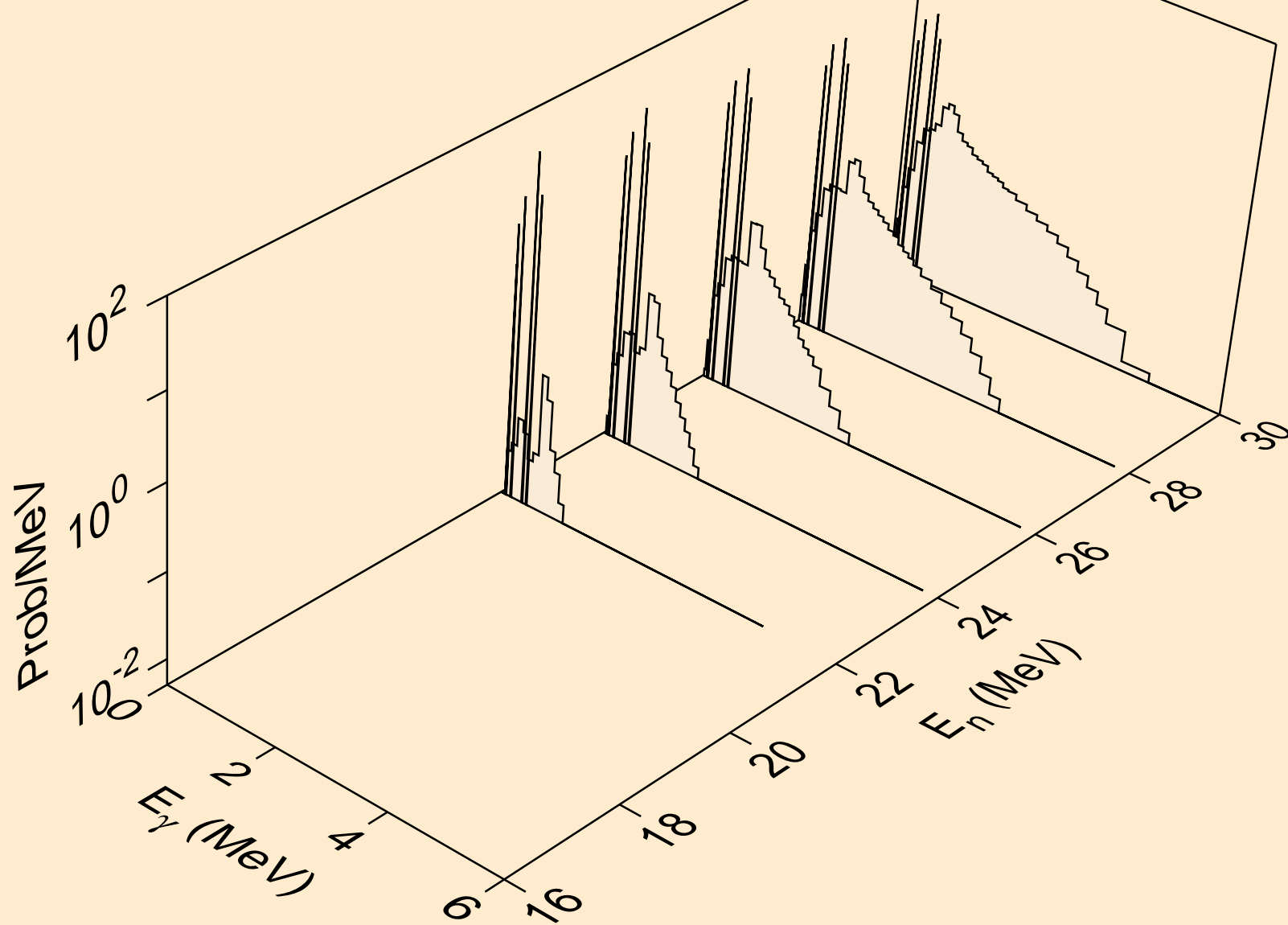

TC101 NEUTRON ACER TENDL-2021 LIBRARY; T=293.6K
Photon emission for (n,pt)

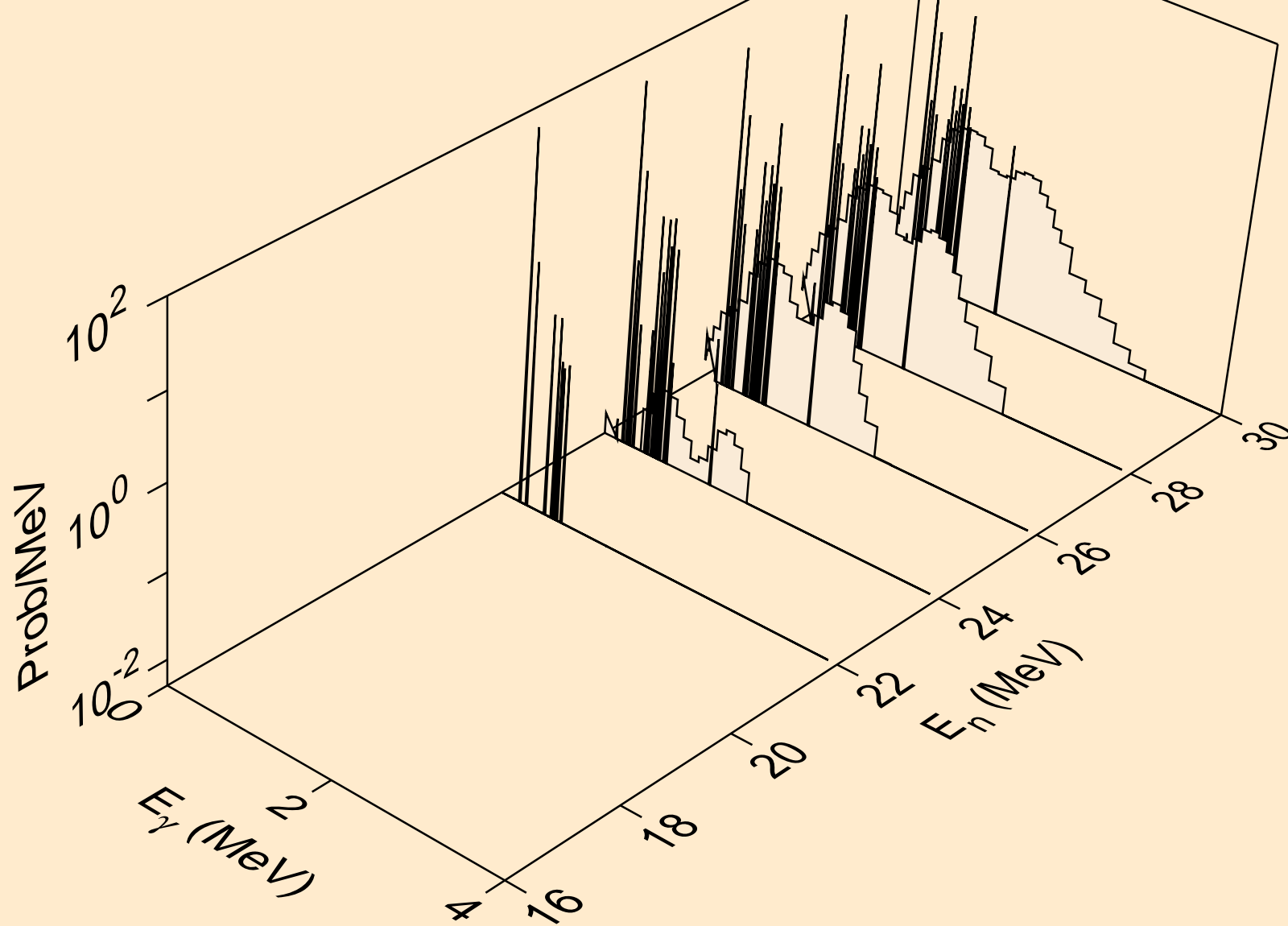

TC101 NEUTRON ACER TENDL-2021 LIBRARY; T=293.6K
Photon emission for (n,da)

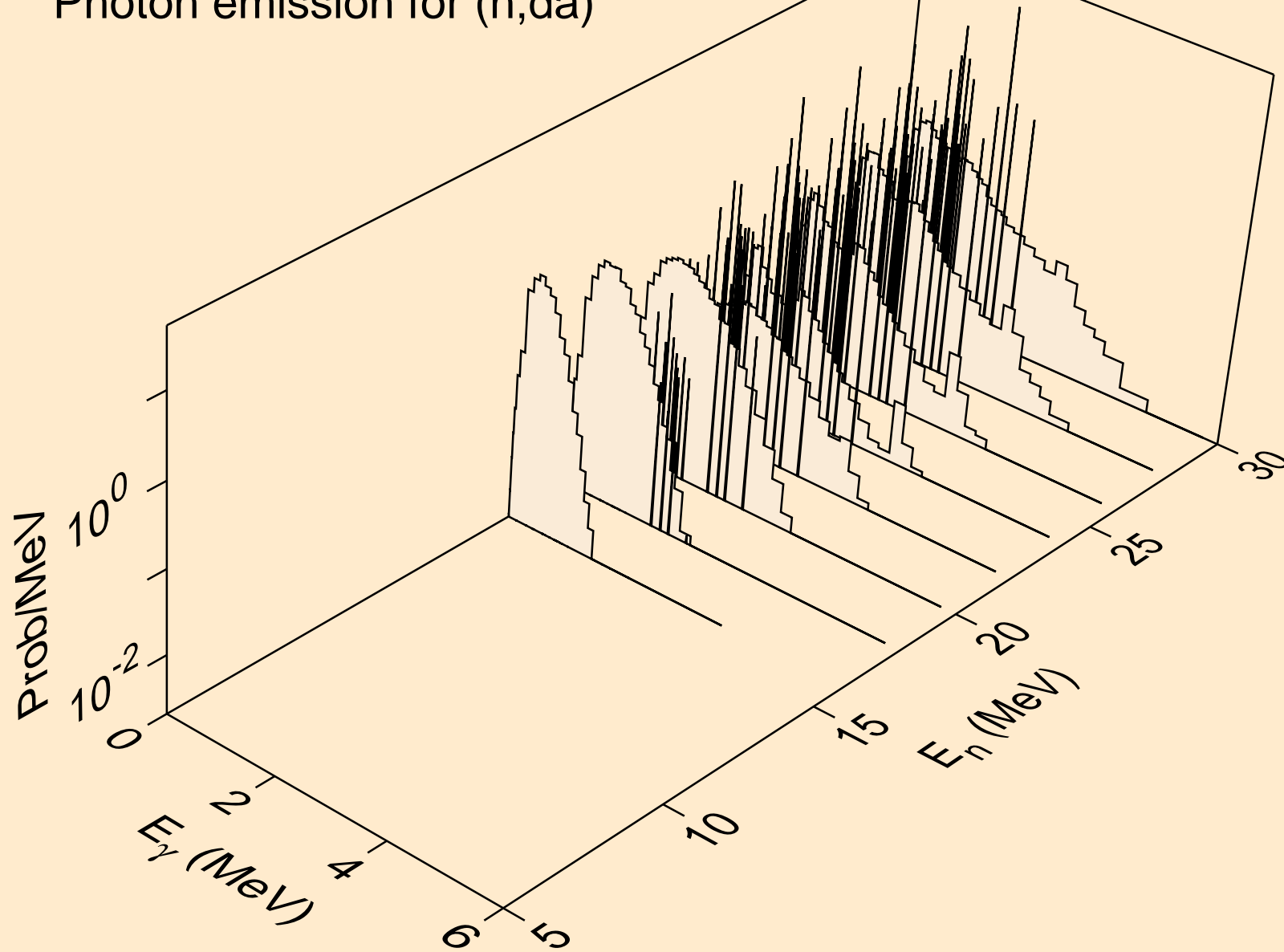

TC101 NEUTRON ACER TENDL-2021 LIBRARY; T=293.6K
thermal capture photon spectrum

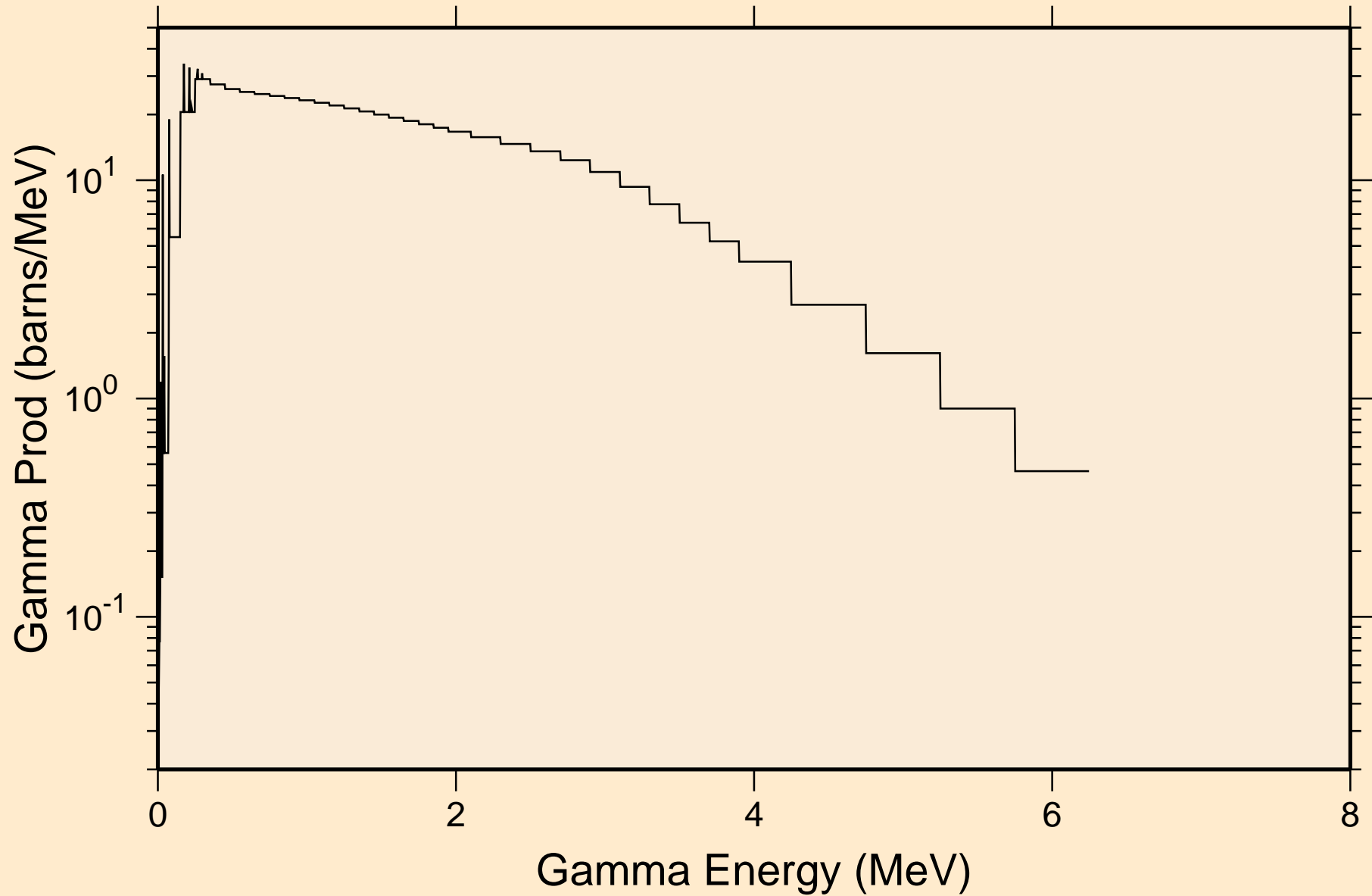

TC101 NEUTRON ACER TENDL-2021 LIBRARY; T=293.6K
14 MeV photon spectrum

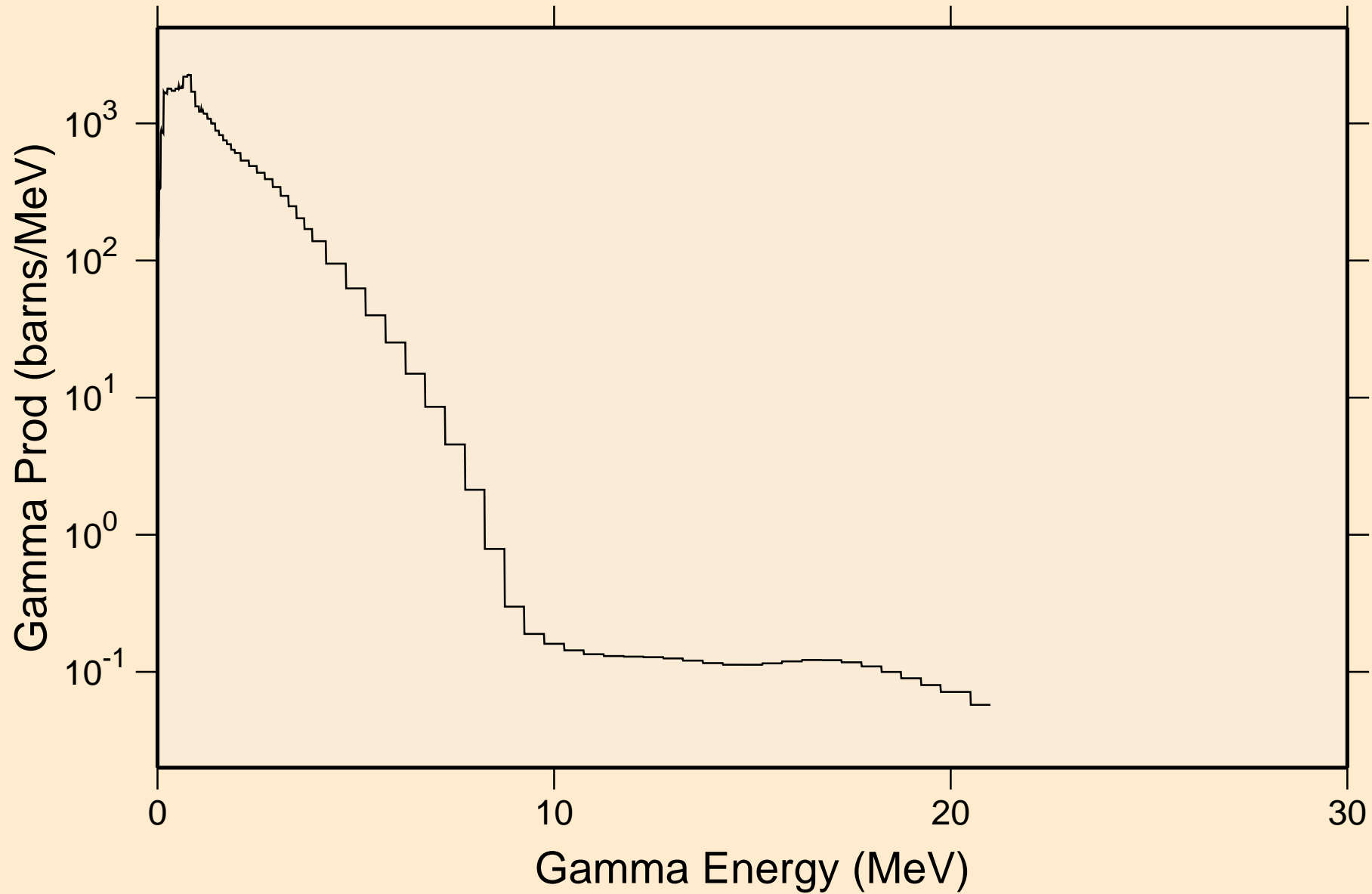

TC101 NEUTRON ACER TENDL-2021 LIBRARY; T=293.6K

Particle heating contributions

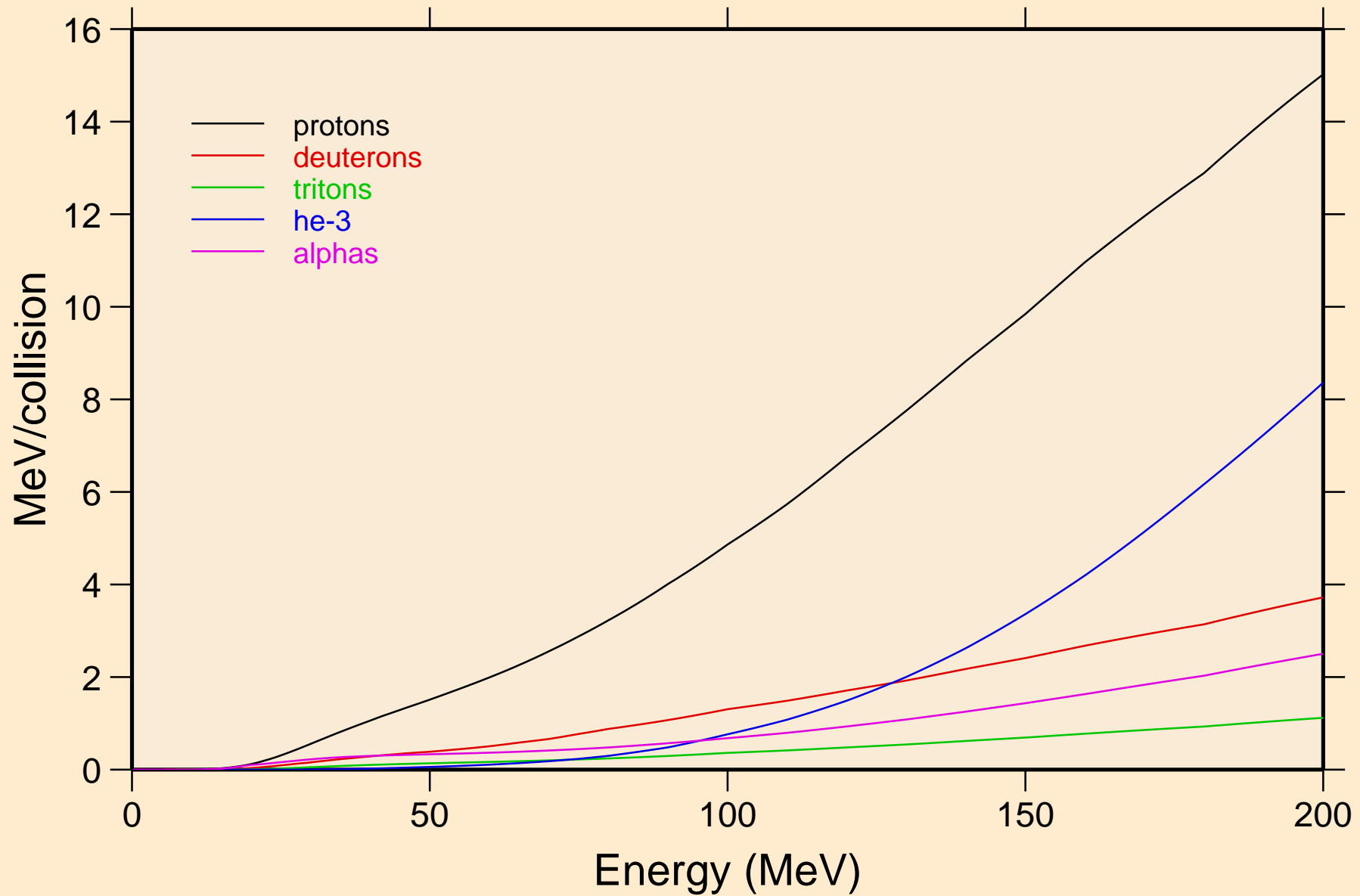

TC101 NEUTRON ACER TENDL-2021 LIBRARY; T=293.6K
Recoil Heating

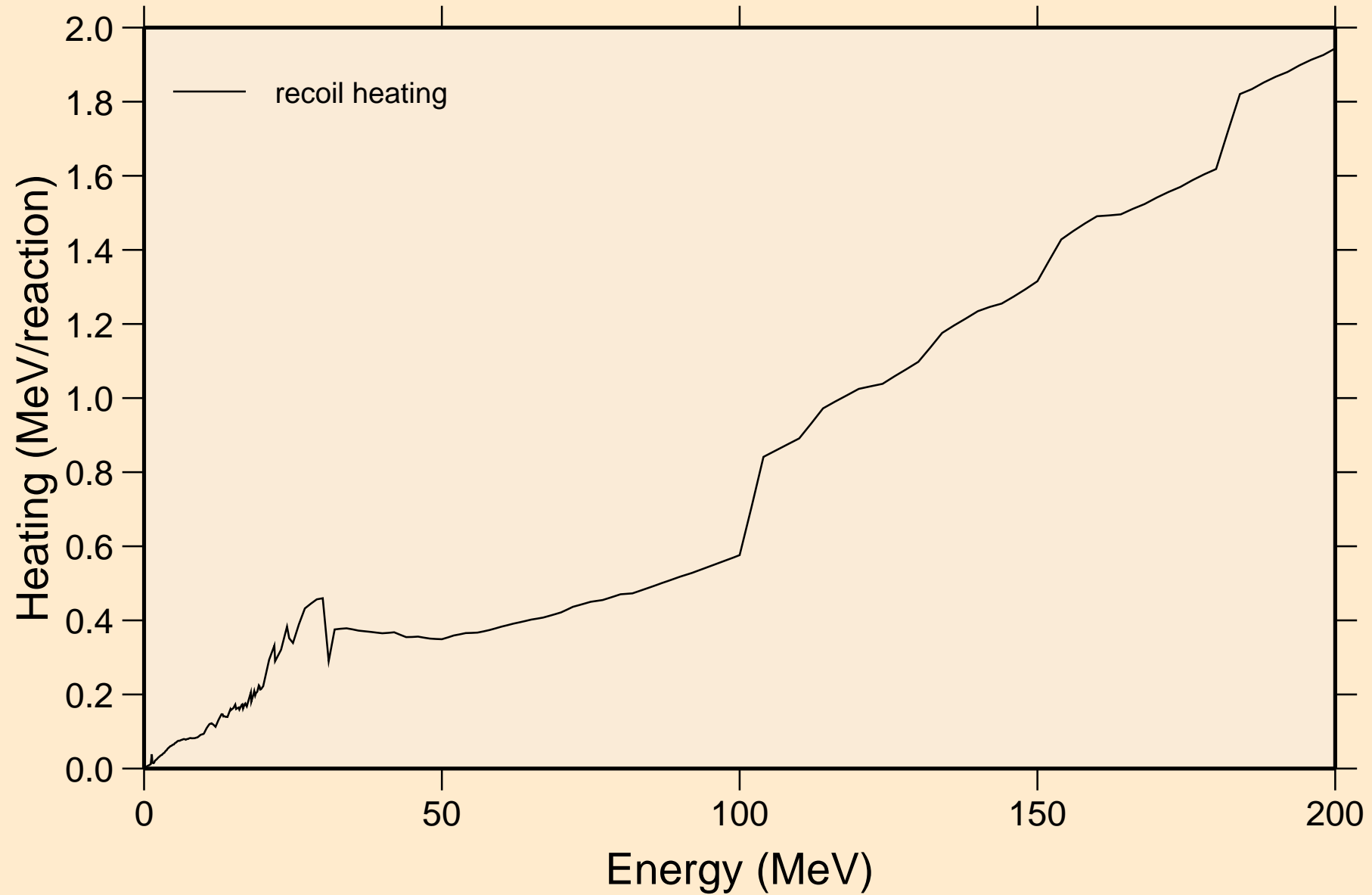

TC101 NEUTRON ACER TENDL-2021 LIBRARY; T=293.6K
Particle production cross sections

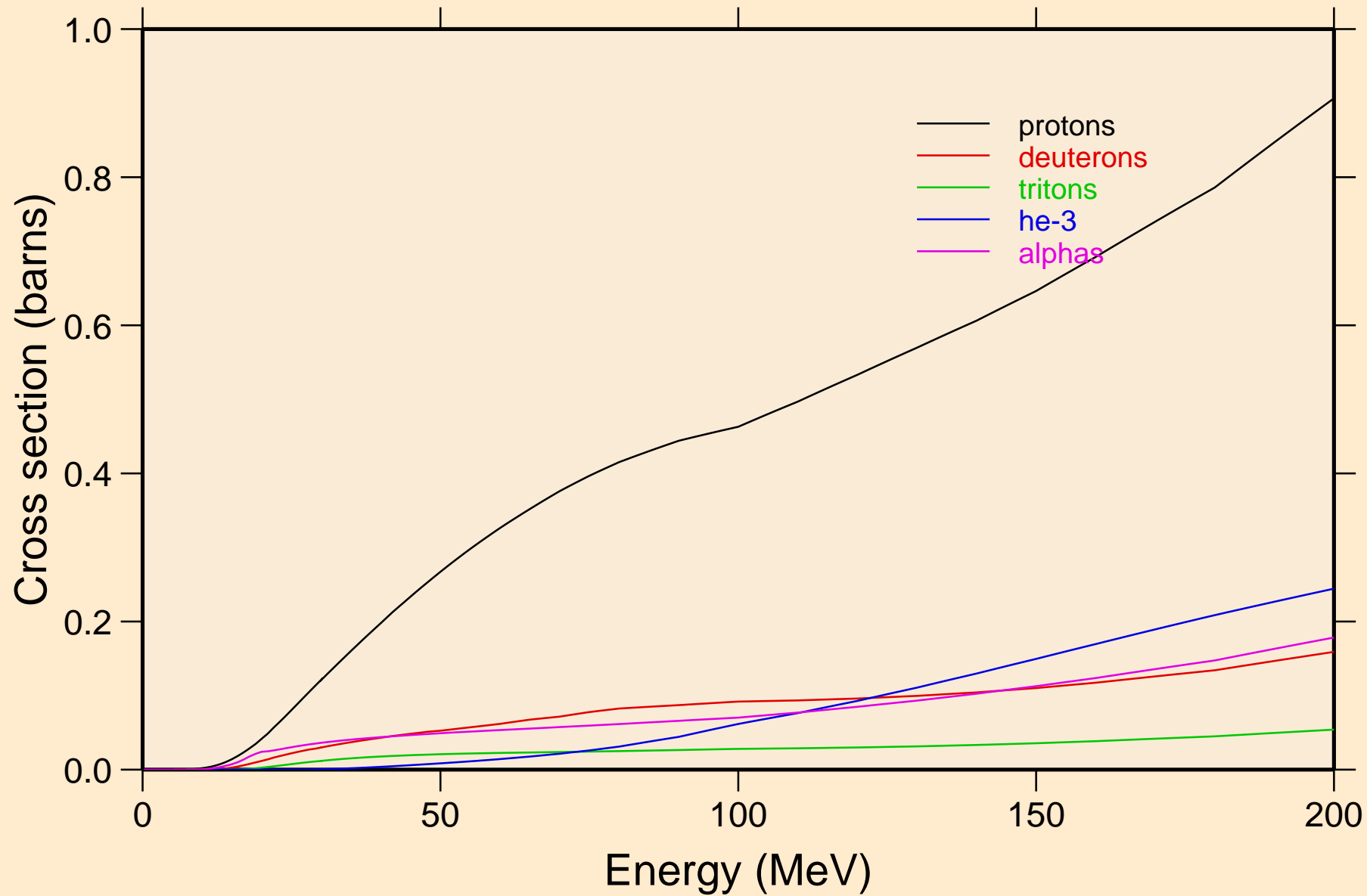

TC101 NEUTRON ACER TENDL-2021 LIBRARY; T=293.6K
protons from (n,x)

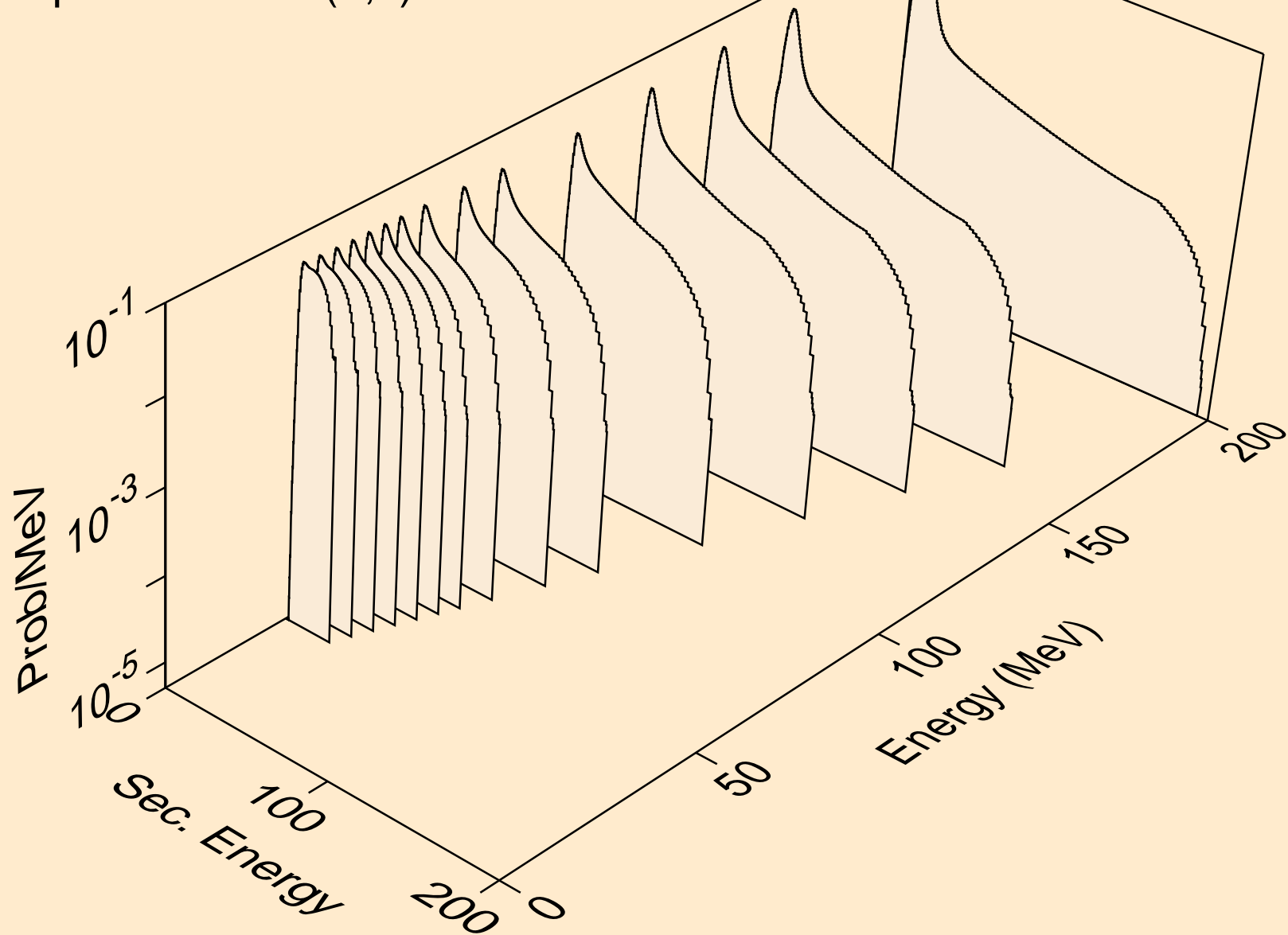

TC101 NEUTRON ACER TENDL-2021 LIBRARY; T=293.6K
protons from (n,n*)p

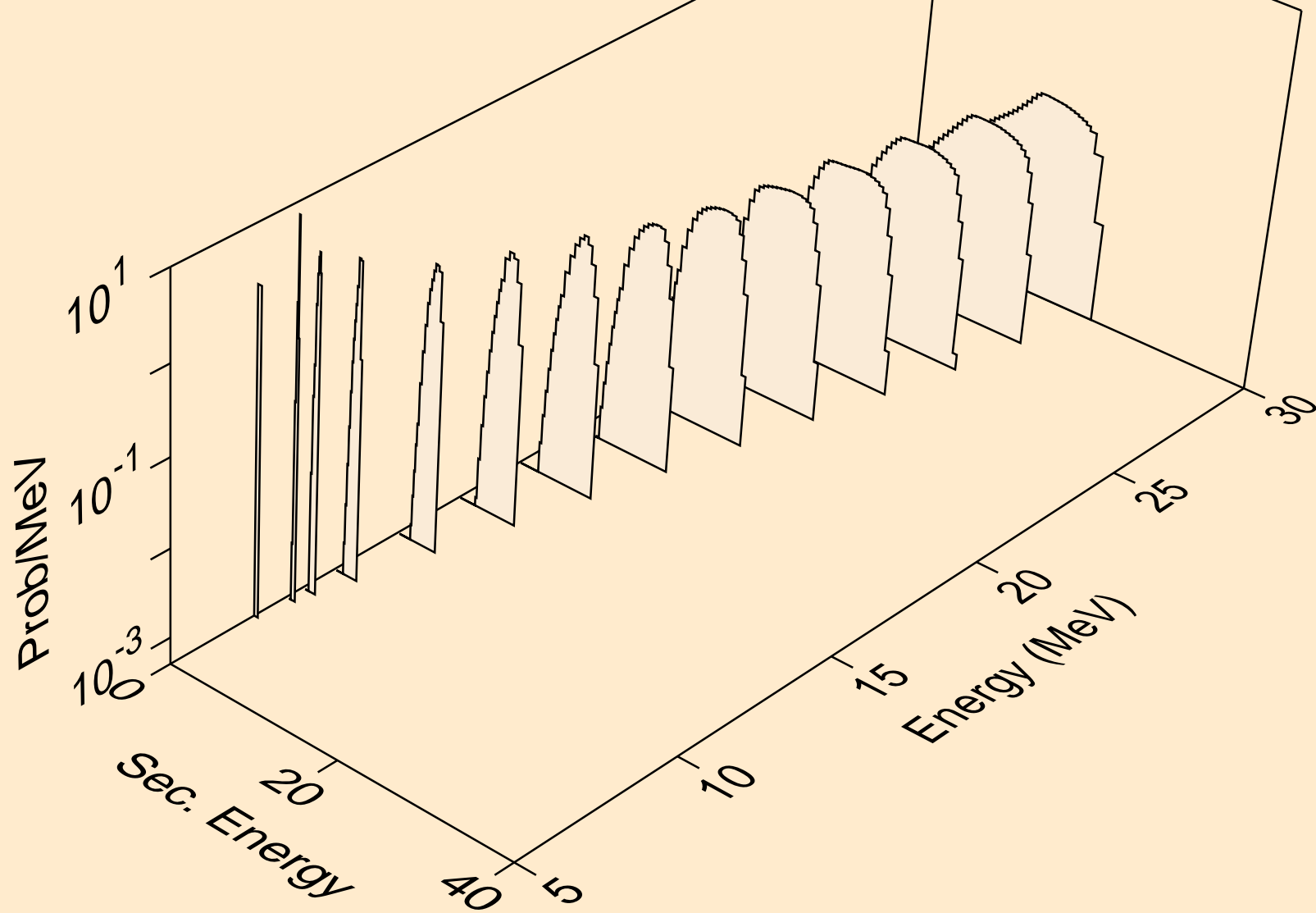

TC101 NEUTRON ACER TENDL-2021 LIBRARY; T=293.6K
protons from (n,2np)

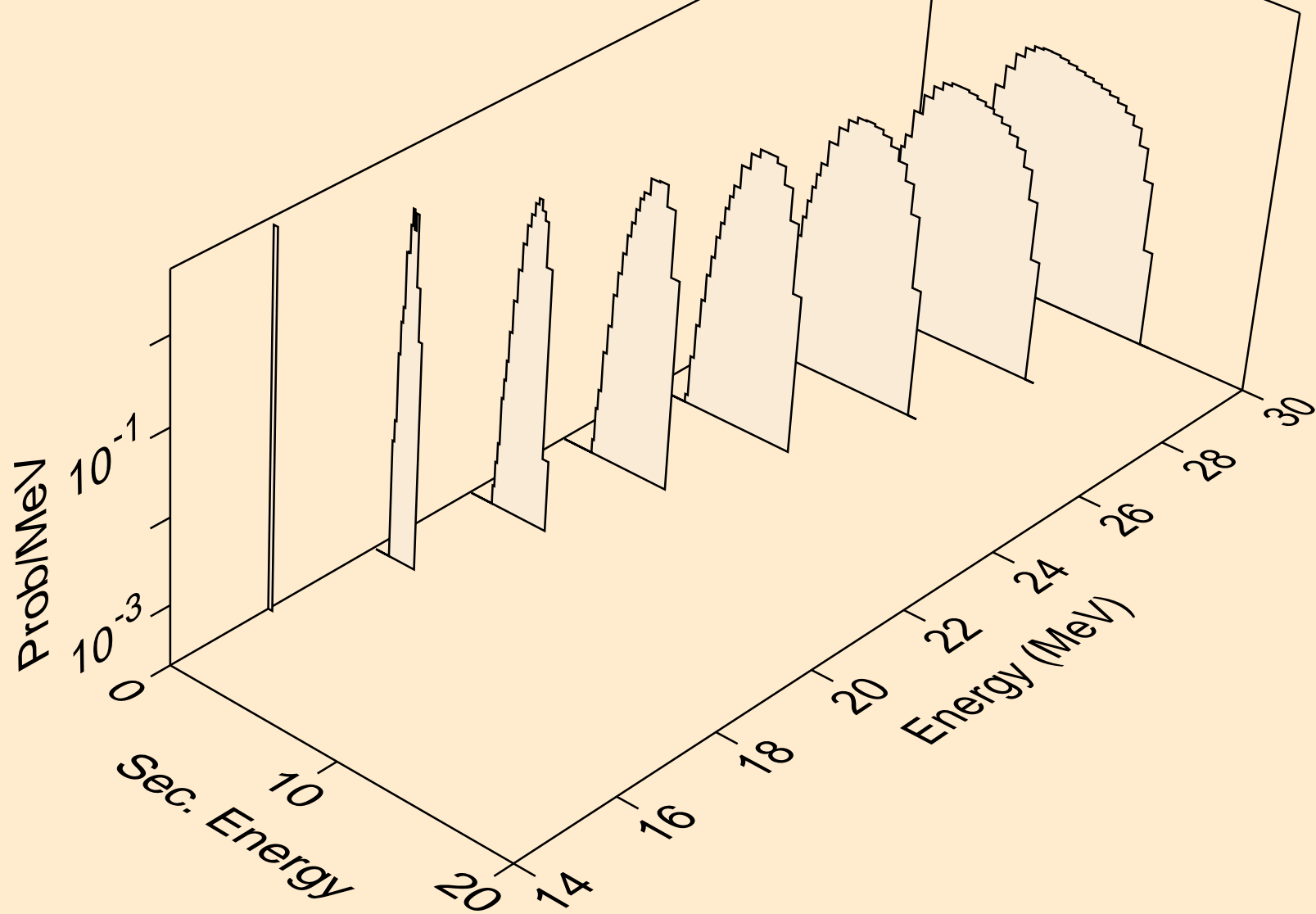

TC101 NEUTRON ACER TENDL-2021 LIBRARY; T=293.6K
protons from (n,3np)

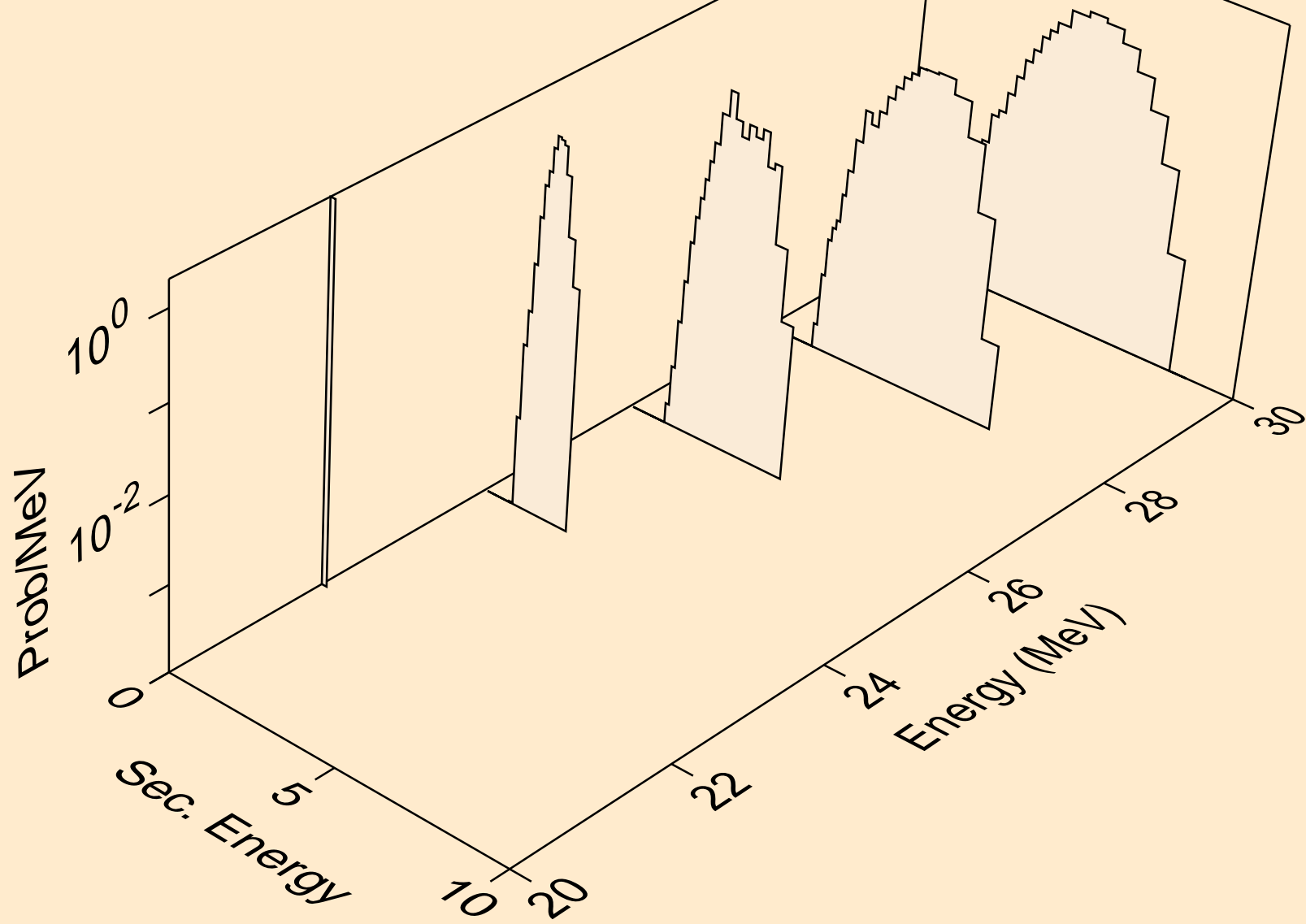

TC101 NEUTRON ACER TENDL-2021 LIBRARY; T=293.6K
protons from (n,2np)

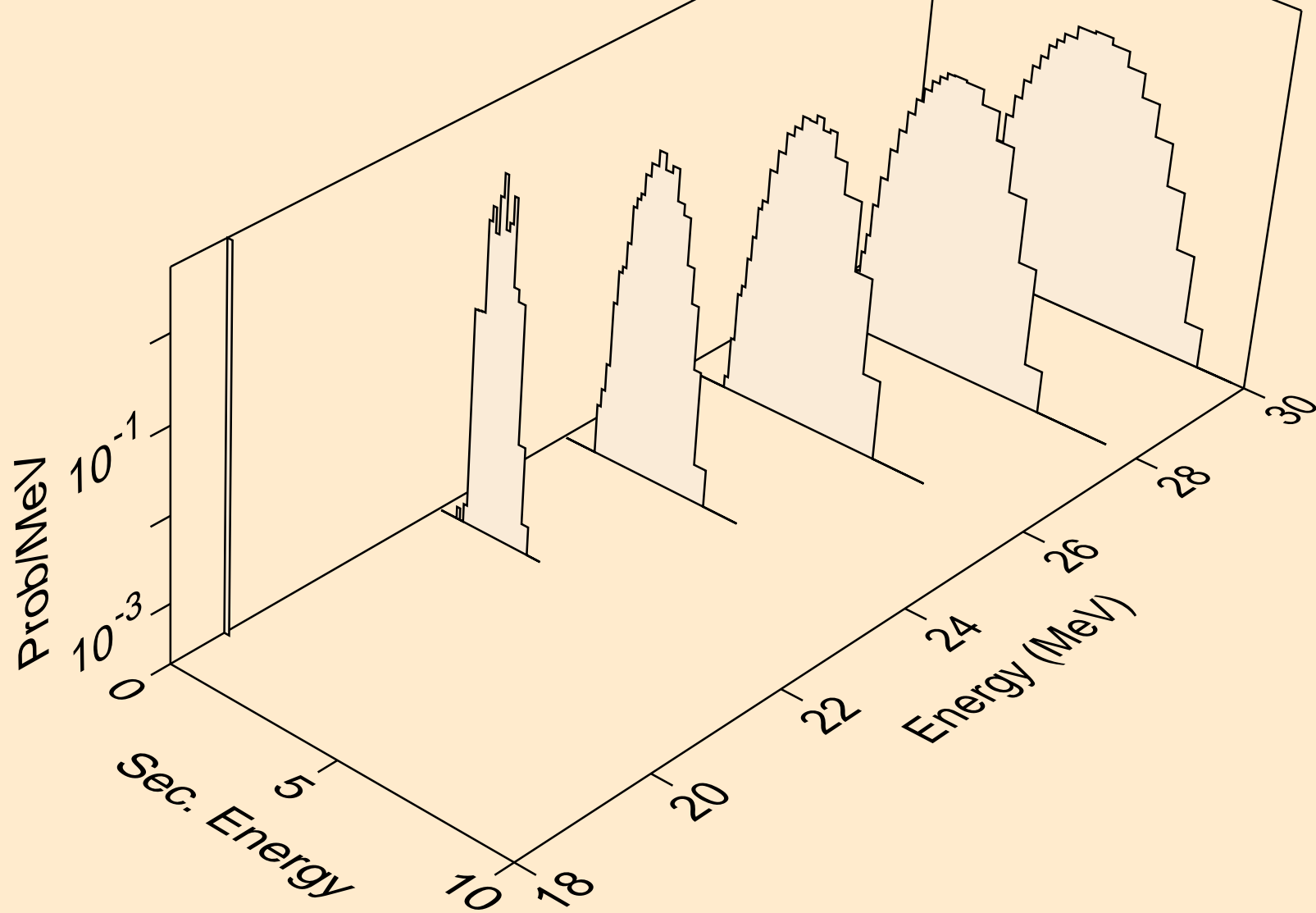

TC101 NEUTRON ACER TENDL-2021 LIBRARY; T=293.6K
protons from (n,npa)

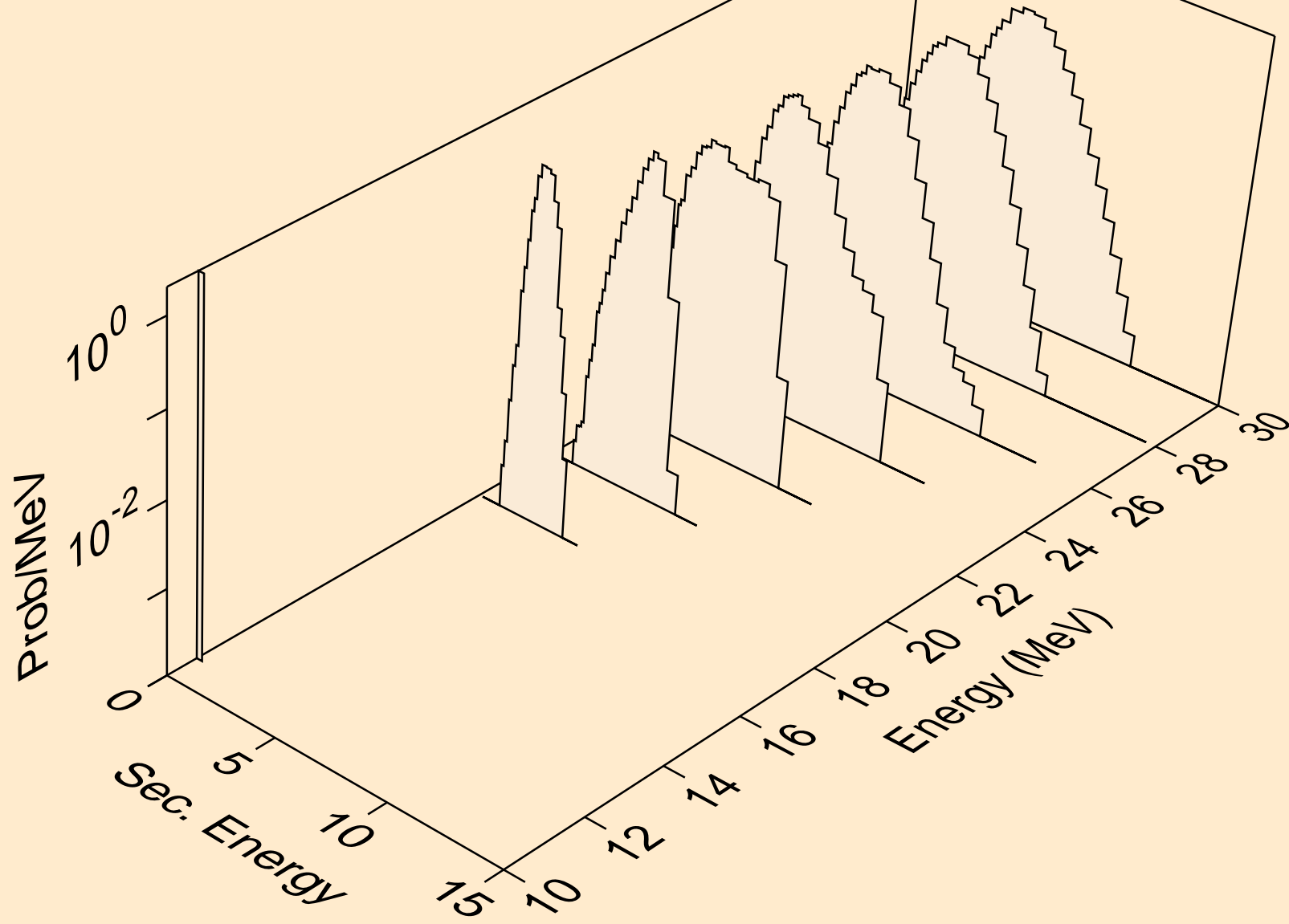

TC101 NEUTRON ACER TENDL-2021 LIBRARY; T=293.6K
protons from (n,p)

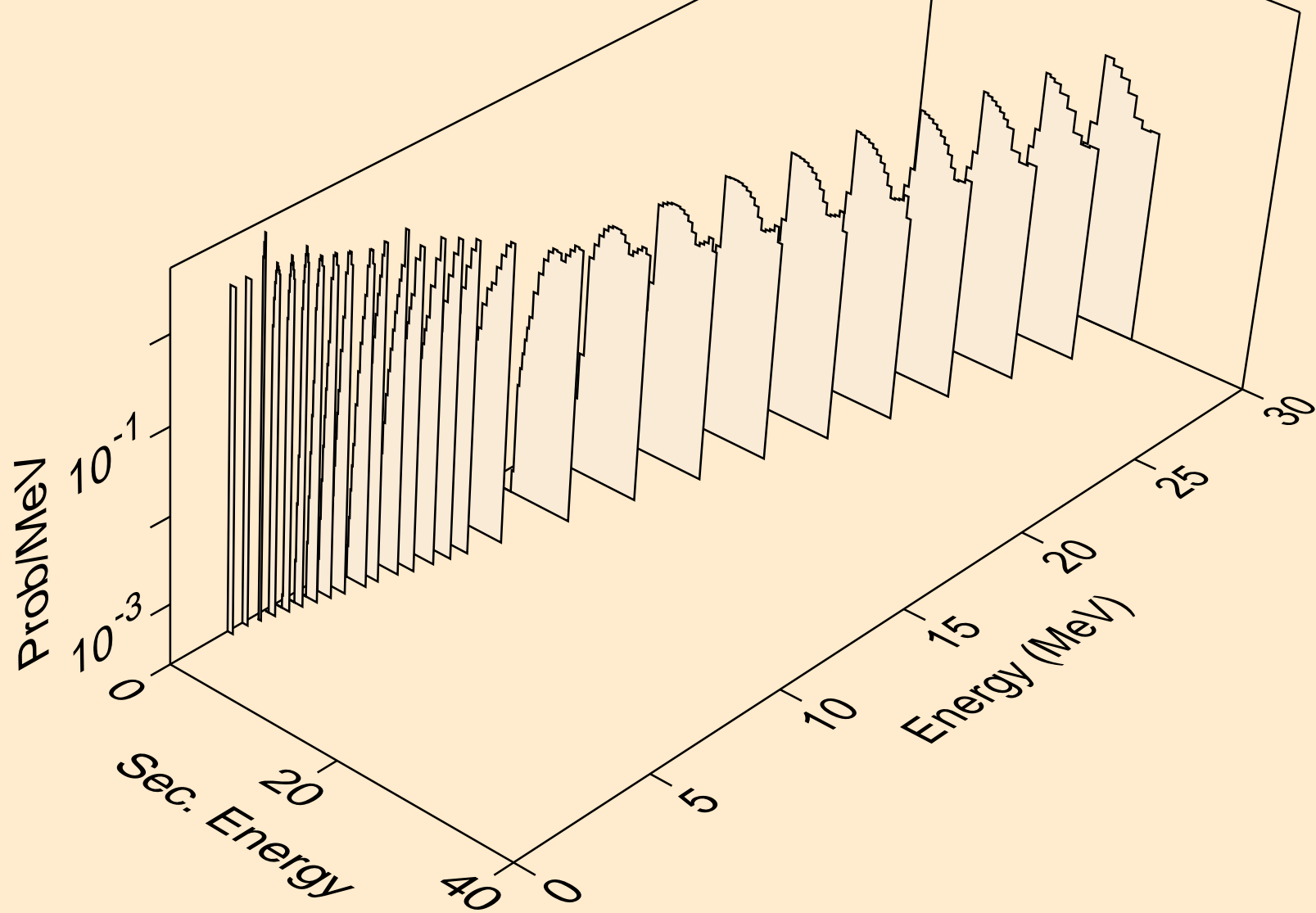

TC101 NEUTRON ACER TENDL-2021 LIBRARY; T=293.6K
protons from (n,2p)

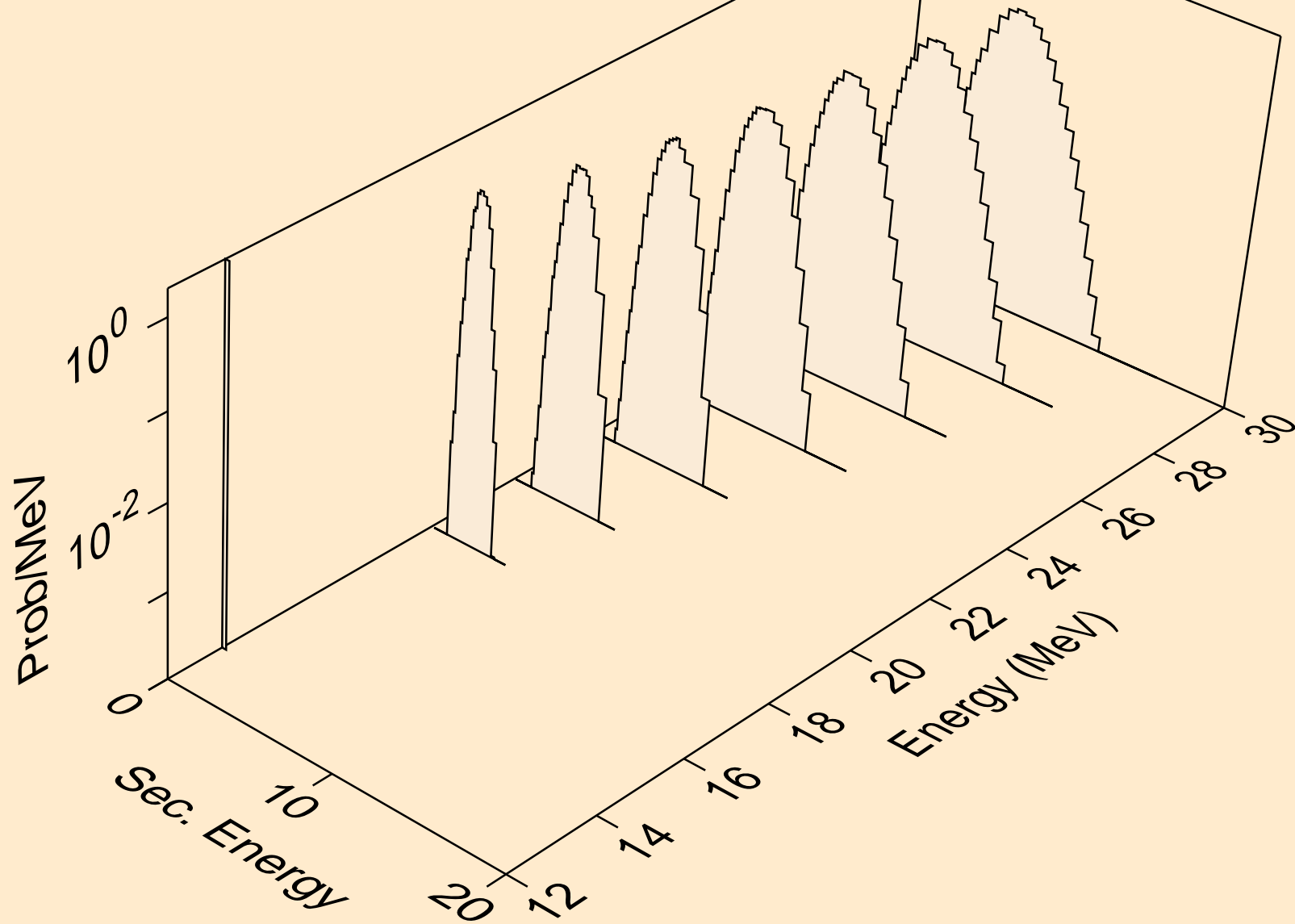

TC101 NEUTRON ACER TENDL-2021 LIBRARY; T=293.6K
protons from (n,p)

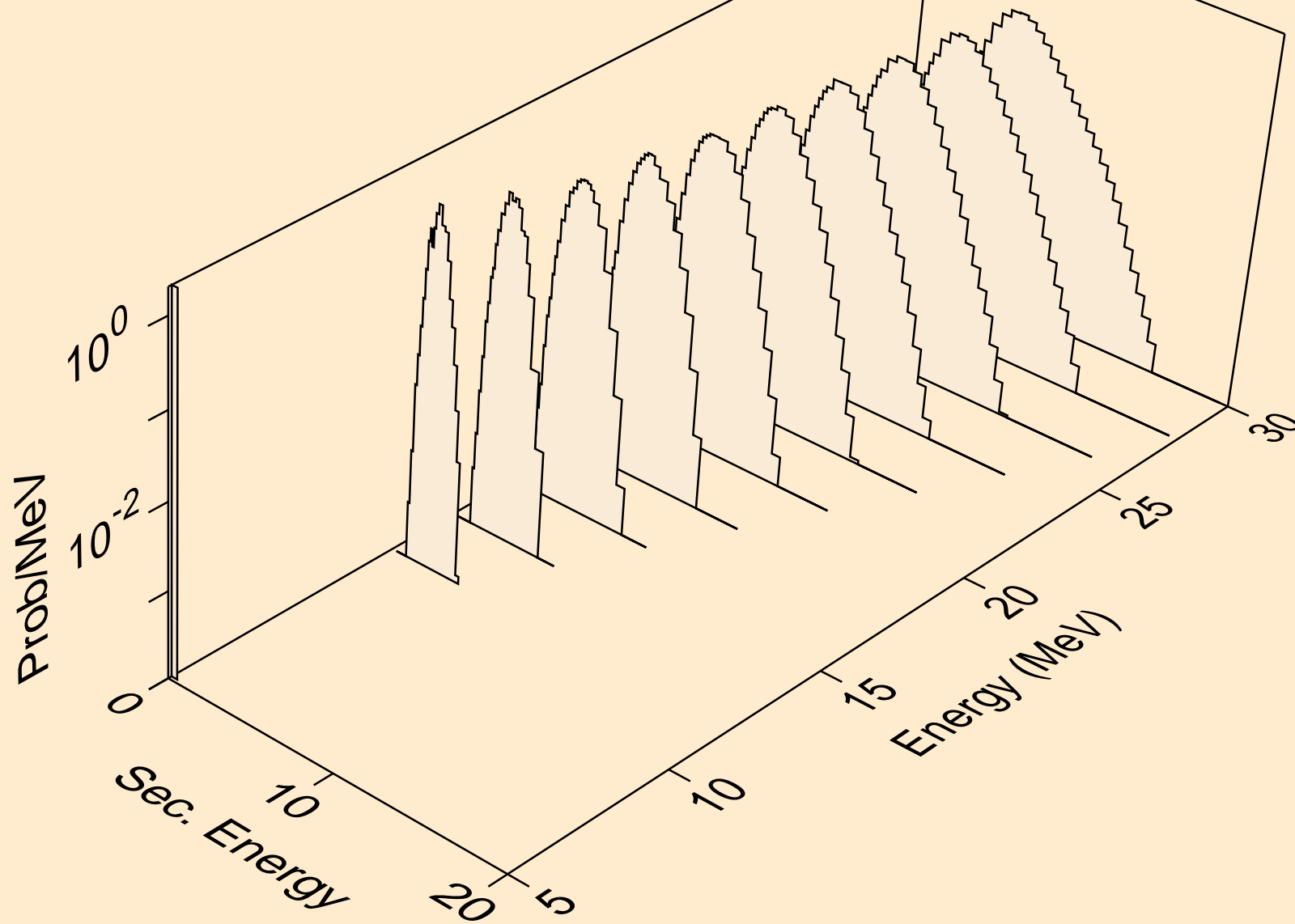

TC101 NEUTRON ACER TENDL-2021 LIBRARY; T=293.6K
protons from (n,pd)

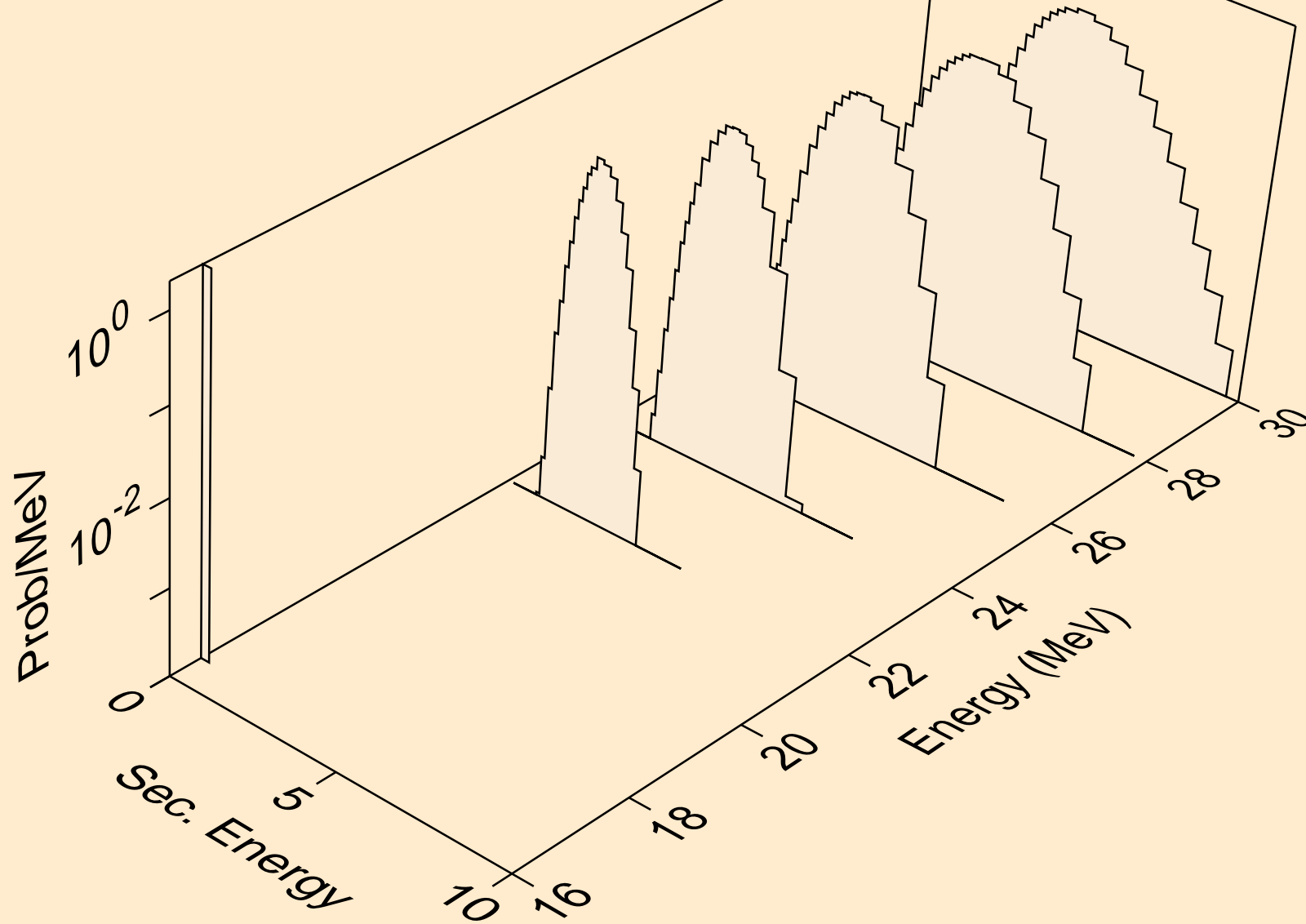

TC101 NEUTRON ACER TENDL-2021 LIBRARY; T=293.6K
protons from (n,pt)

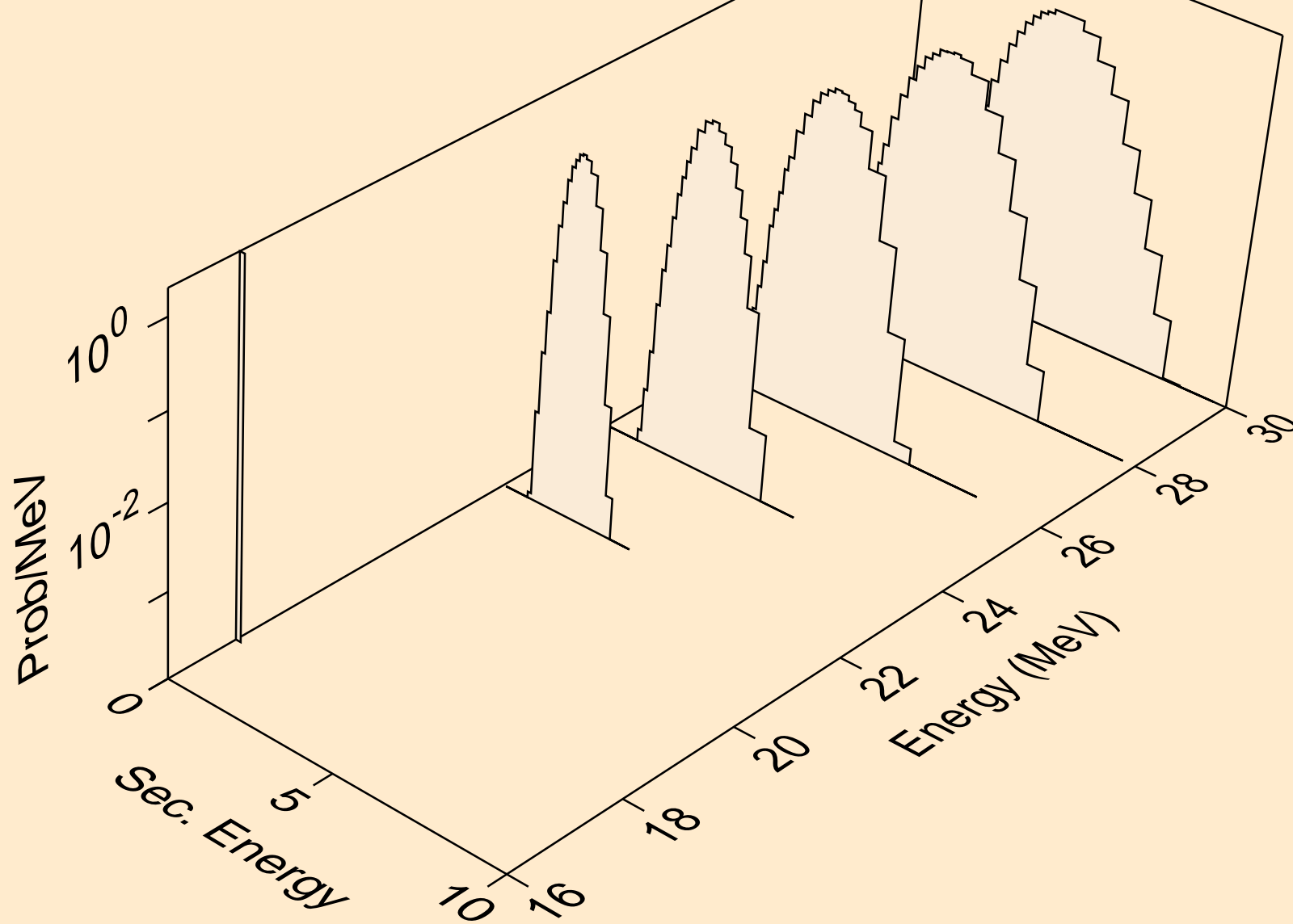

TC101 NEUTRON ACER TENDL-2021 LIBRARY; T=293.6K
deuterons from (n,x)

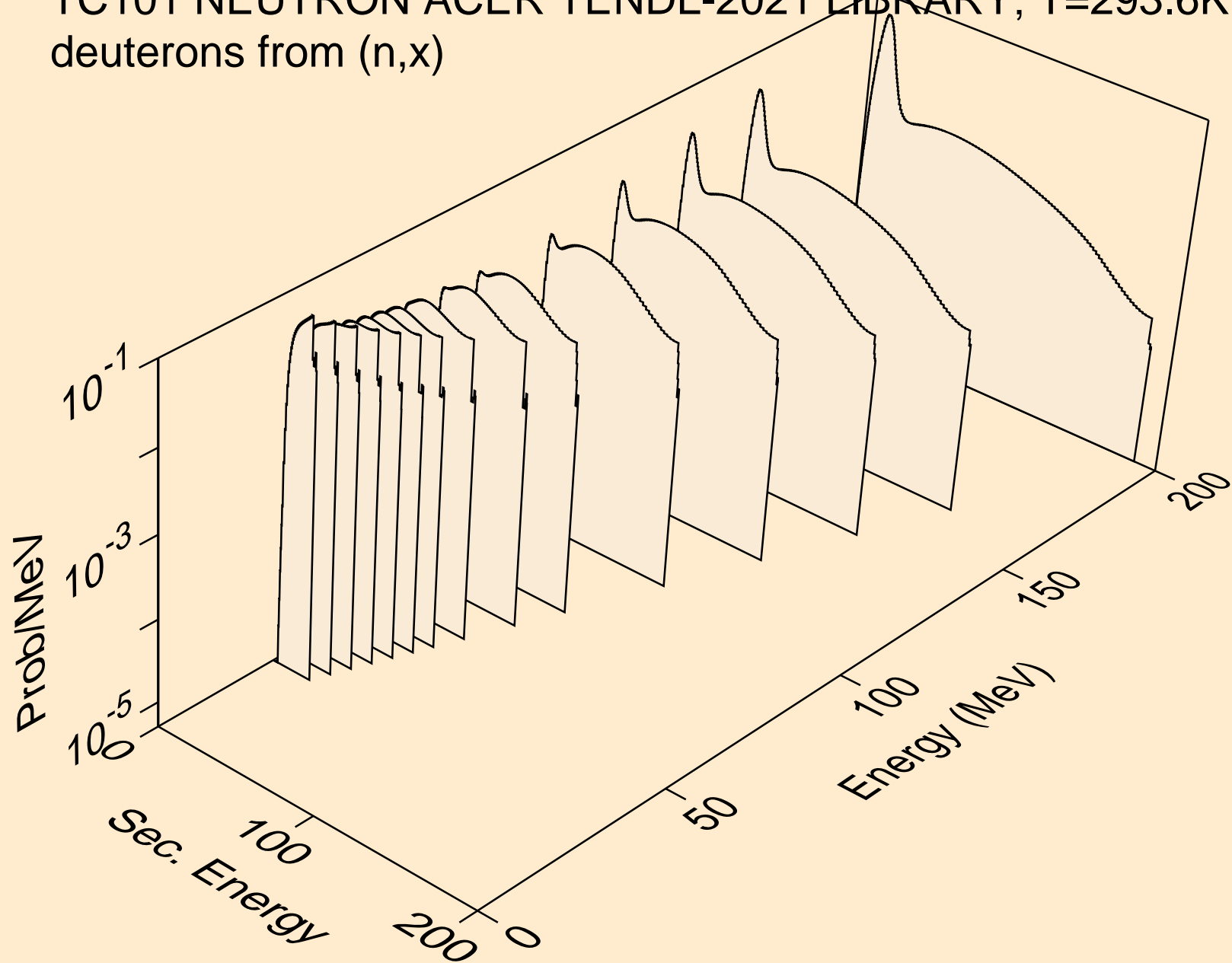

TC101 NEUTRON ACER TENDL-2021 LIBRARY; T=293.6K
deuterons from (n,2nd)

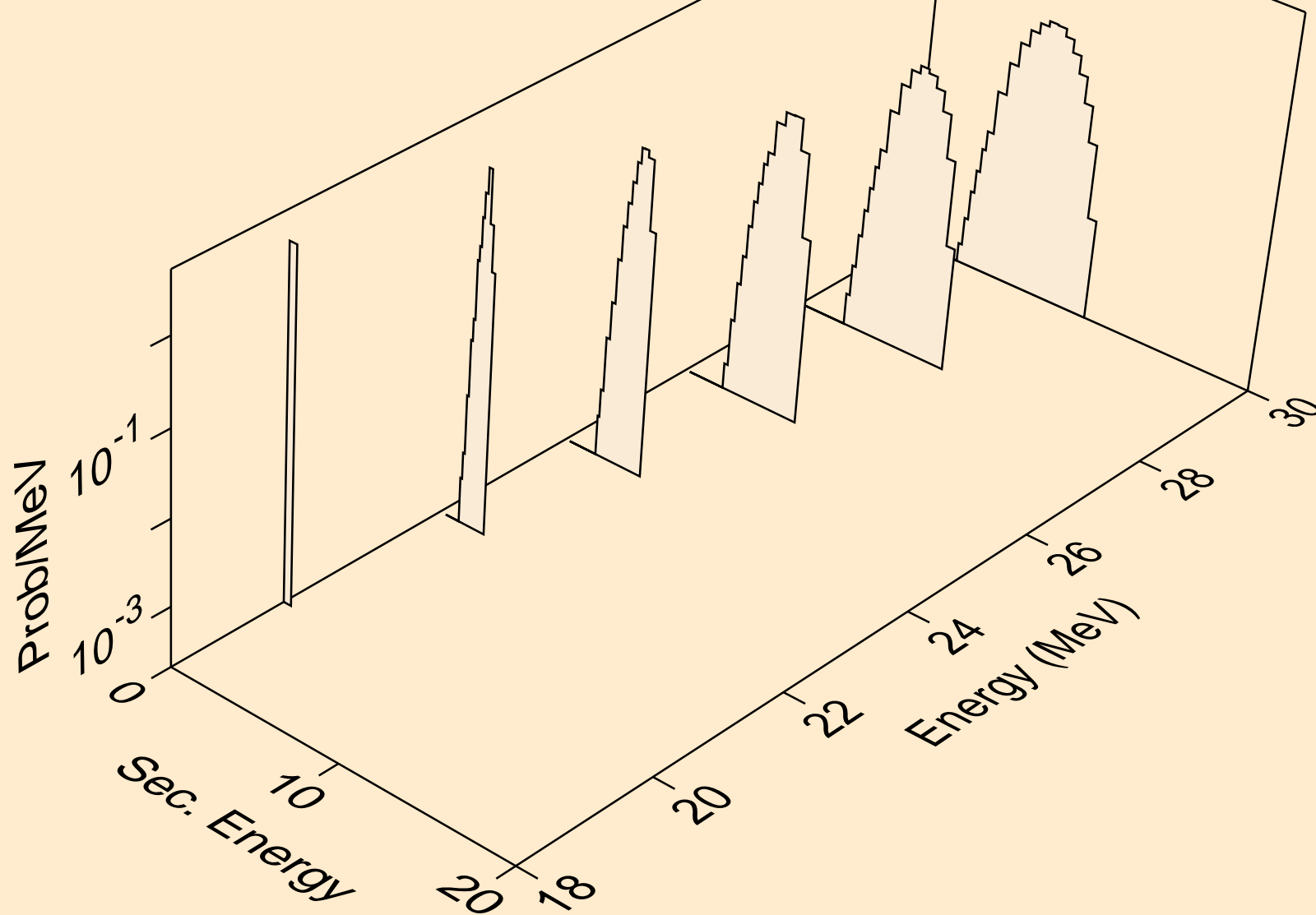

TC101 NEUTRON ACER TENDL-2021 LIBRARY; T=293.6K
deuterons from (n,n*)d

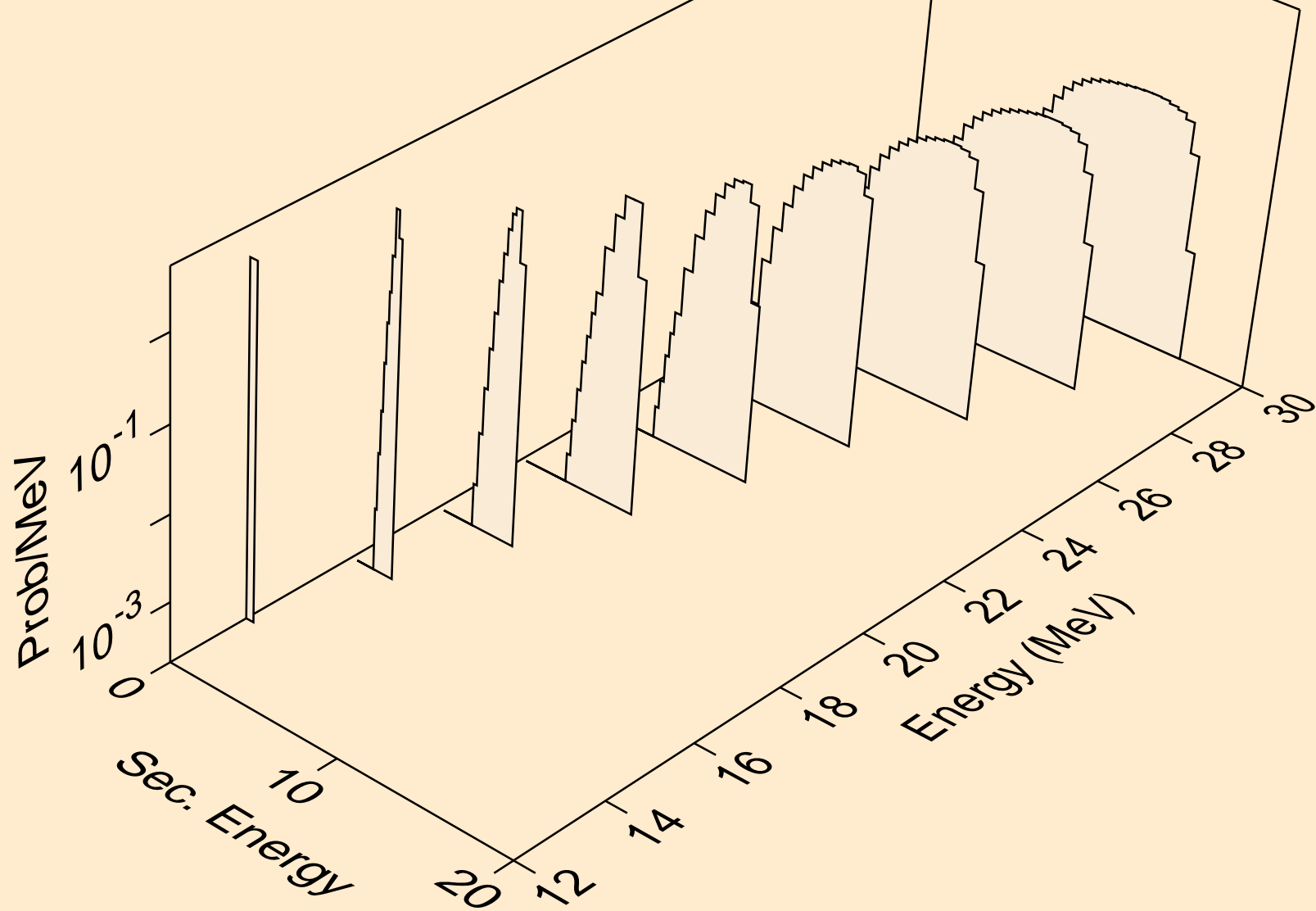

TC101 NEUTRON ACER TENDL-2021 LIBRARY; T=293.6K
deuterons from (n,d)

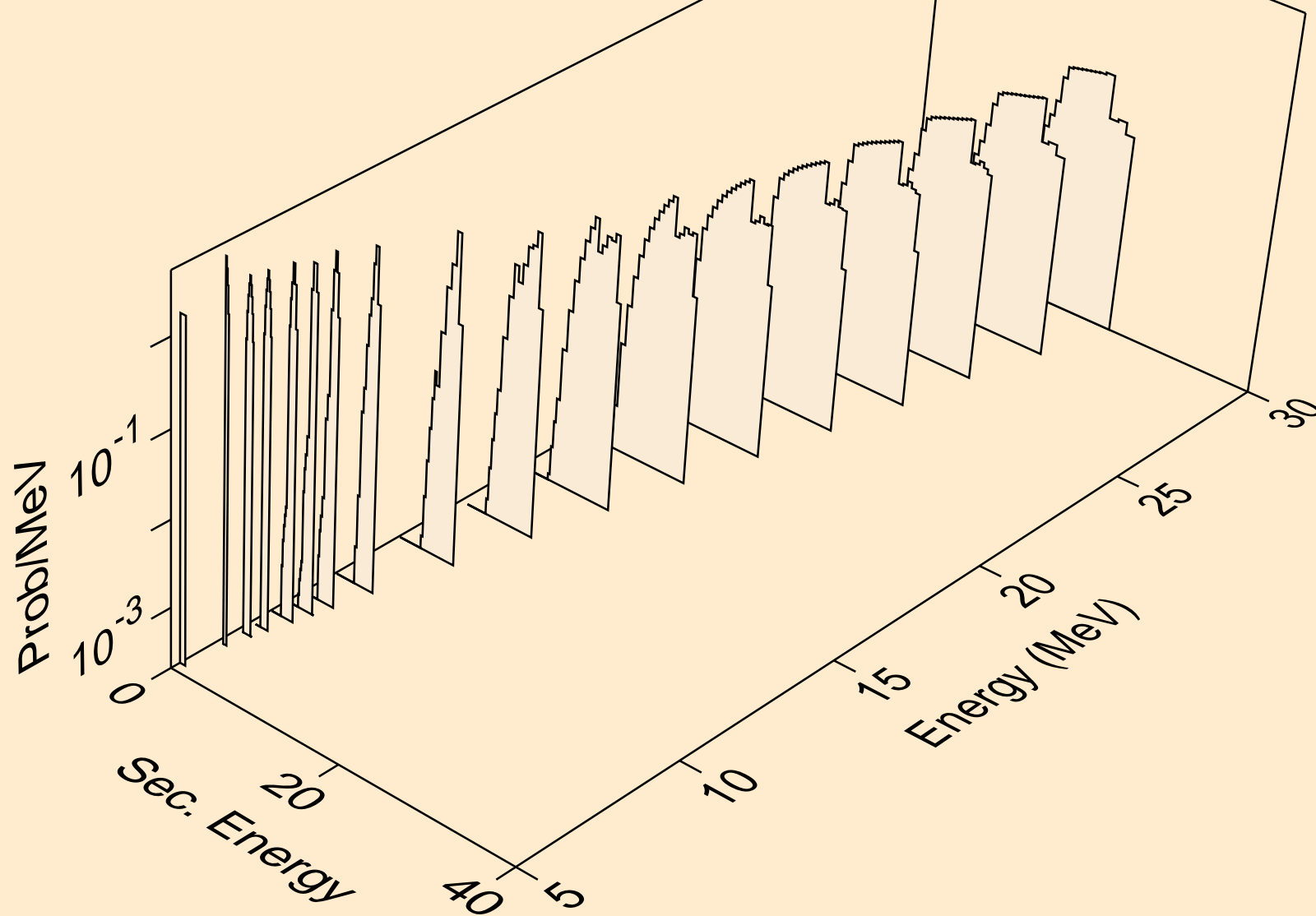

TC101 NEUTRON ACER TENDL-2021 LIBRARY; T=293.6K
deuterons from (n,pd)

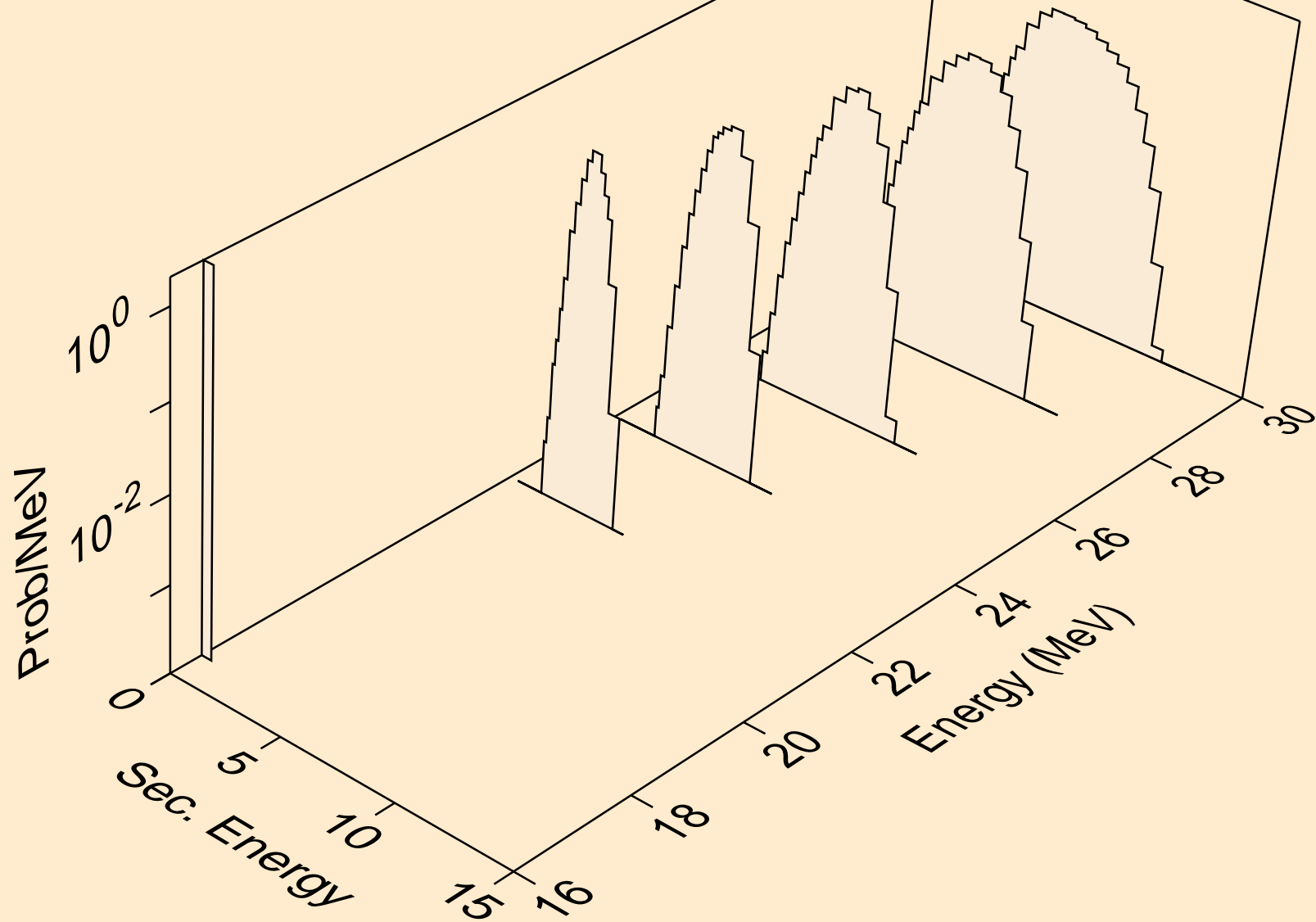

TC101 NEUTRON ACER TENDL-2021 LIBRARY; T=293.6K
deuterons from (n,da)

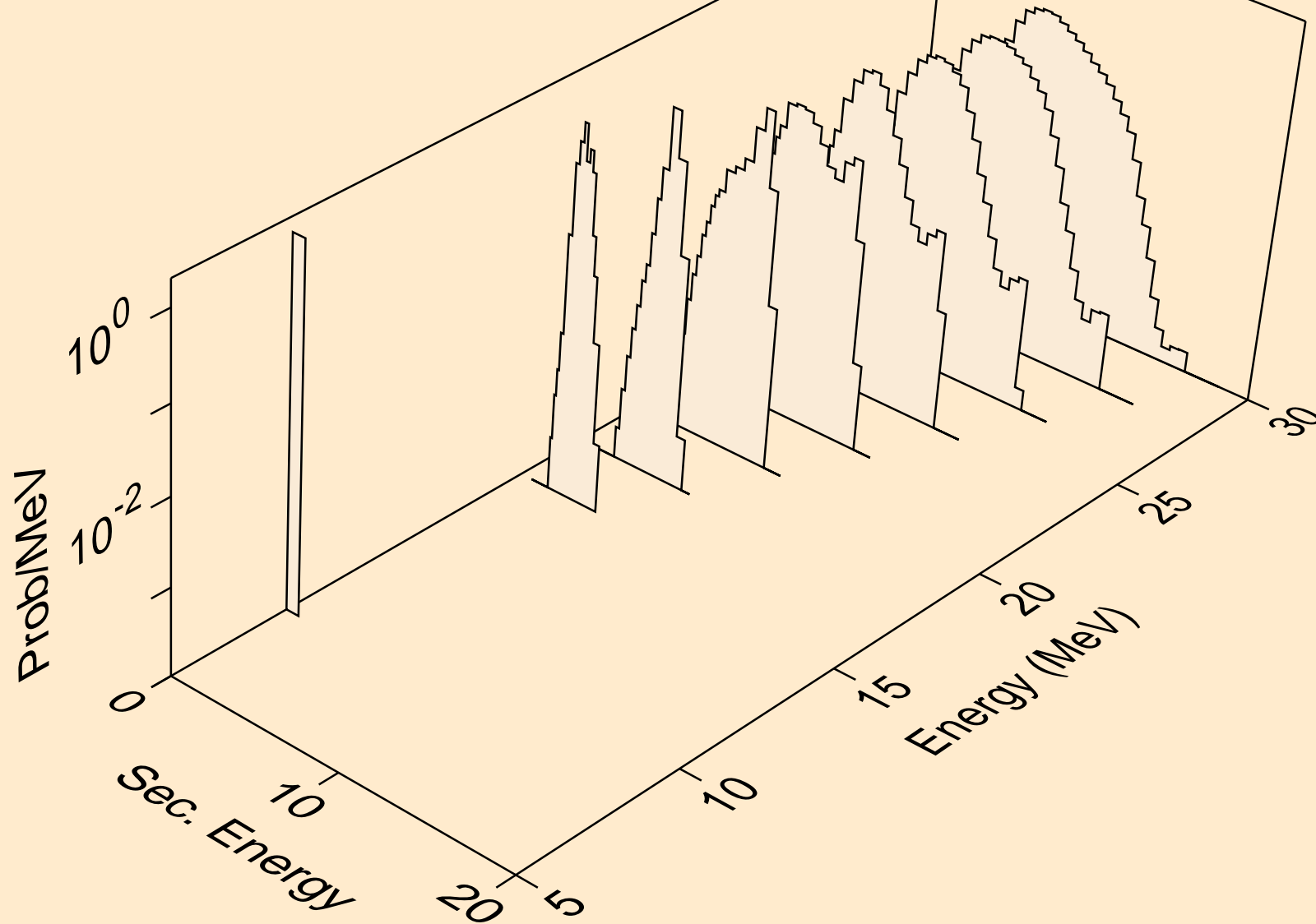

TC101 NEUTRON ACER TENDL-2021 LIBRARY; T=293.6K
tritons from (n,x)

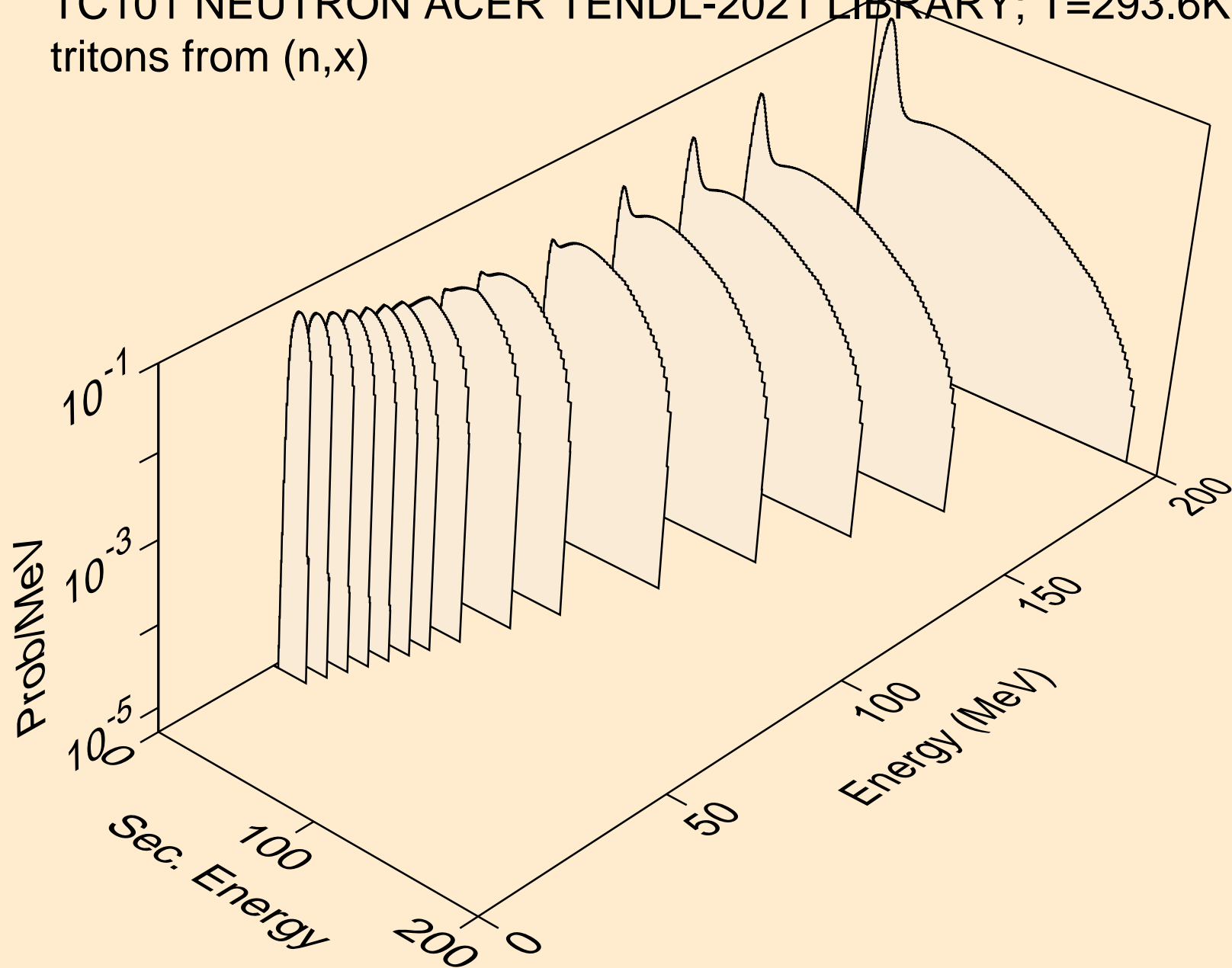

TC101 NEUTRON ACER TENDL-2021 LIBRARY; T=293.6K
tritons from (n,n*)t

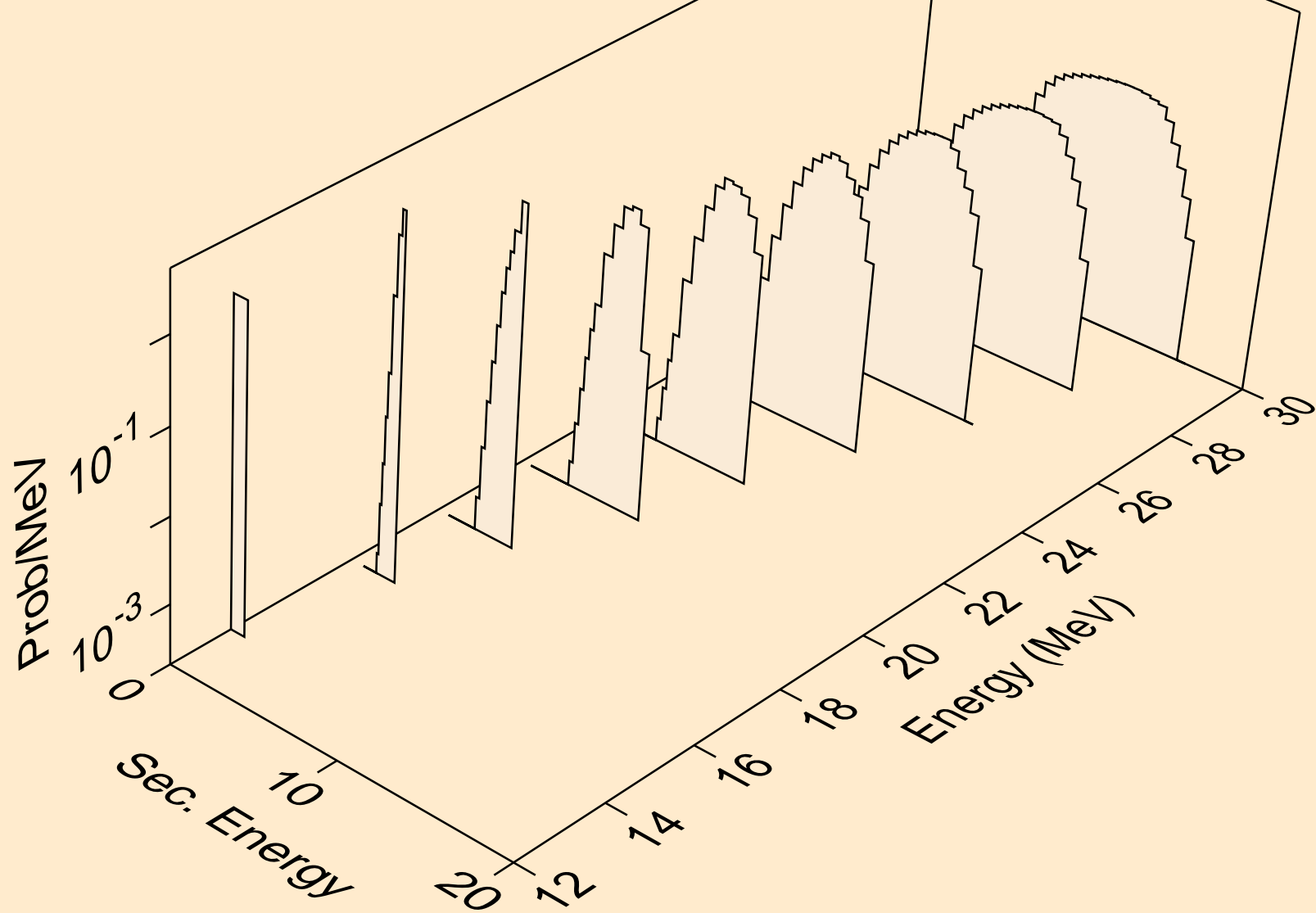

TC101 NEUTRON ACER TENDL-2021 LIBRARY; T=293.6K
tritons from (n,t)

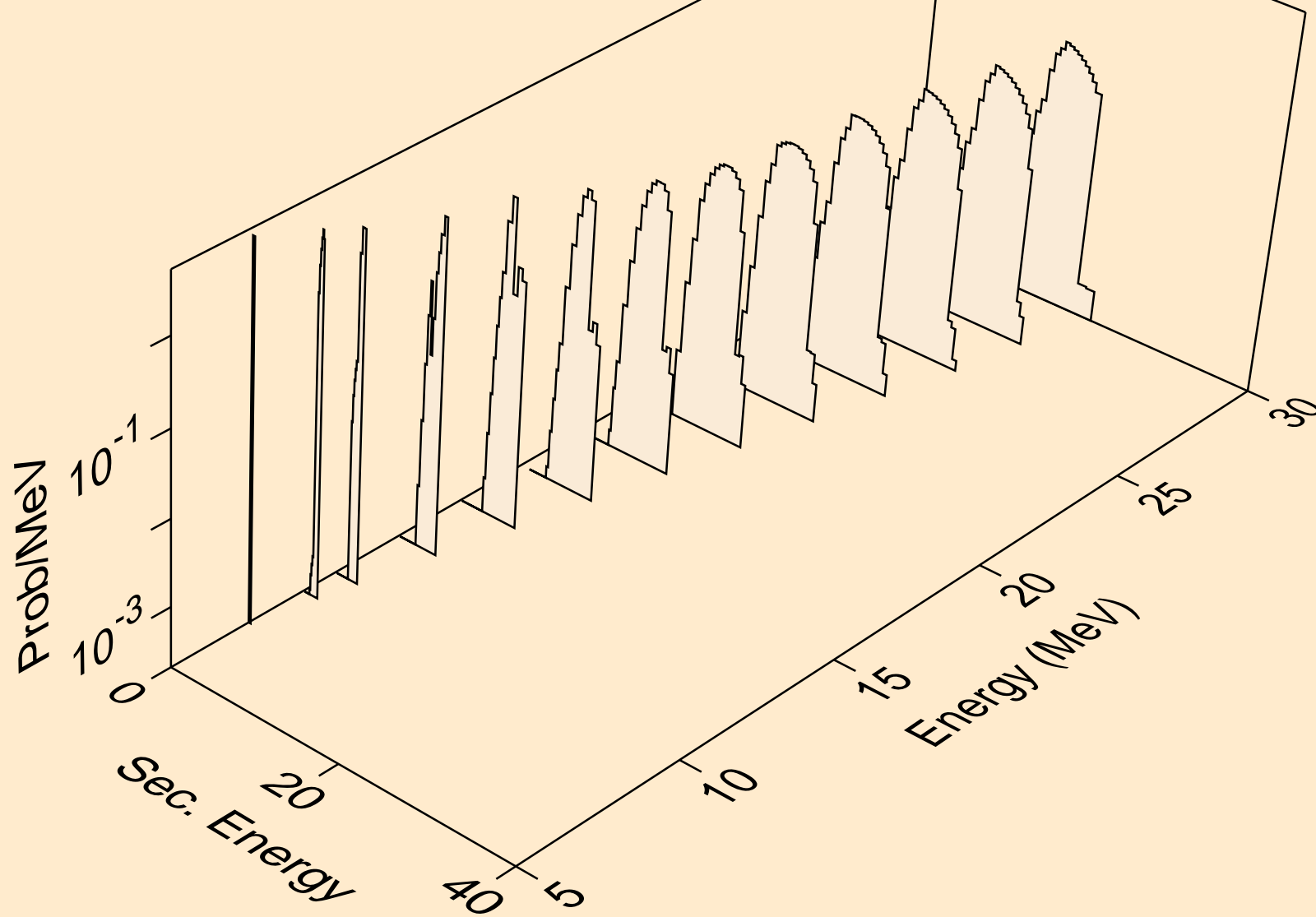

TC101 NEUTRON ACER TENDL-2021 LIBRARY; T=293.6K
tritons from (n,pt)

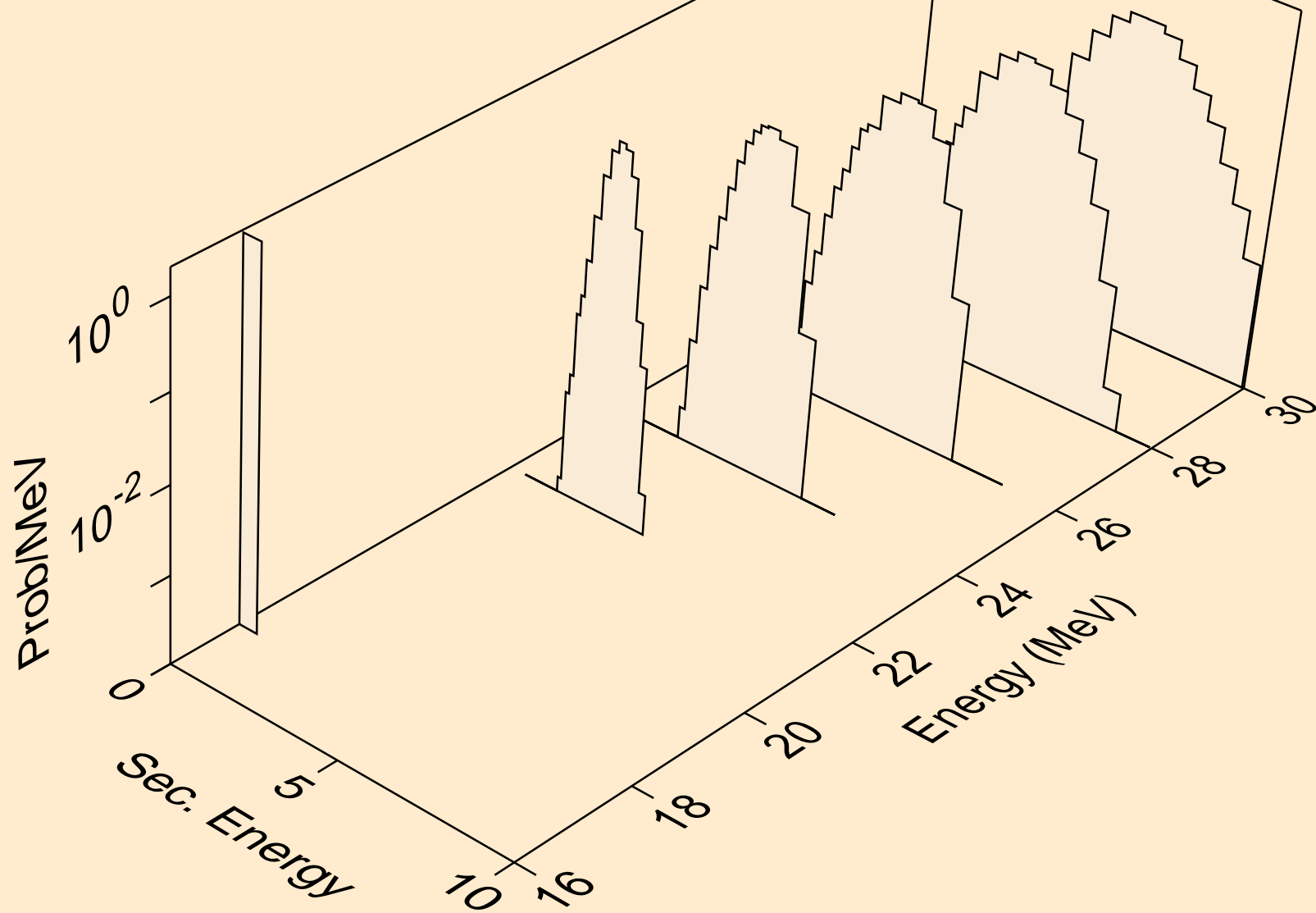

TC101 NEUTRON ACER TENDL-2021 LIBRARY; T=293.6K
he3s from (n,x)

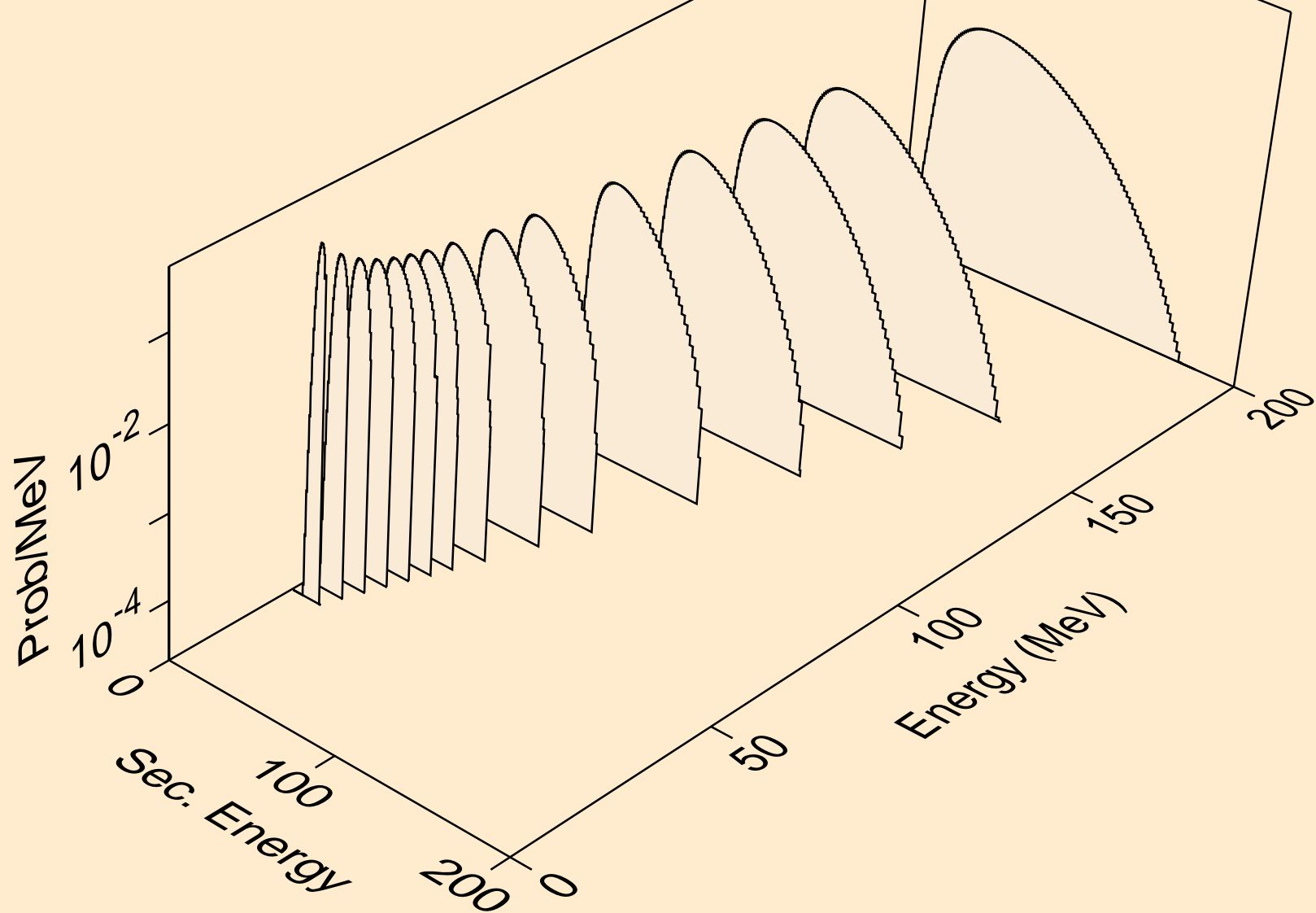

TC101 NEUTRON ACER TENDL-2021 LIBRARY; T=293.6K
he3s from (n,n*)he3

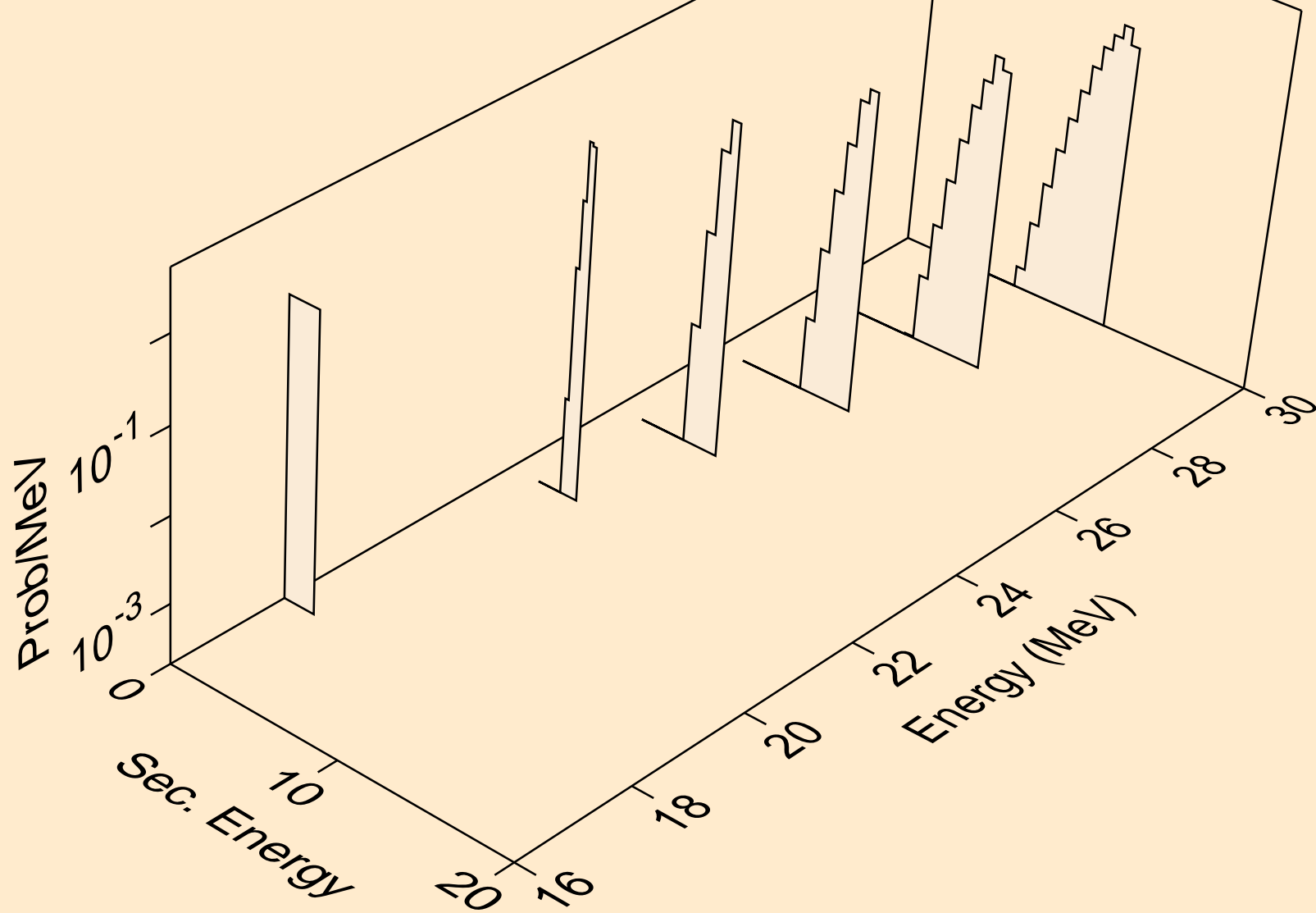

TC101 NEUTRON ACER TENDL-2021 LIBRARY; T=293.6K
he3s from (n,he3)

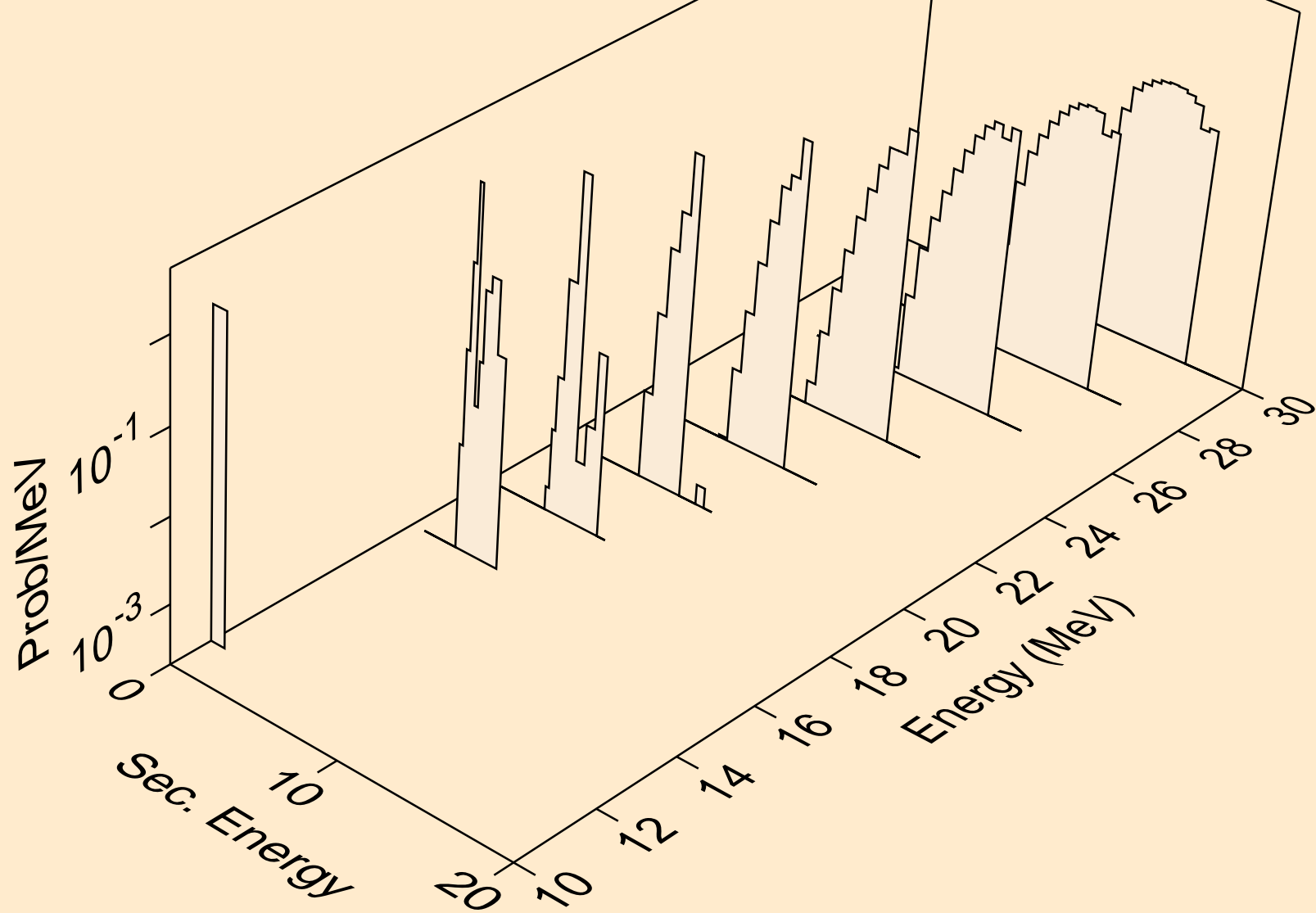

TC101 NEUTRON ACER TENDL-2021 LIBRARY; T=293.6K
alphas from (n,x)

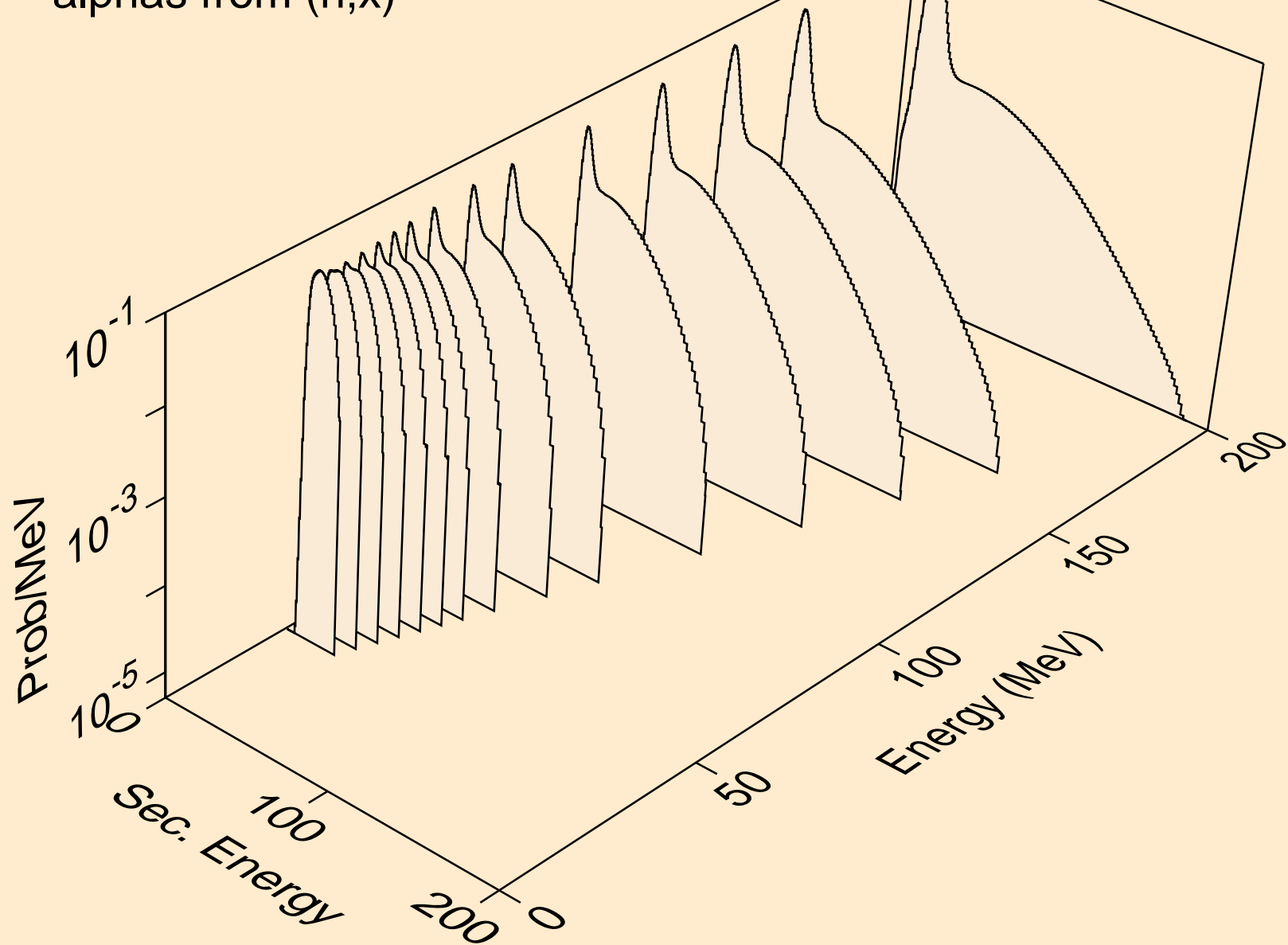

TC101 NEUTRON ACER TENDL-2021 LIBRARY; T=293.6K
alphas from (n,n*)a

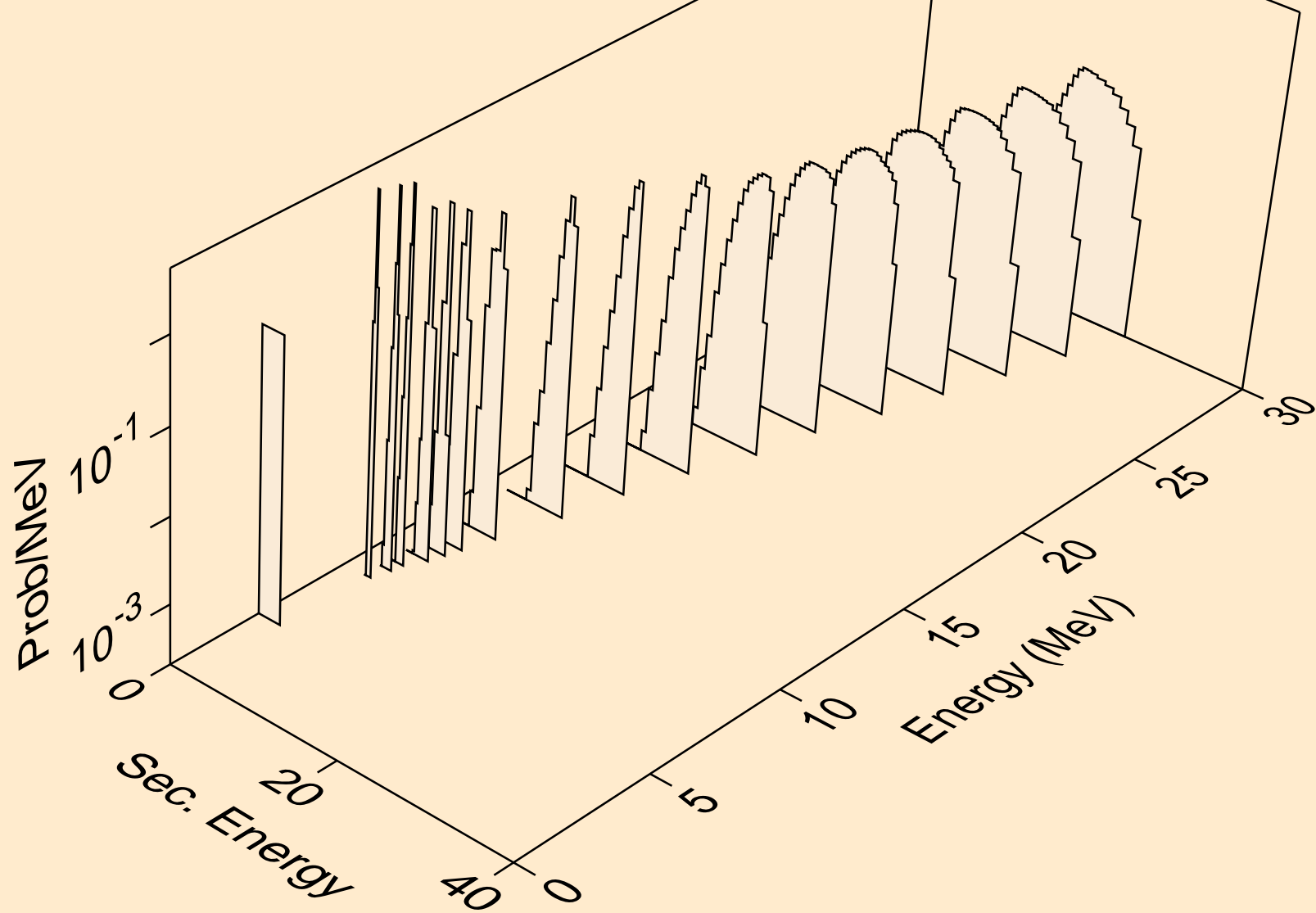

TC101 NEUTRON ACER TENDL-2021 LIBRARY; T=293.6K
alphas from (n,2n)a

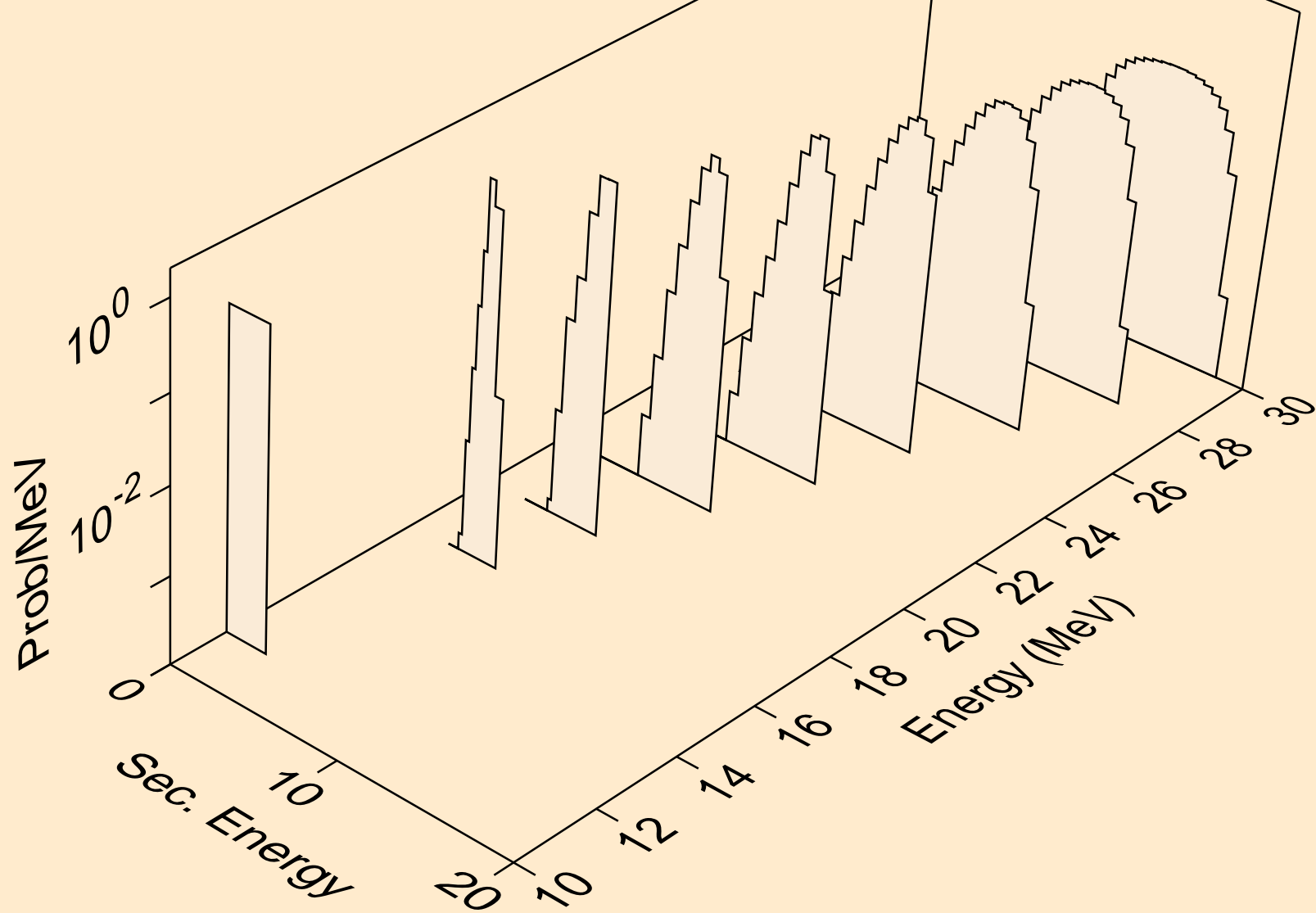

TC101 NEUTRON ACER TENDL-2021 LIBRARY; T=293.6K
alphas from (n,3n)a

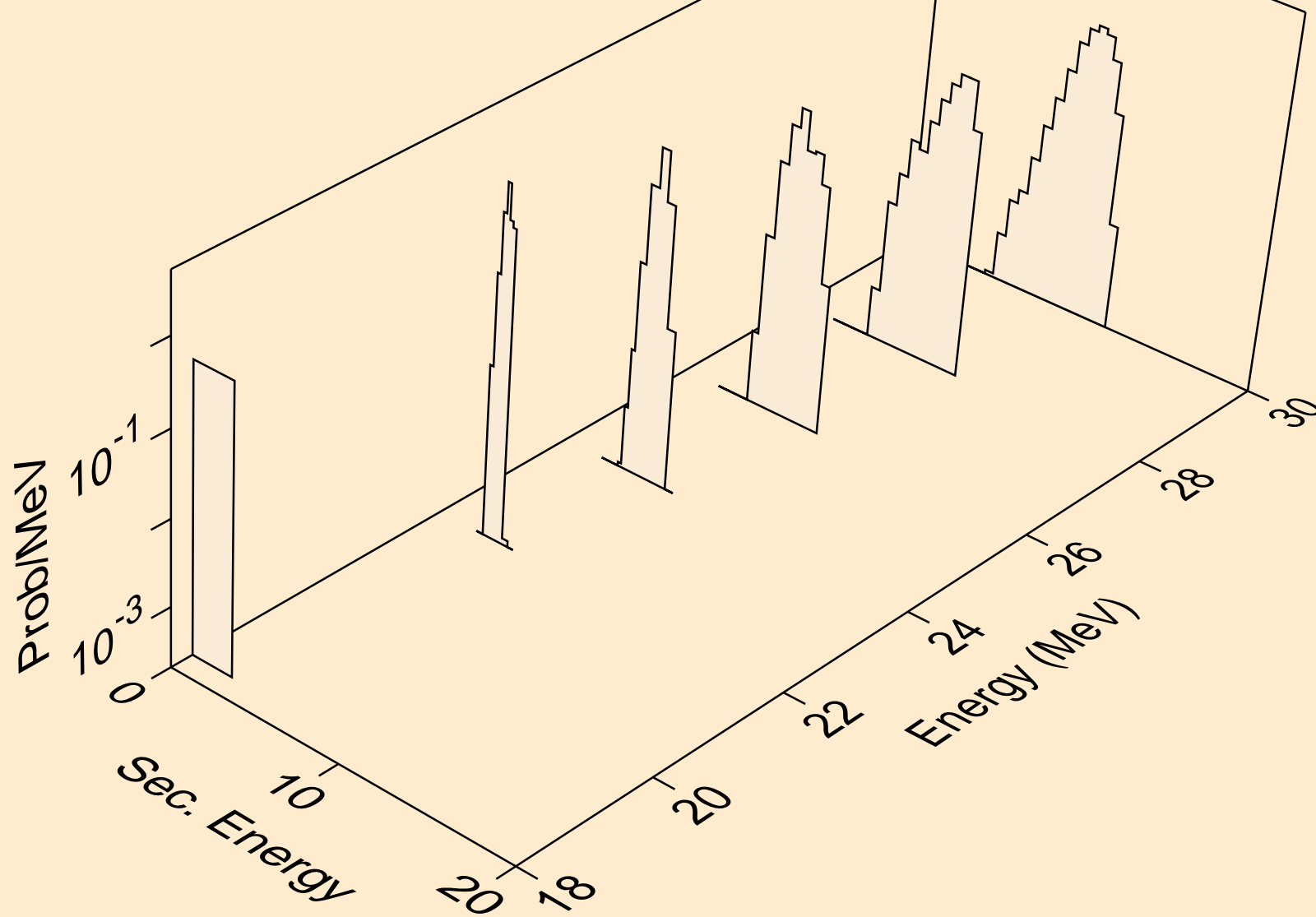

TC101 NEUTRON ACER TENDL-2021 LIBRARY; T=293.6K
alphas from (n,n*)2a

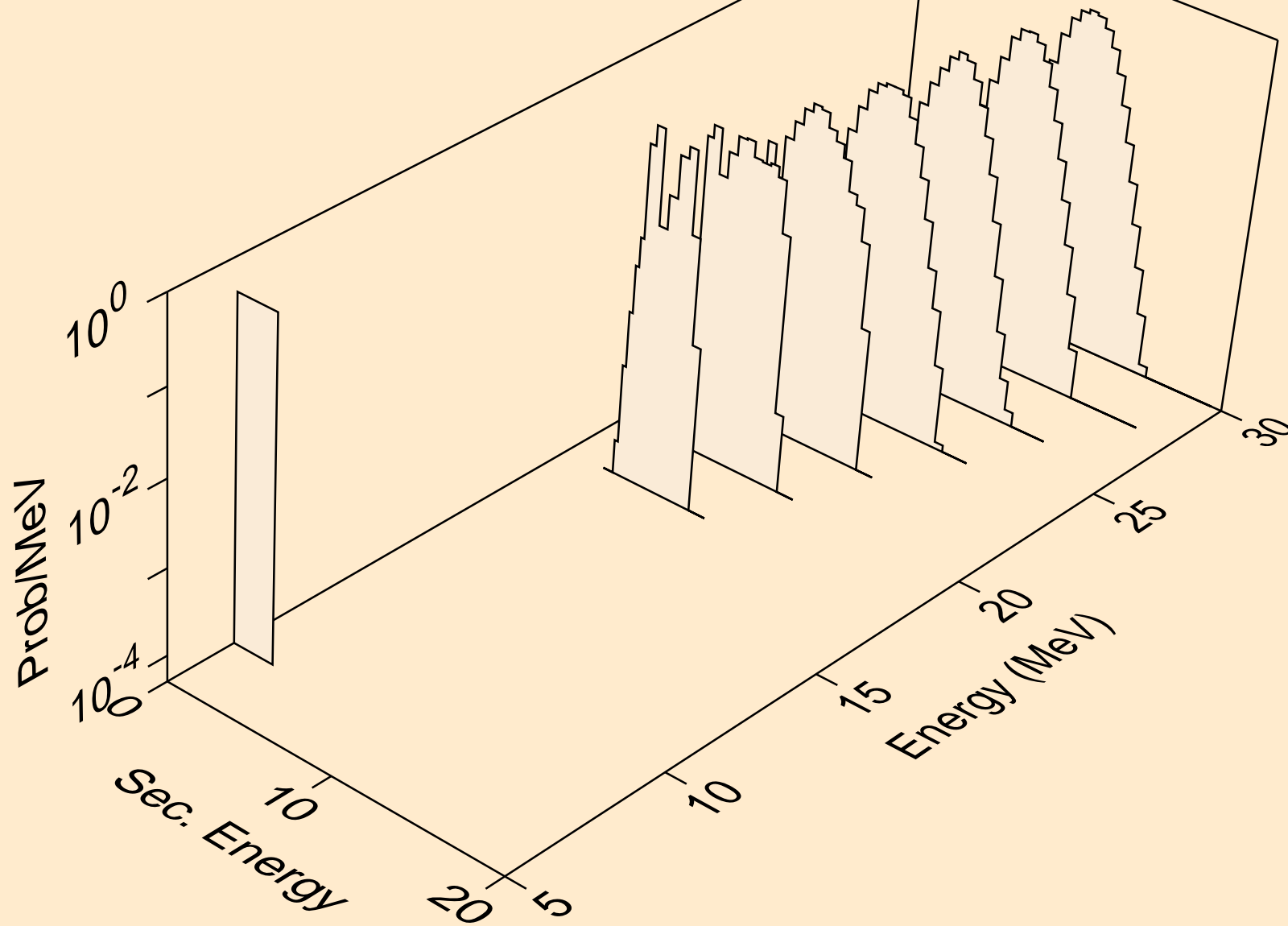

TC101 NEUTRON ACER TENDL-2021 LIBRARY; T=293.6K
alphas from (n,npa)

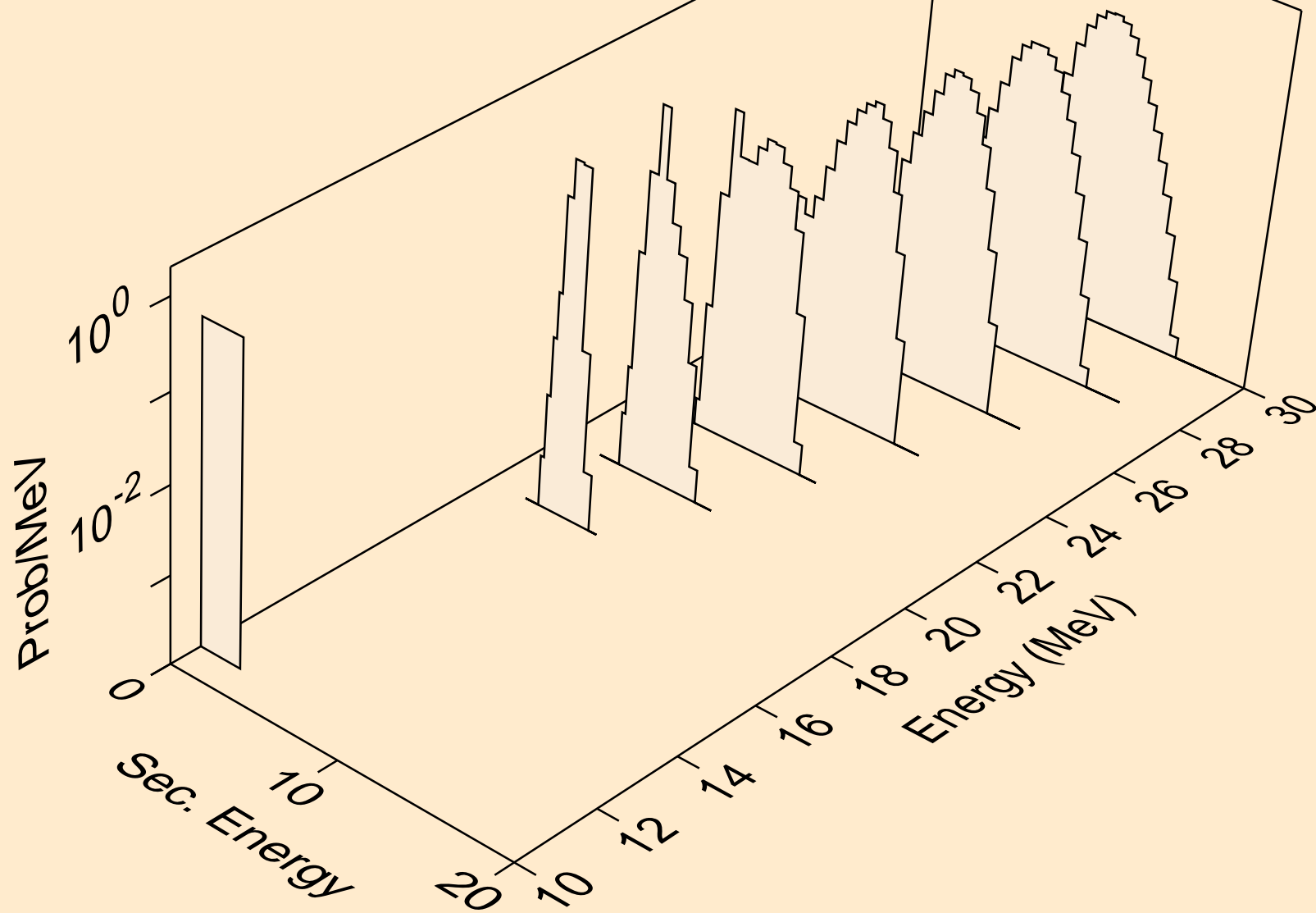

TC101 NEUTRON ACER TENDL-2021 LIBRARY; T=293.6K
alphas from (n,a)

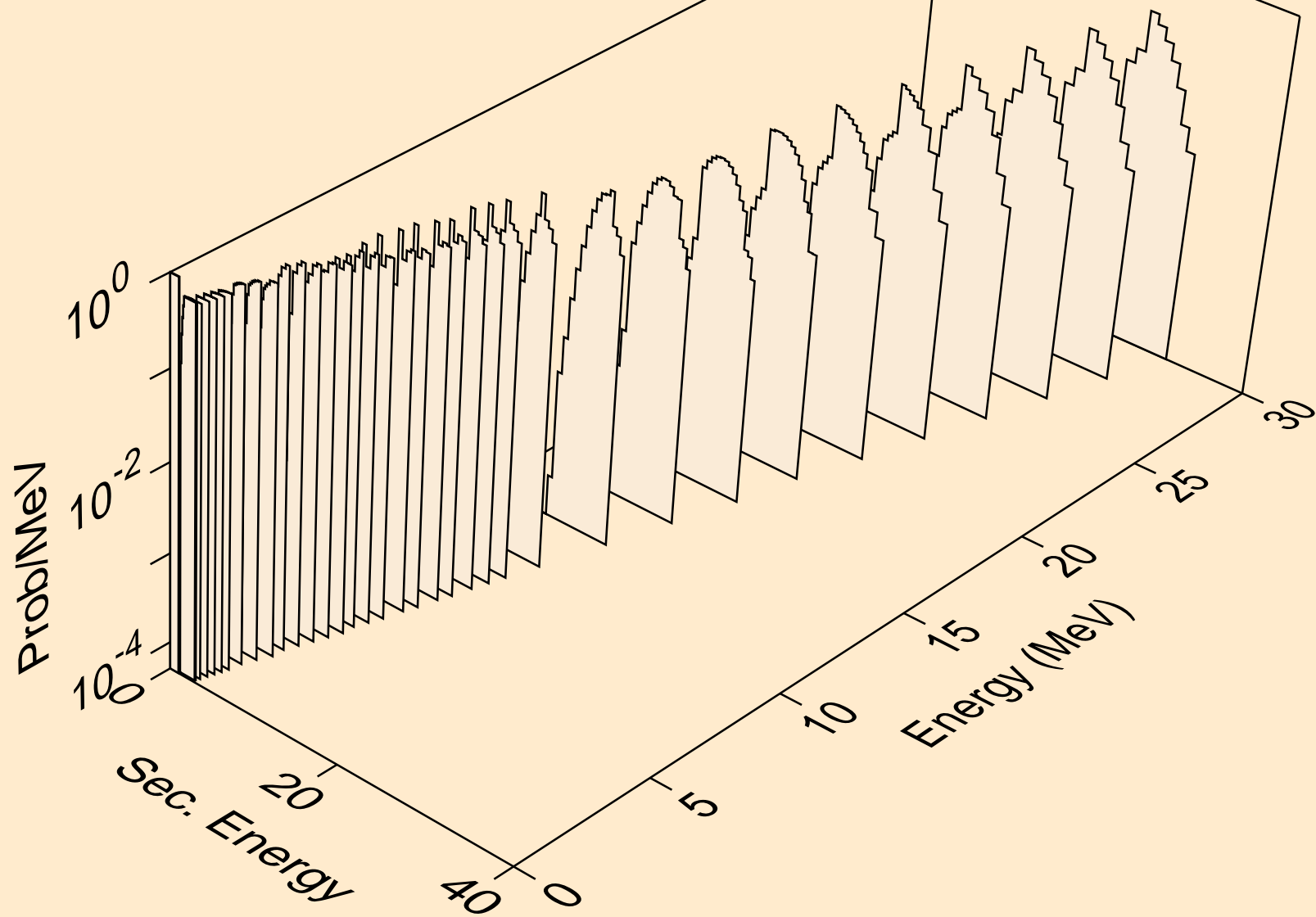

TC101 NEUTRON ACER TENDL-2021 LIBRARY; T=293.6K
alphas from (n,2a)

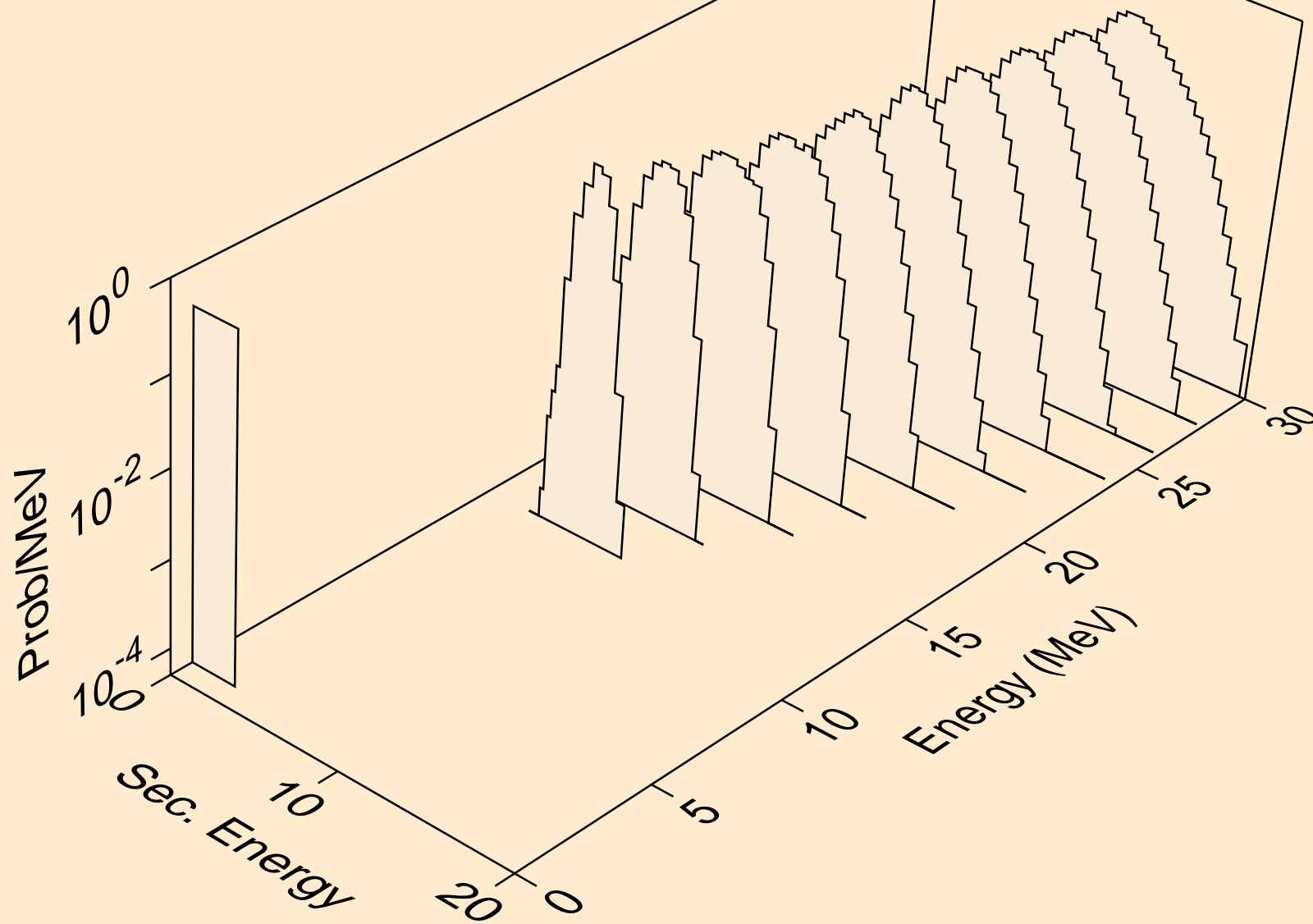

TC101 NEUTRON ACER TENDL-2021 LIBRARY; T=293.6K
alphas from (n,pa)

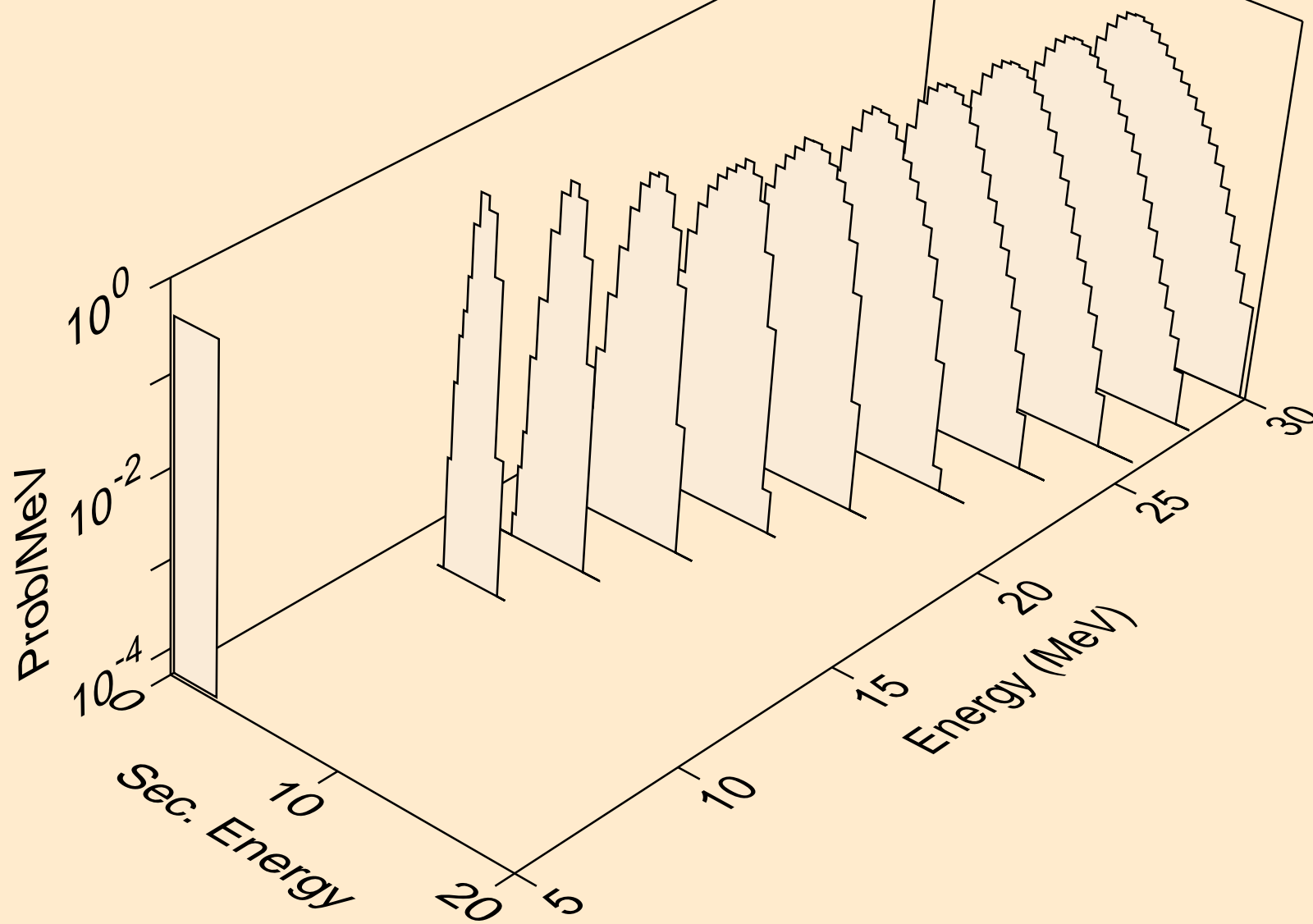

TC101 NEUTRON ACER TENDL-2021 LIBRARY; T=293.6K
alphas from (n,da)

