

TH239 NEUTRON ACER TENDL-2021 LIBRARY; T=293.6K  
Principal cross sections

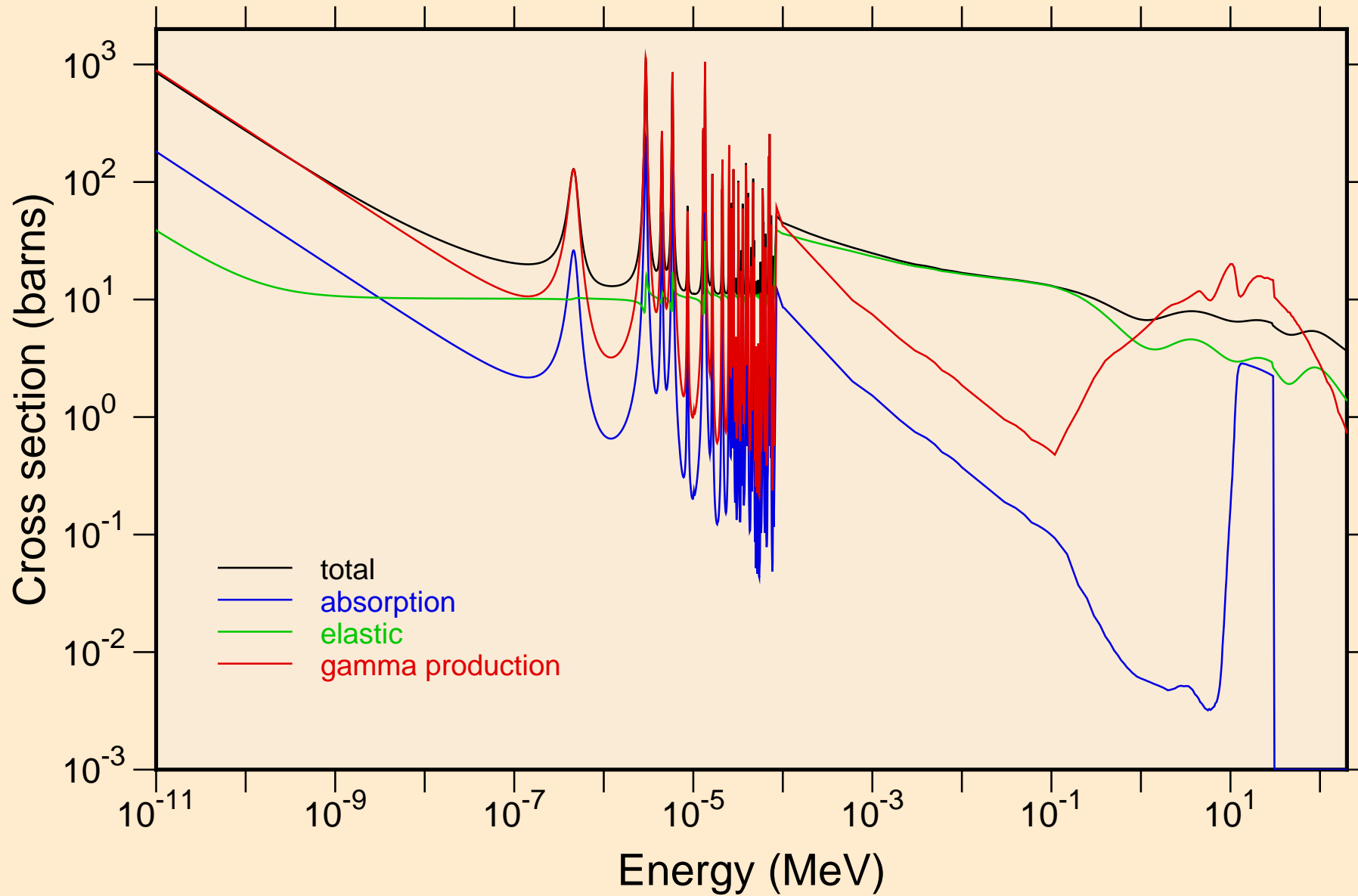

TH239 NEUTRON ACER TENDL-2021 LIBRARY; T=293.6K  
resonance total cross section

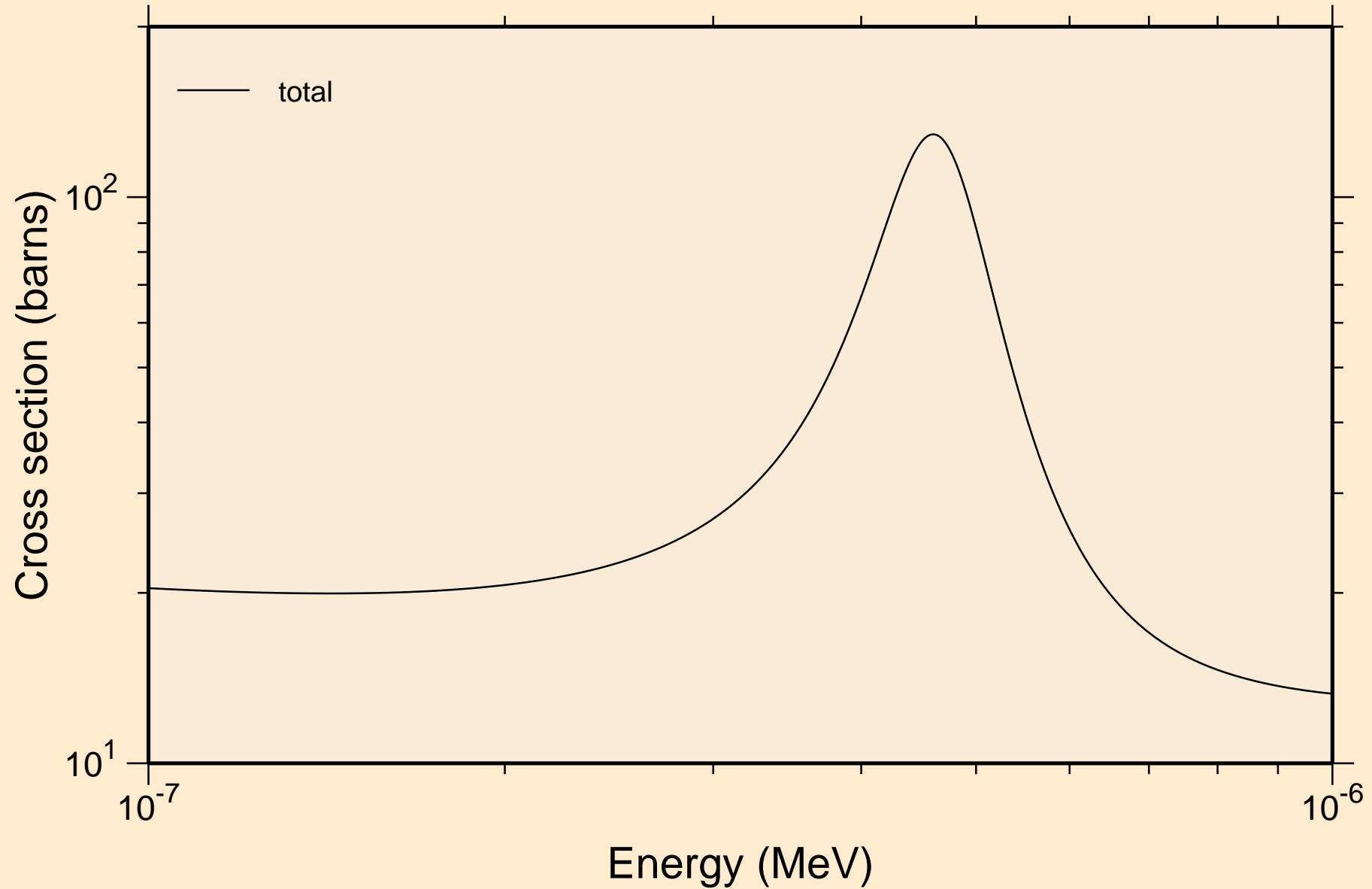

TH239 NEUTRON ACER TENDL-2021 LIBRARY; T=293.6K  
resonance total cross section

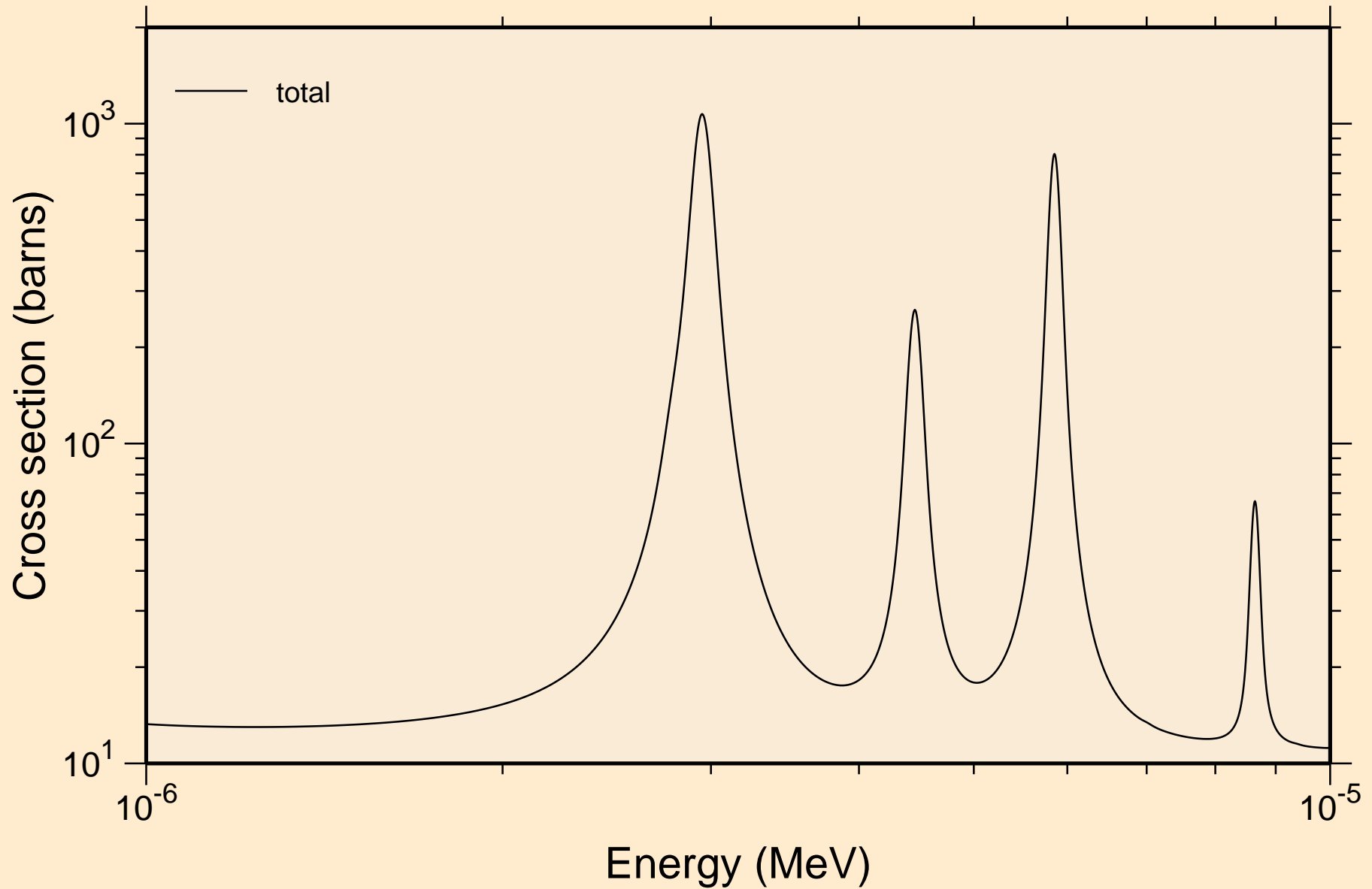

TH239 NEUTRON ACER TENDL-2021 LIBRARY; T=293.6K  
resonance total cross section

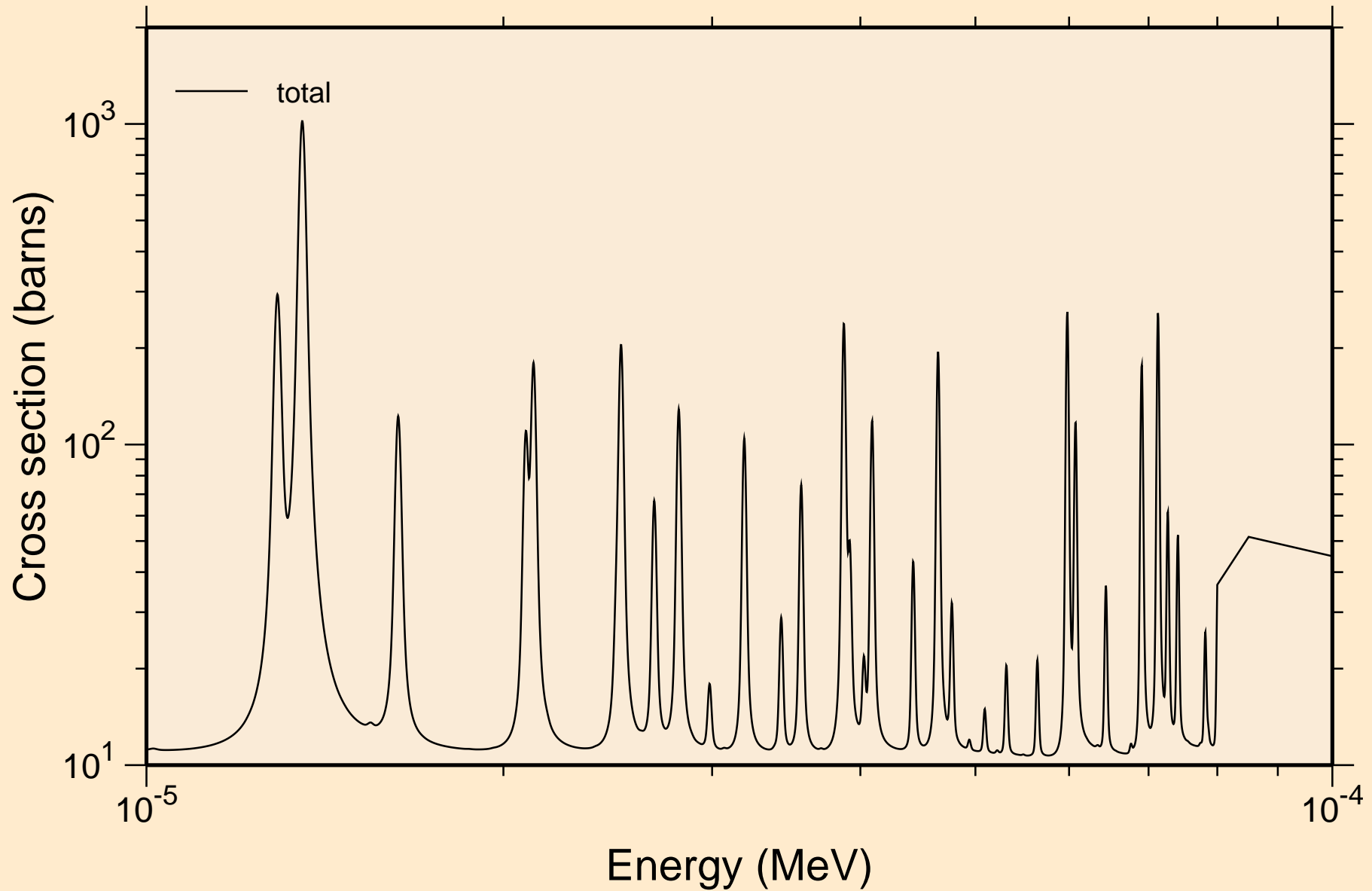

TH239 NEUTRON ACER TENDL-2021 LIBRARY; T=293.6K  
resonance total cross section

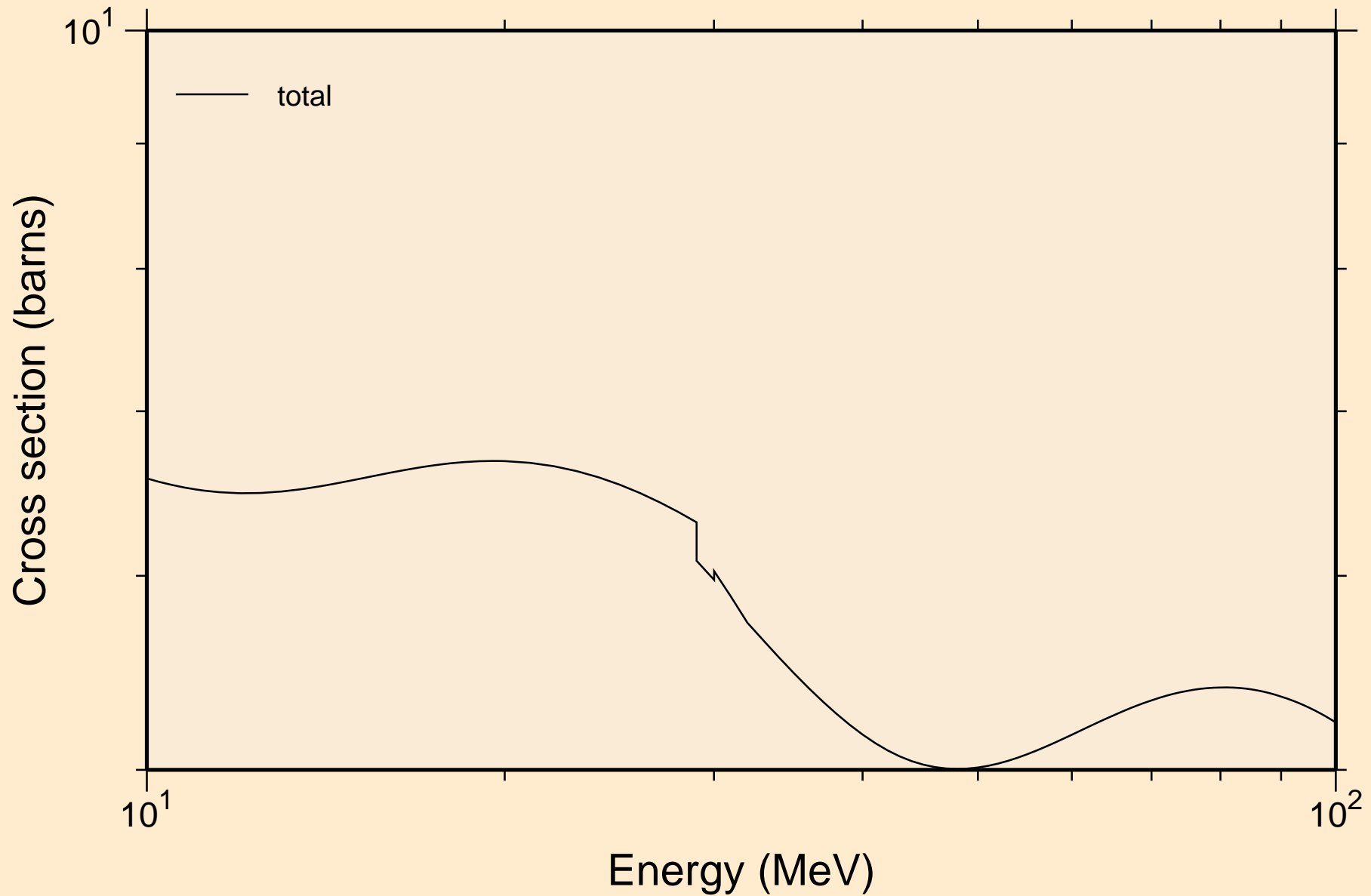

TH239 NEUTRON ACER TENDL-2021 LIBRARY; T=293.6K  
resonance absorption cross sections

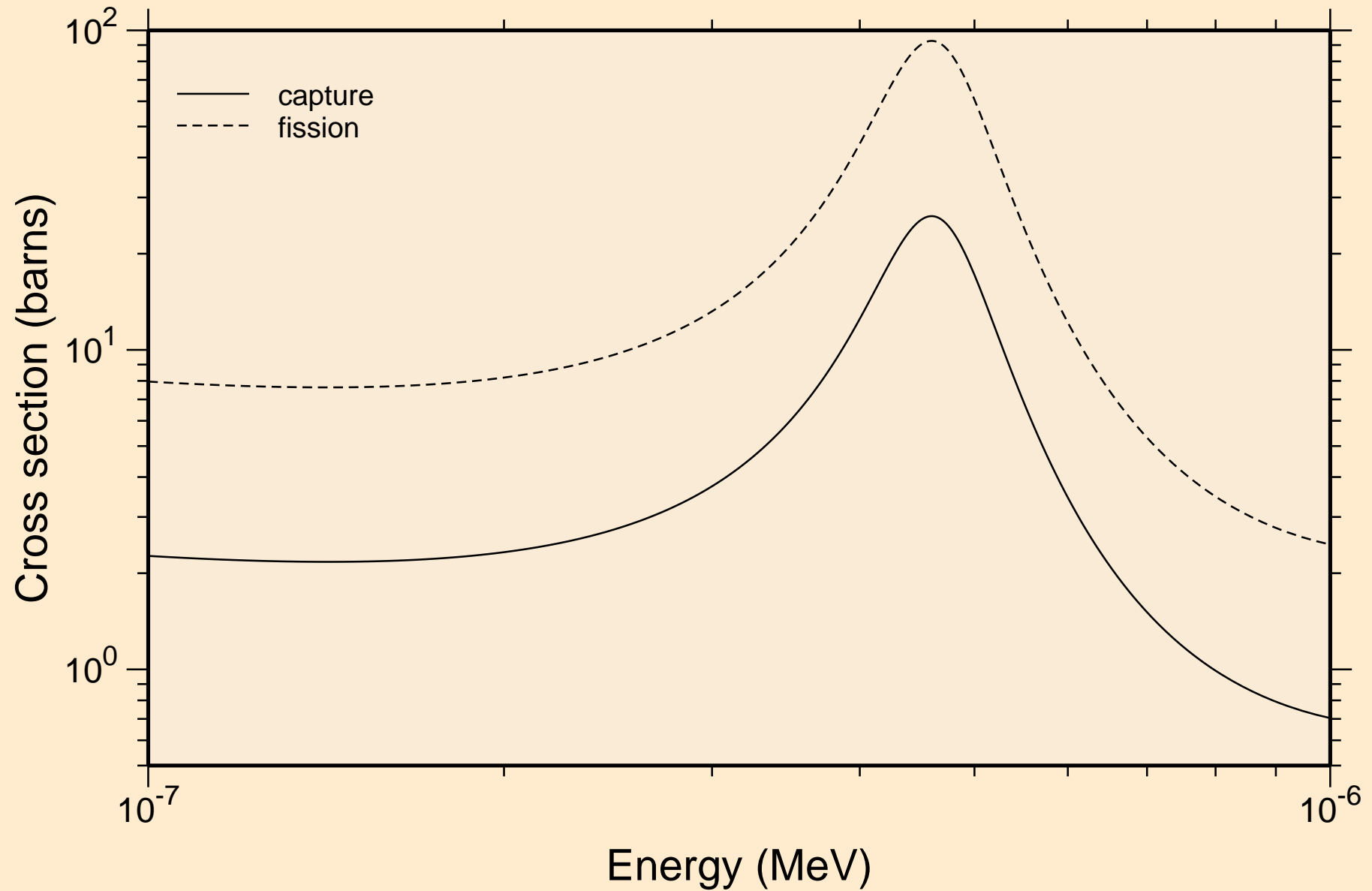

TH239 NEUTRON ACER TENDL-2021 LIBRARY; T=293.6K  
resonance absorption cross sections

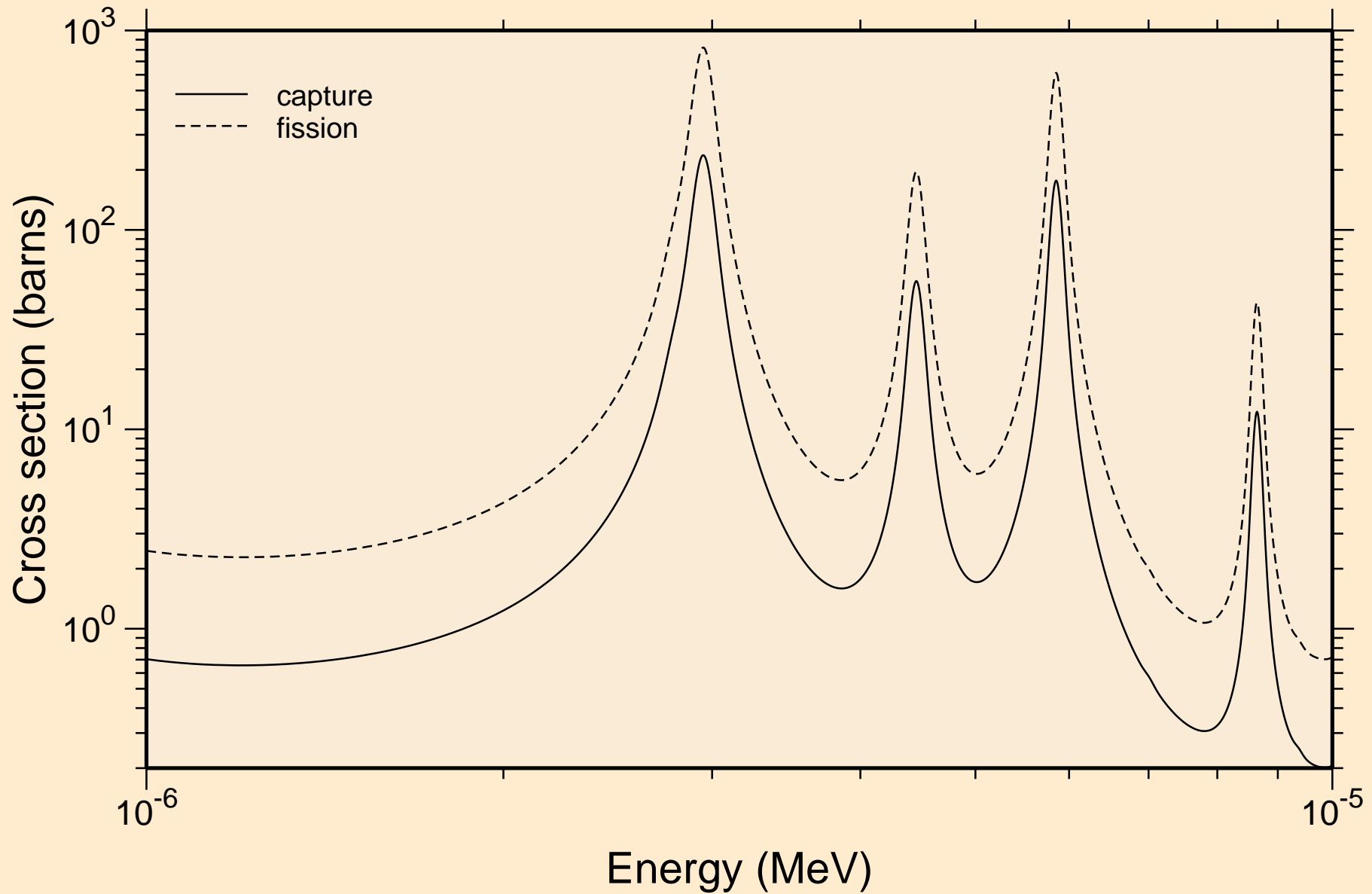

TH239 NEUTRON ACER TENDL-2021 LIBRARY; T=293.6K  
resonance absorption cross sections

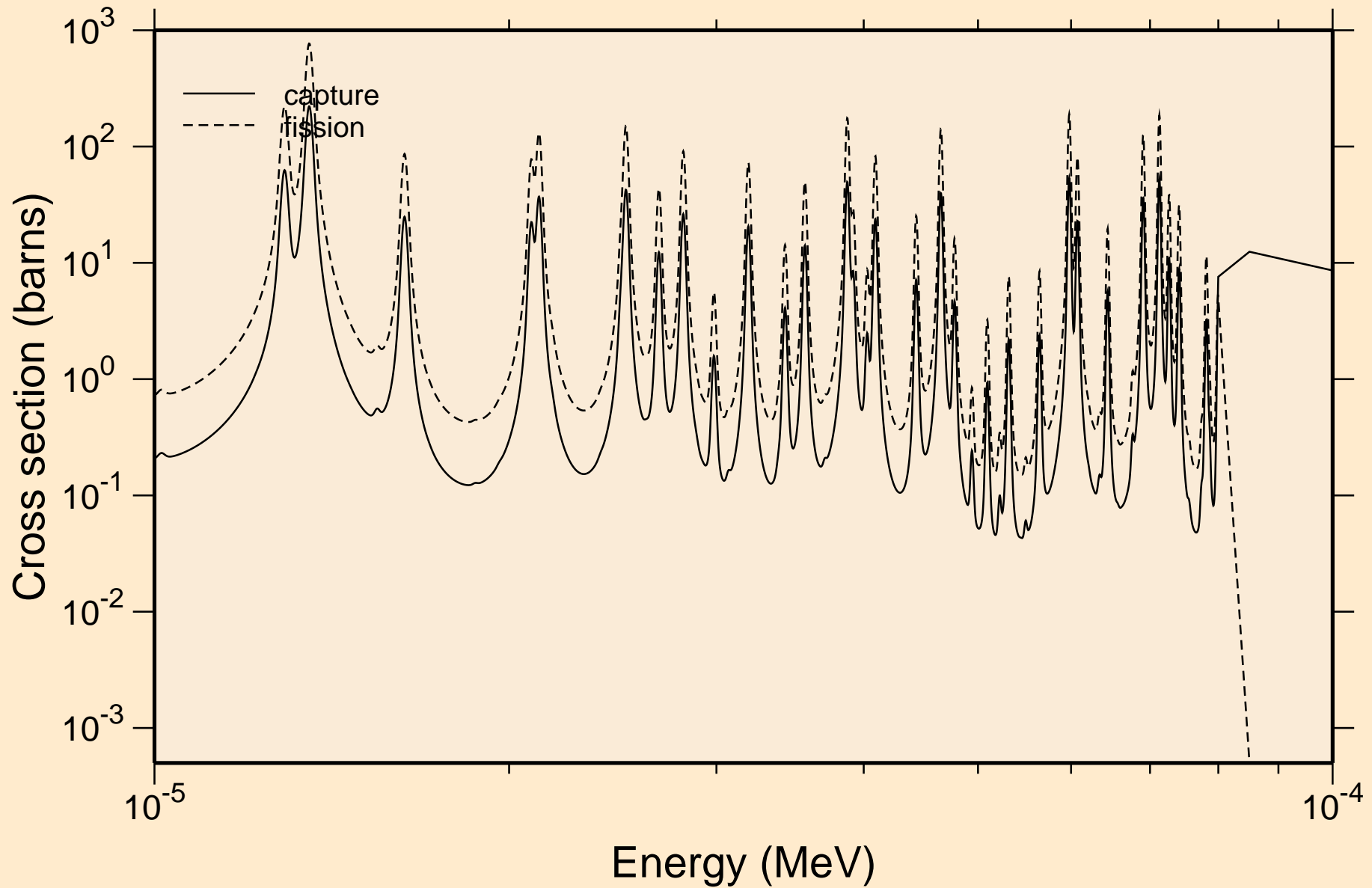



TH239 NEUTRON ACER TENDL-2021 LIBRARY; T=293.6K  
resonance absorption cross sections

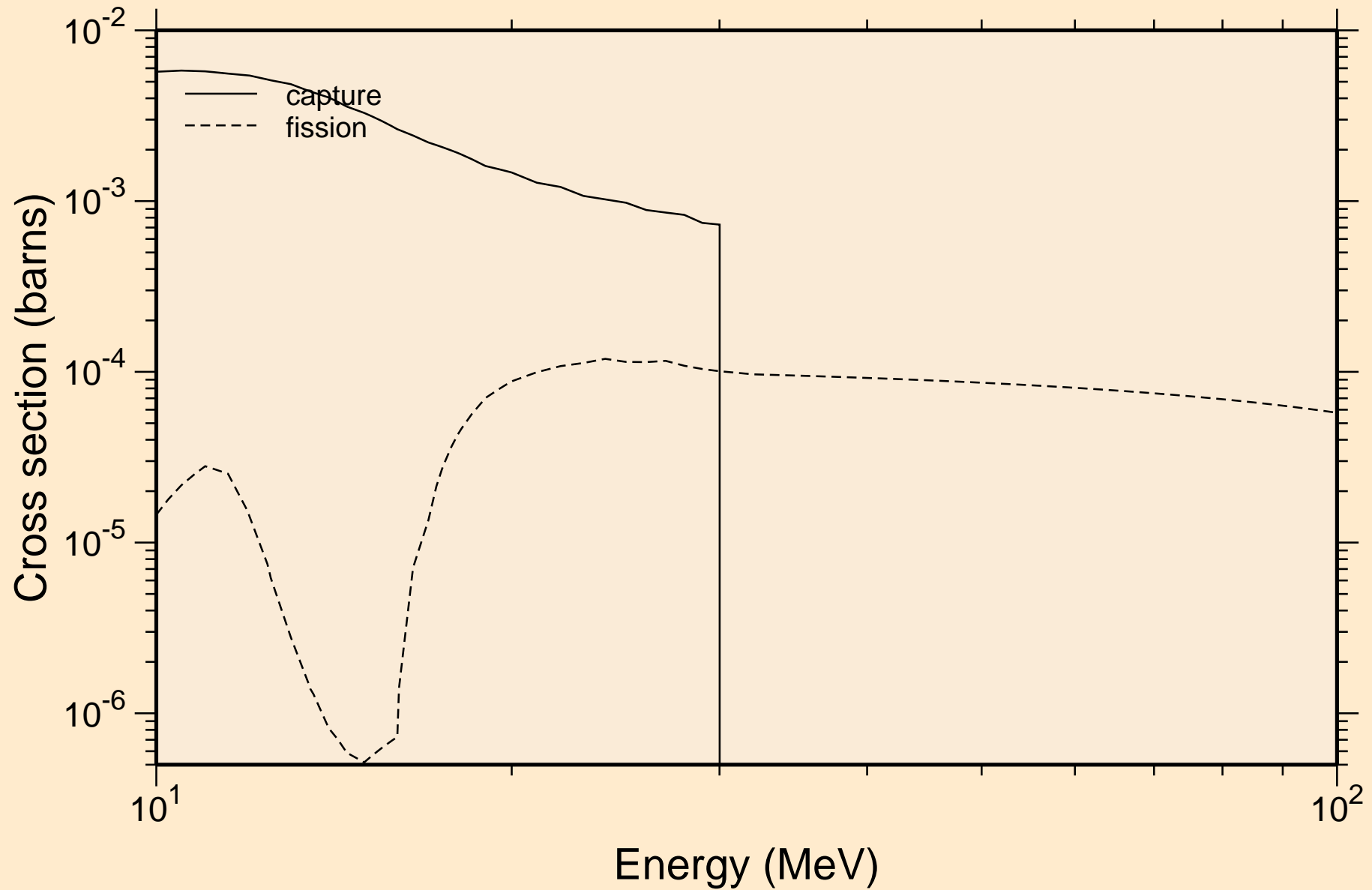

TH239 NEUTRON ACER TENDL-2021 LIBRARY; T=293.6K  
Heating

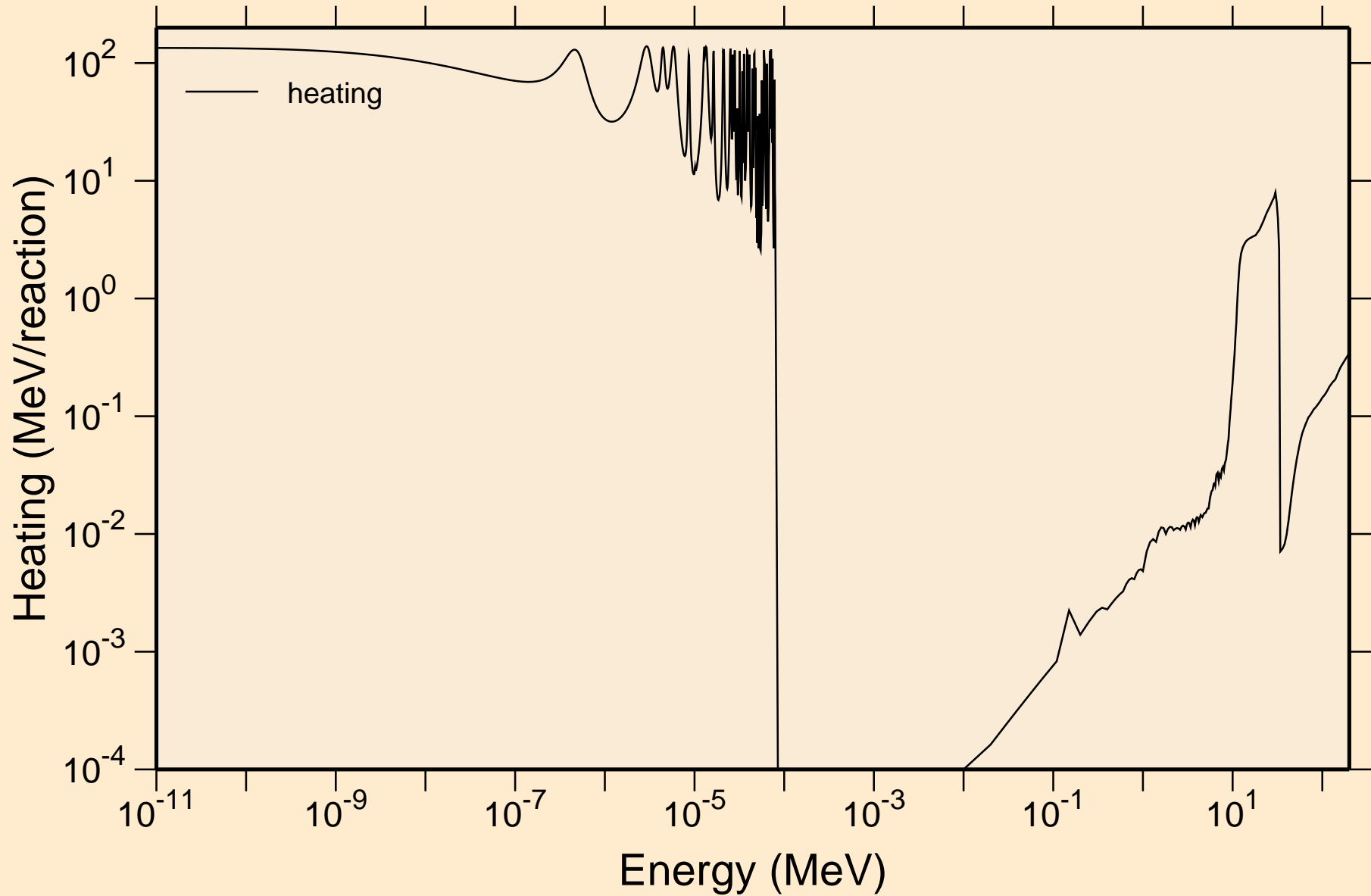

TH239 NEUTRON ACER TENDL-2021 LIBRARY; T=293.6K  
Damage

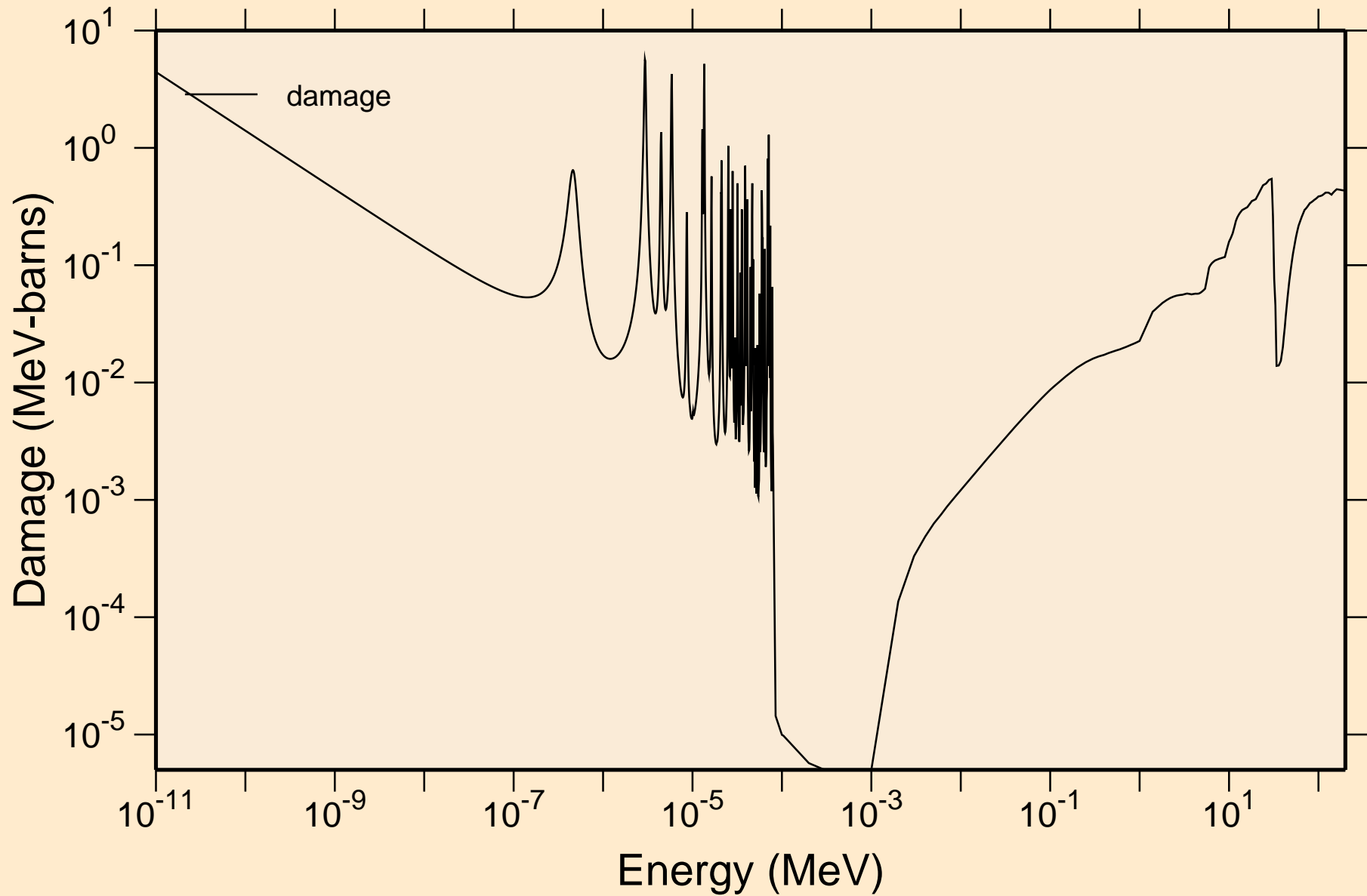

TH239 NEUTRON ACER TENDL-2021 LIBRARY; T=293.6K  
Non-threshold reactions

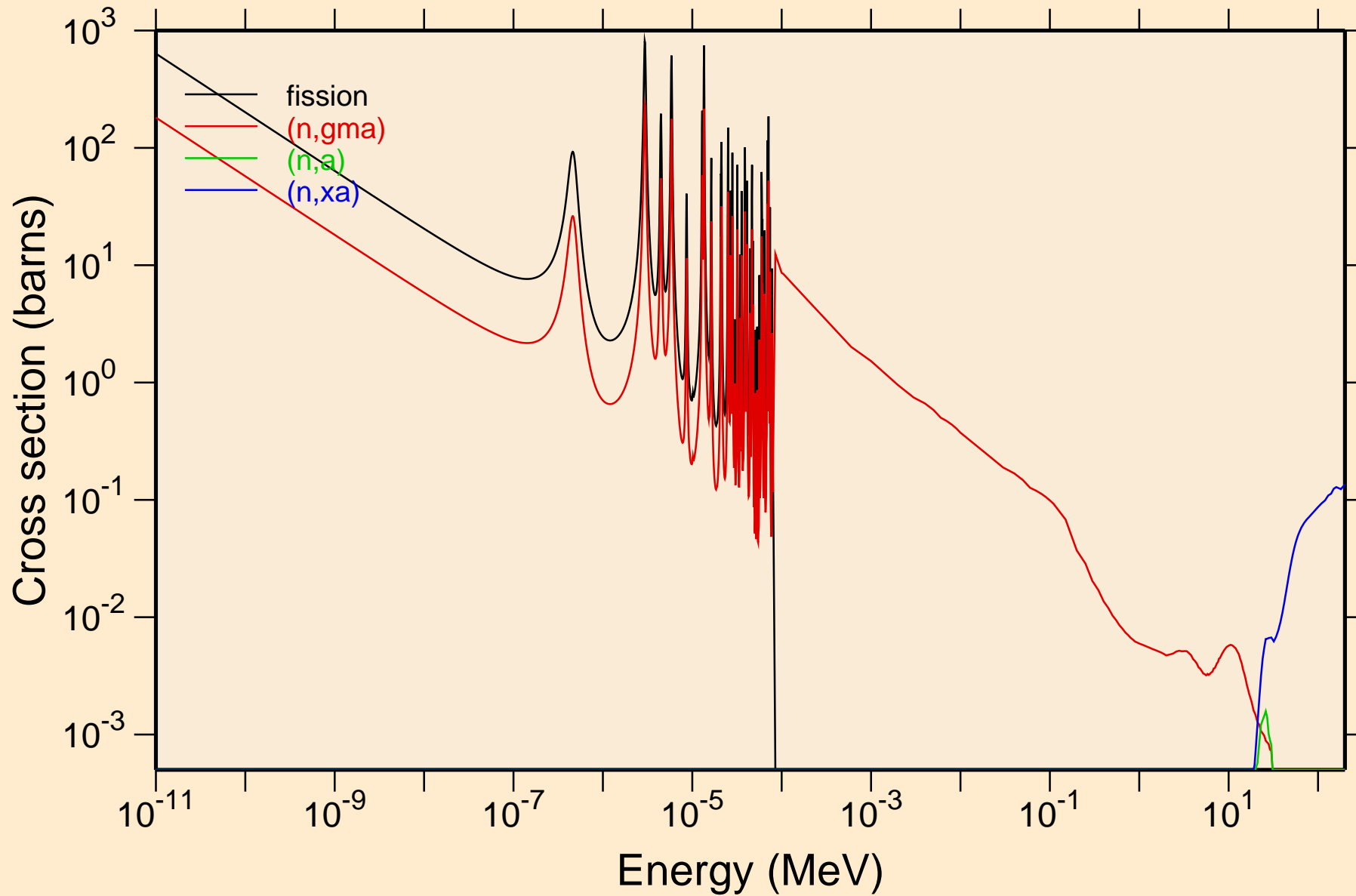

# TH239 NEUTRON ACER TENDL-2021 LIBRARY; T=293.6K

## Principal cross sections

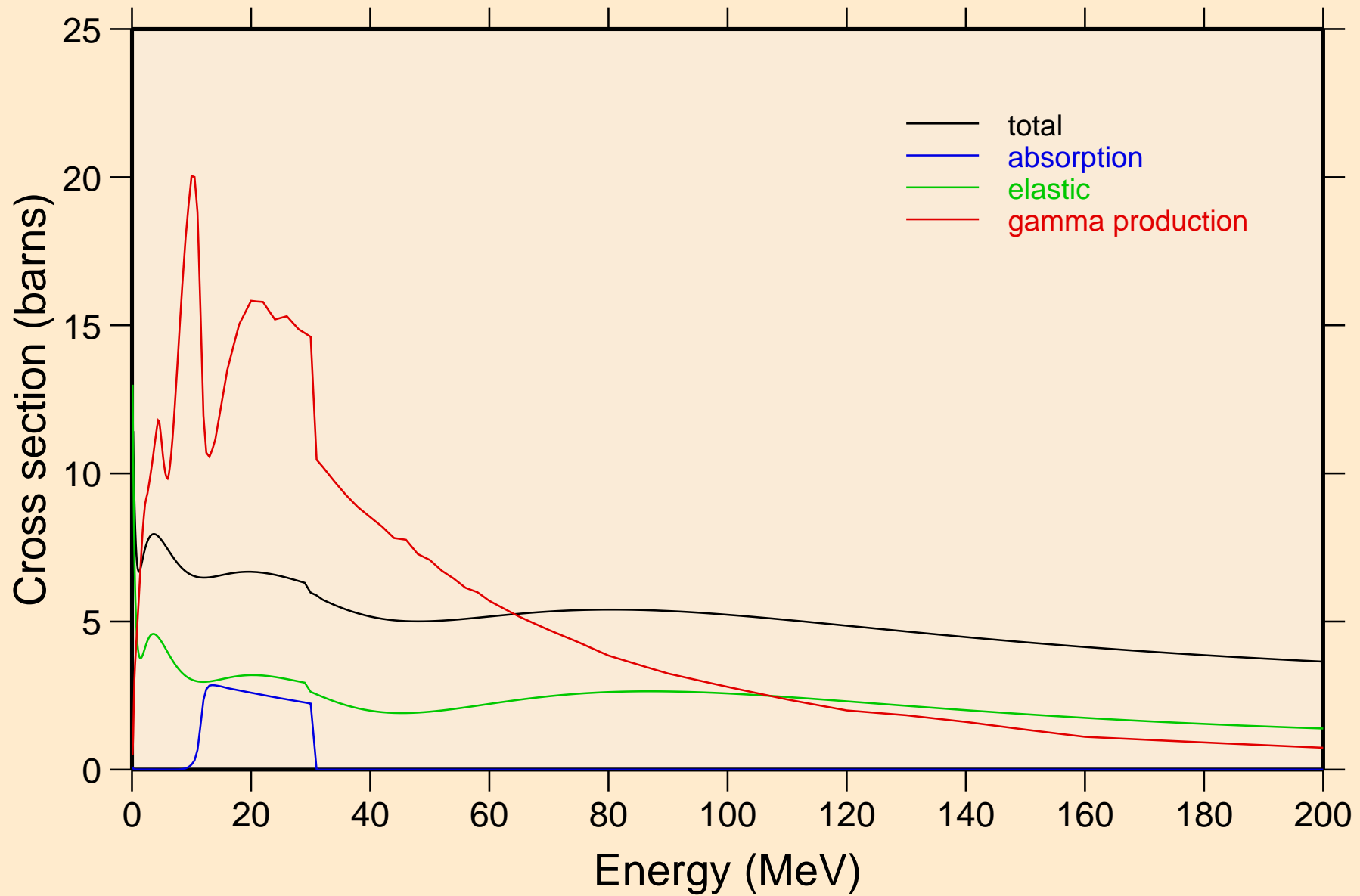

# TH239 NEUTRON ACER TENDL-2021 LIBRARY; T=293.6K

## Heating

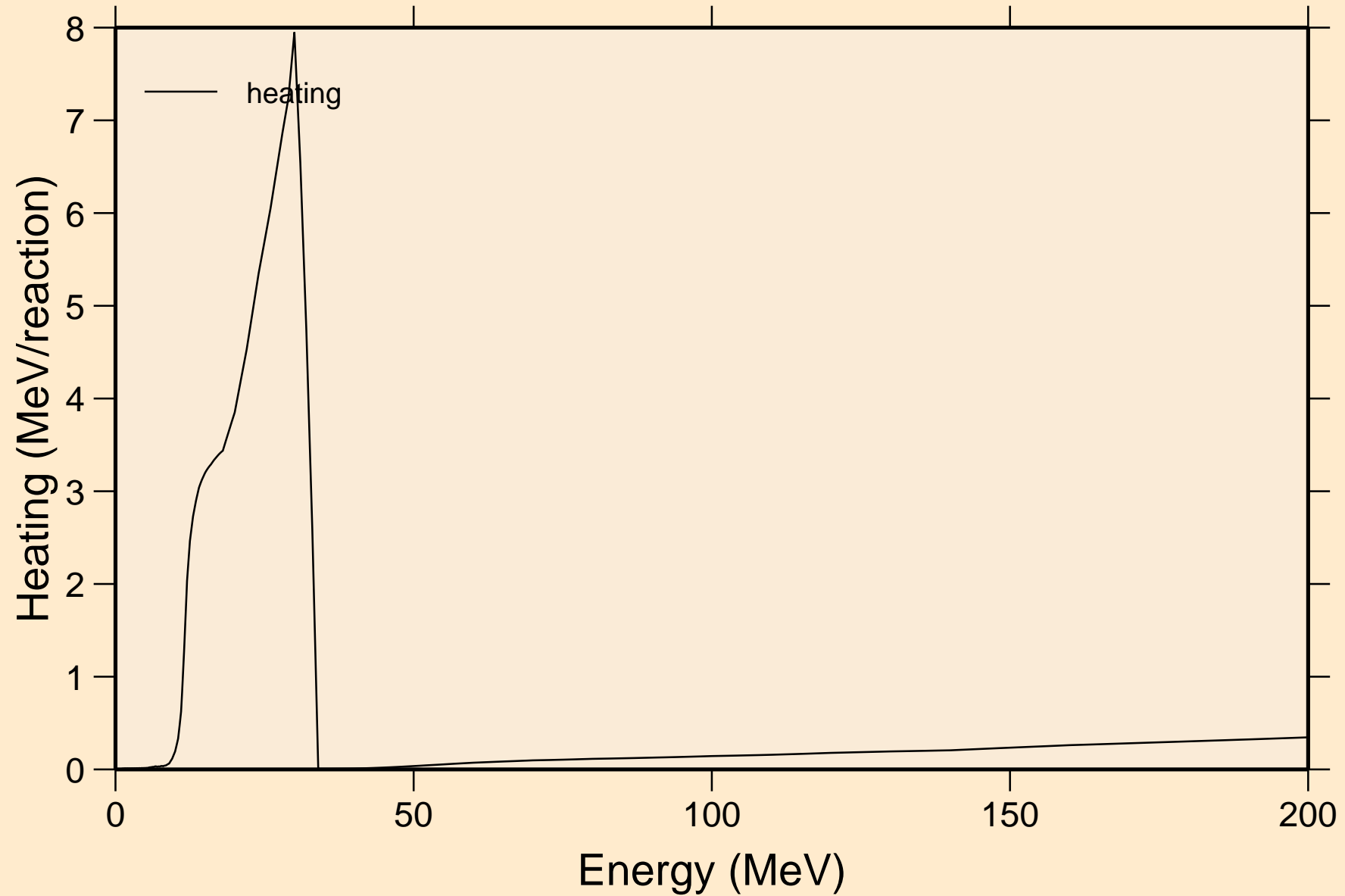

TH239 NEUTRON ACER TENDL-2021 LIBRARY; T=293.6K  
Damage

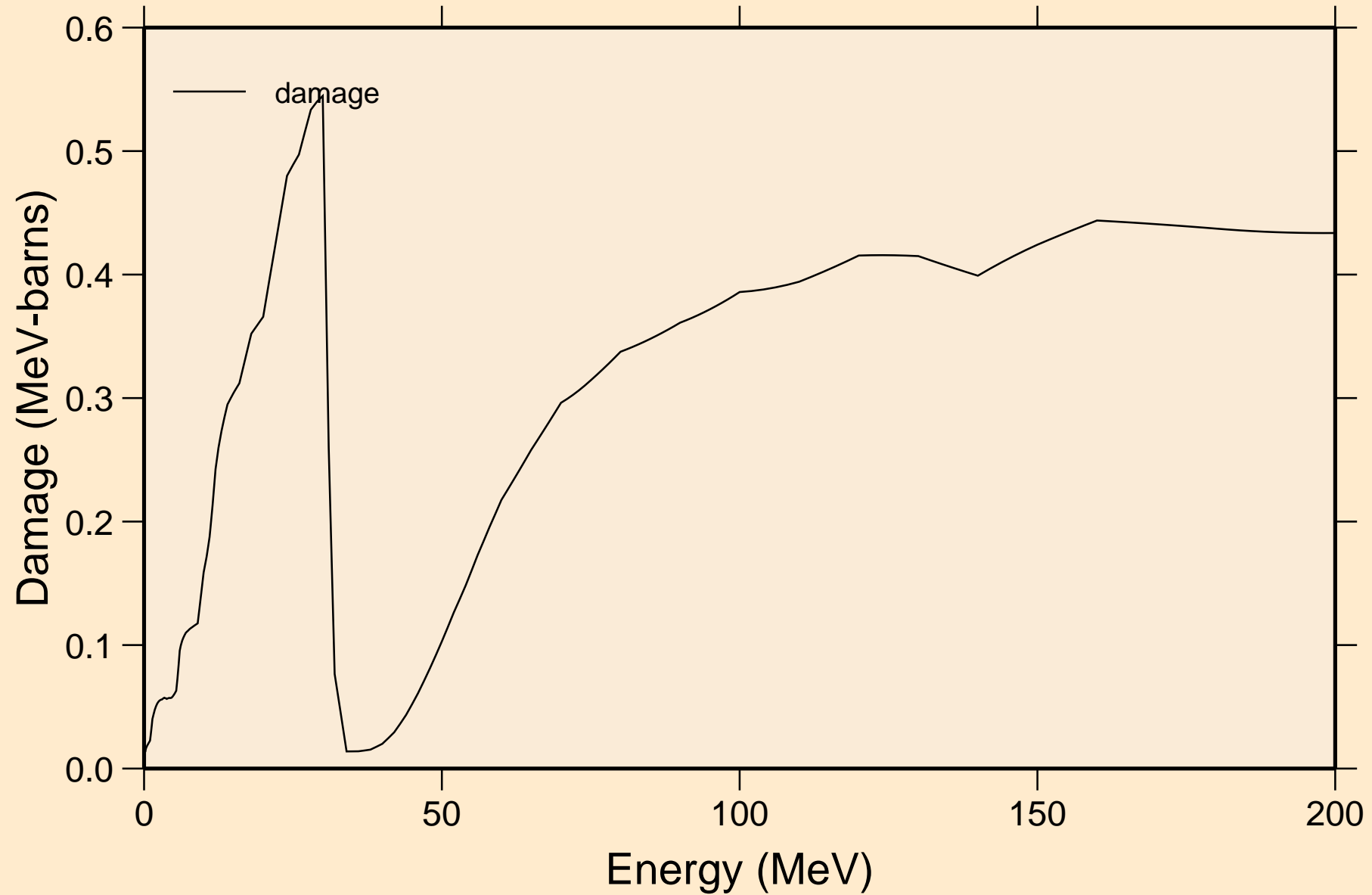

TH239 NEUTRON ACER TENDL-2021 LIBRARY; T=293.6K  
Non-threshold reactions

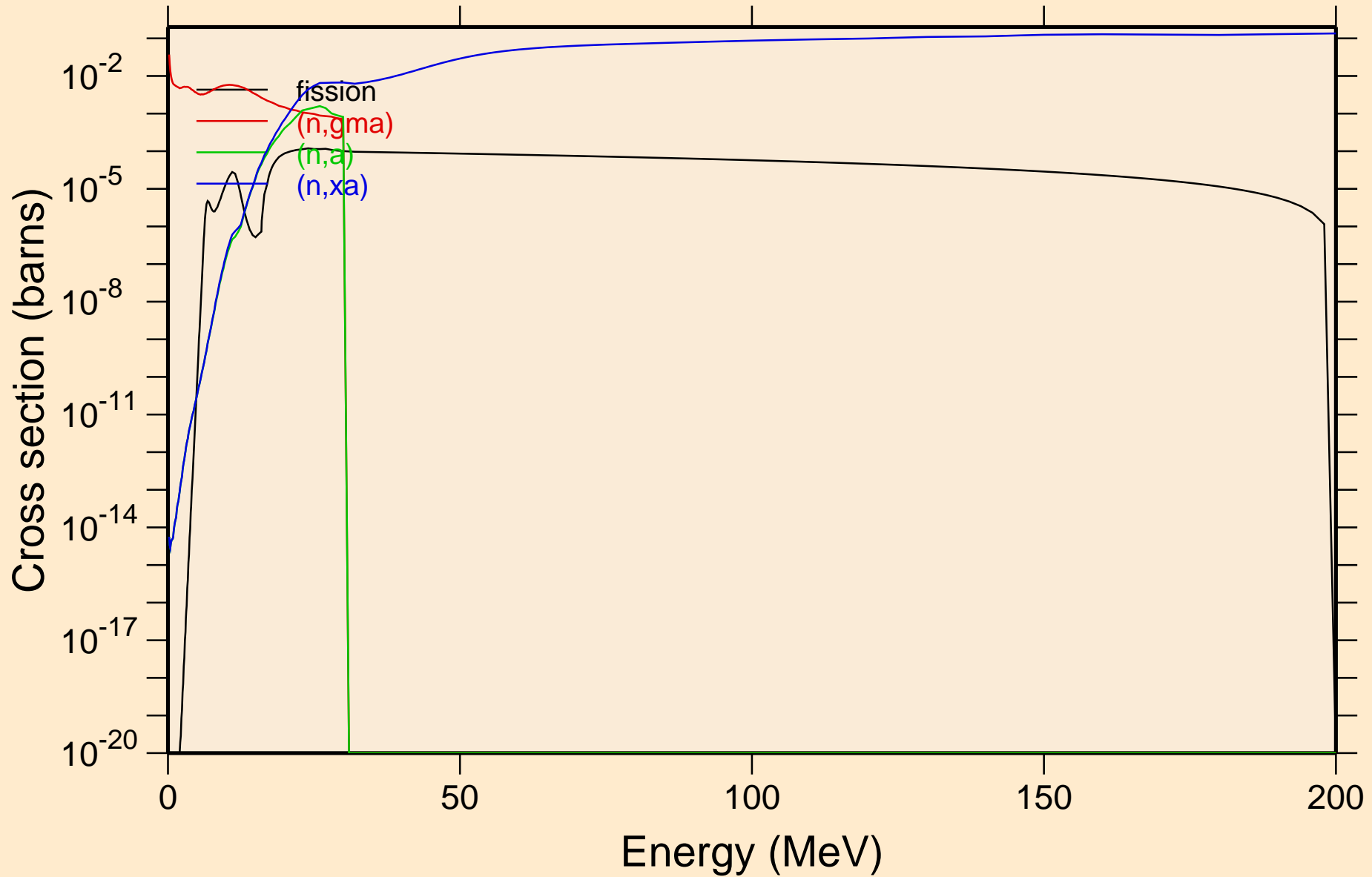



TH239 NEUTRON ACER TENDL-2021 LIBRARY; T=293.6K  
Inelastic levels

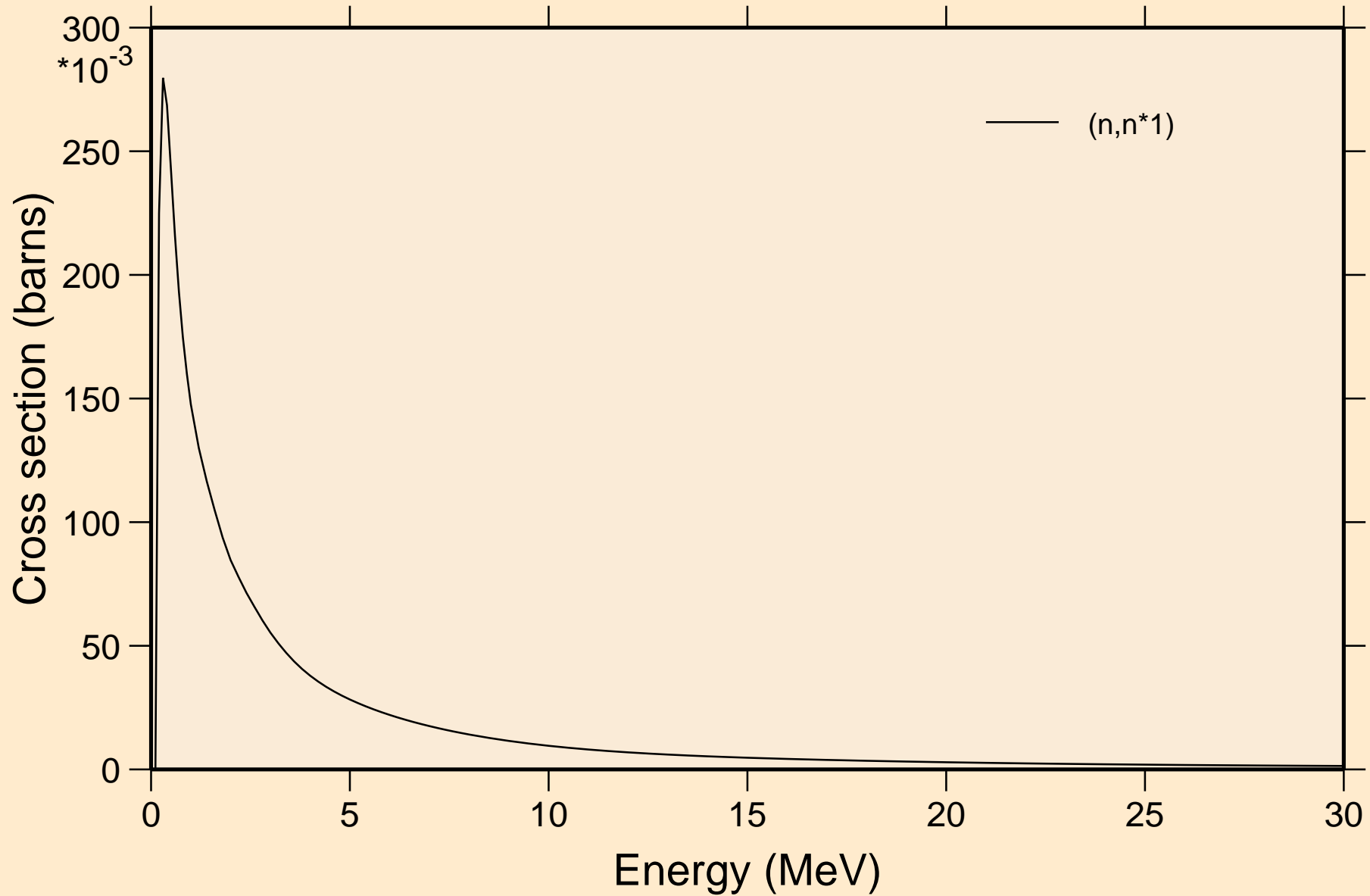

TH239 NEUTRON ACER TENDL-2021 LIBRARY; T=293.6K  
Threshold reactions

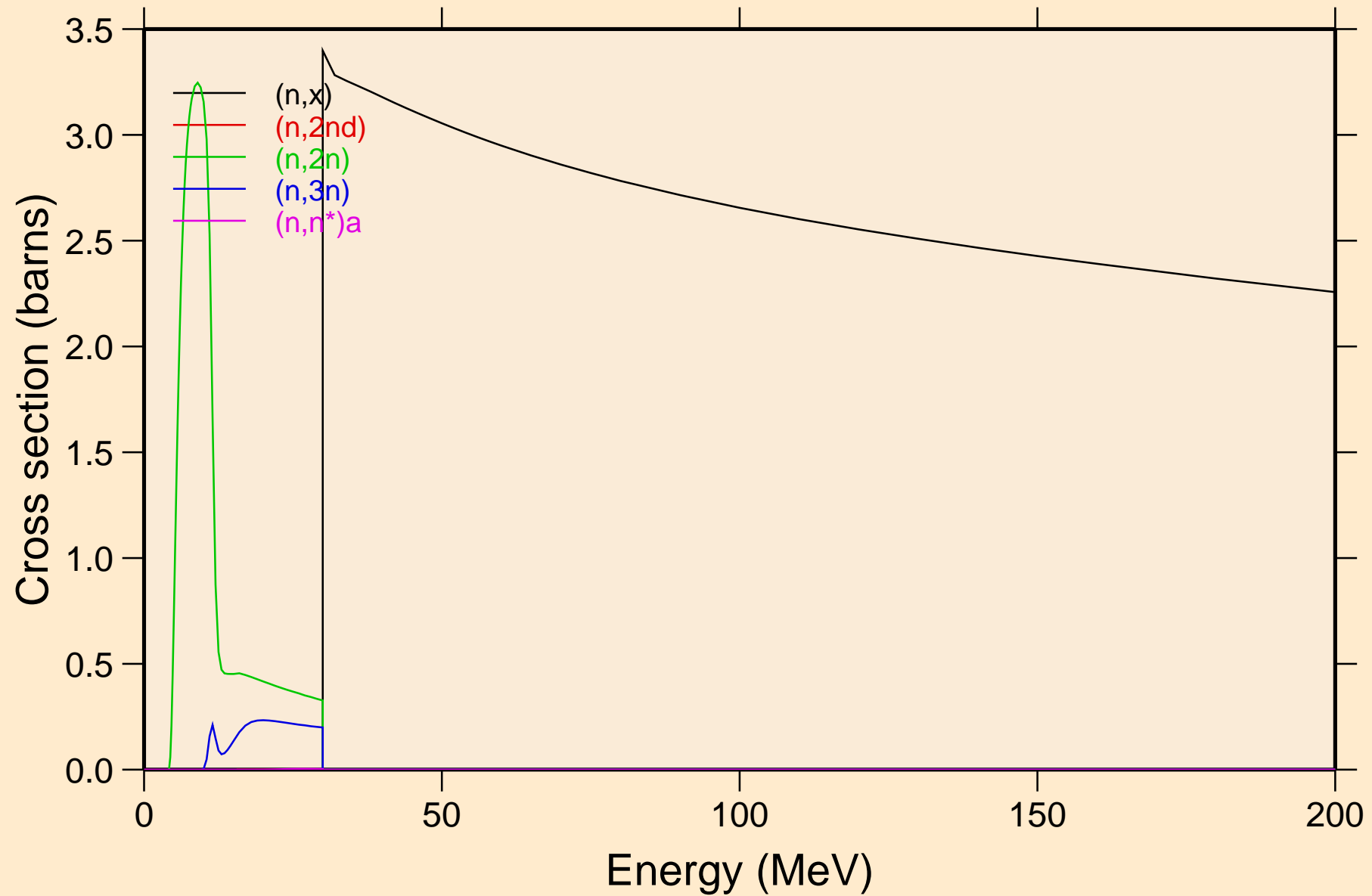

TH239 NEUTRON ACER TENDL-2021 LIBRARY; T=293.6K  
Threshold reactions

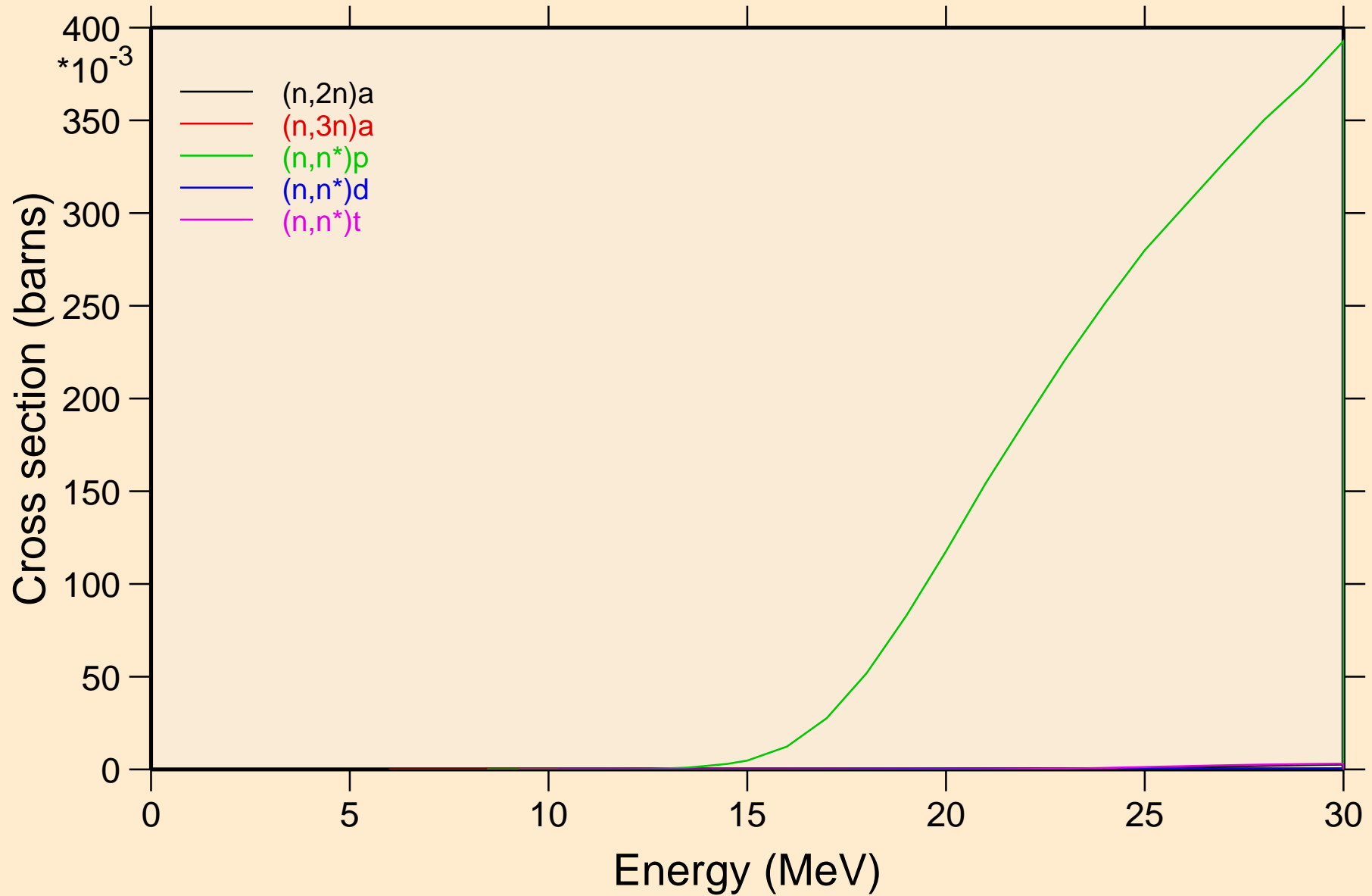

TH239 NEUTRON ACER TENDL-2021 LIBRARY; T=293.6K  
Threshold reactions

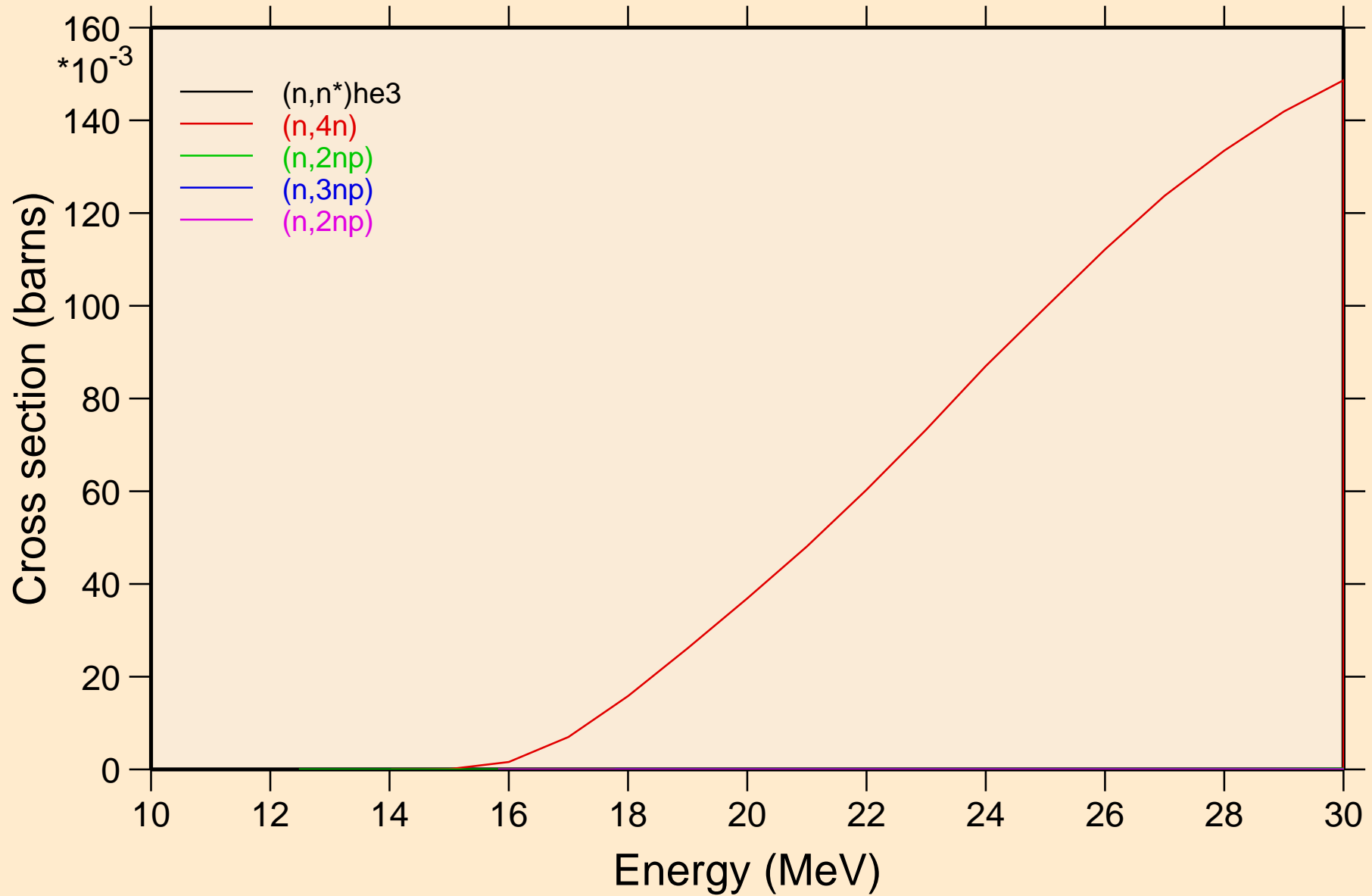

TH239 NEUTRON ACER TENDL-2021 LIBRARY; T=293.6K  
Threshold reactions

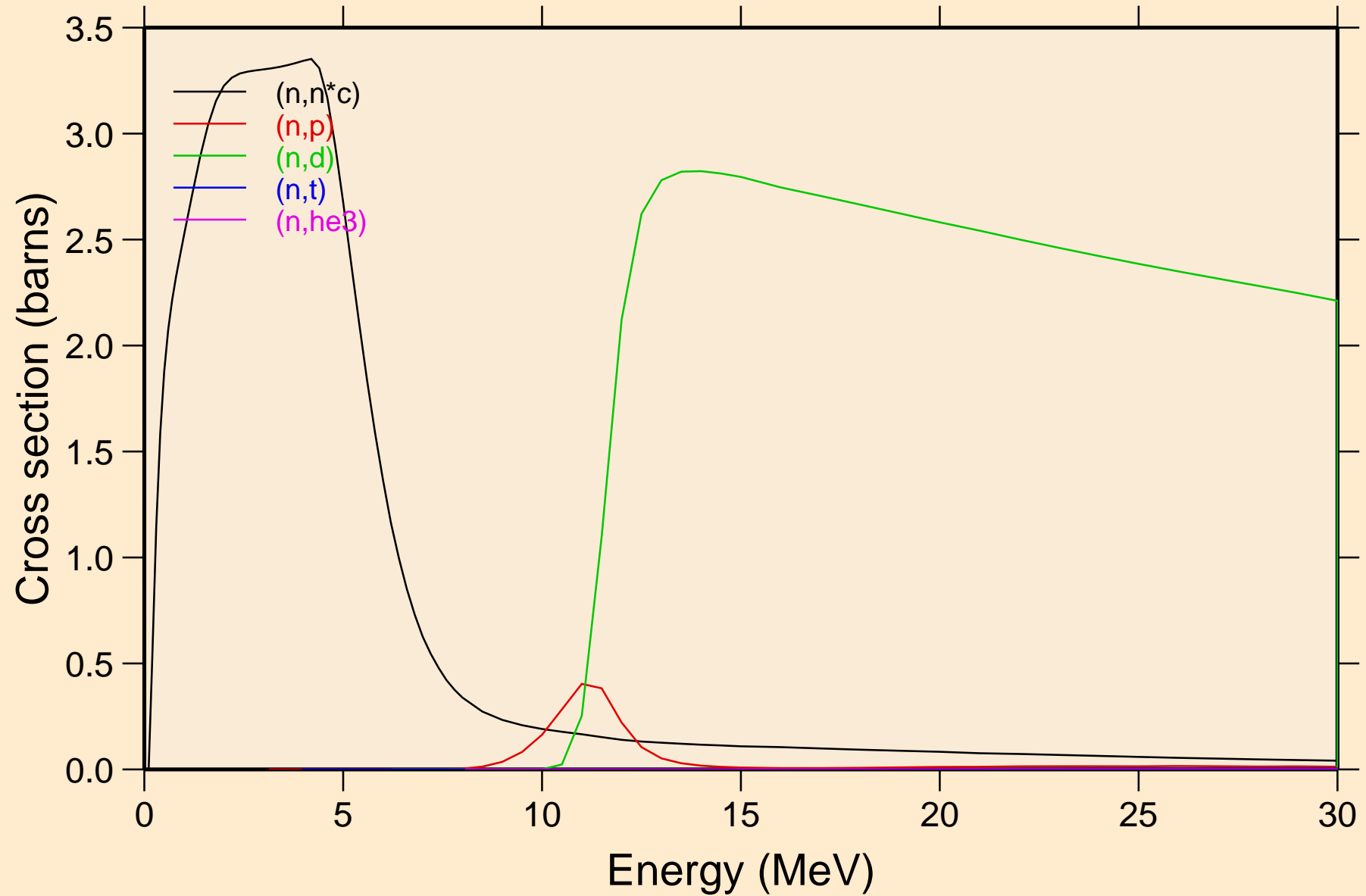

TH239 NEUTRON ACER TENDL-2021 LIBRARY; T=293.6K  
Threshold reactions

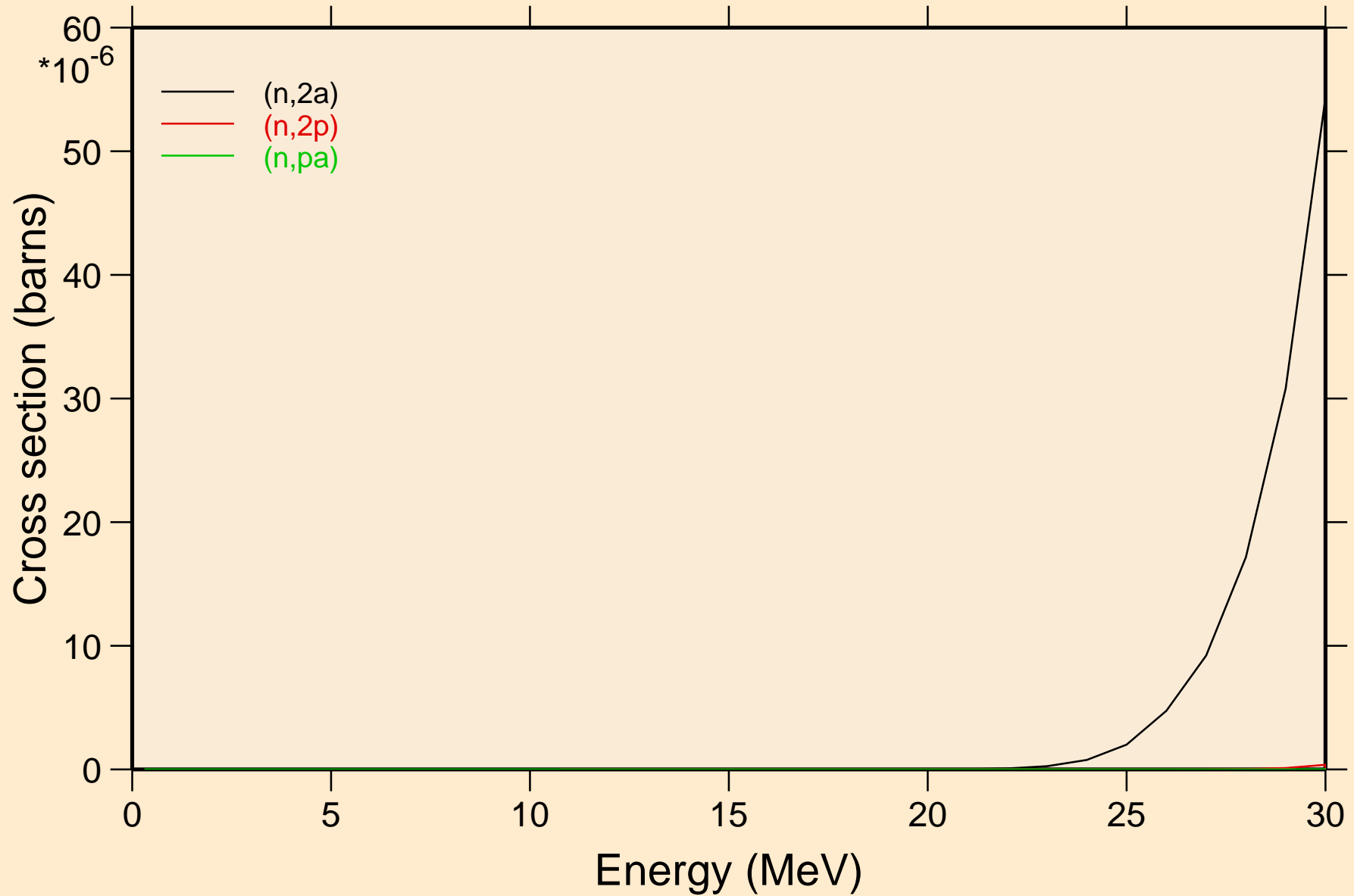

TH239 NEUTRON ACER TENDL-2021 LIBRARY; T=293.6K  
Threshold reactions

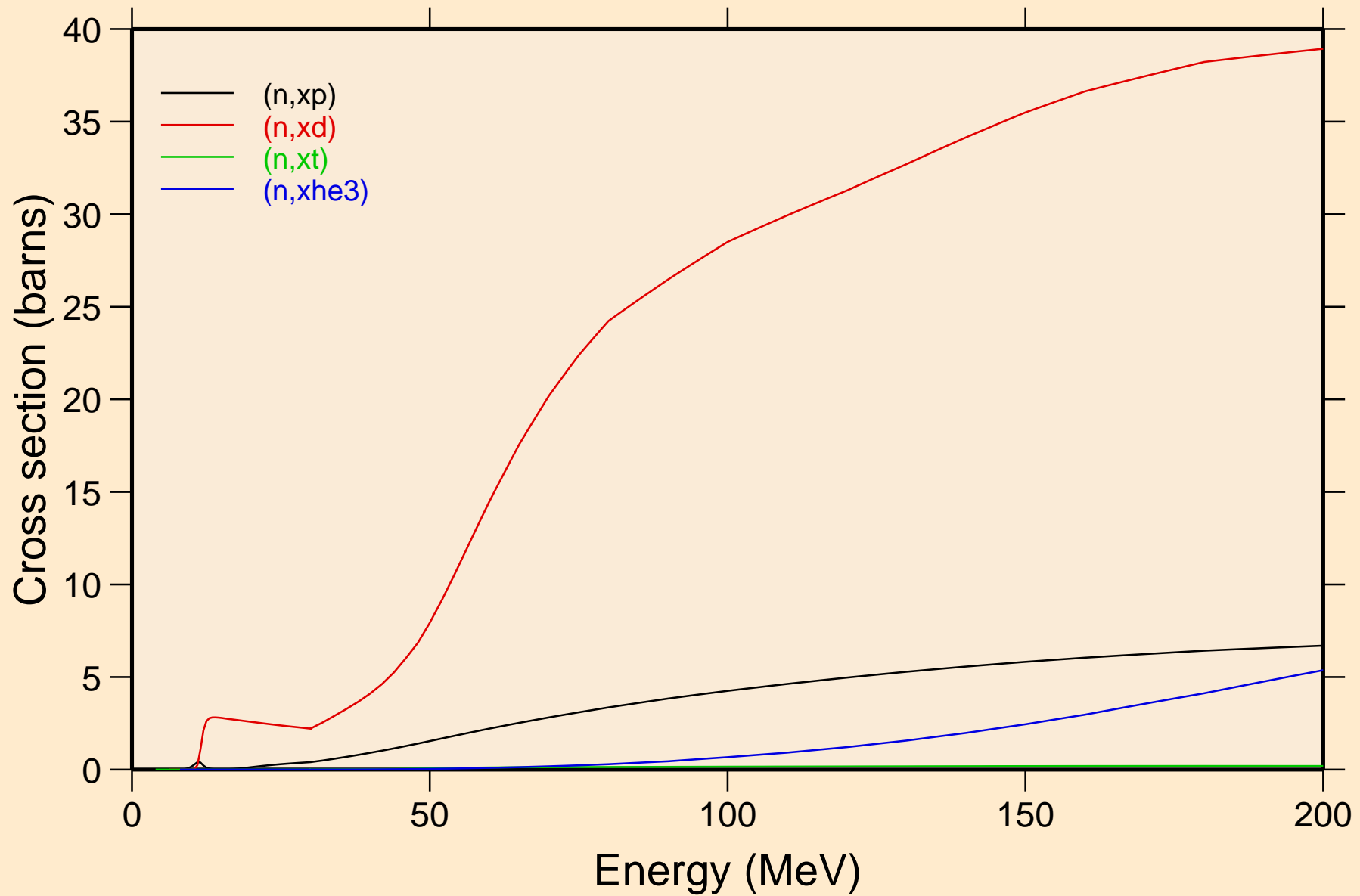

TH239 NEUTRON ACER TENDL-2021 LIBRARY; T=293.6K  
angular distribution for elastic

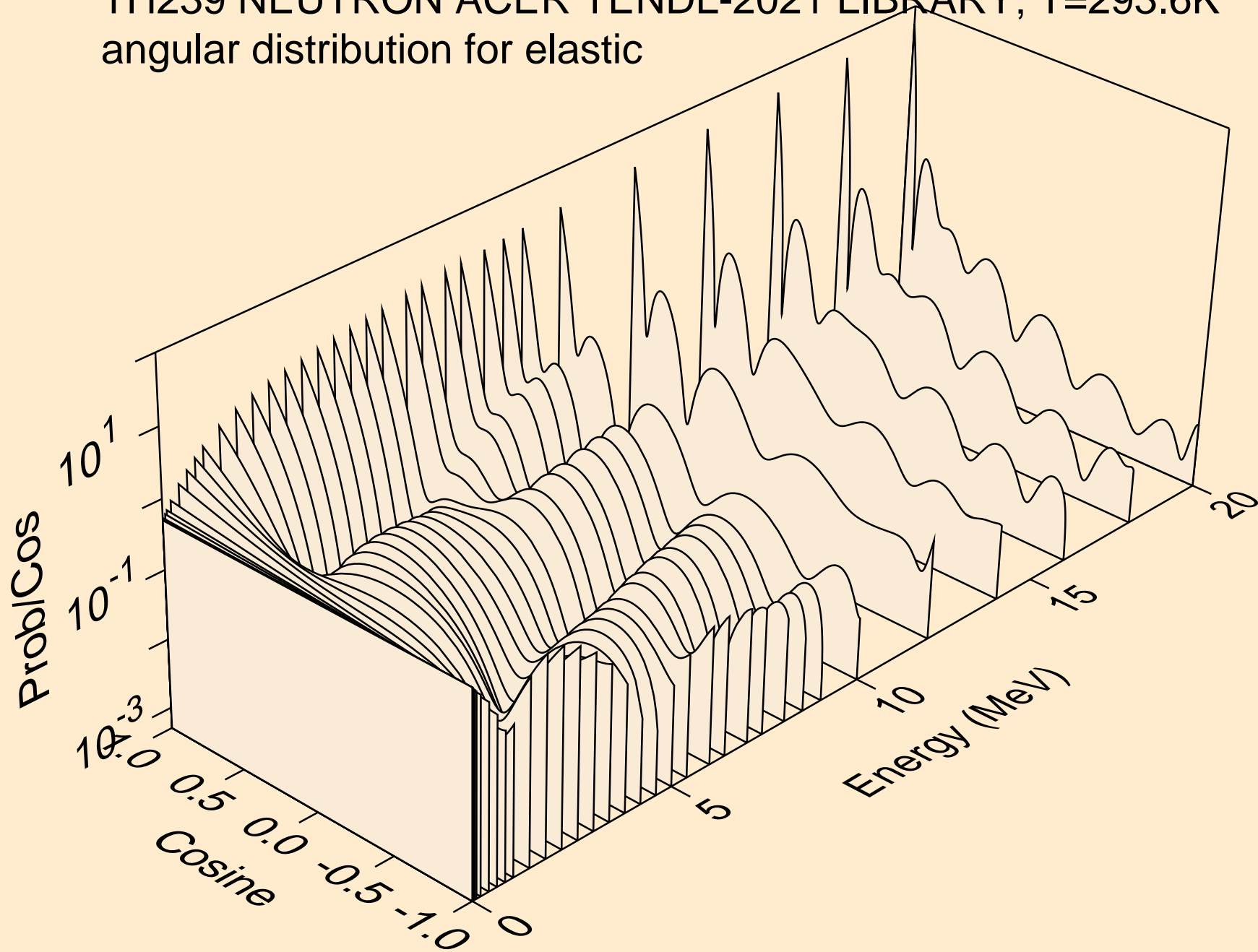



TH239 NEUTRON ACER TENDL-2021 LIBRARY; T=293.6K  
angular distribution for elastic

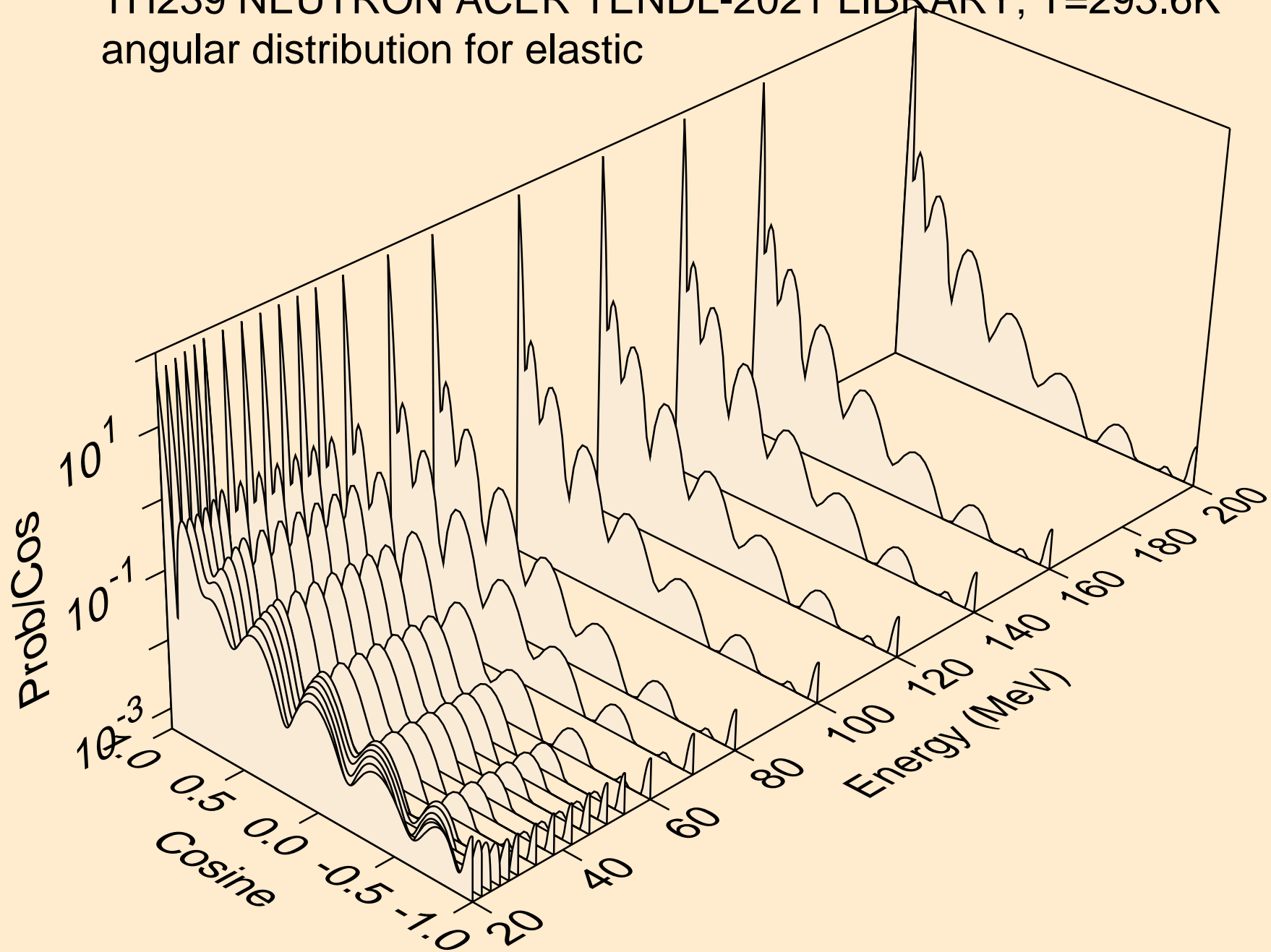

TH239 NEUTRON ACER TENDL-2021 LIBRARY; T=293.6K  
angular distribution for (n,n\*1)

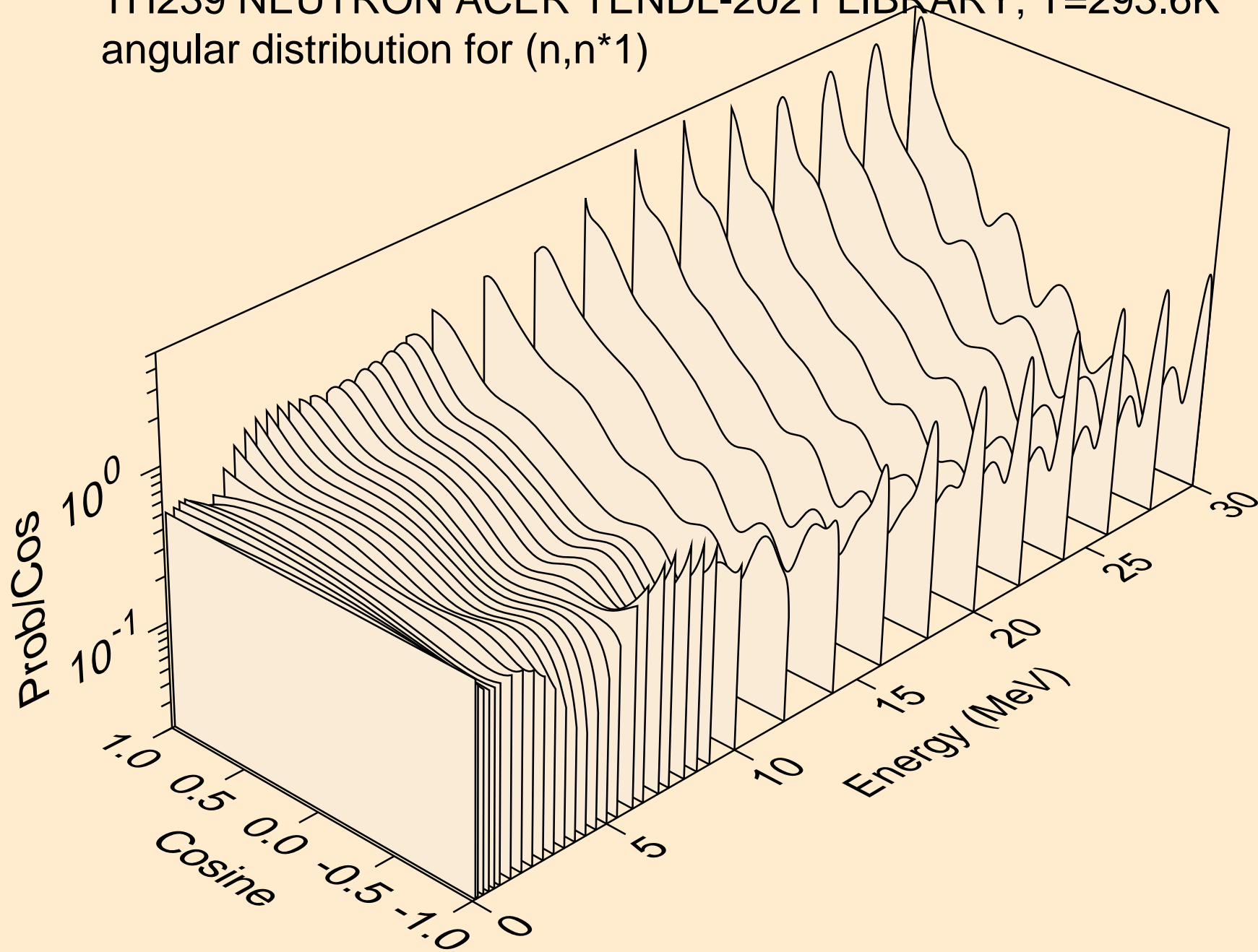

TH239 NEUTRON ACER TENDL-2021 LIBRARY; T=293.6K  
Total fission nubar

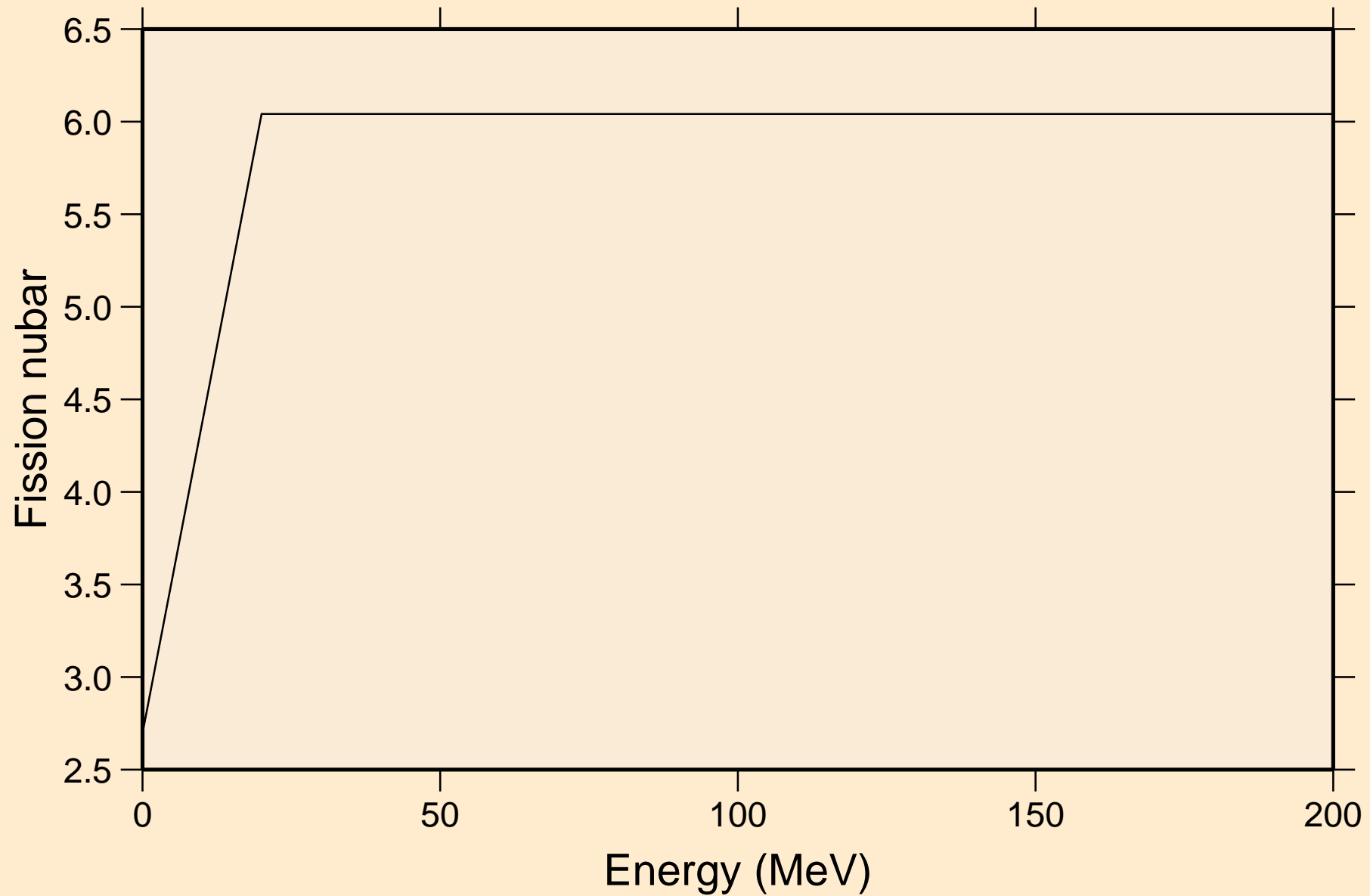

TH239 NEUTRON ACER TENDL-2021 LIBRARY; T=293.6K  
Neutron emission for (n,x)

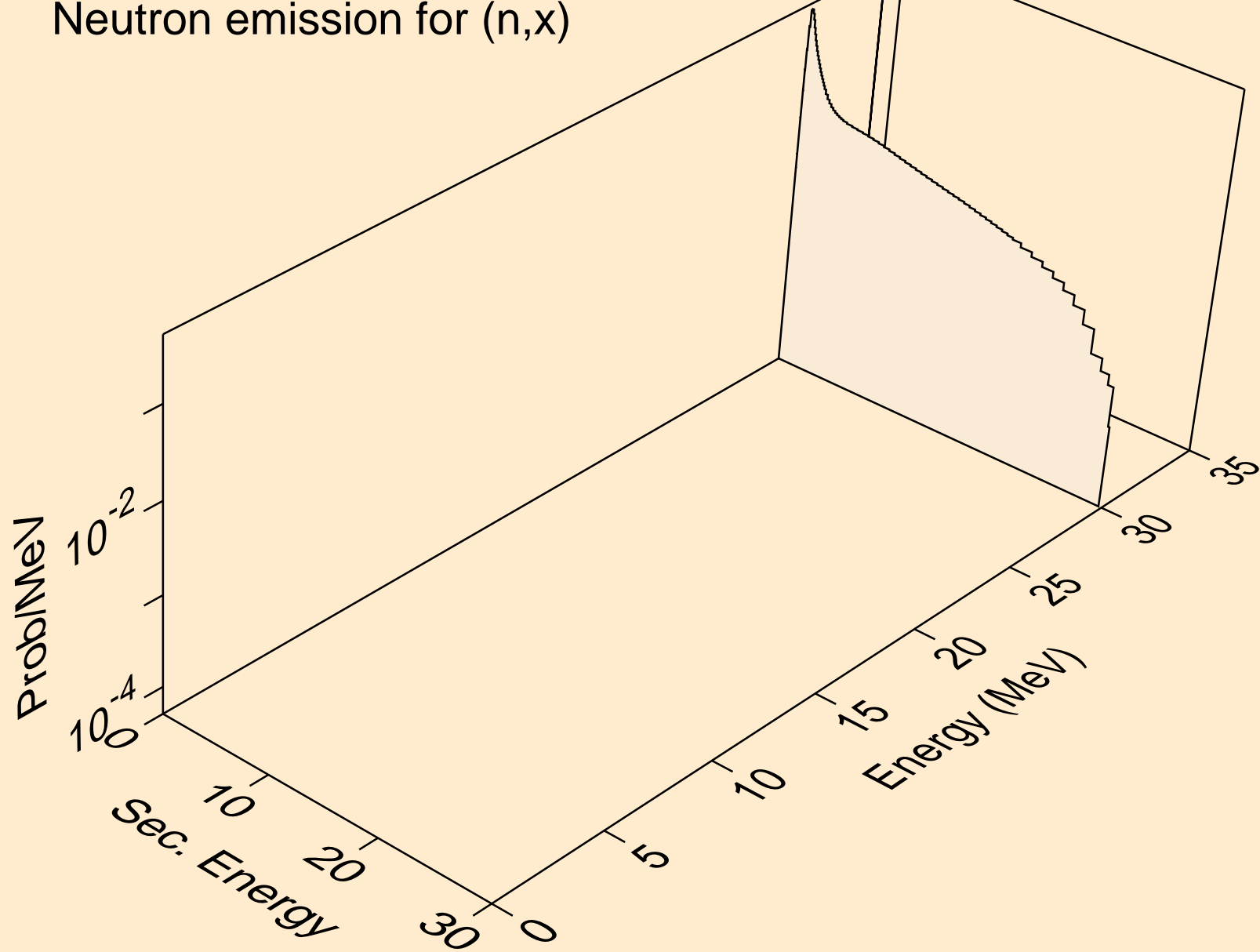

TH239 NEUTRON ACER TENDL-2021 LIBRARY; T=293.6K  
Neutron emission for (n,2nd)

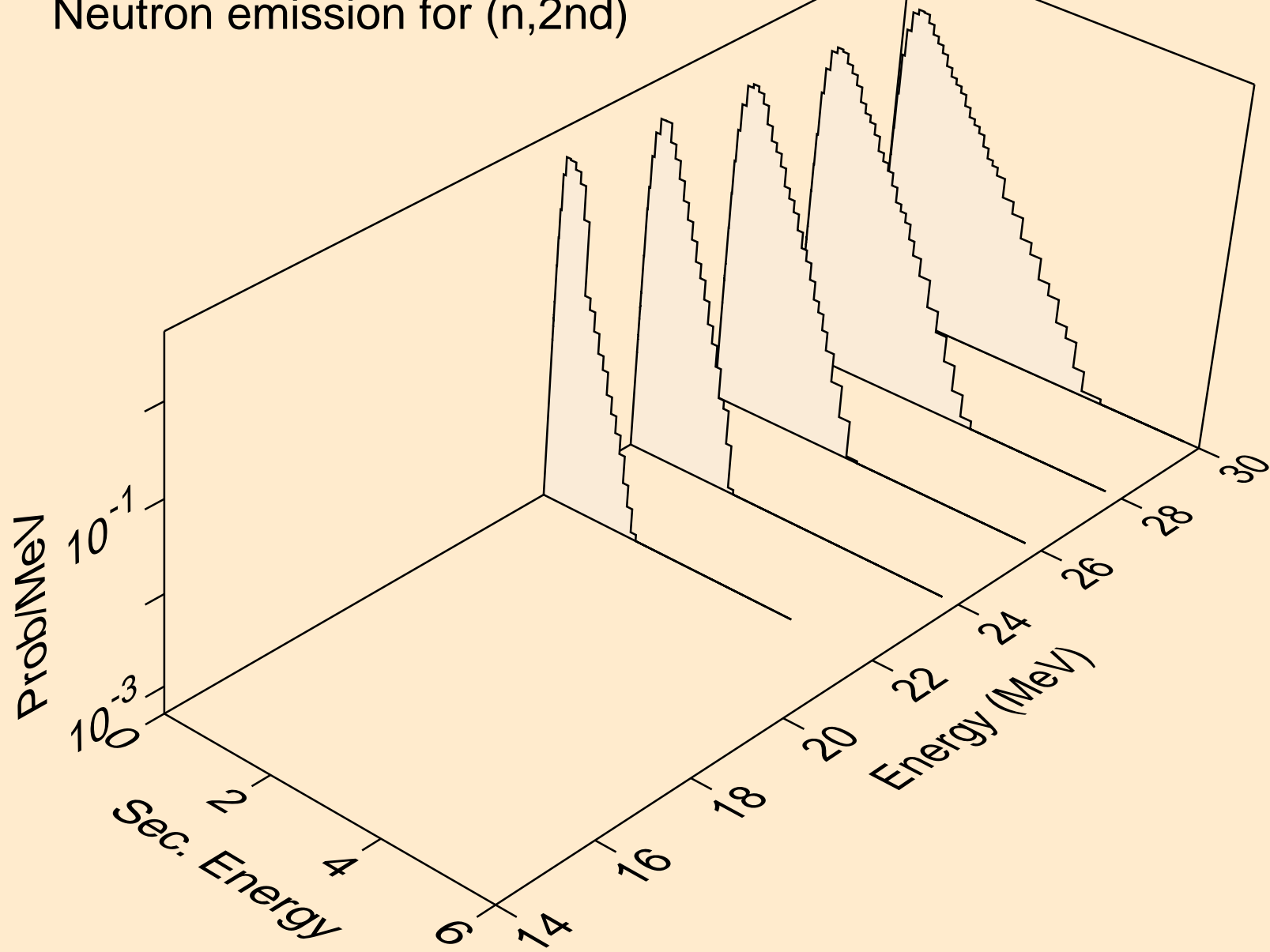

TH239 NEUTRON ACER TENDL-2021 LIBRARY; T=293.6K  
Neutron emission for (n,2n)

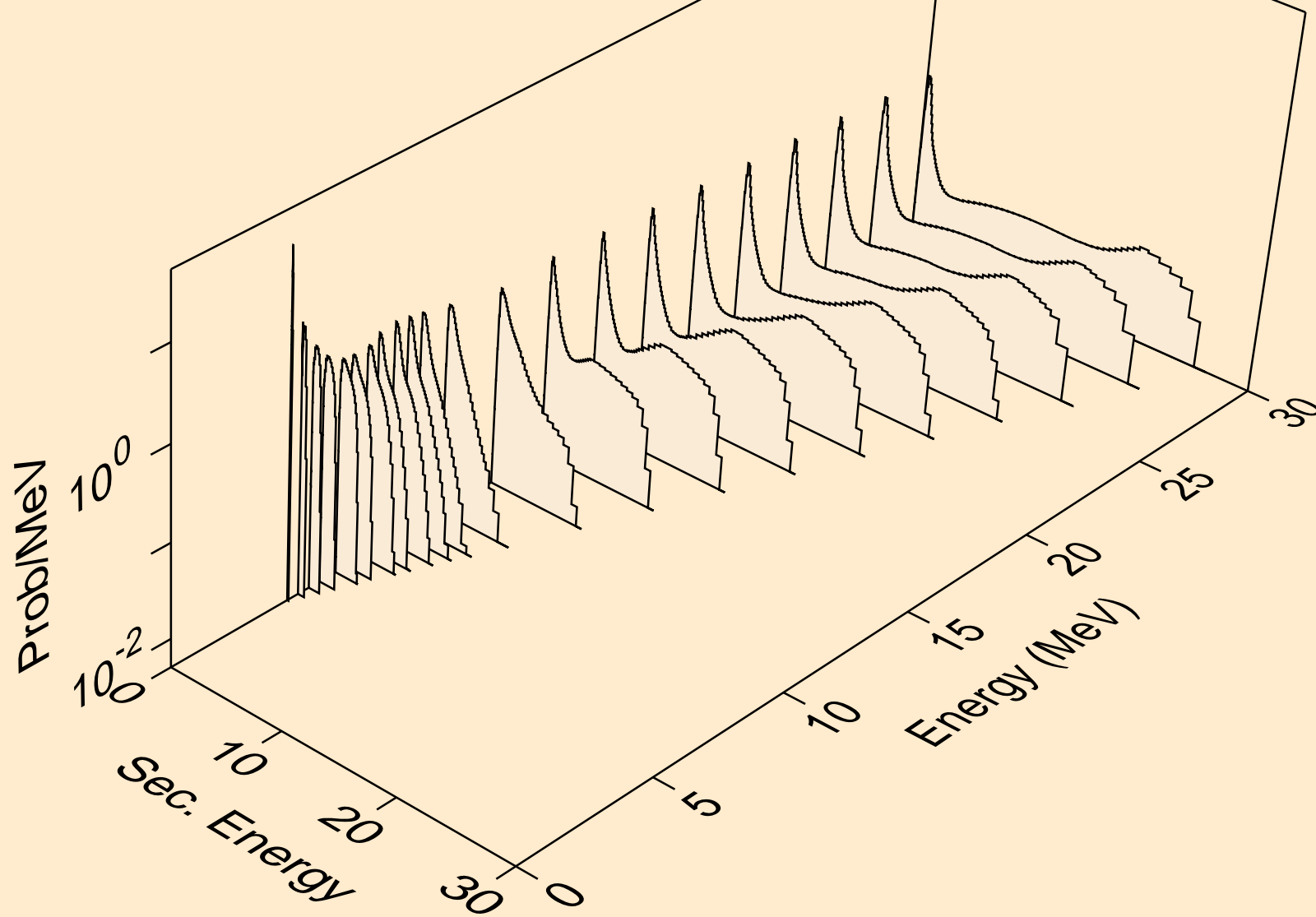

TH239 NEUTRON ACER TENDL-2021 LIBRARY; T=293.6K  
Neutron emission for (n,3n)

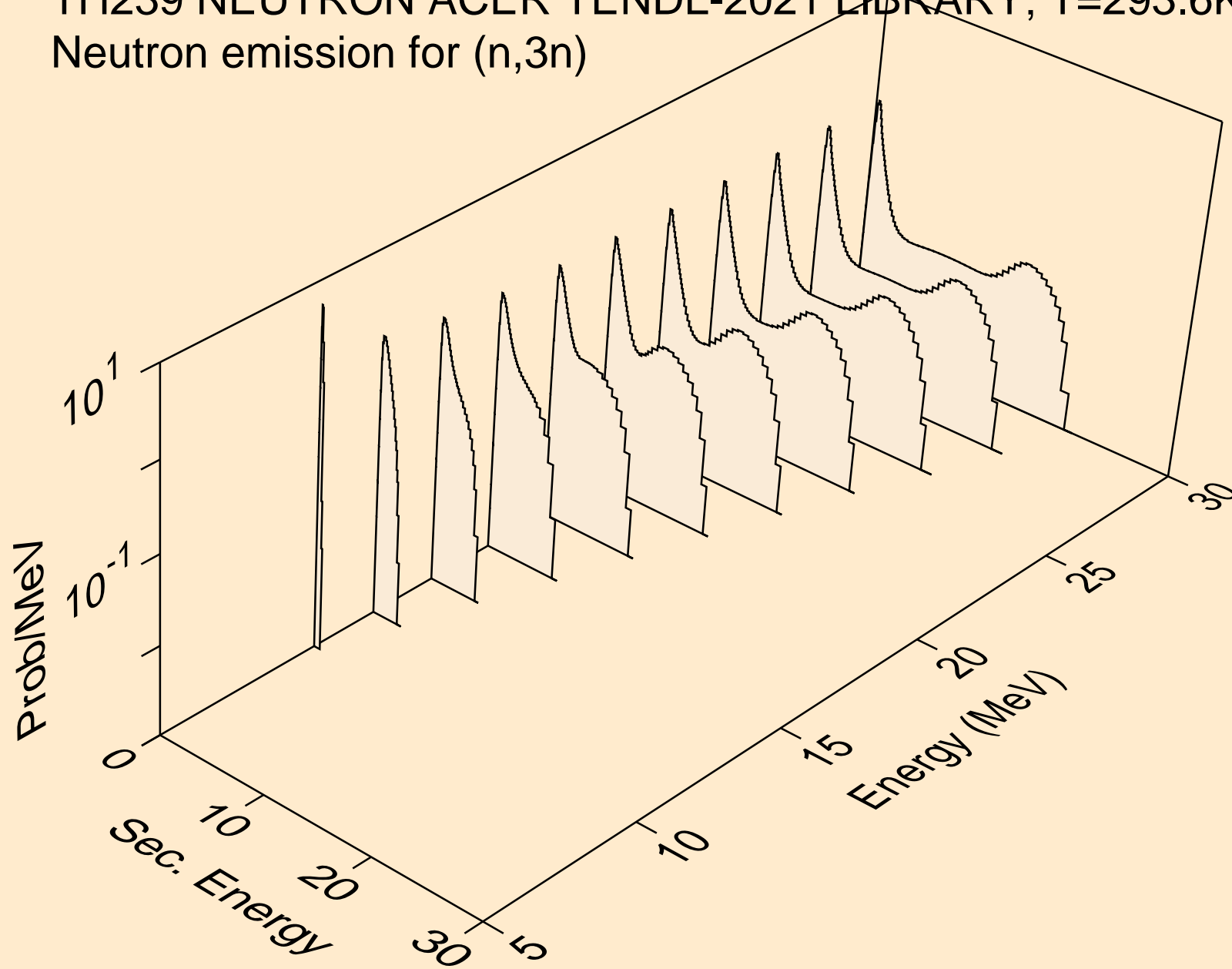

TH239 NEUTRON ACER TENDL-2021 LIBRARY; T=293.6K  
Neutron emission for fission

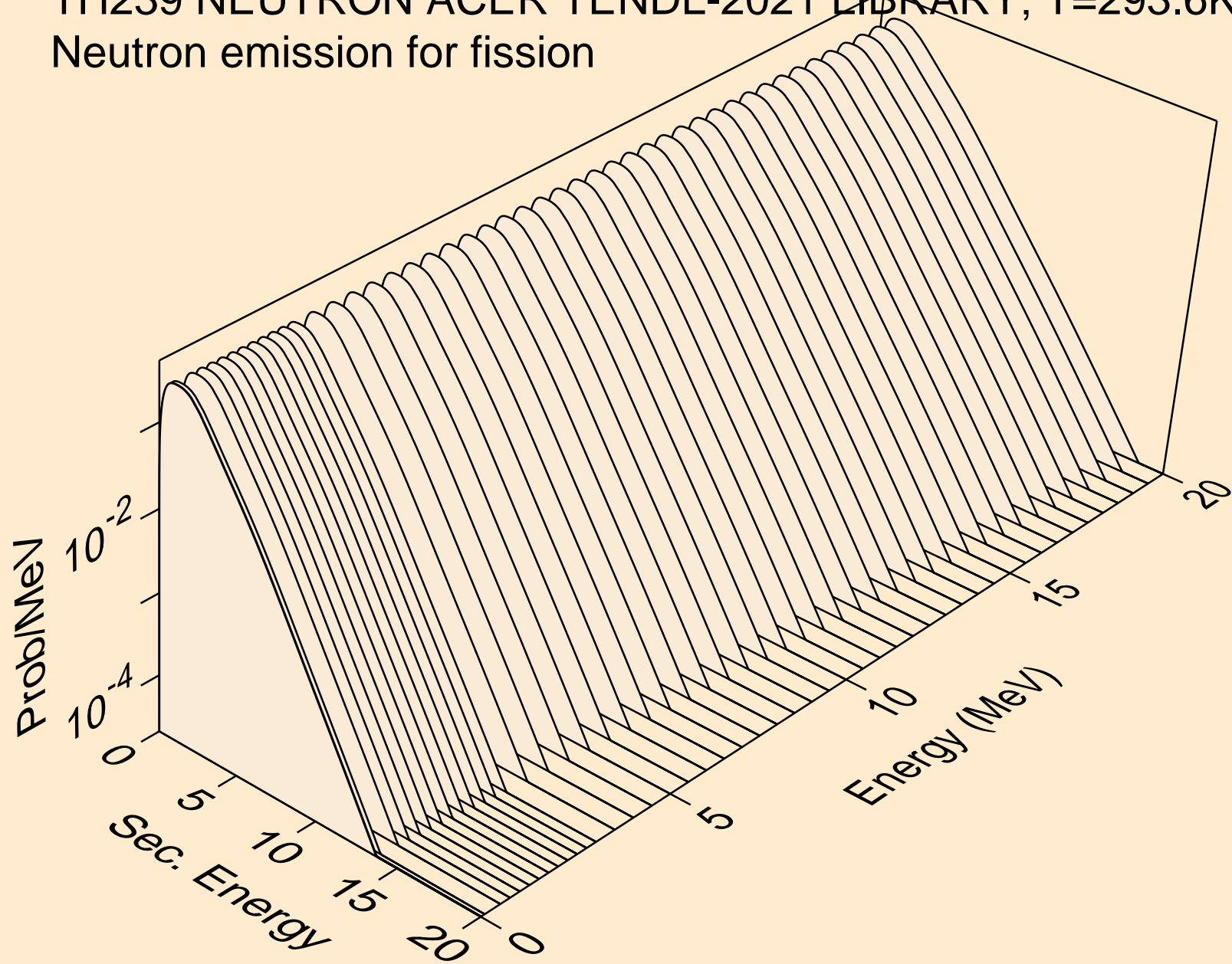



TH239 NEUTRON ACER TENDL-2021 LIBRARY; T=293.6K  
Neutron emission for (n,n\*)a

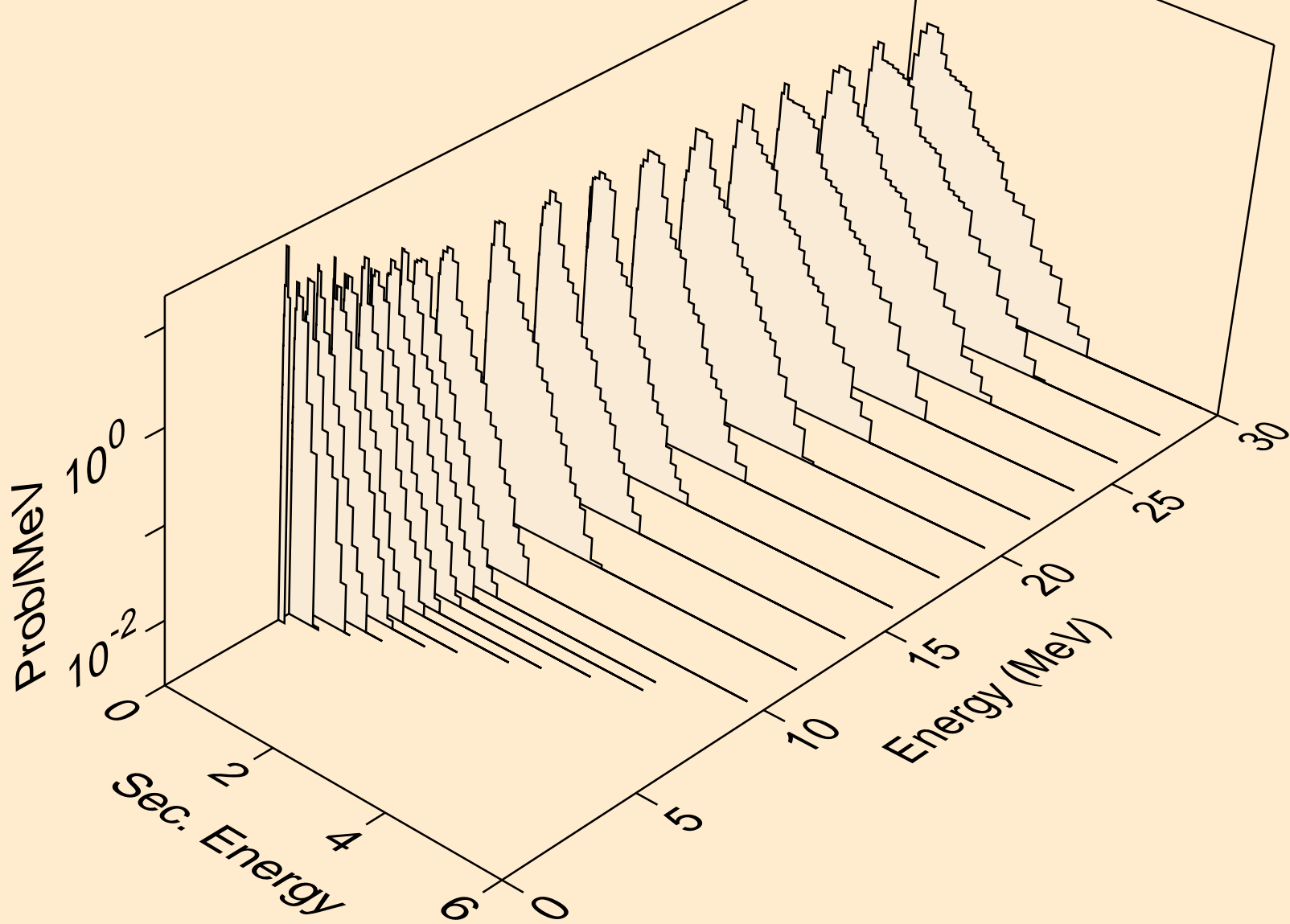

TH239 NEUTRON ACER TENDL-2021 LIBRARY; T=293.6K  
Neutron emission for (n,2n)a

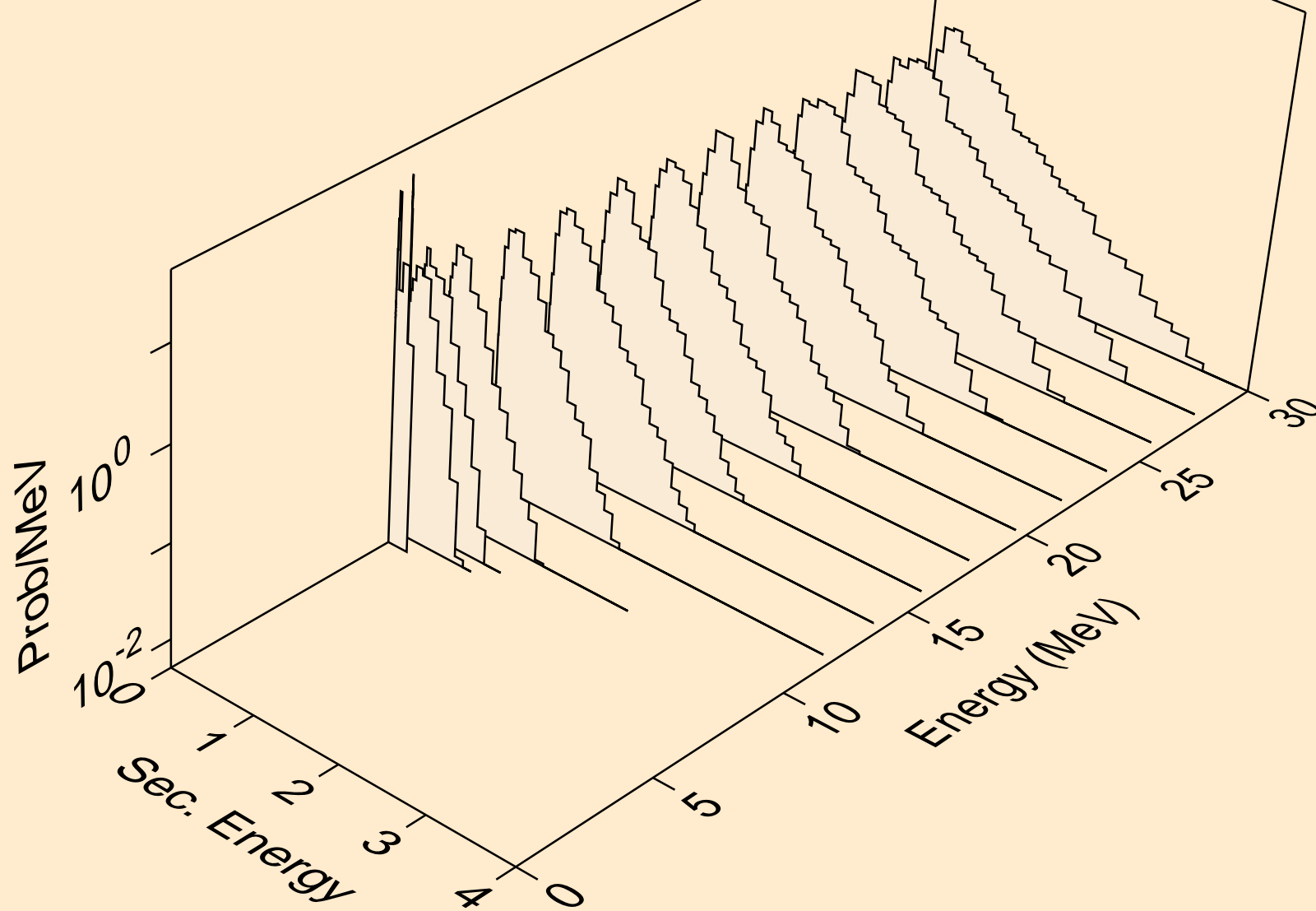

TH239 NEUTRON ACER TENDL-2021 LIBRARY; T=293.6K  
Neutron emission for (n,3n)<sub>a</sub>

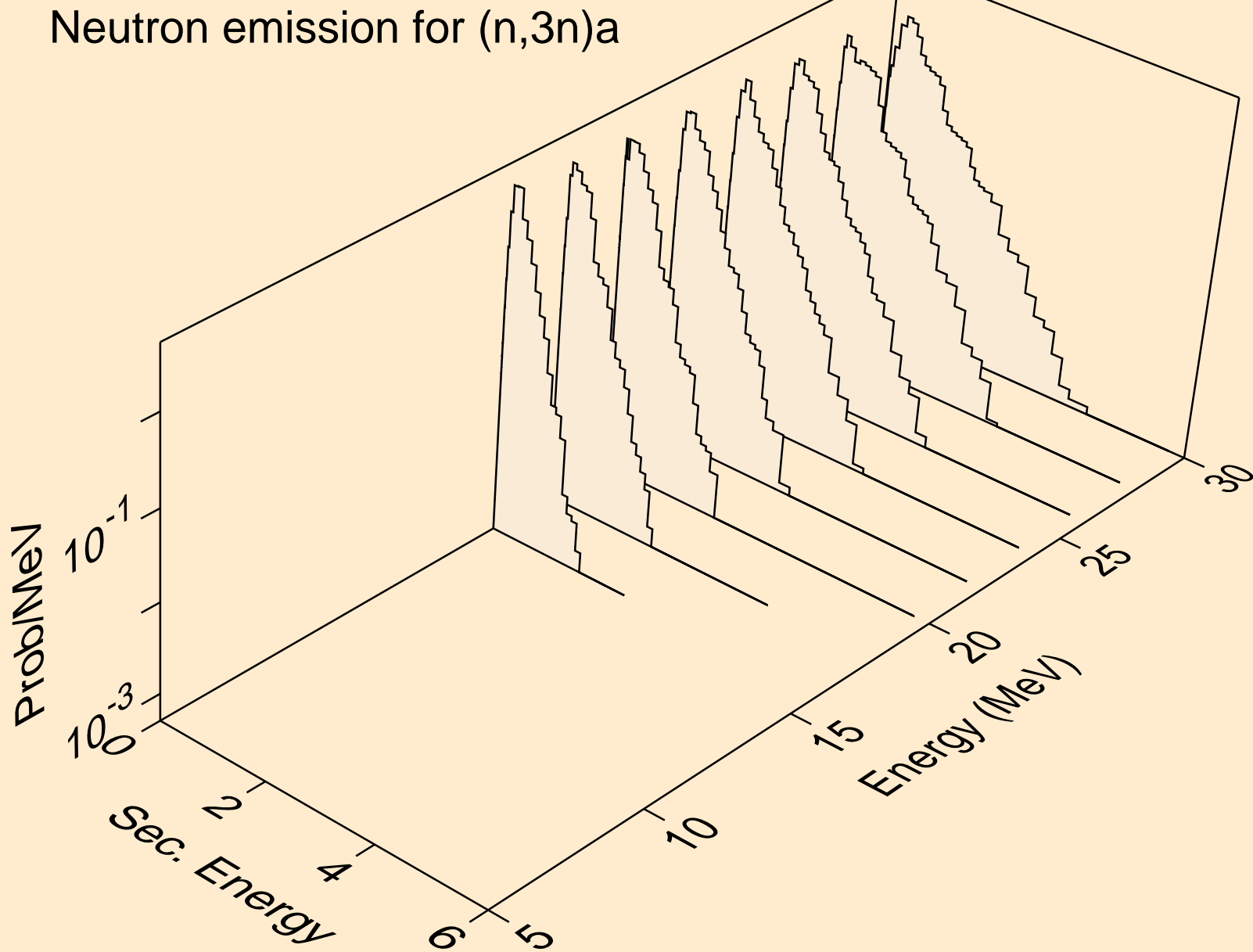

TH239 NEUTRON ACER TENDL-2021 LIBRARY; T=293.6K  
Neutron emission for (n,n\*)p

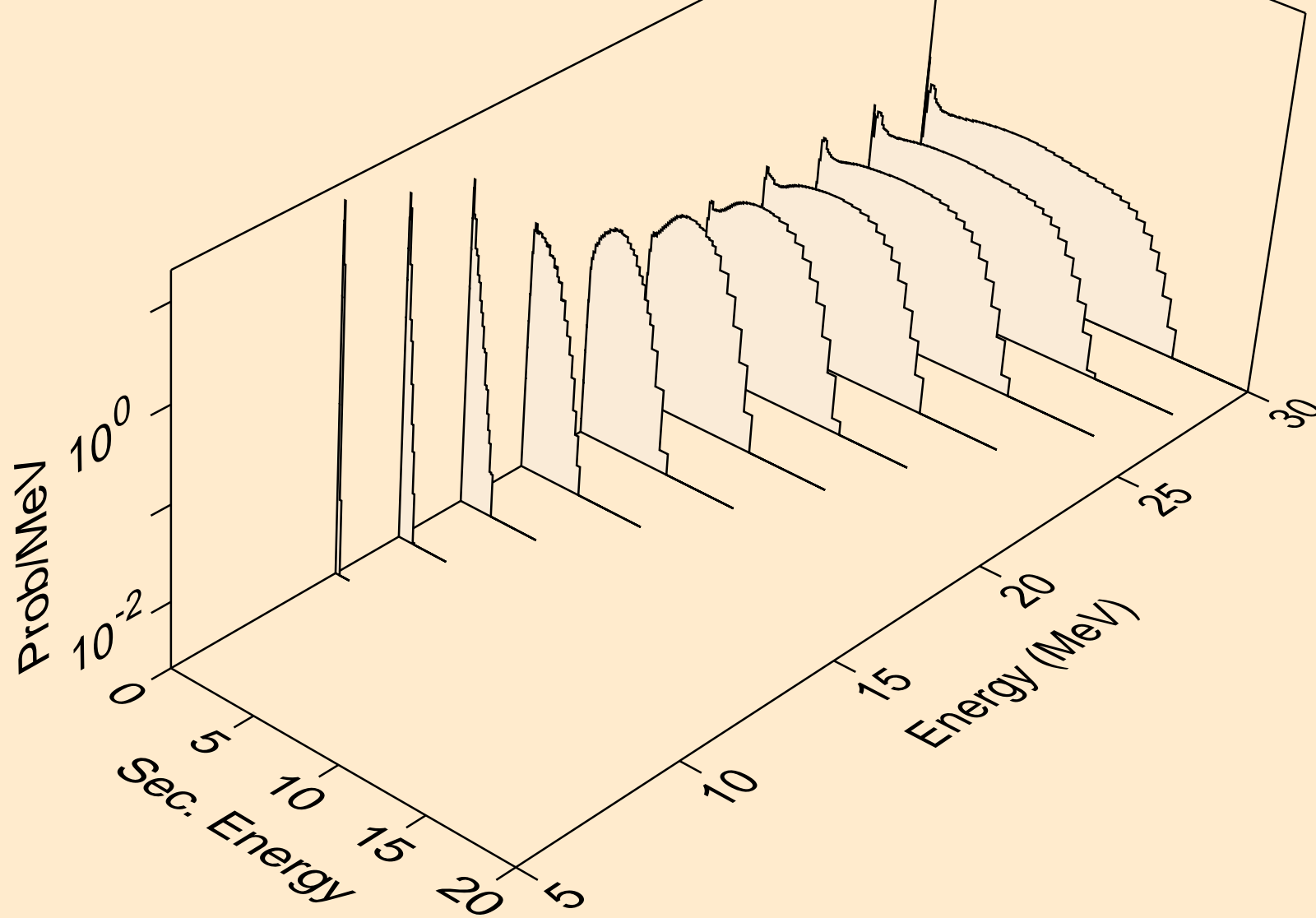

TH239 NEUTRON ACER TENDL-2021 LIBRARY; T=293.6K  
Neutron emission for (n,n\*)d

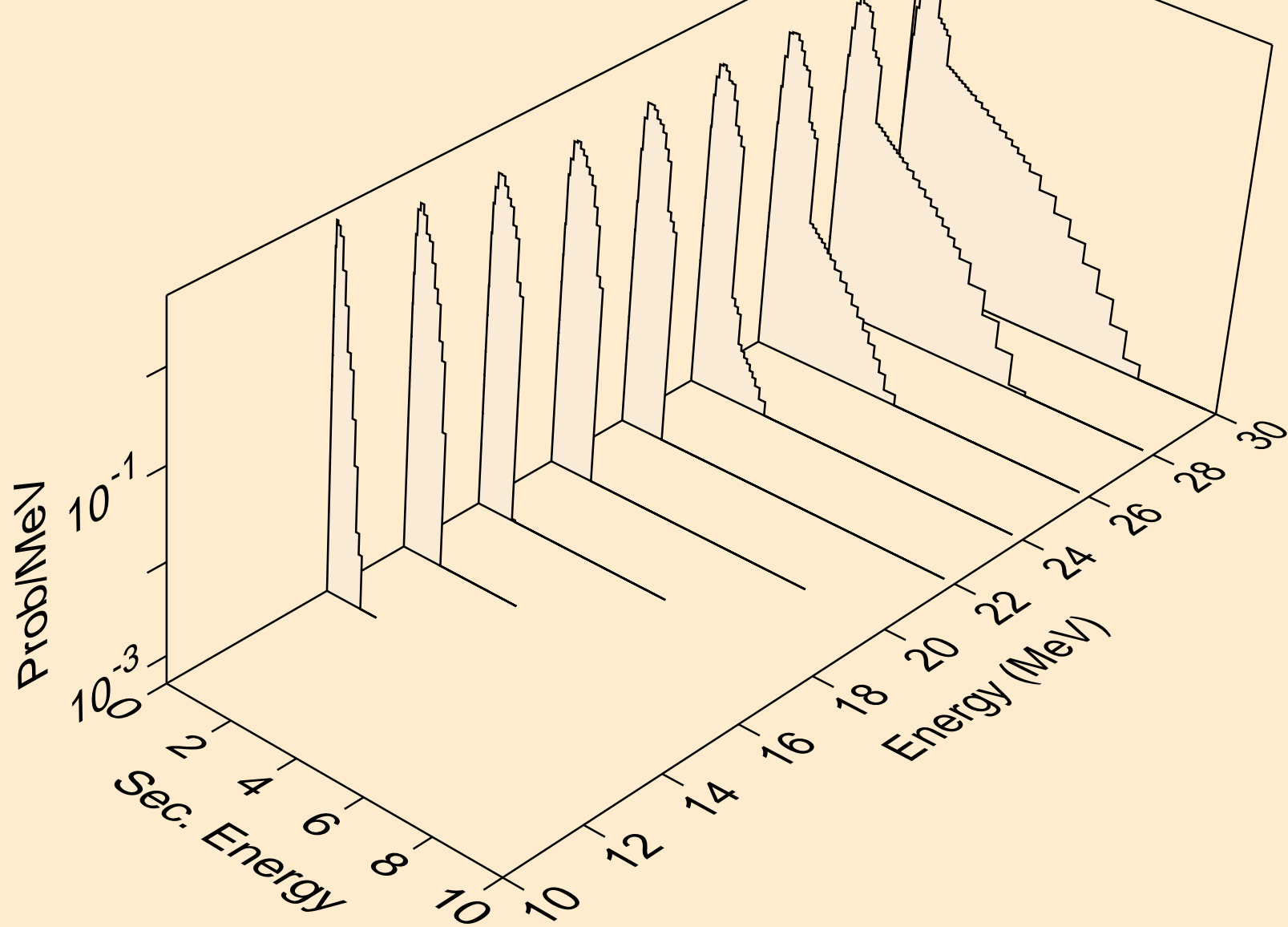

TH239 NEUTRON ACER TENDL-2021 LIBRARY; T=293.6K  
Neutron emission for (n,n\*)t

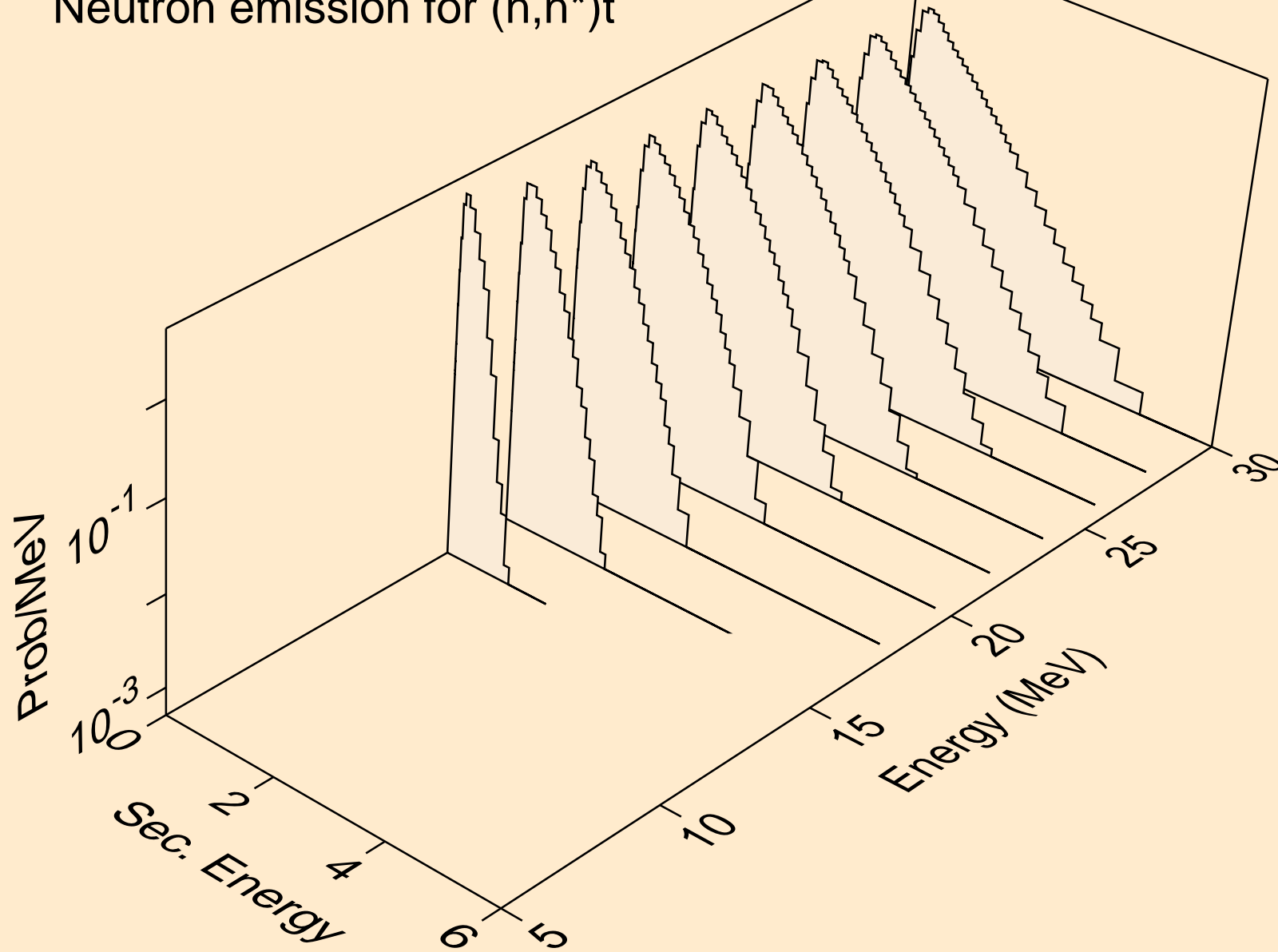

TH239 NEUTRON ACER TENDL-2021 LIBRARY; T=293.6K  
Neutron emission for (n,n\*)he3

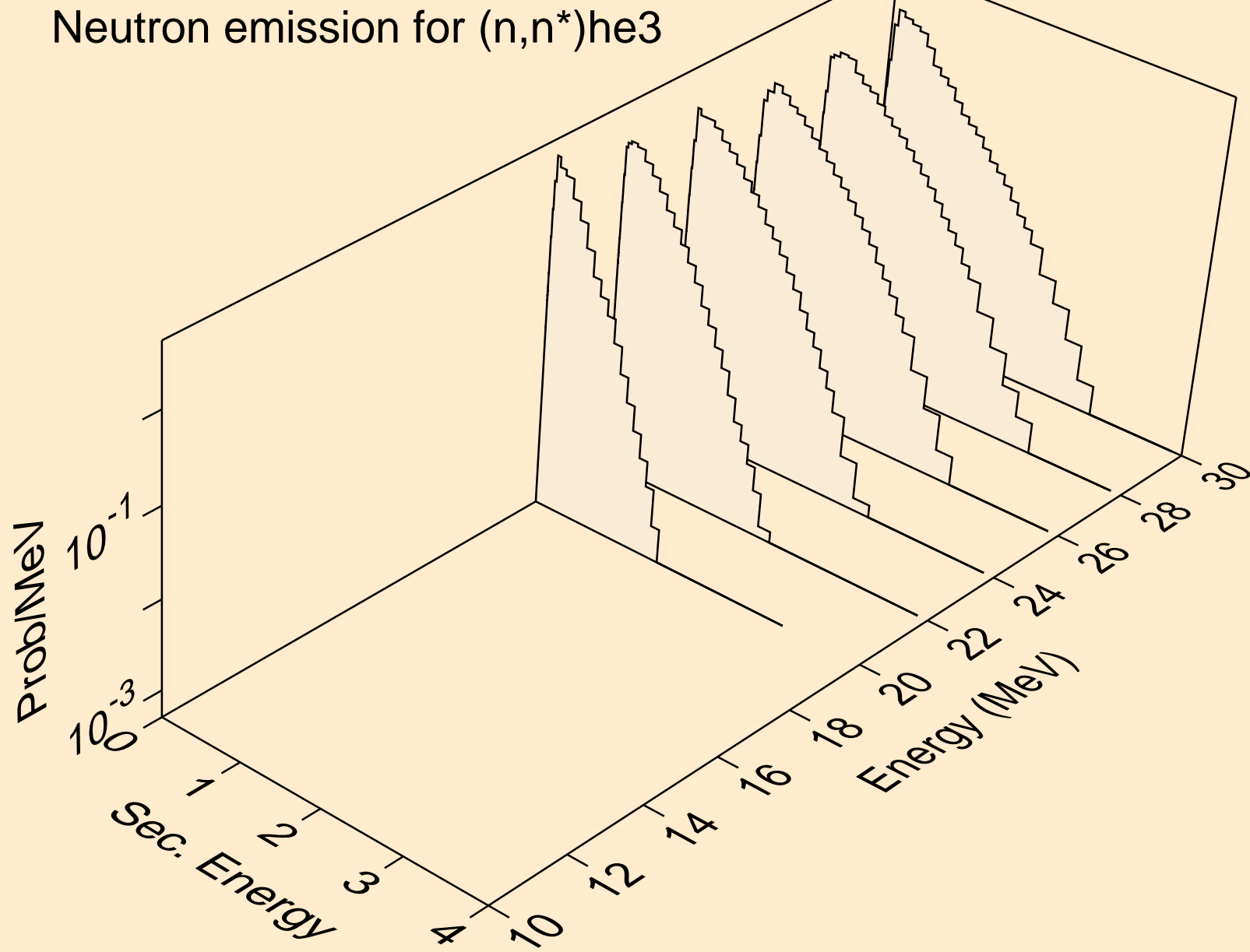

TH239 NEUTRON ACER TENDL-2021 LIBRARY; T=293.6K  
Neutron emission for (n,4n)

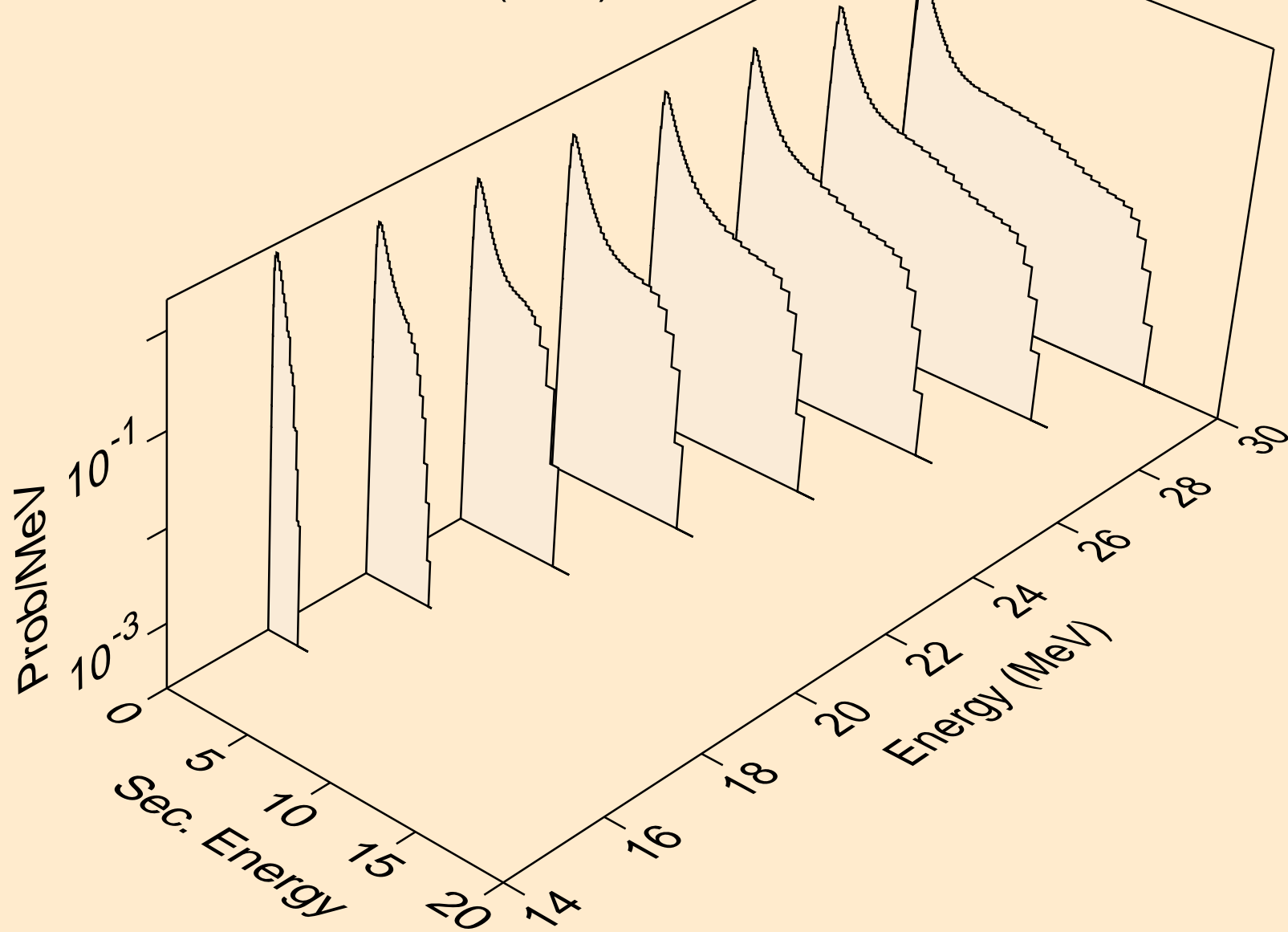



TH239 NEUTRON ACER TENDL-2021 LIBRARY; T=293.6K  
Neutron emission for (n,2np)

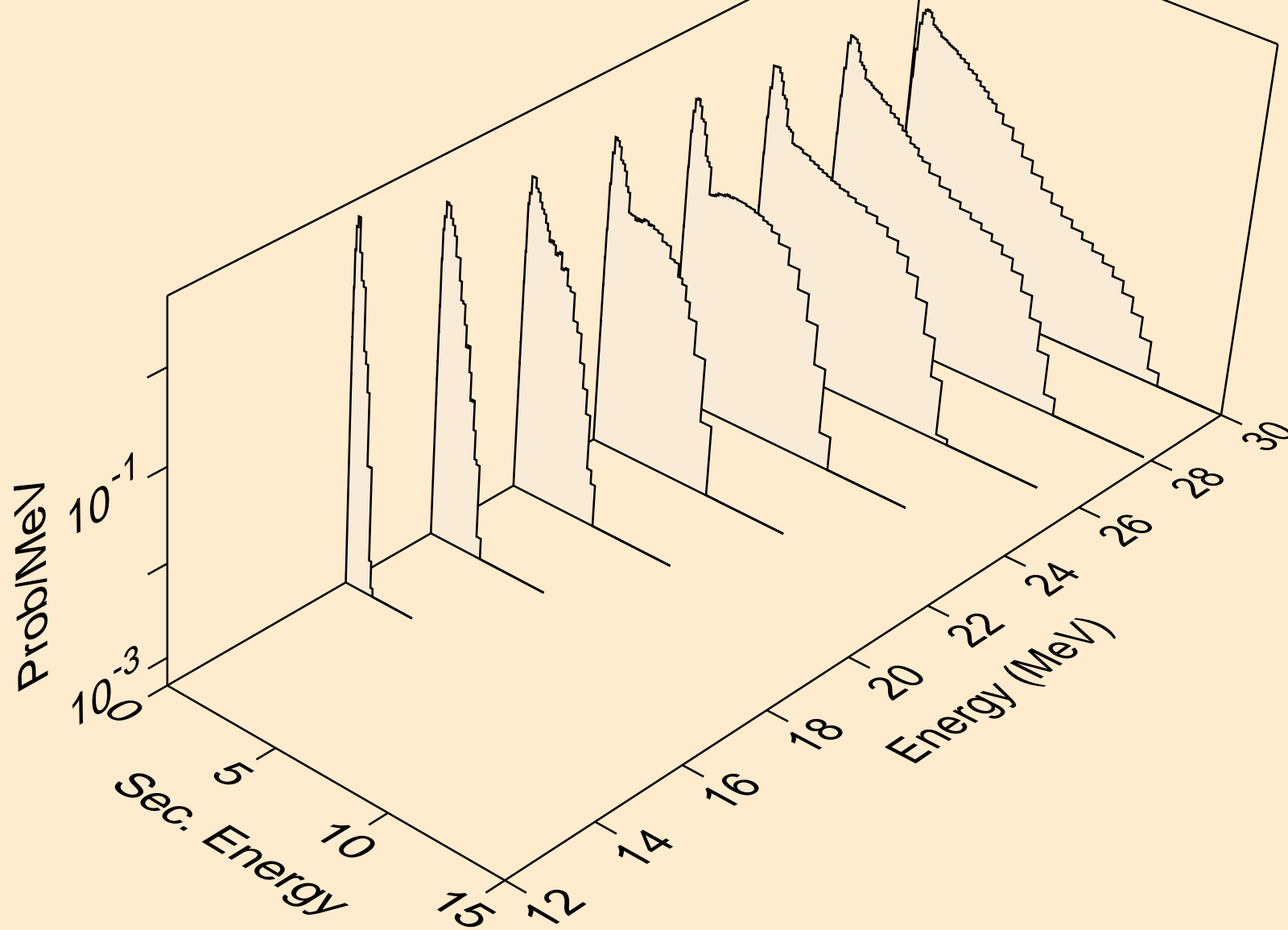

TH239 NEUTRON ACER TENDL-2021 LIBRARY; T=293.6K  
Neutron emission for (n,3np)

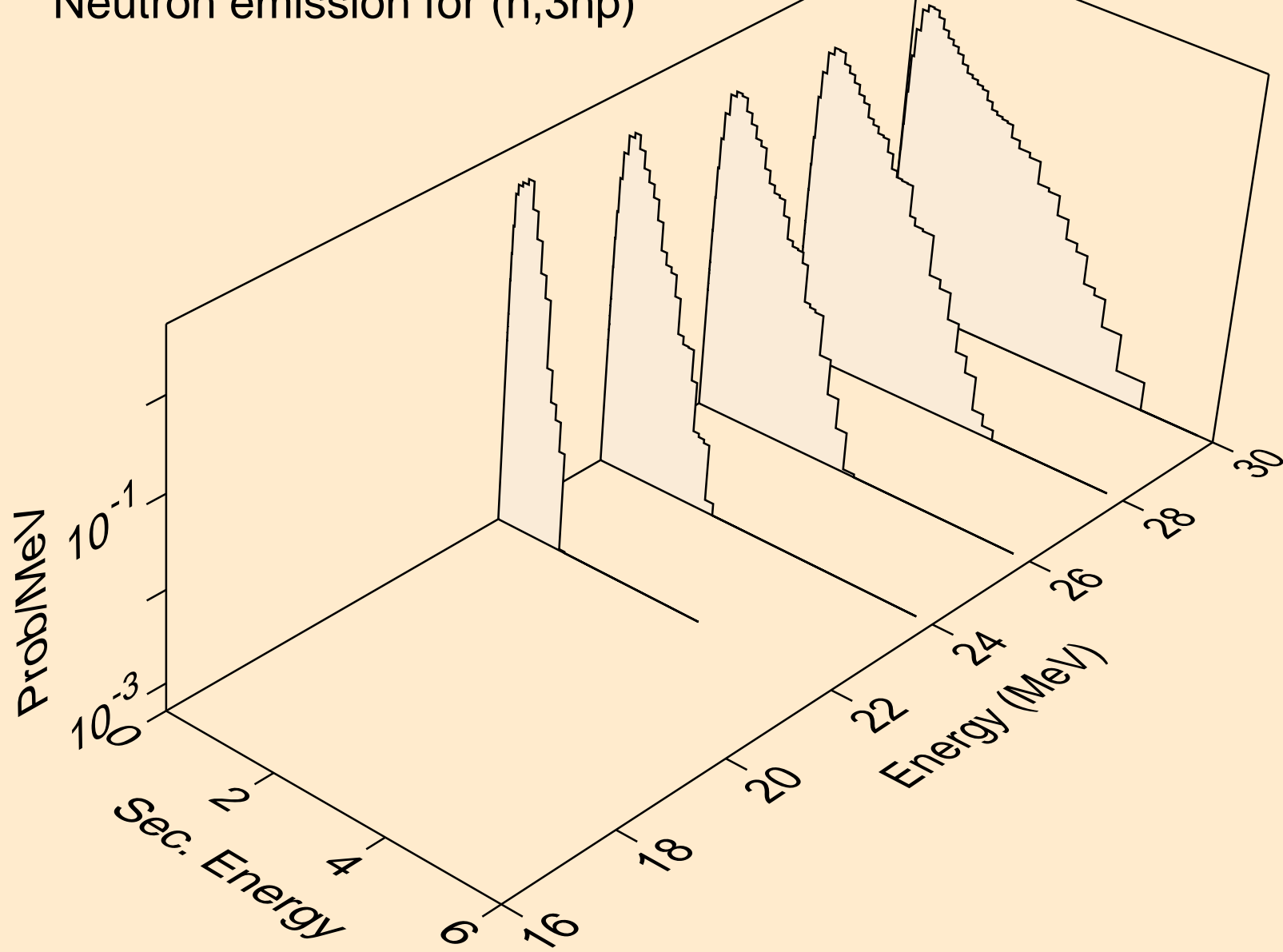

TH239 NEUTRON ACER TENDL-2021 LIBRARY; T=293.6K  
Neutron emission for (n,2np)

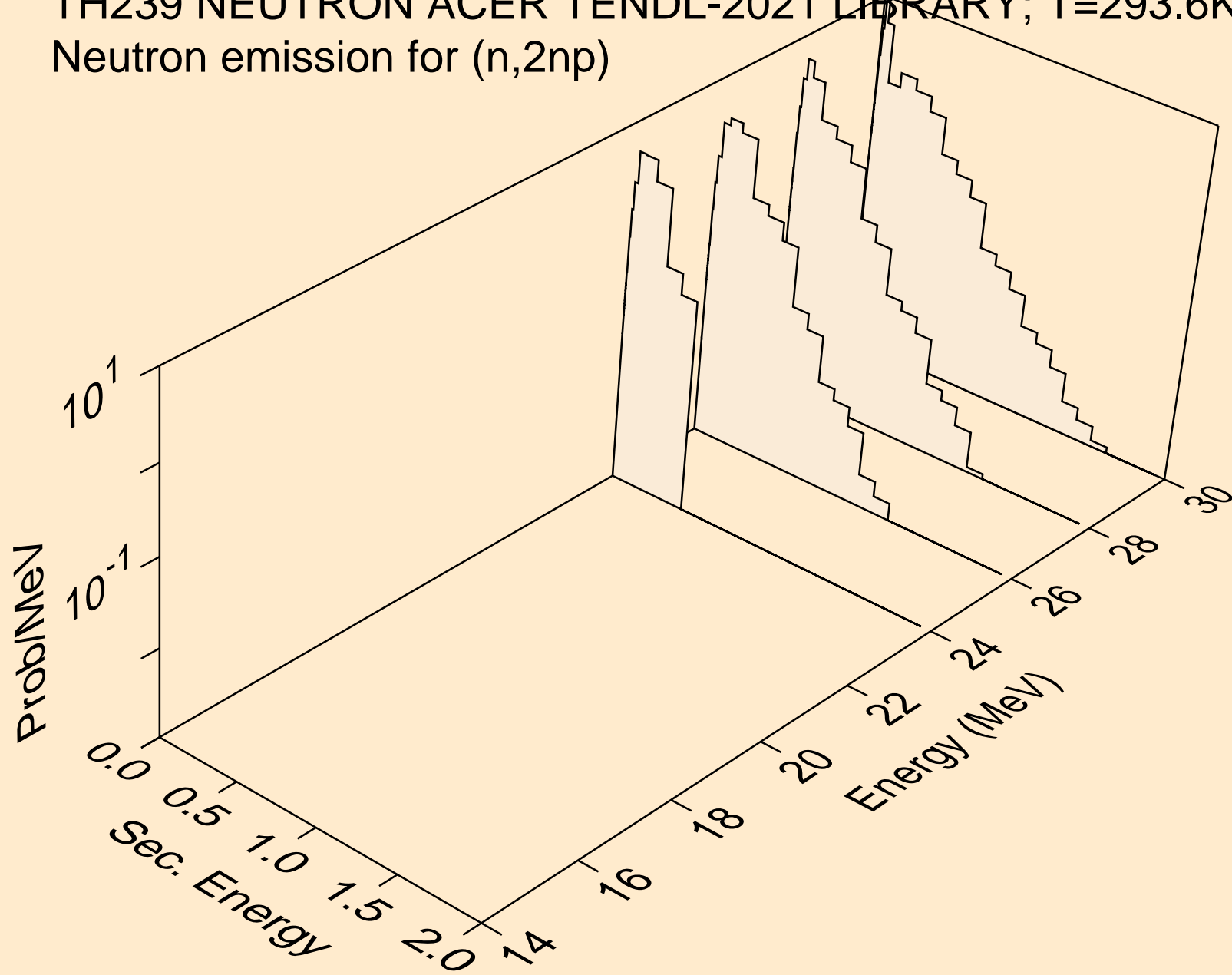

TH239 NEUTRON ACER TENDL-2021 LIBRARY; T=293.6K  
Neutron emission for (n,n\*c)

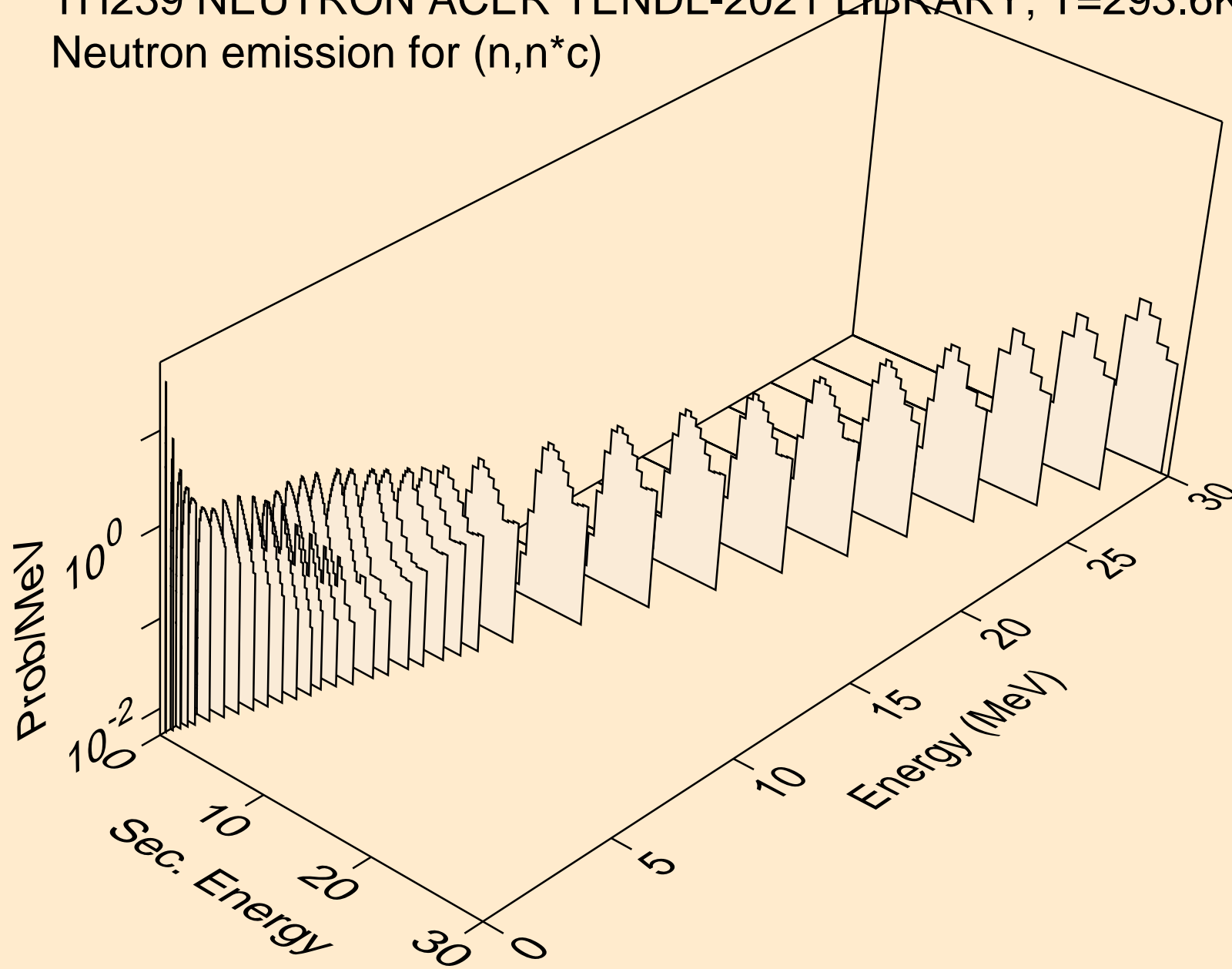

TH239 NEUTRON ACER TENDL-2021 LIBRARY; T=293.6K

Delayed nubar

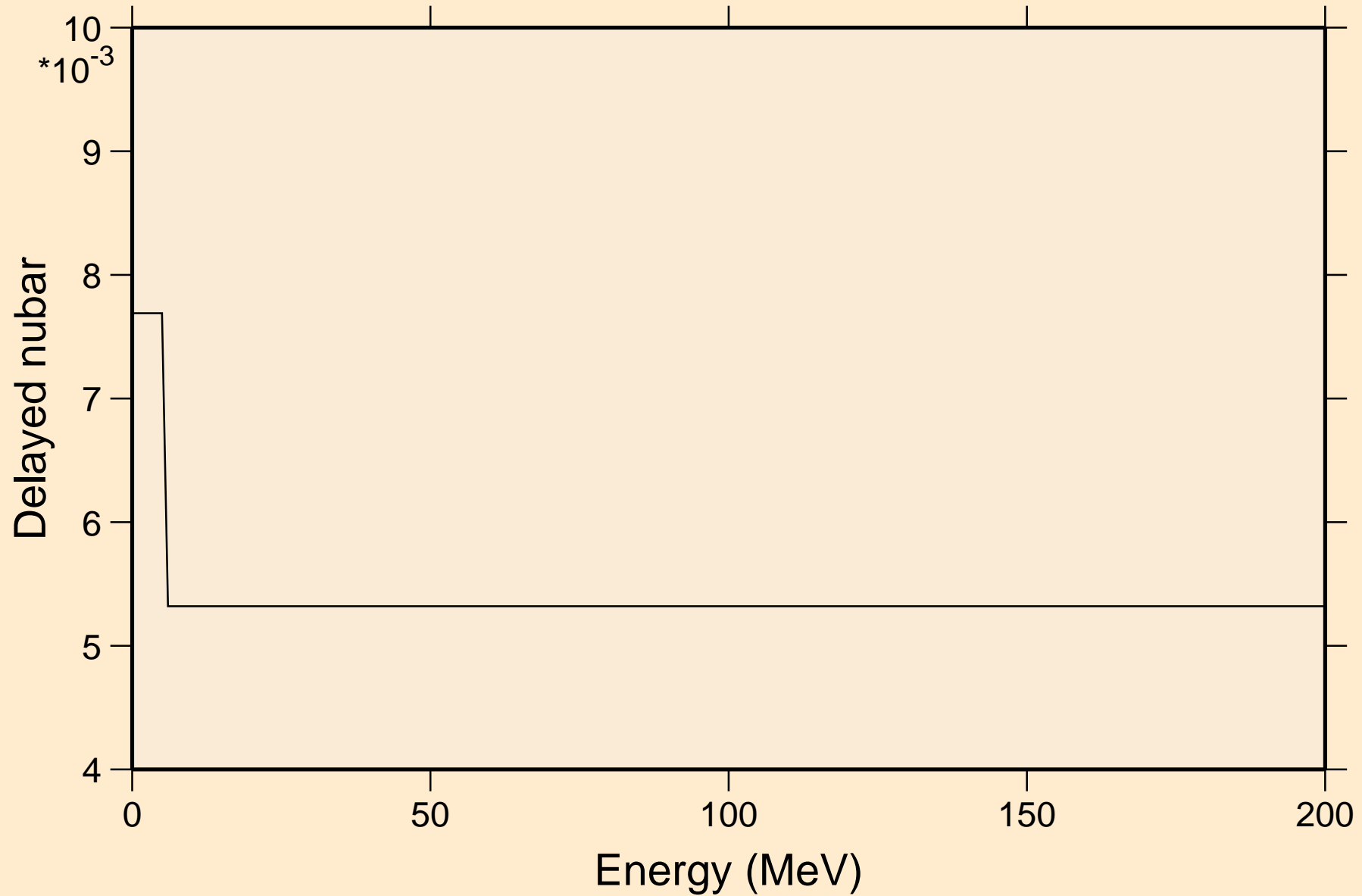

# TH239 NEUTRON ACER TENDL-2021 LIBRARY; T=293.6K

## Delayed neutron spectra

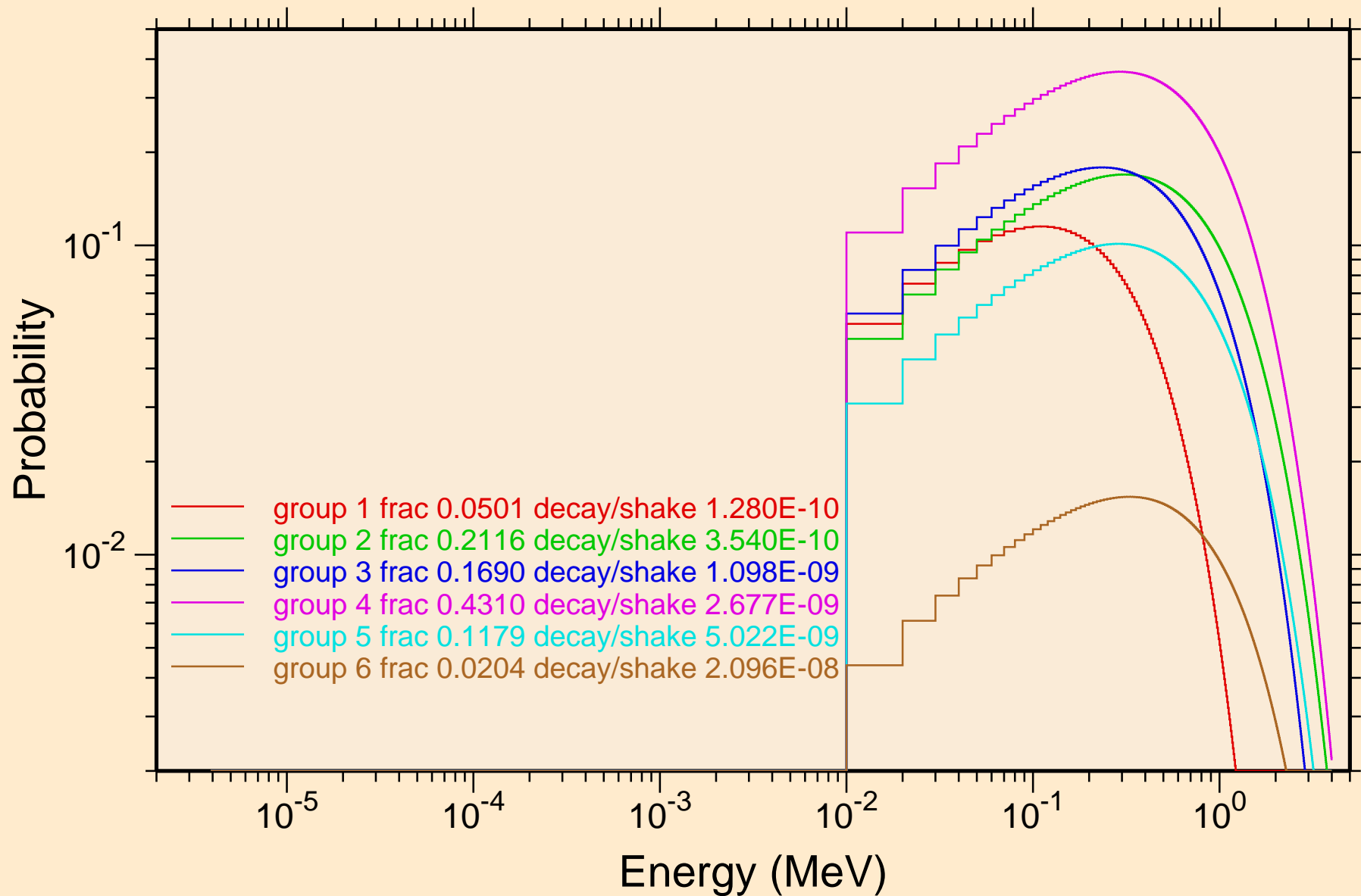

TH239 NEUTRON ACER TENDL-2021 LIBRARY; T=293.6K  
Photon emission for (n,x)

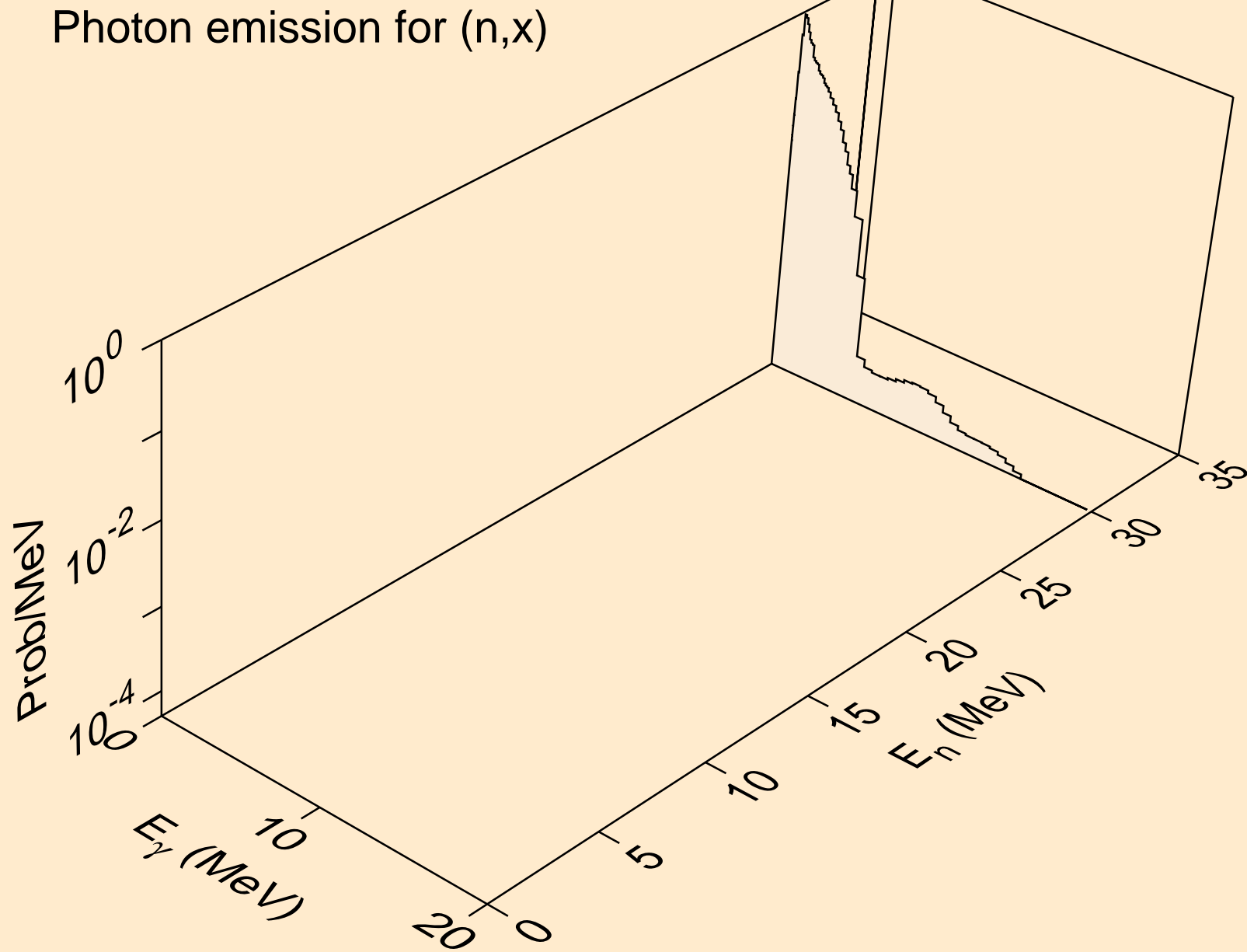

TH239 NEUTRON ACER TENDL-2021 LIBRARY; T=293.6K  
Photon emission for (n,2nd)

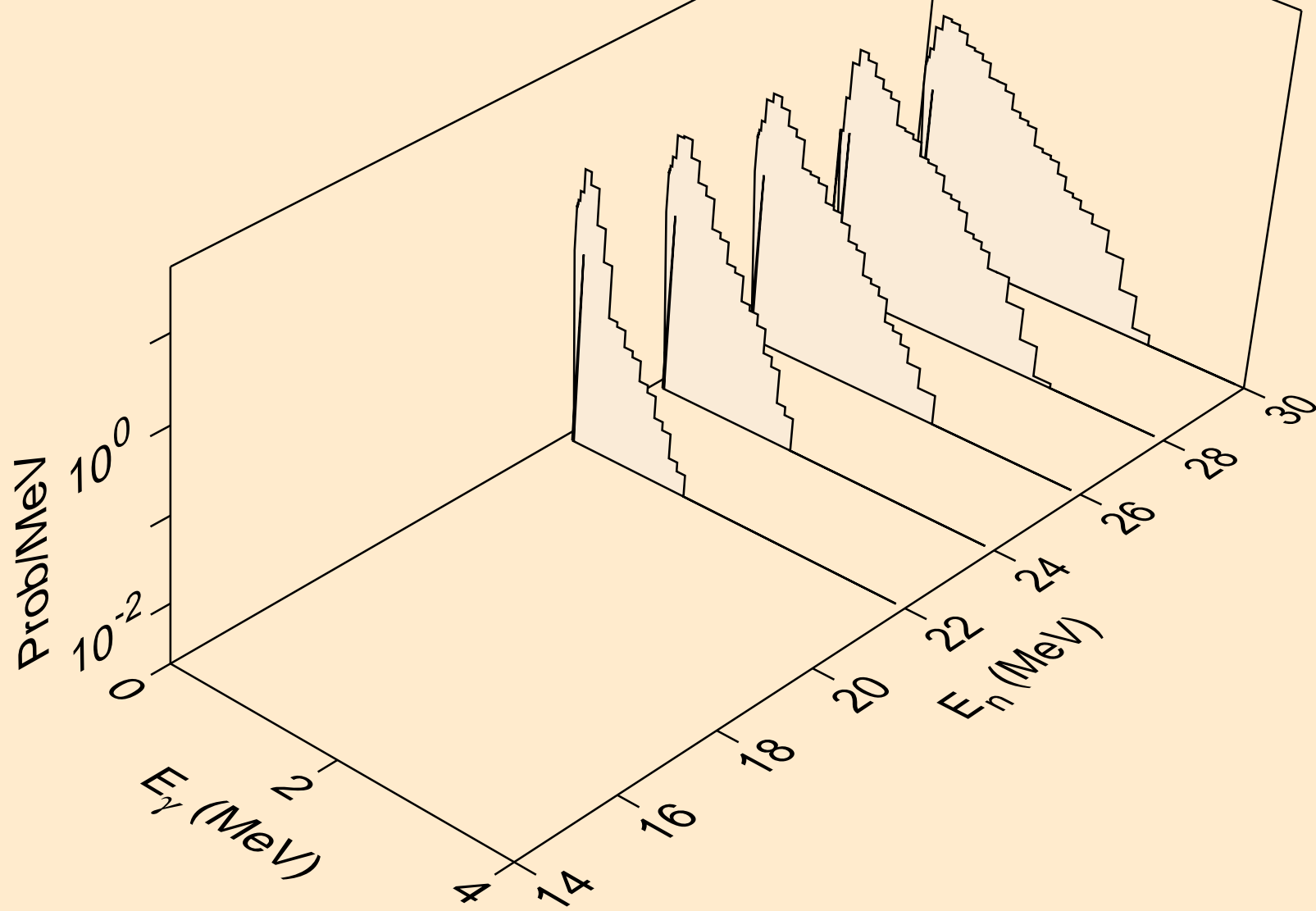



TH239 NEUTRON ACER TENDL-2021 LIBRARY; T=293.6K  
Photon emission for (n,2n)

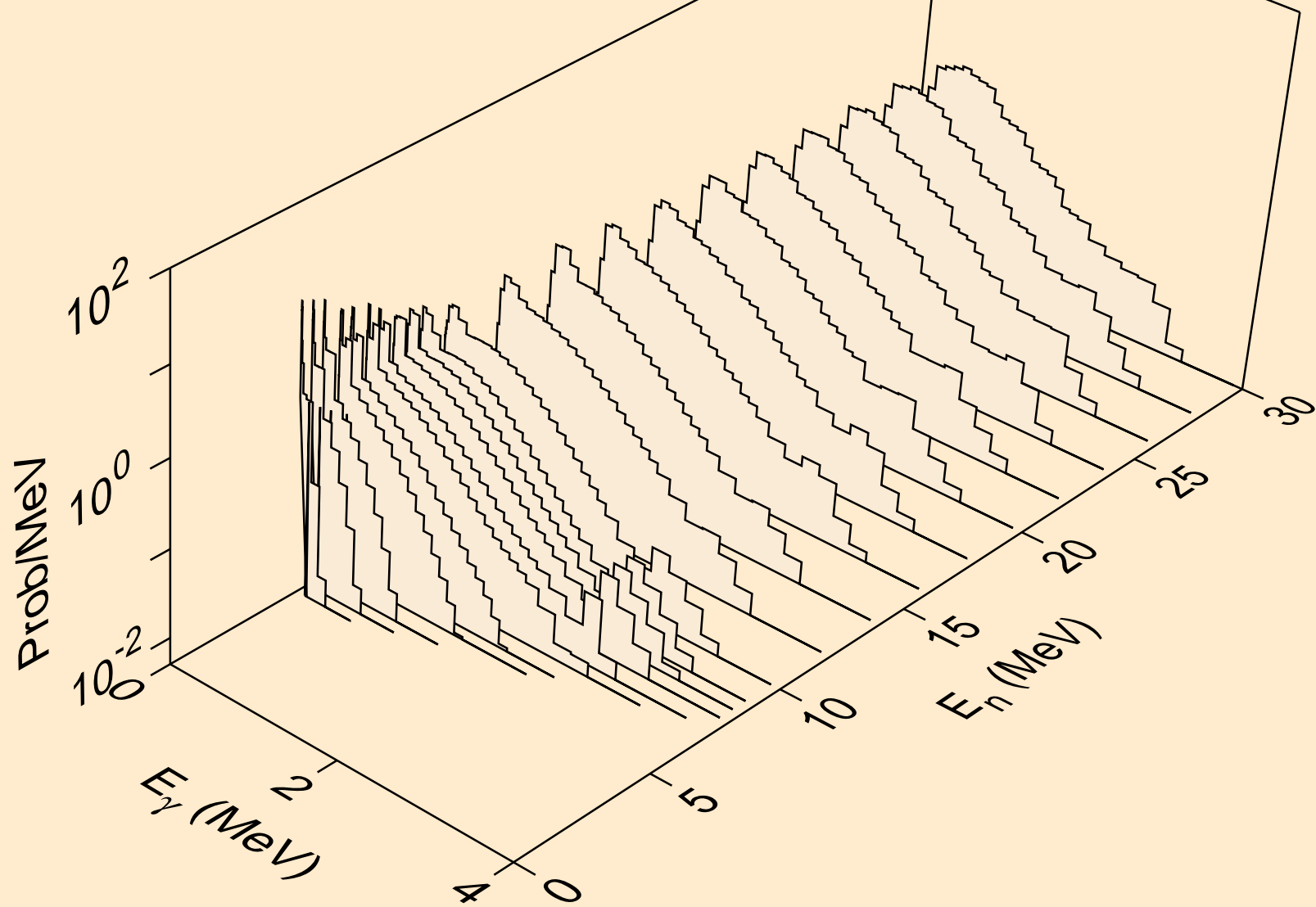

TH239 NEUTRON ACER TENDL-2021 LIBRARY; T=293.6K  
Photon emission for (n,3n)

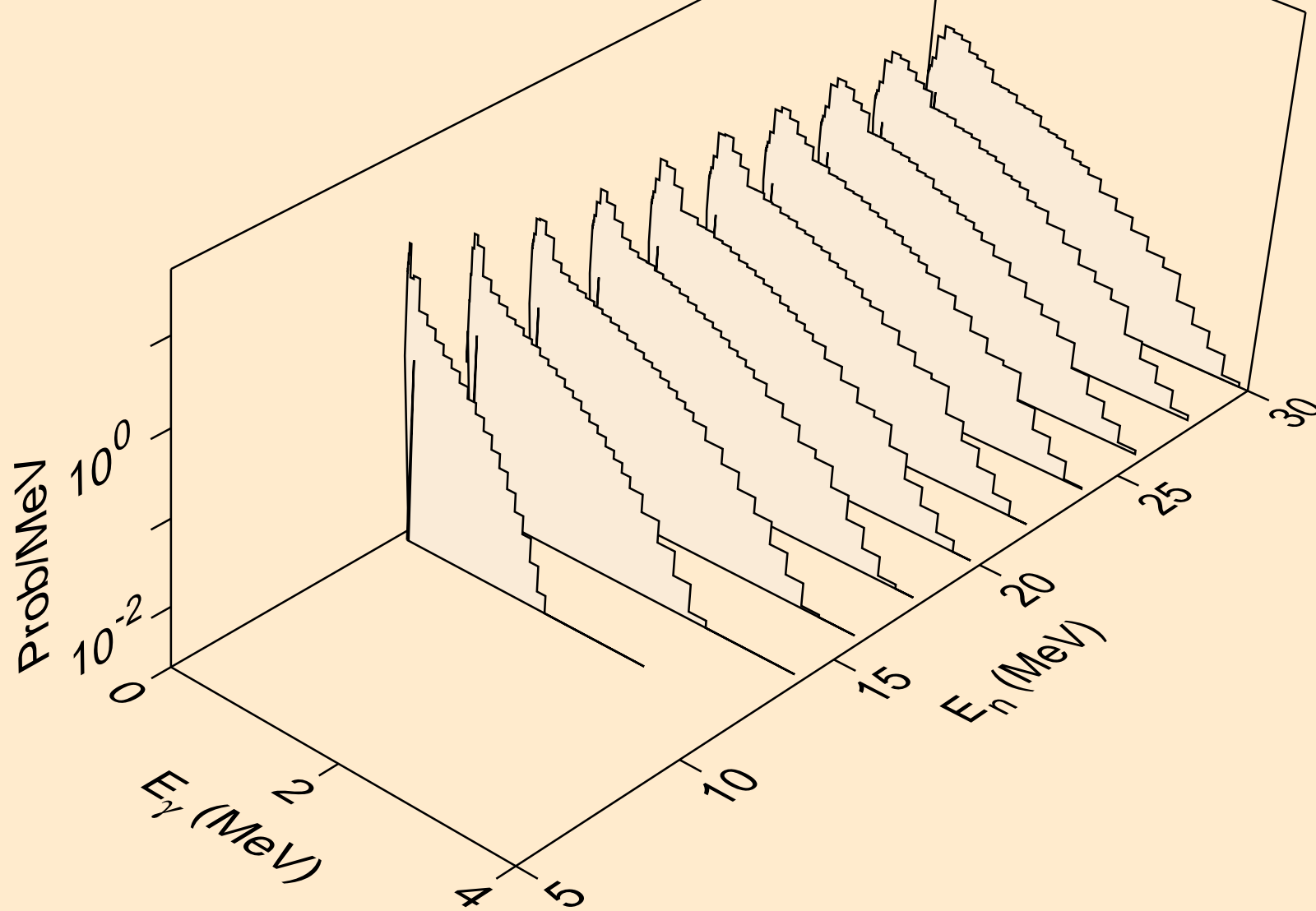

TH239 NEUTRON ACER TENDL-2021 LIBRARY; T=293.6K  
Photon emission for (n,n\*)a

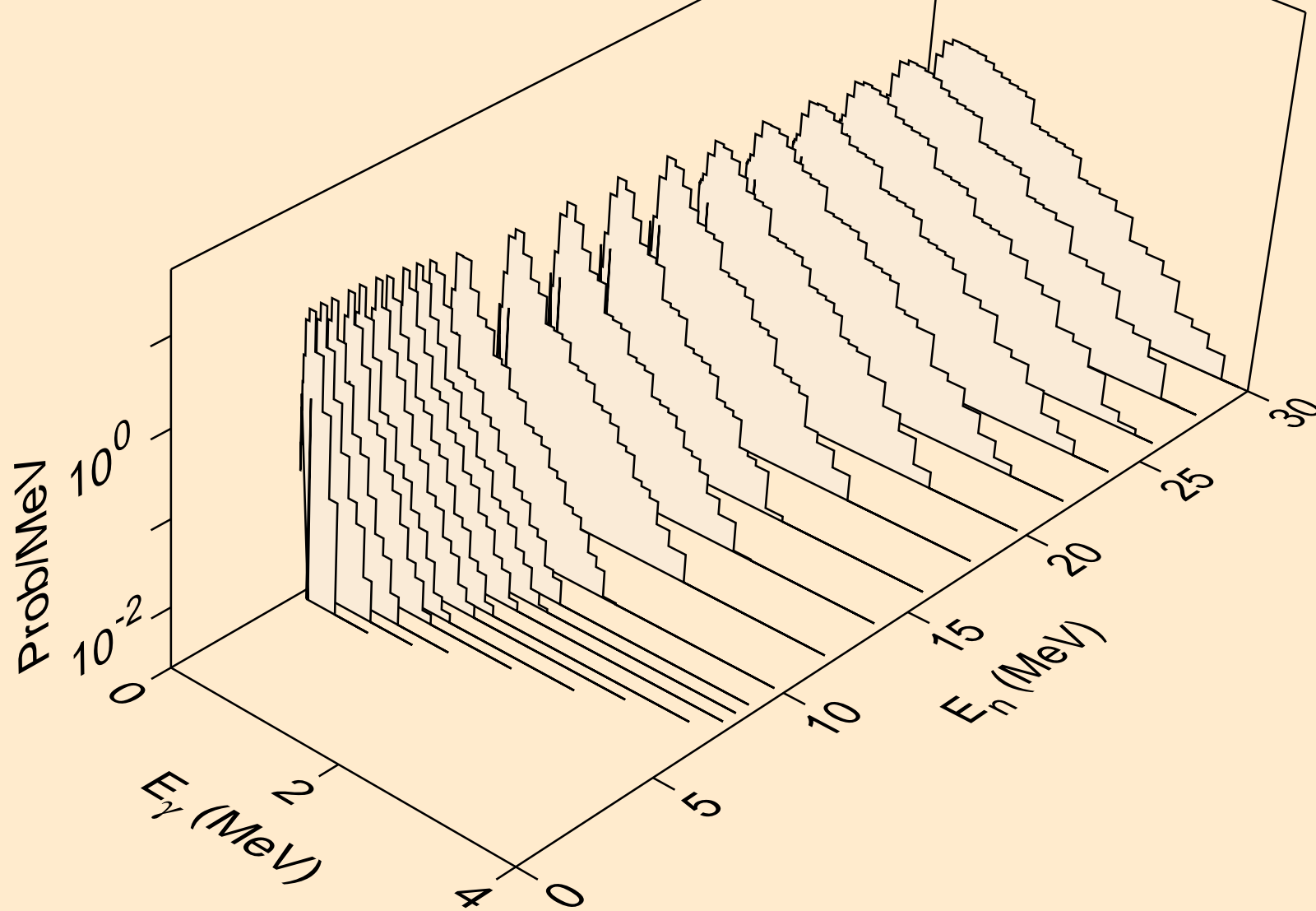

TH239 NEUTRON ACER TENDL-2021 LIBRARY; T=293.6K  
Photon emission for (n,2n)a

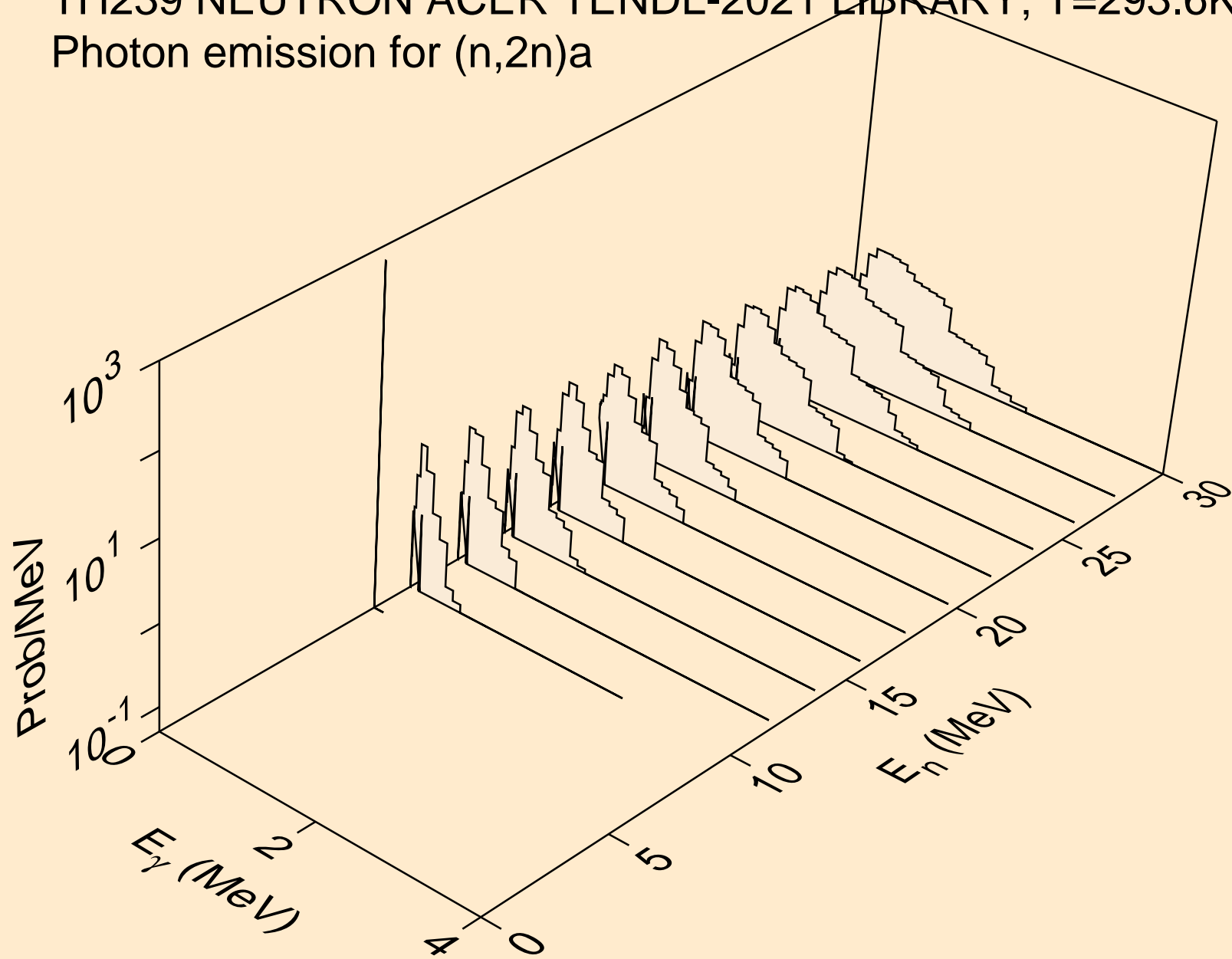

TH239 NEUTRON ACER TENDL-2021 LIBRARY; T=293.6K  
Photon emission for (n,3n)a

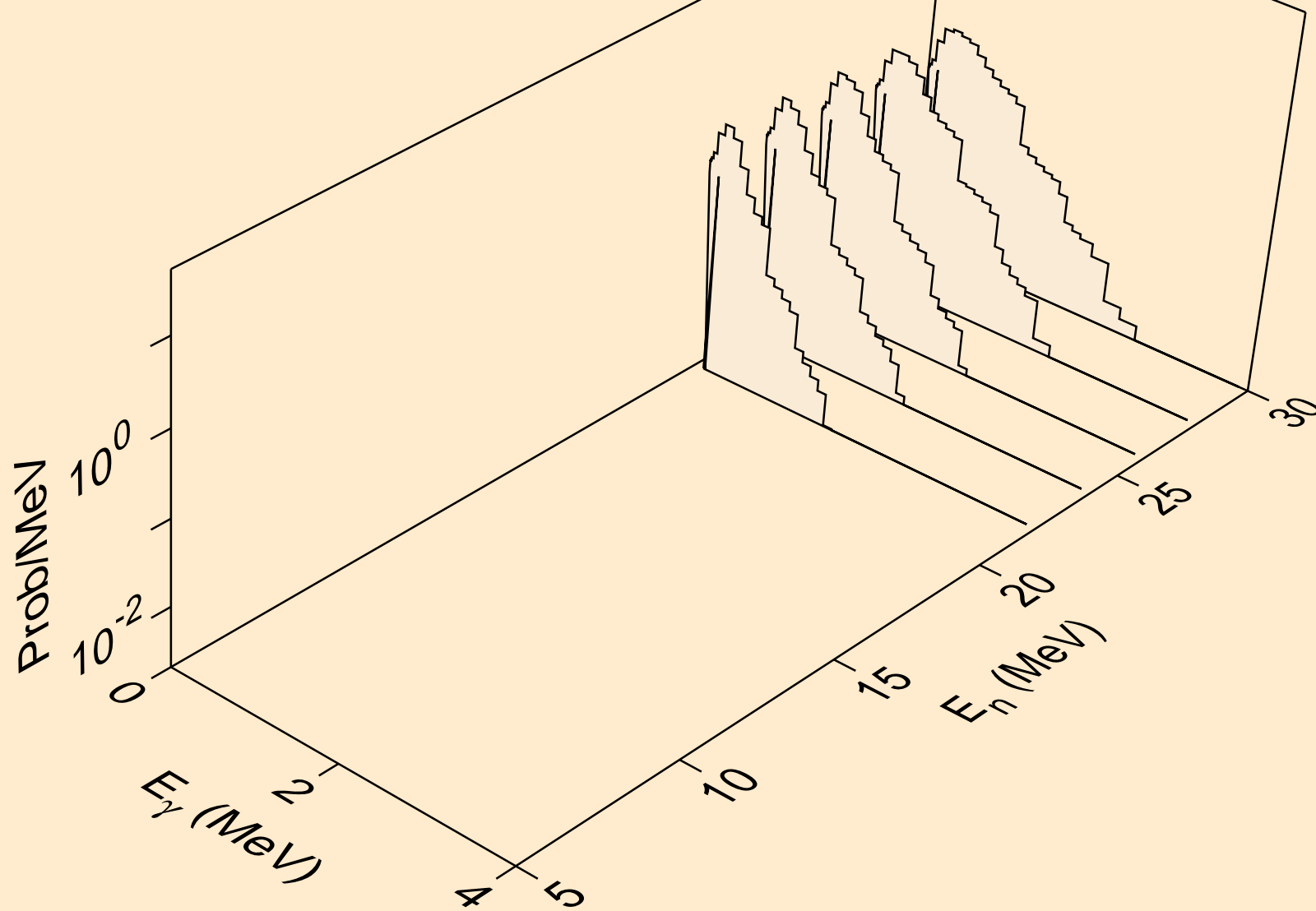

TH239 NEUTRON ACER TENDL-2021 LIBRARY; T=293.6K  
Photon emission for (n,n\*)p

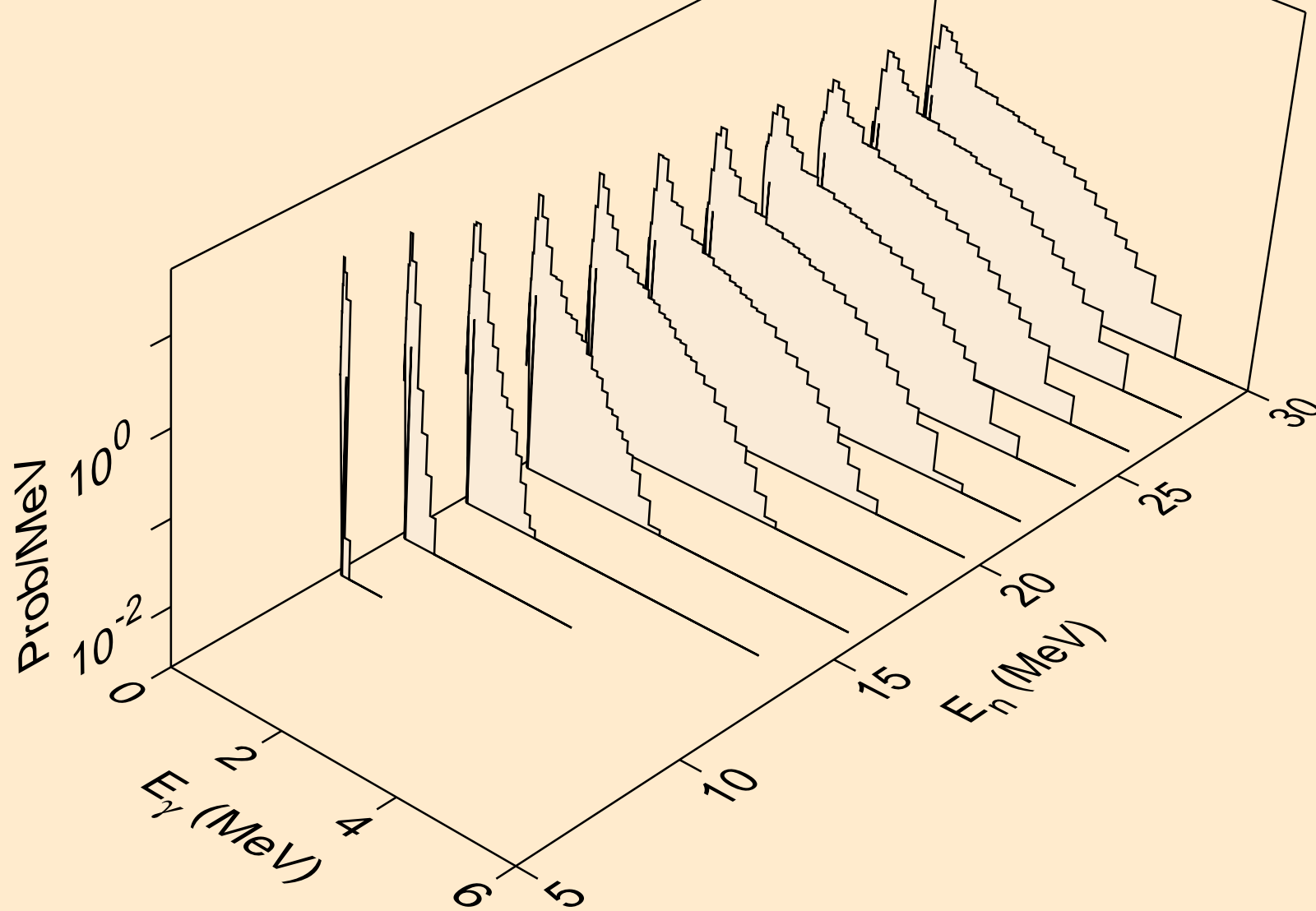

TH239 NEUTRON ACER TENDL-2021 LIBRARY; T=293.6K  
Photon emission for (n,n\*)d

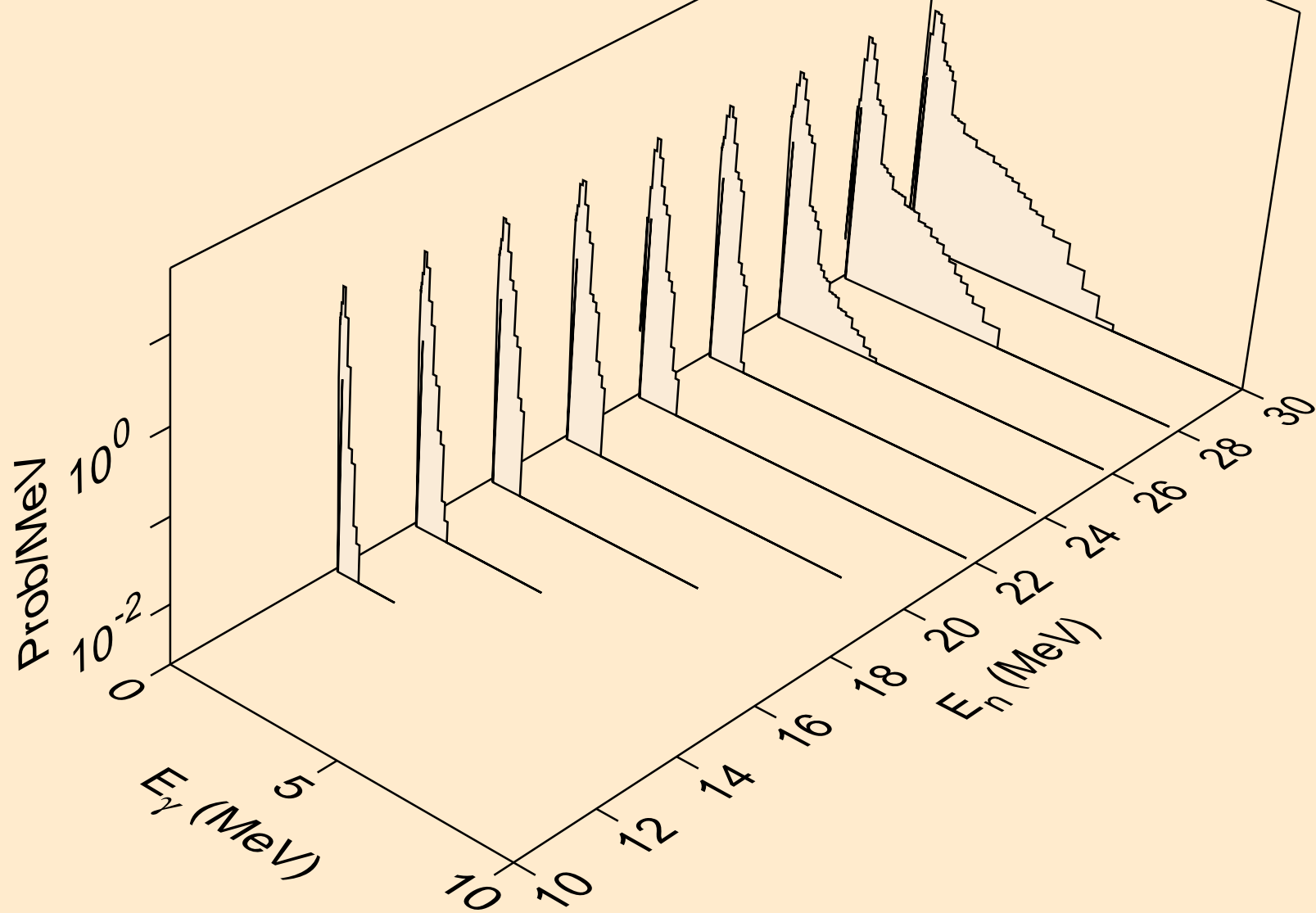

TH239 NEUTRON ACER TENDL-2021 LIBRARY; T=293.6K  
Photon emission for (n,n\*)t

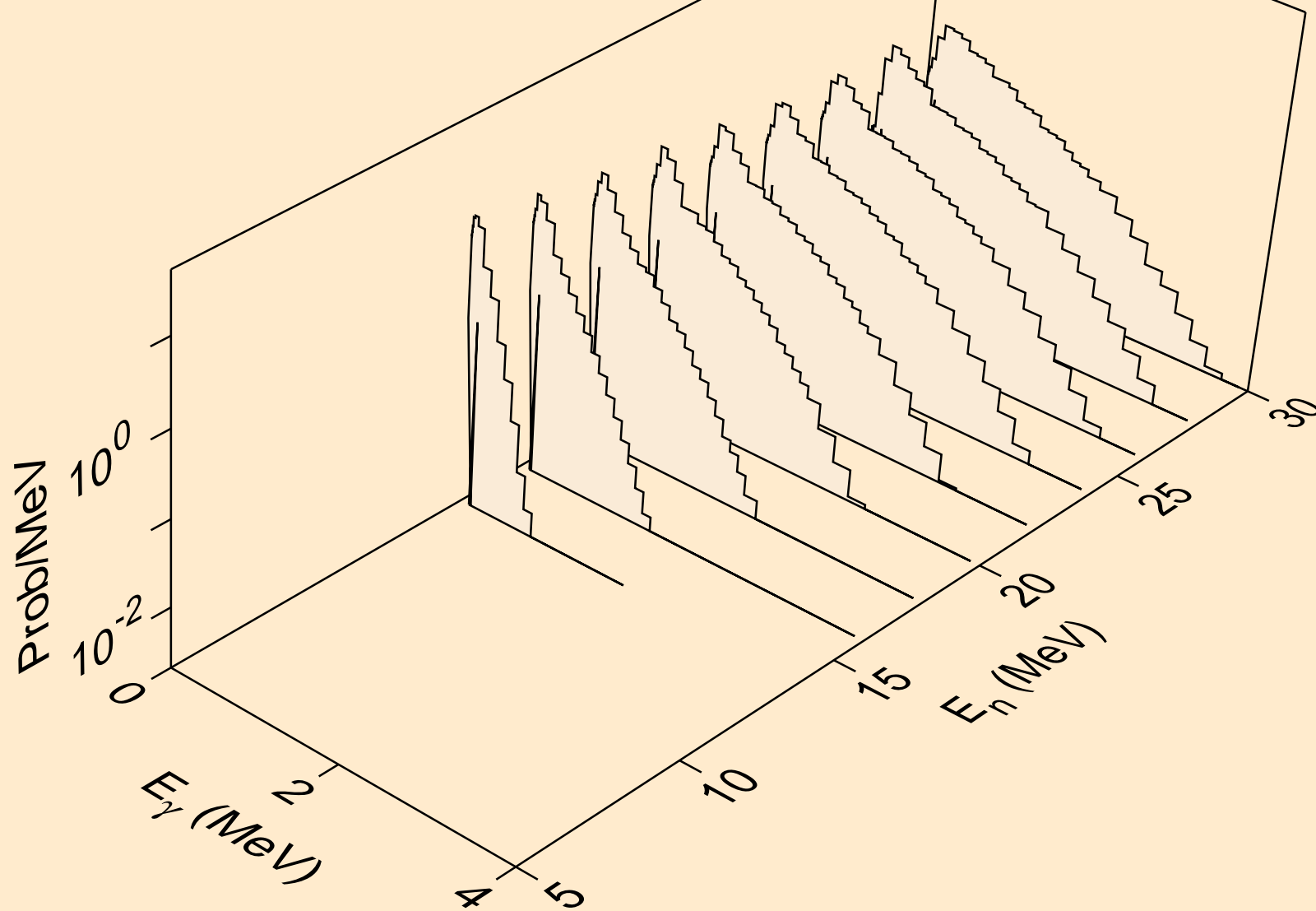



TH239 NEUTRON ACER TENDL-2021 LIBRARY; T=293.6K  
Photon emission for (n,n\*)he3

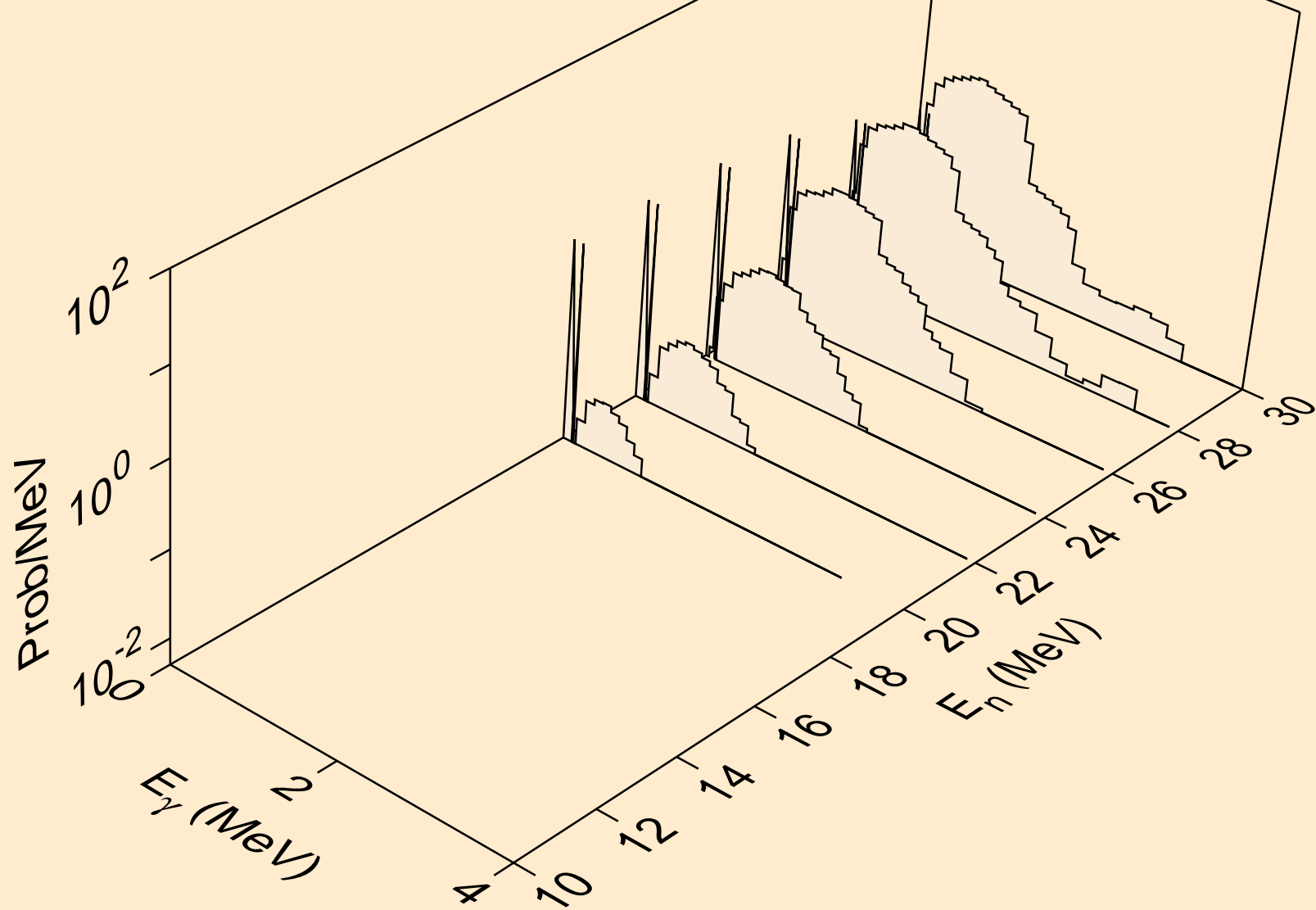

TH239 NEUTRON ACER TENDL-2021 LIBRARY; T=293.6K  
Photon emission for (n,4n)

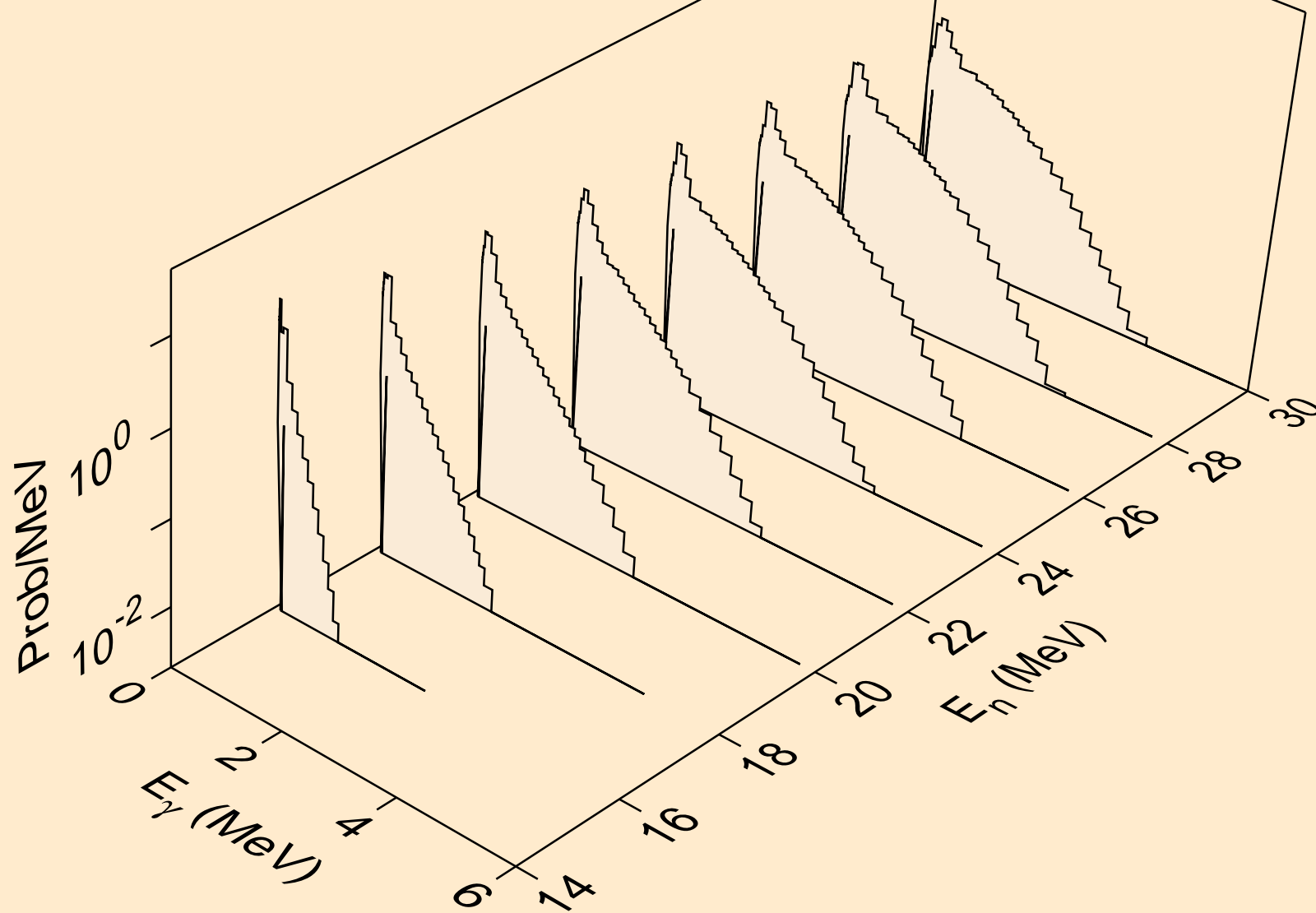

TH239 NEUTRON ACER TENDL-2021 LIBRARY; T=293.6K  
Photon emission for (n,2np)

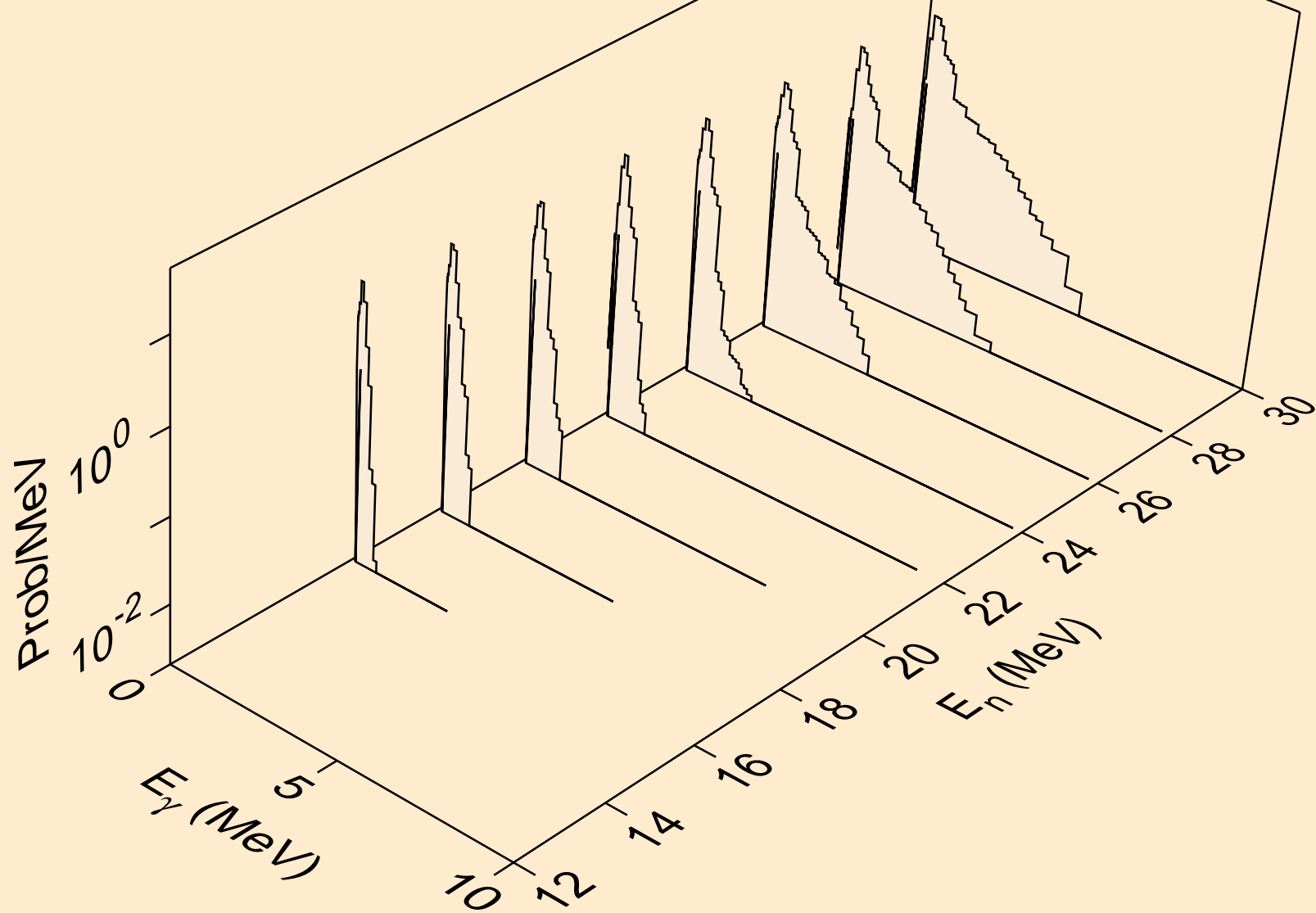

TH239 NEUTRON ACER TENDL-2021 LIBRARY; T=293.6K  
Photon emission for (n,3np)

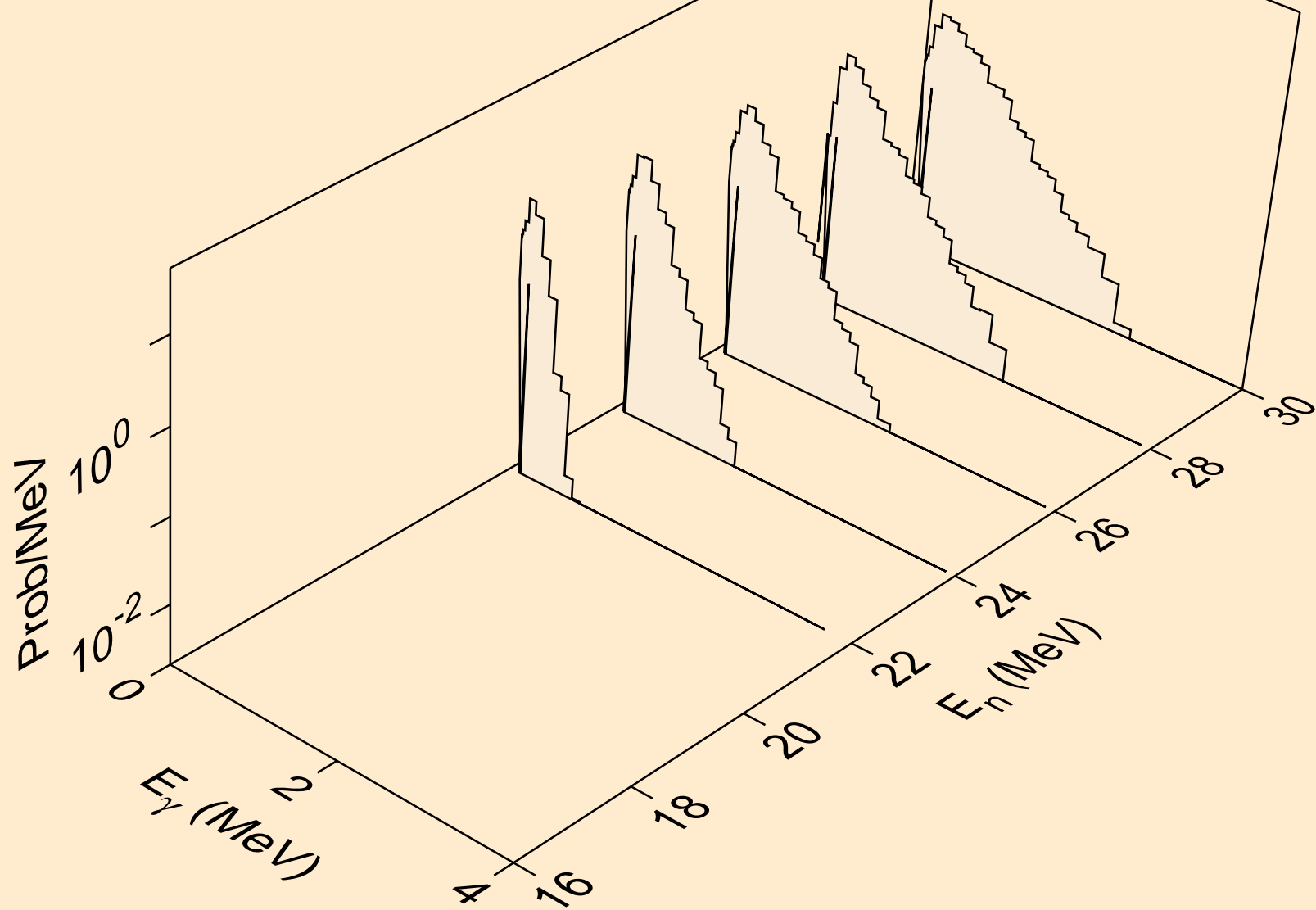

TH239 NEUTRON ACER TENDL-2021 LIBRARY; T=293.6K  
Photon emission for (n,2np)

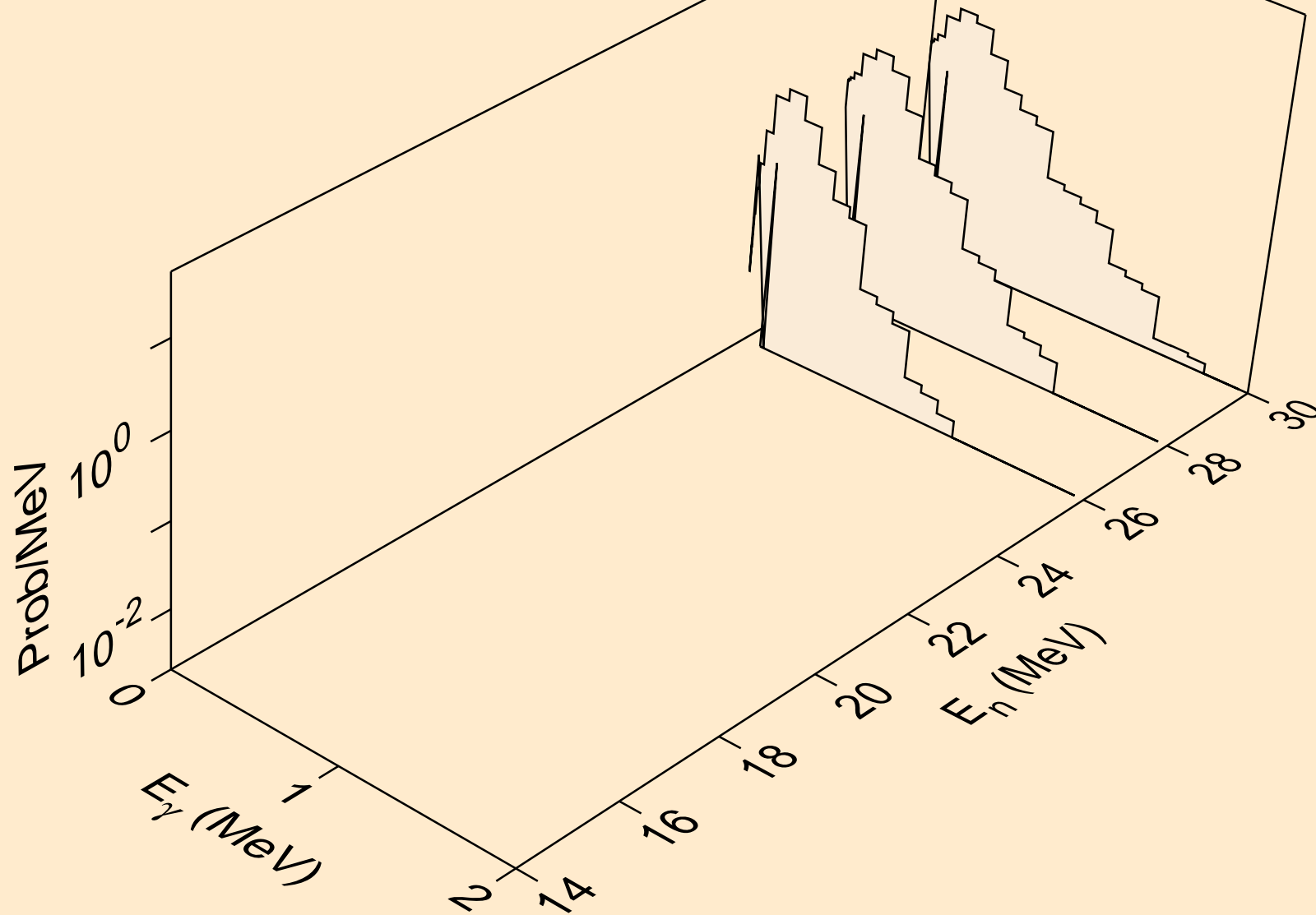

TH239 NEUTRON ACER TENDL-2021 LIBRARY; T=293.6K  
Photon emission for (n,n\*c)

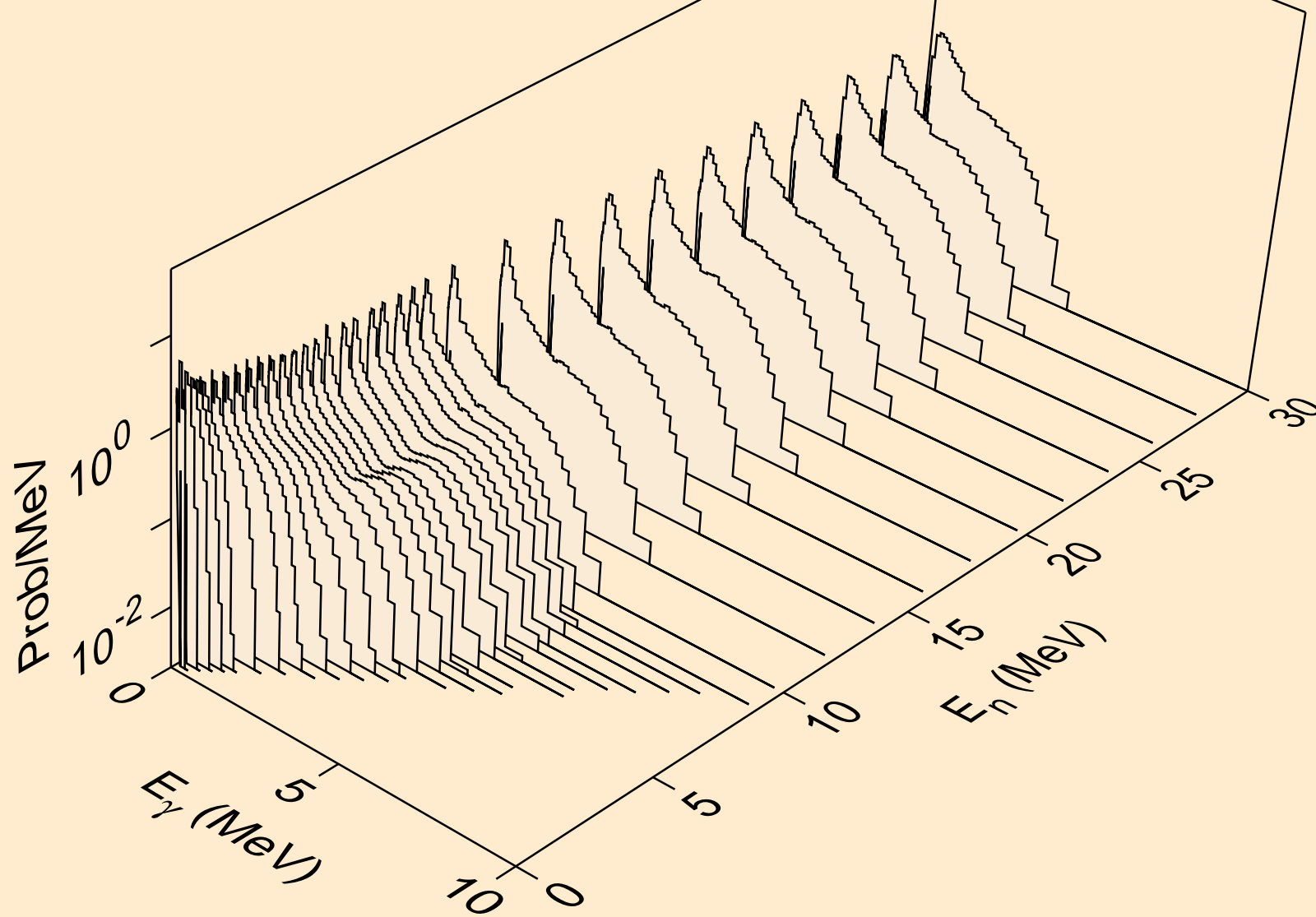

TH239 NEUTRON ACER TENDL-2021 LIBRARY; T=293.6K  
Photon emission for (n,gma)

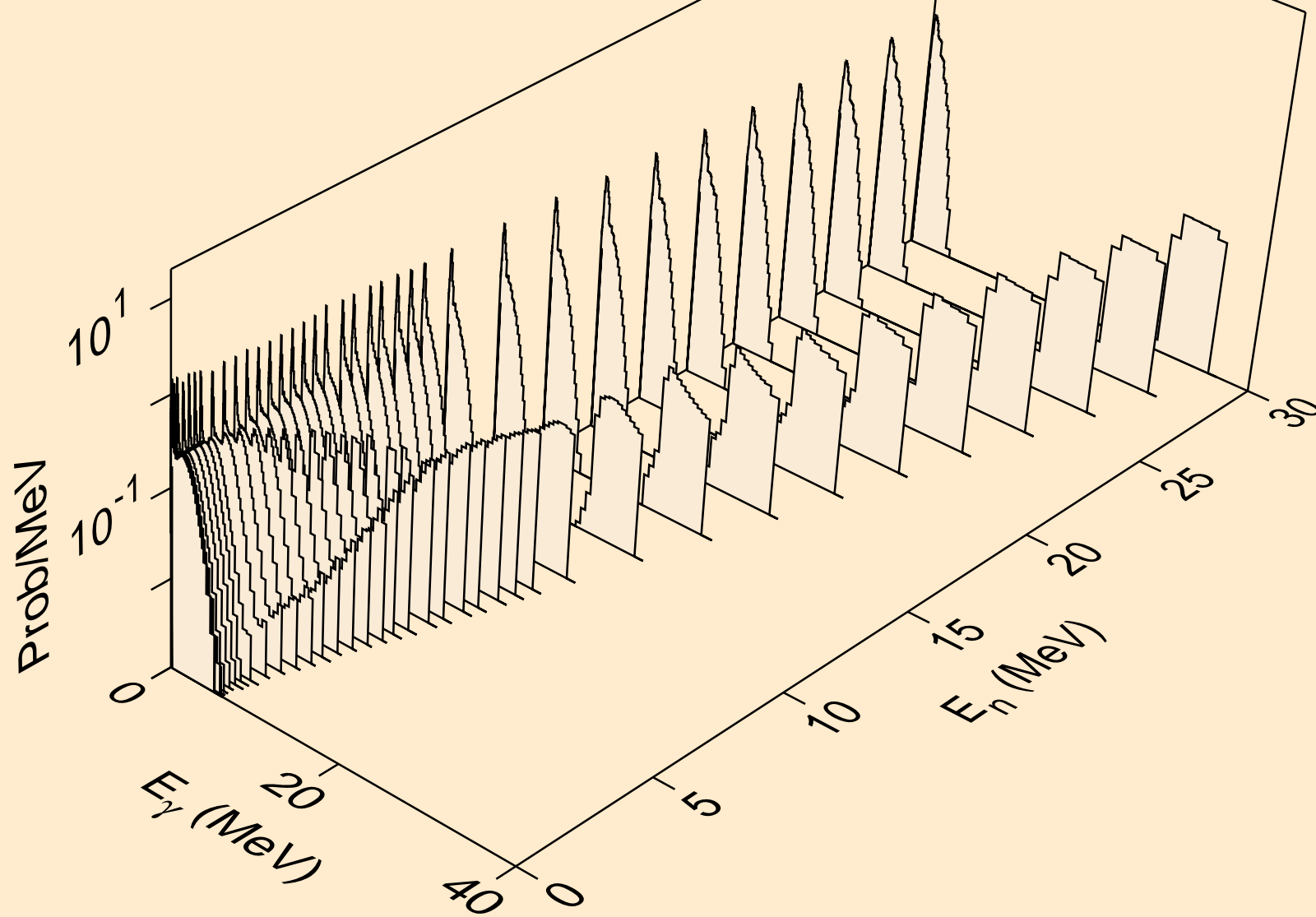

TH239 NEUTRON ACER TENDL-2021 LIBRARY; T=293.6K  
Photon emission for (n,p)

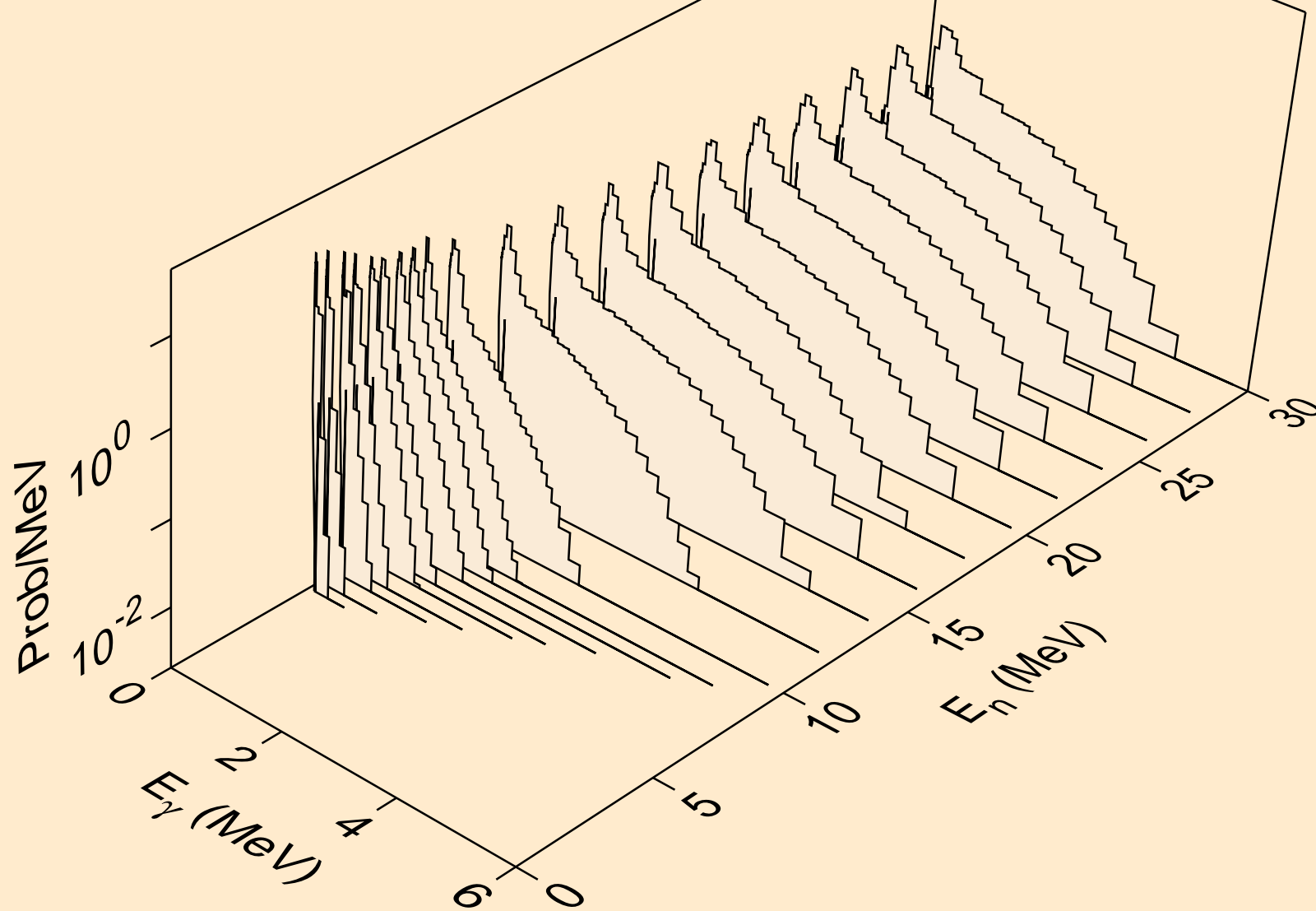



TH239 NEUTRON ACER TENDL-2021 LIBRARY; T=293.6K  
Photon emission for (n,d)

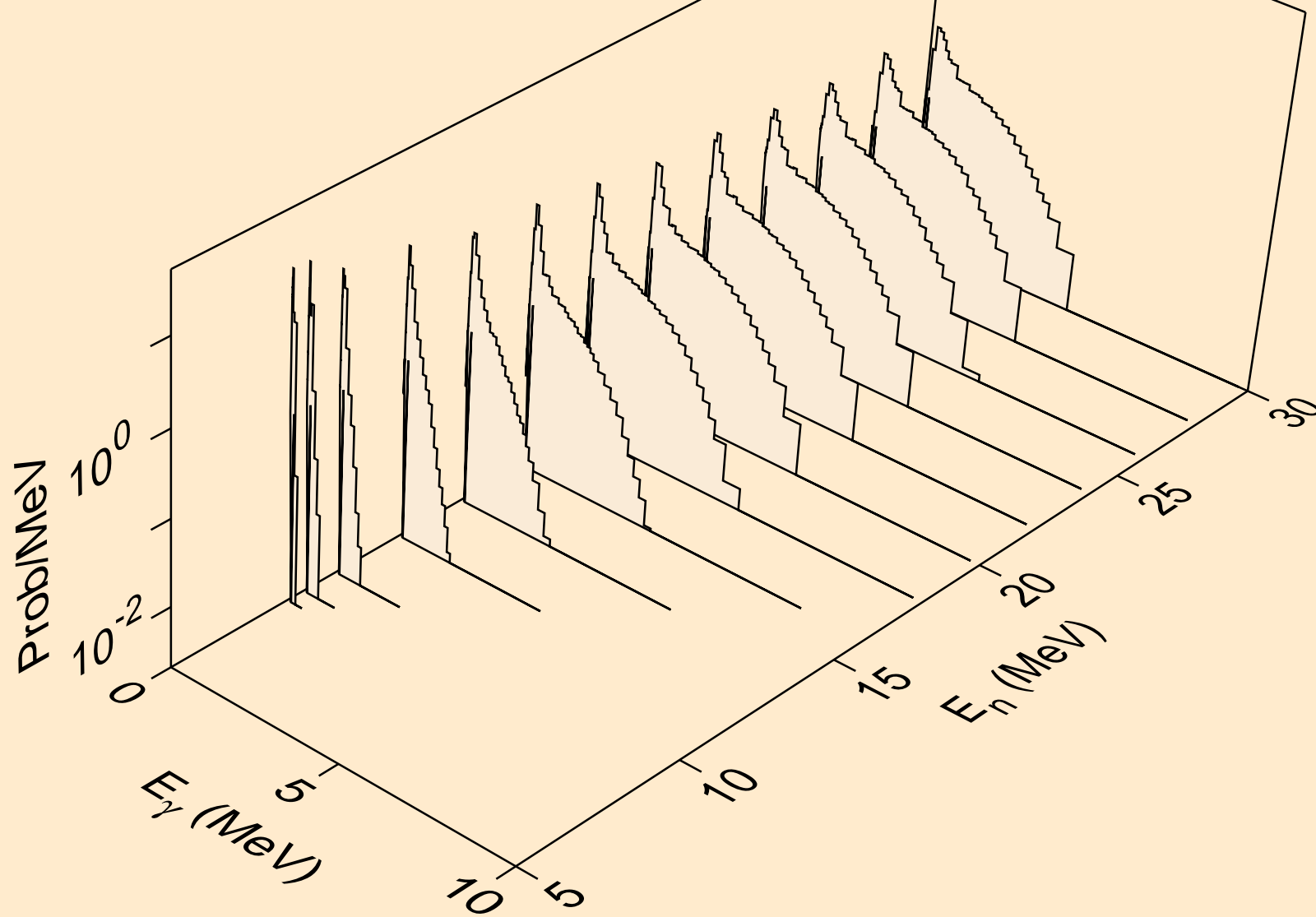

TH239 NEUTRON ACER TENDL-2021 LIBRARY; T=293.6K  
Photon emission for (n,t)

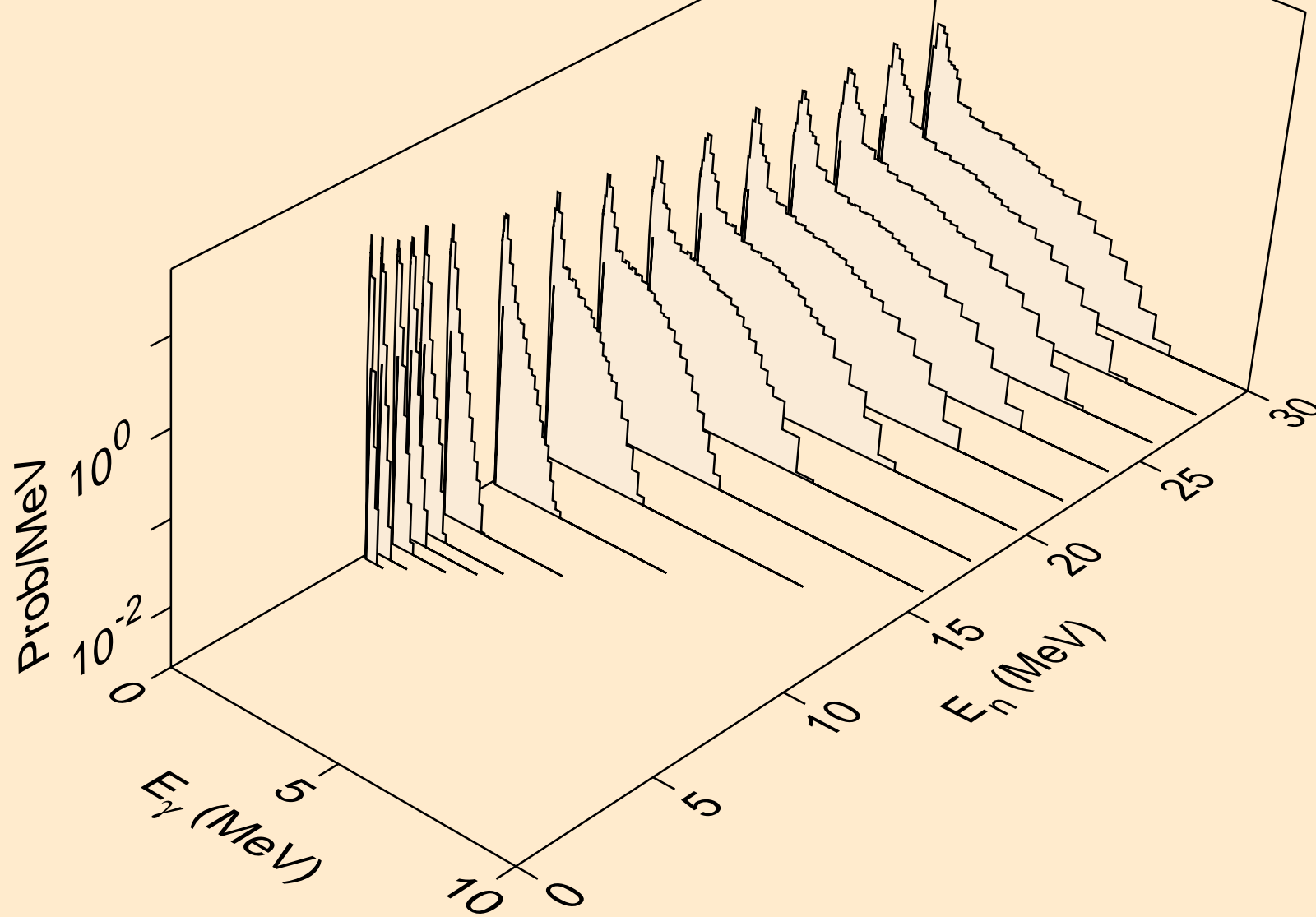

TH239 NEUTRON ACER TENDL-2021 LIBRARY; T=293.6K  
Photon emission for (n,he3)

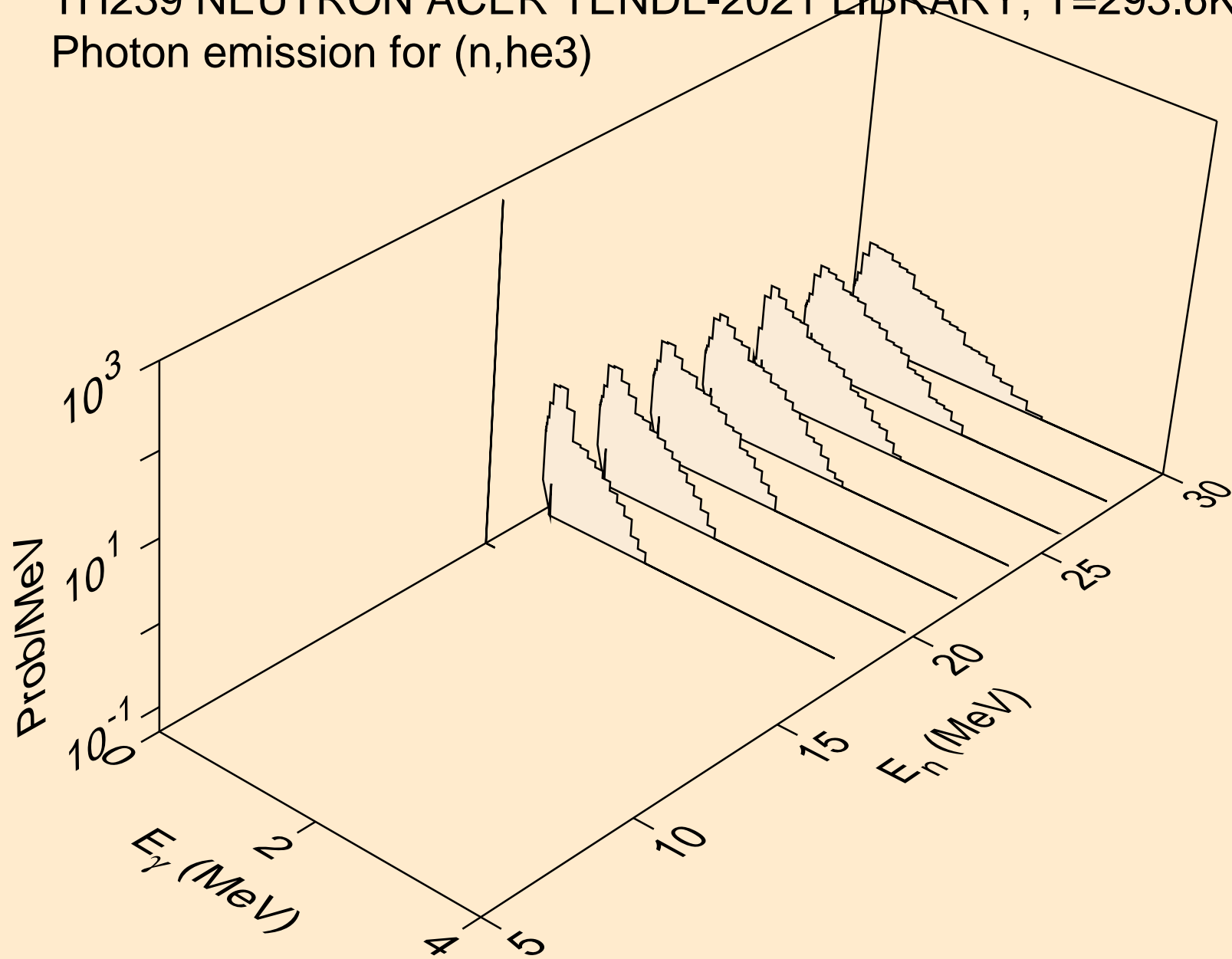

TH239 NEUTRON ACER TENDL-2021 LIBRARY; T=293.6K  
Photon emission for (n,a)

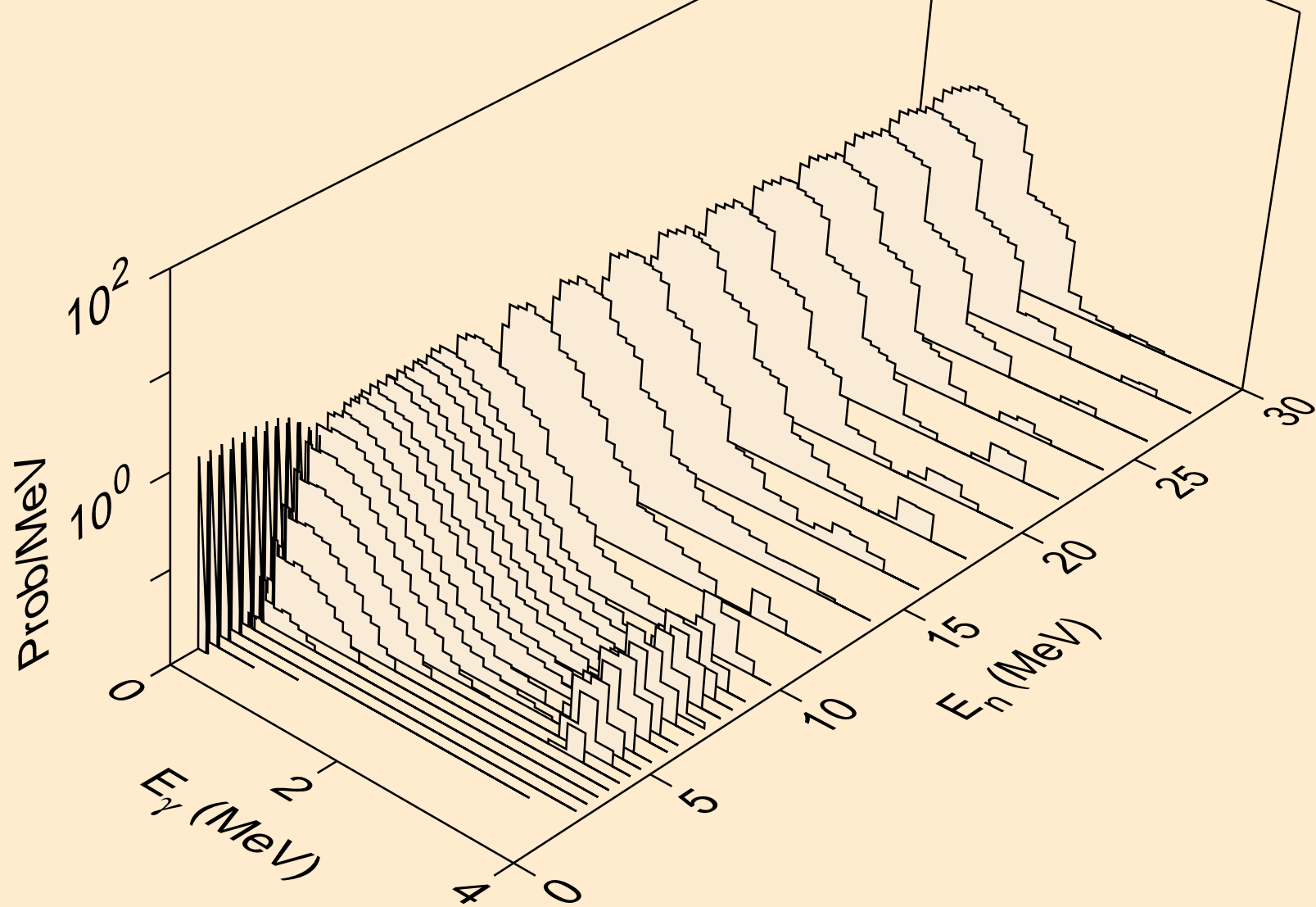

TH239 NEUTRON ACER TENDL-2021 LIBRARY; T=293.6K  
Photon emission for (n,2a)

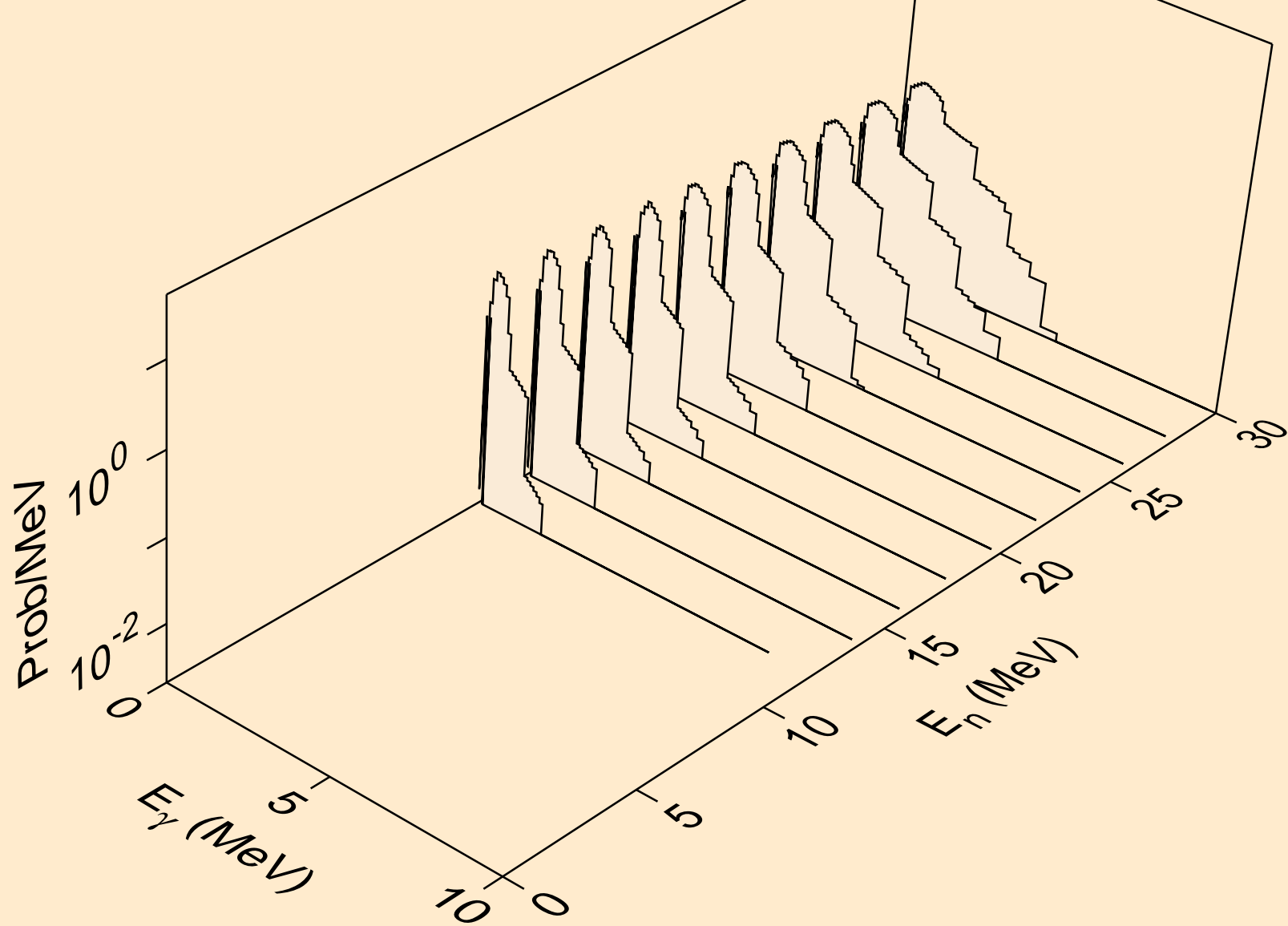

TH239 NEUTRON ACER TENDL-2021 LIBRARY; T=293.6K  
Photon emission for (n,2p)

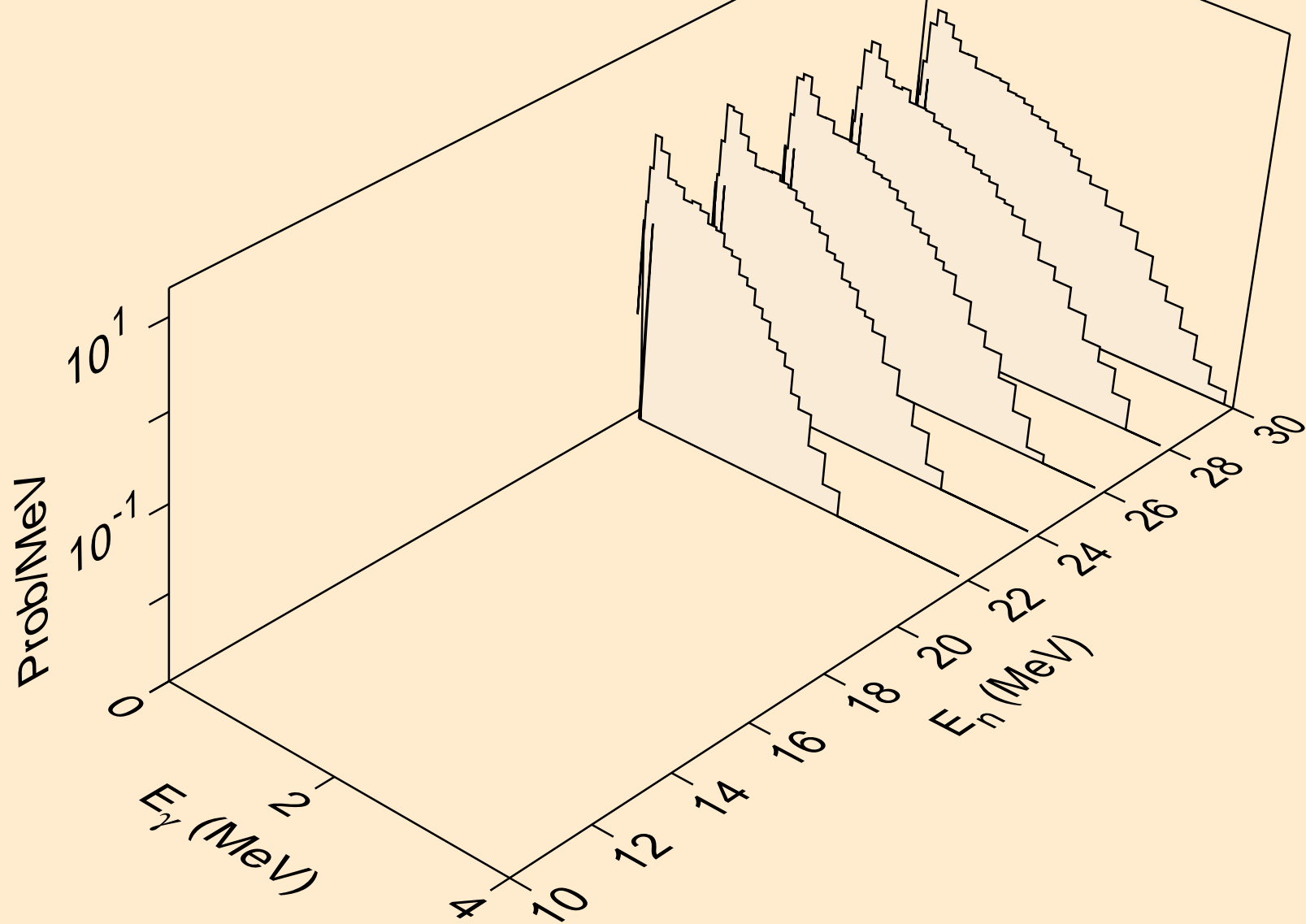

TH239 NEUTRON ACER TENDL-2021 LIBRARY; T=293.6K  
Photon emission for (n,p)

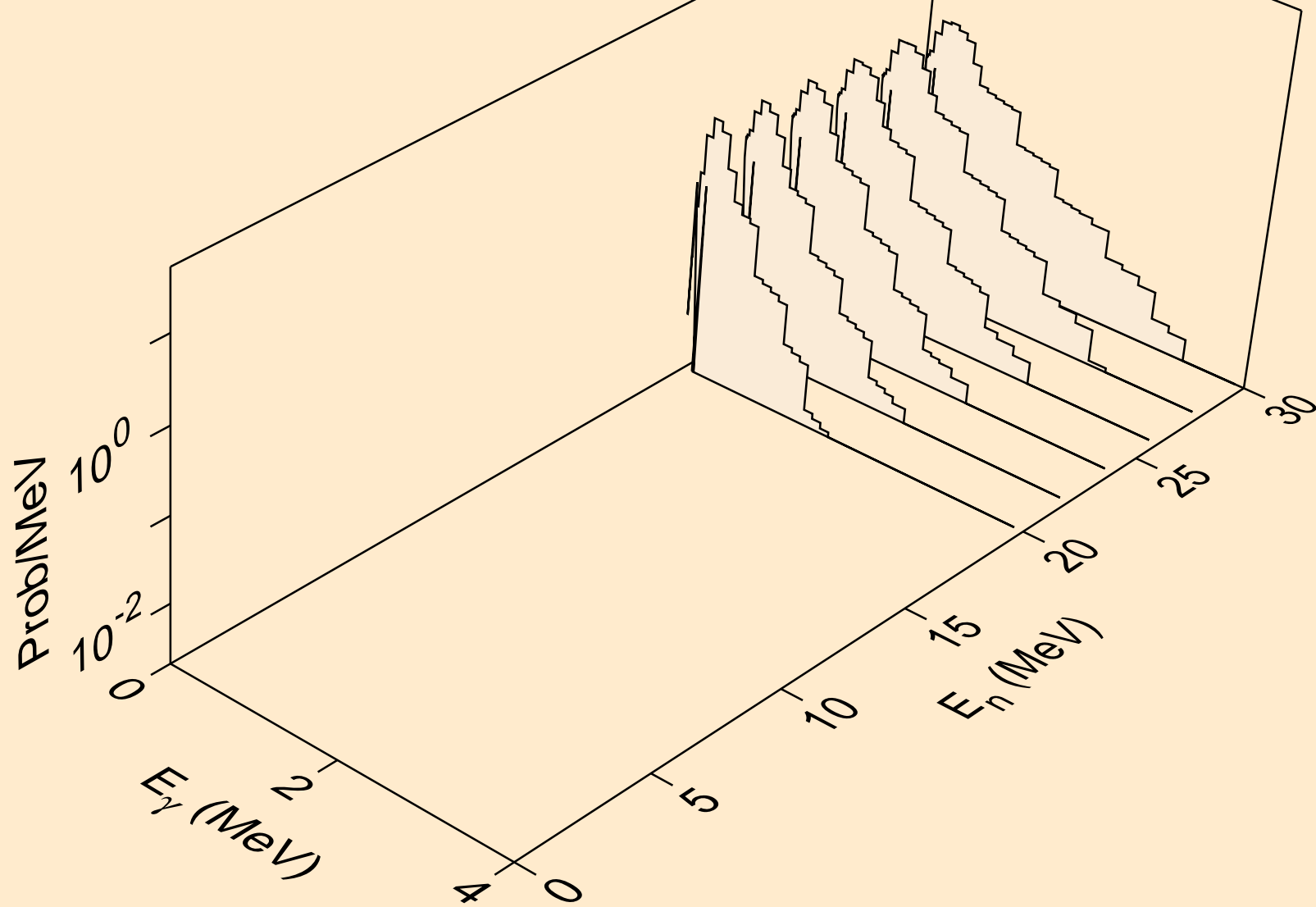

TH239 NEUTRON ACER TENDL-2021 LIBRARY; T=293.6K  
thermal capture photon spectrum

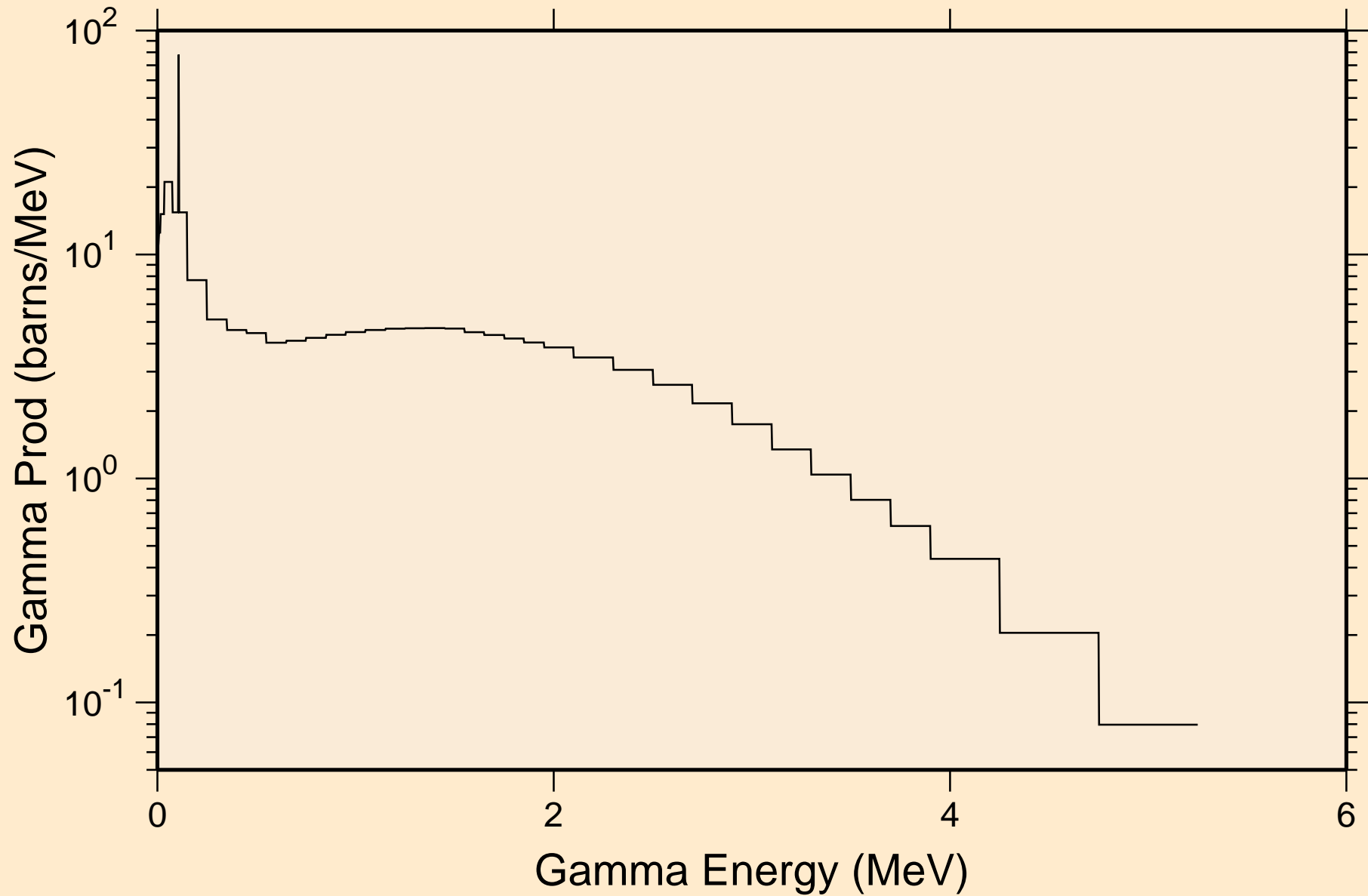



TH239 NEUTRON ACER TENDL-2021 LIBRARY; T=293.6K  
14 MeV photon spectrum

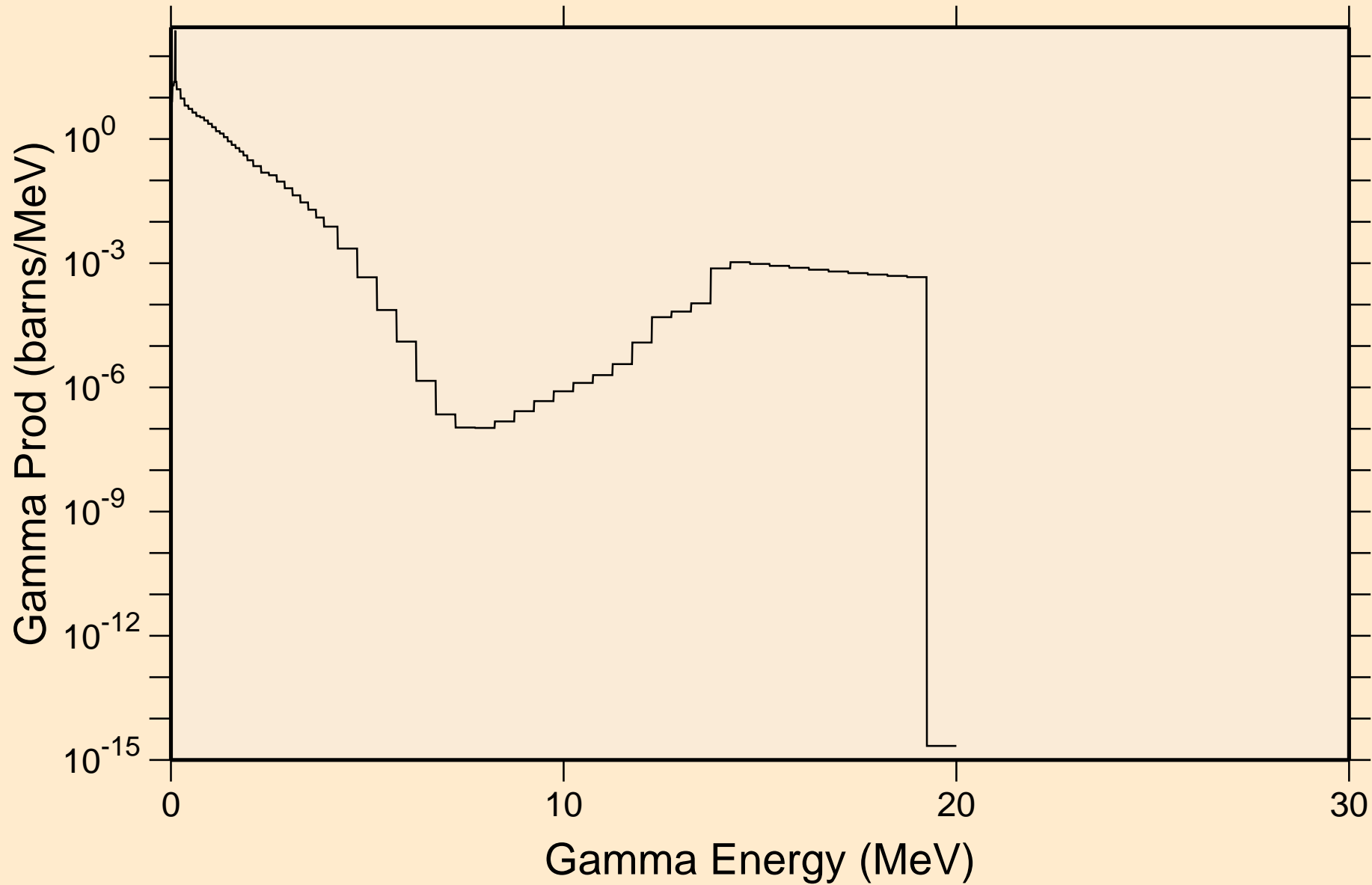

# TH239 NEUTRON ACER TENDL-2021 LIBRARY; T=293.6K

## Particle heating contributions

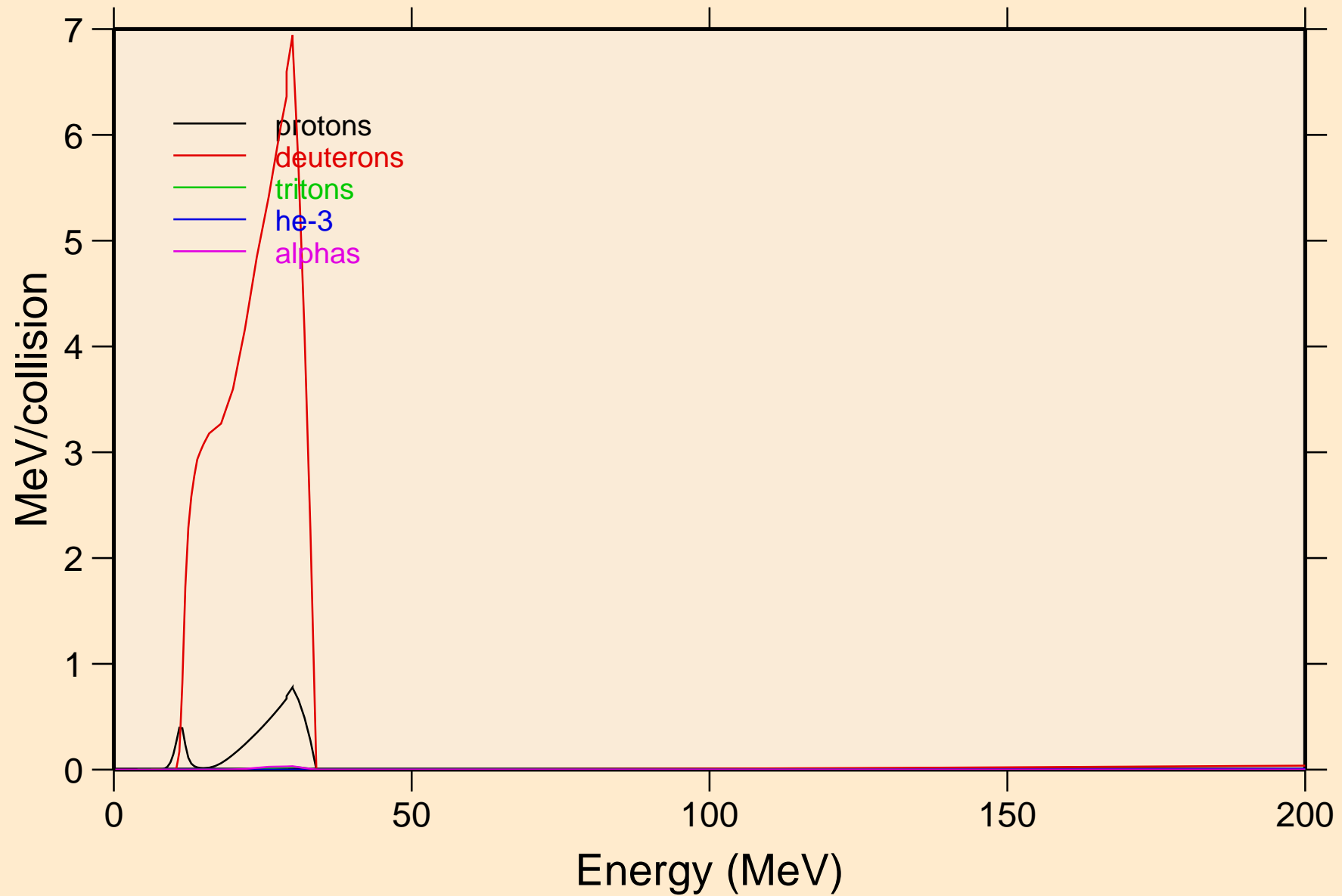

TH239 NEUTRON ACER TENDL-2021 LIBRARY; T=293.6K  
Recoil Heating

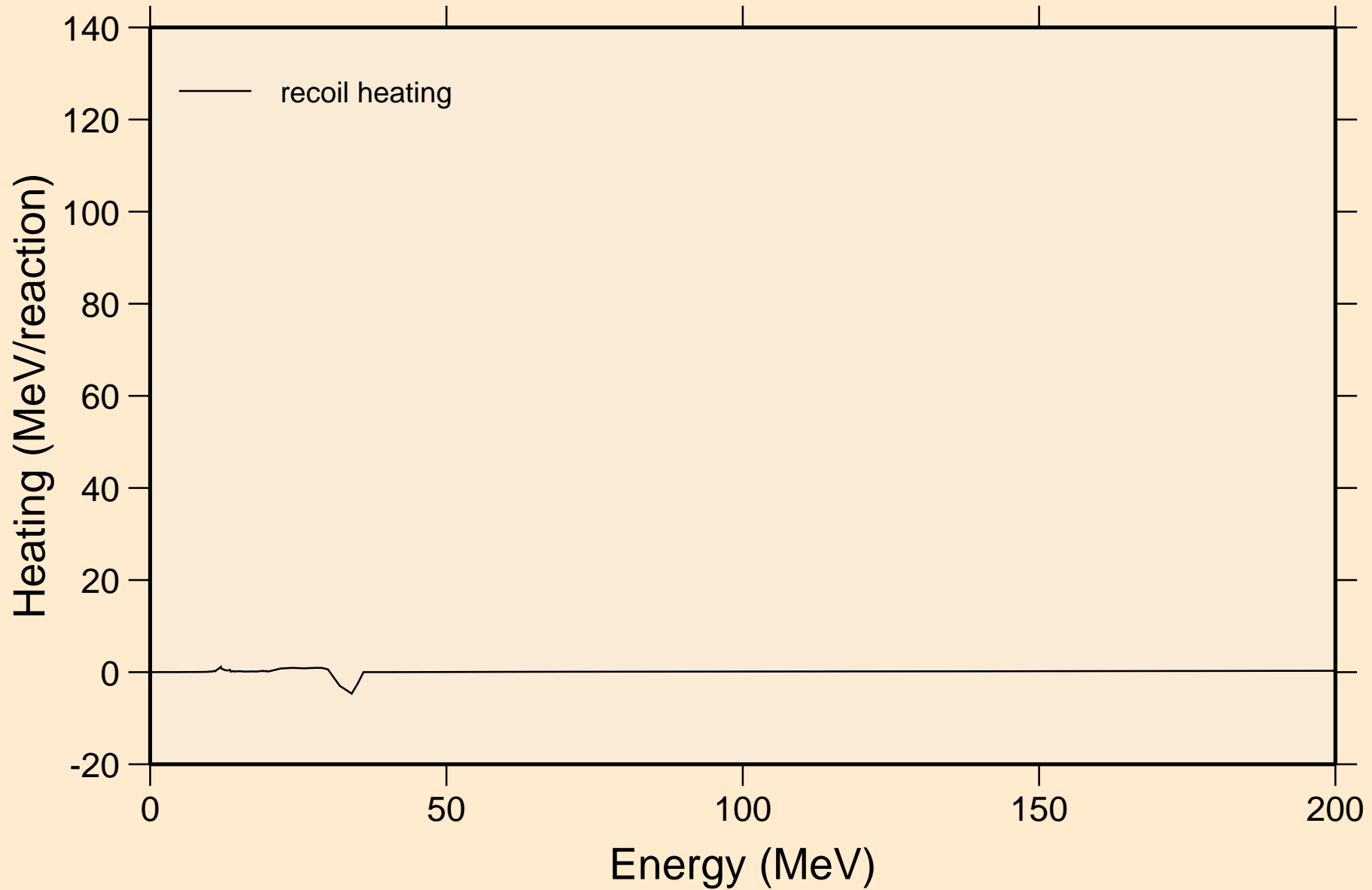

# TH239 NEUTRON ACER TENDL-2021 LIBRARY; T=293.6K

## Particle production cross sections

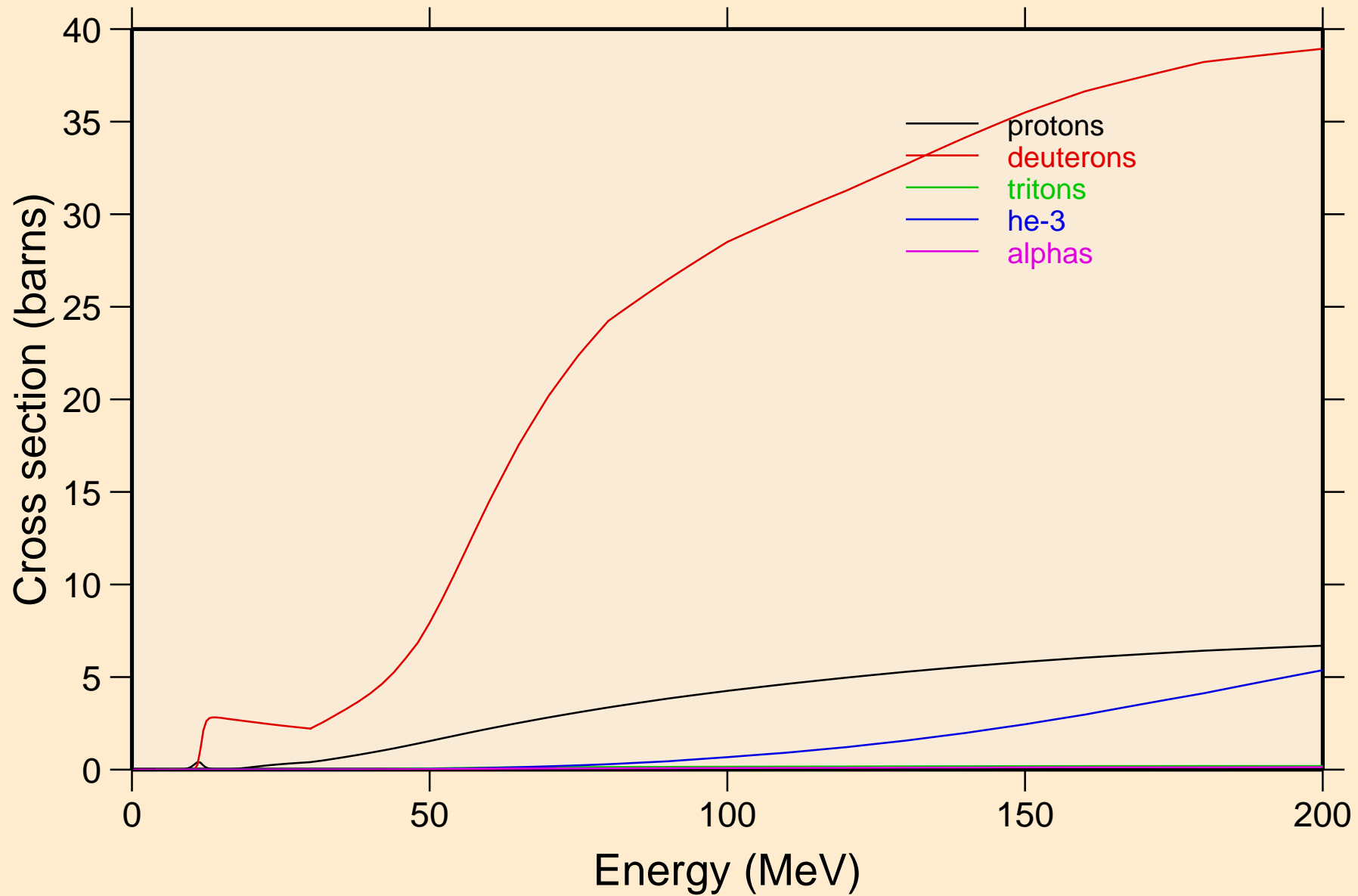

TH239 NEUTRON ACER TENDL-2021 LIBRARY; T=293.6K  
protons from (n,x)

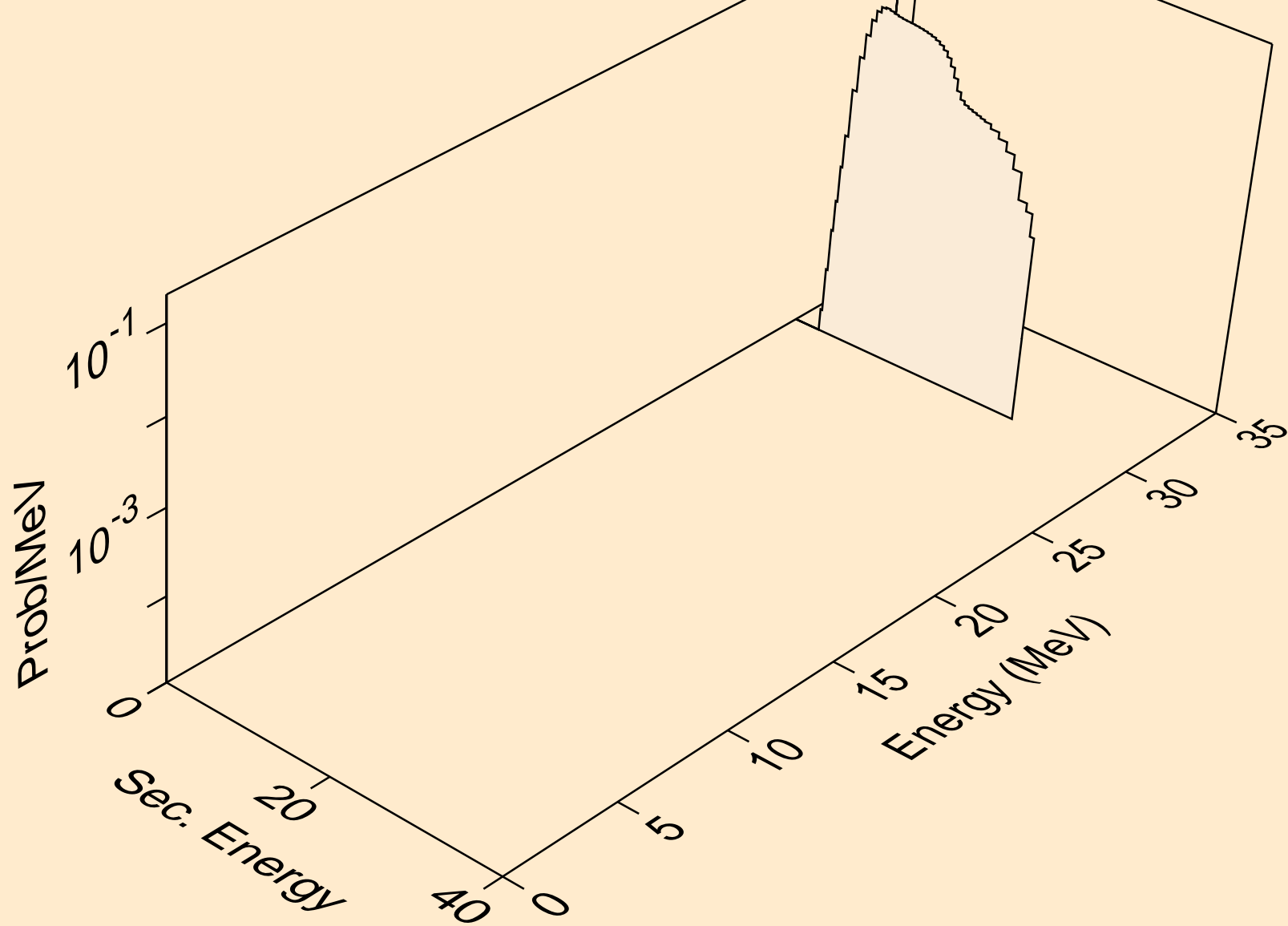

TH239 NEUTRON ACER TENDL-2021 LIBRARY; T=293.6K  
protons from (n,n\*)p

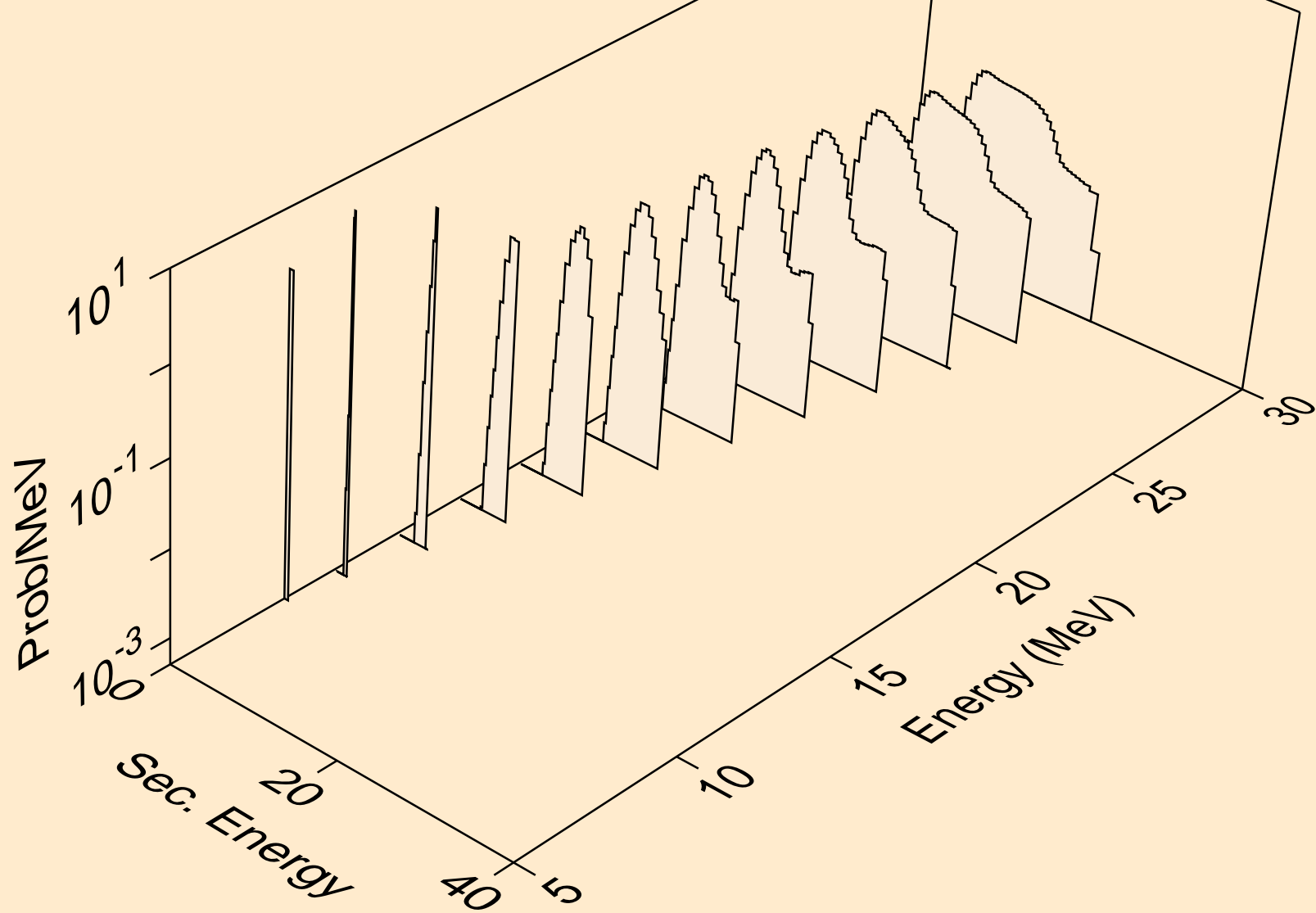

TH239 NEUTRON ACER TENDL-2021 LIBRARY; T=293.6K  
protons from (n,2np)

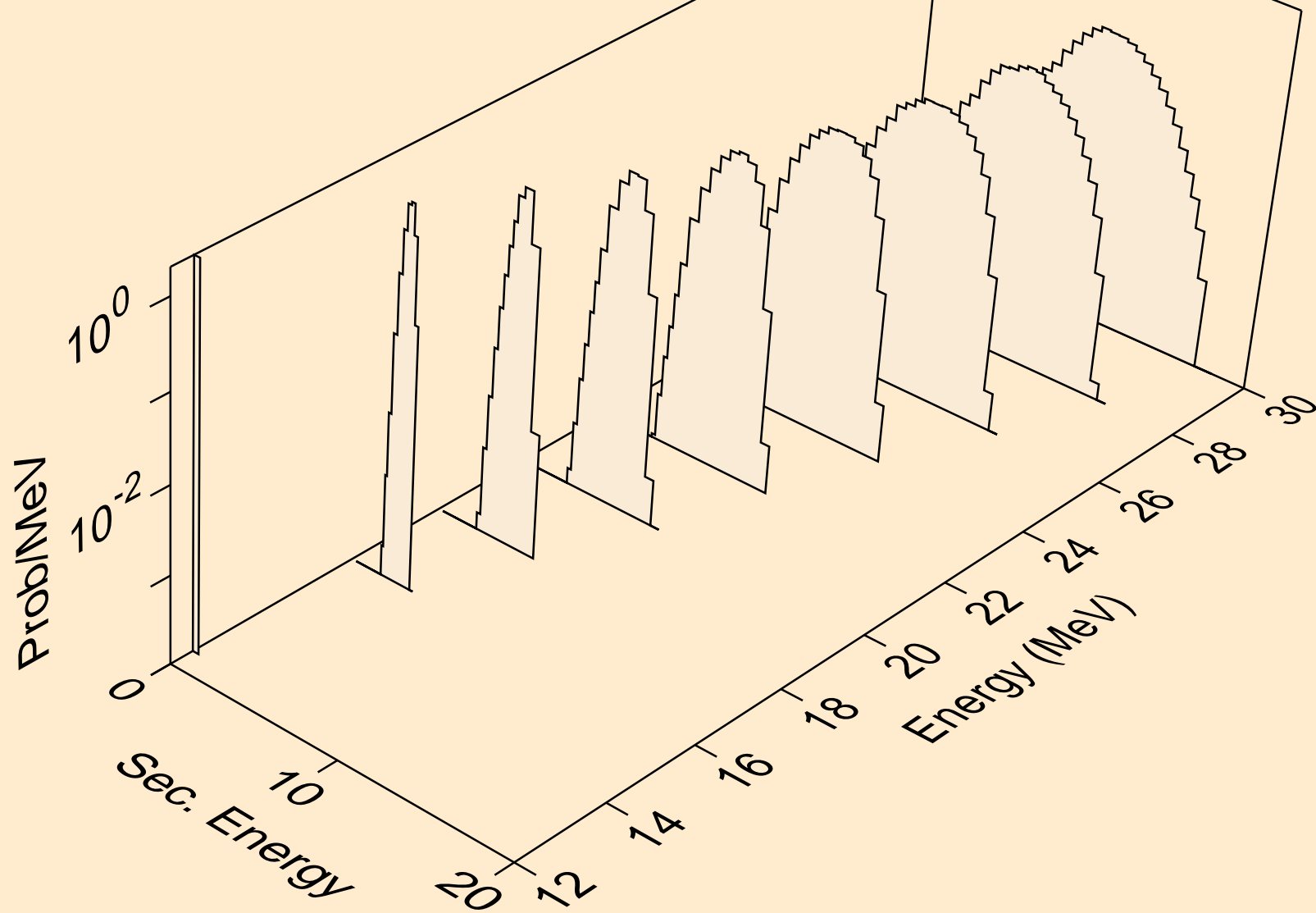

TH239 NEUTRON ACER TENDL-2021 LIBRARY; T=293.6K  
protons from (n,3np)

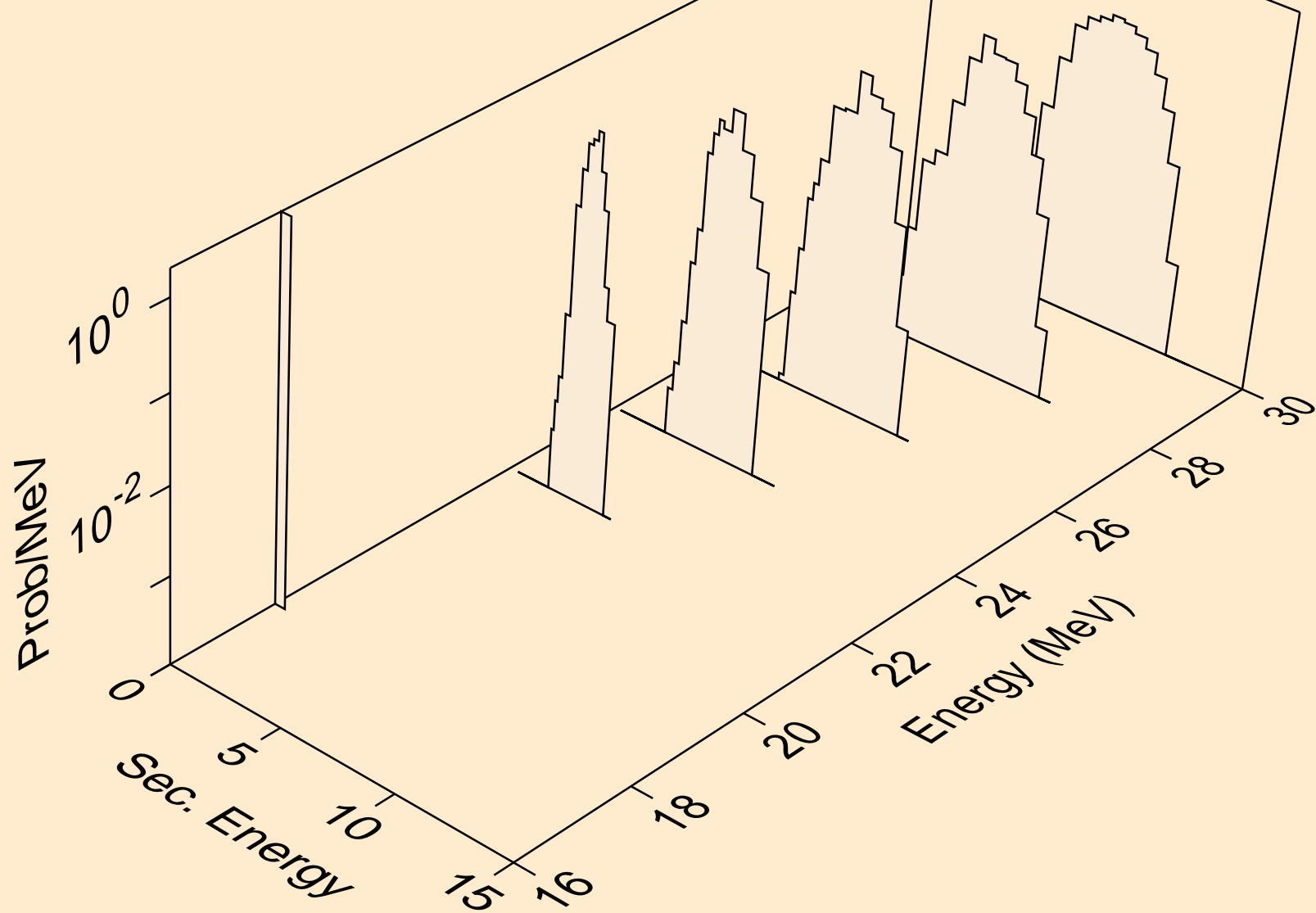



TH239 NEUTRON ACER TENDL-2021 LIBRARY; T=293.6K  
protons from (n,2np)

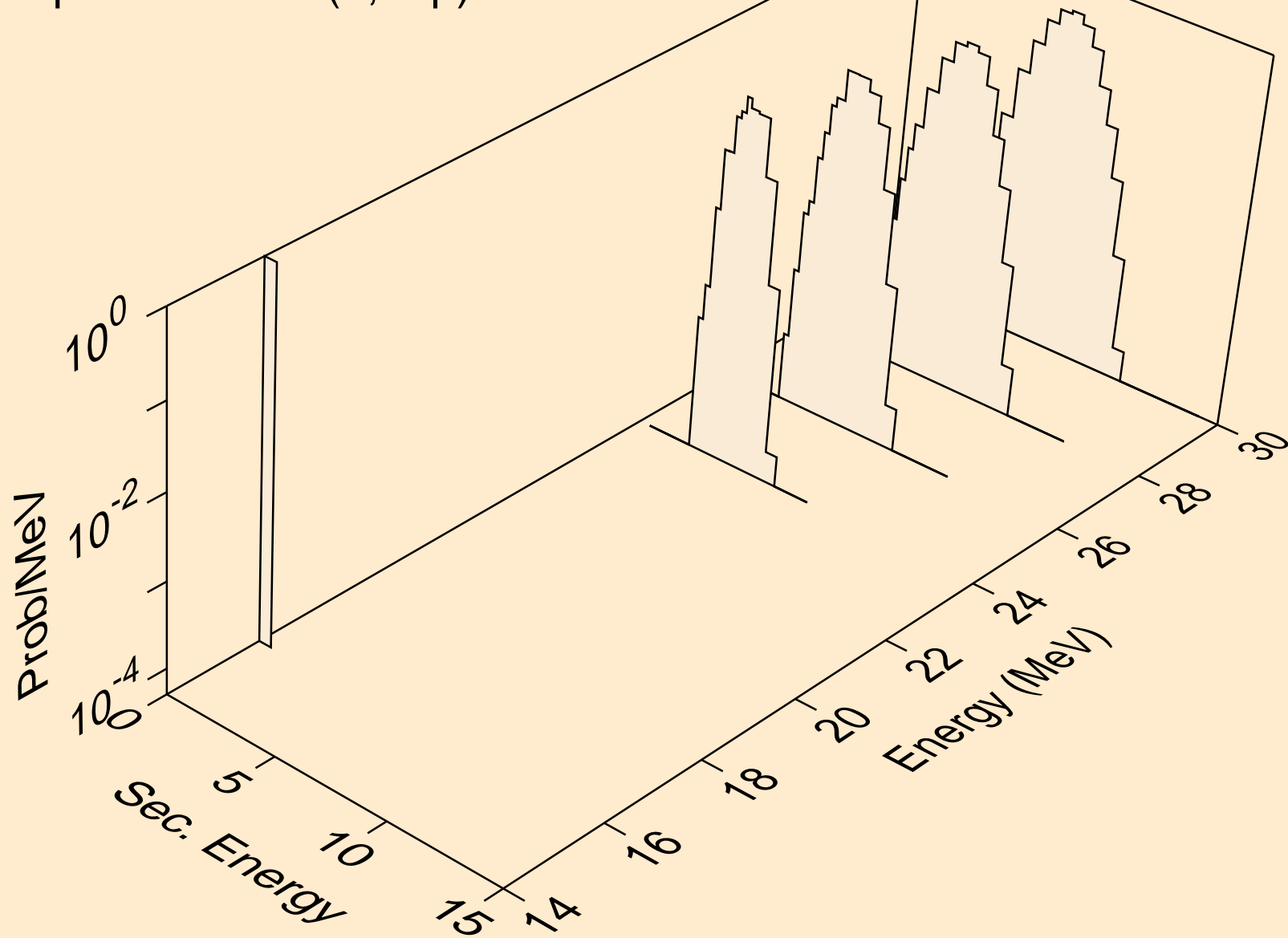

TH239 NEUTRON ACER TENDL-2021 LIBRARY; T=293.6K  
protons from (n,p)

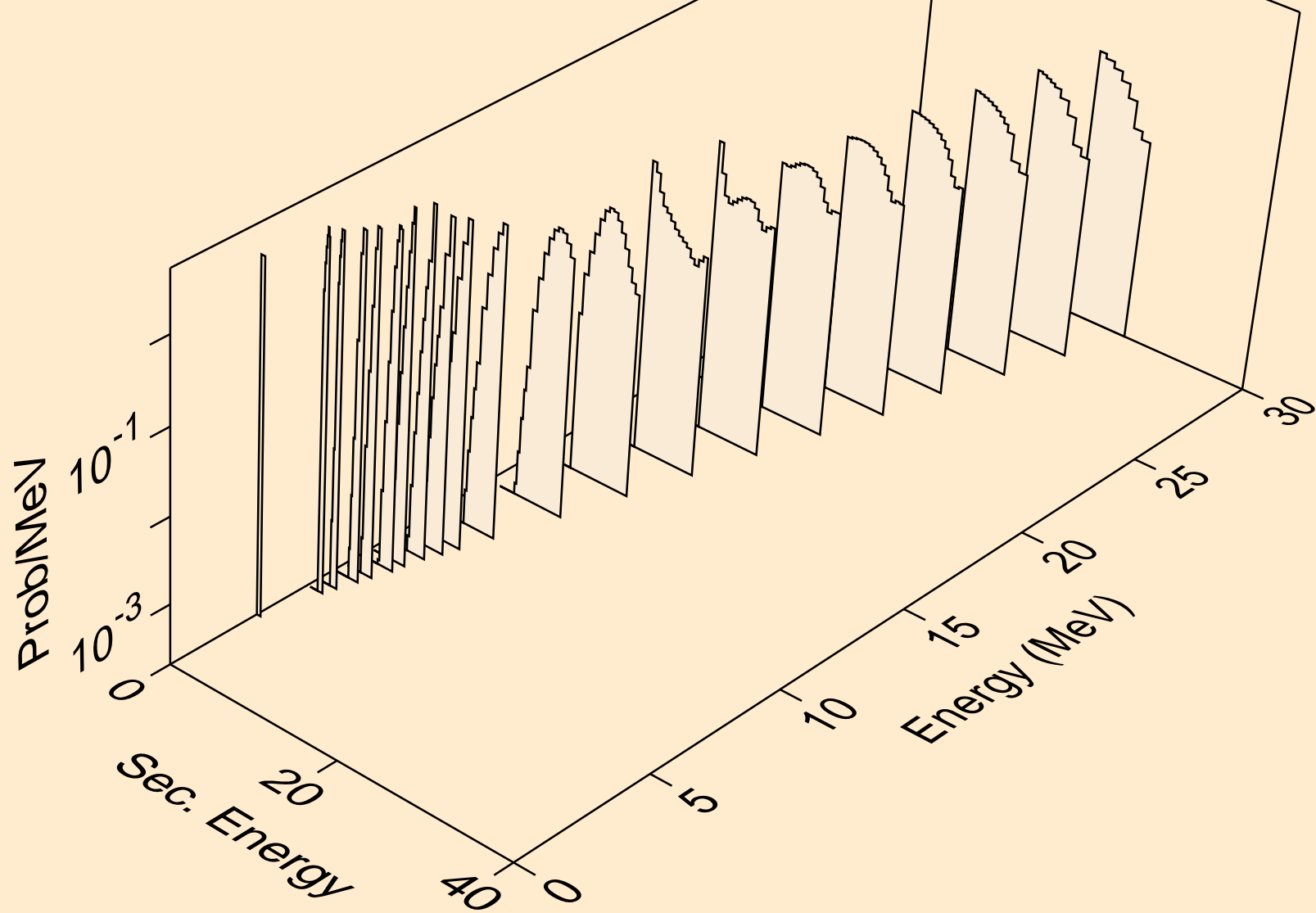

TH239 NEUTRON ACER TENDL-2021 LIBRARY; T=293.6K  
protons from (n,2p)

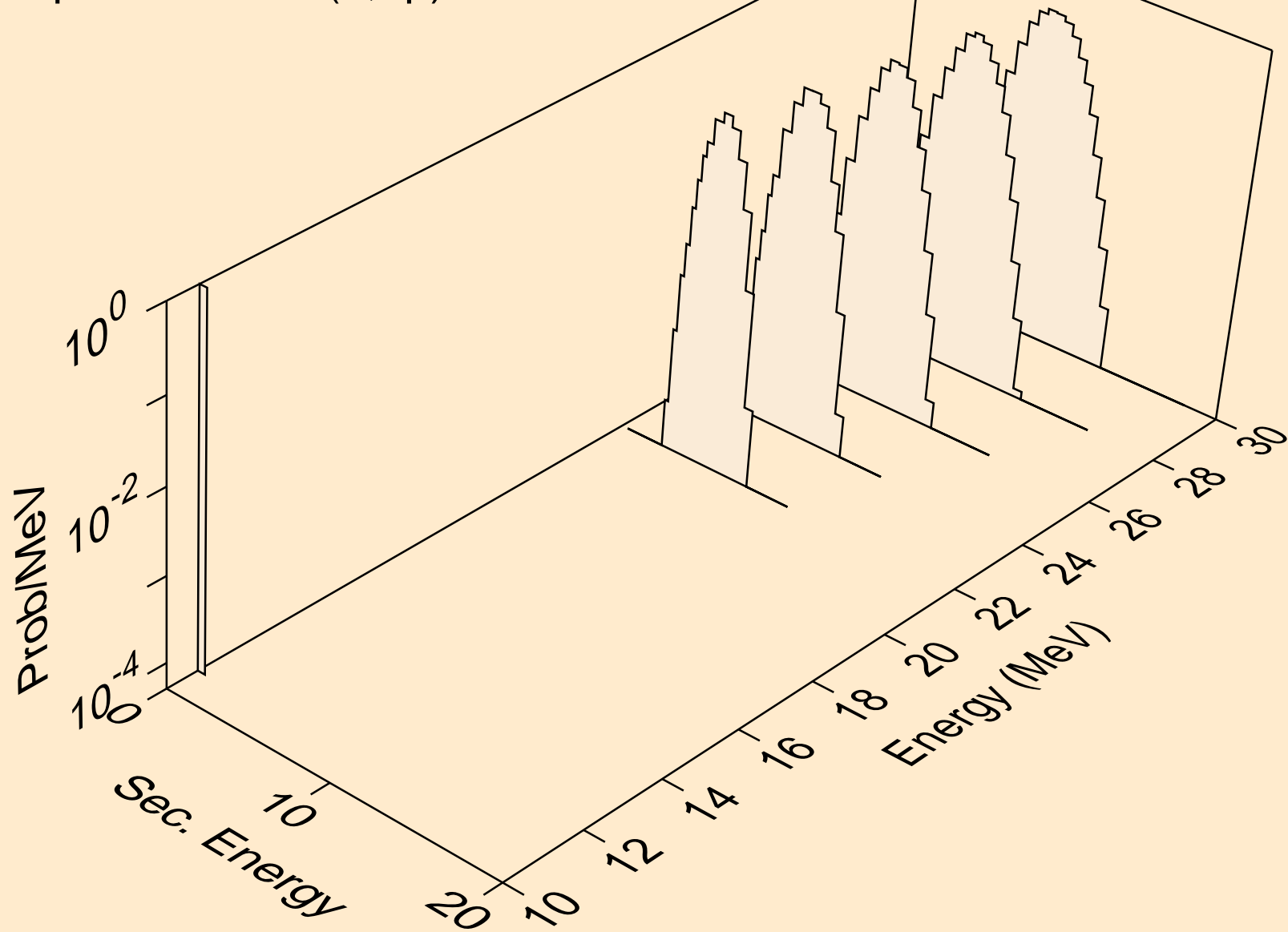

TH239 NEUTRON ACER TENDL-2021 LIBRARY; T=293.6K  
protons from (n,p)

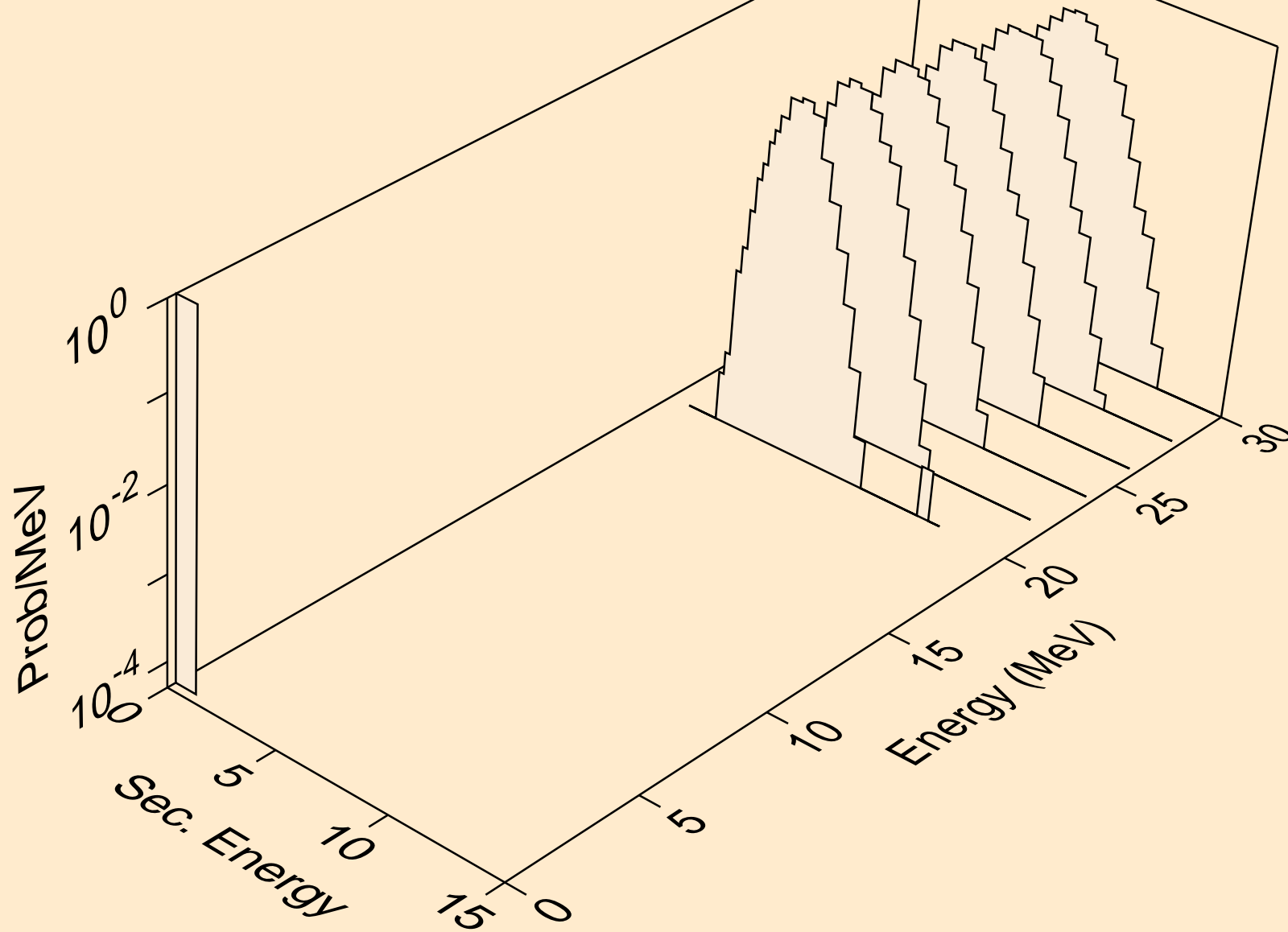

TH239 NEUTRON ACER TENDL-2021 LIBRARY; T=293.6K  
deuterons from (n,x)

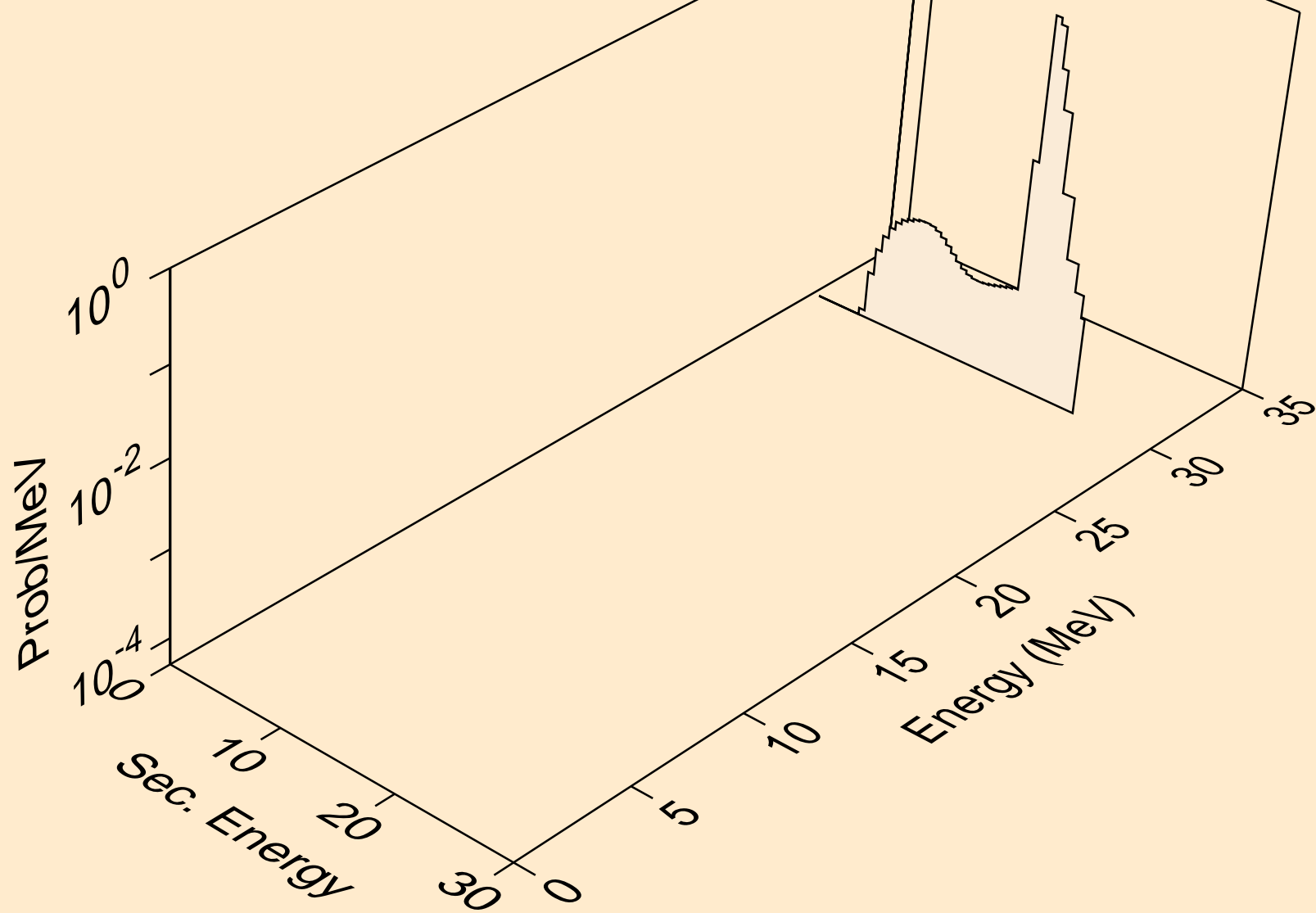

TH239 NEUTRON ACER TENDL-2021 LIBRARY; T=293.6K  
deuterons from (n,2nd)

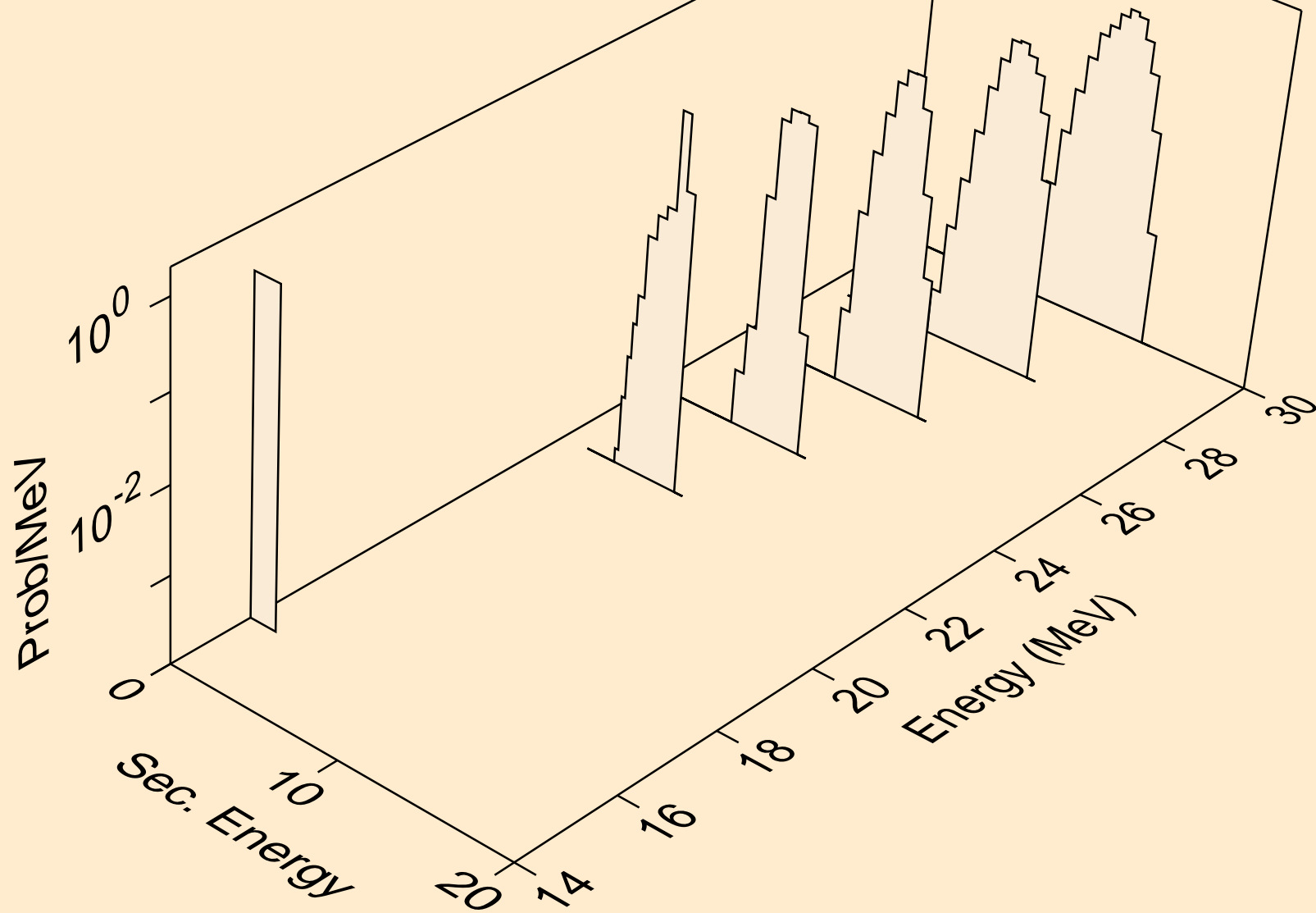

TH239 NEUTRON ACER TENDL-2021 LIBRARY; T=293.6K  
deuterons from (n,n\*)d

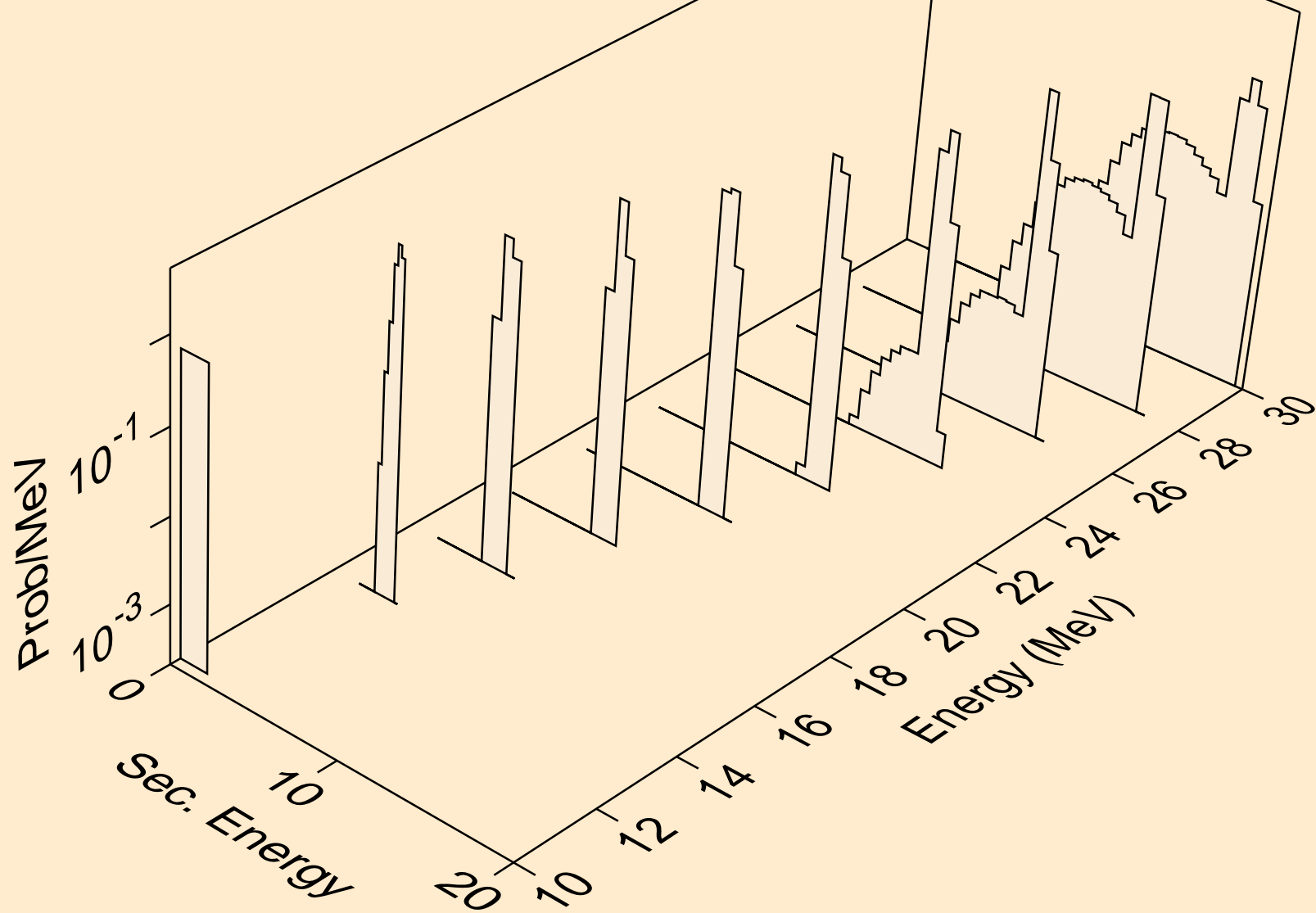

TH239 NEUTRON ACER TENDL-2021 LIBRARY; T=293.6K  
deuterons from (n,d)

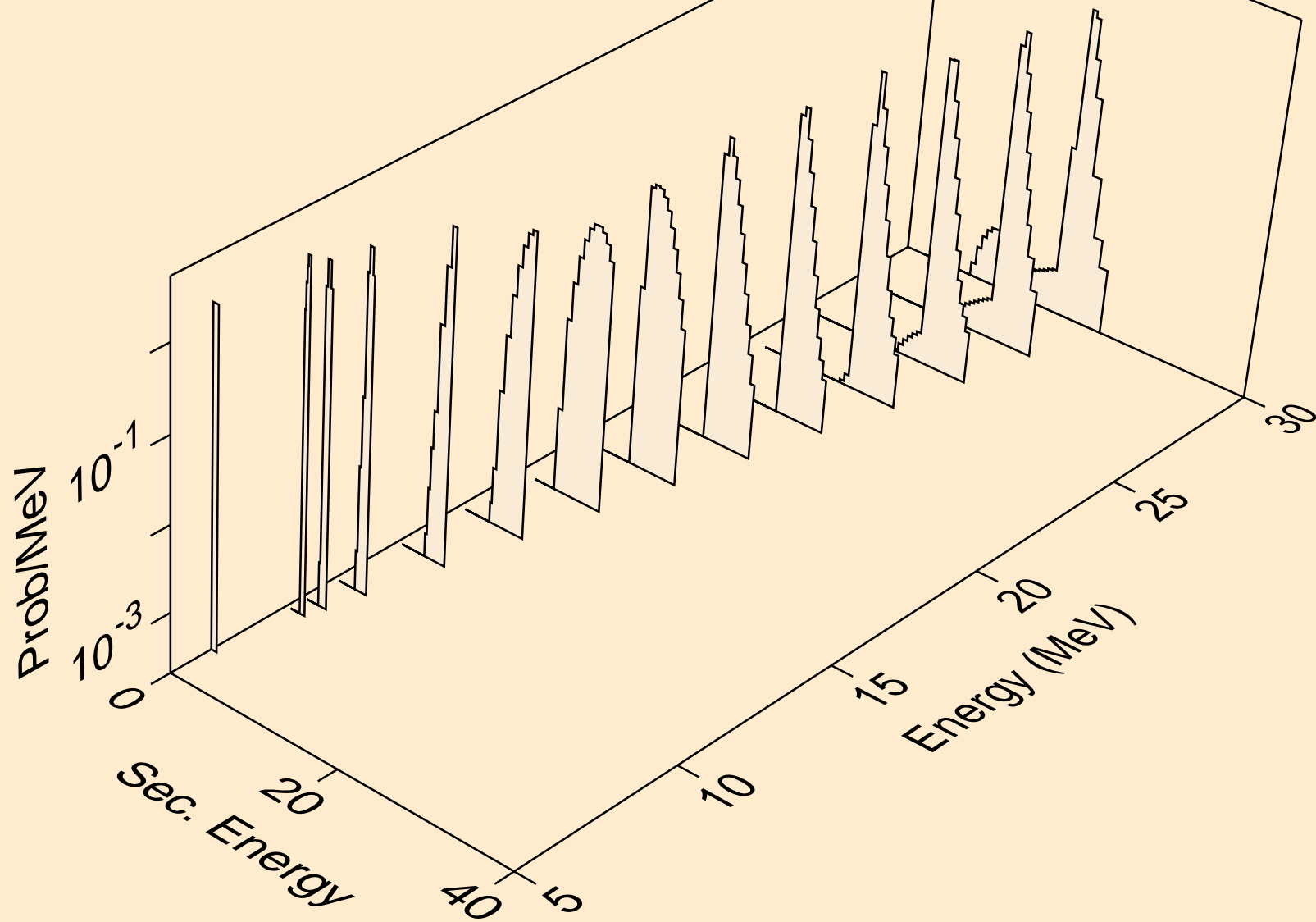



TH239 NEUTRON ACER TENDL-2021 LIBRARY; T=293.6K  
tritons from (n,x)

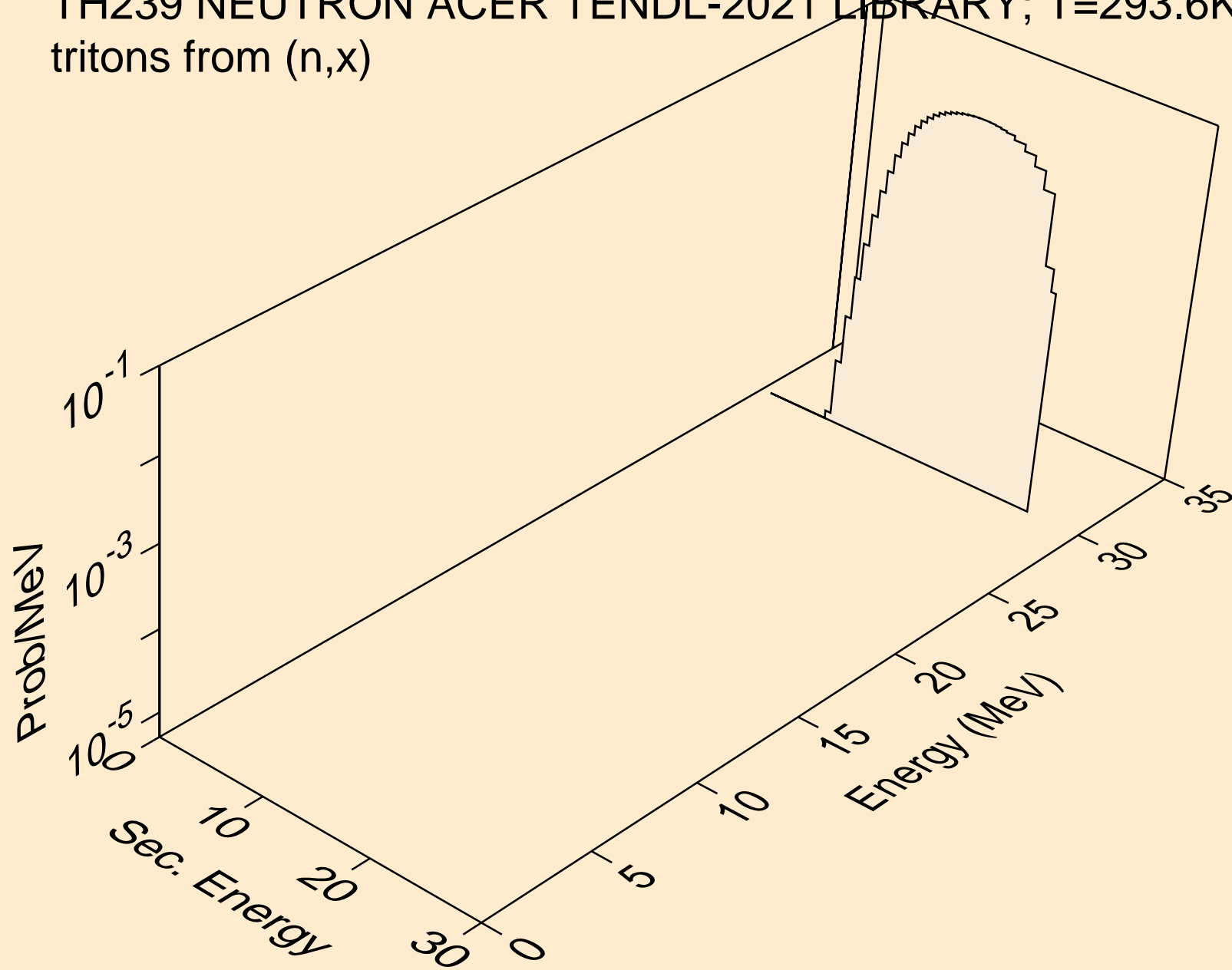

TH239 NEUTRON ACER TENDL-2021 LIBRARY; T=293.6K  
tritons from (n,n\*)t

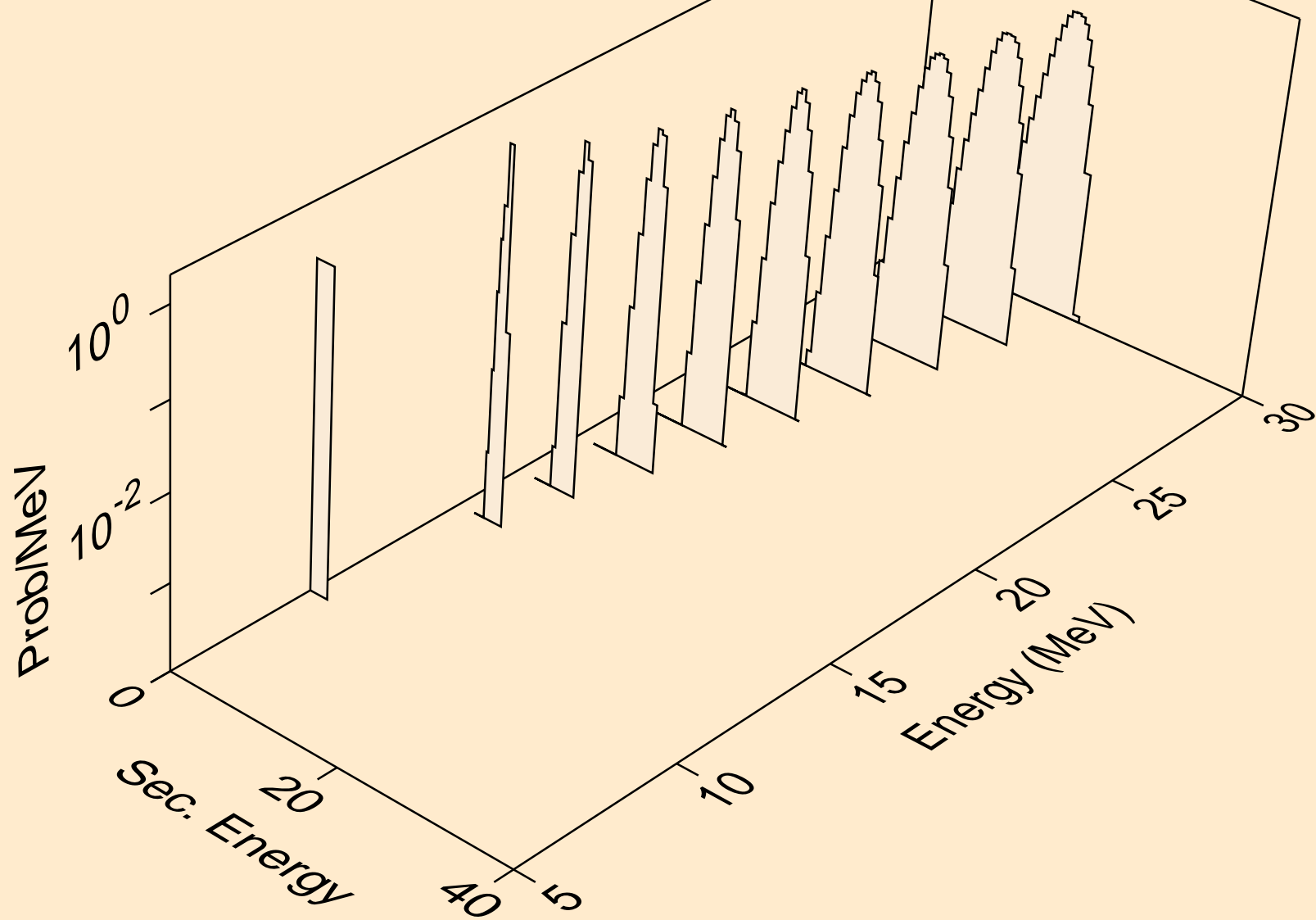

TH239 NEUTRON ACER TENDL-2021 LIBRARY; T=293.6K  
tritons from (n,t)

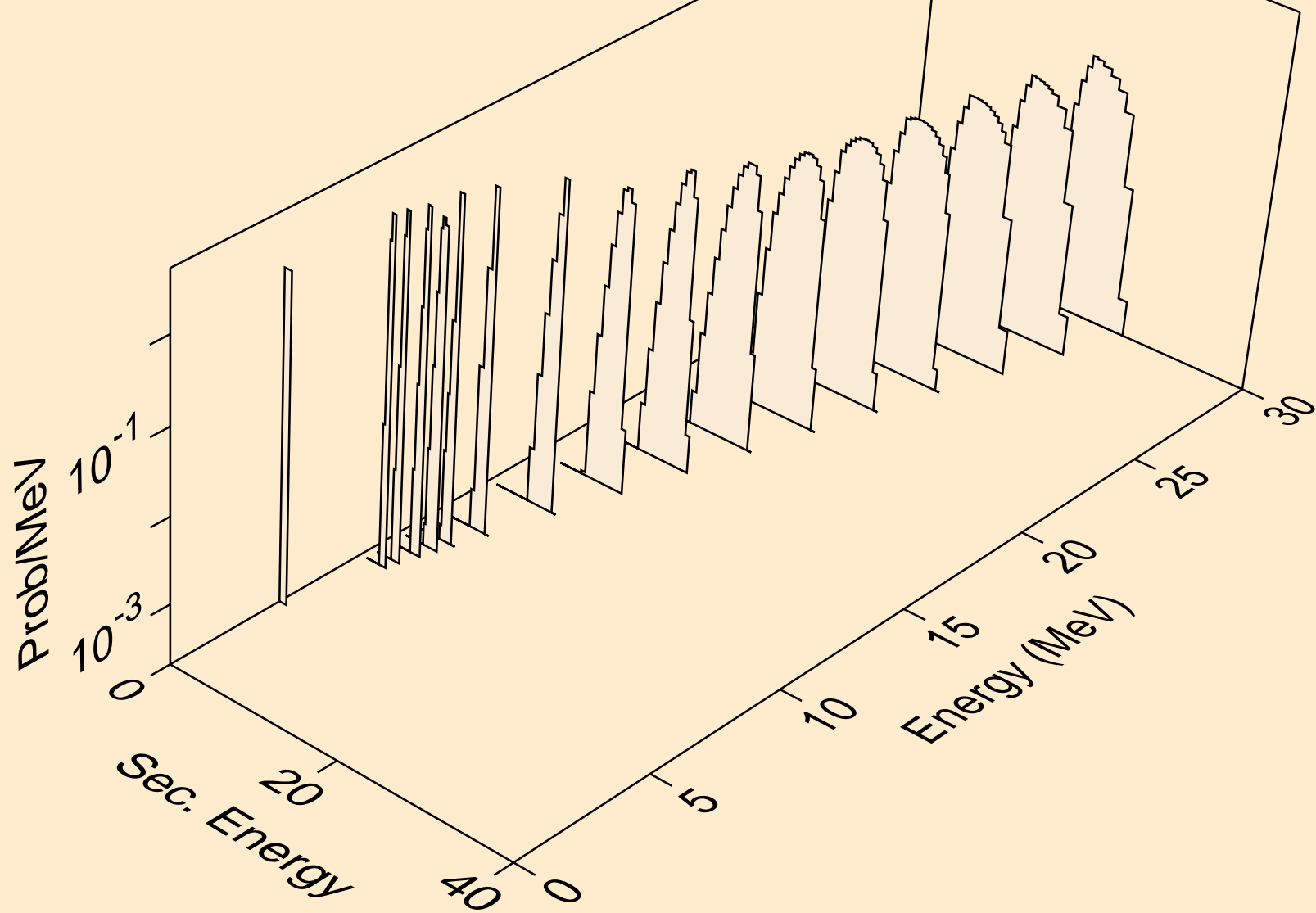

TH239 NEUTRON ACER TENDL-2021 LIBRARY; T=293.6K  
he3s from (n,x)

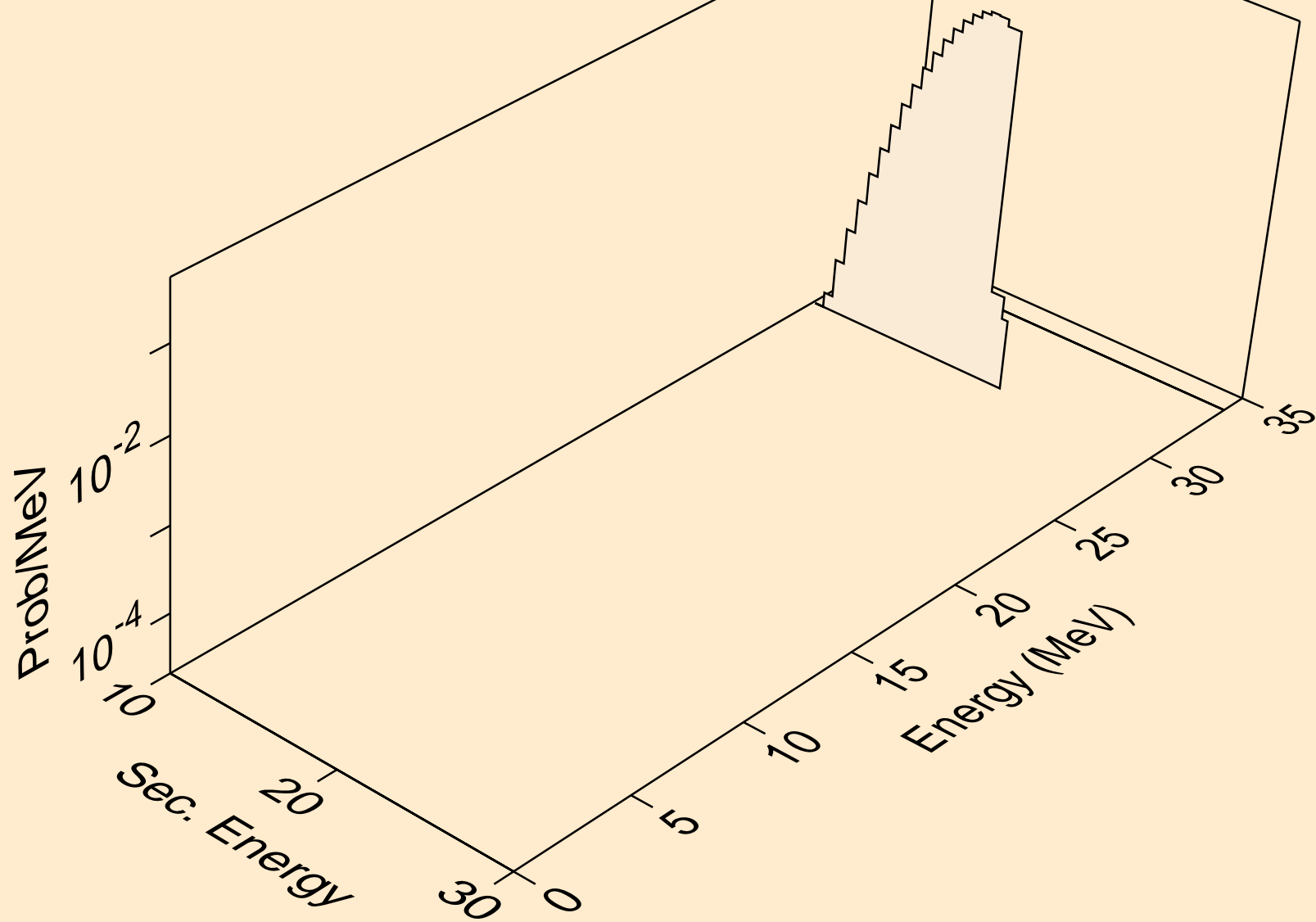

TH239 NEUTRON ACER TENDL-2021 LIBRARY; T=293.6K  
he3s from (n,n\*)he3

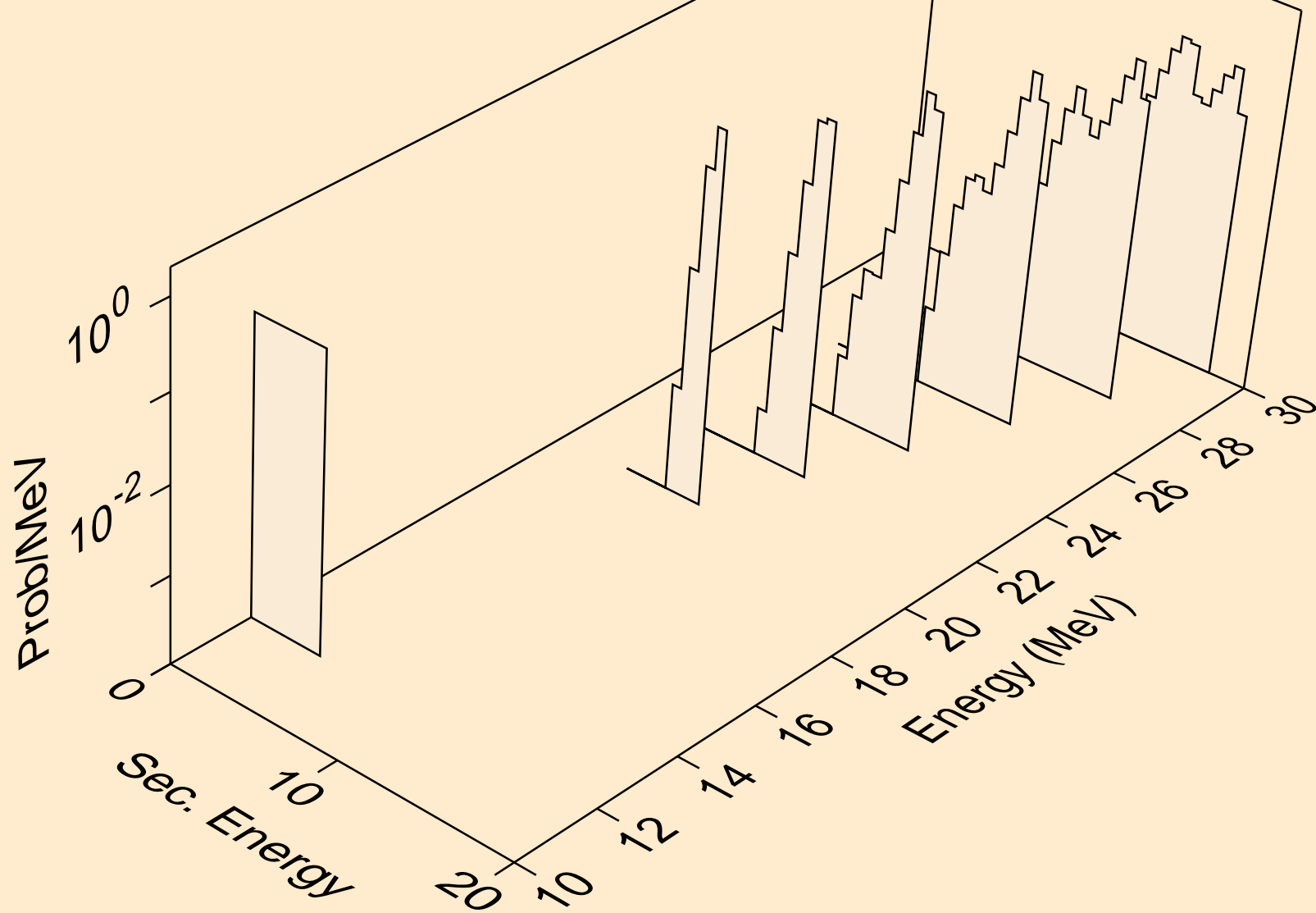

TH239 NEUTRON ACER TENDL-2021 LIBRARY; T=293.6K  
he3s from (n,he3)

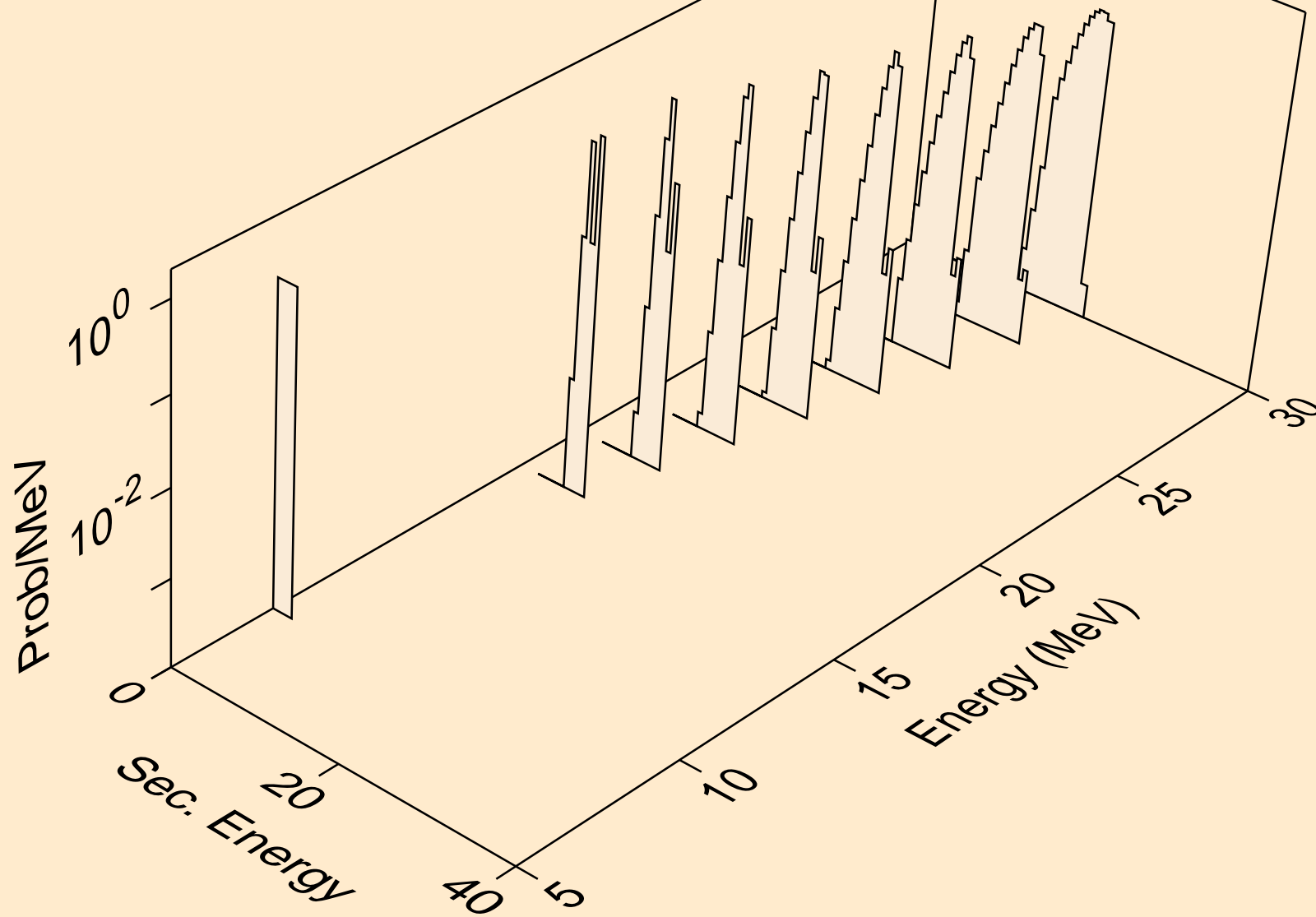

TH239 NEUTRON ACER TENDL-2021 LIBRARY; T=293.6K  
alphas from (n,x)

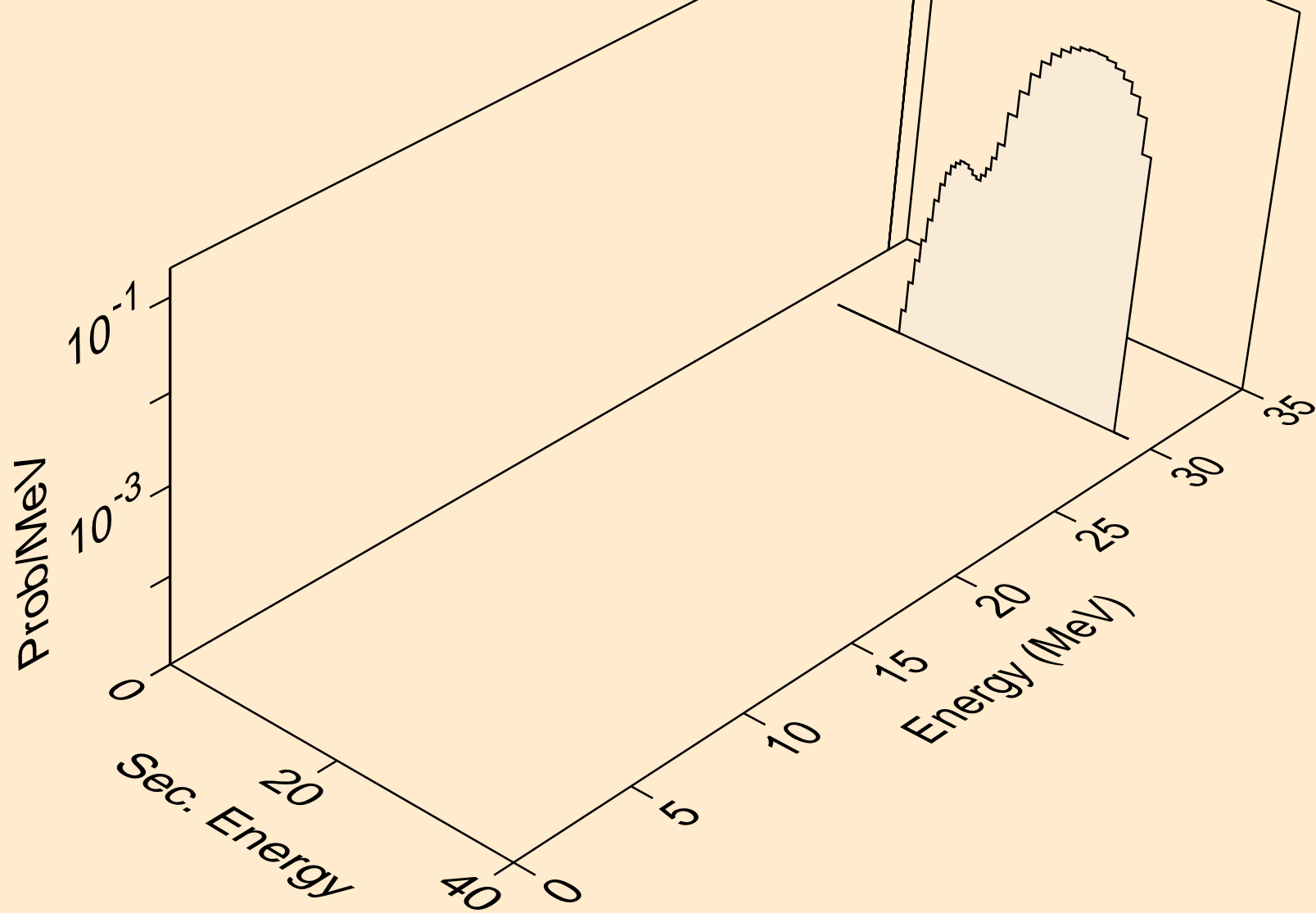

TH239 NEUTRON ACER TENDL-2021 LIBRARY; T=293.6K  
alphas from (n,n\*)a

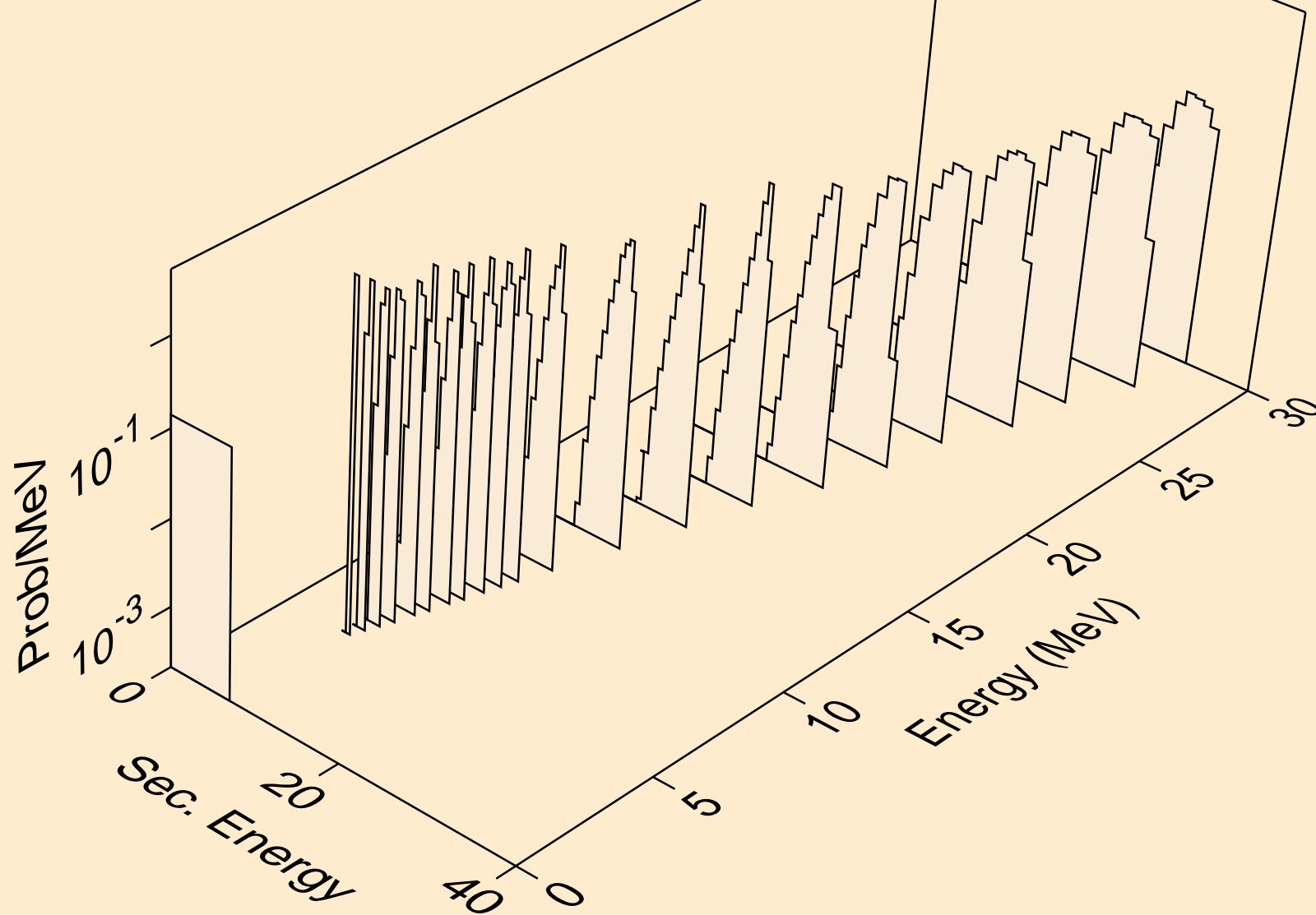



TH239 NEUTRON ACER TENDL-2021 LIBRARY; T=293.6K  
alphas from (n,2n)a

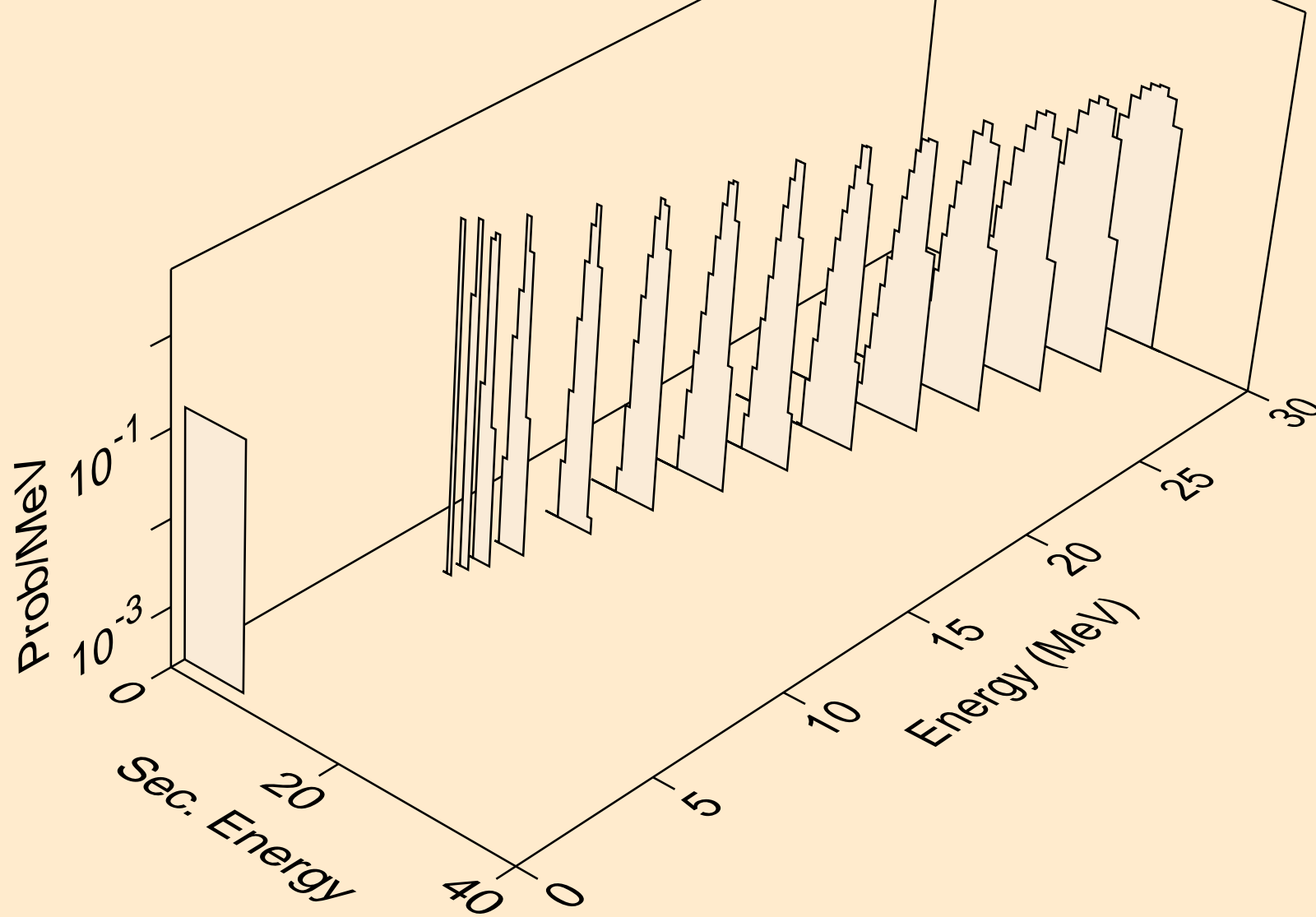

TH239 NEUTRON ACER TENDL-2021 LIBRARY; T=293.6K  
alphas from (n,3n)a

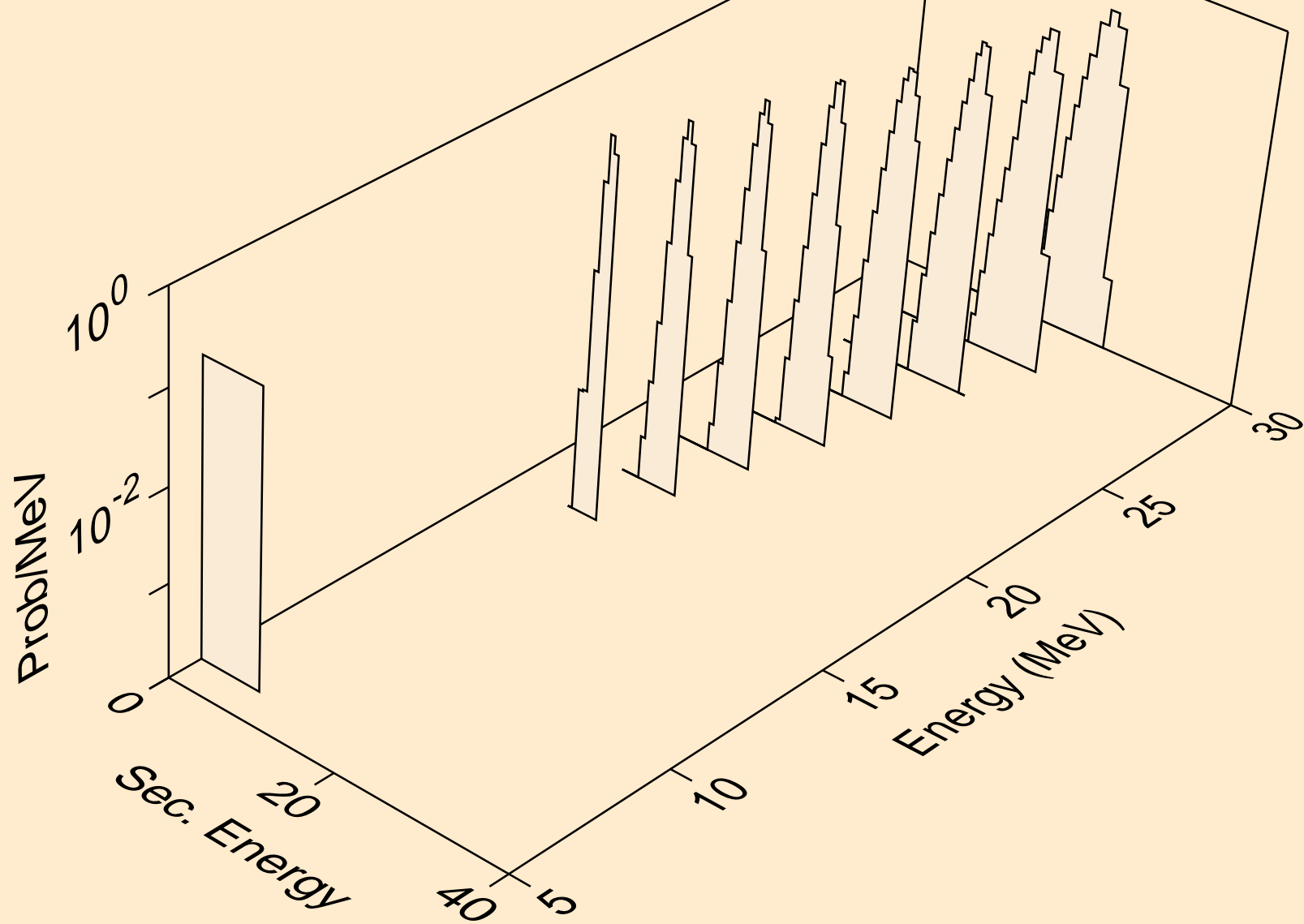

TH239 NEUTRON ACER TENDL-2021 LIBRARY; T=293.6K  
alphas from (n,a)

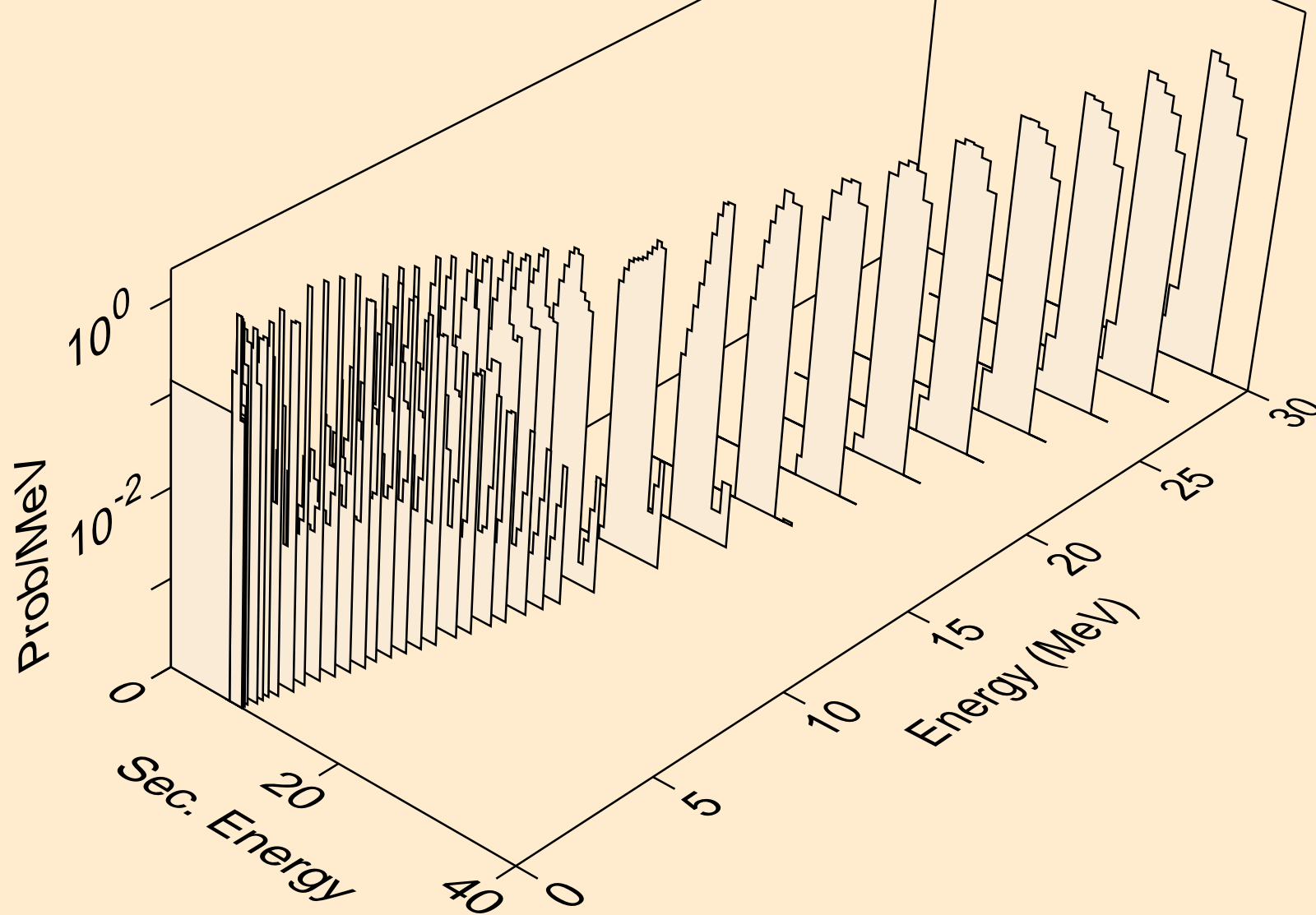

TH239 NEUTRON ACER TENDL-2021 LIBRARY; T=293.6K  
alphas from (n,2a)

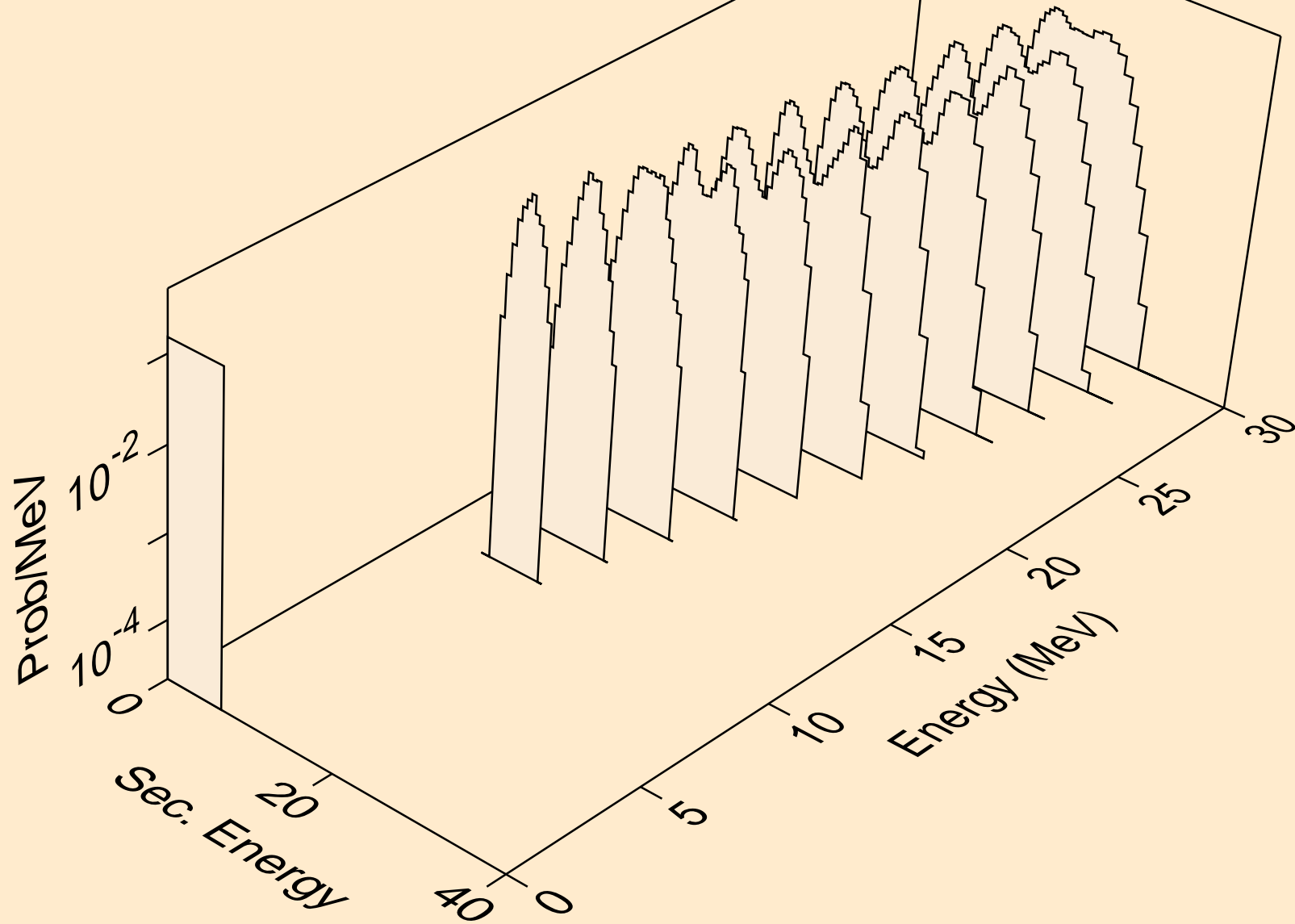

TH239 NEUTRON ACER TENDL-2021 LIBRARY; T=293.6K  
alphas from (n,pa)

