

TL196 NEUTRON ACER TENDL-2021 LIBRARY; T=293.6K
Principal cross sections

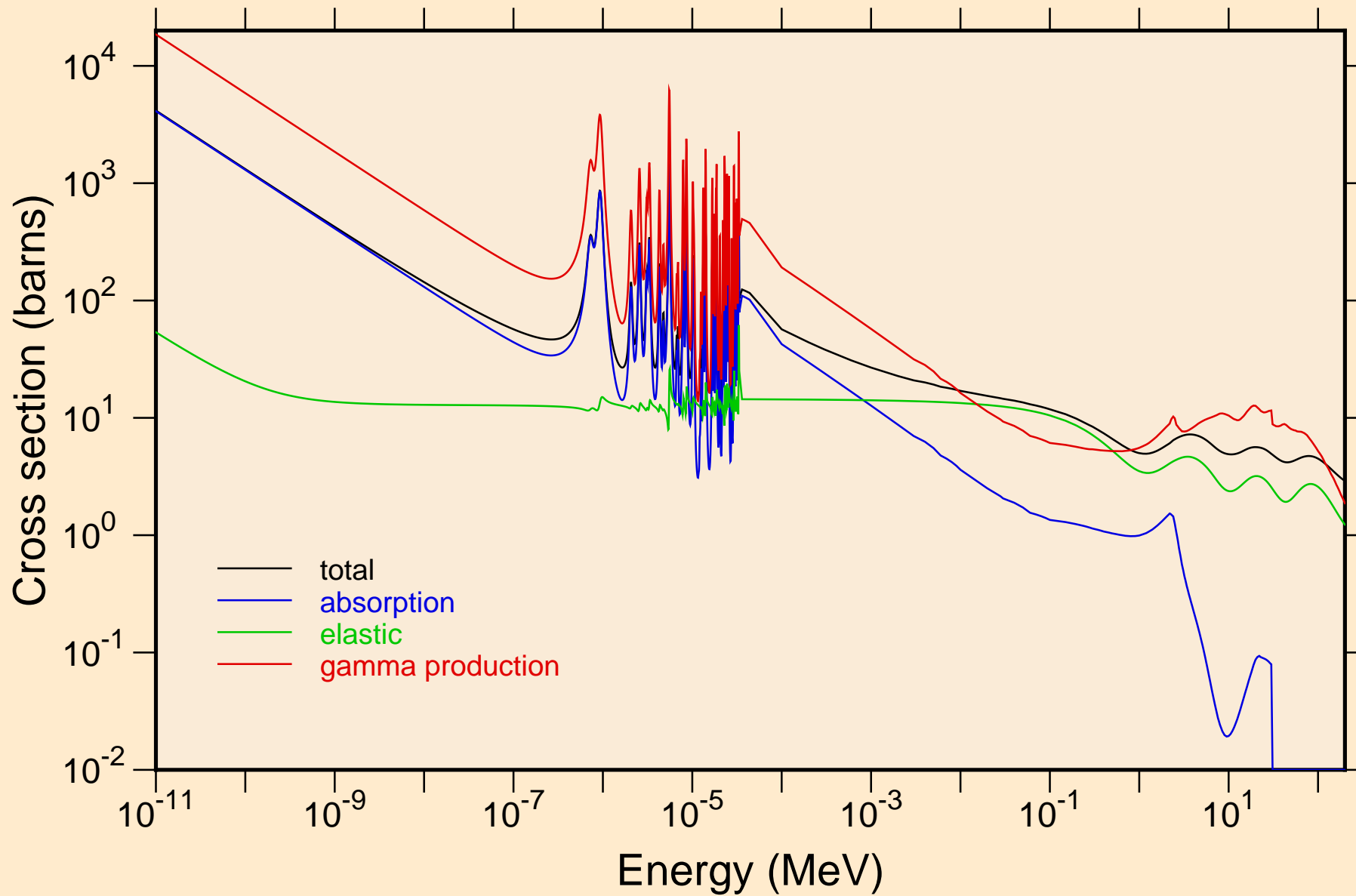

TL196 NEUTRON ACER TENDL-2021 LIBRARY; T=293.6K
resonance total cross section

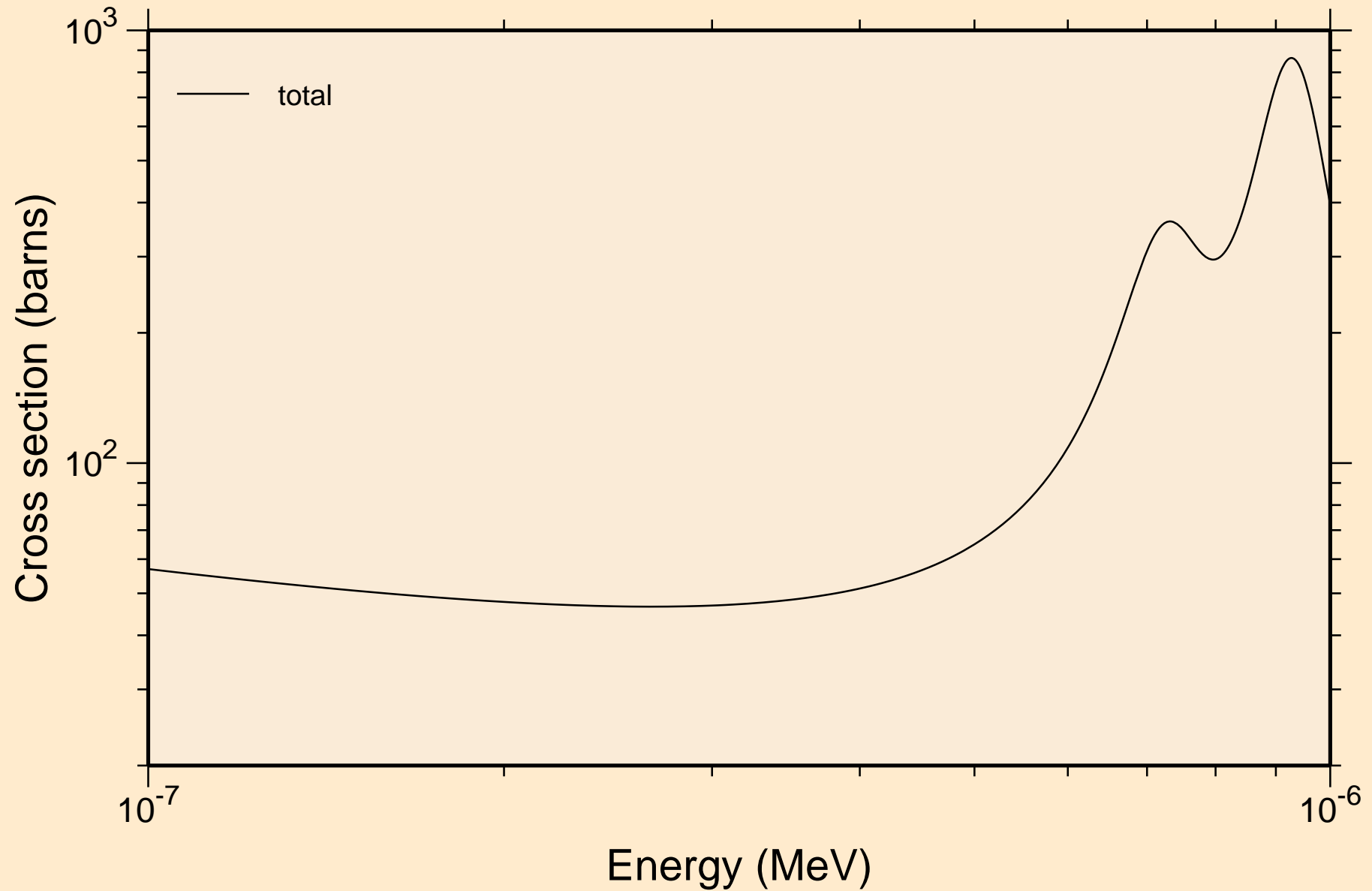

TL196 NEUTRON ACER TENDL-2021 LIBRARY; T=293.6K
resonance total cross section

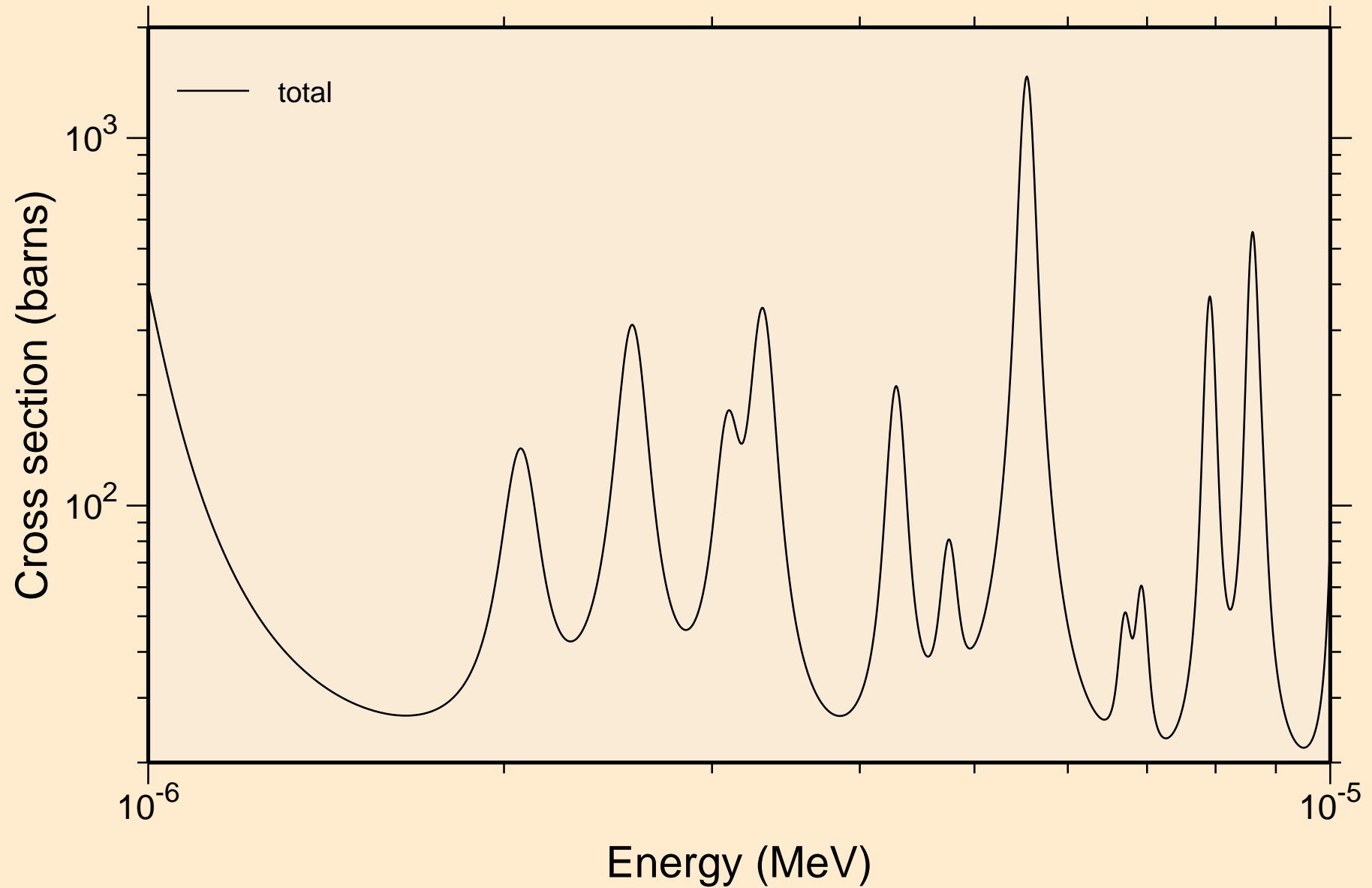

TL196 NEUTRON ACER TENDL-2021 LIBRARY; T=293.6K
resonance total cross section

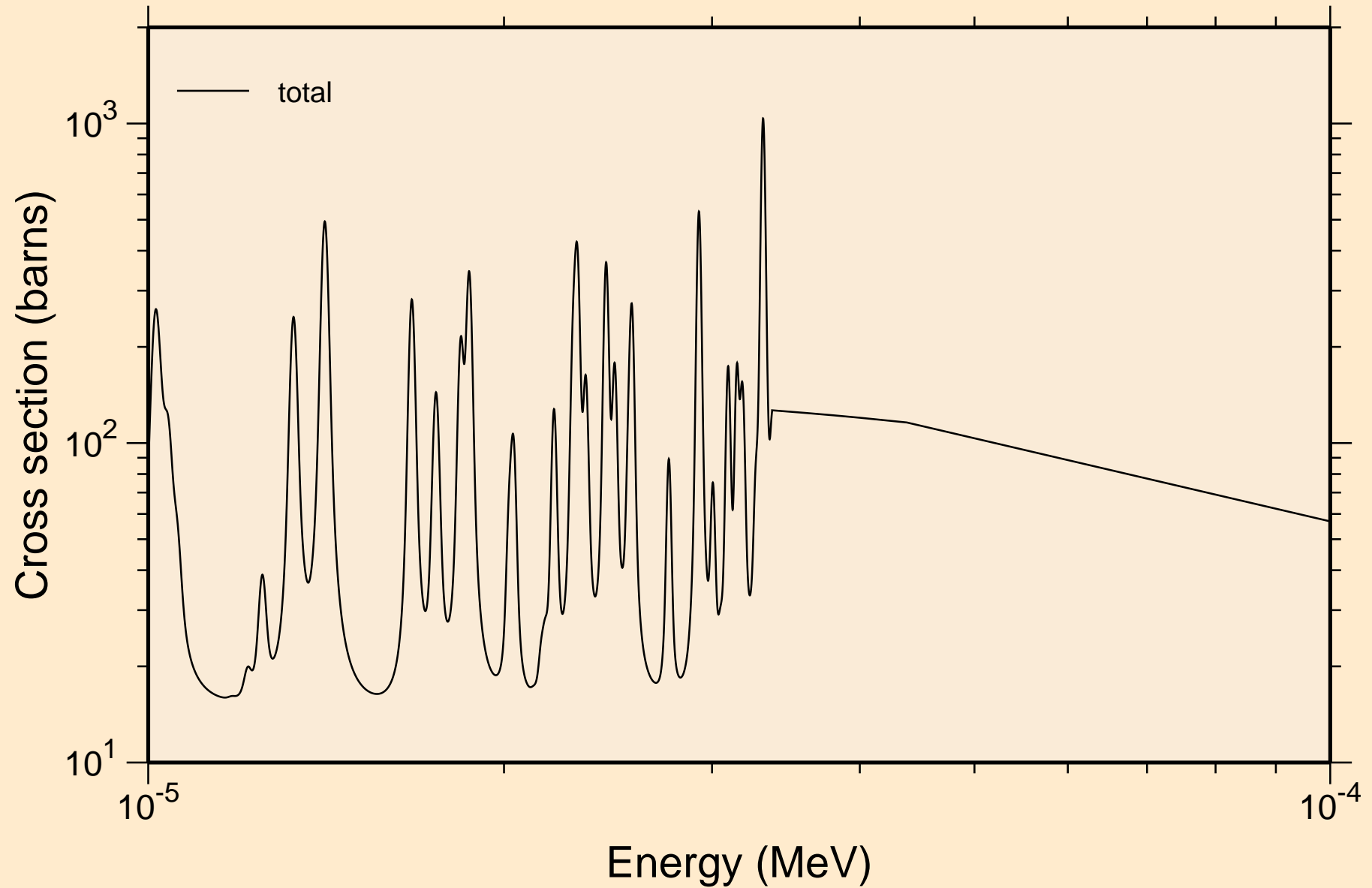

TL196 NEUTRON ACER TENDL-2021 LIBRARY; T=293.6K
resonance total cross section

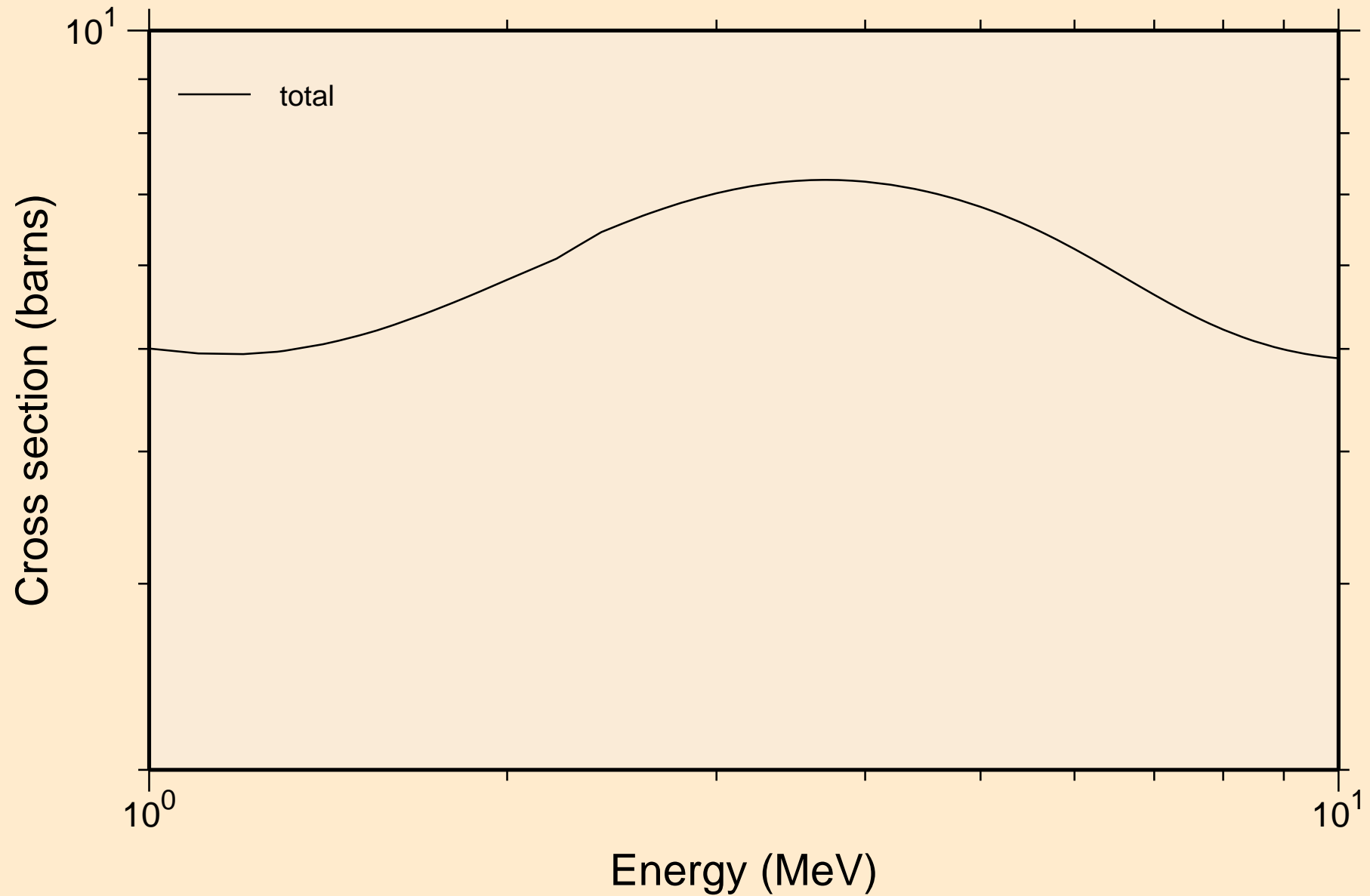

TL196 NEUTRON ACER TENDL-2021 LIBRARY; T=293.6K
resonance absorption cross sections

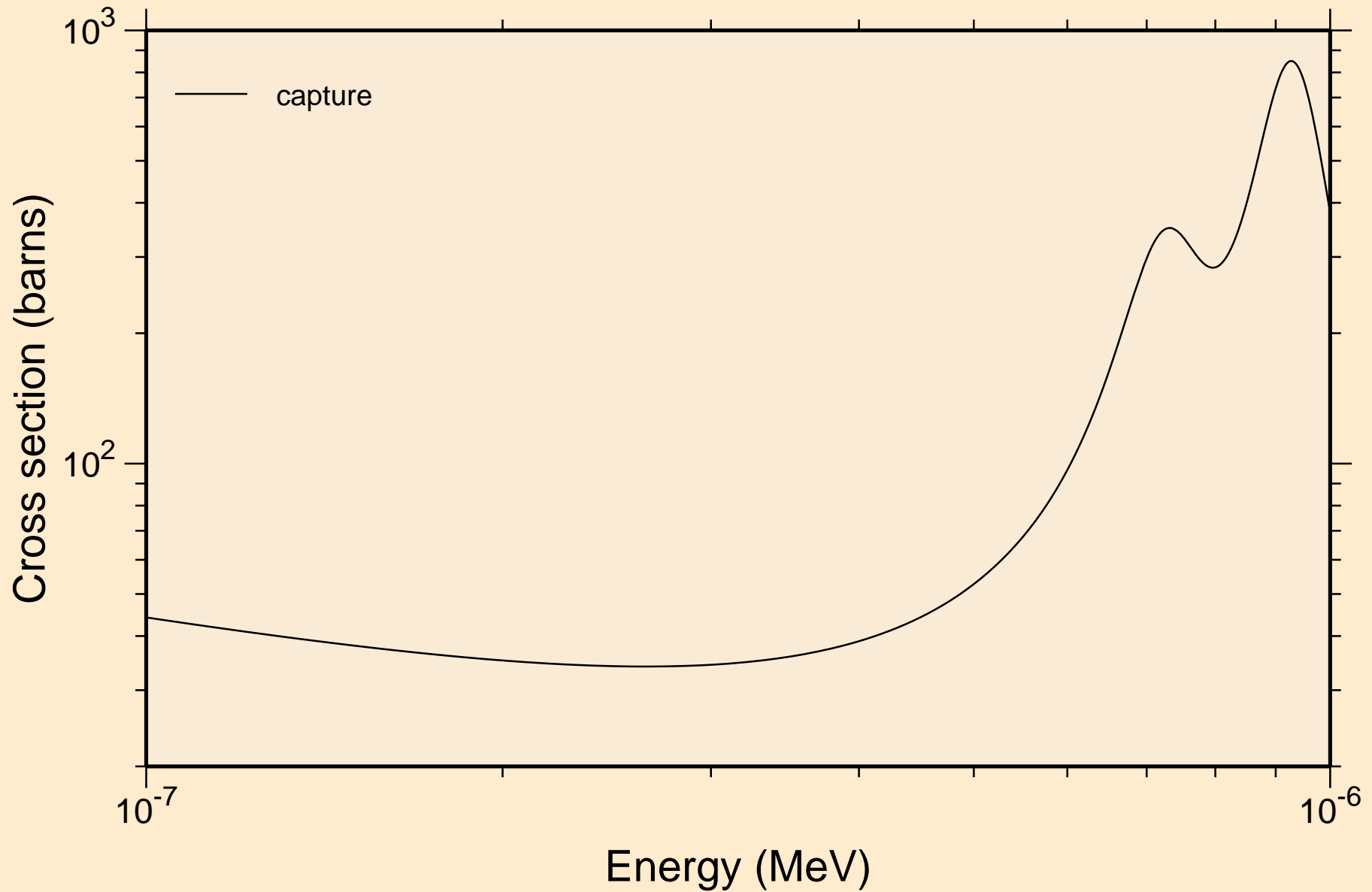

TL196 NEUTRON ACER TENDL-2021 LIBRARY; T=293.6K
resonance absorption cross sections

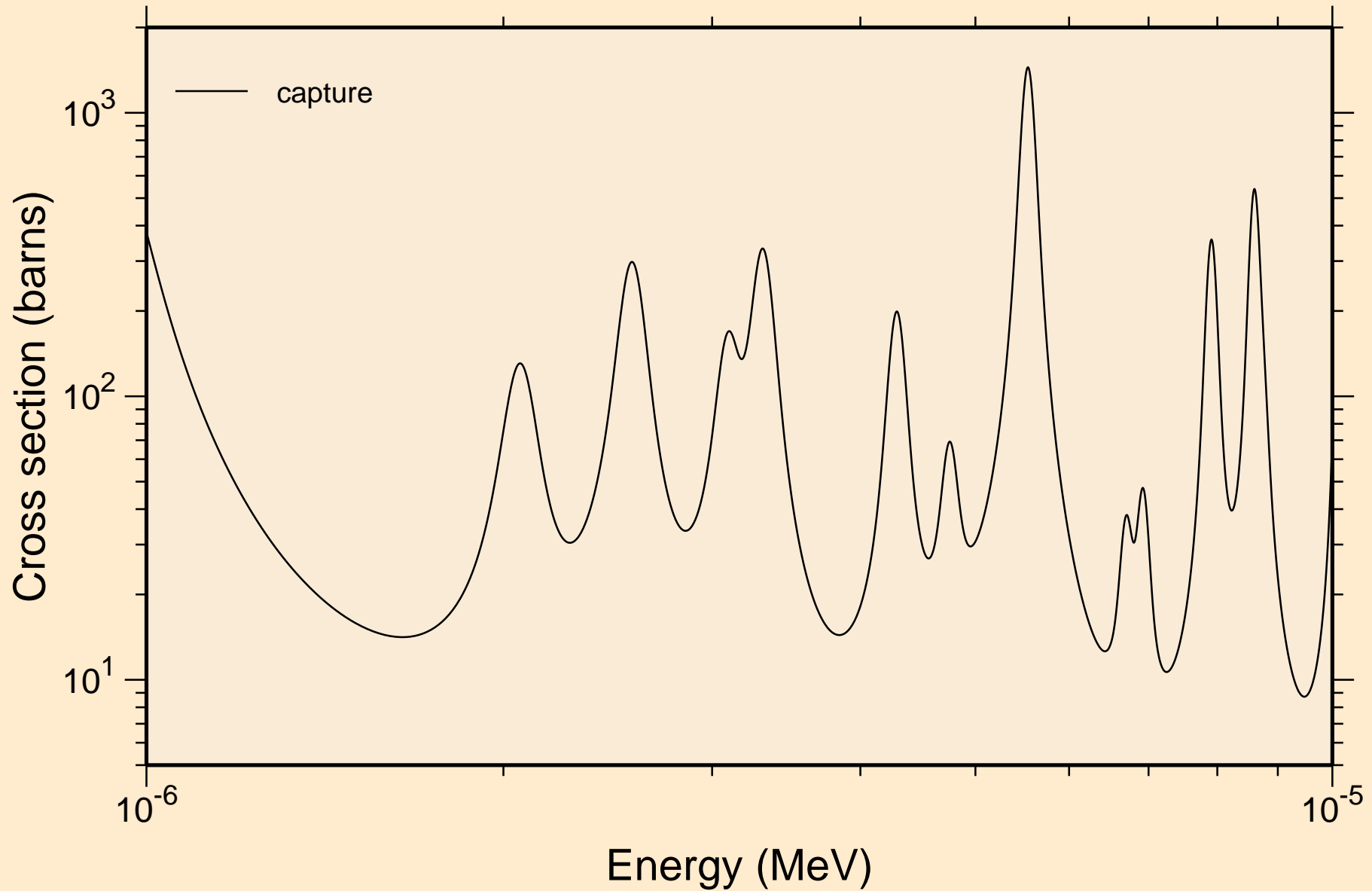

TL196 NEUTRON ACER TENDL-2021 LIBRARY; T=293.6K
resonance absorption cross sections

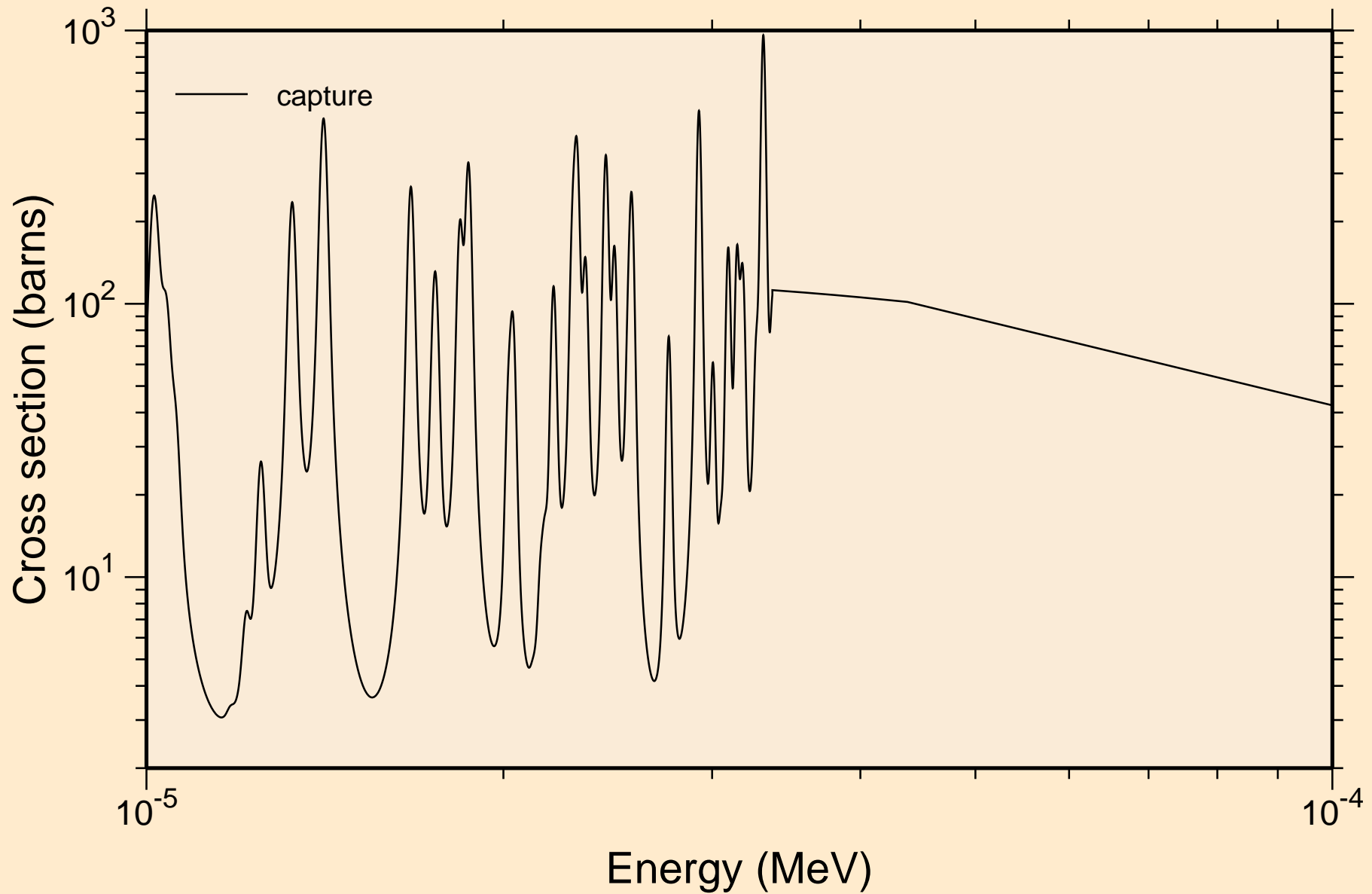

TL196 NEUTRON ACER TENDL-2021 LIBRARY; T=293.6K
resonance absorption cross sections

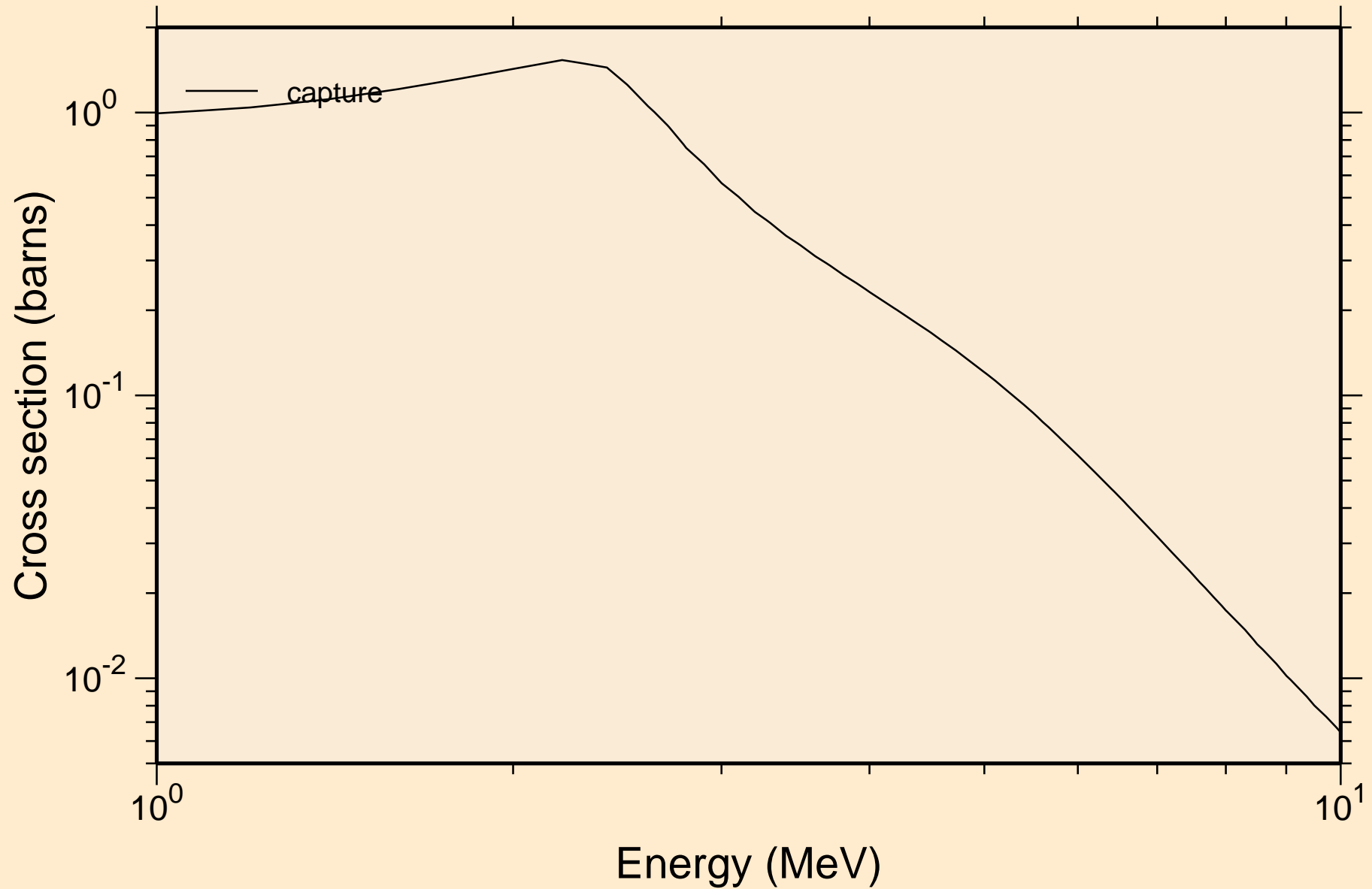

TL196 NEUTRON ACER TENDL-2021 LIBRARY; T=293.6K
Heating

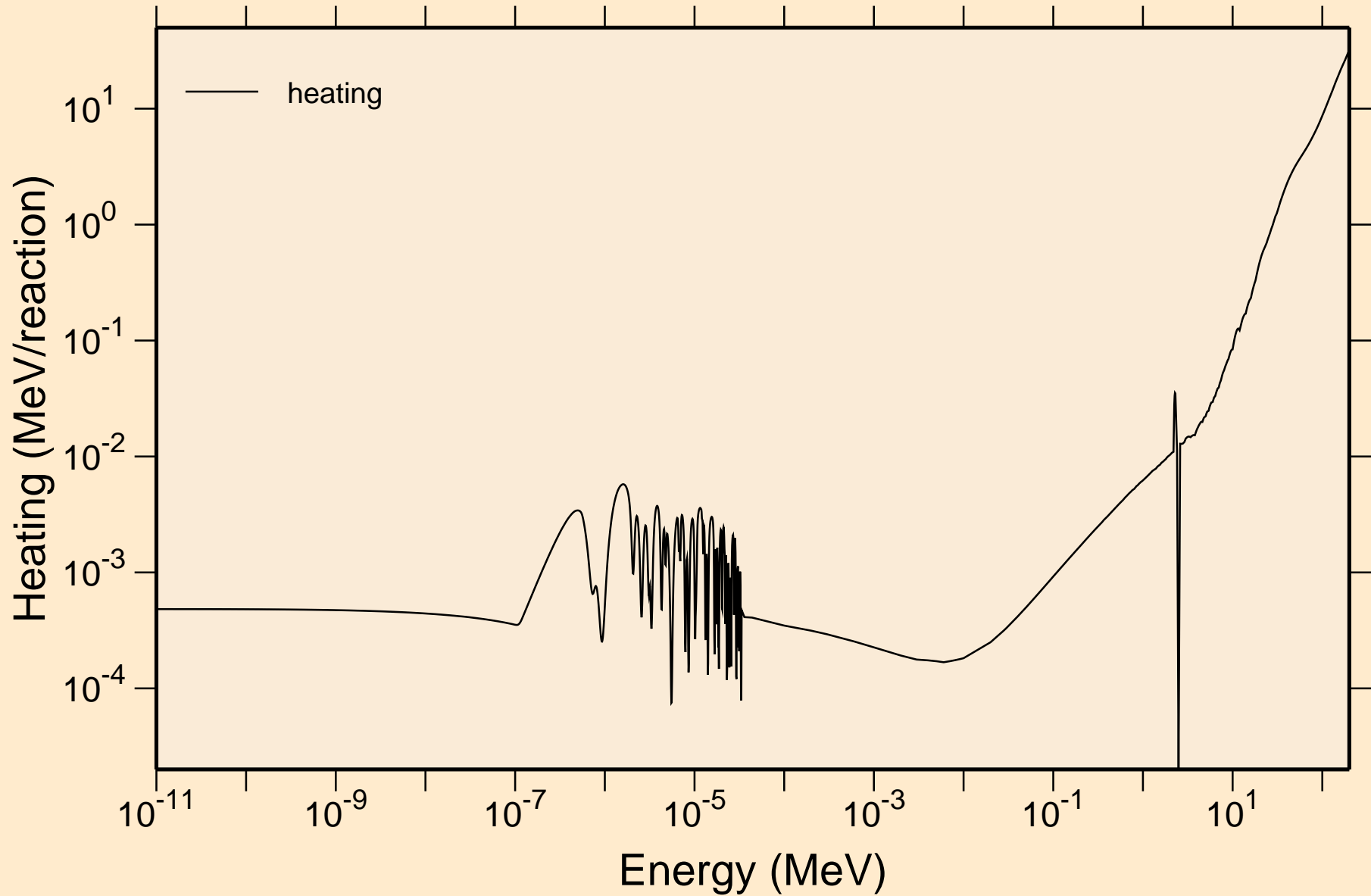

TL196 NEUTRON ACER TENDL-2021 LIBRARY; T=293.6K
Damage

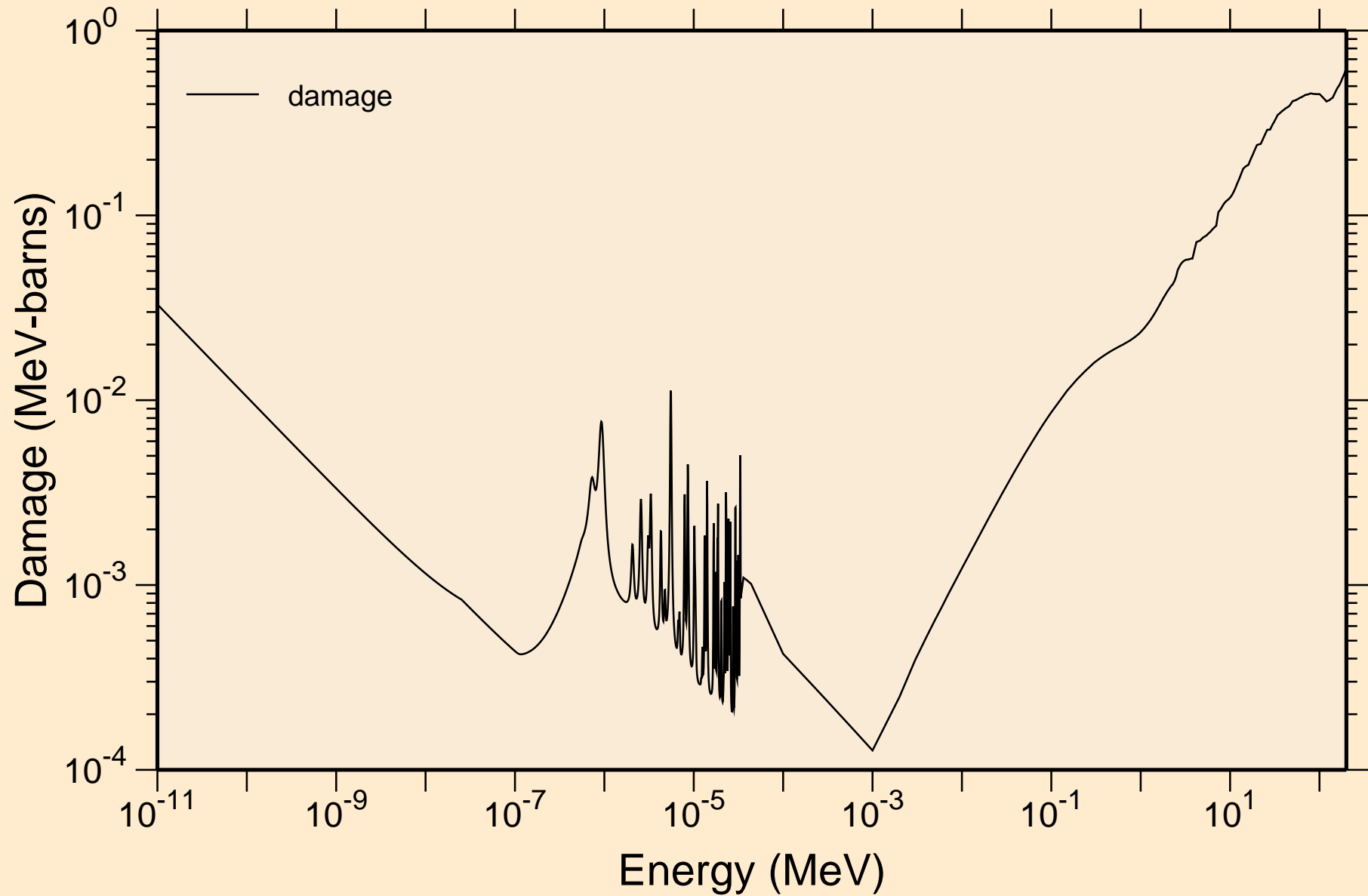

TL196 NEUTRON ACER TENDL-2021 LIBRARY; T=293.6K
Non-threshold reactions

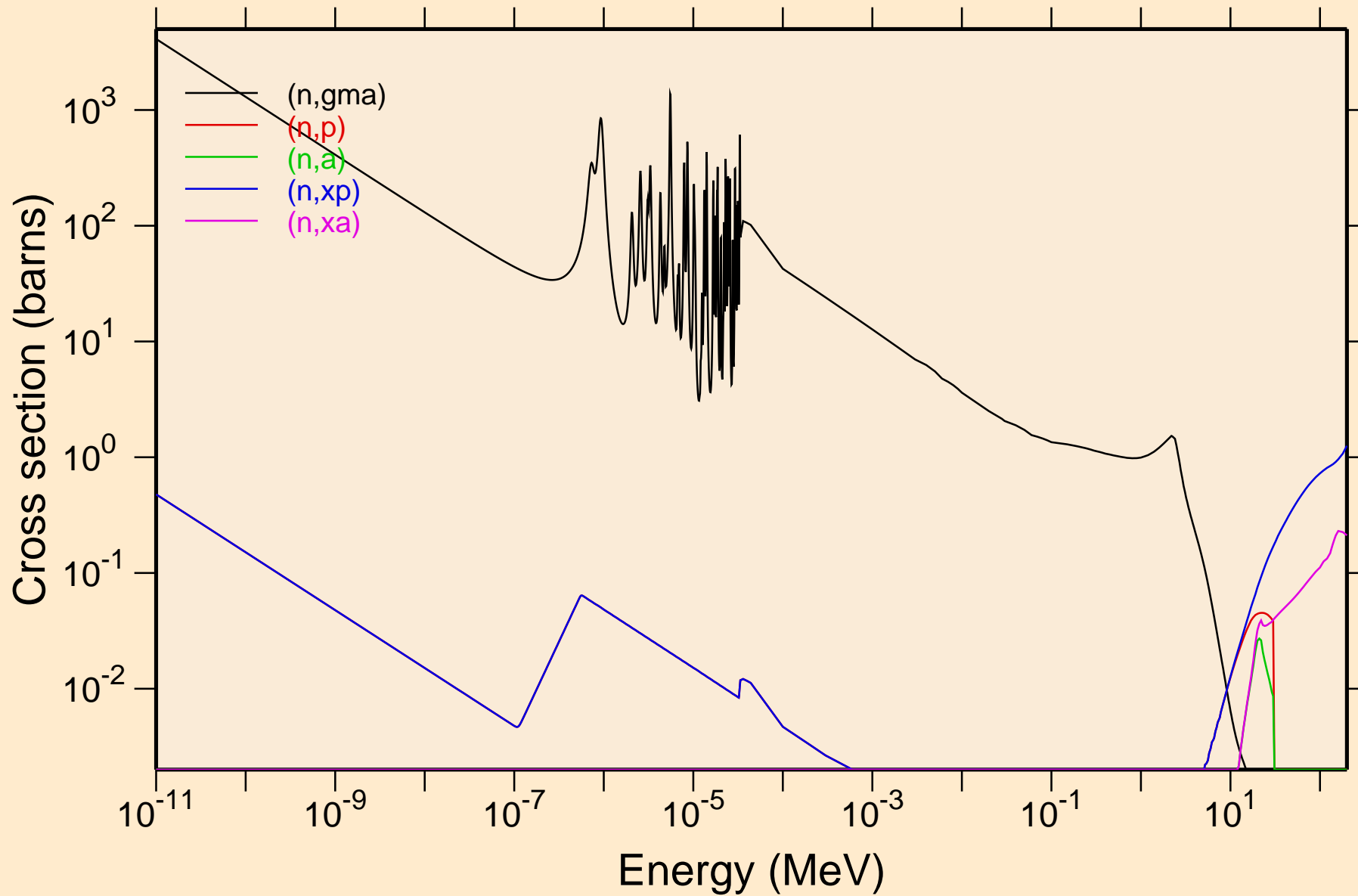

TL196 NEUTRON ACER TENDL-2021 LIBRARY; T=293.6K
Principal cross sections

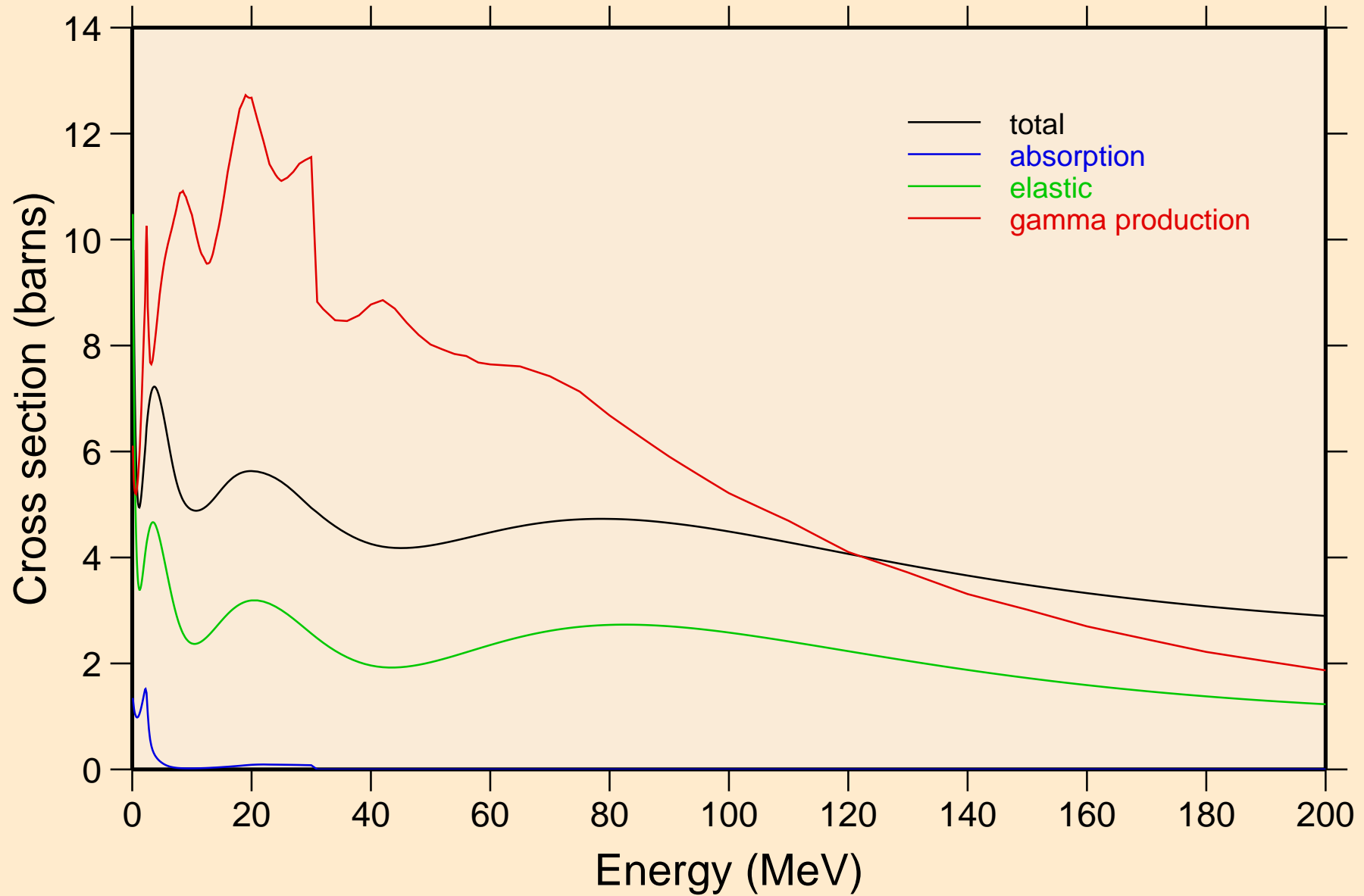

TL196 NEUTRON ACER TENDL-2021 LIBRARY; T=293.6K
Heating

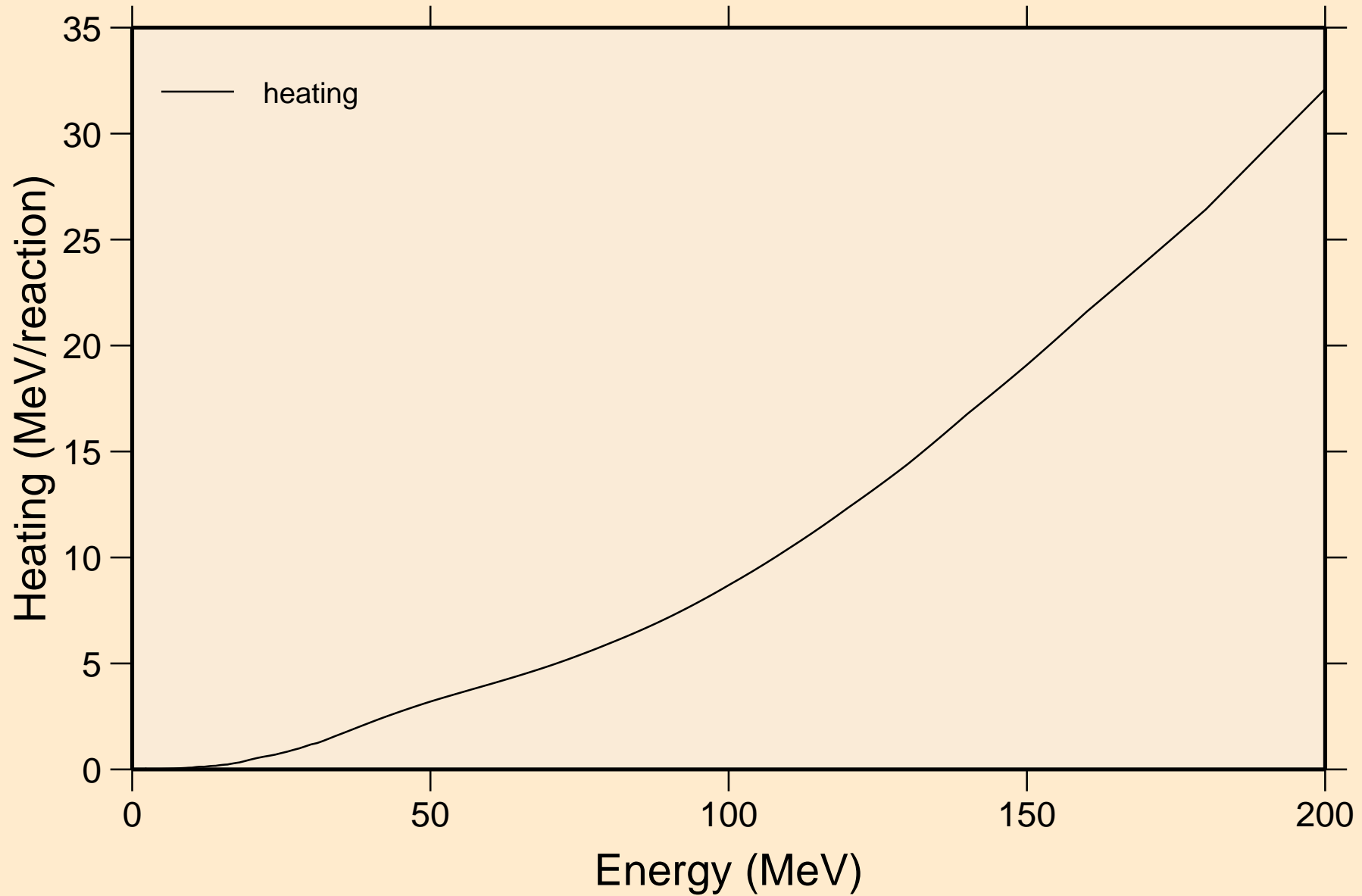

TL196 NEUTRON ACER TENDL-2021 LIBRARY; T=293.6K
Damage

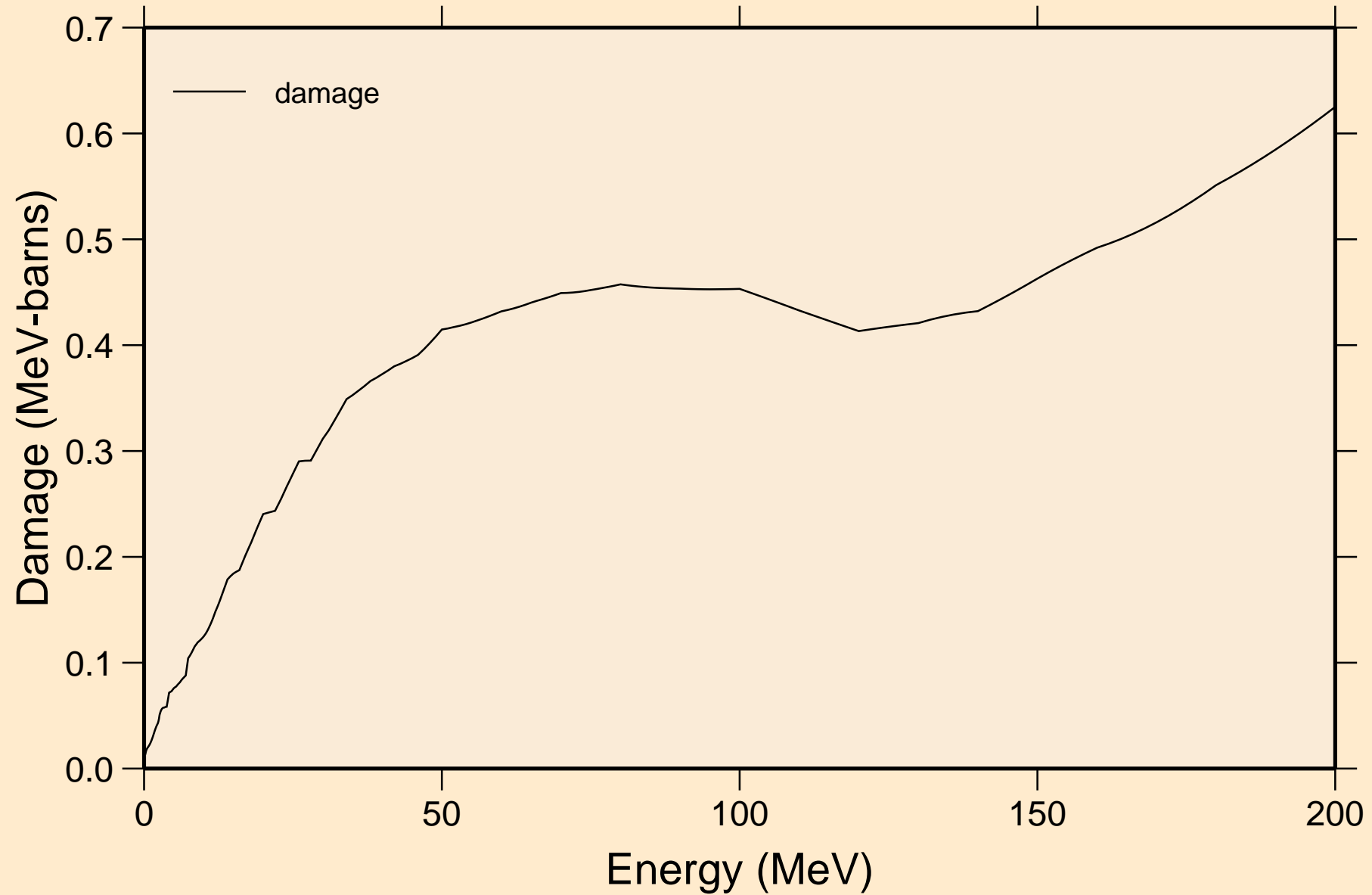

TL196 NEUTRON ACER TENDL-2021 LIBRARY; T=293.6K
Non-threshold reactions

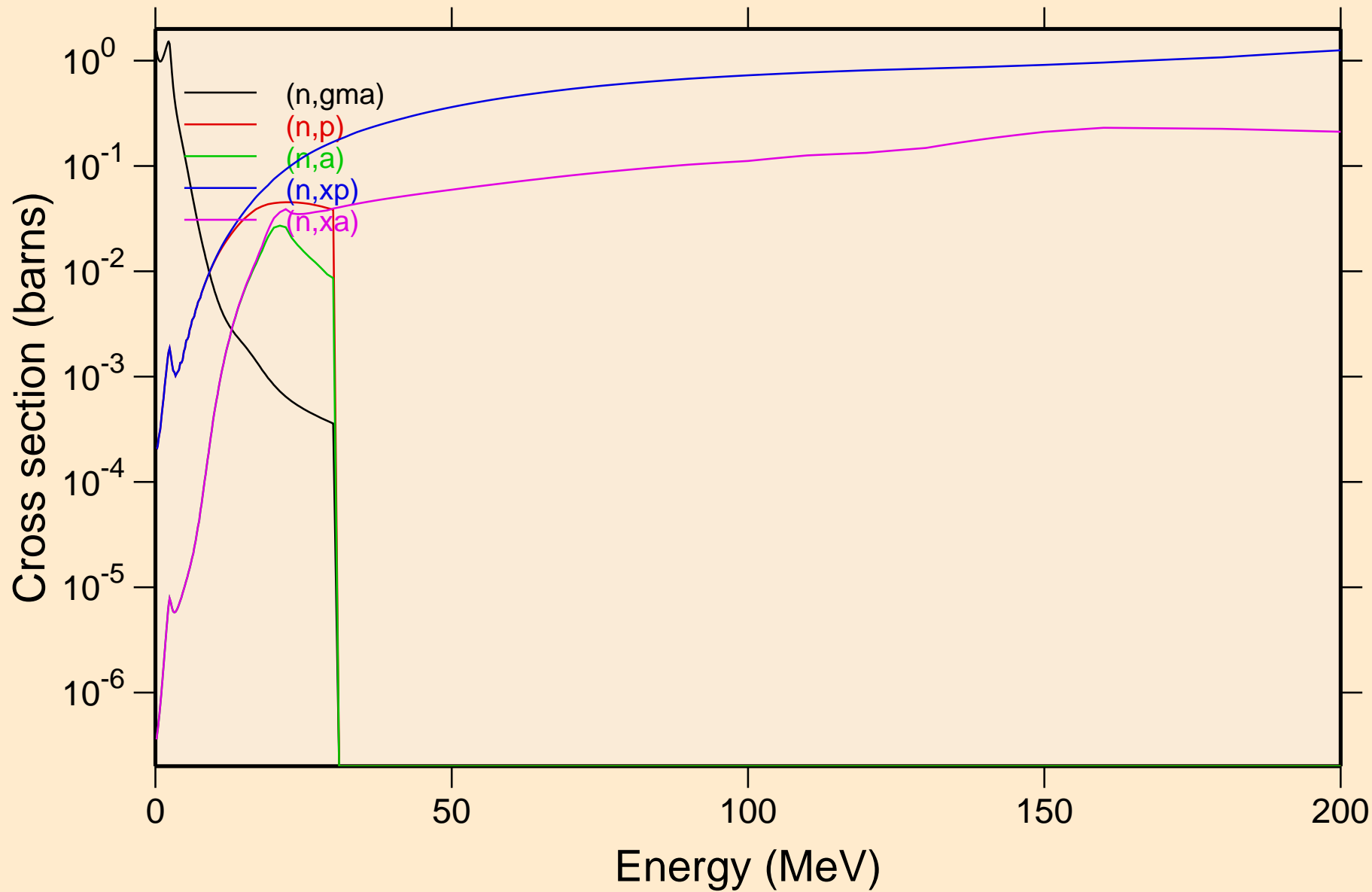

TL196 NEUTRON ACER TENDL-2021 LIBRARY; T=293.6K
Inelastic levels

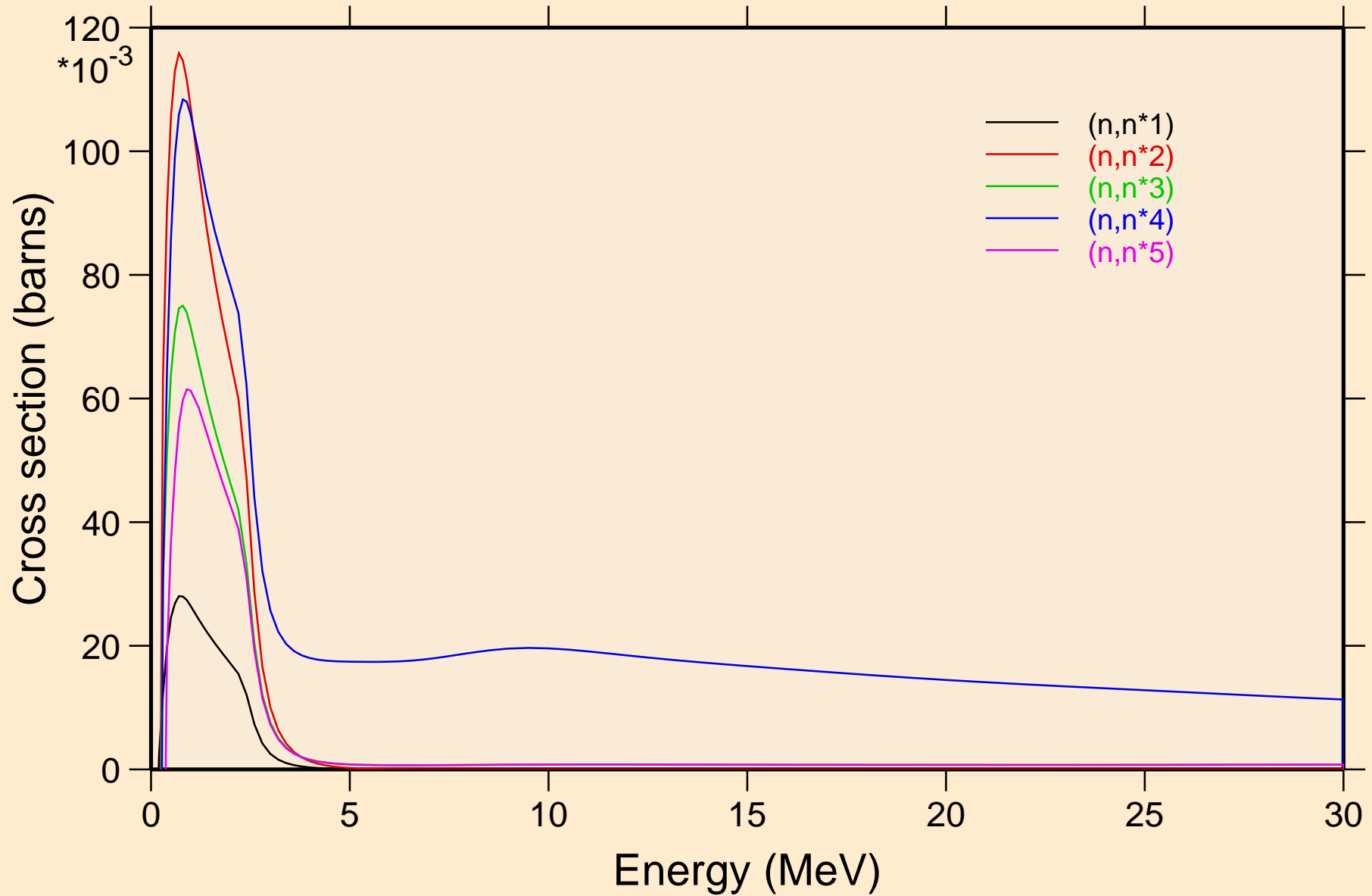

TL196 NEUTRON ACER TENDL-2021 LIBRARY; T=293.6K
Inelastic levels

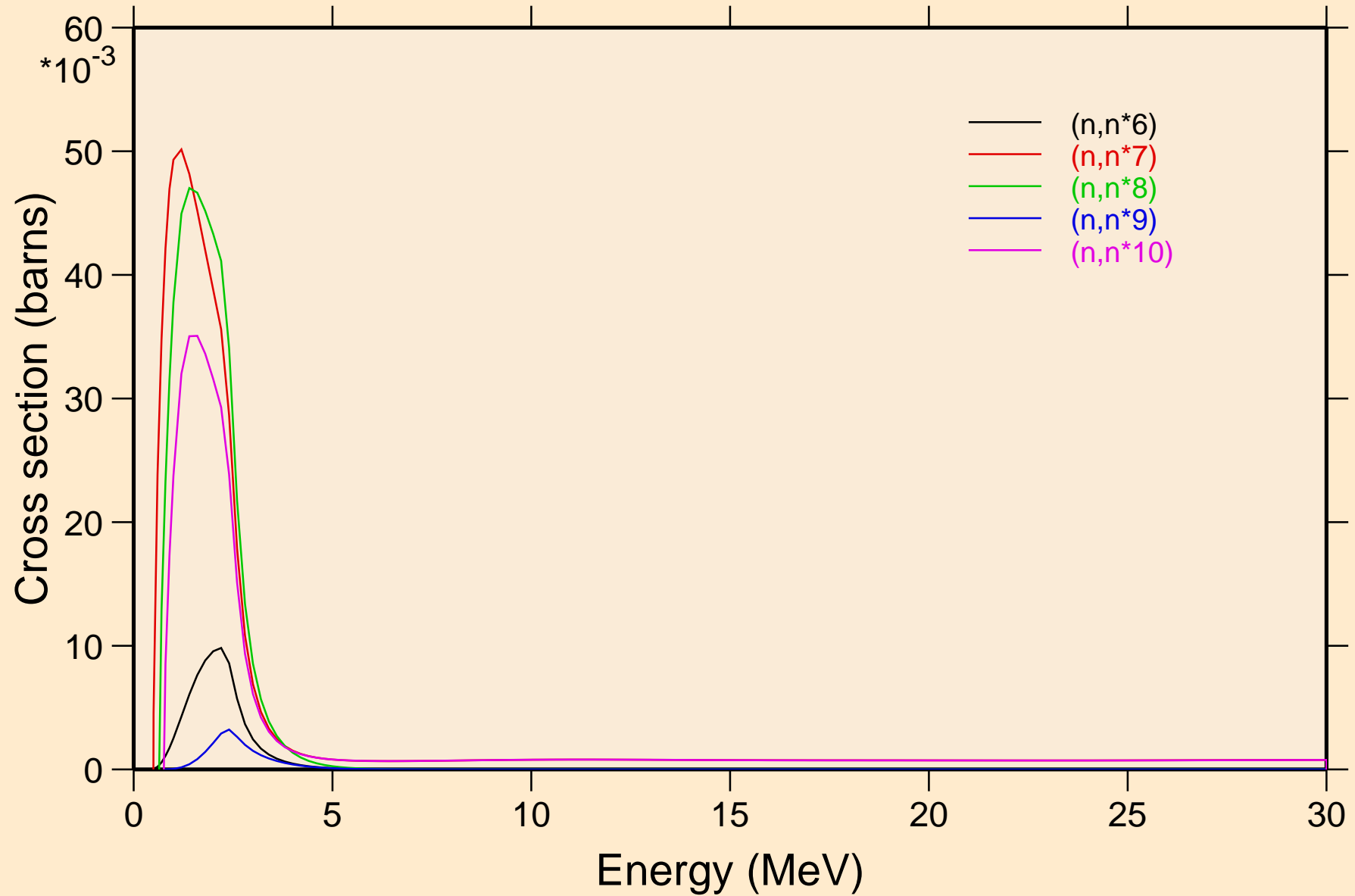

TL196 NEUTRON ACER TENDL-2021 LIBRARY; T=293.6K
Inelastic levels

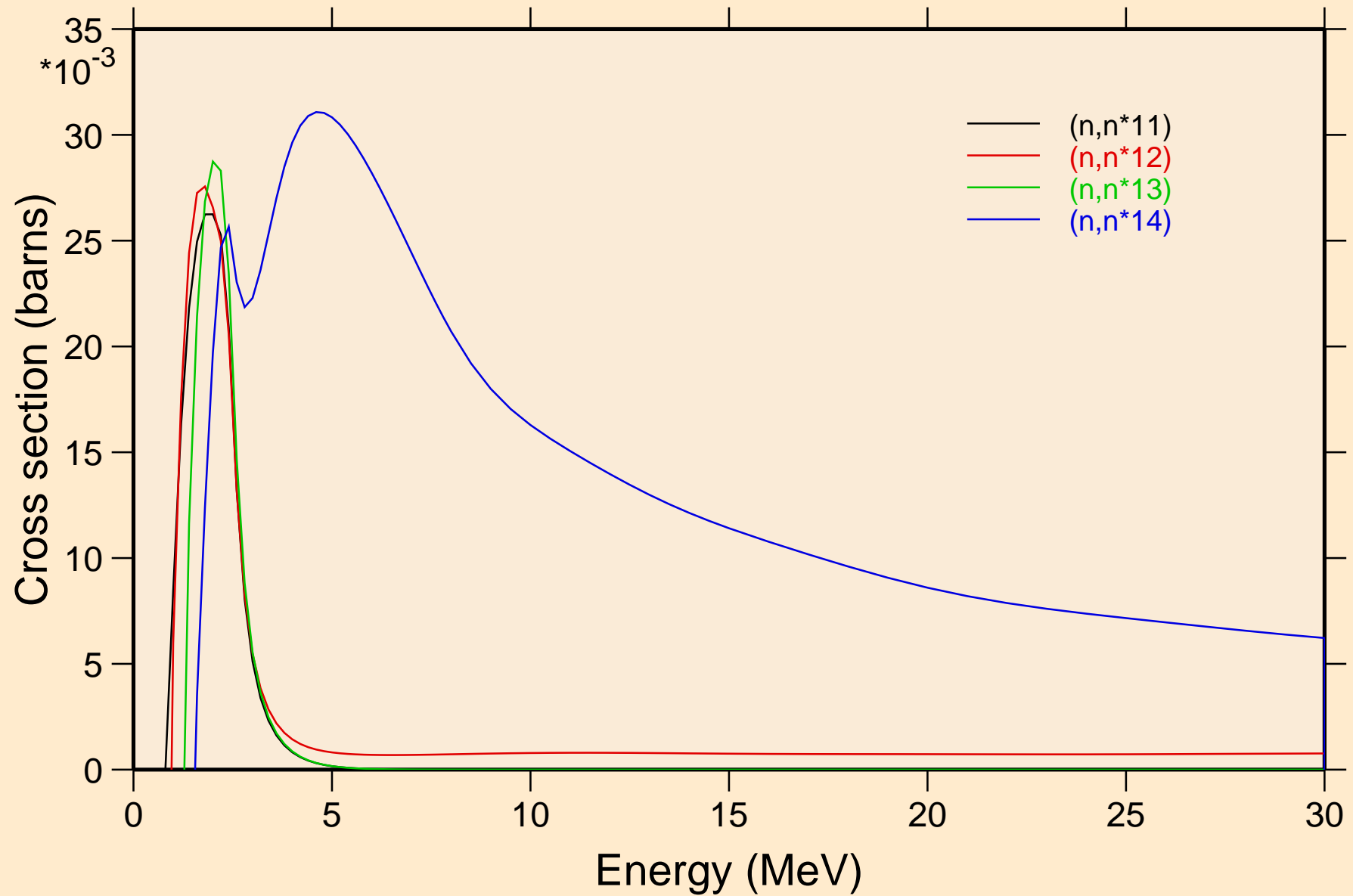

TL196 NEUTRON ACER TENDL-2021 LIBRARY; T=293.6K
Threshold reactions

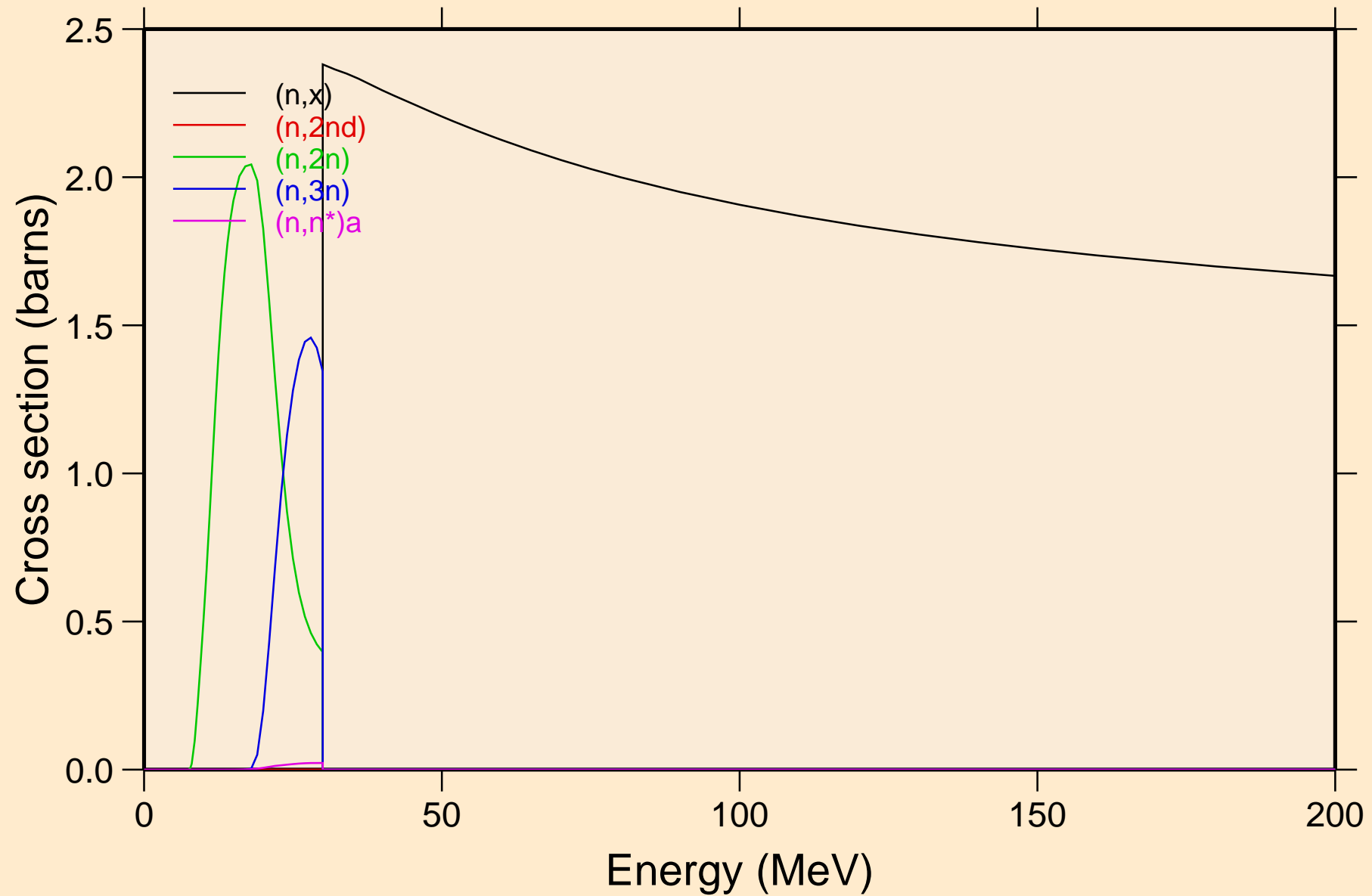

TL196 NEUTRON ACER TENDL-2021 LIBRARY; T=293.6K
Threshold reactions

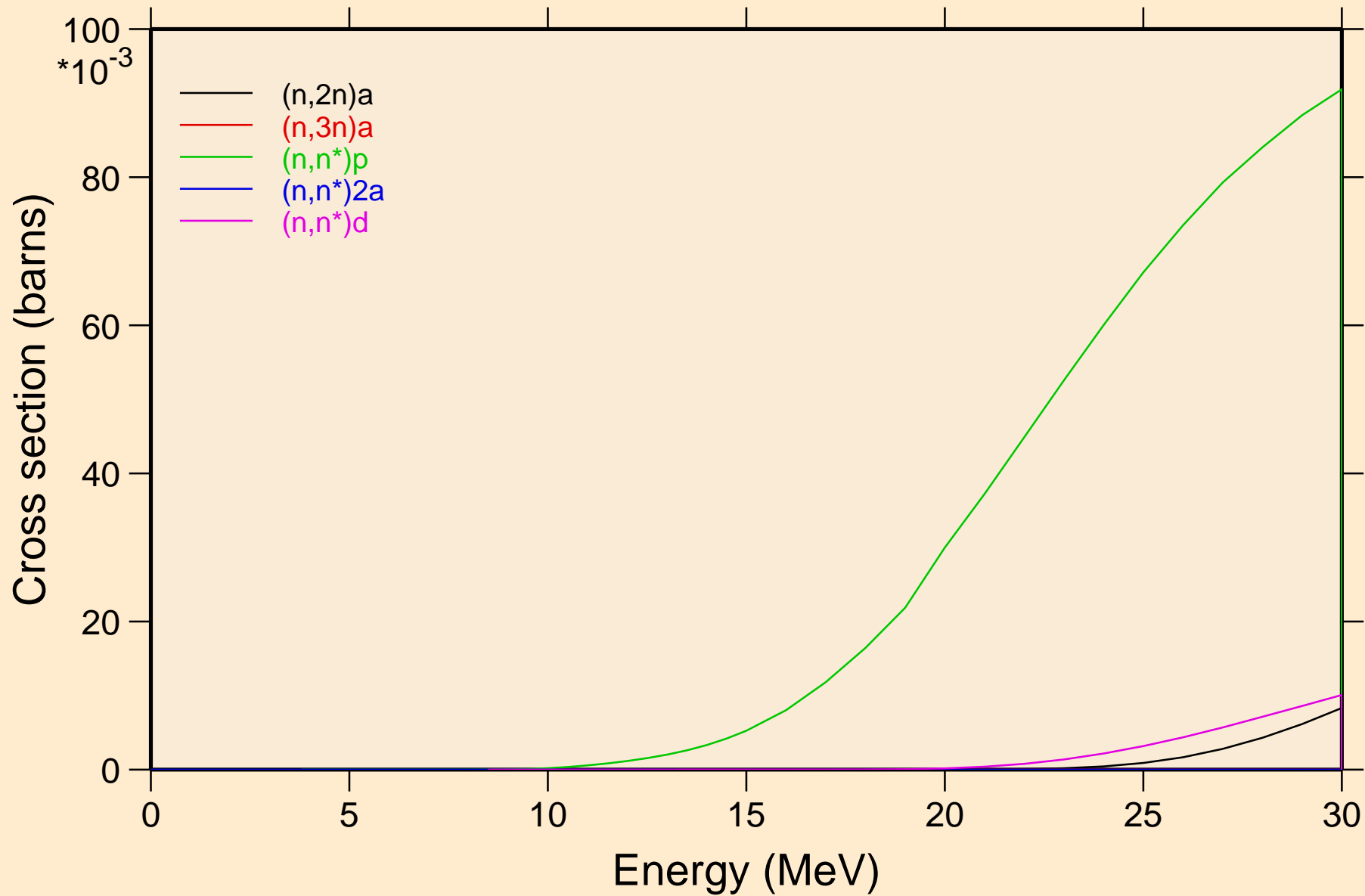

TL196 NEUTRON ACER TENDL-2021 LIBRARY; T=293.6K
Threshold reactions

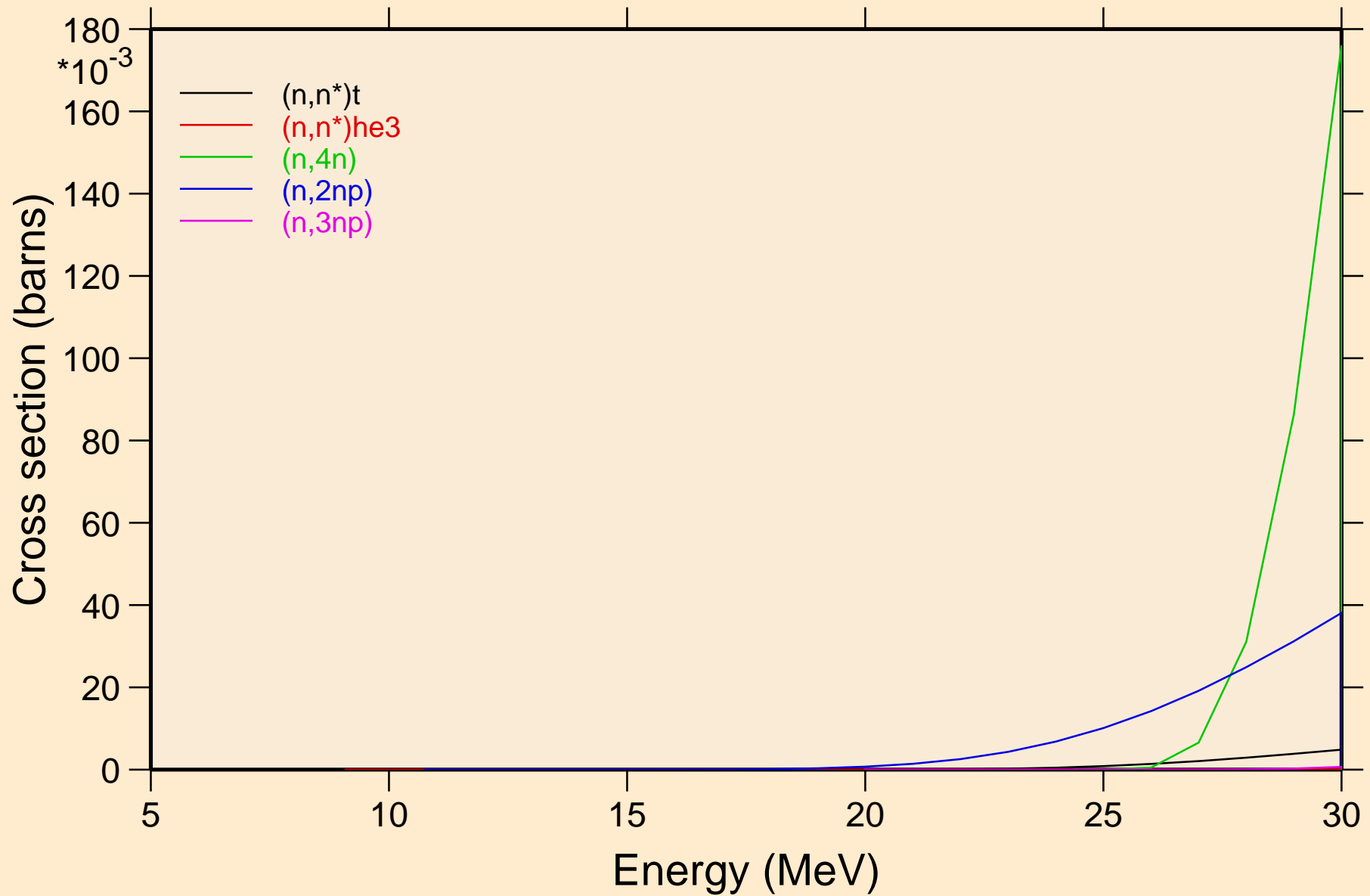

TL196 NEUTRON ACER TENDL-2021 LIBRARY; T=293.6K
Threshold reactions

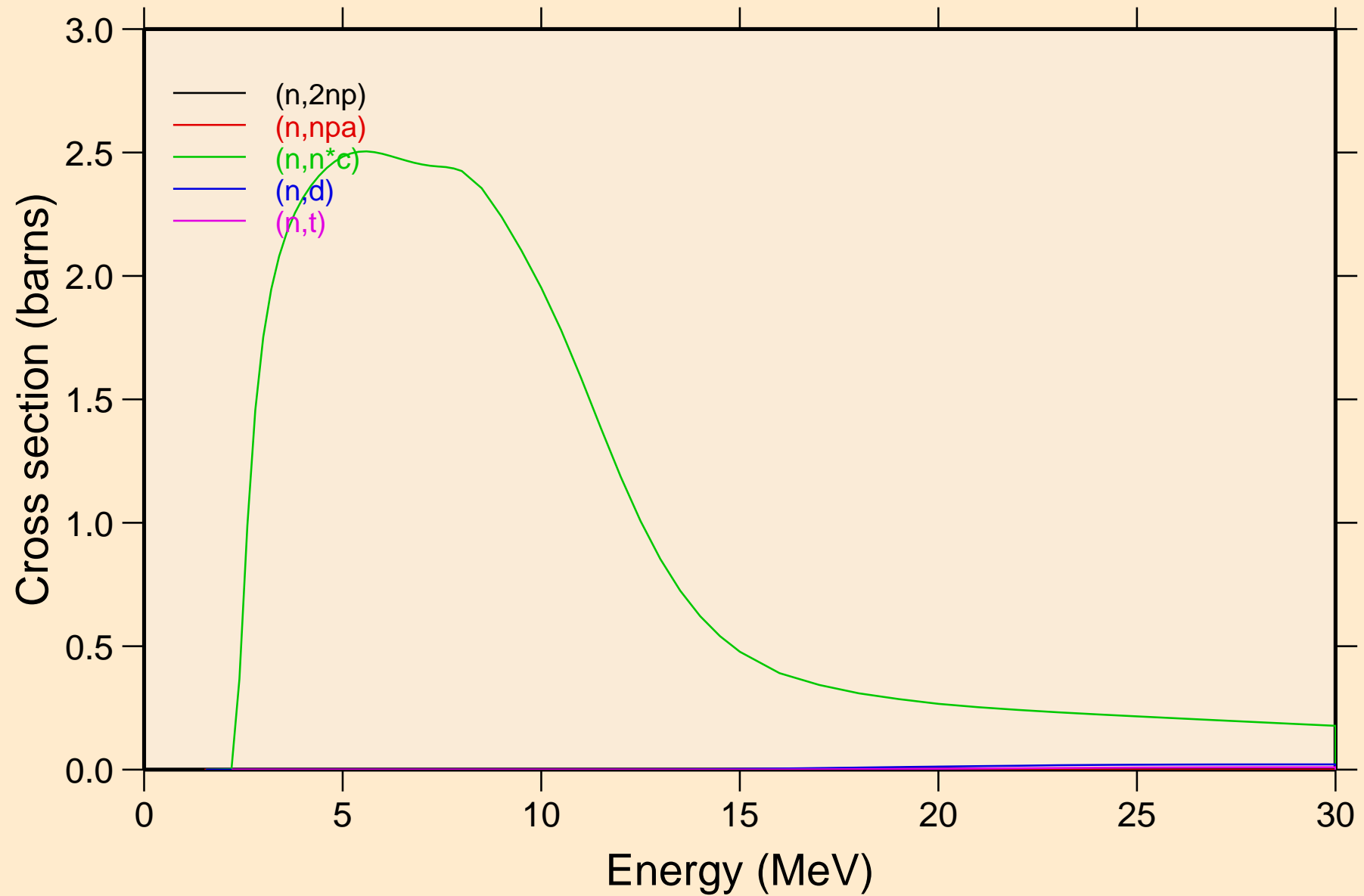

TL196 NEUTRON ACER TENDL-2021 LIBRARY; T=293.6K
Threshold reactions

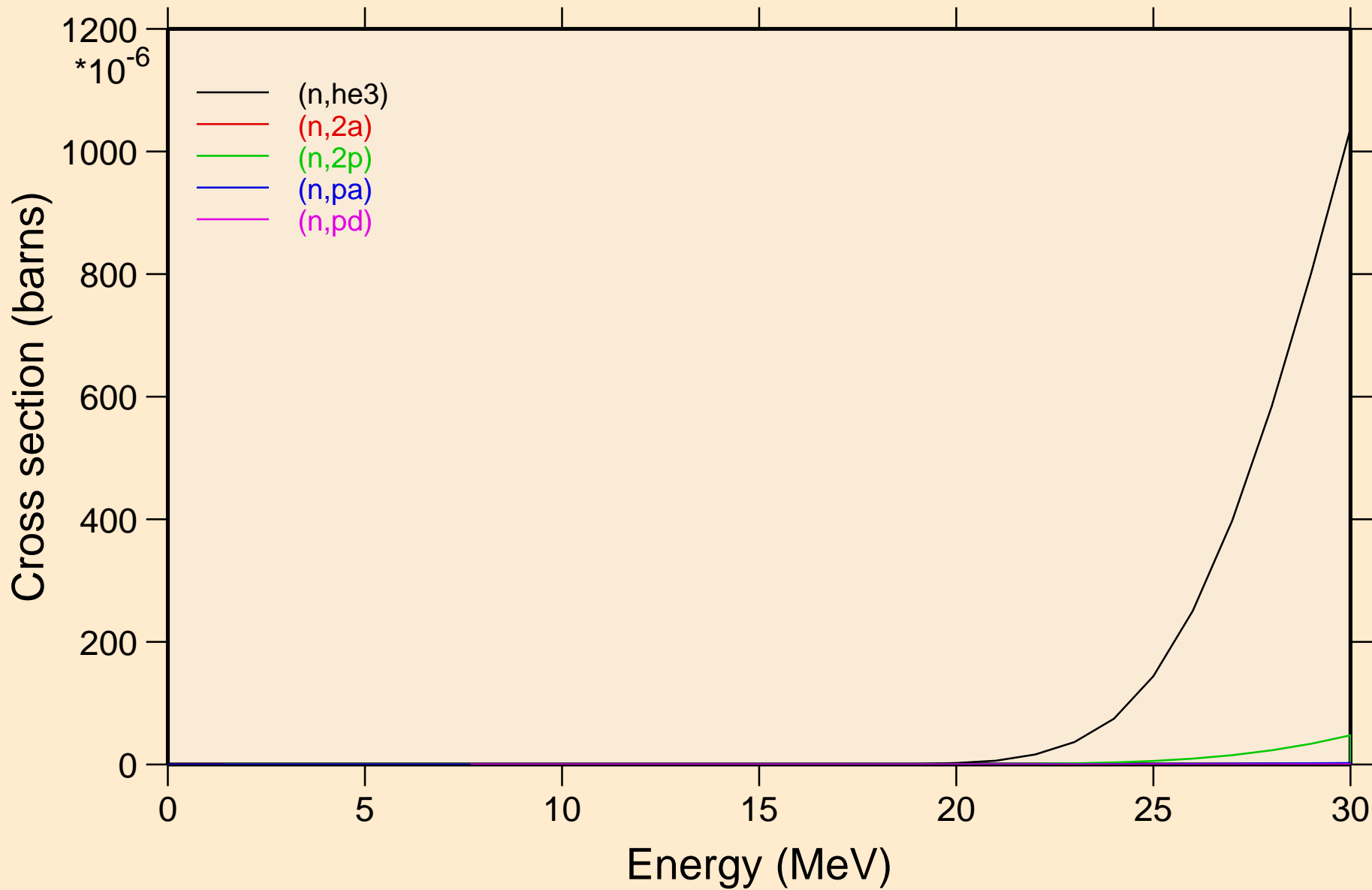

TL196 NEUTRON ACER TENDL-2021 LIBRARY; T=293.6K
Threshold reactions

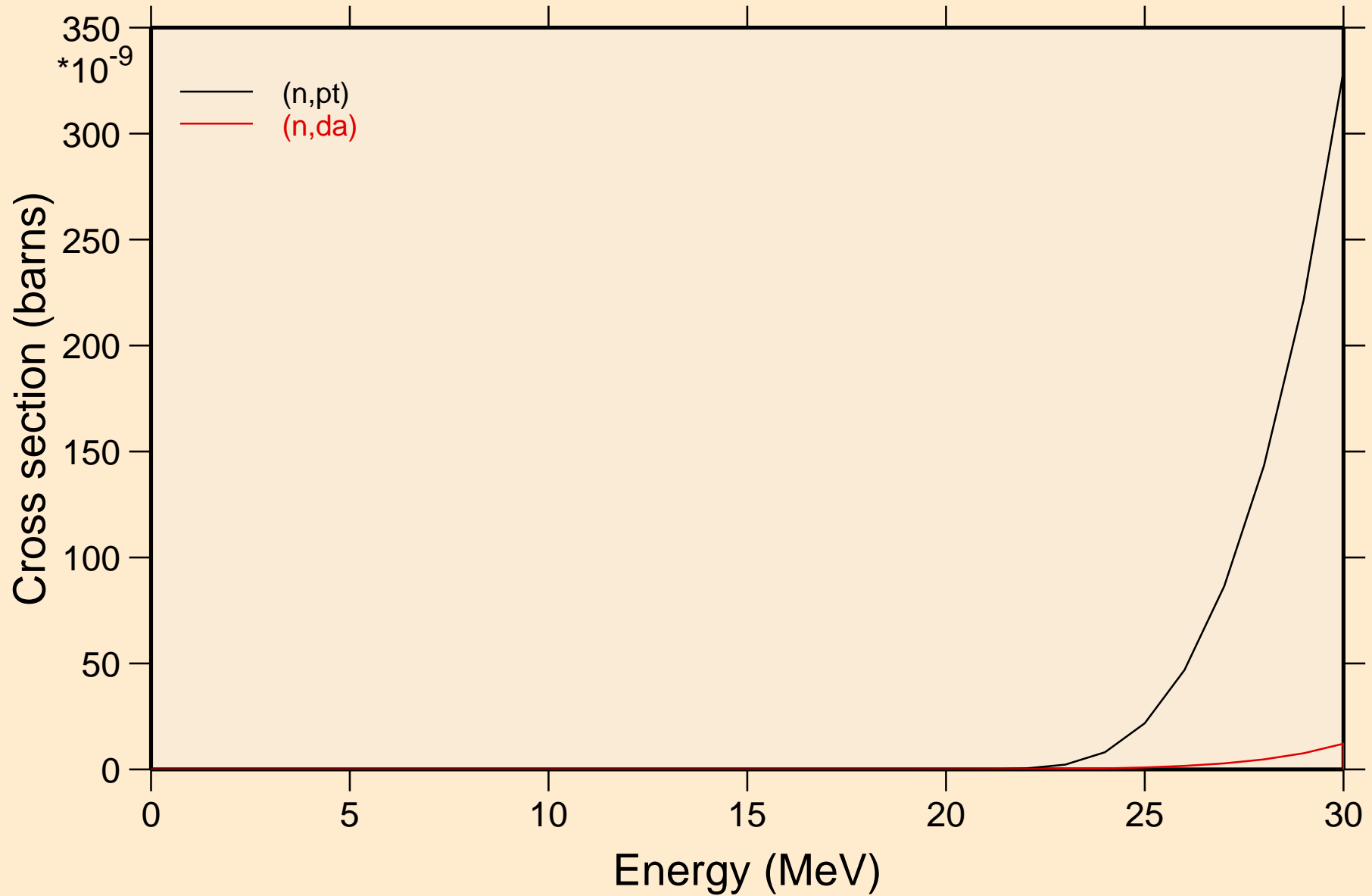

TL196 NEUTRON ACER TENDL-2021 LIBRARY; T=293.6K
Threshold reactions

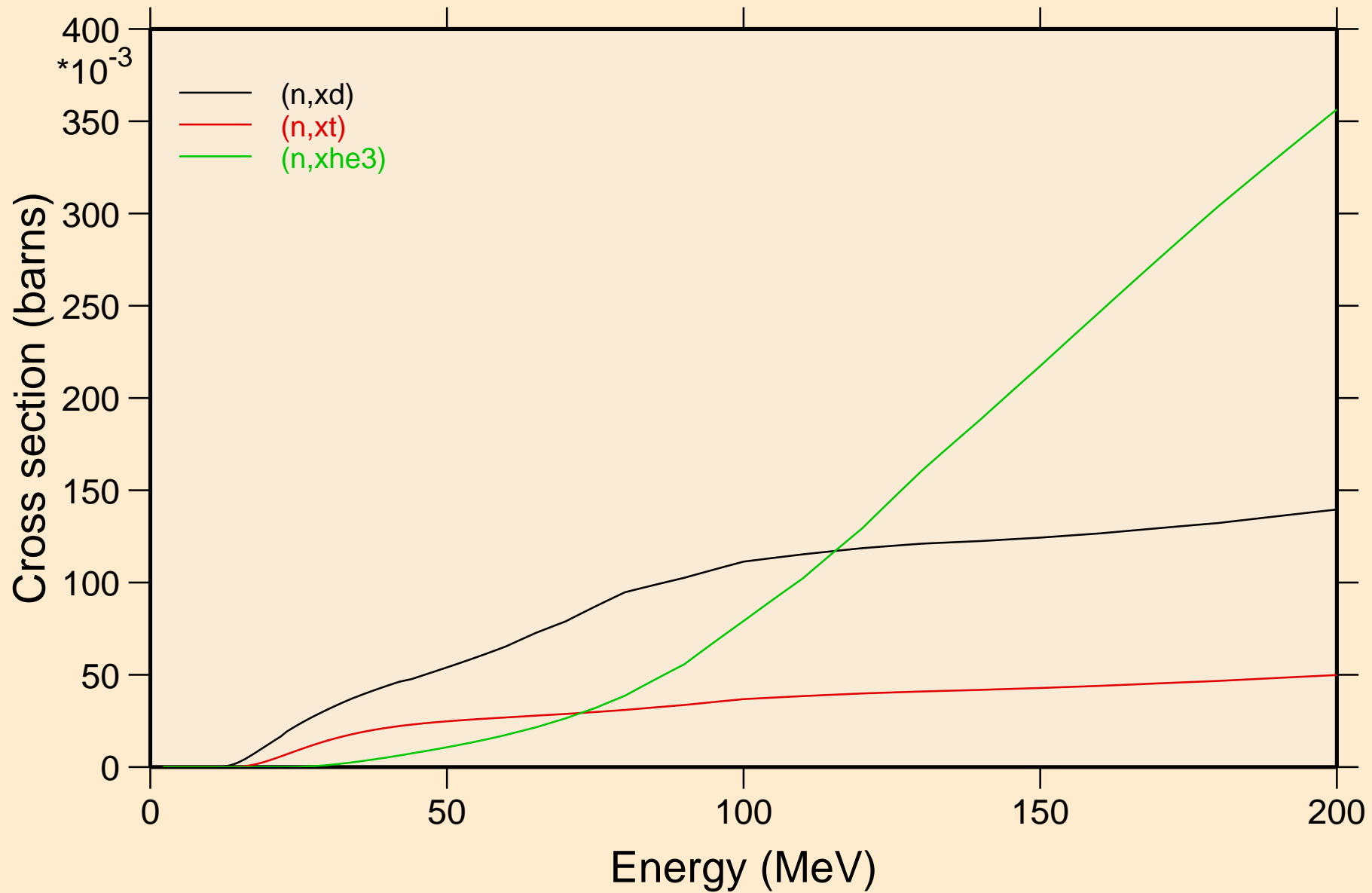

TL196 NEUTRON ACER TENDL-2021 LIBRARY; T=293.6K
angular distribution for elastic

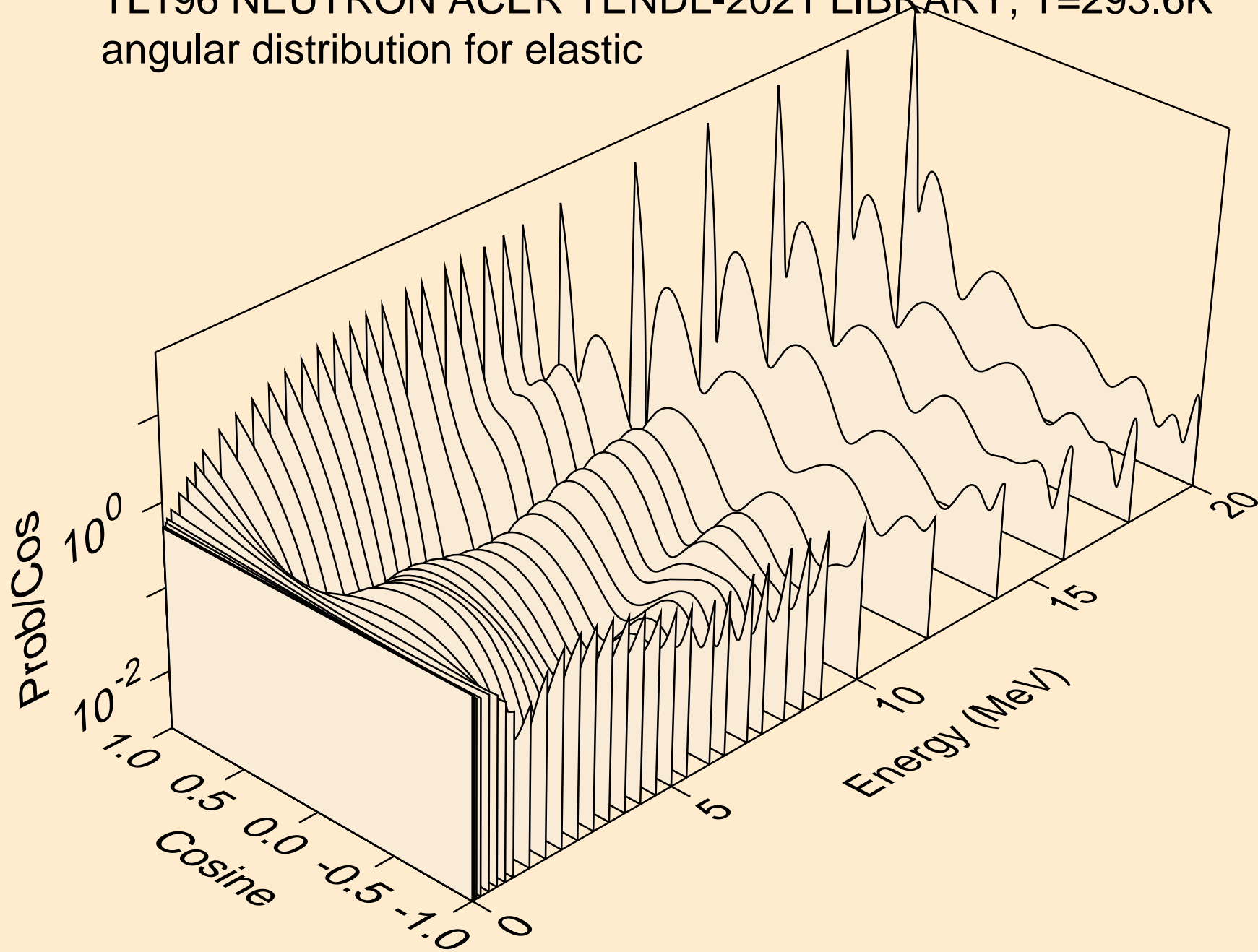

TL196 NEUTRON ACER TENDL-2021 LIBRARY; T=293.6K
angular distribution for elastic

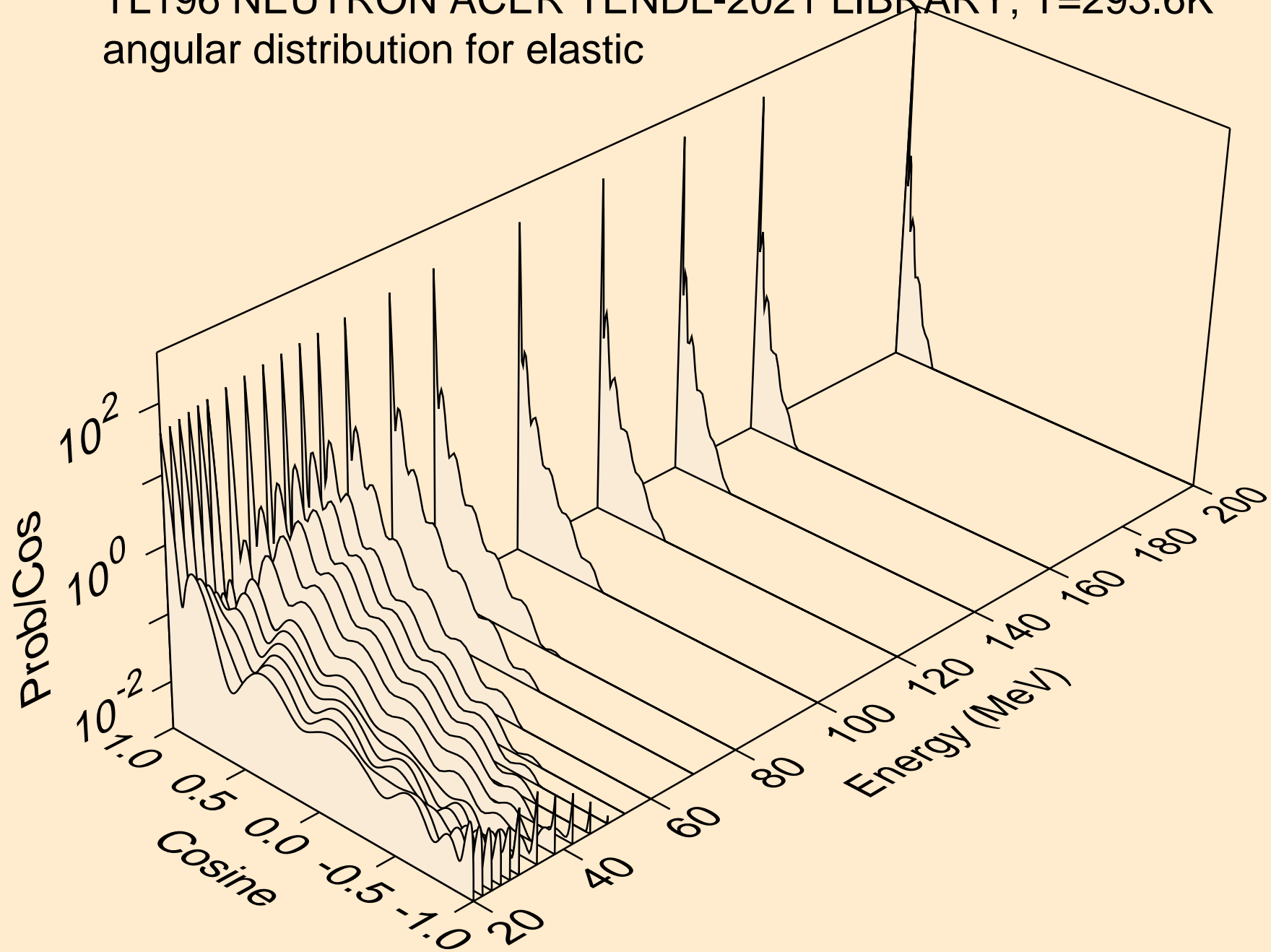

TL196 NEUTRON ACER TENDL-2021 LIBRARY; T=293.6K
angular distribution for (n,n*1)

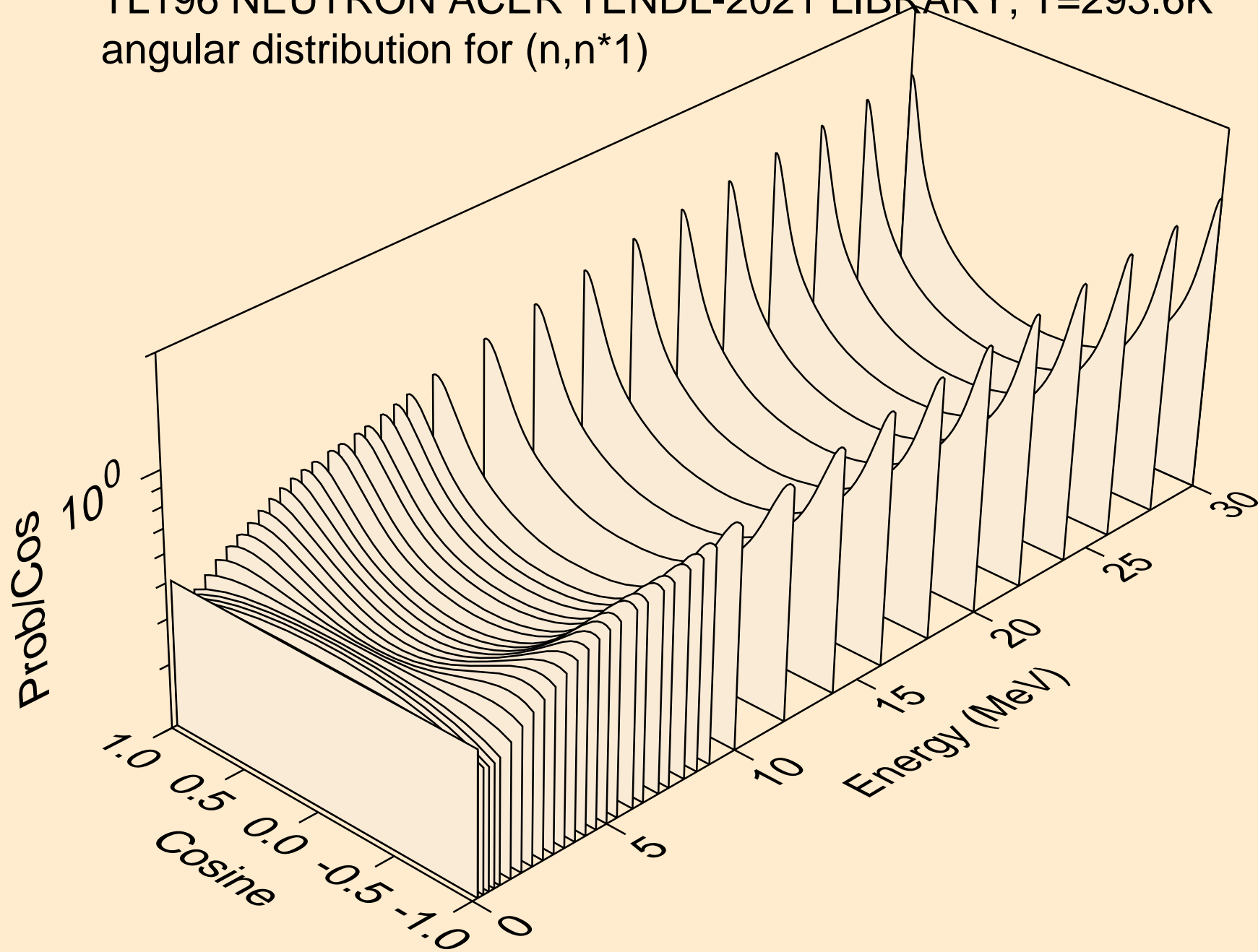

TL196 NEUTRON ACER TENDL-2021 LIBRARY; T=293.6K
angular distribution for (n,n*2)

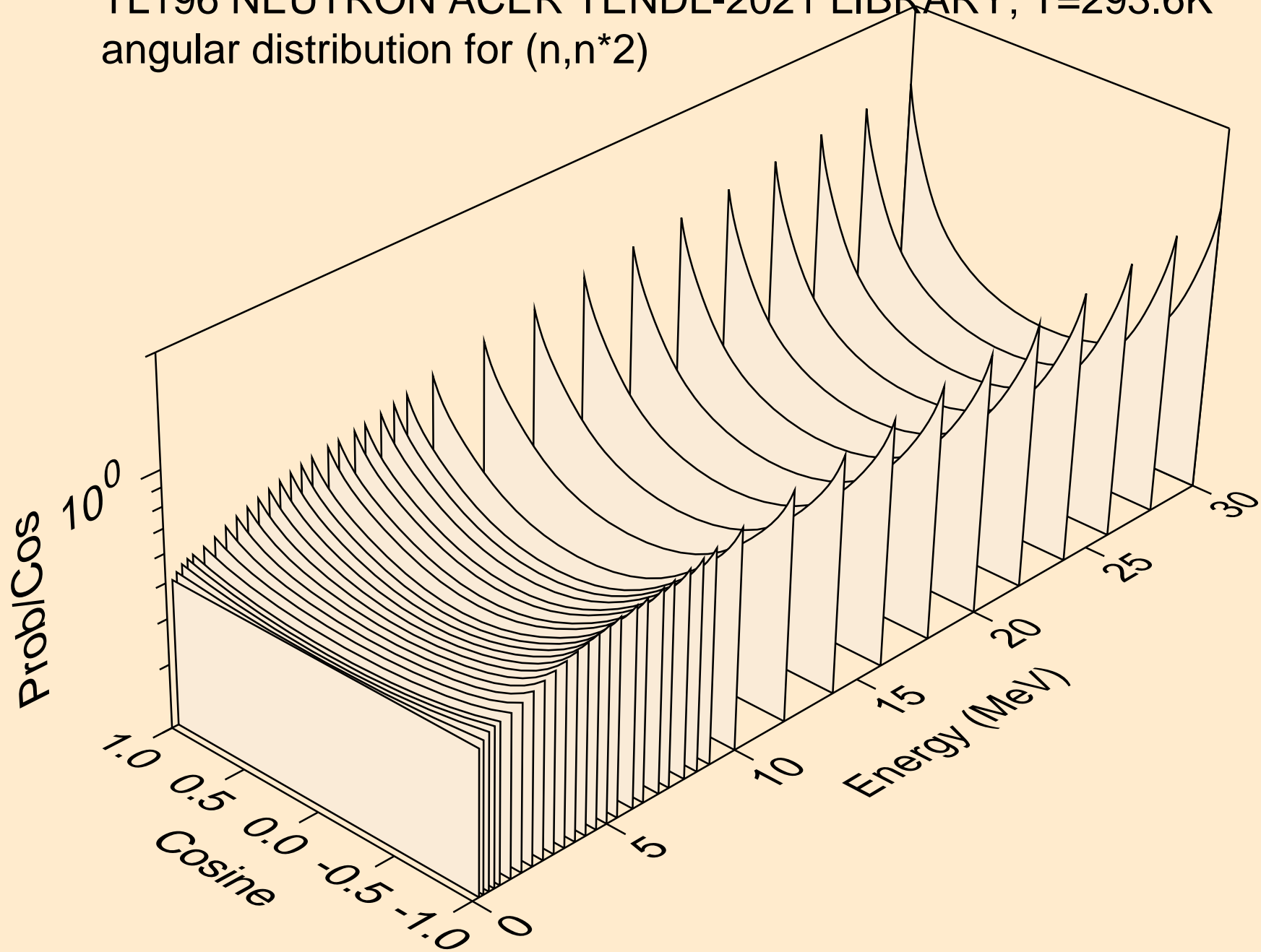

TL196 NEUTRON ACER TENDL-2021 LIBRARY; T=293.6K
angular distribution for (n,n*3)

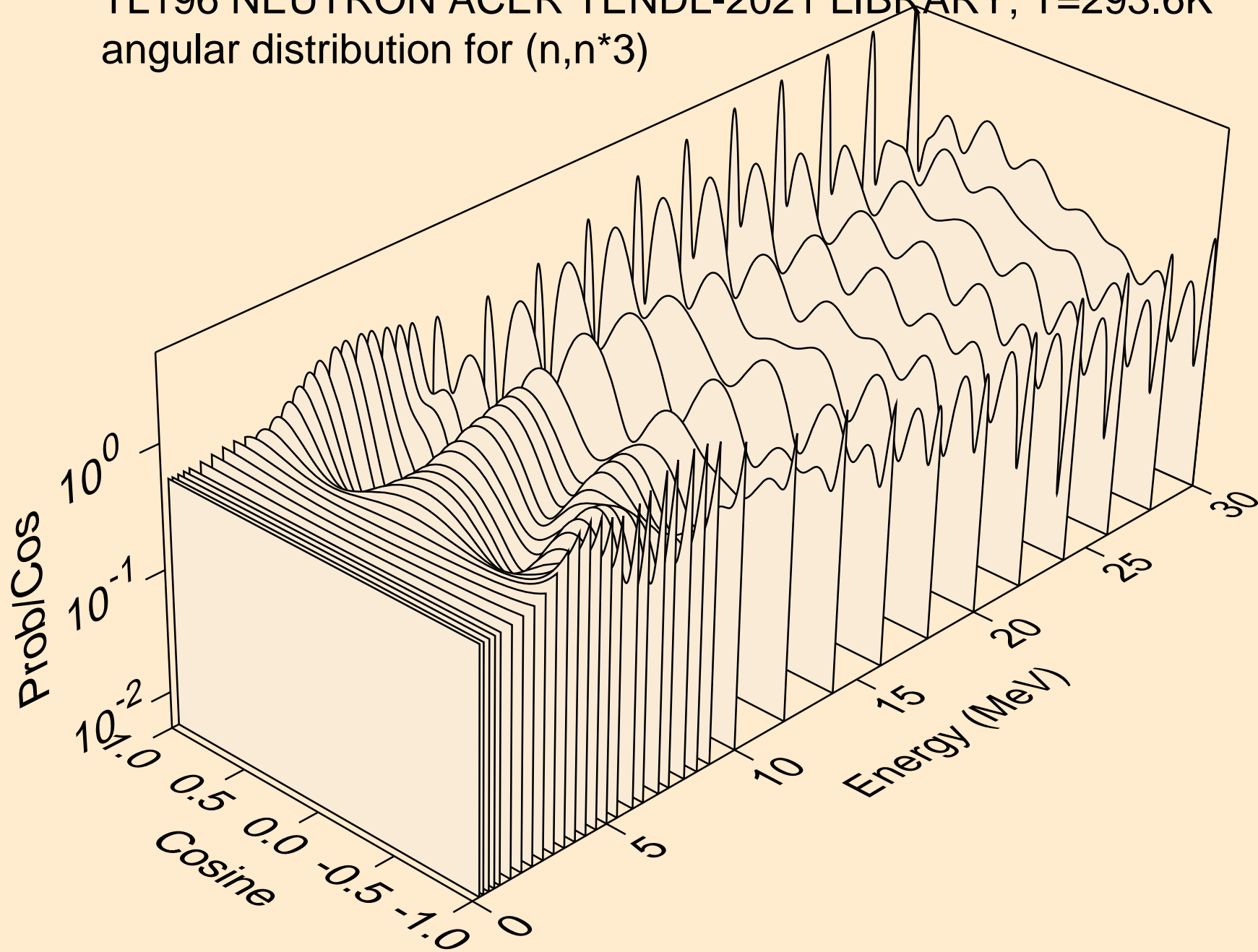

TL196 NEUTRON ACER TENDL-2021 LIBRARY; T=293.6K
angular distribution for (n,n*4)

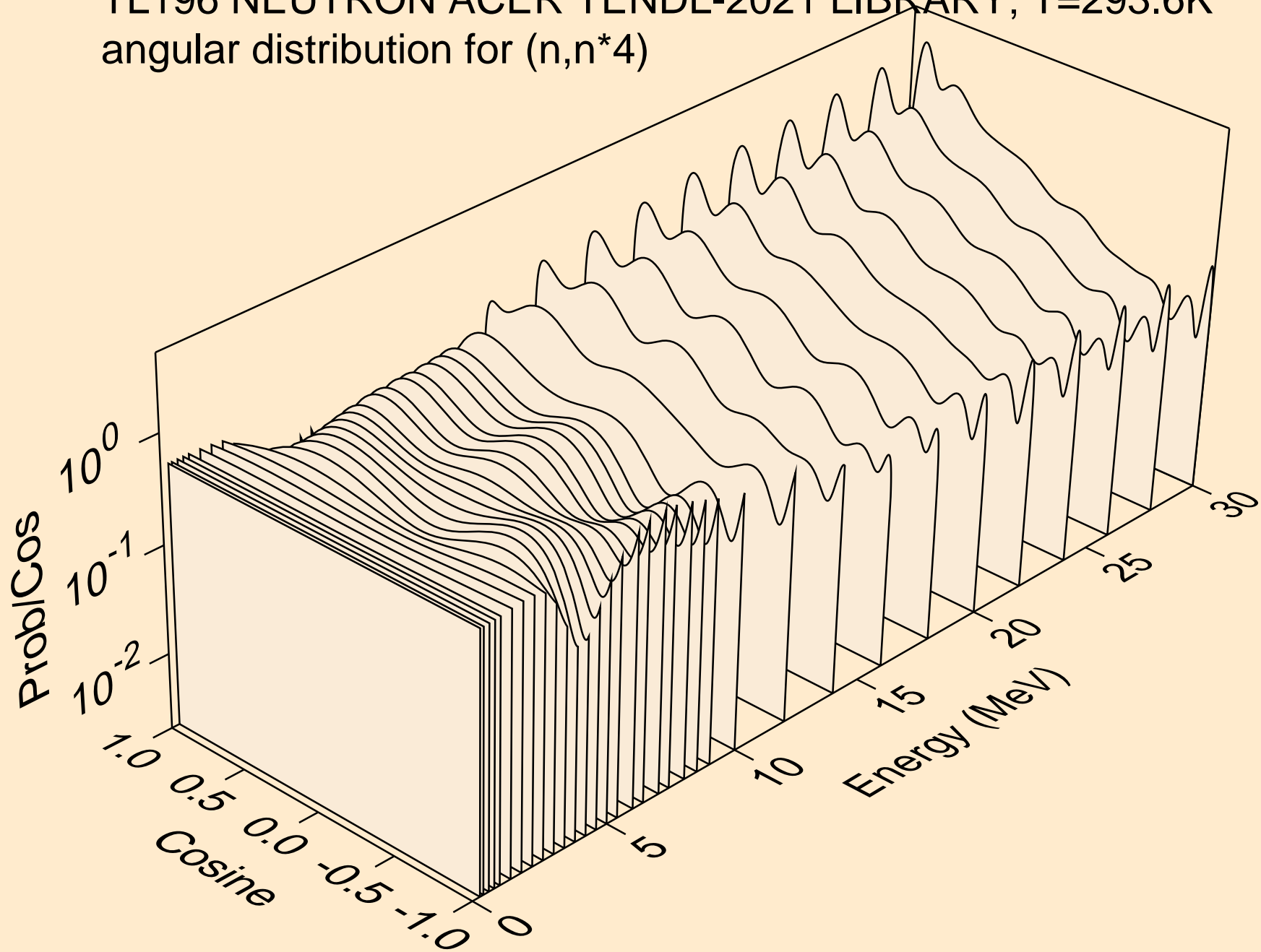

TL196 NEUTRON ACER TENDL-2021 LIBRARY; T=293.6K
angular distribution for (n,n*5)

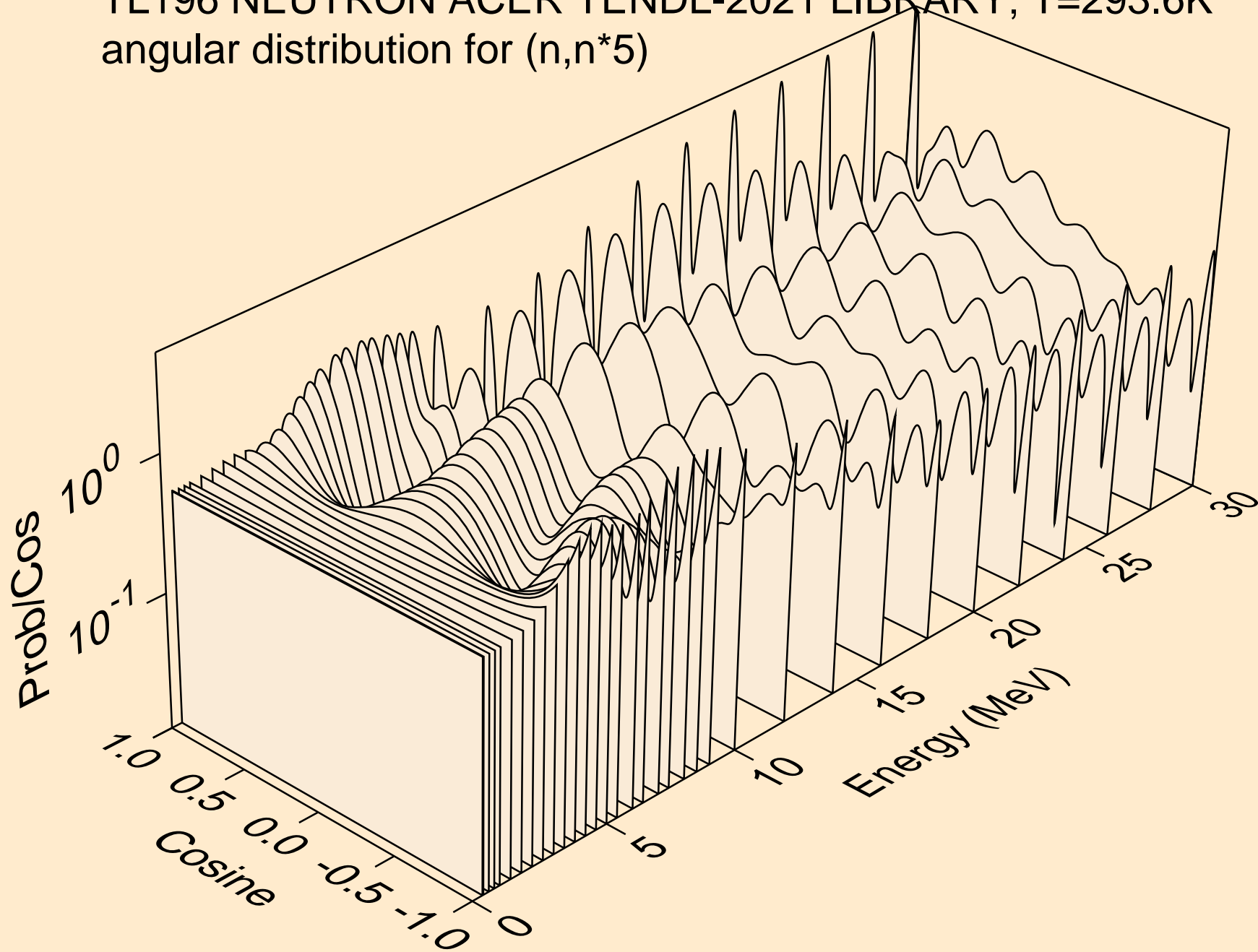

TL196 NEUTRON ACER TENDL-2021 LIBRARY; T=293.6K
angular distribution for (n,n*6)

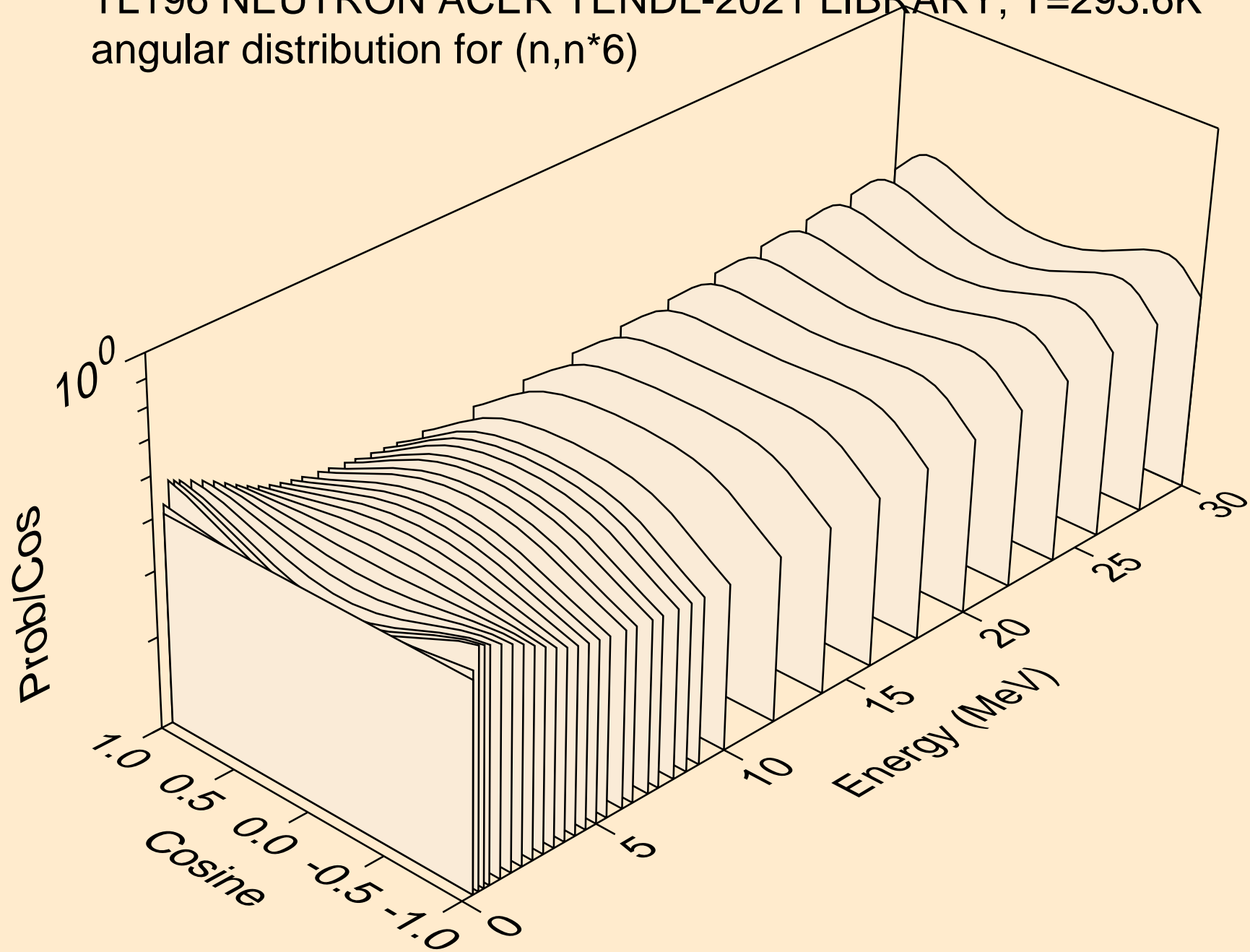

TL196 NEUTRON ACER TENDL-2021 LIBRARY; T=293.6K
angular distribution for (n,n*7)

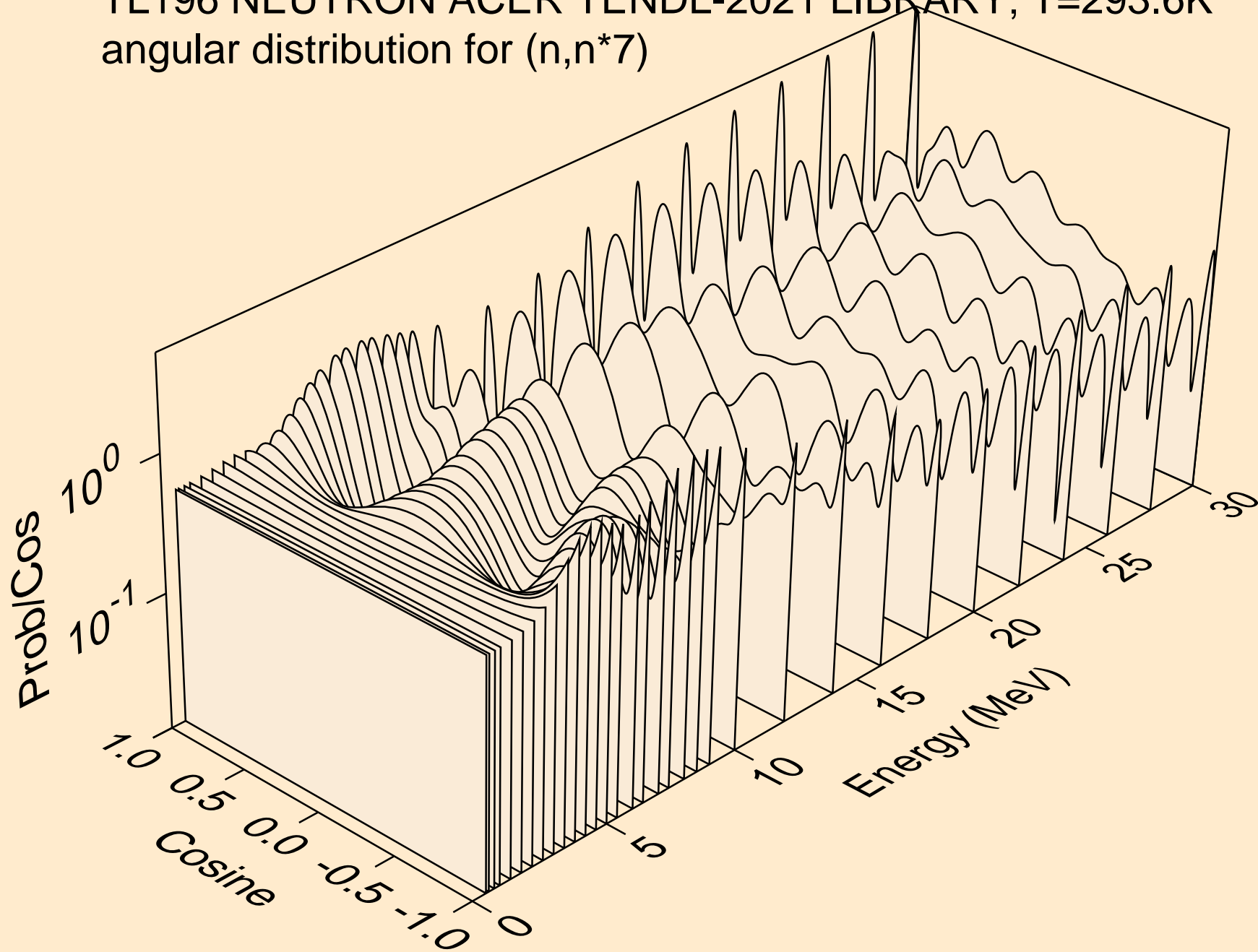

TL196 NEUTRON ACER TENDL-2021 LIBRARY; T=293.6K
angular distribution for (n,n*8)

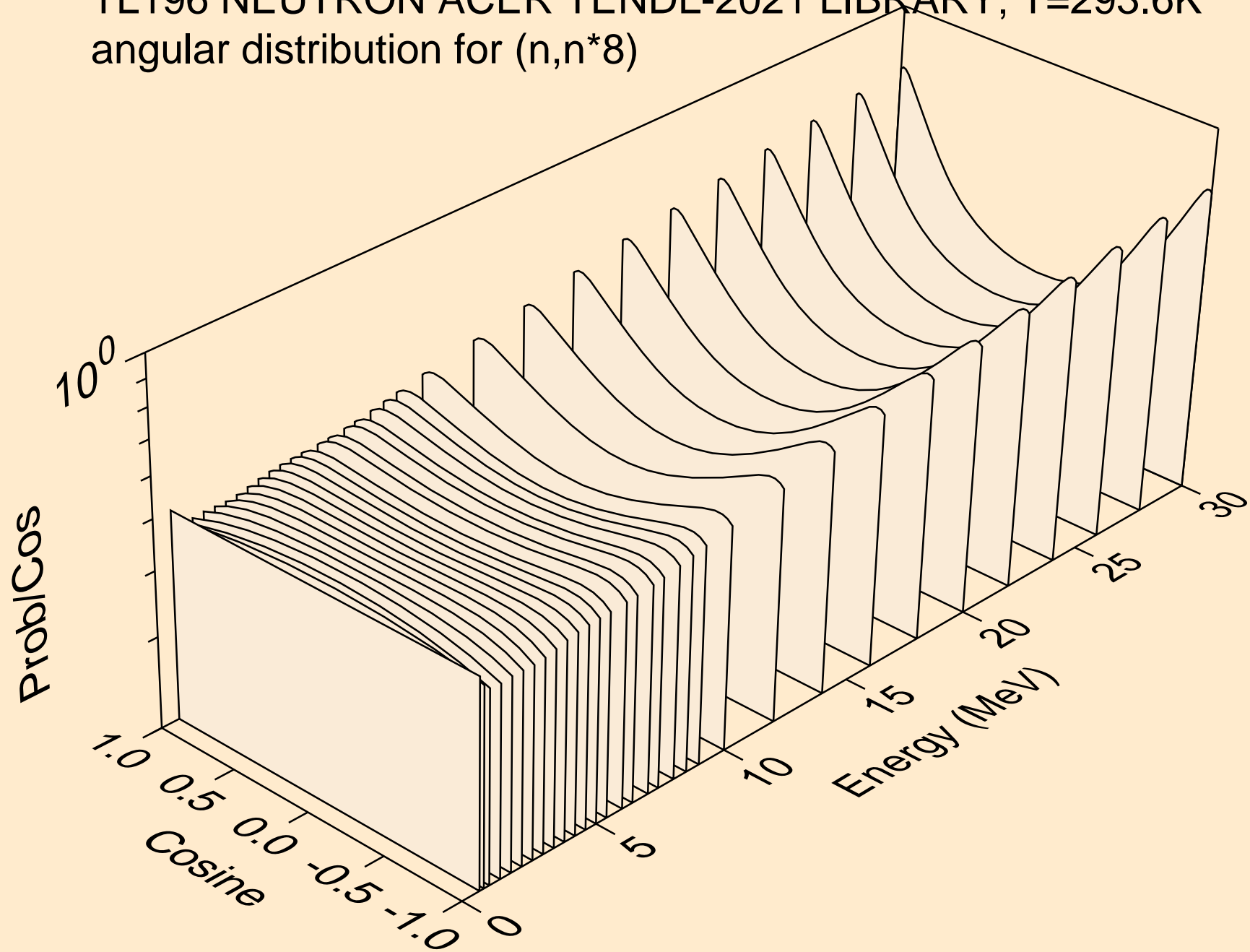

TL196 NEUTRON ACER TENDL-2021 LIBRARY; T=293.6K
angular distribution for (n,n*9)

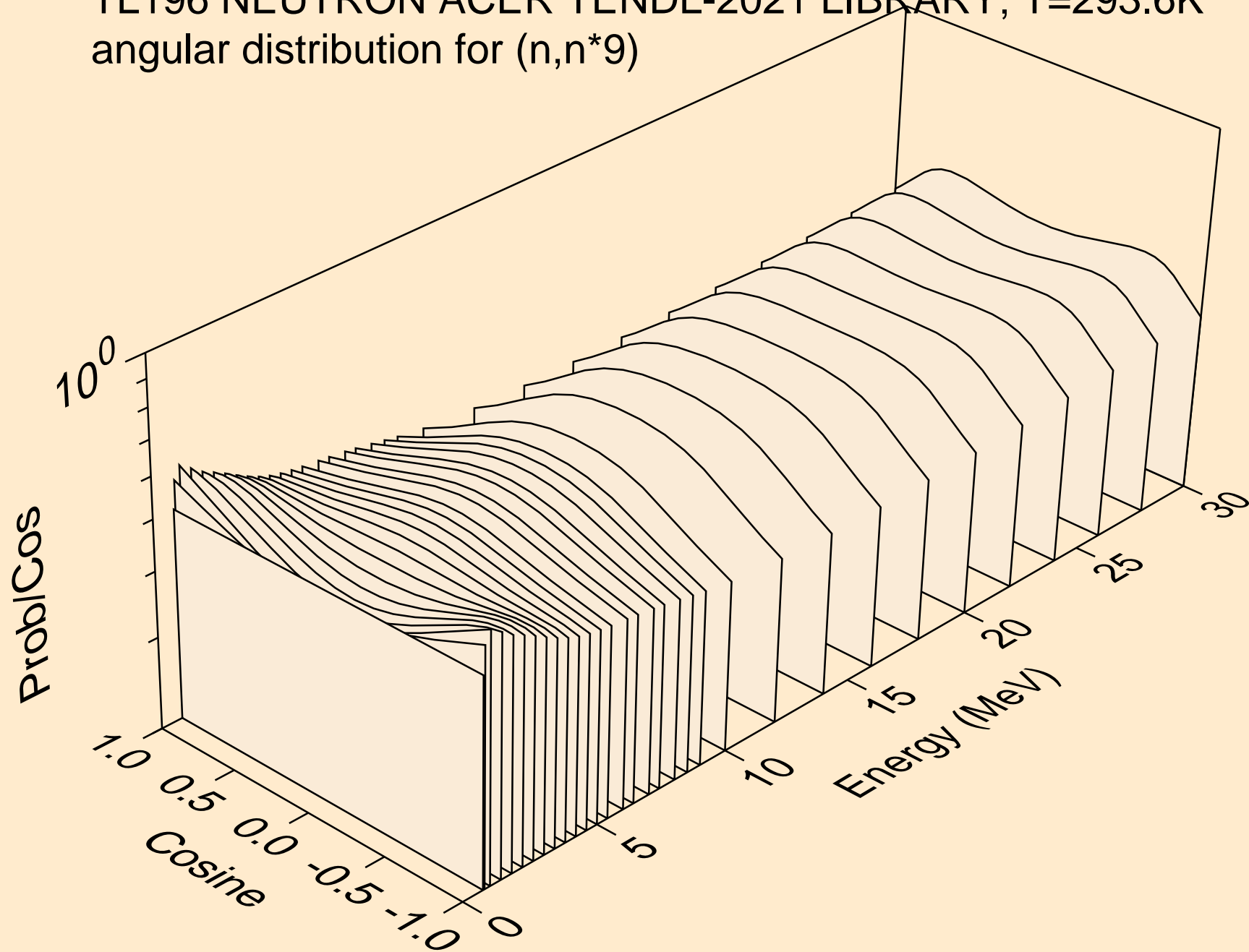

TL196 NEUTRON ACER TENDL-2021 LIBRARY; T=293.6K
angular distribution for (n,n*10)

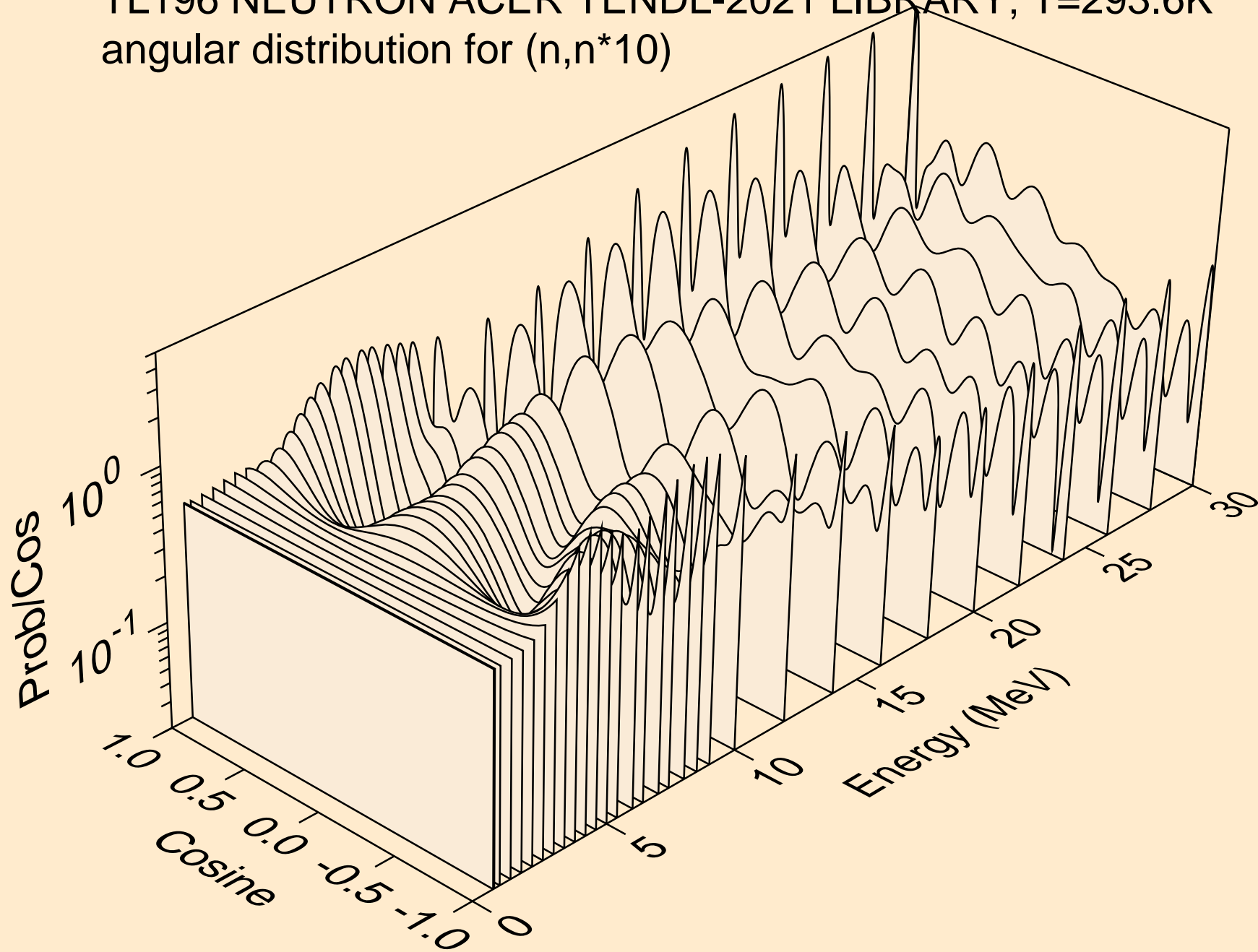

TL196 NEUTRON ACER TENDL-2021 LIBRARY; T=293.6K
angular distribution for (n,n*11)

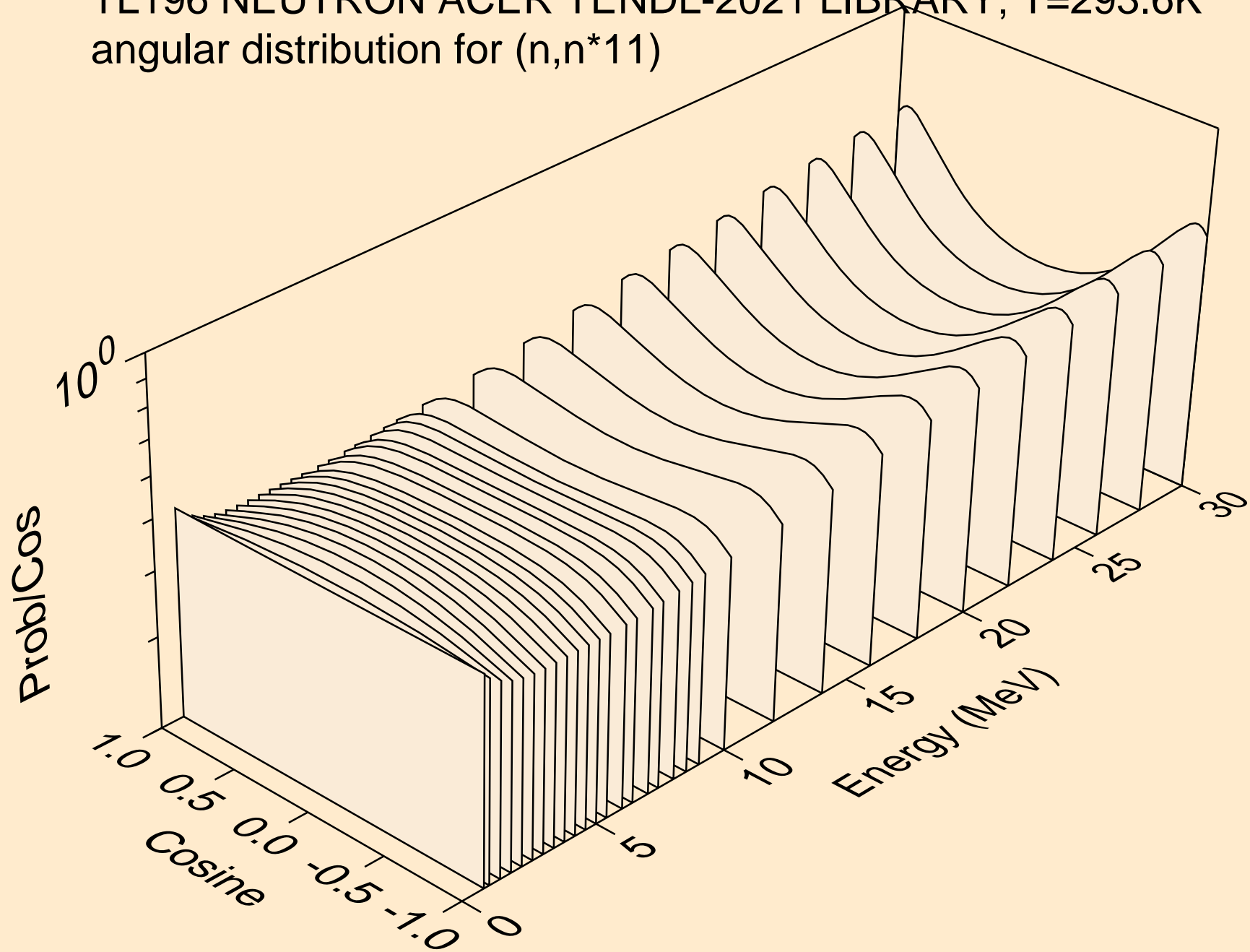

TL196 NEUTRON ACER TENDL-2021 LIBRARY; T=293.6K
angular distribution for (n,n*12)

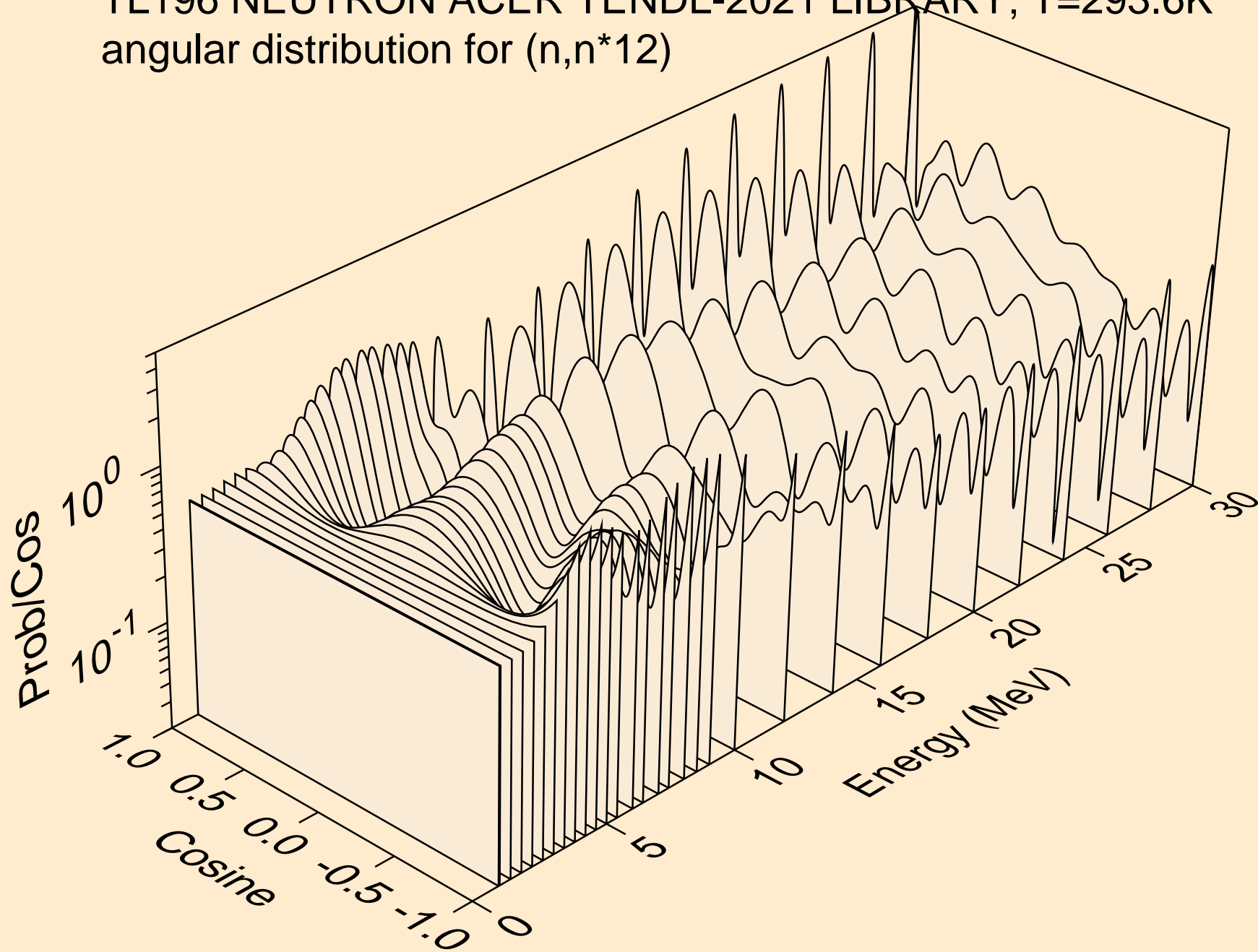

TL196 NEUTRON ACER TENDL-2021 LIBRARY; T=293.6K
angular distribution for (n,n*13)

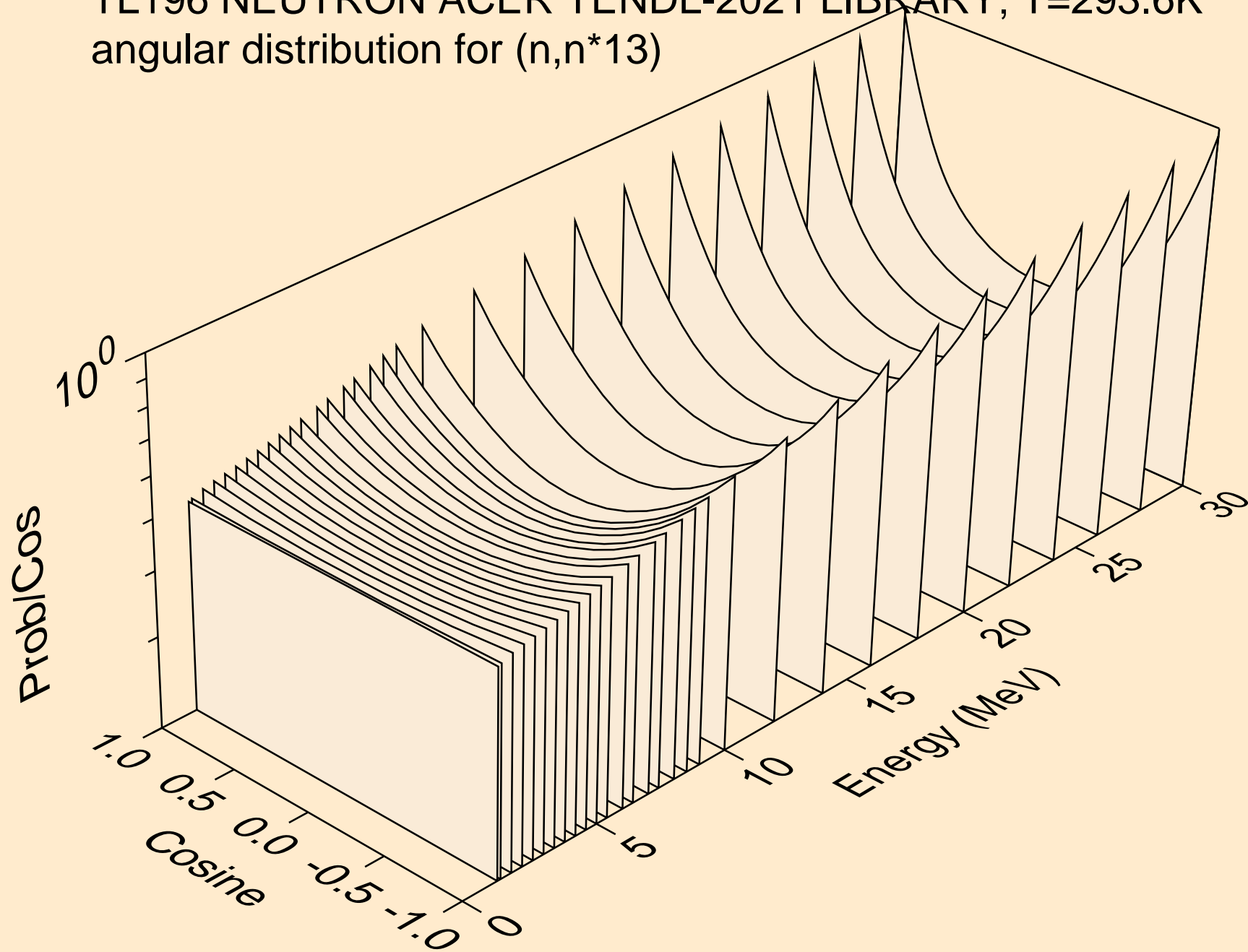

TL196 NEUTRON ACER TENDL-2021 LIBRARY; T=293.6K
angular distribution for (n,n*14)

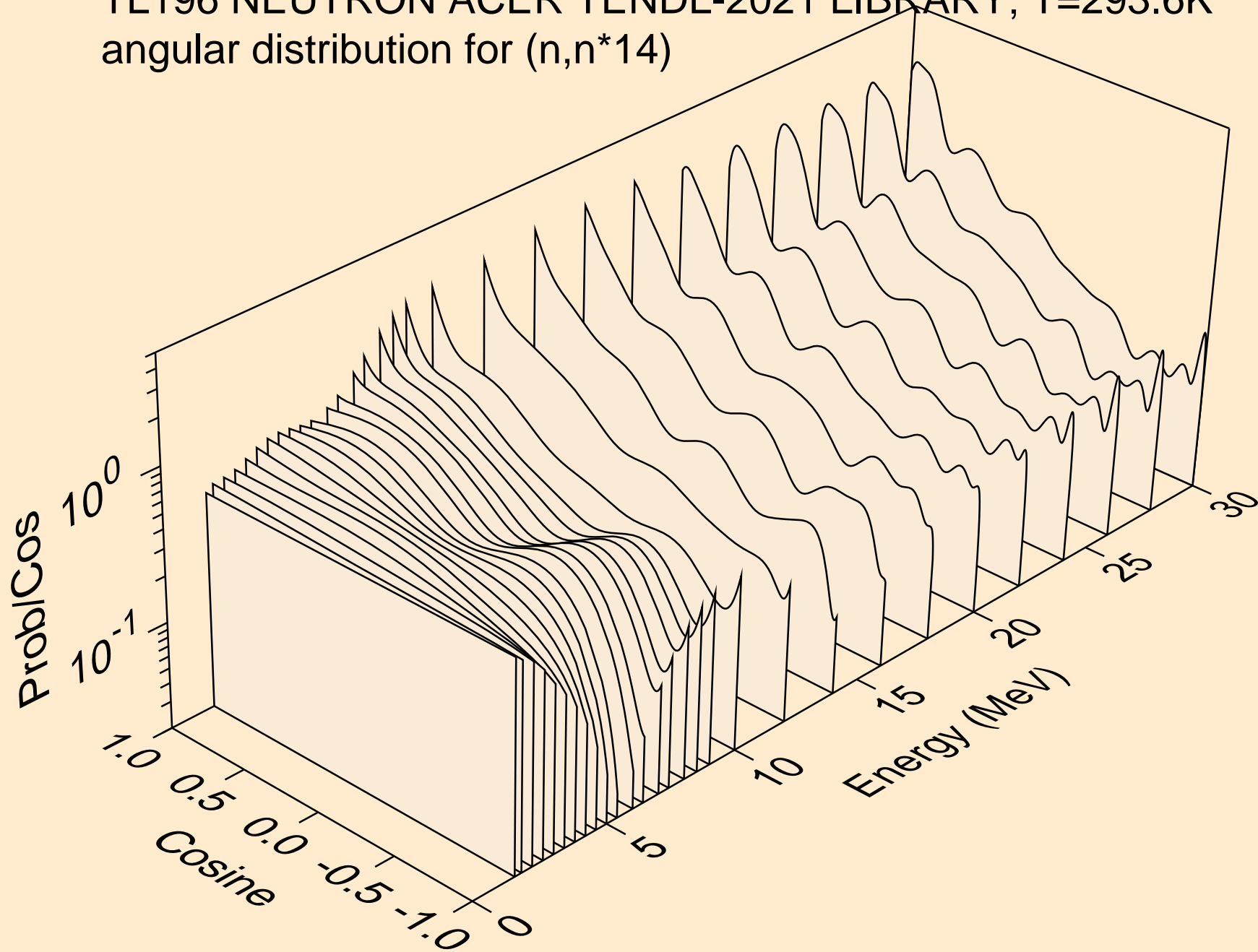

TL196 NEUTRON ACER TENDL-2021 LIBRARY; T=293.6K
Neutron emission for (n,x)

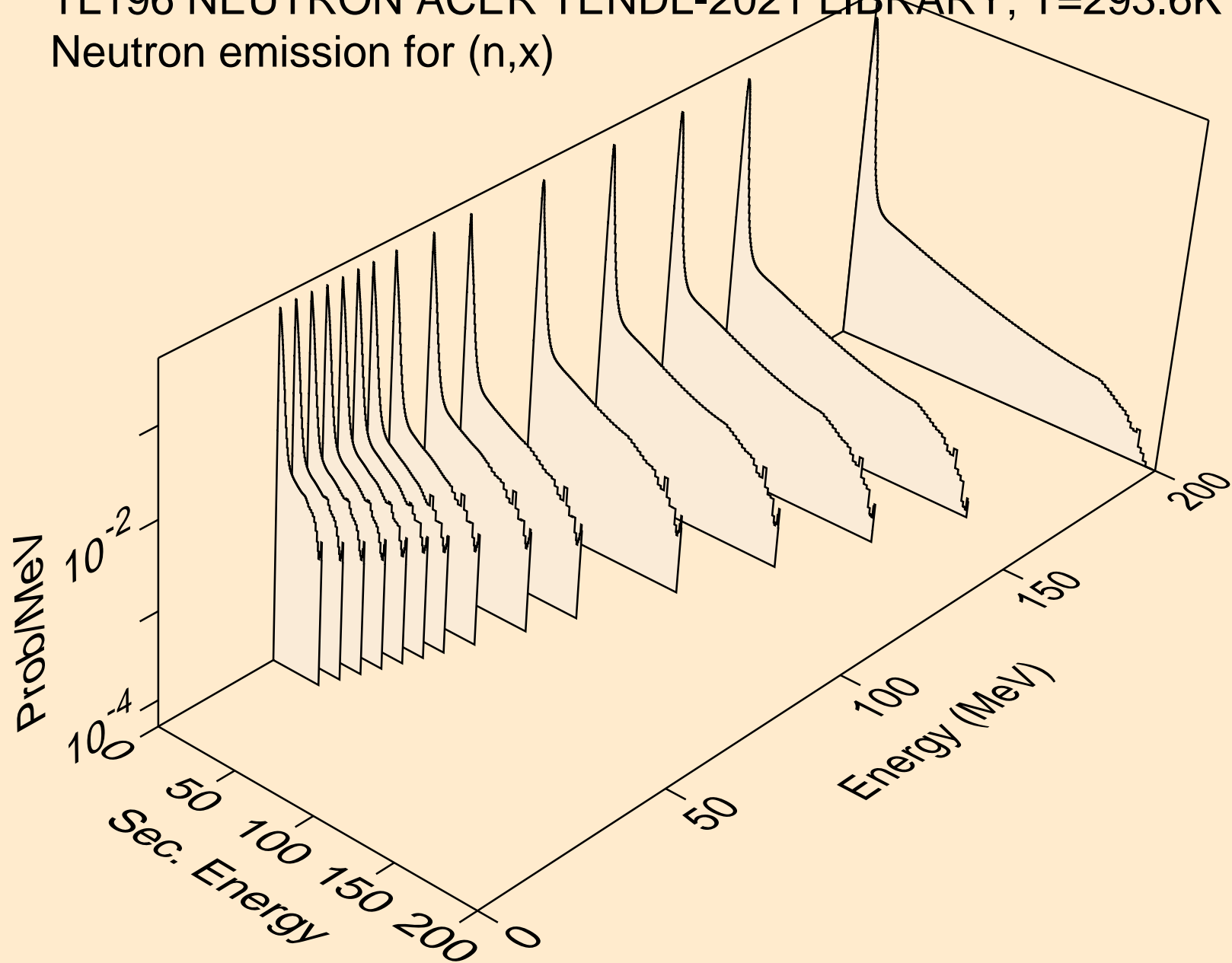

TL196 NEUTRON ACER TENDL-2021 LIBRARY; T=293.6K
Neutron emission for (n,2nd)

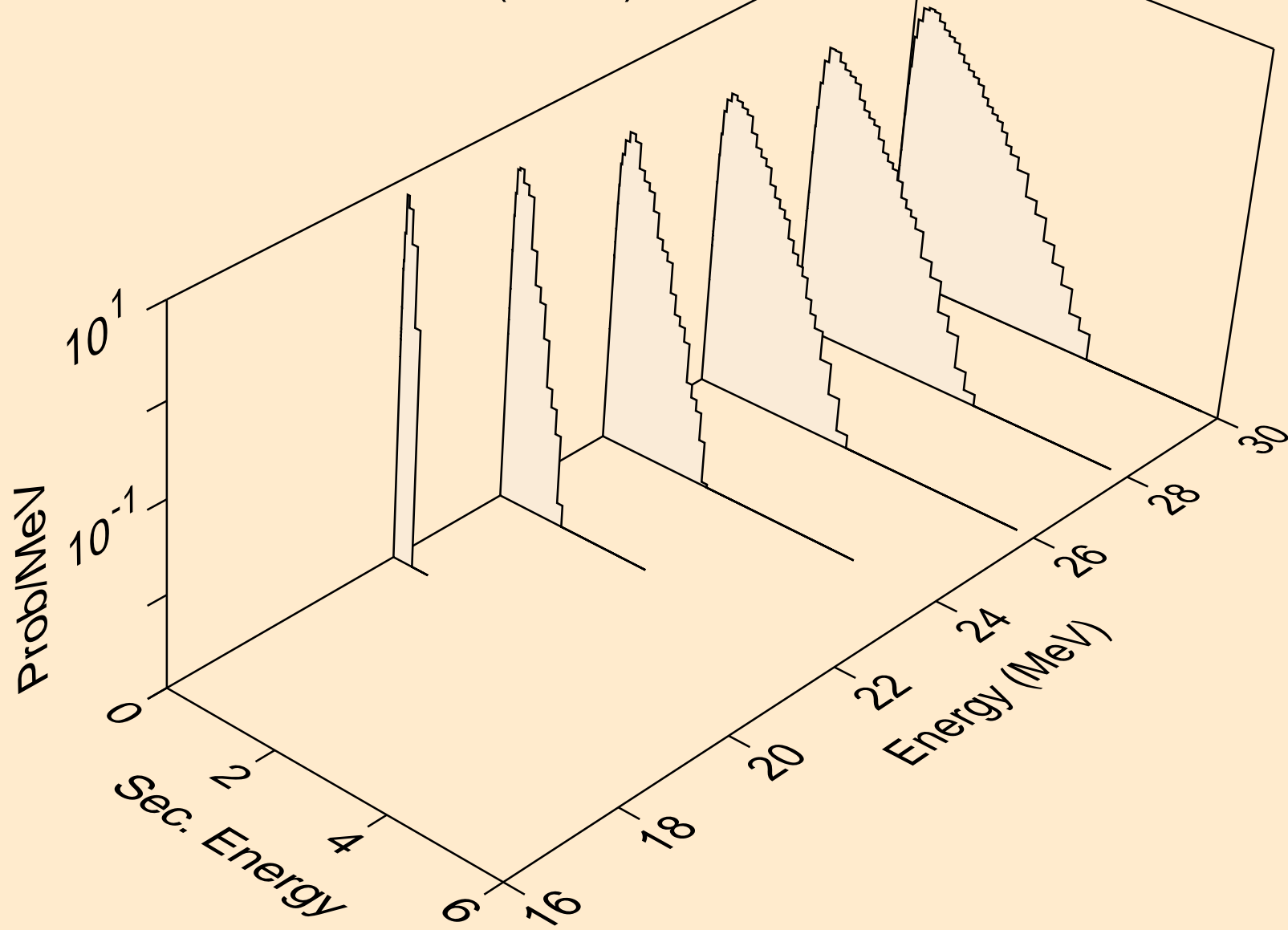

TL196 NEUTRON ACER TENDL-2021 LIBRARY; T=293.6K
Neutron emission for (n,2n)

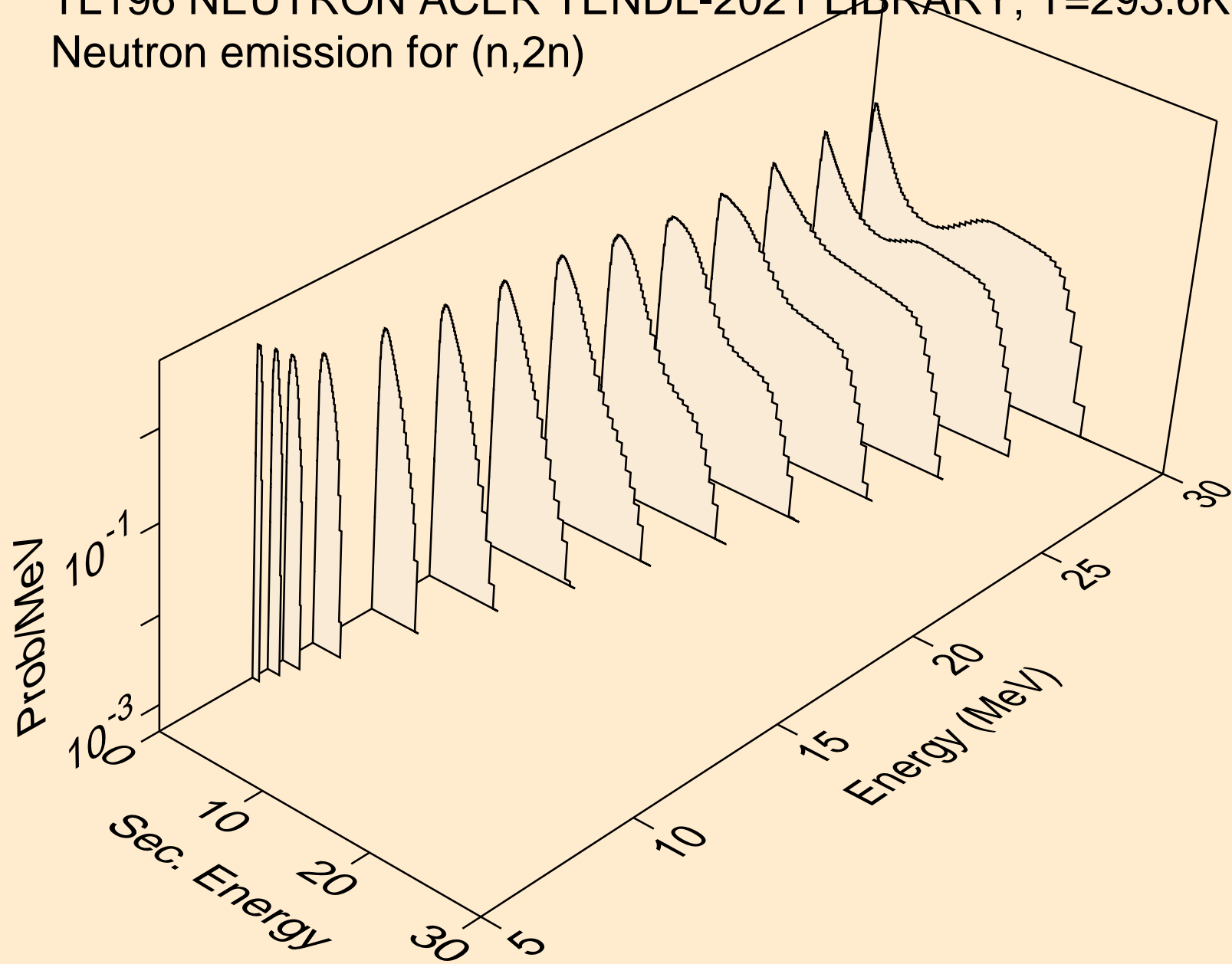

TL196 NEUTRON ACER TENDL-2021 LIBRARY; T=293.6K
Neutron emission for (n,3n)

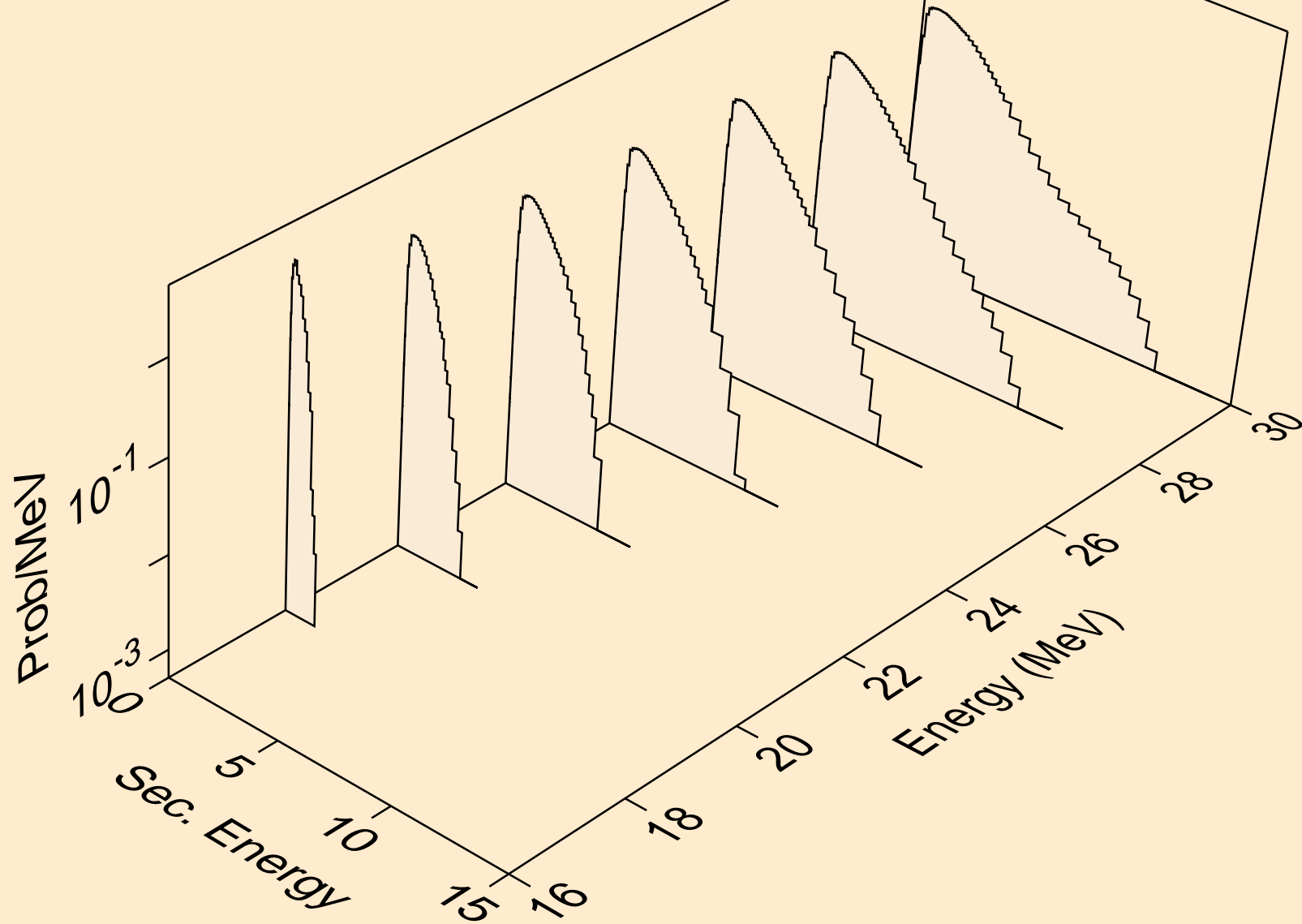

TL196 NEUTRON ACER TENDL-2021 LIBRARY; T=293.6K
Neutron emission for (n,n*)a

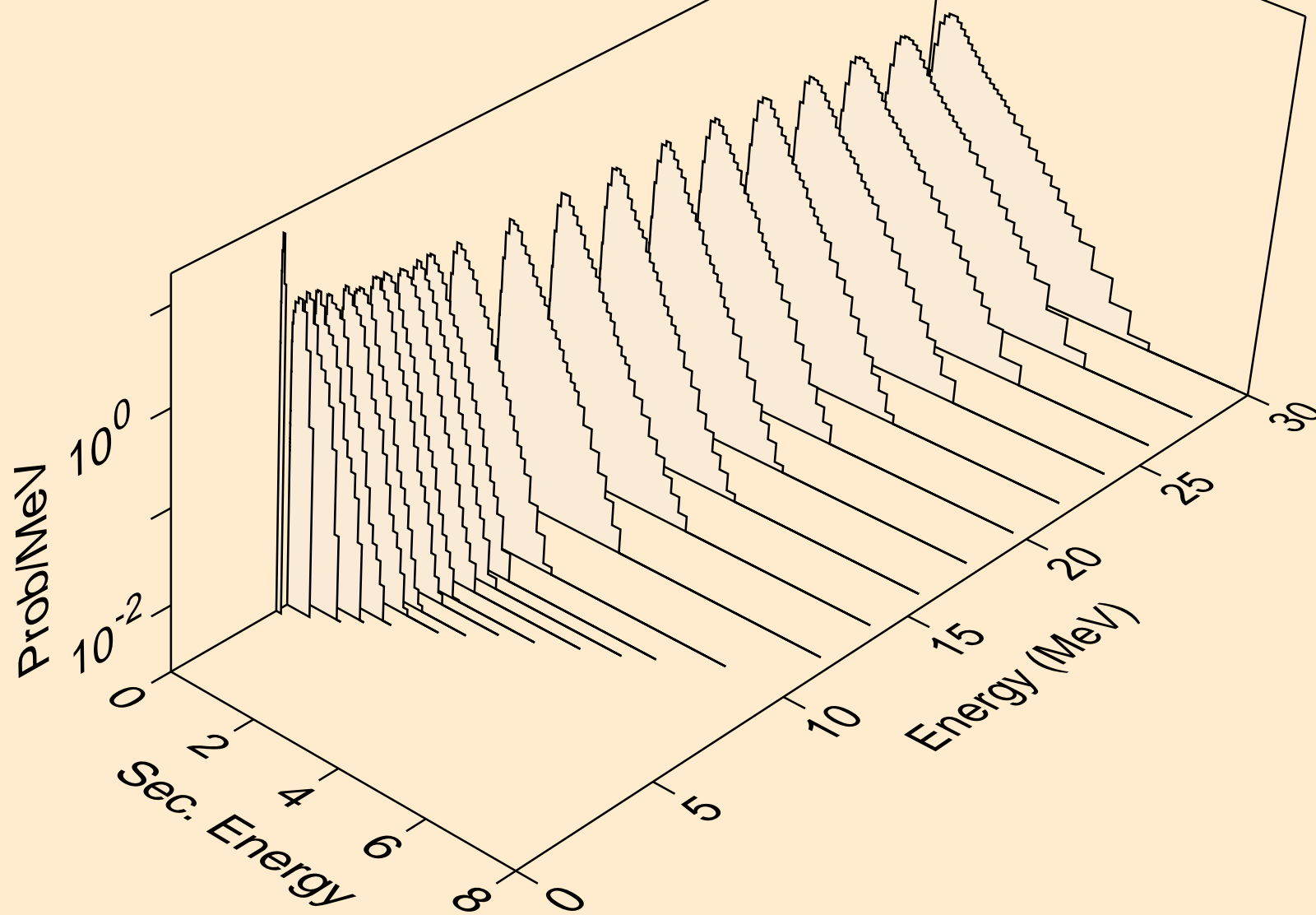

TL196 NEUTRON ACER TENDL-2021 LIBRARY; T=293.6K
Neutron emission for (n,2n)_a

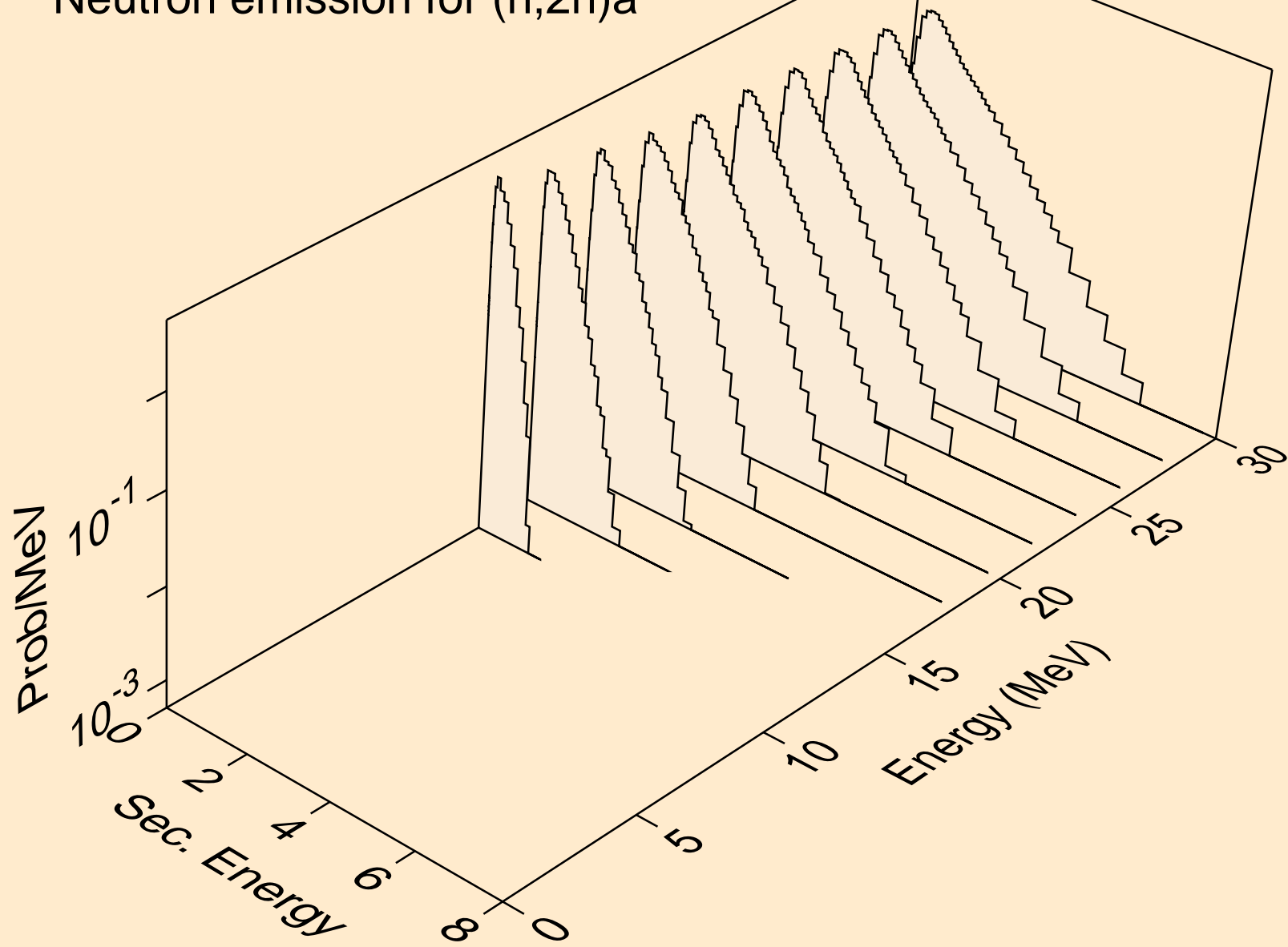

TL196 NEUTRON ACER TENDL-2021 LIBRARY; T=293.6K
Neutron emission for (n,3n)_a

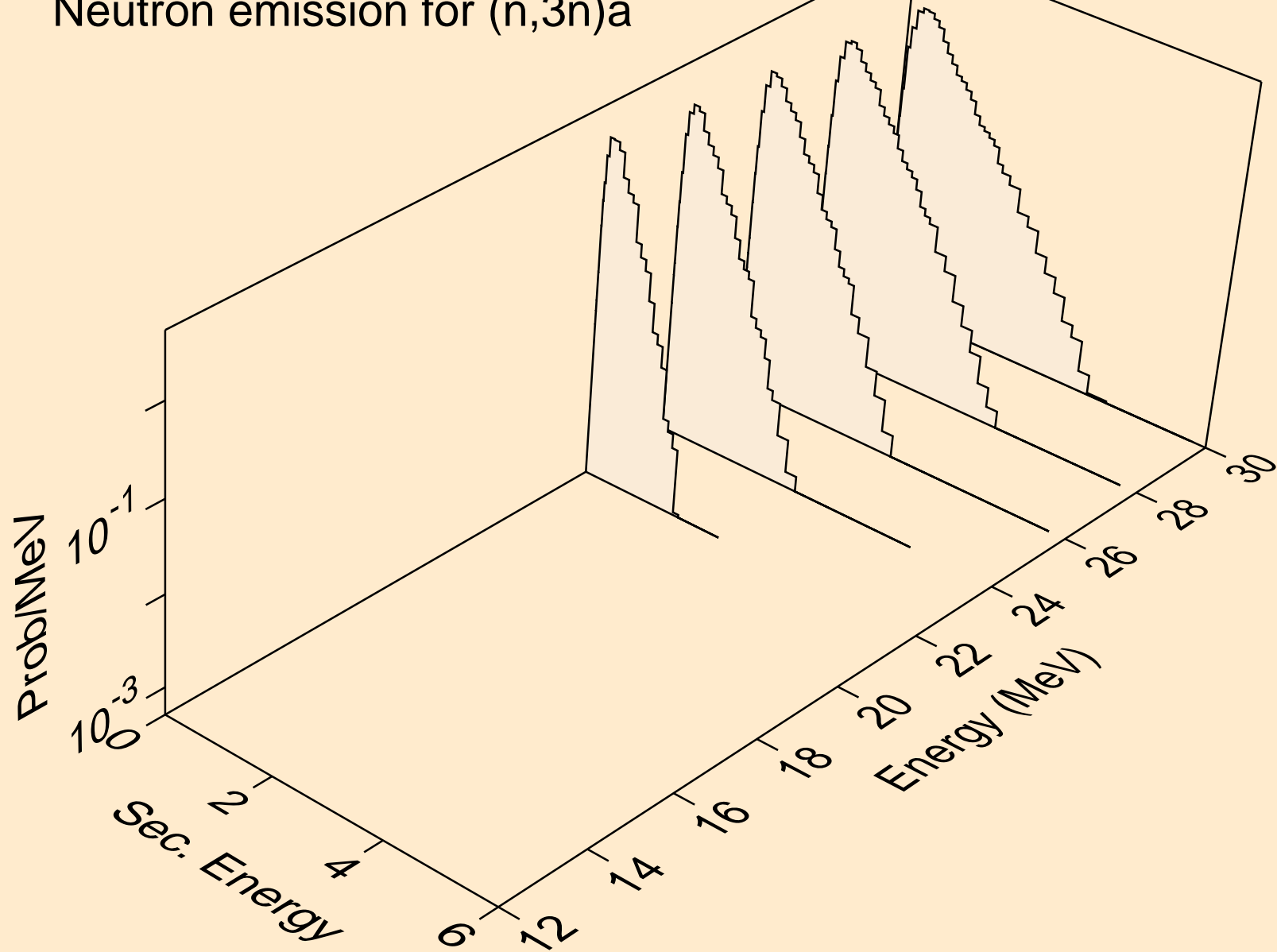

TL196 NEUTRON ACER TENDL-2021 LIBRARY; T=293.6K
Neutron emission for (n,n*)p

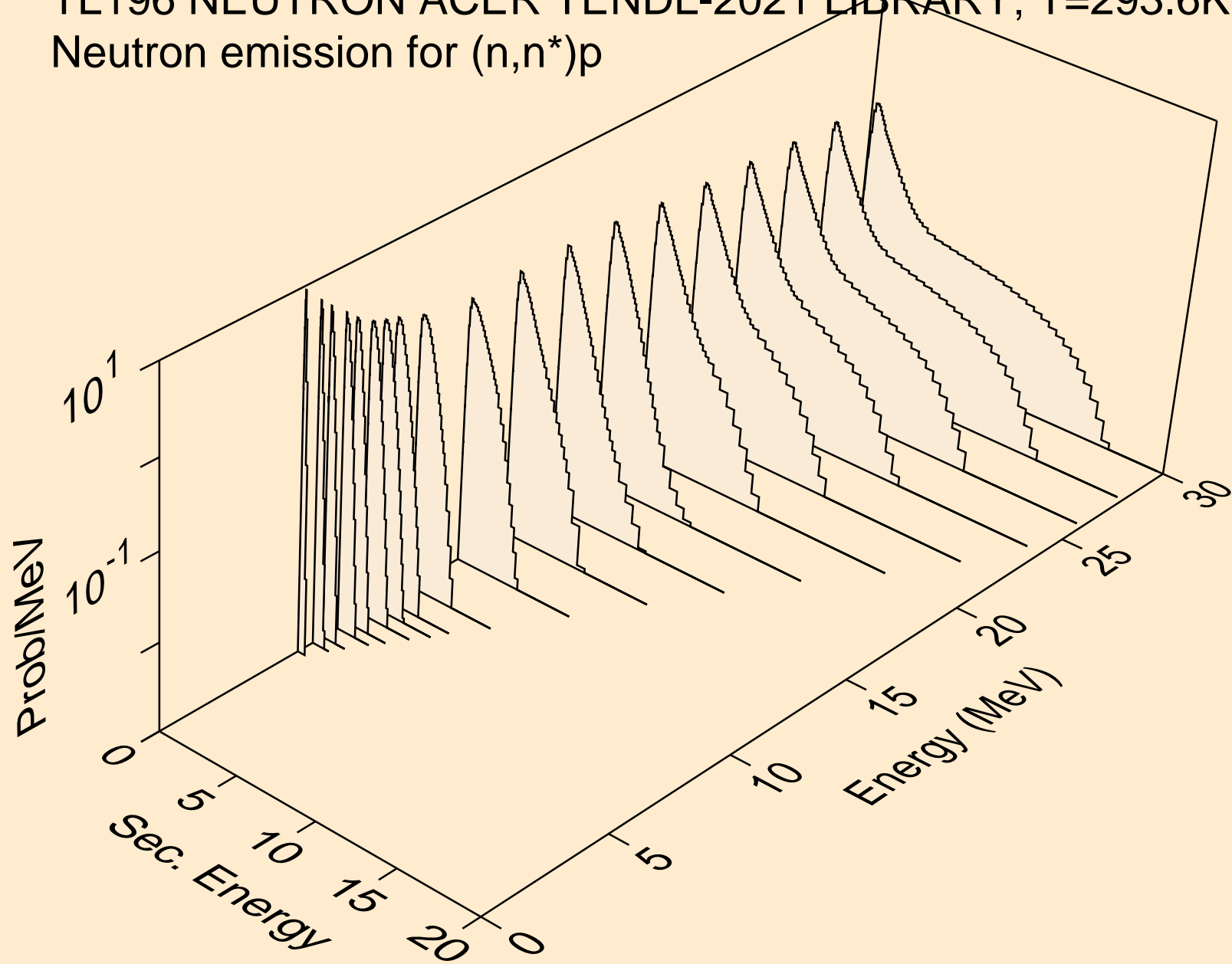

TL196 NEUTRON ACER TENDL-2021 LIBRARY; T=293.6K
Neutron emission for (n,n*)2a

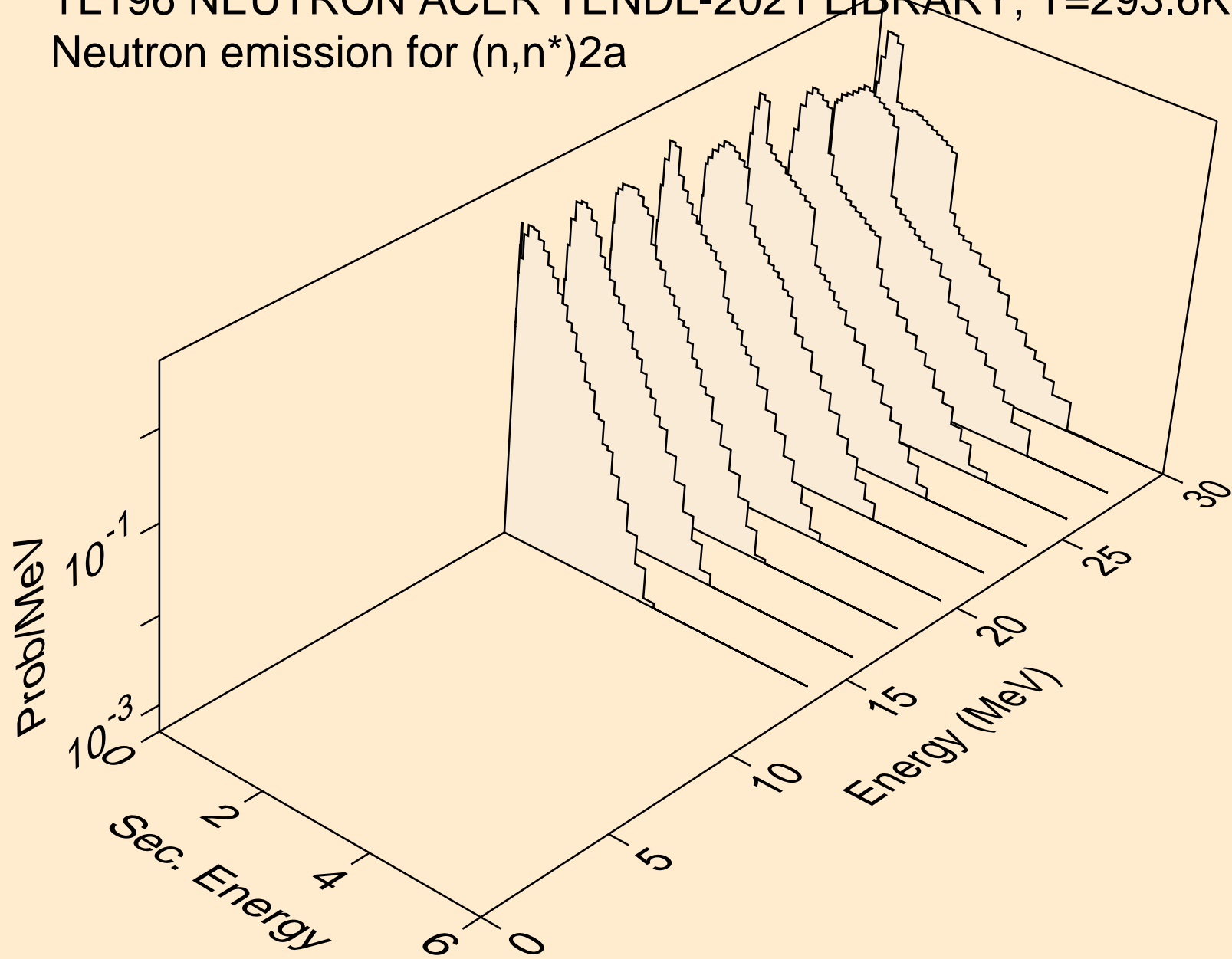

TL196 NEUTRON ACER TENDL-2021 LIBRARY; T=293.6K
Neutron emission for (n,n*)d

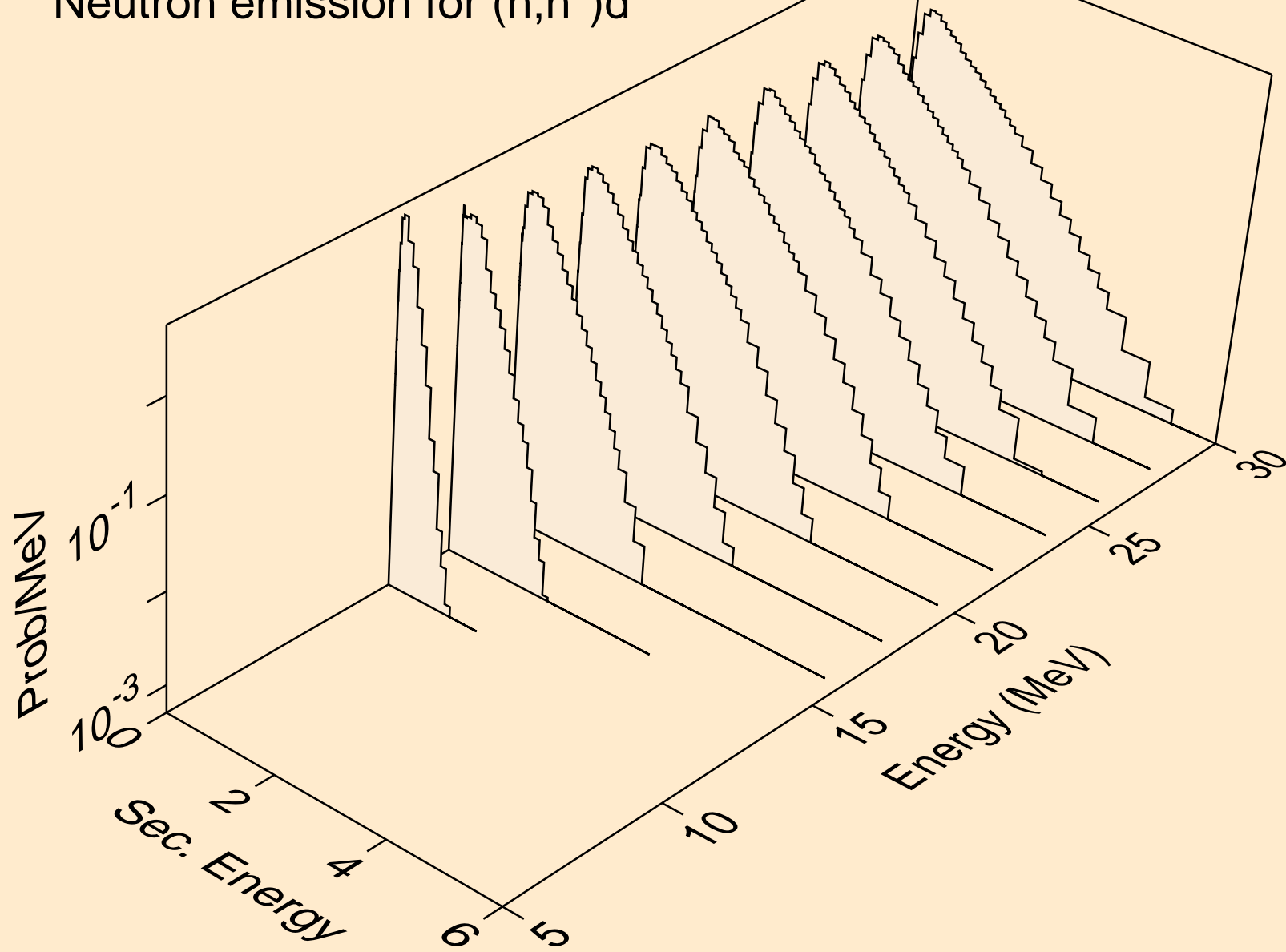

TL196 NEUTRON ACER TENDL-2021 LIBRARY; T=293.6K
Neutron emission for (n,n*)t

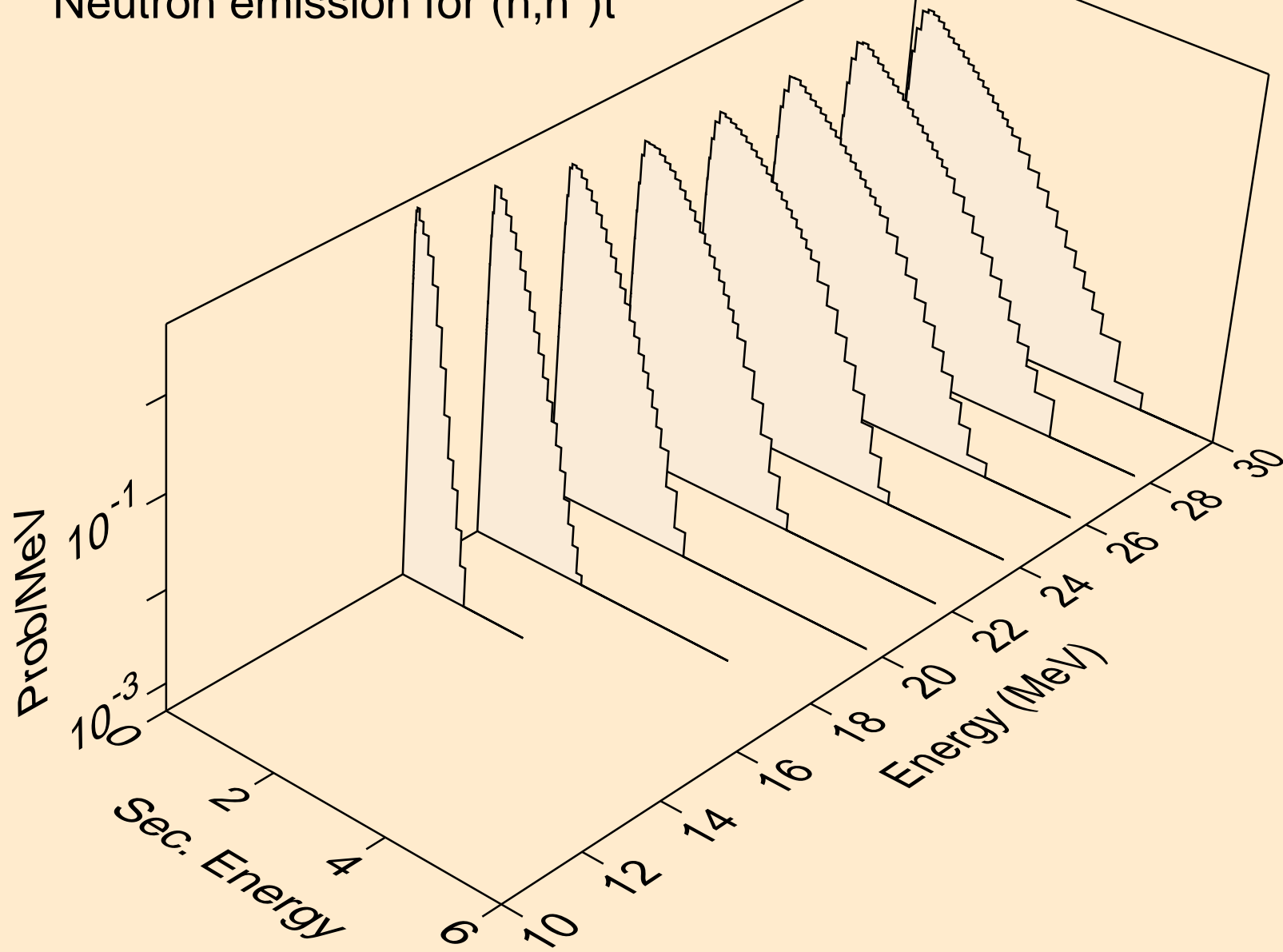

TL196 NEUTRON ACER TENDL-2021 LIBRARY; T=293.6K
Neutron emission for (n,n*)he3

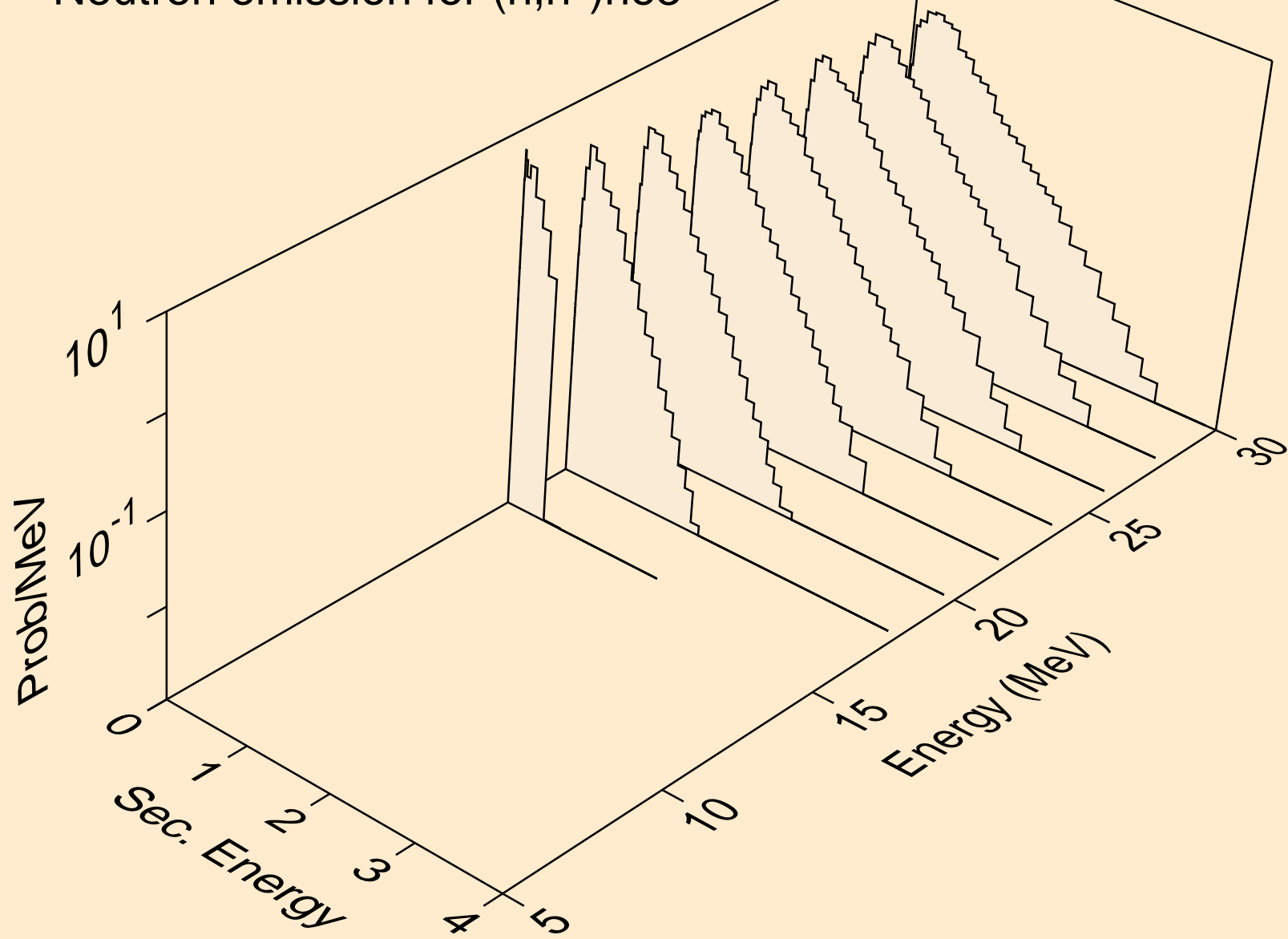

TL196 NEUTRON ACER TENDL-2021 LIBRARY; T=293.6K
Neutron emission for (n,4n)

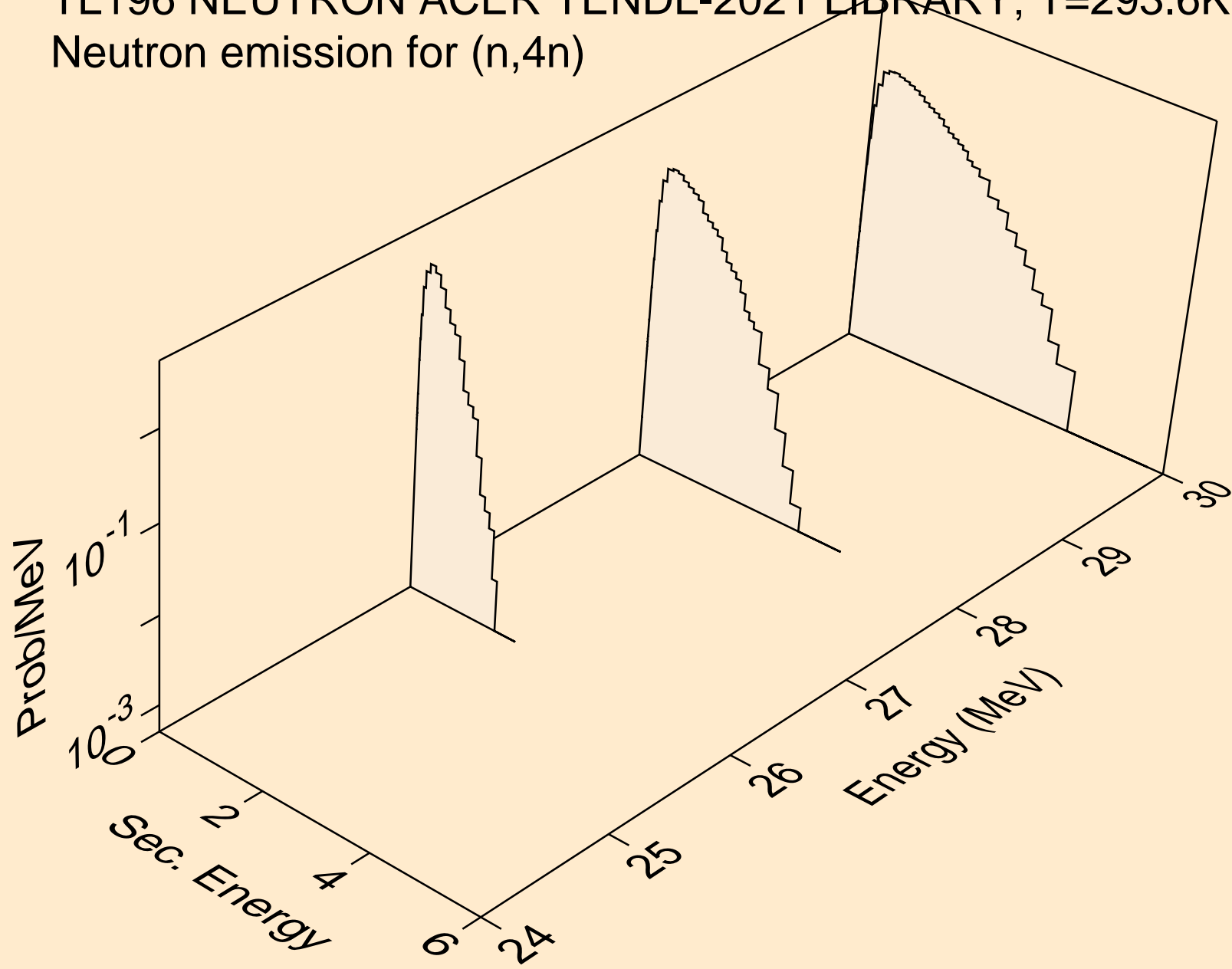

TL196 NEUTRON ACER TENDL-2021 LIBRARY; T=293.6K
Neutron emission for (n,2np)

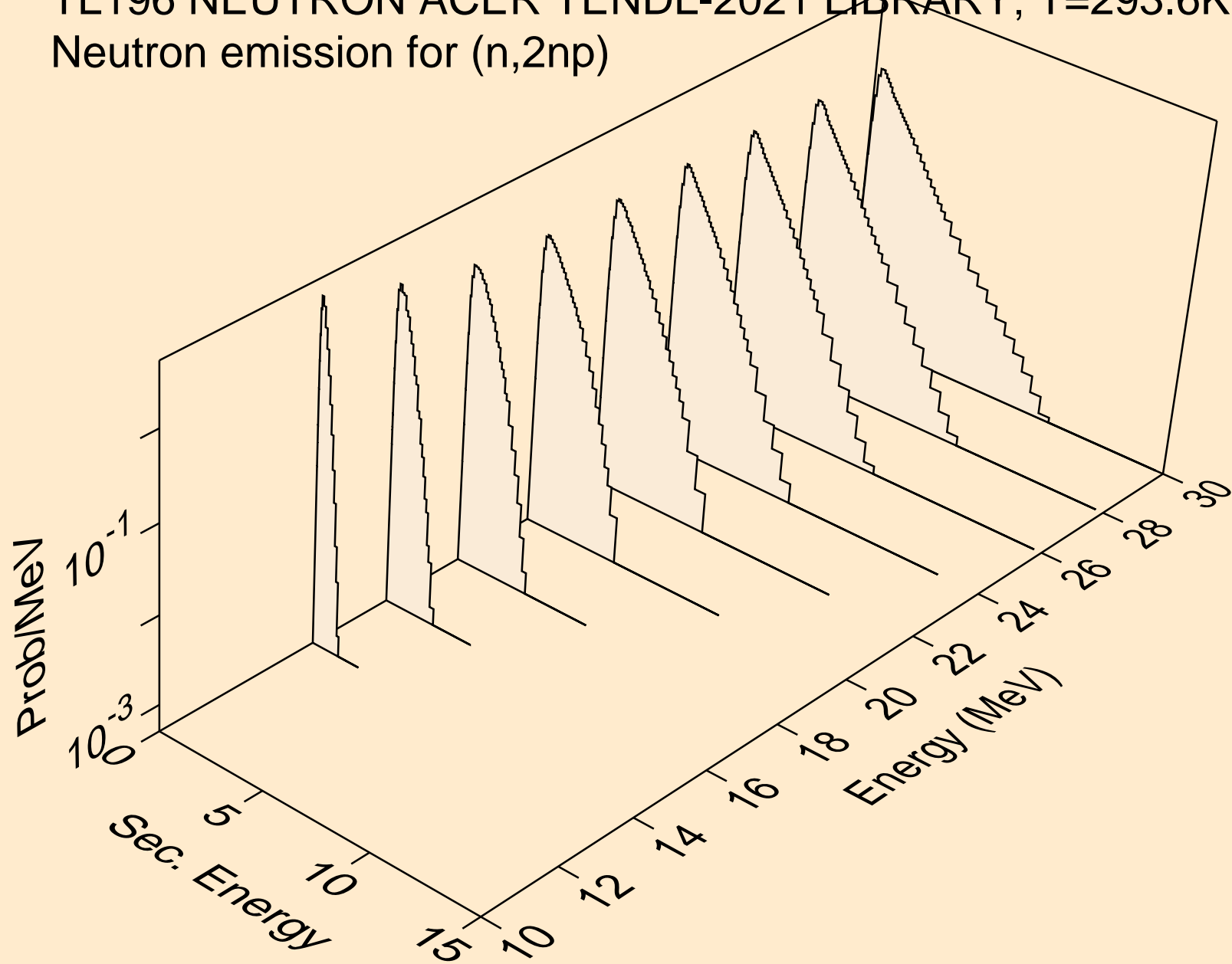

TL196 NEUTRON ACER TENDL-2021 LIBRARY; T=293.6K
Neutron emission for (n,3np)

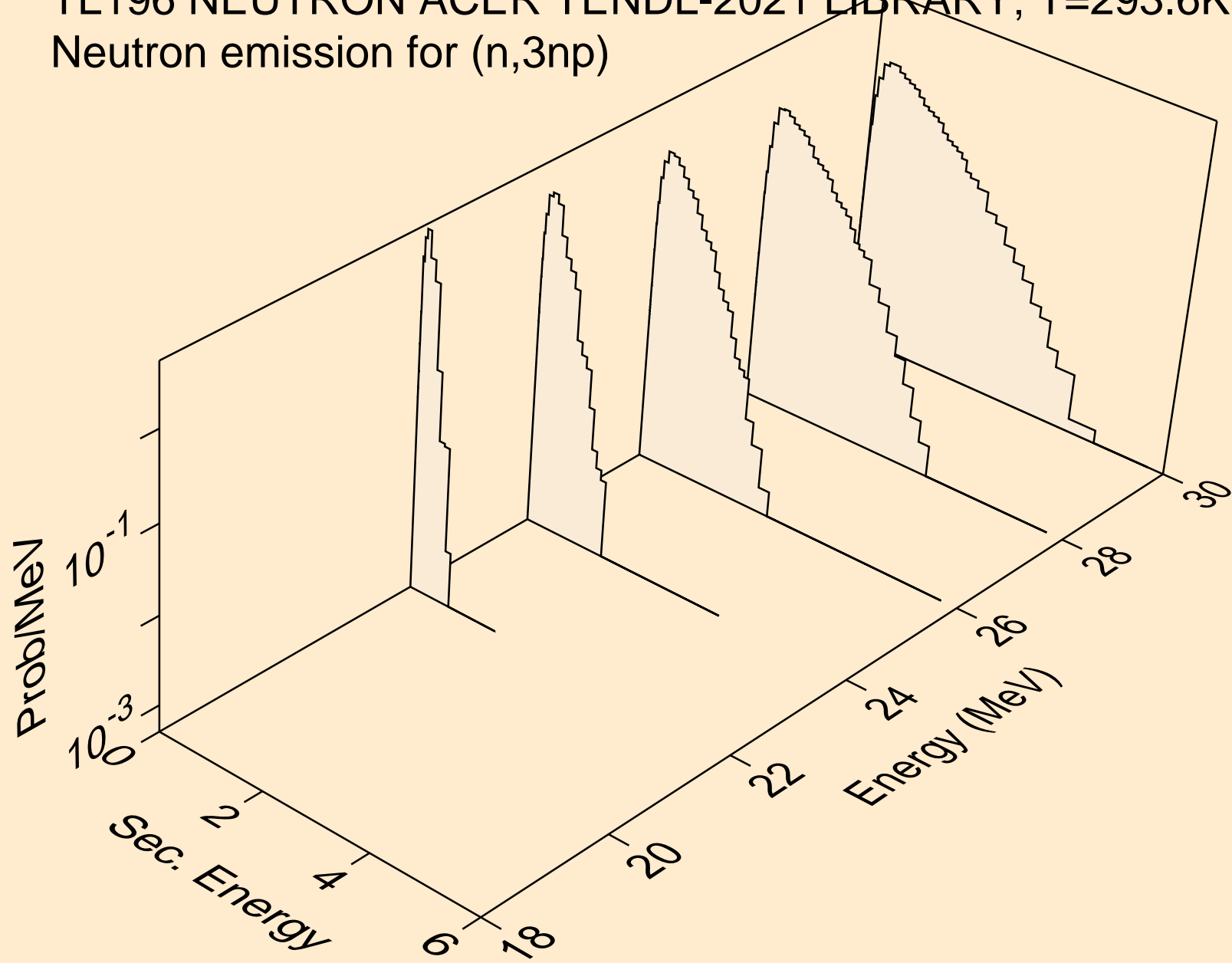

TL196 NEUTRON ACER TENDL-2021 LIBRARY; T=293.6K
Neutron emission for (n,2np)

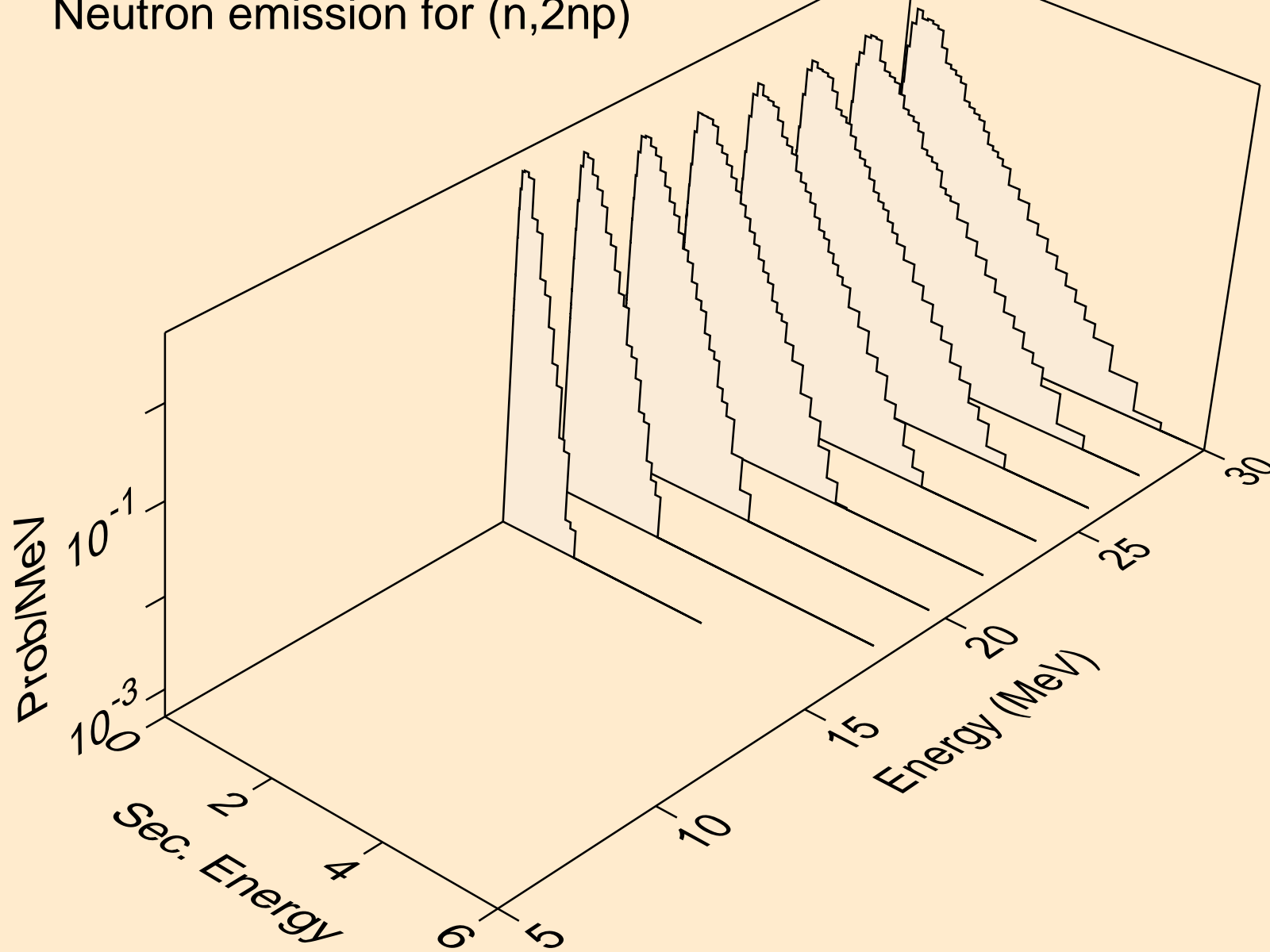

TL196 NEUTRON ACER TENDL-2021 LIBRARY; T=293.6K
Neutron emission for (n,npa)

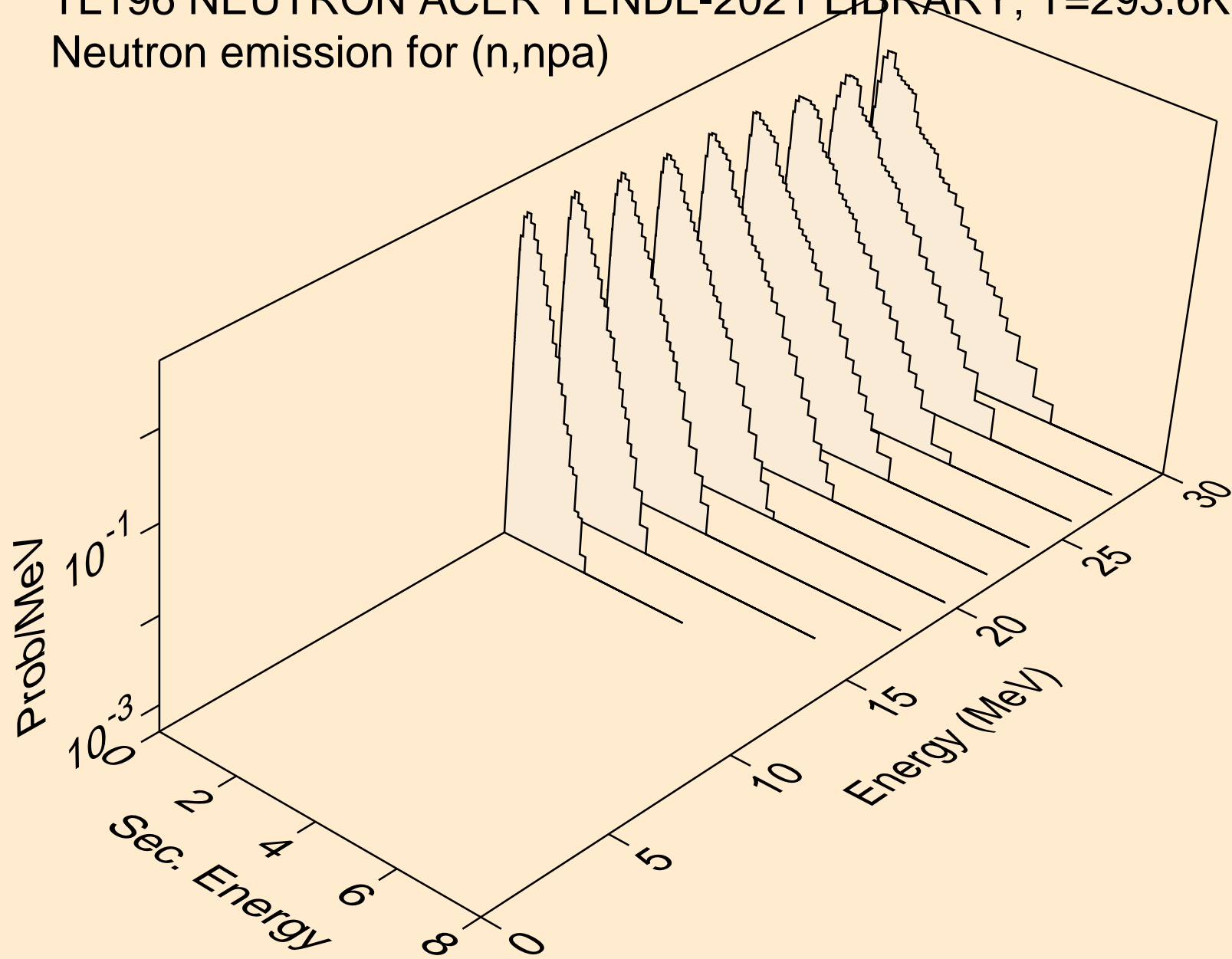

TL196 NEUTRON ACER TENDL-2021 LIBRARY; T=293.6K
Neutron emission for (n,n*c)

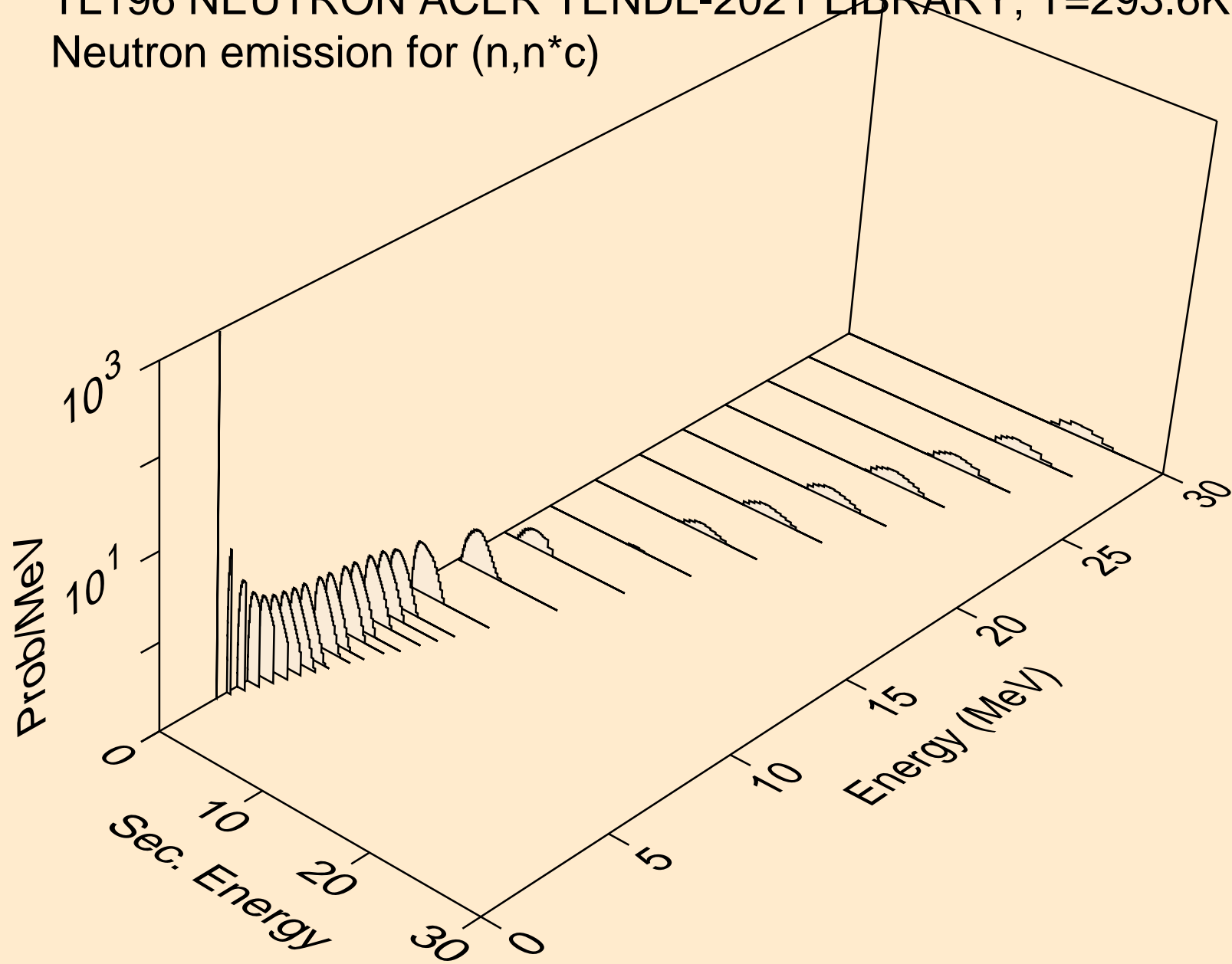

TL196 NEUTRON ACER TENDL-2021 LIBRARY; T=293.6K
Photon emission for (n,x)

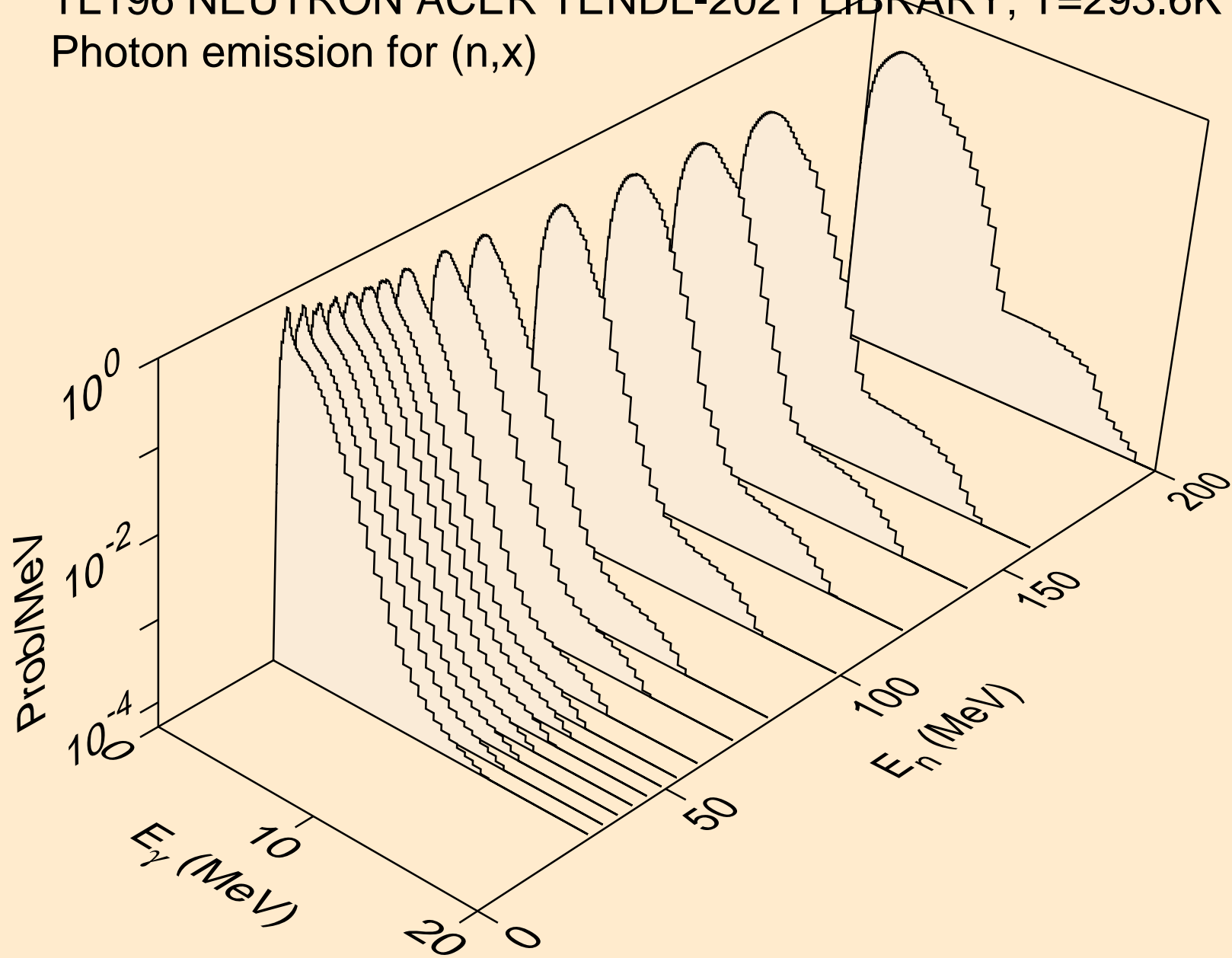

TL196 NEUTRON ACER TENDL-2021 LIBRARY; T=293.6K
Photon emission for (n,2nd)

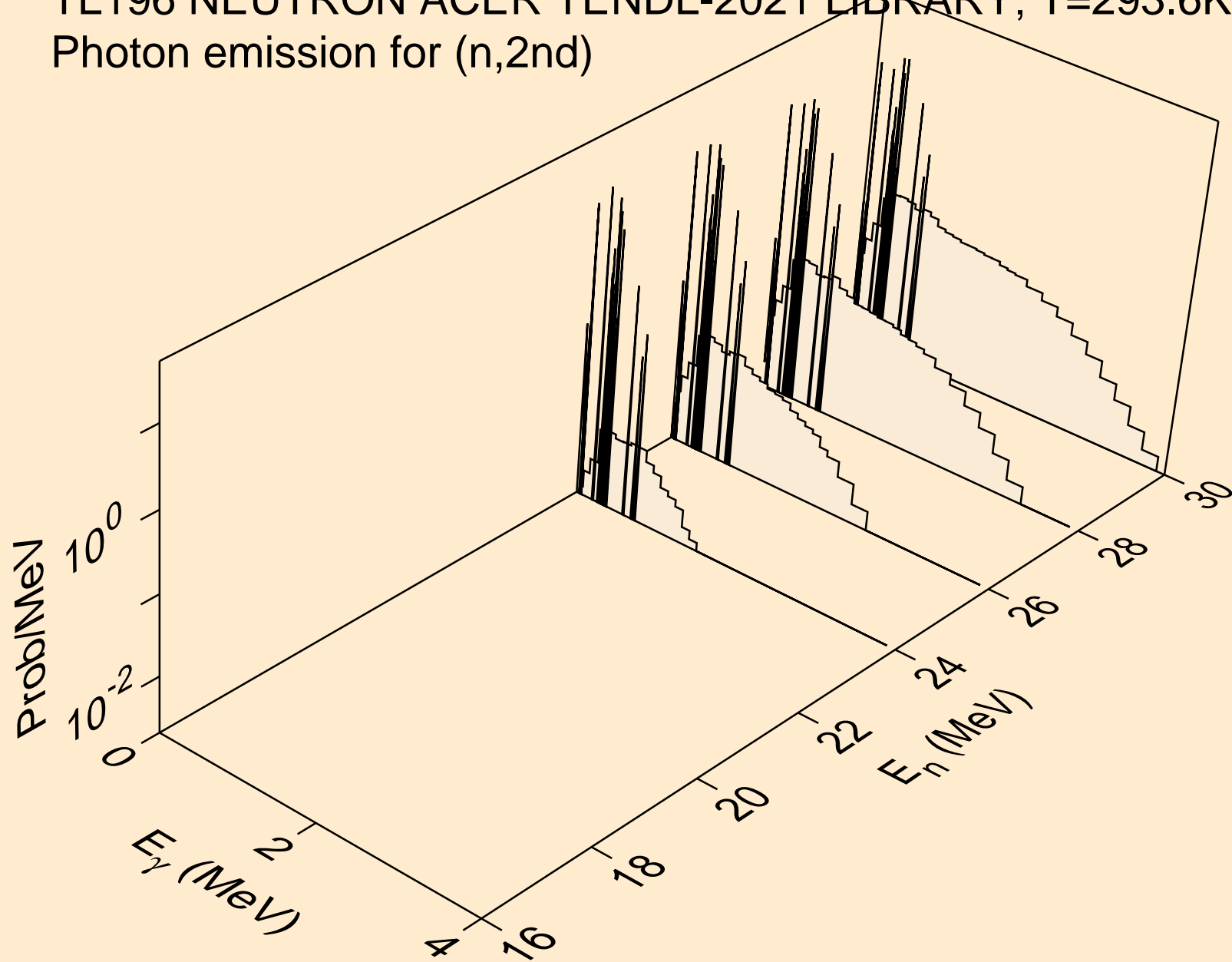

TL196 NEUTRON ACER TENDL-2021 LIBRARY; T=293.6K
Photon emission for (n,2n)

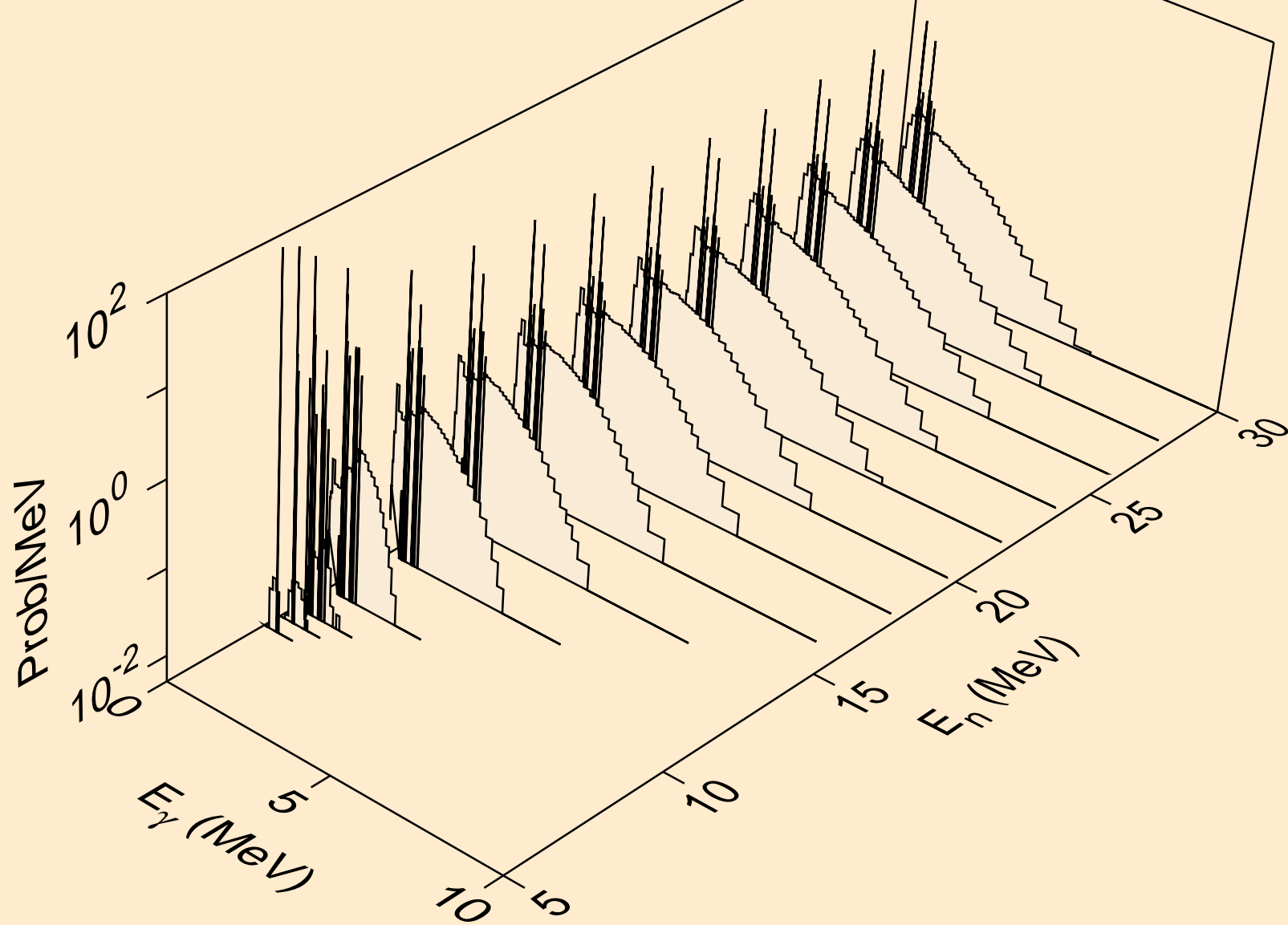

TL196 NEUTRON ACER TENDL-2021 LIBRARY; T=293.6K
Photon emission for (n,3n)

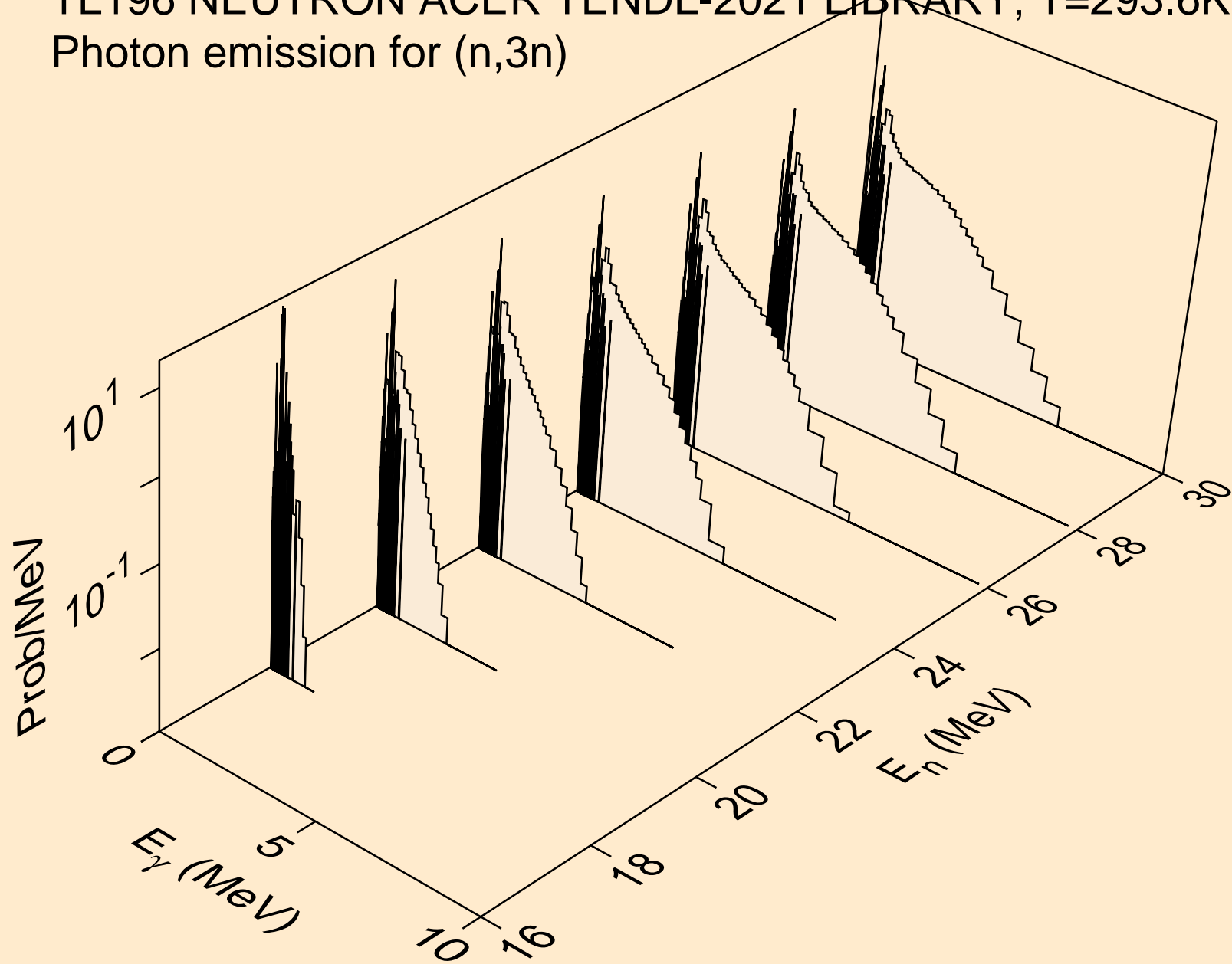

TL196 NEUTRON ACER TENDL-2021 LIBRARY; T=293.6K
Photon emission for (n,n*)a

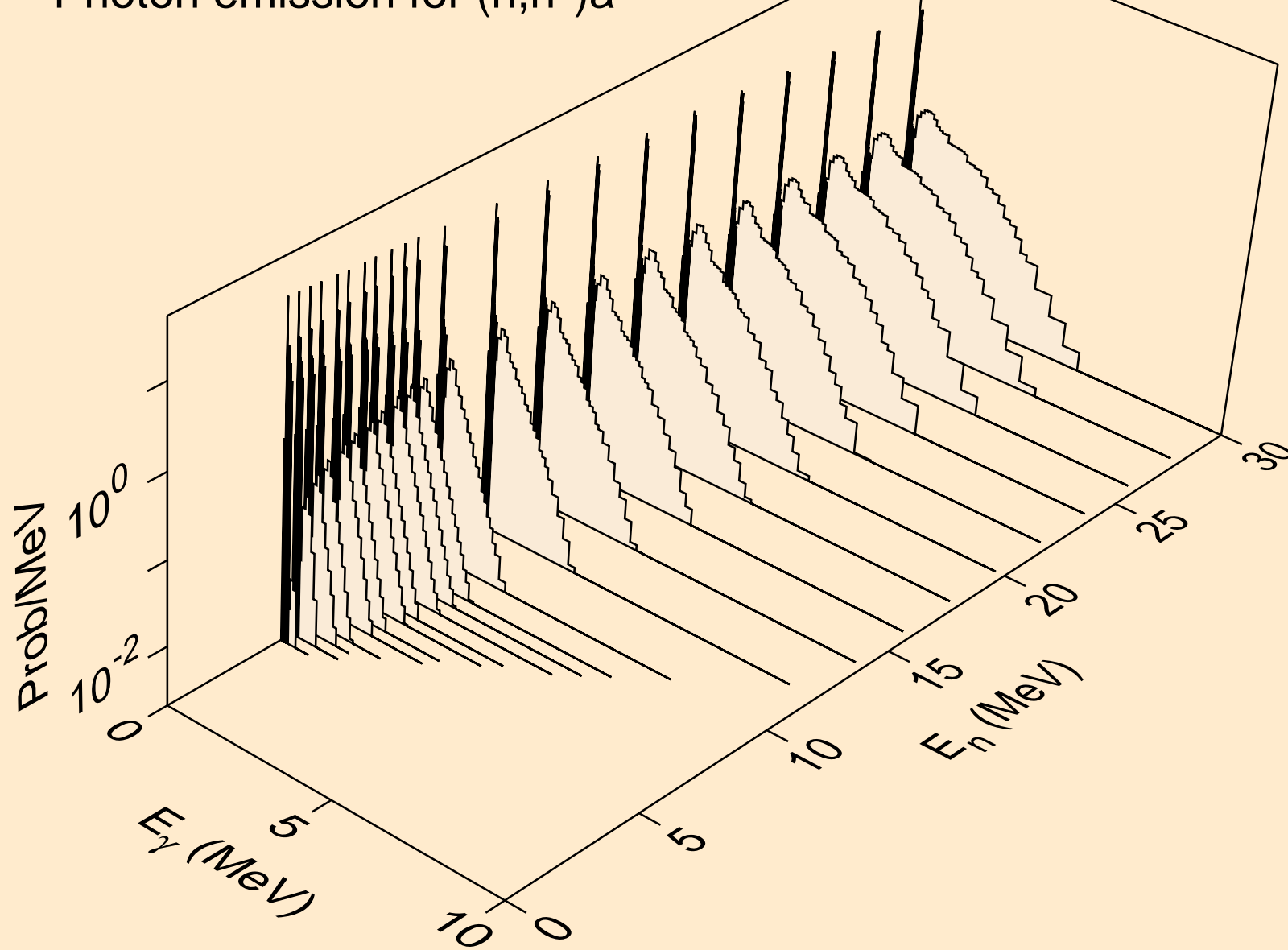

TL196 NEUTRON ACER TENDL-2021 LIBRARY; T=293.6K
Photon emission for (n,2n)a

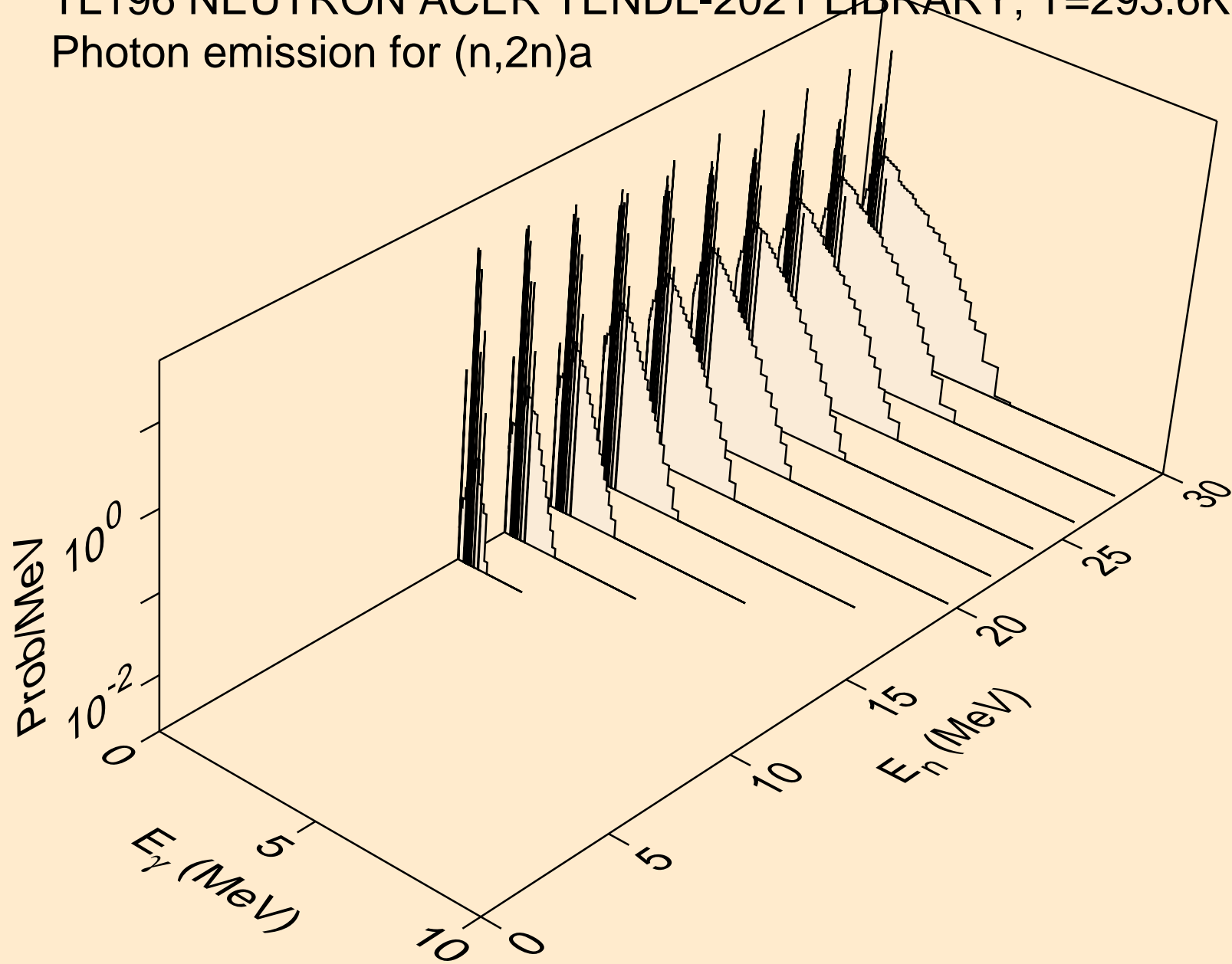

TL196 NEUTRON ACER TENDL-2021 LIBRARY; T=293.6K
Photon emission for (n,3n)a

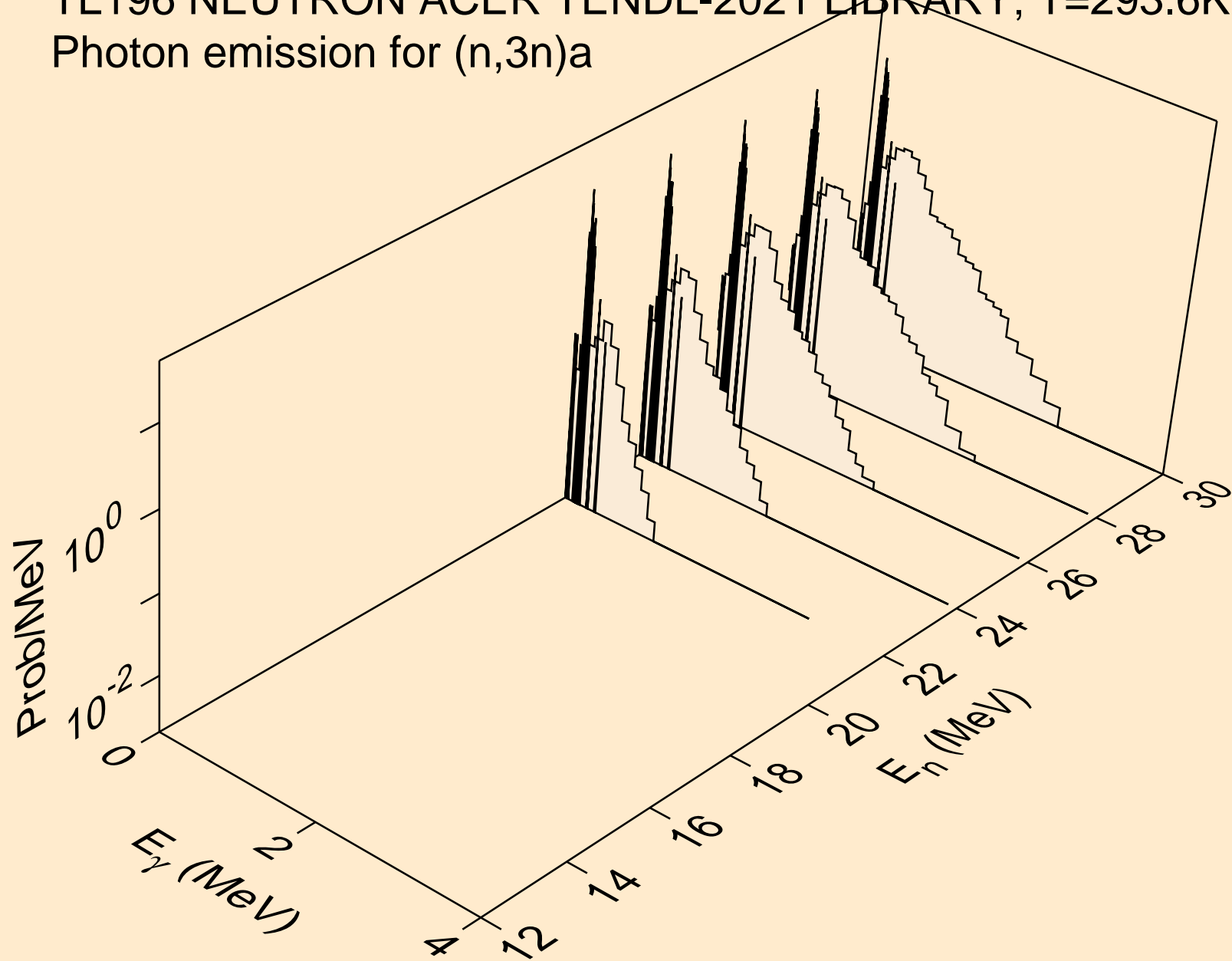

TL196 NEUTRON ACER TENDL-2021 LIBRARY; T=293.6K
Photon emission for (n,n*)p

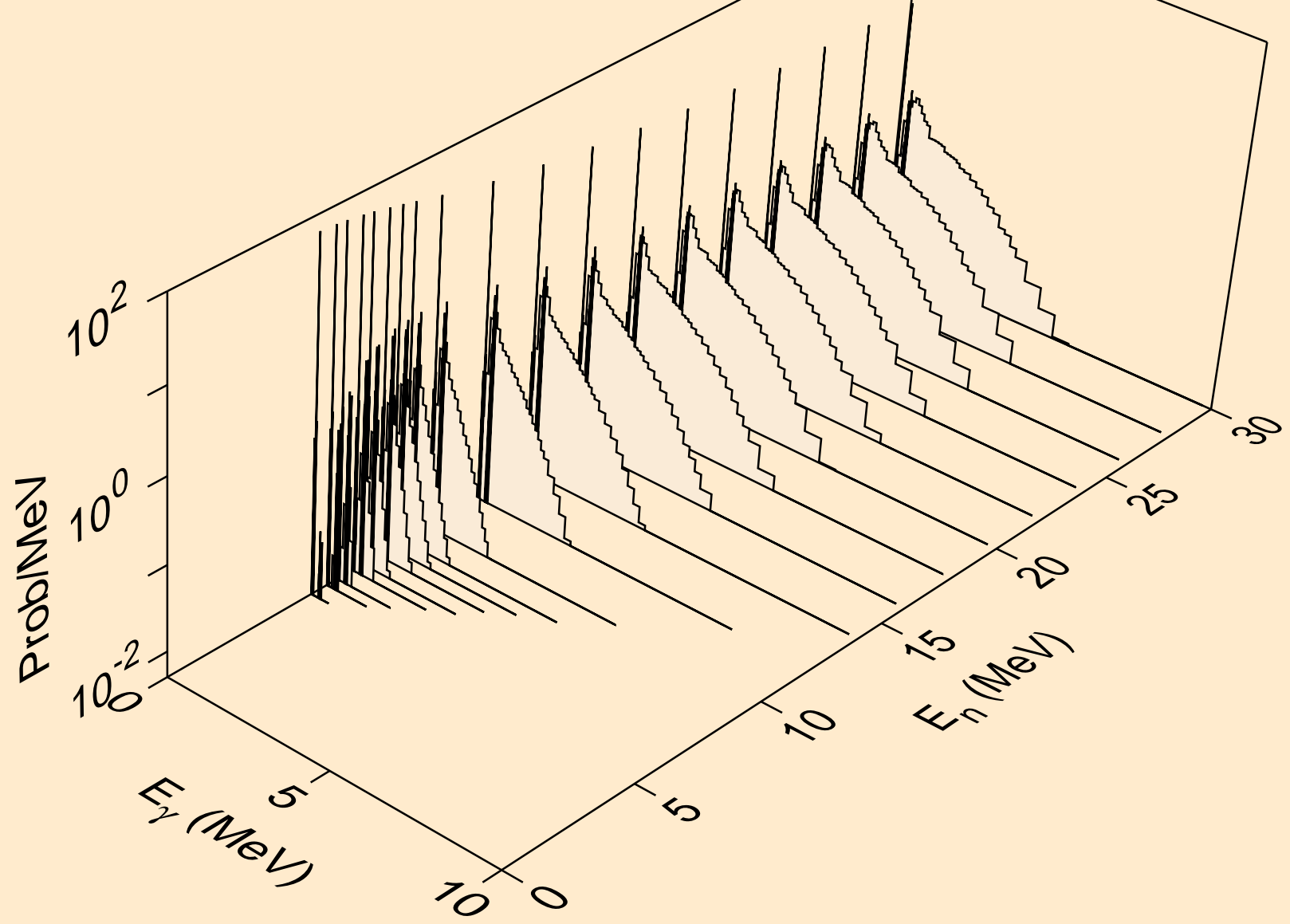

TL196 NEUTRON ACER TENDL-2021 LIBRARY; T=293.6K
Photon emission for (n,n*)2a

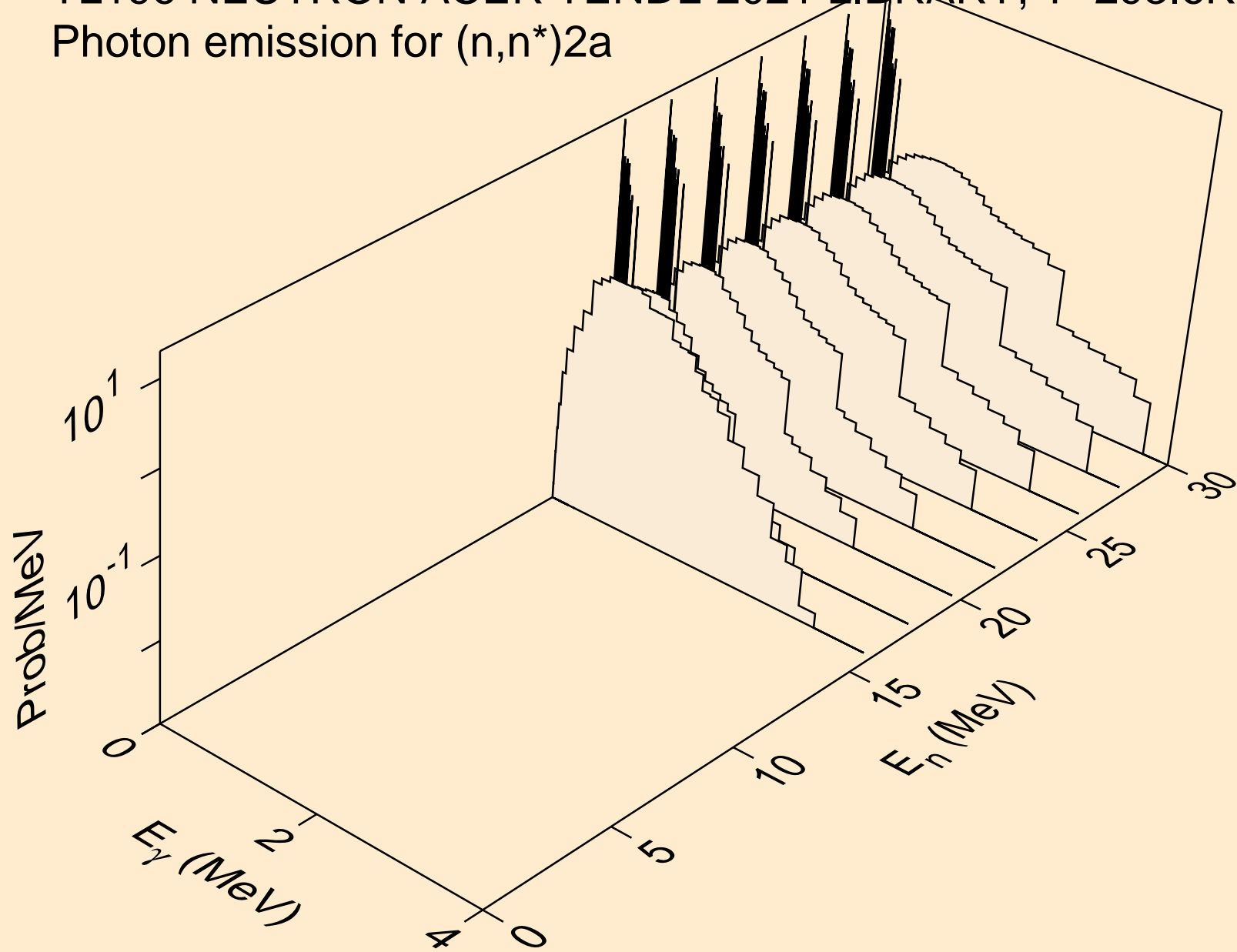

TL196 NEUTRON ACER TENDL-2021 LIBRARY; T=293.6K
Photon emission for (n,n*)d

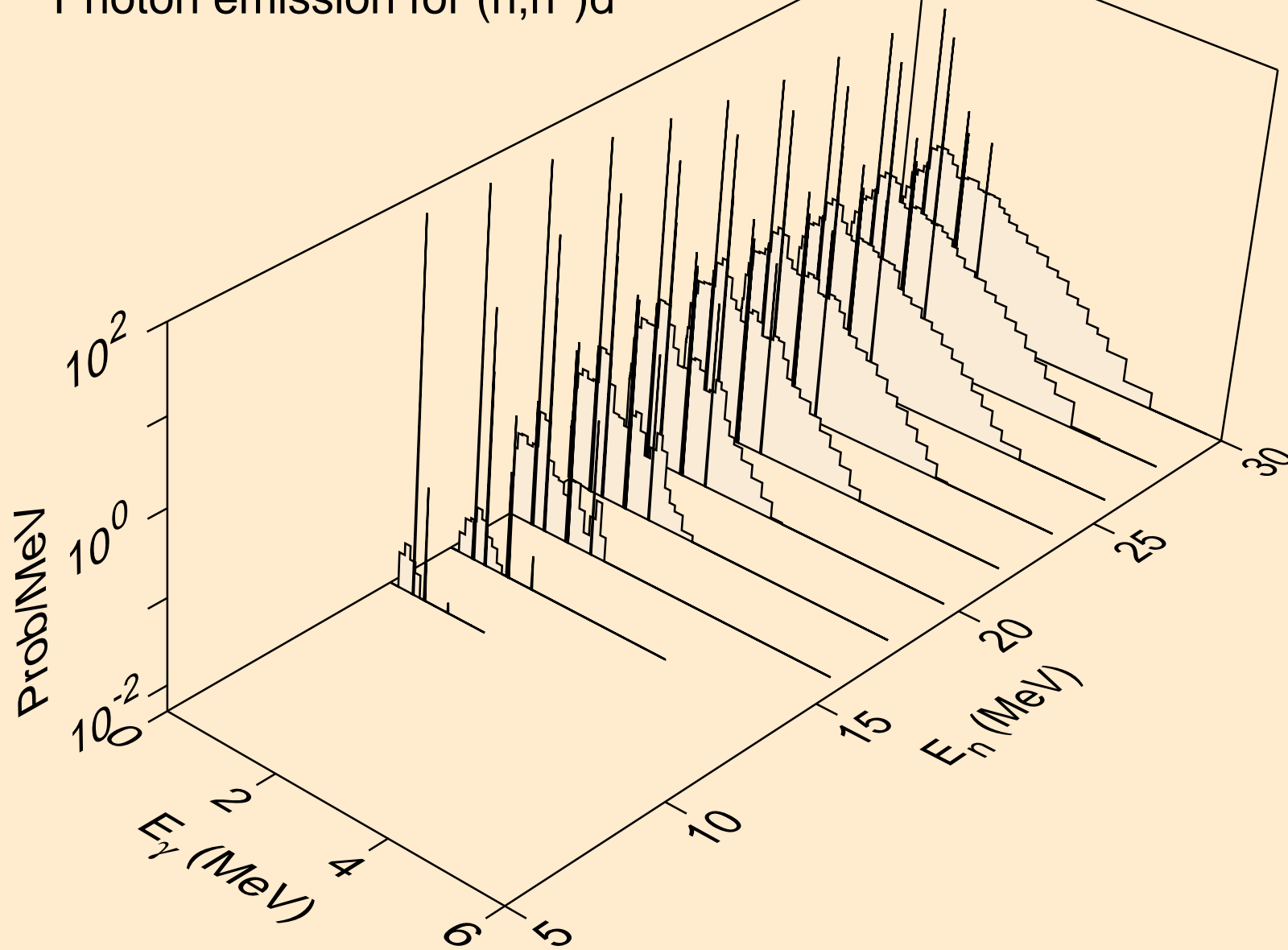

TL196 NEUTRON ACER TENDL-2021 LIBRARY; T=293.6K
Photon emission for (n,n*)t

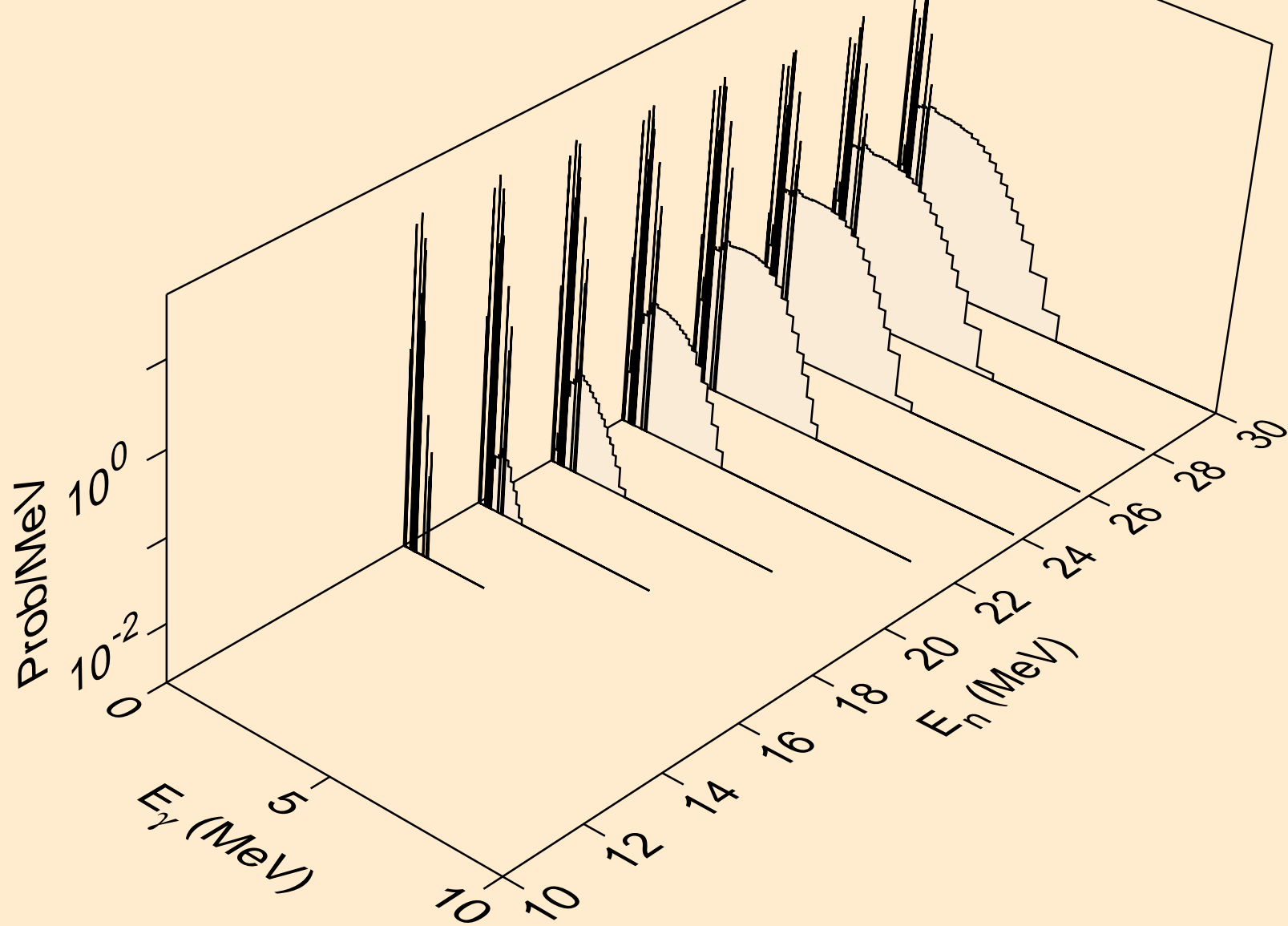

TL196 NEUTRON ACER TENDL-2021 LIBRARY; T=293.6K
Photon emission for (n,n*)he3

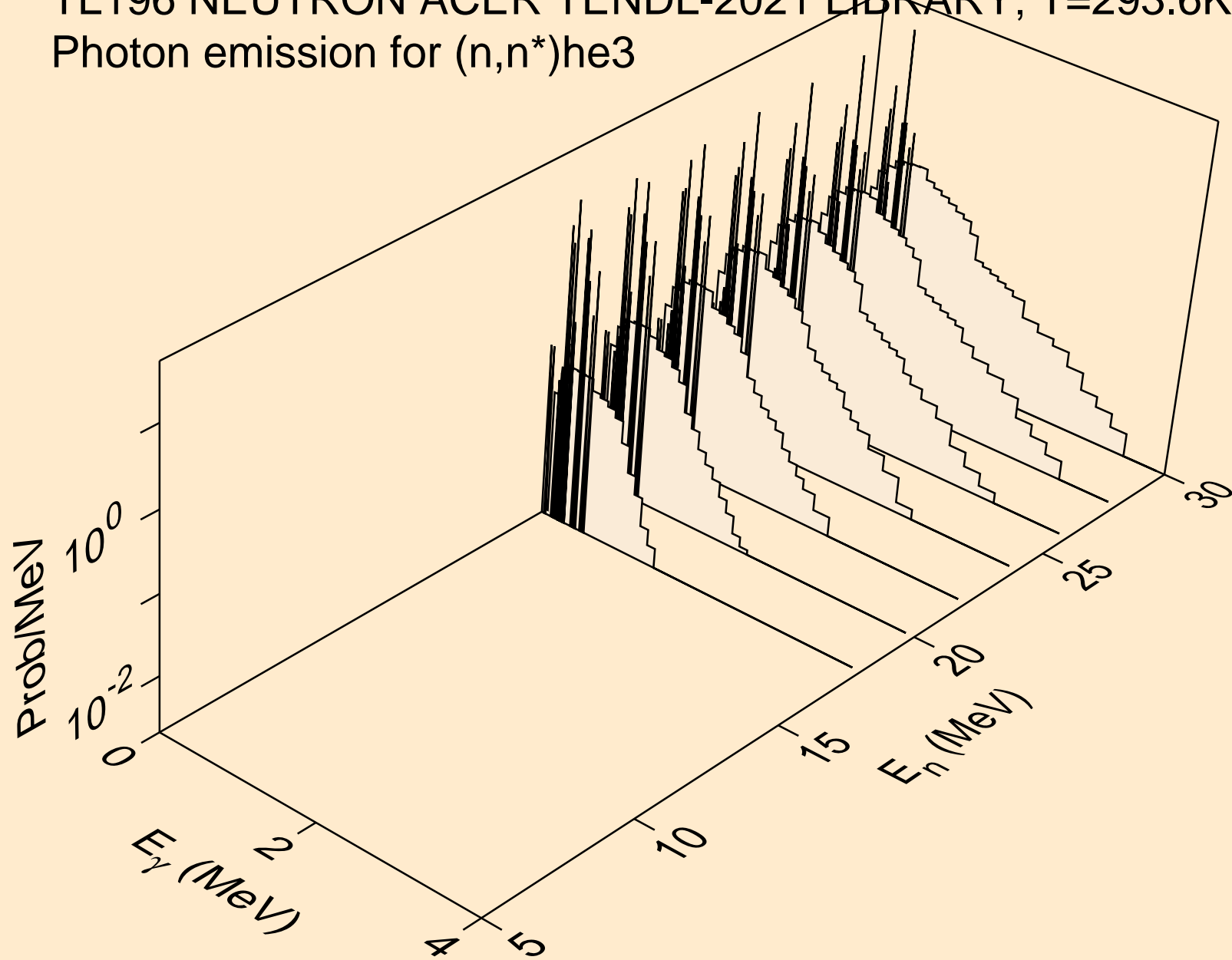

TL196 NEUTRON ACER TENDL-2021 LIBRARY; T=293.6K
Photon emission for (n,4n)

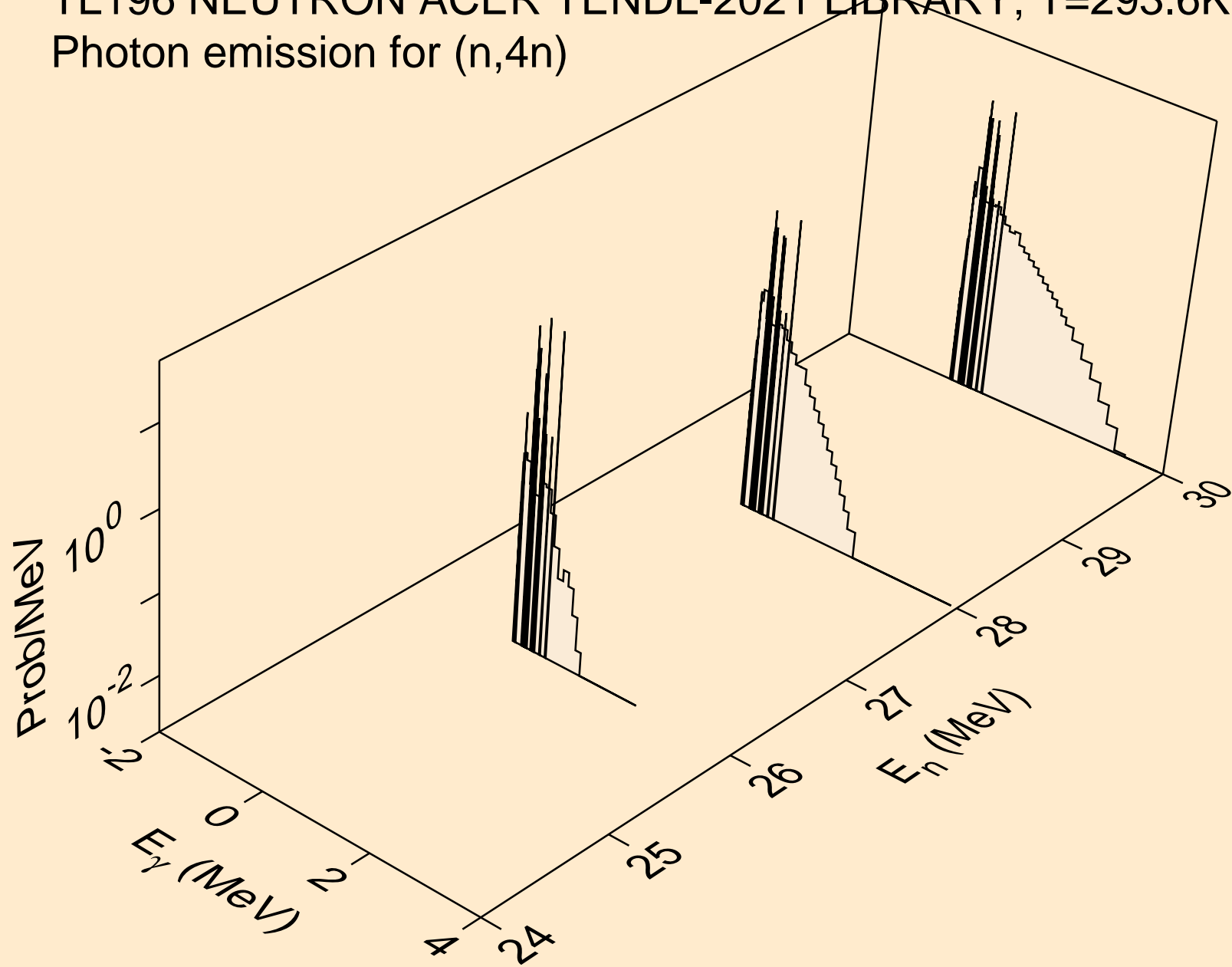

TL196 NEUTRON ACER TENDL-2021 LIBRARY; T=293.6K
Photon emission for (n,2np)

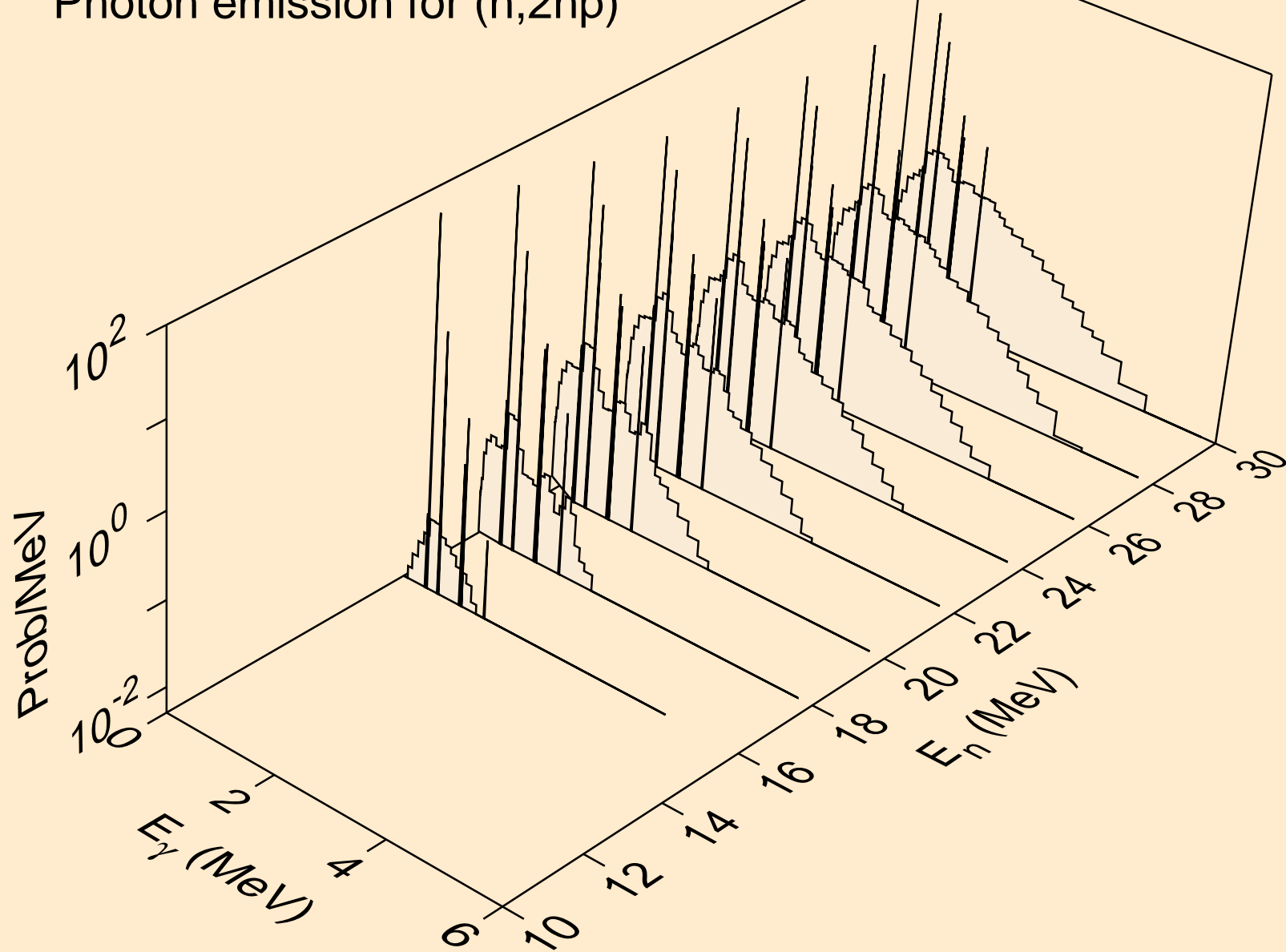

TL196 NEUTRON ACER TENDL-2021 LIBRARY; T=293.6K
Photon emission for (n,3np)

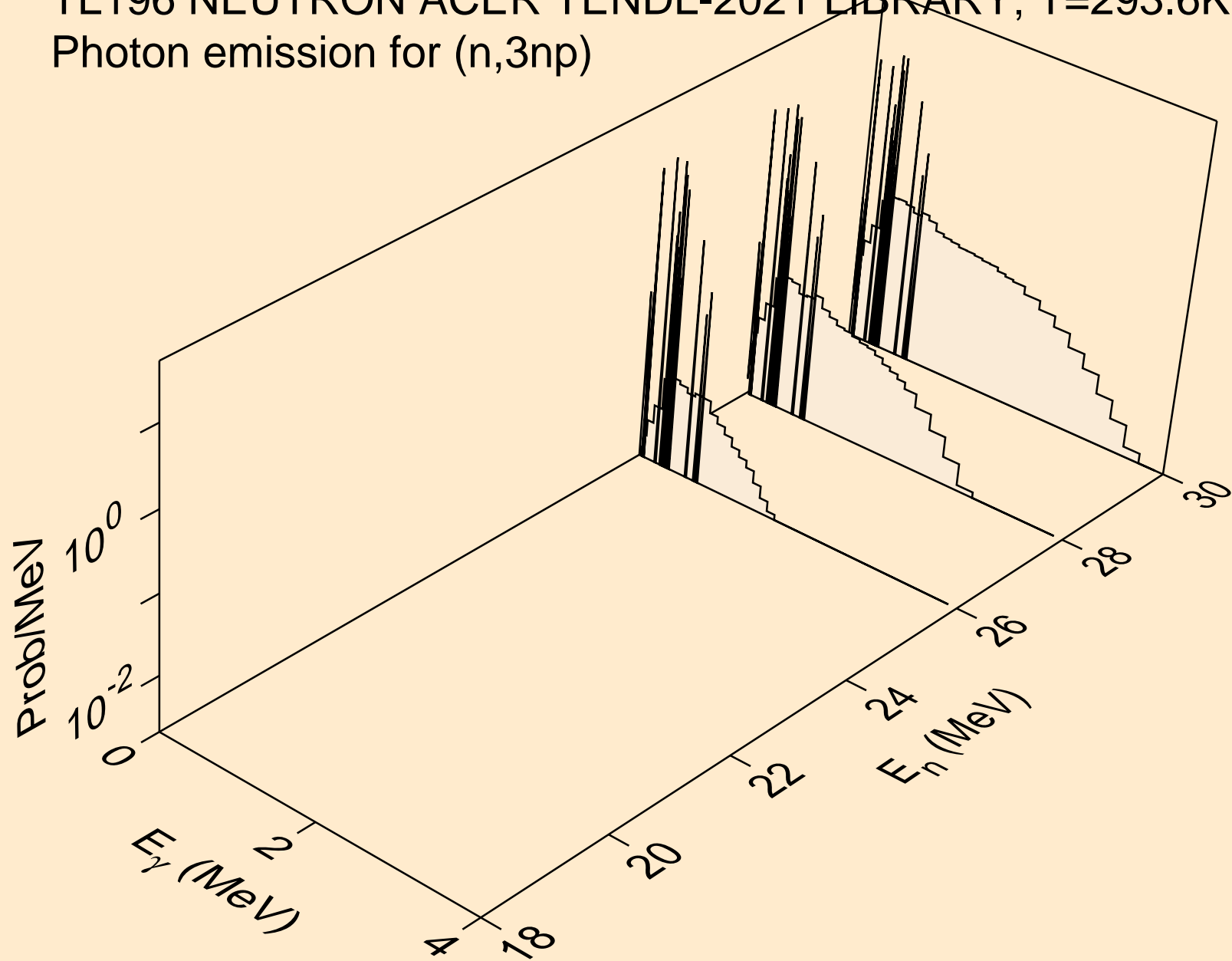

TL196 NEUTRON ACER TENDL-2021 LIBRARY; T=293.6K
Photon emission for (n,2np)

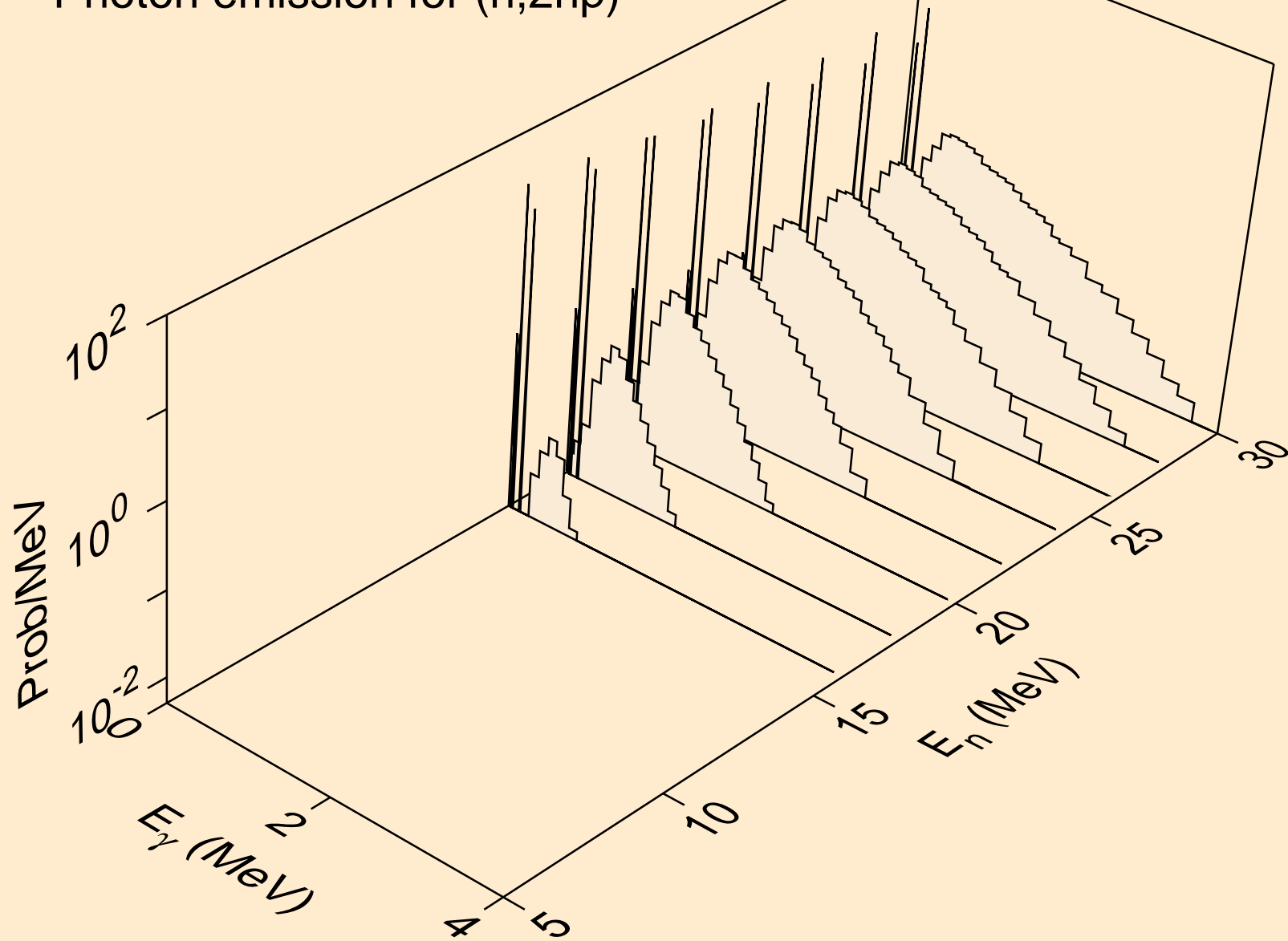

TL196 NEUTRON ACER TENDL-2021 LIBRARY; T=293.6K
Photon emission for (n,npa)

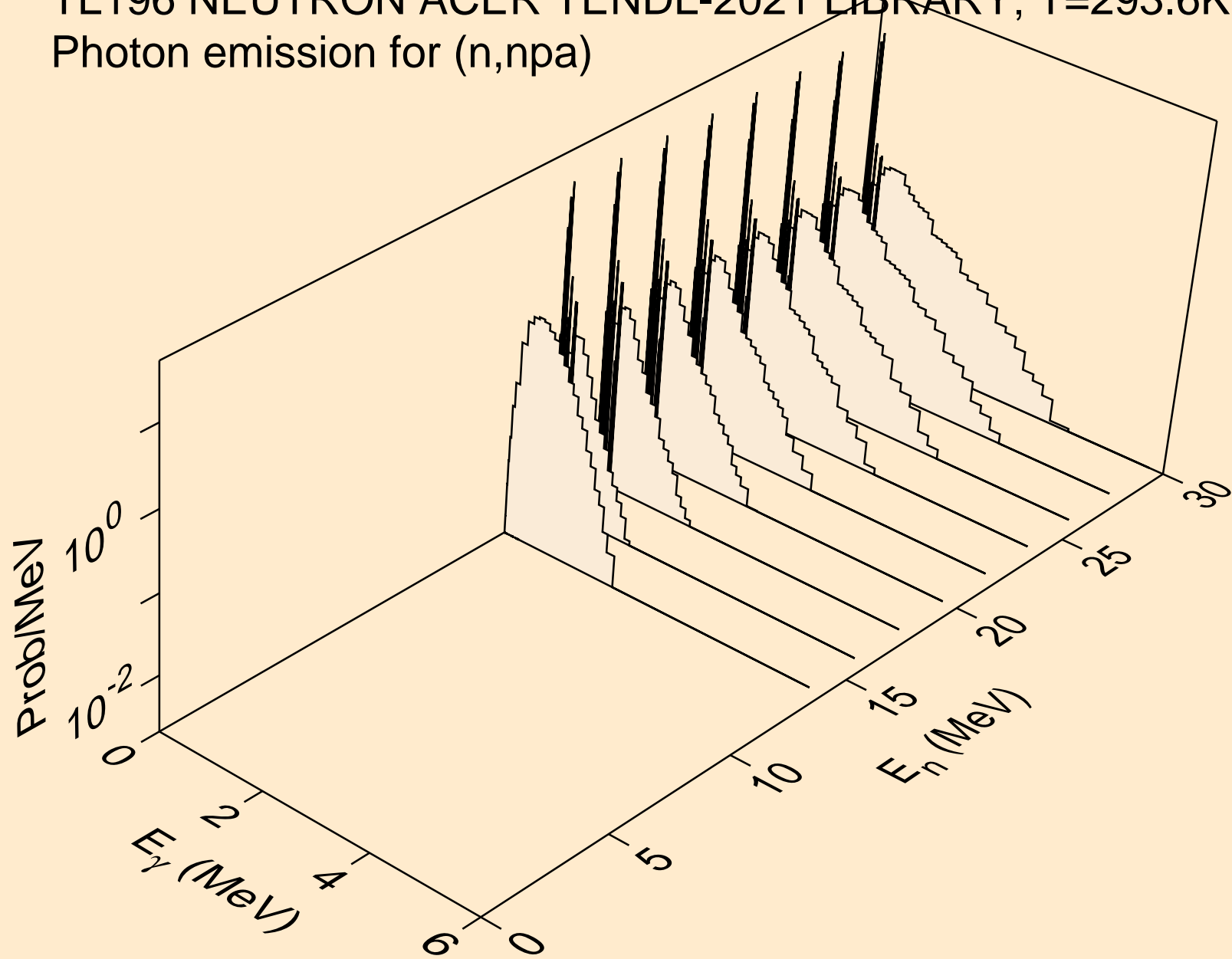

TL196 NEUTRON ACER TENDL-2021 LIBRARY; T=293.6K
Photon emission for (n,n*c)

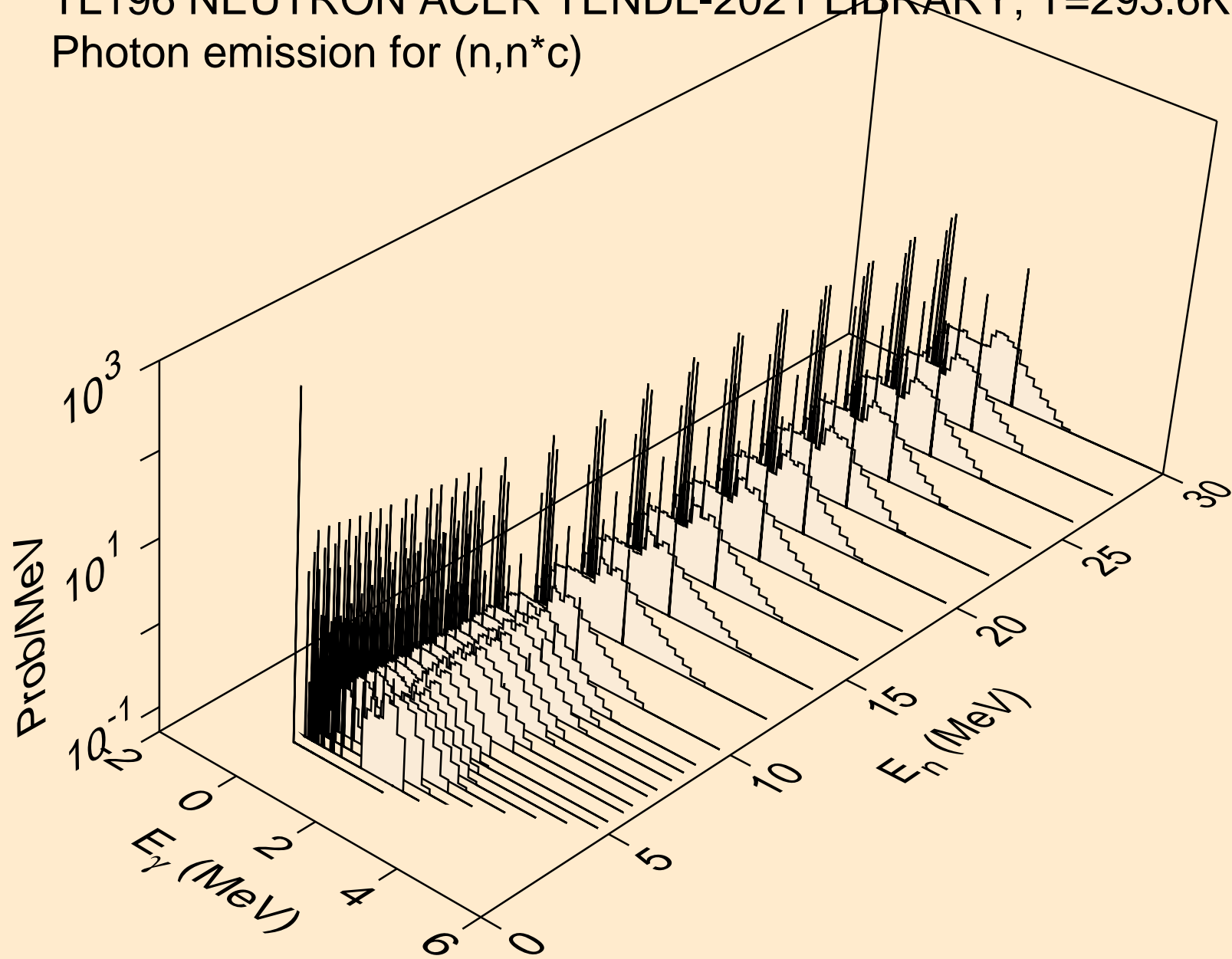

TL196 NEUTRON ACER TENDL-2021 LIBRARY; T=293.6K
Photon emission for (n,gma)

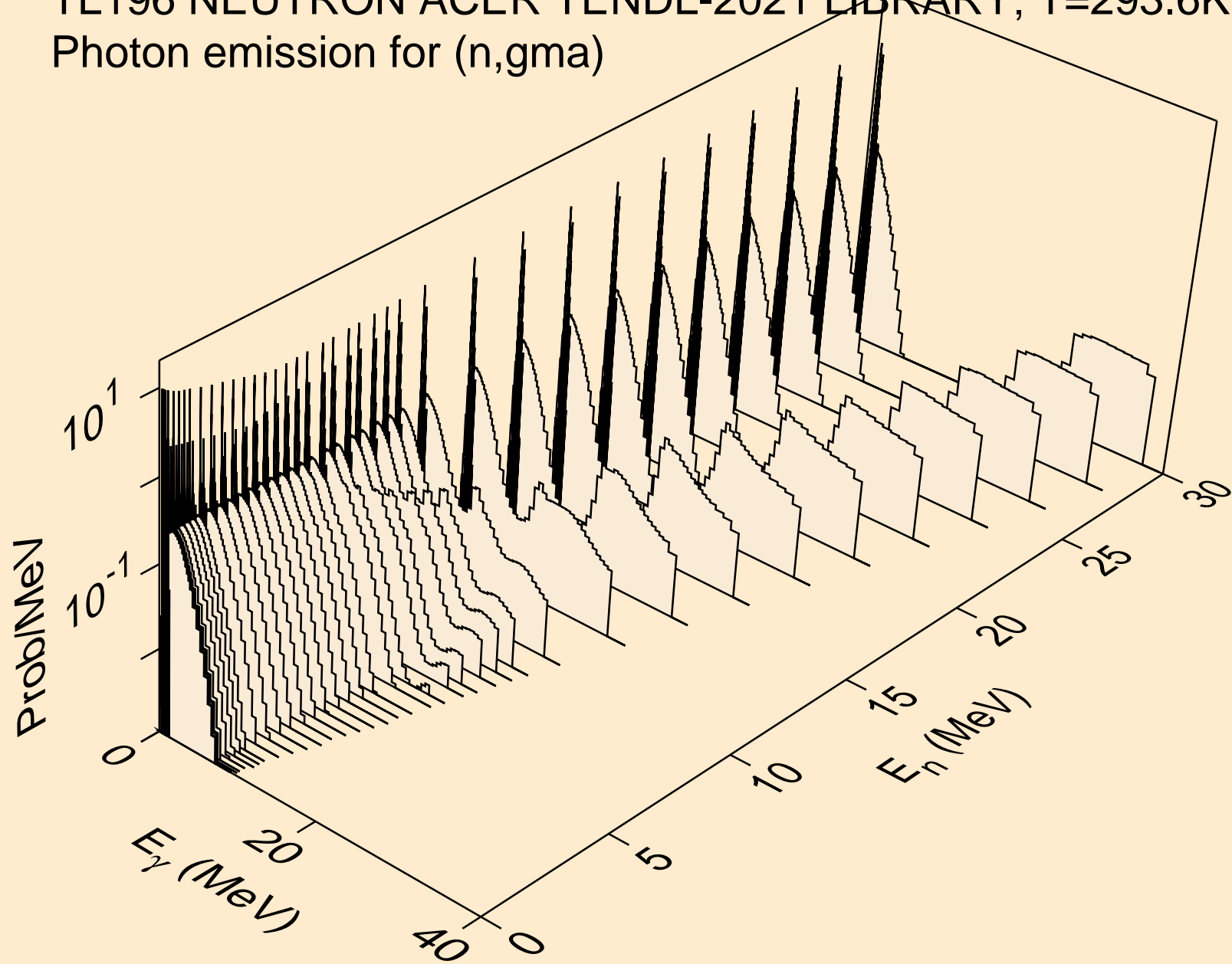

TL196 NEUTRON ACER TENDL-2021 LIBRARY; T=293.6K
Photon emission for (n,p)

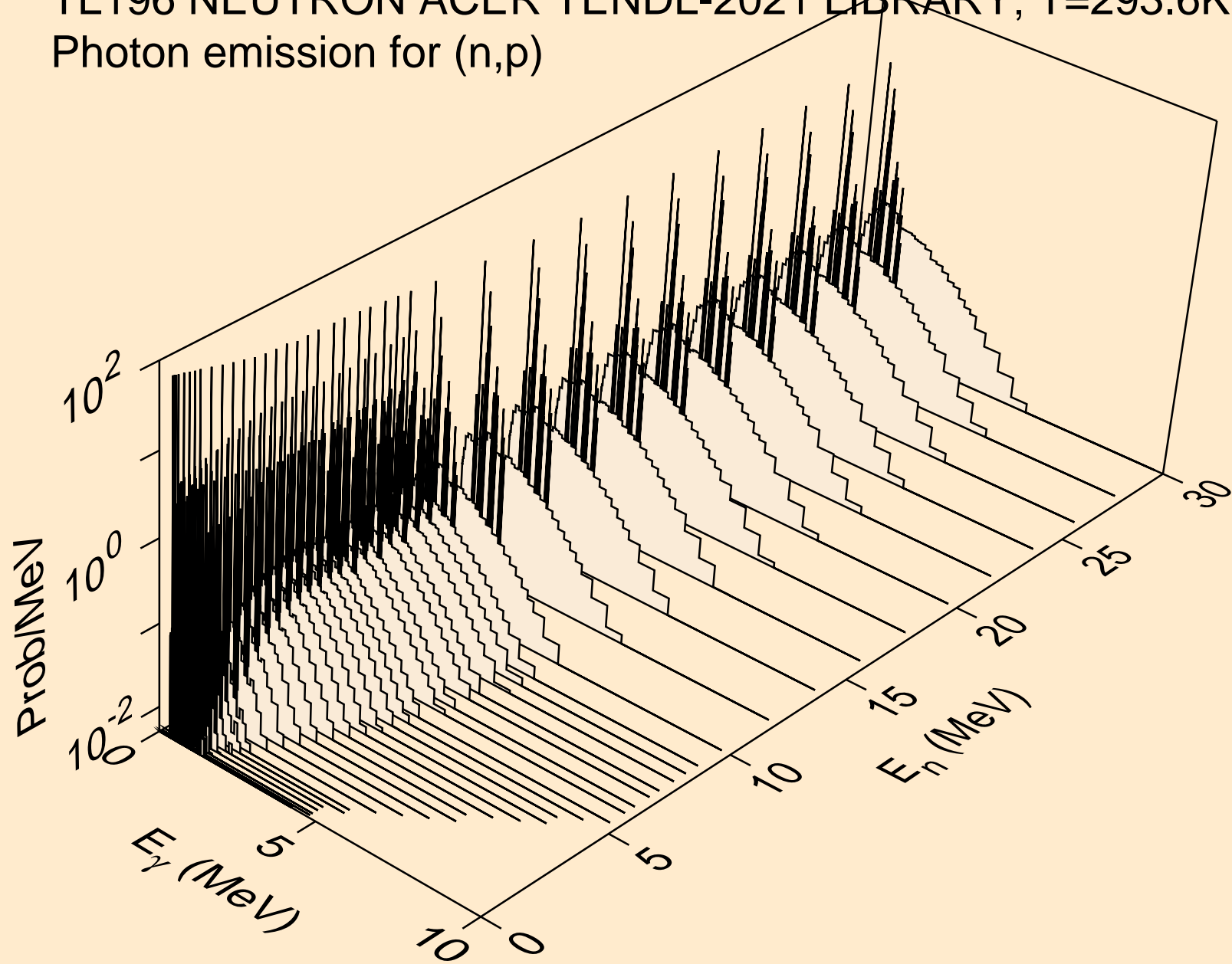

TL196 NEUTRON ACER TENDL-2021 LIBRARY; T=293.6K
Photon emission for (n,d)

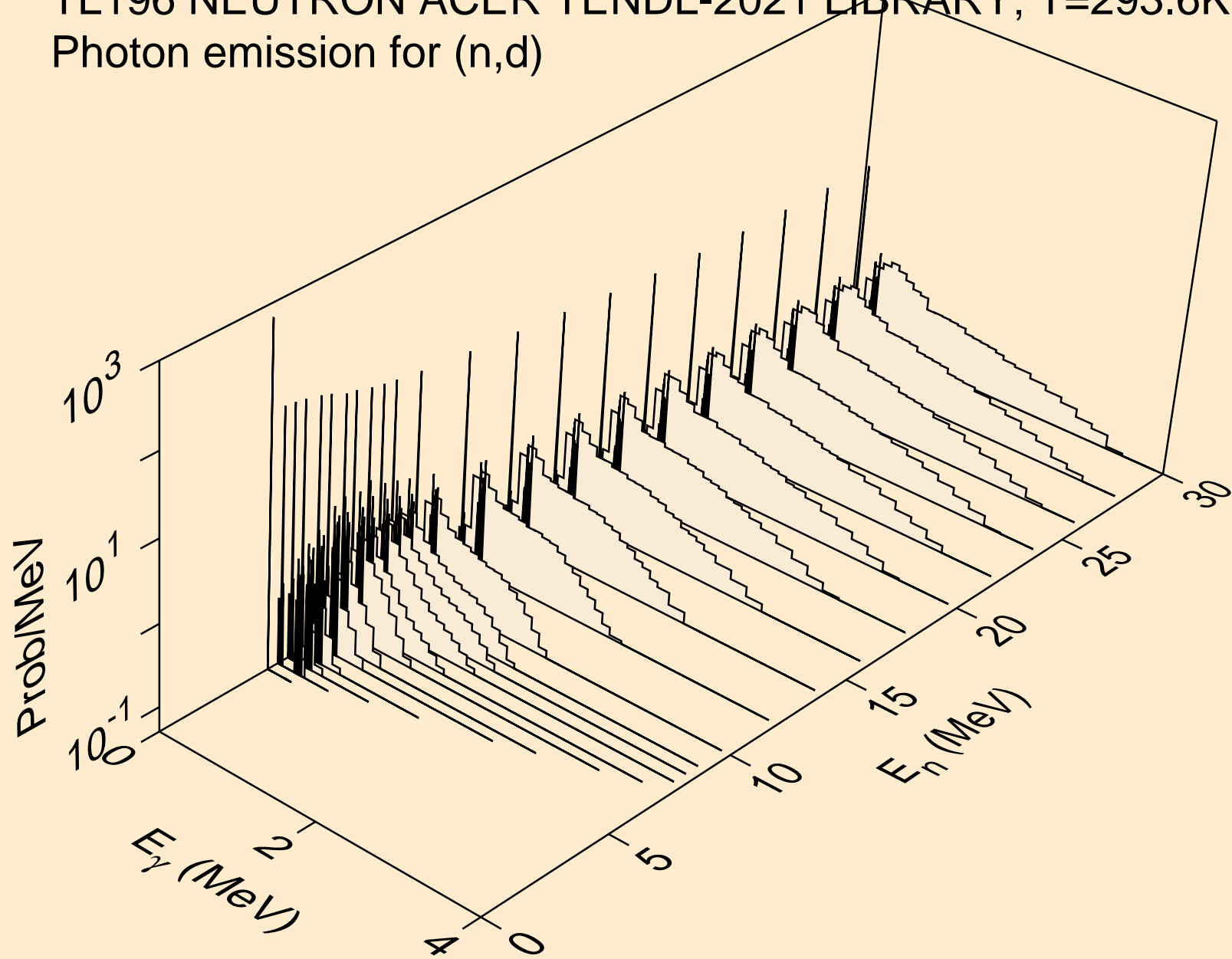

TL196 NEUTRON ACER TENDL-2021 LIBRARY; T=293.6K
Photon emission for (n,t)

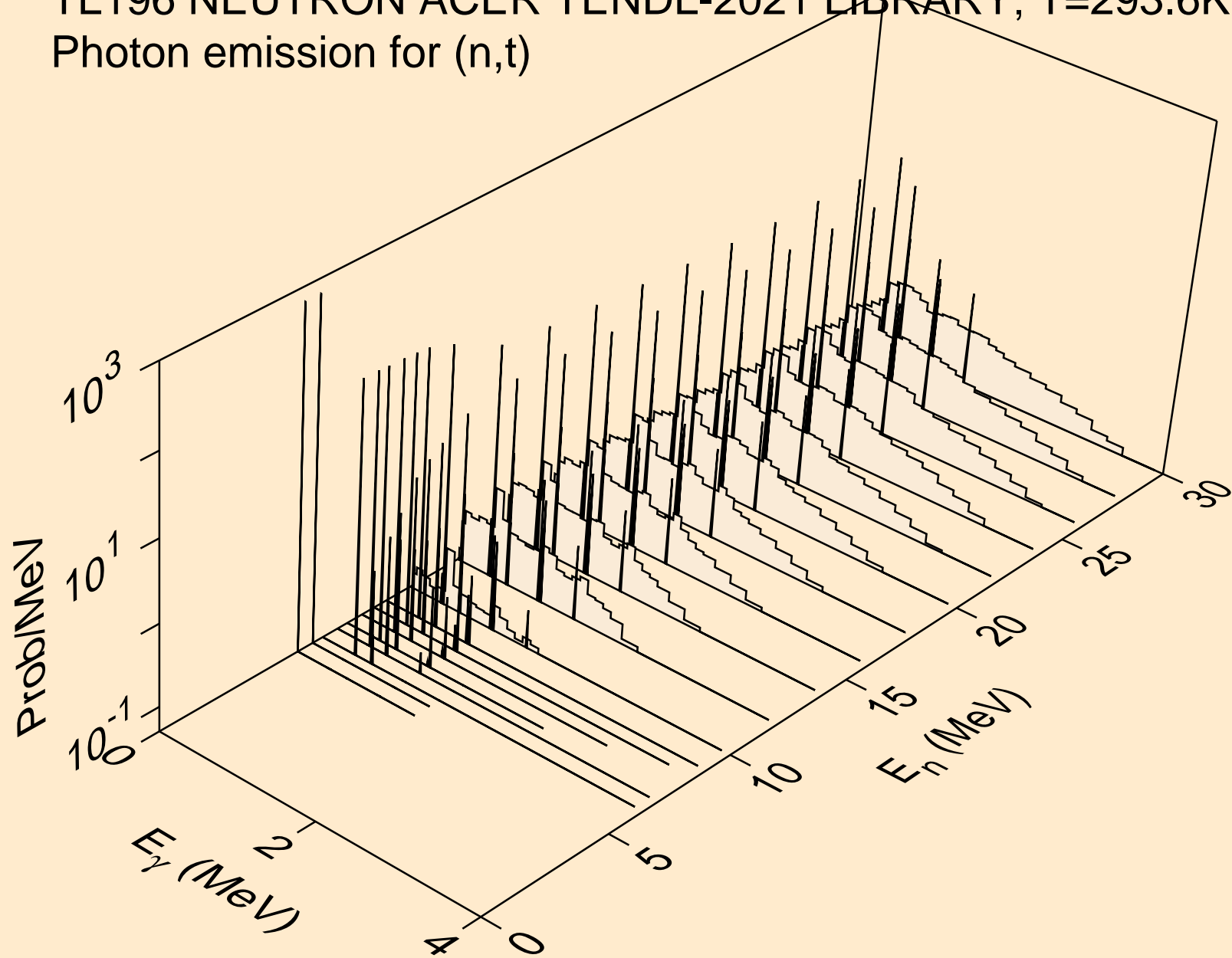

TL196 NEUTRON ACER TENDL-2021 LIBRARY; T=293.6K
Photon emission for (n,he3)

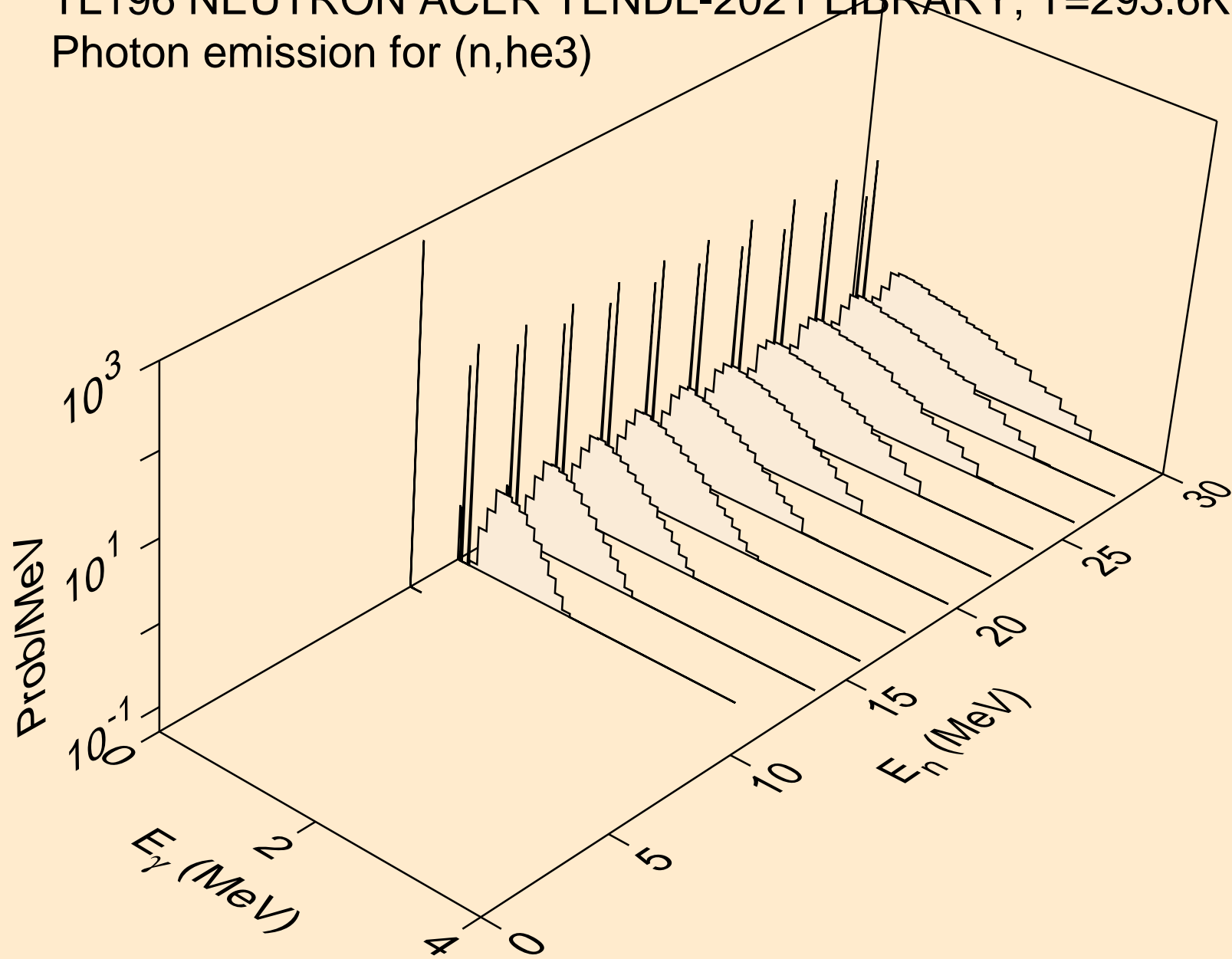

TL196 NEUTRON ACER TENDL-2021 LIBRARY; T=293.6K
Photon emission for (n,a)

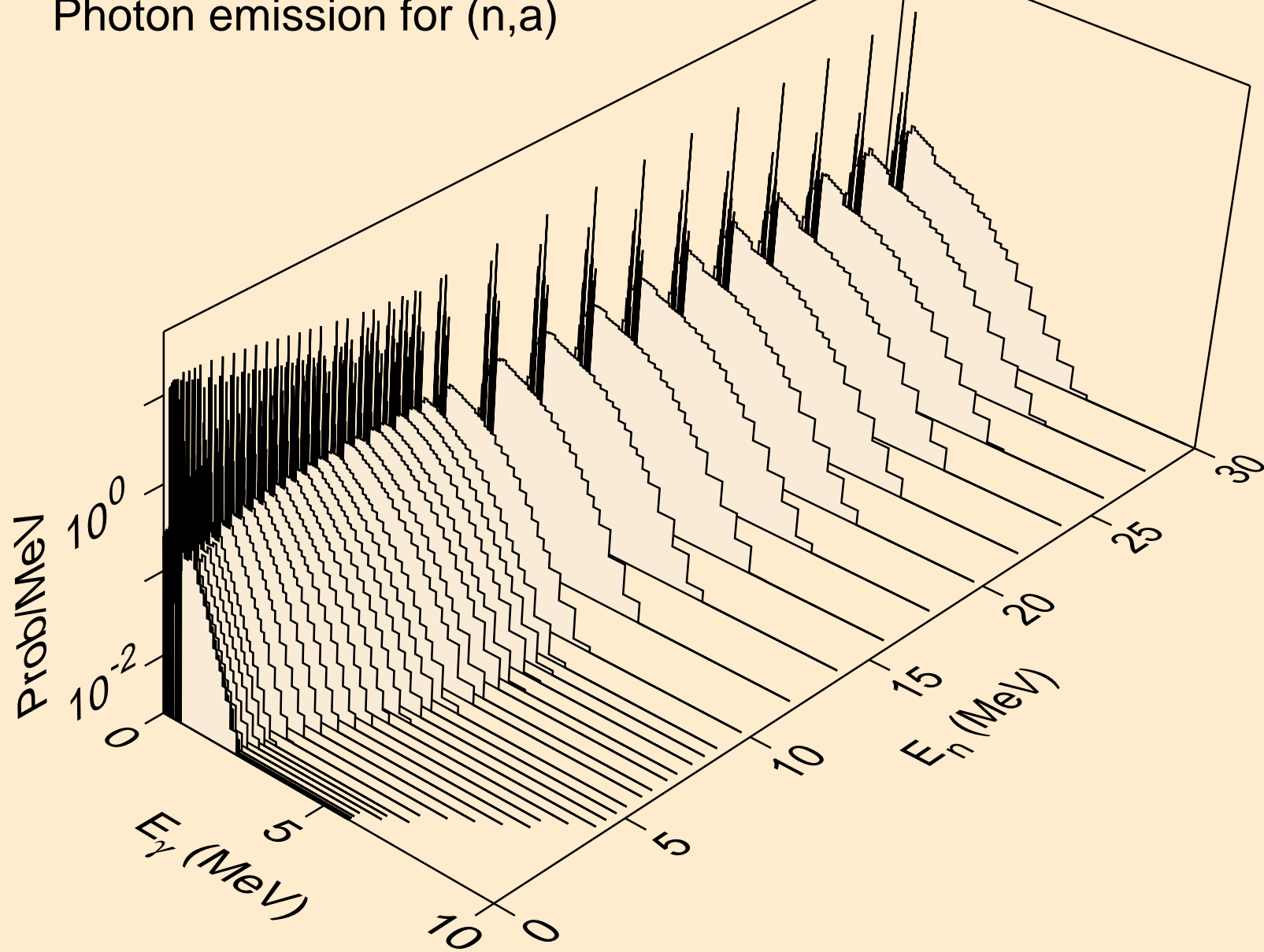

TL196 NEUTRON ACER TENDL-2021 LIBRARY; T=293.6K
Photon emission for (n,2a)

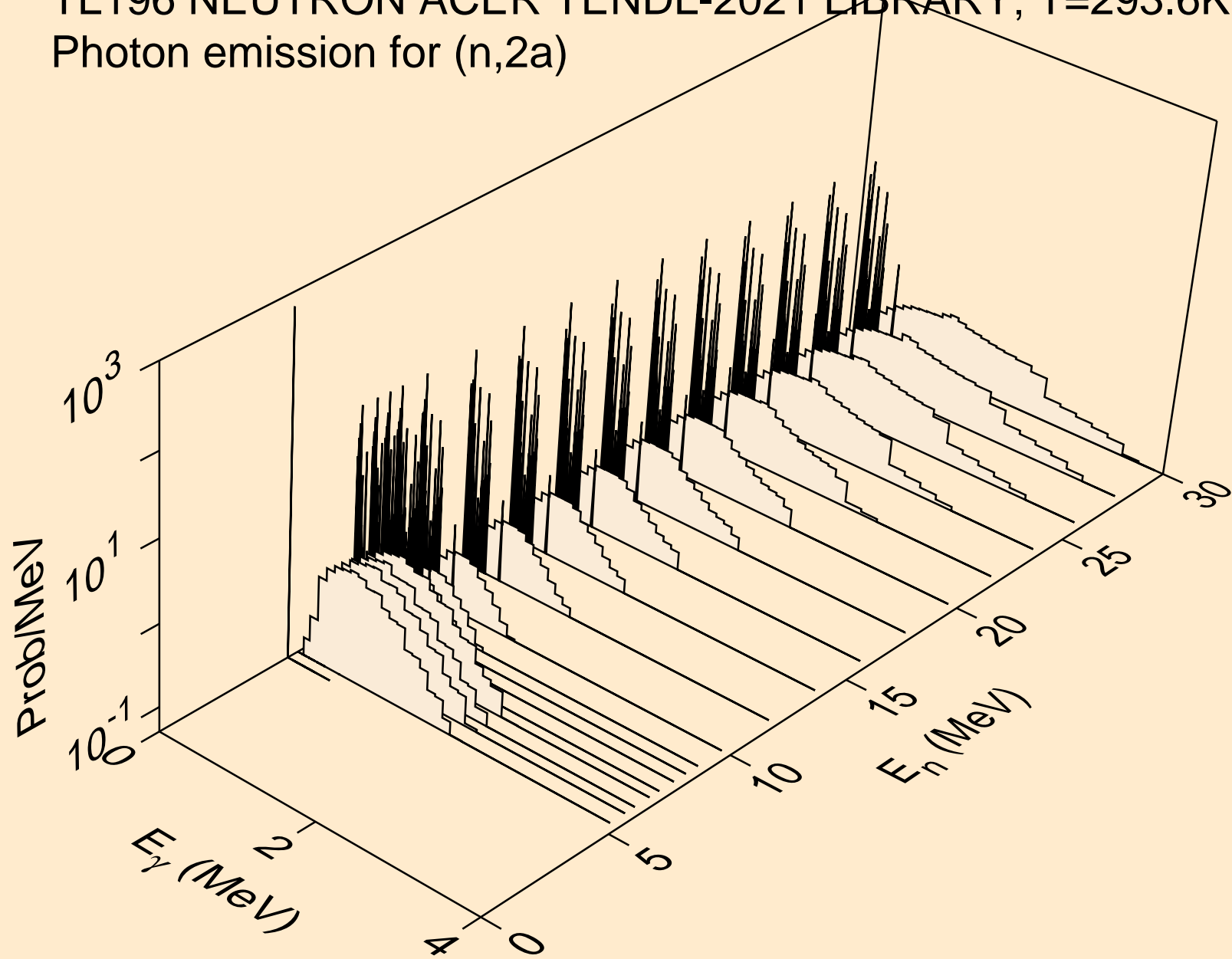

TL196 NEUTRON ACER TENDL-2021 LIBRARY; T=293.6K
Photon emission for (n,2p)

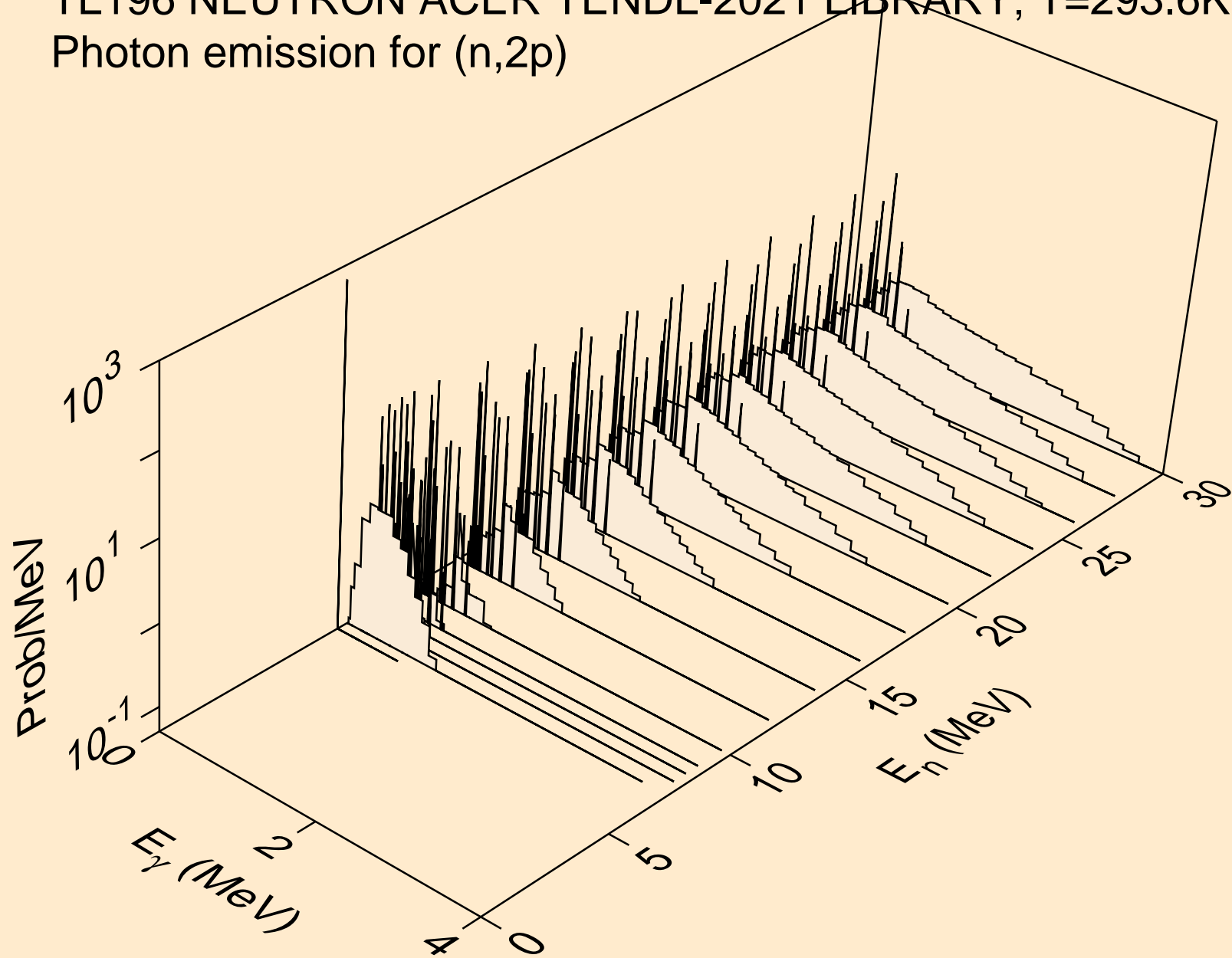

TL196 NEUTRON ACER TENDL-2021 LIBRARY; T=293.6K
Photon emission for (n,p)

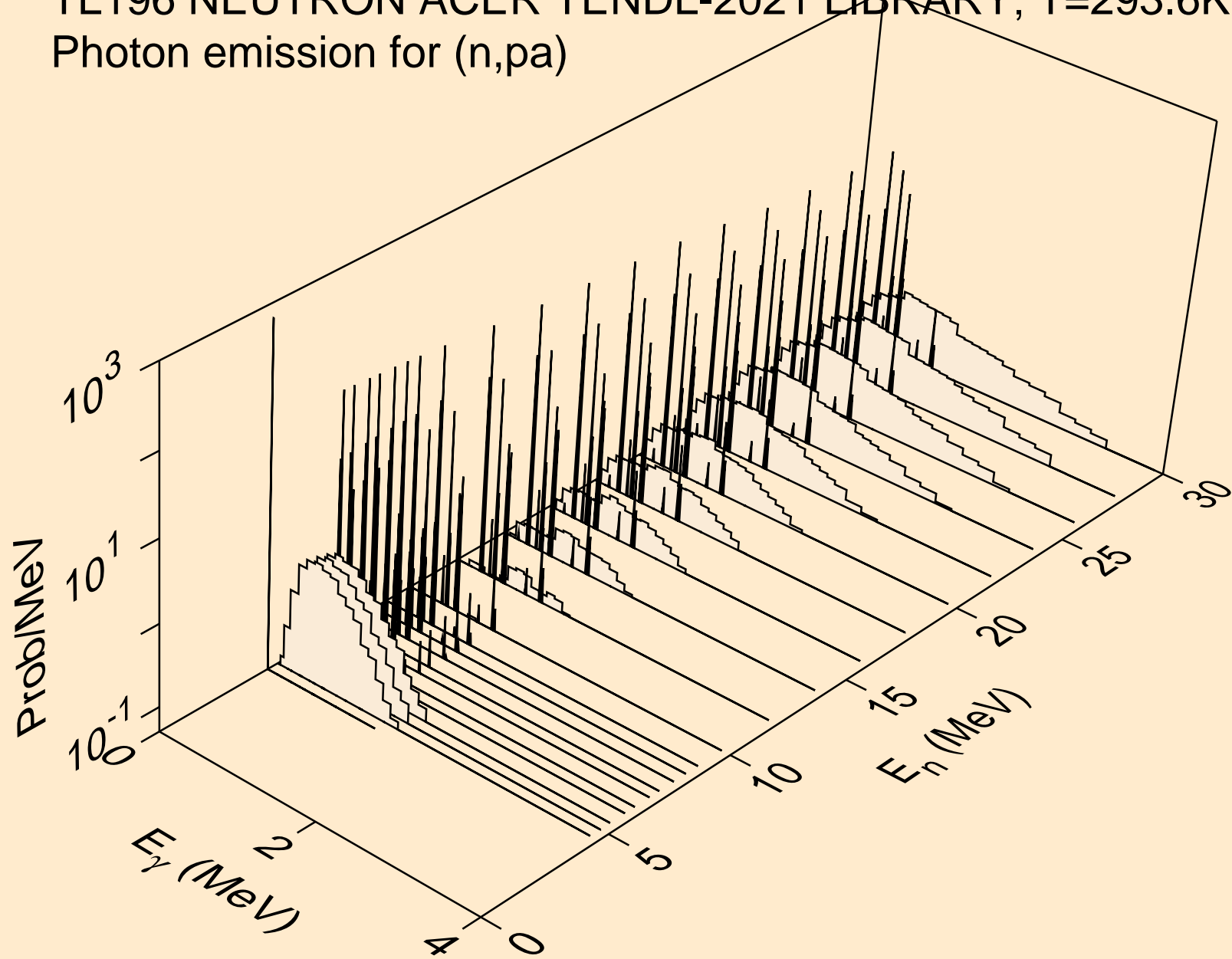

TL196 NEUTRON ACER TENDL-2021 LIBRARY; T=293.6K
Photon emission for (n,pd)

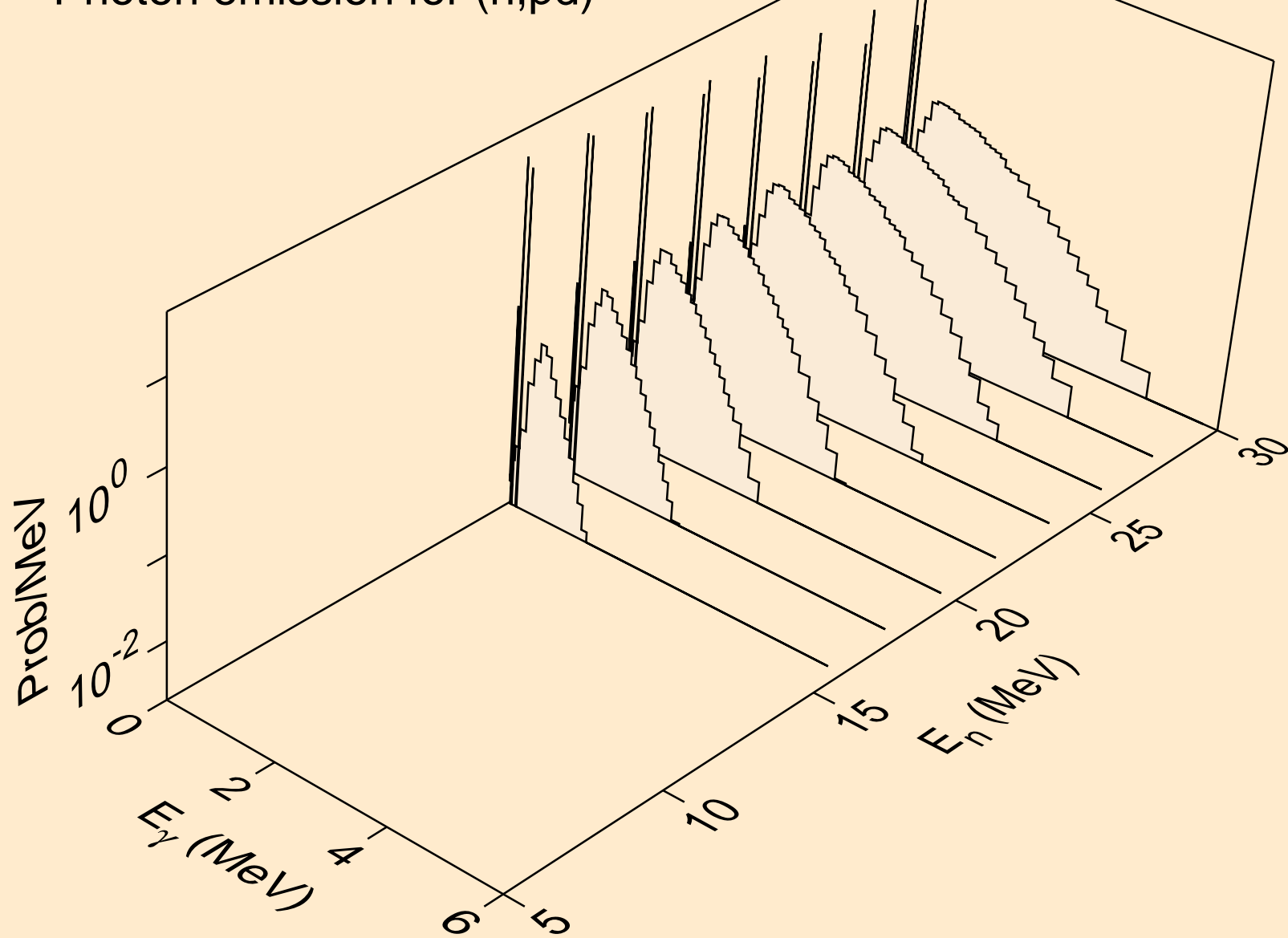

TL196 NEUTRON ACER TENDL-2021 LIBRARY; T=293.6K
Photon emission for (n,pt)

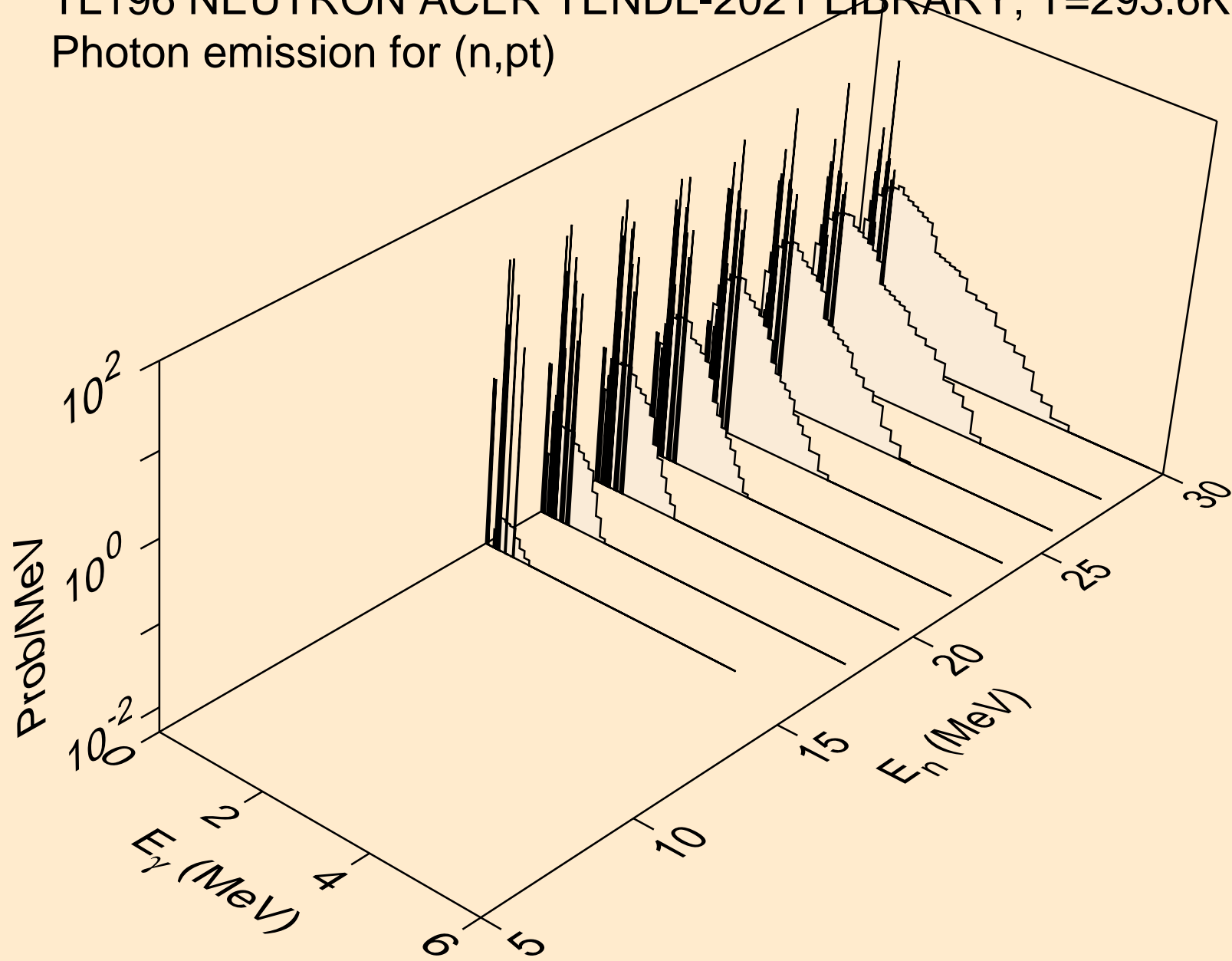

TL196 NEUTRON ACER TENDL-2021 LIBRARY; T=293.6K
Photon emission for (n,da)

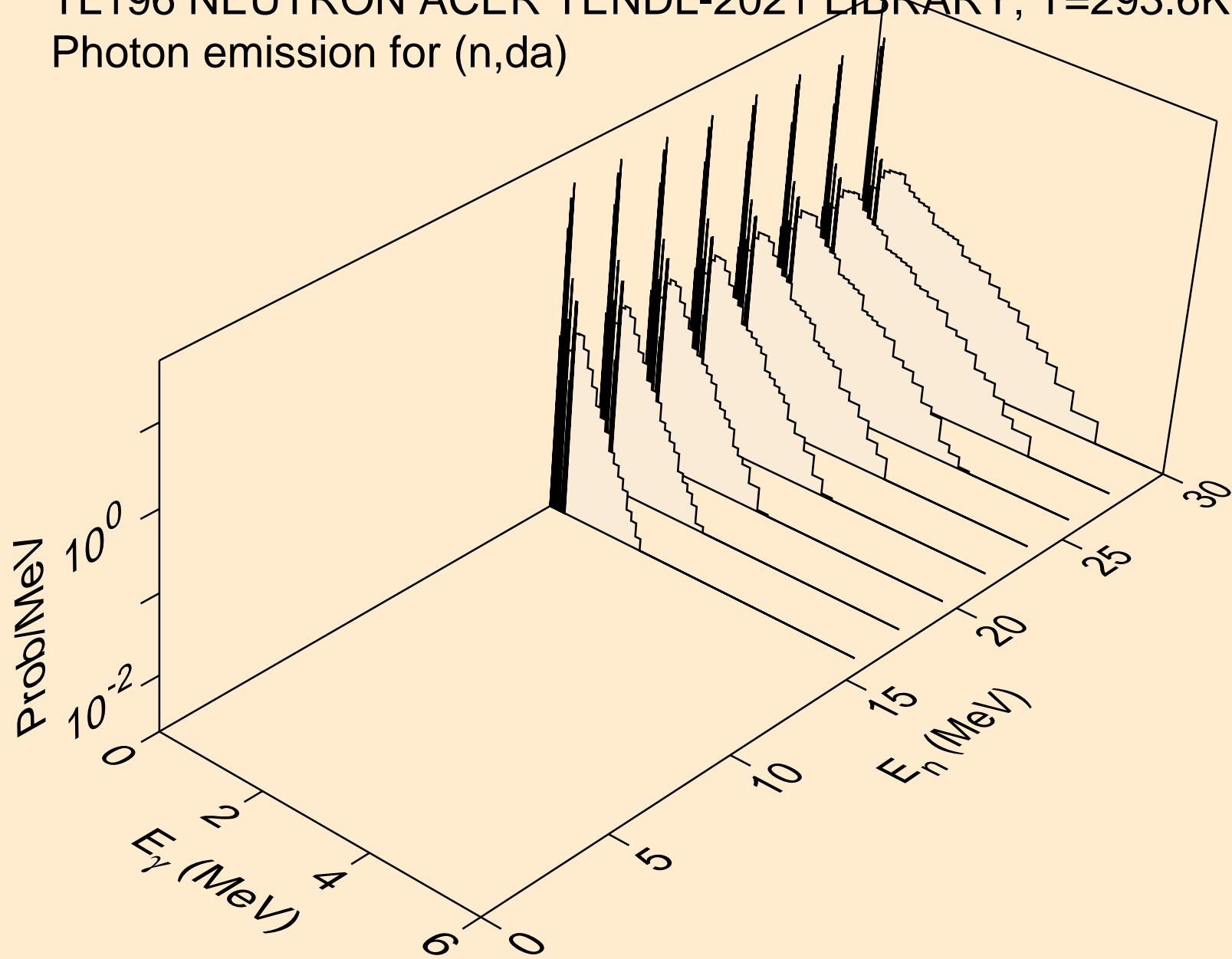

TL196 NEUTRON ACER TENDL-2021 LIBRARY; T=293.6K
thermal capture photon spectrum

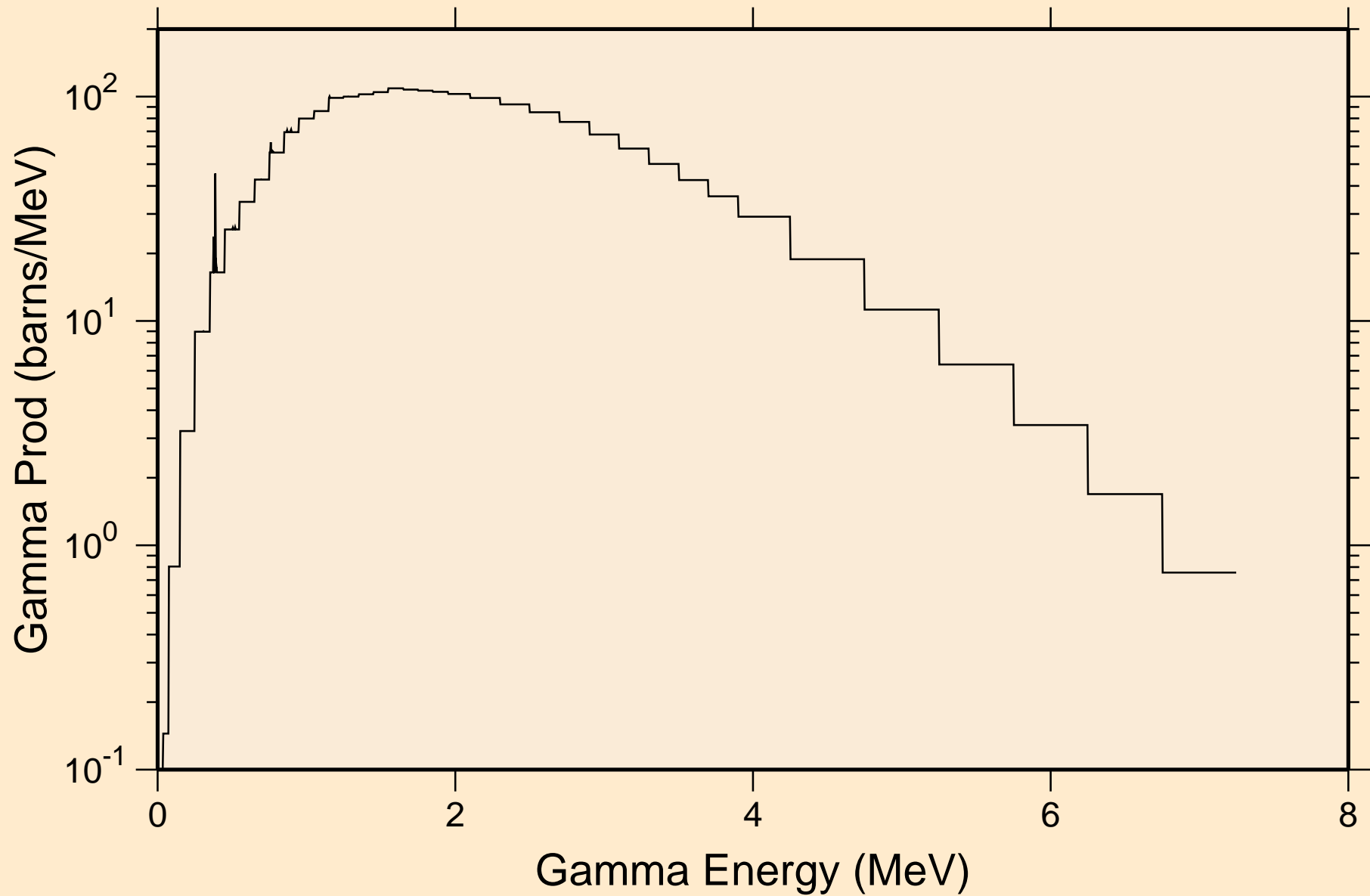

TL196 NEUTRON ACER TENDL-2021 LIBRARY; T=293.6K
14 MeV photon spectrum

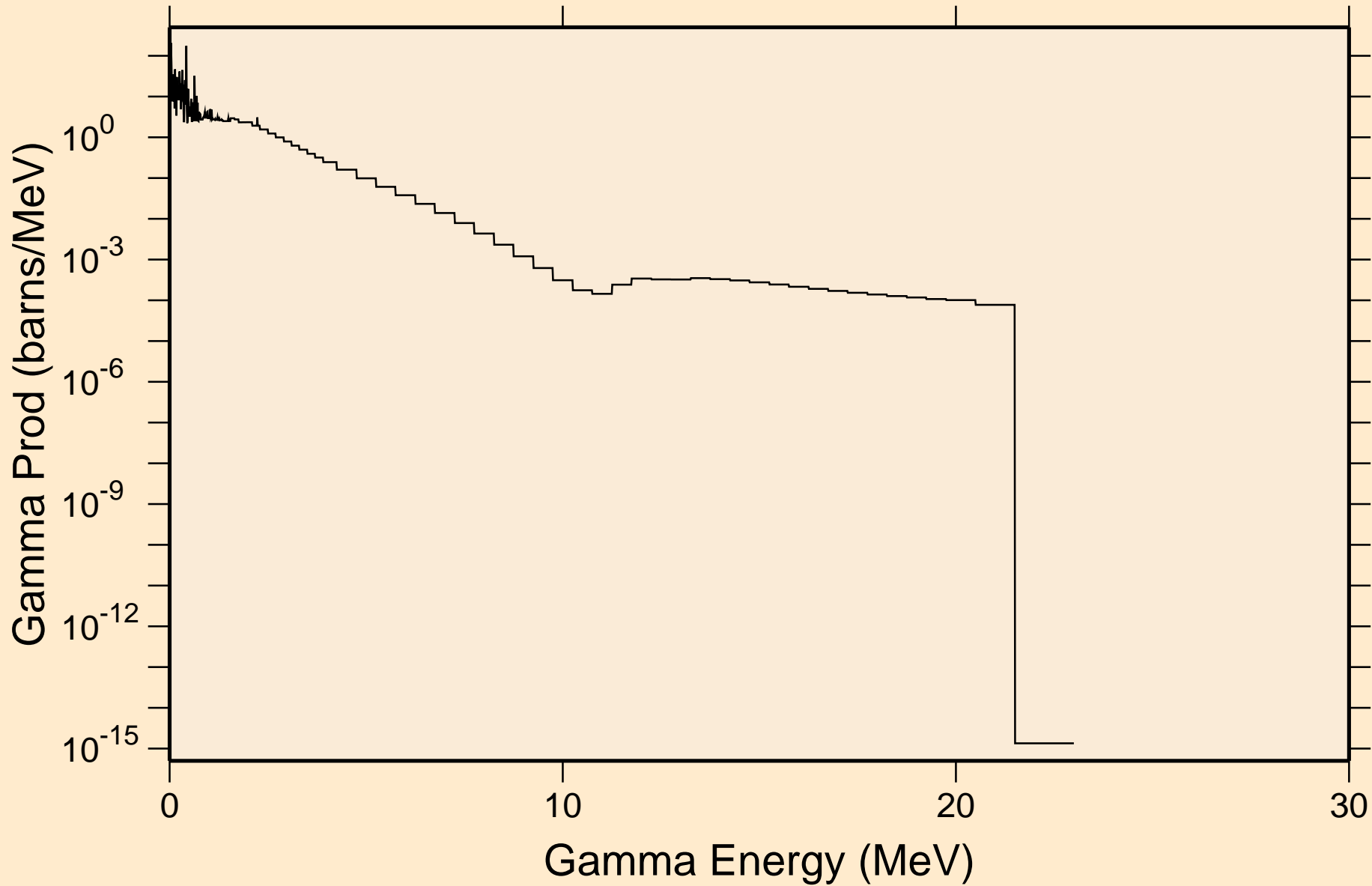

TL196 NEUTRON ACER TENDL-2021 LIBRARY; T=293.6K
Particle heating contributions

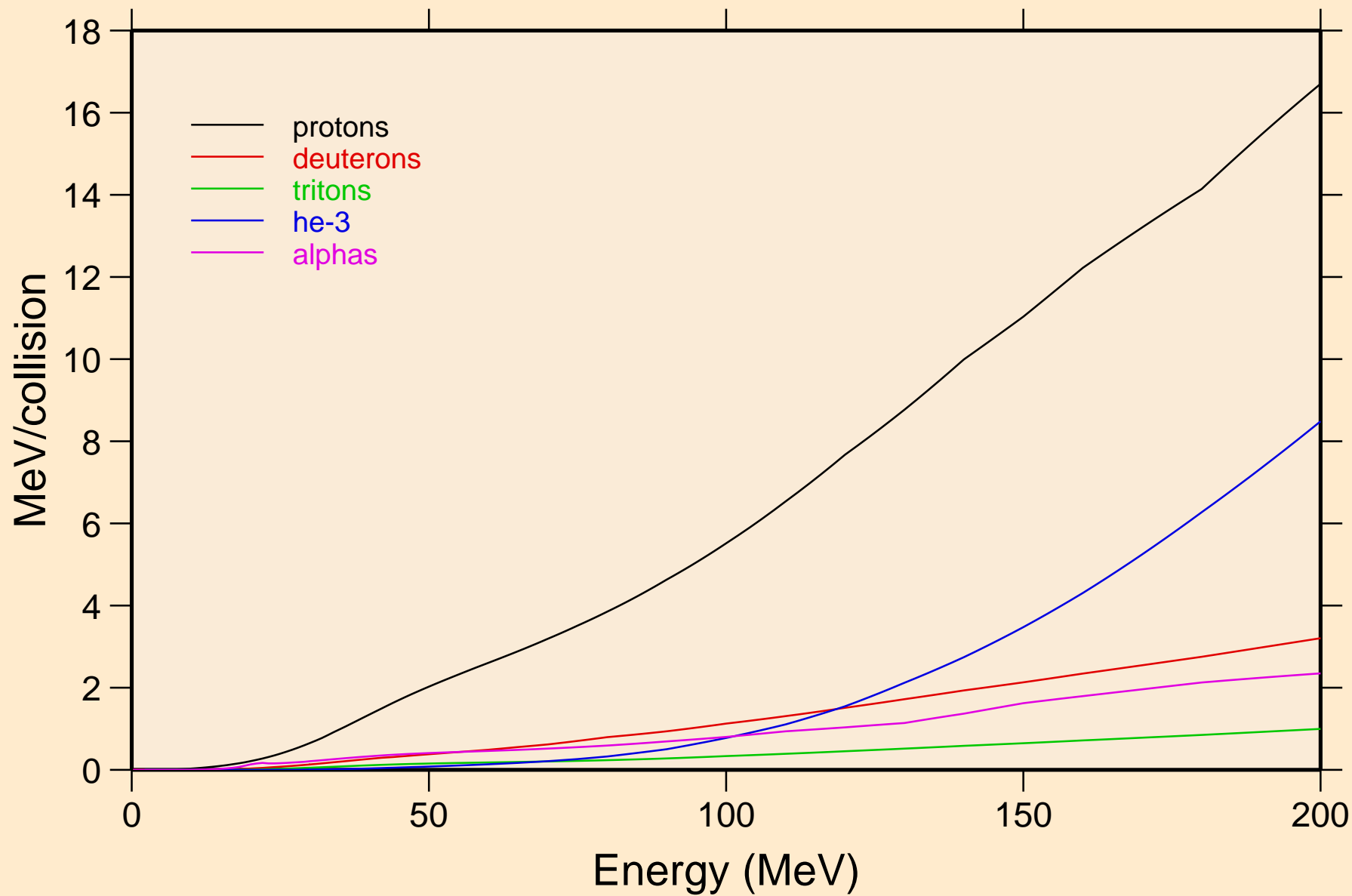

TL196 NEUTRON ACER TENDL-2021 LIBRARY; T=293.6K
Recoil Heating

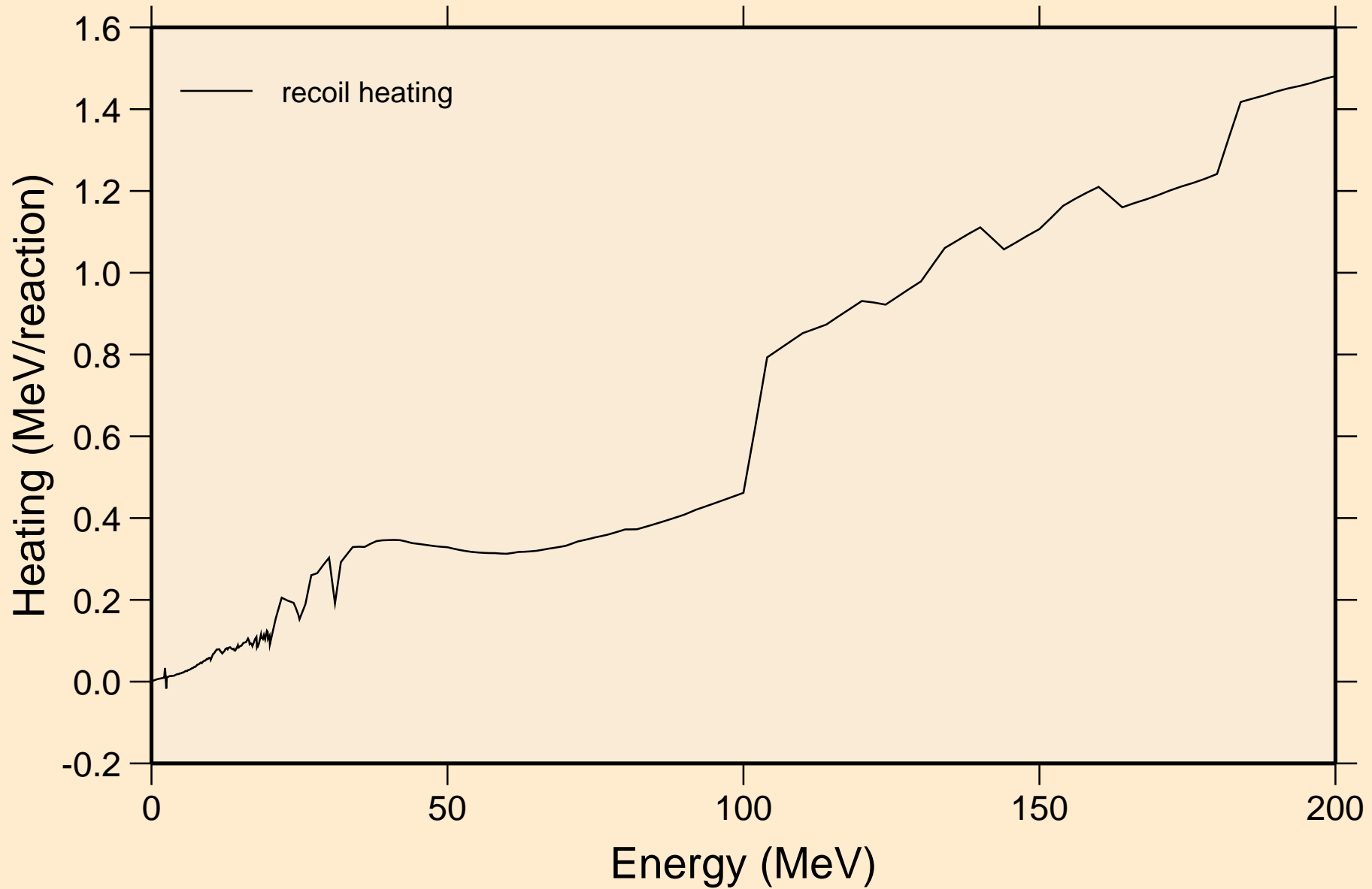

TL196 NEUTRON ACER TENDL-2021 LIBRARY; T=293.6K
Particle production cross sections

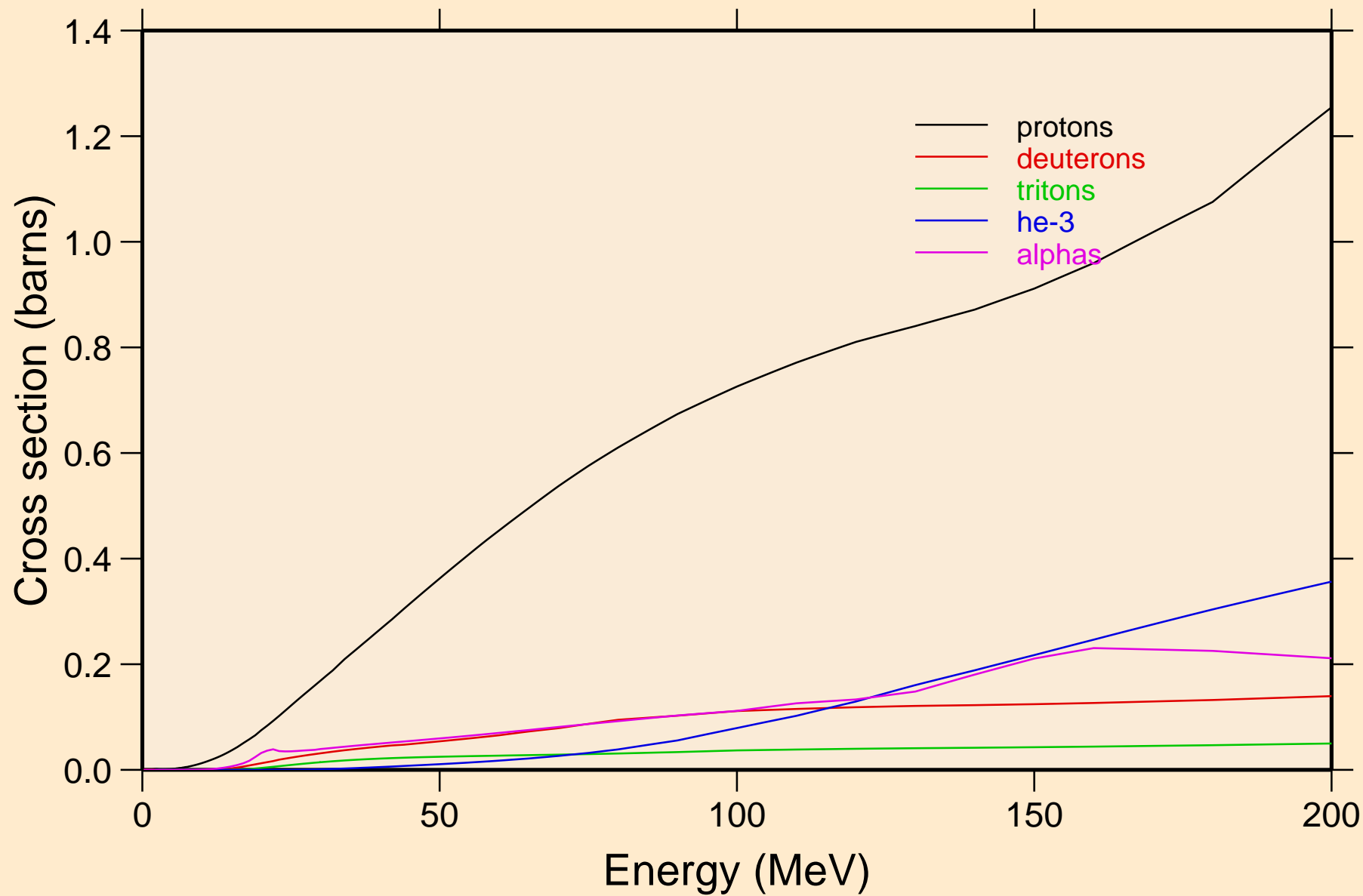

TL196 NEUTRON ACER TENDL-2021 LIBRARY; T=293.6K
protons from (n,x)

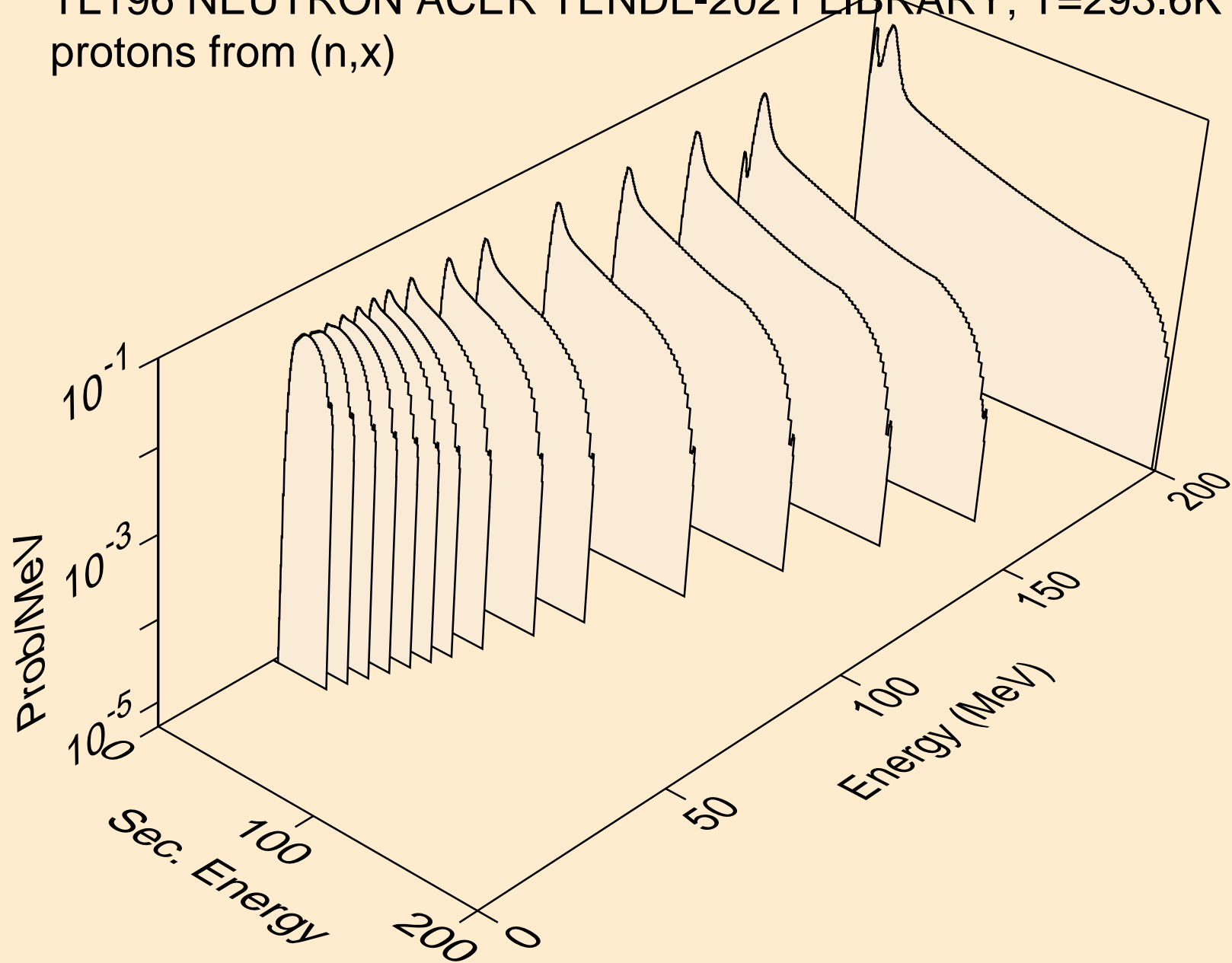

TL196 NEUTRON ACER TENDL-2021 LIBRARY; T=293.6K
protons from (n,n*)p

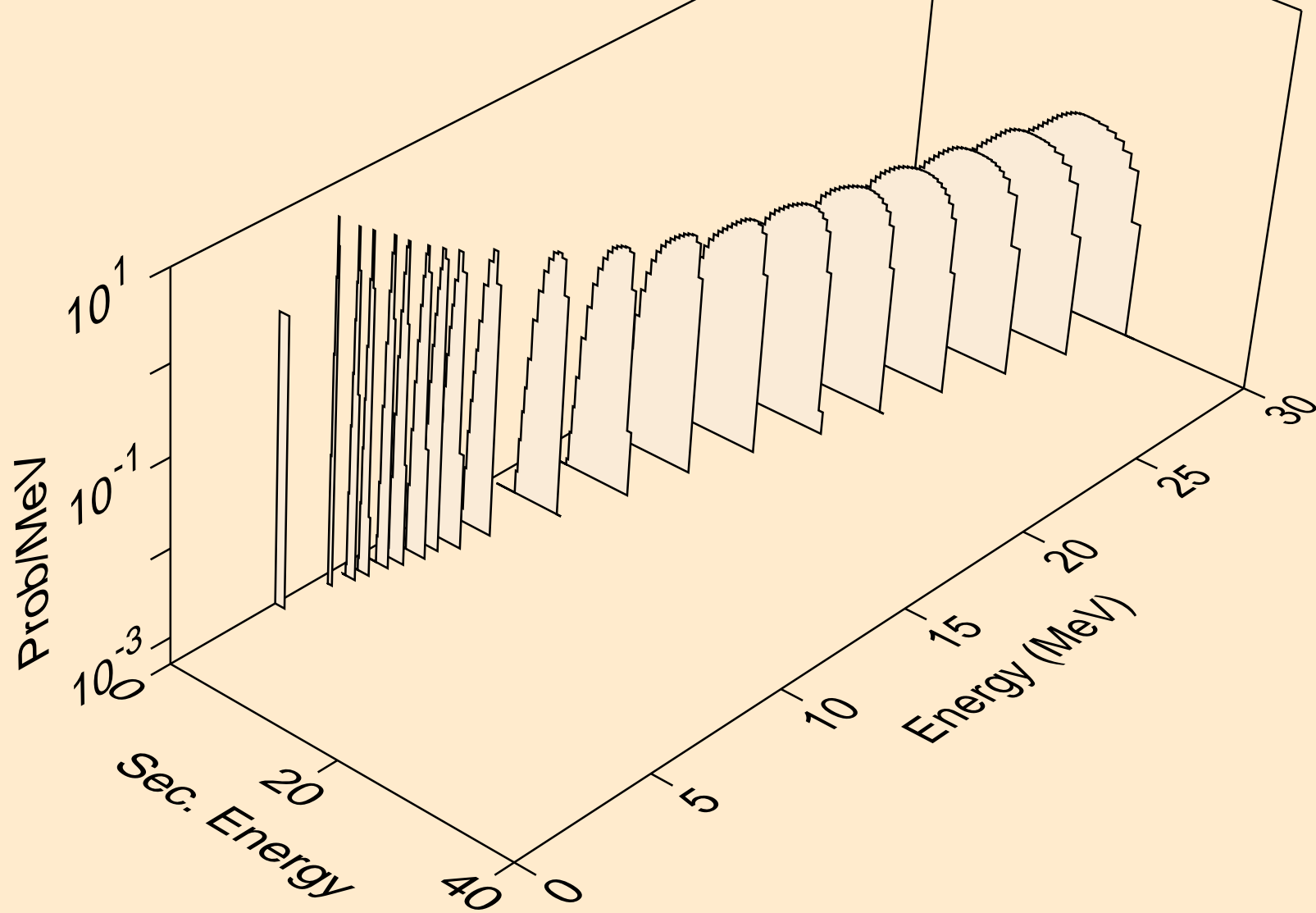

TL196 NEUTRON ACER TENDL-2021 LIBRARY; T=293.6K
protons from (n,2np)

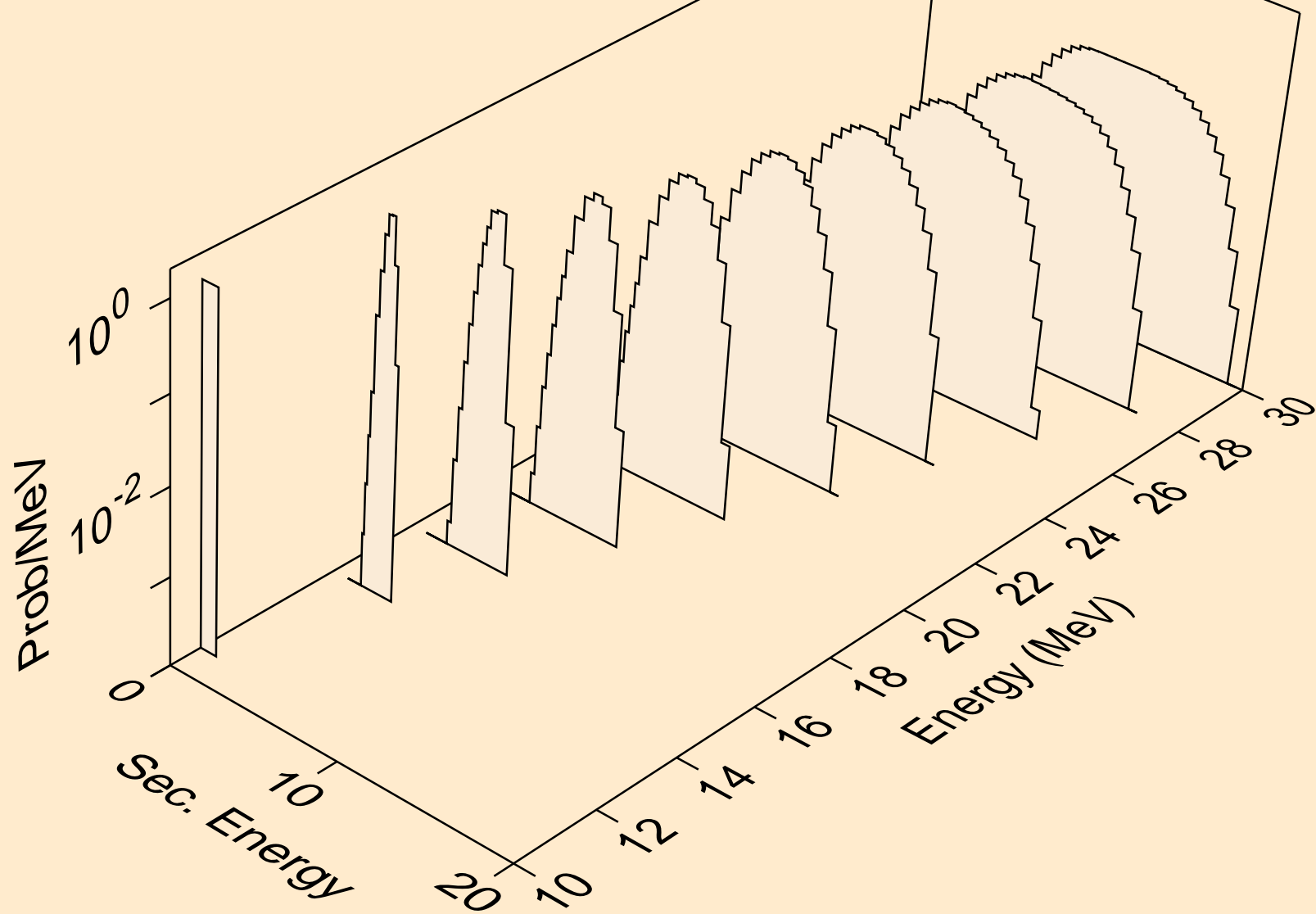

TL196 NEUTRON ACER TENDL-2021 LIBRARY; T=293.6K
protons from (n,3np)

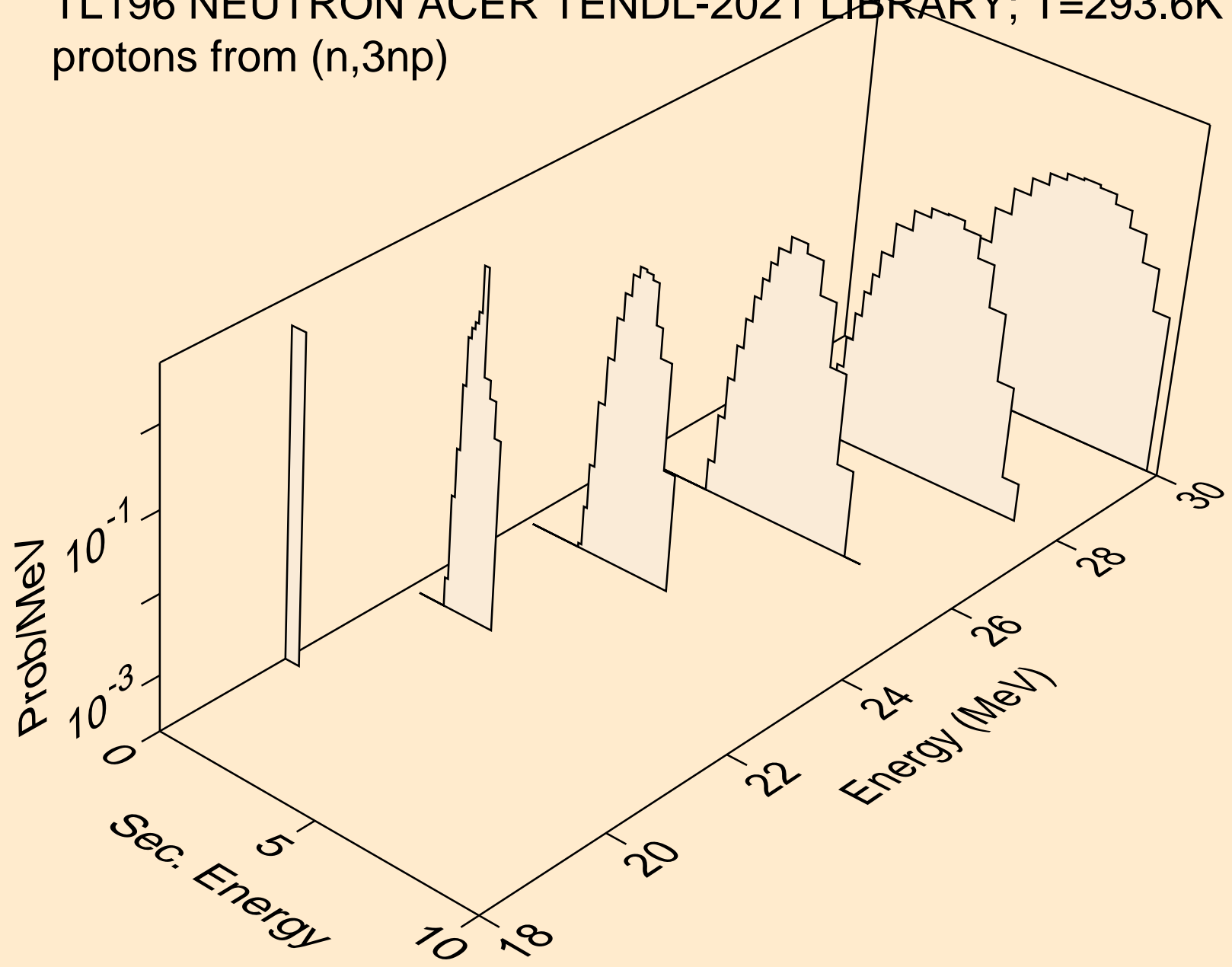

TL196 NEUTRON ACER TENDL-2021 LIBRARY; T=293.6K
protons from (n,2np)

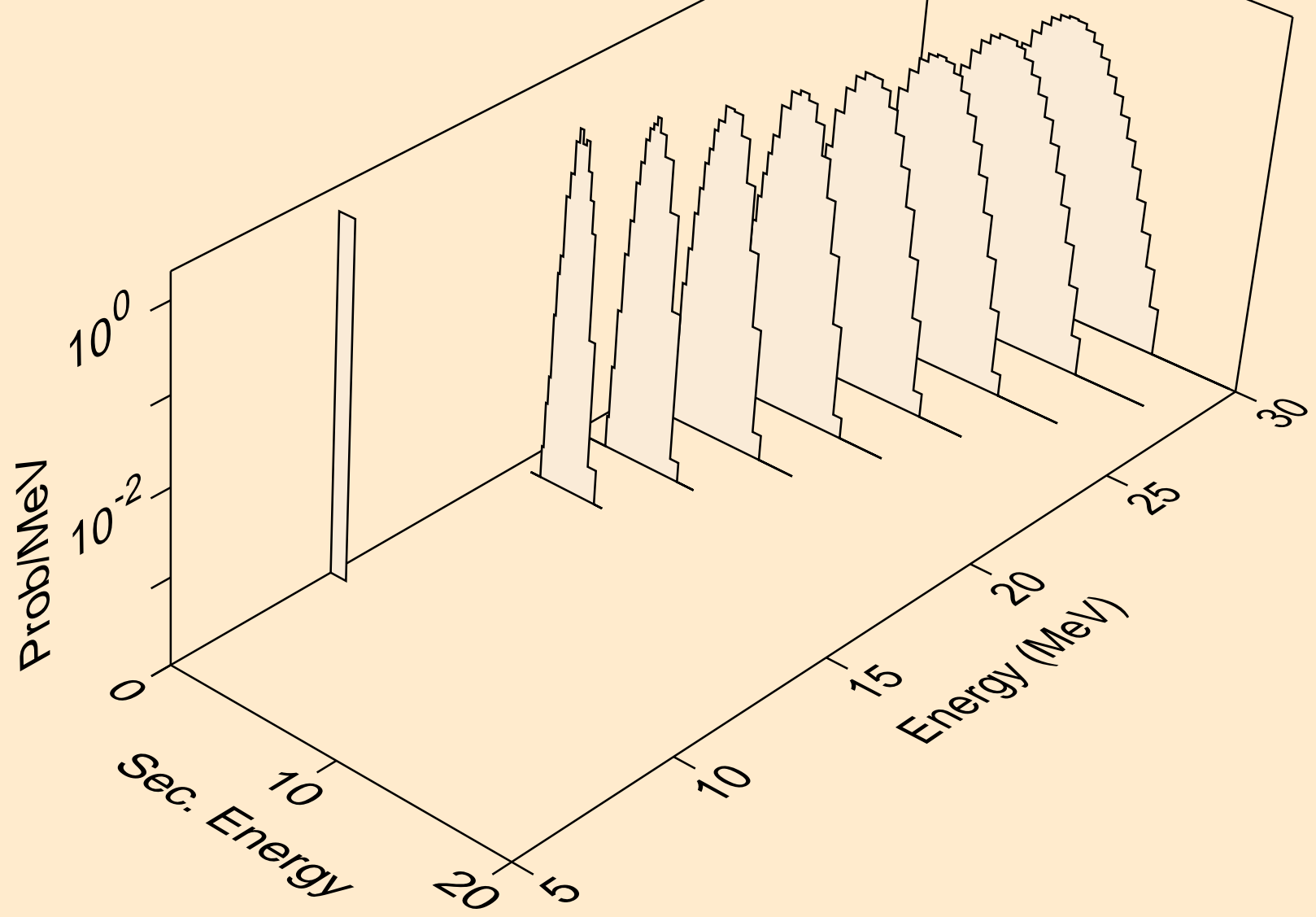

TL196 NEUTRON ACER TENDL-2021 LIBRARY; T=293.6K
protons from (n,npa)

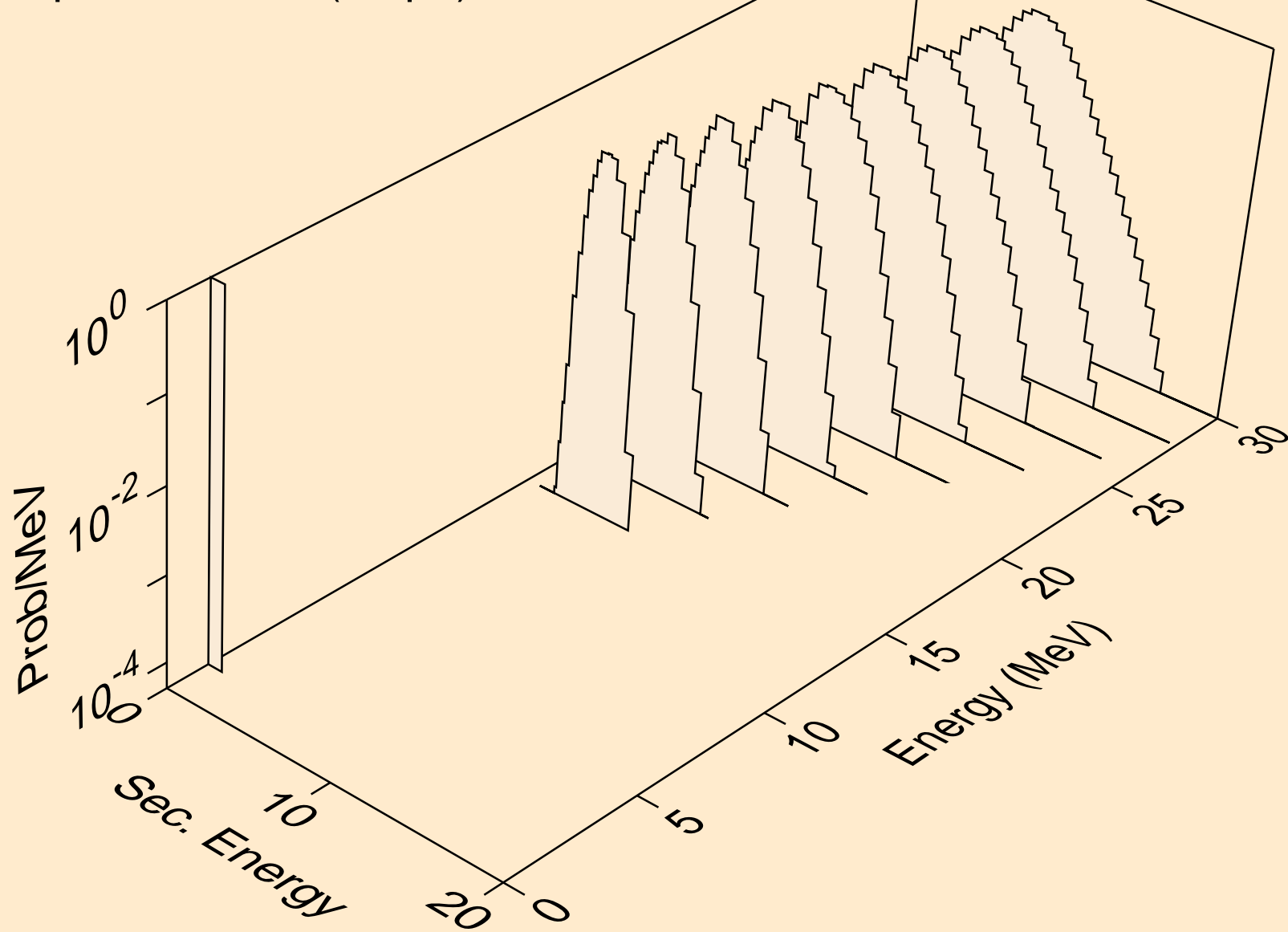

TL196 NEUTRON ACER TENDL-2021 LIBRARY; T=293.6K
protons from (n,p)

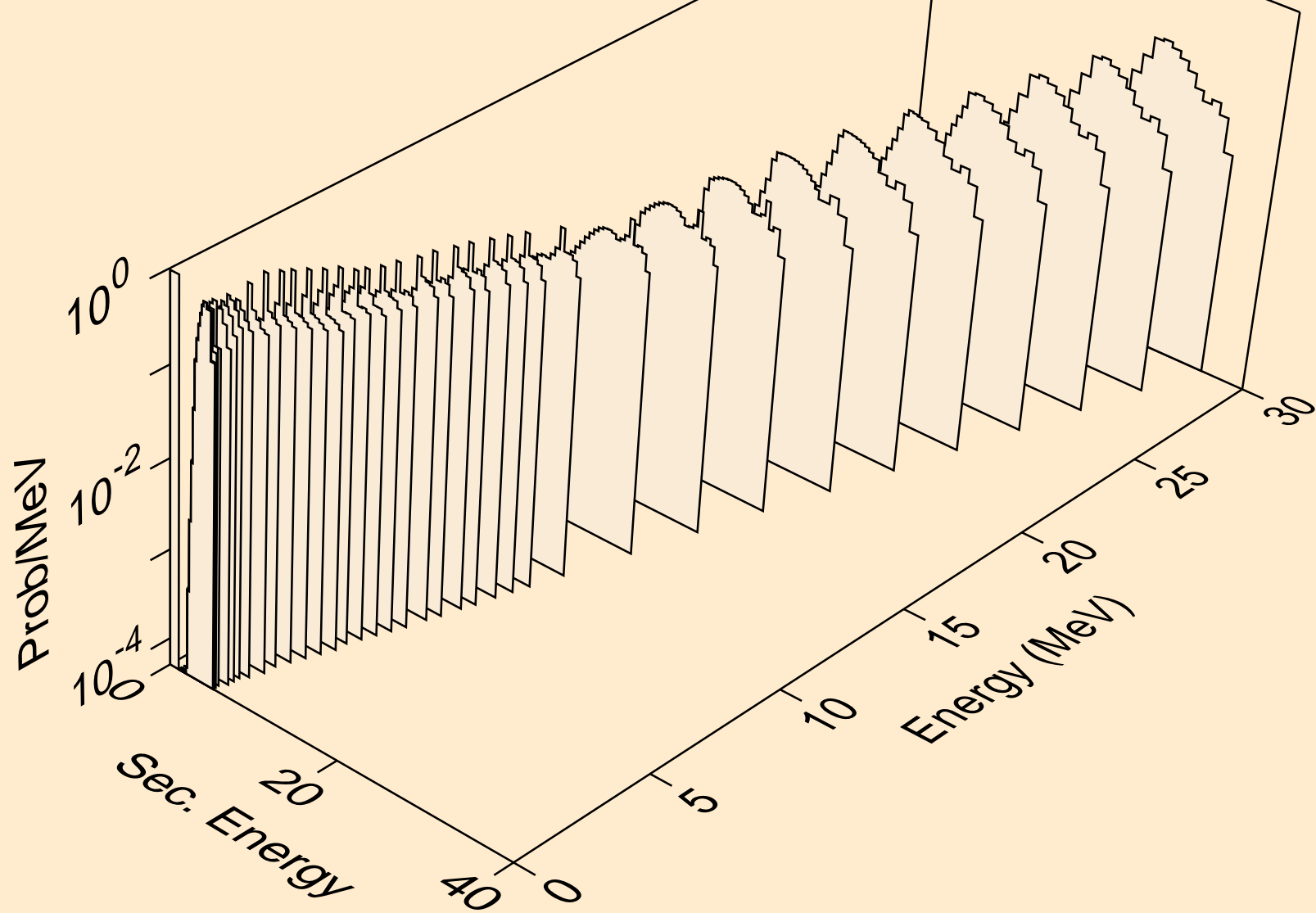

TL196 NEUTRON ACER TENDL-2021 LIBRARY; T=293.6K
protons from (n,2p)

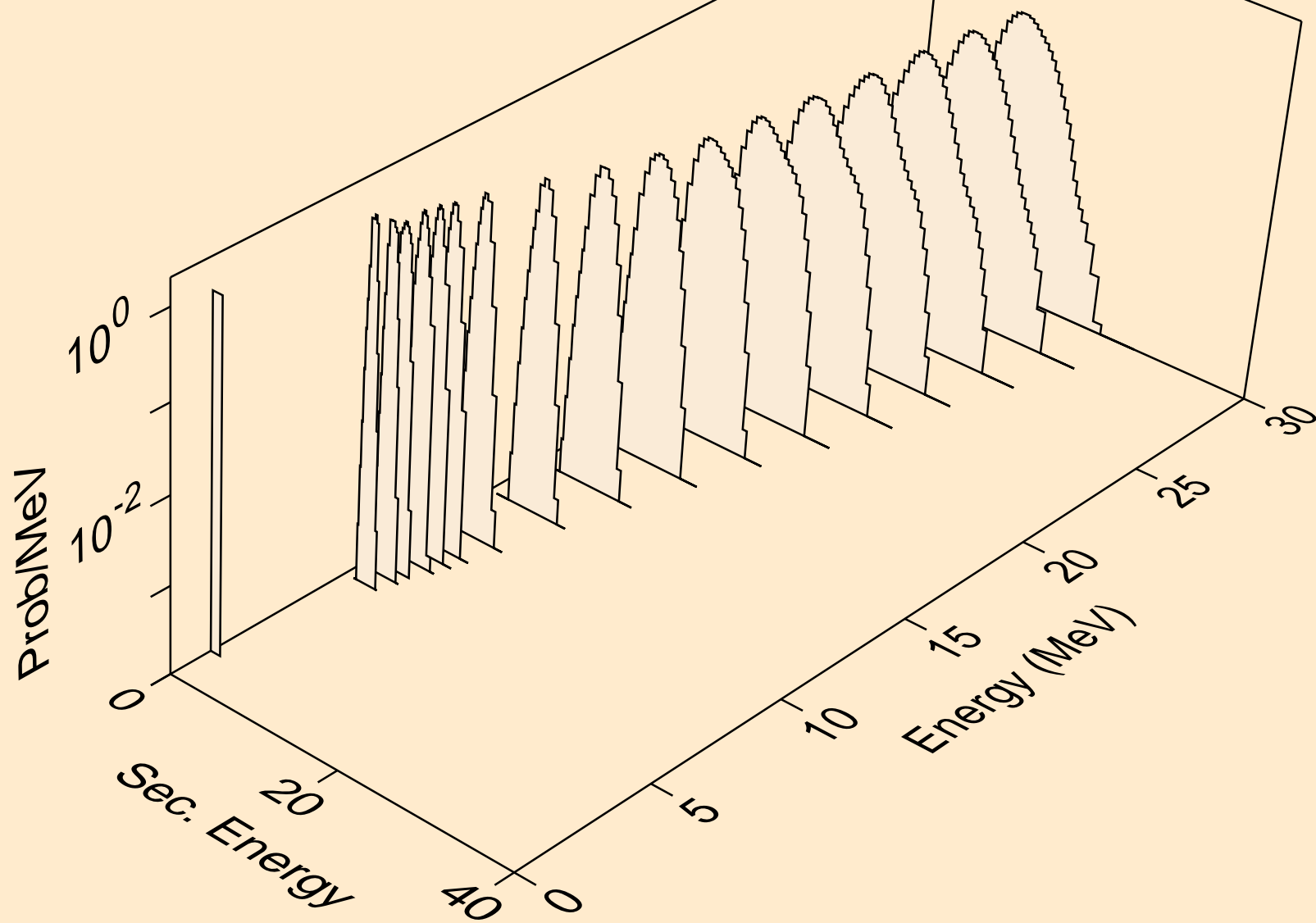

TL196 NEUTRON ACER TENDL-2021 LIBRARY; T=293.6K
protons from (n,p)

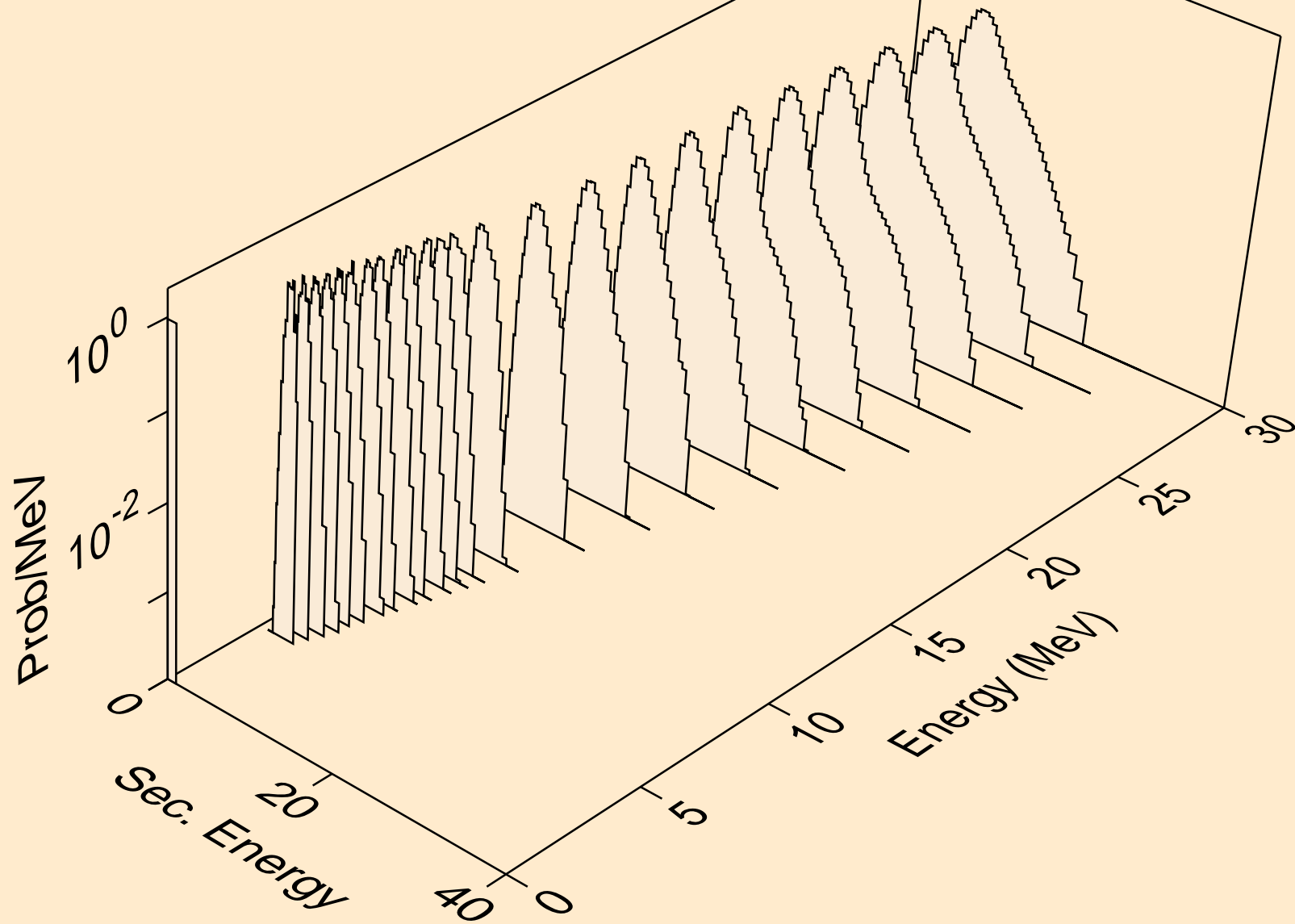

TL196 NEUTRON ACER TENDL-2021 LIBRARY; T=293.6K
protons from (n,pd)

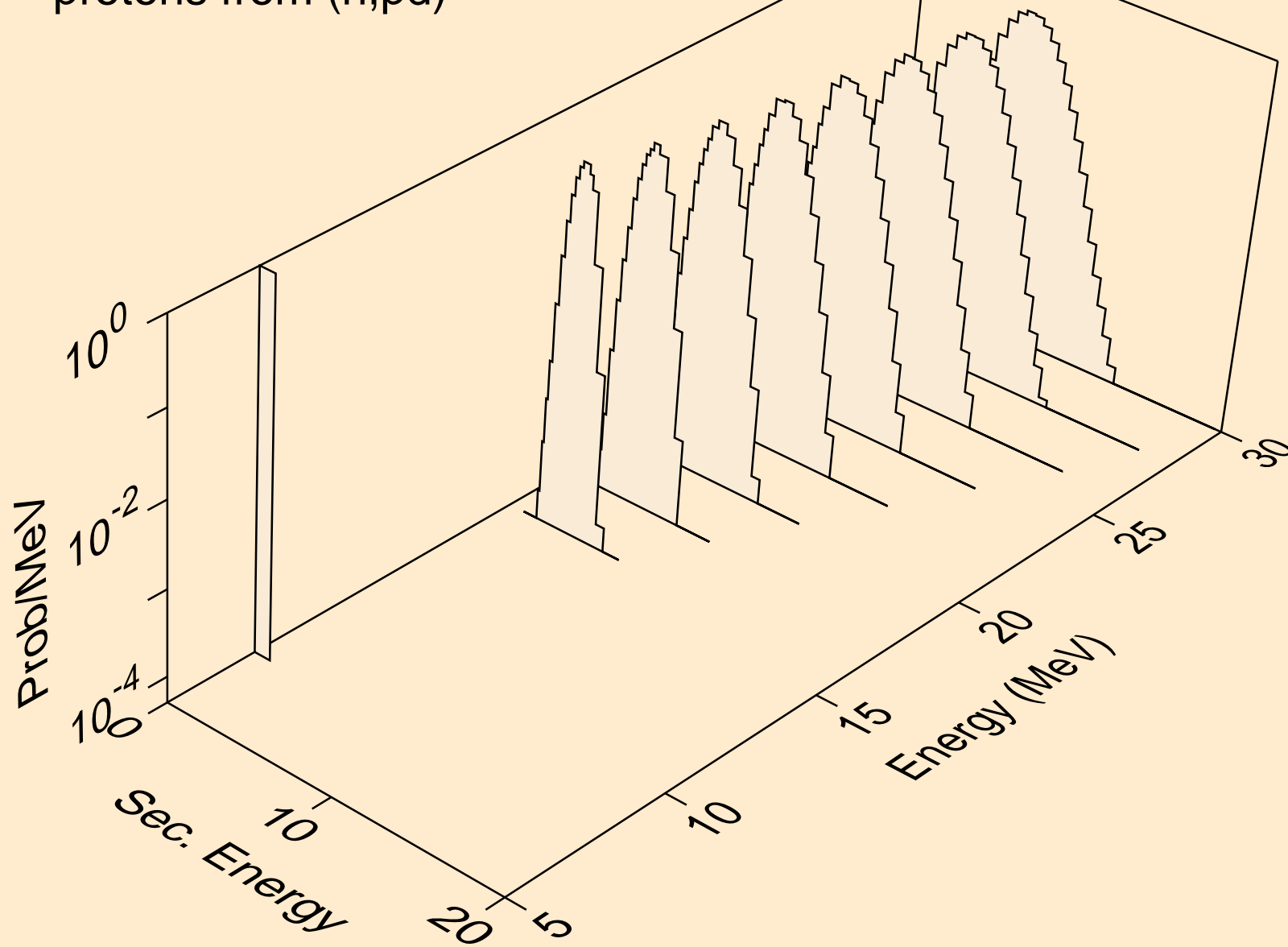

TL196 NEUTRON ACER TENDL-2021 LIBRARY; T=293.6K
protons from (n,pt)

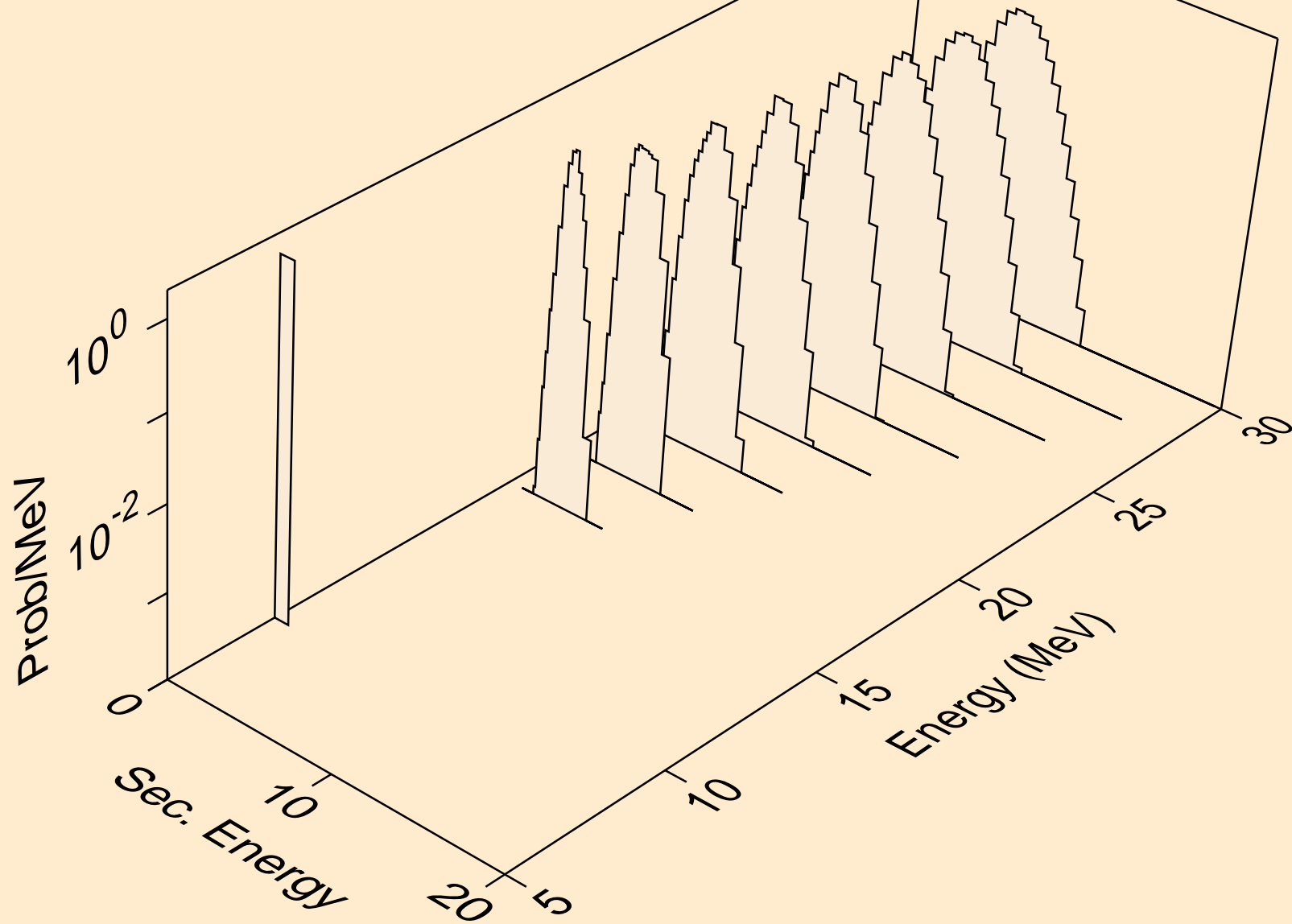

TL196 NEUTRON ACER TENDL-2021 LIBRARY; T=293.6K
deuterons from (n,x)

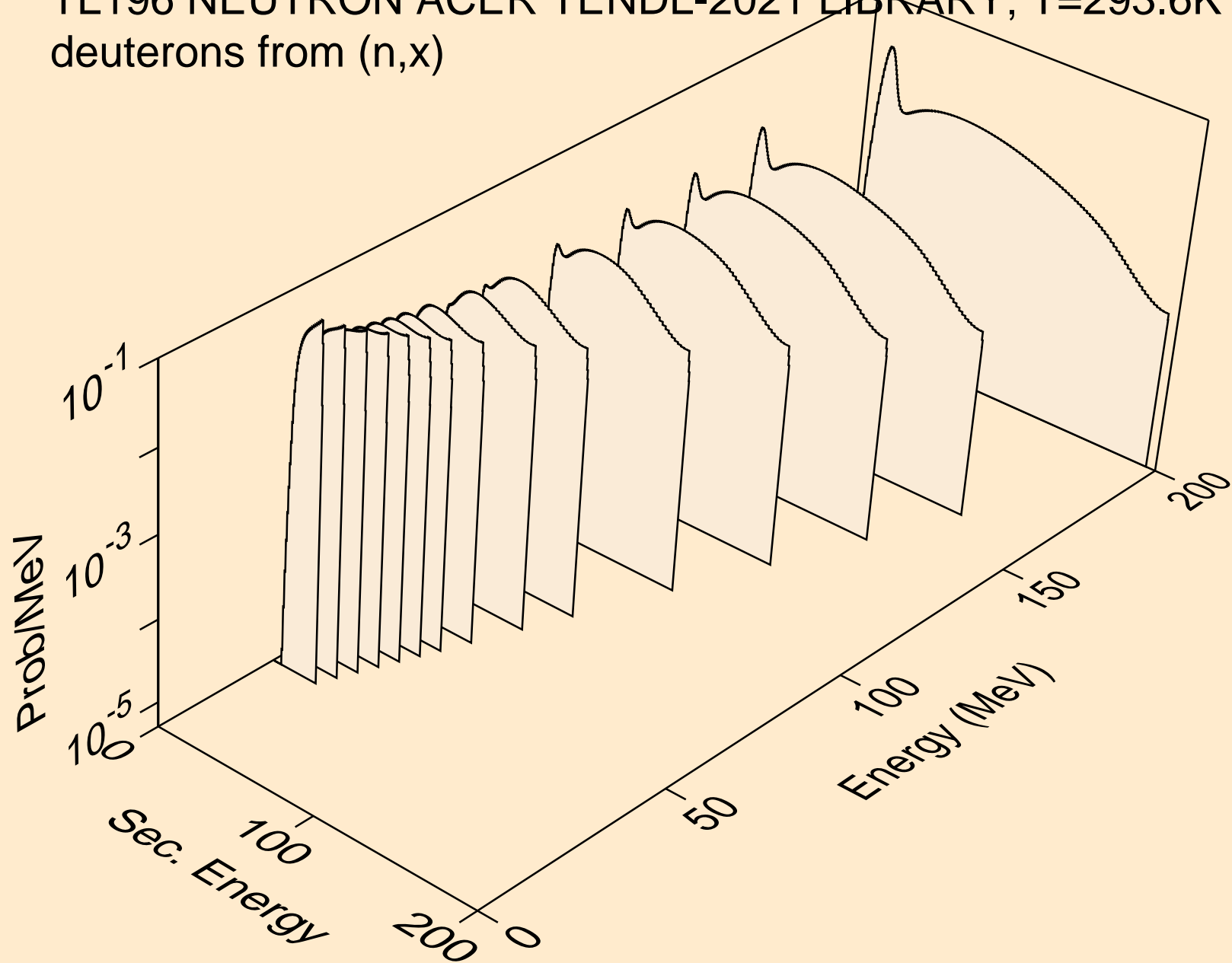

TL196 NEUTRON ACER TENDL-2021 LIBRARY; T=293.6K
deuterons from (n,2nd)

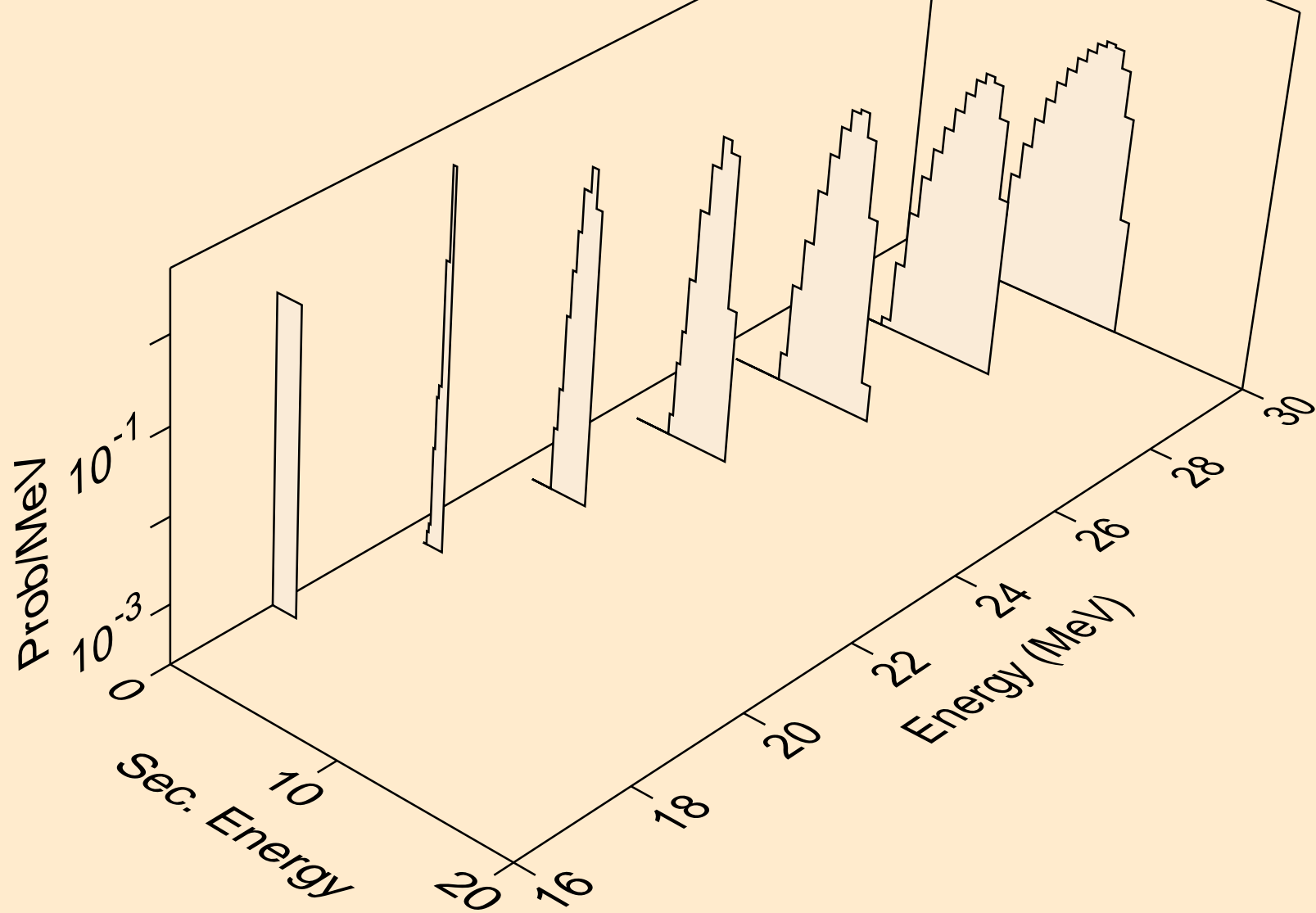

TL196 NEUTRON ACER TENDL-2021 LIBRARY; T=293.6K
deuterons from (n,n*)d

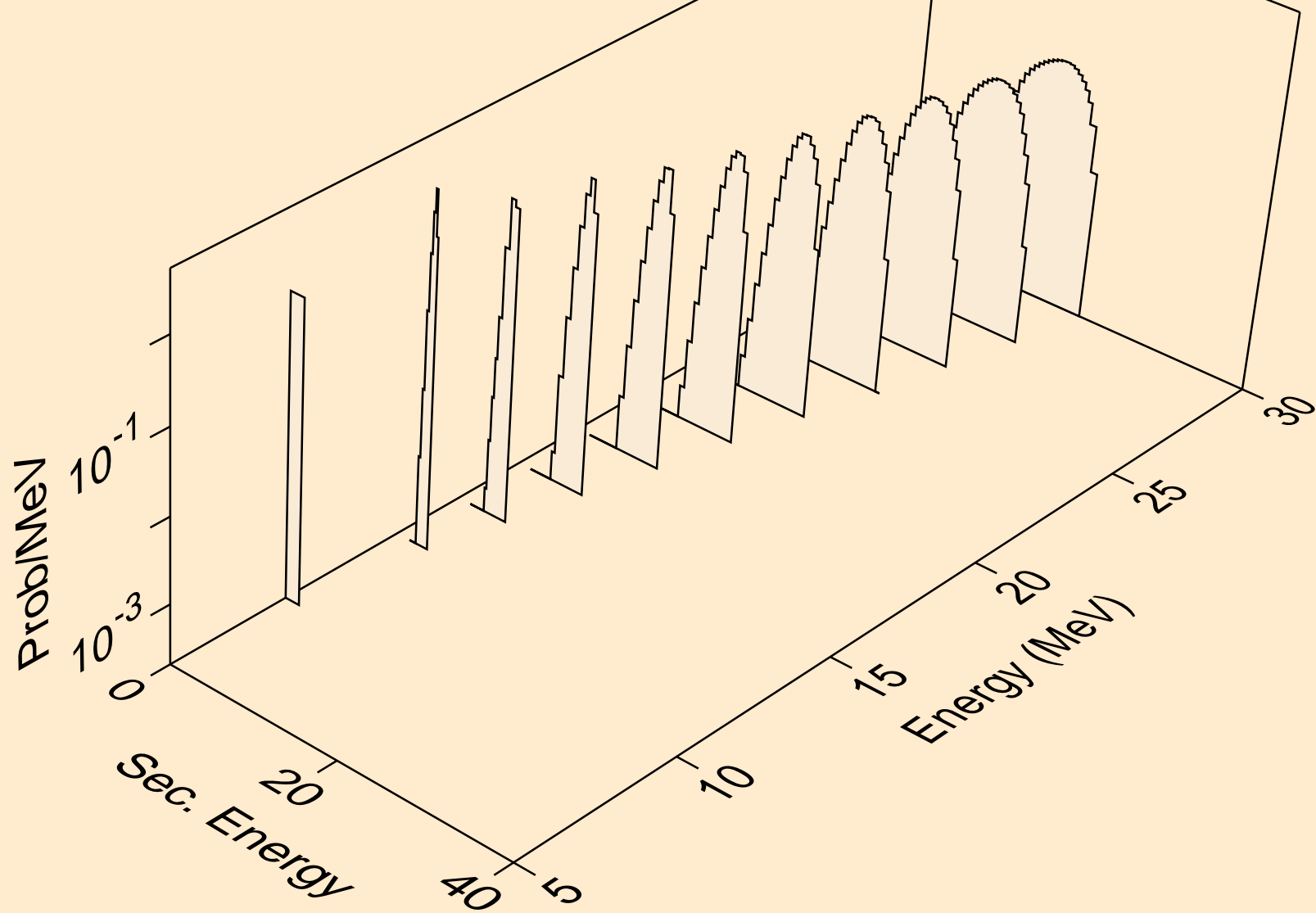

TL196 NEUTRON ACER TENDL-2021 LIBRARY; T=293.6K
deuterons from (n,d)

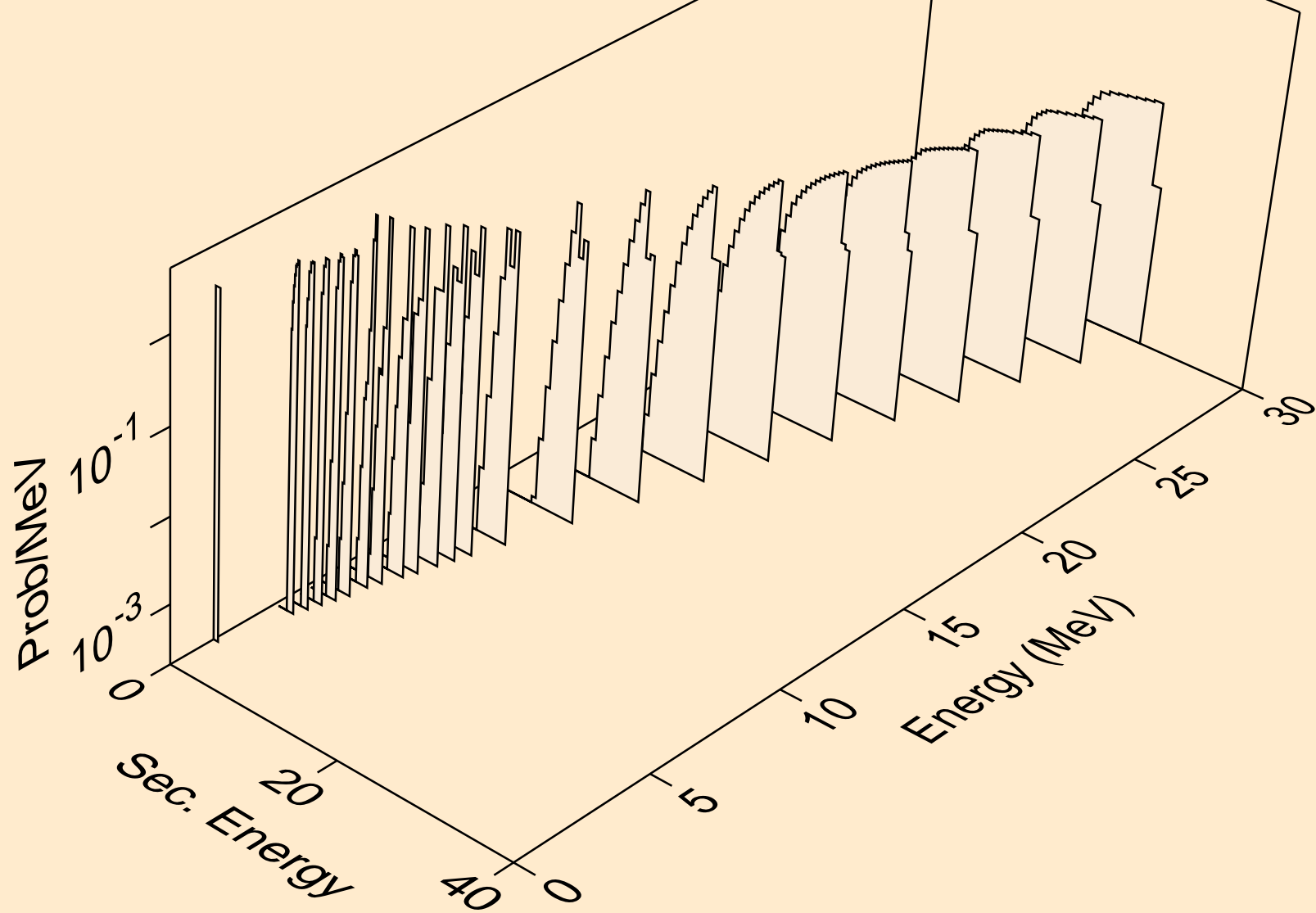

TL196 NEUTRON ACER TENDL-2021 LIBRARY; T=293.6K
deuterons from (n,pd)

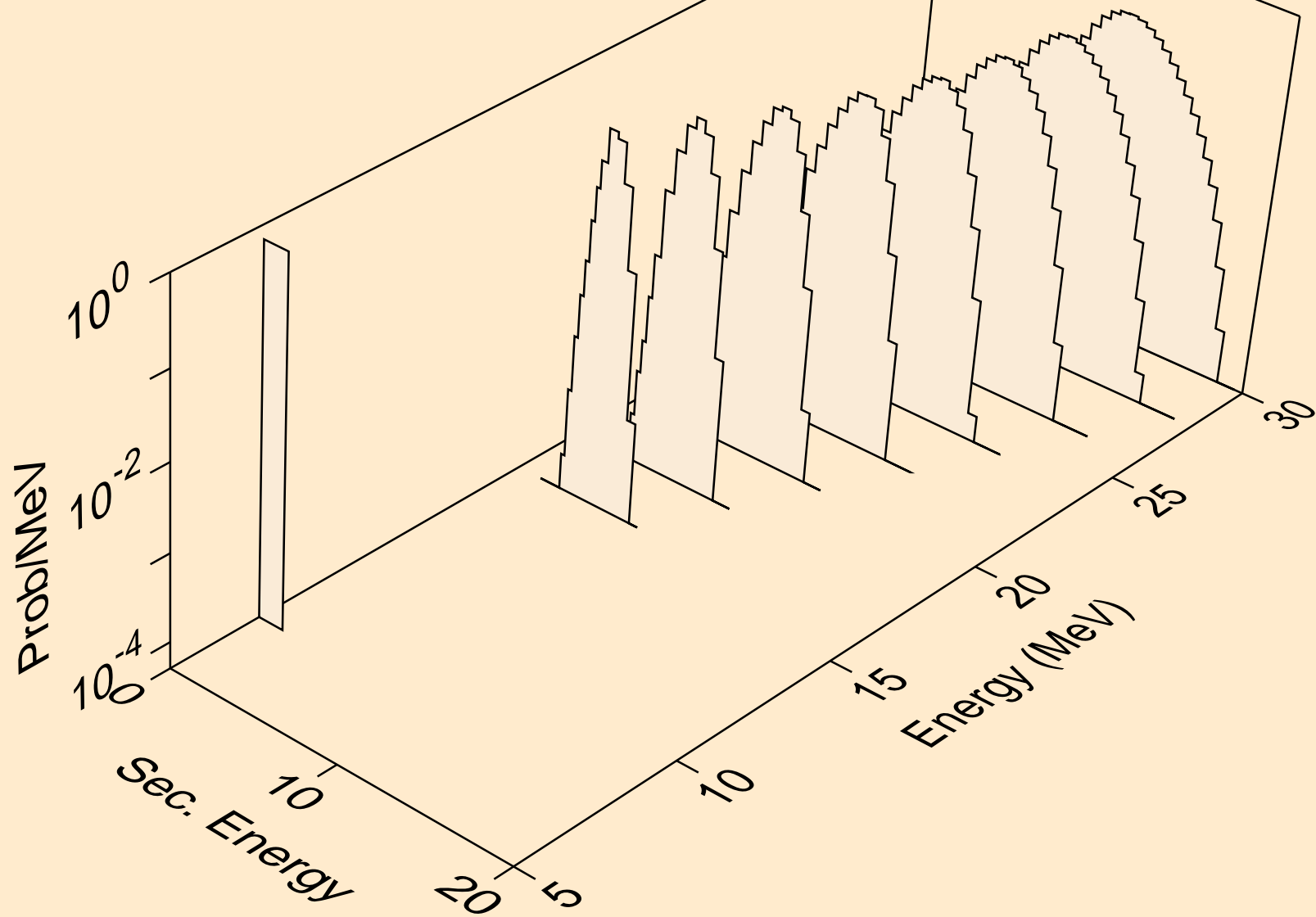

TL196 NEUTRON ACER TENDL-2021 LIBRARY; T=293.6K
deuterons from (n,da)

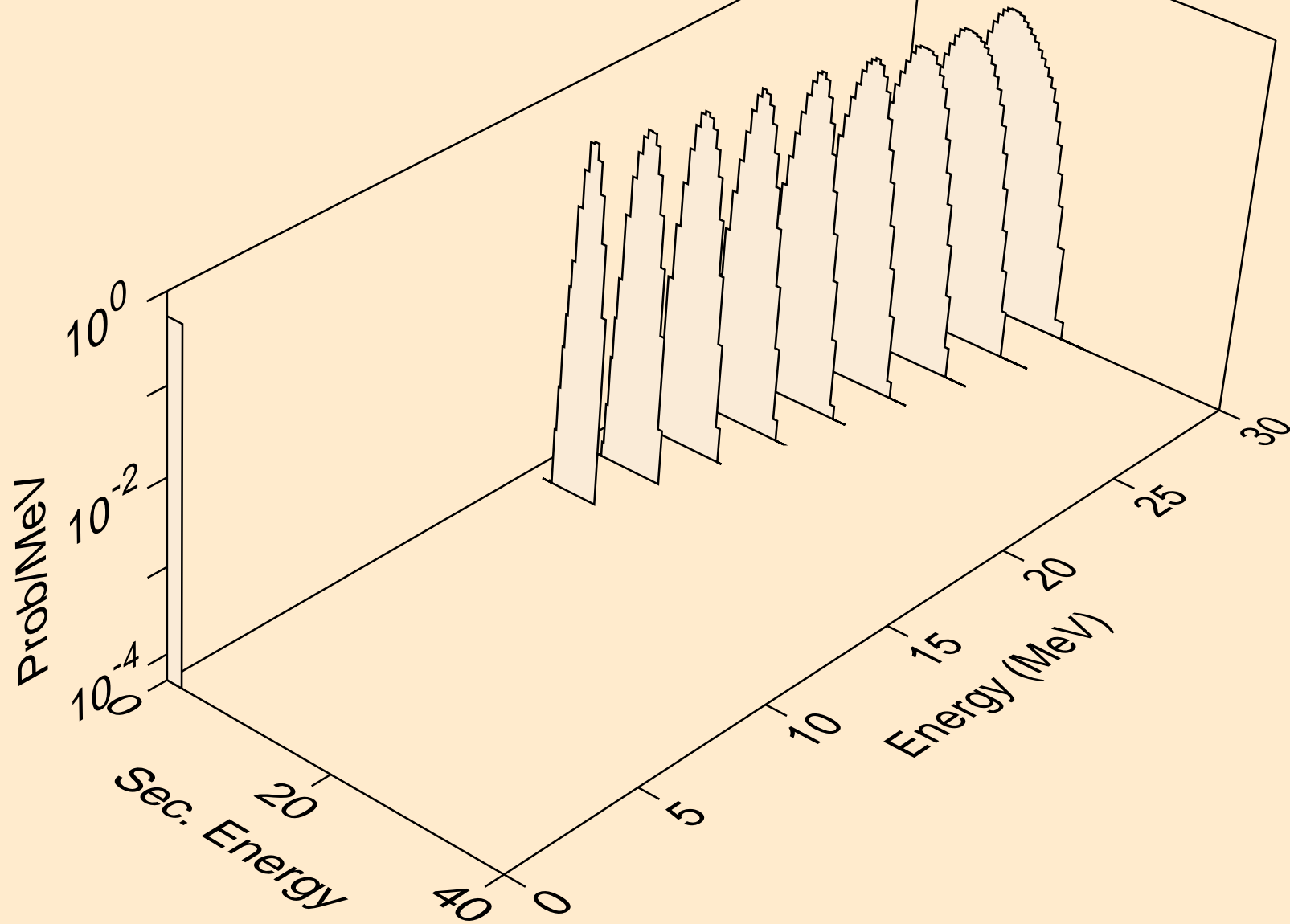

TL196 NEUTRON ACER TENDL-2021 LIBRARY; T=293.6K
tritons from (n,x)

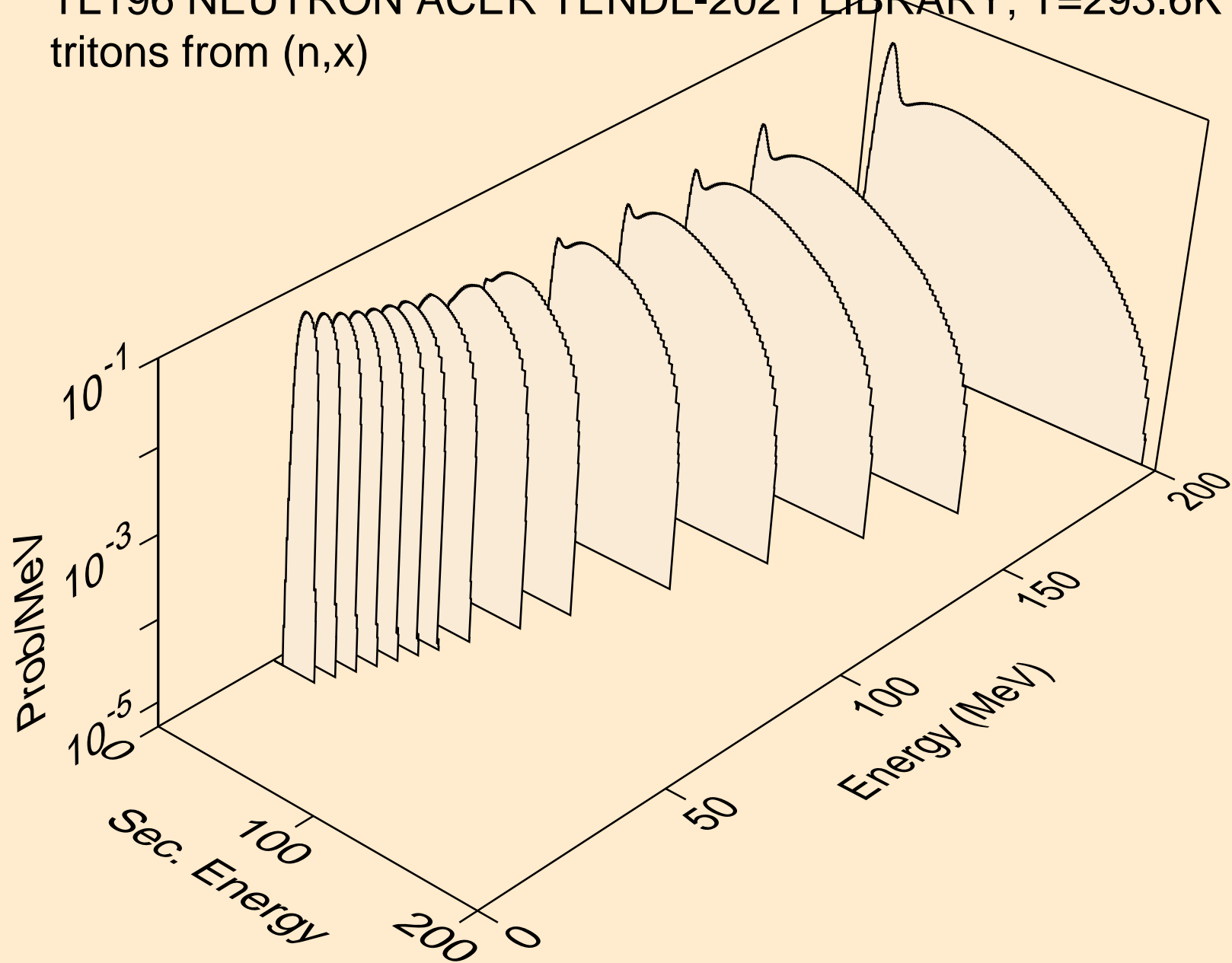

TL196 NEUTRON ACER TENDL-2021 LIBRARY; T=293.6K
tritons from (n,n*)t

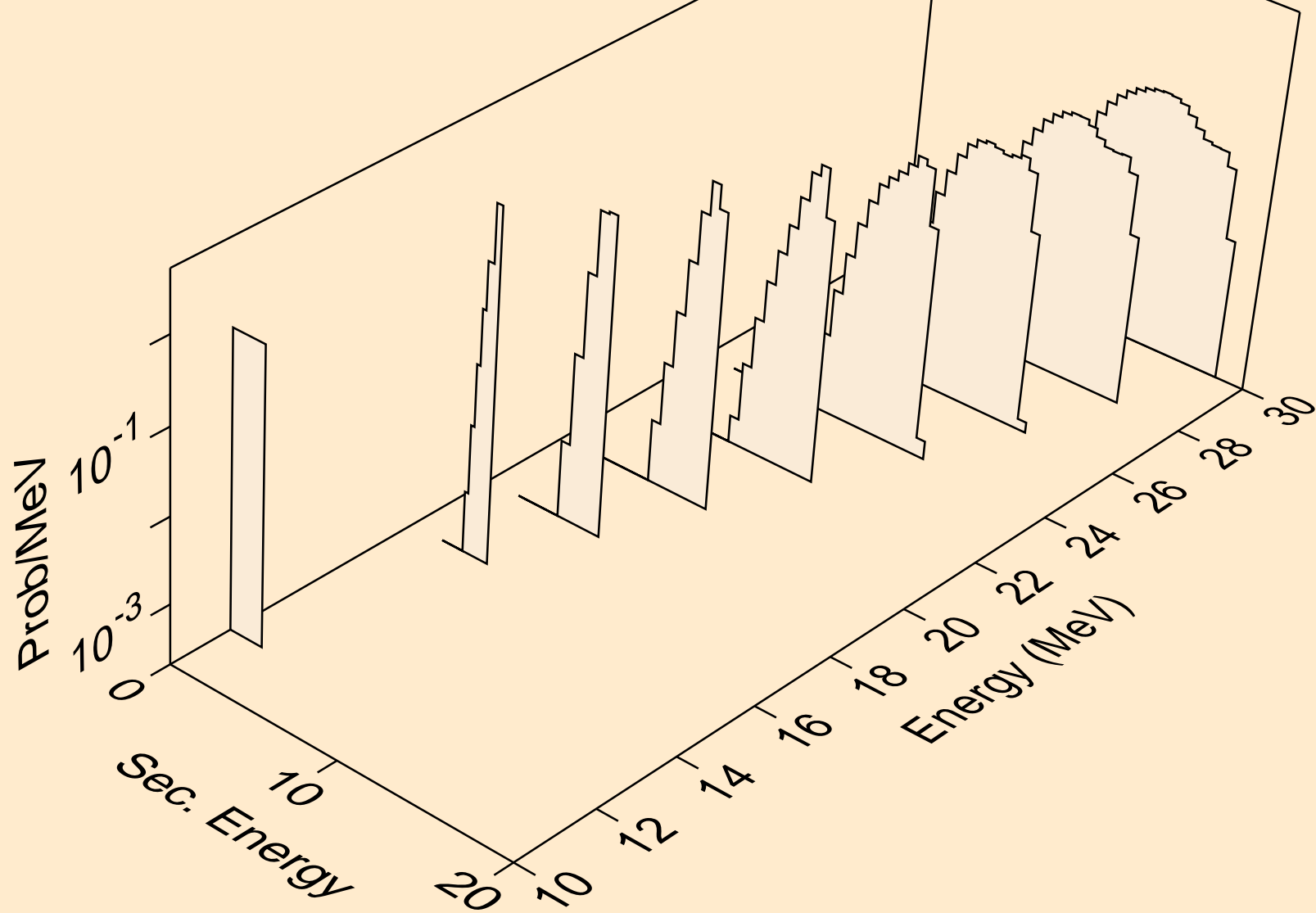

TL196 NEUTRON ACER TENDL-2021 LIBRARY; T=293.6K
tritons from (n,t)

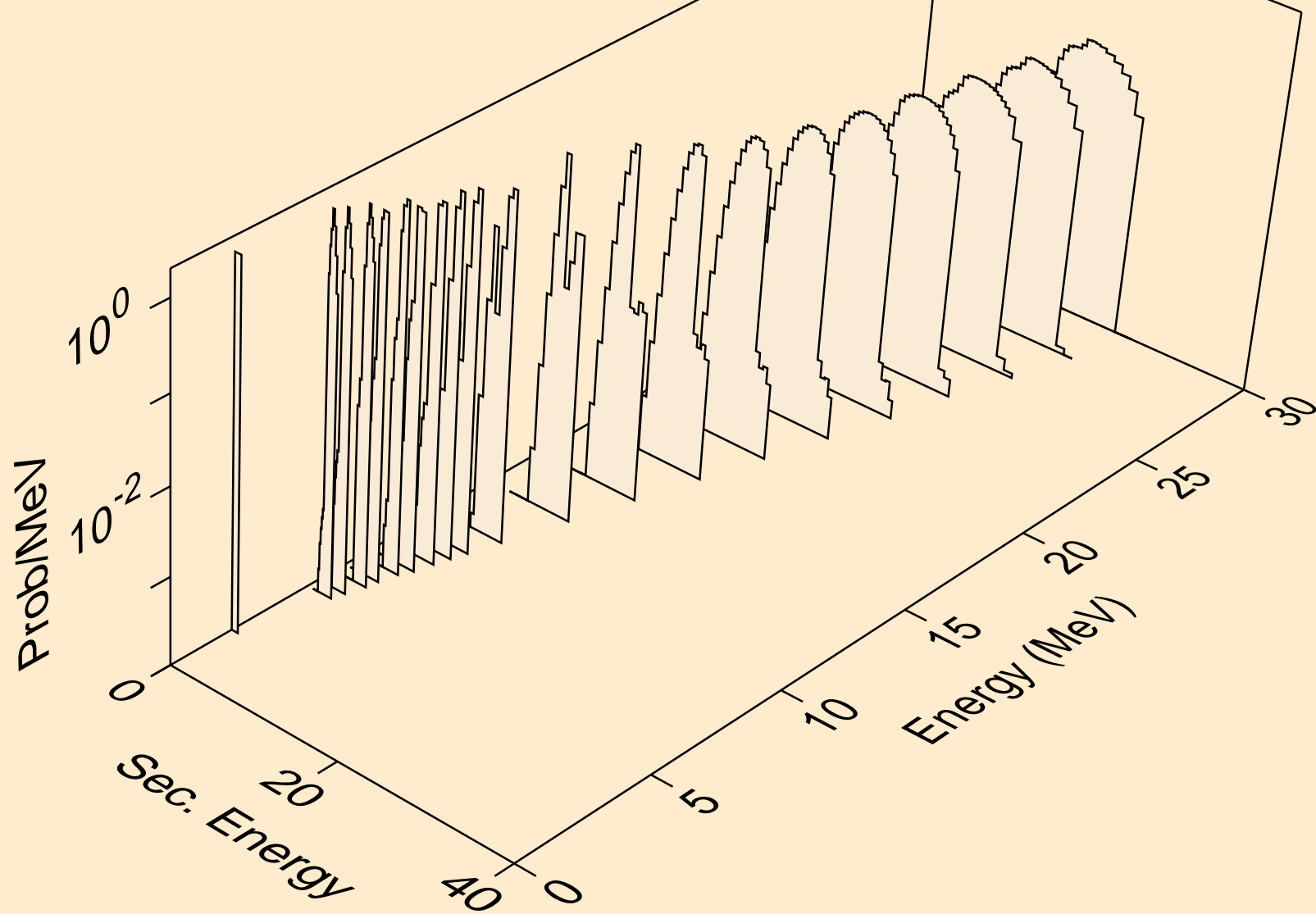

TL196 NEUTRON ACER TENDL-2021 LIBRARY; T=293.6K
tritons from (n,pt)

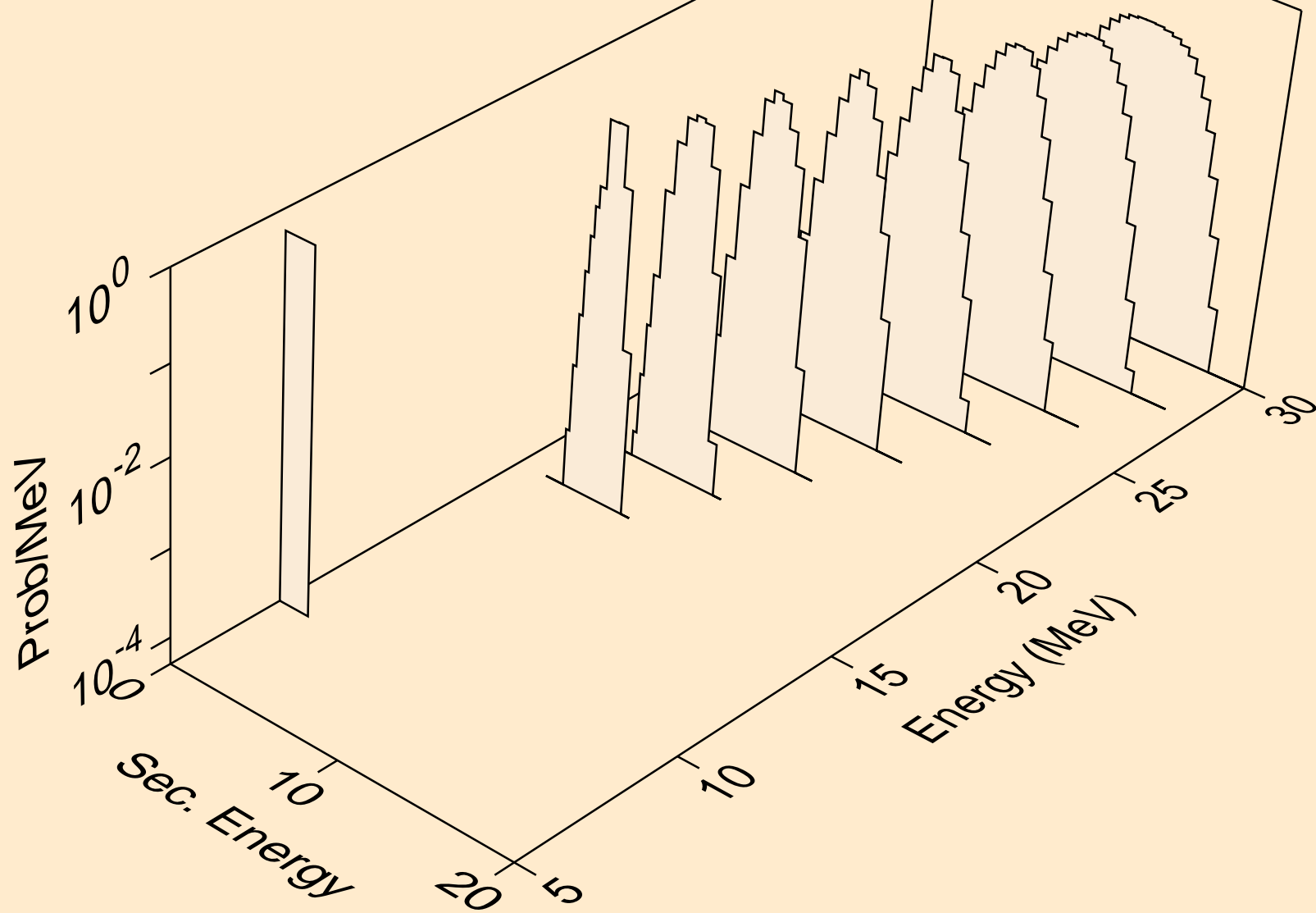

TL196 NEUTRON ACER TENDL-2021 LIBRARY; T=293.6K
he3s from (n,x)

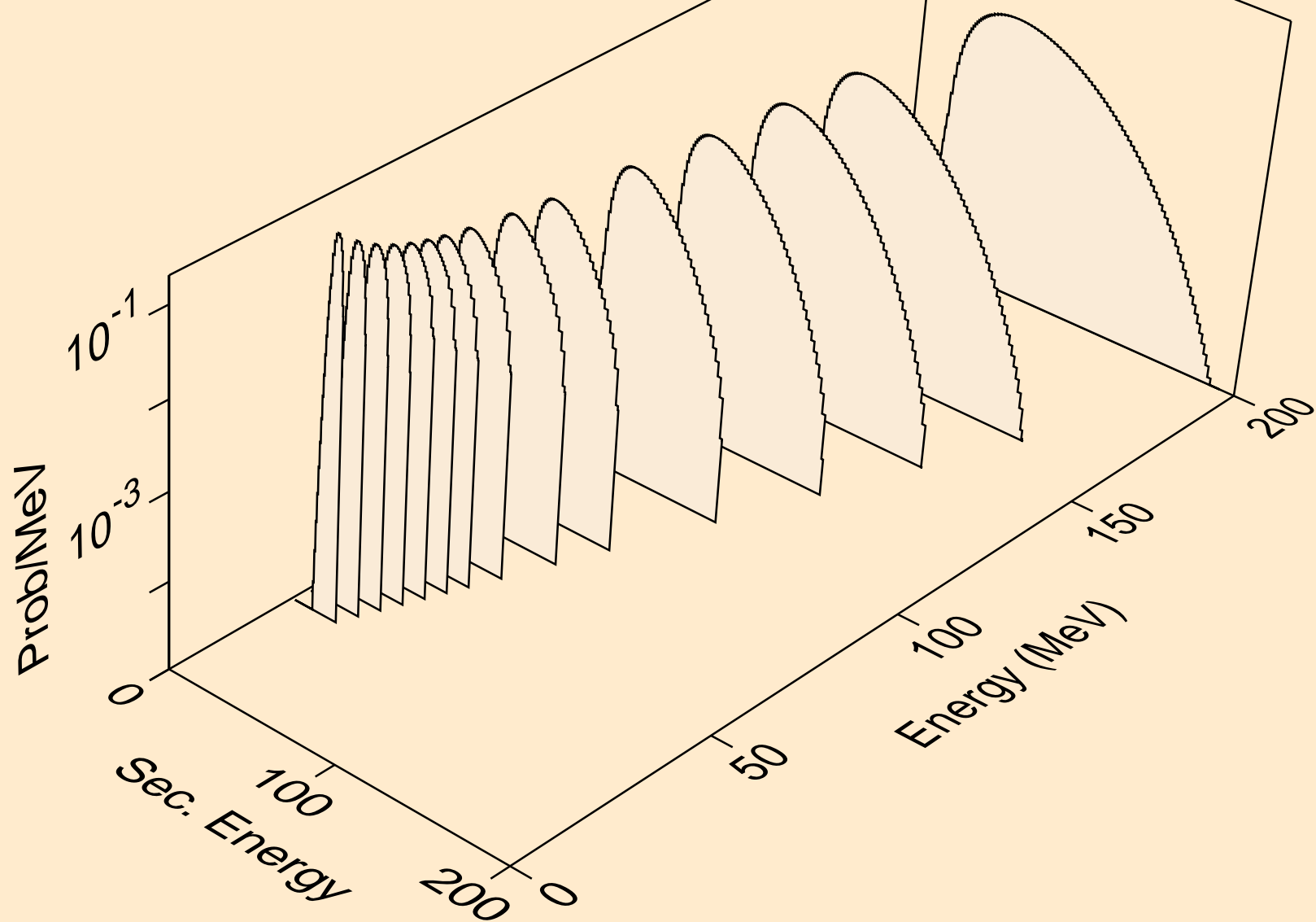

TL196 NEUTRON ACER TENDL-2021 LIBRARY; T=293.6K
he3s from (n,n*)he3

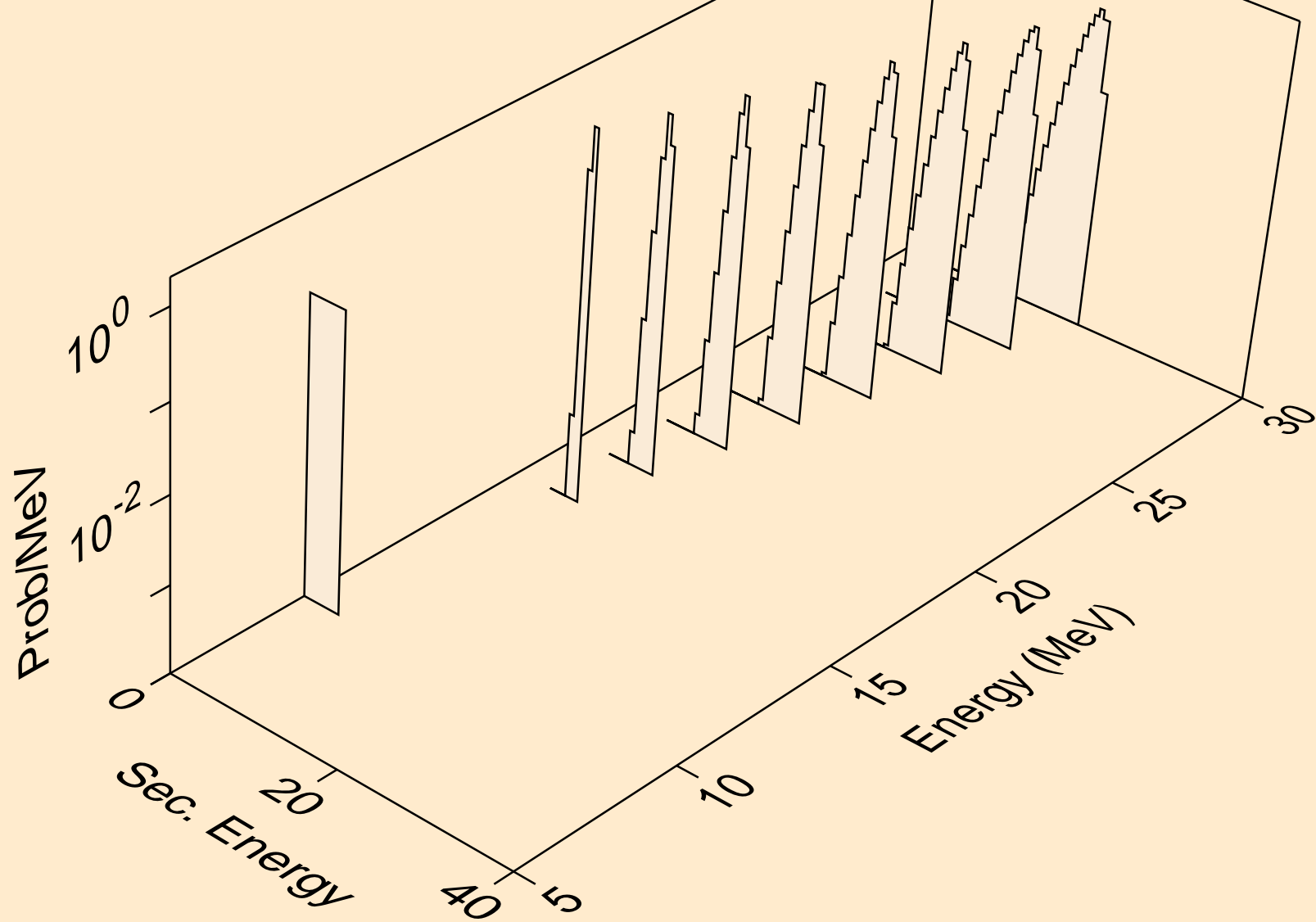

TL196 NEUTRON ACER TENDL-2021 LIBRARY; T=293.6K
he3s from (n,he3)

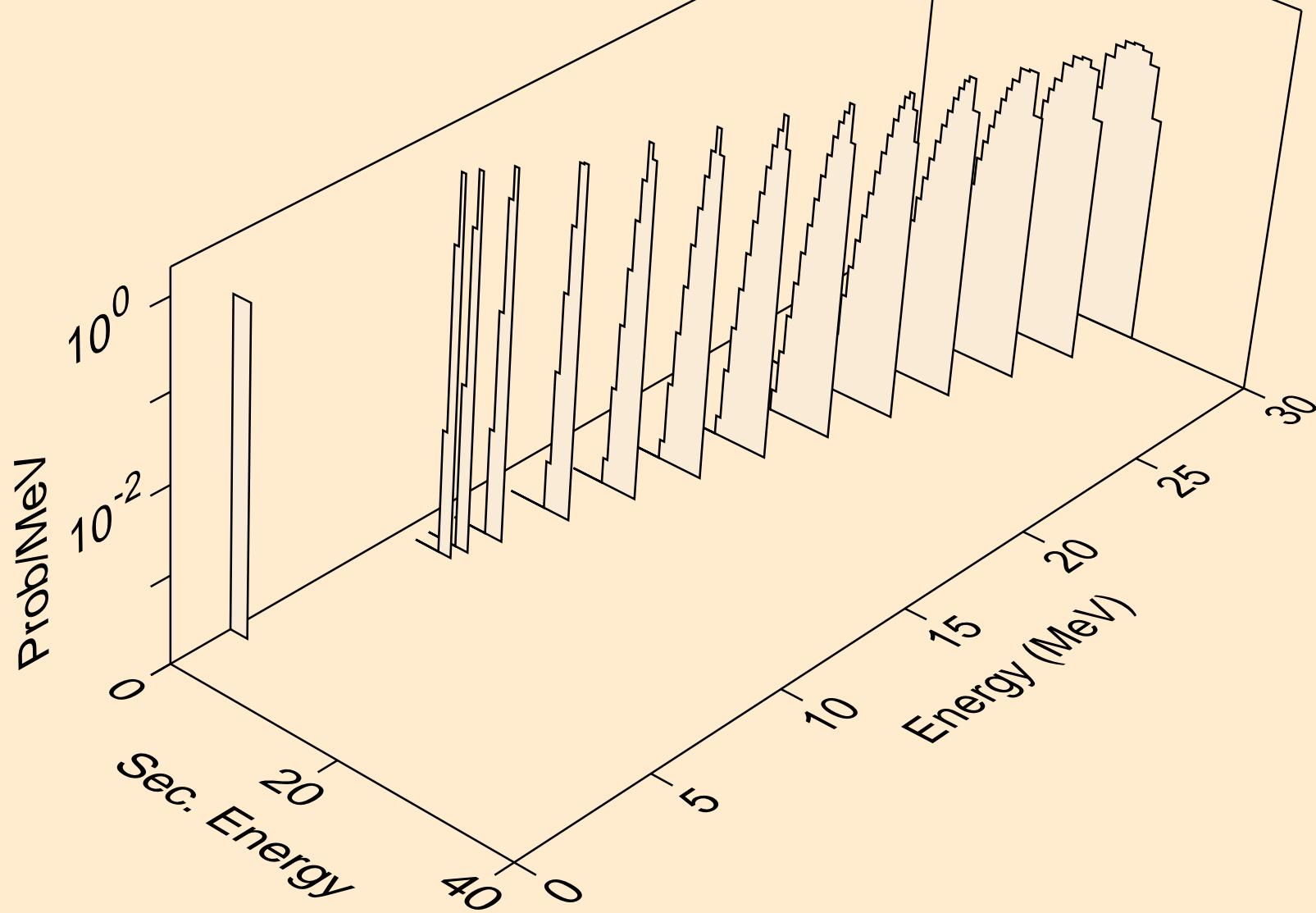

TL196 NEUTRON ACER TENDL-2021 LIBRARY; T=293.6K
alphas from (n,x)

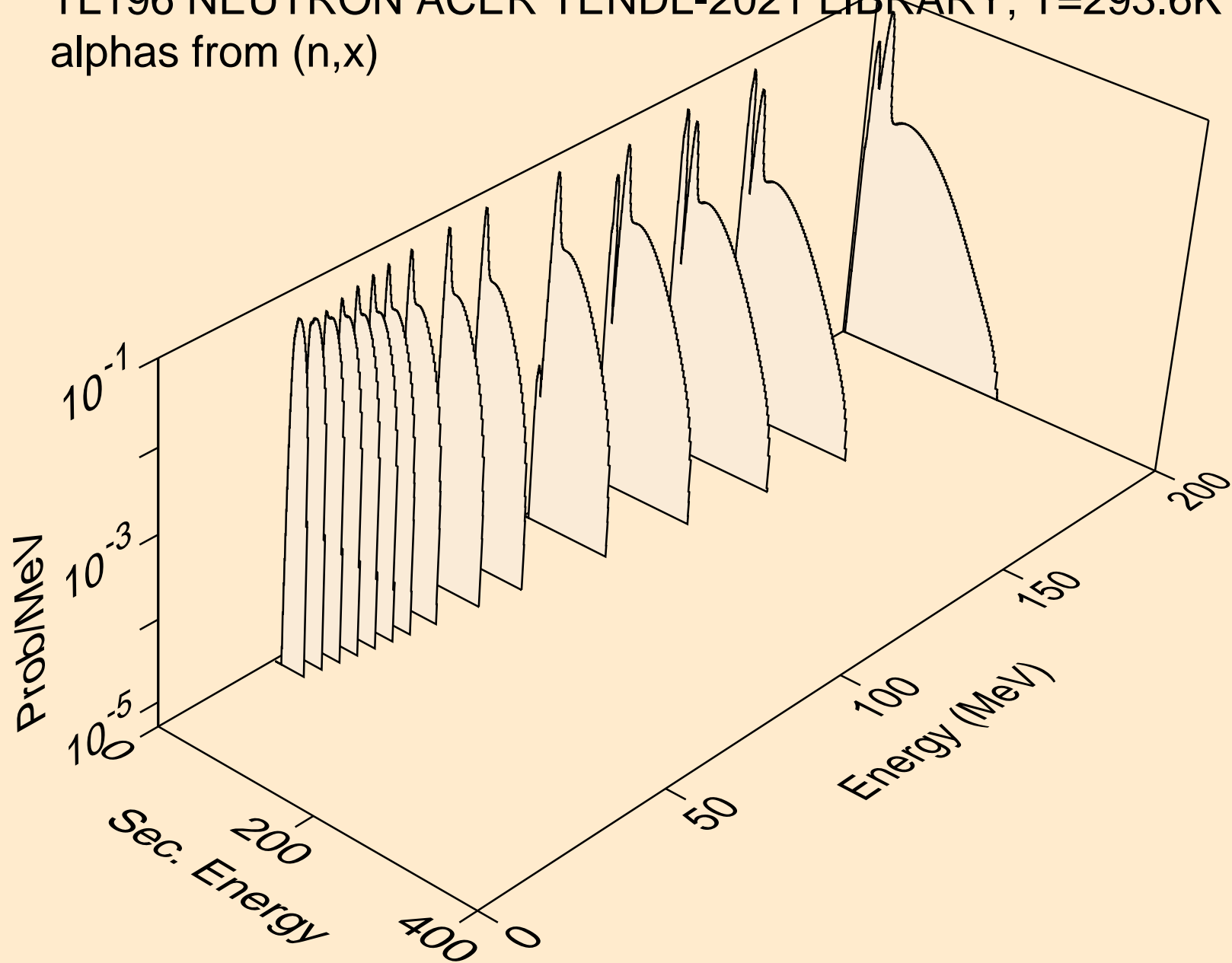

TL196 NEUTRON ACER TENDL-2021 LIBRARY; T=293.6K
alphas from (n,n*)a

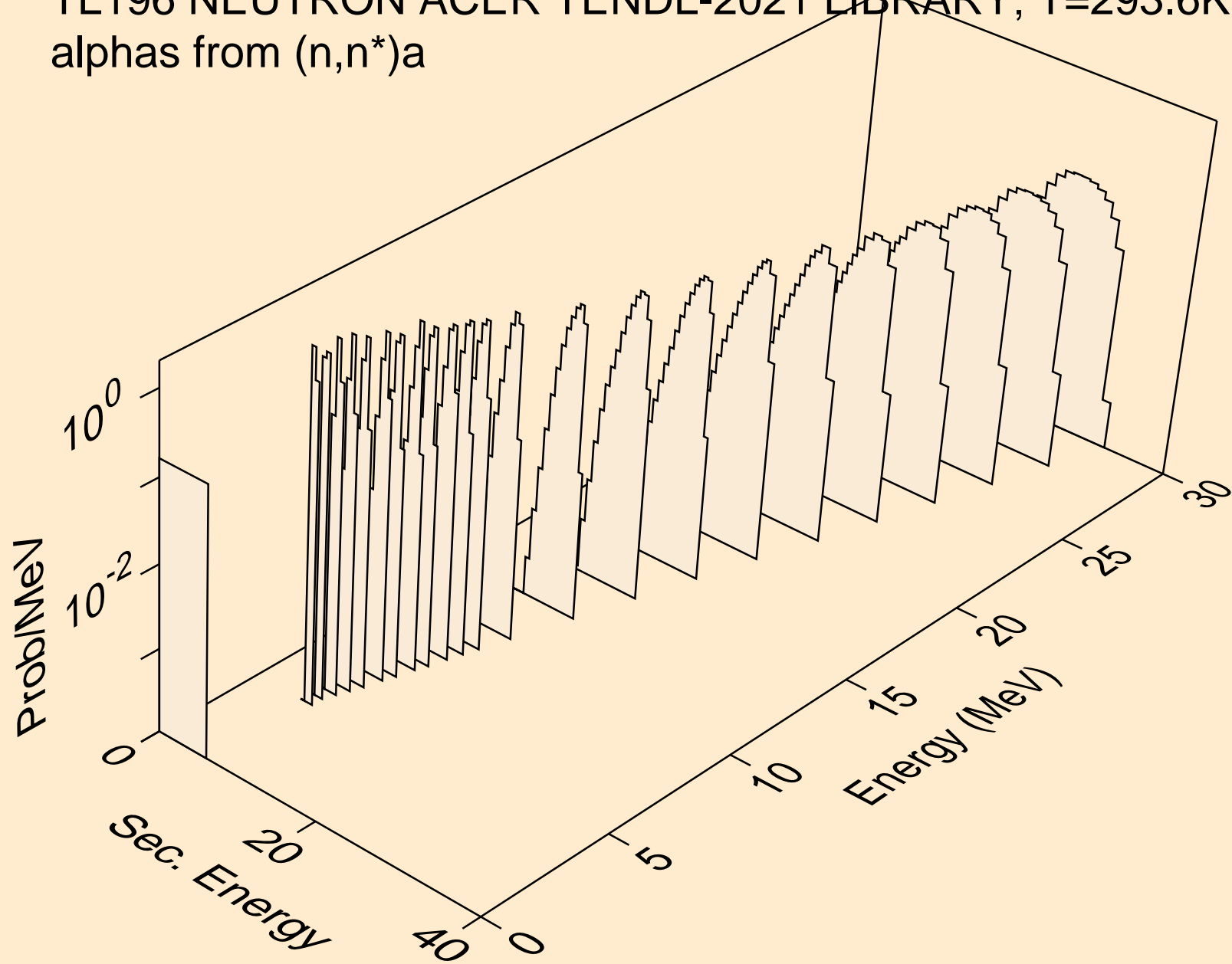

TL196 NEUTRON ACER TENDL-2021 LIBRARY; T=293.6K
alphas from (n,2n)a

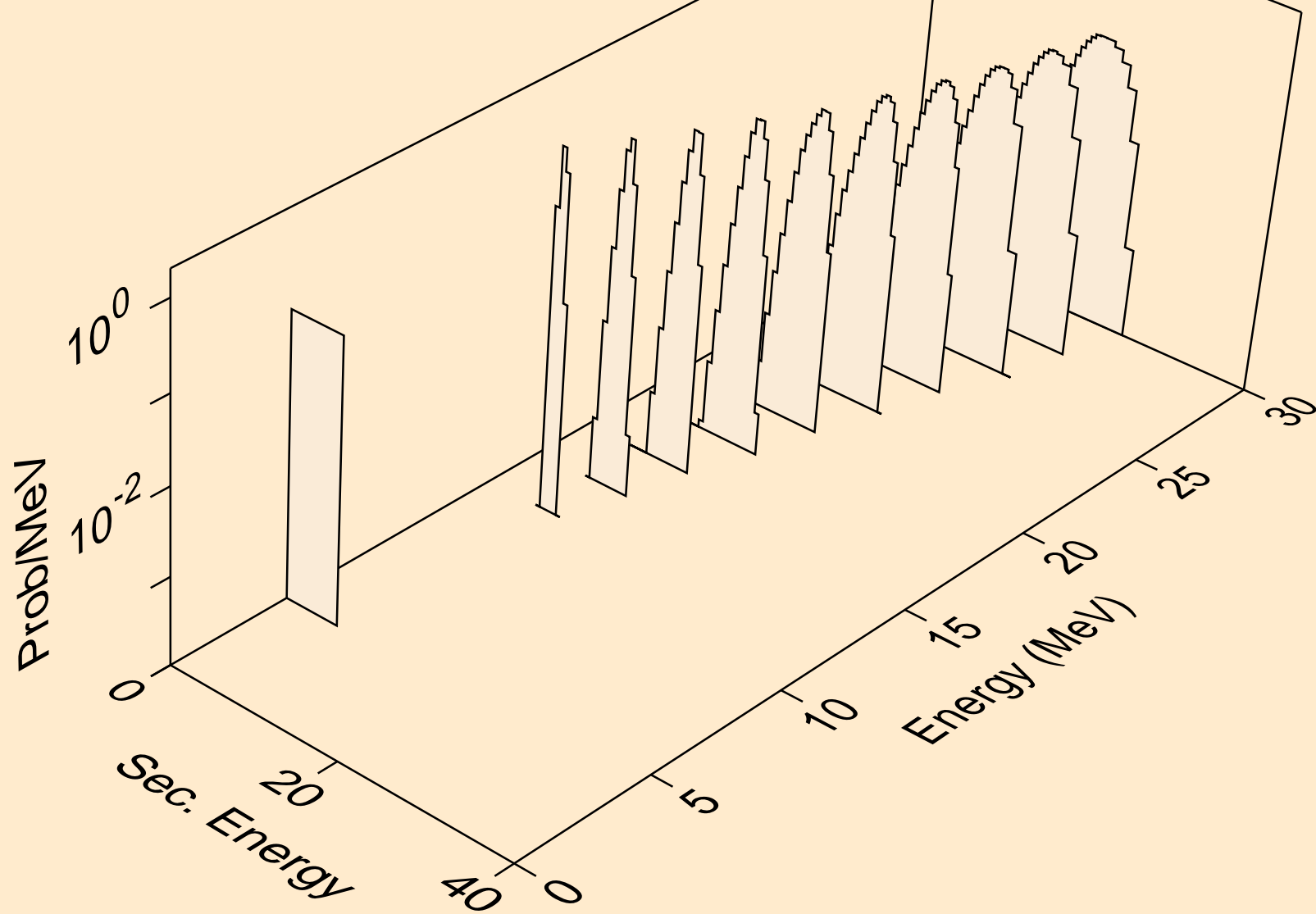

TL196 NEUTRON ACER TENDL-2021 LIBRARY; T=293.6K
alphas from (n,3n)a

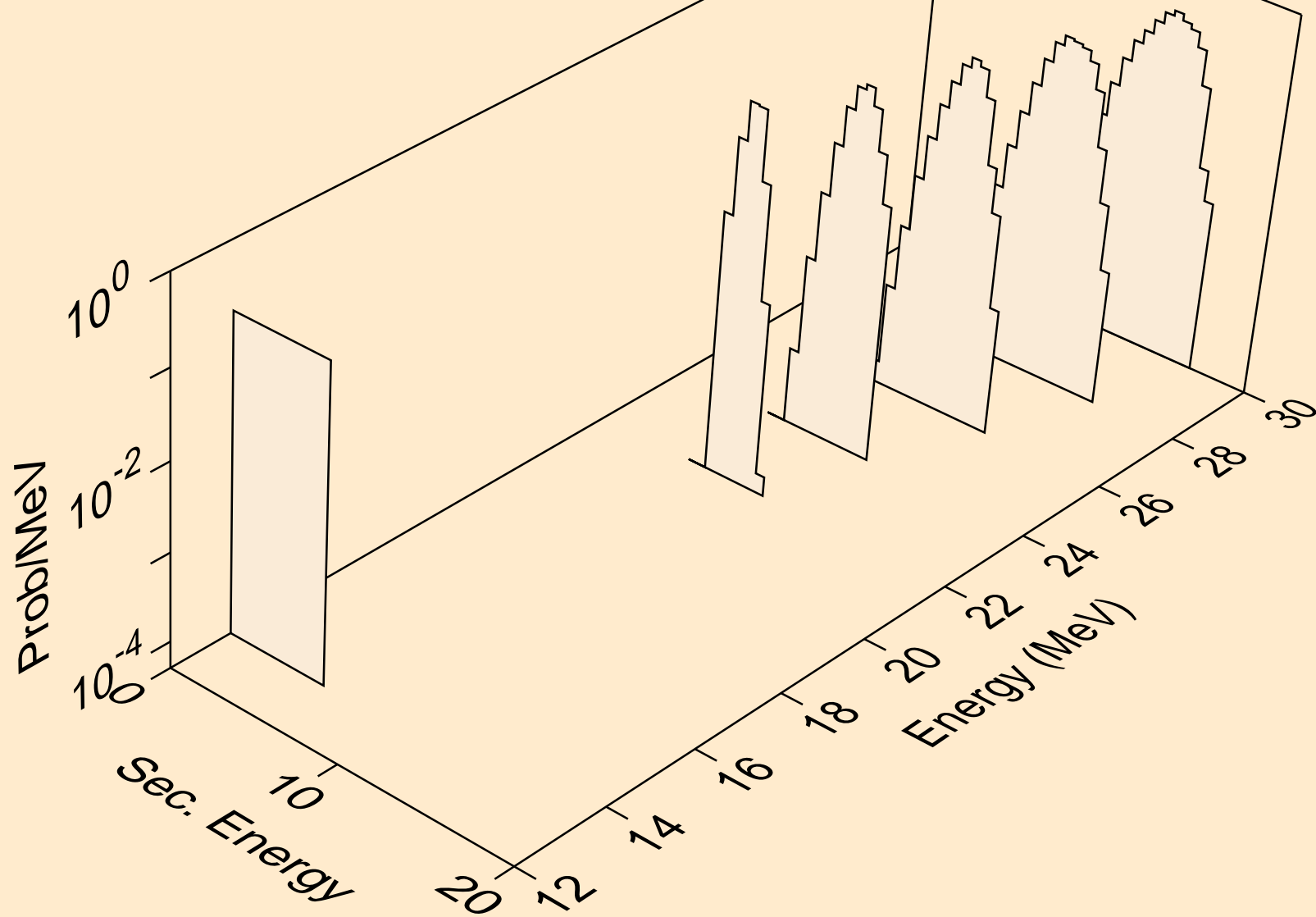

TL196 NEUTRON ACER TENDL-2021 LIBRARY; T=293.6K
alphas from (n,n*)2a

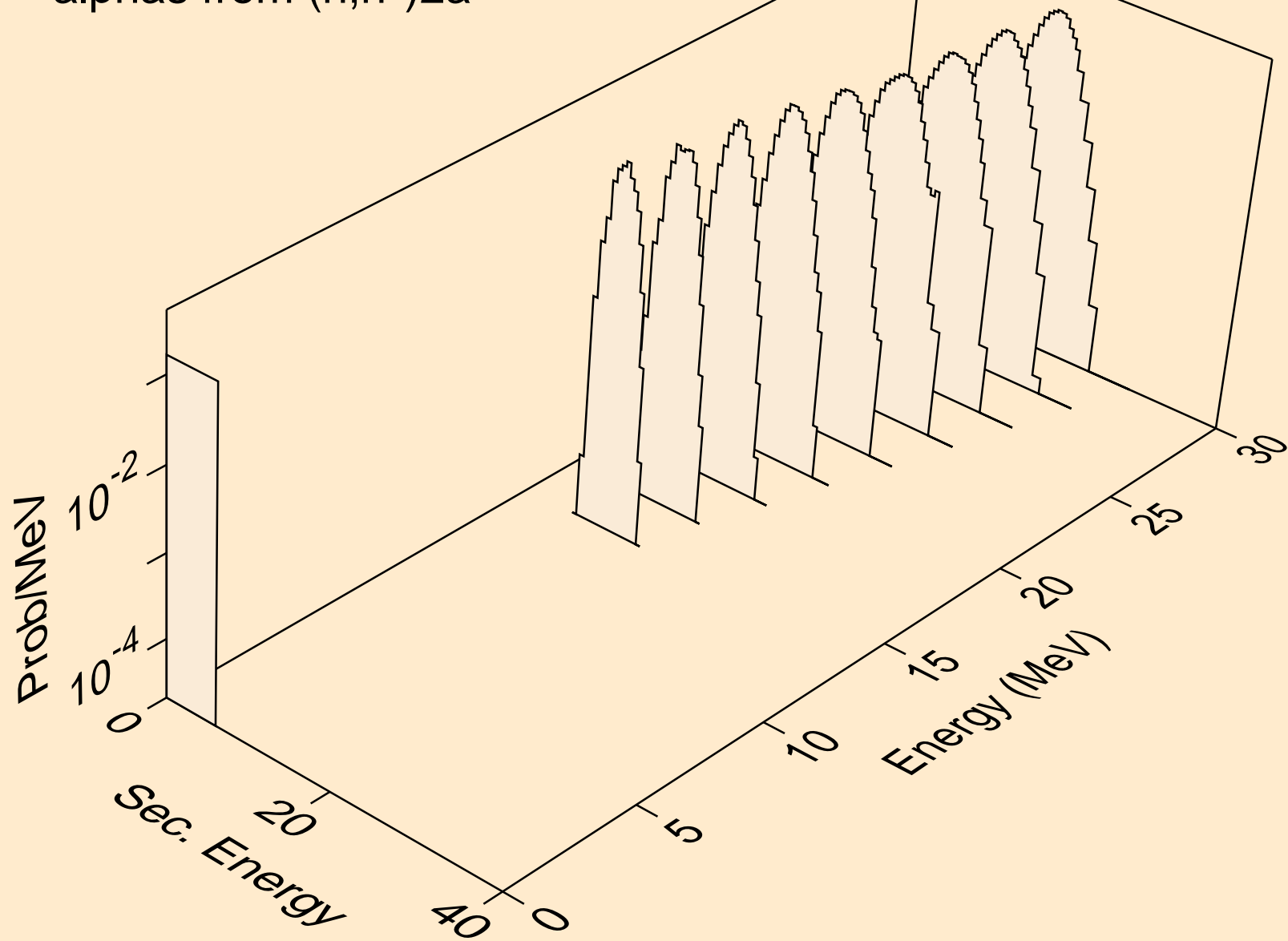

TL196 NEUTRON ACER TENDL-2021 LIBRARY; T=293.6K
alphas from (n,npa)

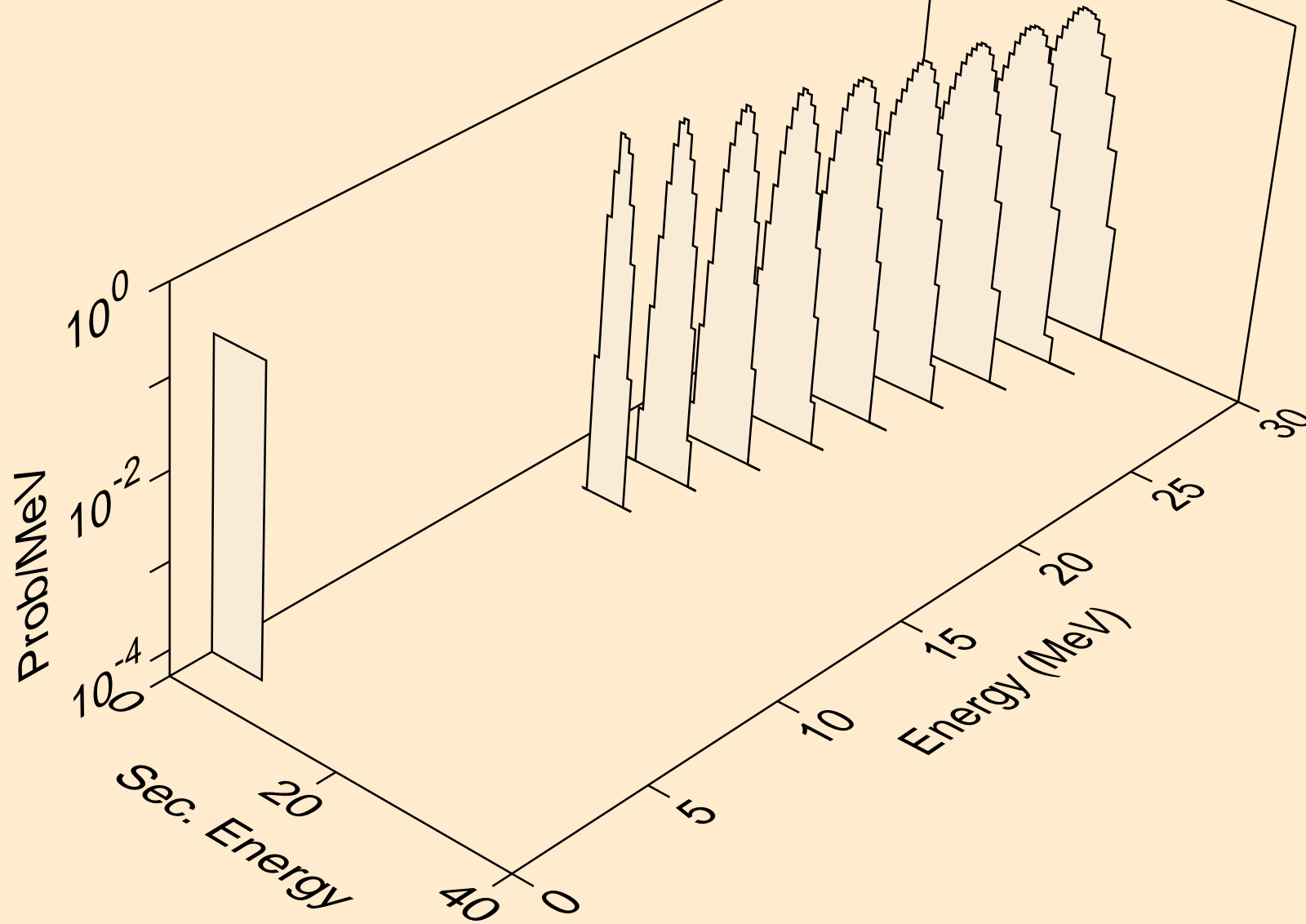

TL196 NEUTRON ACER TENDL-2021 LIBRARY; T=293.6K
alphas from (n,a)

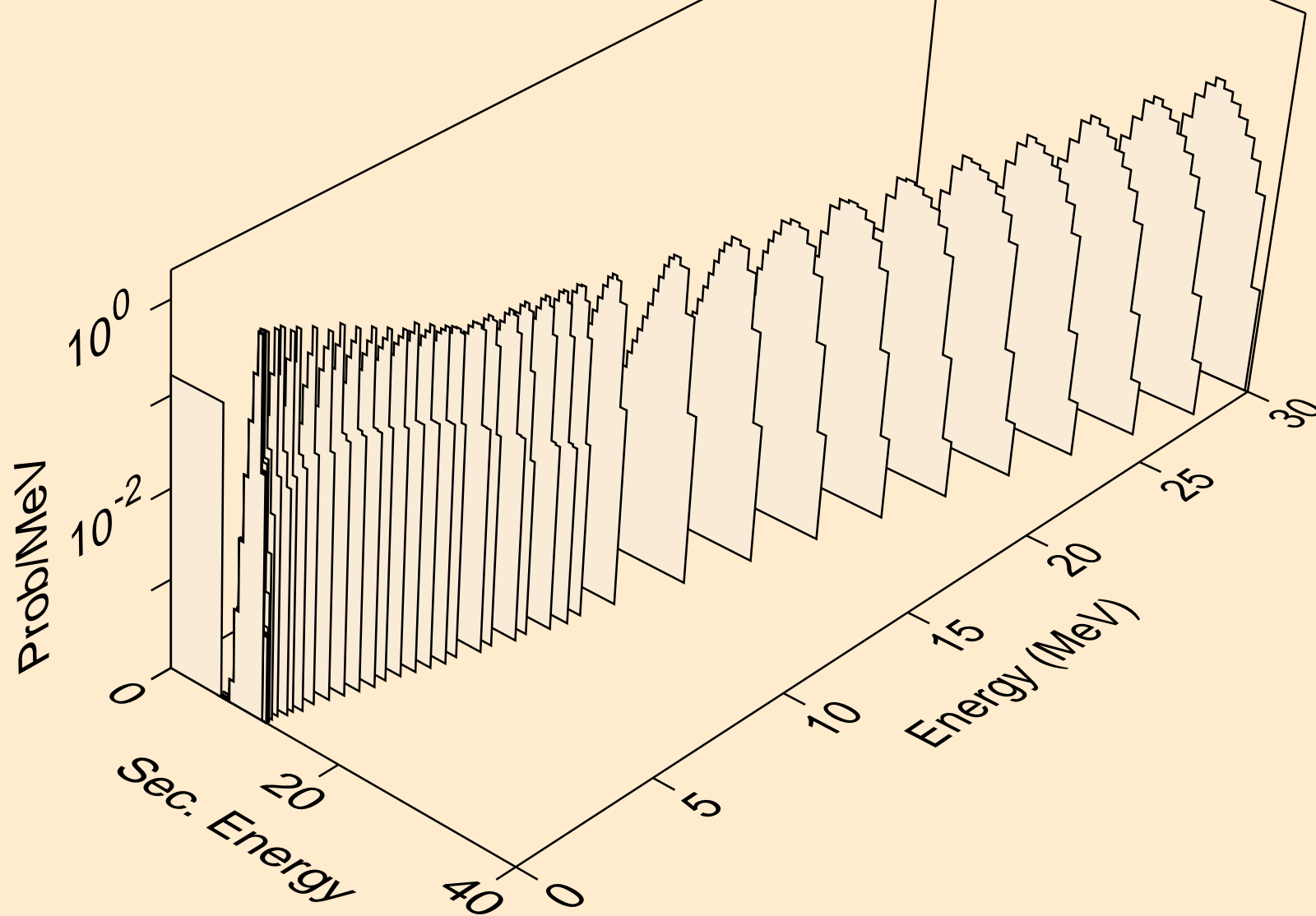

TL196 NEUTRON ACER TENDL-2021 LIBRARY; T=293.6K
alphas from (n,2a)

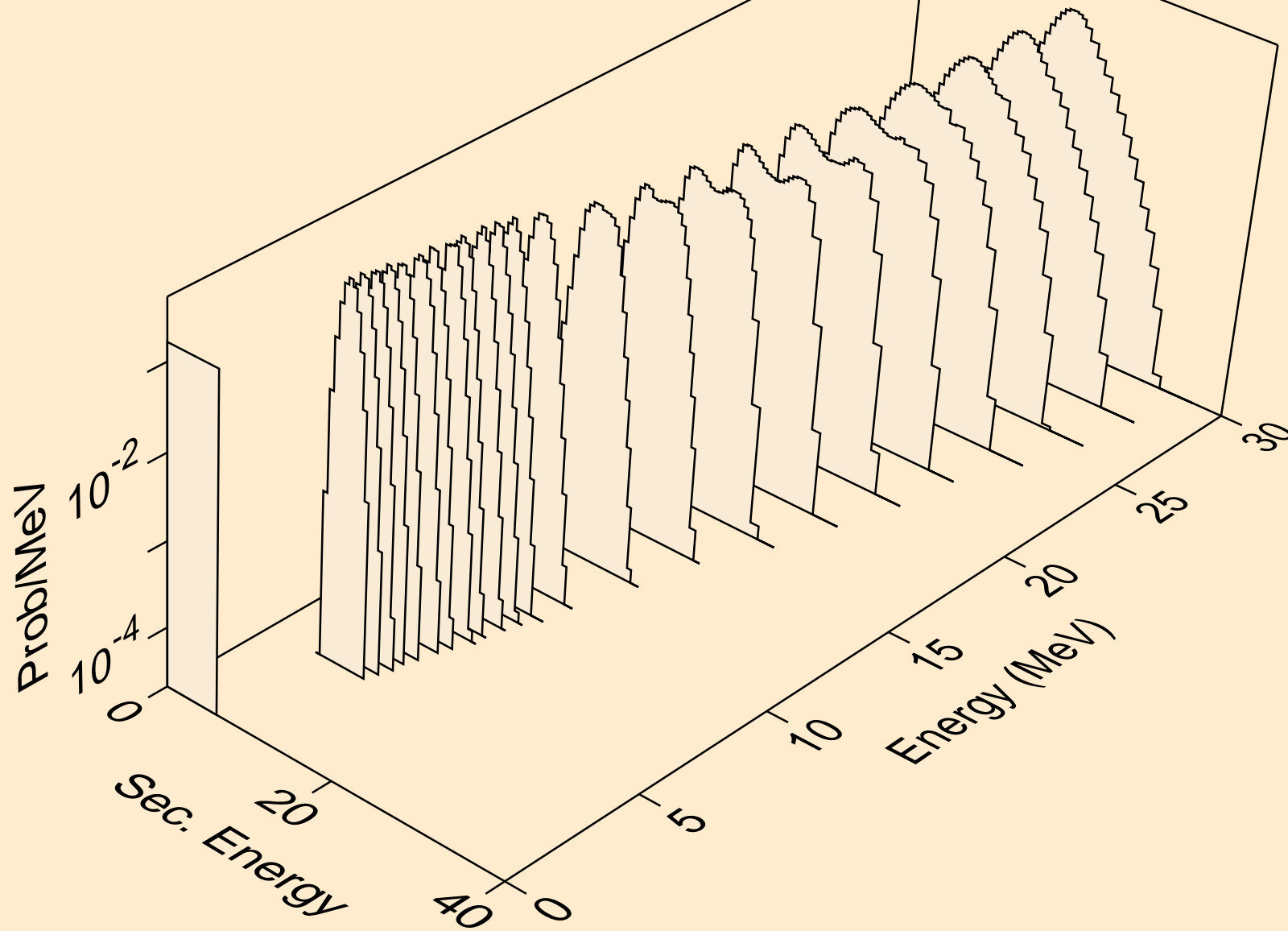

TL196 NEUTRON ACER TENDL-2021 LIBRARY; T=293.6K
alphas from (n,pa)

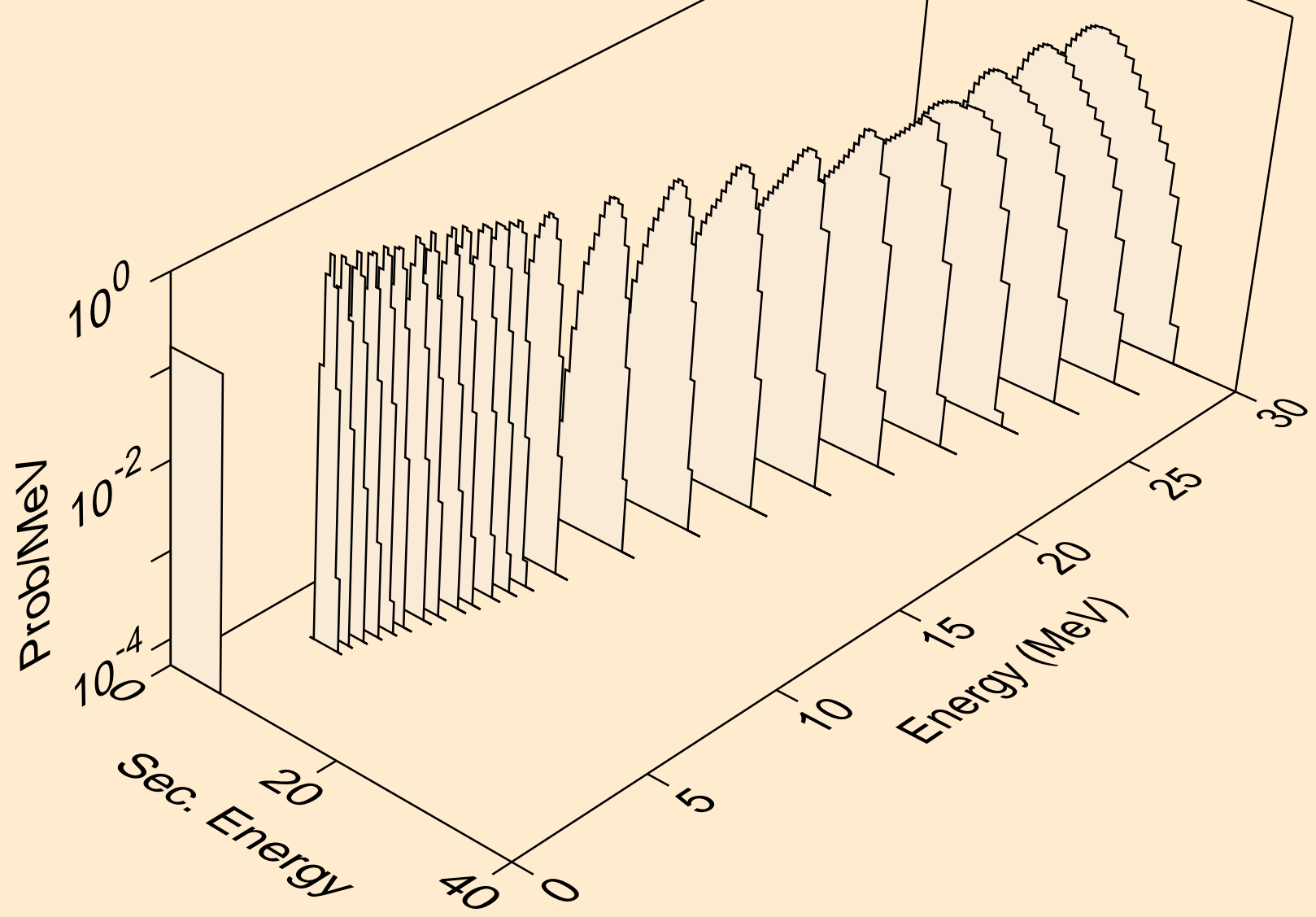

TL196 NEUTRON ACER TENDL-2021 LIBRARY; T=293.6K
alphas from (n,da)

