

TL207 NEUTRON ACER TENDL-2021 LIBRARY; T=293.6K  
Principal cross sections

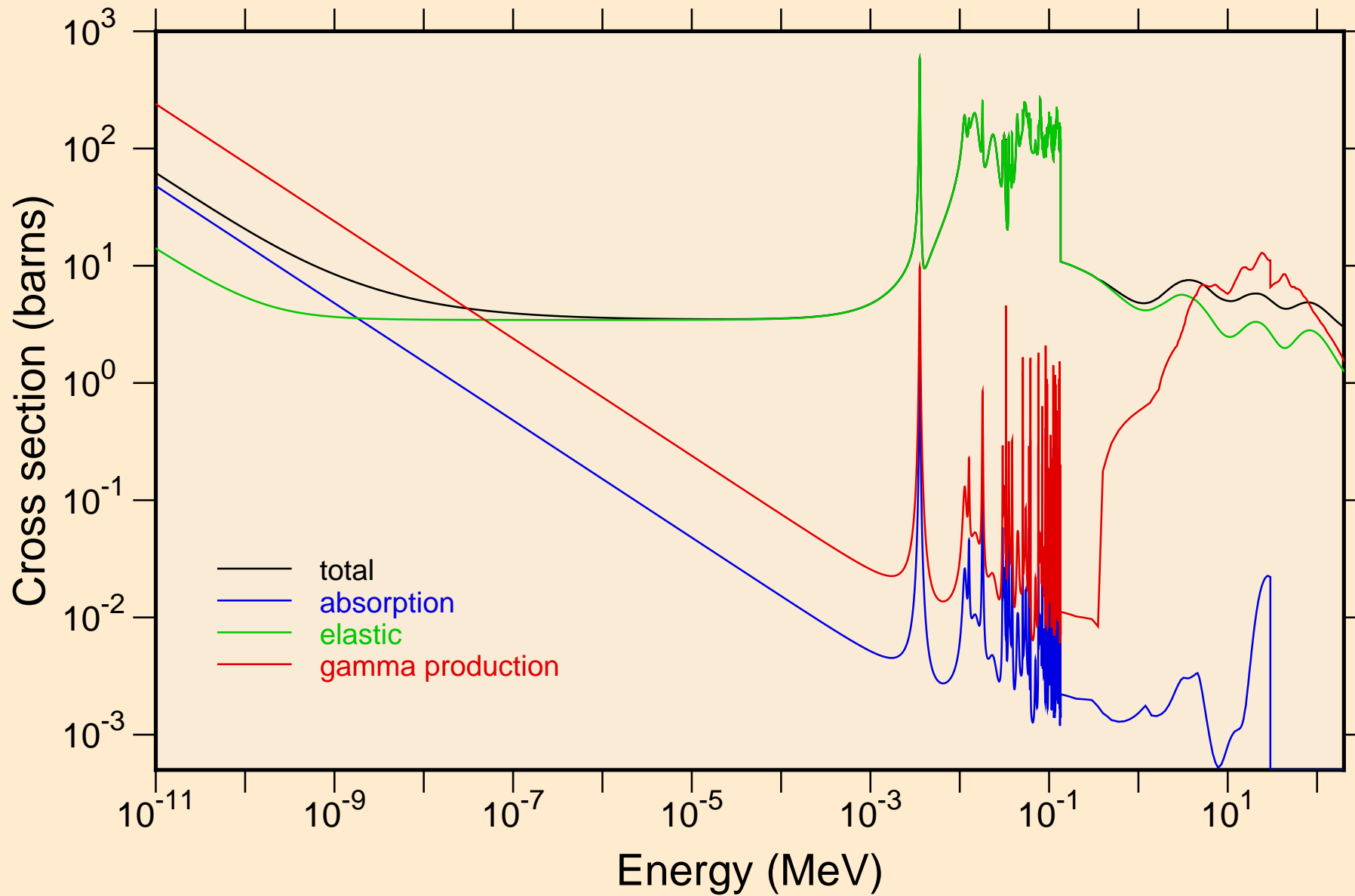

TL207 NEUTRON ACER TENDL-2021 LIBRARY; T=293.6K  
resonance total cross section

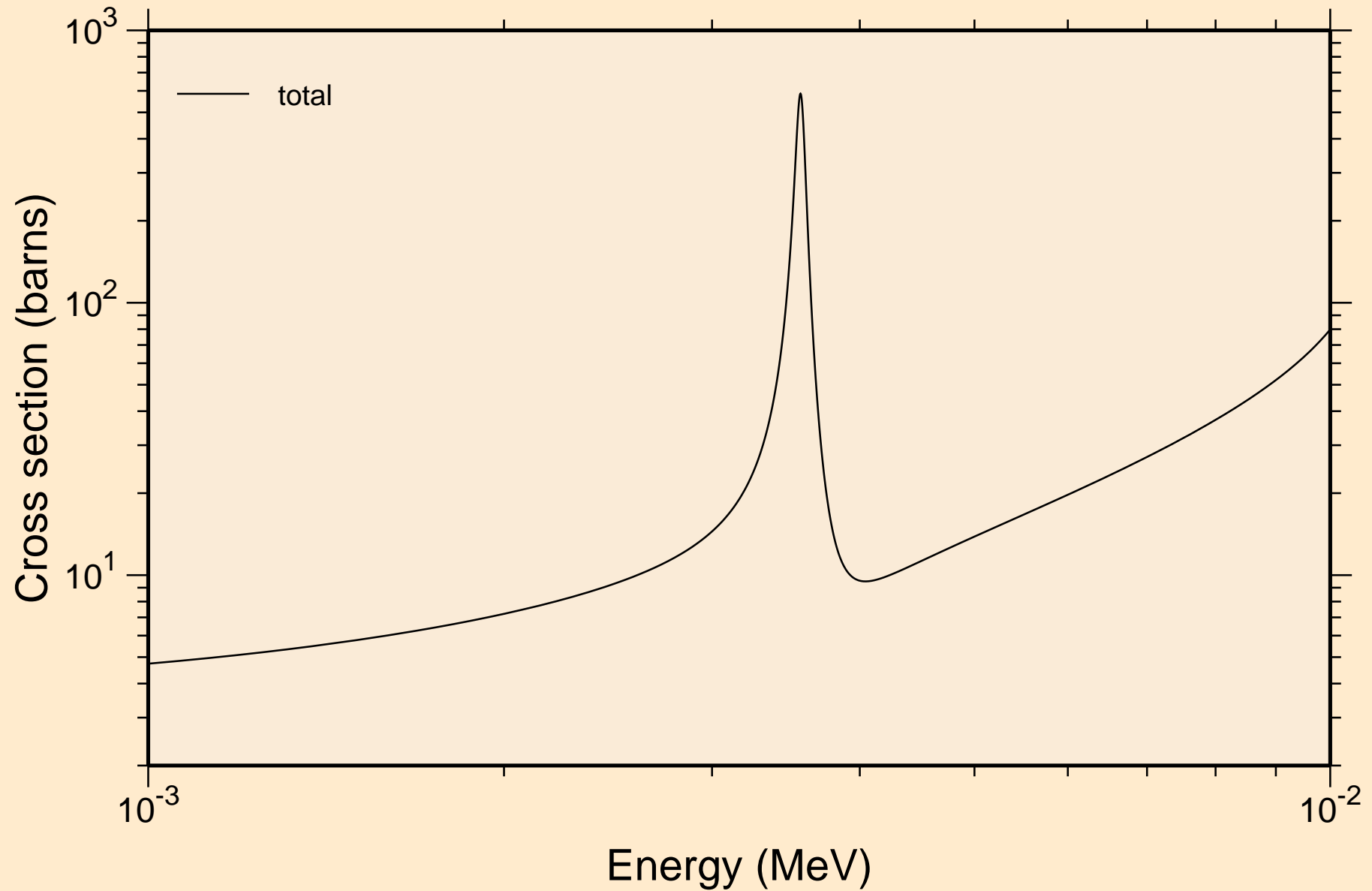

TL207 NEUTRON ACER TENDL-2021 LIBRARY; T=293.6K  
resonance total cross section

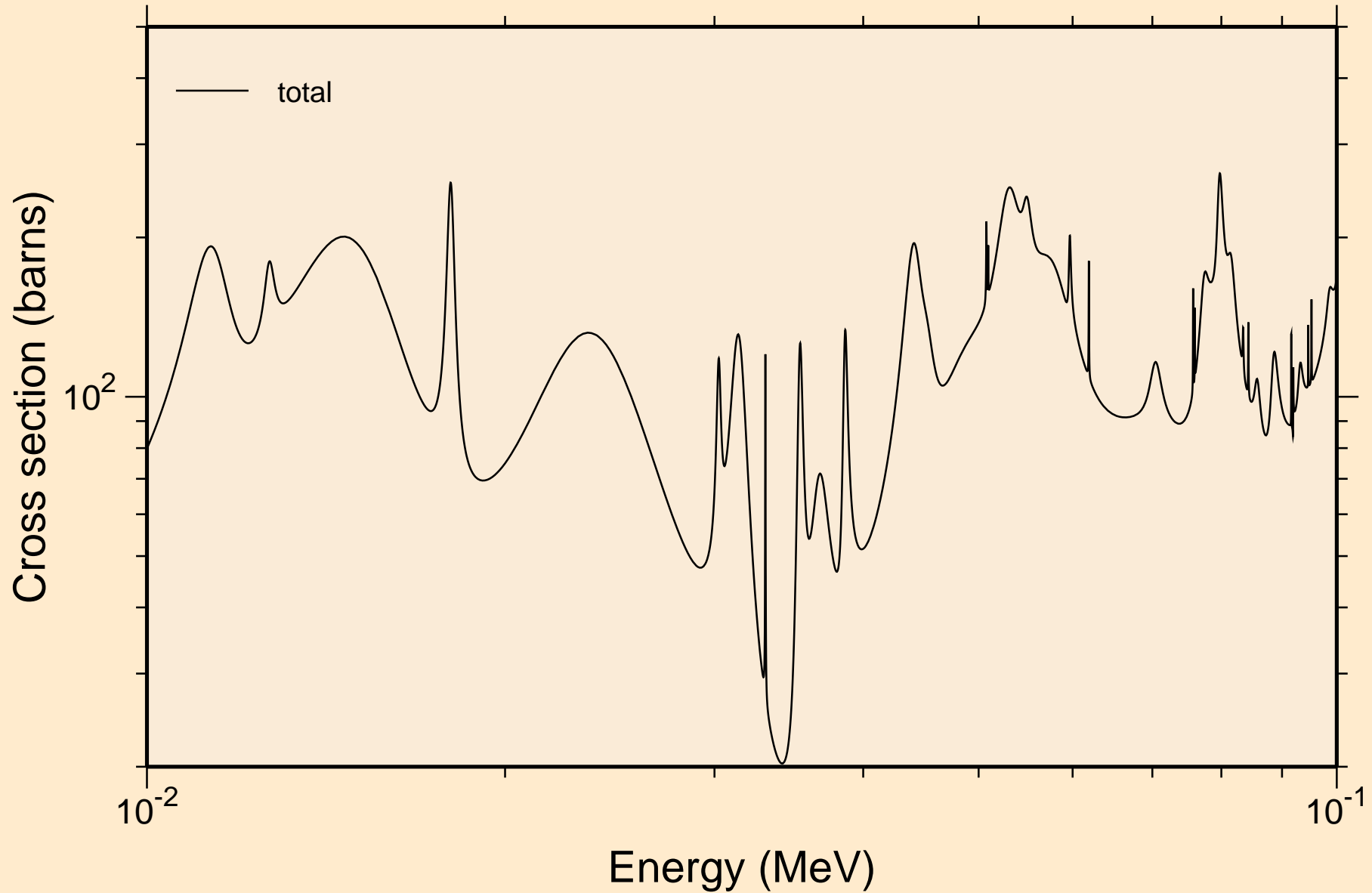

TL207 NEUTRON ACER TENDL-2021 LIBRARY; T=293.6K  
resonance total cross section

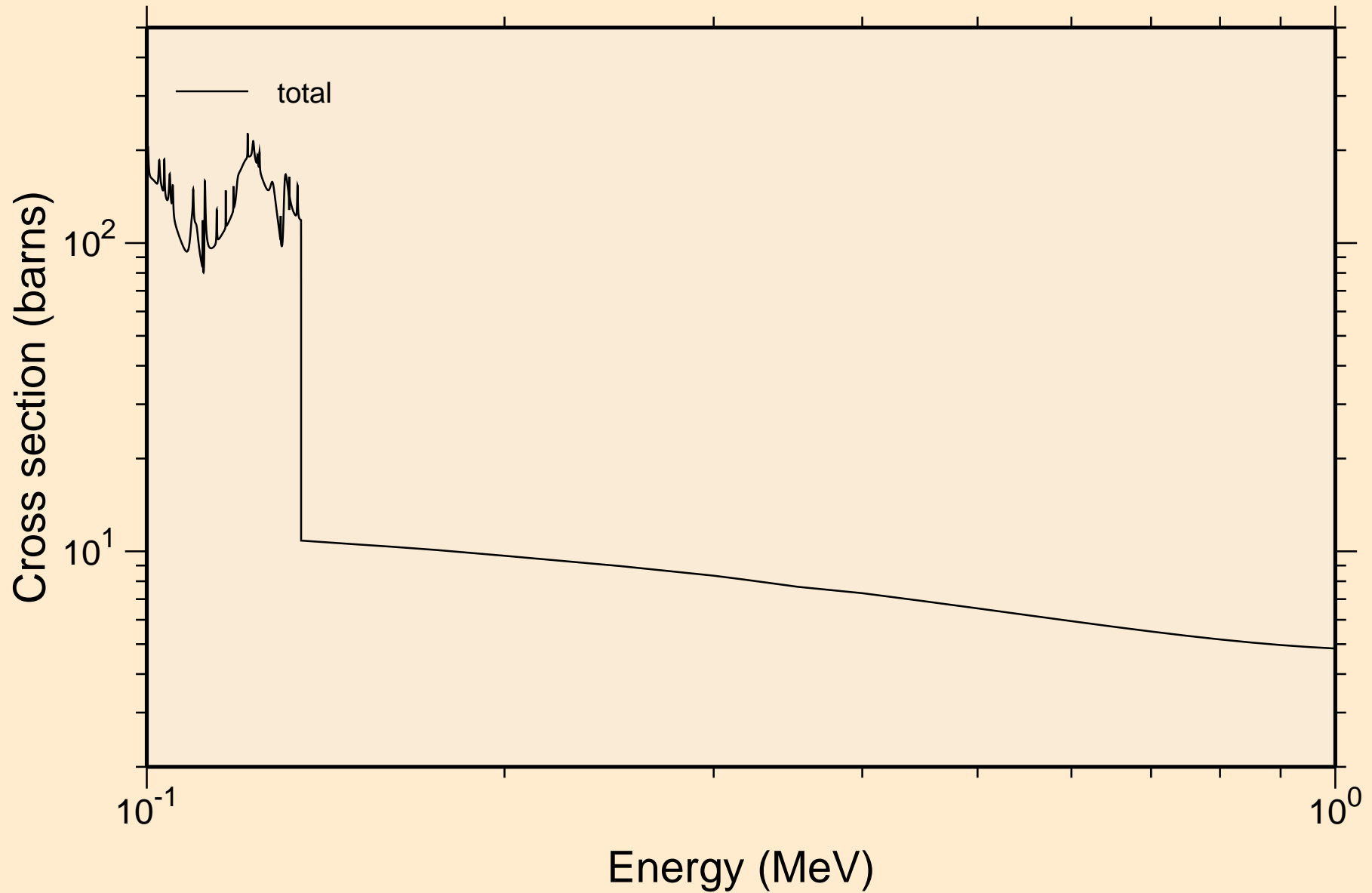

TL207 NEUTRON ACER TENDL-2021 LIBRARY; T=293.6K  
resonance total cross section

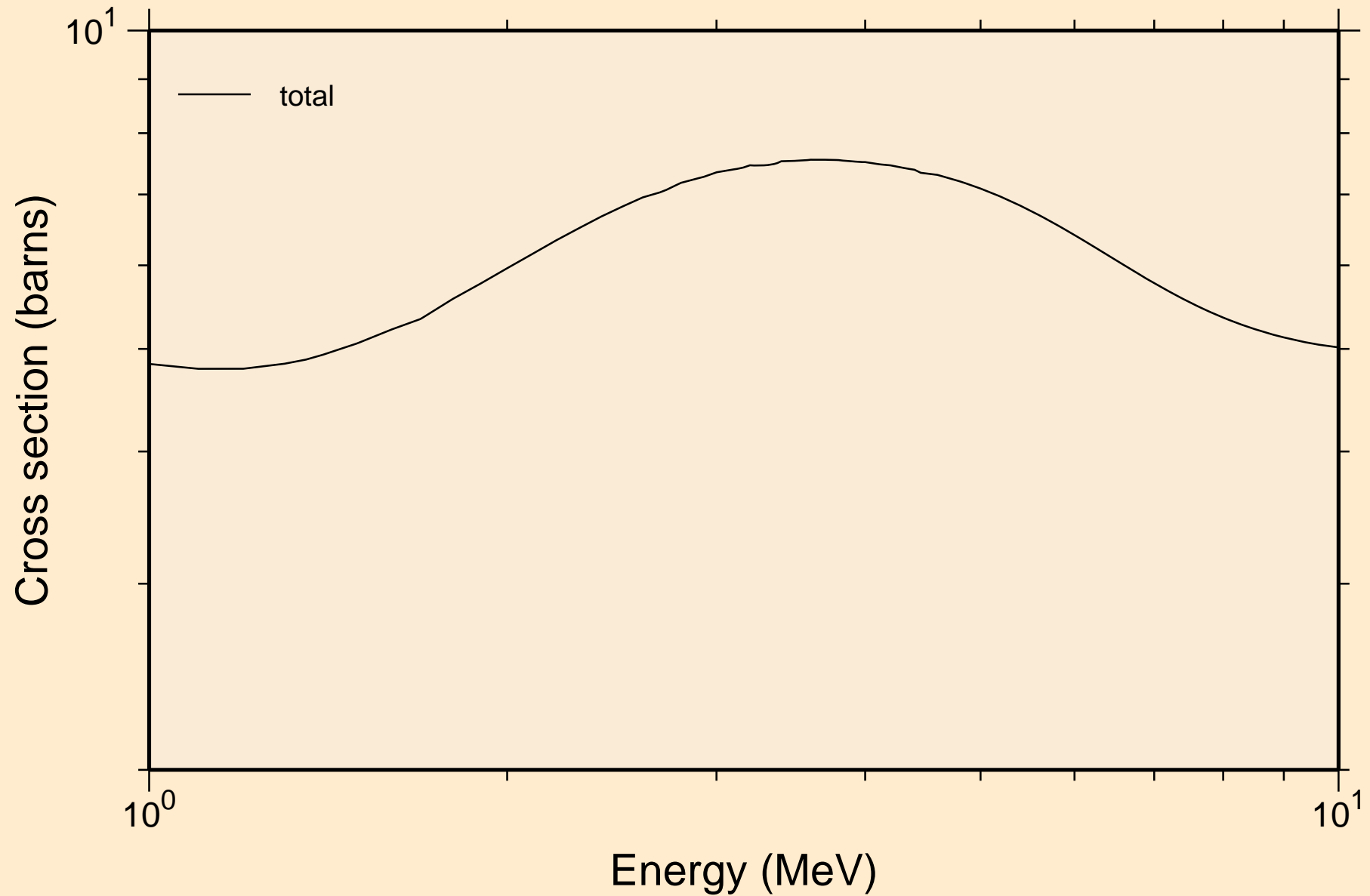

TL207 NEUTRON ACER TENDL-2021 LIBRARY; T=293.6K  
resonance absorption cross sections

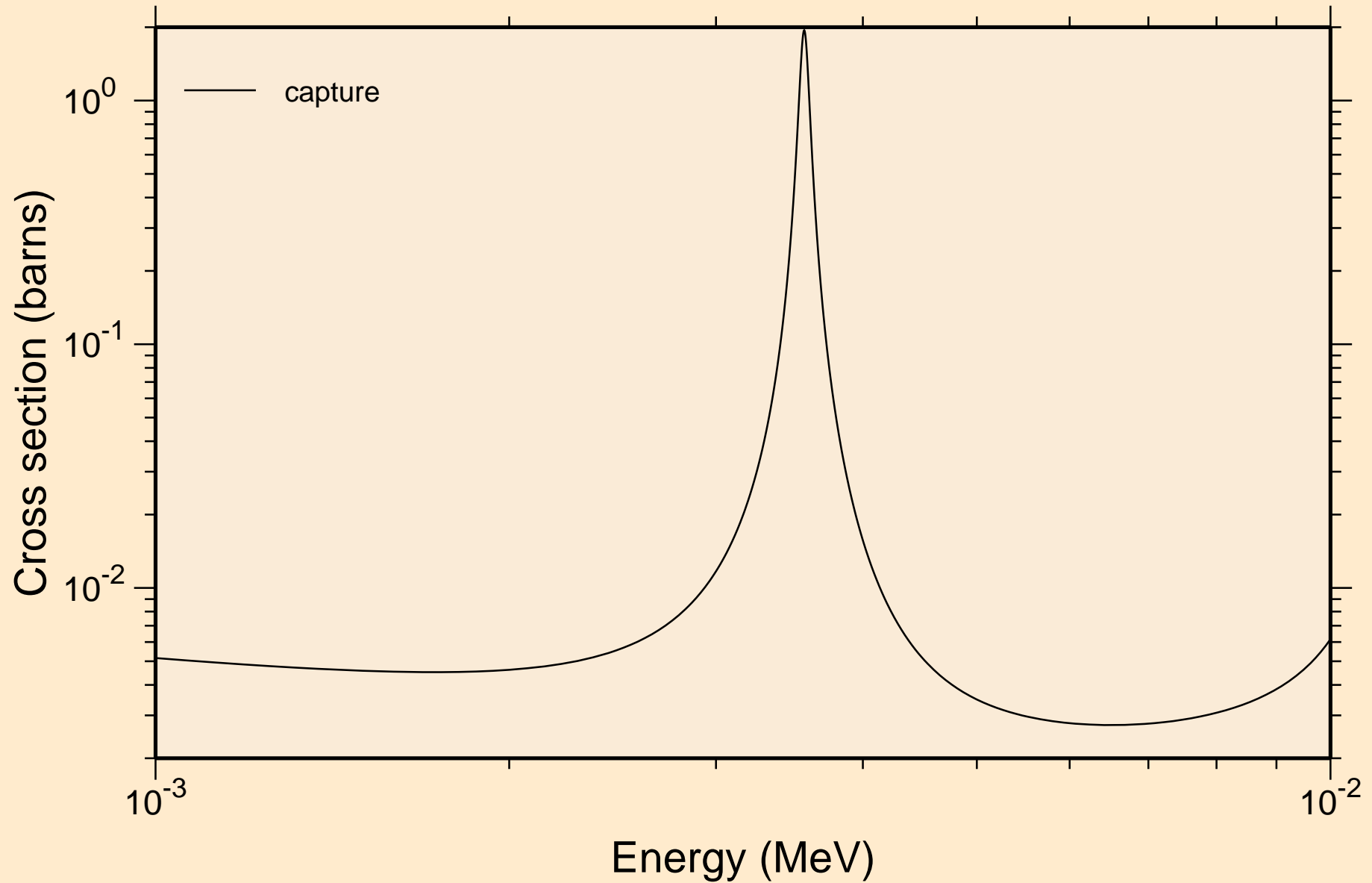

TL207 NEUTRON ACER TENDL-2021 LIBRARY; T=293.6K  
resonance absorption cross sections

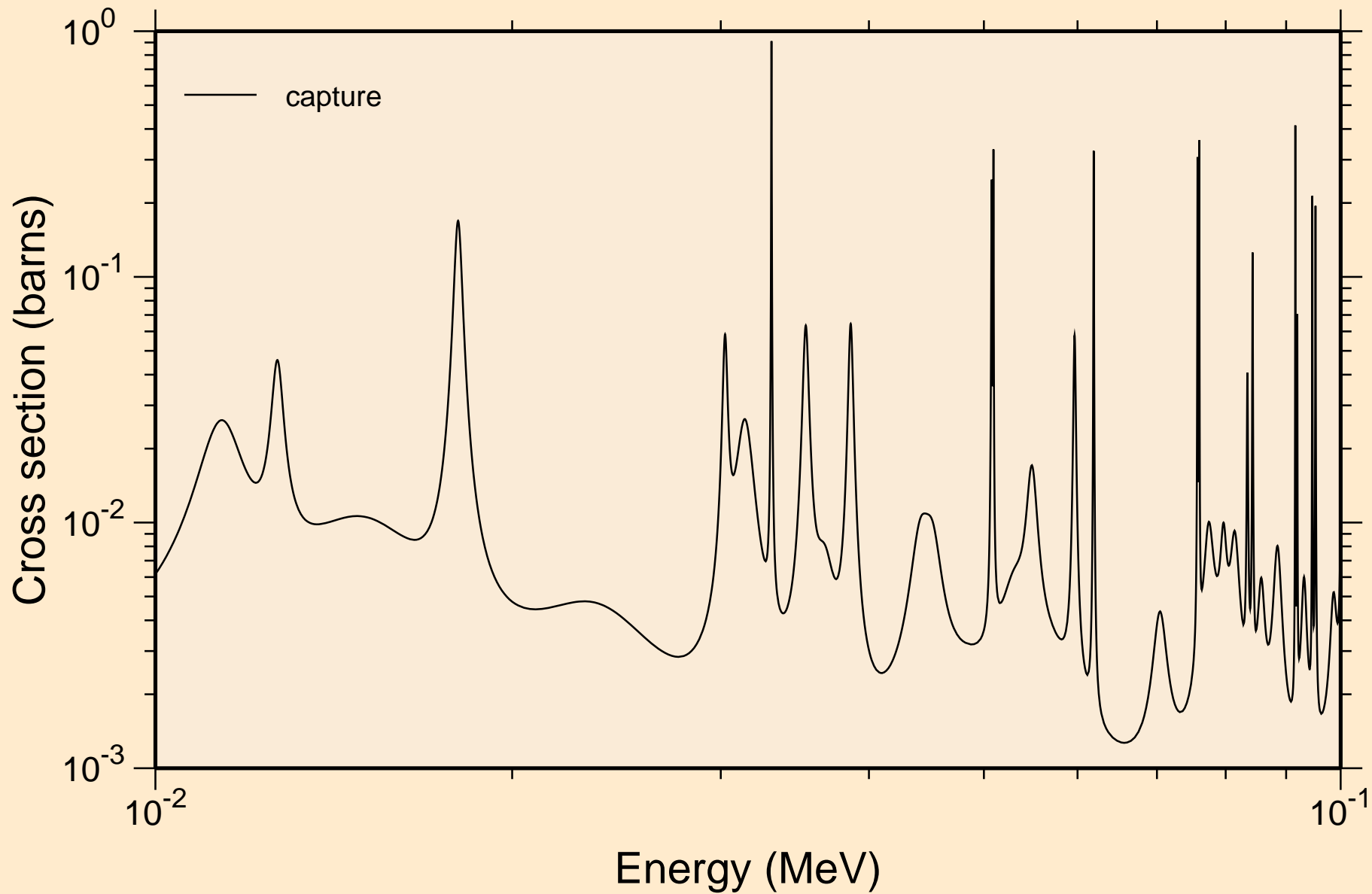

TL207 NEUTRON ACER TENDL-2021 LIBRARY; T=293.6K  
resonance absorption cross sections

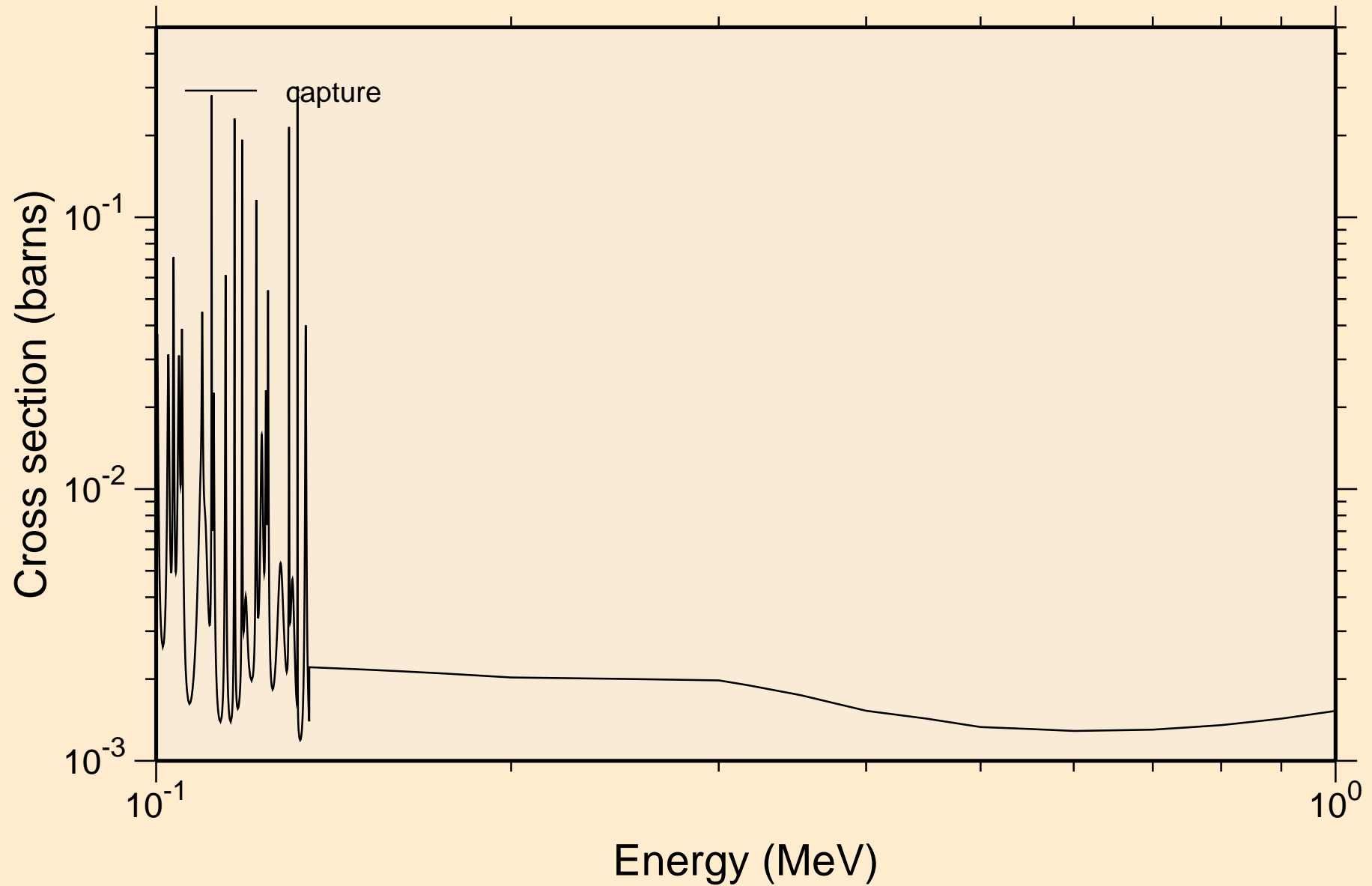



TL207 NEUTRON ACER TENDL-2021 LIBRARY; T=293.6K  
resonance absorption cross sections

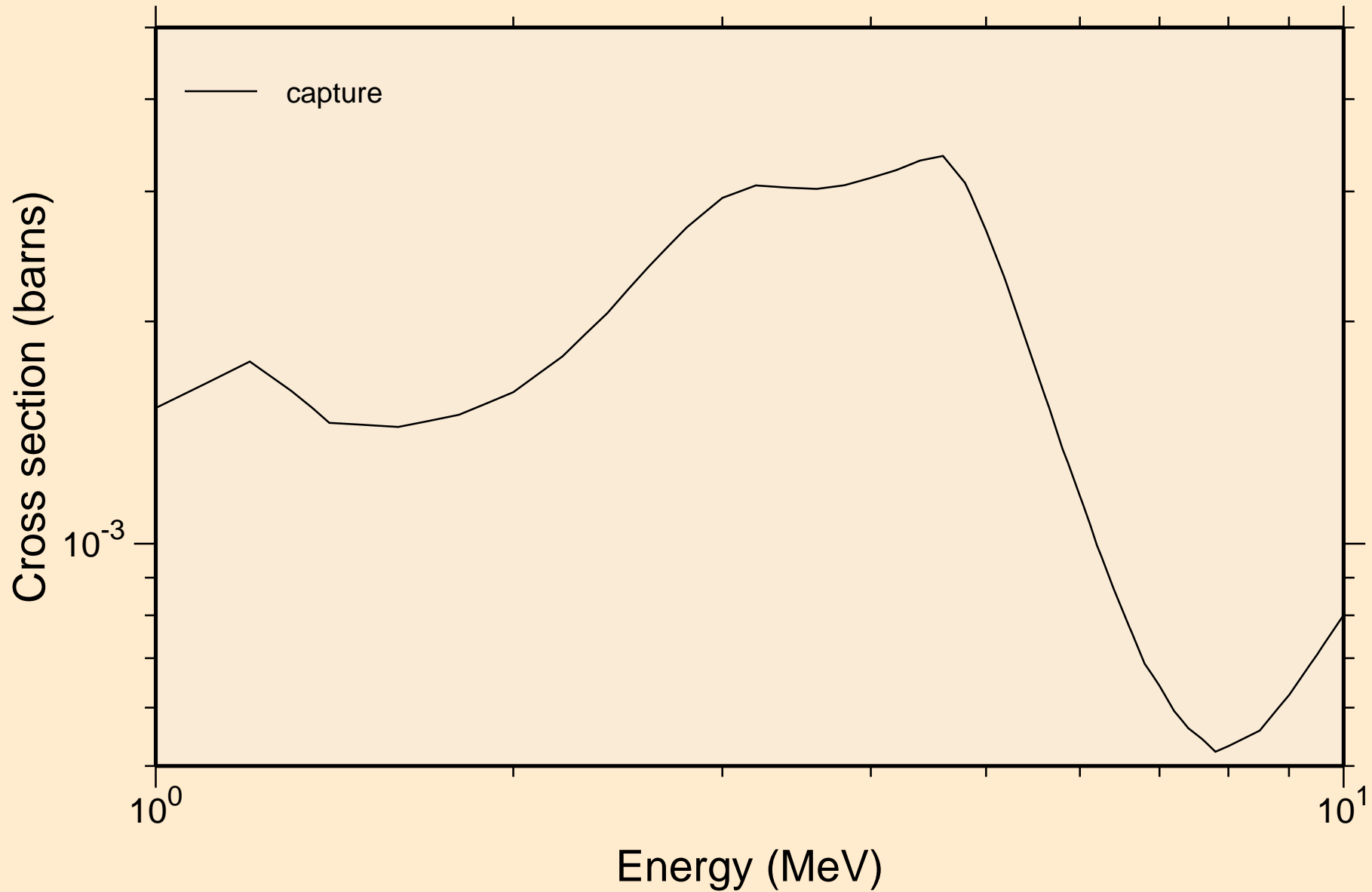

TL207 NEUTRON ACER TENDL-2021 LIBRARY; T=293.6K  
Heating

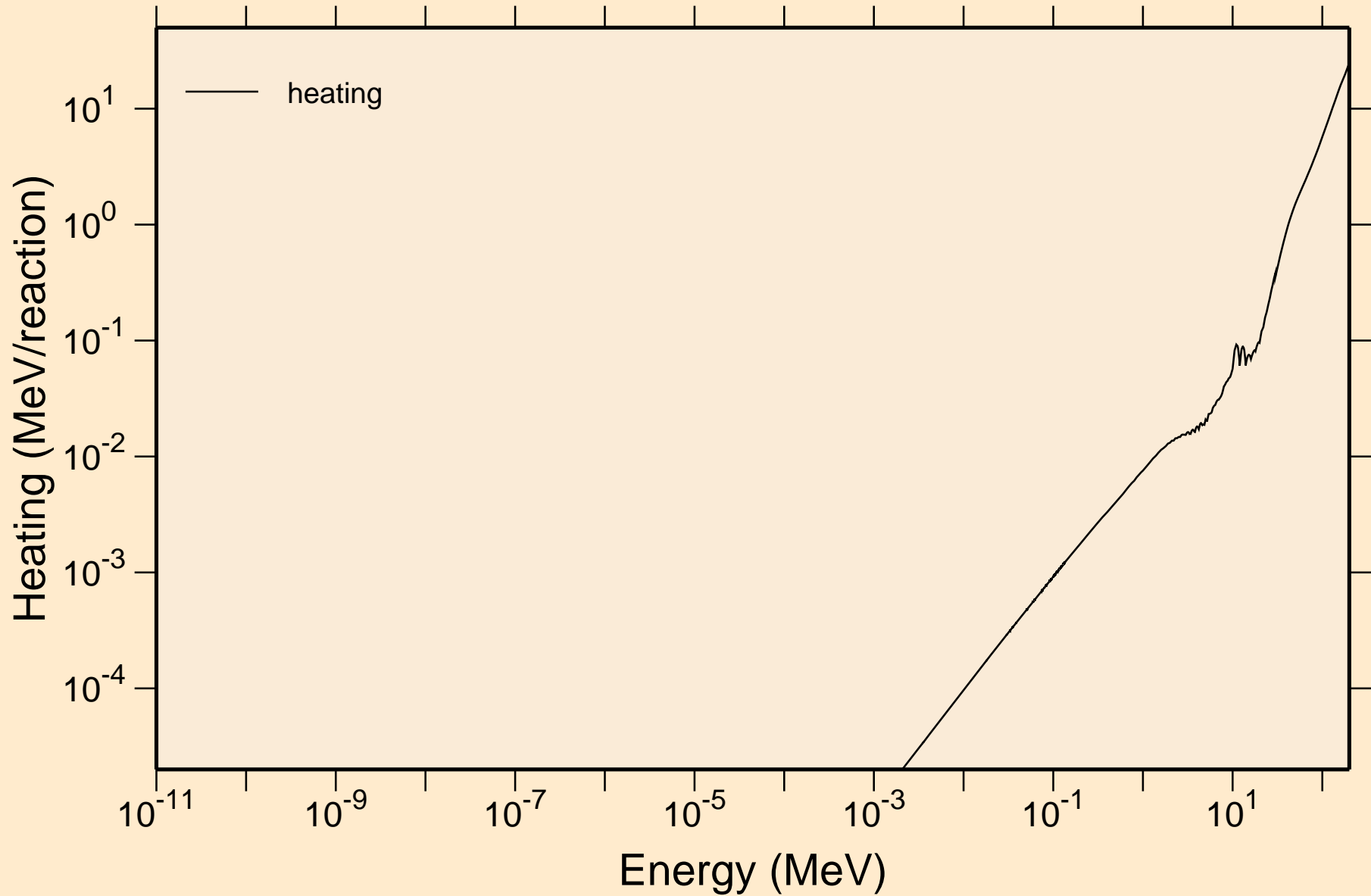

TL207 NEUTRON ACER TENDL-2021 LIBRARY; T=293.6K  
Damage

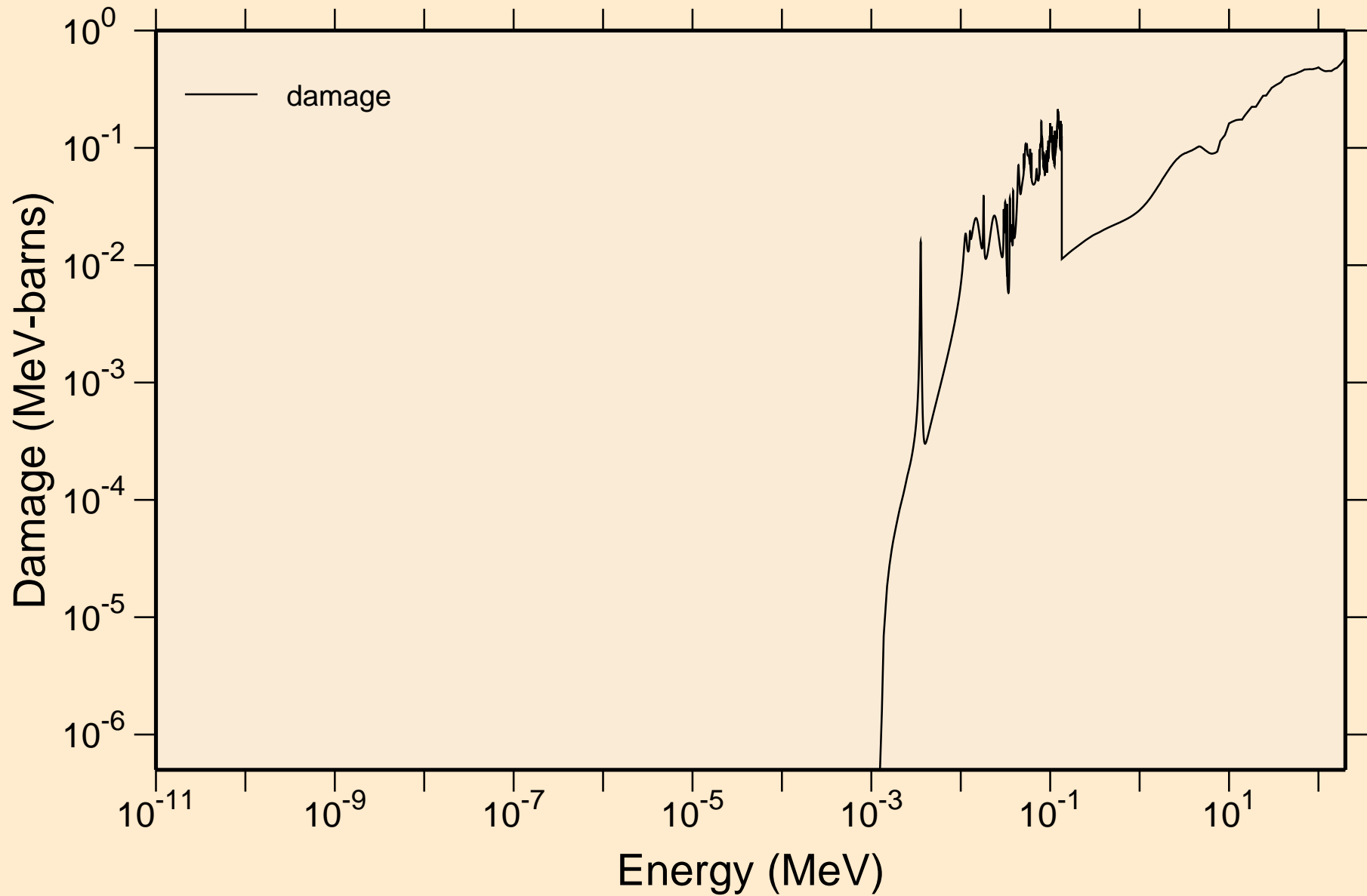

TL207 NEUTRON ACER TENDL-2021 LIBRARY; T=293.6K  
Non-threshold reactions

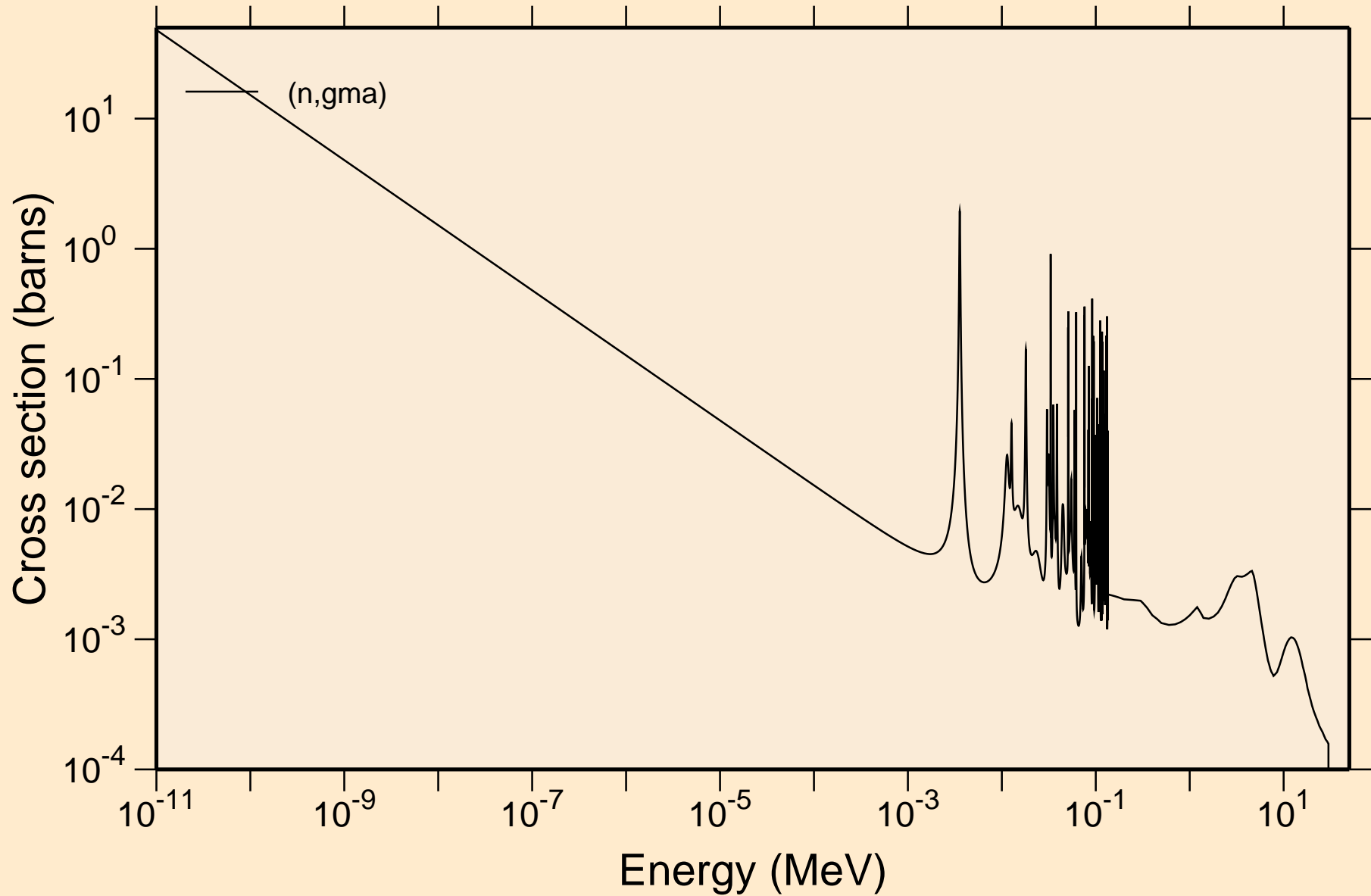

TL207 NEUTRON ACER TENDL-2021 LIBRARY; T=293.6K  
Principal cross sections

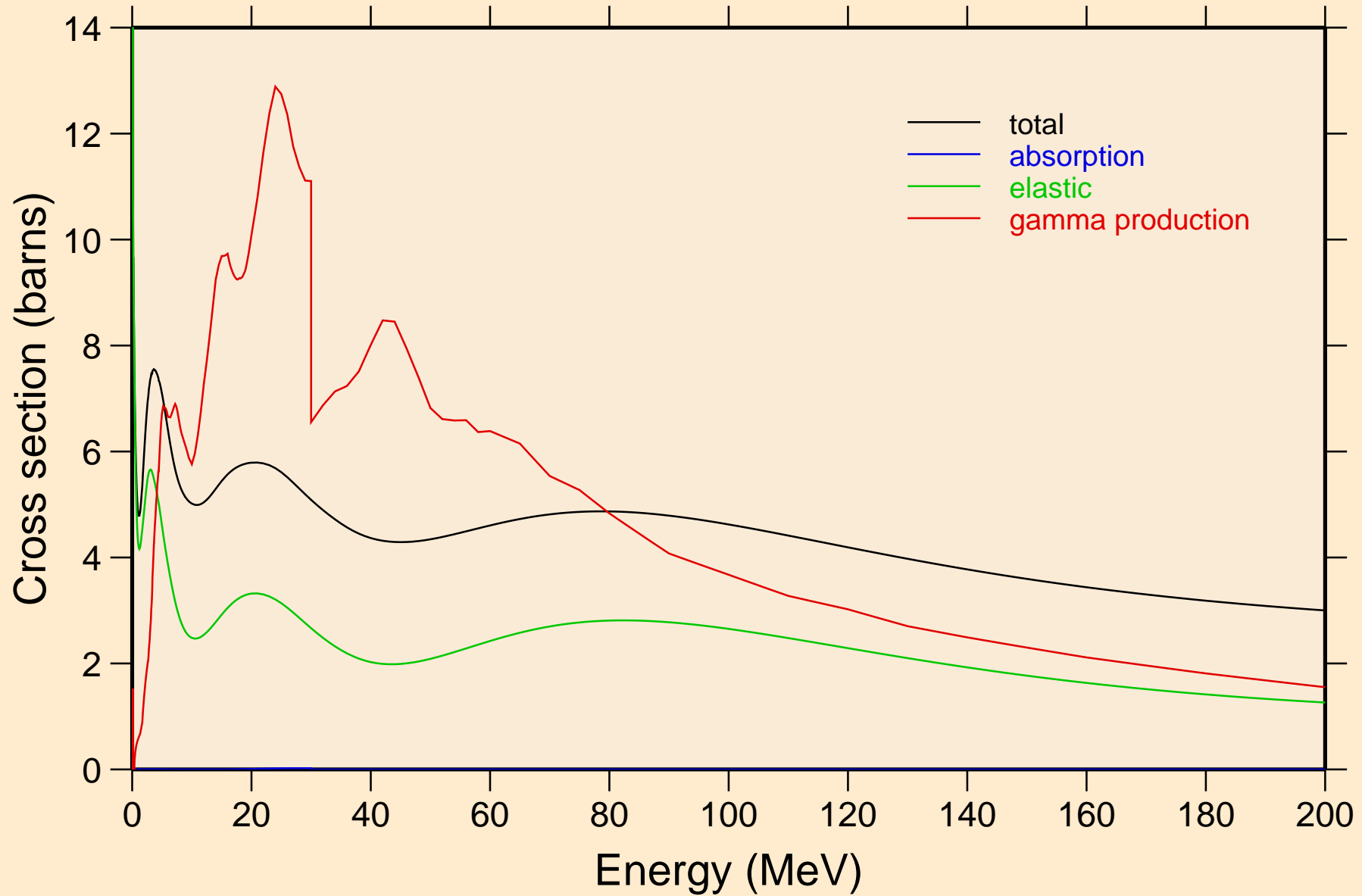

TL207 NEUTRON ACER TENDL-2021 LIBRARY; T=293.6K  
Heating

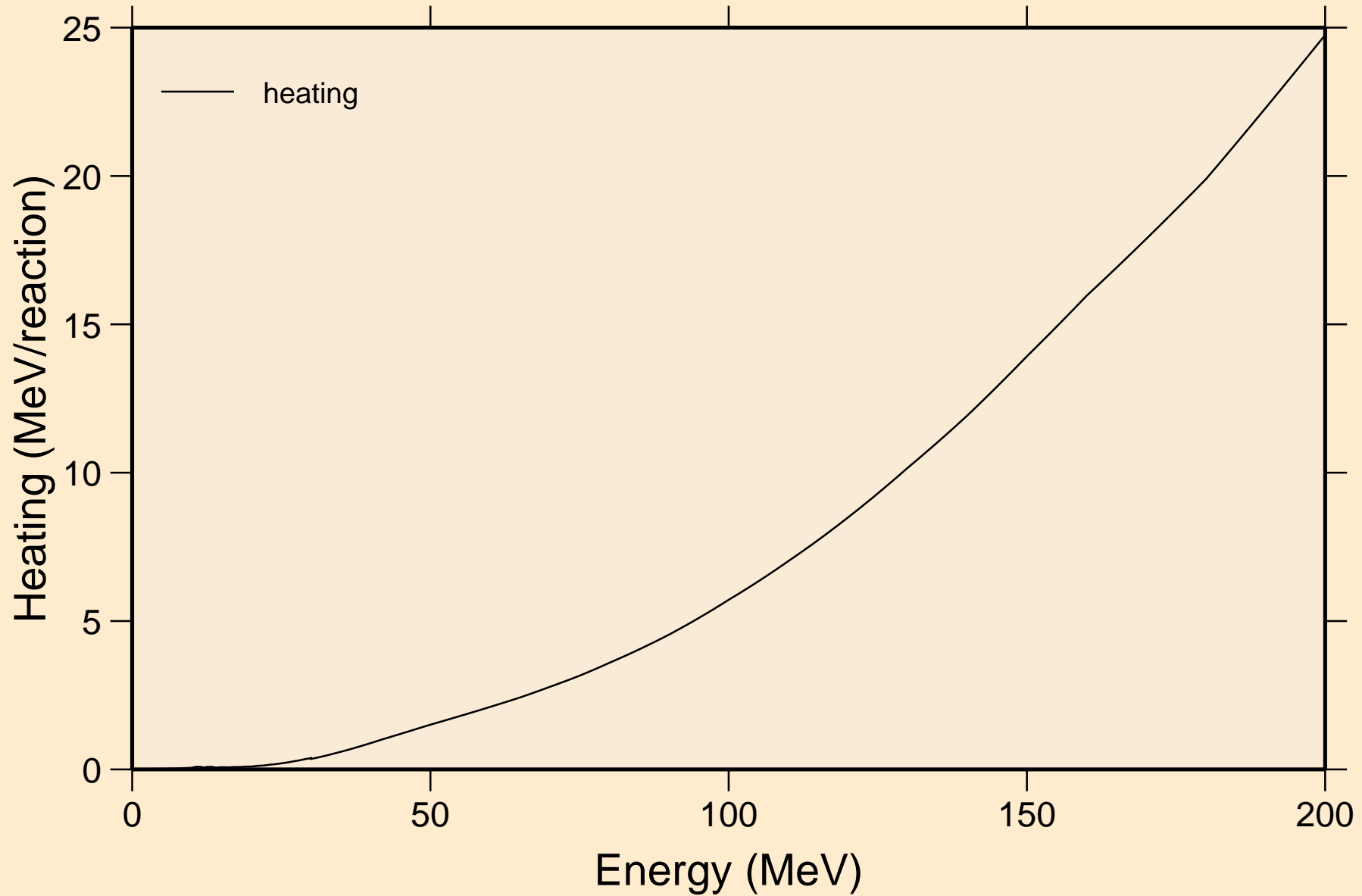

TL207 NEUTRON ACER TENDL-2021 LIBRARY; T=293.6K  
Damage

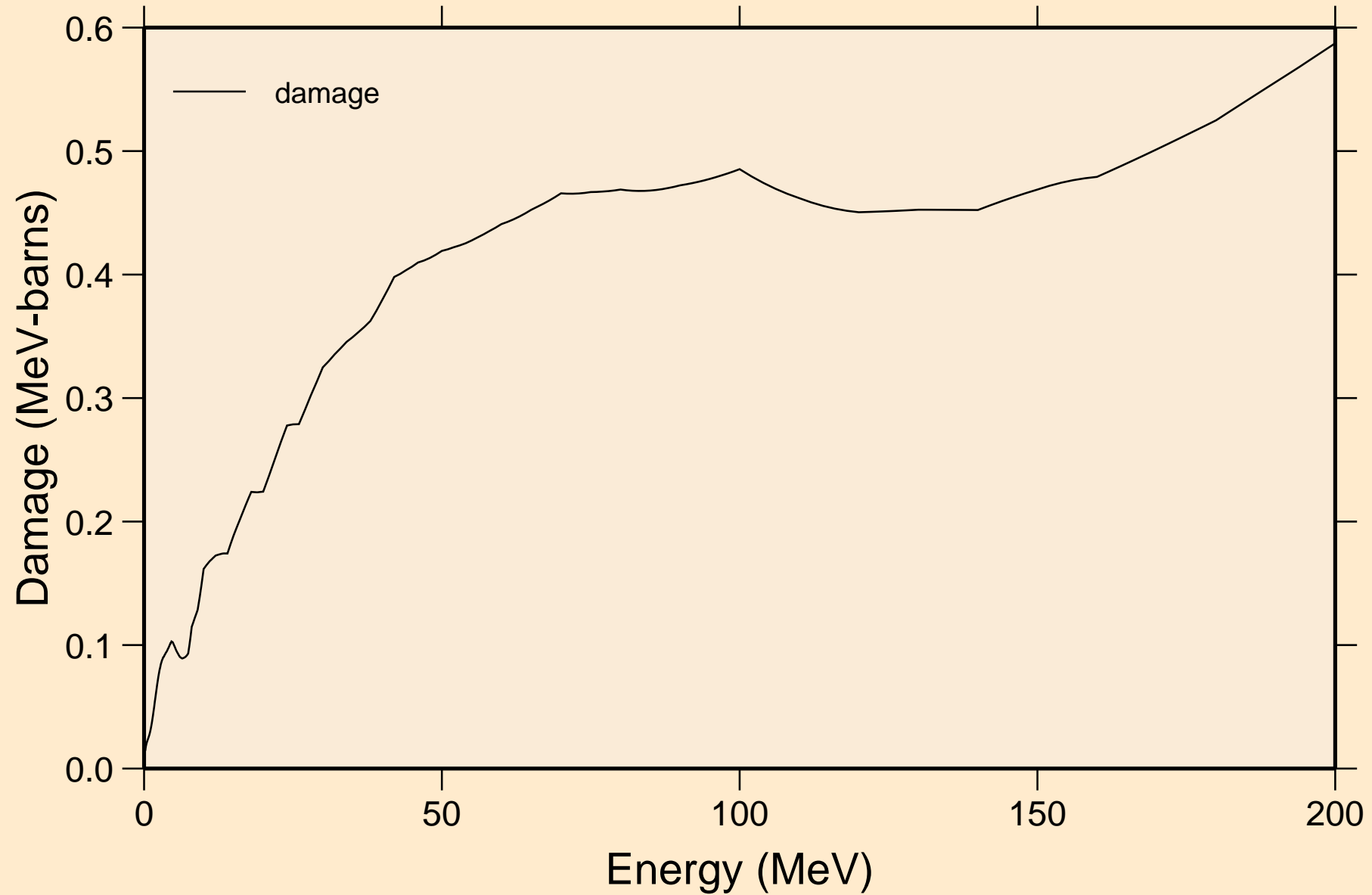

TL207 NEUTRON ACER TENDL-2021 LIBRARY; T=293.6K  
Non-threshold reactions

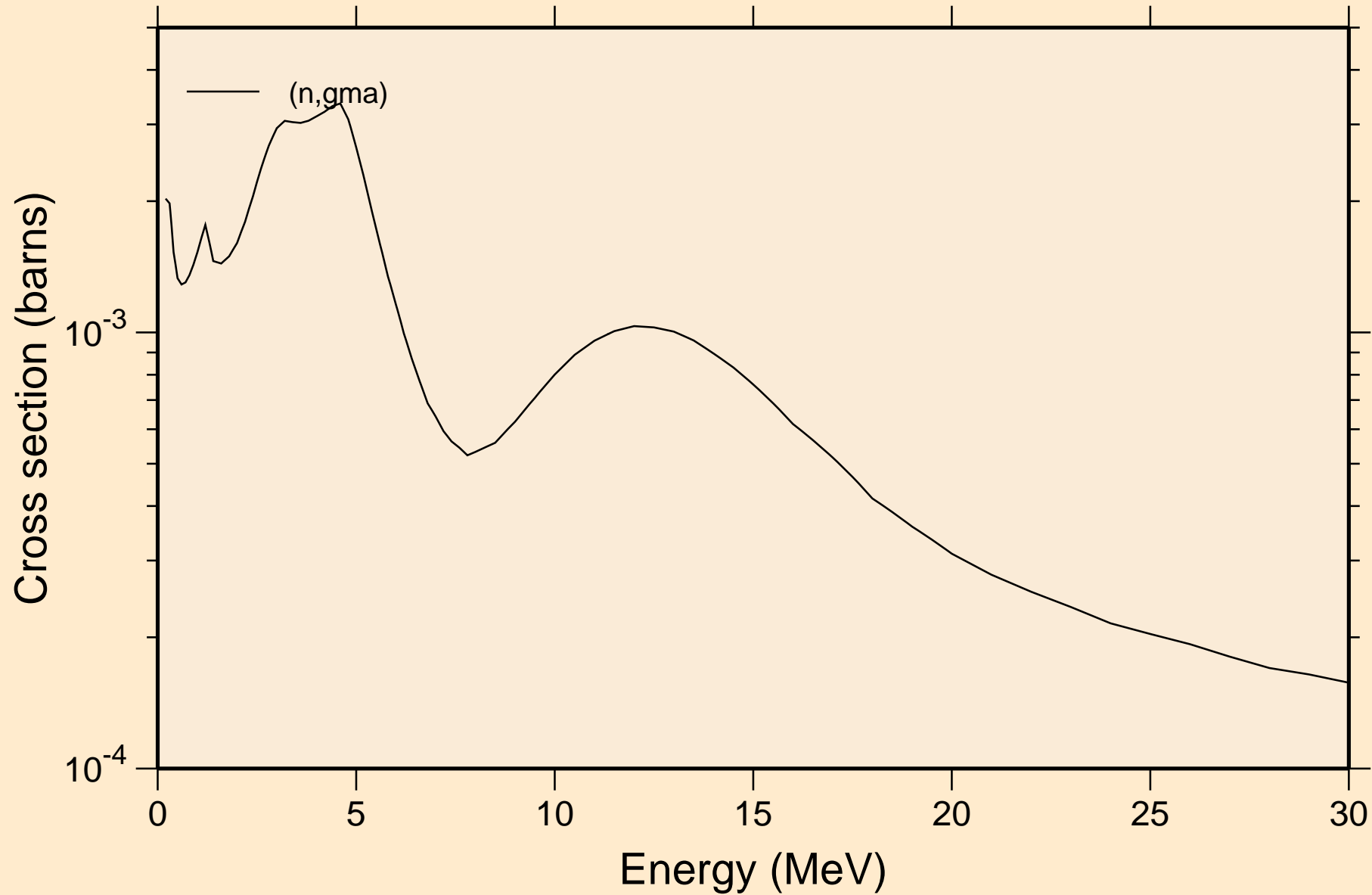



TL207 NEUTRON ACER TENDL-2021 LIBRARY; T=293.6K  
Inelastic levels

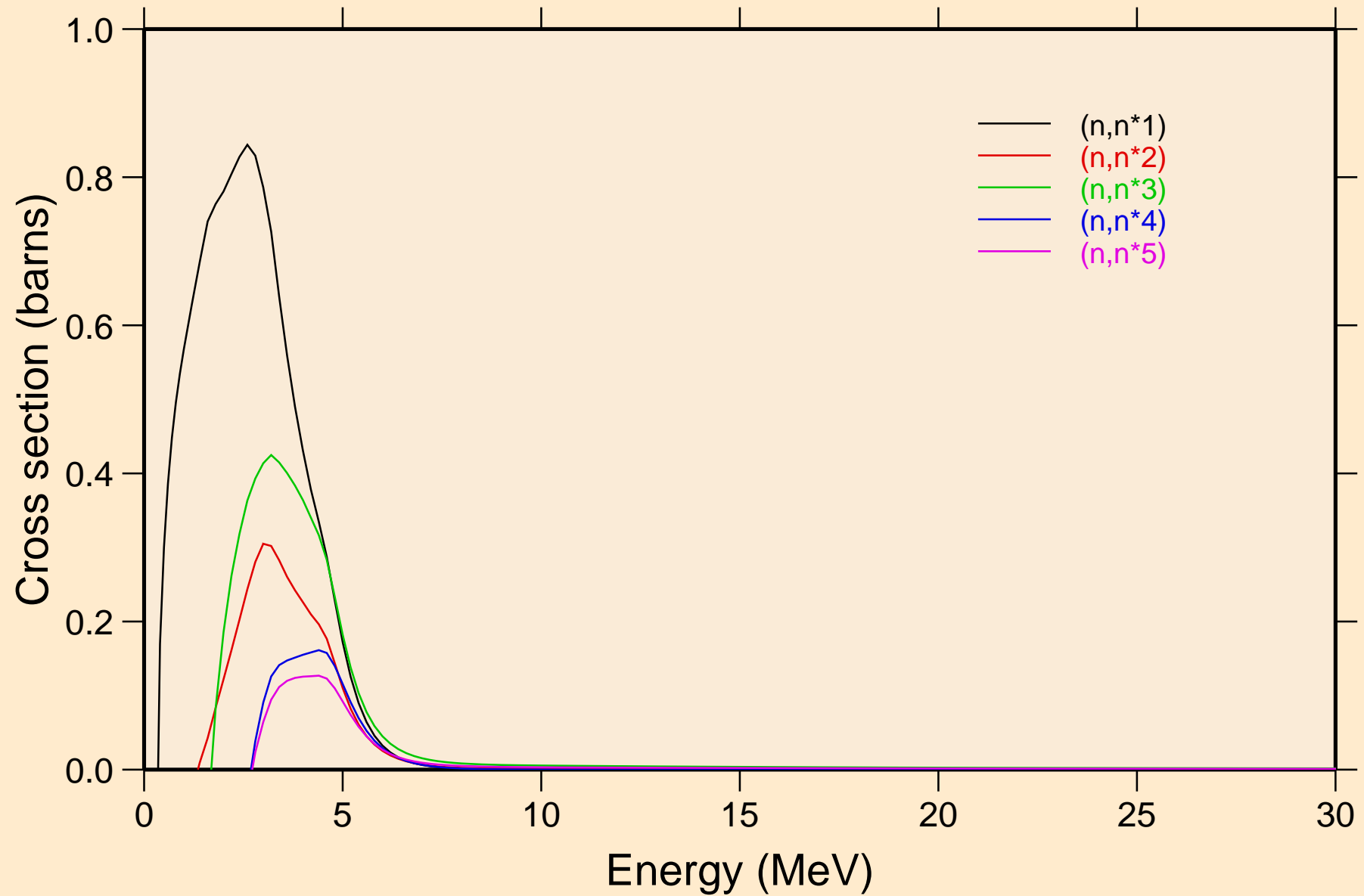

TL207 NEUTRON ACER TENDL-2021 LIBRARY; T=293.6K  
Inelastic levels

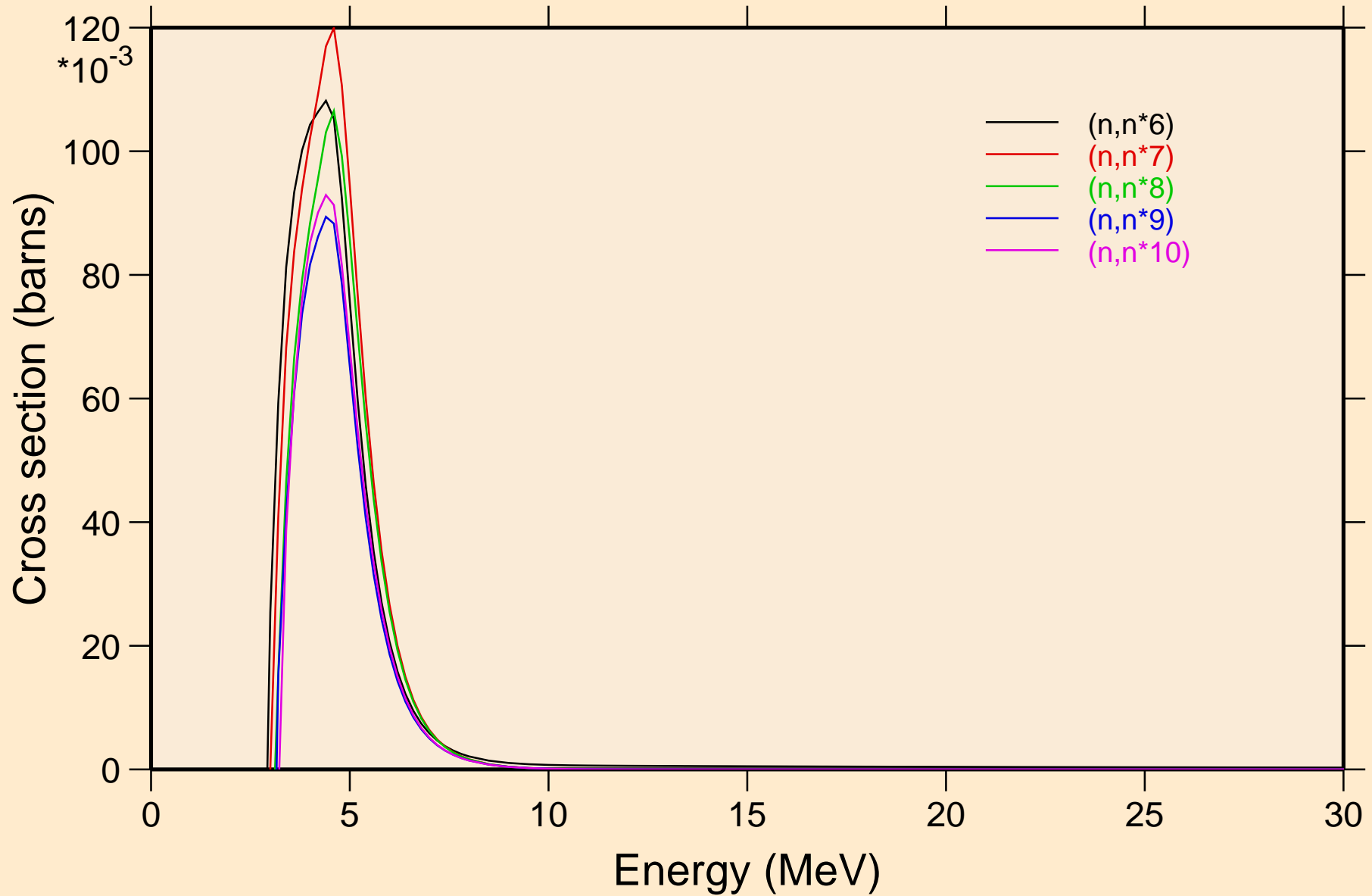

TL207 NEUTRON ACER TENDL-2021 LIBRARY; T=293.6K  
Inelastic levels

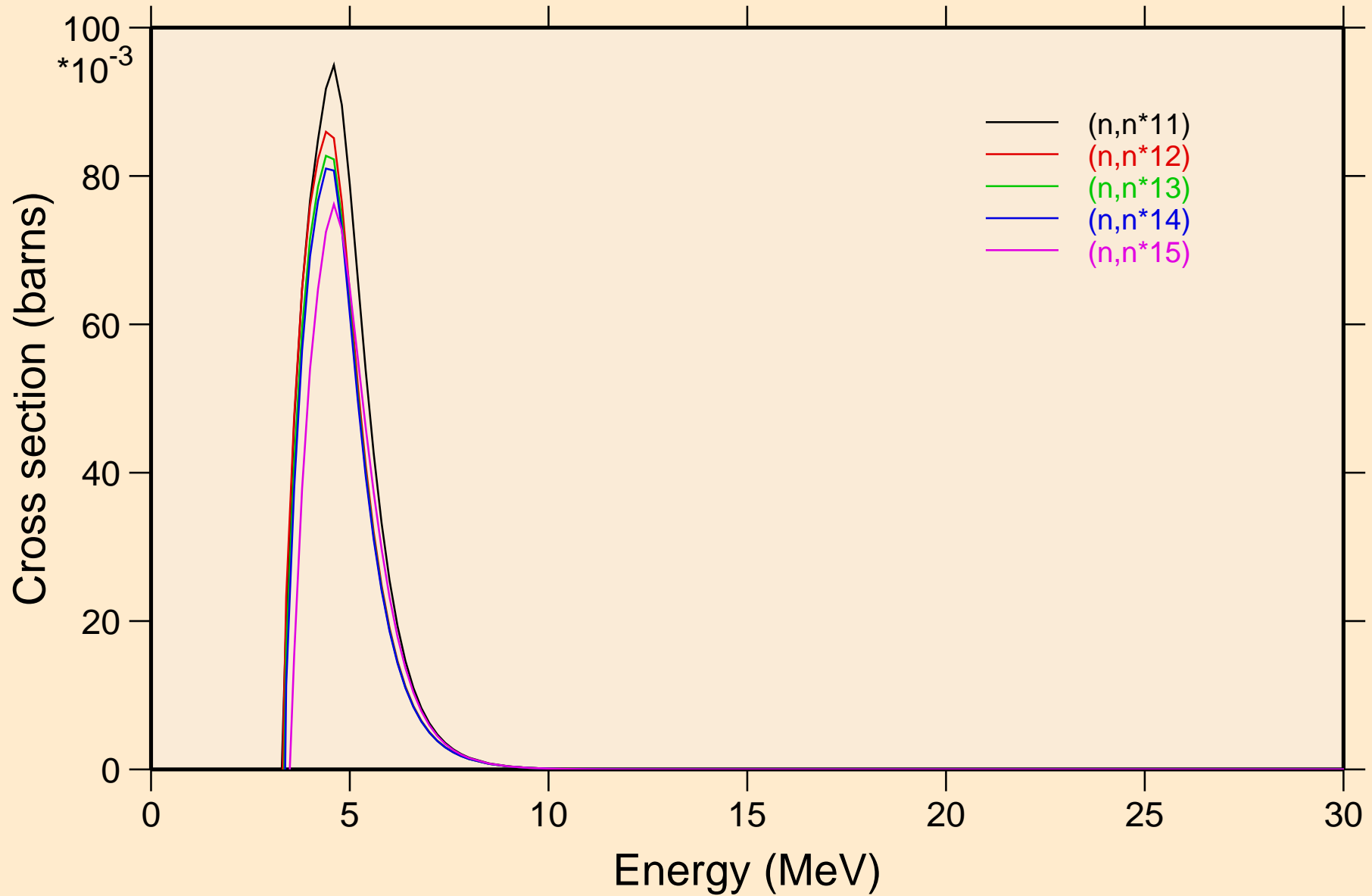

TL207 NEUTRON ACER TENDL-2021 LIBRARY; T=293.6K  
Inelastic levels

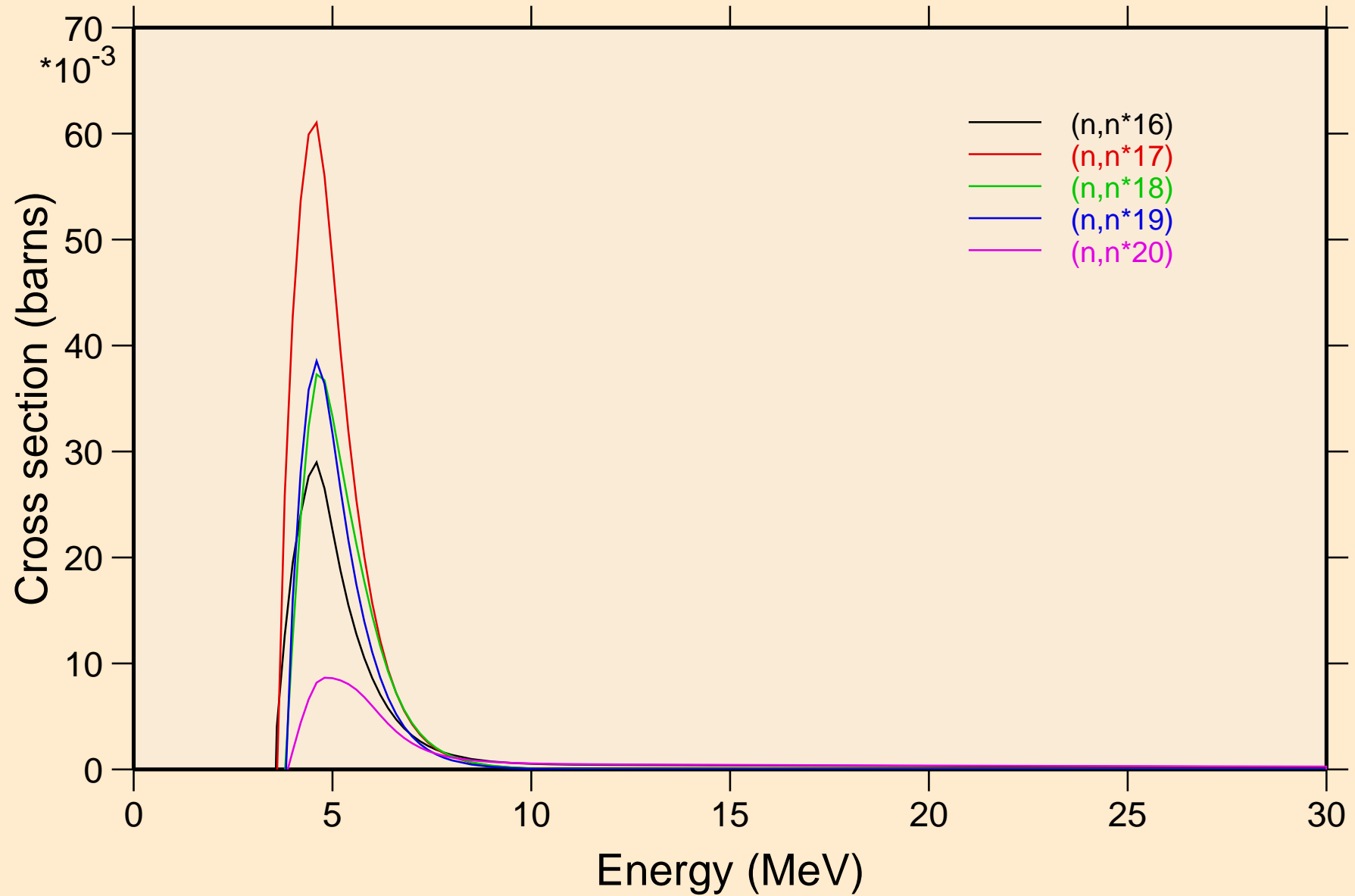

TL207 NEUTRON ACER TENDL-2021 LIBRARY; T=293.6K  
Inelastic levels

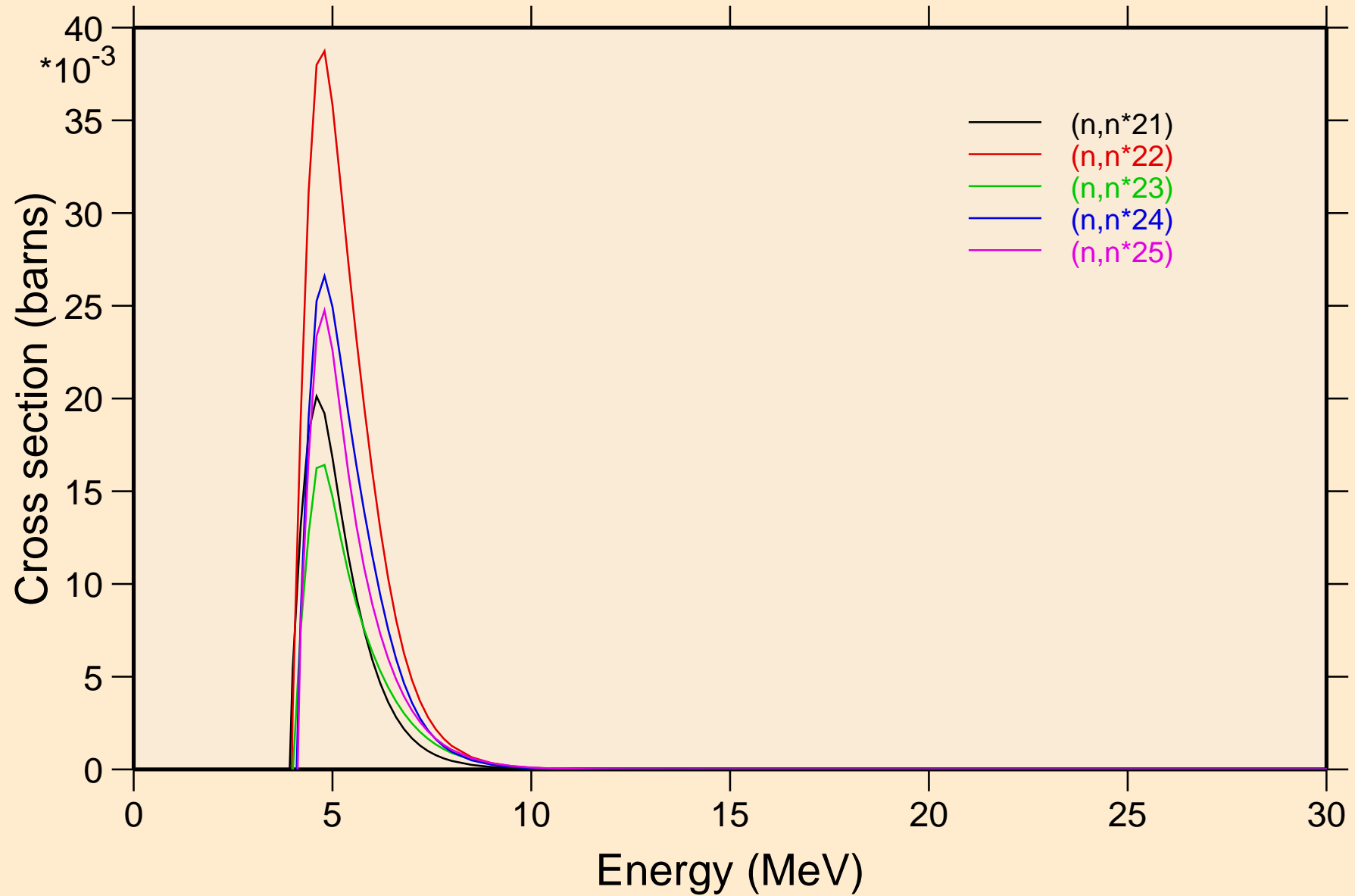

TL207 NEUTRON ACER TENDL-2021 LIBRARY; T=293.6K  
Inelastic levels

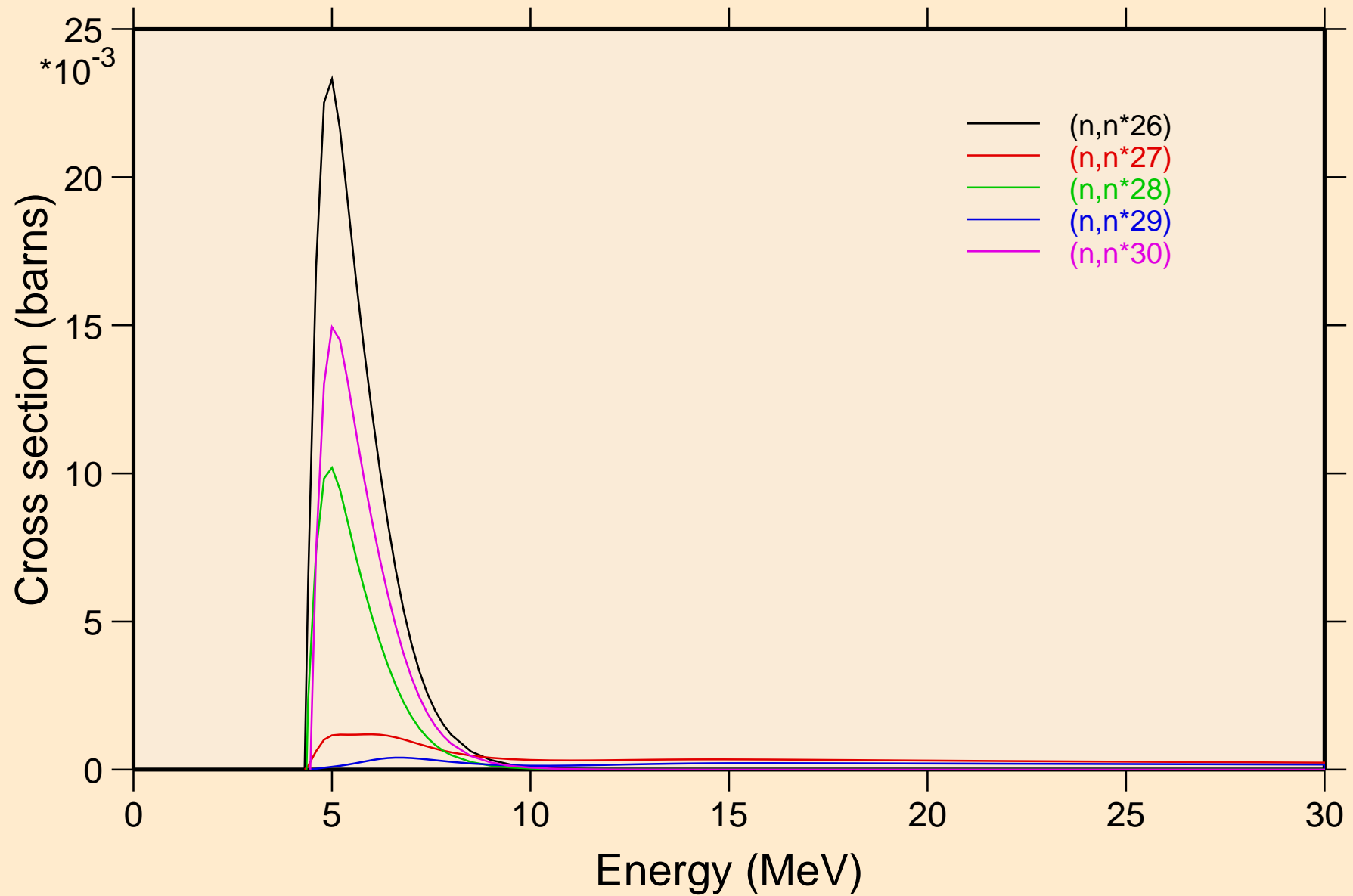

TL207 NEUTRON ACER TENDL-2021 LIBRARY; T=293.6K  
Threshold reactions

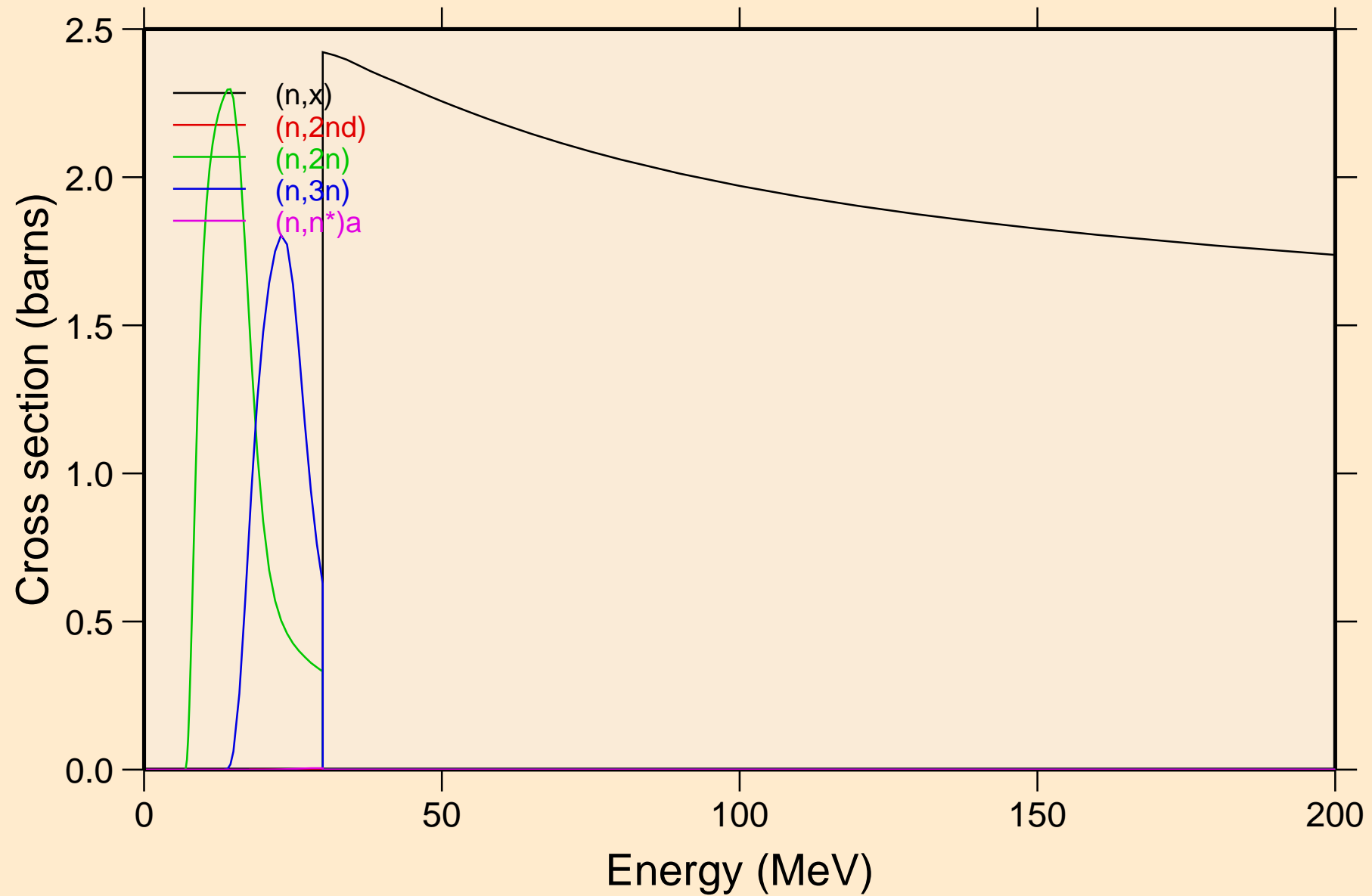

TL207 NEUTRON ACER TENDL-2021 LIBRARY; T=293.6K  
Threshold reactions

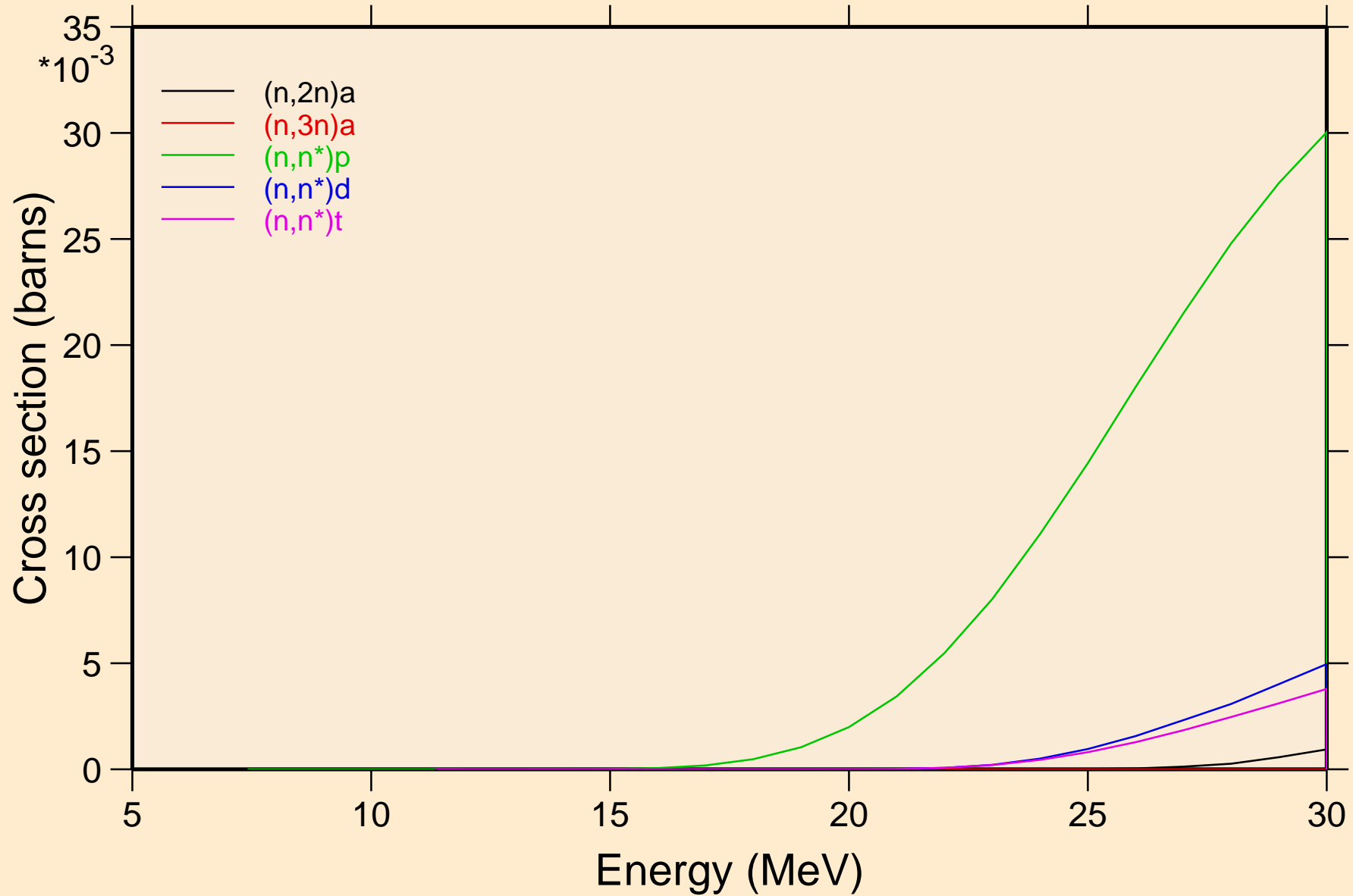



TL207 NEUTRON ACER TENDL-2021 LIBRARY; T=293.6K  
Threshold reactions

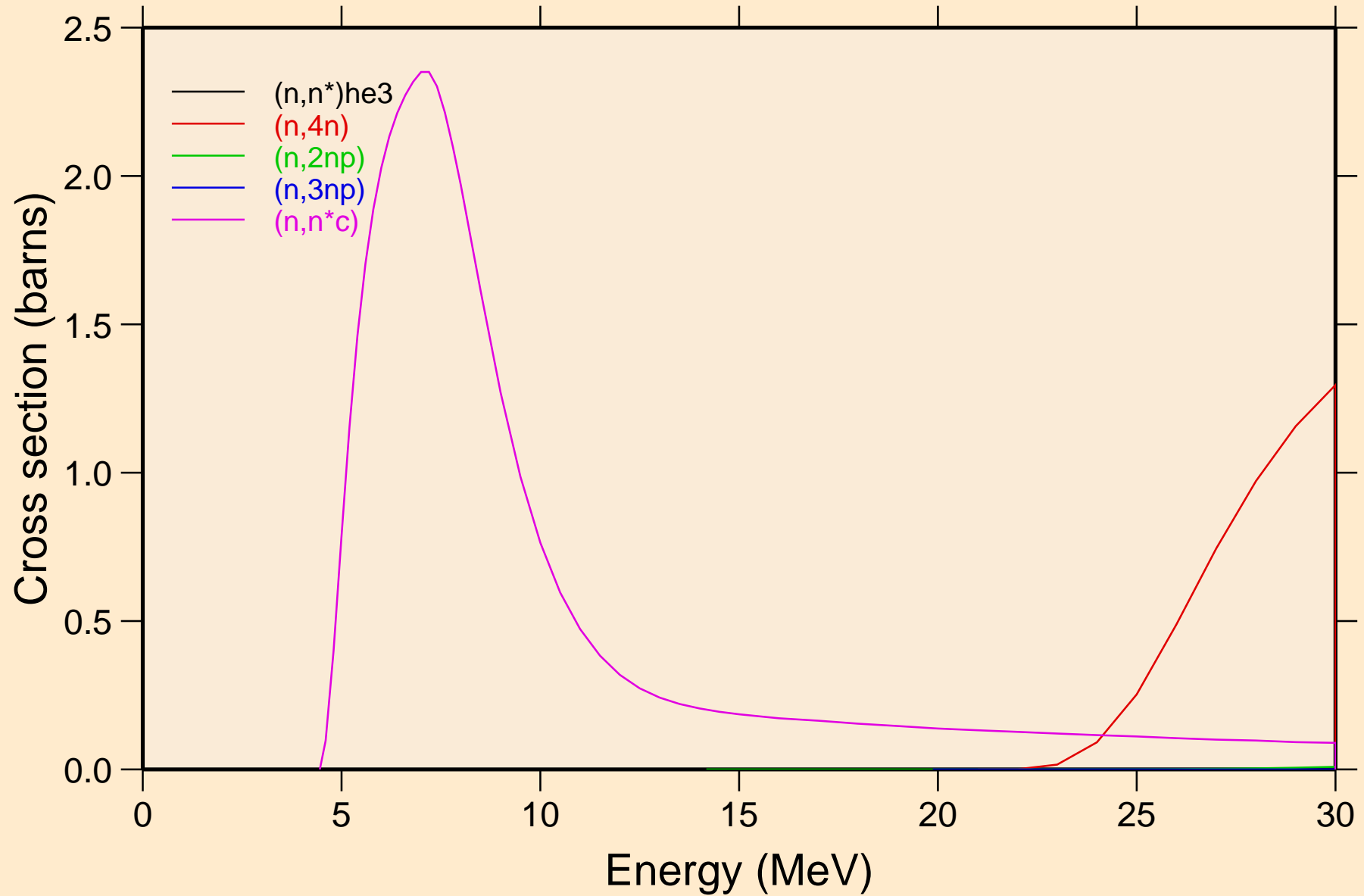

TL207 NEUTRON ACER TENDL-2021 LIBRARY; T=293.6K  
Threshold reactions

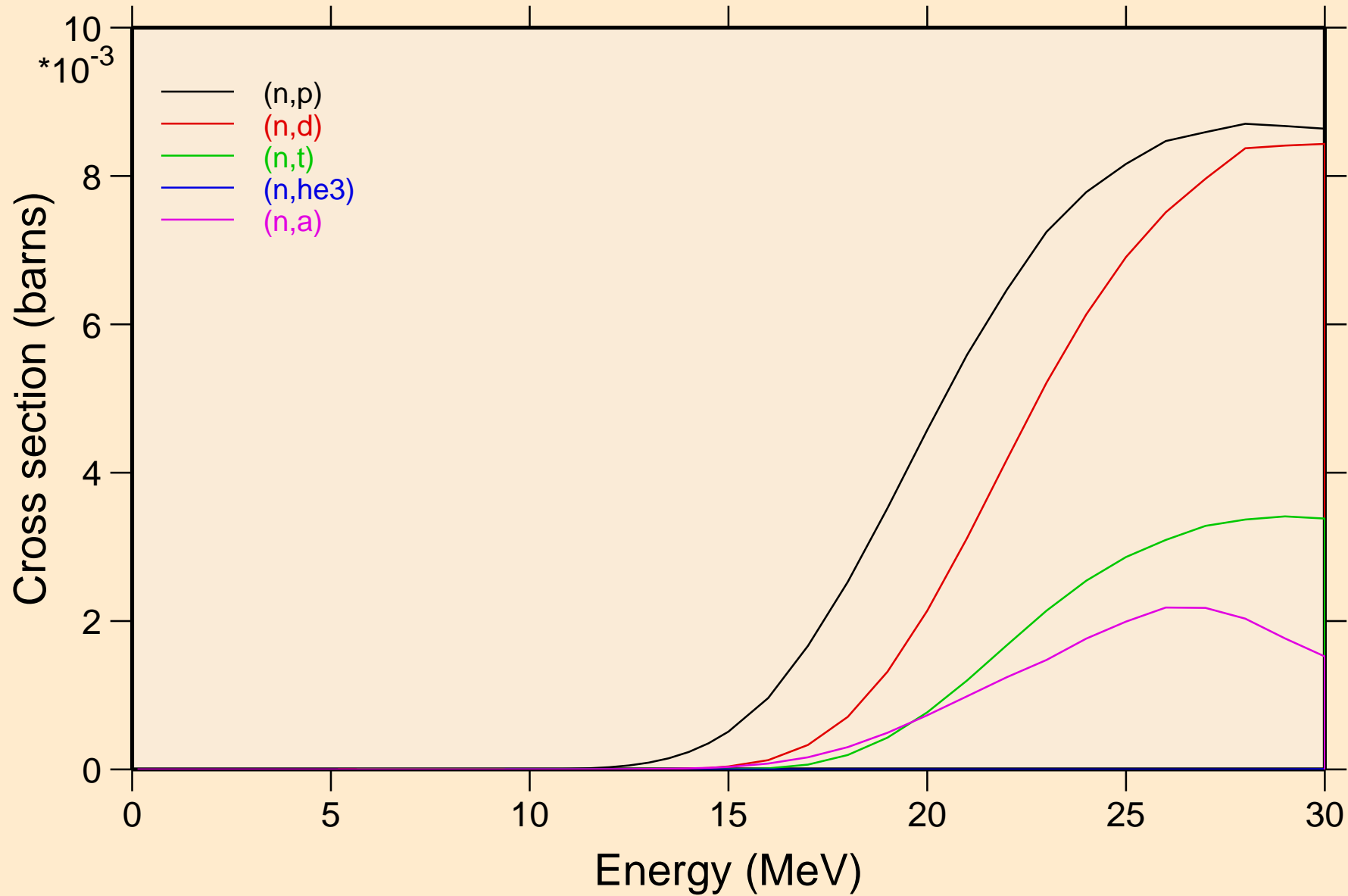

TL207 NEUTRON ACER TENDL-2021 LIBRARY; T=293.6K  
Threshold reactions

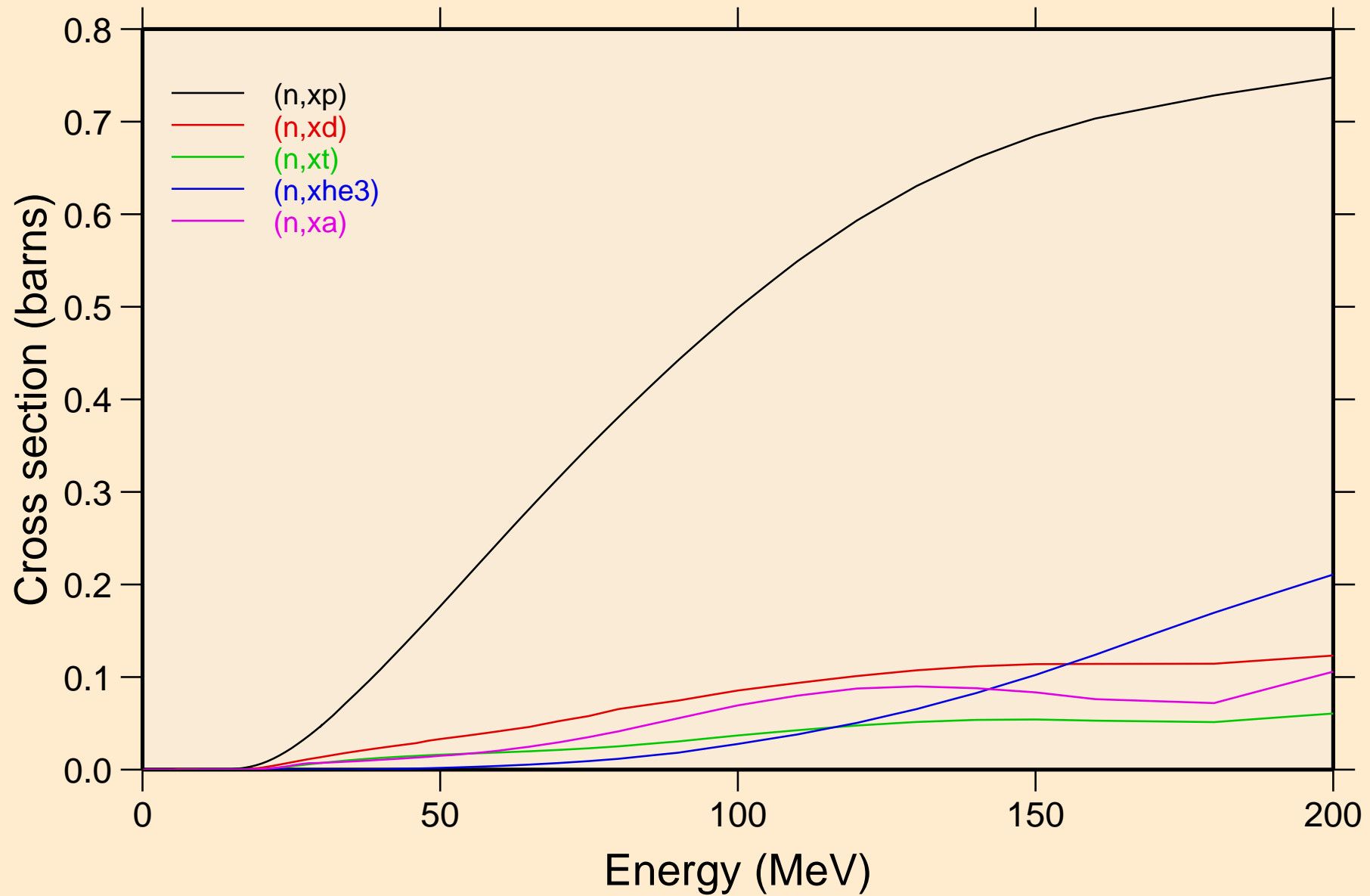

TL207 NEUTRON ACER TENDL-2021 LIBRARY; T=293.6K  
angular distribution for elastic

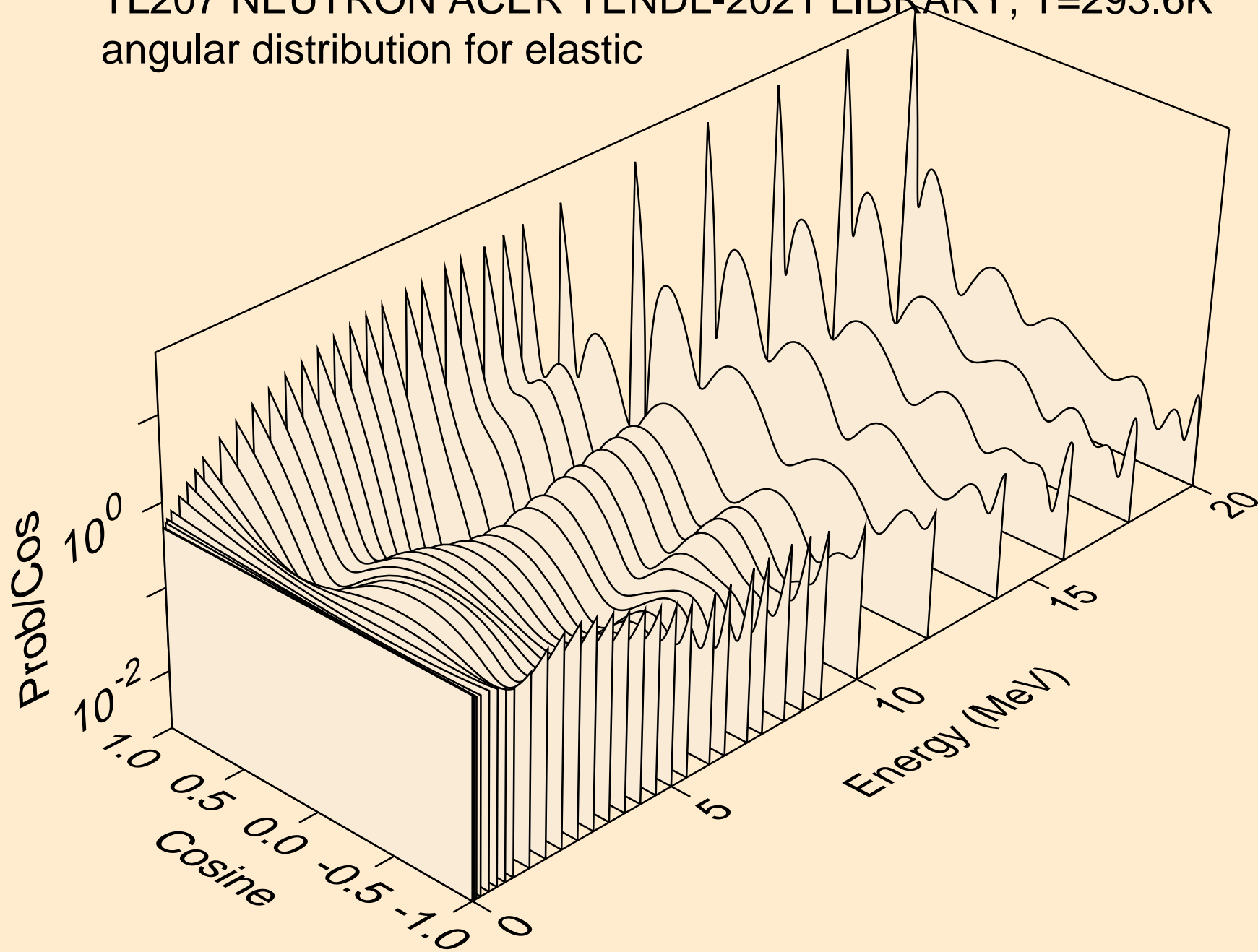

TL207 NEUTRON ACER TENDL-2021 LIBRARY; T=293.6K  
angular distribution for elastic

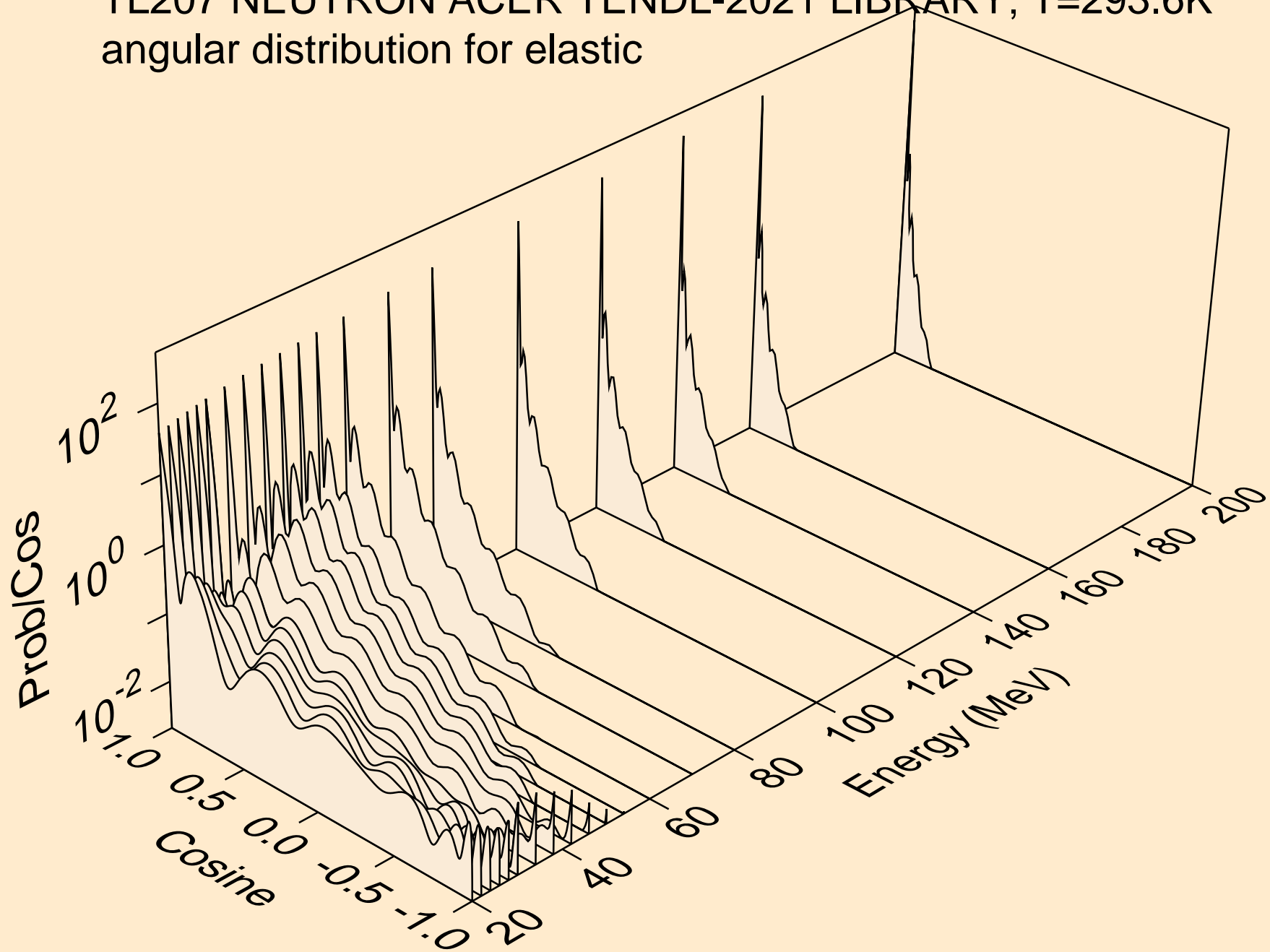

TL207 NEUTRON ACER TENDL-2021 LIBRARY; T=293.6K  
angular distribution for (n,n\*1)

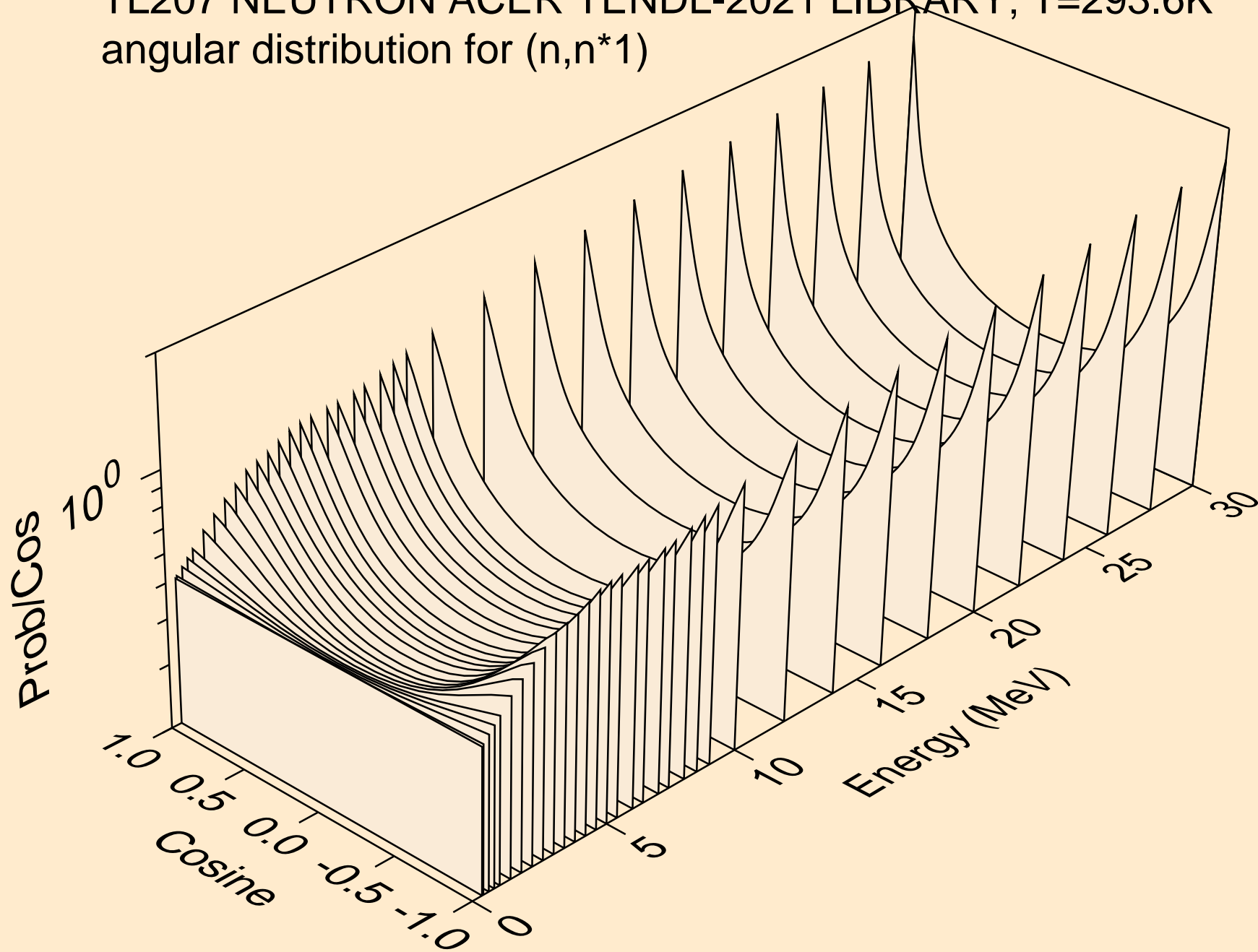

TL207 NEUTRON ACER TENDL-2021 LIBRARY; T=293.6K  
angular distribution for (n,n\*2)

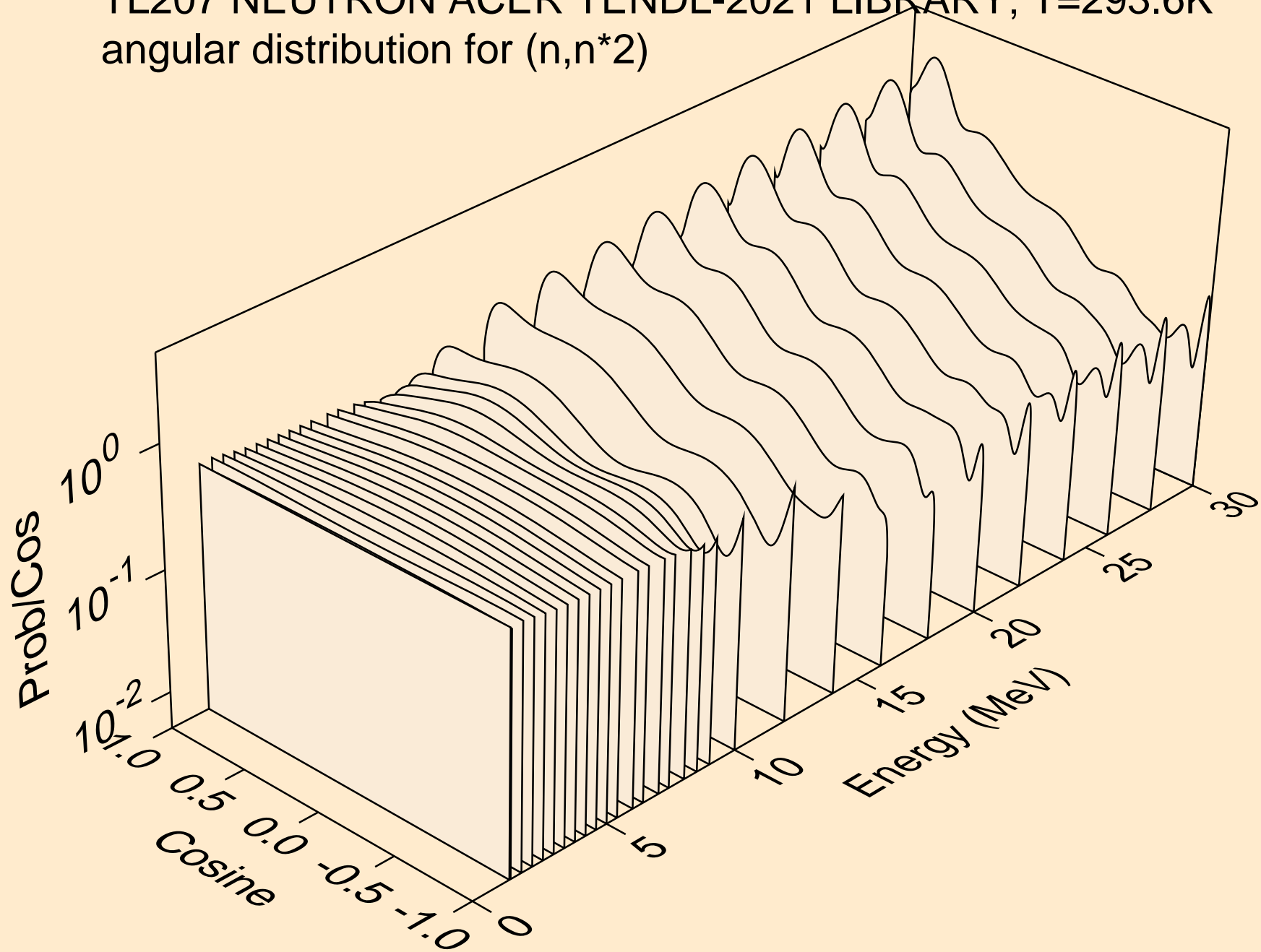

TL207 NEUTRON ACER TENDL-2021 LIBRARY; T=293.6K  
angular distribution for (n,n\*3)

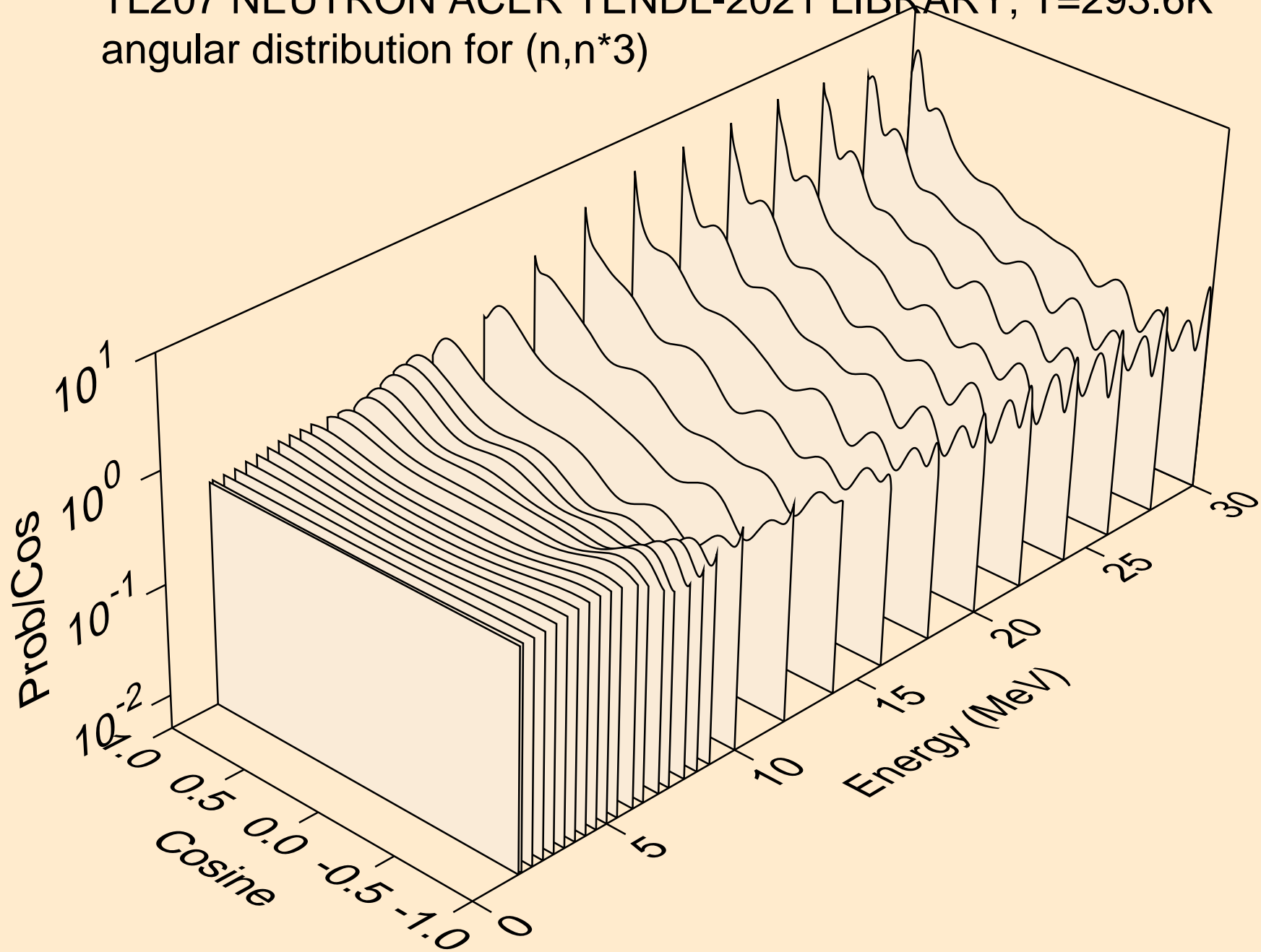



TL207 NEUTRON ACER TENDL-2021 LIBRARY; T=293.6K  
angular distribution for (n,n\*4)

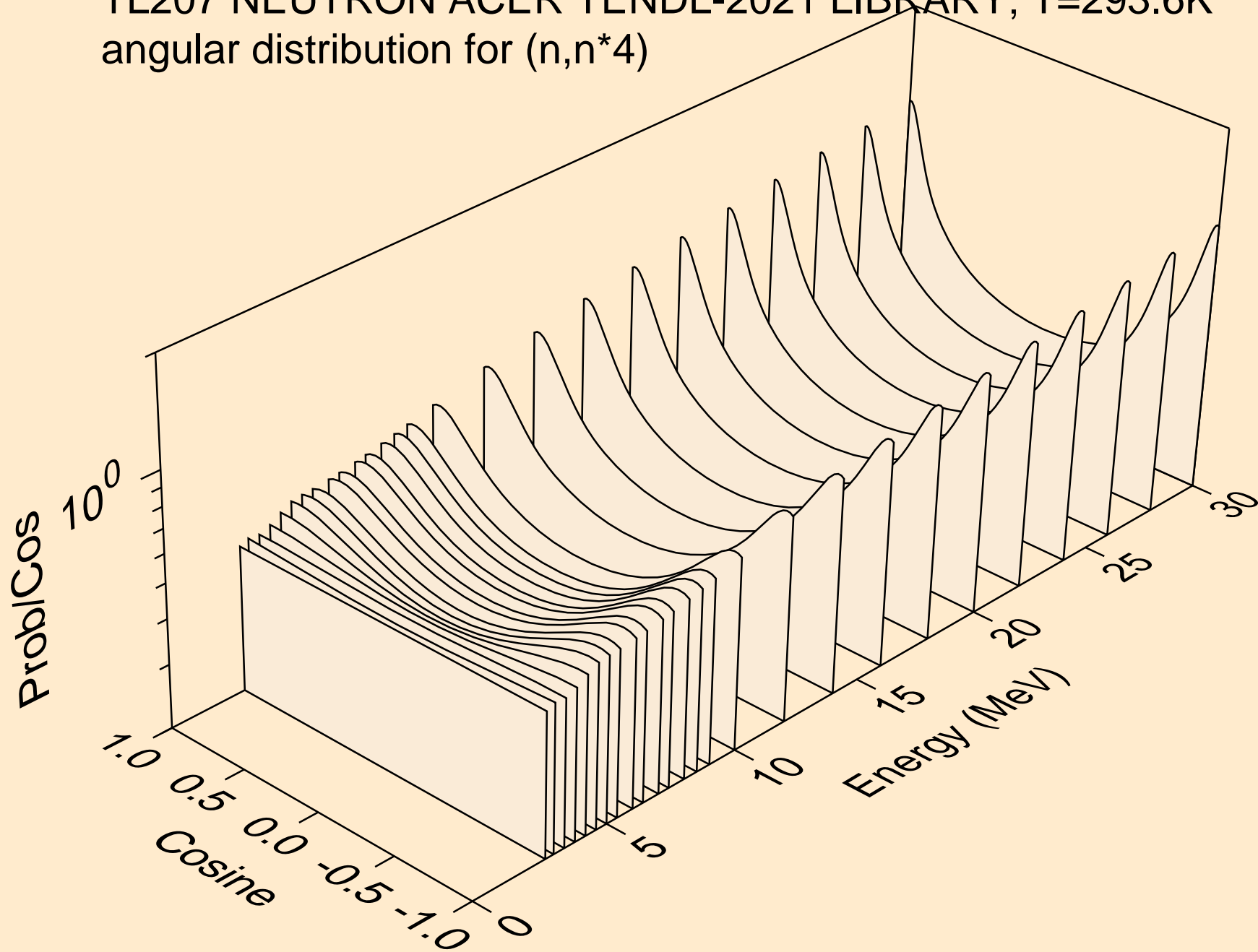

TL207 NEUTRON ACER TENDL-2021 LIBRARY; T=293.6K  
angular distribution for (n,n\*5)

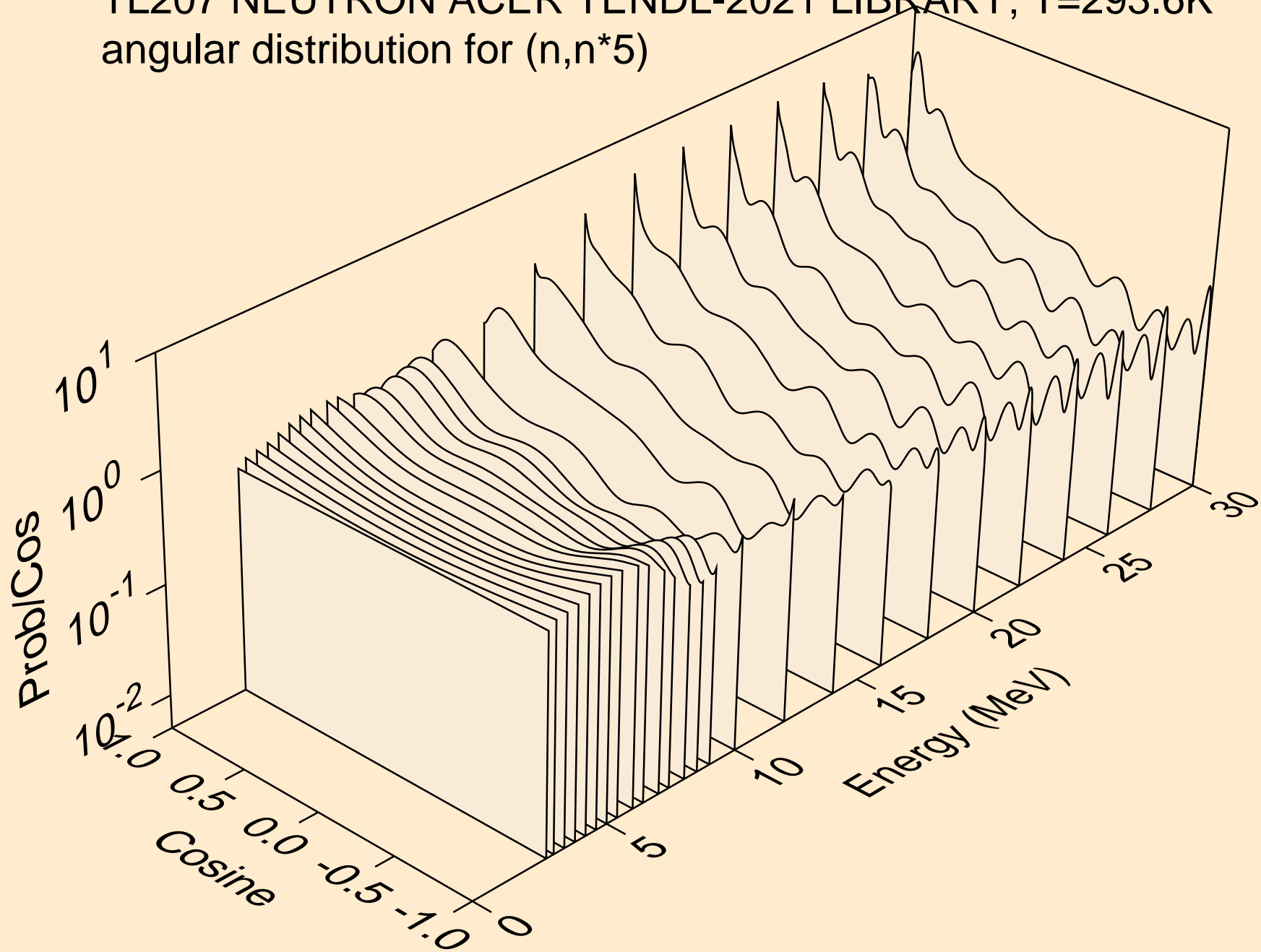

TL207 NEUTRON ACER TENDL-2021 LIBRARY; T=293.6K  
angular distribution for (n,n\*6)

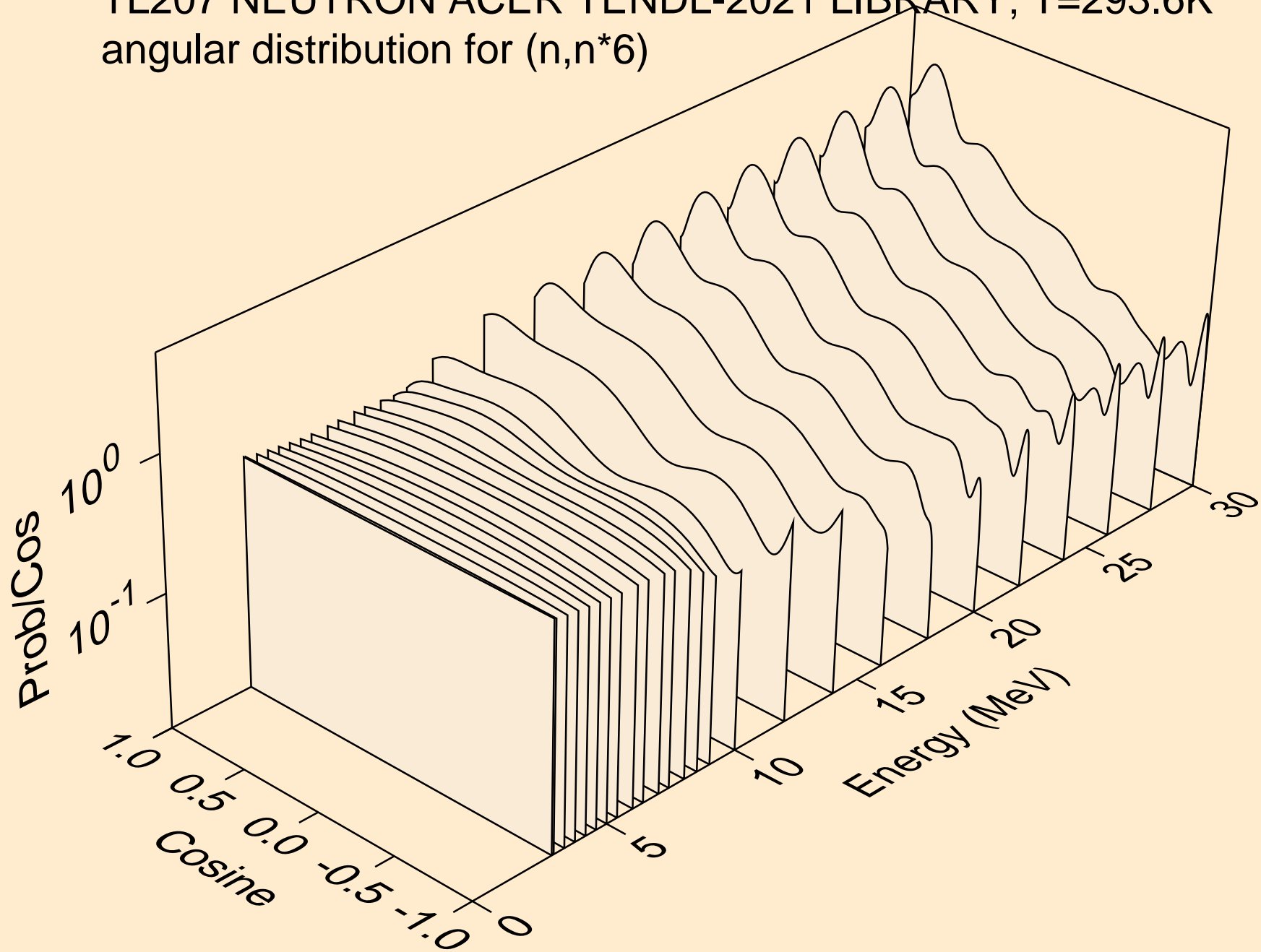

TL207 NEUTRON ACER TENDL-2021 LIBRARY; T=293.6K  
angular distribution for (n,n\*7)

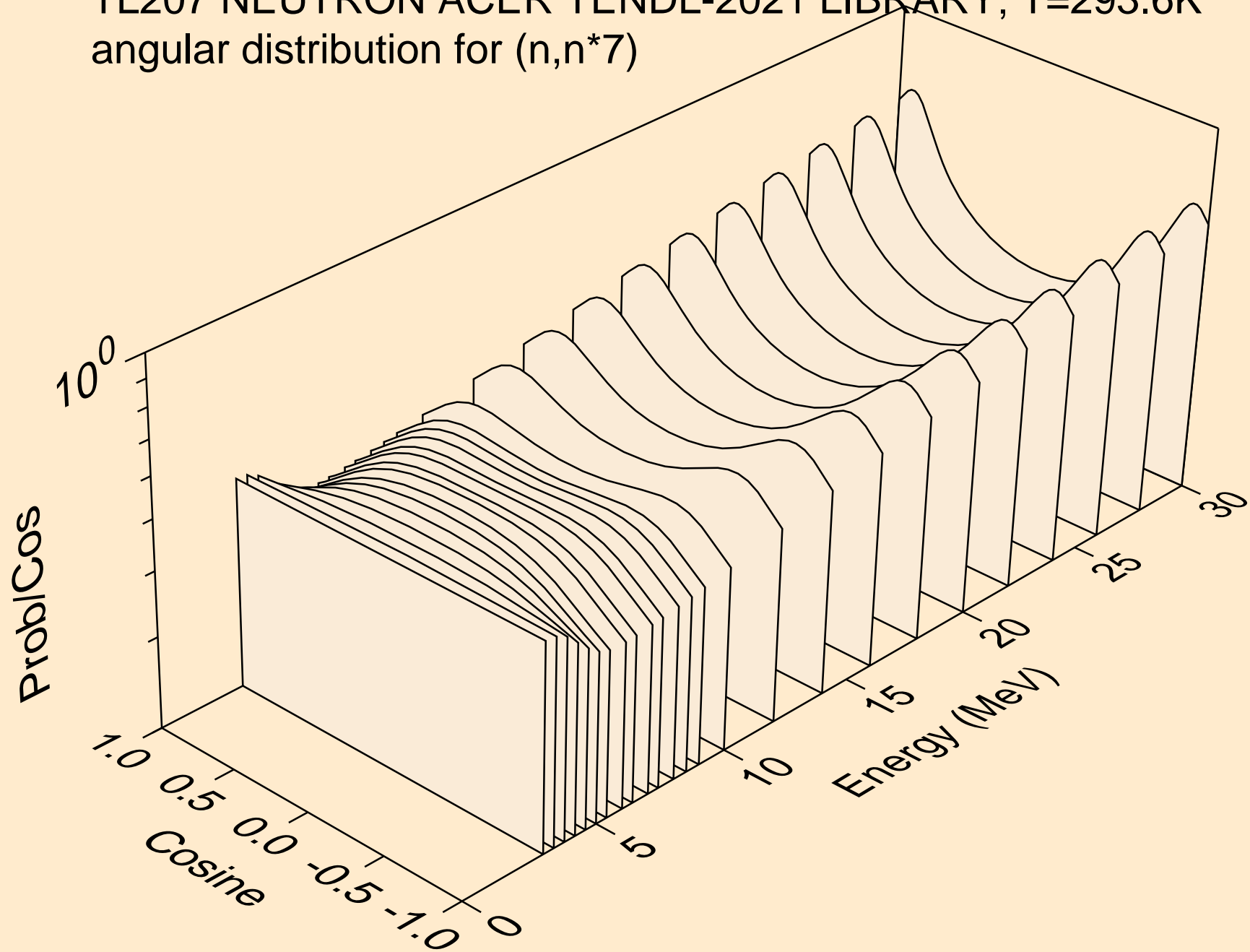

TL207 NEUTRON ACER TENDL-2021 LIBRARY; T=293.6K  
angular distribution for (n,n\*8)

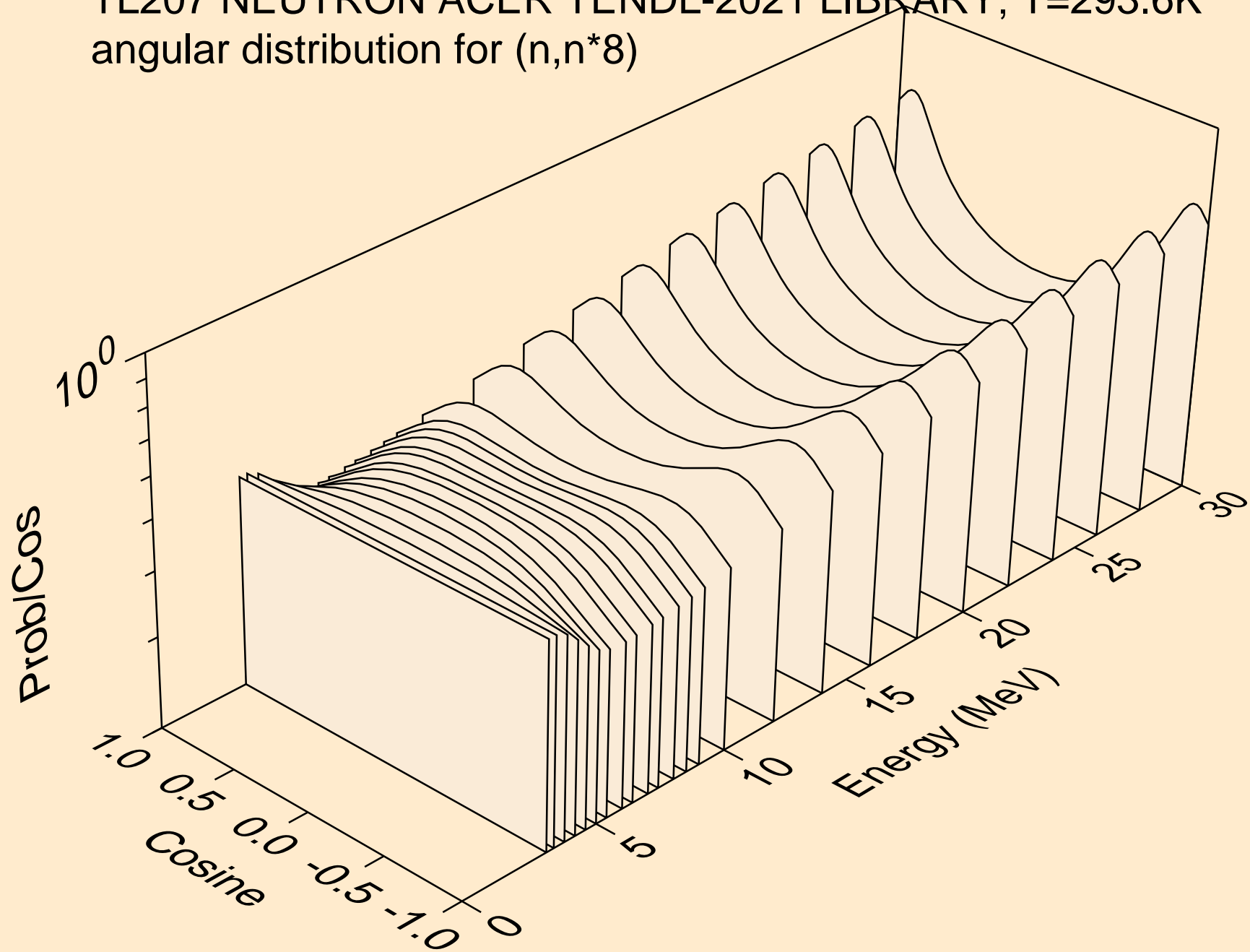

TL207 NEUTRON ACER TENDL-2021 LIBRARY; T=293.6K  
angular distribution for (n,n\*9)

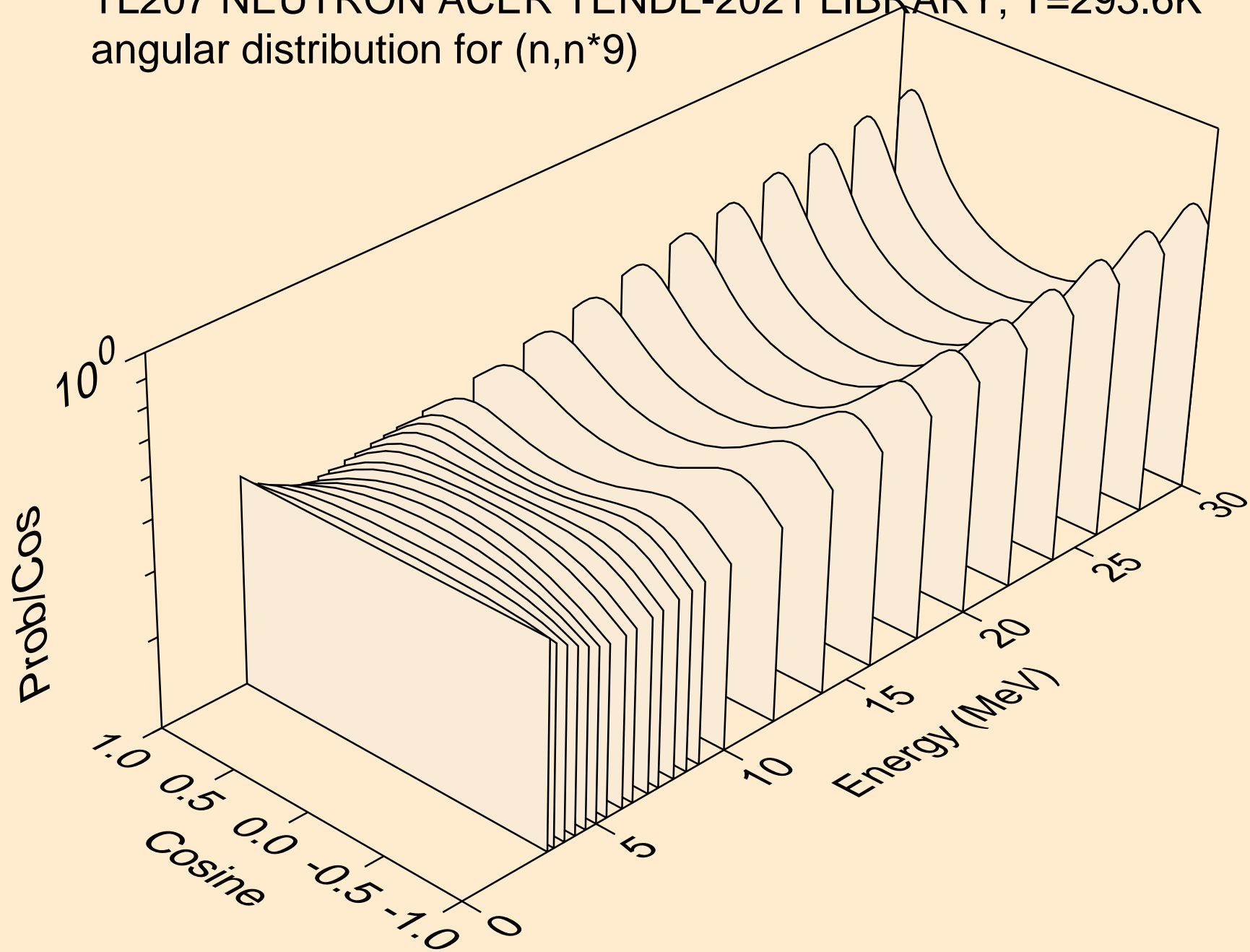

TL207 NEUTRON ACER TENDL-2021 LIBRARY; T=293.6K  
angular distribution for (n,n\*10)

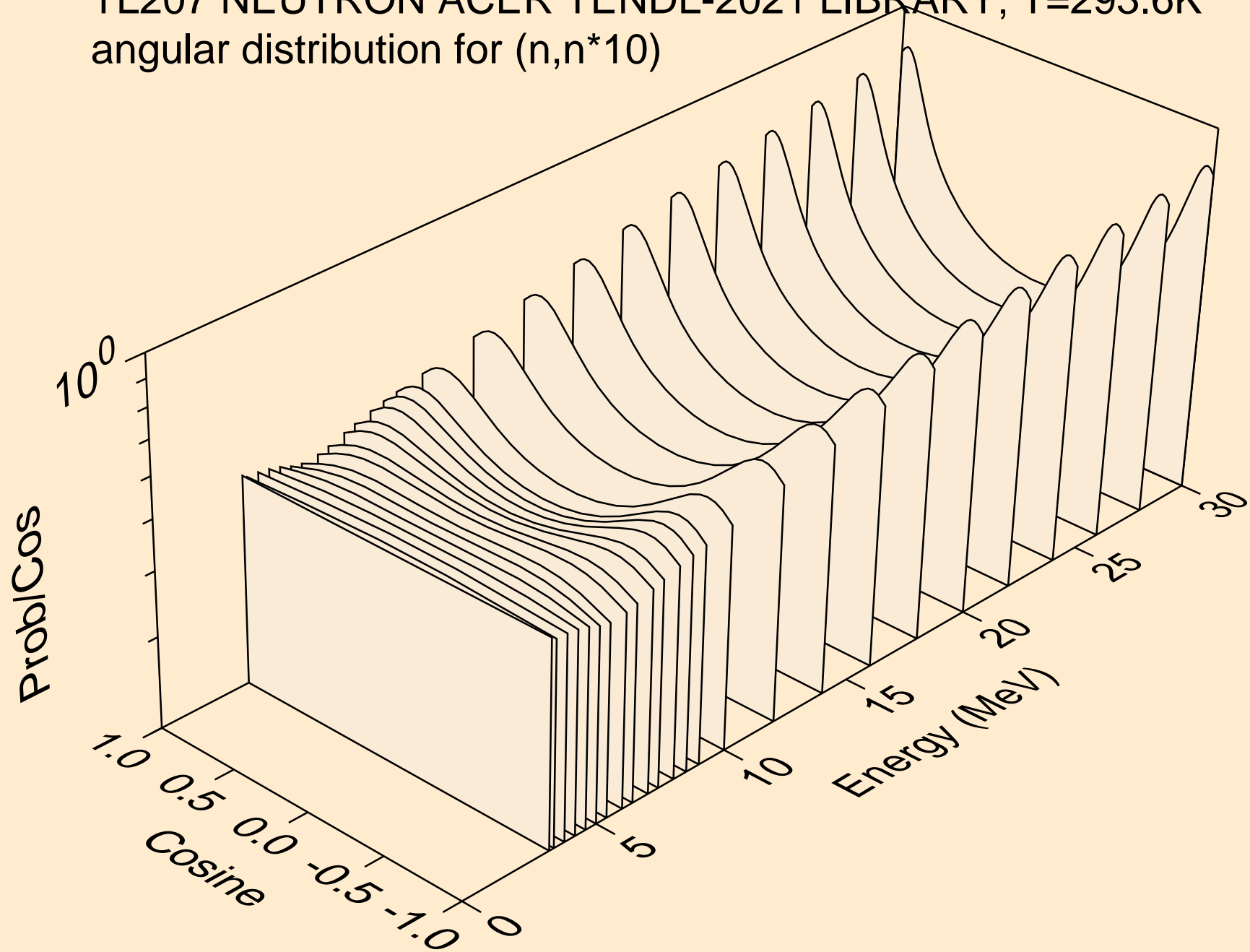

TL207 NEUTRON ACER TENDL-2021 LIBRARY; T=293.6K  
angular distribution for (n,n\*11)

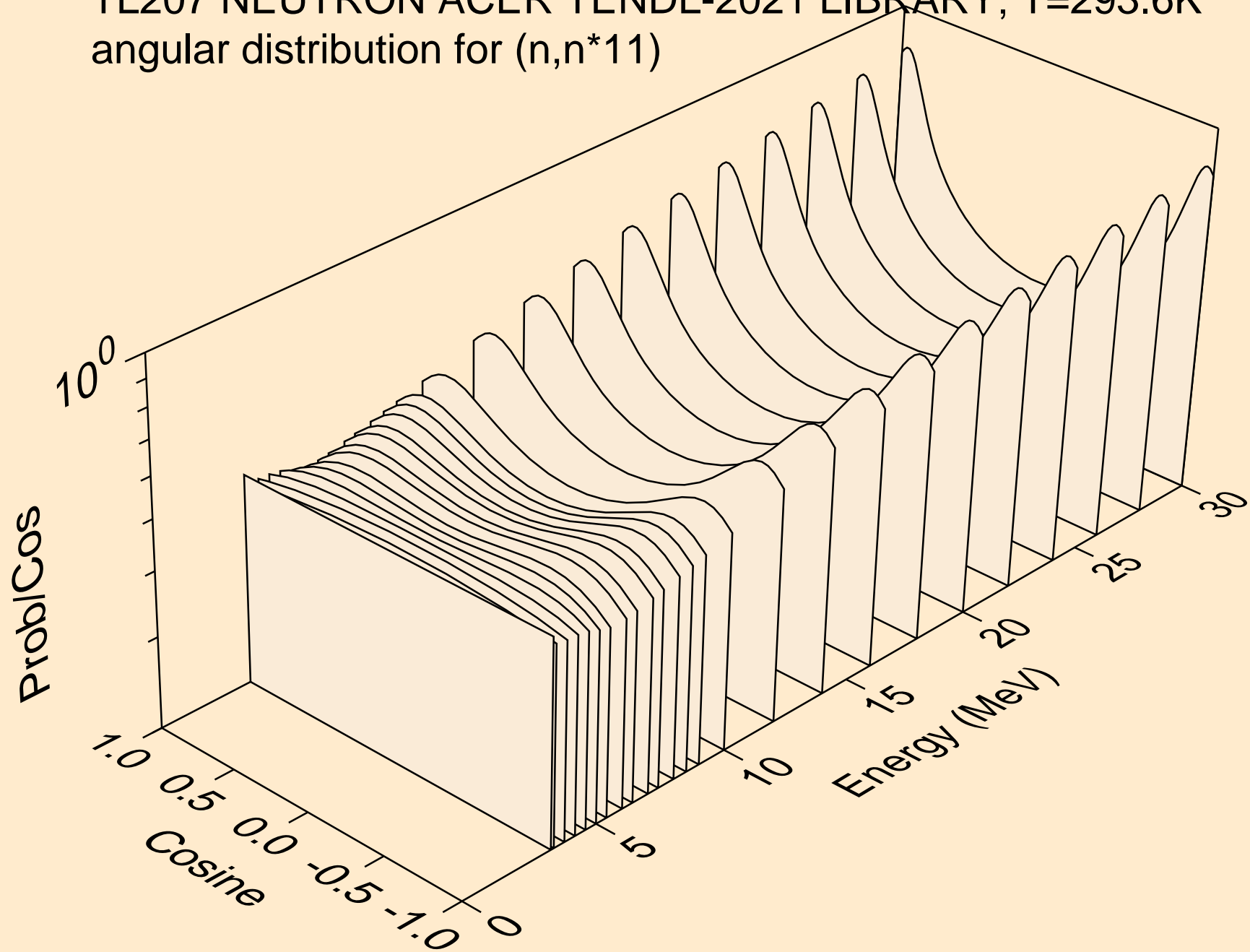



TL207 NEUTRON ACER TENDL-2021 LIBRARY; T=293.6K  
angular distribution for (n,n\*12)

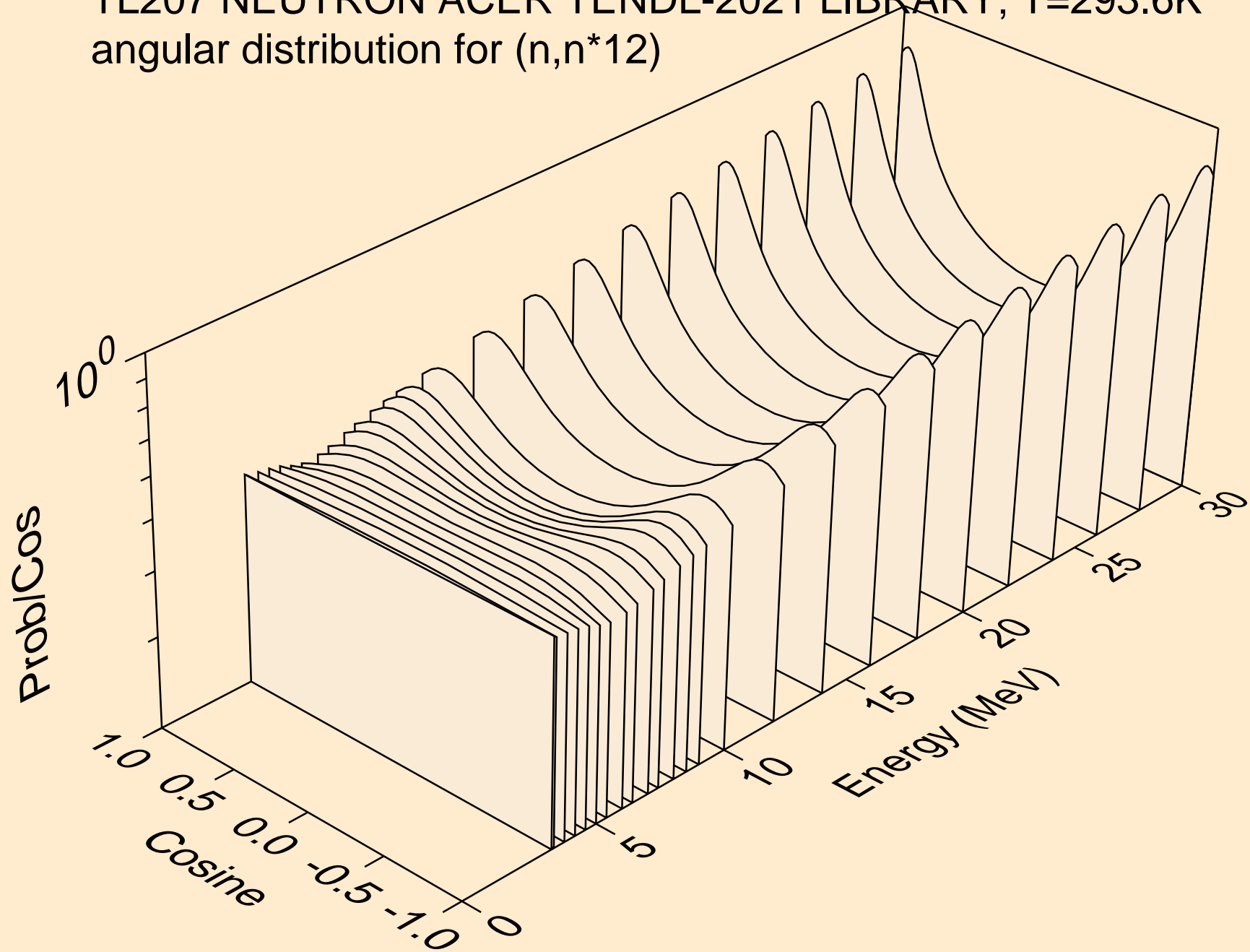

TL207 NEUTRON ACER TENDL-2021 LIBRARY; T=293.6K  
angular distribution for (n,n\*13)

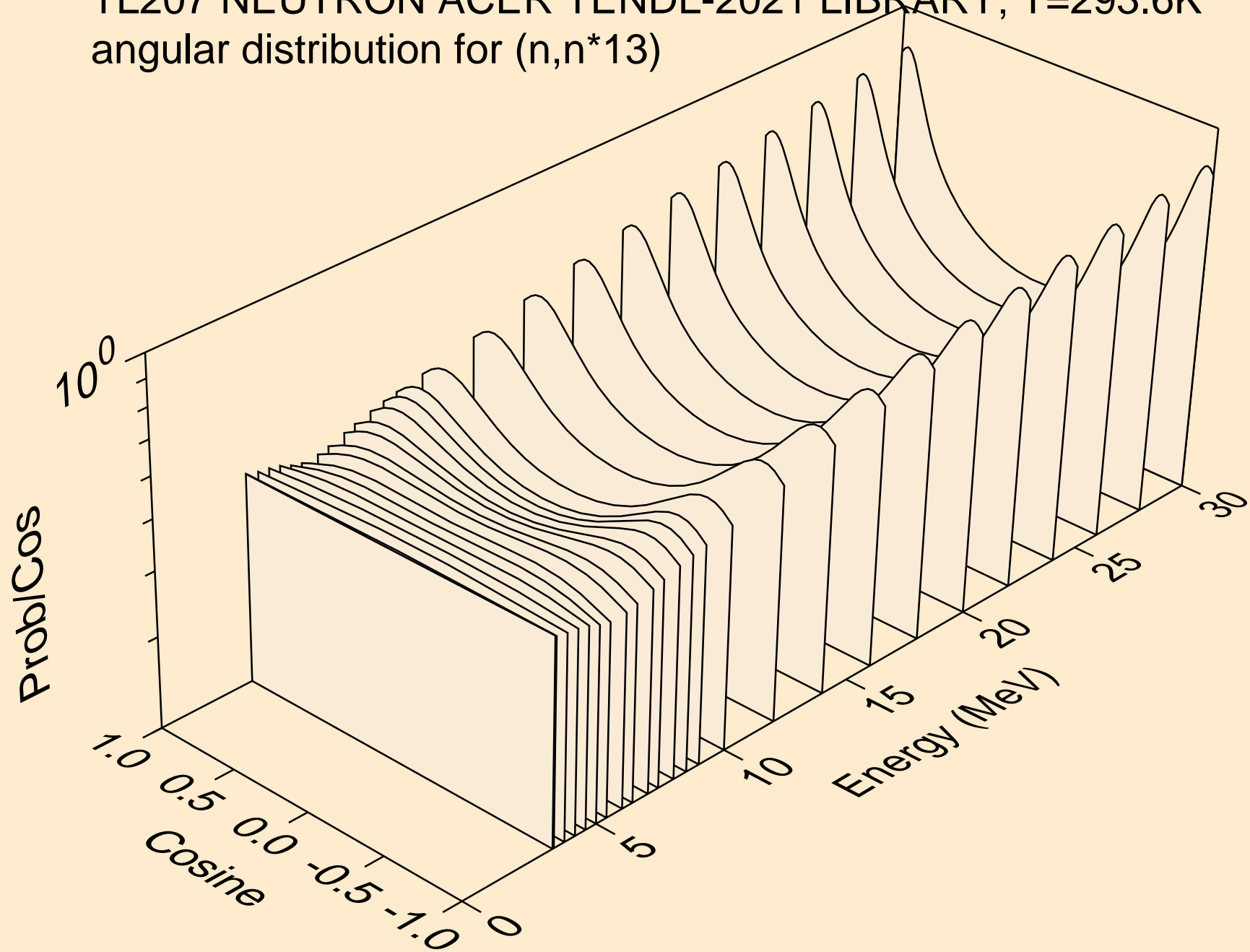

TL207 NEUTRON ACER TENDL-2021 LIBRARY; T=293.6K  
angular distribution for (n,n\*14)

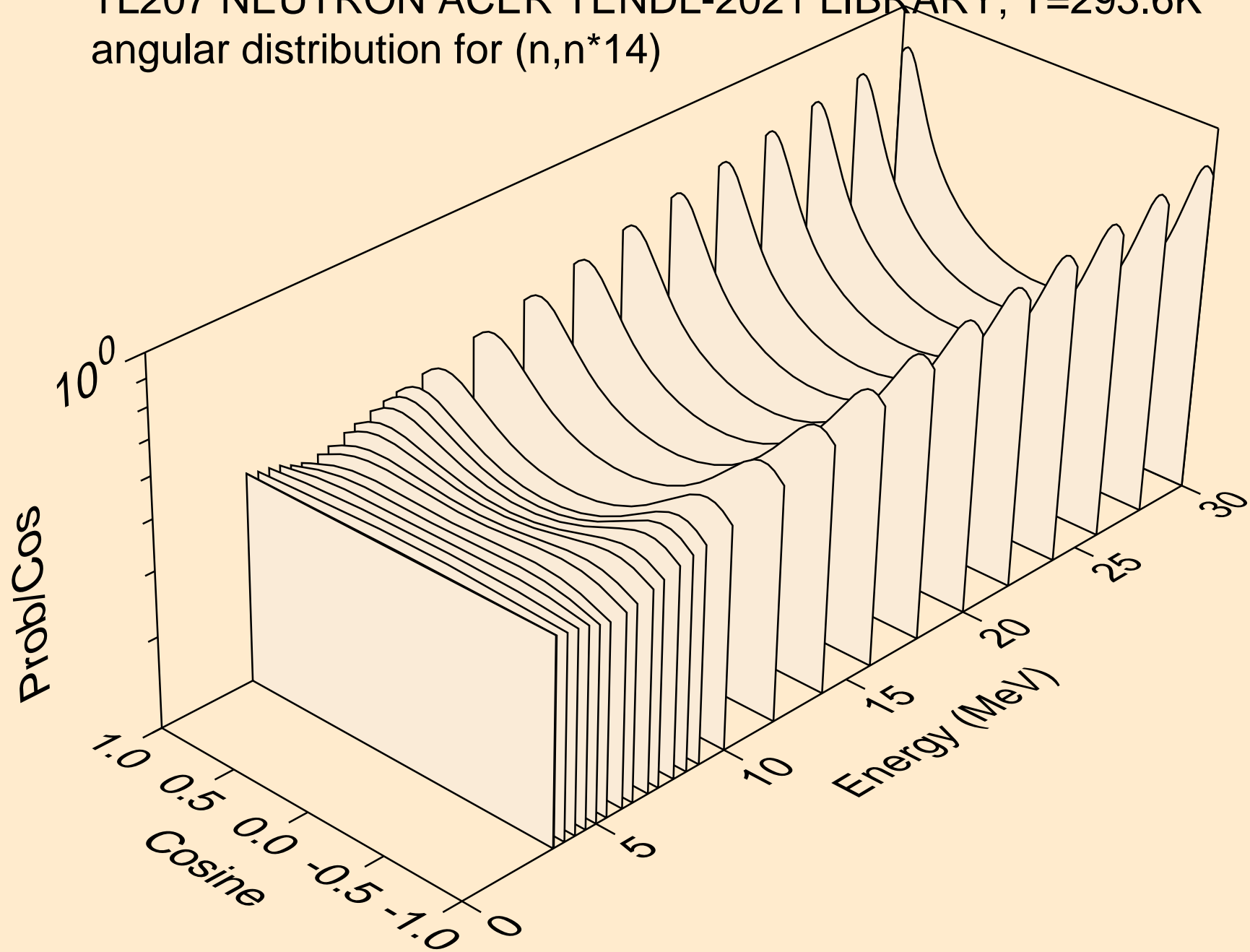

TL207 NEUTRON ACER TENDL-2021 LIBRARY; T=293.6K  
angular distribution for (n,n\*15)

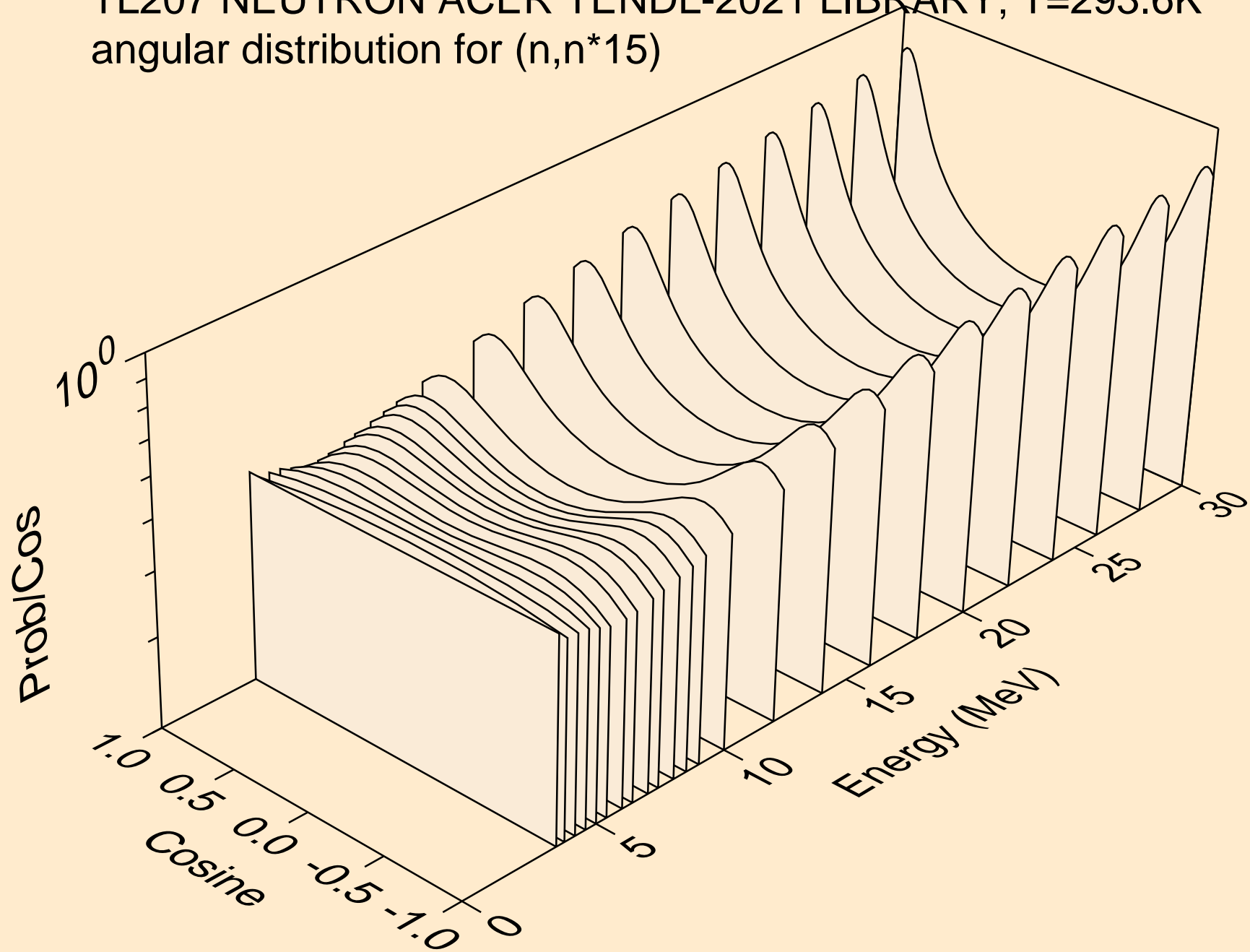

TL207 NEUTRON ACER TENDL-2021 LIBRARY; T=293.6K  
angular distribution for (n,n\*16)

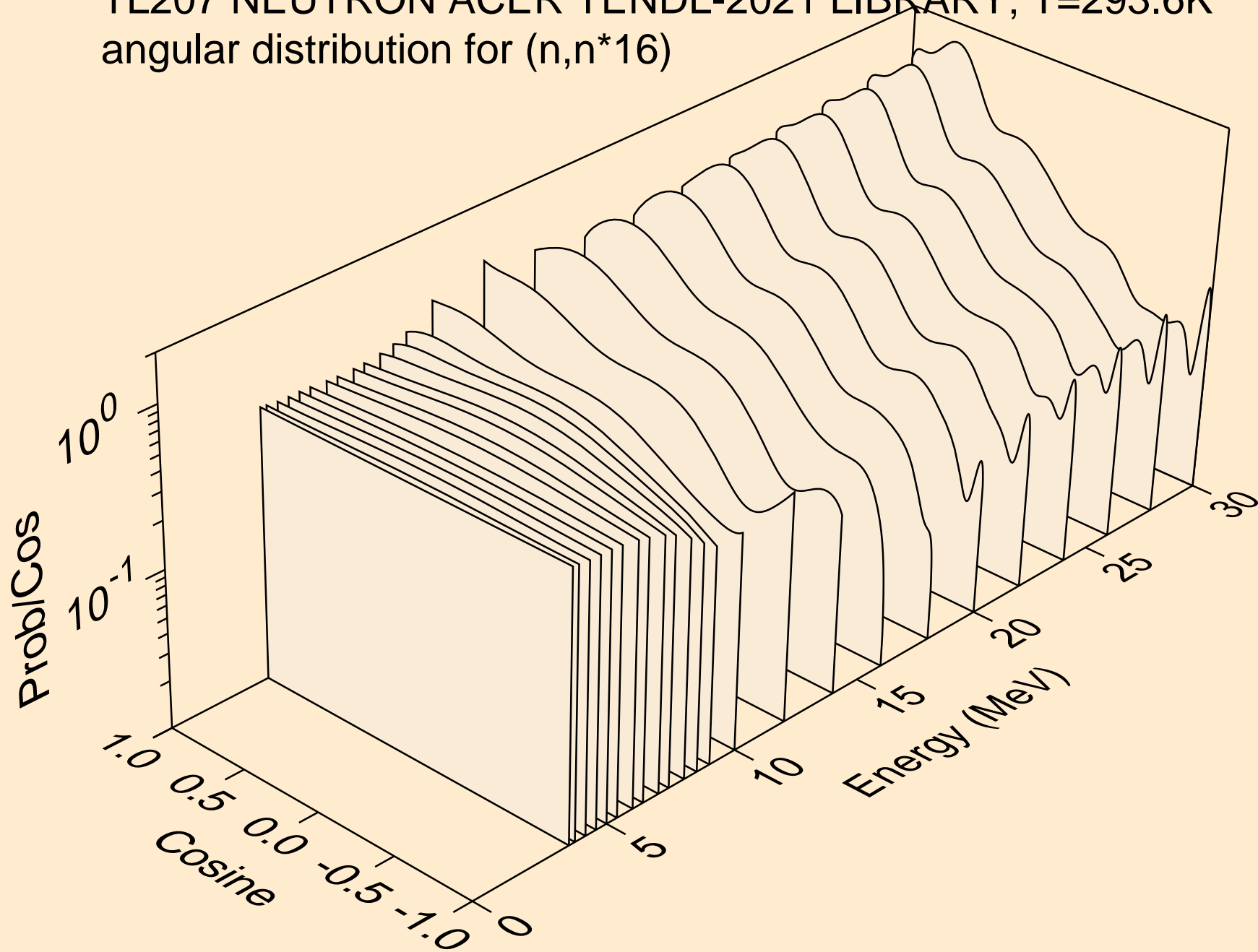

TL207 NEUTRON ACER TENDL-2021 LIBRARY; T=293.6K  
angular distribution for (n,n\*17)

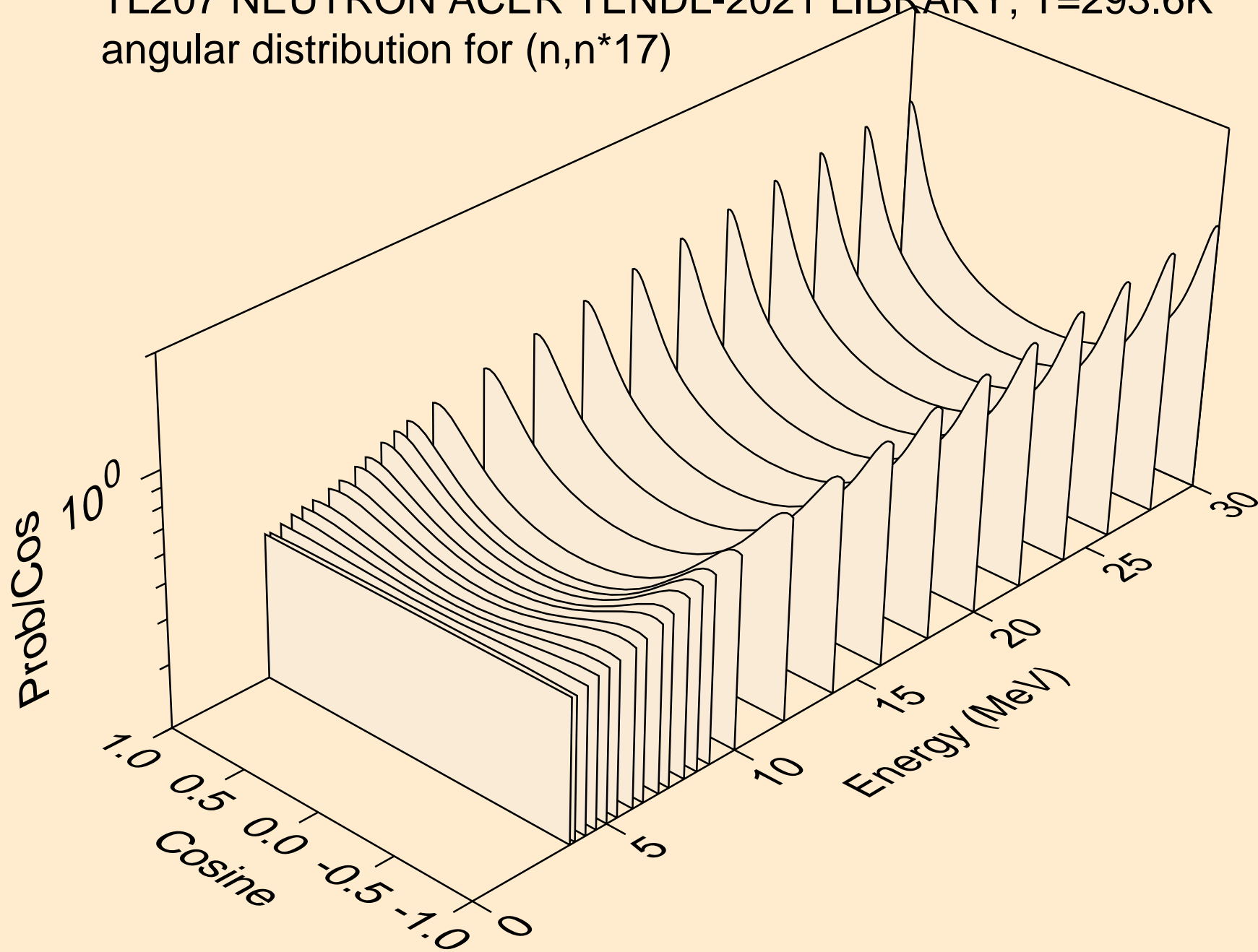

TL207 NEUTRON ACER TENDL-2021 LIBRARY; T=293.6K  
angular distribution for (n,n\*18)

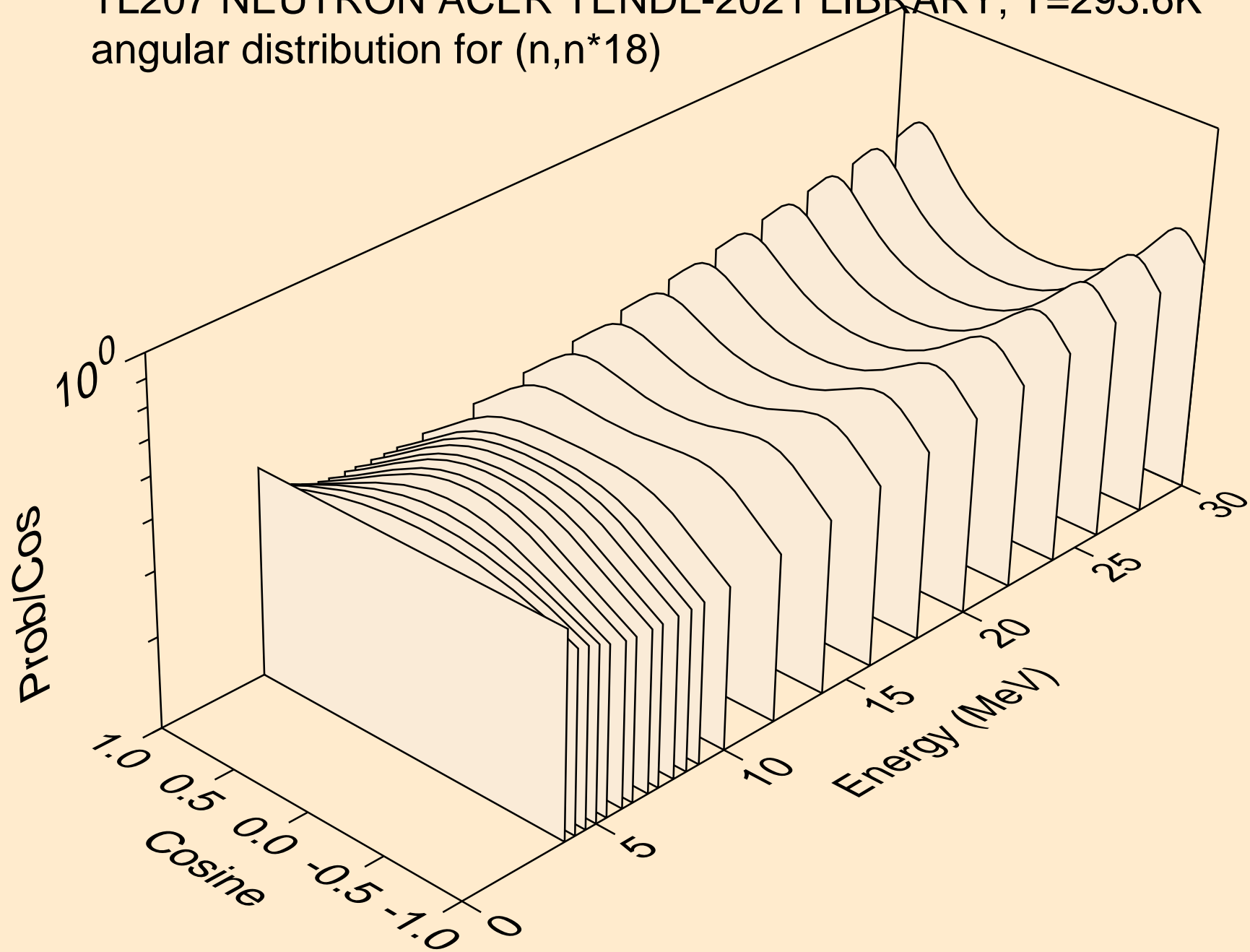

TL207 NEUTRON ACER TENDL-2021 LIBRARY; T=293.6K  
angular distribution for (n,n\*19)

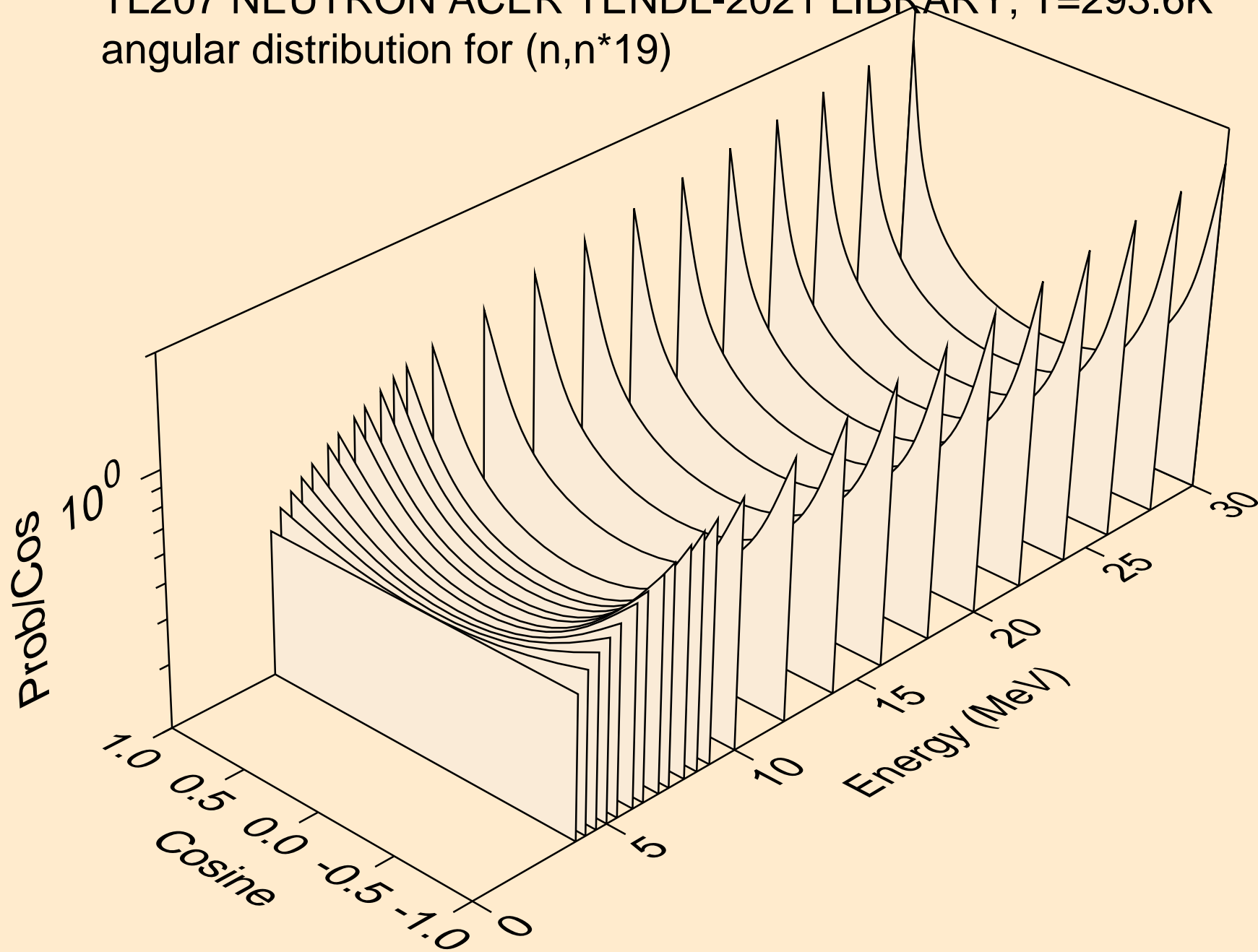



TL207 NEUTRON ACER TENDL-2021 LIBRARY; T=293.6K  
angular distribution for (n,n\*20)

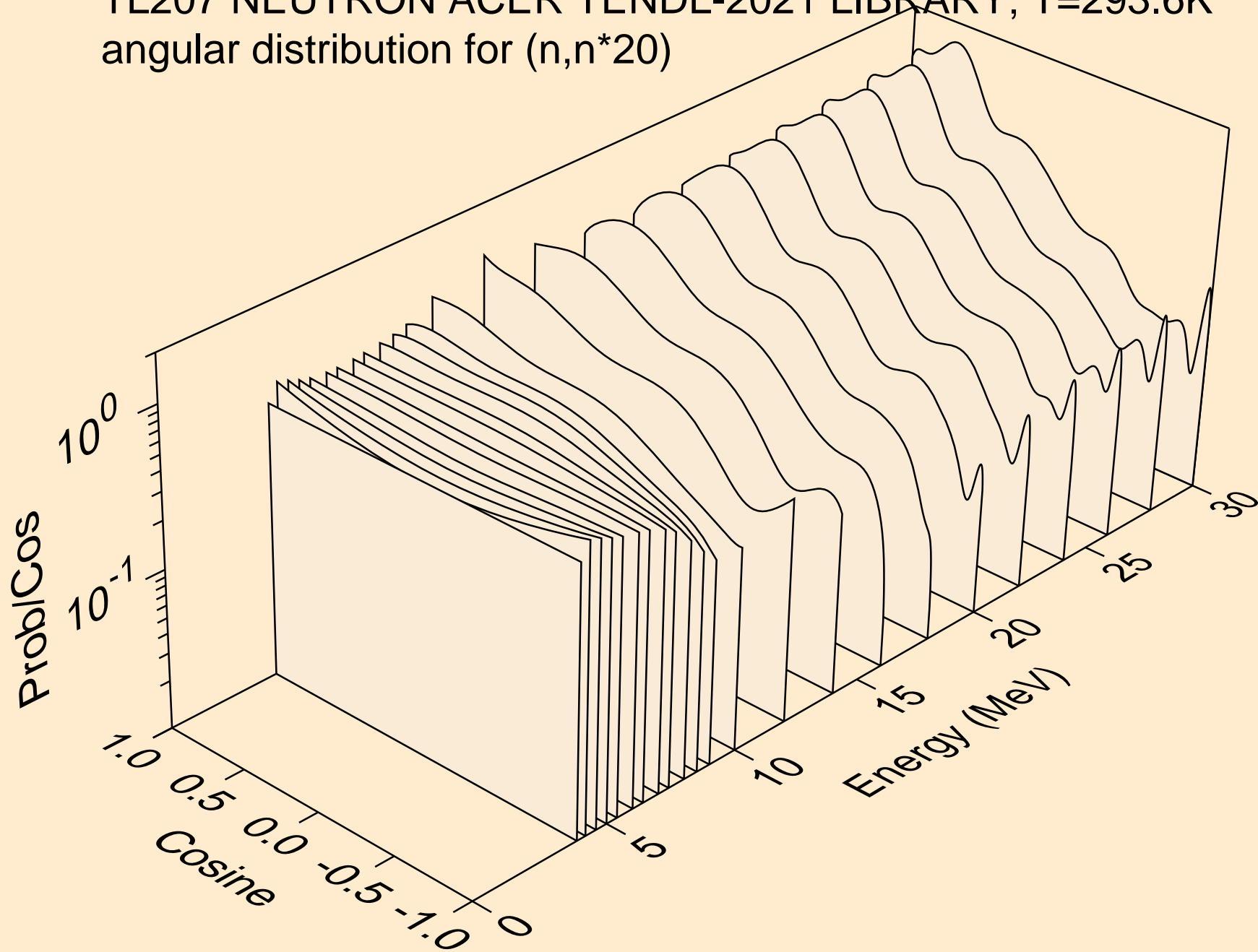

TL207 NEUTRON ACER TENDL-2021 LIBRARY; T=293.6K  
angular distribution for (n,n\*21)

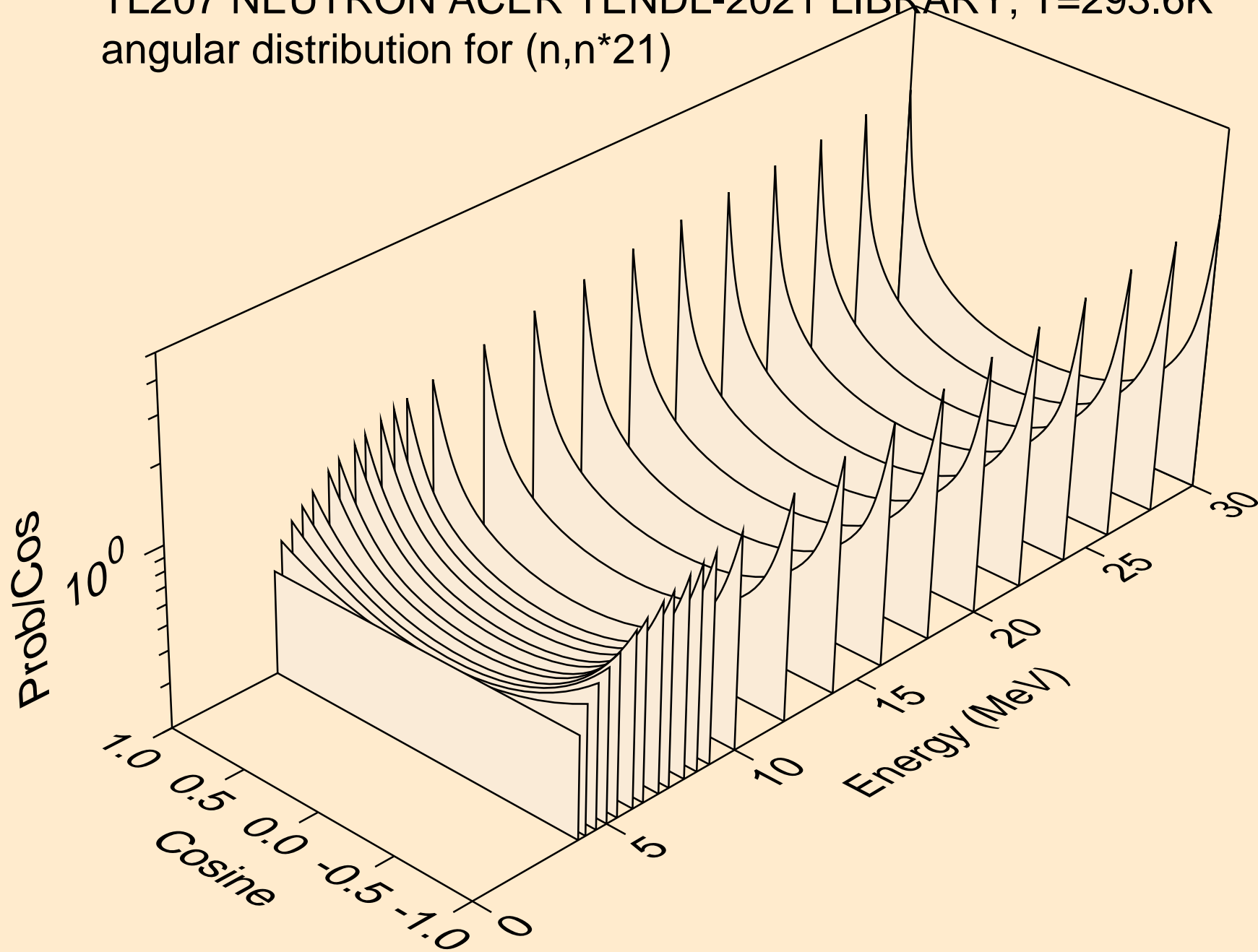

TL207 NEUTRON ACER TENDL-2021 LIBRARY; T=293.6K  
angular distribution for (n,n\*22)

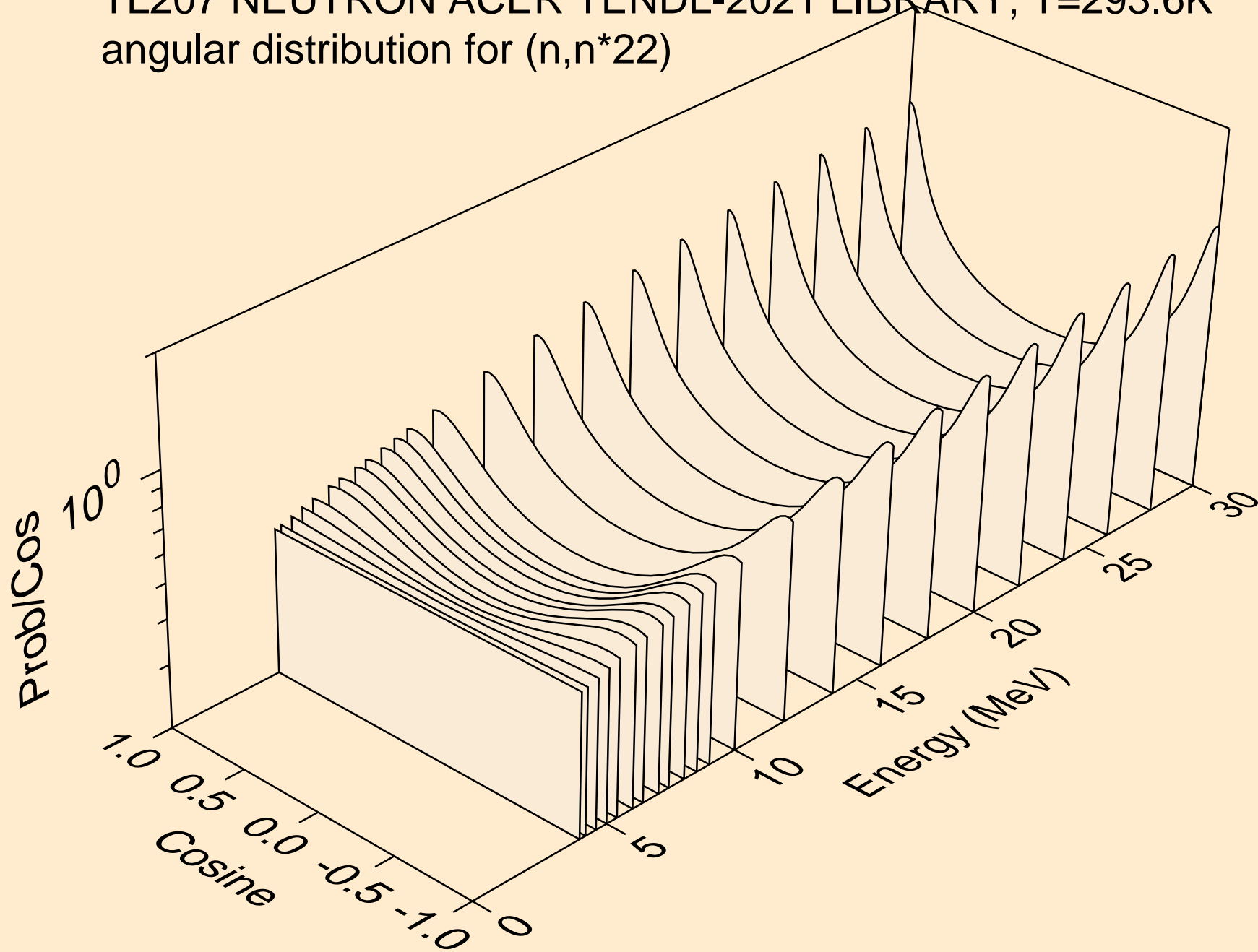

TL207 NEUTRON ACER TENDL-2021 LIBRARY; T=293.6K  
angular distribution for (n,n\*23)

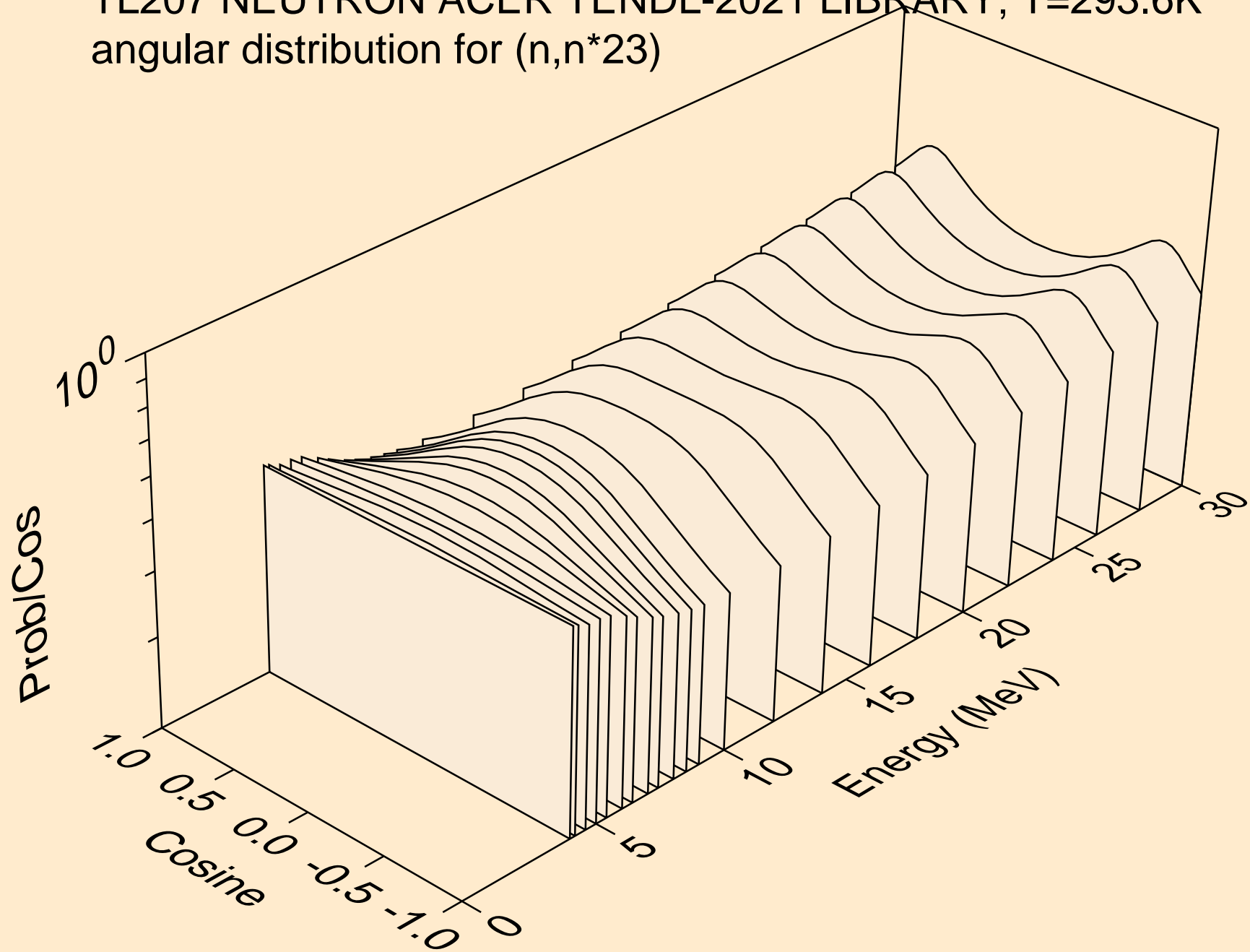

TL207 NEUTRON ACER TENDL-2021 LIBRARY; T=293.6K  
angular distribution for (n,n\*24)

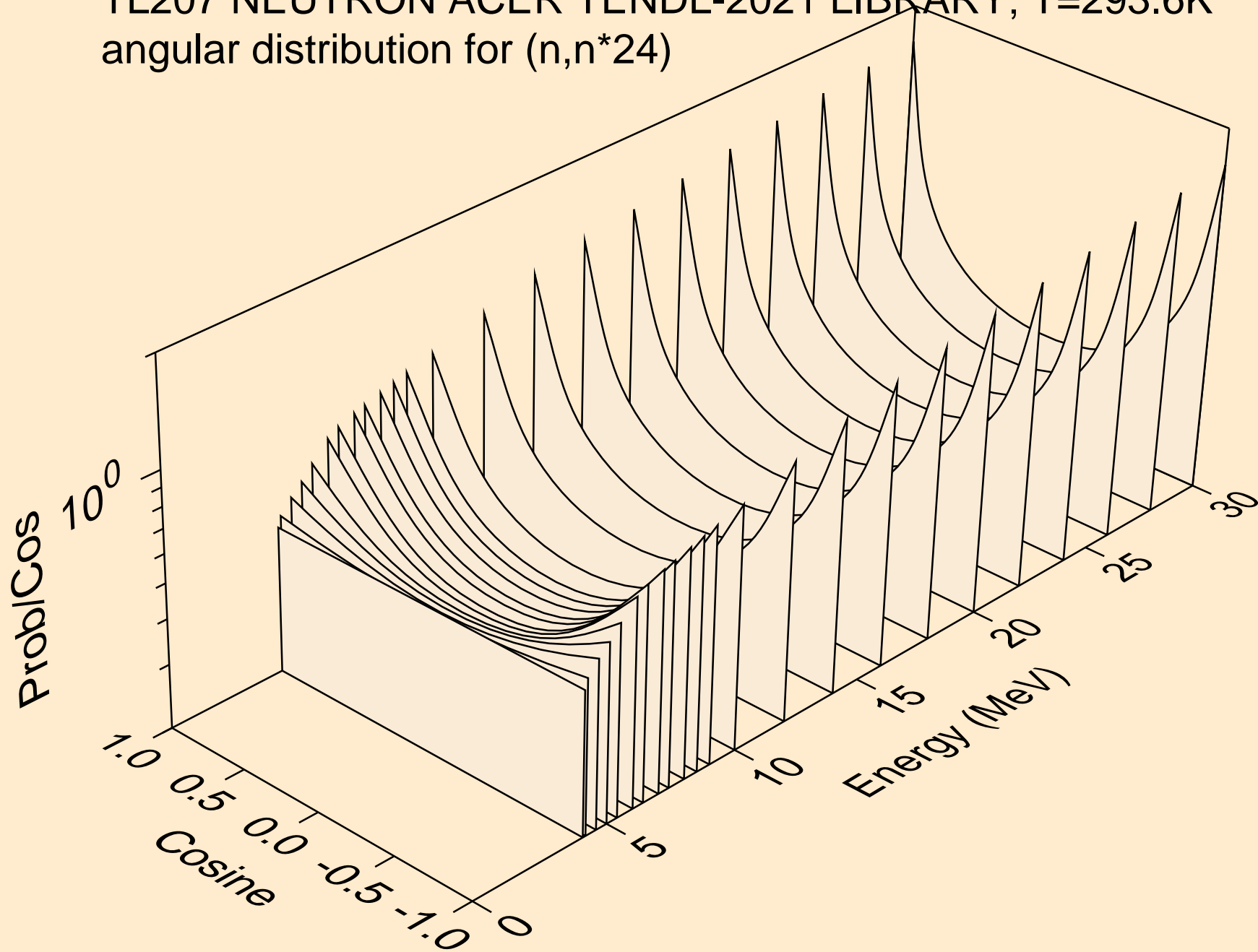

TL207 NEUTRON ACER TENDL-2021 LIBRARY; T=293.6K  
angular distribution for (n,n\*25)

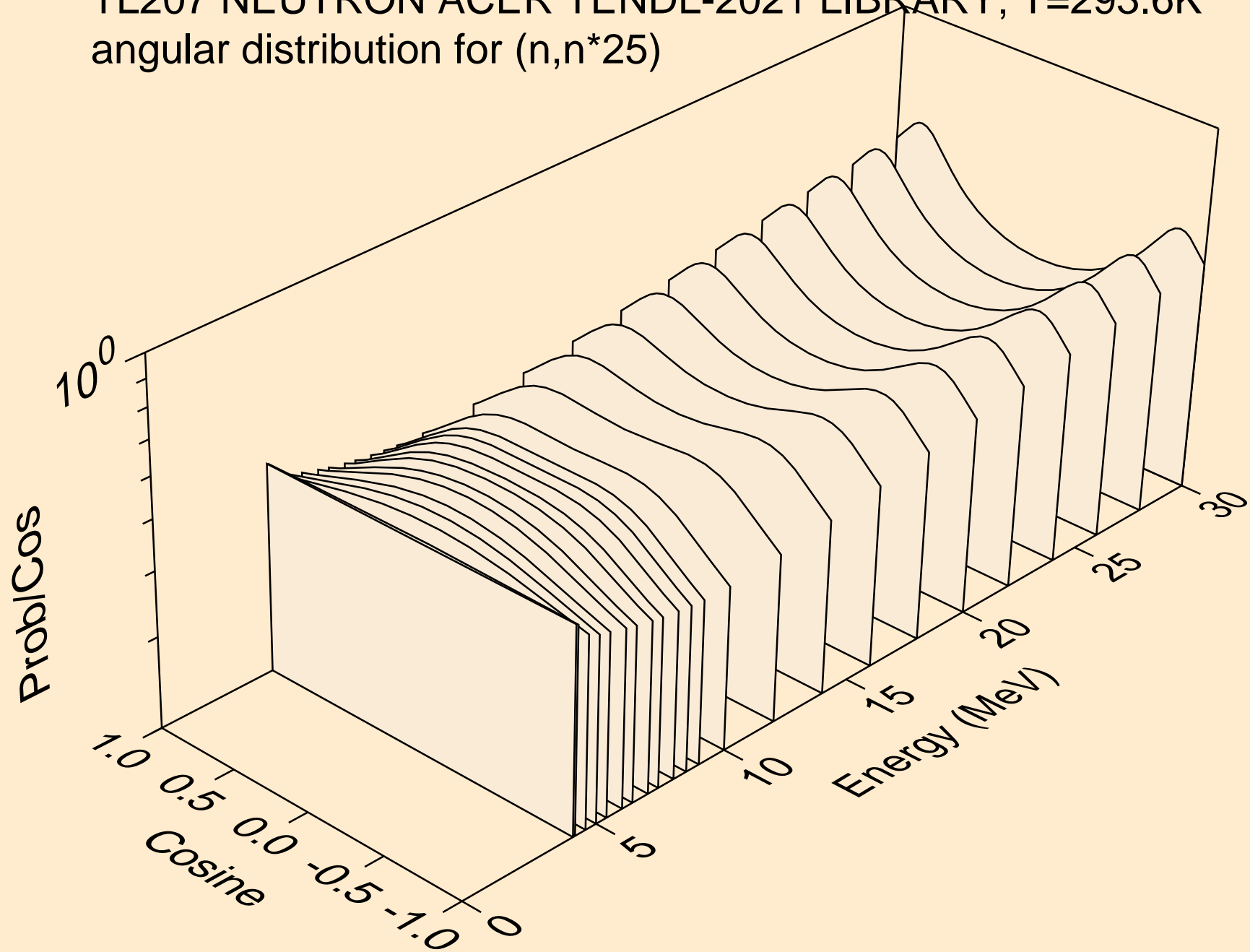

TL207 NEUTRON ACER TENDL-2021 LIBRARY; T=293.6K  
angular distribution for (n,n\*26)

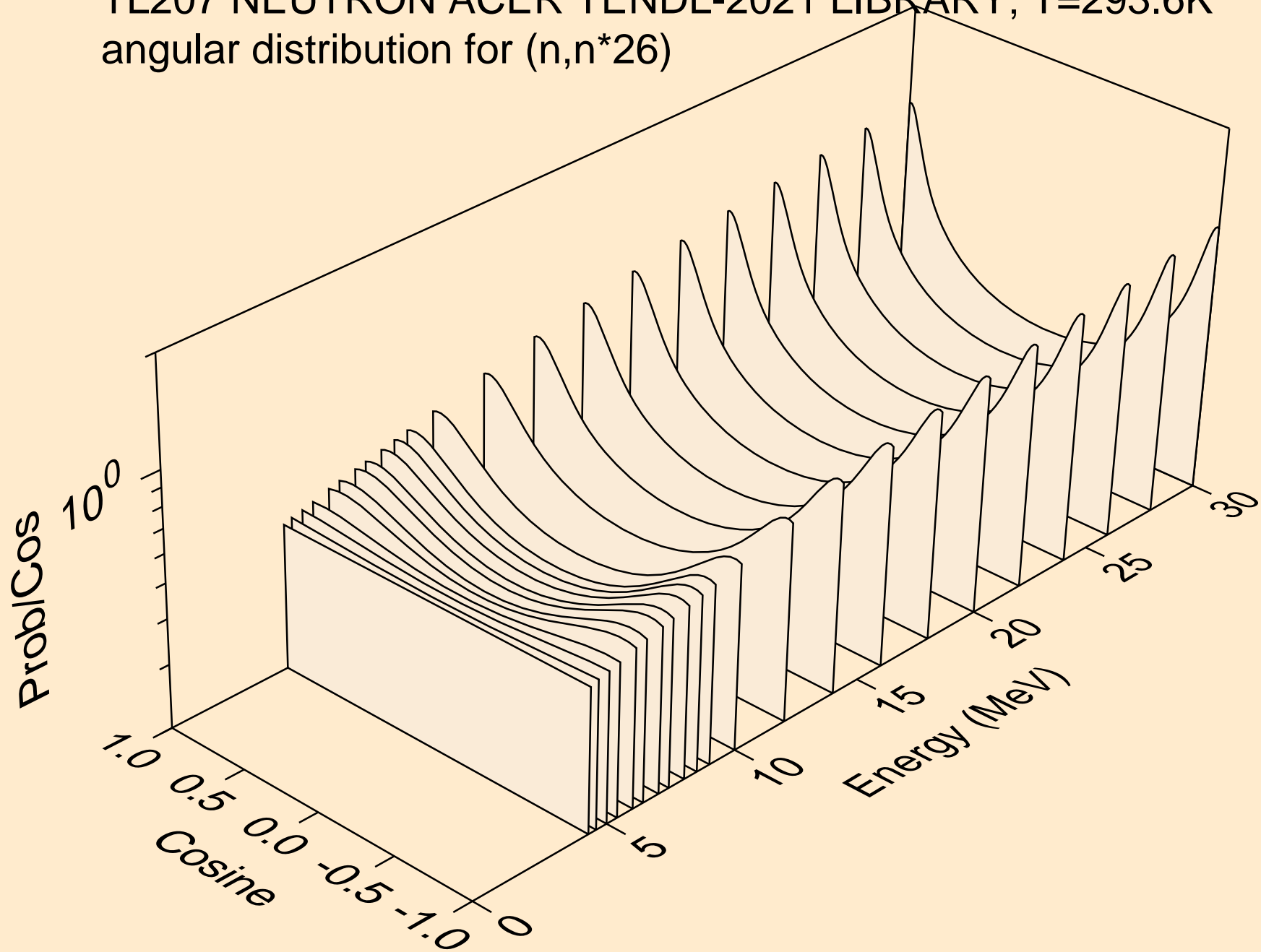

TL207 NEUTRON ACER TENDL-2021 LIBRARY; T=293.6K  
angular distribution for (n,n\*27)

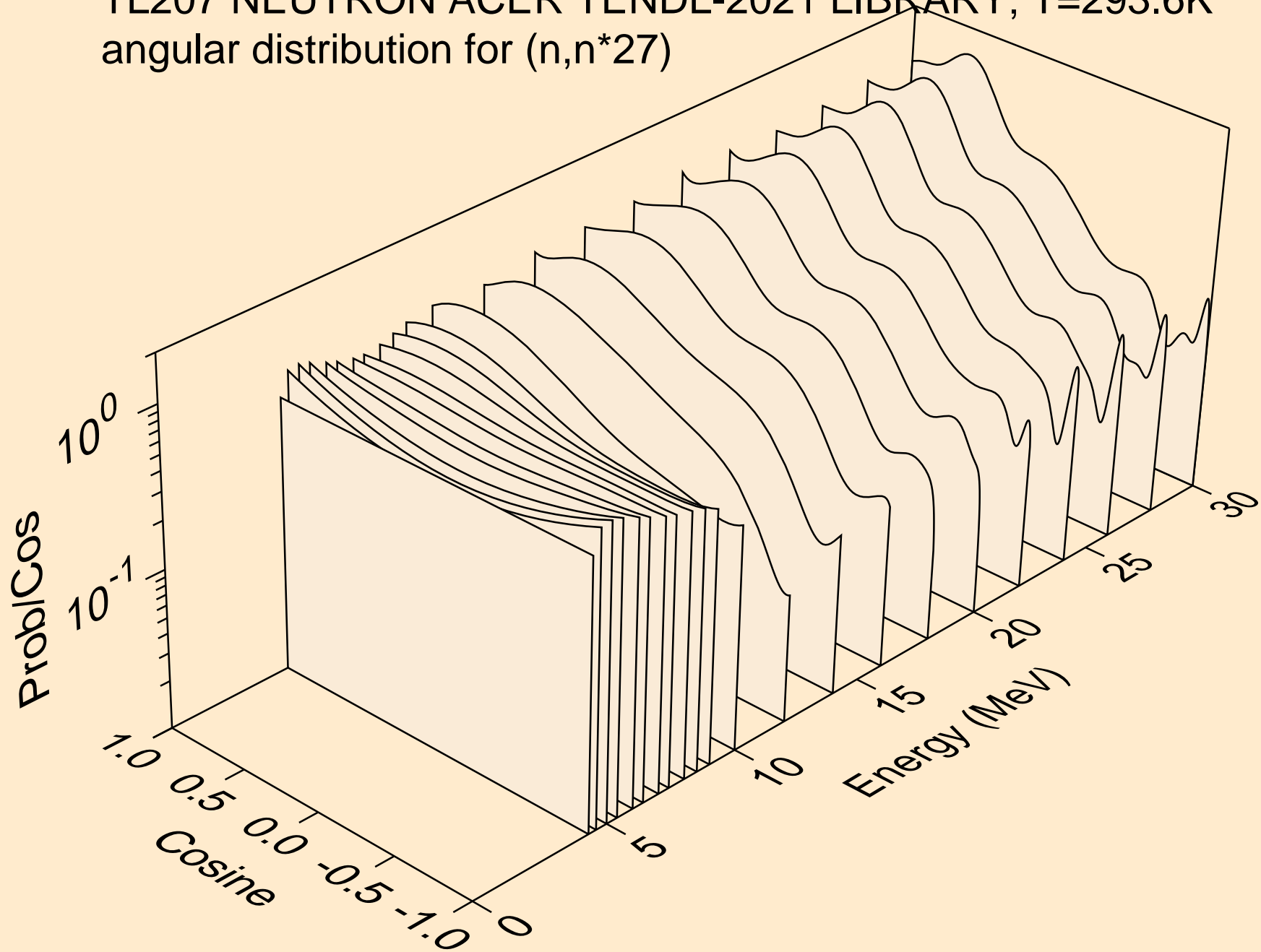



TL207 NEUTRON ACER TENDL-2021 LIBRARY; T=293.6K  
angular distribution for (n,n\*28)

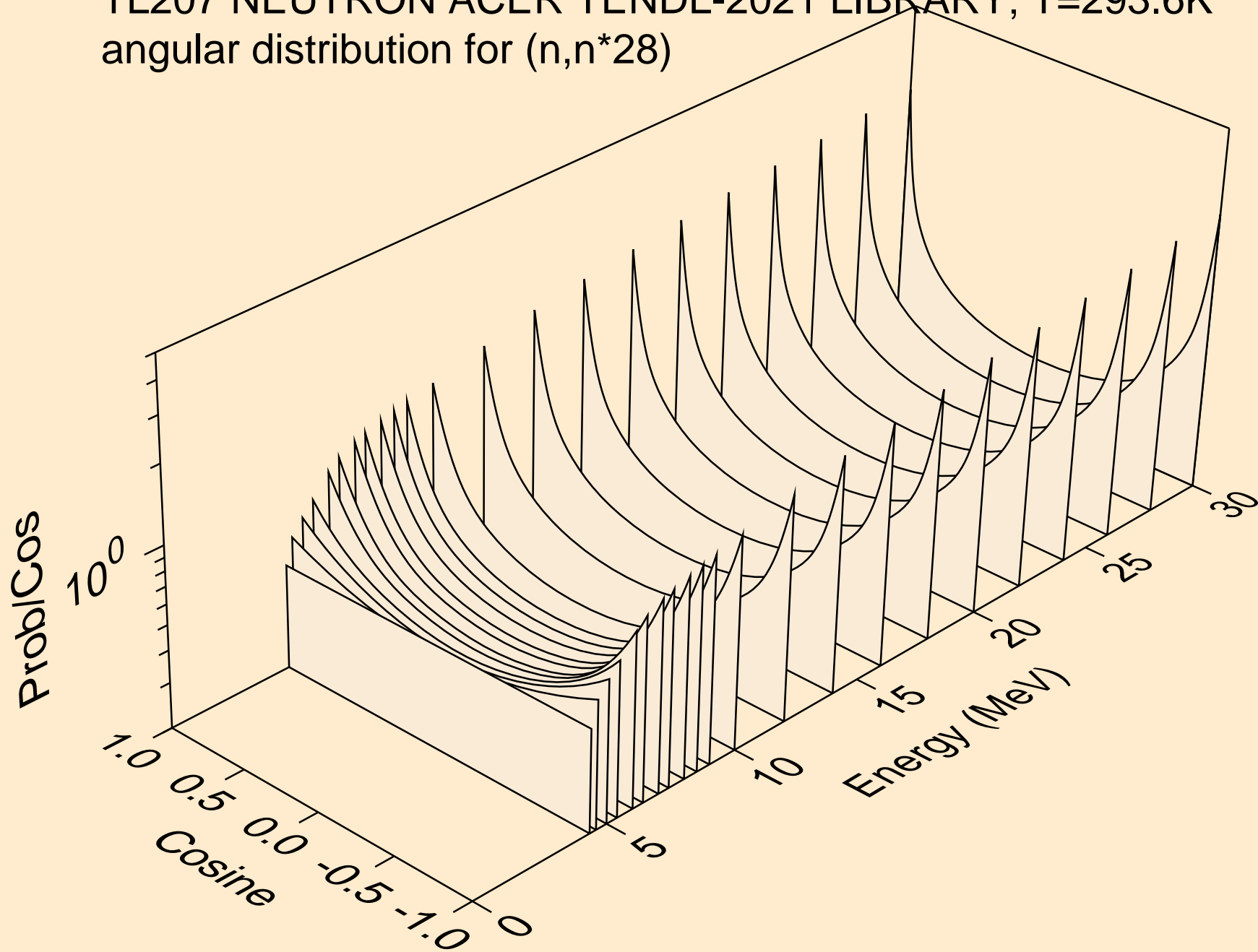

TL207 NEUTRON ACER TENDL-2021 LIBRARY; T=293.6K  
angular distribution for (n,n\*29)

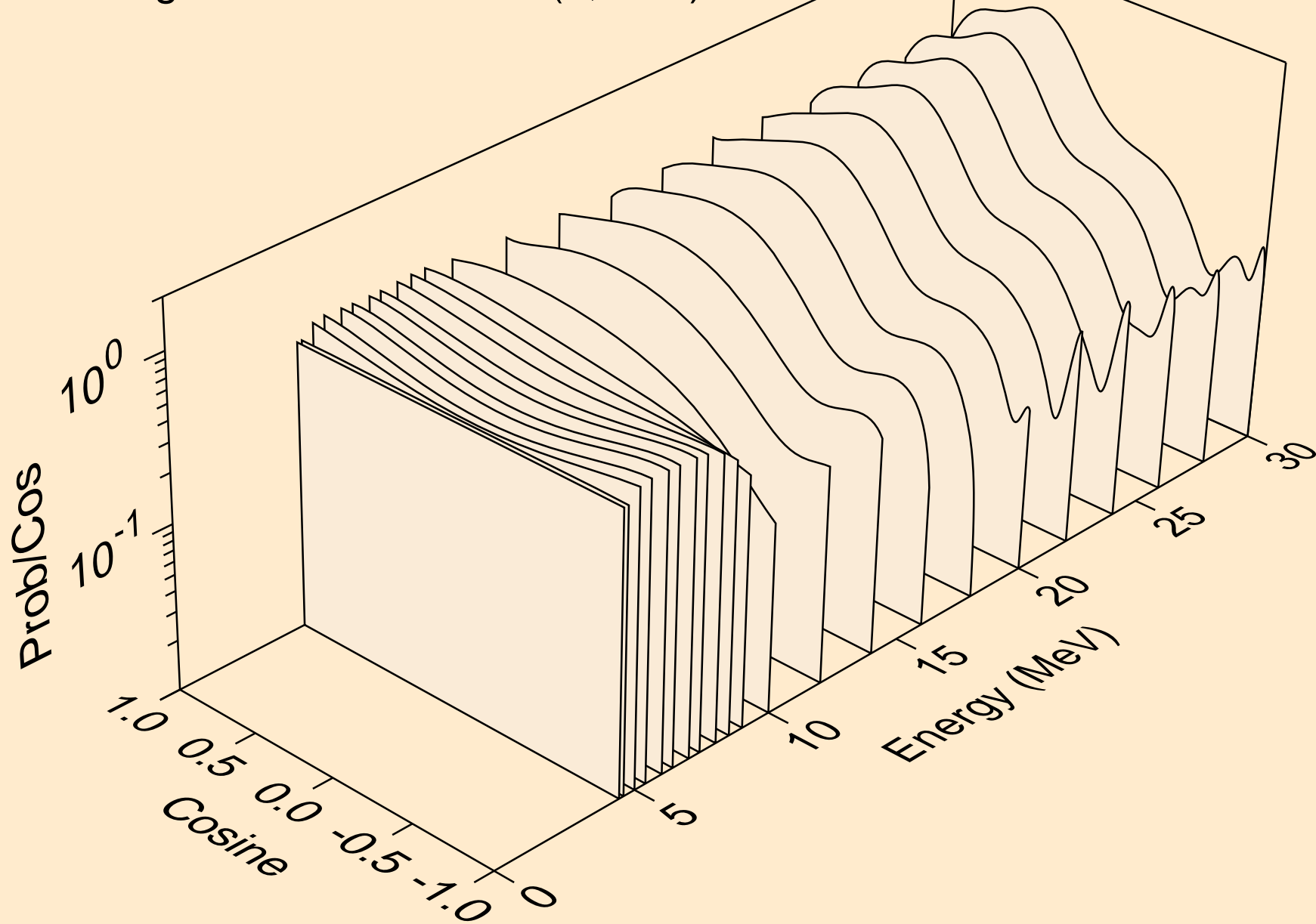

TL207 NEUTRON ACER TENDL-2021 LIBRARY; T=293.6K  
angular distribution for (n,n\*30)

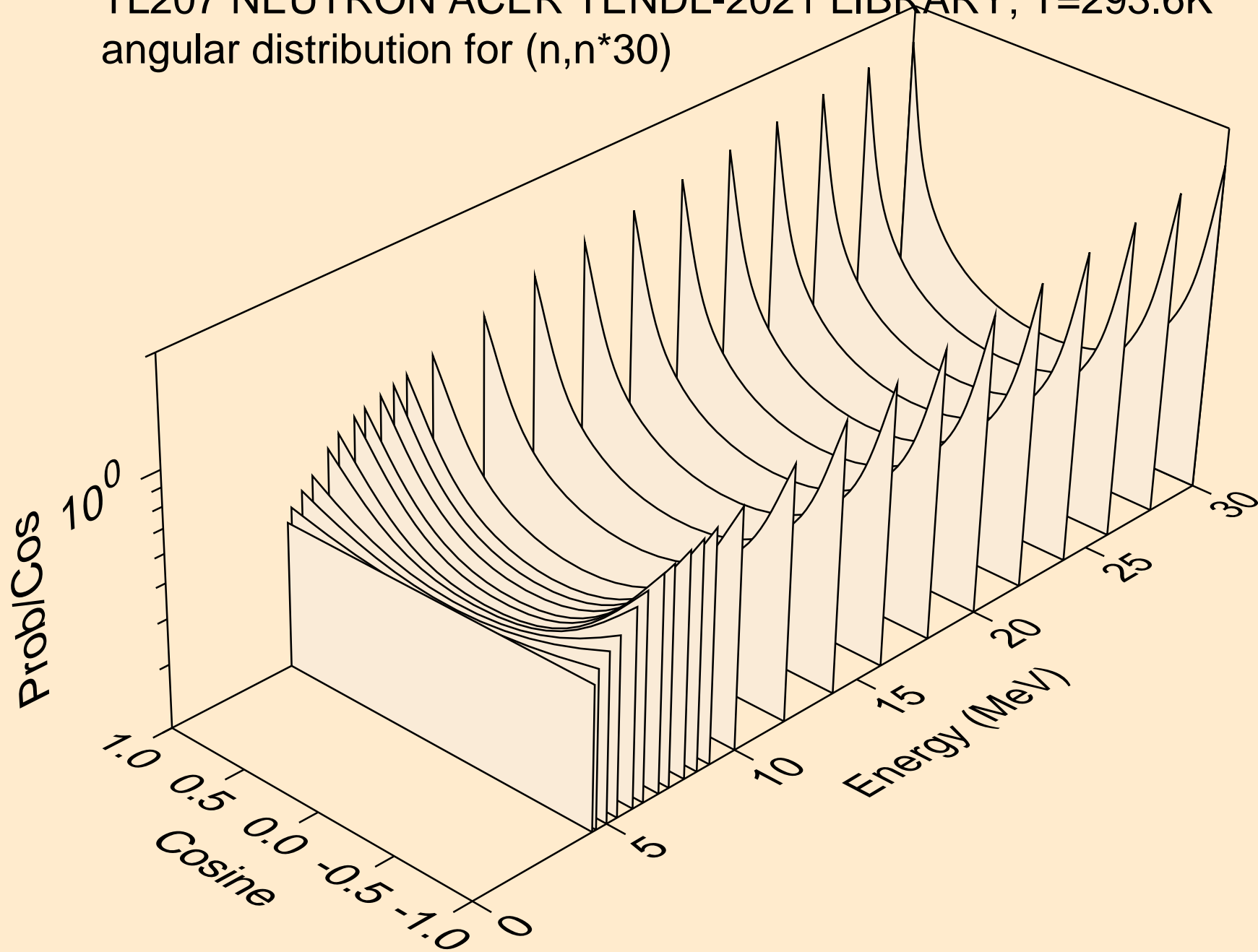

TL207 NEUTRON ACER TENDL-2021 LIBRARY; T=293.6K  
Neutron emission for (n,x)

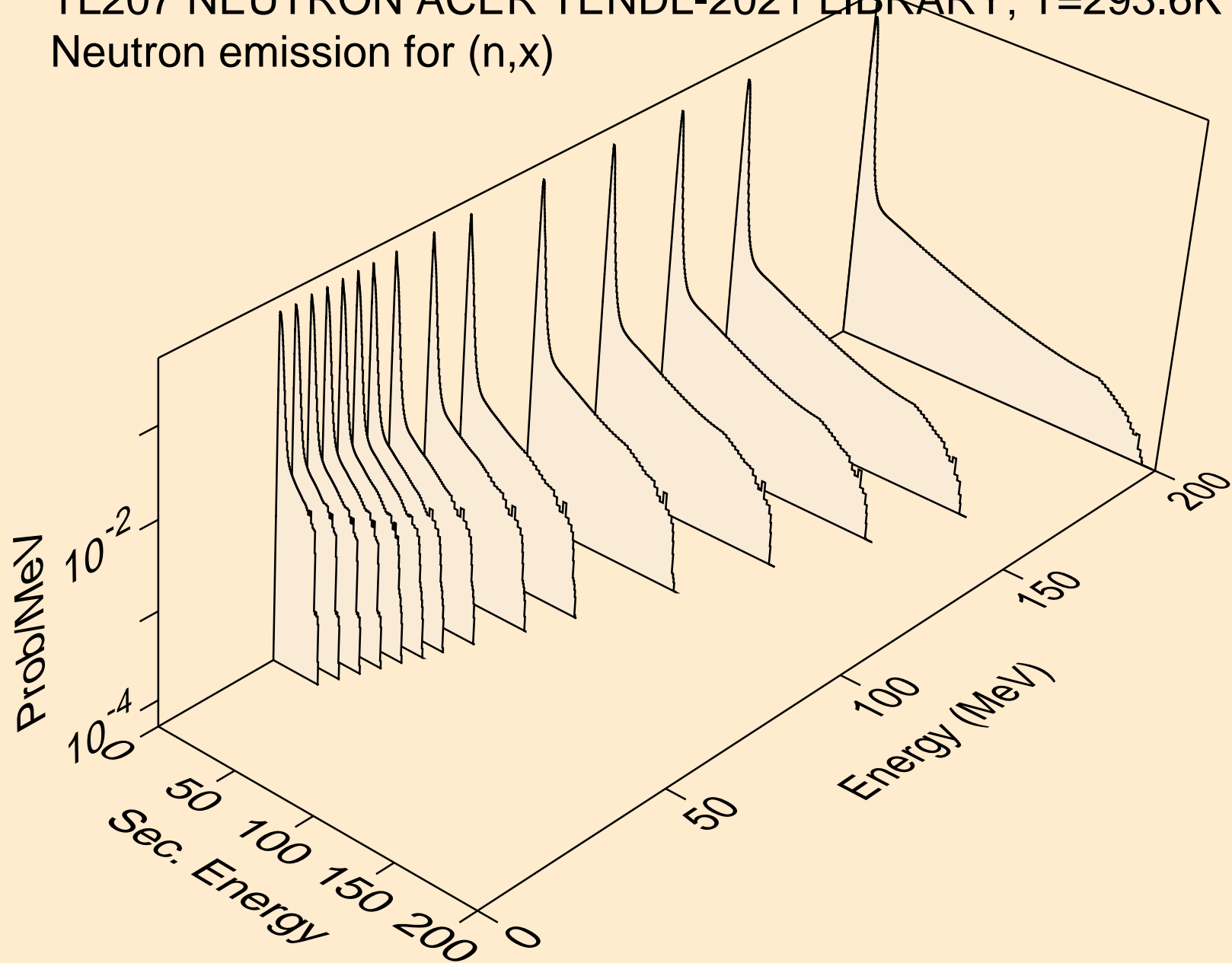

TL207 NEUTRON ACER TENDL-2021 LIBRARY; T=293.6K  
Neutron emission for (n,2nd)

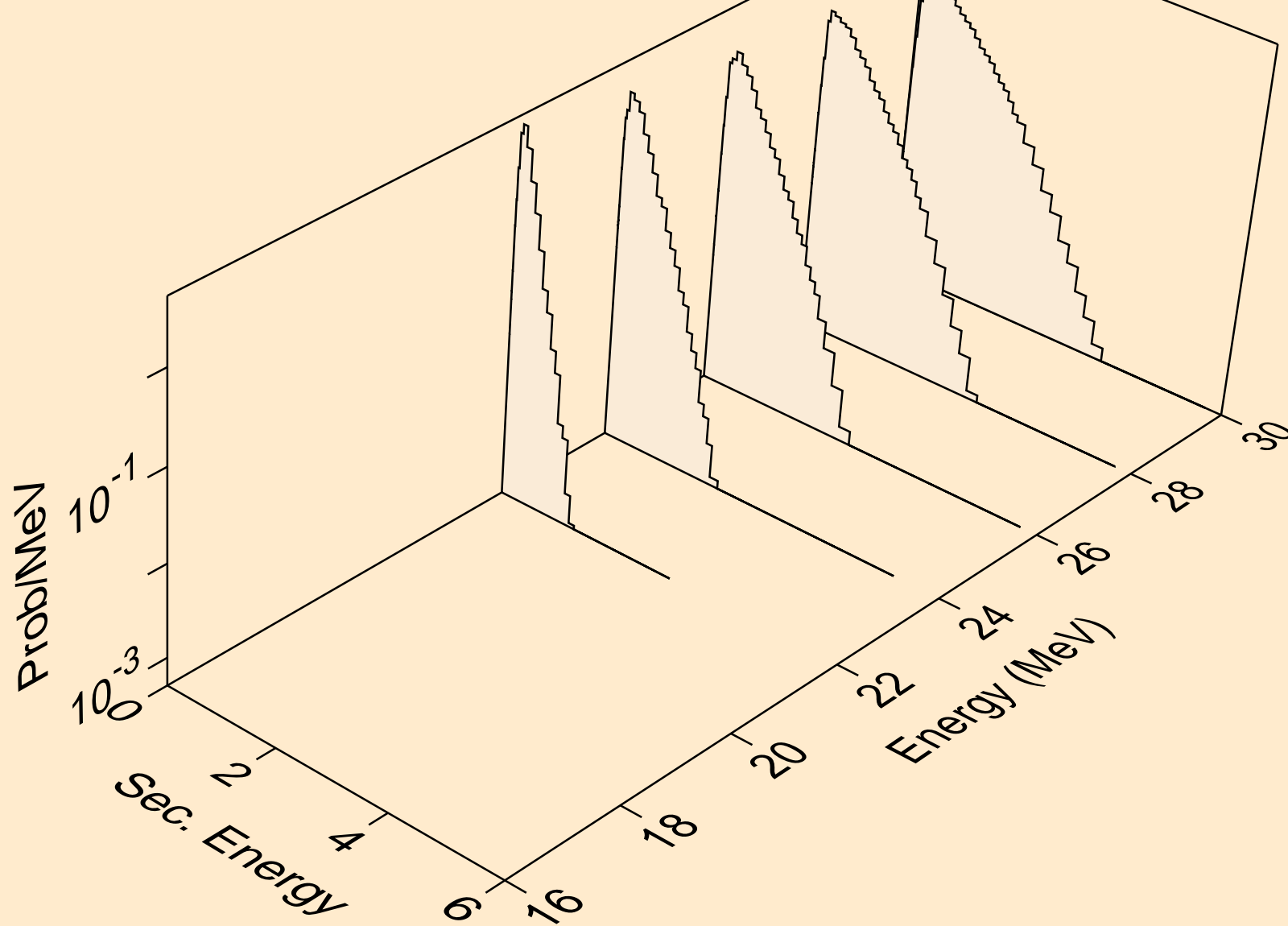

TL207 NEUTRON ACER TENDL-2021 LIBRARY; T=293.6K  
Neutron emission for (n,2n)

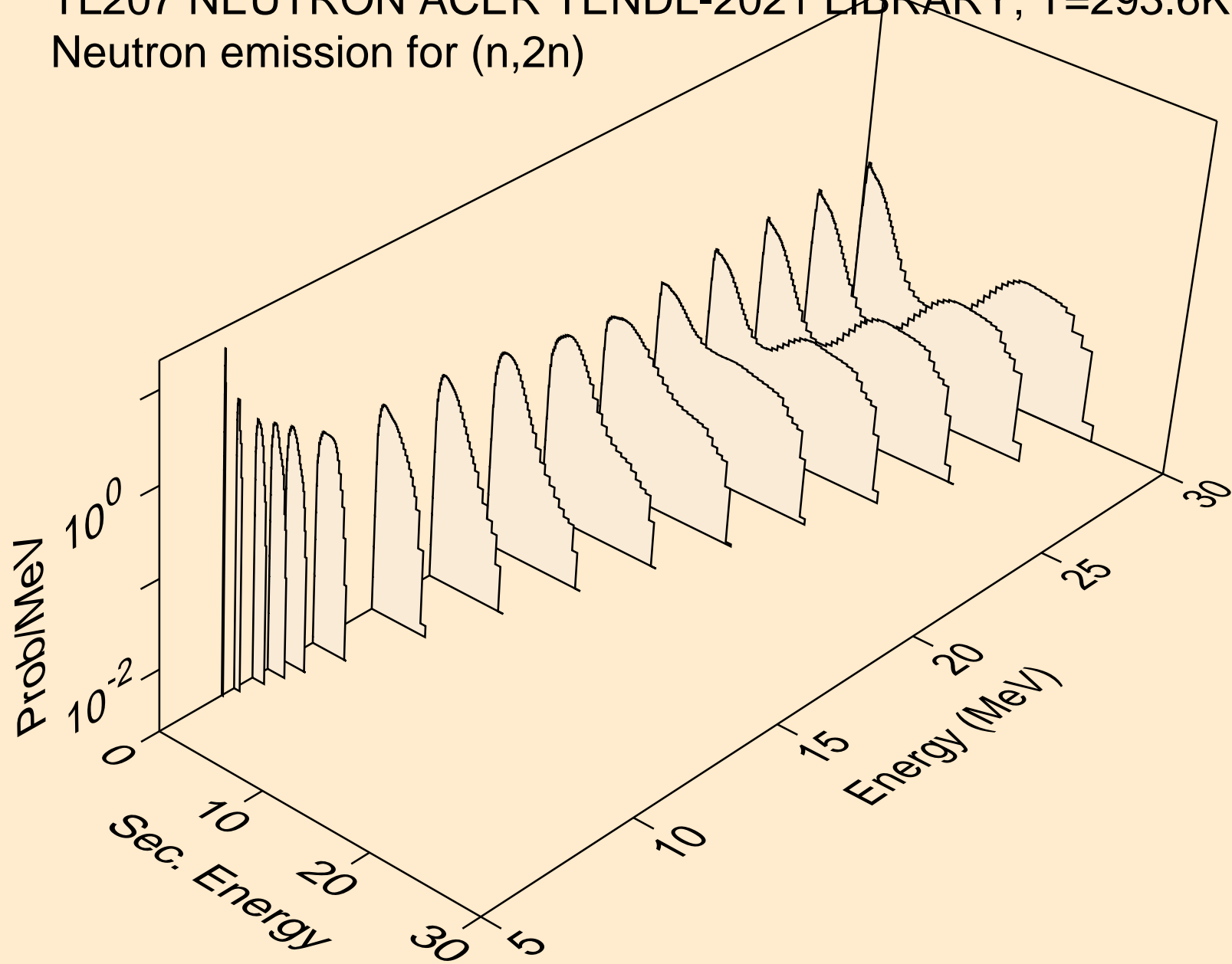

TL207 NEUTRON ACER TENDL-2021 LIBRARY; T=293.6K  
Neutron emission for (n,3n)

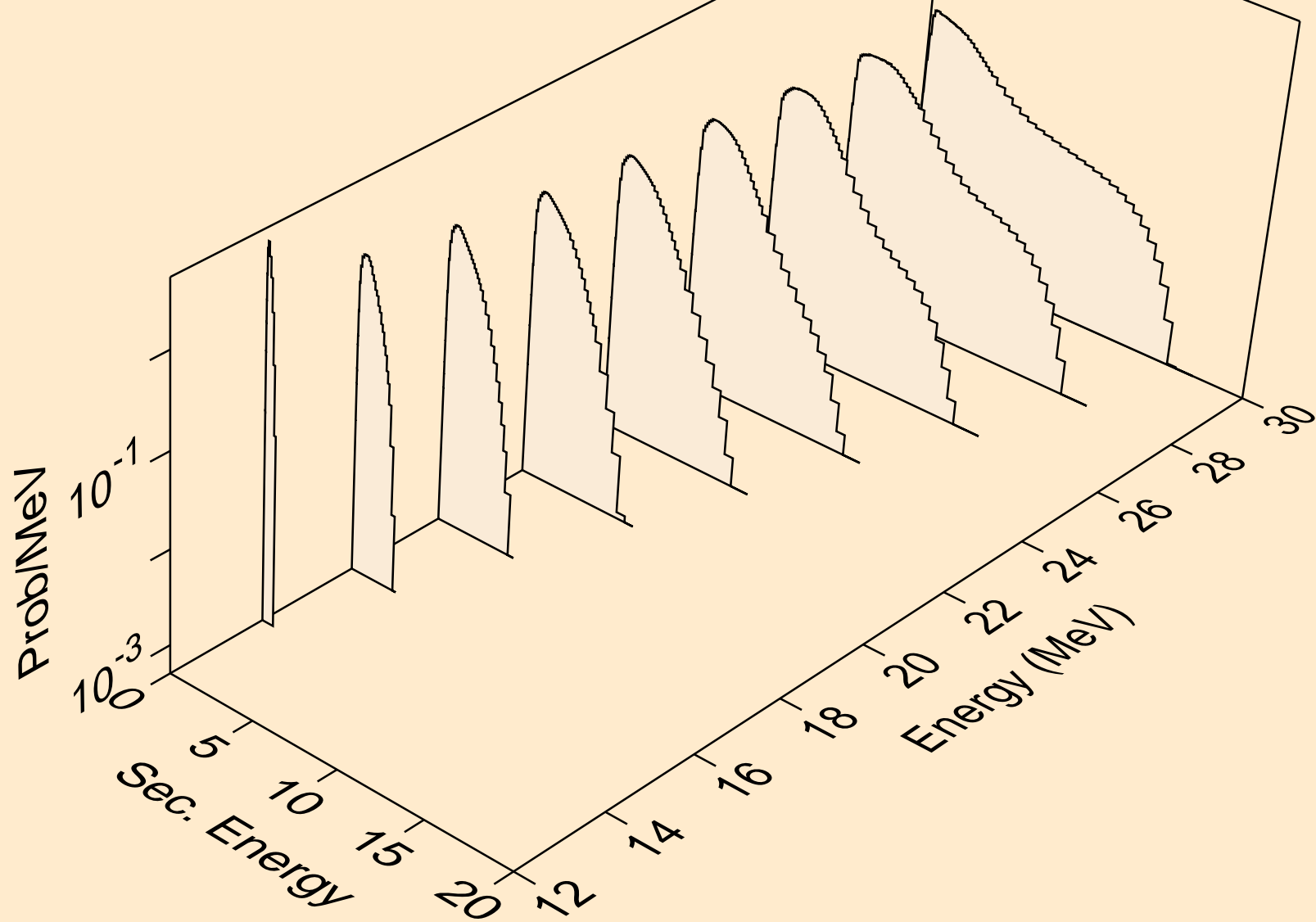

TL207 NEUTRON ACER TENDL-2021 LIBRARY; T=293.6K  
Neutron emission for (n,n\*)a

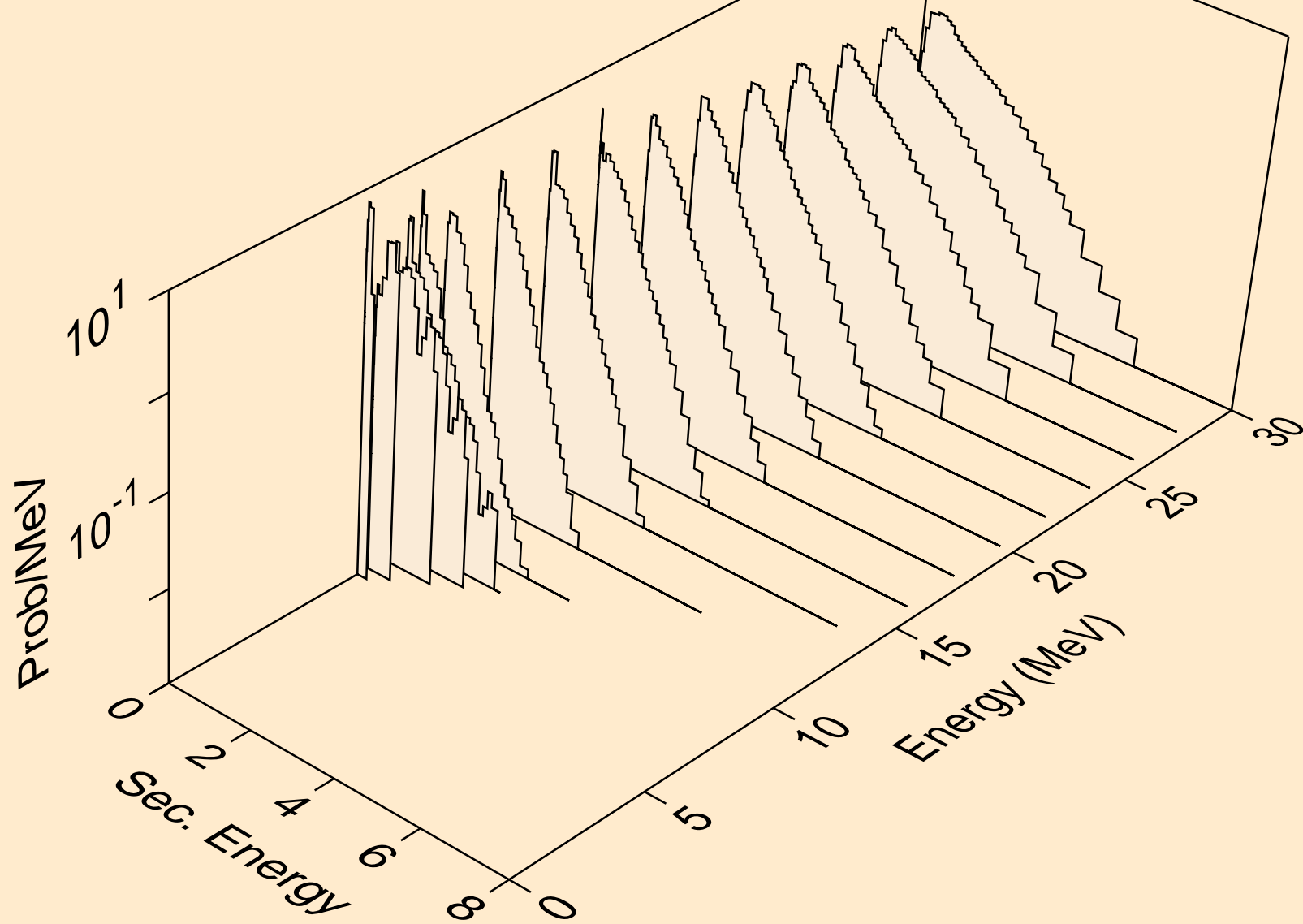



TL207 NEUTRON ACER TENDL-2021 LIBRARY; T=293.6K  
Neutron emission for (n,2n)<sub>a</sub>

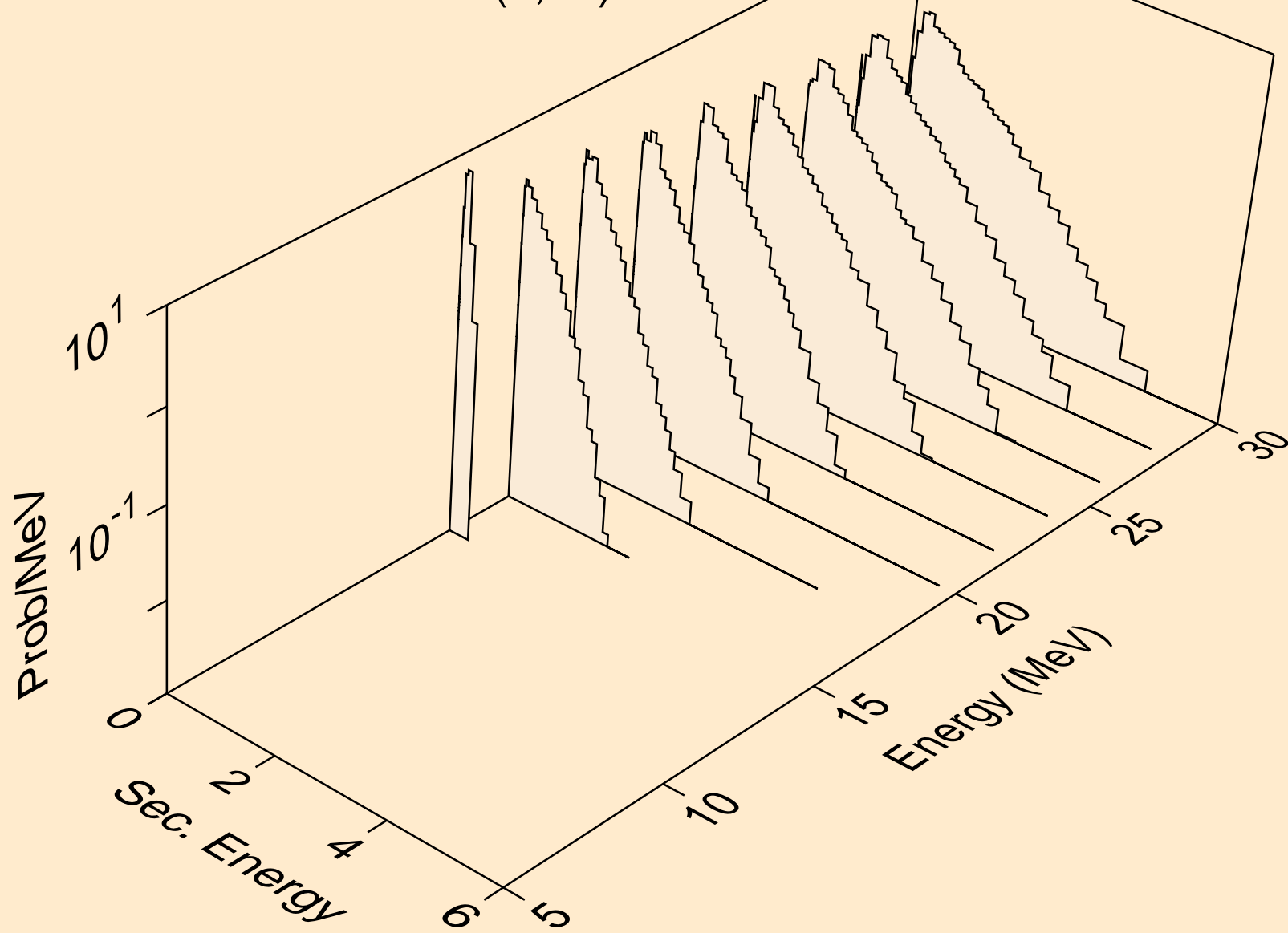

TL207 NEUTRON ACER TENDL-2021 LIBRARY; T=293.6K  
Neutron emission for (n,3n)<sub>a</sub>

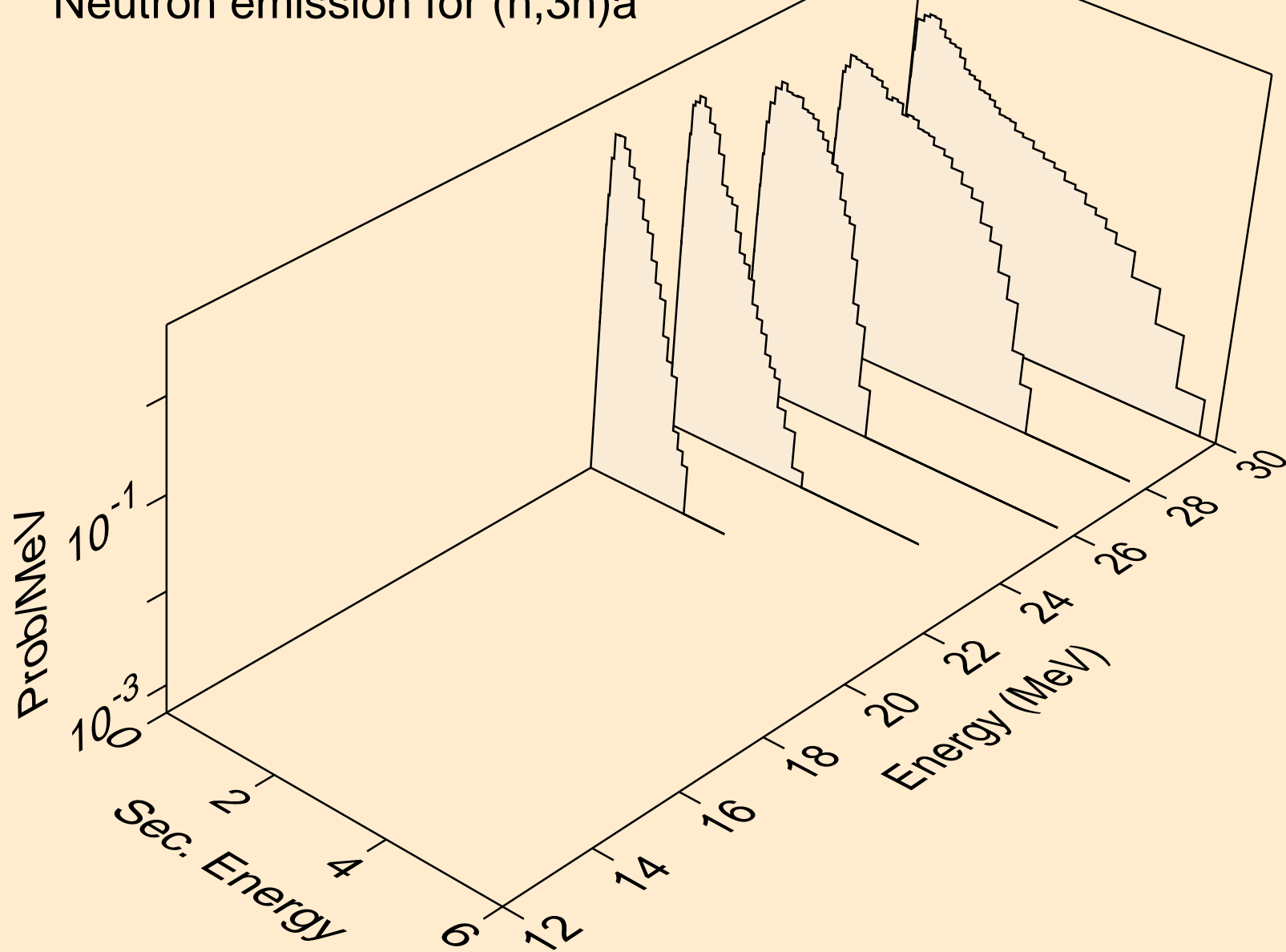

TL207 NEUTRON ACER TENDL-2021 LIBRARY; T=293.6K  
Neutron emission for (n,n\*)p

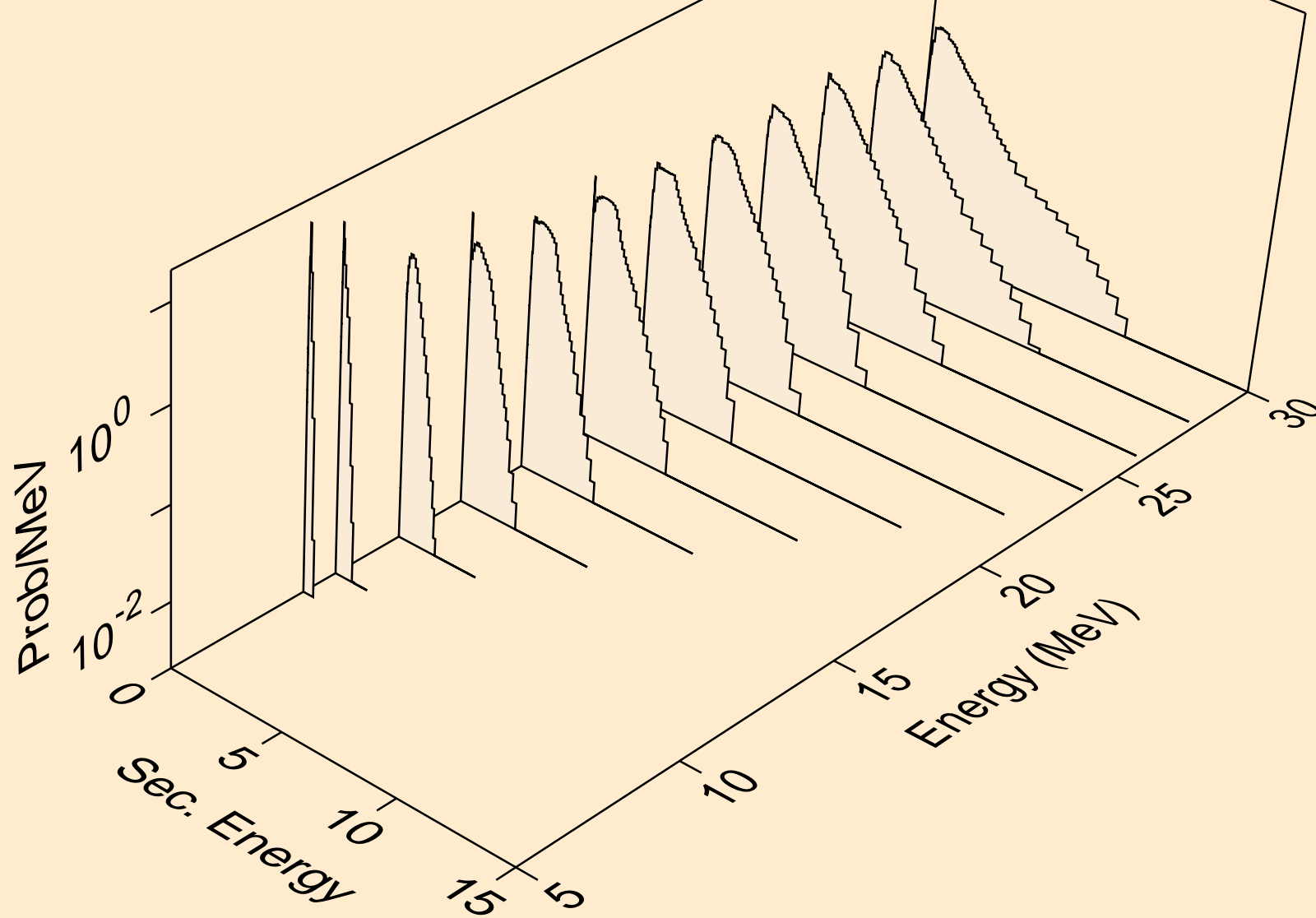

TL207 NEUTRON ACER TENDL-2021 LIBRARY; T=293.6K  
Neutron emission for (n,n\*)d

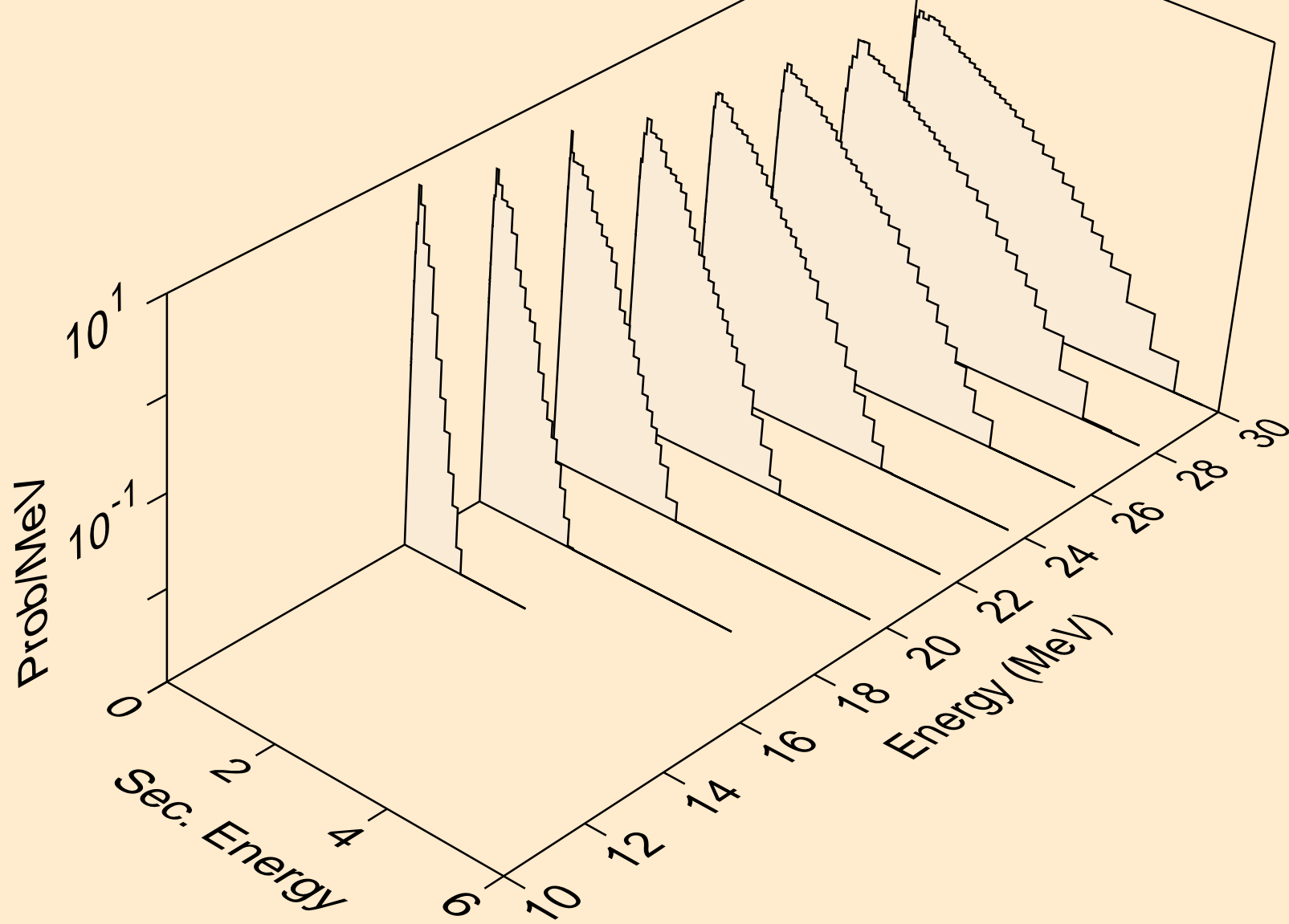

TL207 NEUTRON ACER TENDL-2021 LIBRARY; T=293.6K  
Neutron emission for (n,n\*)t

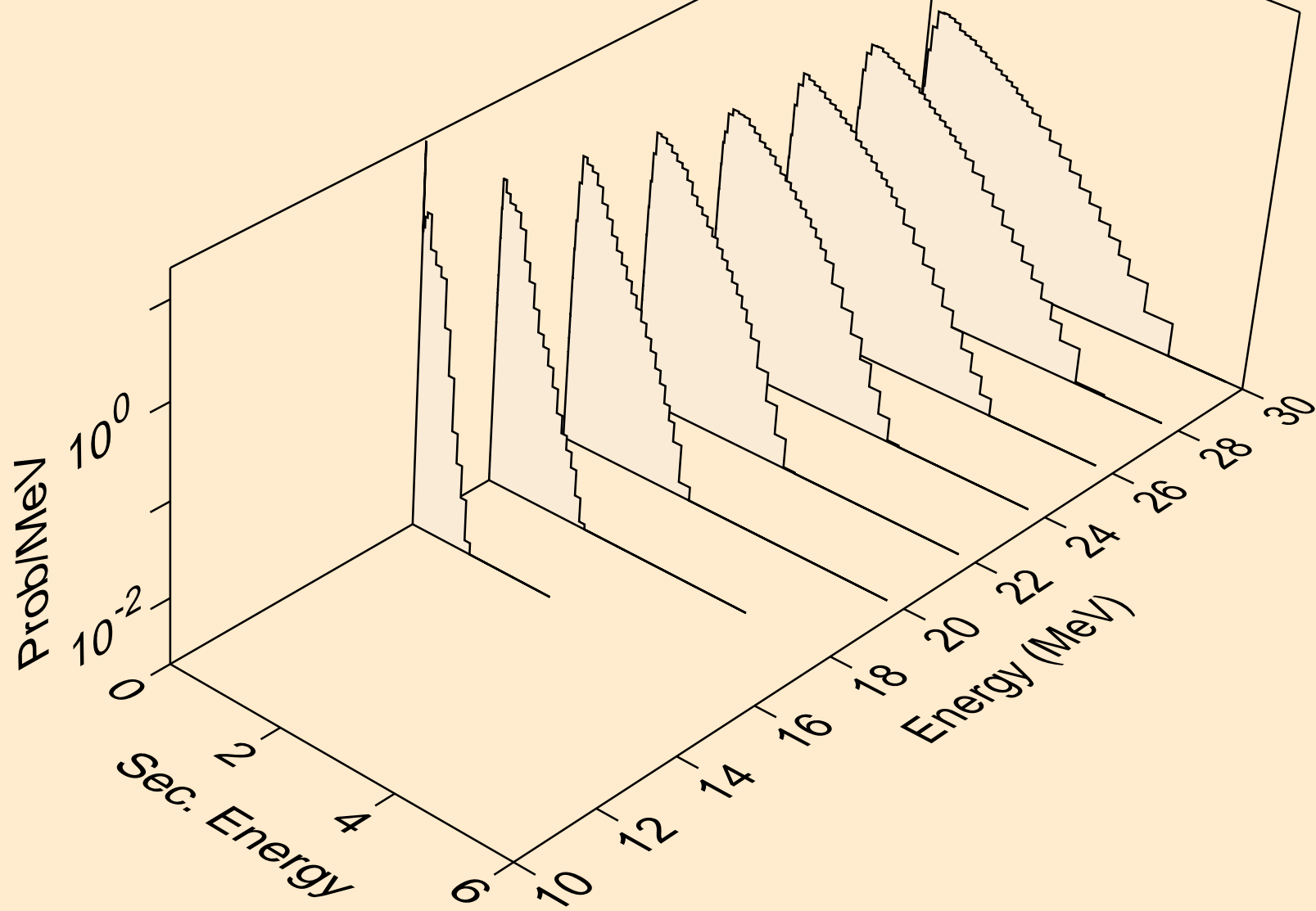

TL207 NEUTRON ACER TENDL-2021 LIBRARY; T=293.6K  
Neutron emission for (n,n\*)he3

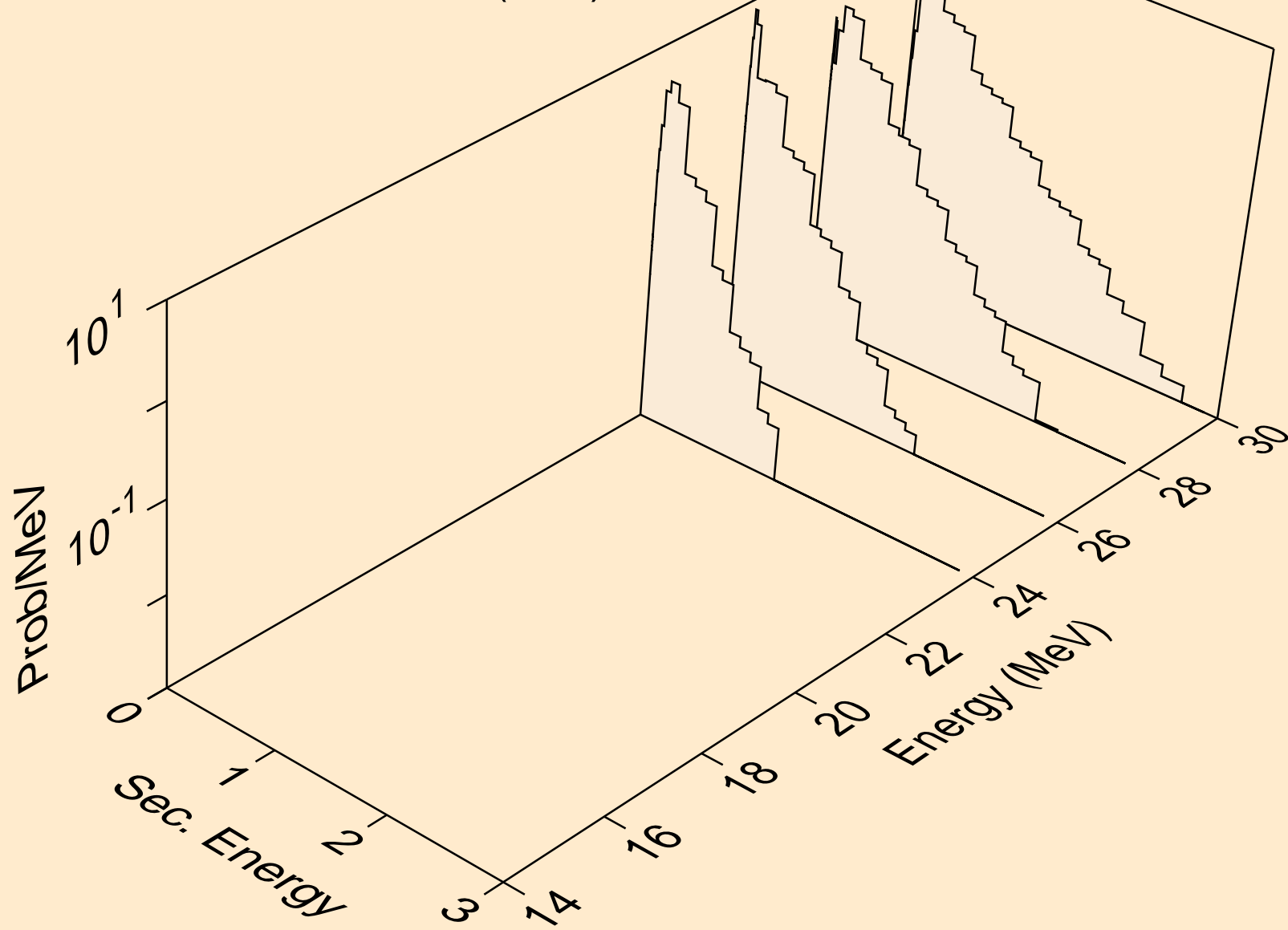

TL207 NEUTRON ACER TENDL-2021 LIBRARY; T=293.6K  
Neutron emission for (n,4n)

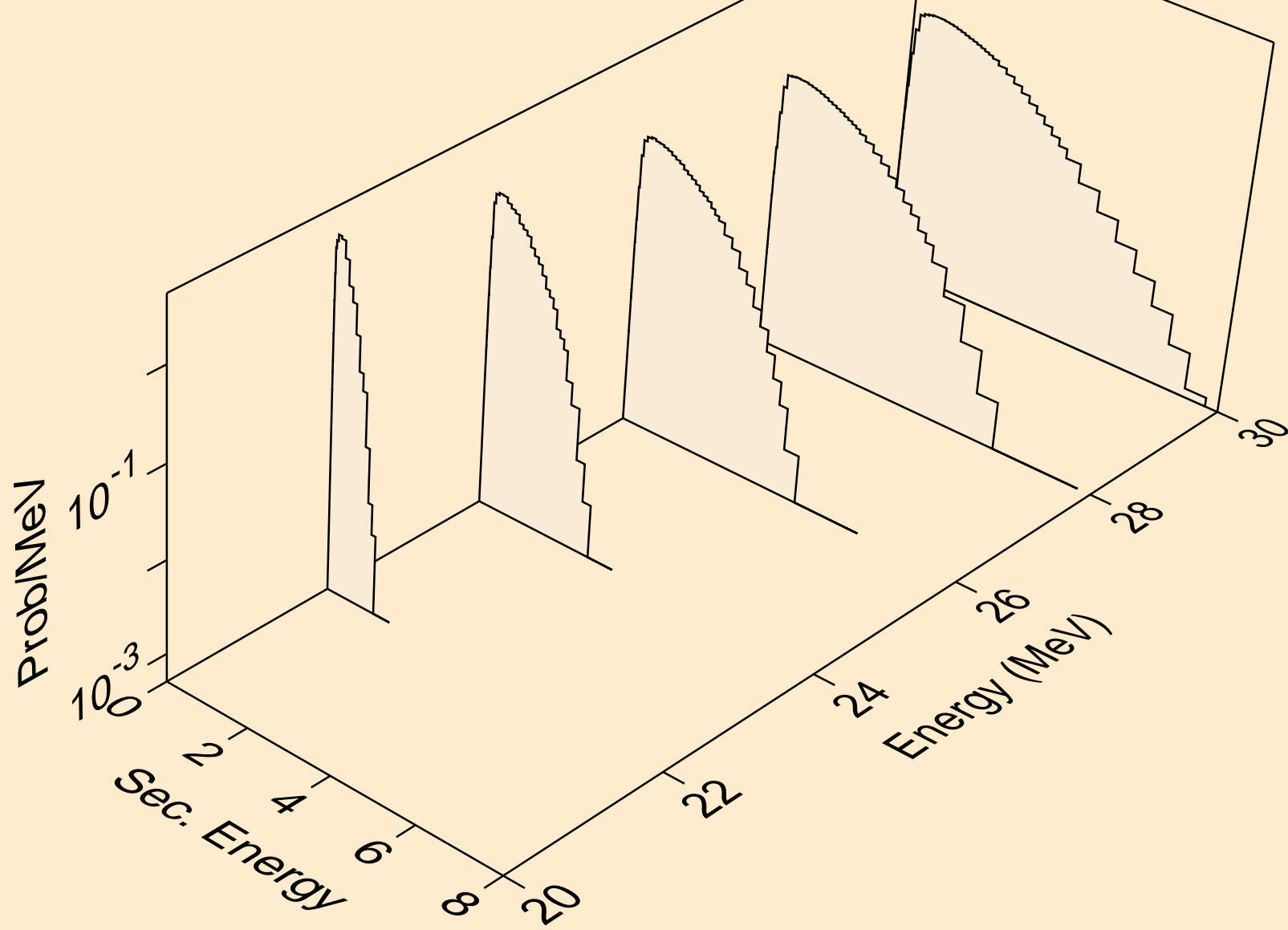

TL207 NEUTRON ACER TENDL-2021 LIBRARY; T=293.6K  
Neutron emission for (n,2np)

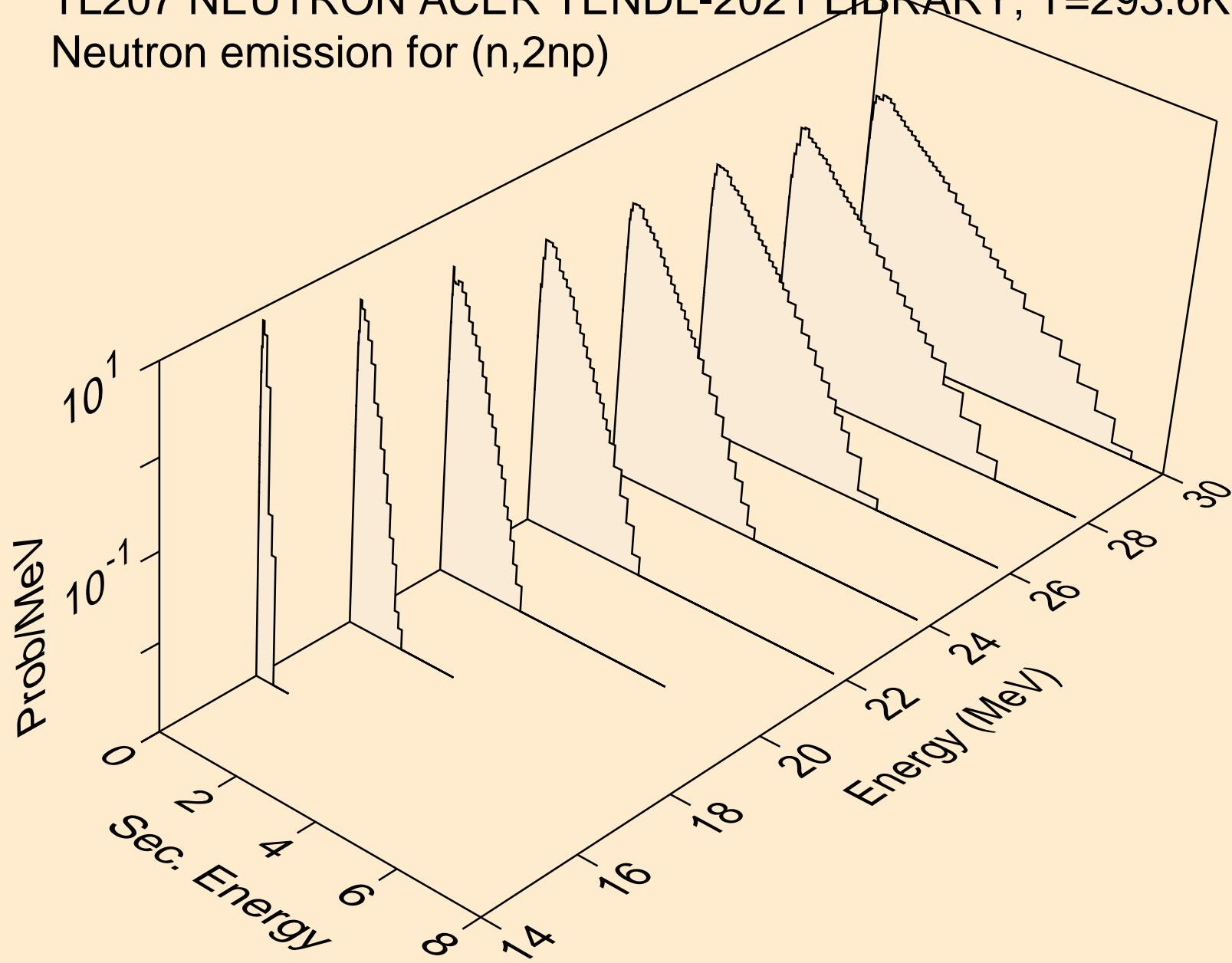



TL207 NEUTRON ACER TENDL-2021 LIBRARY; T=293.6K  
Neutron emission for (n,3np)

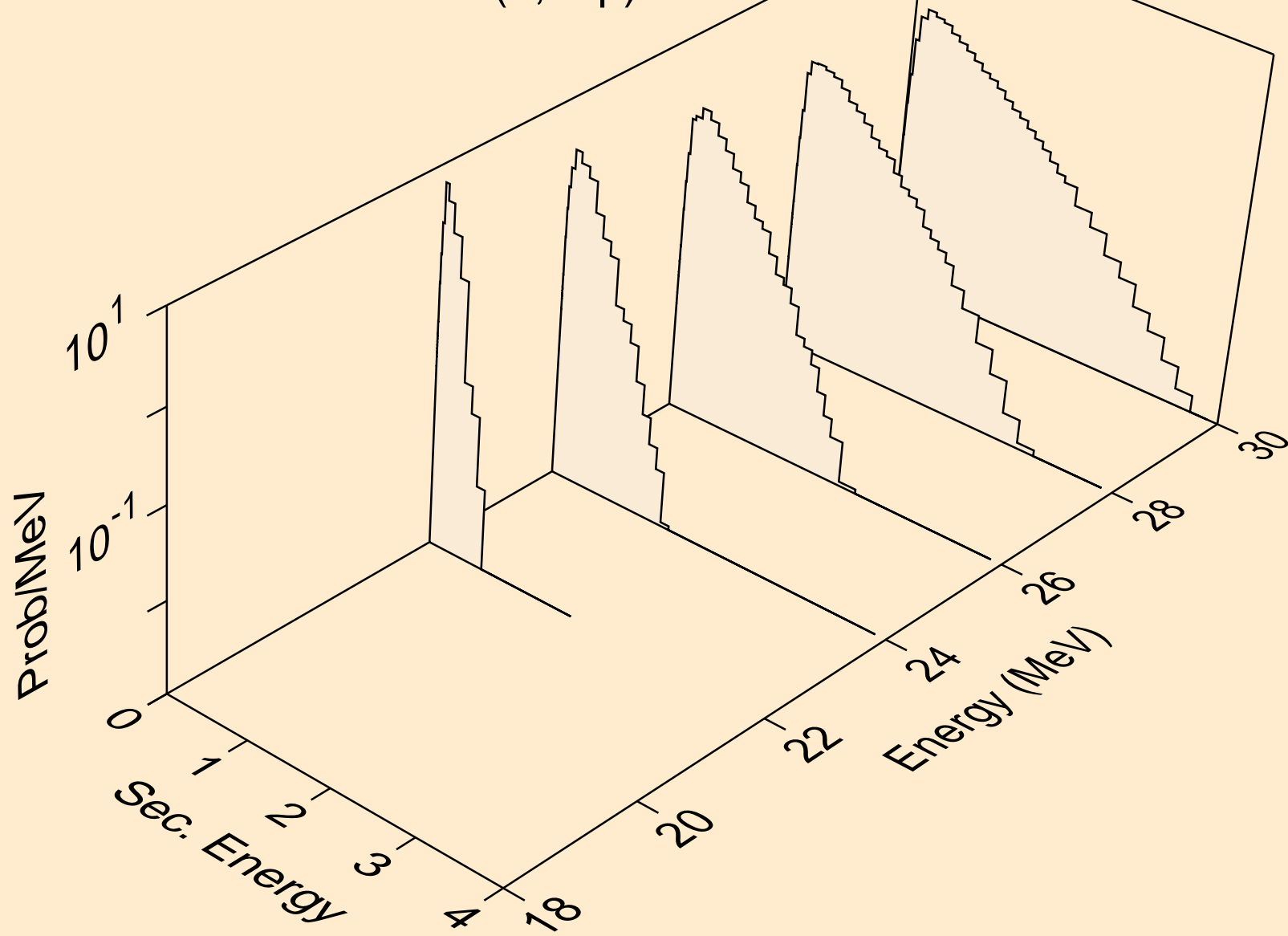

TL207 NEUTRON ACER TENDL-2021 LIBRARY; T=293.6K  
Neutron emission for (n,n\*c)

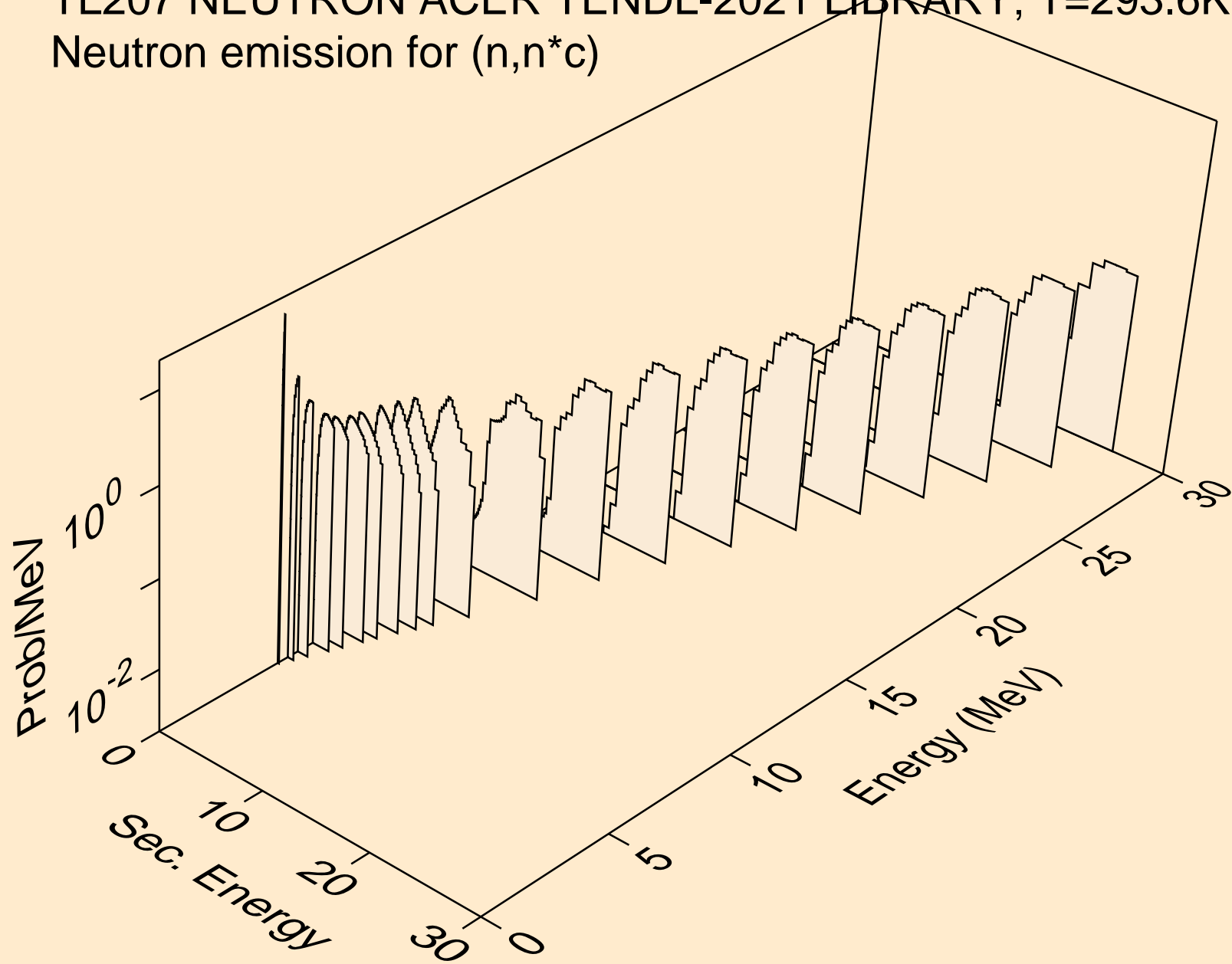

TL207 NEUTRON ACER TENDL-2021 LIBRARY; T=293.6K  
Photon emission for (n,x)

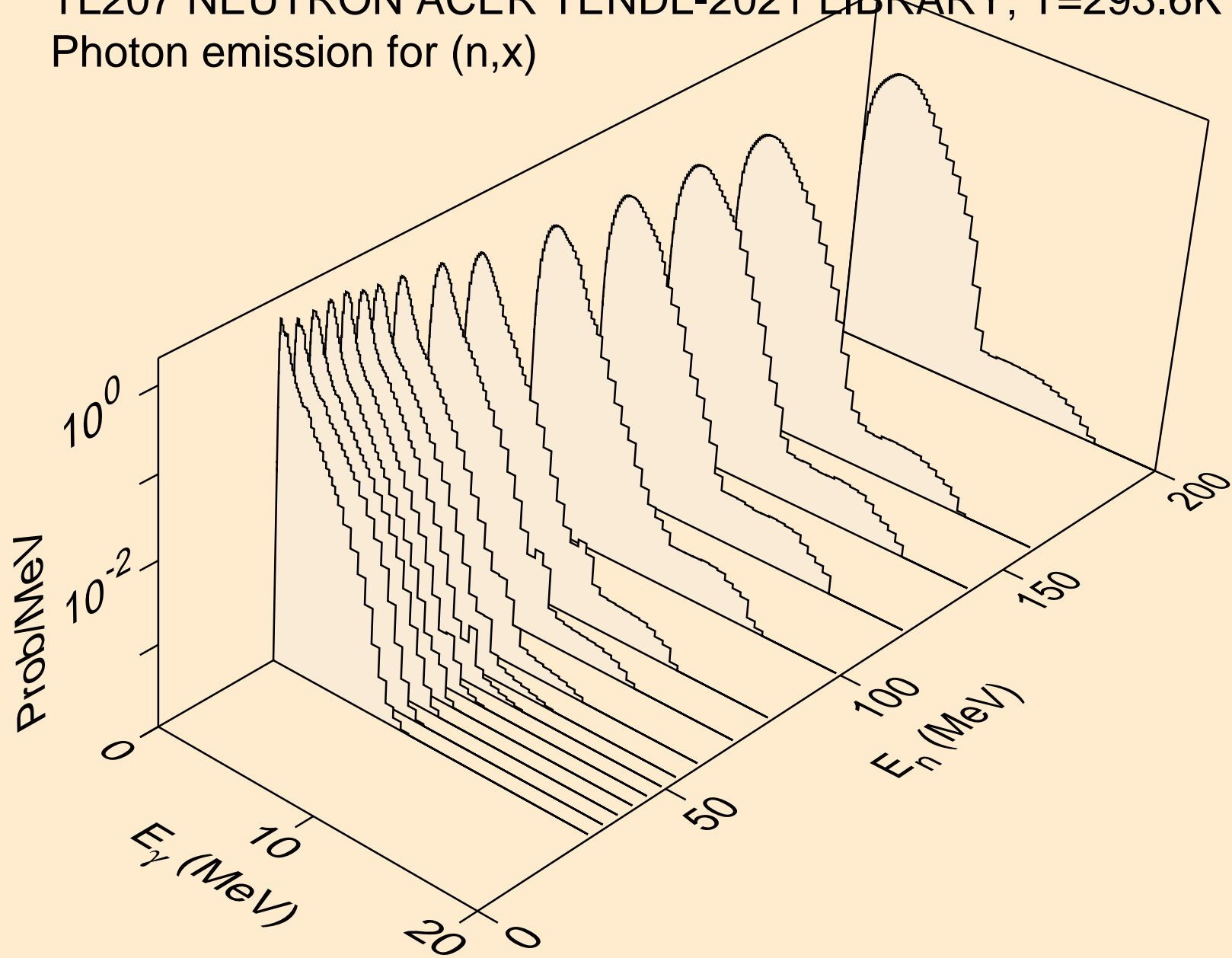

TL207 NEUTRON ACER TENDL-2021 LIBRARY; T=293.6K  
Photon emission for (n,2nd)

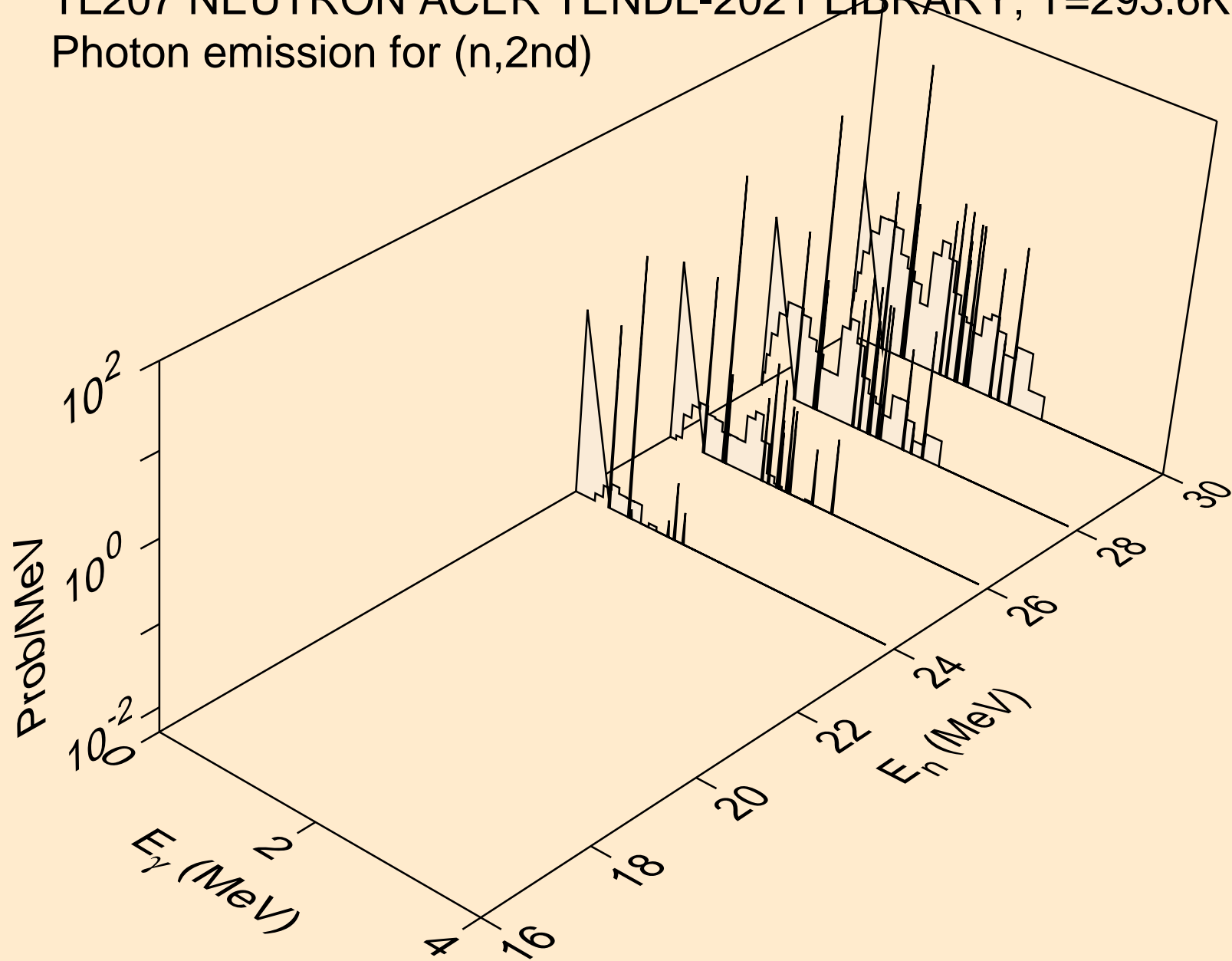

TL207 NEUTRON ACER TENDL-2021 LIBRARY; T=293.6K  
Photon emission for (n,2n)

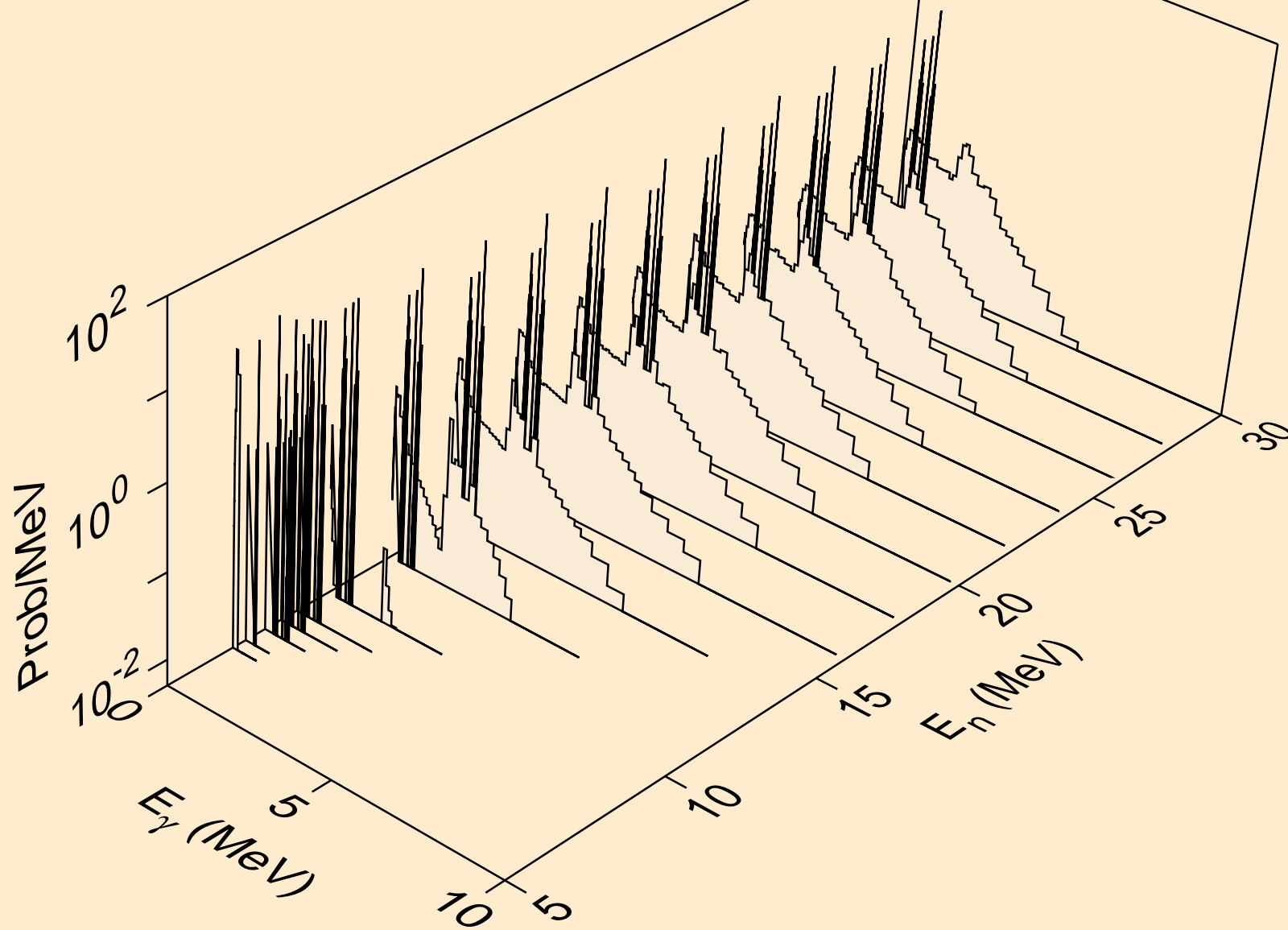

TL207 NEUTRON ACER TENDL-2021 LIBRARY; T=293.6K  
Photon emission for (n,3n)

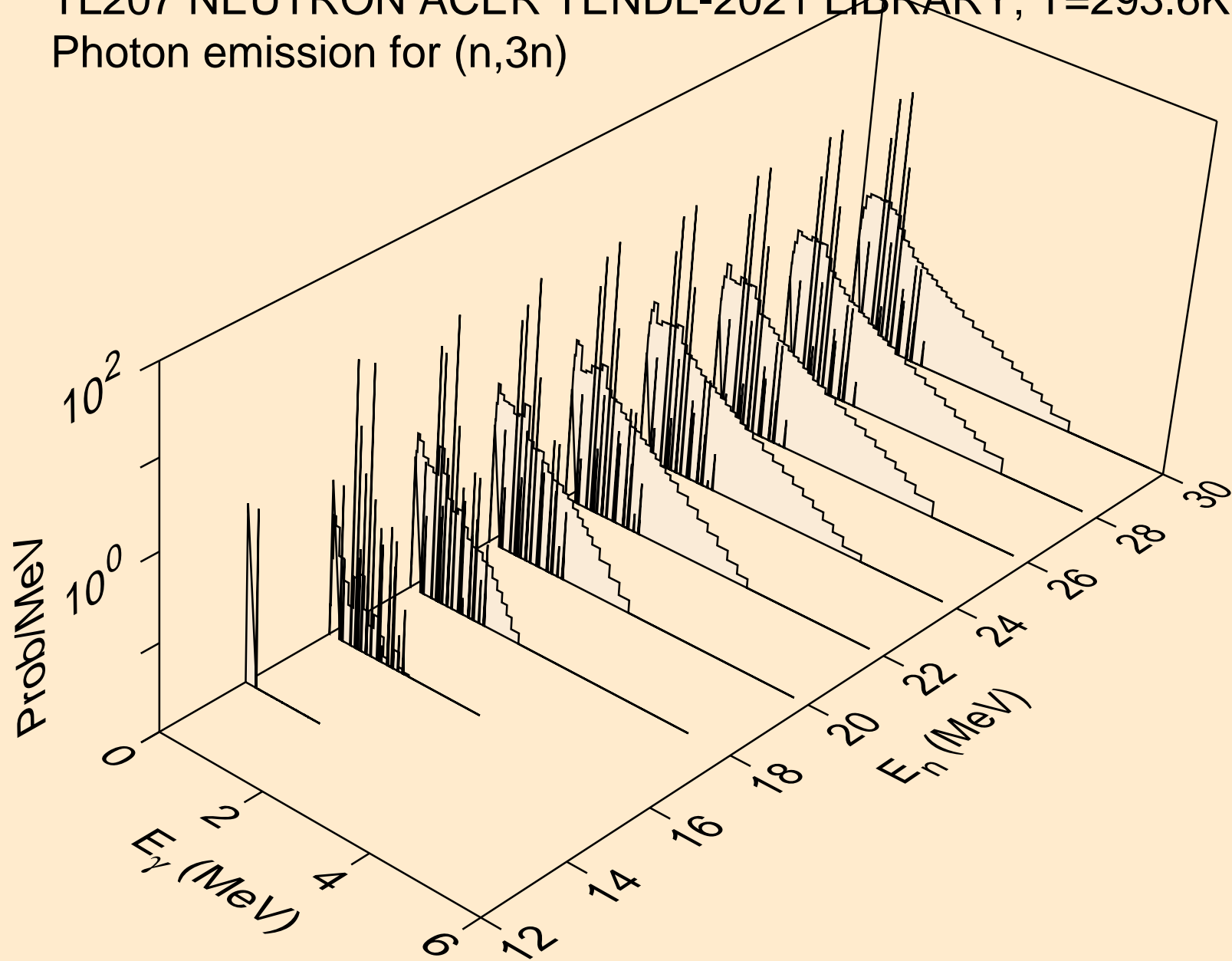

TL207 NEUTRON ACER TENDL-2021 LIBRARY; T=293.6K  
Photon emission for (n,n\*)a

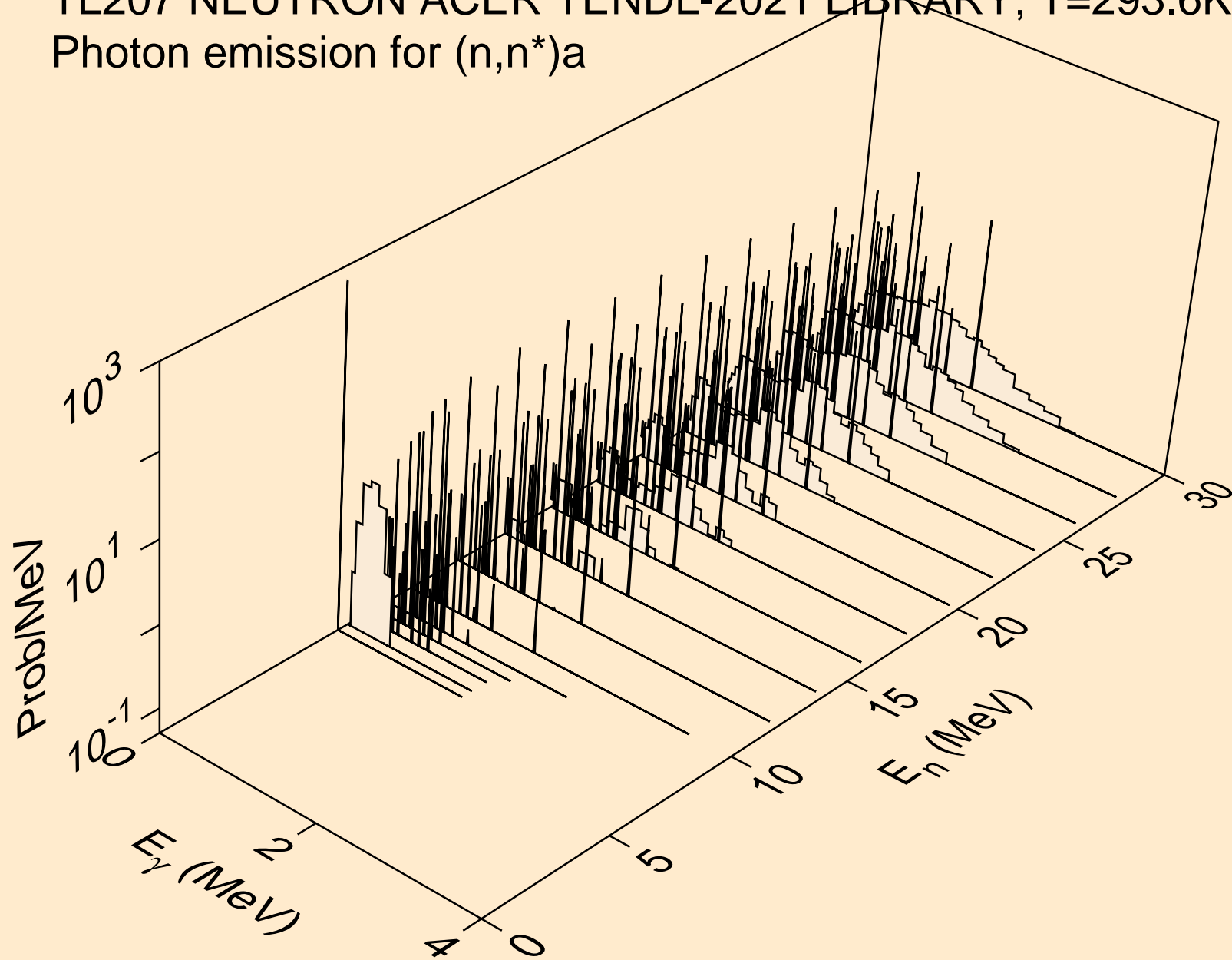

TL207 NEUTRON ACER TENDL-2021 LIBRARY; T=293.6K  
Photon emission for (n,2n)a

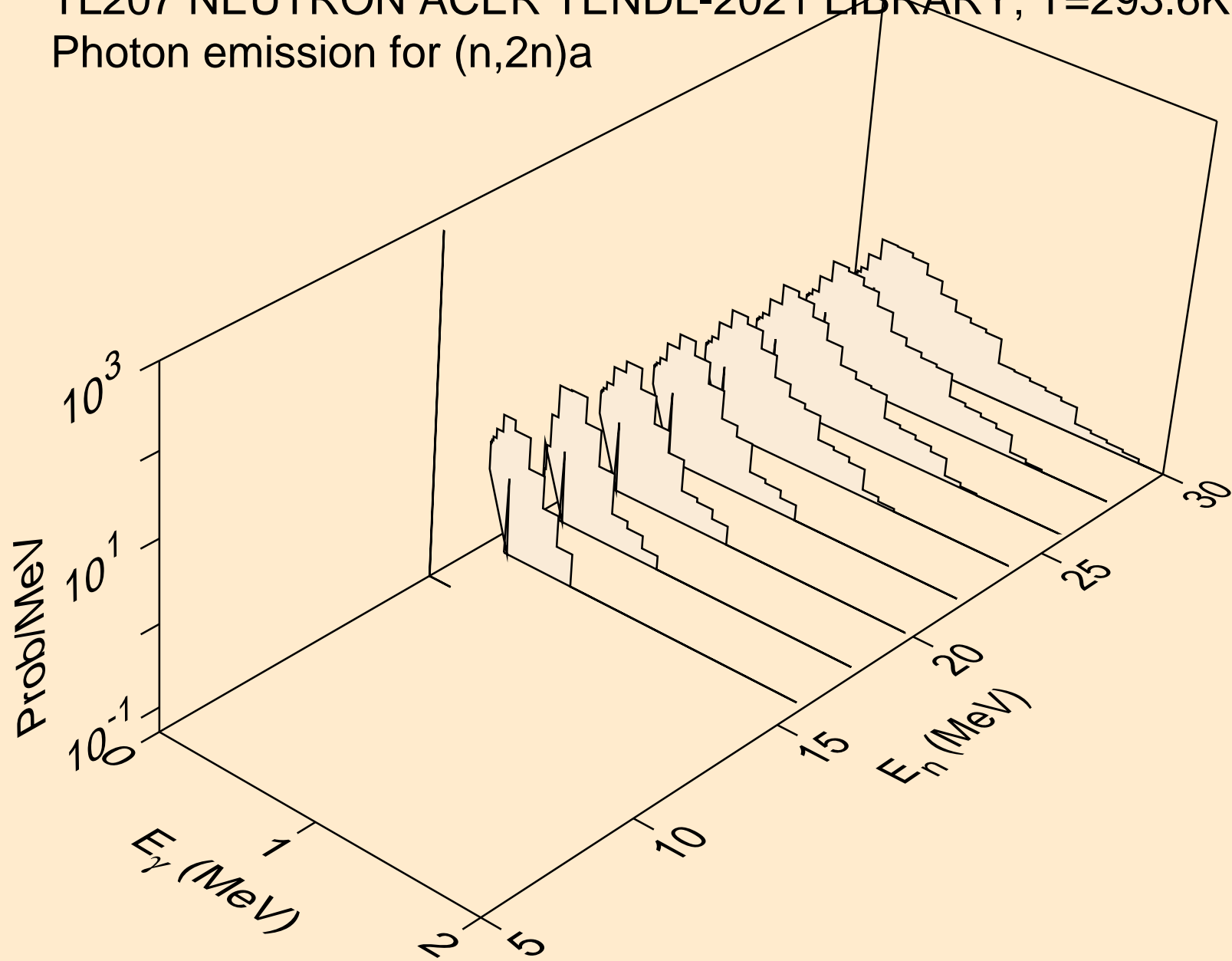



TL207 NEUTRON ACER TENDL-2021 LIBRARY; T=293.6K  
Photon emission for (n,3n)a

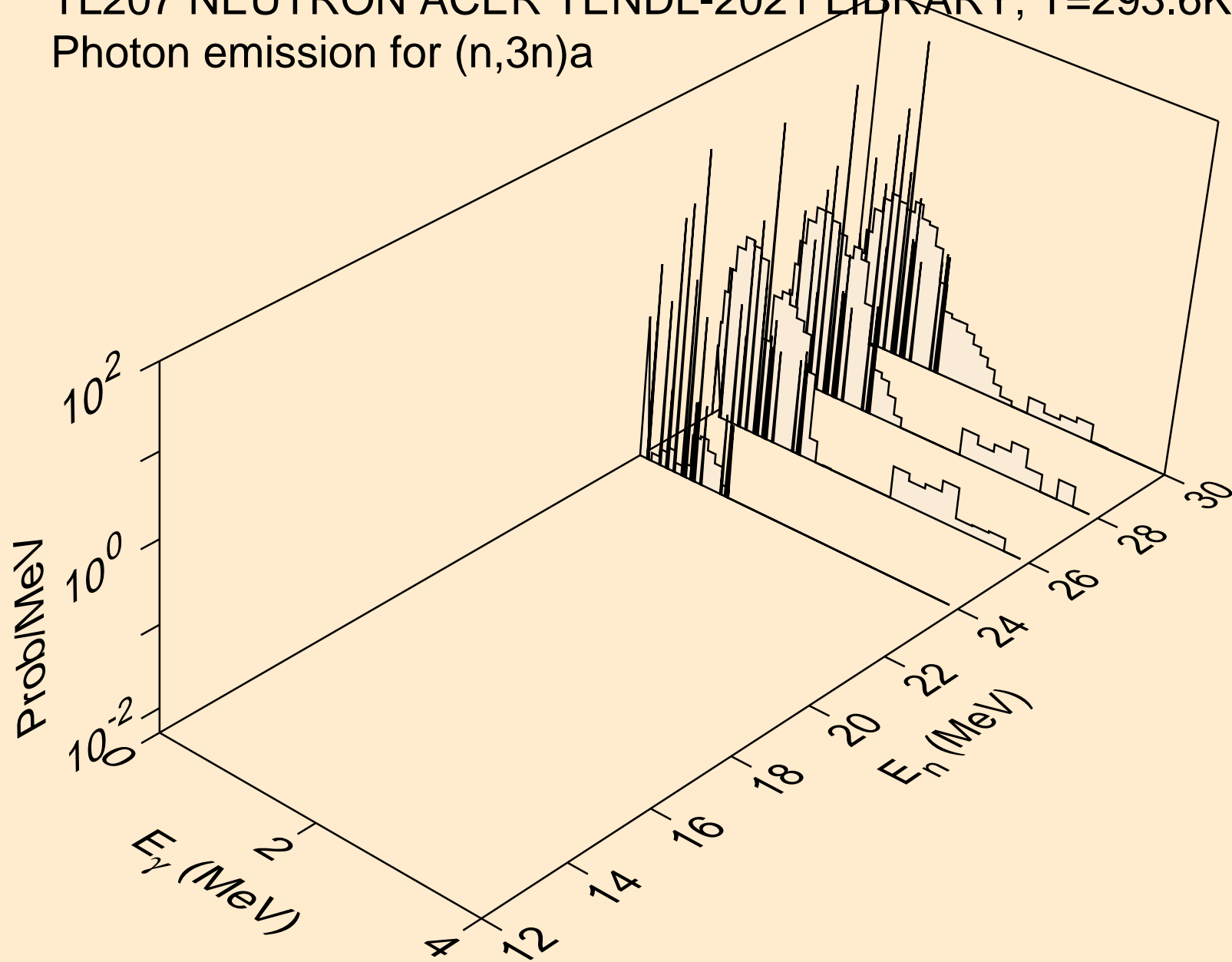

TL207 NEUTRON ACER TENDL-2021 LIBRARY; T=293.6K  
Photon emission for (n,n\*)p

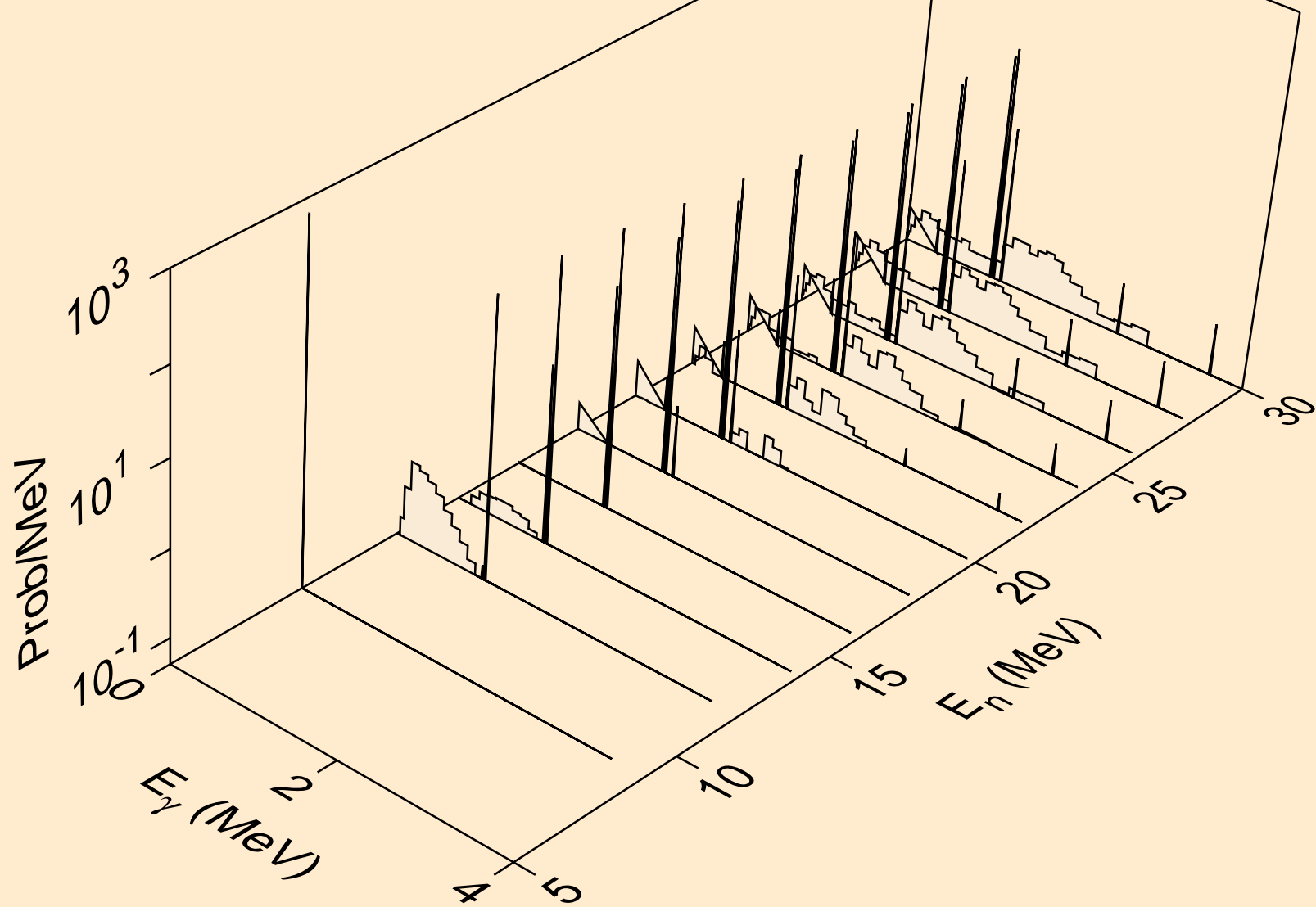

TL207 NEUTRON ACER TENDL-2021 LIBRARY; T=293.6K  
Photon emission for (n,n\*)d

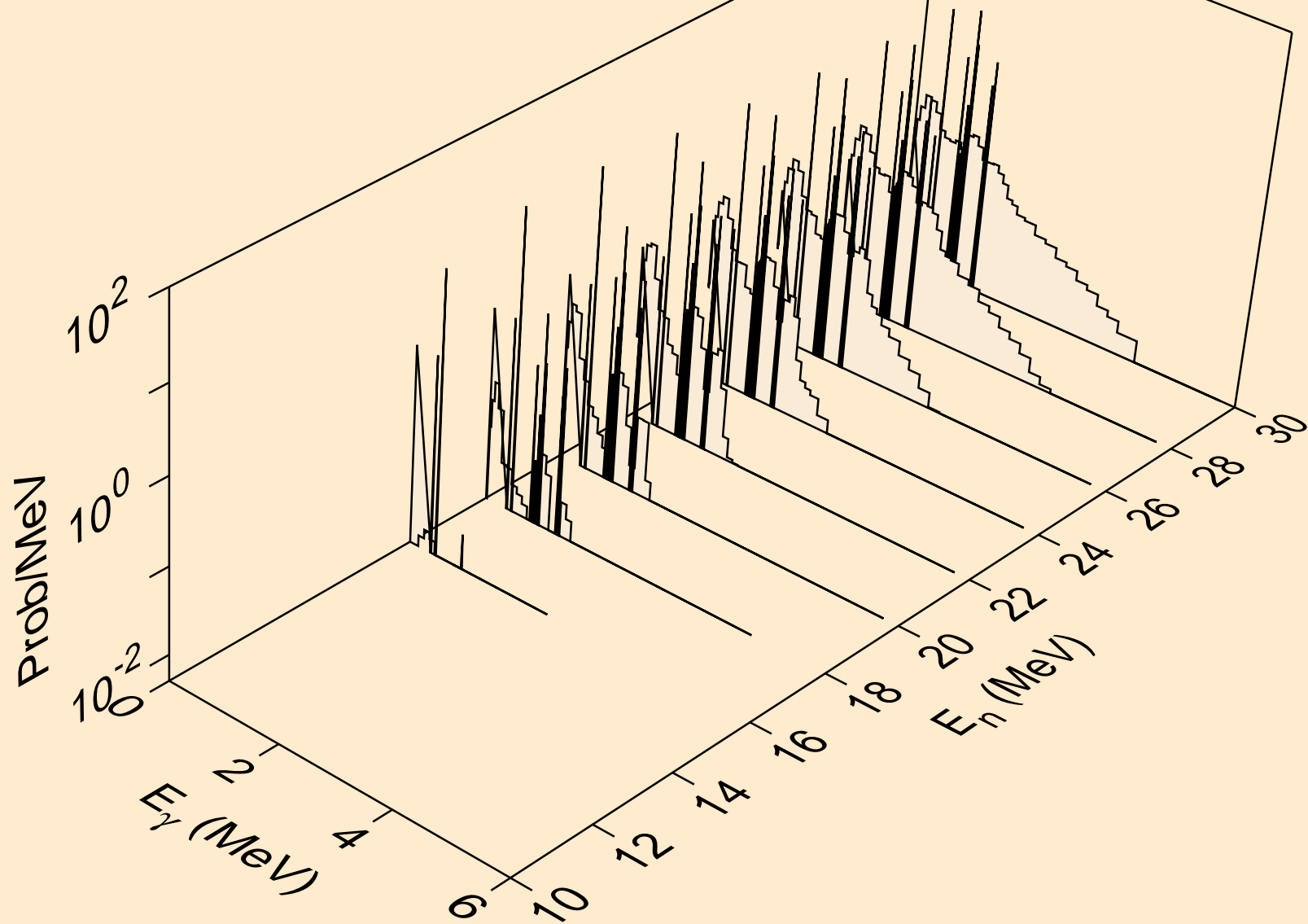

TL207 NEUTRON ACER TENDL-2021 LIBRARY; T=293.6K  
Photon emission for (n,n\*)t

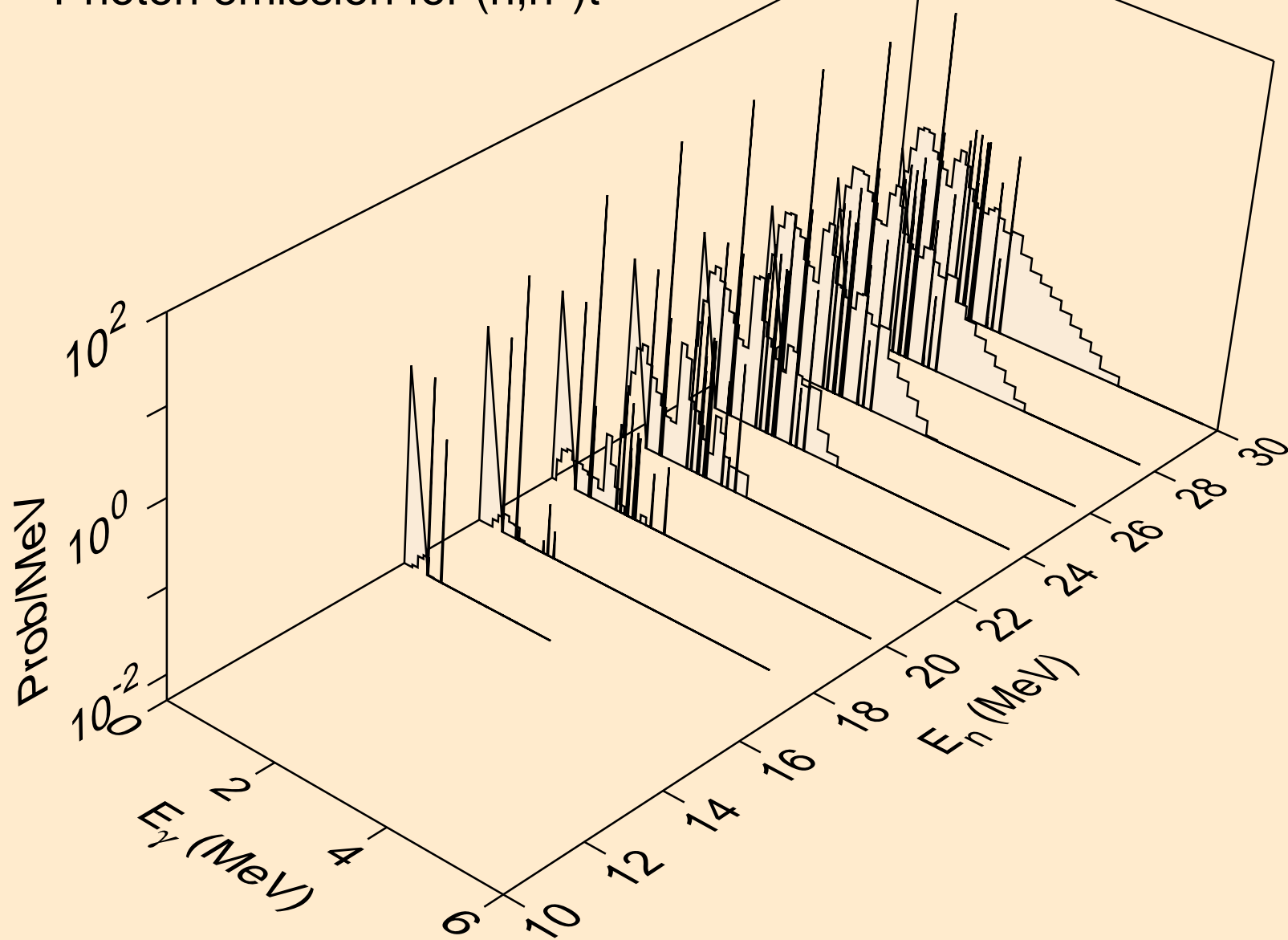

TL207 NEUTRON ACER TENDL-2021 LIBRARY; T=293.6K  
Photon emission for (n,n\*)he3

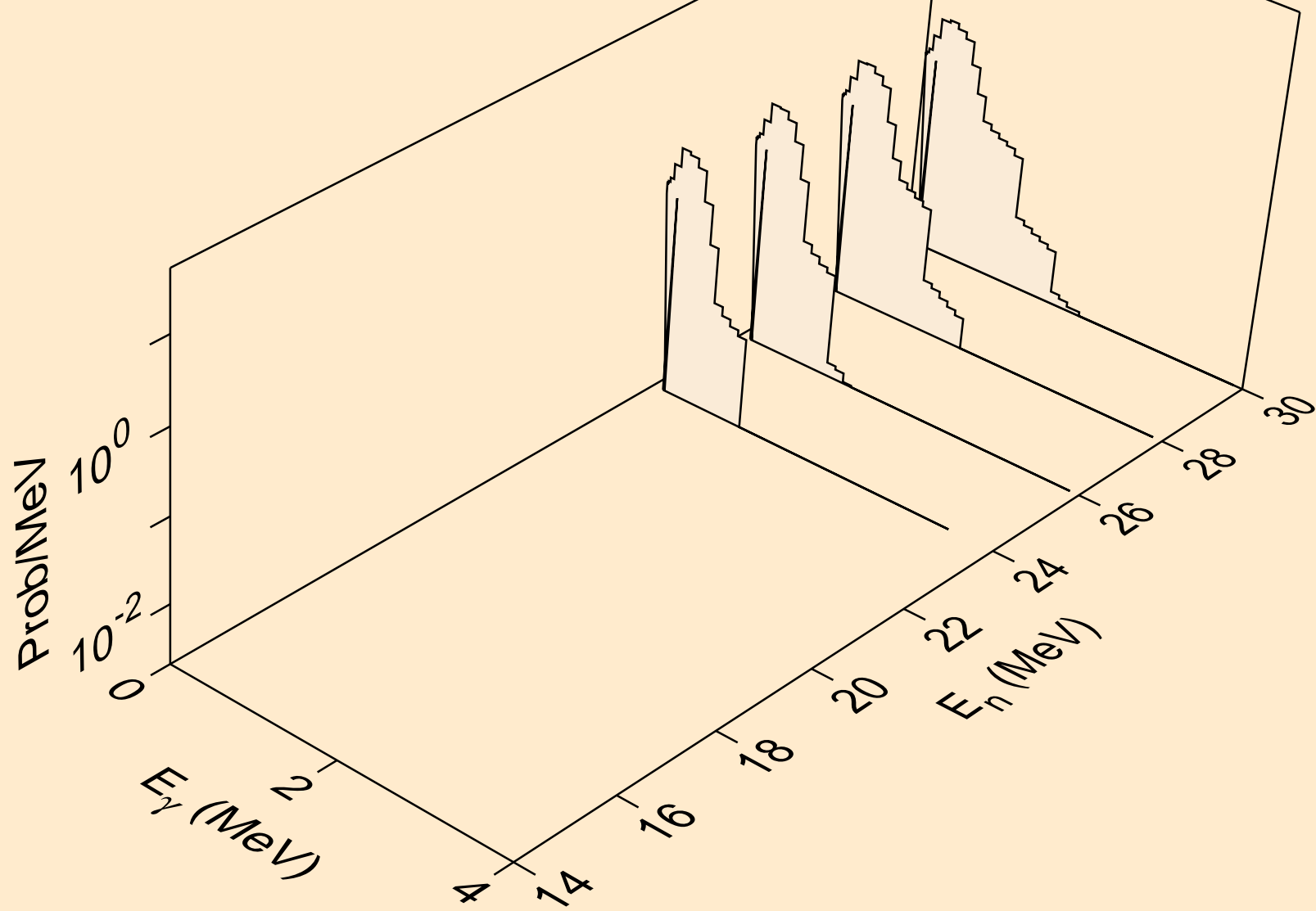

TL207 NEUTRON ACER TENDL-2021 LIBRARY; T=293.6K  
Photon emission for (n,4n)

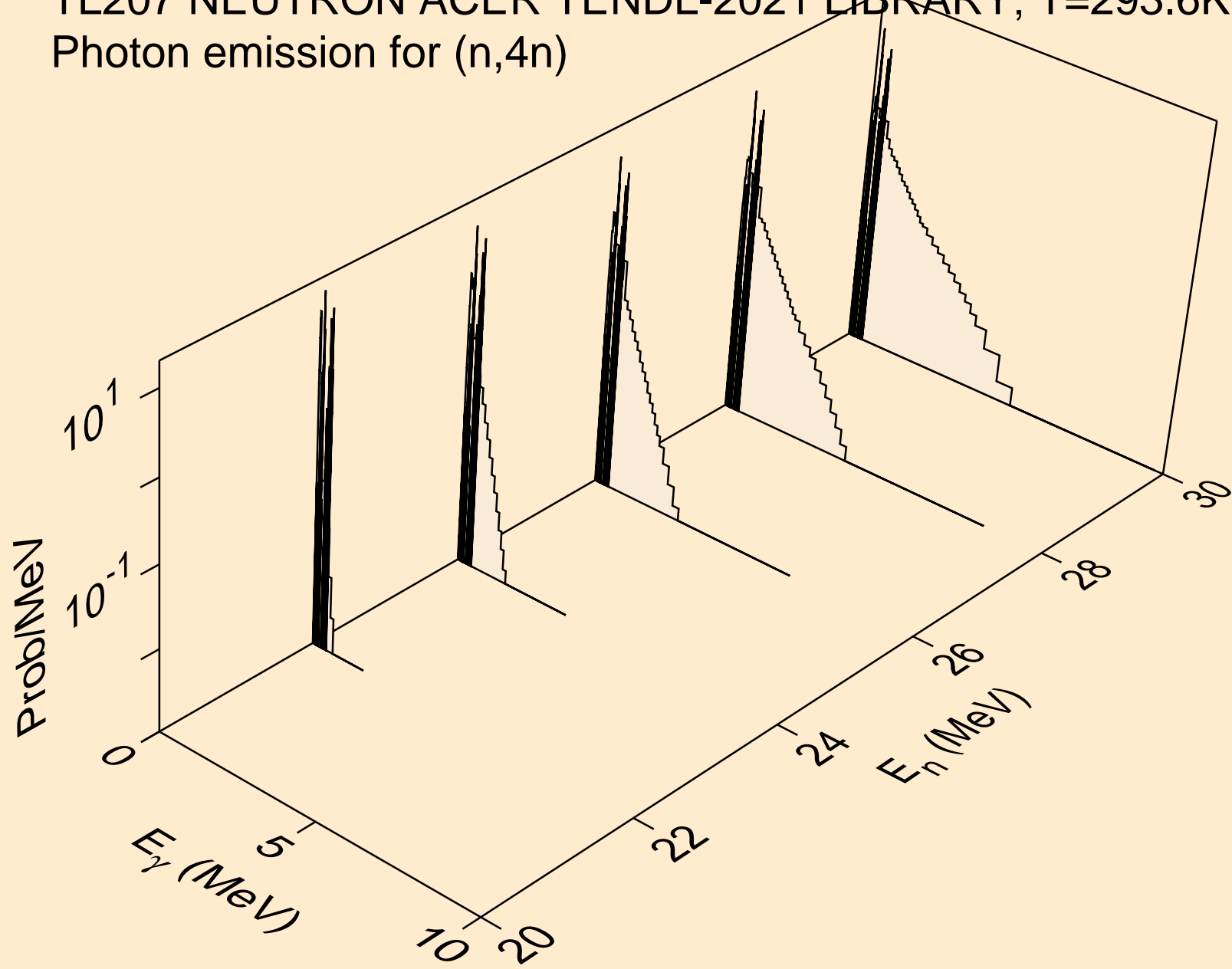

TL207 NEUTRON ACER TENDL-2021 LIBRARY; T=293.6K  
Photon emission for (n,2np)

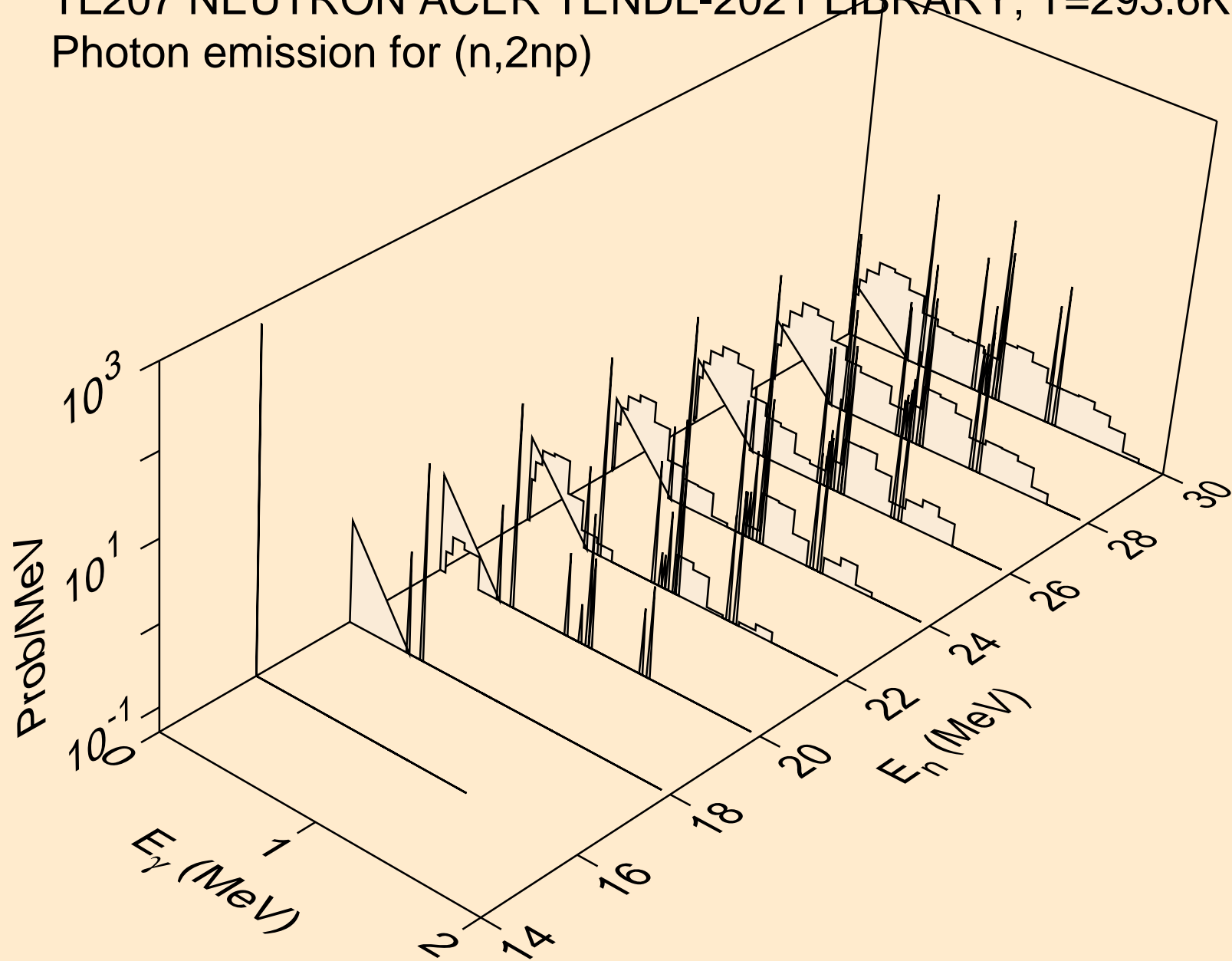

TL207 NEUTRON ACER TENDL-2021 LIBRARY; T=293.6K  
Photon emission for (n,3np)

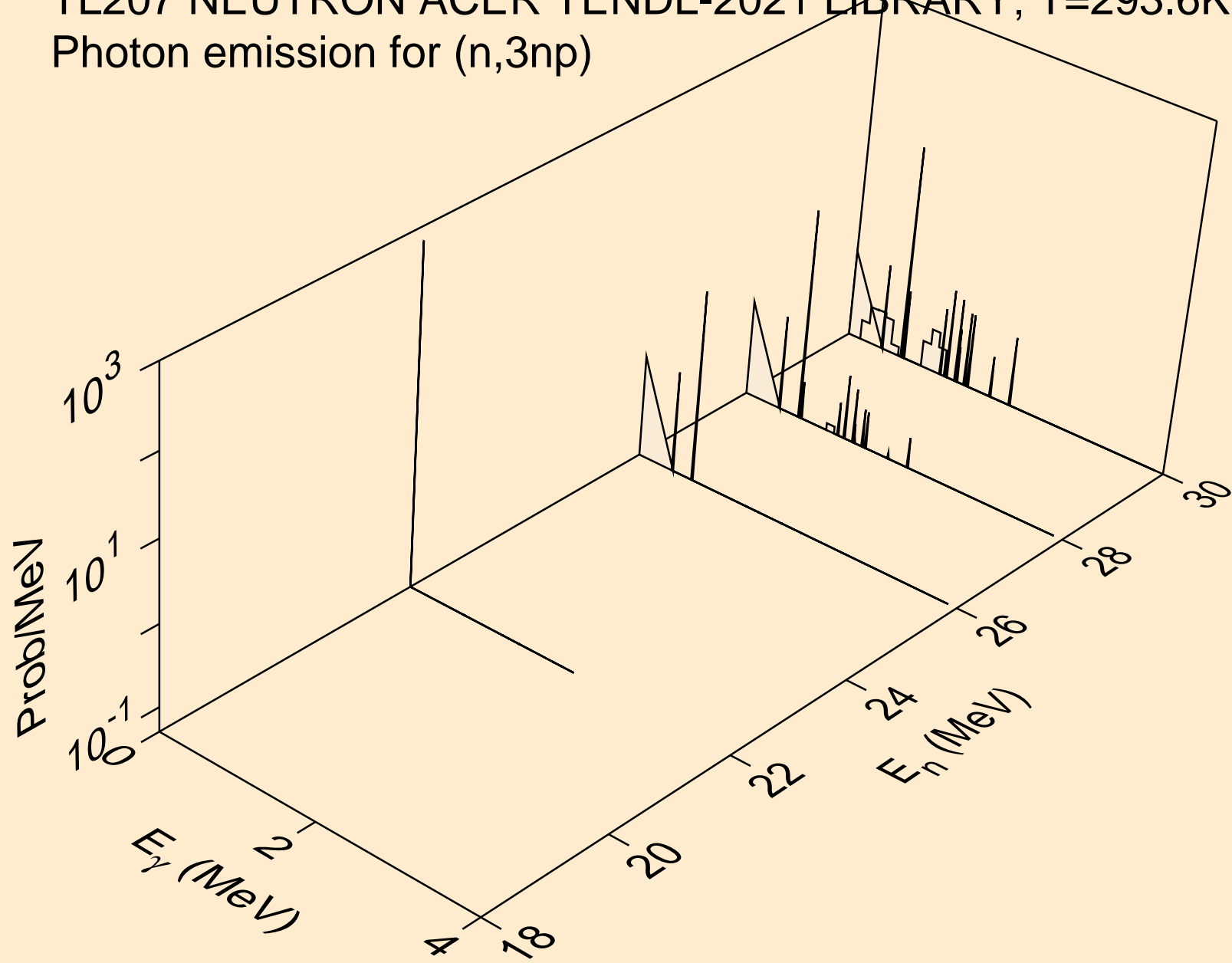



TL207 NEUTRON ACER TENDL-2021 LIBRARY; T=293.6K  
Photon emission for (n,n\*c)

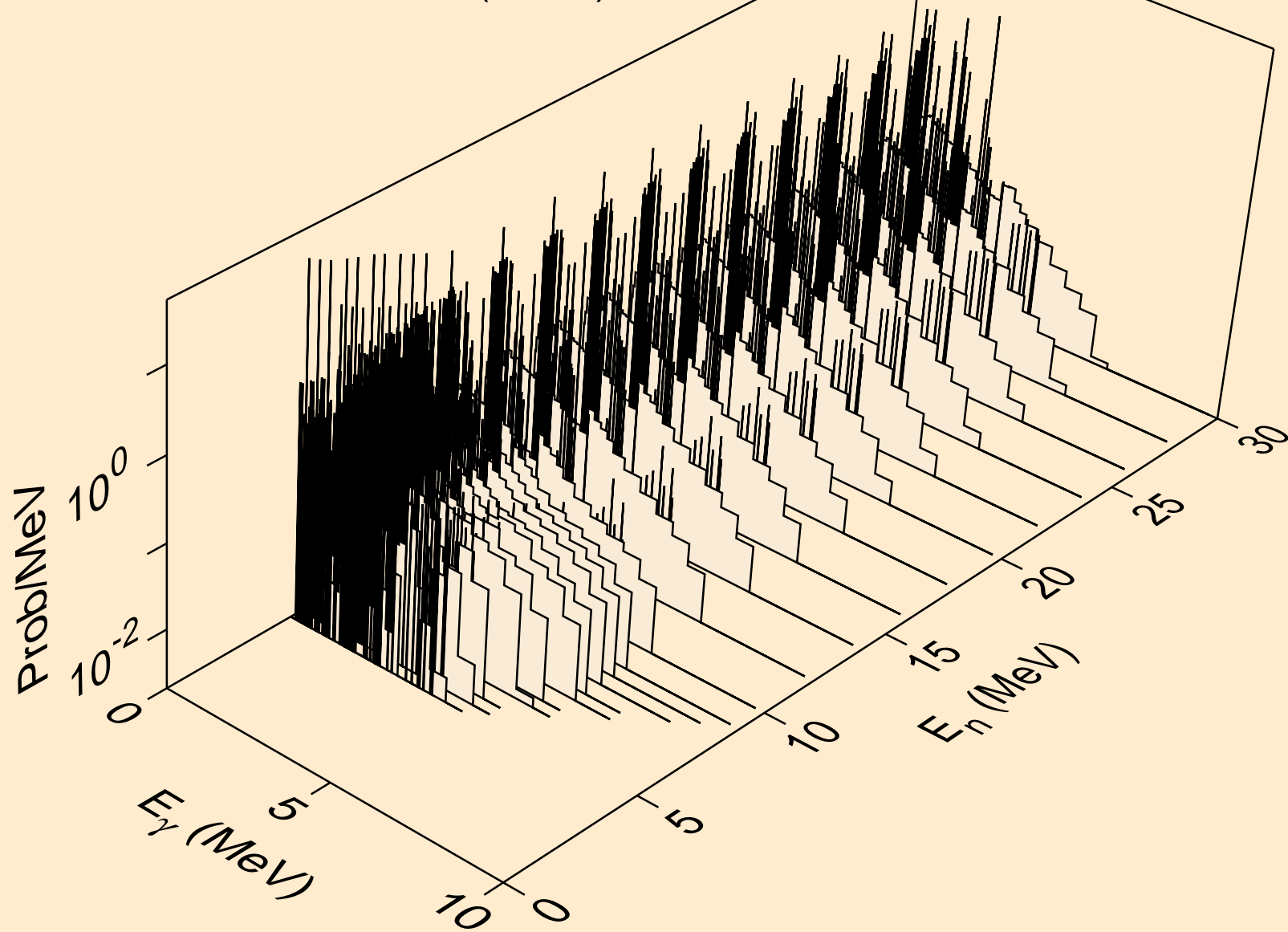

TL207 NEUTRON ACER TENDL-2021 LIBRARY; T=293.6K  
Photon emission for (n,gma)

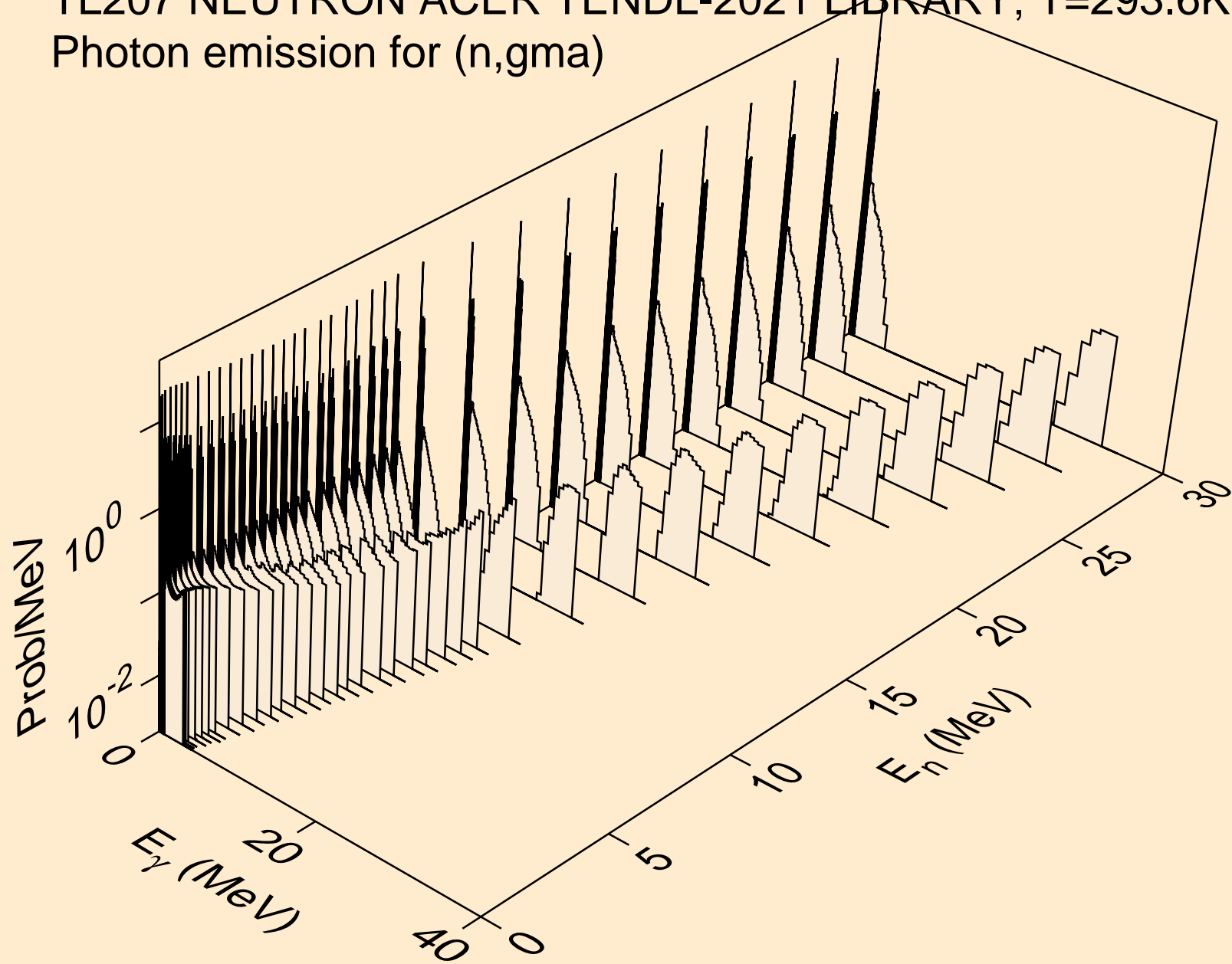

TL207 NEUTRON ACER TENDL-2021 LIBRARY; T=293.6K  
Photon emission for (n,p)

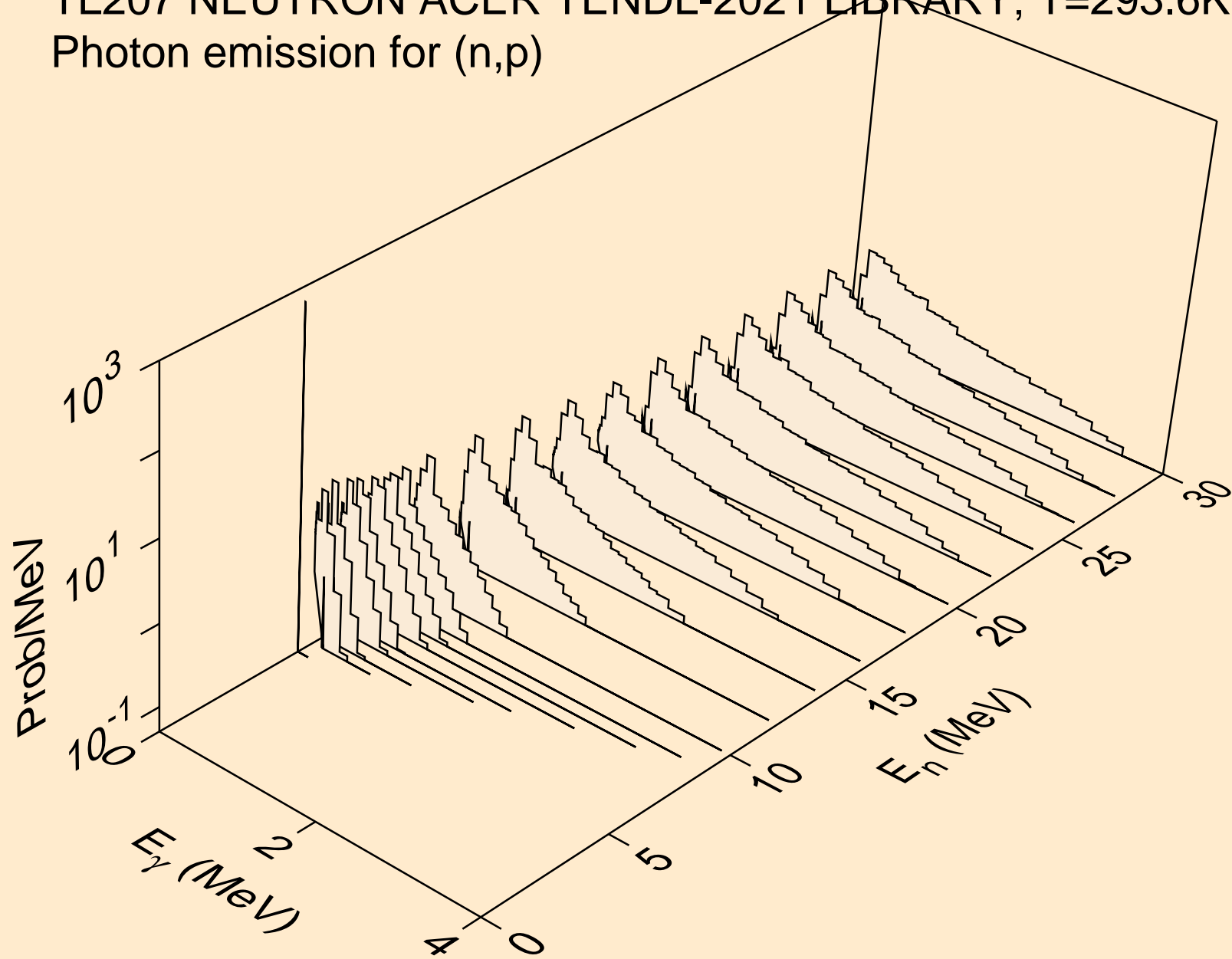

TL207 NEUTRON ACER TENDL-2021 LIBRARY; T=293.6K  
Photon emission for (n,d)

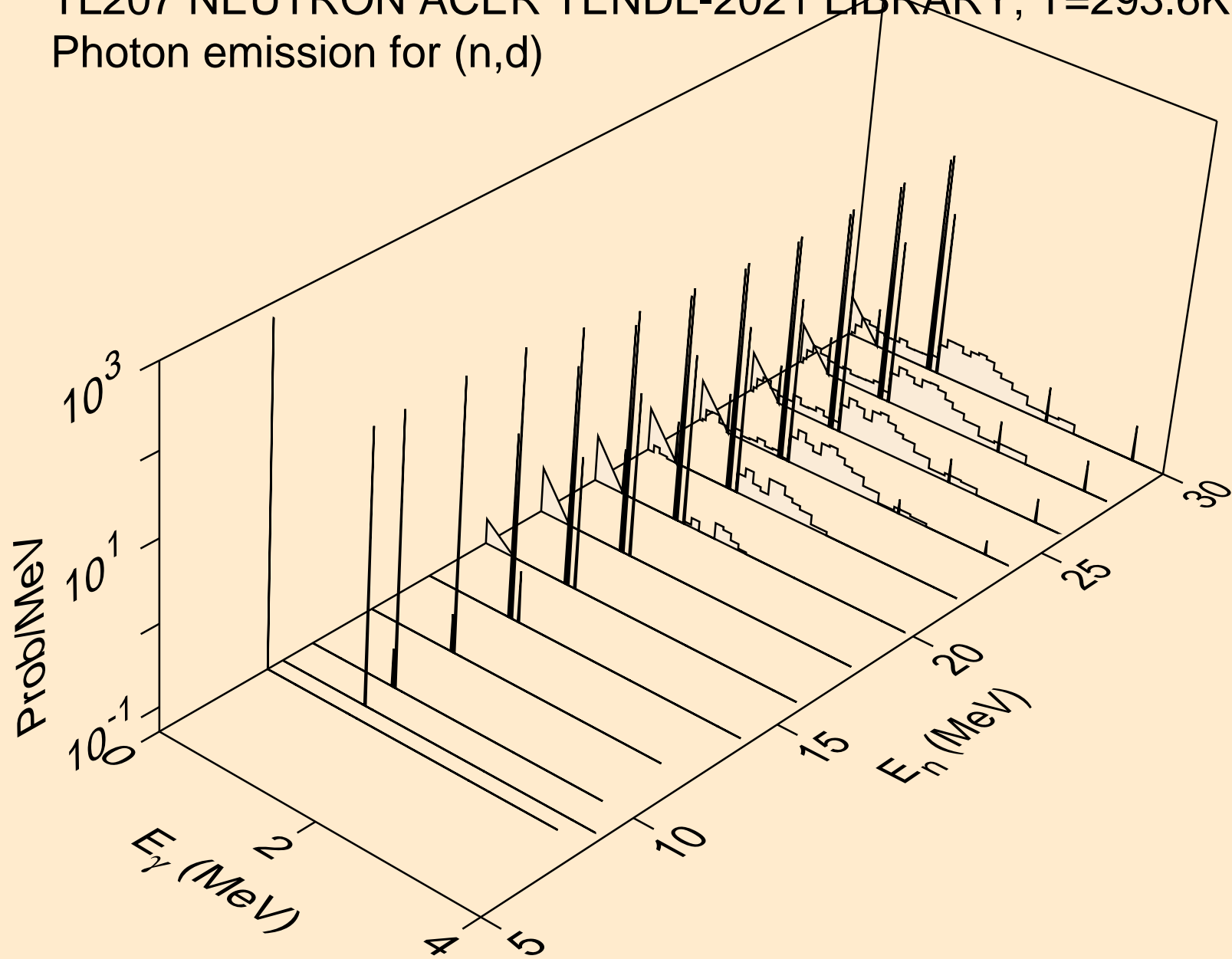

TL207 NEUTRON ACER TENDL-2021 LIBRARY; T=293.6K  
Photon emission for (n,t)

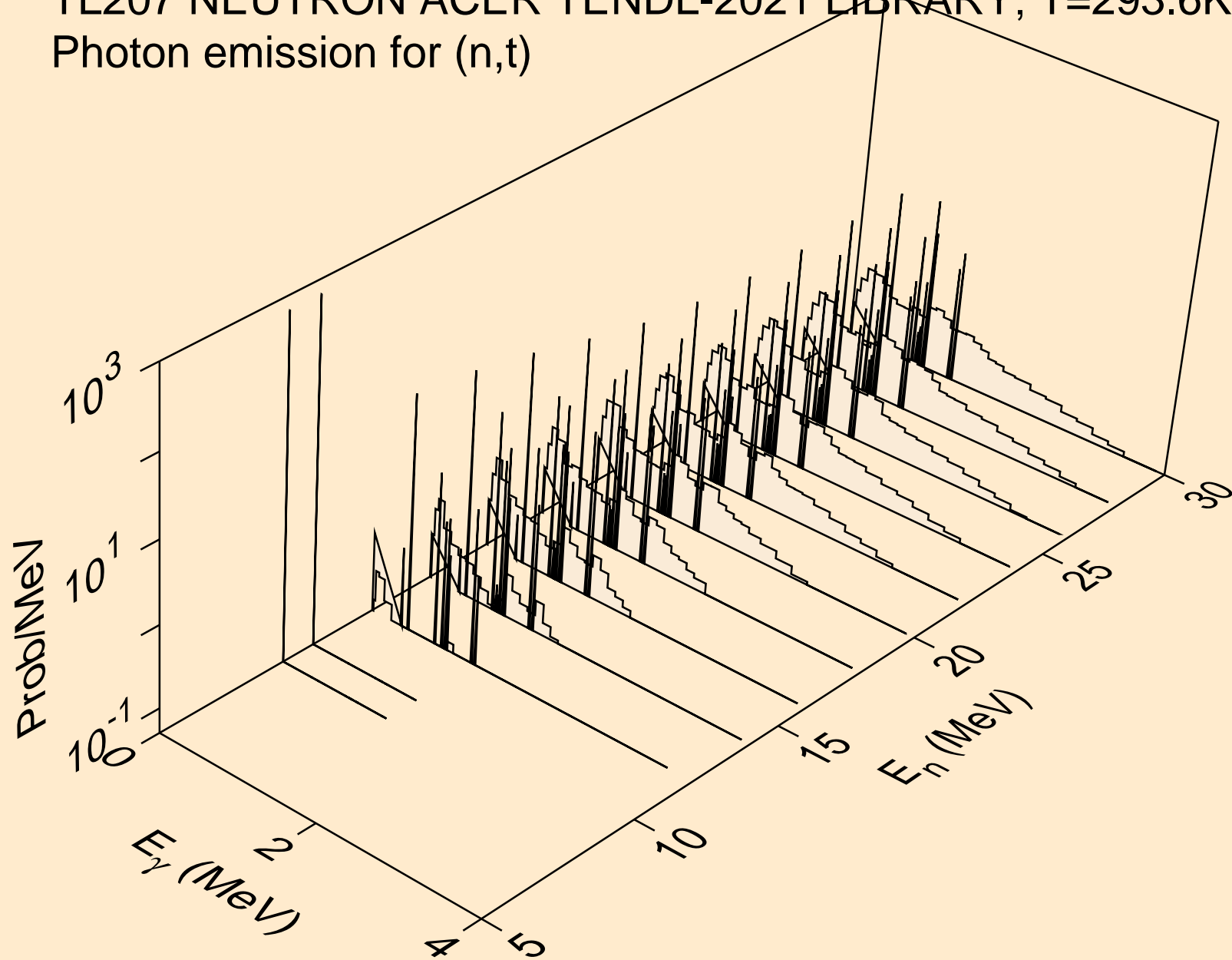

TL207 NEUTRON ACER TENDL-2021 LIBRARY; T=293.6K  
Photon emission for (n,he3)

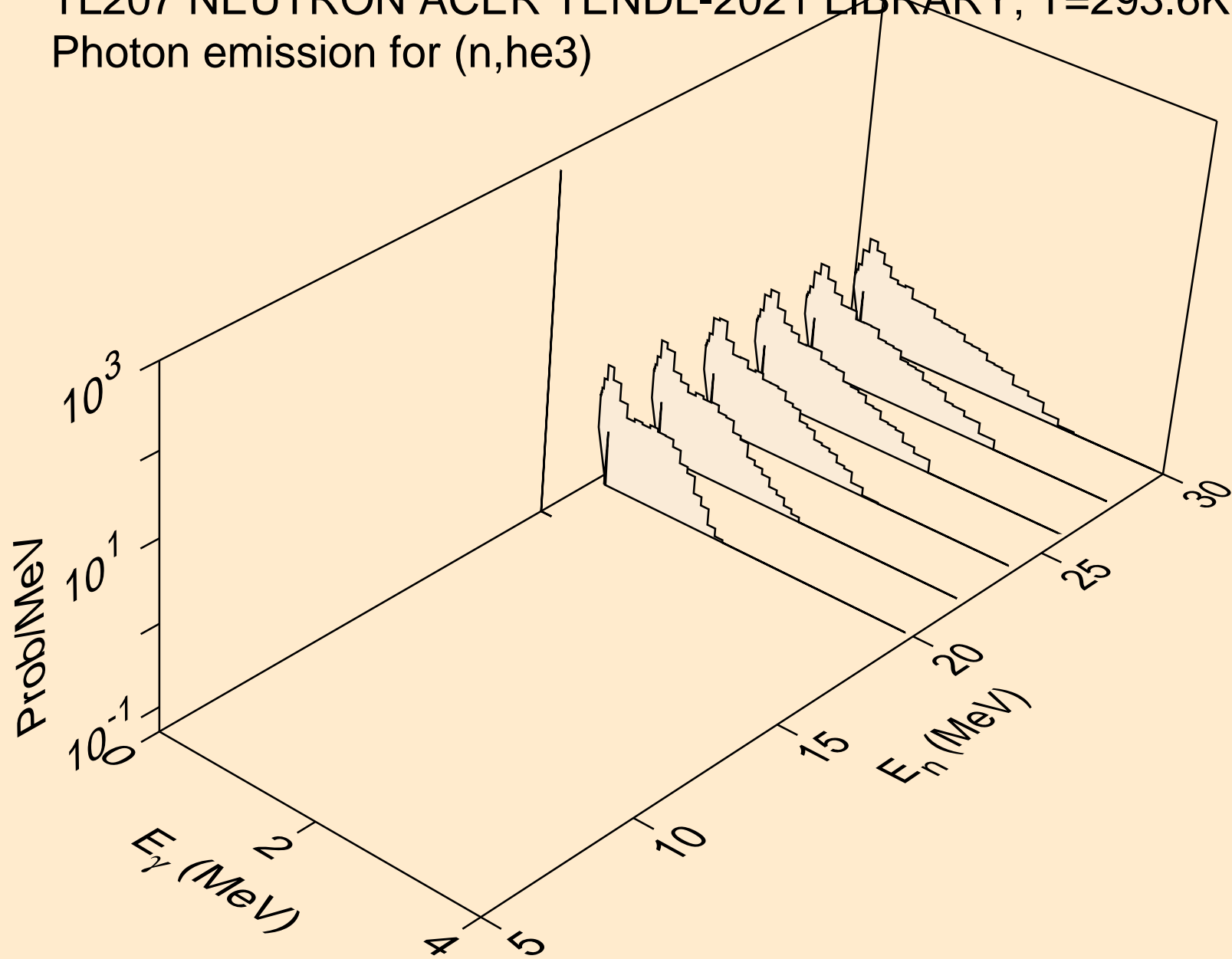

TL207 NEUTRON ACER TENDL-2021 LIBRARY; T=293.6K  
Photon emission for (n,a)

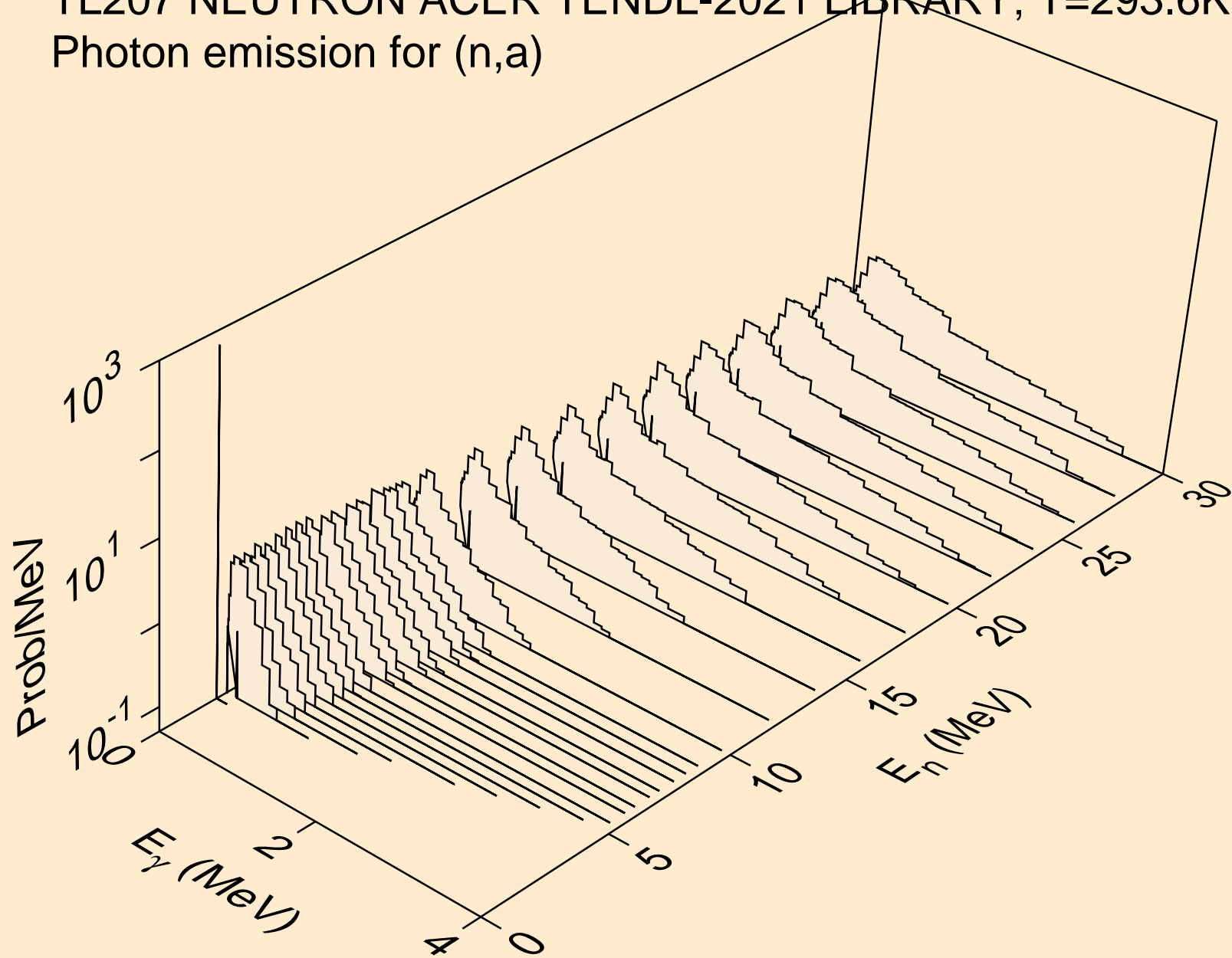

TL207 NEUTRON ACER TENDL-2021 LIBRARY; T=293.6K  
thermal capture photon spectrum

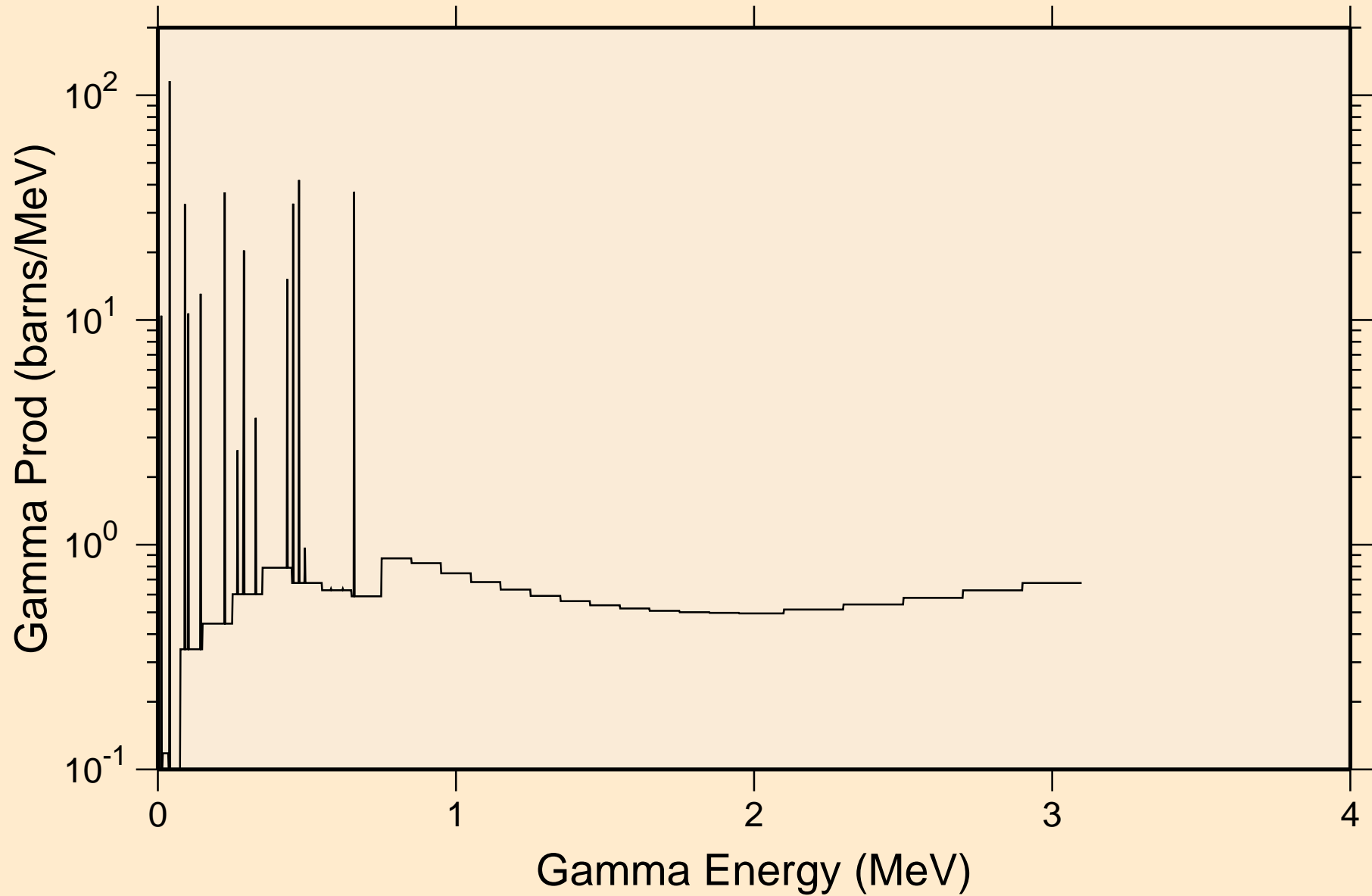



TL207 NEUTRON ACER TENDL-2021 LIBRARY; T=293.6K  
14 MeV photon spectrum

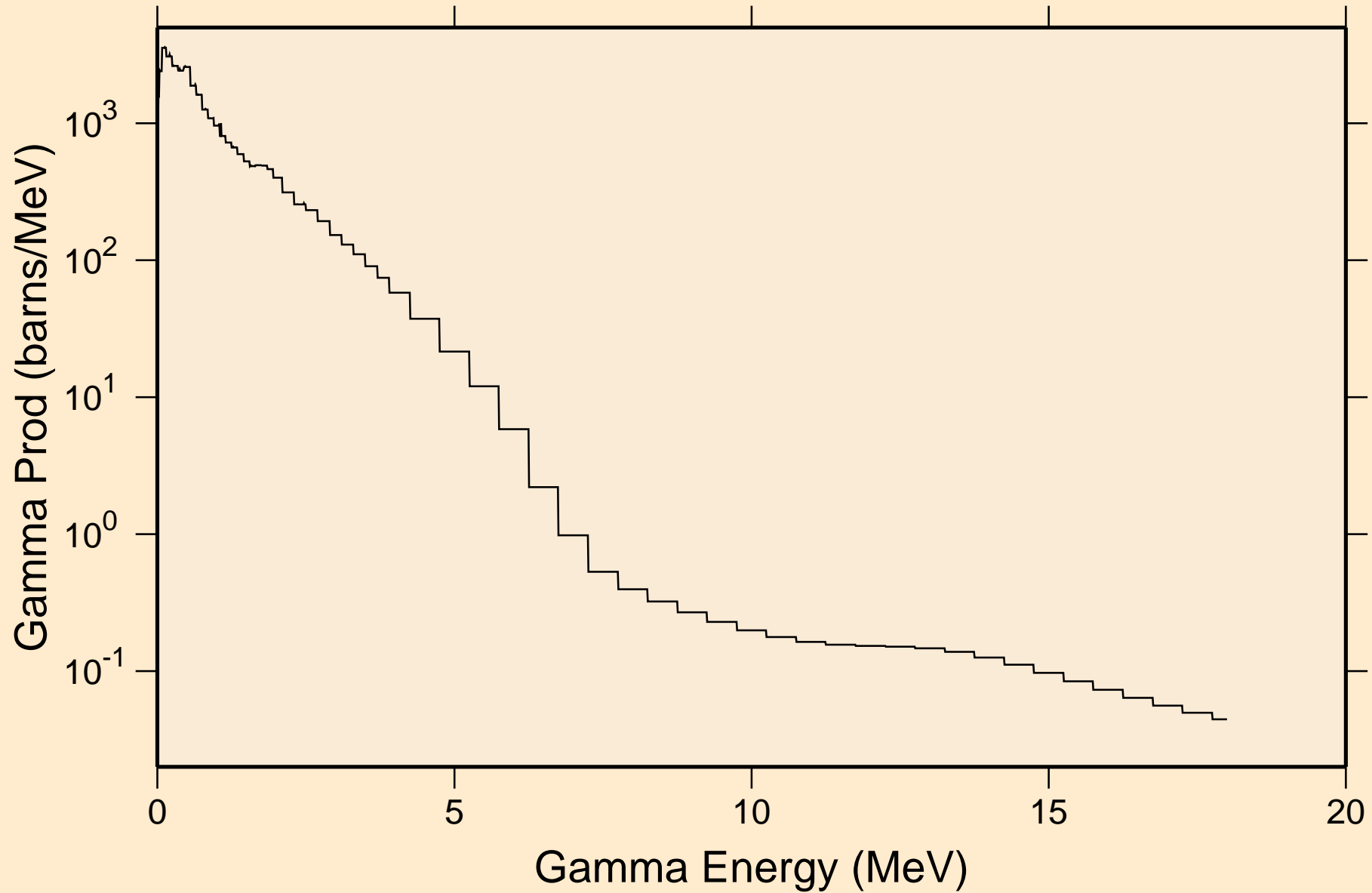

TL207 NEUTRON ACER TENDL-2021 LIBRARY; T=293.6K  
Particle heating contributions

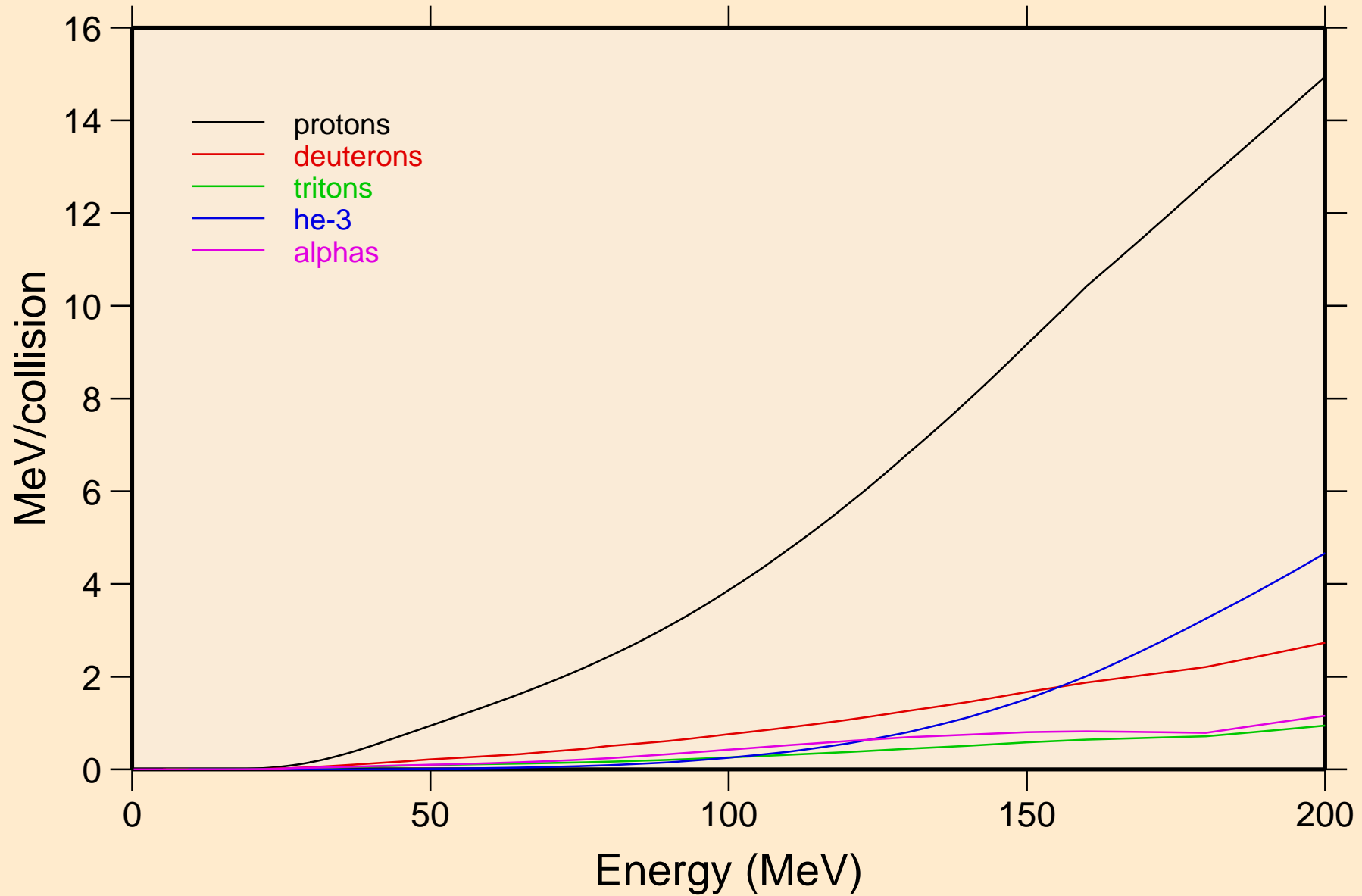

TL207 NEUTRON ACER TENDL-2021 LIBRARY; T=293.6K  
Recoil Heating

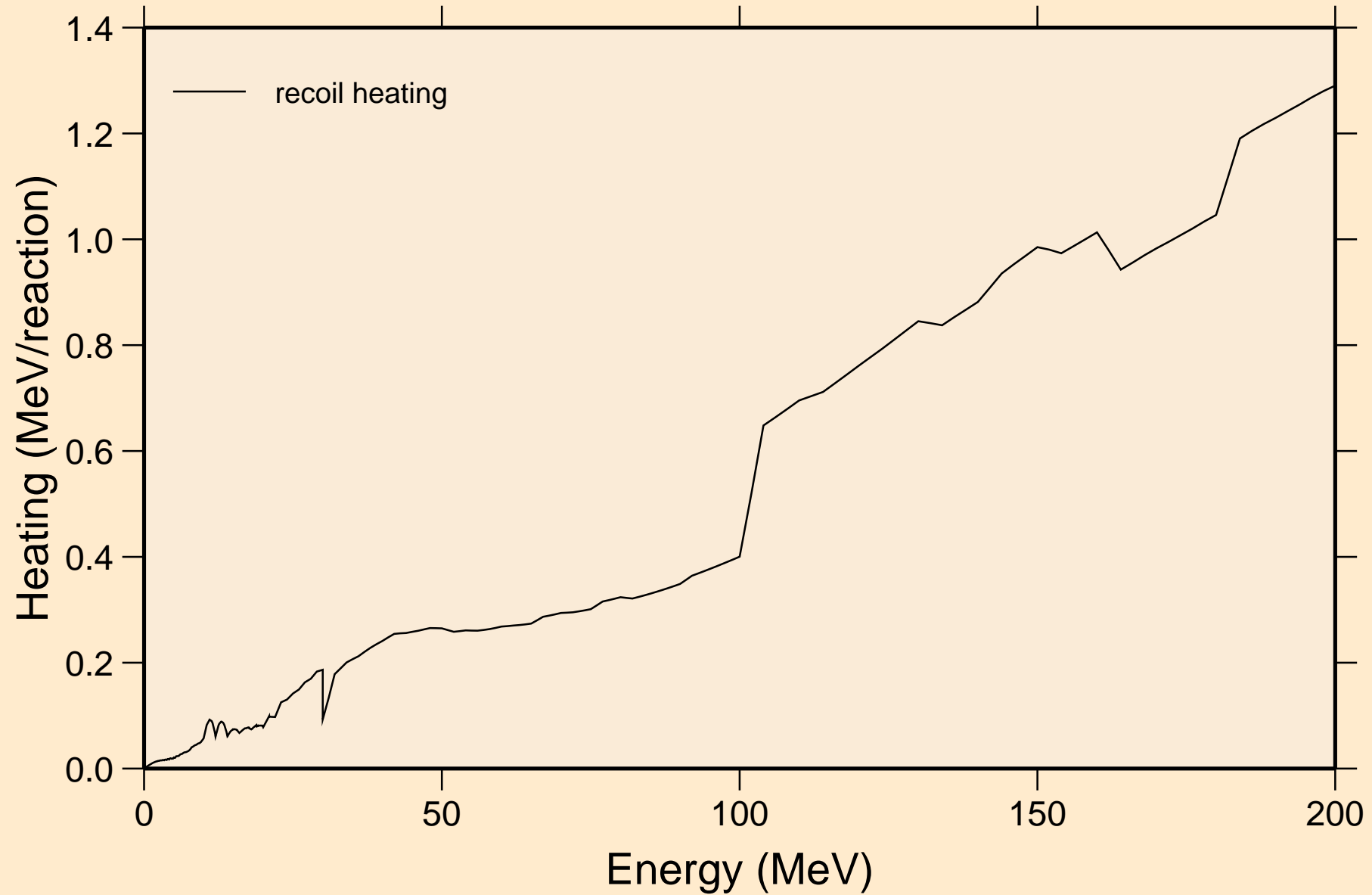

TL207 NEUTRON ACER TENDL-2021 LIBRARY; T=293.6K  
Particle production cross sections

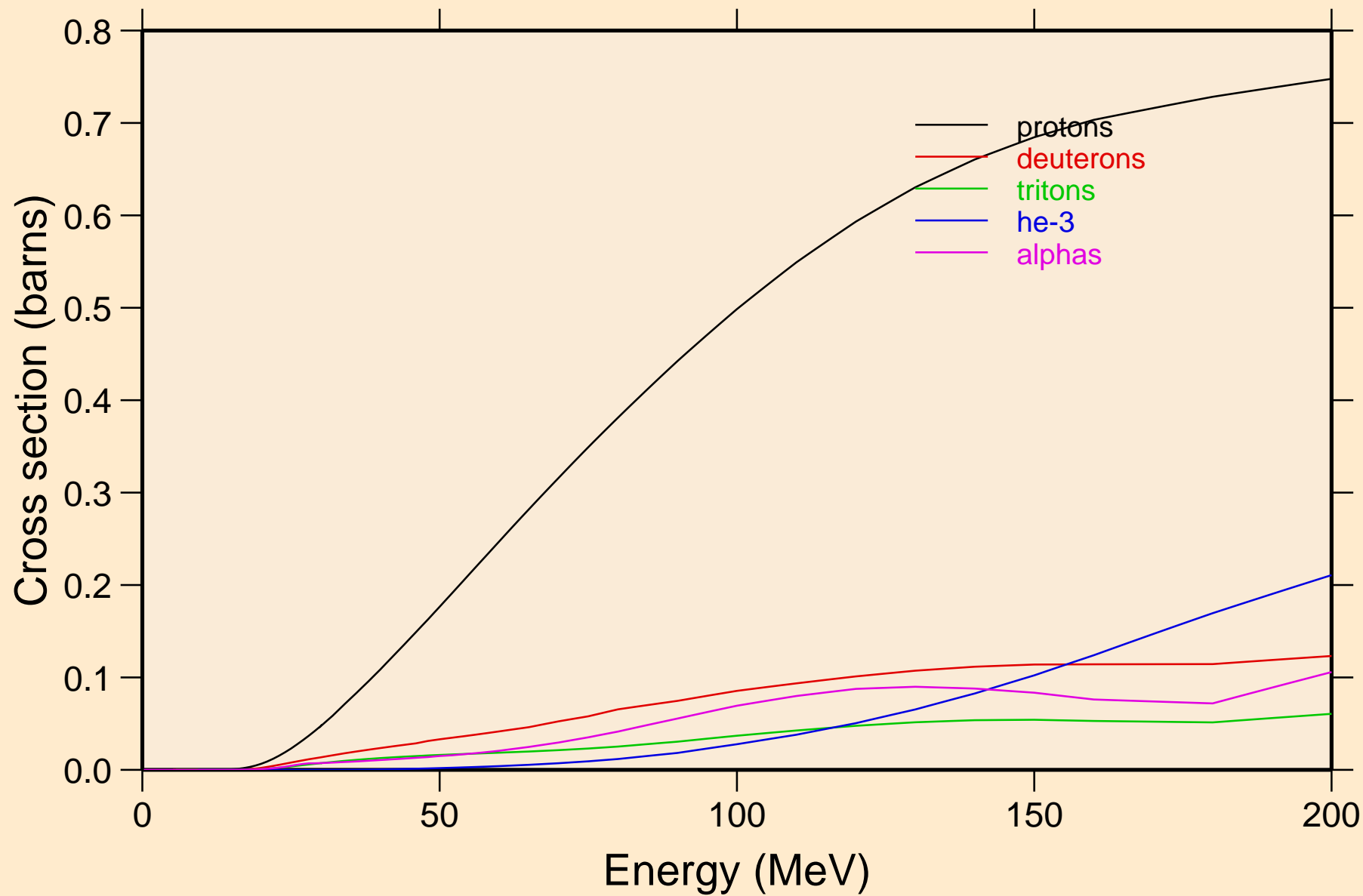

TL207 NEUTRON ACER TENDL-2021 LIBRARY; T=293.6K  
protons from (n,x)

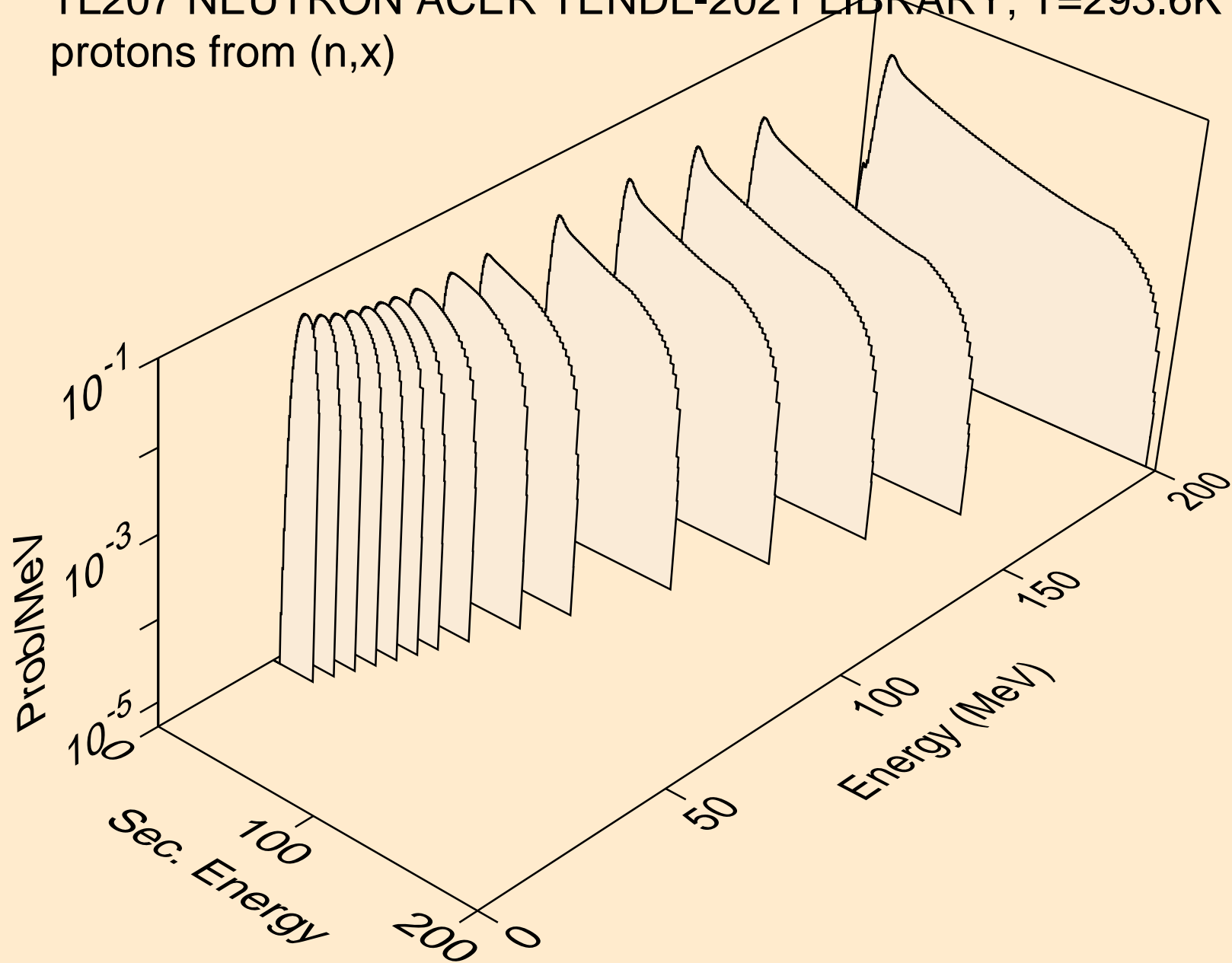

TL207 NEUTRON ACER TENDL-2021 LIBRARY; T=293.6K  
protons from (n,n\*)p

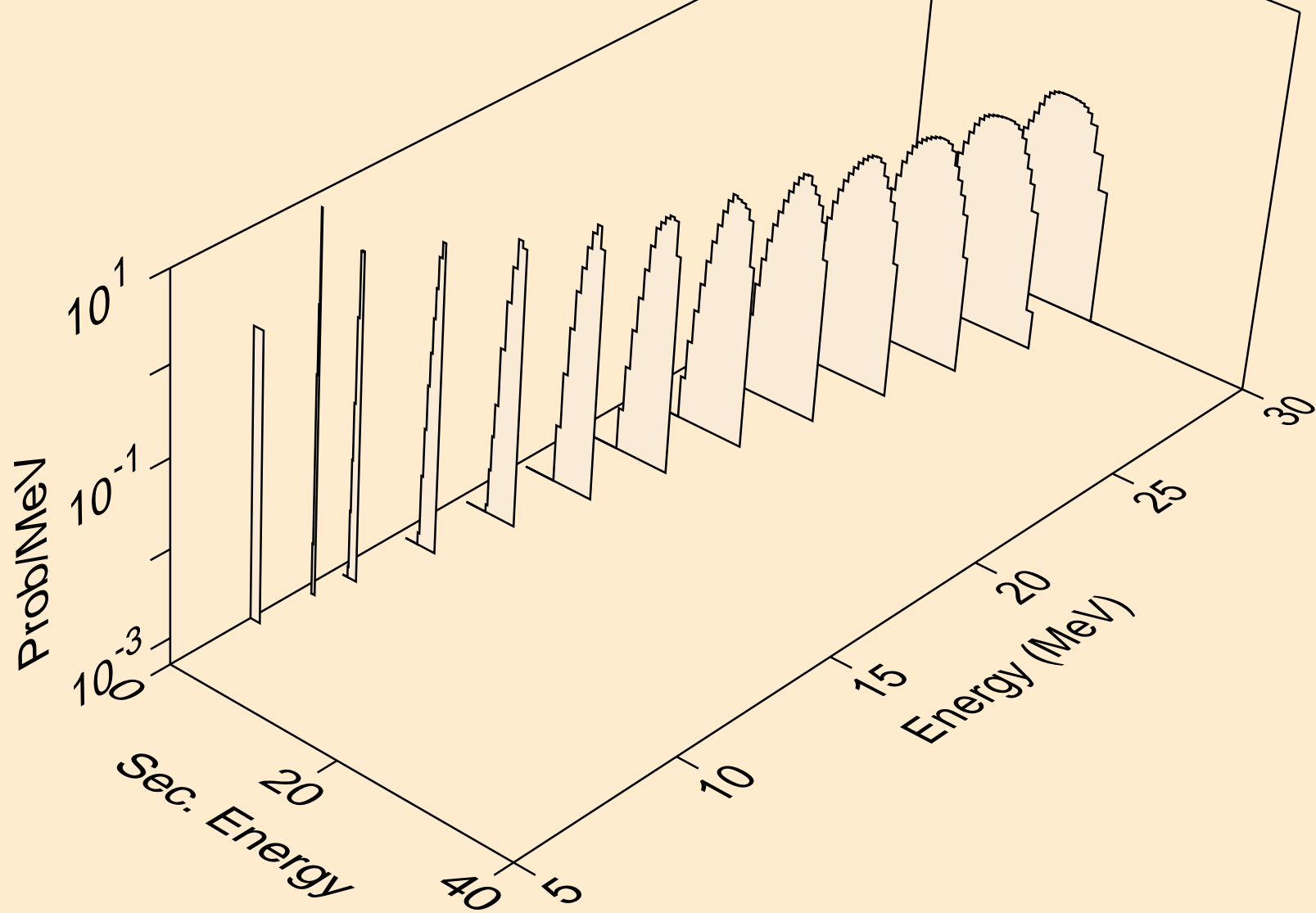

TL207 NEUTRON ACER TENDL-2021 LIBRARY; T=293.6K  
protons from (n,2np)

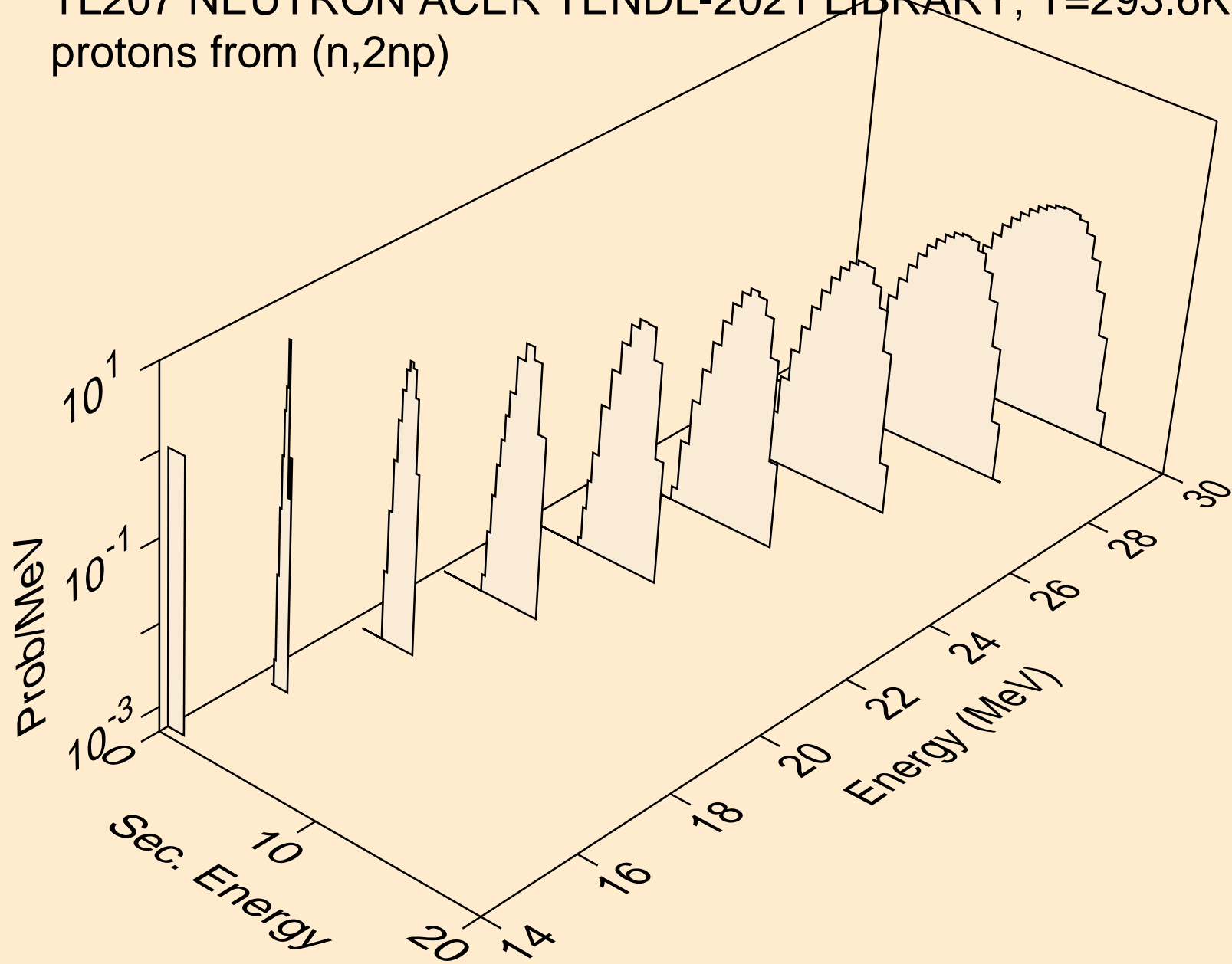

TL207 NEUTRON ACER TENDL-2021 LIBRARY; T=293.6K  
protons from (n,3np)

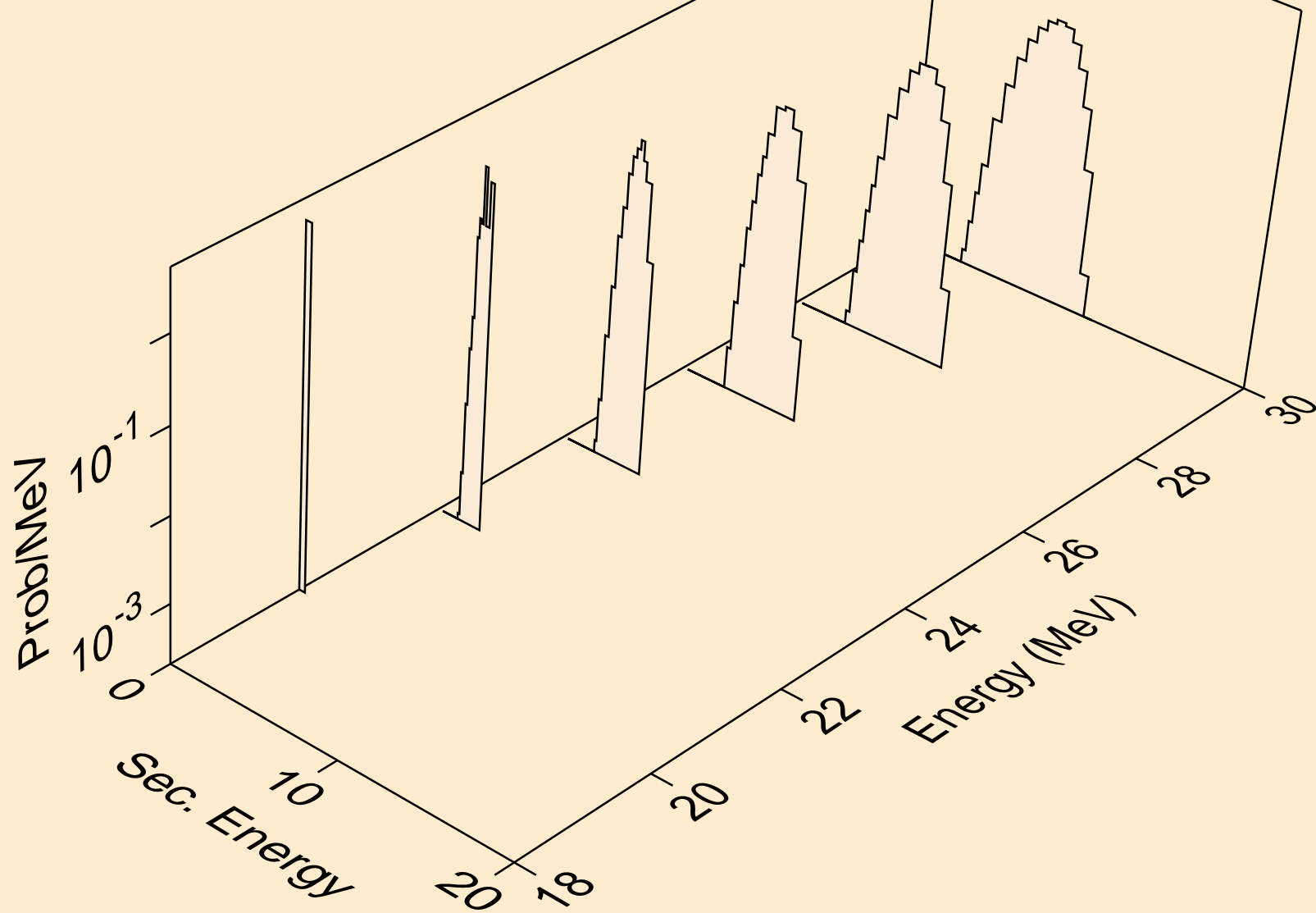



TL207 NEUTRON ACER TENDL-2021 LIBRARY; T=293.6K  
protons from (n,p)

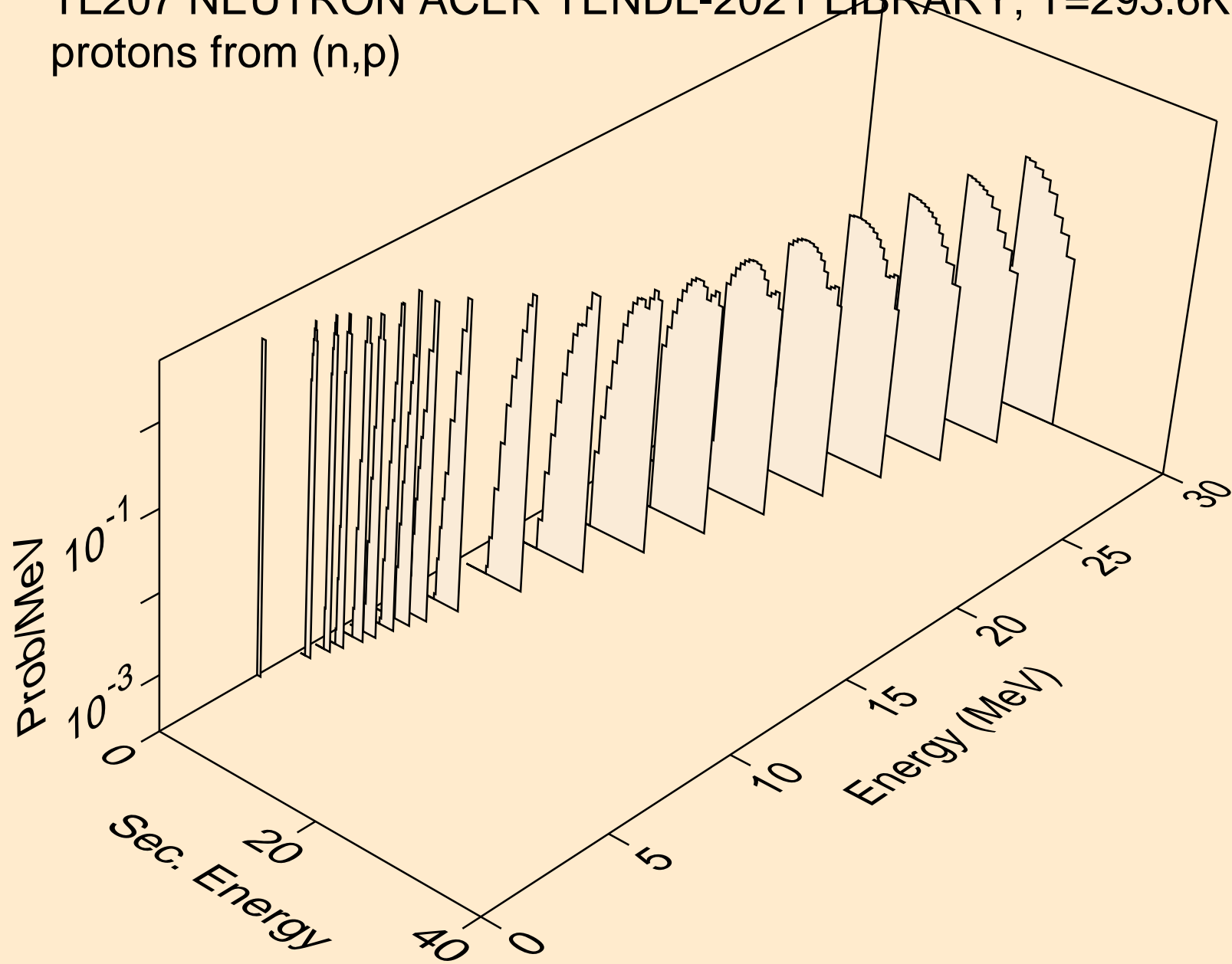

TL207 NEUTRON ACER TENDL-2021 LIBRARY; T=293.6K  
deuterons from (n,x)

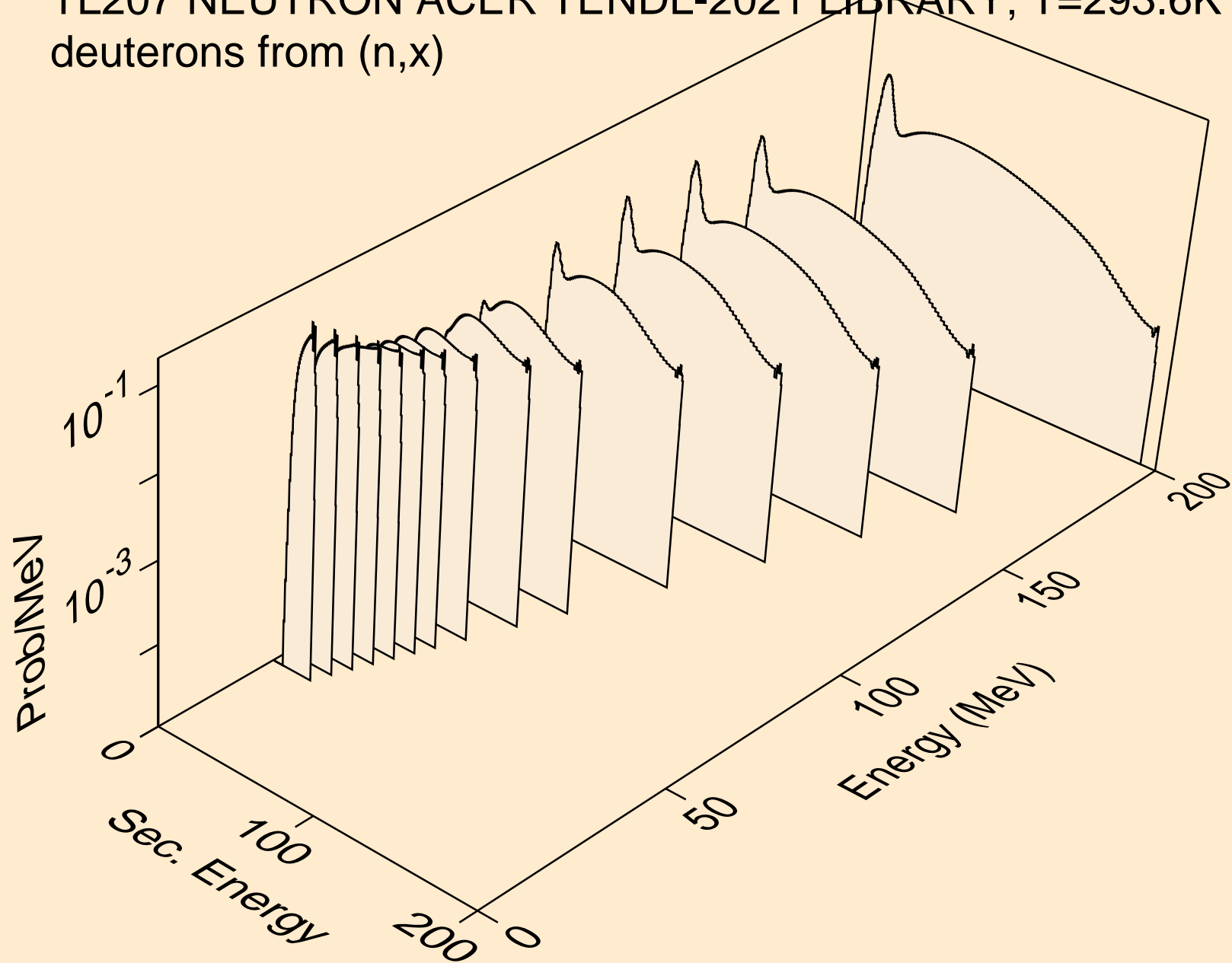

TL207 NEUTRON ACER TENDL-2021 LIBRARY; T=293.6K  
deuterons from (n,2nd)

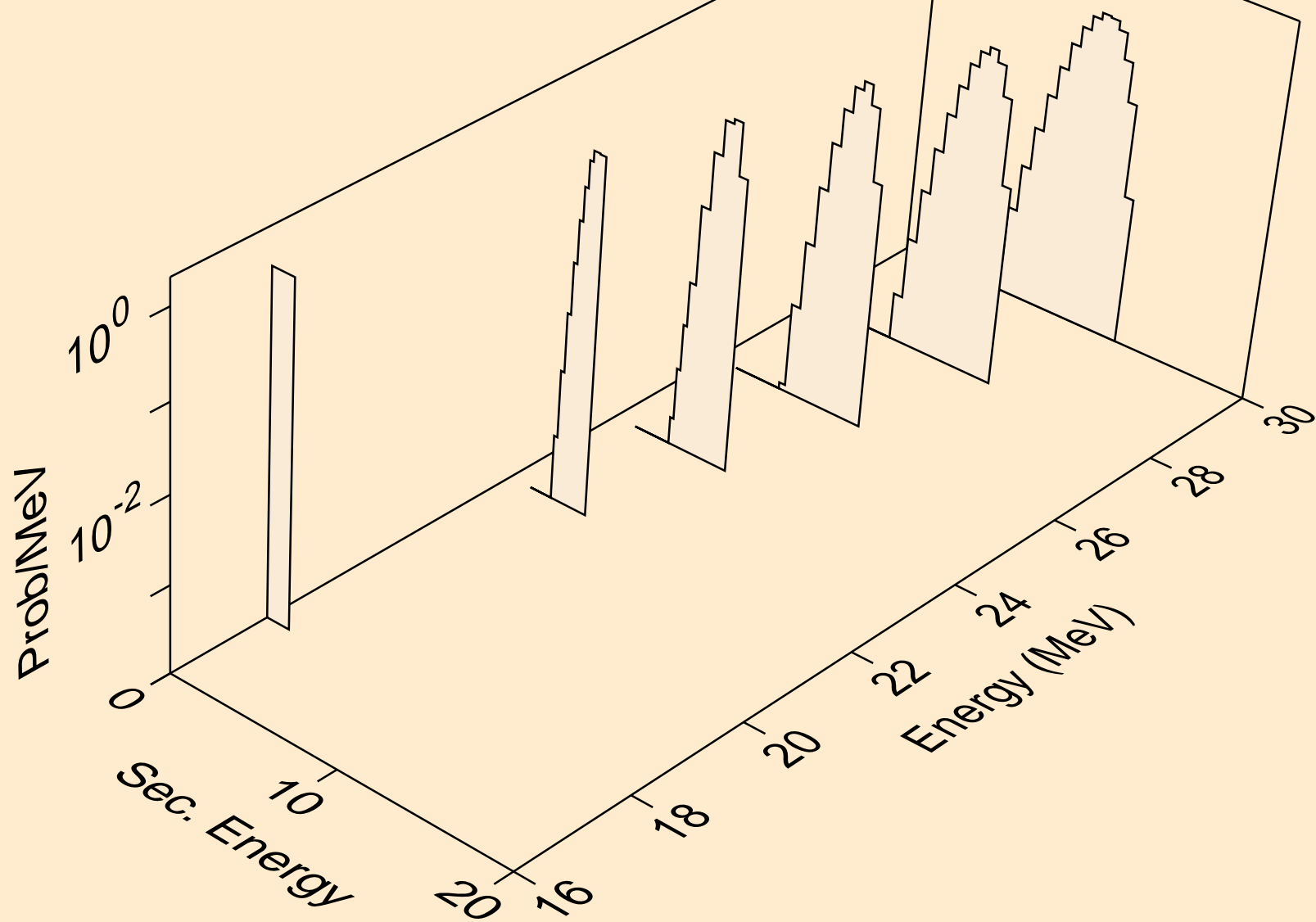

TL207 NEUTRON ACER TENDL-2021 LIBRARY; T=293.6K  
deuterons from (n,n\*)d

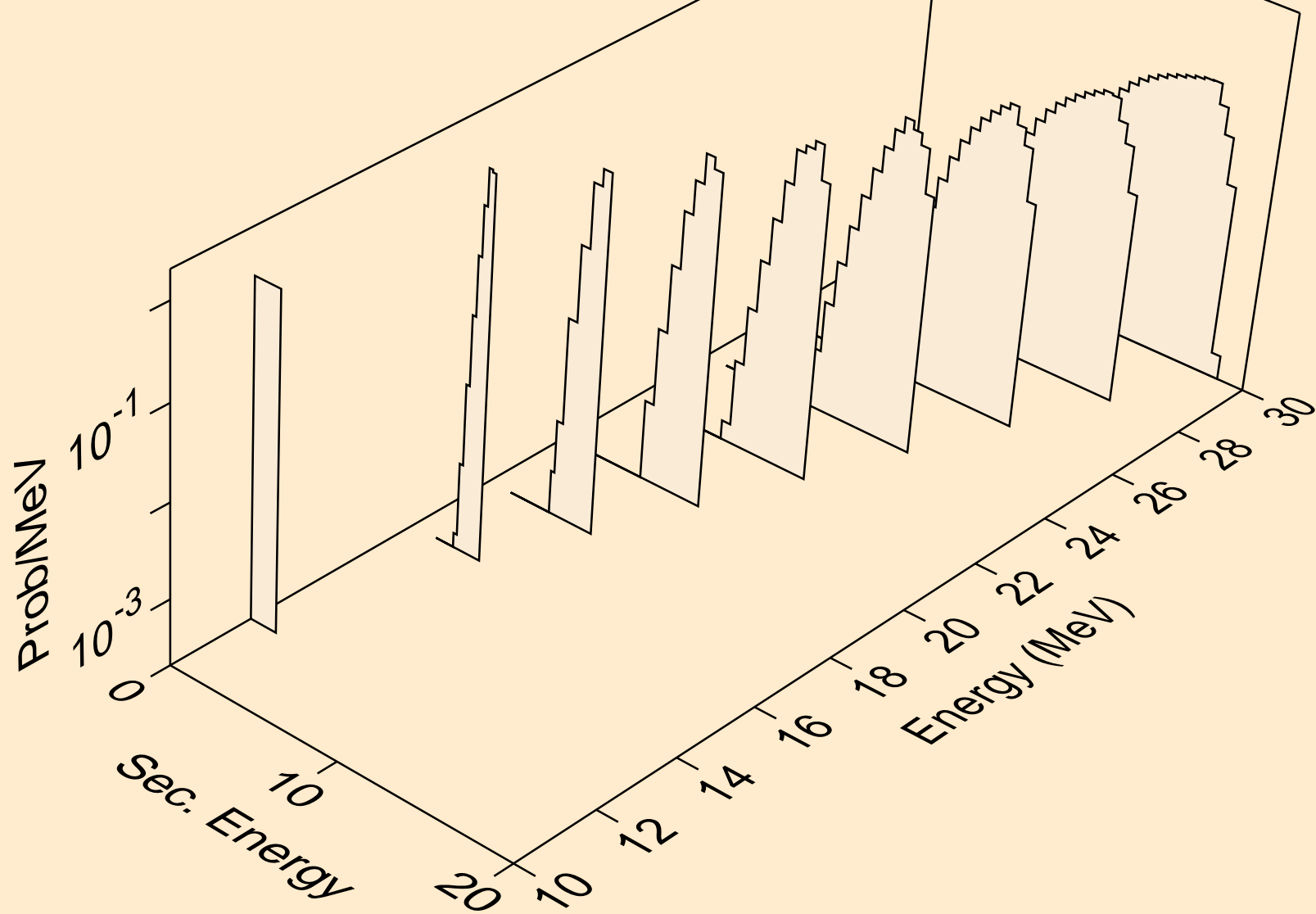

TL207 NEUTRON ACER TENDL-2021 LIBRARY; T=293.6K  
deuterons from (n,d)

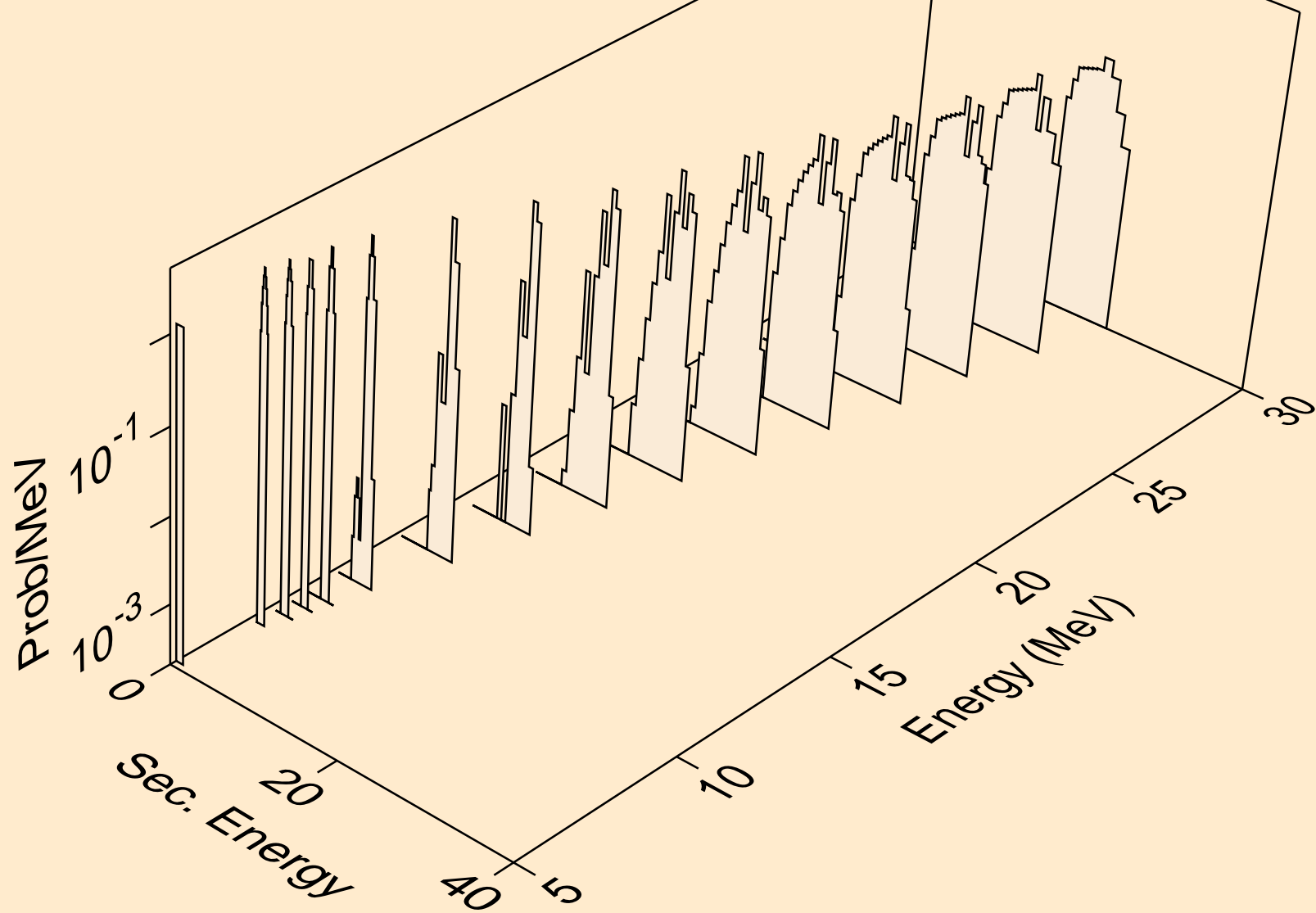

TL207 NEUTRON ACER TENDL-2021 LIBRARY; T=293.6K  
tritons from (n,x)

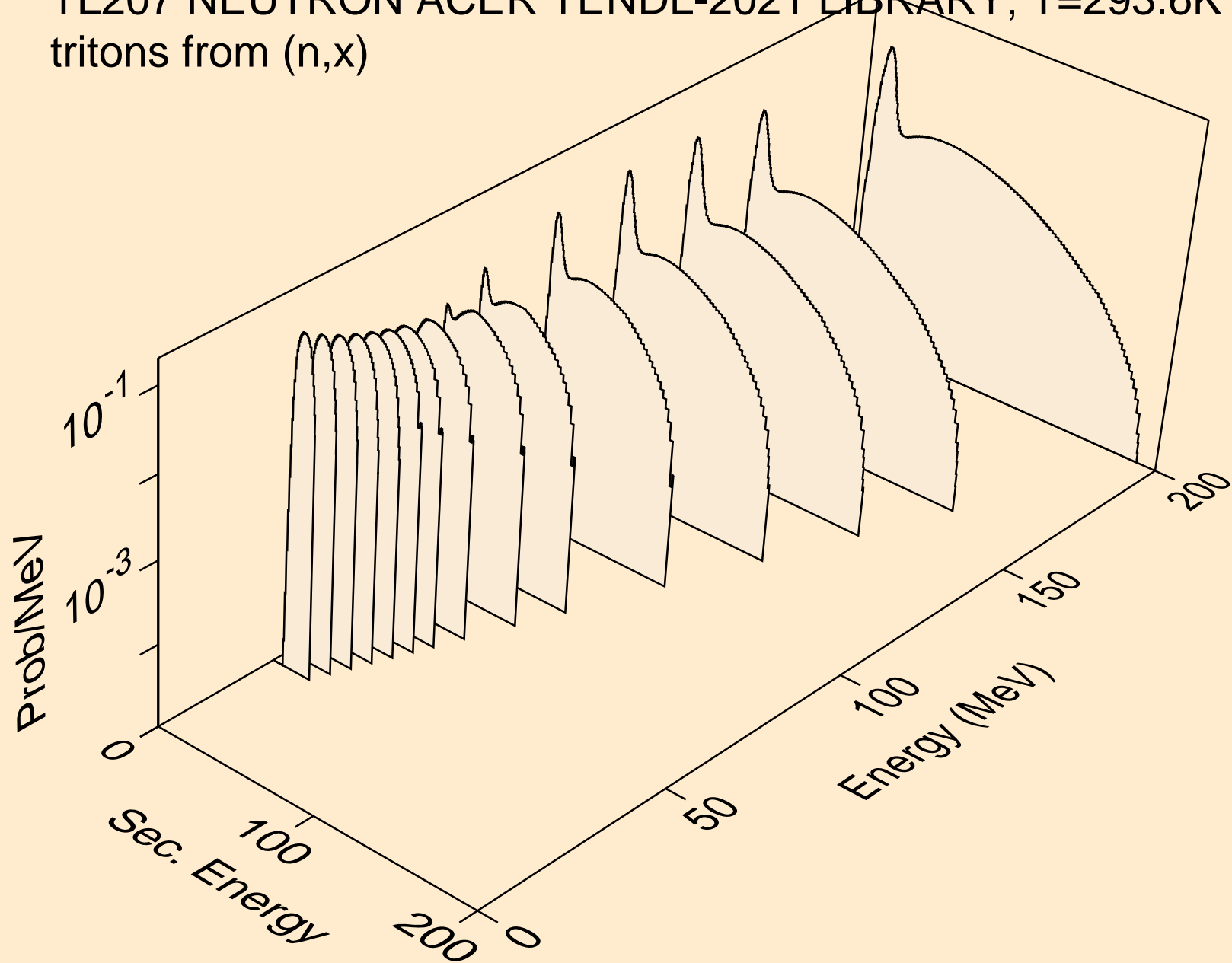

TL207 NEUTRON ACER TENDL-2021 LIBRARY; T=293.6K  
tritons from (n,n\*)t

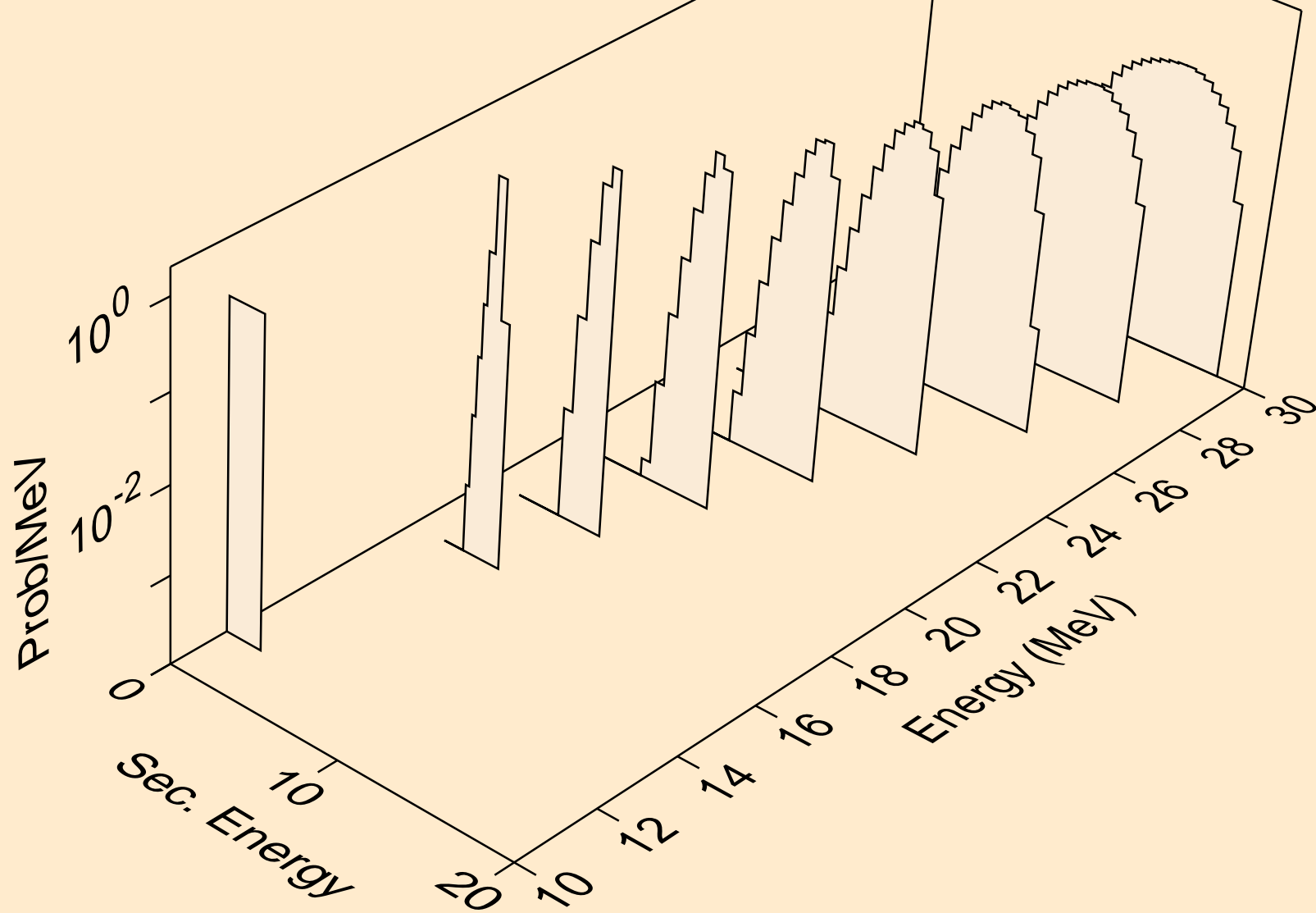

TL207 NEUTRON ACER TENDL-2021 LIBRARY; T=293.6K  
tritons from (n,t)

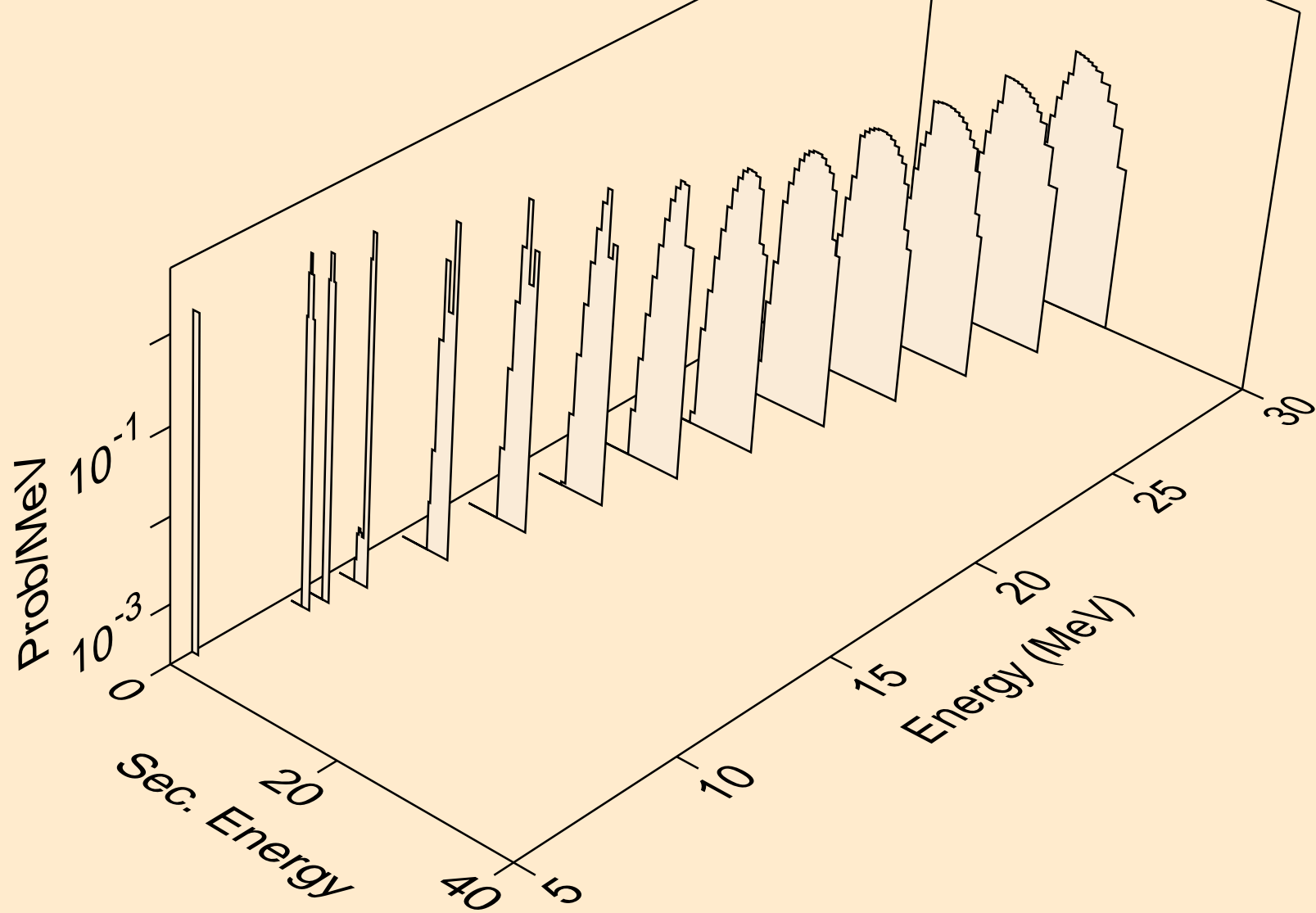



TL207 NEUTRON ACER TENDL-2021 LIBRARY; T=293.6K  
he3s from (n,x)

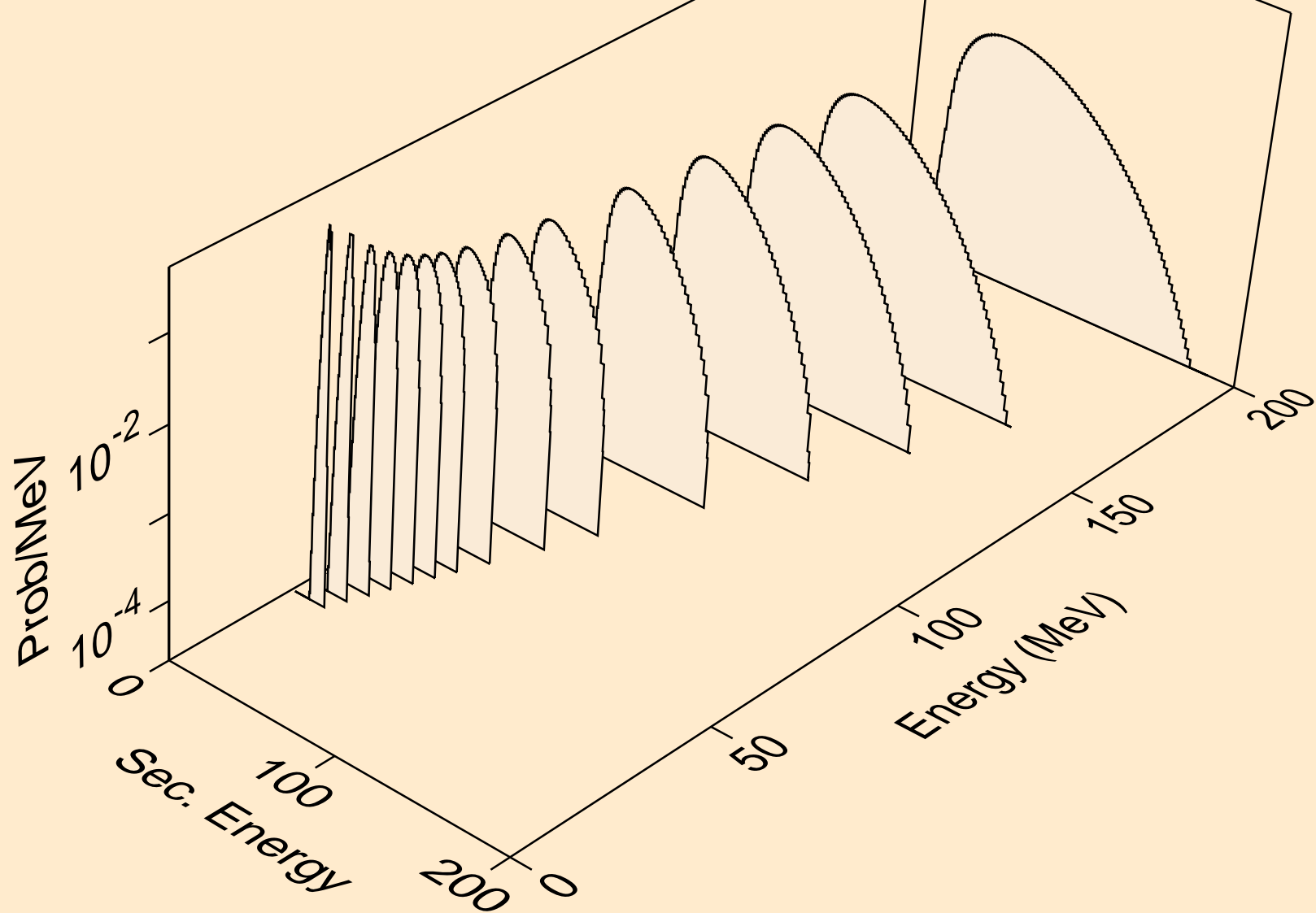

TL207 NEUTRON ACER TENDL-2021 LIBRARY; T=293.6K  
he3s from (n,n\*)he3

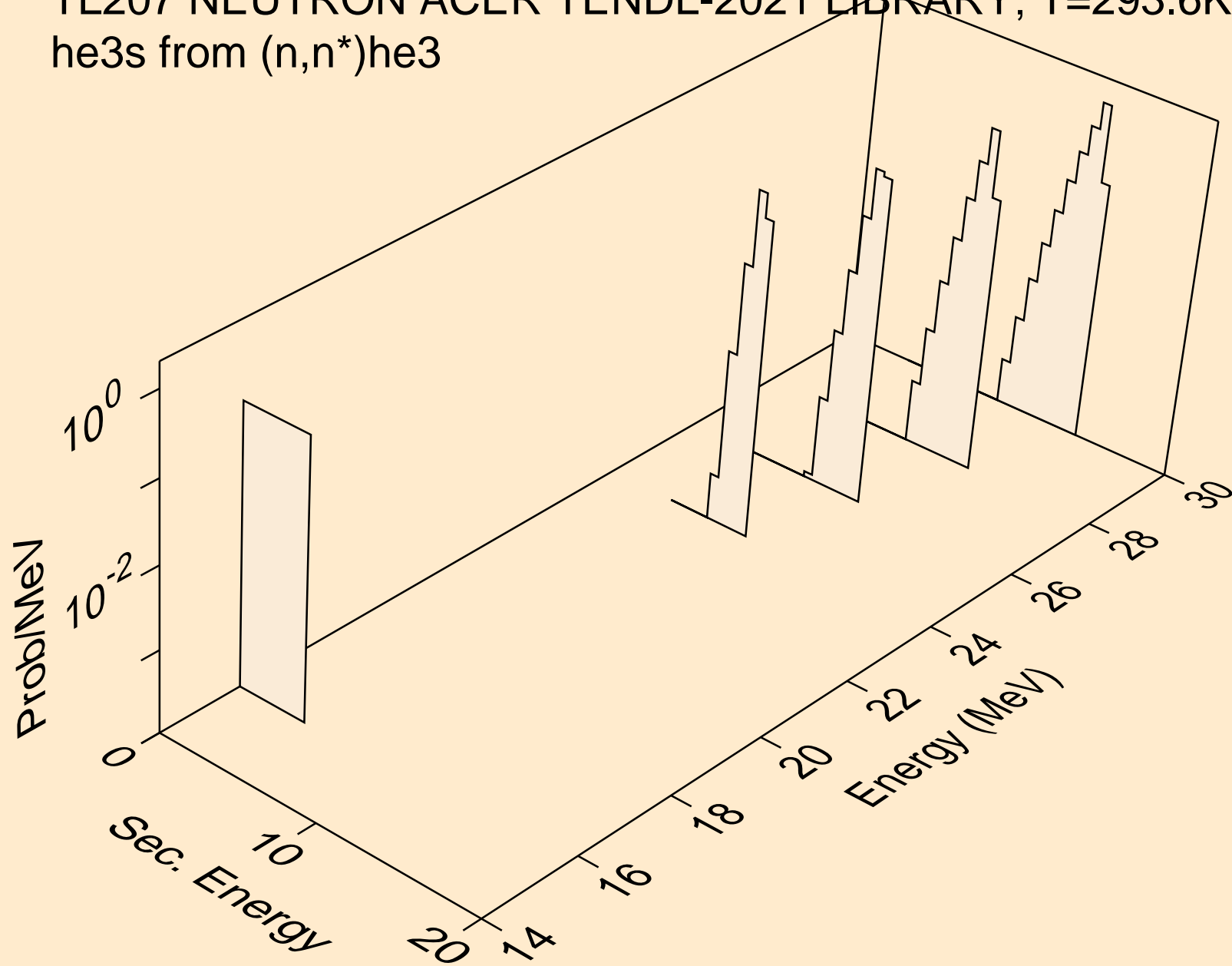

TL207 NEUTRON ACER TENDL-2021 LIBRARY; T=293.6K  
he3s from (n,he3)

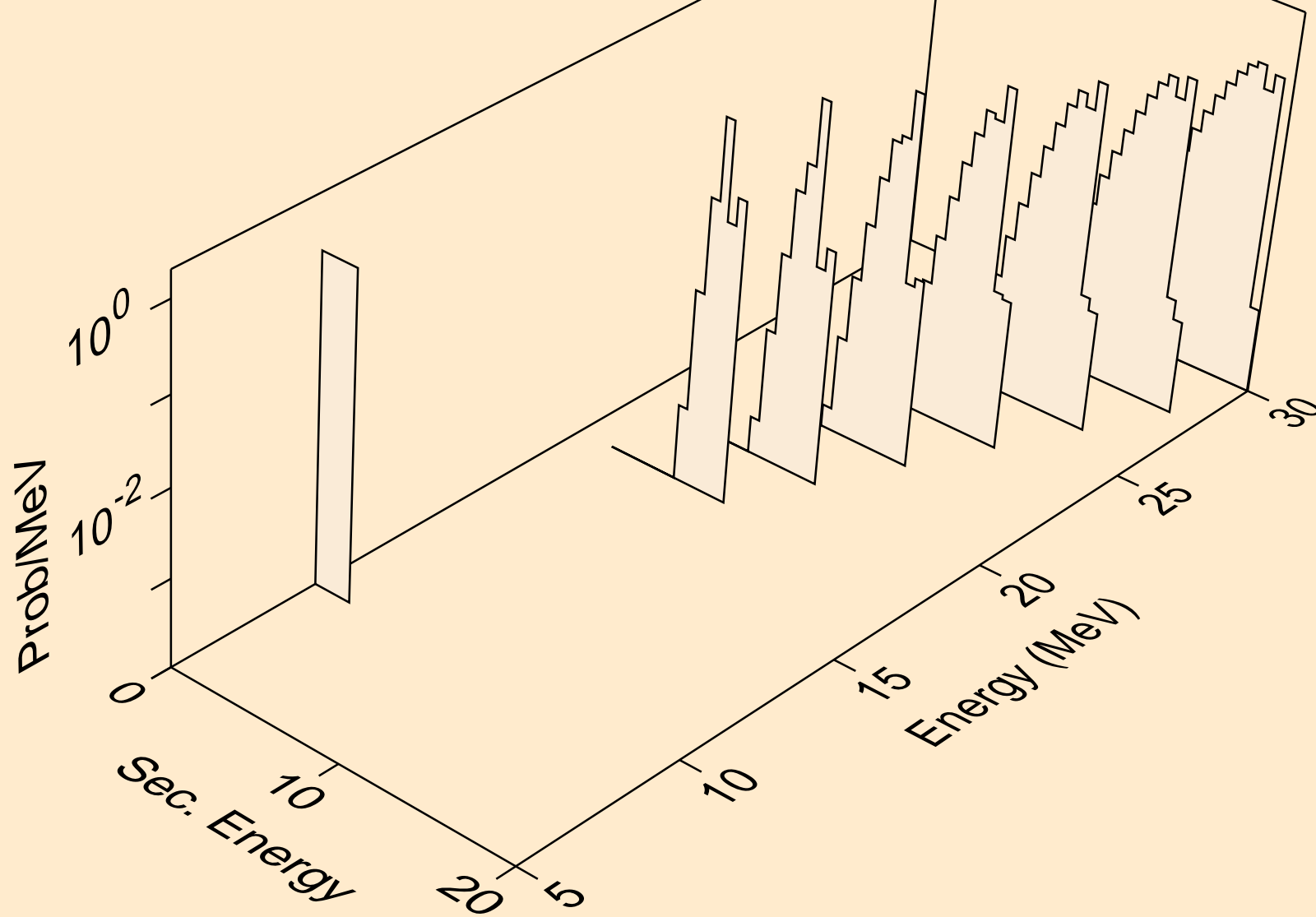

TL207 NEUTRON ACER TENDL-2021 LIBRARY; T=293.6K  
alphas from (n,x)

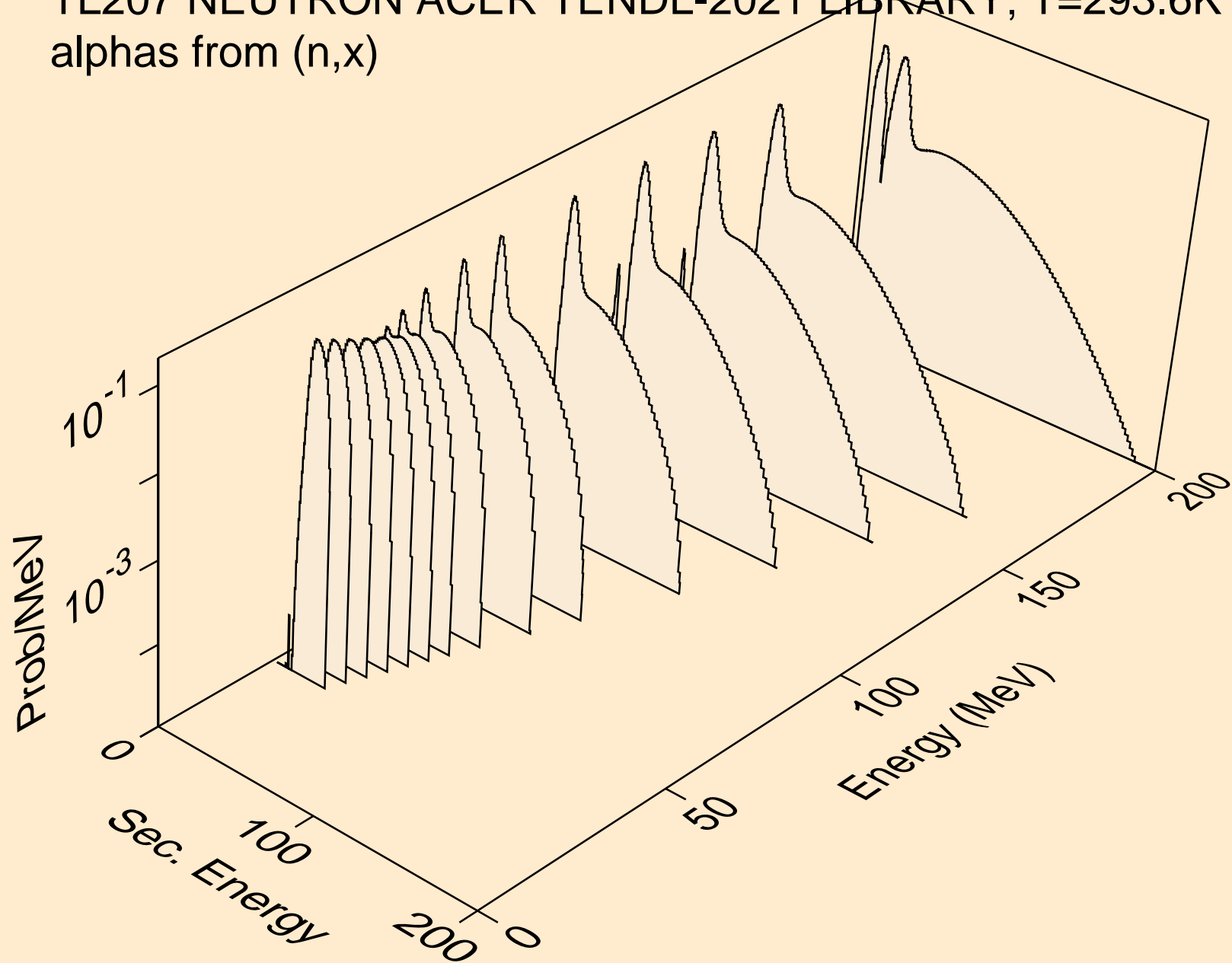

TL207 NEUTRON ACER TENDL-2021 LIBRARY; T=293.6K  
alphas from (n,n\*)a

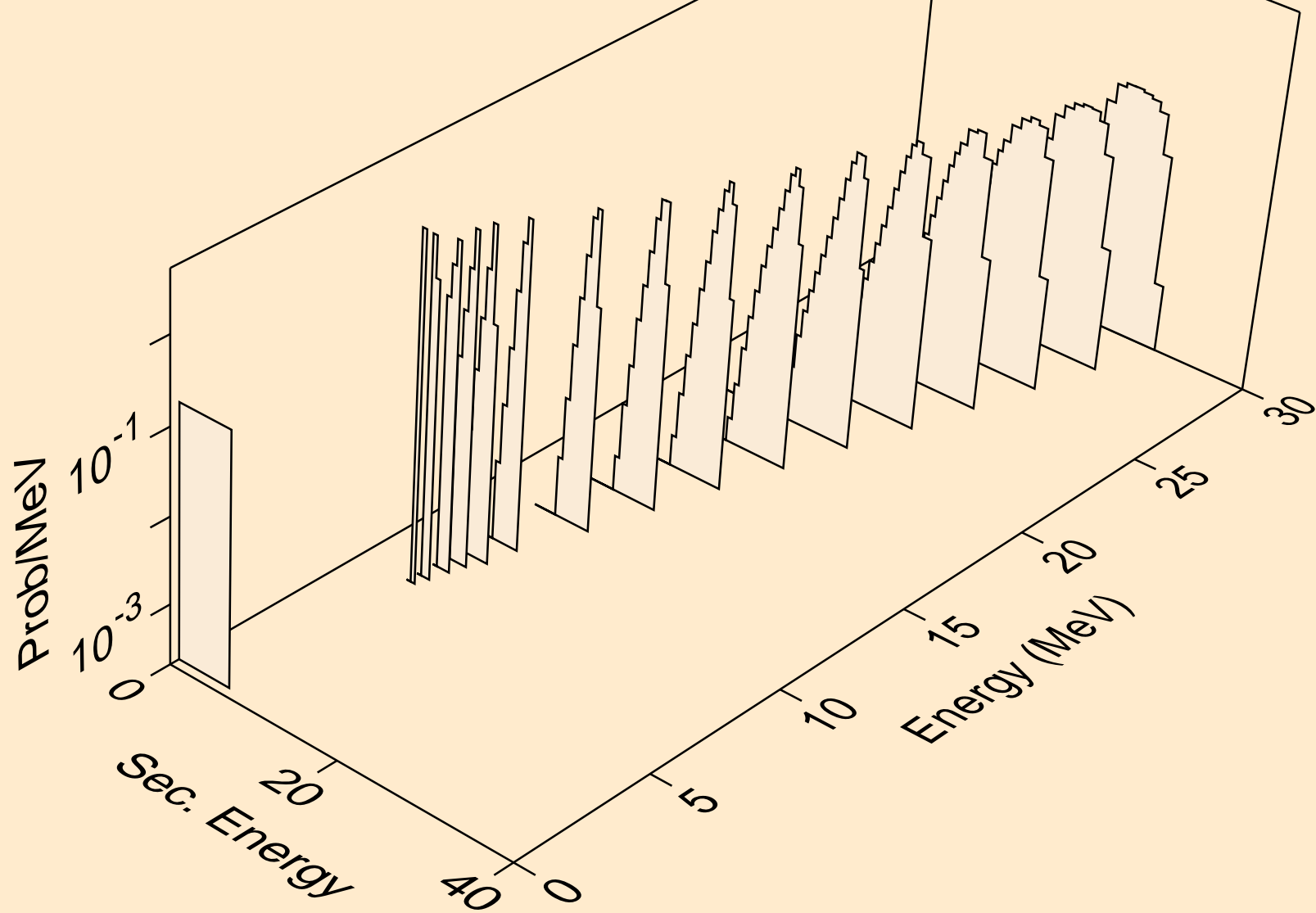

TL207 NEUTRON ACER TENDL-2021 LIBRARY; T=293.6K  
alphas from (n,2n)a

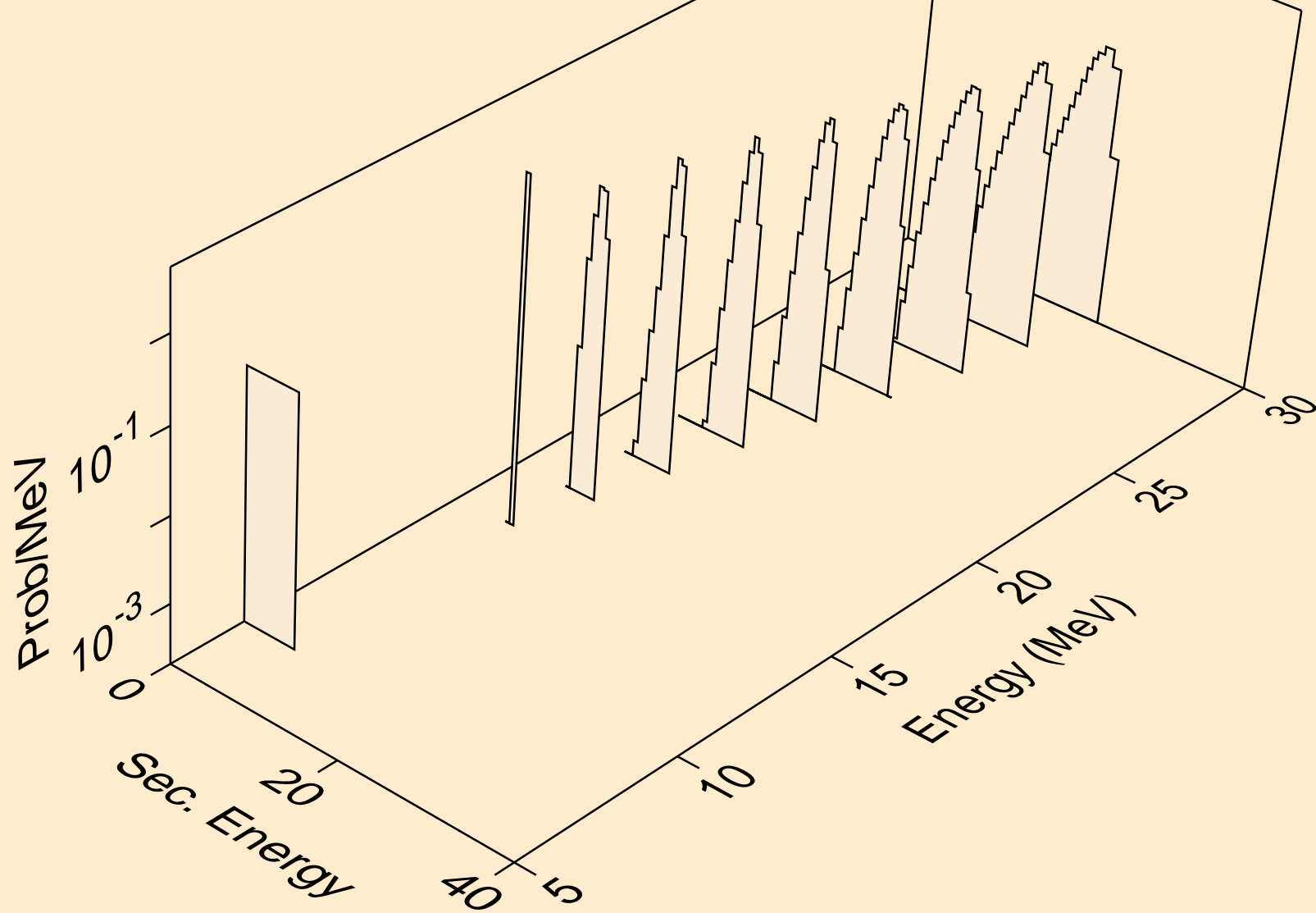

TL207 NEUTRON ACER TENDL-2021 LIBRARY; T=293.6K  
alphas from (n,3n)a

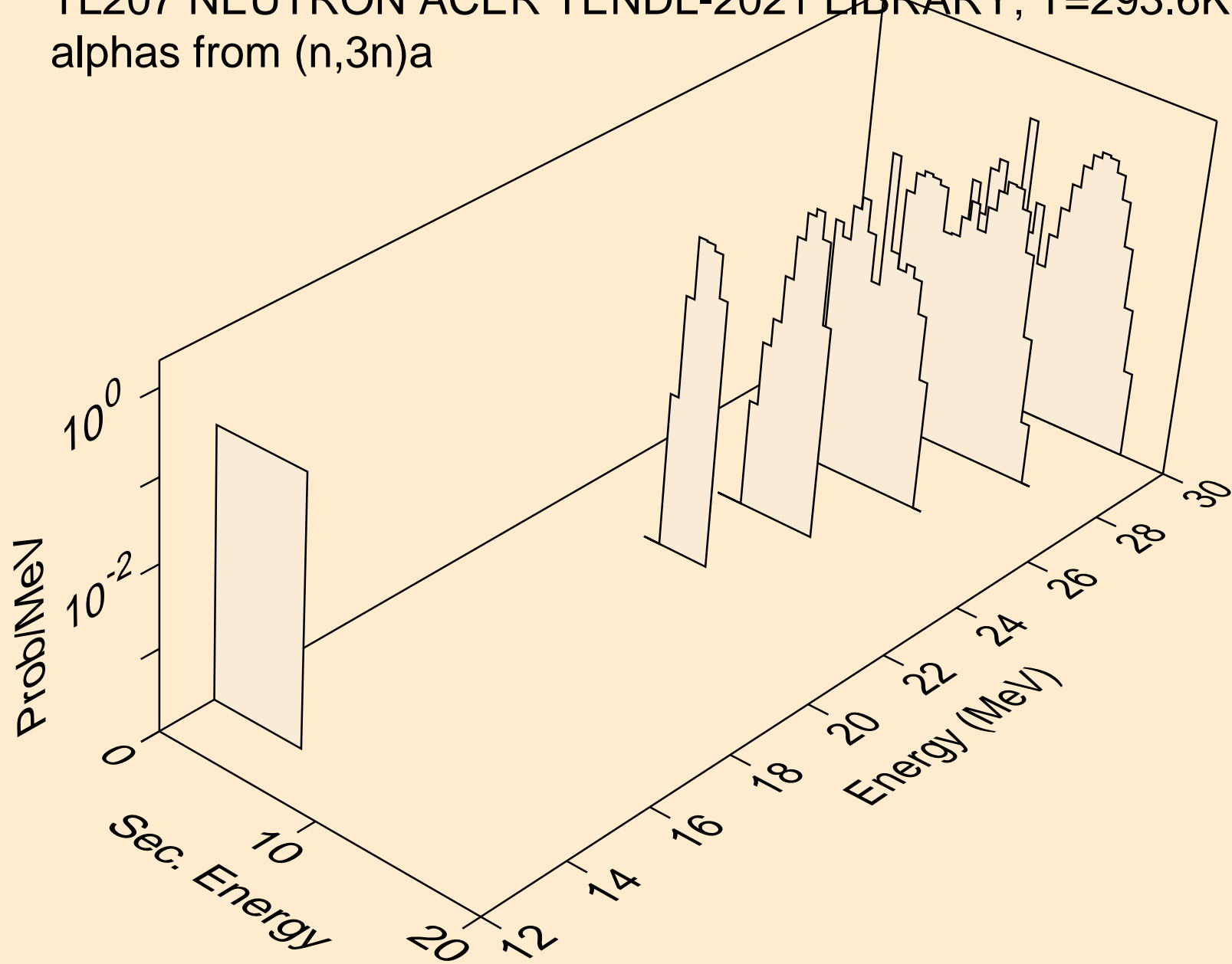

TL207 NEUTRON ACER TENDL-2021 LIBRARY; T=293.6K  
alphas from (n,a)

