

TM150 NEUTRON ACER TENDL-2021 LIBRARY; T=293.6K  
Principal cross sections

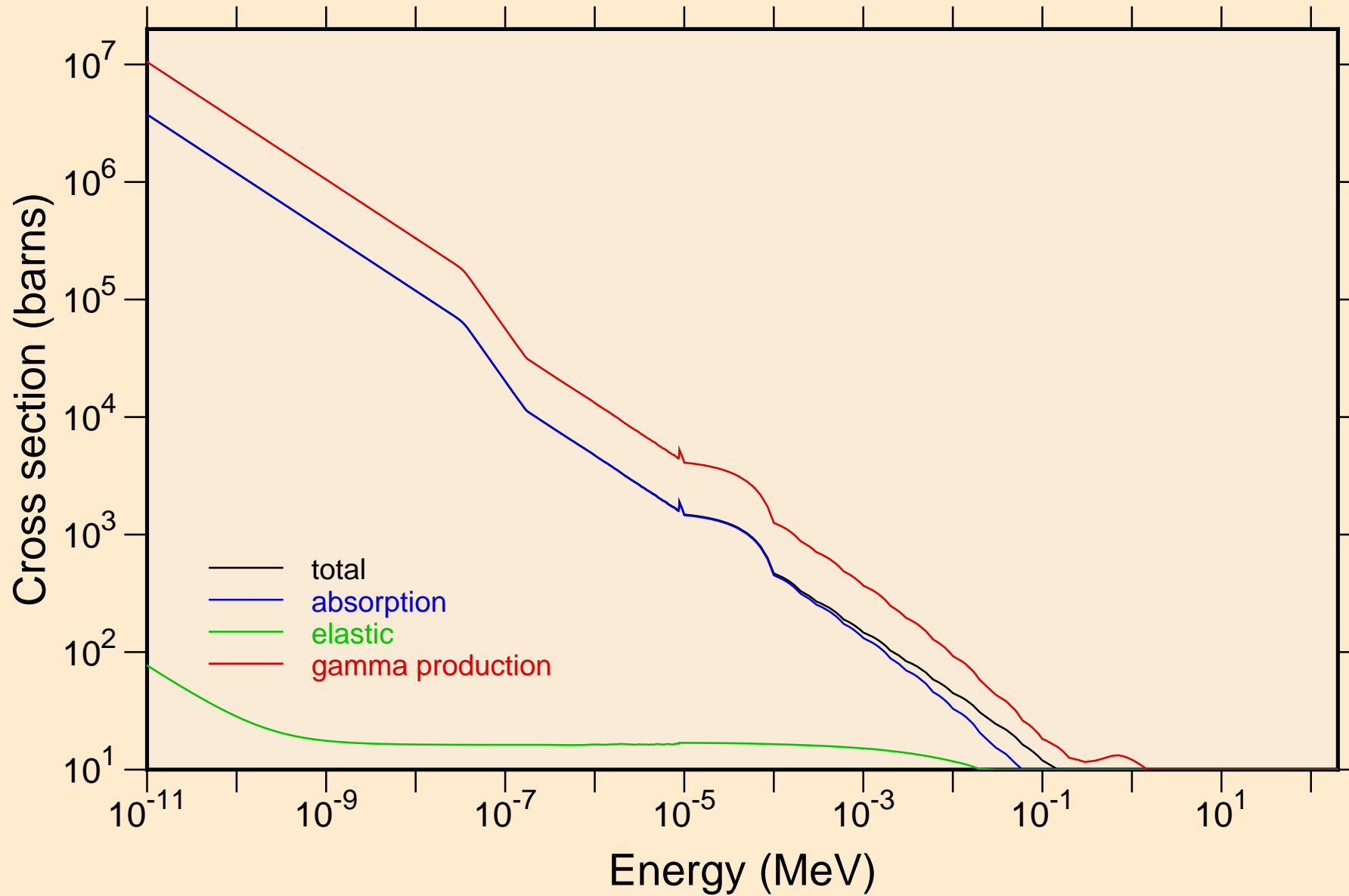

TM150 NEUTRON ACER TENDL-2021 LIBRARY; T=293.6K  
Heating

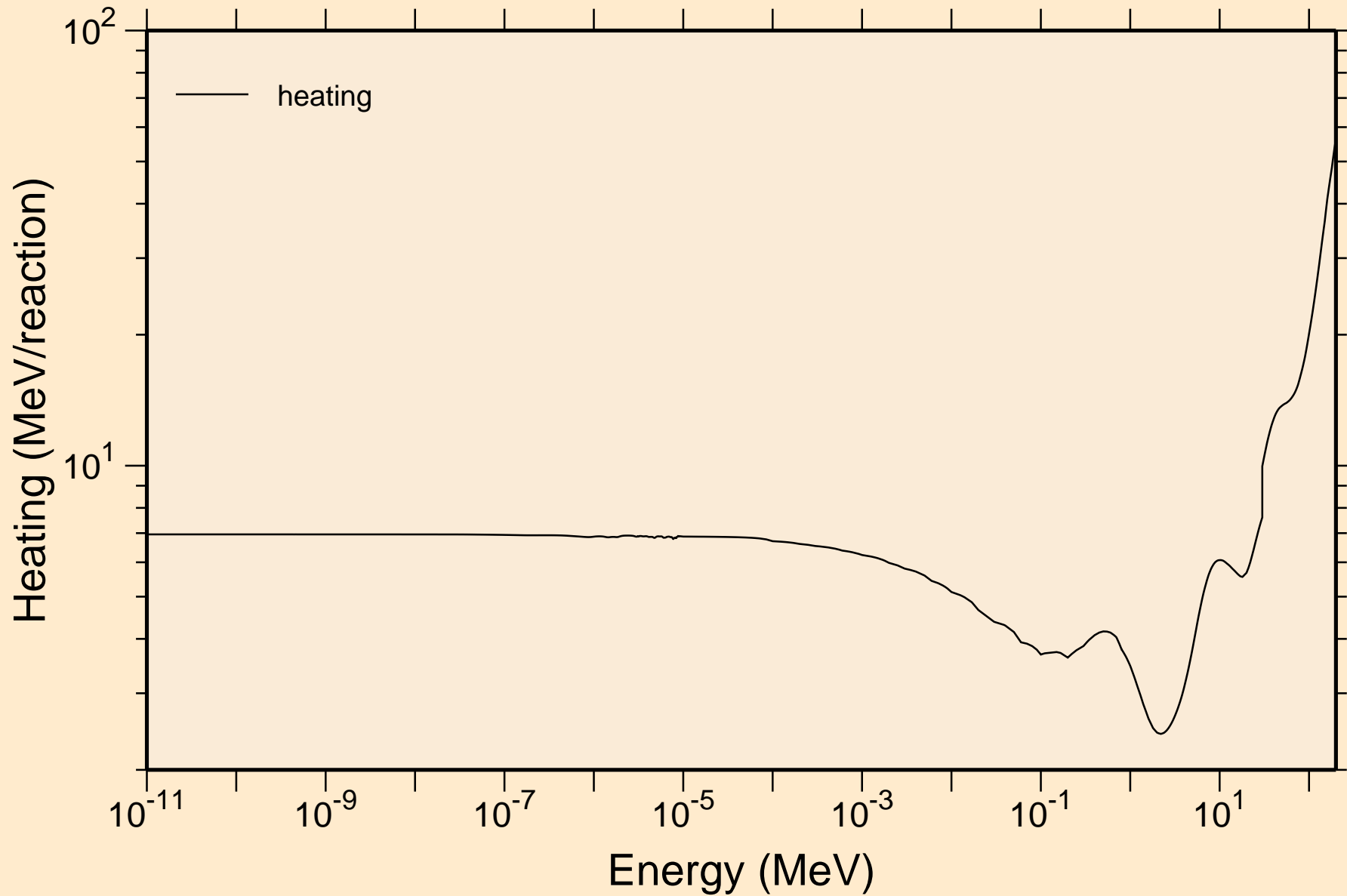

# TM150 NEUTRON ACER TENDL-2021 LIBRARY; T=293.6K

## Damage

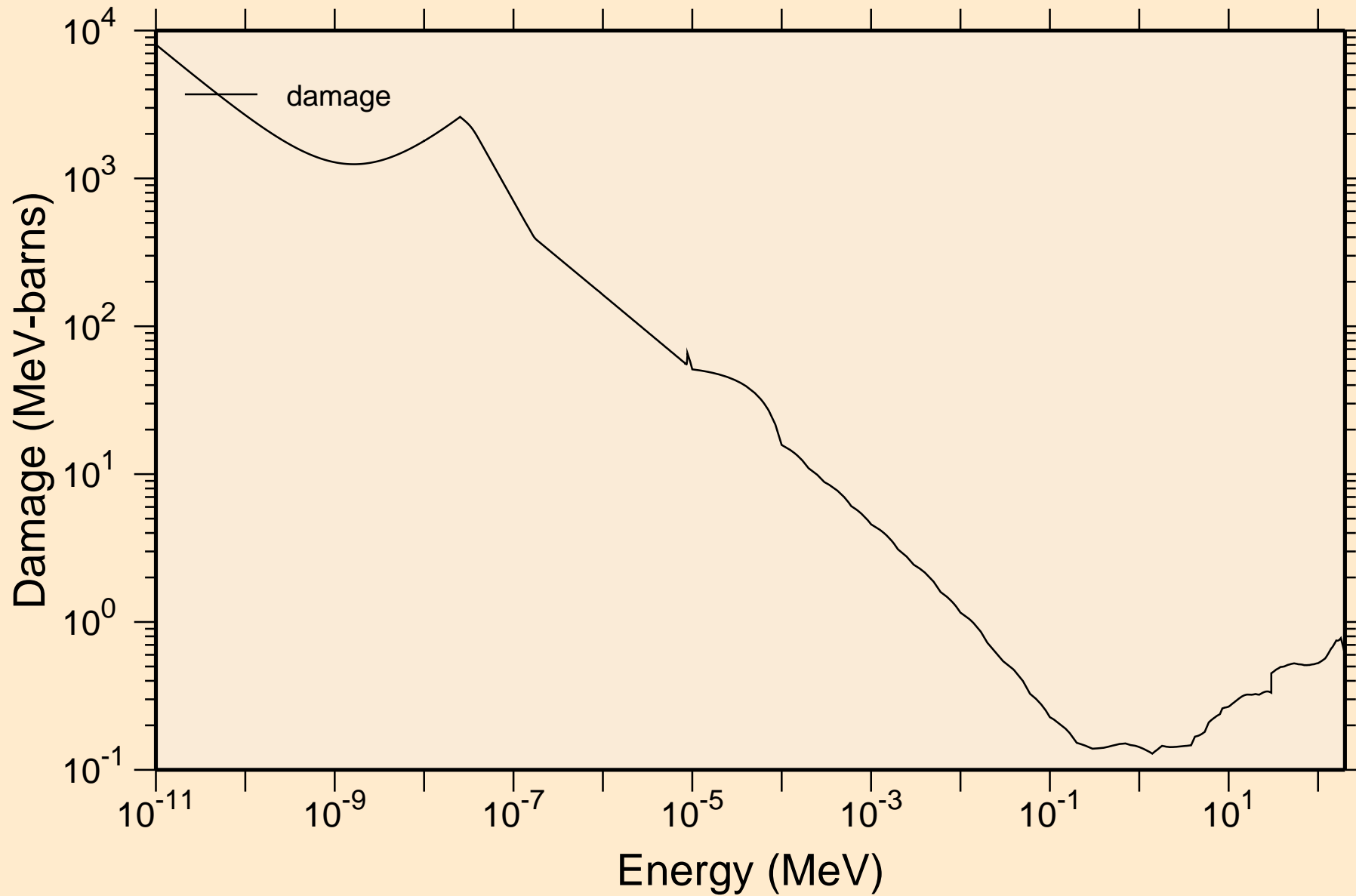

TM150 NEUTRON ACER TENDL-2021 LIBRARY; T=293.6K  
Non-threshold reactions

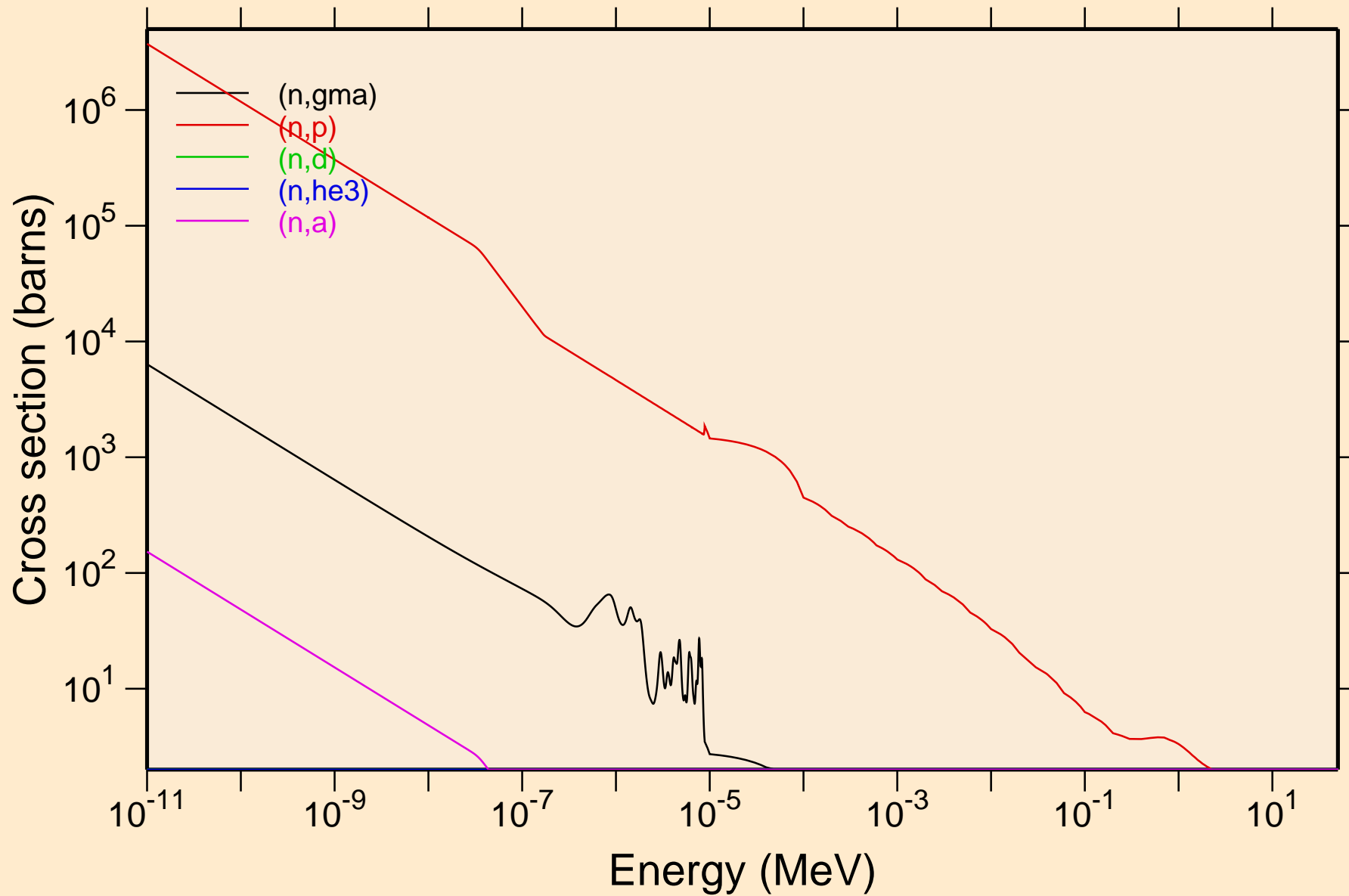

TM150 NEUTRON ACER TENDL-2021 LIBRARY; T=293.6K  
Non-threshold reactions

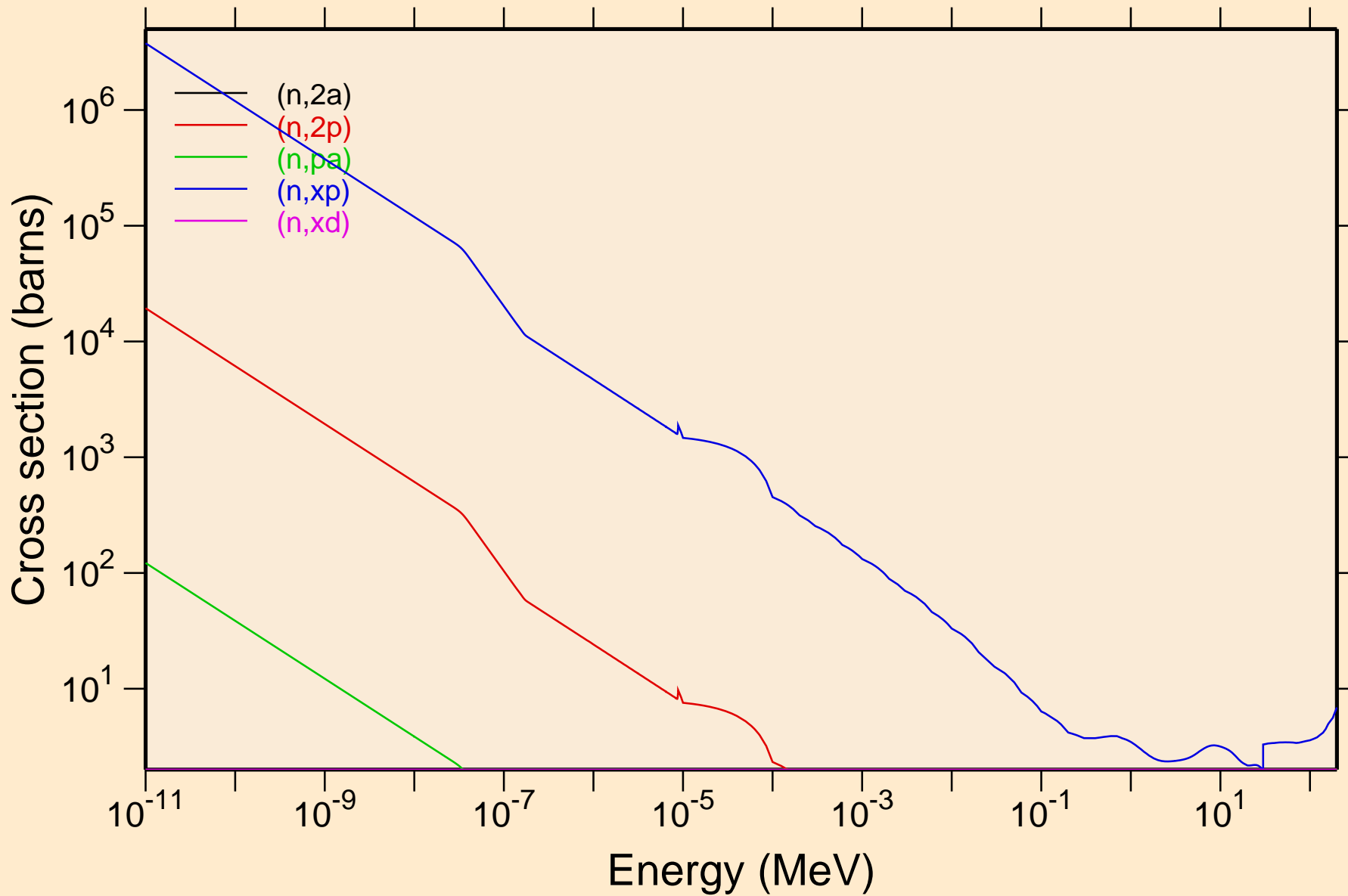

TM150 NEUTRON ACER TENDL-2021 LIBRARY; T=293.6K  
Non-threshold reactions

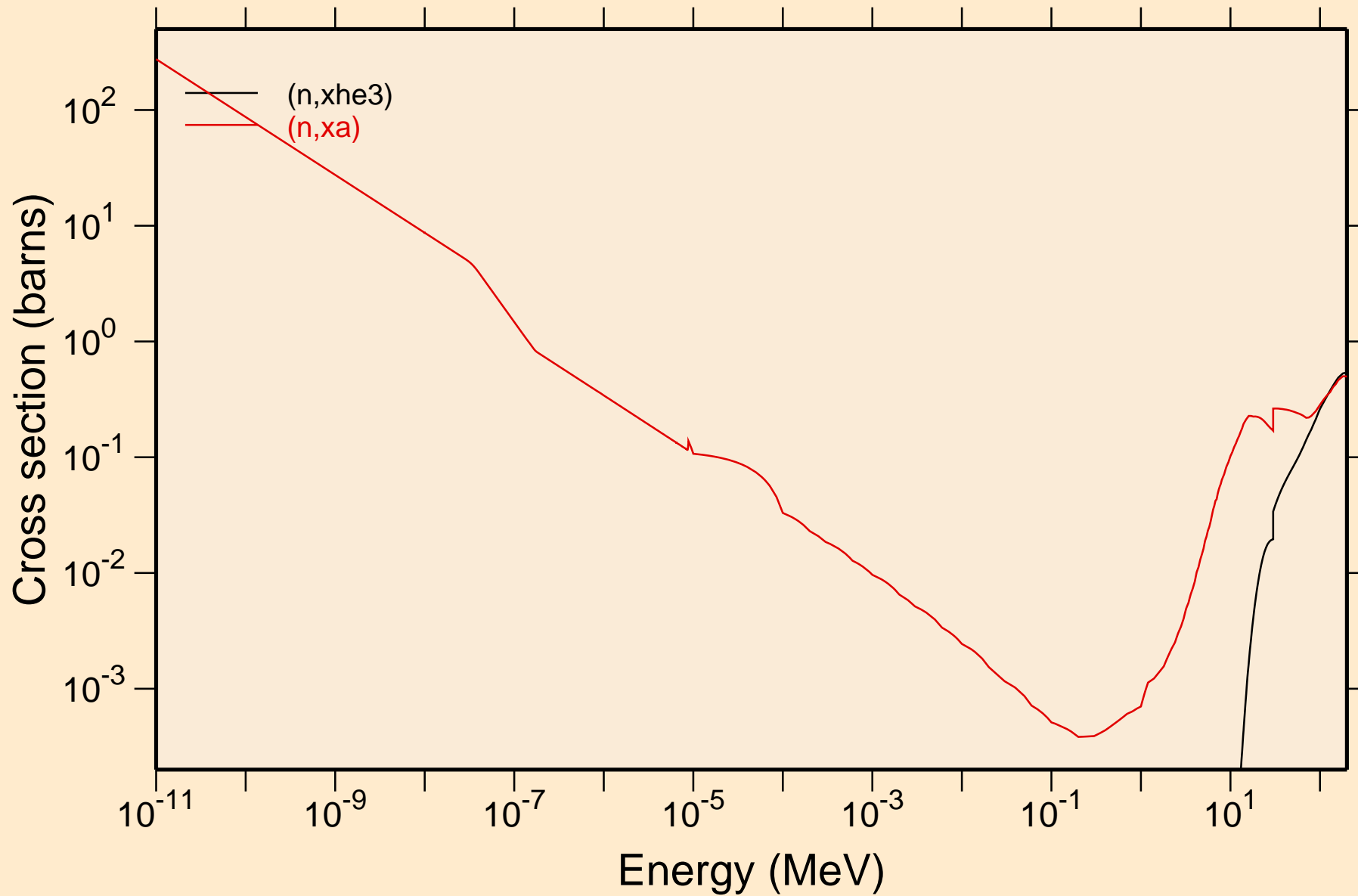

TM150 NEUTRON ACER TENDL-2021 LIBRARY; T=293.6K  
Principal cross sections

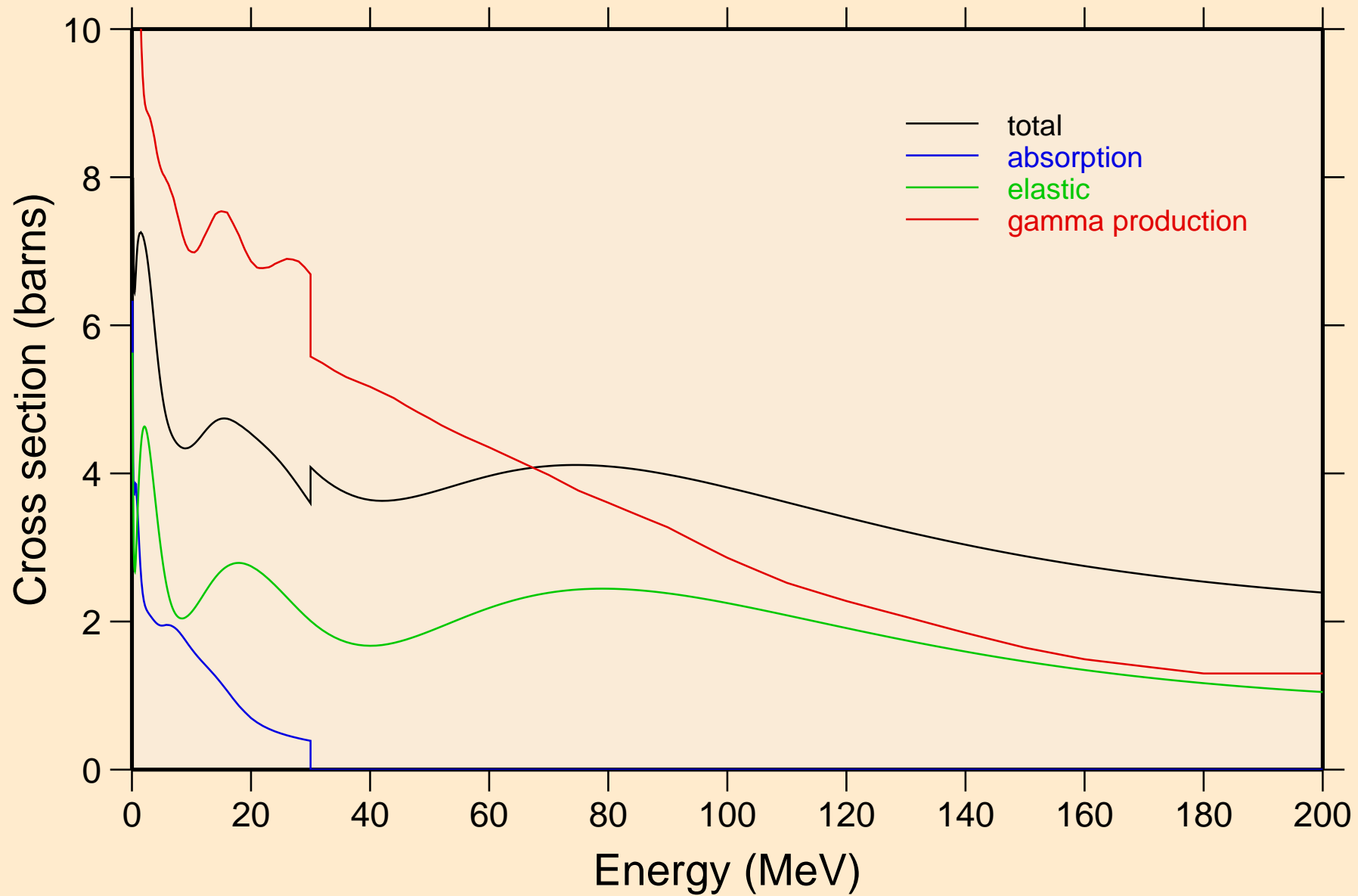

TM150 NEUTRON ACER TENDL-2021 LIBRARY; T=293.6K  
Heating

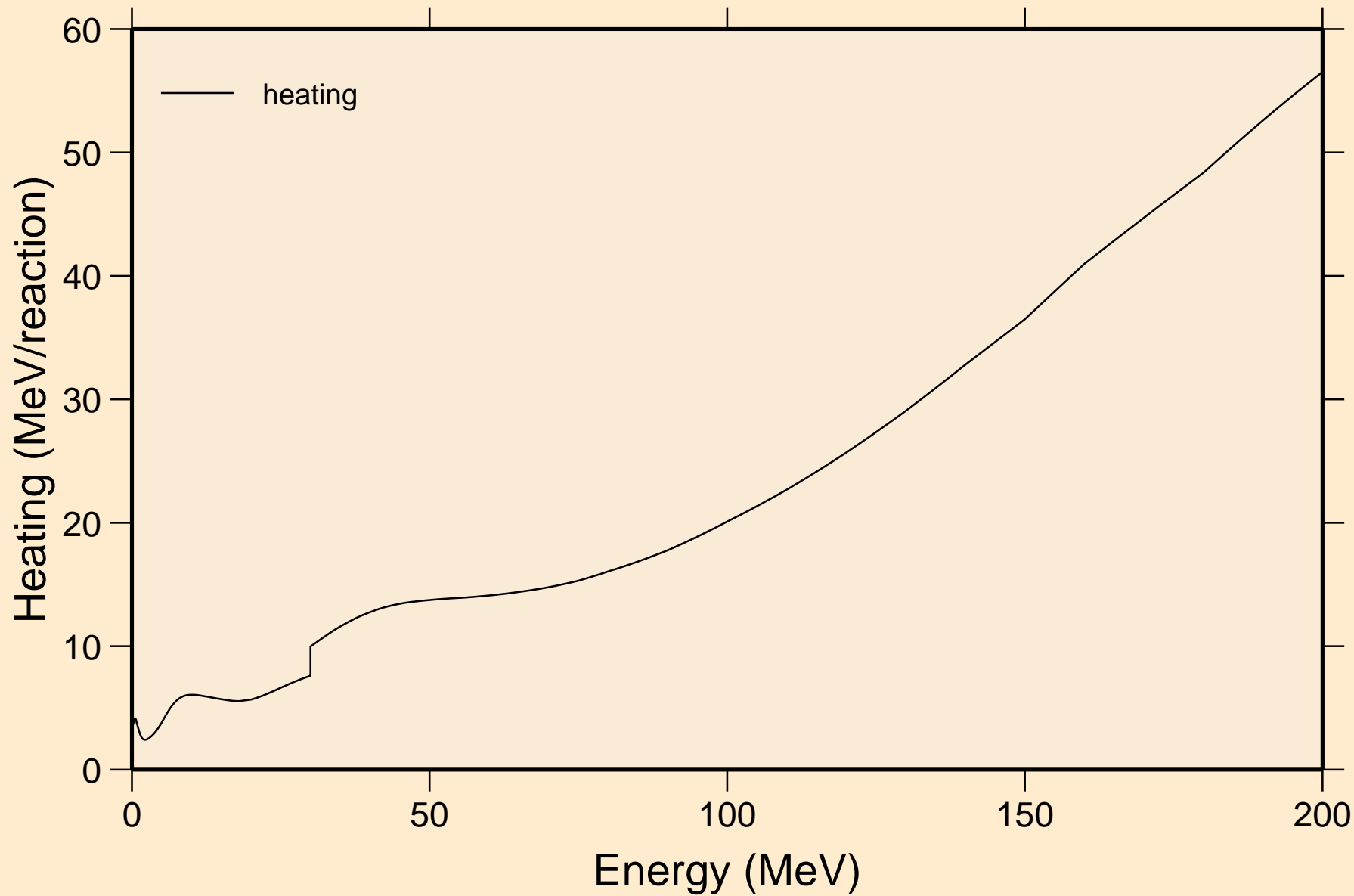



TM150 NEUTRON ACER TENDL-2021 LIBRARY; T=293.6K  
Damage

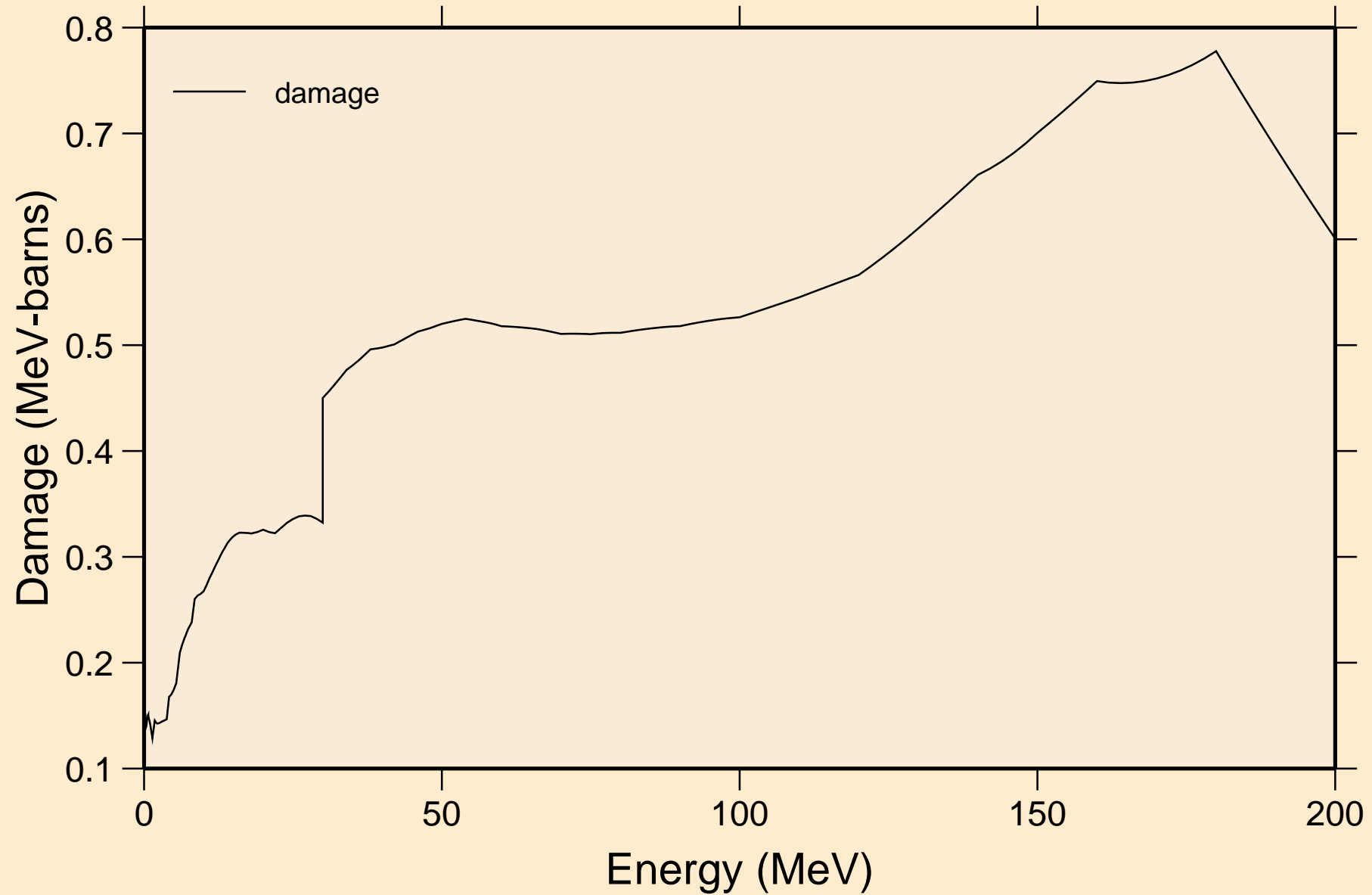

TM150 NEUTRON ACER TENDL-2021 LIBRARY; T=293.6K  
Non-threshold reactions

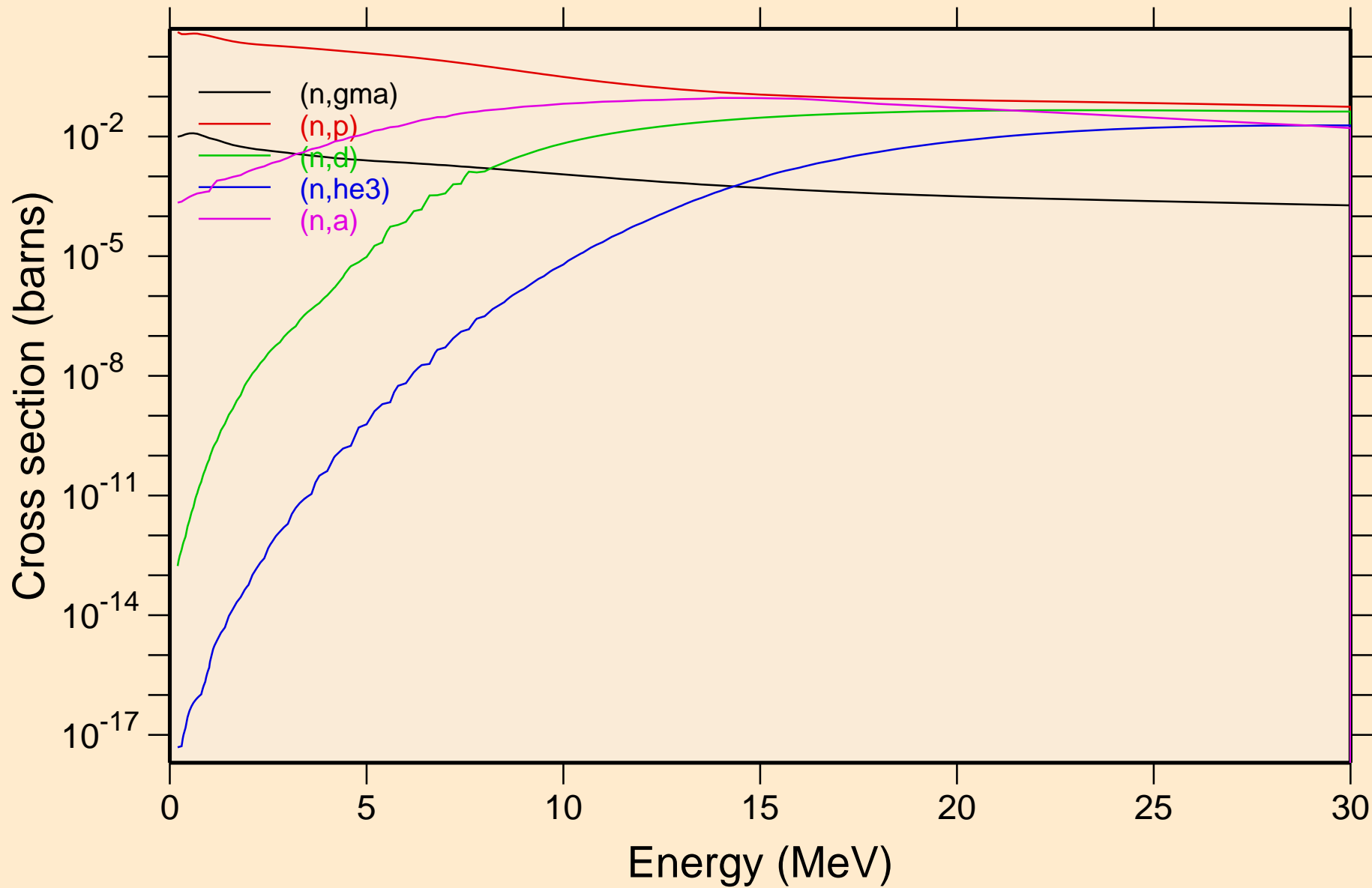

TM150 NEUTRON ACER TENDL-2021 LIBRARY; T=293.6K  
Non-threshold reactions

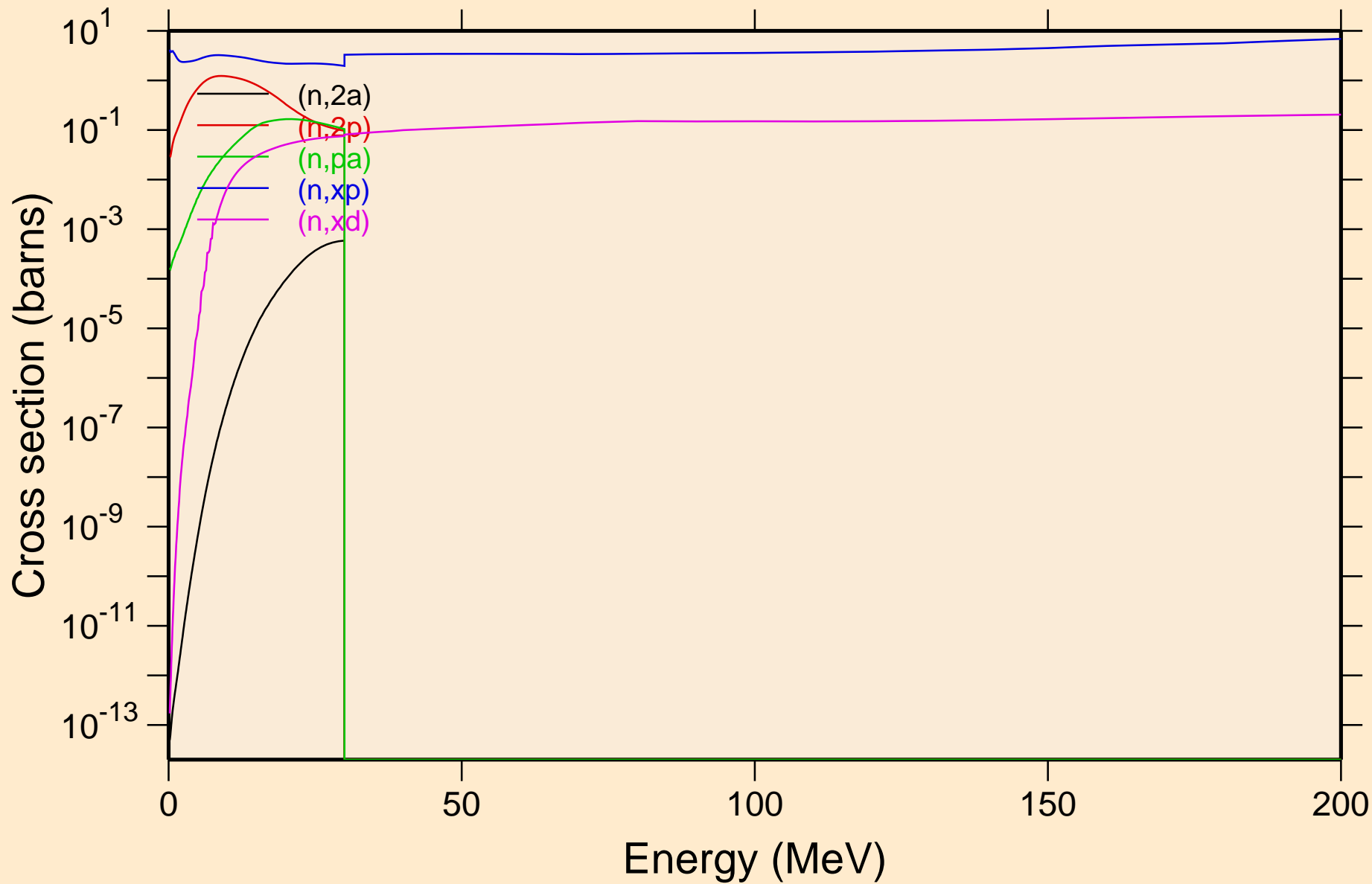

TM150 NEUTRON ACER TENDL-2021 LIBRARY; T=293.6K  
Non-threshold reactions

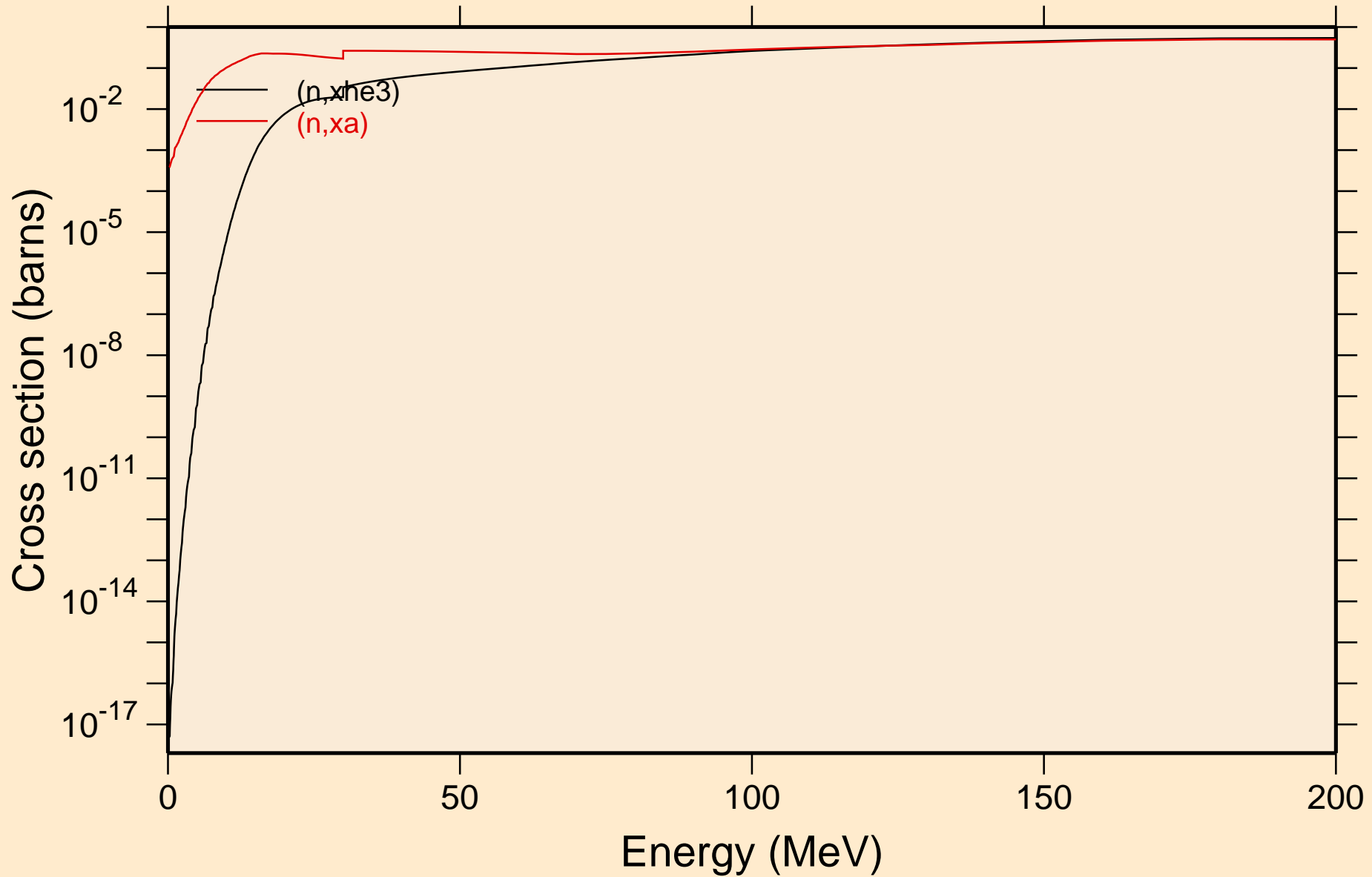

TM150 NEUTRON ACER TENDL-2021 LIBRARY; T=293.6K  
Inelastic levels

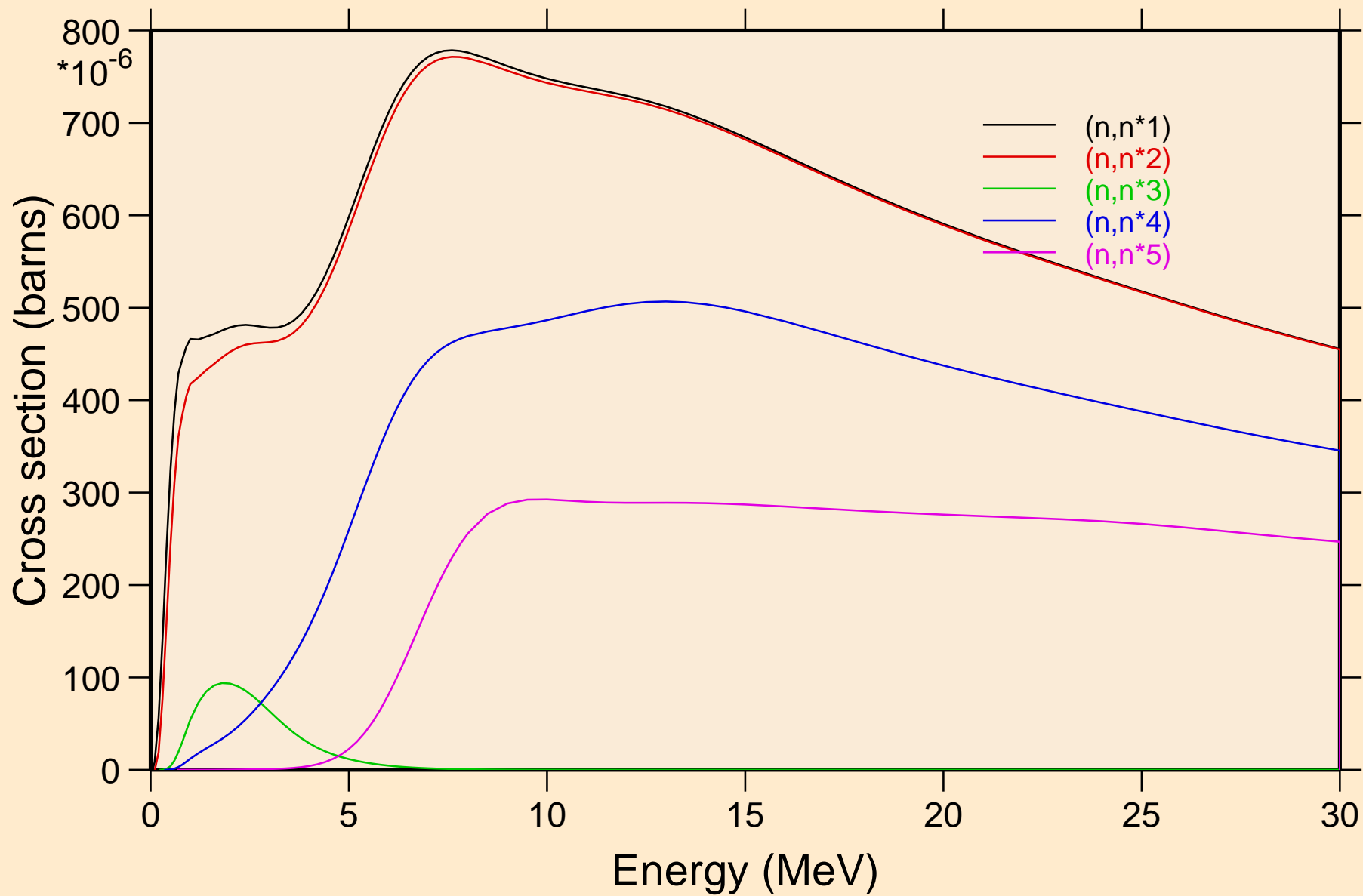

TM150 NEUTRON ACER TENDL-2021 LIBRARY; T=293.6K  
Inelastic levels

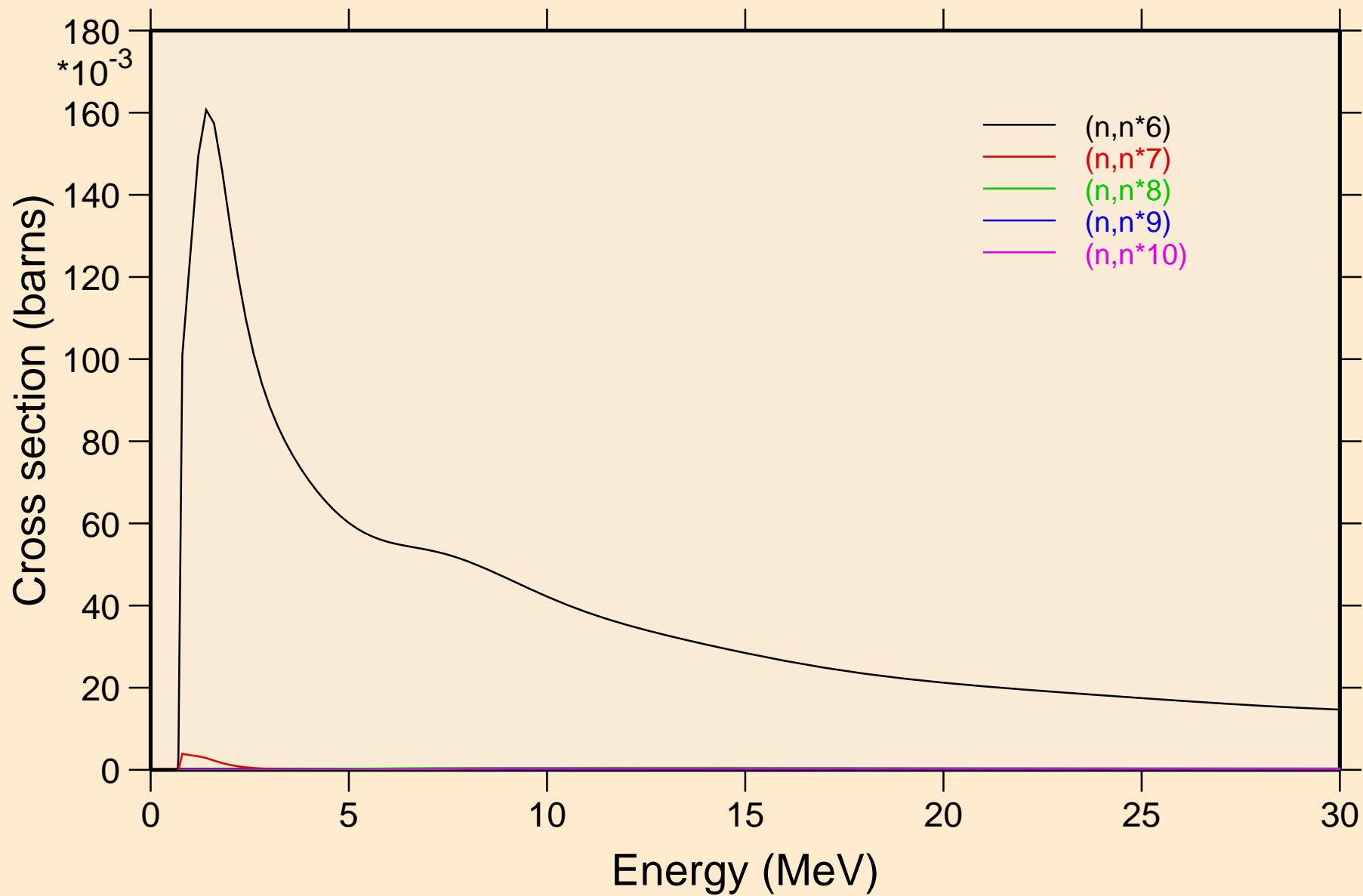

TM150 NEUTRON ACER TENDL-2021 LIBRARY; T=293.6K  
Inelastic levels

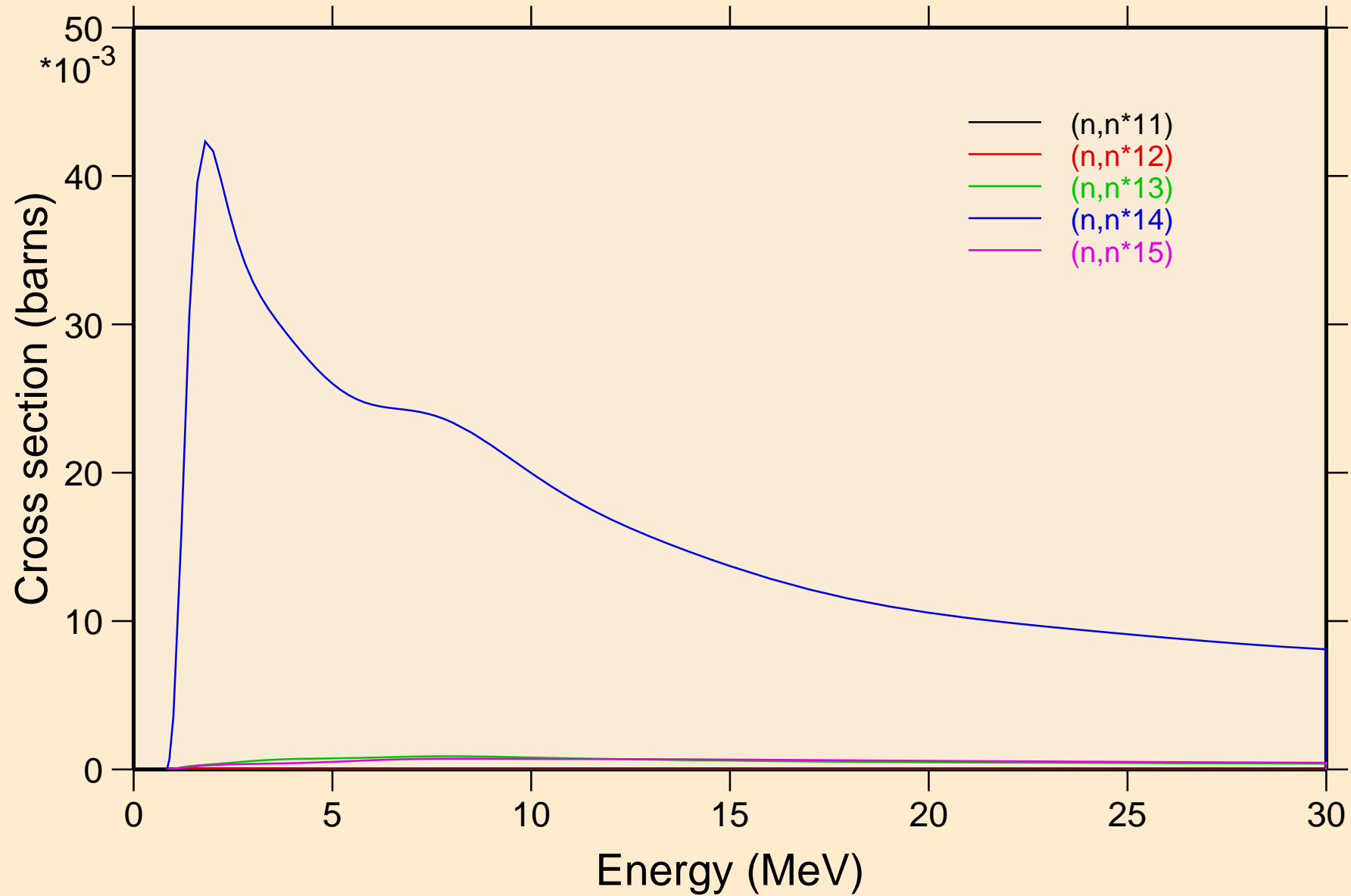

TM150 NEUTRON ACER TENDL-2021 LIBRARY; T=293.6K  
Inelastic levels

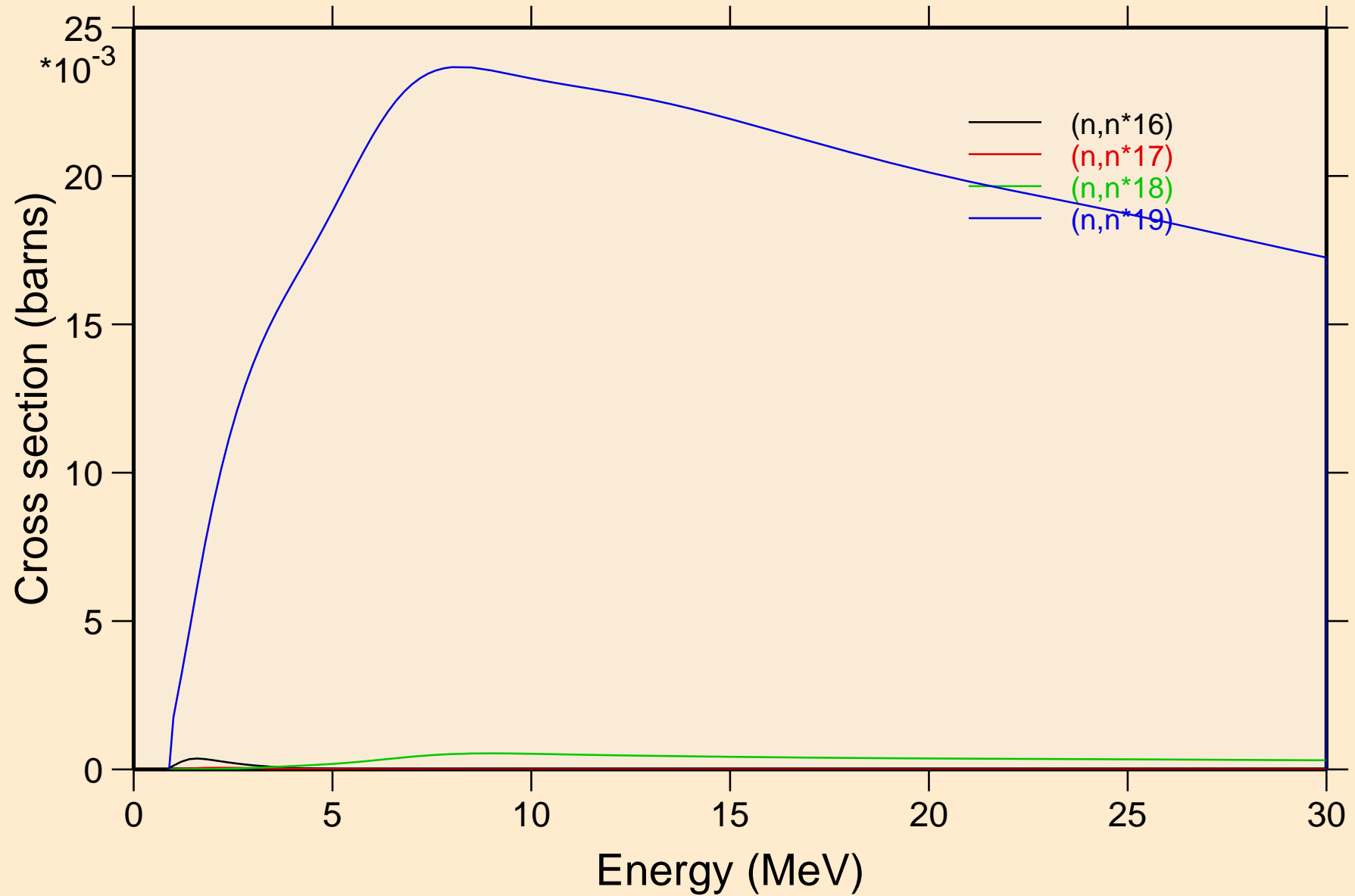



TM150 NEUTRON ACER TENDL-2021 LIBRARY; T=293.6K  
Threshold reactions

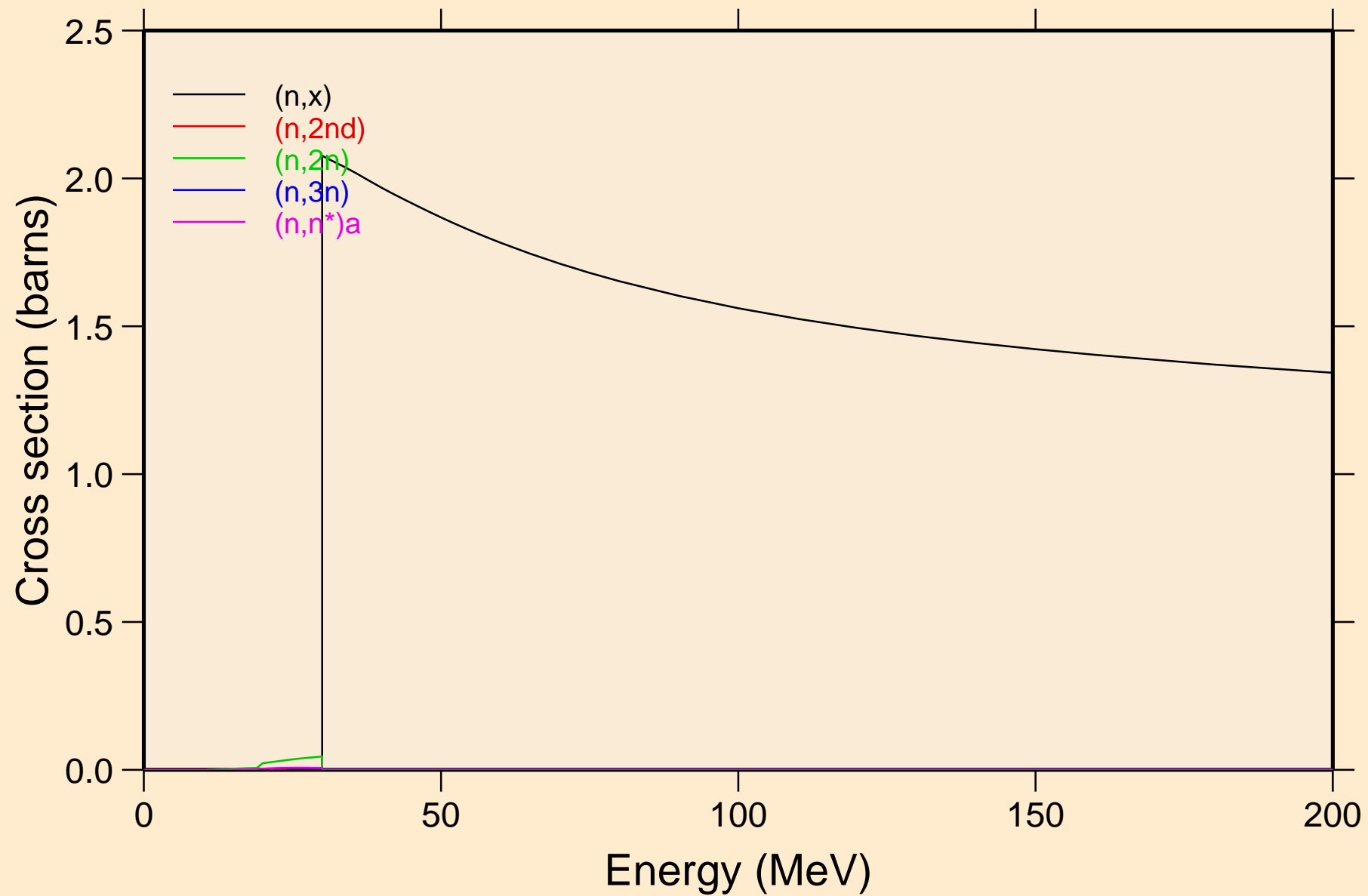

TM150 NEUTRON ACER TENDL-2021 LIBRARY; T=293.6K  
Threshold reactions

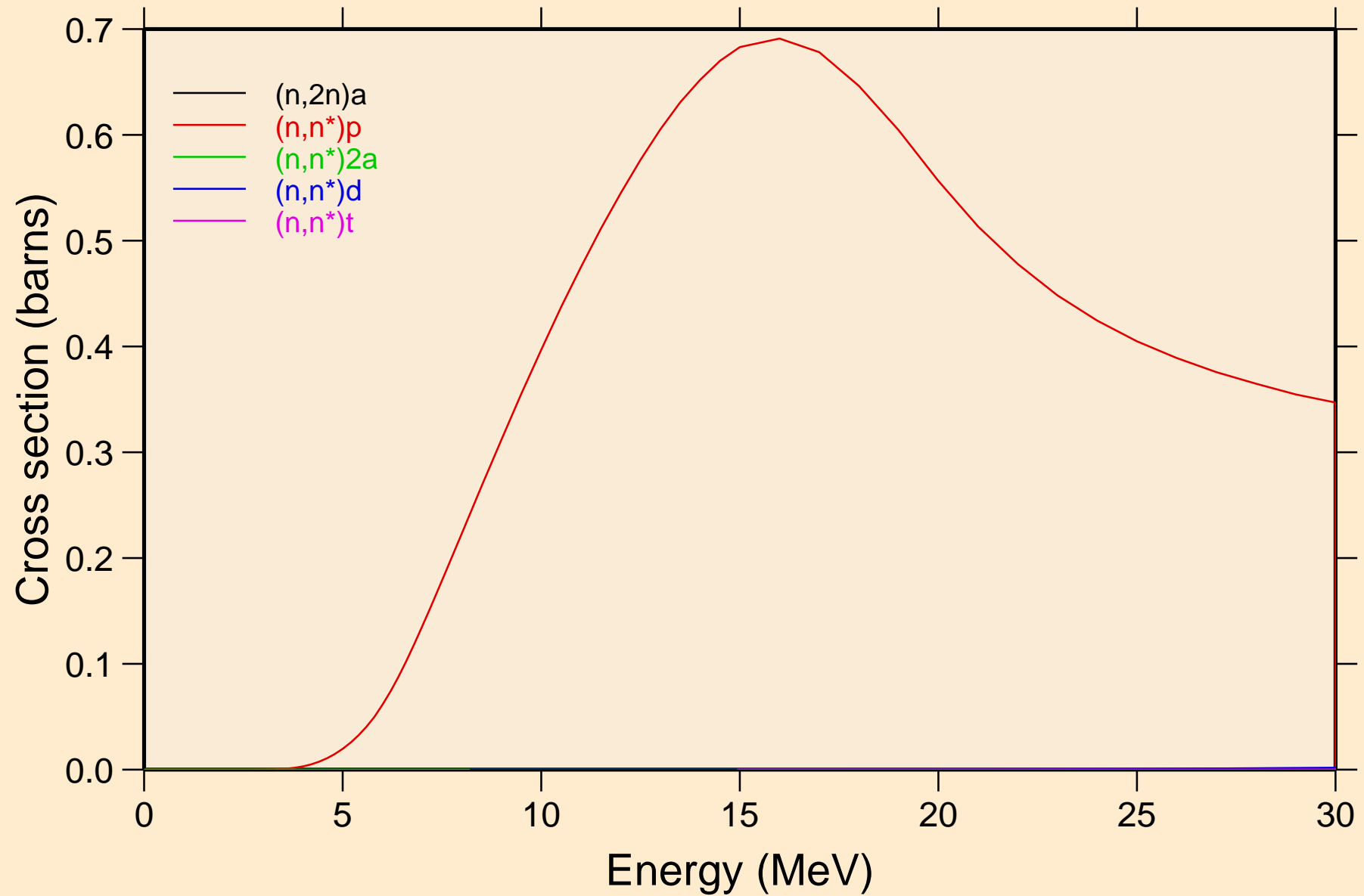

TM150 NEUTRON ACER TENDL-2021 LIBRARY; T=293.6K  
Threshold reactions

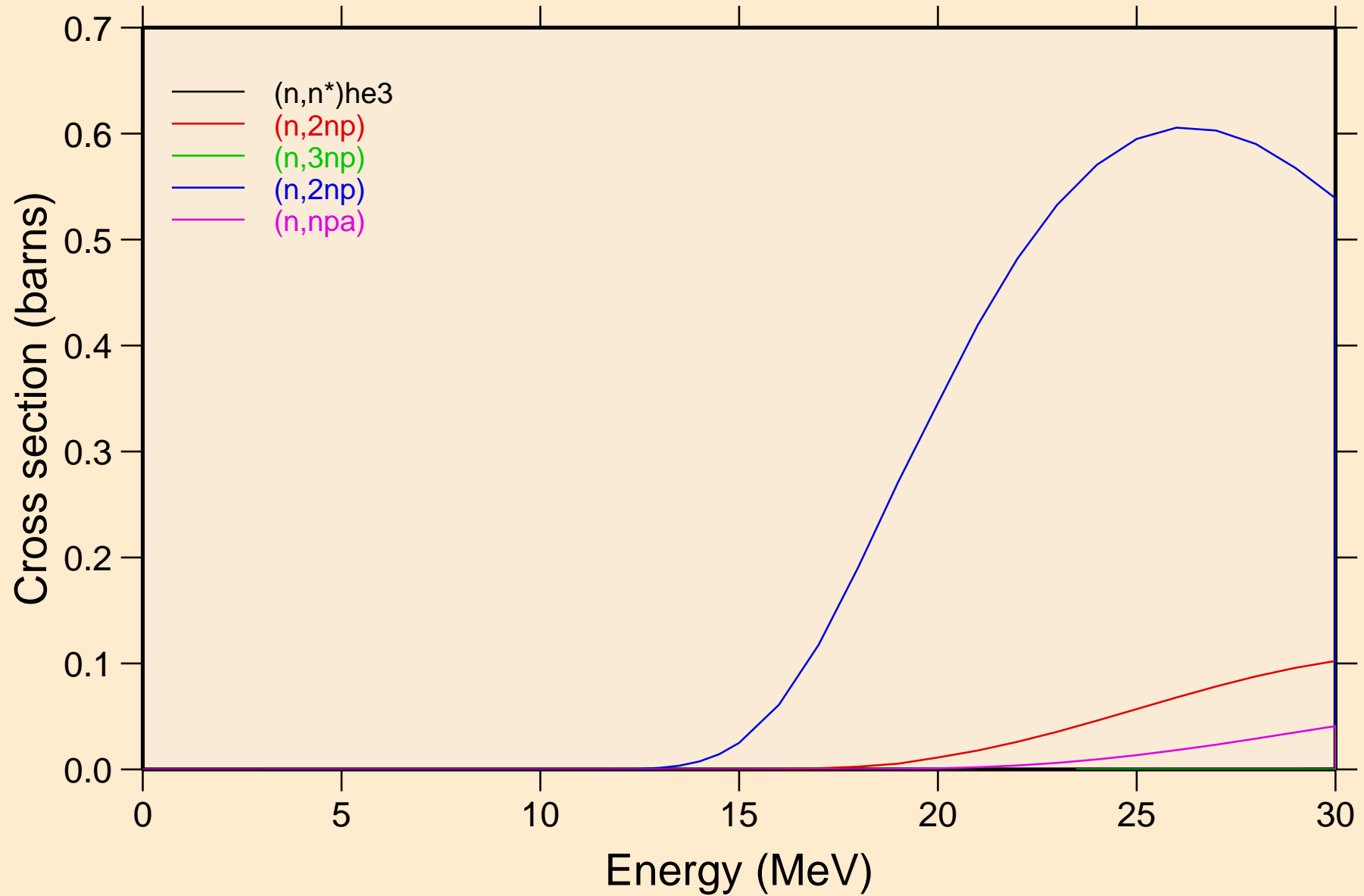

TM150 NEUTRON ACER TENDL-2021 LIBRARY; T=293.6K  
Threshold reactions

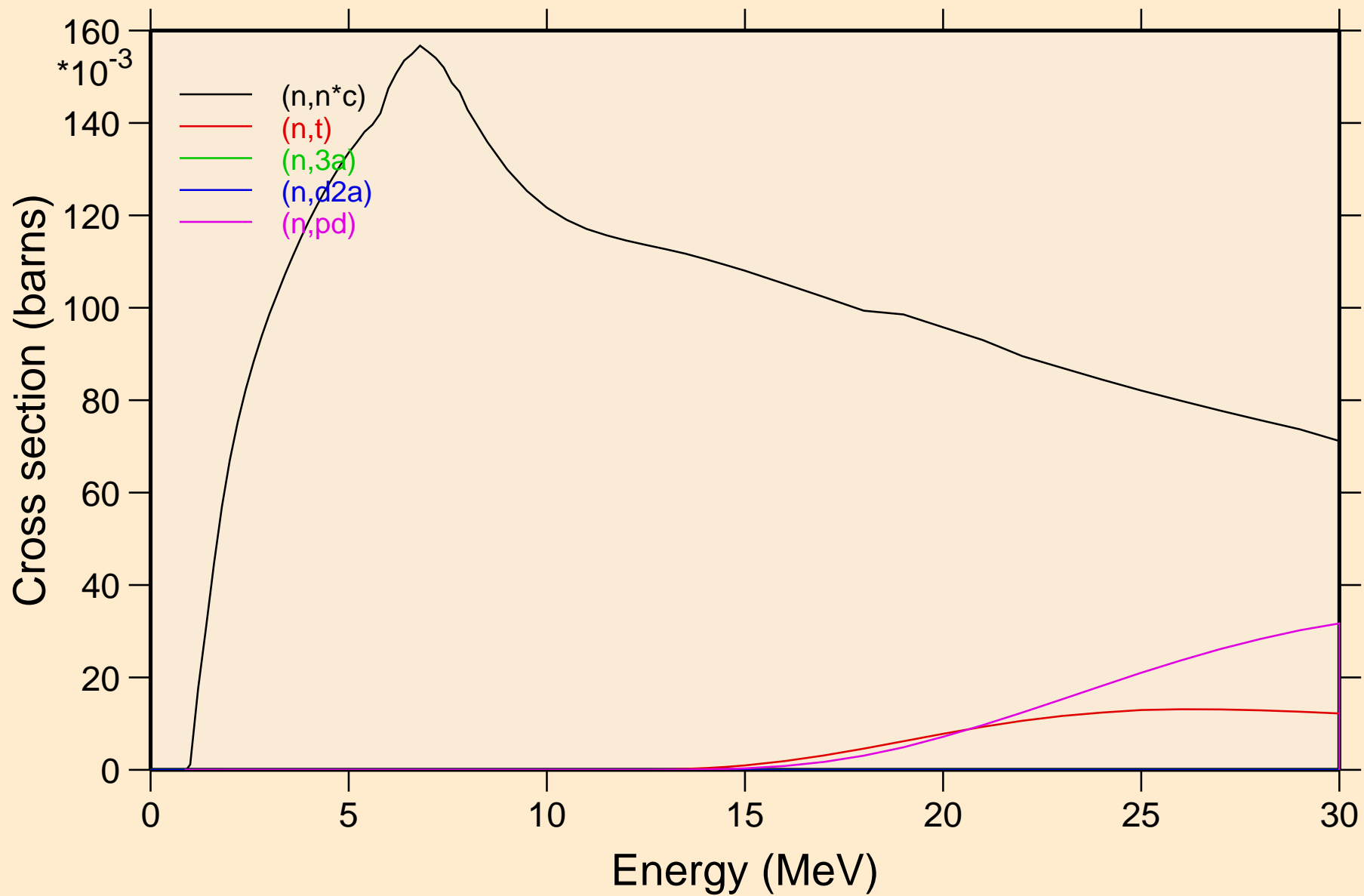

TM150 NEUTRON ACER TENDL-2021 LIBRARY; T=293.6K  
Threshold reactions

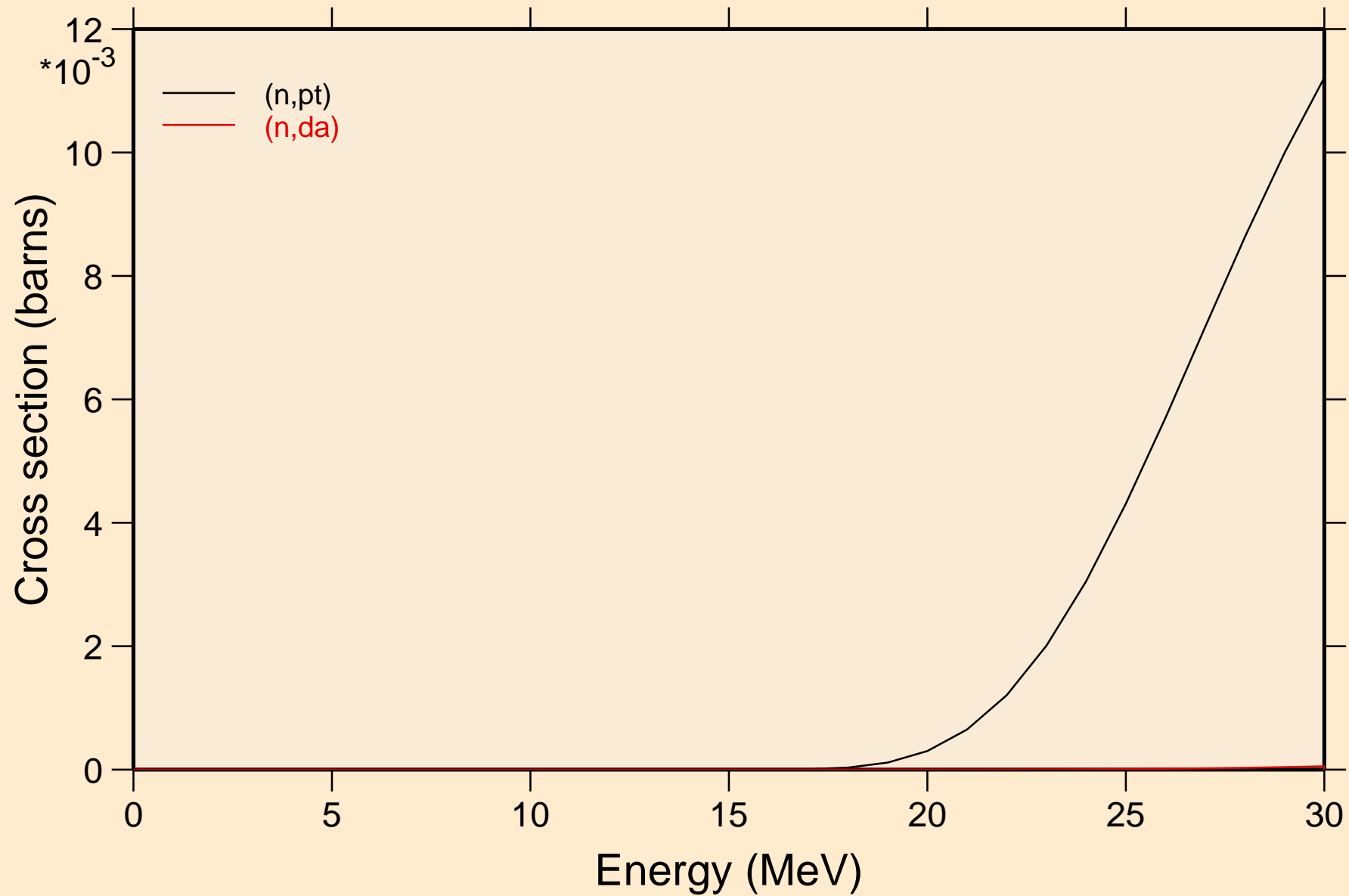

TM150 NEUTRON ACER TENDL-2021 LIBRARY; T=293.6K  
Threshold reactions

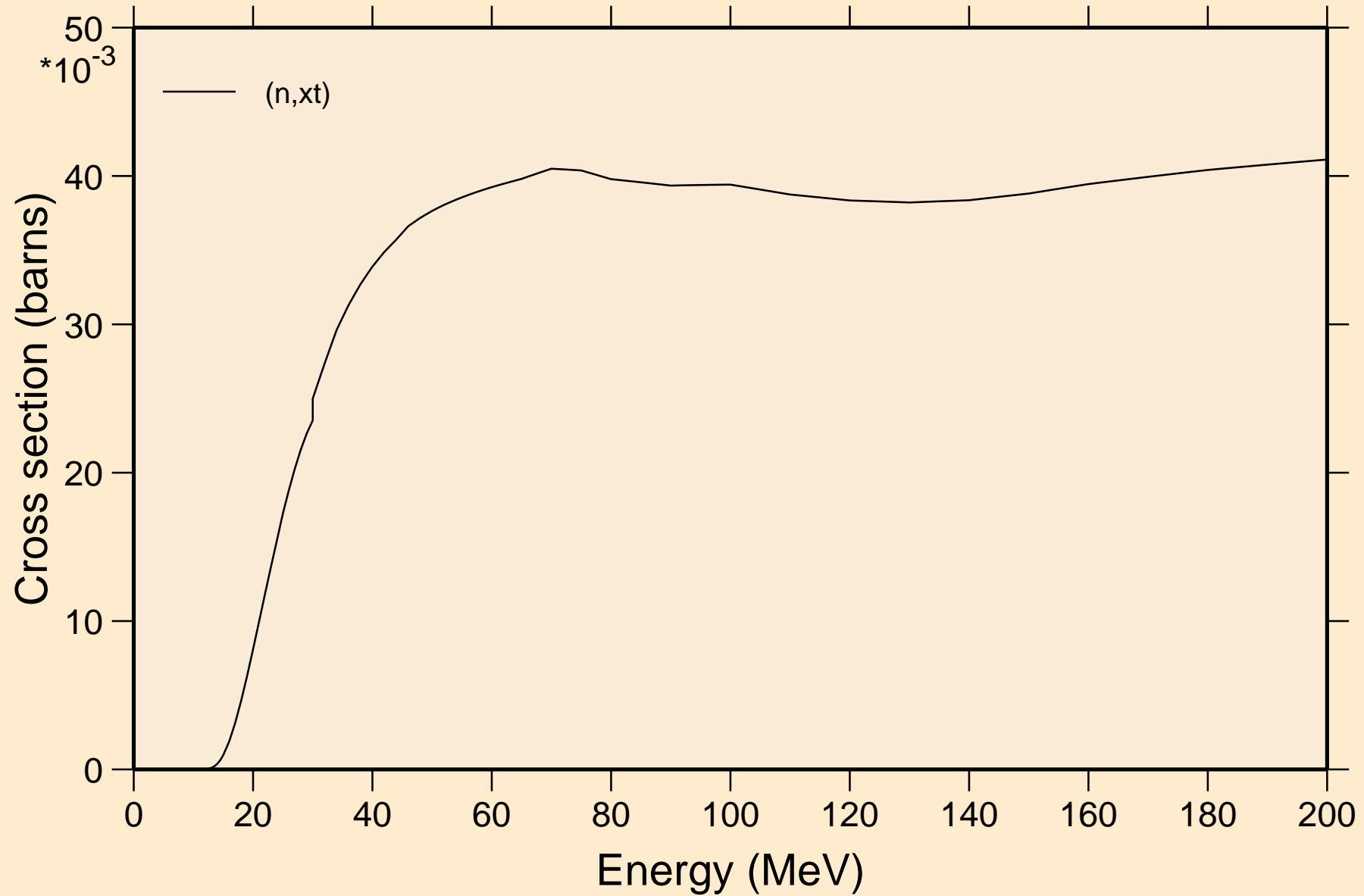

TM150 NEUTRON ACER TENDL-2021 LIBRARY; T=293.6K  
angular distribution for elastic

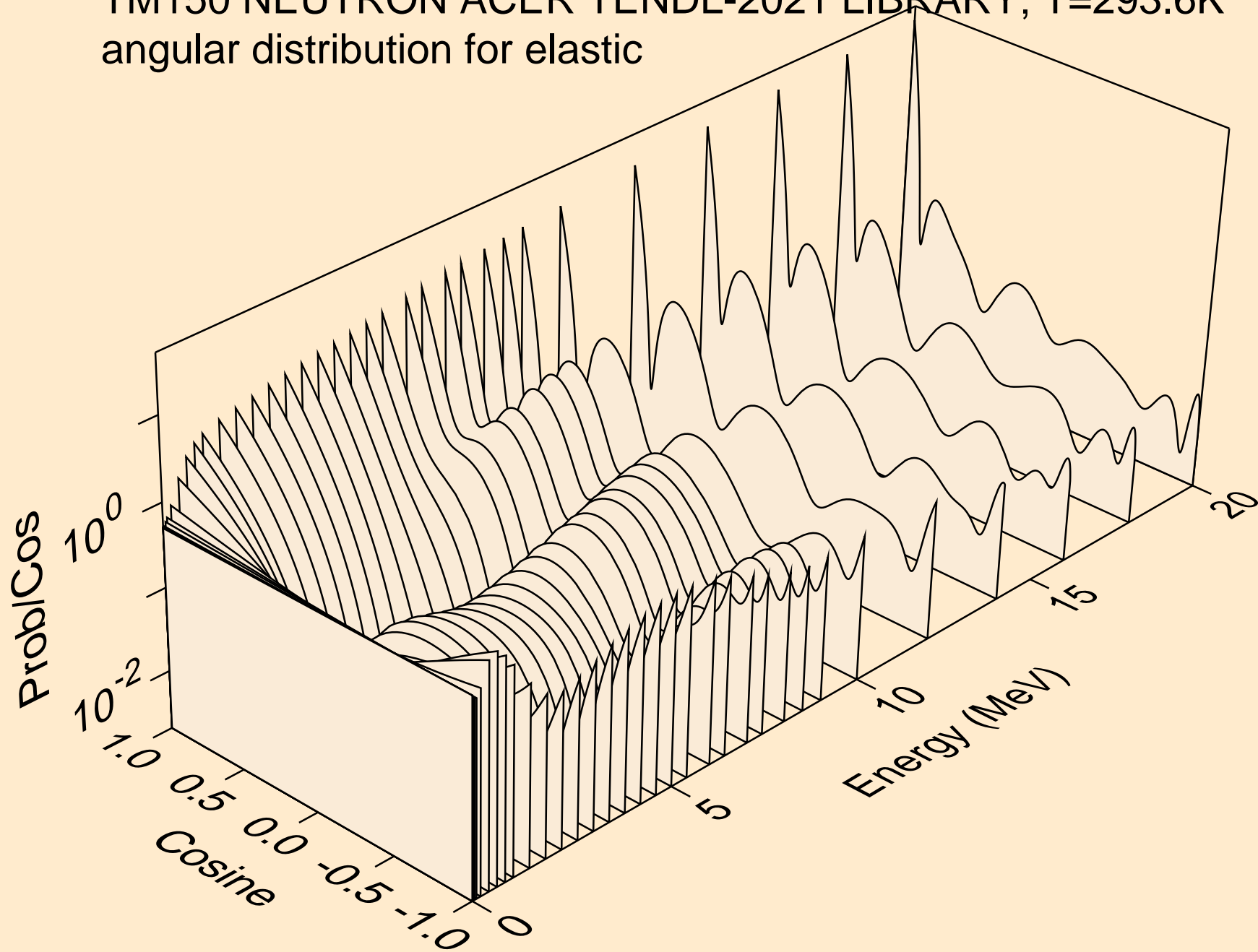

TM150 NEUTRON ACER TENDL-2021 LIBRARY; T=293.6K  
angular distribution for elastic

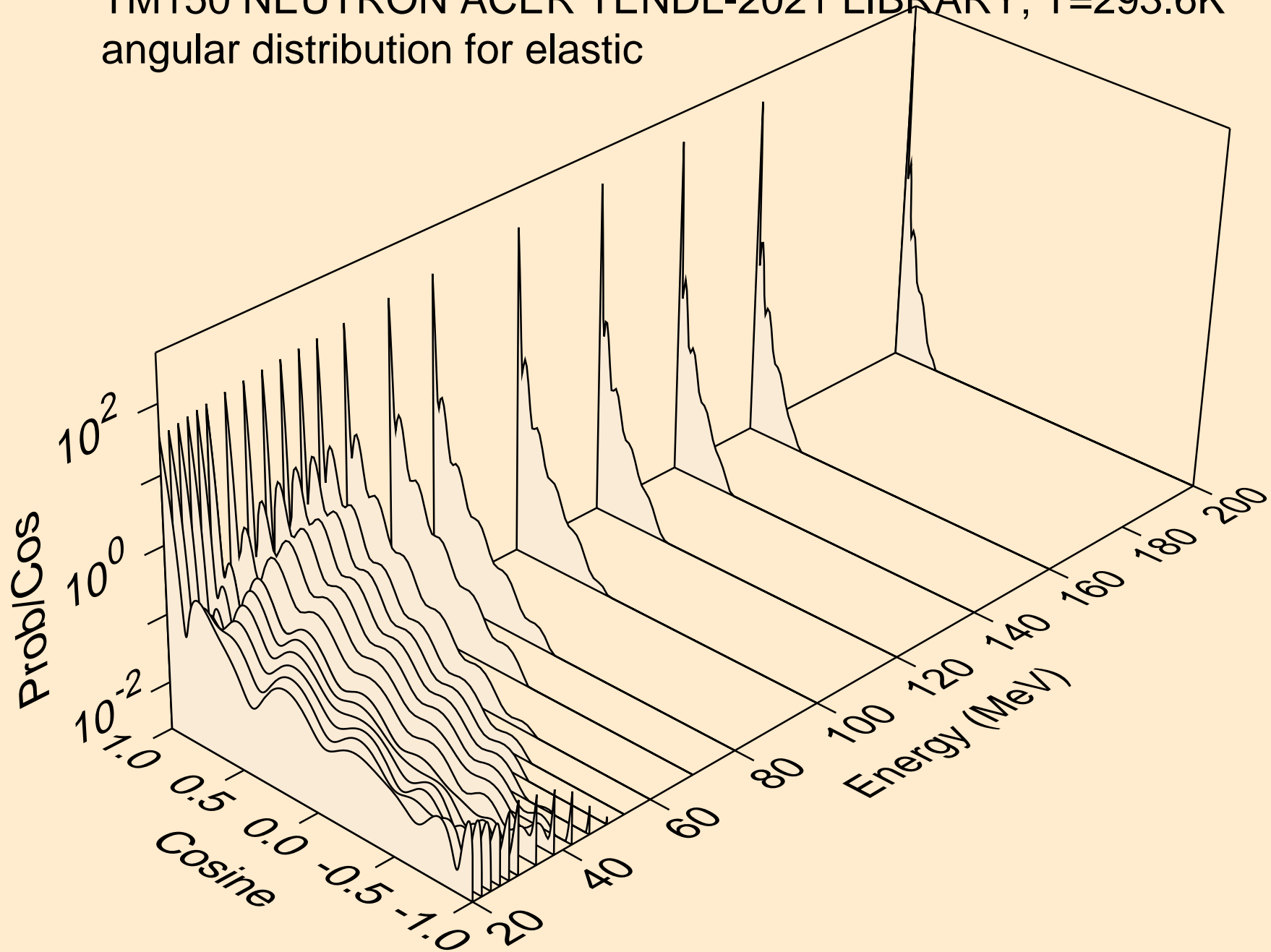



TM150 NEUTRON ACER TENDL-2021 LIBRARY; T=293.6K  
angular distribution for (n,n\*1)

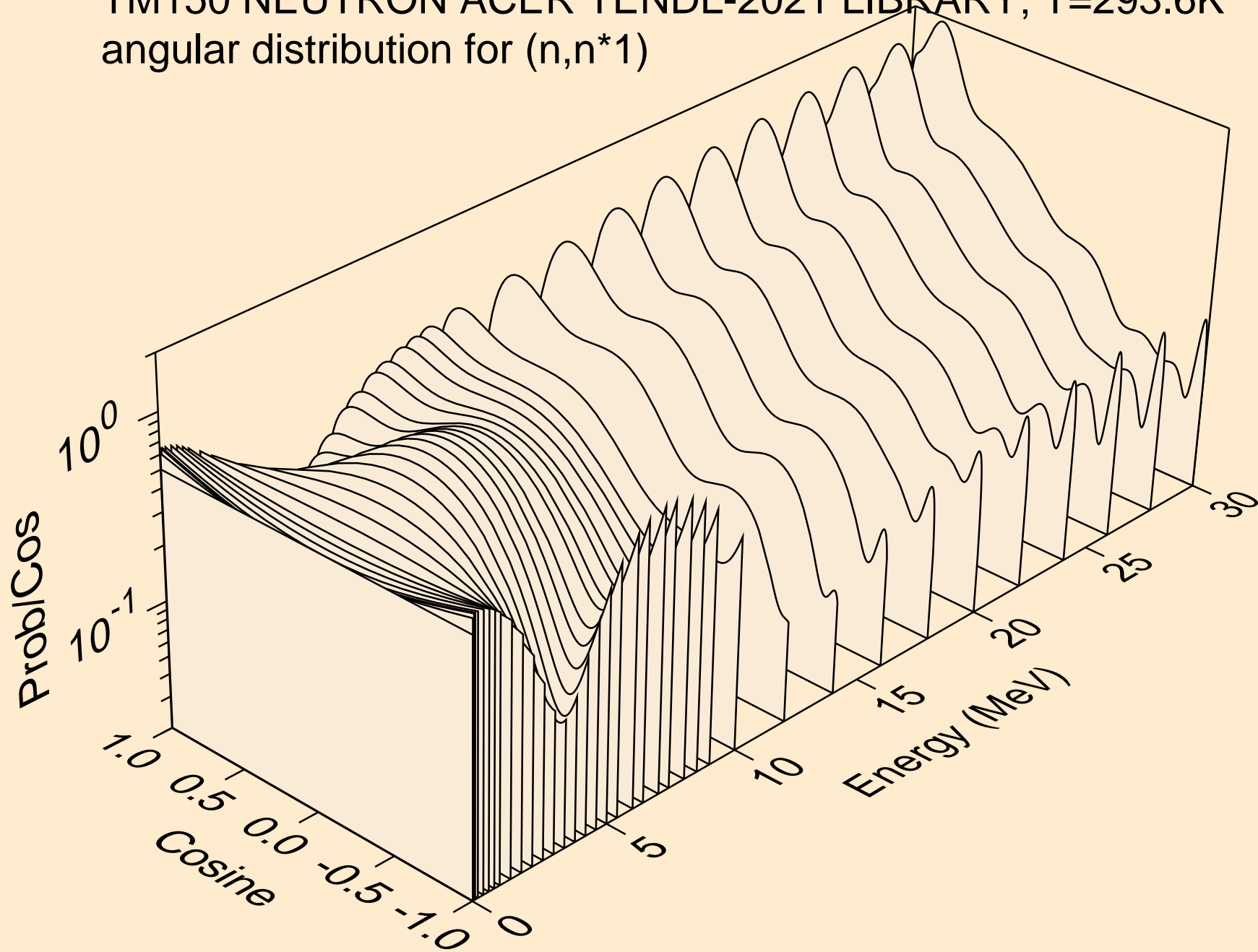

TM150 NEUTRON ACER TENDL-2021 LIBRARY; T=293.6K  
angular distribution for (n,n\*2)

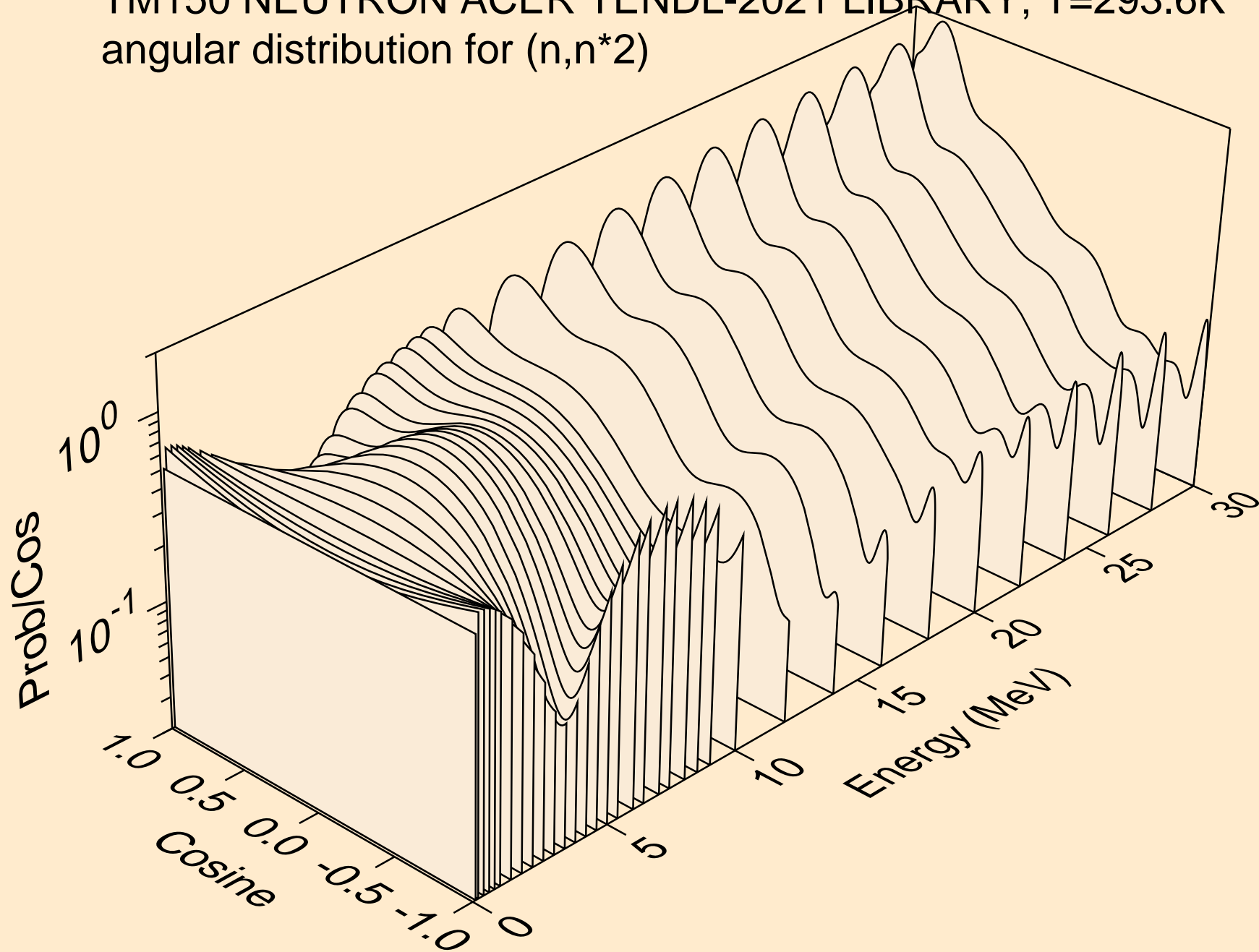

TM150 NEUTRON ACER TENDL-2021 LIBRARY; T=293.6K  
angular distribution for (n,n\*3)

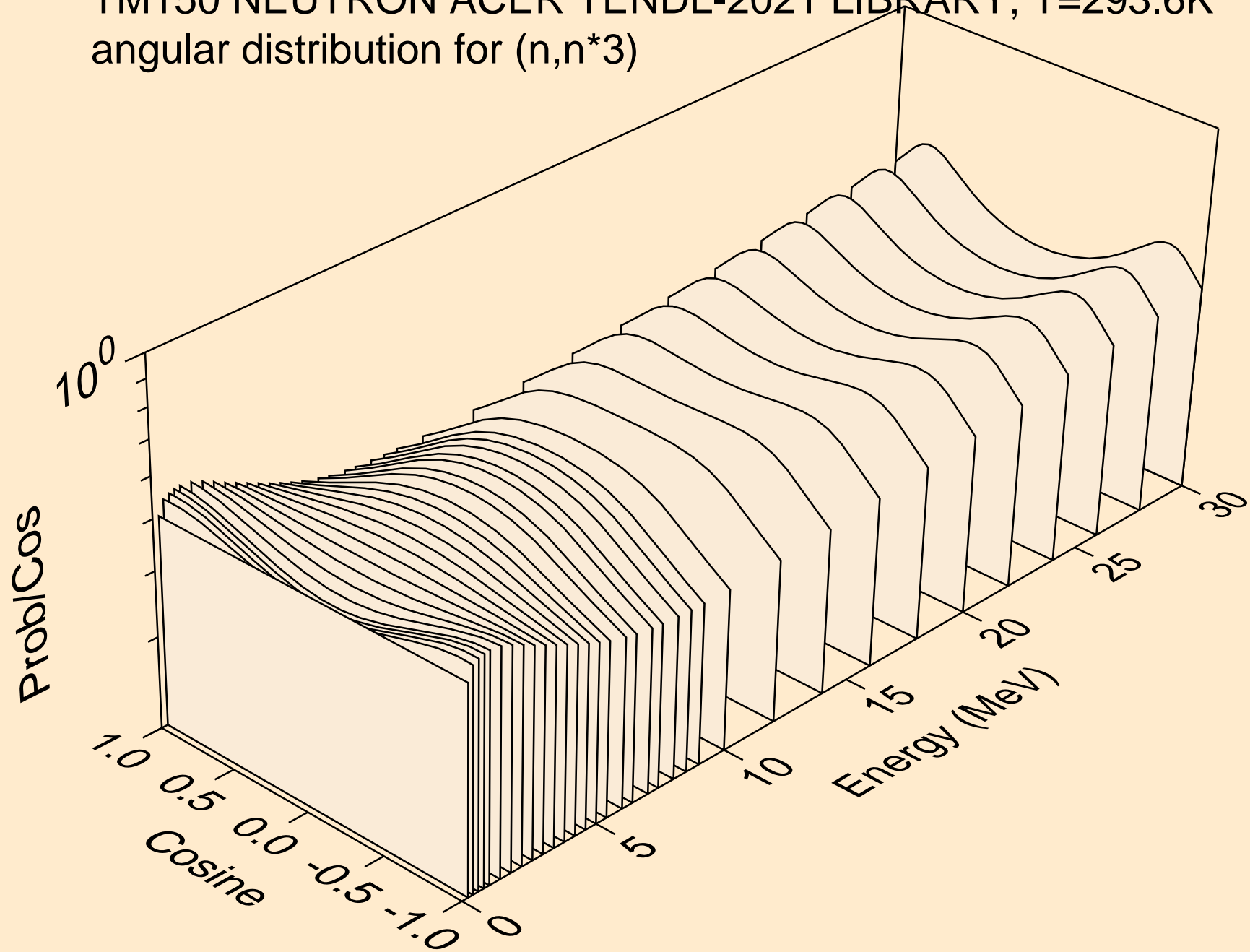

TM150 NEUTRON ACER TENDL-2021 LIBRARY; T=293.6K  
angular distribution for (n,n\*4)

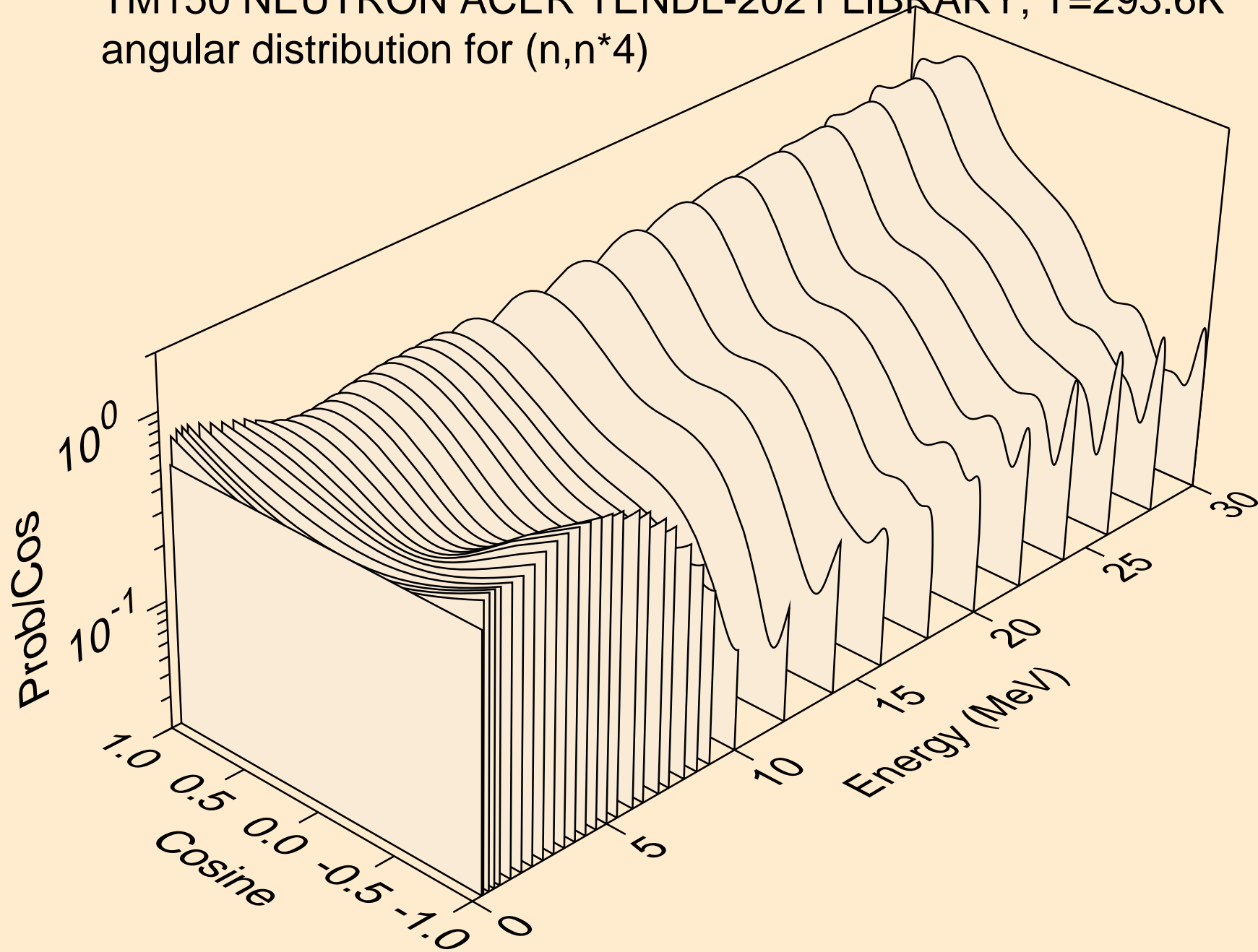

TM150 NEUTRON ACER TENDL-2021 LIBRARY; T=293.6K  
angular distribution for (n,n\*5)

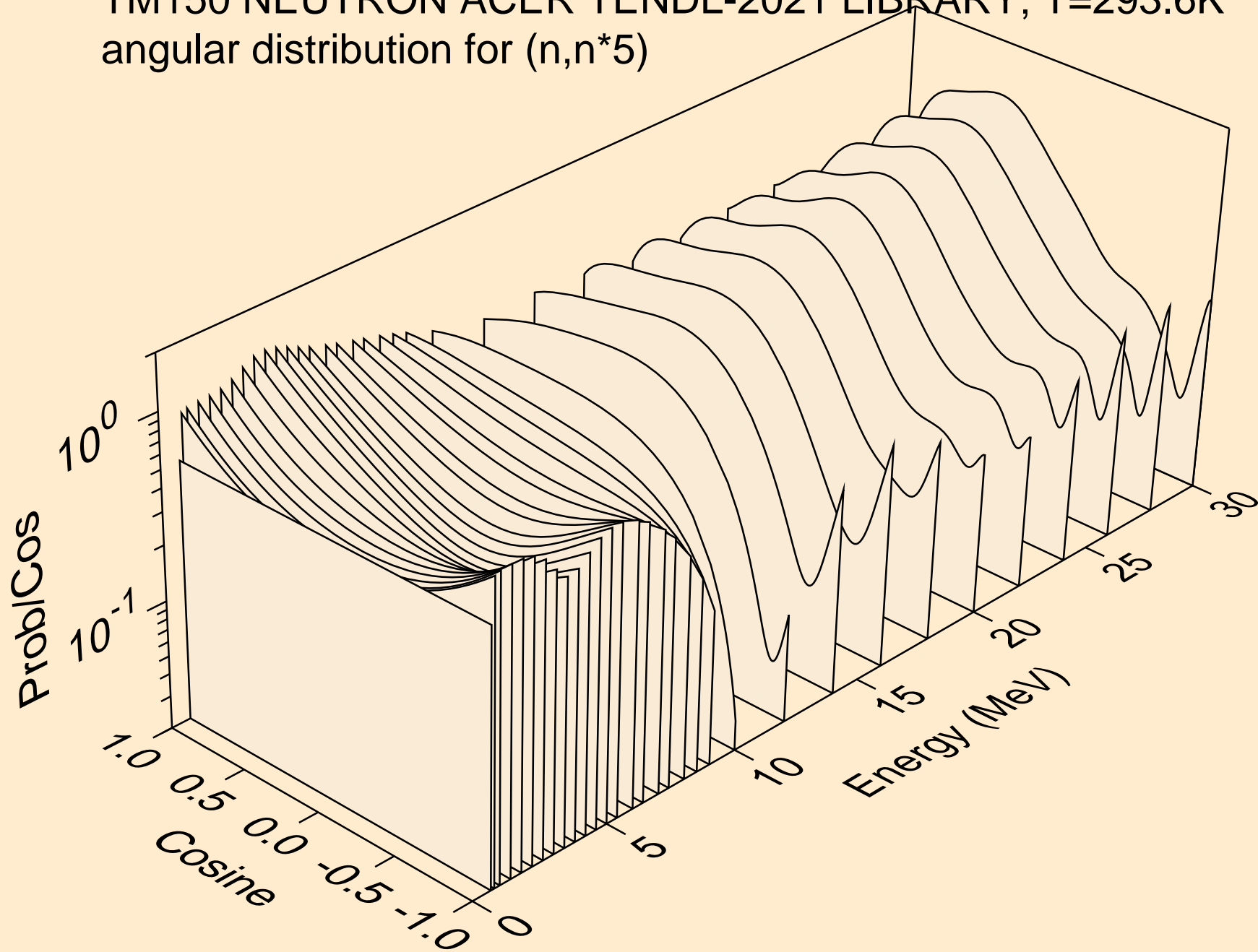

TM150 NEUTRON ACER TENDL-2021 LIBRARY; T=293.6K  
angular distribution for (n,n\*6)

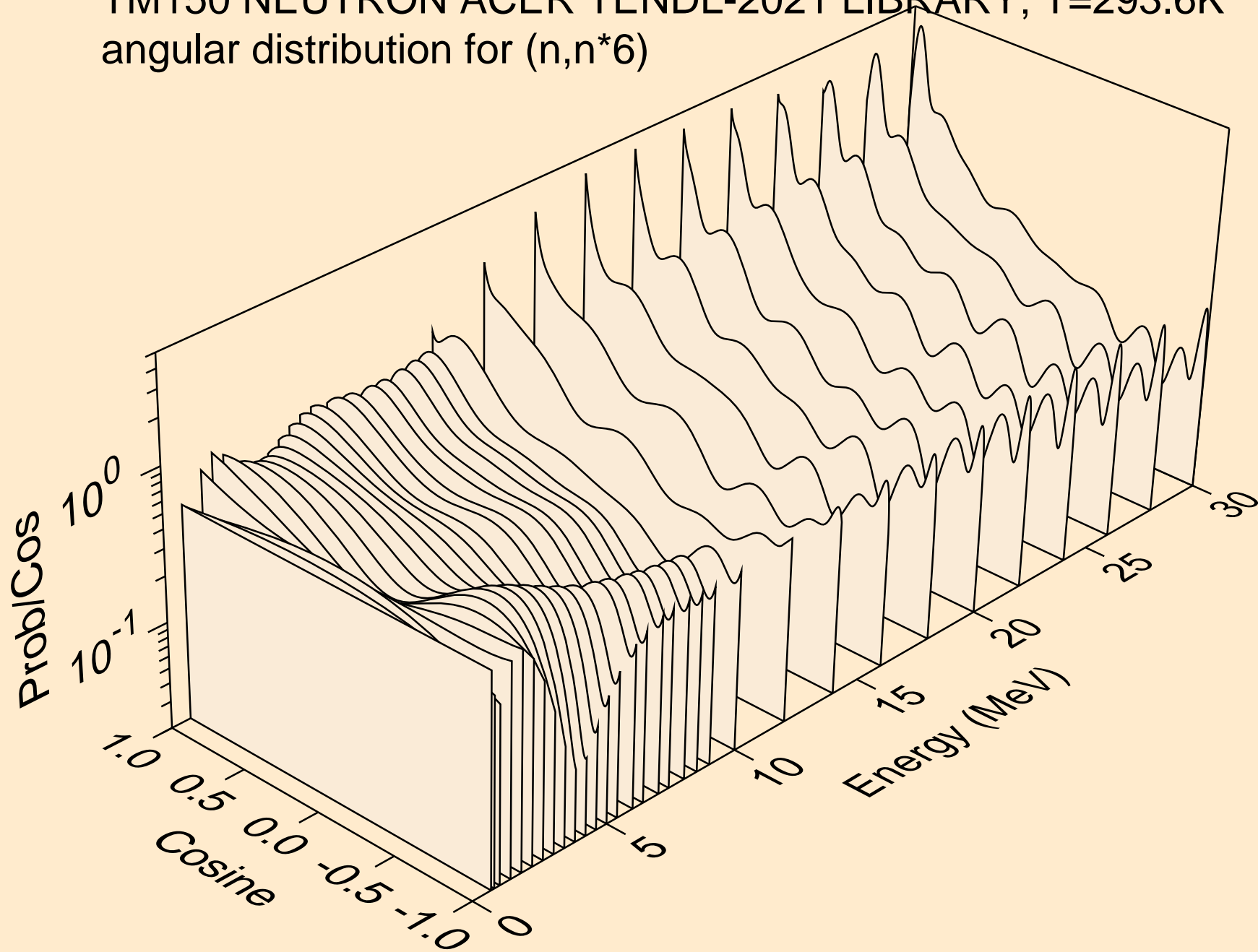

TM150 NEUTRON ACER TENDL-2021 LIBRARY; T=293.6K  
angular distribution for (n,n\*7)

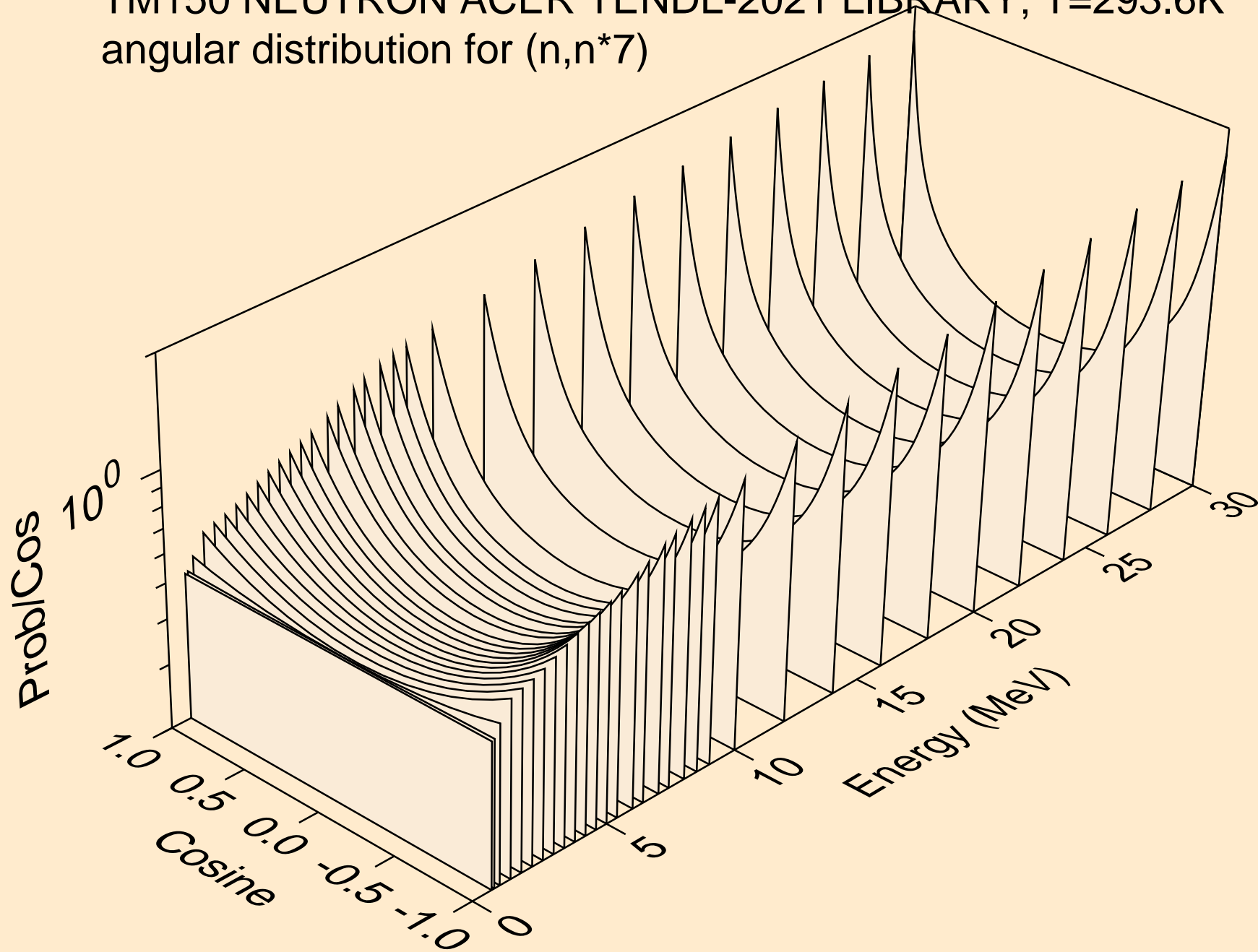

TM150 NEUTRON ACER TENDL-2021 LIBRARY; T=293.6K  
angular distribution for (n,n\*8)

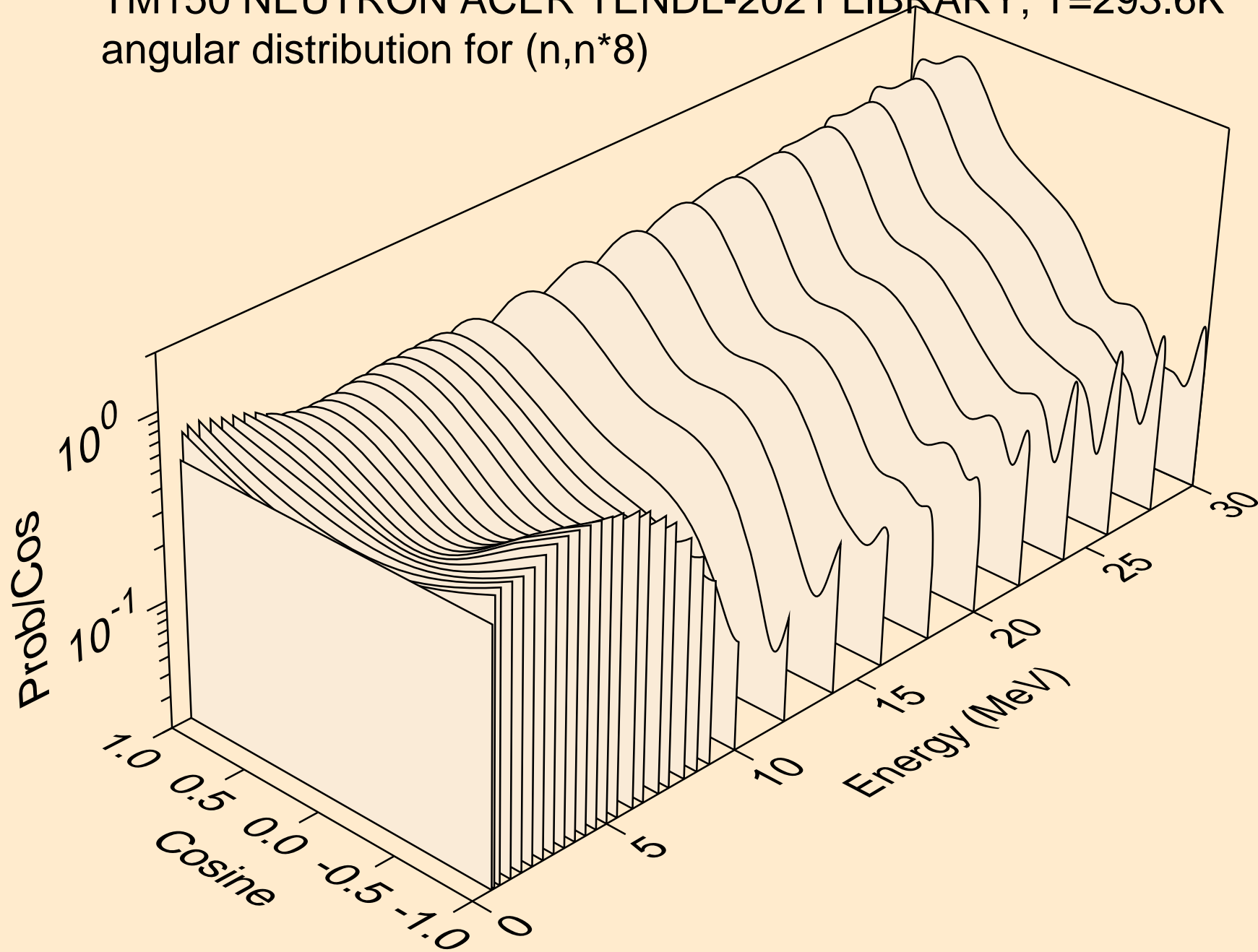



TM150 NEUTRON ACER TENDL-2021 LIBRARY; T=293.6K  
angular distribution for (n,n\*9)

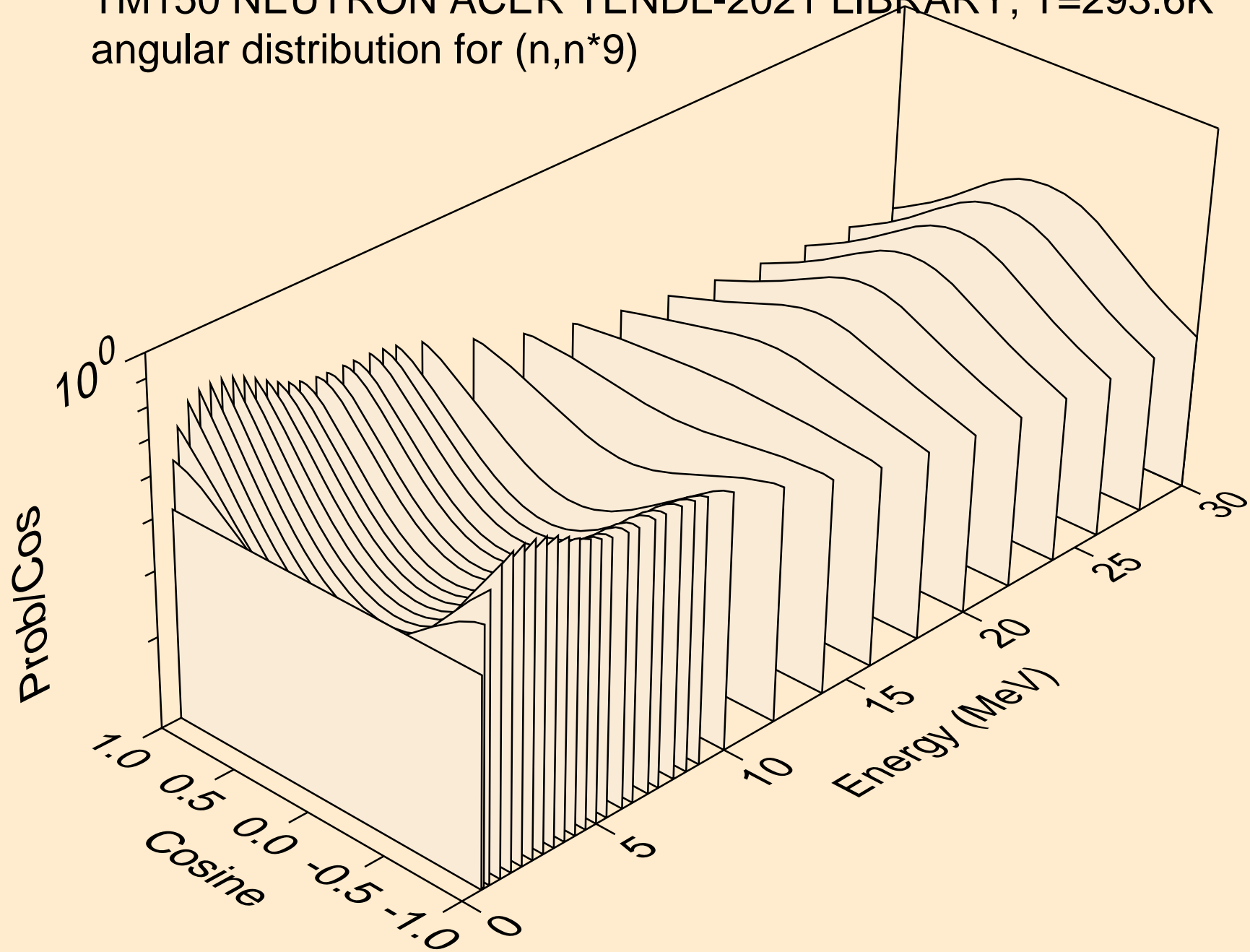

TM150 NEUTRON ACER TENDL-2021 LIBRARY; T=293.6K  
angular distribution for (n,n\*10)

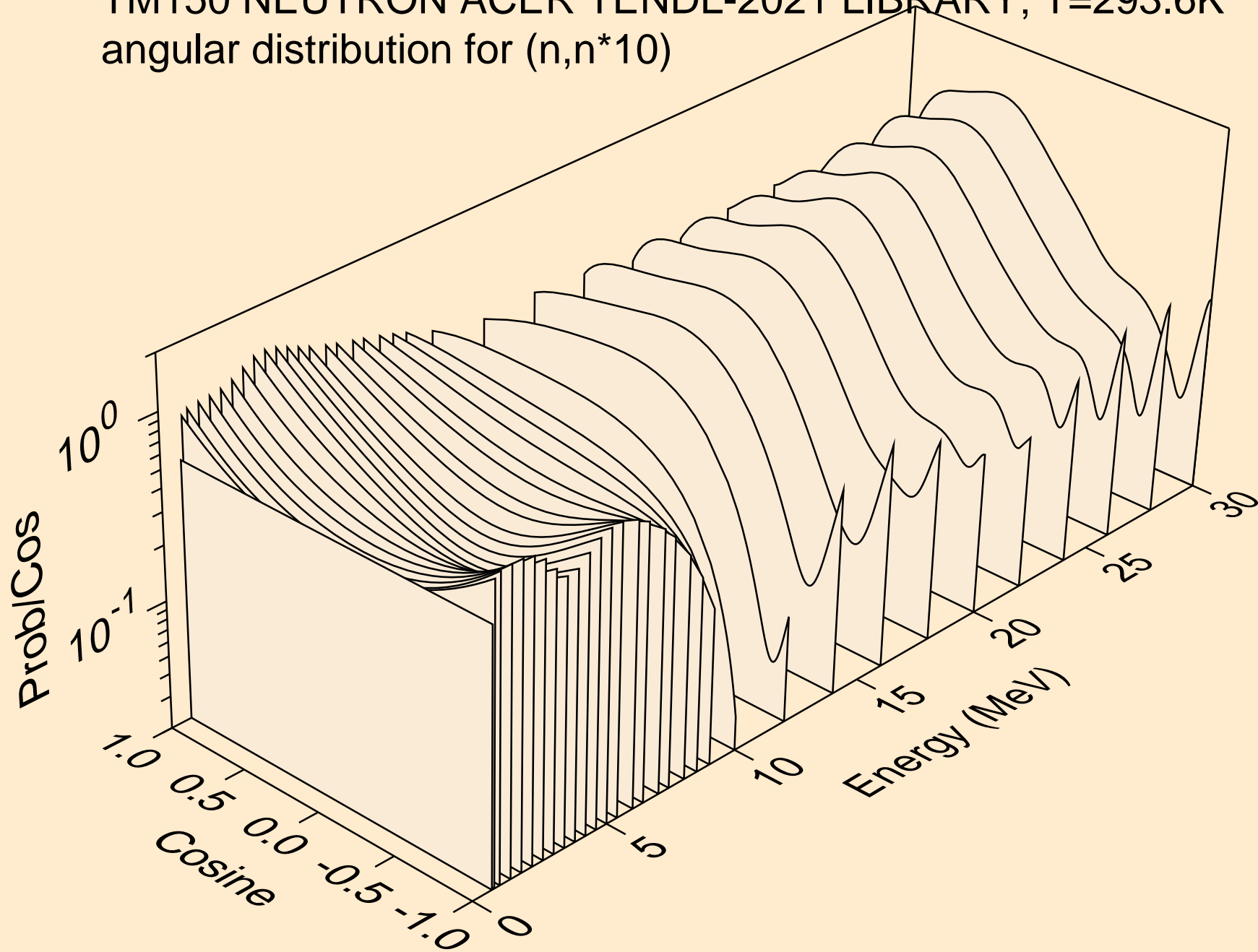

TM150 NEUTRON ACER TENDL-2021 LIBRARY; T=293.6K  
angular distribution for (n,n\*11)

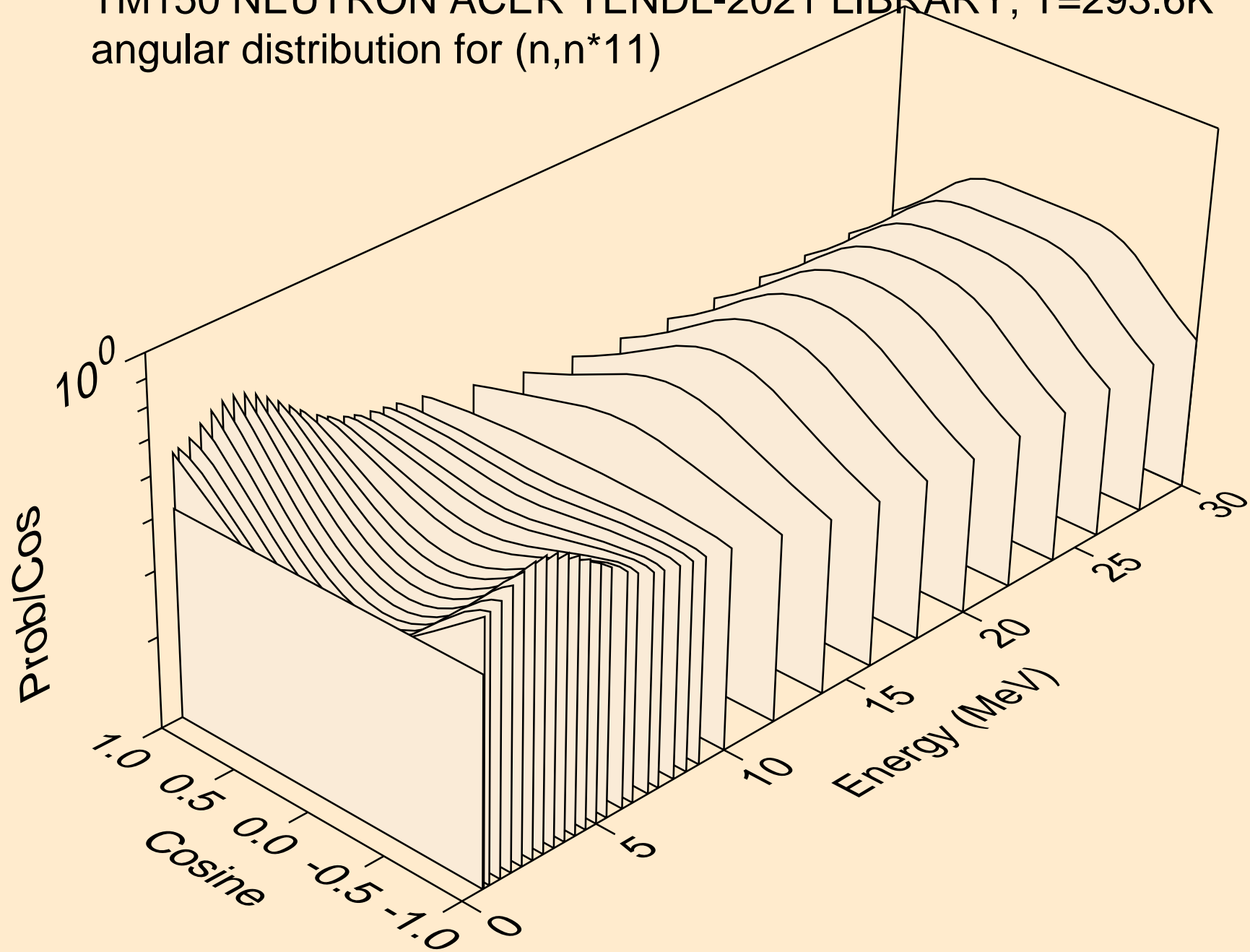

TM150 NEUTRON ACER TENDL-2021 LIBRARY; T=293.6K  
angular distribution for (n,n\*12)

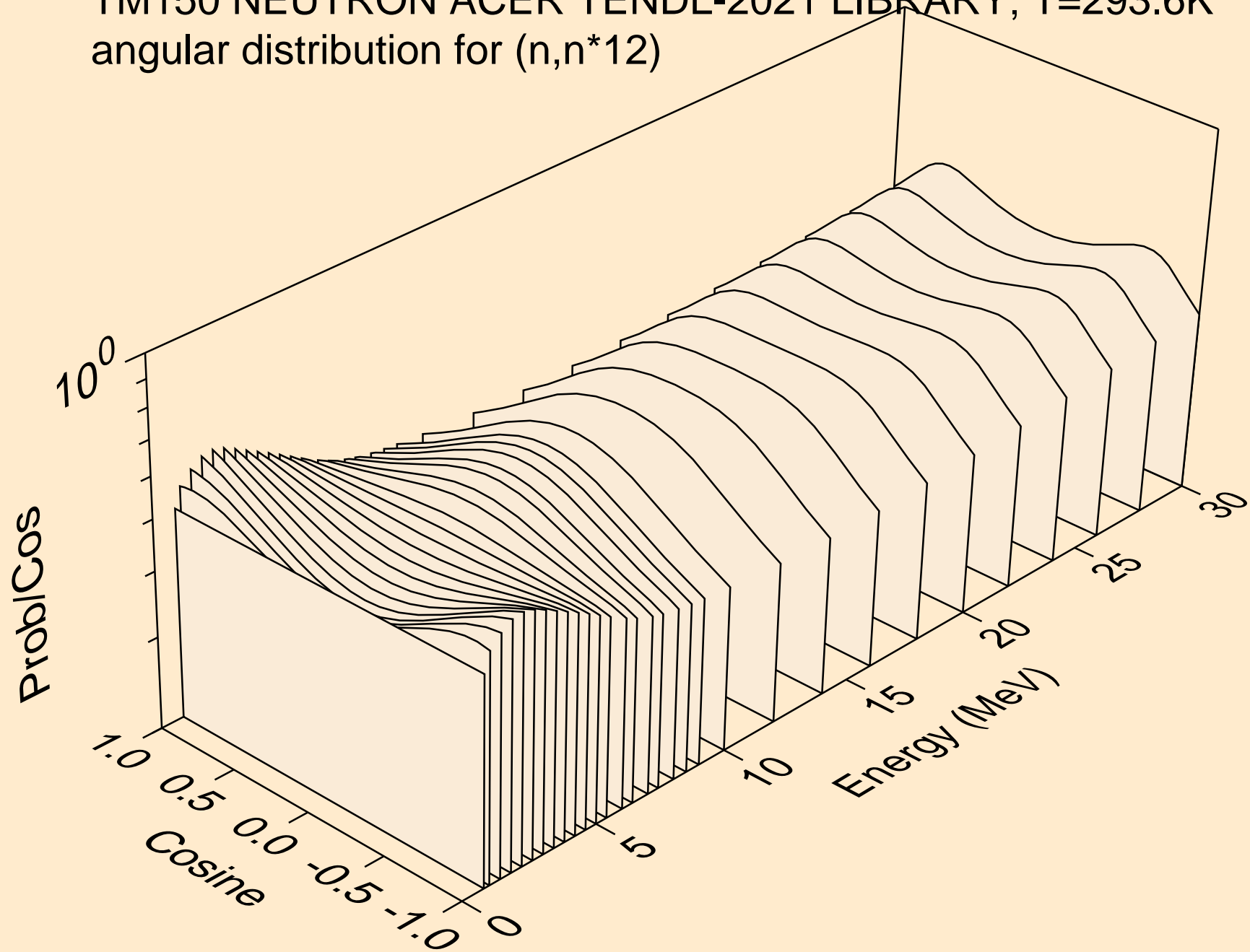

TM150 NEUTRON ACER TENDL-2021 LIBRARY; T=293.6K  
angular distribution for (n,n\*13)

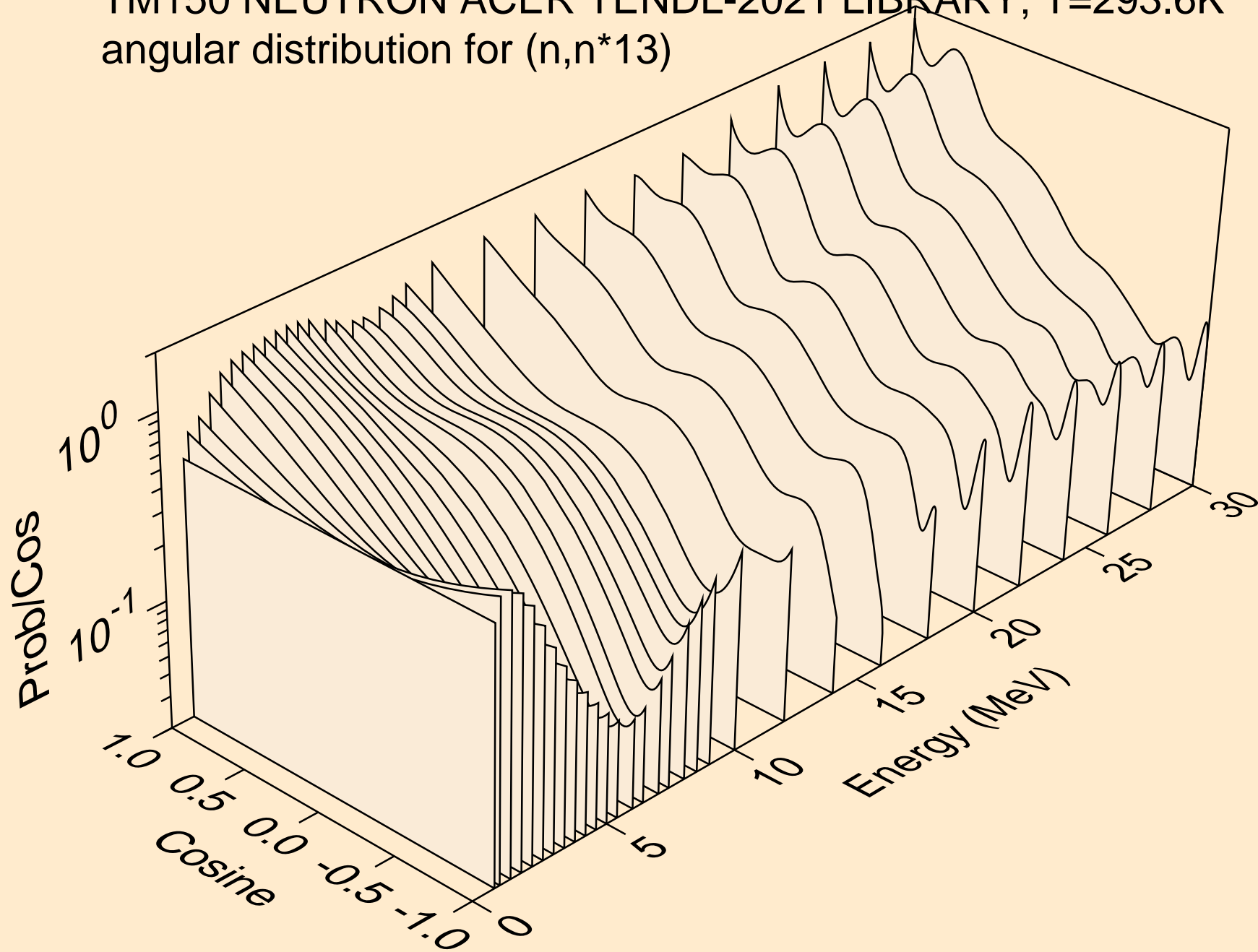

TM150 NEUTRON ACER TENDL-2021 LIBRARY; T=293.6K  
angular distribution for (n,n\*14)

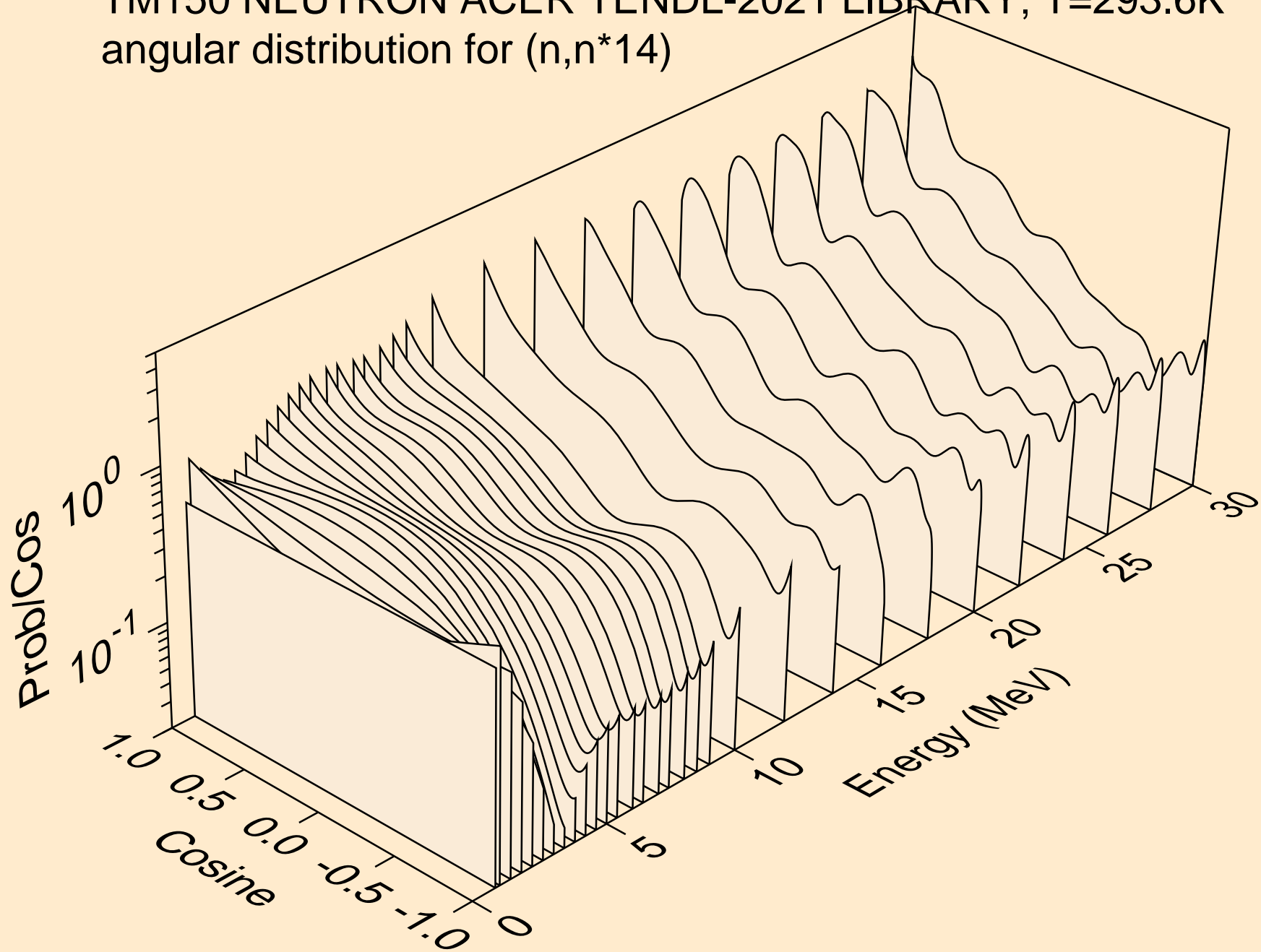

TM150 NEUTRON ACER TENDL-2021 LIBRARY; T=293.6K  
angular distribution for (n,n\*15)

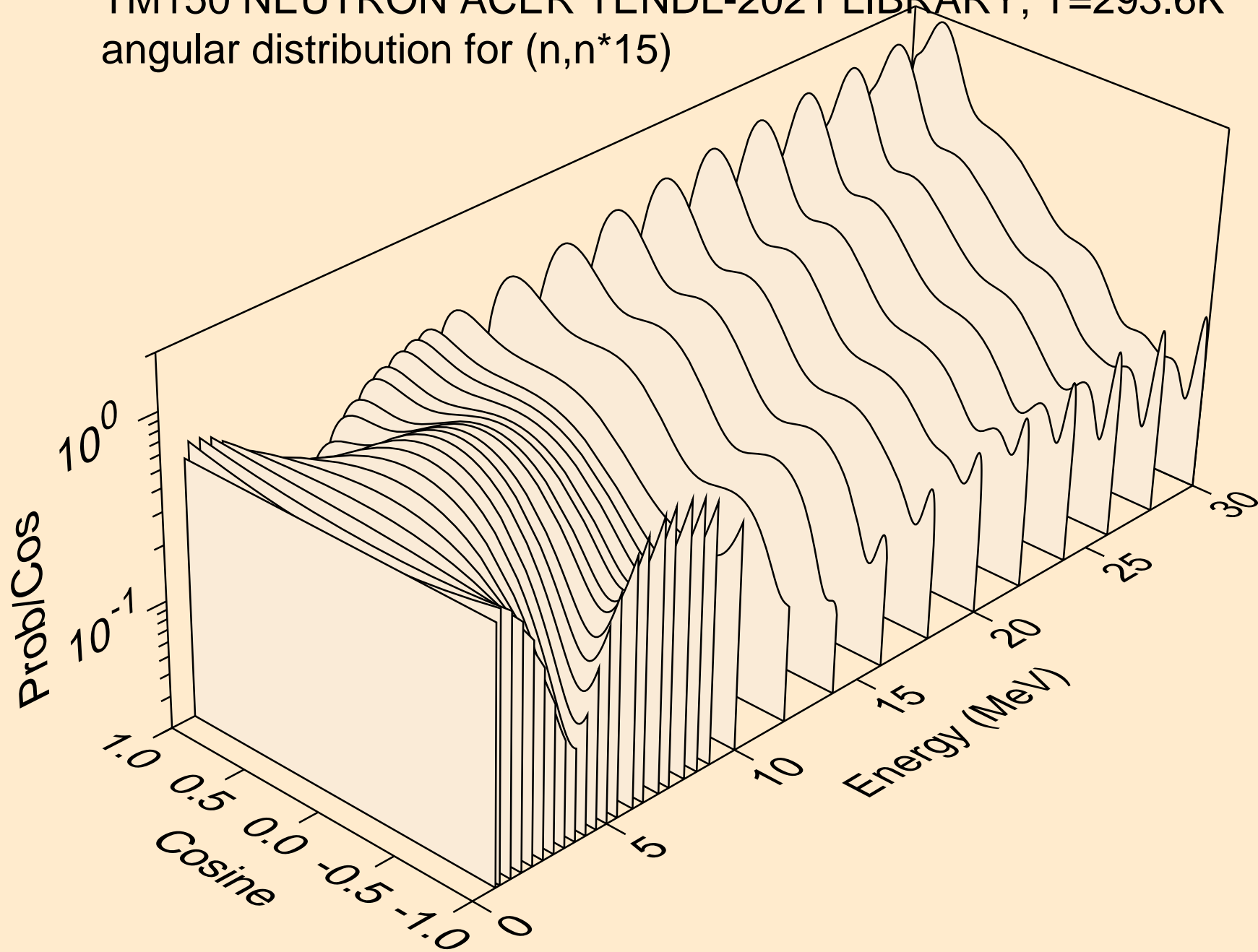

TM150 NEUTRON ACER TENDL-2021 LIBRARY; T=293.6K  
angular distribution for (n,n\*16)

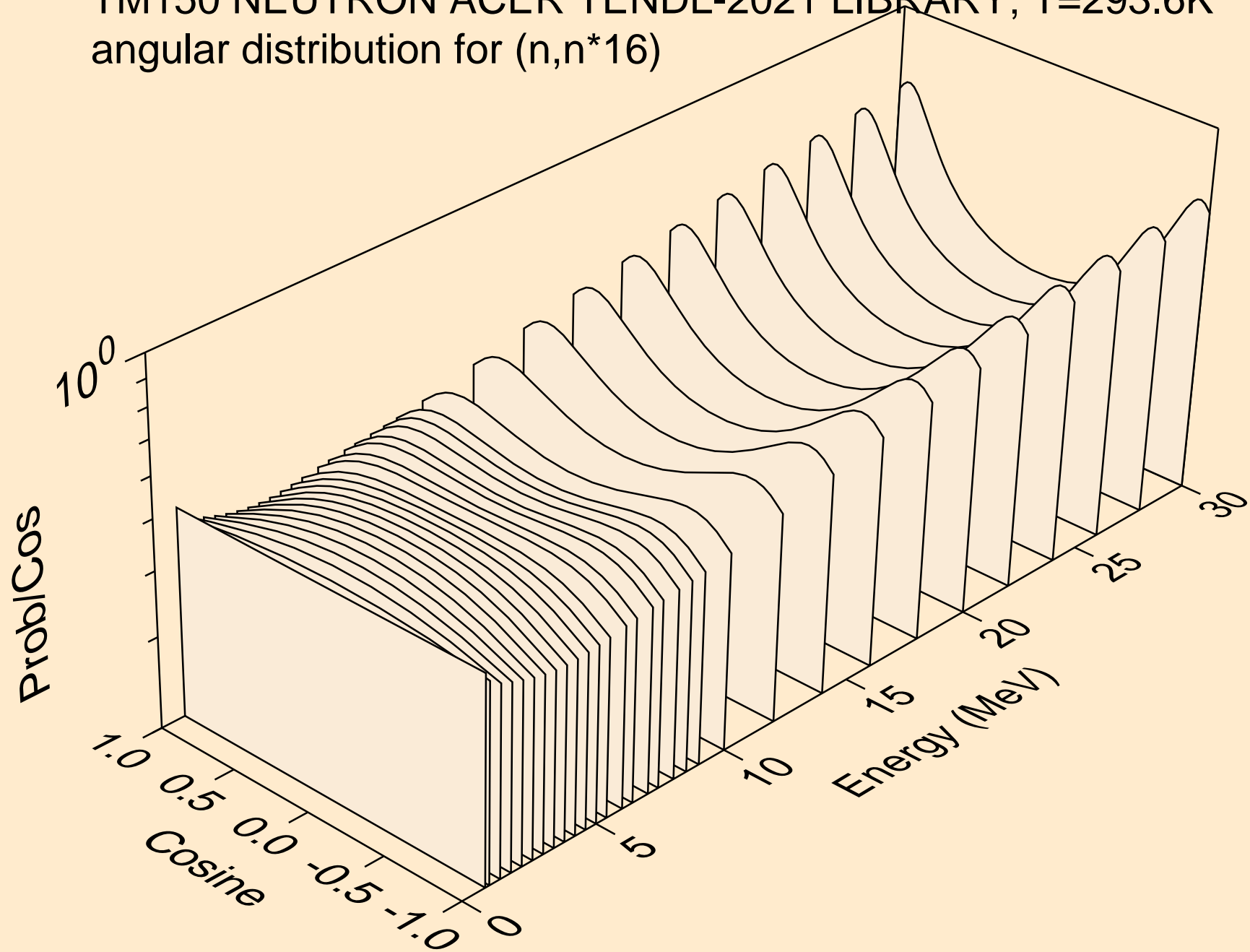



TM150 NEUTRON ACER TENDL-2021 LIBRARY; T=293.6K  
angular distribution for (n,n\*17)

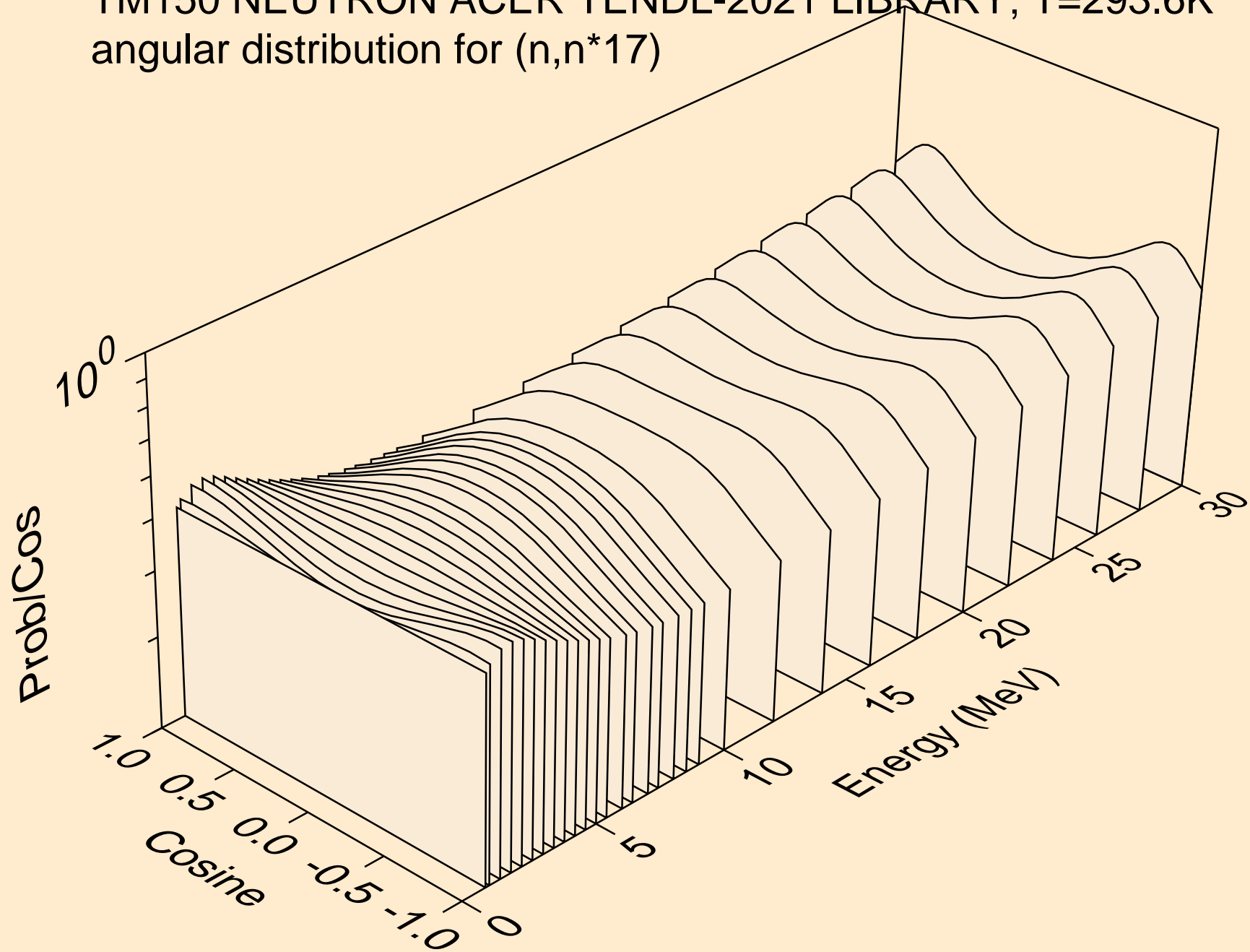

TM150 NEUTRON ACER TENDL-2021 LIBRARY; T=293.6K  
angular distribution for (n,n\*18)

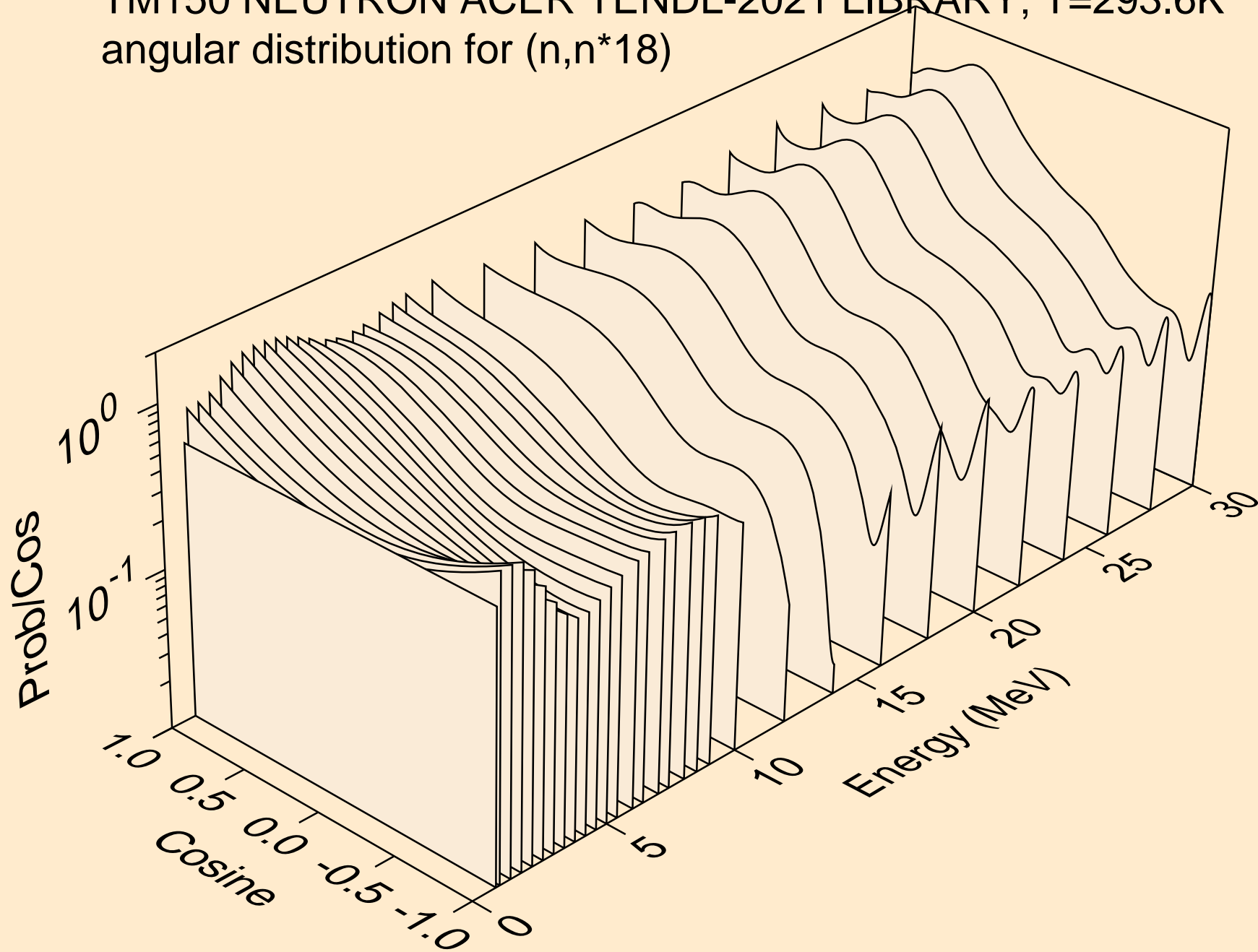

TM150 NEUTRON ACER TENDL-2021 LIBRARY; T=293.6K  
angular distribution for (n,n\*19)

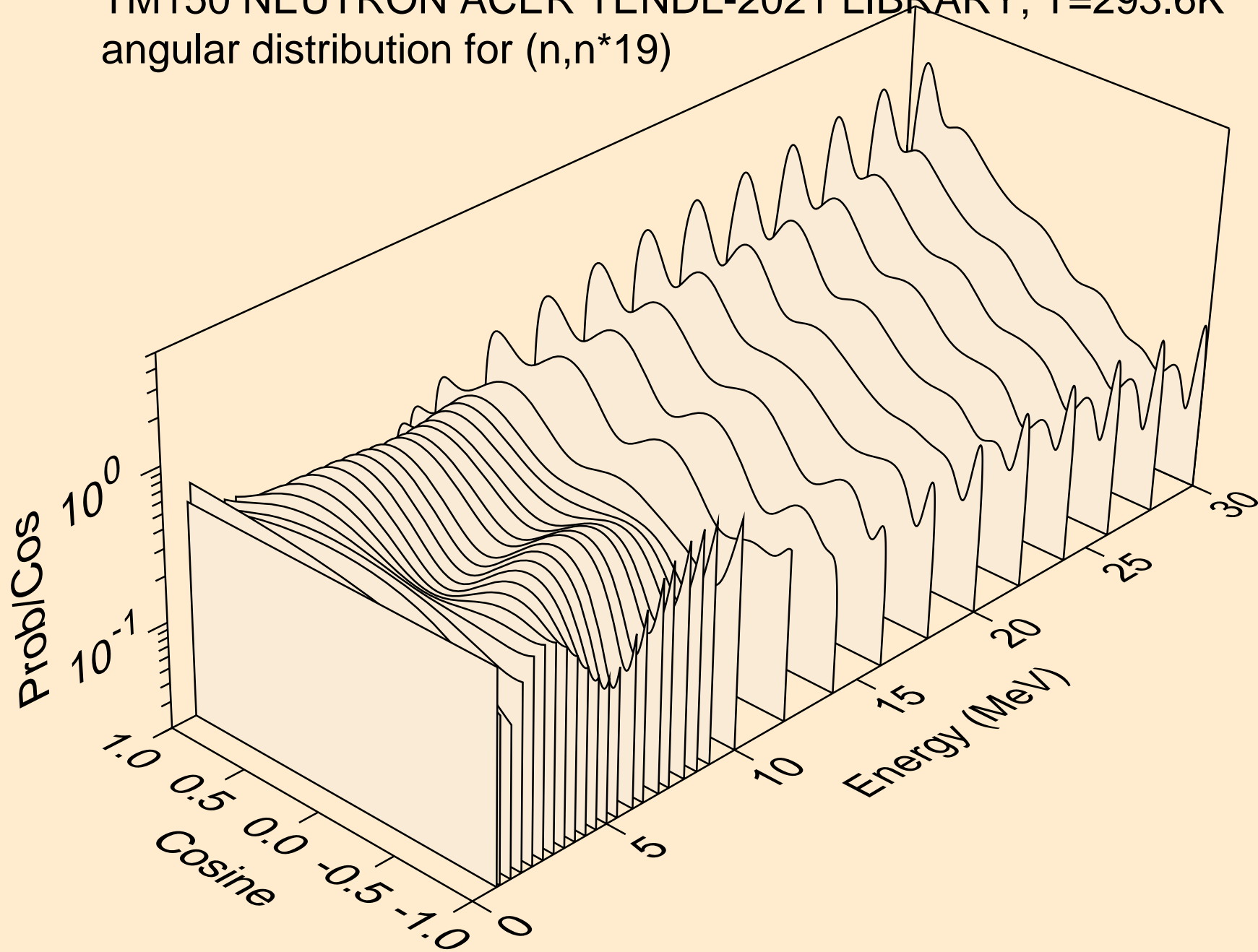

TM150 NEUTRON ACER TENDL-2021 LIBRARY; T=293.6K  
Neutron emission for (n,x)

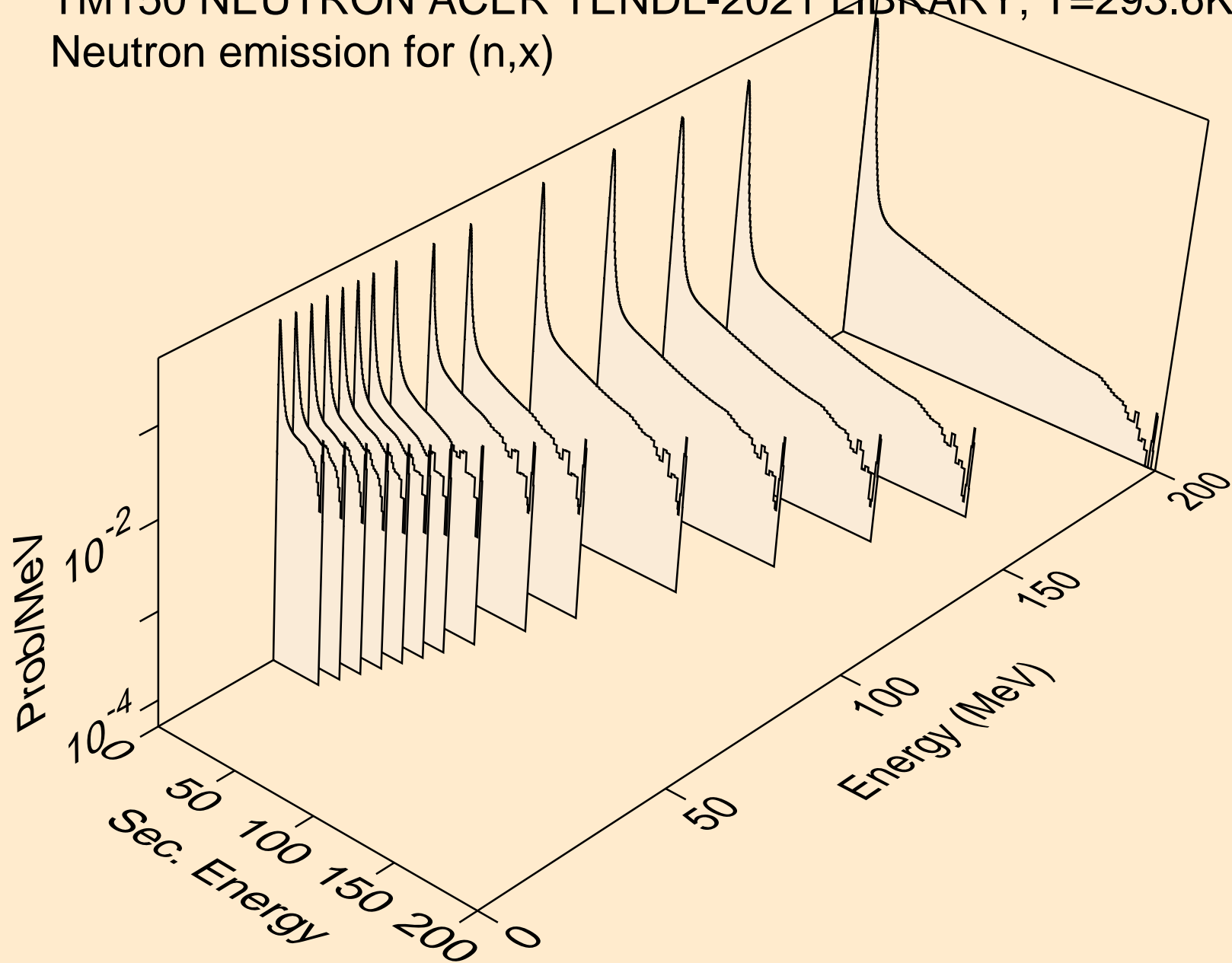

TM150 NEUTRON ACER TENDL-2021 LIBRARY; T=293.6K  
Neutron emission for (n,2nd)

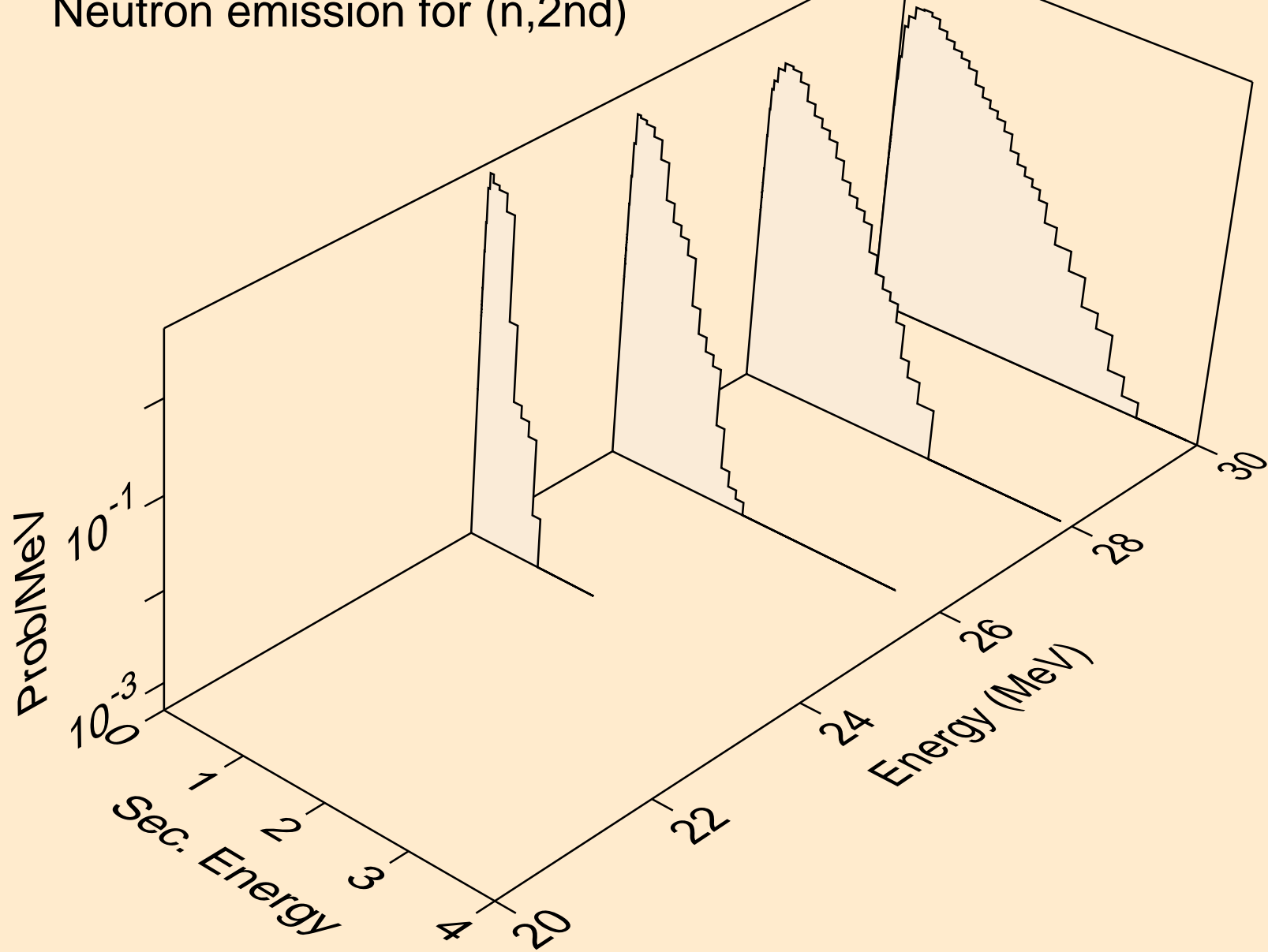

TM150 NEUTRON ACER TENDL-2021 LIBRARY; T=293.6K  
Neutron emission for (n,2n)

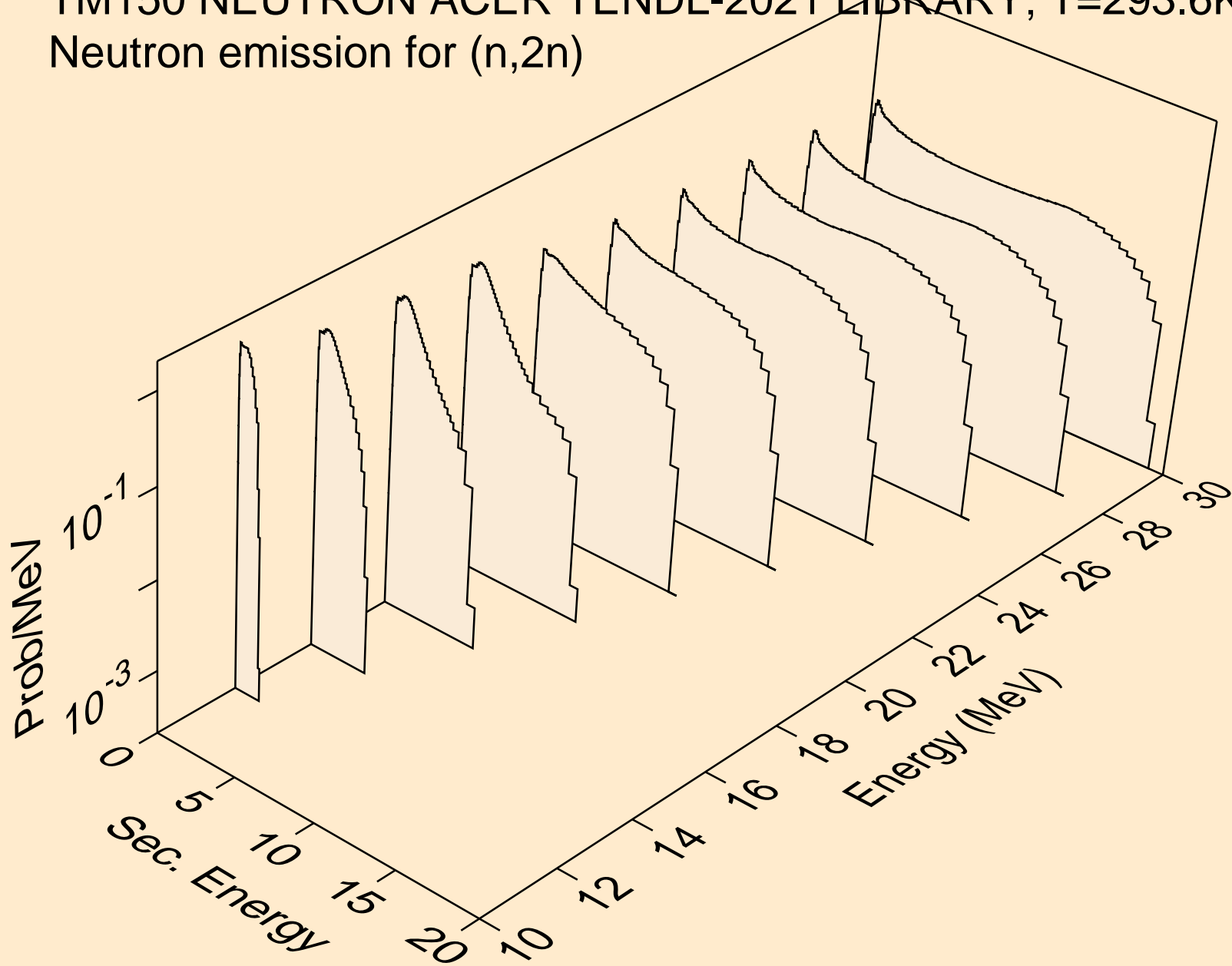

TM150 NEUTRON ACER TENDL-2021 LIBRARY; T=293.6K  
Neutron emission for (n,3n)

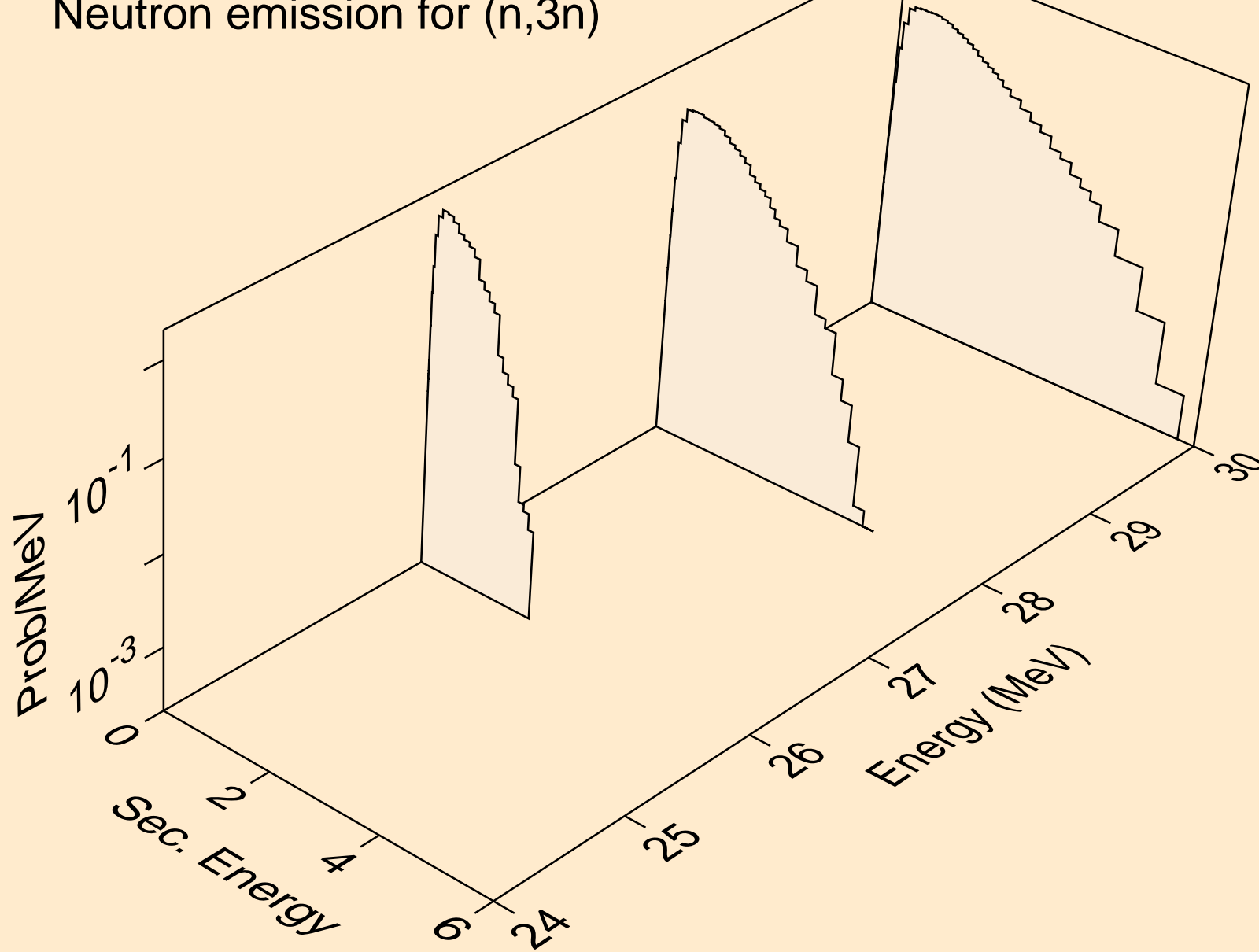

TM150 NEUTRON ACER TENDL-2021 LIBRARY; T=293.6K  
Neutron emission for (n,n\*)a

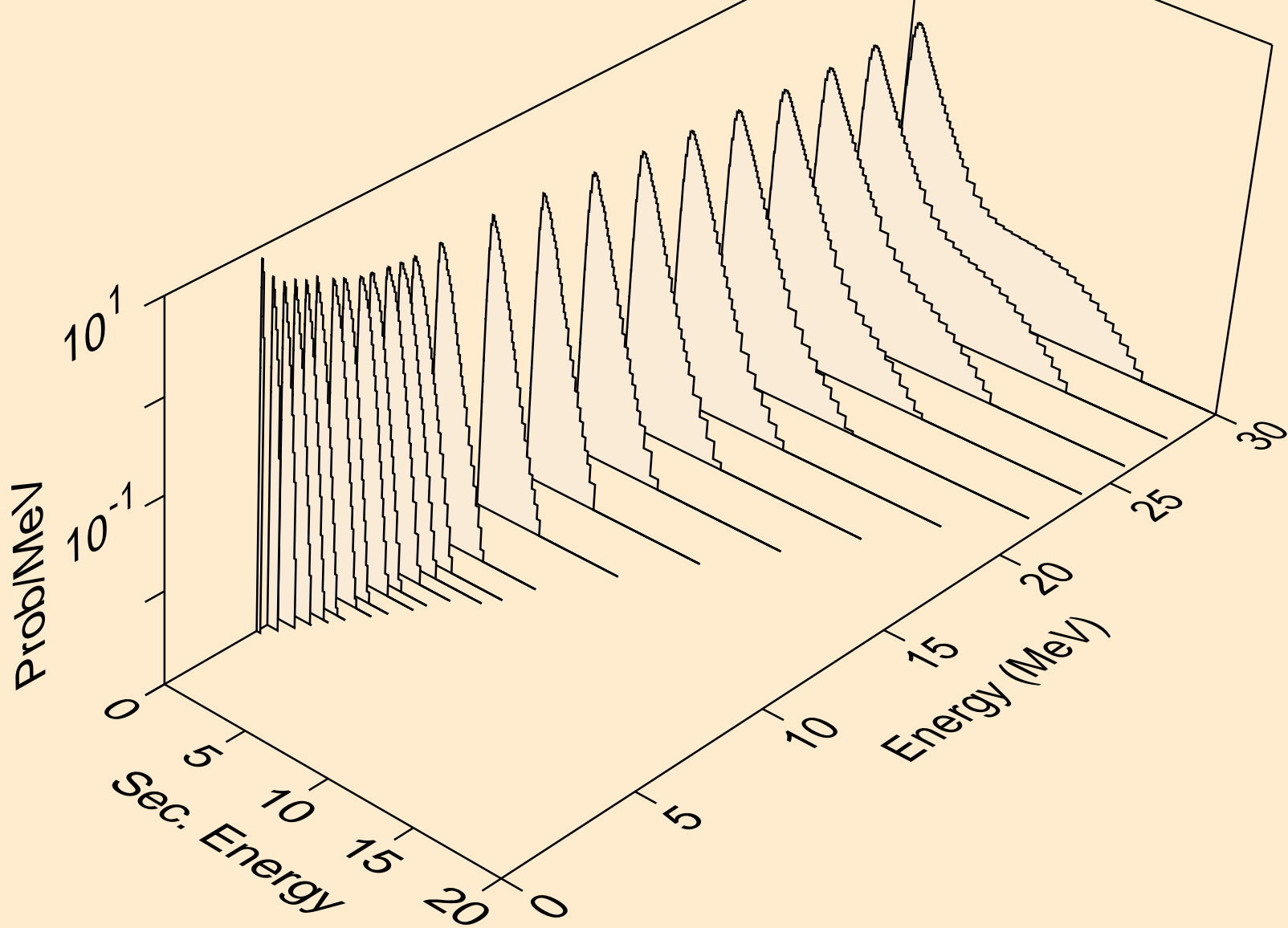



TM150 NEUTRON ACER TENDL-2021 LIBRARY; T=293.6K  
Neutron emission for (n,2n)<sub>a</sub>

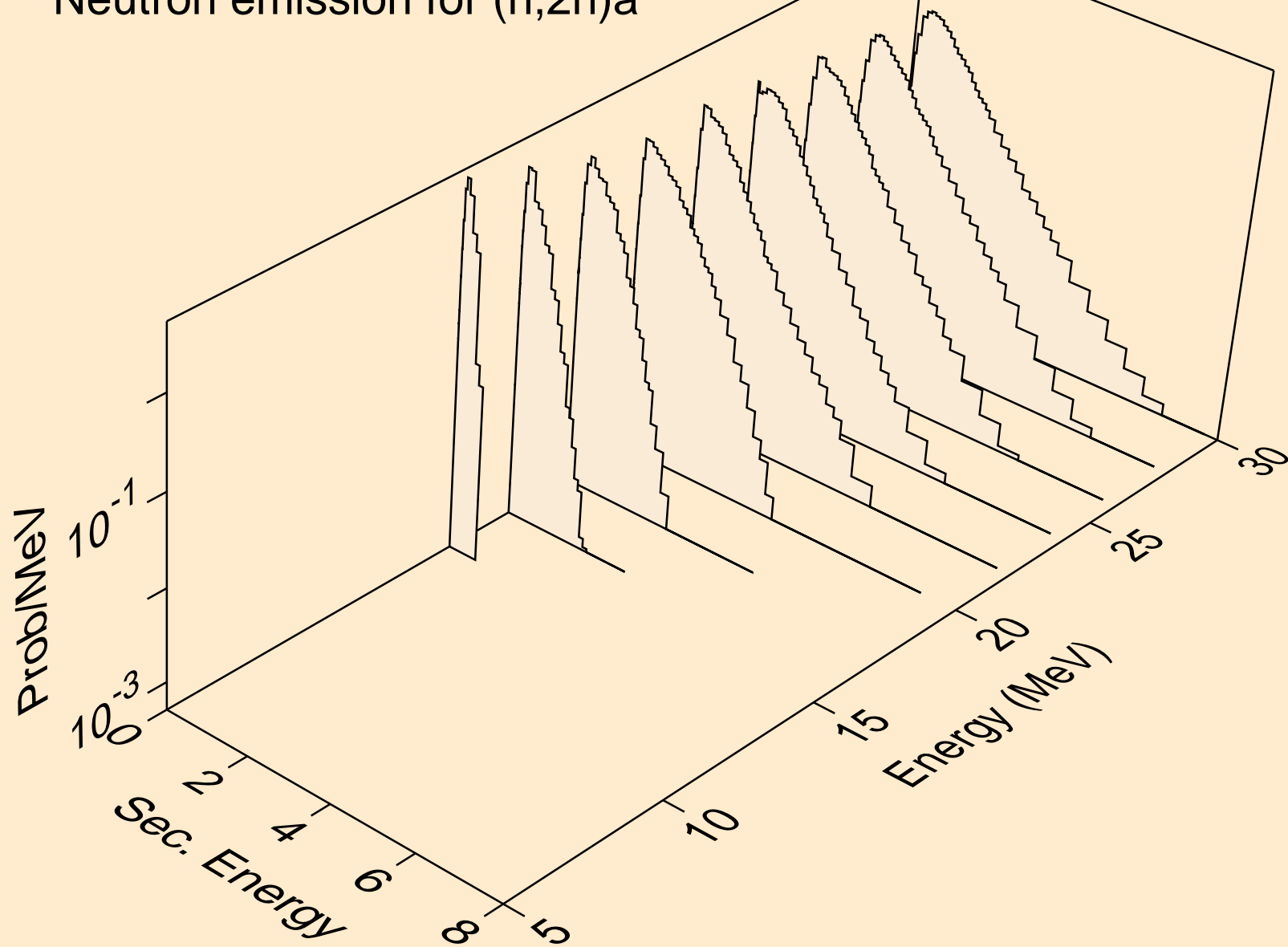

TM150 NEUTRON ACER TENDL-2021 LIBRARY; T=293.6K  
Neutron emission for (n,n\*)p

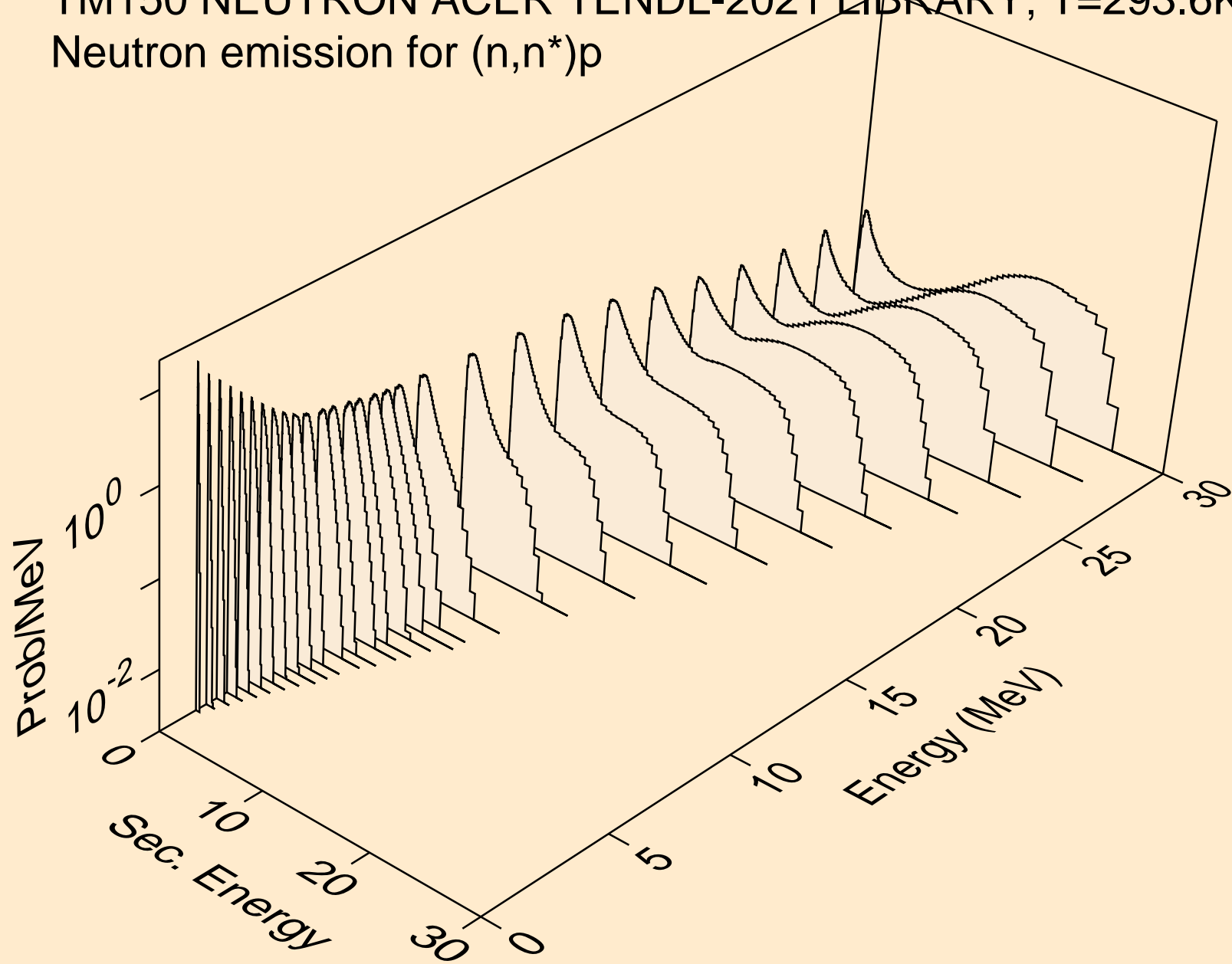

TM150 NEUTRON ACER TENDL-2021 LIBRARY; T=293.6K  
Neutron emission for (n,n\*)2a

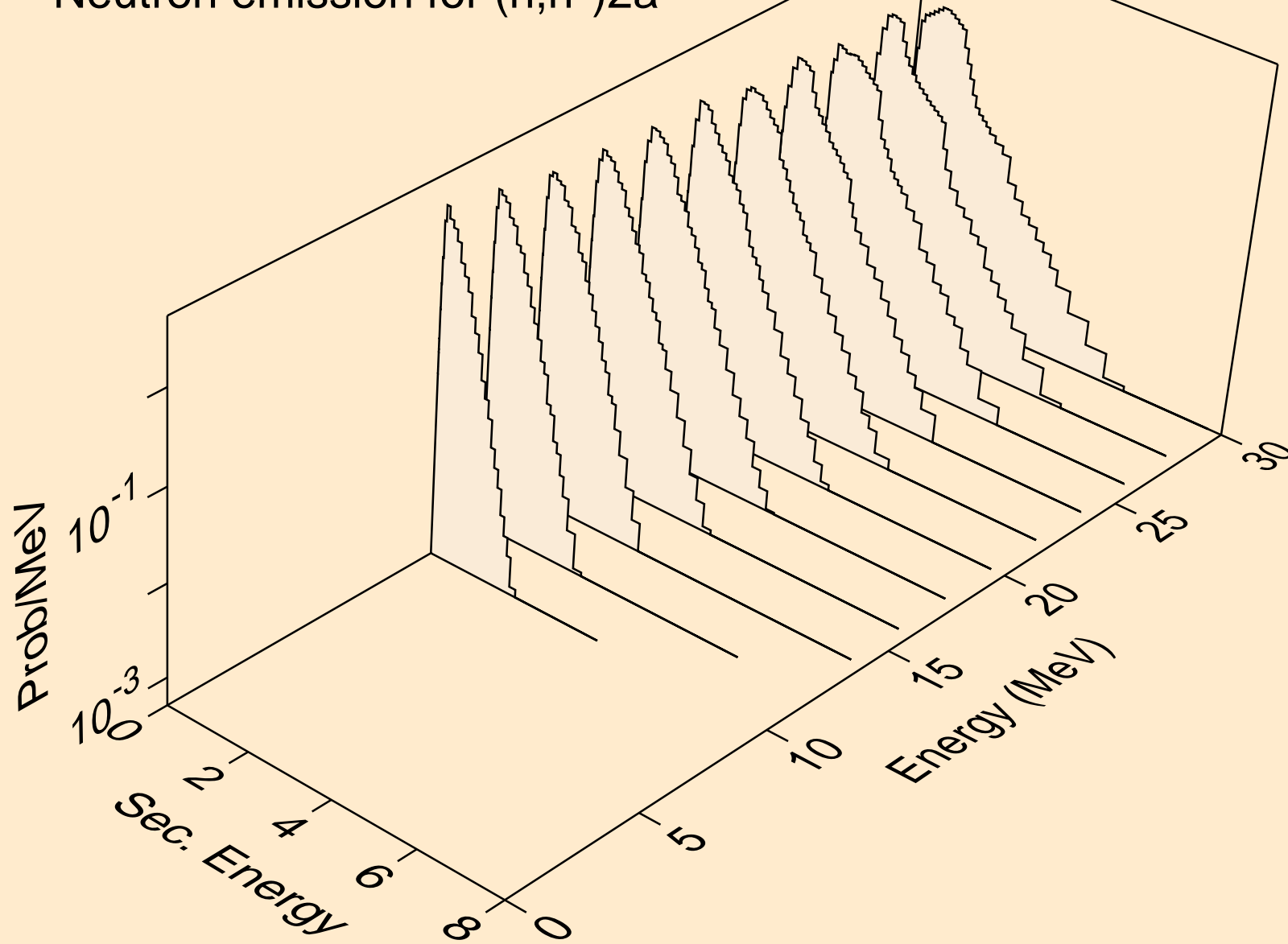

TM150 NEUTRON ACER TENDL-2021 LIBRARY; T=293.6K  
Neutron emission for (n,n\*)d

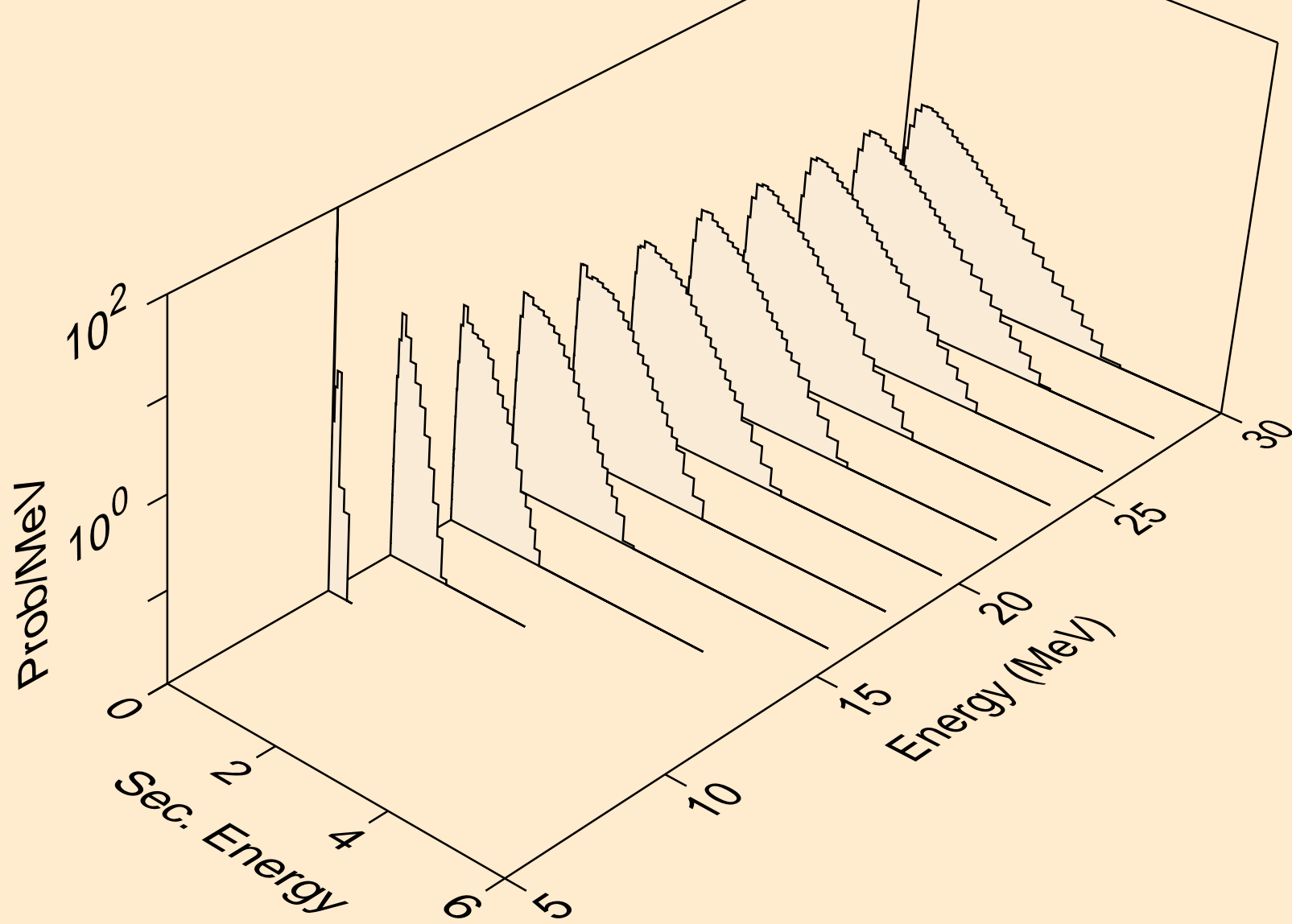

TM150 NEUTRON ACER TENDL-2021 LIBRARY; T=293.6K  
Neutron emission for (n,n\*)t

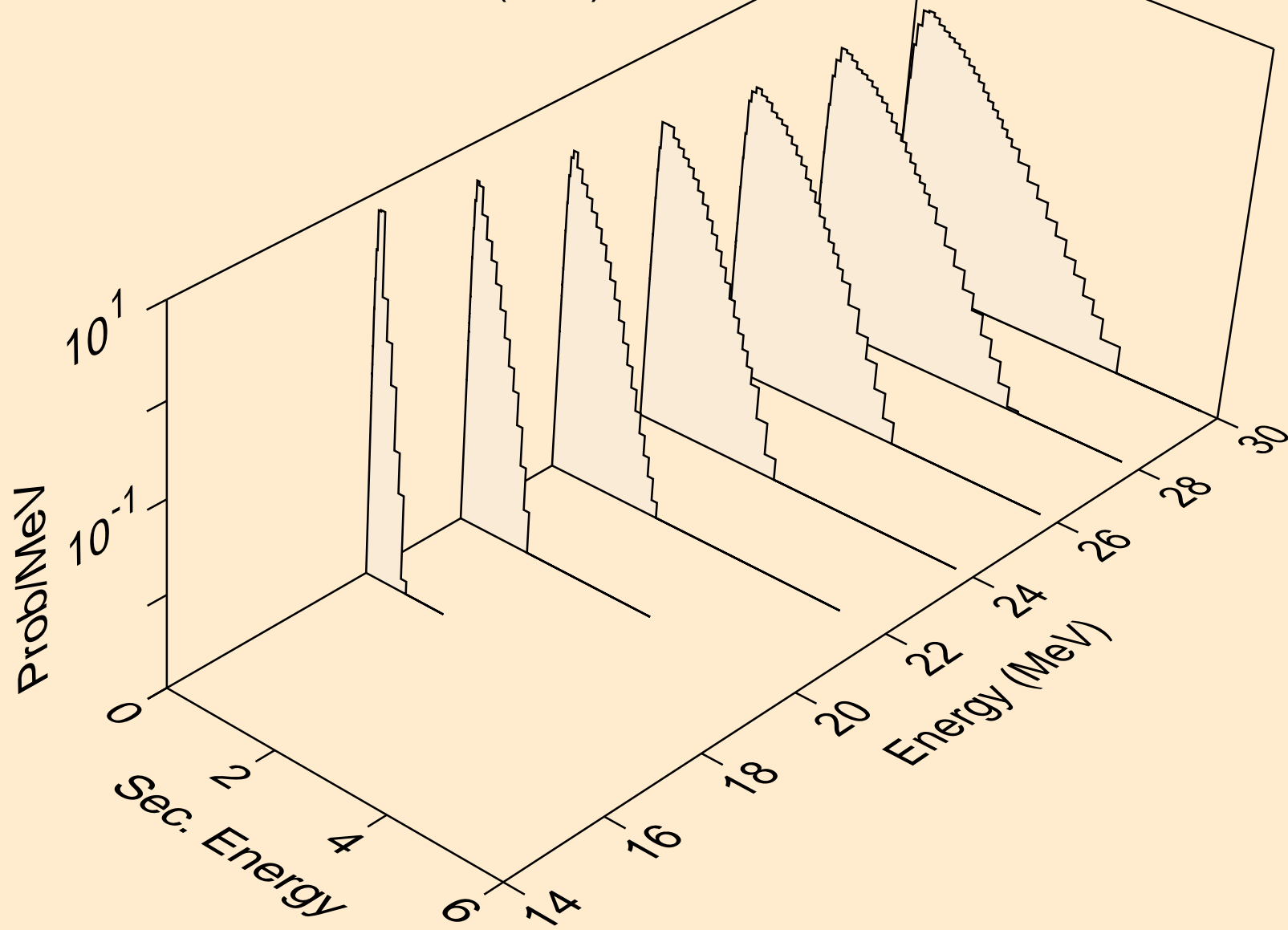

TM150 NEUTRON ACER TENDL-2021 LIBRARY; T=293.6K  
Neutron emission for (n,n\*)he3

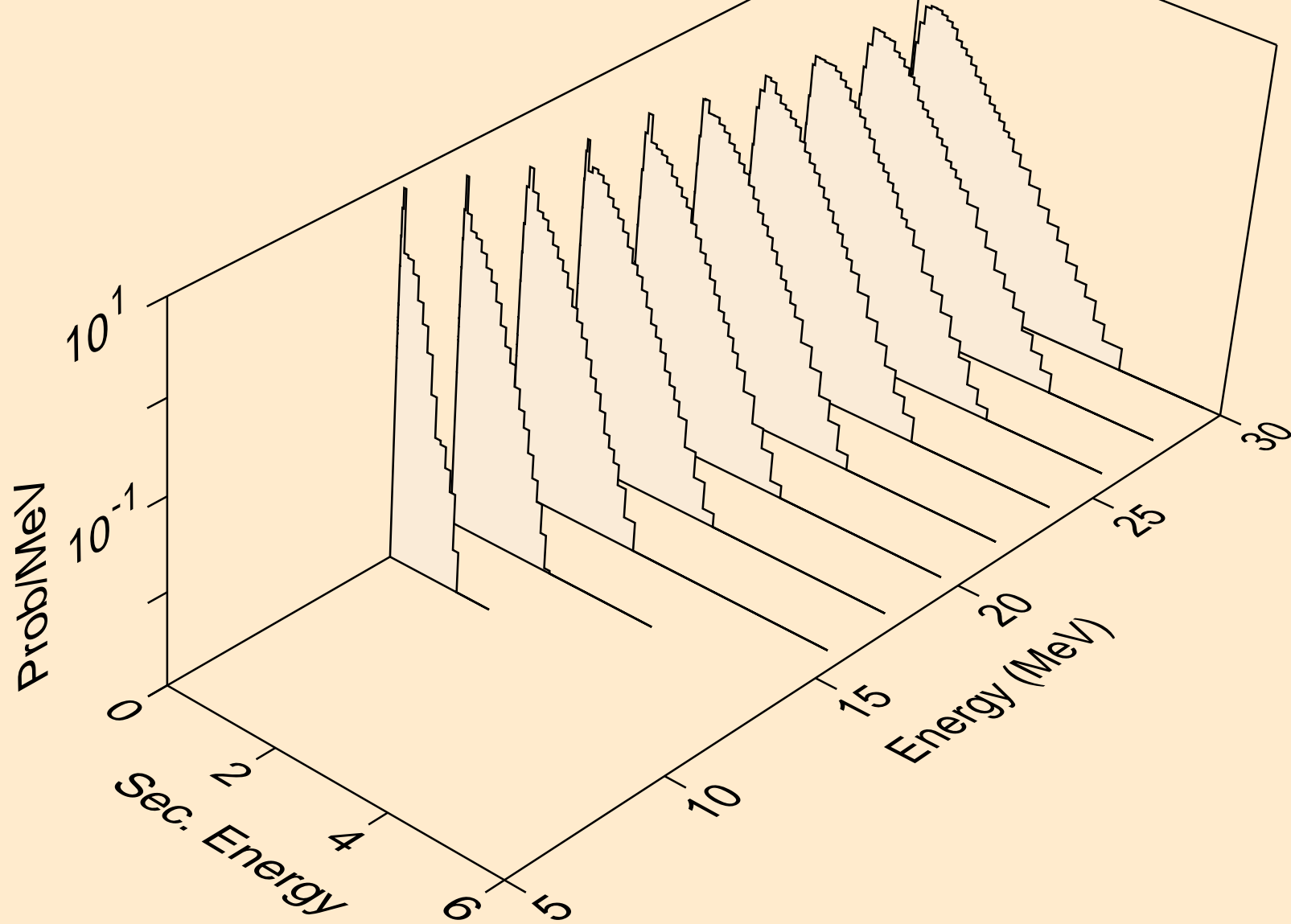

TM150 NEUTRON ACER TENDL-2021 LIBRARY; T=293.6K  
Neutron emission for (n,2np)

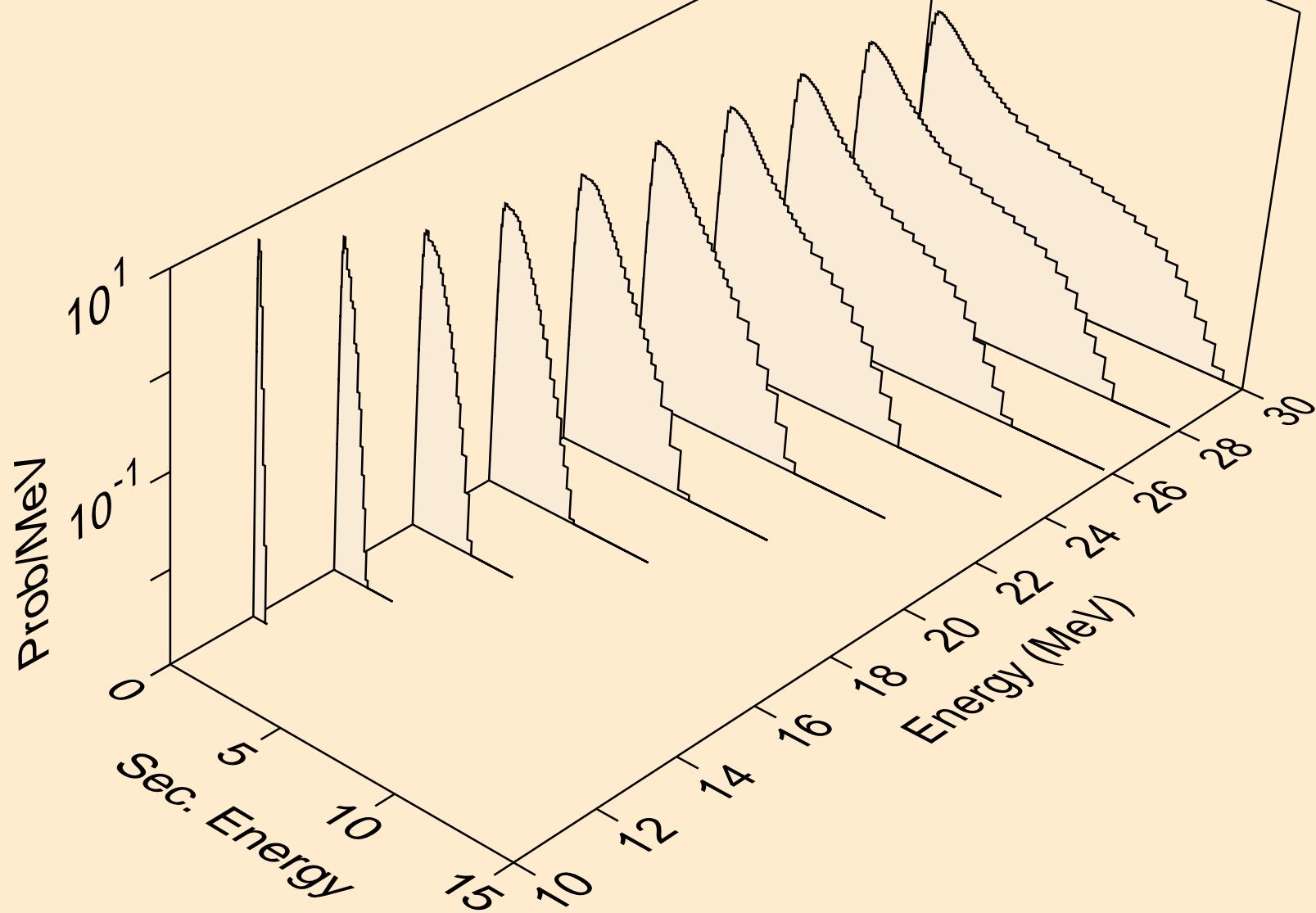

TM150 NEUTRON ACER TENDL-2021 LIBRARY; T=293.6K  
Neutron emission for (n,3np)

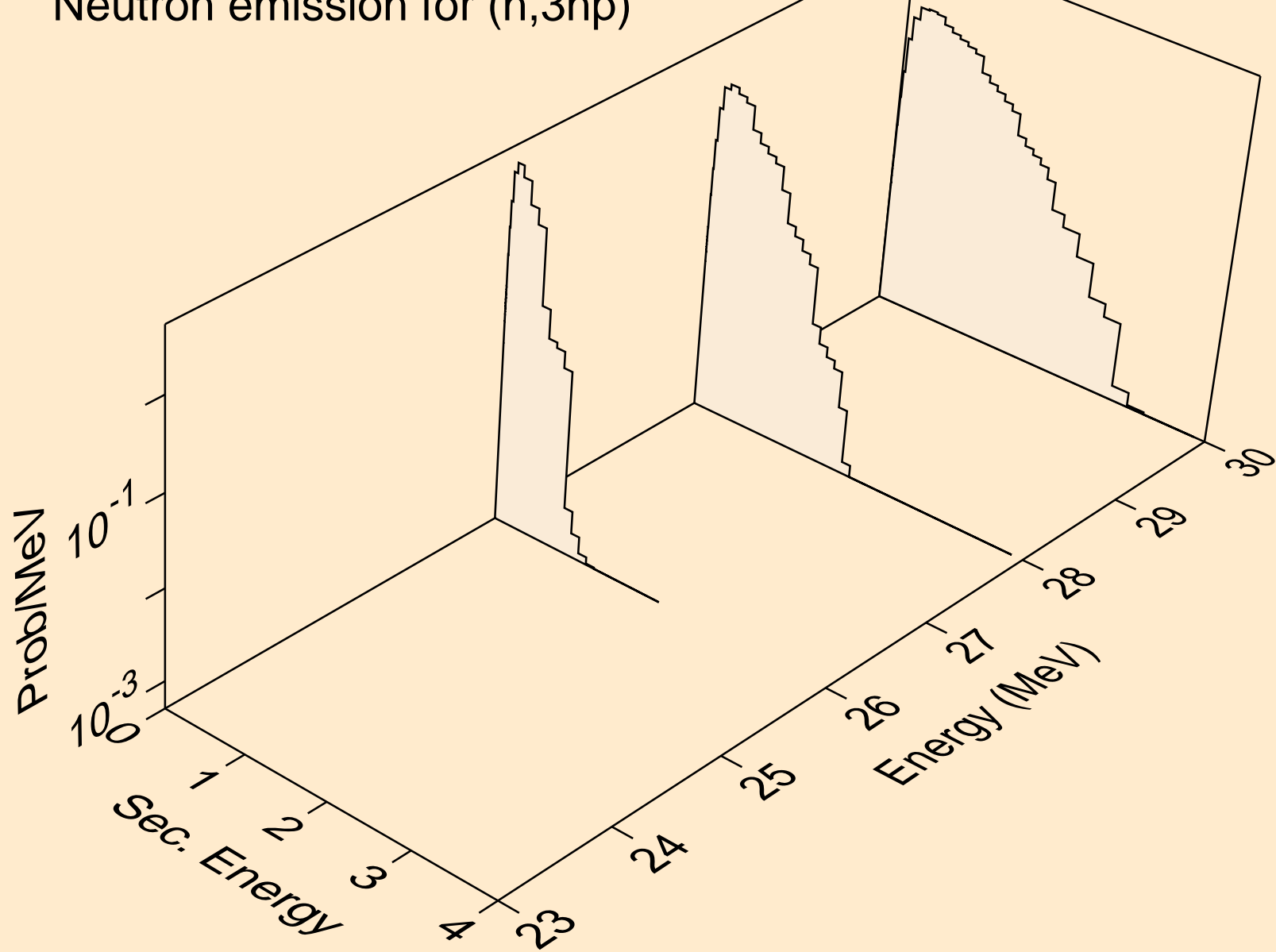



TM150 NEUTRON ACER TENDL-2021 LIBRARY; T=293.6K  
Neutron emission for (n,2np)

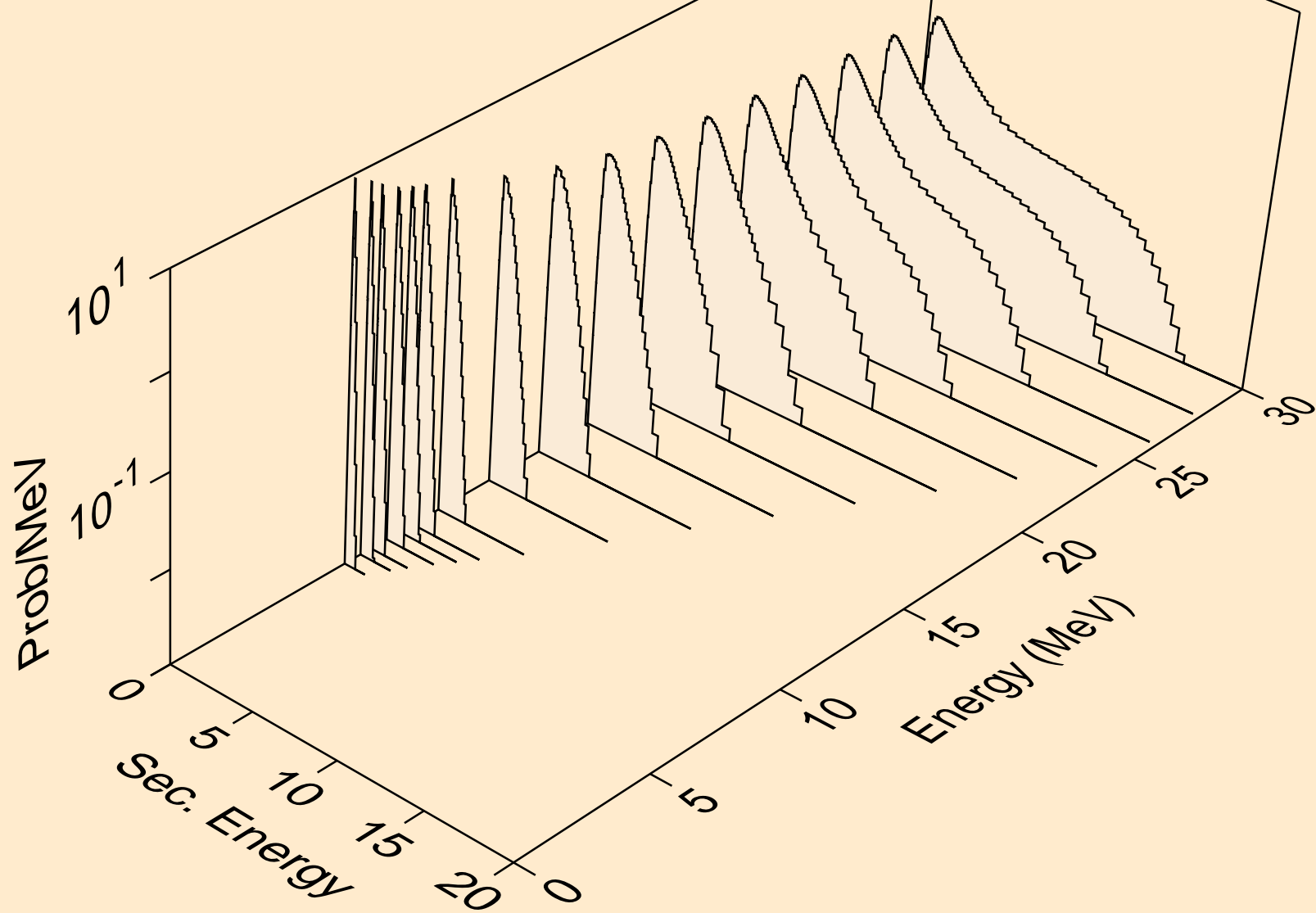

TM150 NEUTRON ACER TENDL-2021 LIBRARY; T=293.6K  
Neutron emission for (n,npa)

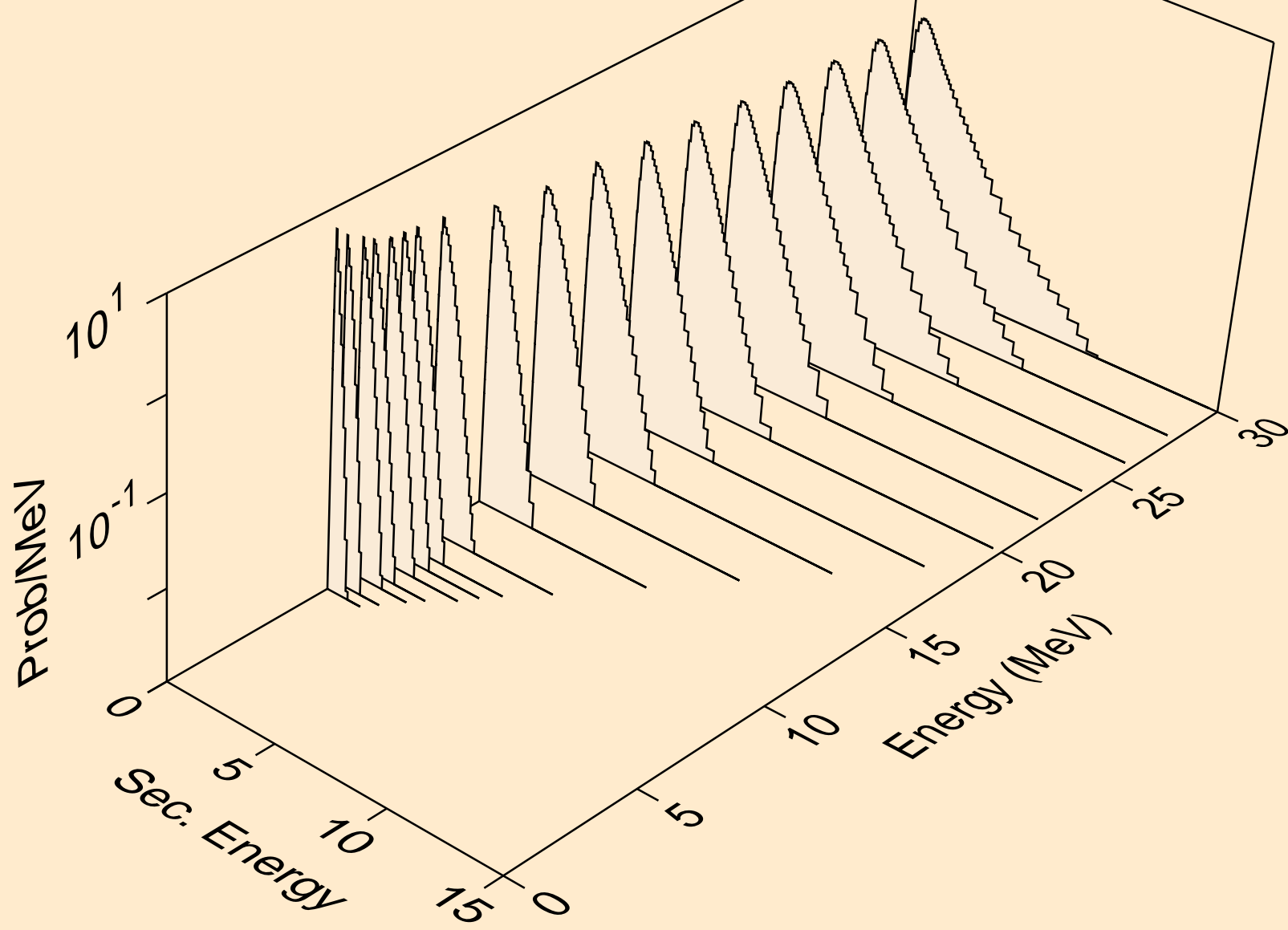

TM150 NEUTRON ACER TENDL-2021 LIBRARY; T=293.6K  
Neutron emission for (n,n\*c)

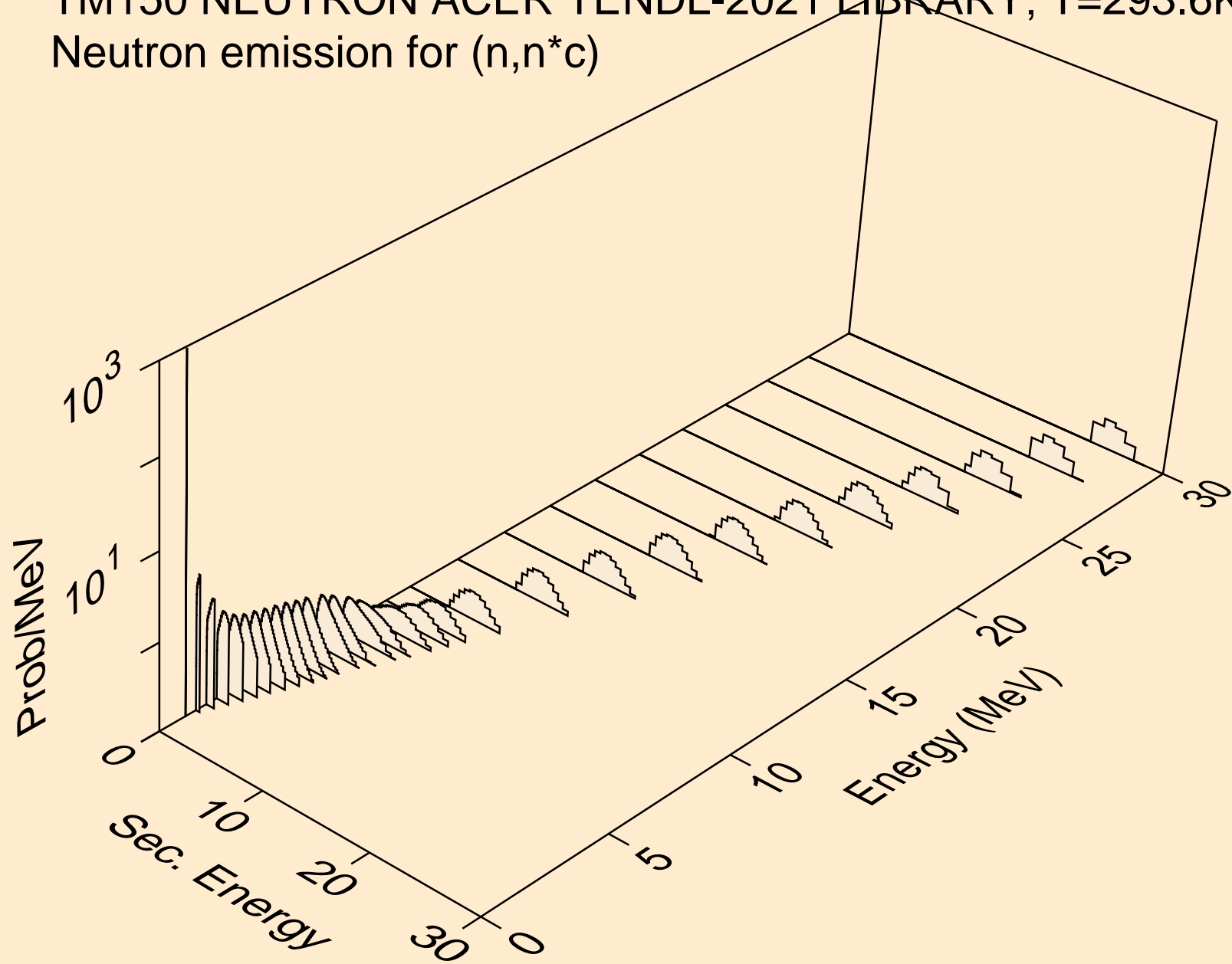

TM150 NEUTRON ACER TENDL-2021 LIBRARY; T=293.6K  
Photon emission for (n,x)

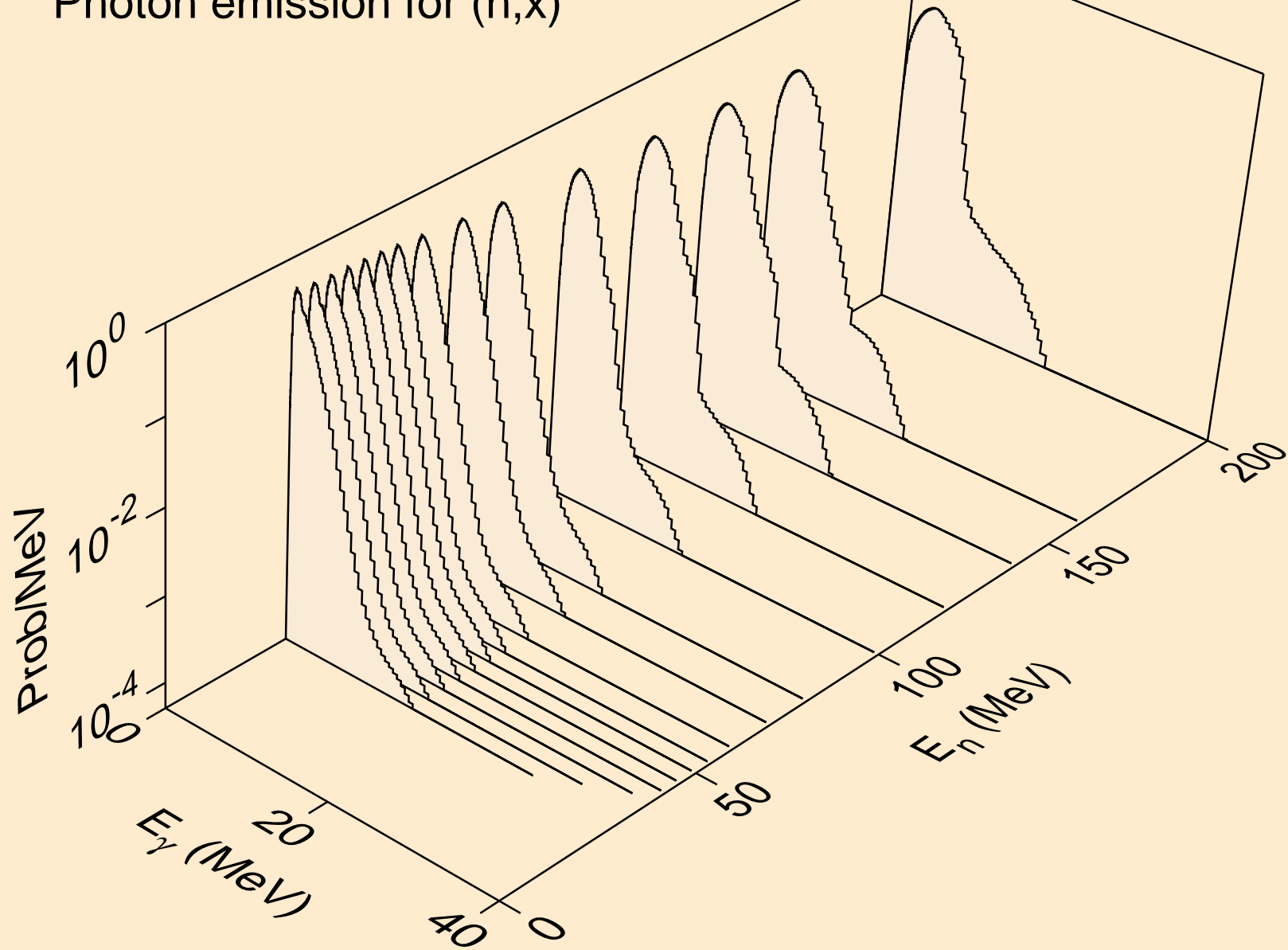

TM150 NEUTRON ACER TENDL-2021 LIBRARY; T=293.6K  
Photon emission for (n,2nd)

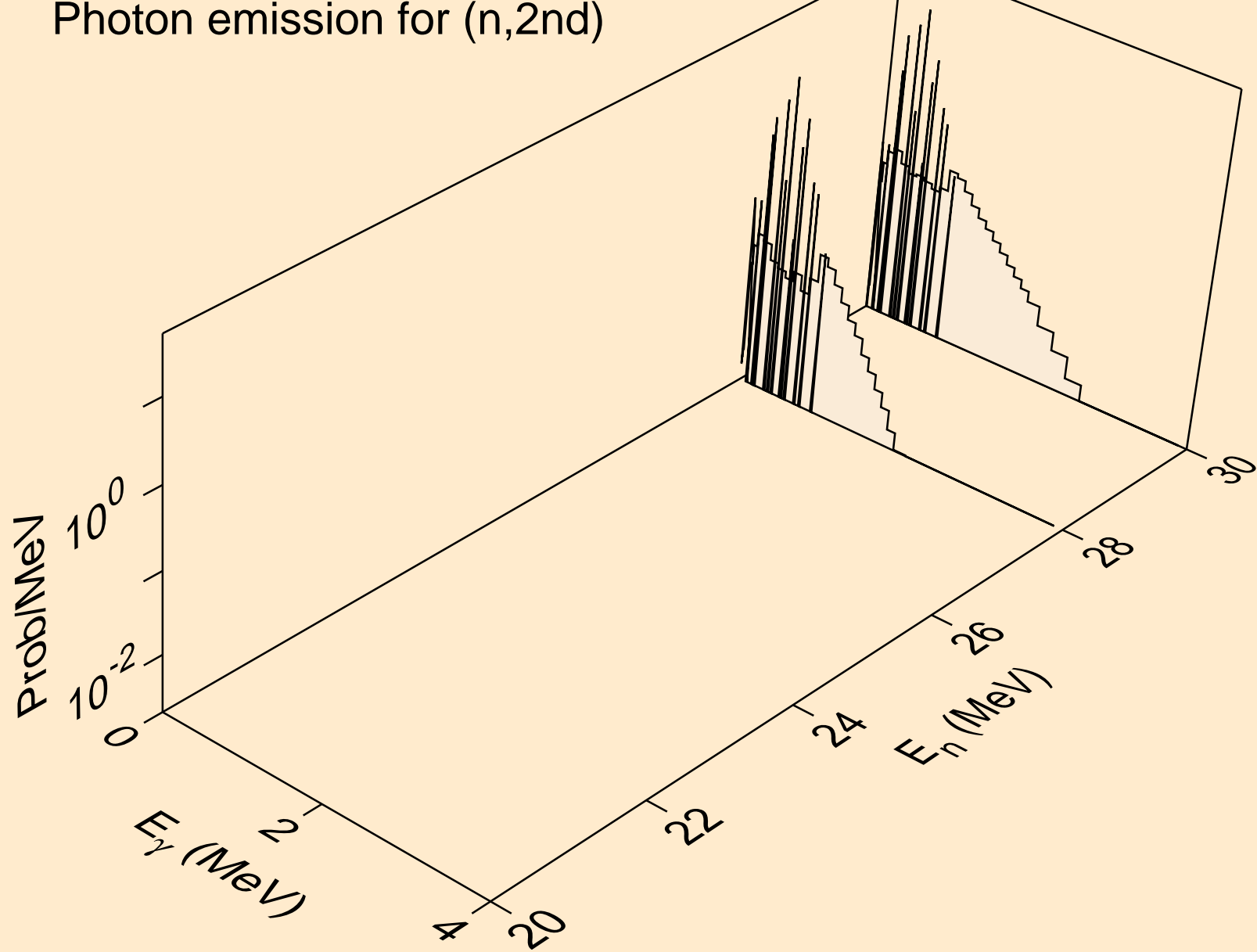

TM150 NEUTRON ACER TENDL-2021 LIBRARY; T=293.6K  
Photon emission for (n,2n)

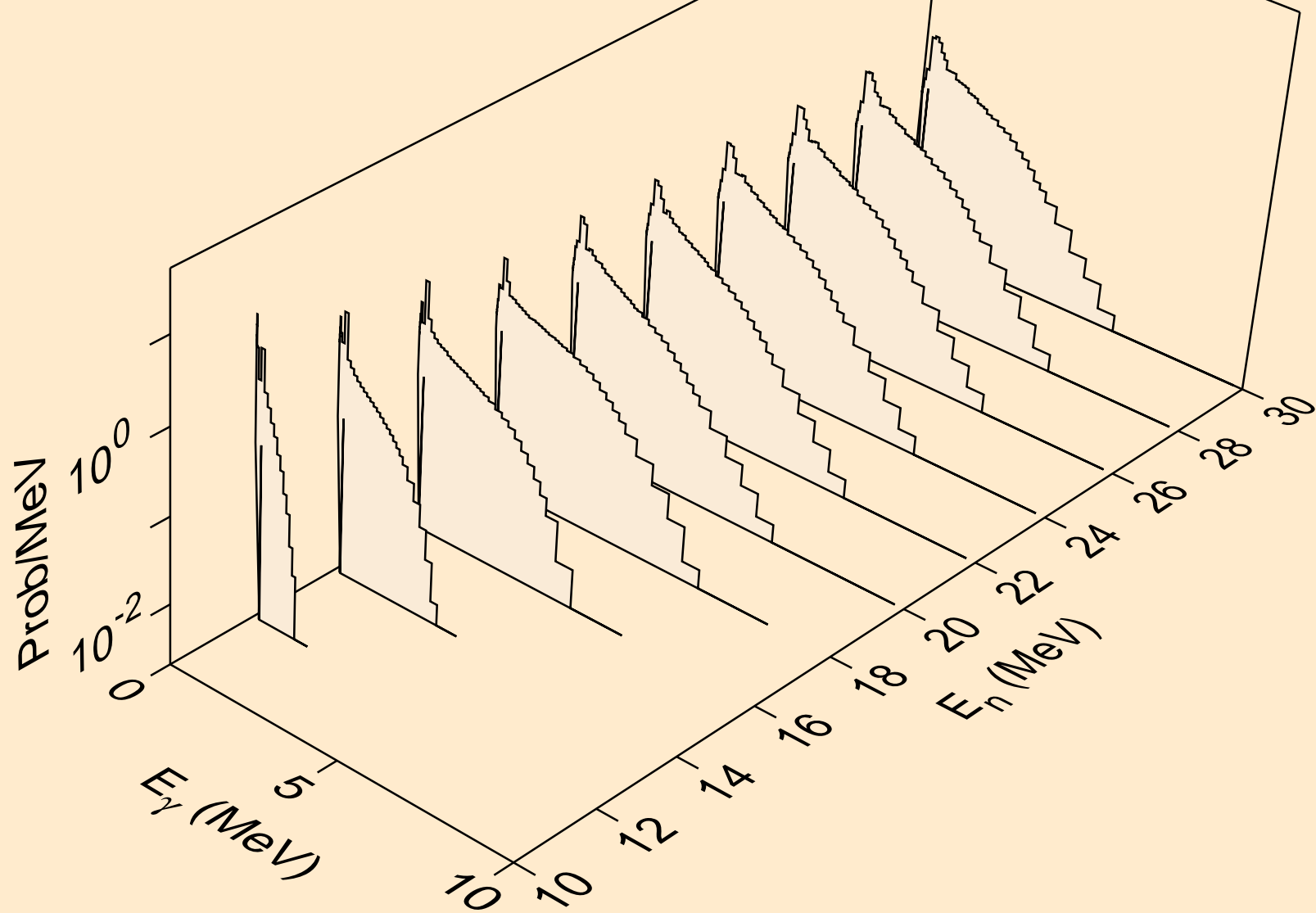

TM150 NEUTRON ACER TENDL-2021 LIBRARY; T=293.6K  
Photon emission for (n,3n)

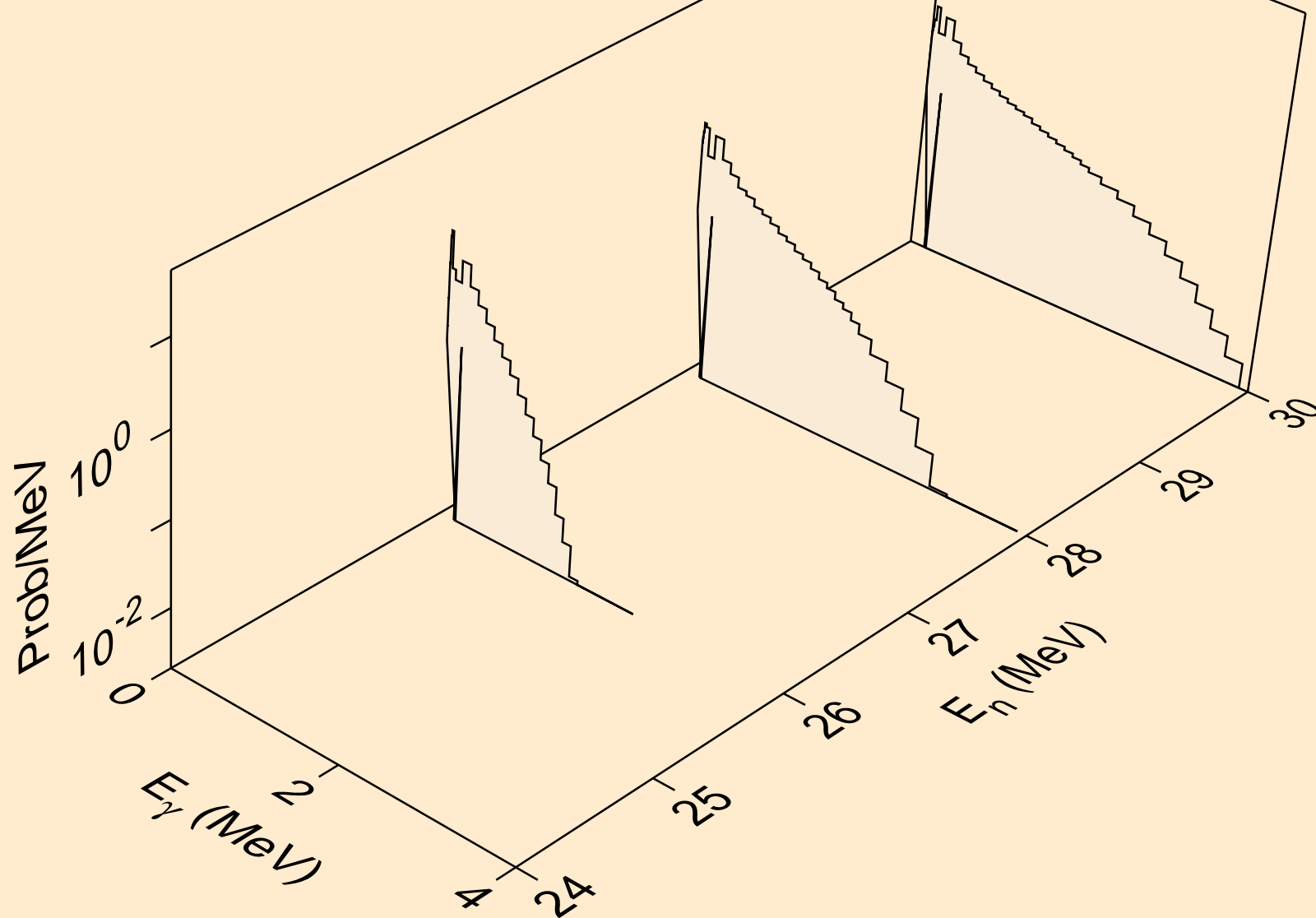

TM150 NEUTRON ACER TENDL-2021 LIBRARY; T=293.6K  
Photon emission for (n,n\*)a

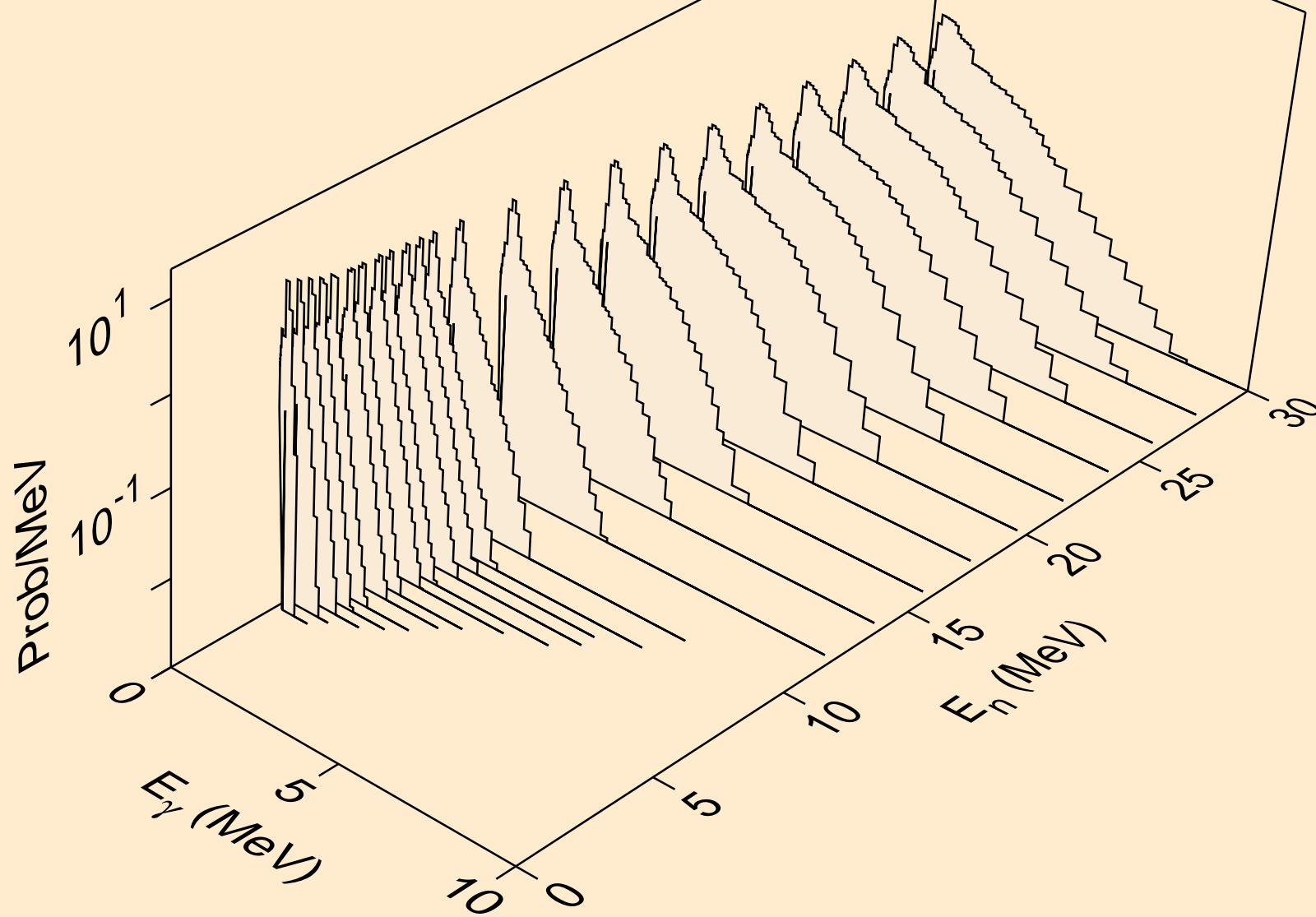



TM150 NEUTRON ACER TENDL-2021 LIBRARY; T=293.6K  
Photon emission for (n,2n)a

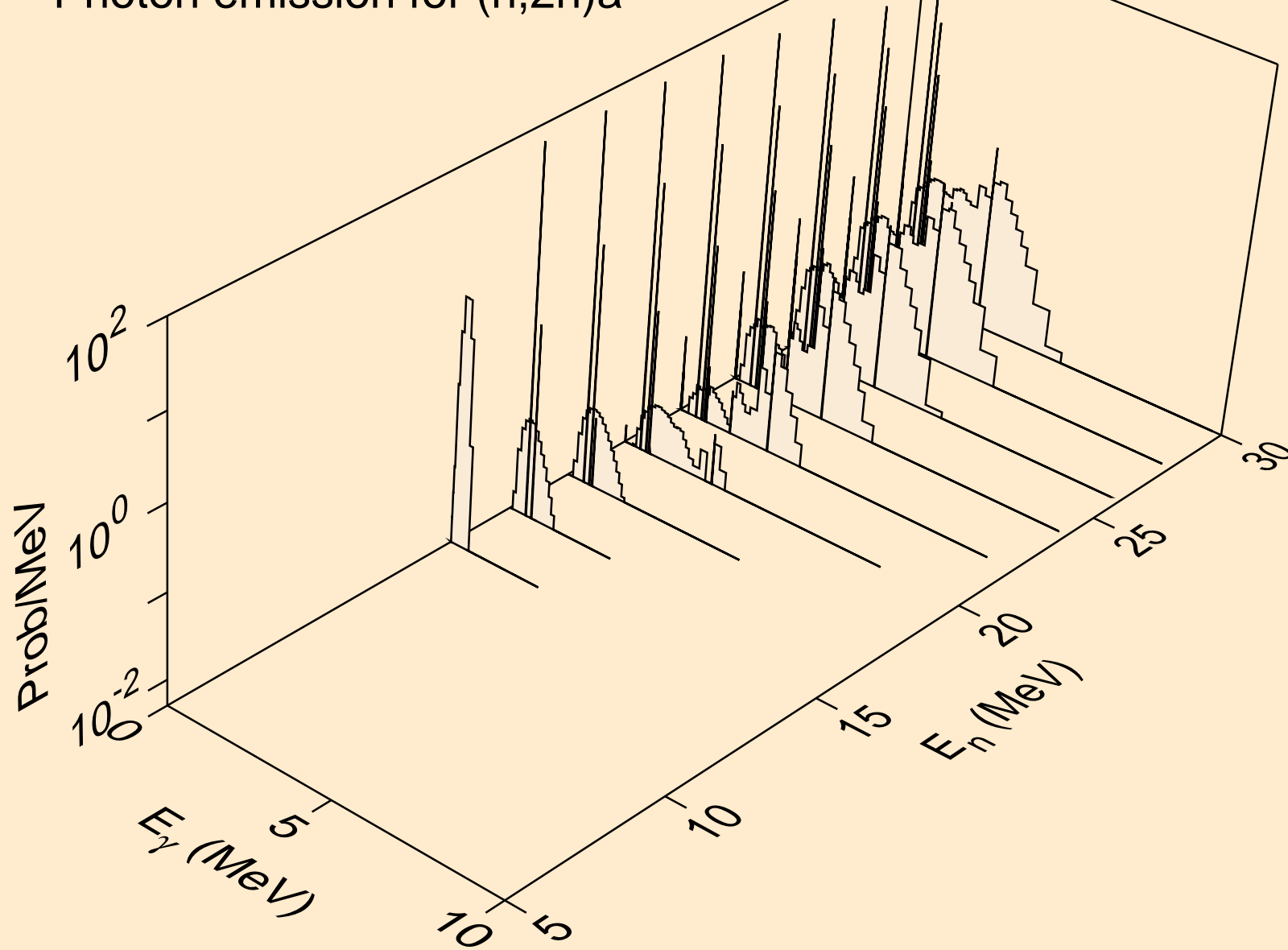

TM150 NEUTRON ACER TENDL-2021 LIBRARY; T=293.6K  
Photon emission for (n,n\*)p

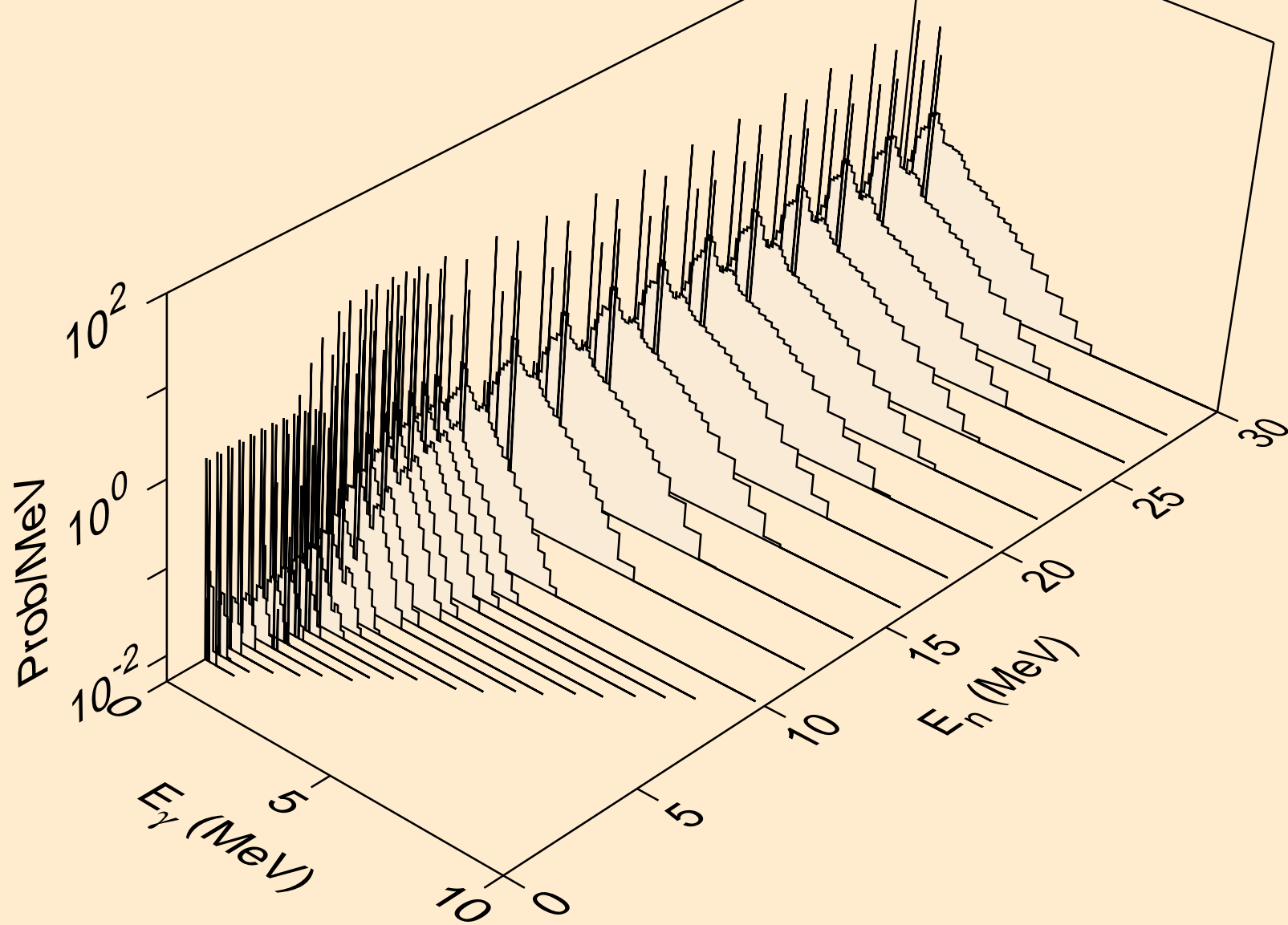

TM150 NEUTRON ACER TENDL-2021 LIBRARY; T=293.6K  
Photon emission for (n,n\*)2a

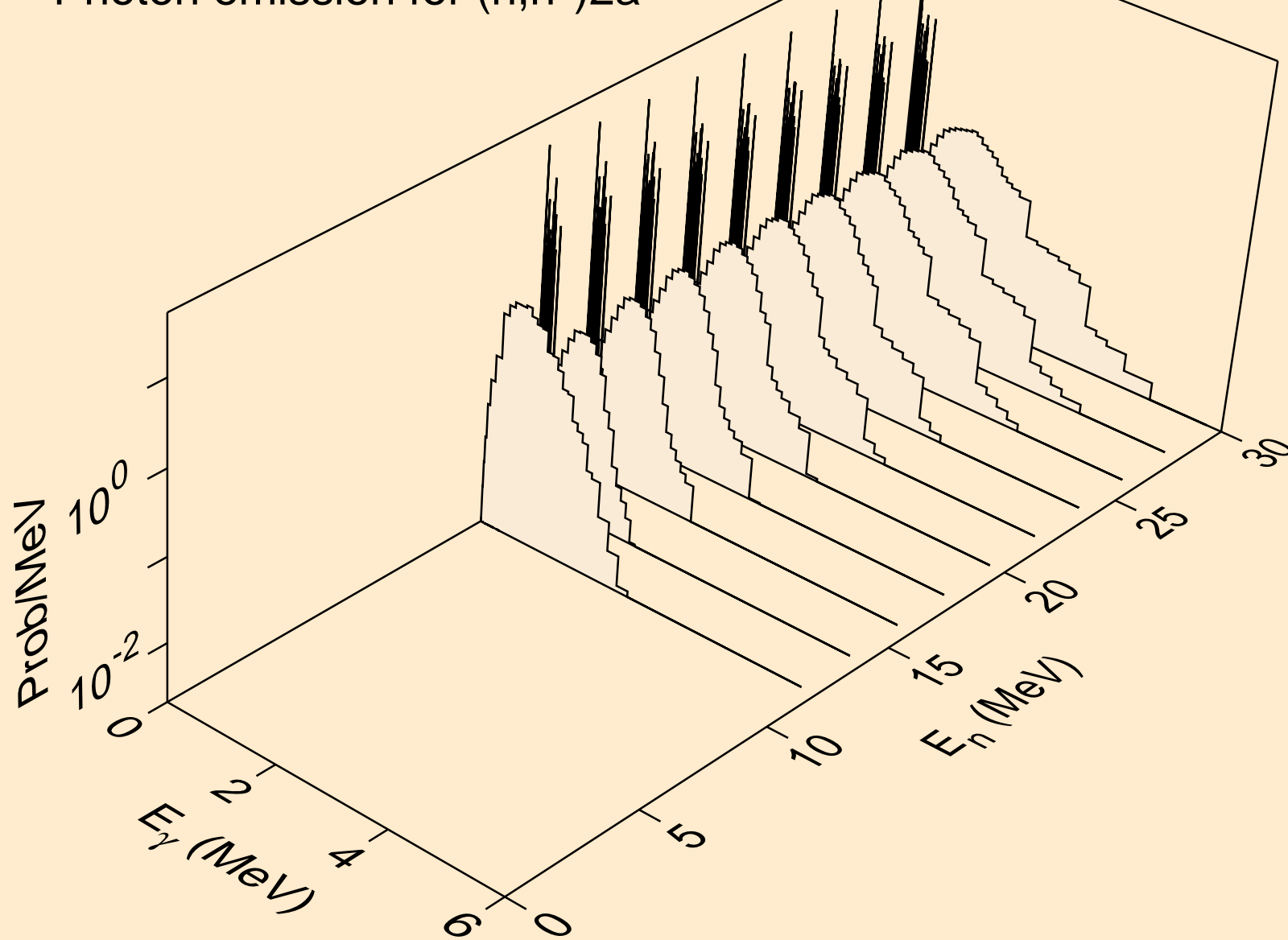

TM150 NEUTRON ACER TENDL-2021 LIBRARY; T=293.6K  
Photon emission for (n,n\*)d

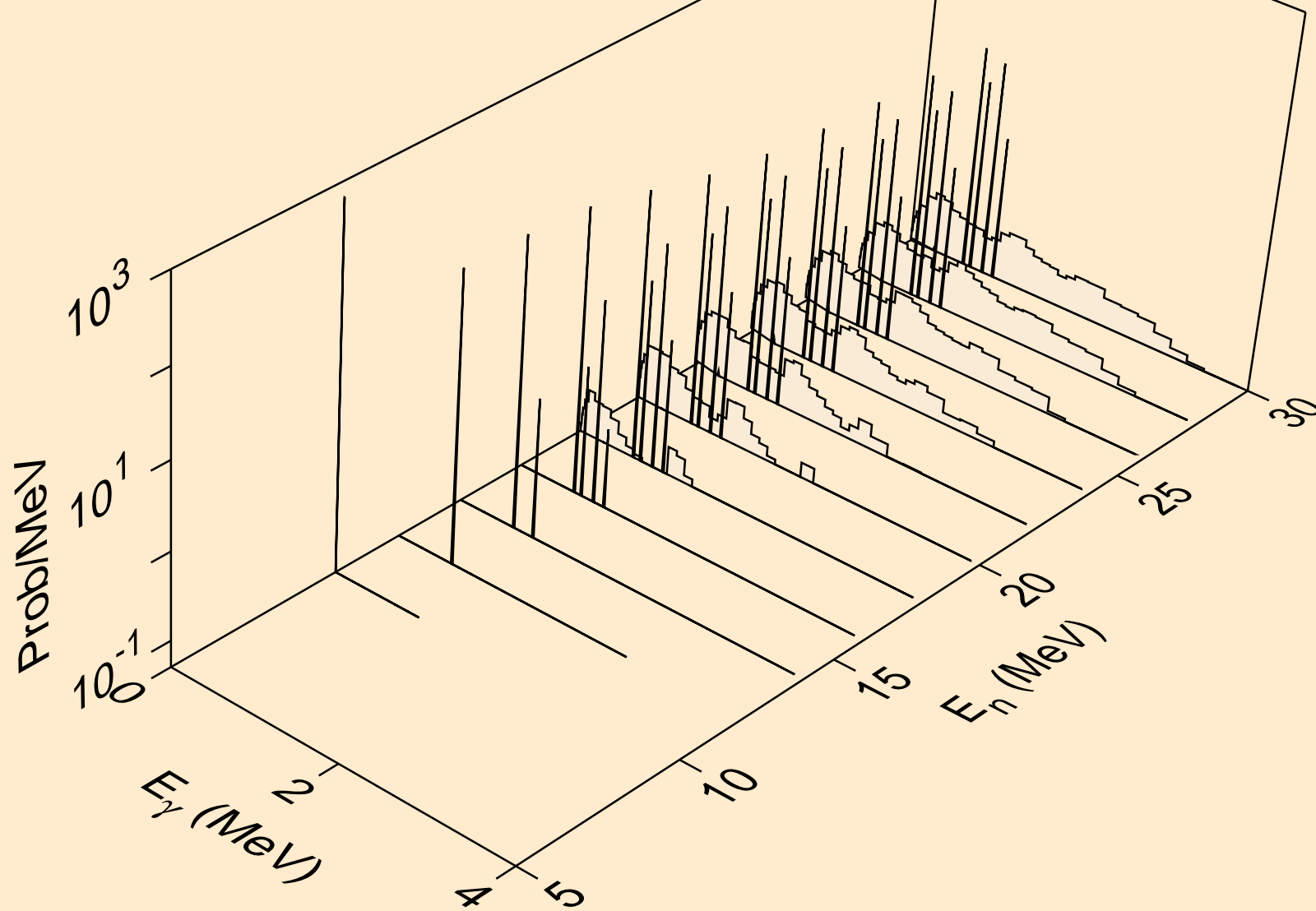

TM150 NEUTRON ACER TENDL-2021 LIBRARY; T=293.6K  
Photon emission for (n,n\*)t

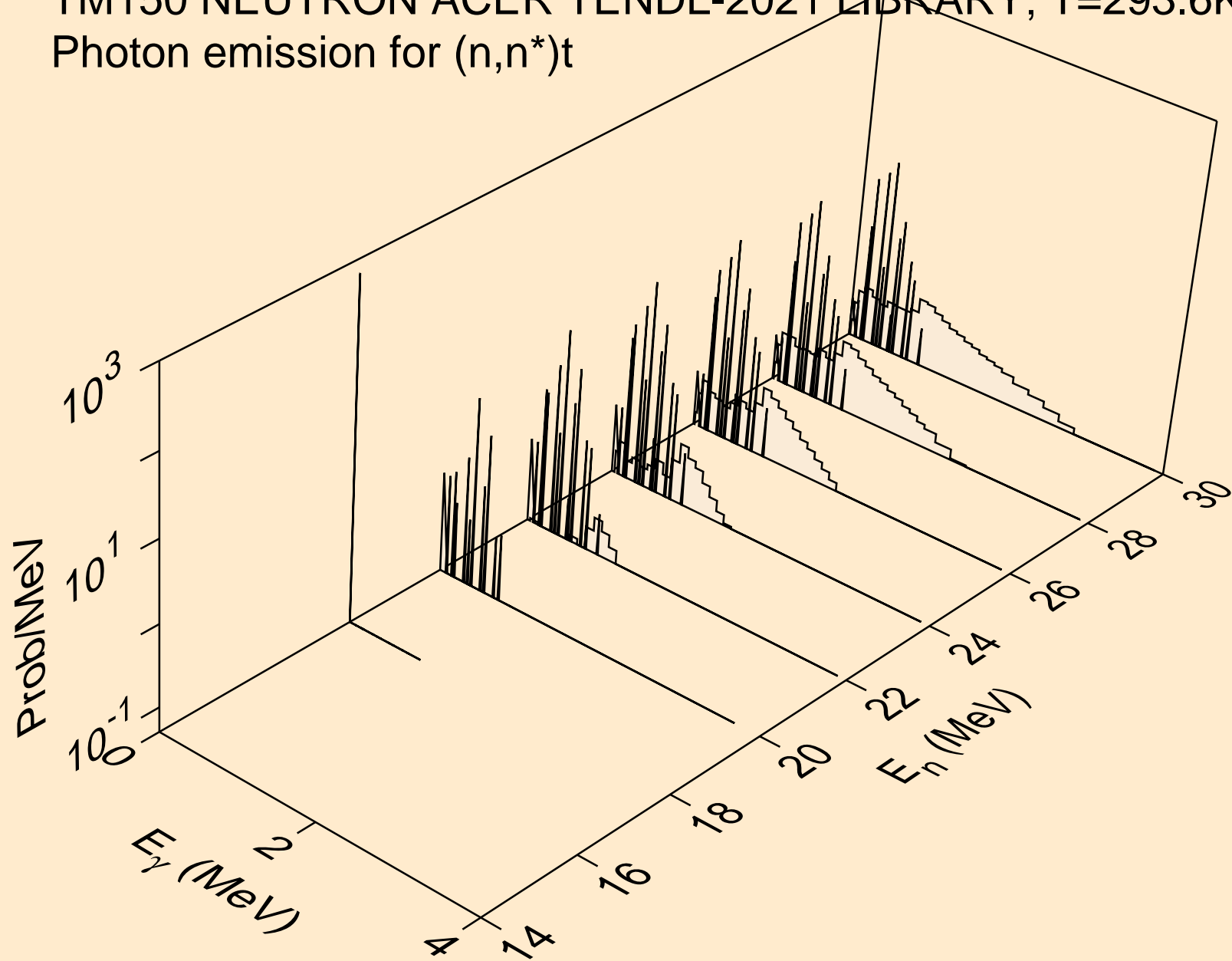

TM150 NEUTRON ACER TENDL-2021 LIBRARY; T=293.6K  
Photon emission for (n,n\*)he3

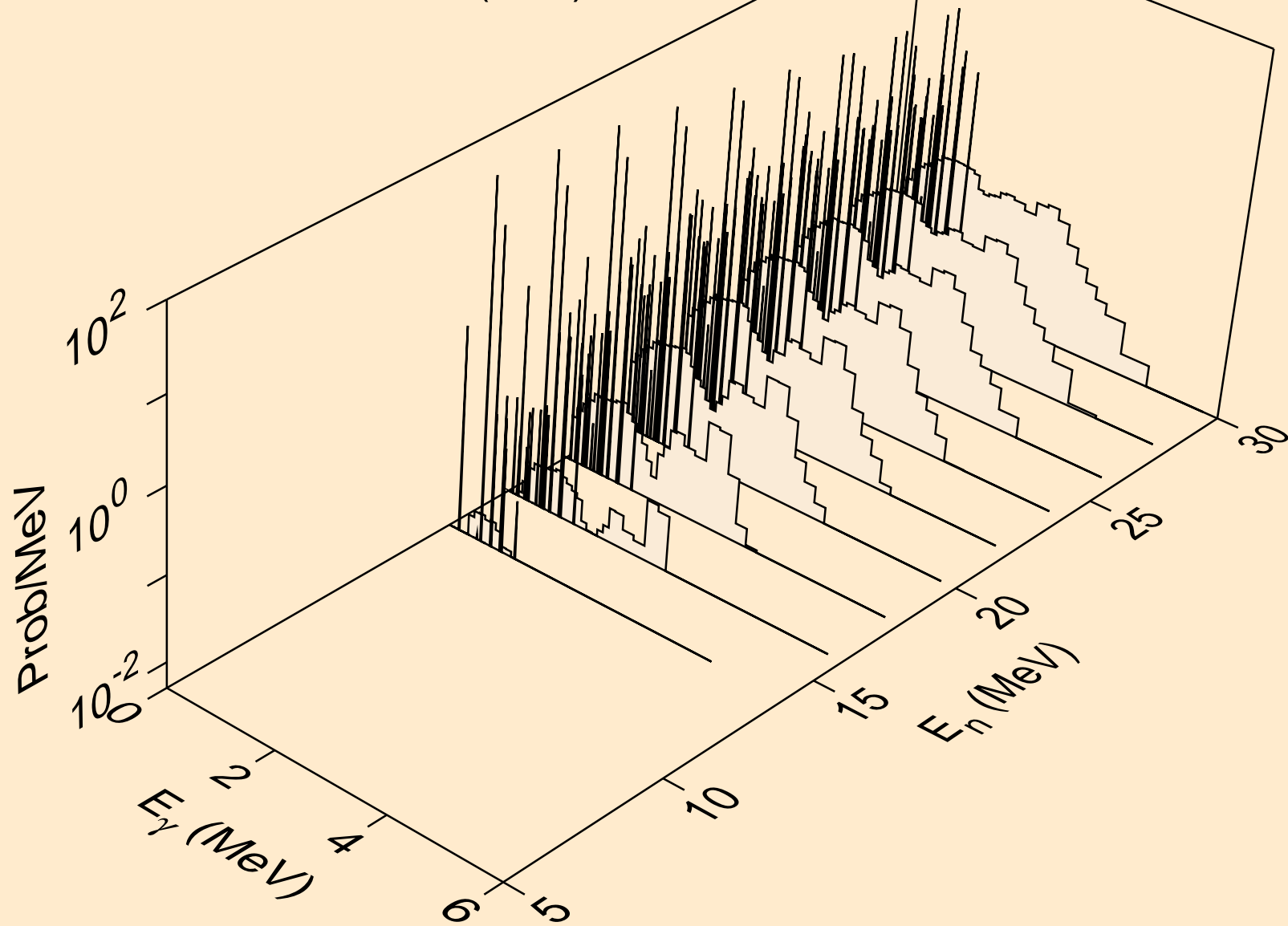

TM150 NEUTRON ACER TENDL-2021 LIBRARY; T=293.6K  
Photon emission for (n,2np)

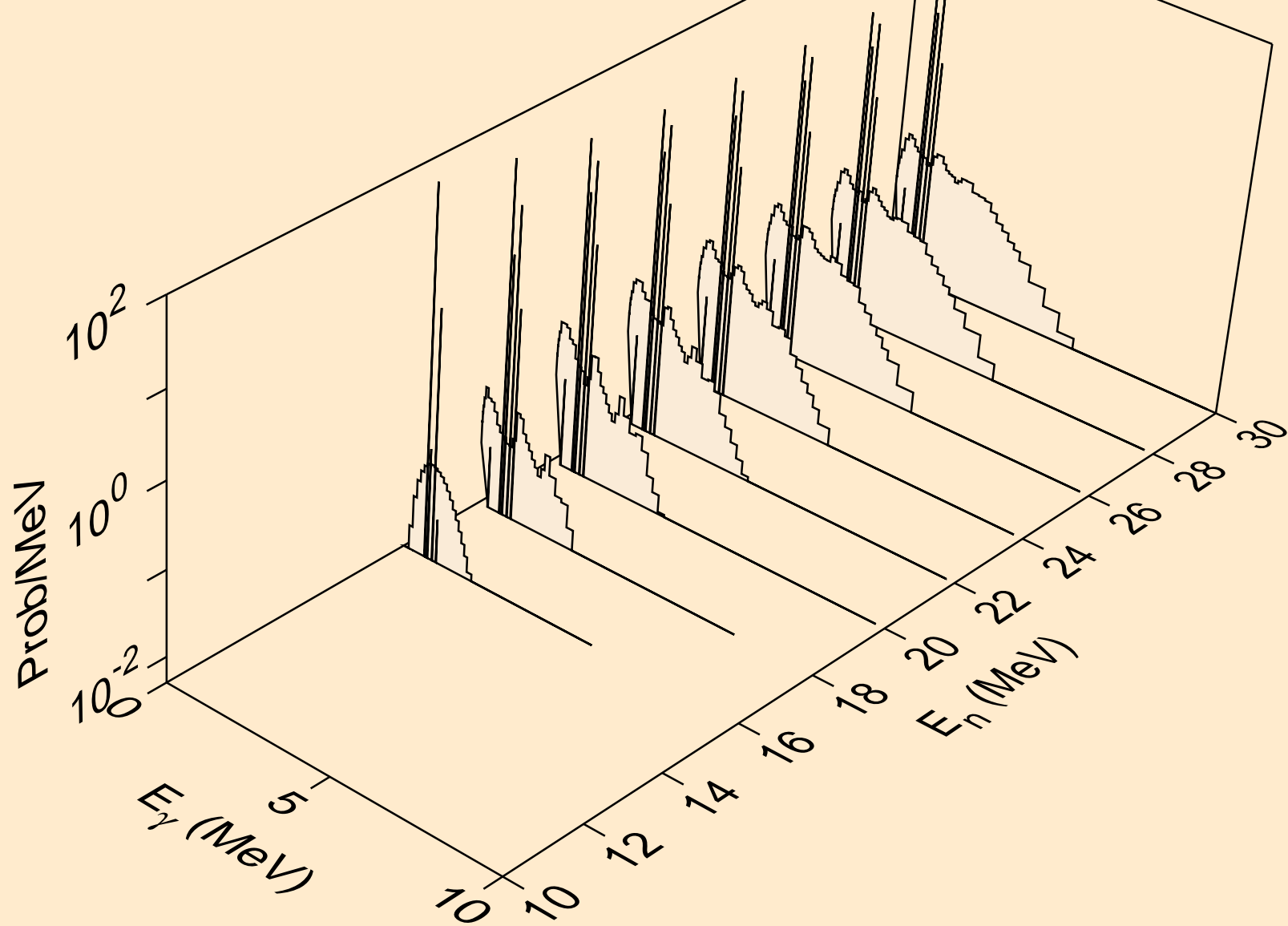

TM150 NEUTRON ACER TENDL-2021 LIBRARY; T=293.6K  
Photon emission for (n,3np)

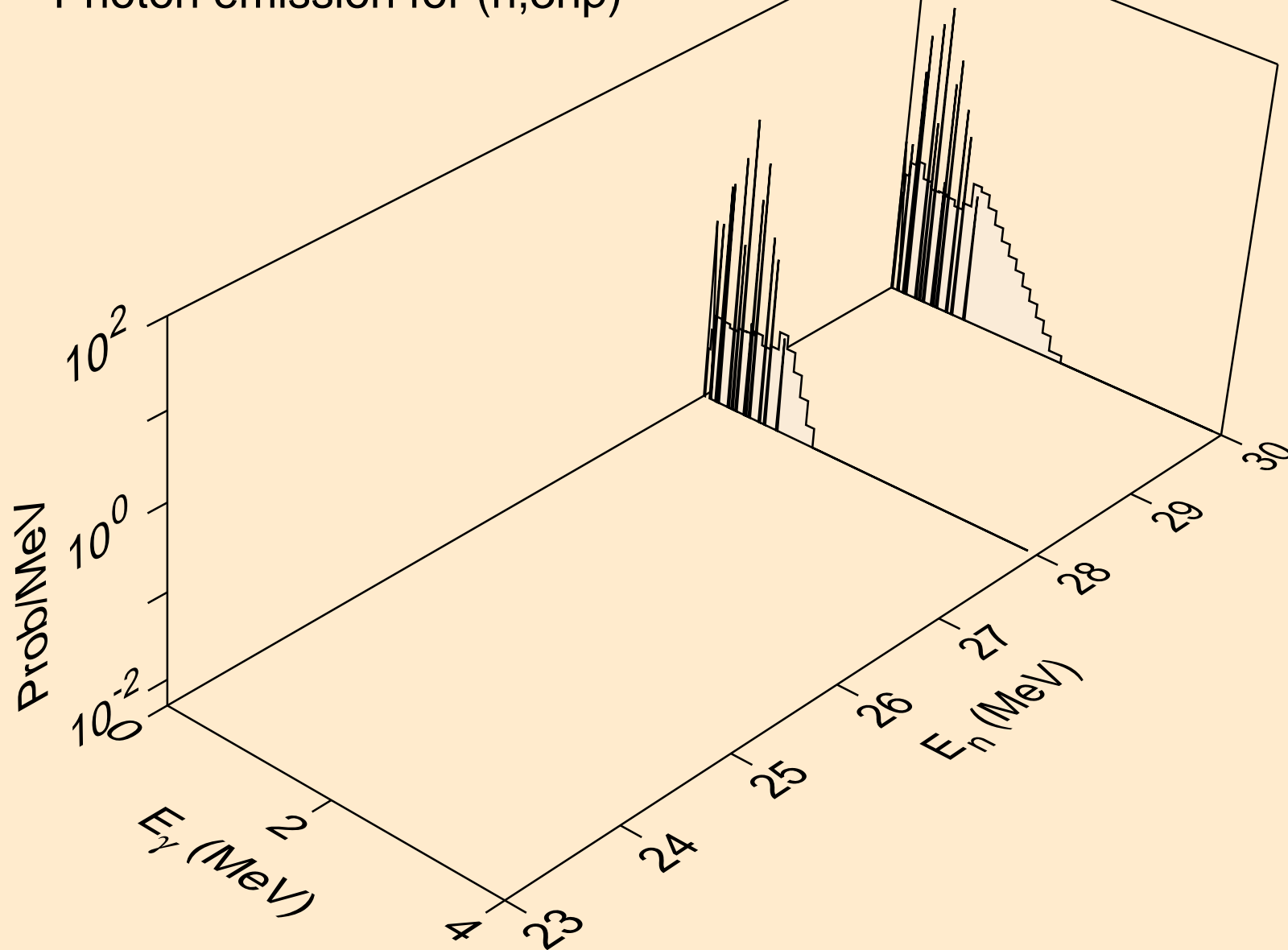



TM150 NEUTRON ACER TENDL-2021 LIBRARY; T=293.6K  
Photon emission for (n,2np)

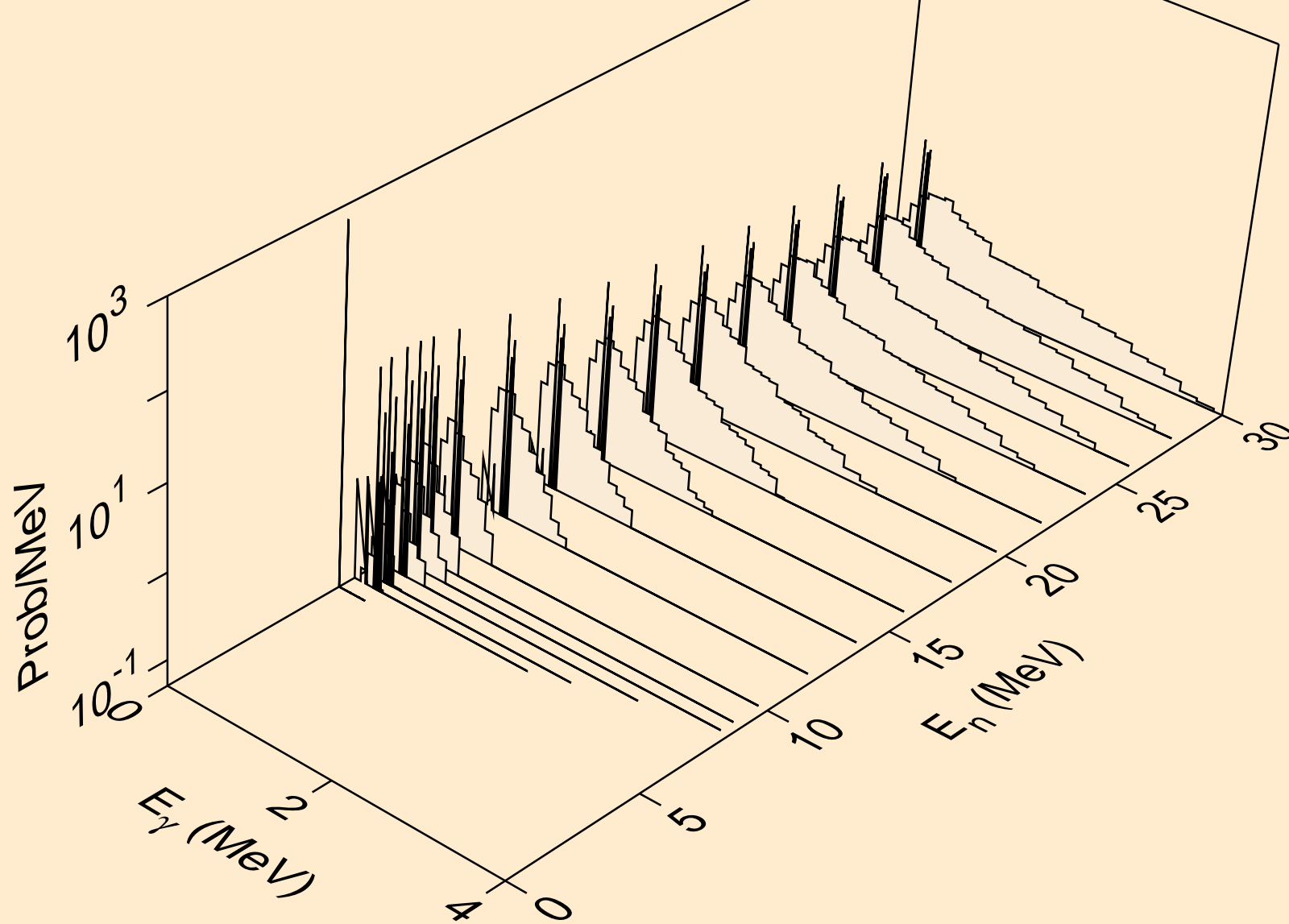

TM150 NEUTRON ACER TENDL-2021 LIBRARY; T=293.6K  
Photon emission for (n,npa)

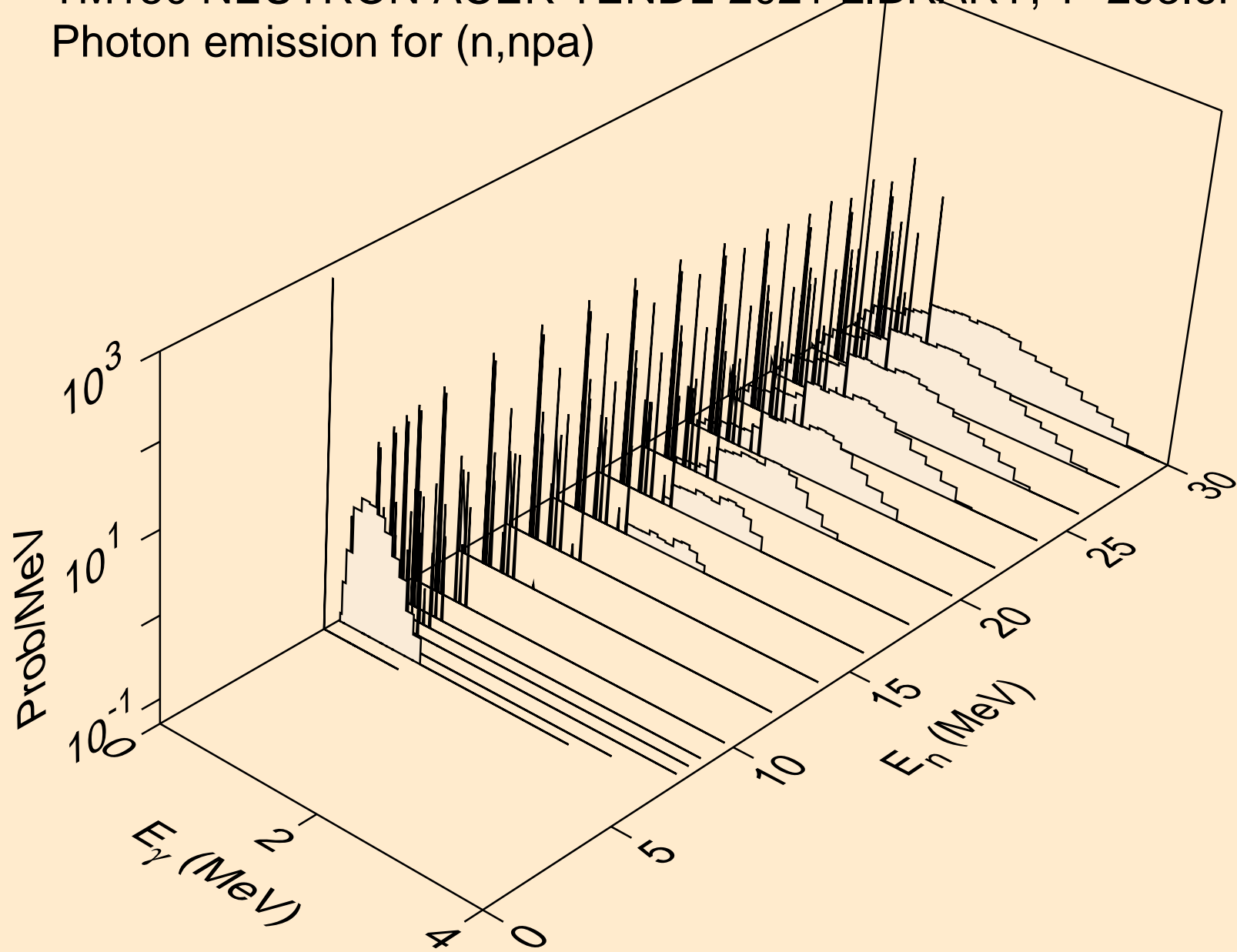

TM150 NEUTRON ACER TENDL-2021 LIBRARY; T=293.6K  
Photon emission for (n,n\*c)

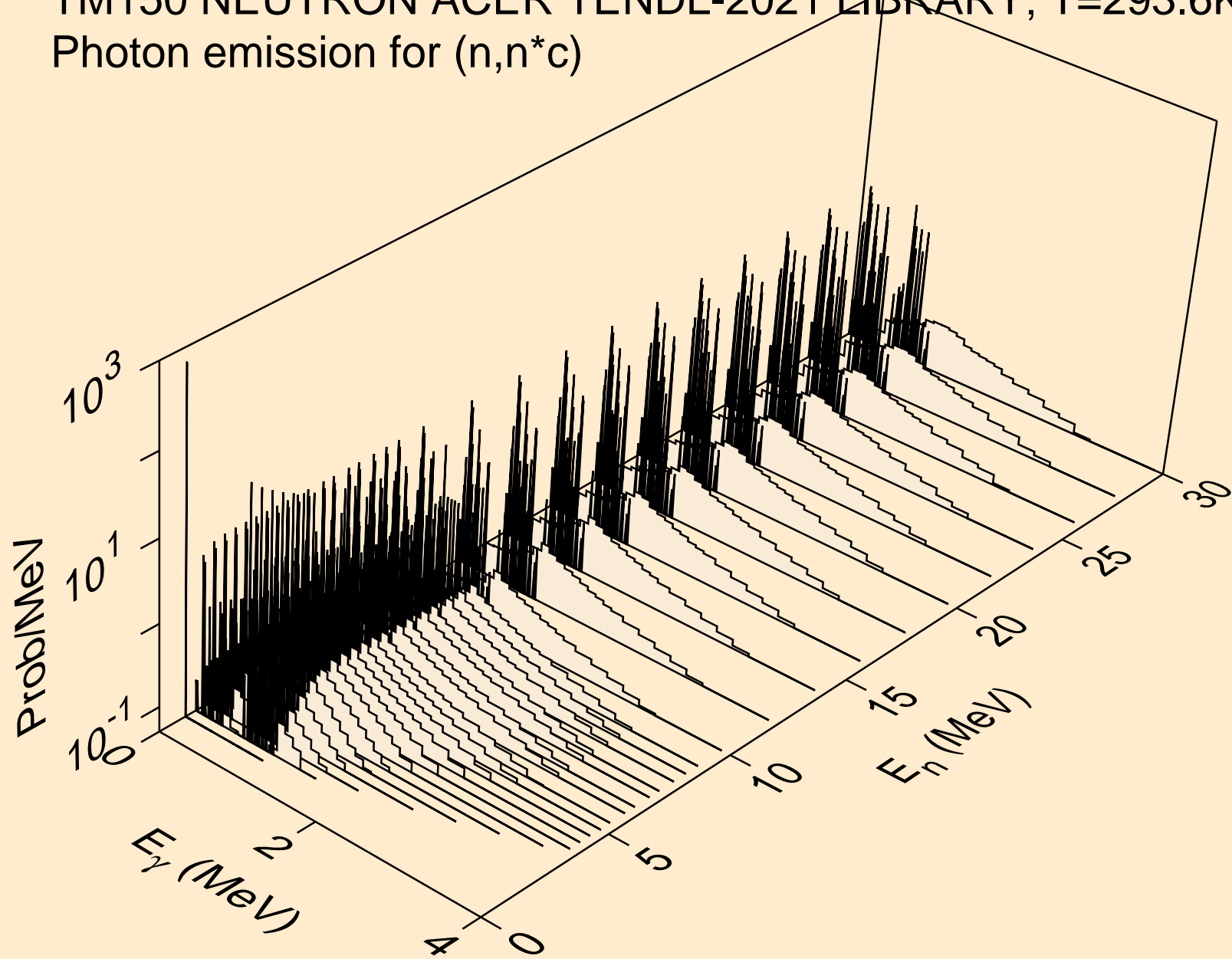

TM150 NEUTRON ACER TENDL-2021 LIBRARY; T=293.6K  
Photon emission for (n,gma)

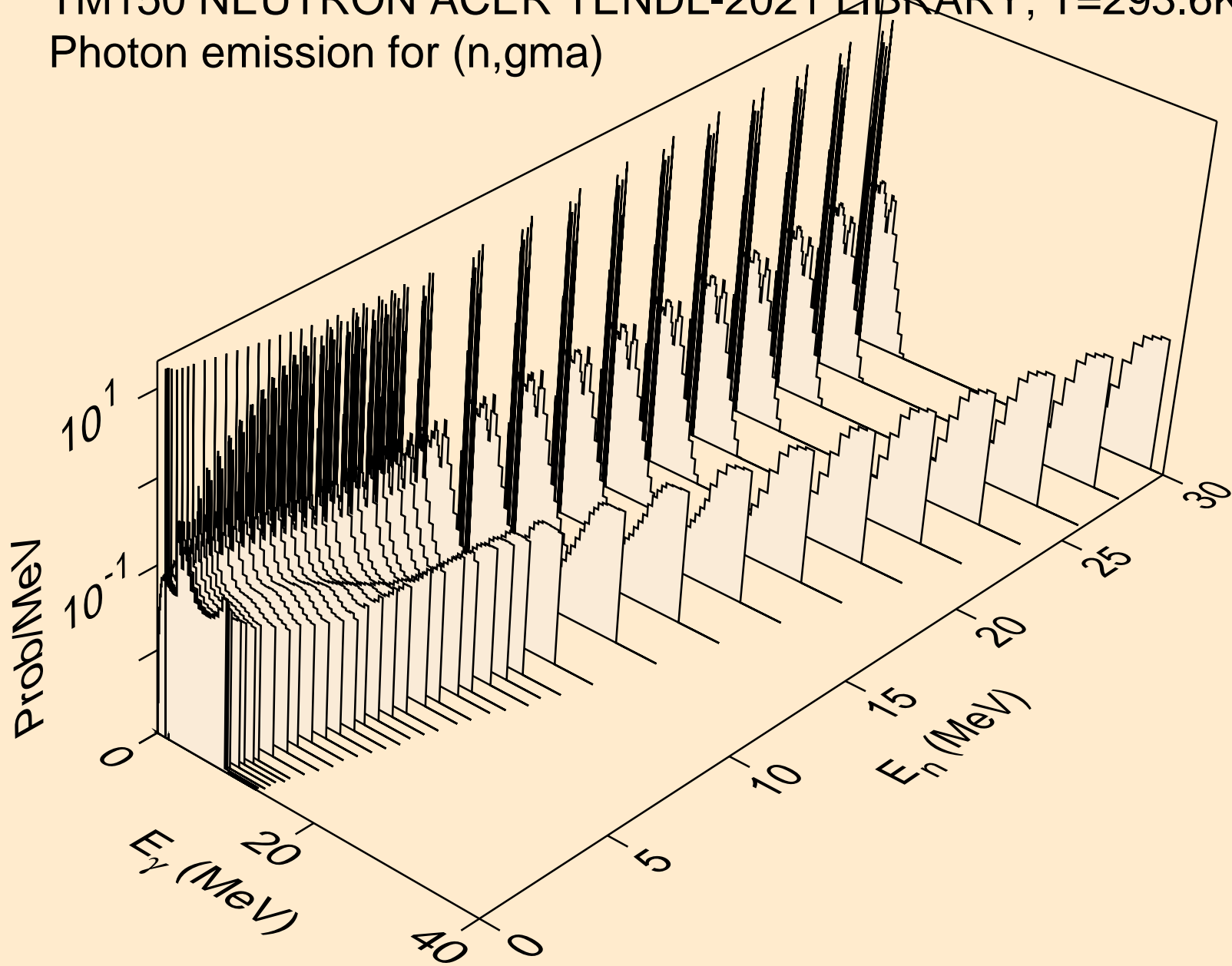

TM150 NEUTRON ACER TENDL-2021 LIBRARY; T=293.6K  
Photon emission for (n,p)

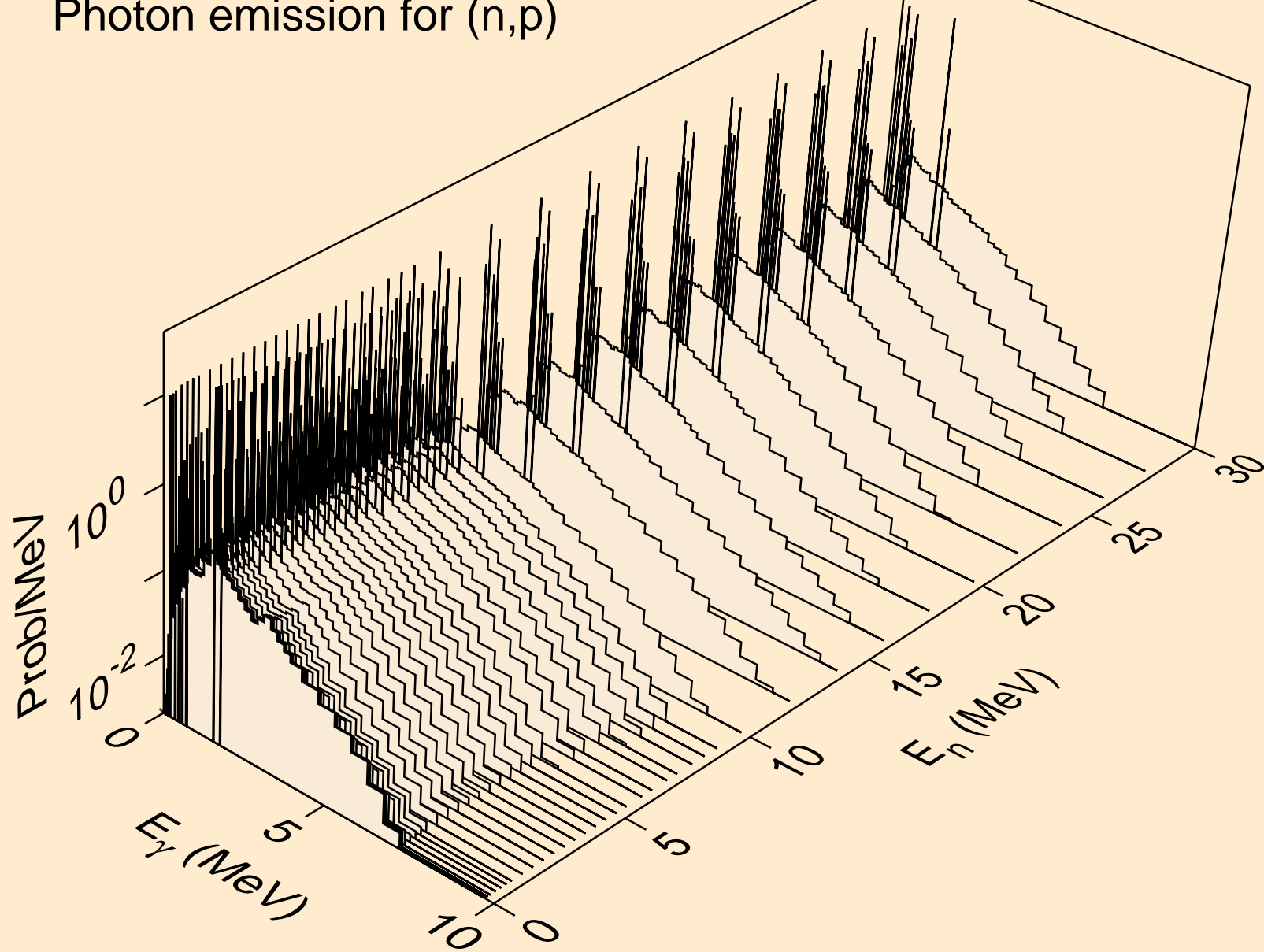

TM150 NEUTRON ACER TENDL-2021 LIBRARY; T=293.6K  
Photon emission for (n,d)

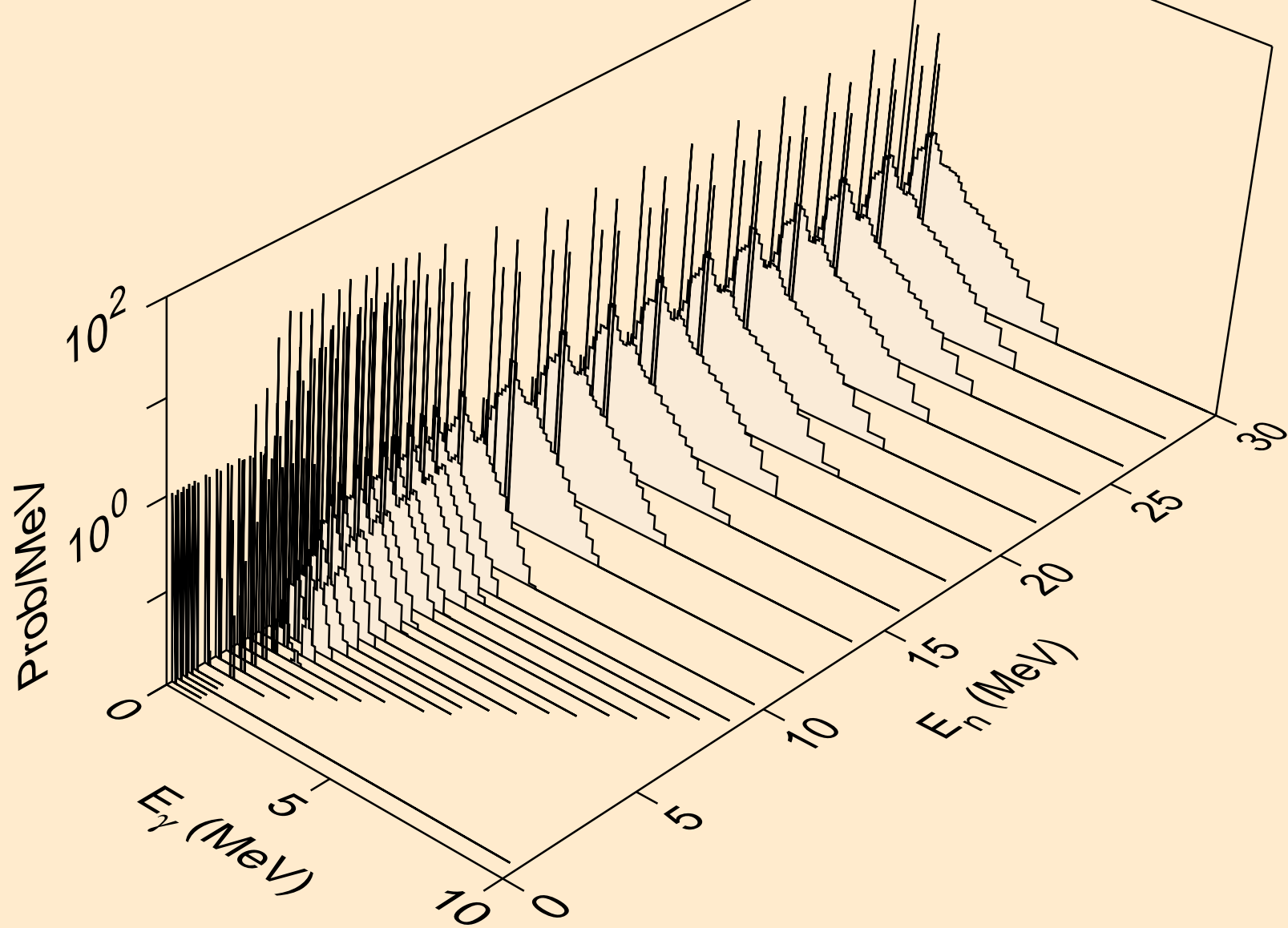

TM150 NEUTRON ACER TENDL-2021 LIBRARY; T=293.6K  
Photon emission for (n,t)

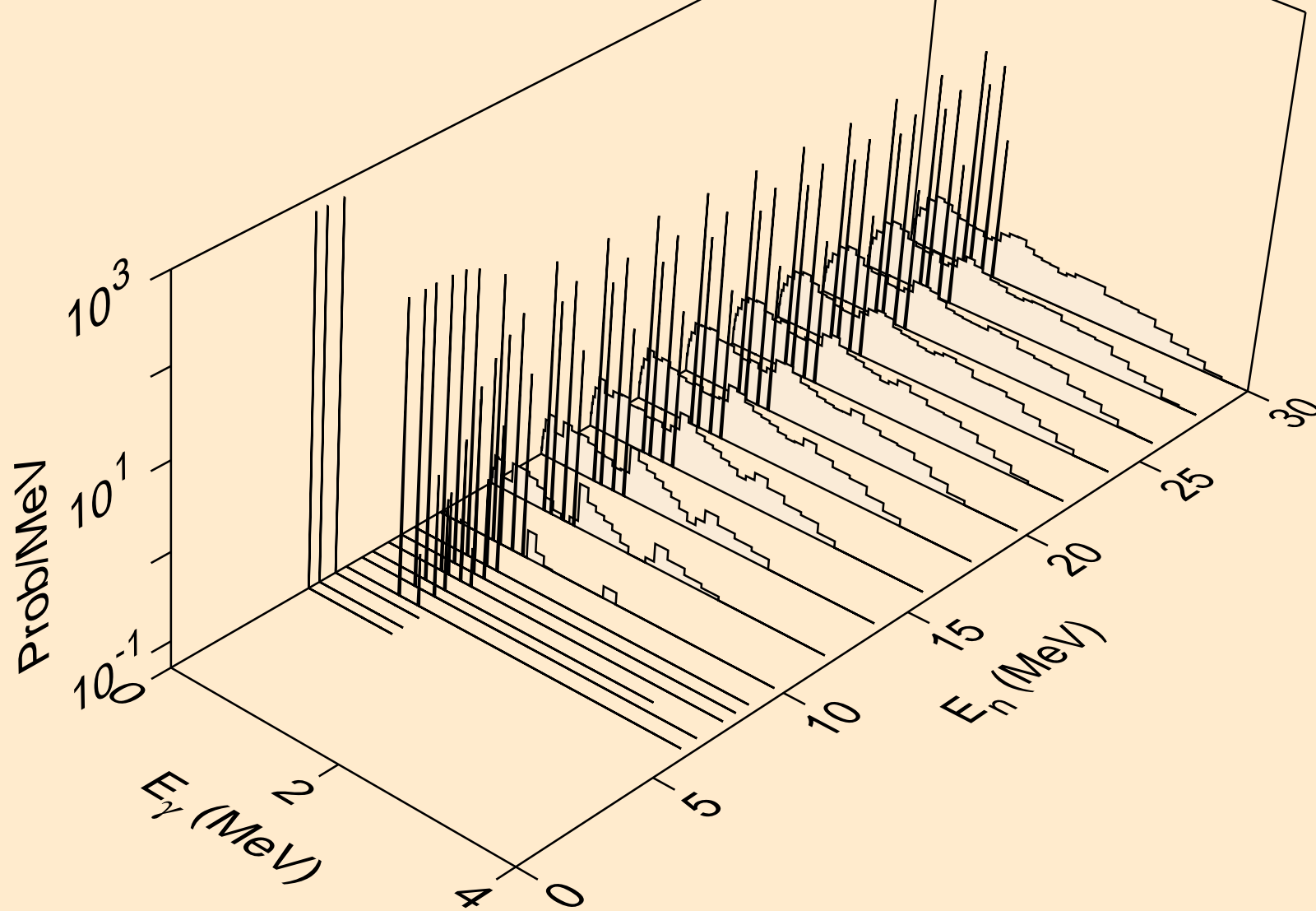

TM150 NEUTRON ACER TENDL-2021 LIBRARY; T=293.6K  
Photon emission for (n,he3)

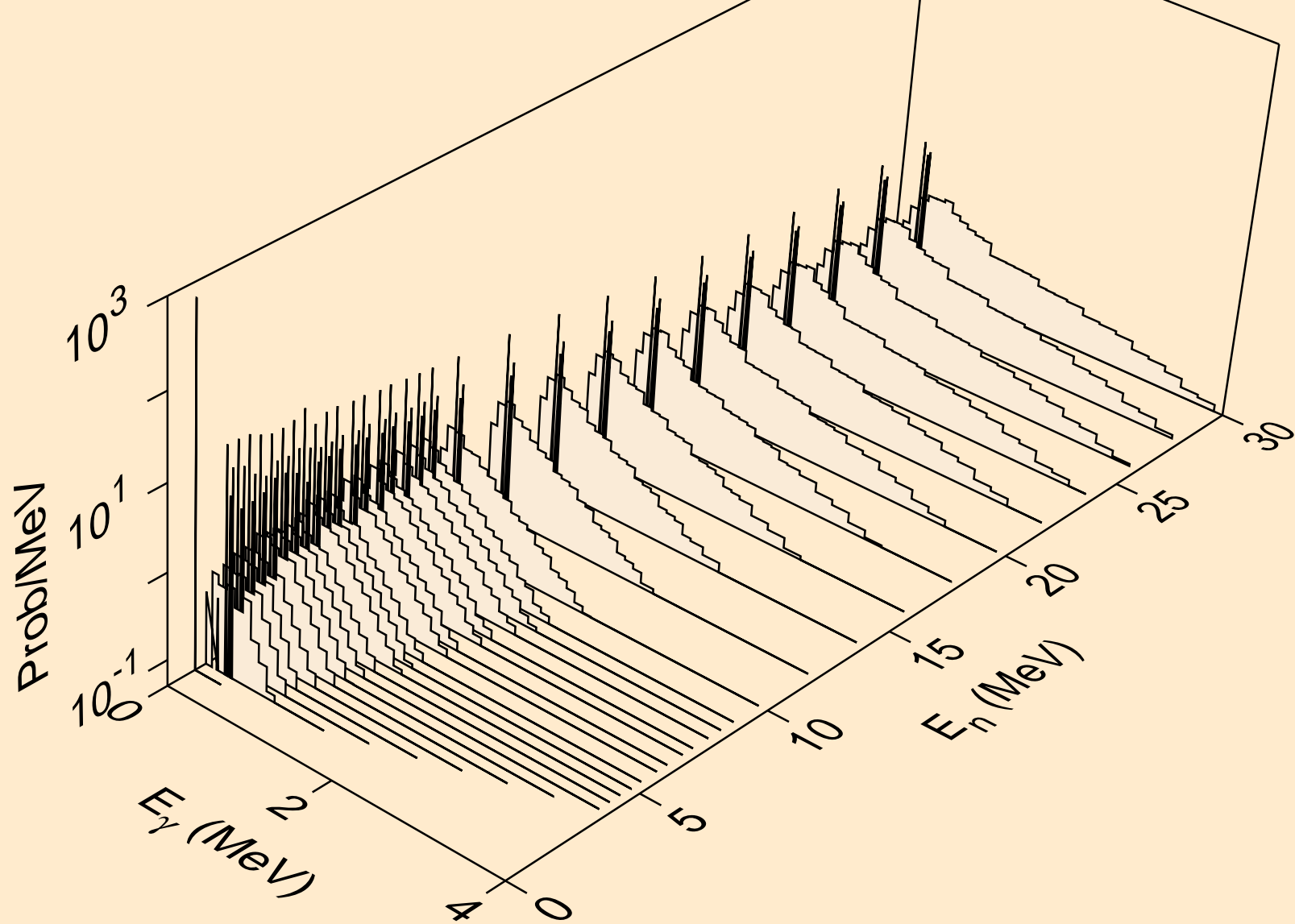



TM150 NEUTRON ACER TENDL-2021 LIBRARY; T=293.6K  
Photon emission for (n,a)

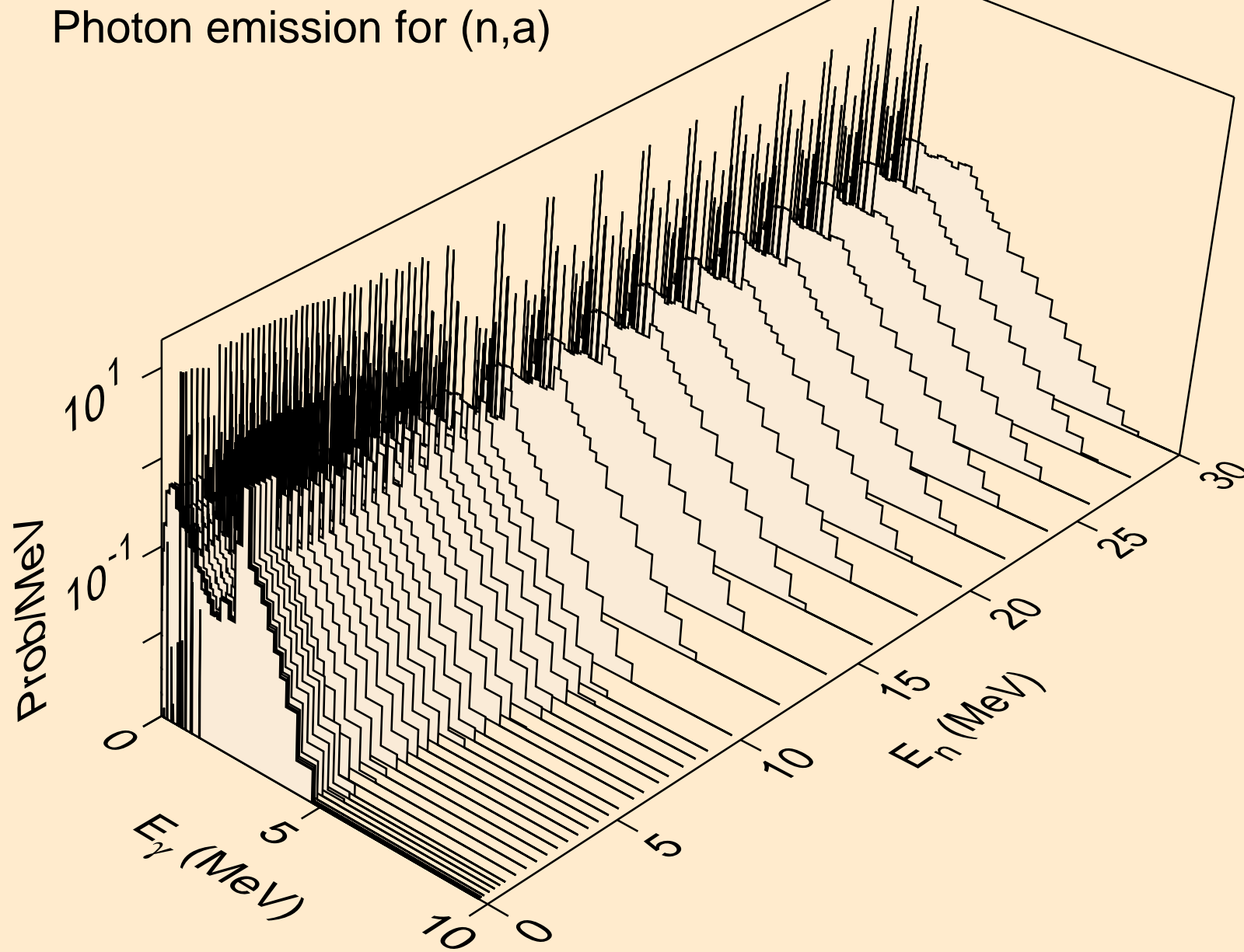

TM150 NEUTRON ACER TENDL-2021 LIBRARY; T=293.6K  
Photon emission for (n,2a)

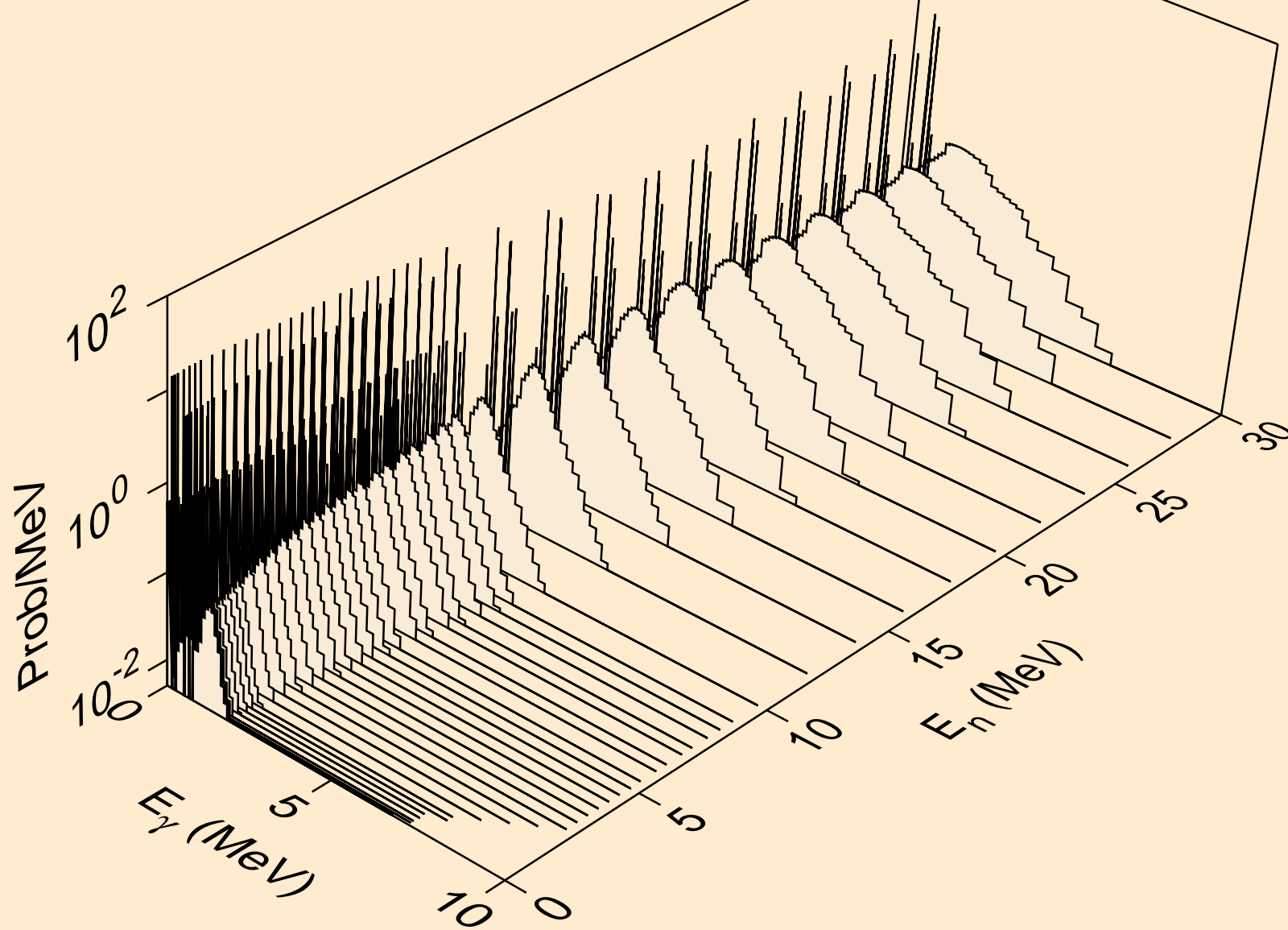

TM150 NEUTRON ACER TENDL-2021 LIBRARY; T=293.6K  
Photon emission for (n,3a)

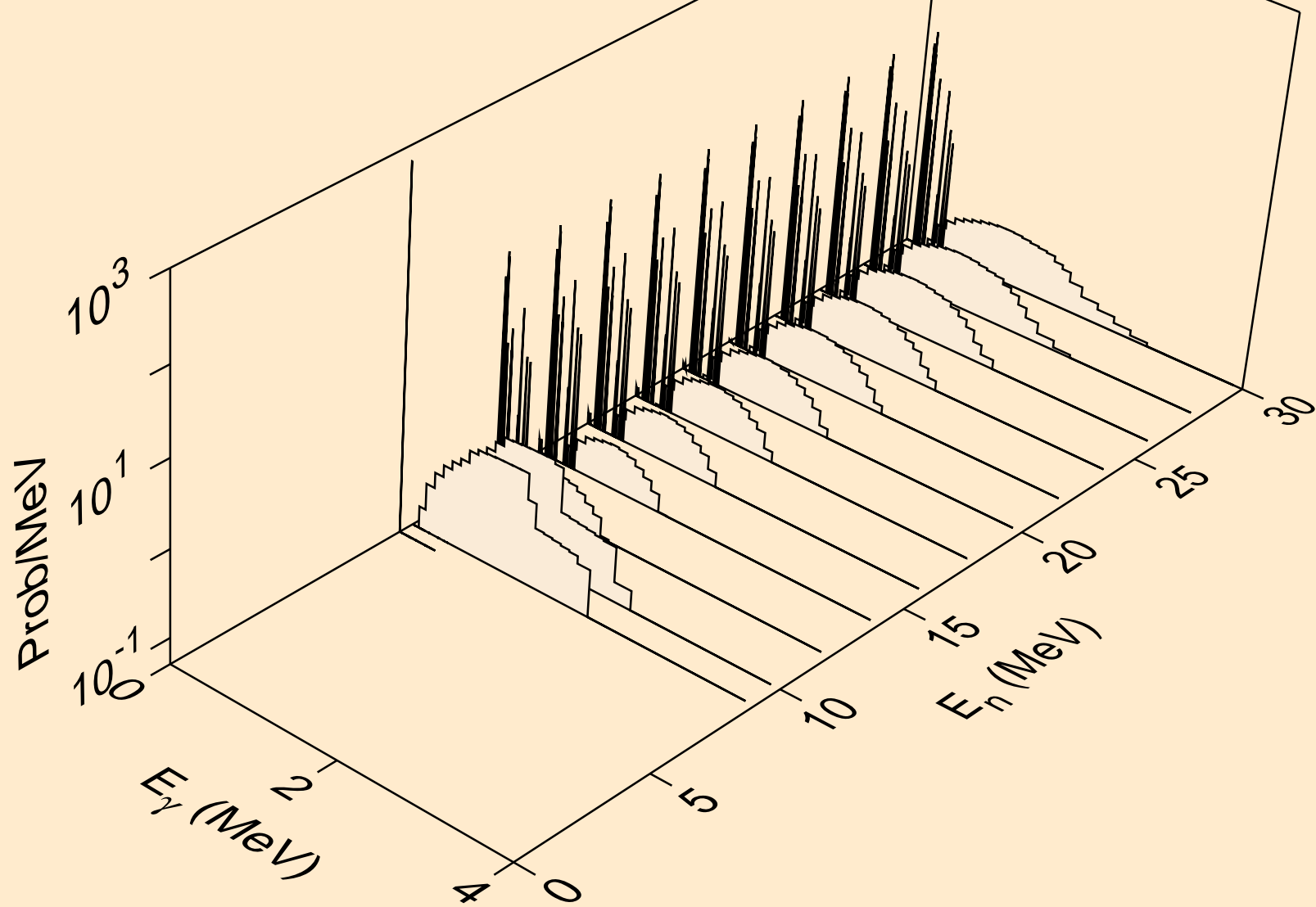

TM150 NEUTRON ACER TENDL-2021 LIBRARY; T=293.6K  
Photon emission for (n,2p)

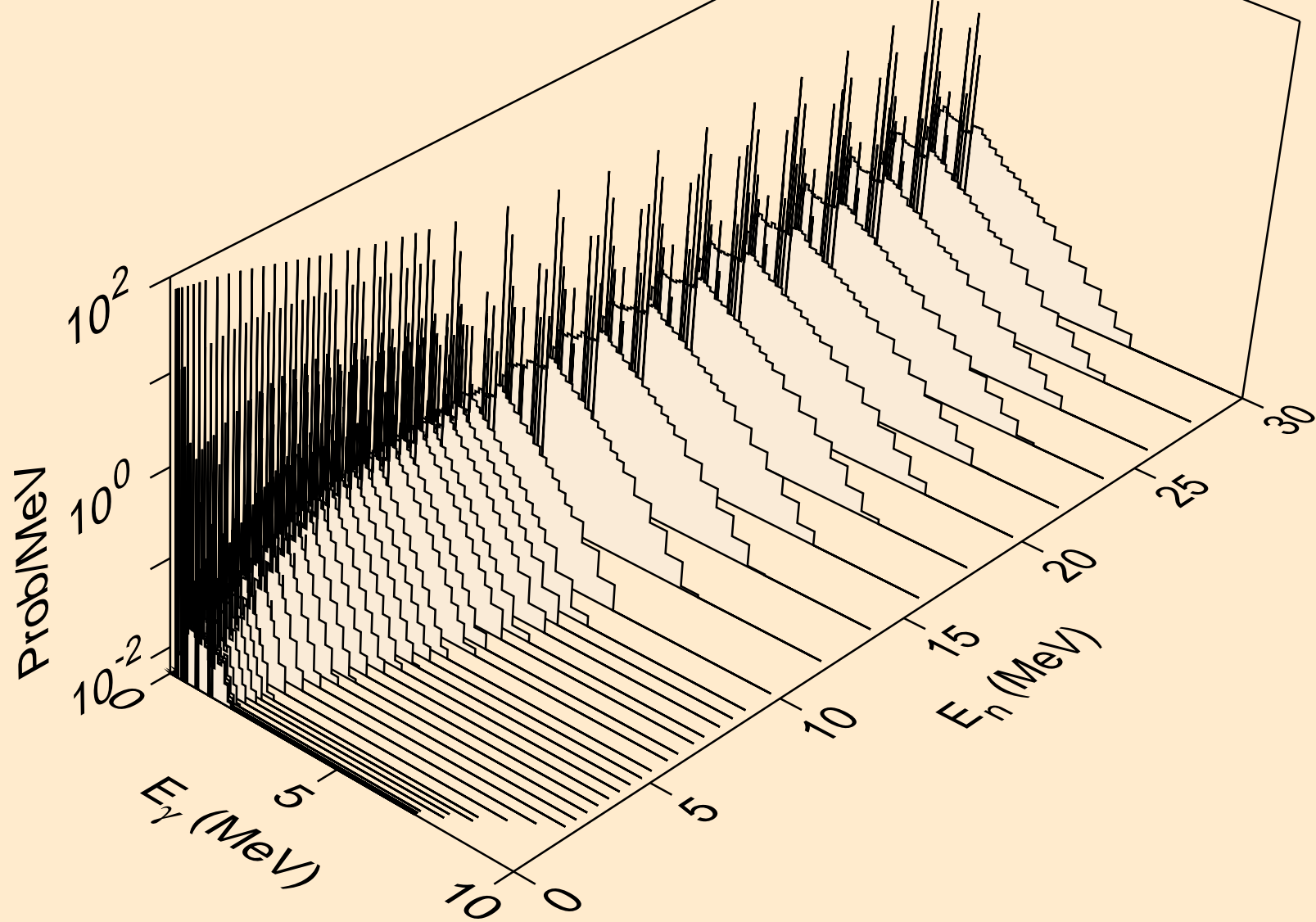

TM150 NEUTRON ACER TENDL-2021 LIBRARY; T=293.6K  
Photon emission for (n,p $\alpha$ )

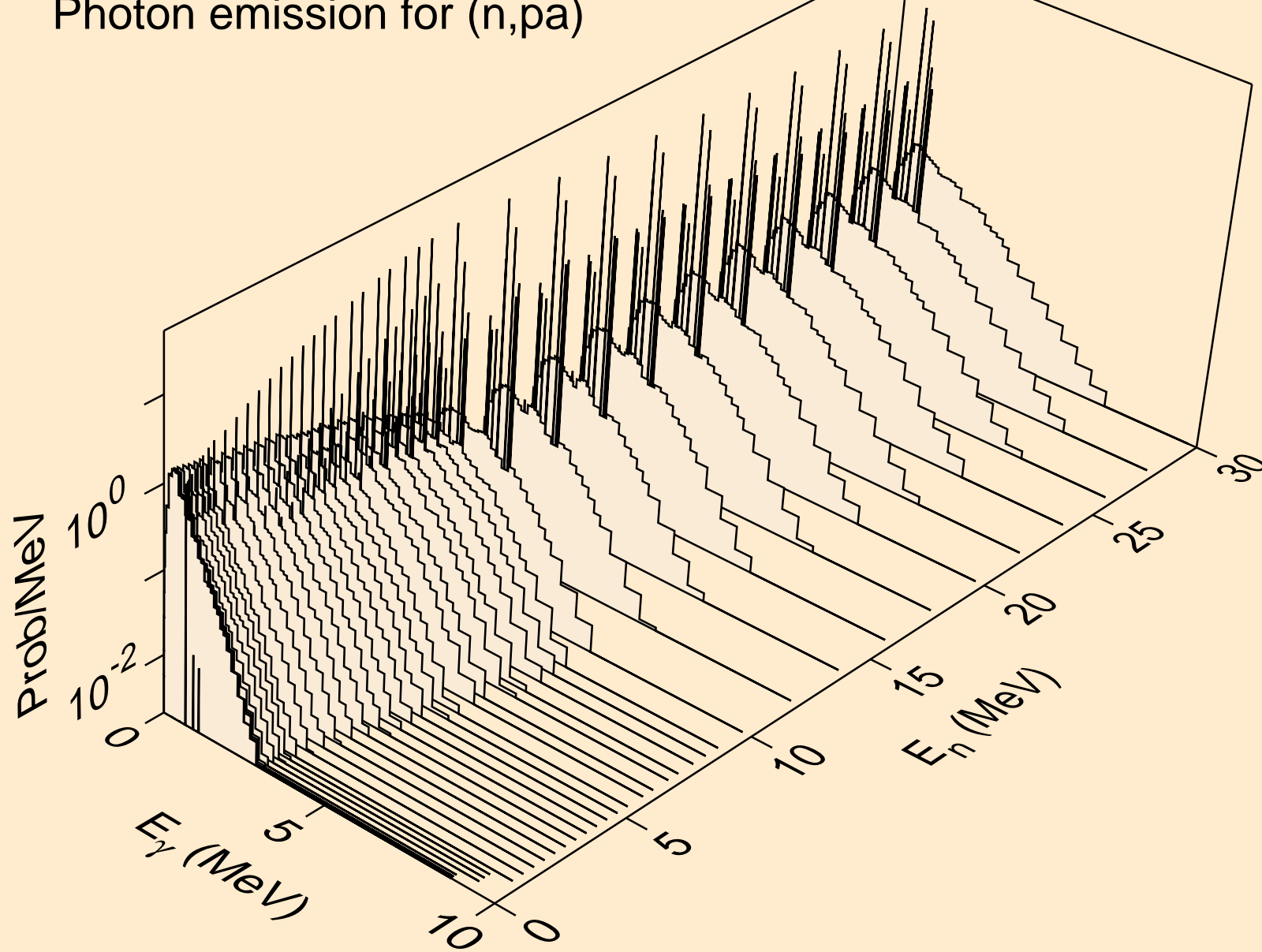

TM150 NEUTRON ACER TENDL-2021 LIBRARY; T=293.6K  
Photon emission for (n,d2a)

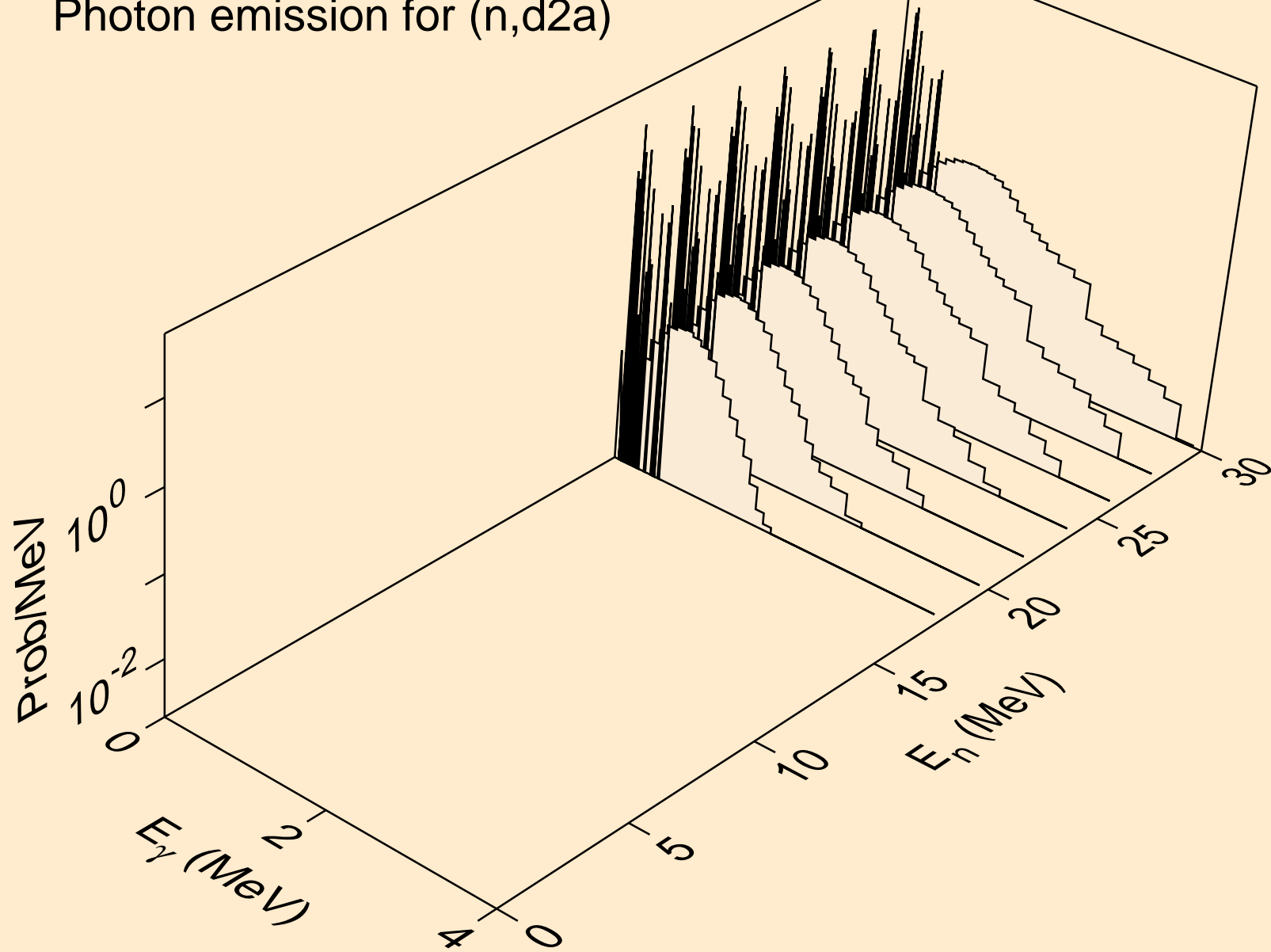

TM150 NEUTRON ACER TENDL-2021 LIBRARY; T=293.6K  
Photon emission for (n,pd)

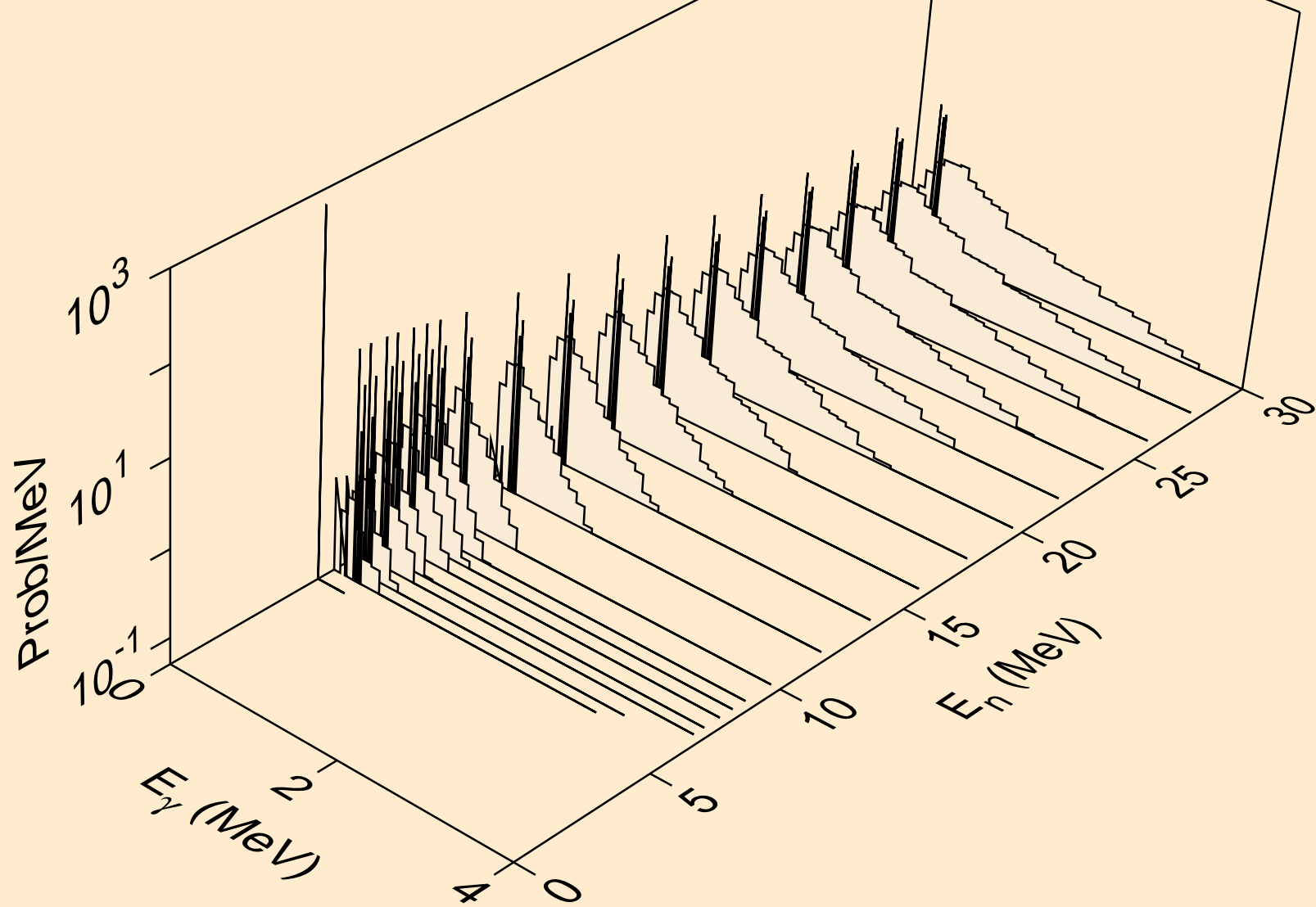

TM150 NEUTRON ACER TENDL-2021 LIBRARY; T=293.6K  
Photon emission for (n,pt)

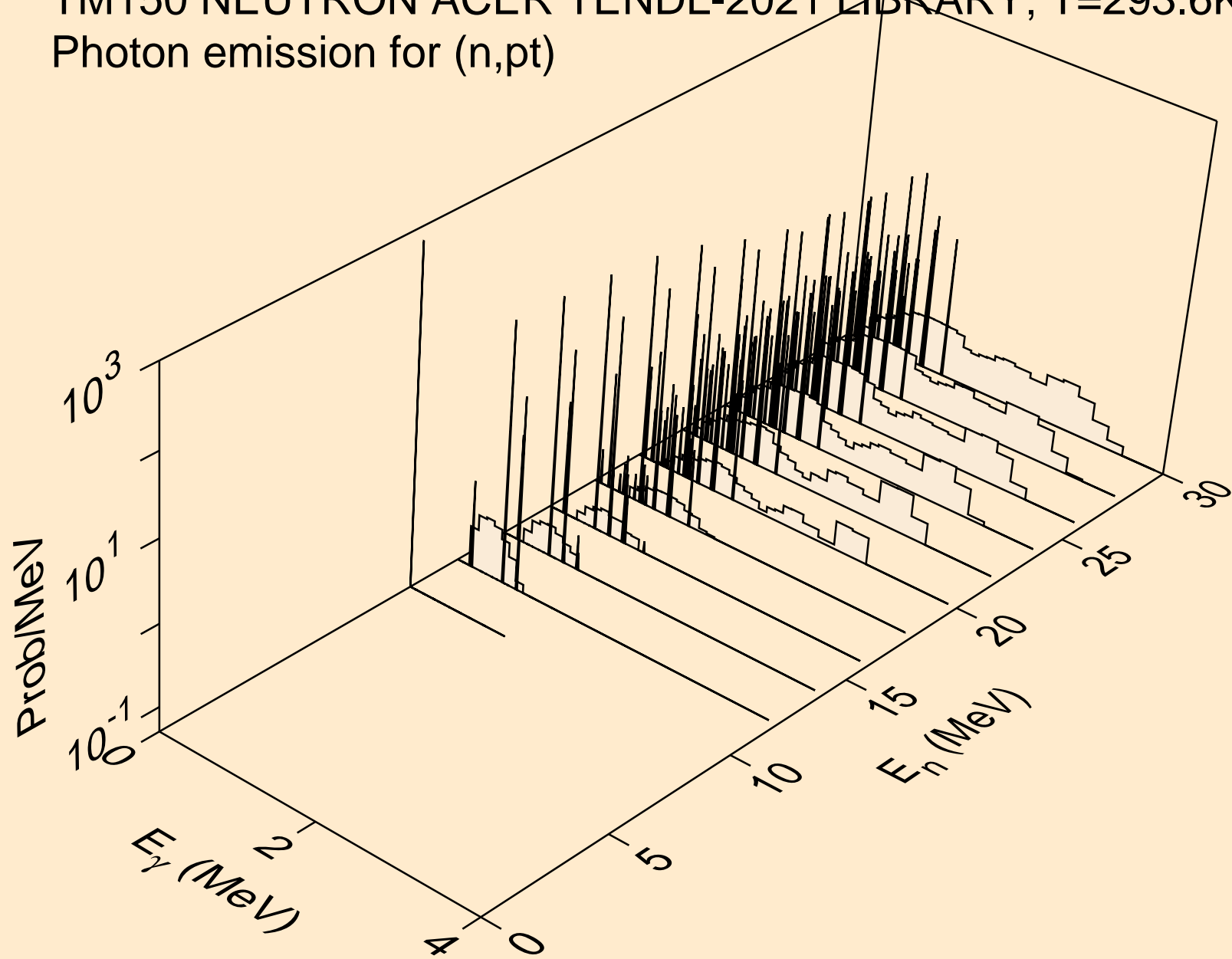



TM150 NEUTRON ACER TENDL-2021 LIBRARY; T=293.6K  
Photon emission for (n,da)

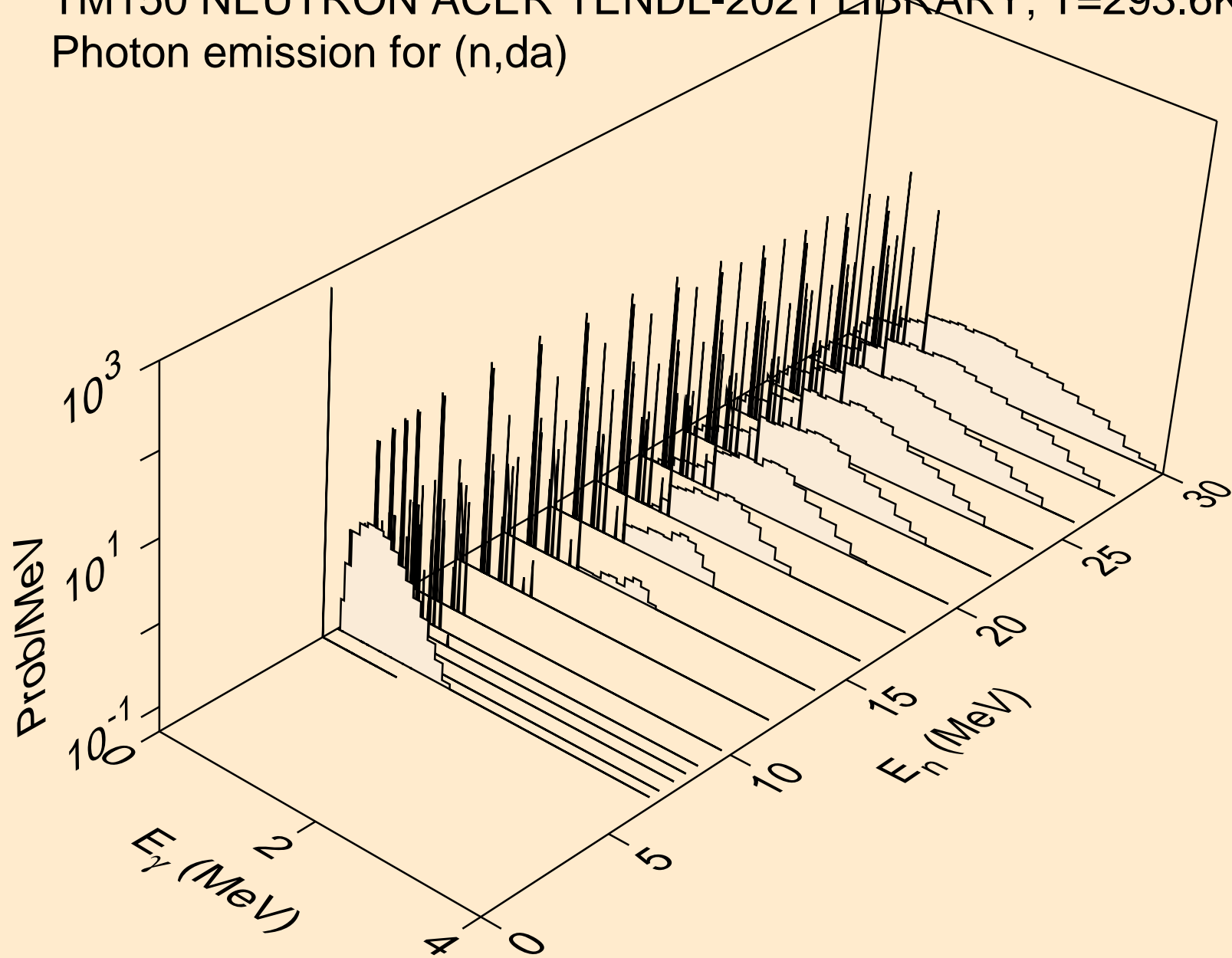

TM150 NEUTRON ACER TENDL-2021 LIBRARY; T=293.6K  
thermal capture photon spectrum

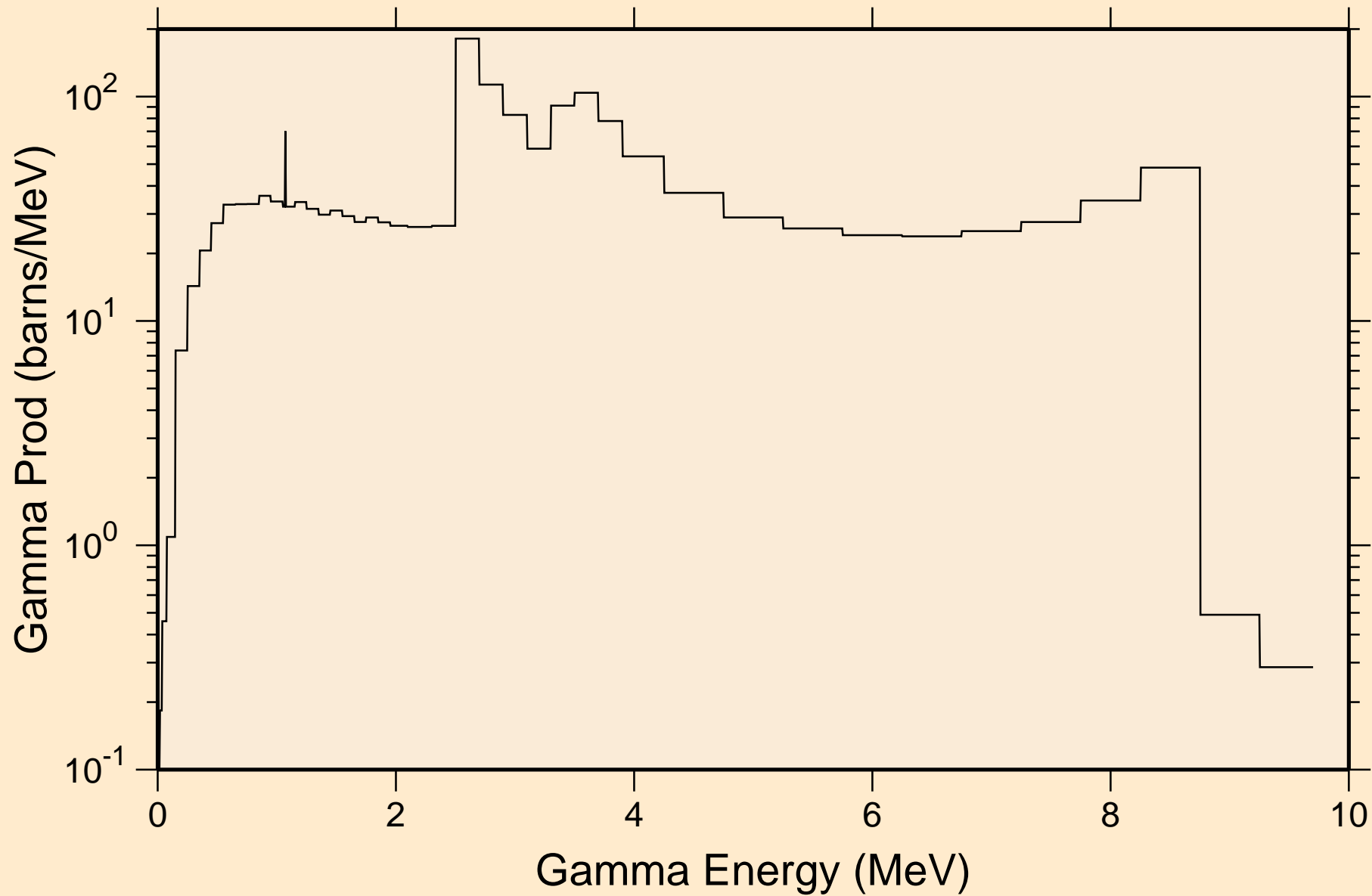

TM150 NEUTRON ACER TENDL-2021 LIBRARY; T=293.6K  
14 MeV photon spectrum

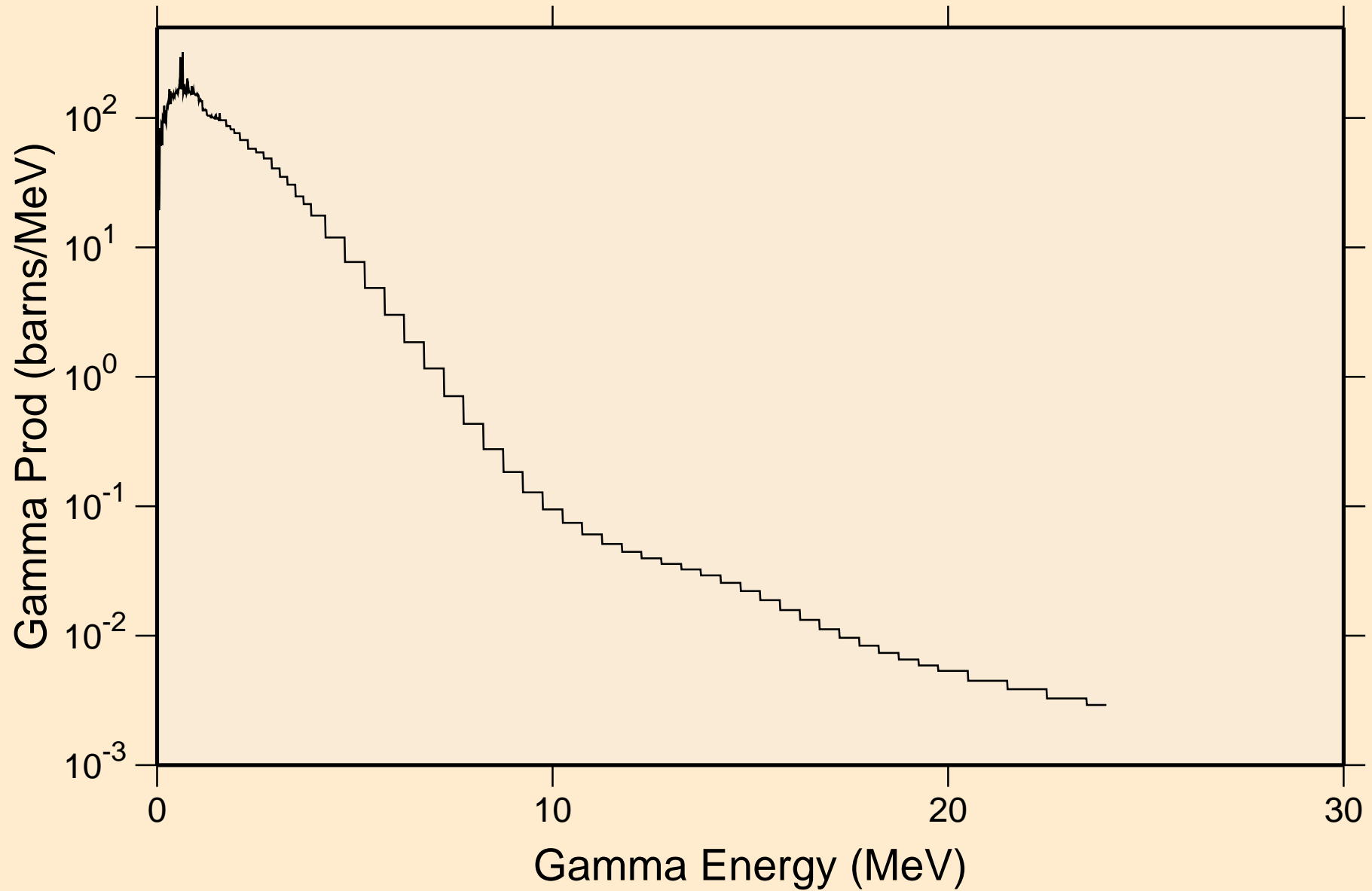

# TM150 NEUTRON ACER TENDL-2021 LIBRARY; T=293.6K

## Particle heating contributions

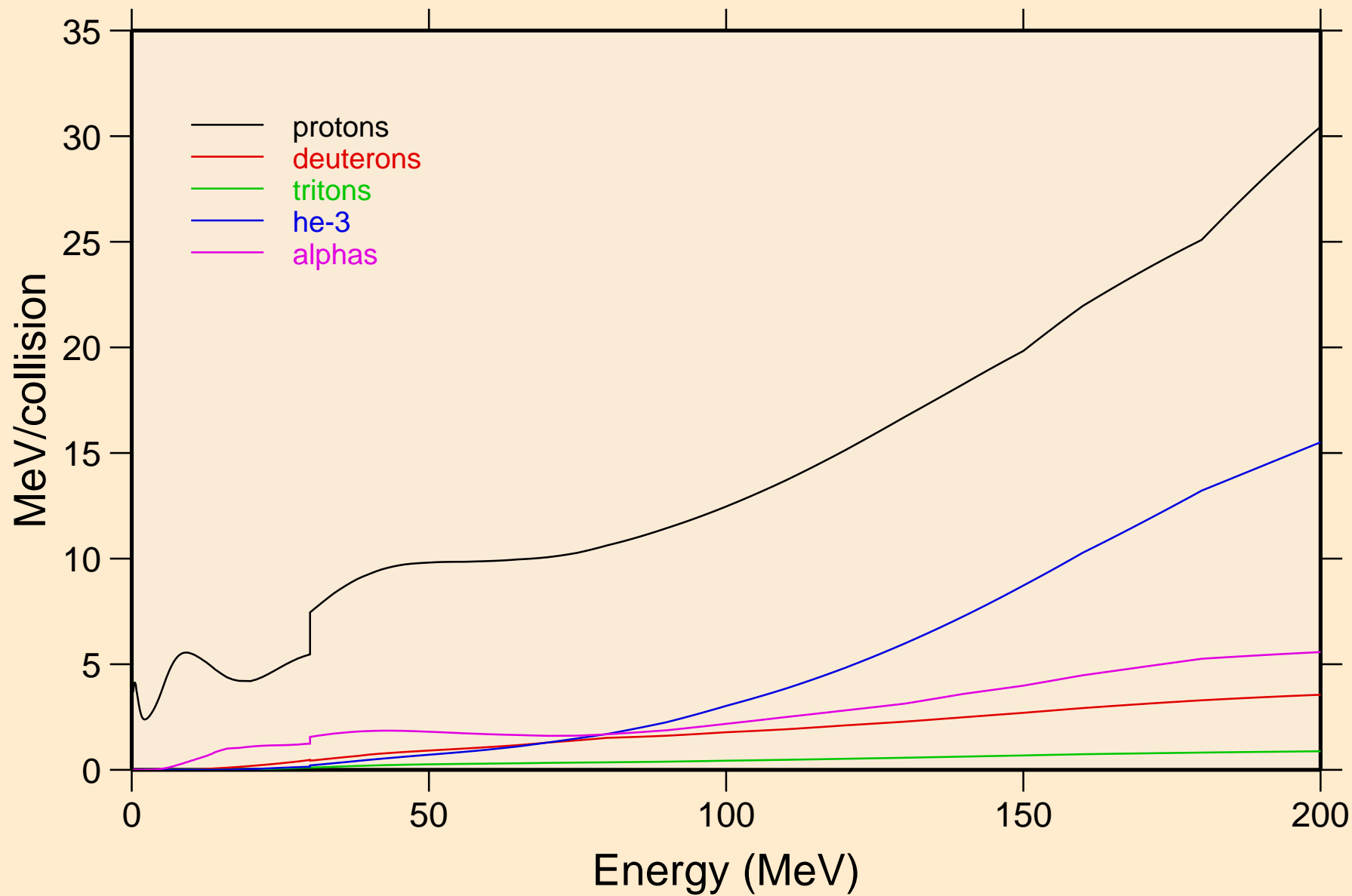

TM150 NEUTRON ACER TENDL-2021 LIBRARY; T=293.6K  
Recoil Heating

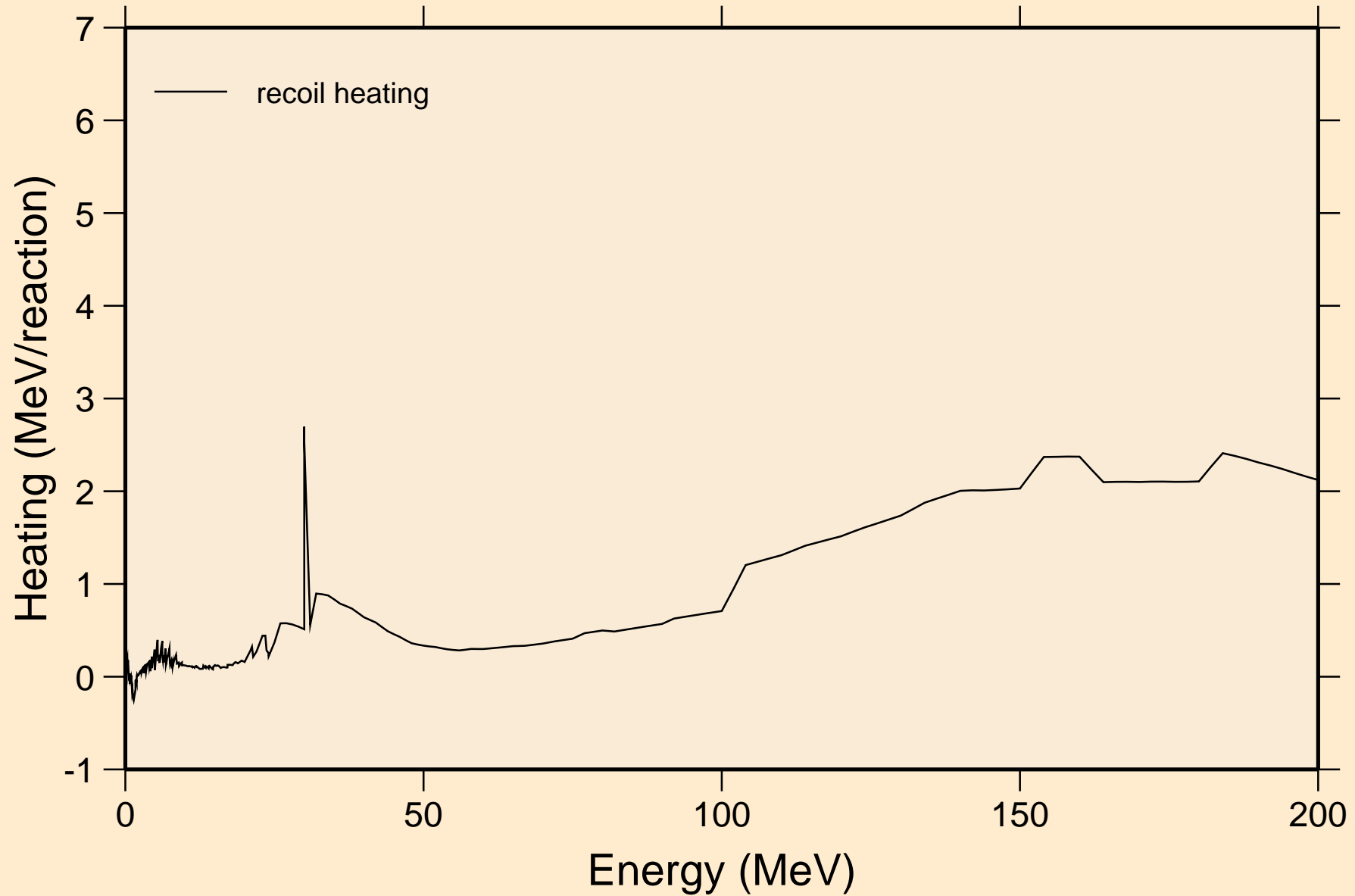

TM150 NEUTRON ACER TENDL-2021 LIBRARY; T=293.6K  
Particle production cross sections

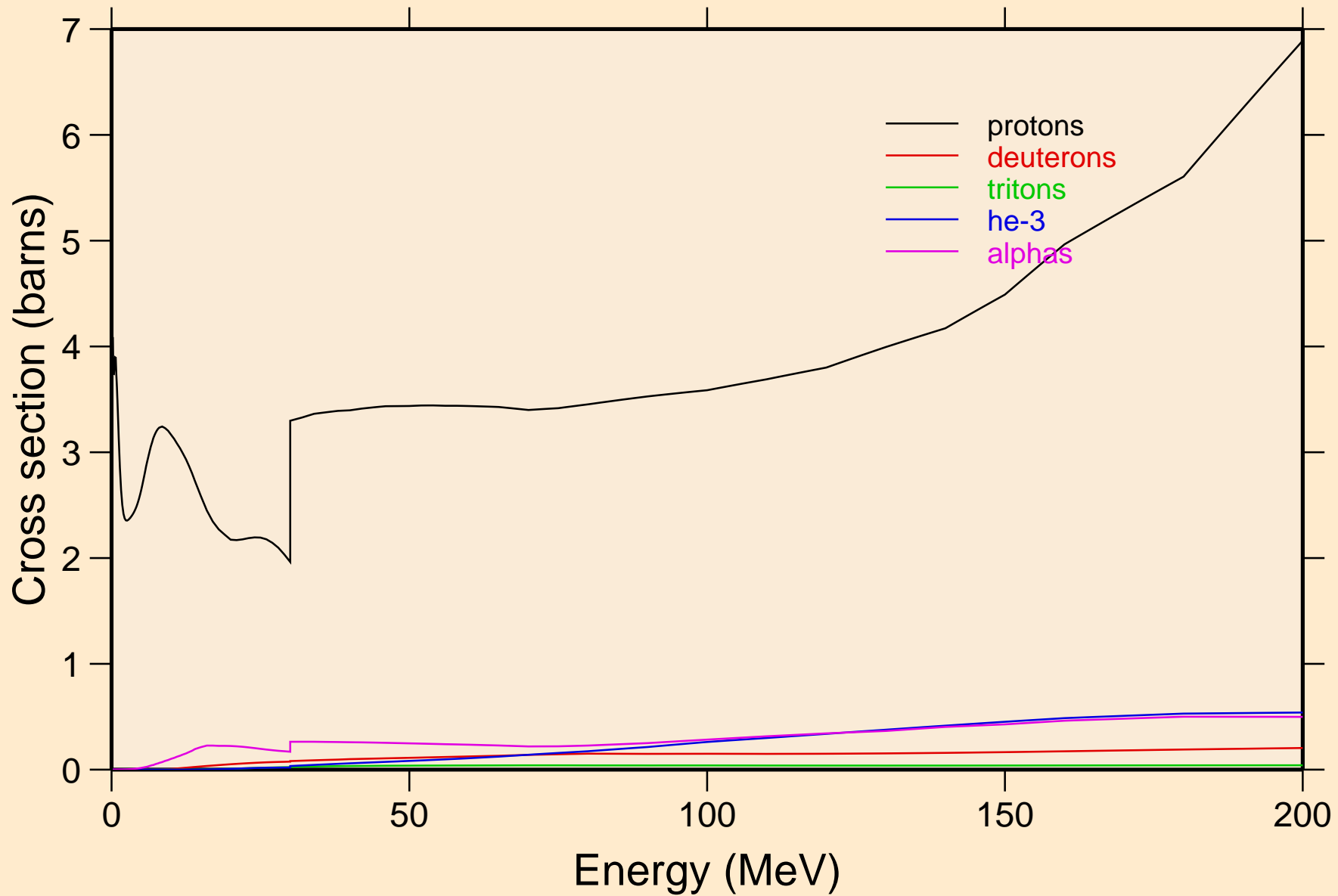

TM150 NEUTRON ACER TENDL-2021 LIBRARY; T=293.6K  
protons from (n,x)

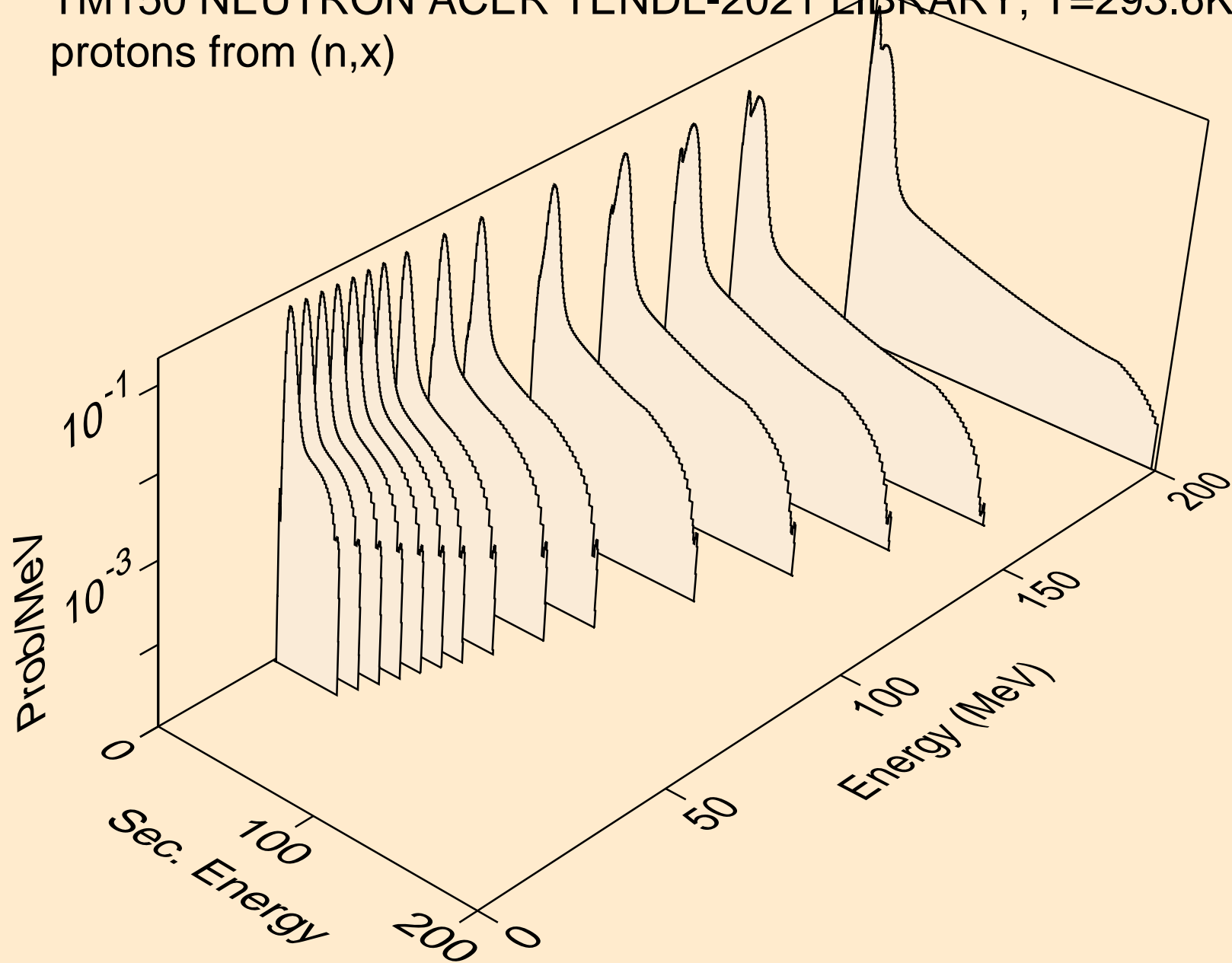

TM150 NEUTRON ACER TENDL-2021 LIBRARY; T=293.6K  
protons from (n,n\*)p

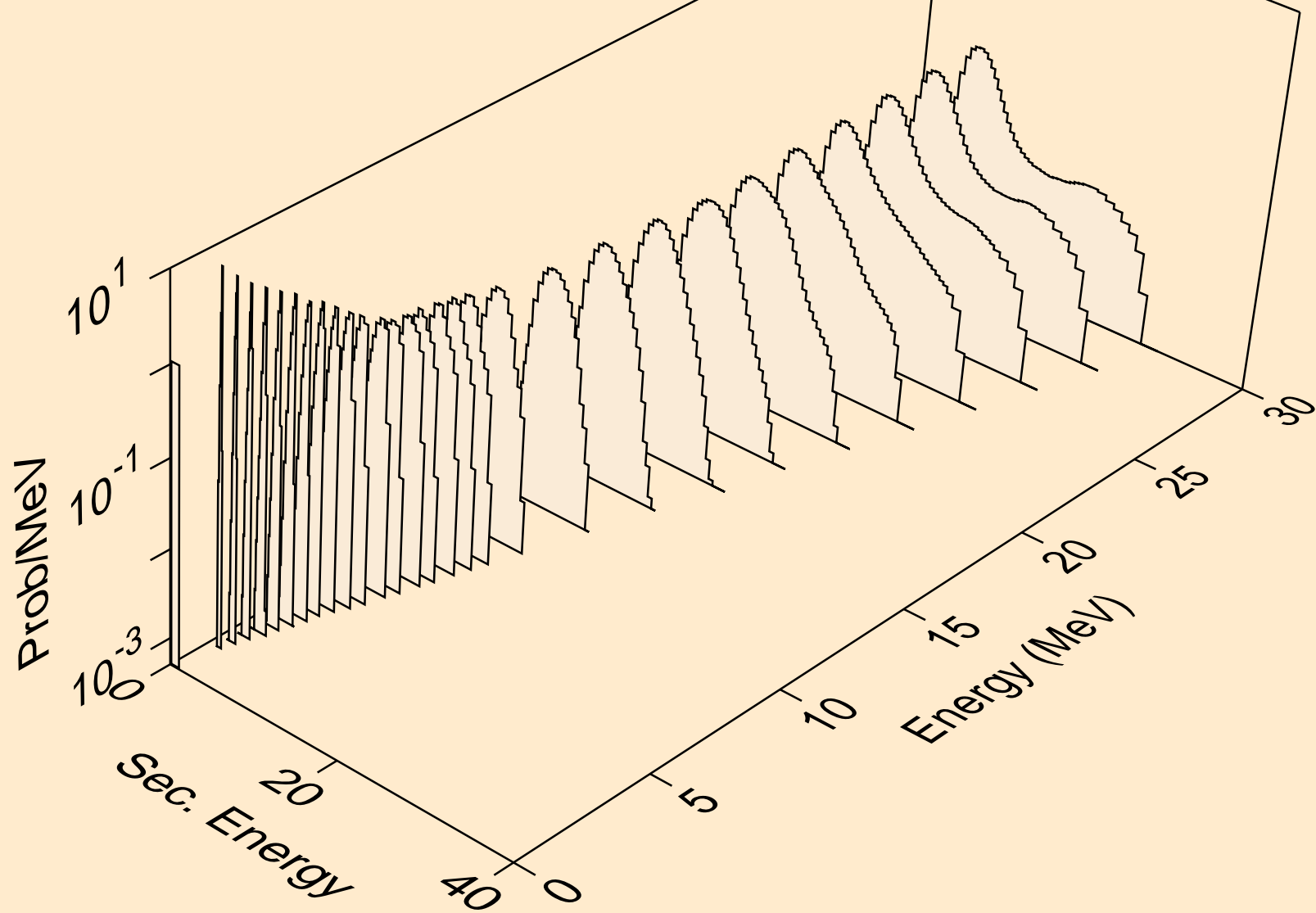



TM150 NEUTRON ACER TENDL-2021 LIBRARY; T=293.6K  
protons from (n,2np)

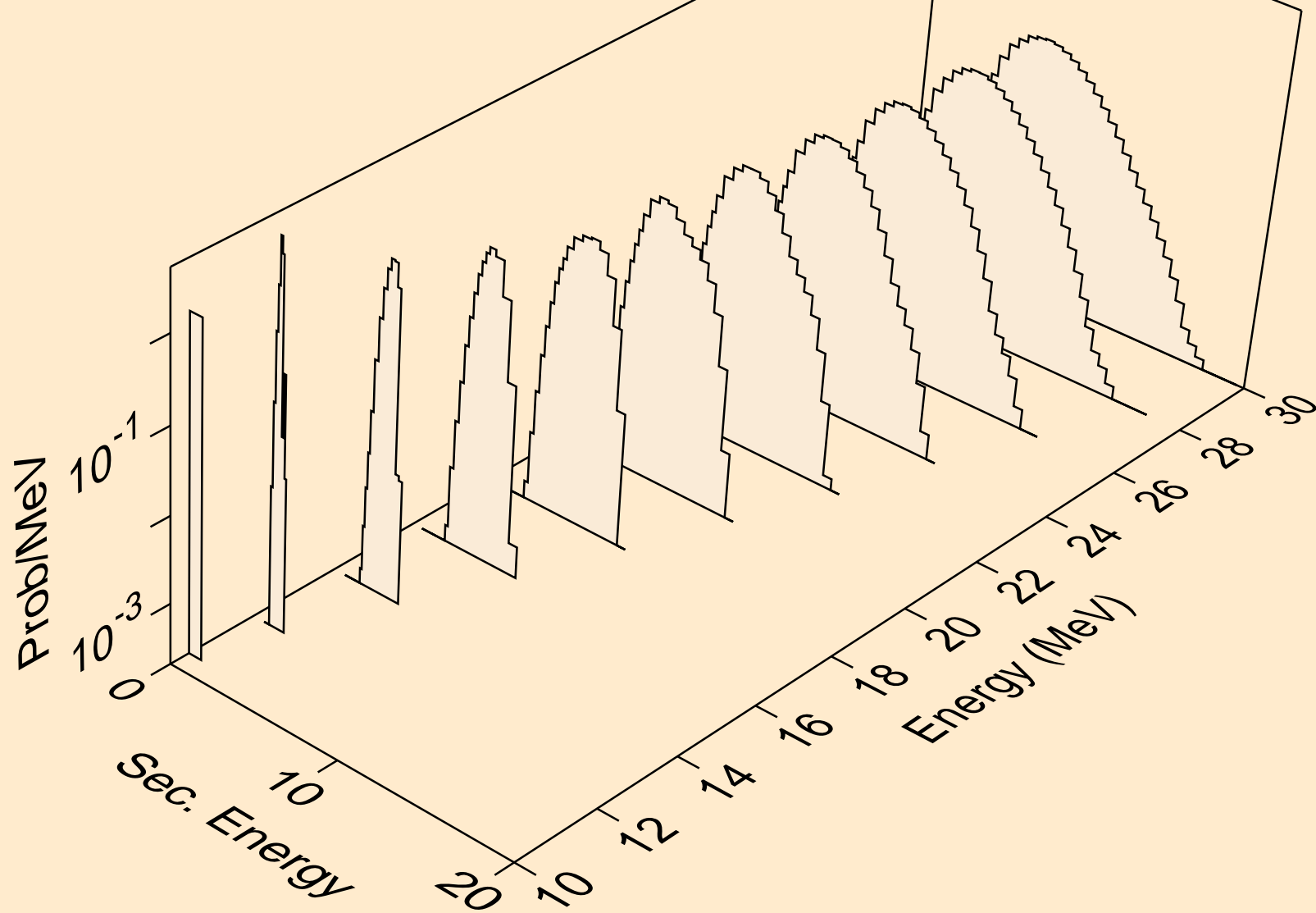

TM150 NEUTRON ACER TENDL-2021 LIBRARY; T=293.6K  
protons from (n,3np)

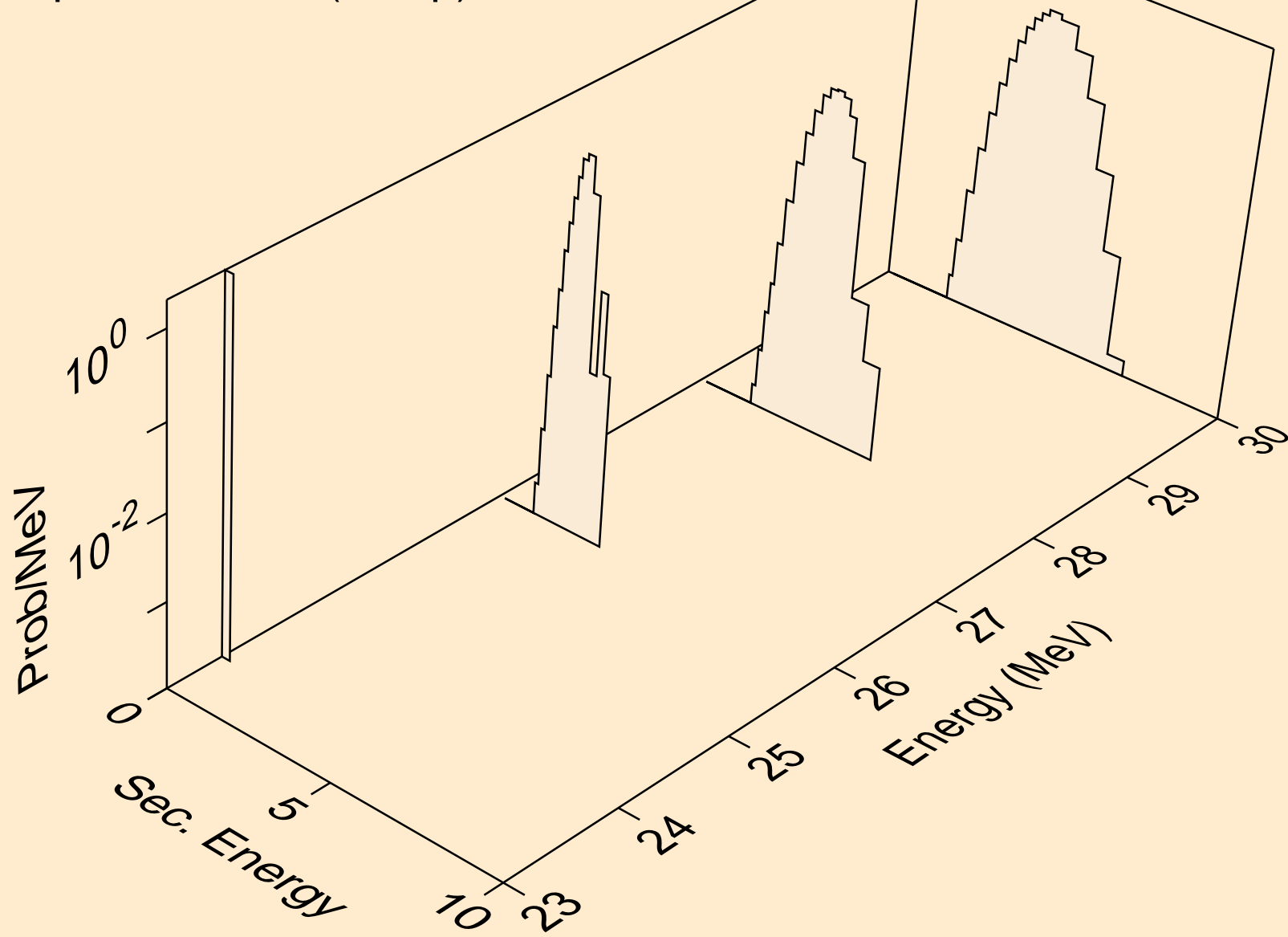

TM150 NEUTRON ACER TENDL-2021 LIBRARY; T=293.6K  
protons from (n,2np)

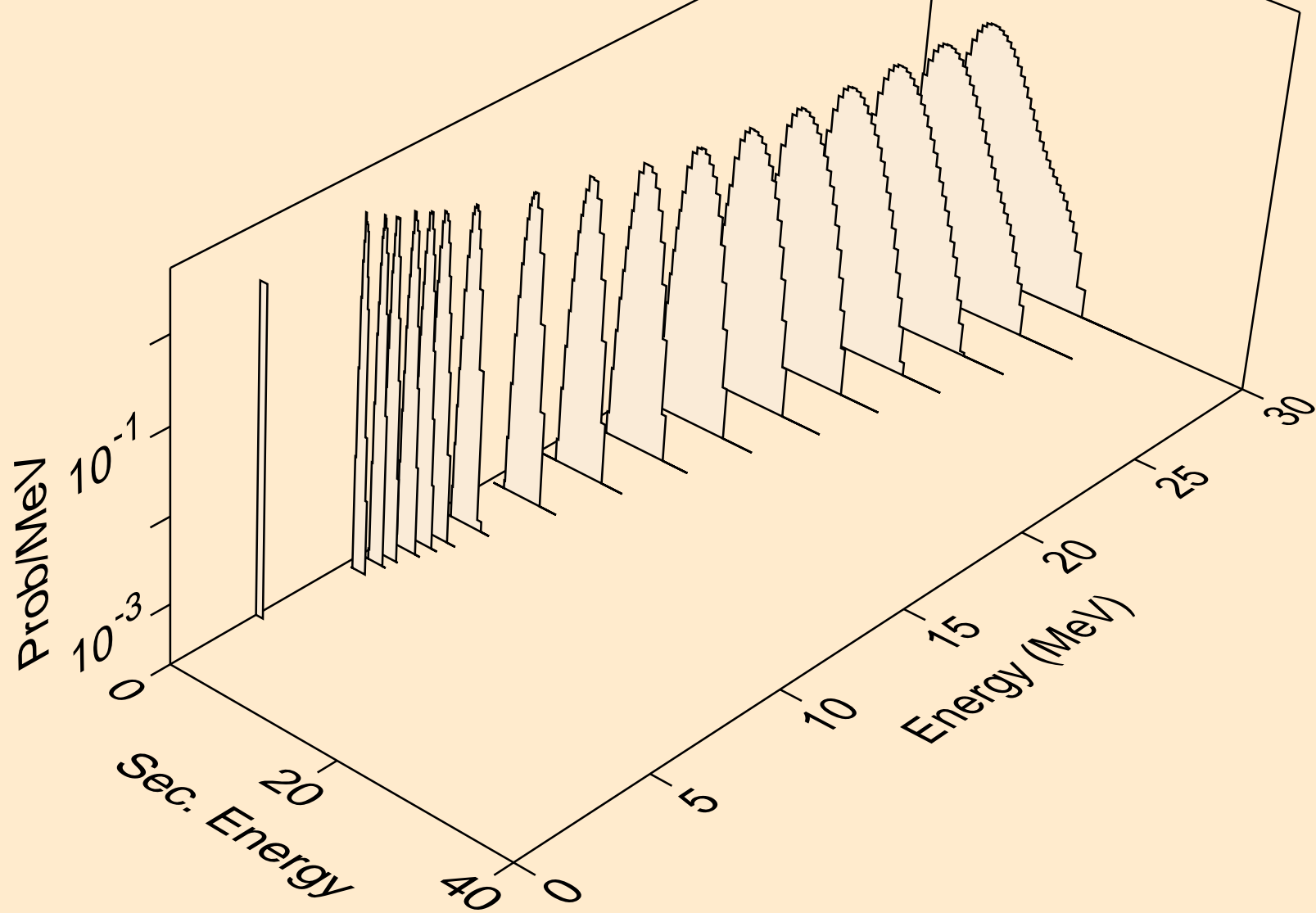

TM150 NEUTRON ACER TENDL-2021 LIBRARY; T=293.6K  
protons from (n,npa)

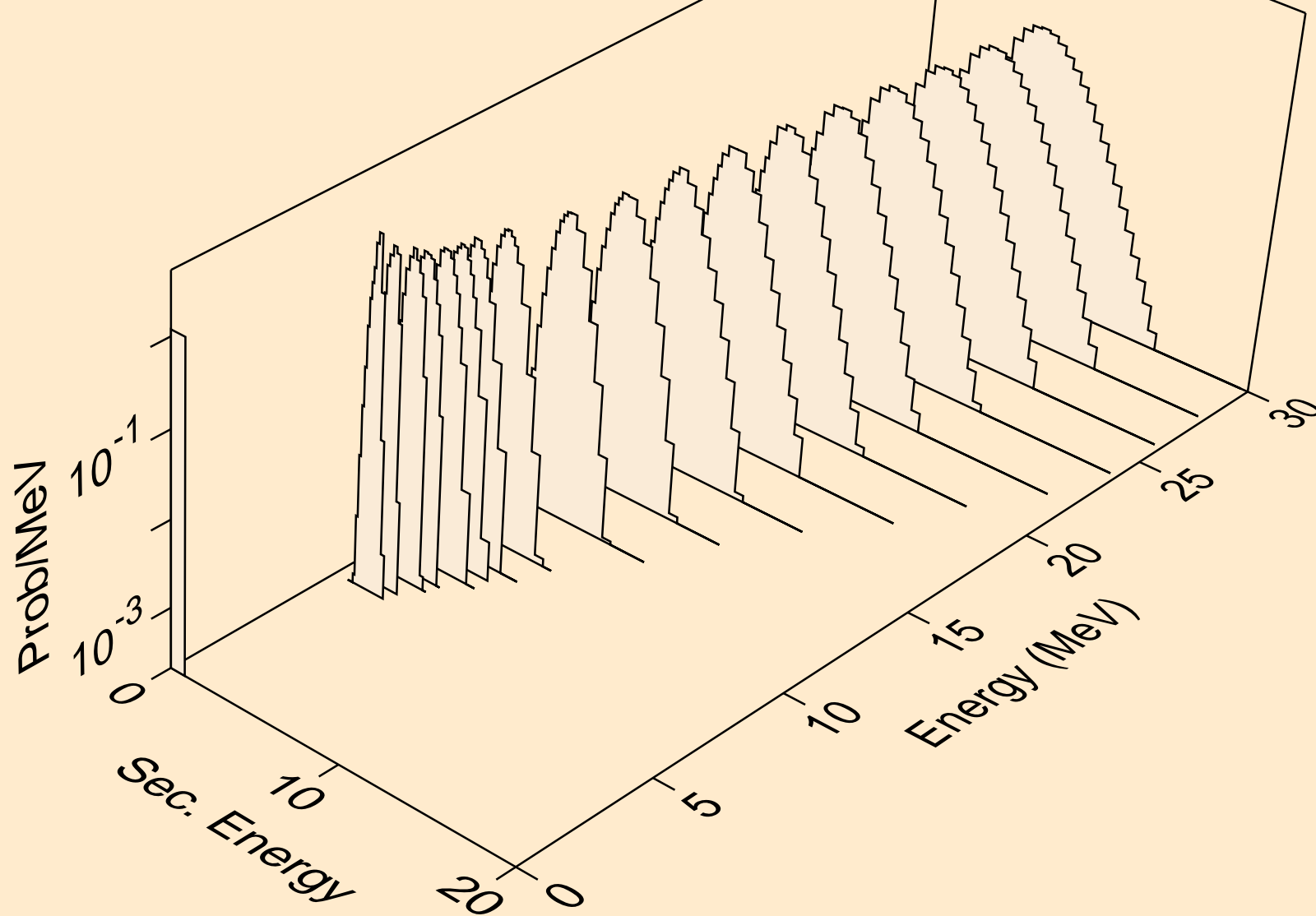

TM150 NEUTRON ACER TENDL-2021 LIBRARY; T=293.6K  
protons from (n,p)

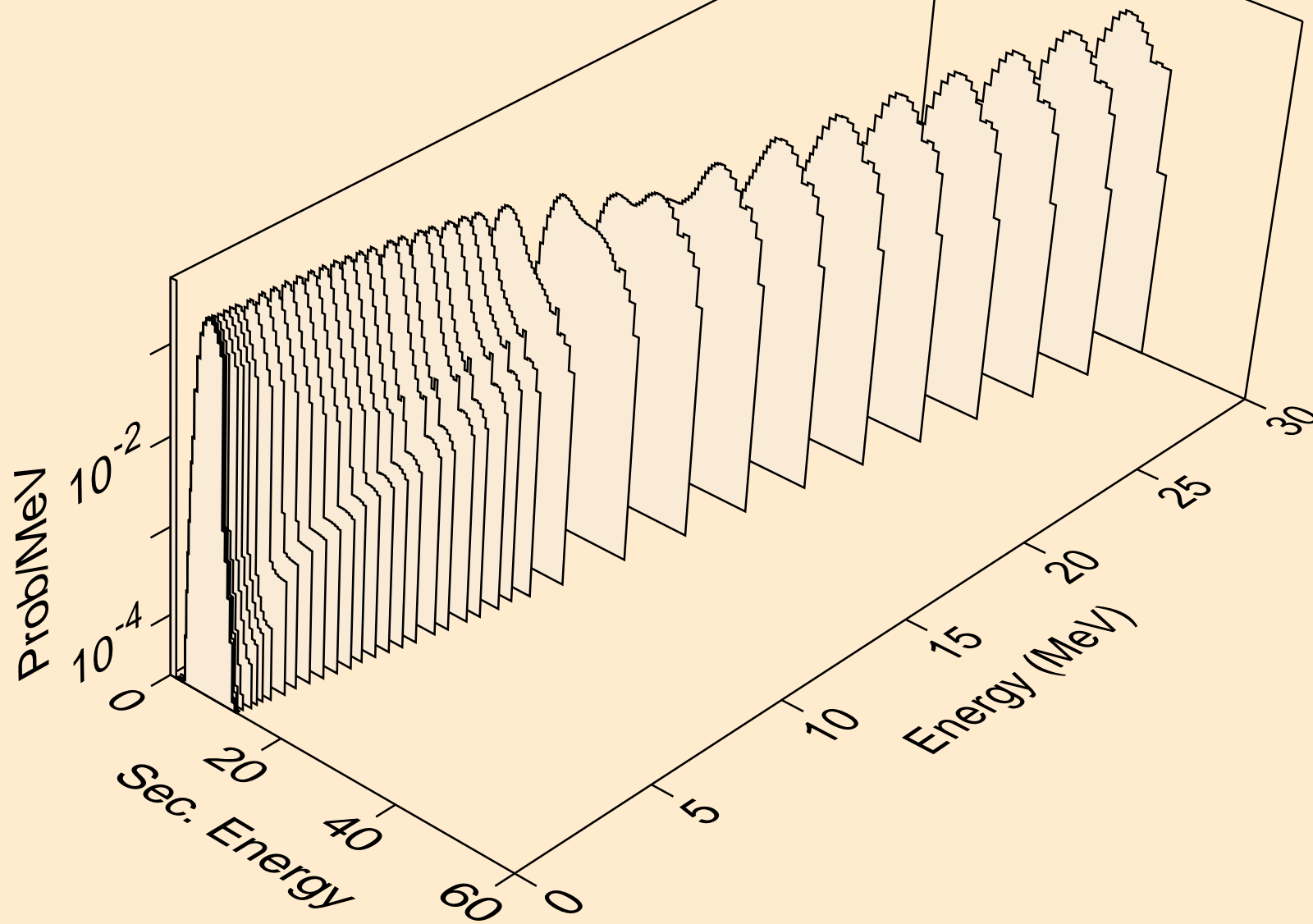

TM150 NEUTRON ACER TENDL-2021 LIBRARY; T=293.6K  
protons from (n,2p)

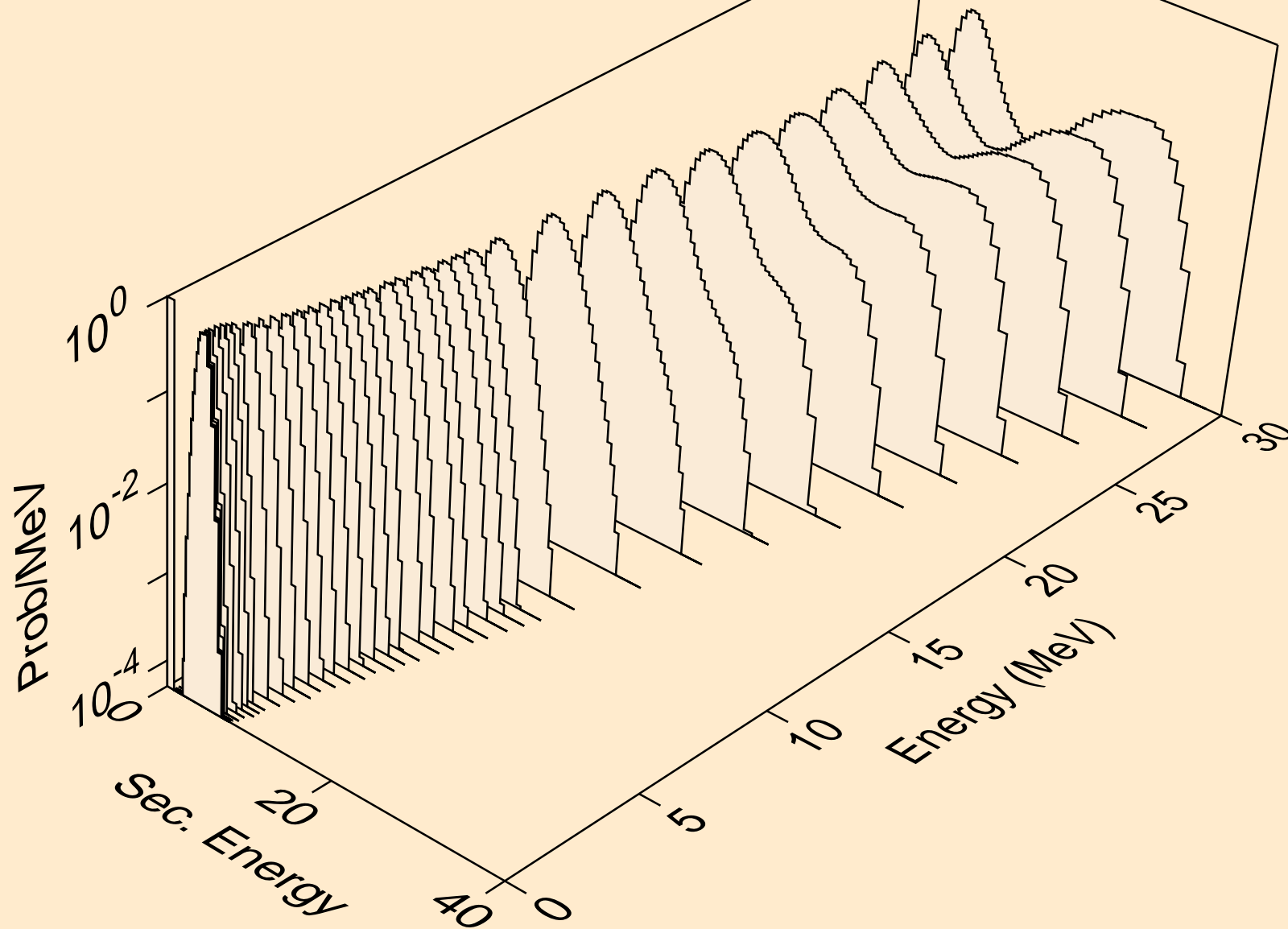

TM150 NEUTRON ACER TENDL-2021 LIBRARY; T=293.6K  
protons from (n,p)

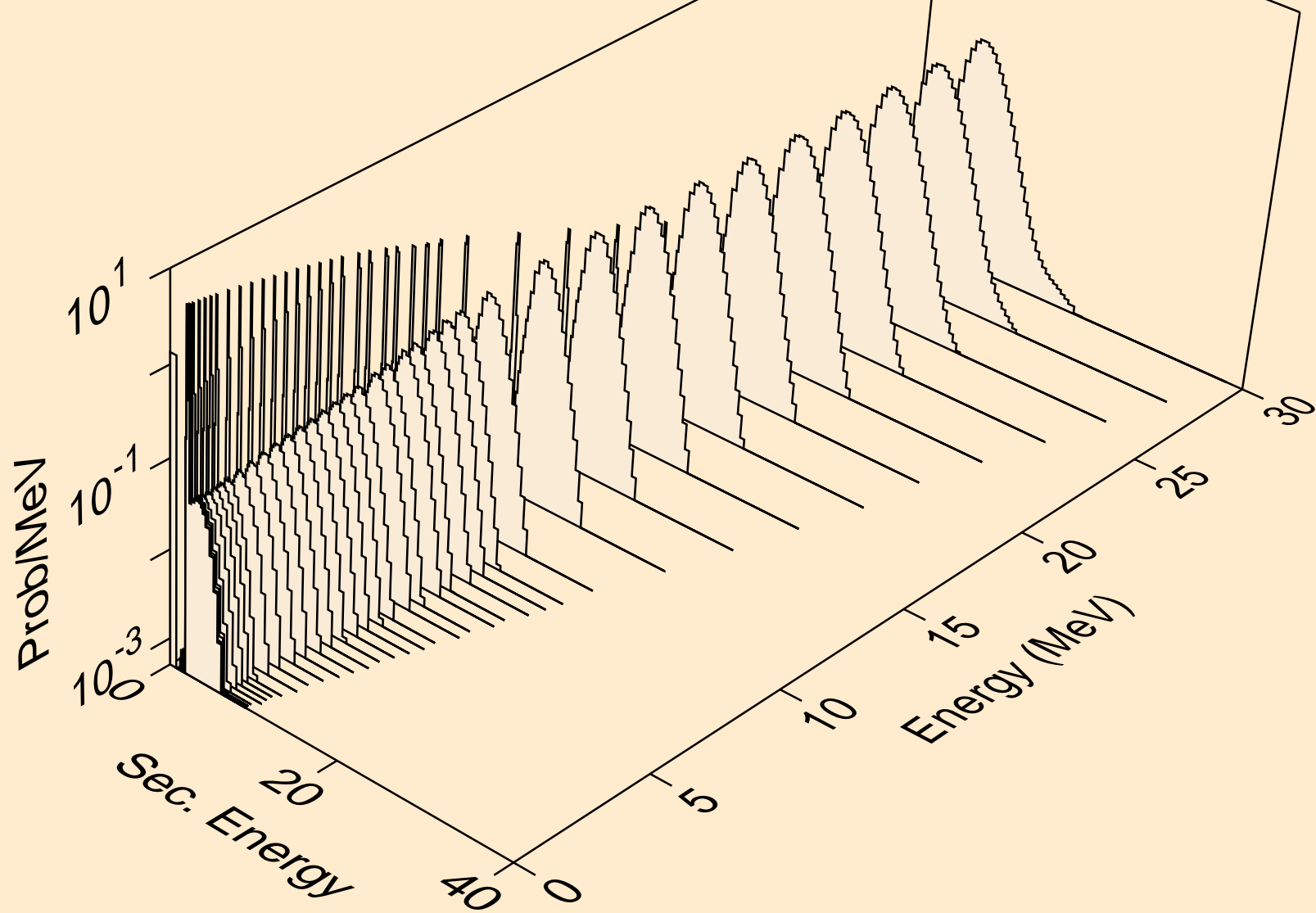

TM150 NEUTRON ACER TENDL-2021 LIBRARY; T=293.6K  
protons from (n,pd)

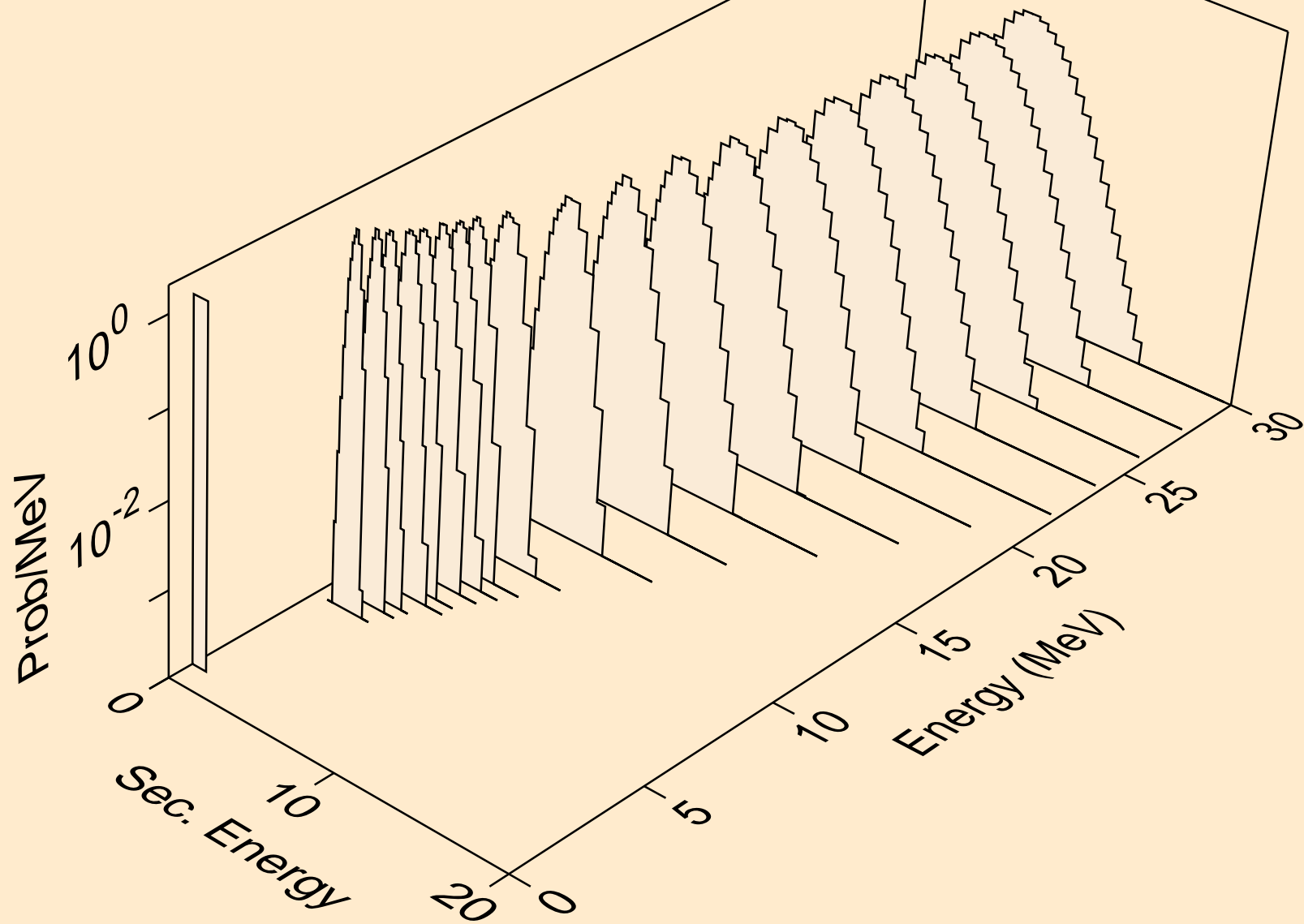



TM150 NEUTRON ACER TENDL-2021 LIBRARY; T=293.6K  
protons from (n,pt)

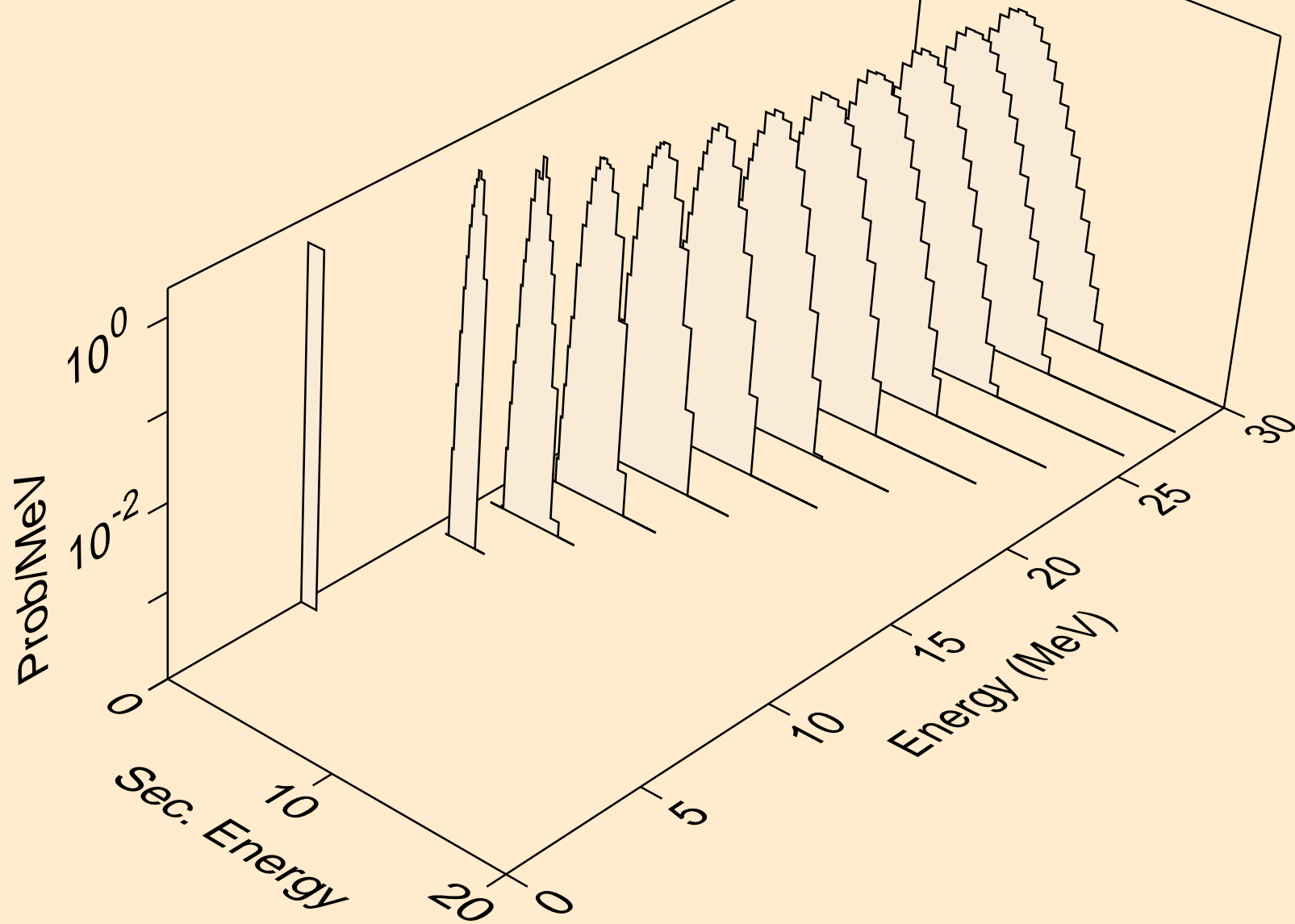

TM150 NEUTRON ACER TENDL-2021 LIBRARY; T=293.6K  
deuterons from (n,x)

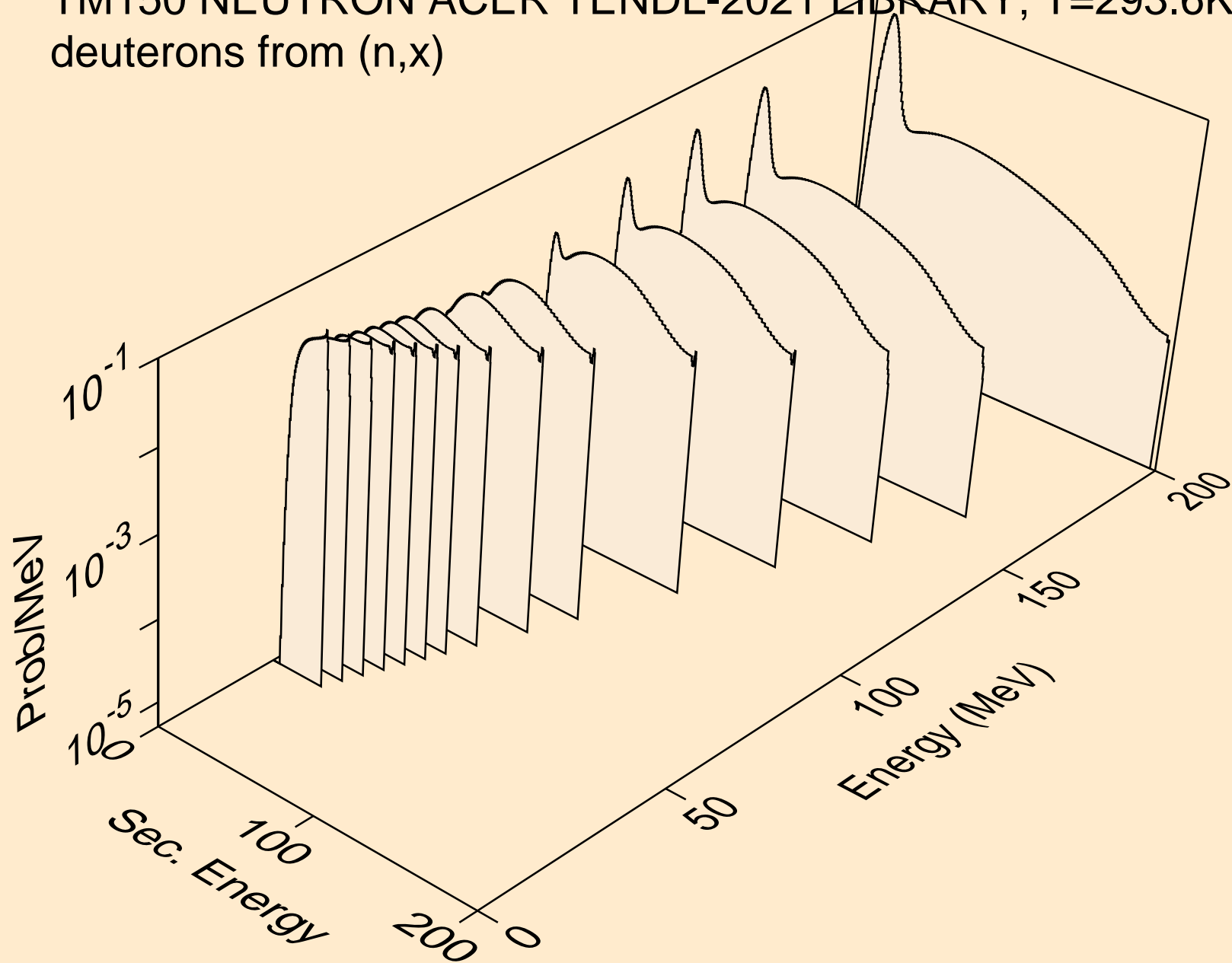

TM150 NEUTRON ACER TENDL-2021 LIBRARY; T=293.6K  
deuterons from (n,2nd)

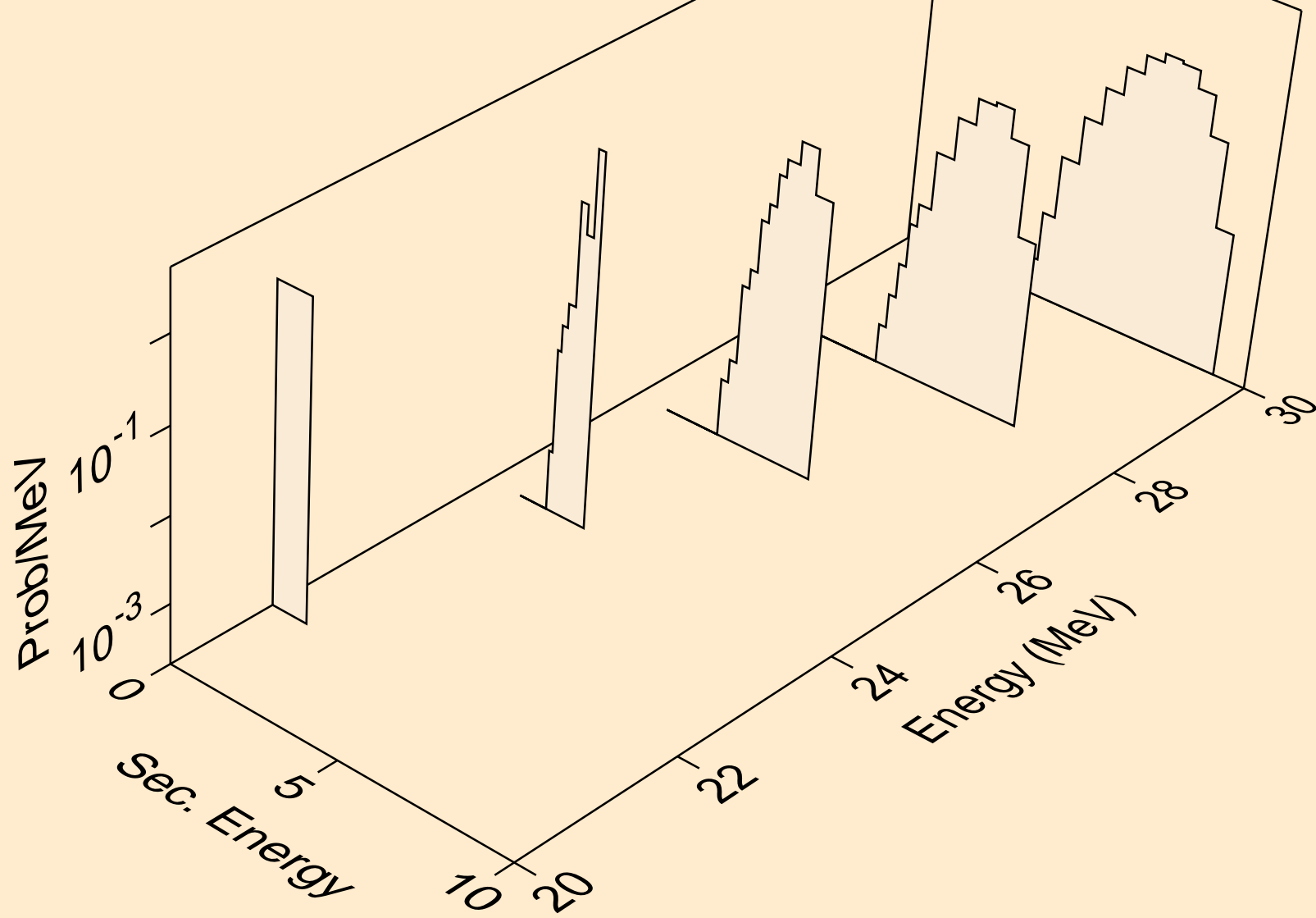

TM150 NEUTRON ACER TENDL-2021 LIBRARY; T=293.6K  
deuterons from (n,n\*)d

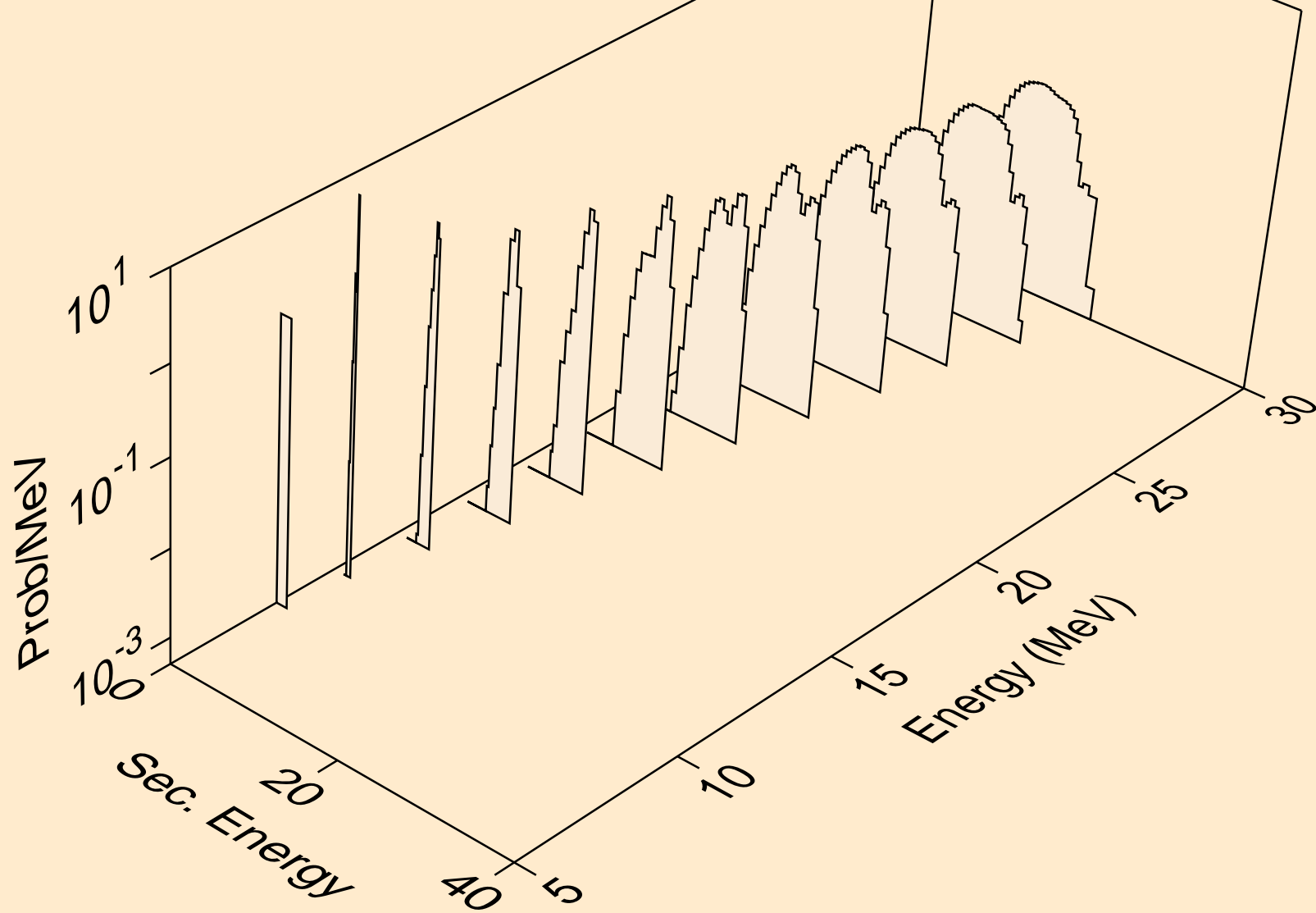

TM150 NEUTRON ACER TENDL-2021 LIBRARY; T=293.6K  
deuterons from (n,d)

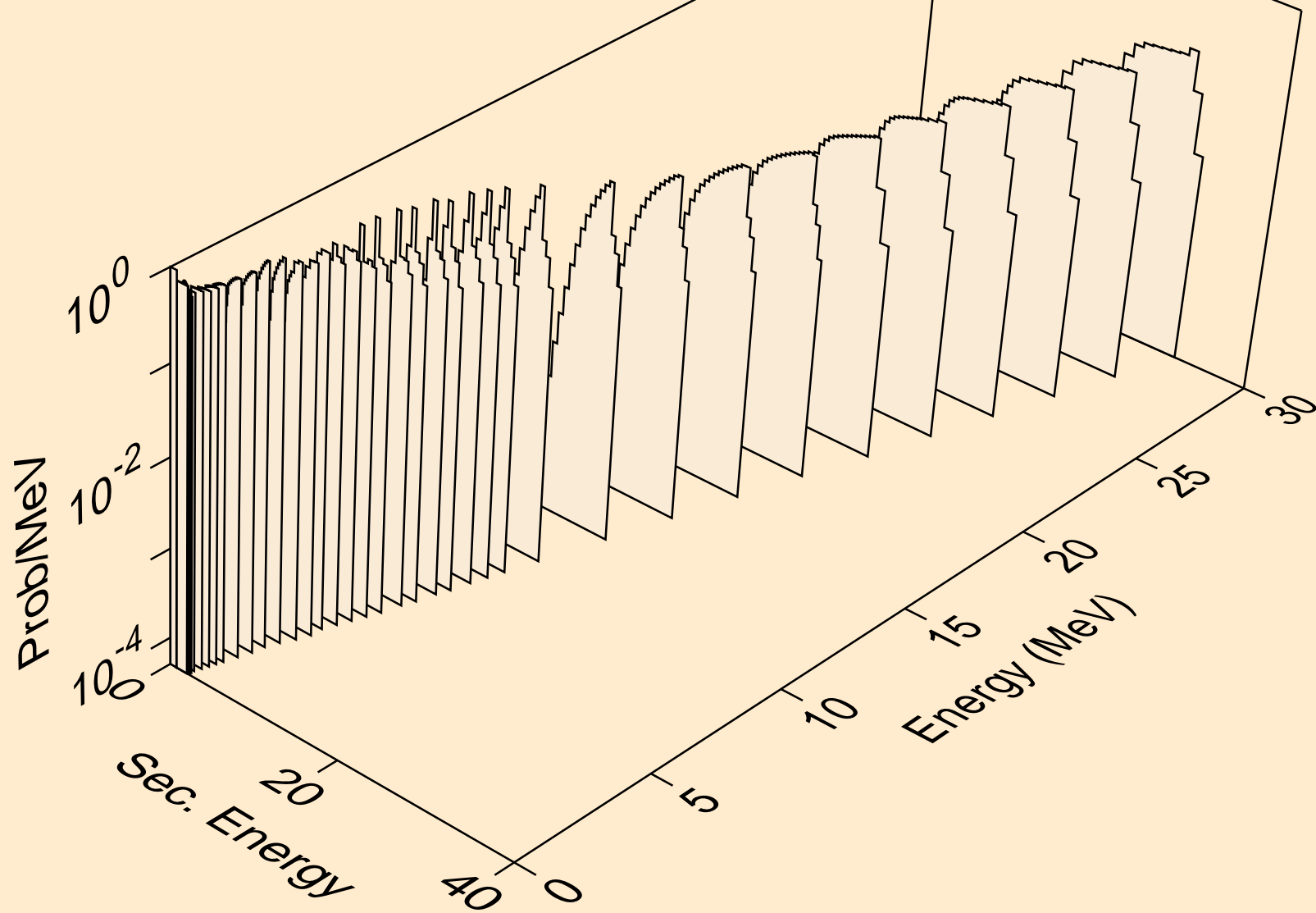

TM150 NEUTRON ACER TENDL-2021 LIBRARY; T=293.6K  
deuterons from (n,d2a)

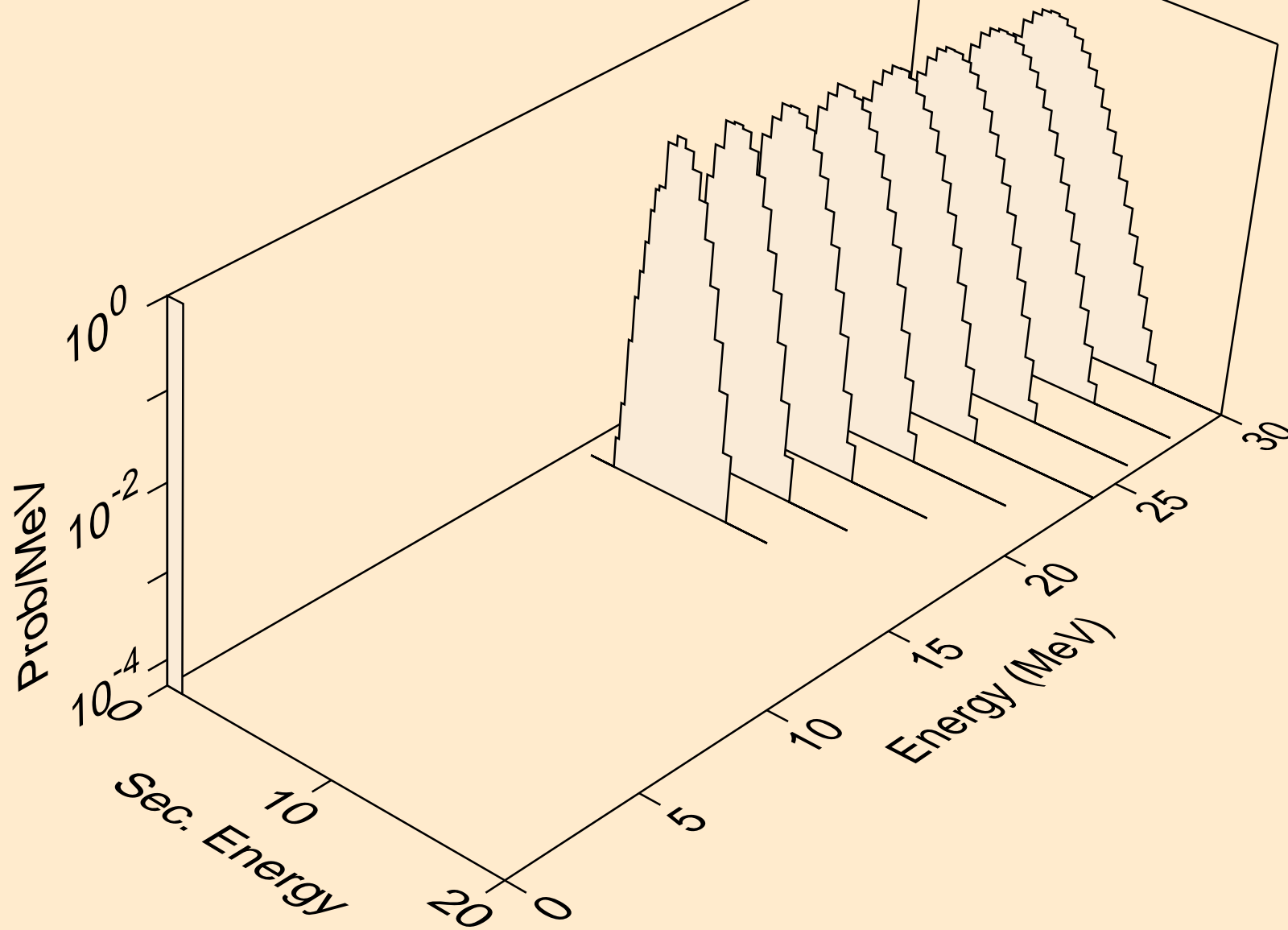

TM150 NEUTRON ACER TENDL-2021 LIBRARY; T=293.6K  
deuterons from (n,pd)

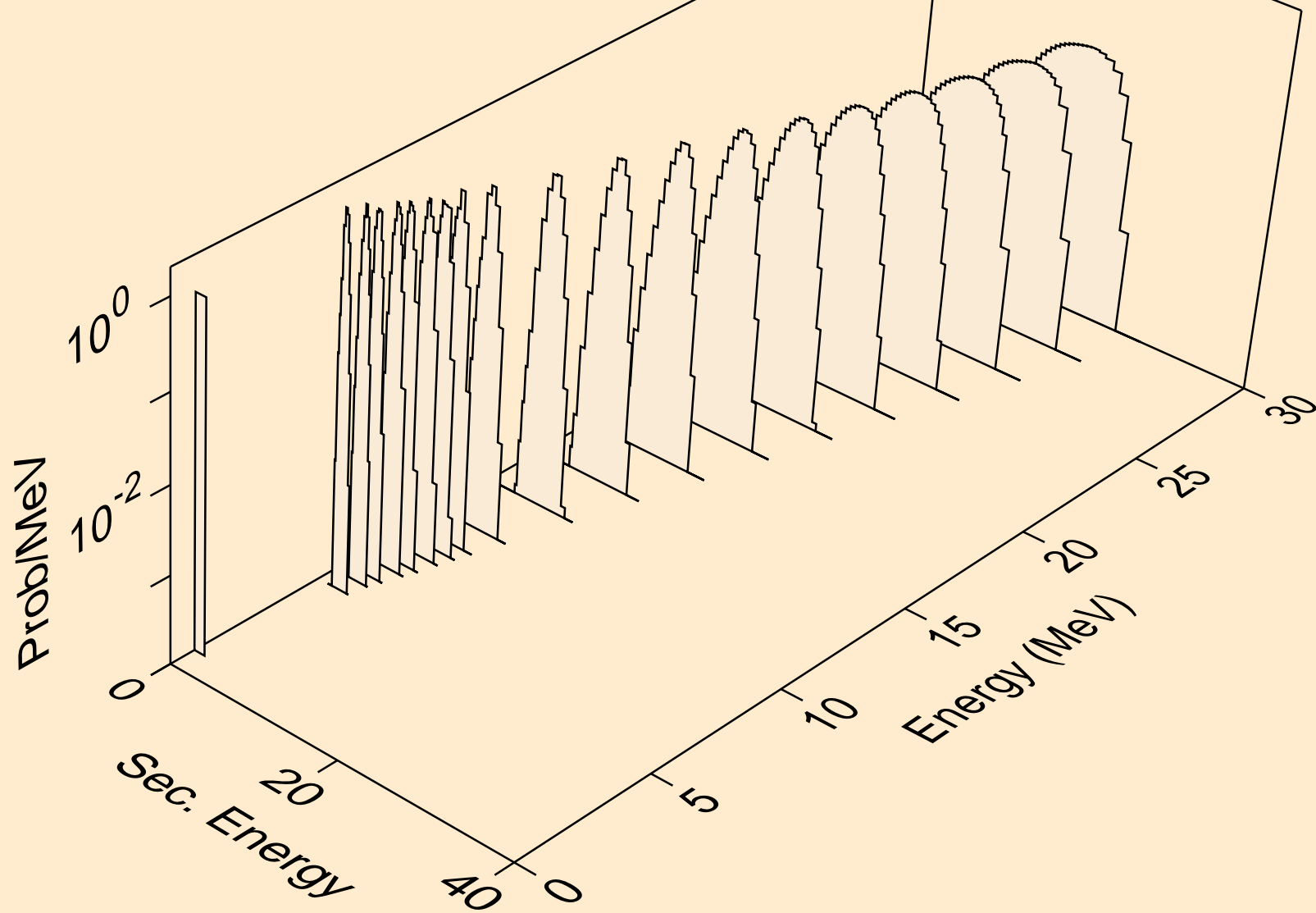

TM150 NEUTRON ACER TENDL-2021 LIBRARY; T=293.6K  
deuterons from (n,da)

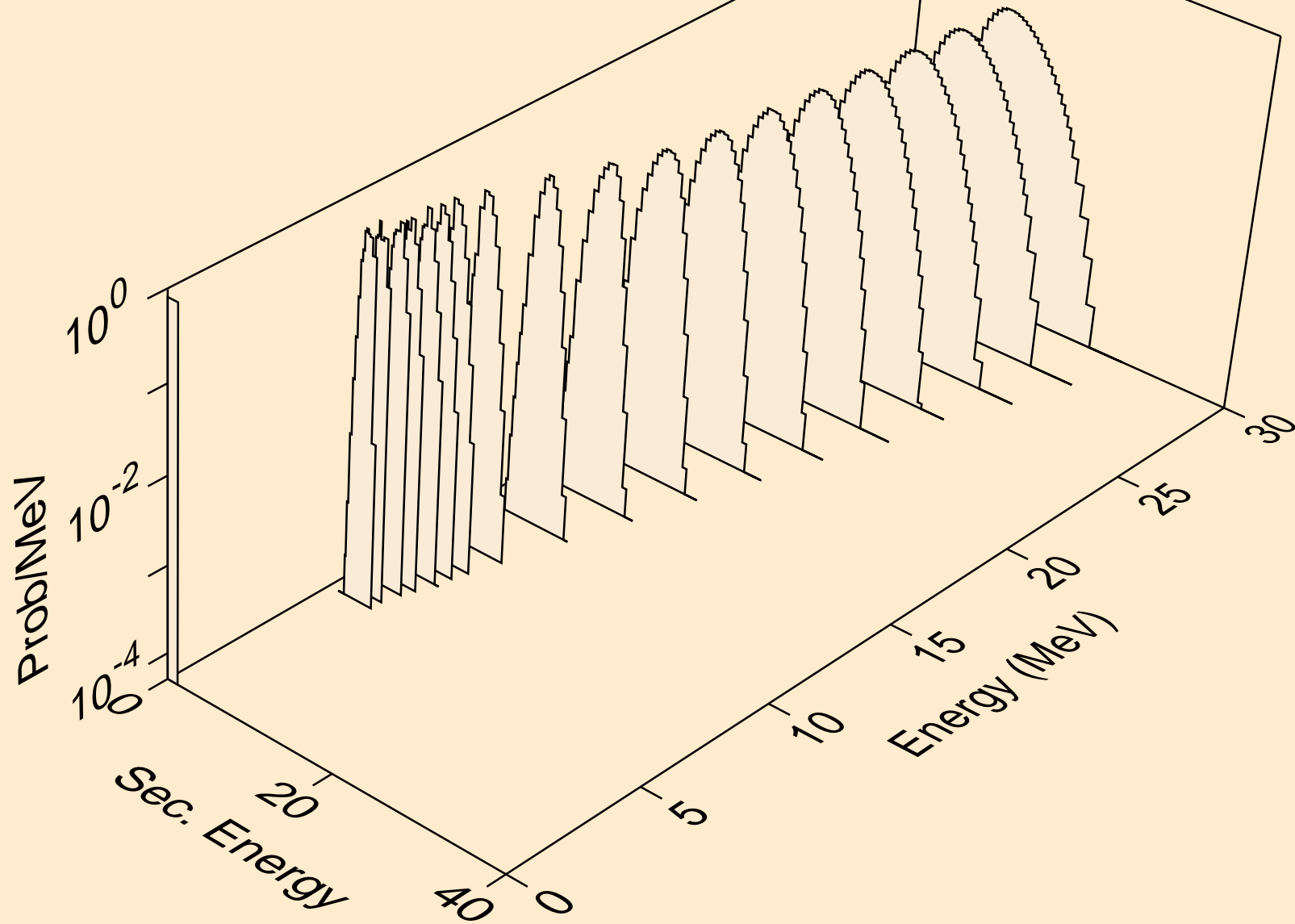



TM150 NEUTRON ACER TENDL-2021 LIBRARY; T=293.6K  
tritons from (n,x)

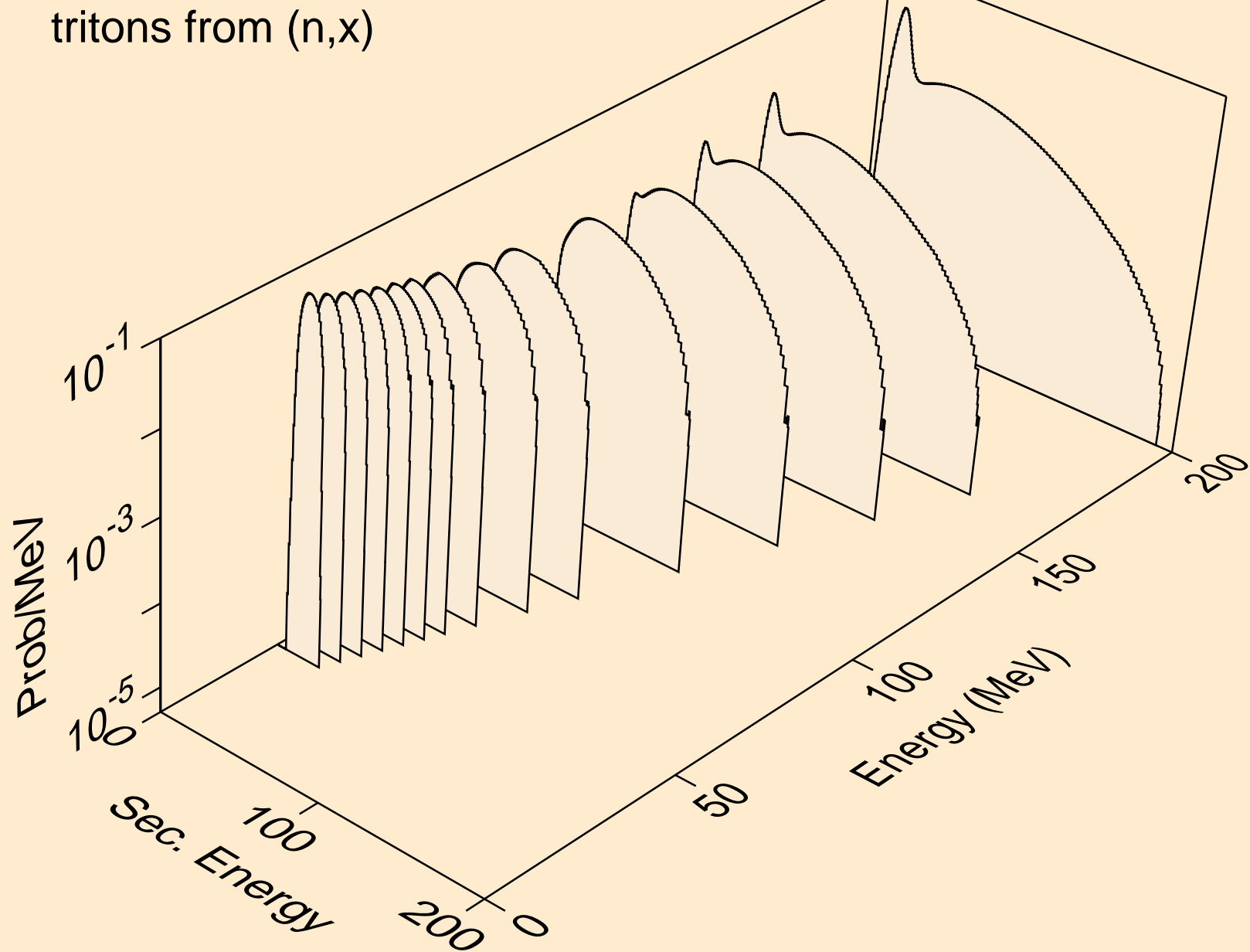

TM150 NEUTRON ACER TENDL-2021 LIBRARY; T=293.6K  
tritons from (n,n\*)t

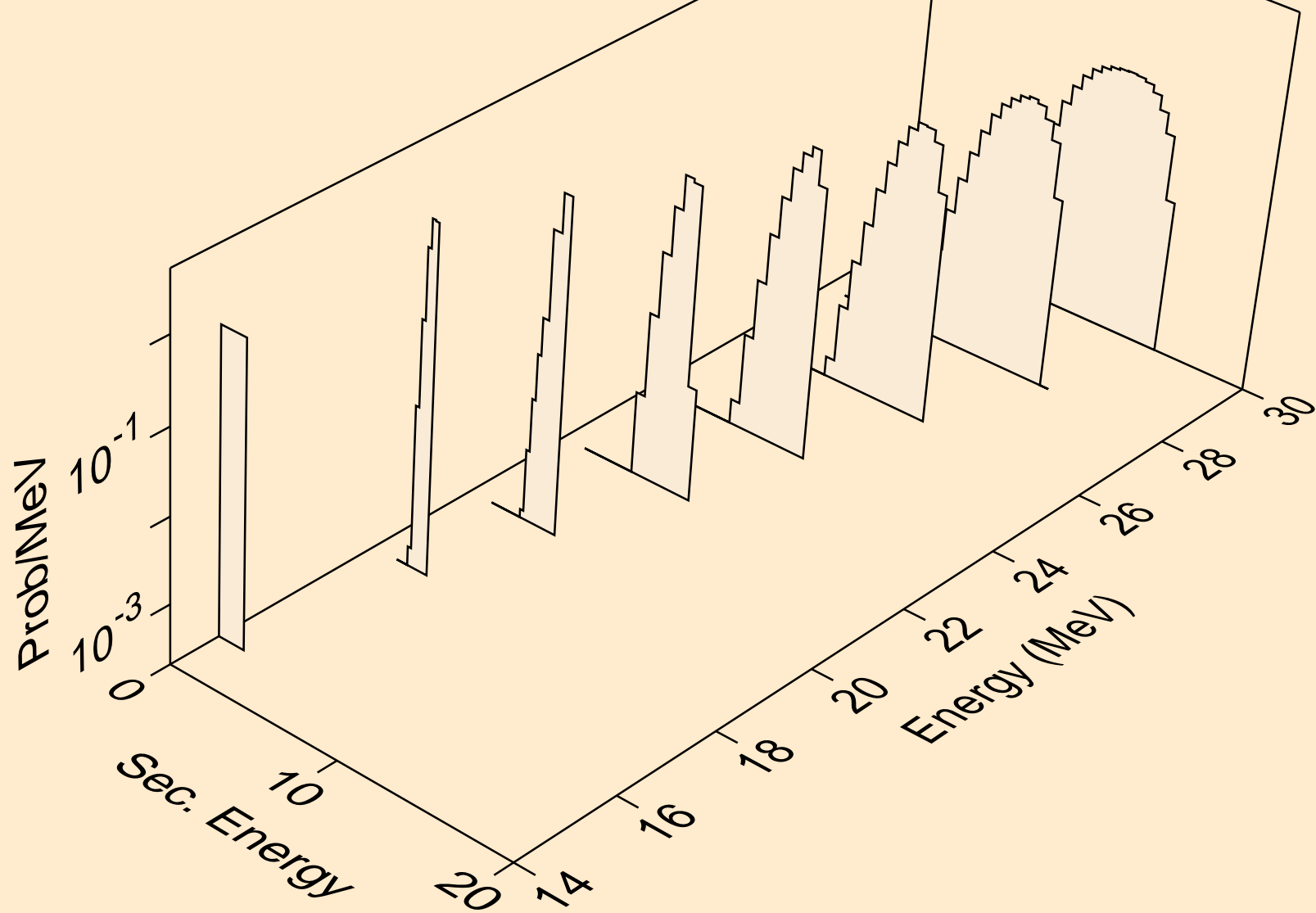

TM150 NEUTRON ACER TENDL-2021 LIBRARY; T=293.6K  
tritons from (n,t)

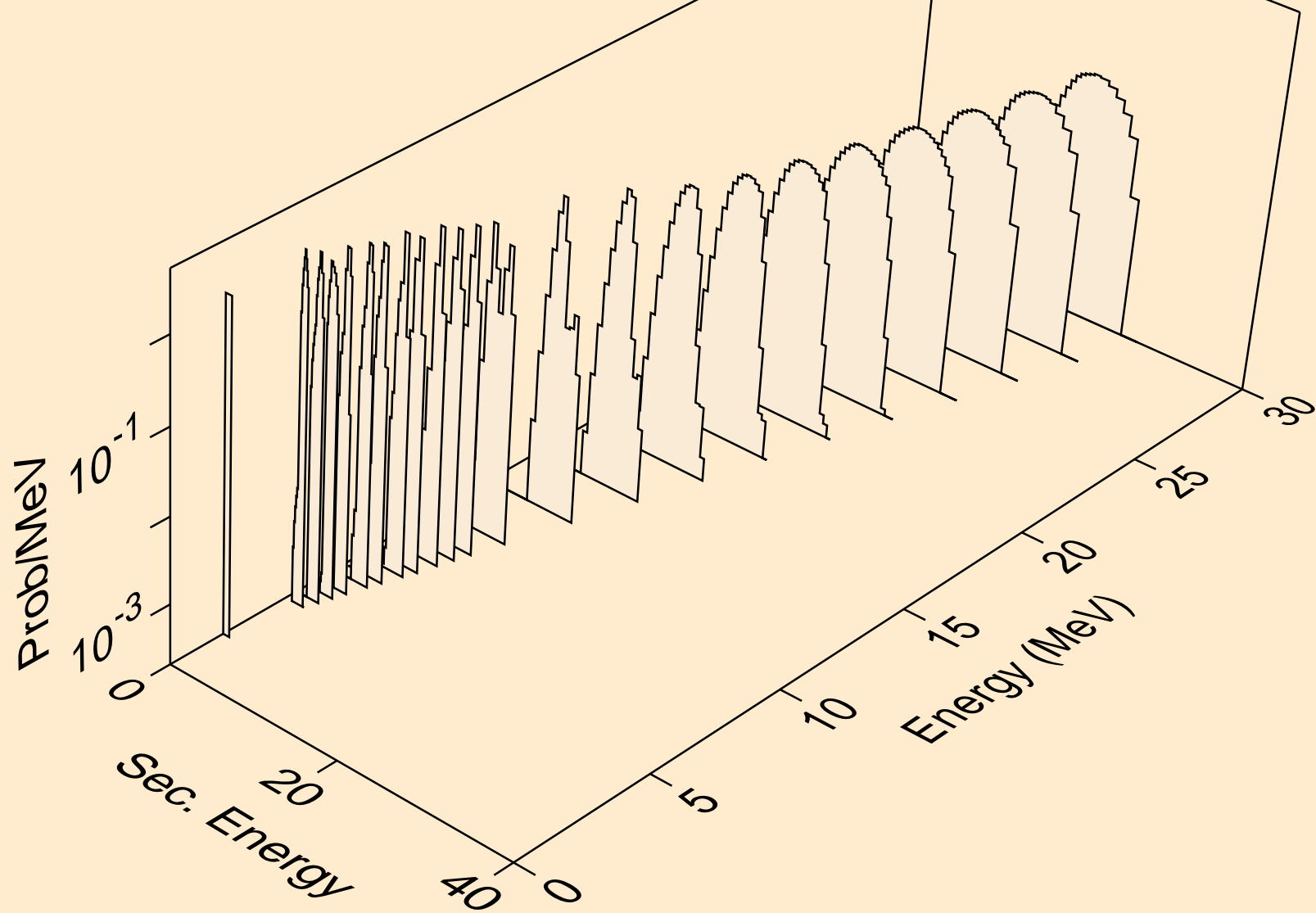

TM150 NEUTRON ACER TENDL-2021 LIBRARY; T=293.6K  
tritons from (n,pt)

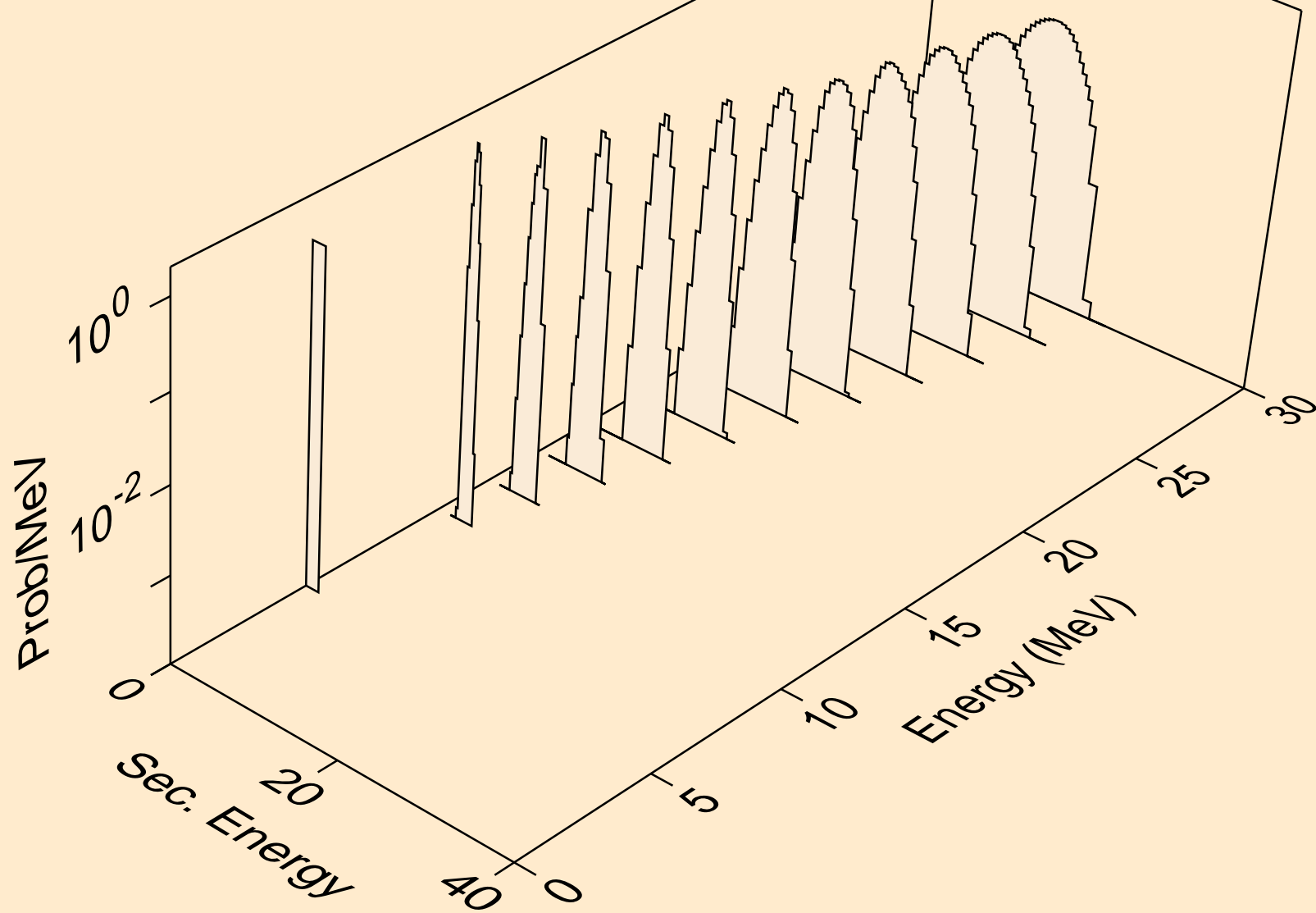

TM150 NEUTRON ACER TENDL-2021 LIBRARY; T=293.6K  
he3s from (n,x)

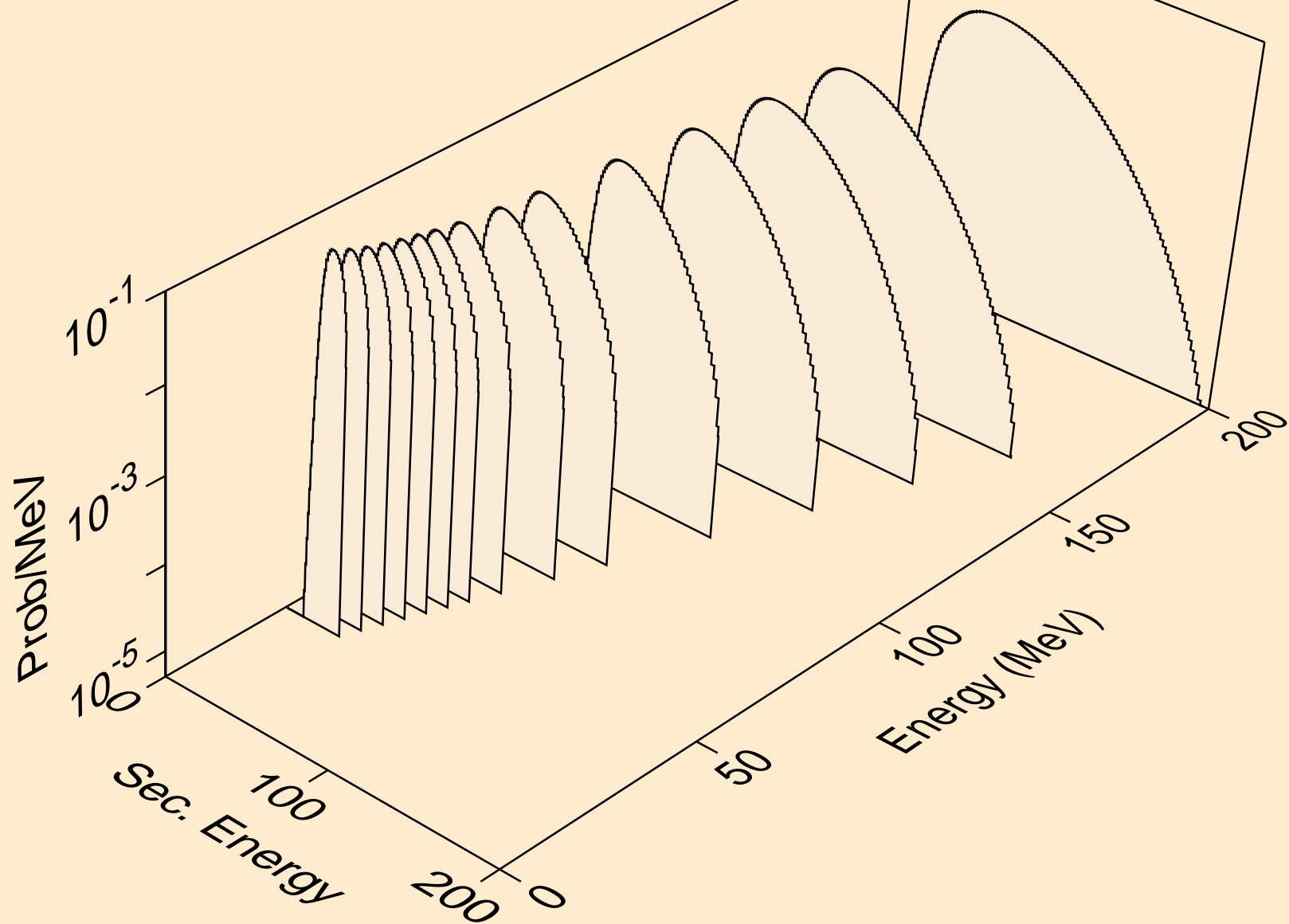

TM150 NEUTRON ACER TENDL-2021 LIBRARY; T=293.6K  
he3s from (n,n\*)he3

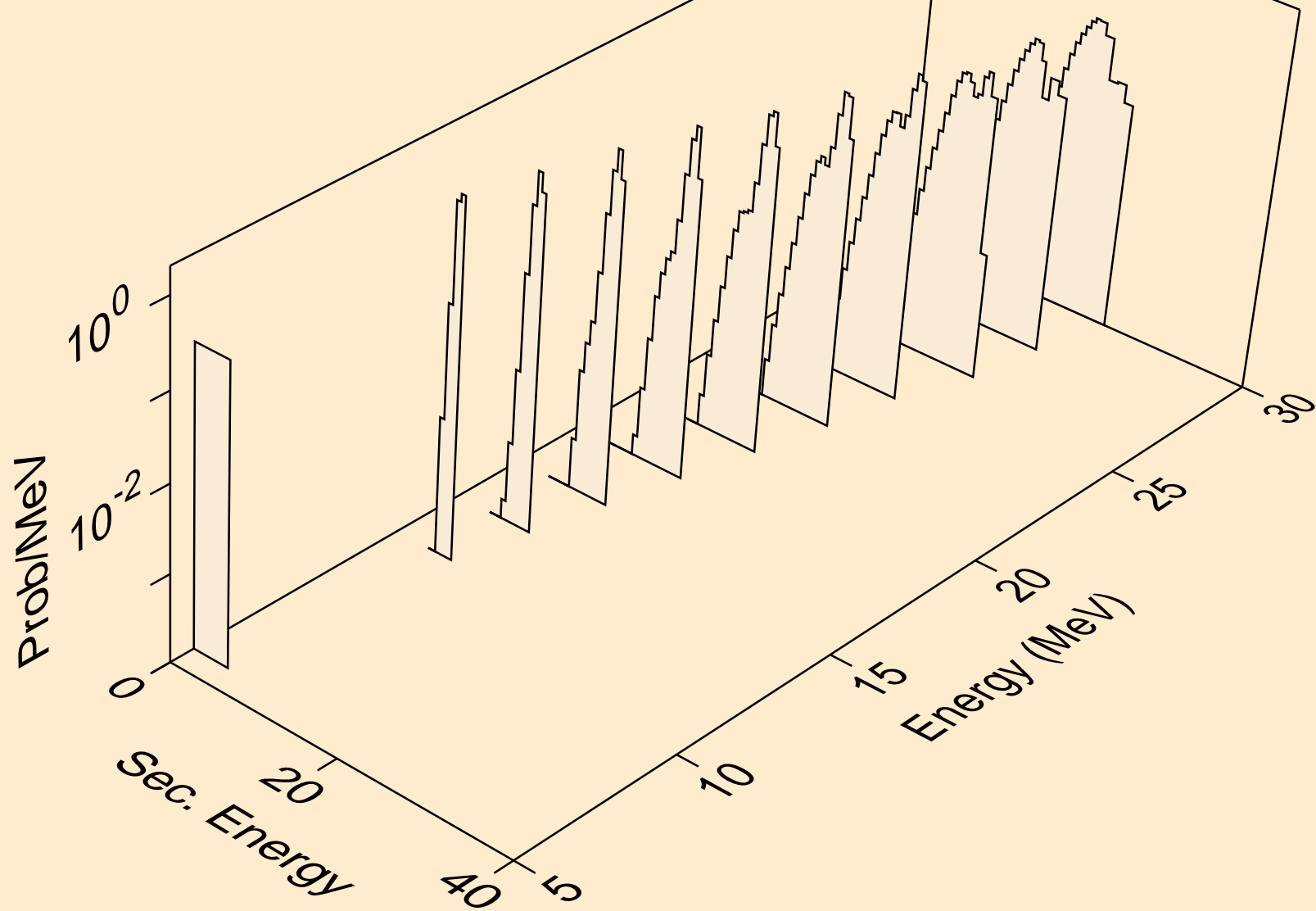

TM150 NEUTRON ACER TENDL-2021 LIBRARY; T=293.6K  
he3s from (n,he3)

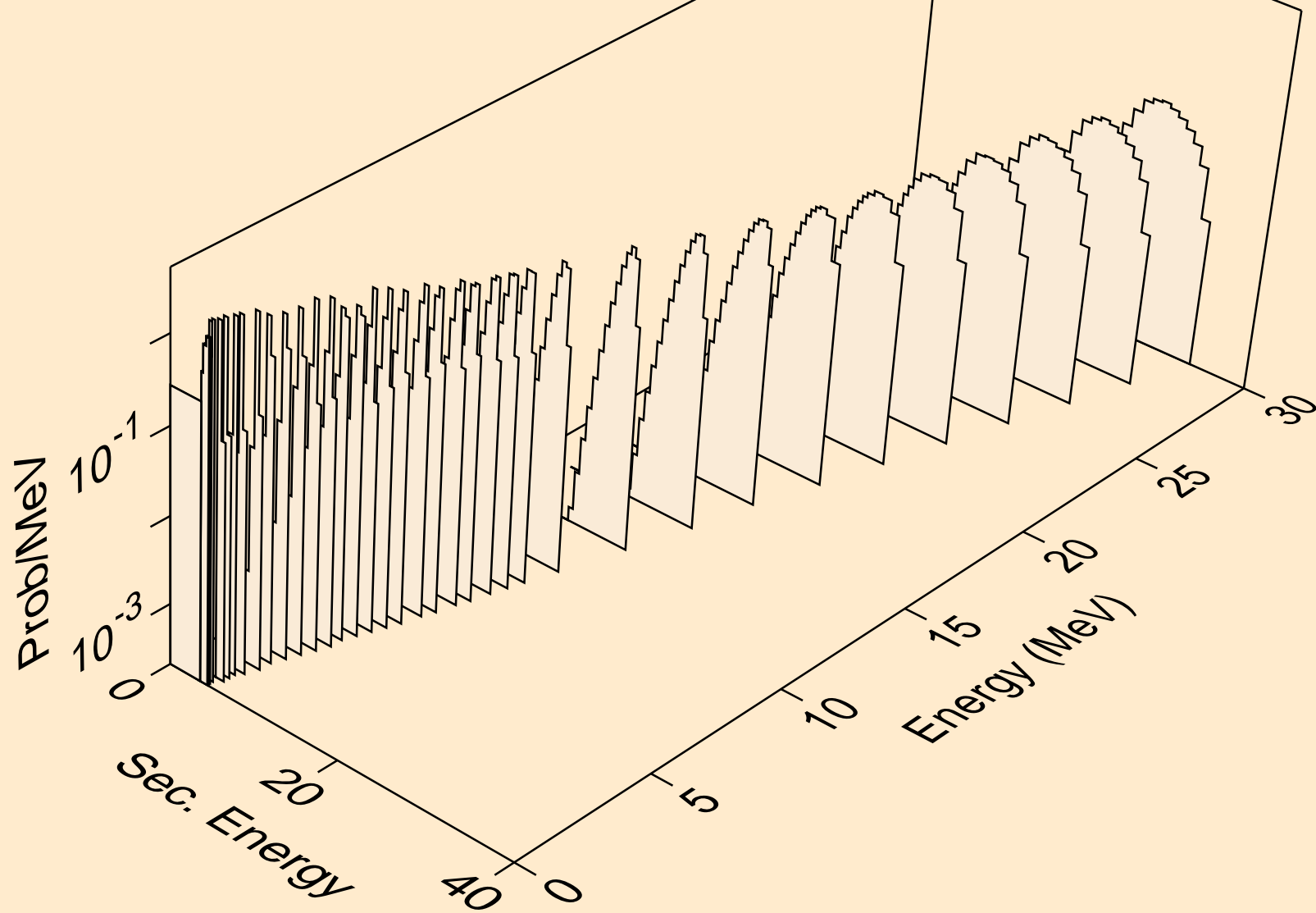

TM150 NEUTRON ACER TENDL-2021 LIBRARY; T=293.6K  
alphas from (n,x)

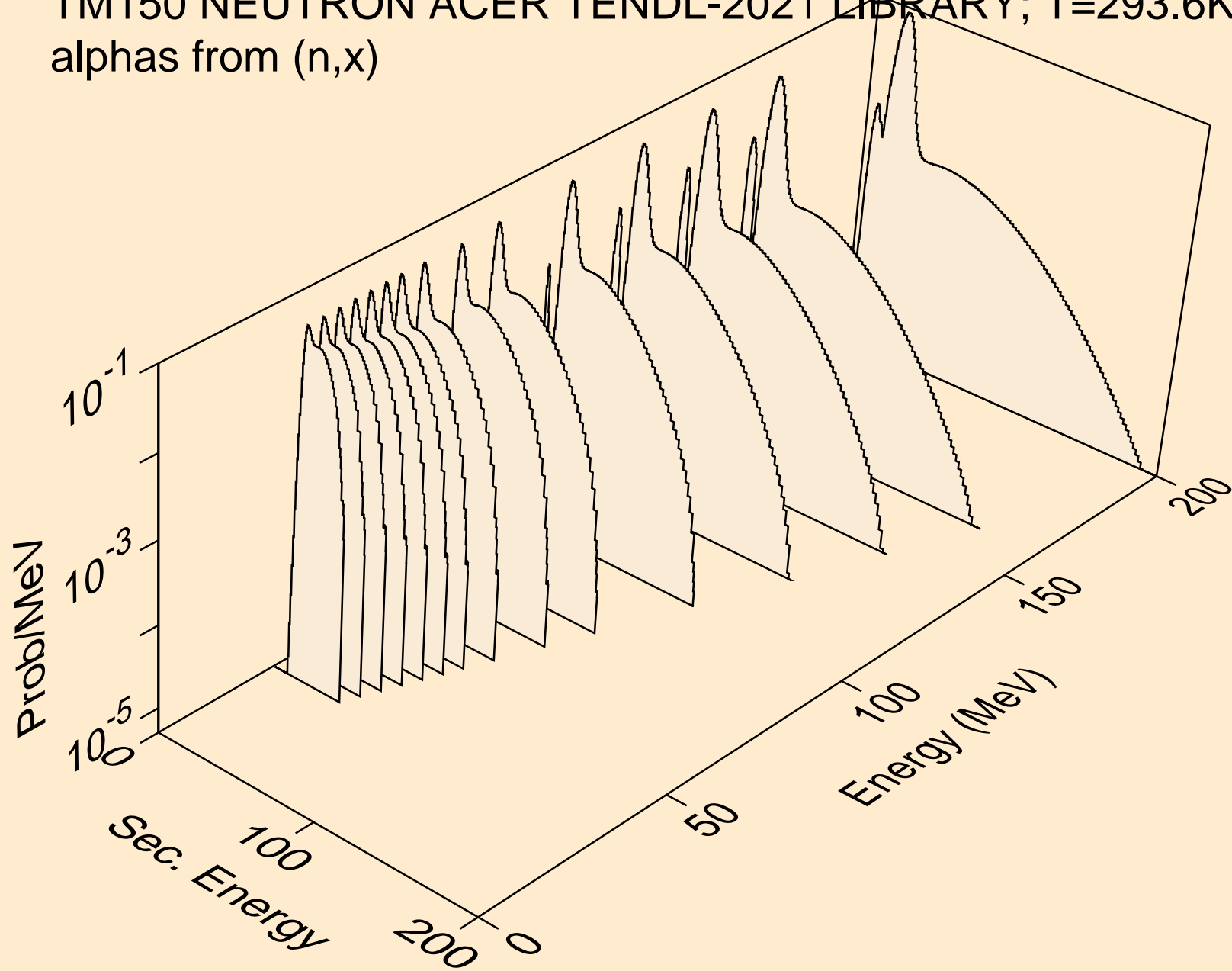



TM150 NEUTRON ACER TENDL-2021 LIBRARY; T=293.6K  
alphas from (n,n\*)a

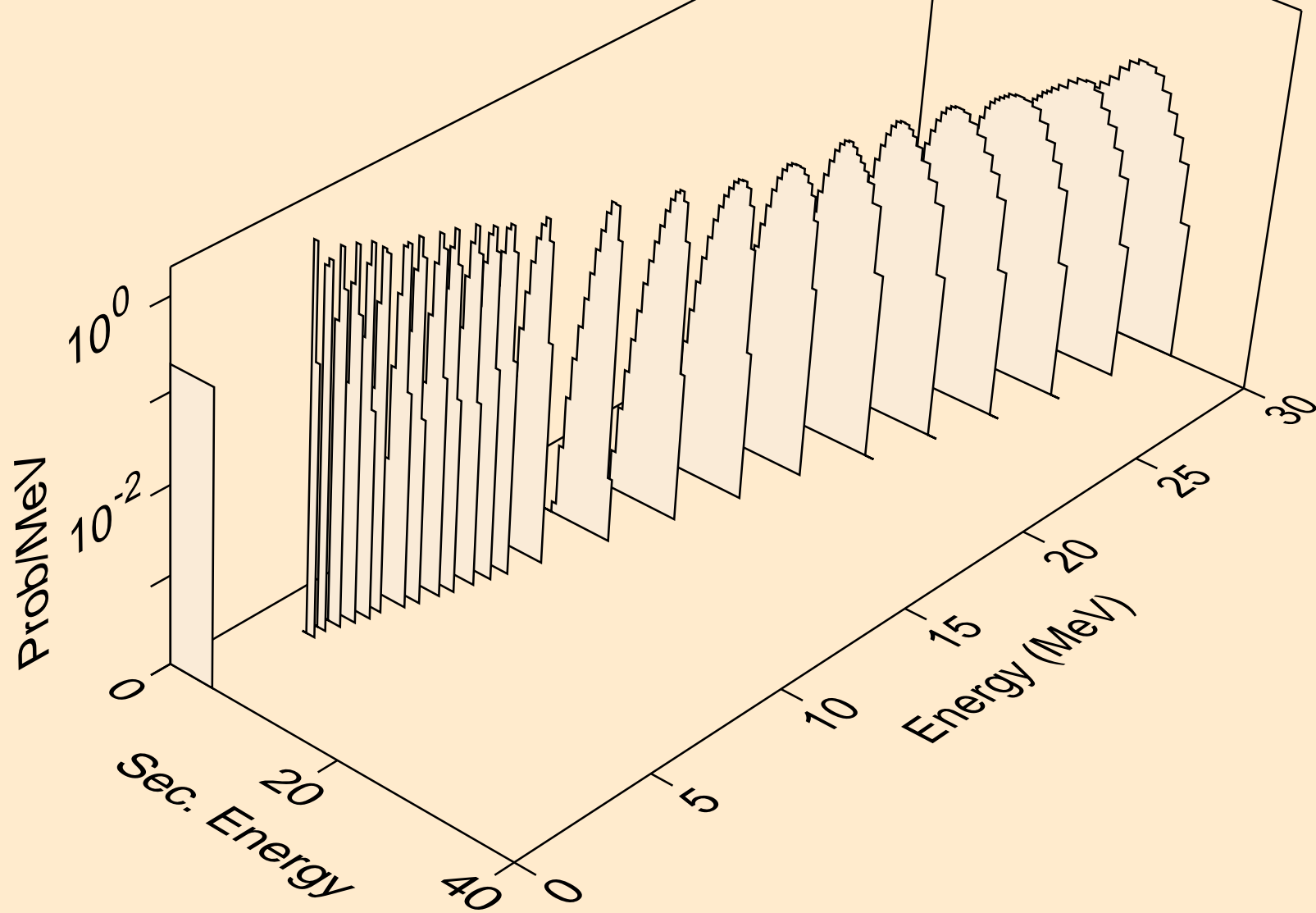

TM150 NEUTRON ACER TENDL-2021 LIBRARY; T=293.6K  
alphas from (n,2n)a

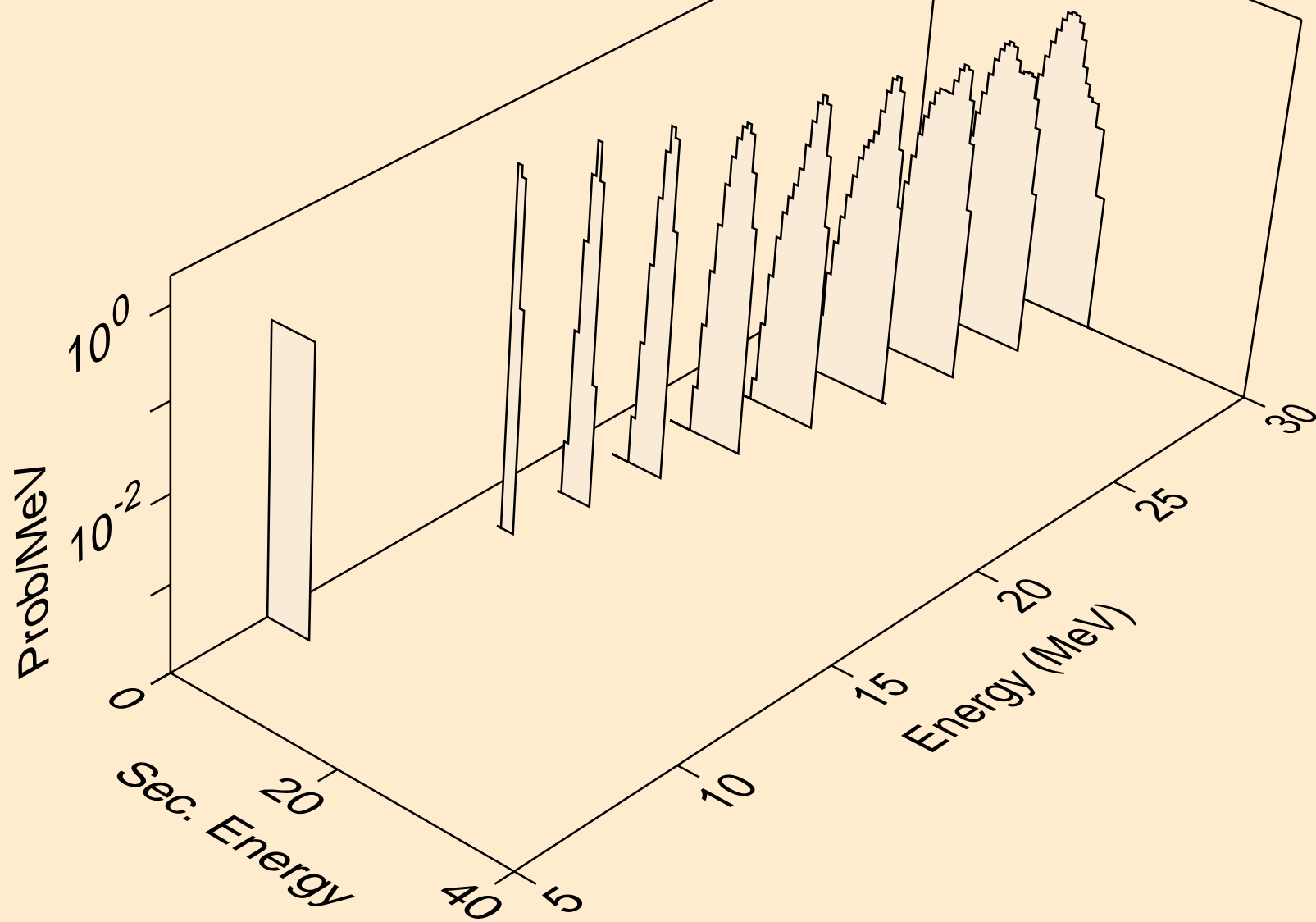

TM150 NEUTRON ACER TENDL-2021 LIBRARY; T=293.6K  
alphas from (n,n\*)2a

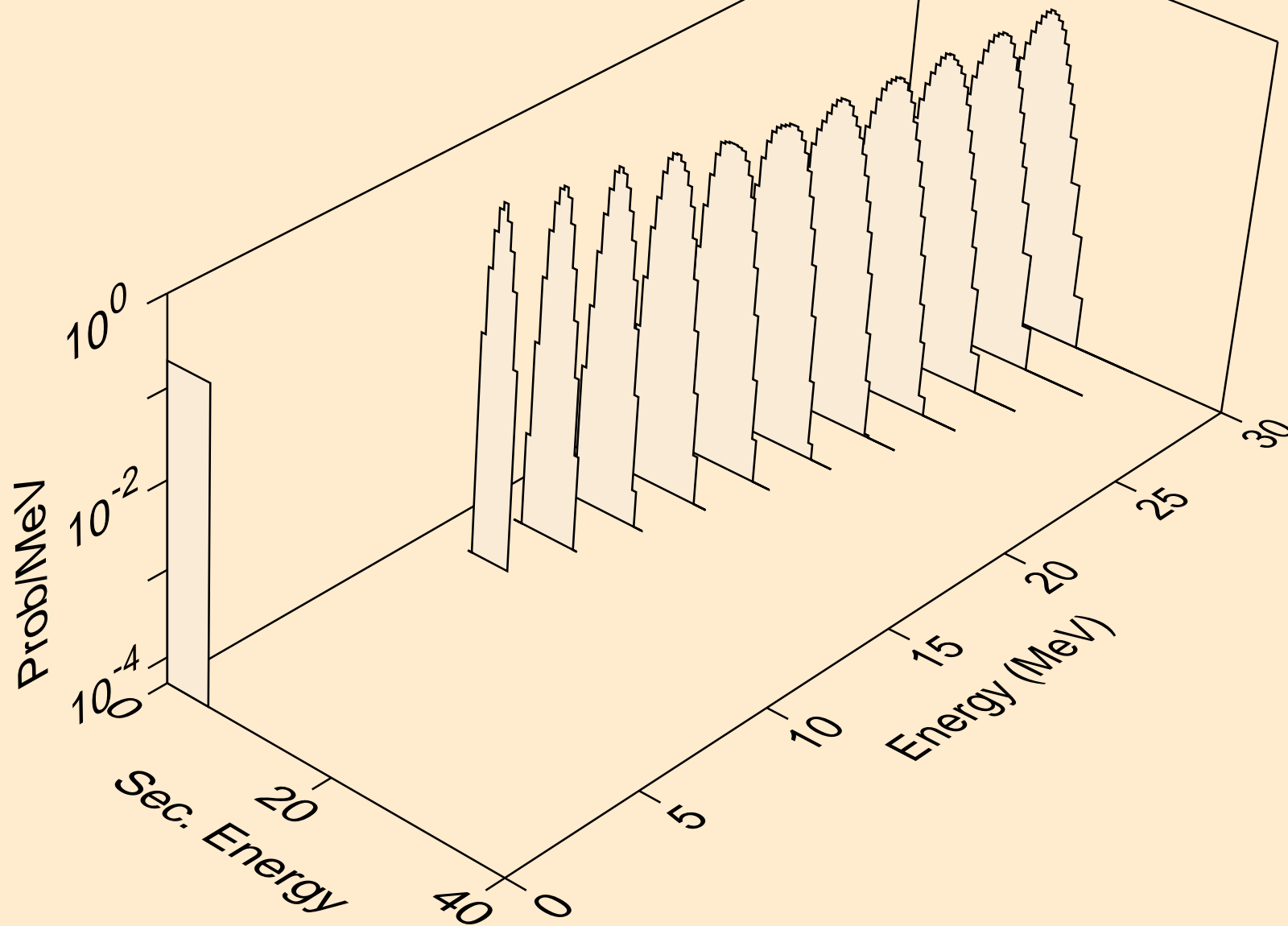

TM150 NEUTRON ACER TENDL-2021 LIBRARY; T=293.6K  
alphas from (n,npa)

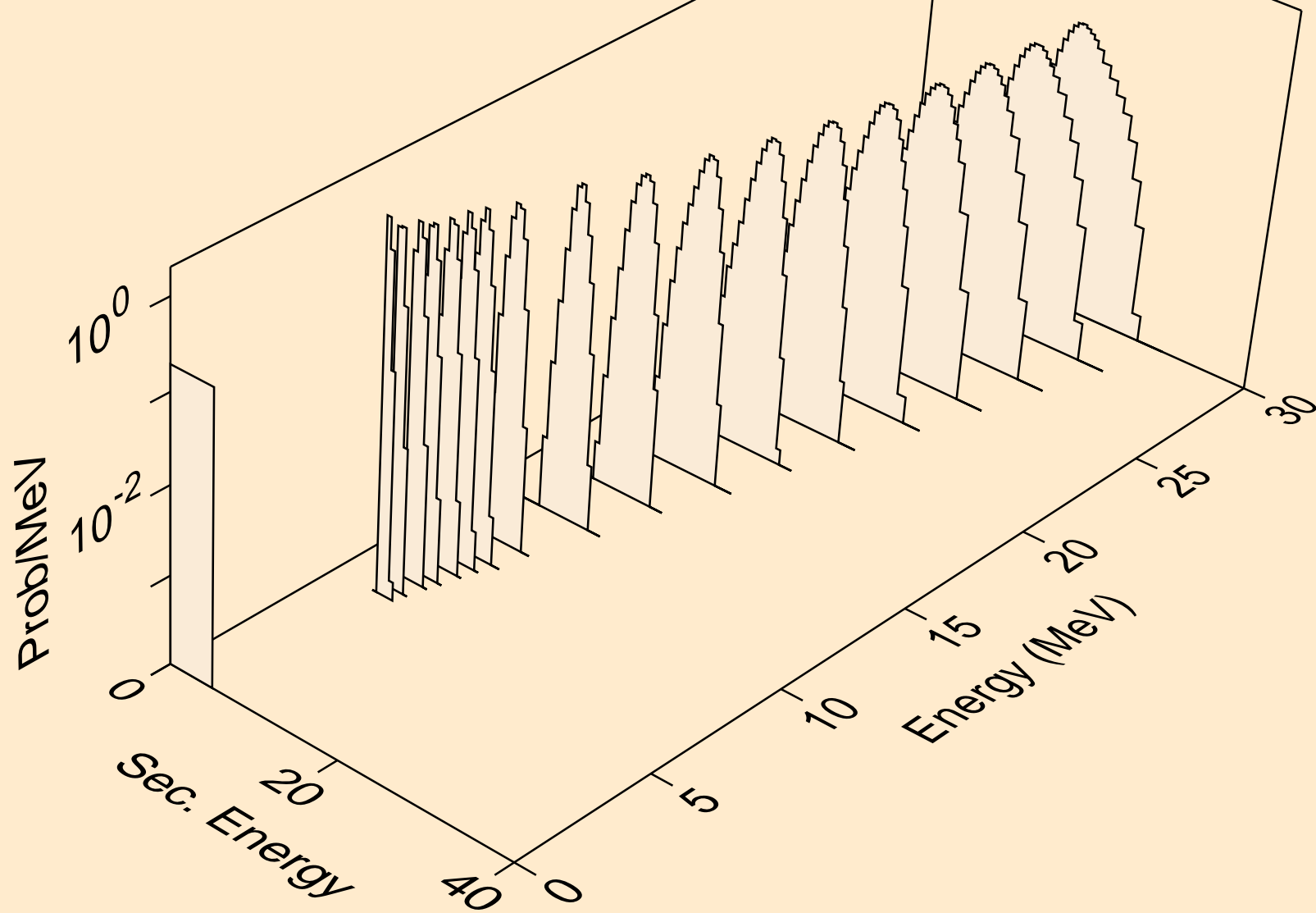

TM150 NEUTRON ACER TENDL-2021 LIBRARY; T=293.6K  
alphas from (n,a)

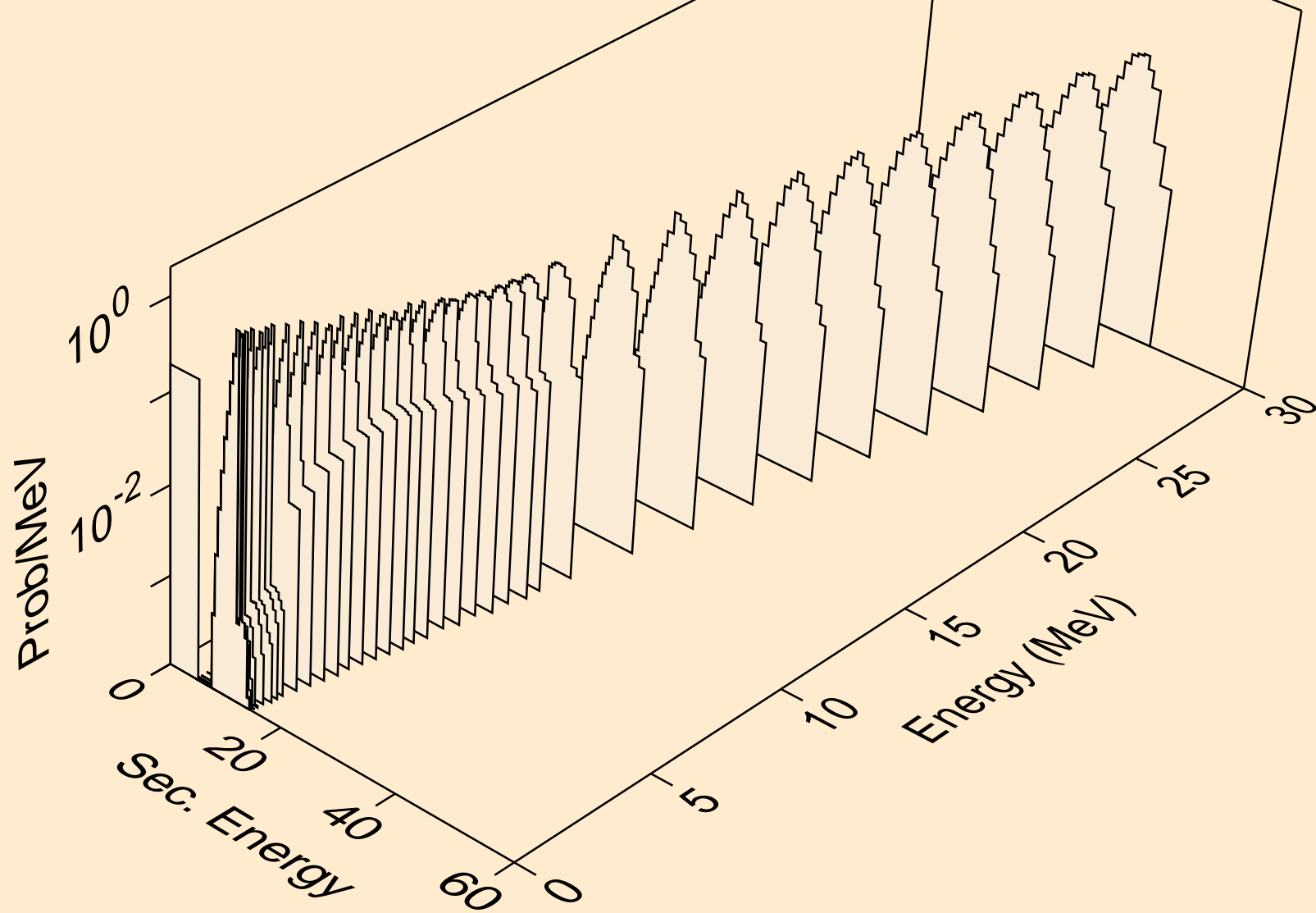

TM150 NEUTRON ACER TENDL-2021 LIBRARY; T=293.6K  
alphas from (n,2a)

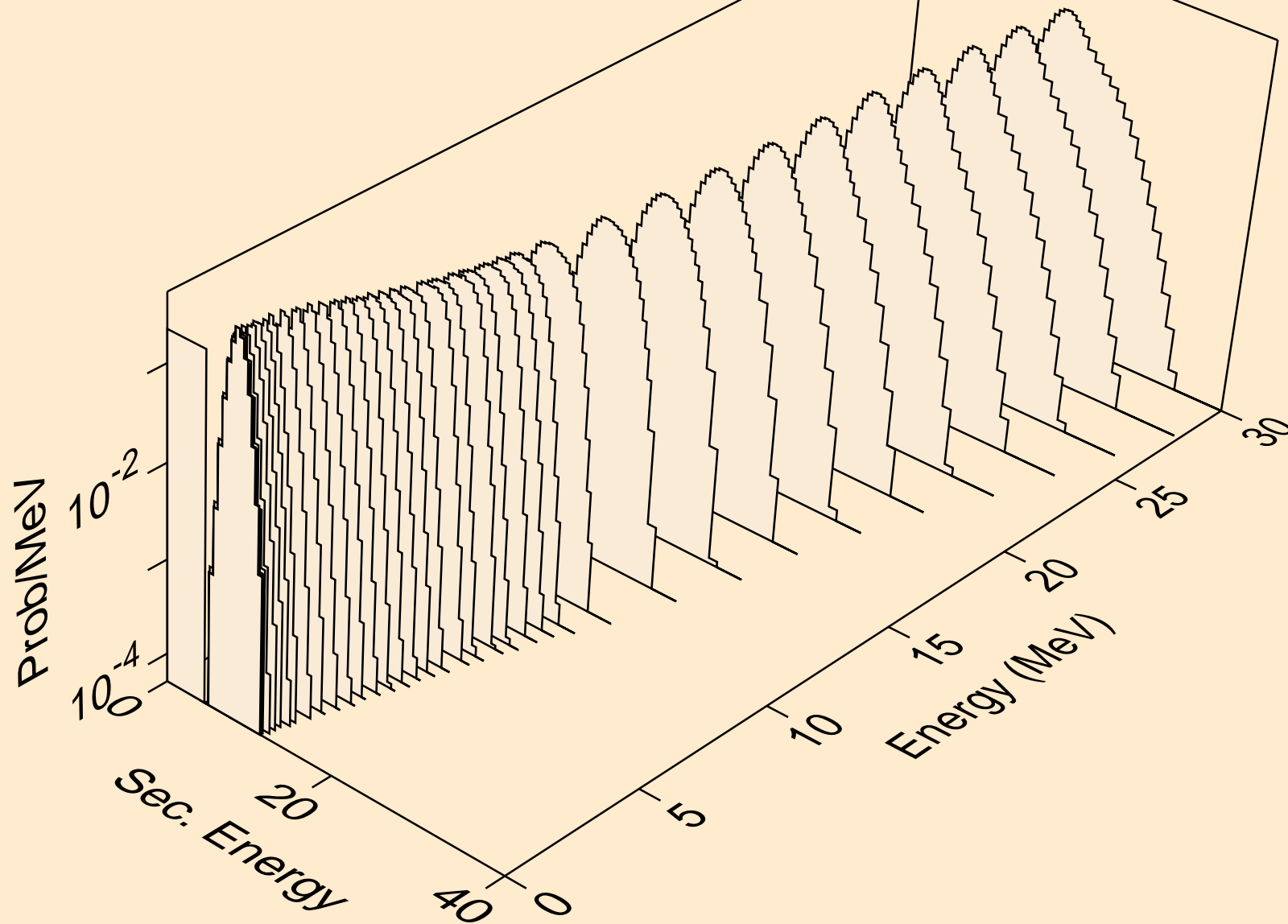

TM150 NEUTRON ACER TENDL-2021 LIBRARY; T=293.6K  
alphas from (n,3a)

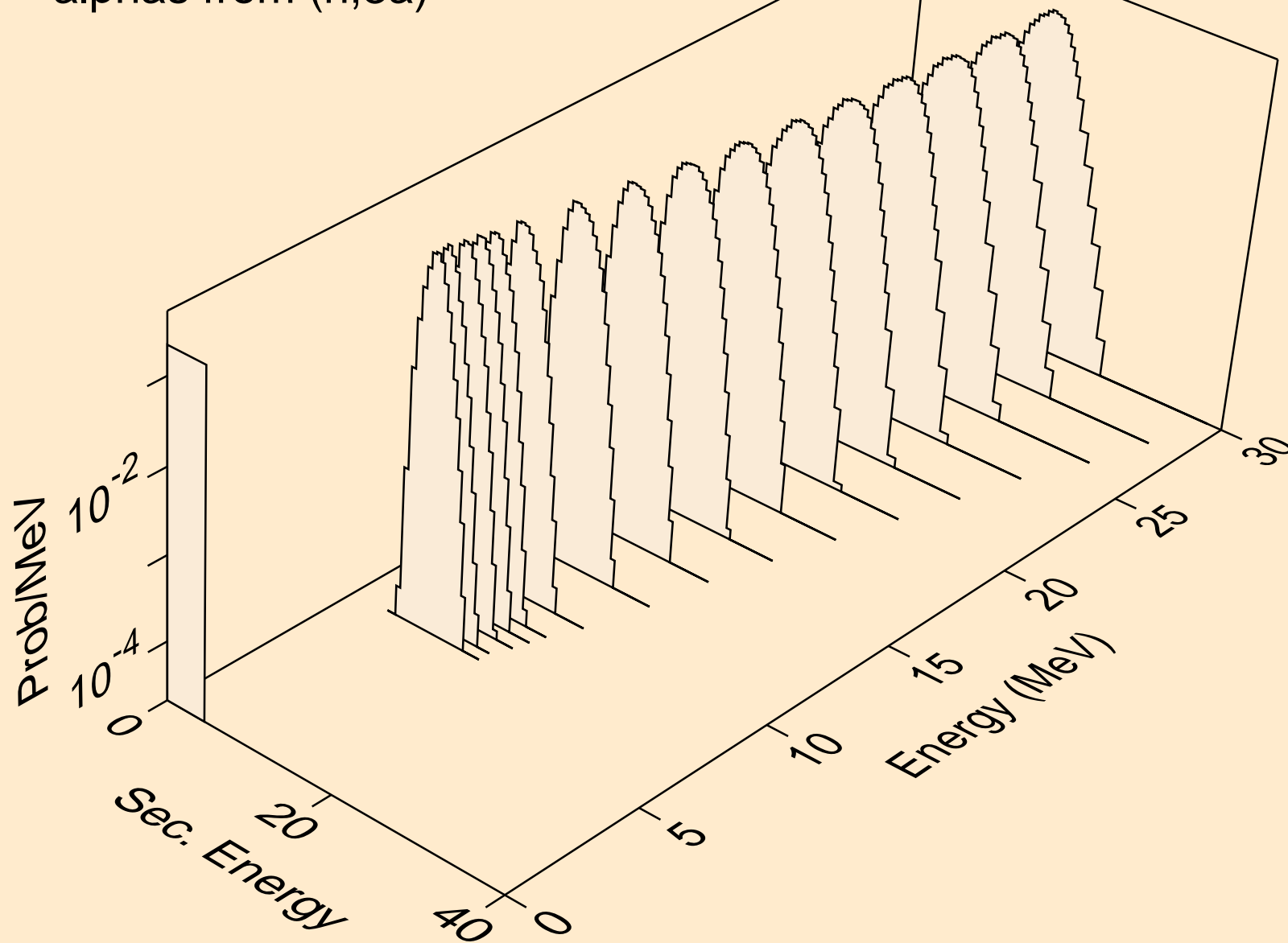

TM150 NEUTRON ACER TENDL-2021 LIBRARY; T=293.6K  
alphas from (n,pa)

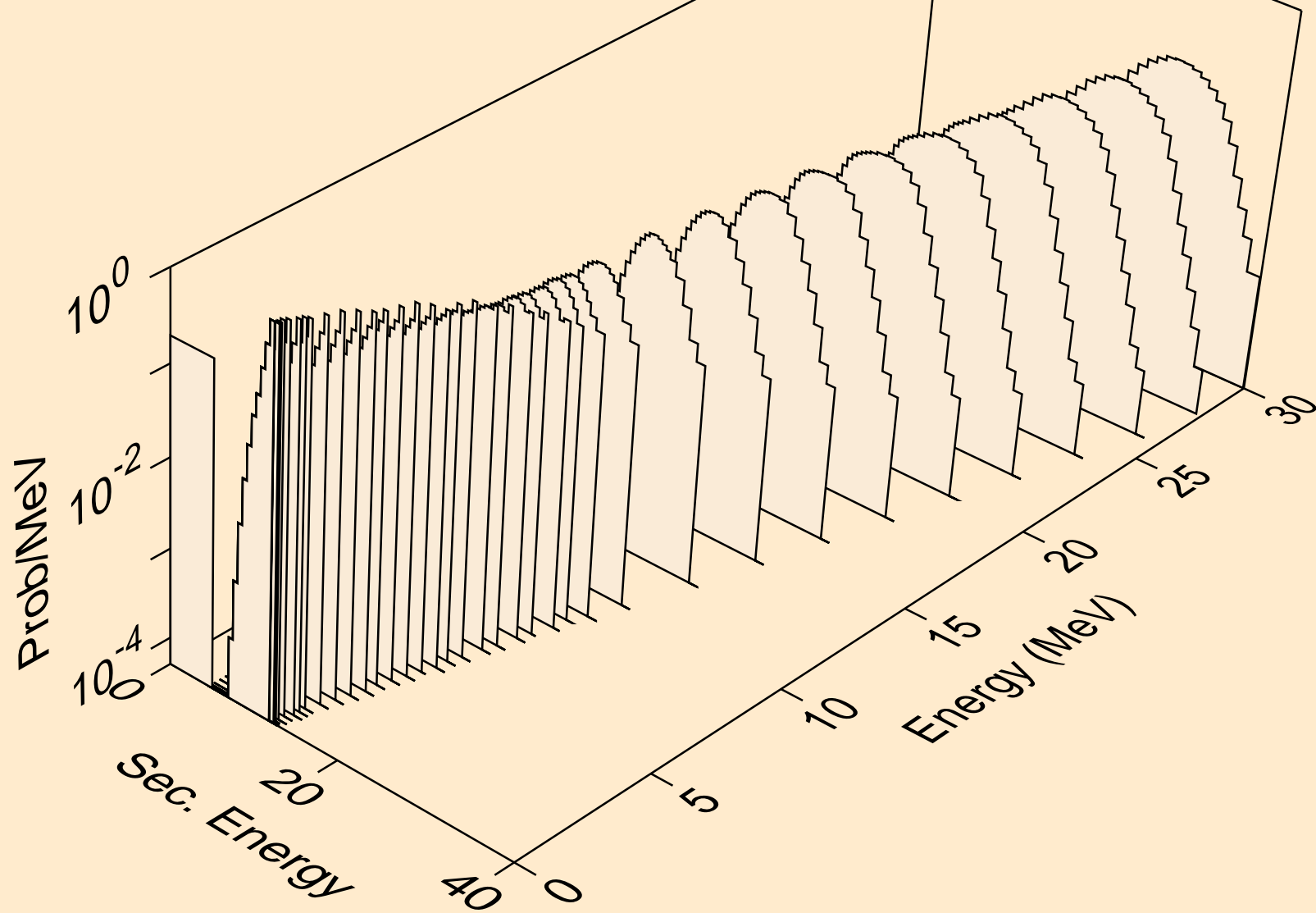



TM150 NEUTRON ACER TENDL-2021 LIBRARY; T=293.6K  
alphas from (n,d2a)

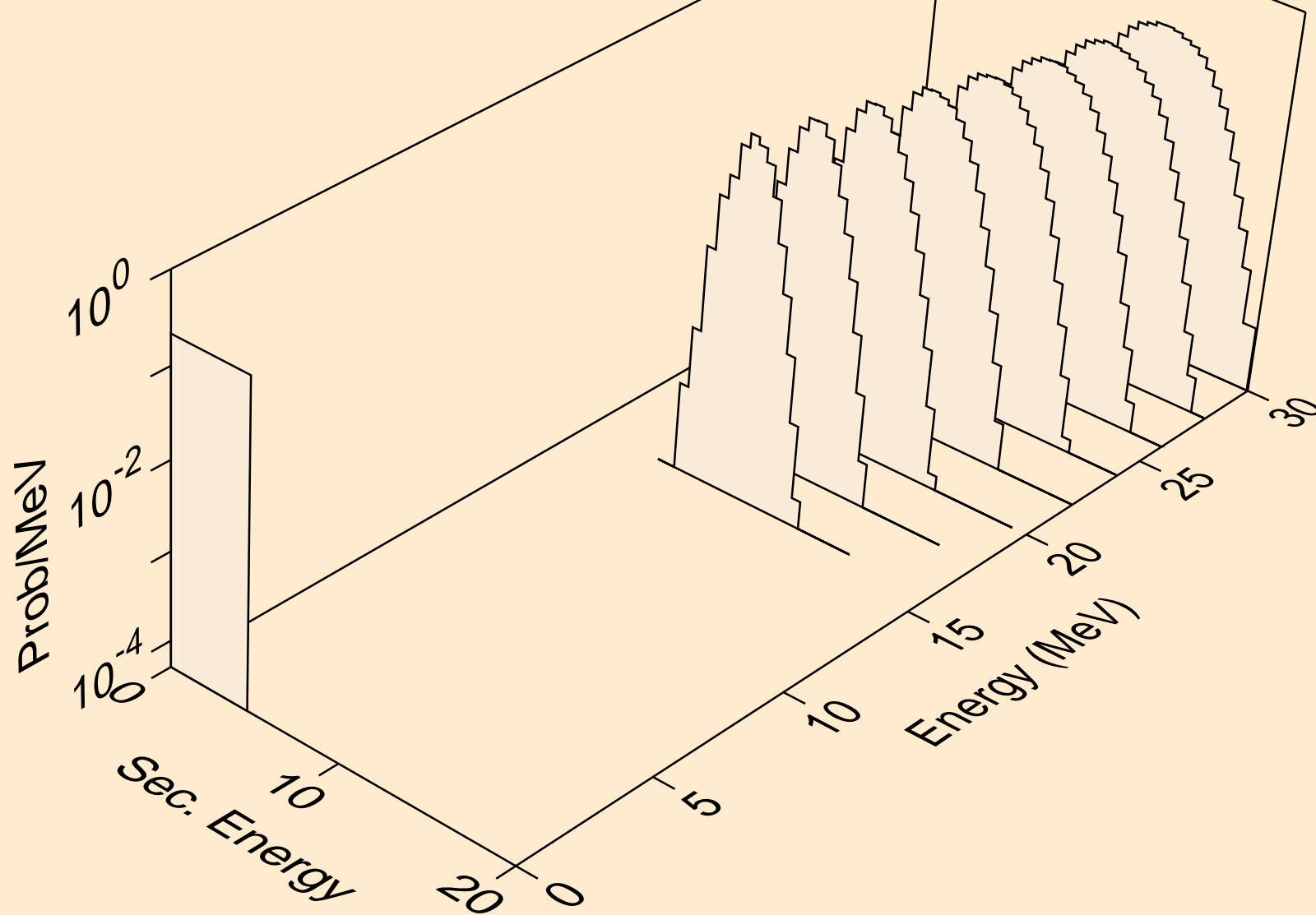

TM150 NEUTRON ACER TENDL-2021 LIBRARY; T=293.6K  
alphas from (n,da)

