

Program EVALPLOT  
(Version 2018-1)

by

Dermott E. Cullen  
(Present Contact Information)

Dermott E. Cullen  
1466 Hudson Way  
Livermore, CA 94550  
U.S.A.

Tele: 925-443-1911

E.Mail:redcullen1@comcast.net

Web:redcullen1.net/HOMEPAGE.NEW

Press Mouse Button to Start

MAT 6931

Major

293 Kelvin Cross Sections

69-Tm-171

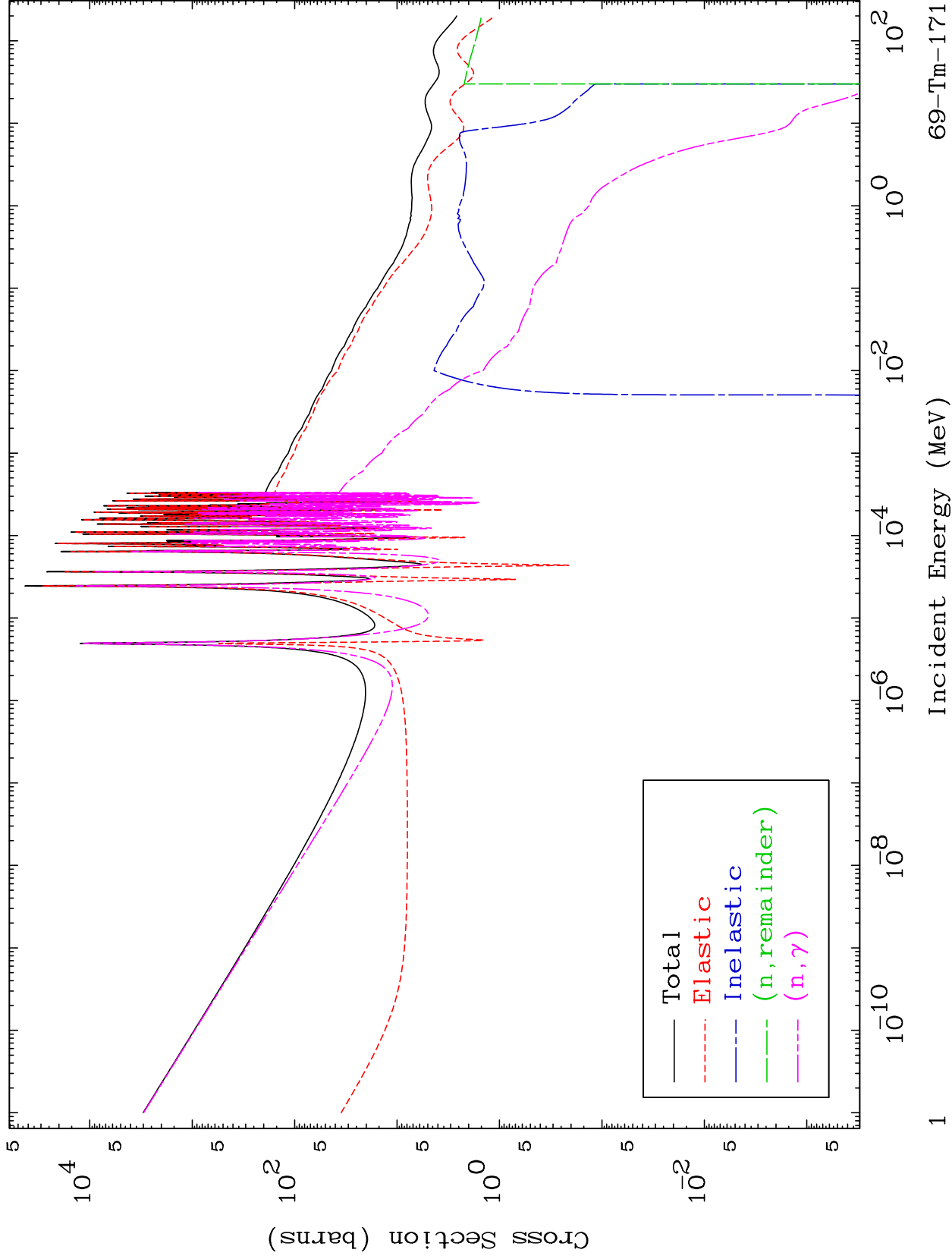

MAT 6931

Neutron Production  
293 Kelvin Cross Sections

69-Tm-171

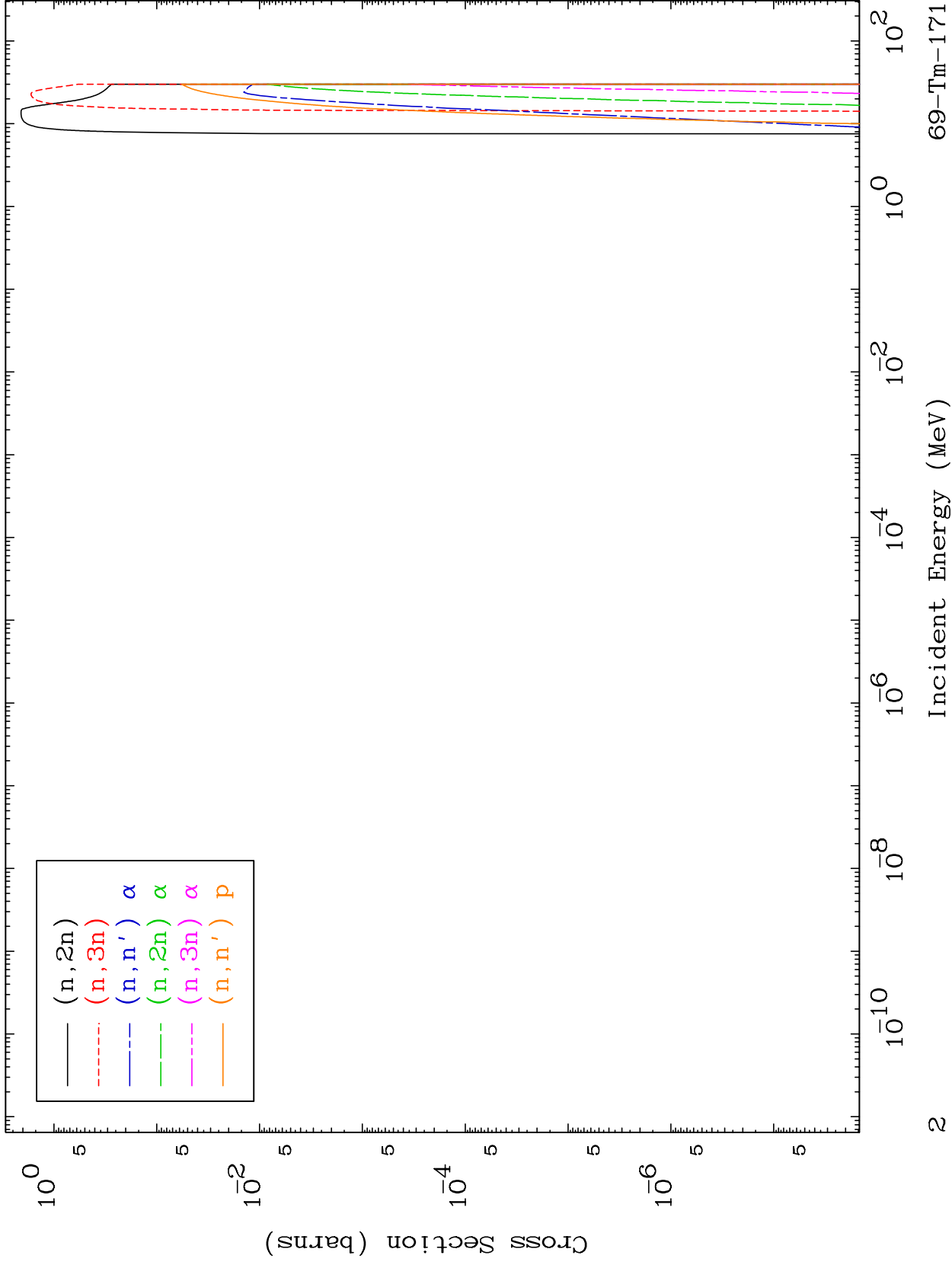

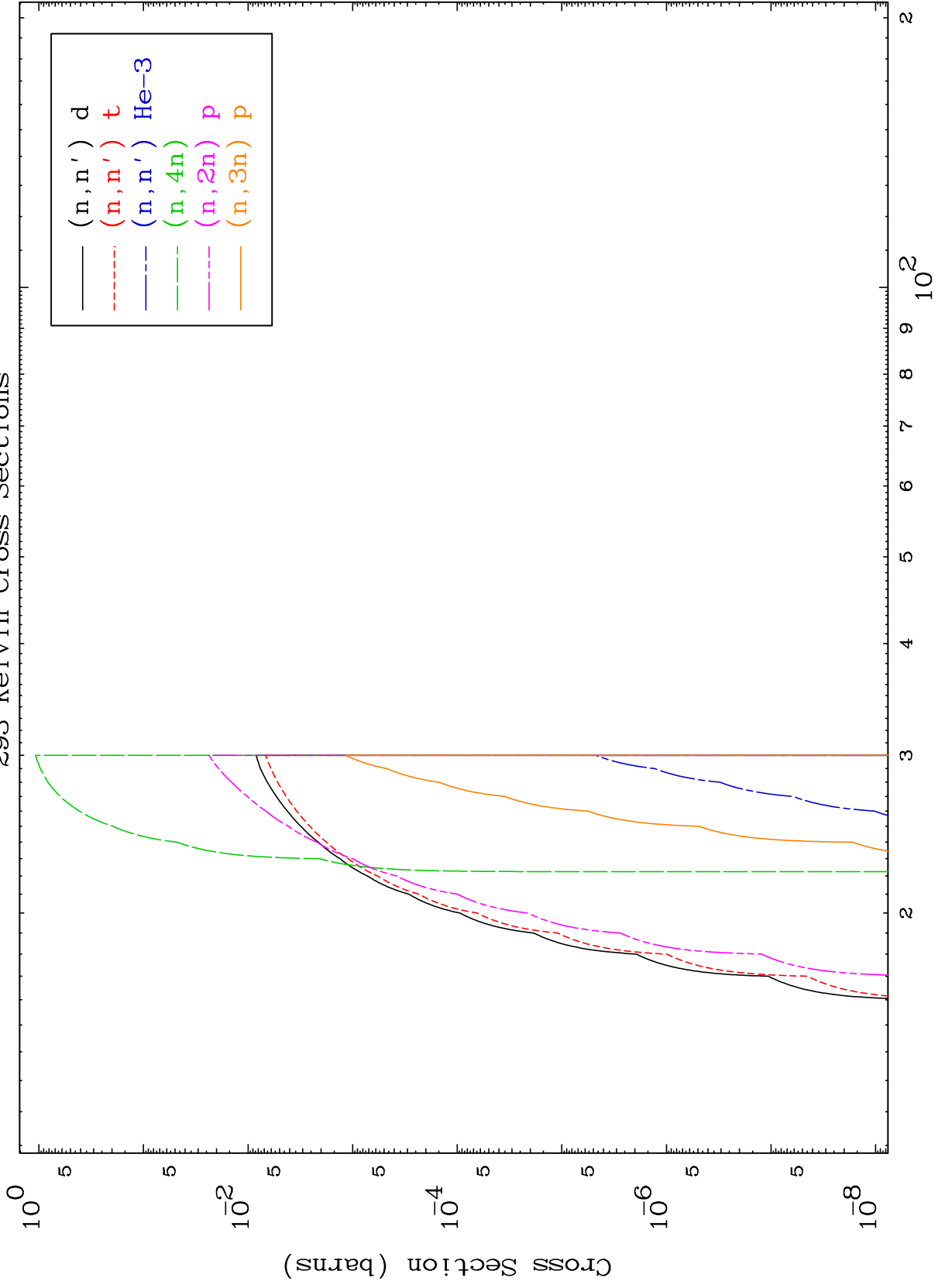

MAT 6931

Charged Particle  
293 Kelvin Cross Sections

69-Tm-171

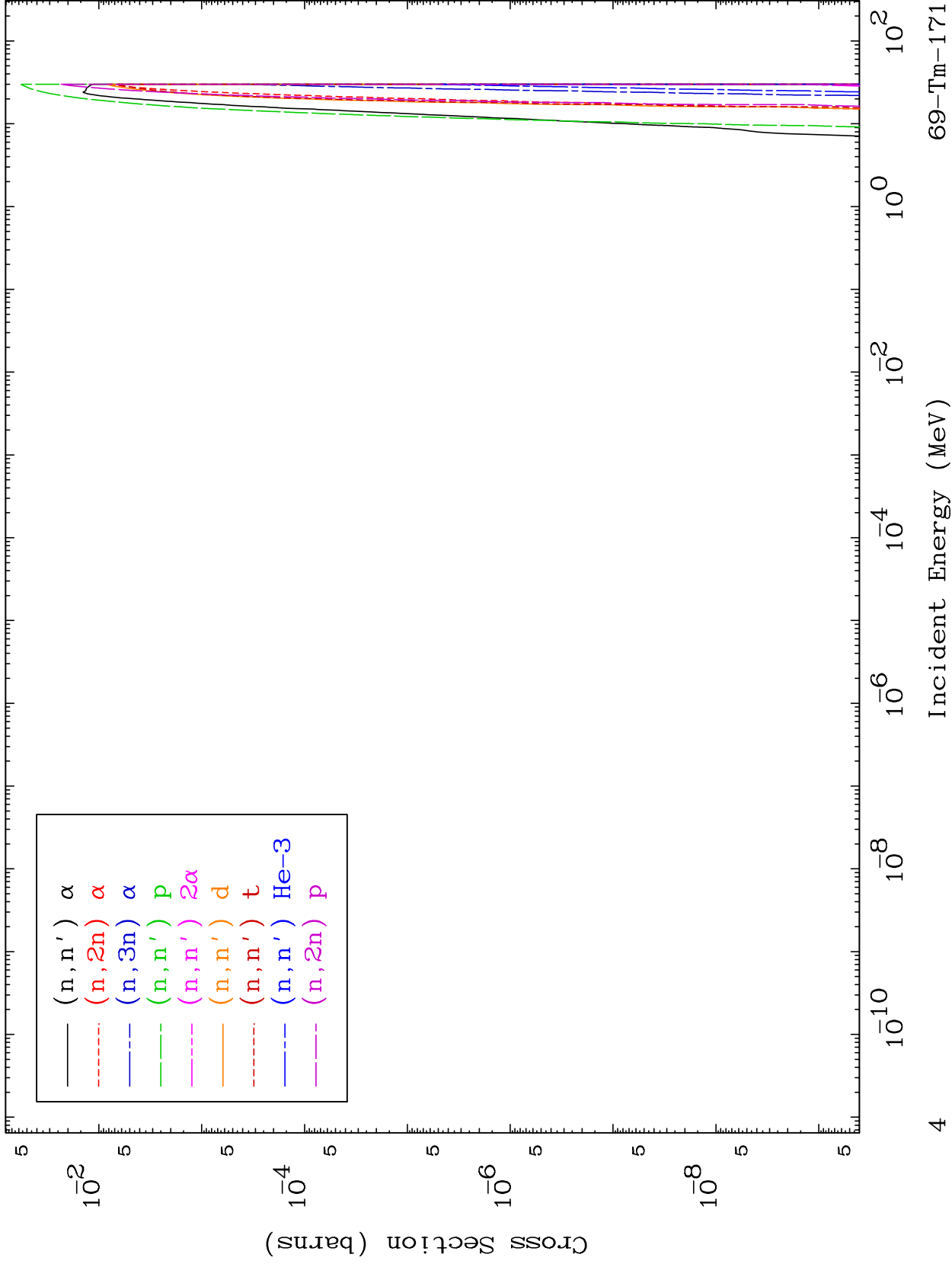

MAT 6931

Charged Particle  
293 Kelvin Cross Sections

69-Tm-171

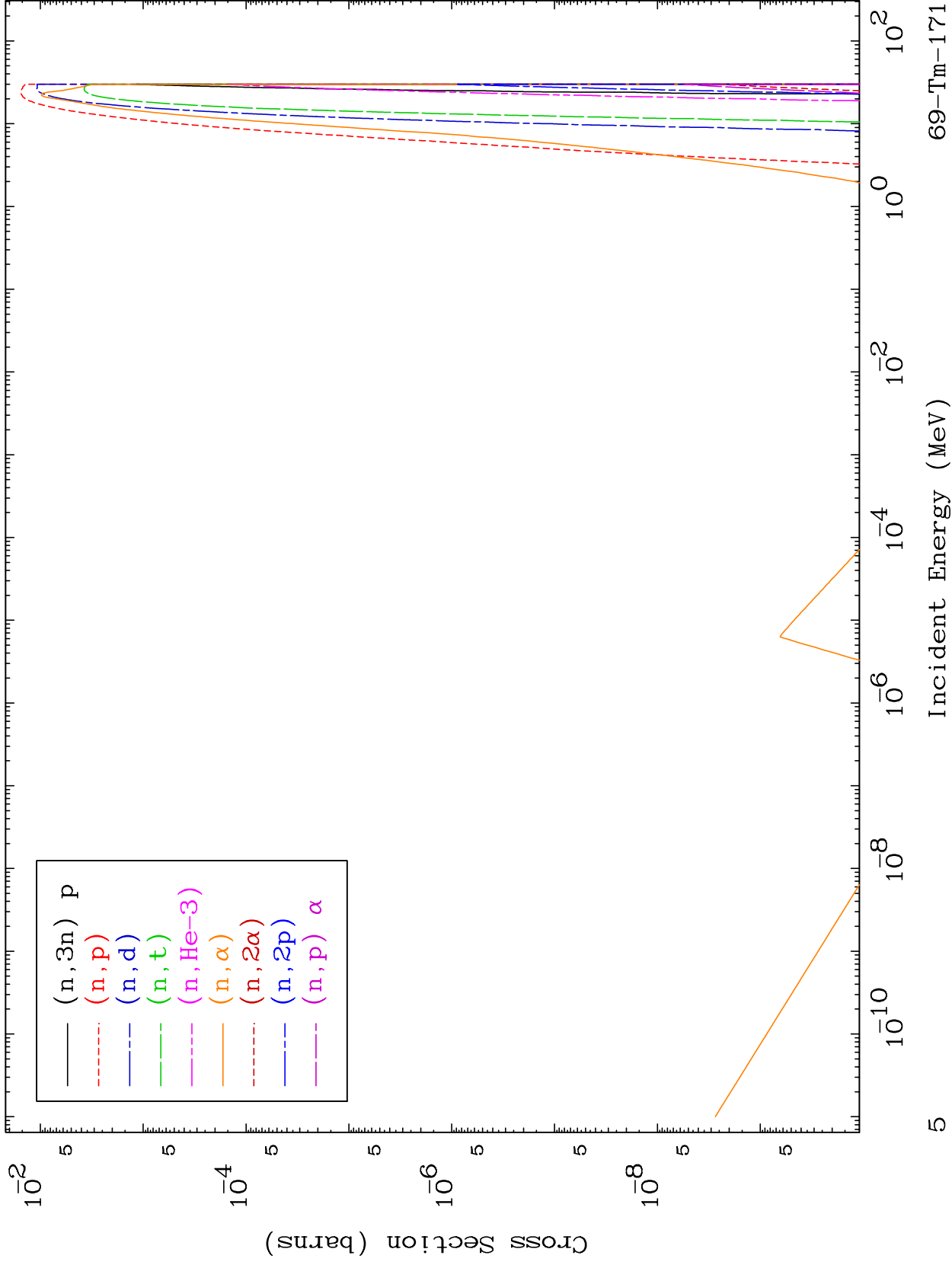

MAT 6931

Particle Production  
293 Kelvin Cross Sections

69-Tm-171

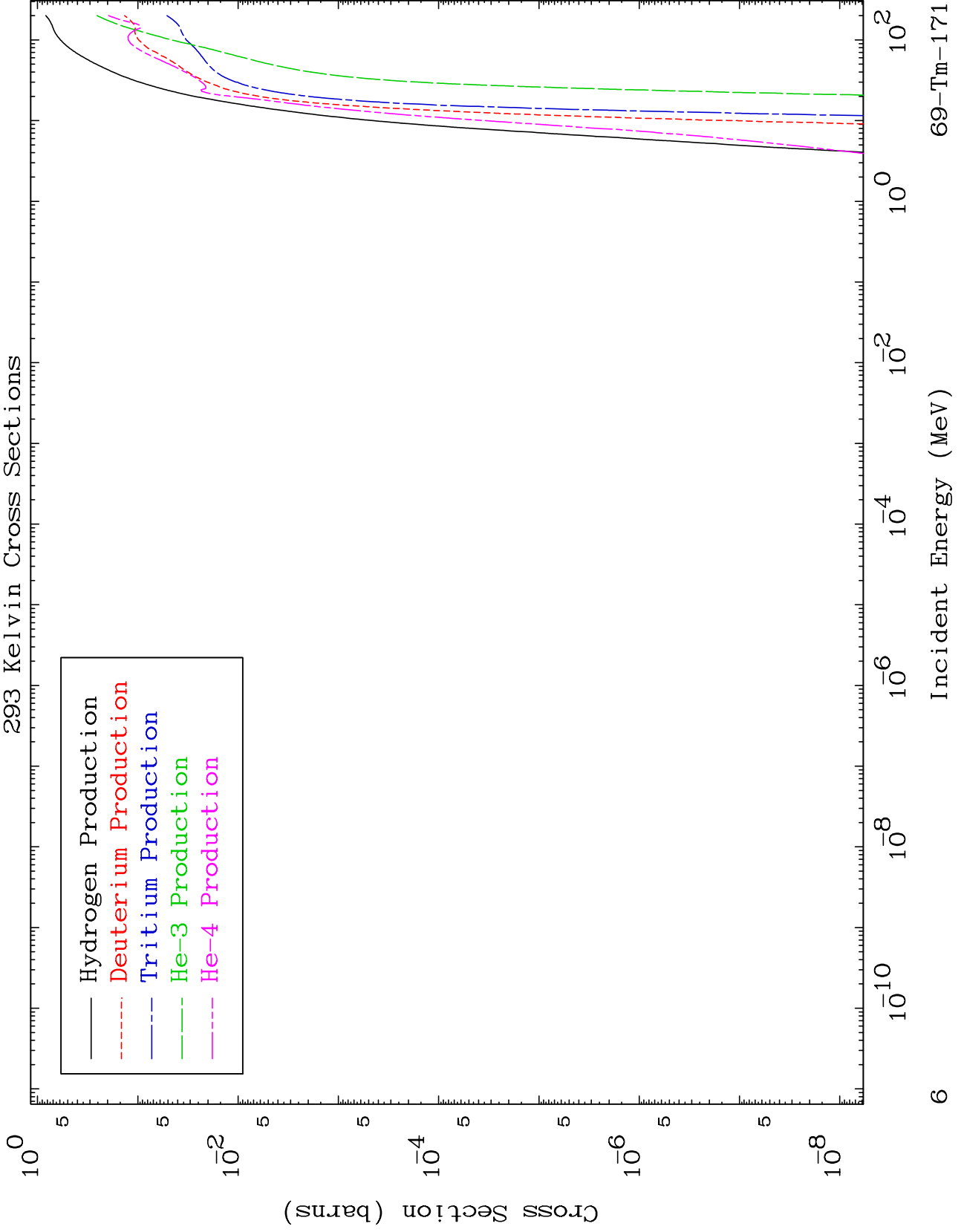

MAT 6931

(n,n') Level

69-Tm-171

293 Kelvin Cross Sections

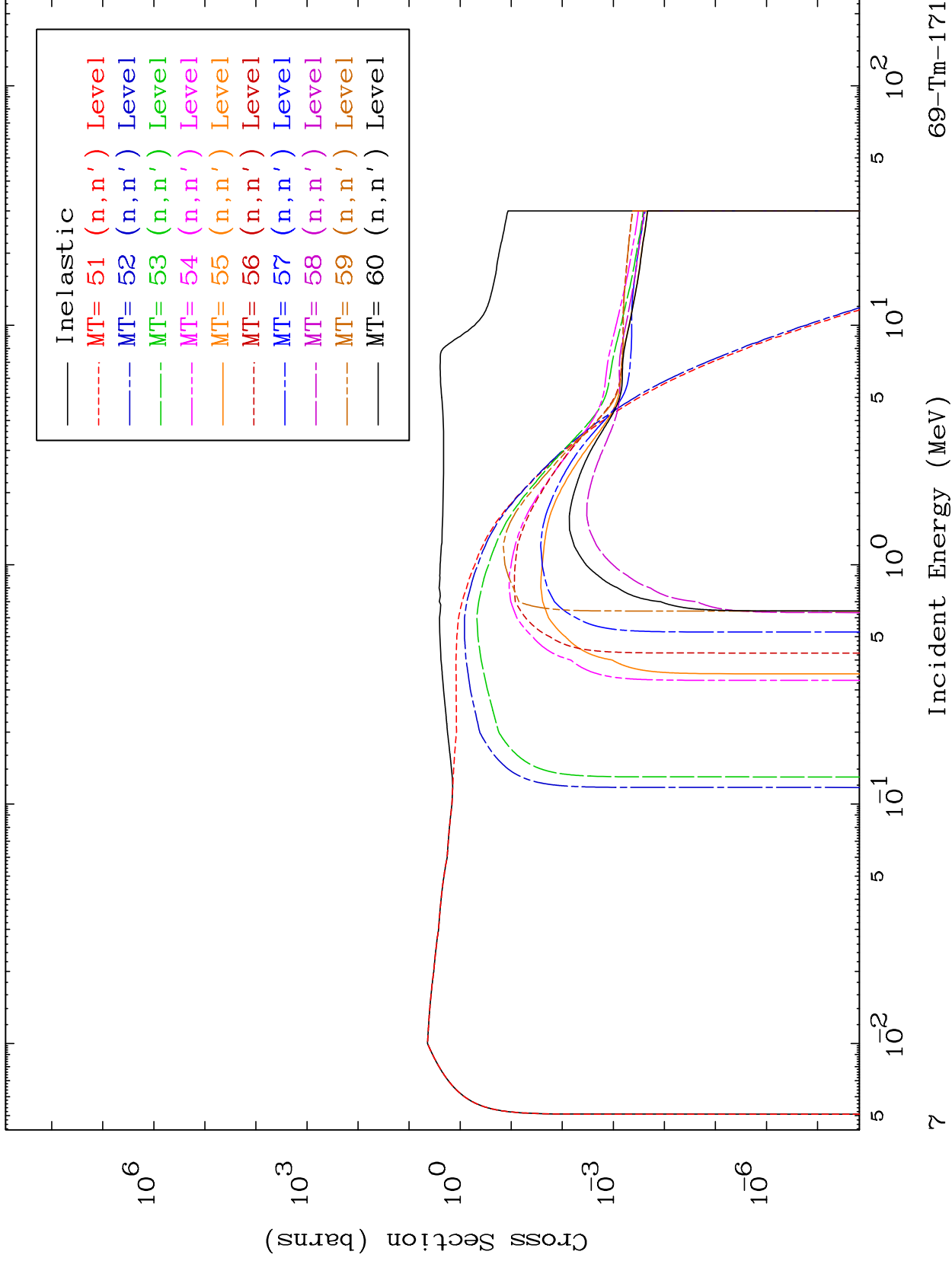

7

Incident Energy (MeV)

69-Tm-171



MAT 6931

(n,n') Level

69-Tm-171

293 Kelvin Cross Sections

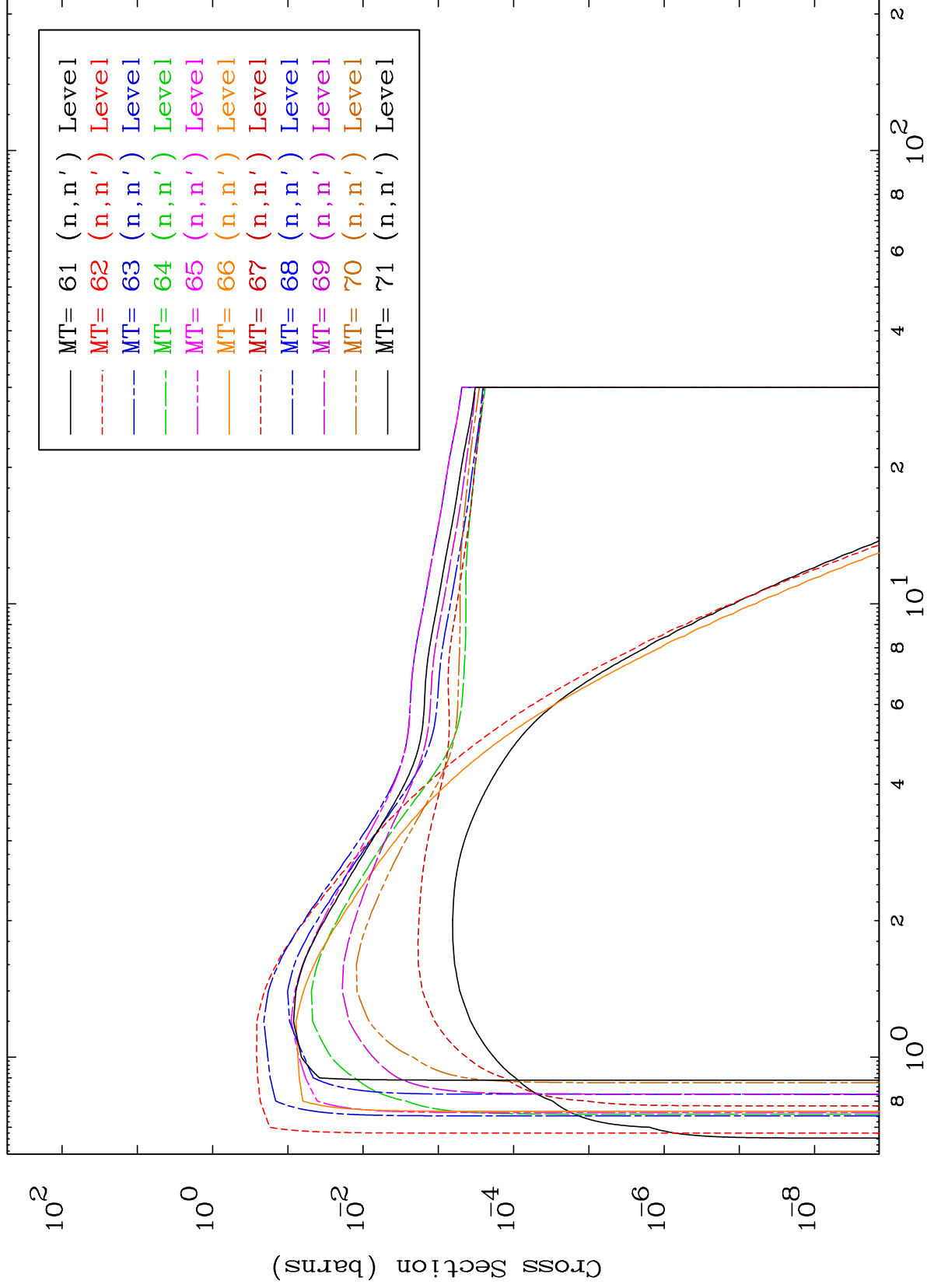

8

Incident Energy (MeV)

69-Tm-171

293 Kelvin Cross Sections

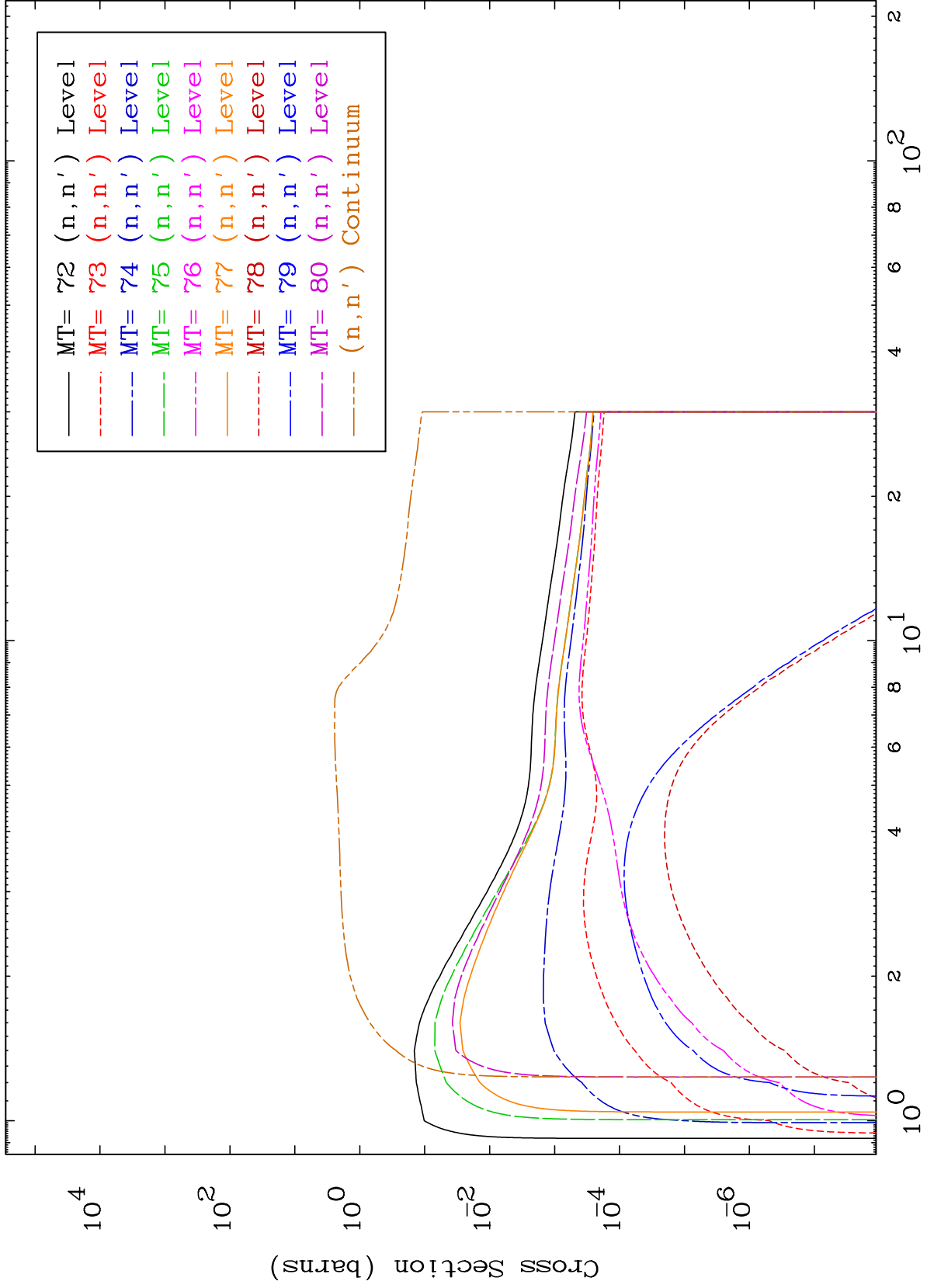

MAT 6931

(n,p) Levels  
293 Kelvin Cross Sections

69-Tm-171

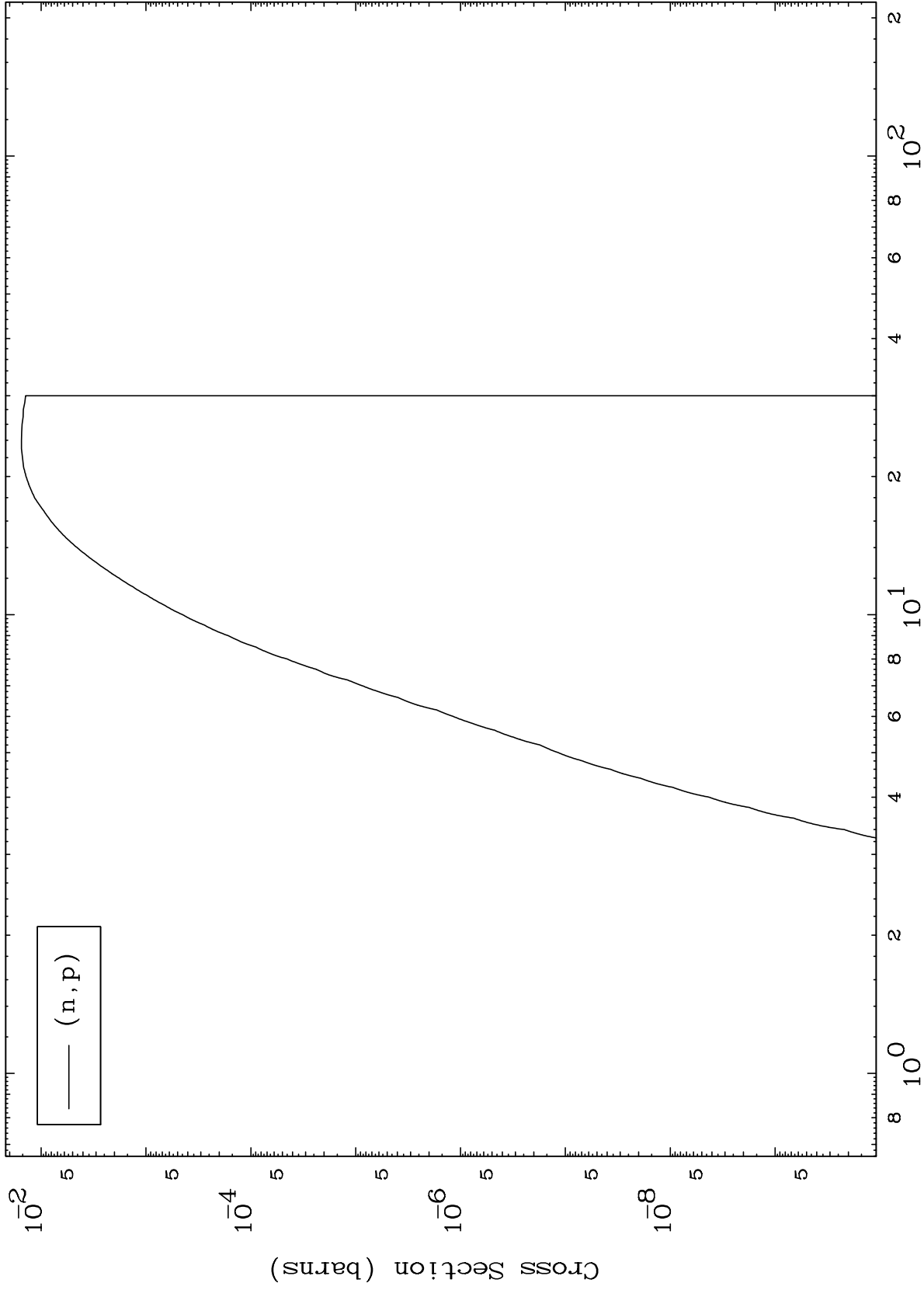

10

Incident Energy (MeV)

69-Tm-171

MAT 6931

(n,d) Levels  
293 Kelvin Cross Sections

69-Tm-171

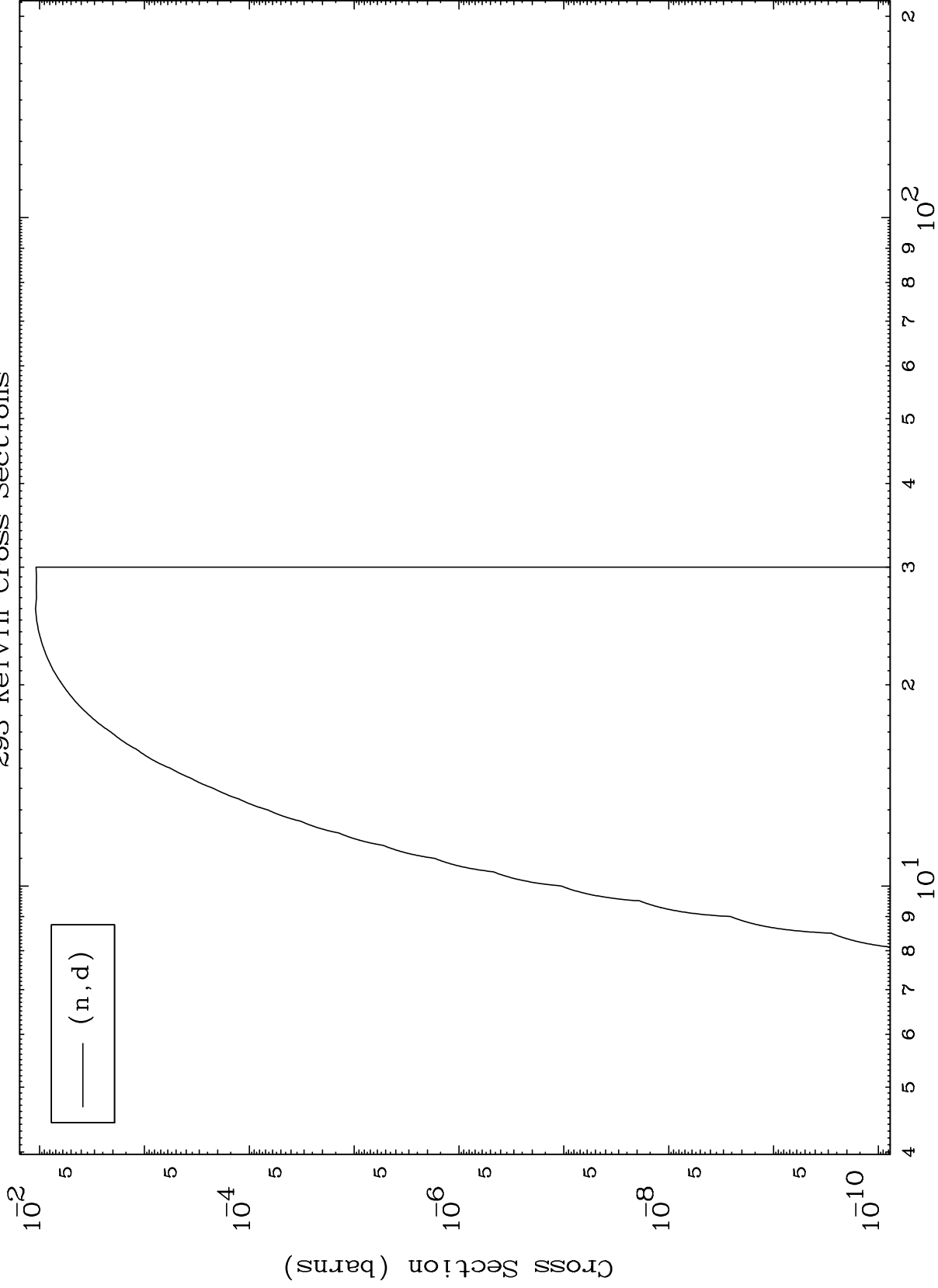

11

Incident Energy (MeV)

69-Tm-171

MAT 6931

(n,t) Levels  
293 Kelvin Cross Sections

69-Tm-171

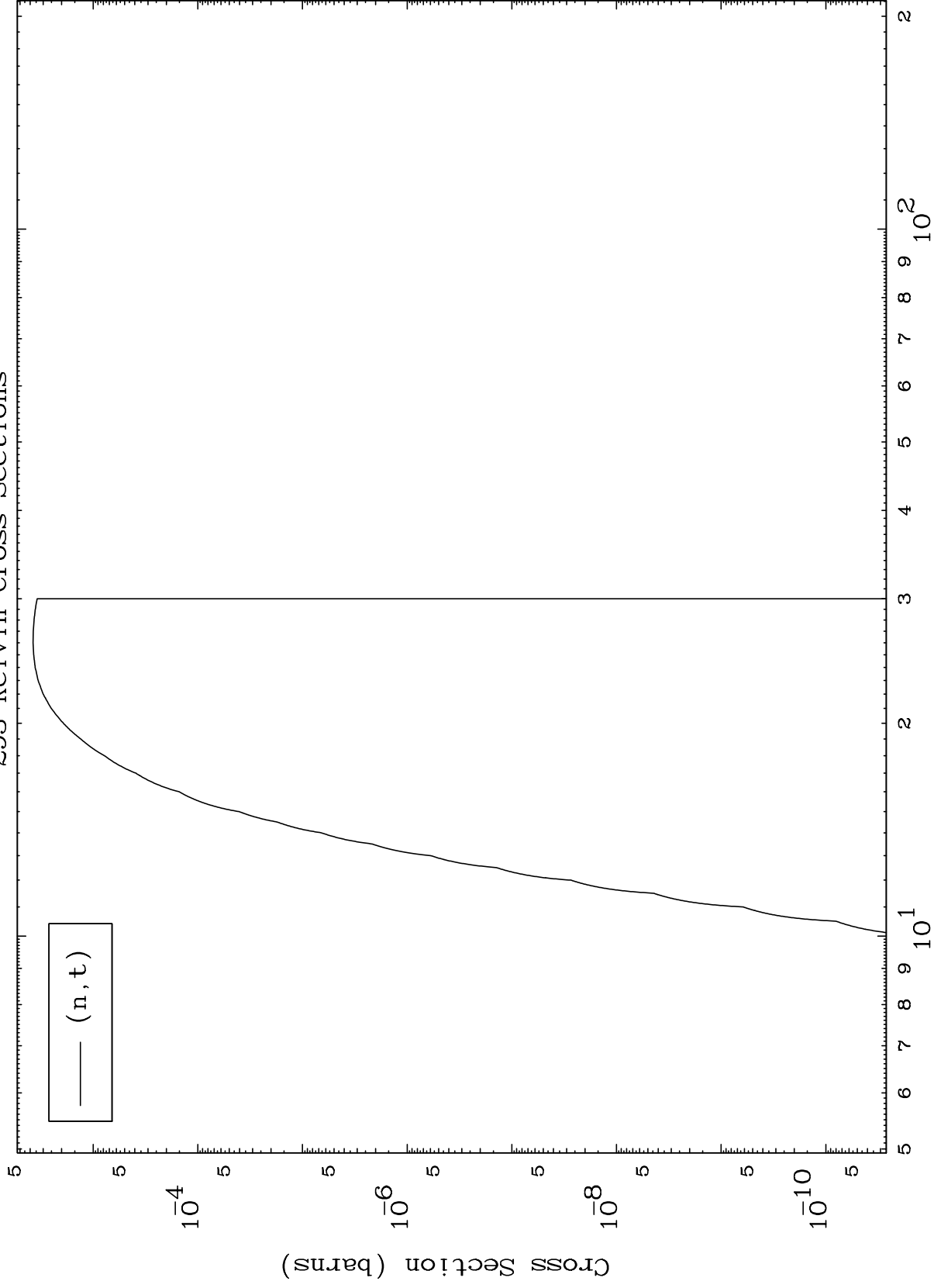

12

Incident Energy (MeV)

69-Tm-171

MAT 6931

(n,He3) Levels  
293 Kelvin Cross Sections

69-Tm-171

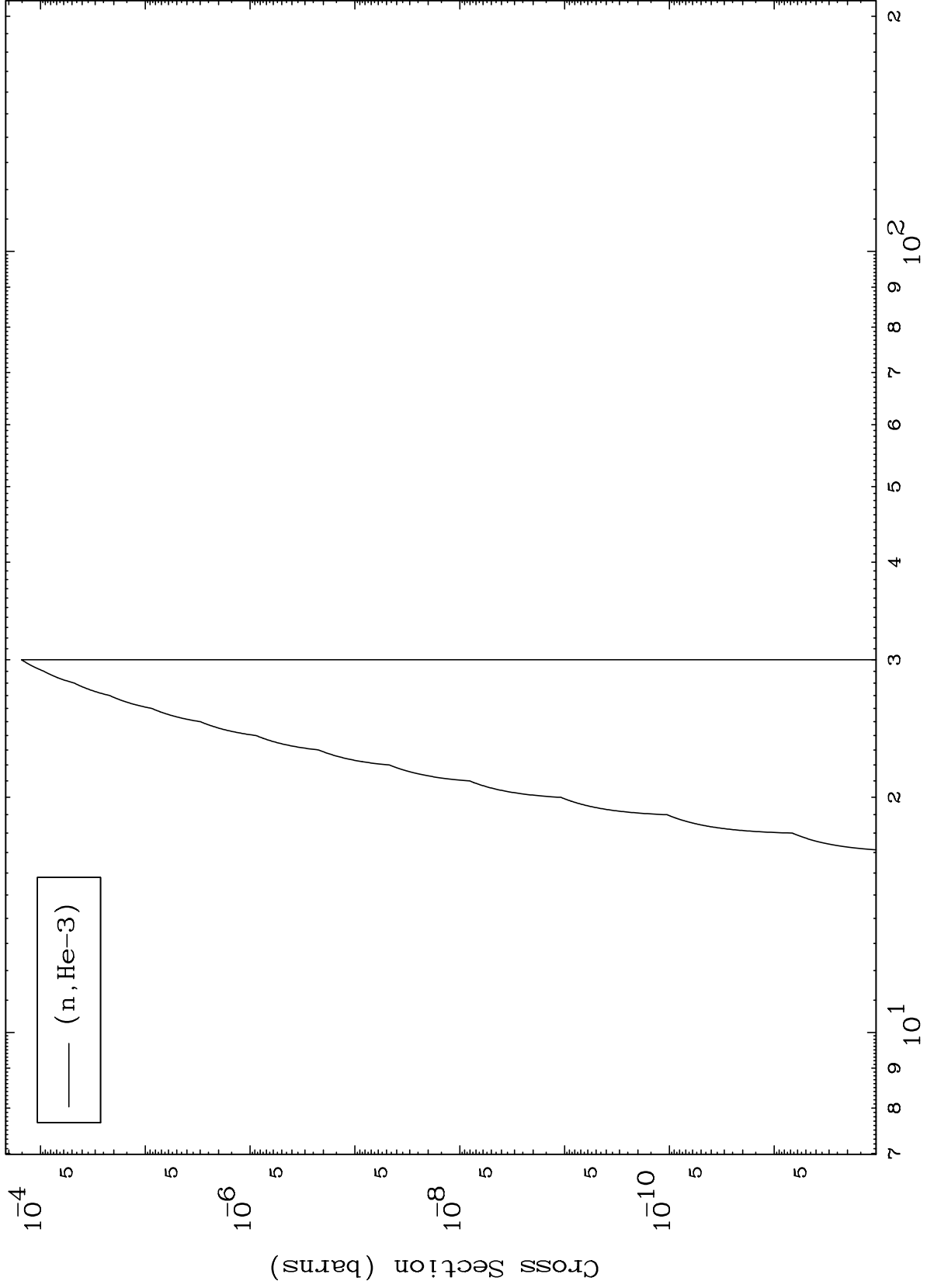

13

Incident Energy (MeV)

69-Tm-171

MAT 6931

(n,  $\alpha$ ) Levels  
293 Kelvin Cross Sections

69-Tm-171

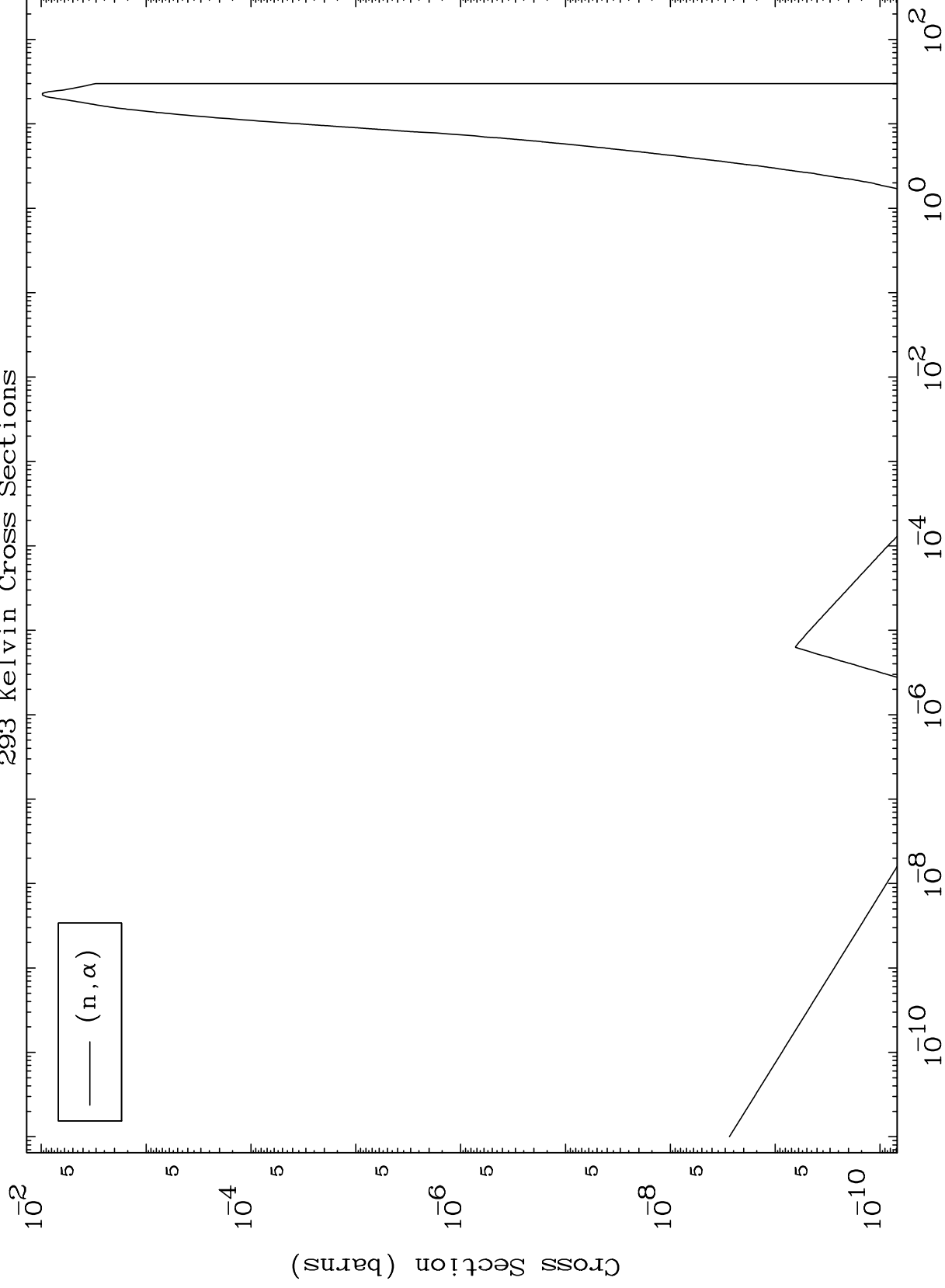

14

Incident Energy (MeV)

69-Tm-171

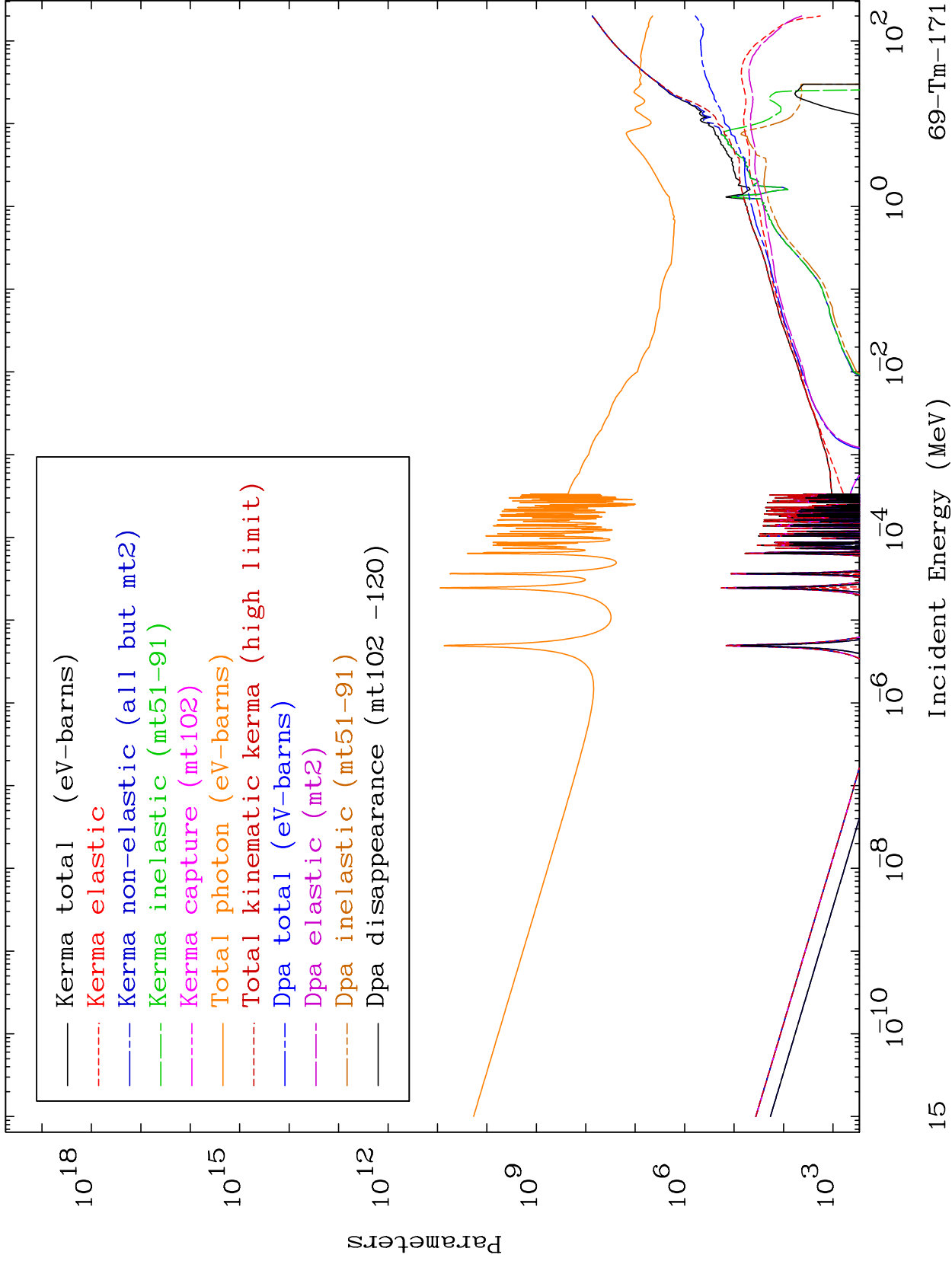





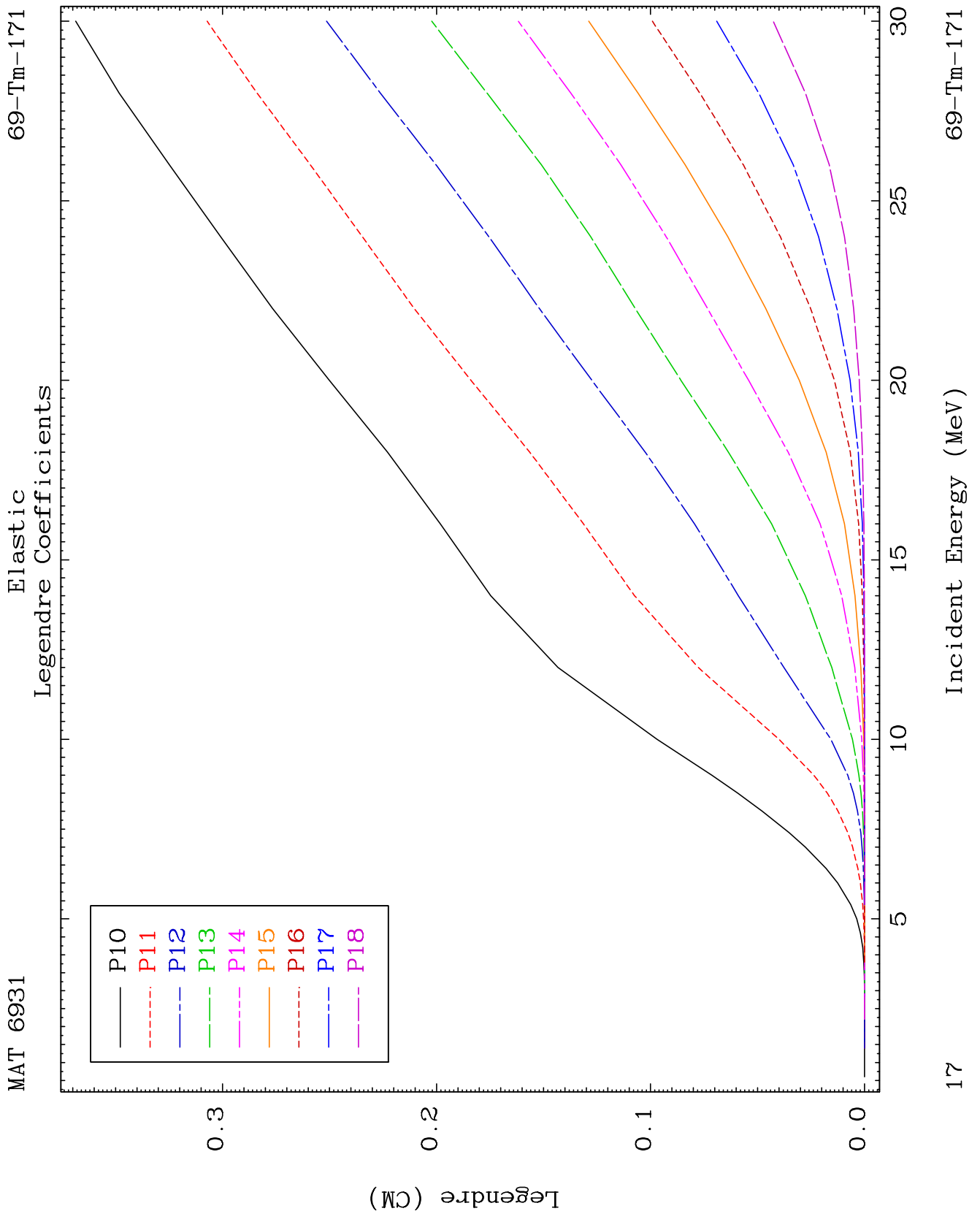

MAT 6931

### Elastic Legendre Coefficients

69-Tm-171

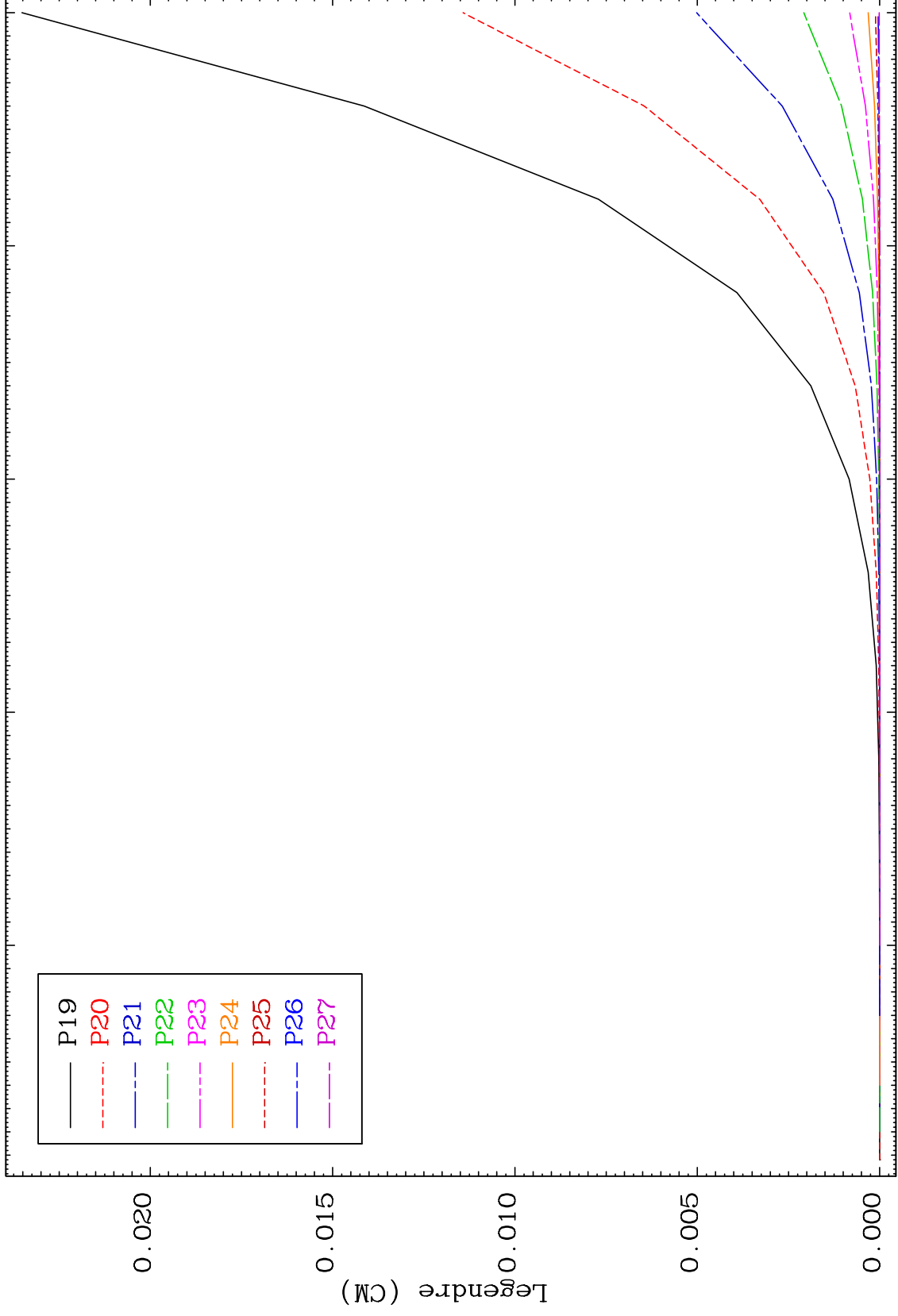

18

Incident Energy (MeV)

69-Tm-171

MAT 6931

Elastic  
Legendre Coefficients

69-Tm-171

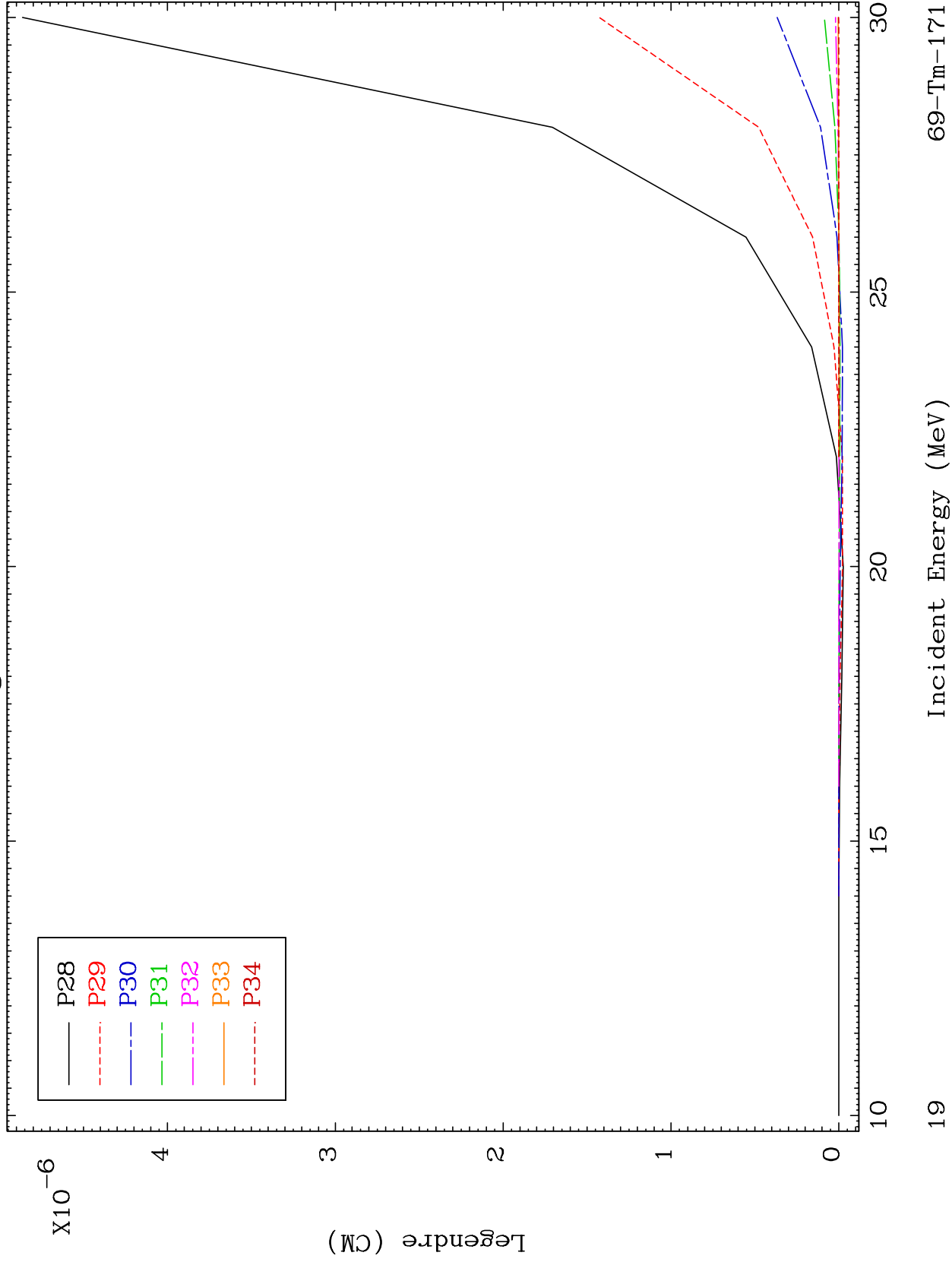

10

Incident Energy (MeV)

69-Tm-171



MAT 6931

MT= 51 (n,n') Level  
Legendre Coefficients

69-Tm-171

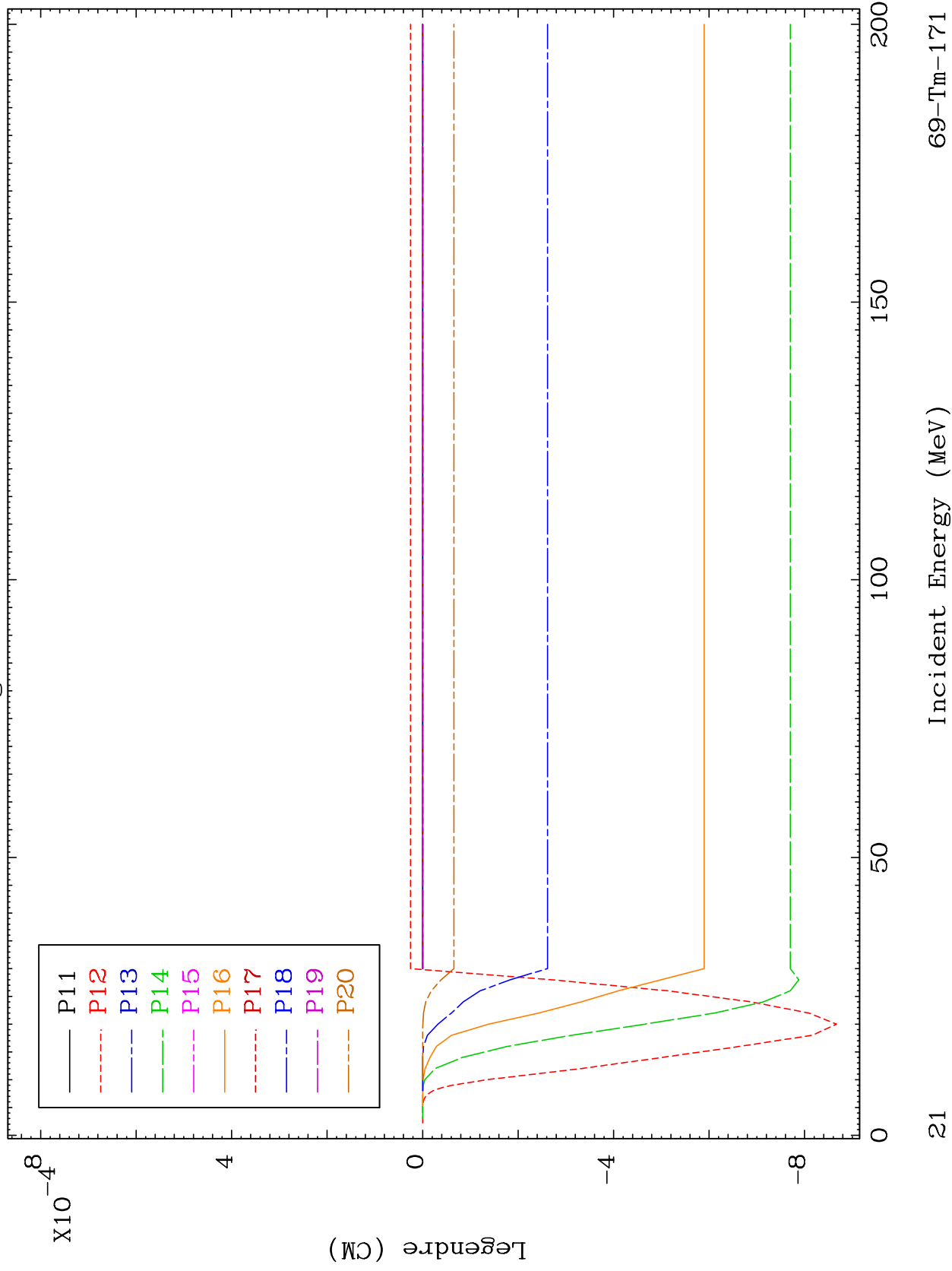

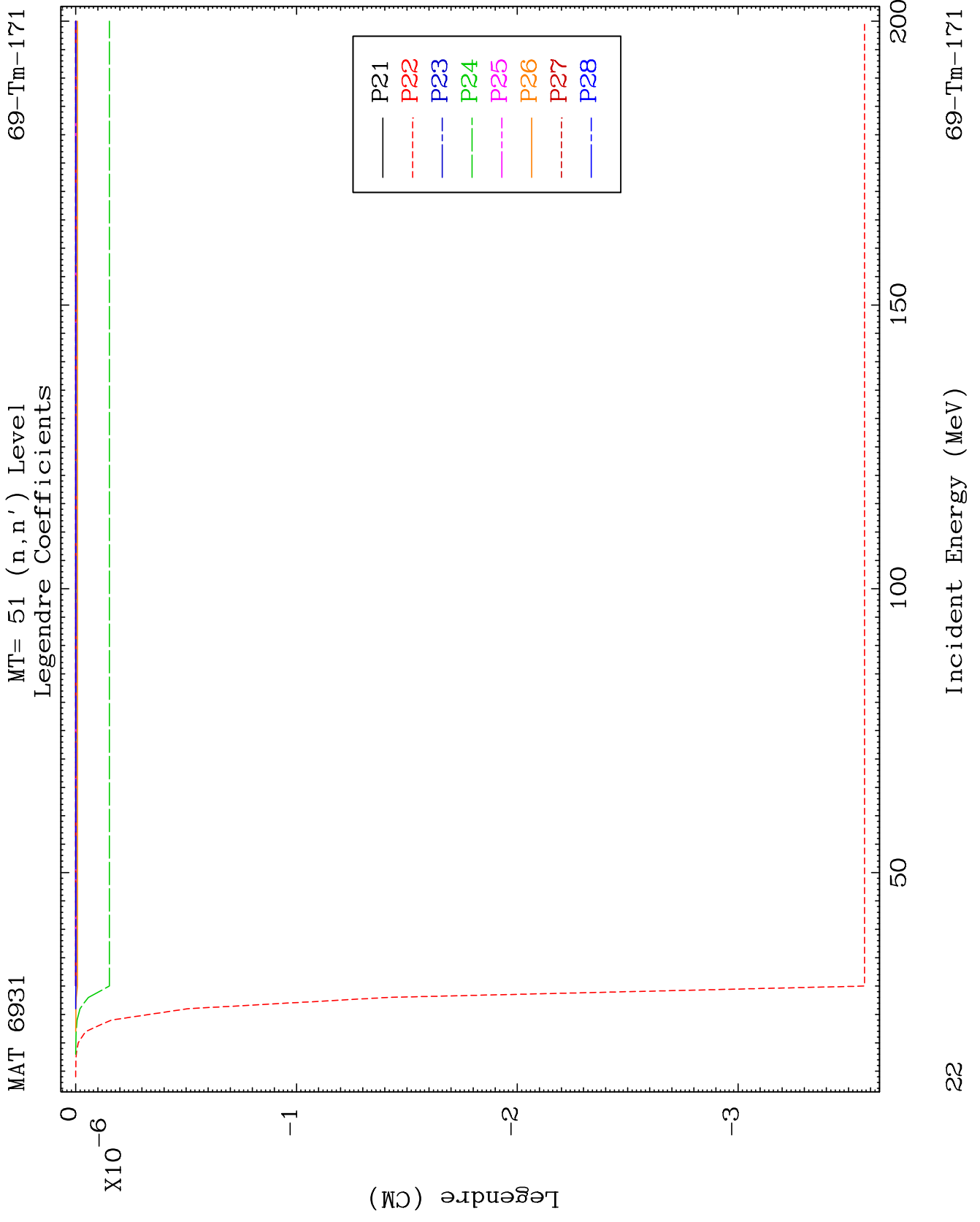

MAT 6931

MT= 52 (n,n') Level  
Legendre Coefficients

69-Tm-171

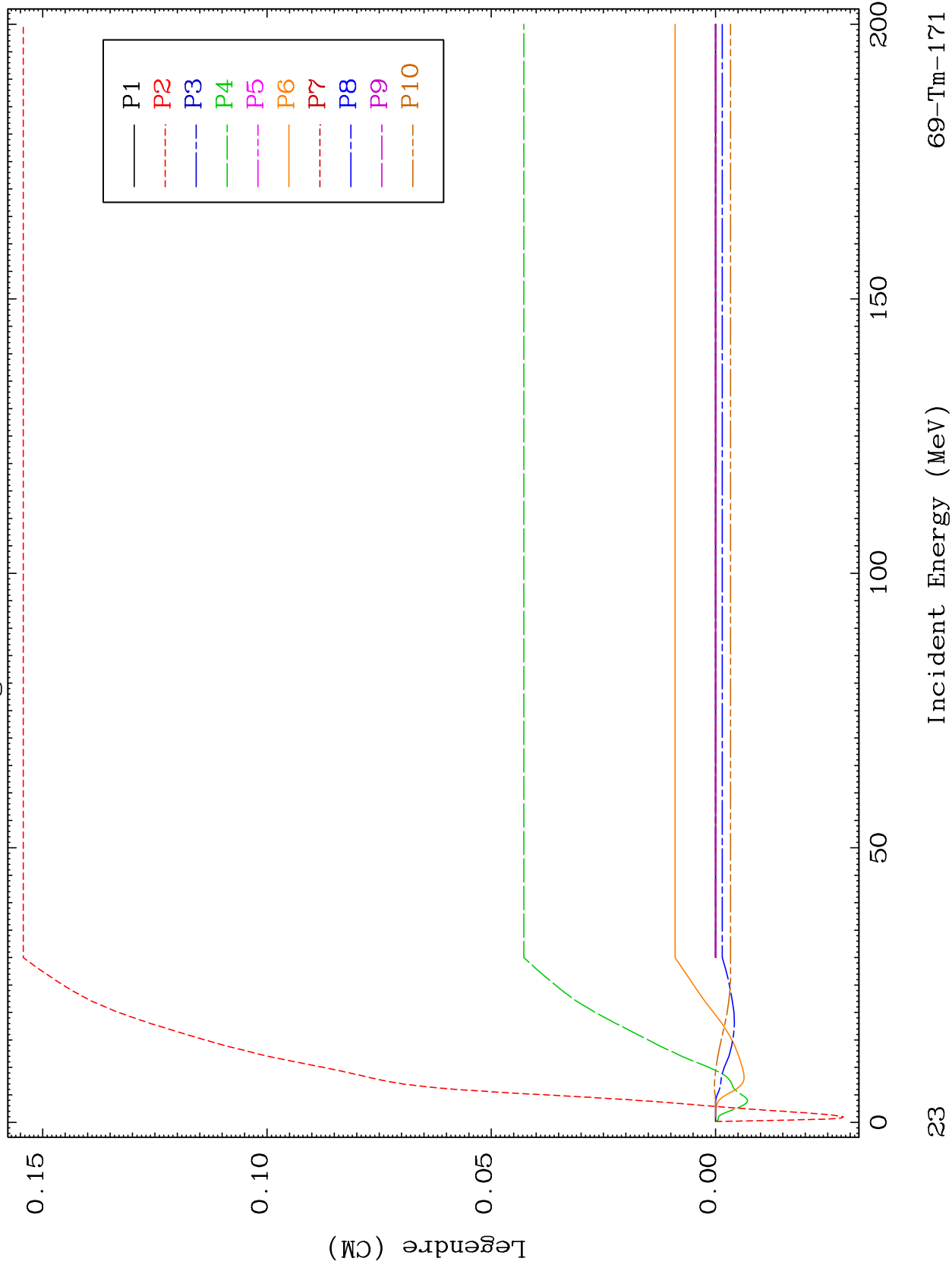

23

Incident Energy (MeV)

69-Tm-171



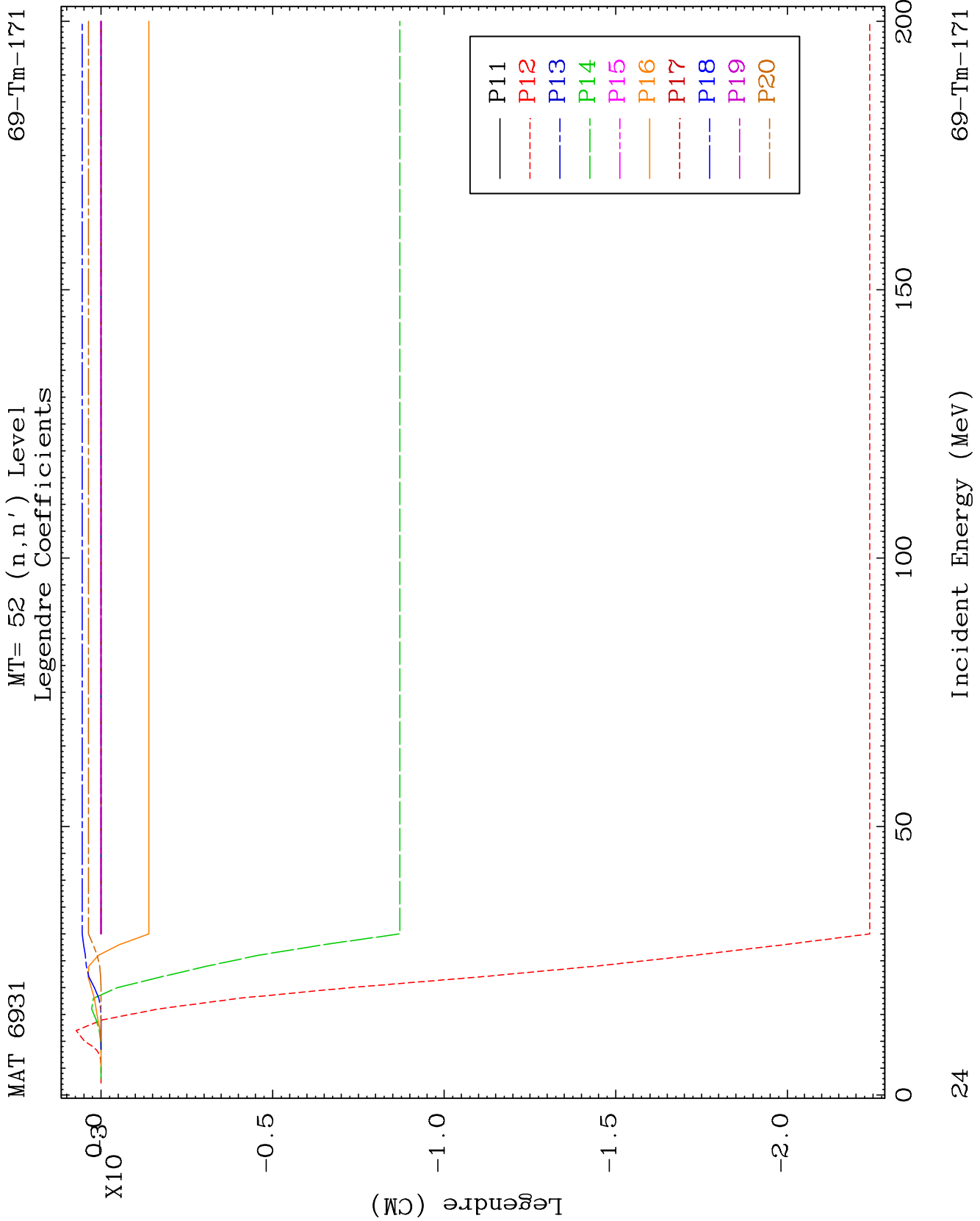

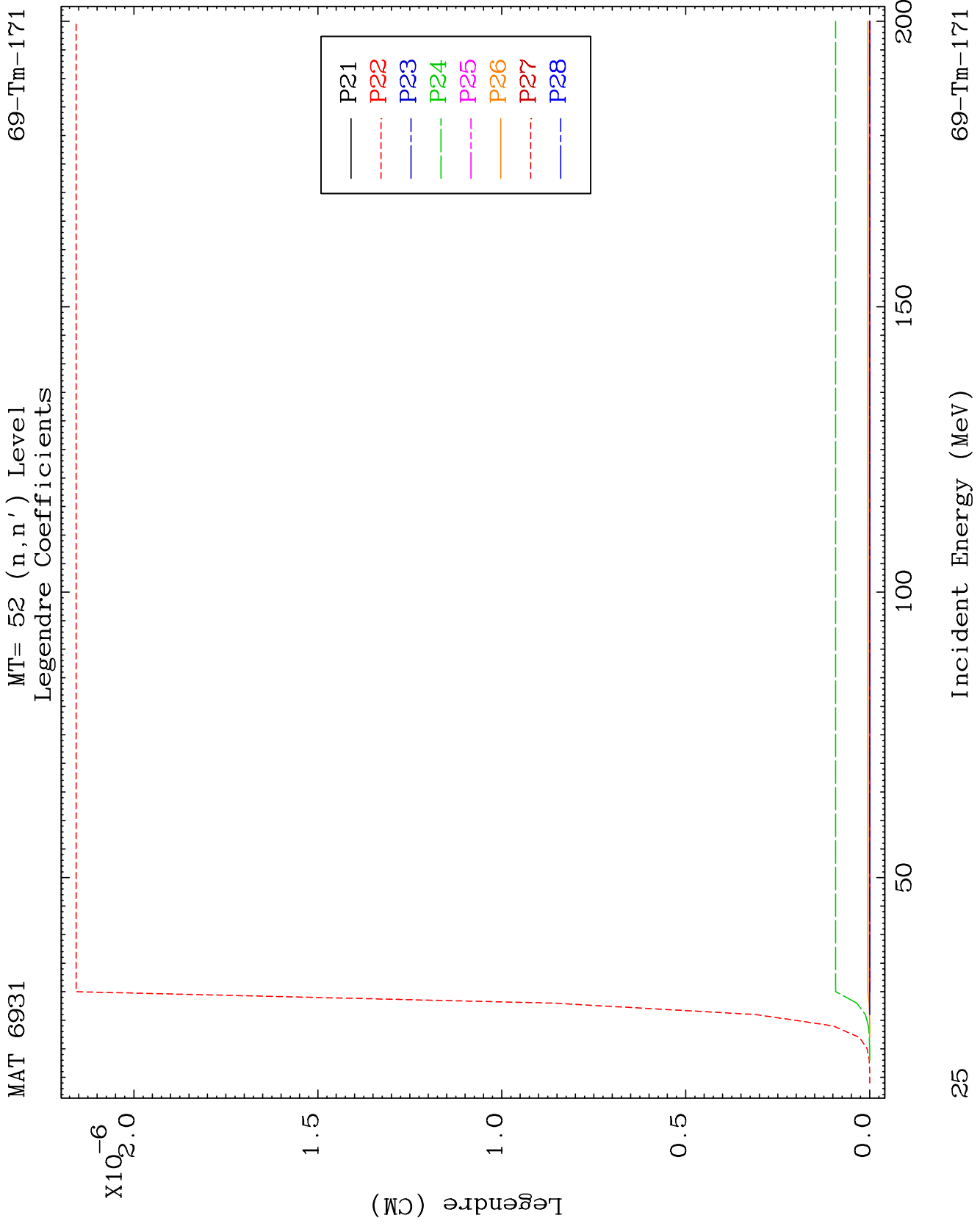

MAT 6931

MT= 53 (n,n') Level  
Legendre Coefficients

69-Tm-171

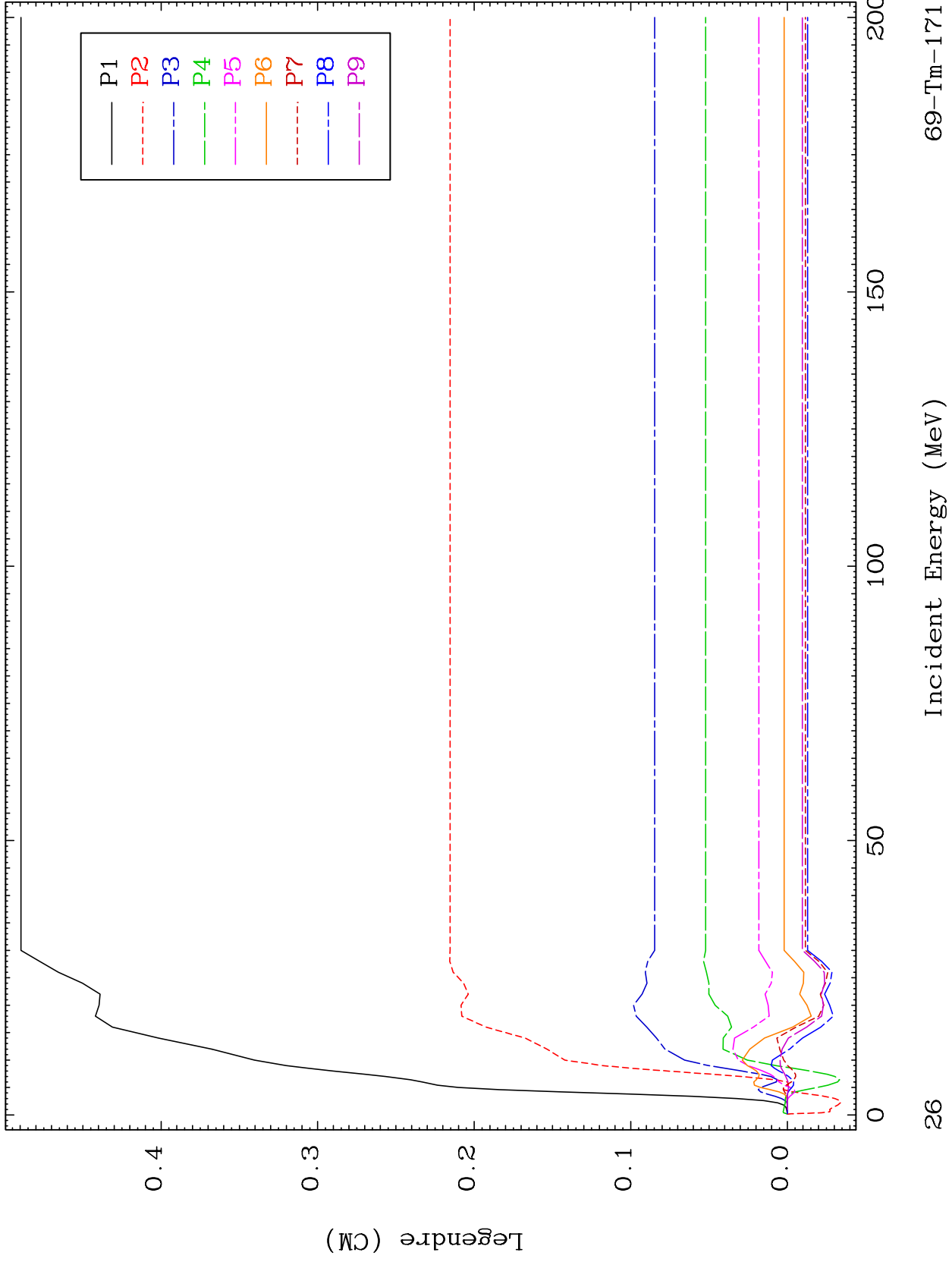

26

Incident Energy (MeV)

69-Tm-171

MAT 6931

MT= 53 (n,n') Level  
Legendre Coefficients

69-Tm-171

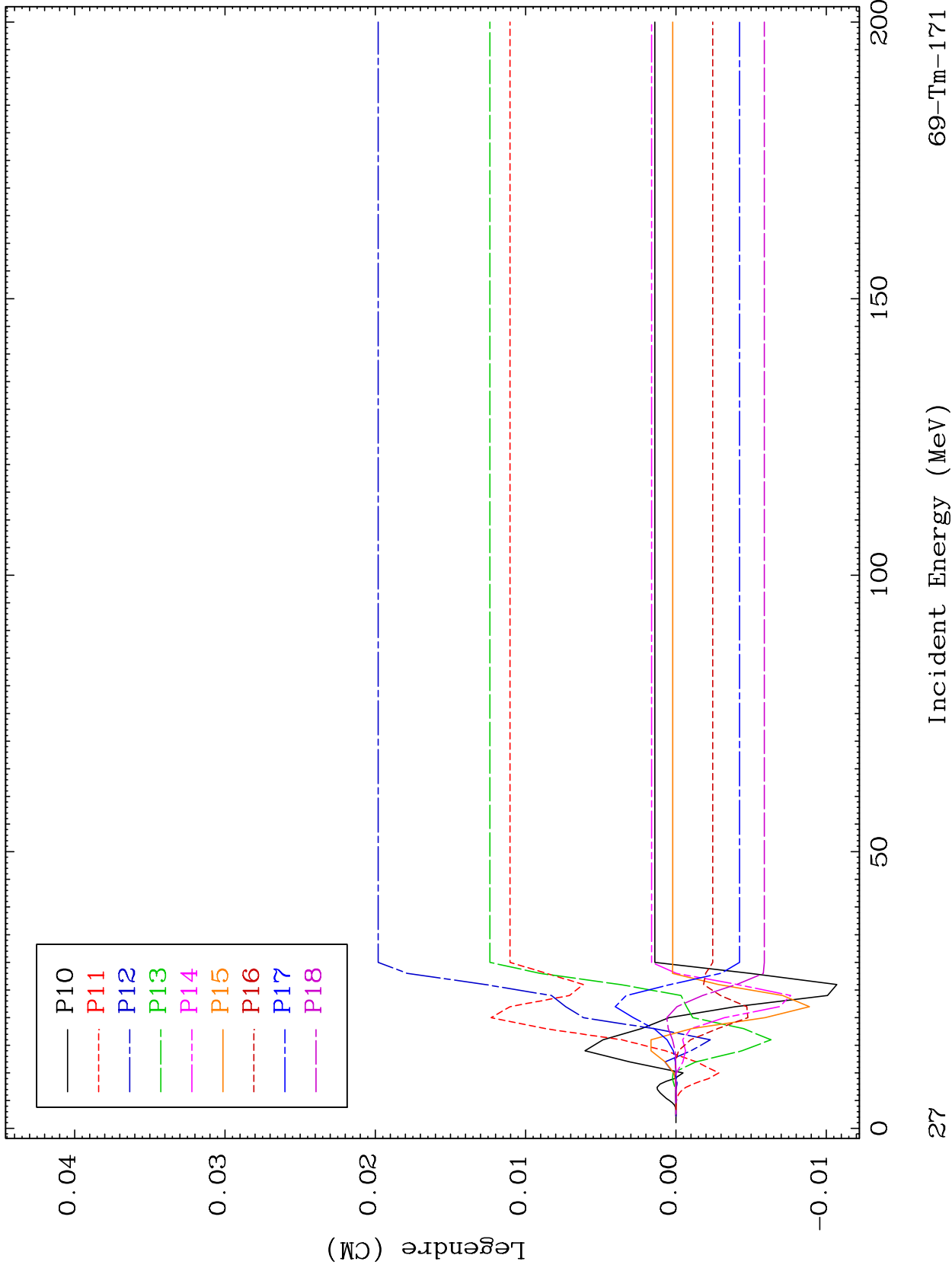

MAT 6931

MT= 53 (n,n') Level  
Legendre Coefficients

69-Tm-171

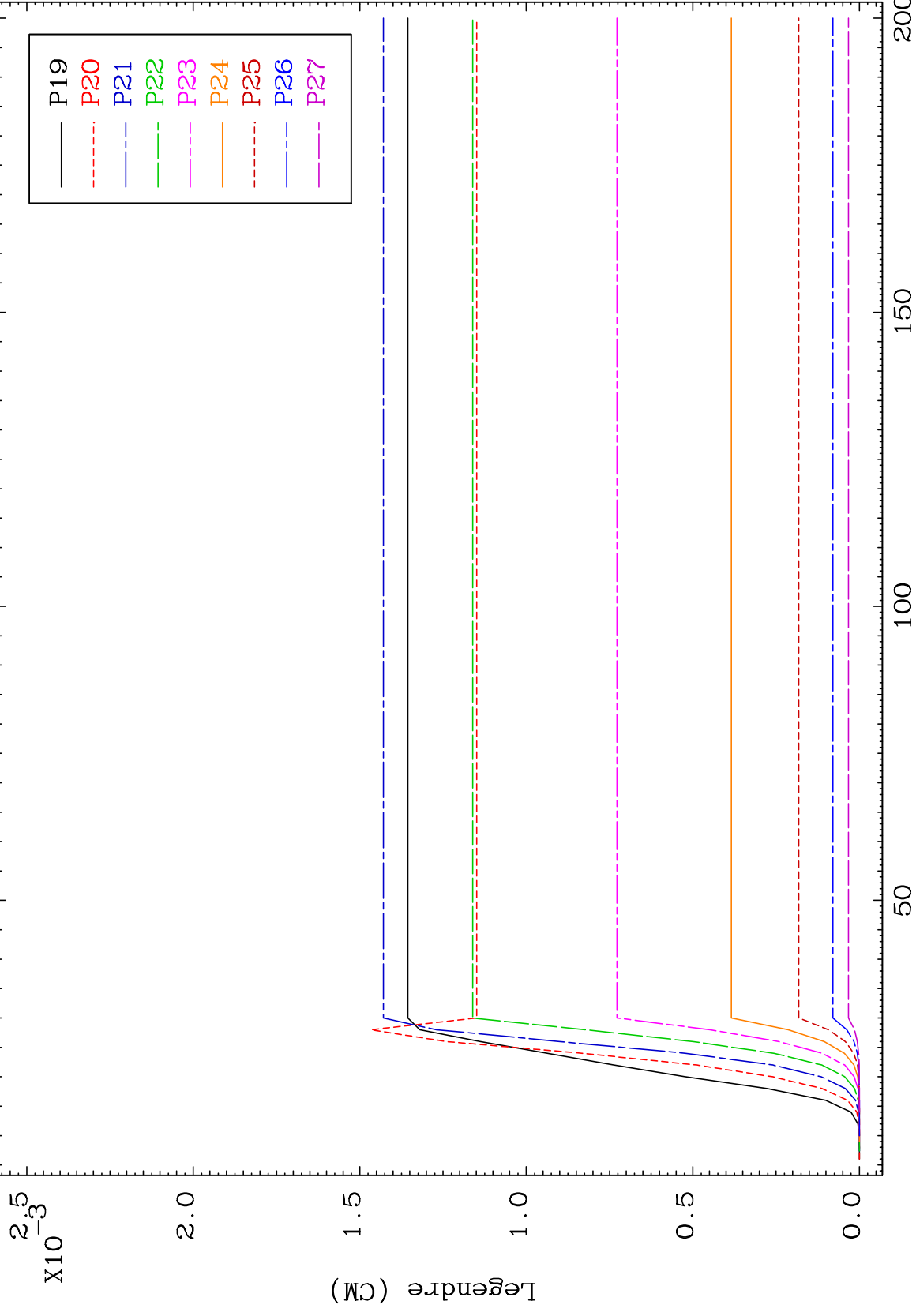

28

Incident Energy (MeV)

69-Tm-171

MAT 6931

MT= 53 (n,n') Level  
Legendre Coefficients

69-Tm-171

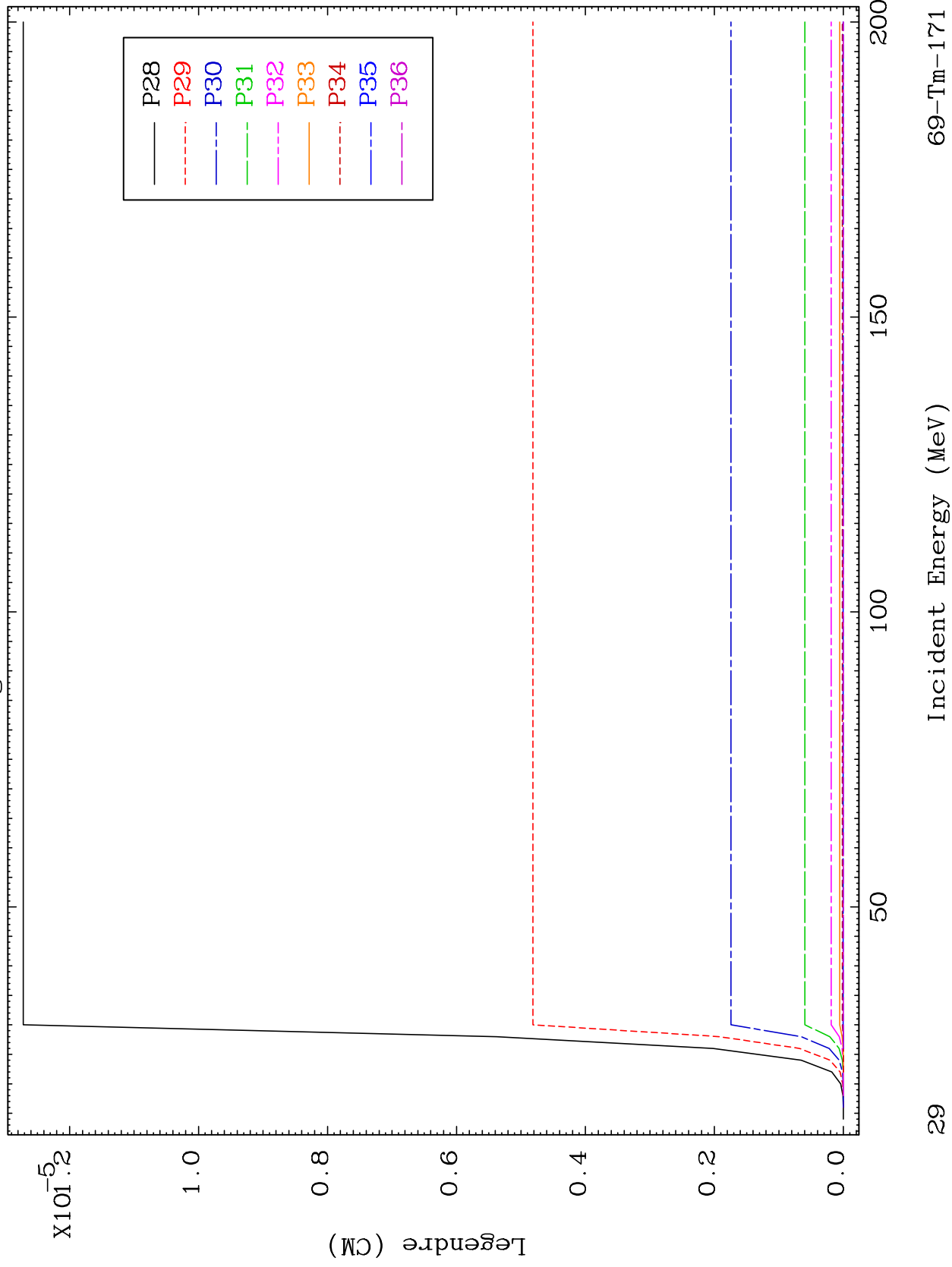

29

MAT 6931

MT= 54 (n,n') Level  
Legendre Coefficients

69-Tm-171

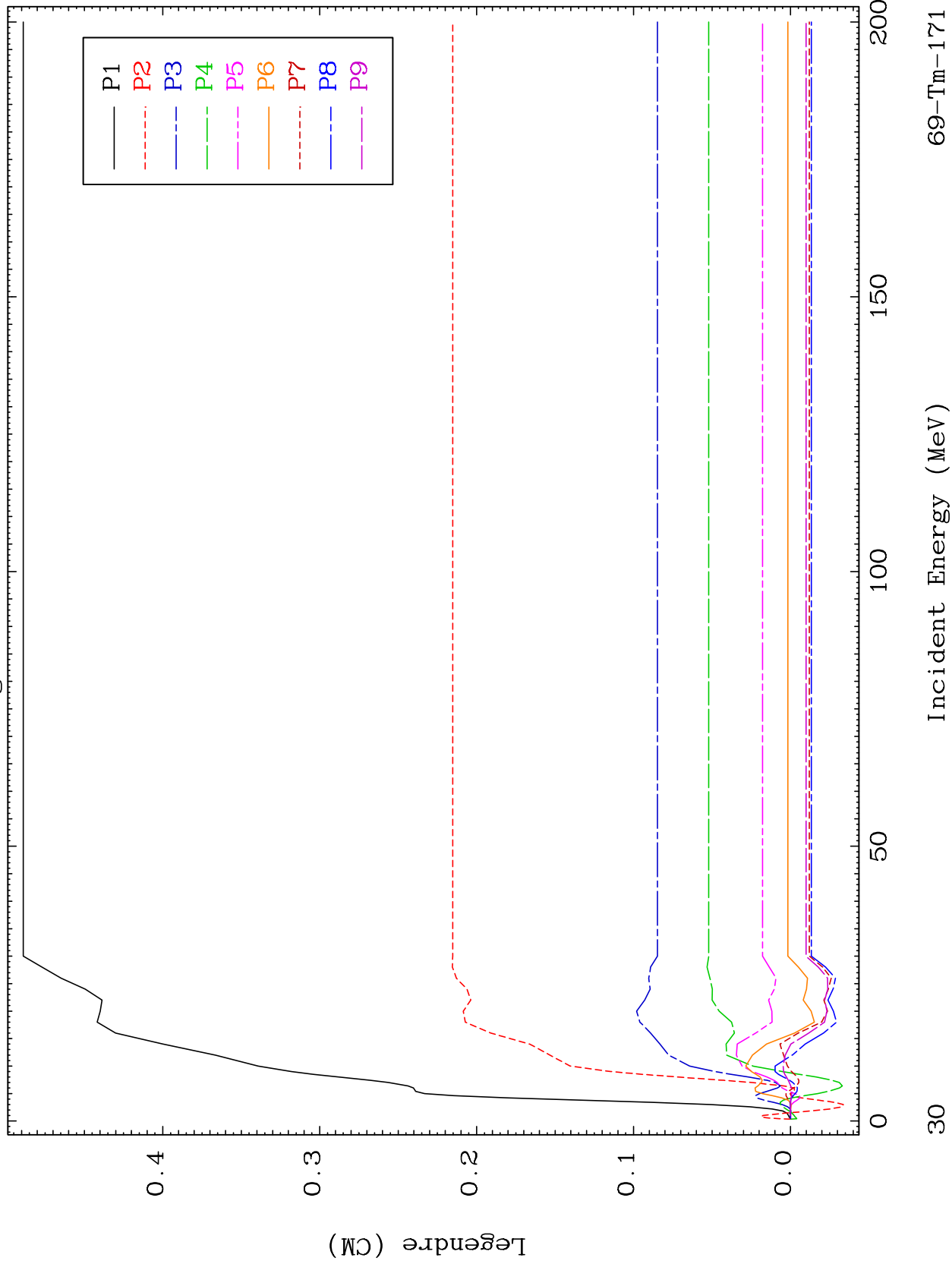

69-Tm-171

Incident Energy (MeV)

MAT 6931

MT= 54 (n,n') Level  
Legendre Coefficients

69-Tm-171

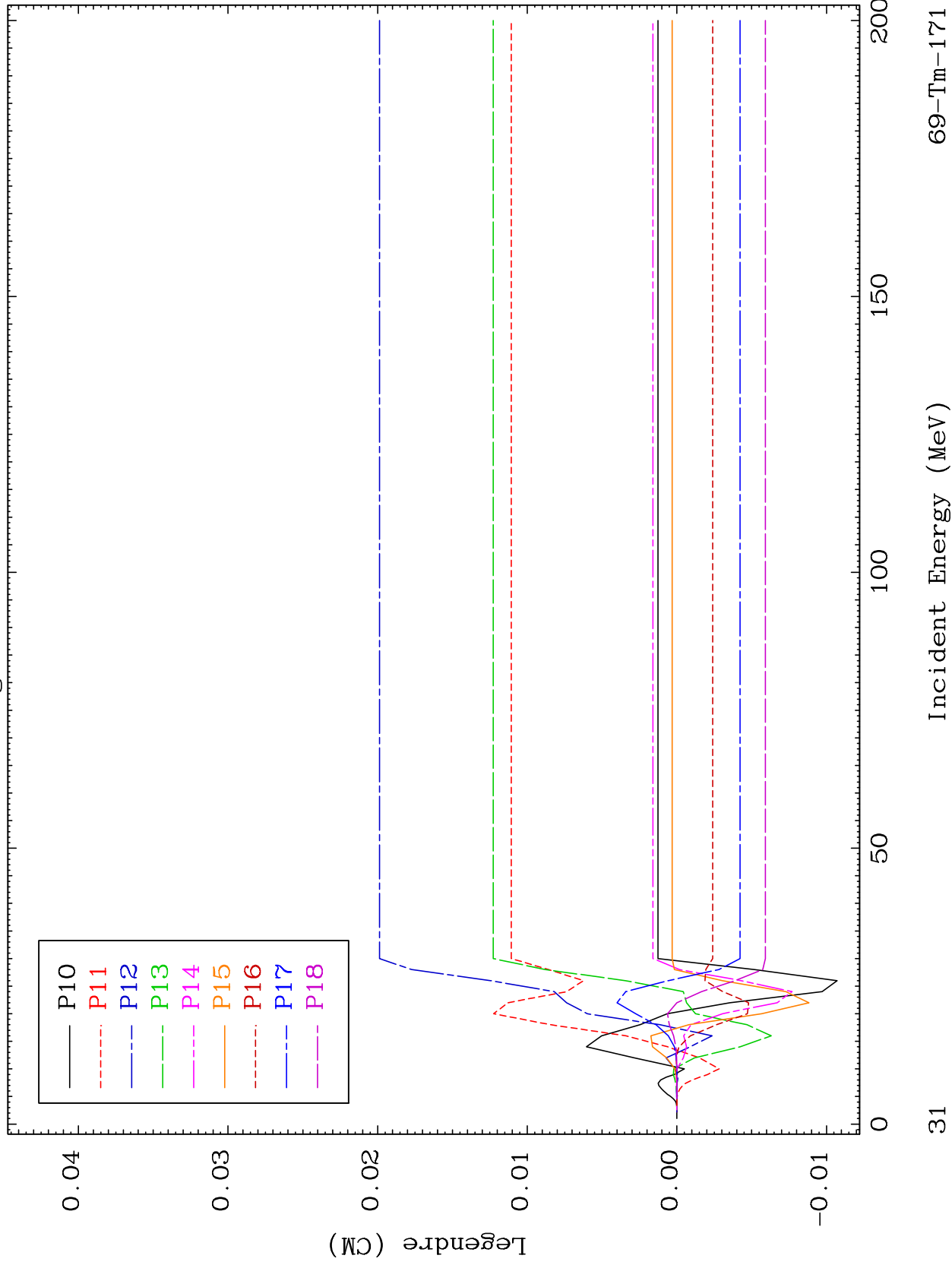

31



MAT 6931

MT= 54 (n,n') Level  
Legendre Coefficients

69-Tm-171

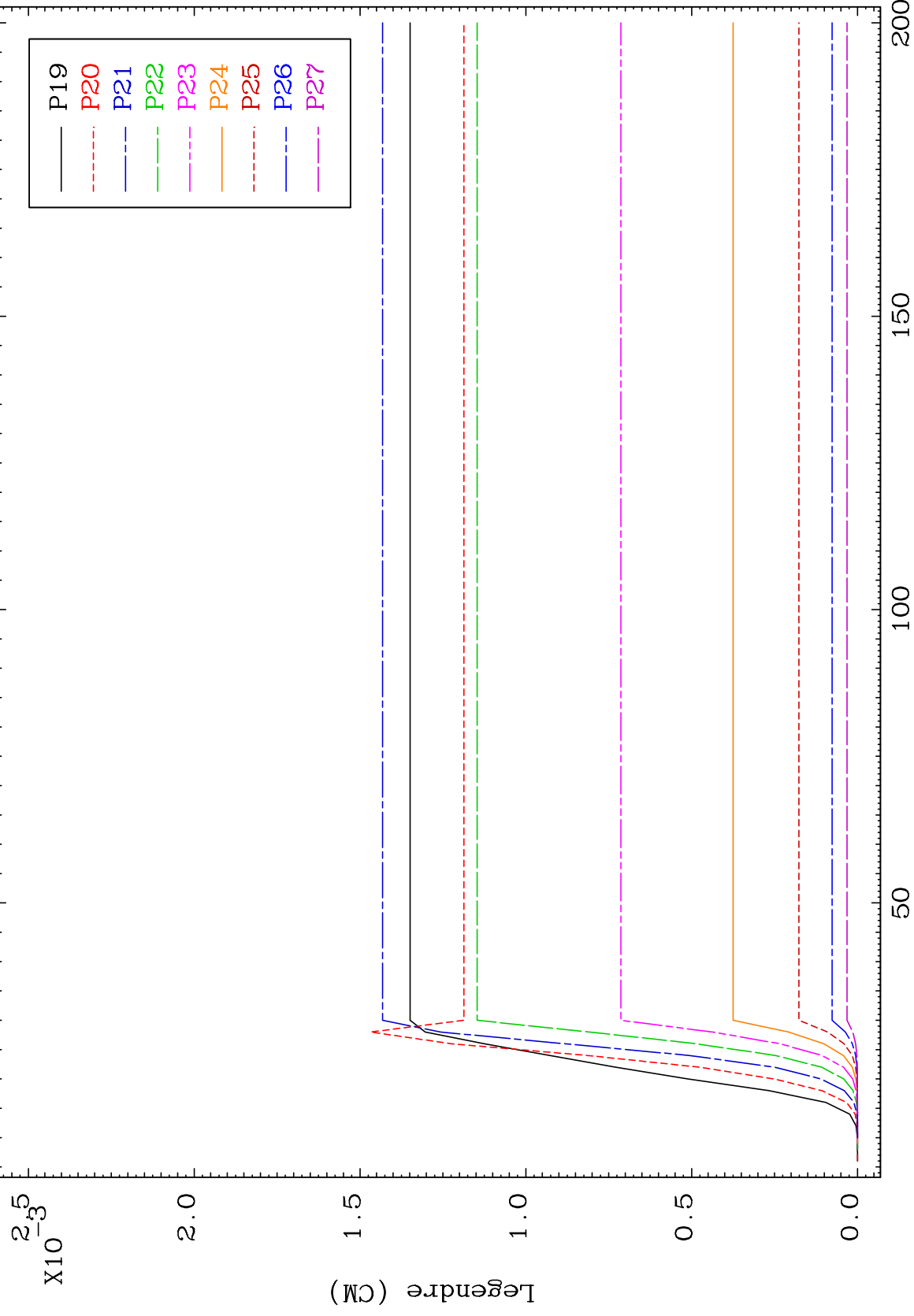

32

Incident Energy (MeV)

69-Tm-171

MAT 6931

MT= 54 (n,n') Level  
Legendre Coefficients

69-Tm-171

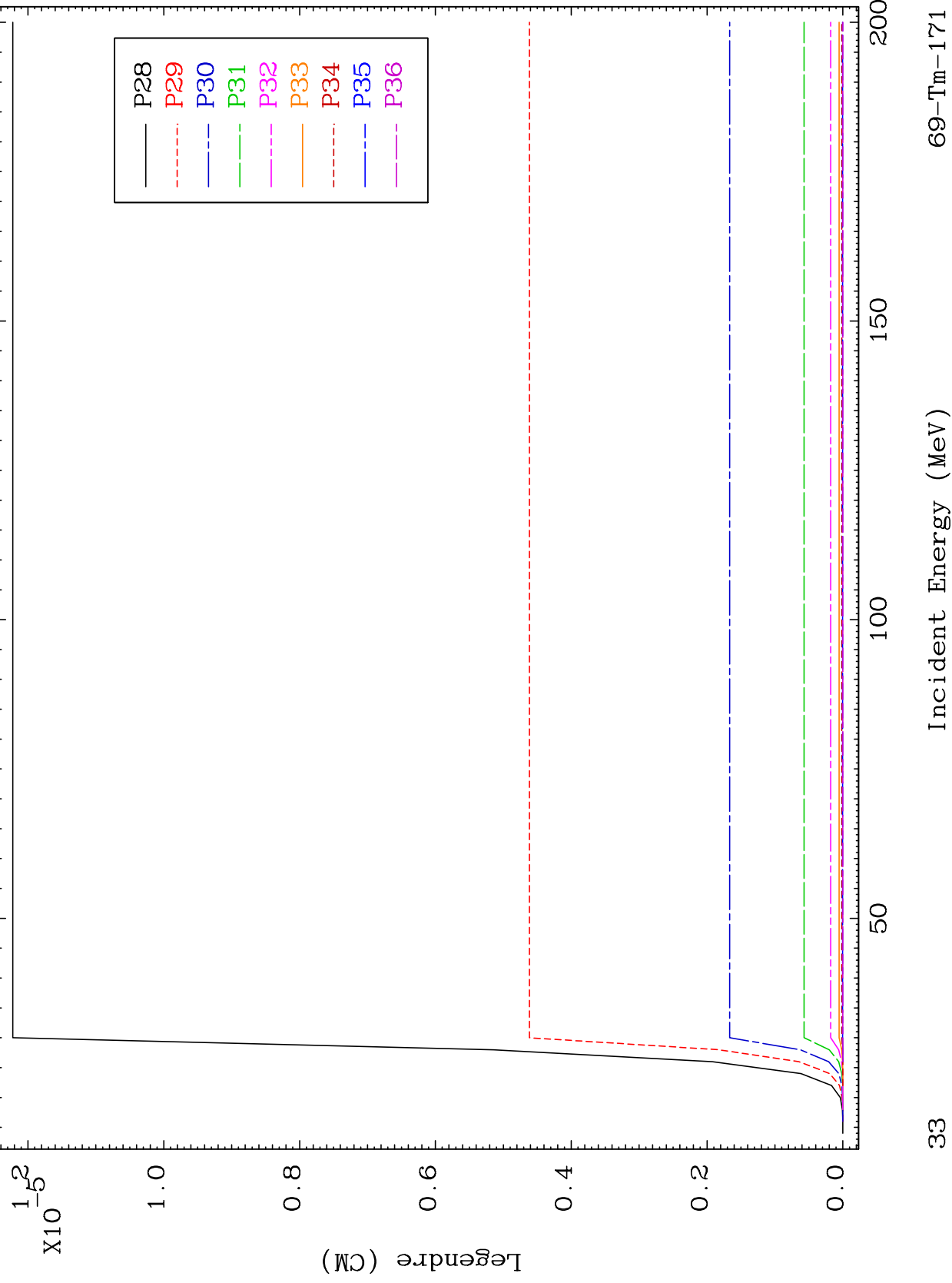

33

MAT 6931

MT= 55 (n,n') Level  
Legendre Coefficients

69-Tm-171

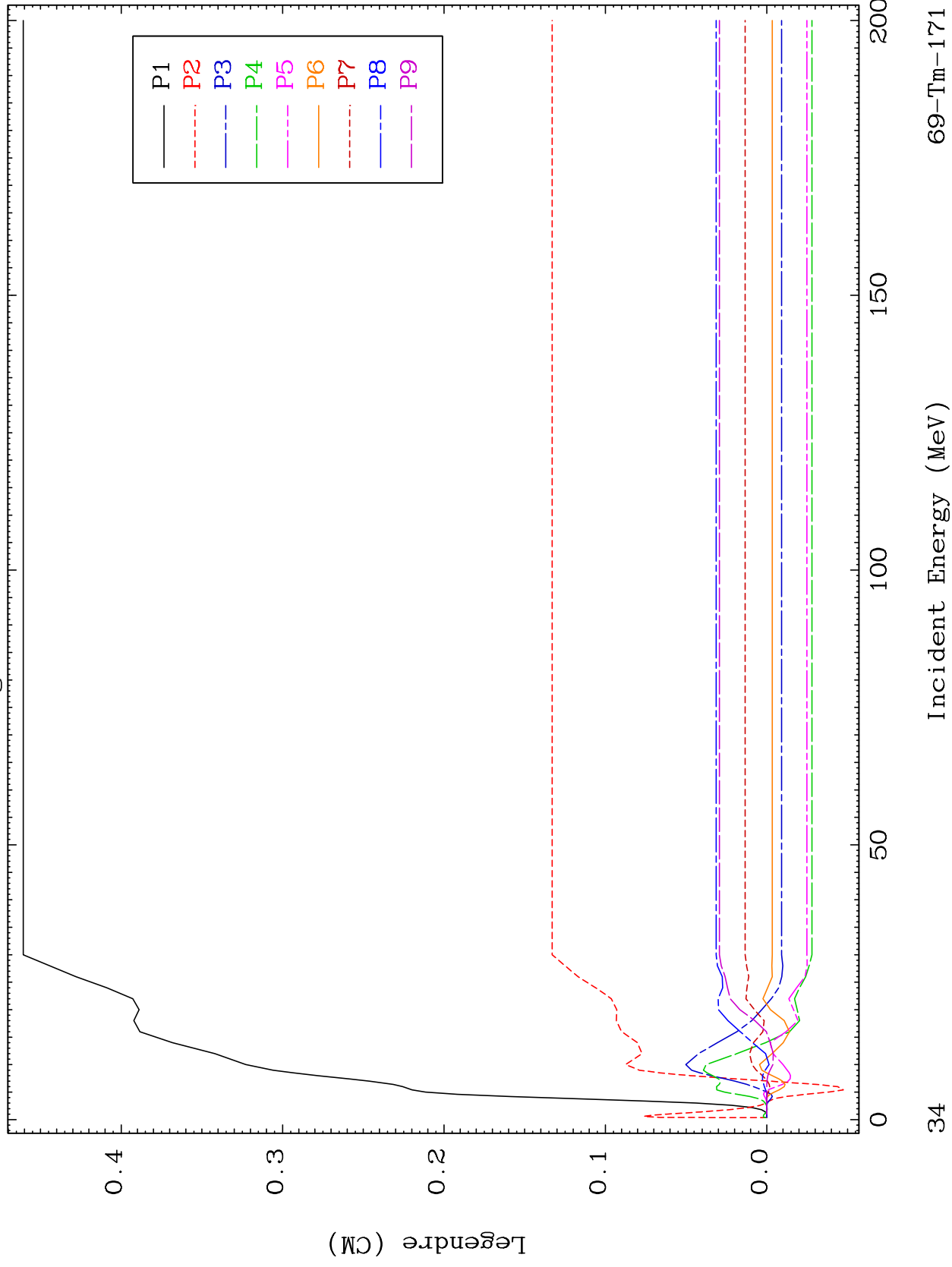

MAT 6931

MT= 55 (n,n') Level  
Legendre Coefficients

69-Tm-171

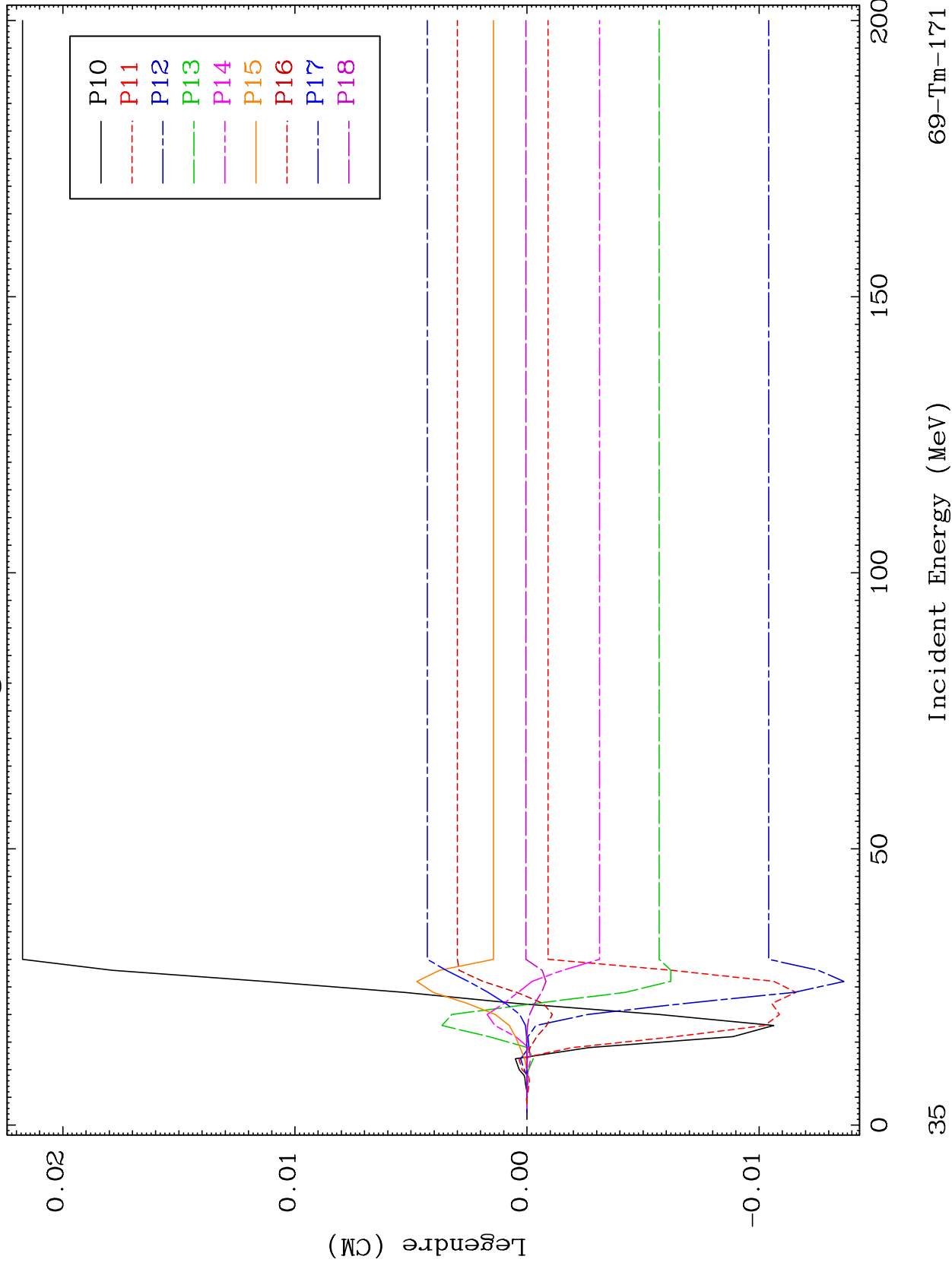

69-Tm-171

Incident Energy (MeV)

35

MAT 6931

MT= 55 (n,n') Level  
Legendre Coefficients

69-Tm-171

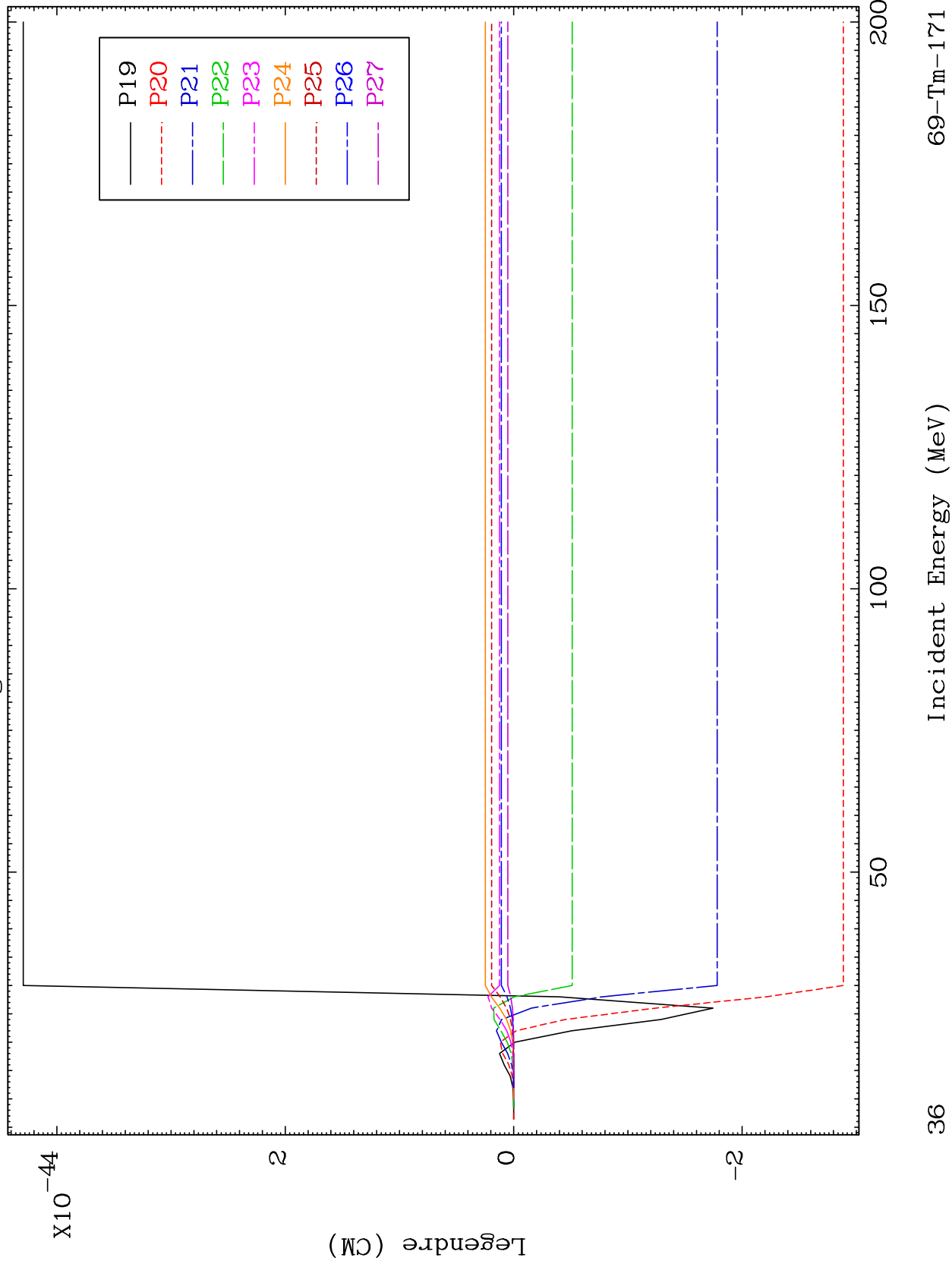

36

69-Tm-171

MAT 6931

MT= 55 (n,n') Level  
Legendre Coefficients

69-Tm-171

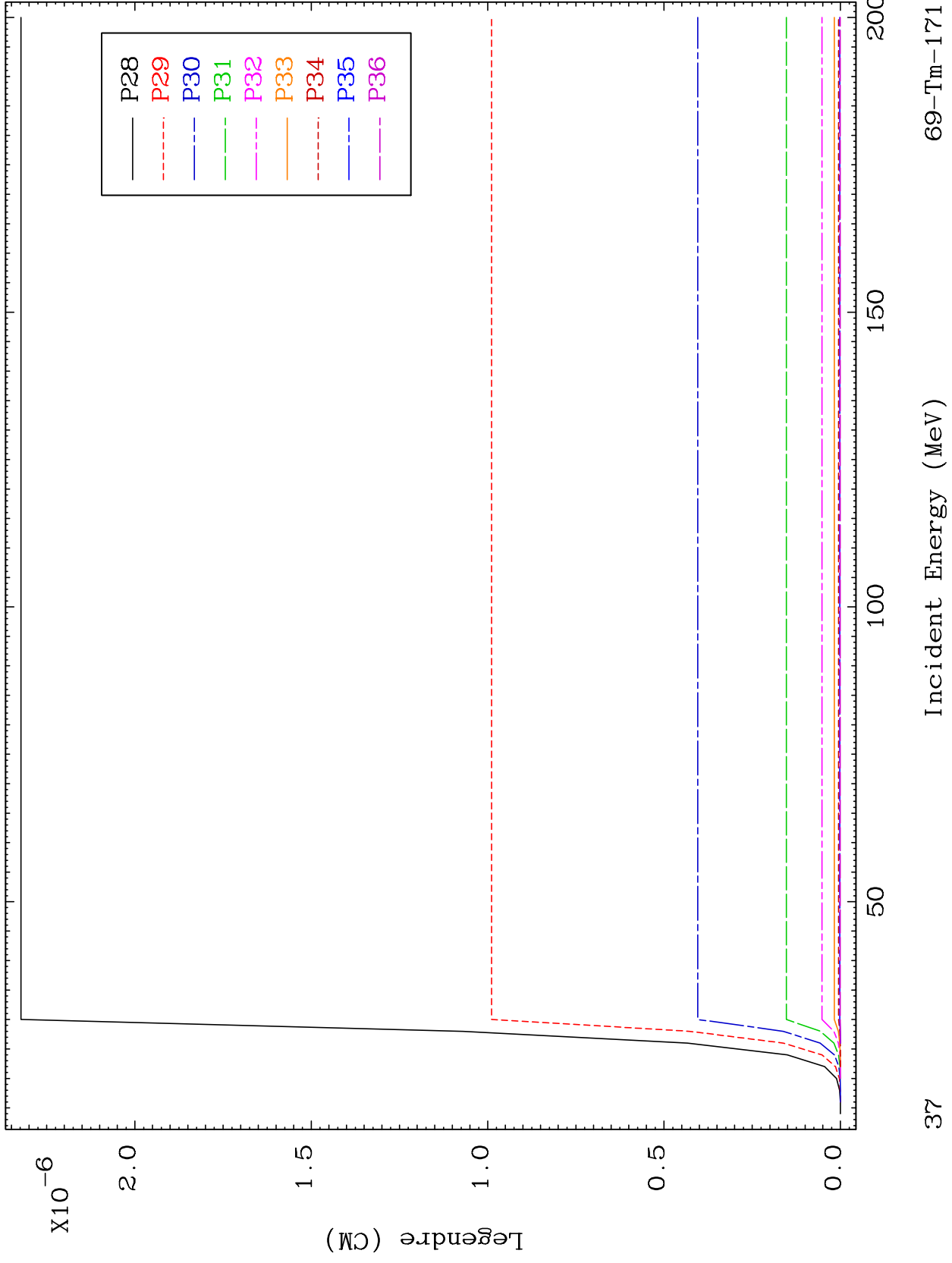

37

MAT 6931

MT= 56 (n,n') Level  
Legendre Coefficients

69-Tm-171

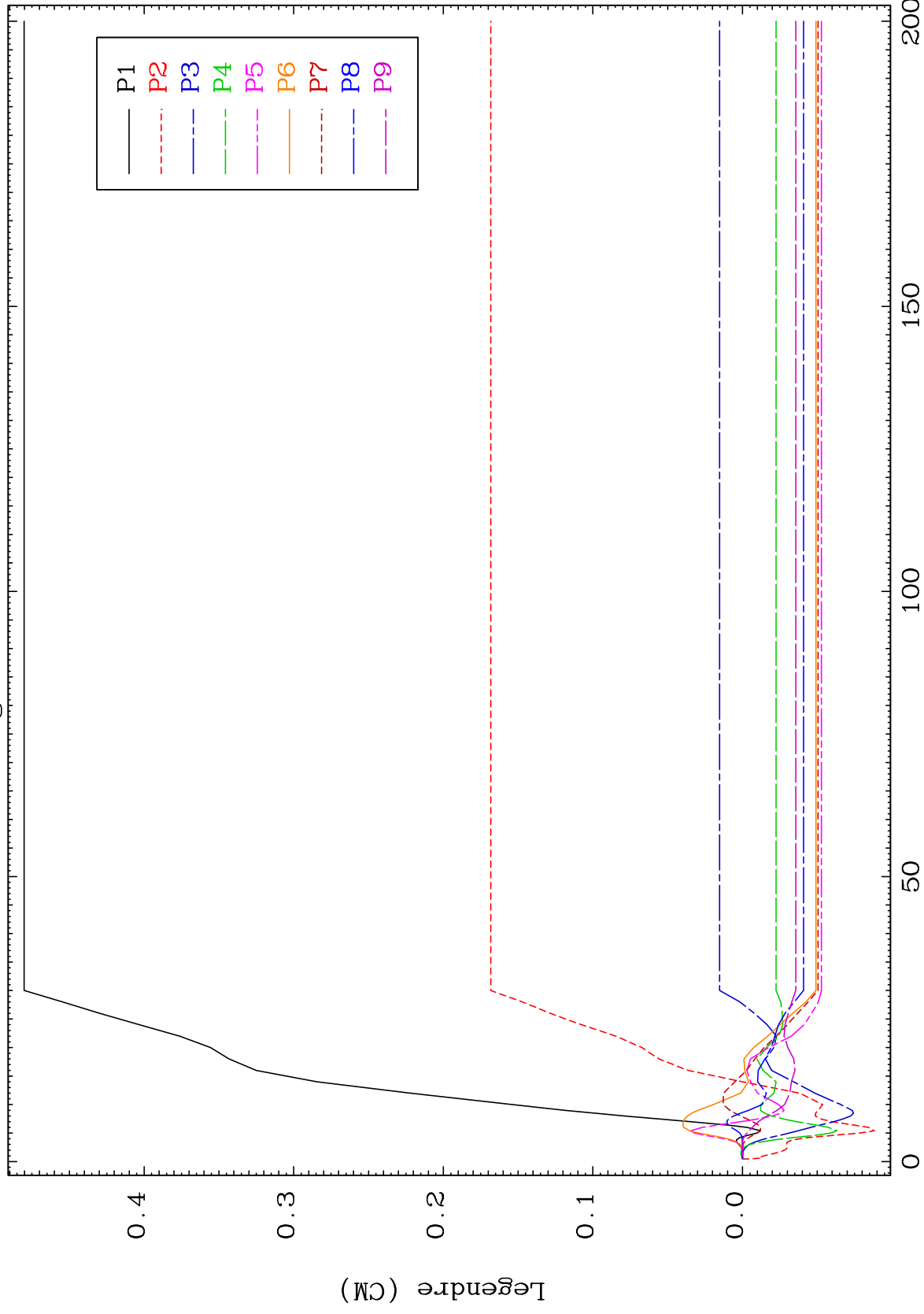

38

69-Tm-171

69-Tm-171

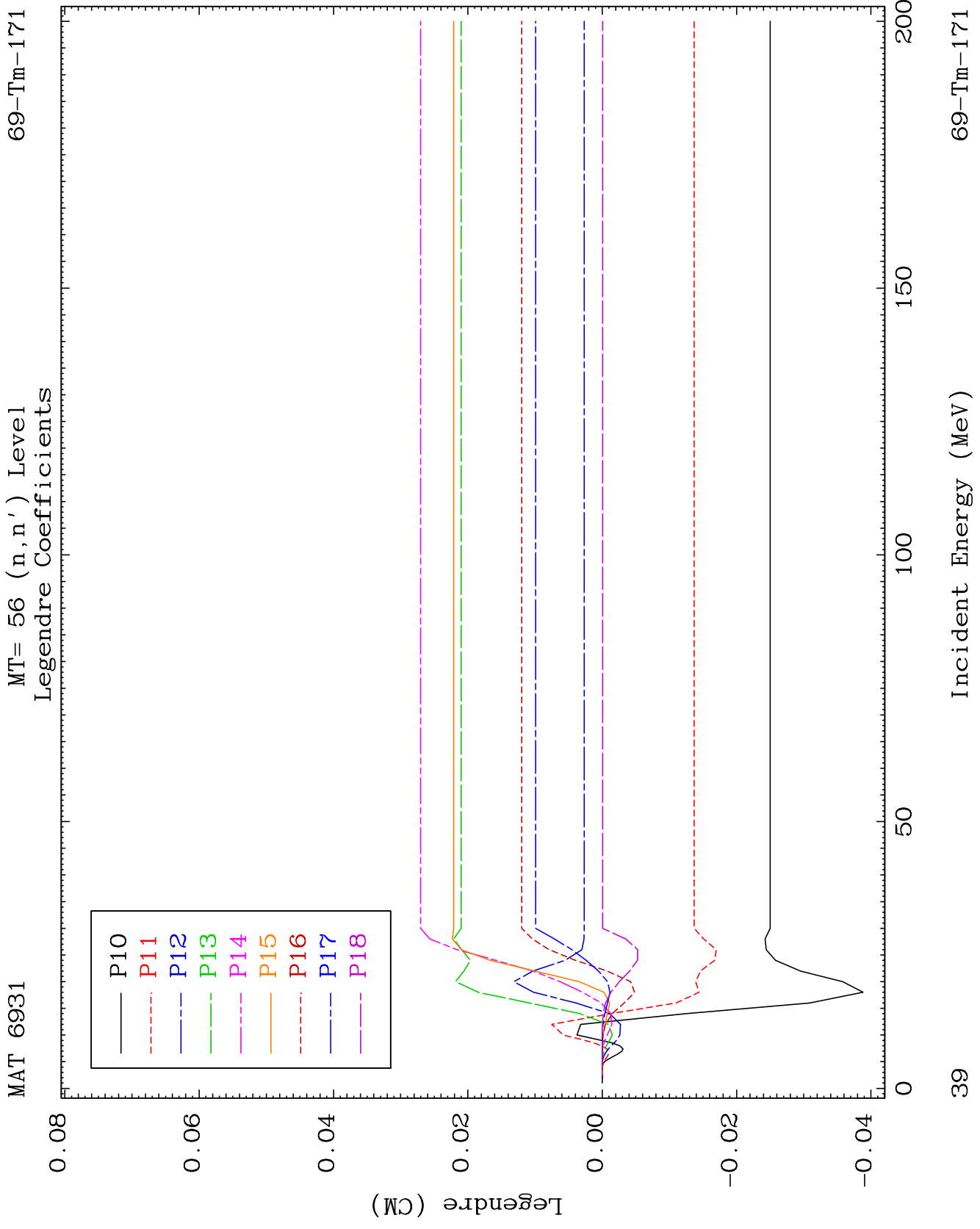





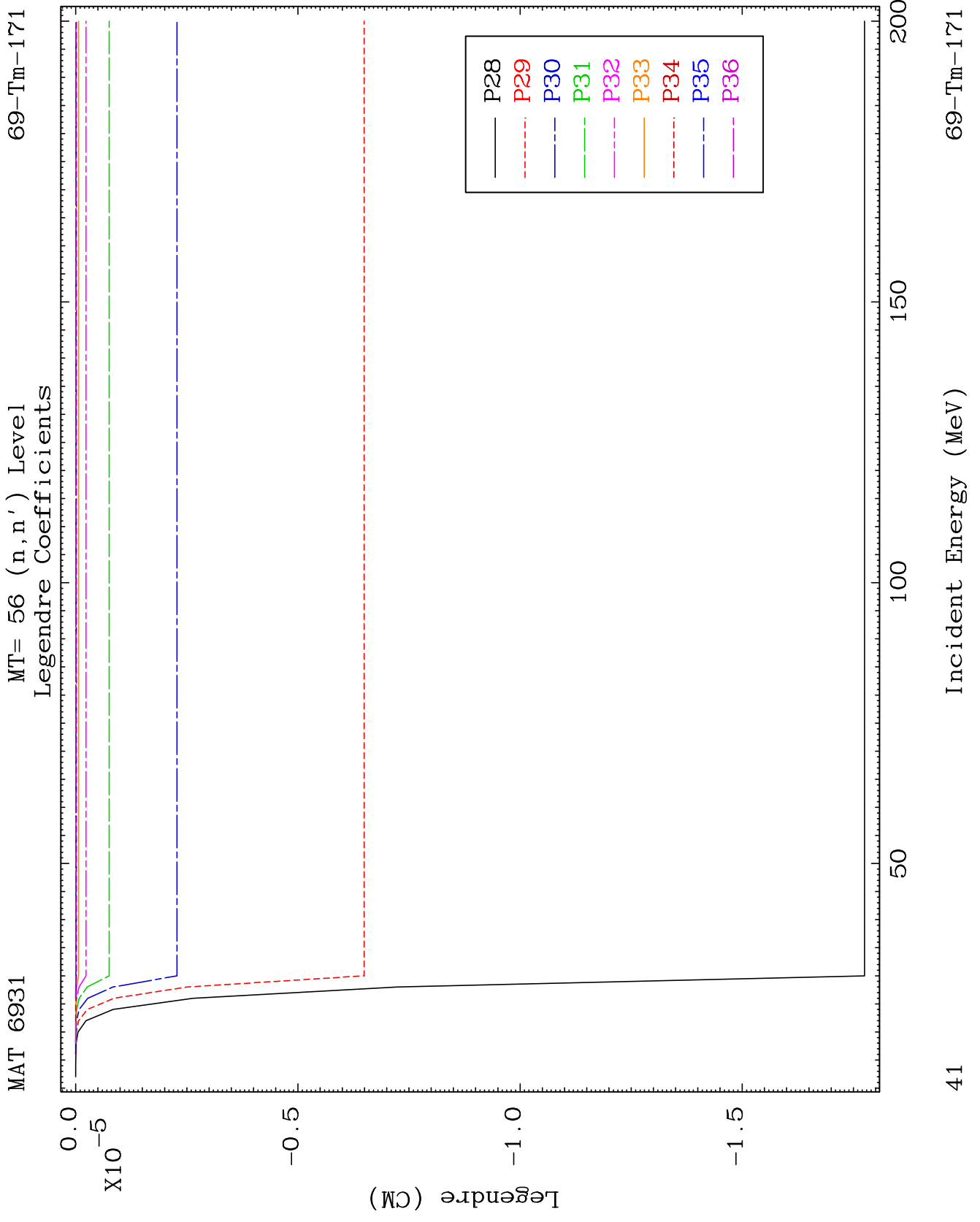

MAT 6931

MT= 57 (n,n') Level  
Legendre Coefficients

69-Tm-171

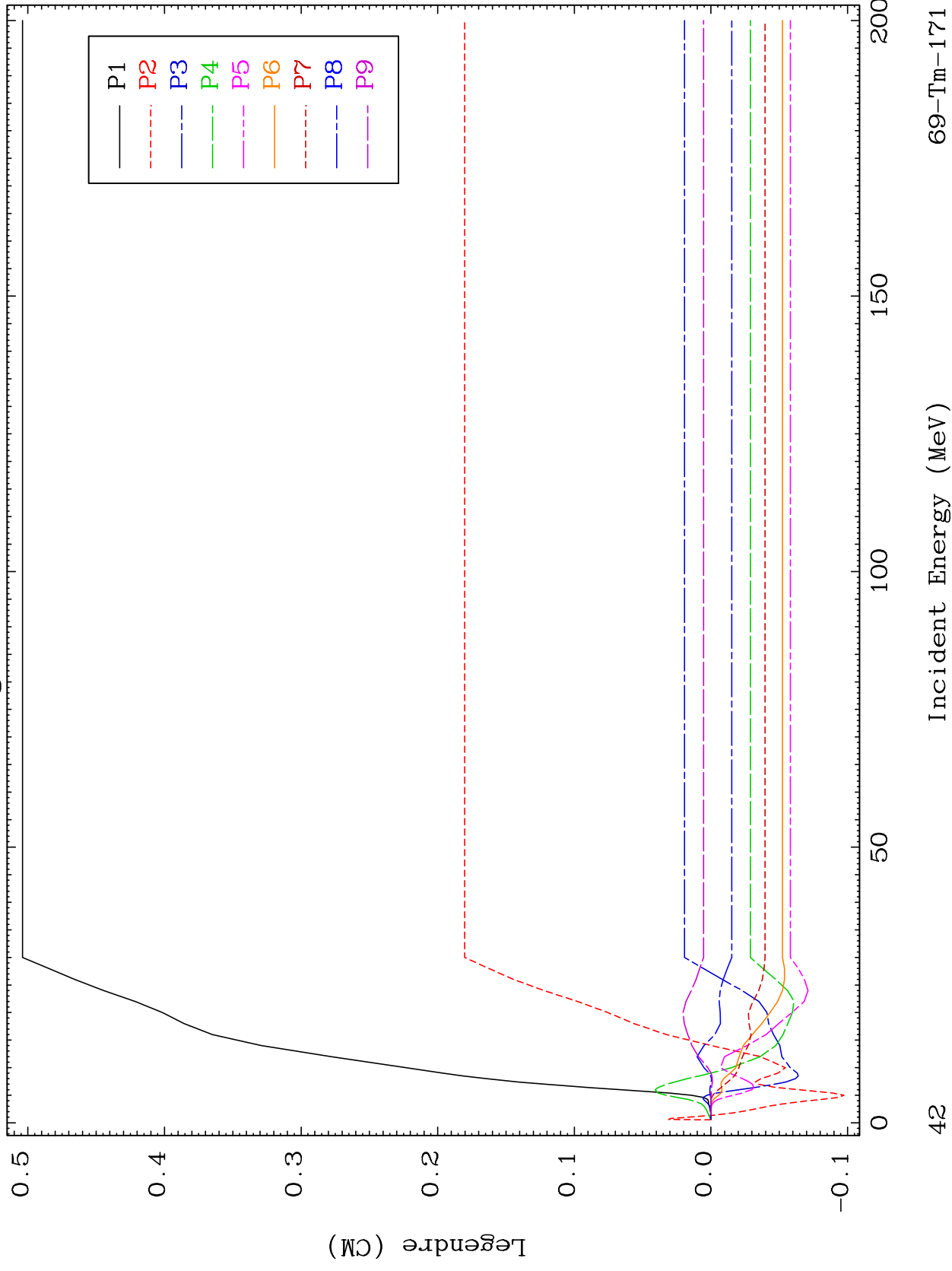

69-Tm-171

Incident Energy (MeV)

42

MAT 6931

MT= 57 (n,n') Level  
Legendre Coefficients

69-Tm-171

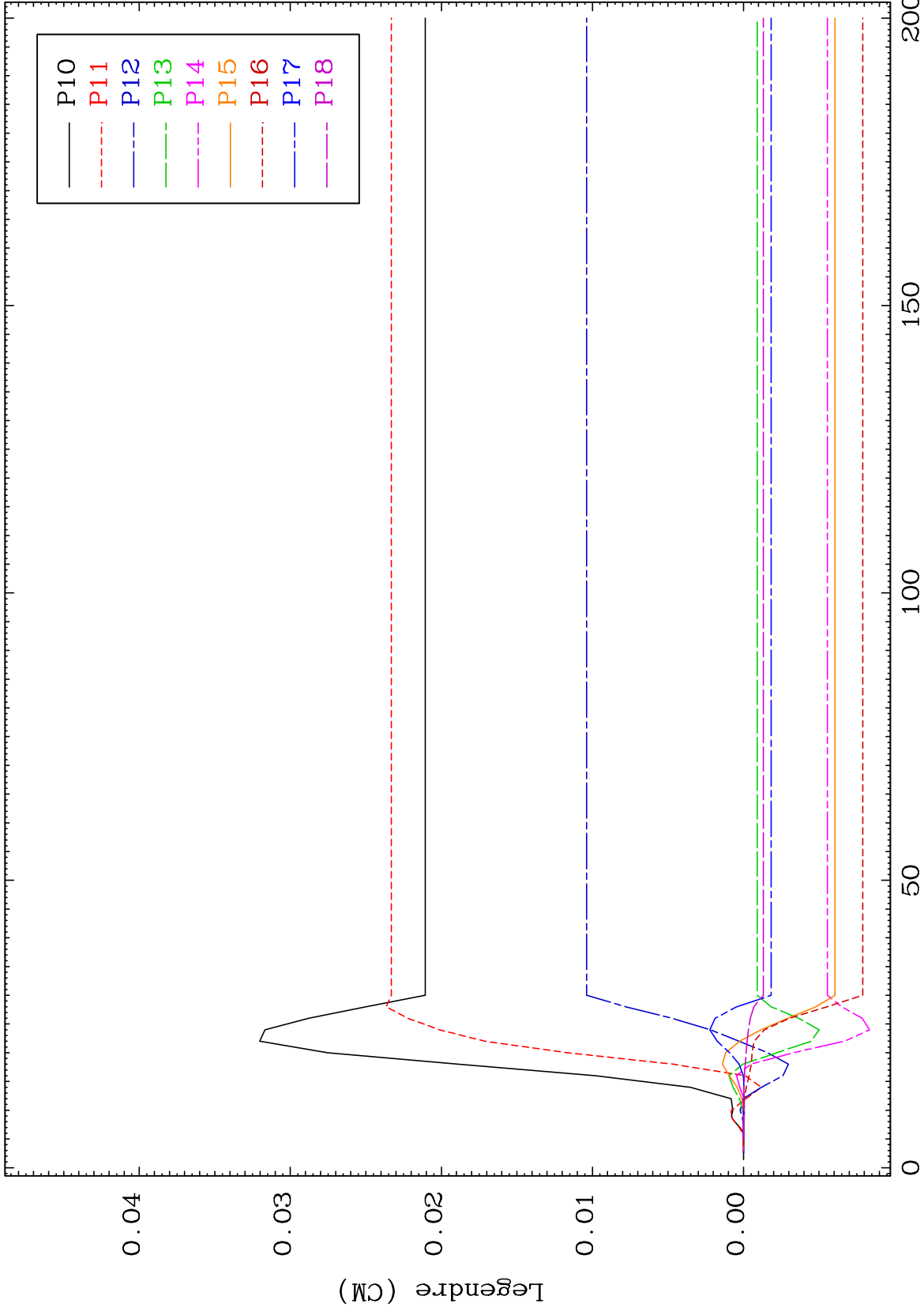

43

Incident Energy (MeV)

69-Tm-171

MAT 6931

MT= 57 (n,n') Level  
Legendre Coefficients

69-Tm-171

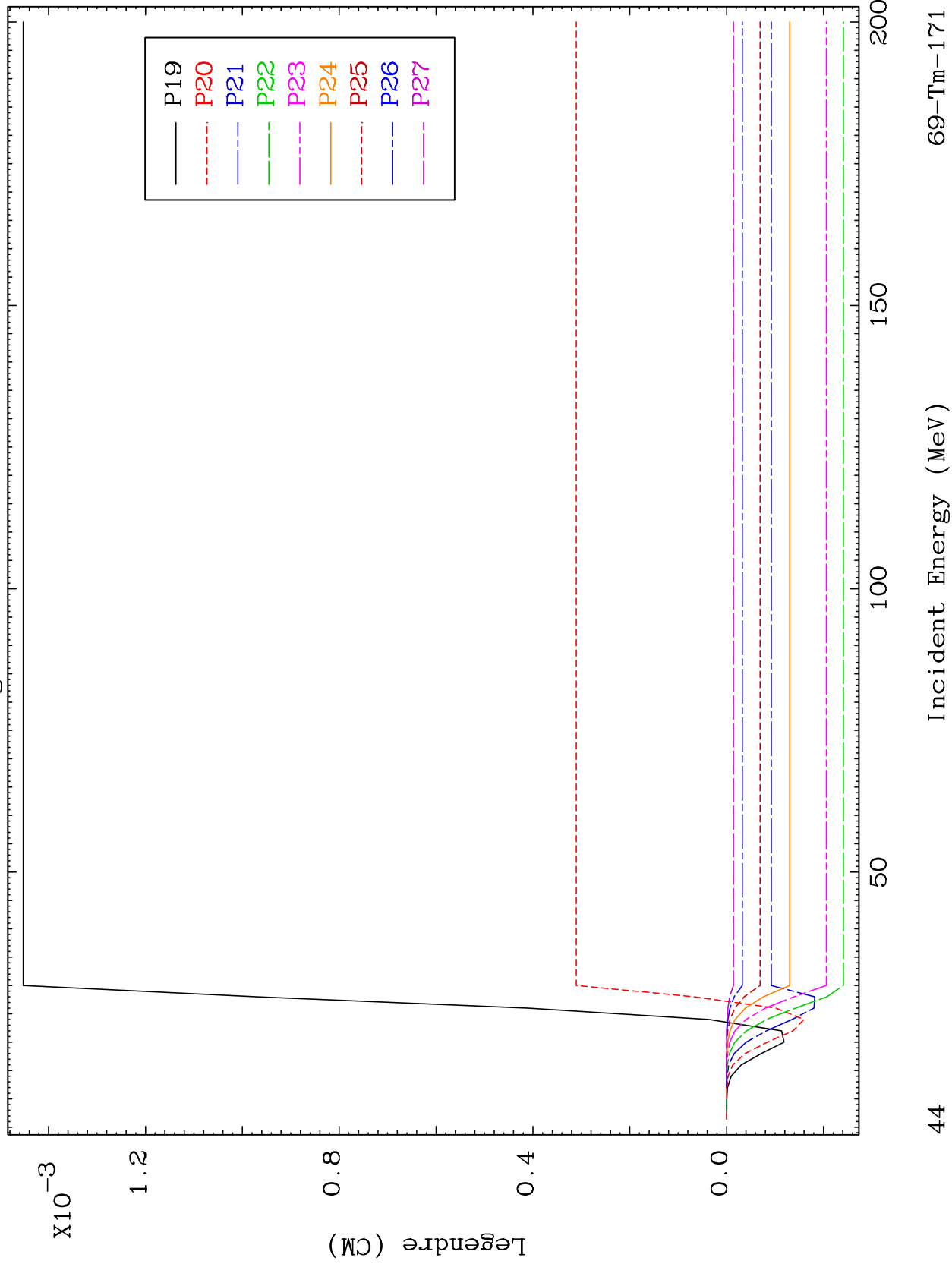

44

Incident Energy (MeV)

69-Tm-171

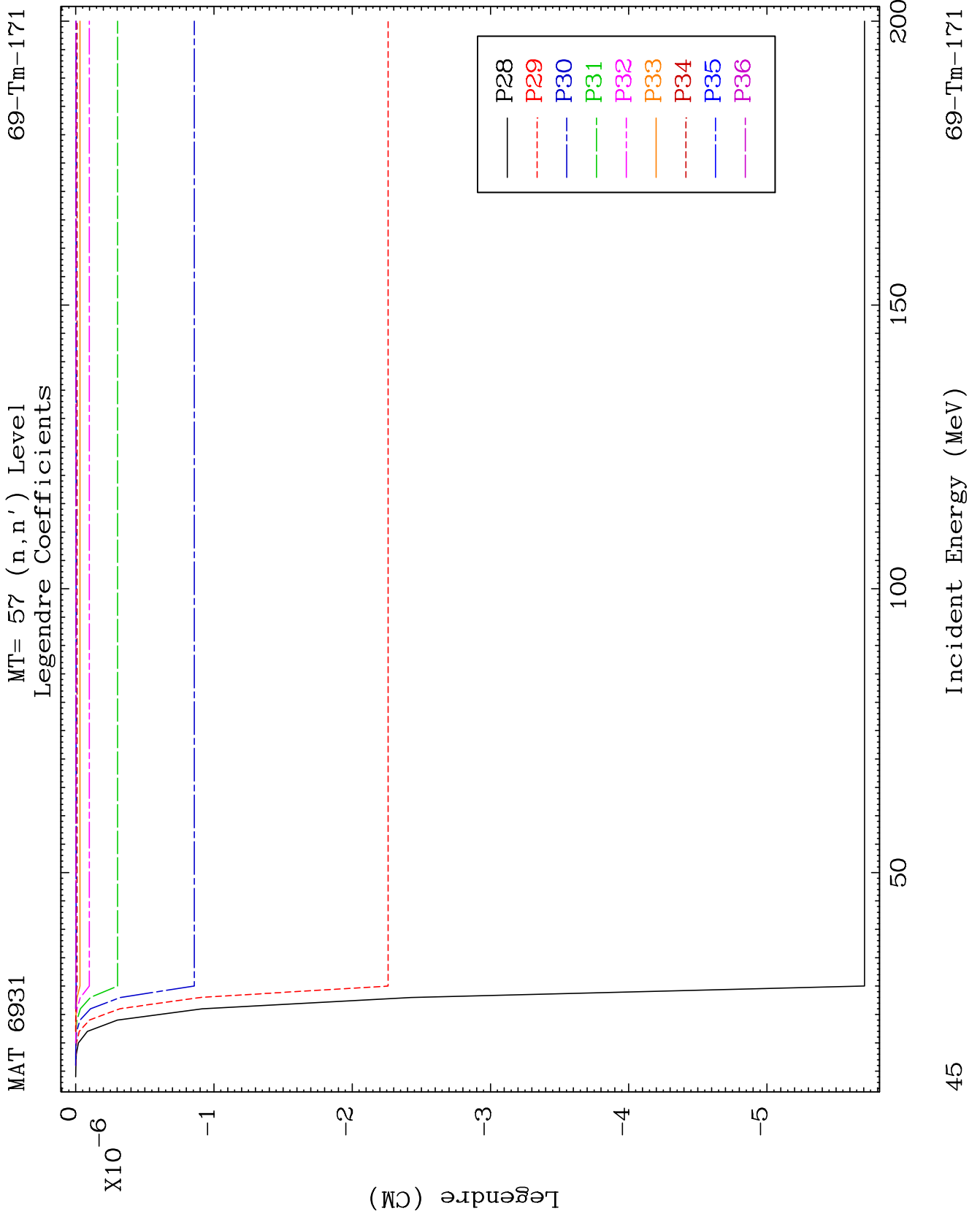

MAT 6931

MT= 58 (n,n') Level  
Legendre Coefficients

69-Tm-171

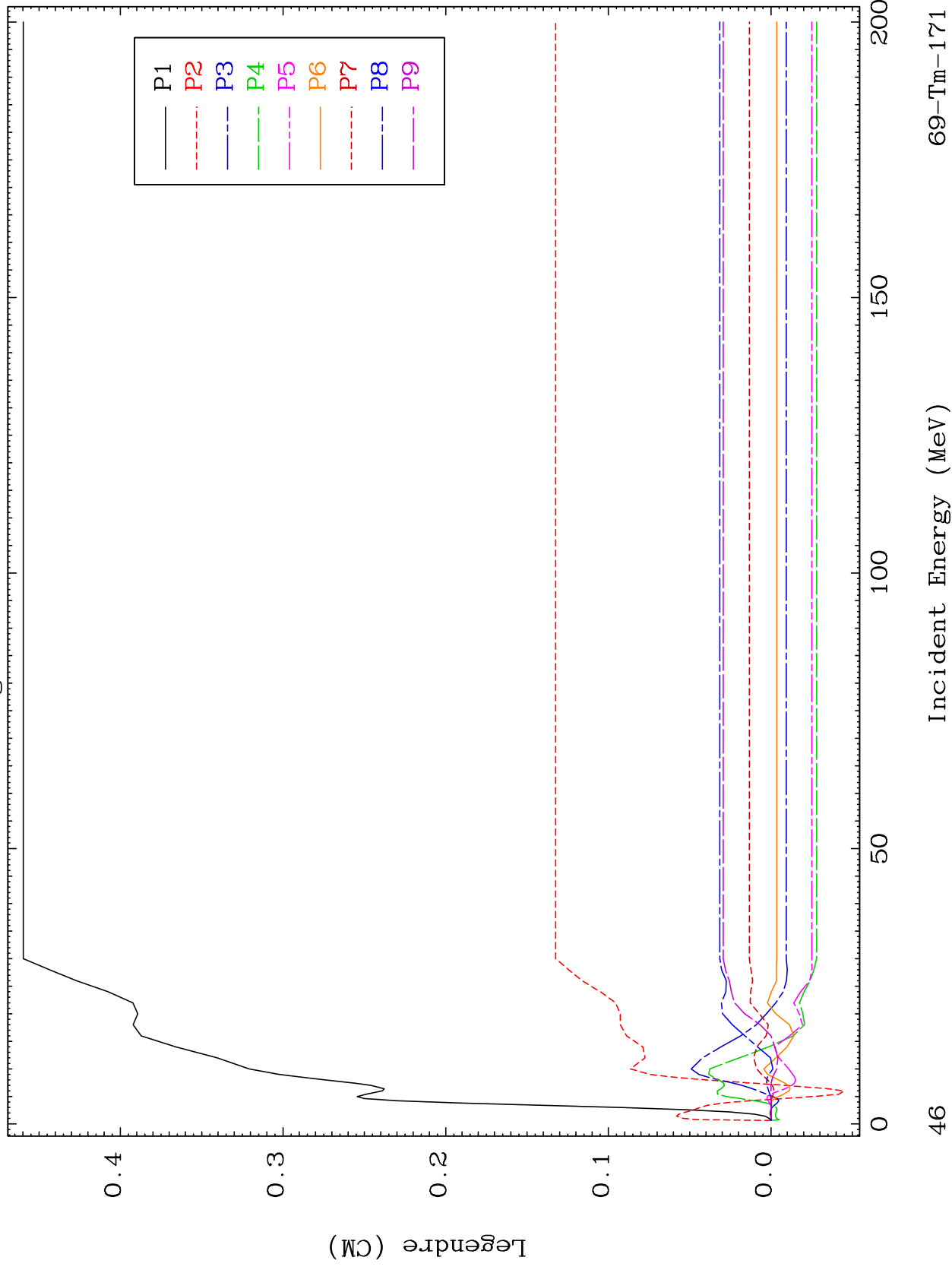

69-Tm-171

Incident Energy (MeV)

46

MAT 6931

MT= 58 (n,n') Level  
Legendre Coefficients

69-Tm-171

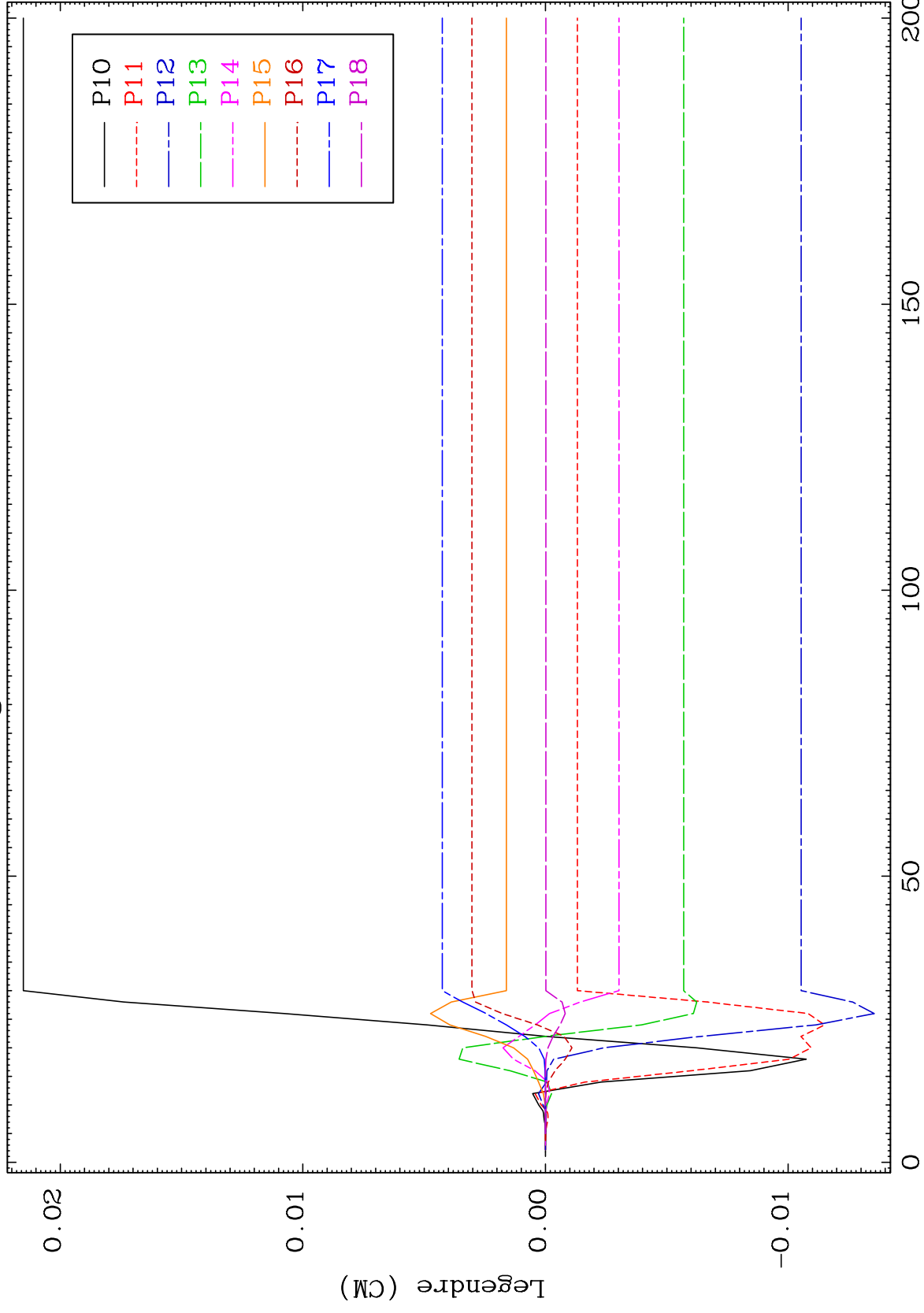

47

Incident Energy (MeV)

69-Tm-171



MAT 6931

MT= 58 (n,n') Level  
Legendre Coefficients

69-Tm-171

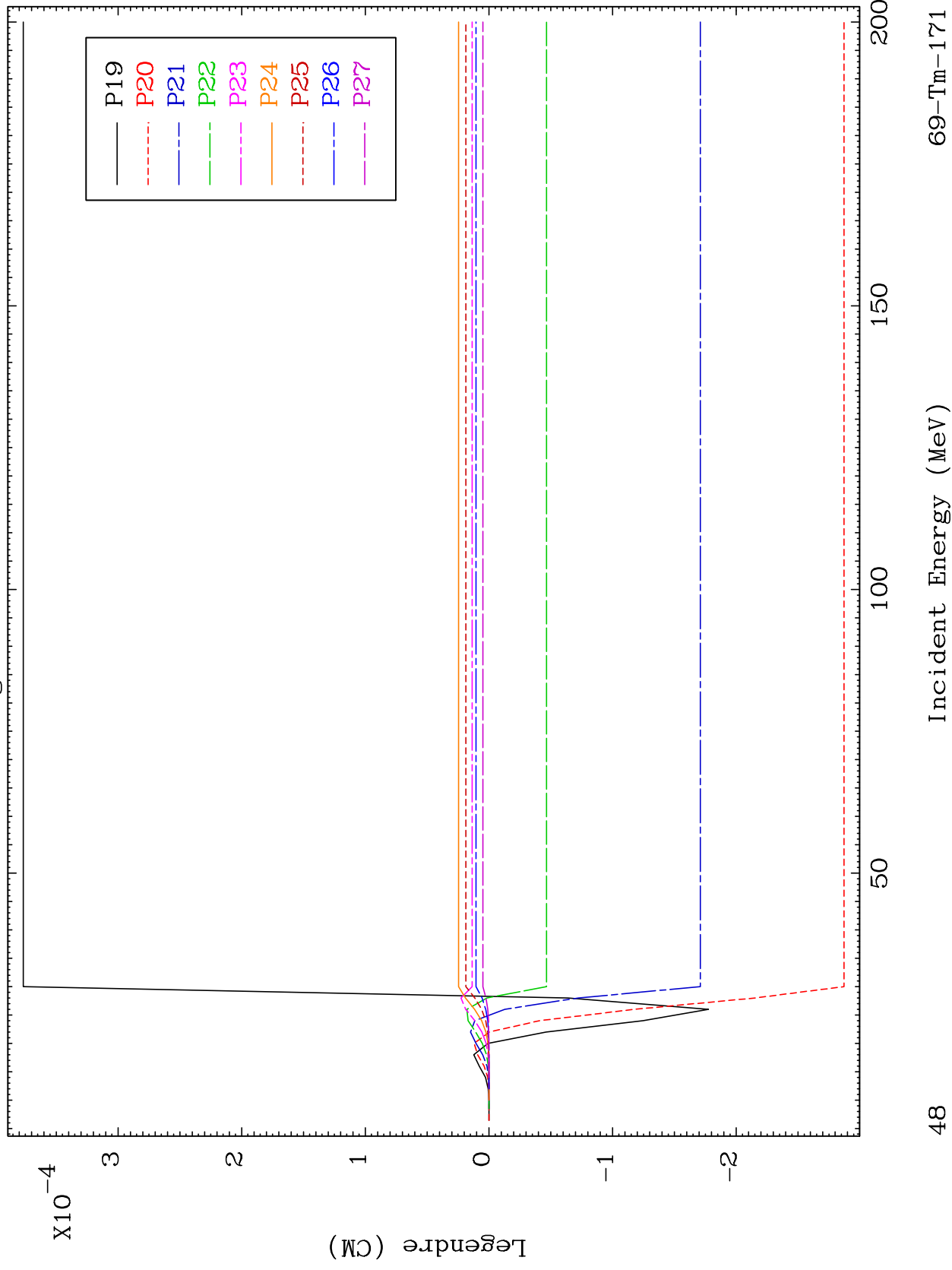

48

Incident Energy (MeV)

69-Tm-171

MAT 6931

MT= 58 (n,n') Level  
Legendre Coefficients

69-Tm-171

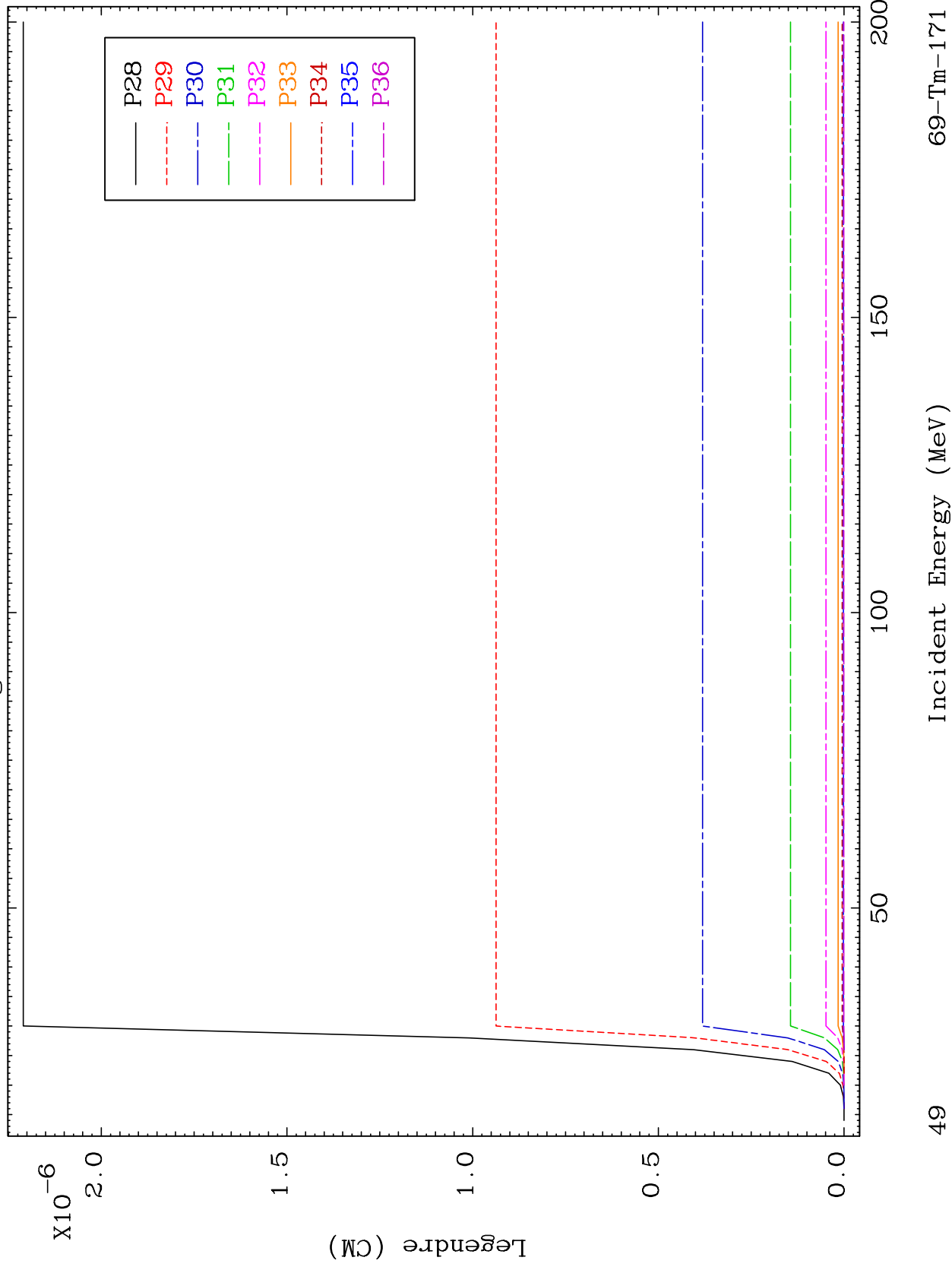

49

Incident Energy (MeV)

69-Tm-171

MAT 6931

MT= 59 (n,n') Level  
Legendre Coefficients

69-Tm-171

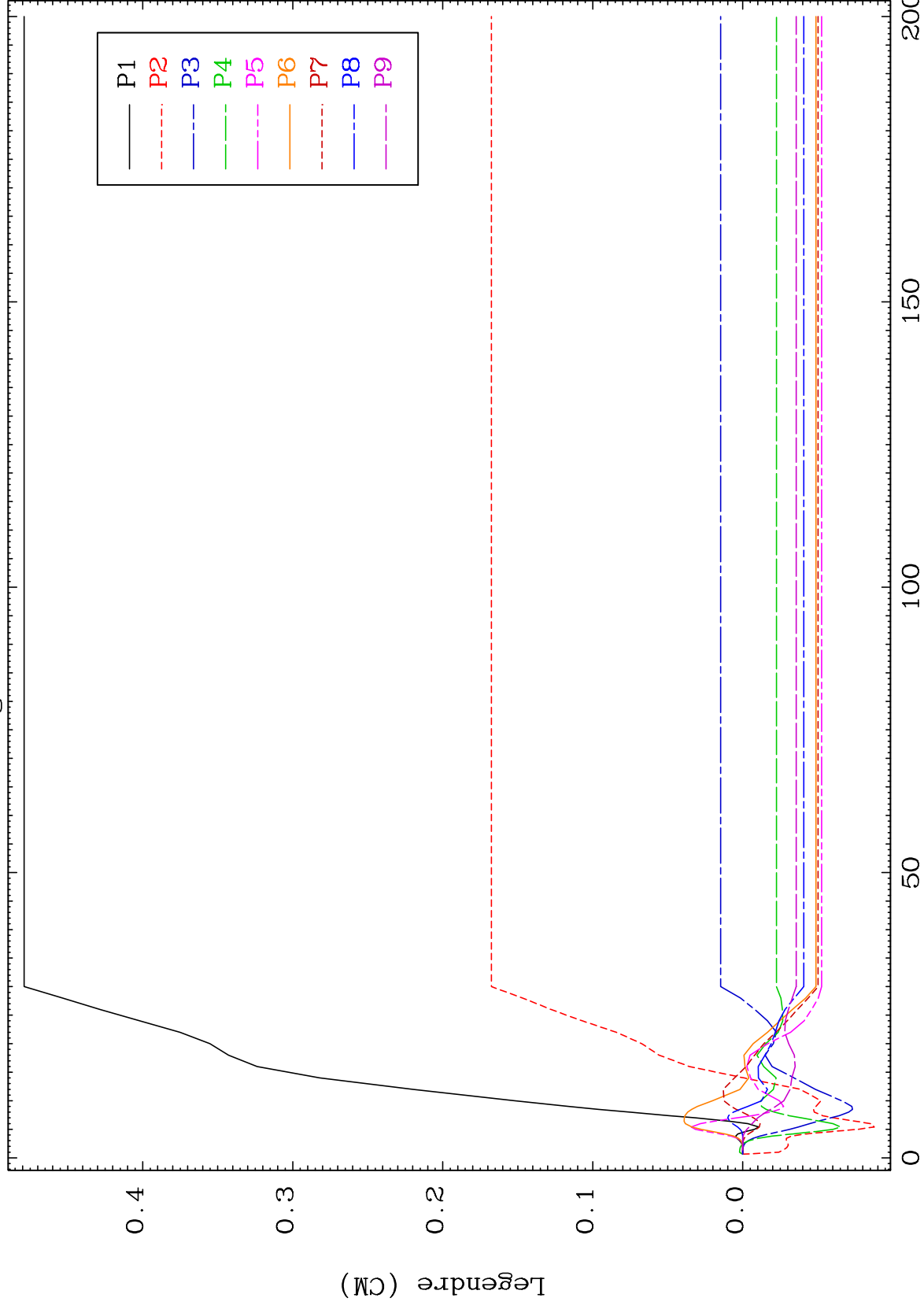

69-Tm-171

Incident Energy (MeV)

50

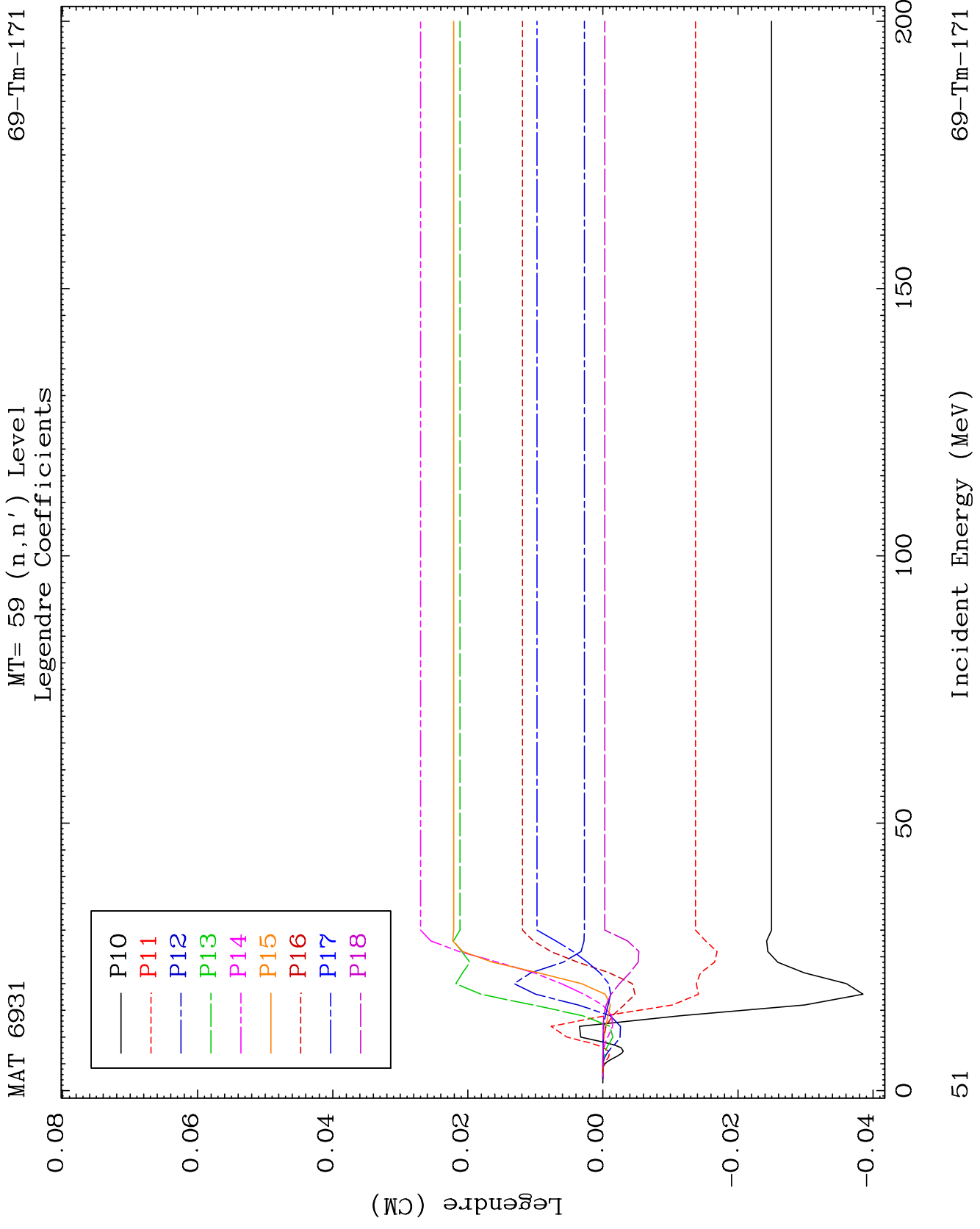

MAT 6931

MT= 59 (n,n') Level  
Legendre Coefficients

69-Tm-171

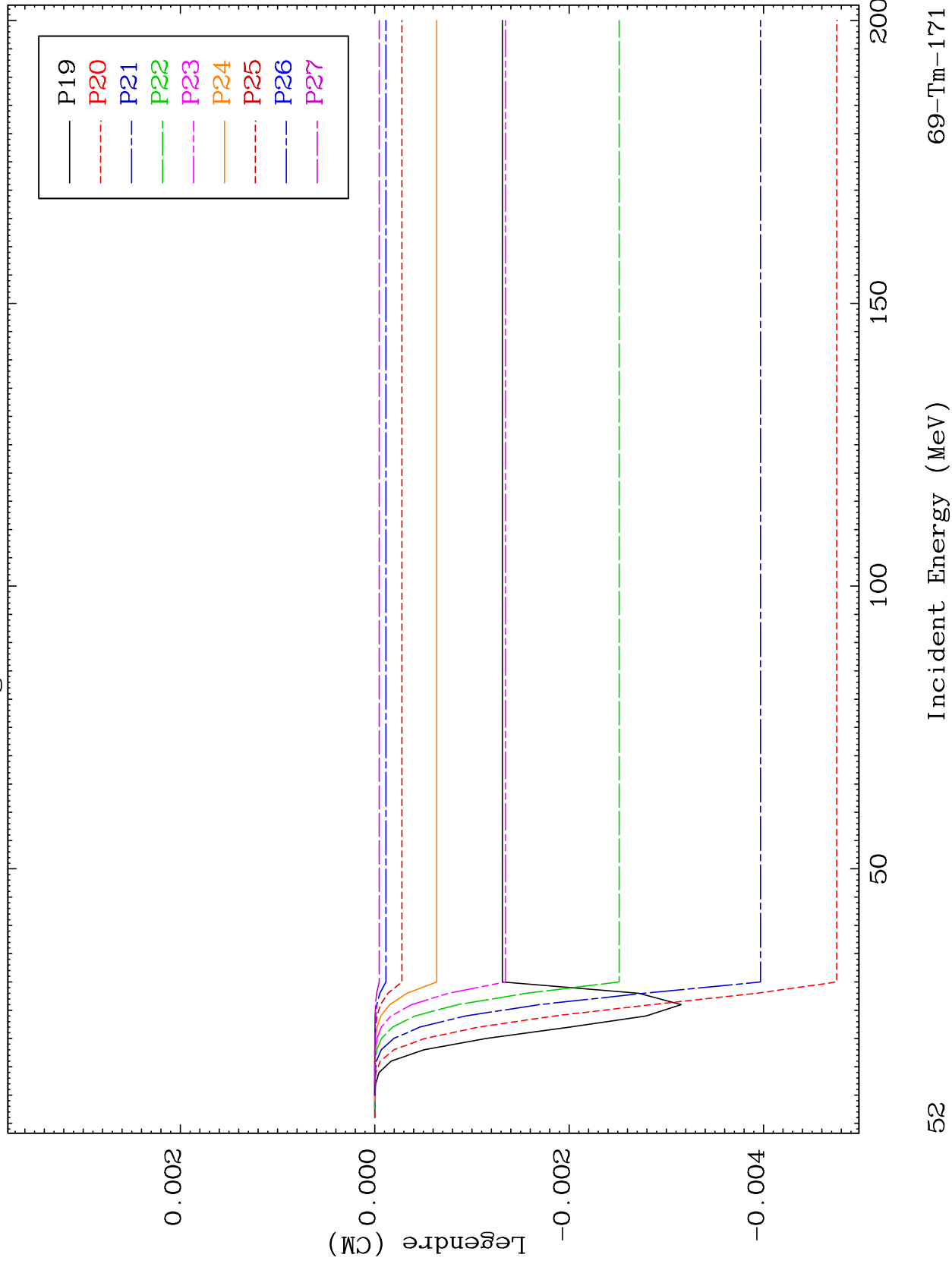

52

Incident Energy (MeV)

69-Tm-171

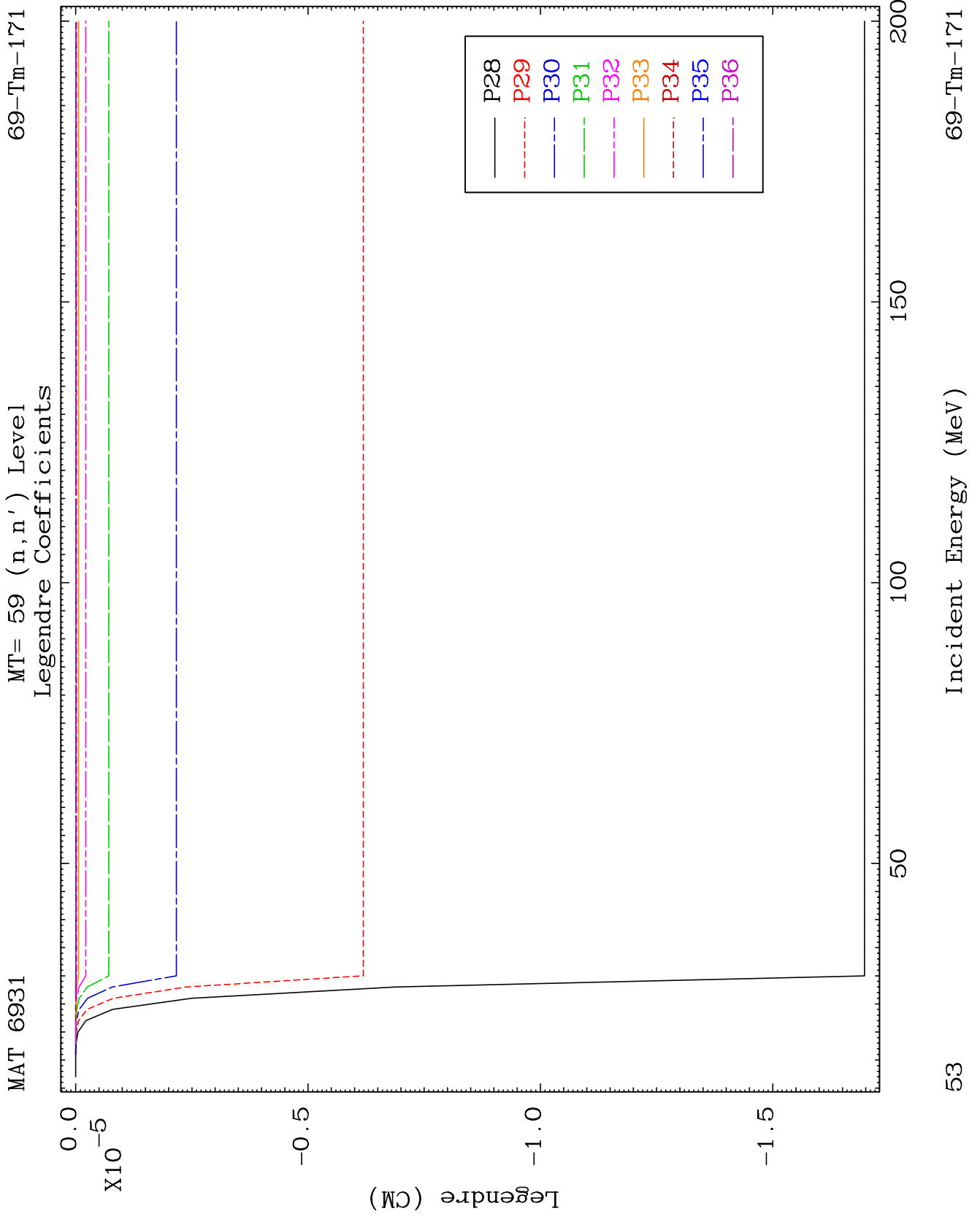

MAT 6931

MT= 60 (n,n') Level  
Legendre Coefficients

69-Tm-171

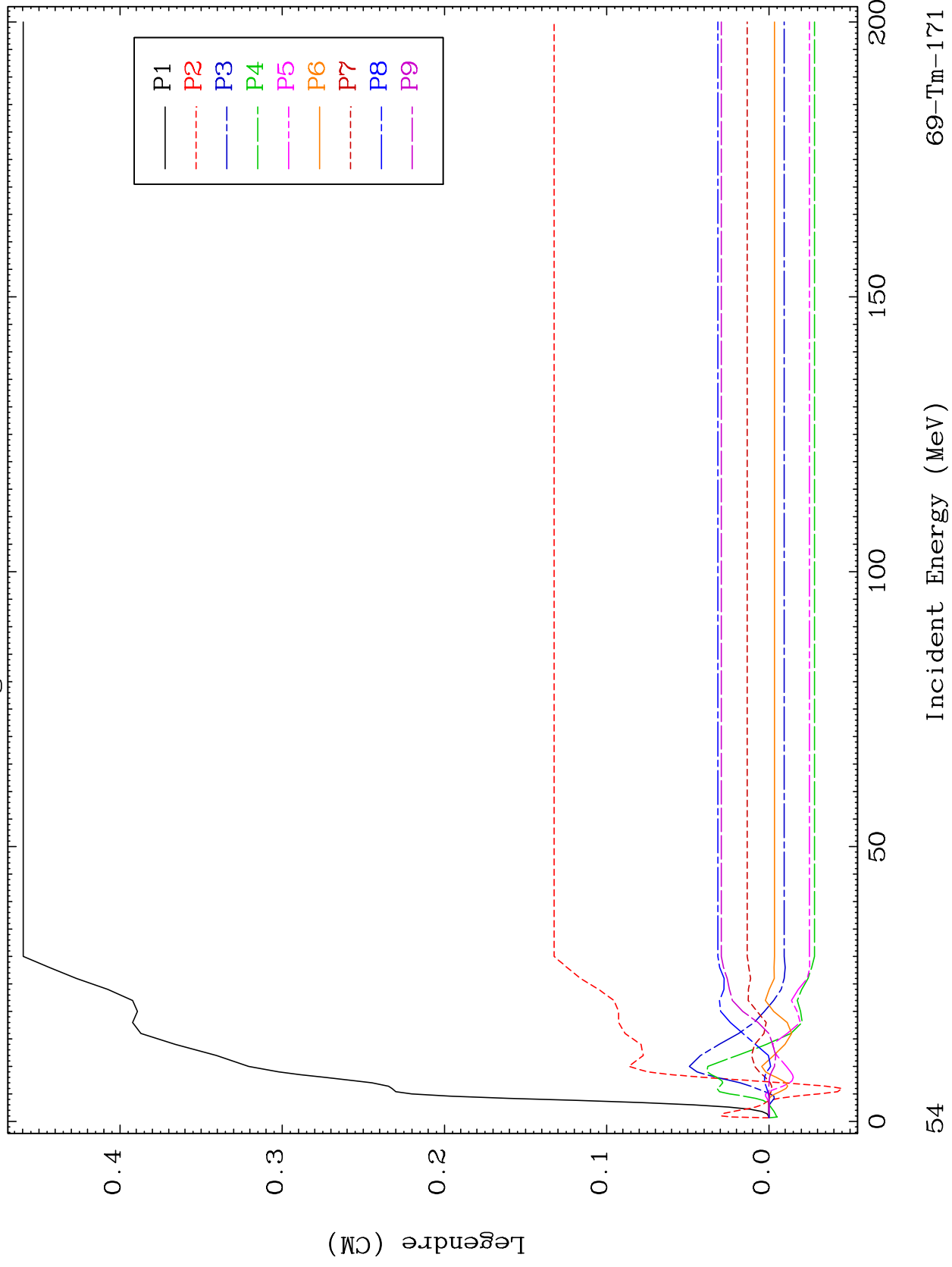

54

69-Tm-171

MAT 6931

MT= 60 (n,n') Level  
Legendre Coefficients

69-Tm-171

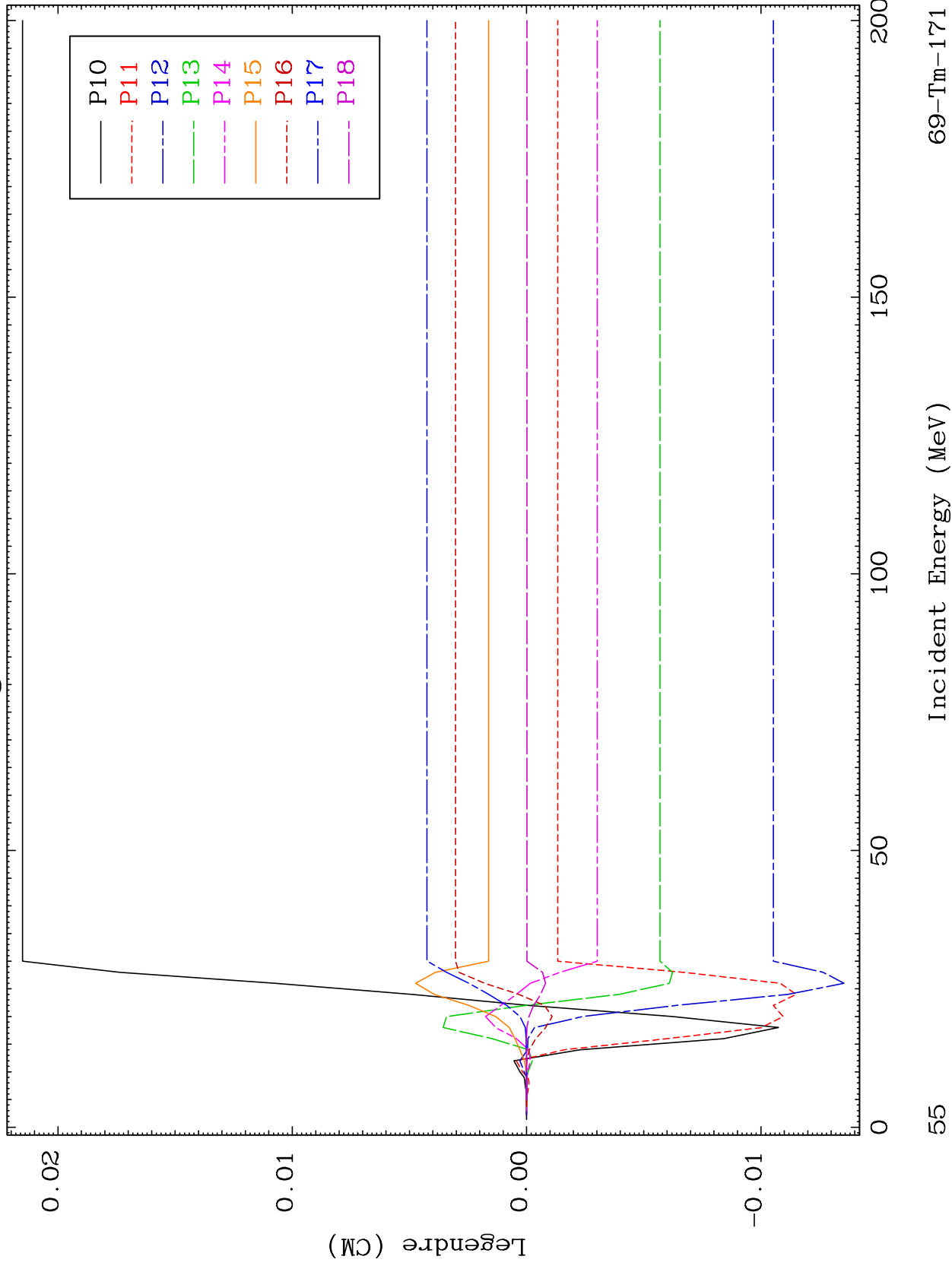

69-Tm-171

Incident Energy (MeV)

55



MAT 6931

MT= 60 (n,n') Level  
Legendre Coefficients

69-Tm-171

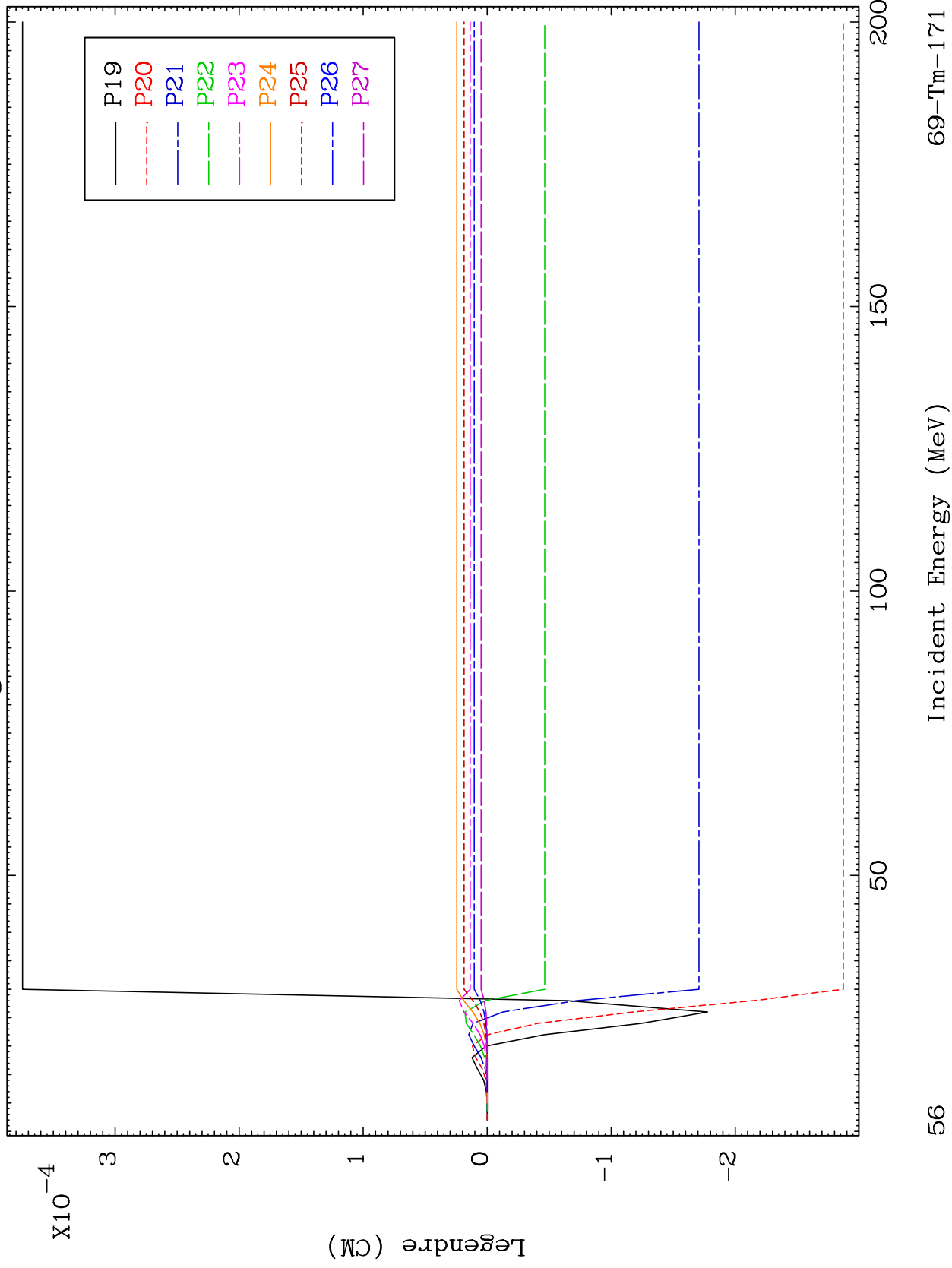

56

Incident Energy (MeV)

69-Tm-171

MAT 6931

MT= 60 (n,n') Level  
Legendre Coefficients

69-Tm-171

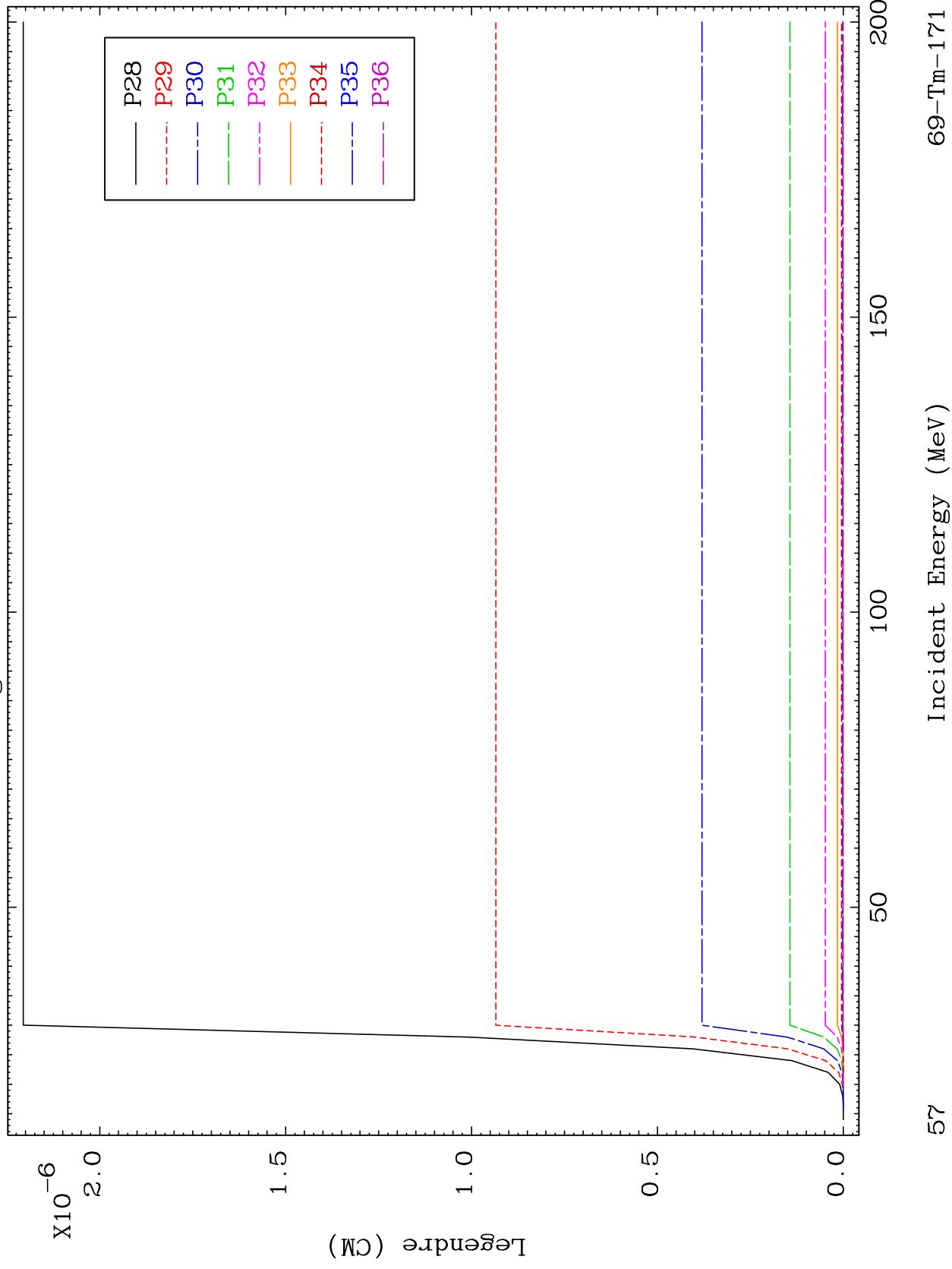



MAT 6931

MT= 61 (n,n') Level  
Legendre Coefficients

69-Tm-171

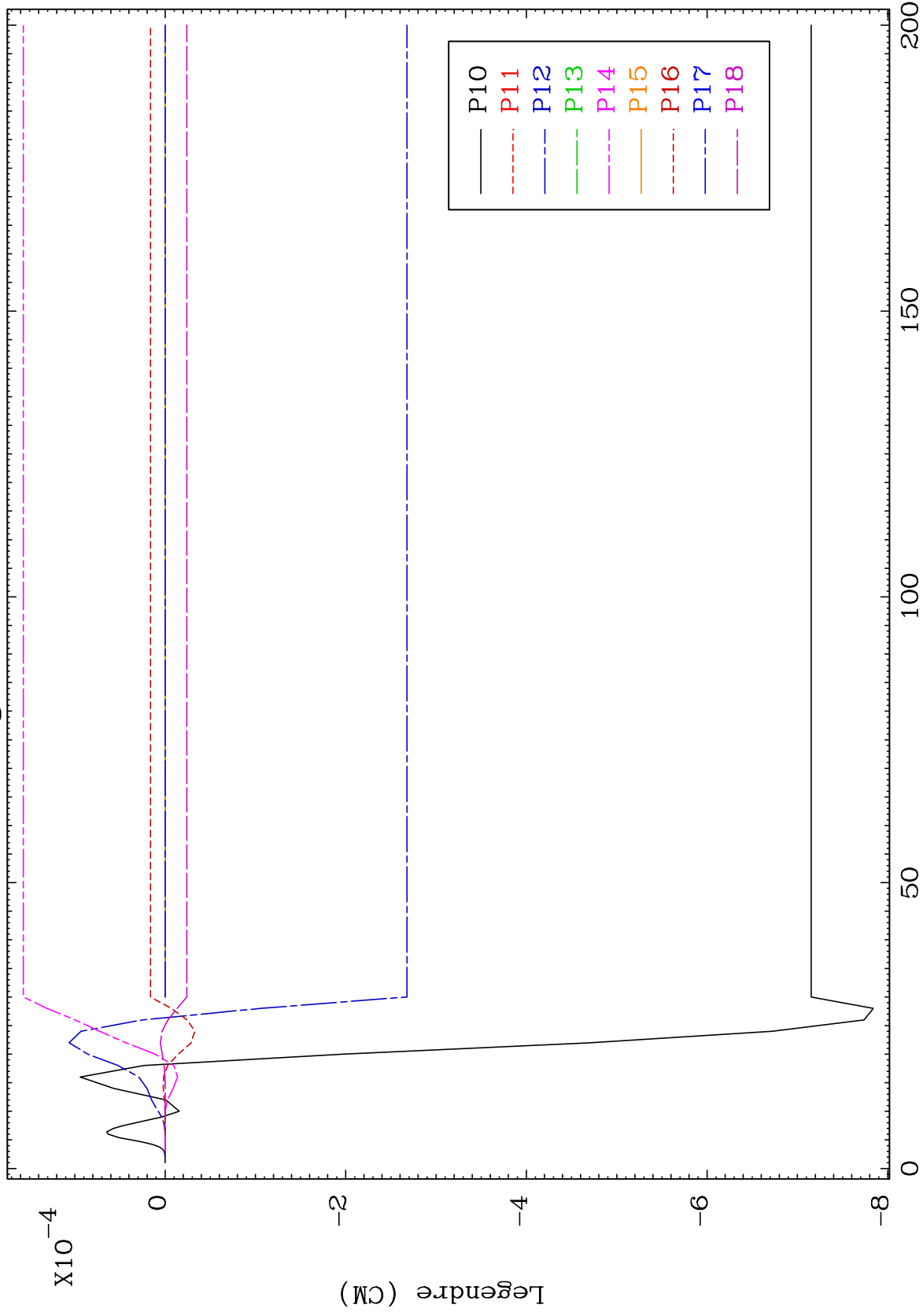

59

69-Tm-171



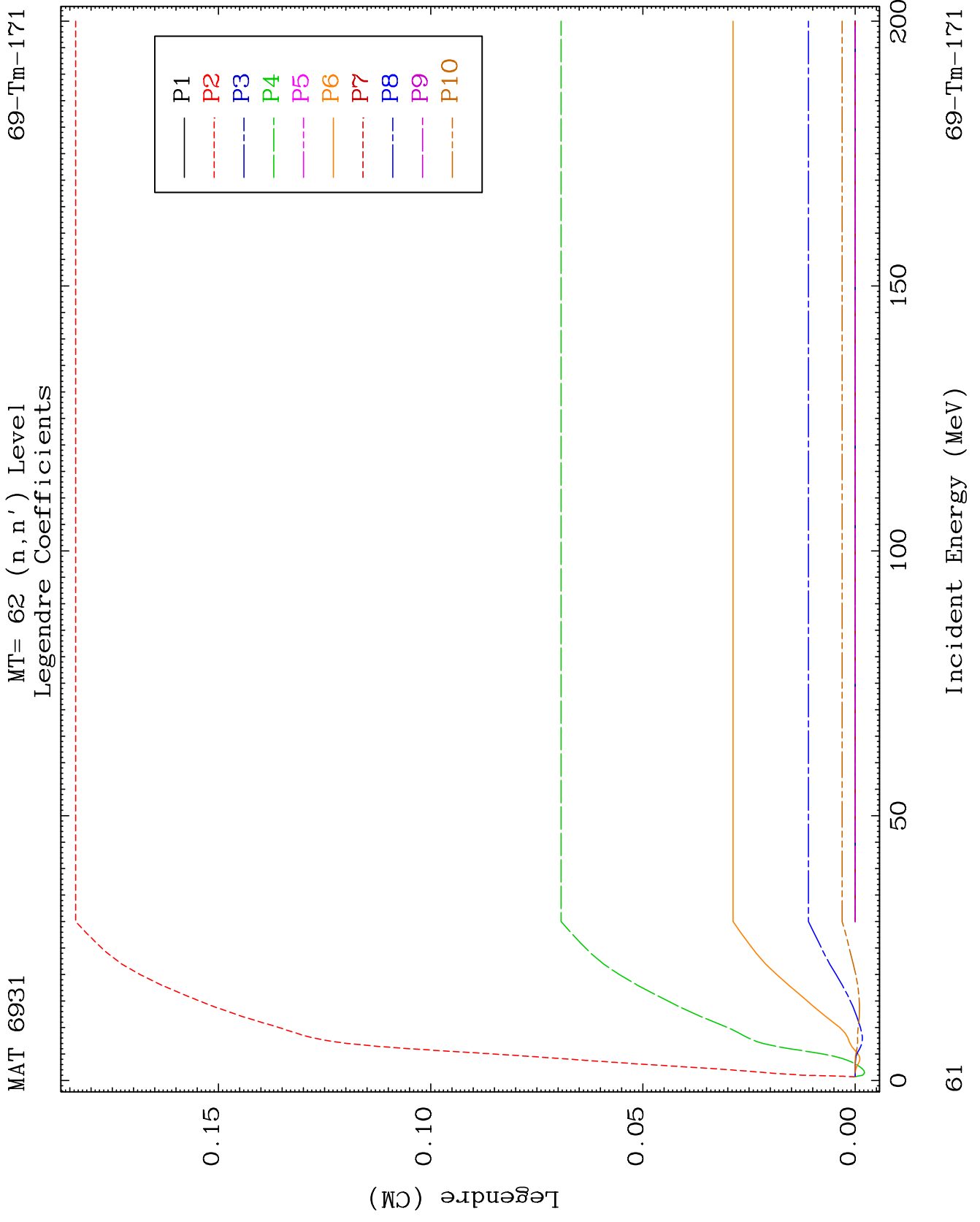

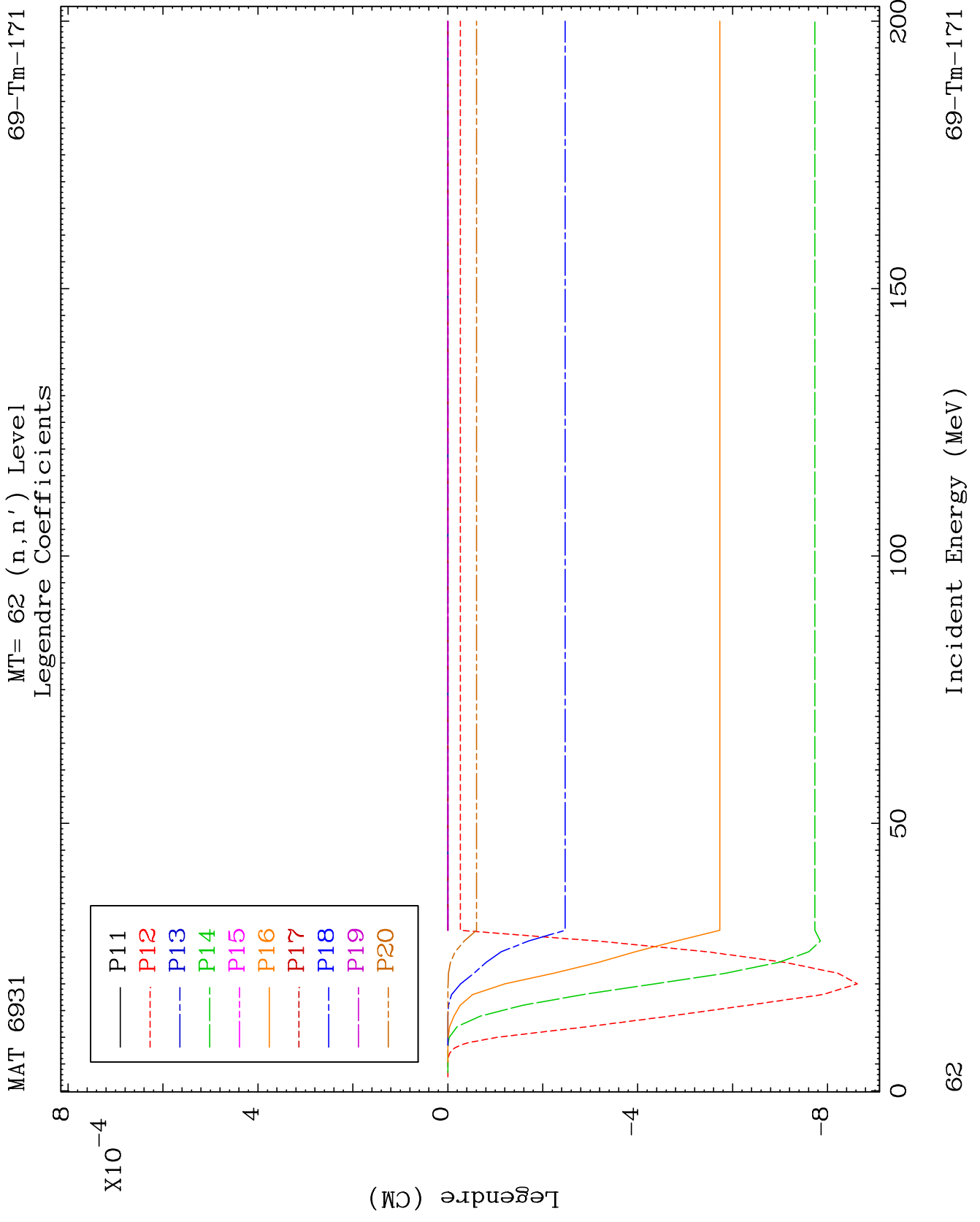

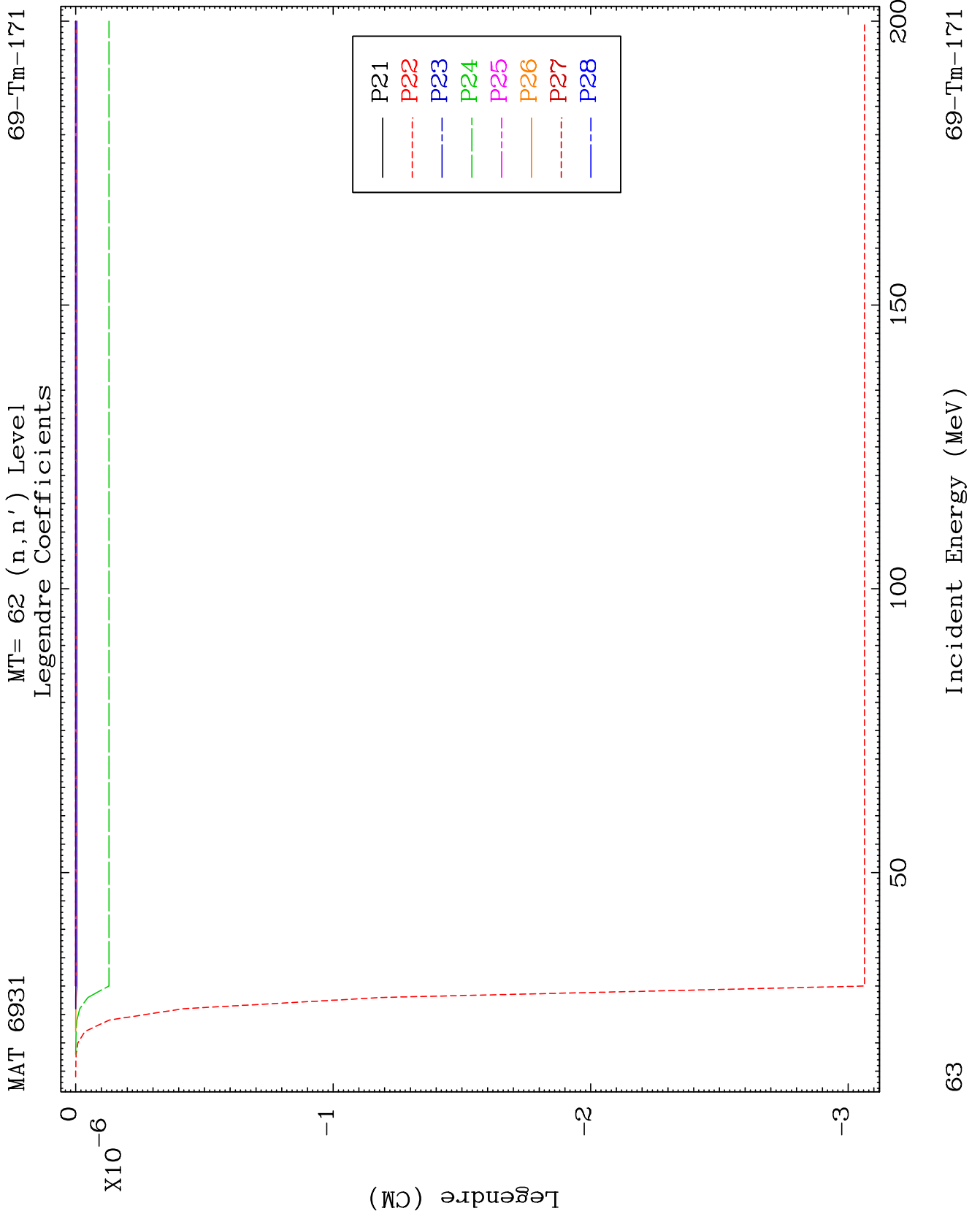



MAT 6931

MT= 63 (n,n') Level  
Legendre Coefficients

69-Tm-171

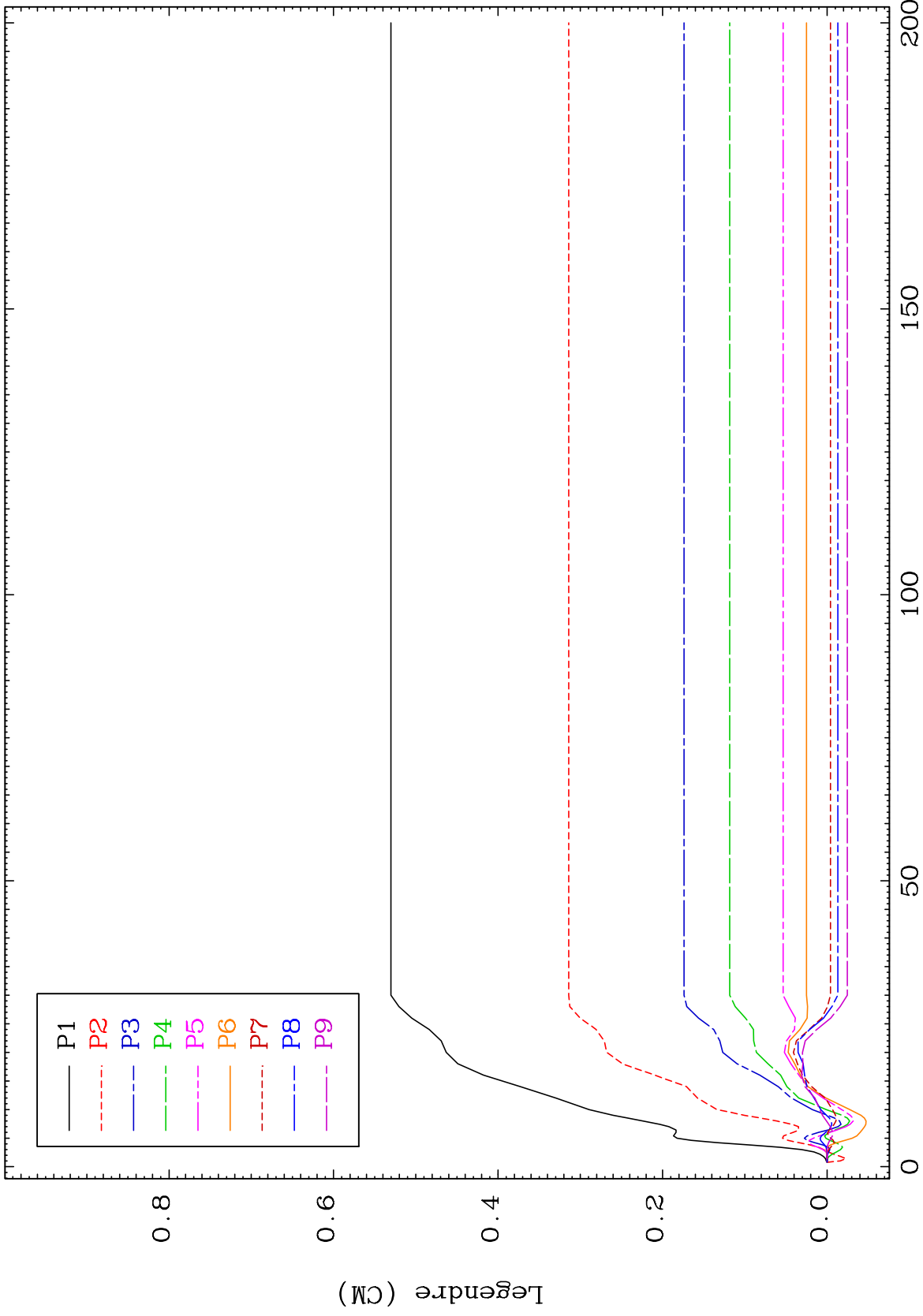

64

Incident Energy (MeV)

69-Tm-171

MAT 6931

MT= 63 (n,n') Level  
Legendre Coefficients

69-Tm-171

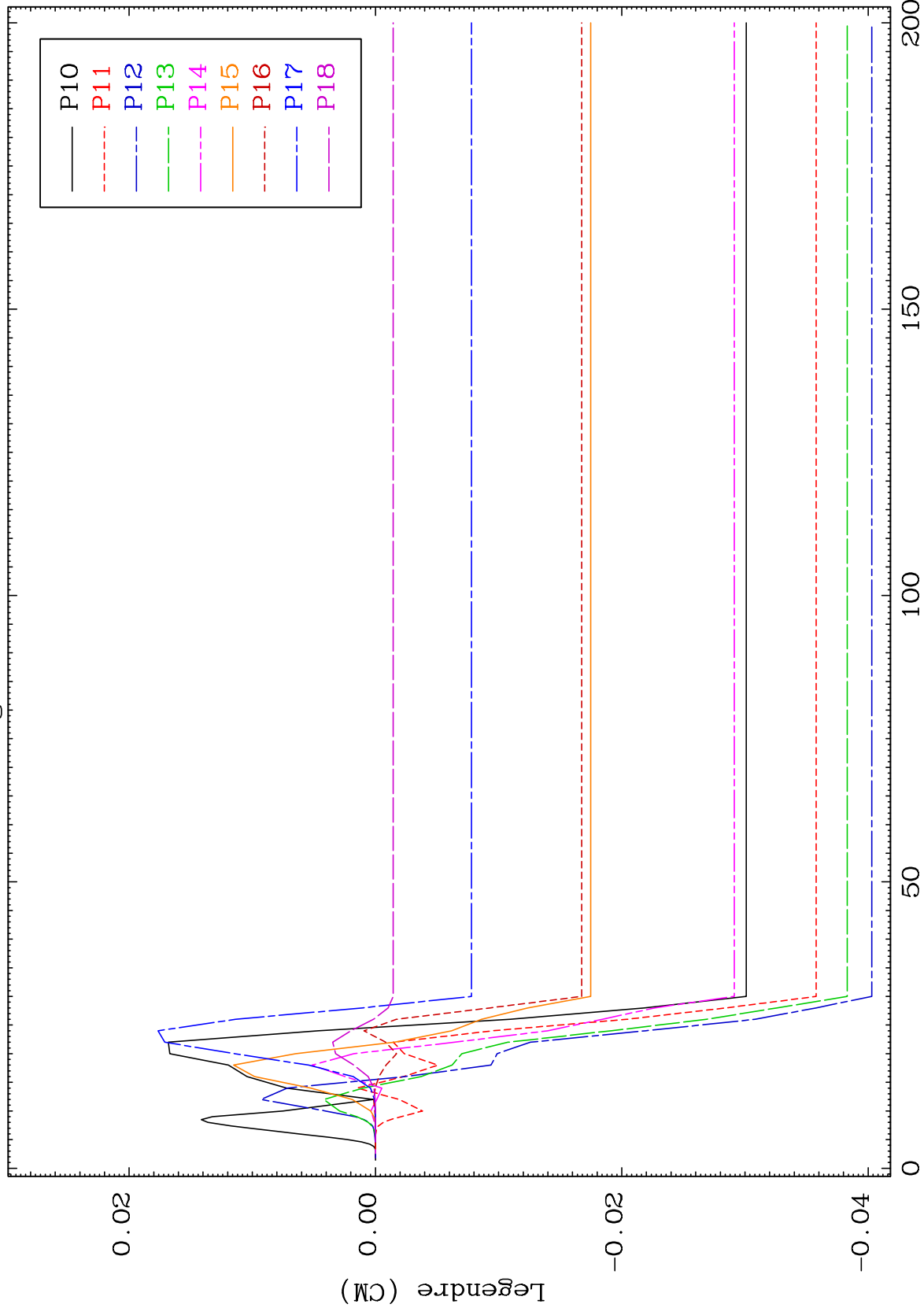

65

Incident Energy (MeV)

69-Tm-171

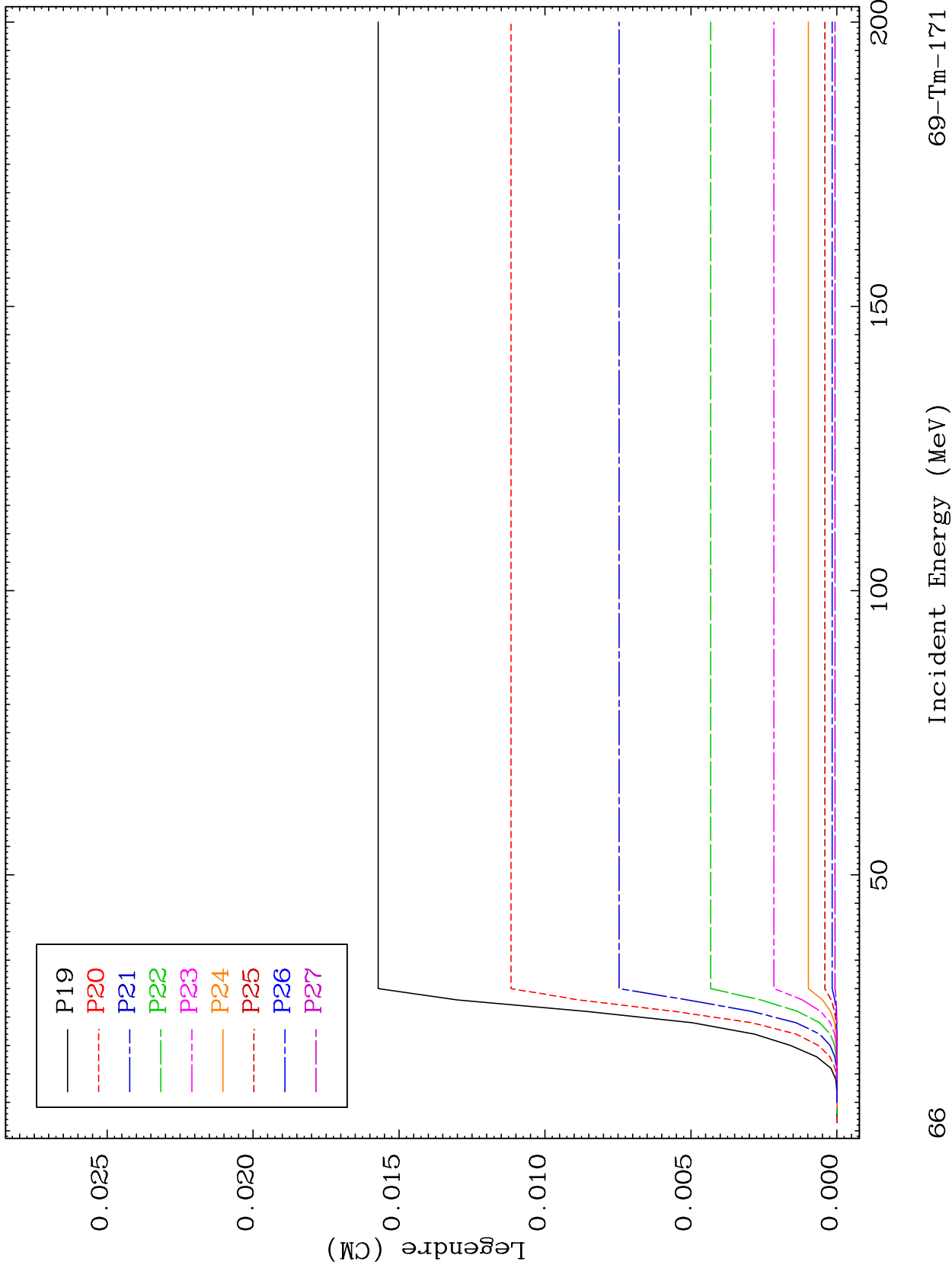

MAT 6931

MT= 63 (n,n') Level  
Legendre Coefficients

69-Tm-171

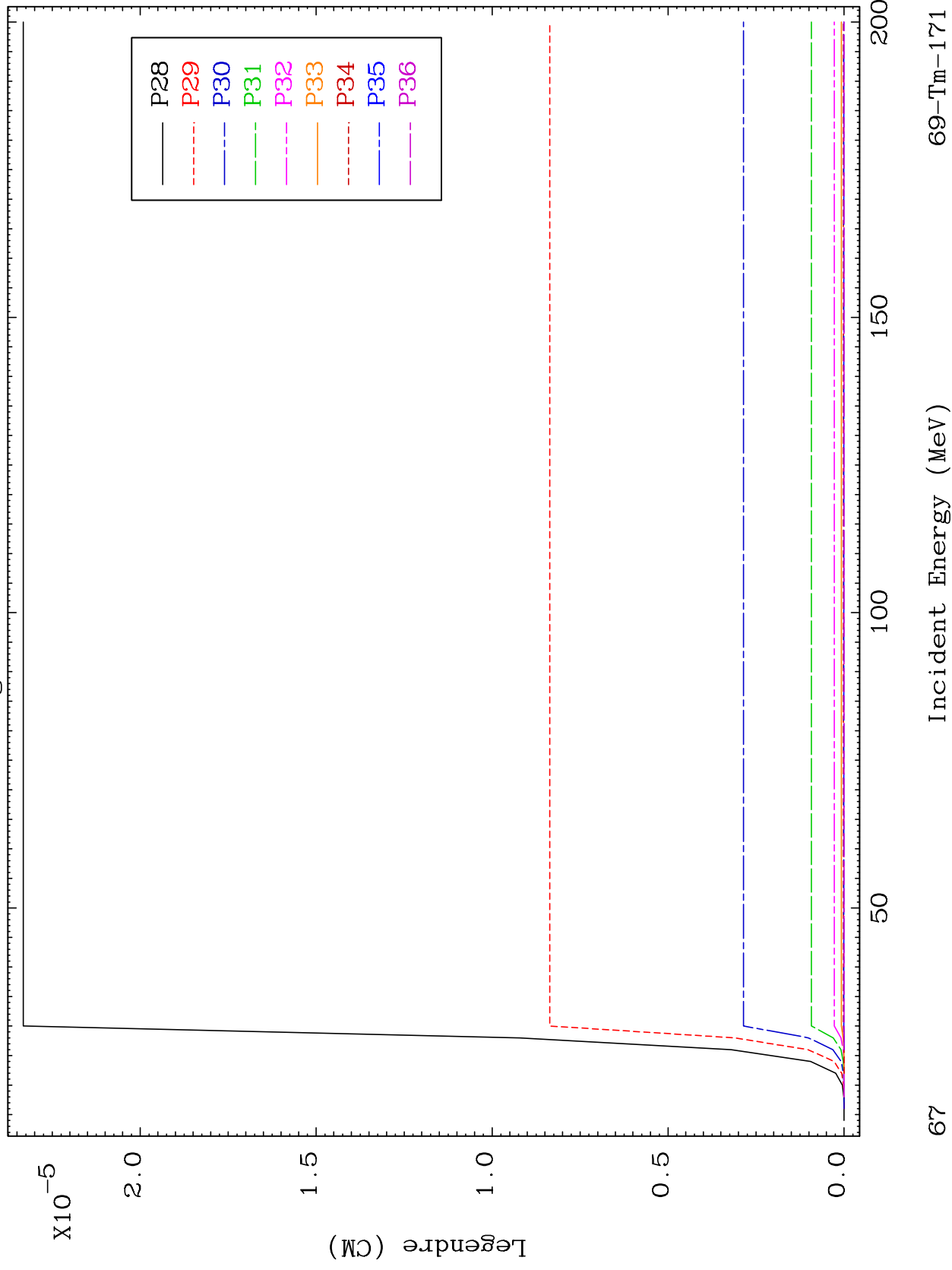



MAT 6931

MT= 64 (n,n') Level  
Legendre Coefficients

69-Tm-171

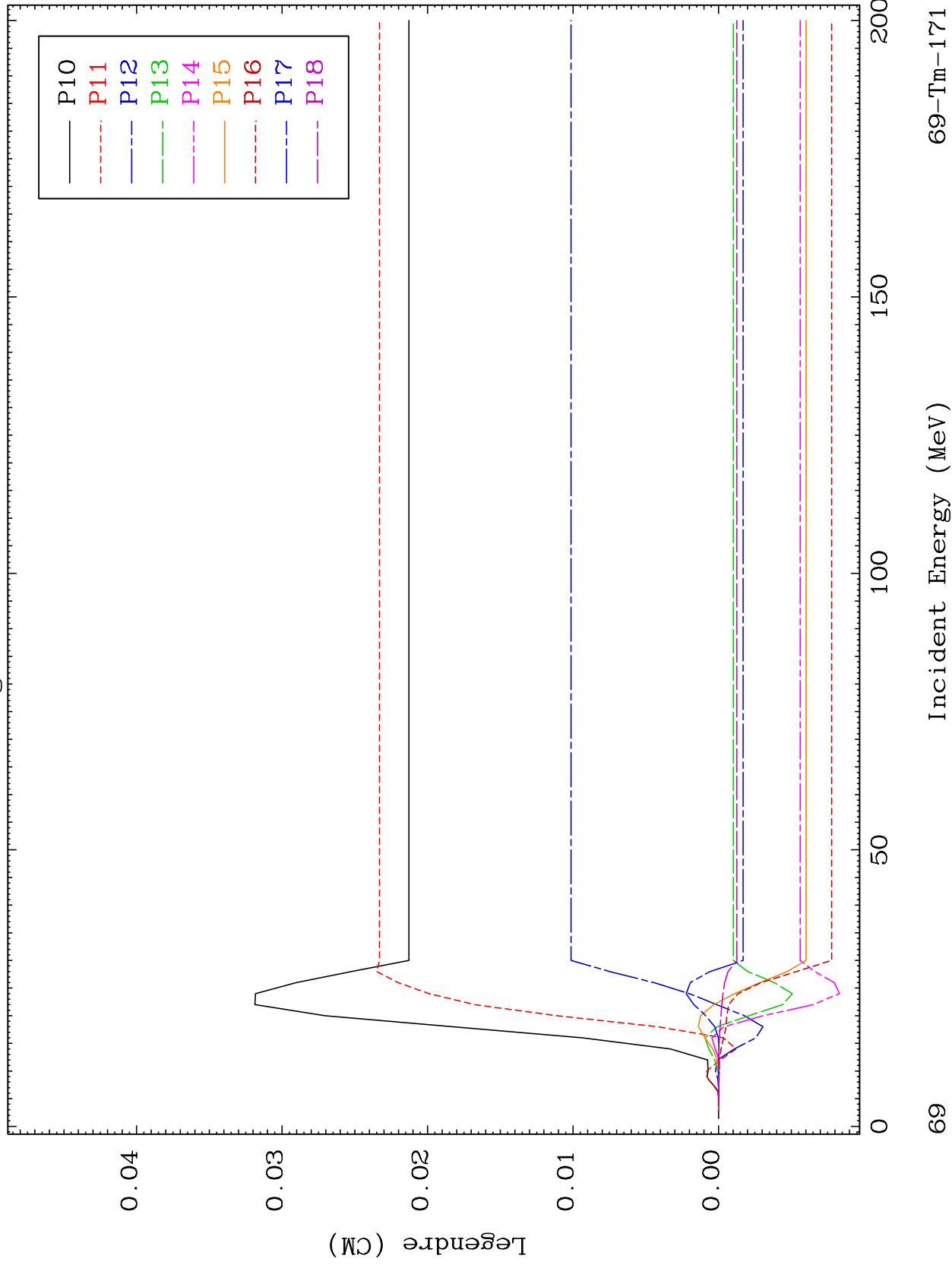

69-Tm-171

Incident Energy (MeV)

69

MAT 6931

MT= 64 (n,n') Level  
Legendre Coefficients

69-Tm-171

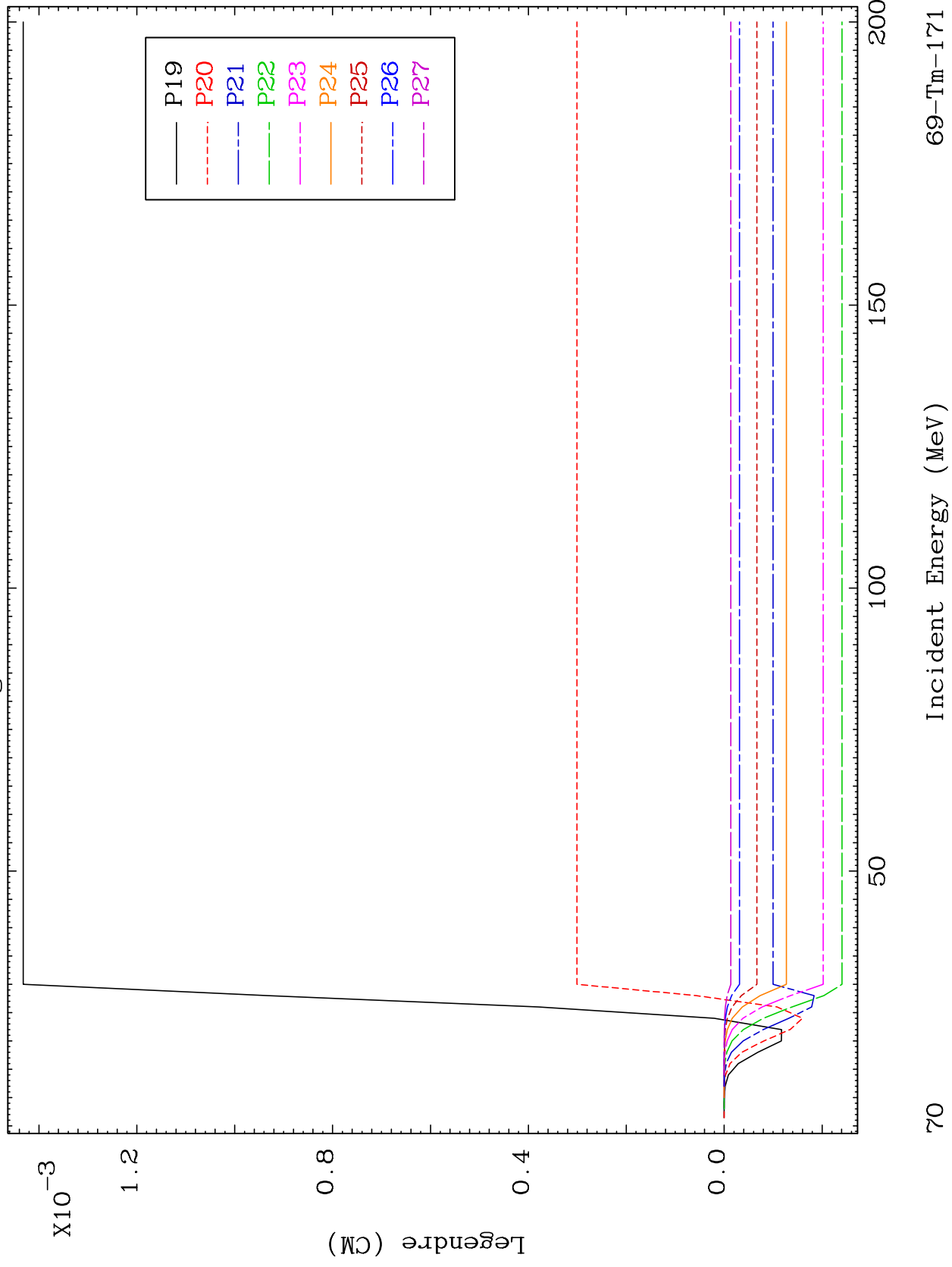

70

Incident Energy (MeV)

69-Tm-171

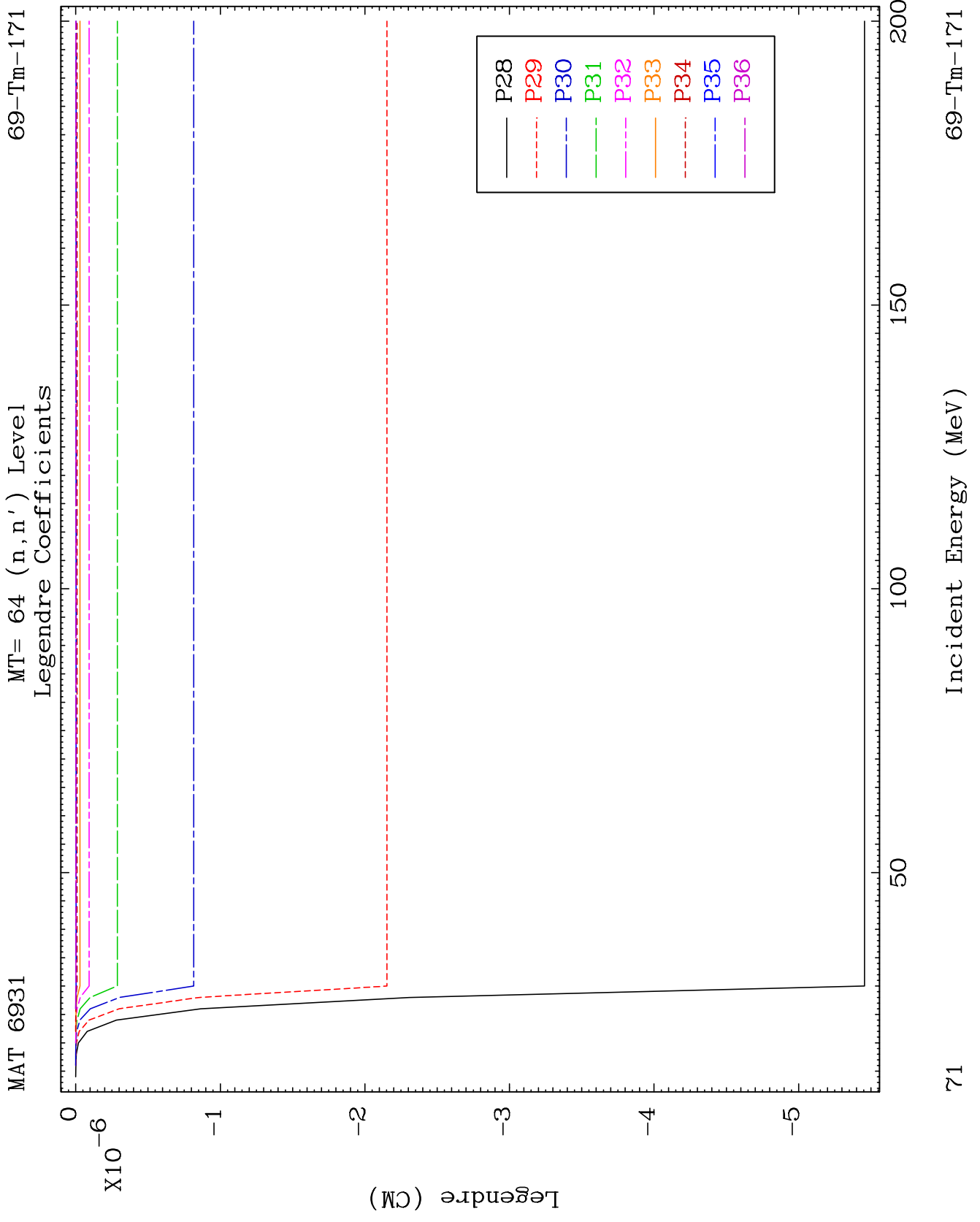



MAT 6931

MT= 65 (n,n') Level  
Legendre Coefficients

69-Tm-171

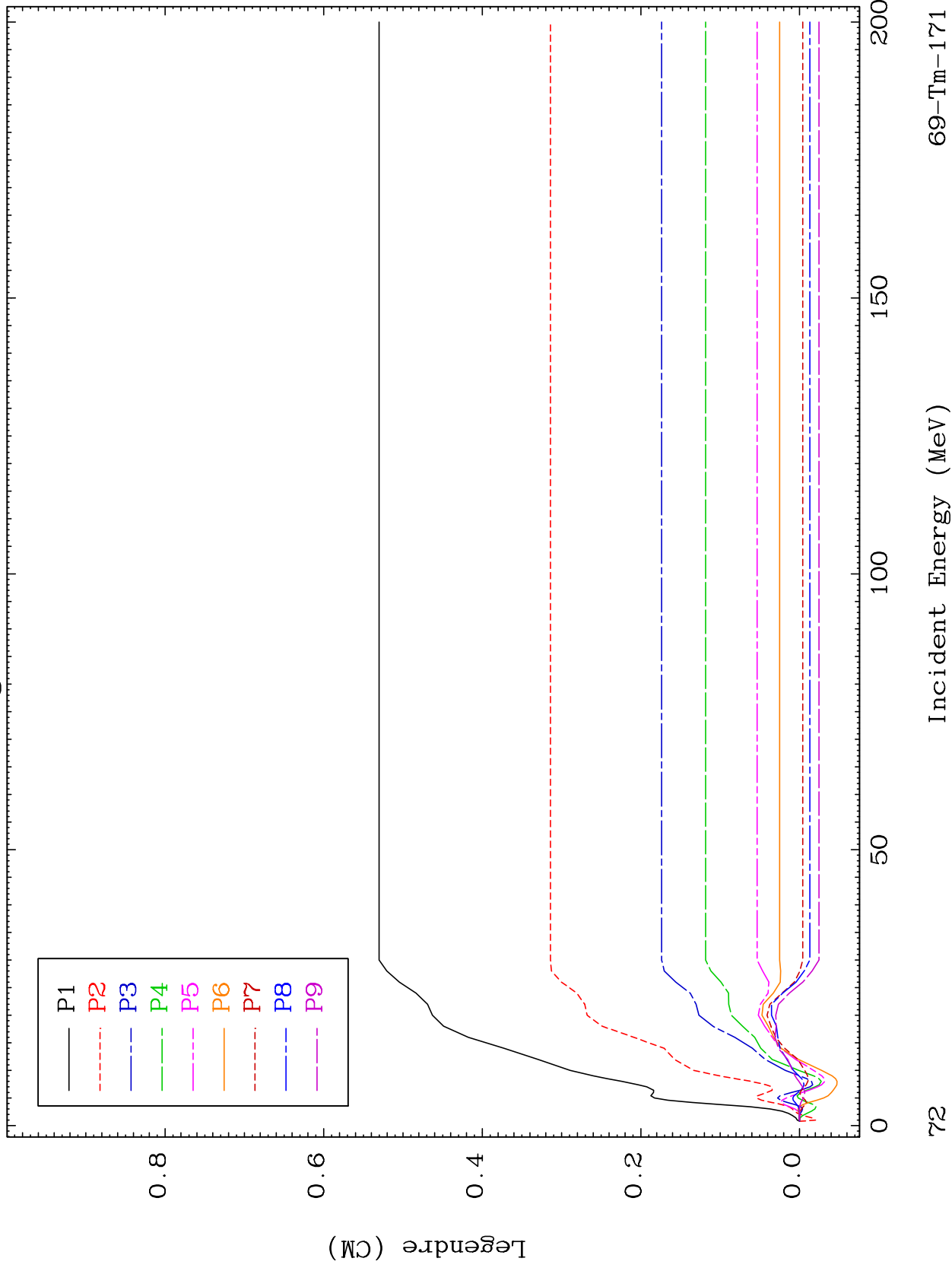

MAT 6931

MT= 65 (n,n') Level  
Legendre Coefficients

69-Tm-171

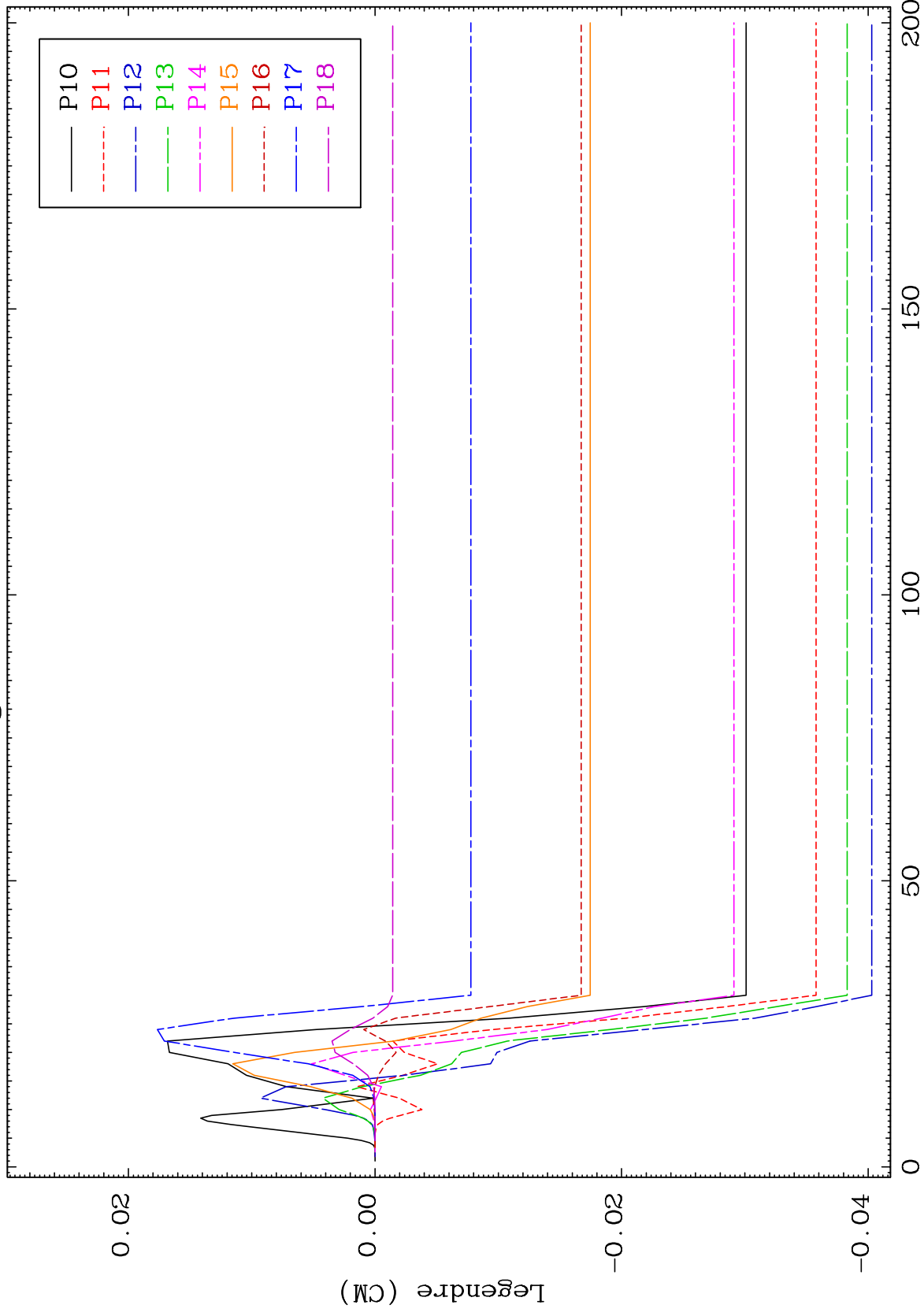

73

Incident Energy (MeV)

69-Tm-171

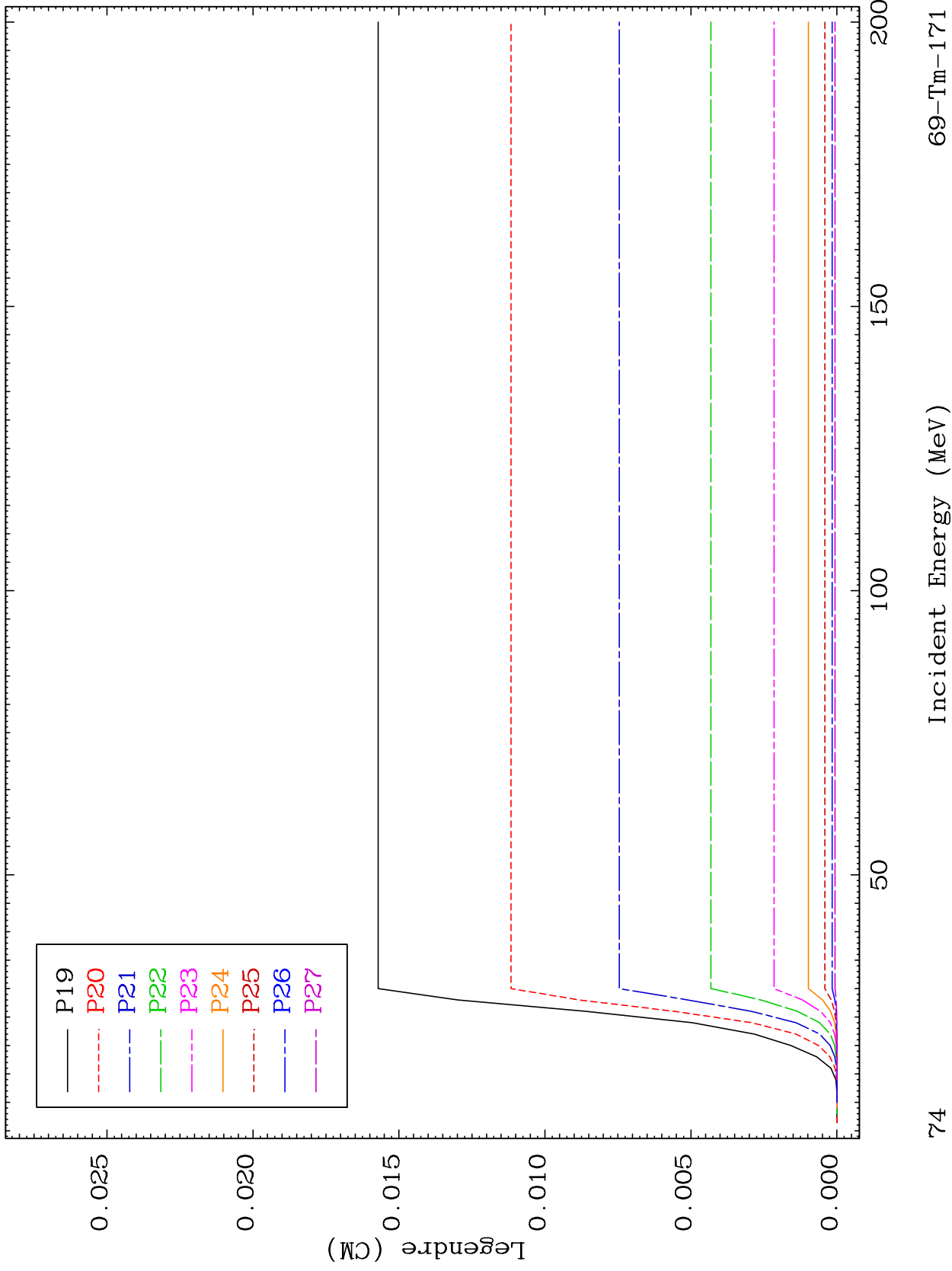

MAT 6931

MT= 65 (n,n') Level  
Legendre Coefficients

69-Tm-171

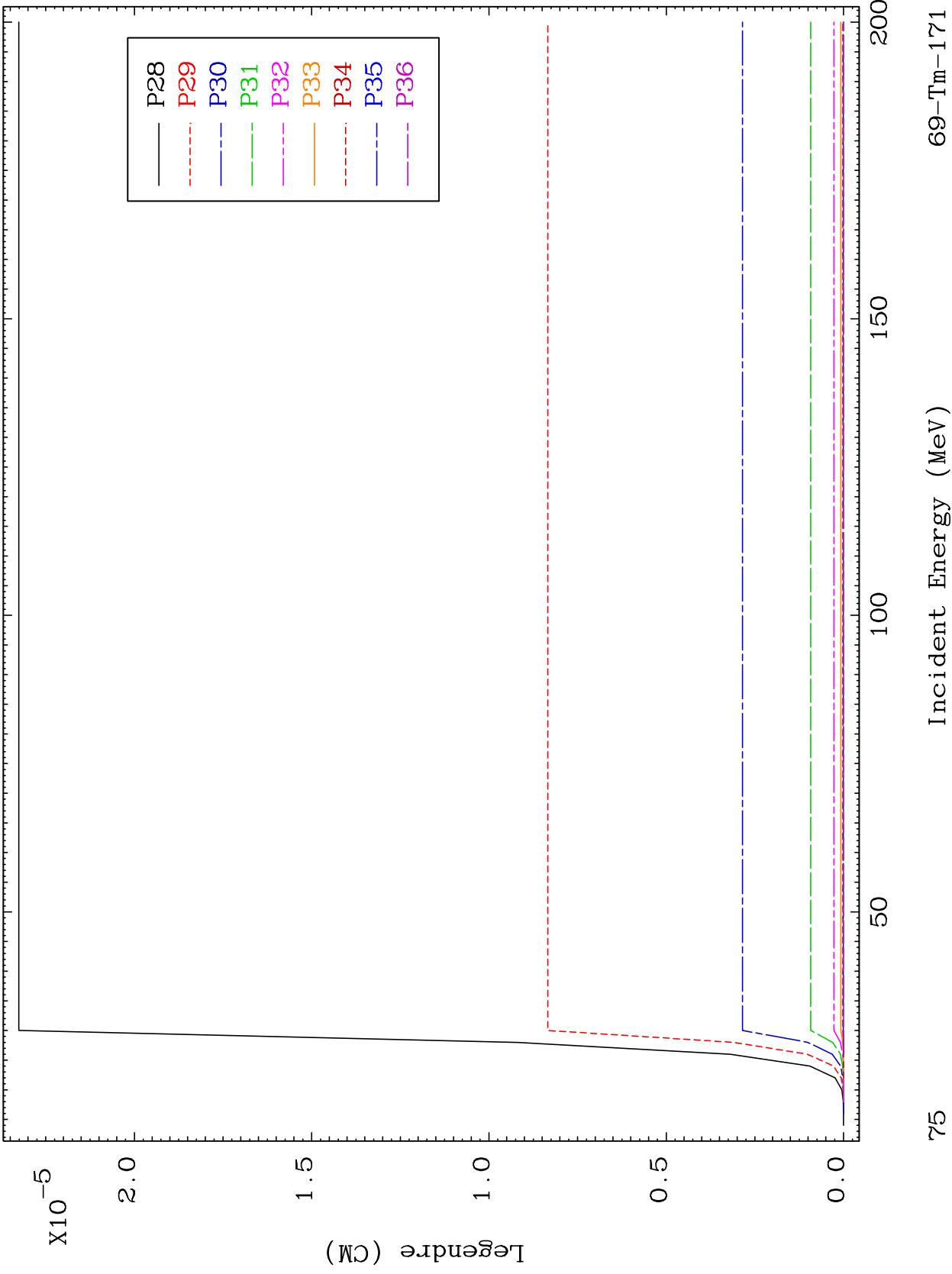



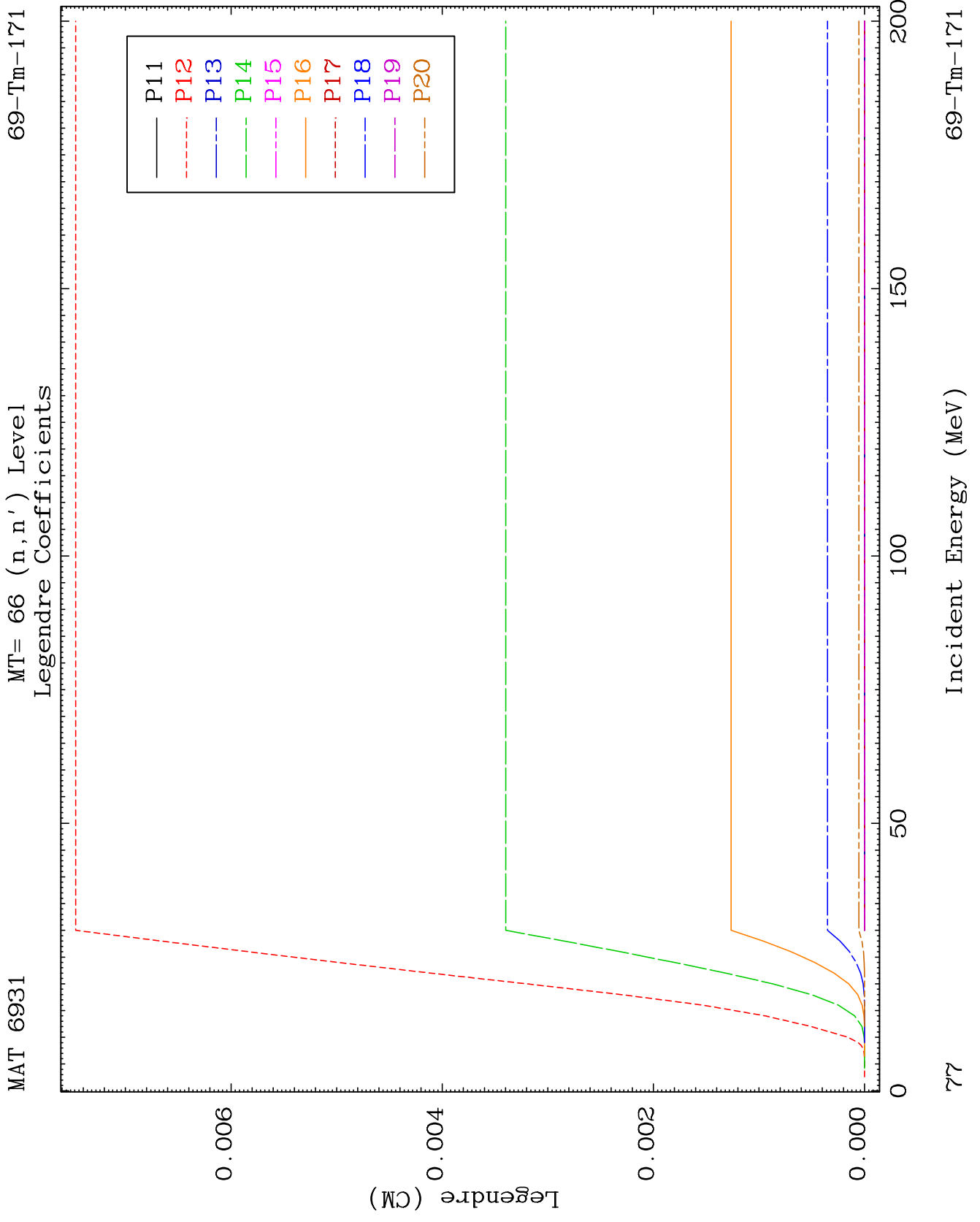

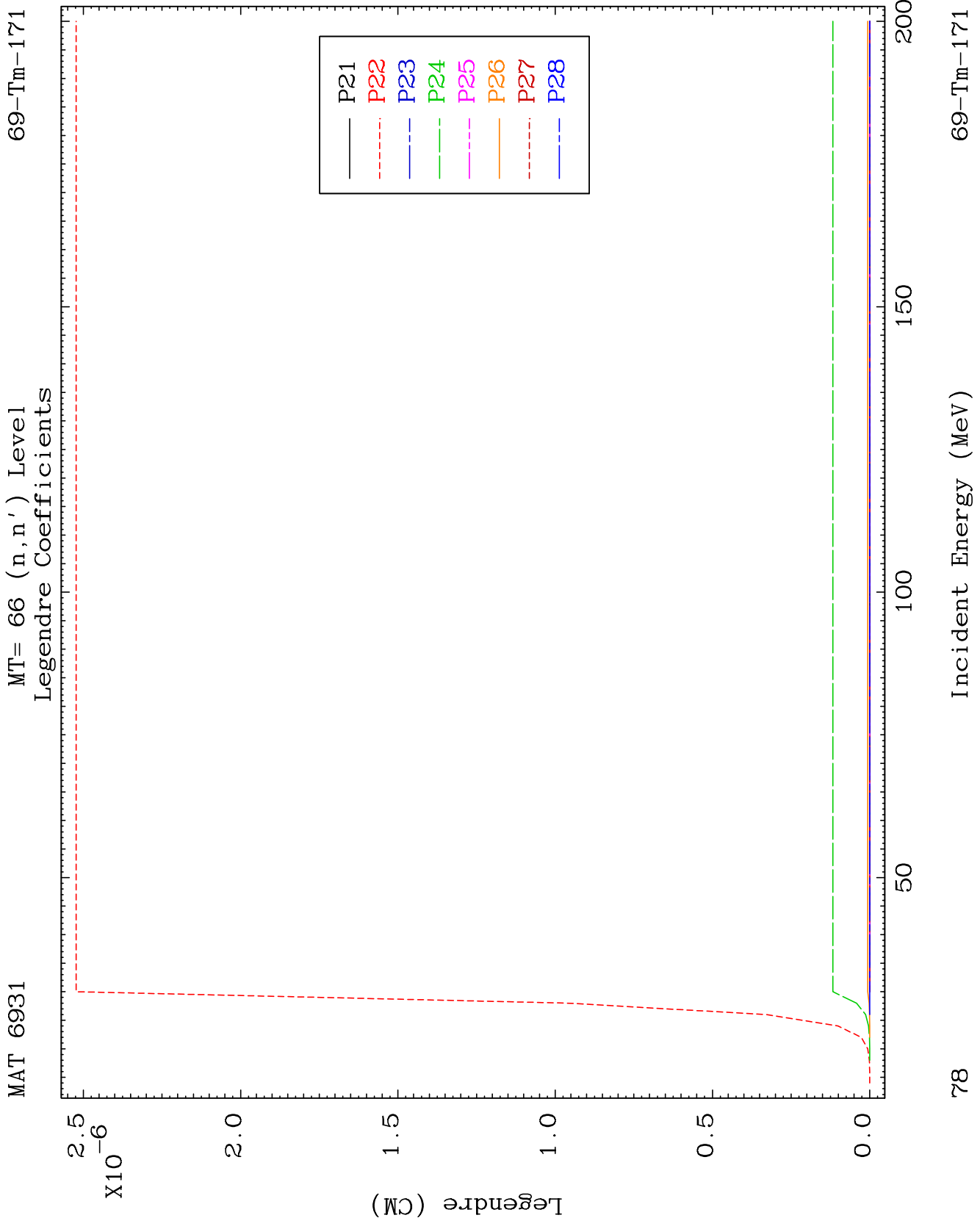

MAT 6931

MT= 67 (n,n') Level  
Legendre Coefficients

69-Tm-171

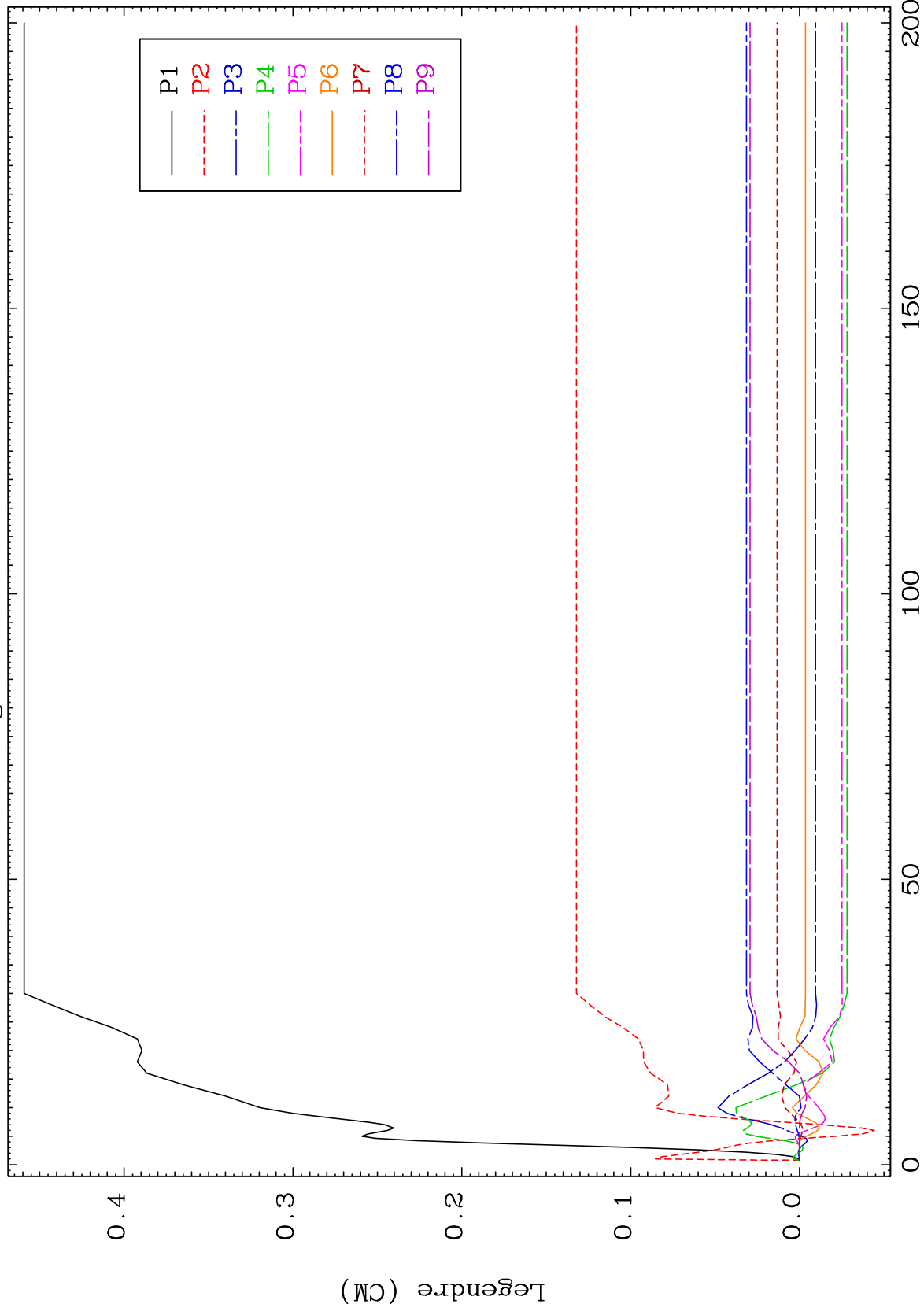

79

Incident Energy (MeV)

69-Tm-171



MAT 6931

MT= 67 (n,n') Level  
Legendre Coefficients

69-Tm-171

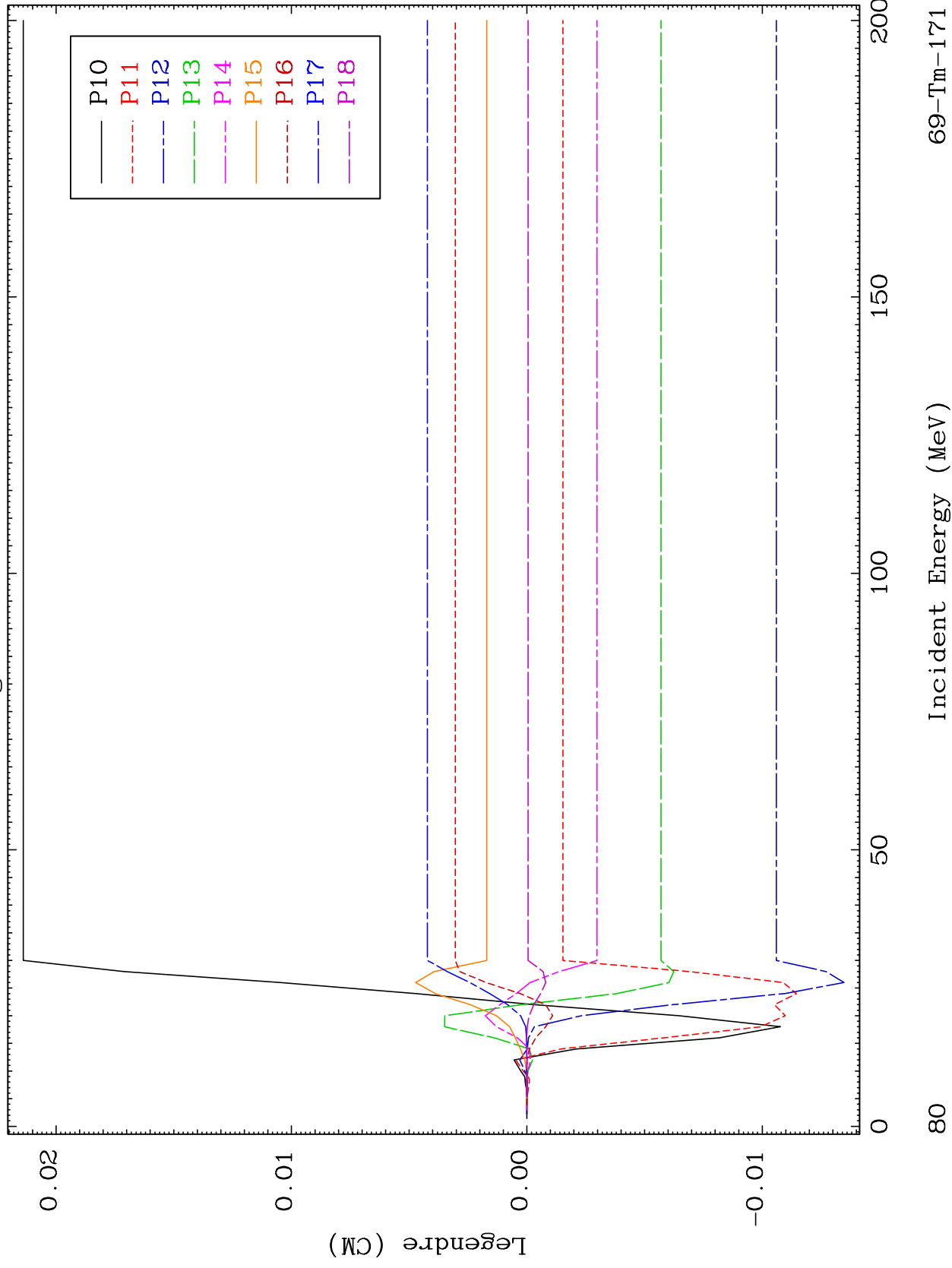

69-Tm-171

Incident Energy (MeV)

80



MAT 6931

MT= 67 (n,n') Level  
Legendre Coefficients

69-Tm-171

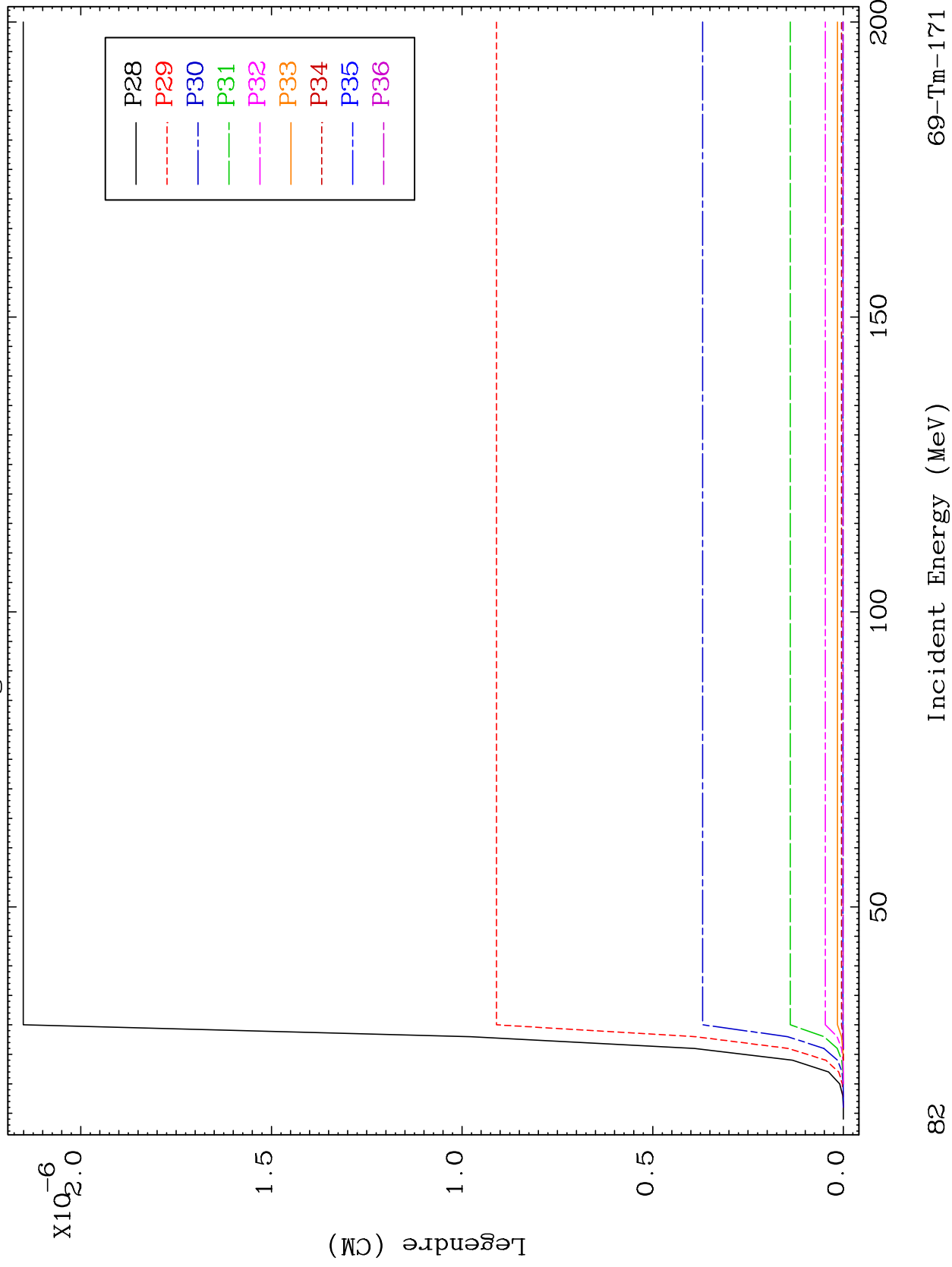

82

69-Tm-171

MAT 6931

MT= 68 (n,n') Level  
Legendre Coefficients

69-Tm-171

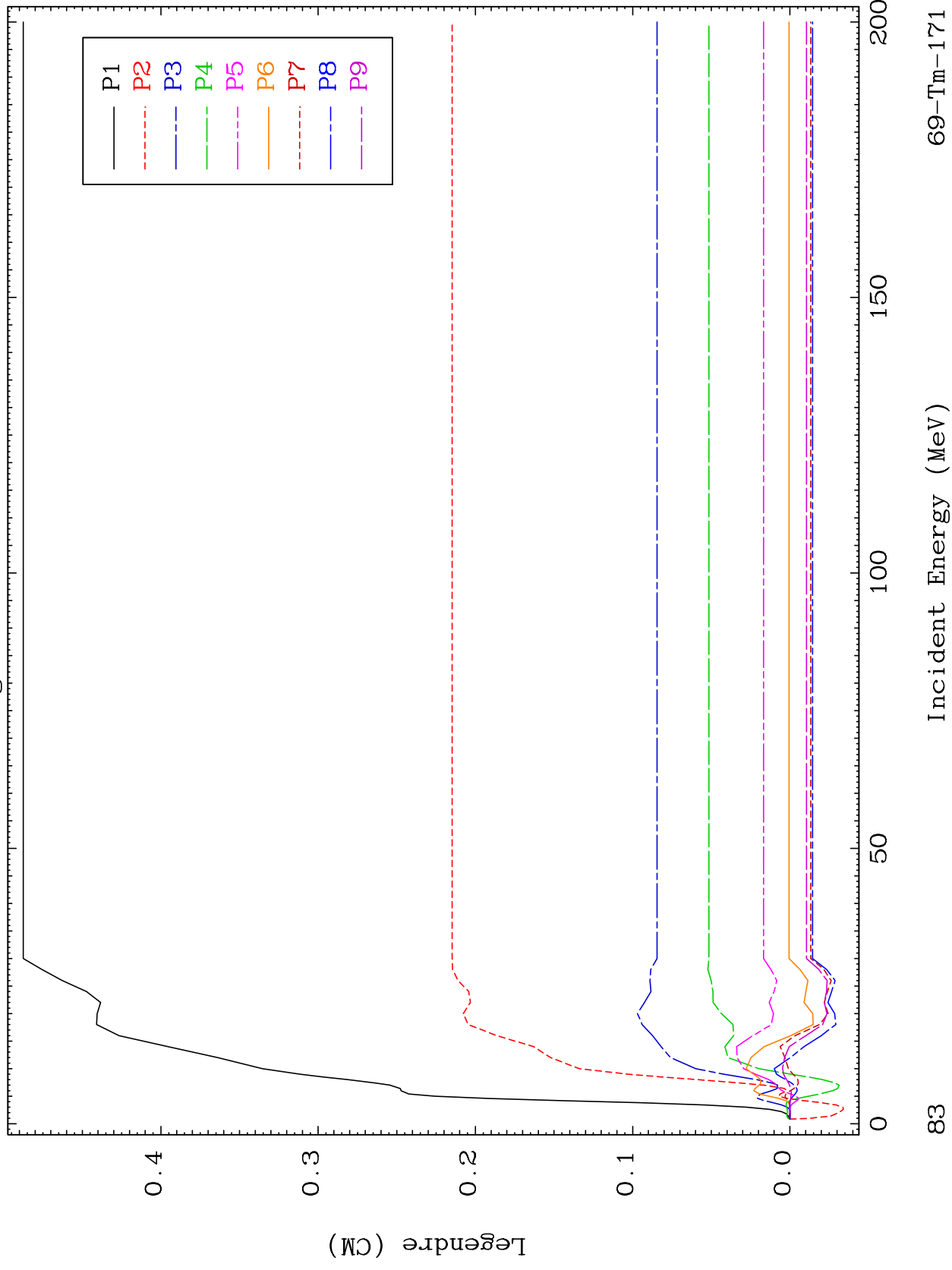

69-Tm-171

Incident Energy (MeV)

83

MAT 6931

MT= 68 (n,n') Level  
Legendre Coefficients

69-Tm-171

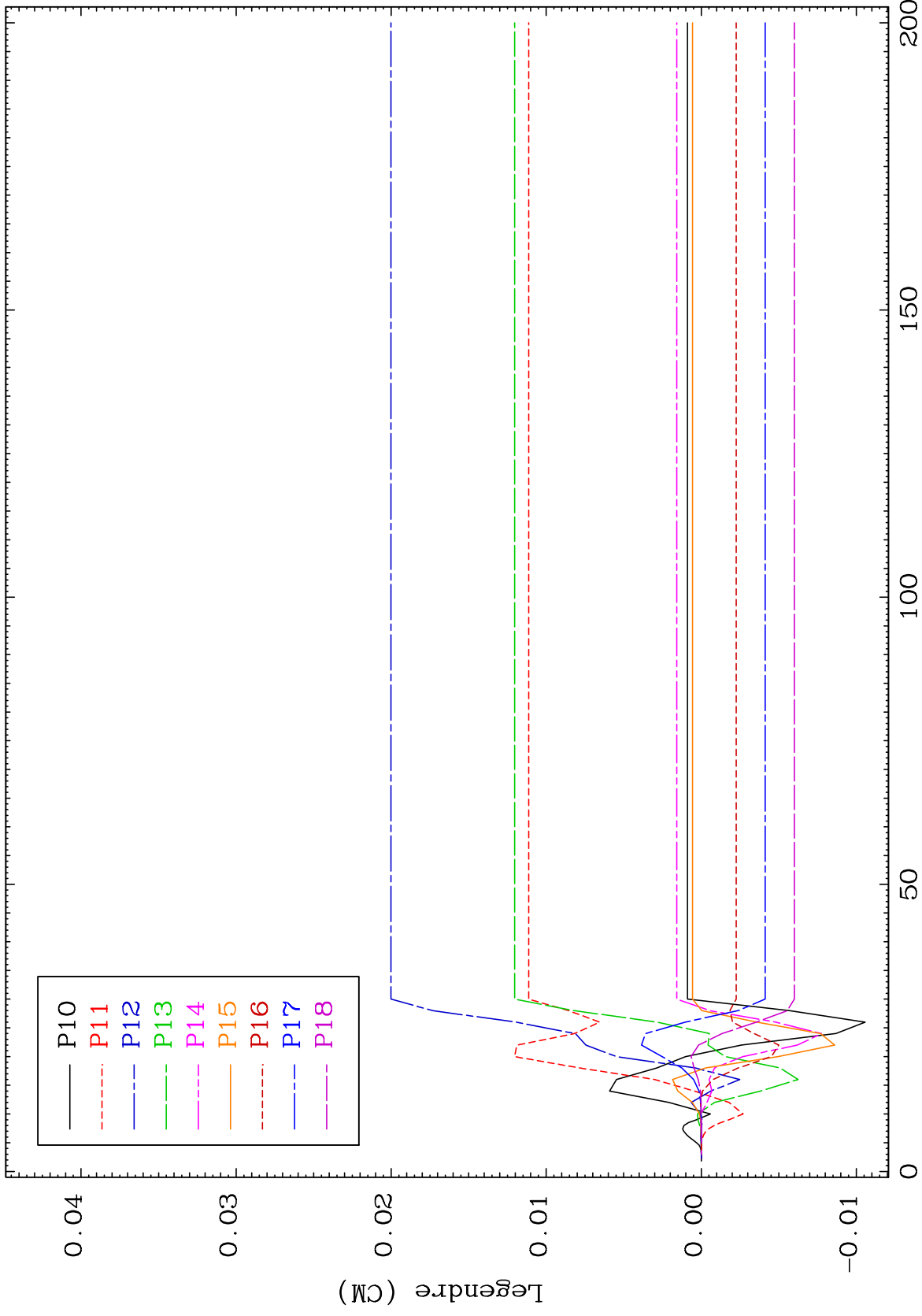

84

Incident Energy (MeV)

69-Tm-171

MAT 6931

MT= 68 (n,n') Level  
Legendre Coefficients

69-Tm-171

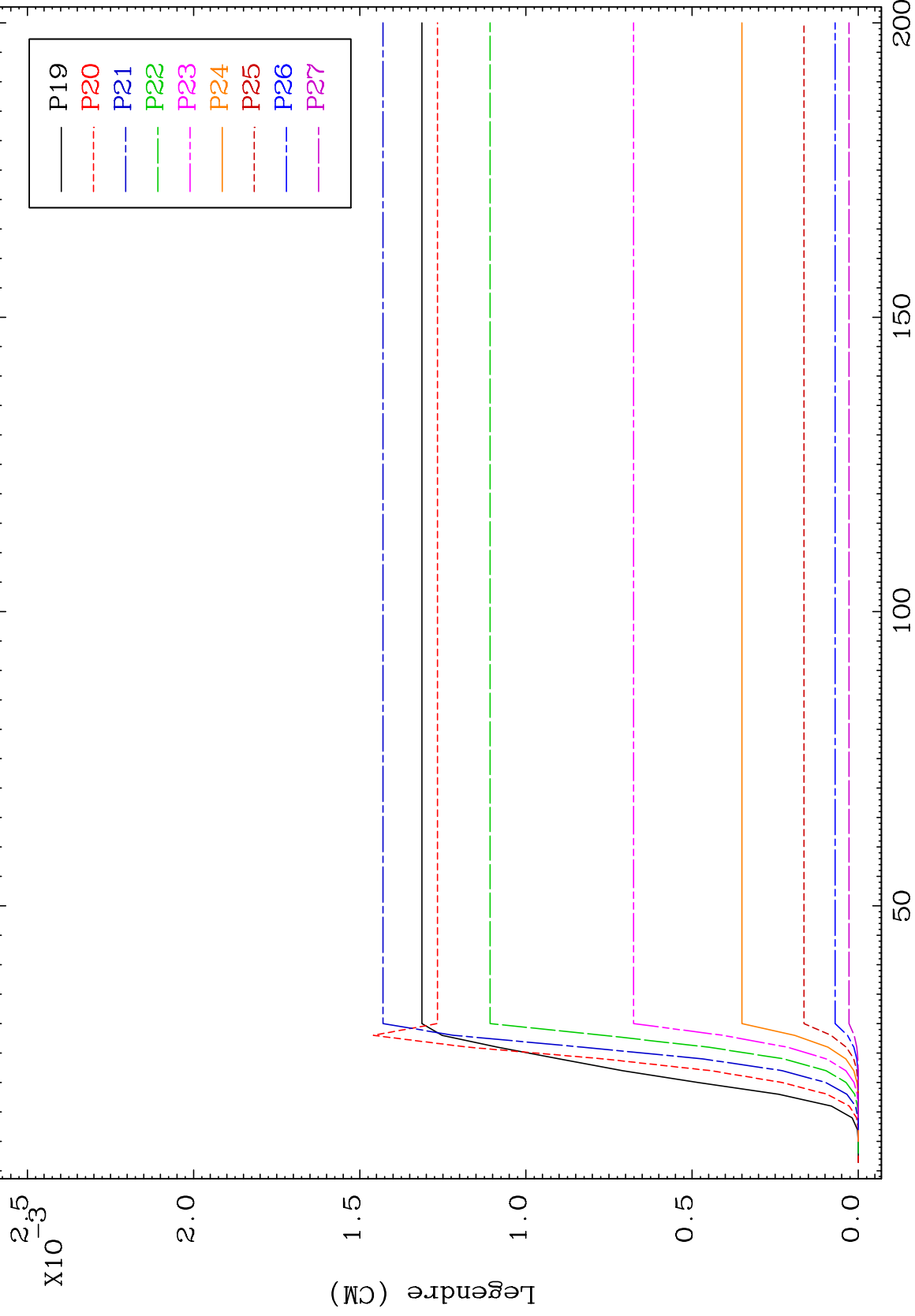

85

Incident Energy (MeV)

69-Tm-171

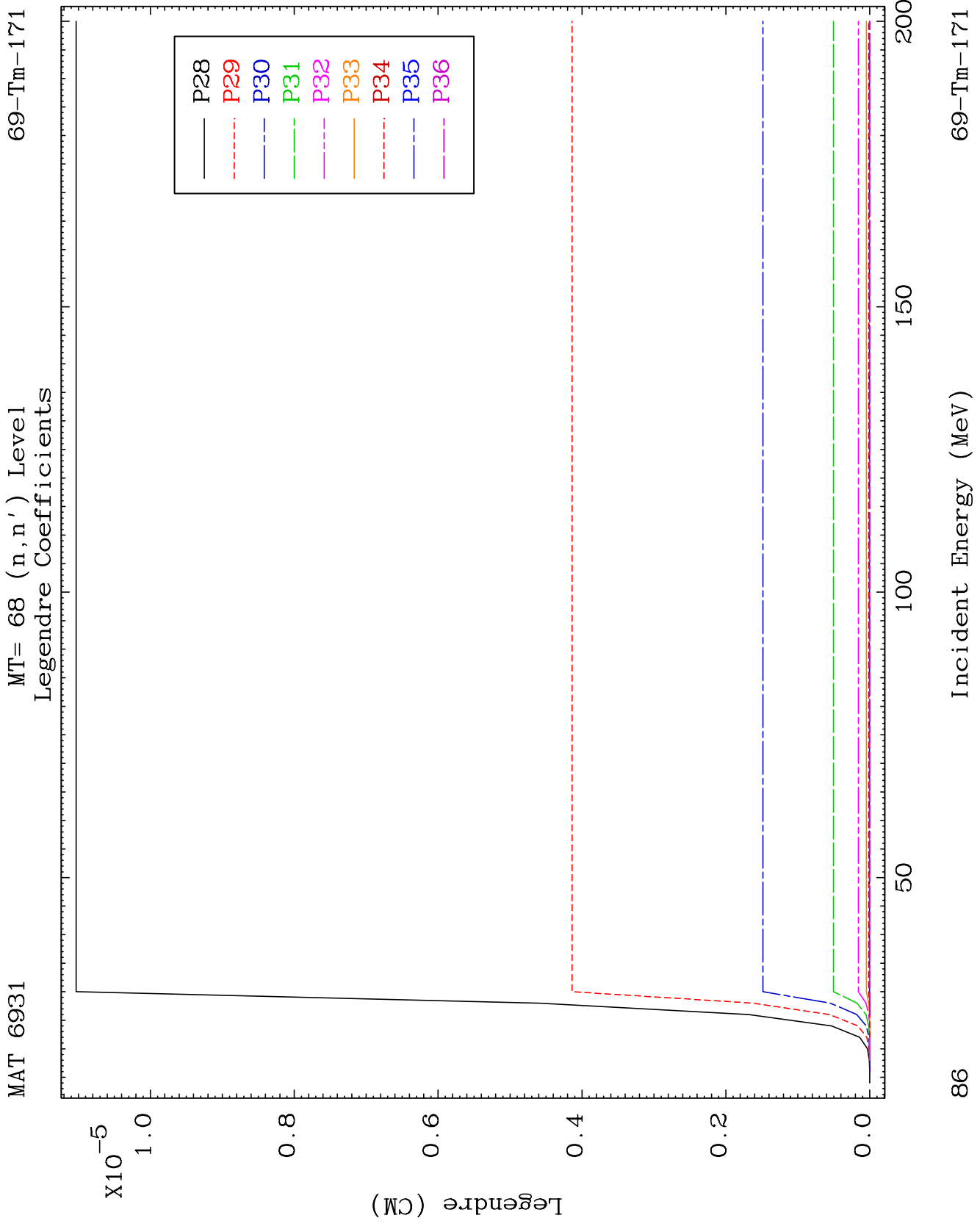

MAT 6931

MT= 69 (n,n') Level  
Legendre Coefficients

69-Tm-171

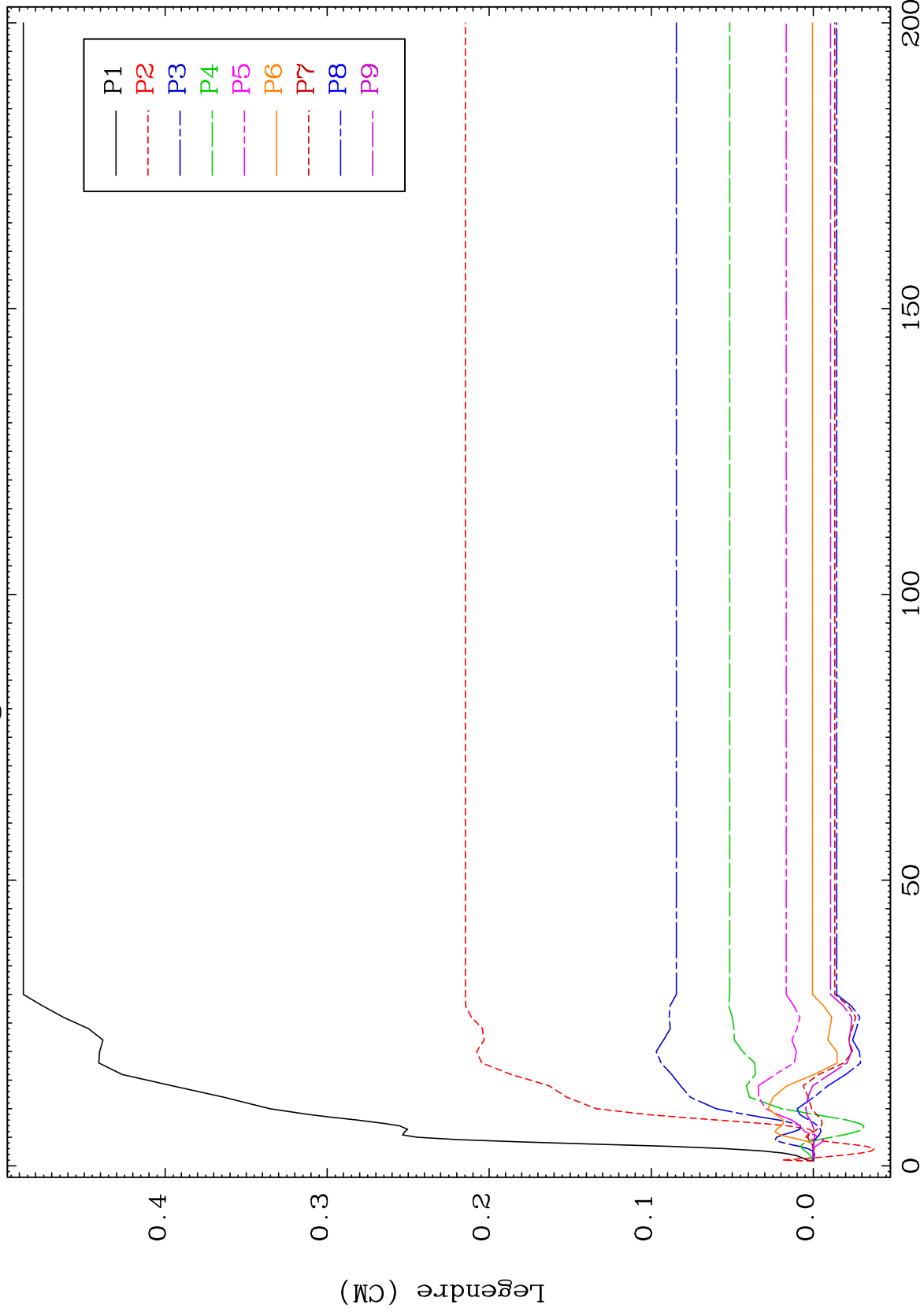

87

Incident Energy (MeV)

69-Tm-171



MAT 6931

MT= 69 (n,n') Level  
Legendre Coefficients

69-Tm-171

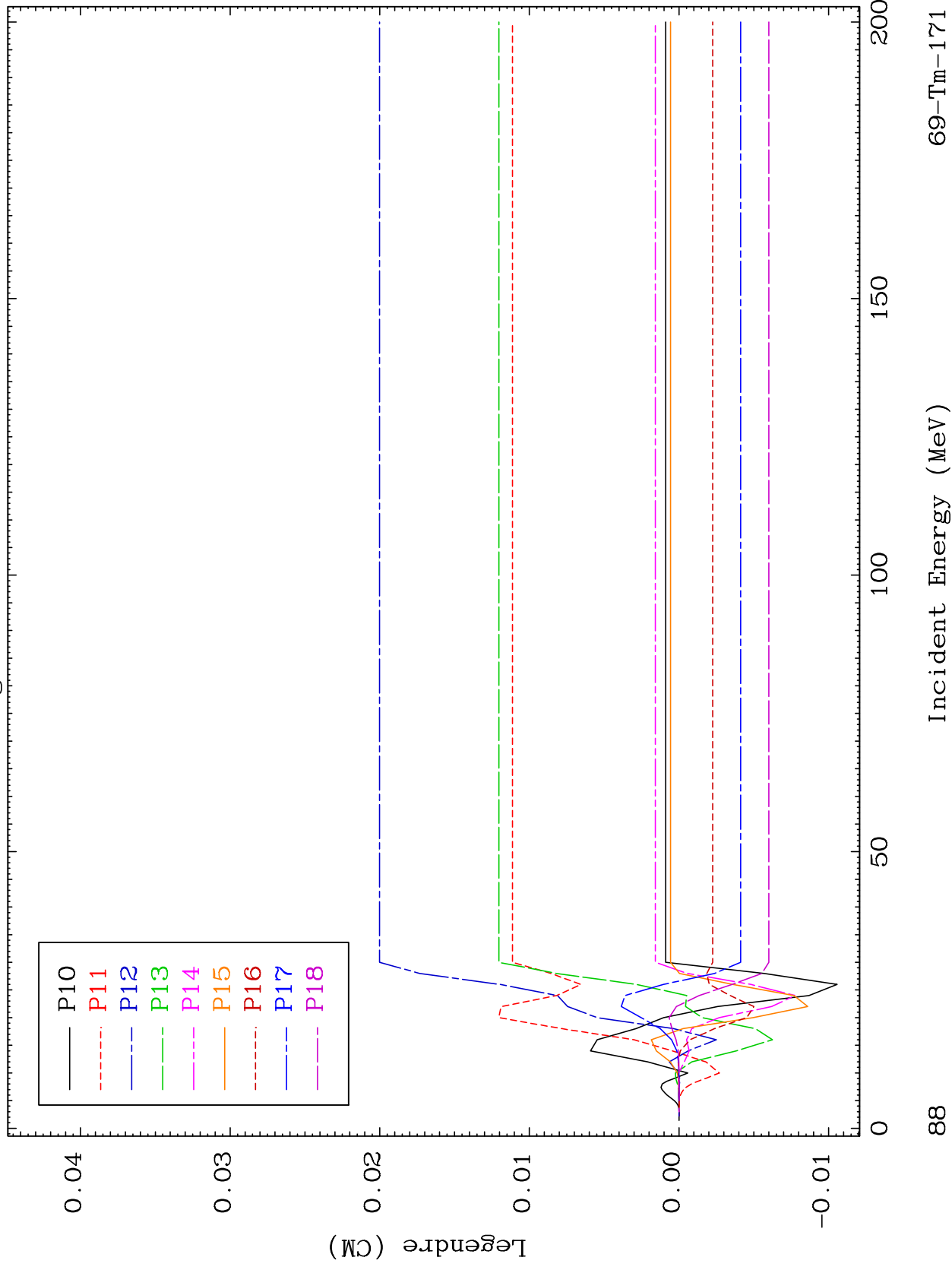

88

Incident Energy (MeV)

69-Tm-171

MAT 6931

MT= 69 (n,n') Level  
Legendre Coefficients

69-Tm-171

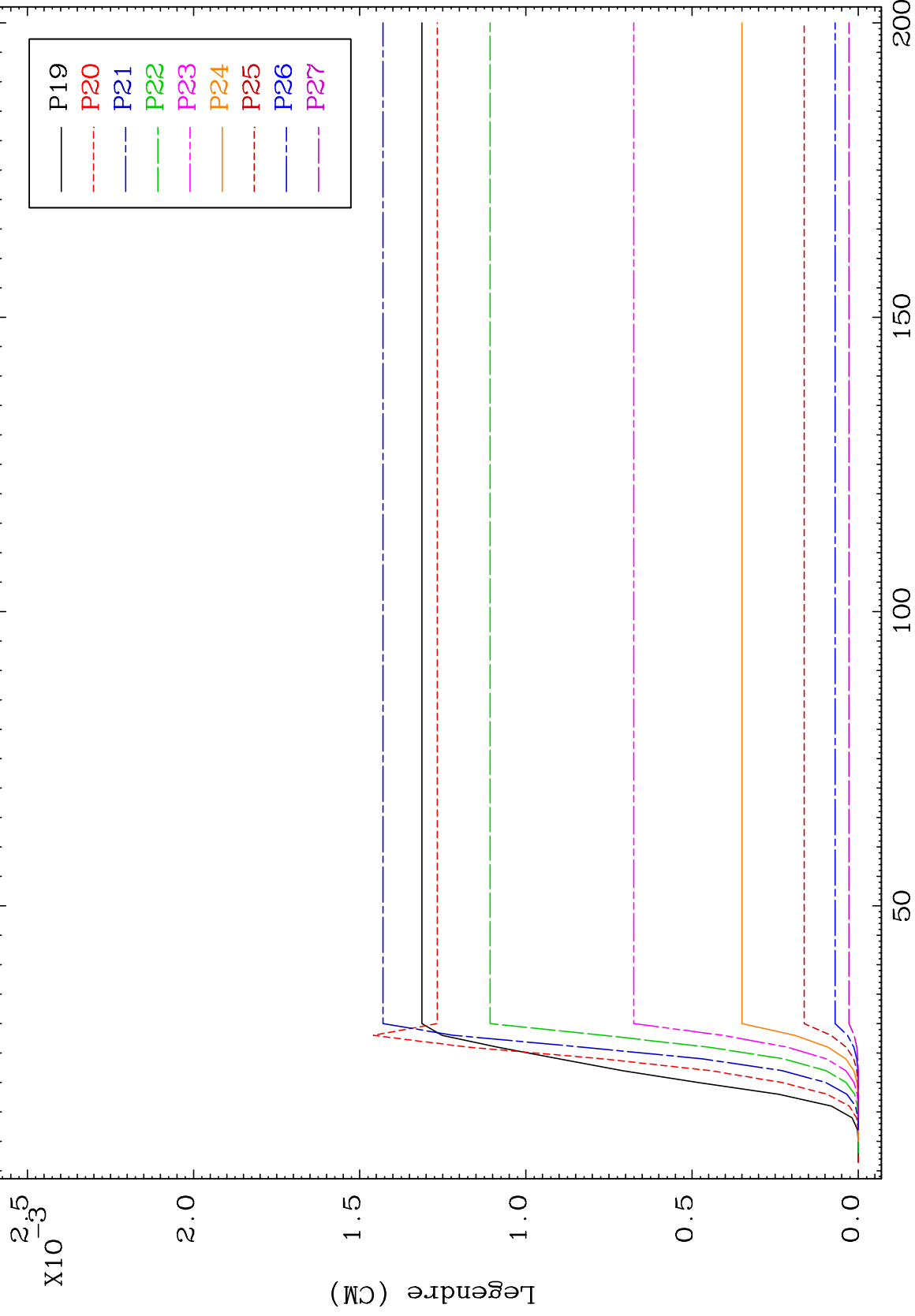

89

Incident Energy (MeV)

69-Tm-171



MAT 6931

MT= 70 (n,n') Level  
Legendre Coefficients

69-Tm-171

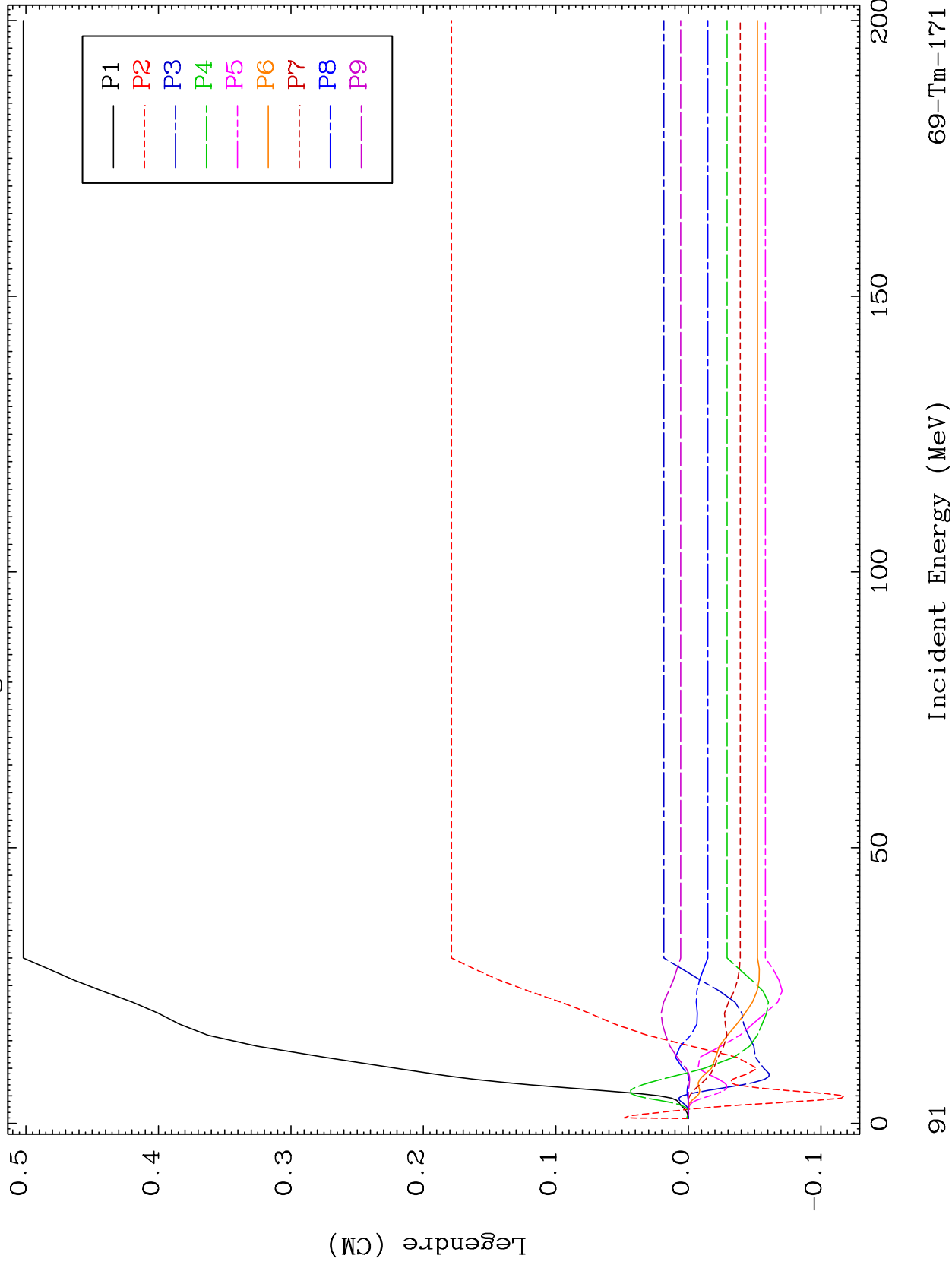

69-Tm-171

Incident Energy (MeV)

91

MAT 6931

MT= 70 (n,n') Level  
Legendre Coefficients

69-Tm-171

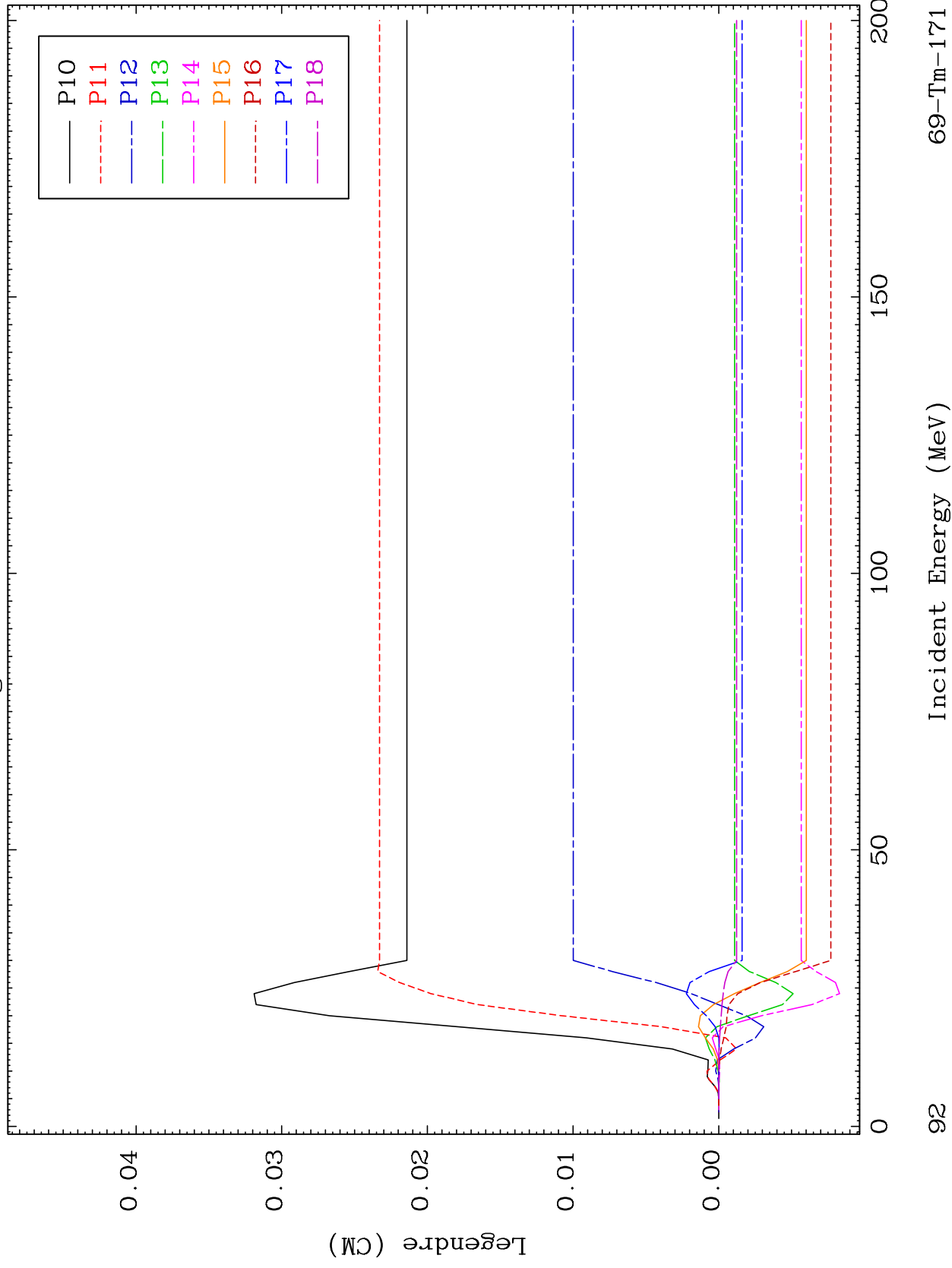

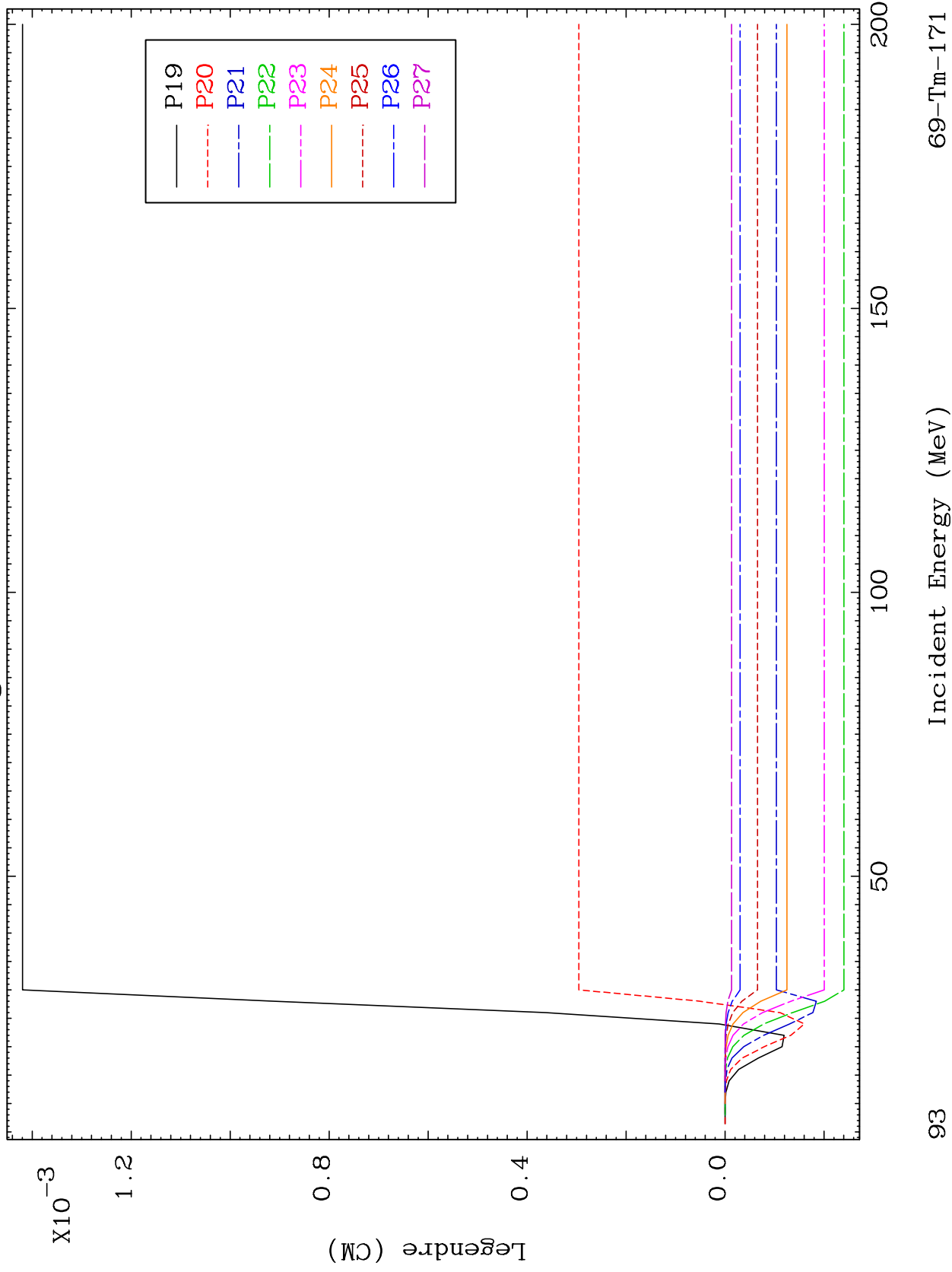

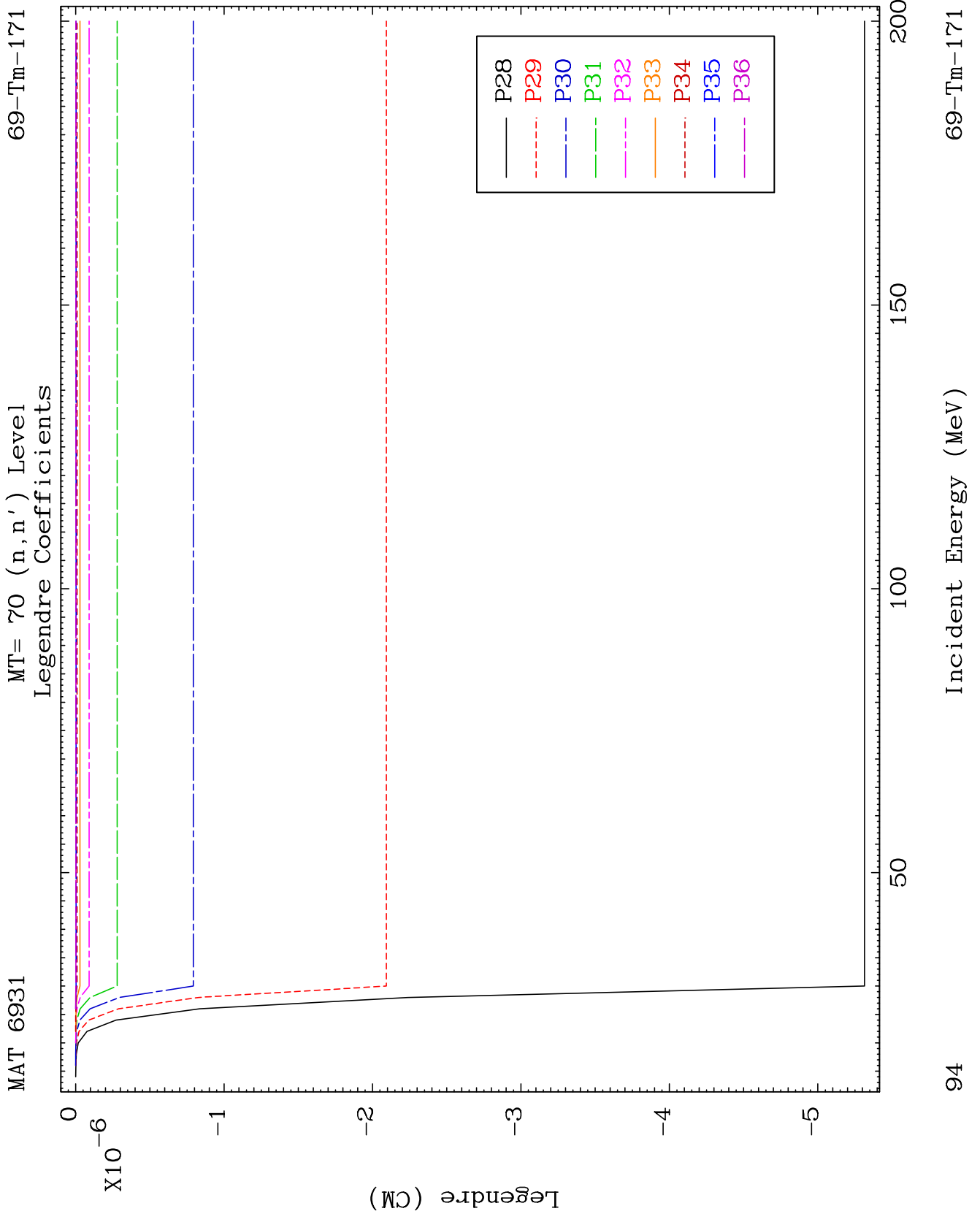

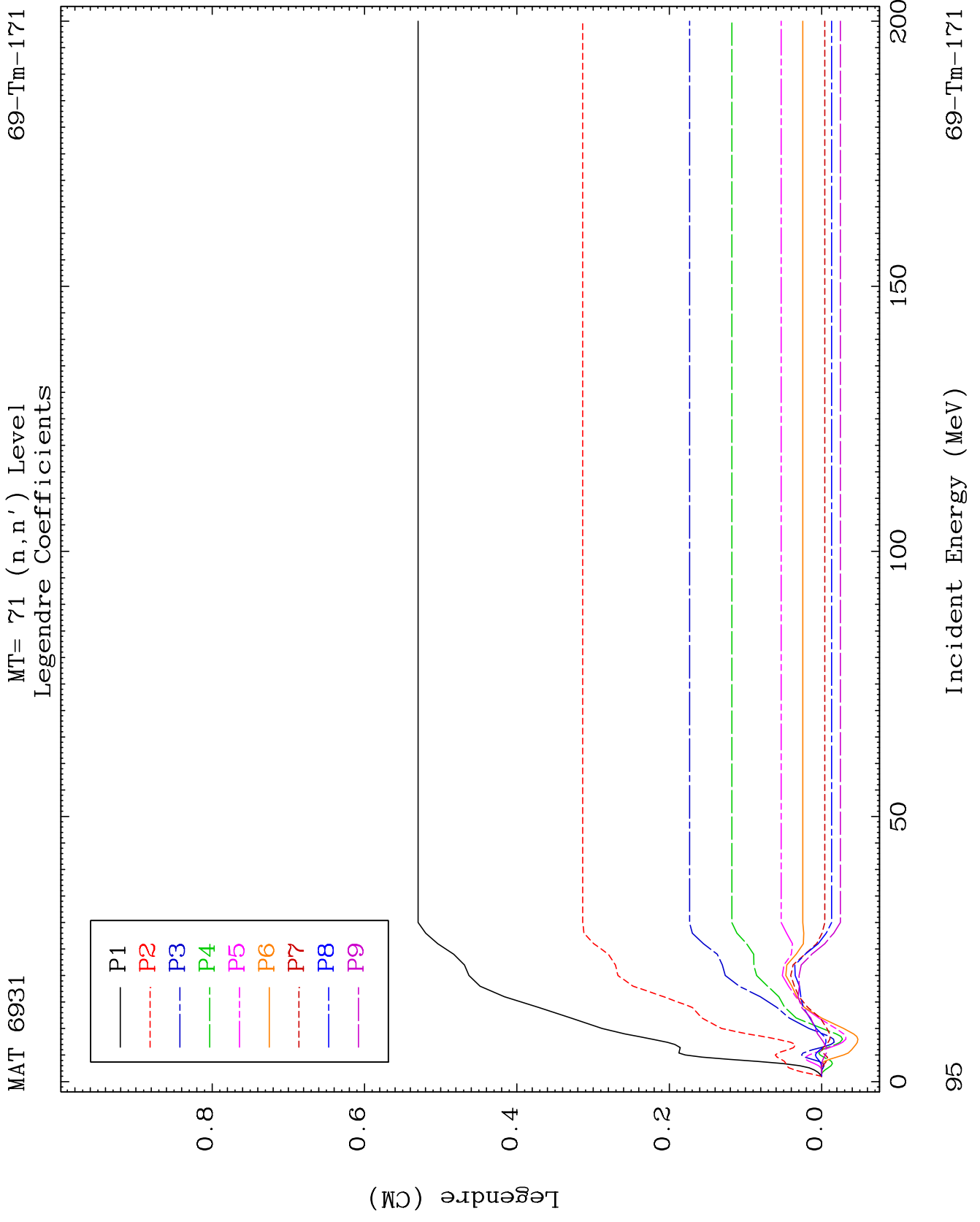



MAT 6931

MT= 71 (n,n') Level  
Legendre Coefficients

69-Tm-171

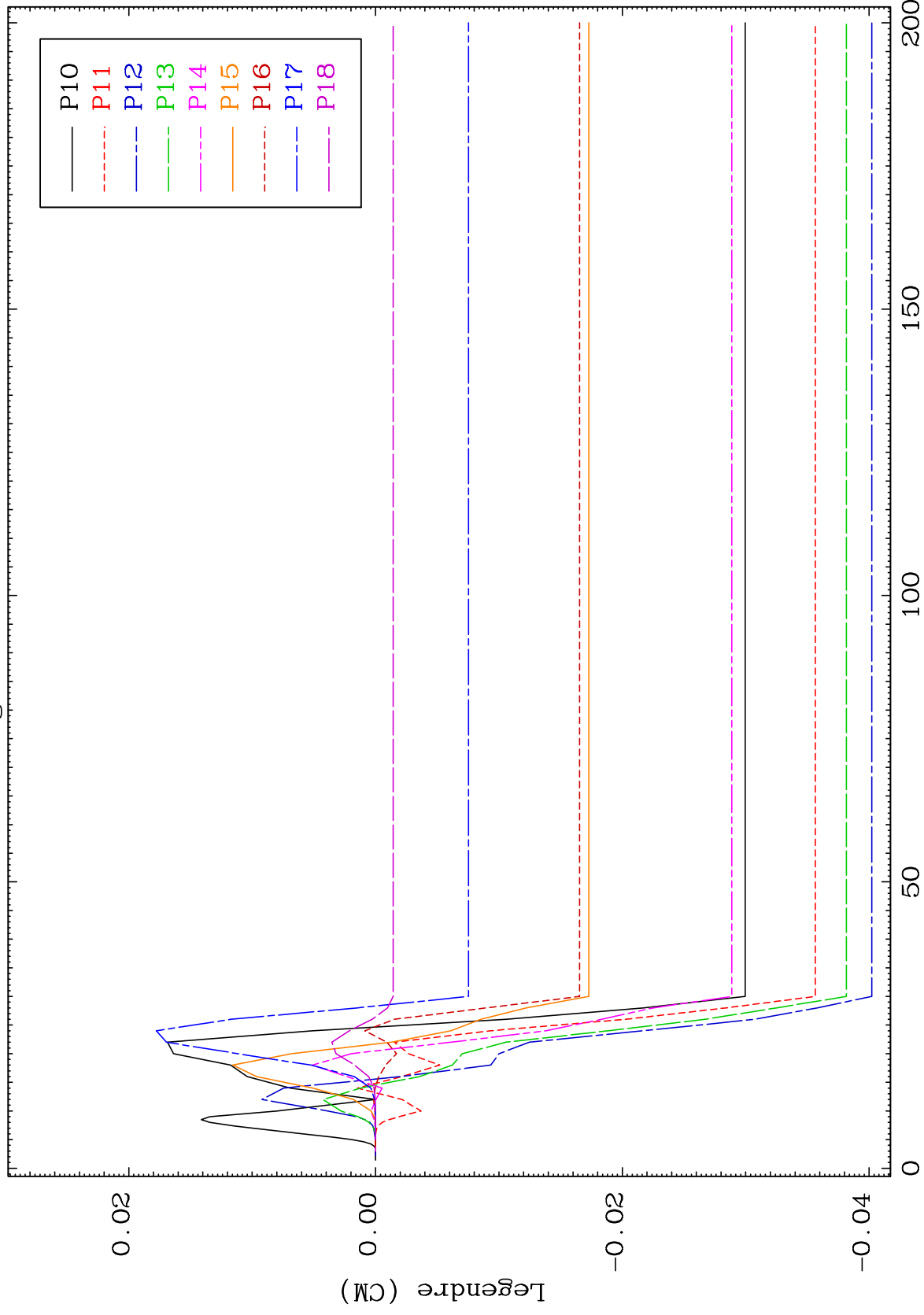

96

Incident Energy (MeV)

69-Tm-171

MAT 6931

MT= 71 (n,n') Level  
Legendre Coefficients

69-Tm-171

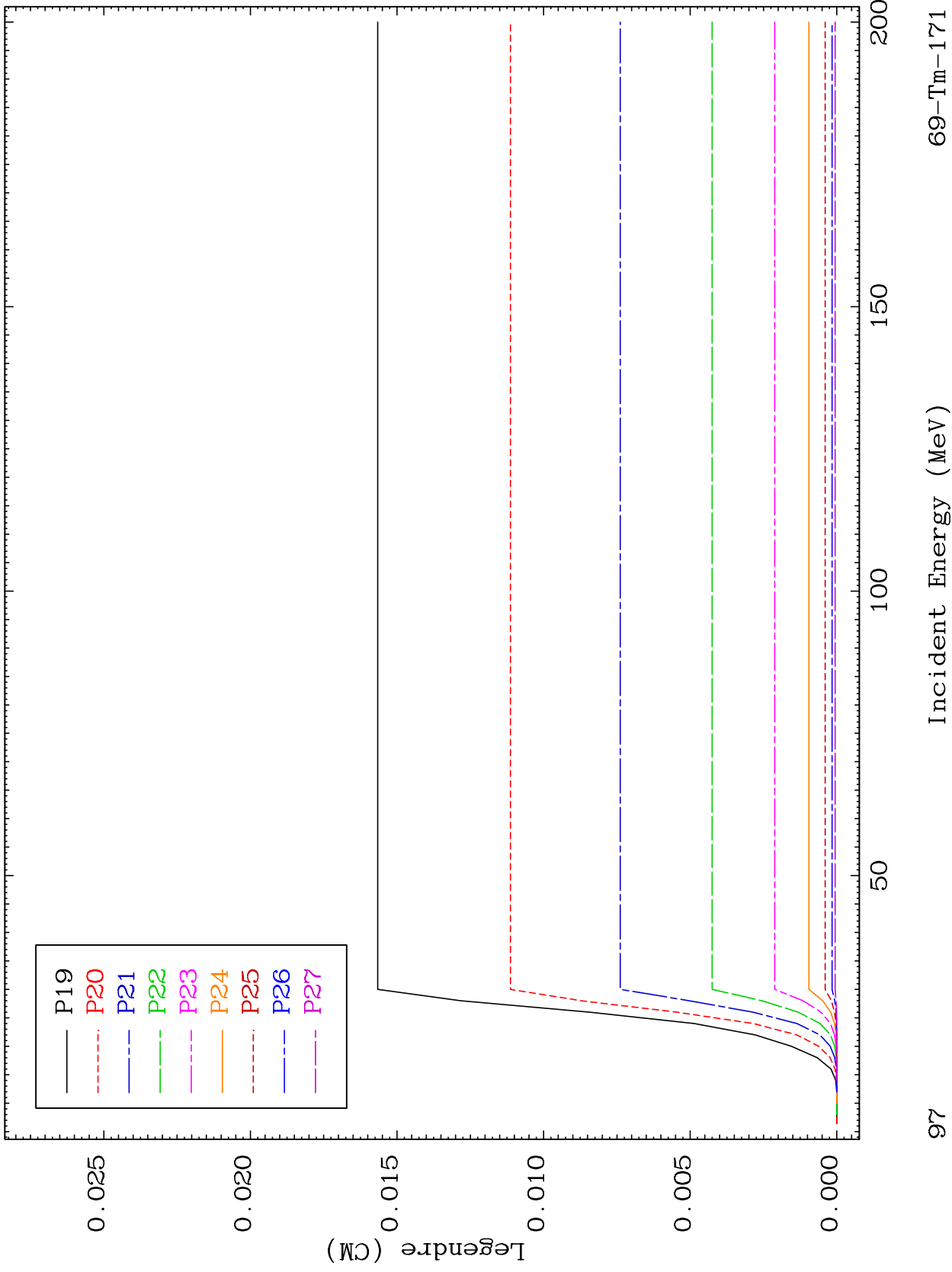

MAT 6931

MT= 71 (n,n') Level  
Legendre Coefficients

69-Tm-171

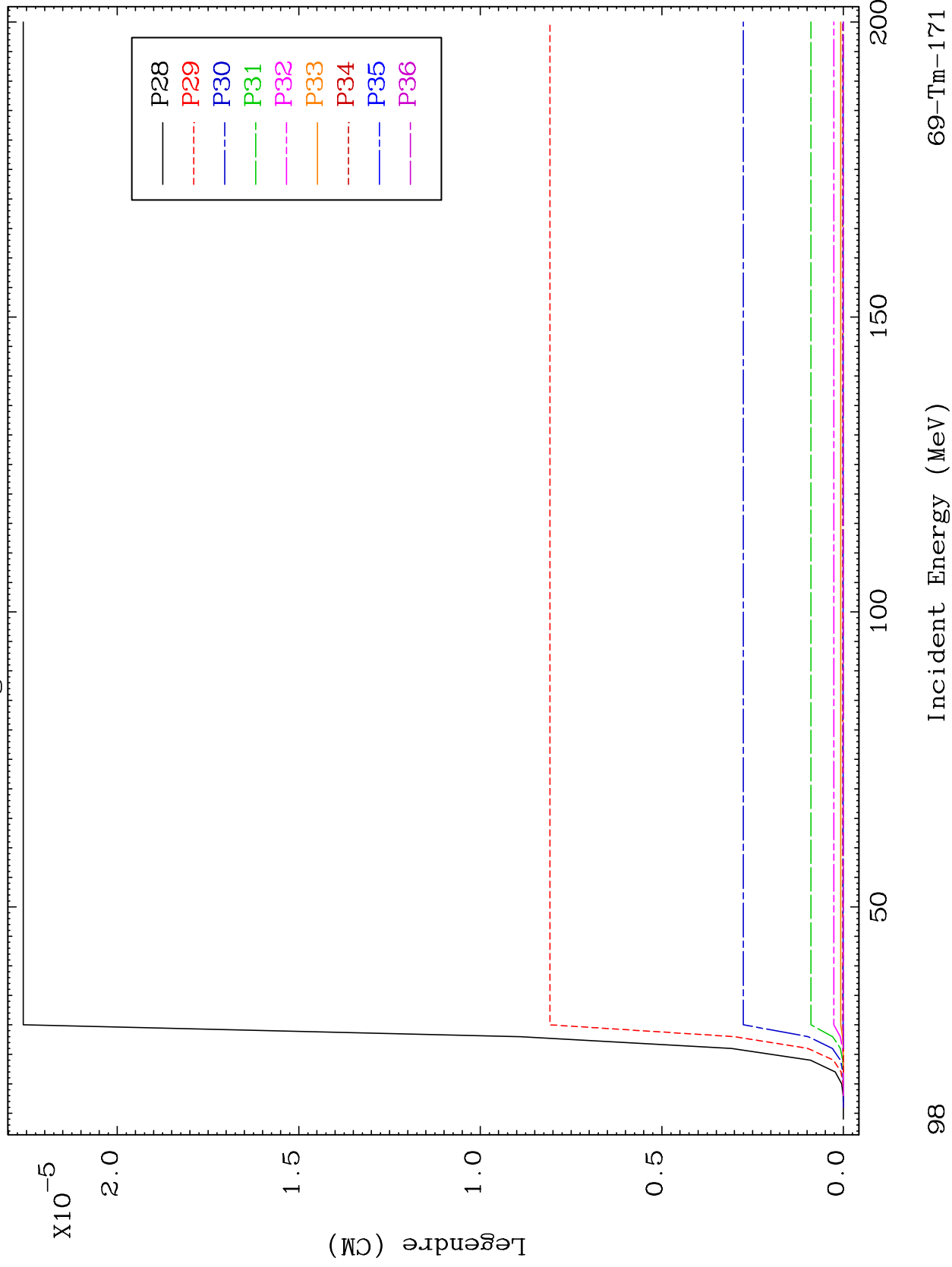

98

69-Tm-171

MAT 6931

MT= 72 (n,n') Level  
Legendre Coefficients

69-Tm-171

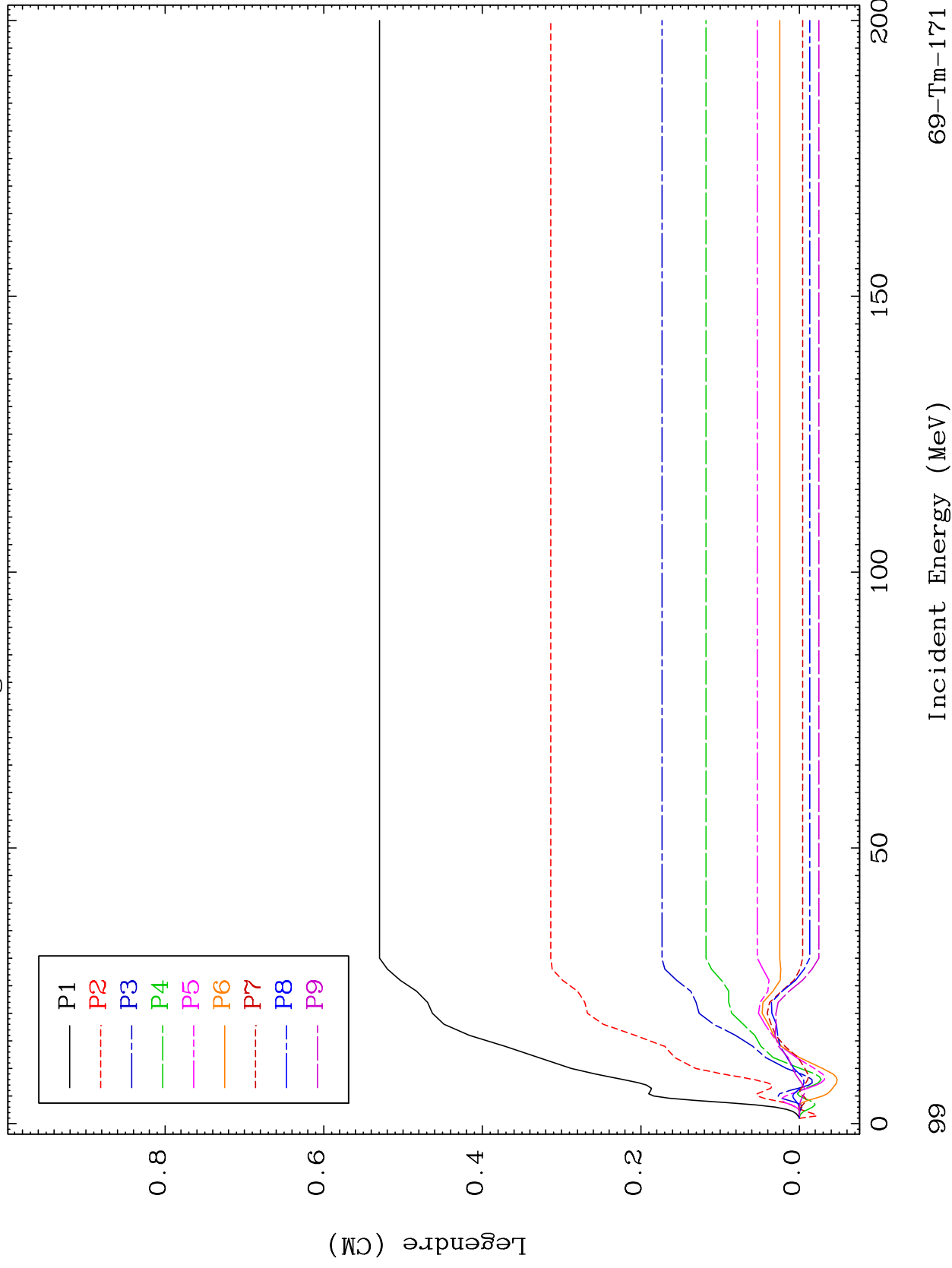

99

Incident Energy (MeV)

69-Tm-171



MAT 6931

MT= 72 (n,n') Level  
Legendre Coefficients

69-Tm-171

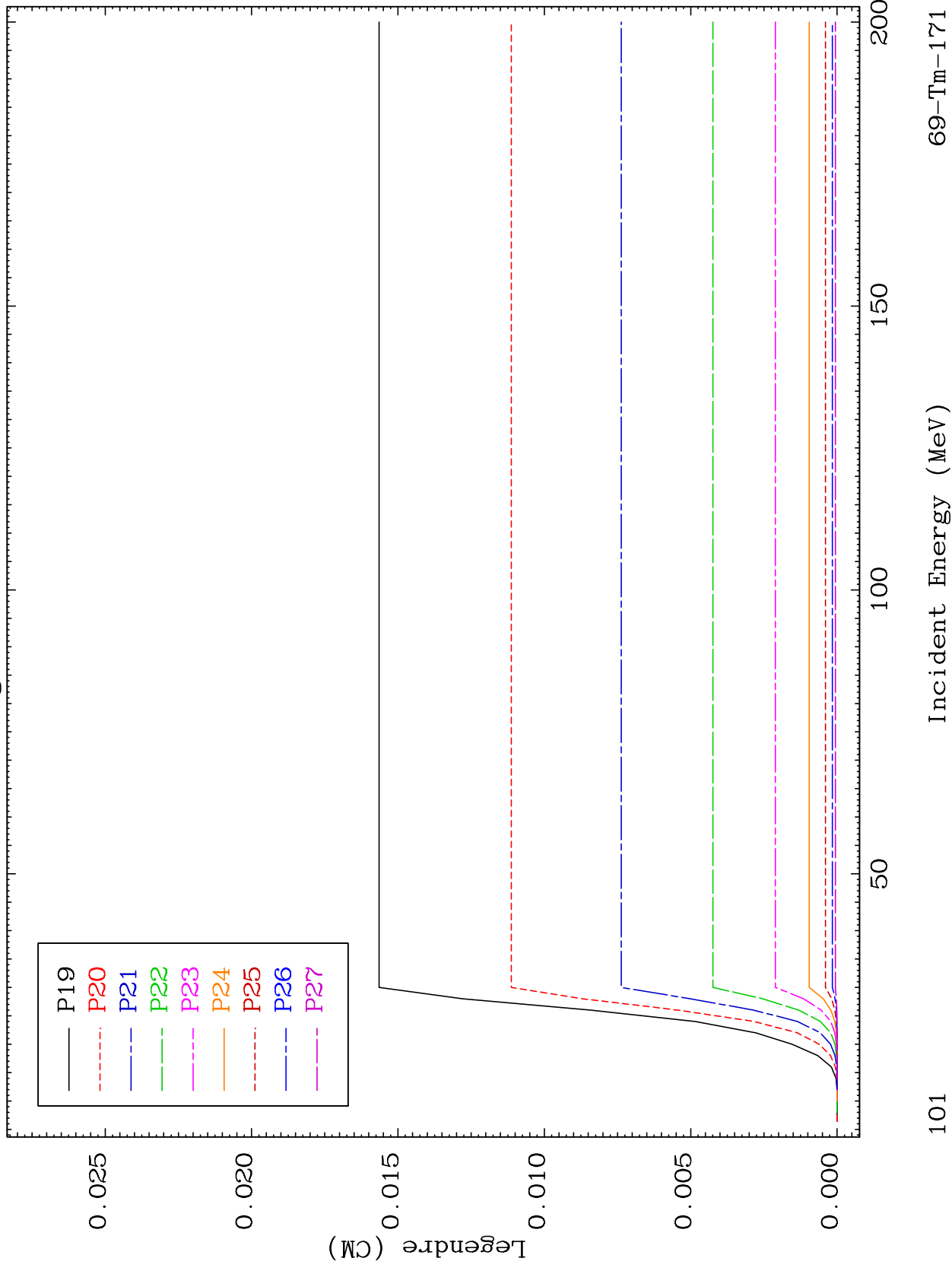

101

Incident Energy (MeV)

69-Tm-171

MAT 6931

MT= 72 (n,n') Level  
Legendre Coefficients

69-Tm-171

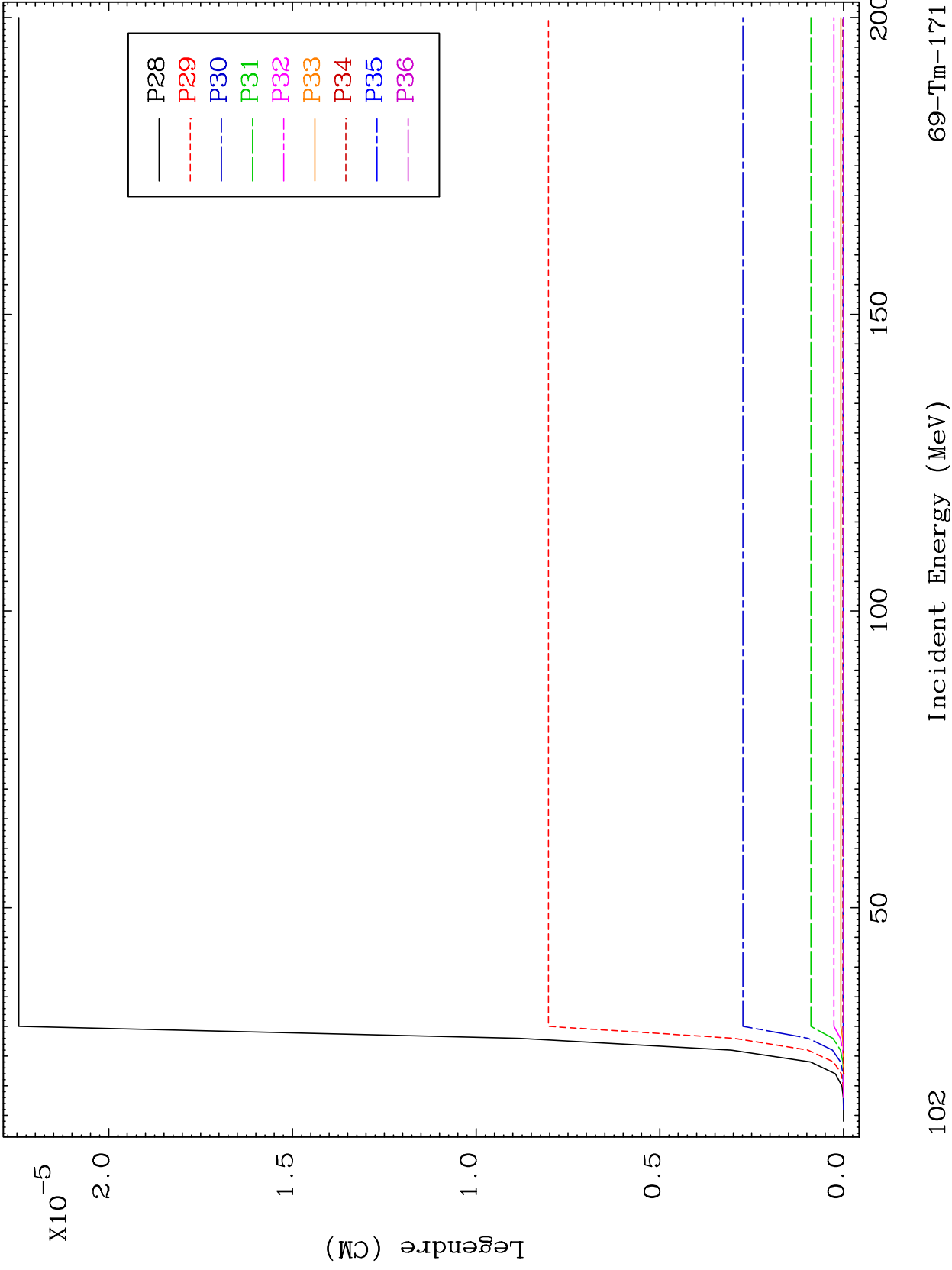

102

Incident Energy (MeV)

69-Tm-171

MAT 6931

MT= 73 (n,n') Level  
Legendre Coefficients

69-Tm-171

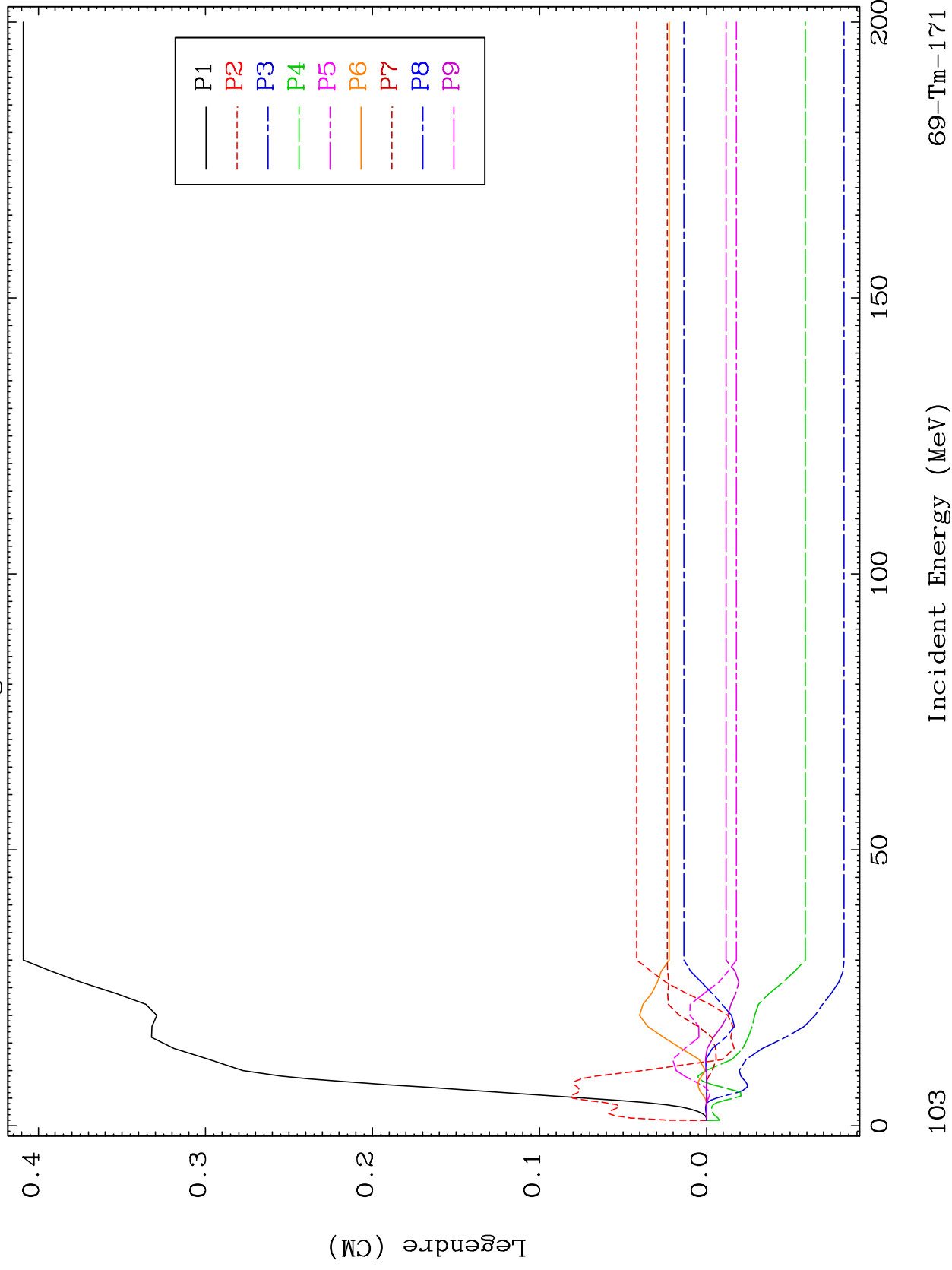

69-Tm-171

Incident Energy (MeV)

103



MAT 6931

MT= 73 (n,n') Level  
Legendre Coefficients

69-Tm-171

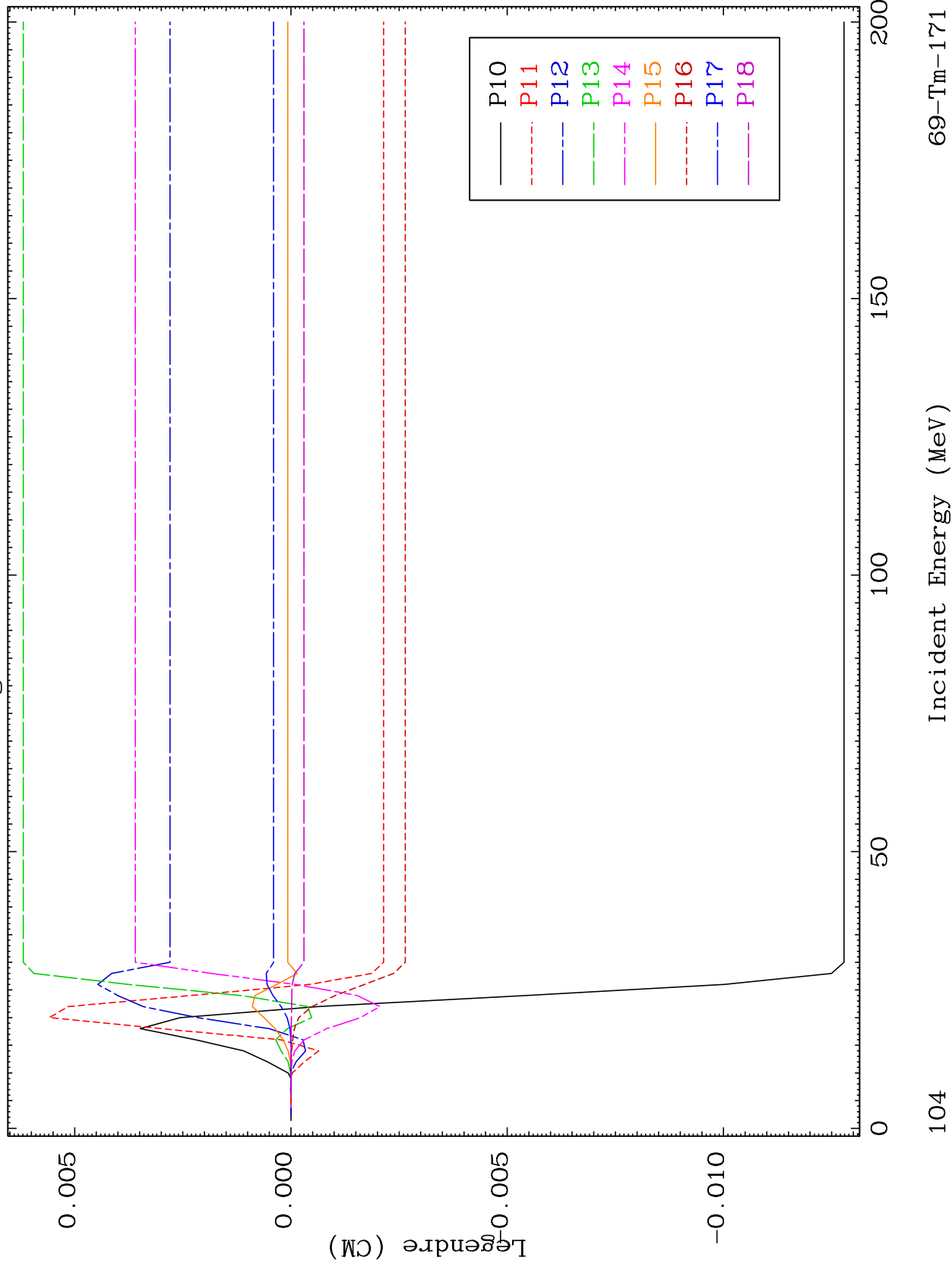

104

MAT 6931

MT= 73 (n,n') Level  
Legendre Coefficients

69-Tm-171

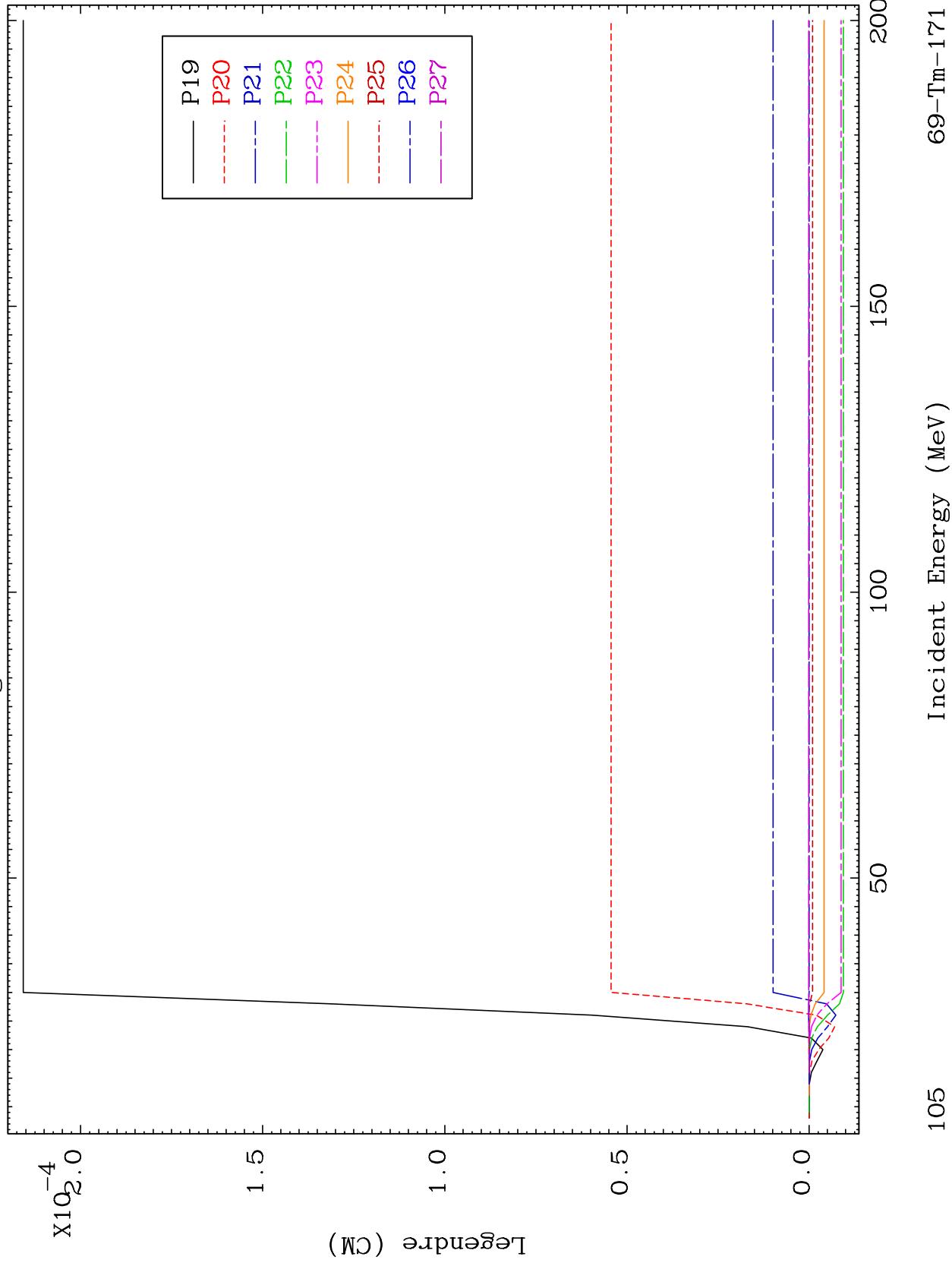

105

Incident Energy (MeV)

69-Tm-171



MAT 6931

MT= 74 (n,n') Level  
Legendre Coefficients

69-Tm-171

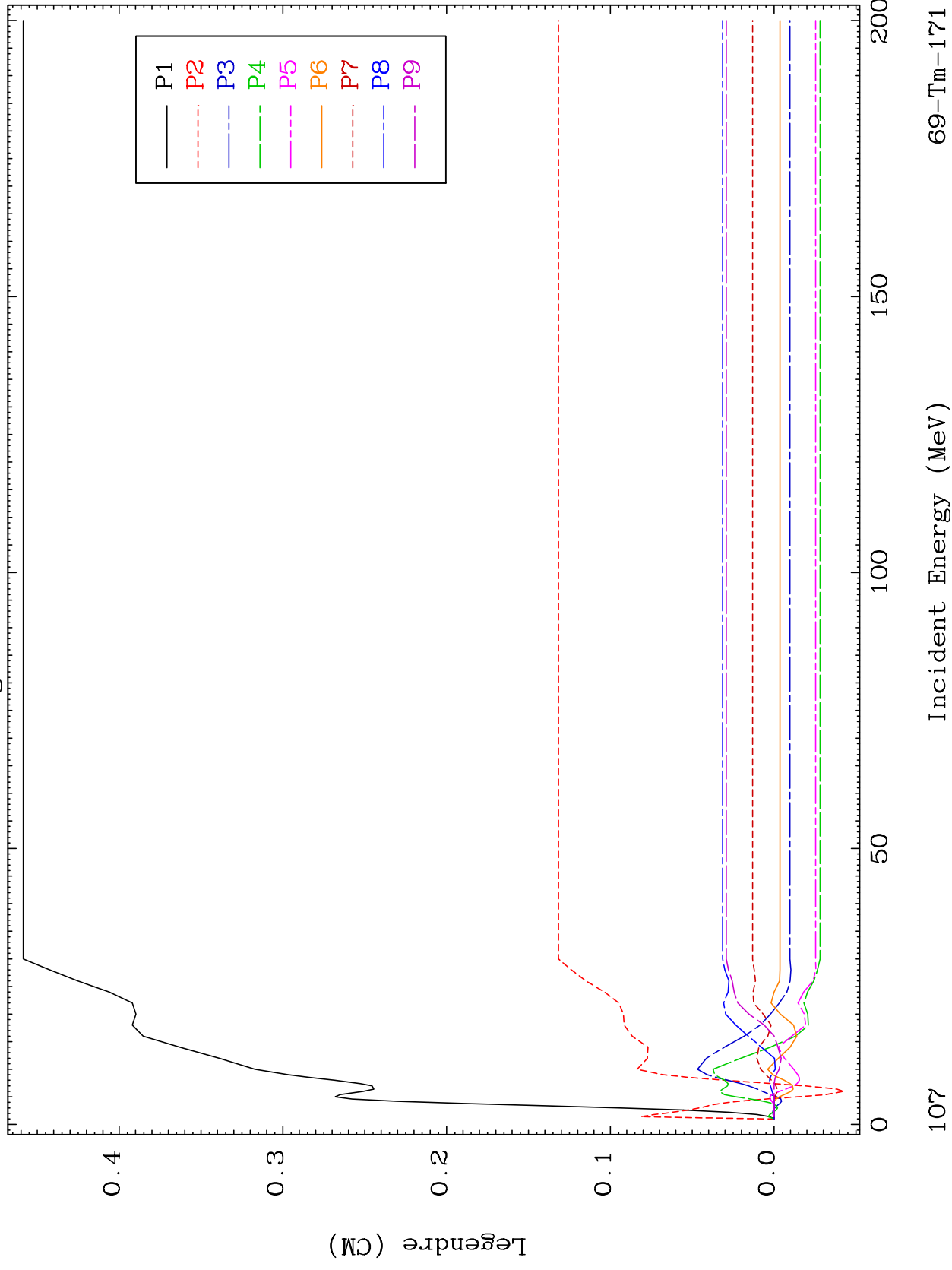

69-Tm-171

Incident Energy (MeV)

107

MAT 6931

MT= 74 (n,n') Level  
Legendre Coefficients

69-Tm-171

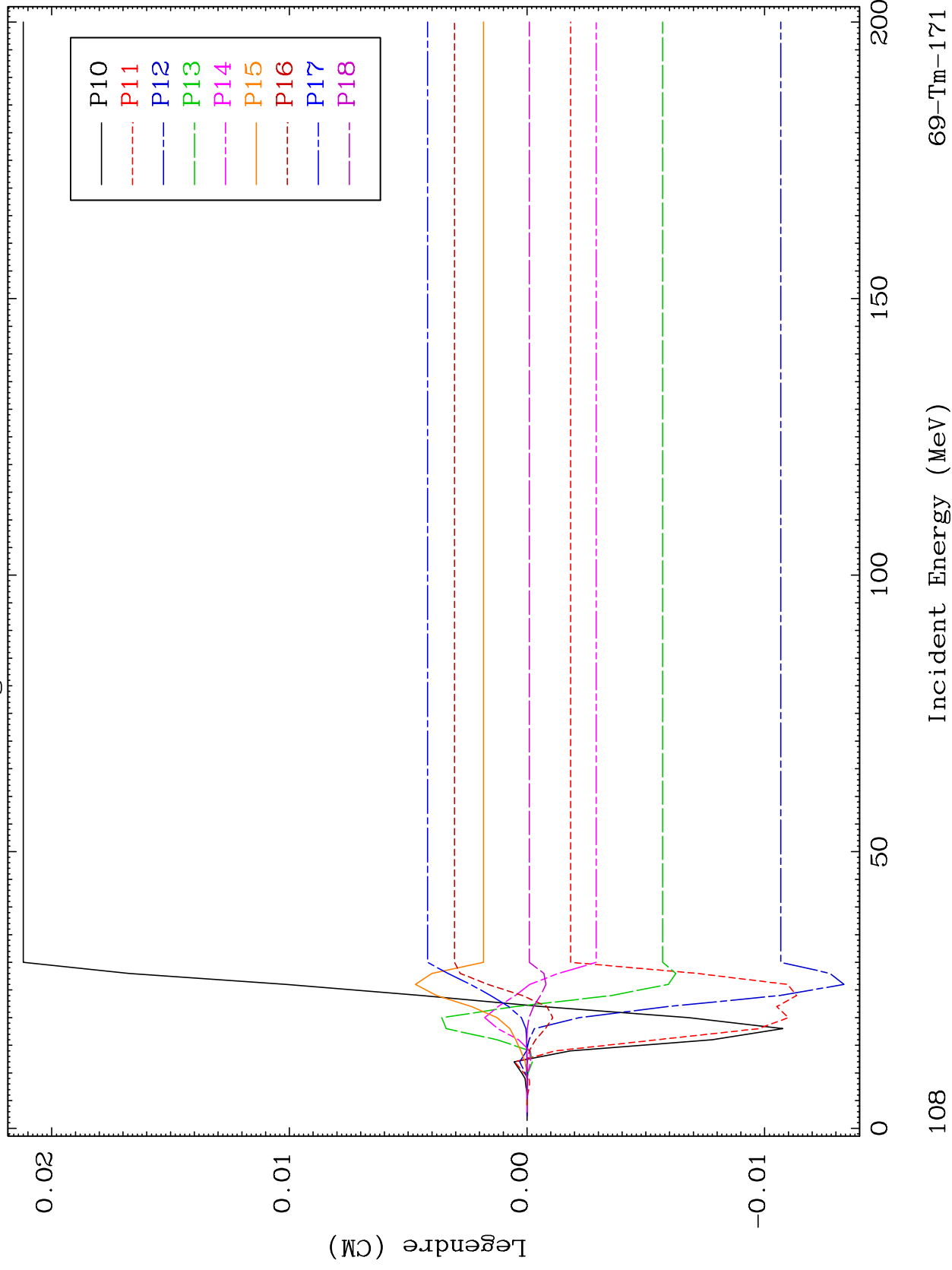

69-Tm-171

Incident Energy (MeV)

108

MAT 6931

MT= 74 (n,n') Level  
Legendre Coefficients

69-Tm-171

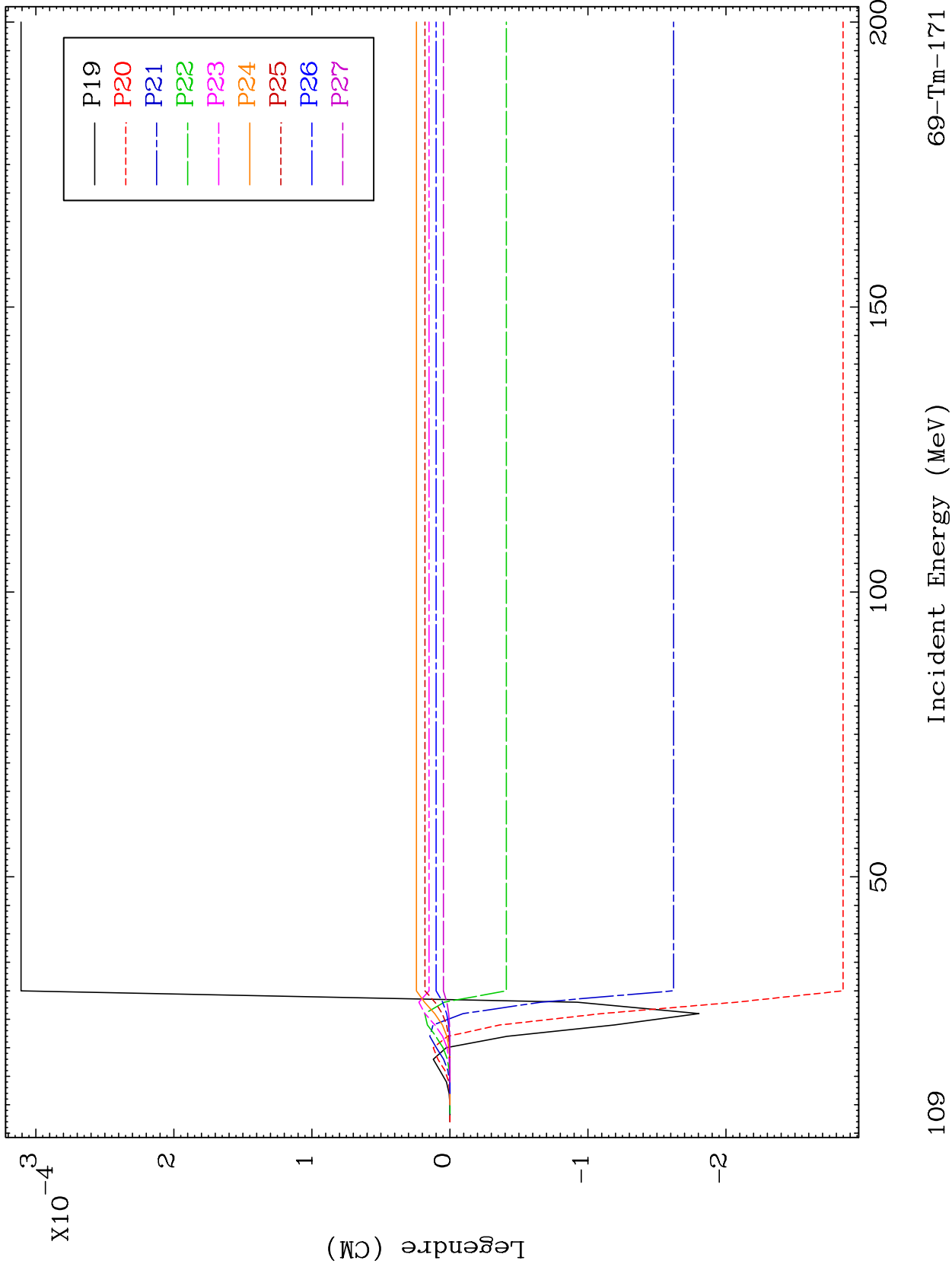

MAT 6931

MT= 74 (n,n') Level  
Legendre Coefficients

69-Tm-171

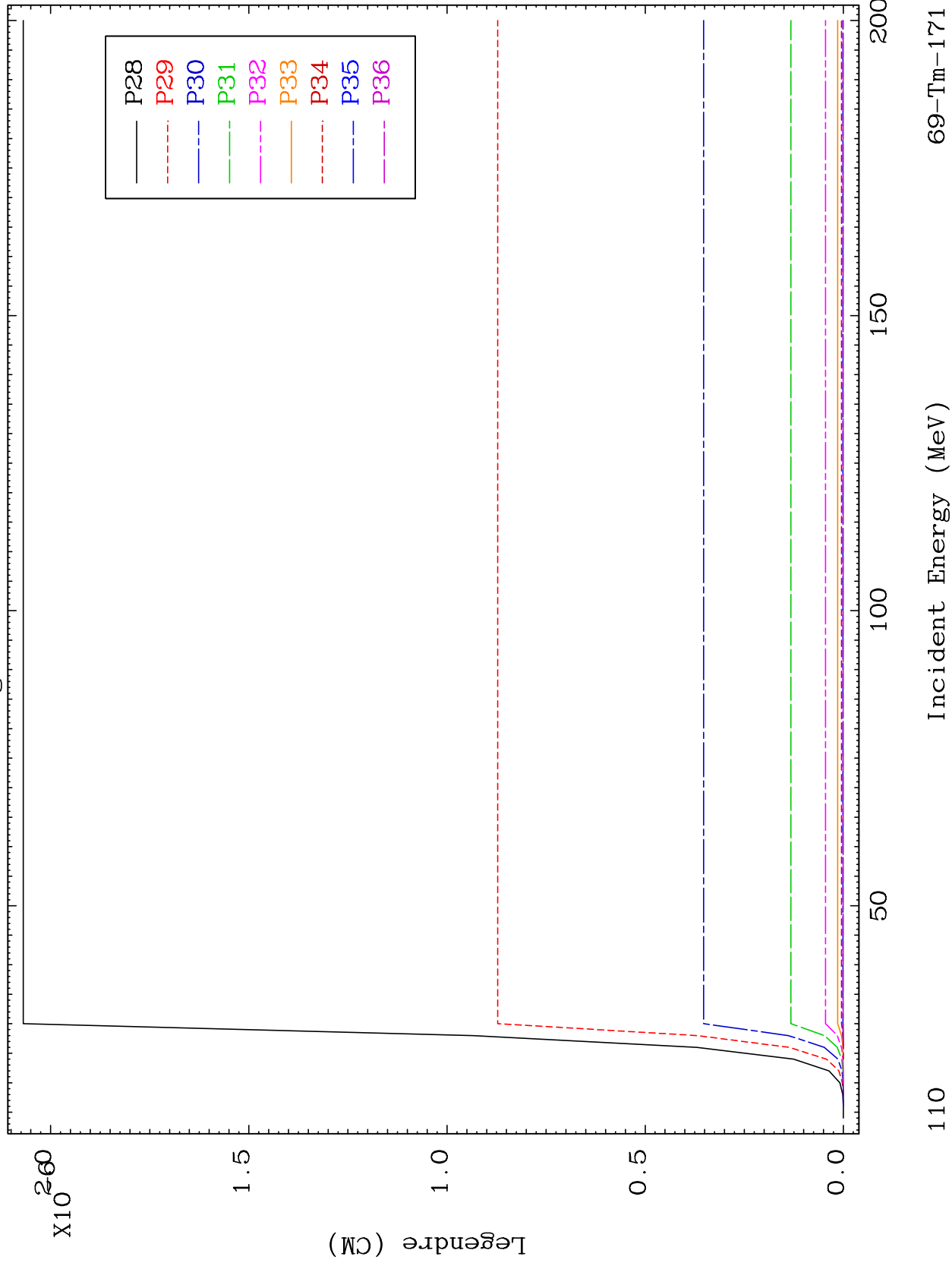

MAT 6931

MT= 75 (n,n') Level  
Legendre Coefficients

69-Tm-171

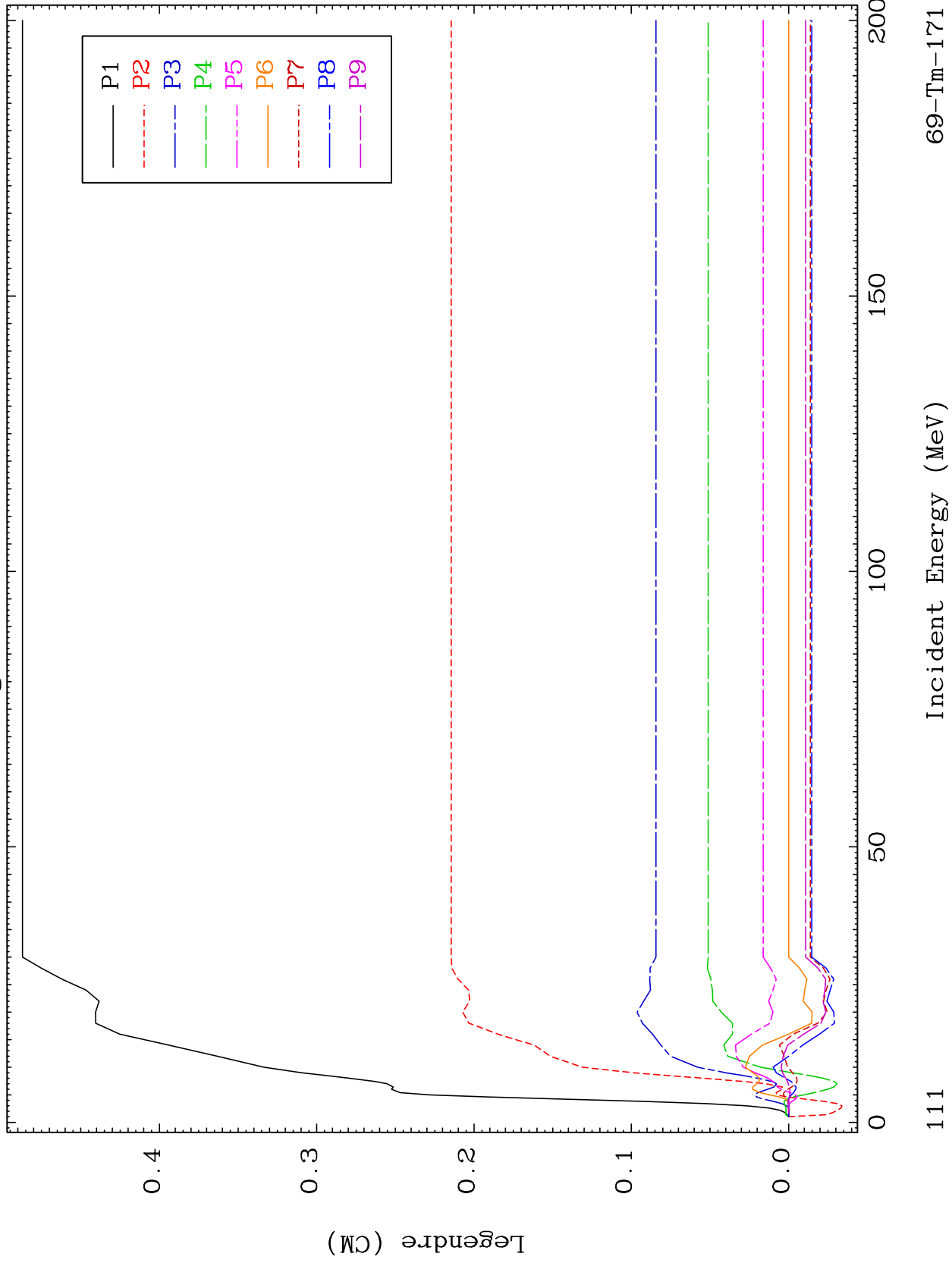

111

Incident Energy (MeV)

69-Tm-171



MAT 6931

MT= 75 (n,n') Level  
Legendre Coefficients

69-Tm-171

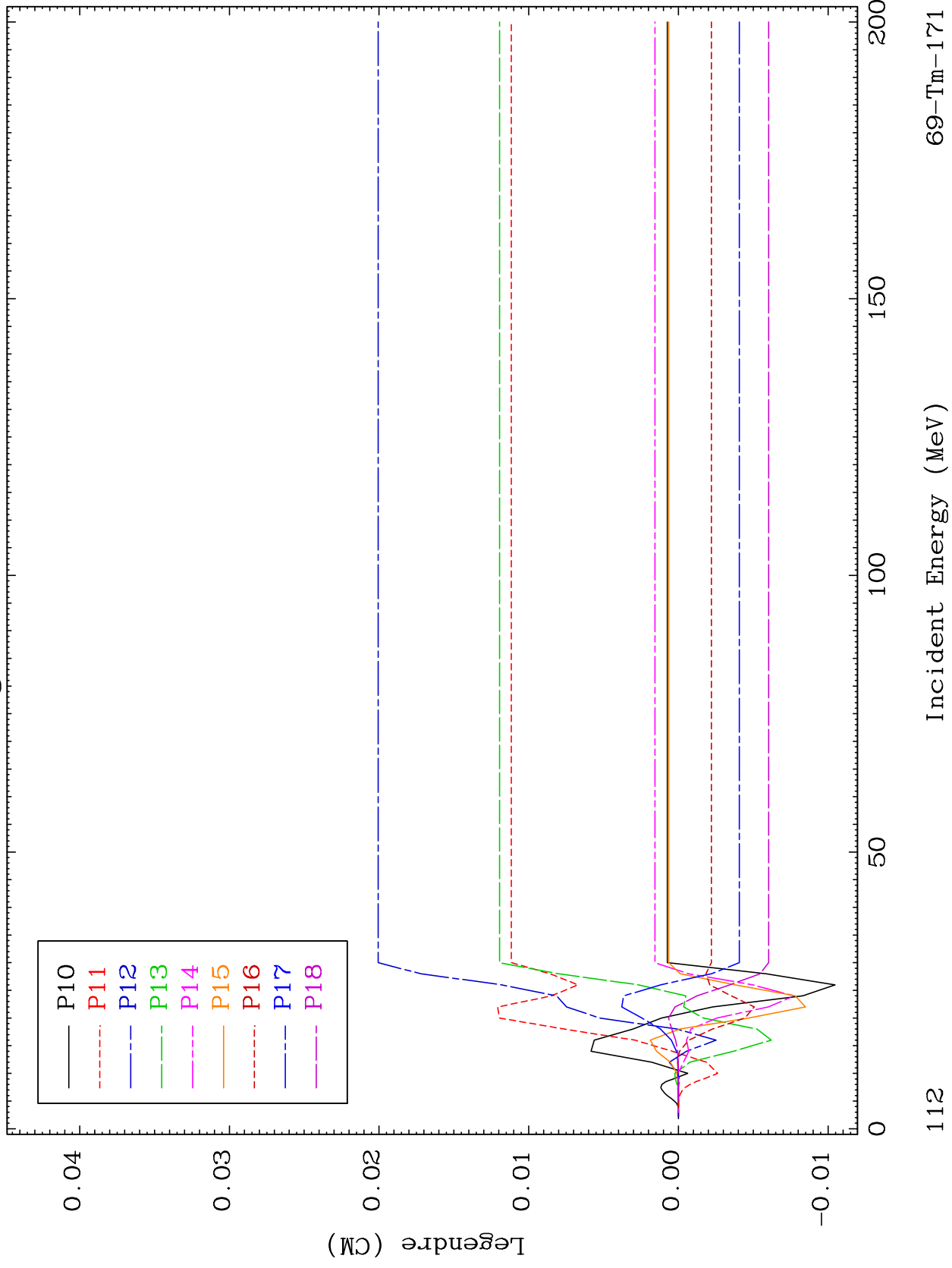

112

Incident Energy (MeV)

69-Tm-171

MAT 6931

MT= 75 (n,n') Level  
Legendre Coefficients

69-Tm-171

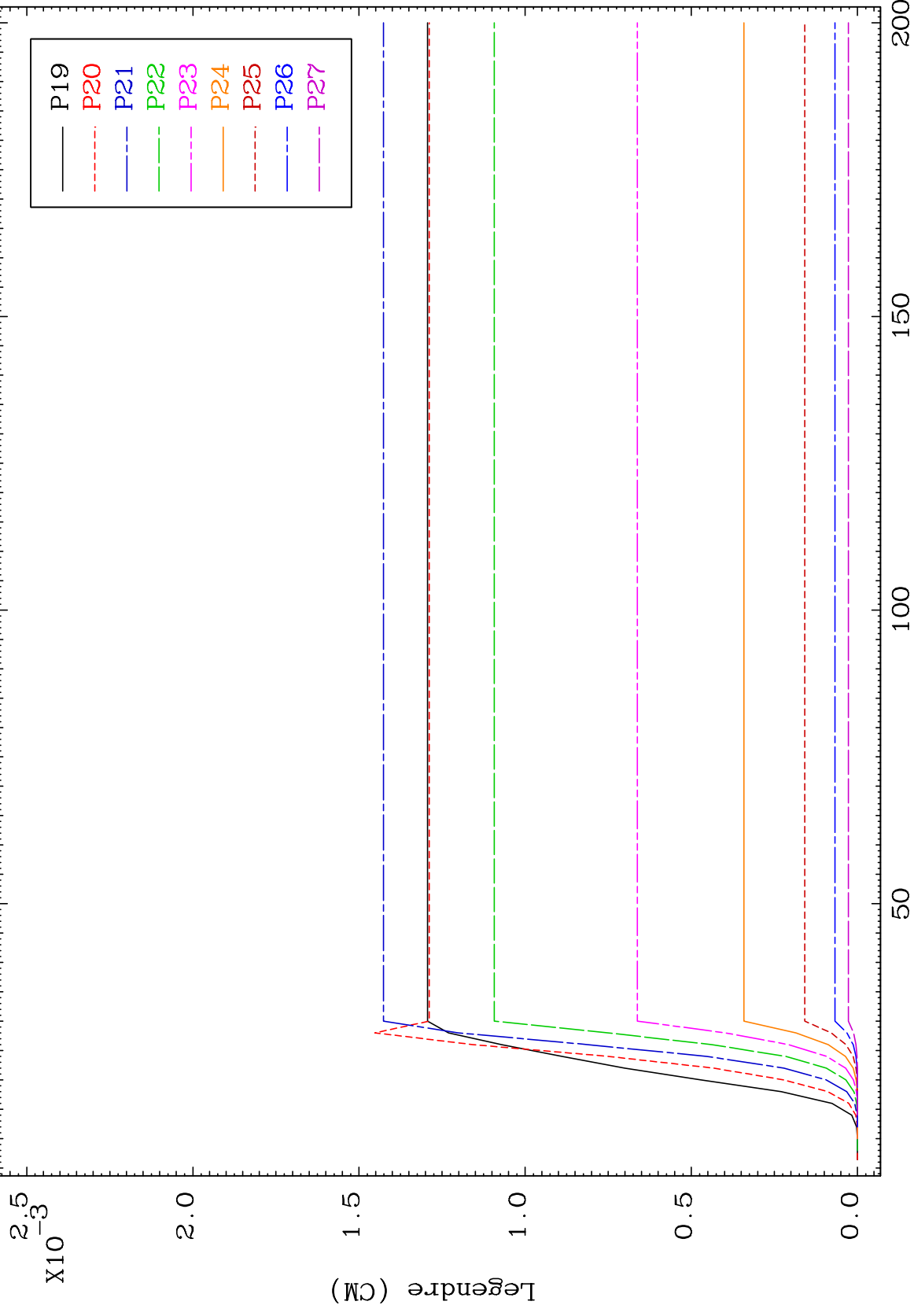

113

Incident Energy (MeV)

69-Tm-171

MAT 6931

MT= 75 (n,n') Level  
Legendre Coefficients

69-Tm-171

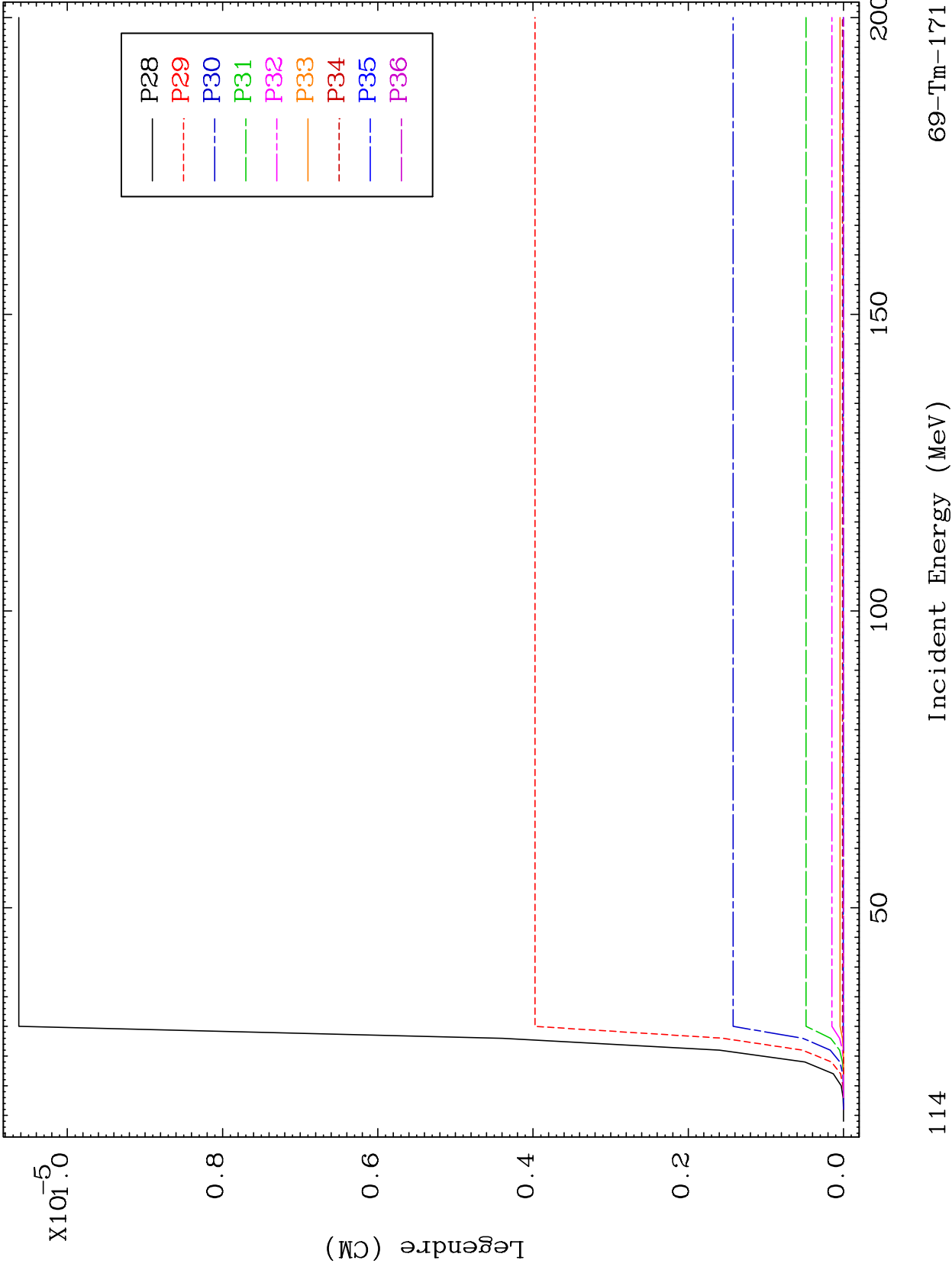

114

Incident Energy (MeV)

69-Tm-171

MAT 6931

MT= 76 (n,n') Level  
Legendre Coefficients

69-Tm-171

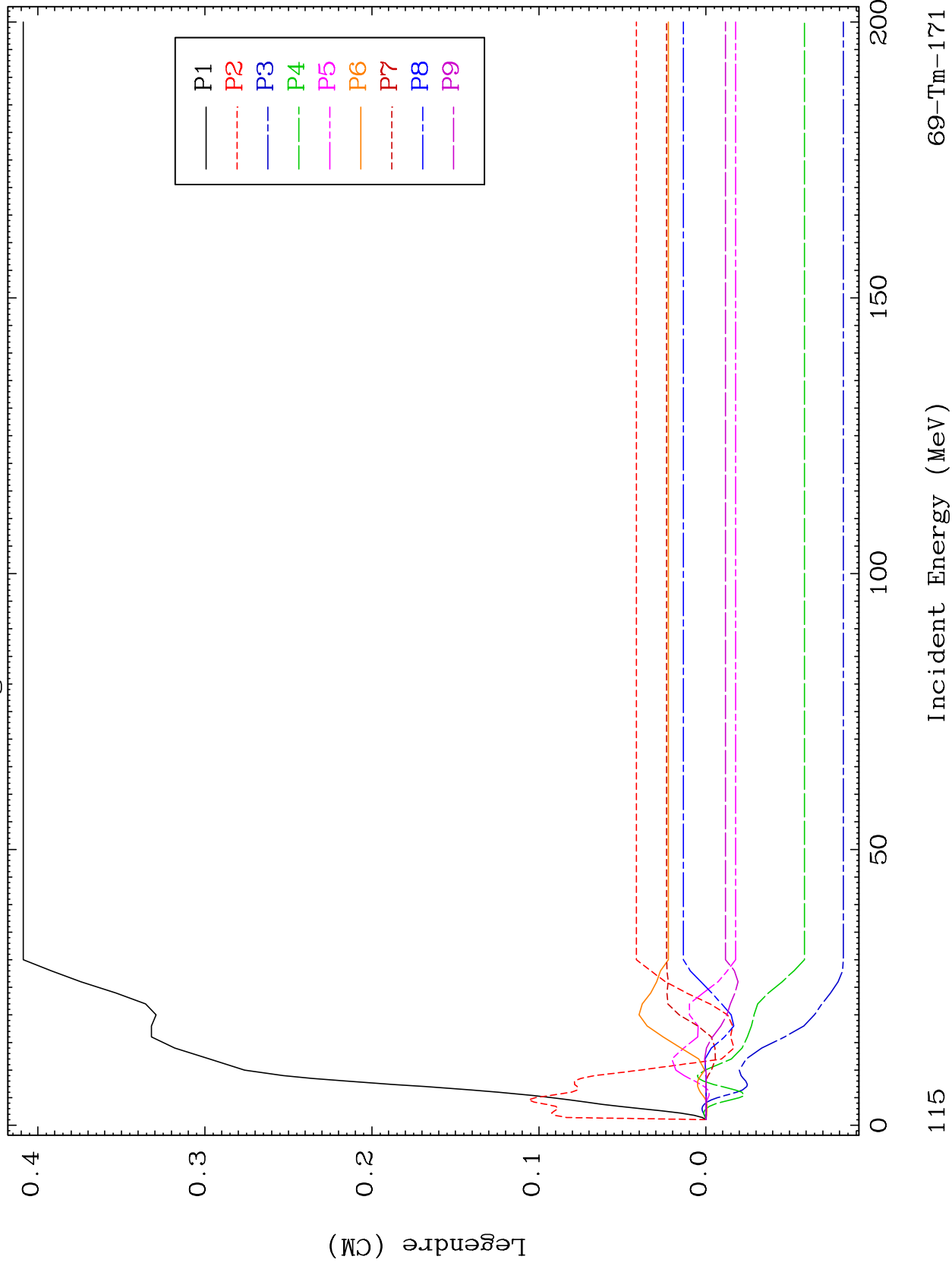

69-Tm-171

Incident Energy (MeV)

115

MAT 6931

MT= 76 (n,n') Level  
Legendre Coefficients

69-Tm-171

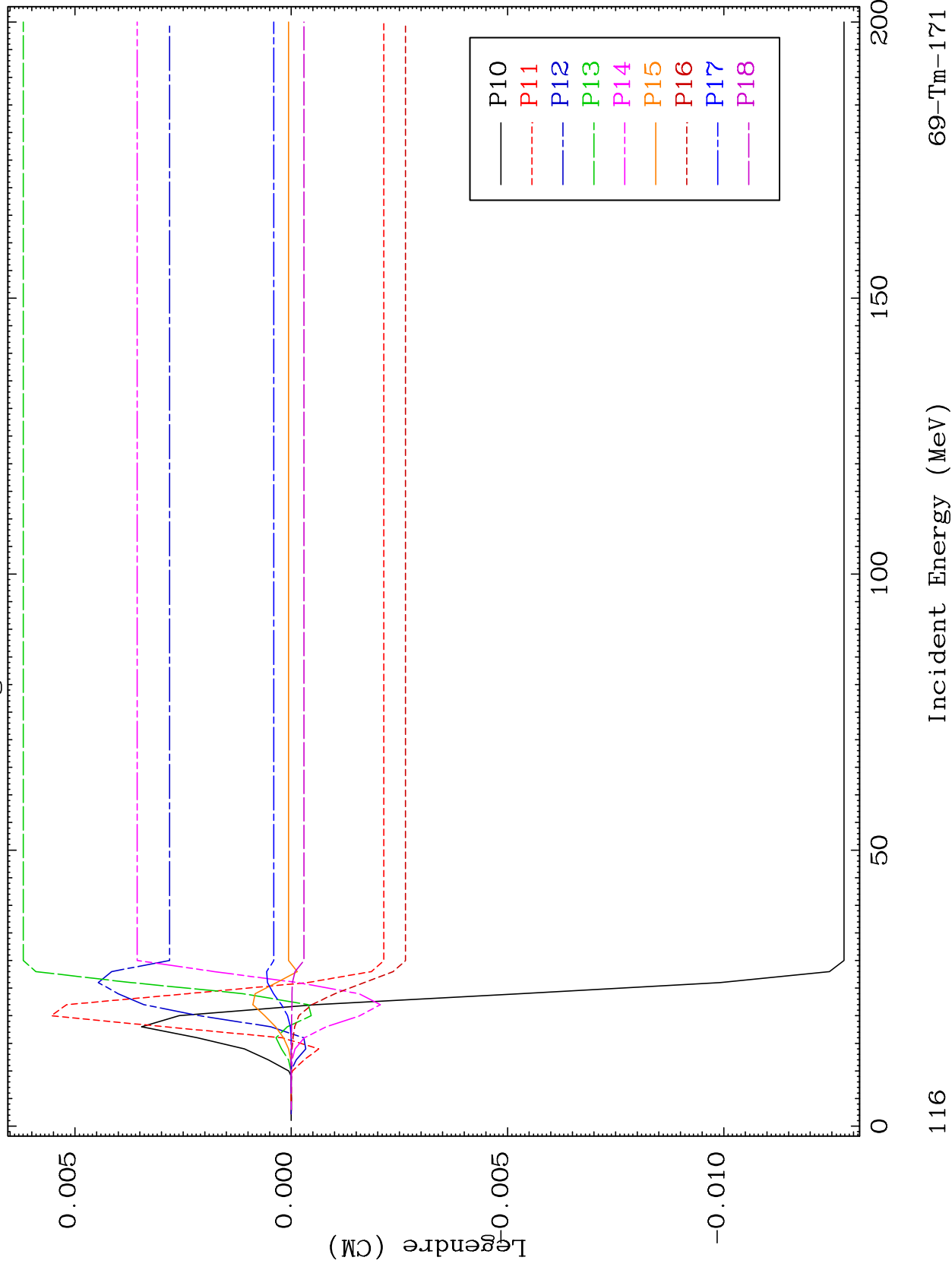

116

Incident Energy (MeV)

69-Tm-171

MAT 6931

MT= 76 (n,n') Level  
Legendre Coefficients

69-Tm-171

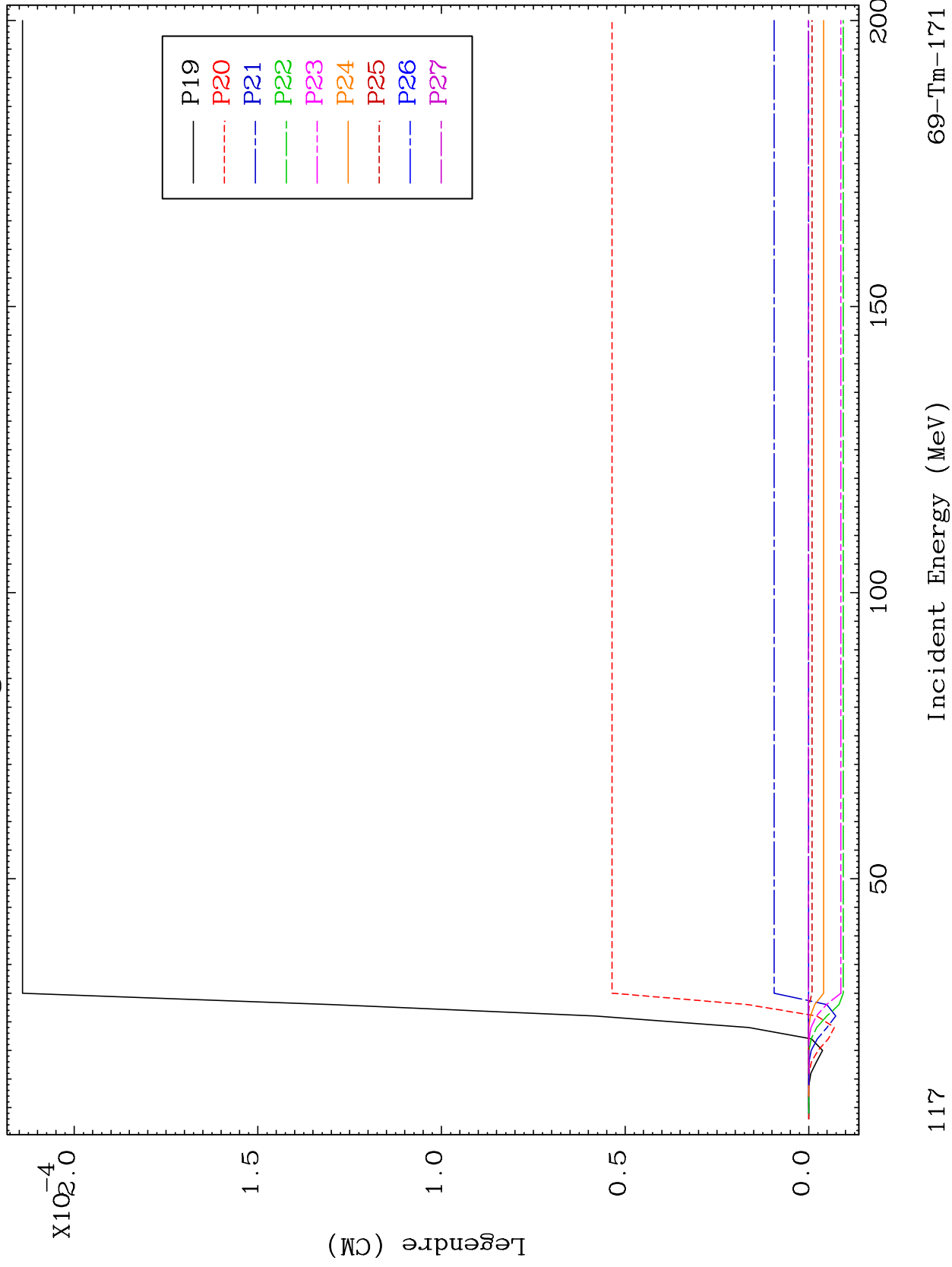

117

Incident Energy (MeV)

69-Tm-171



MAT 6931

MT= 77 (n,n') Level  
Legendre Coefficients

69-Tm-171

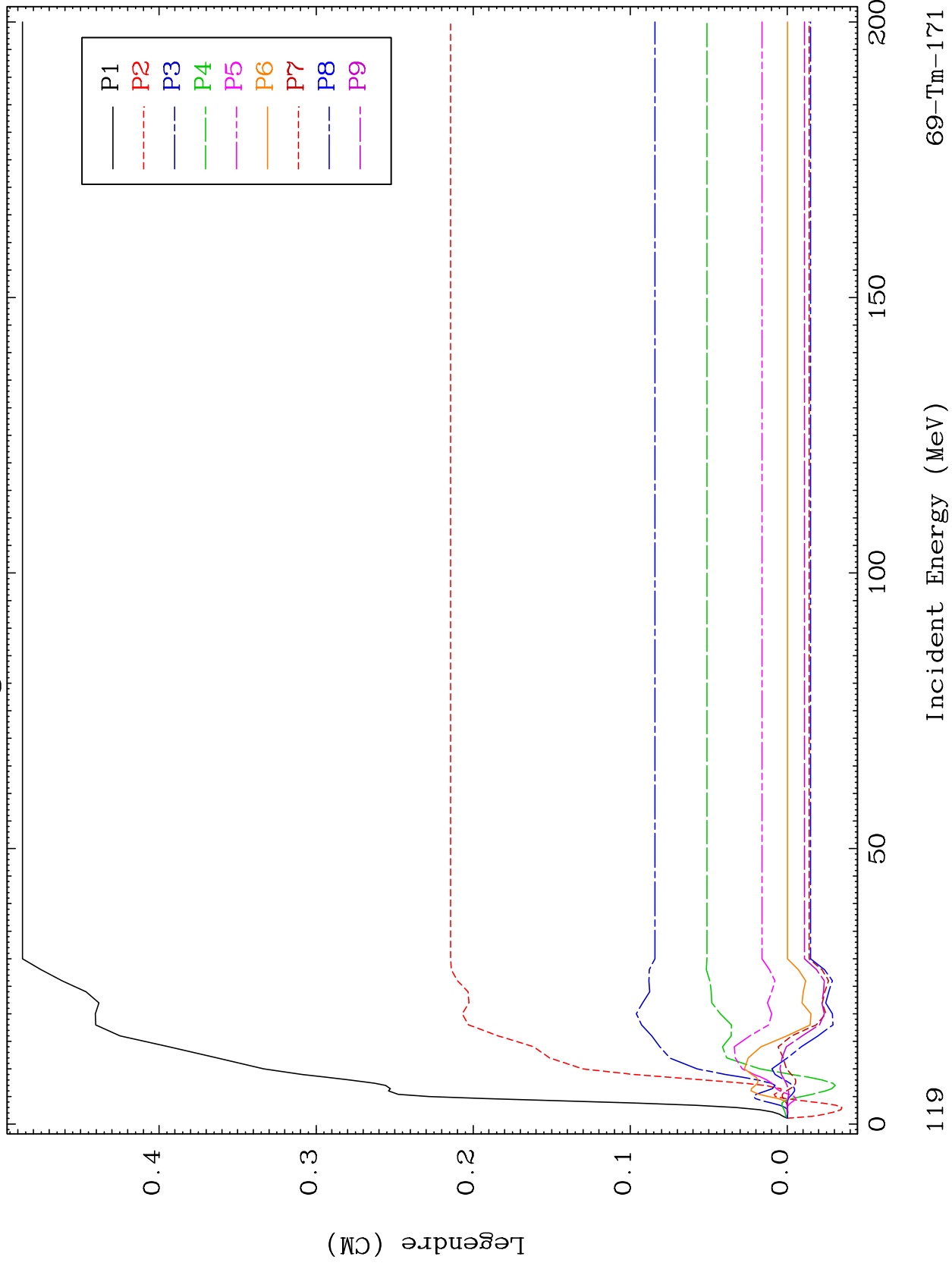

69-Tm-171

Incident Energy (MeV)

119



MAT 6931

MT= 77 (n,n') Level  
Legendre Coefficients

69-Tm-171

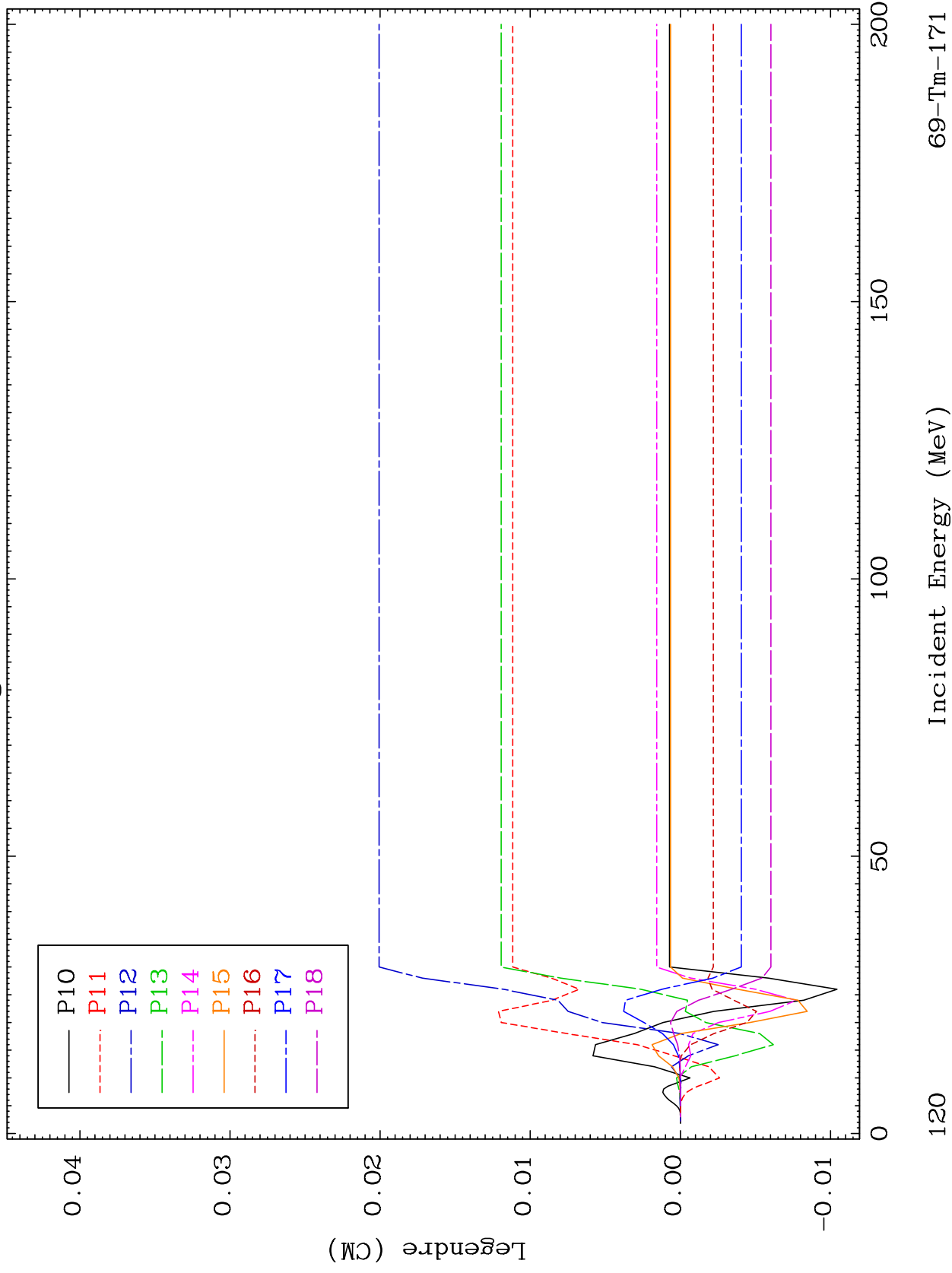

MAT 6931

MT= 77 (n,n') Level  
Legendre Coefficients

69-Tm-171

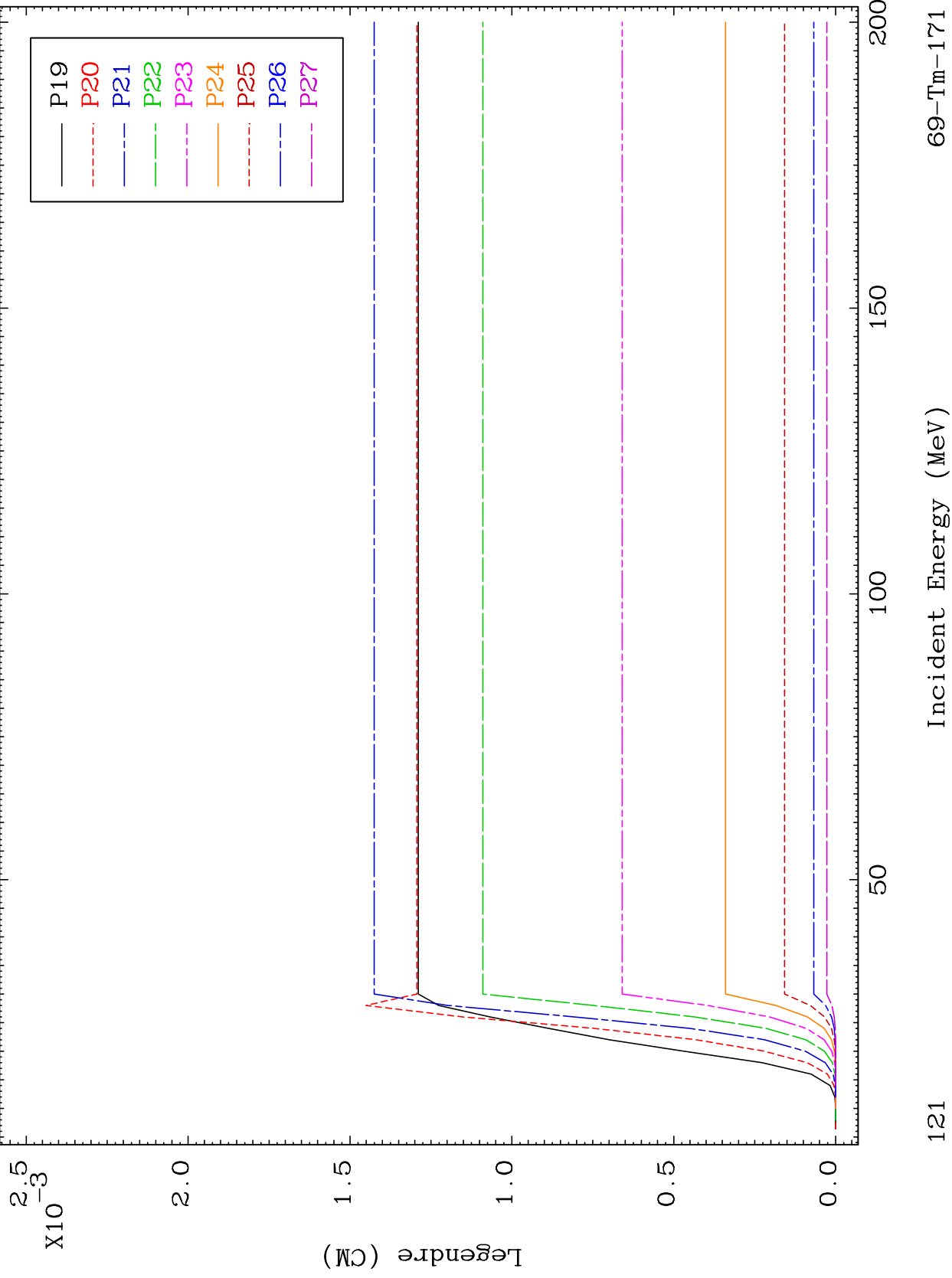

121

69-Tm-171

MAT 6931

MT= 77 (n,n') Level  
Legendre Coefficients

69-Tm-171

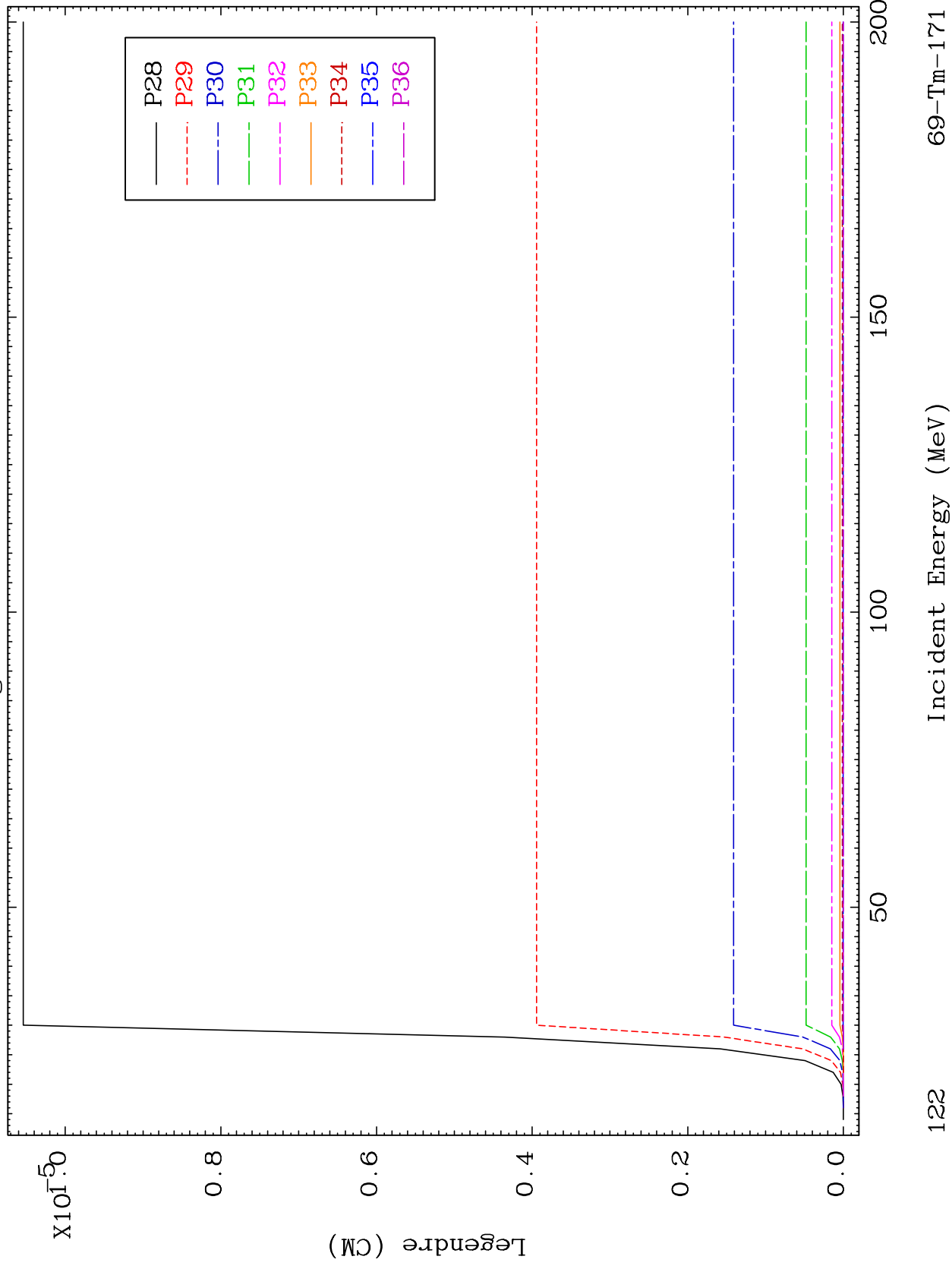

122

MAT 6931

MT= 78 (n,n') Level  
Legendre Coefficients

69-Tm-171

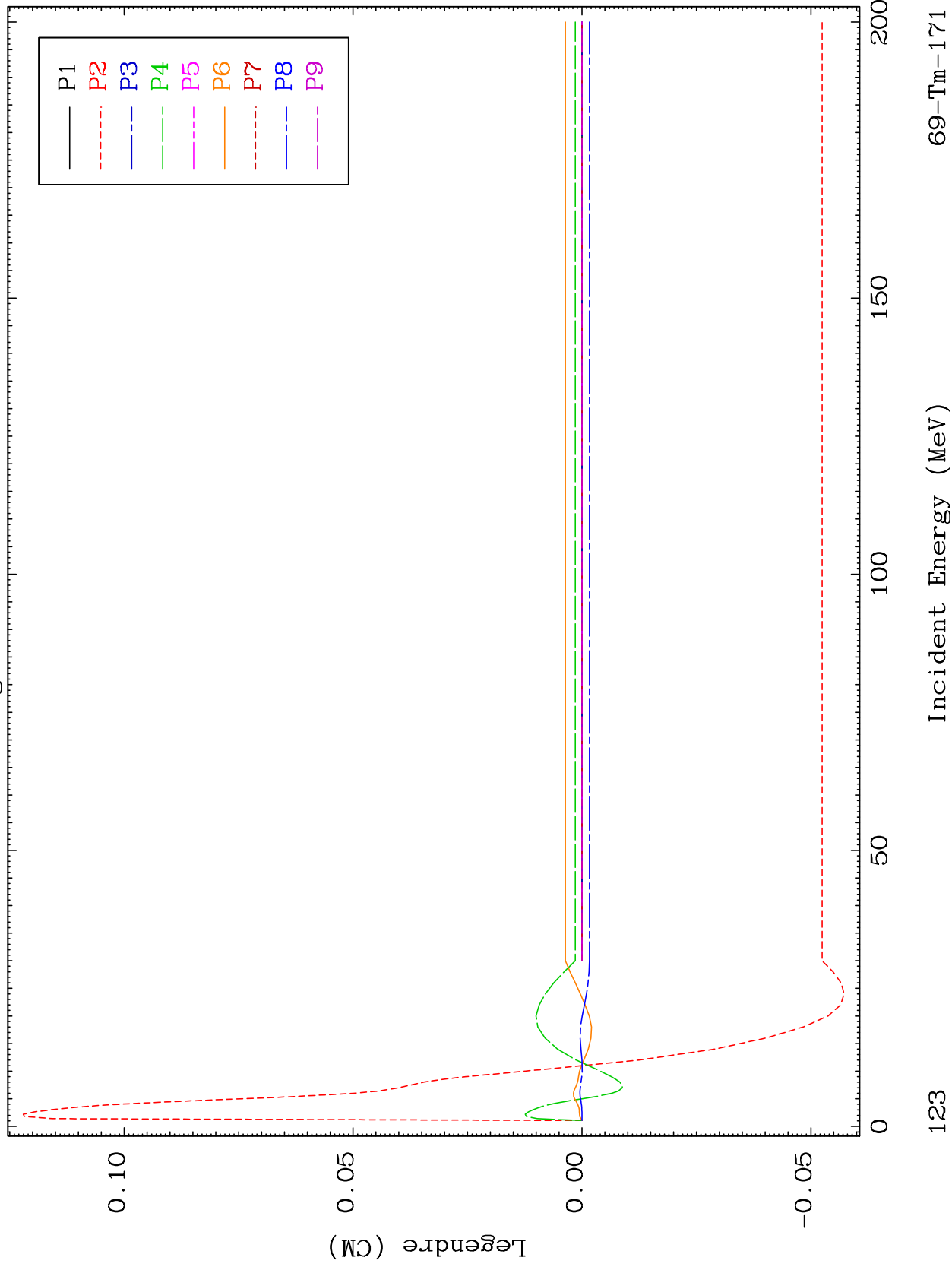

69-Tm-171

Incident Energy (MeV)

123

MAT 6931

MT= 78 (n,n') Level  
Legendre Coefficients

69-Tm-171

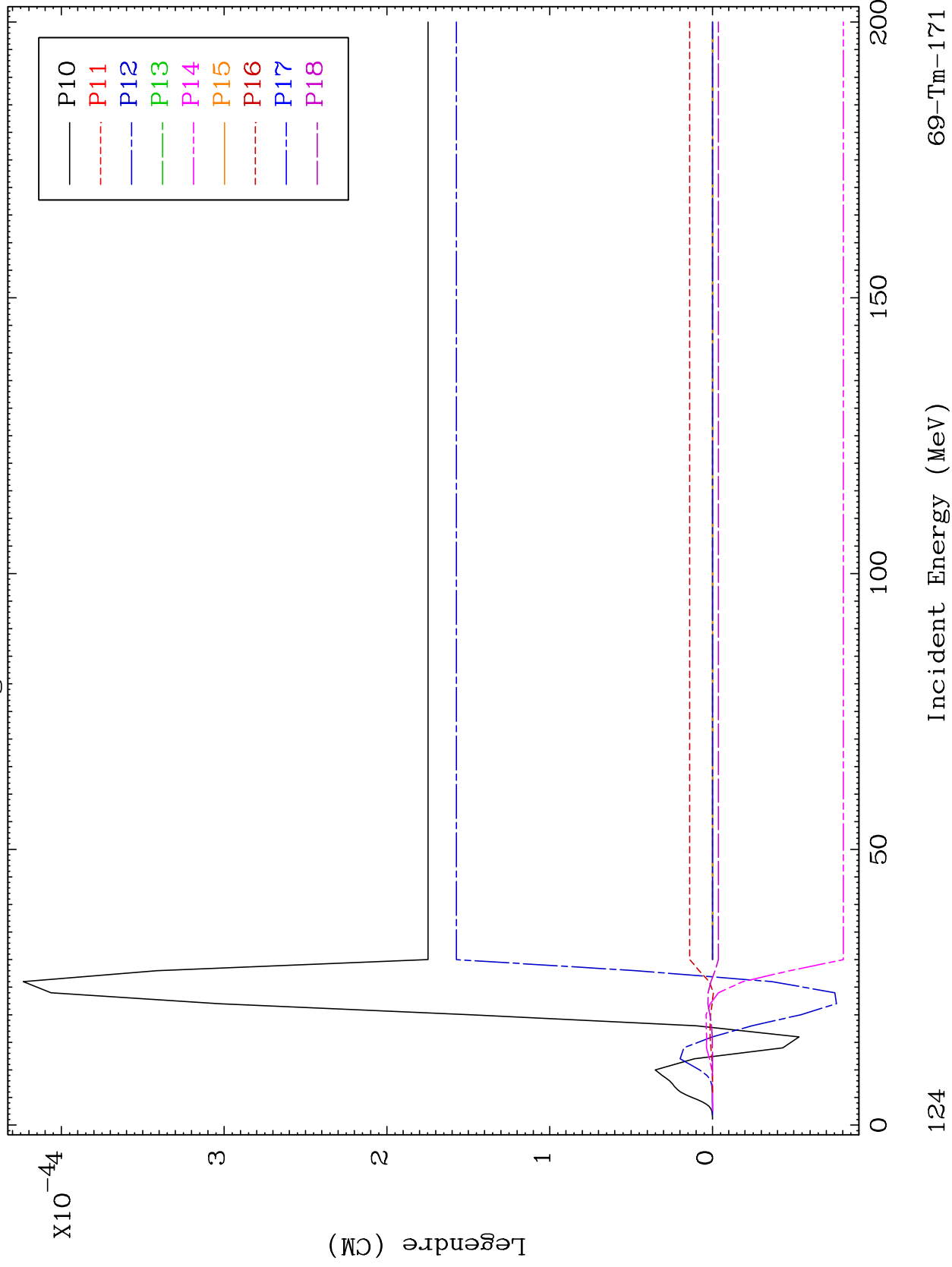



MAT 6931

MT= 79 (n,n') Level  
Legendre Coefficients

69-Tm-171

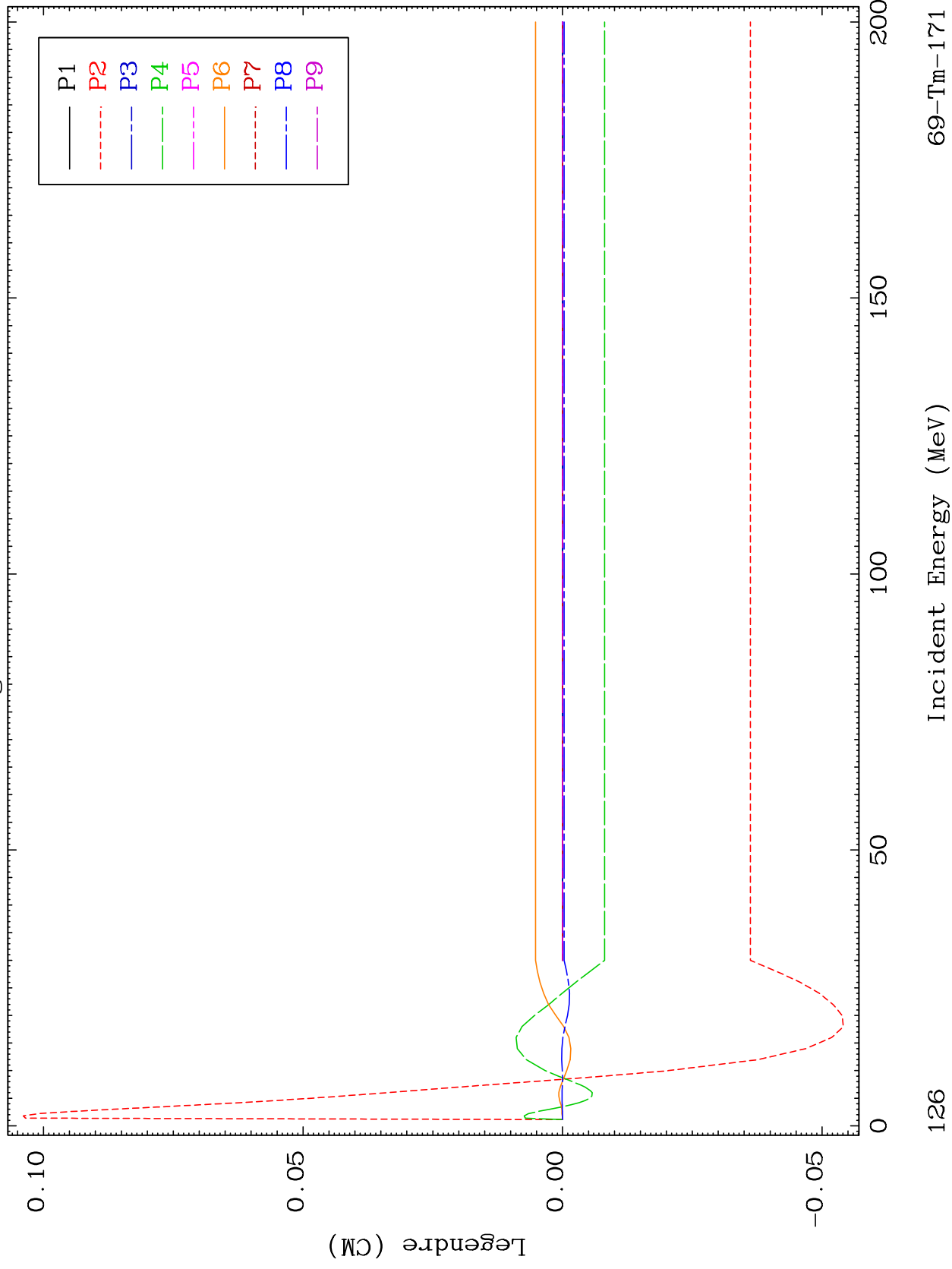

69-Tm-171

Incident Energy (MeV)

126

MAT 6931

MT= 79 (n,n') Level  
Legendre Coefficients

69-Tm-171

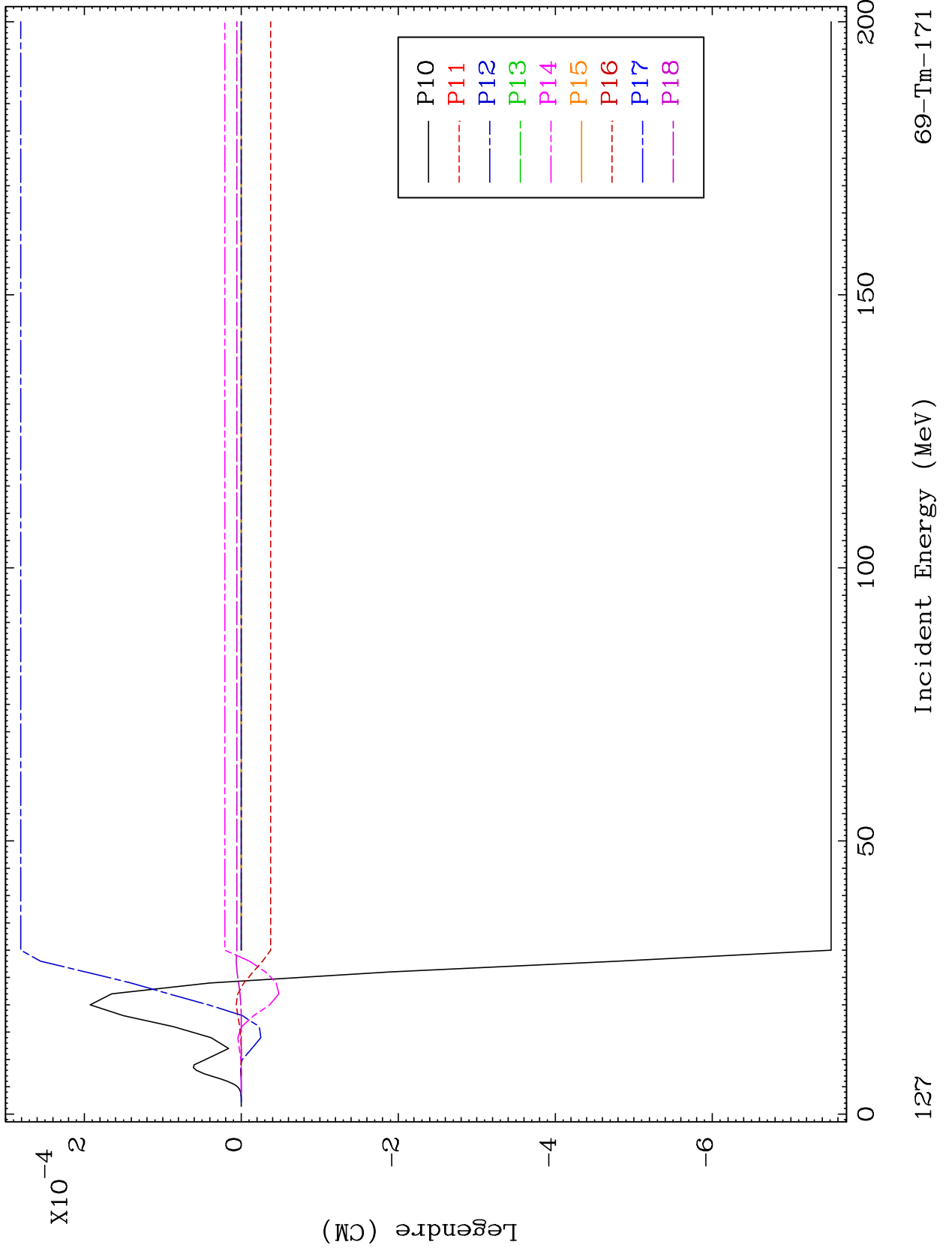



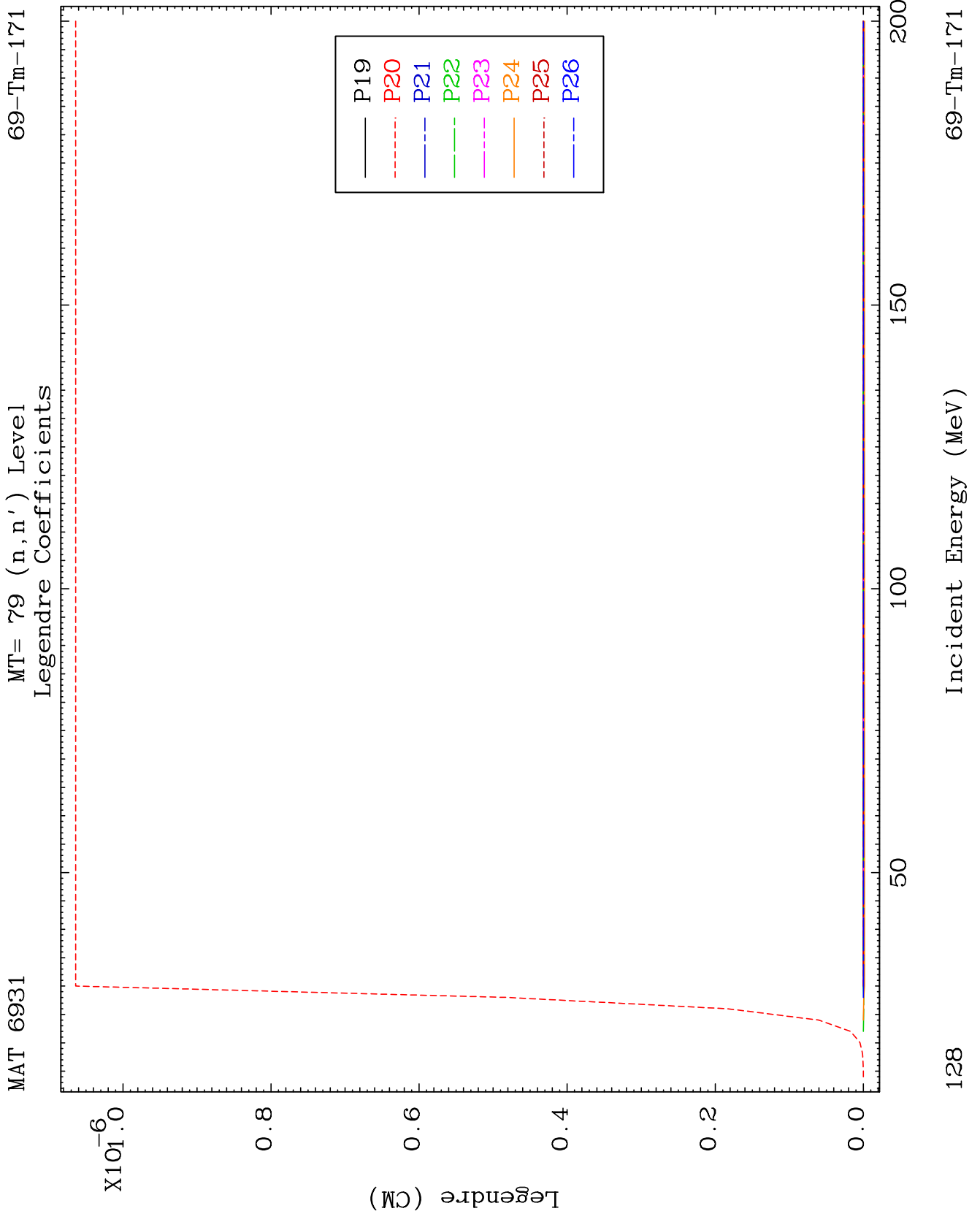

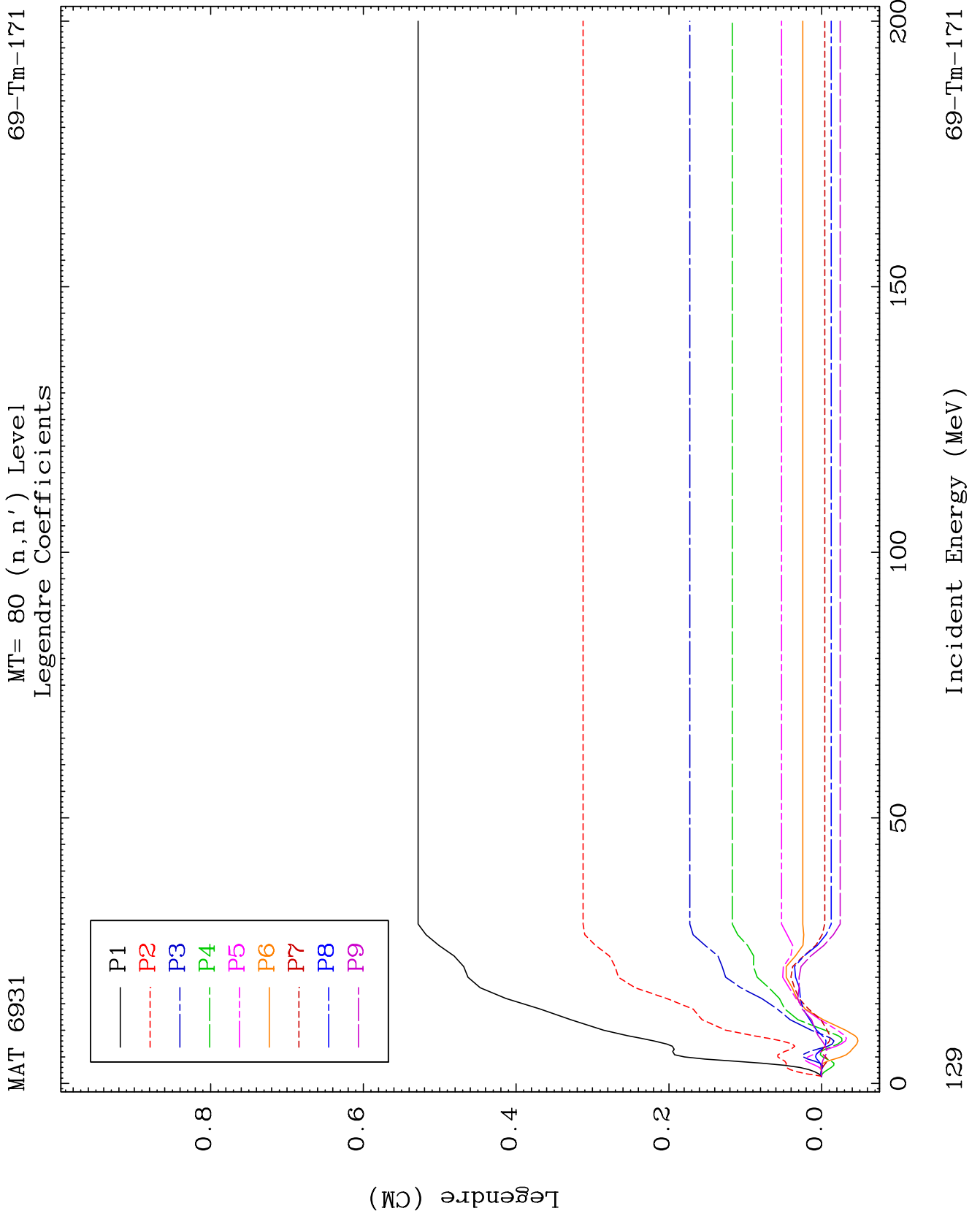

MAT 6931

MT= 80 (n,n') Level  
Legendre Coefficients

69-Tm-171

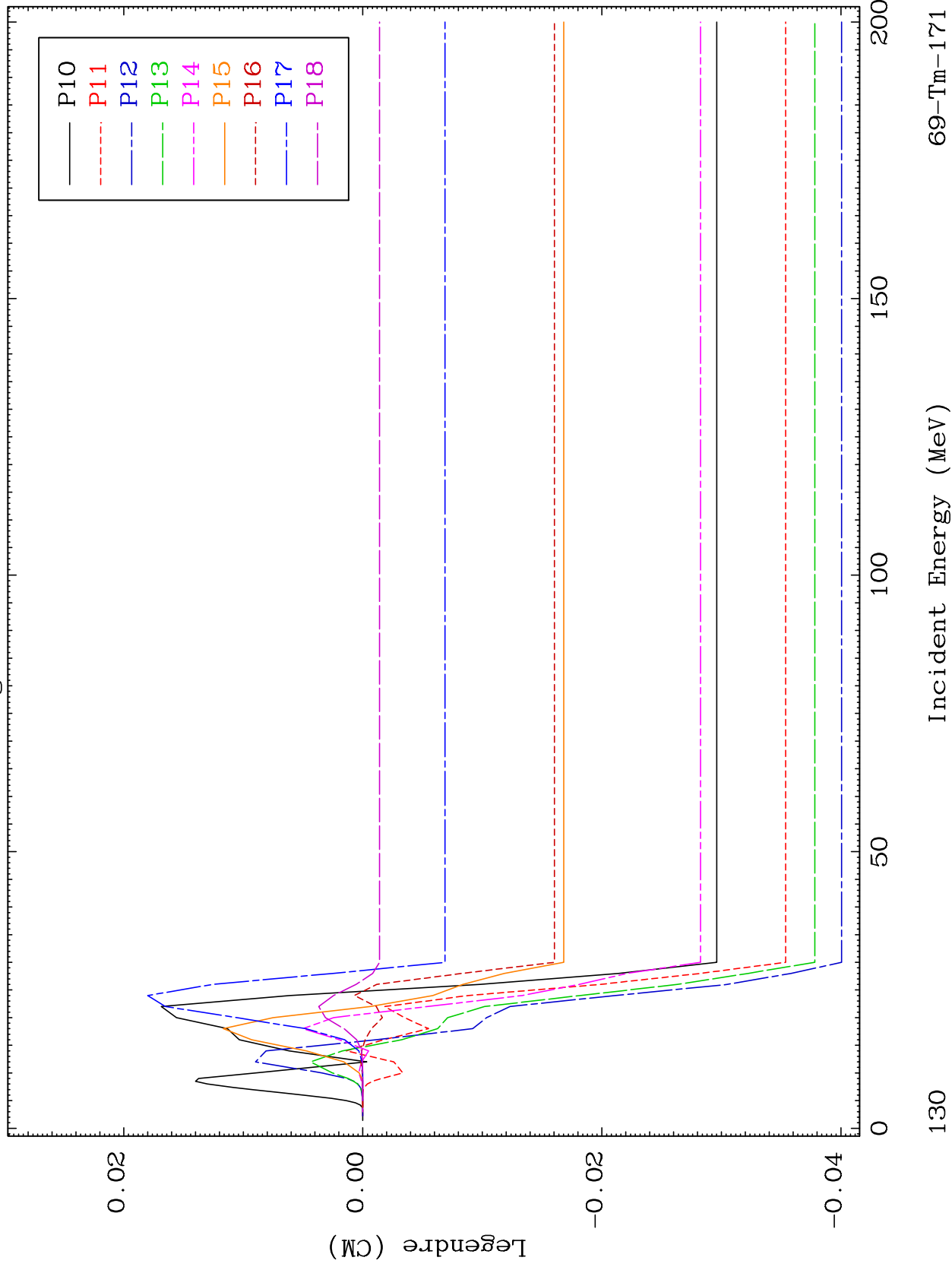

130

Incident Energy (MeV)

69-Tm-171

MAT 6931

MT= 80 (n,n') Level  
Legendre Coefficients

69-Tm-171

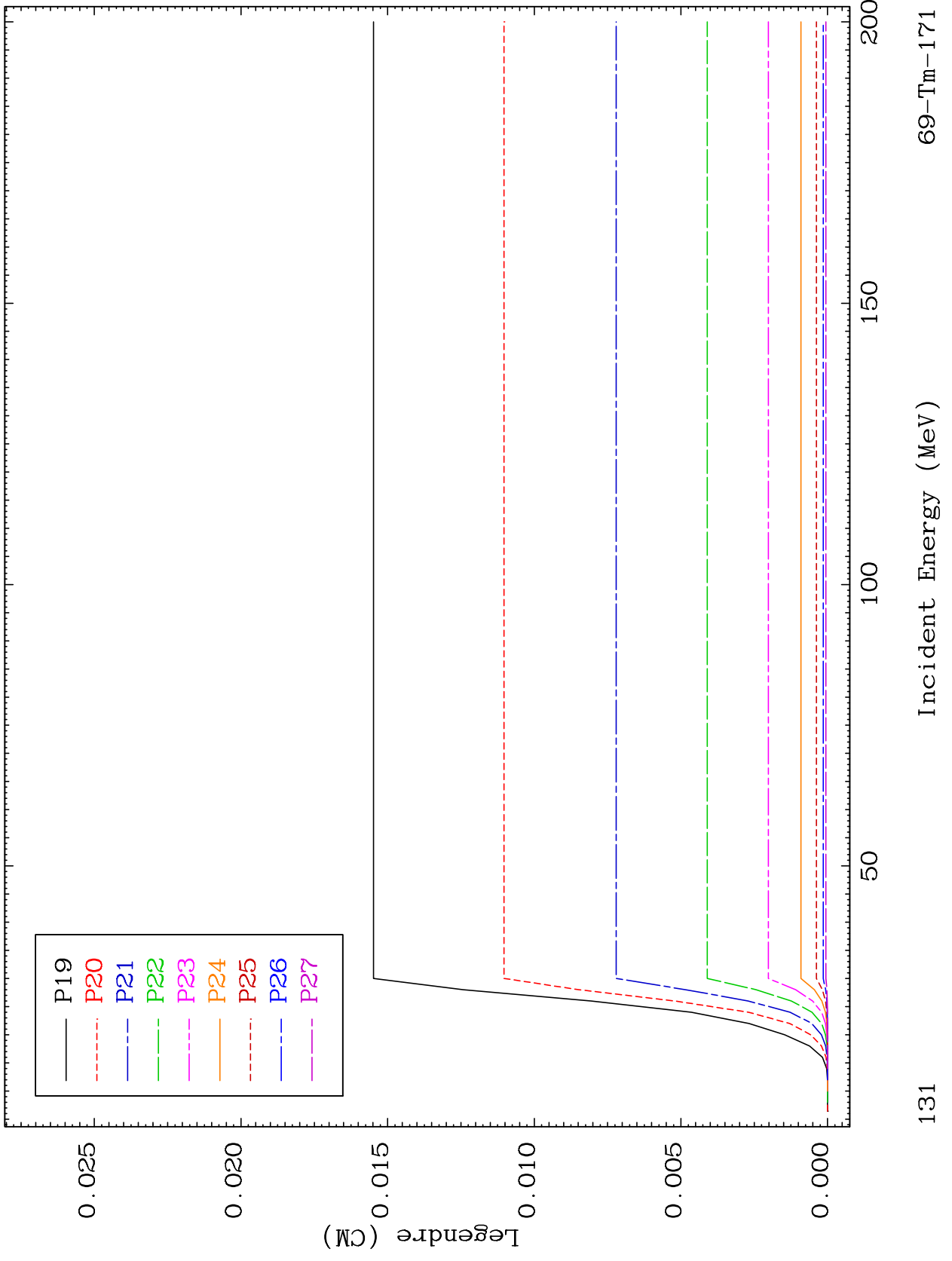

131

Incident Energy (MeV)

69-Tm-171

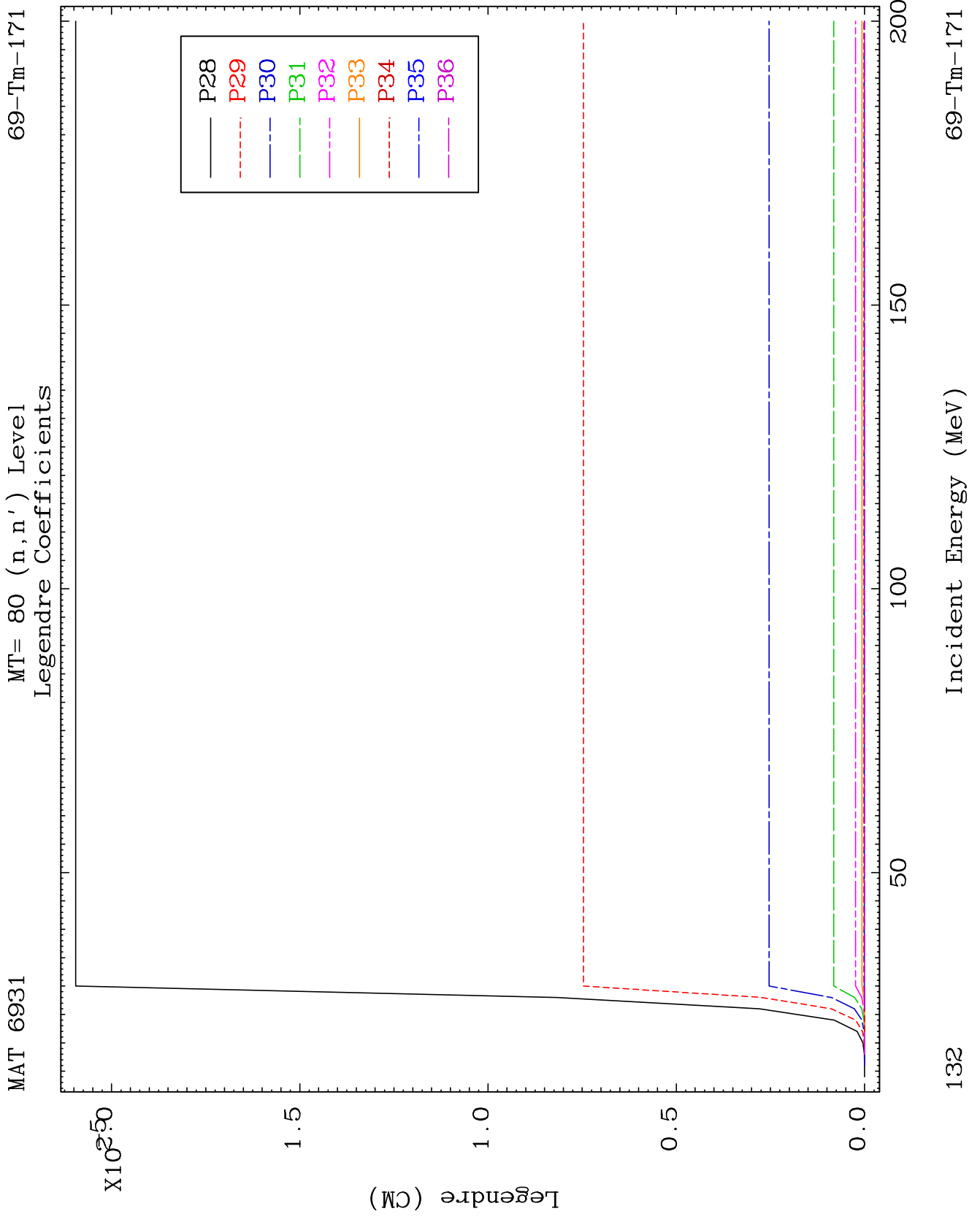

MAT 6931

$(n,2n) \alpha$

69-Tm-171

Radionuclide Production Cross Section

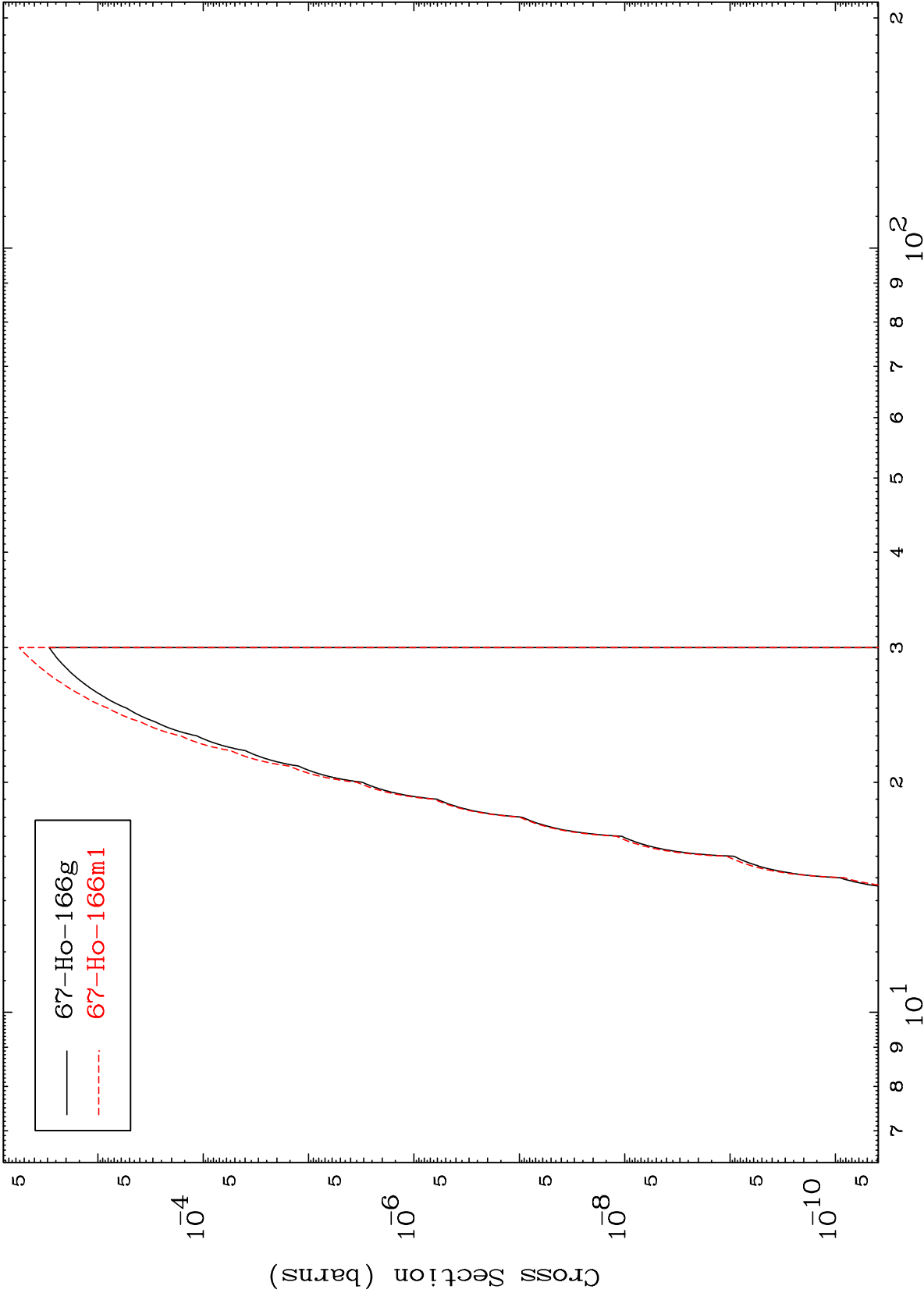

133

Incident Energy (MeV)

69-Tm-171

MAT 6931

(n,n') He-3

69-Tm-171

Radionuclide Production Cross Section

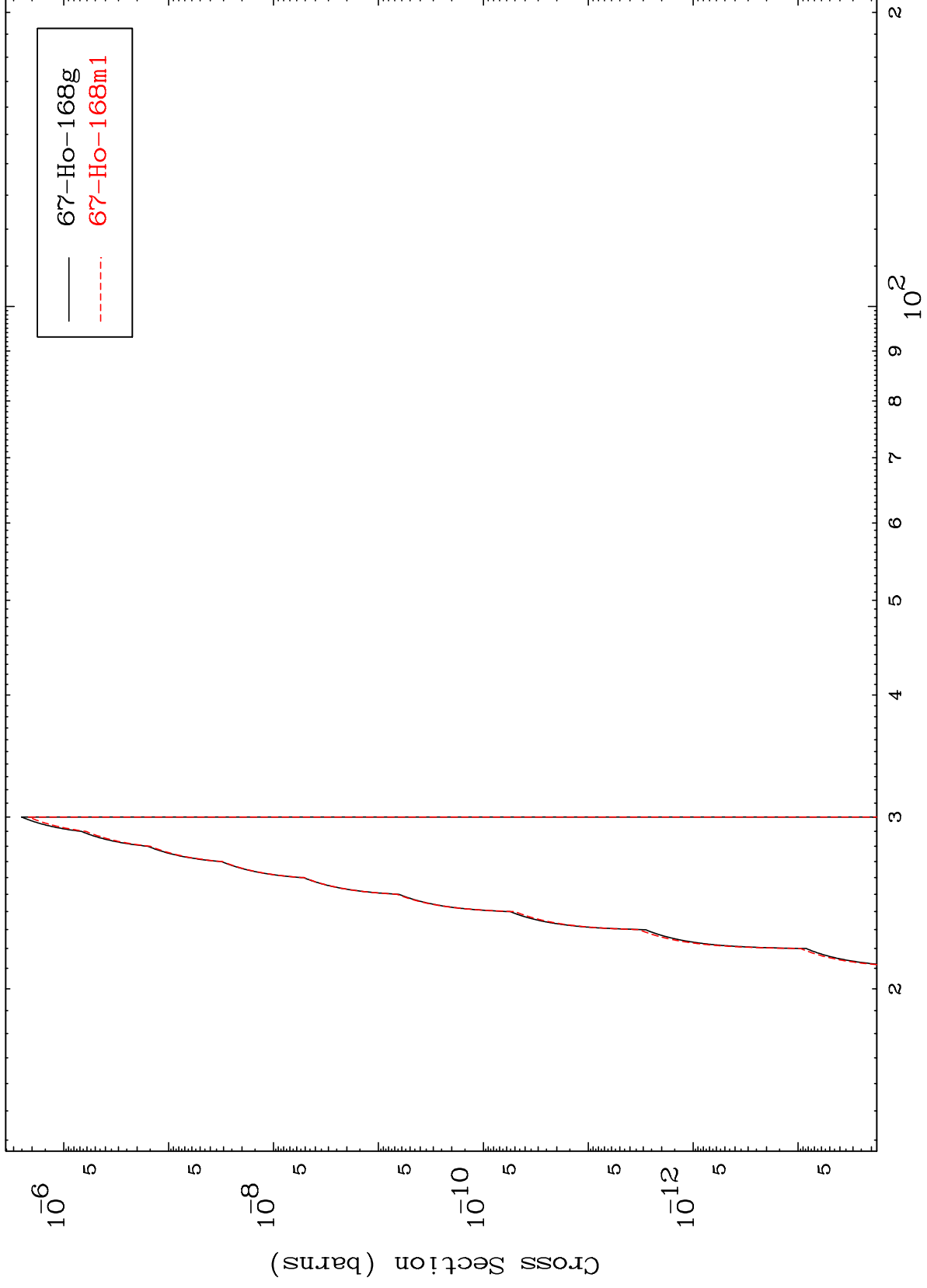

134

Incident Energy (MeV)

69-Tm-171

MAT 6931

(n,  $\alpha$ )

69-Tm-171

Radionuclide Production Cross Section

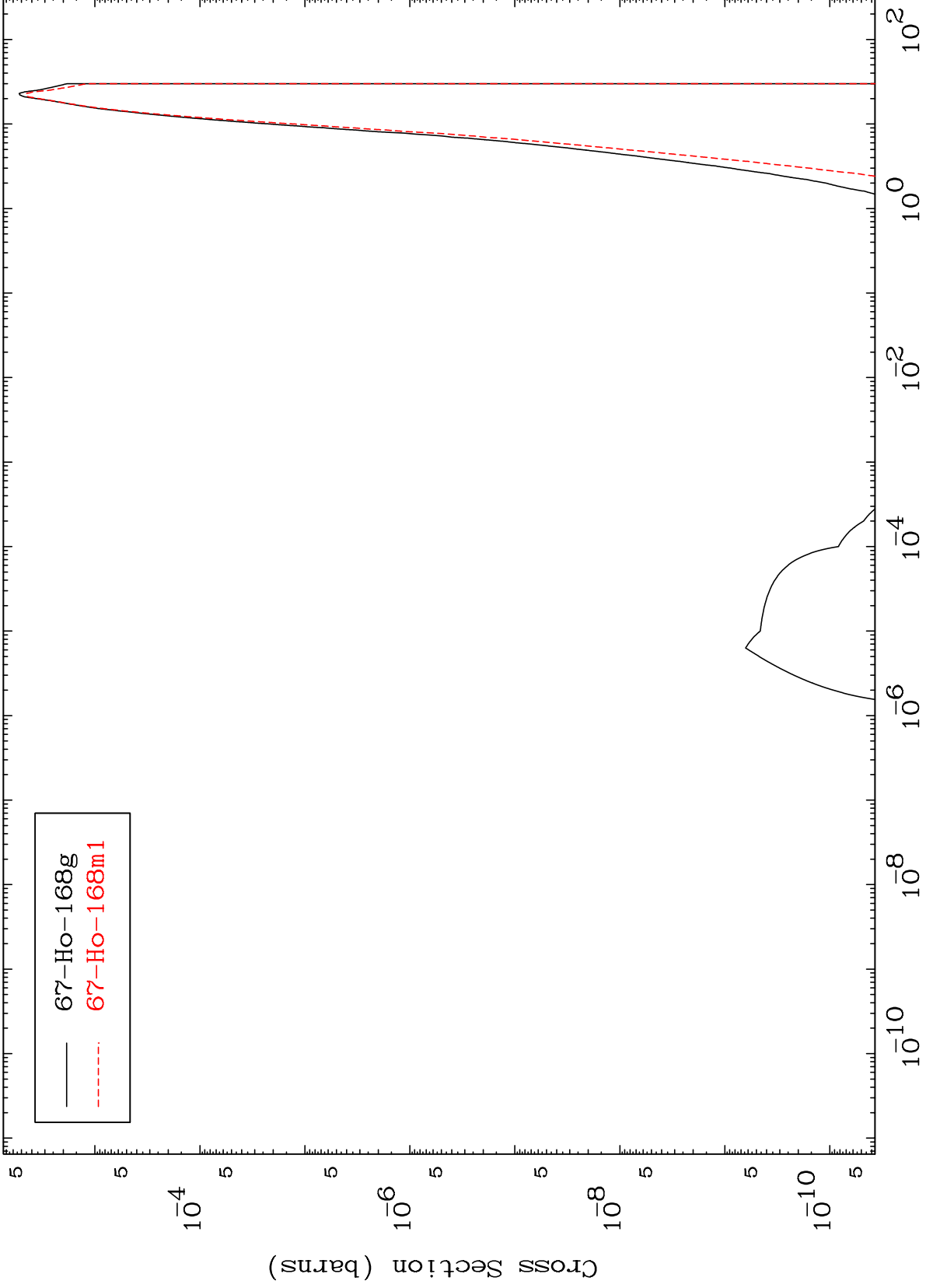

135

Incident Energy (MeV)

69-Tm-171



MAT 6931

(n,2p)

69-Tm-171

