

TM176 NEUTRON ACER TENDL-2021 LIBRARY; T=293.6K
Principal cross sections

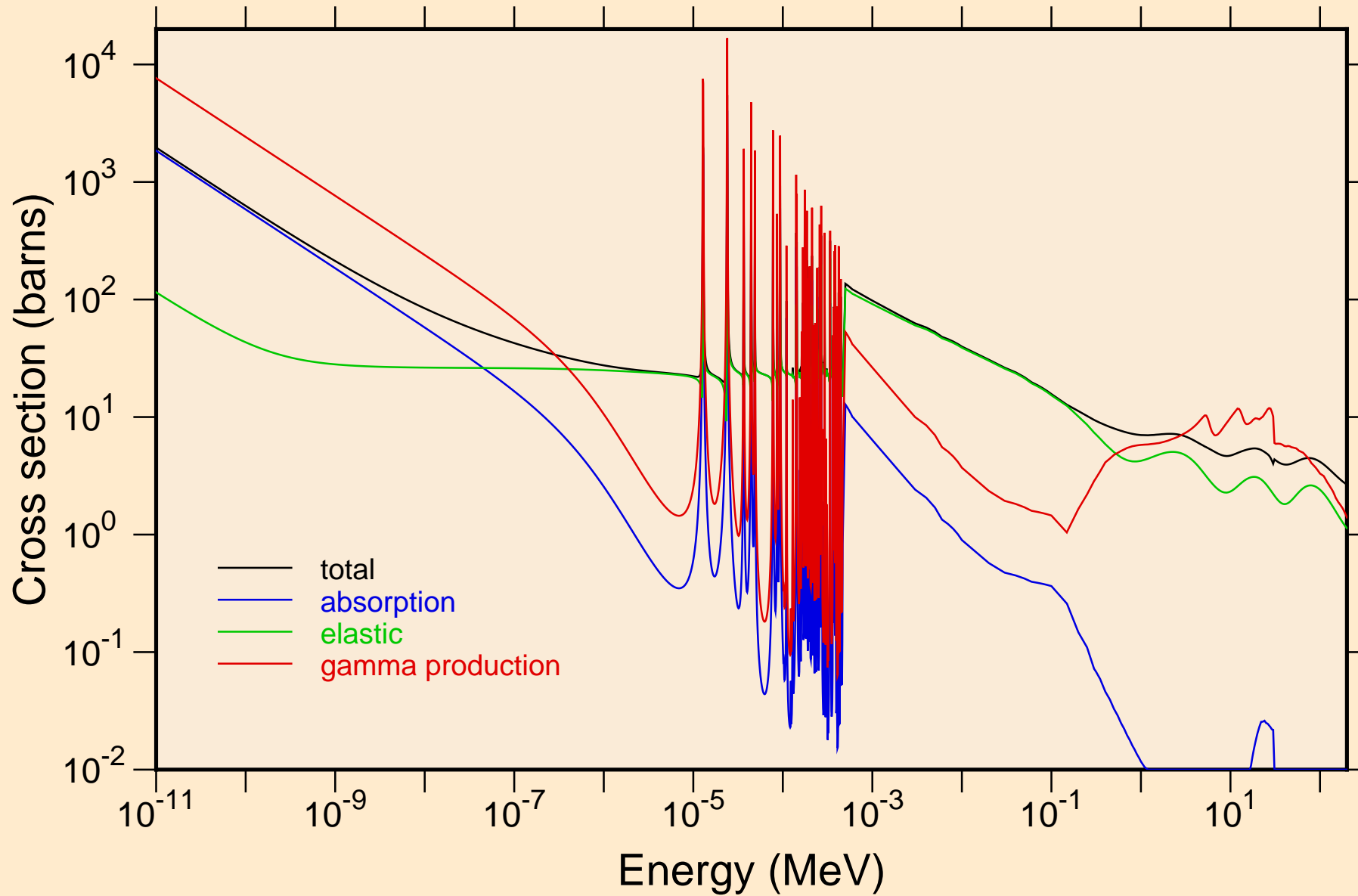

TM176 NEUTRON ACER TENDL-2021 LIBRARY; T=293.6K
resonance total cross section

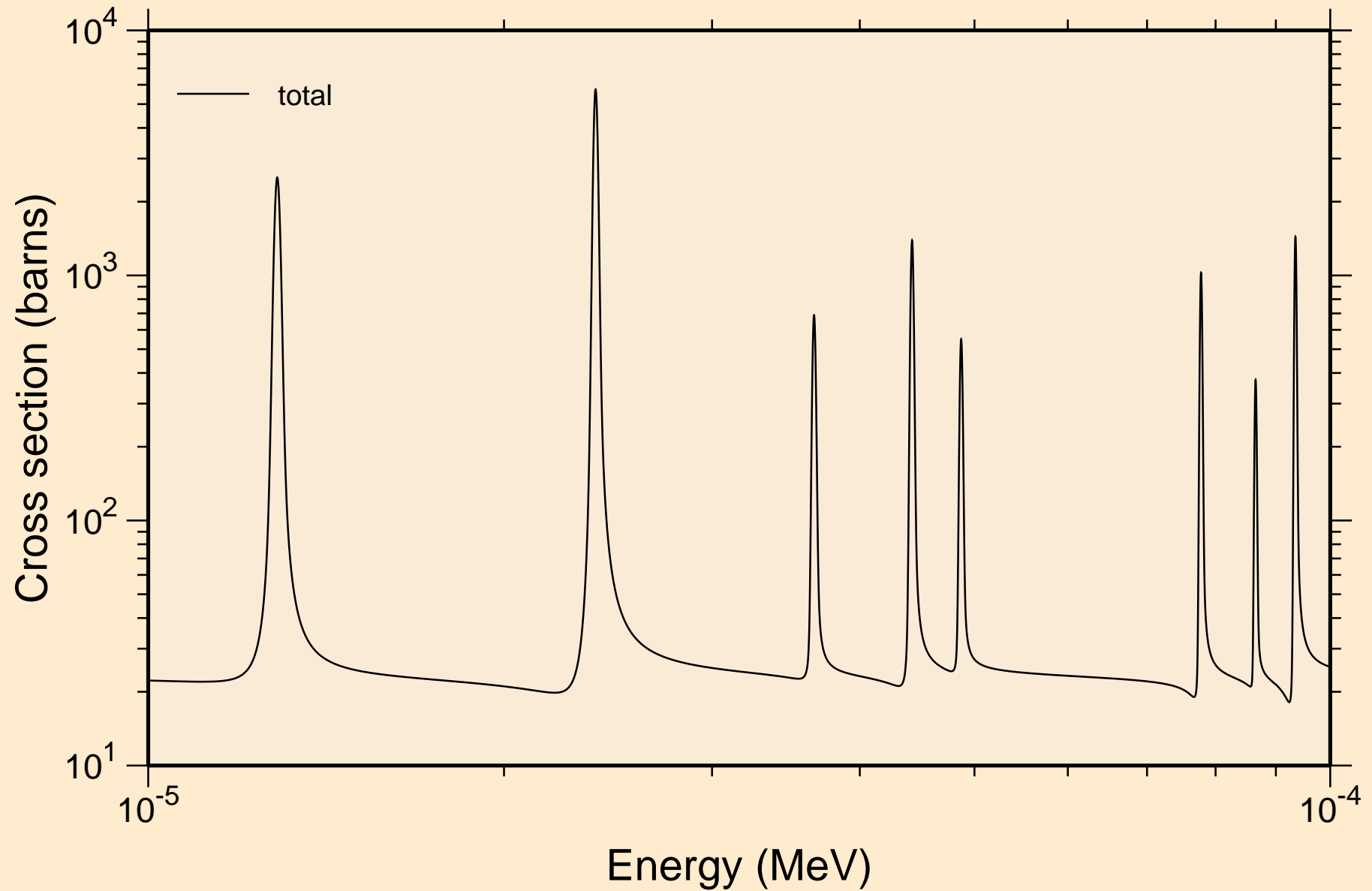

TM176 NEUTRON ACER TENDL-2021 LIBRARY; T=293.6K
resonance total cross section

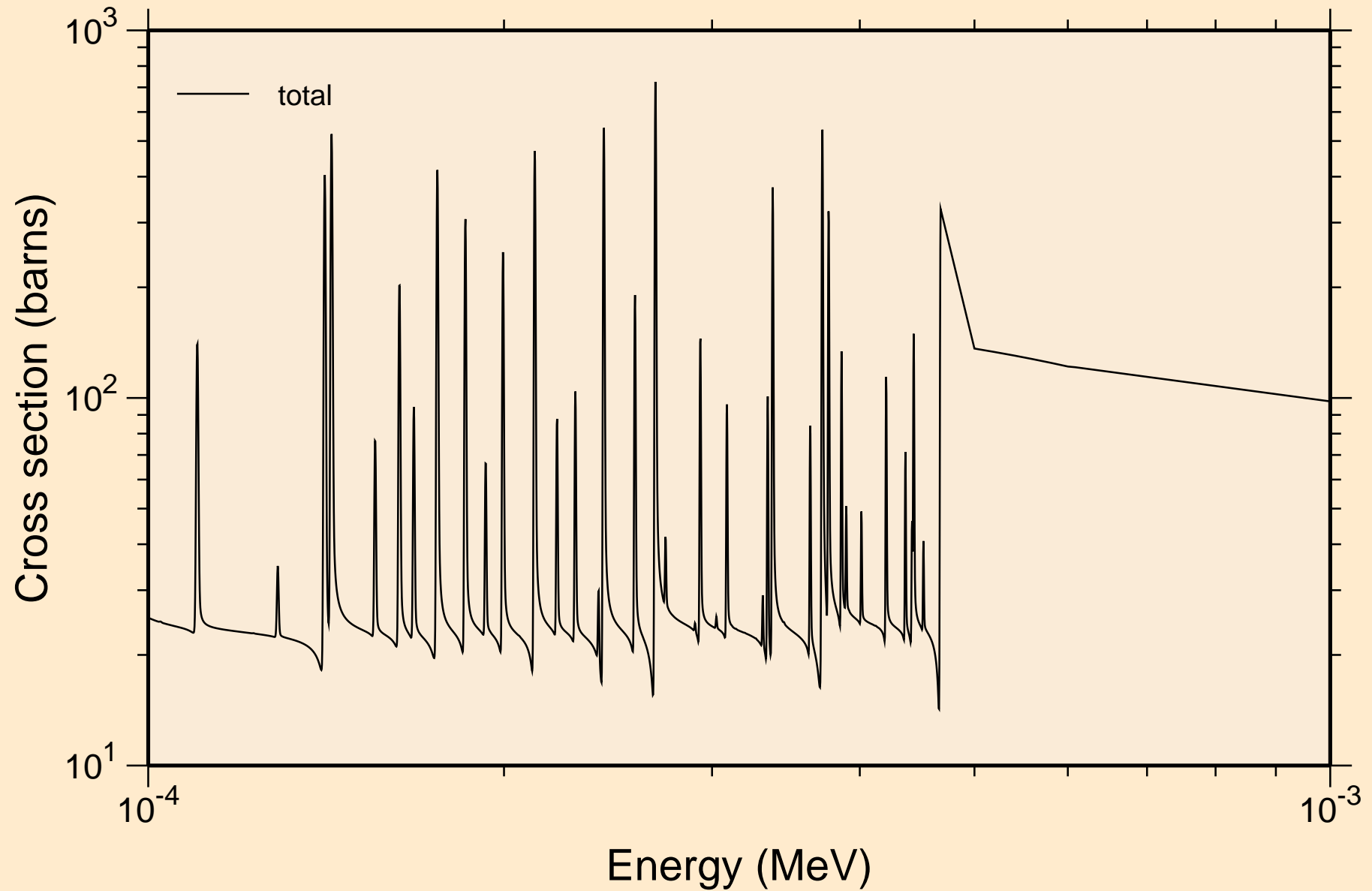

TM176 NEUTRON ACER TENDL-2021 LIBRARY; T=293.6K
resonance total cross section

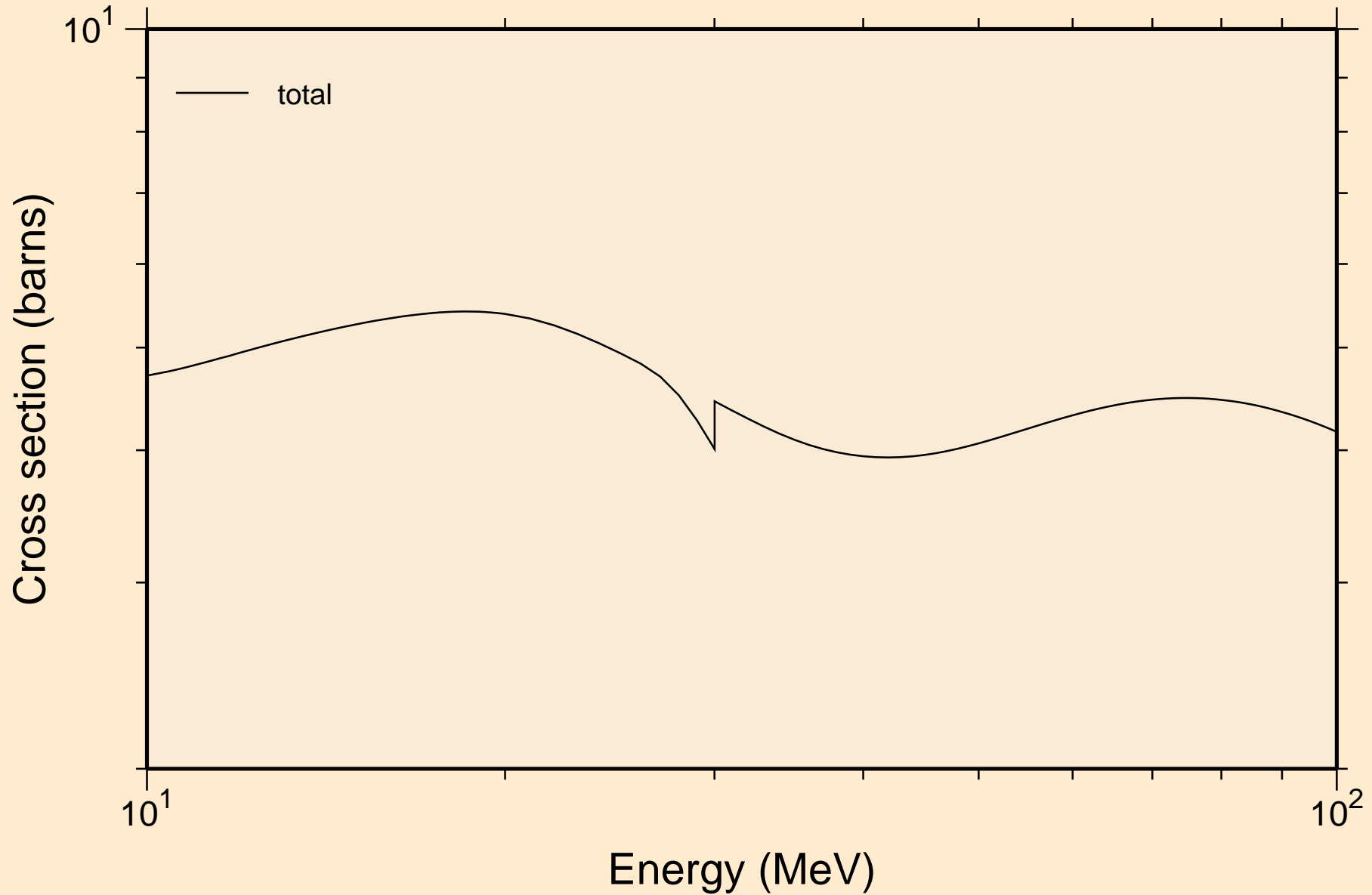

TM176 NEUTRON ACER TENDL-2021 LIBRARY; T=293.6K
resonance absorption cross sections

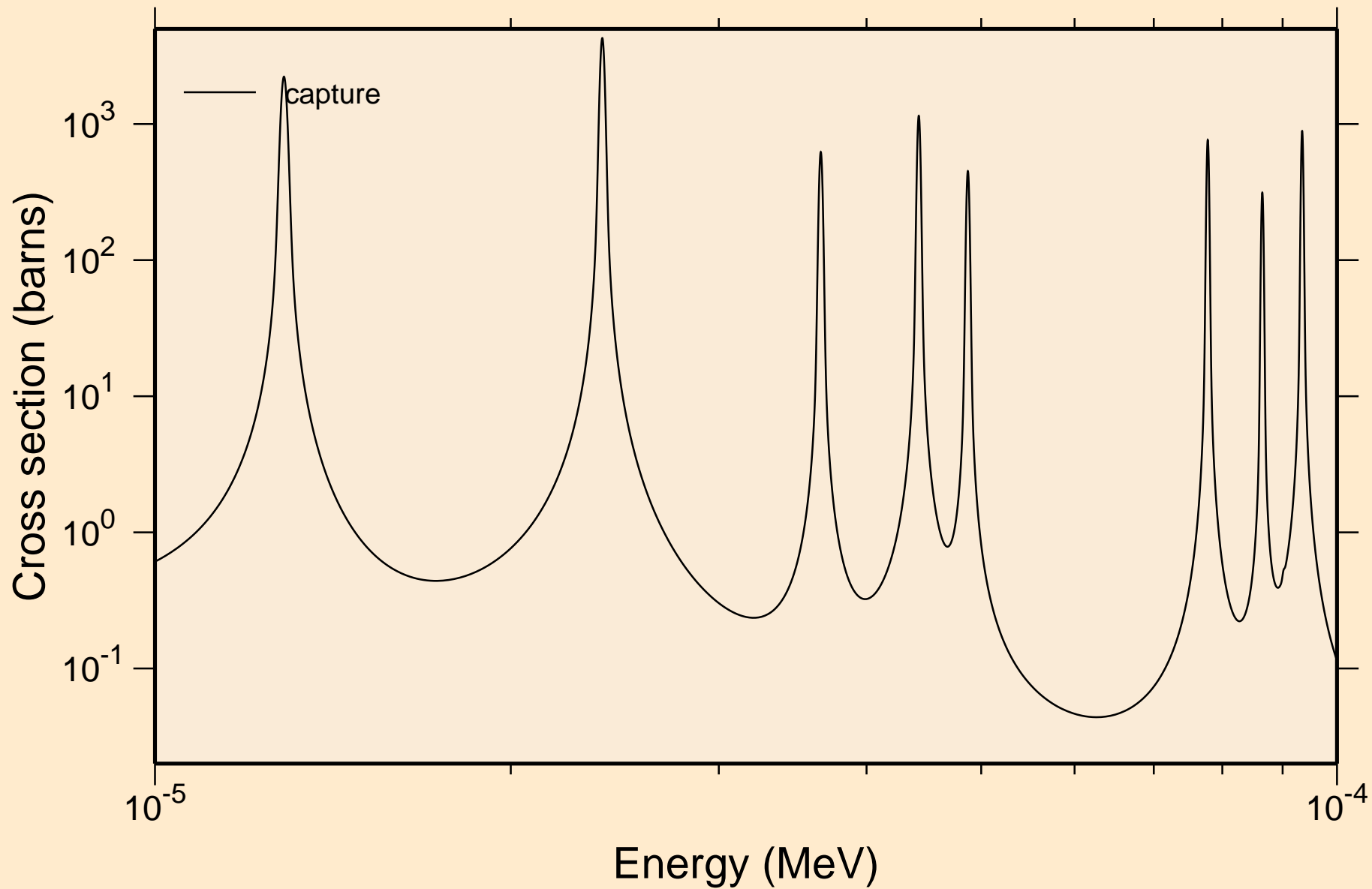

TM176 NEUTRON ACER TENDL-2021 LIBRARY; T=293.6K
resonance absorption cross sections

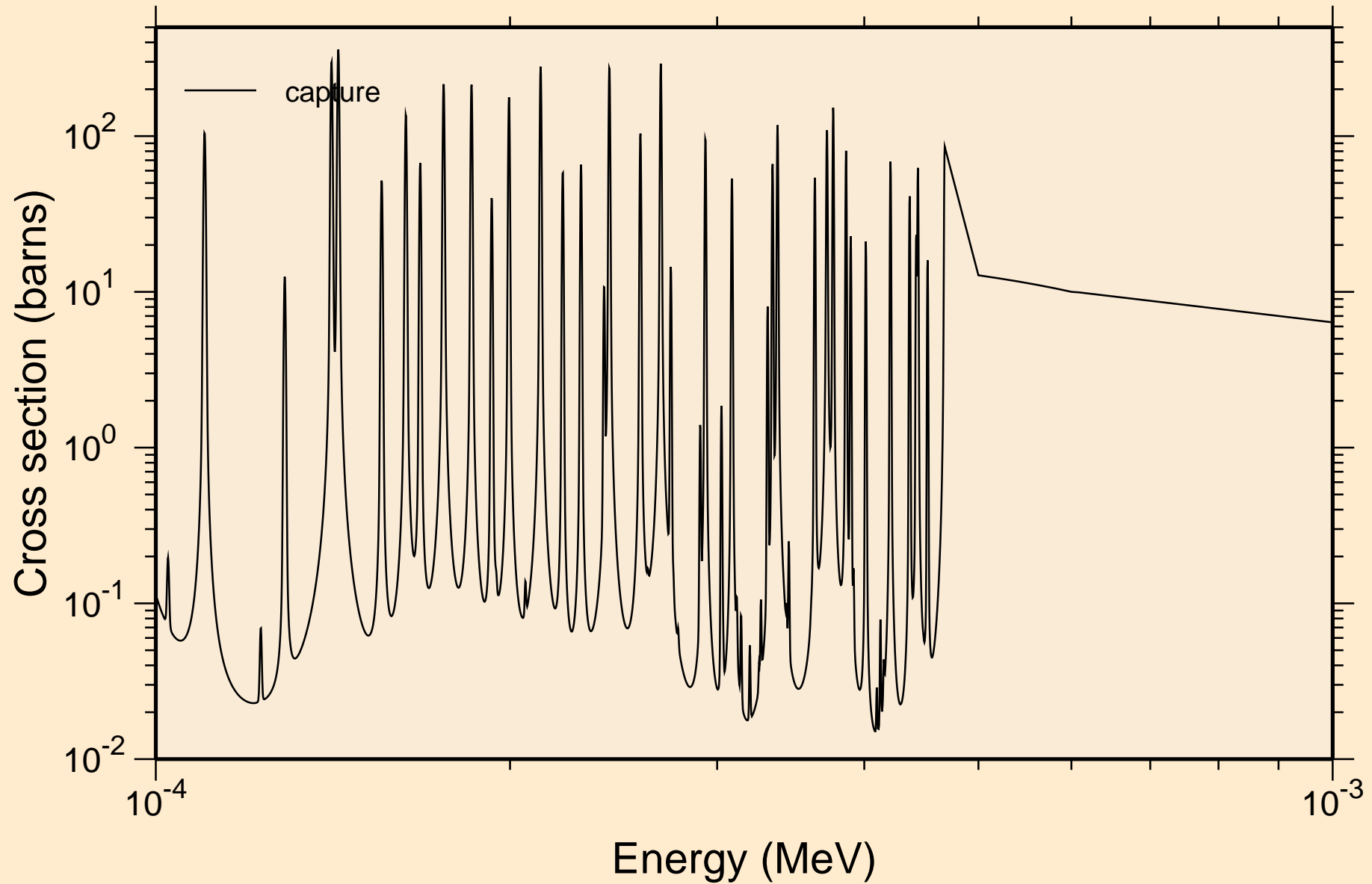

TM176 NEUTRON ACER TENDL-2021 LIBRARY; T=293.6K
resonance absorption cross sections

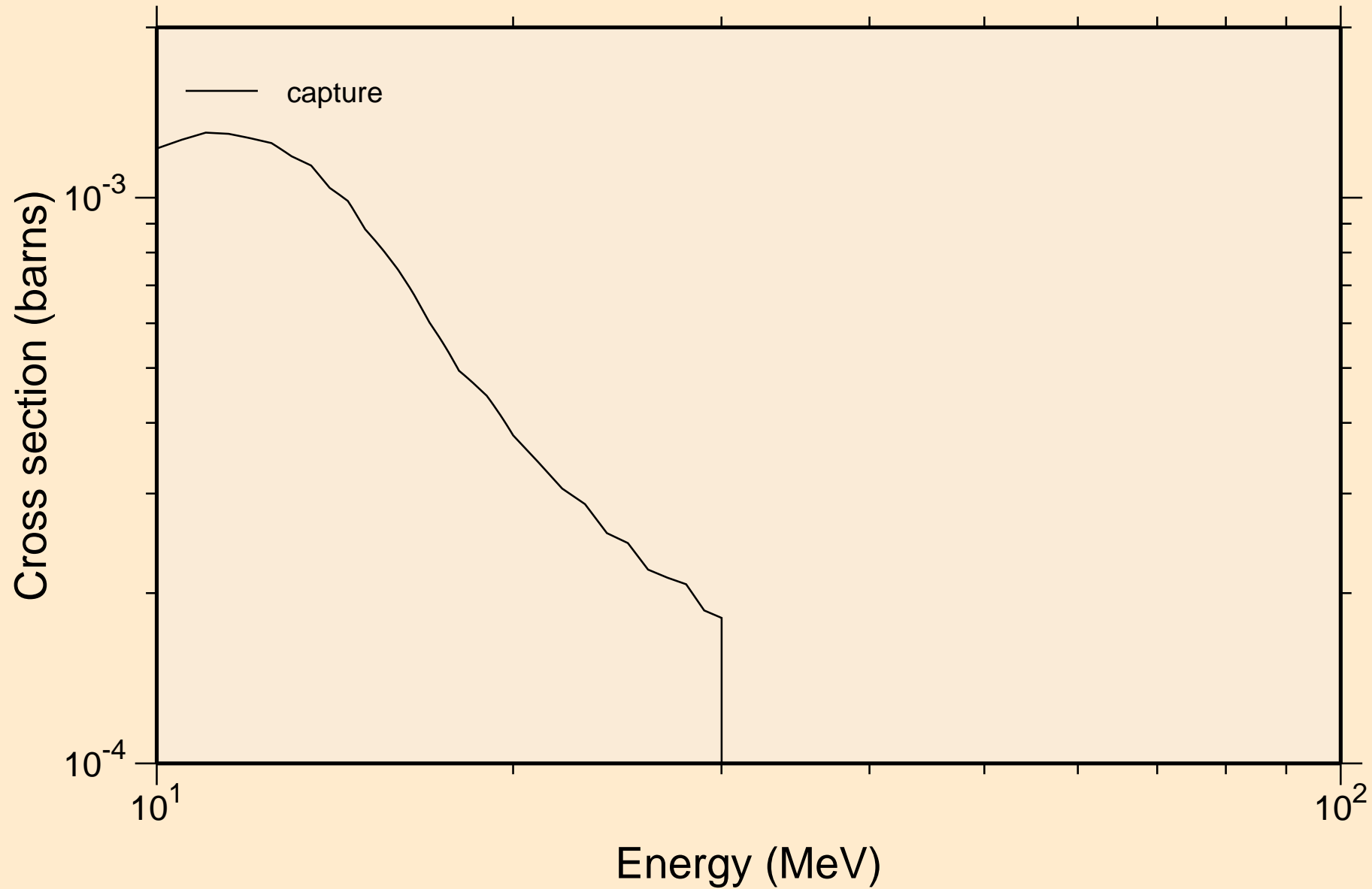

TM176 NEUTRON ACER TENDL-2021 LIBRARY; T=293.6K
Heating

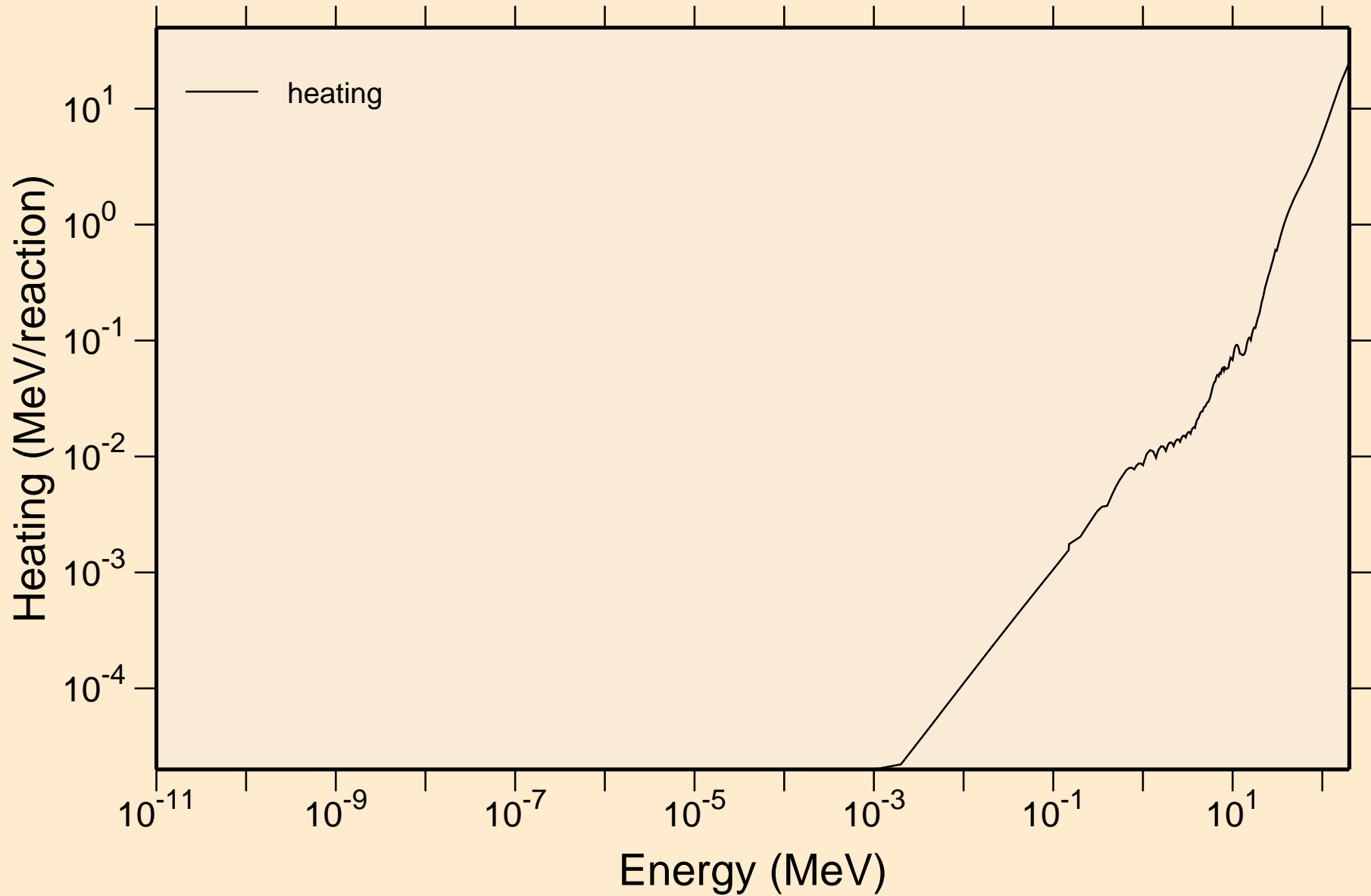

TM176 NEUTRON ACER TENDL-2021 LIBRARY; T=293.6K
Damage

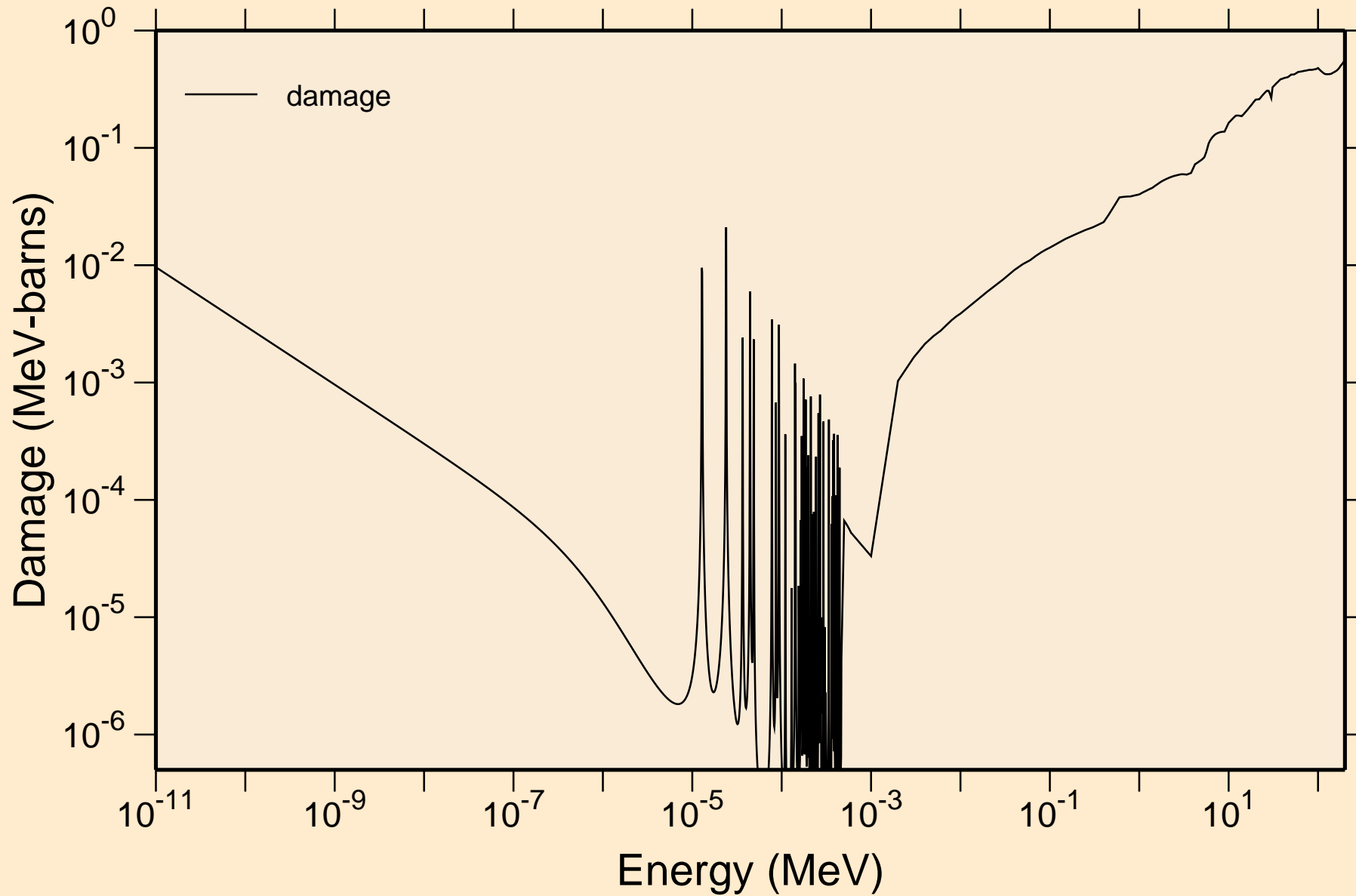

TM176 NEUTRON ACER TENDL-2021 LIBRARY; T=293.6K
Non-threshold reactions

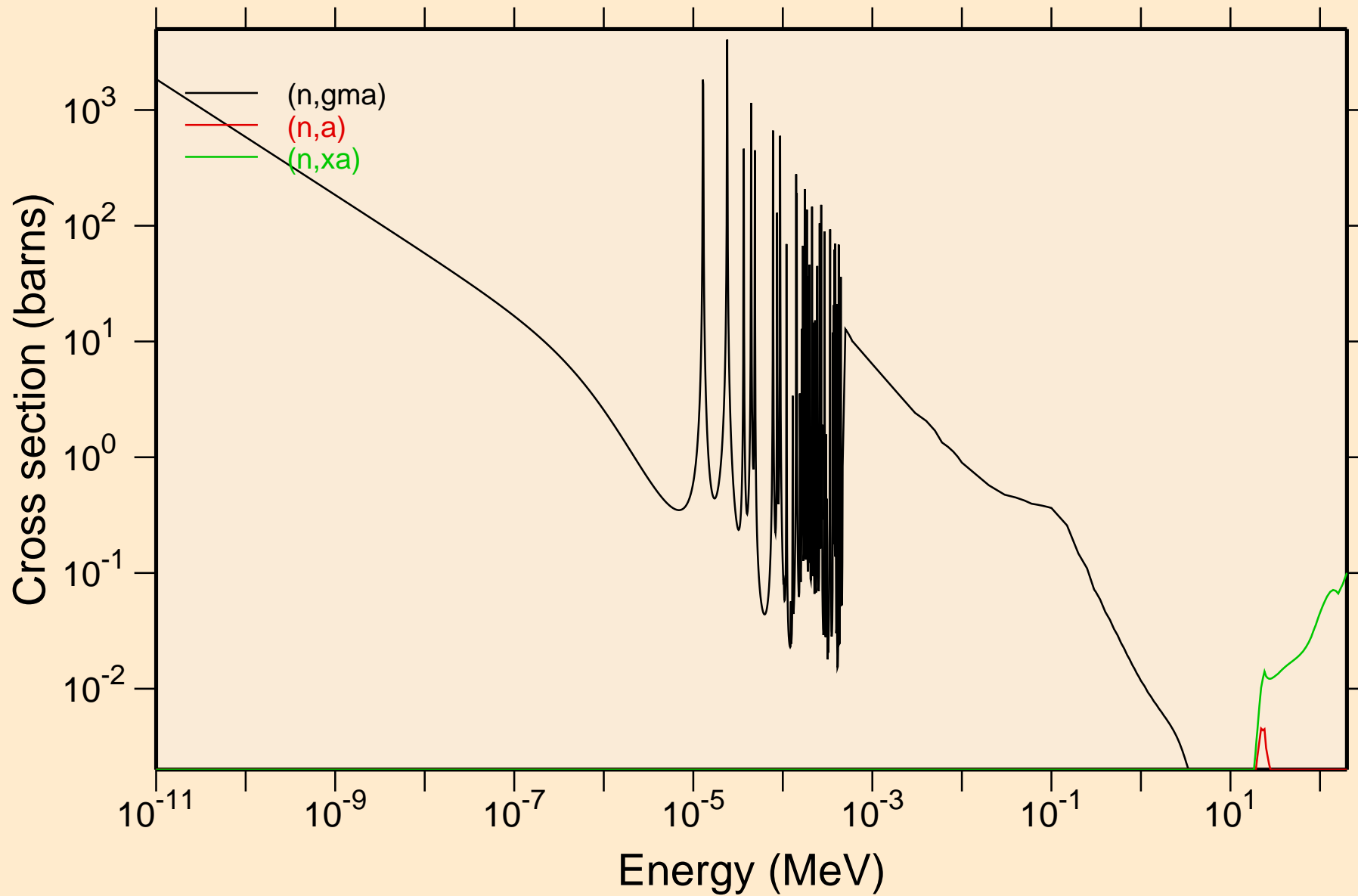

TM176 NEUTRON ACER TENDL-2021 LIBRARY; T=293.6K

Principal cross sections

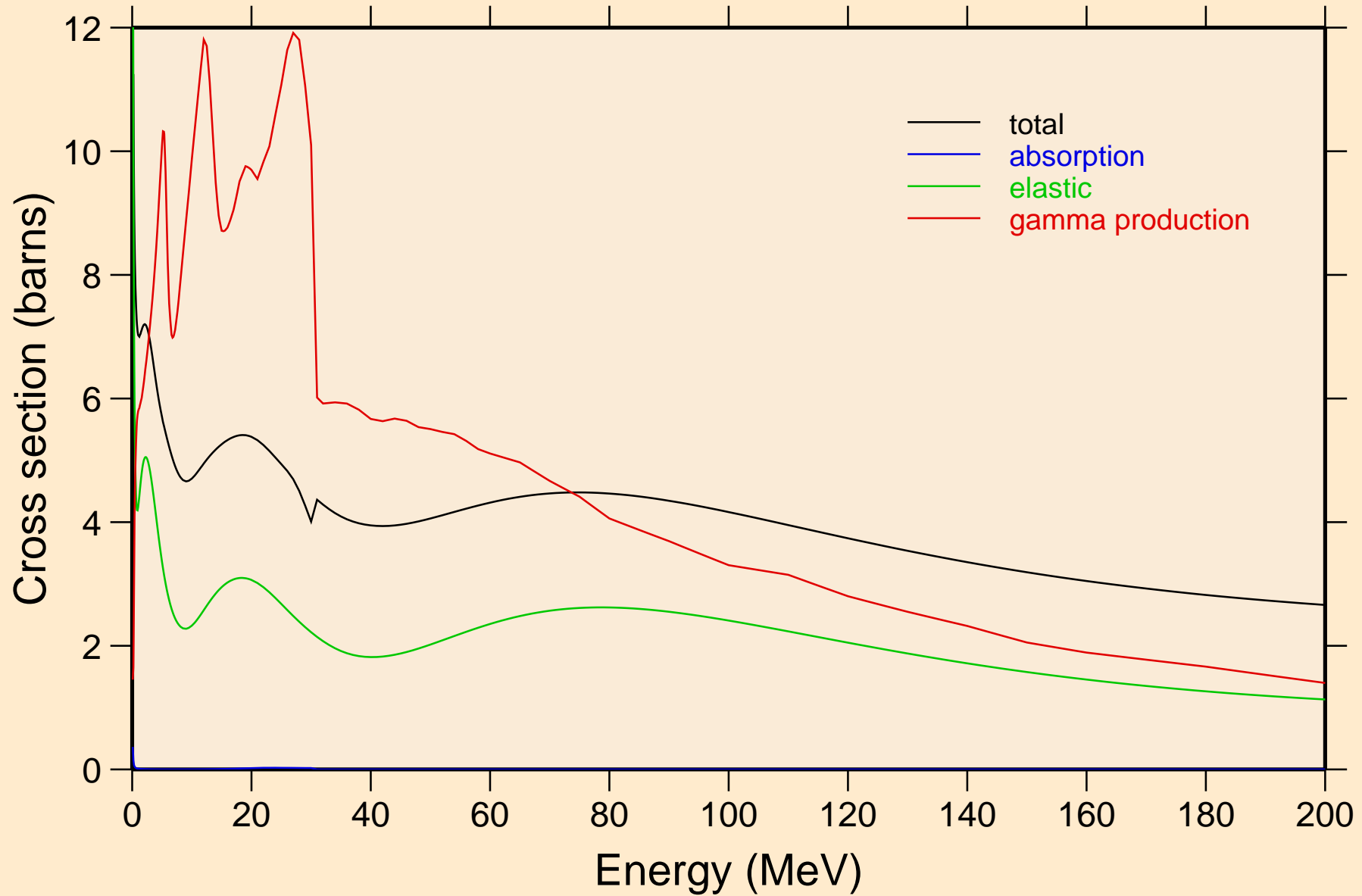

TM176 NEUTRON ACER TENDL-2021 LIBRARY; T=293.6K
Heating

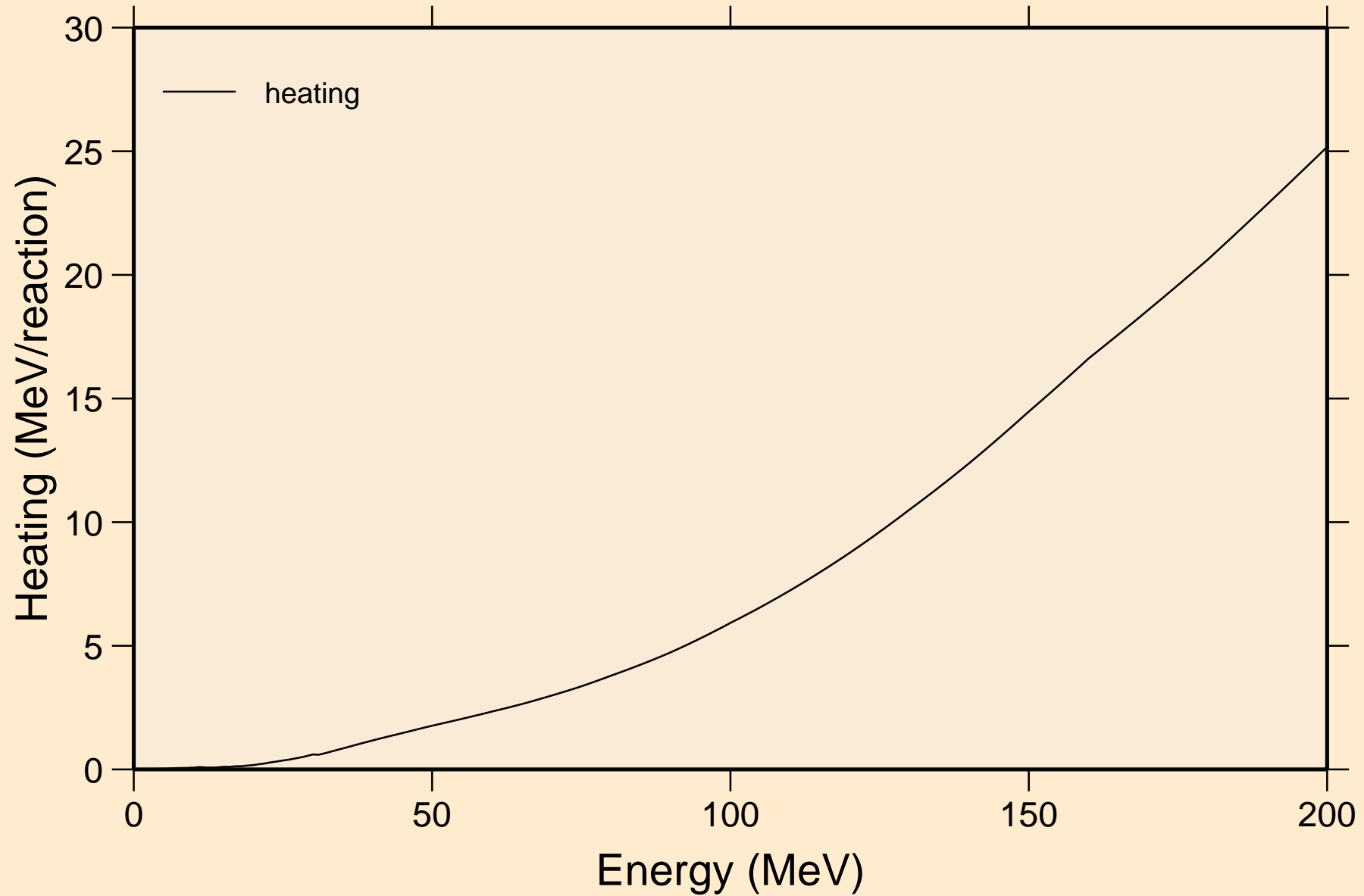

TM176 NEUTRON ACER TENDL-2021 LIBRARY; T=293.6K
Damage

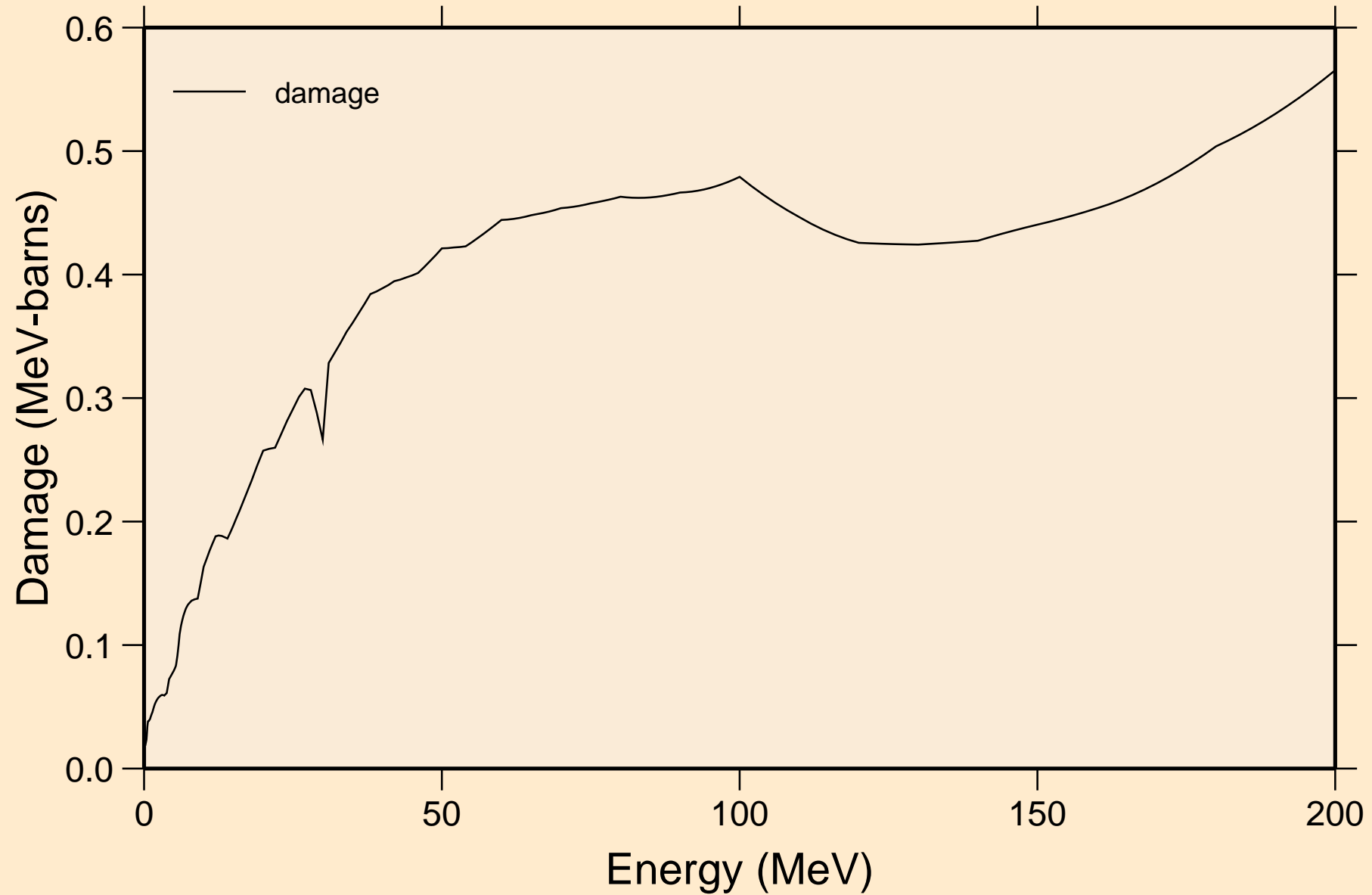

TM176 NEUTRON ACER TENDL-2021 LIBRARY; T=293.6K
Non-threshold reactions

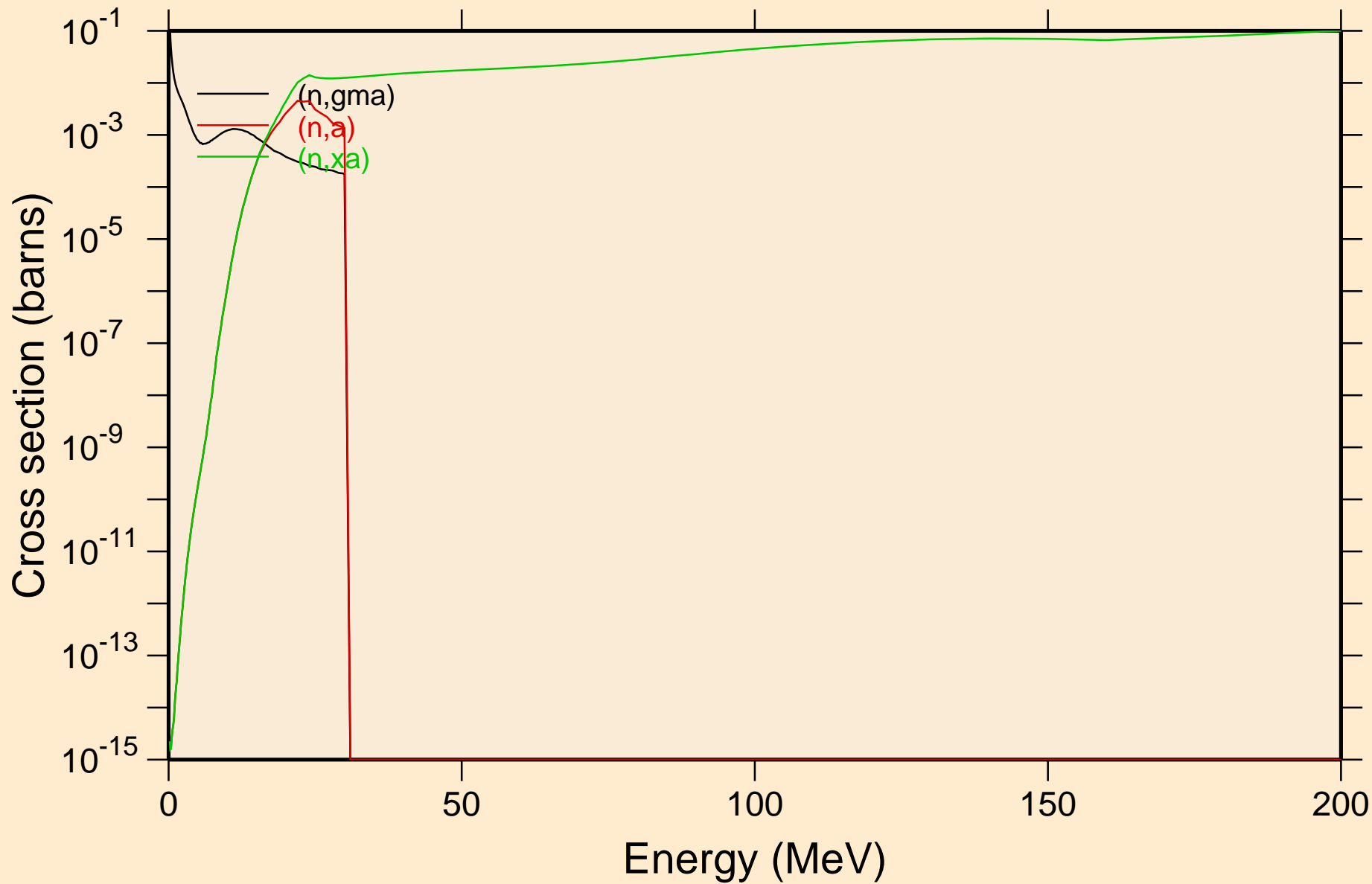

TM176 NEUTRON ACER TENDL-2021 LIBRARY; T=293.6K
Inelastic levels

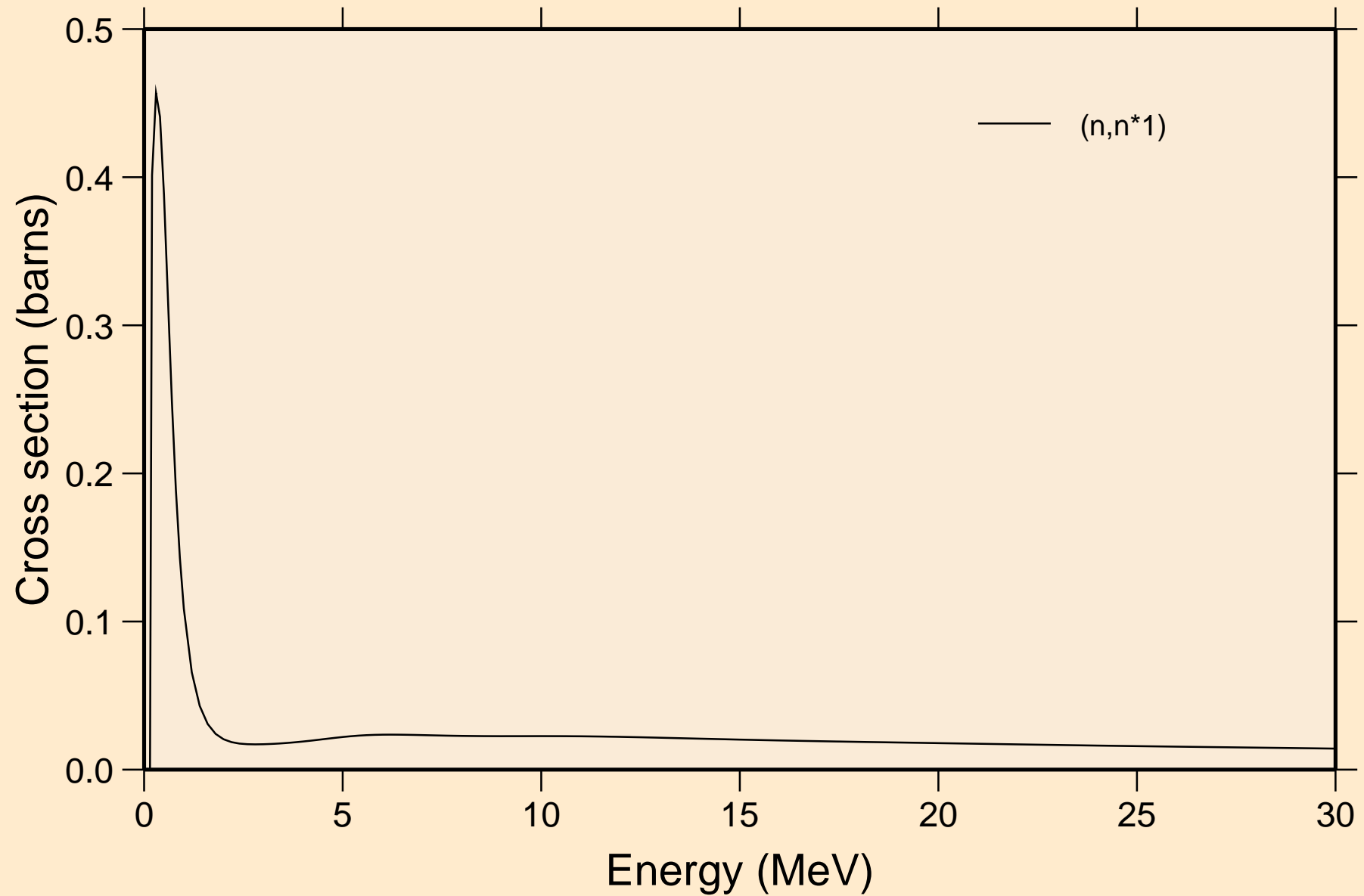

TM176 NEUTRON ACER TENDL-2021 LIBRARY; T=293.6K
Threshold reactions

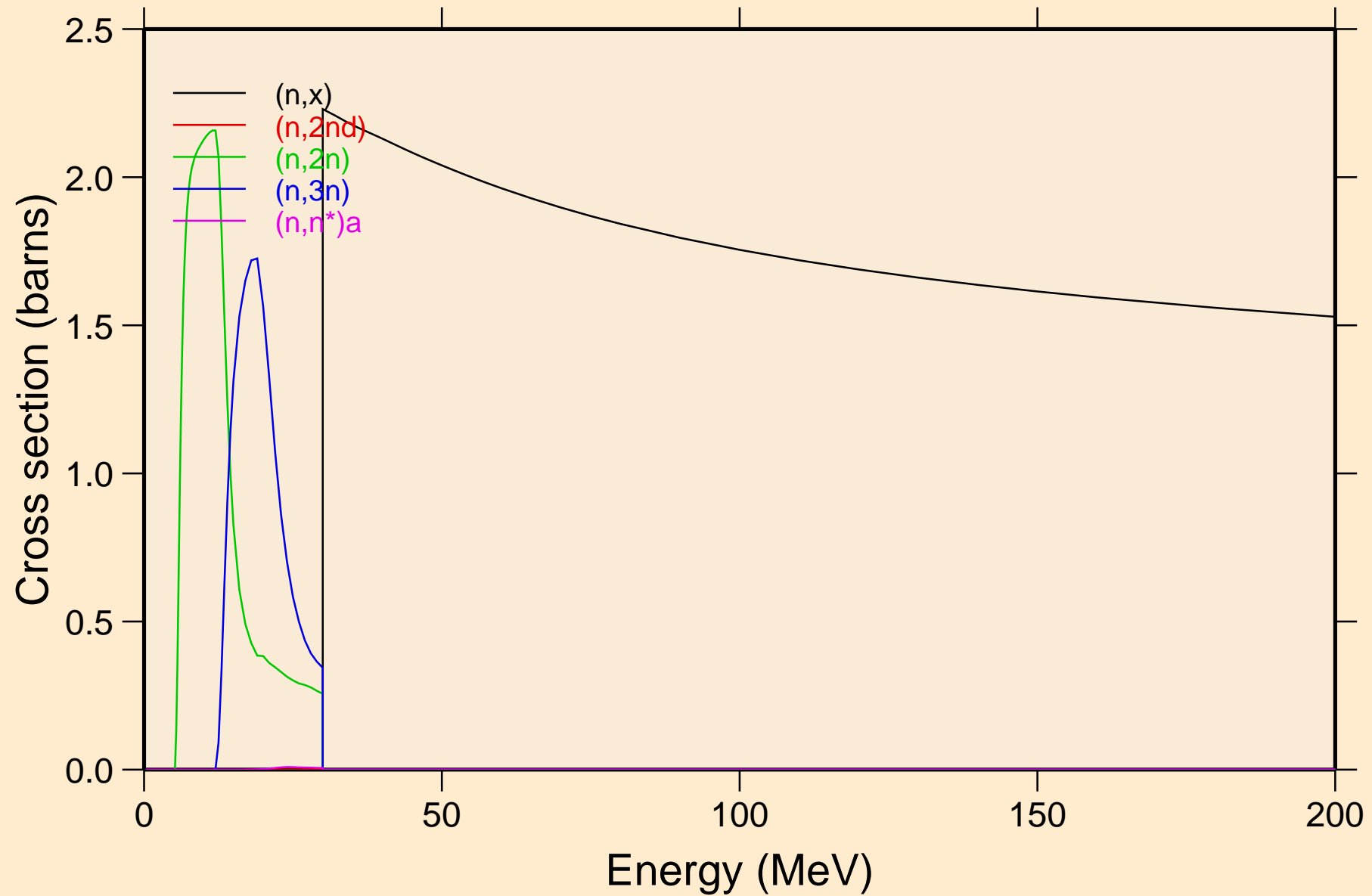

TM176 NEUTRON ACER TENDL-2021 LIBRARY; T=293.6K
Threshold reactions

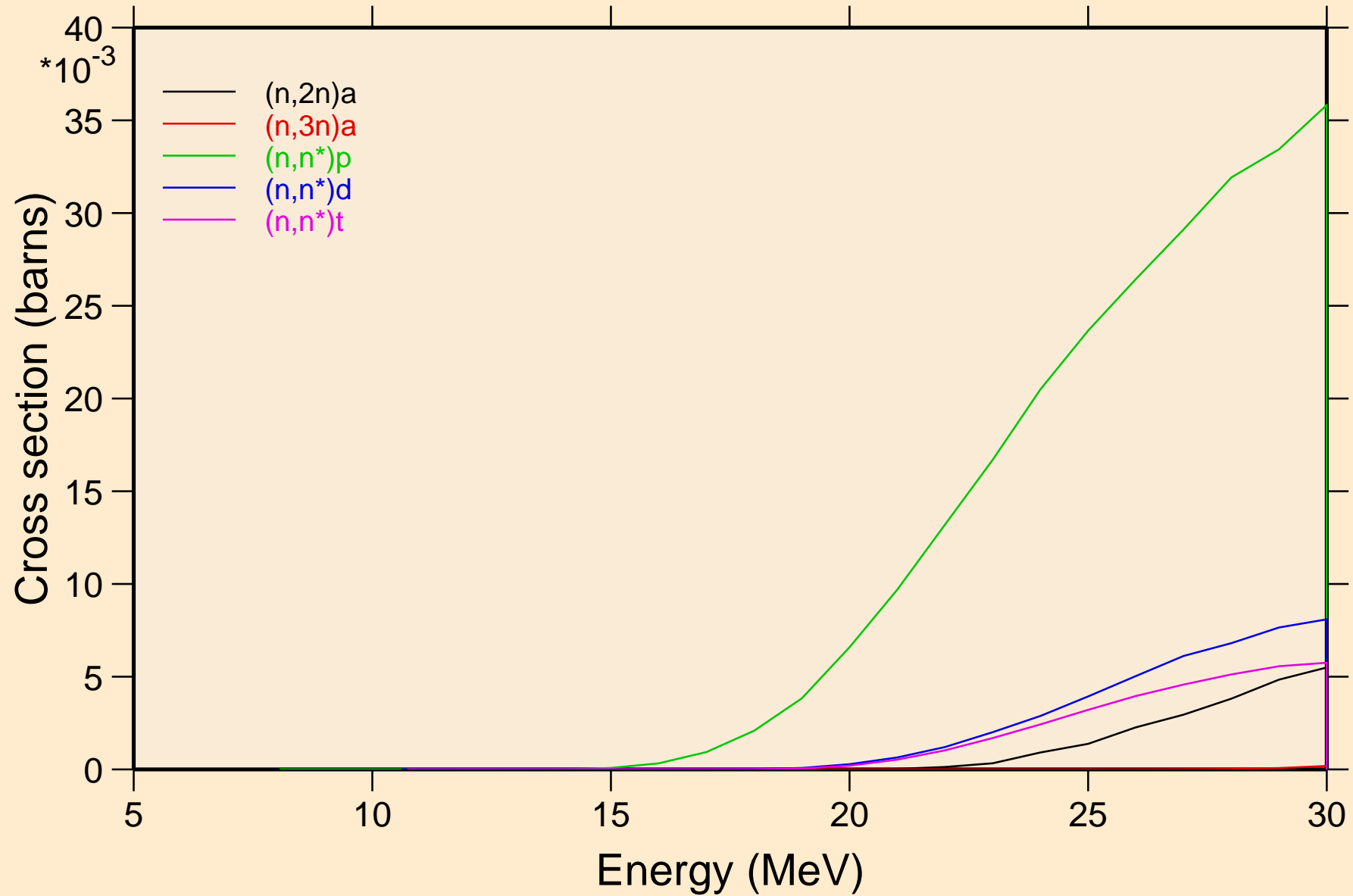

TM176 NEUTRON ACER TENDL-2021 LIBRARY; T=293.6K
Threshold reactions

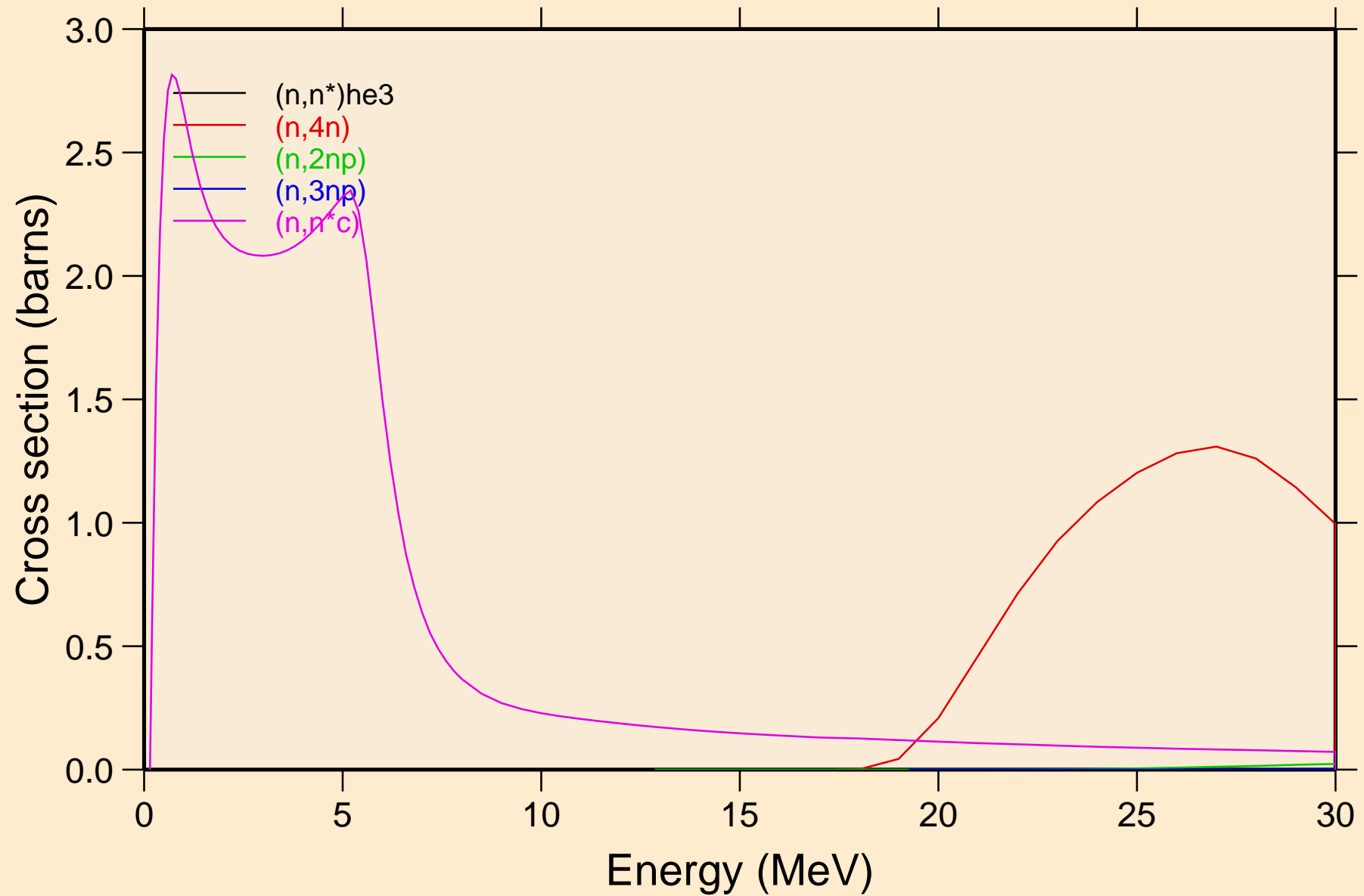

TM176 NEUTRON ACER TENDL-2021 LIBRARY; T=293.6K
Threshold reactions

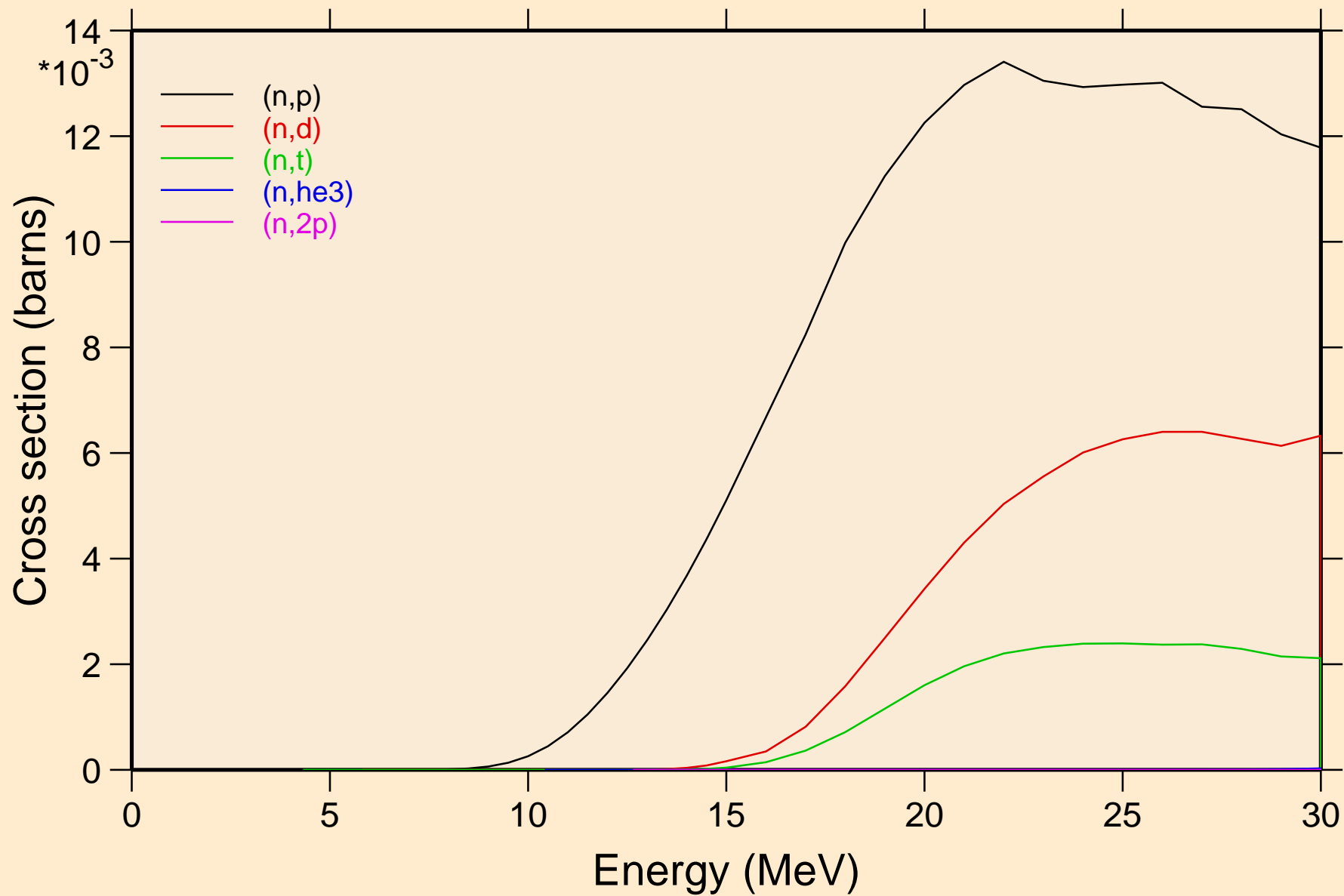

TM176 NEUTRON ACER TENDL-2021 LIBRARY; T=293.6K
Threshold reactions

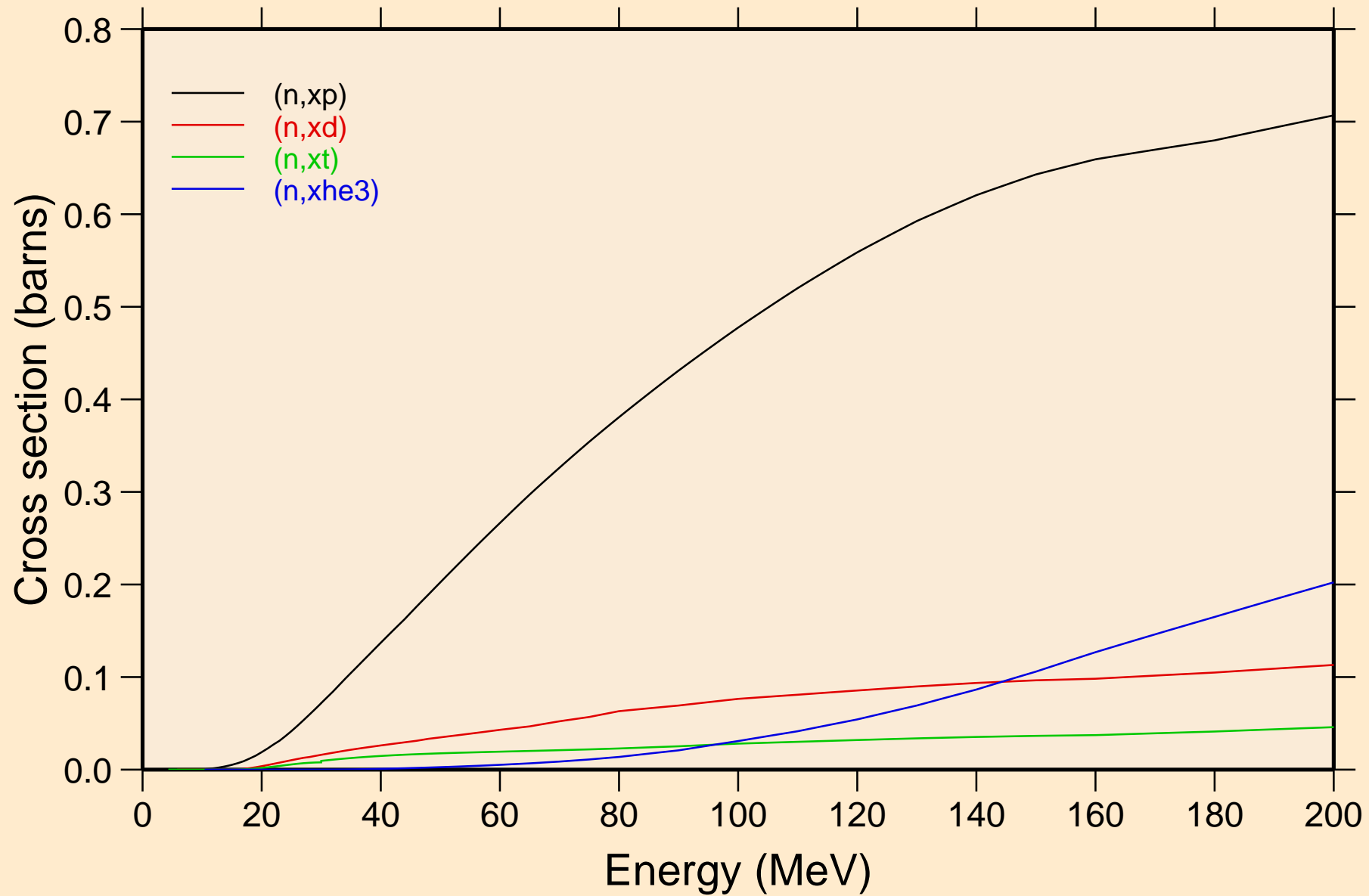

TM176 NEUTRON ACER TENDL-2021 LIBRARY; T=293.6K
angular distribution for elastic

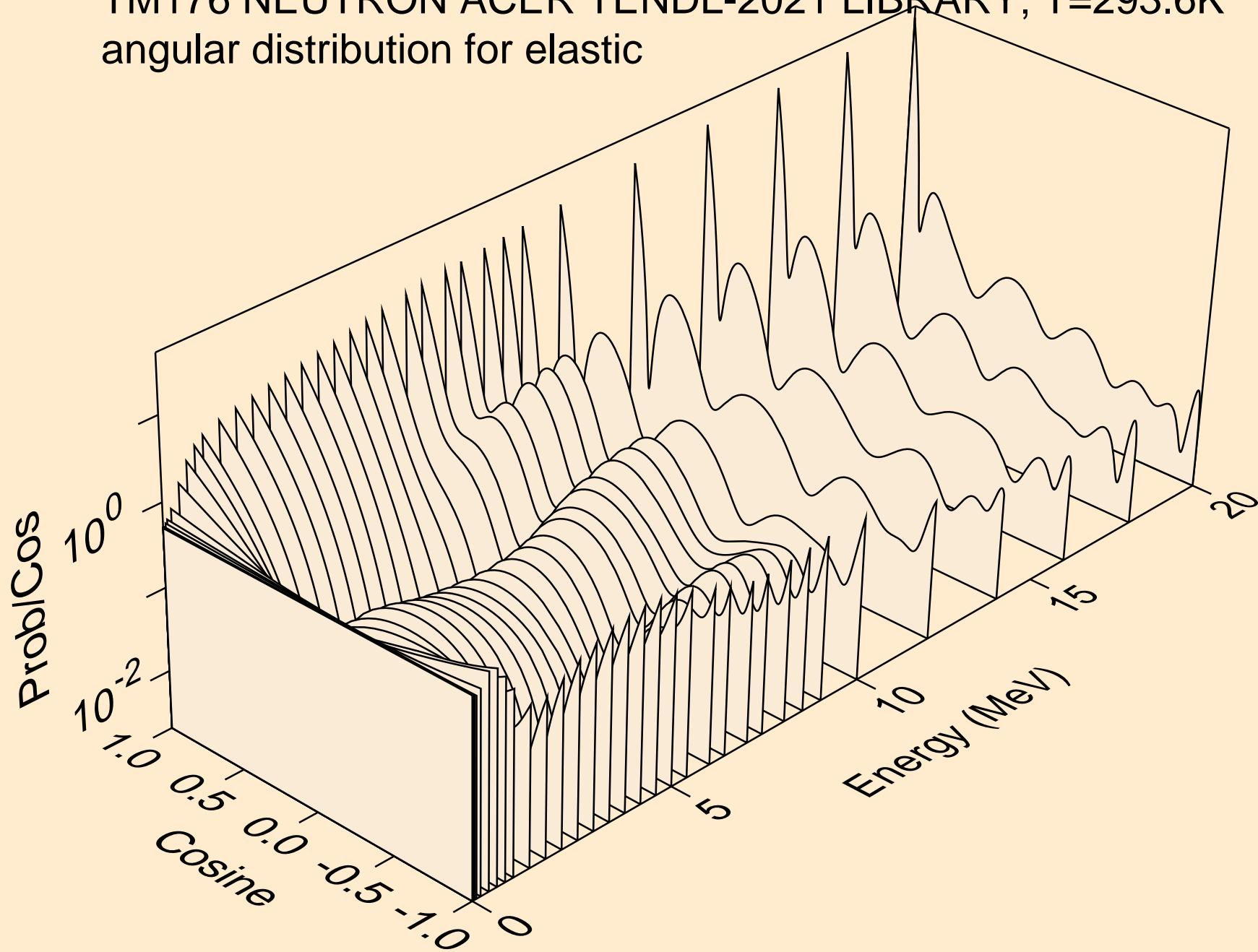

TM176 NEUTRON ACER TENDL-2021 LIBRARY; T=293.6K
angular distribution for elastic

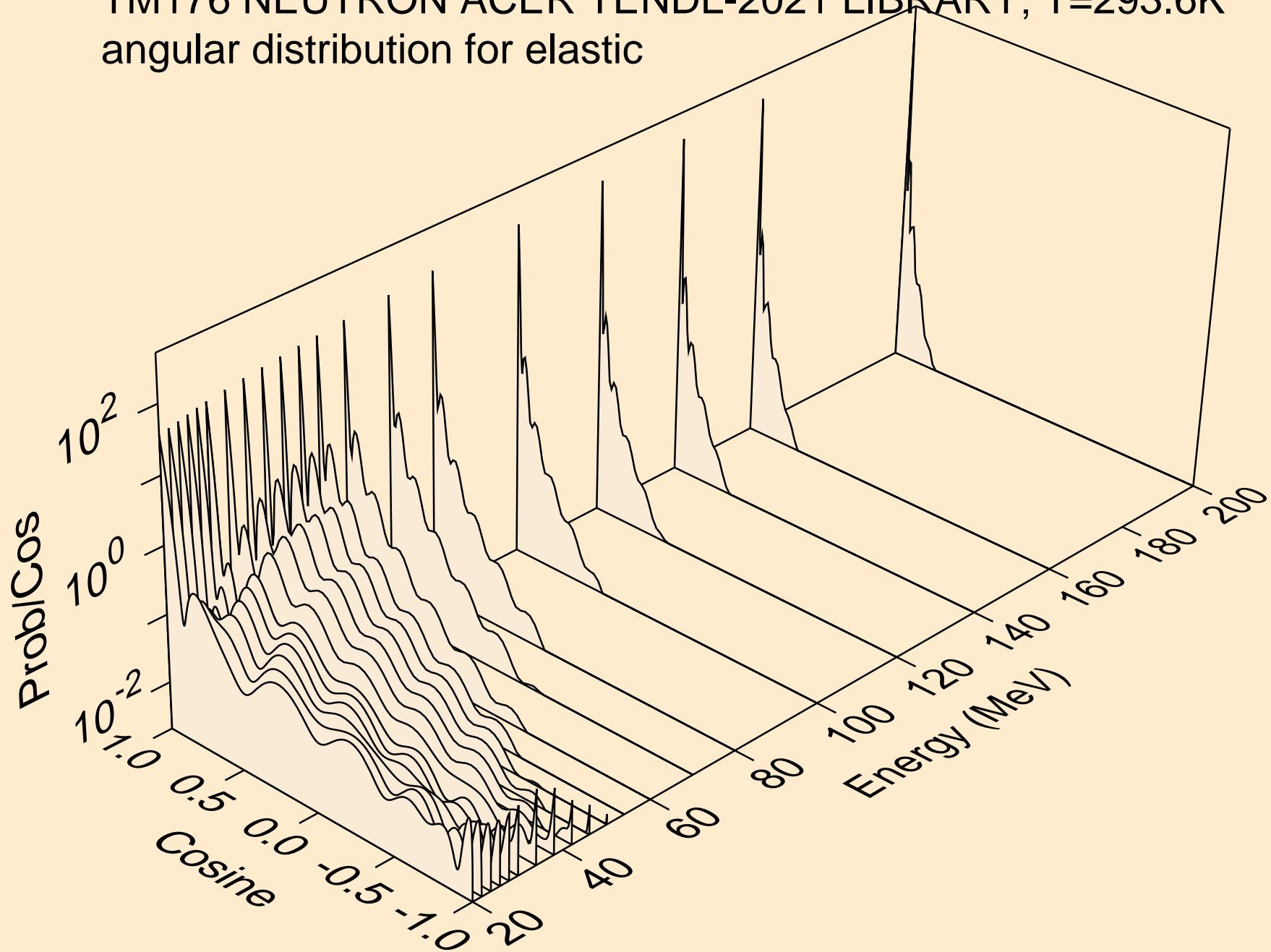

TM176 NEUTRON ACER TENDL-2021 LIBRARY; T=293.6K
angular distribution for (n,n*1)

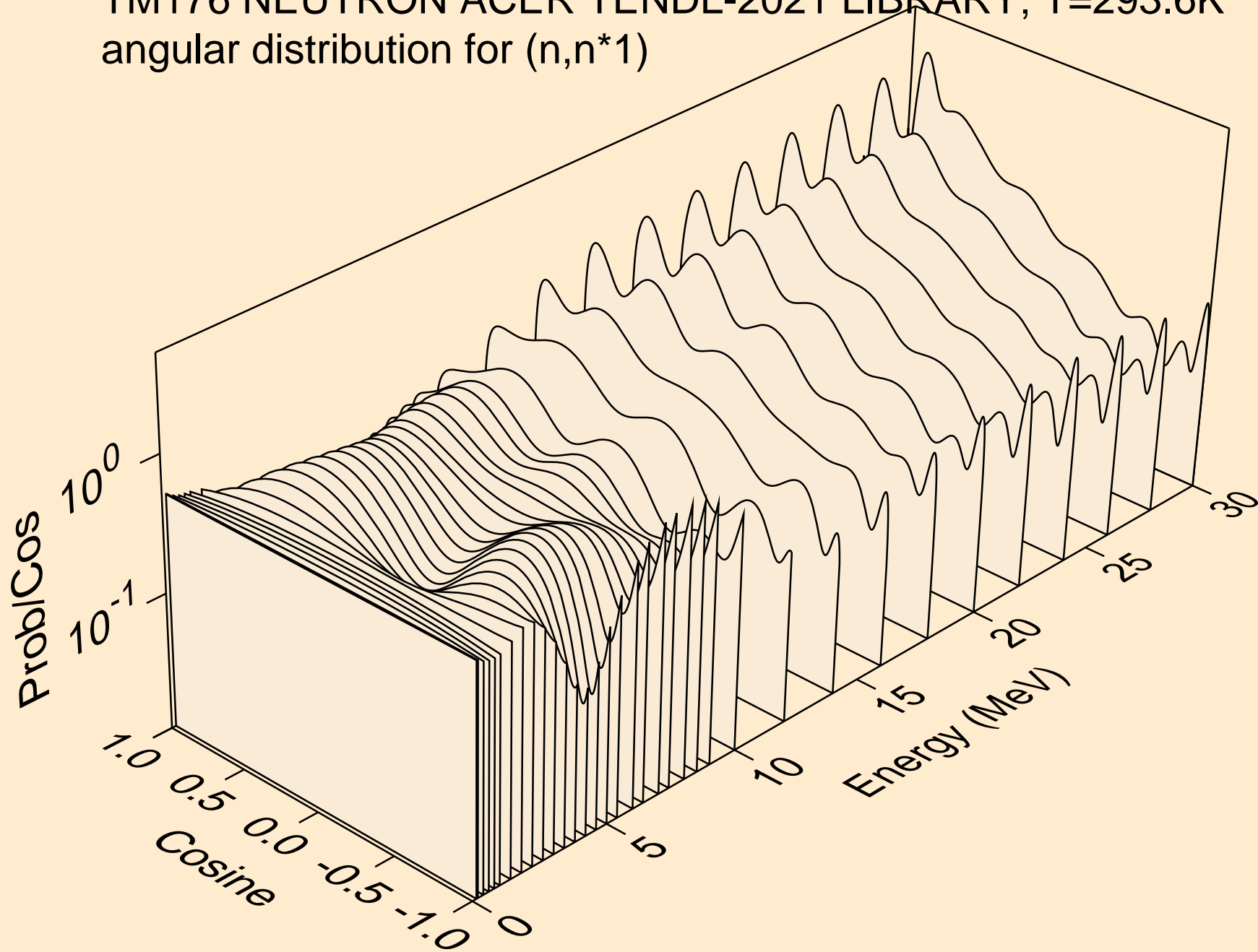

TM176 NEUTRON ACER TENDL-2021 LIBRARY; T=293.6K
Neutron emission for (n,x)

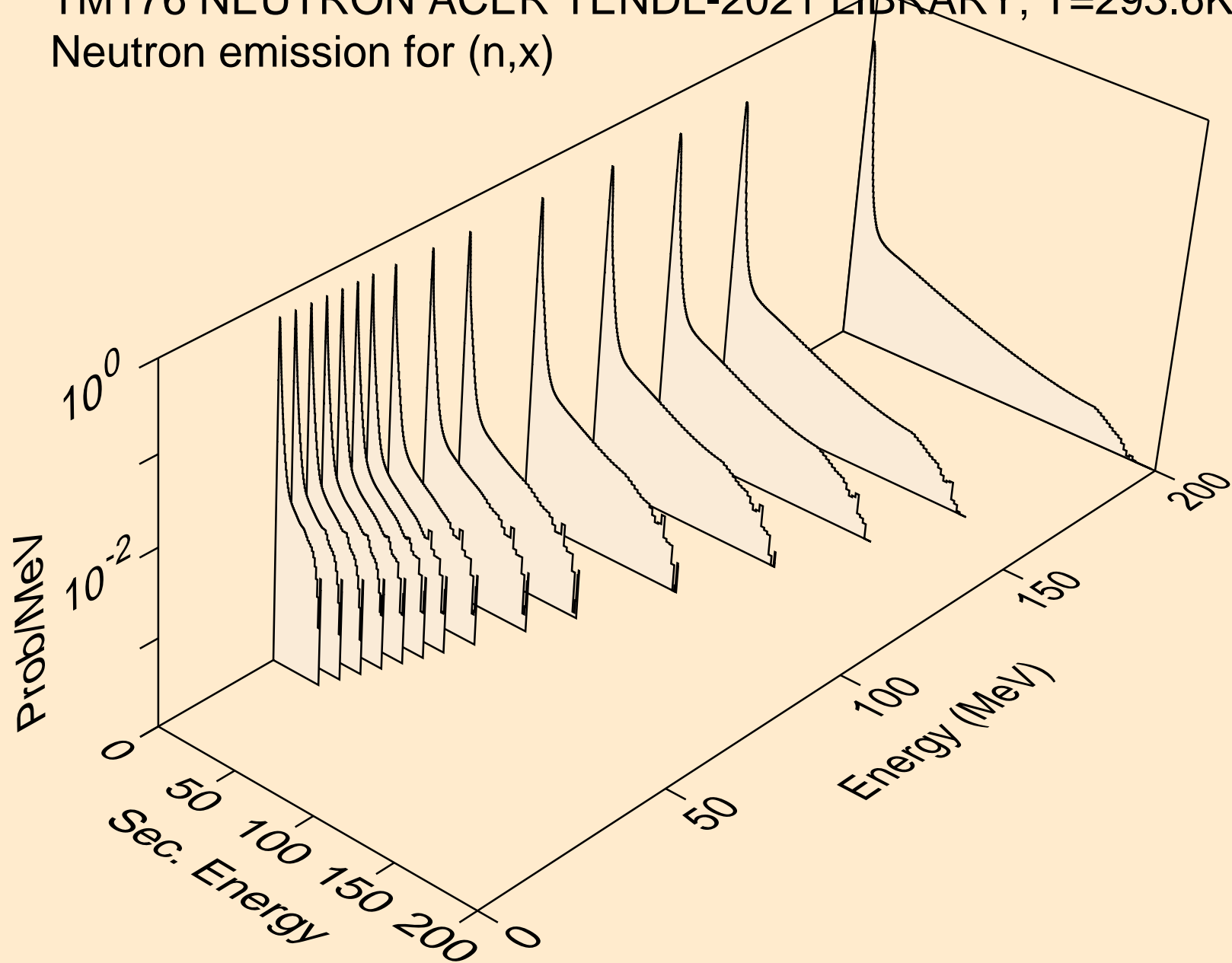

TM176 NEUTRON ACER TENDL-2021 LIBRARY; T=293.6K
Neutron emission for (n,2nd)

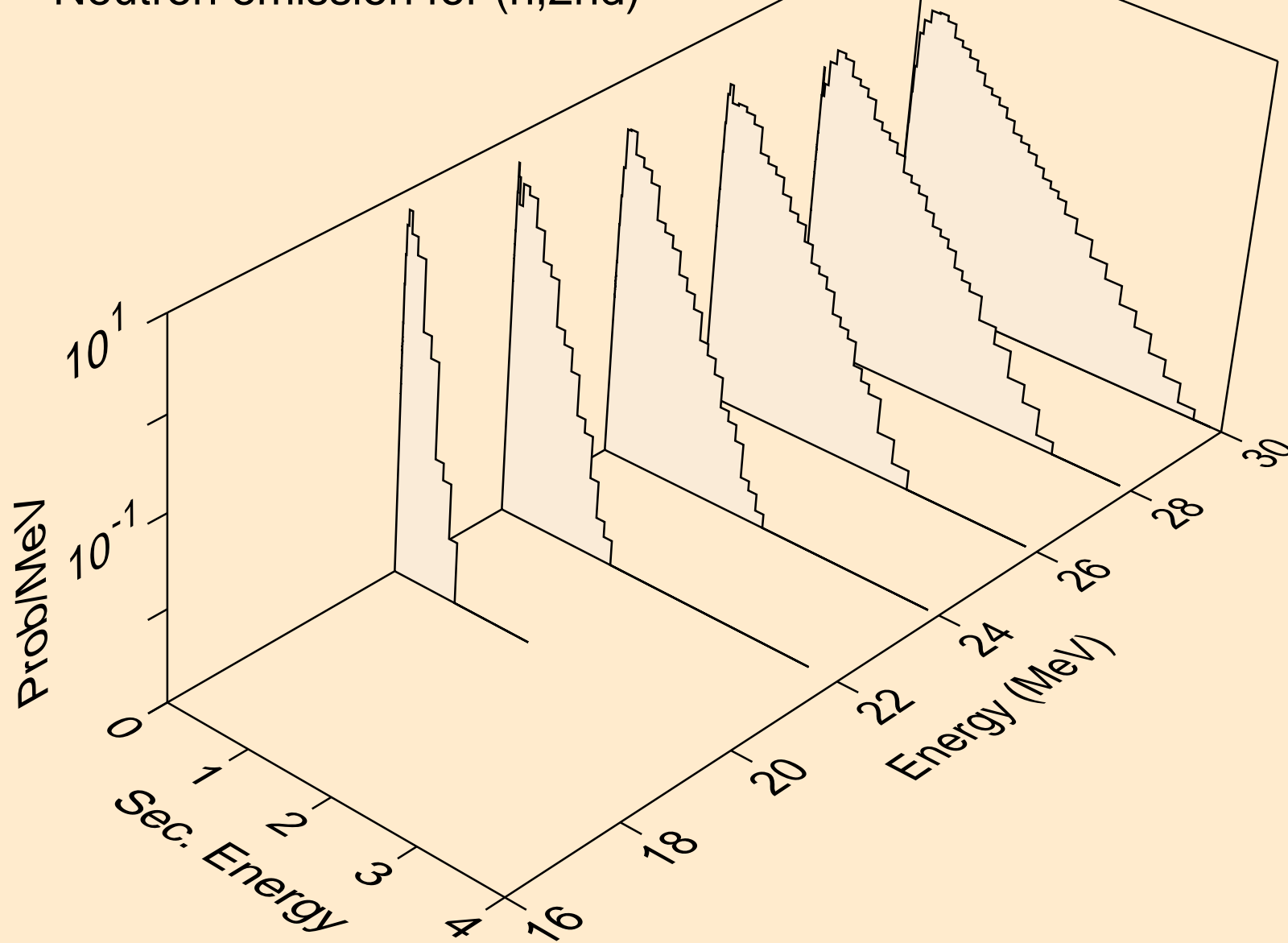

TM176 NEUTRON ACER TENDL-2021 LIBRARY; T=293.6K
Neutron emission for (n,2n)

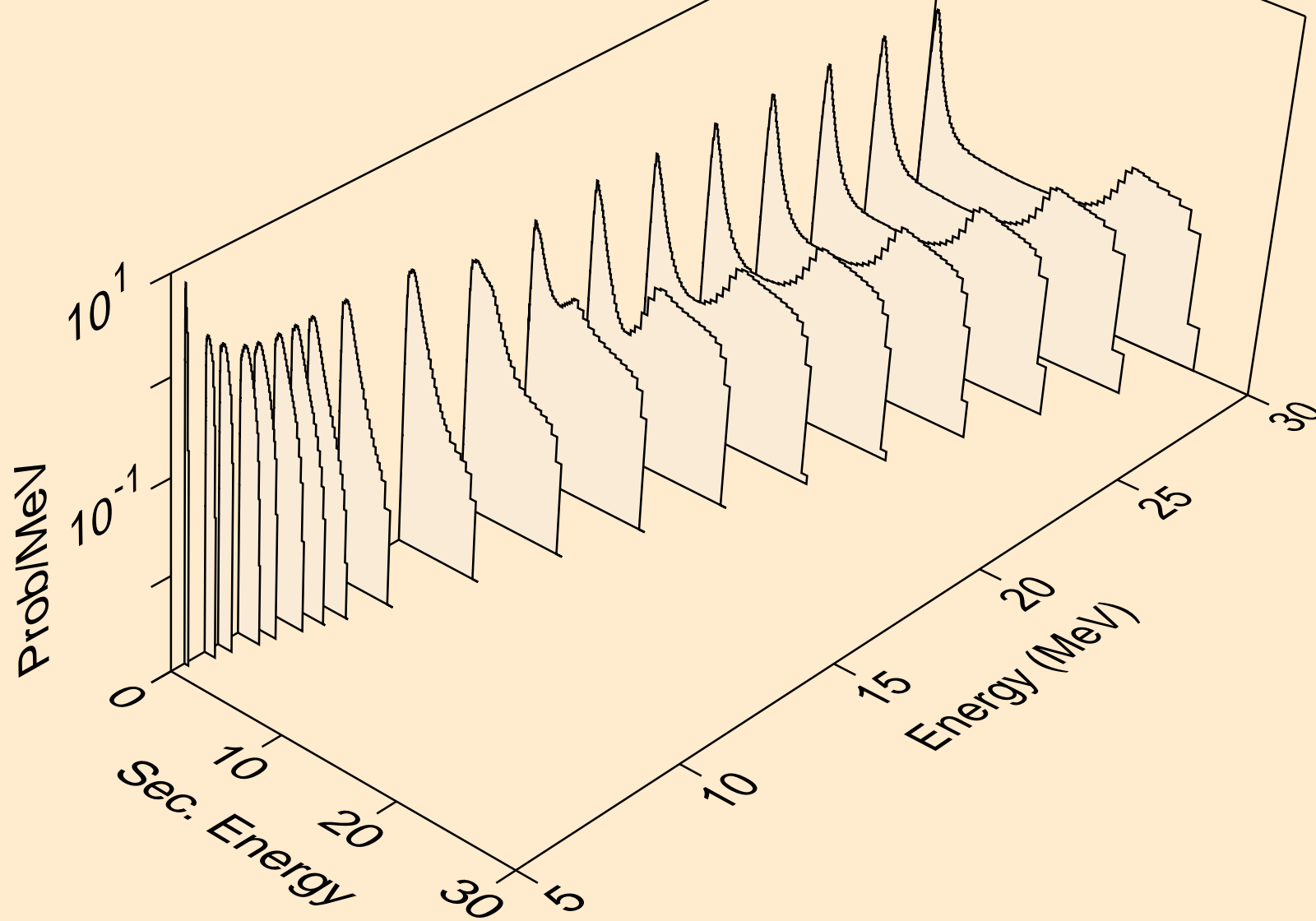

TM176 NEUTRON ACER TENDL-2021 LIBRARY; T=293.6K
Neutron emission for (n,3n)

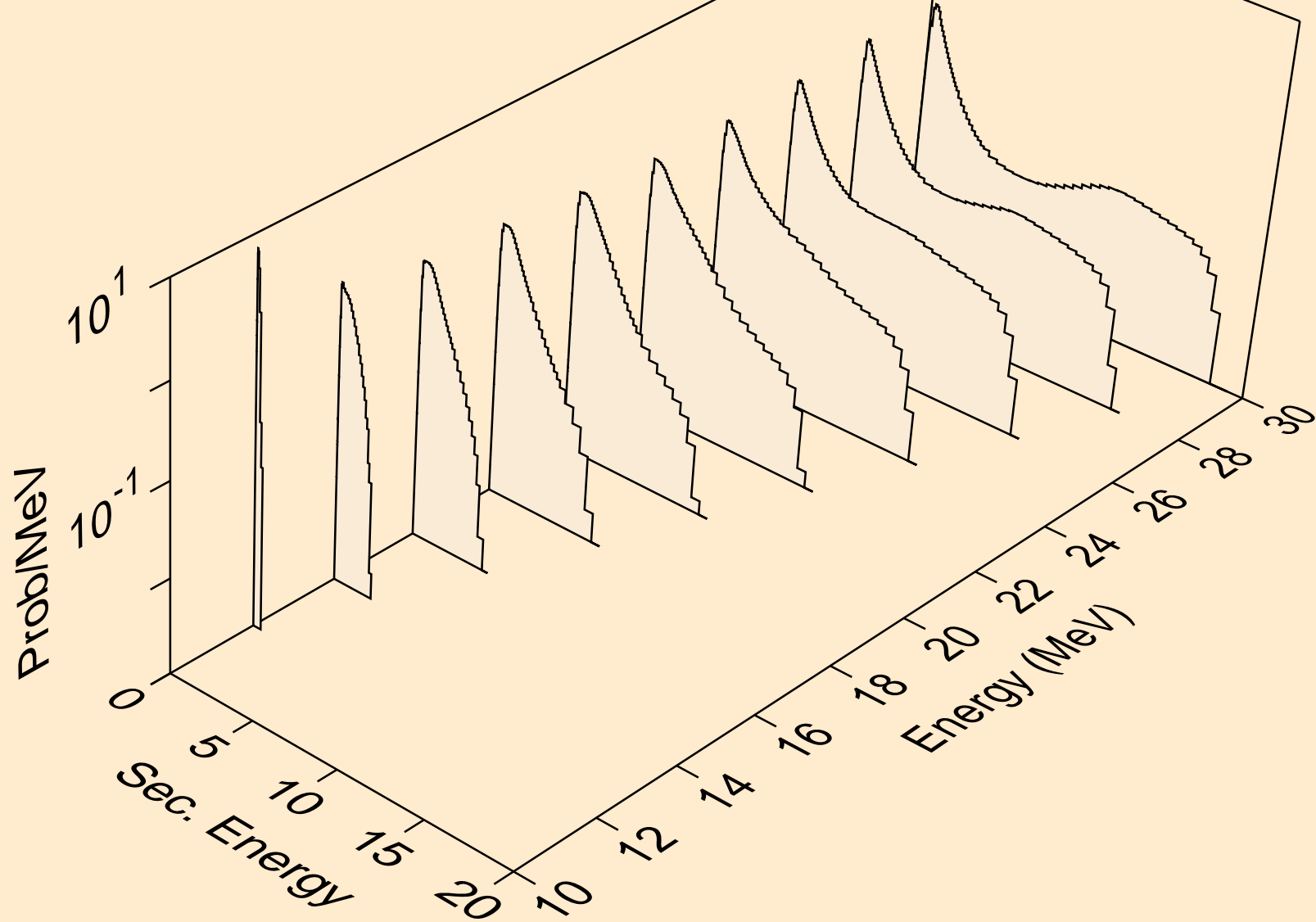

TM176 NEUTRON ACER TENDL-2021 LIBRARY; T=293.6K
Neutron emission for (n,n*)a

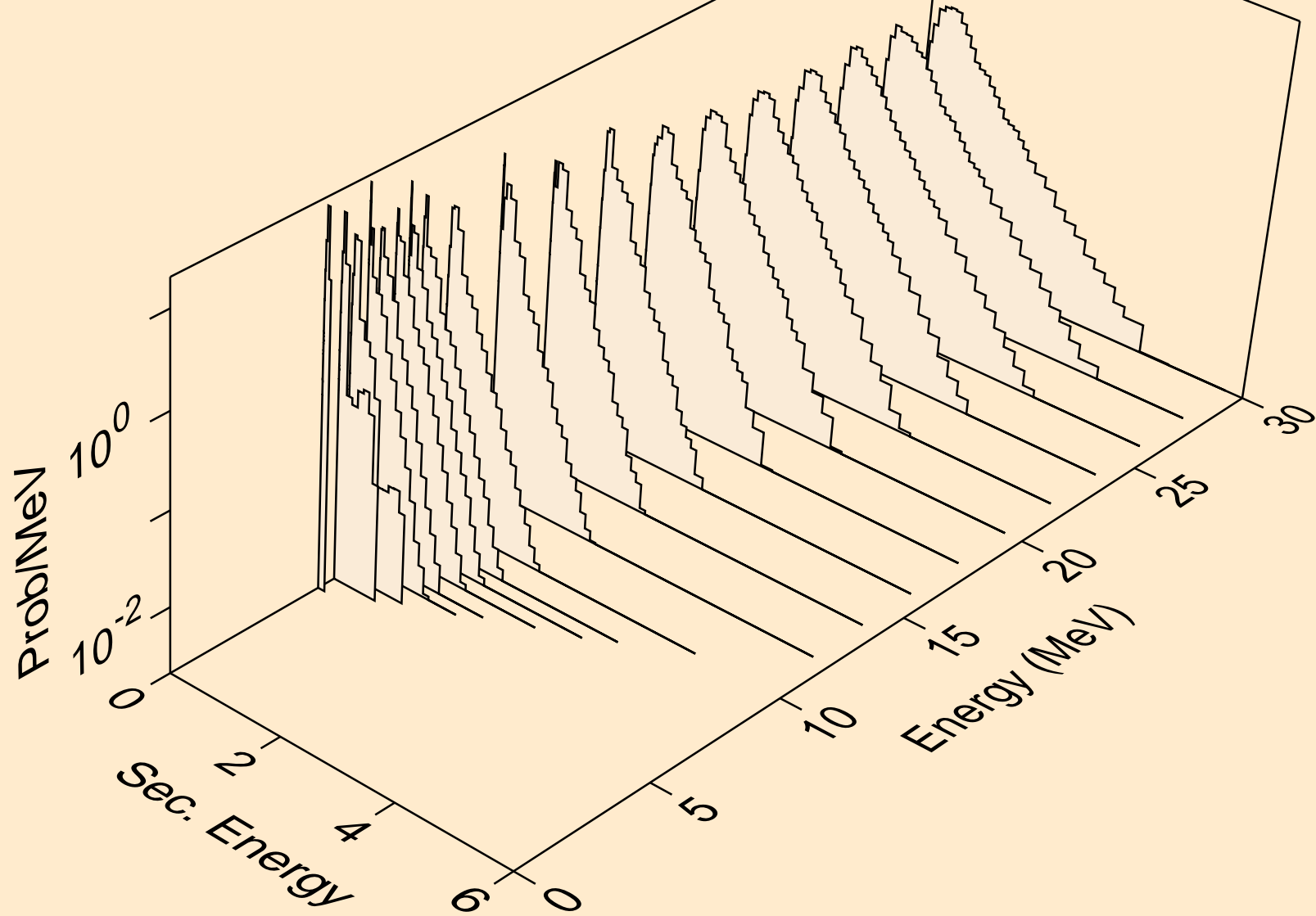

TM176 NEUTRON ACER TENDL-2021 LIBRARY; T=293.6K
Neutron emission for (n,2n)_a

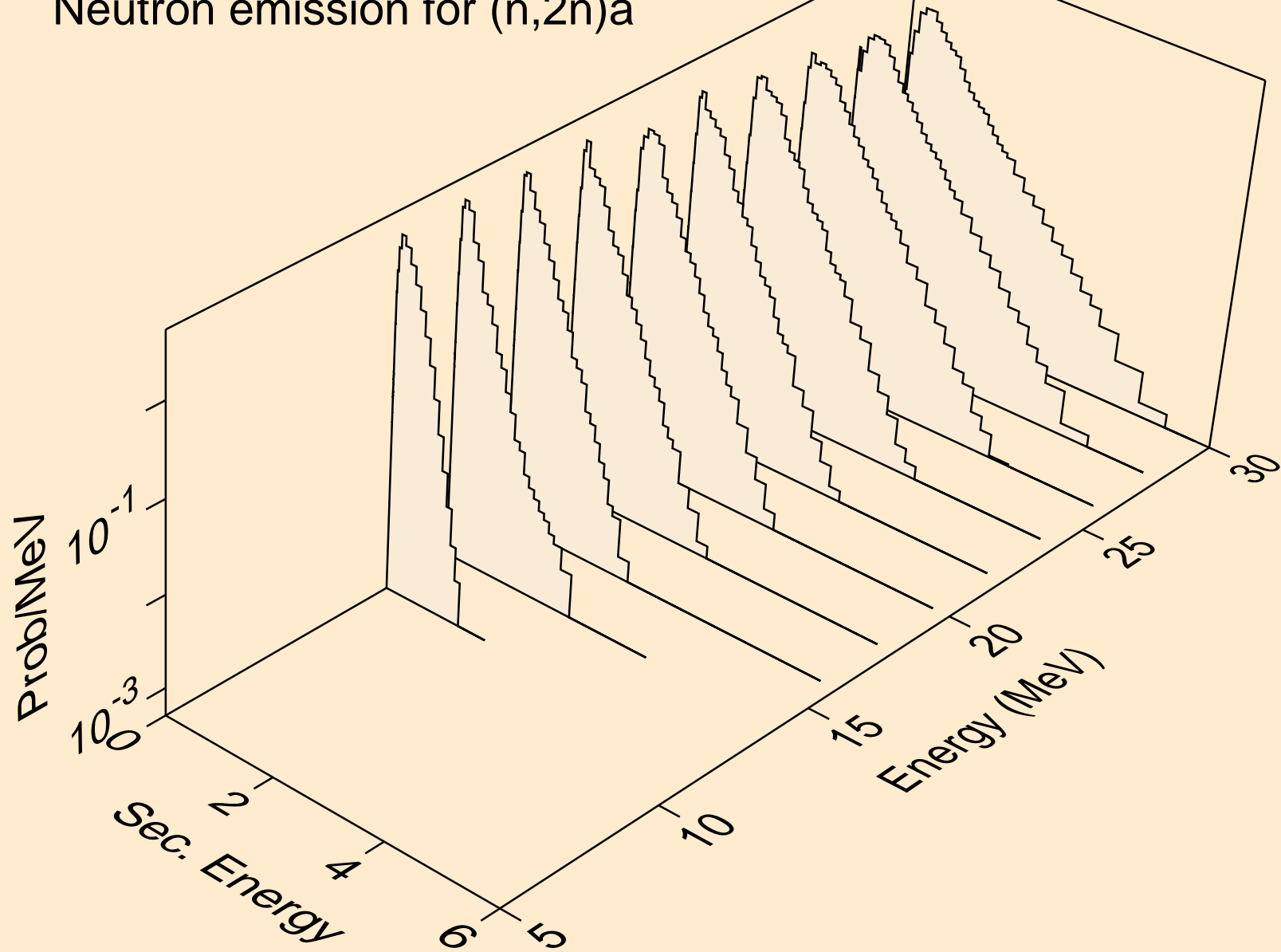

TM176 NEUTRON ACER TENDL-2021 LIBRARY; T=293.6K
Neutron emission for (n,3n)a

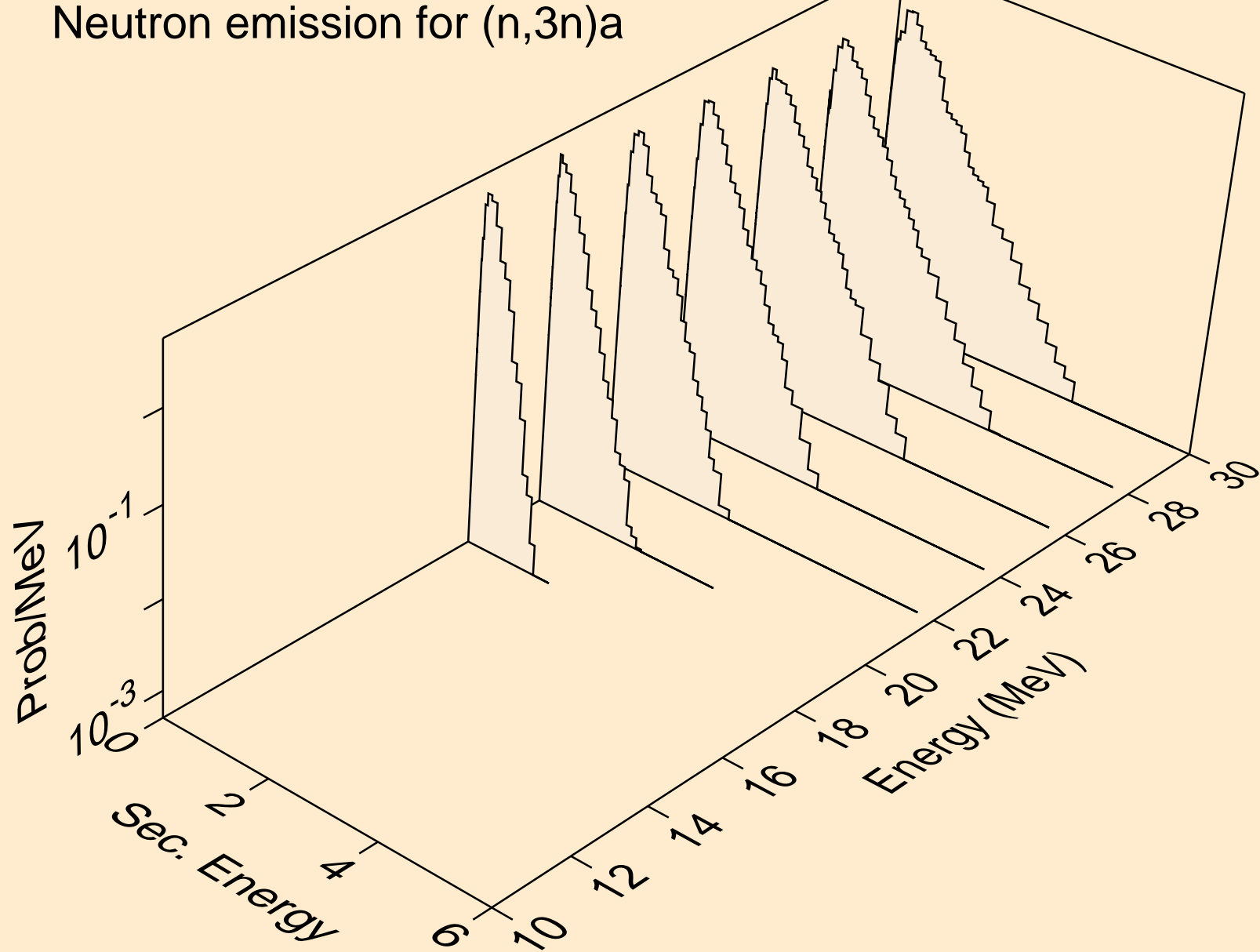

TM176 NEUTRON ACER TENDL-2021 LIBRARY; T=293.6K
Neutron emission for (n,n*)p

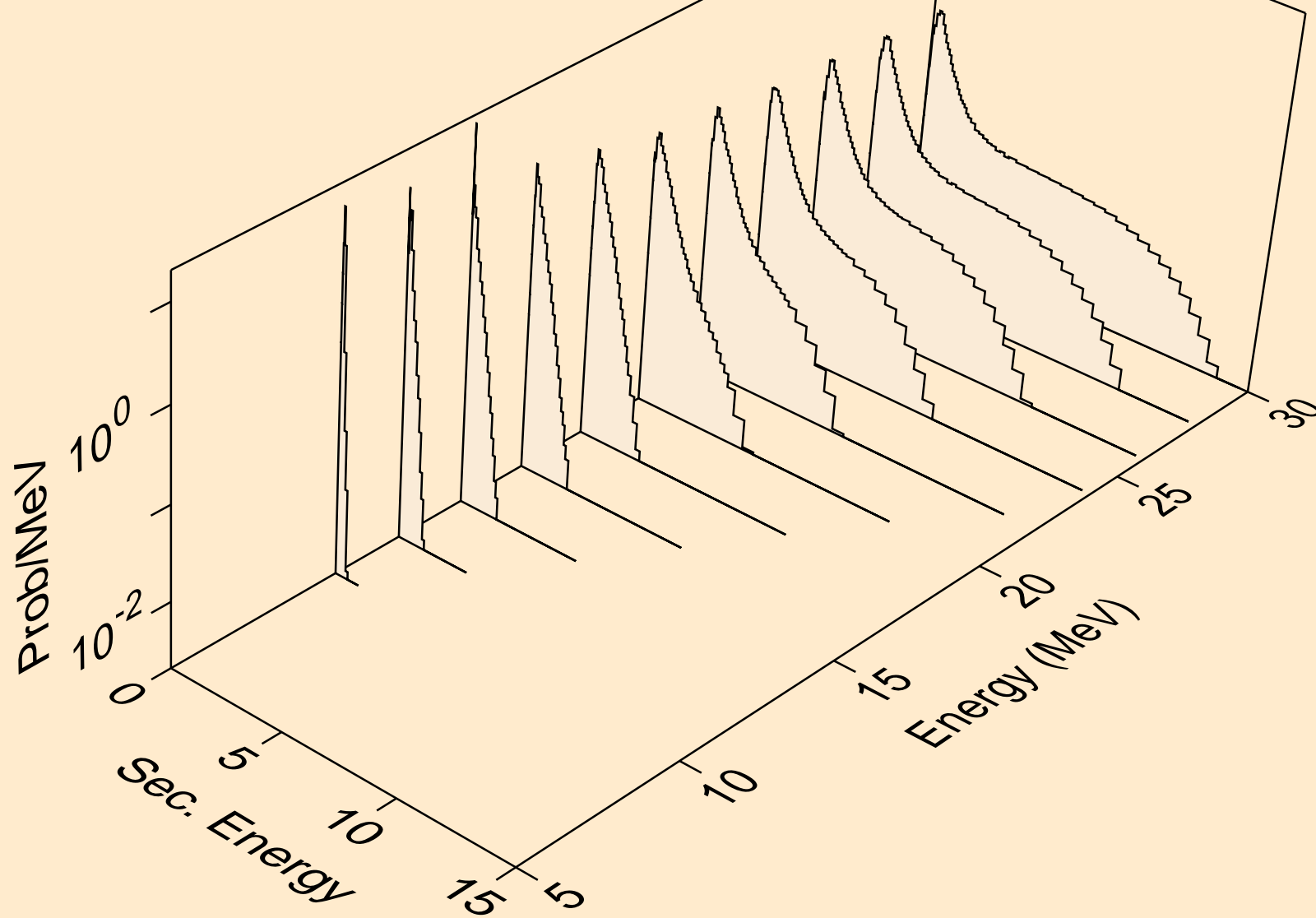

TM176 NEUTRON ACER TENDL-2021 LIBRARY; T=293.6K
Neutron emission for (n,n*)d

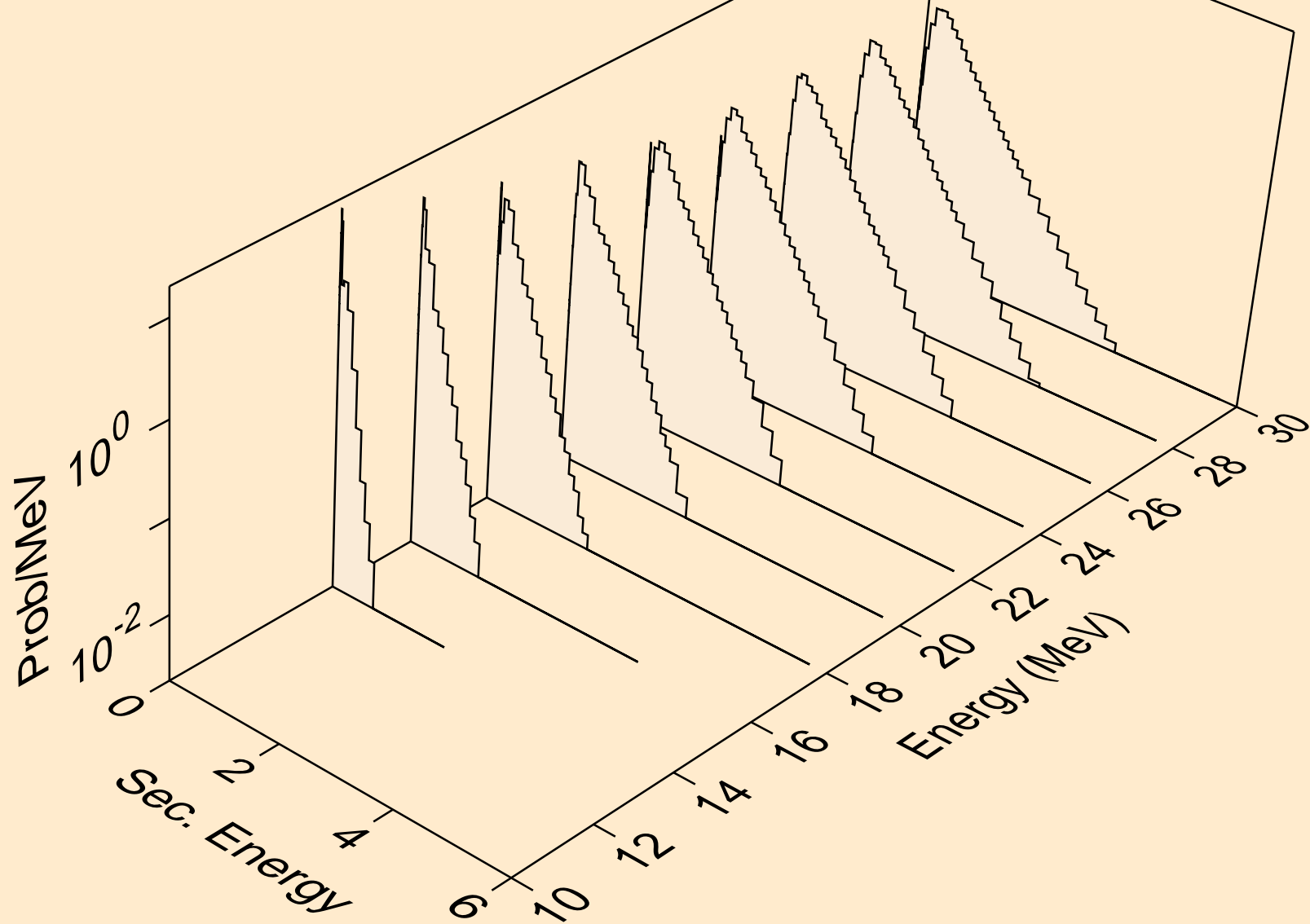

TM176 NEUTRON ACER TENDL-2021 LIBRARY; T=293.6K
Neutron emission for (n,n*)t

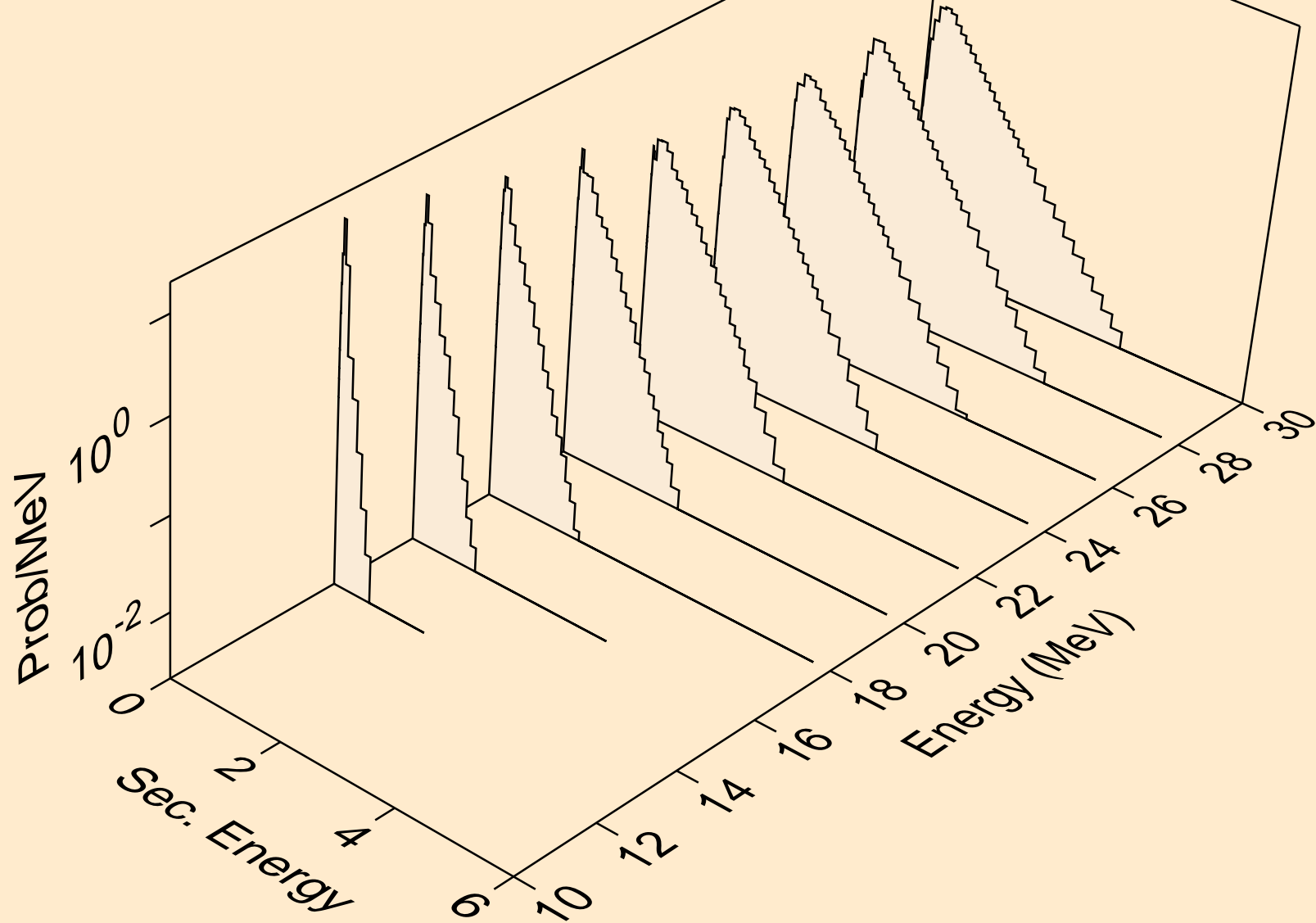

TM176 NEUTRON ACER TENDL-2021 LIBRARY; T=293.6K
Neutron emission for (n,n*)he3

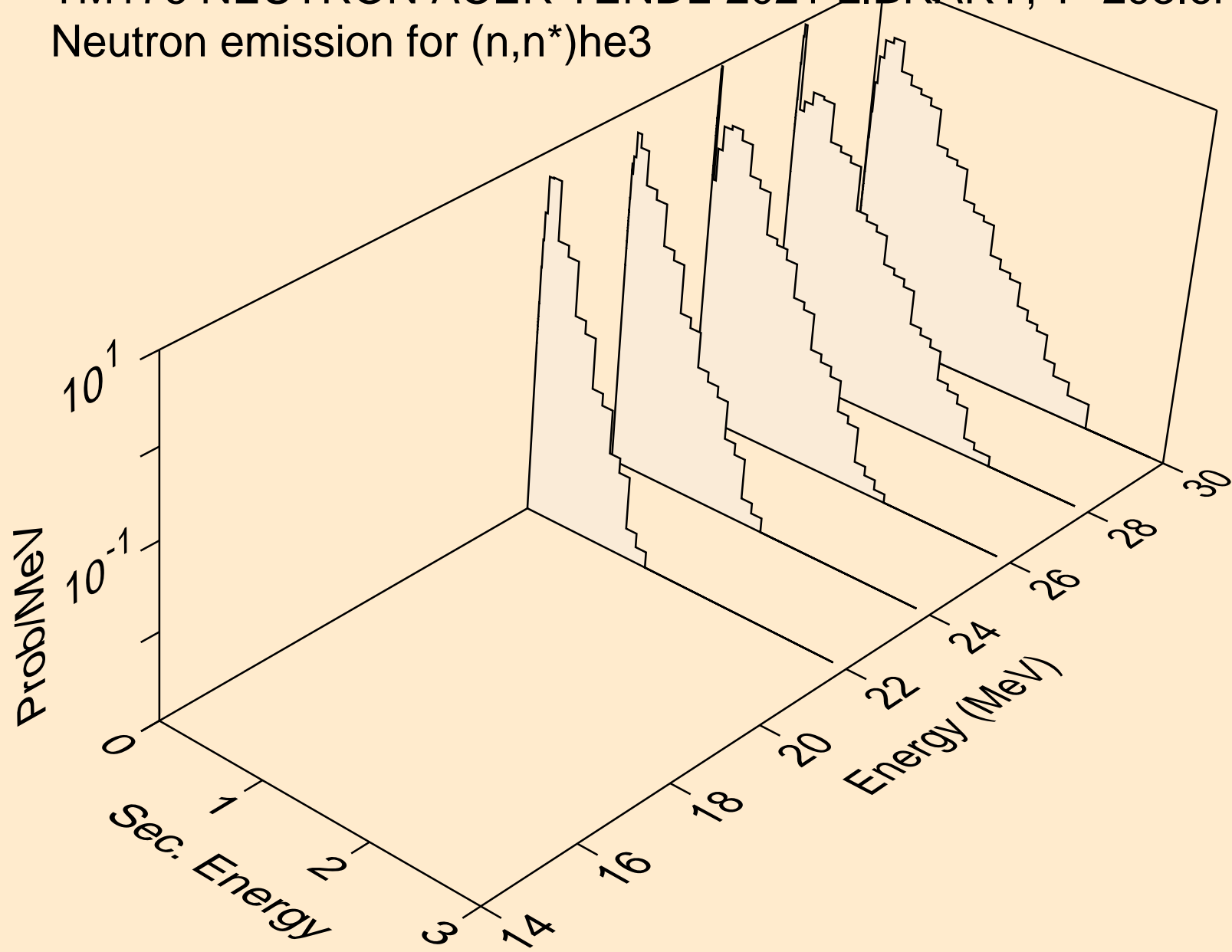

TM176 NEUTRON ACER TENDL-2021 LIBRARY; T=293.6K
Neutron emission for (n,4n)

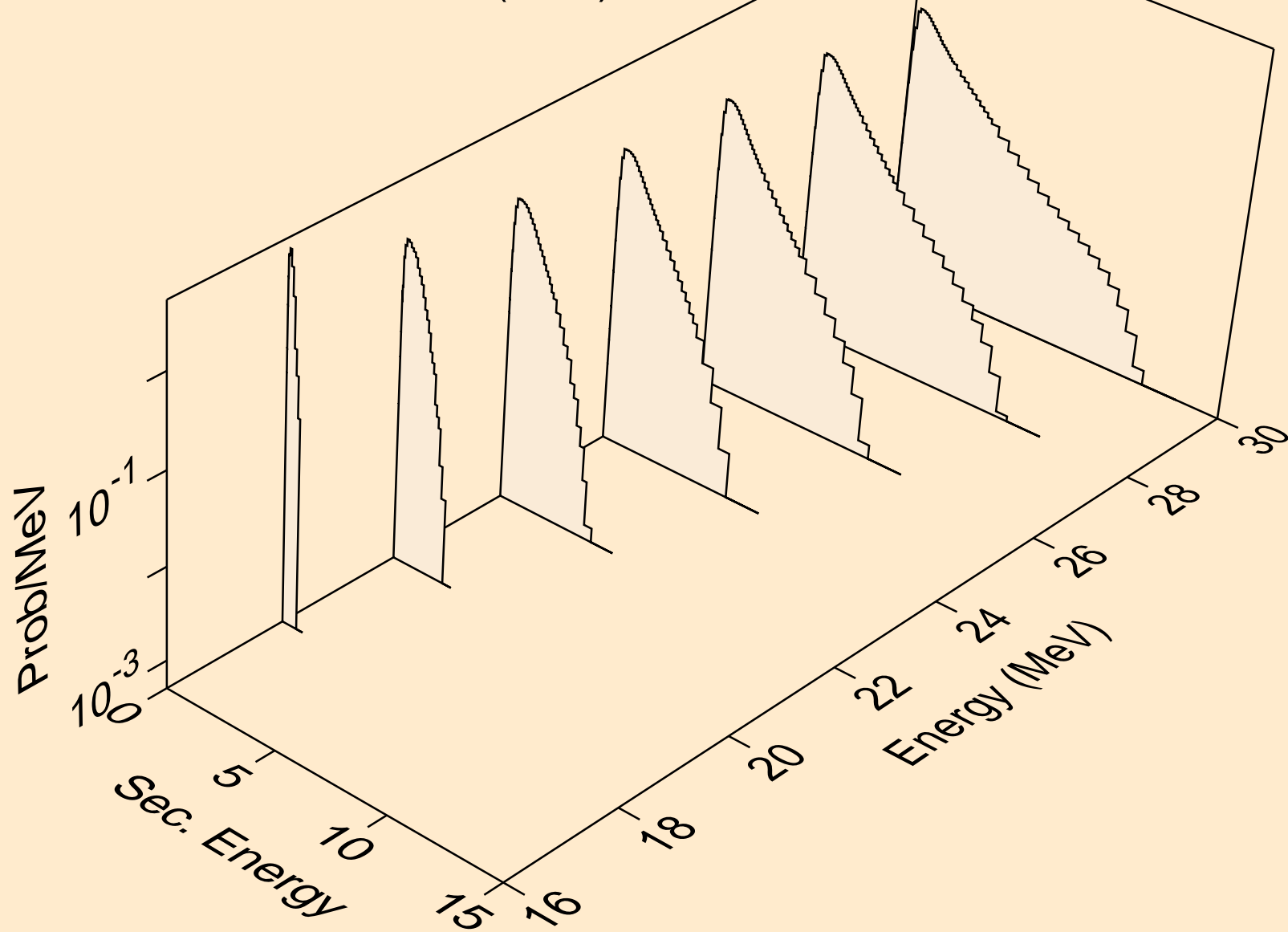

TM176 NEUTRON ACER TENDL-2021 LIBRARY; T=293.6K
Neutron emission for (n,2np)

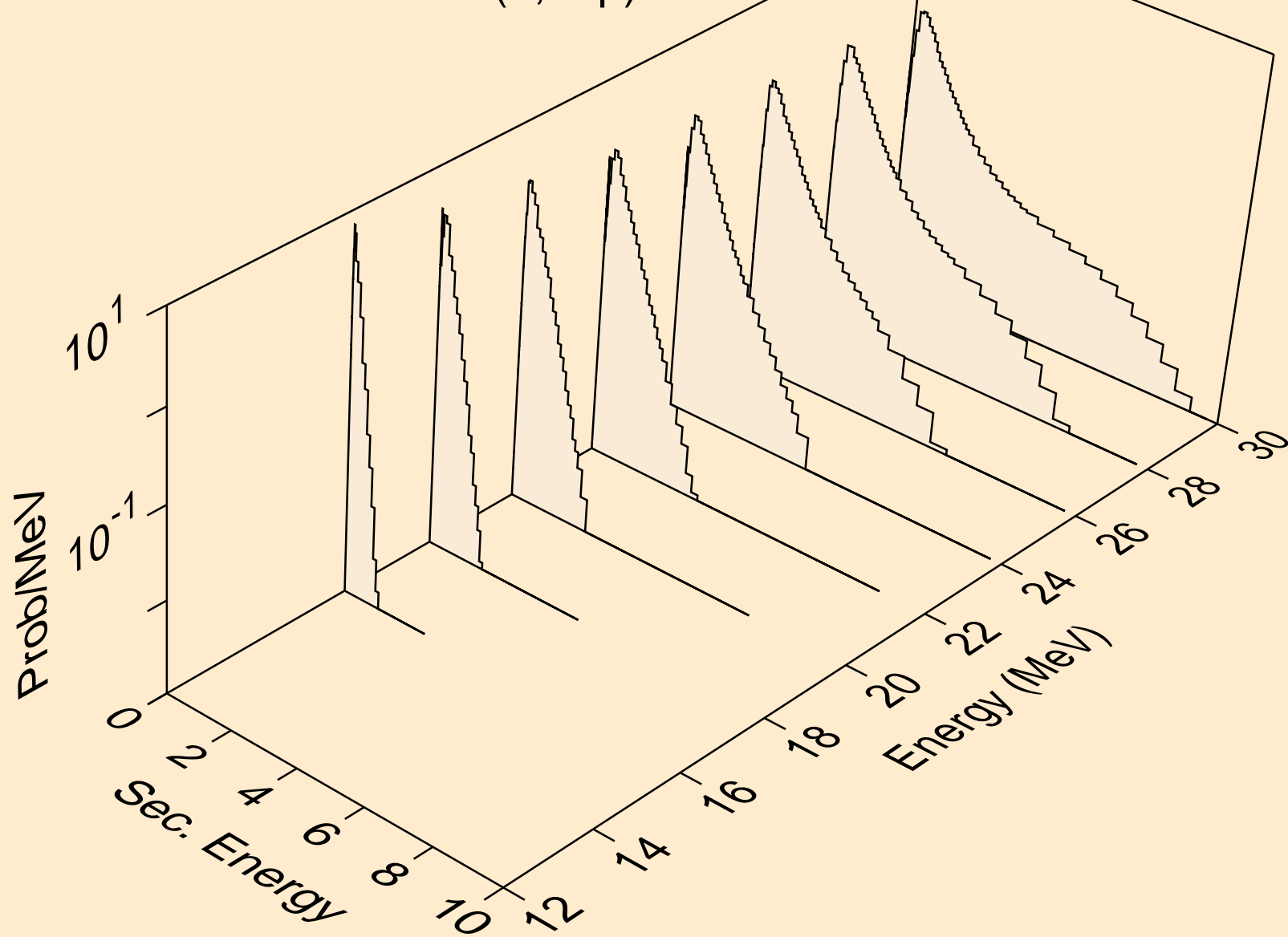

TM176 NEUTRON ACER TENDL-2021 LIBRARY; T=293.6K
Neutron emission for (n,3np)

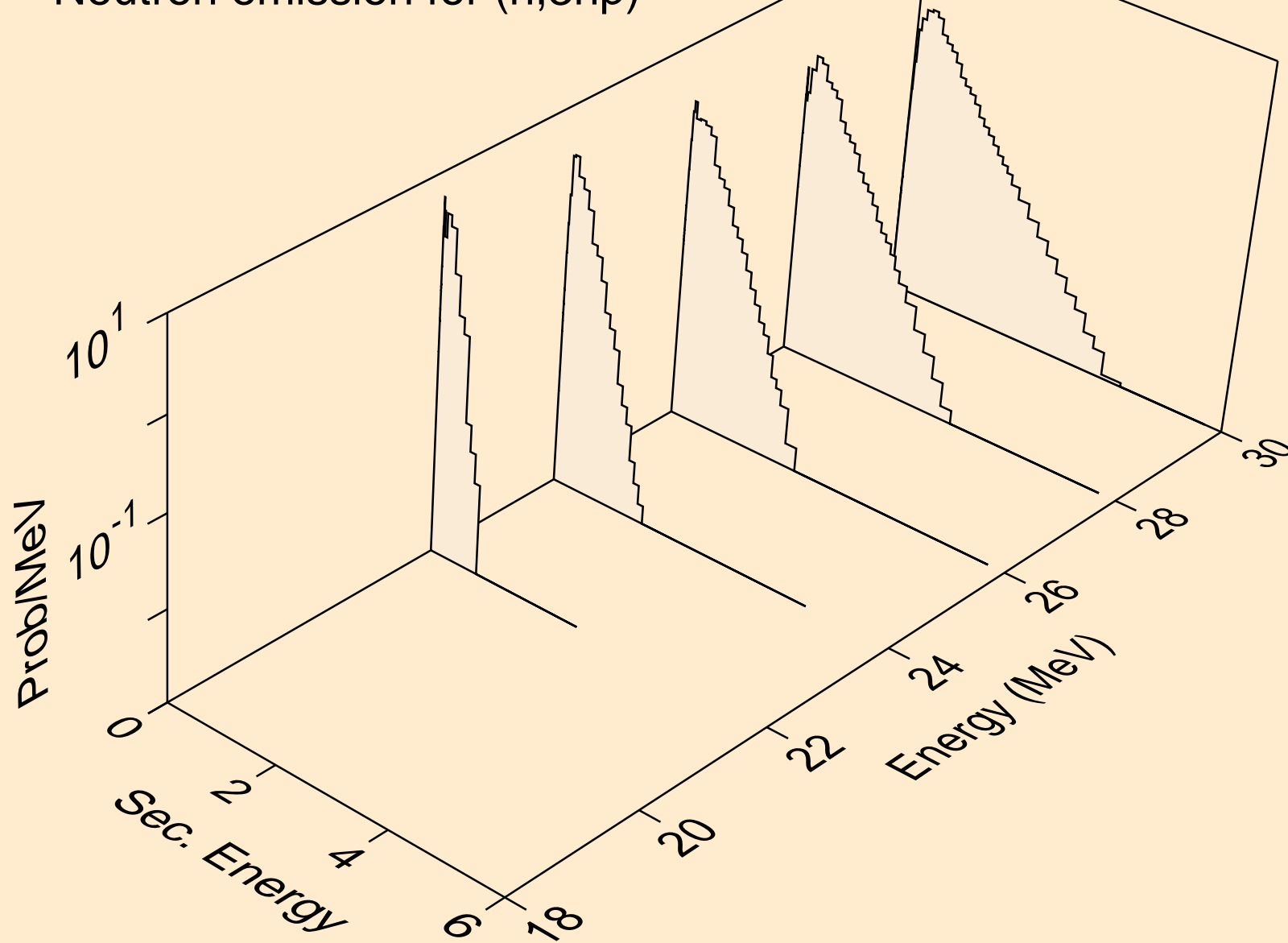

TM176 NEUTRON ACER TENDL-2021 LIBRARY; T=293.6K
Neutron emission for (n,n*c)

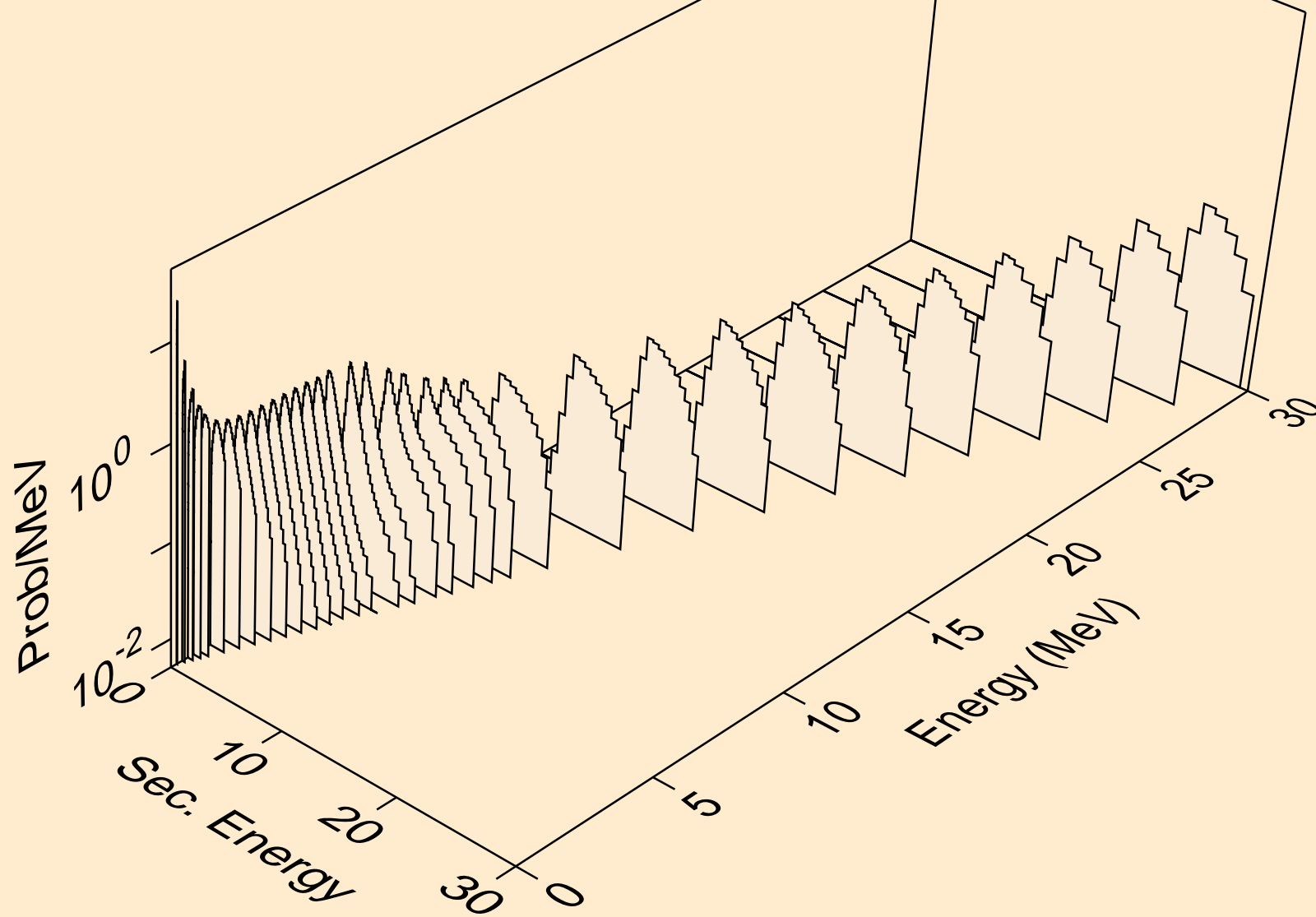

TM176 NEUTRON ACER TENDL-2021 LIBRARY; T=293.6K
Photon emission for (n,x)

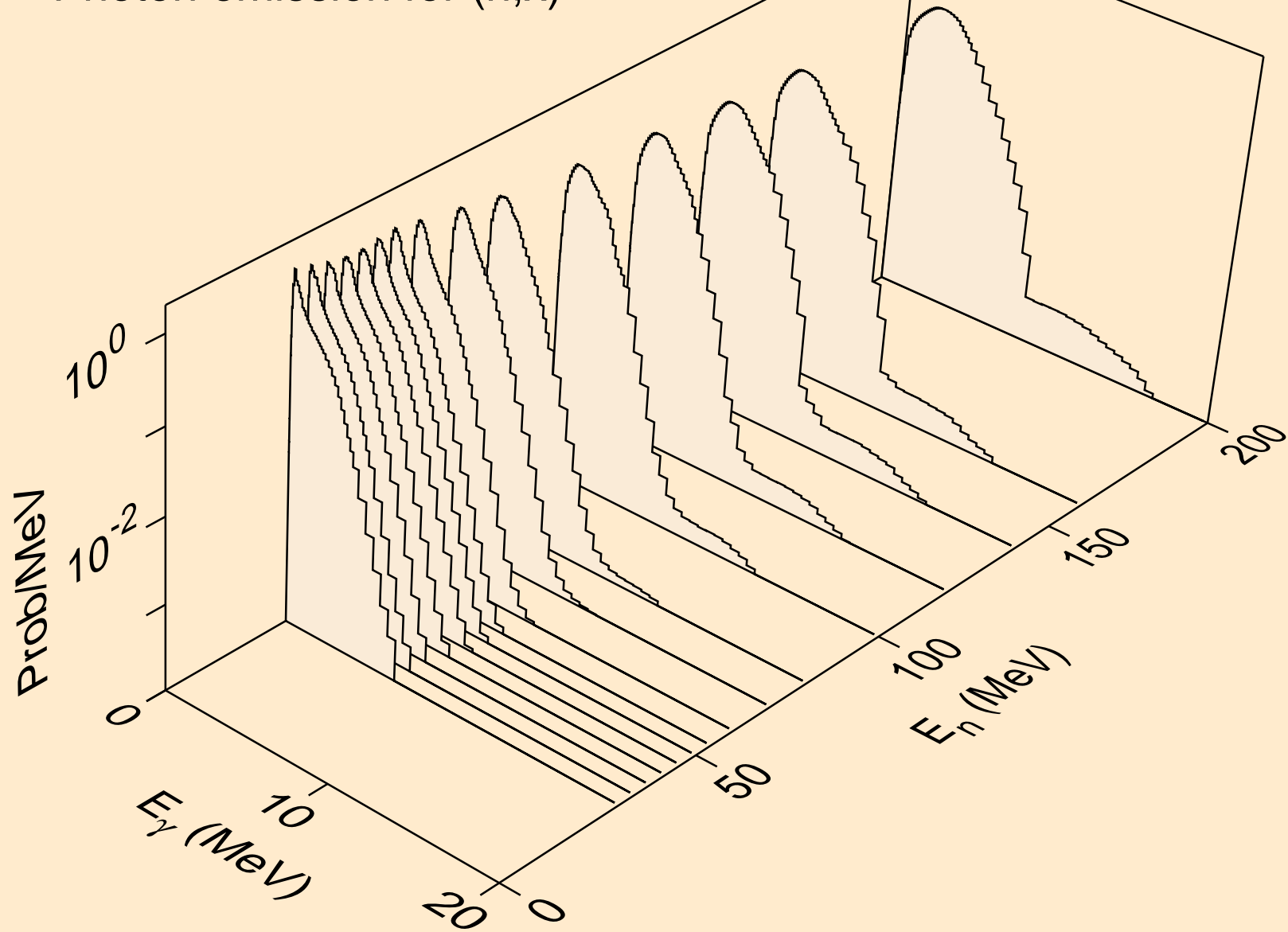

TM176 NEUTRON ACER TENDL-2021 LIBRARY; T=293.6K
Photon emission for (n,2nd)

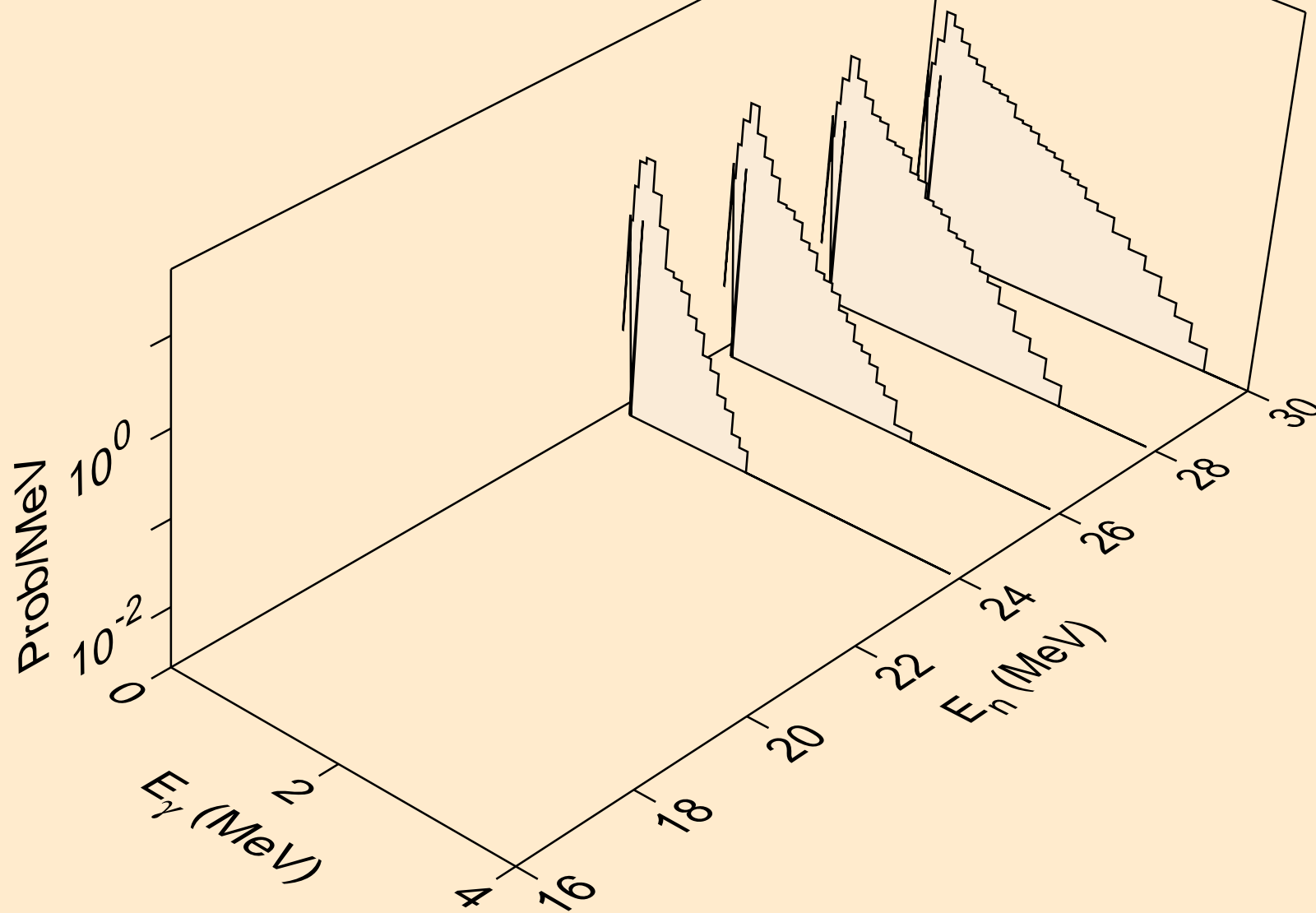

TM176 NEUTRON ACER TENDL-2021 LIBRARY; T=293.6K
Photon emission for (n,2n)

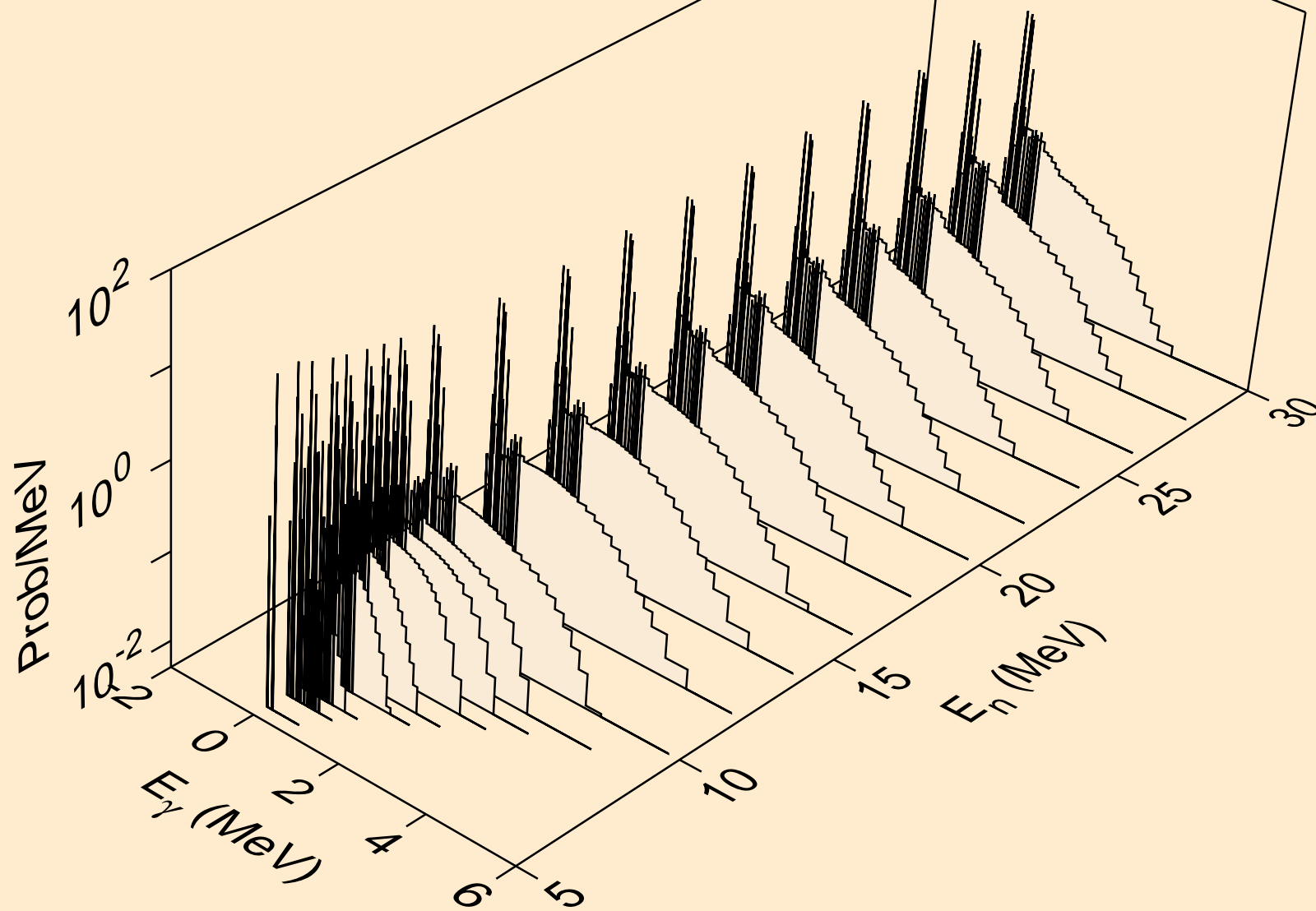

TM176 NEUTRON ACER TENDL-2021 LIBRARY; T=293.6K
Photon emission for (n,3n)

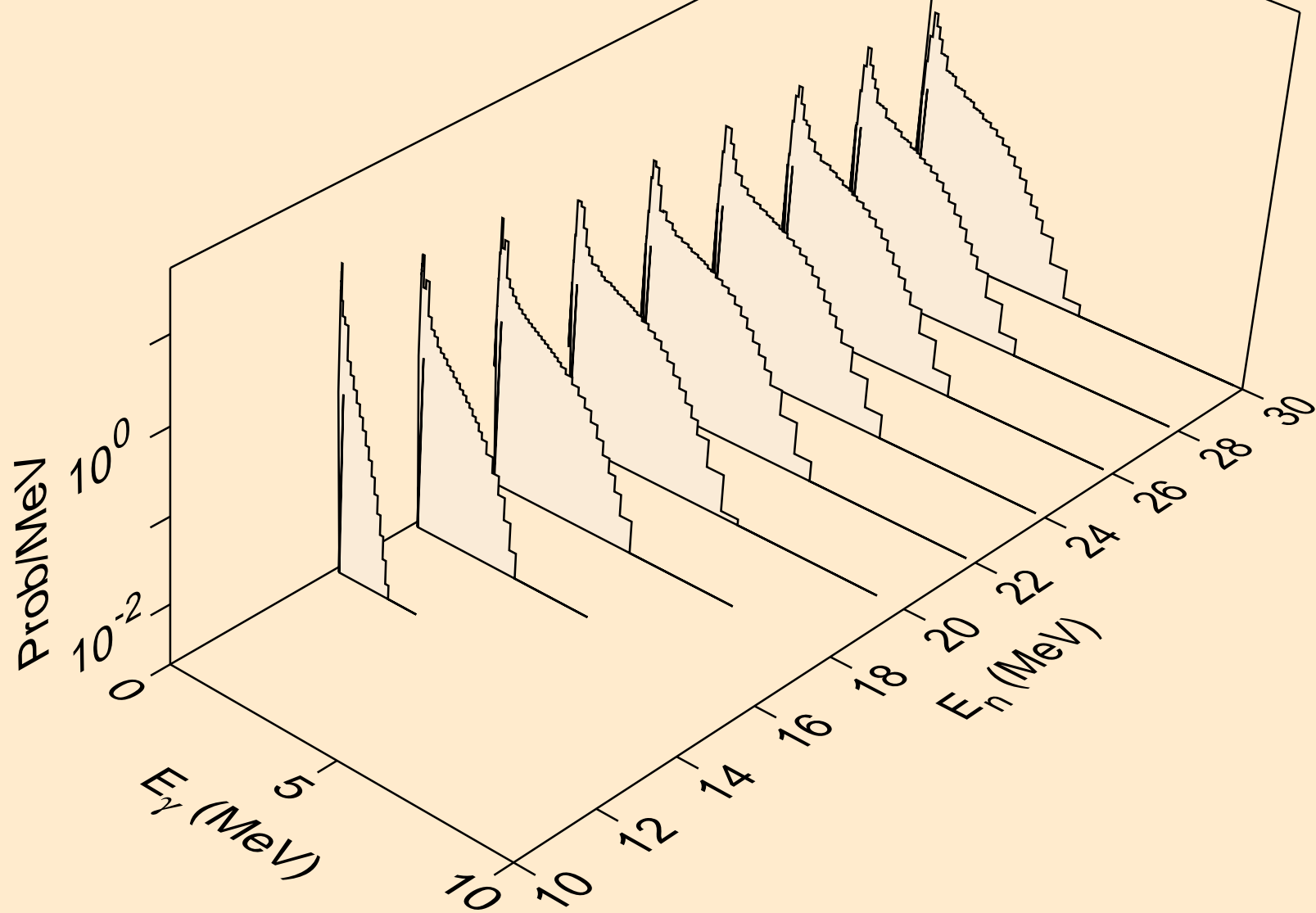

TM176 NEUTRON ACER TENDL-2021 LIBRARY; T=293.6K
Photon emission for (n,n*)a

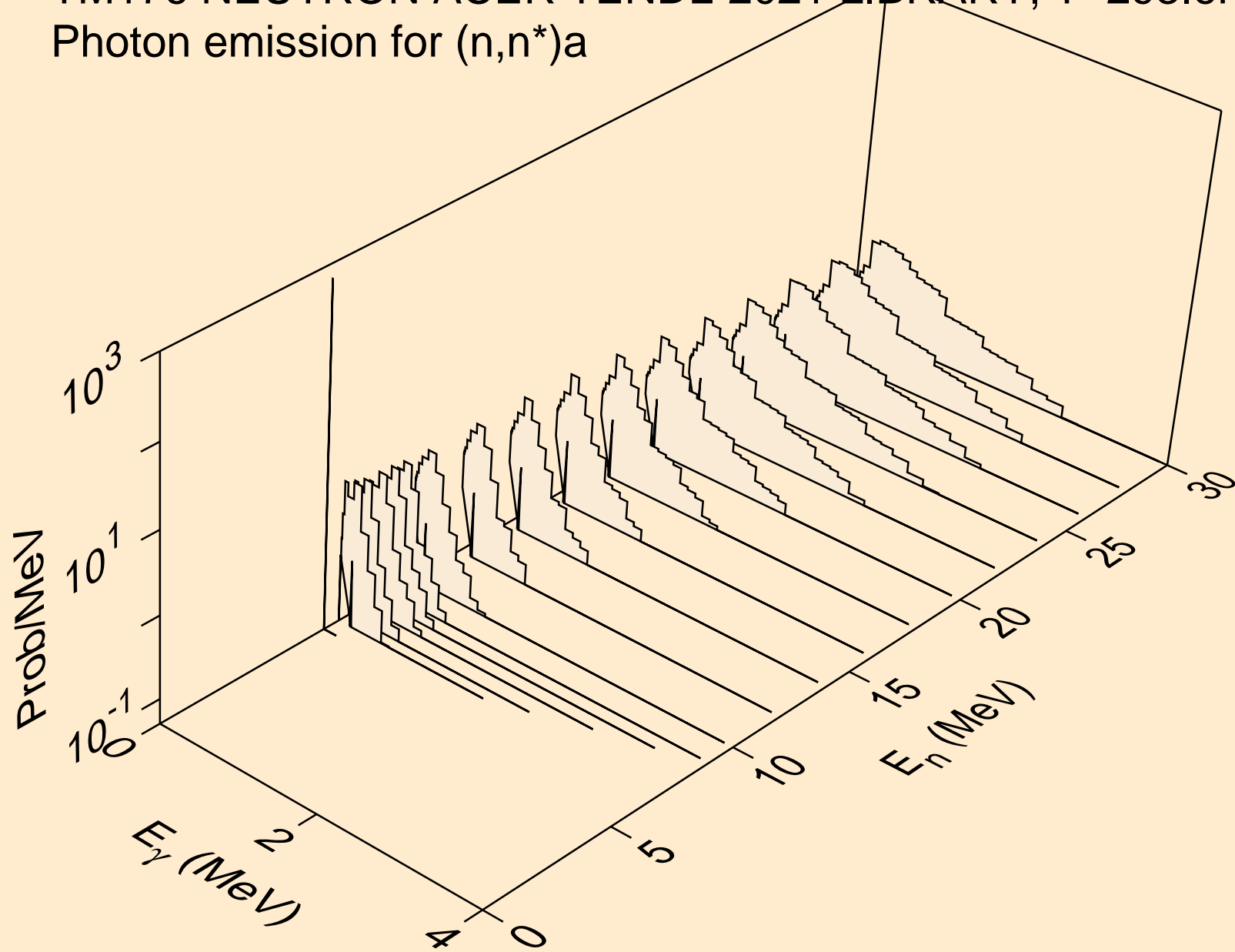

TM176 NEUTRON ACER TENDL-2021 LIBRARY; T=293.6K
Photon emission for (n,2n)a

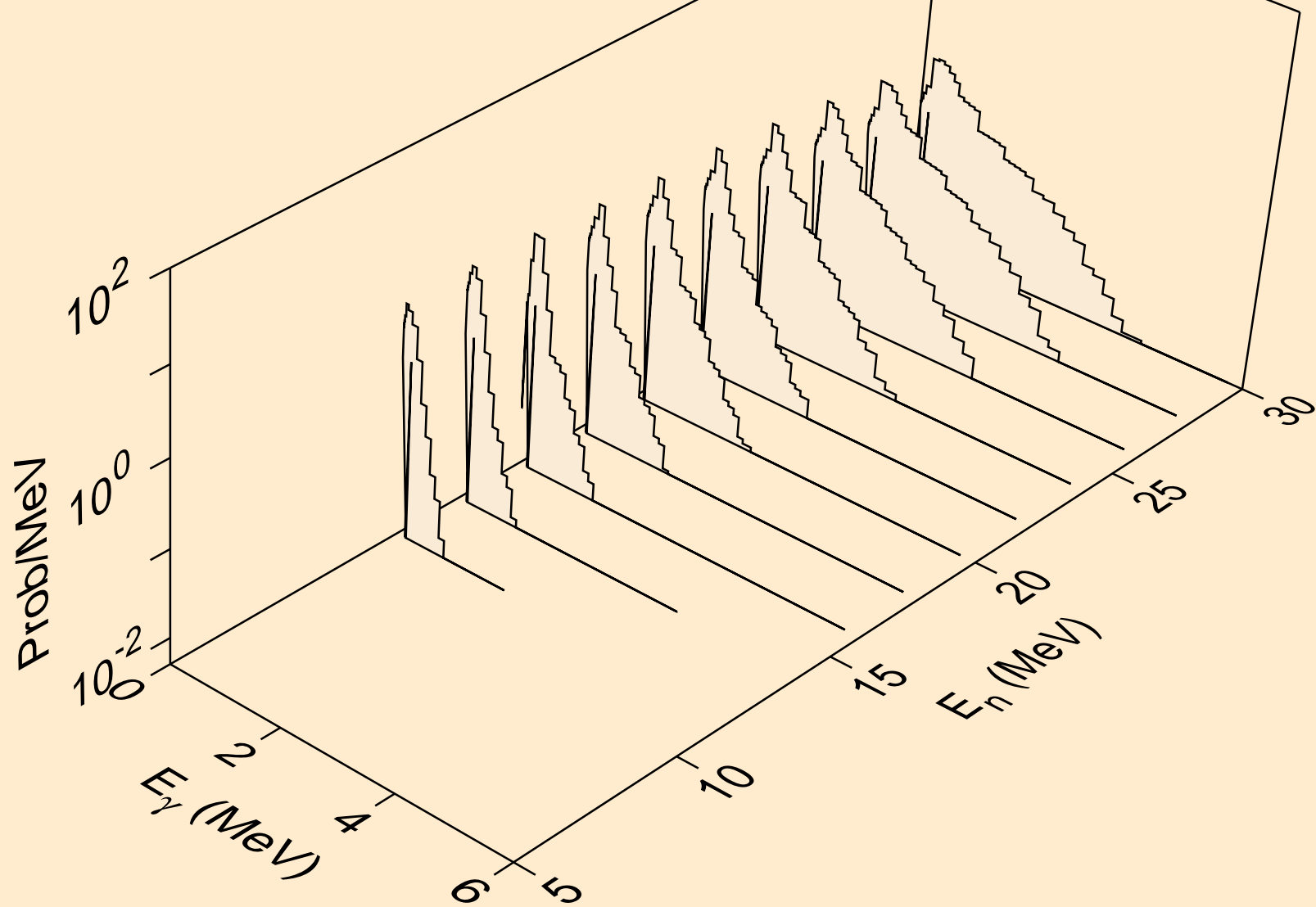

TM176 NEUTRON ACER TENDL-2021 LIBRARY; T=293.6K
Photon emission for (n,3n)a

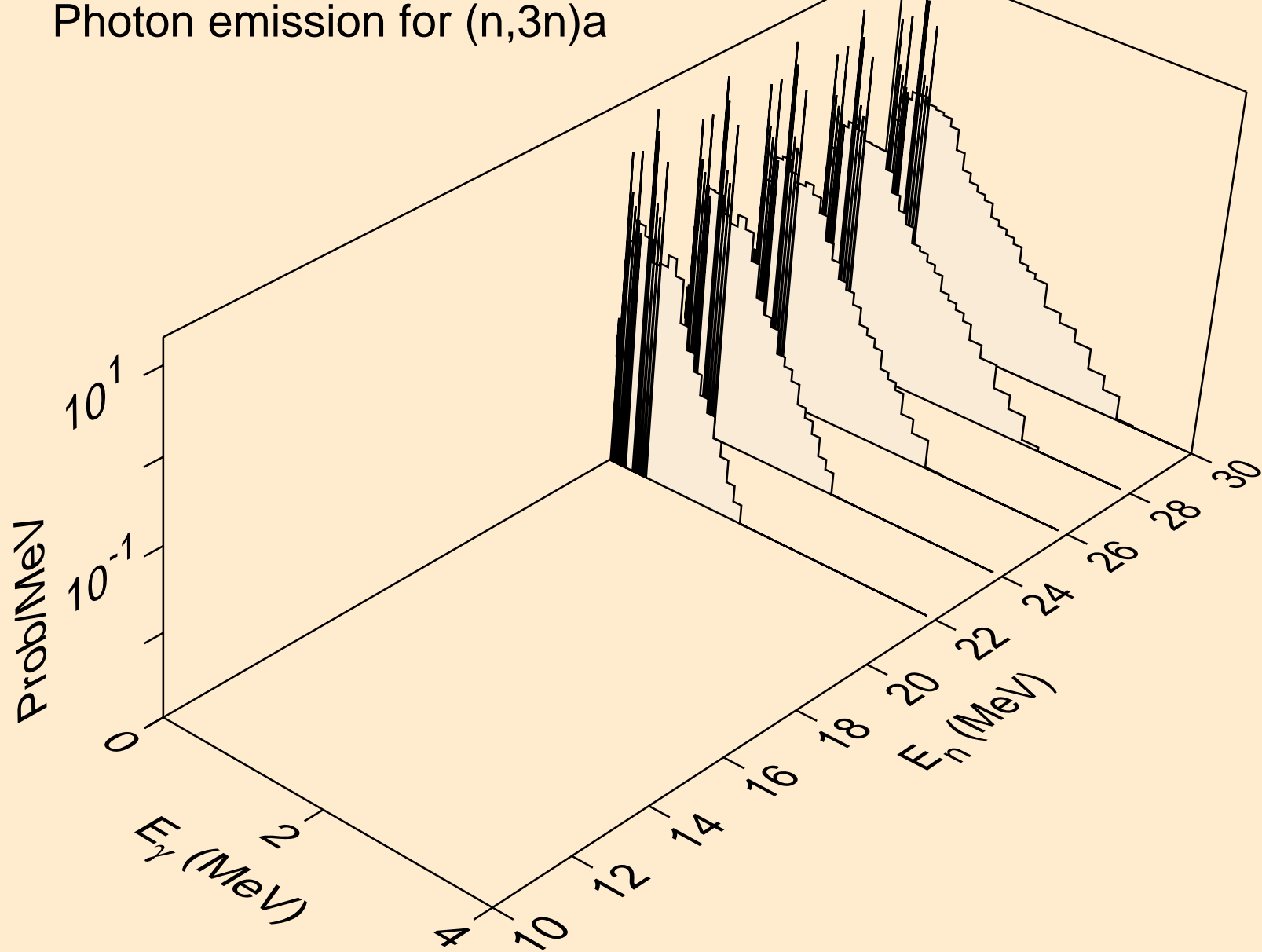

TM176 NEUTRON ACER TENDL-2021 LIBRARY; T=293.6K
Photon emission for (n,n*)p

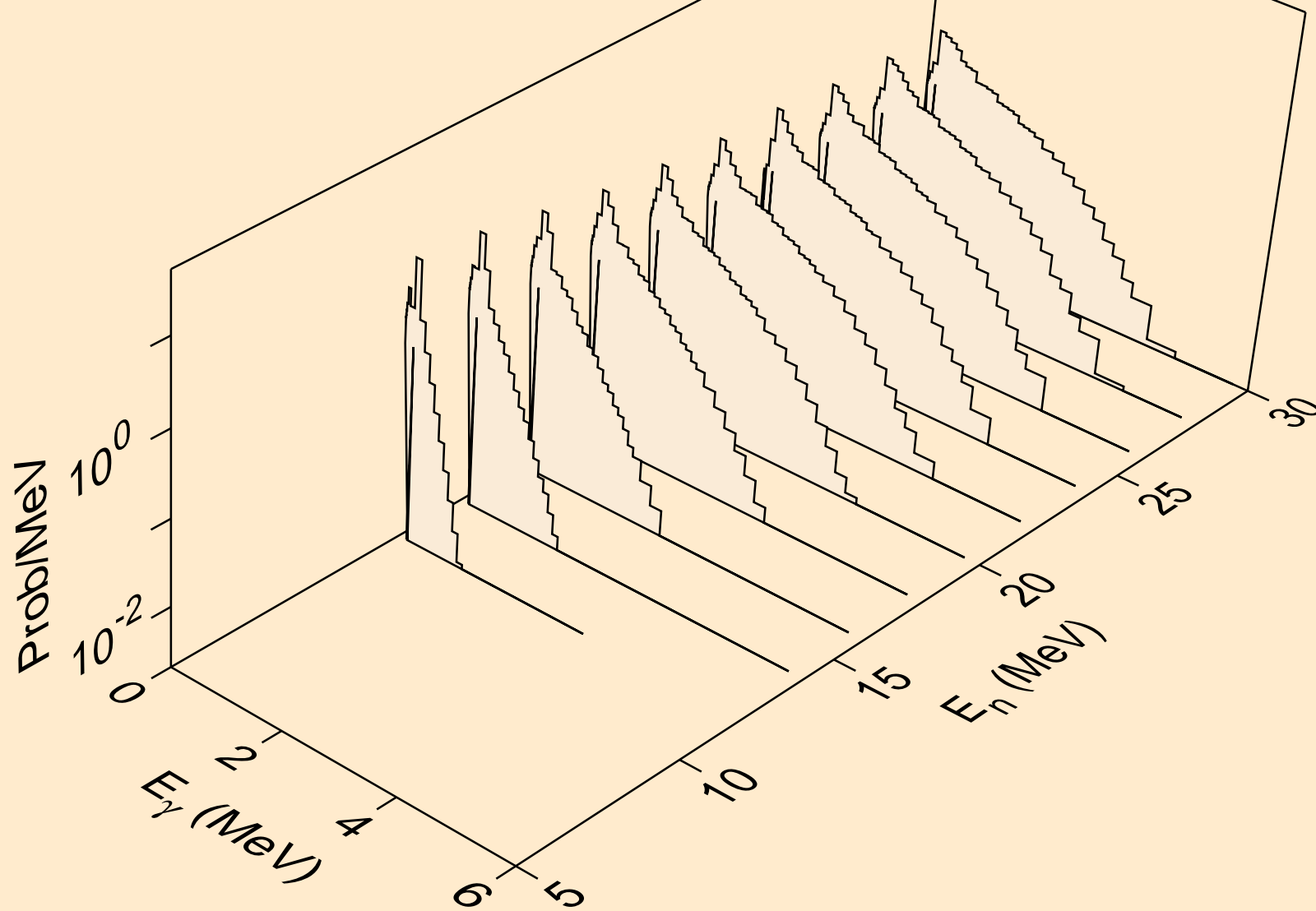

TM176 NEUTRON ACER TENDL-2021 LIBRARY; T=293.6K
Photon emission for (n,n*)d

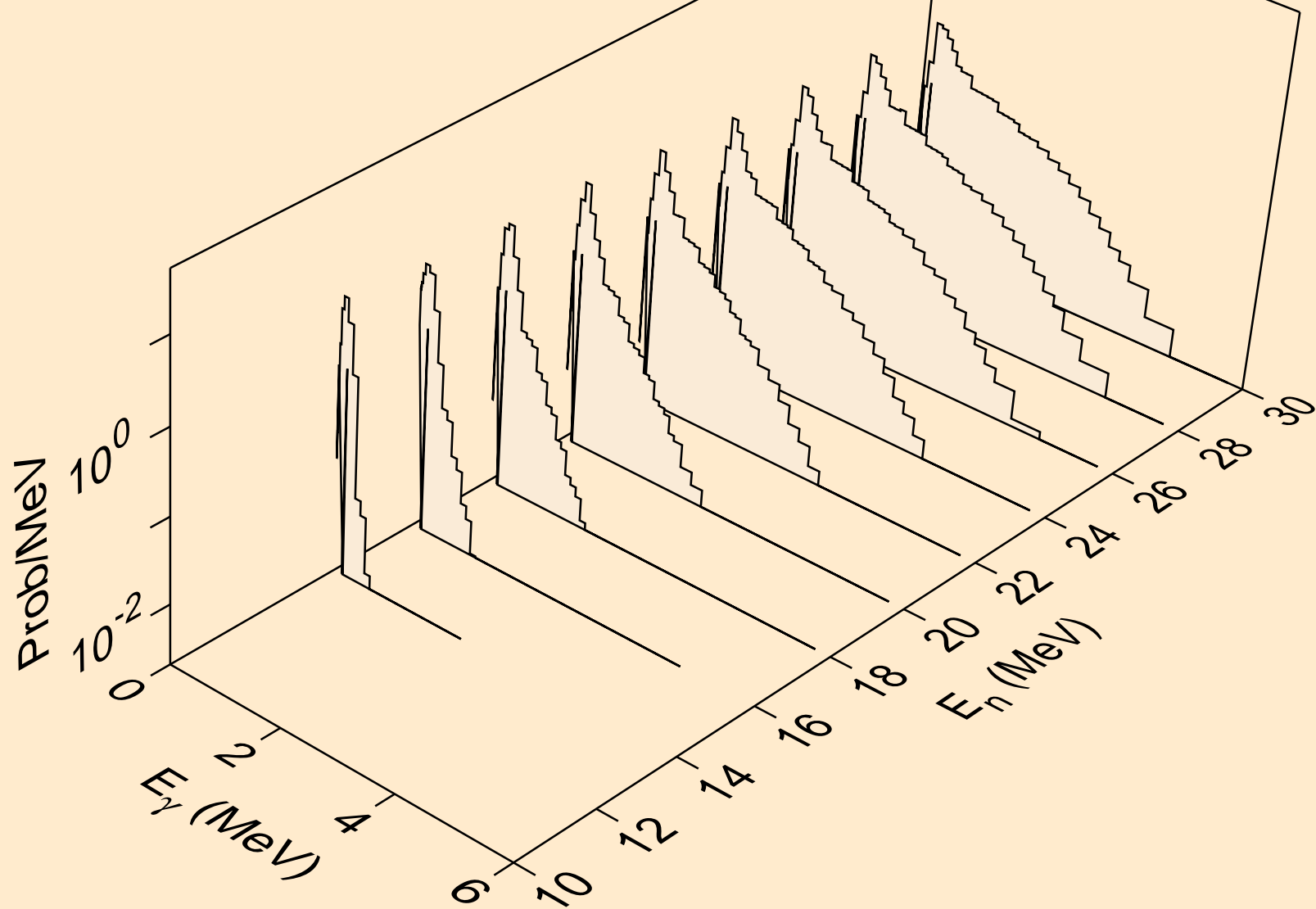

TM176 NEUTRON ACER TENDL-2021 LIBRARY; T=293.6K
Photon emission for (n,n*)t

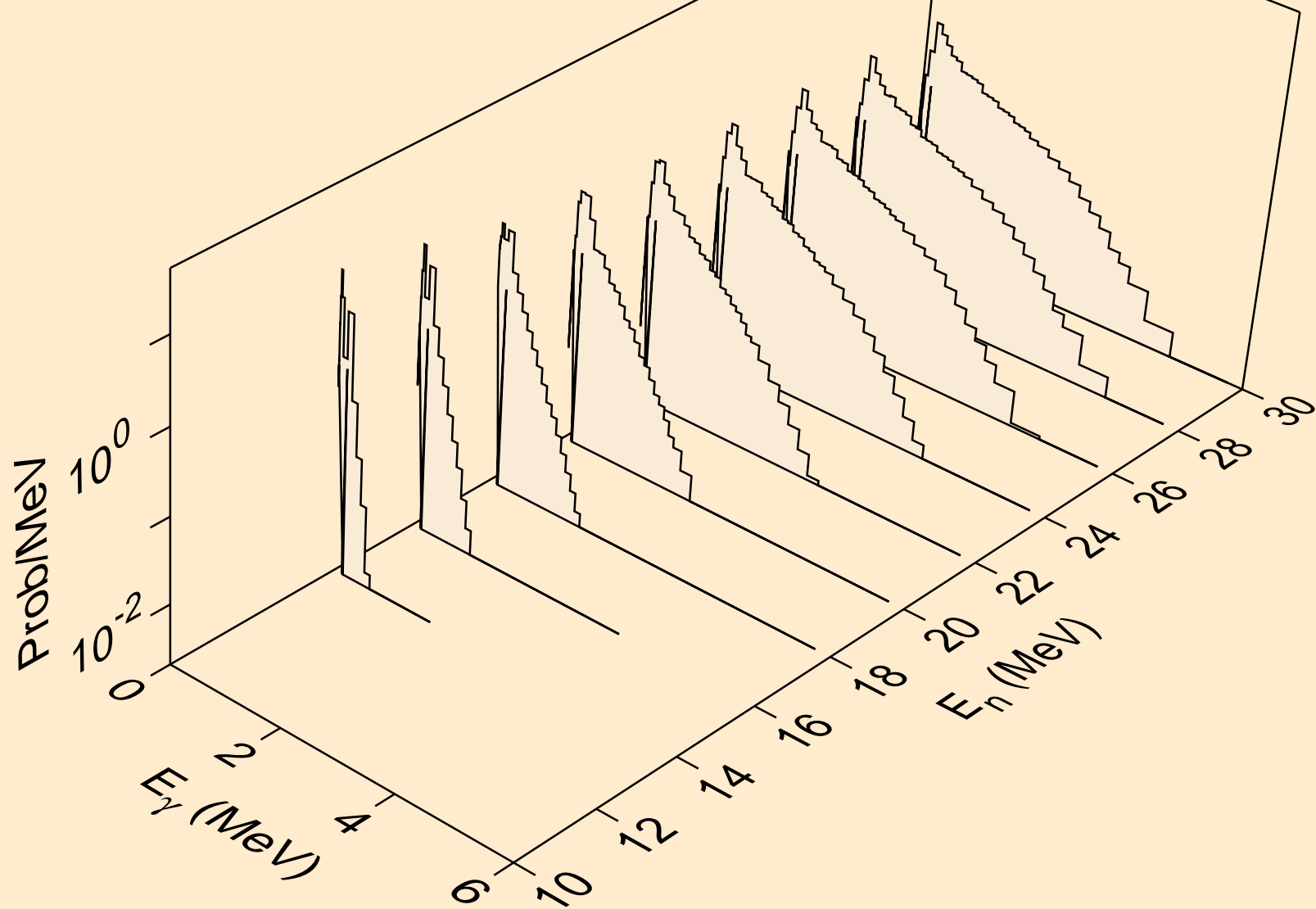

TM176 NEUTRON ACER TENDL-2021 LIBRARY; T=293.6K
Photon emission for (n,n*)he3

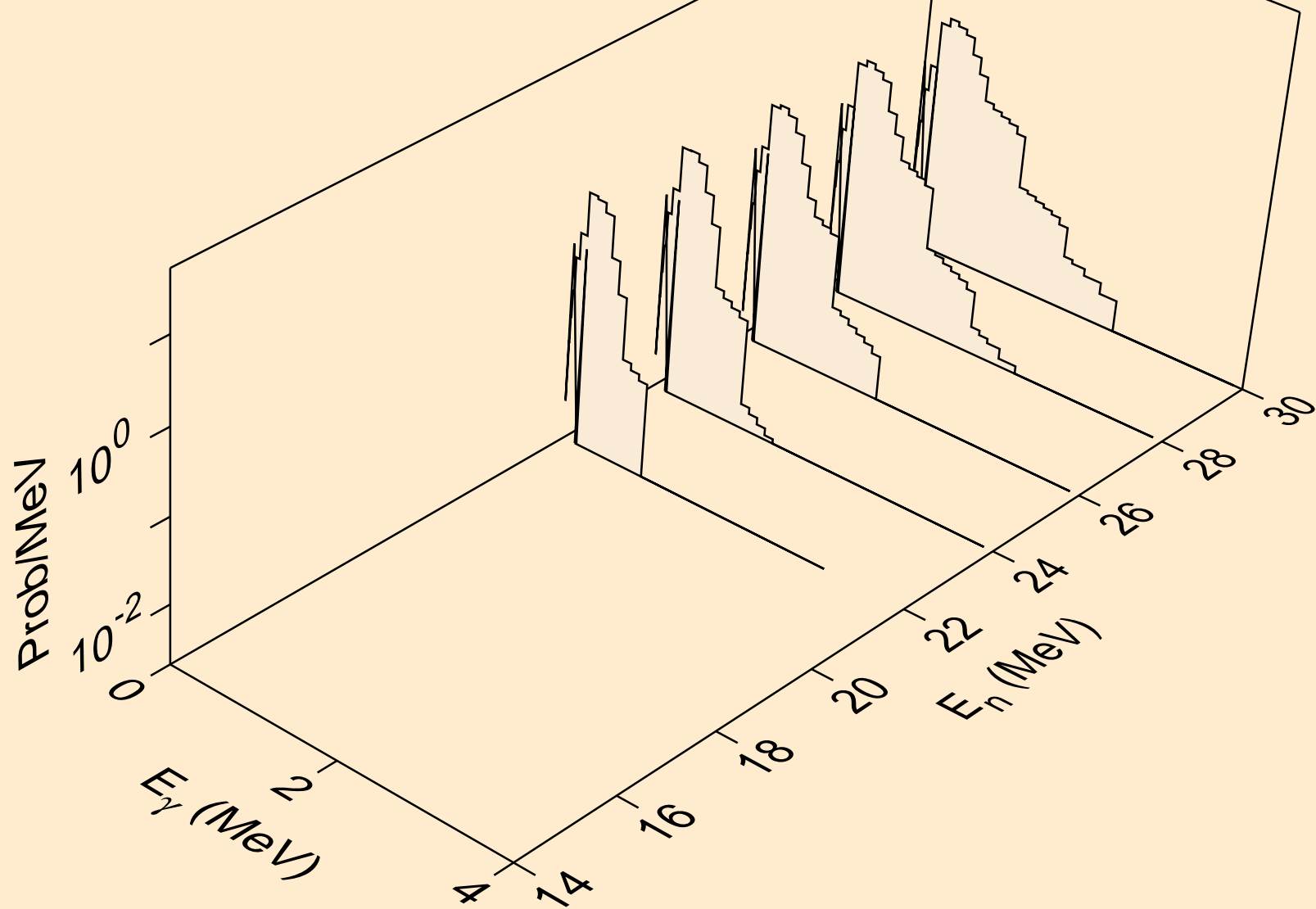

TM176 NEUTRON ACER TENDL-2021 LIBRARY; T=293.6K
Photon emission for (n,4n)

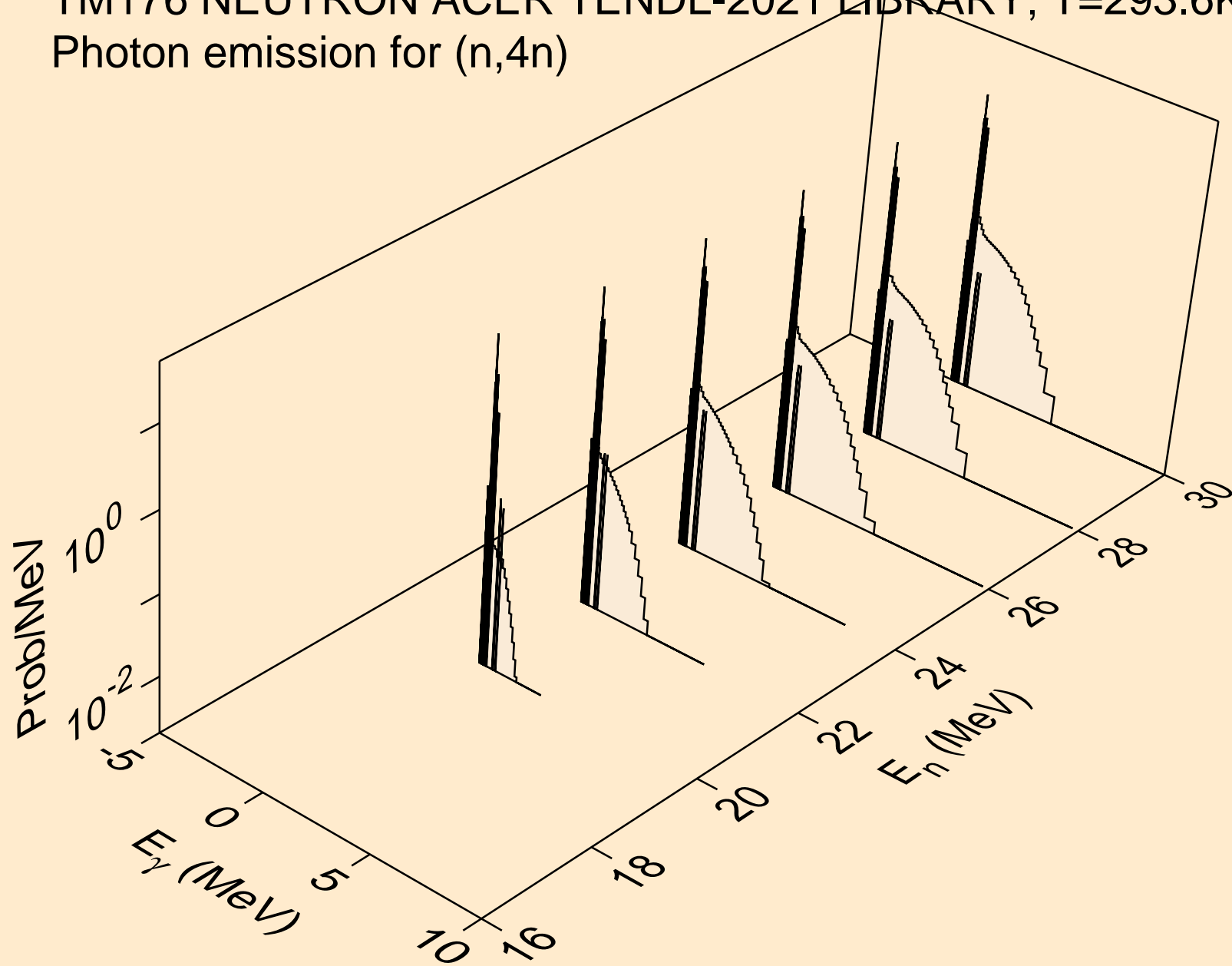

TM176 NEUTRON ACER TENDL-2021 LIBRARY; T=293.6K
Photon emission for (n,2np)

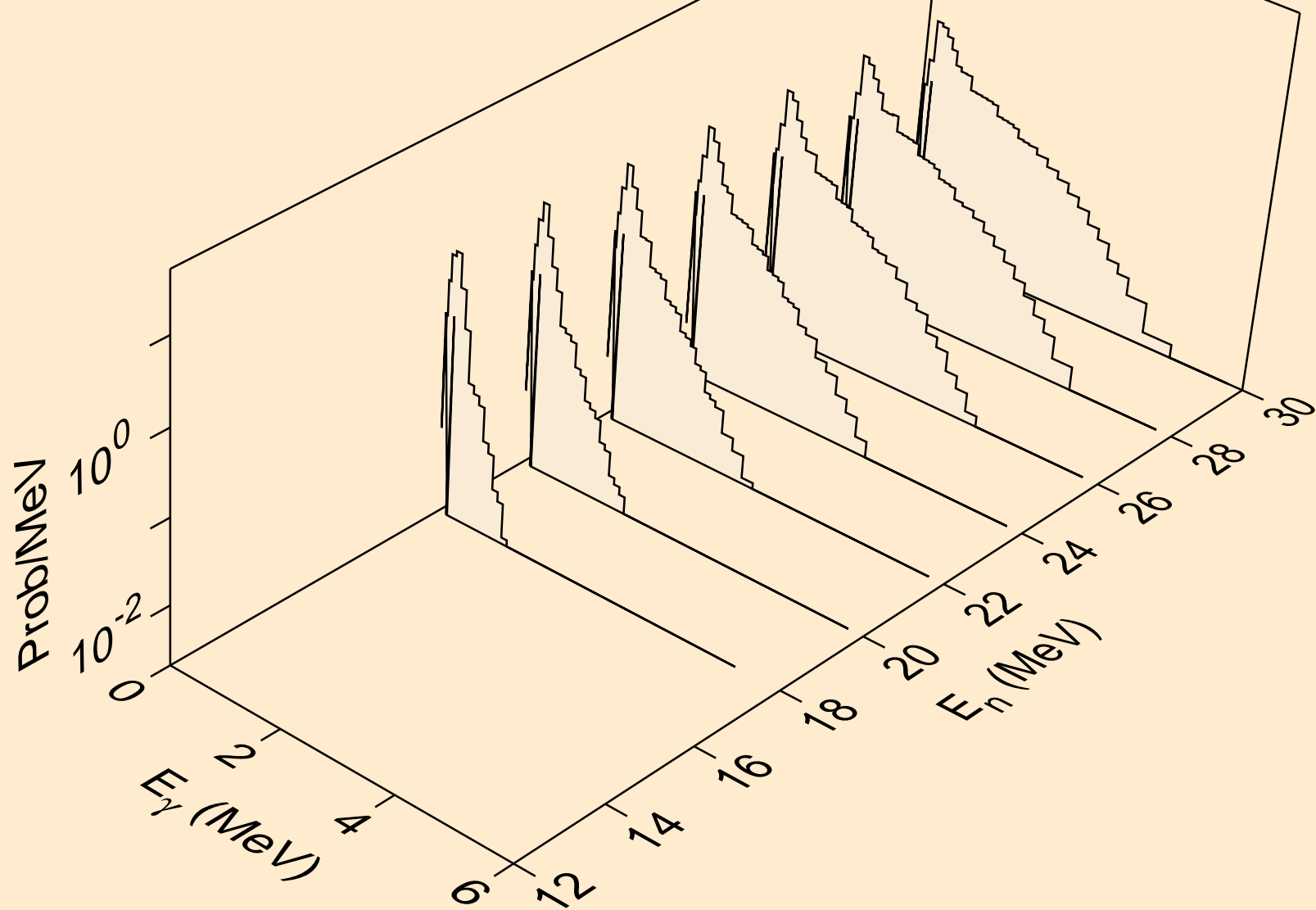

TM176 NEUTRON ACER TENDL-2021 LIBRARY; T=293.6K
Photon emission for (n,3np)

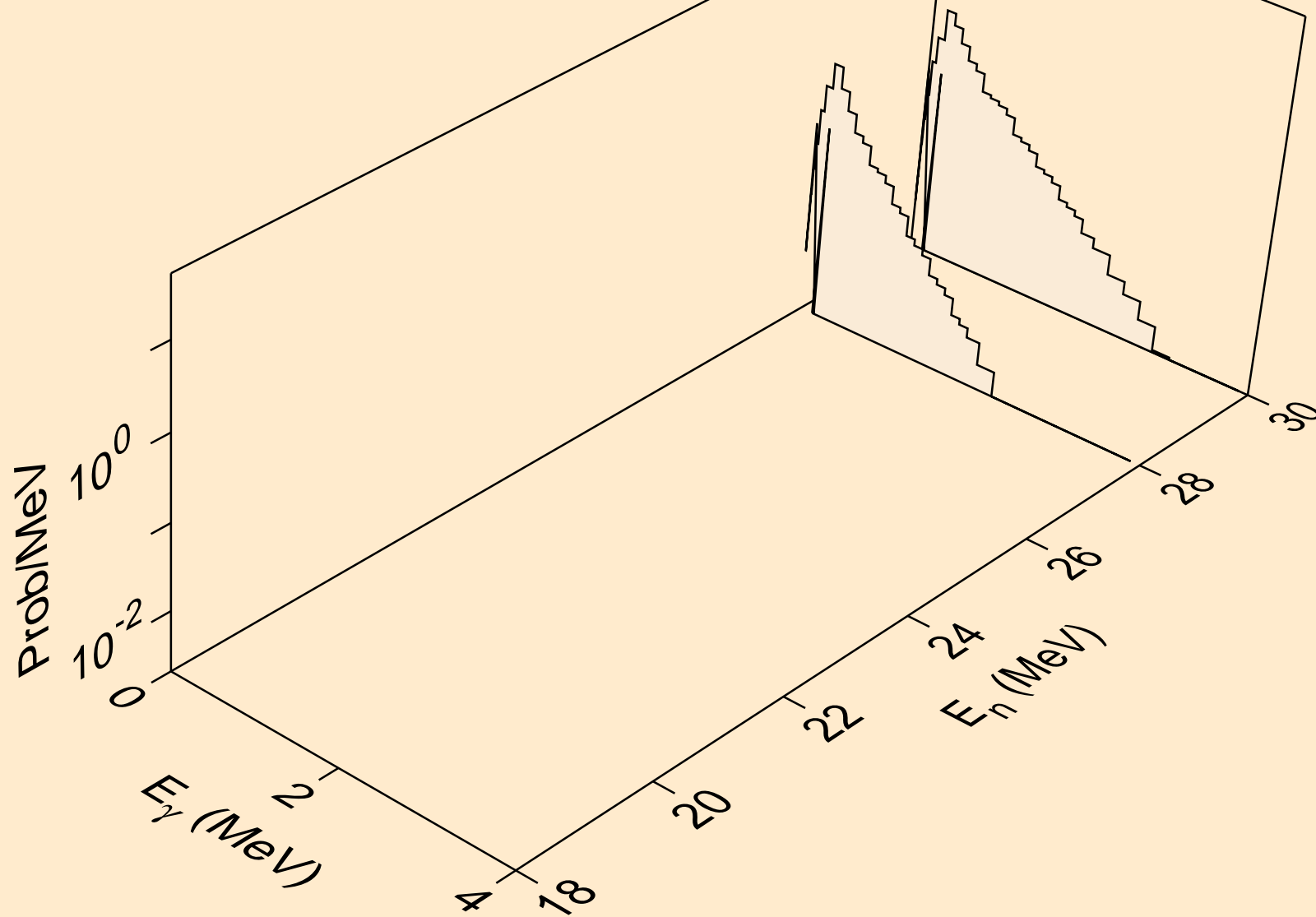

TM176 NEUTRON ACER TENDL-2021 LIBRARY; T=293.6K
Photon emission for (n,n*c)

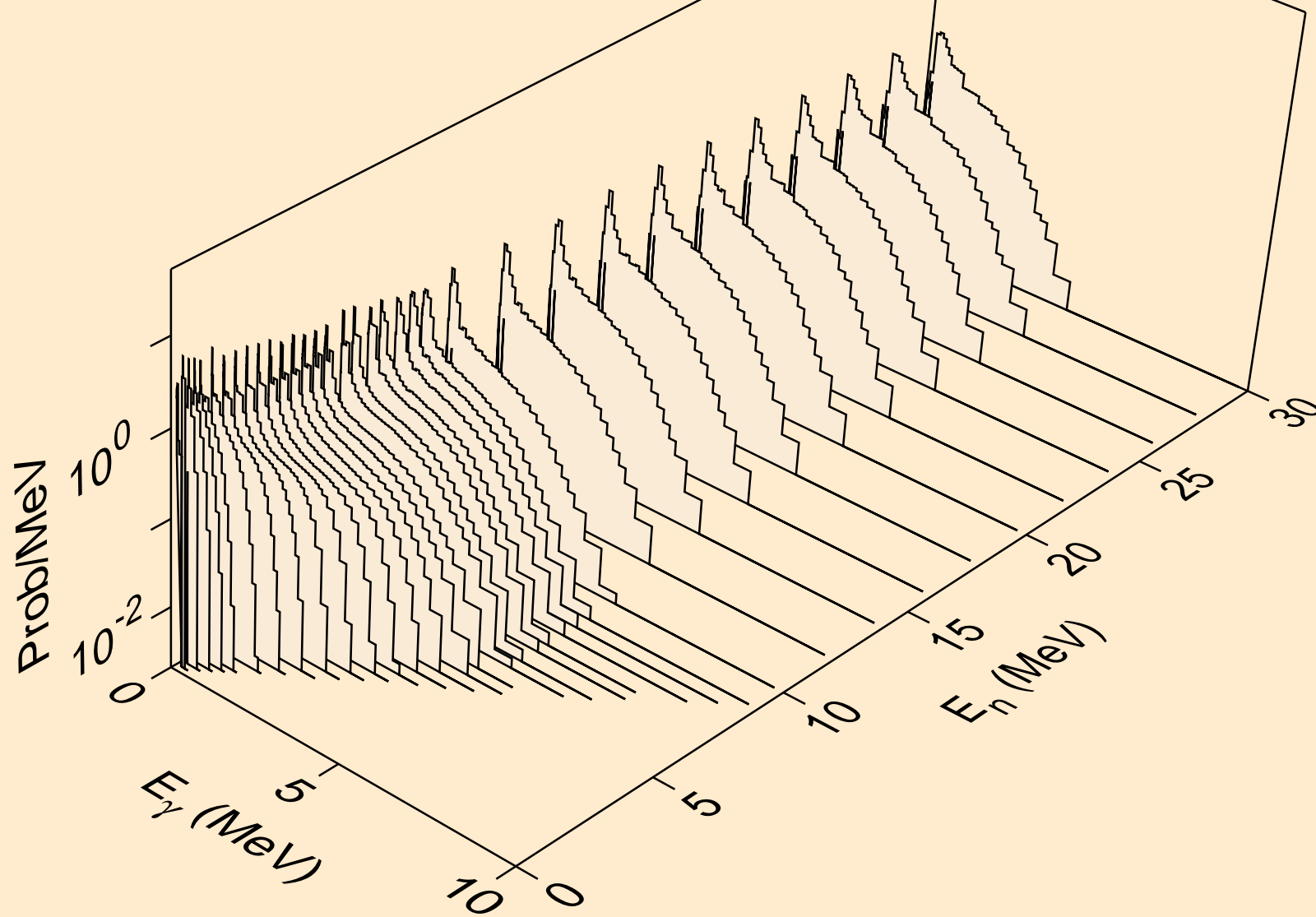

TM176 NEUTRON ACER TENDL-2021 LIBRARY; T=293.6K
Photon emission for (n,gma)

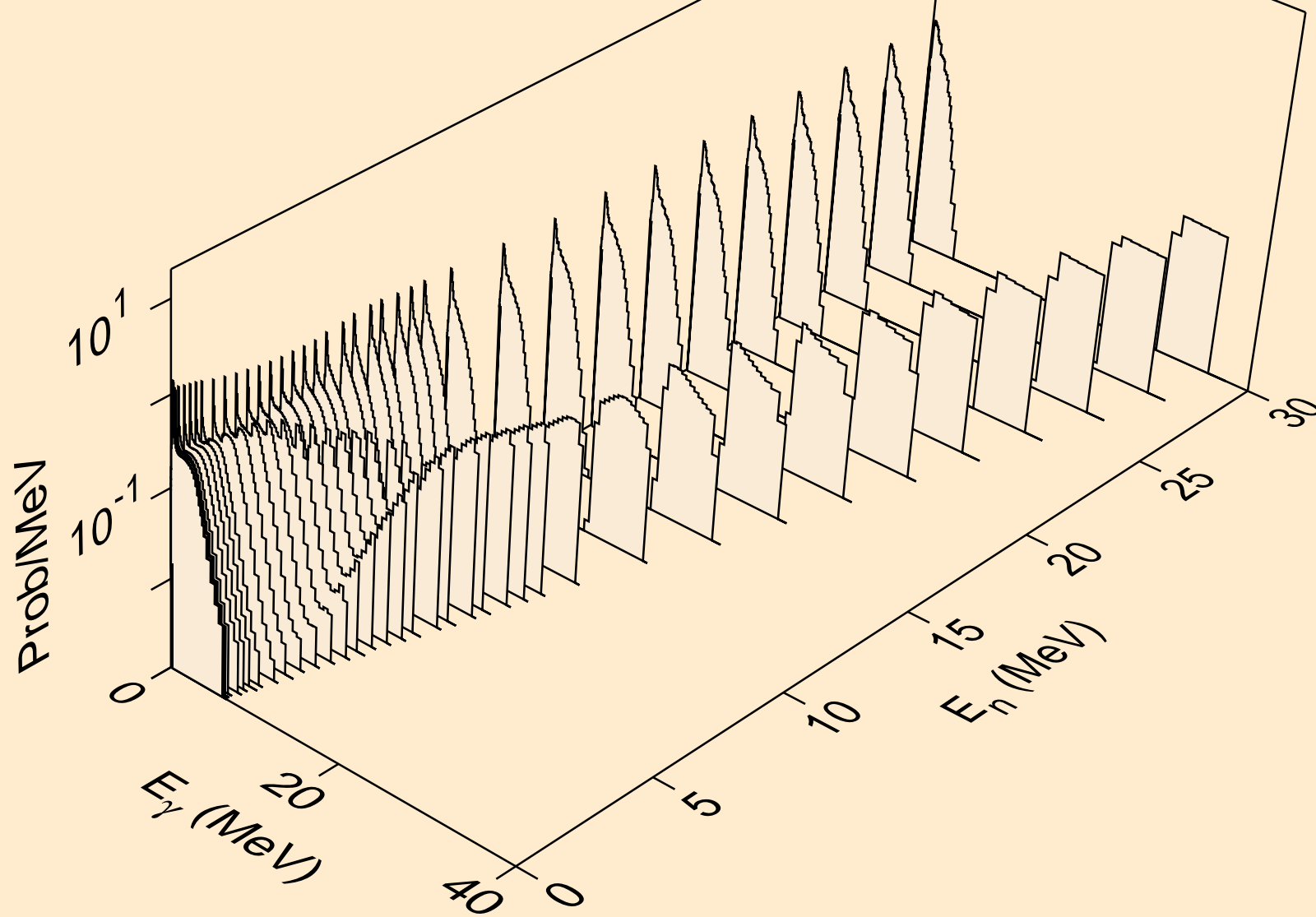

TM176 NEUTRON ACER TENDL-2021 LIBRARY; T=293.6K
Photon emission for (n,p)

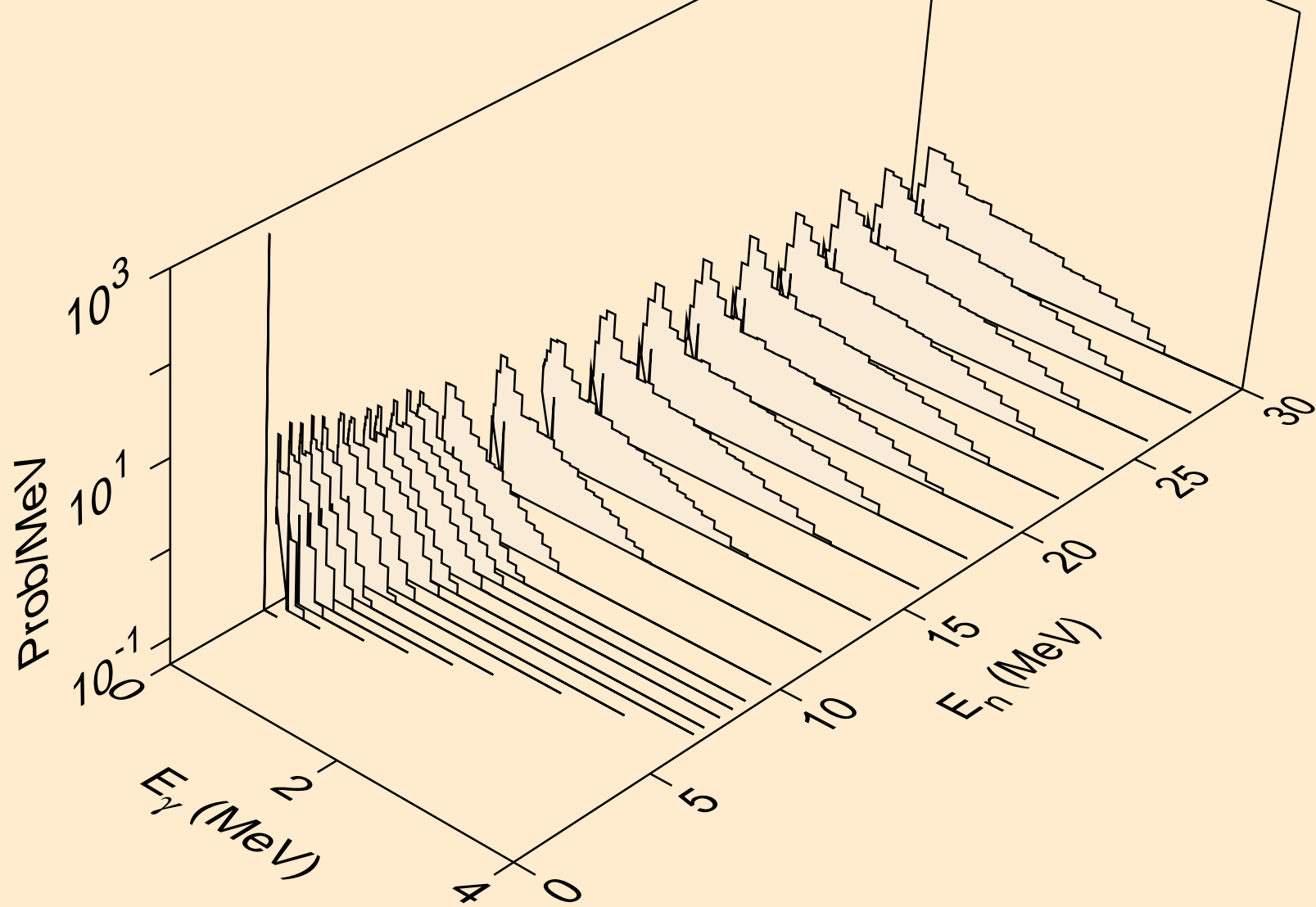

TM176 NEUTRON ACER TENDL-2021 LIBRARY; T=293.6K
Photon emission for (n,d)

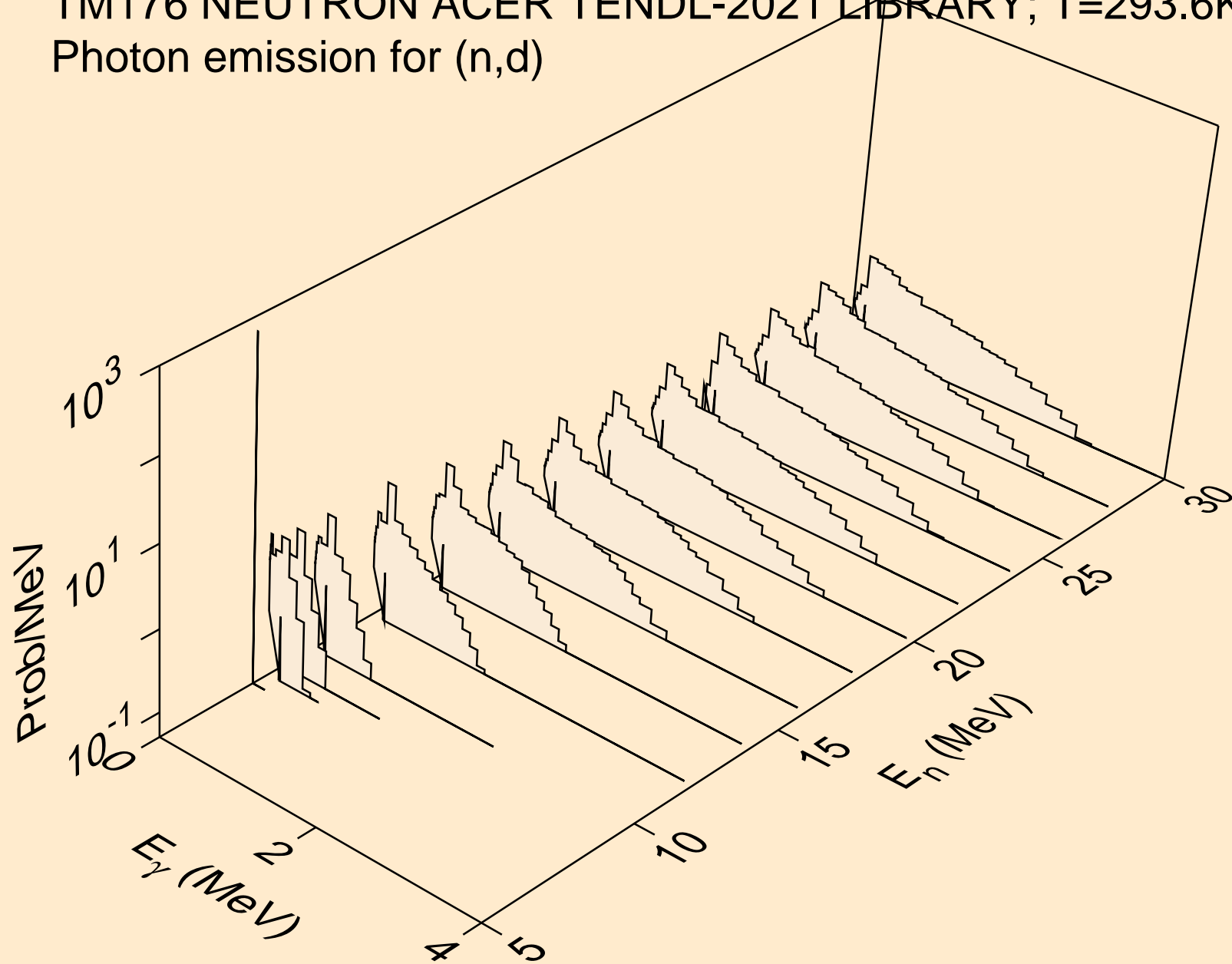

TM176 NEUTRON ACER TENDL-2021 LIBRARY; T=293.6K
Photon emission for (n,t)

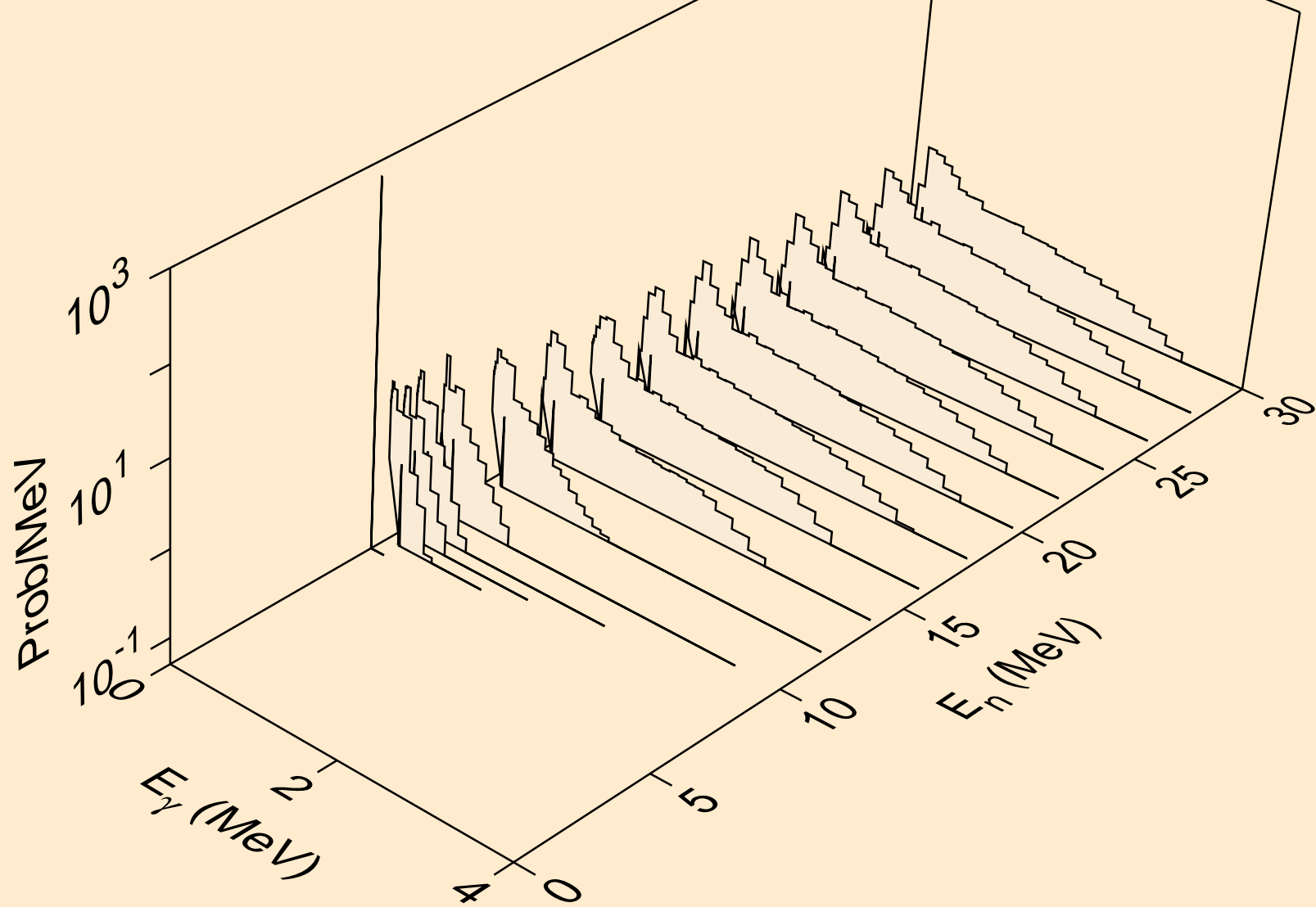

TM176 NEUTRON ACER TENDL-2021 LIBRARY; T=293.6K
Photon emission for (n,he3)

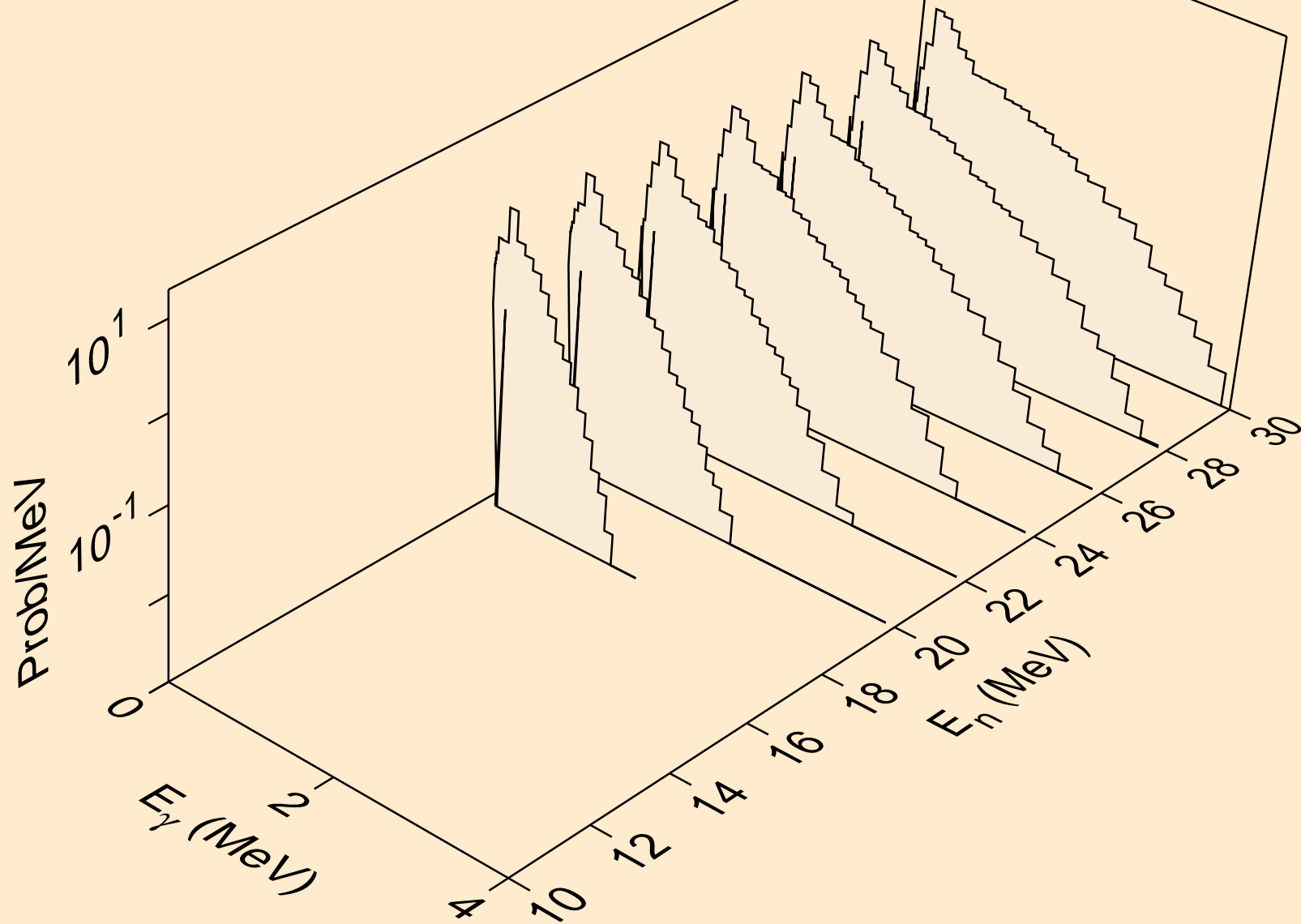

TM176 NEUTRON ACER TENDL-2021 LIBRARY; T=293.6K
Photon emission for (n,a)

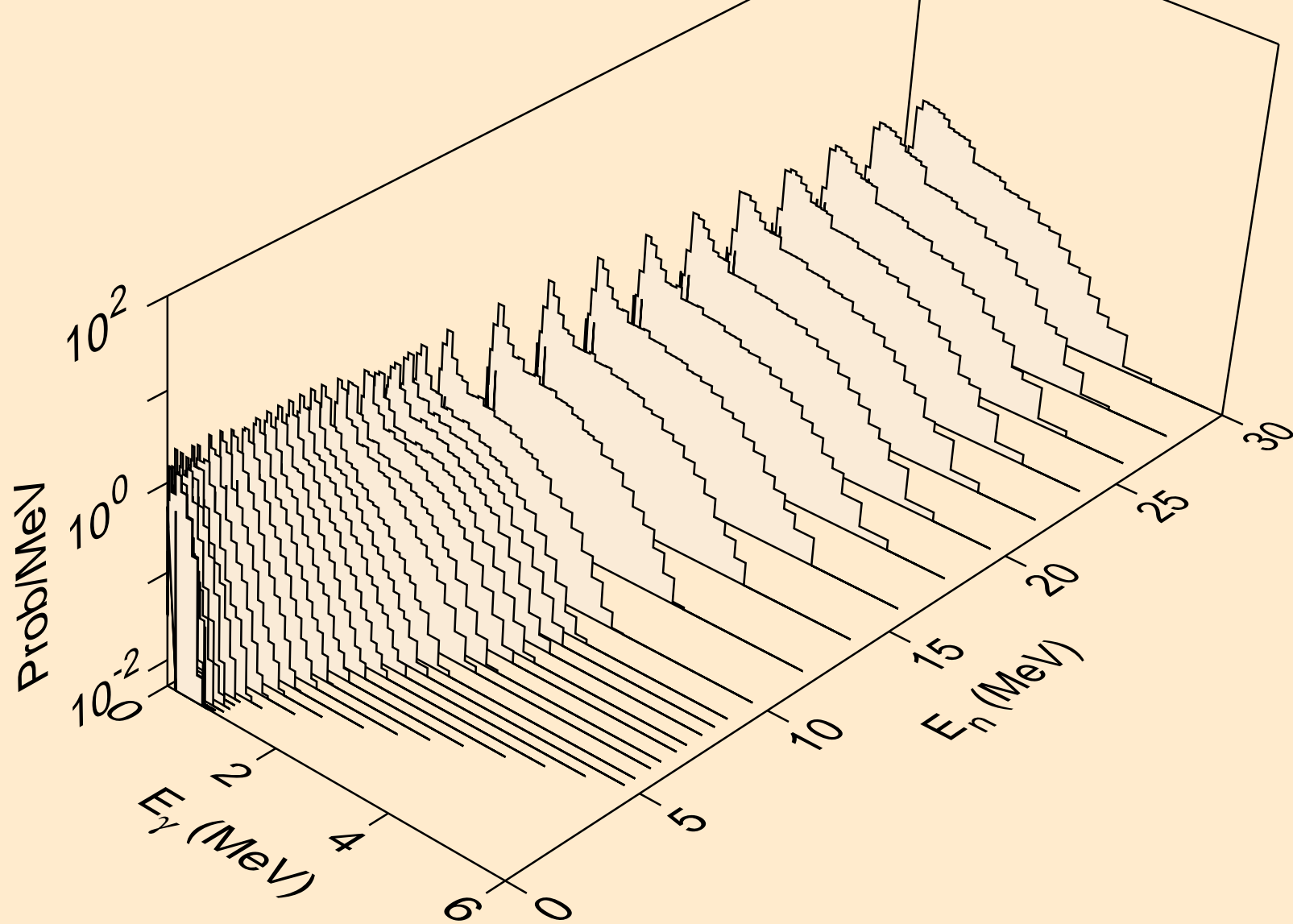

TM176 NEUTRON ACER TENDL-2021 LIBRARY; T=293.6K
Photon emission for (n,2p)

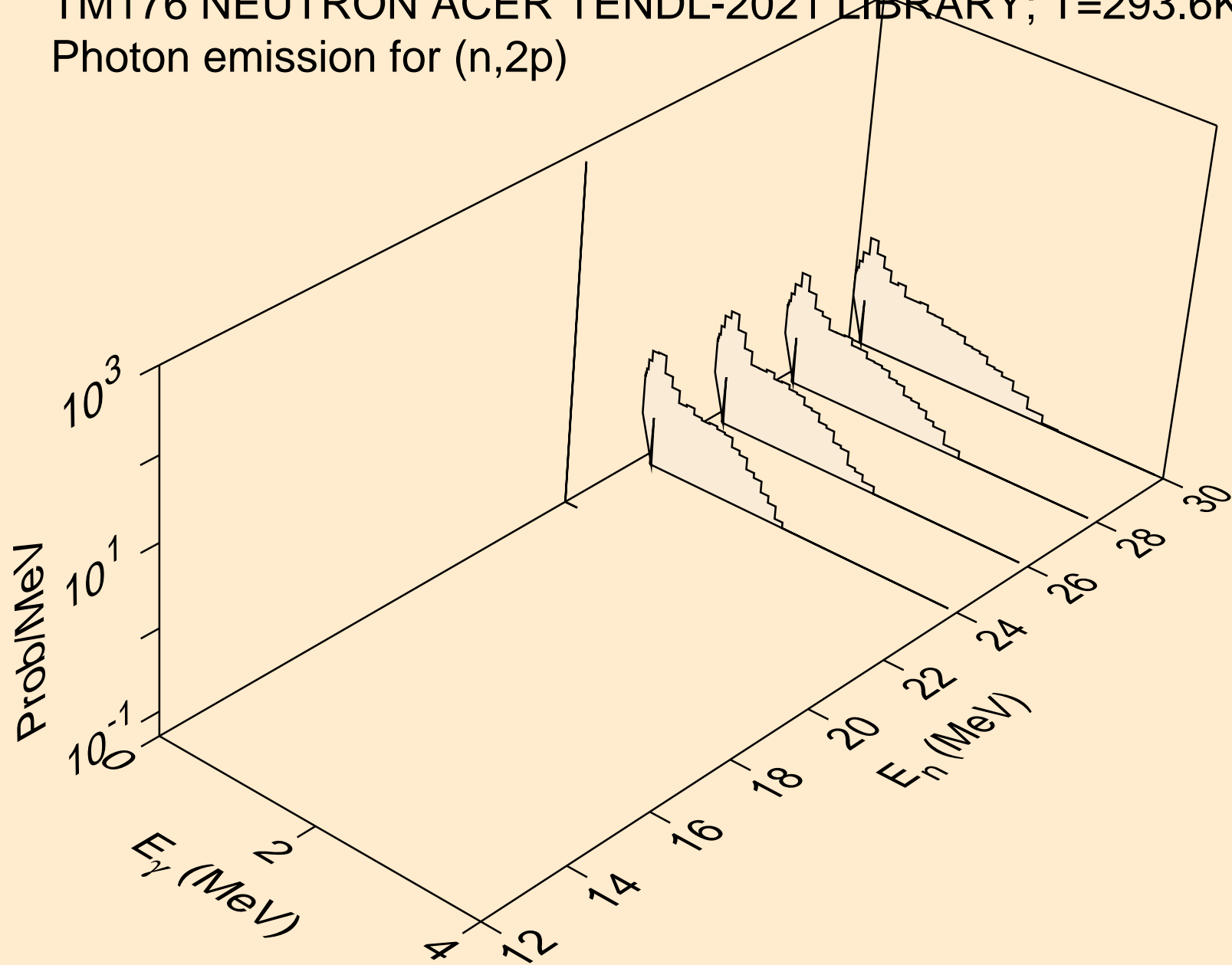

TM176 NEUTRON ACER TENDL-2021 LIBRARY; T=293.6K
thermal capture photon spectrum

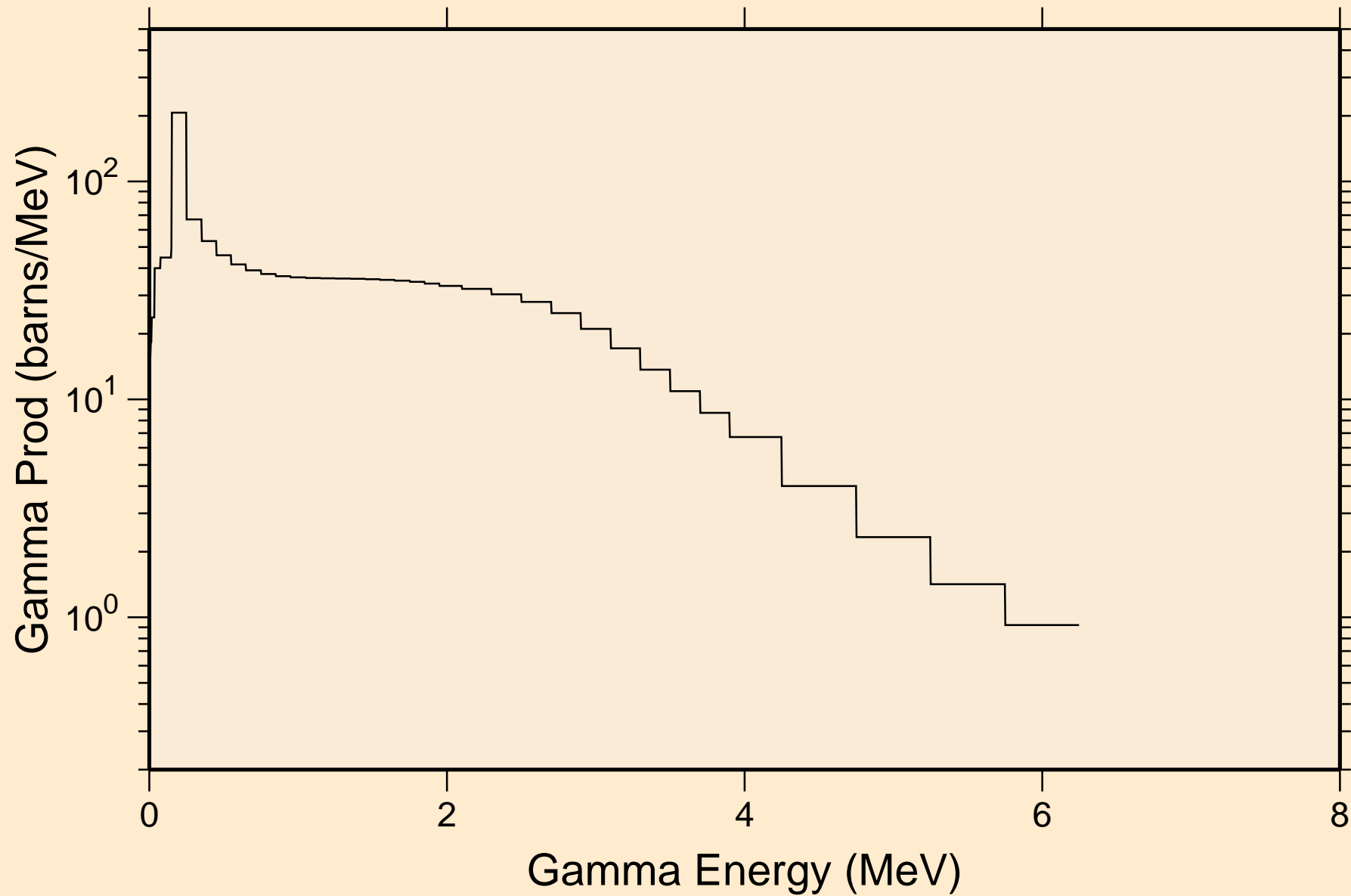

TM176 NEUTRON ACER TENDL-2021 LIBRARY; T=293.6K
14 MeV photon spectrum

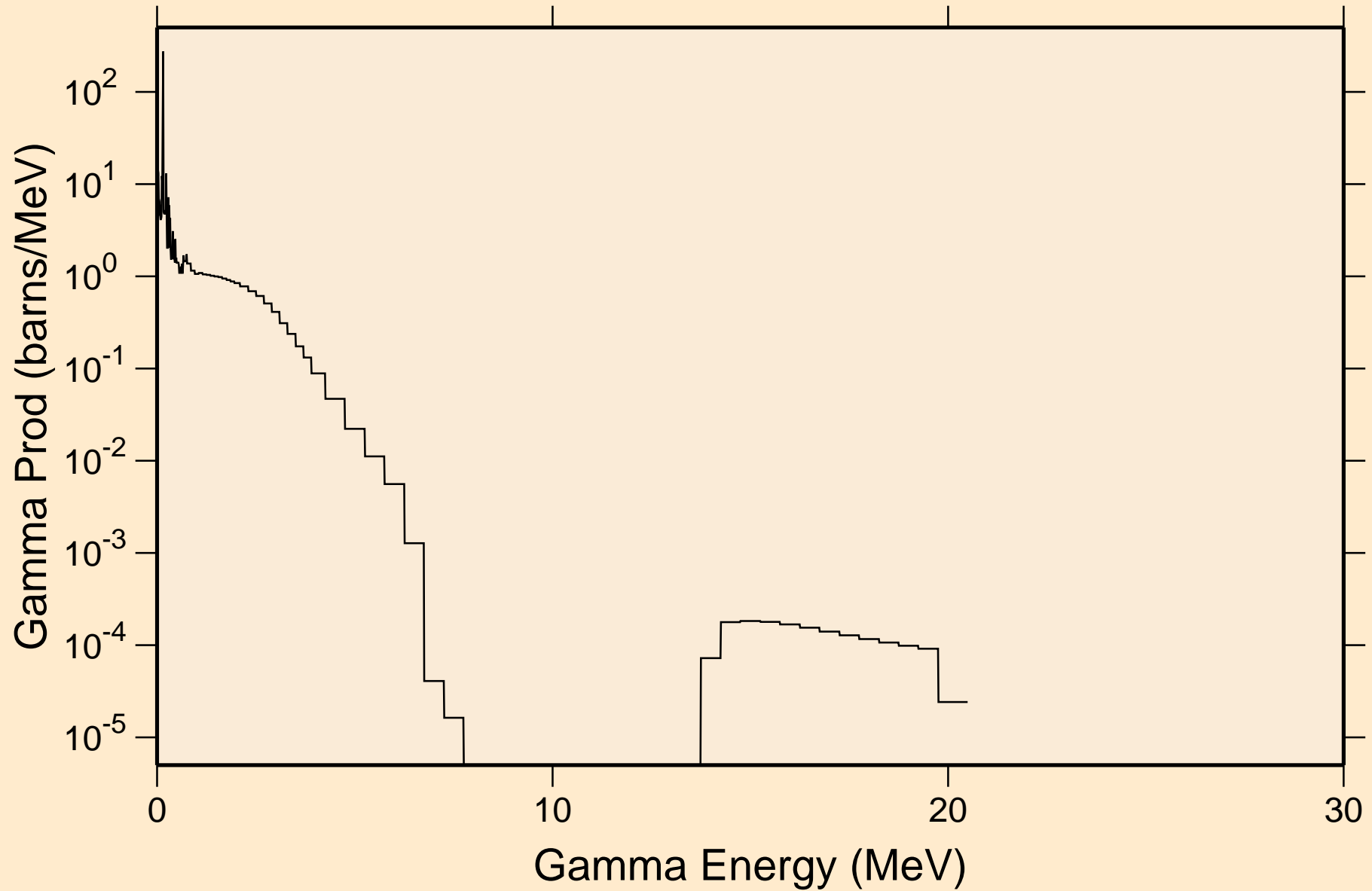

TM176 NEUTRON ACER TENDL-2021 LIBRARY; T=293.6K
Particle heating contributions

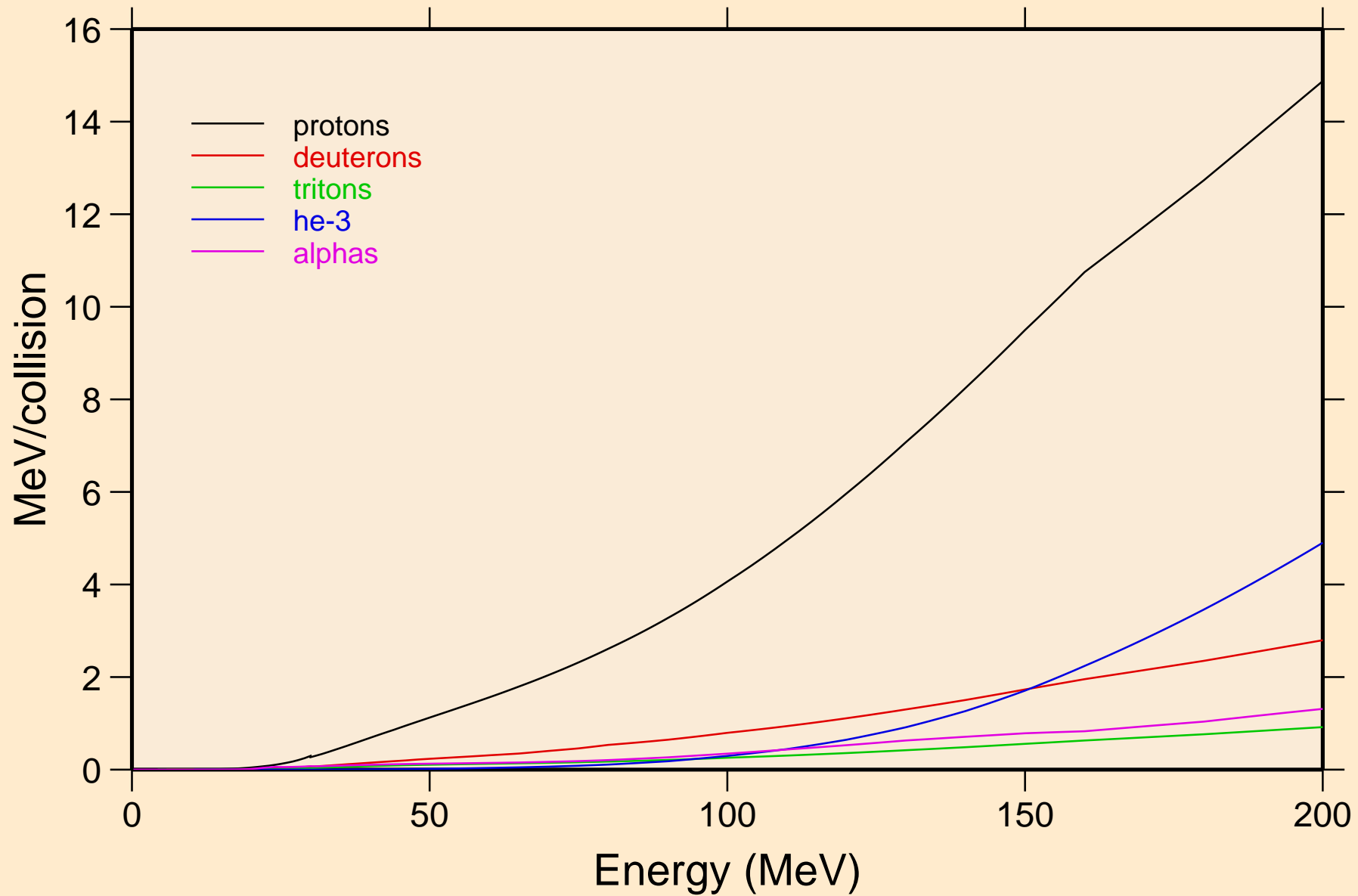

TM176 NEUTRON ACER TENDL-2021 LIBRARY; T=293.6K
Recoil Heating

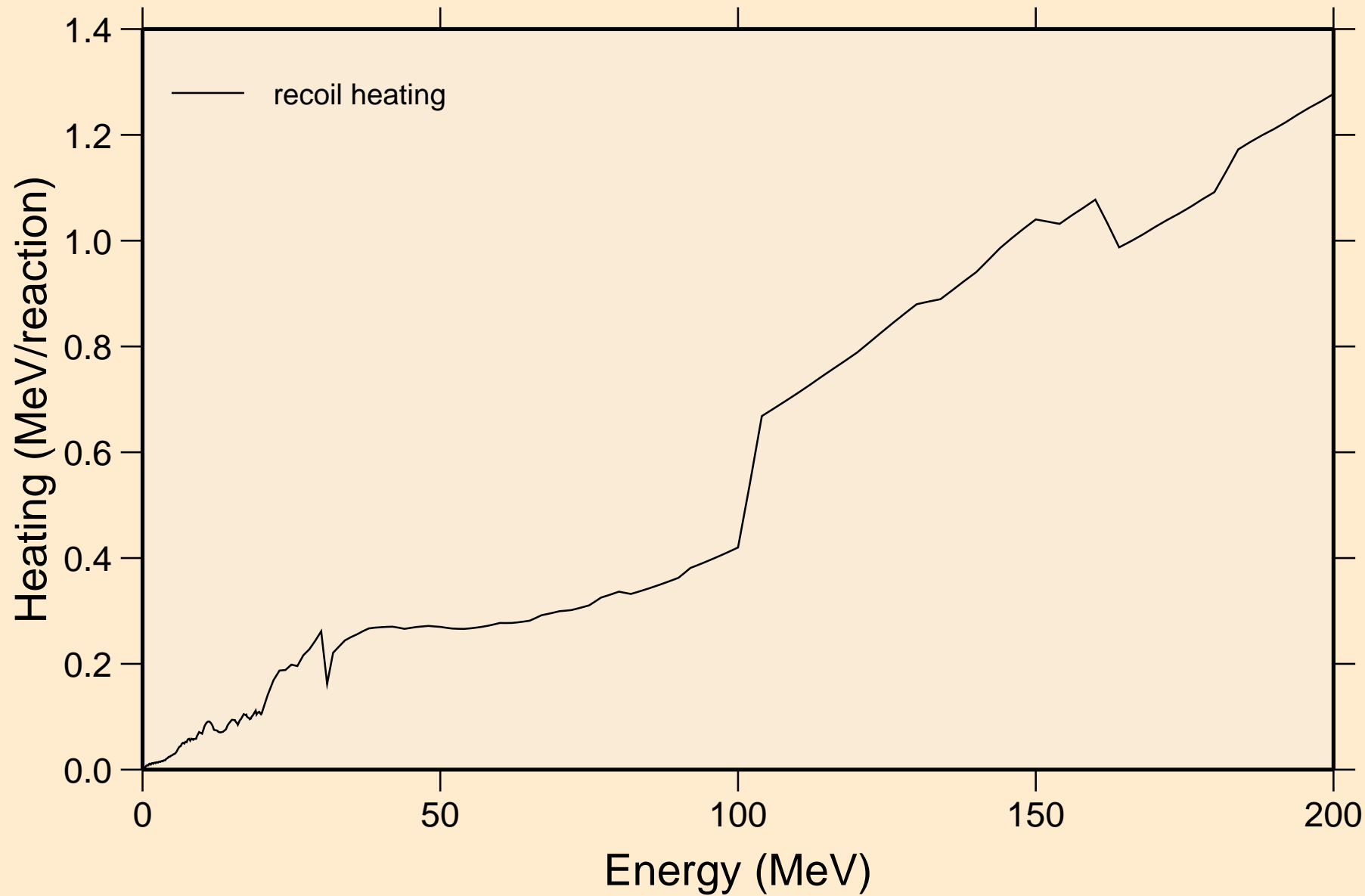

TM176 NEUTRON ACER TENDL-2021 LIBRARY; T=293.6K
Particle production cross sections

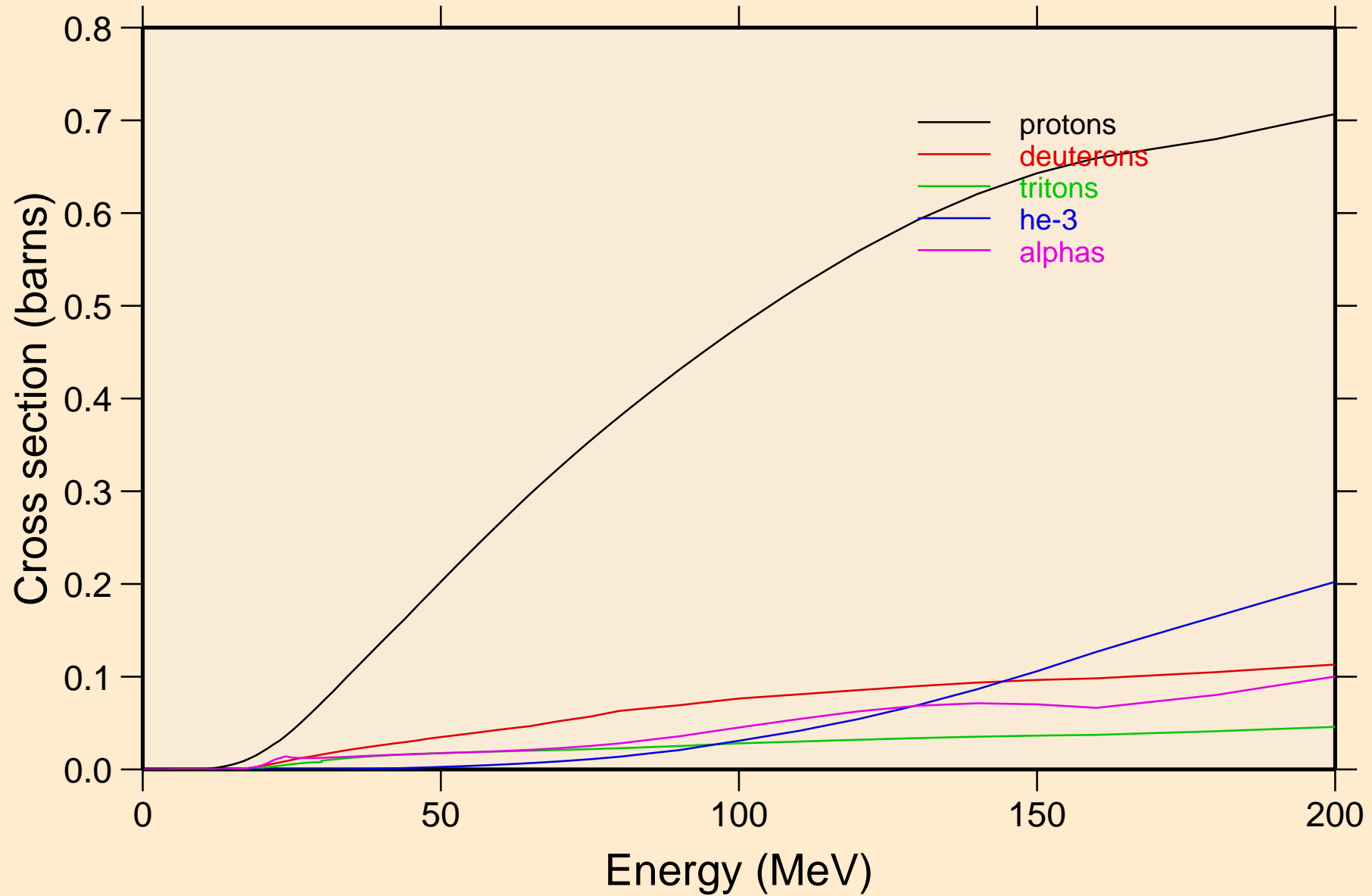

TM176 NEUTRON ACER TENDL-2021 LIBRARY; T=293.6K
protons from (n,x)

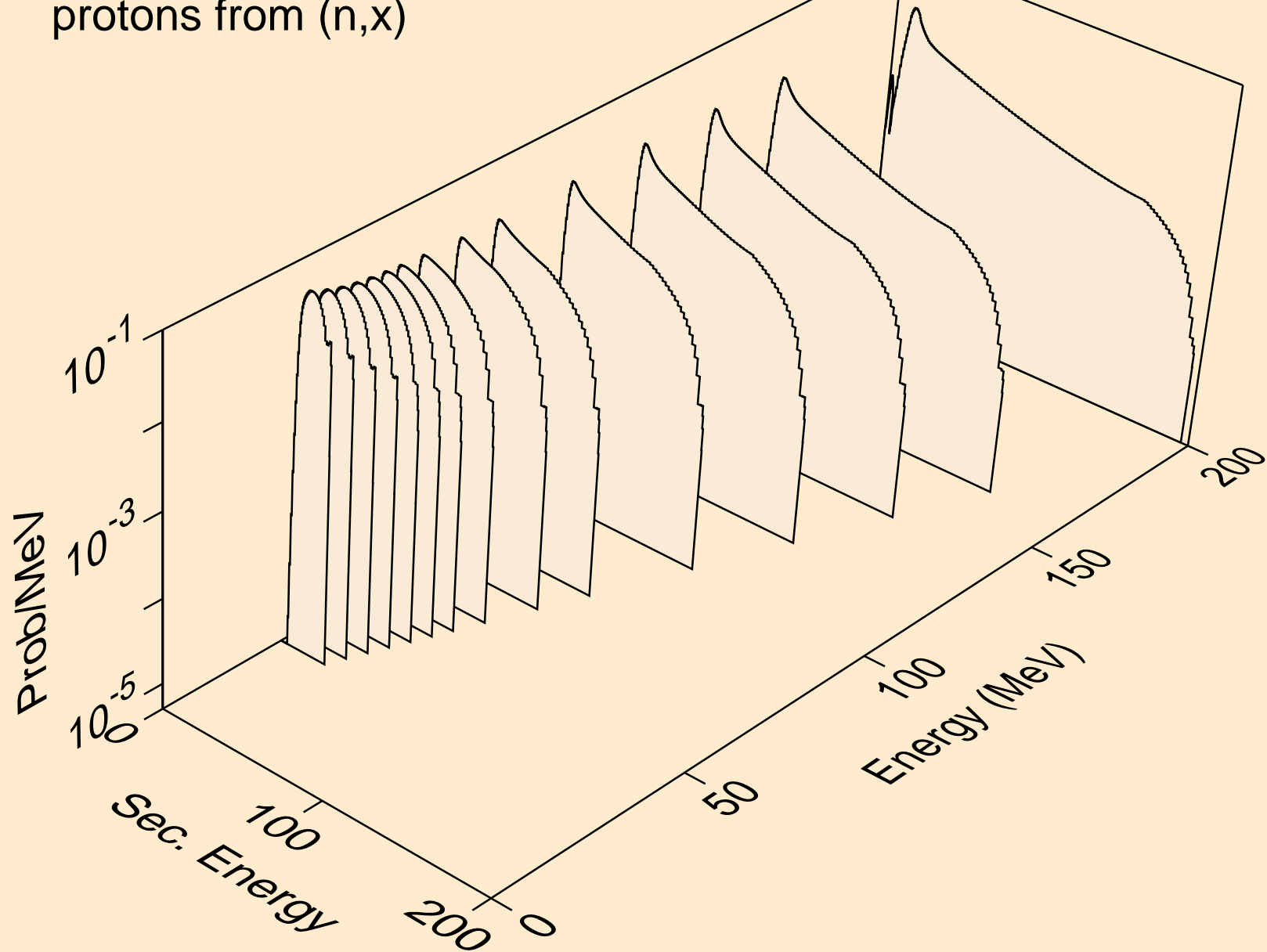

TM176 NEUTRON ACER TENDL-2021 LIBRARY; T=293.6K
protons from (n,n*)p

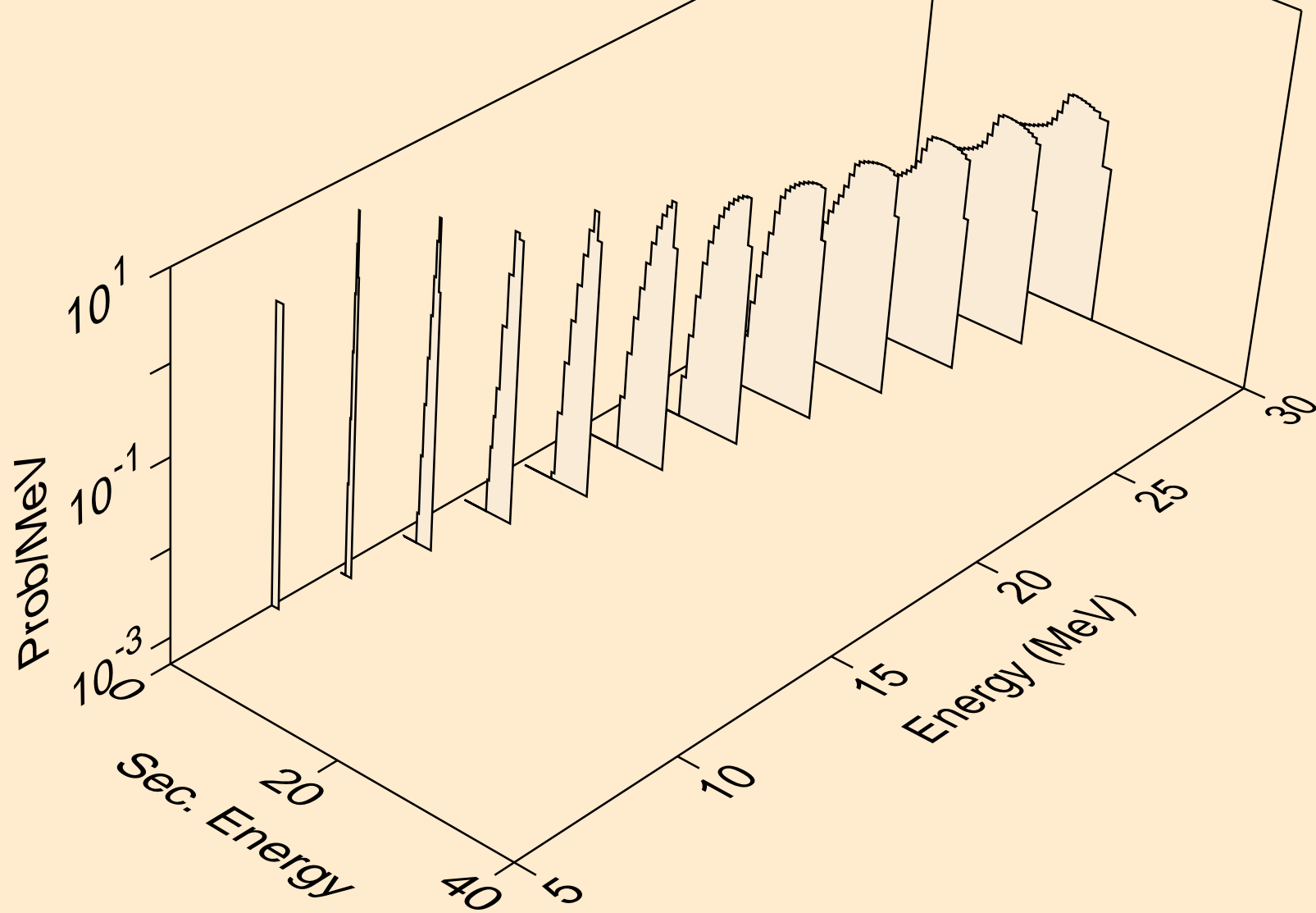

TM176 NEUTRON ACER TENDL-2021 LIBRARY; T=293.6K
protons from (n,2np)

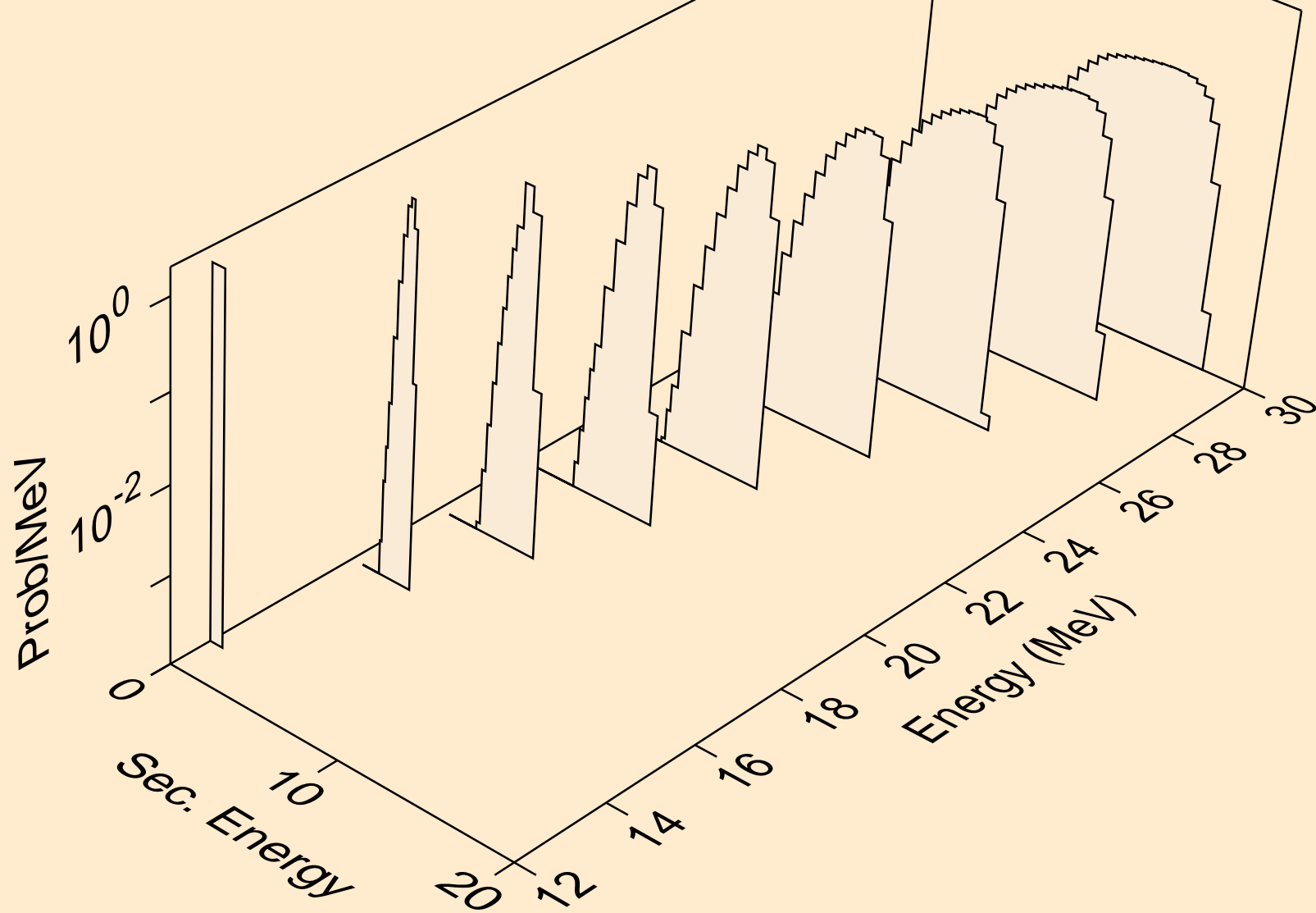

TM176 NEUTRON ACER TENDL-2021 LIBRARY; T=293.6K
protons from (n,3np)

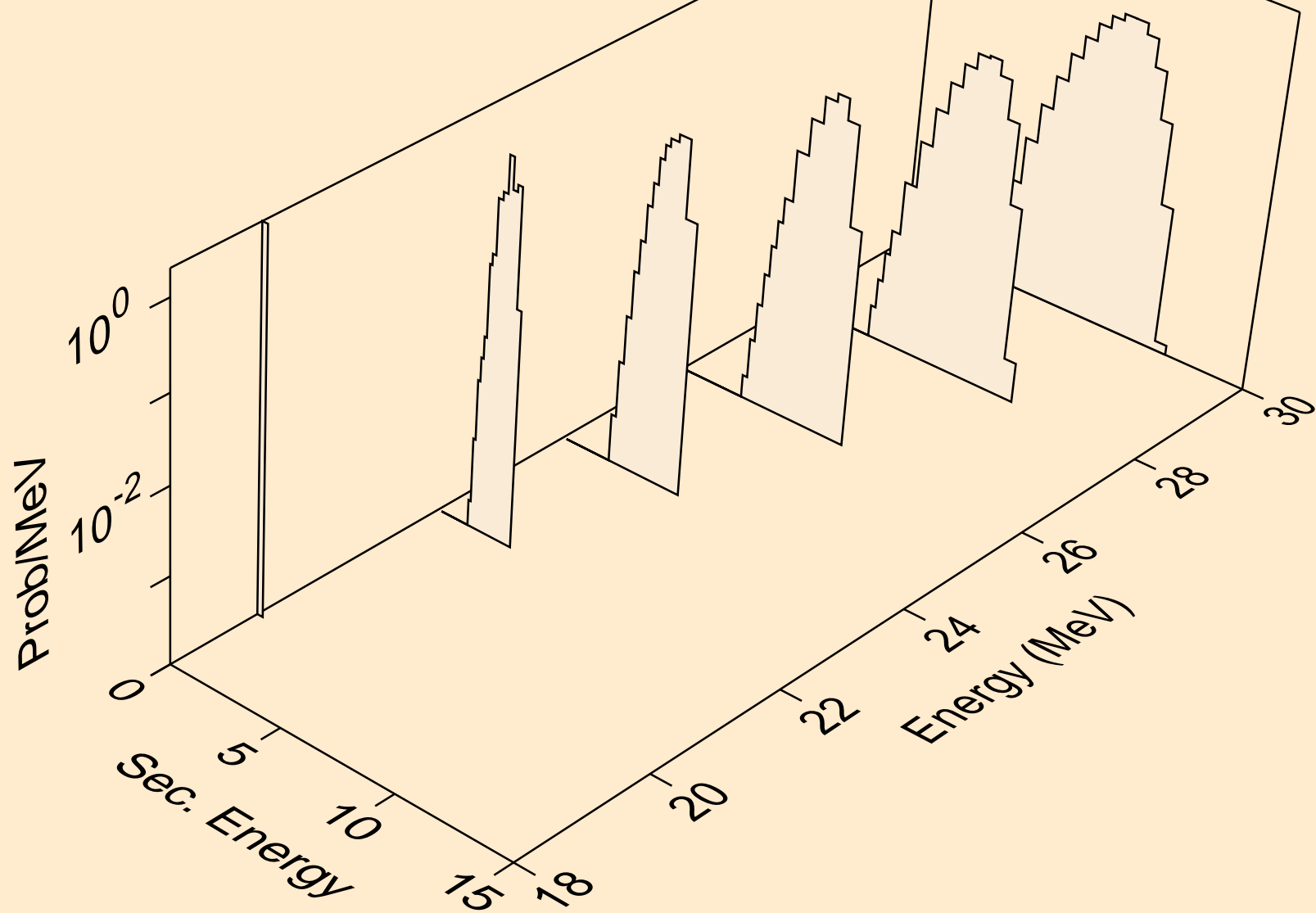

TM176 NEUTRON ACER TENDL-2021 LIBRARY; T=293.6K
protons from (n,p)

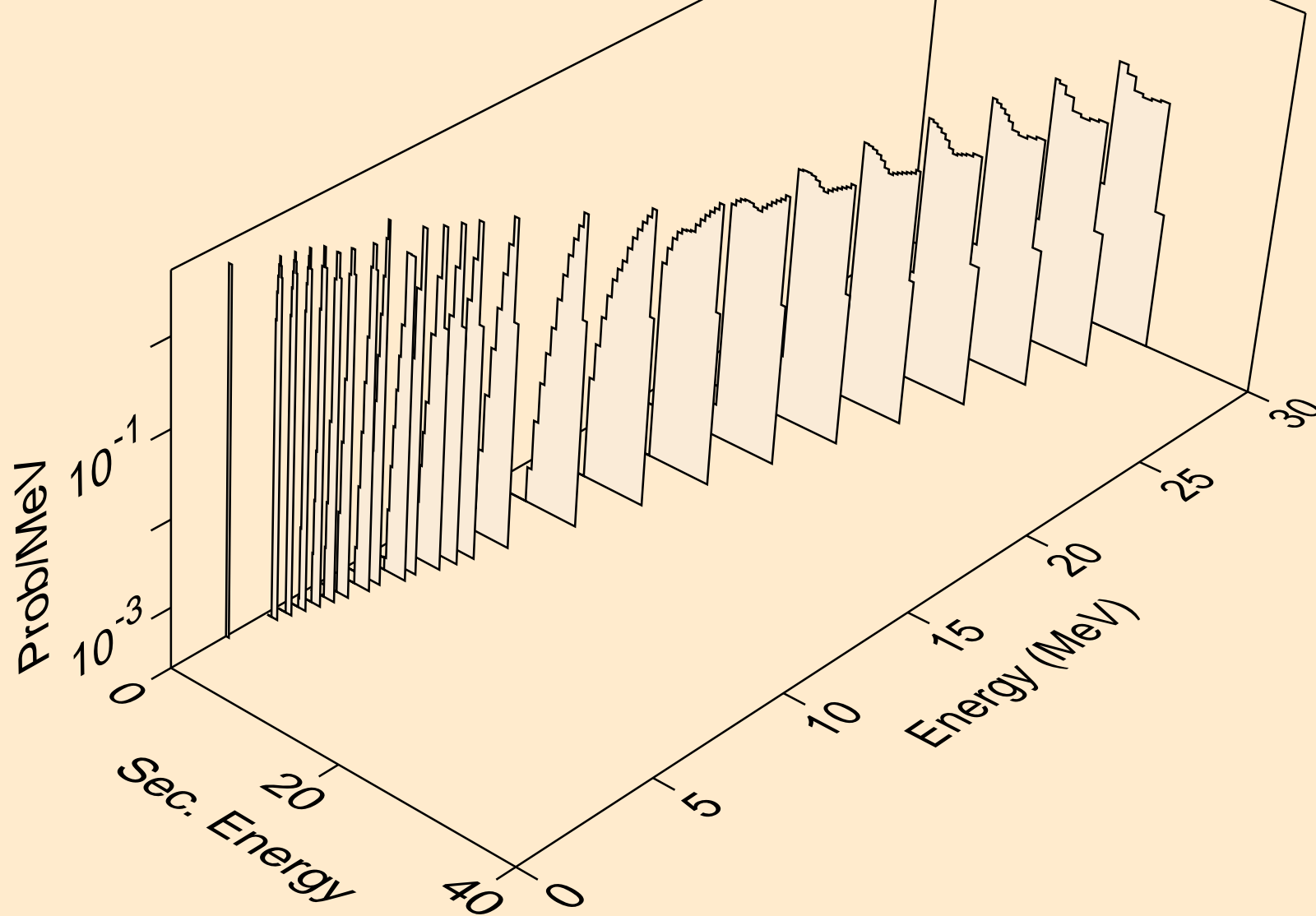

TM176 NEUTRON ACER TENDL-2021 LIBRARY; T=293.6K
protons from (n,2p)

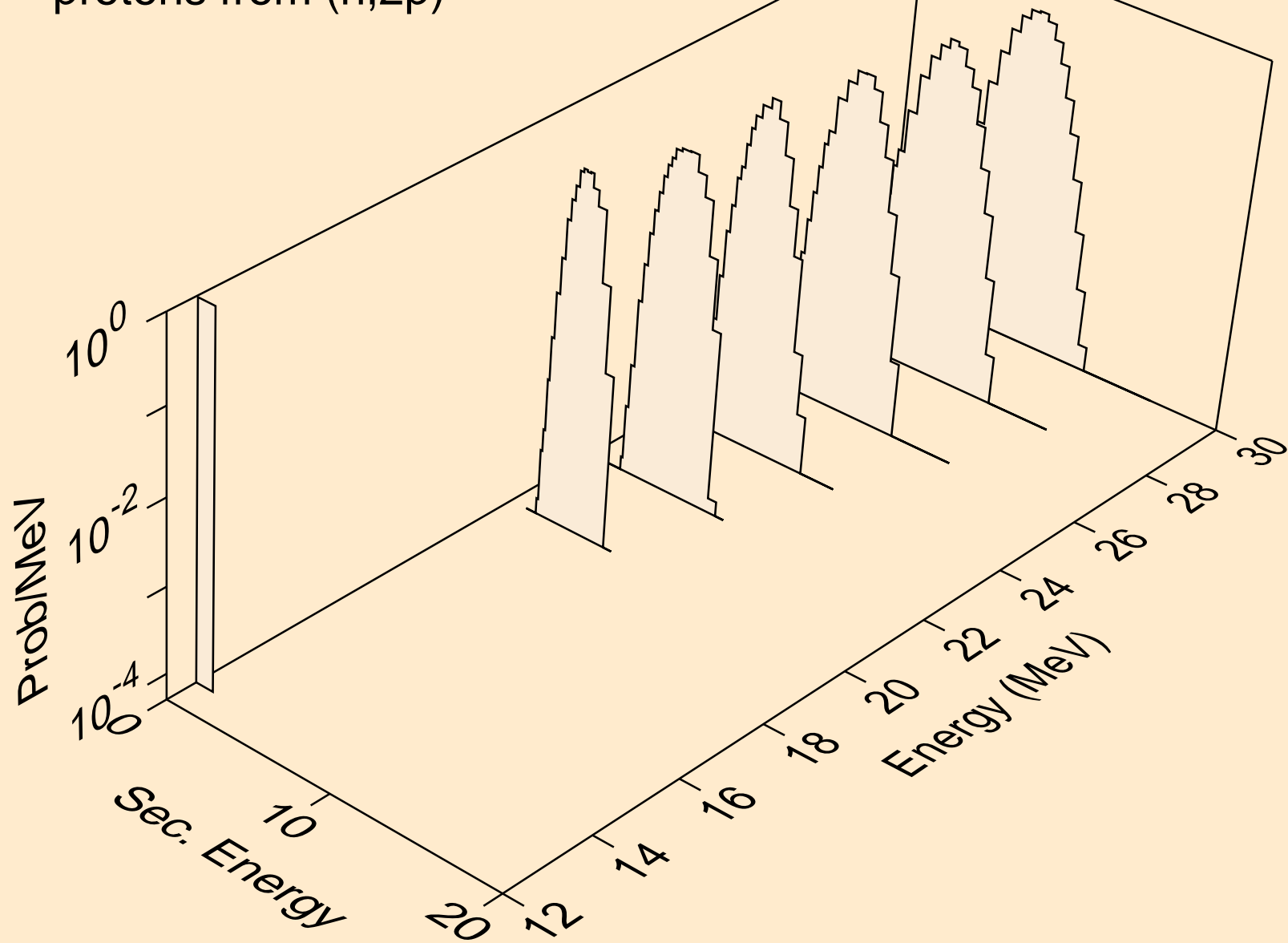

TM176 NEUTRON ACER TENDL-2021 LIBRARY; T=293.6K
deuterons from (n,x)

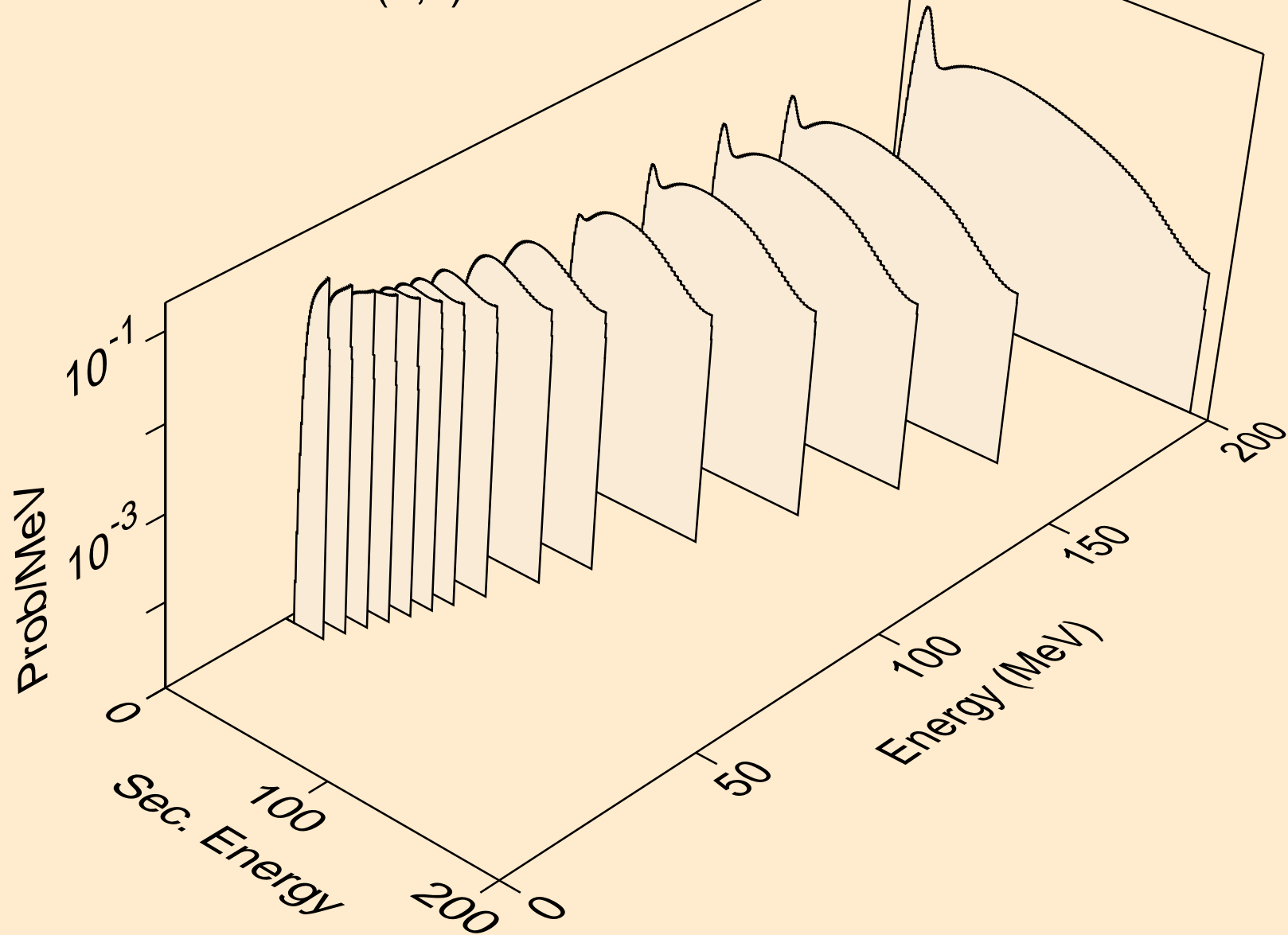

TM176 NEUTRON ACER TENDL-2021 LIBRARY; T=293.6K
deuterons from (n,2nd)

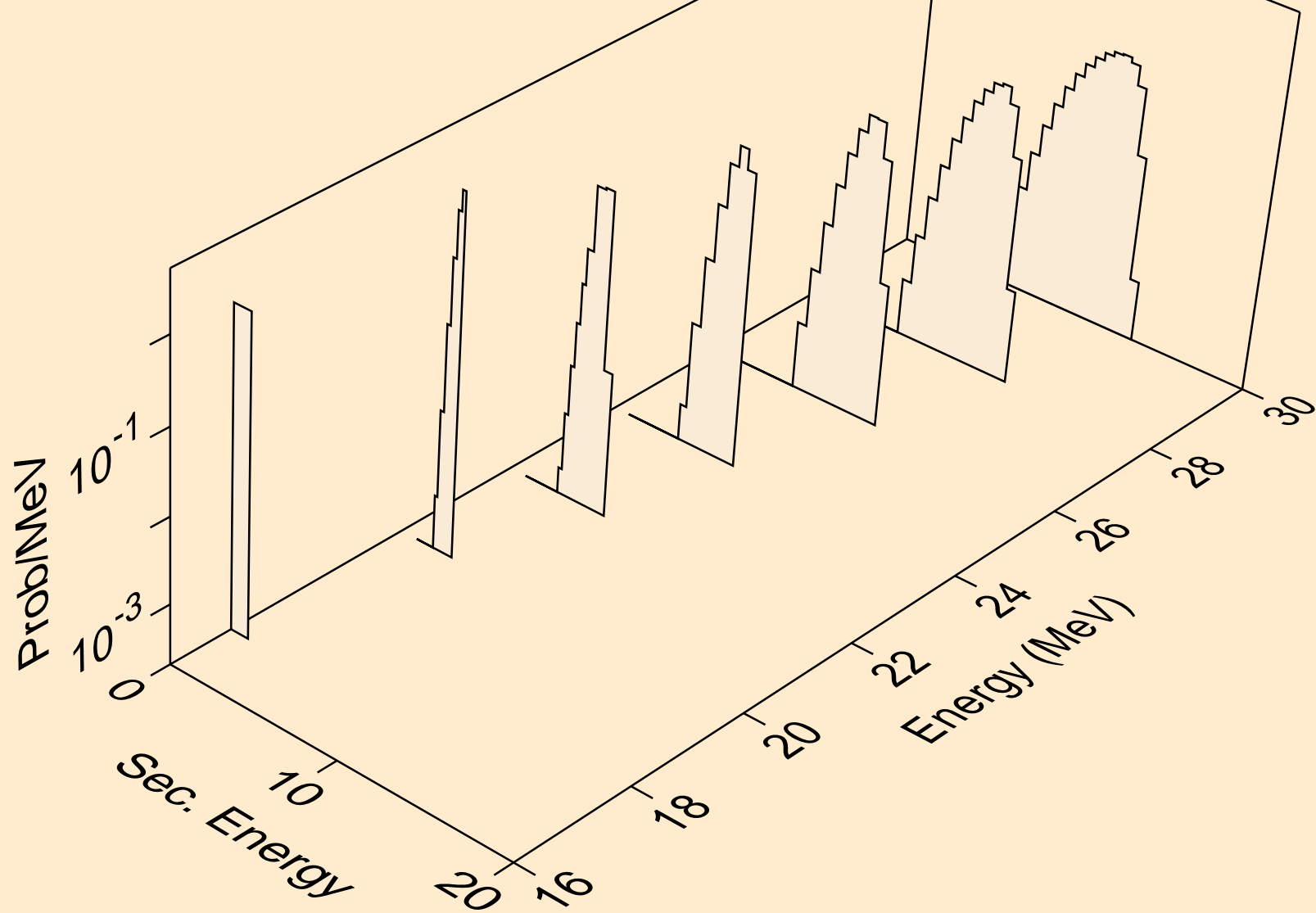

TM176 NEUTRON ACER TENDL-2021 LIBRARY; T=293.6K
deuterons from (n,n*)d

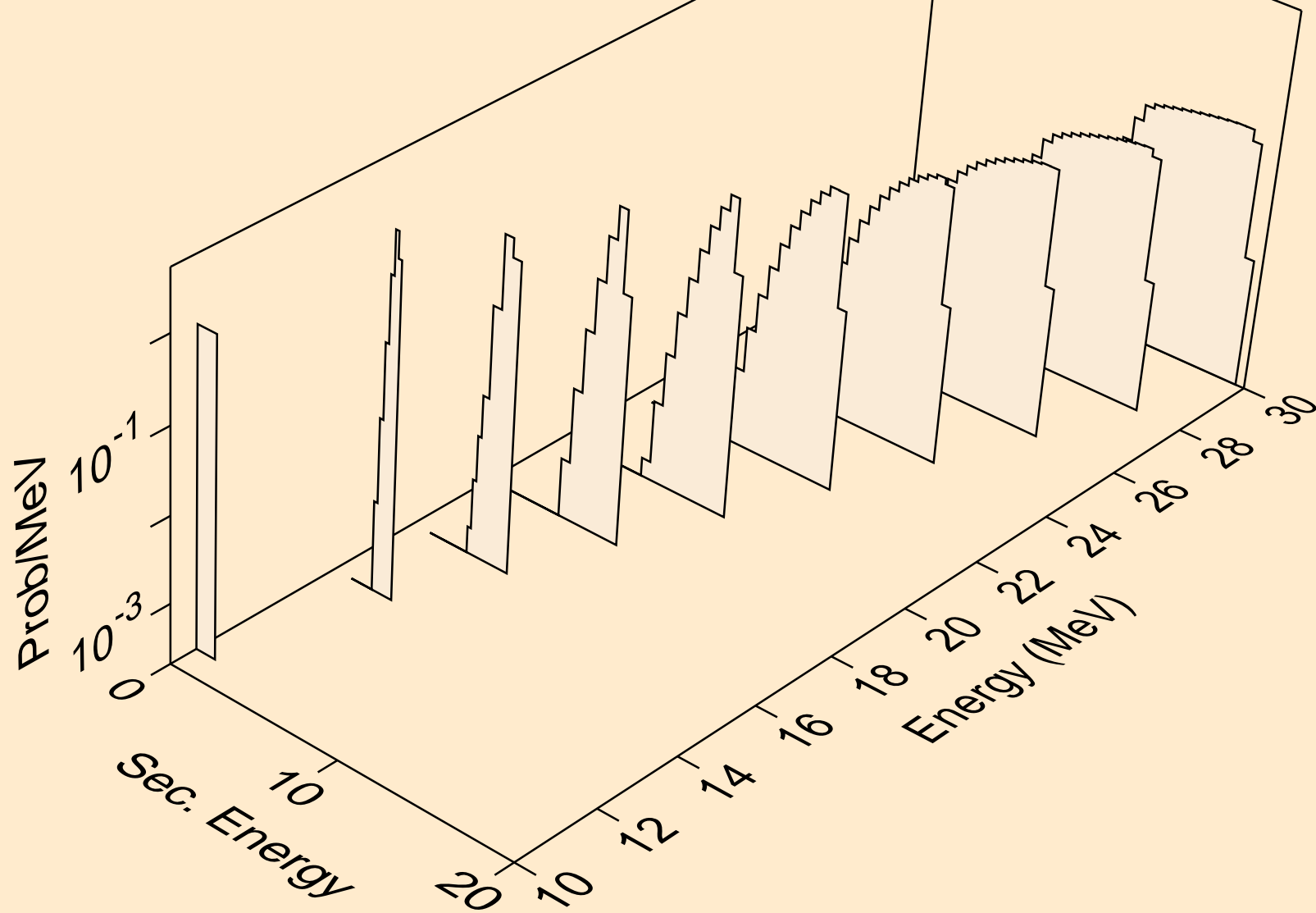

TM176 NEUTRON ACER TENDL-2021 LIBRARY; T=293.6K
deuterons from (n,d)

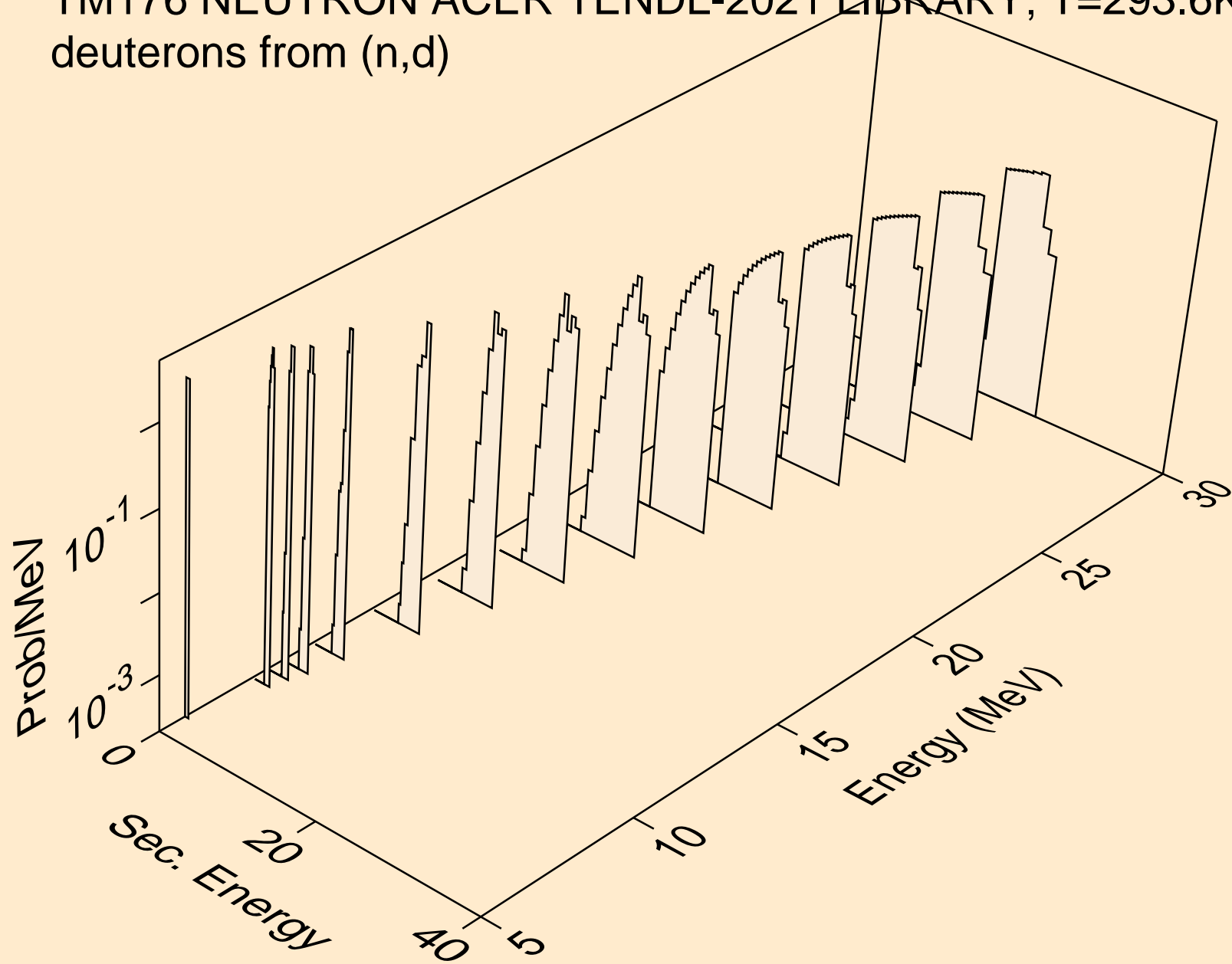

TM176 NEUTRON ACER TENDL-2021 LIBRARY; T=293.6K
tritons from (n,x)

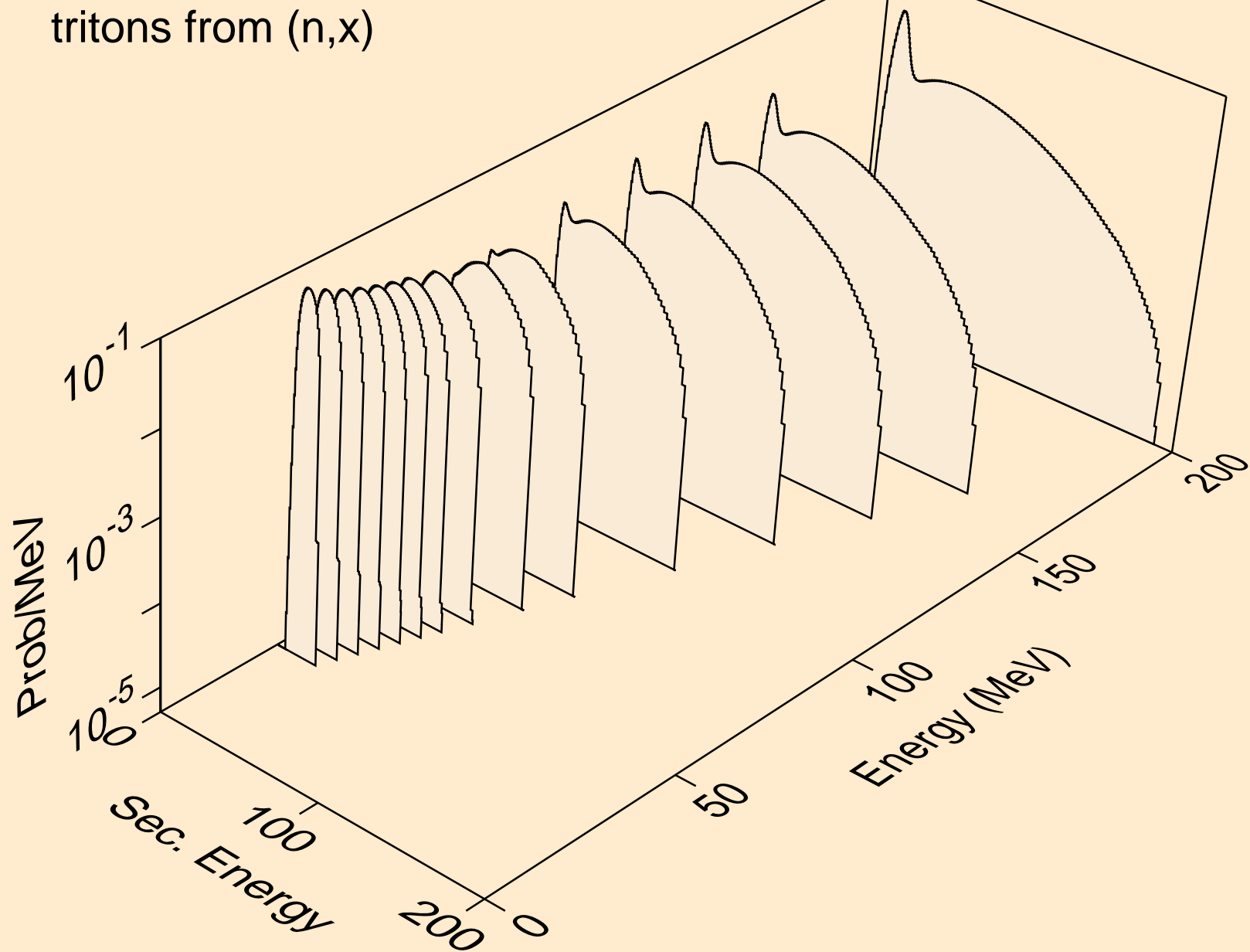

TM176 NEUTRON ACER TENDL-2021 LIBRARY; T=293.6K
tritons from (n,n*)t

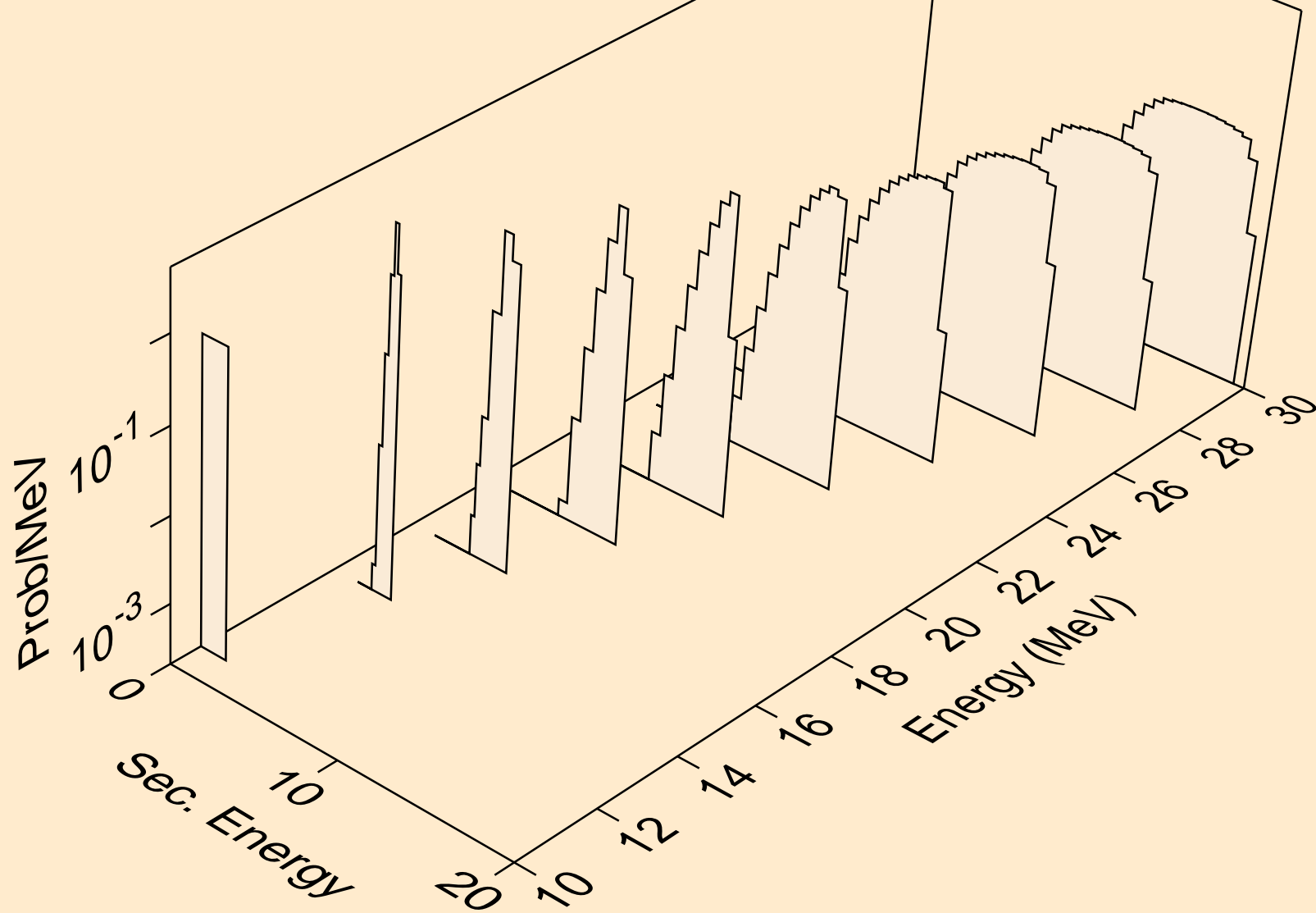

TM176 NEUTRON ACER TENDL-2021 LIBRARY; T=293.6K
tritons from (n,t)

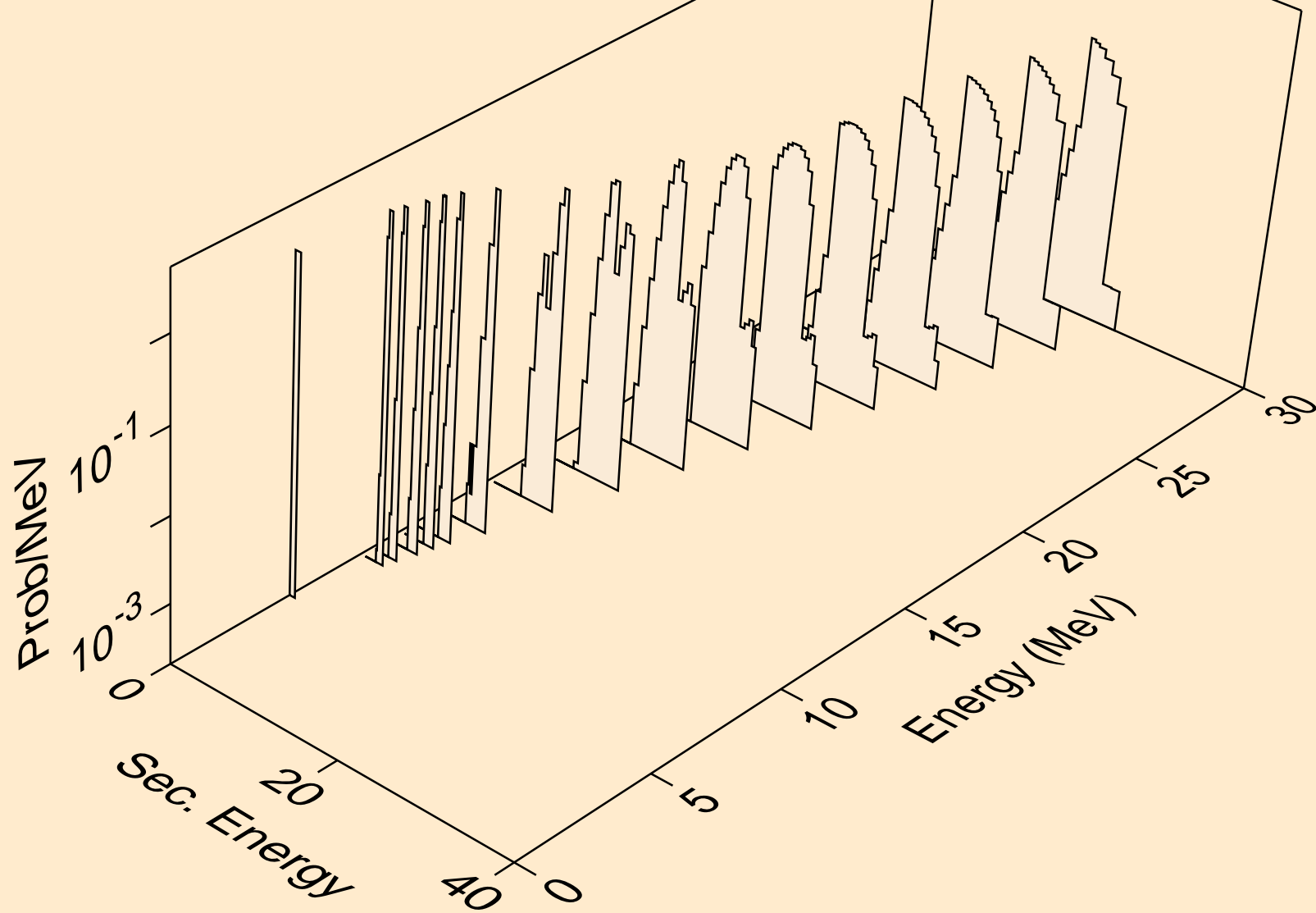

TM176 NEUTRON ACER TENDL-2021 LIBRARY; T=293.6K
he3s from (n,x)

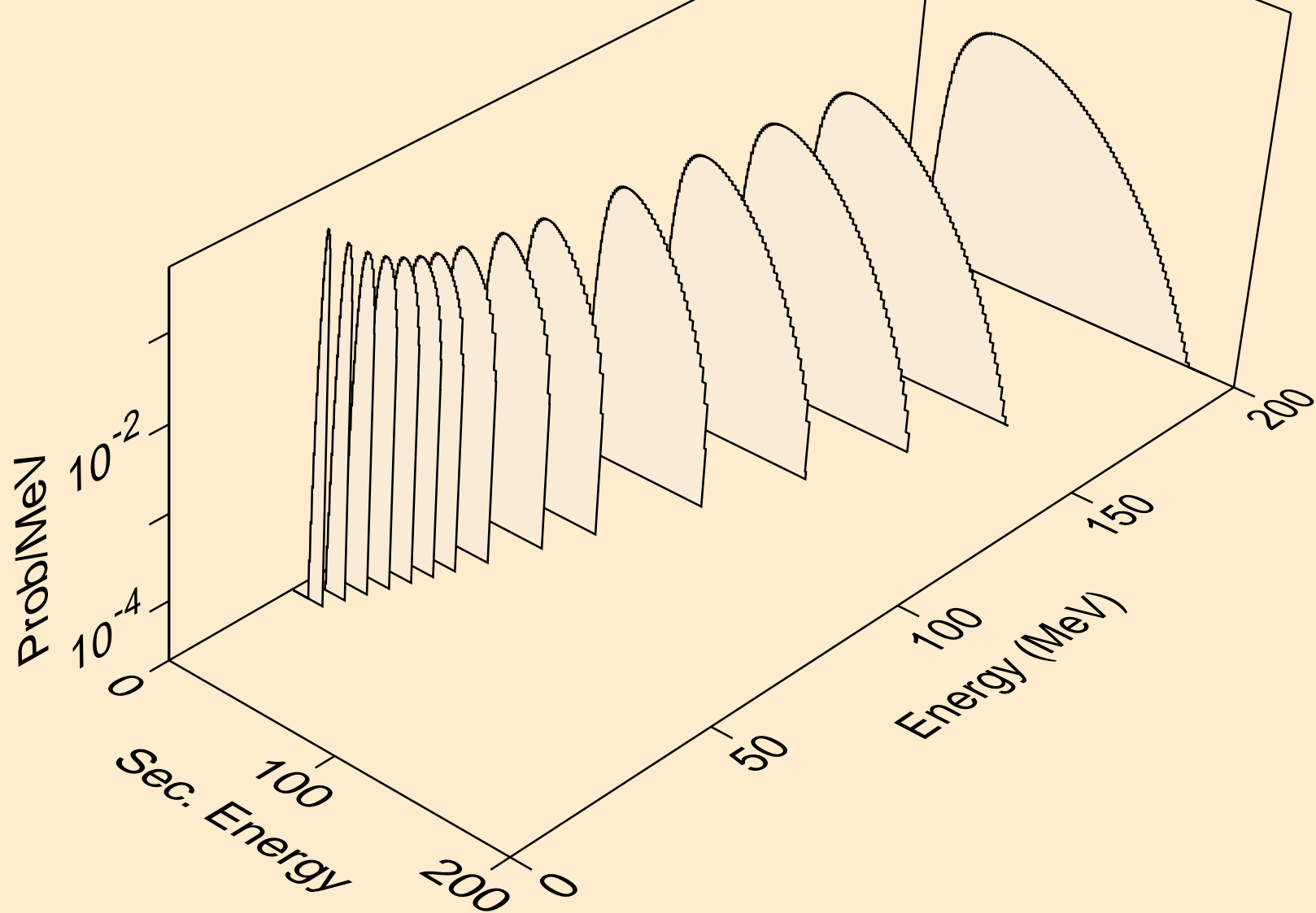

TM176 NEUTRON ACER TENDL-2021 LIBRARY; T=293.6K
he3s from (n,n*)he3

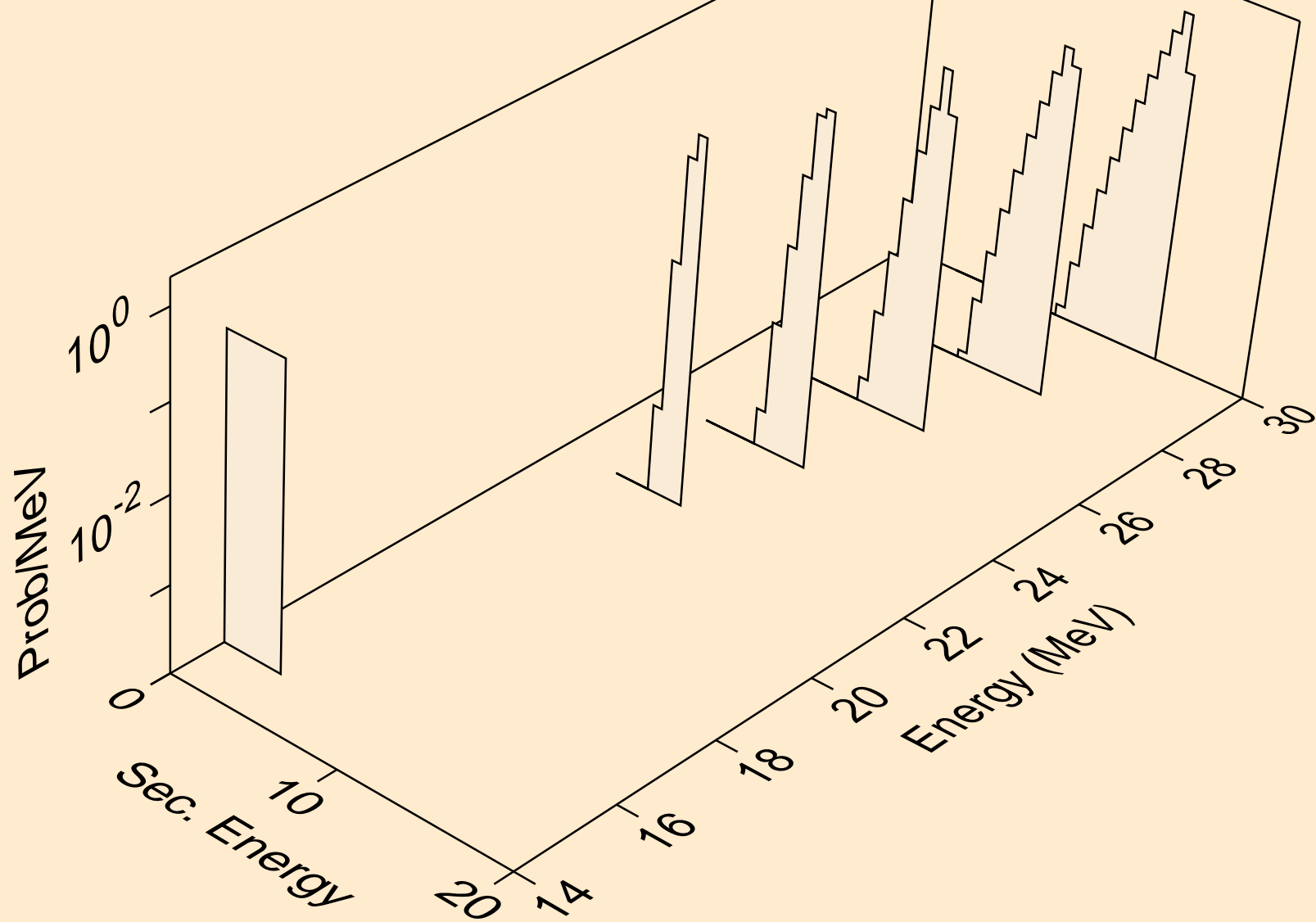

TM176 NEUTRON ACER TENDL-2021 LIBRARY; T=293.6K
he3s from (n,he3)

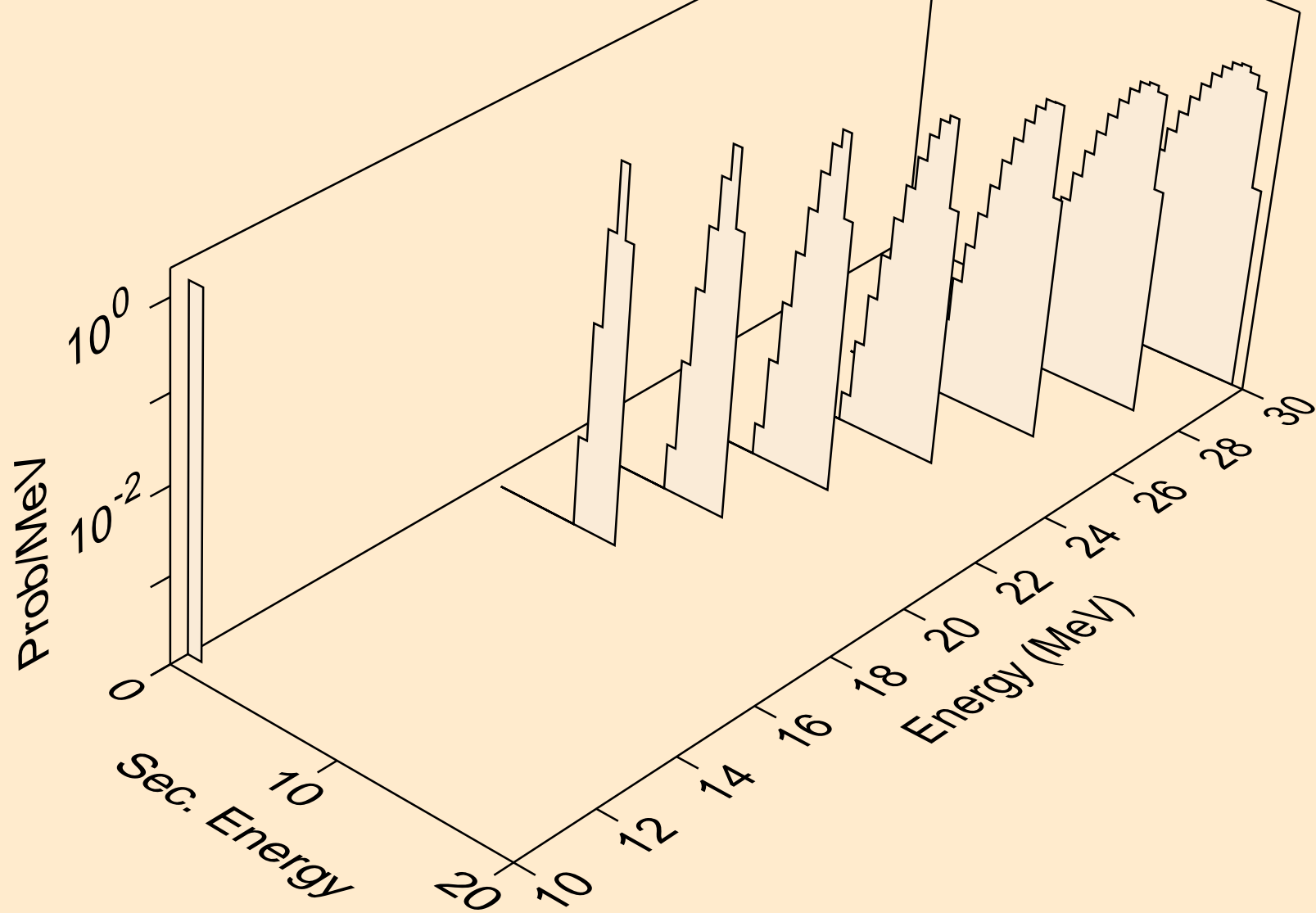

TM176 NEUTRON ACER TENDL-2021 LIBRARY; T=293.6K
alphas from (n,x)

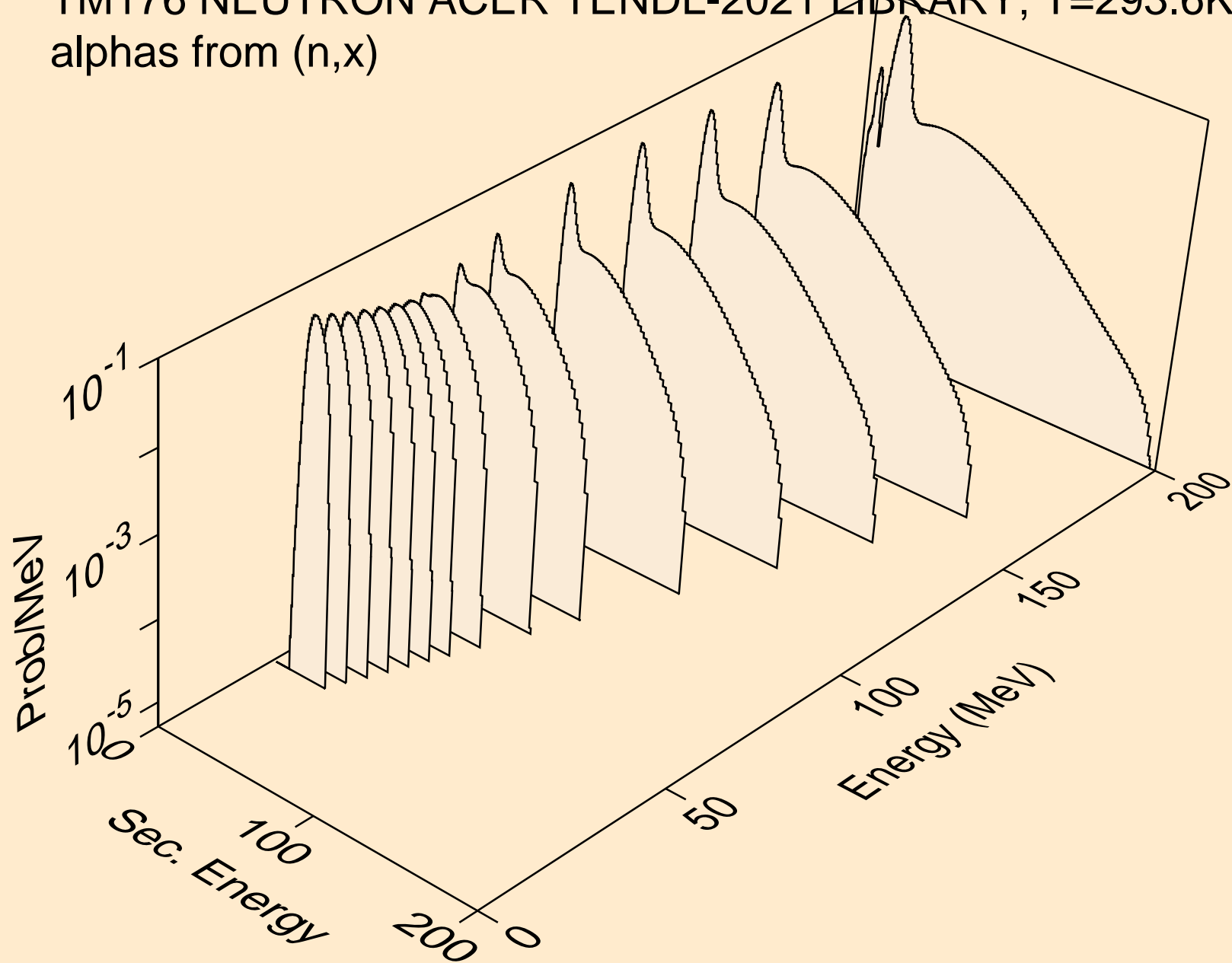

TM176 NEUTRON ACER TENDL-2021 LIBRARY; T=293.6K
alphas from (n,n*)a

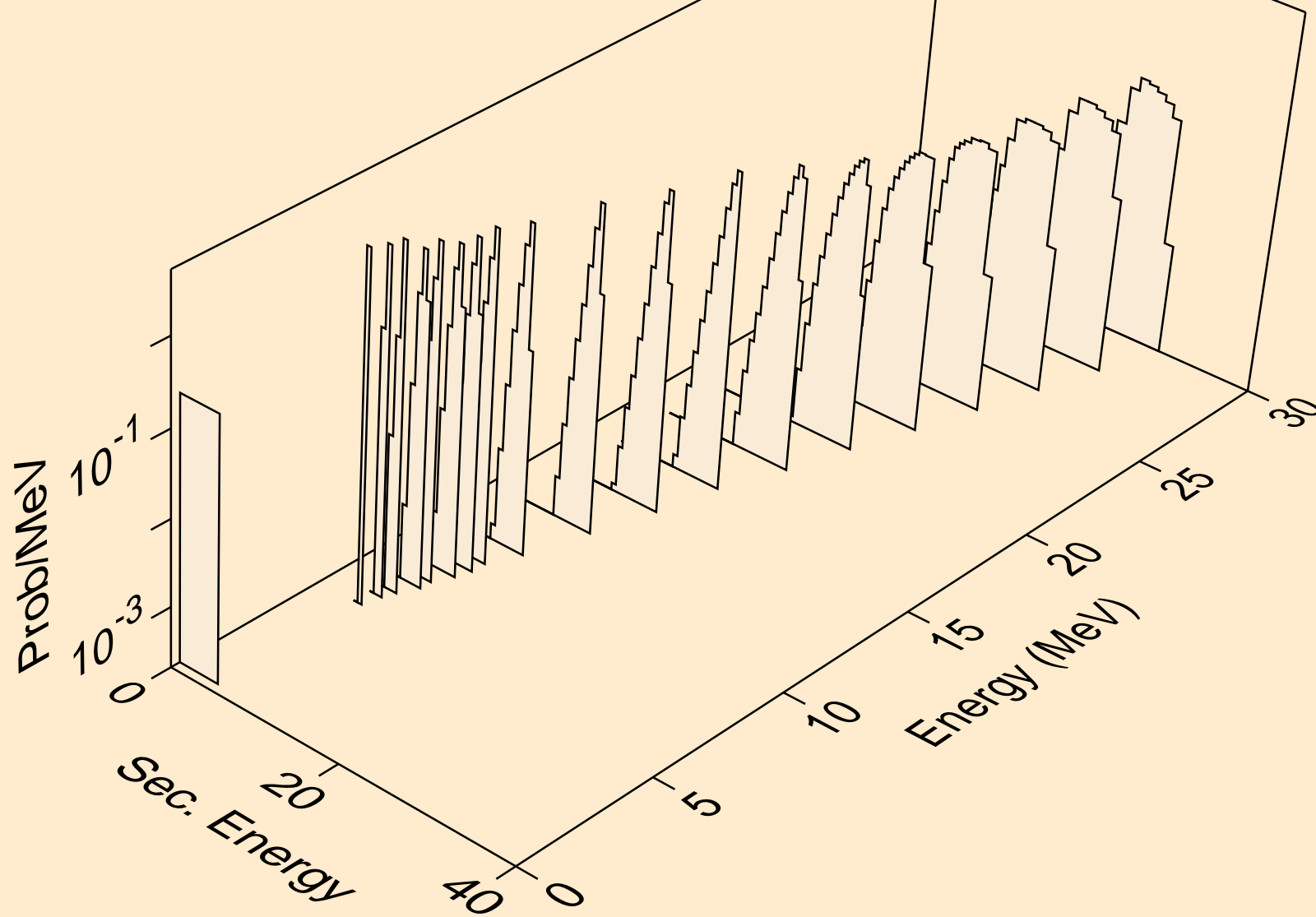

TM176 NEUTRON ACER TENDL-2021 LIBRARY; T=293.6K
alphas from (n,2n)a

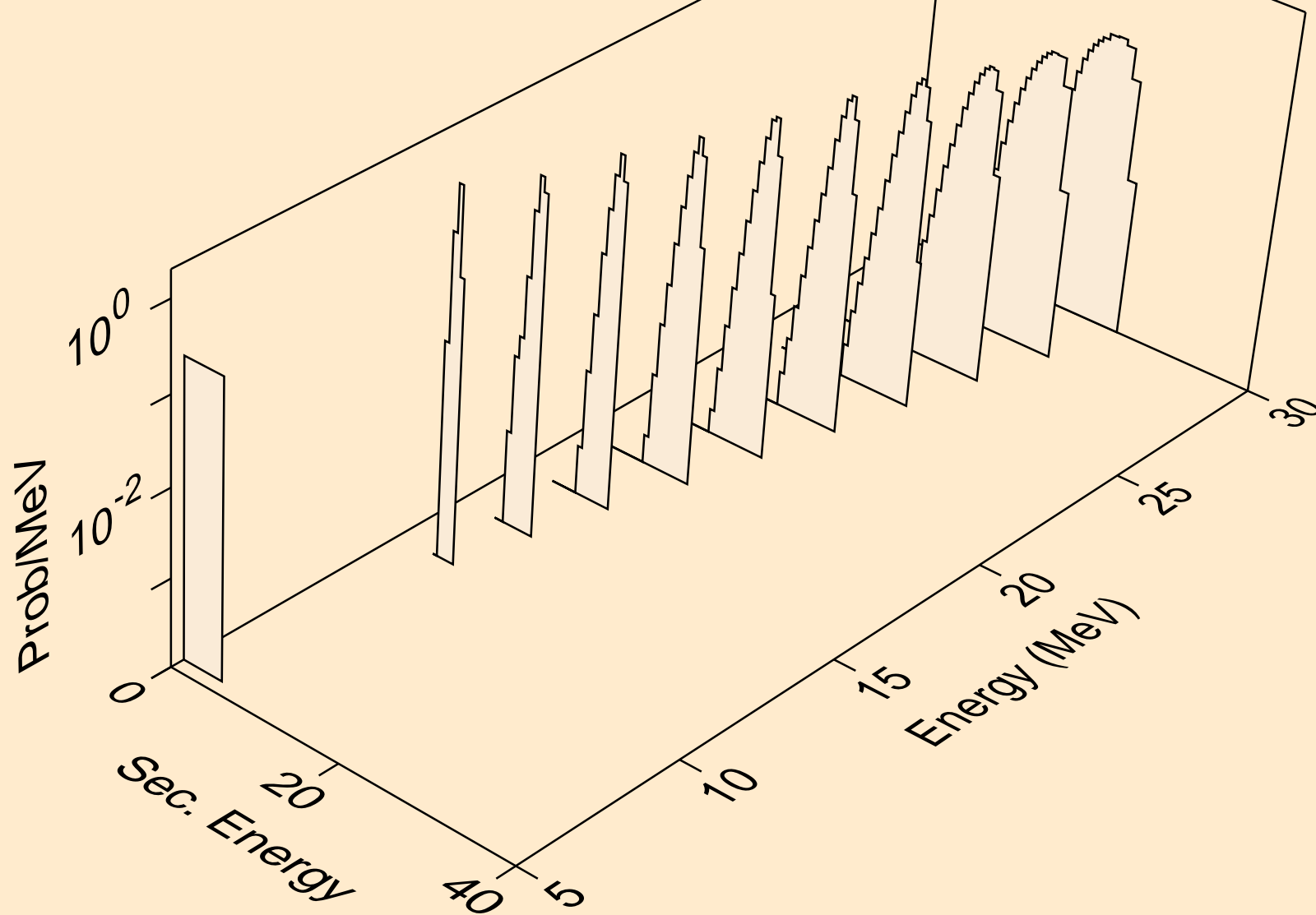

TM176 NEUTRON ACER TENDL-2021 LIBRARY; T=293.6K
alphas from (n,3n)a

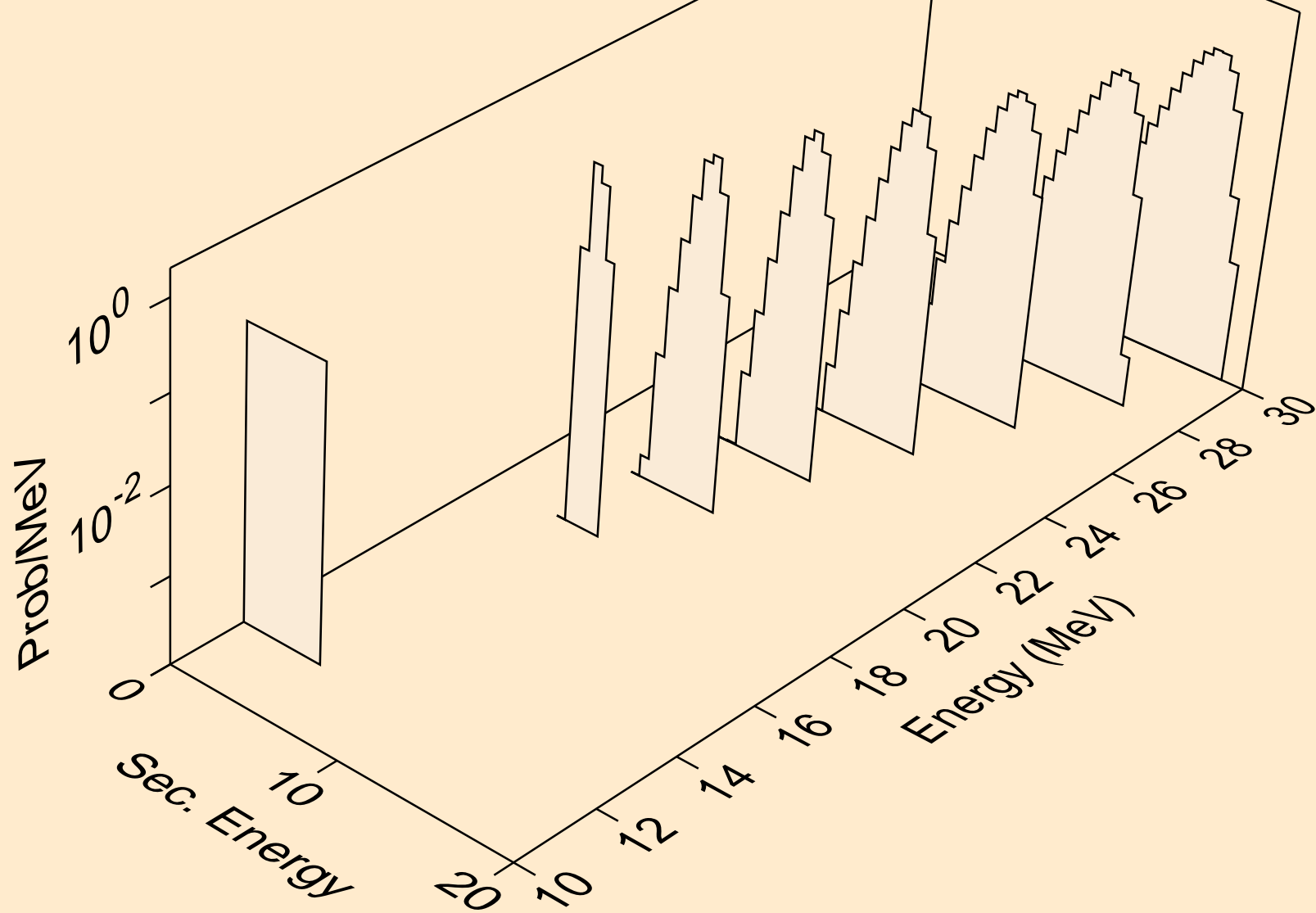

TM176 NEUTRON ACER TENDL-2021 LIBRARY; T=293.6K
alphas from (n,a)

