

U227 NEUTRON ACER TENDL-2021 LIBRARY; T=293.6K

Principal cross sections

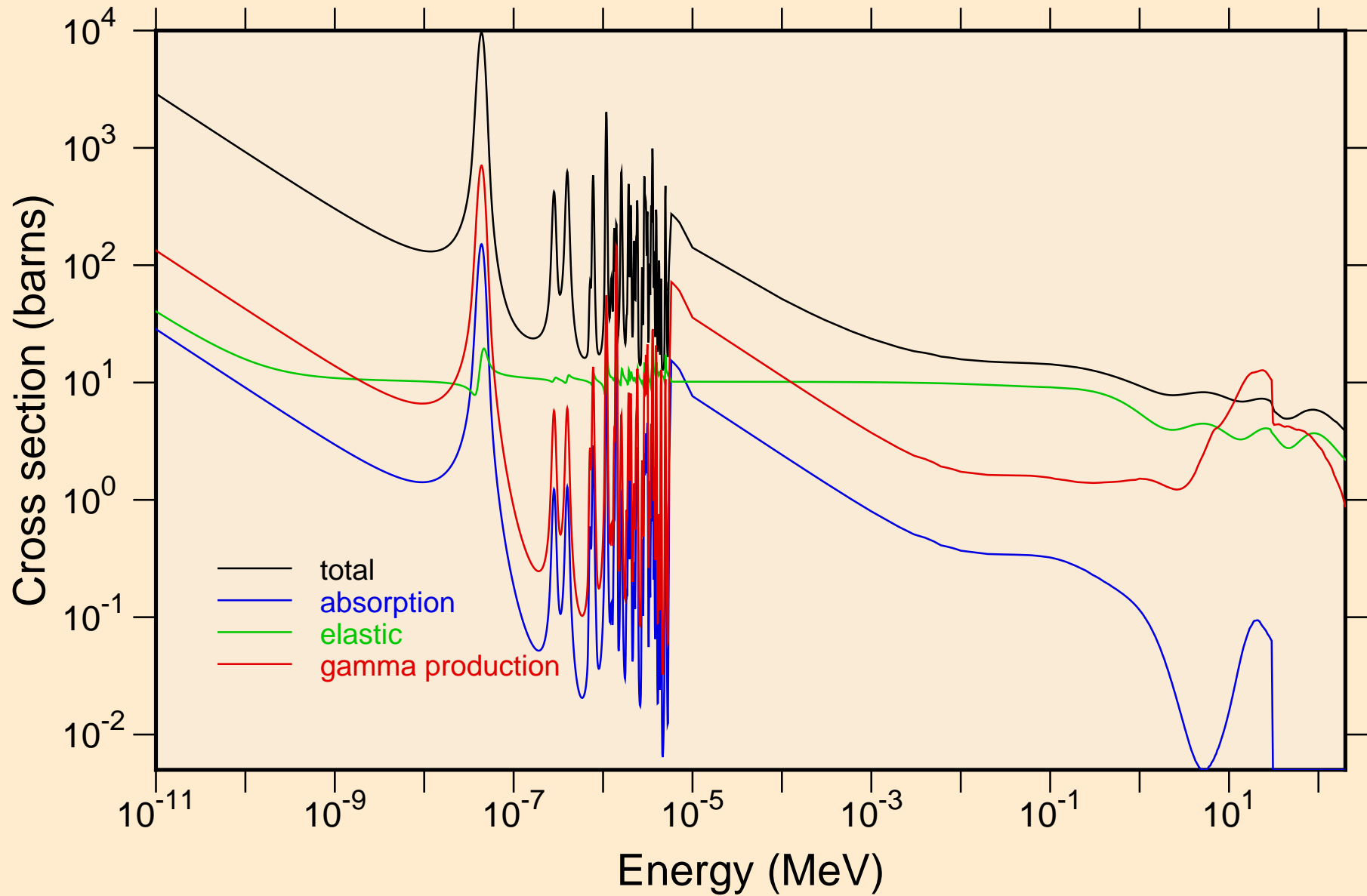

U227 NEUTRON ACER TENDL-2021 LIBRARY; T=293.6K
resonance total cross section

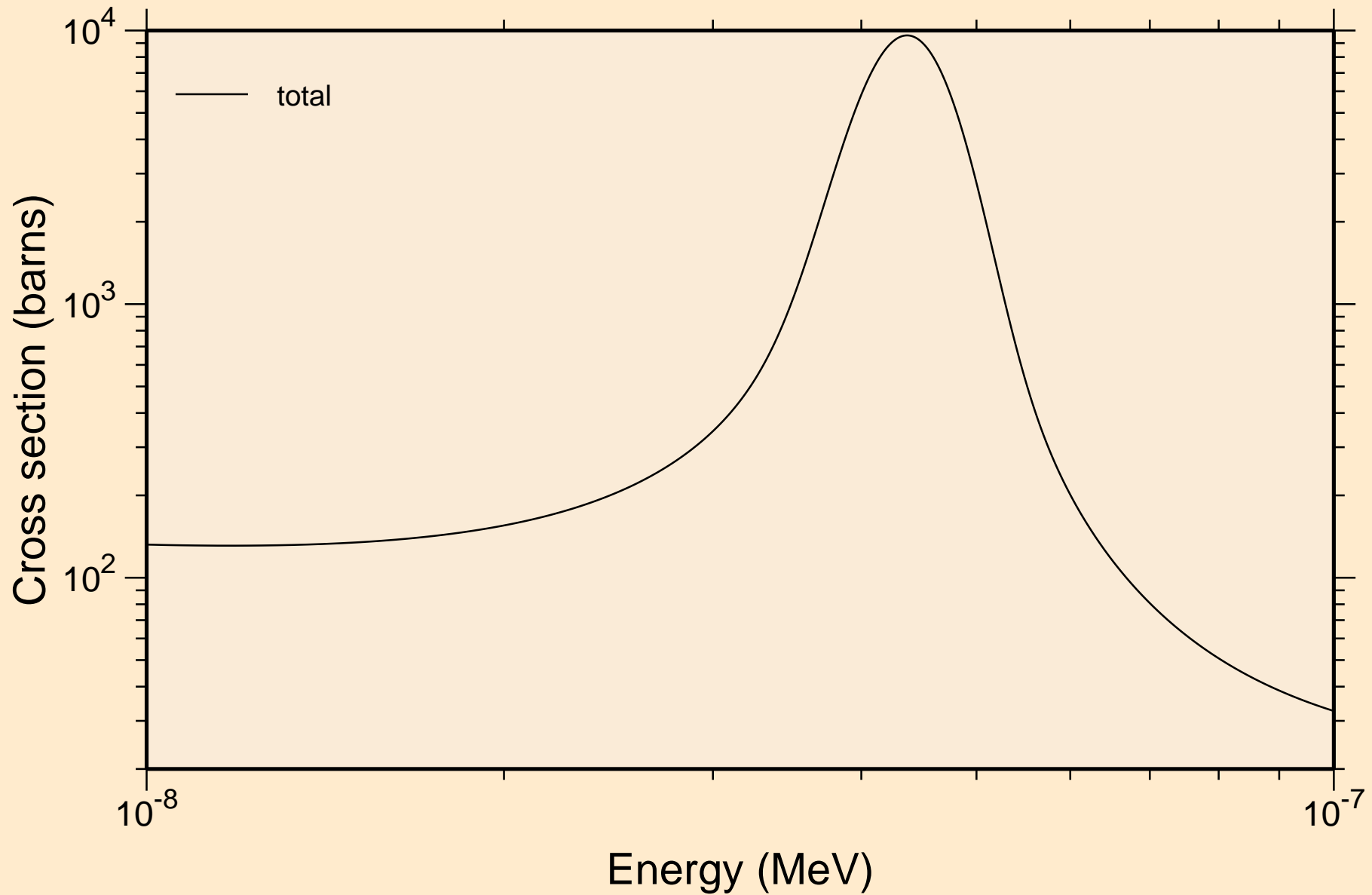

U227 NEUTRON ACER TENDL-2021 LIBRARY; T=293.6K
resonance total cross section

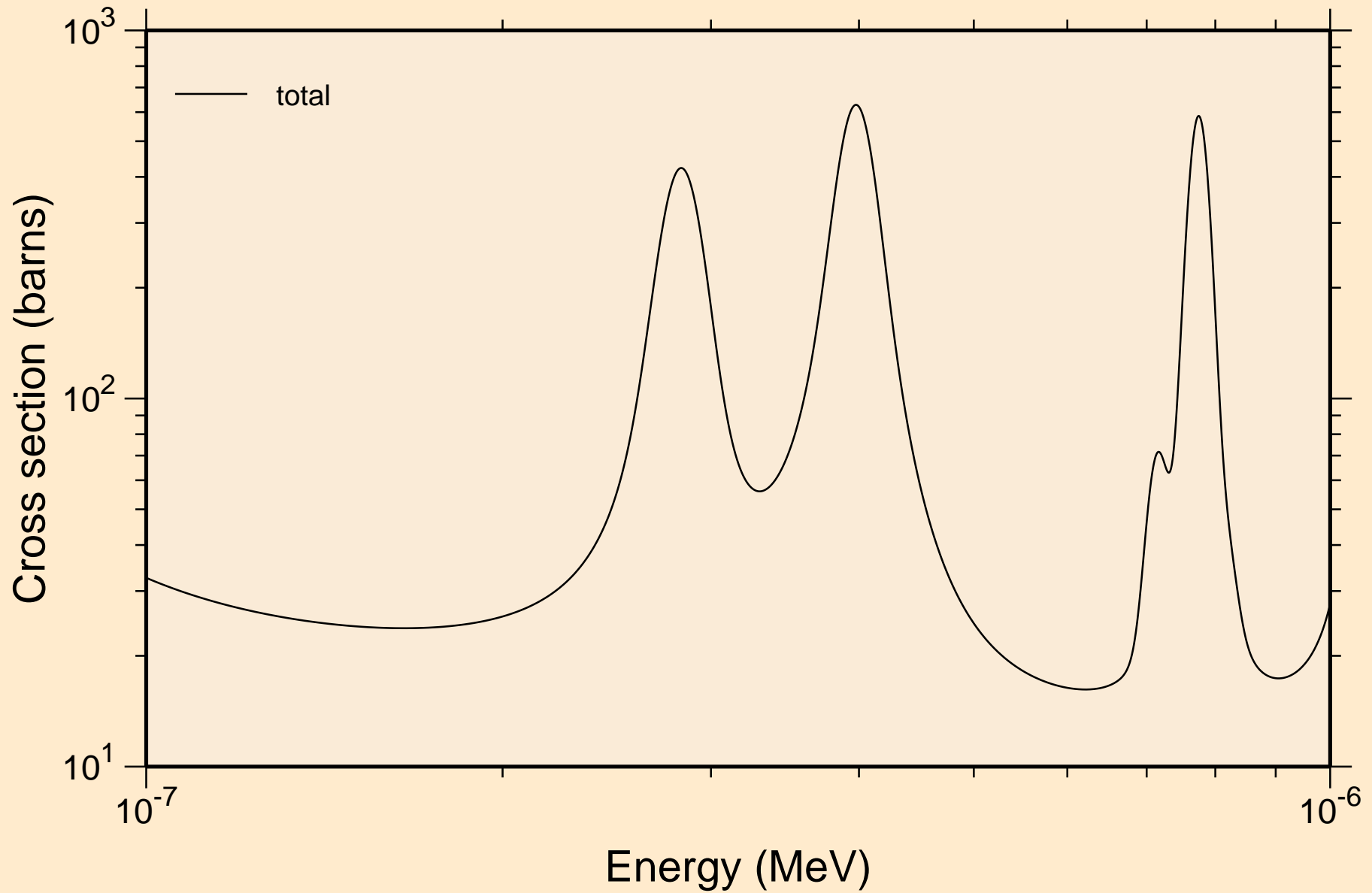

U227 NEUTRON ACER TENDL-2021 LIBRARY; T=293.6K
resonance total cross section

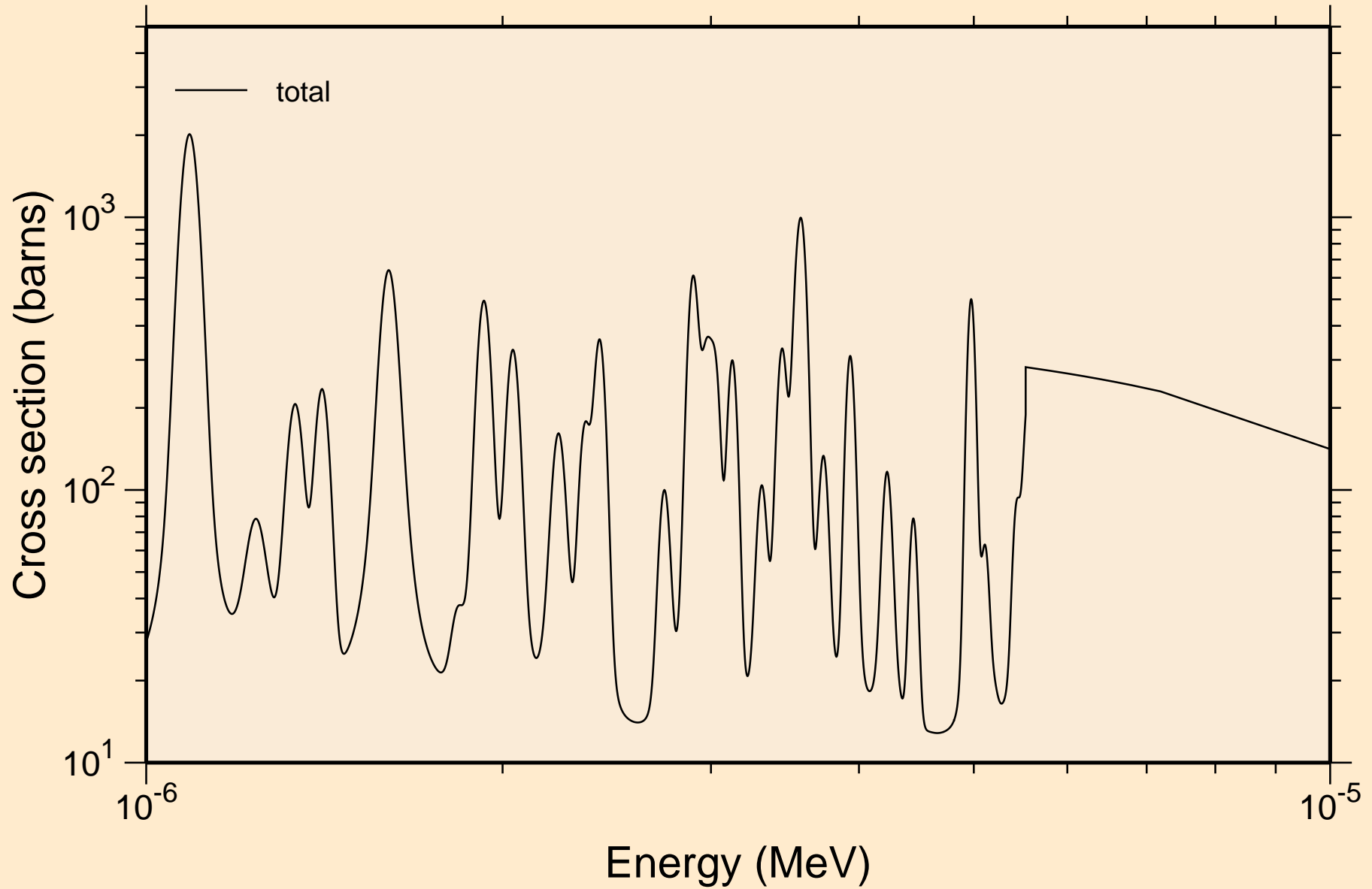

U227 NEUTRON ACER TENDL-2021 LIBRARY; T=293.6K
resonance total cross section

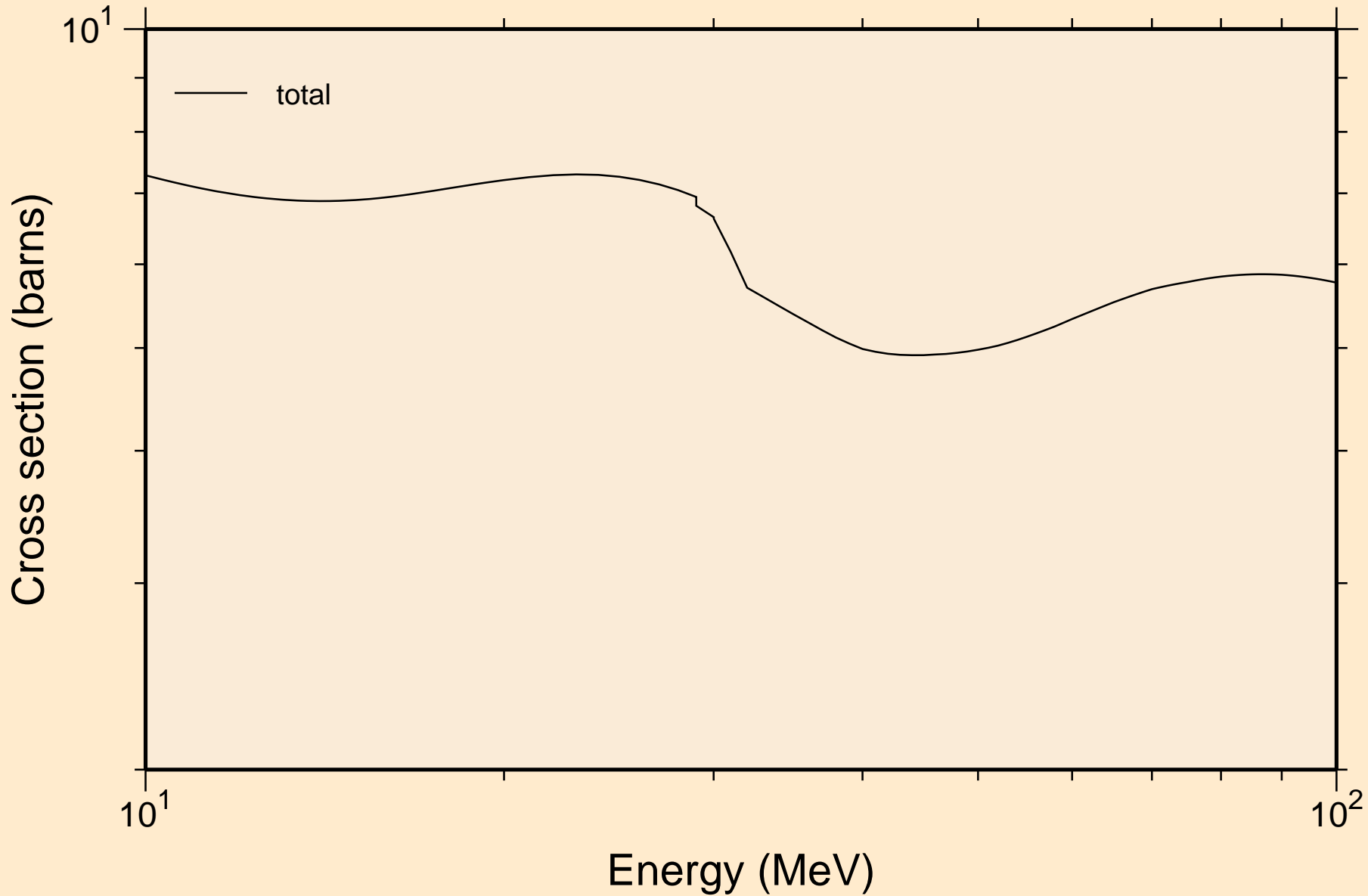

U227 NEUTRON ACER TENDL-2021 LIBRARY; T=293.6K
resonance absorption cross sections

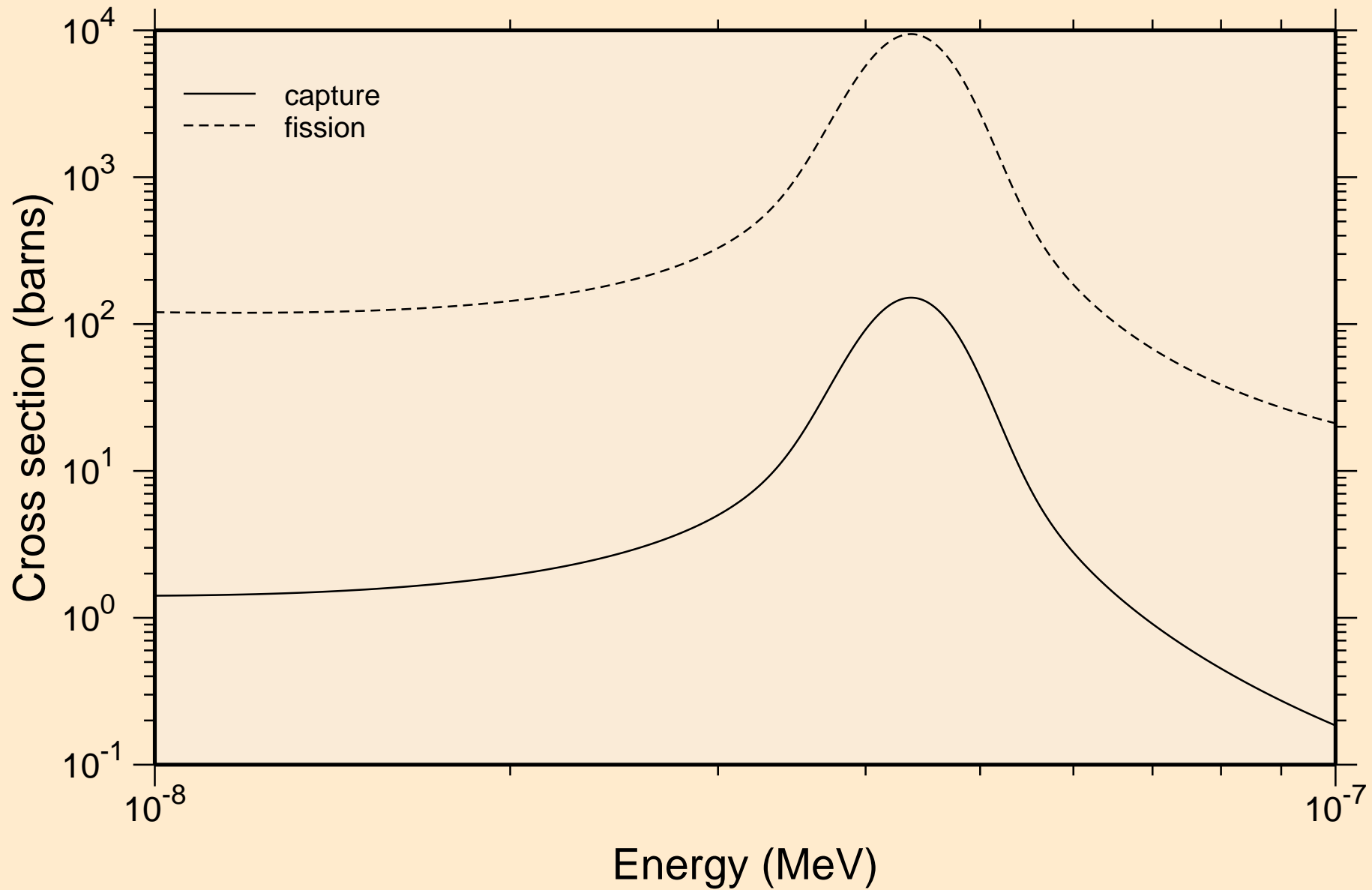

U227 NEUTRON ACER TENDL-2021 LIBRARY; T=293.6K
resonance absorption cross sections

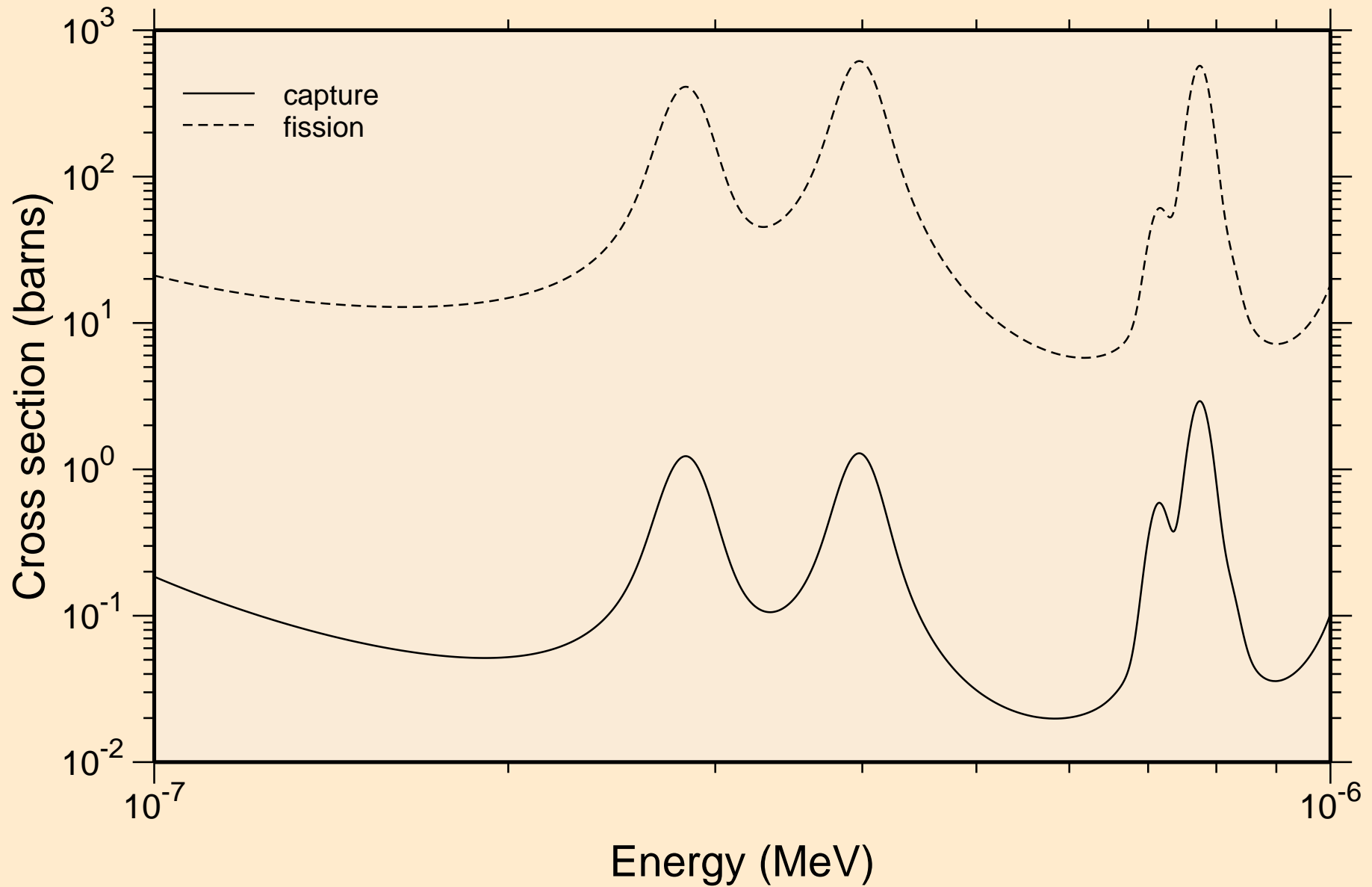

U227 NEUTRON ACER TENDL-2021 LIBRARY; T=293.6K
resonance absorption cross sections

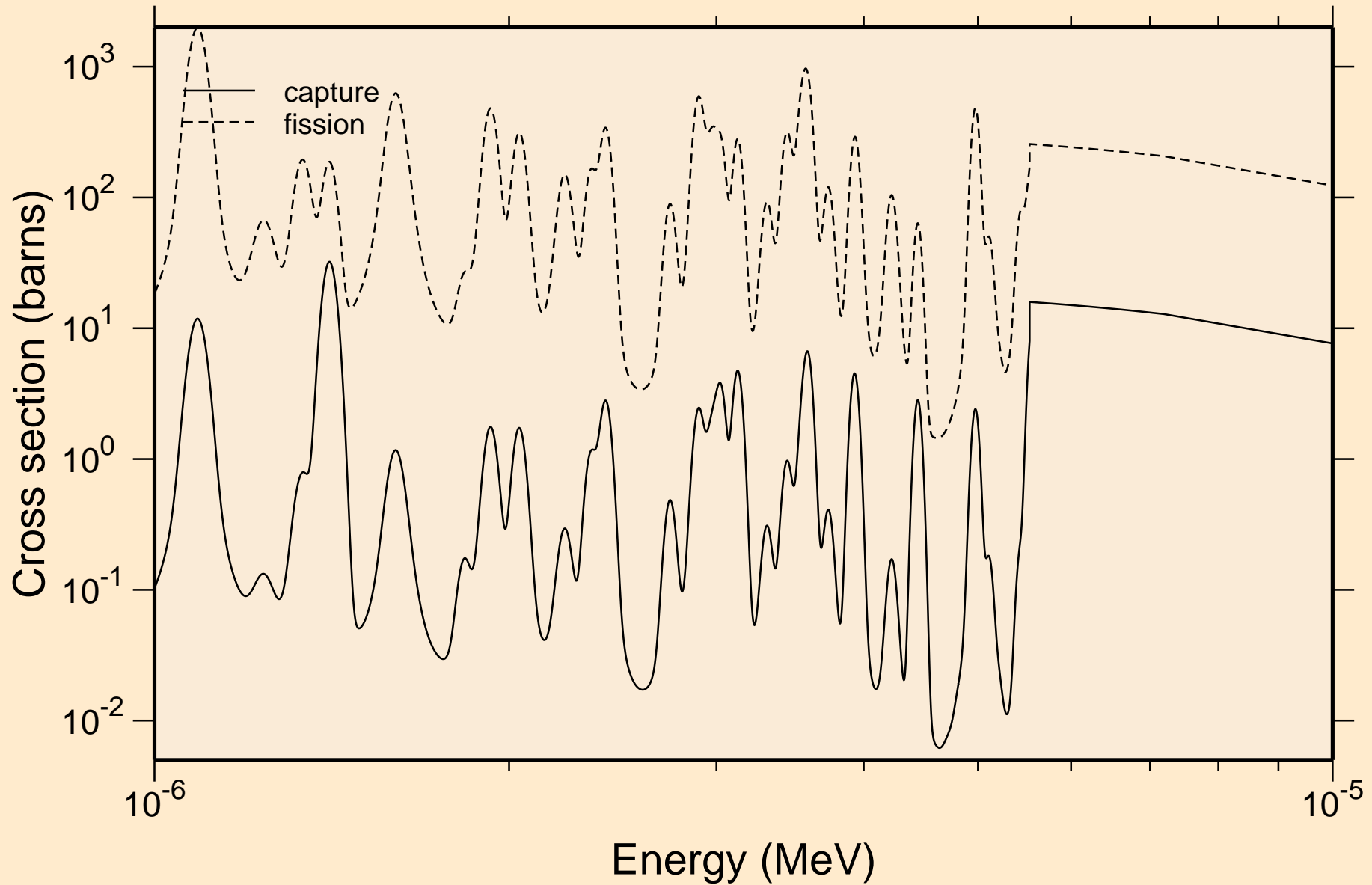

U227 NEUTRON ACER TENDL-2021 LIBRARY; T=293.6K
resonance absorption cross sections

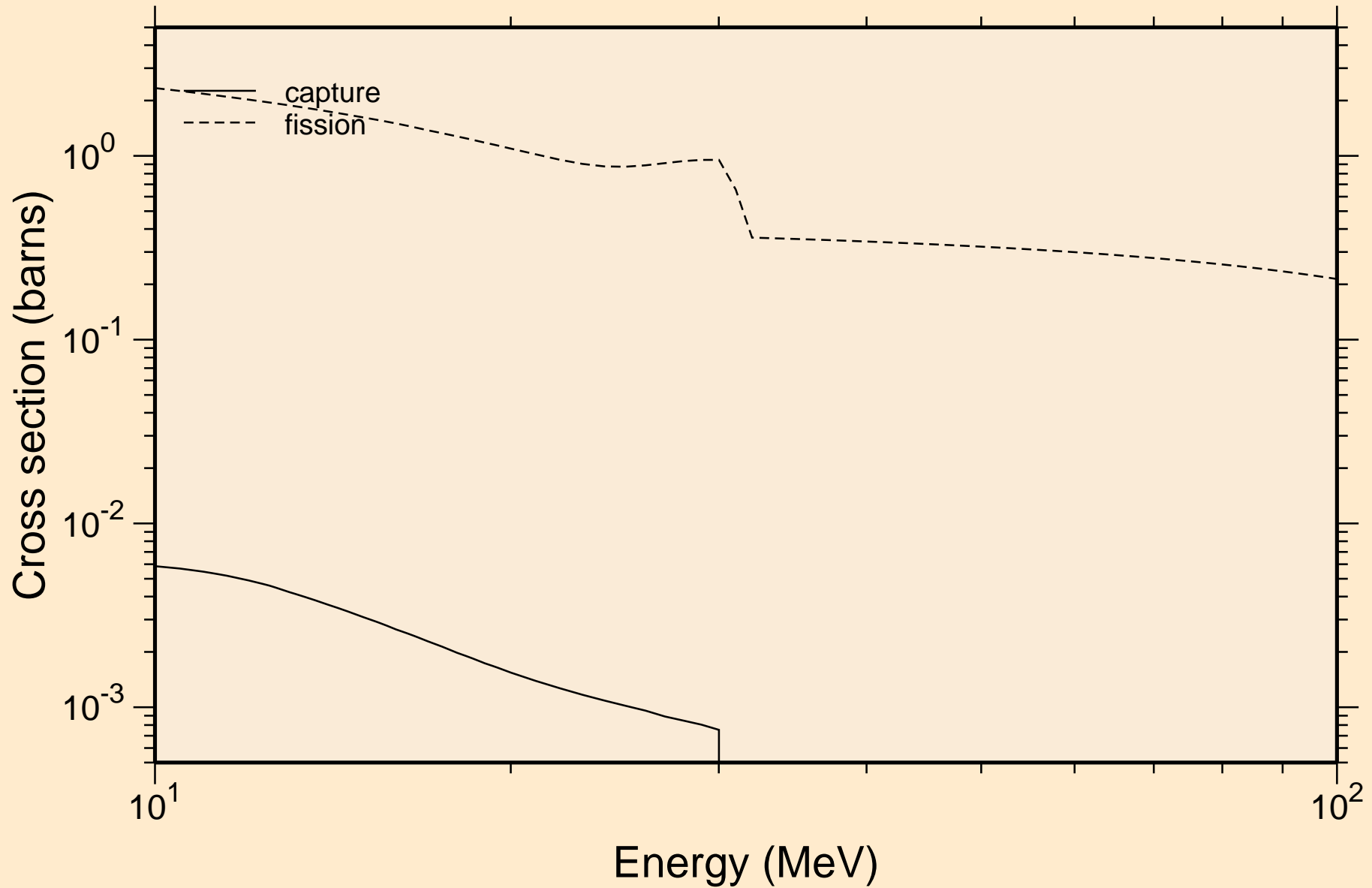

U227 NEUTRON ACER TENDL-2021 LIBRARY; T=293.6K

Heating

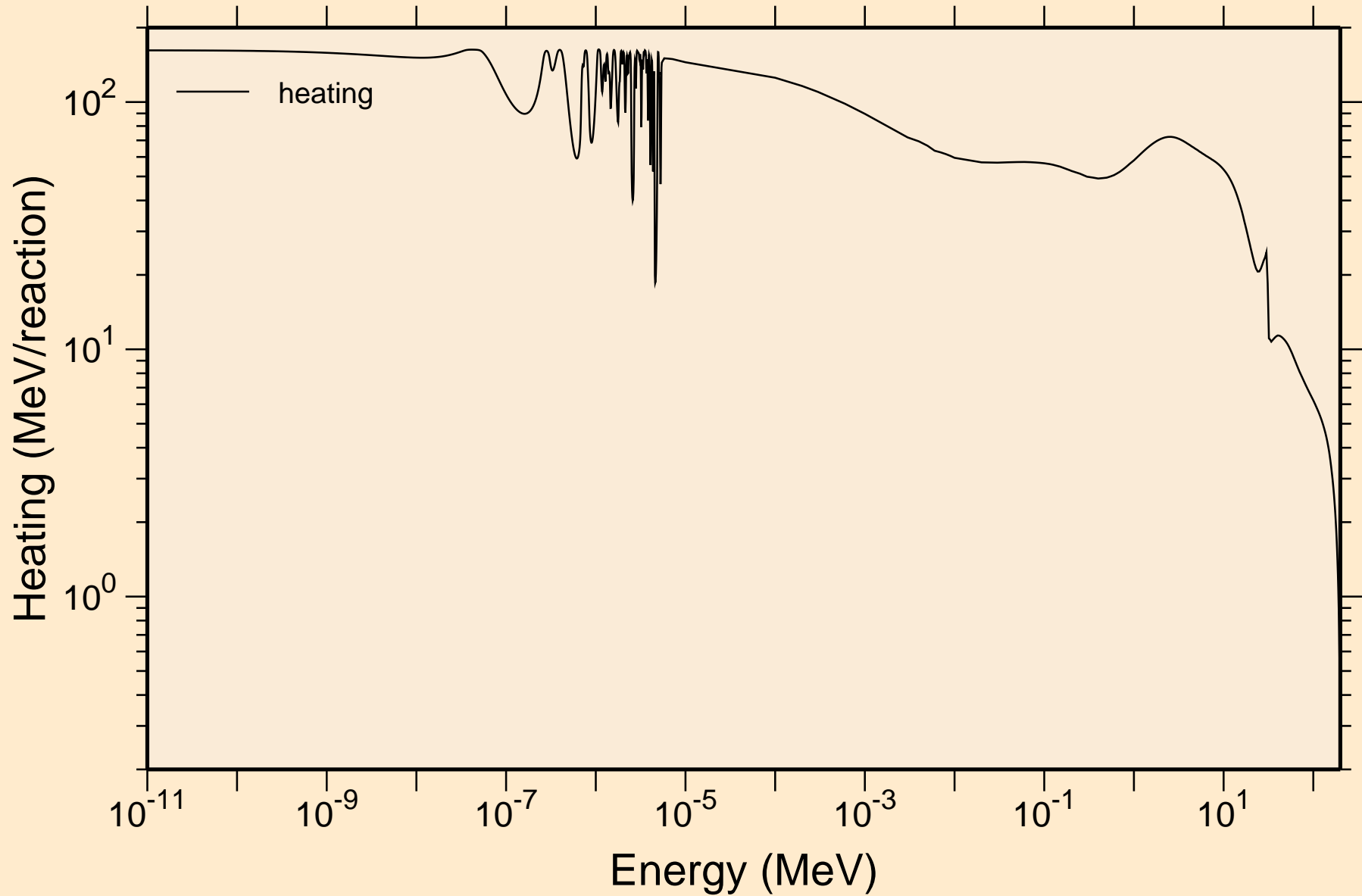

U227 NEUTRON ACER TENDL-2021 LIBRARY; T=293.6K
Damage

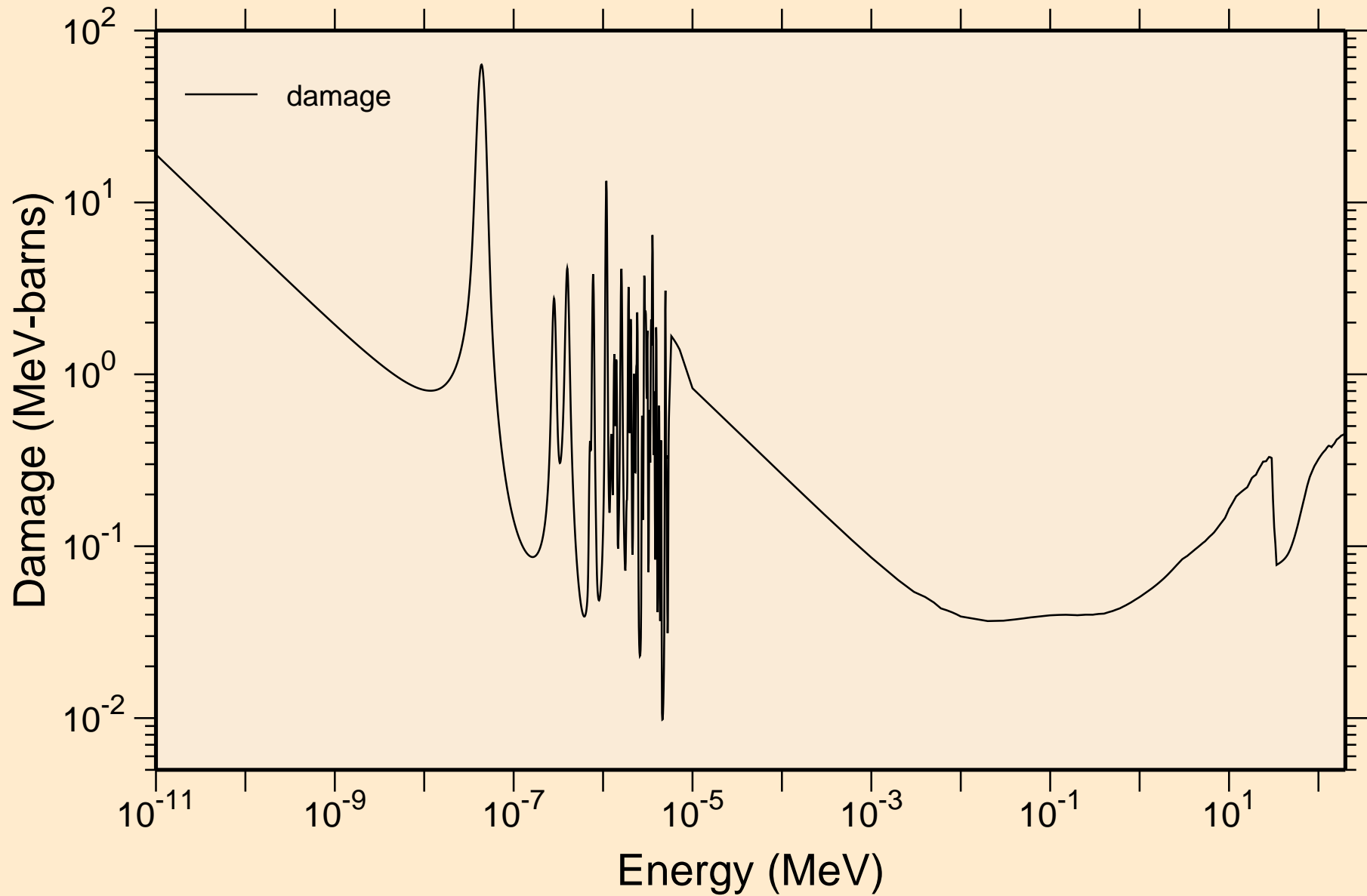

U227 NEUTRON ACER TENDL-2021 LIBRARY; T=293.6K

Non-threshold reactions

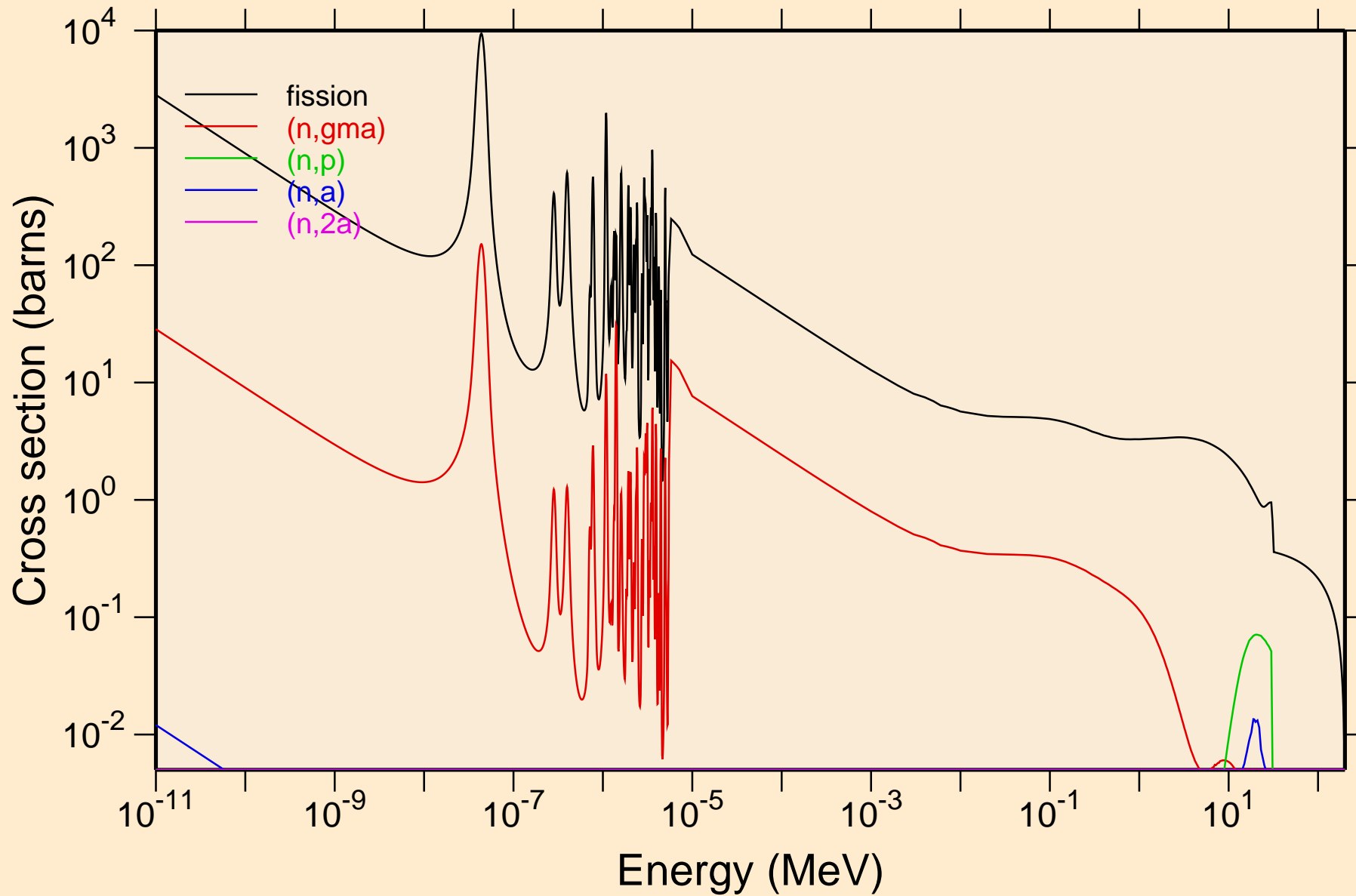

U227 NEUTRON ACER TENDL-2021 LIBRARY; T=293.6K
Non-threshold reactions

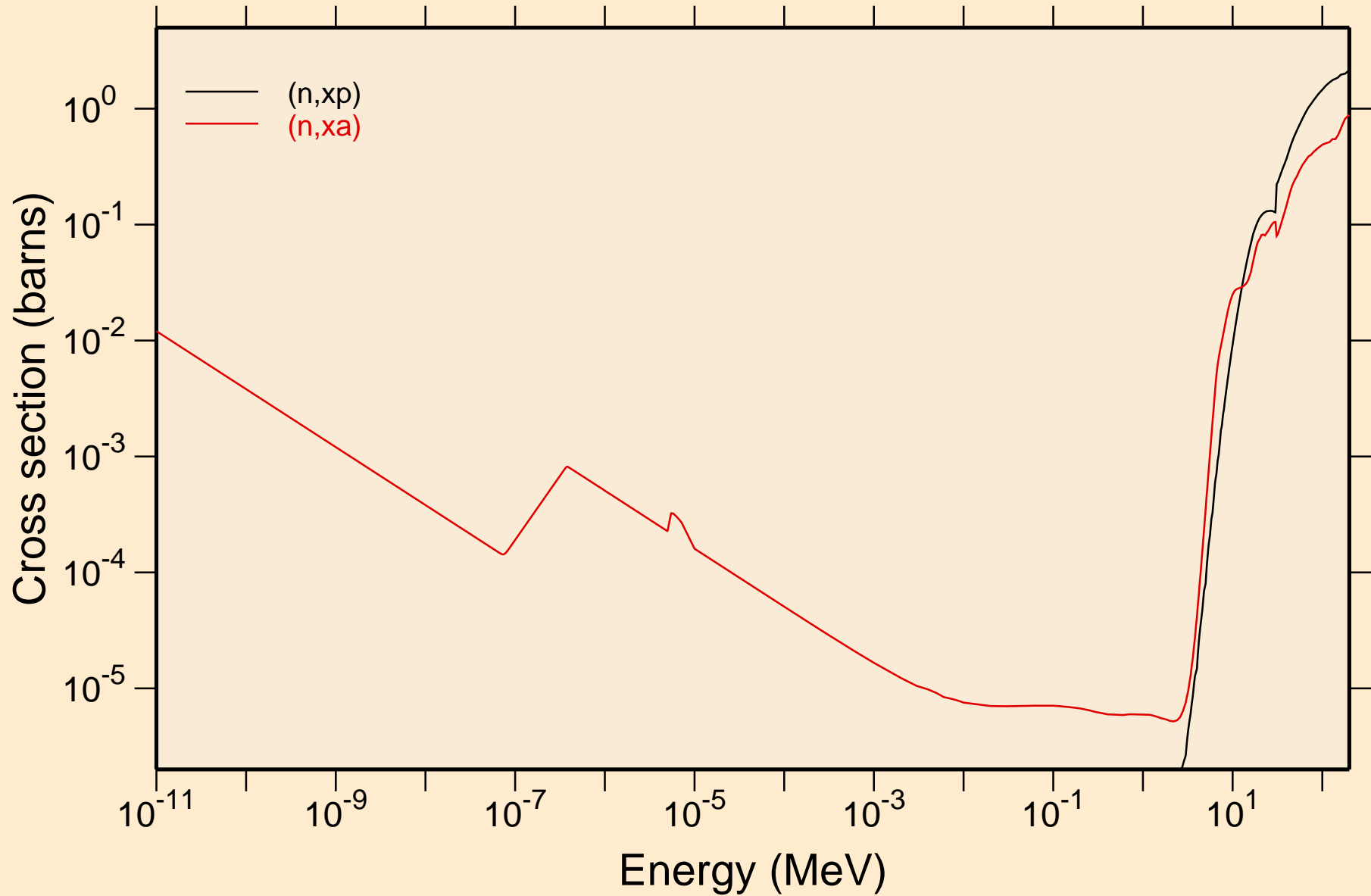

U227 NEUTRON ACER TENDL-2021 LIBRARY; T=293.6K
Principal cross sections

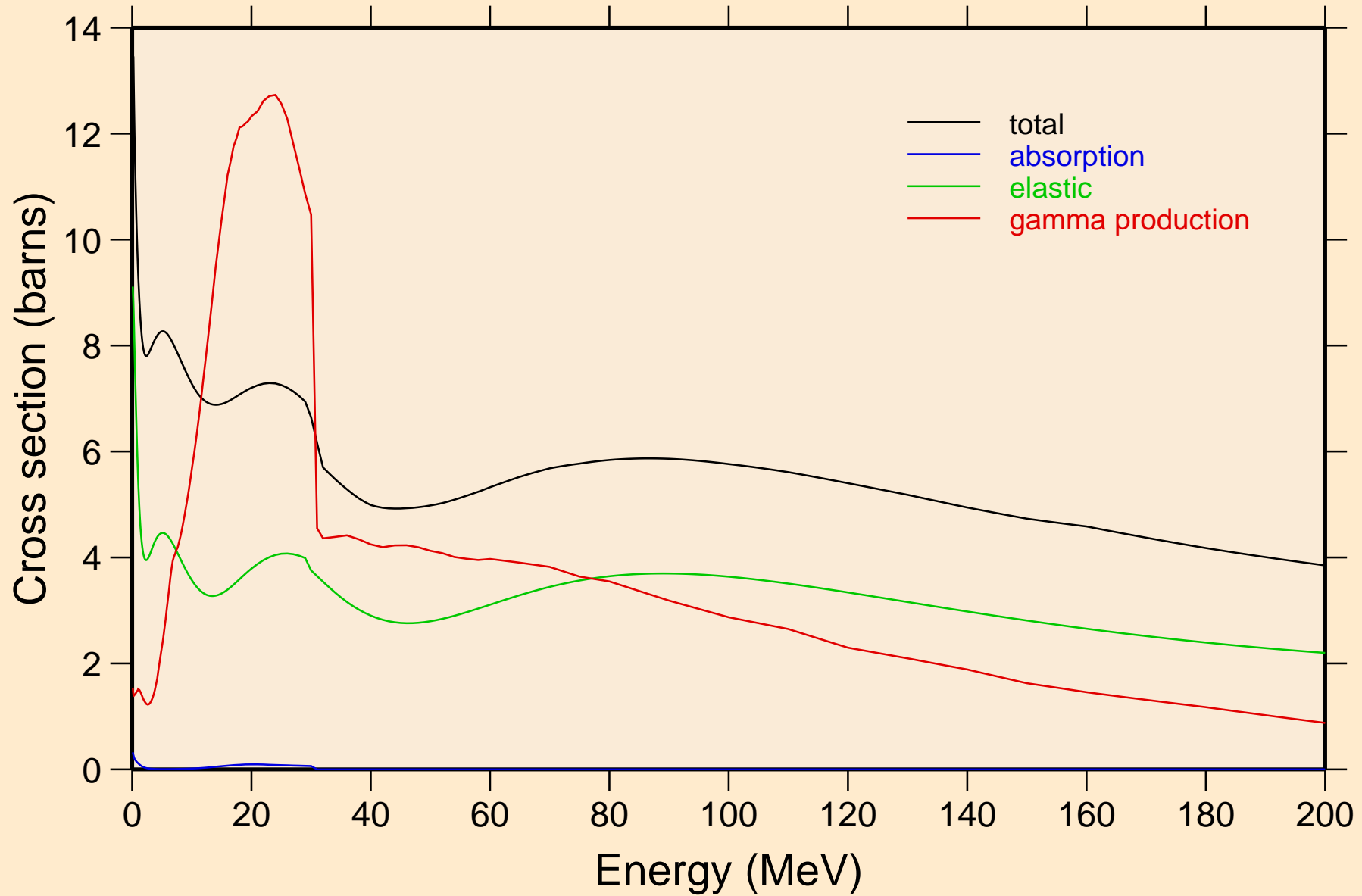

U227 NEUTRON ACER TENDL-2021 LIBRARY; T=293.6K

Heating

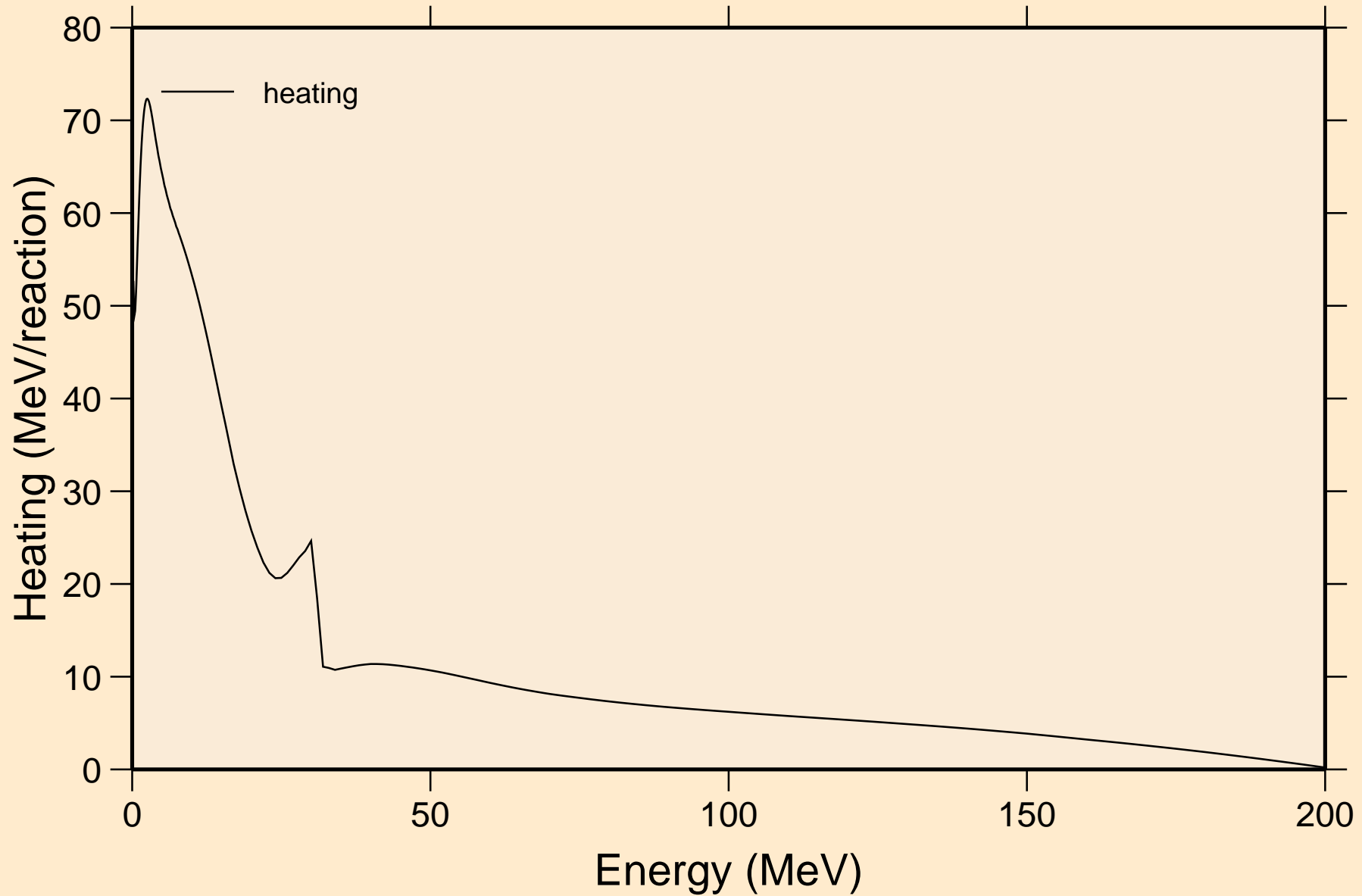

U227 NEUTRON ACER TENDL-2021 LIBRARY; T=293.6K
Damage

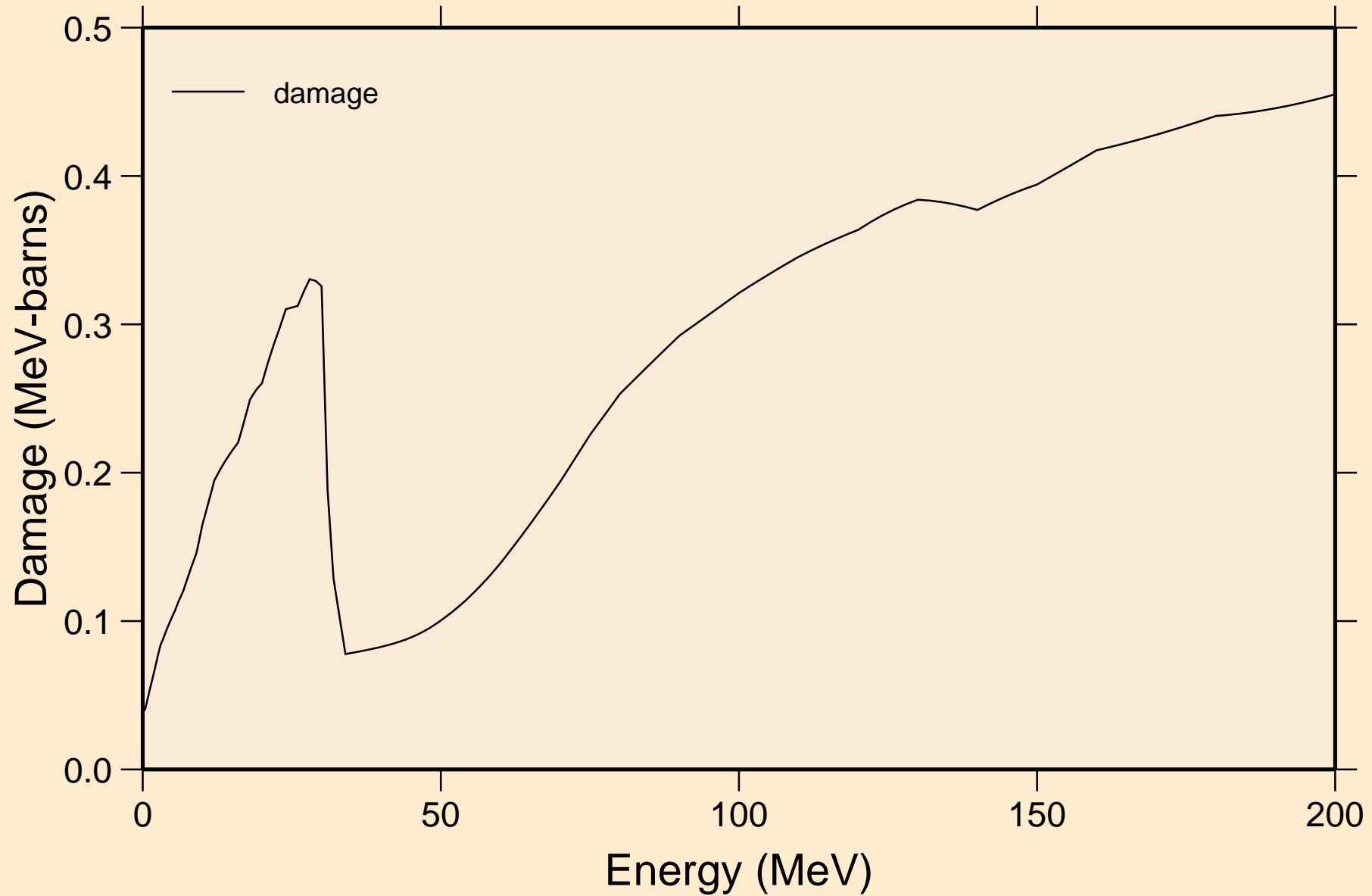

U227 NEUTRON ACER TENDL-2021 LIBRARY; T=293.6K
Non-threshold reactions

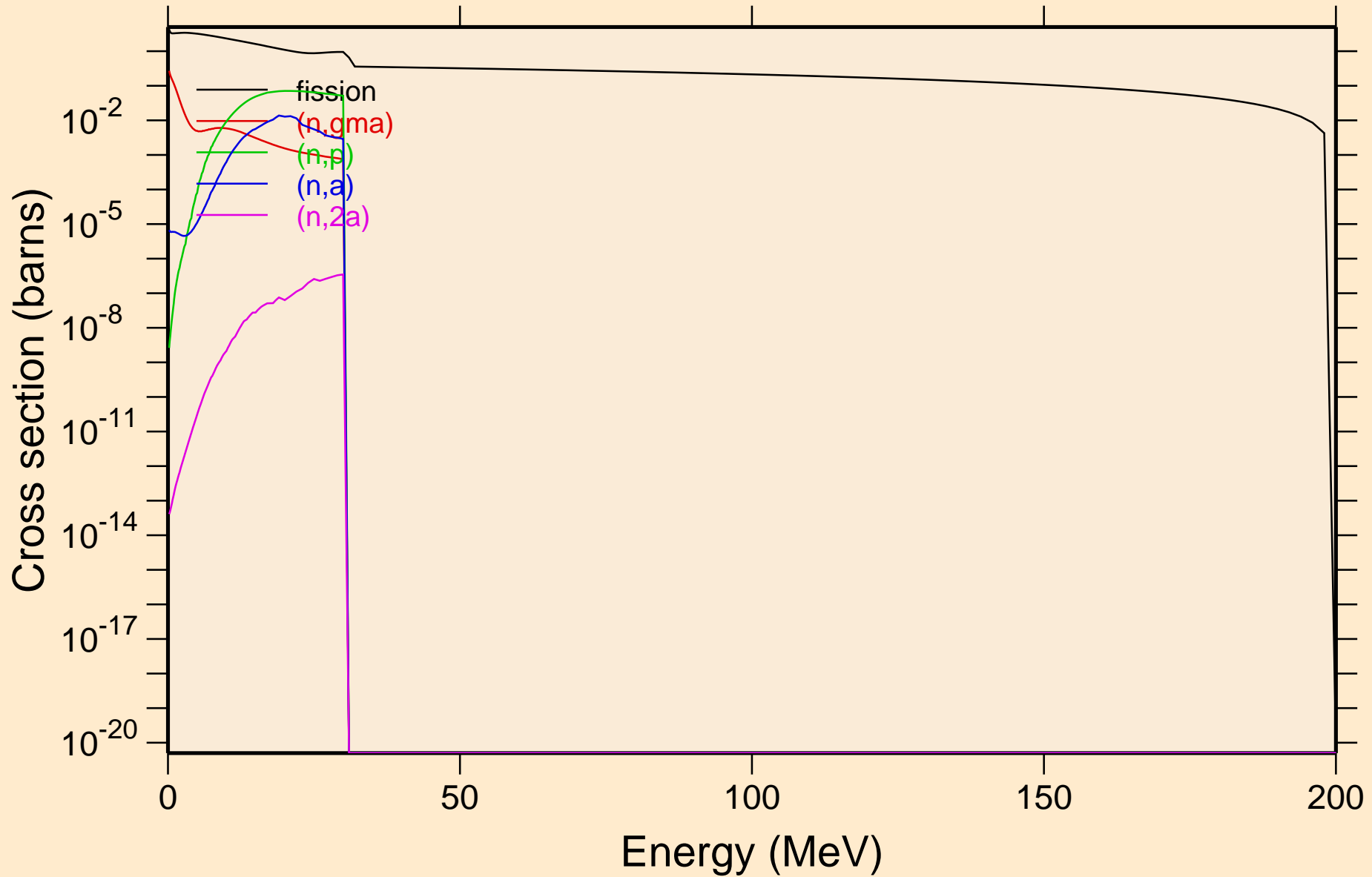

U227 NEUTRON ACER TENDL-2021 LIBRARY; T=293.6K
Non-threshold reactions

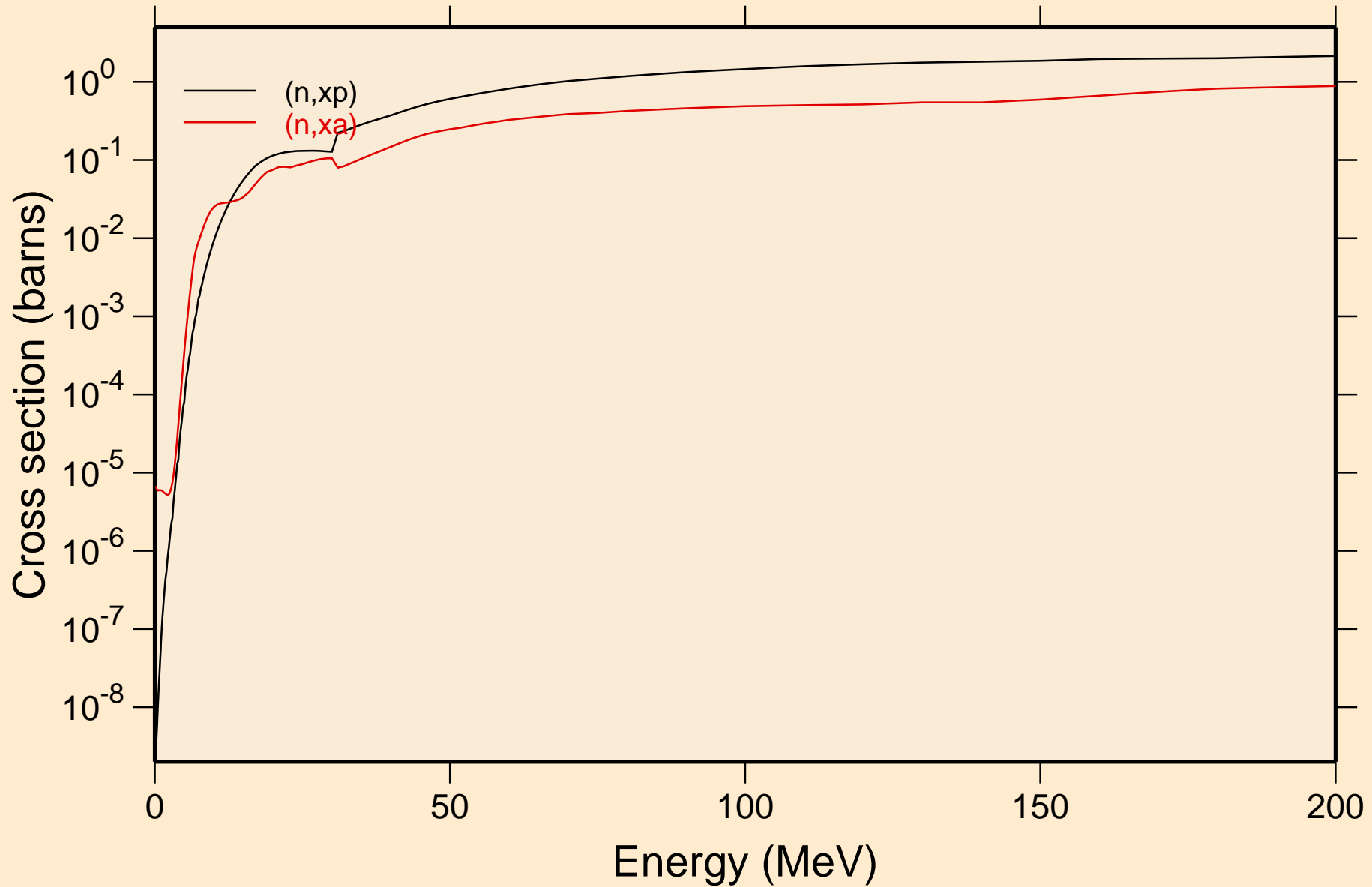

U227 NEUTRON ACER TENDL-2021 LIBRARY; T=293.6K
Inelastic levels

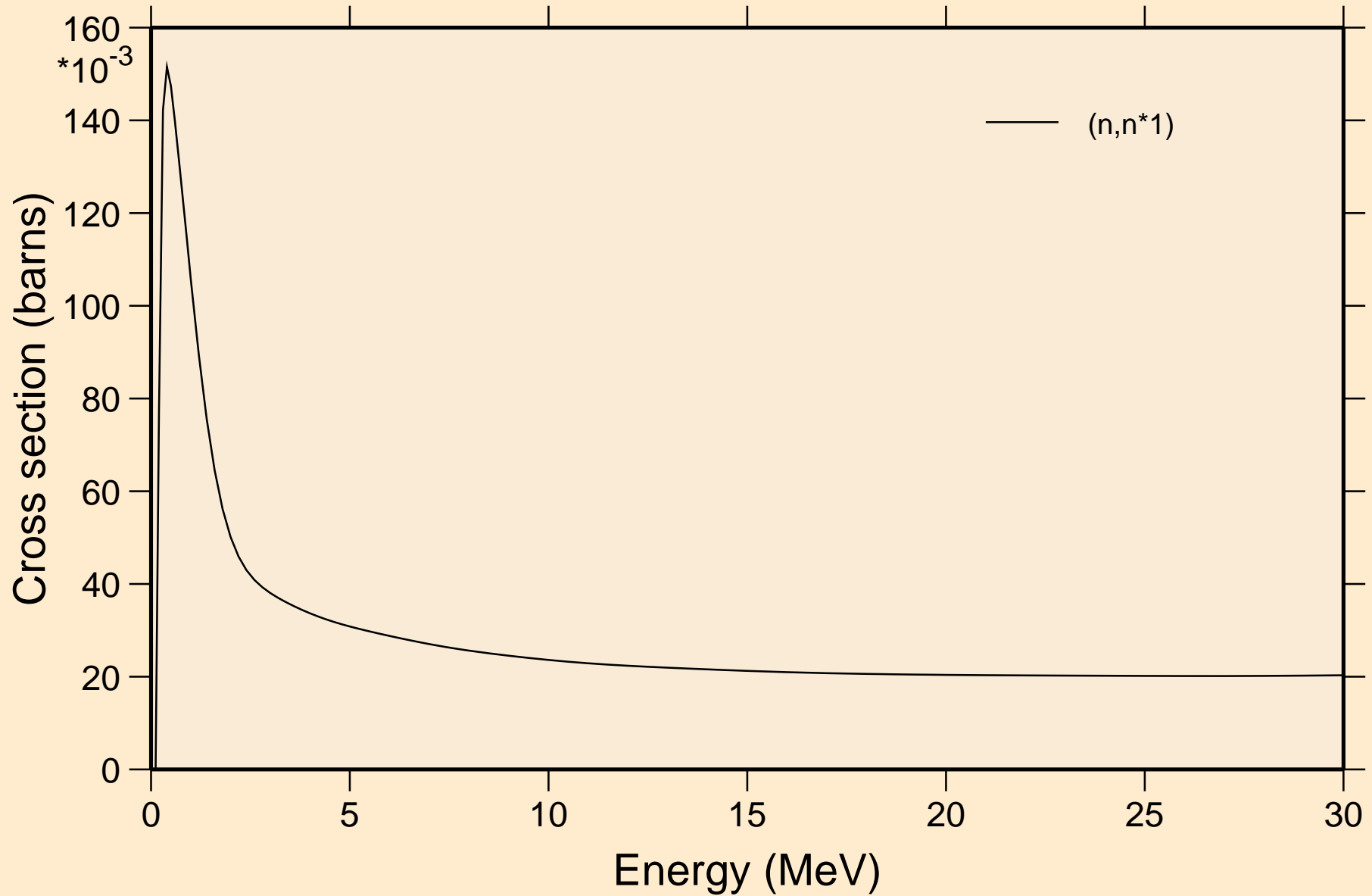

U227 NEUTRON ACER TENDL-2021 LIBRARY; T=293.6K

Threshold reactions

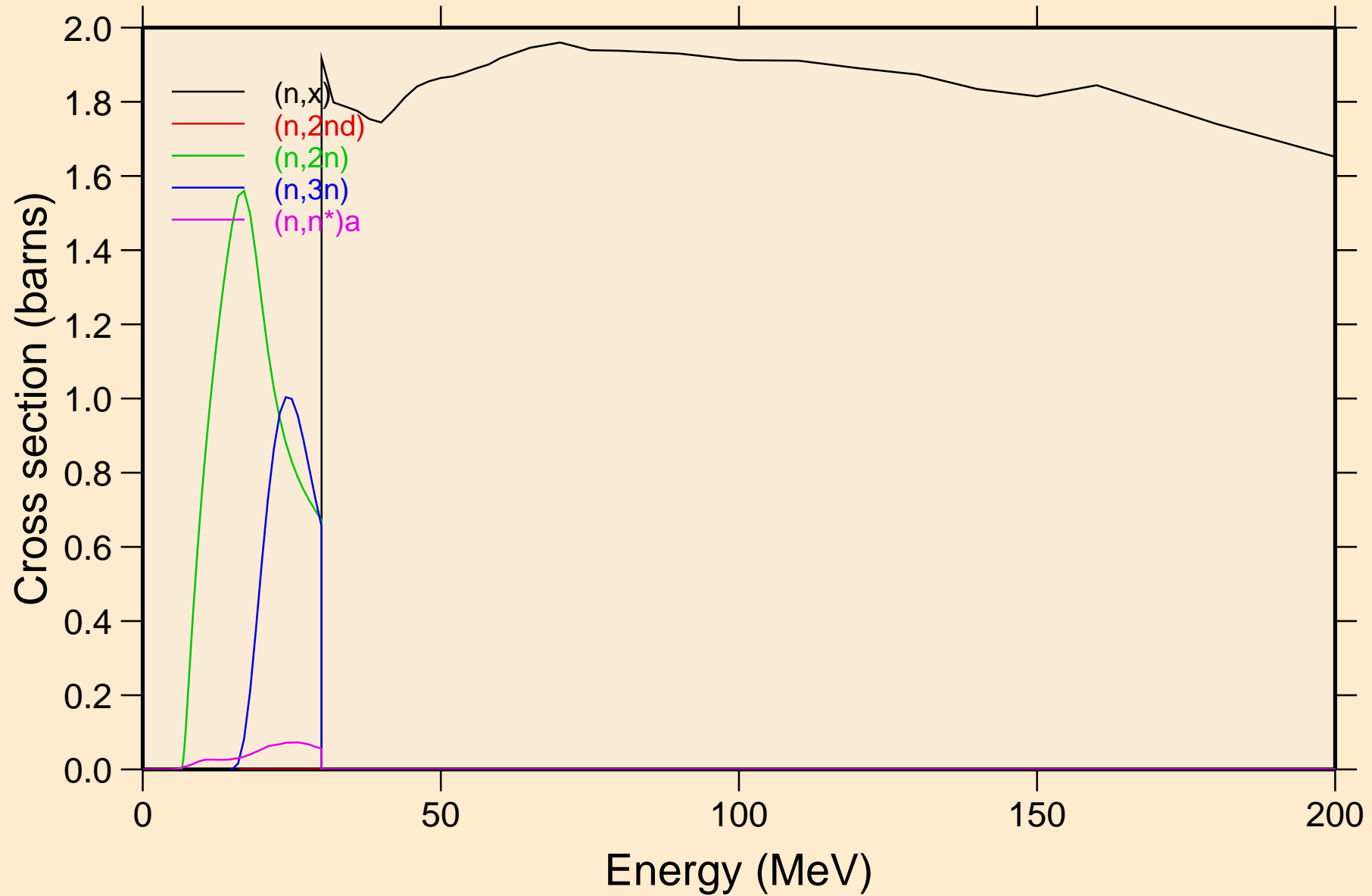

U227 NEUTRON ACER TENDL-2021 LIBRARY; T=293.6K
Threshold reactions

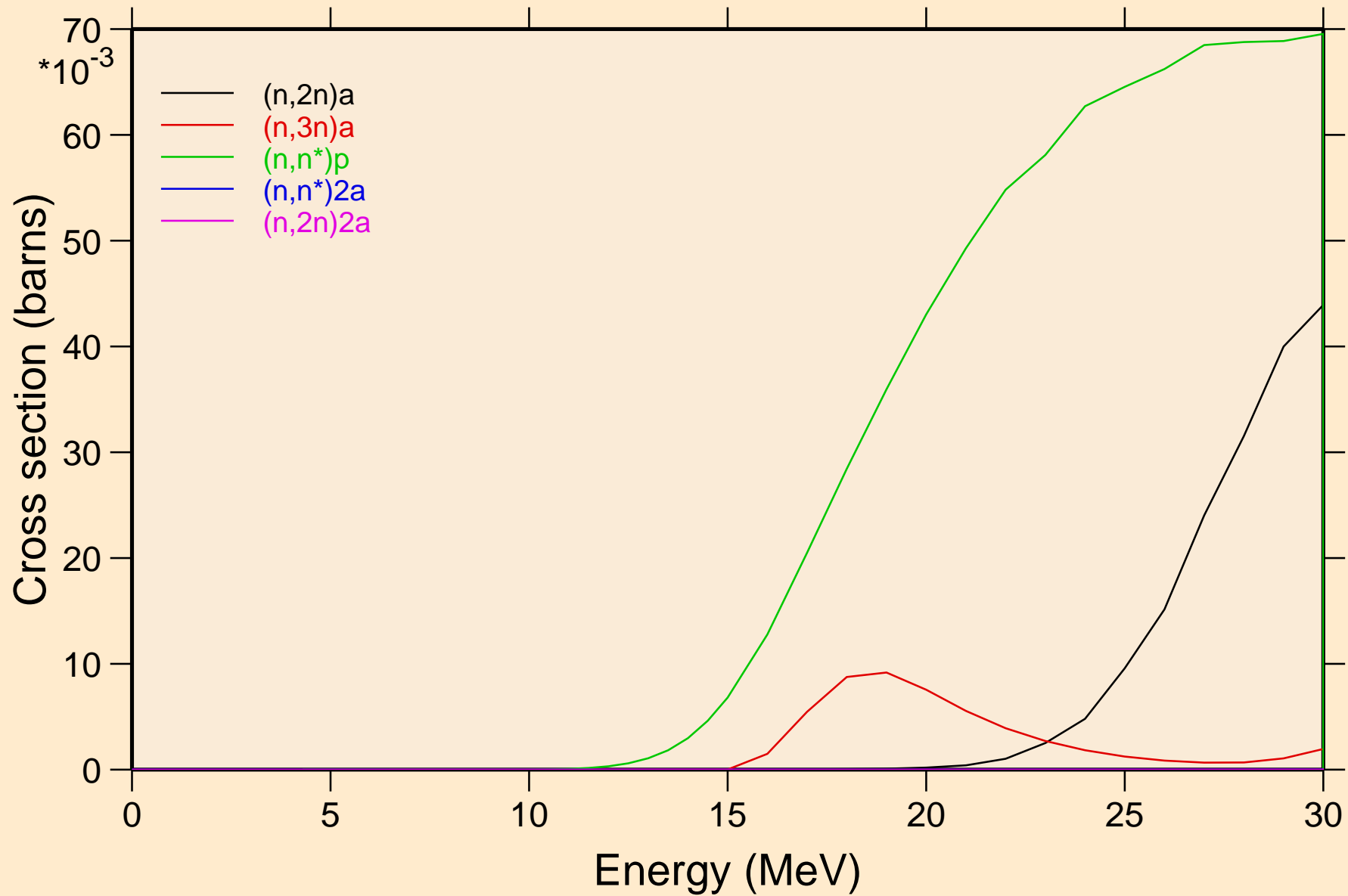

U227 NEUTRON ACER TENDL-2021 LIBRARY; T=293.6K

Threshold reactions

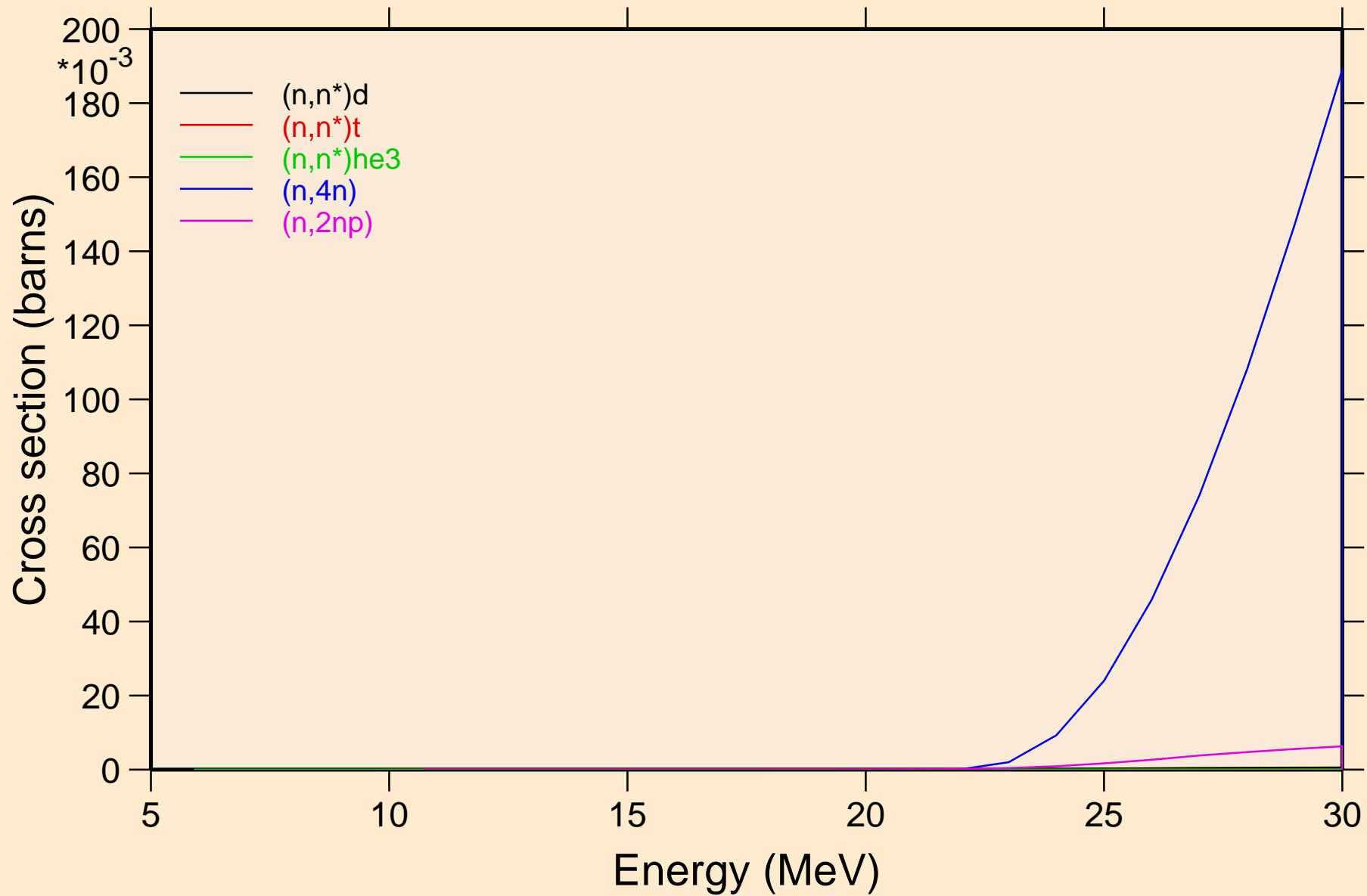

U227 NEUTRON ACER TENDL-2021 LIBRARY; T=293.6K
Threshold reactions

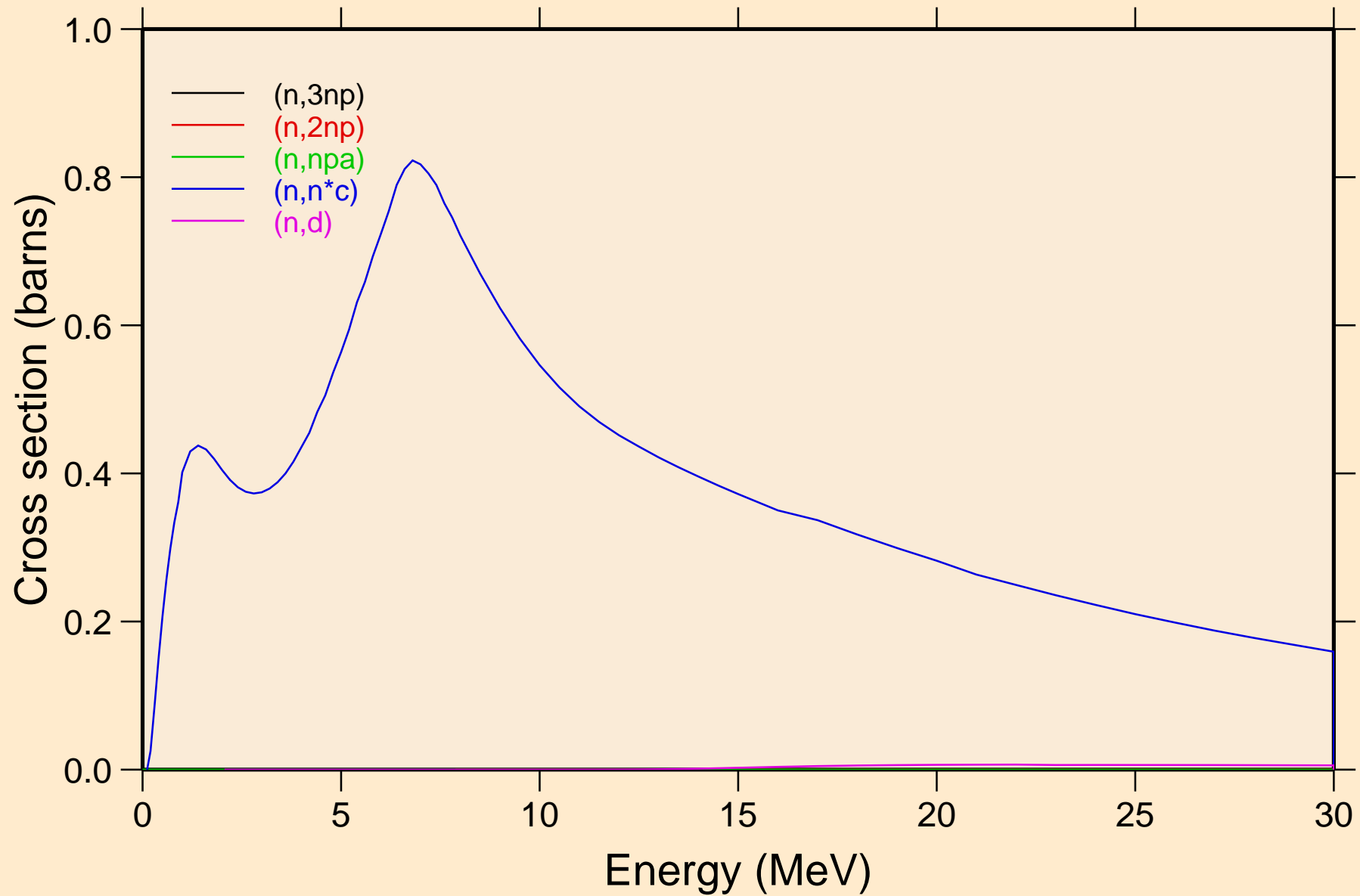

U227 NEUTRON ACER TENDL-2021 LIBRARY; T=293.6K
Threshold reactions

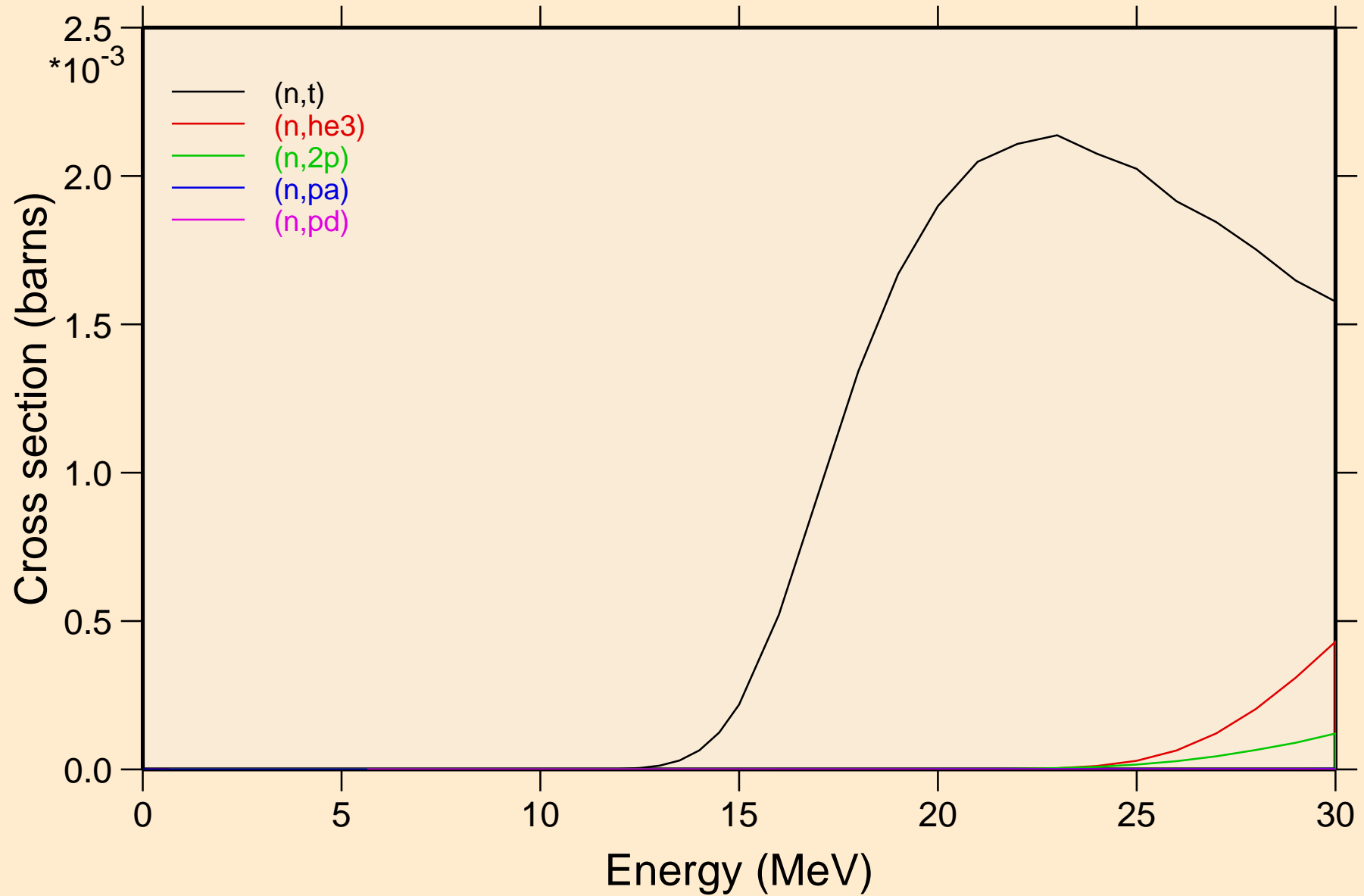

U227 NEUTRON ACER TENDL-2021 LIBRARY; T=293.6K
Threshold reactions

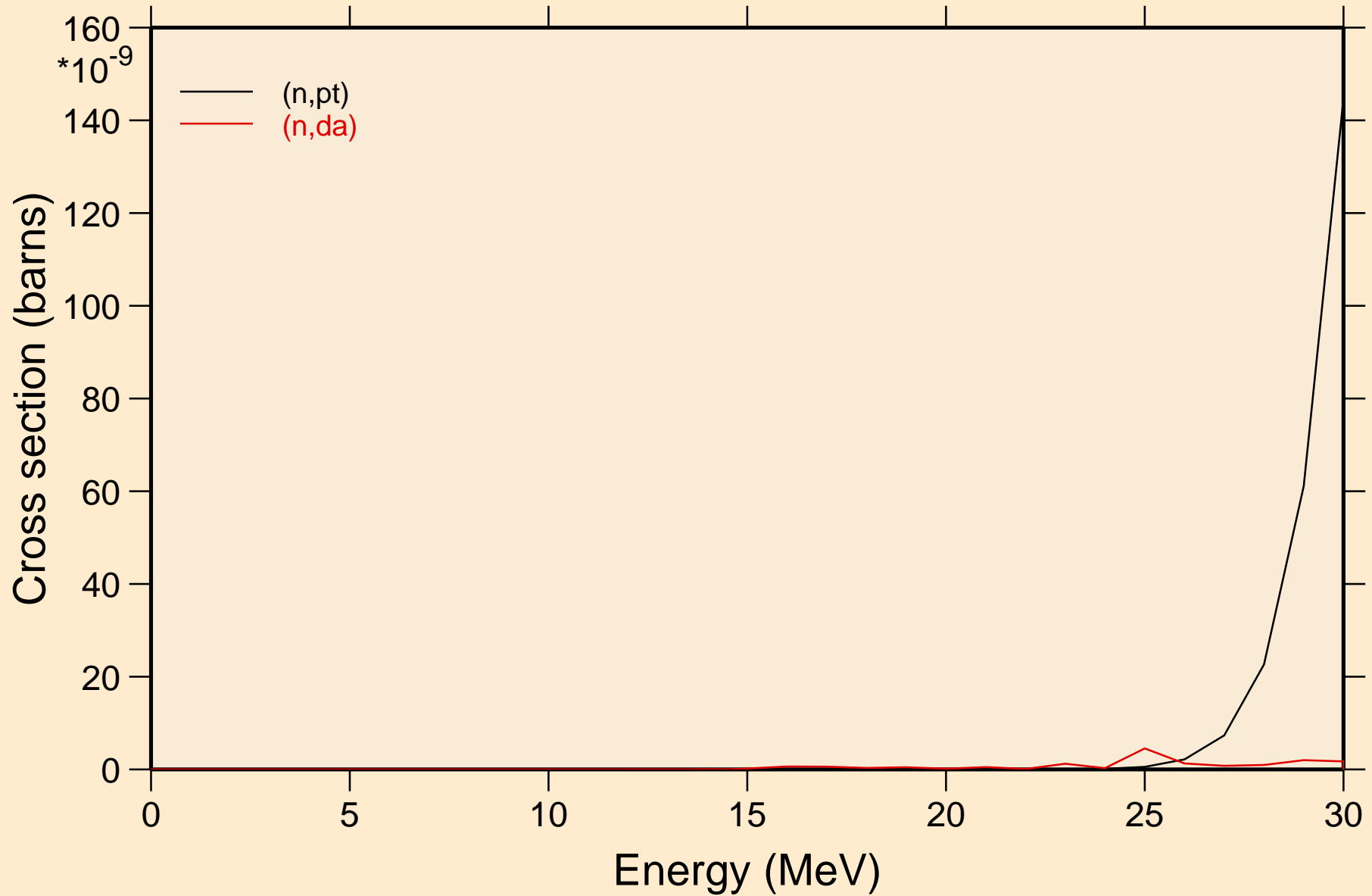

U227 NEUTRON ACER TENDL-2021 LIBRARY; T=293.6K

Threshold reactions

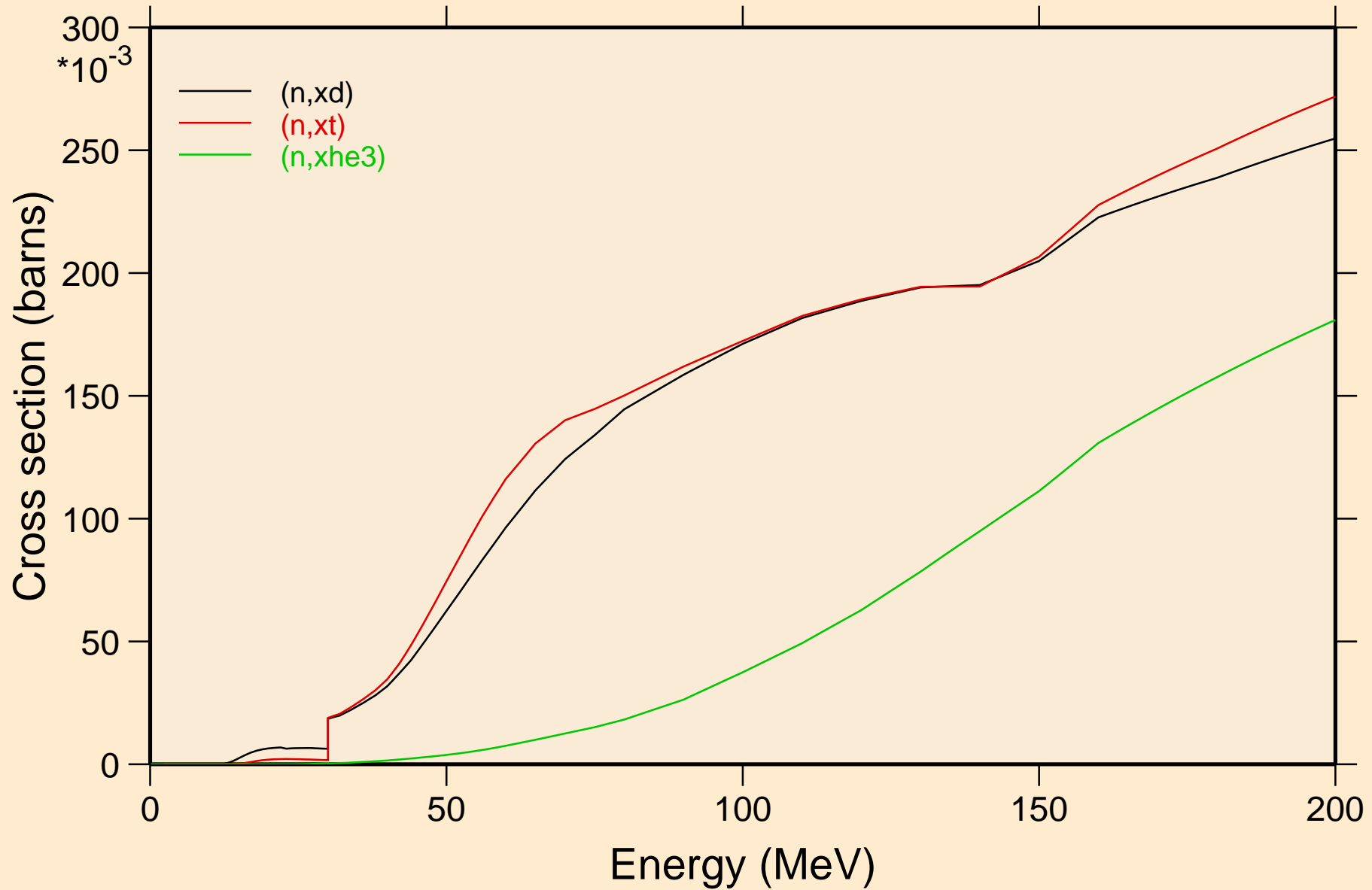

U227 NEUTRON ACER TENDL-2021 LIBRARY; T=293.6K
angular distribution for elastic

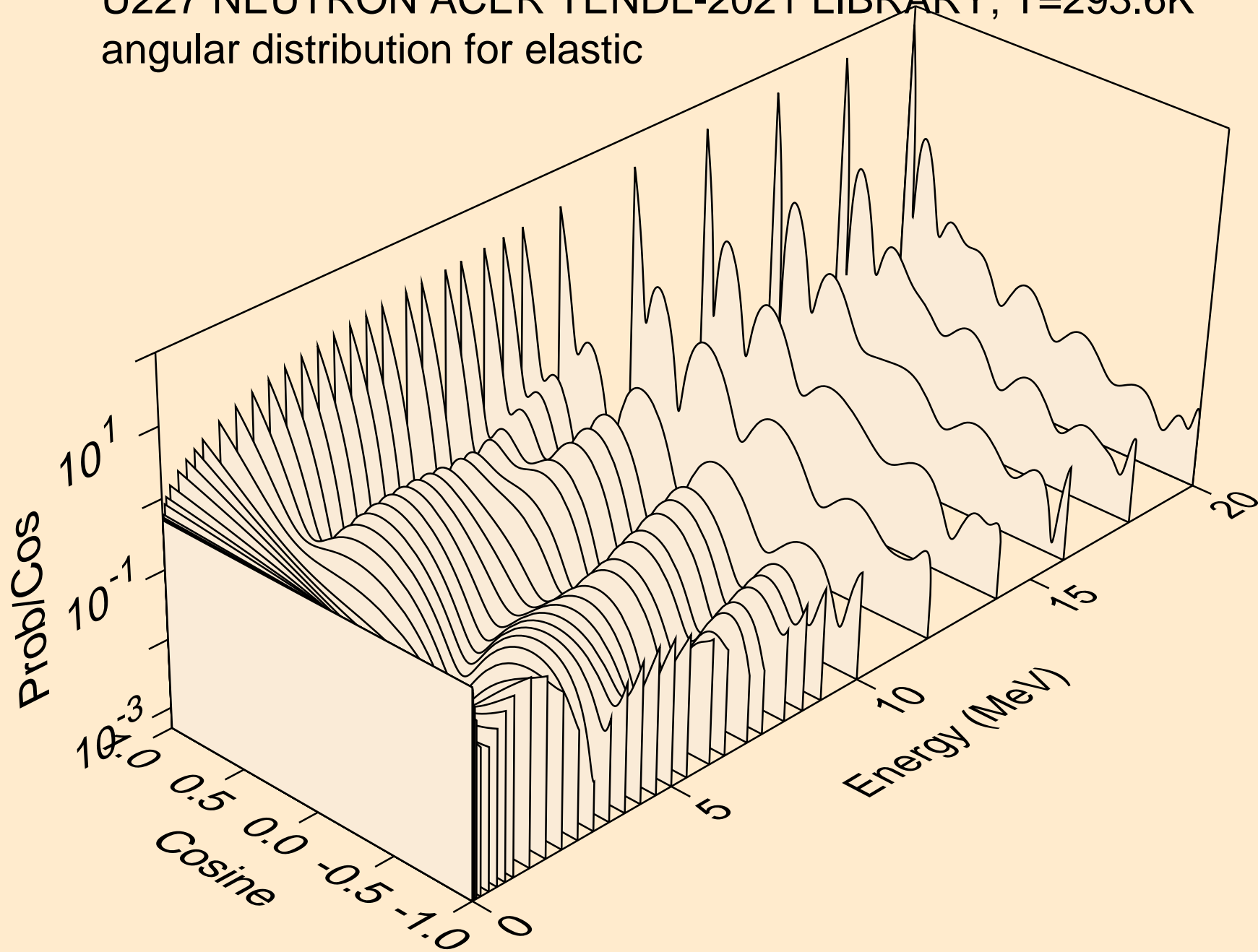

U227 NEUTRON ACER TENDL-2021 LIBRARY; T=293.6K
angular distribution for elastic

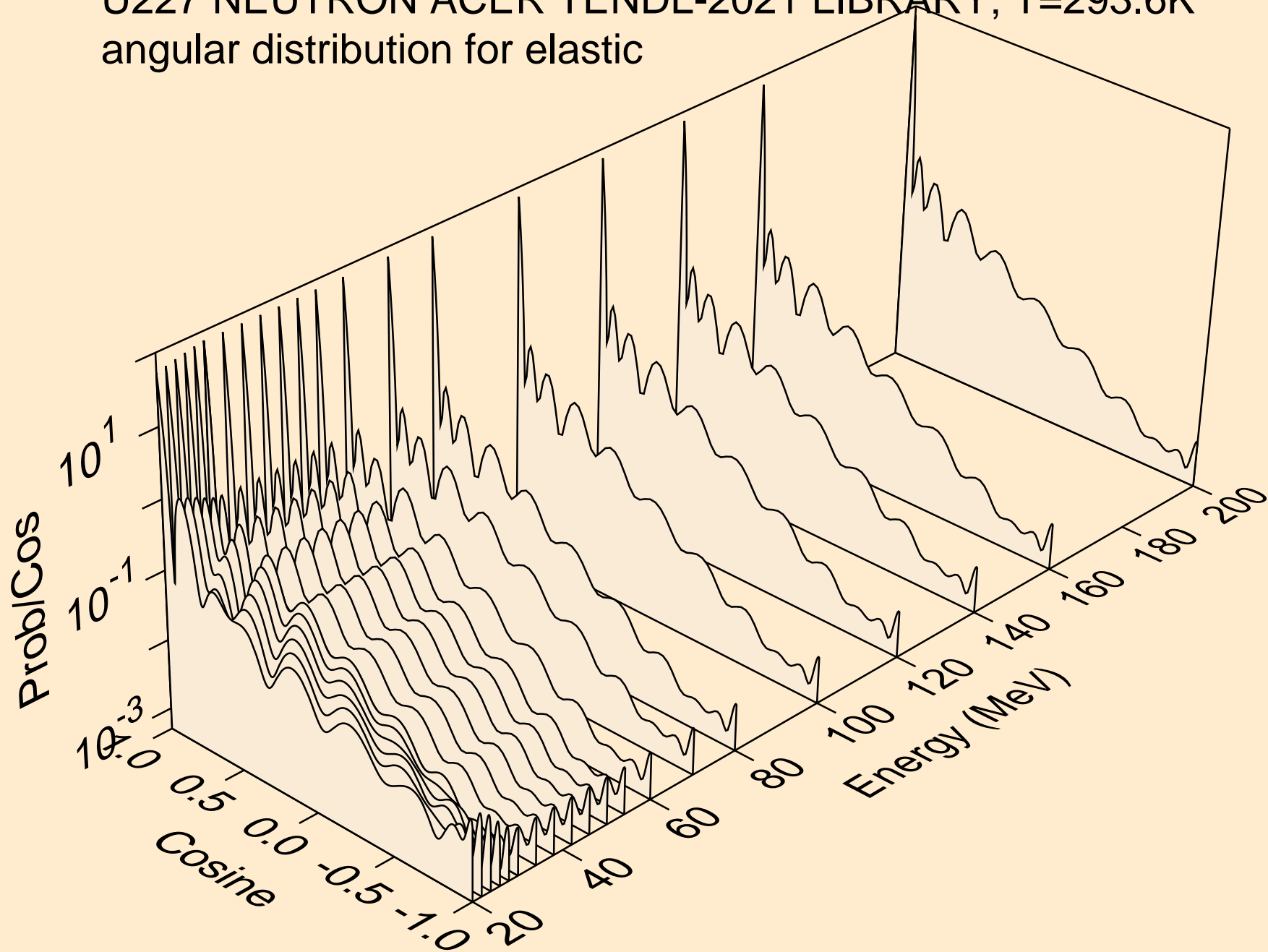

U227 NEUTRON ACER TENDL-2021 LIBRARY; T=293.6K
angular distribution for (n,n*1)

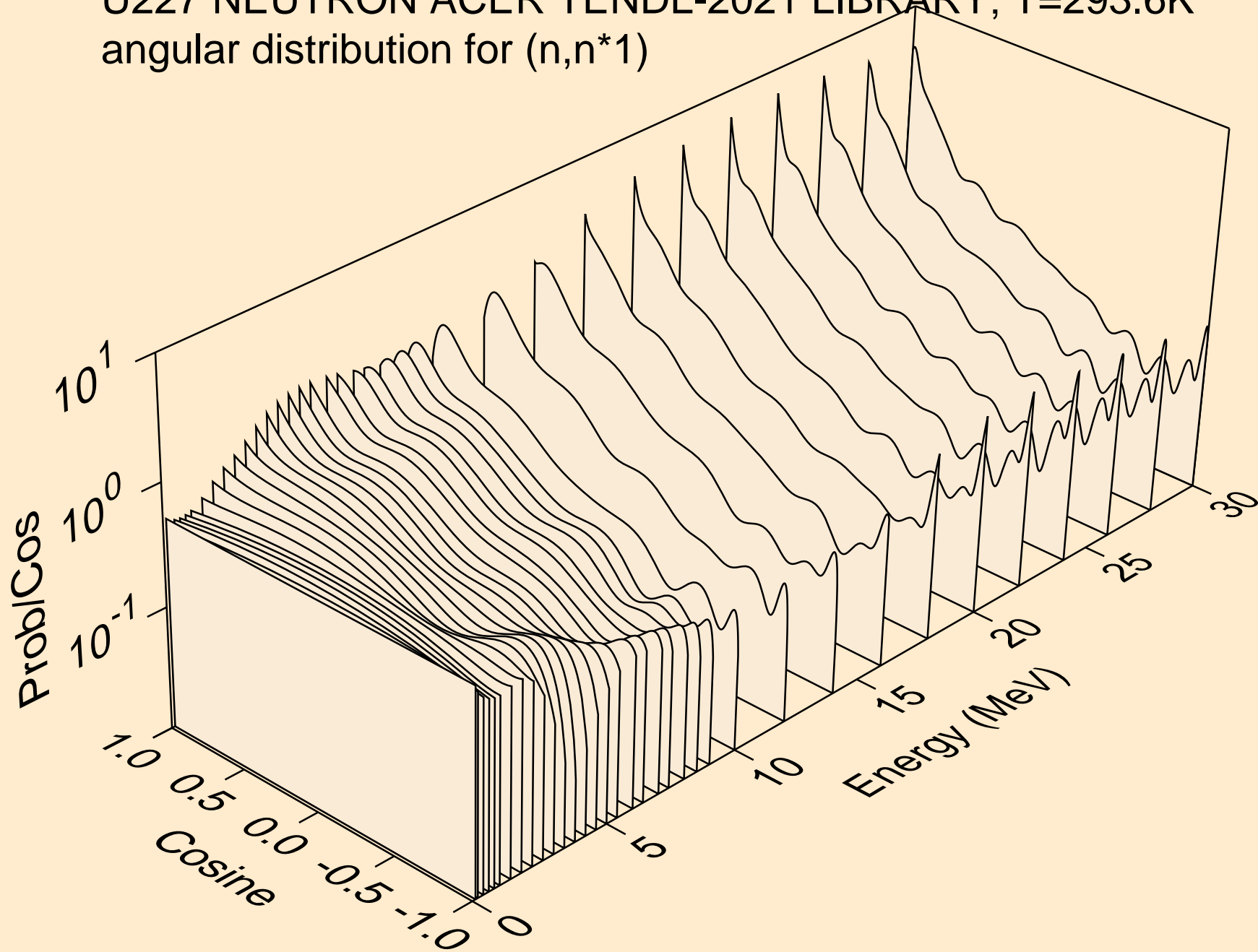

U227 NEUTRON ACER TENDL-2021 LIBRARY; T=293.6K

Total fission nubar

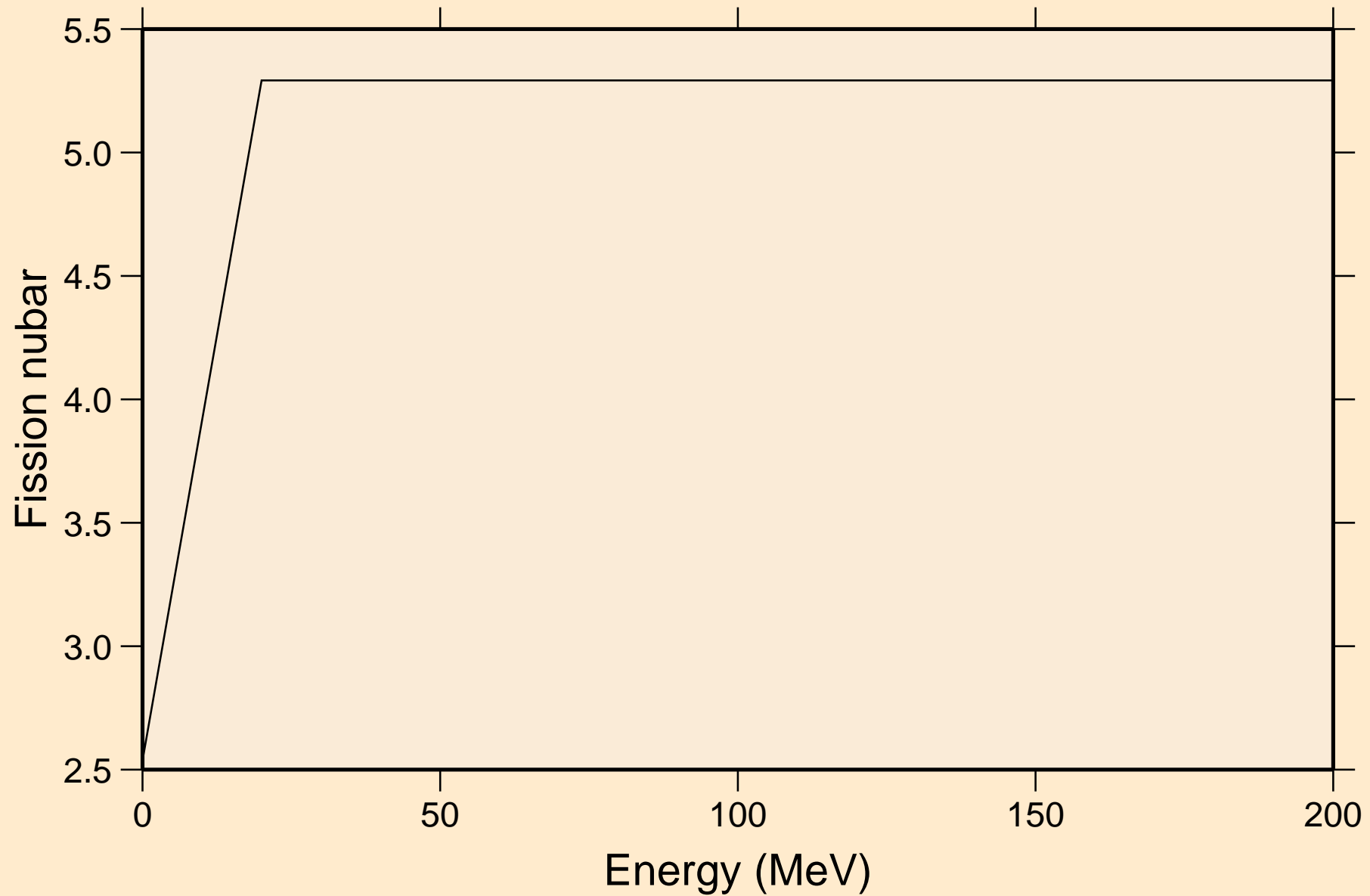

U227 NEUTRON ACER TENDL-2021 LIBRARY; T=293.6K
Neutron emission for (n,x)

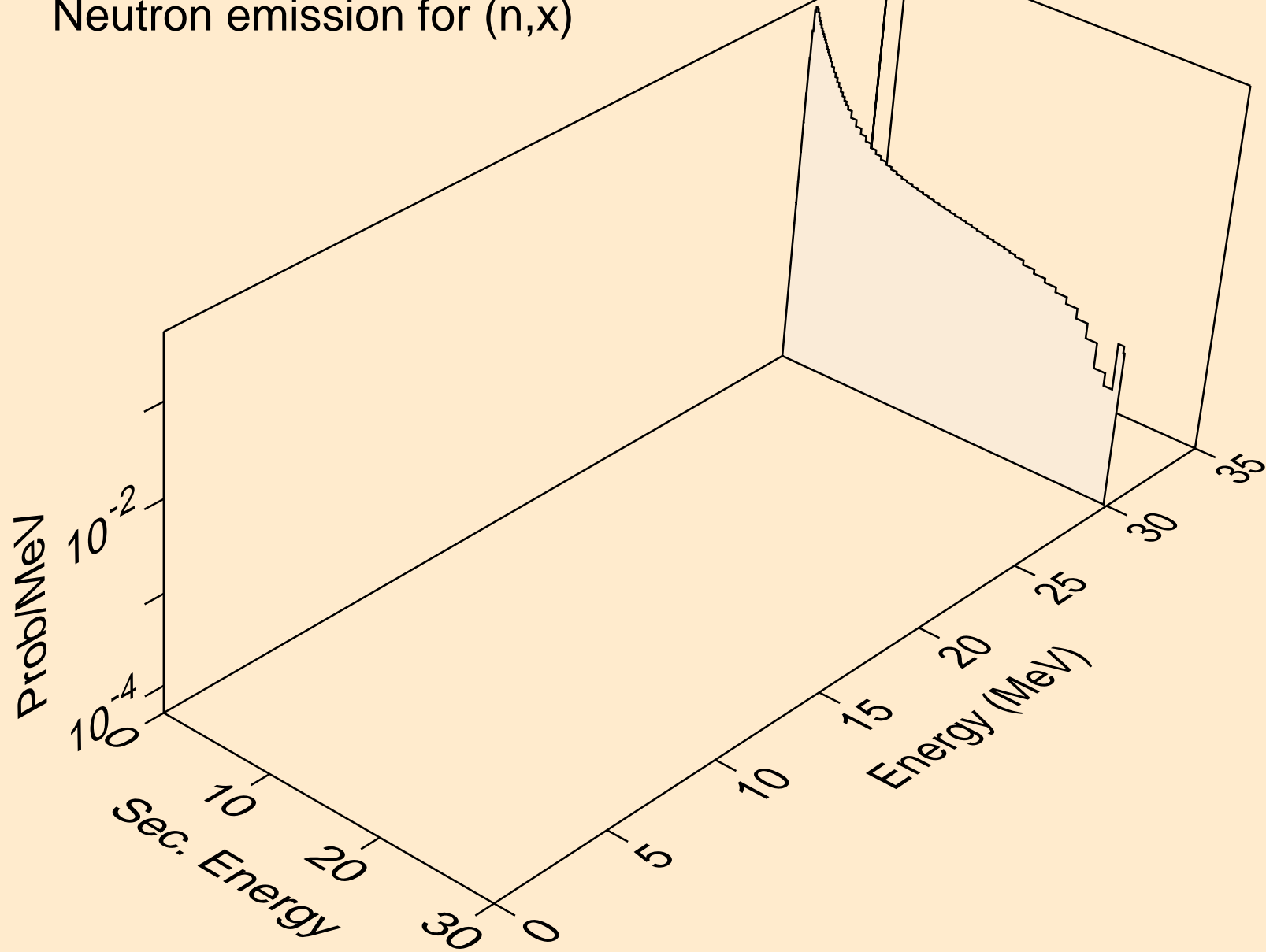

U227 NEUTRON ACER TENDL-2021 LIBRARY; T=293.6K
Neutron emission for (n,2nd)

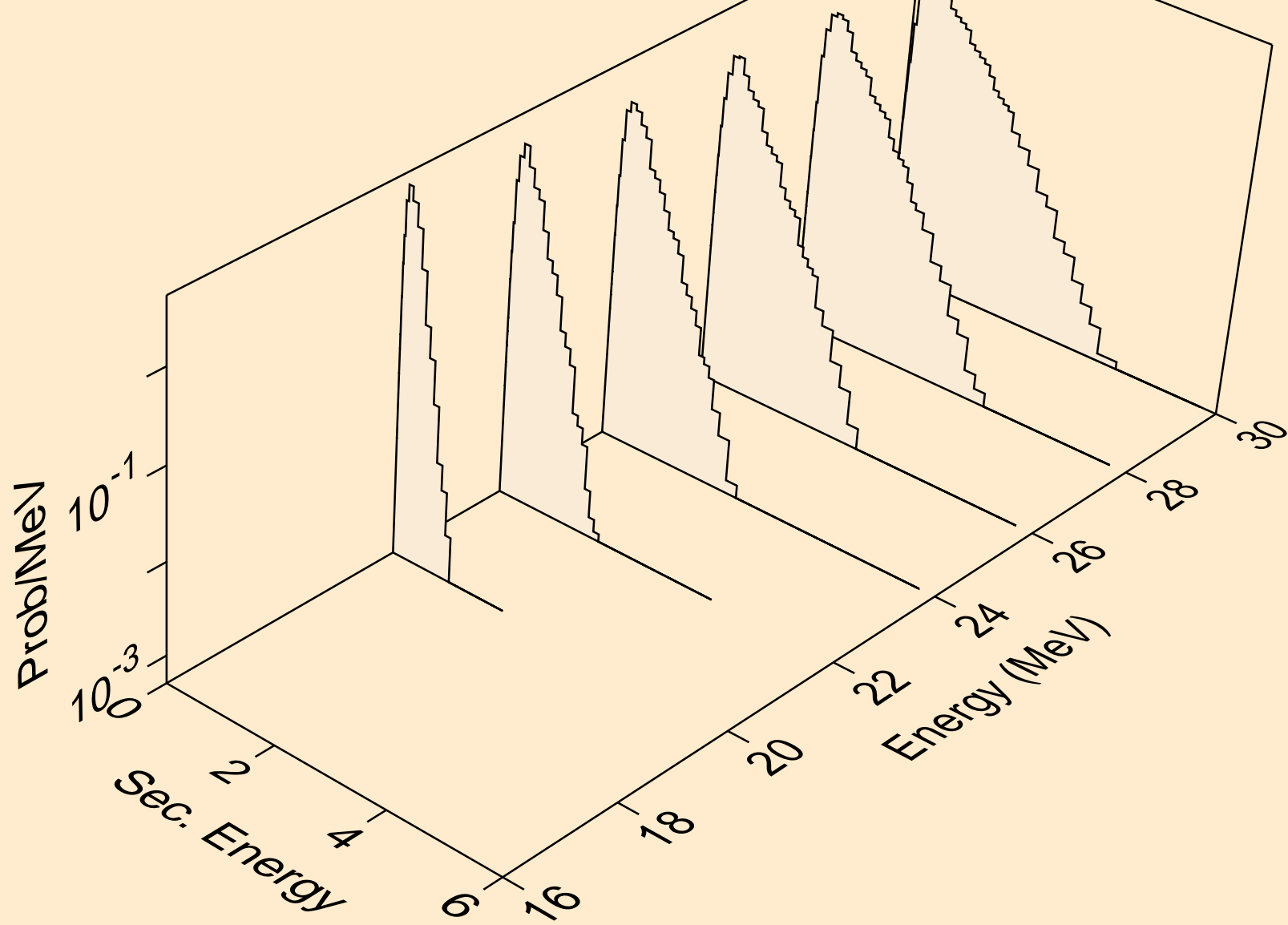

U227 NEUTRON ACER TENDL-2021 LIBRARY; T=293.6K
Neutron emission for (n,2n)

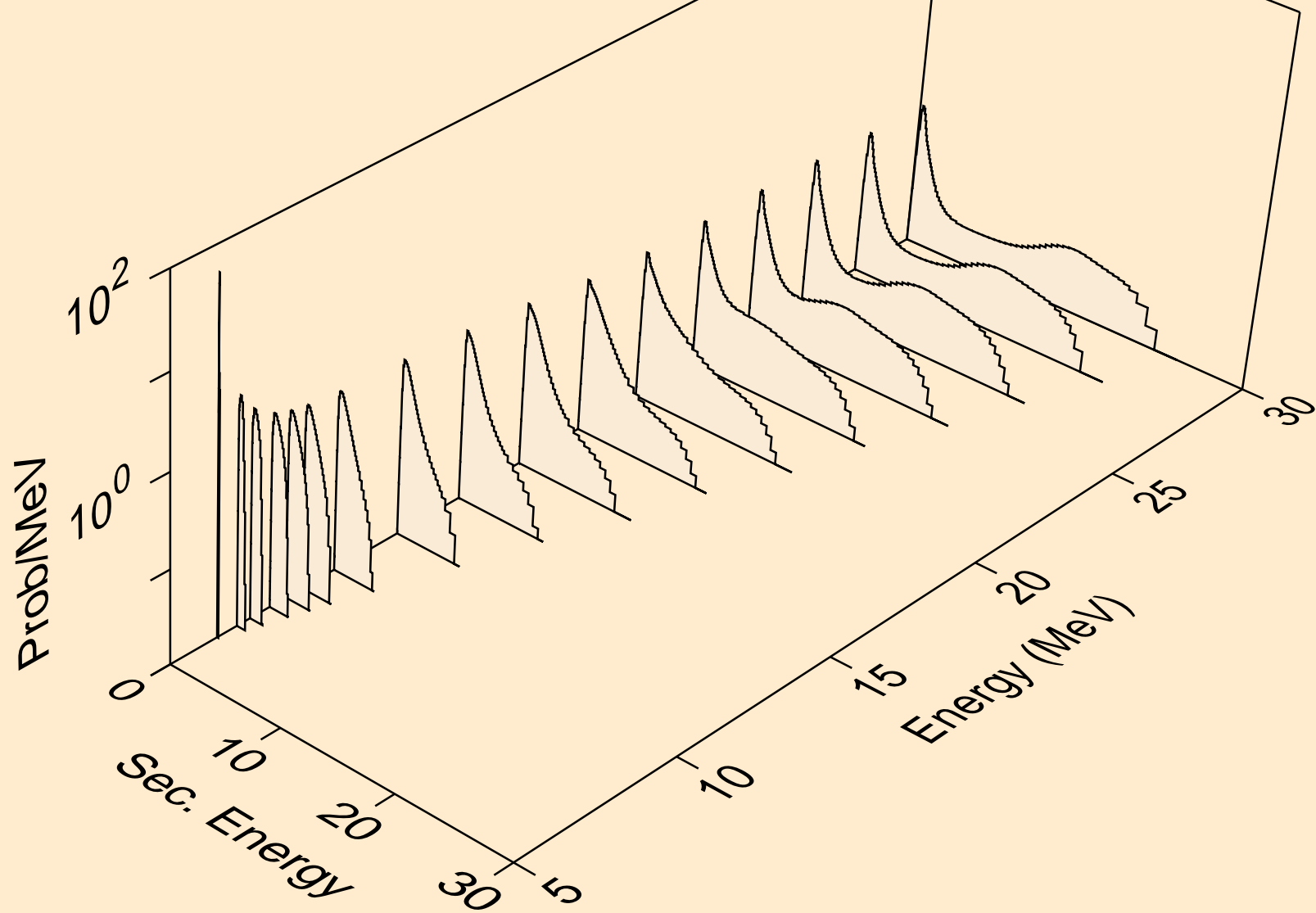

U227 NEUTRON ACER TENDL-2021 LIBRARY; T=293.6K
Neutron emission for (n,3n)

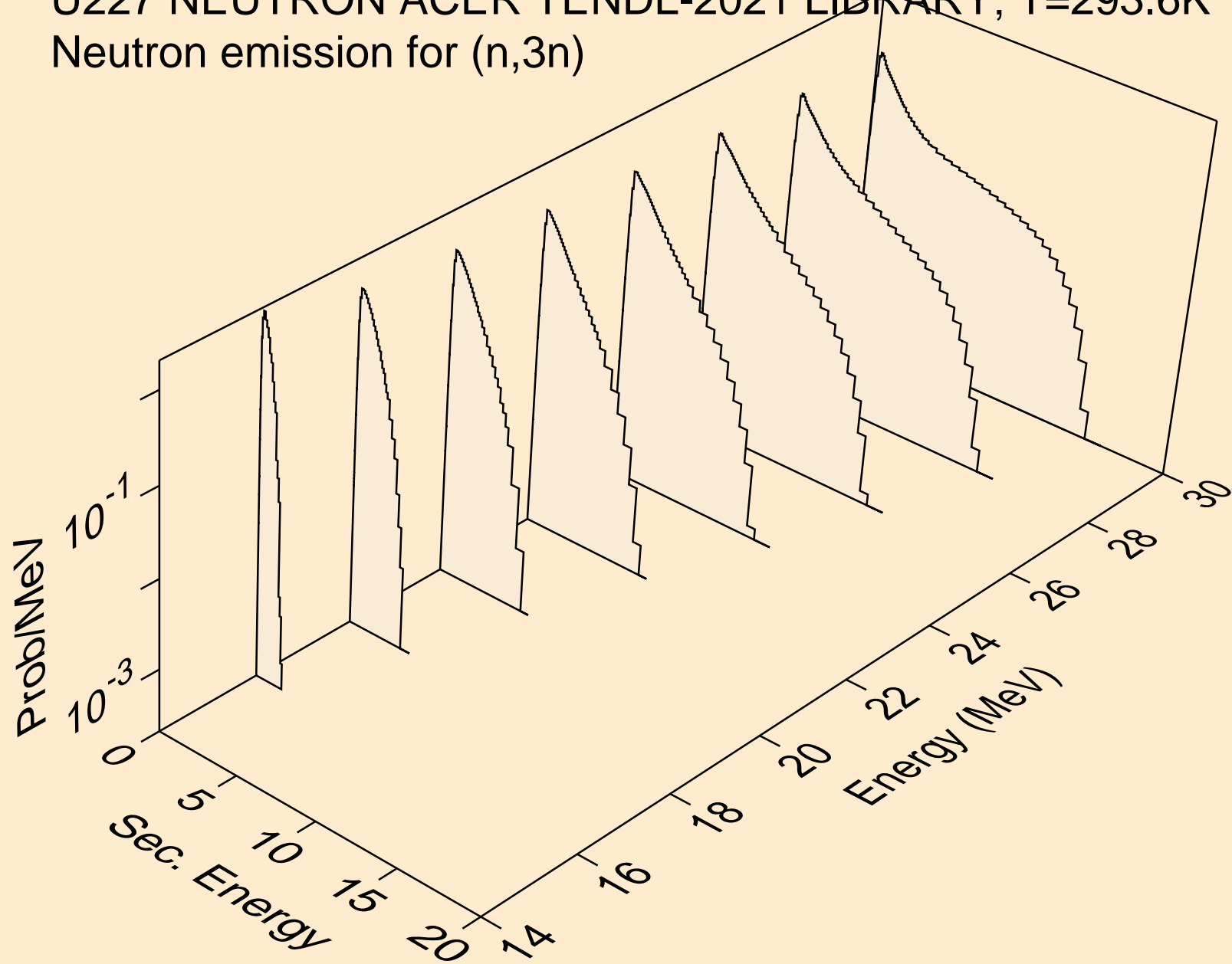

U227 NEUTRON ACER TENDL-2021 LIBRARY; T=293.6K
Neutron emission for fission

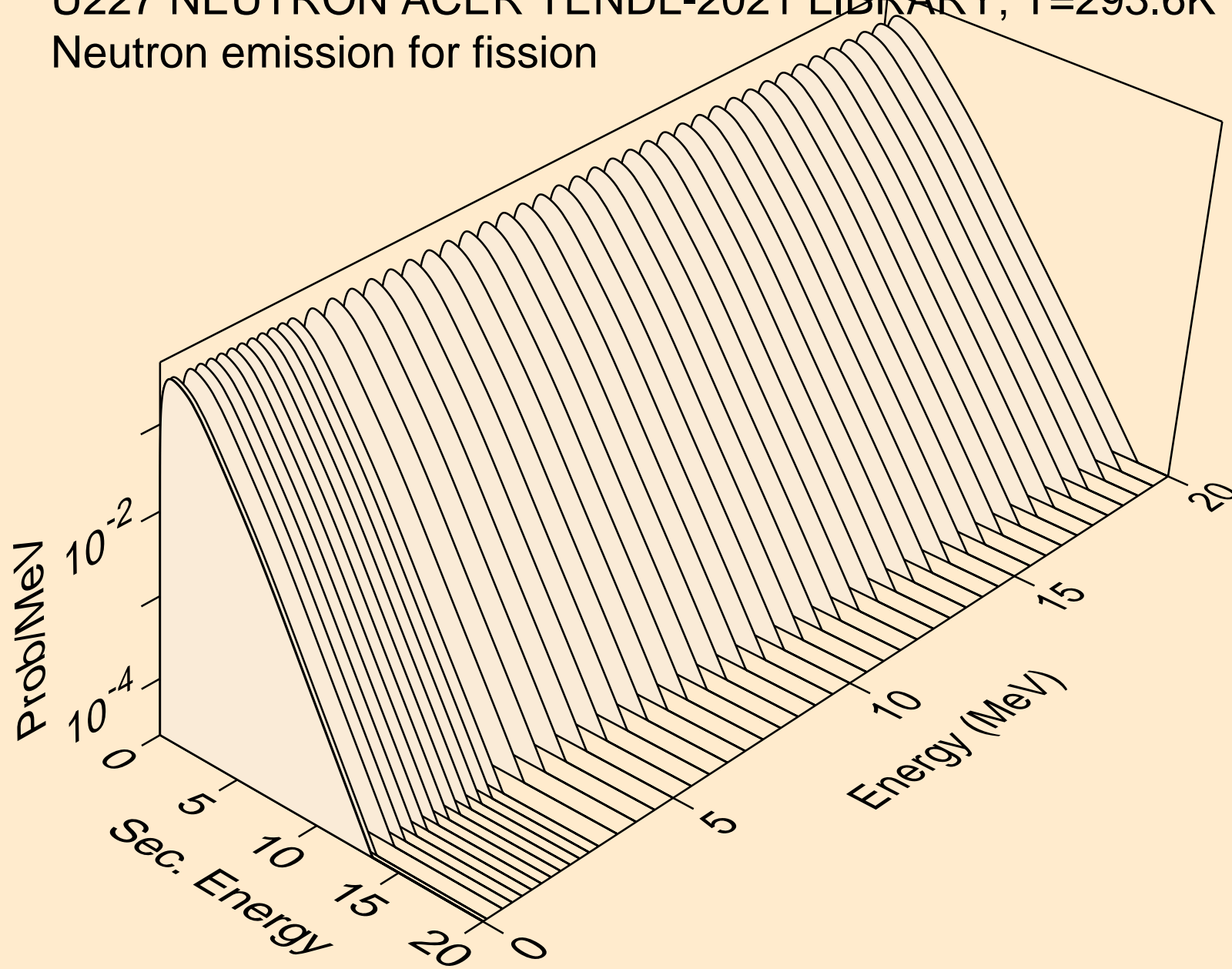

U227 NEUTRON ACER TENDL-2021 LIBRARY; T=293.6K
Neutron emission for (n,n*)a

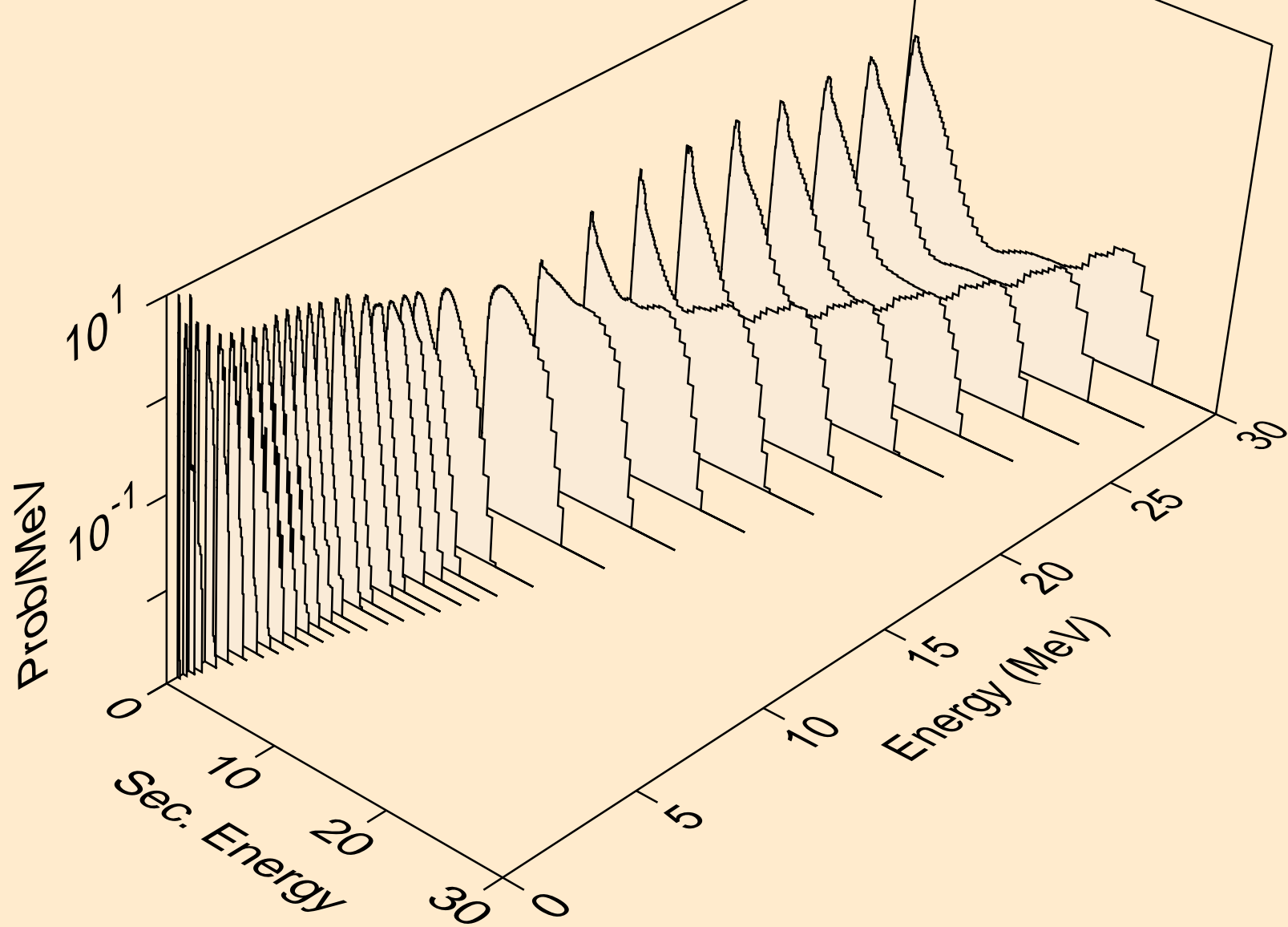

U227 NEUTRON ACER TENDL-2021 LIBRARY; T=293.6K
Neutron emission for (n,2n)a

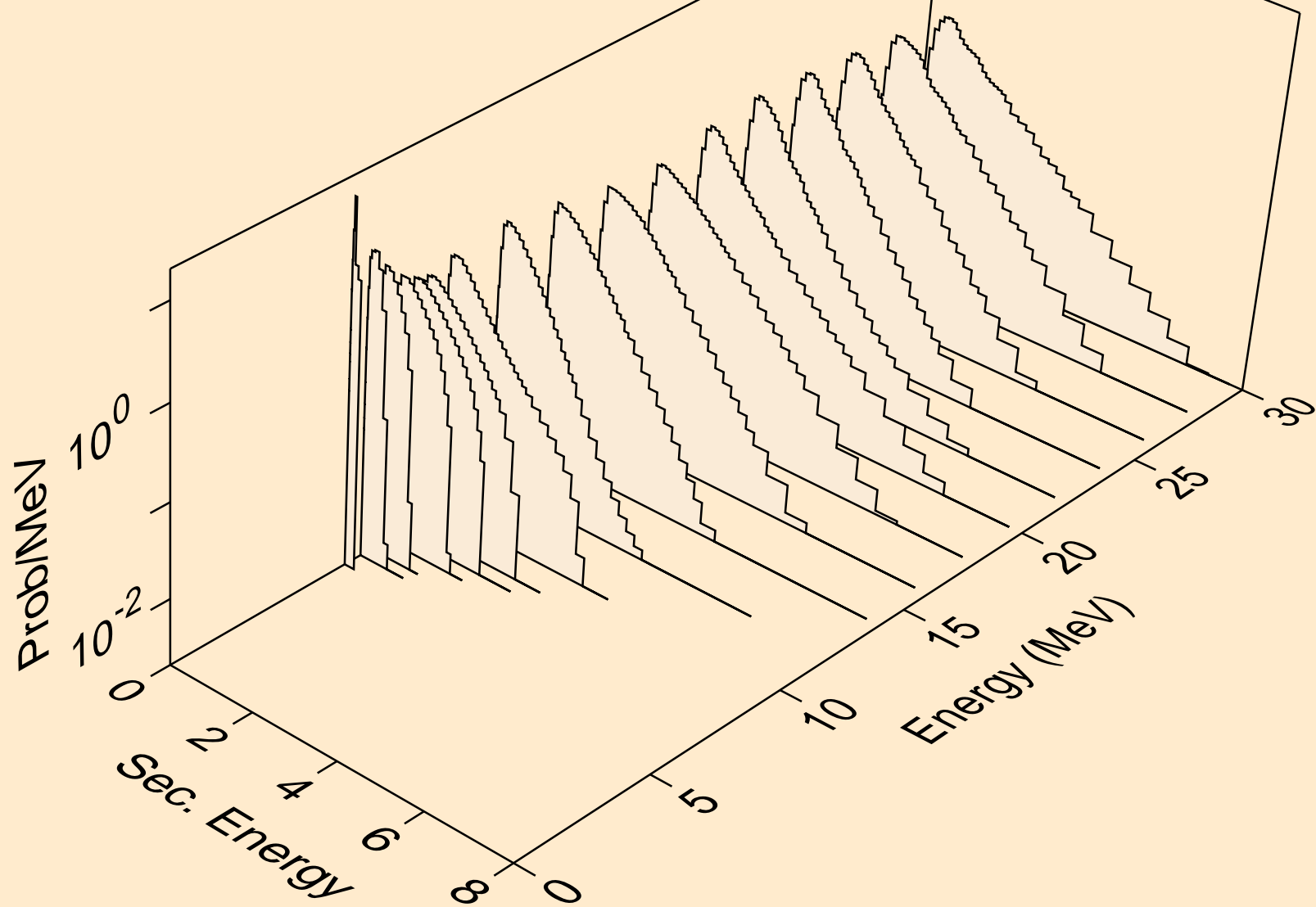

U227 NEUTRON ACER TENDL-2021 LIBRARY; T=293.6K
Neutron emission for (n,3n)a

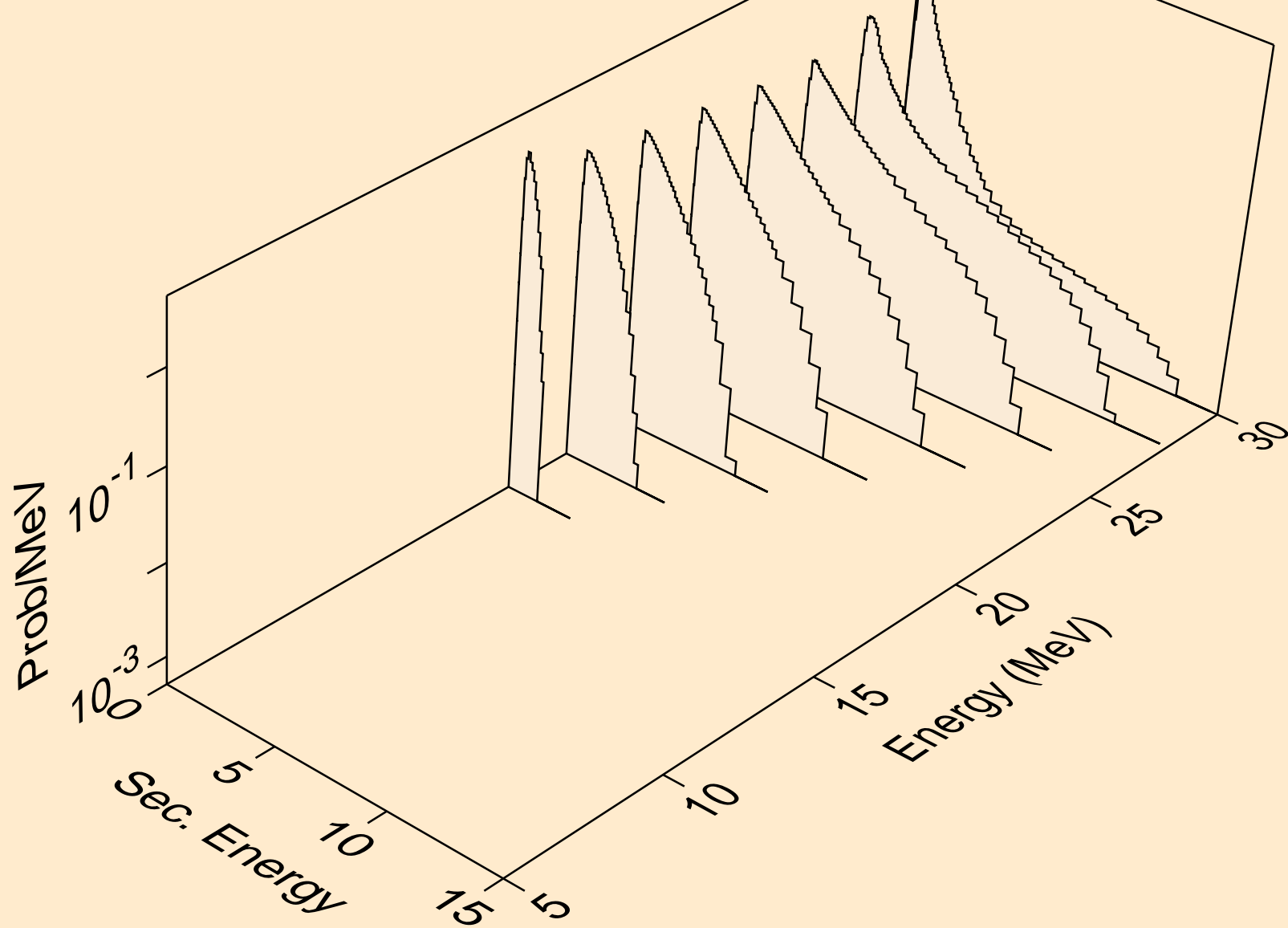

U227 NEUTRON ACER TENDL-2021 LIBRARY; T=293.6K
Neutron emission for (n,n*)p

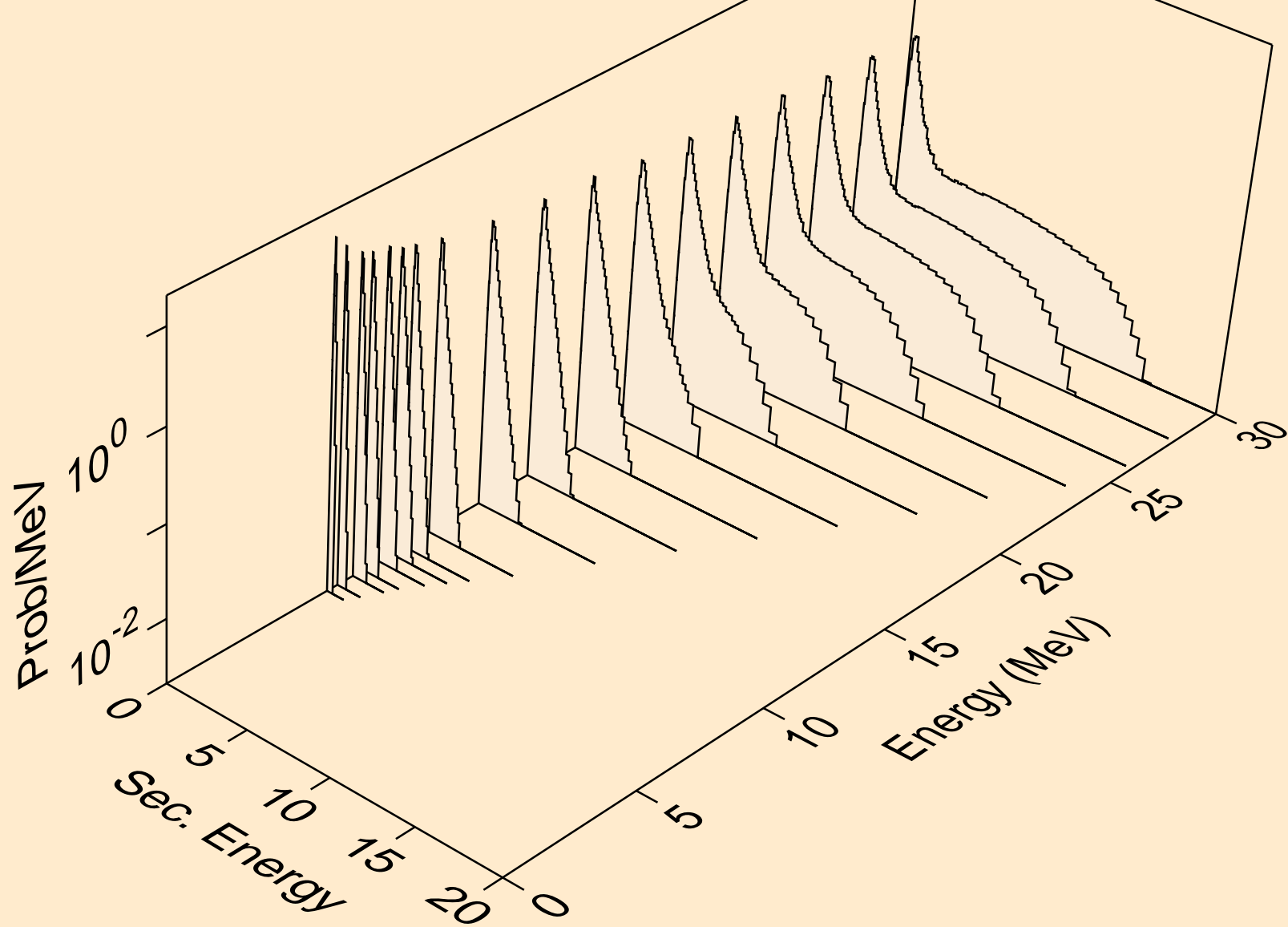

U227 NEUTRON ACER TENDL-2021 LIBRARY; T=293.6K
Neutron emission for (n,n*)2a

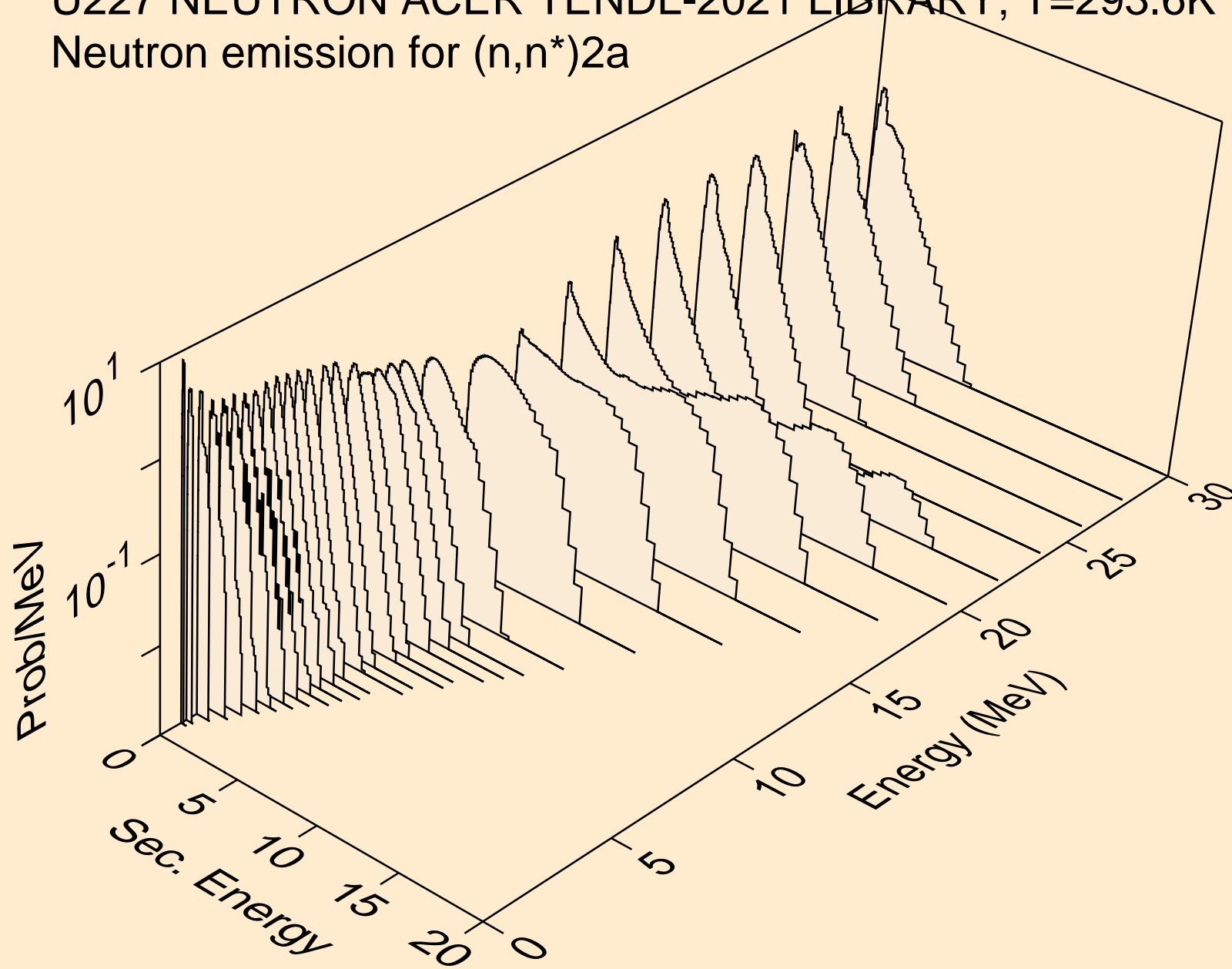

U227 NEUTRON ACER TENDL-2021 LIBRARY; T=293.6K
Neutron emission for (n,2n)2a

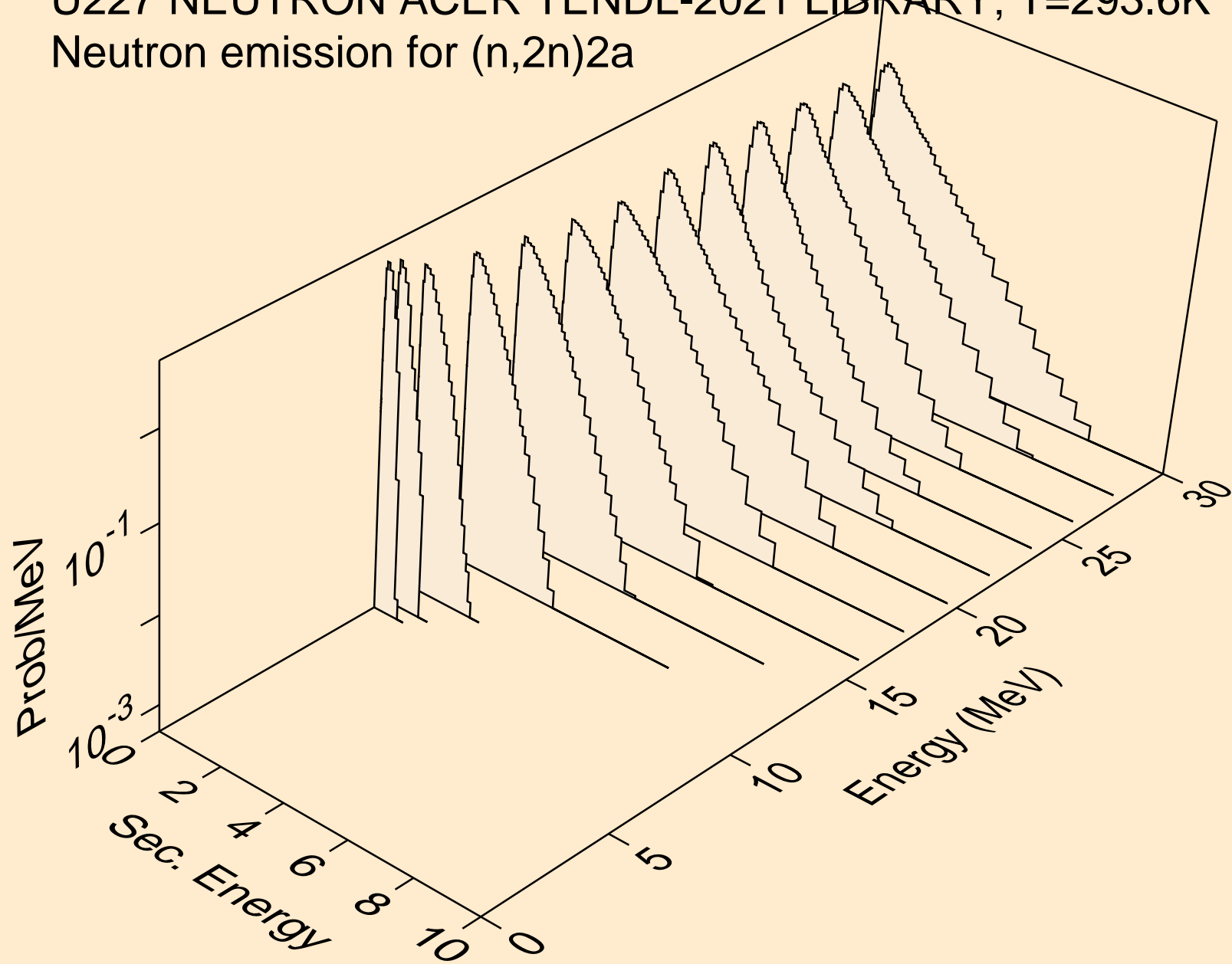

U227 NEUTRON ACER TENDL-2021 LIBRARY; T=293.6K
Neutron emission for (n,n*)d

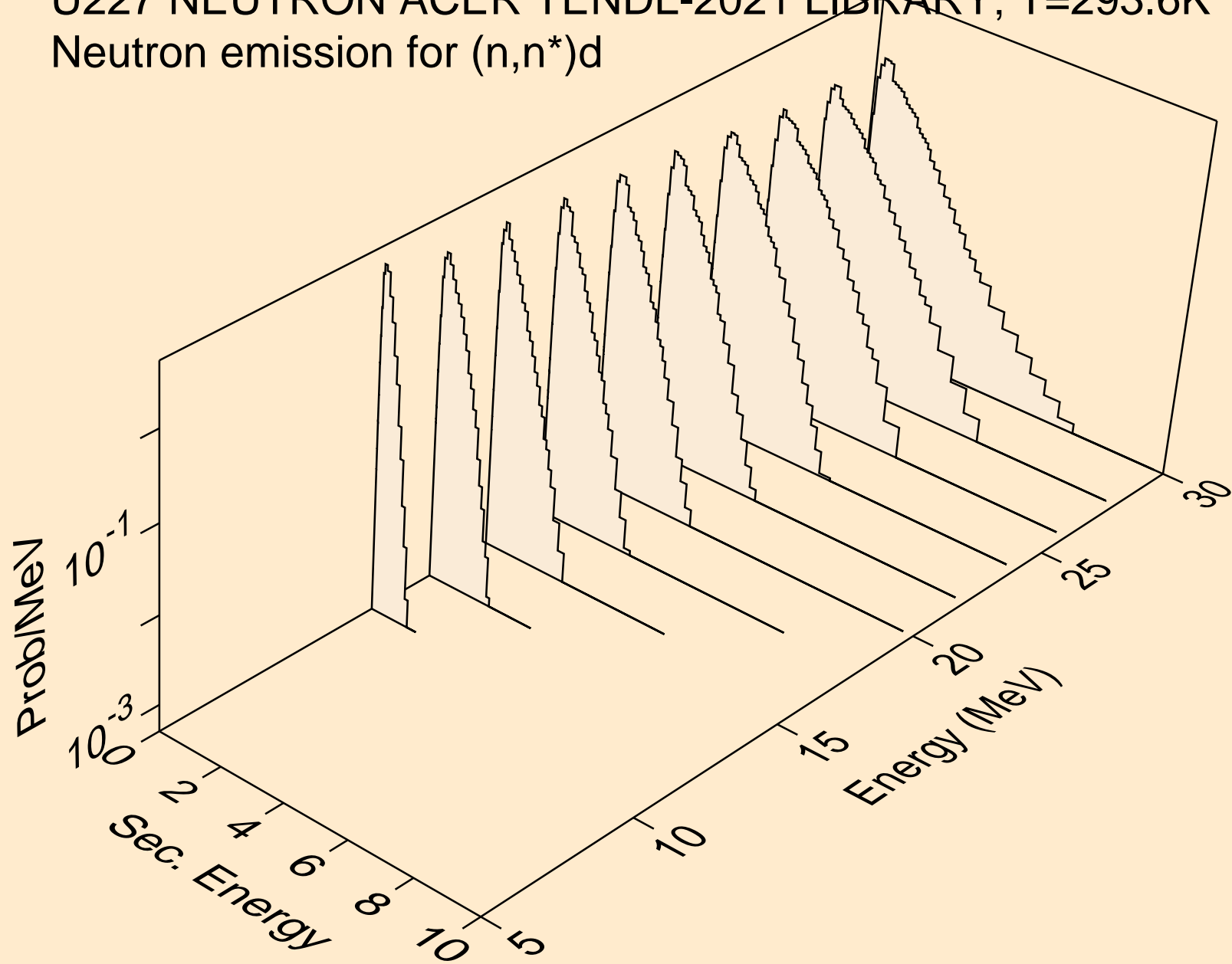

U227 NEUTRON ACER TENDL-2021 LIBRARY; T=293.6K
Neutron emission for (n,n*)t

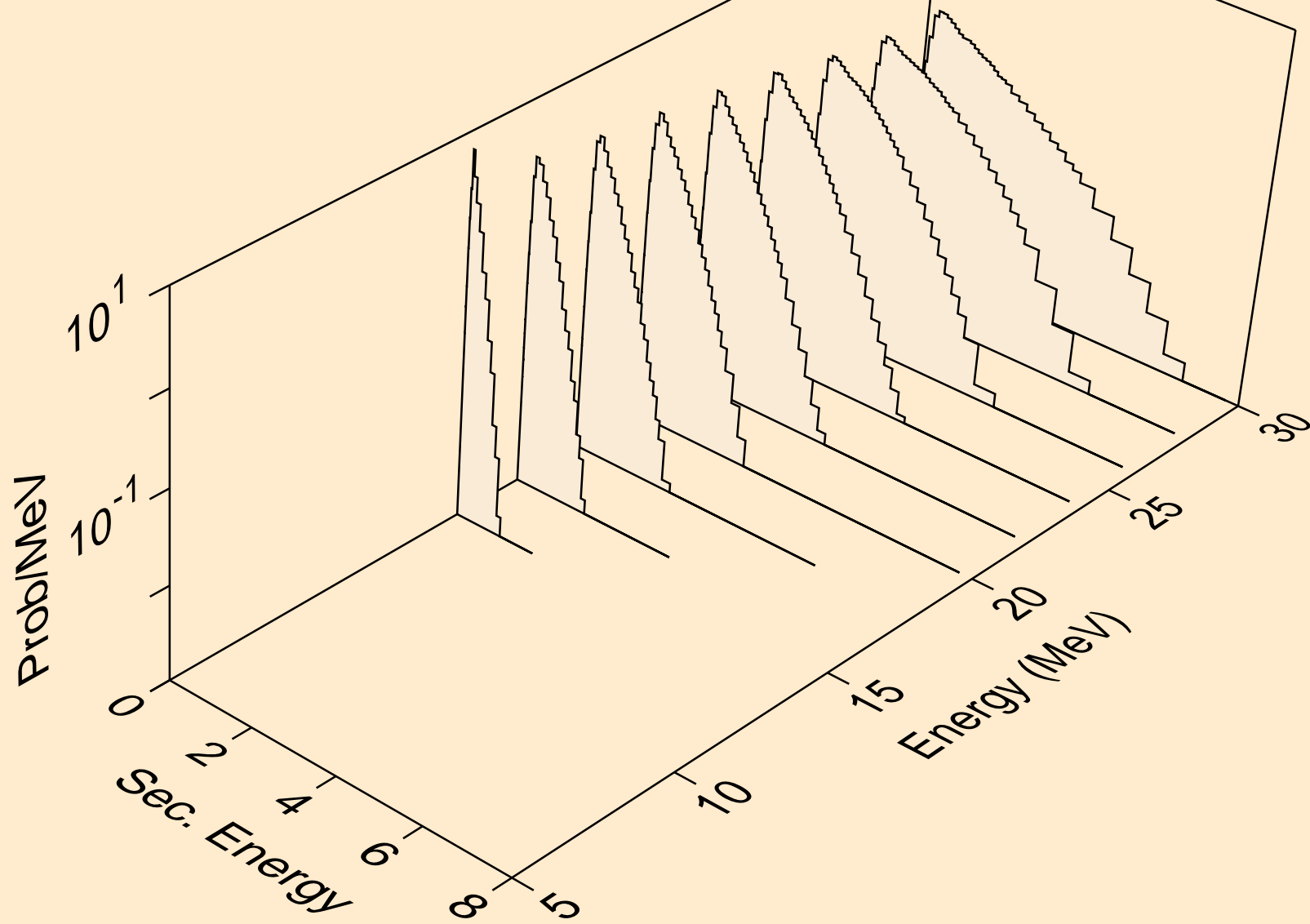

U227 NEUTRON ACER TENDL-2021 LIBRARY; T=293.6K
Neutron emission for (n,n*)he3

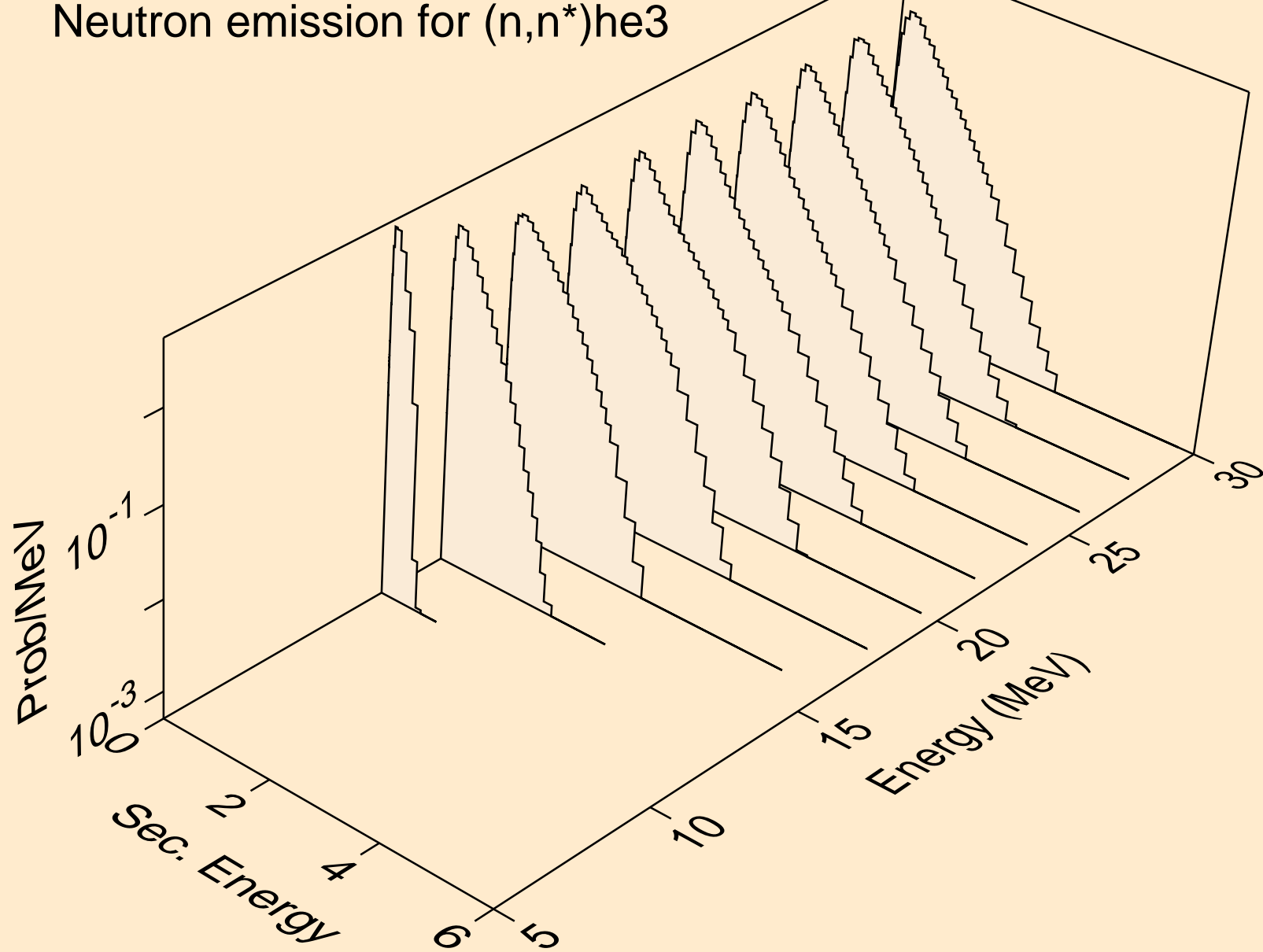

U227 NEUTRON ACER TENDL-2021 LIBRARY; T=293.6K
Neutron emission for (n,4n)

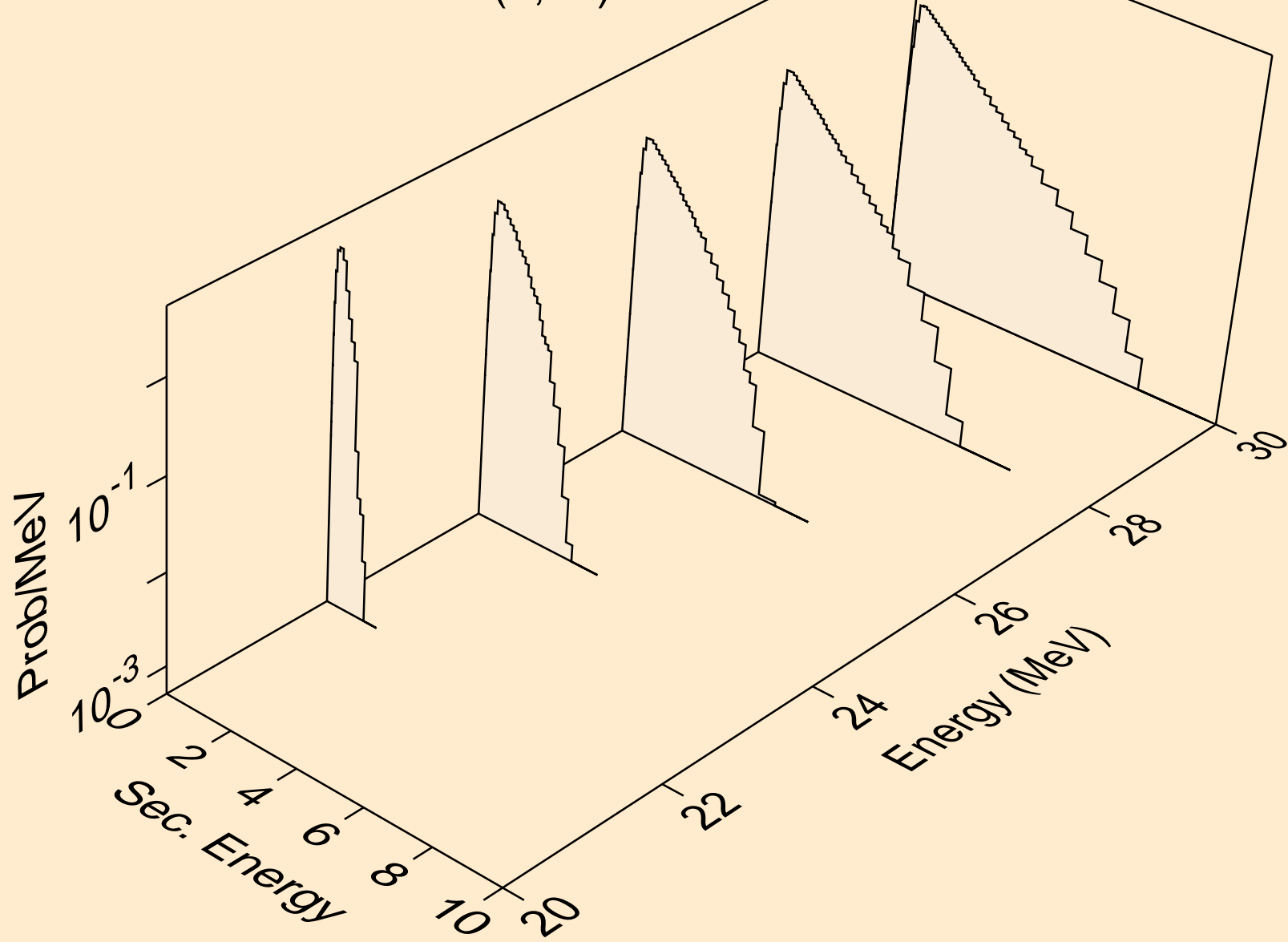

U227 NEUTRON ACER TENDL-2021 LIBRARY; T=293.6K
Neutron emission for (n,2np)

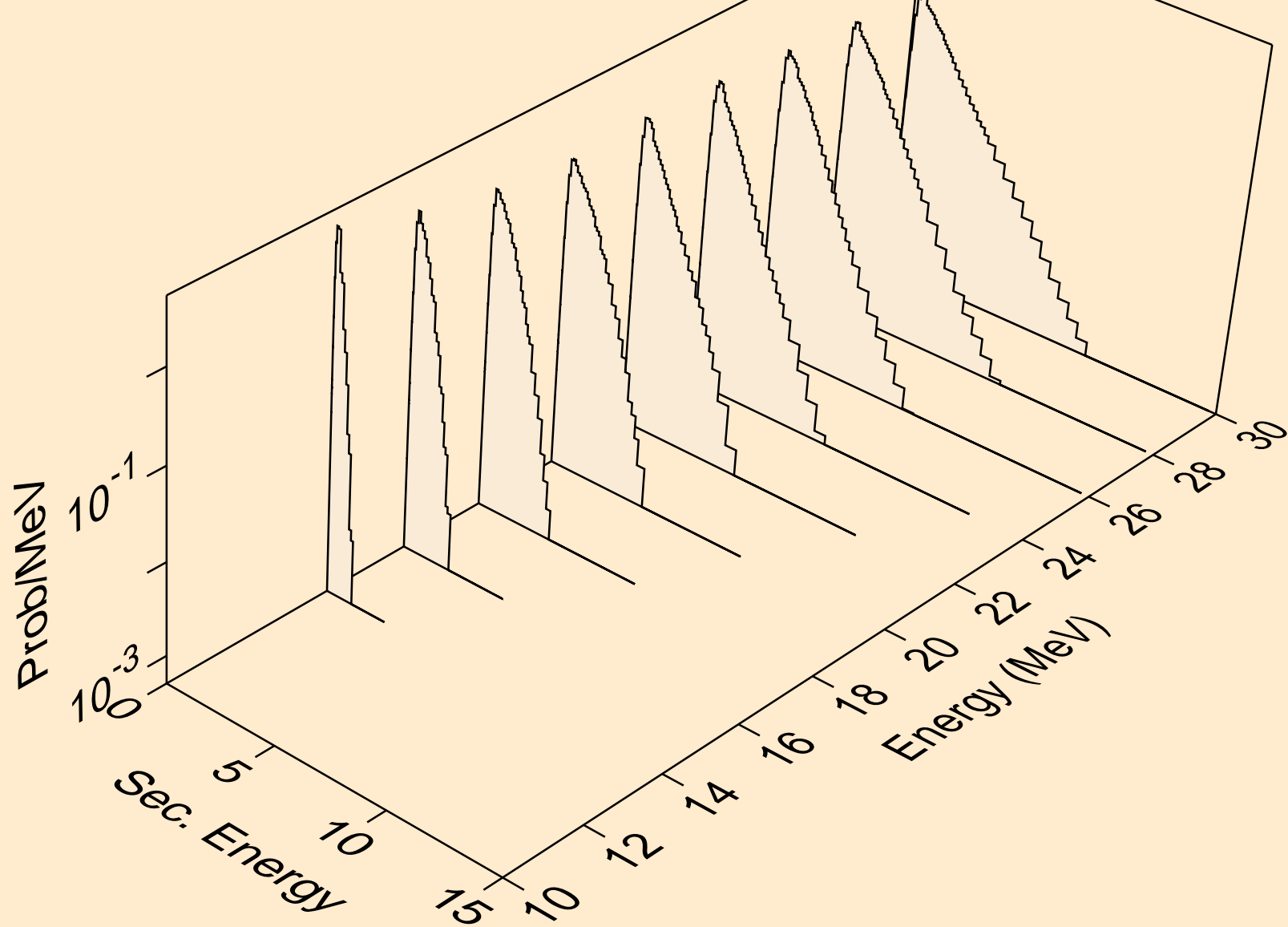

U227 NEUTRON ACER TENDL-2021 LIBRARY; T=293.6K
Neutron emission for (n,3np)

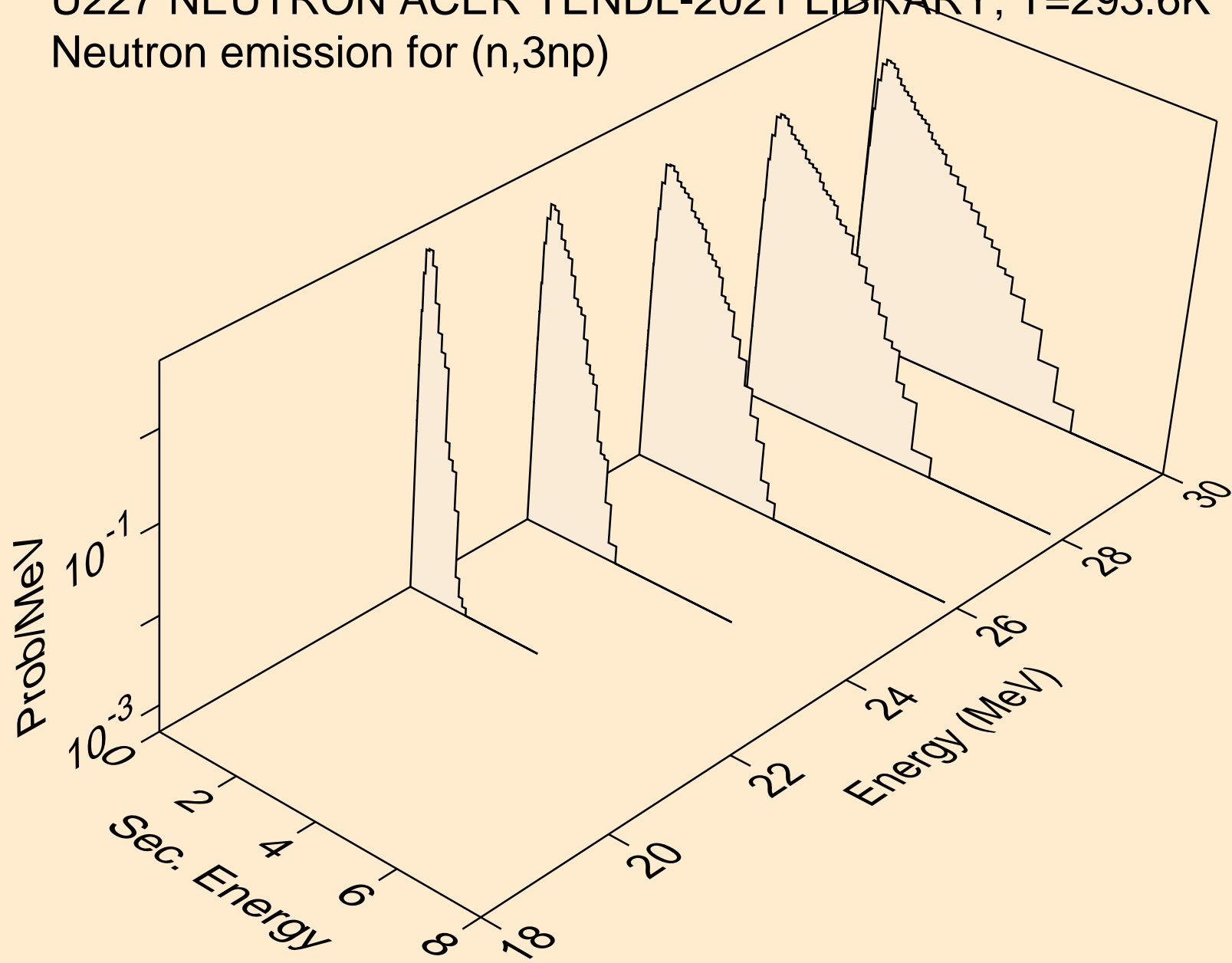

U227 NEUTRON ACER TENDL-2021 LIBRARY; T=293.6K
Neutron emission for (n,2np)

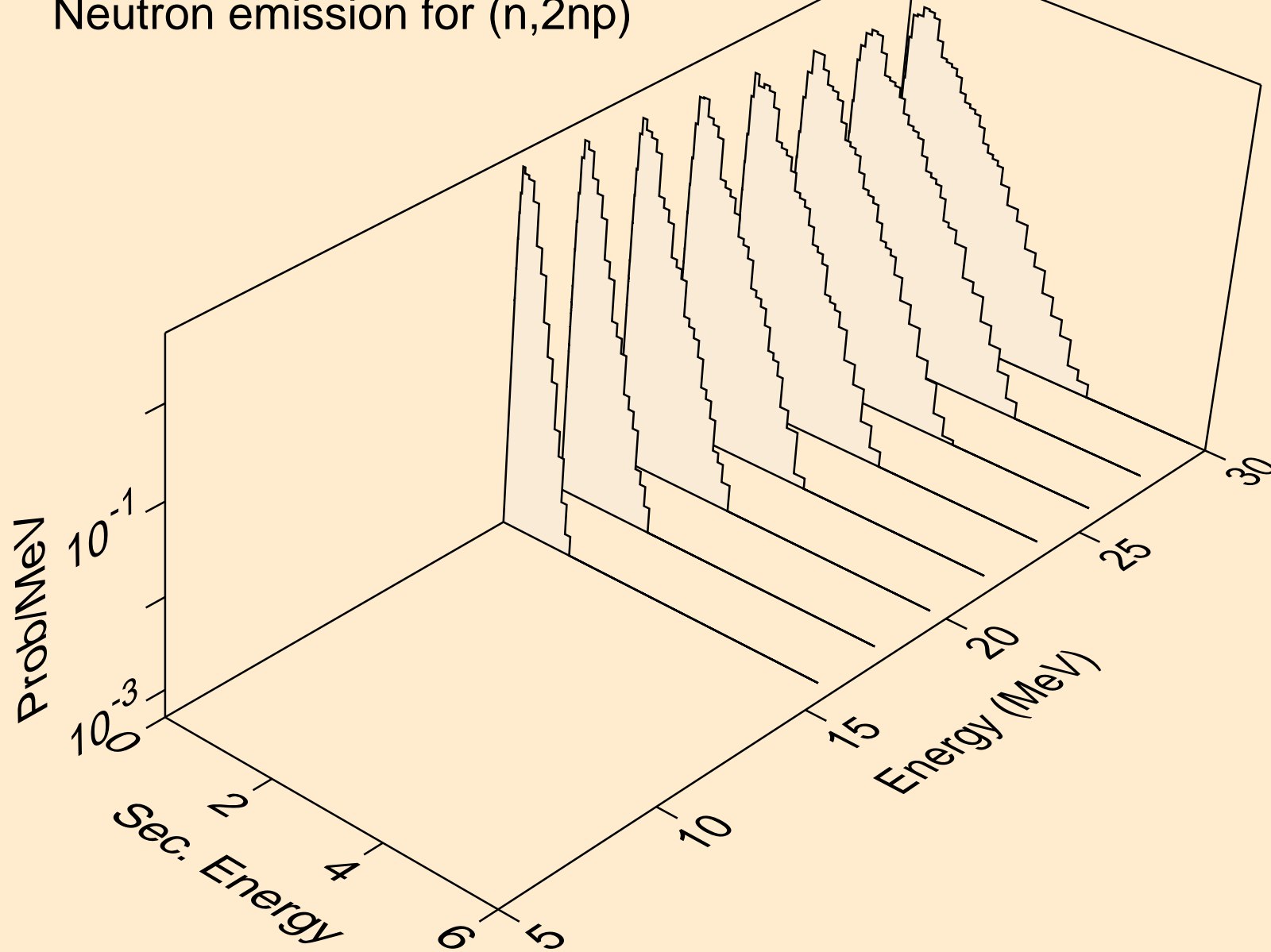

U227 NEUTRON ACER TENDL-2021 LIBRARY; T=293.6K
Neutron emission for (n,npa)

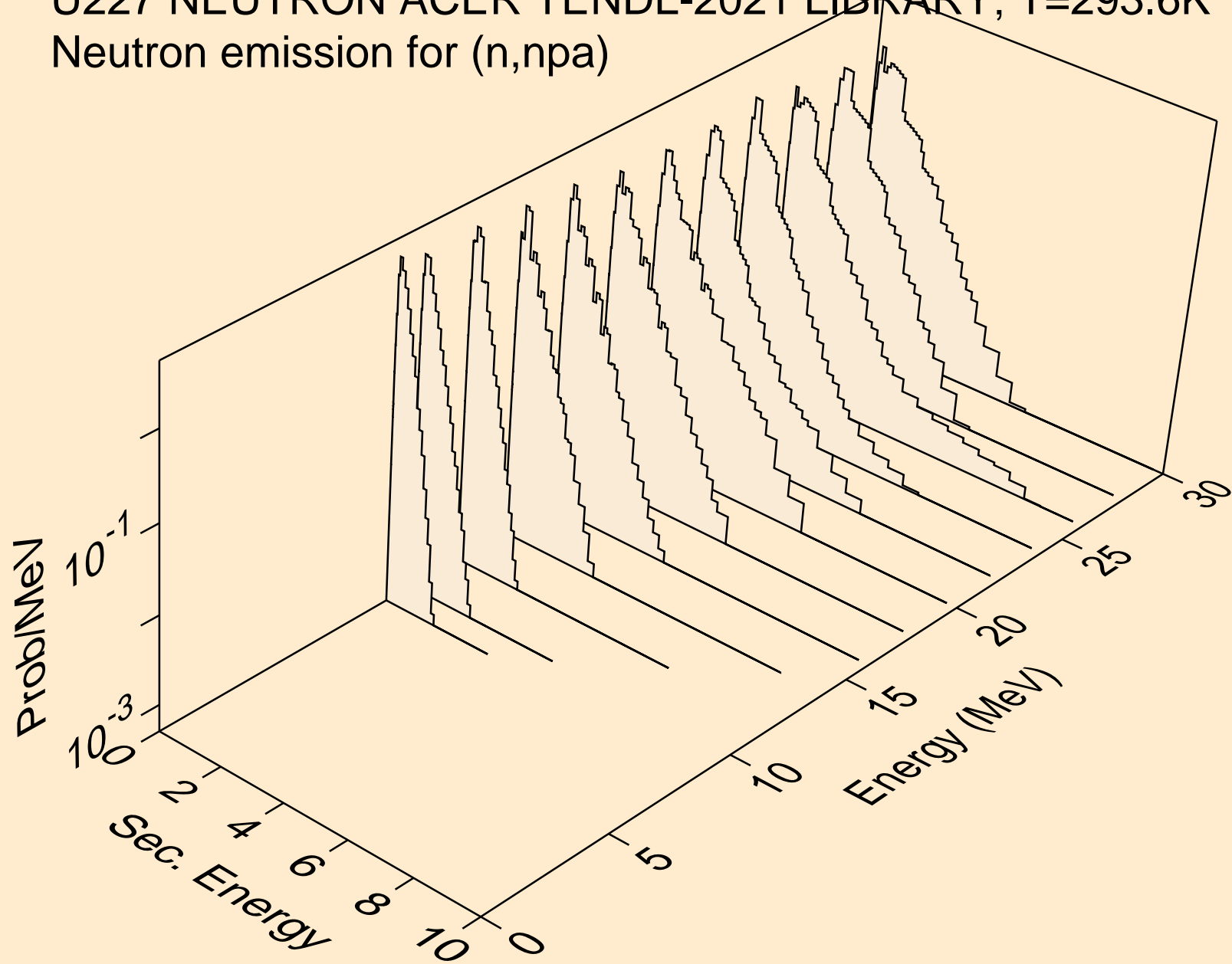

U227 NEUTRON ACER TENDL-2021 LIBRARY; T=293.6K
Neutron emission for (n,n*c)

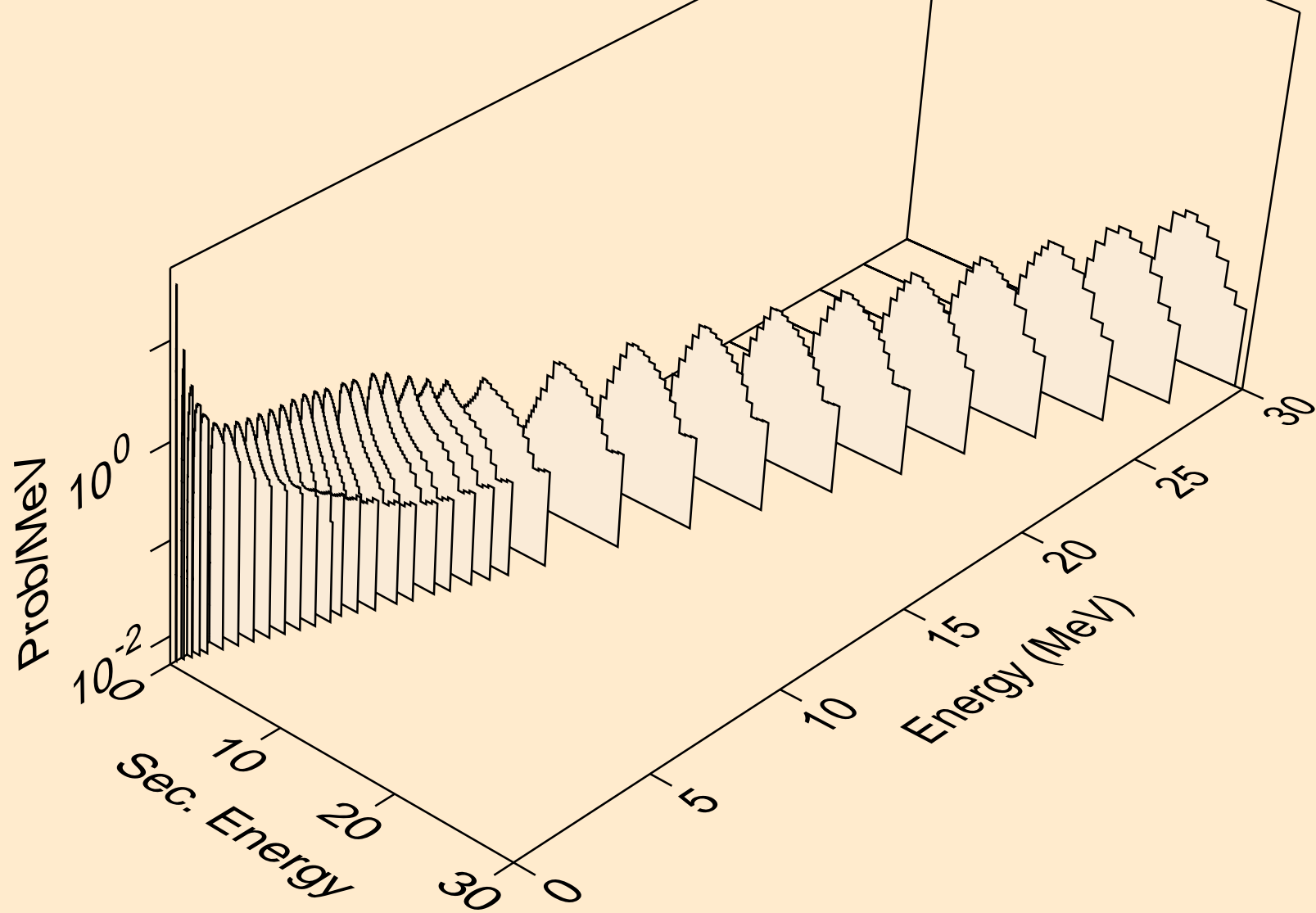

U227 NEUTRON ACER TENDL-2021 LIBRARY; T=293.6K

Delayed nubar

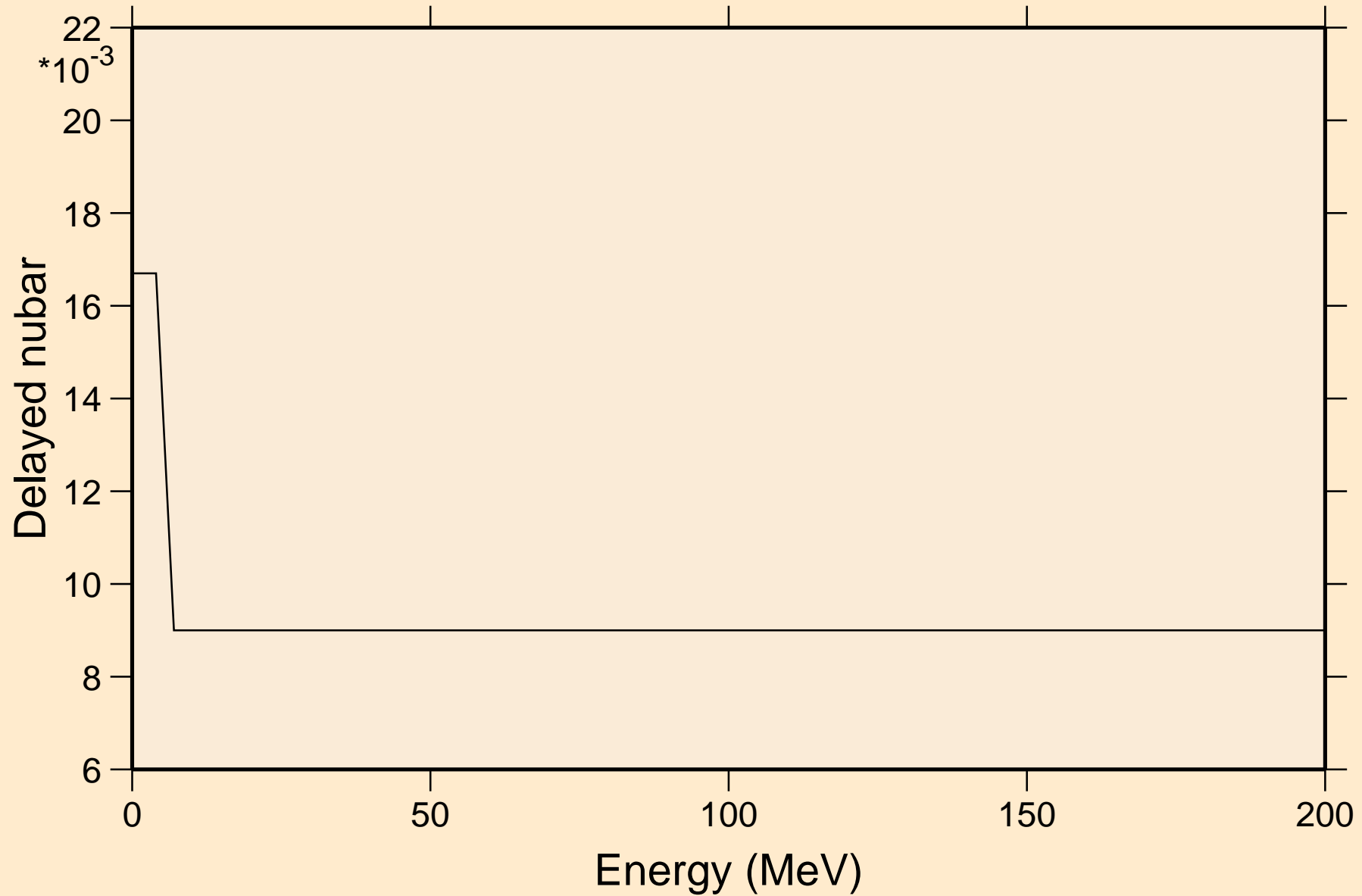

U227 NEUTRON ACER TENDL-2021 LIBRARY; T=293.6K

Delayed neutron spectra

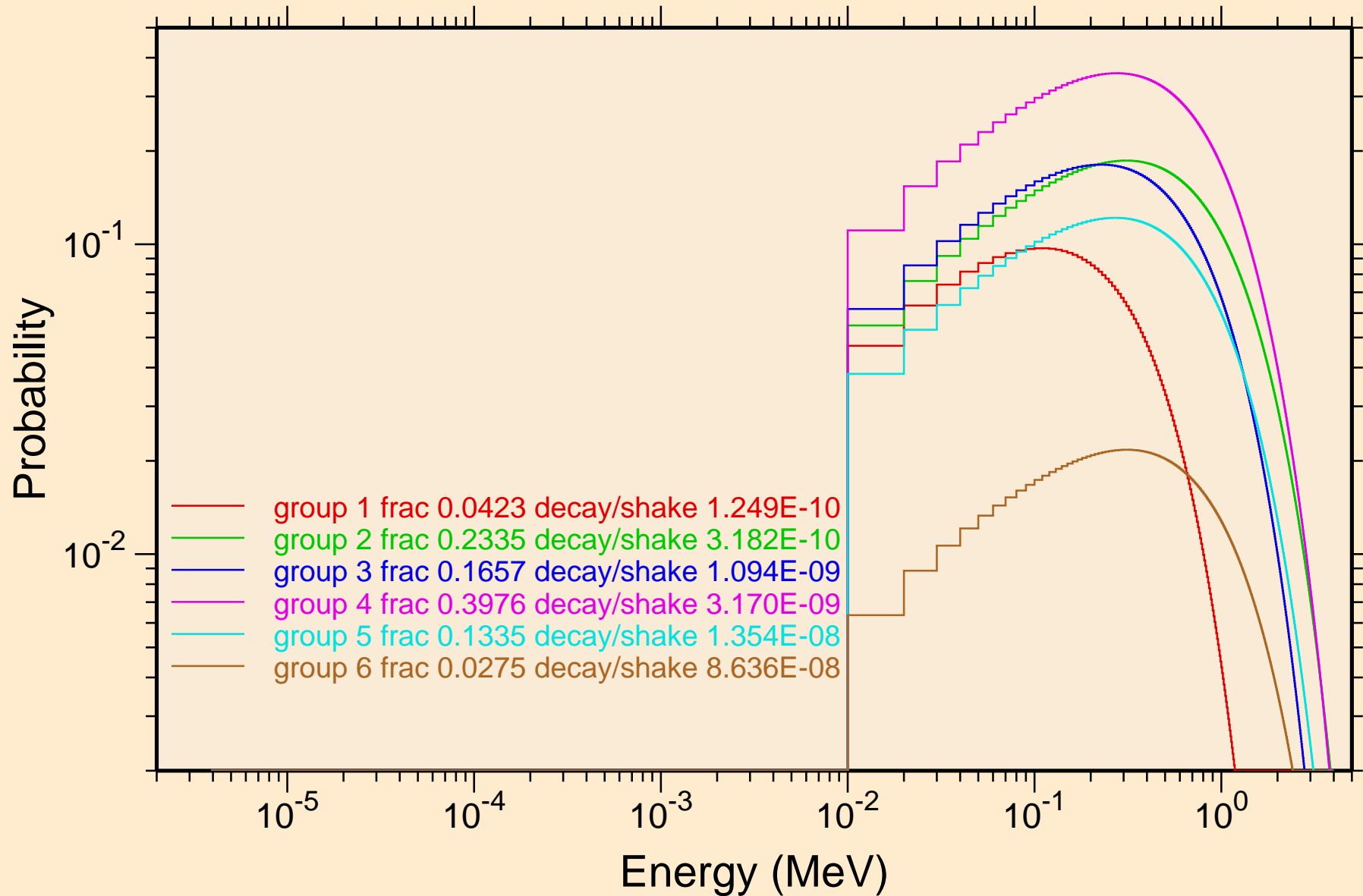

U227 NEUTRON ACER TENDL-2021 LIBRARY; T=293.6K
Photon emission for (n,x)

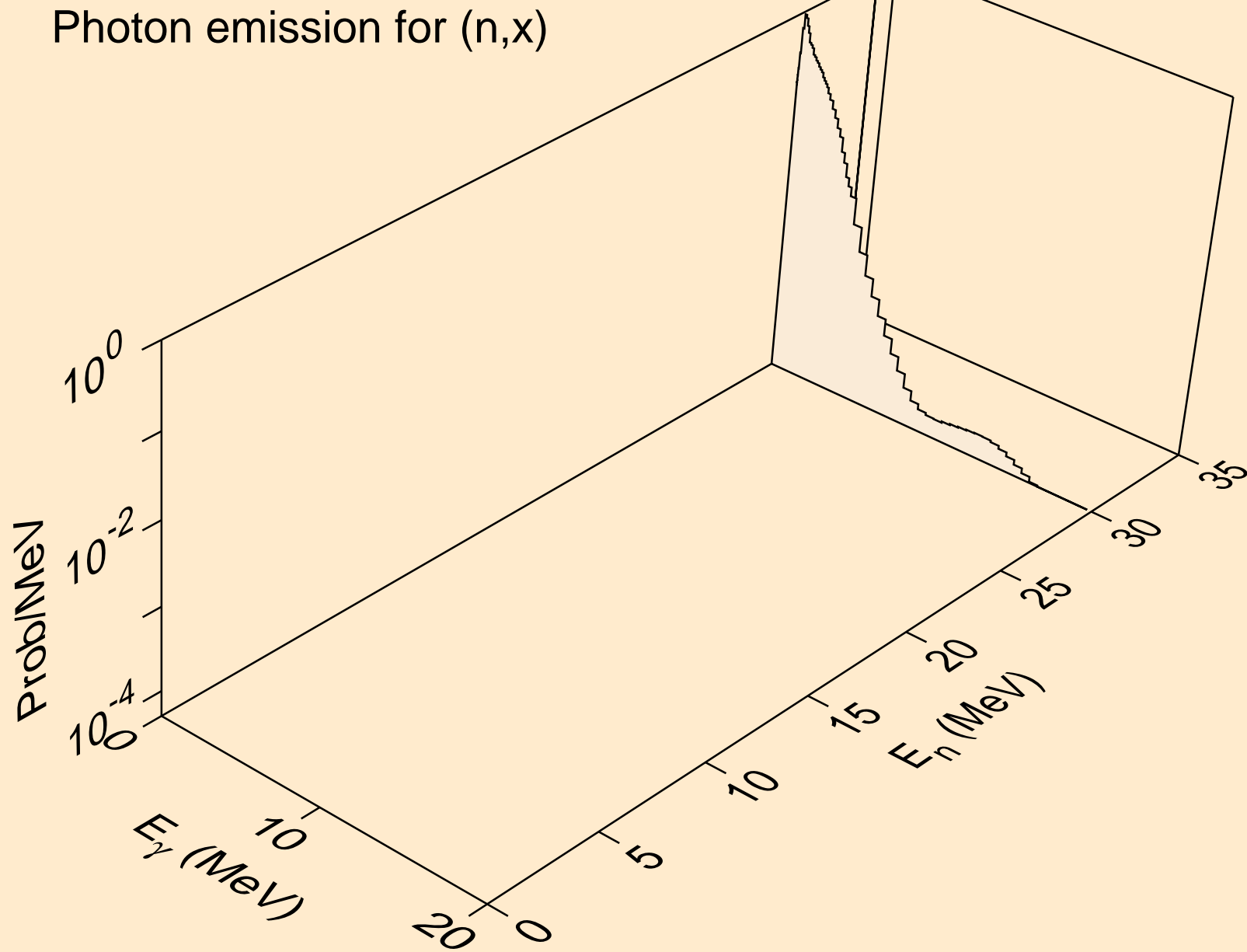

U227 NEUTRON ACER TENDL-2021 LIBRARY; T=293.6K
Photon emission for (n,2nd)

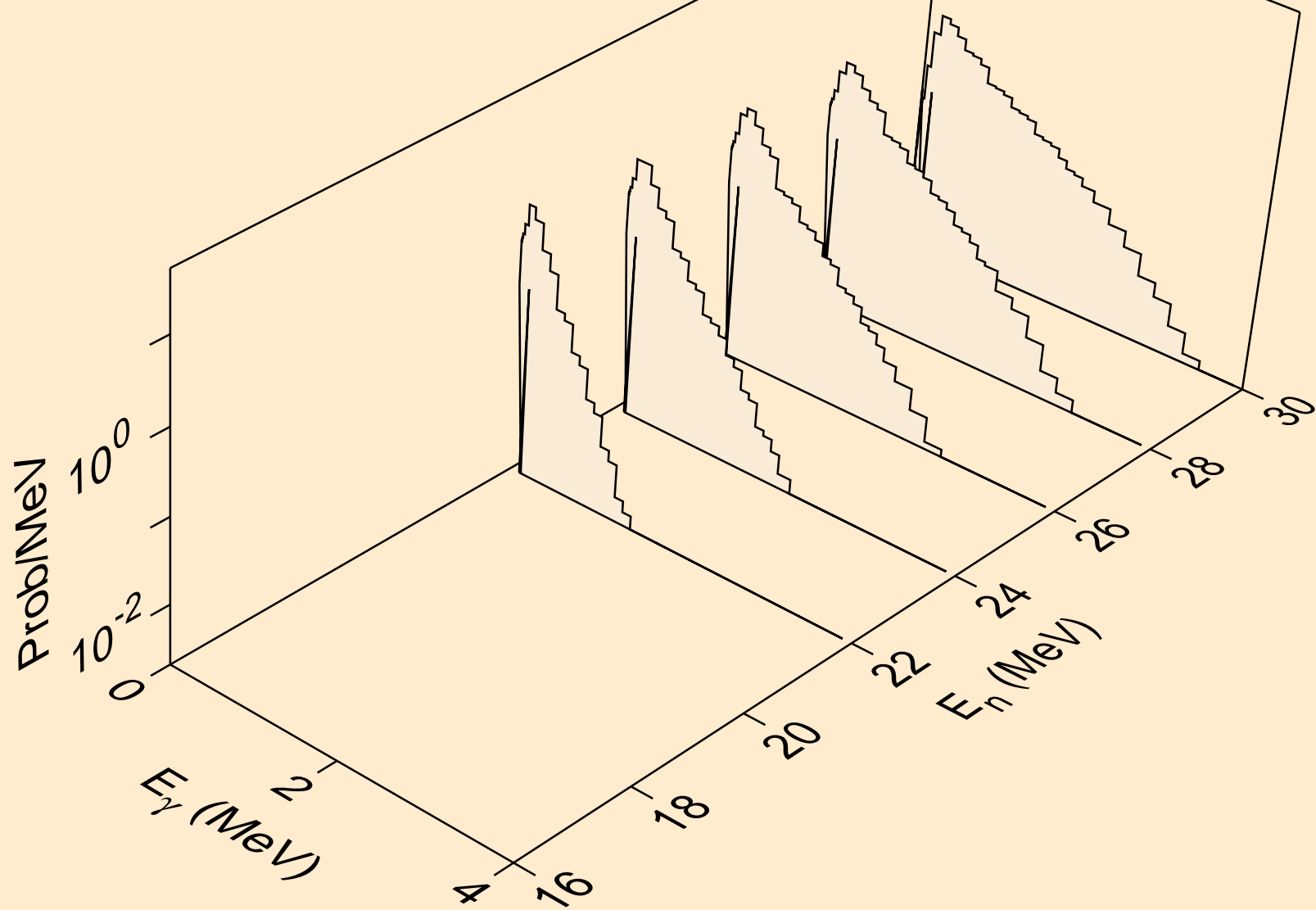

U227 NEUTRON ACER TENDL-2021 LIBRARY; T=293.6K
Photon emission for (n,2n)

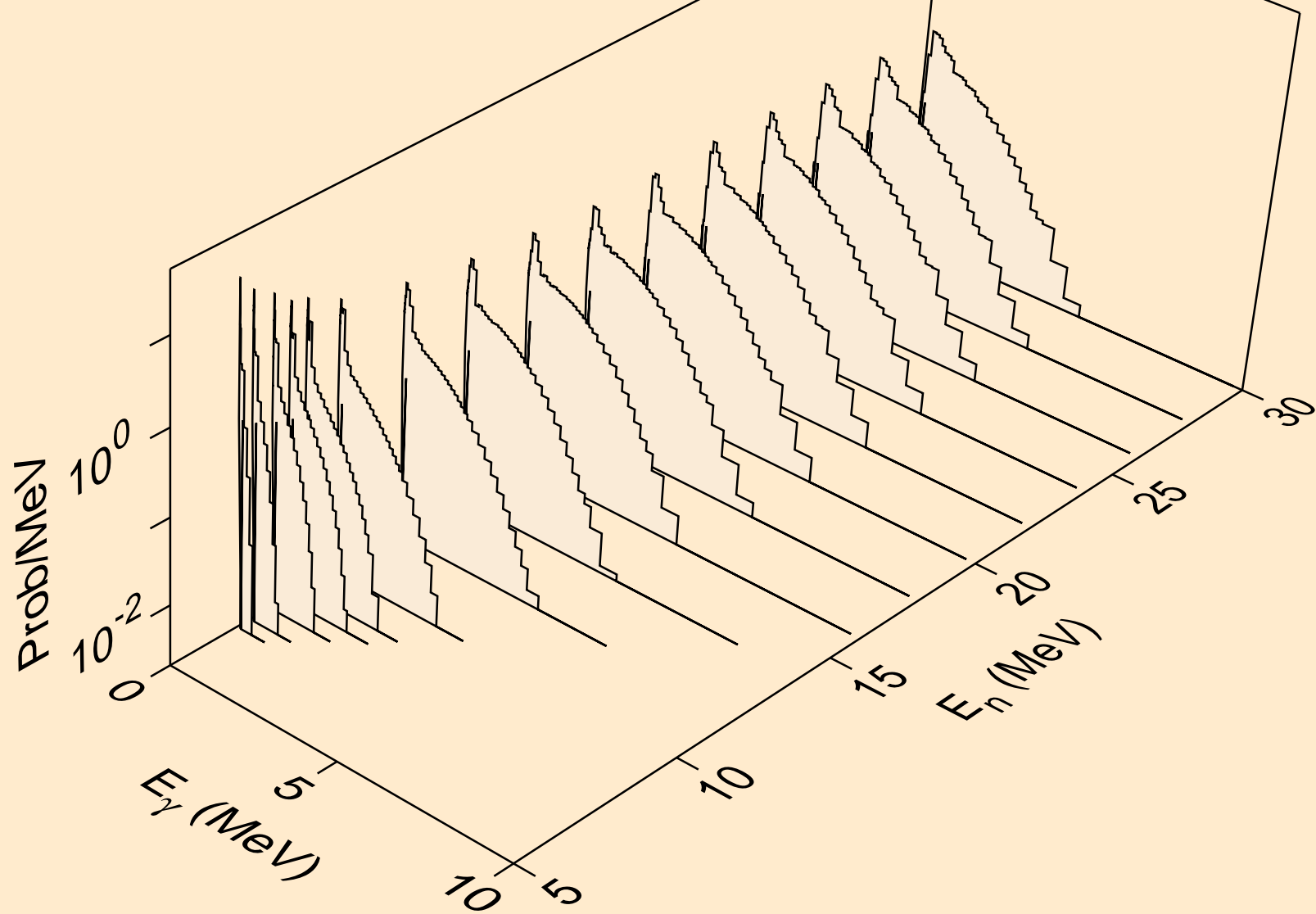

U227 NEUTRON ACER TENDL-2021 LIBRARY; T=293.6K
Photon emission for (n,3n)

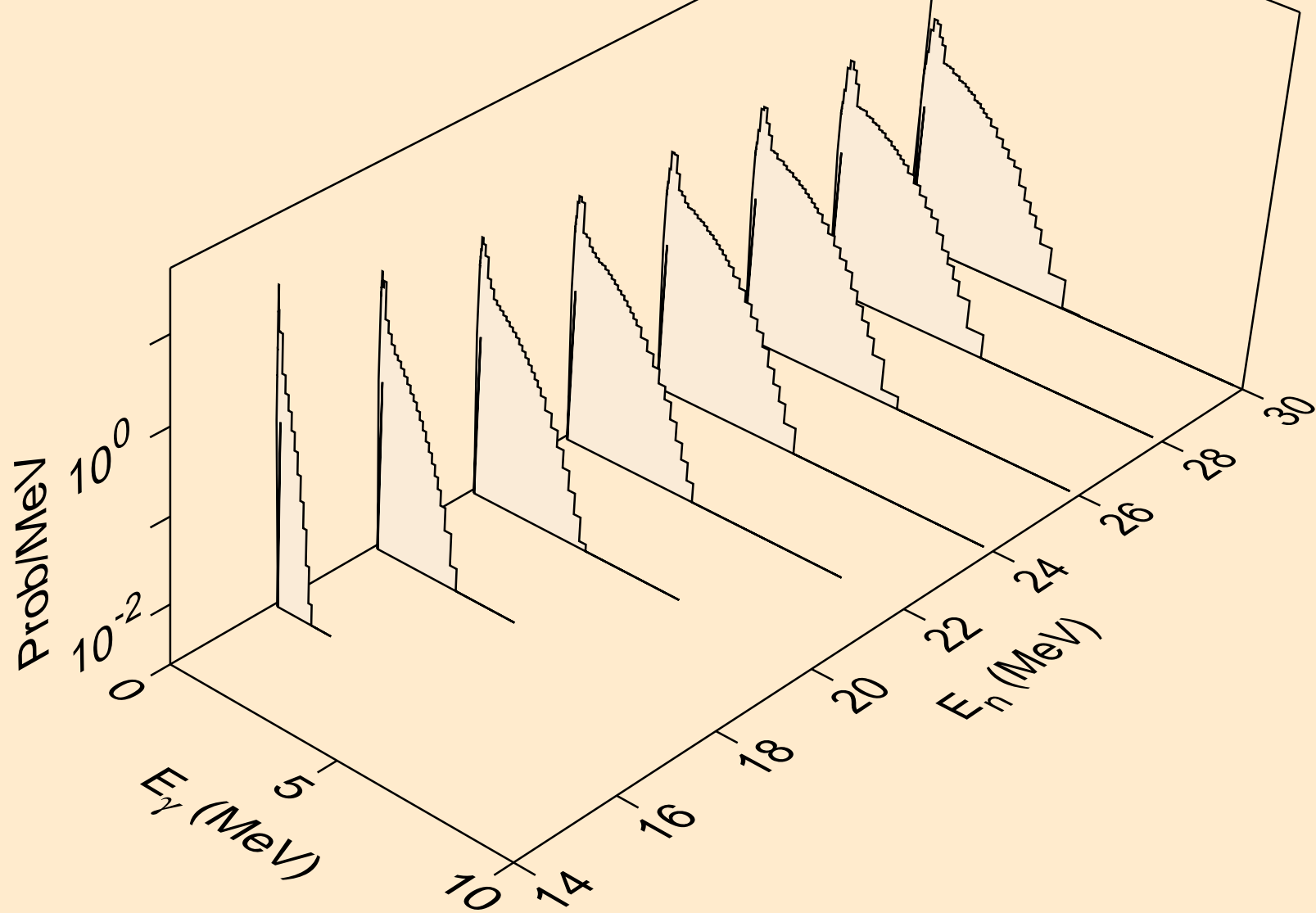

U227 NEUTRON ACER TENDL-2021 LIBRARY; T=293.6K
Photon emission for (n,n*)a

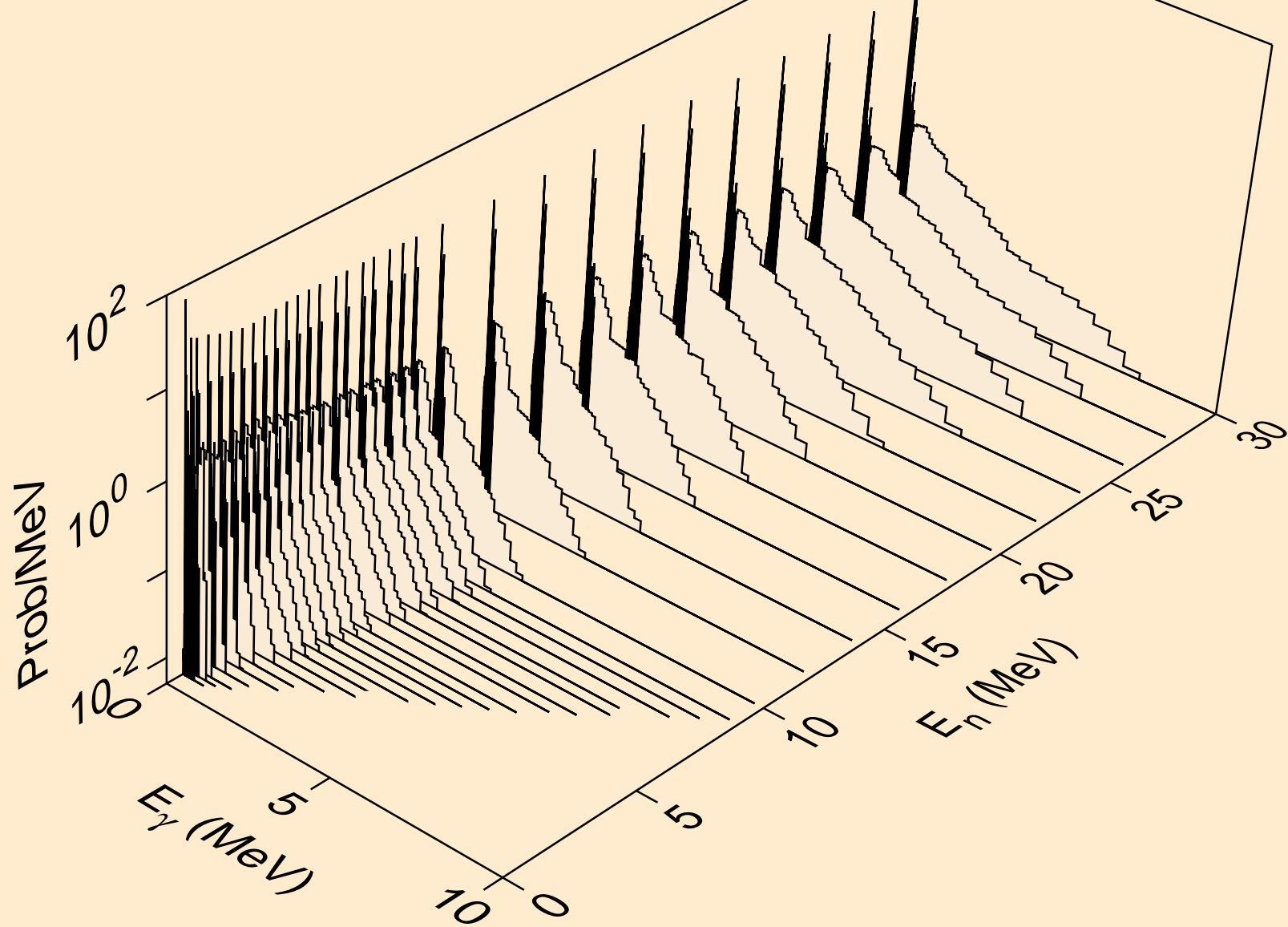

U227 NEUTRON ACER TENDL-2021 LIBRARY; T=293.6K
Photon emission for (n,2n)a

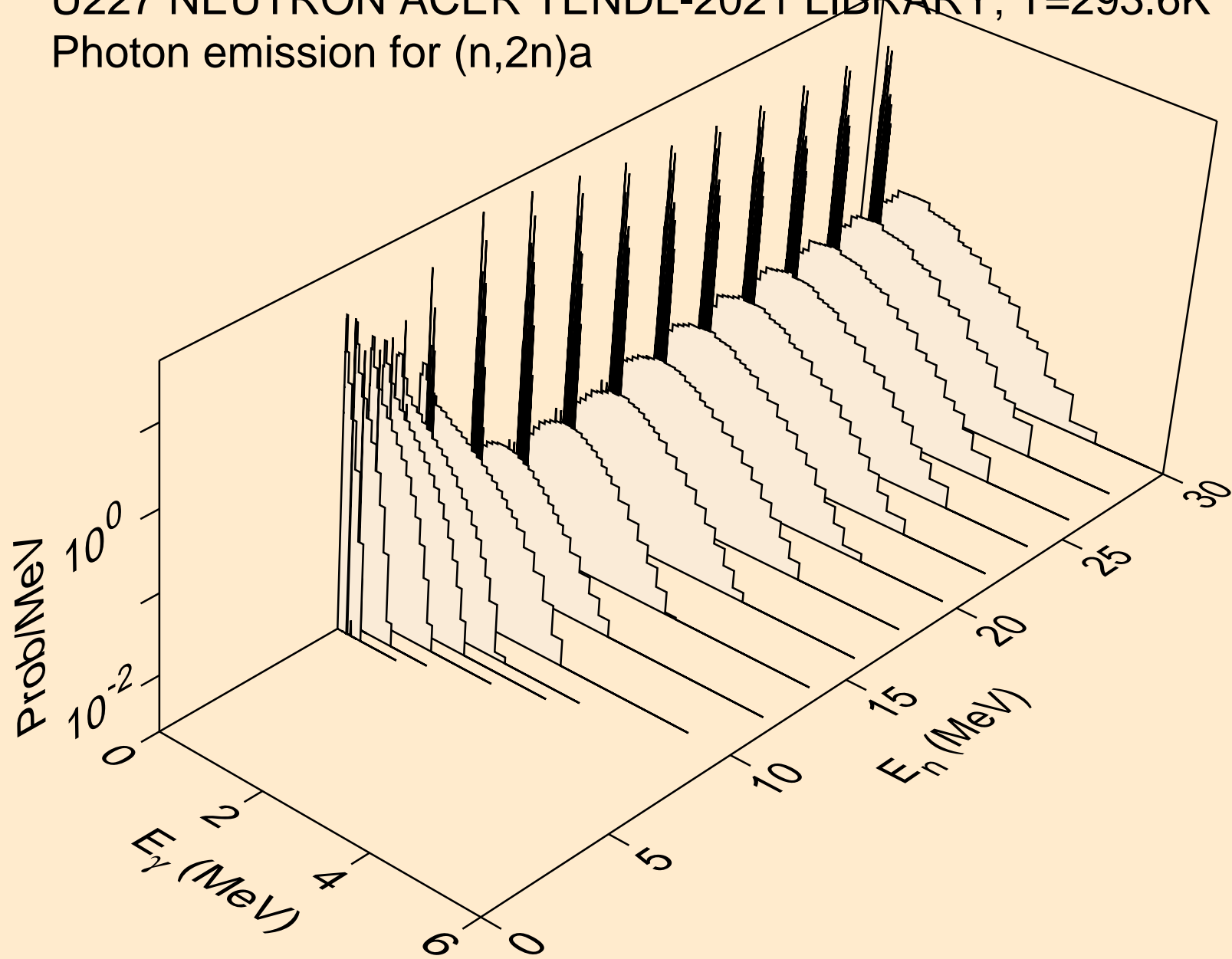

U227 NEUTRON ACER TENDL-2021 LIBRARY; T=293.6K
Photon emission for (n,3n)a

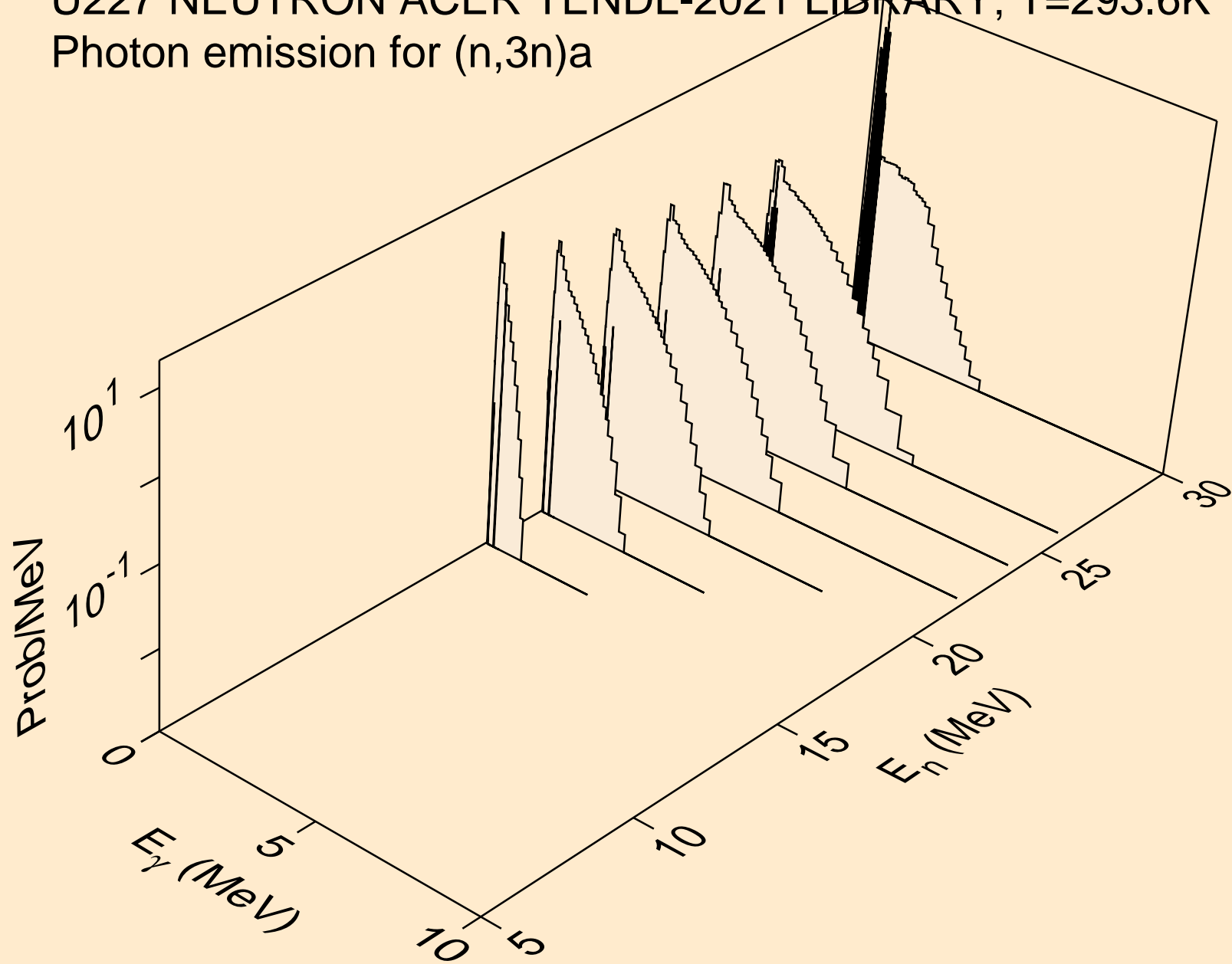

U227 NEUTRON ACER TENDL-2021 LIBRARY; T=293.6K
Photon emission for (n,n*)p

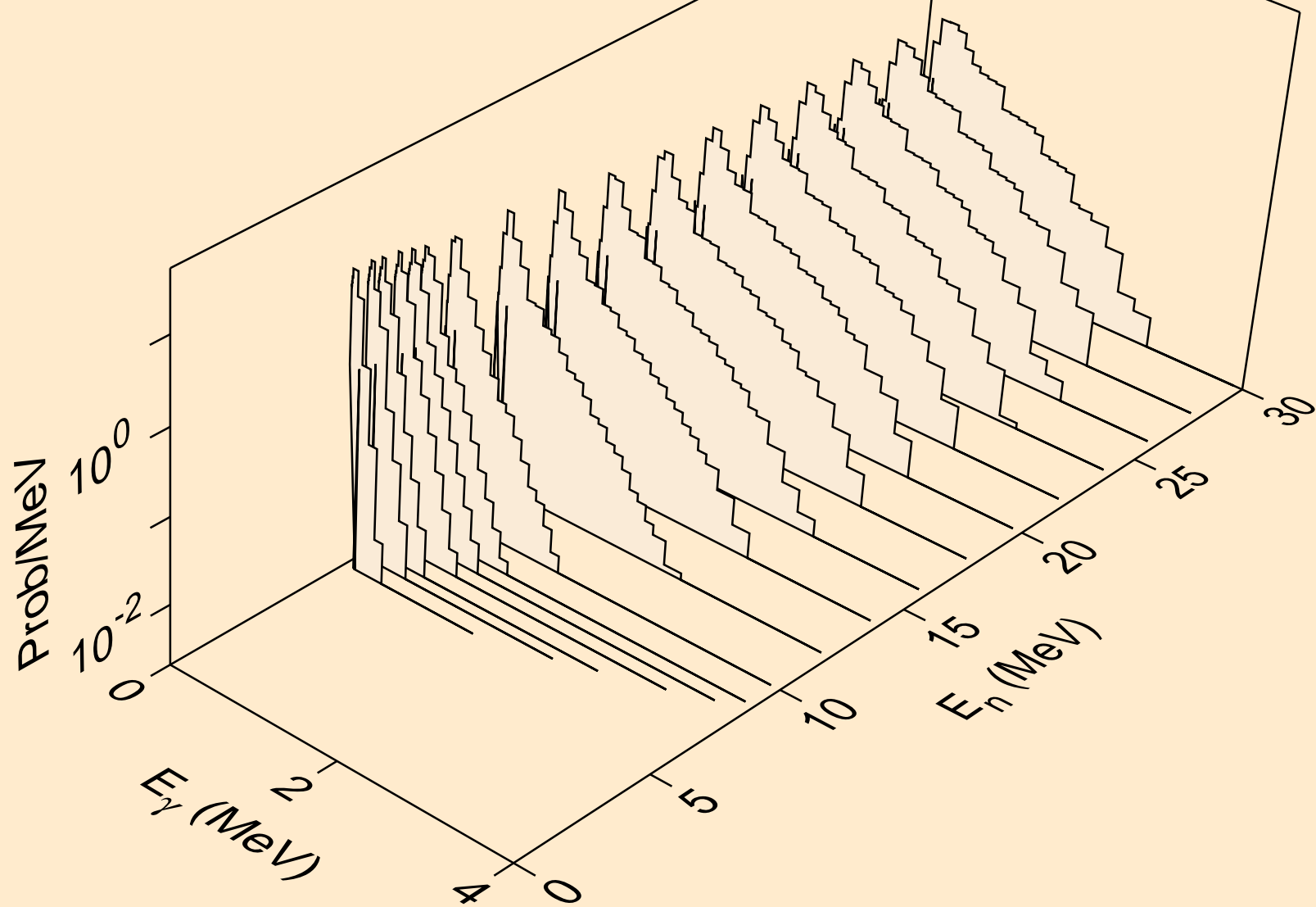

U227 NEUTRON ACER TENDL-2021 LIBRARY; T=293.6K
Photon emission for (n,n*)2a

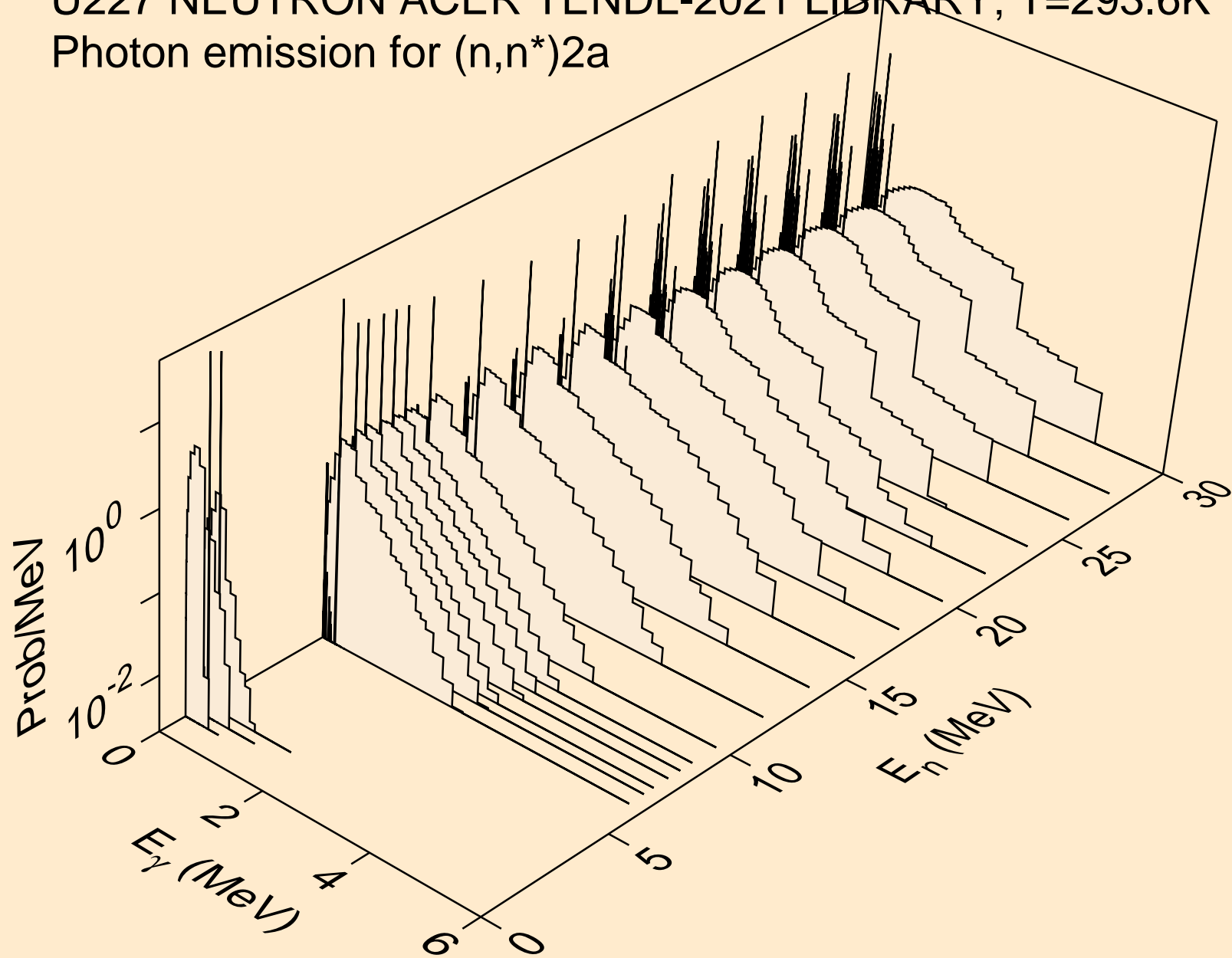

U227 NEUTRON ACER TENDL-2021 LIBRARY; T=293.6K
Photon emission for (n,2n)2a

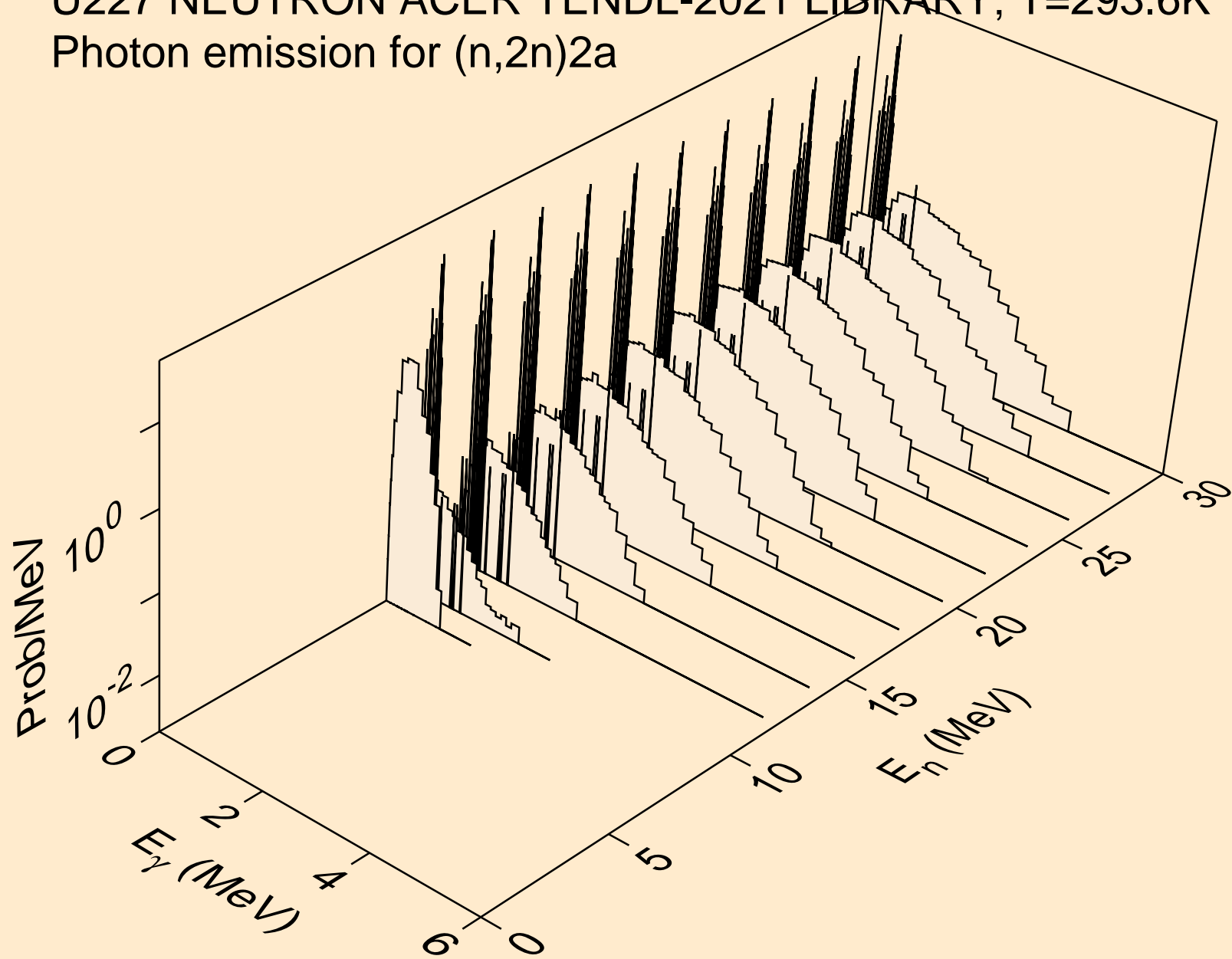

U227 NEUTRON ACER TENDL-2021 LIBRARY; T=293.6K
Photon emission for (n,n*)d

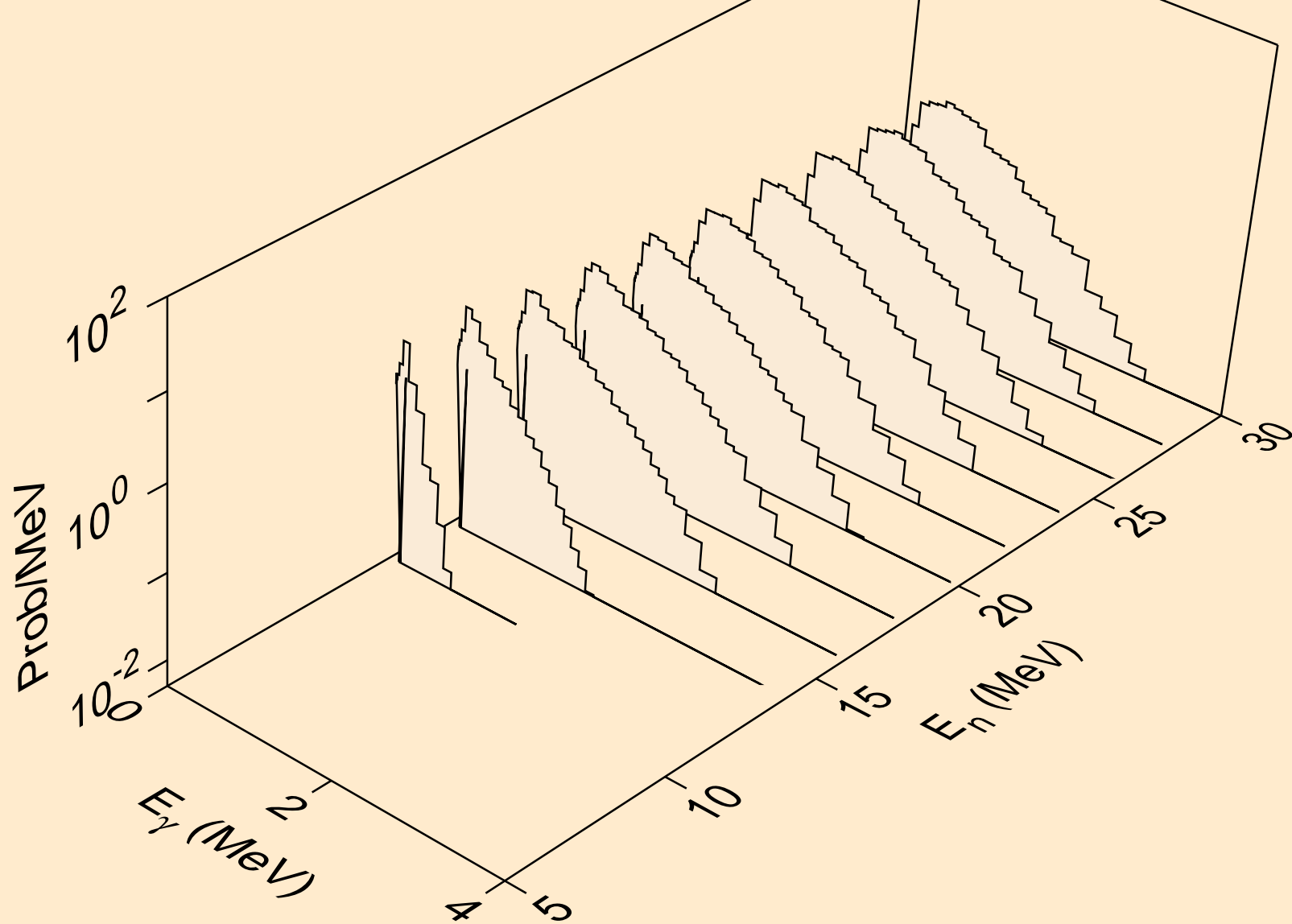

U227 NEUTRON ACER TENDL-2021 LIBRARY; T=293.6K
Photon emission for (n,n*)t

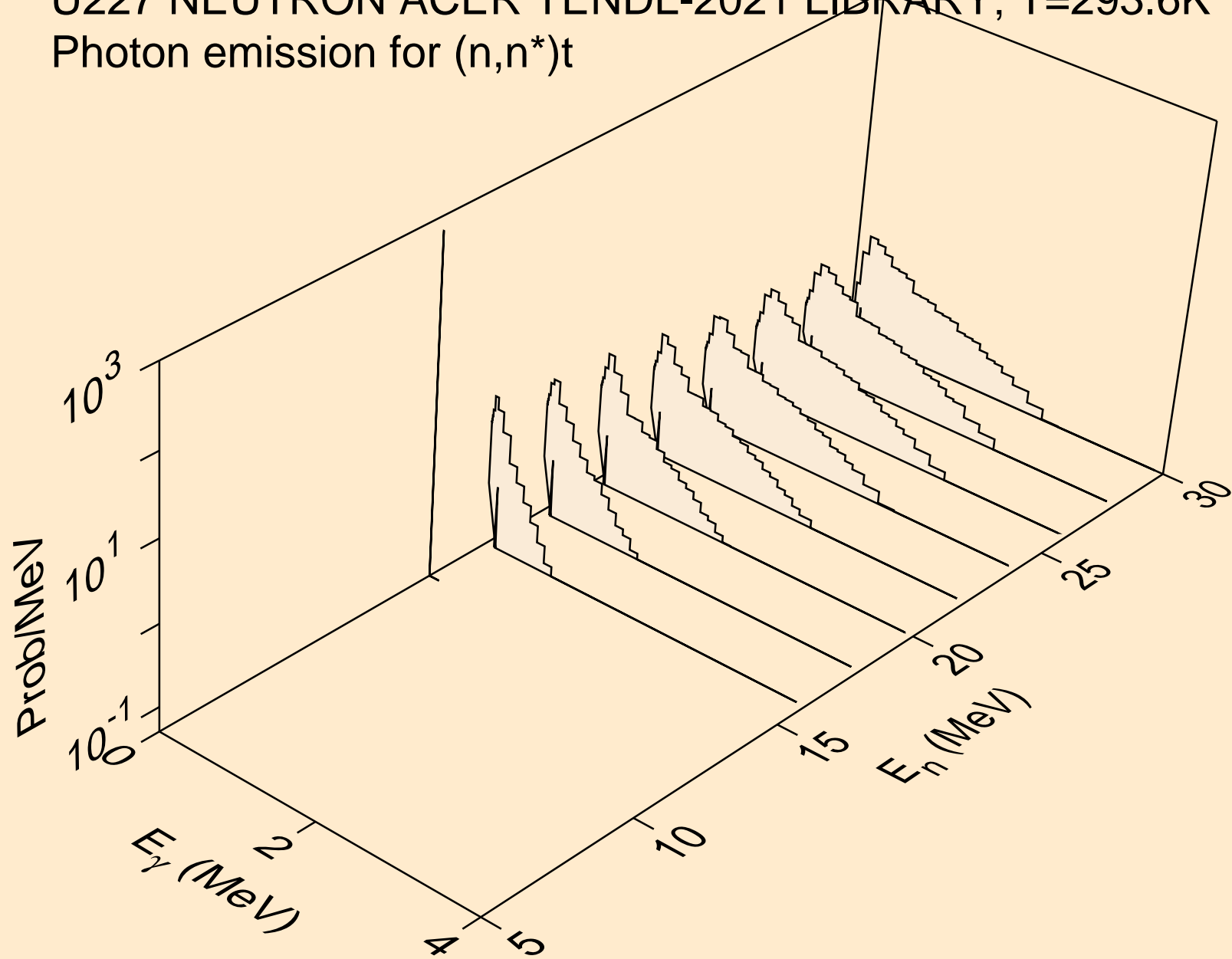

U227 NEUTRON ACER TENDL-2021 LIBRARY; T=293.6K
Photon emission for (n,n*)he3

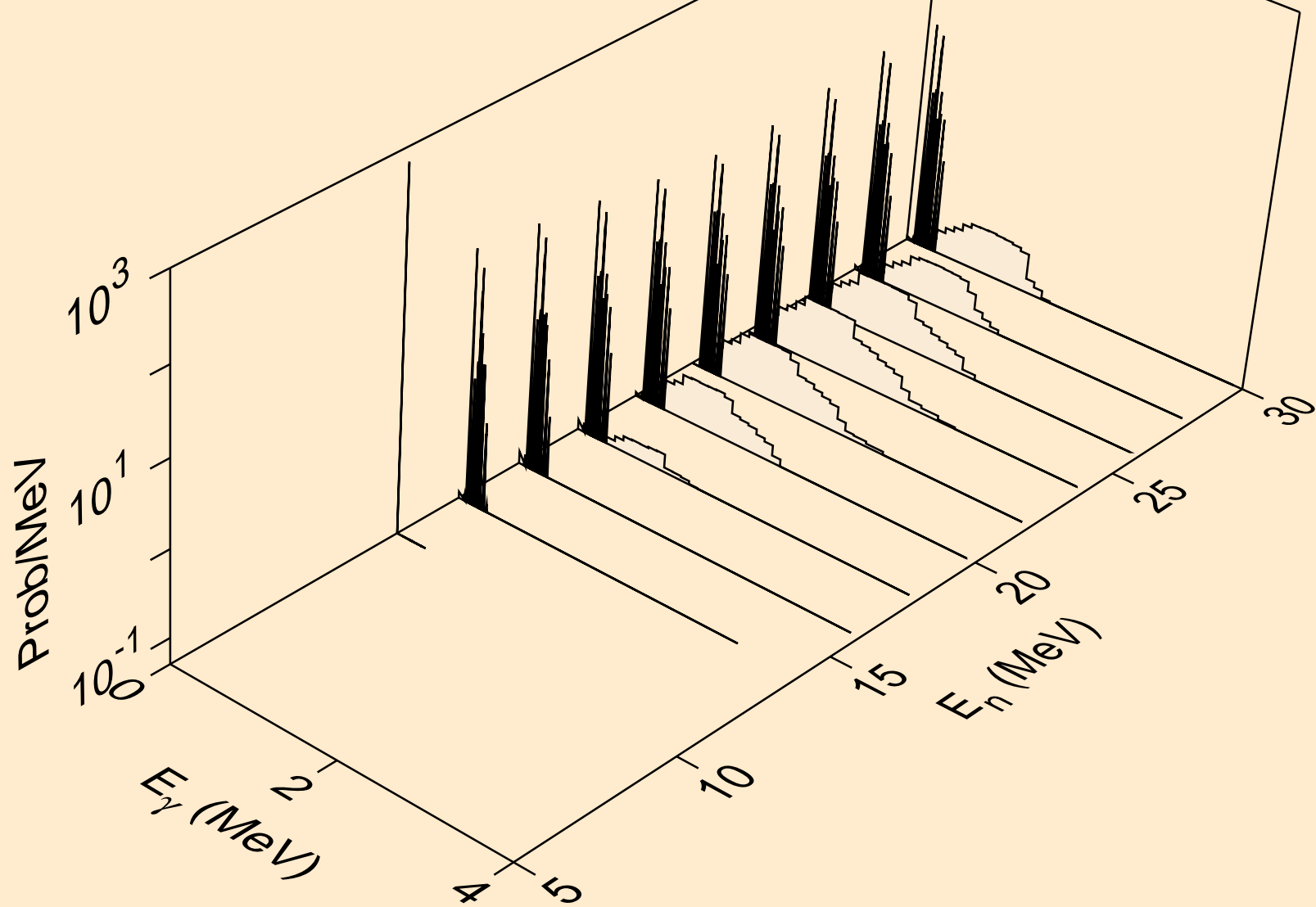

U227 NEUTRON ACER TENDL-2021 LIBRARY; T=293.6K
Photon emission for (n,4n)

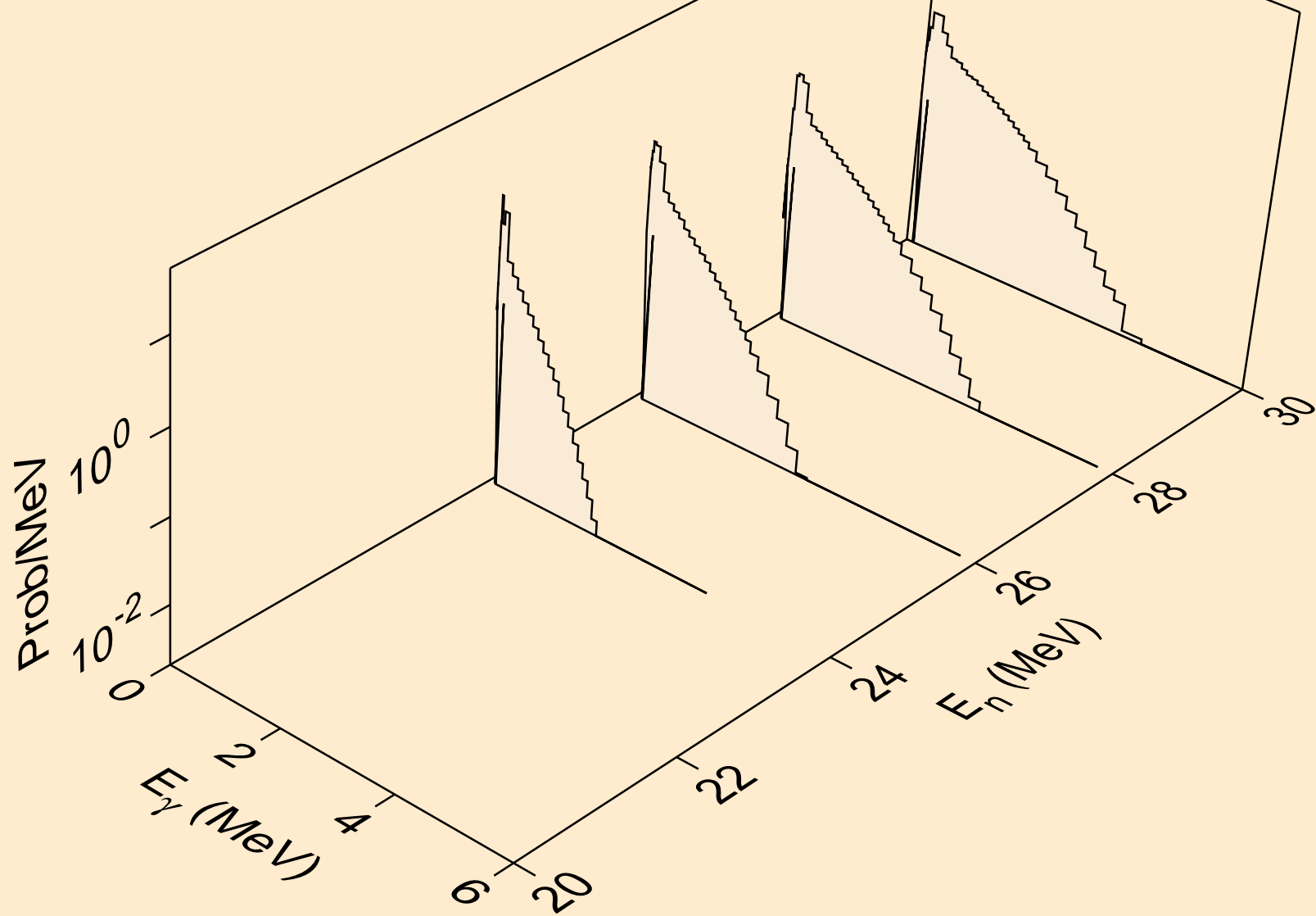

U227 NEUTRON ACER TENDL-2021 LIBRARY; T=293.6K
Photon emission for (n,2np)

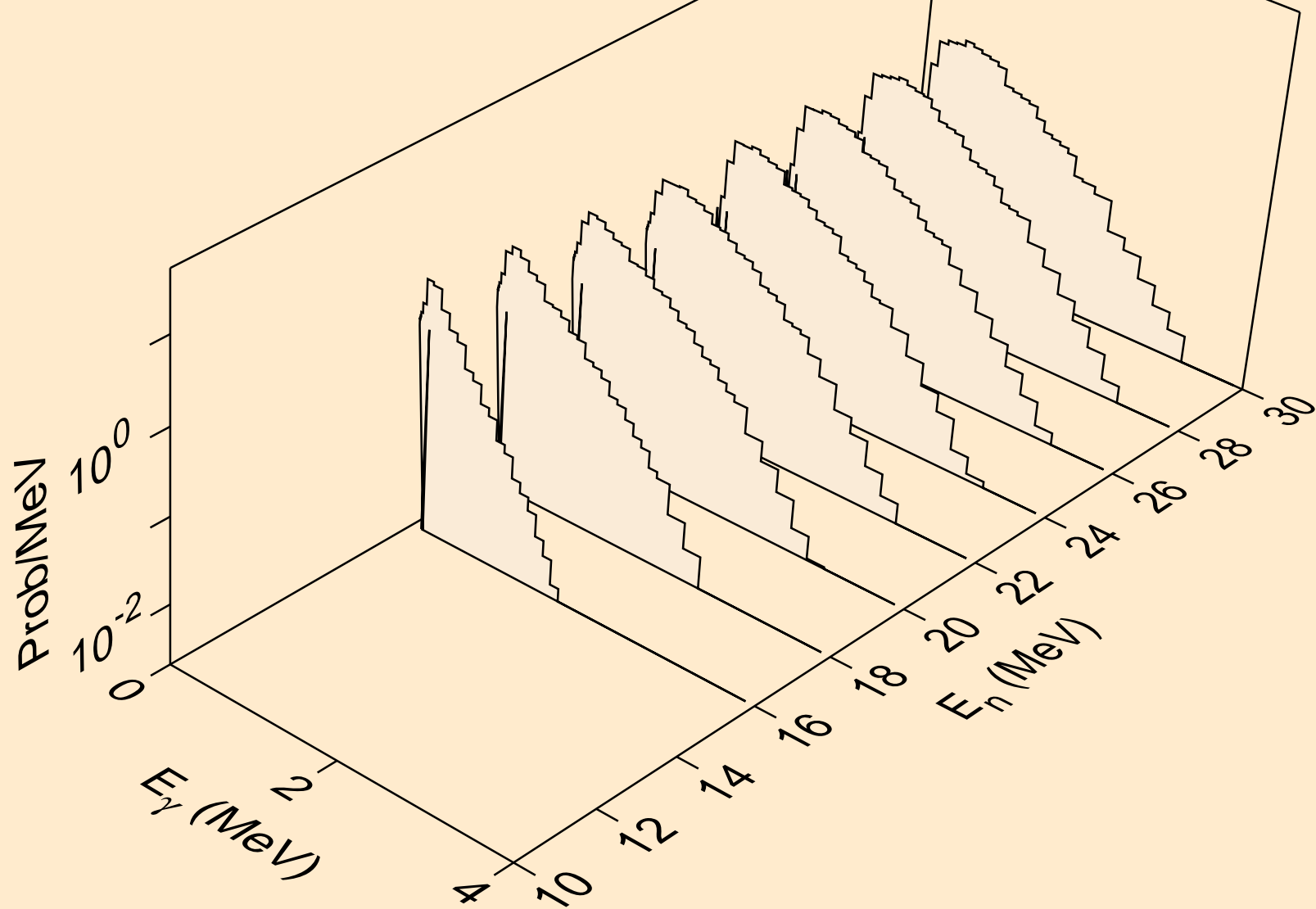

U227 NEUTRON ACER TENDL-2021 LIBRARY; T=293.6K
Photon emission for (n,3np)

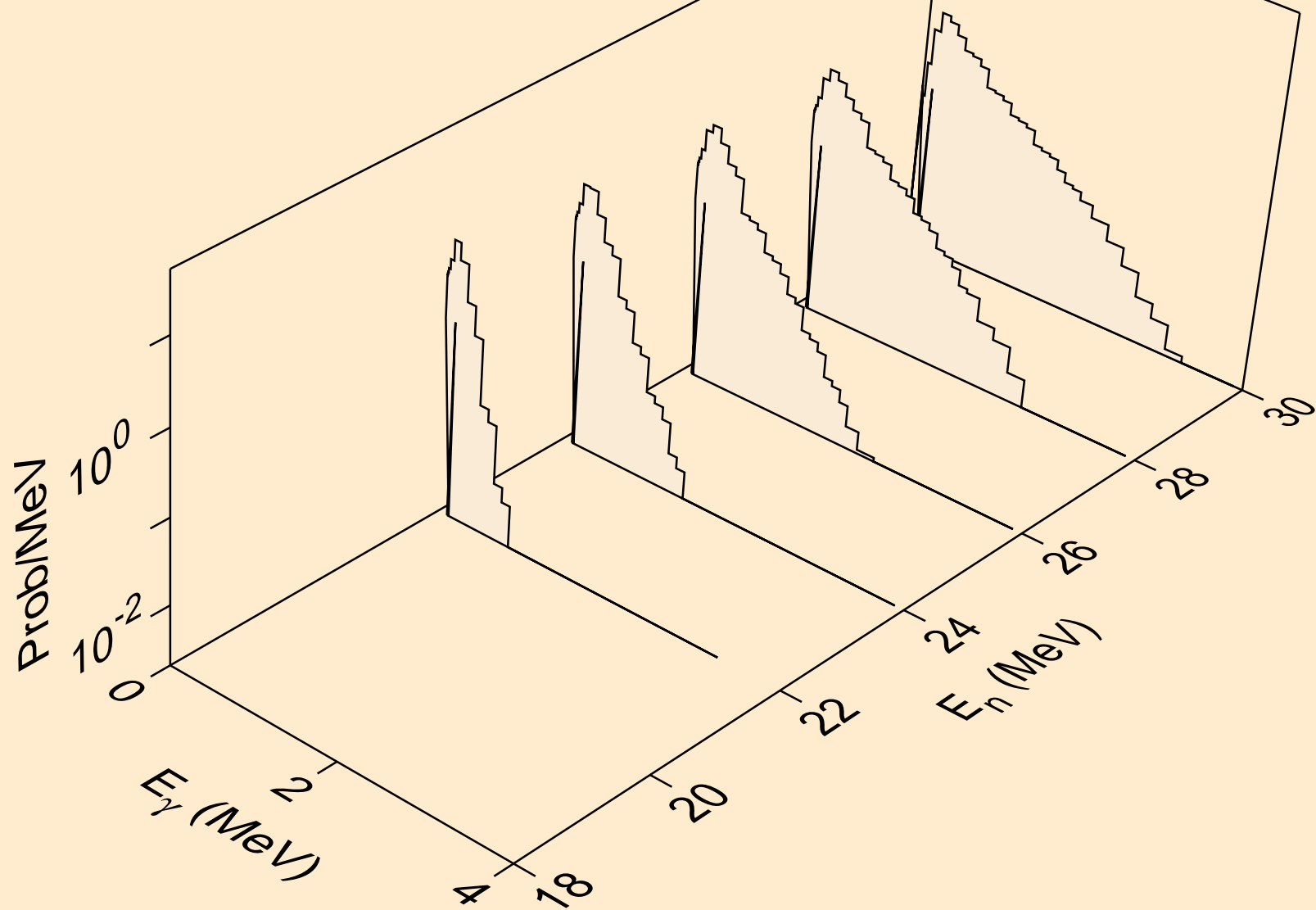

U227 NEUTRON ACER TENDL-2021 LIBRARY; T=293.6K
Photon emission for (n,2np)

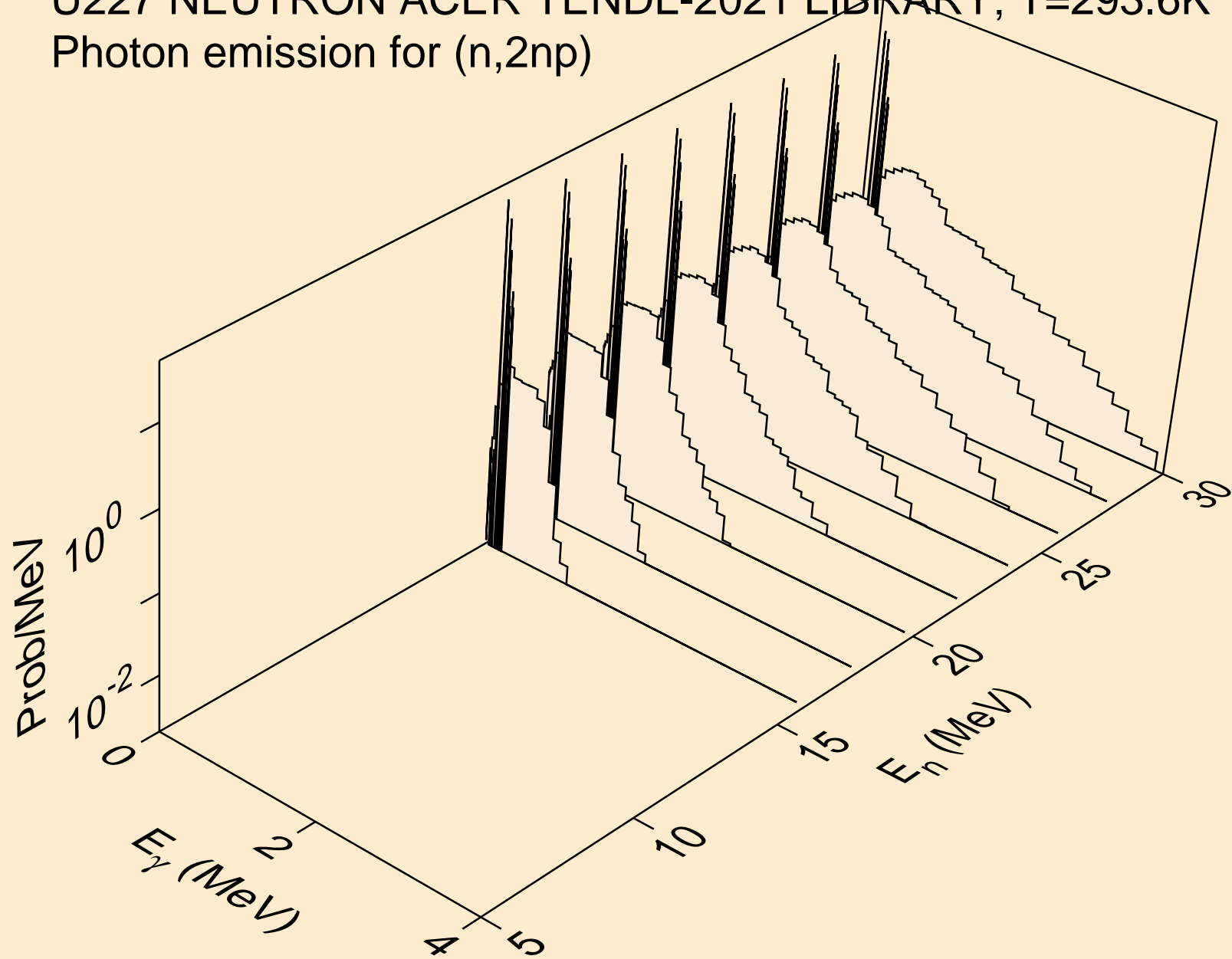

U227 NEUTRON ACER TENDL-2021 LIBRARY; T=293.6K
Photon emission for (n,npa)

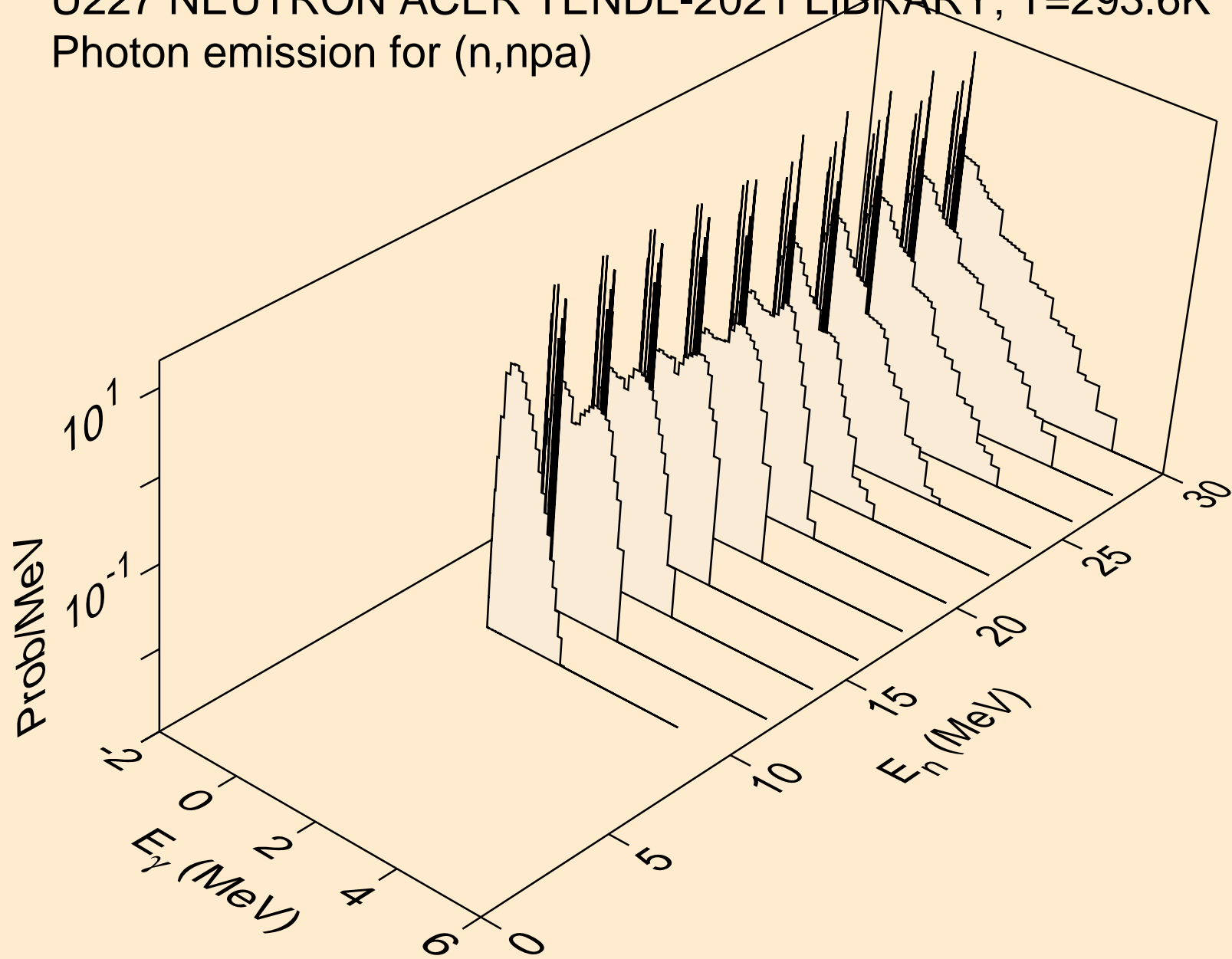

U227 NEUTRON ACER TENDL-2021 LIBRARY; T=293.6K
Photon emission for (n,n*c)

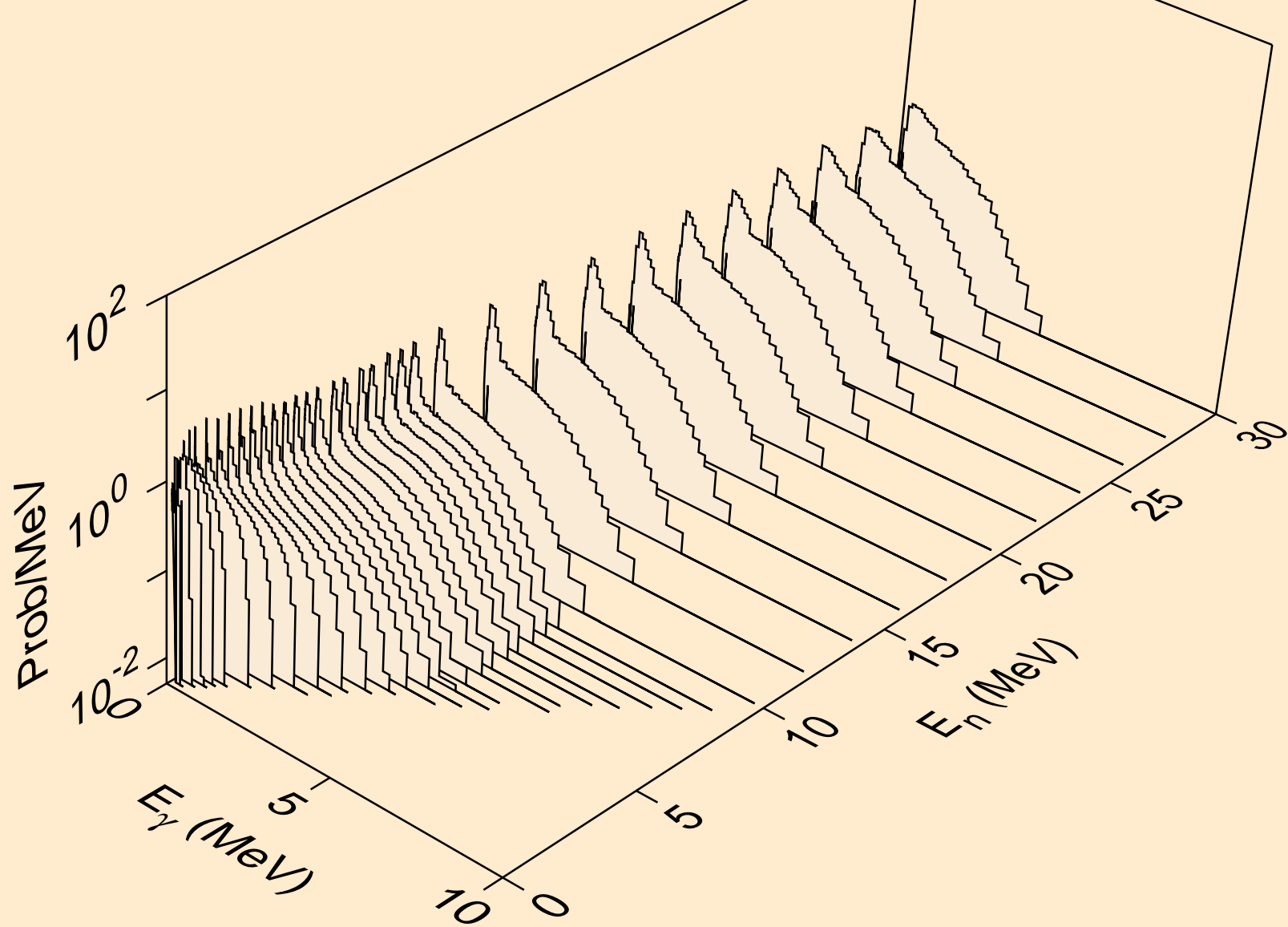

U227 NEUTRON ACER TENDL-2021 LIBRARY; T=293.6K
Photon emission for (n,gma)

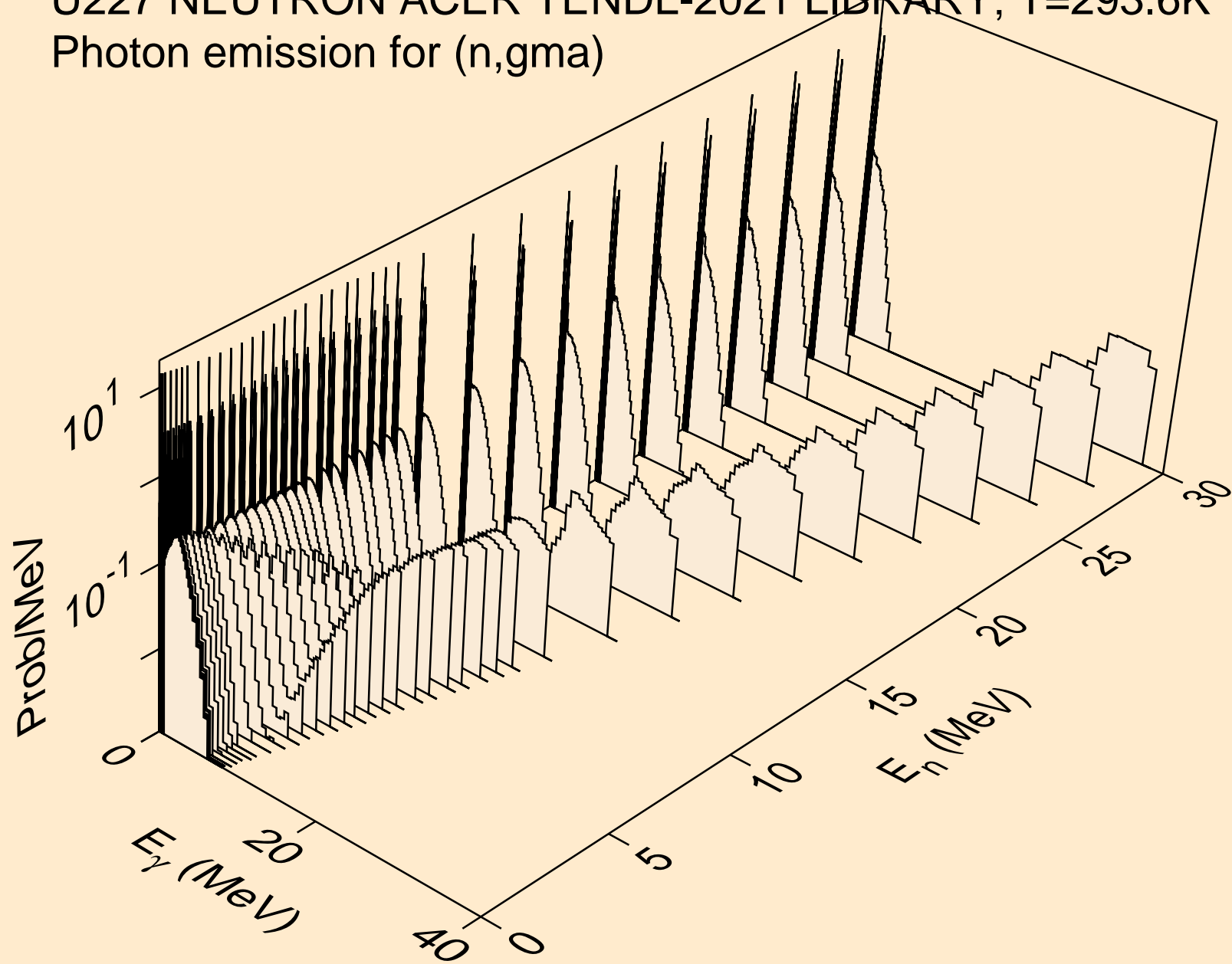

U227 NEUTRON ACER TENDL-2021 LIBRARY; T=293.6K
Photon emission for (n,p)

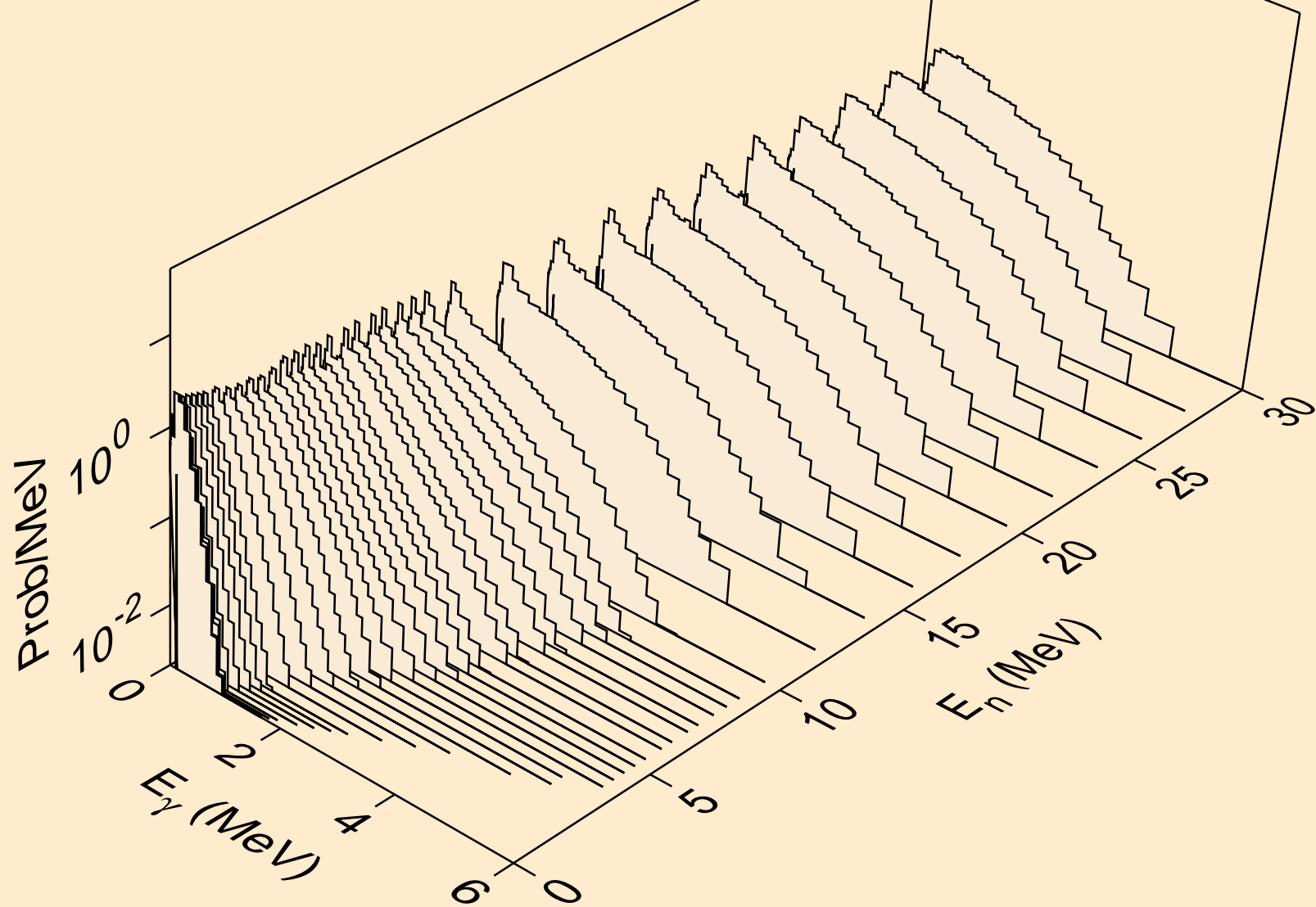

U227 NEUTRON ACER TENDL-2021 LIBRARY; T=293.6K
Photon emission for (n,d)

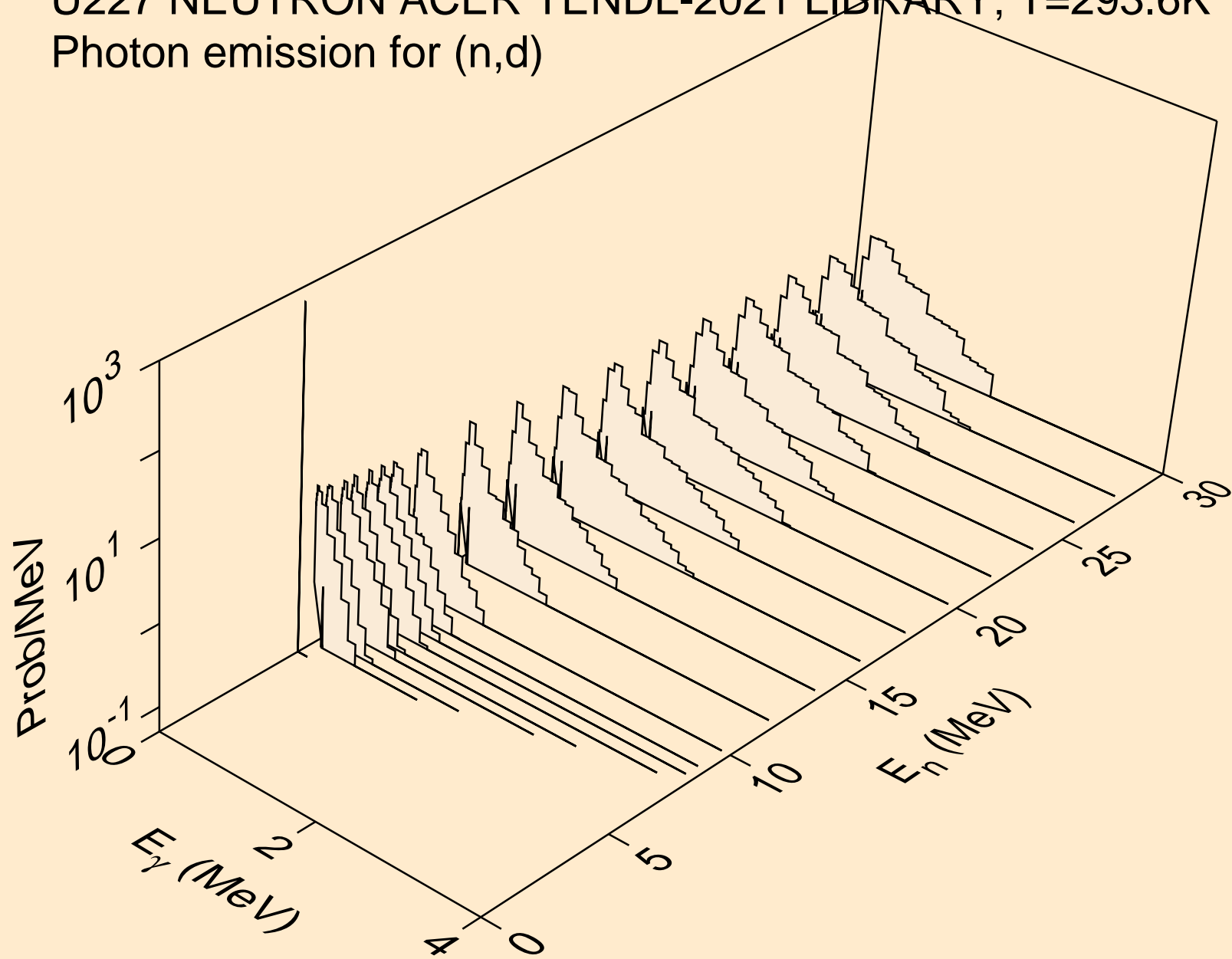

U227 NEUTRON ACER TENDL-2021 LIBRARY; T=293.6K
Photon emission for (n,t)

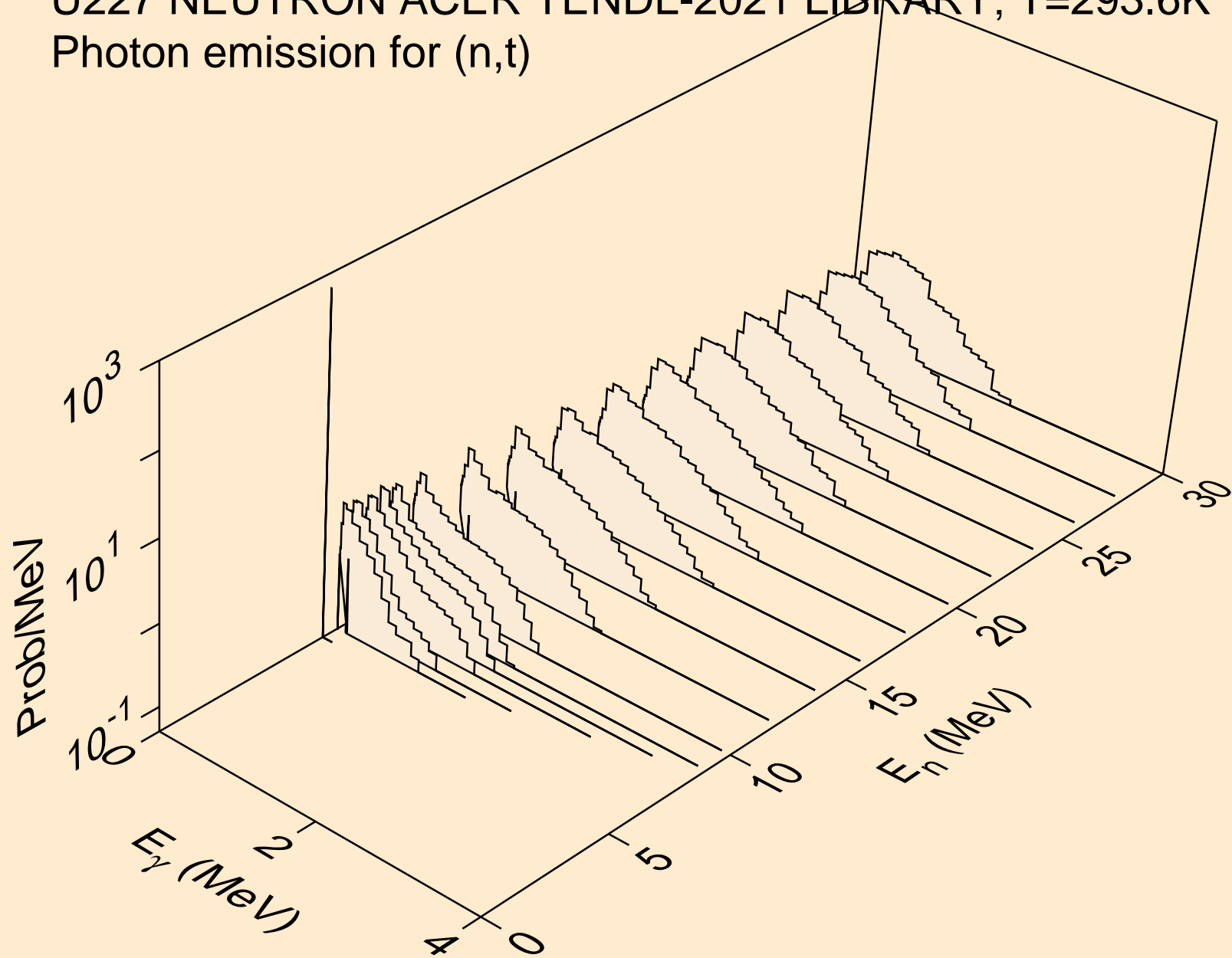

U227 NEUTRON ACER TENDL-2021 LIBRARY; T=293.6K
Photon emission for (n,he3)

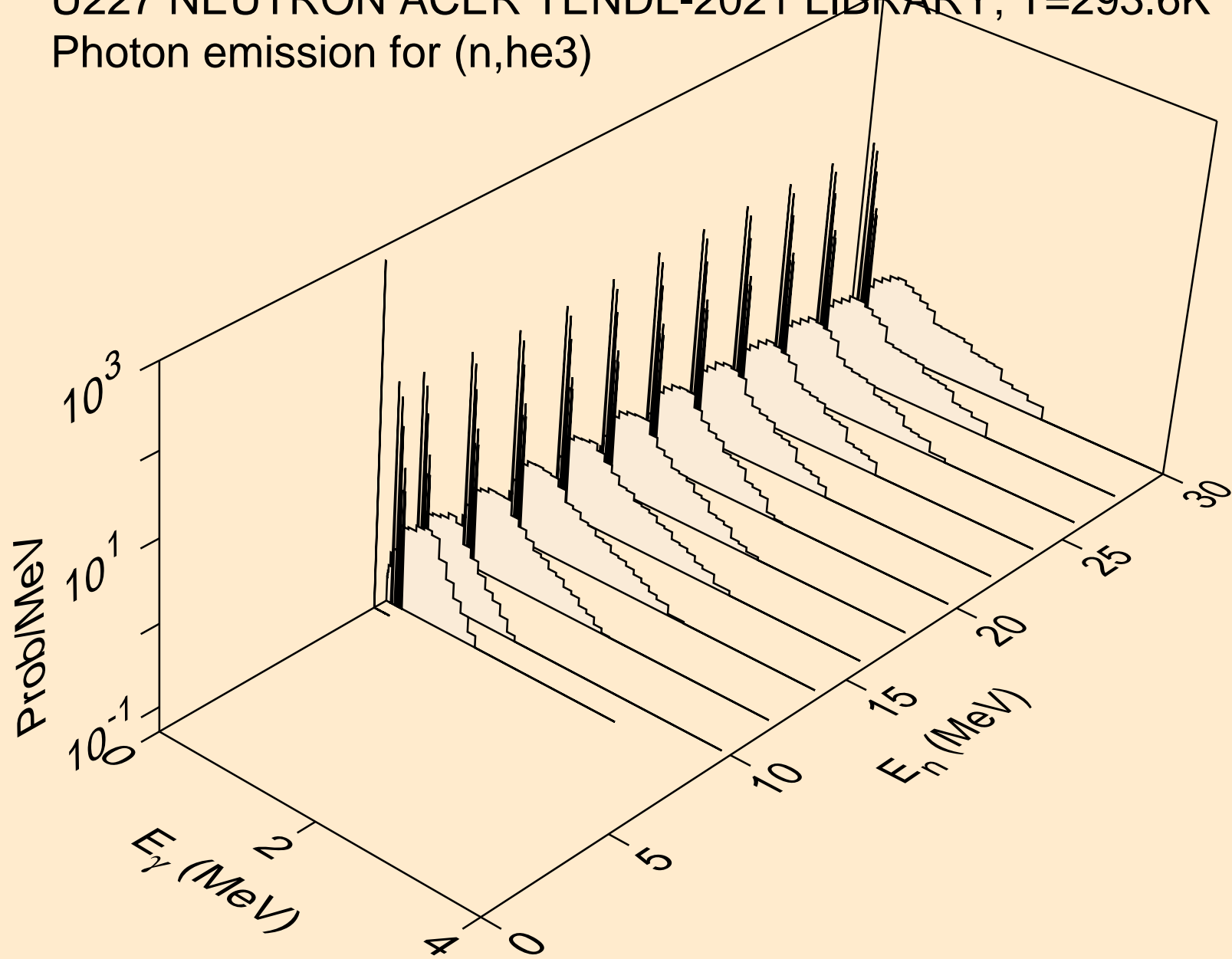

U227 NEUTRON ACER TENDL-2021 LIBRARY; T=293.6K
Photon emission for (n,a)

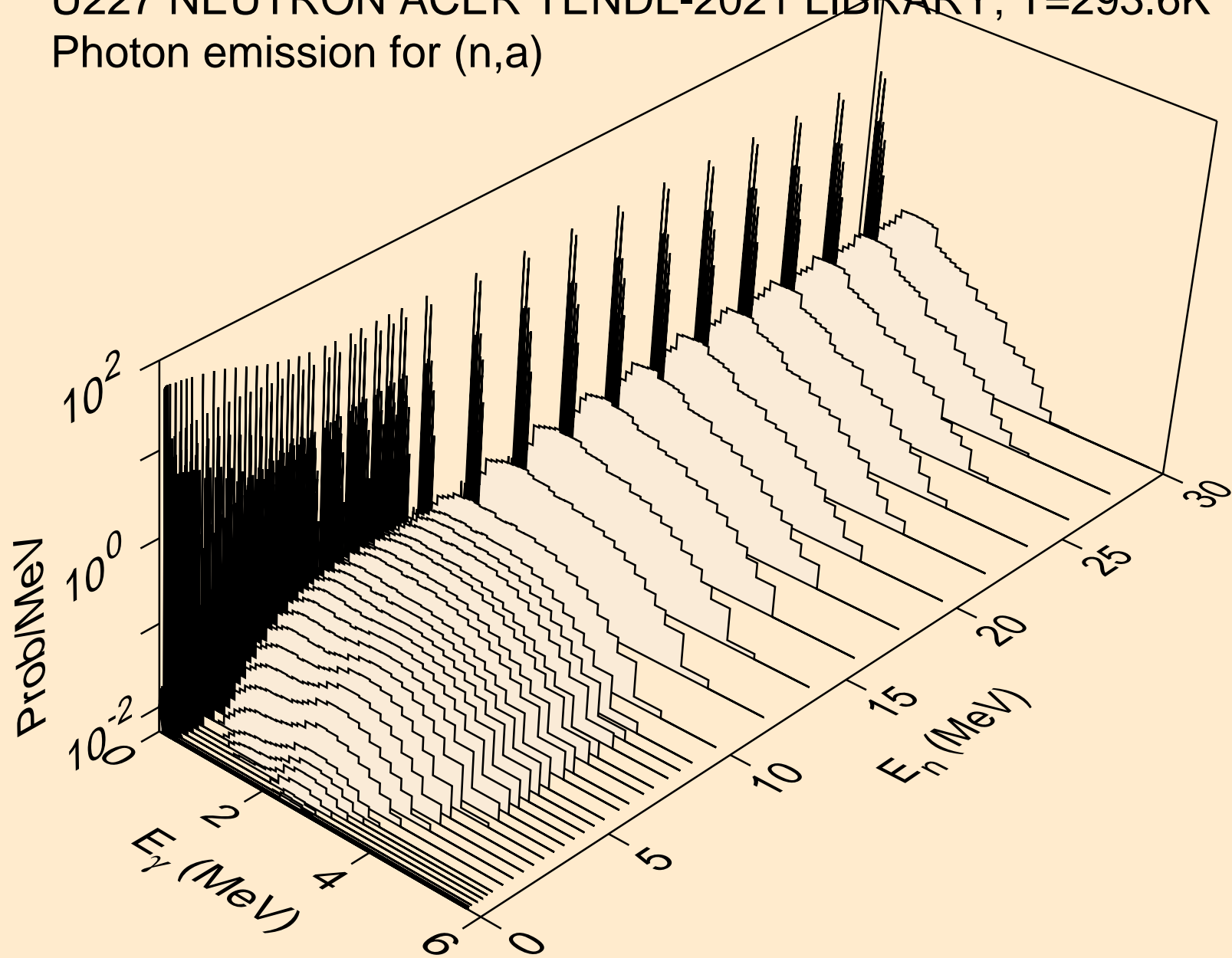

U227 NEUTRON ACER TENDL-2021 LIBRARY; T=293.6K
Photon emission for (n,2a)

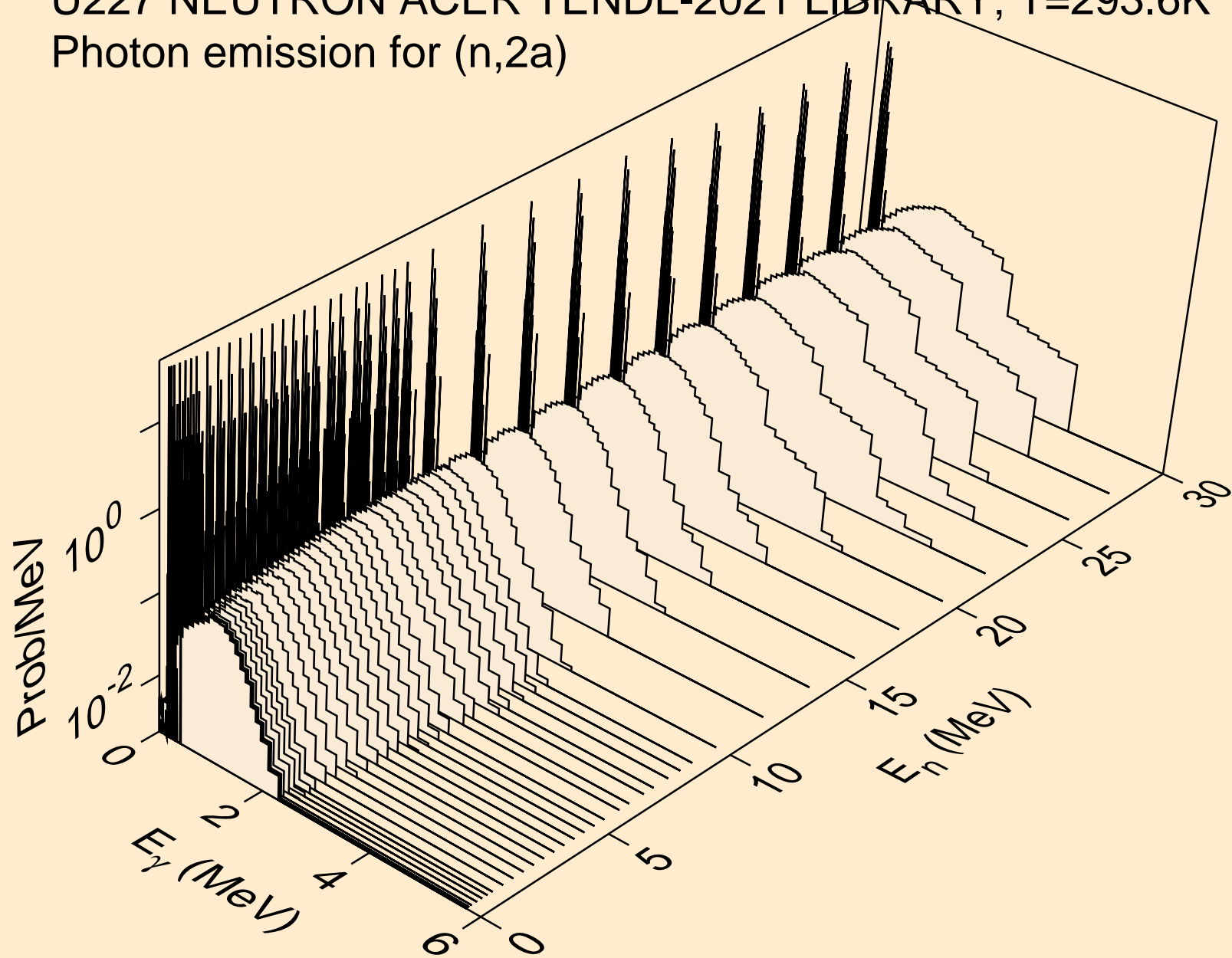

U227 NEUTRON ACER TENDL-2021 LIBRARY; T=293.6K
Photon emission for (n,2p)

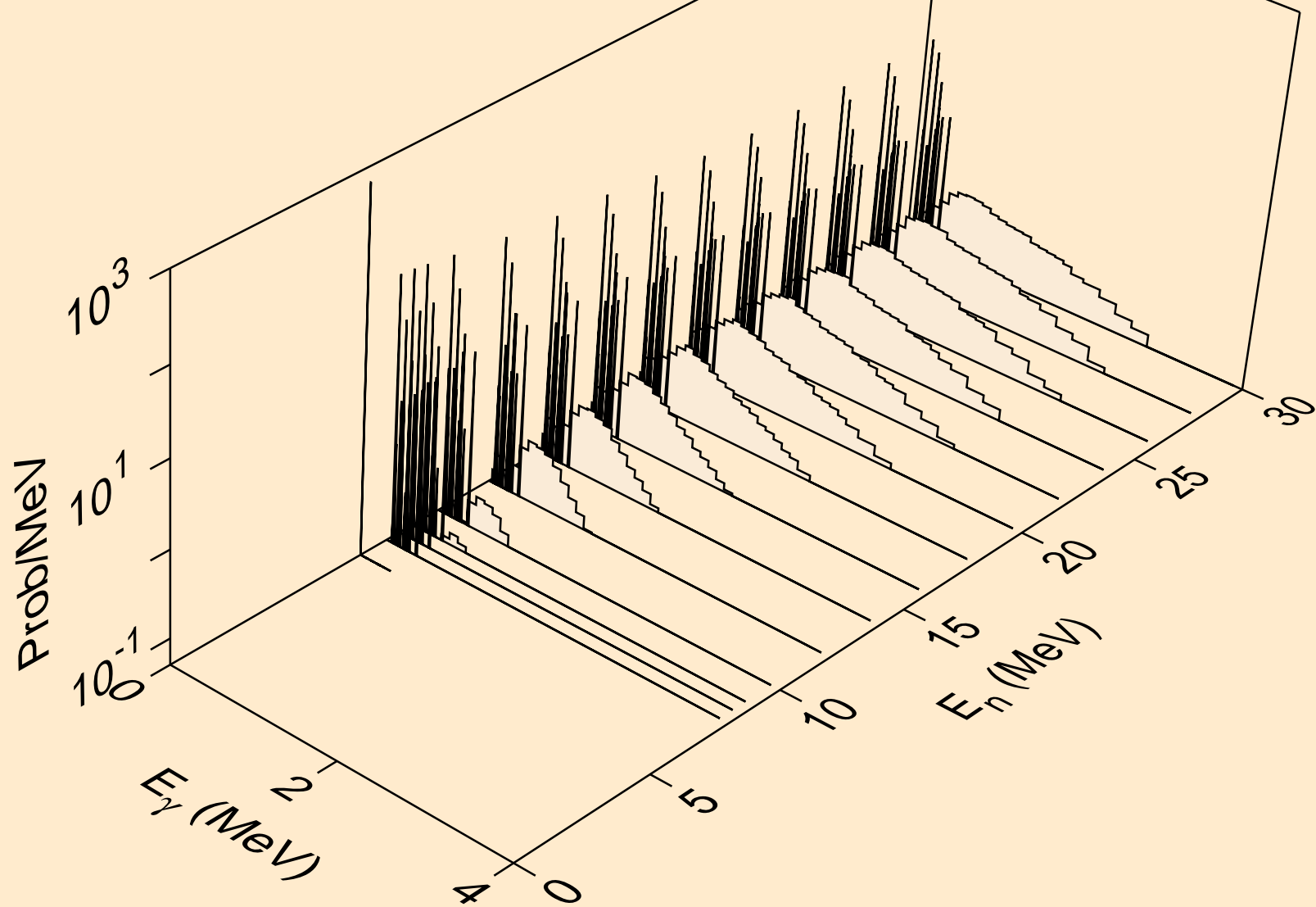

U227 NEUTRON ACER TENDL-2021 LIBRARY; T=293.6K
Photon emission for (n,p α)

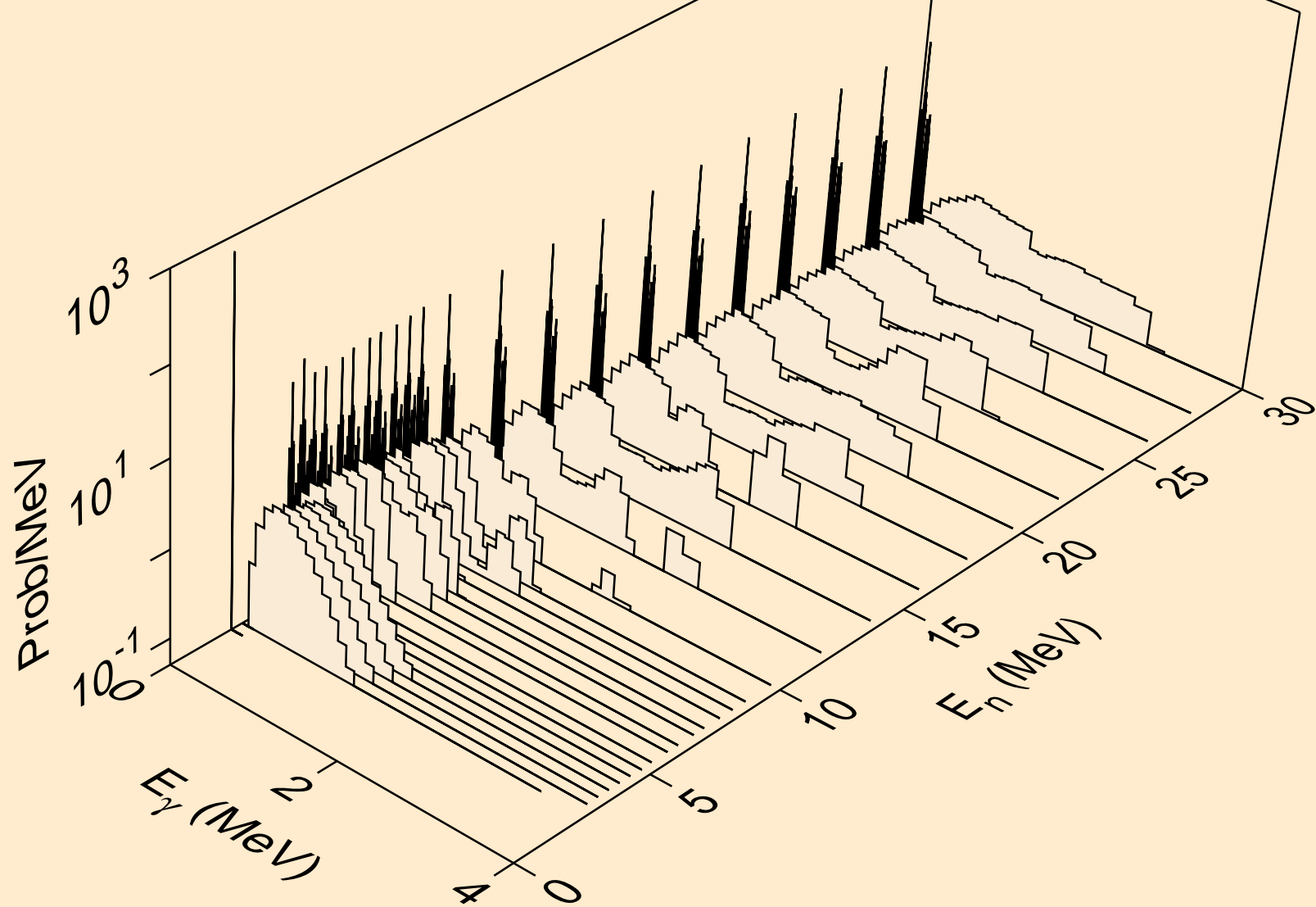

U227 NEUTRON ACER TENDL-2021 LIBRARY; T=293.6K
Photon emission for (n,pd)

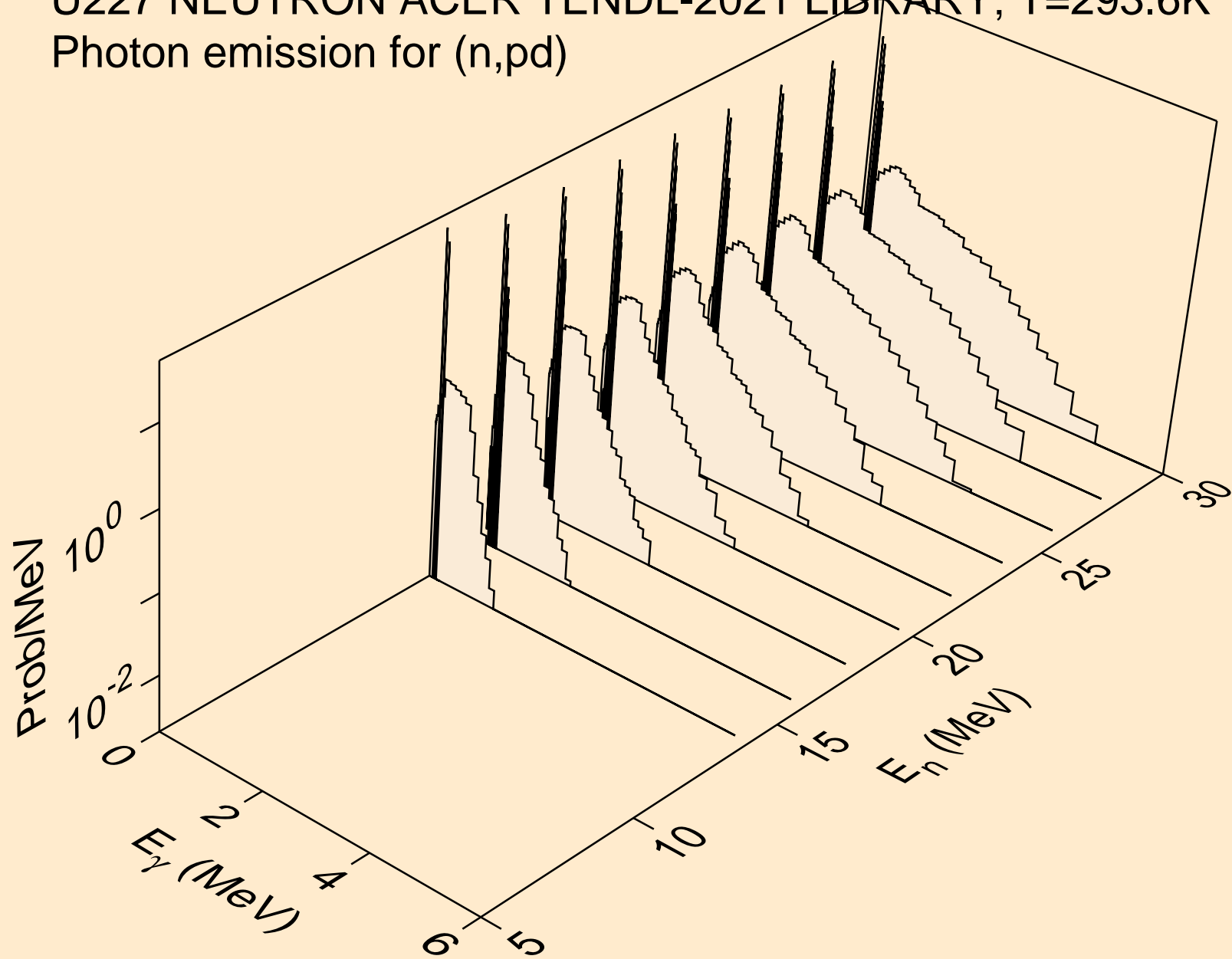

U227 NEUTRON ACER TENDL-2021 LIBRARY; T=293.6K
Photon emission for (n,pt)

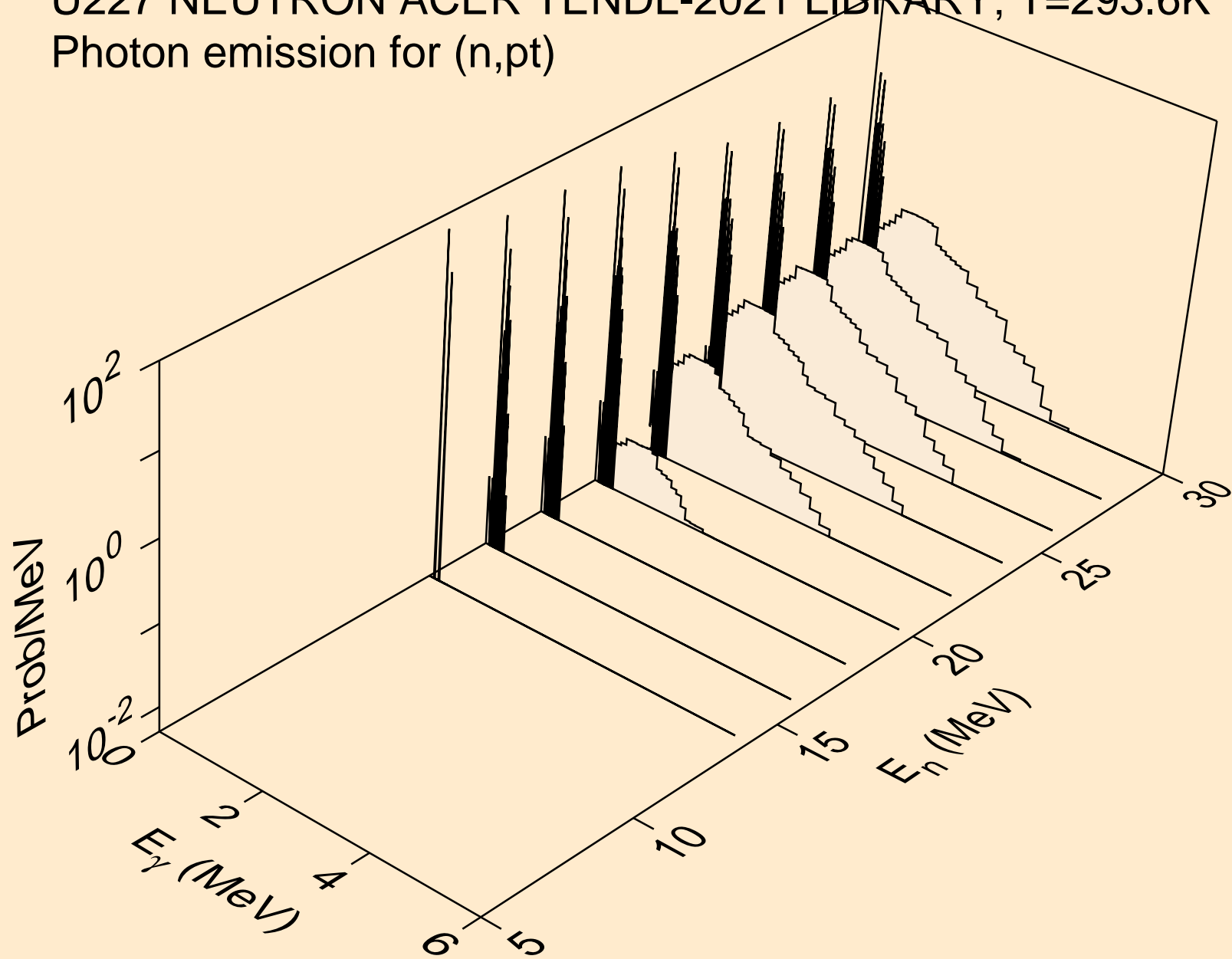

U227 NEUTRON ACER TENDL-2021 LIBRARY; T=293.6K
Photon emission for (n,da)

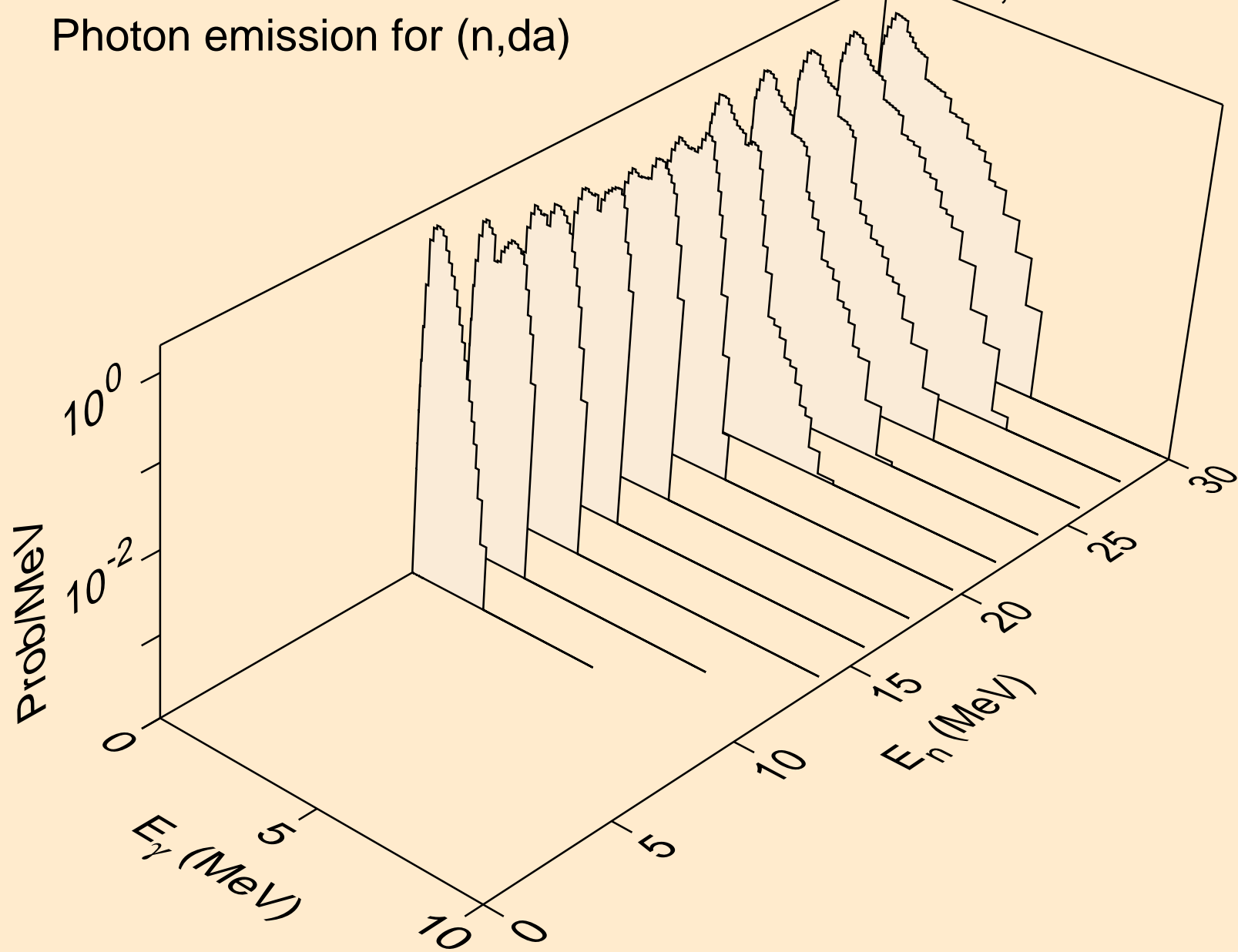

U227 NEUTRON ACER TENDL-2021 LIBRARY; T=293.6K
thermal capture photon spectrum

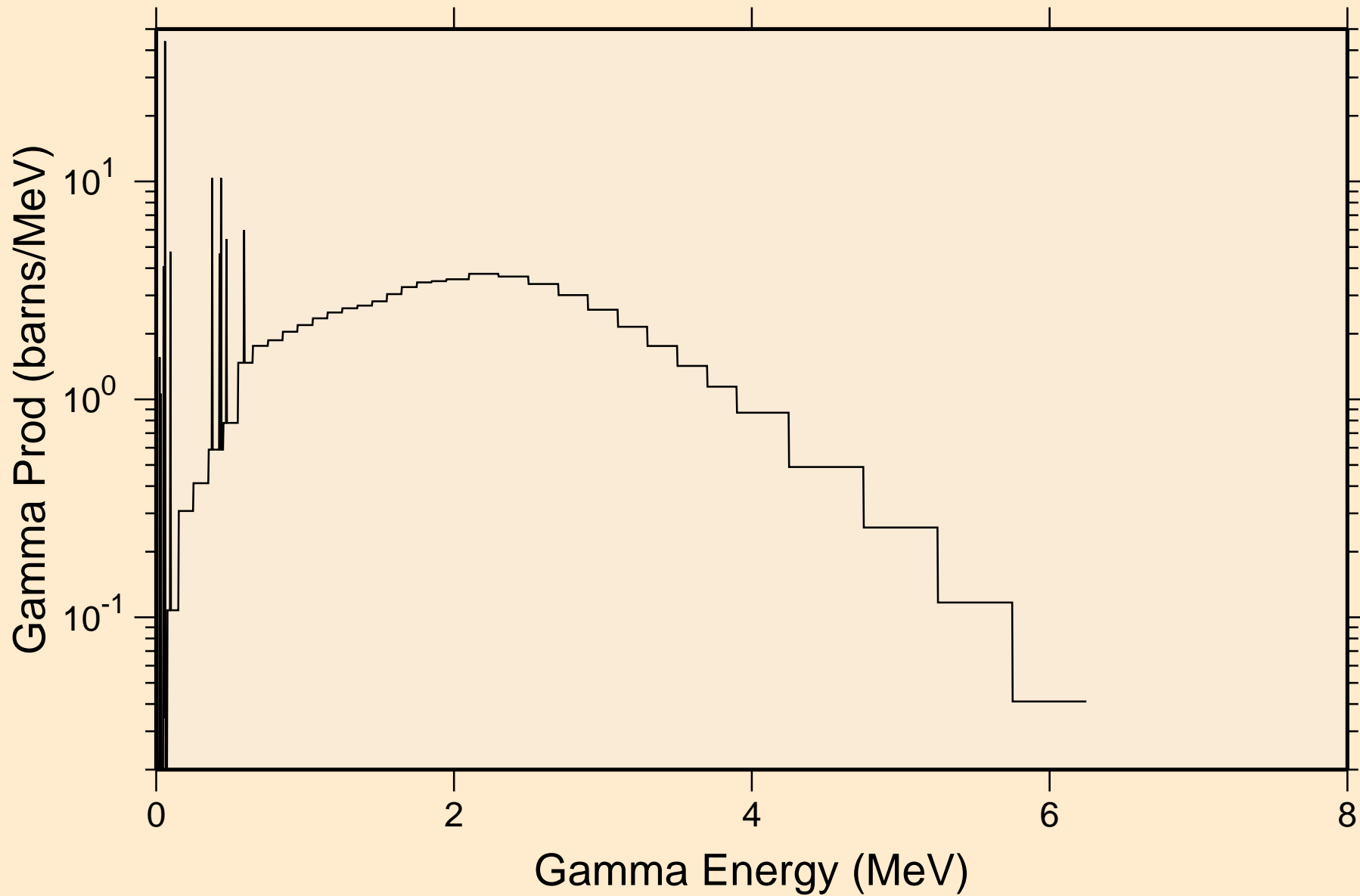

U227 NEUTRON ACER TENDL-2021 LIBRARY; T=293.6K
14 MeV photon spectrum

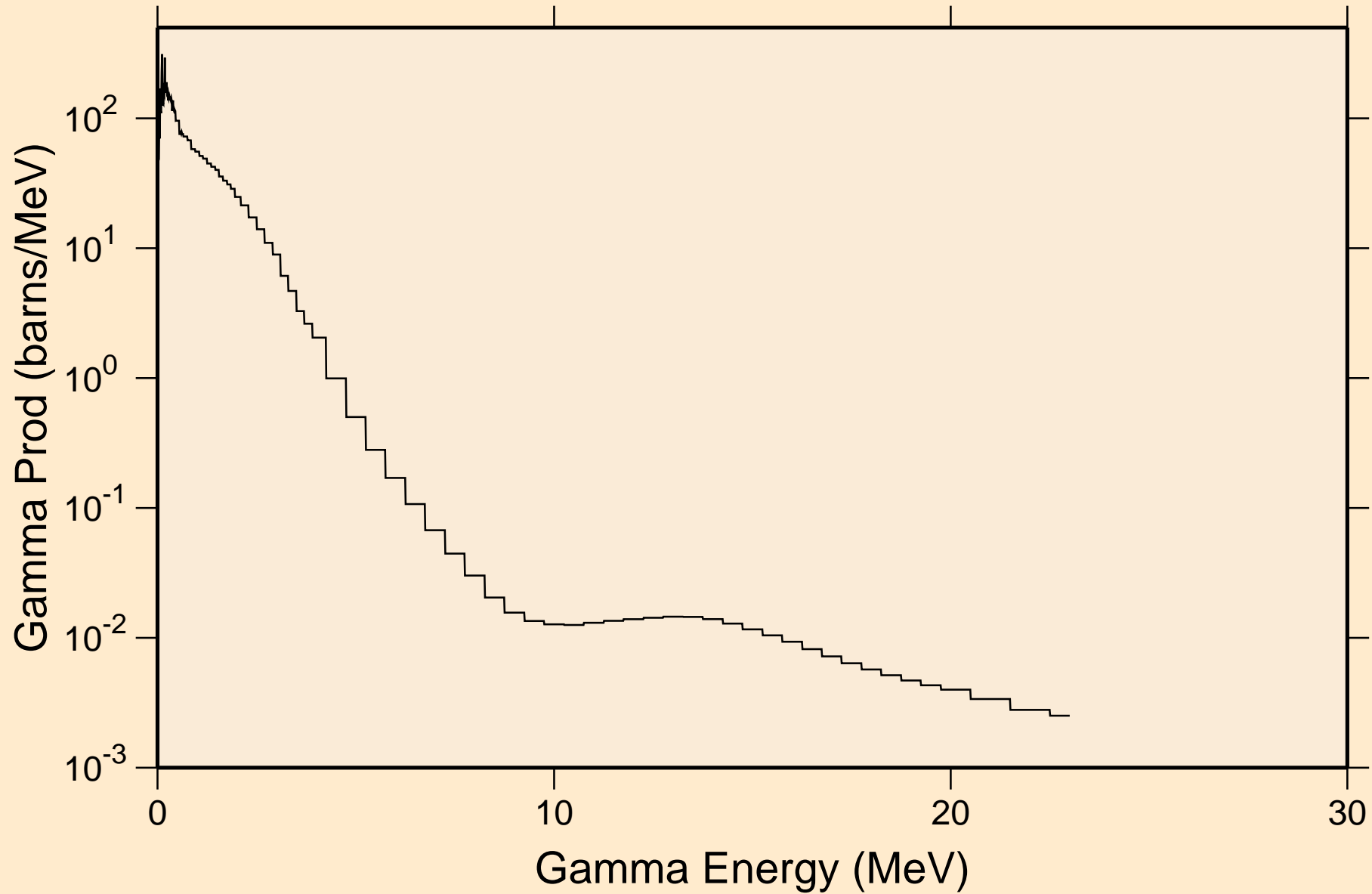

U227 NEUTRON ACER TENDL-2021 LIBRARY; T=293.6K

Particle heating contributions

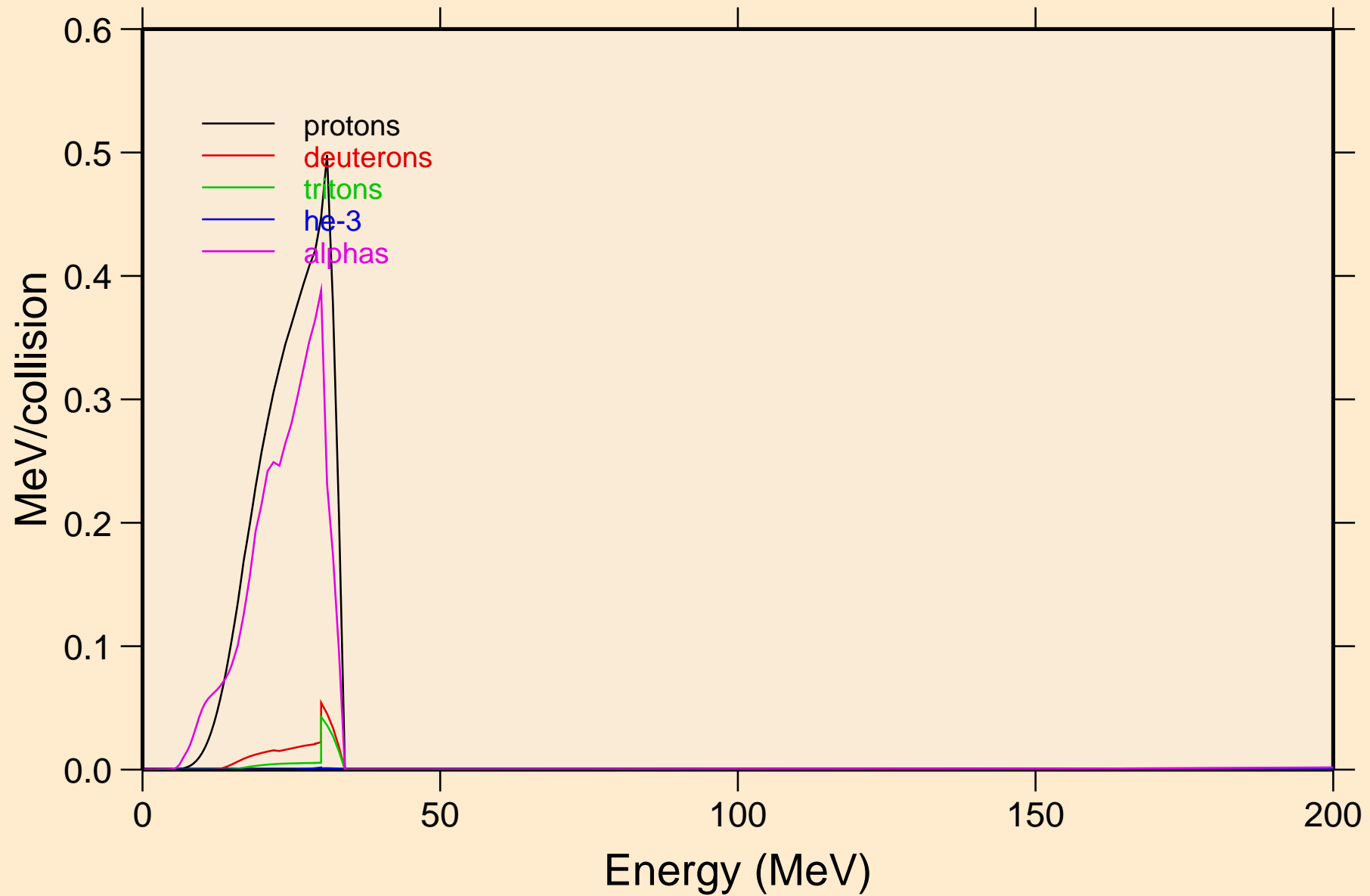

U227 NEUTRON ACER TENDL-2021 LIBRARY; T=293.6K
Recoil Heating

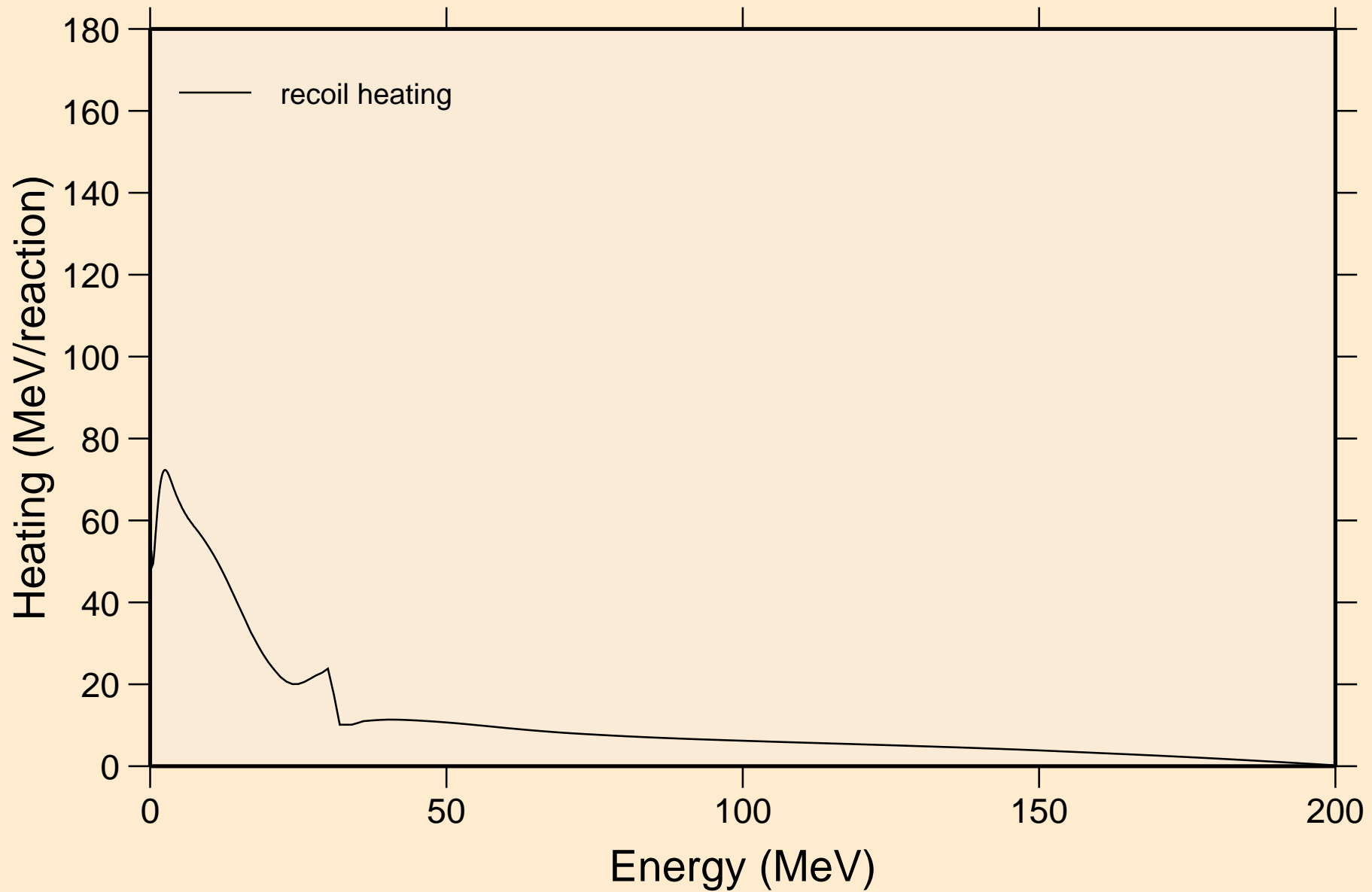

U227 NEUTRON ACER TENDL-2021 LIBRARY; T=293.6K
Particle production cross sections

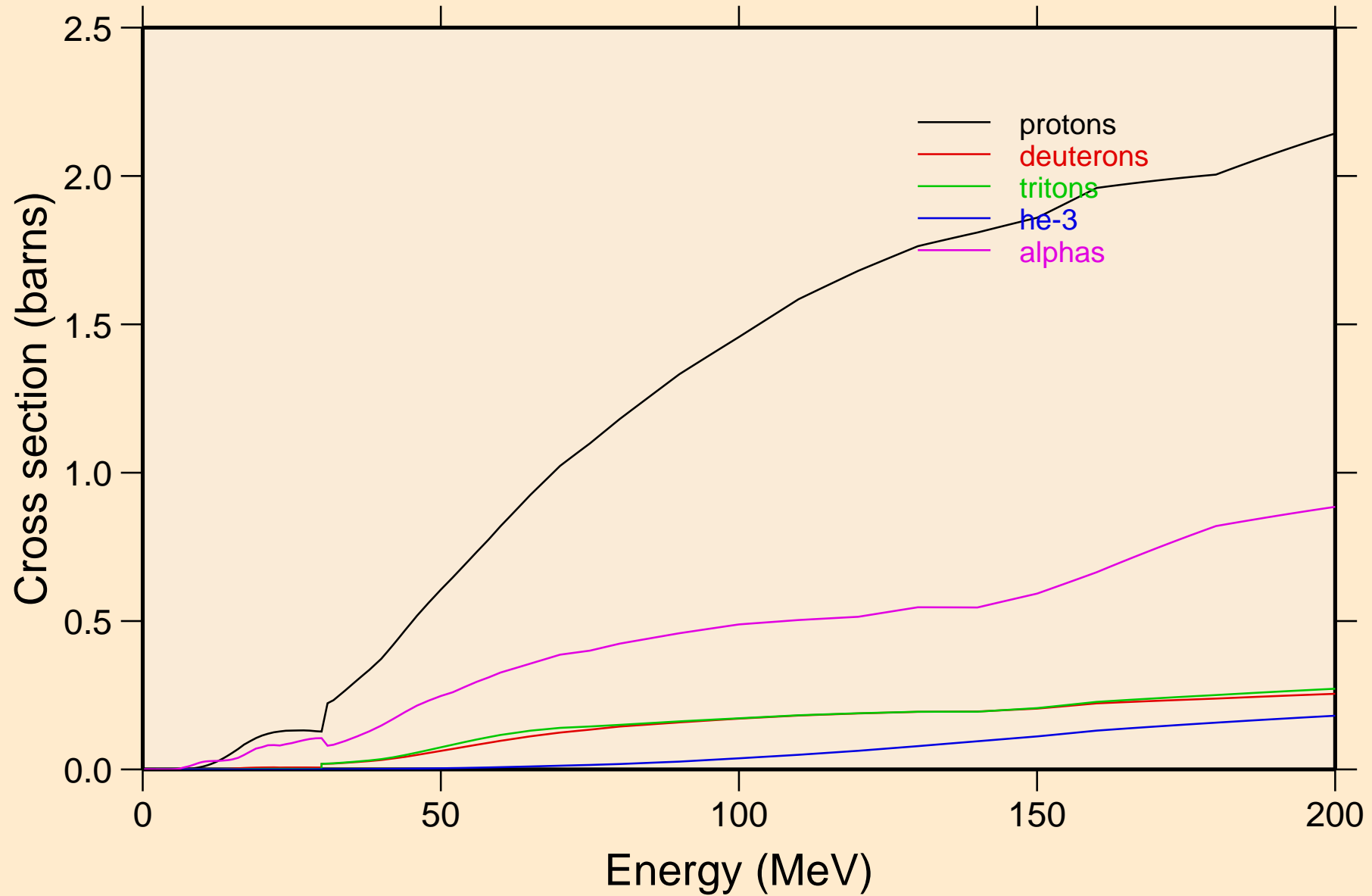

U227 NEUTRON ACER TENDL-2021 LIBRARY; T=293.6K
protons from (n,x)

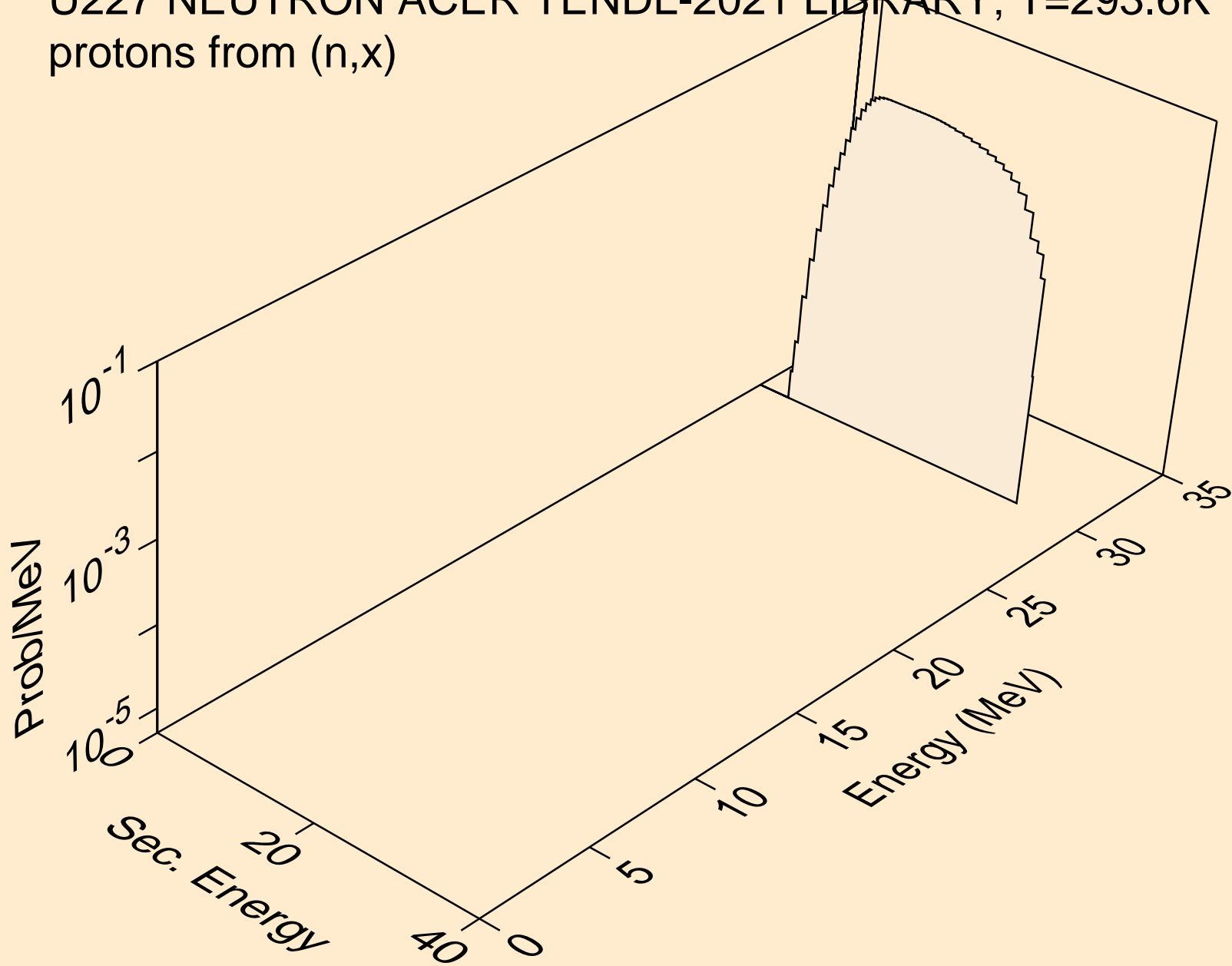

U227 NEUTRON ACER TENDL-2021 LIBRARY; T=293.6K
protons from (n,n*)p

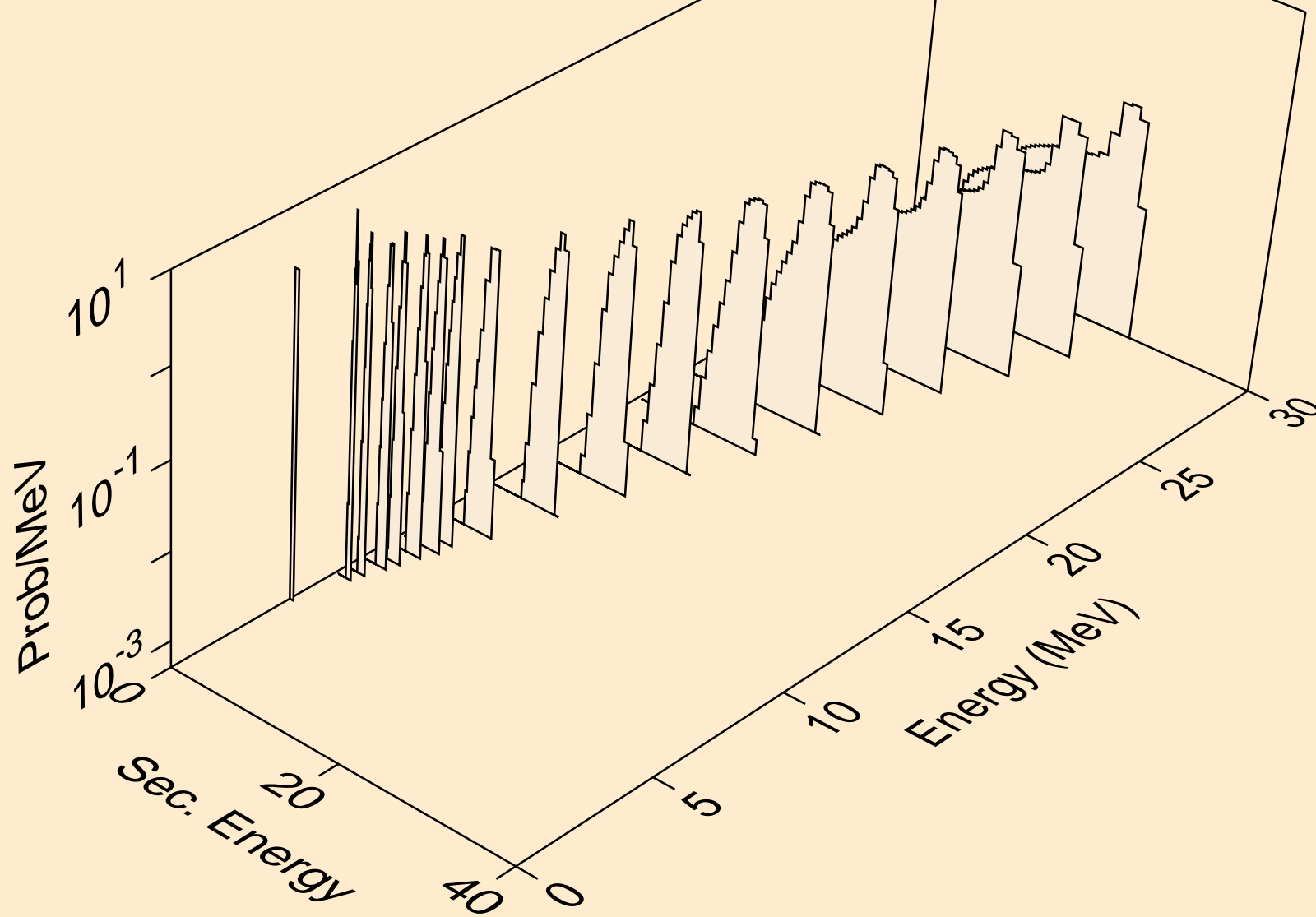

U227 NEUTRON ACER TENDL-2021 LIBRARY; T=293.6K
protons from (n,2np)

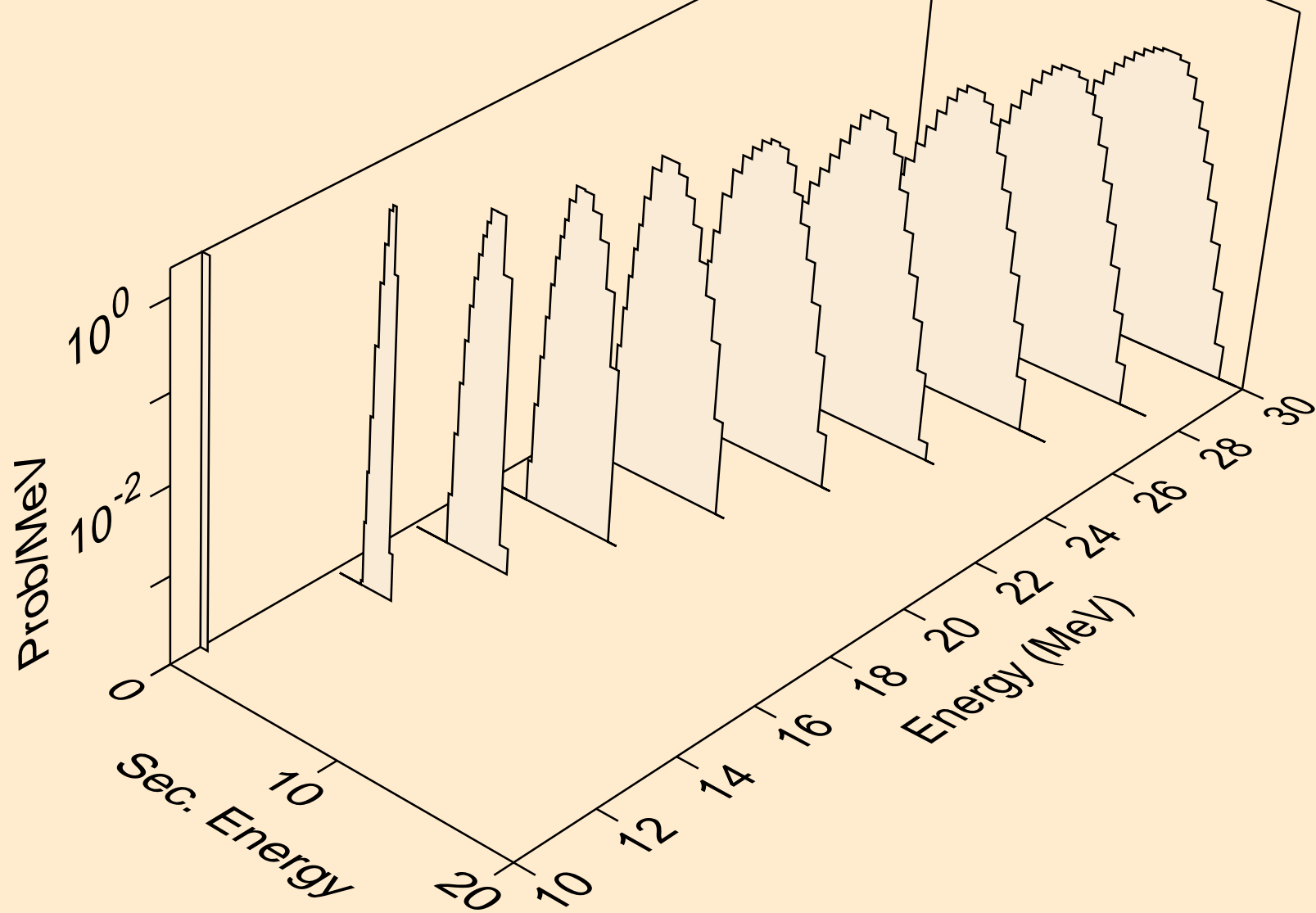

U227 NEUTRON ACER TENDL-2021 LIBRARY; T=293.6K
protons from (n,3np)

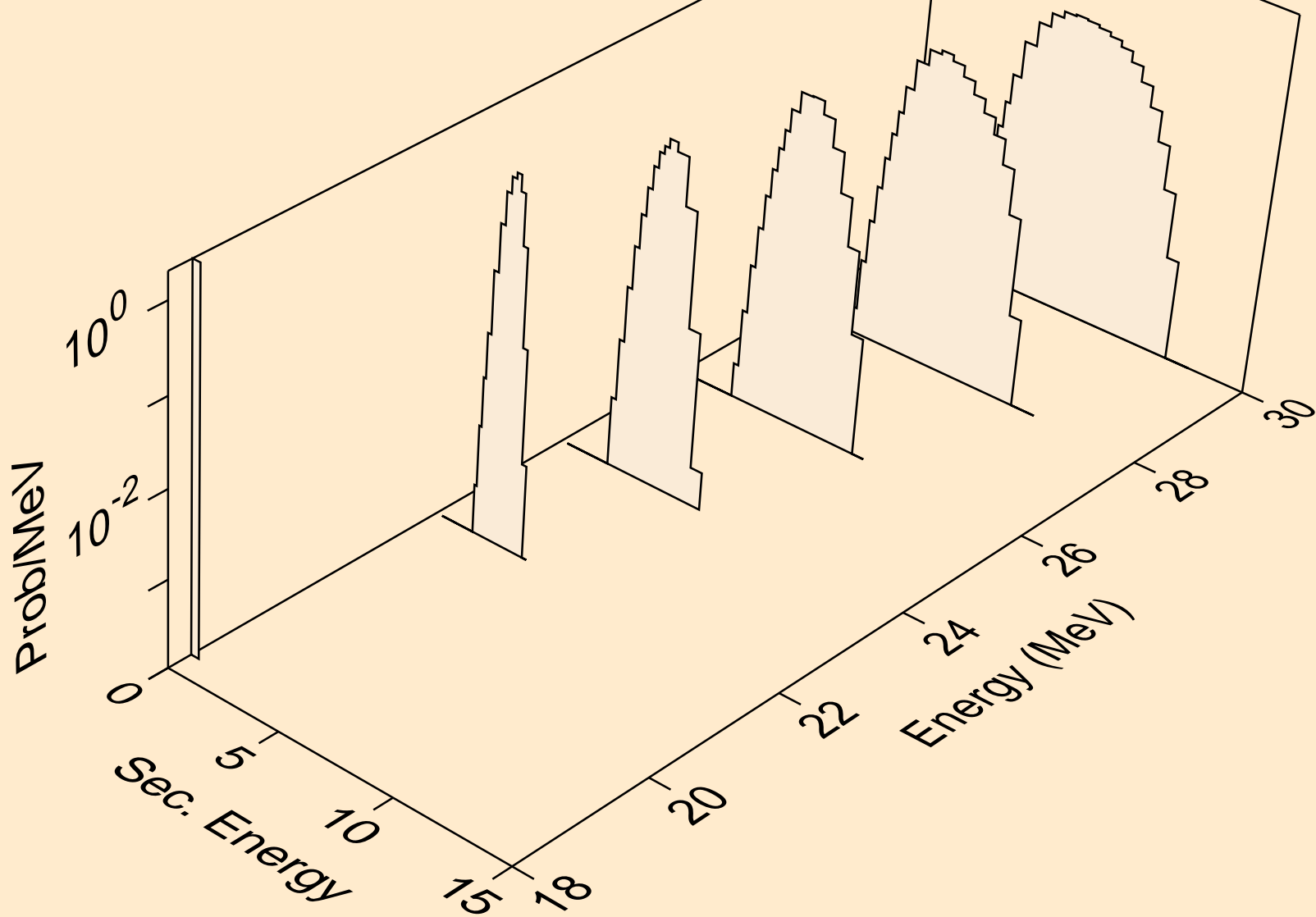

U227 NEUTRON ACER TENDL-2021 LIBRARY; T=293.6K
protons from (n,2np)

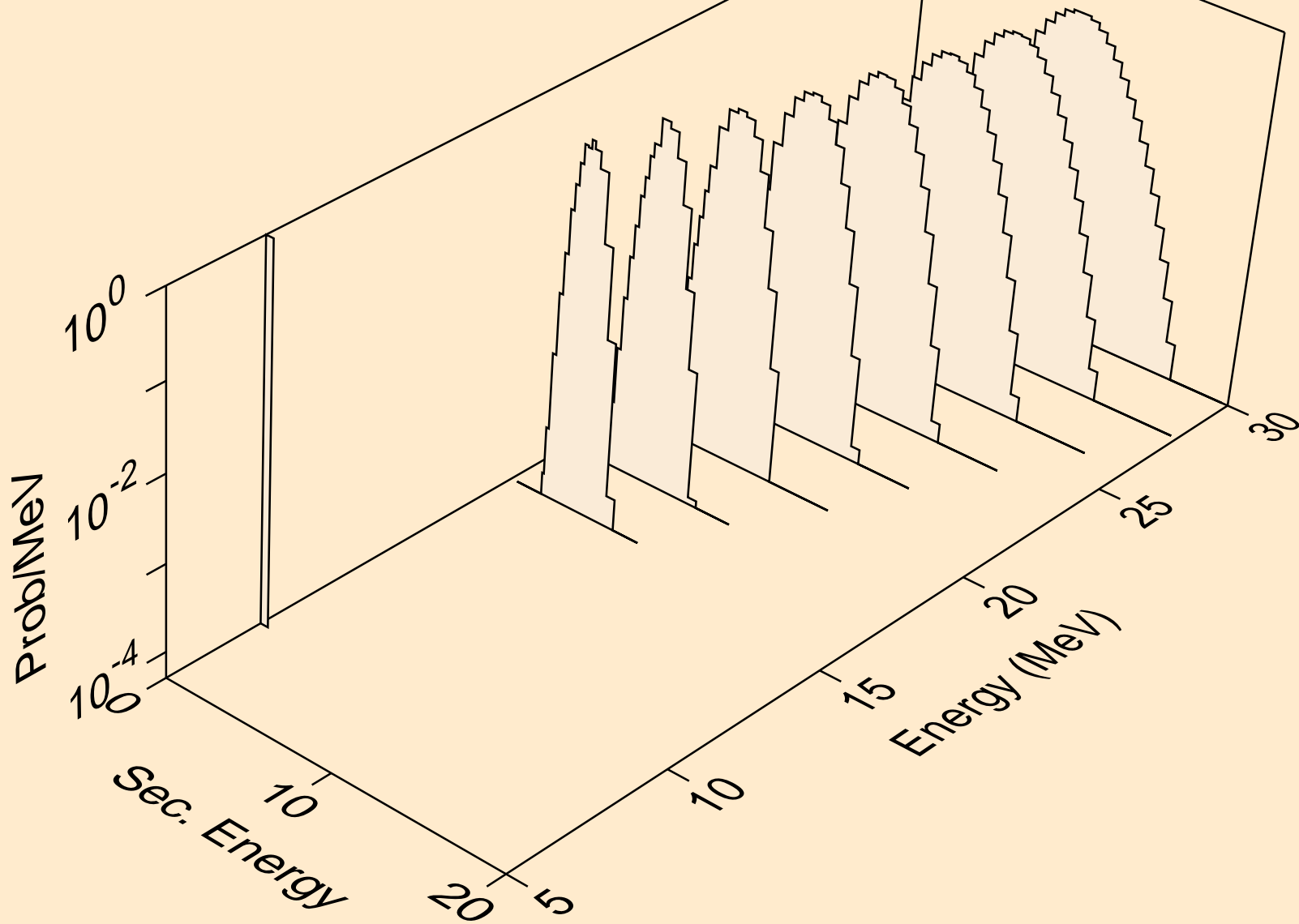

U227 NEUTRON ACER TENDL-2021 LIBRARY; T=293.6K
protons from (n,npa)

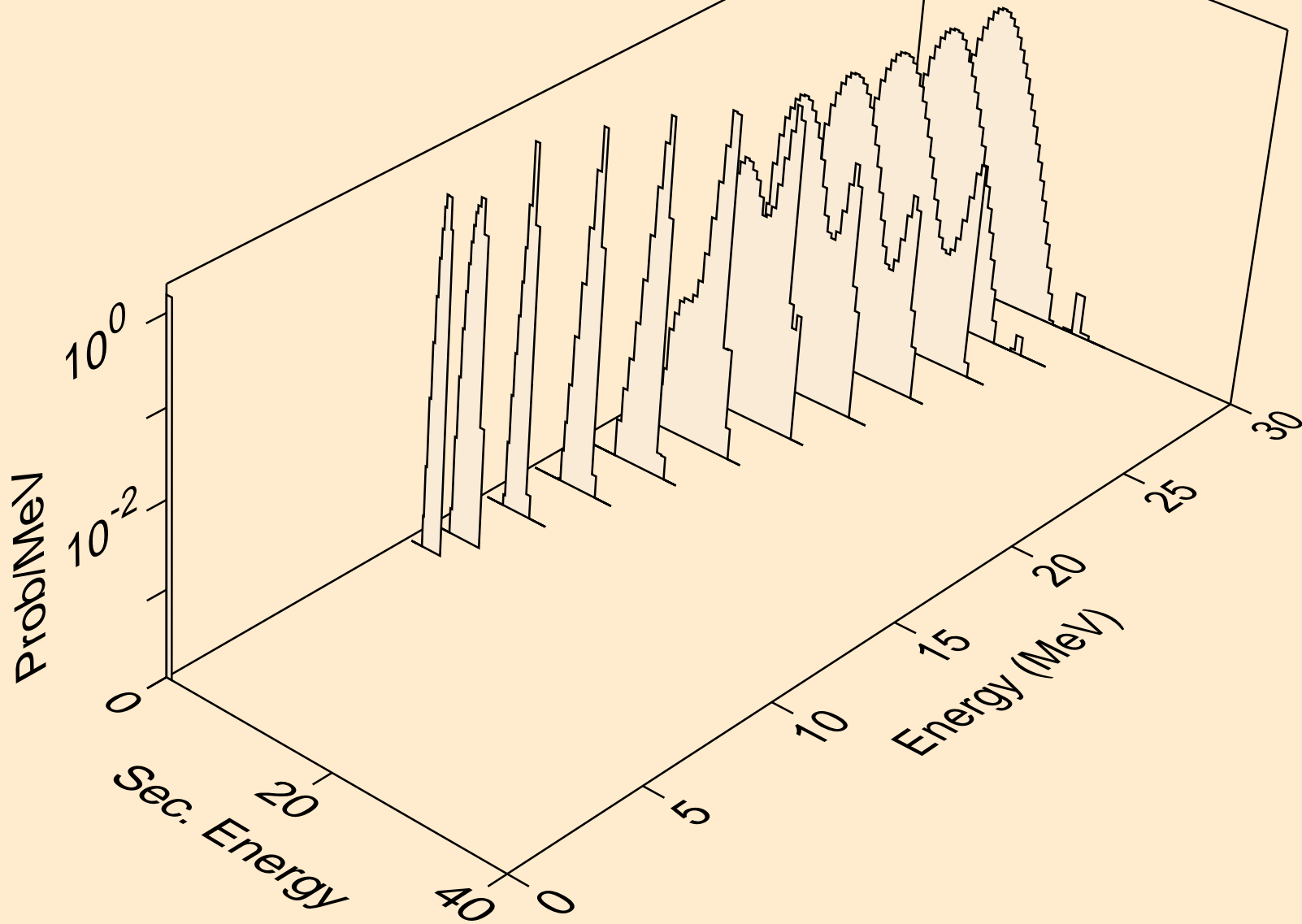

U227 NEUTRON ACER TENDL-2021 LIBRARY; T=293.6K
protons from (n,p)

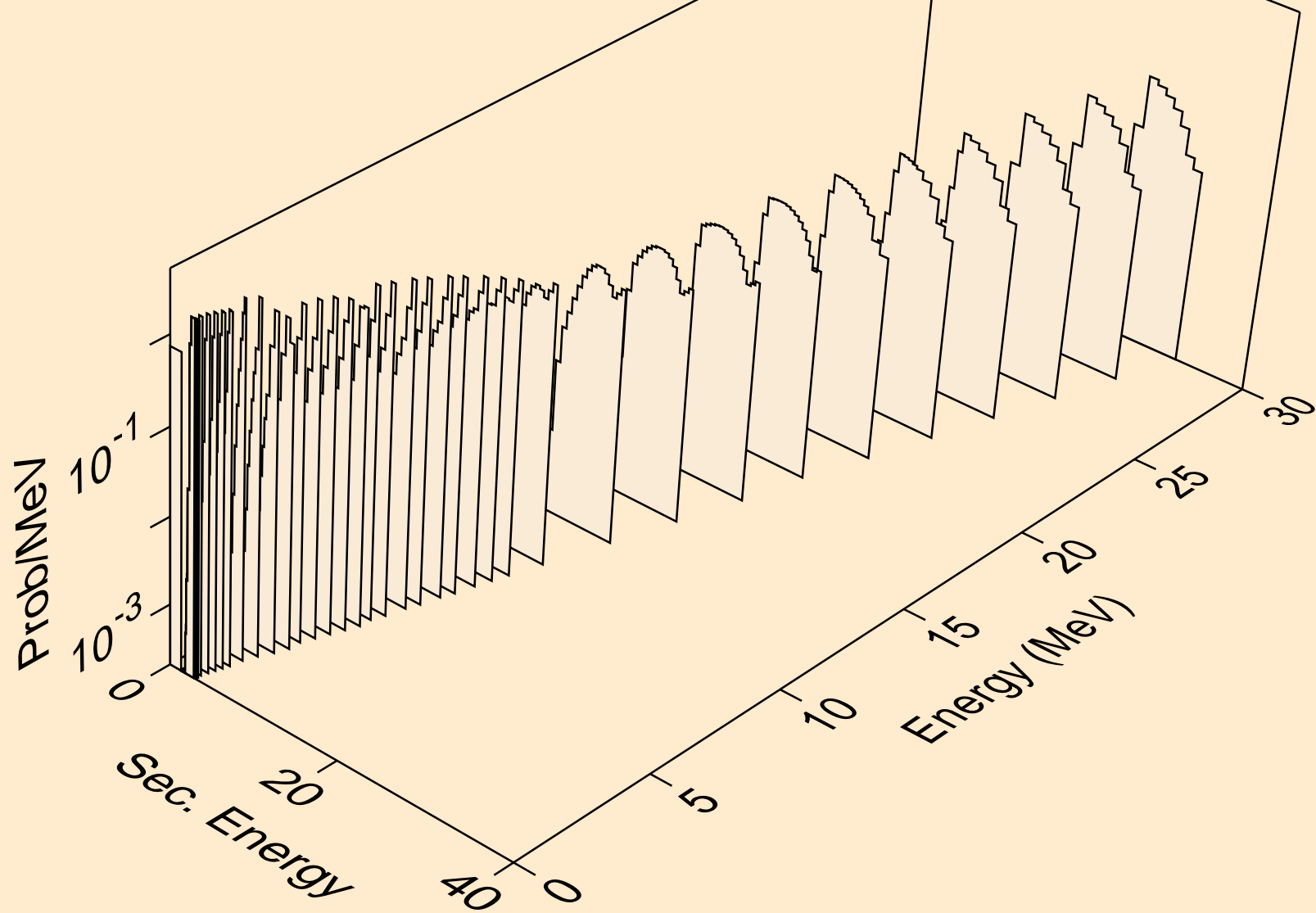

U227 NEUTRON ACER TENDL-2021 LIBRARY; T=293.6K
protons from (n,2p)

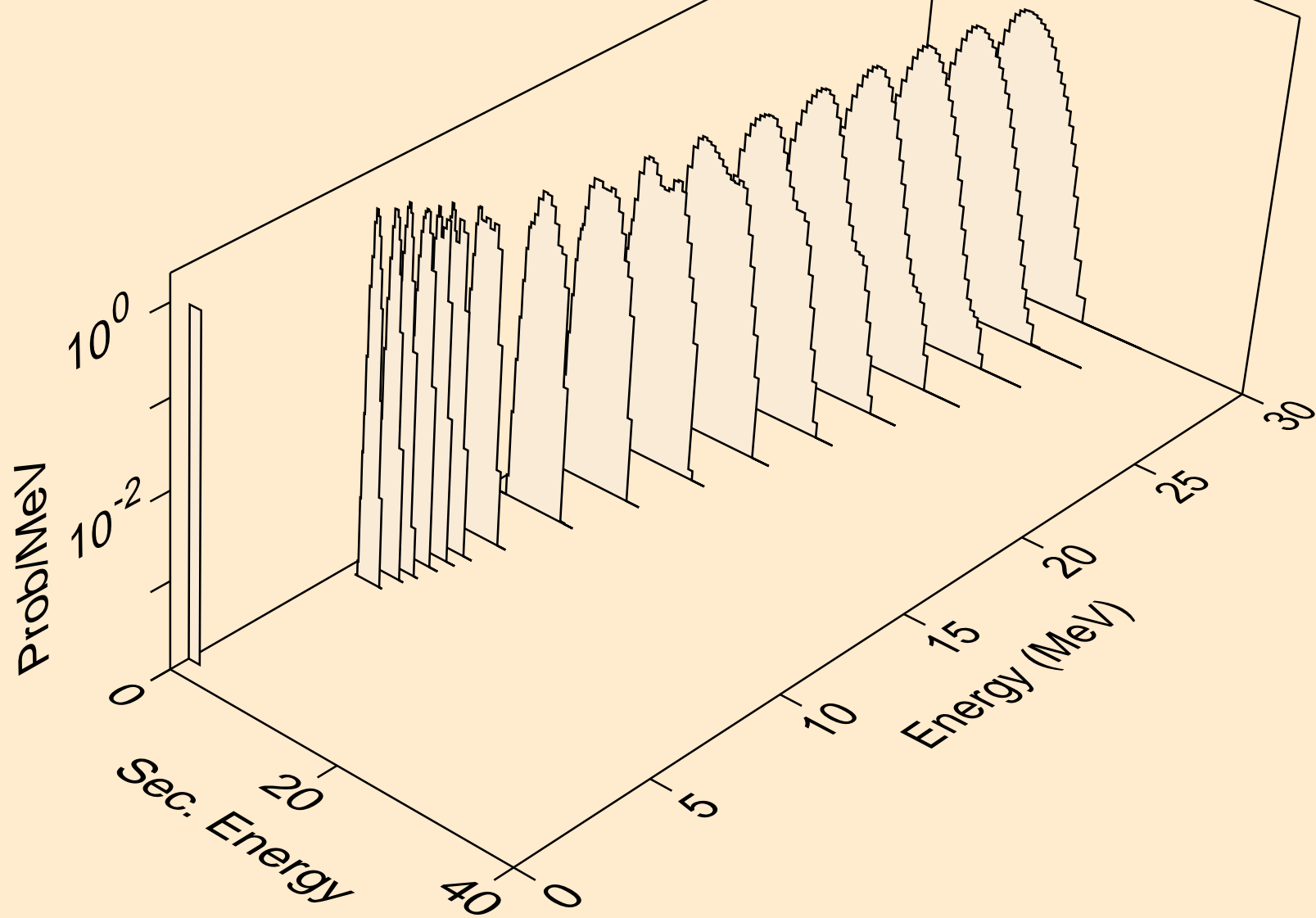

U227 NEUTRON ACER TENDL-2021 LIBRARY; T=293.6K
protons from (n,p)

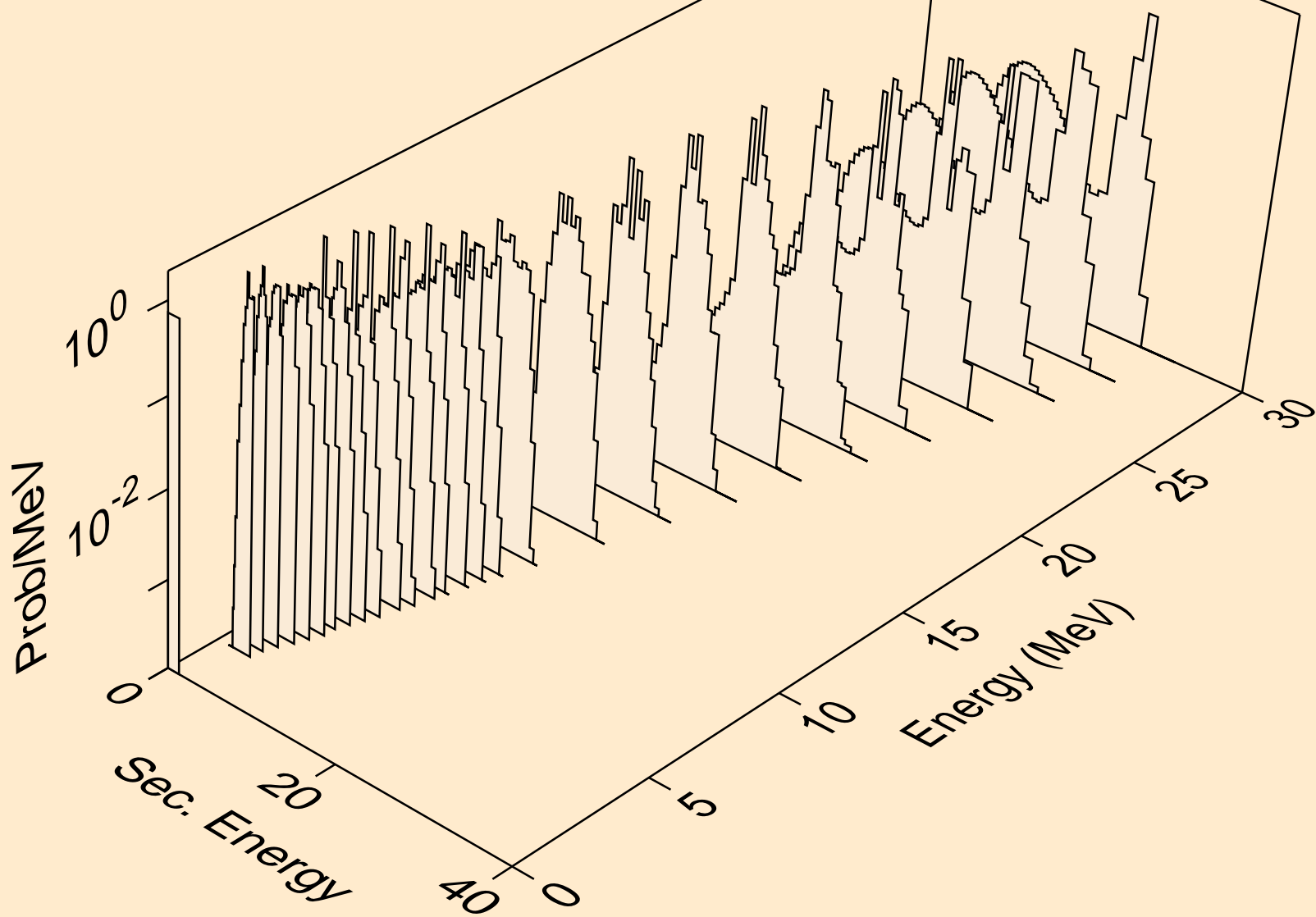

U227 NEUTRON ACER TENDL-2021 LIBRARY; T=293.6K
protons from (n,pd)

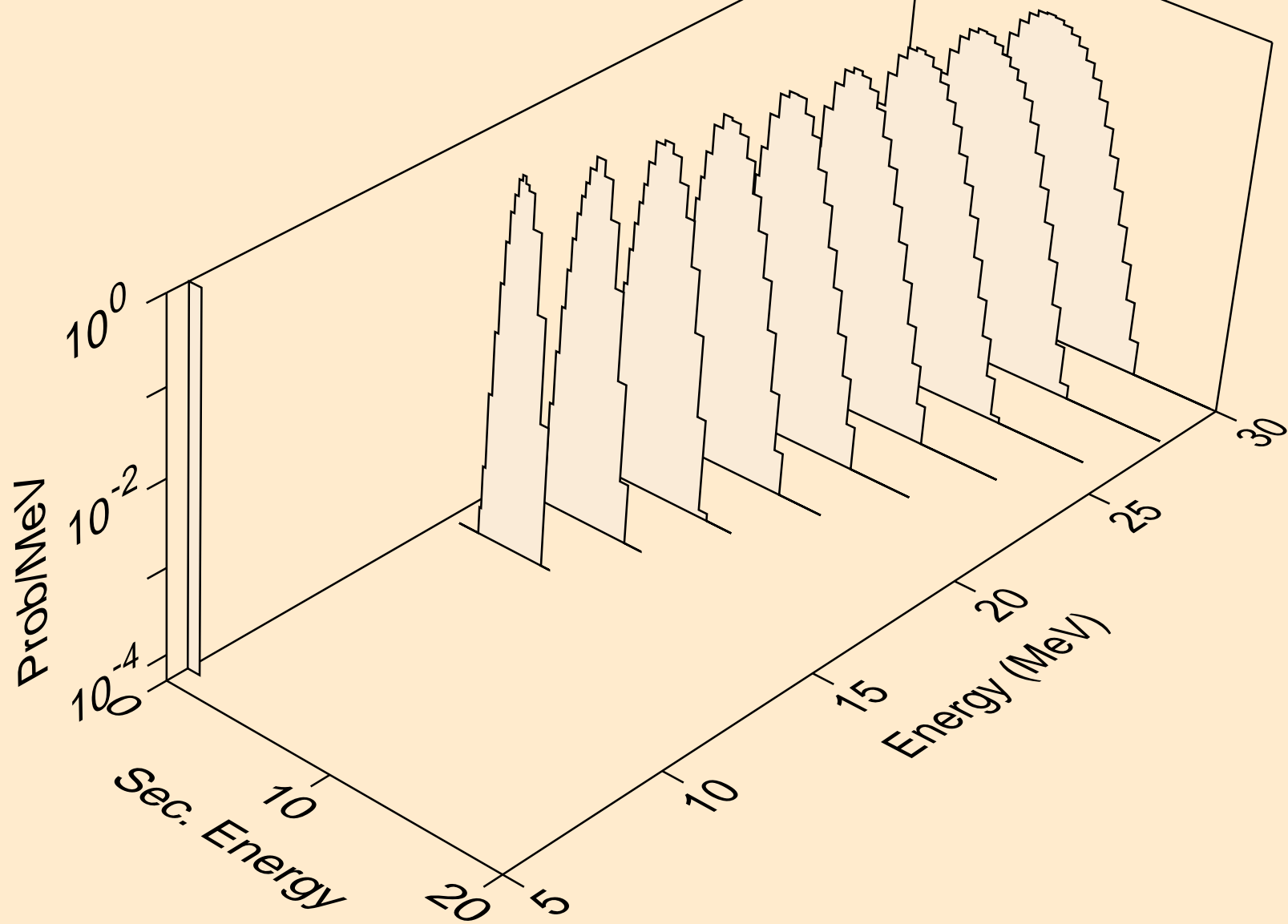

U227 NEUTRON ACER TENDL-2021 LIBRARY; T=293.6K
protons from (n,pt)

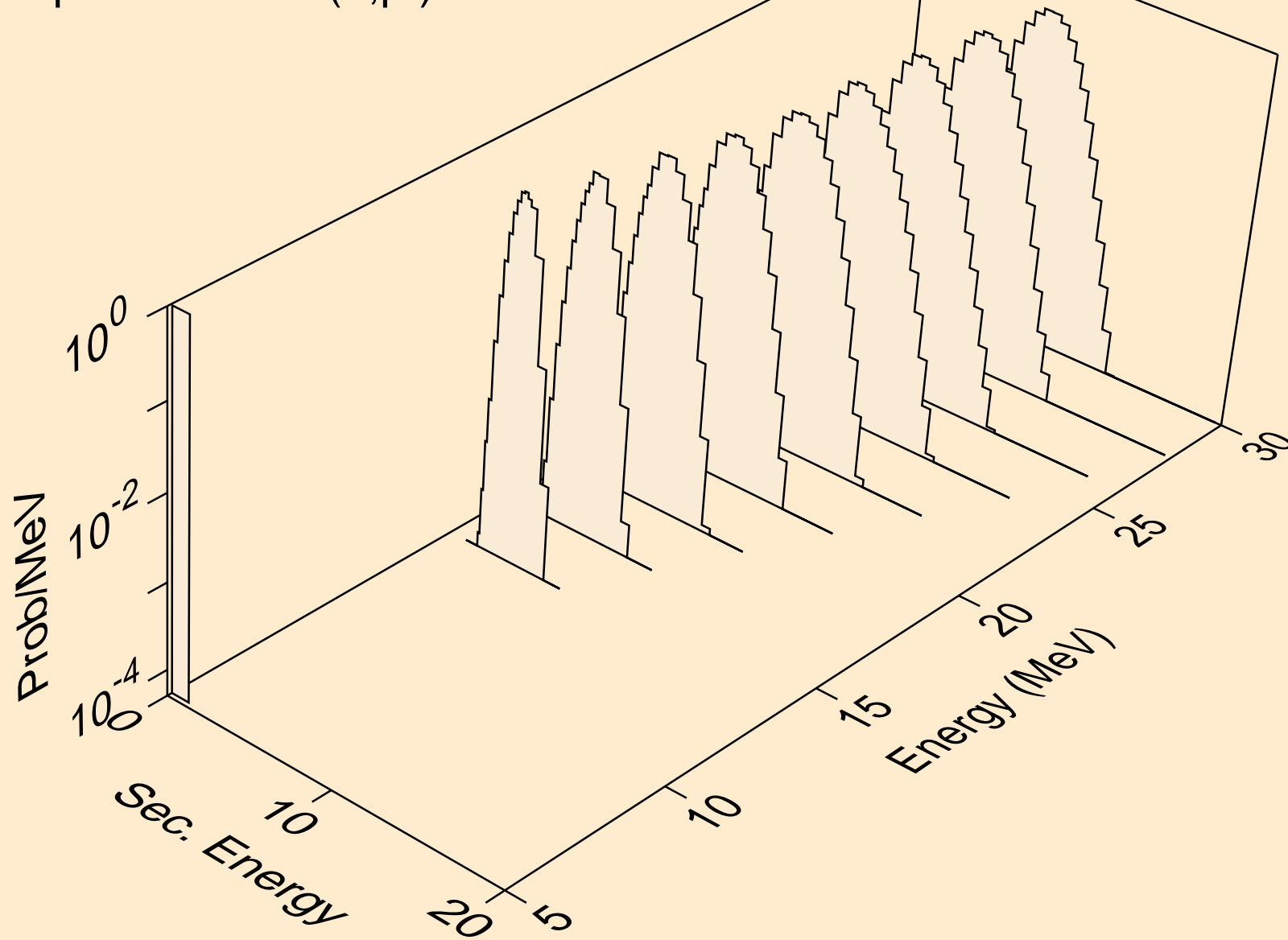

U227 NEUTRON ACER TENDL-2021 LIBRARY; T=293.6K
deuterons from (n,x)

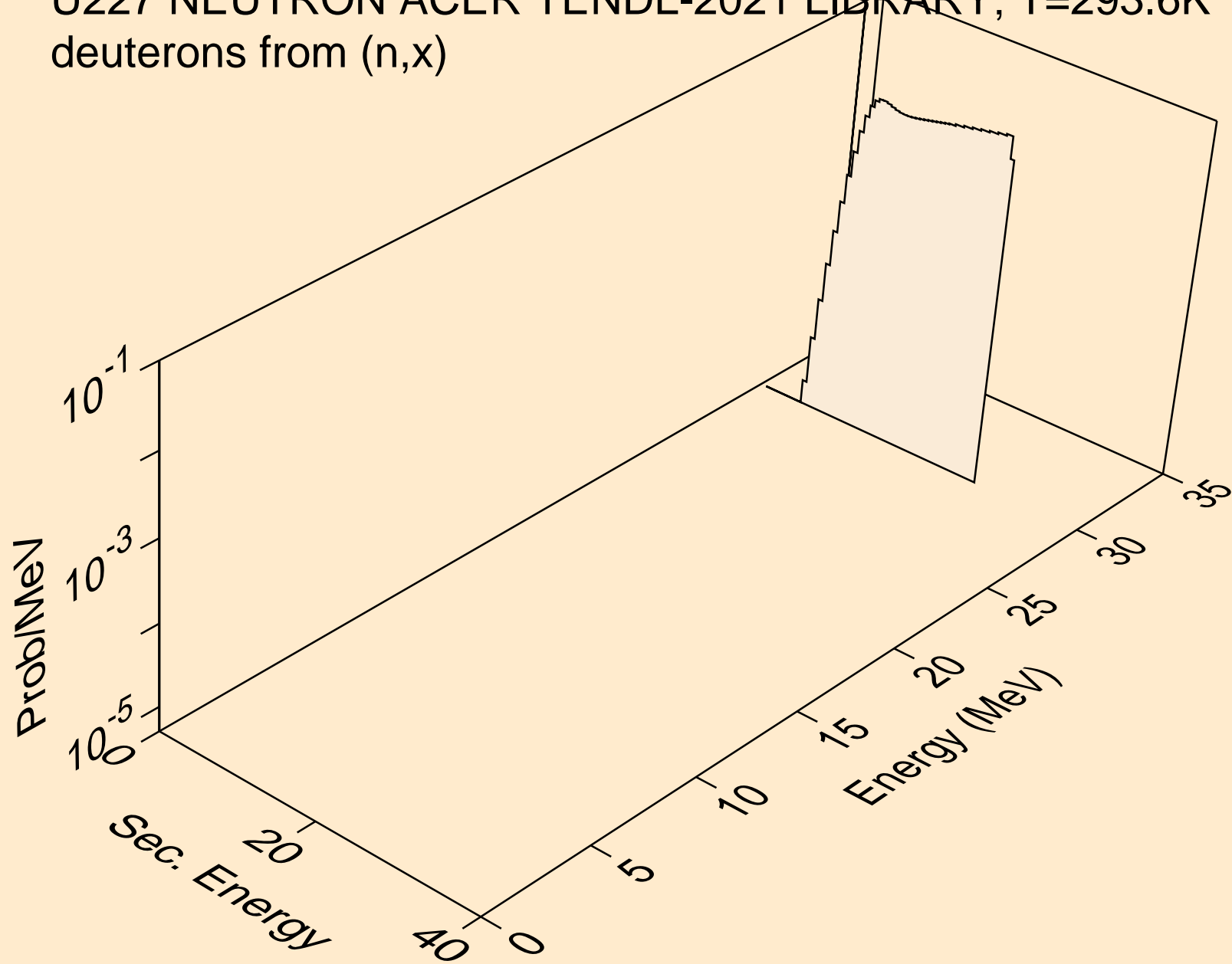

U227 NEUTRON ACER TENDL-2021 LIBRARY; T=293.6K
deuterons from (n,2nd)

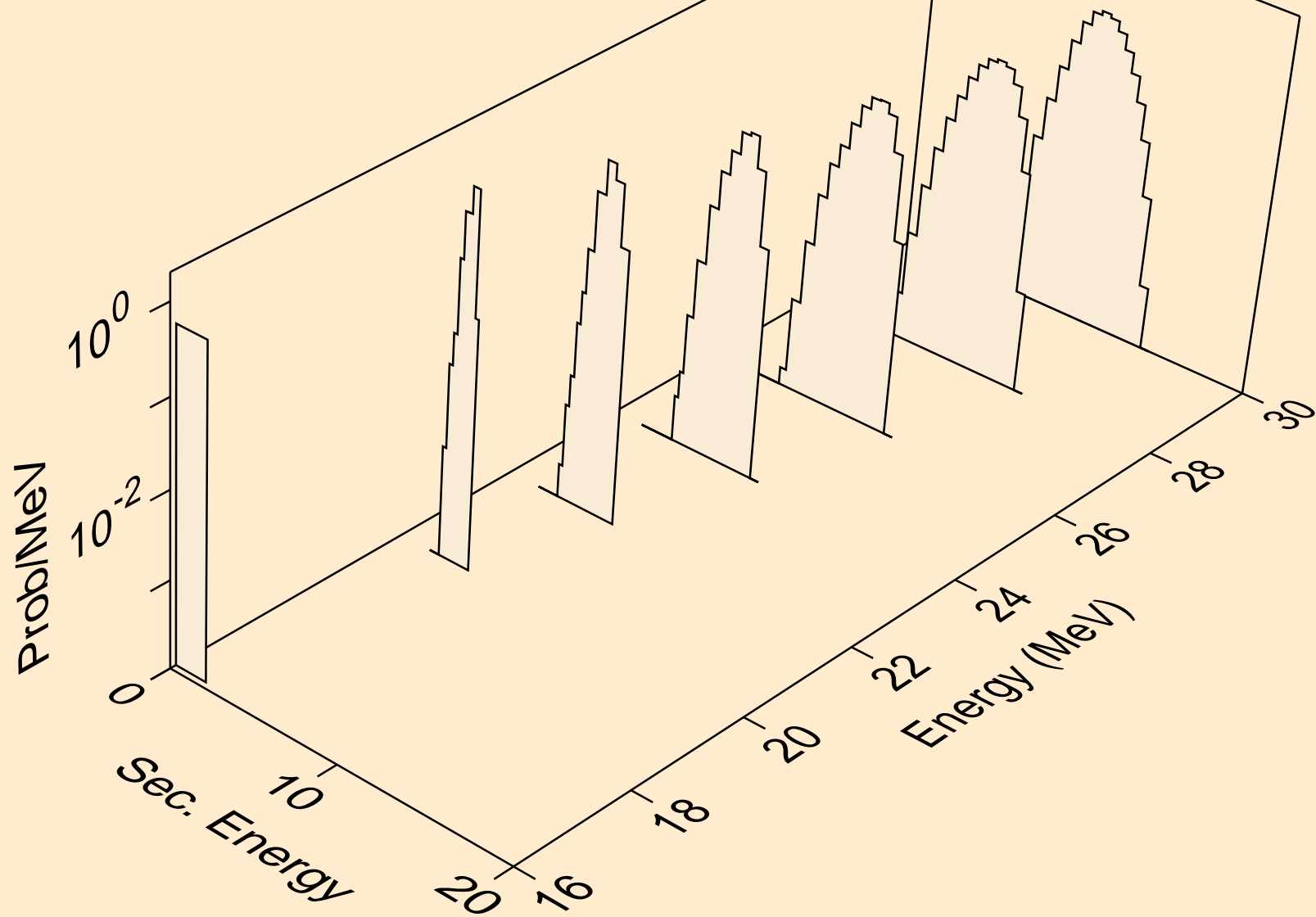

U227 NEUTRON ACER TENDL-2021 LIBRARY; T=293.6K
deuterons from (n,n*)d

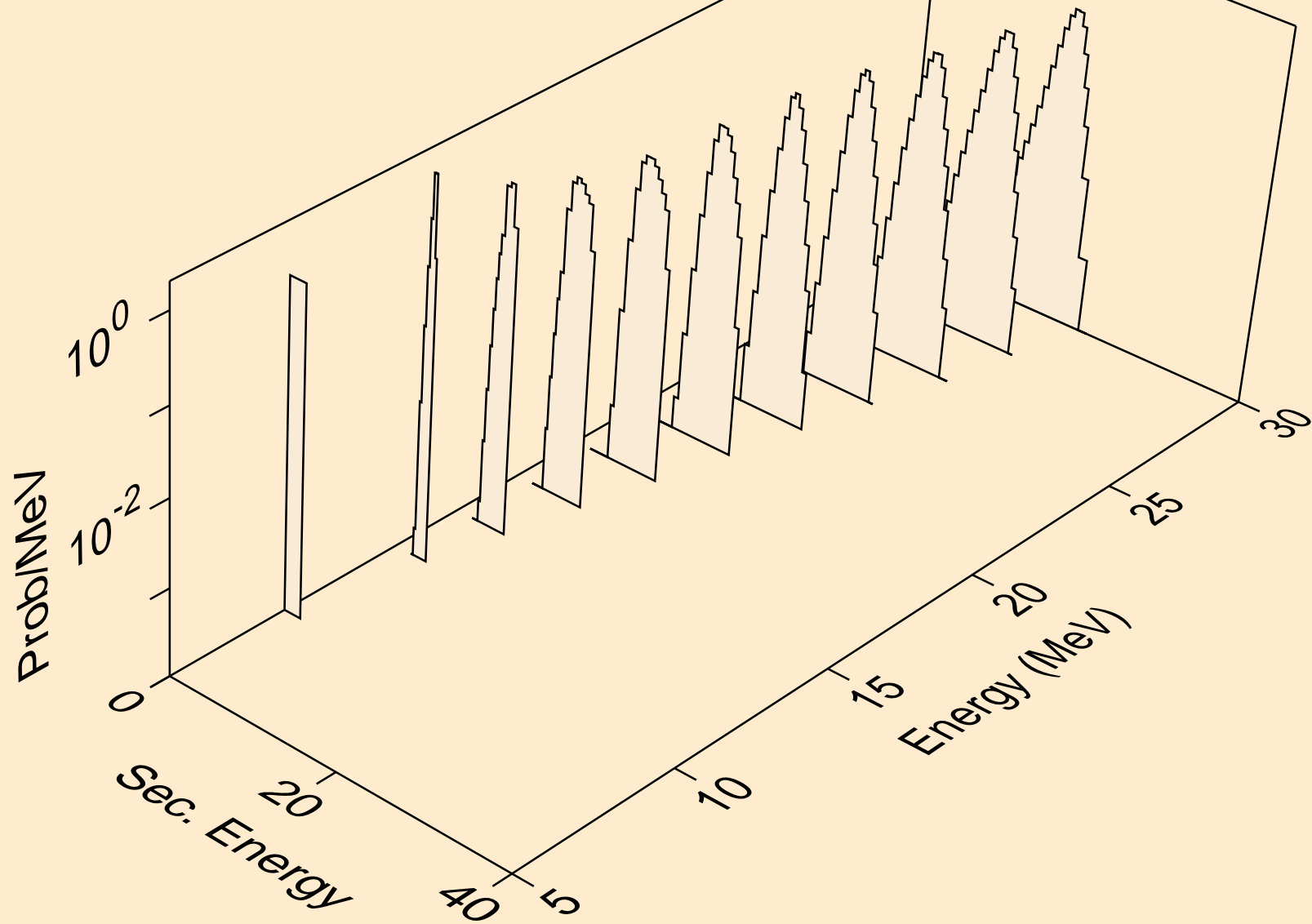

U227 NEUTRON ACER TENDL-2021 LIBRARY; T=293.6K
deuterons from (n,d)

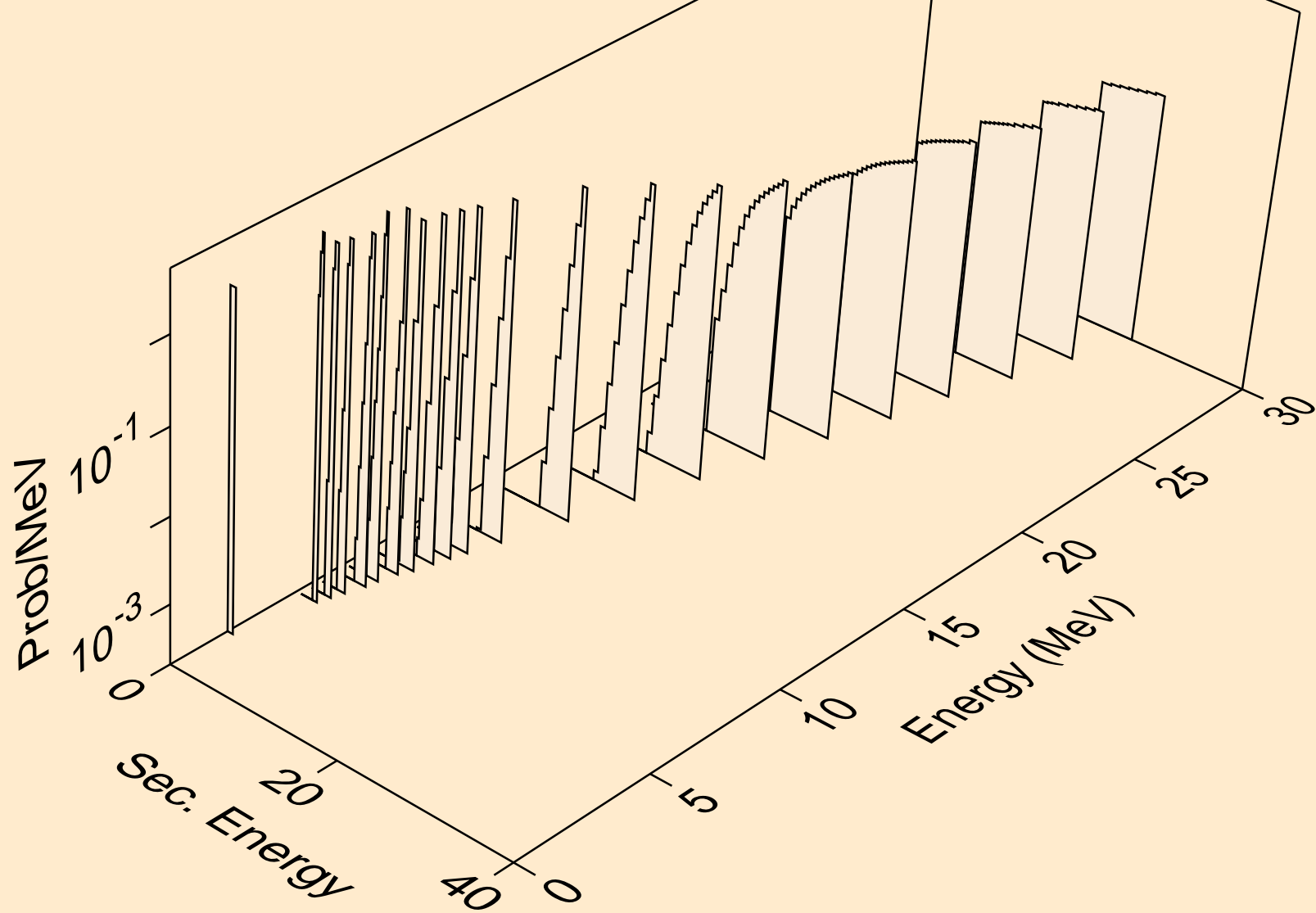

U227 NEUTRON ACER TENDL-2021 LIBRARY; T=293.6K
deuterons from (n,pd)

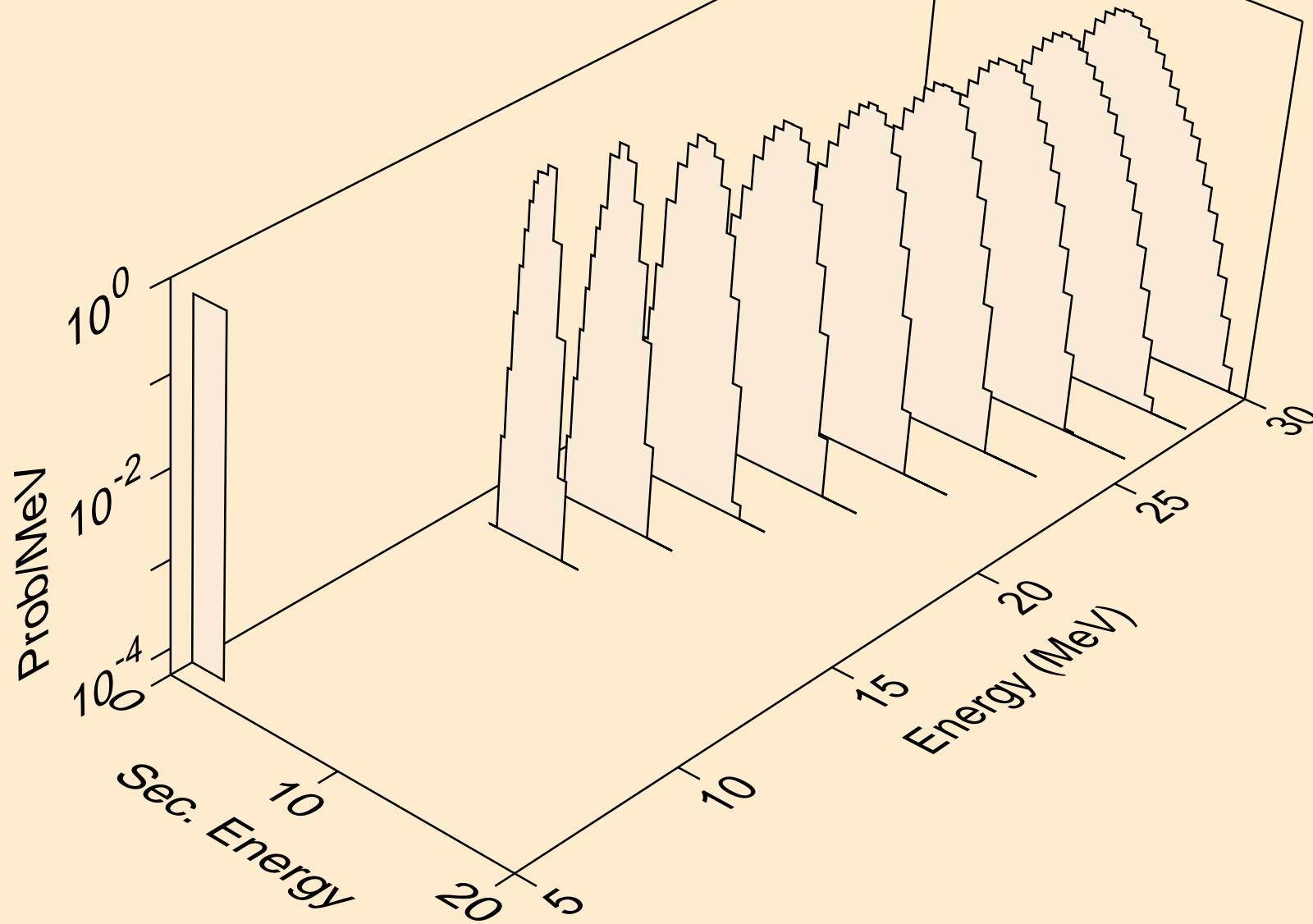

U227 NEUTRON ACER TENDL-2021 LIBRARY; T=293.6K
deuterons from (n,da)

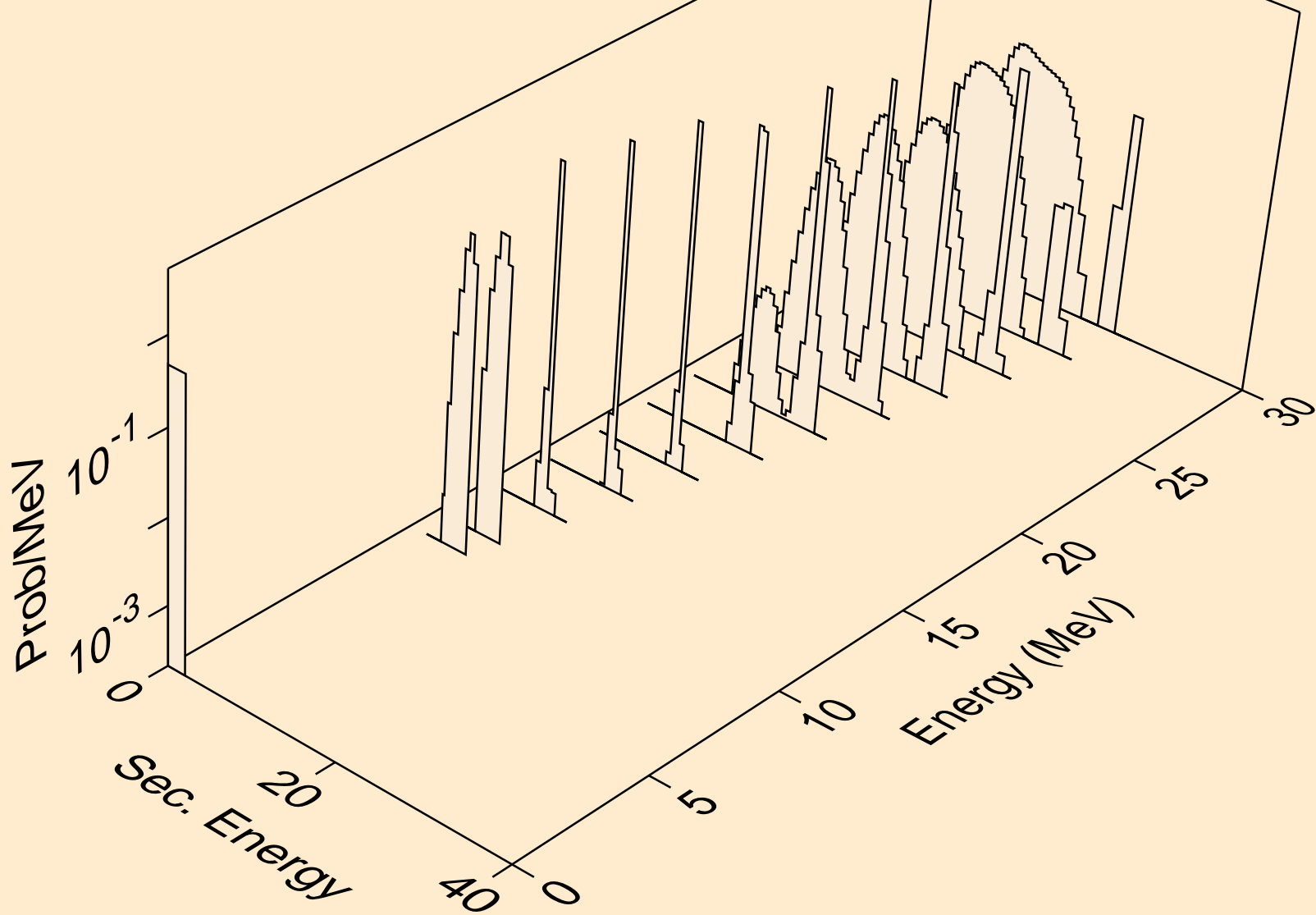

U227 NEUTRON ACER TENDL-2021 LIBRARY; T=293.6K
tritons from (n,x)

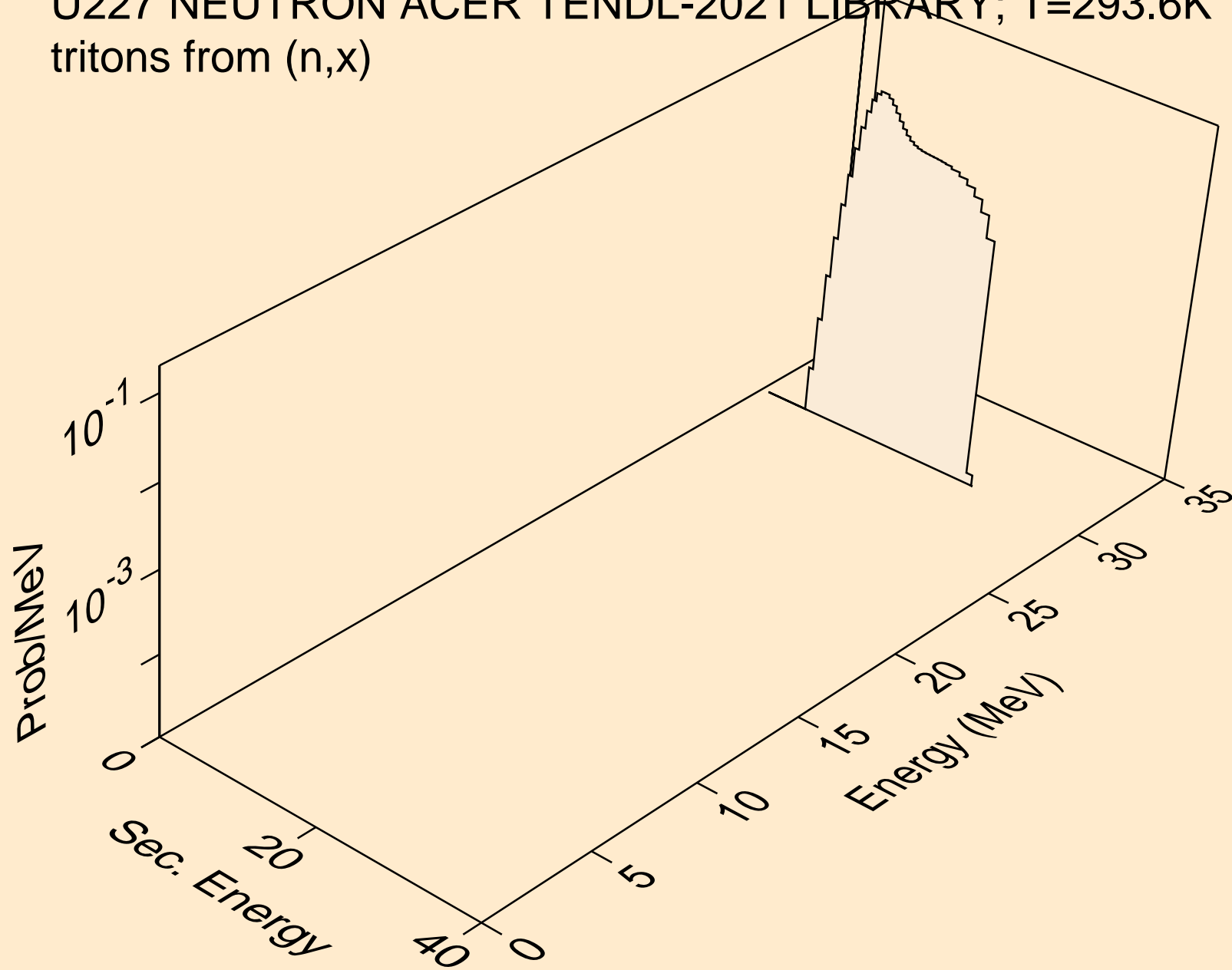

U227 NEUTRON ACER TENDL-2021 LIBRARY; T=293.6K
tritons from (n,n*)t

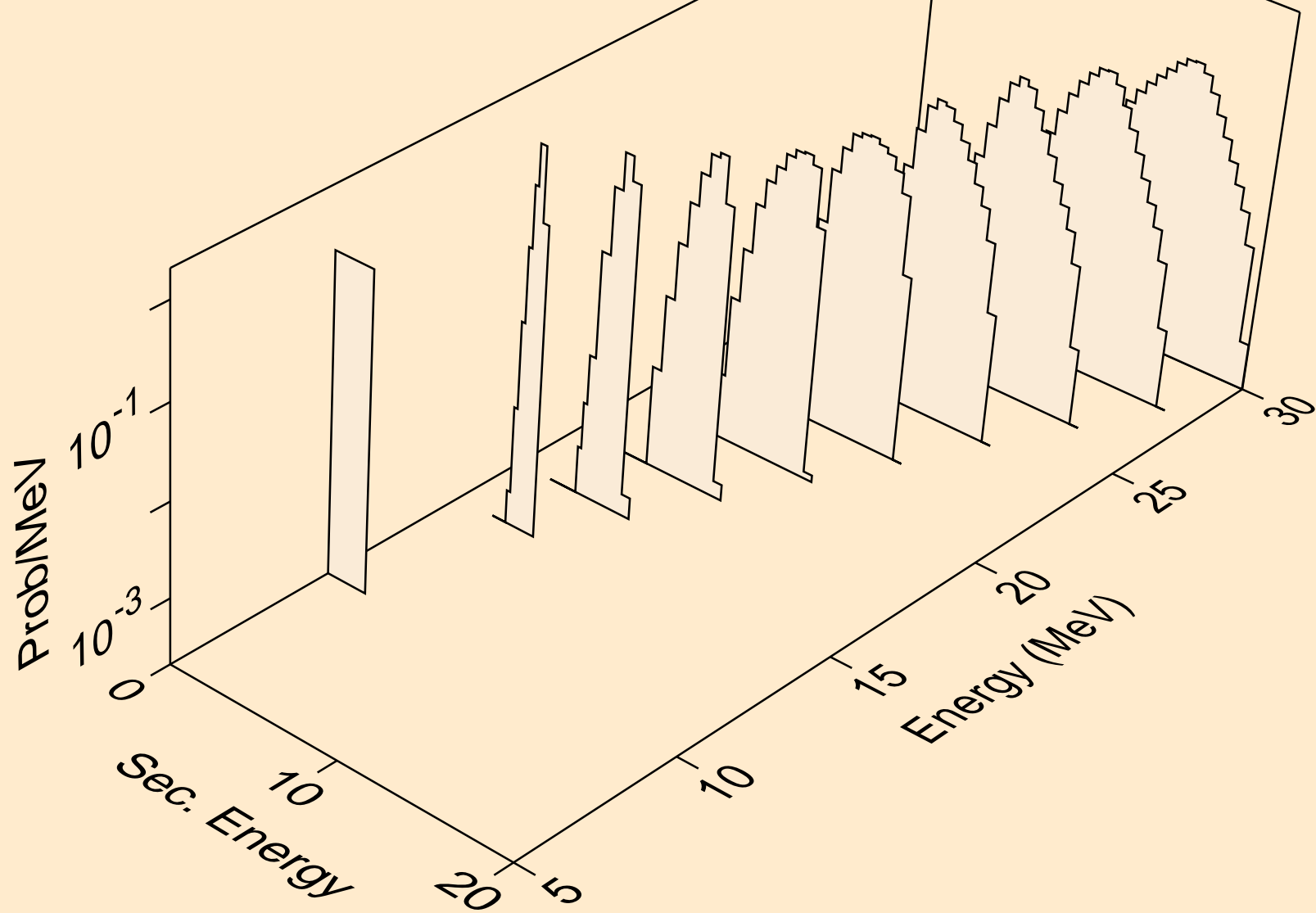

U227 NEUTRON ACER TENDL-2021 LIBRARY; T=293.6K
tritons from (n,t)

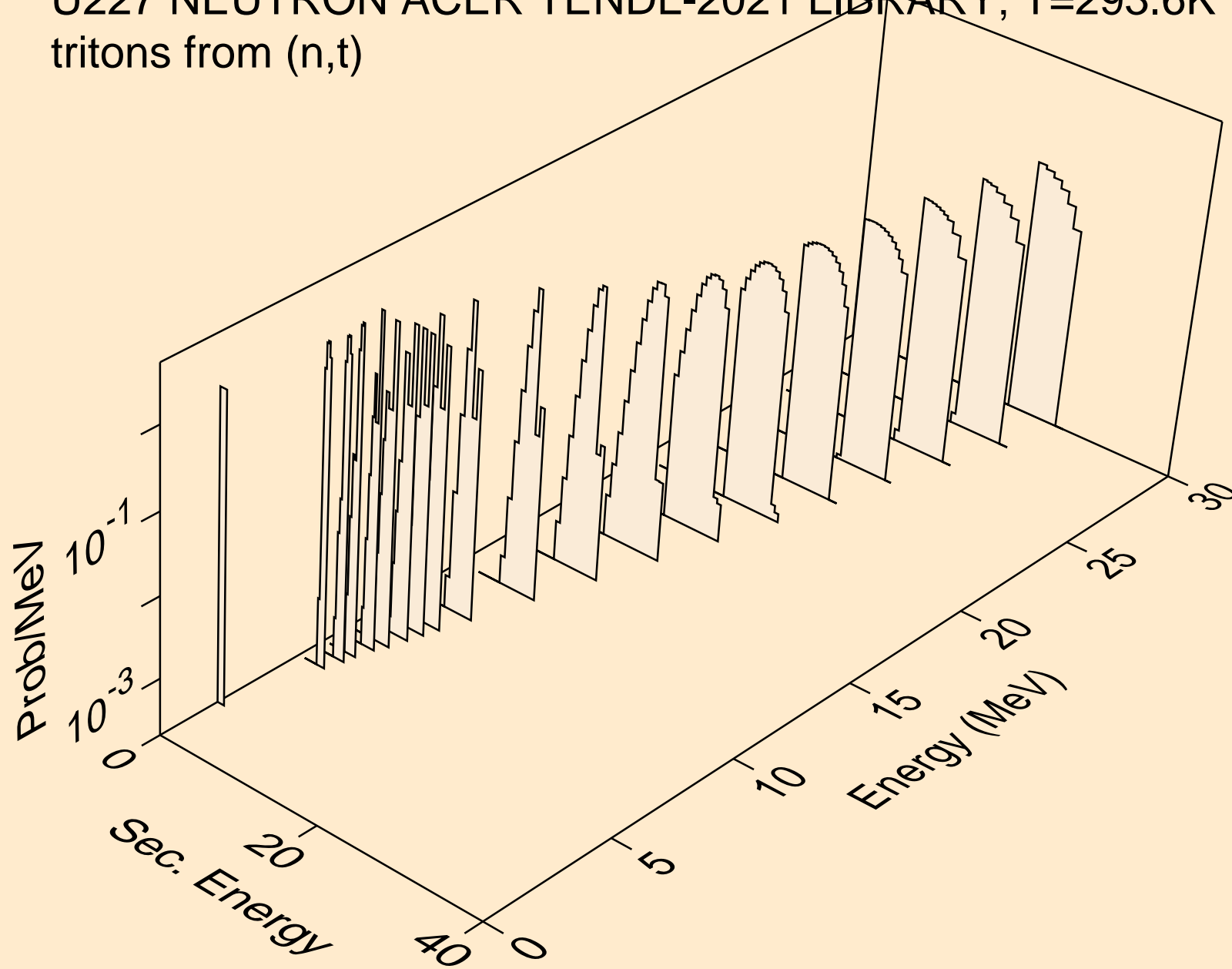

U227 NEUTRON ACER TENDL-2021 LIBRARY; T=293.6K
tritons from (n,pt)

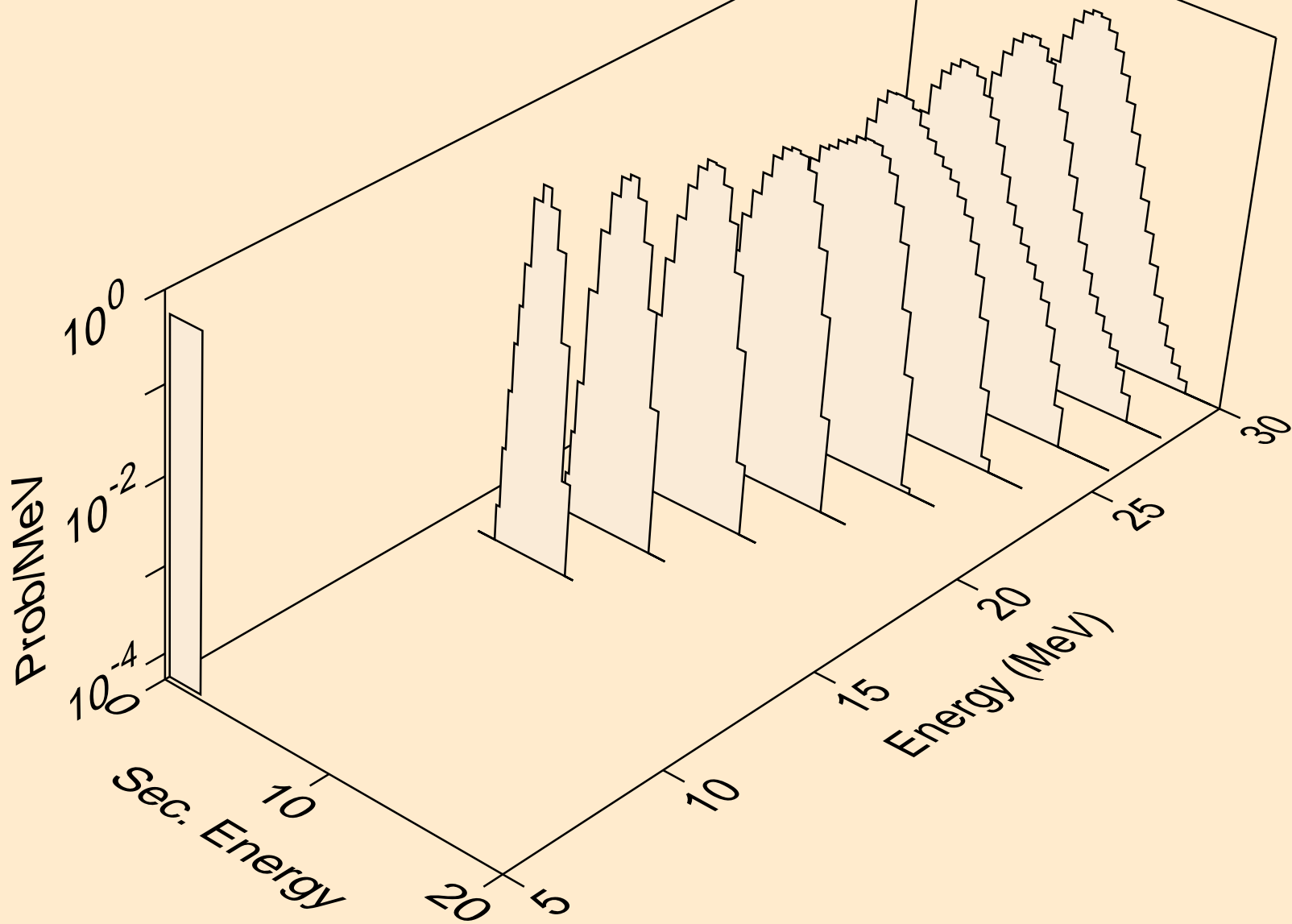

U227 NEUTRON ACER TENDL-2021 LIBRARY; T=293.6K
he3s from (n,x)

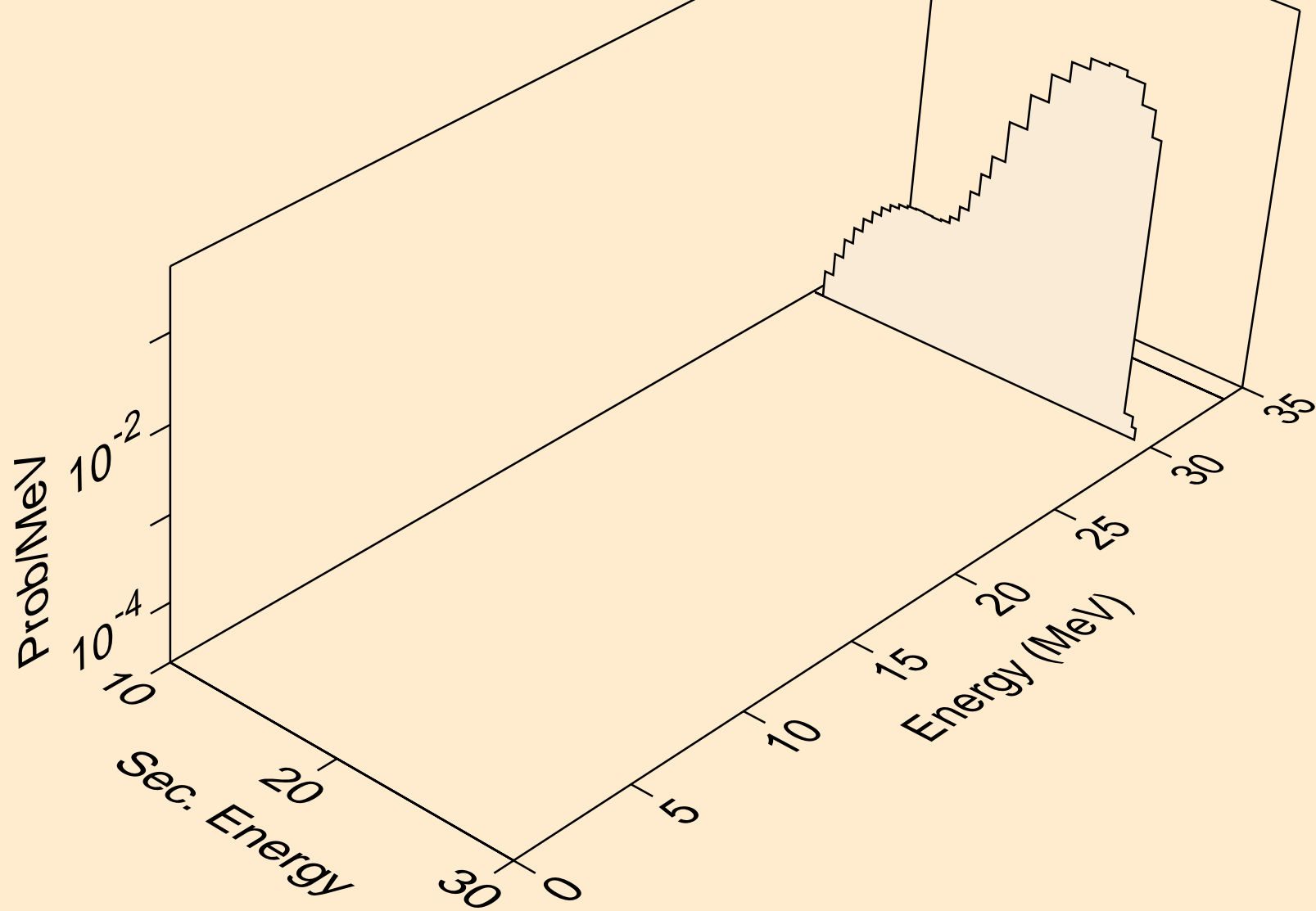

U227 NEUTRON ACER TENDL-2021 LIBRARY; T=293.6K
he3s from (n,n*)he3

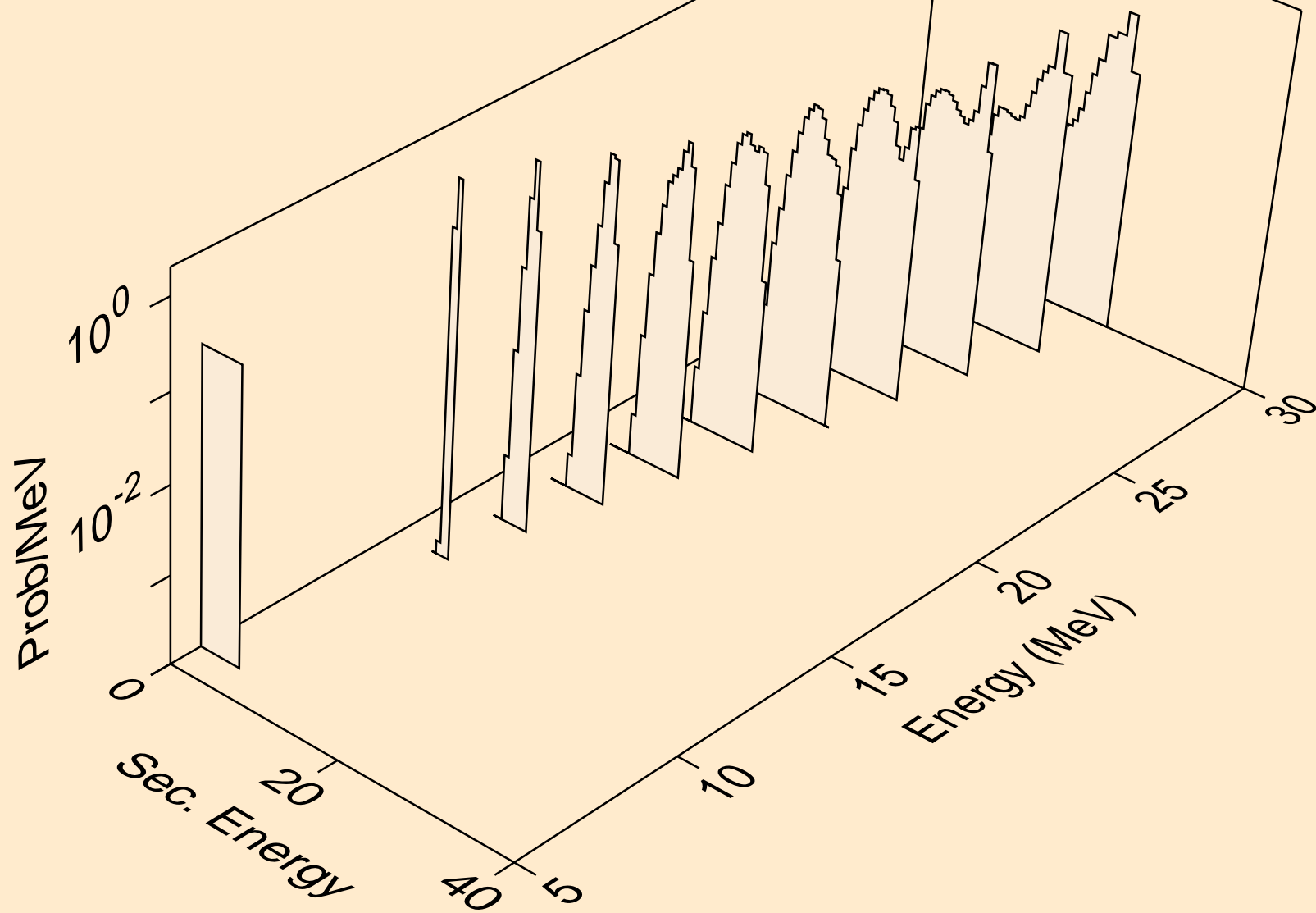

U227 NEUTRON ACER TENDL-2021 LIBRARY; T=293.6K
he3s from (n,he3)

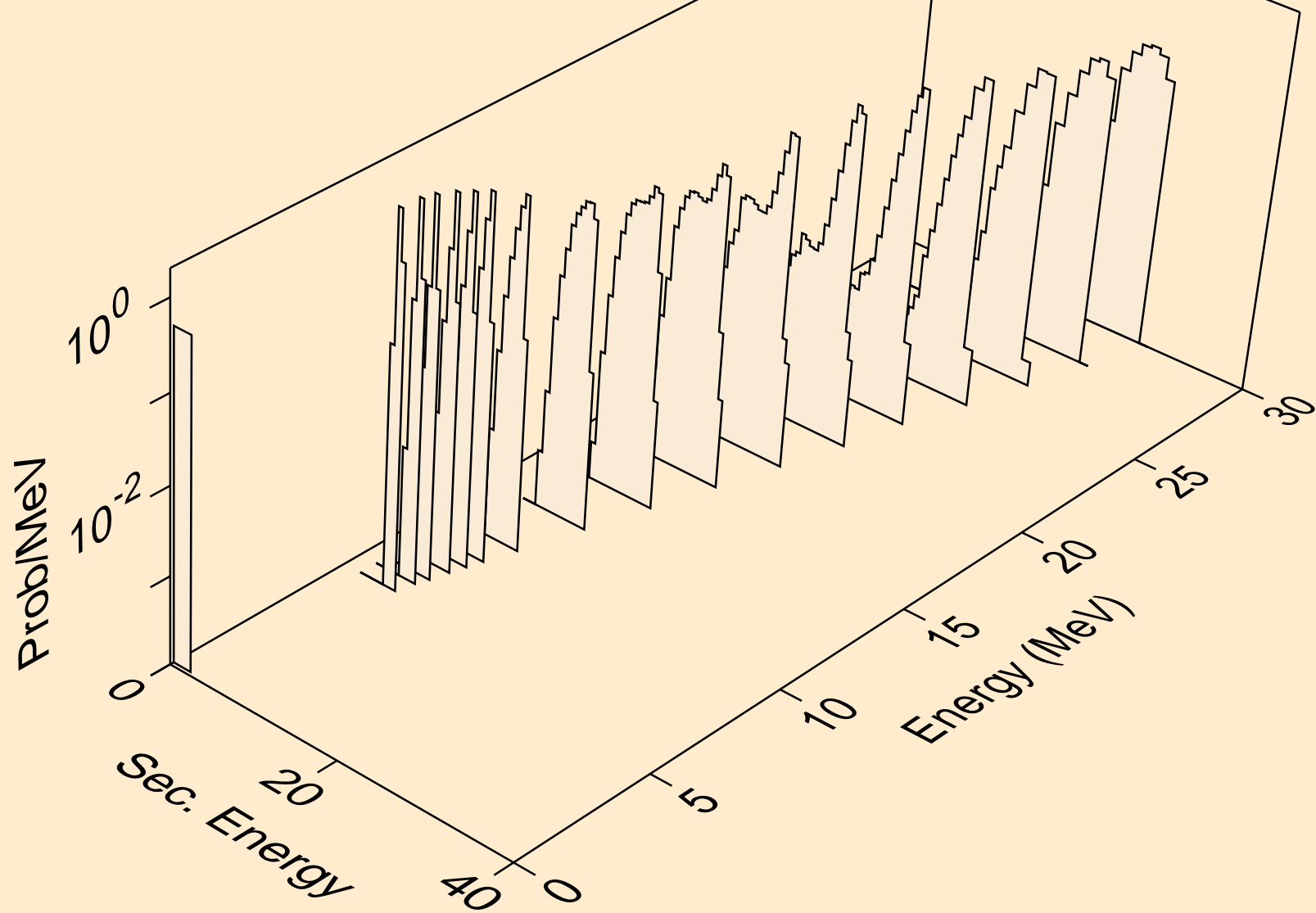

U227 NEUTRON ACER TENDL-2021 LIBRARY; T=293.6K
alphas from (n,x)

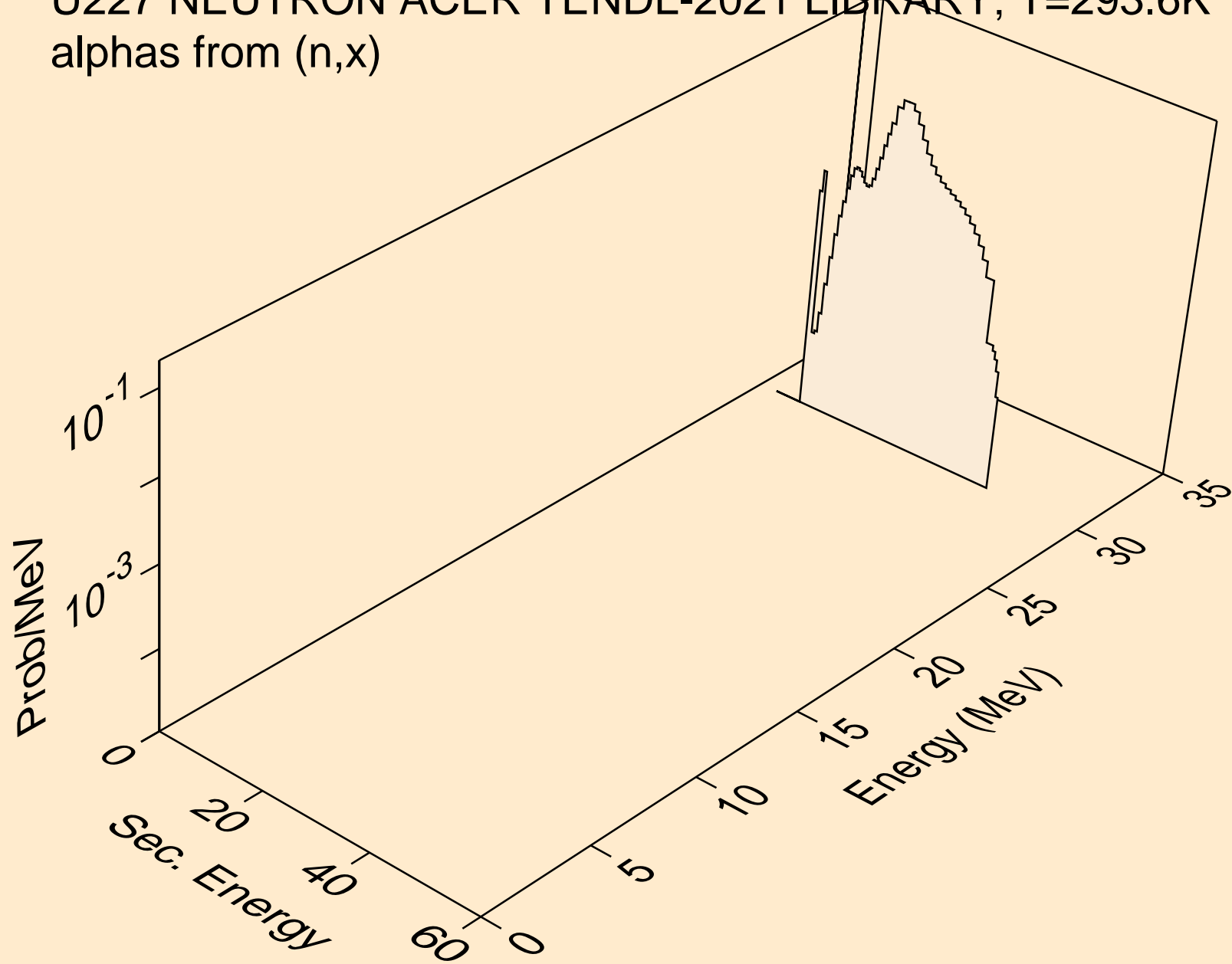

U227 NEUTRON ACER TENDL-2021 LIBRARY; T=293.6K
alphas from (n,n*)a

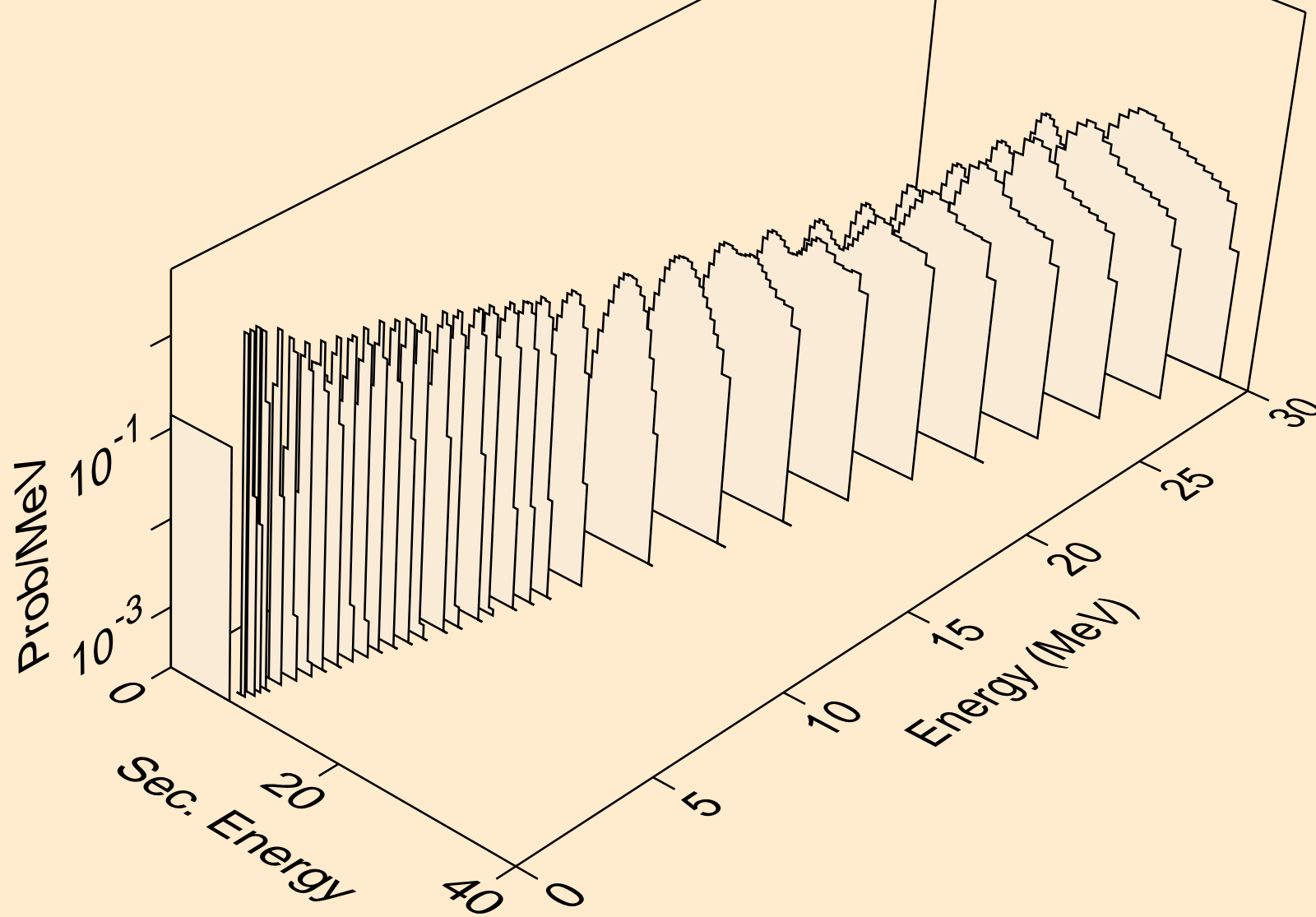

U227 NEUTRON ACER TENDL-2021 LIBRARY; T=293.6K
alphas from (n,2n)a

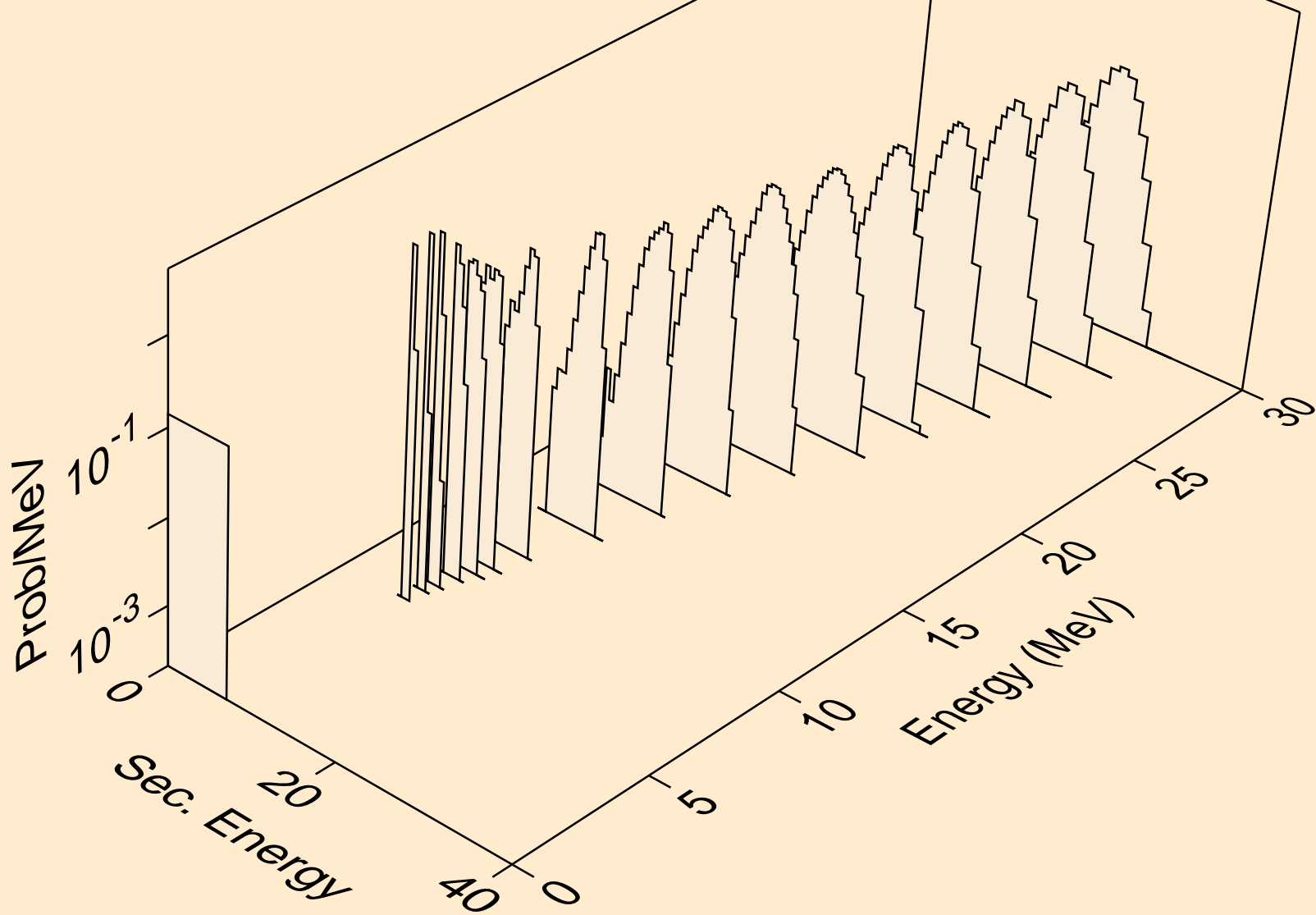

U227 NEUTRON ACER TENDL-2021 LIBRARY; T=293.6K
alphas from (n,3n)a

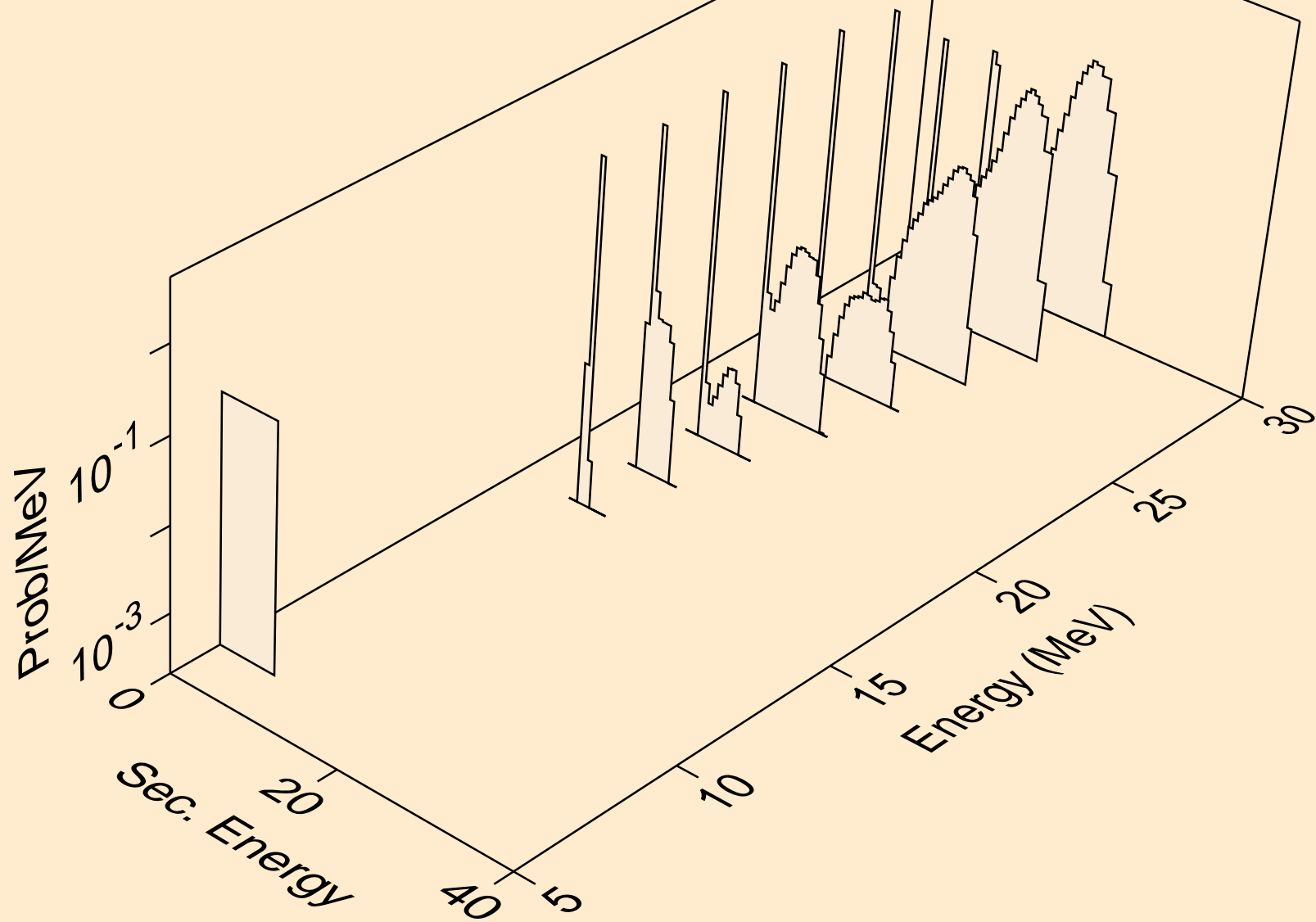

U227 NEUTRON ACER TENDL-2021 LIBRARY; T=293.6K
alphas from (n,n*)2a

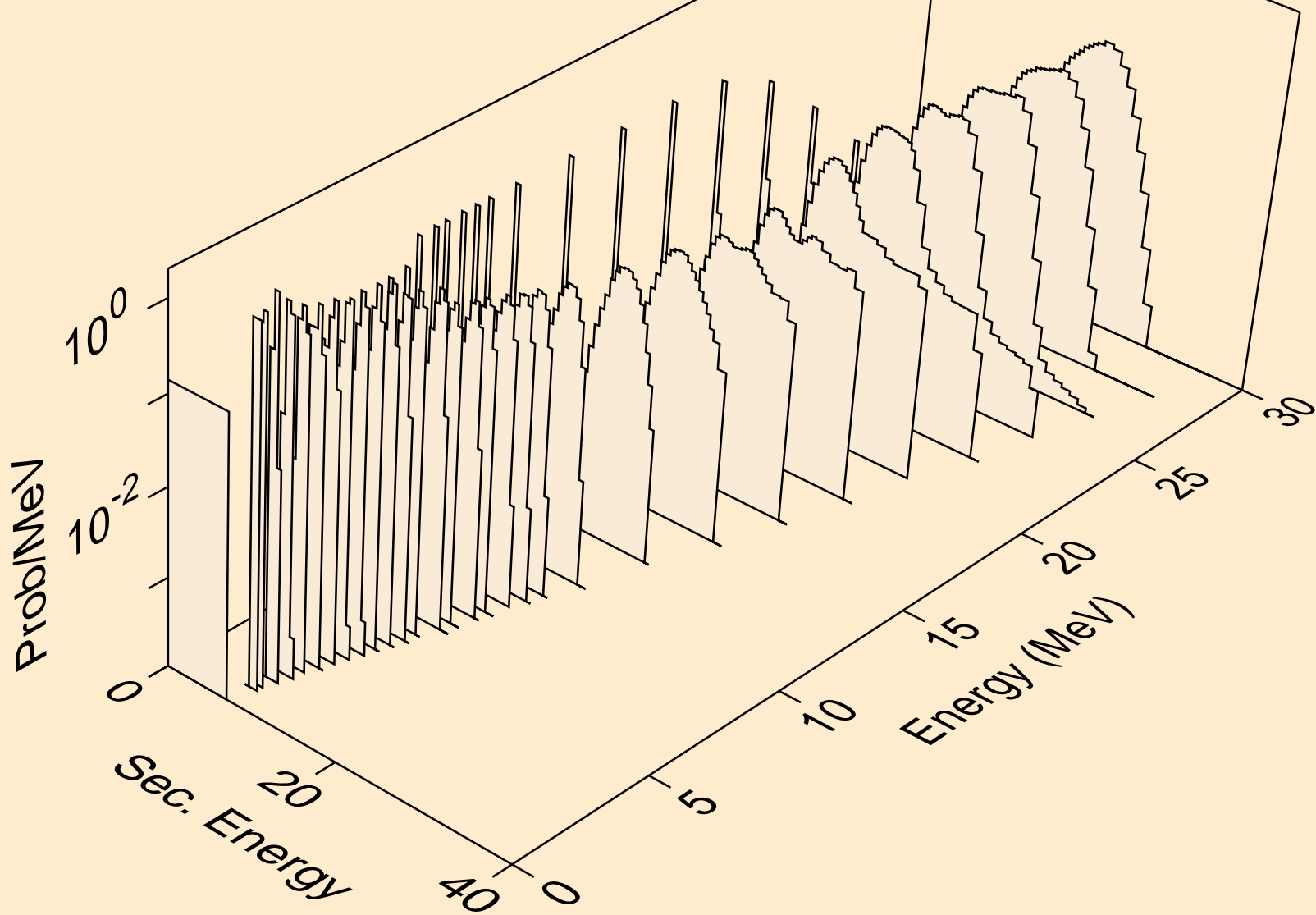

U227 NEUTRON ACER TENDL-2021 LIBRARY; T=293.6K
alphas from (n,2n)2a

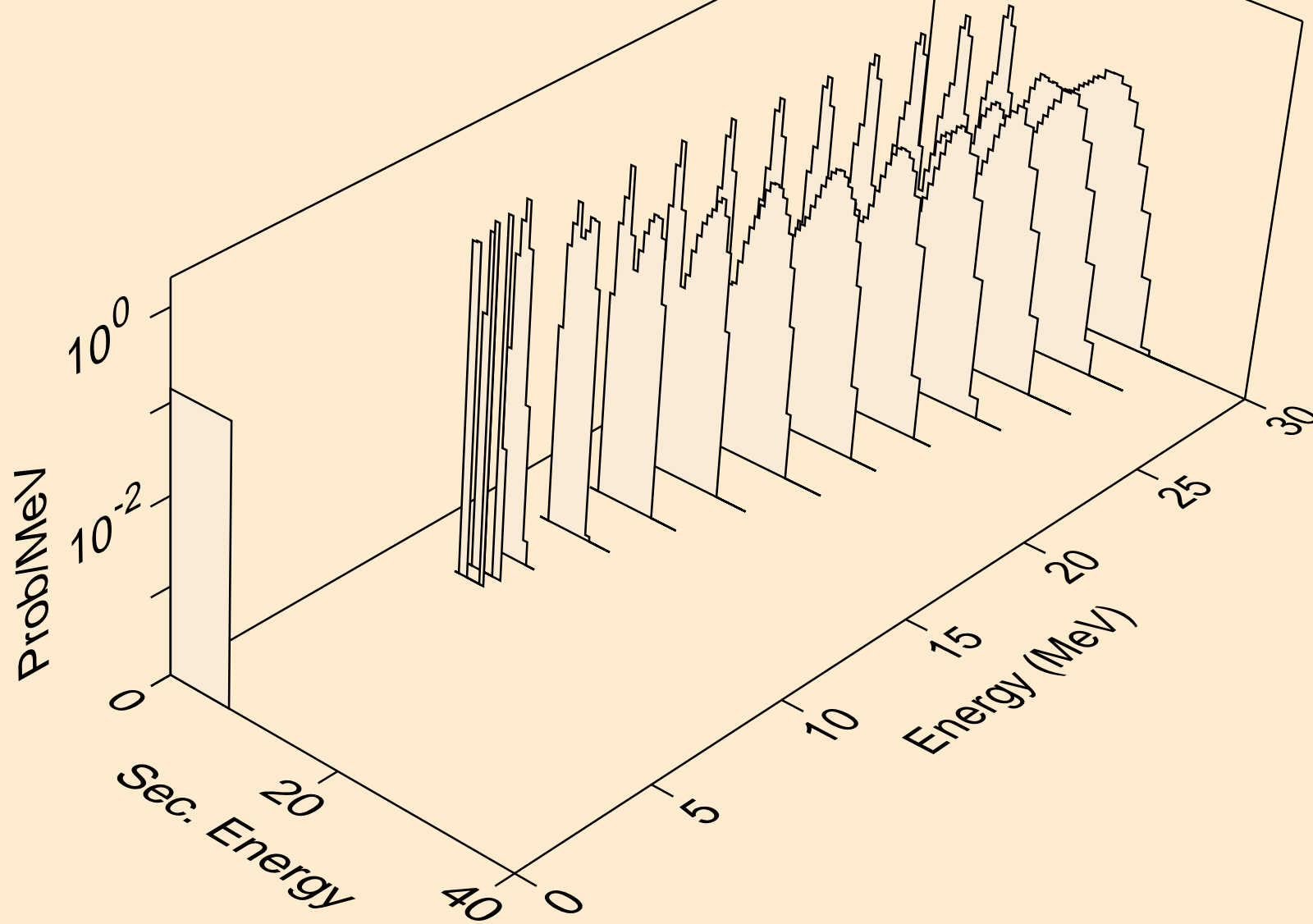

U227 NEUTRON ACER TENDL-2021 LIBRARY; T=293.6K
alphas from (n,npa)

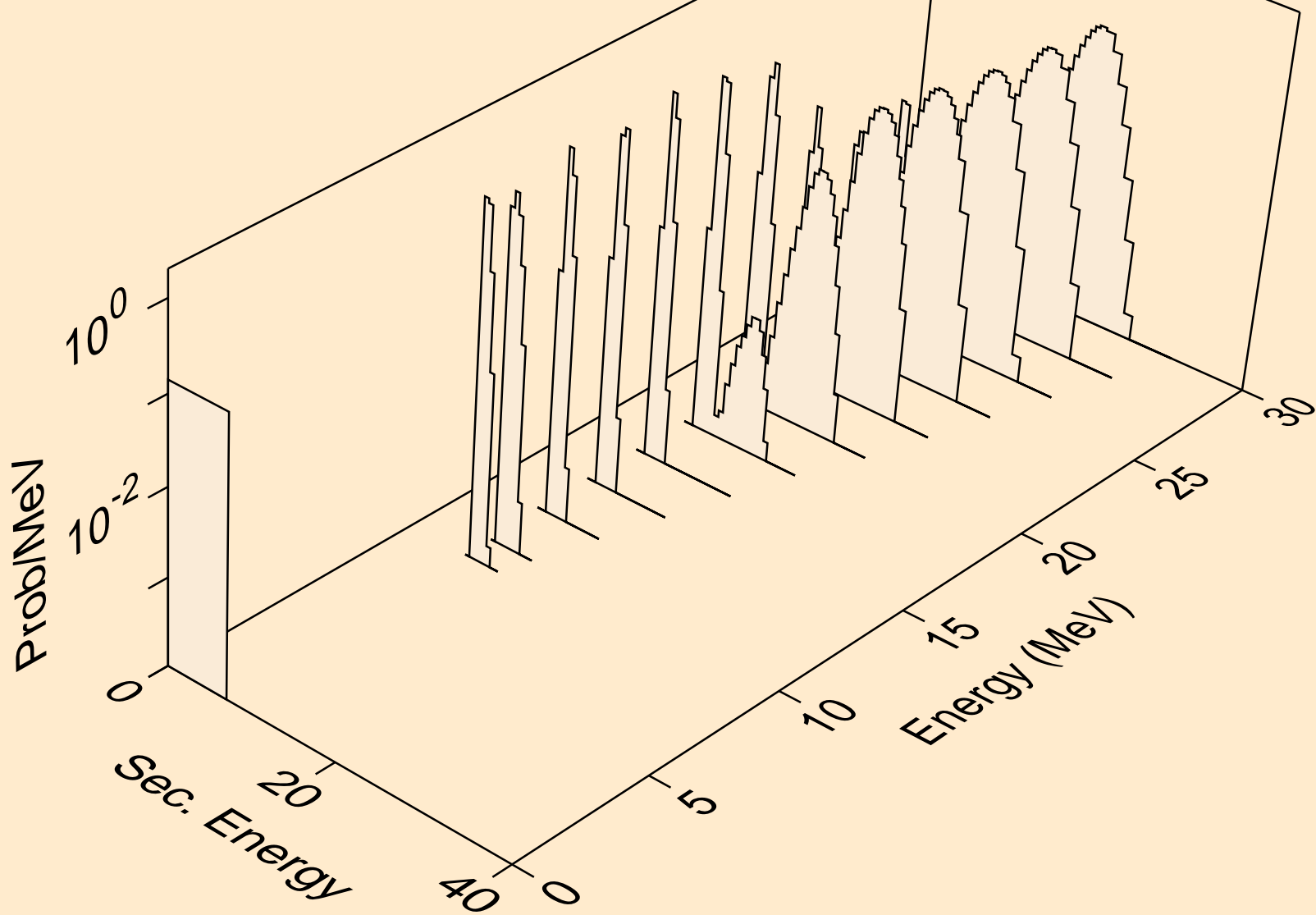

U227 NEUTRON ACER TENDL-2021 LIBRARY; T=293.6K
alphas from (n,a)

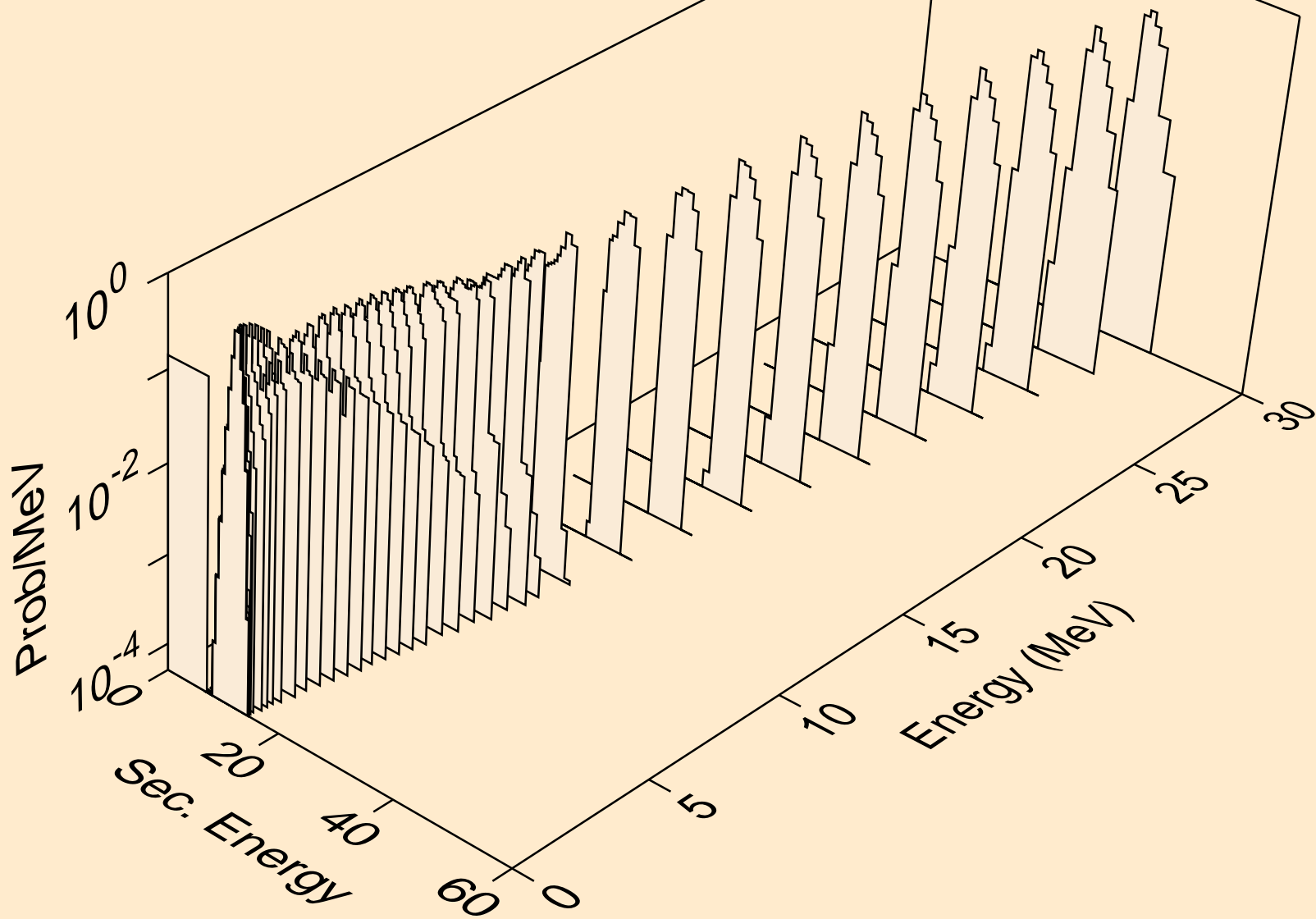

U227 NEUTRON ACER TENDL-2021 LIBRARY; T=293.6K
alphas from (n,2a)

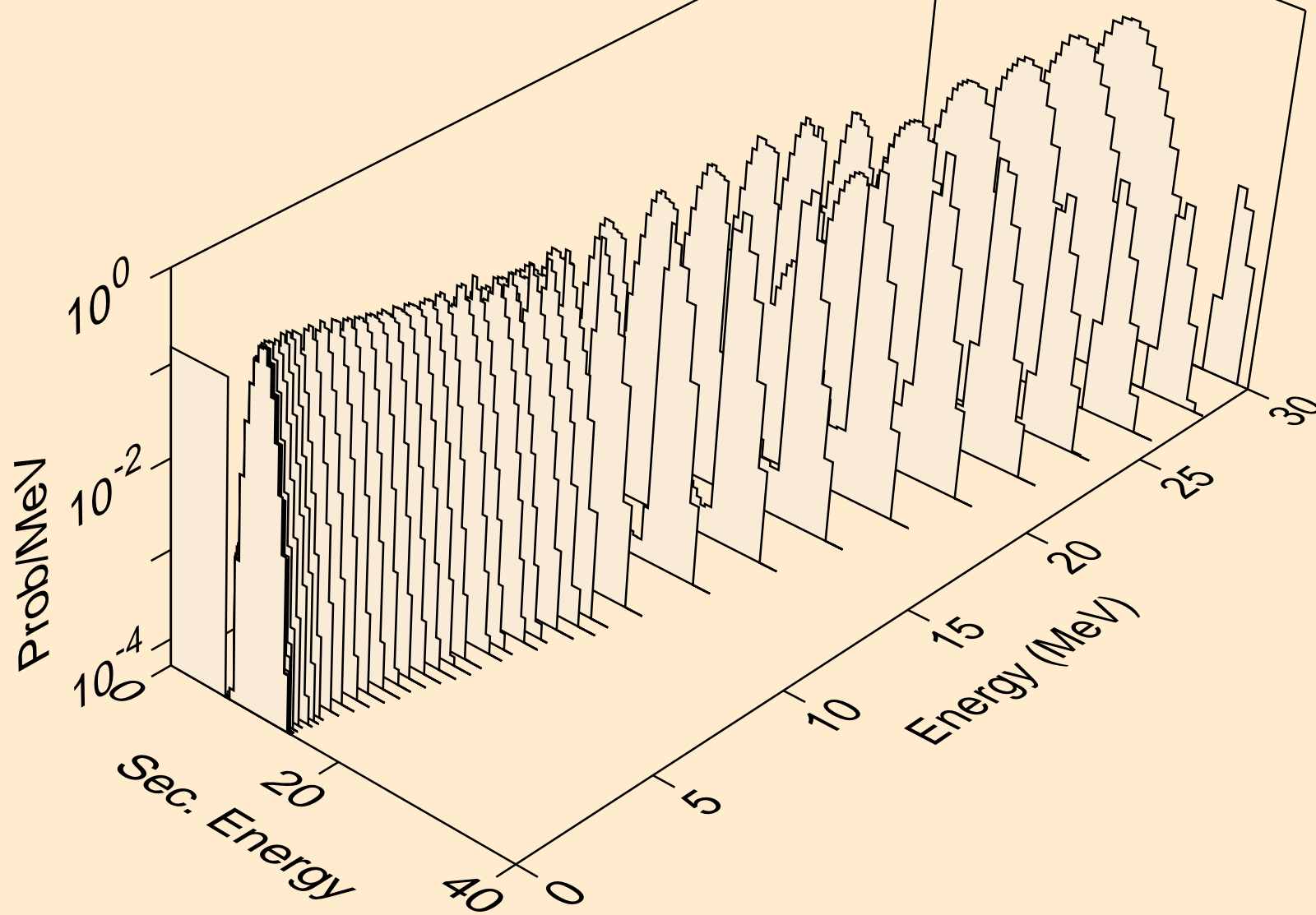

U227 NEUTRON ACER TENDL-2021 LIBRARY; T=293.6K
alphas from (n,pa)

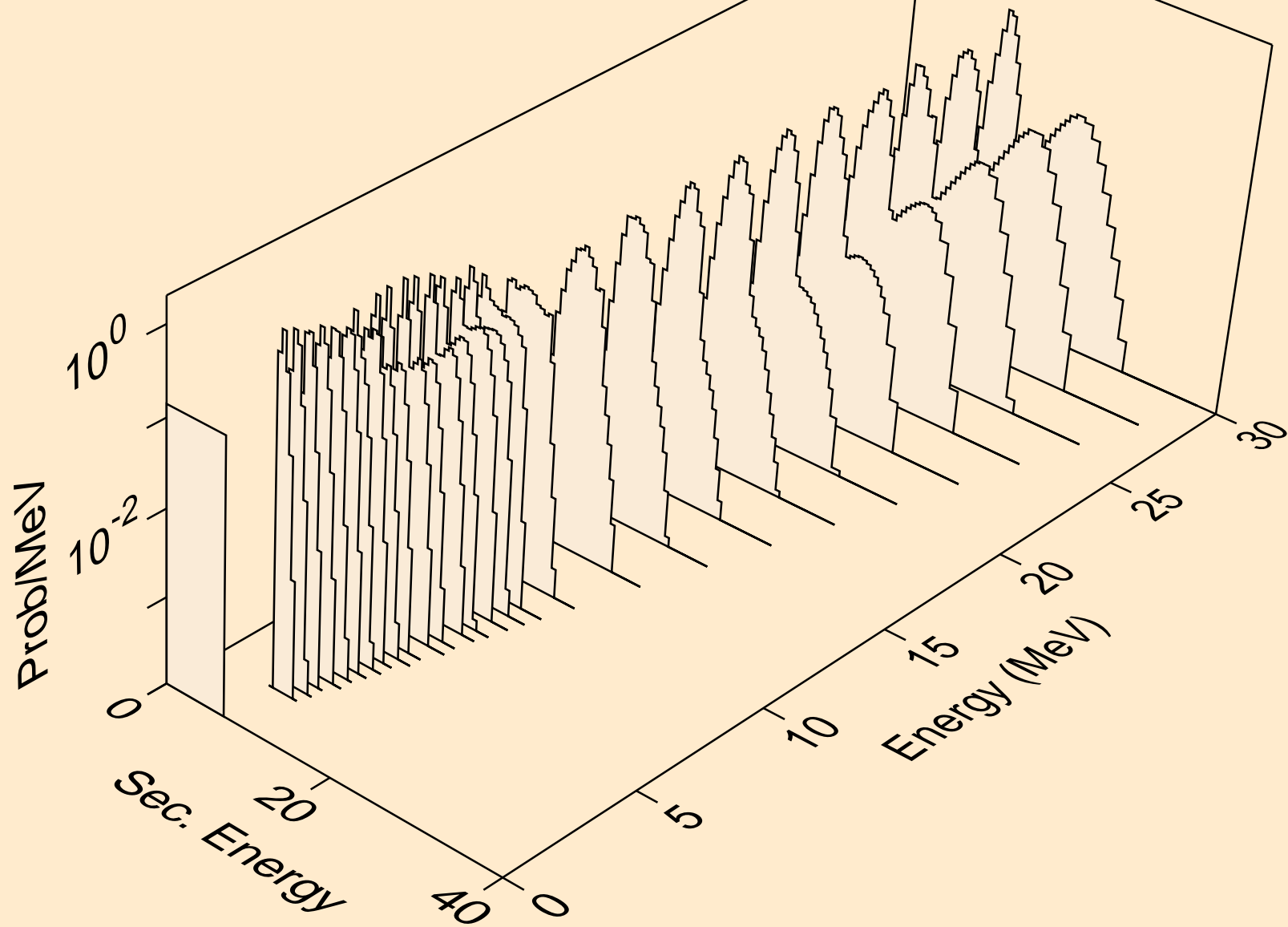

U227 NEUTRON ACER TENDL-2021 LIBRARY; T=293.6K
alphas from (n,da)

