

U231 NEUTRON ACER TENDL-2021 LIBRARY; T=293.6K

Principal cross sections

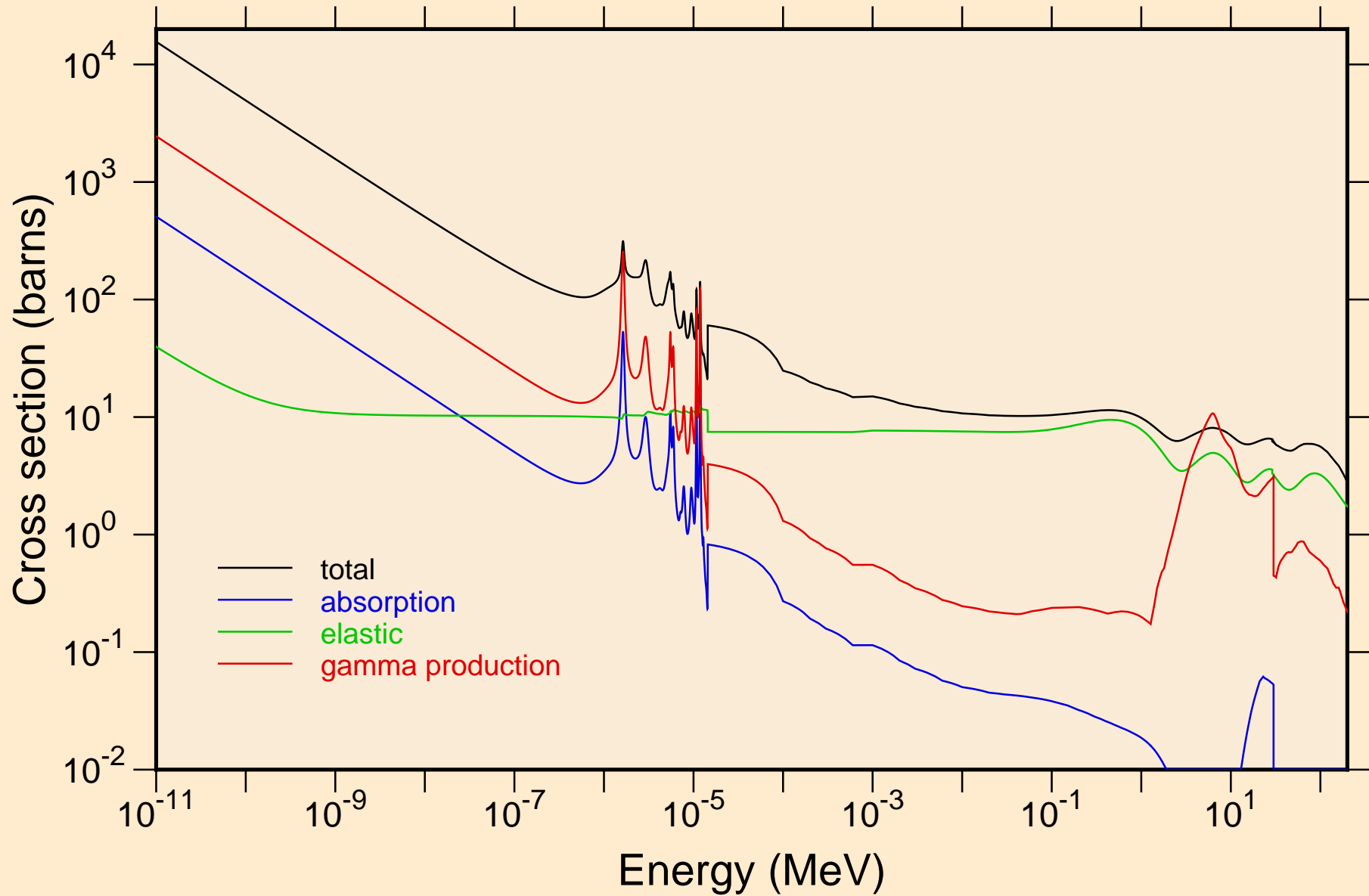

U231 NEUTRON ACER TENDL-2021 LIBRARY; T=293.6K
resonance total cross section

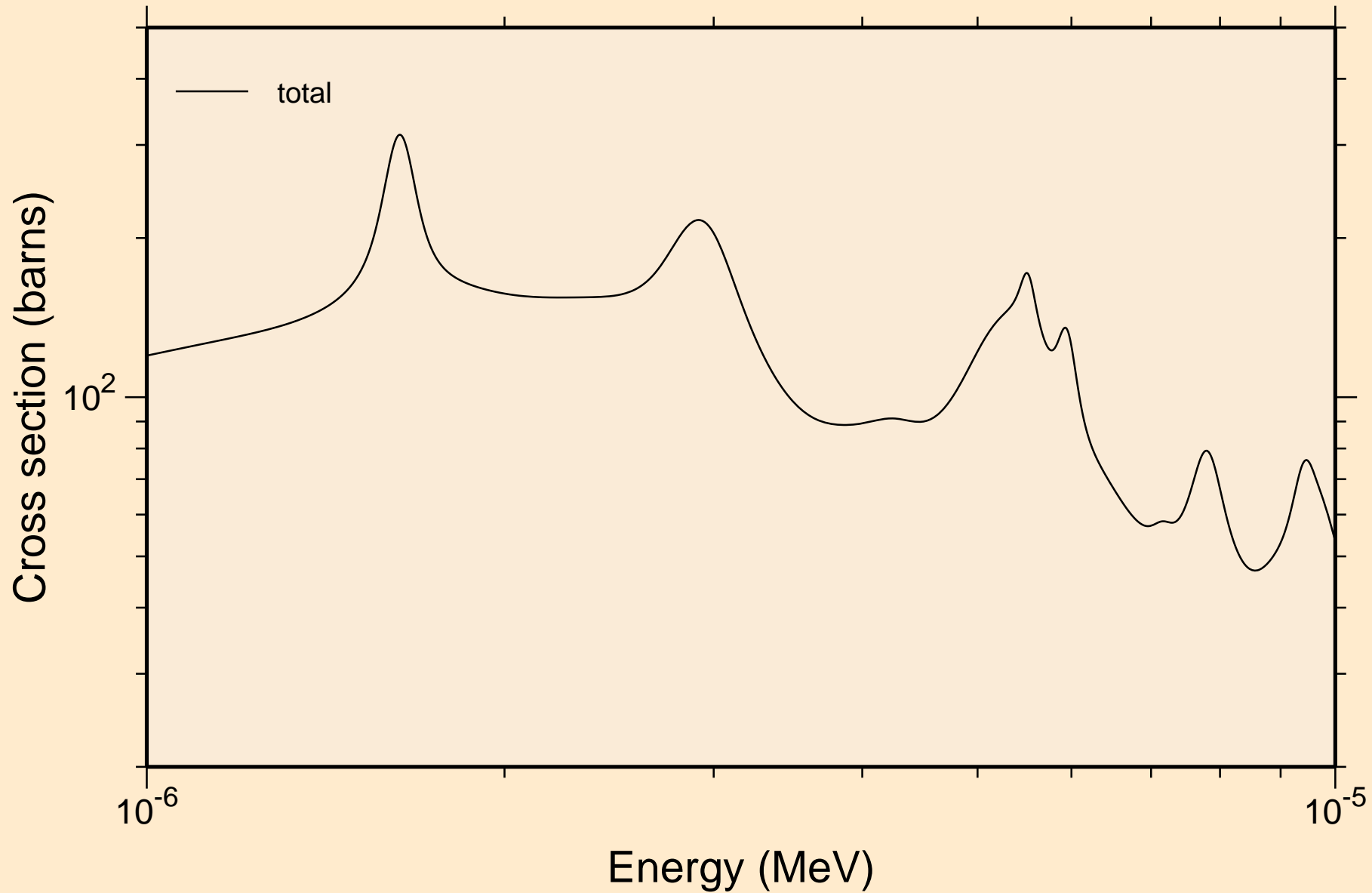

U231 NEUTRON ACER TENDL-2021 LIBRARY; T=293.6K
resonance total cross section

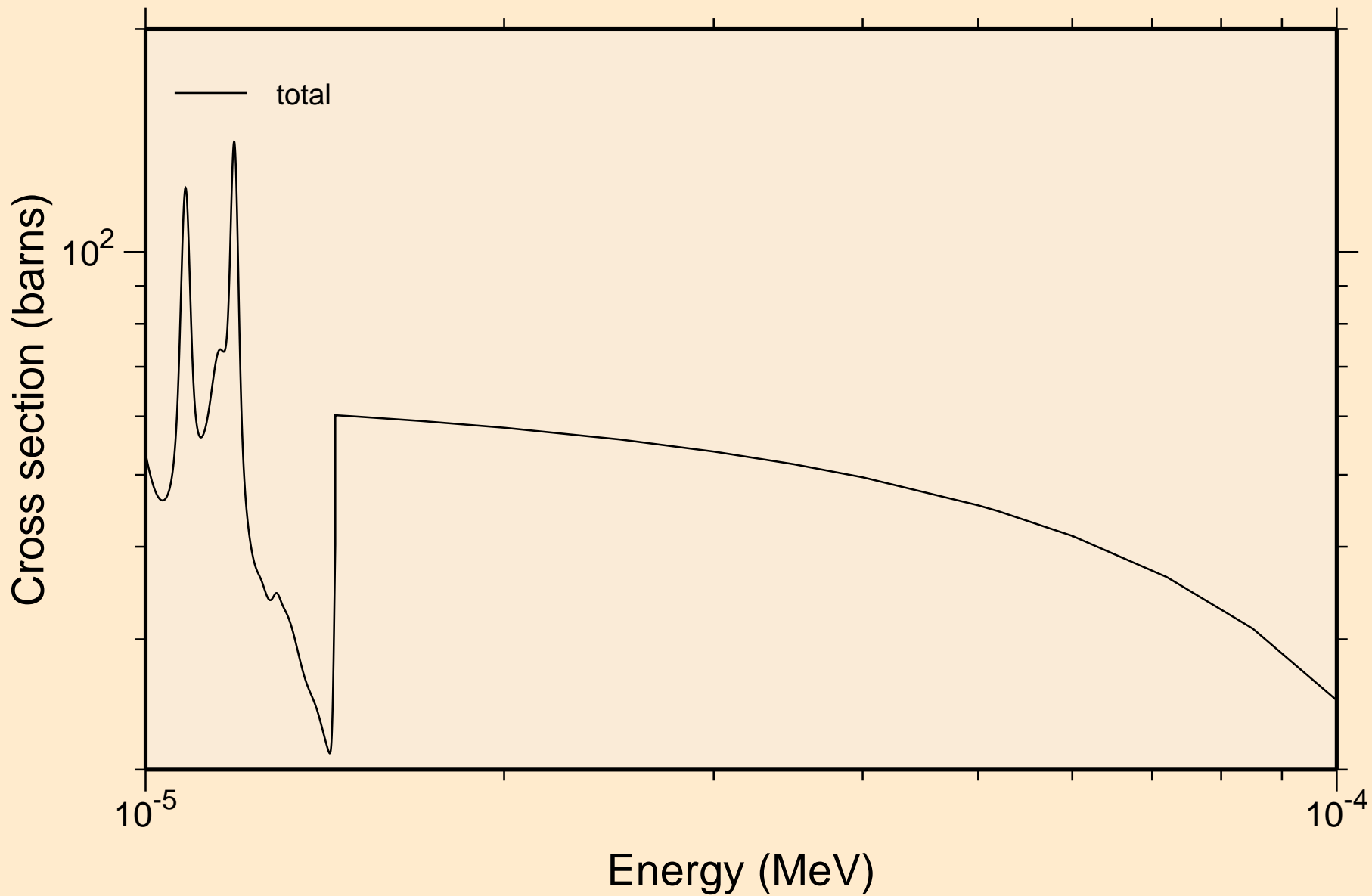

U231 NEUTRON ACER TENDL-2021 LIBRARY; T=293.6K
resonance total cross section

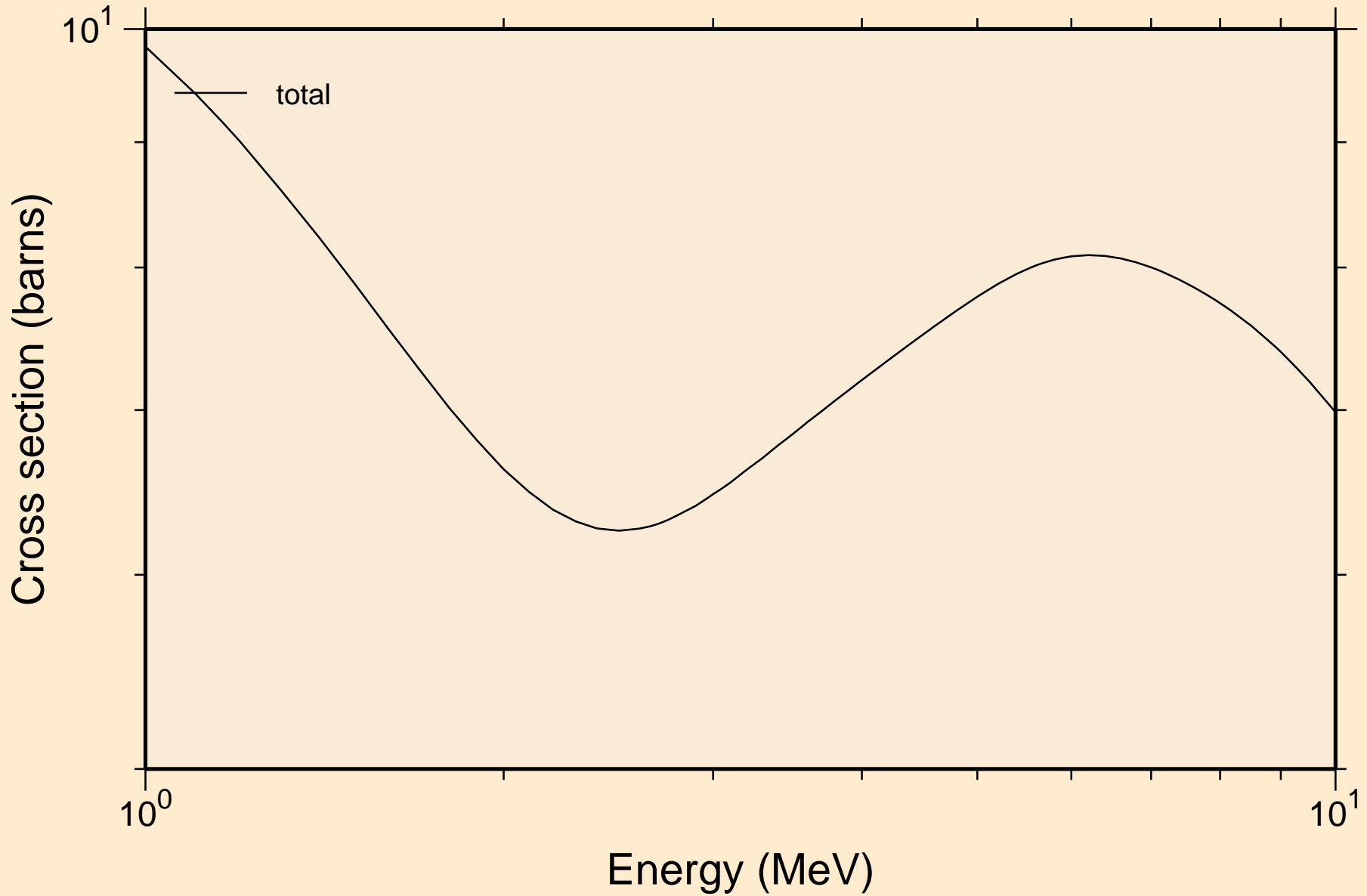

U231 NEUTRON ACER TENDL-2021 LIBRARY; T=293.6K
resonance absorption cross sections

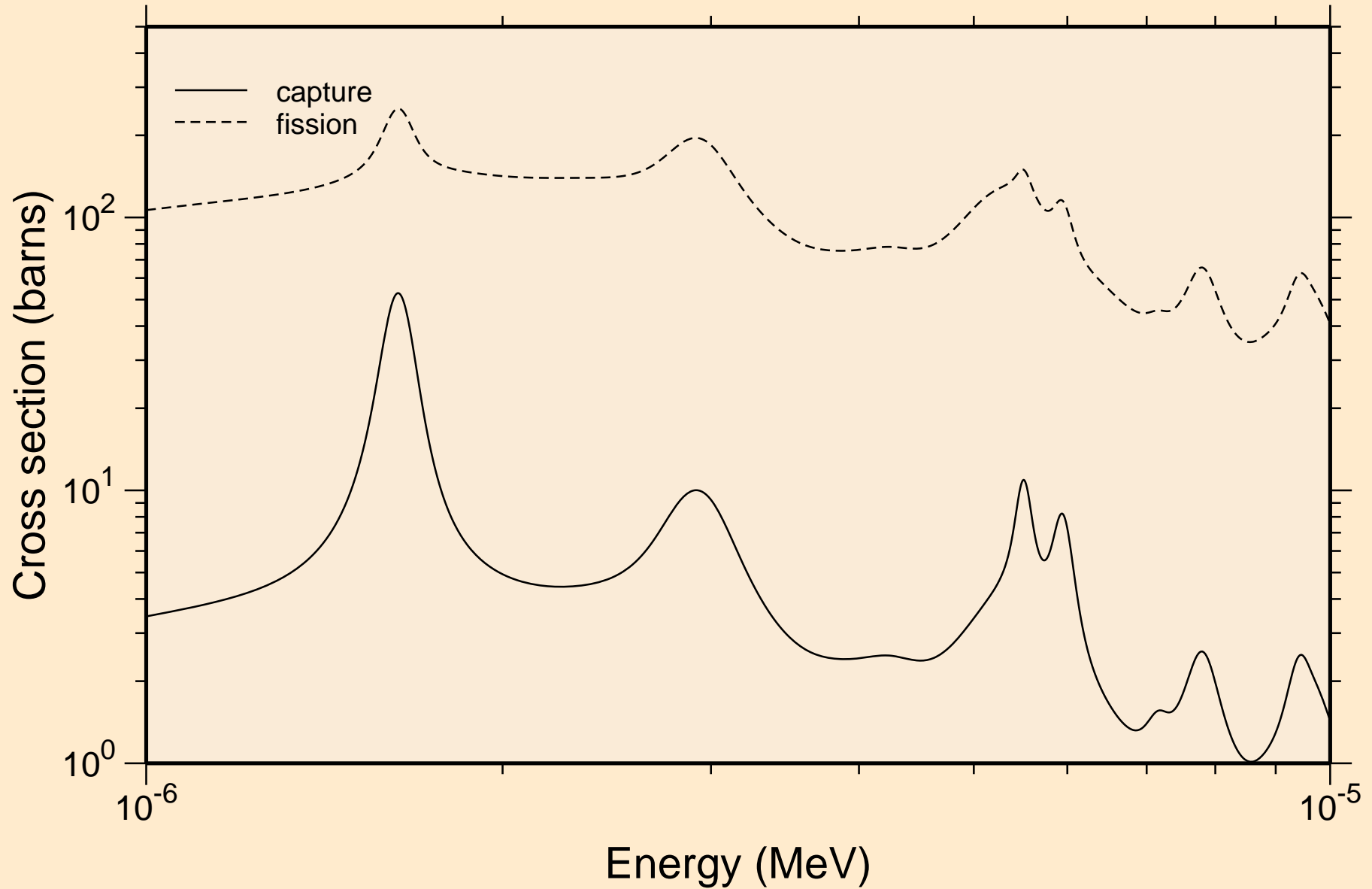

U231 NEUTRON ACER TENDL-2021 LIBRARY; T=293.6K
resonance absorption cross sections

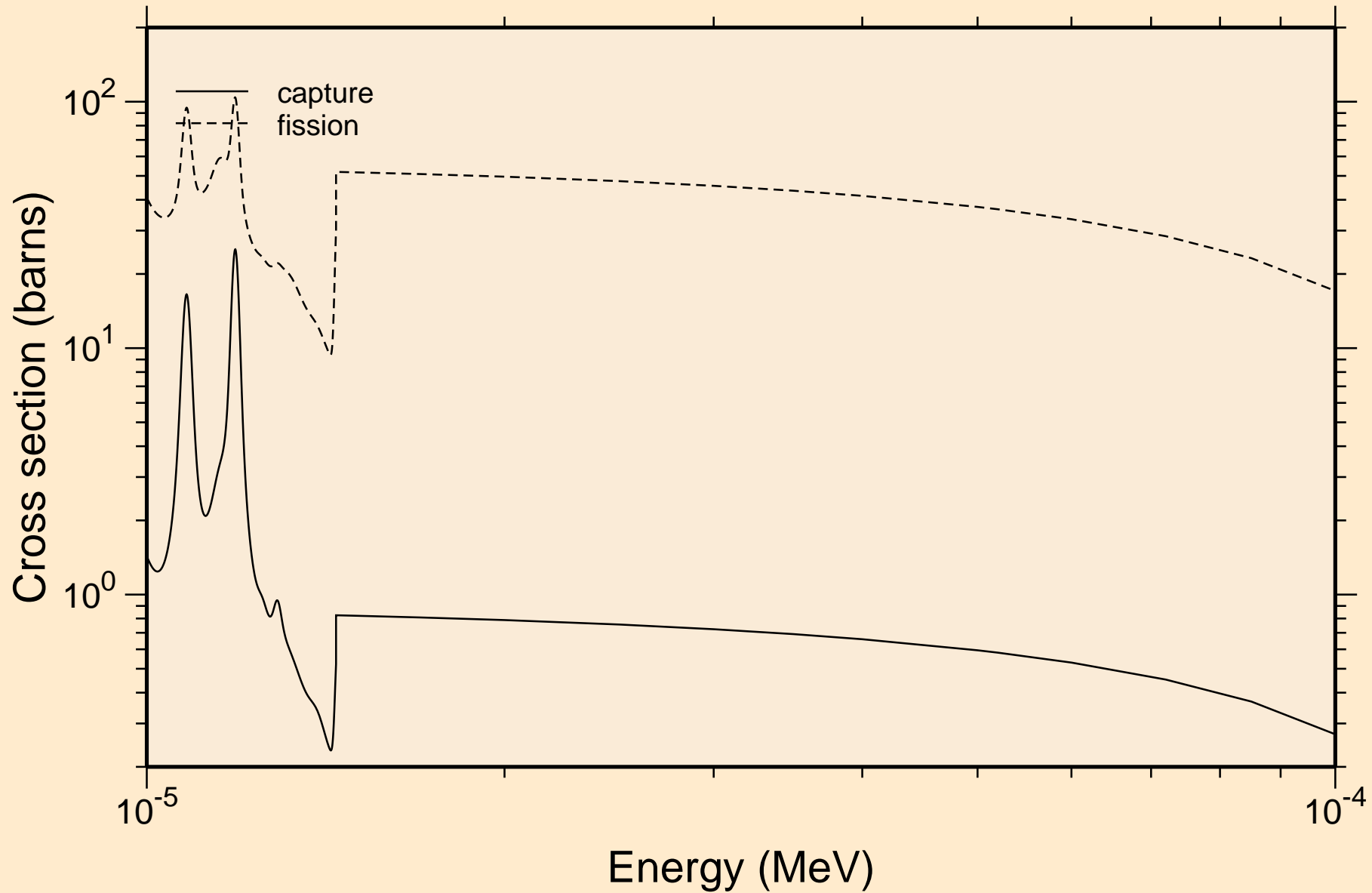

U231 NEUTRON ACER TENDL-2021 LIBRARY; T=293.6K
resonance absorption cross sections

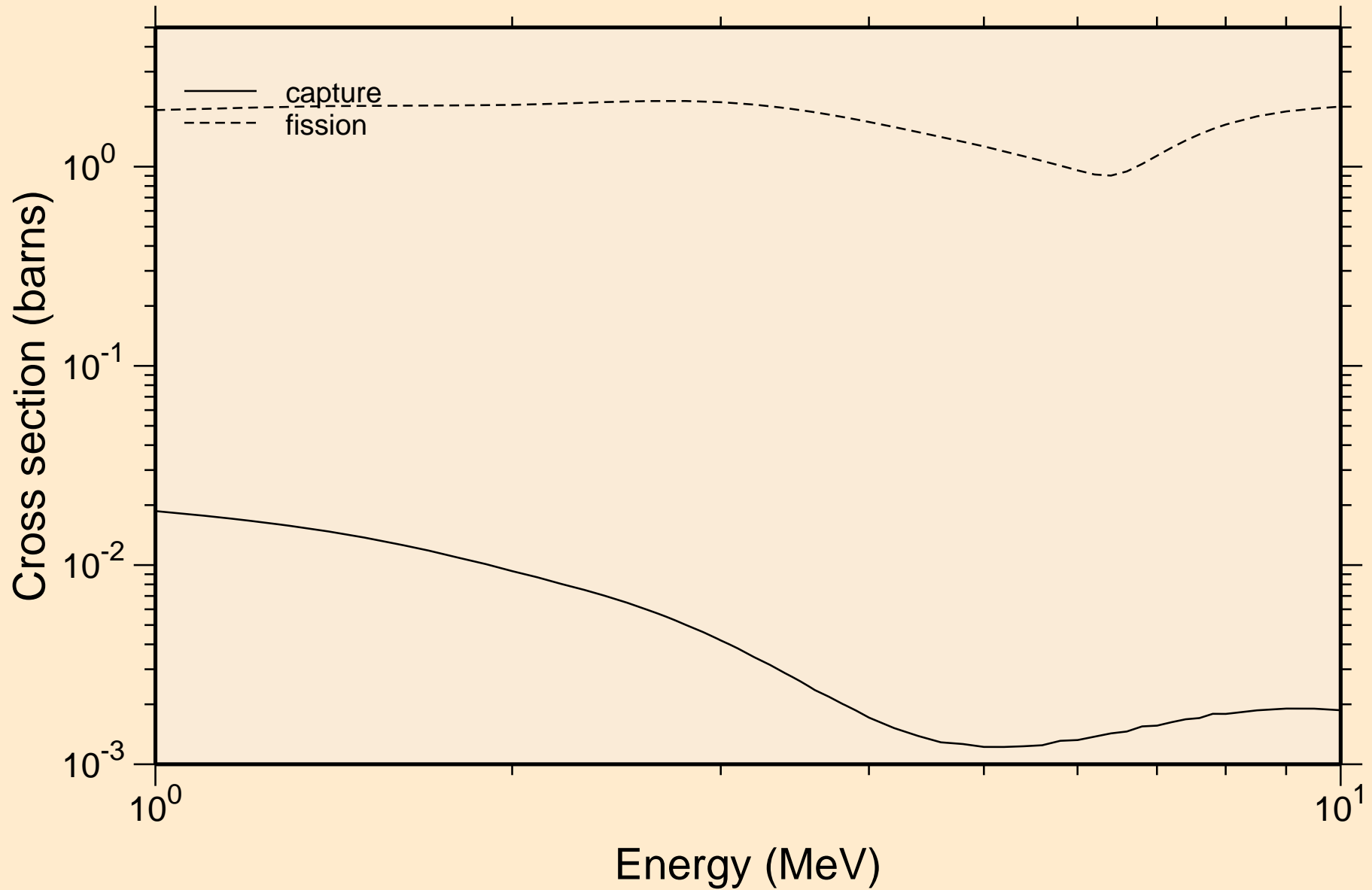

U231 NEUTRON ACER TENDL-2021 LIBRARY; T=293.6K
Heating

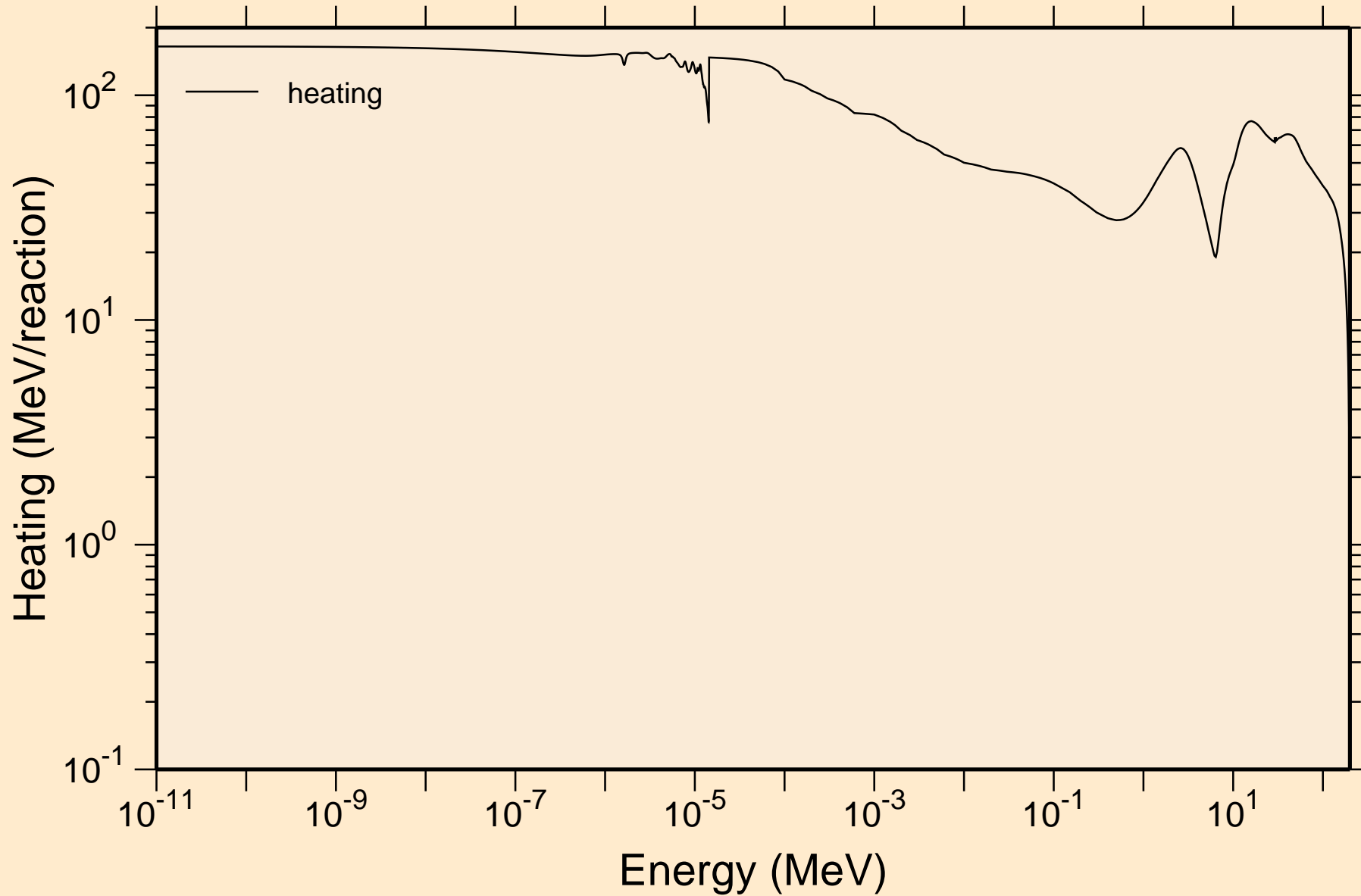

U231 NEUTRON ACER TENDL-2021 LIBRARY; T=293.6K
Damage

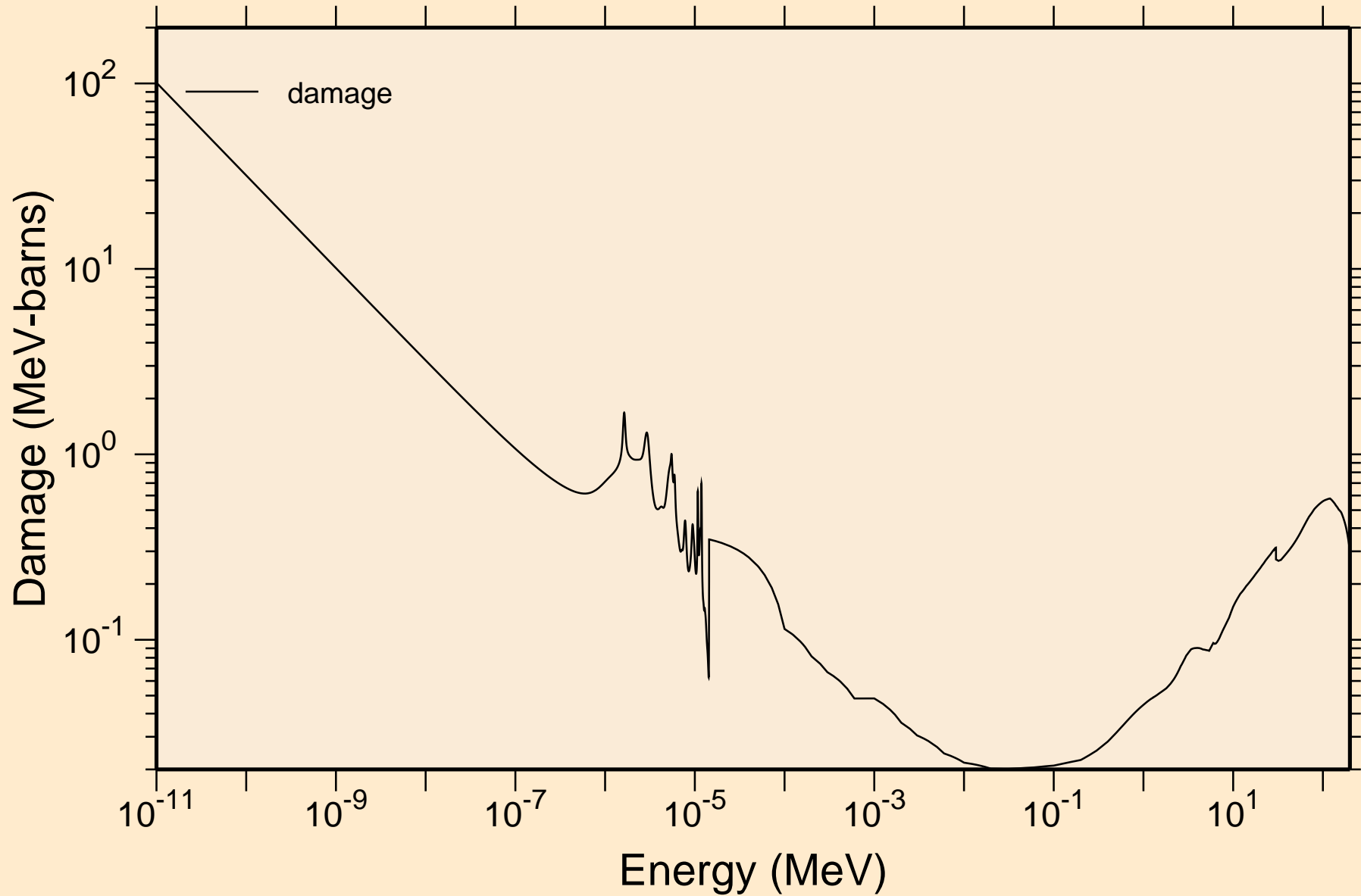

U231 NEUTRON ACER TENDL-2021 LIBRARY; T=293.6K

Non-threshold reactions

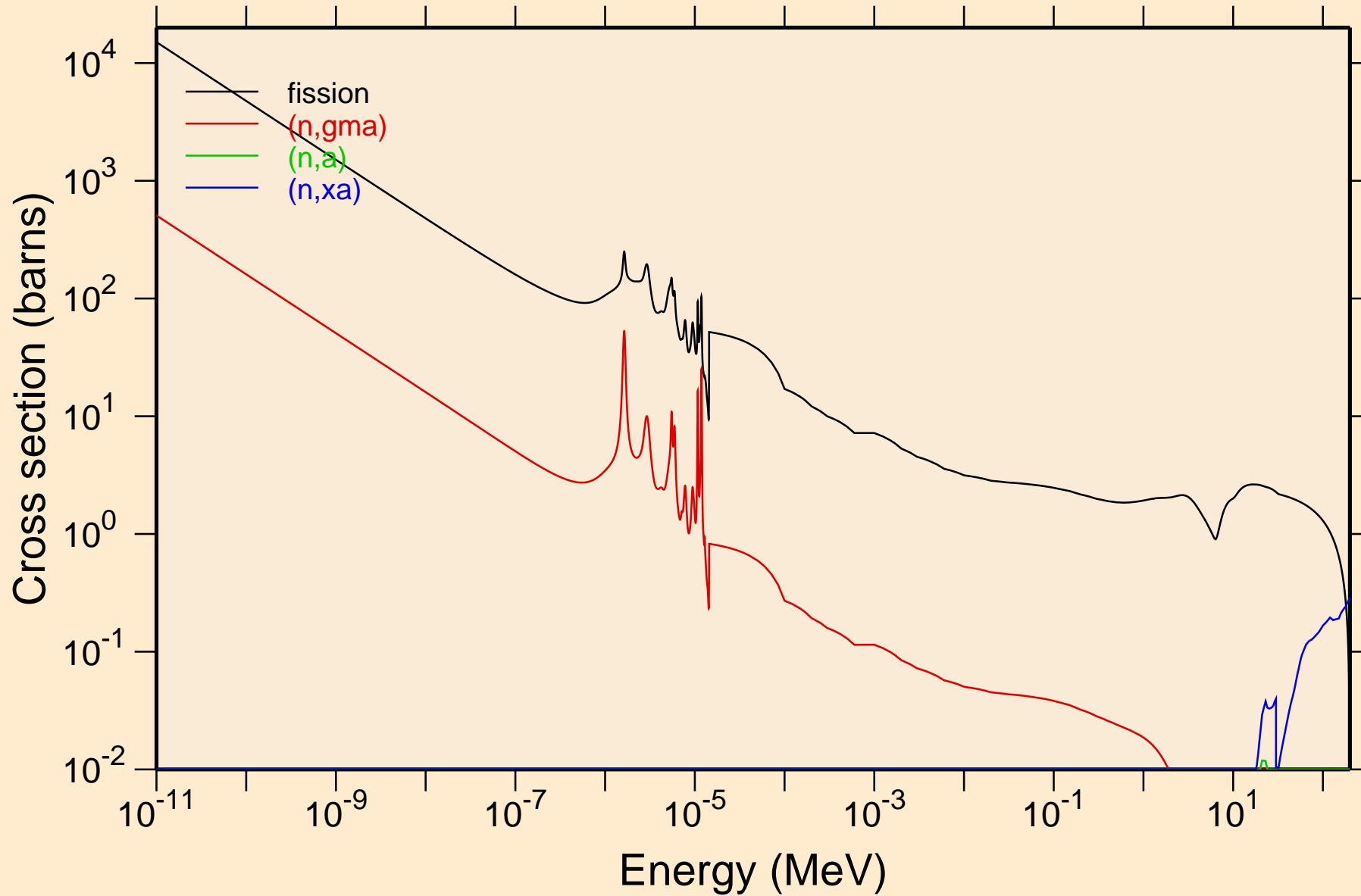

U231 NEUTRON ACER TENDL-2021 LIBRARY; T=293.6K

Principal cross sections

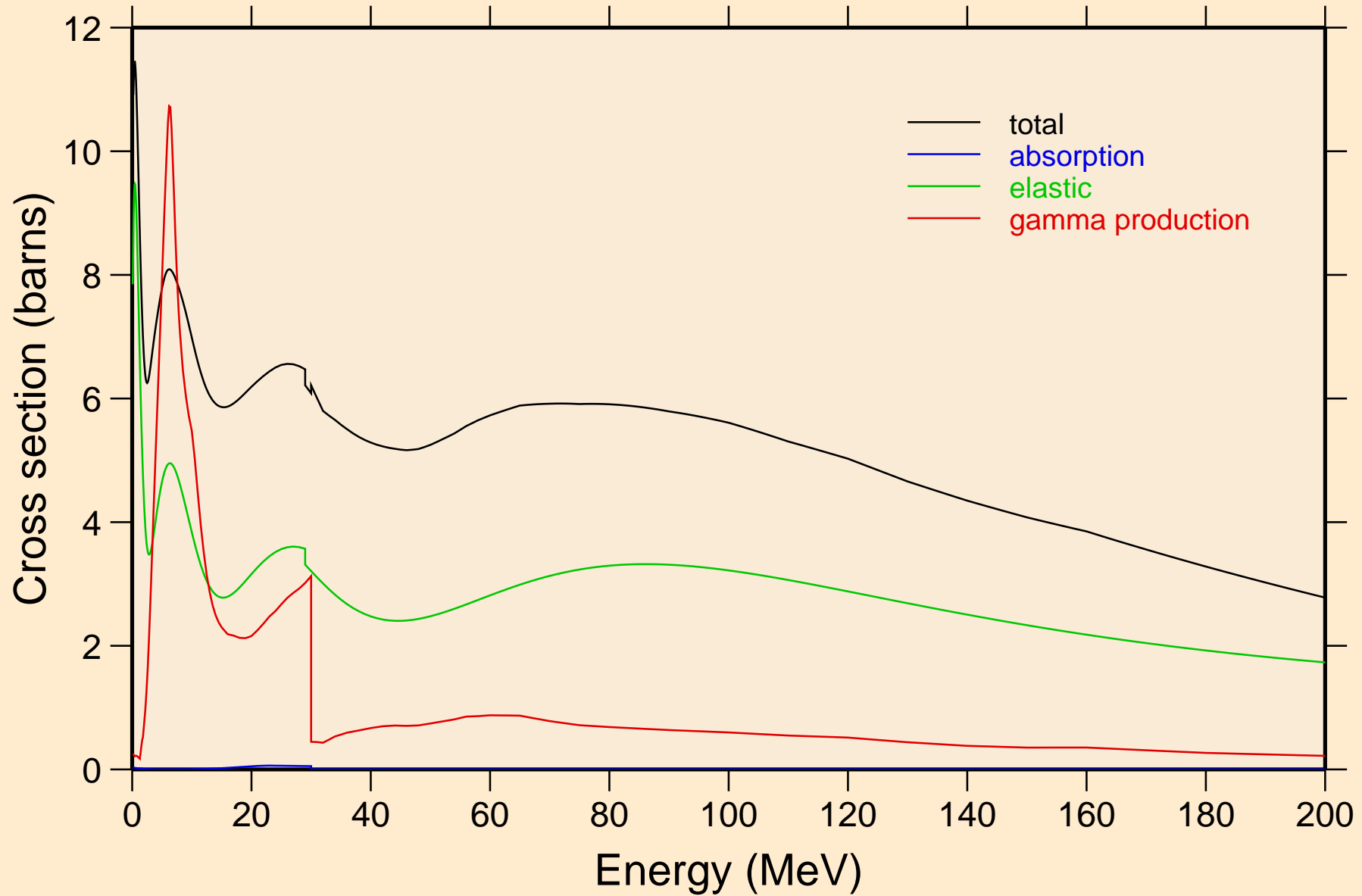

U231 NEUTRON ACER TENDL-2021 LIBRARY; T=293.6K

Heating

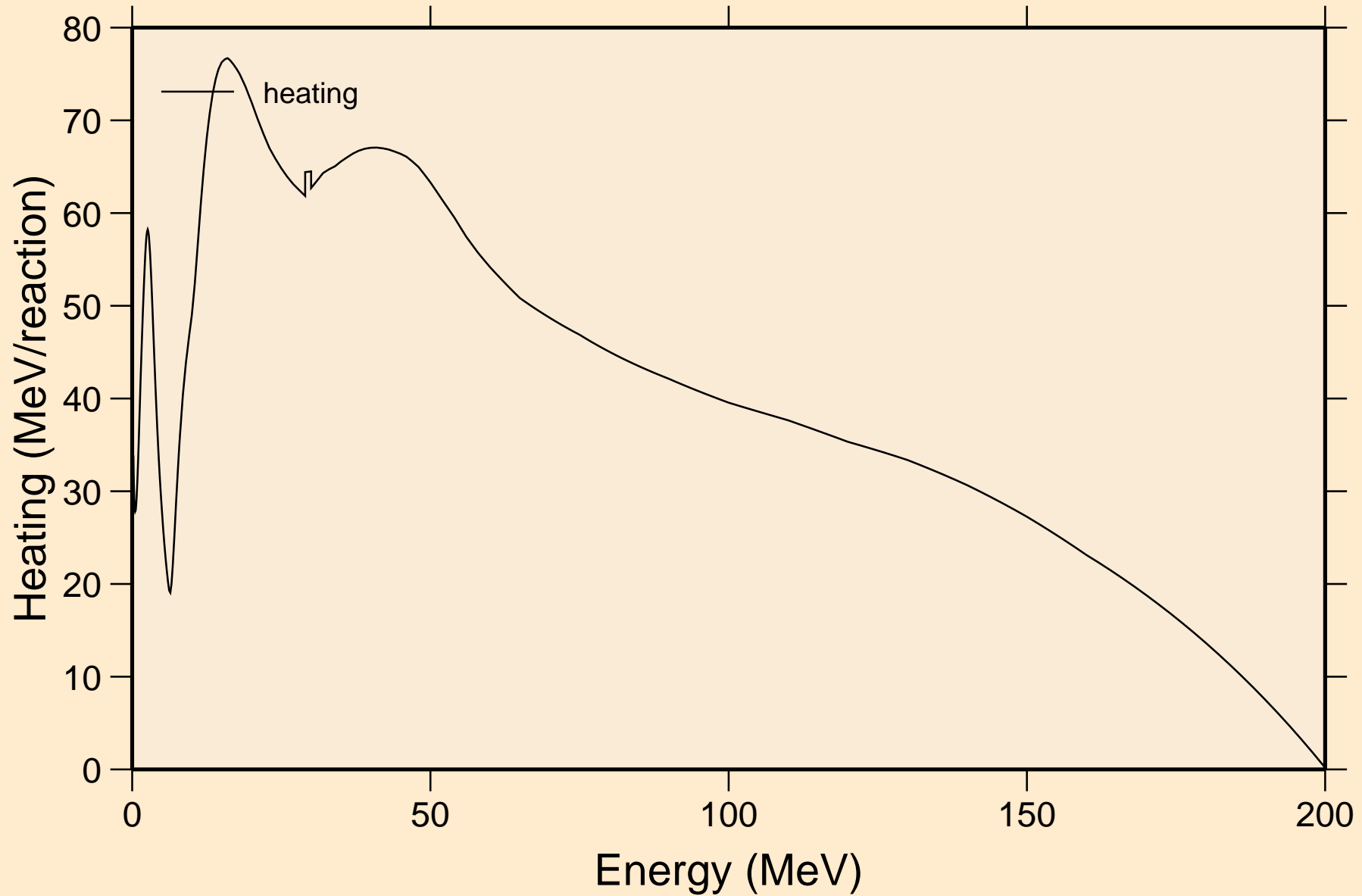

U231 NEUTRON ACER TENDL-2021 LIBRARY; T=293.6K
Damage

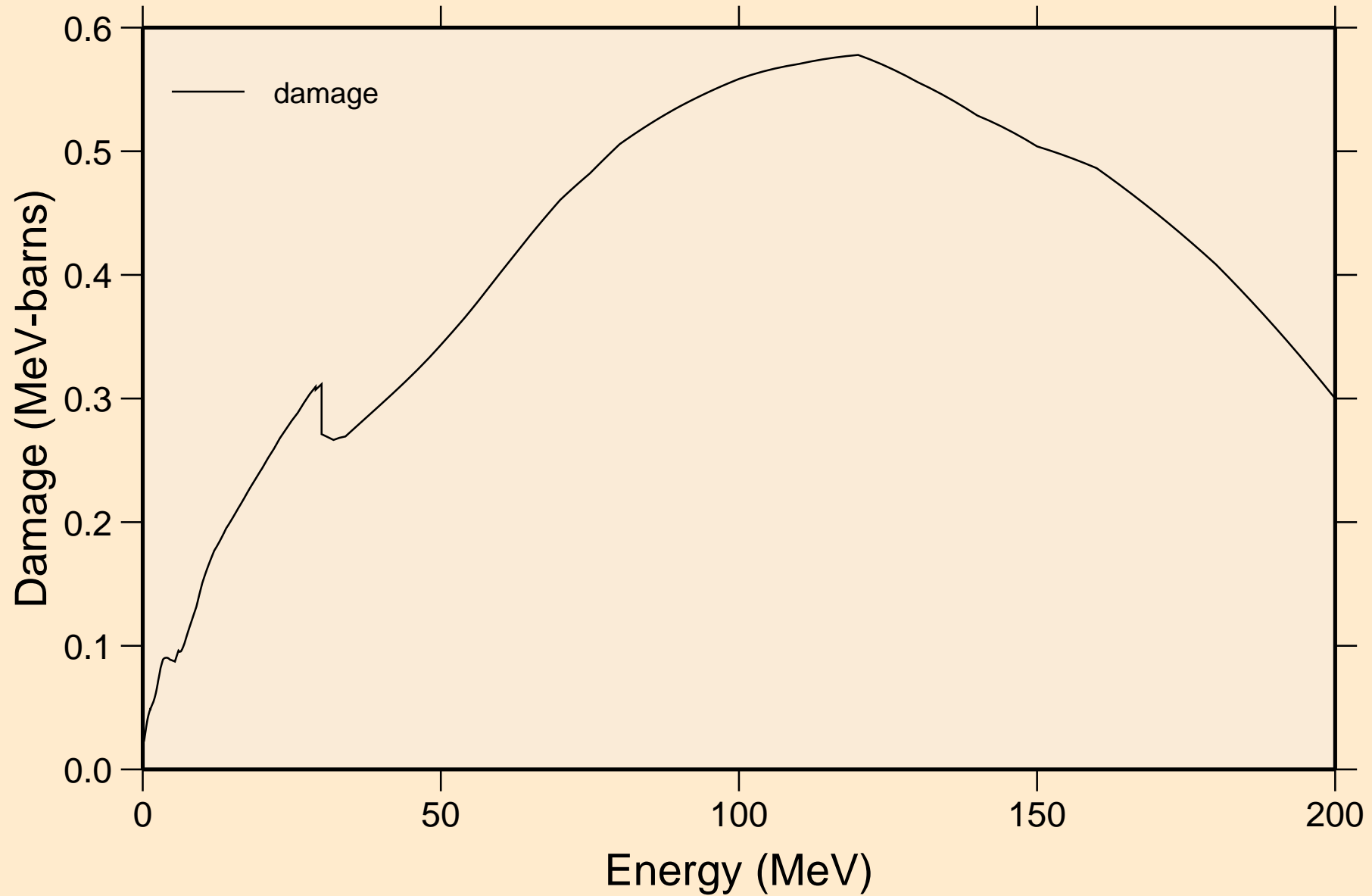

U231 NEUTRON ACER TENDL-2021 LIBRARY; T=293.6K

Non-threshold reactions

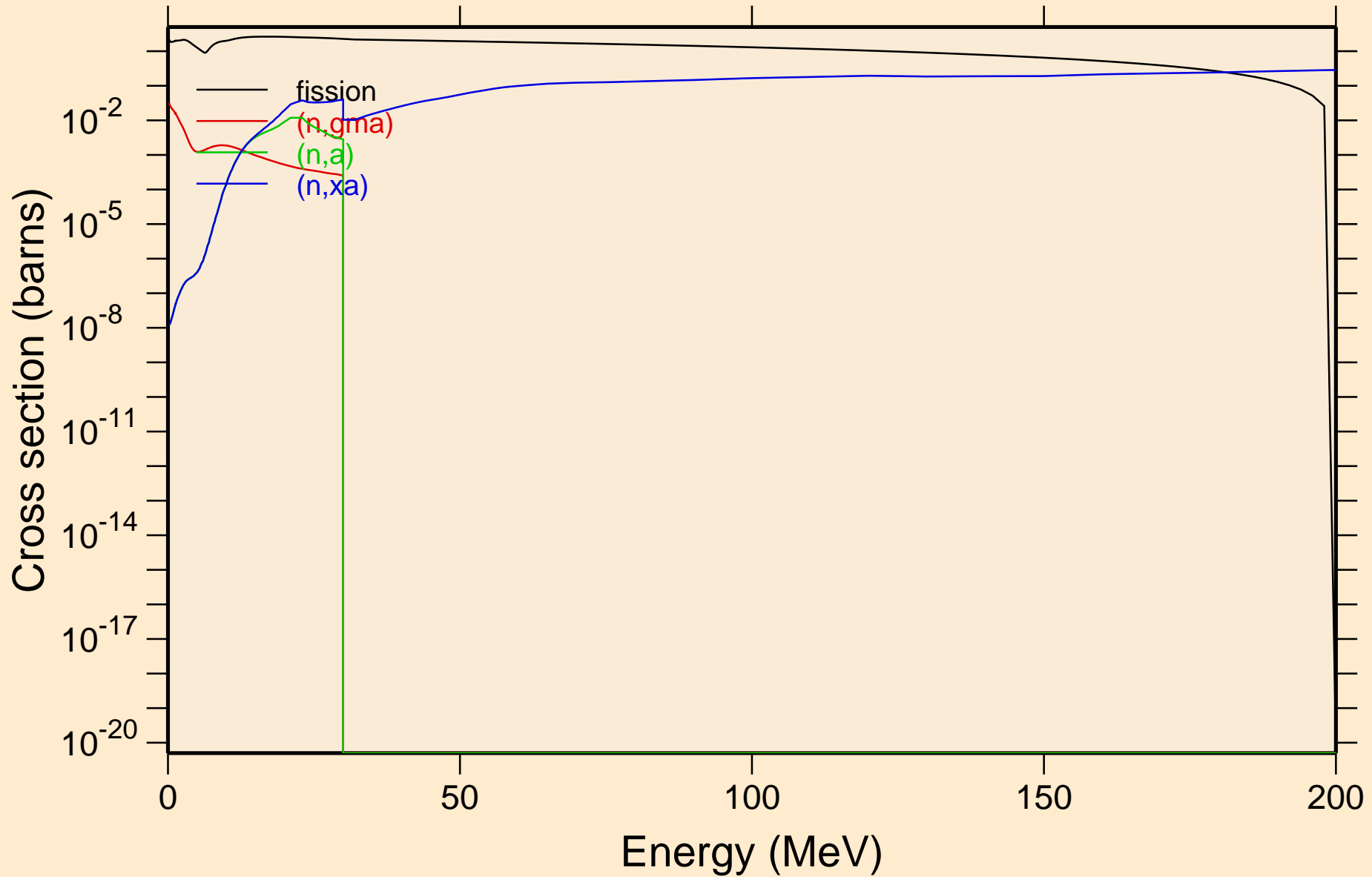

U231 NEUTRON ACER TENDL-2021 LIBRARY; T=293.6K
Inelastic levels

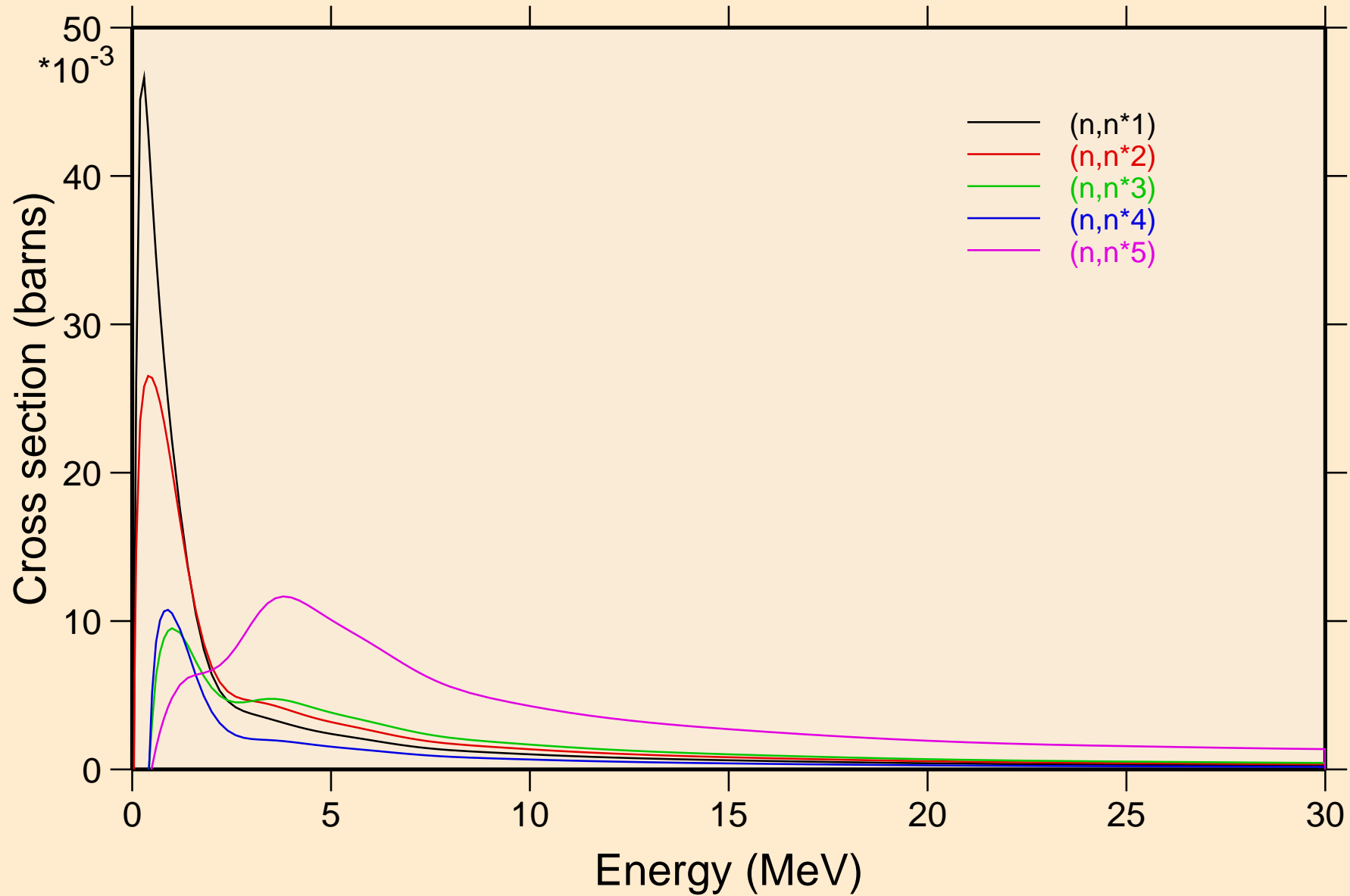

U231 NEUTRON ACER TENDL-2021 LIBRARY; T=293.6K
Inelastic levels

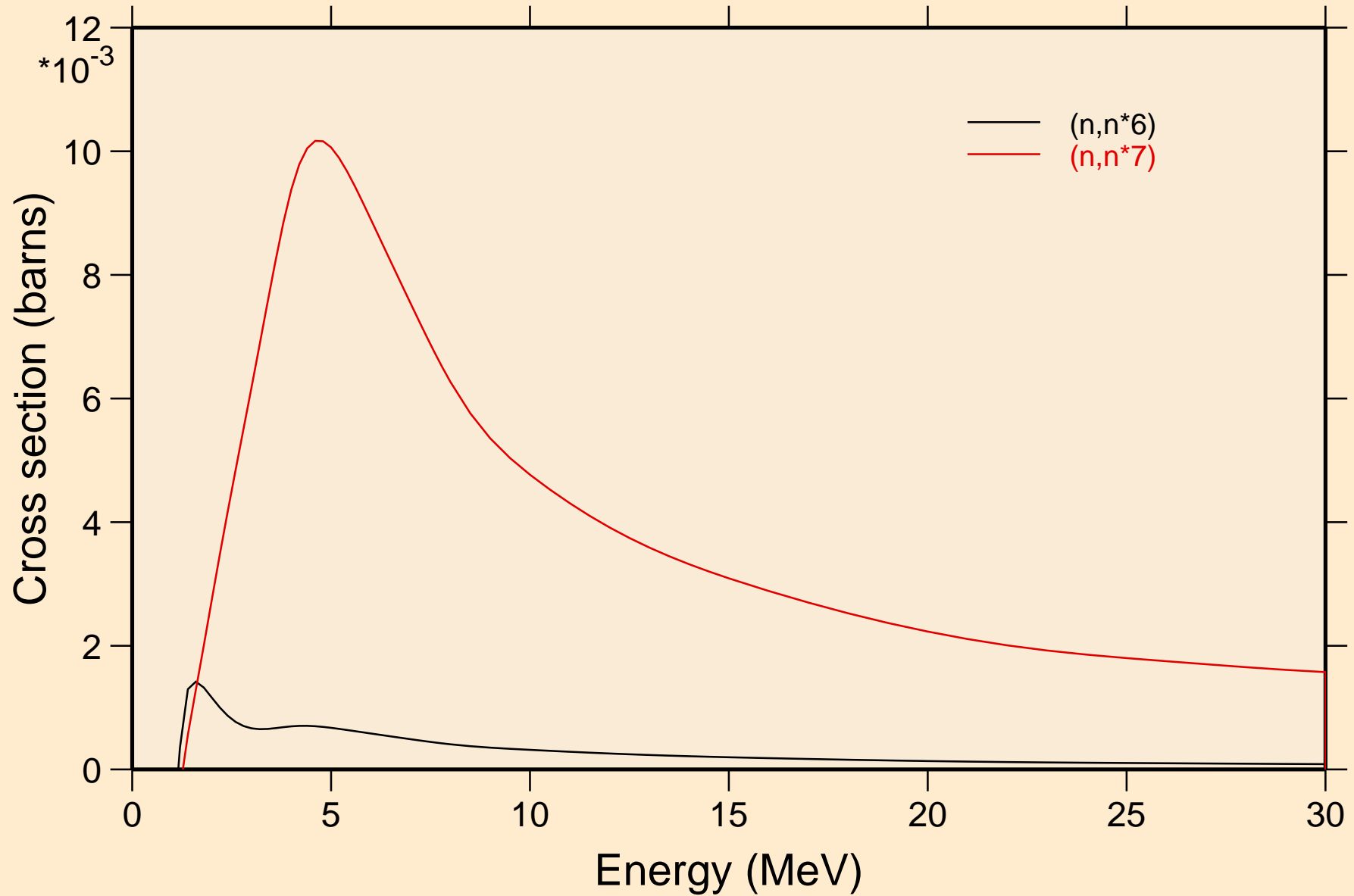

U231 NEUTRON ACER TENDL-2021 LIBRARY; T=293.6K
Threshold reactions

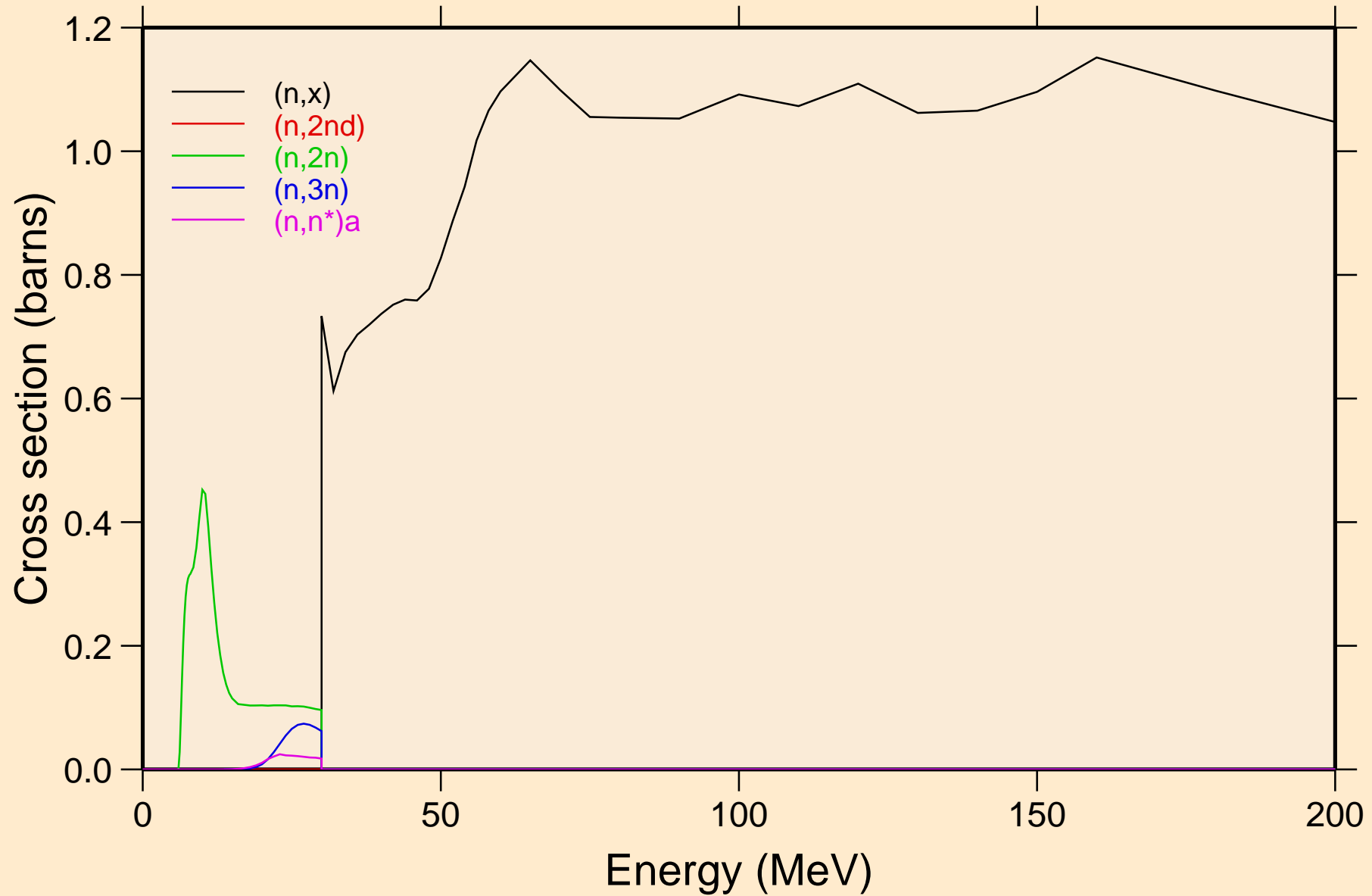

U231 NEUTRON ACER TENDL-2021 LIBRARY; T=293.6K
Threshold reactions

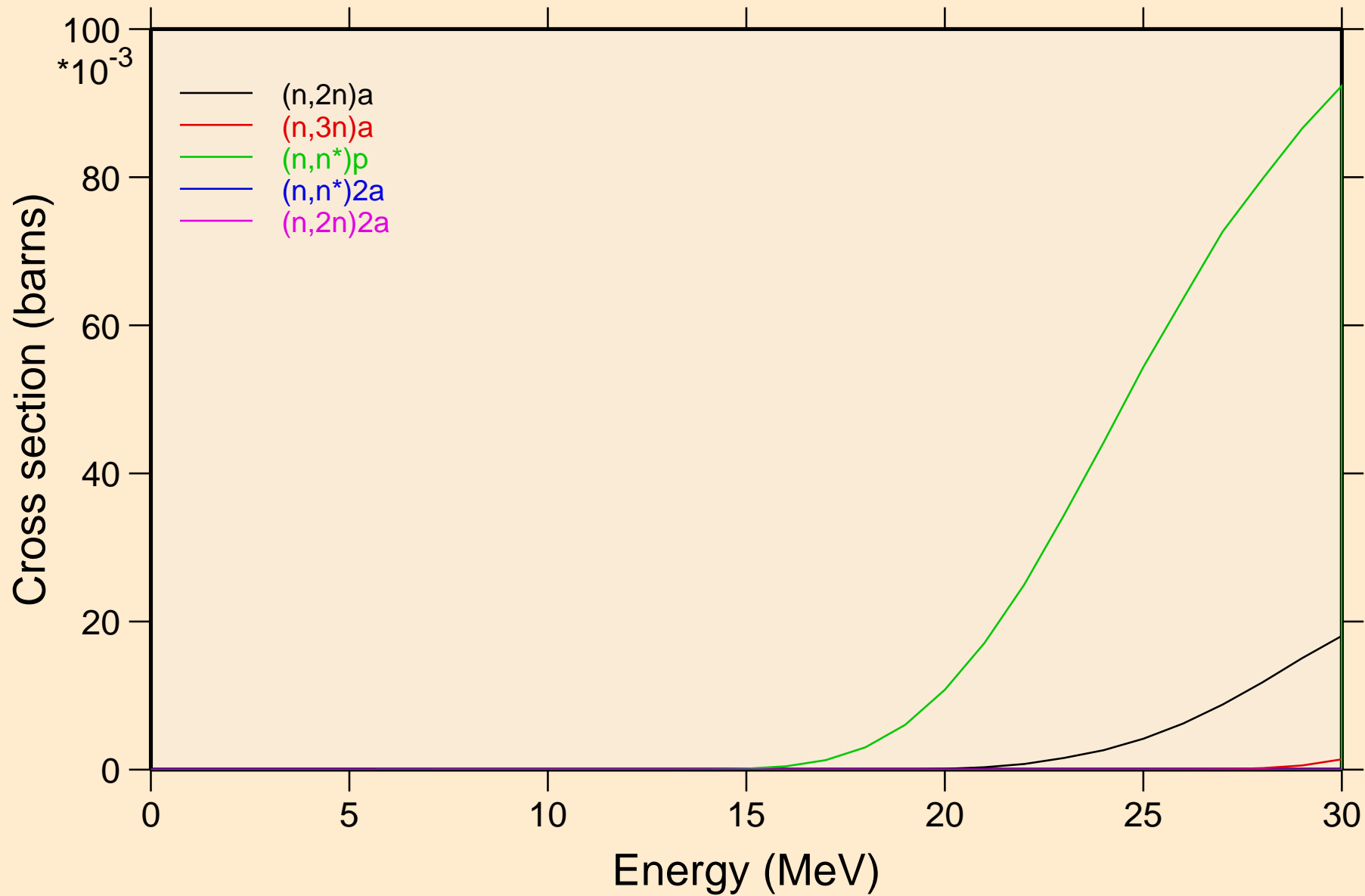

U231 NEUTRON ACER TENDL-2021 LIBRARY; T=293.6K

Threshold reactions

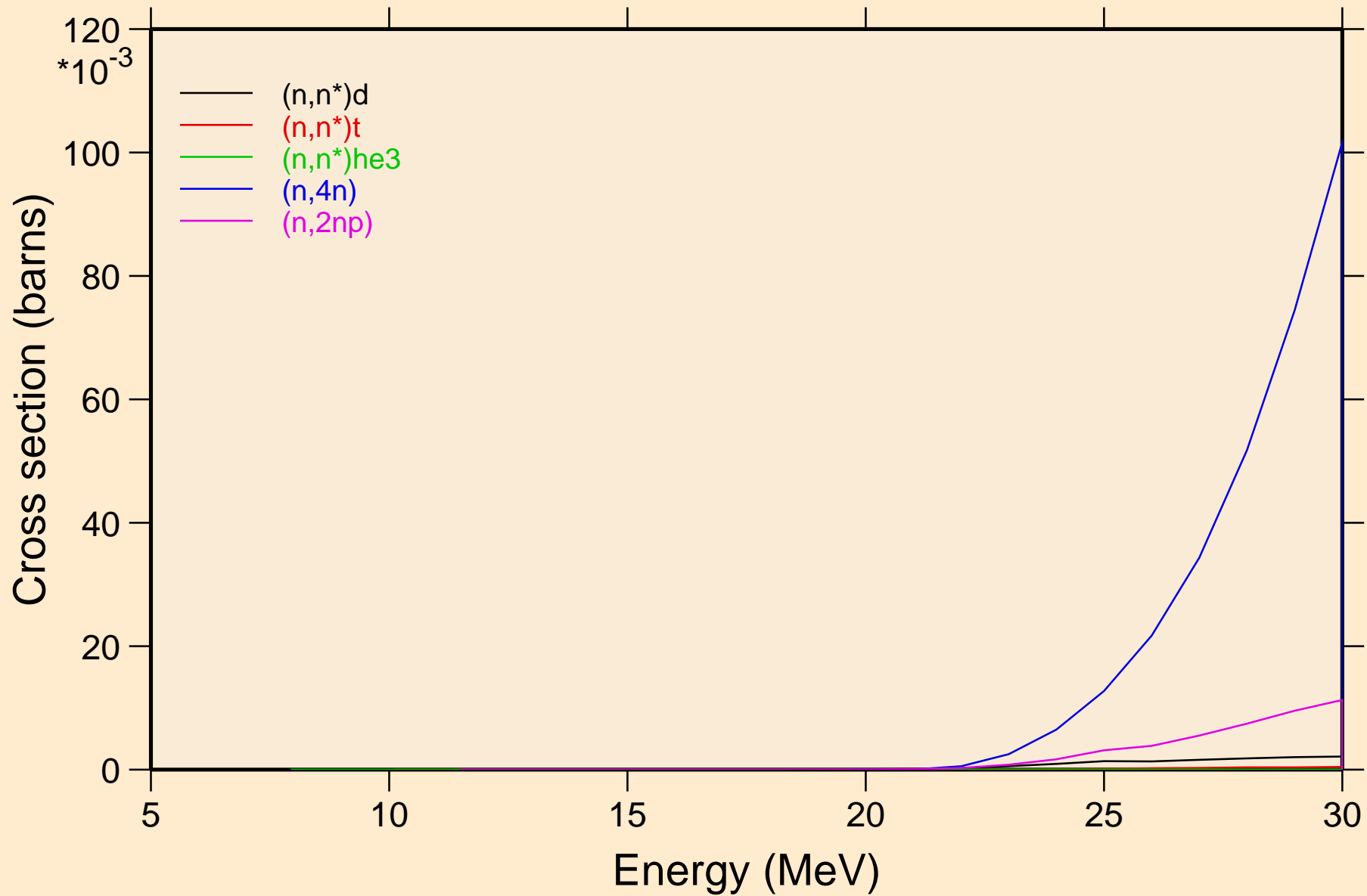

U231 NEUTRON ACER TENDL-2021 LIBRARY; T=293.6K
Threshold reactions

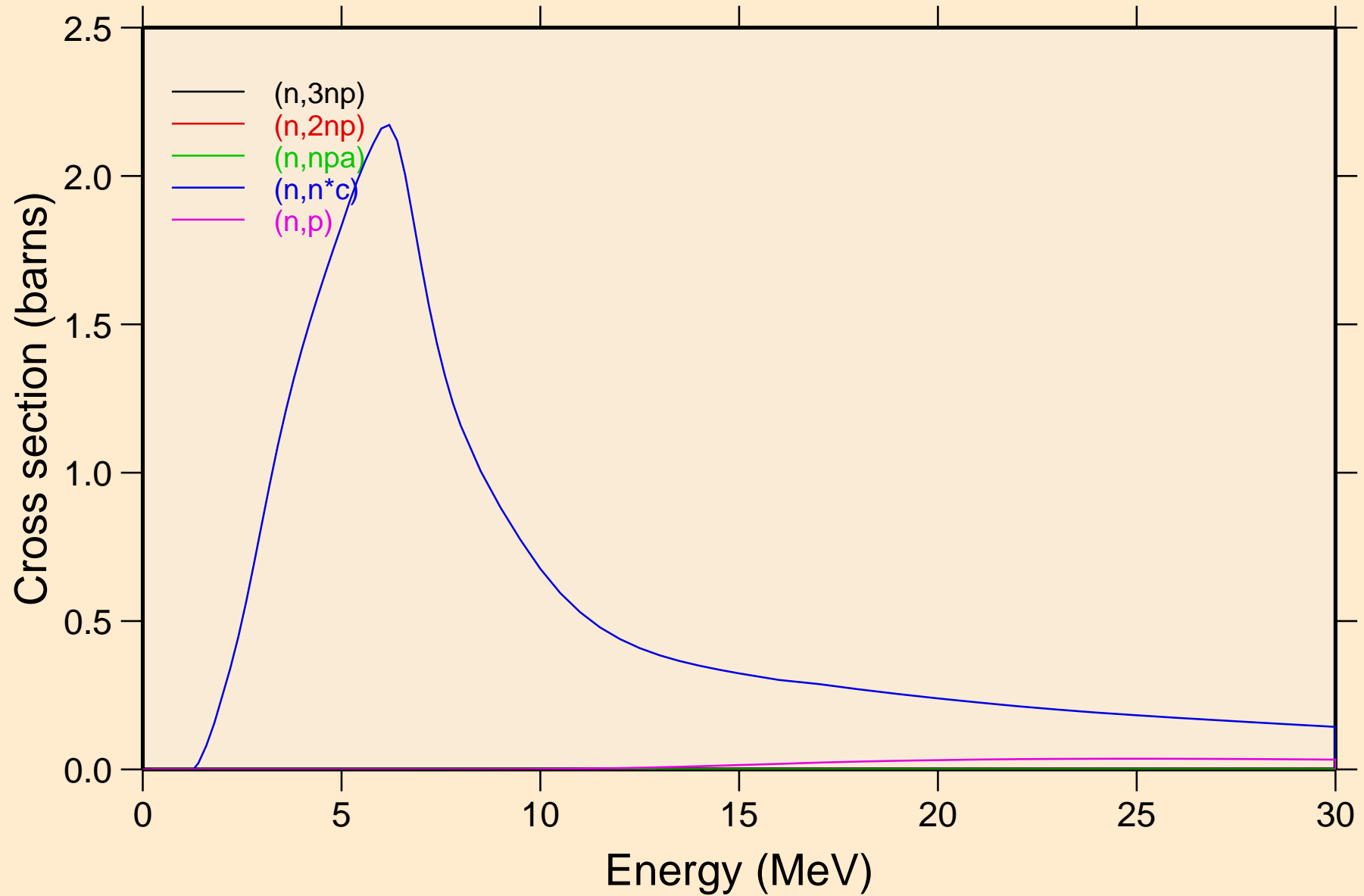

U231 NEUTRON ACER TENDL-2021 LIBRARY; T=293.6K
Threshold reactions

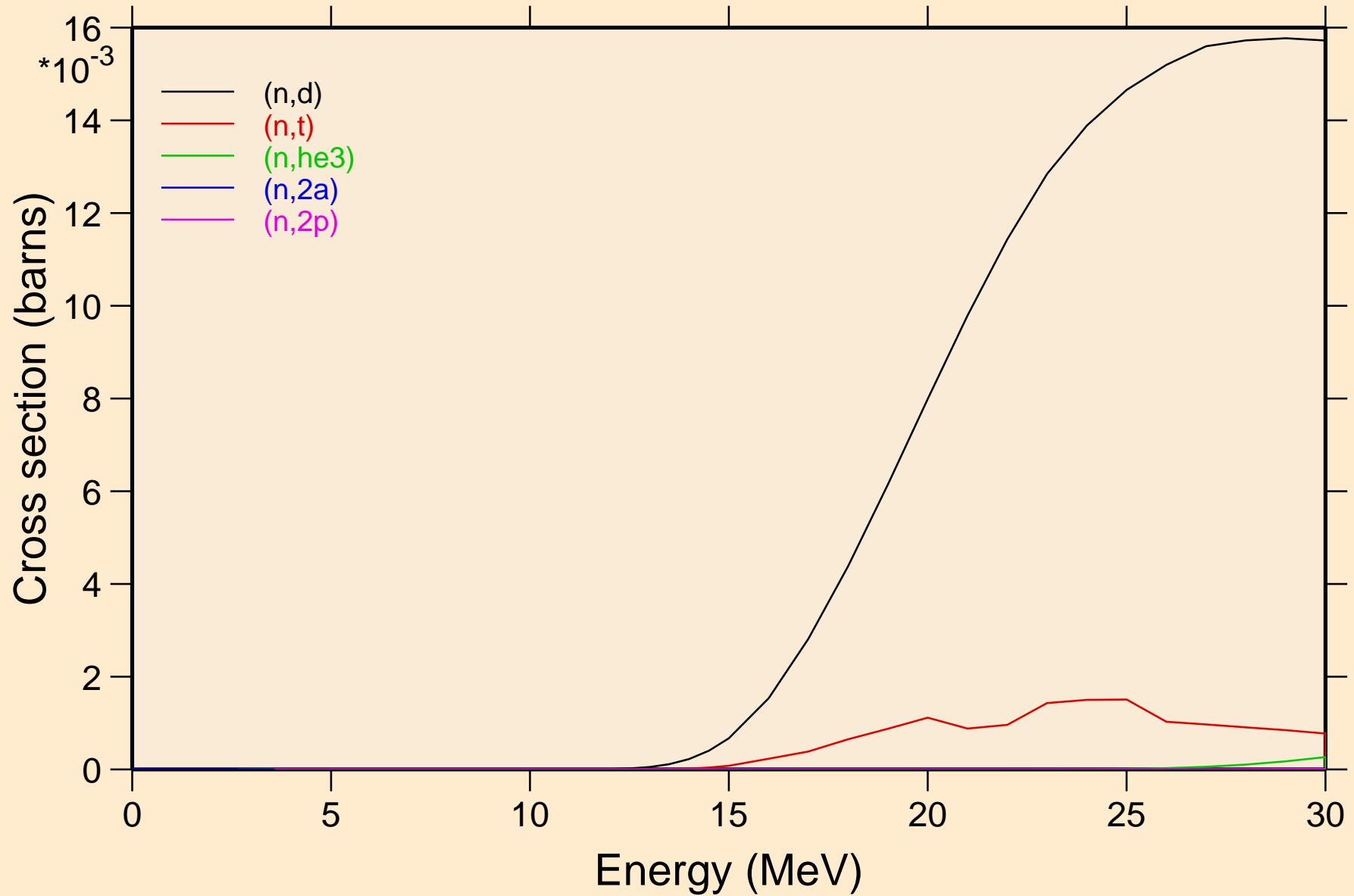

U231 NEUTRON ACER TENDL-2021 LIBRARY; T=293.6K
Threshold reactions

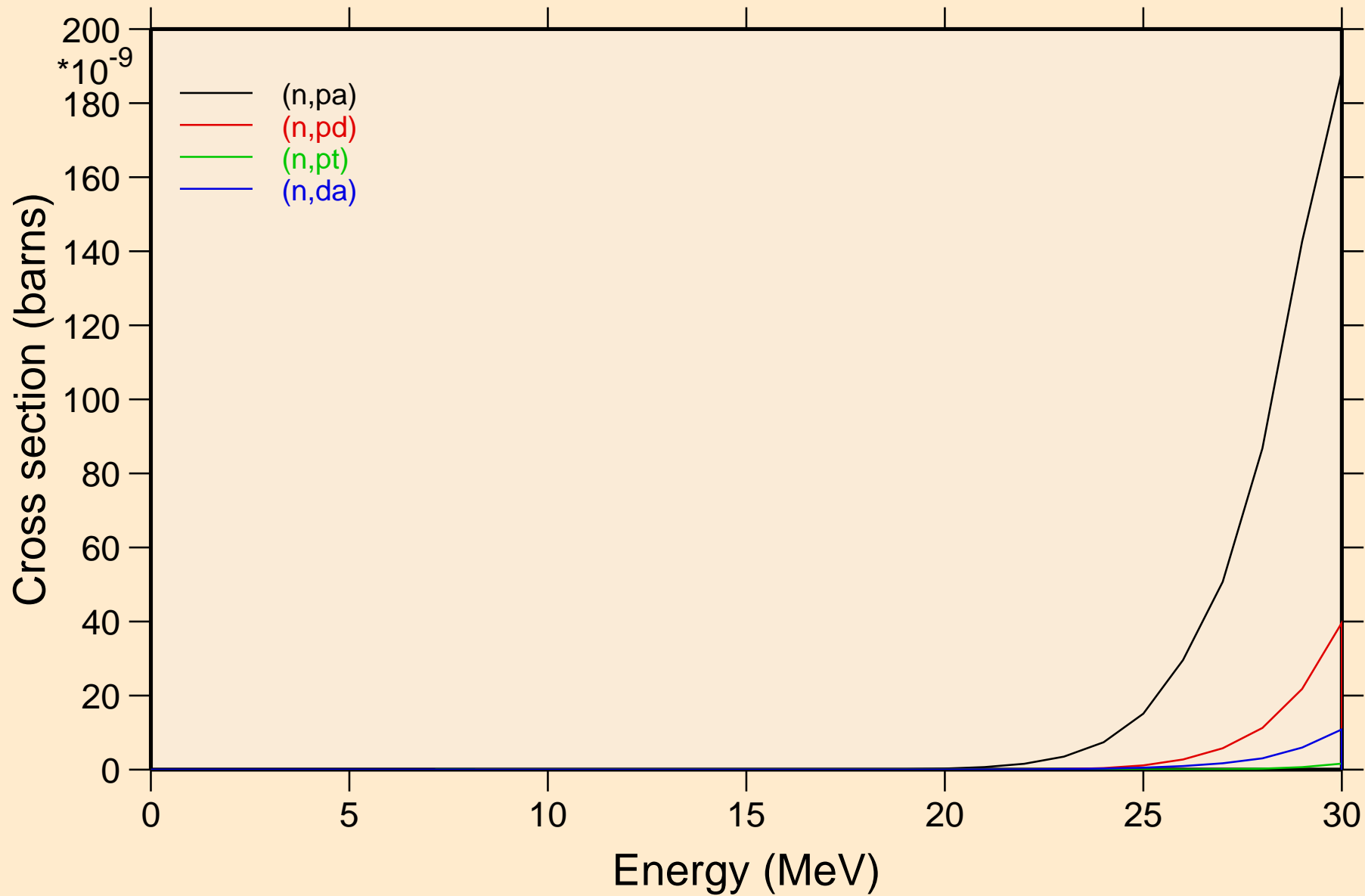

U231 NEUTRON ACER TENDL-2021 LIBRARY; T=293.6K
Threshold reactions

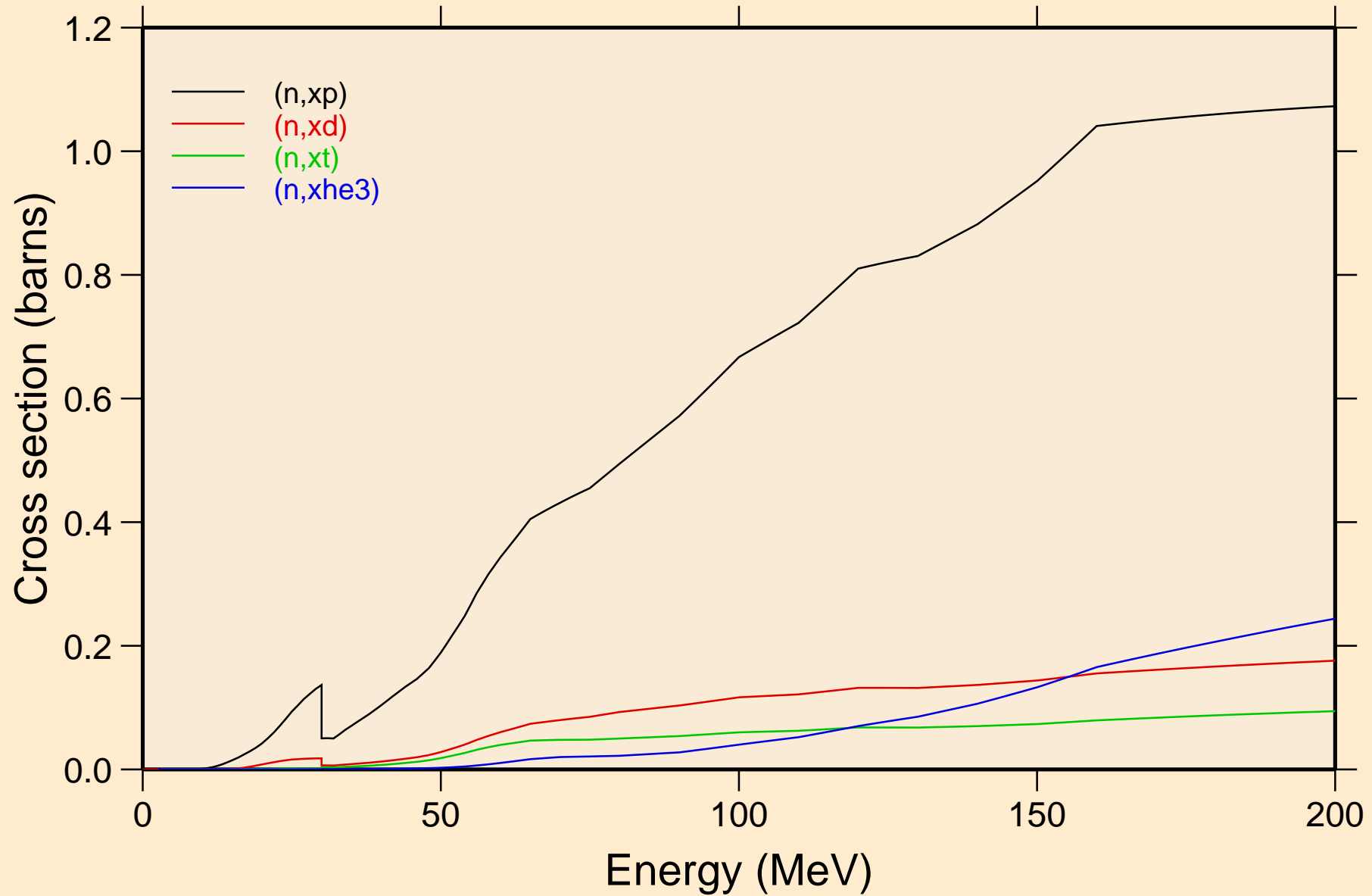

U231 NEUTRON ACER TENDL-2021 LIBRARY; T=293.6K
angular distribution for elastic

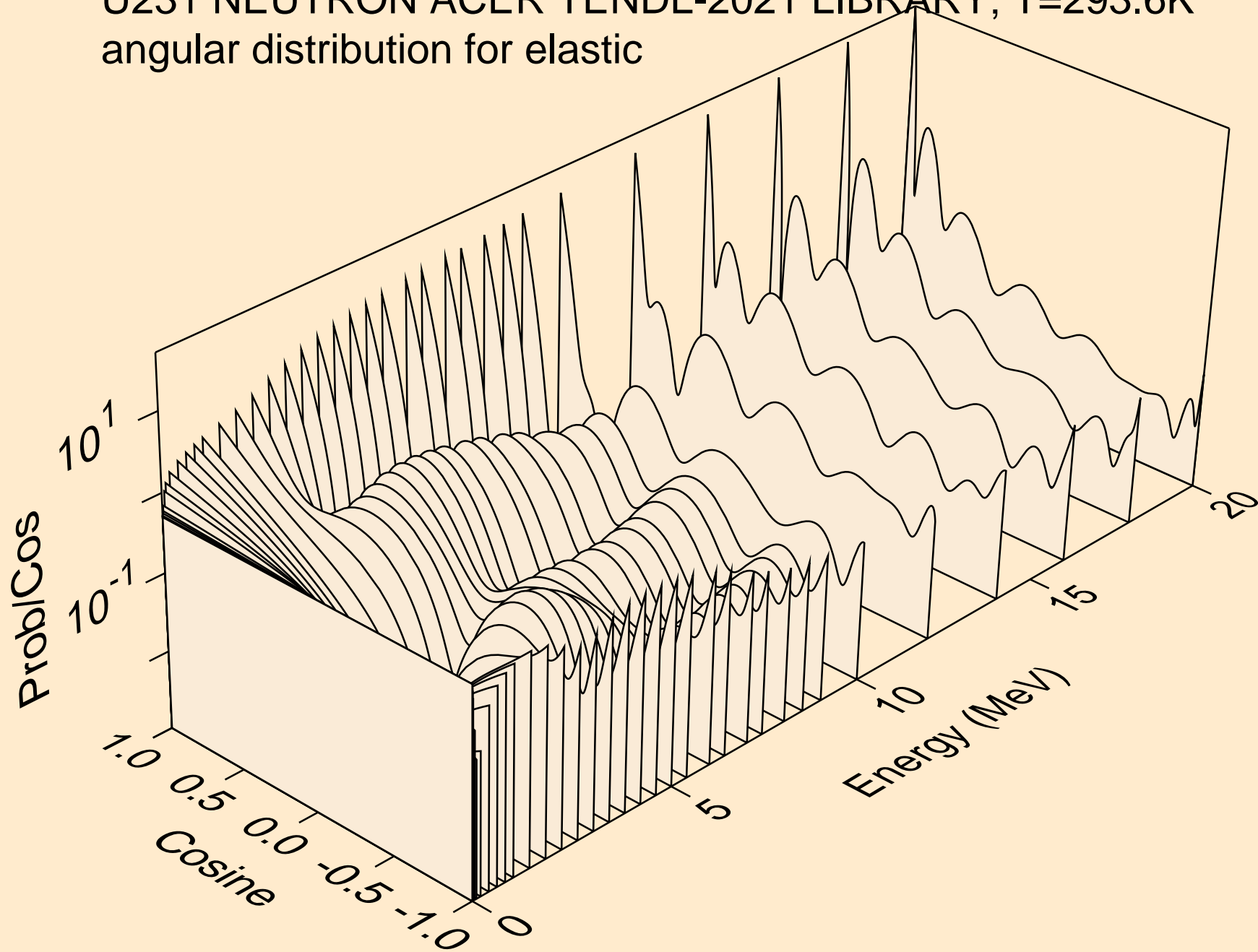

U231 NEUTRON ACER TENDL-2021 LIBRARY; T=293.6K
angular distribution for elastic

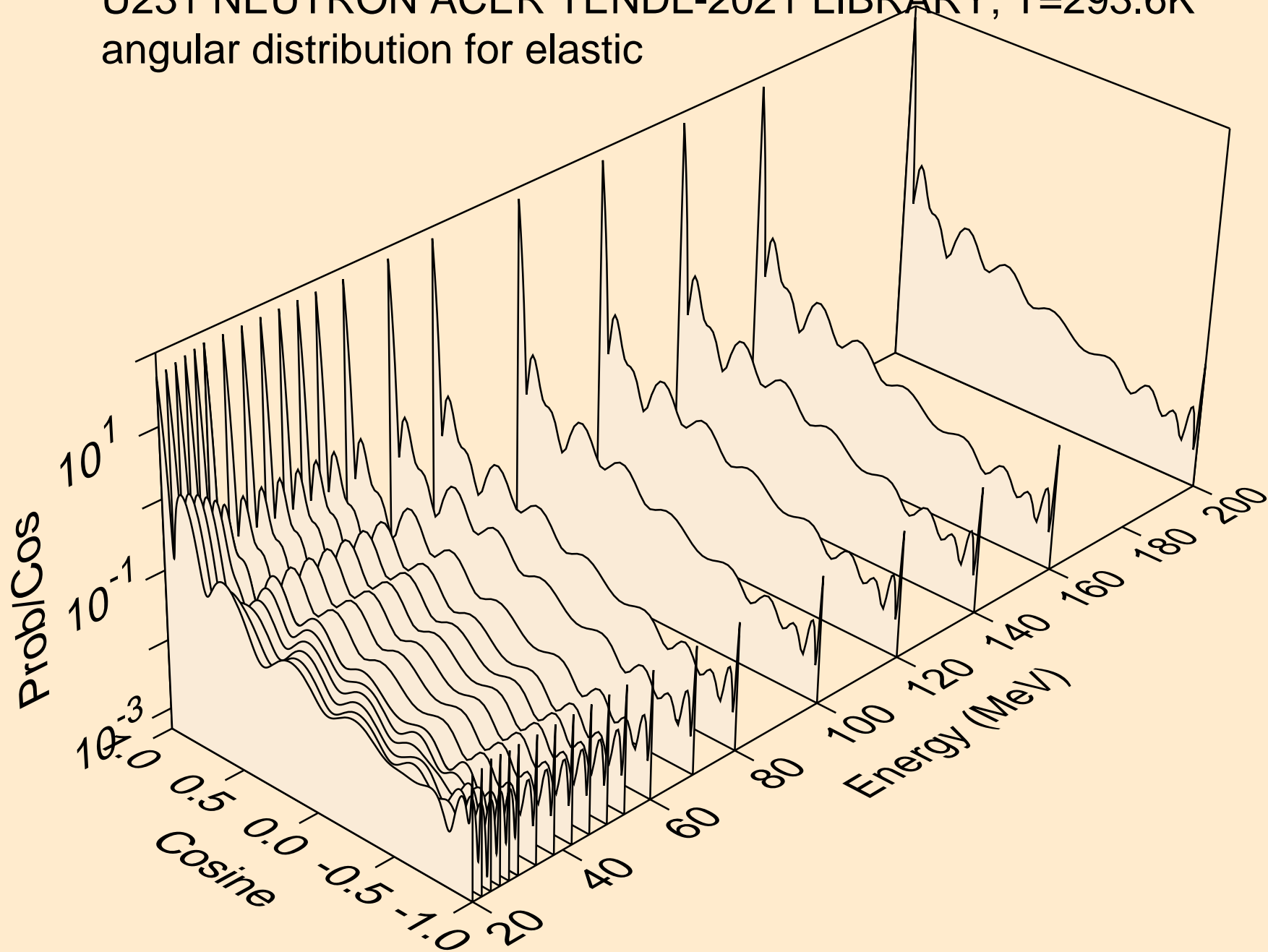

U231 NEUTRON ACER TENDL-2021 LIBRARY; T=293.6K
angular distribution for (n,n*1)

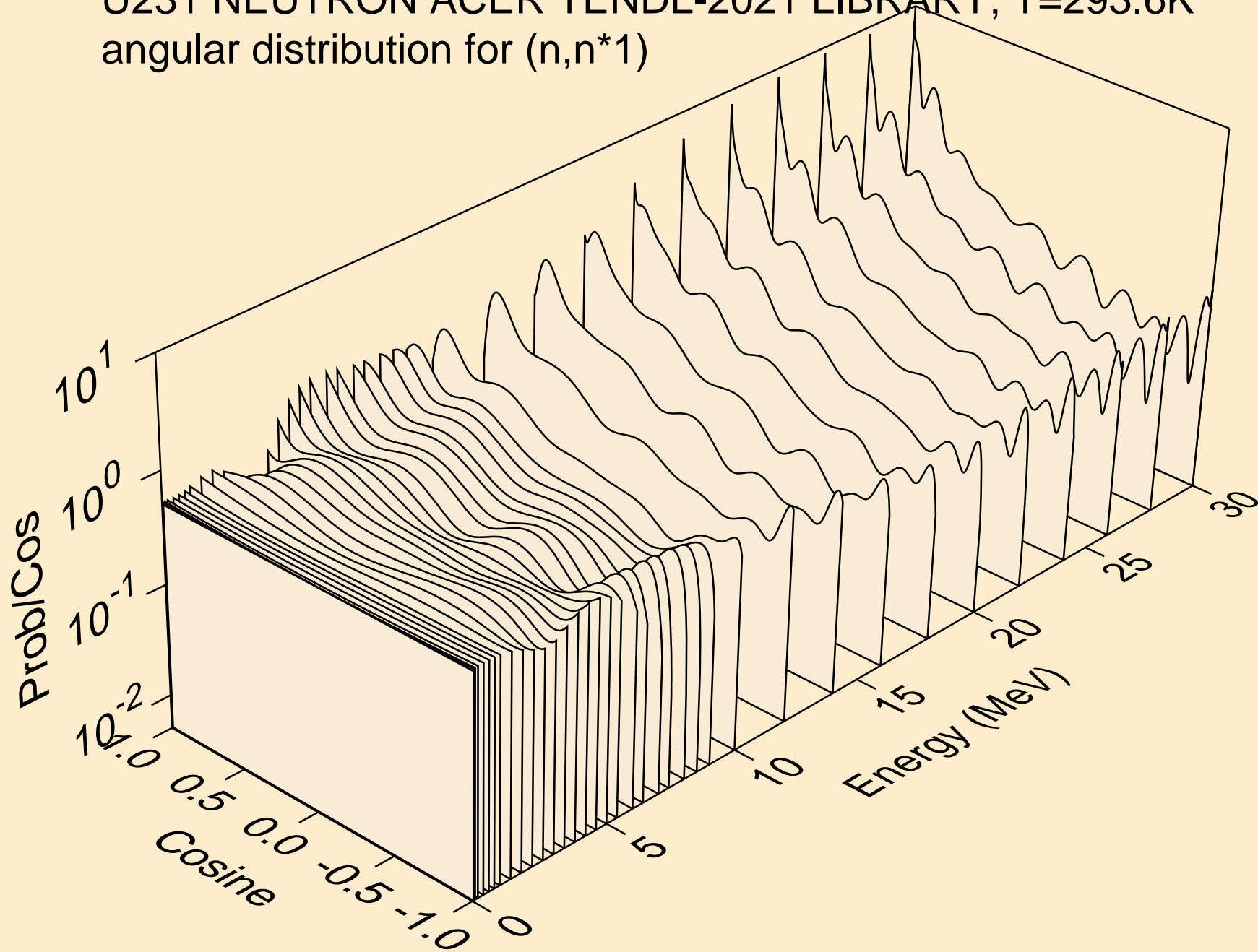

U231 NEUTRON ACER TENDL-2021 LIBRARY; T=293.6K
angular distribution for (n,n*2)

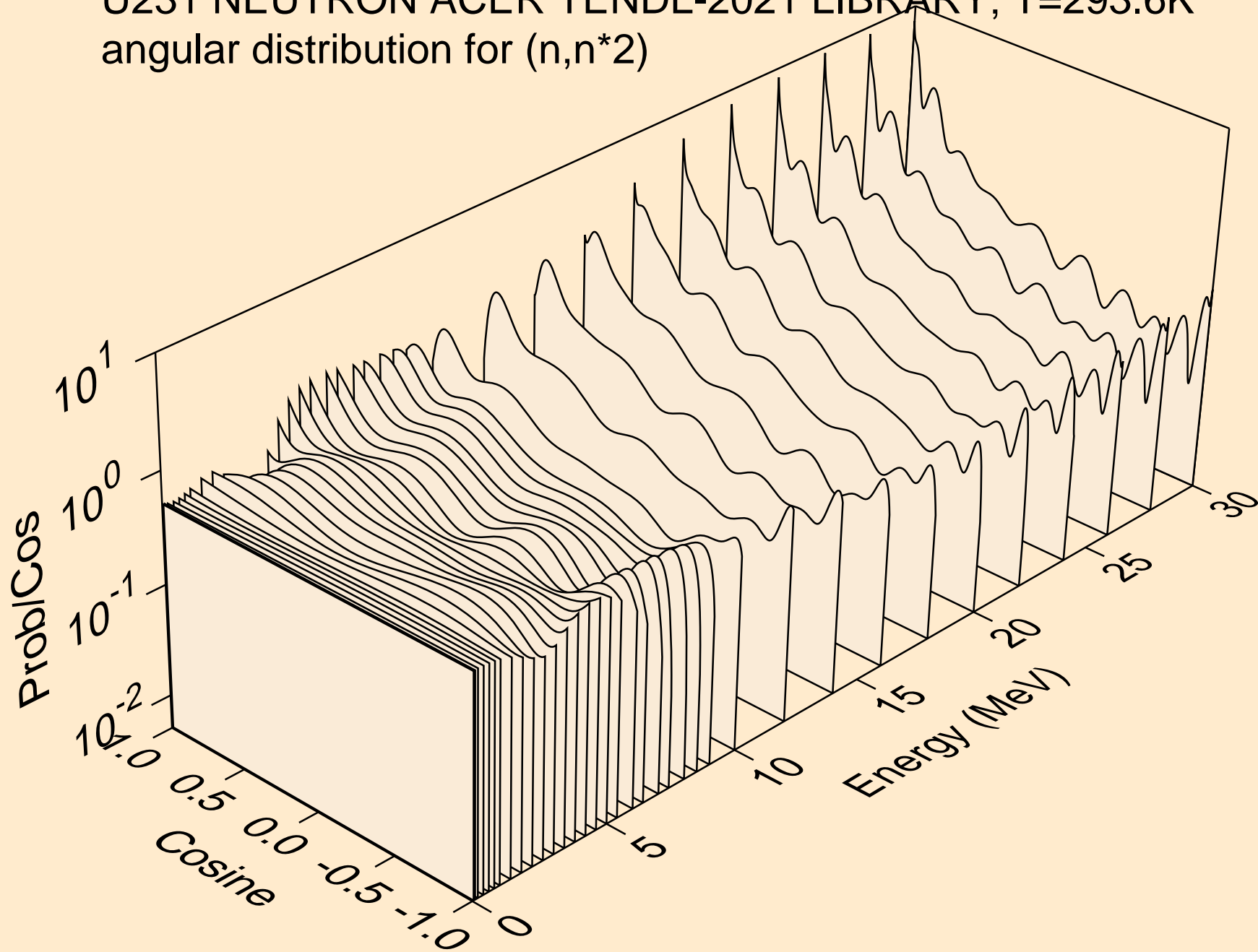

U231 NEUTRON ACER TENDL-2021 LIBRARY; T=293.6K
angular distribution for (n,n*3)

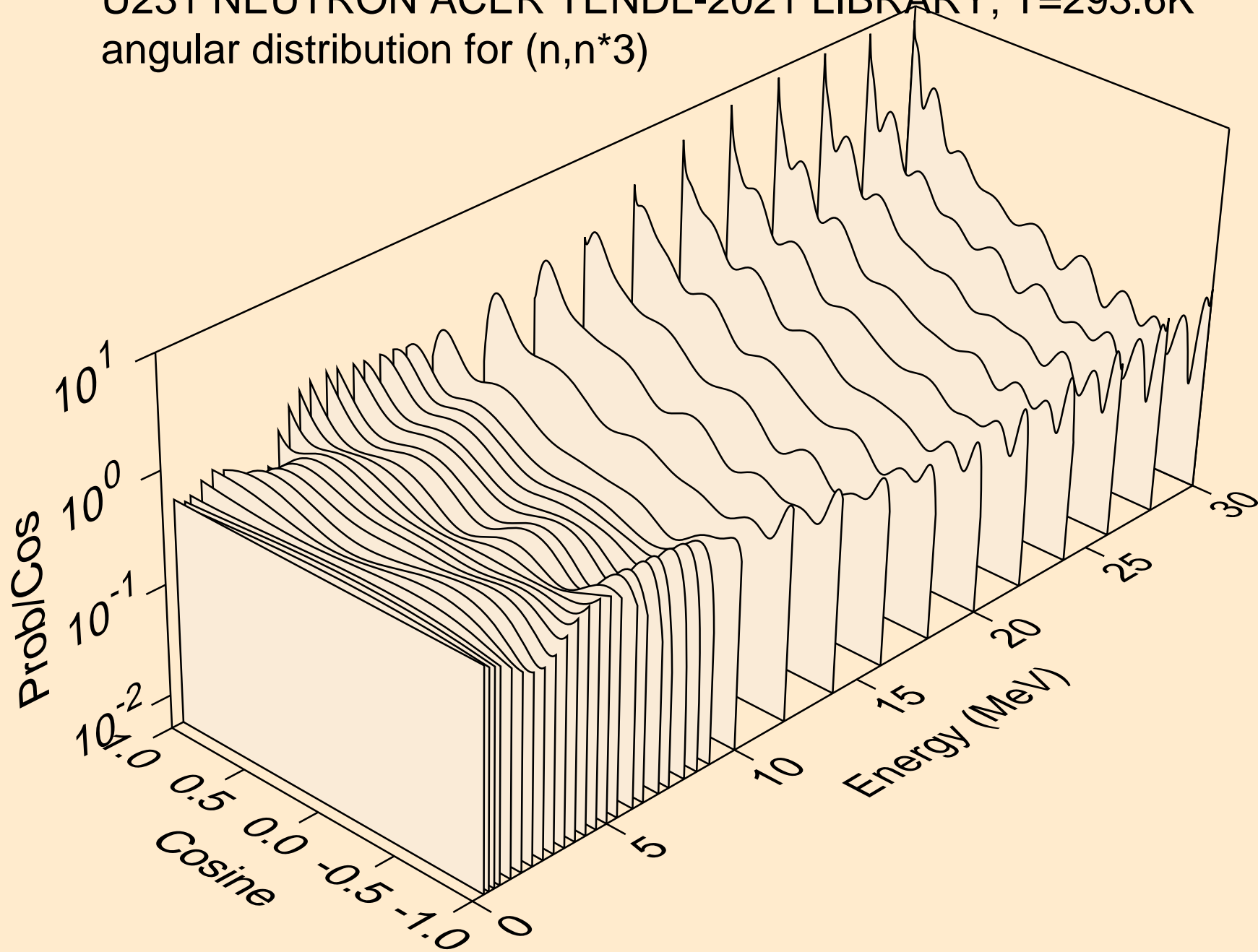

U231 NEUTRON ACER TENDL-2021 LIBRARY; T=293.6K
angular distribution for (n,n*4)

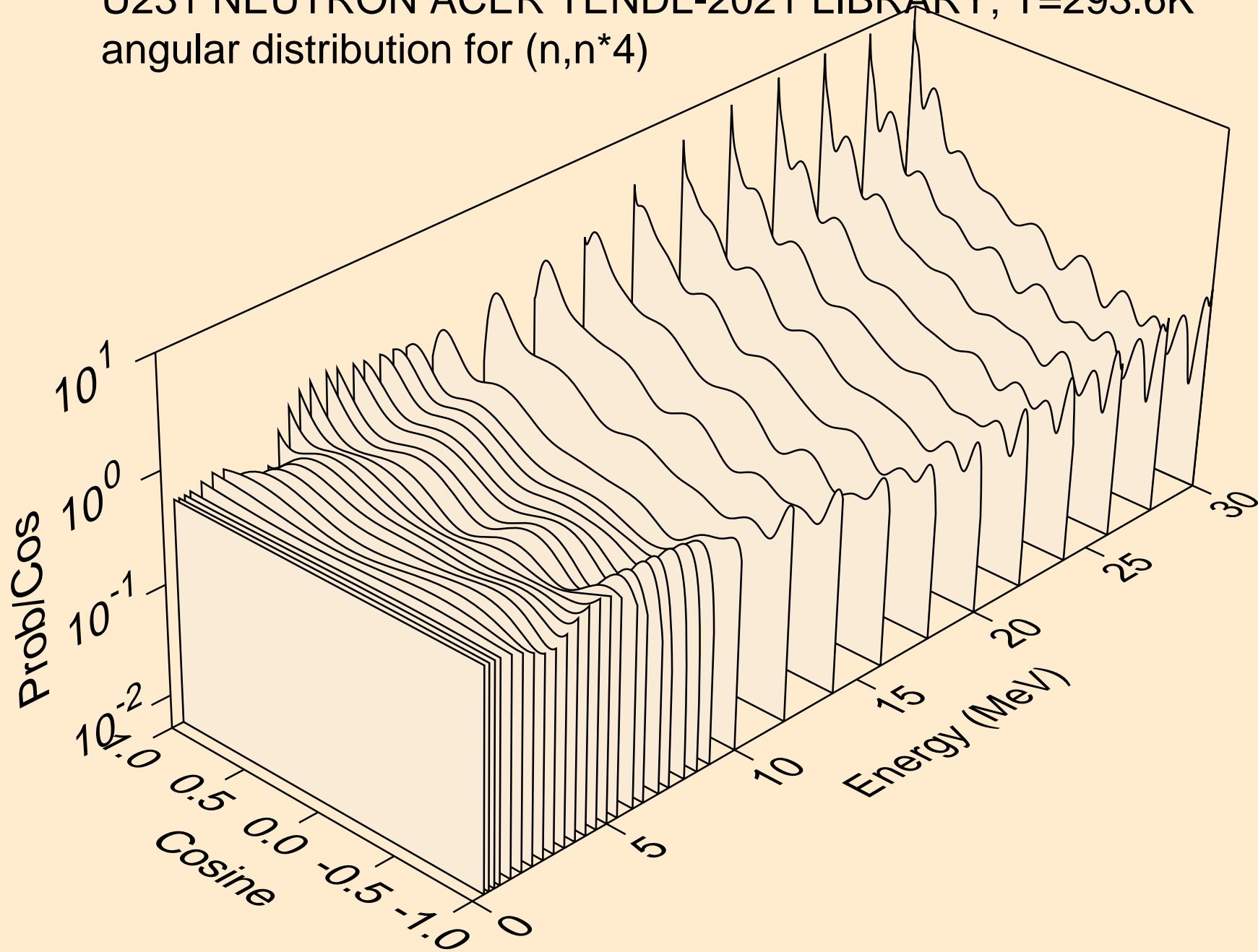

U231 NEUTRON ACER TENDL-2021 LIBRARY; T=293.6K
angular distribution for (n,n*5)

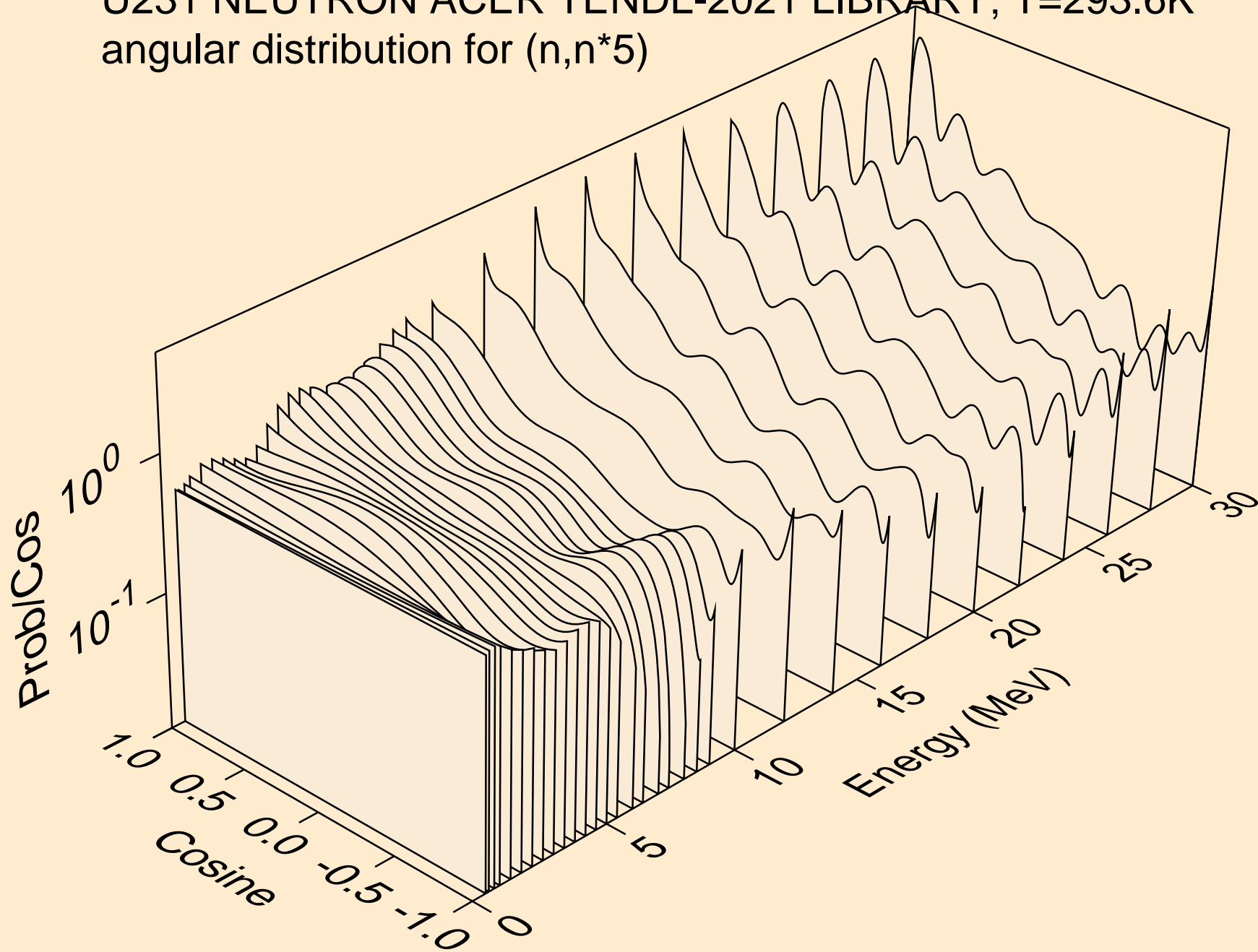

U231 NEUTRON ACER TENDL-2021 LIBRARY; T=293.6K
angular distribution for (n,n*6)

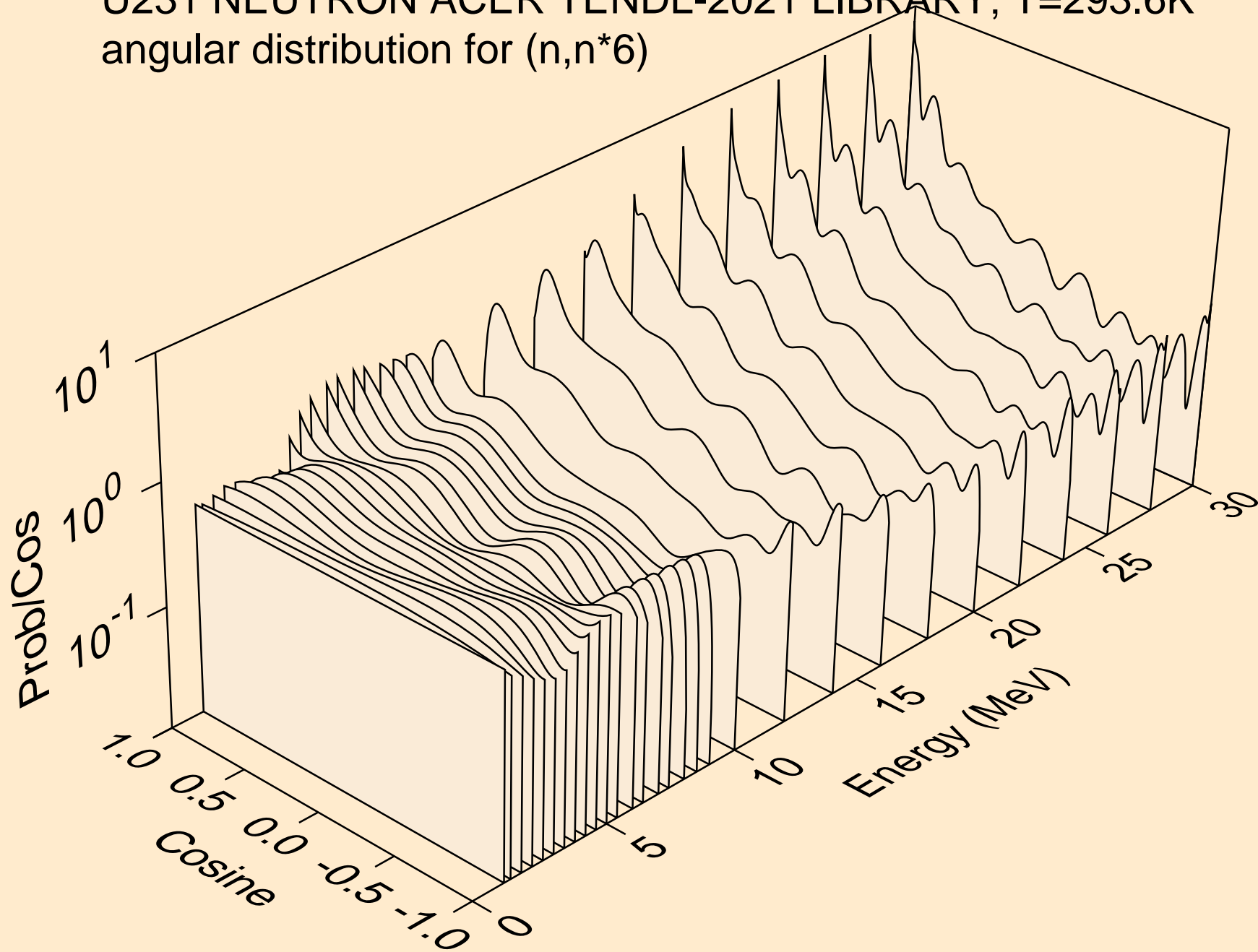

U231 NEUTRON ACER TENDL-2021 LIBRARY; T=293.6K
angular distribution for (n,n*7)

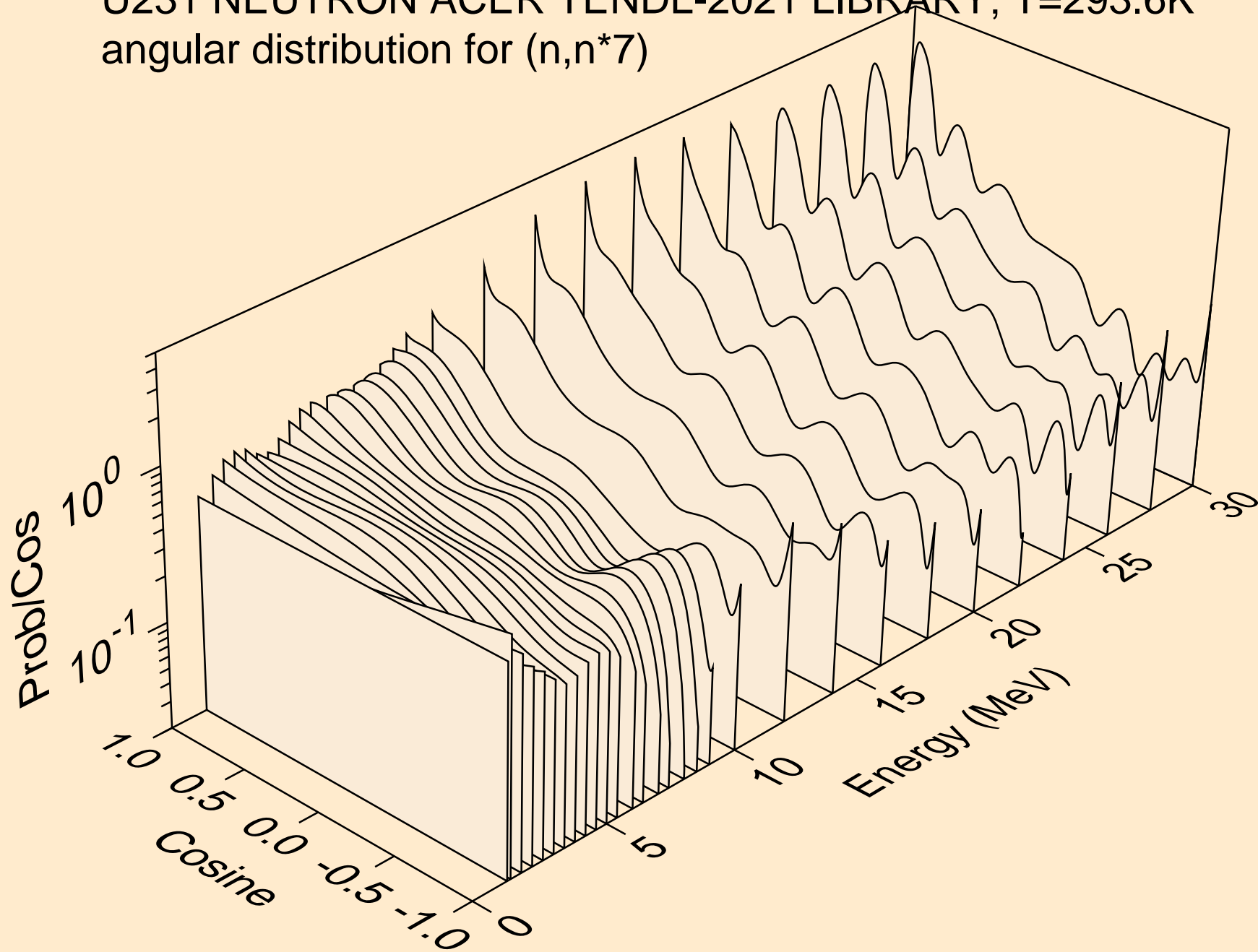

U231 NEUTRON ACER TENDL-2021 LIBRARY; T=293.6K

Total fission nubar

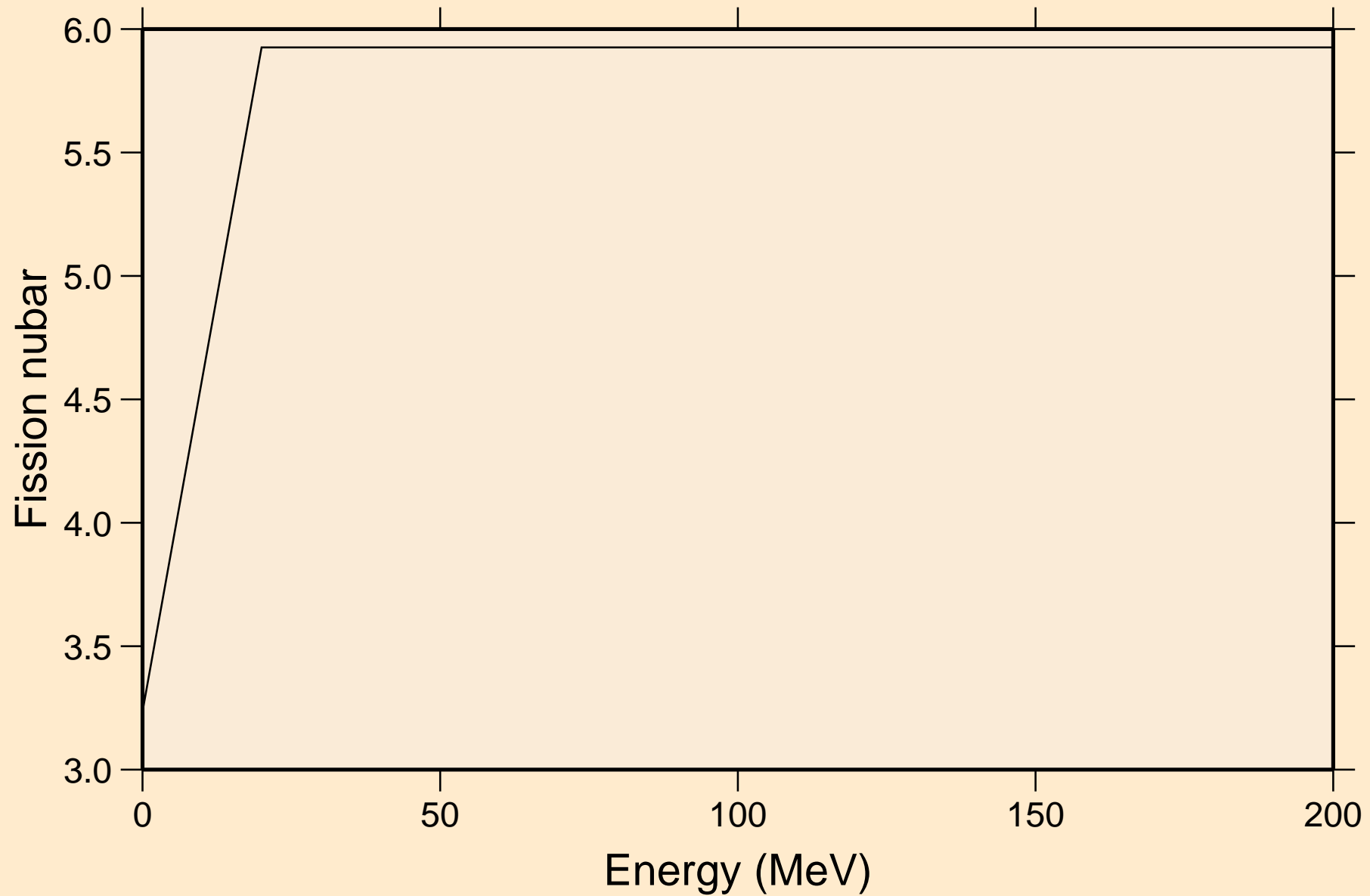

U231 NEUTRON ACER TENDL-2021 LIBRARY; T=293.6K
Neutron emission for (n,x)

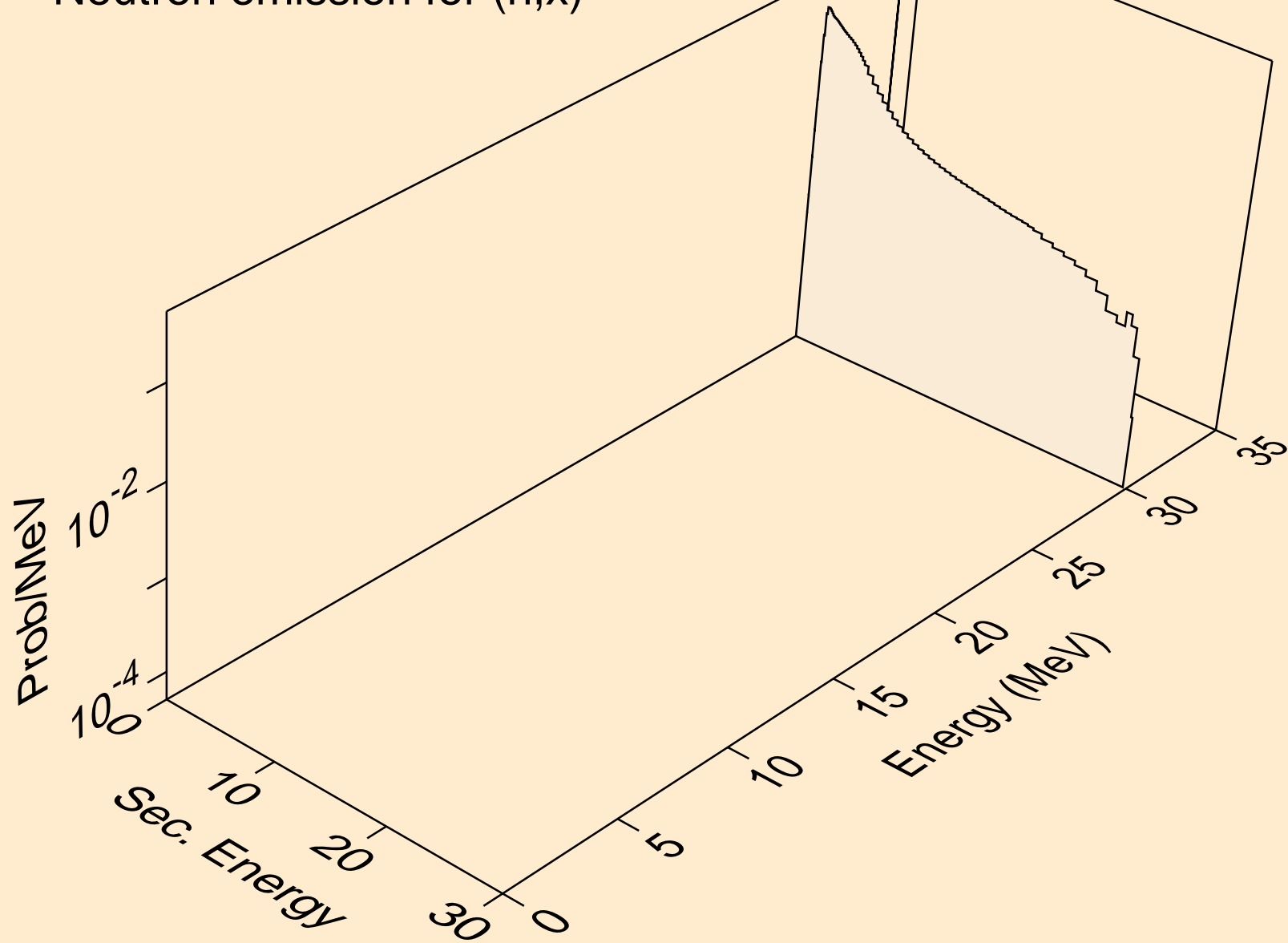

U231 NEUTRON ACER TENDL-2021 LIBRARY; T=293.6K
Neutron emission for (n,2nd)

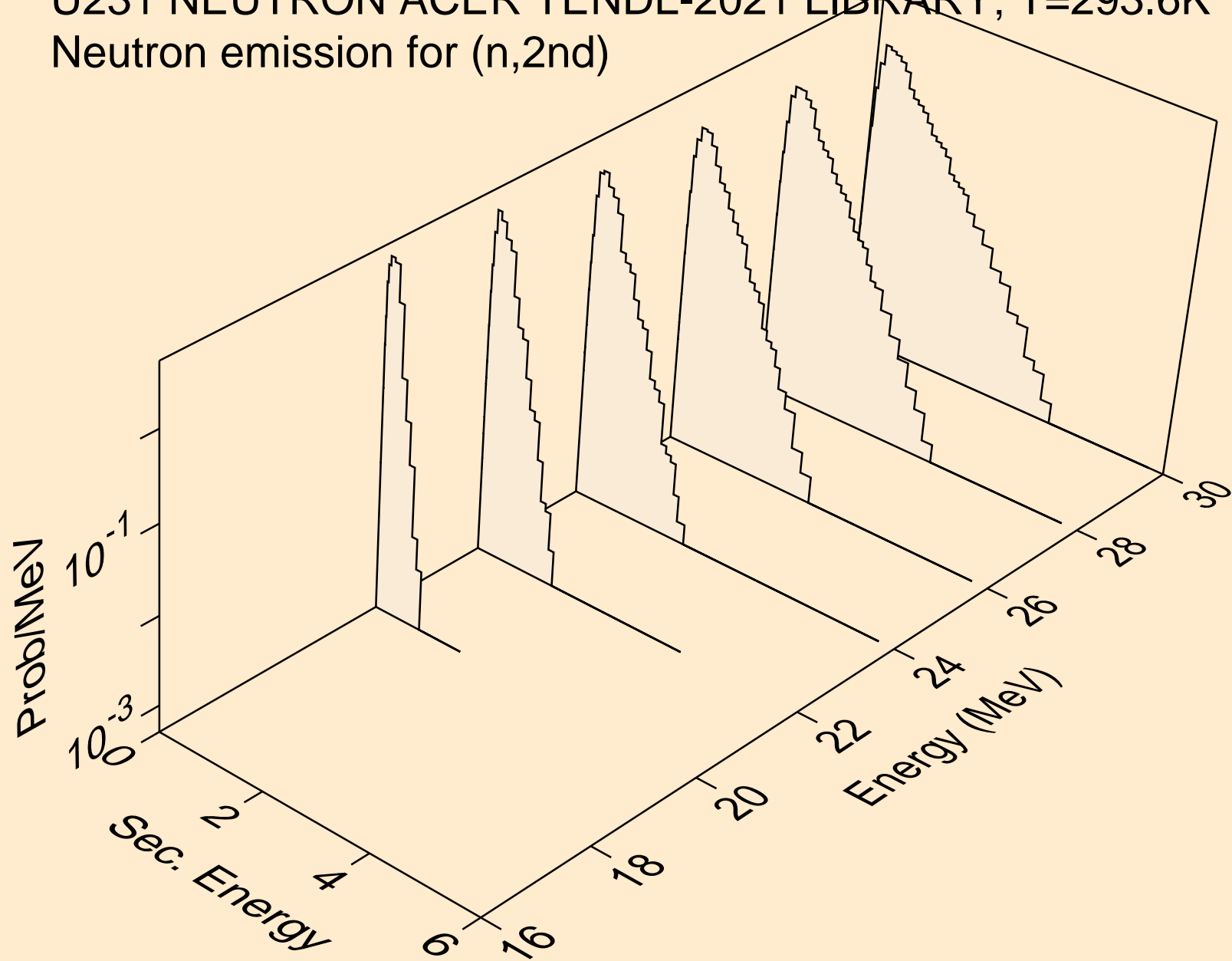

U231 NEUTRON ACER TENDL-2021 LIBRARY; T=293.6K
Neutron emission for (n,2n)

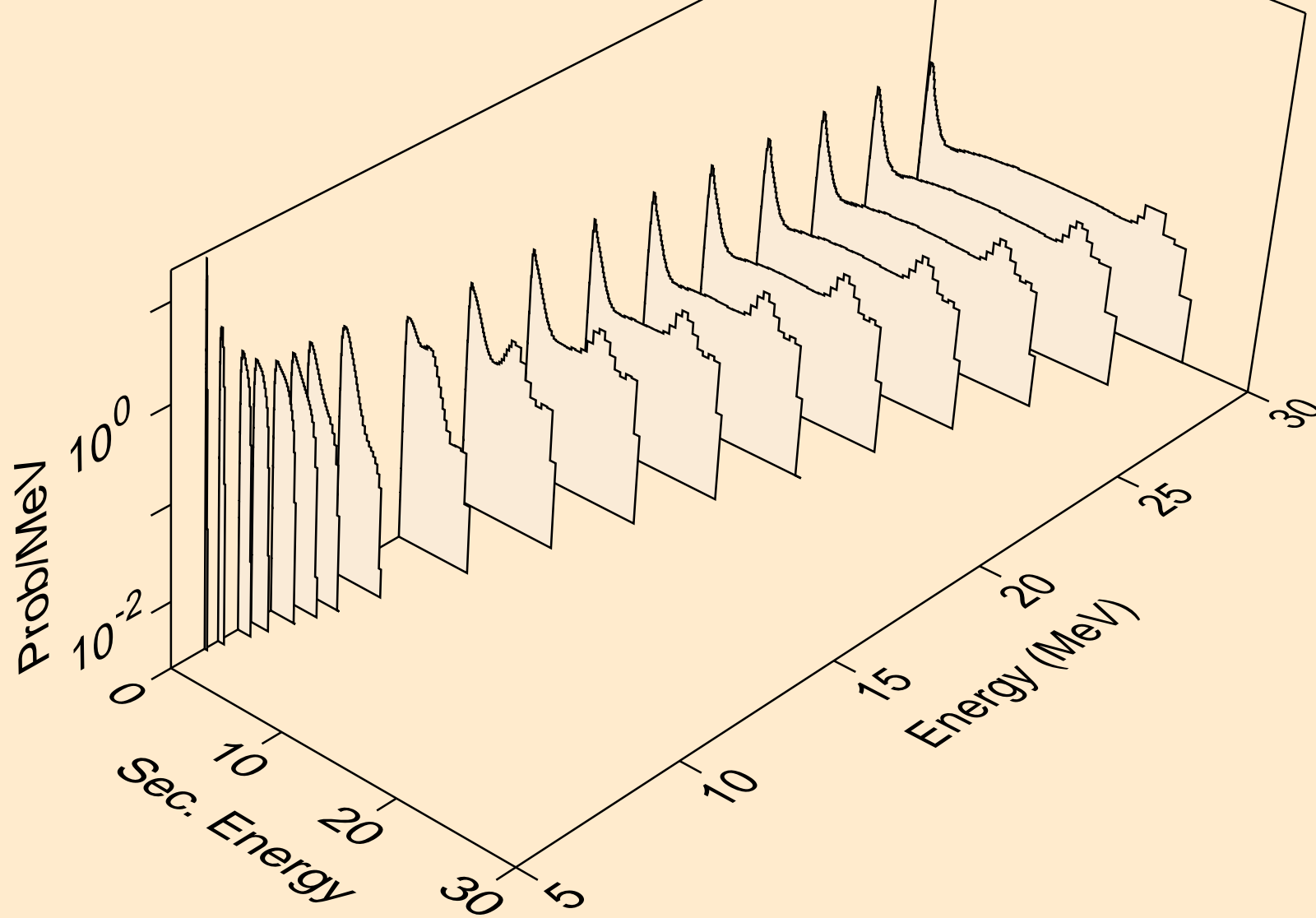

U231 NEUTRON ACER TENDL-2021 LIBRARY; T=293.6K
Neutron emission for (n,3n)

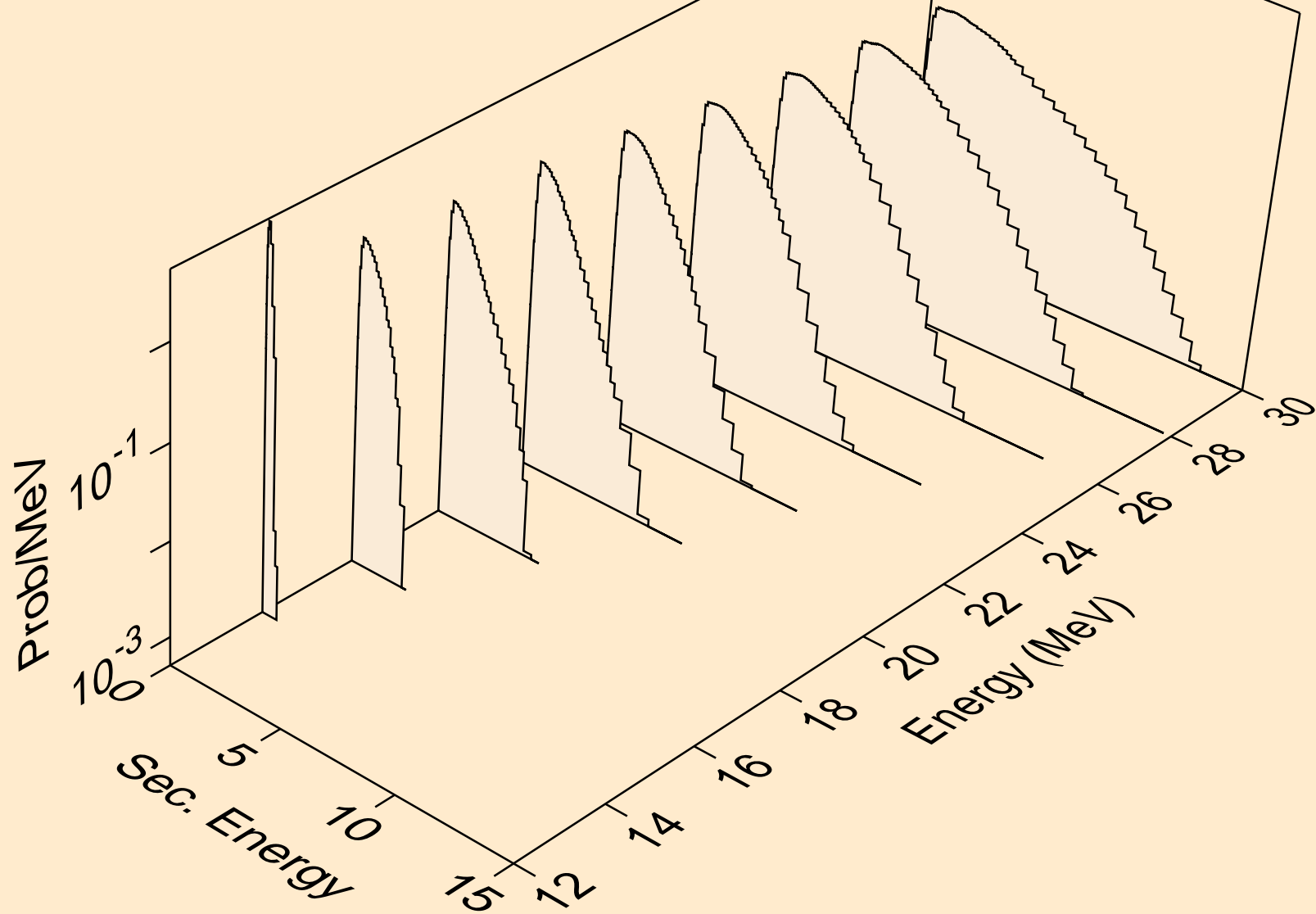

U231 NEUTRON ACER TENDL-2021 LIBRARY; T=293.6K
Neutron emission for fission

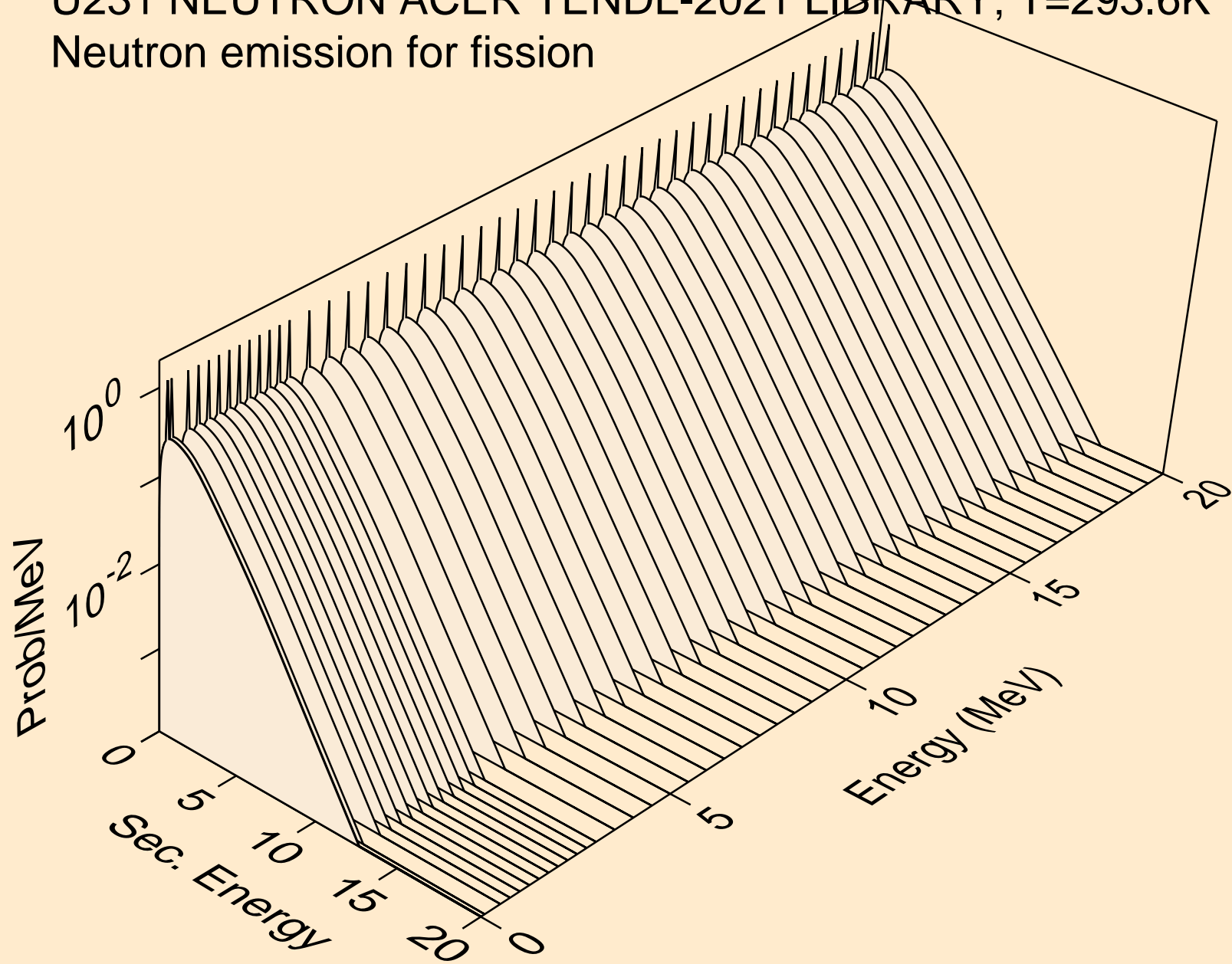

U231 NEUTRON ACER TENDL-2021 LIBRARY; T=293.6K
Neutron emission for (n,n*)a

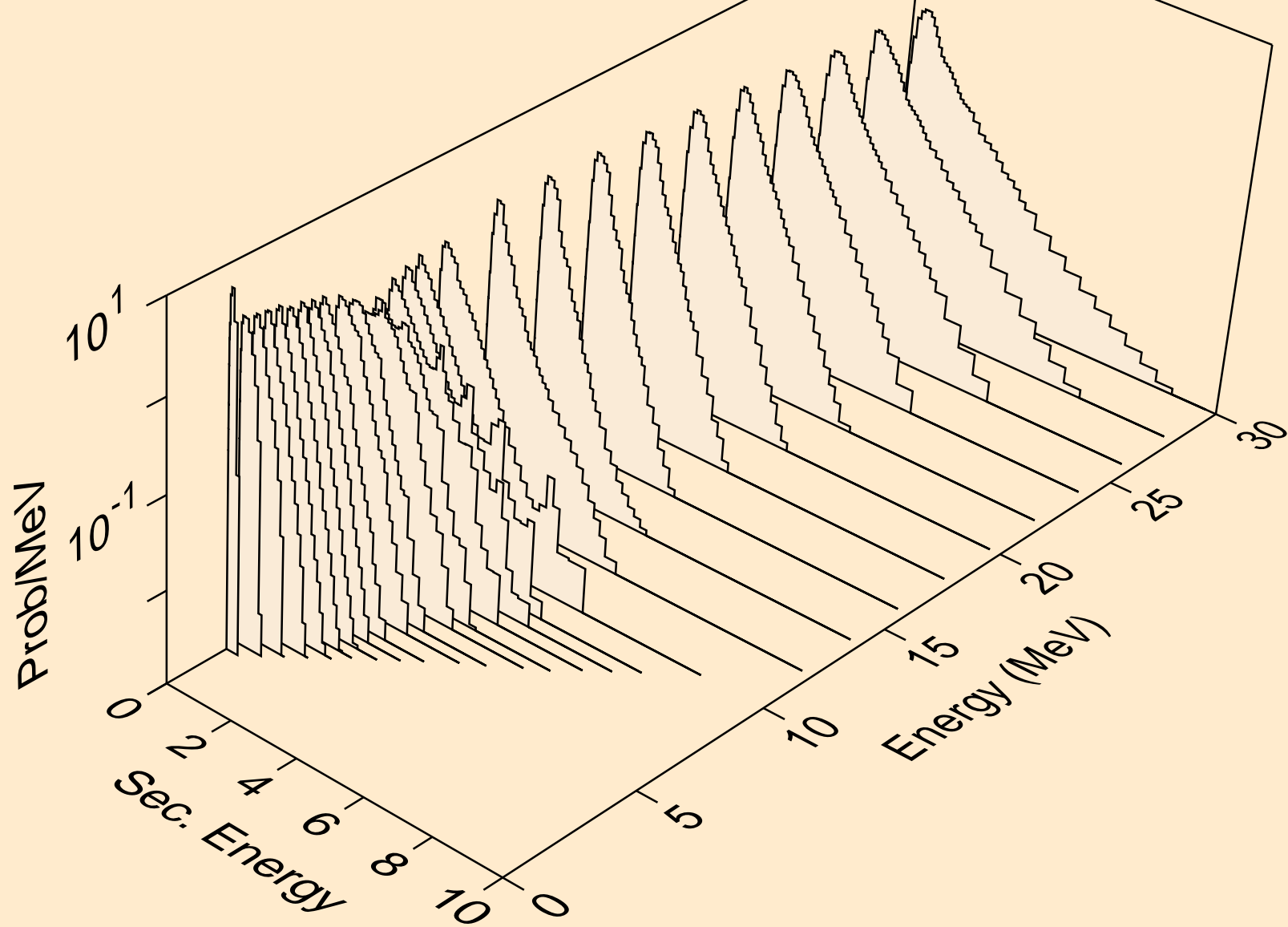

U231 NEUTRON ACER TENDL-2021 LIBRARY; T=293.6K
Neutron emission for (n,2n)a

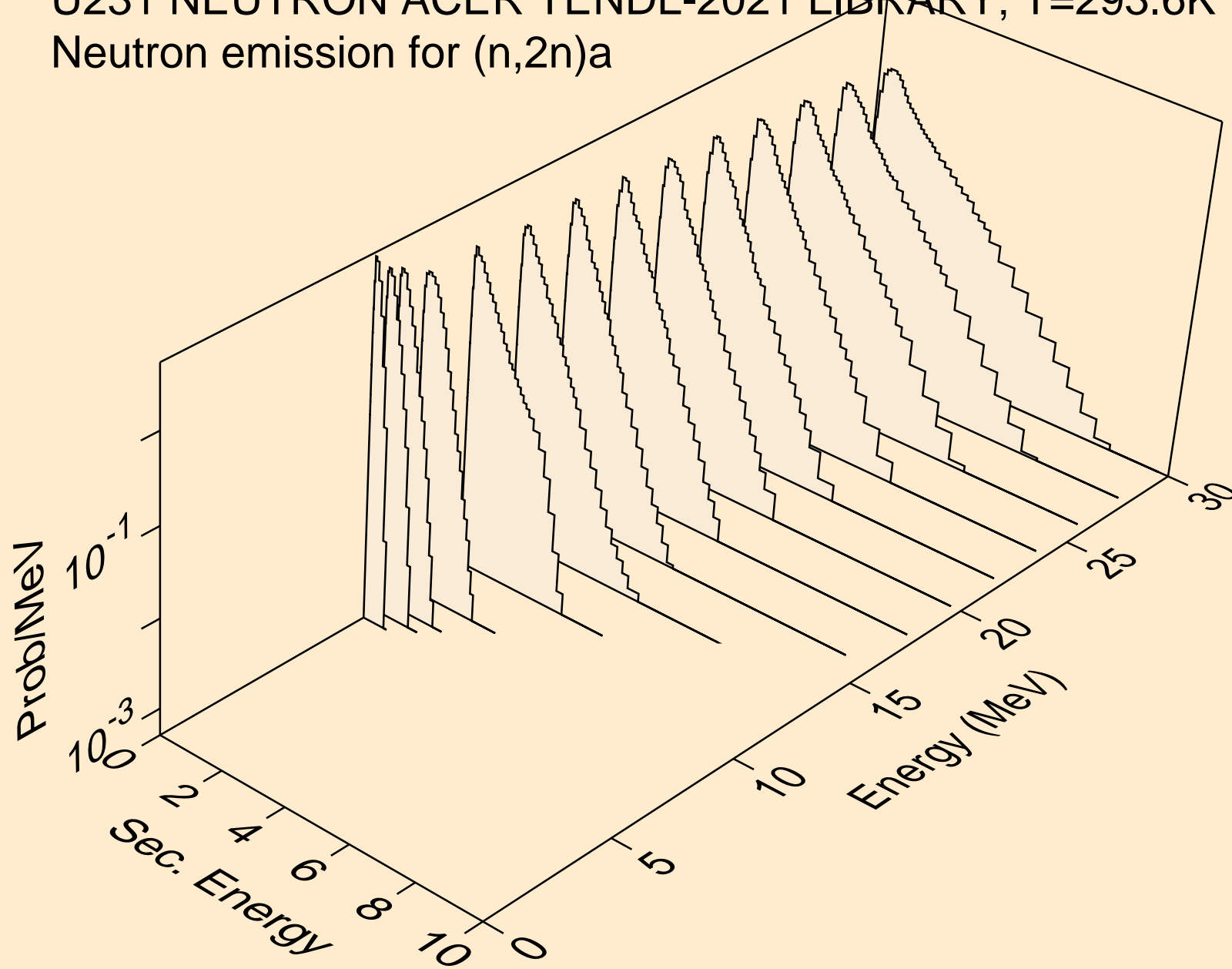

U231 NEUTRON ACER TENDL-2021 LIBRARY; T=293.6K
Neutron emission for (n,3n)a

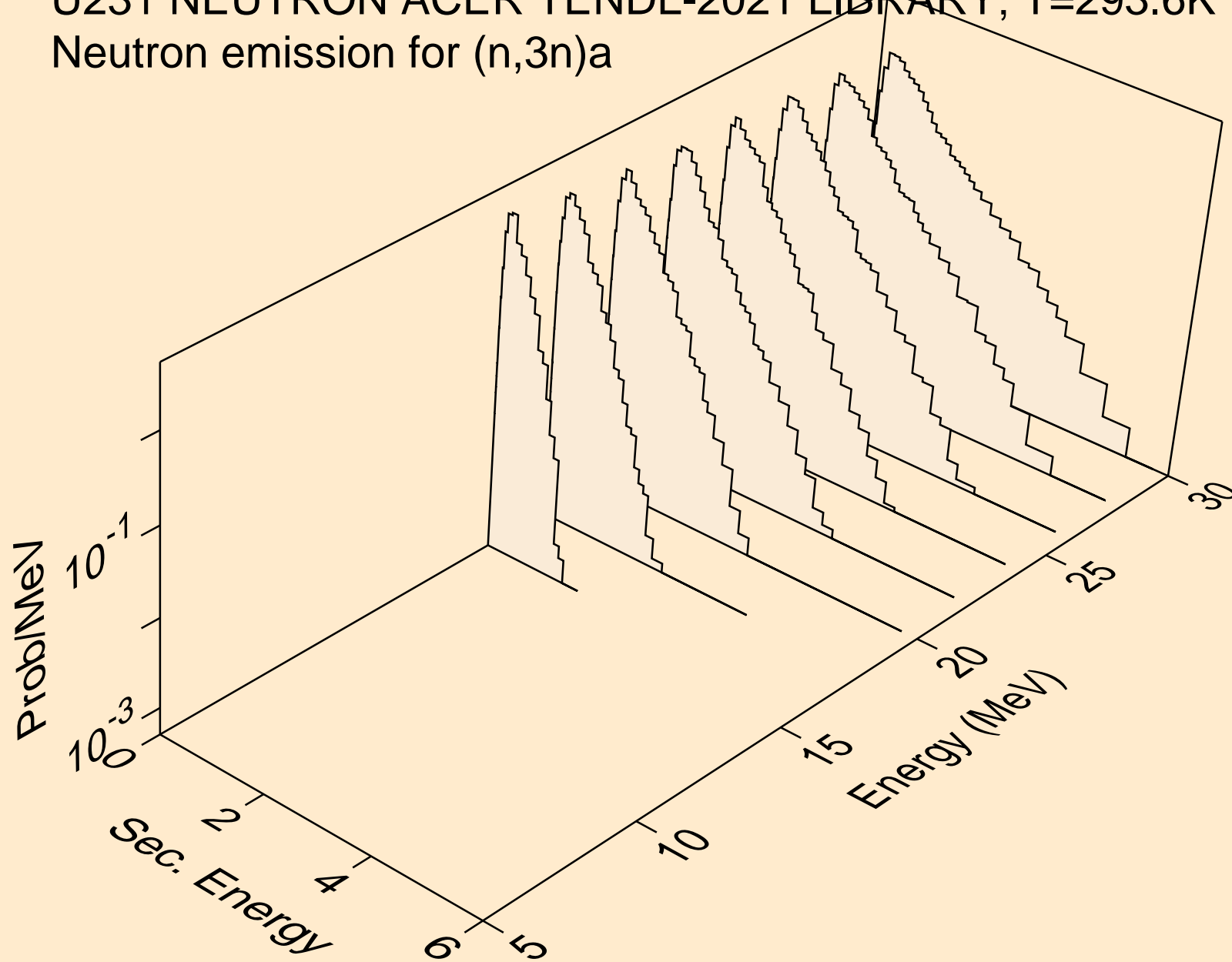

U231 NEUTRON ACER TENDL-2021 LIBRARY; T=293.6K
Neutron emission for (n,n*)p

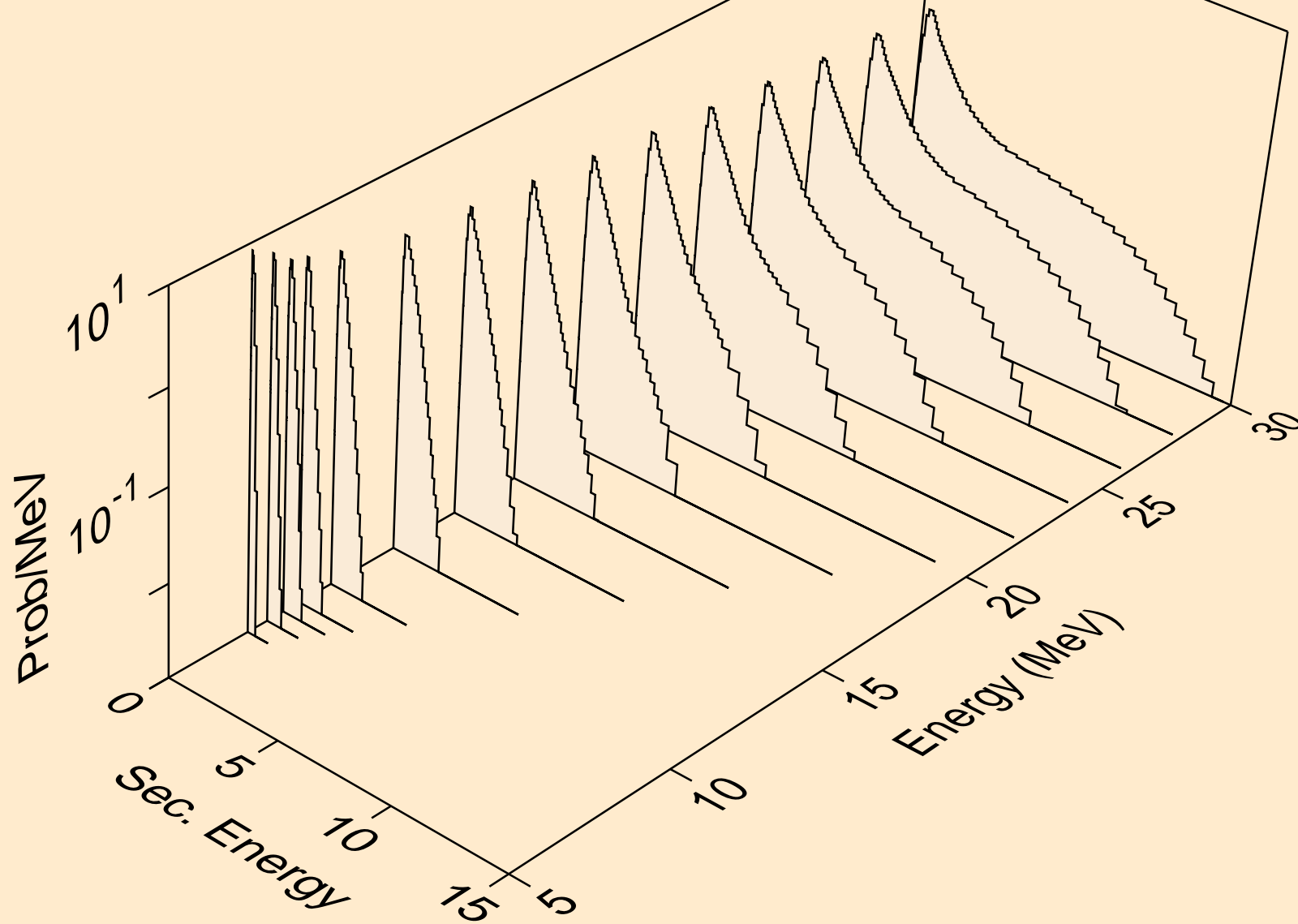

U231 NEUTRON ACER TENDL-2021 LIBRARY; T=293.6K
Neutron emission for (n,n*)2a

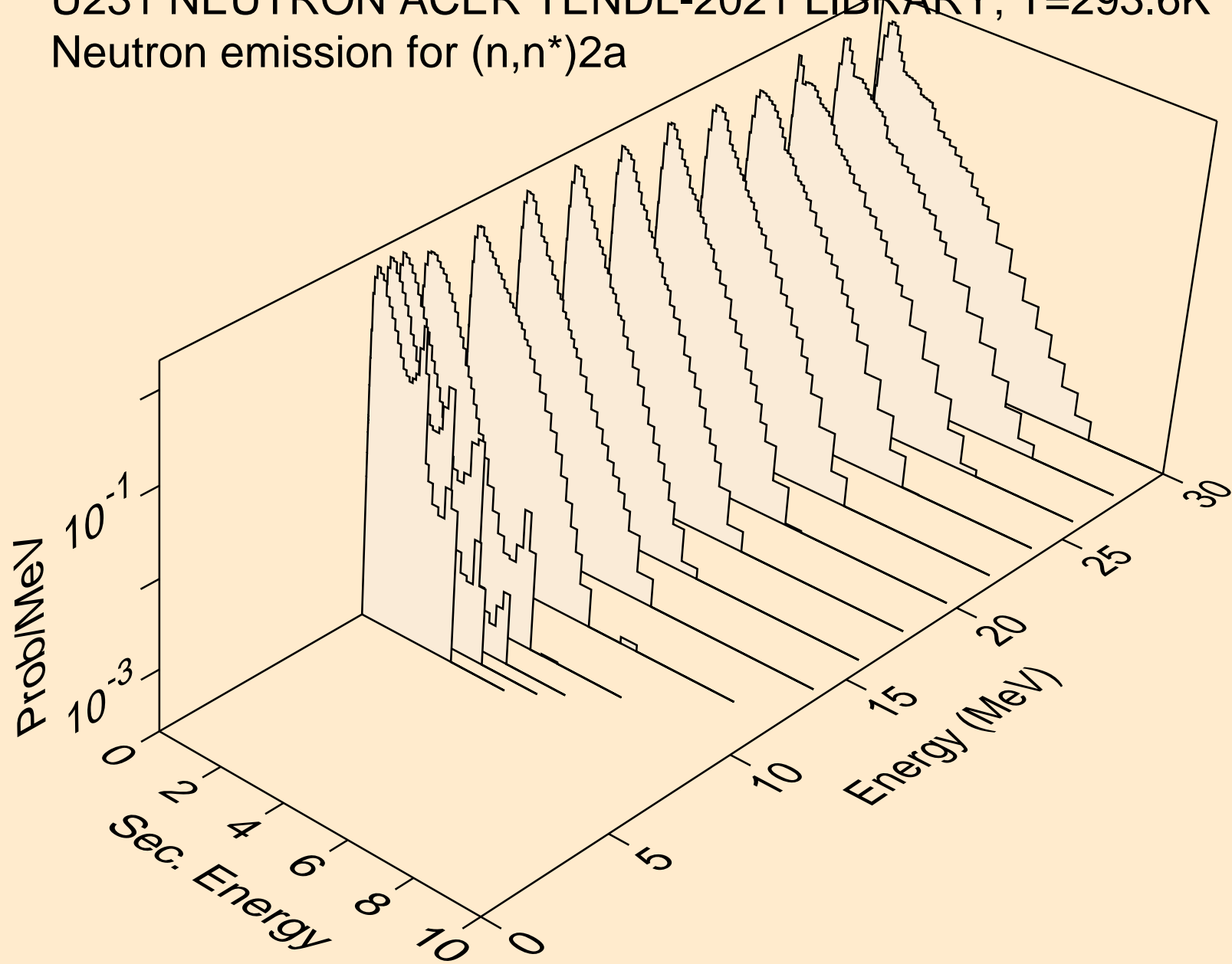

U231 NEUTRON ACER TENDL-2021 LIBRARY; T=293.6K
Neutron emission for (n,2n)2a

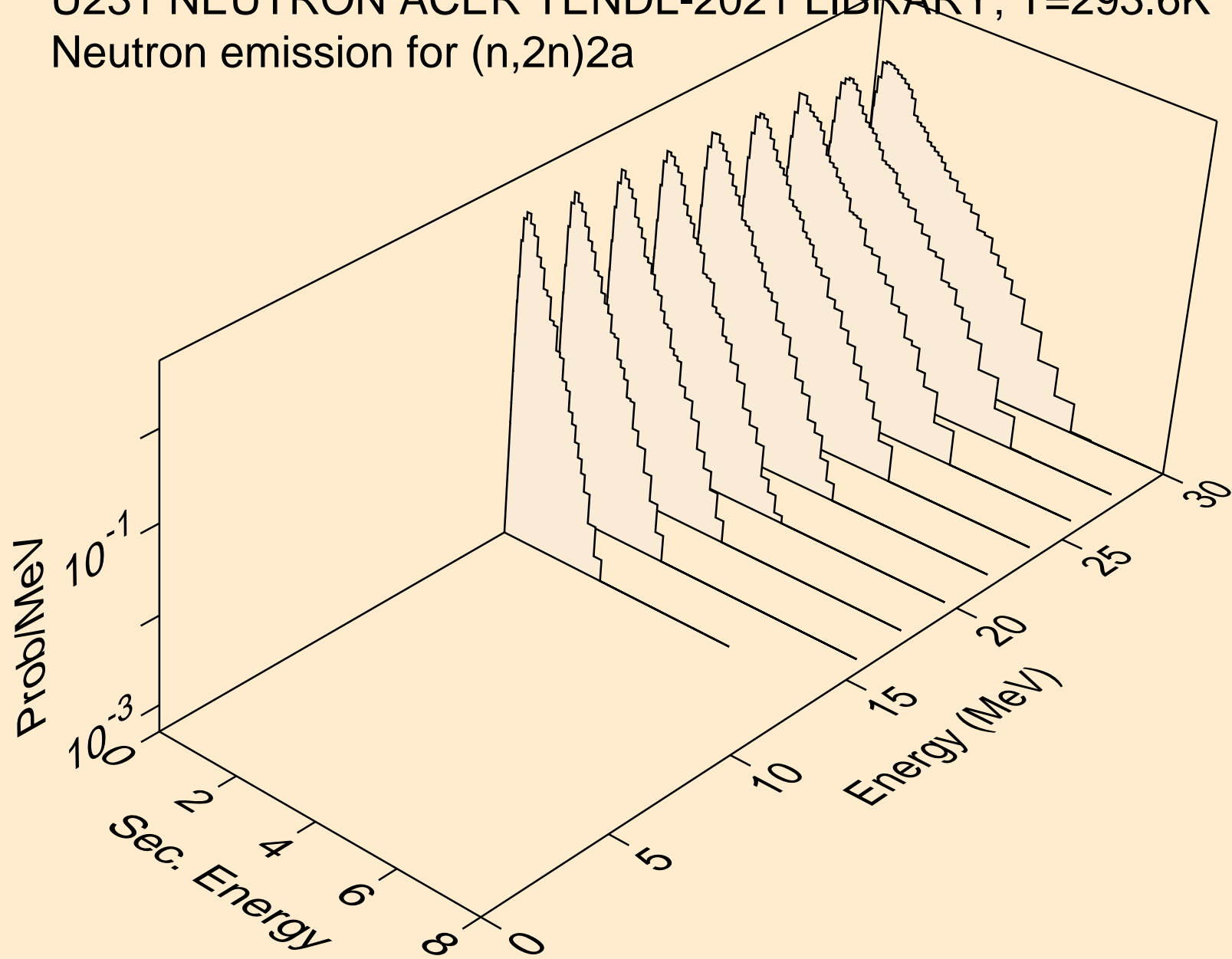

U231 NEUTRON ACER TENDL-2021 LIBRARY; T=293.6K
Neutron emission for (n,n*)d

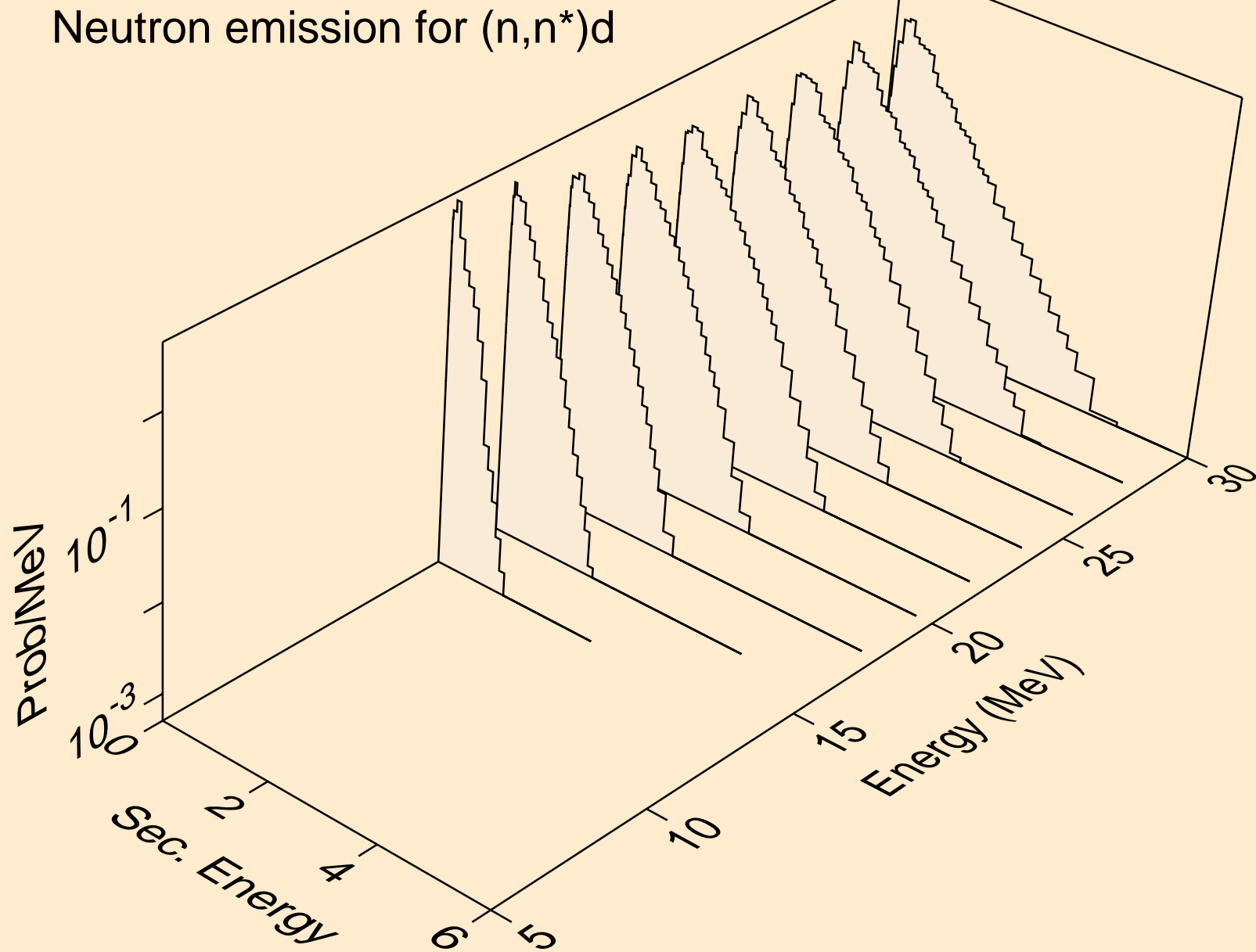

U231 NEUTRON ACER TENDL-2021 LIBRARY; T=293.6K
Neutron emission for (n,n*)t

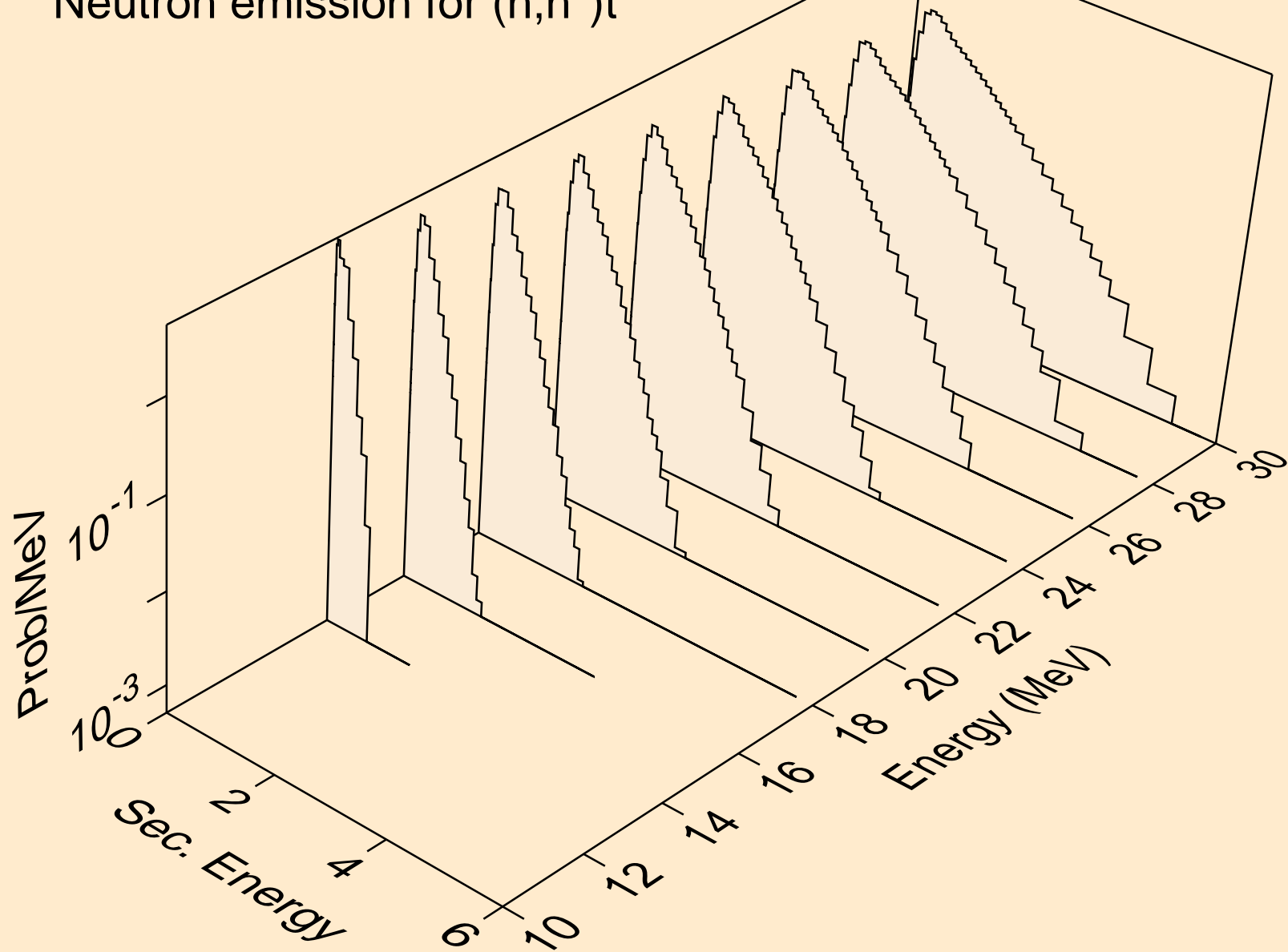

U231 NEUTRON ACER TENDL-2021 LIBRARY; T=293.6K
Neutron emission for (n,n*)he3

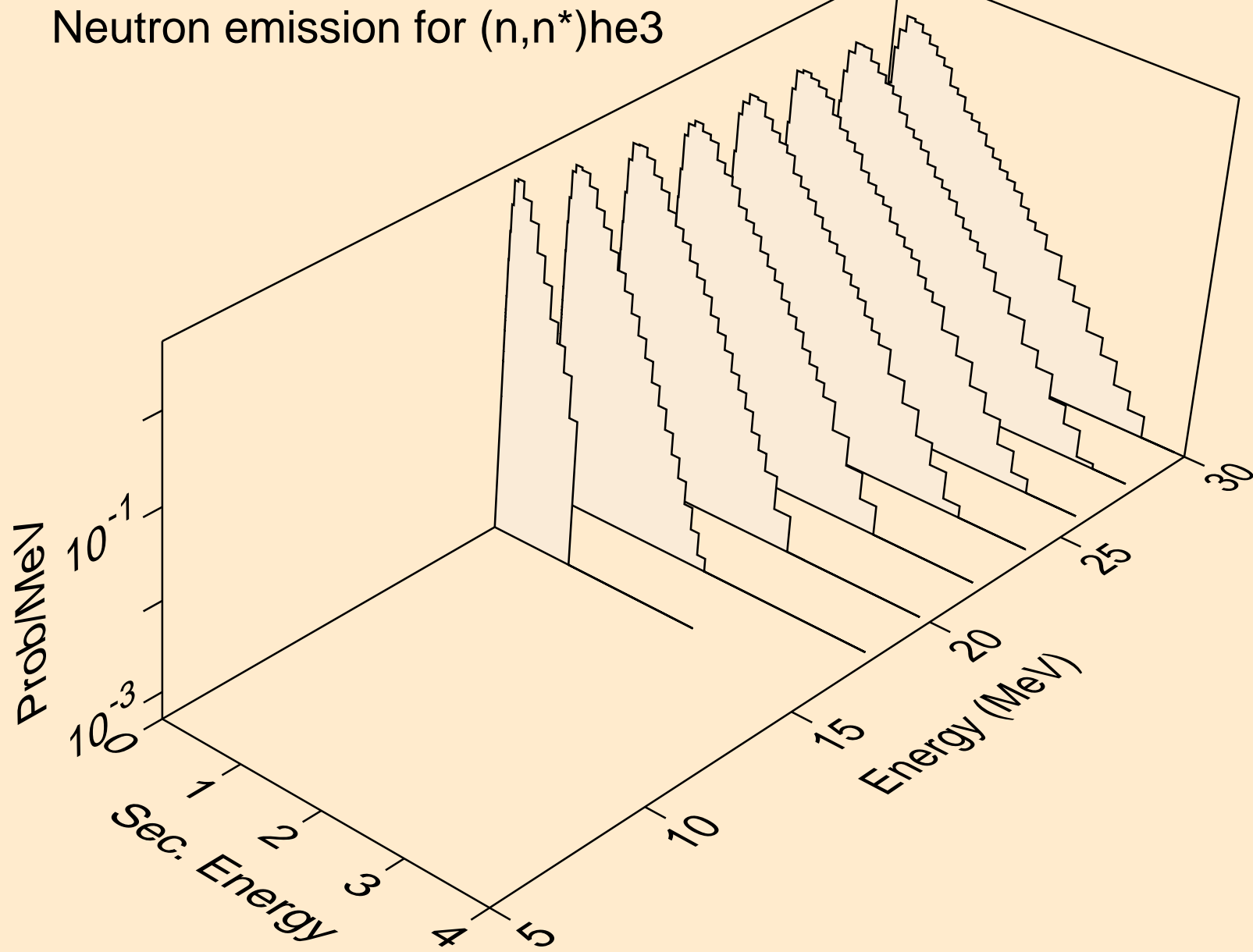

U231 NEUTRON ACER TENDL-2021 LIBRARY; T=293.6K
Neutron emission for (n,4n)

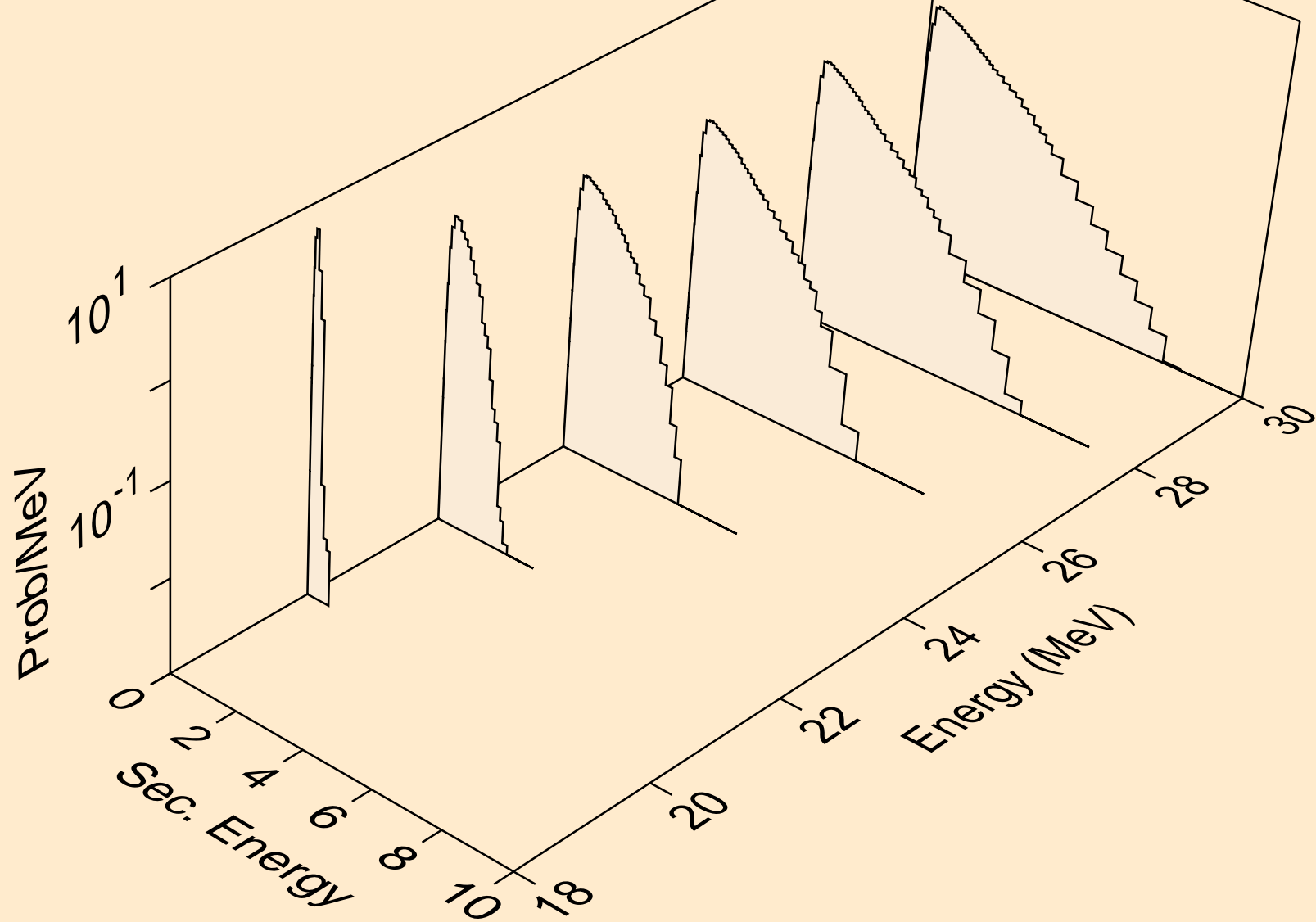

U231 NEUTRON ACER TENDL-2021 LIBRARY; T=293.6K
Neutron emission for (n,2np)

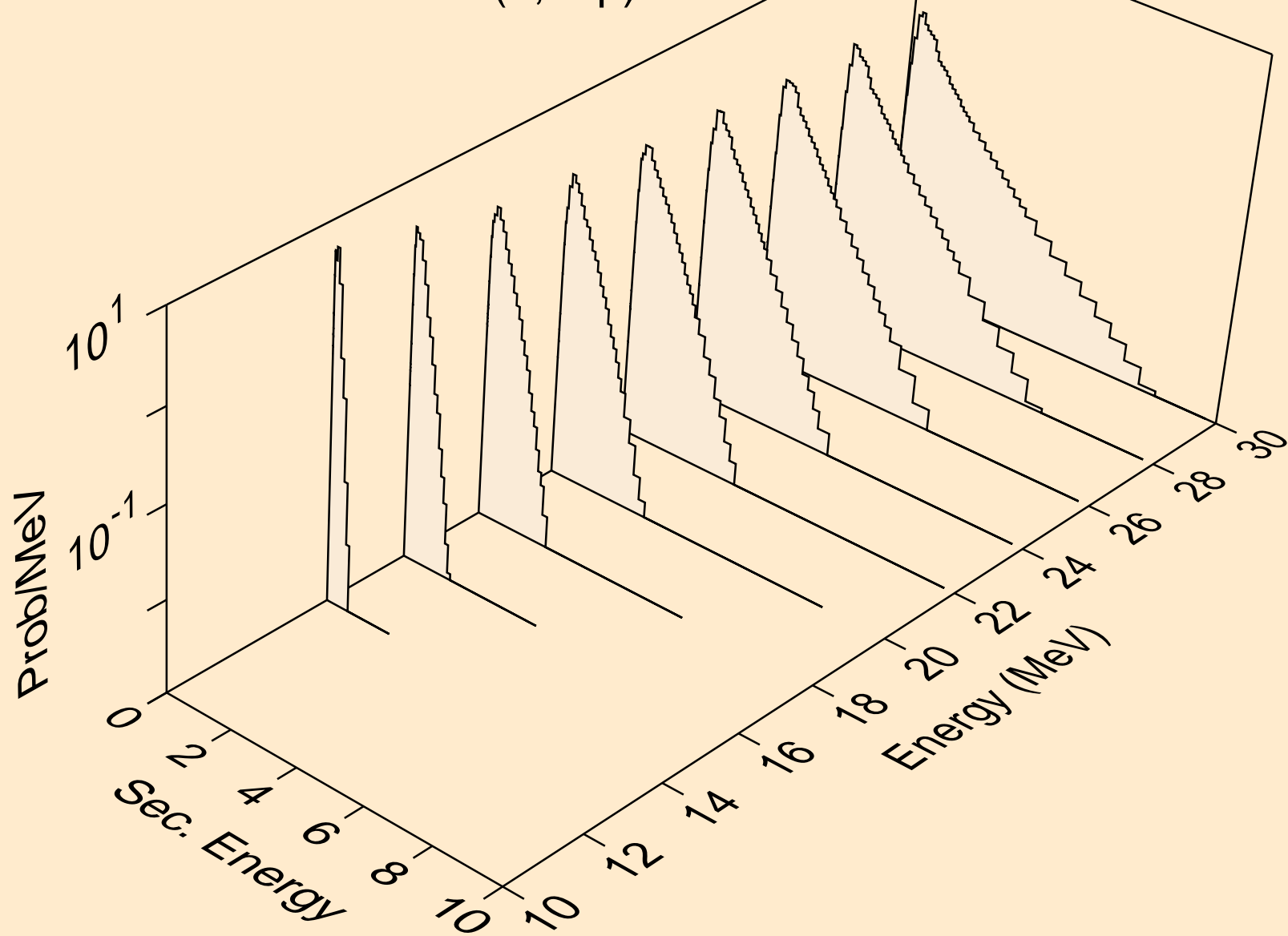

U231 NEUTRON ACER TENDL-2021 LIBRARY; T=293.6K
Neutron emission for (n,3np)

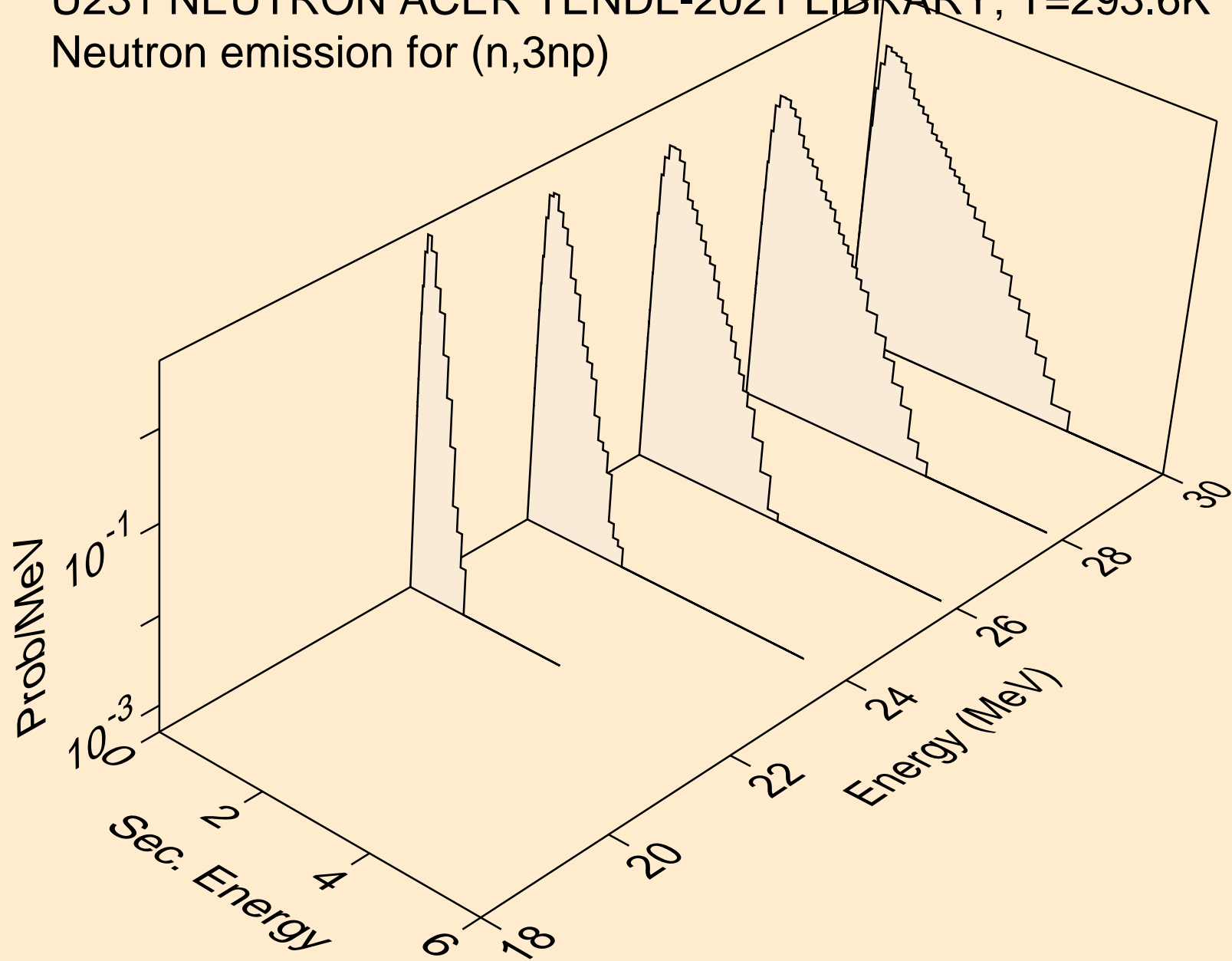

U231 NEUTRON ACER TENDL-2021 LIBRARY; T=293.6K
Neutron emission for (n,2np)

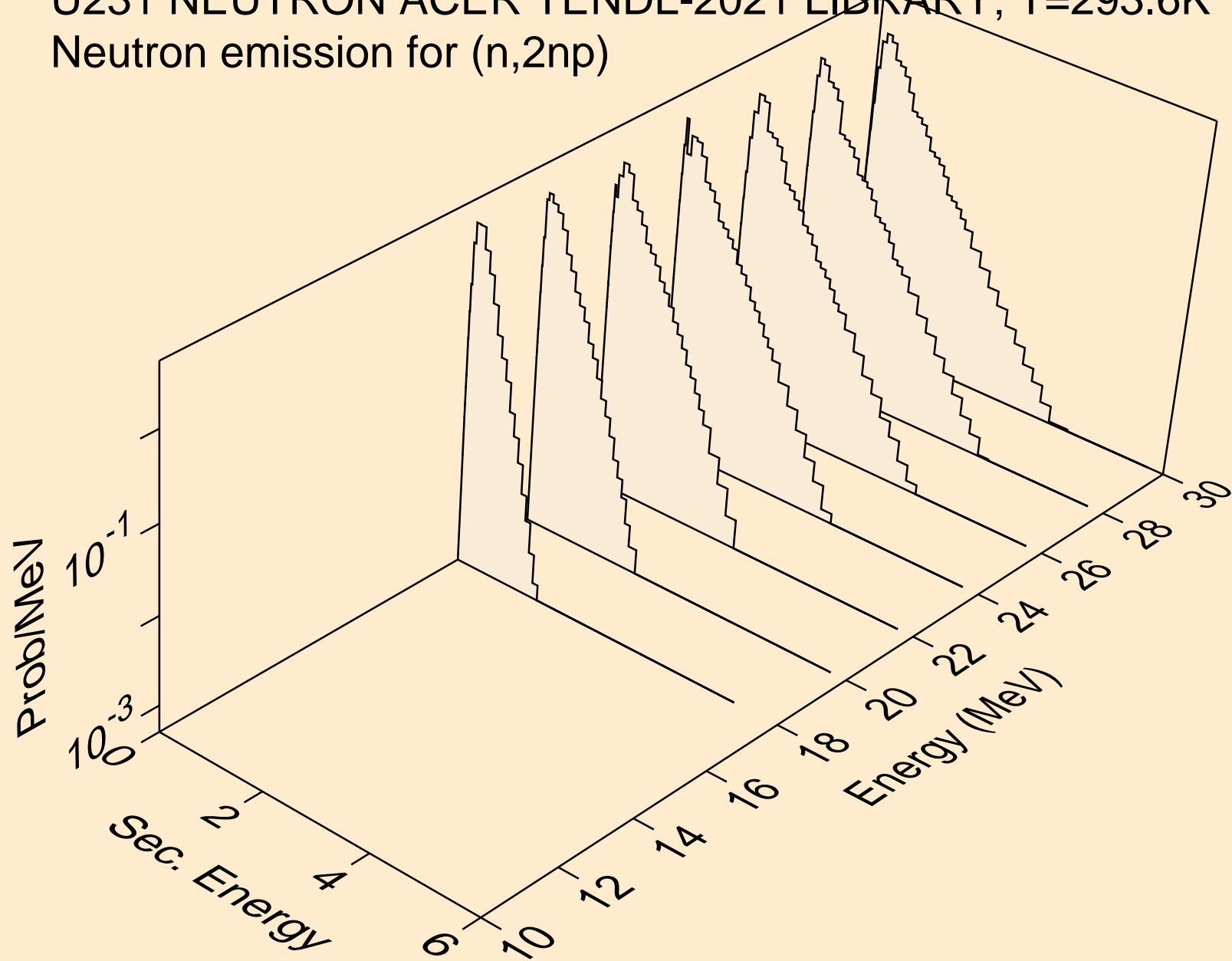

U231 NEUTRON ACER TENDL-2021 LIBRARY; T=293.6K
Neutron emission for (n,npa)

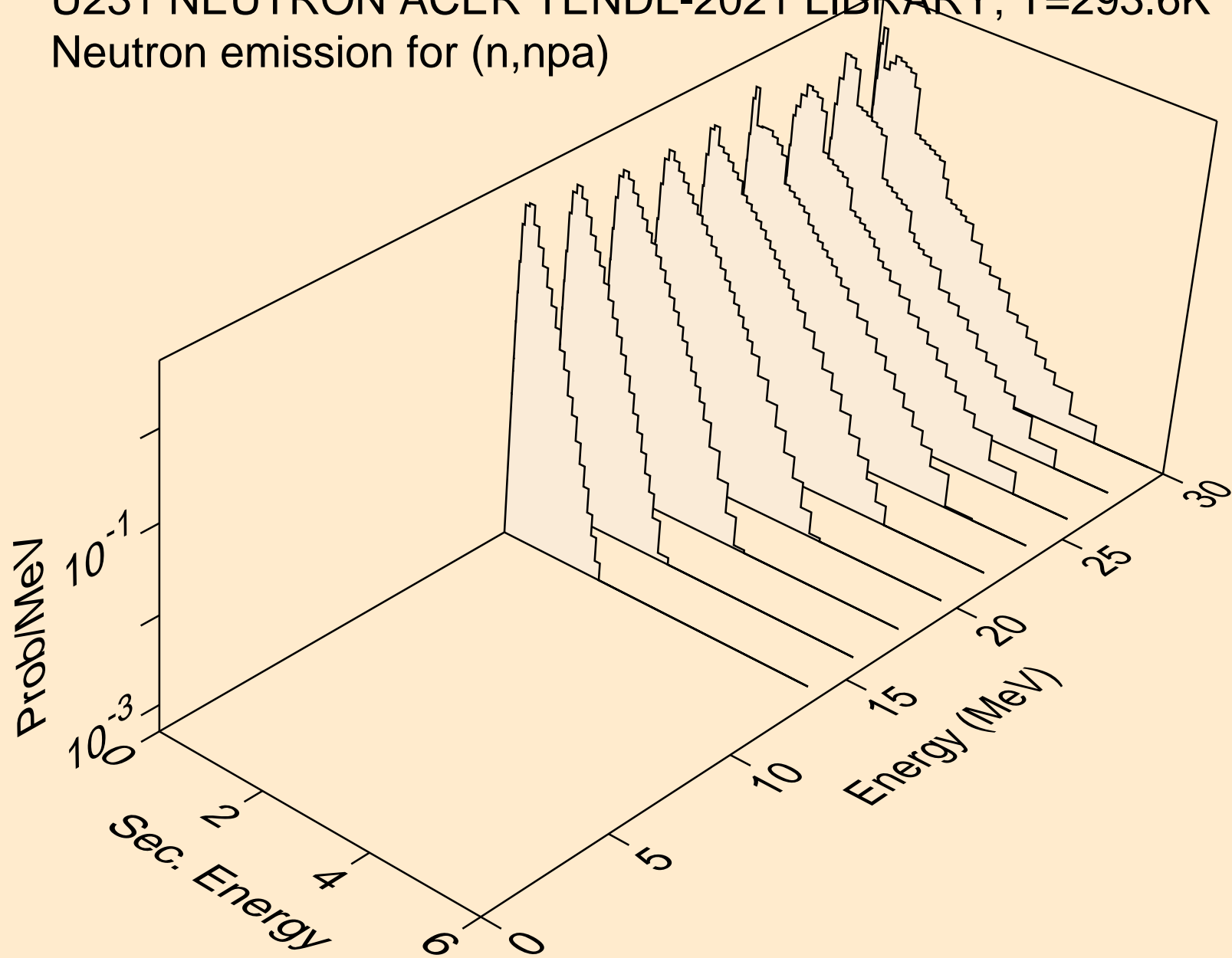

U231 NEUTRON ACER TENDL-2021 LIBRARY; T=293.6K
Neutron emission for (n,n*c)

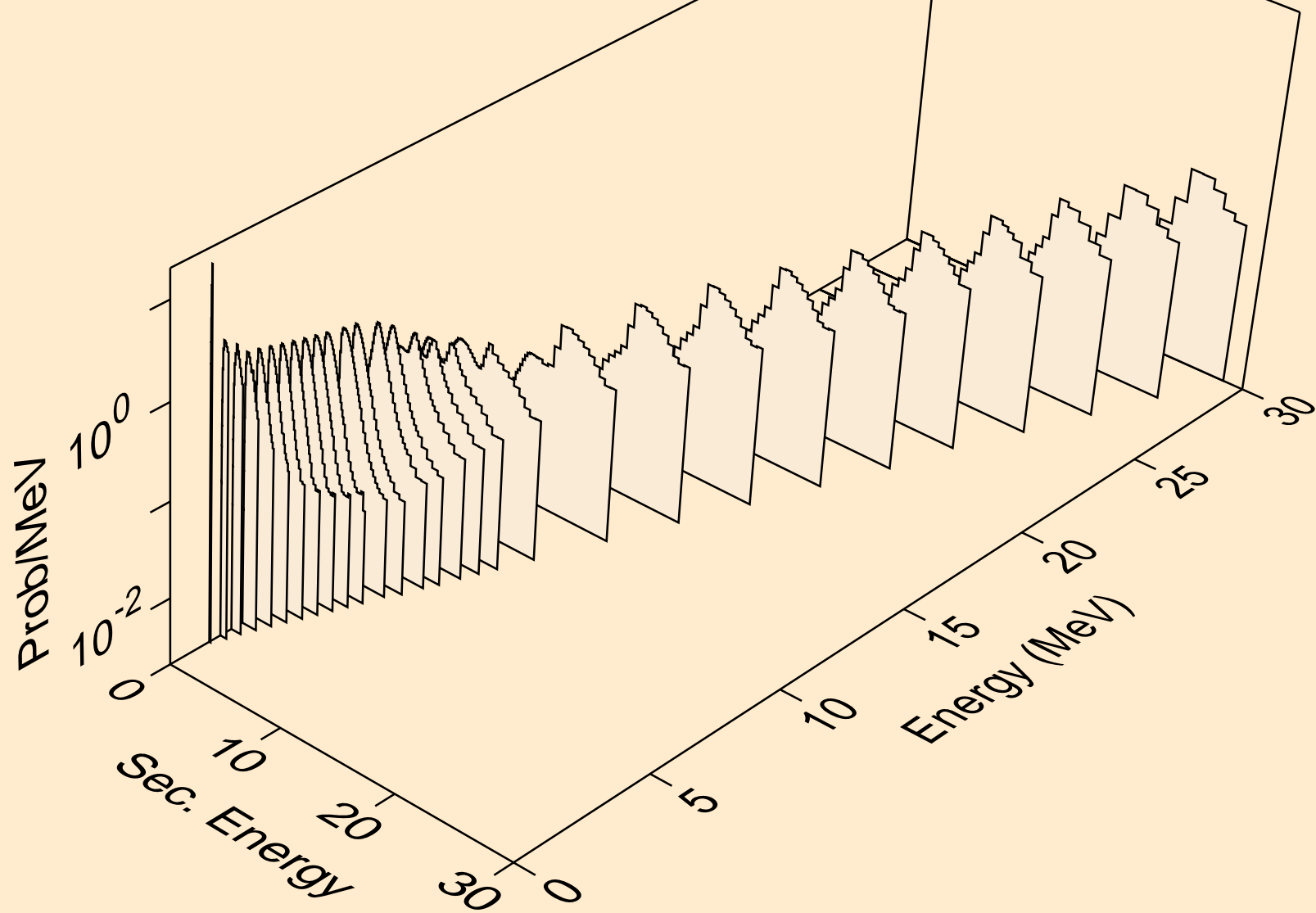

U231 NEUTRON ACER TENDL-2021 LIBRARY; T=293.6K

Delayed nubar

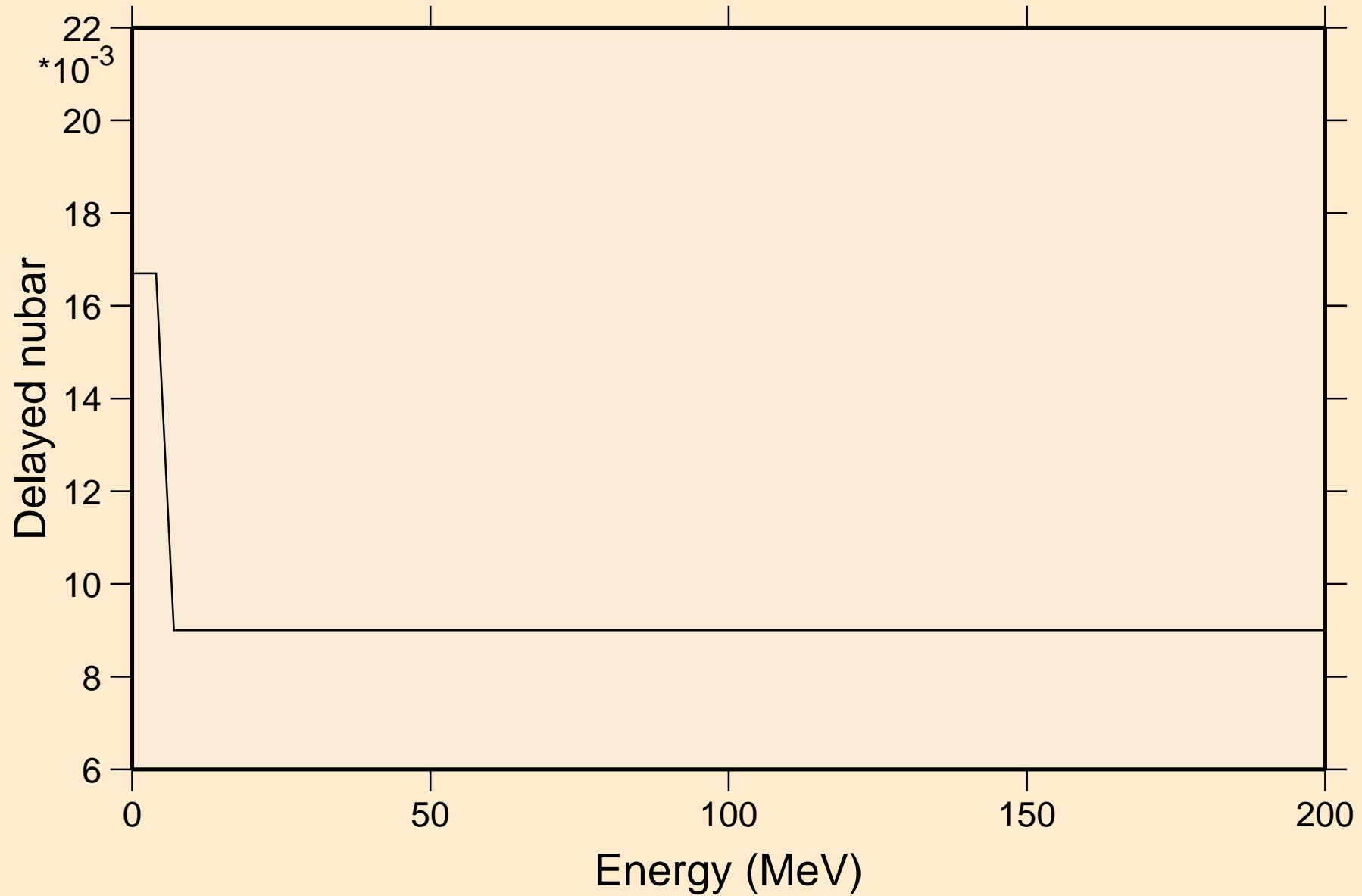

U231 NEUTRON ACER TENDL-2021 LIBRARY; T=293.6K

Delayed neutron spectra

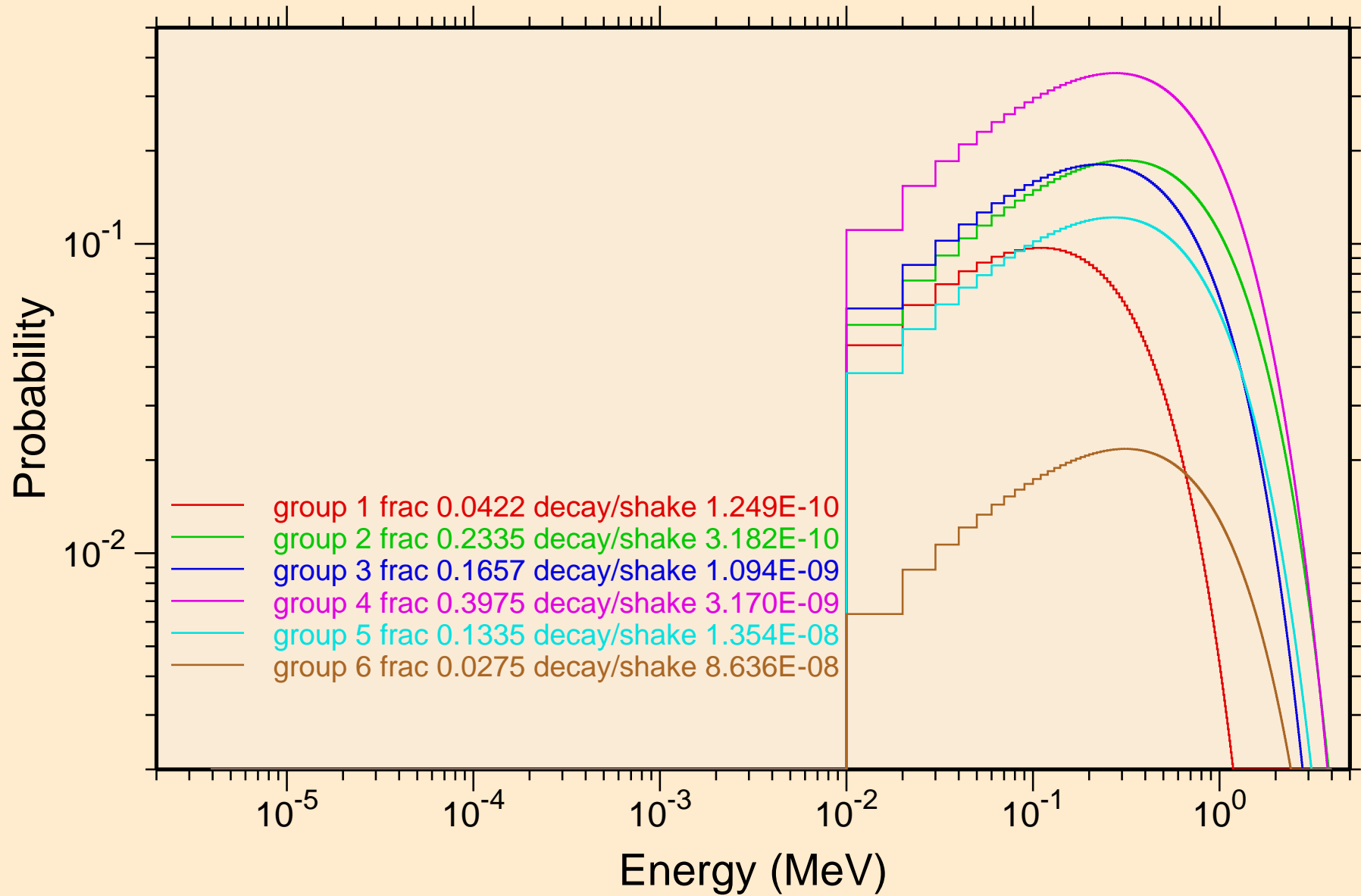

U231 NEUTRON ACER TENDL-2021 LIBRARY; T=293.6K
Photon emission for (n,x)

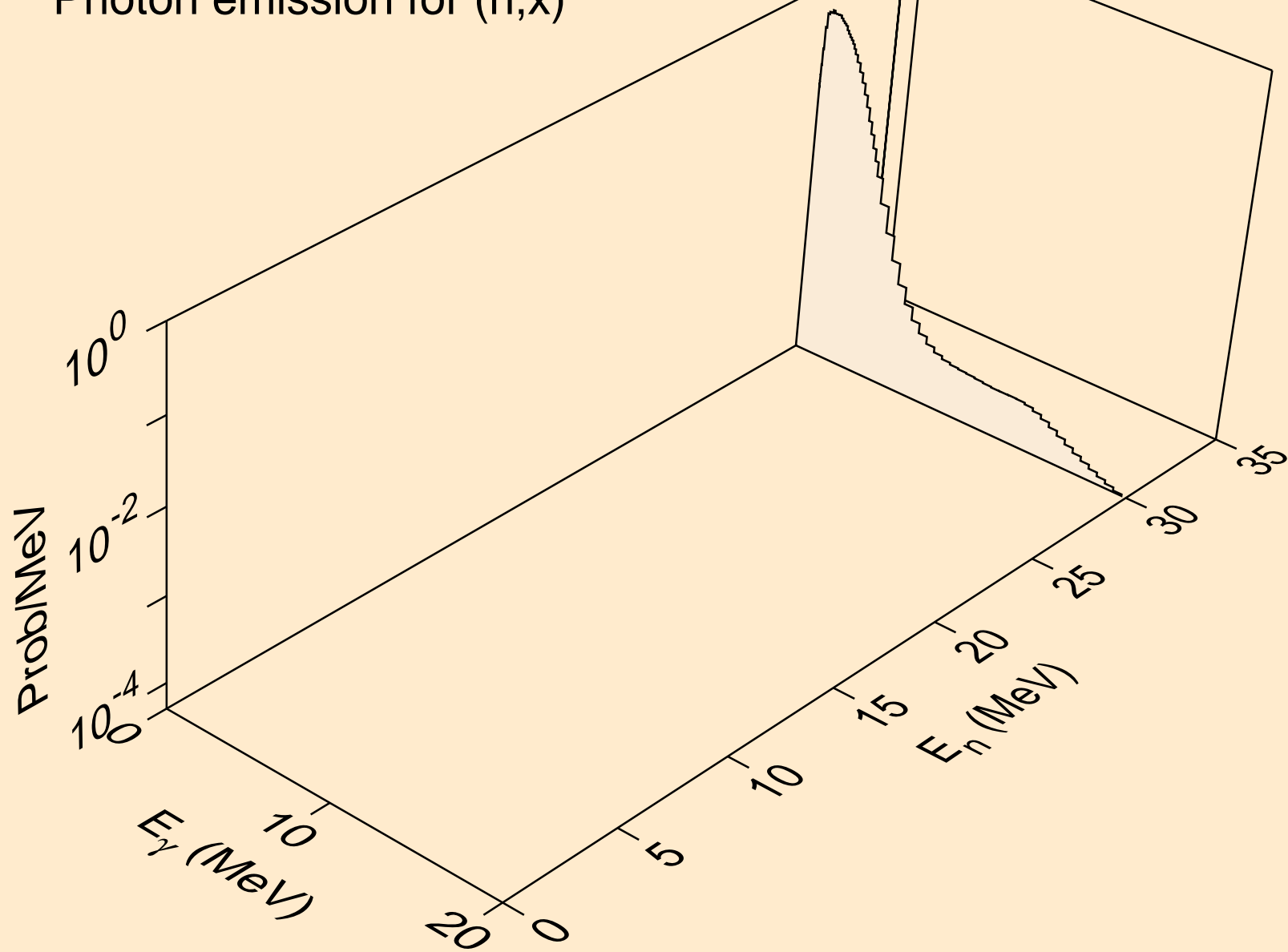

U231 NEUTRON ACER TENDL-2021 LIBRARY; T=293.6K
Photon emission for (n,2nd)

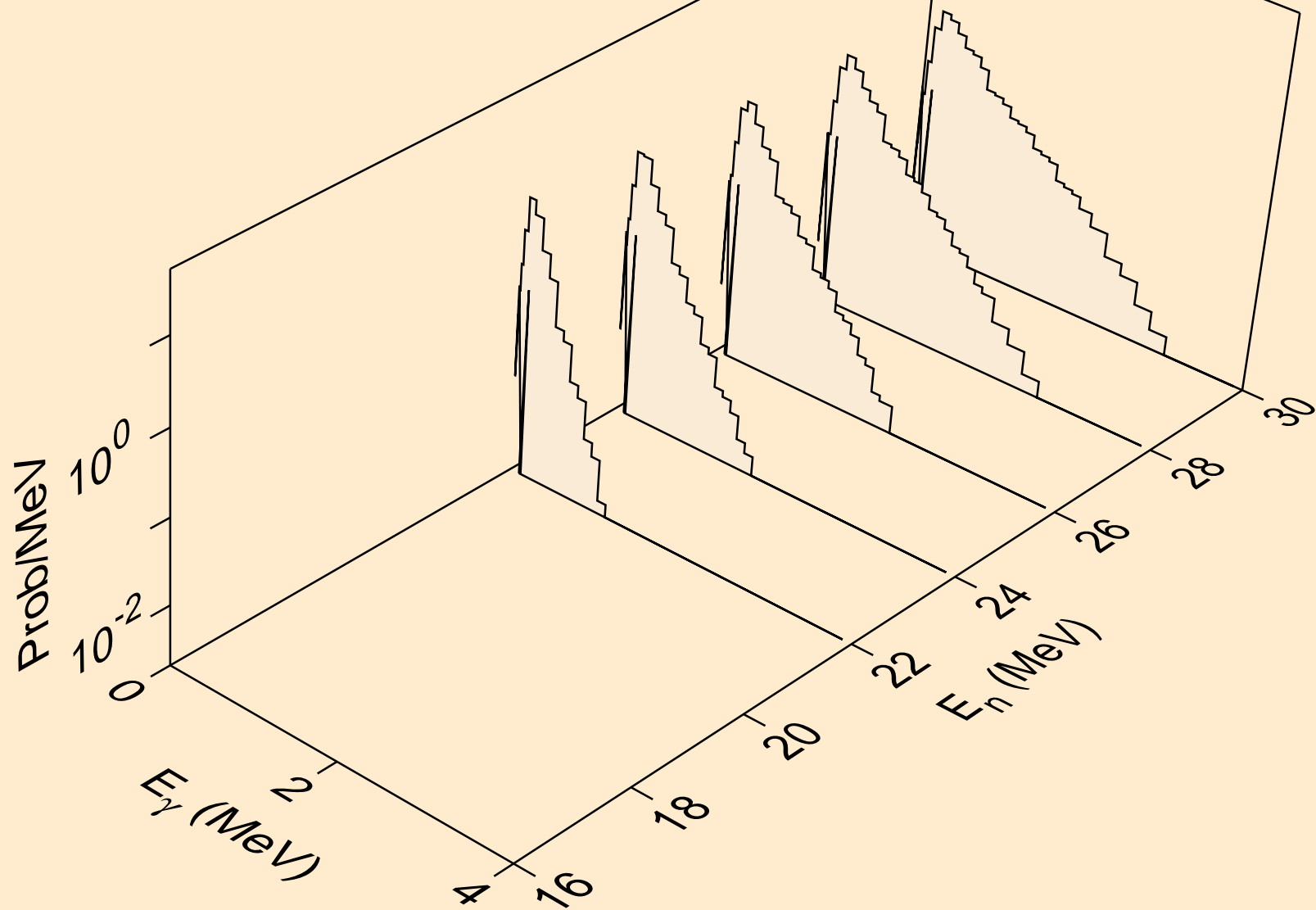

U231 NEUTRON ACER TENDL-2021 LIBRARY; T=293.6K
Photon emission for (n,2n)

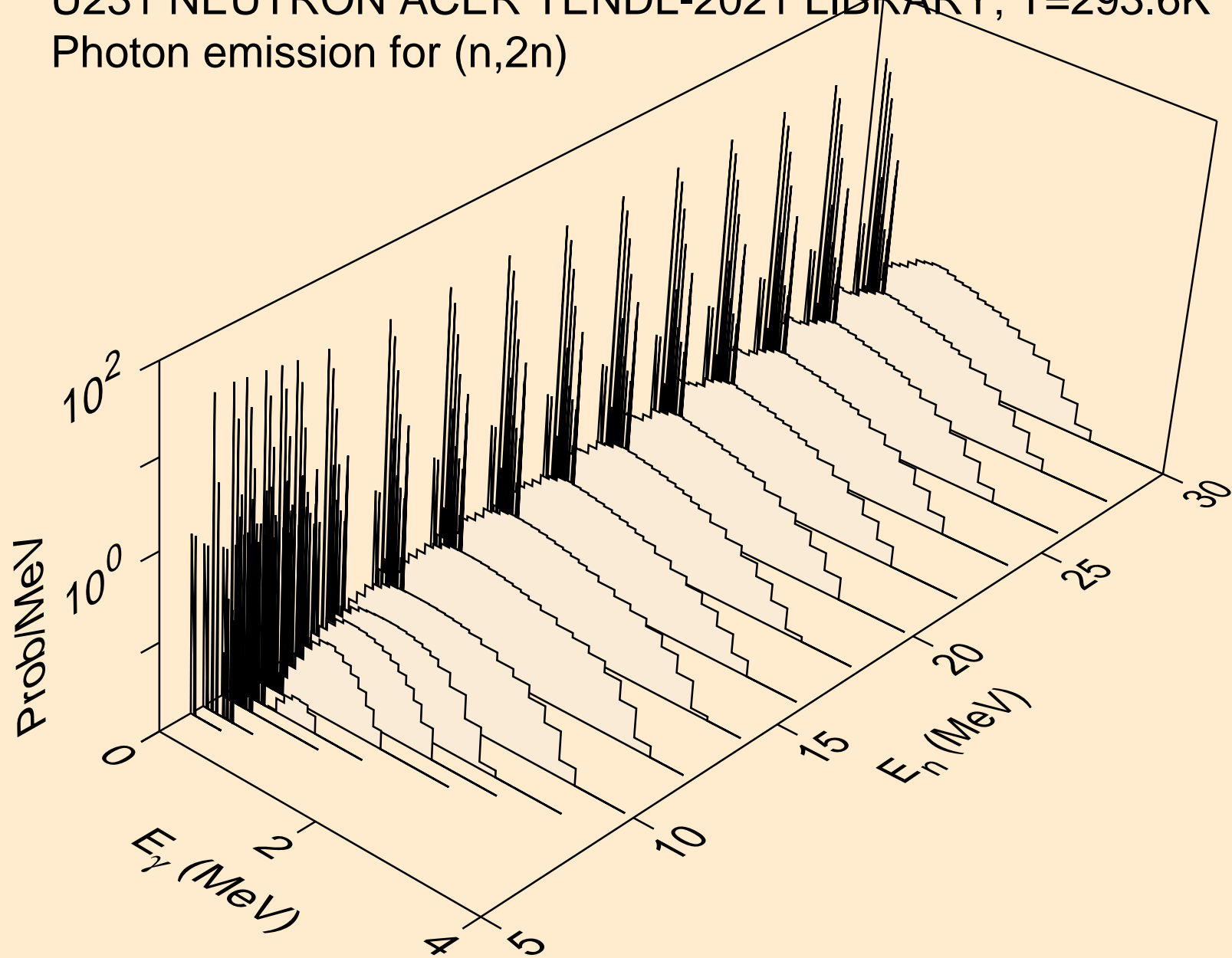

U231 NEUTRON ACER TENDL-2021 LIBRARY; T=293.6K
Photon emission for (n,3n)

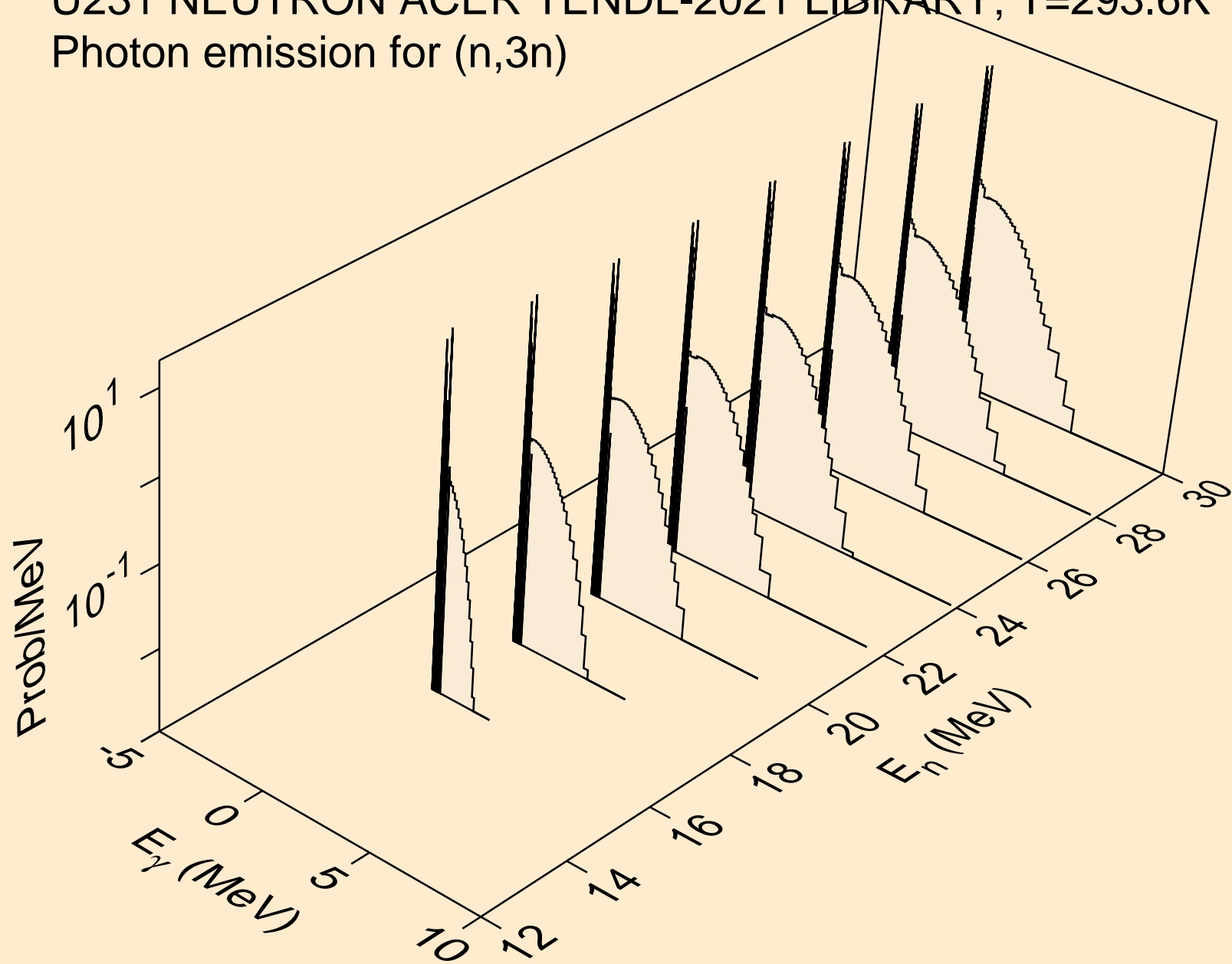

U231 NEUTRON ACER TENDL-2021 LIBRARY; T=293.6K
Photon emission for (n,n*)a

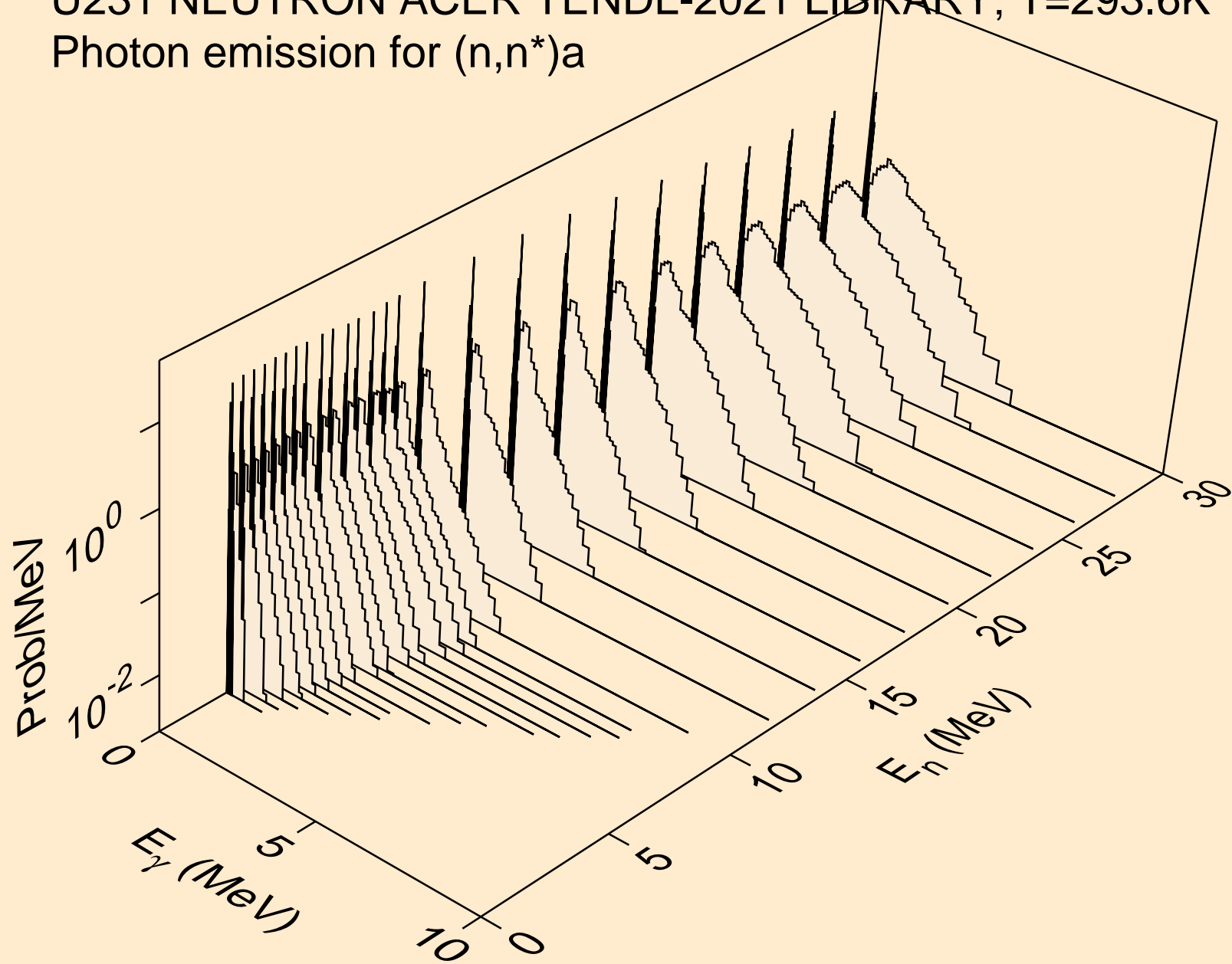

U231 NEUTRON ACER TENDL-2021 LIBRARY; T=293.6K
Photon emission for (n,2n)a

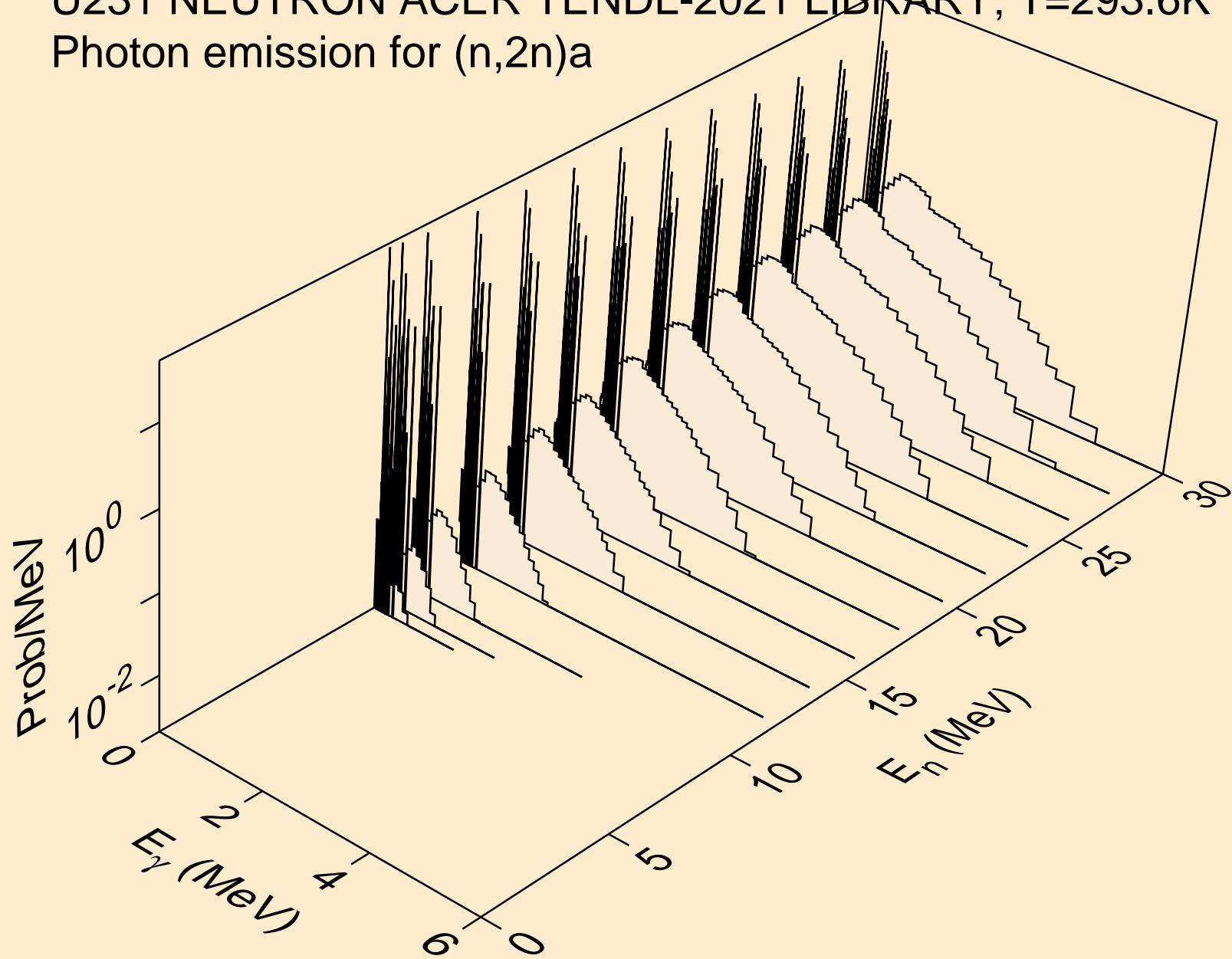

U231 NEUTRON ACER TENDL-2021 LIBRARY; T=293.6K
Photon emission for (n,3n)a

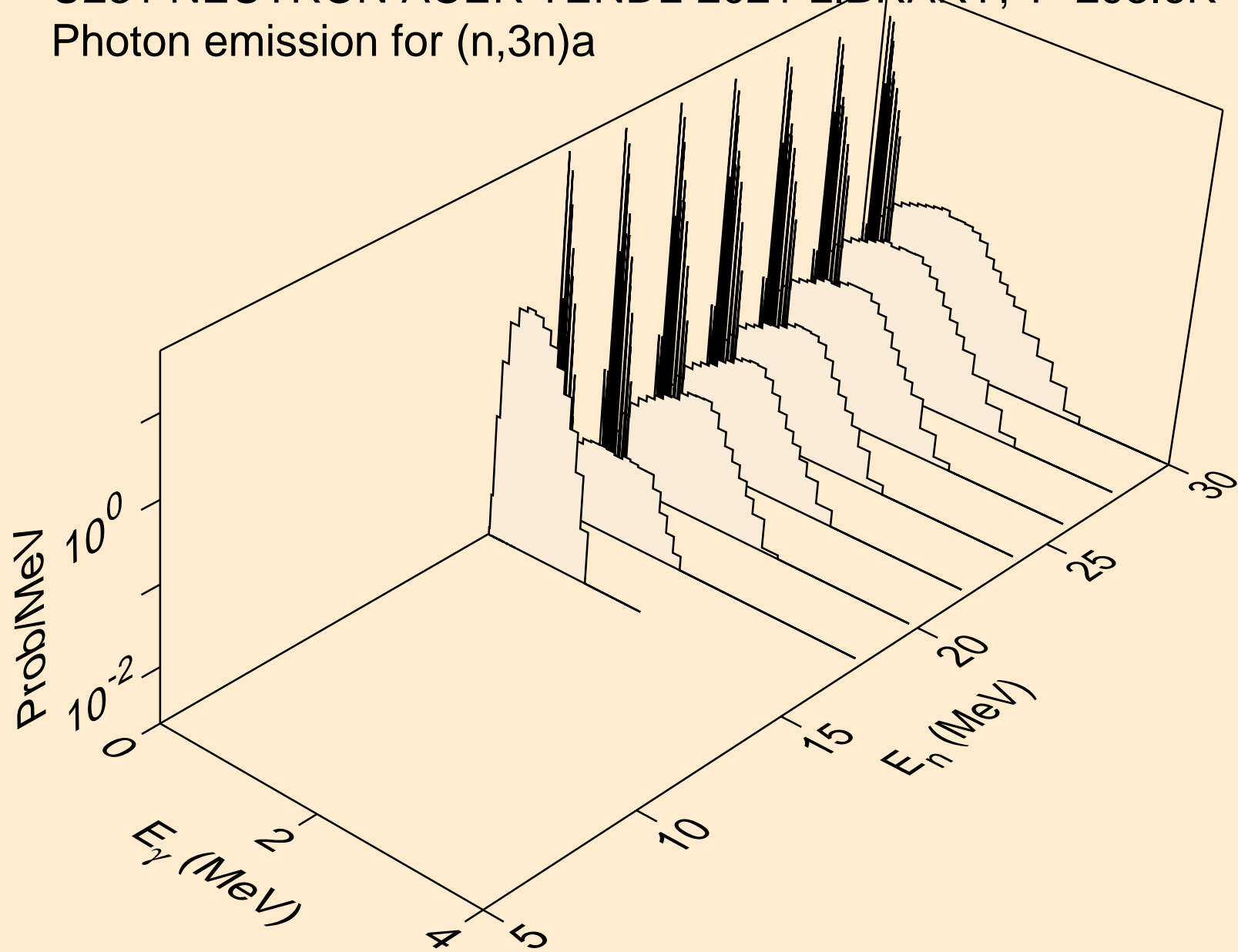

U231 NEUTRON ACER TENDL-2021 LIBRARY; T=293.6K
Photon emission for (n,n*)p

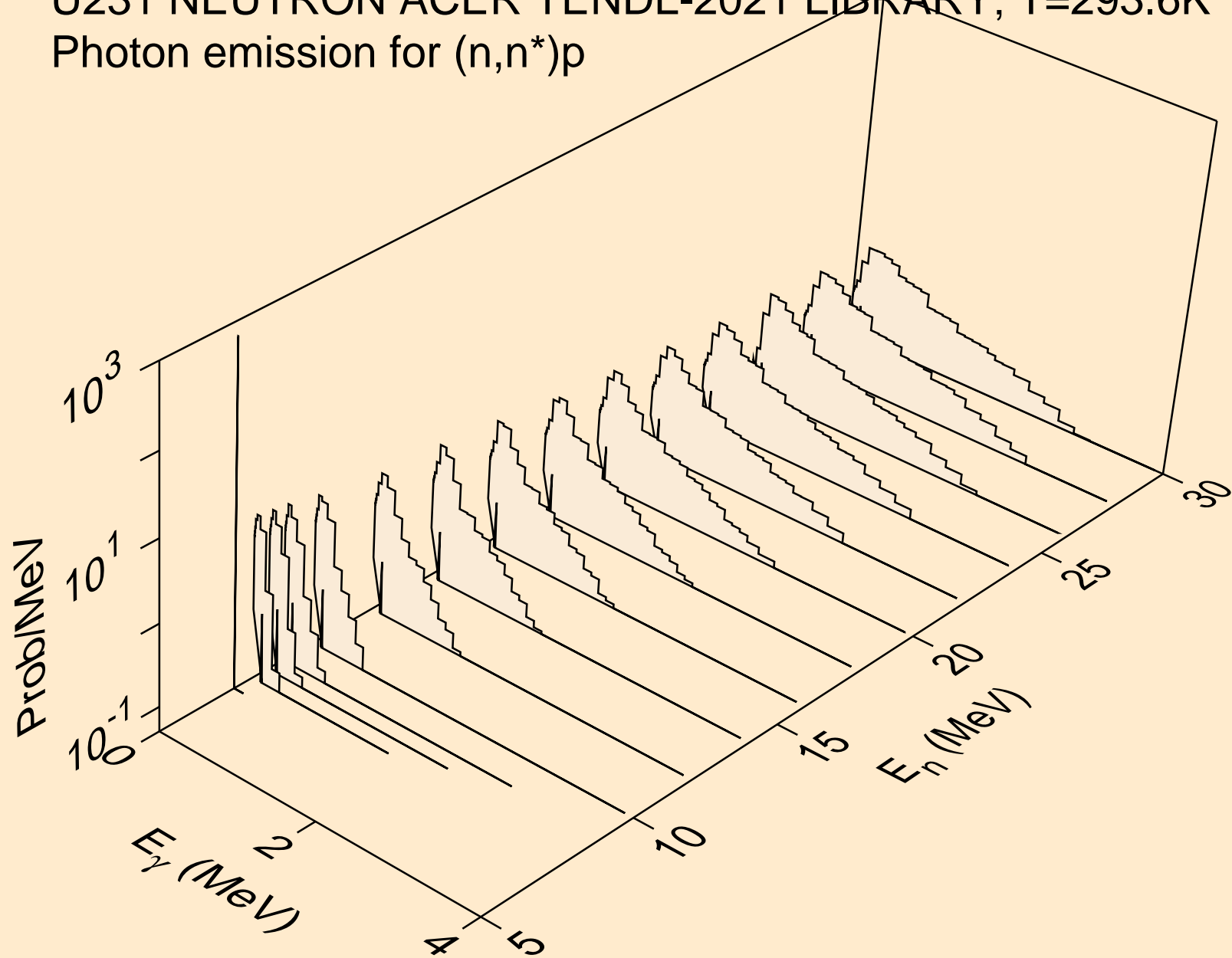

U231 NEUTRON ACER TENDL-2021 LIBRARY; T=293.6K
Photon emission for (n,n*)2a

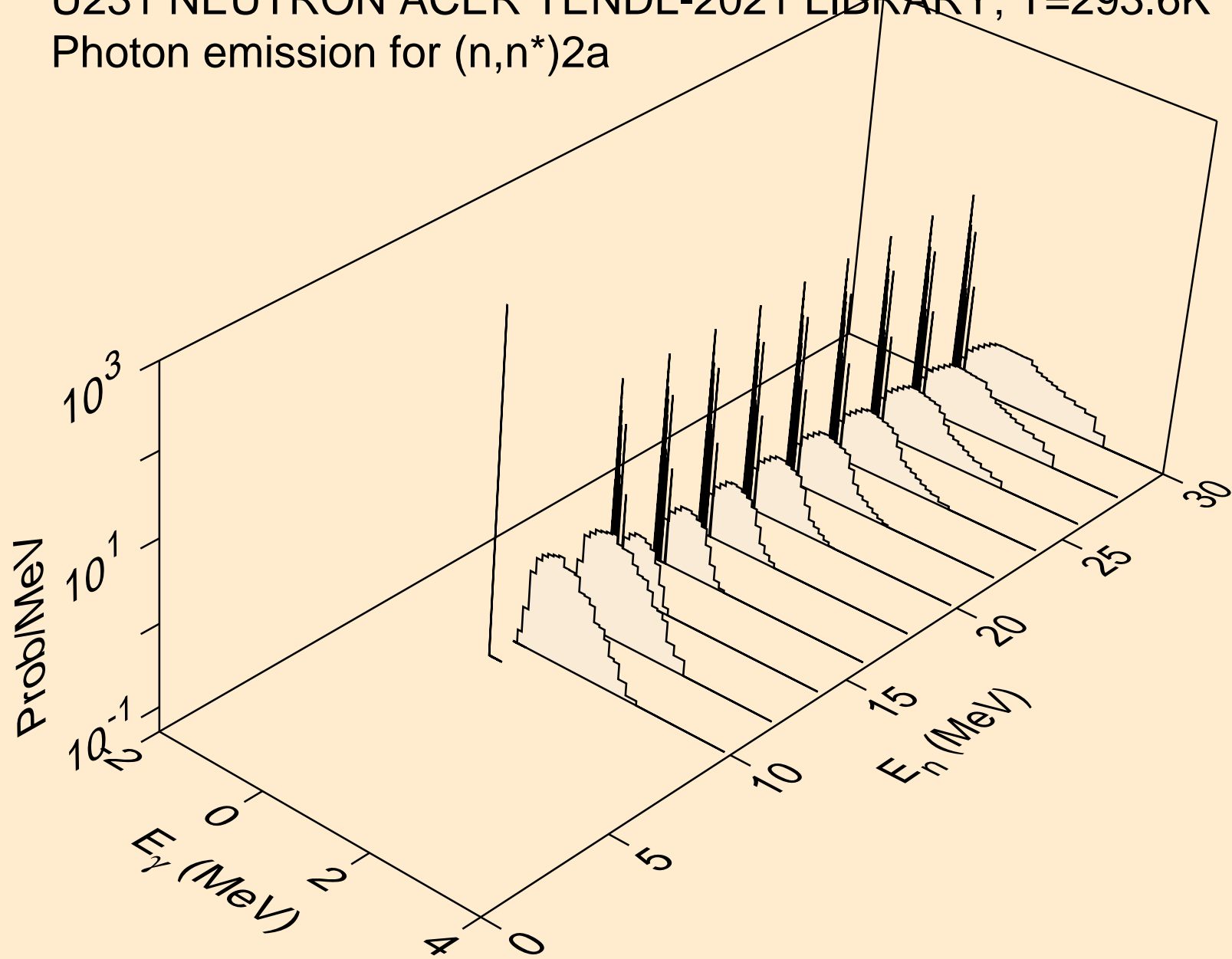

U231 NEUTRON ACER TENDL-2021 LIBRARY; T=293.6K
Photon emission for (n,2n)2a

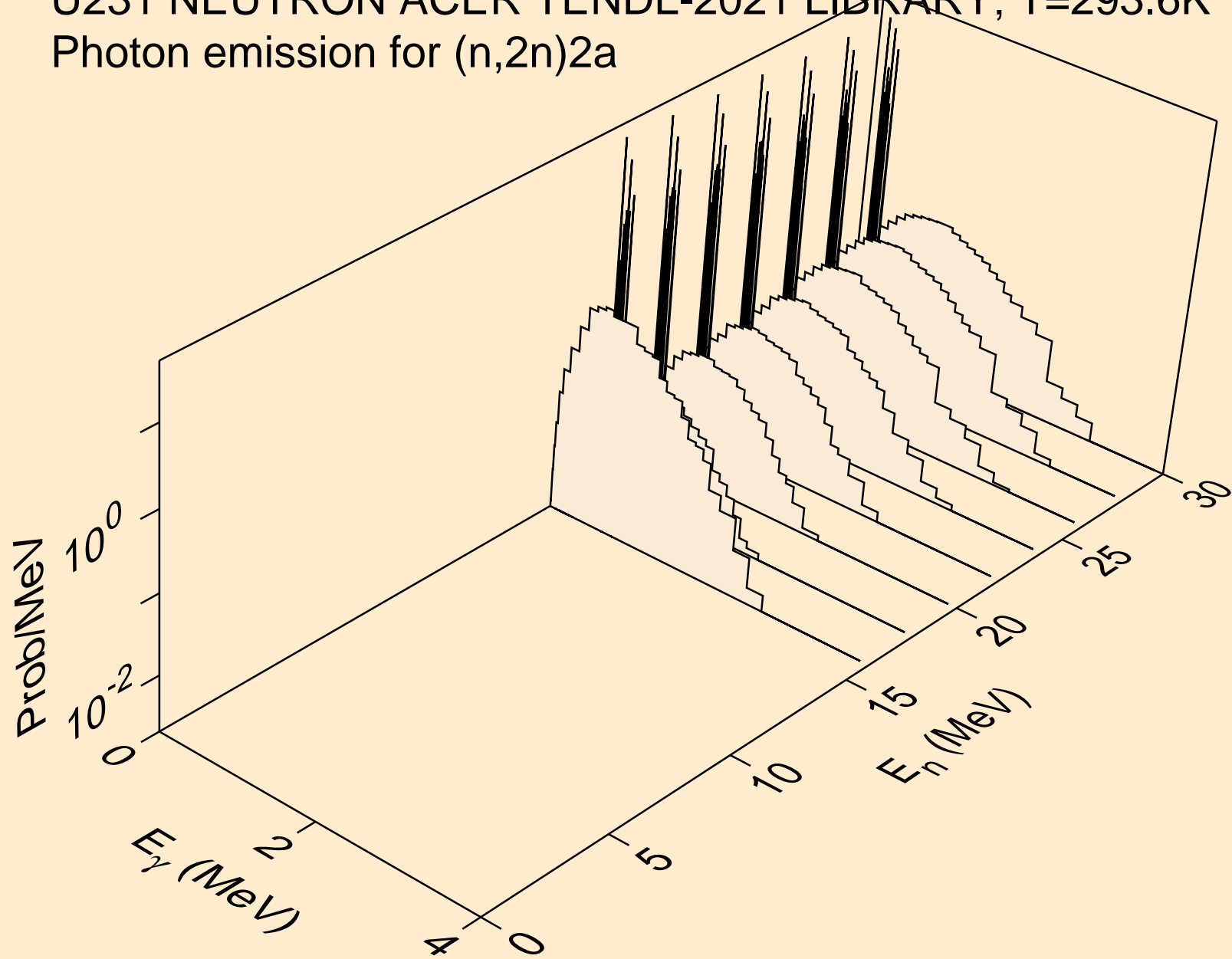

U231 NEUTRON ACER TENDL-2021 LIBRARY; T=293.6K
Photon emission for (n,n*)d

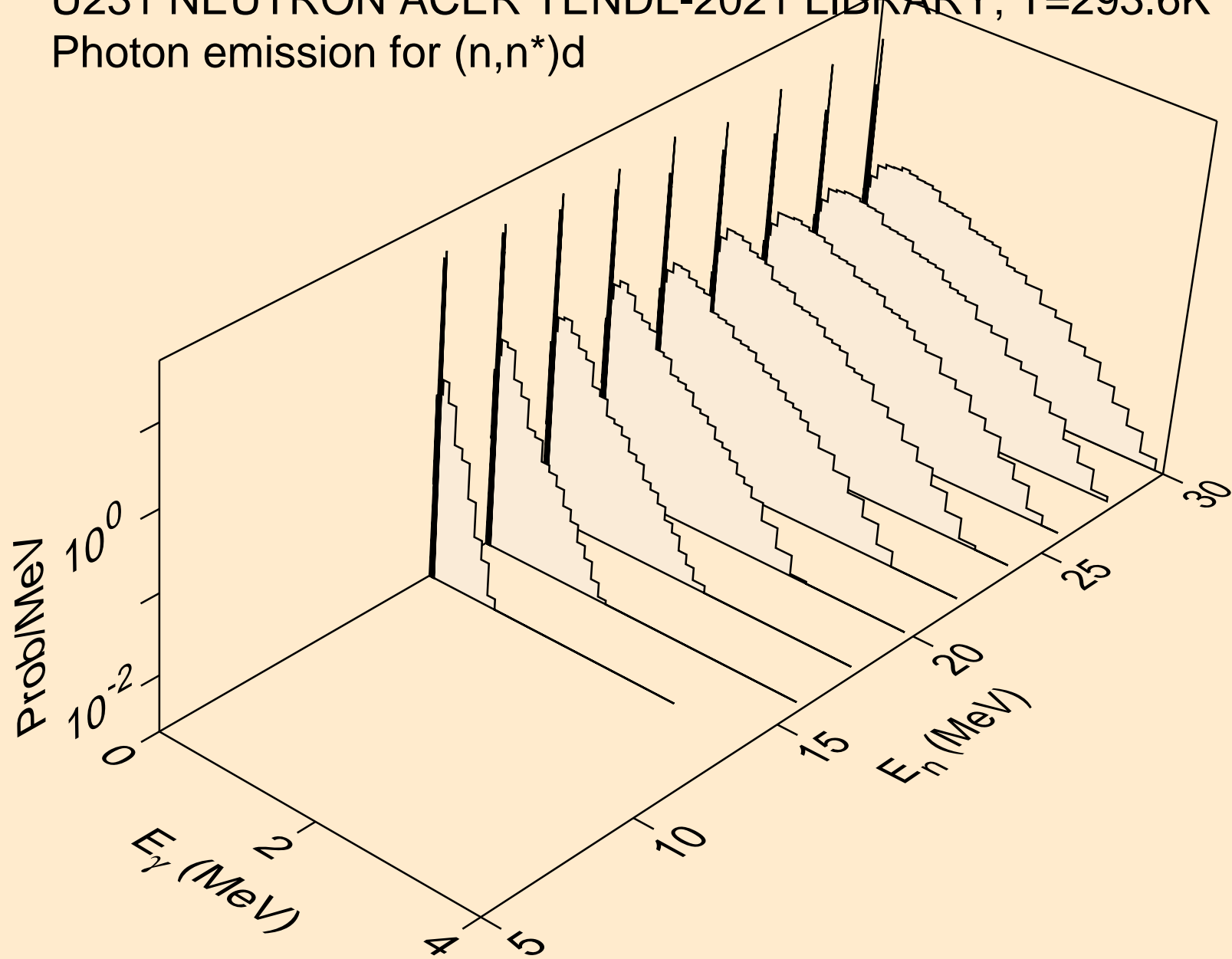

U231 NEUTRON ACER TENDL-2021 LIBRARY; T=293.6K
Photon emission for (n,n*)t

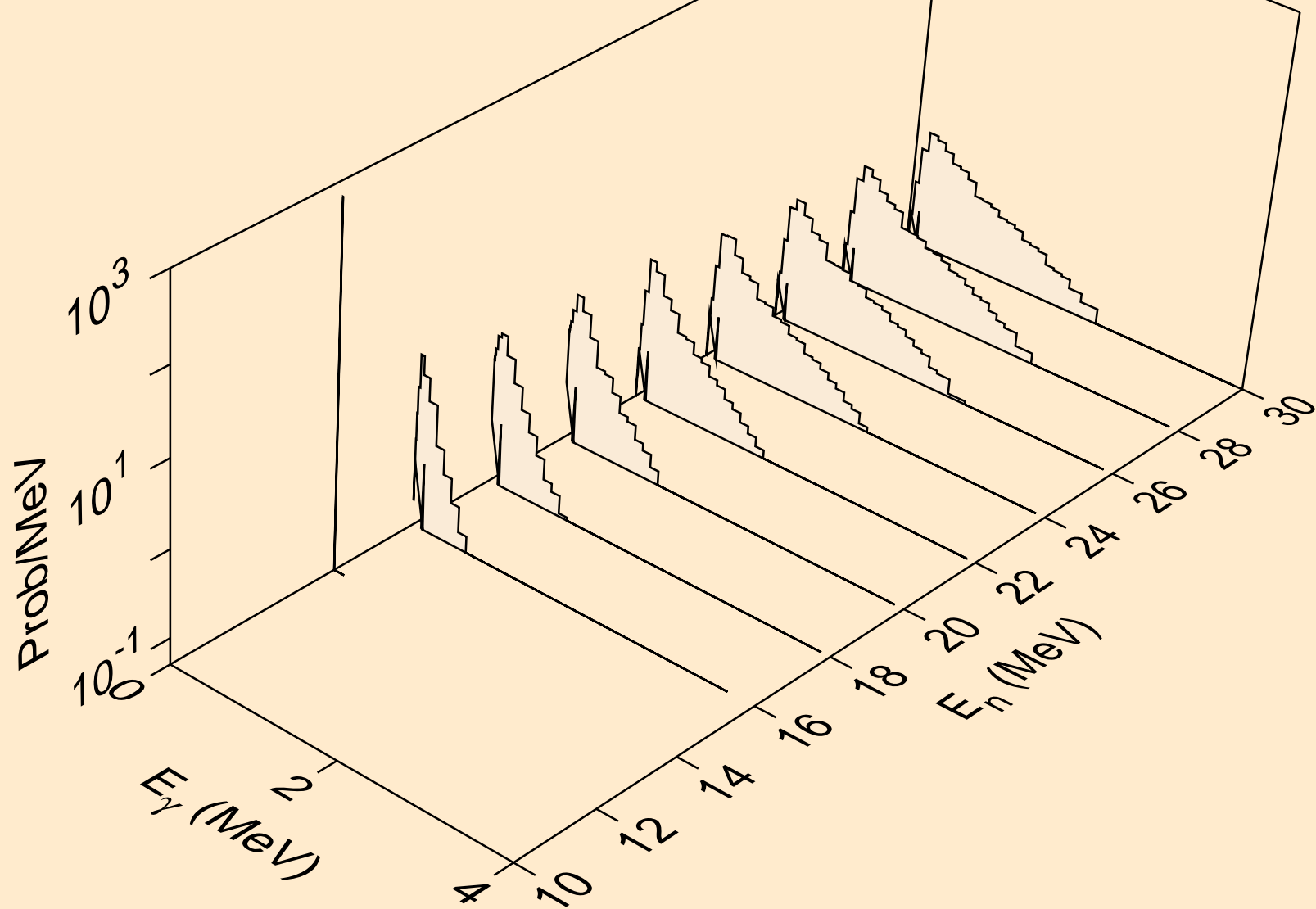

U231 NEUTRON ACER TENDL-2021 LIBRARY; T=293.6K
Photon emission for (n,n*)he3

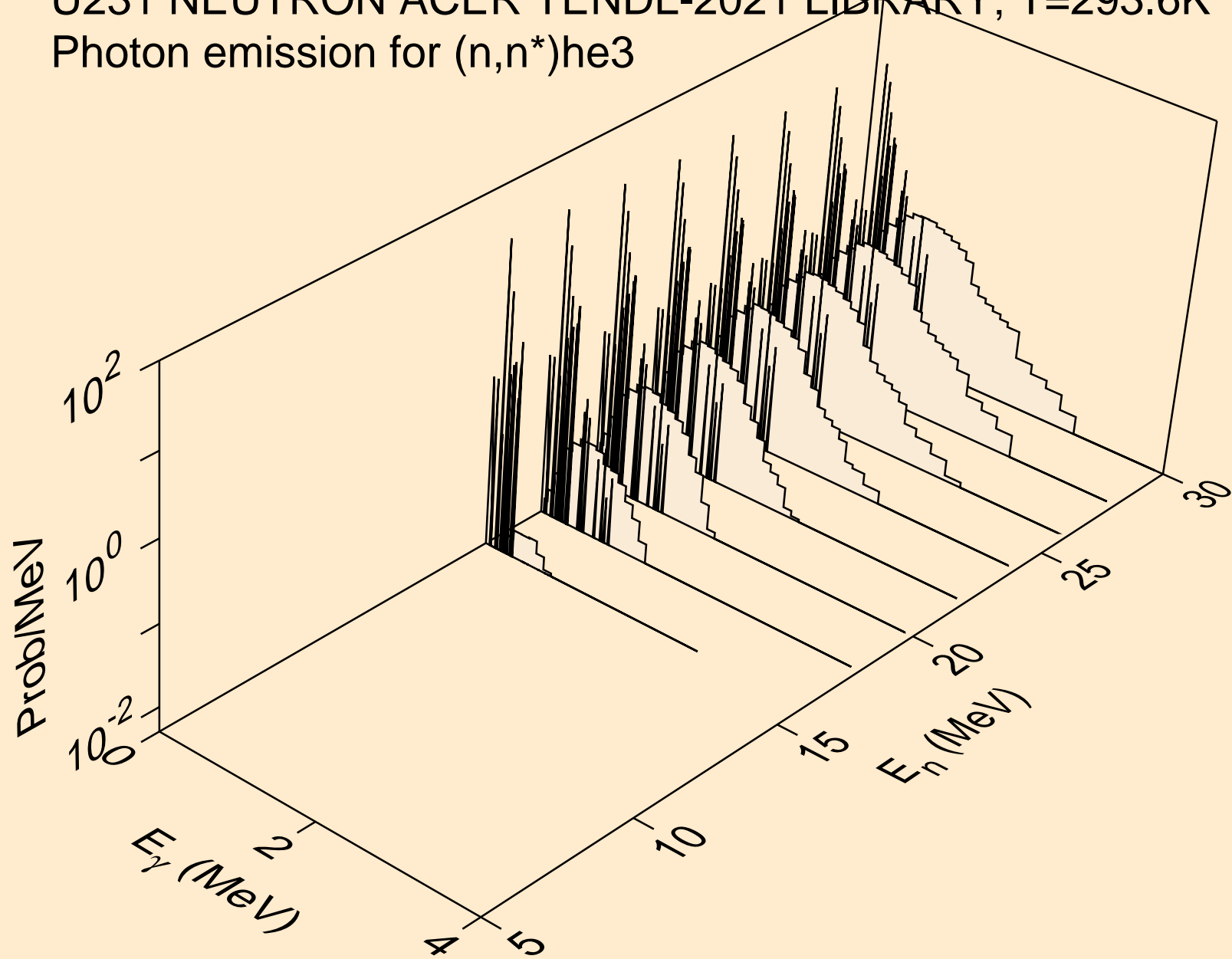

U231 NEUTRON ACER TENDL-2021 LIBRARY; T=293.6K
Photon emission for (n,4n)

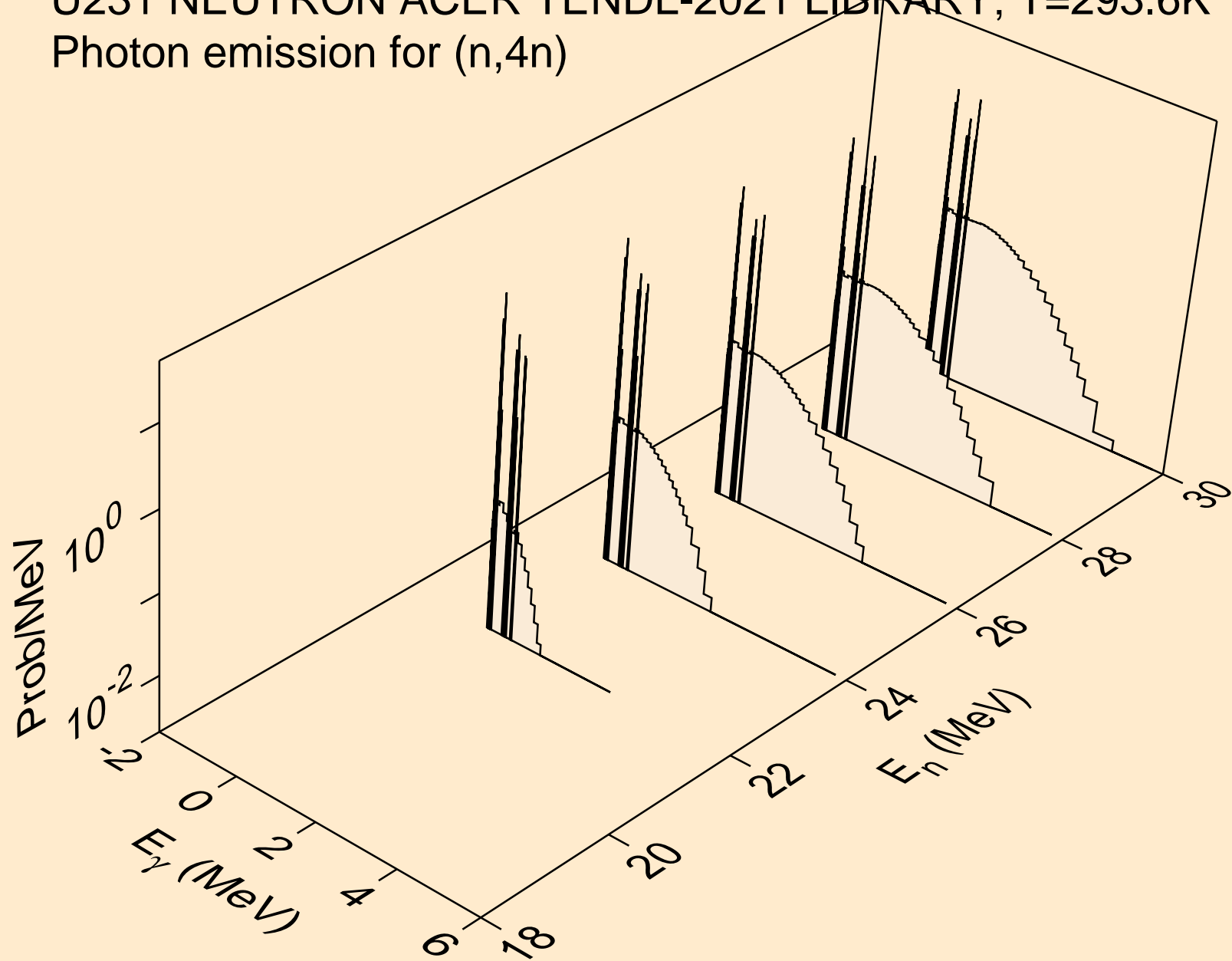

U231 NEUTRON ACER TENDL-2021 LIBRARY; T=293.6K
Photon emission for (n,2np)

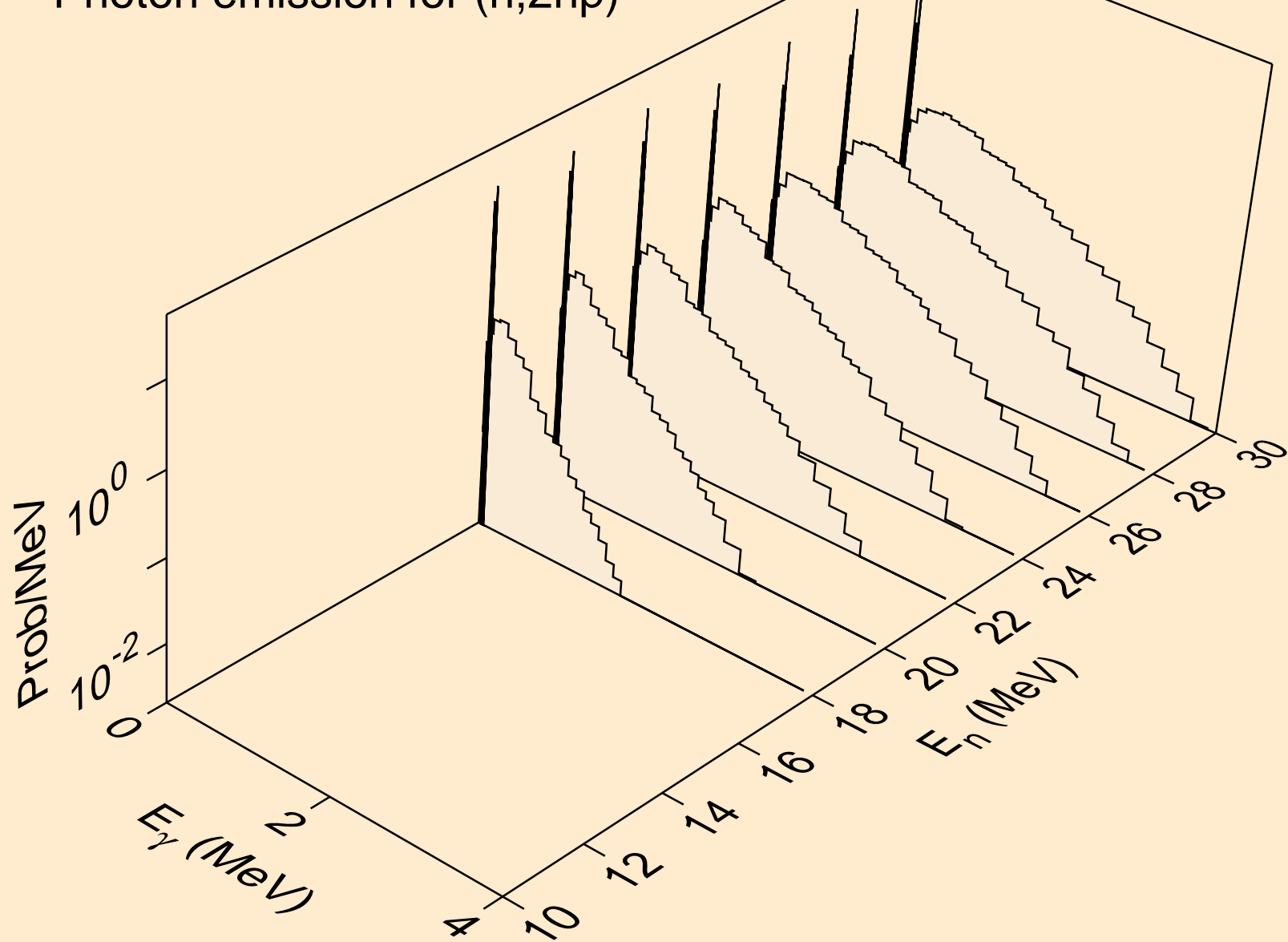

U231 NEUTRON ACER TENDL-2021 LIBRARY; T=293.6K
Photon emission for (n,3np)

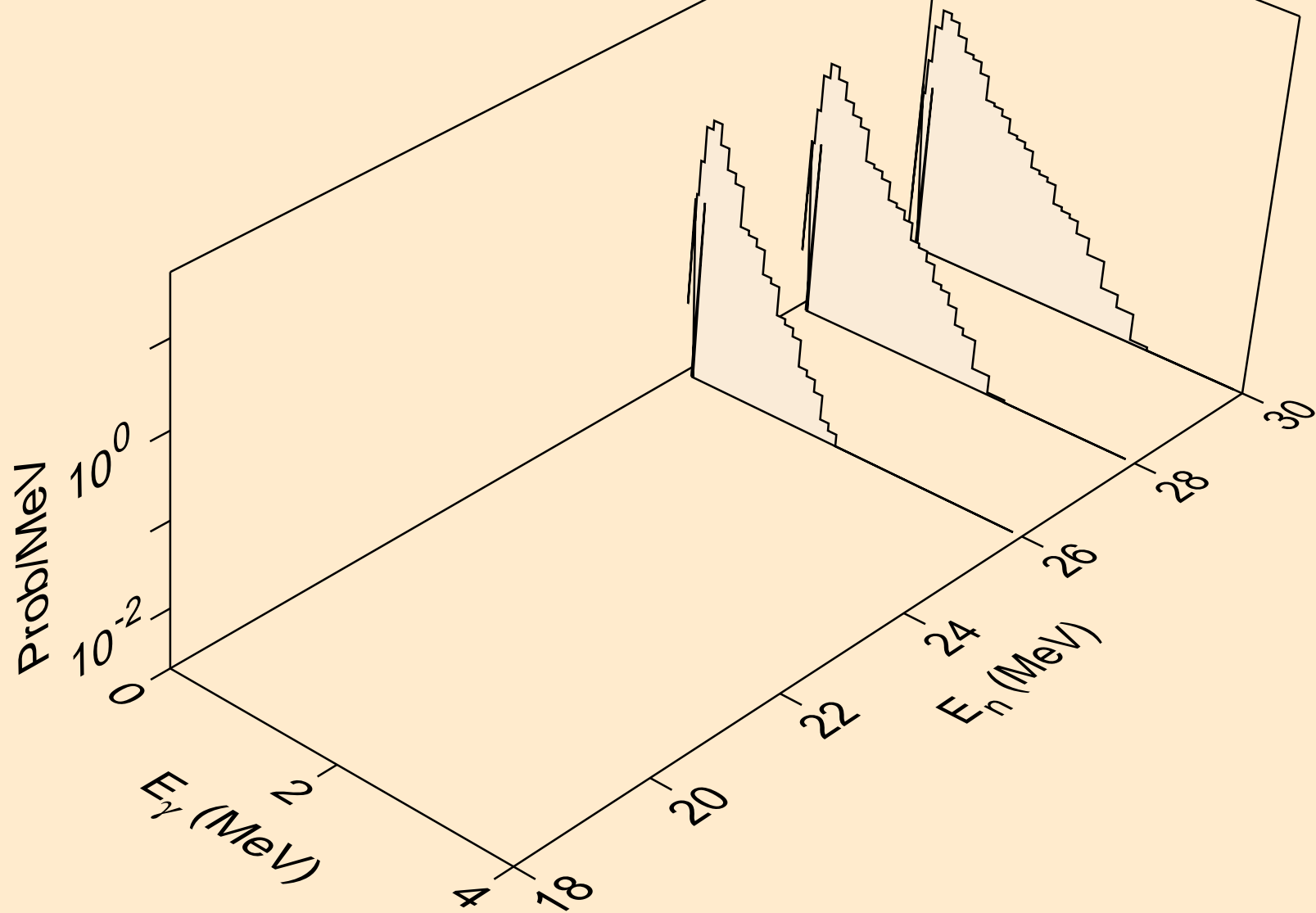

U231 NEUTRON ACER TENDL-2021 LIBRARY; T=293.6K
Photon emission for (n,2np)

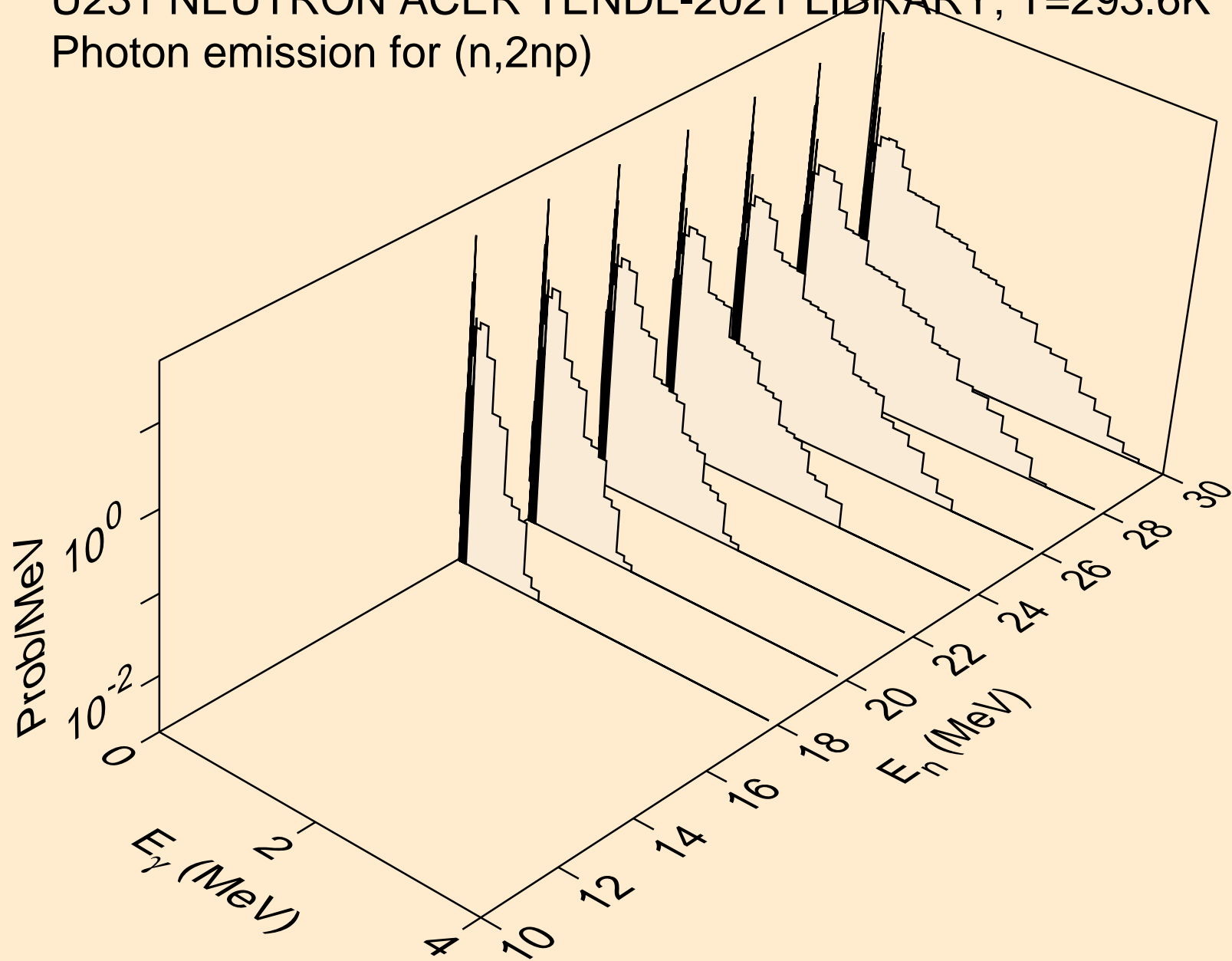

U231 NEUTRON ACER TENDL-2021 LIBRARY; T=293.6K
Photon emission for (n,npa)

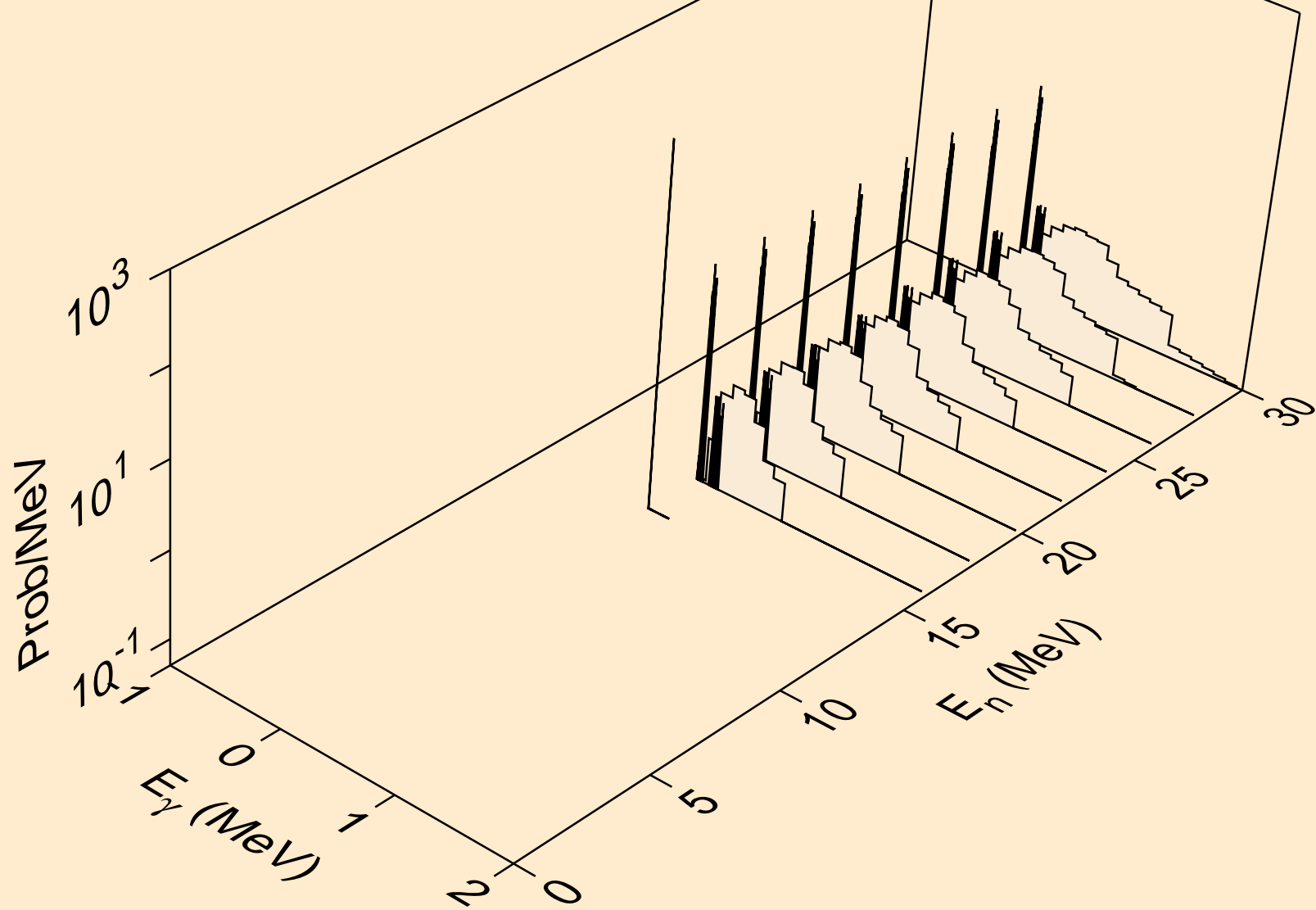

U231 NEUTRON ACER TENDL-2021 LIBRARY; T=293.6K
Photon emission for (n,n*c)

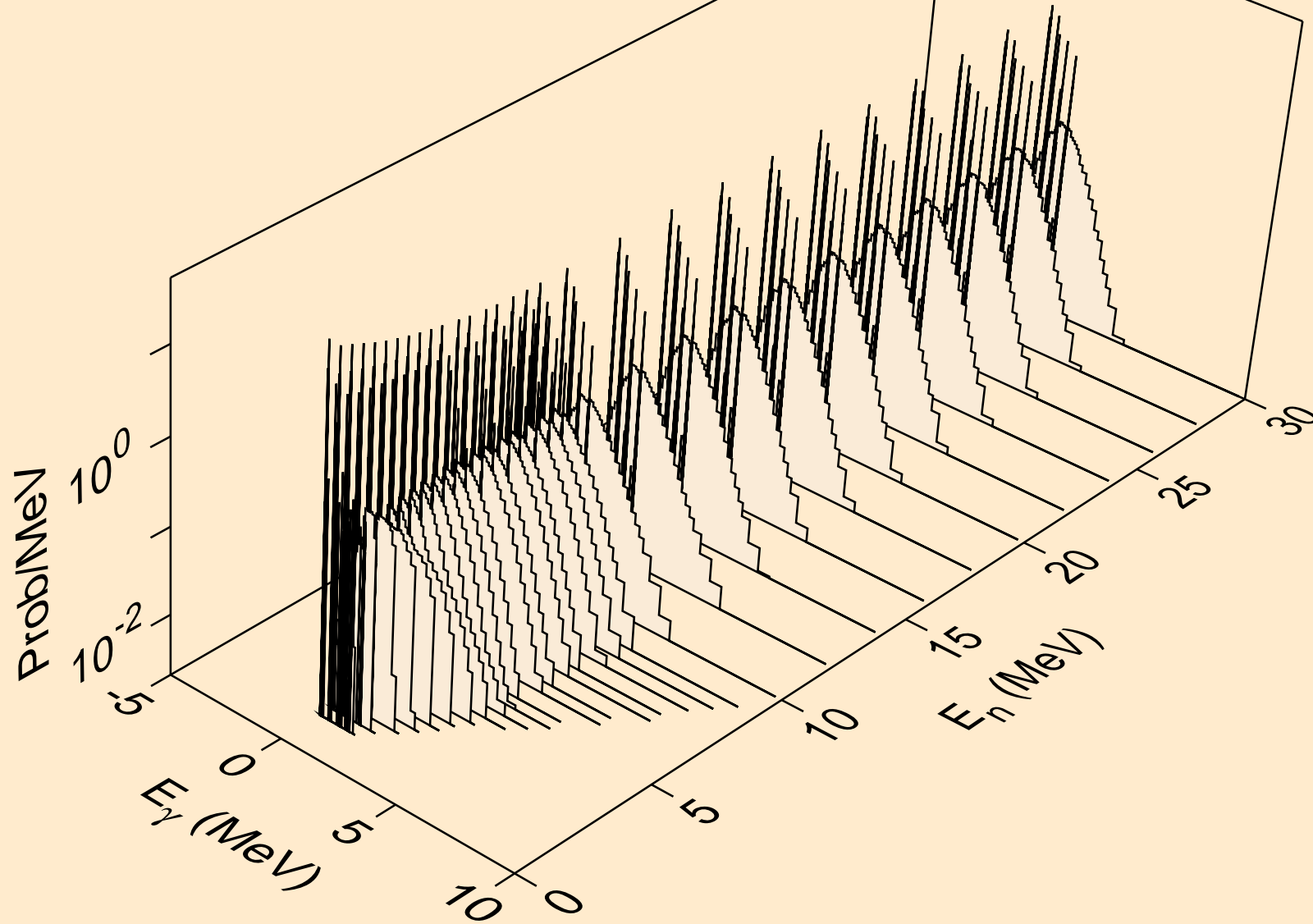

U231 NEUTRON ACER TENDL-2021 LIBRARY; T=293.6K
Photon emission for (n,gma)

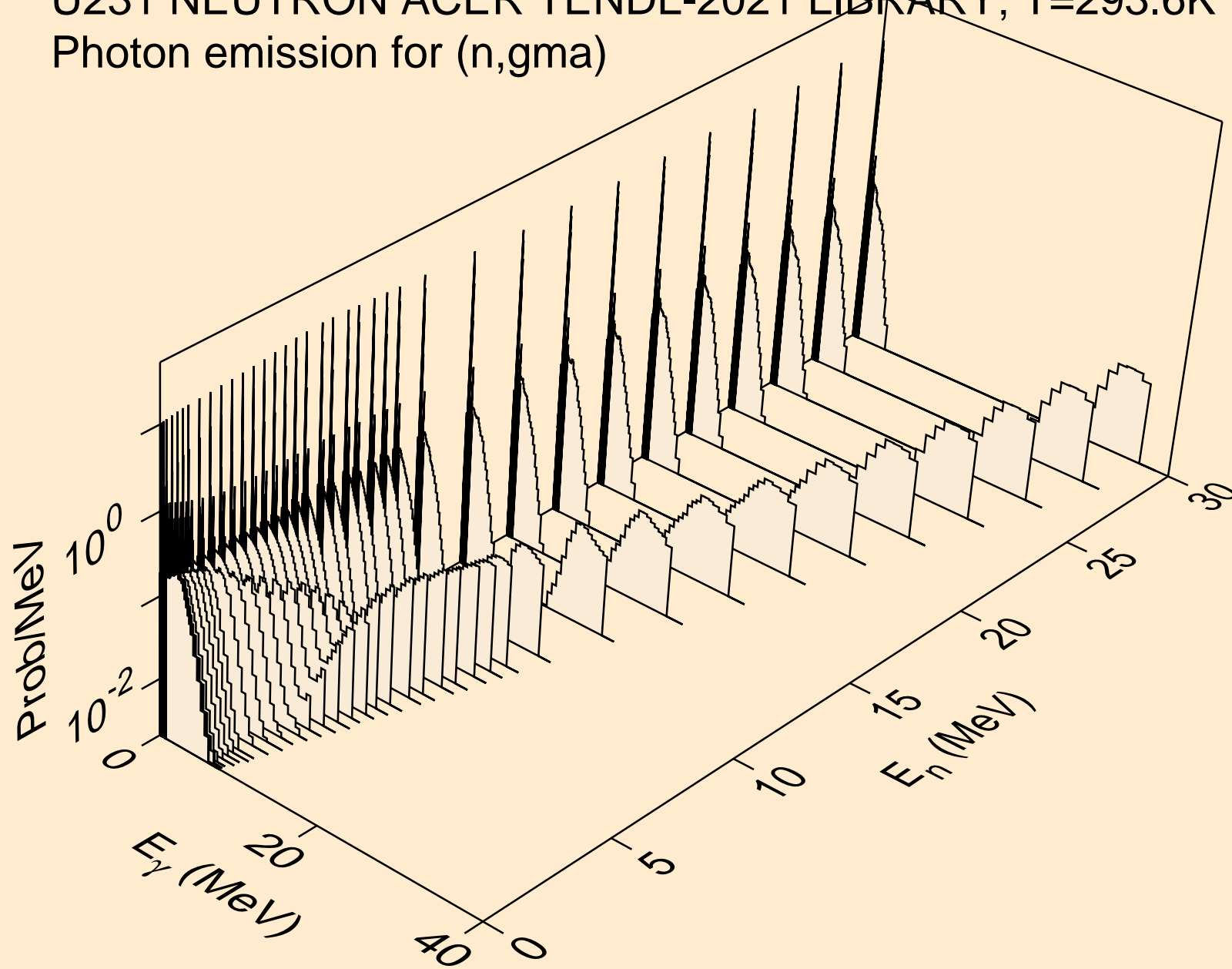

U231 NEUTRON ACER TENDL-2021 LIBRARY; T=293.6K
Photon emission for (n,p)

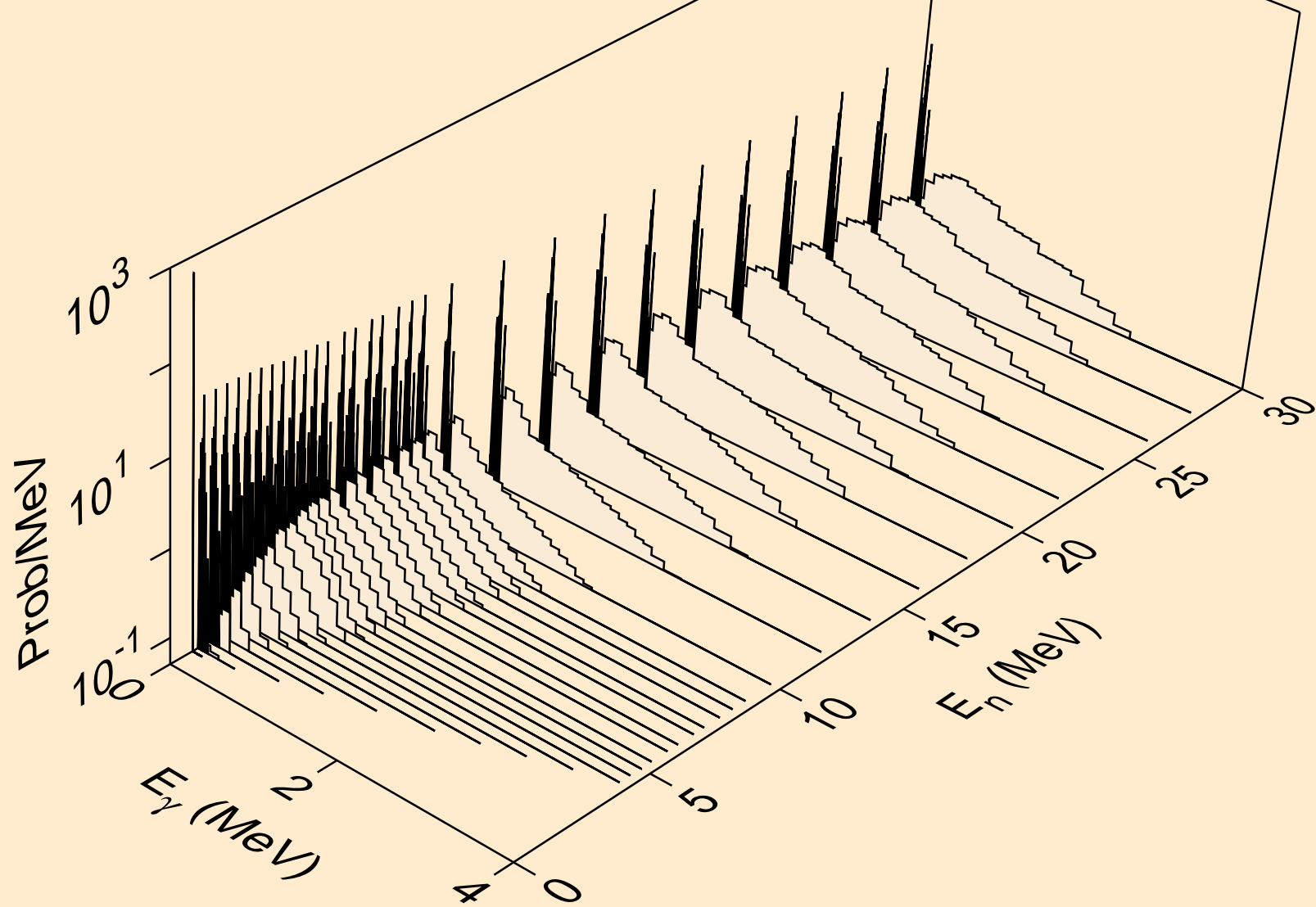

U231 NEUTRON ACER TENDL-2021 LIBRARY; T=293.6K
Photon emission for (n,d)

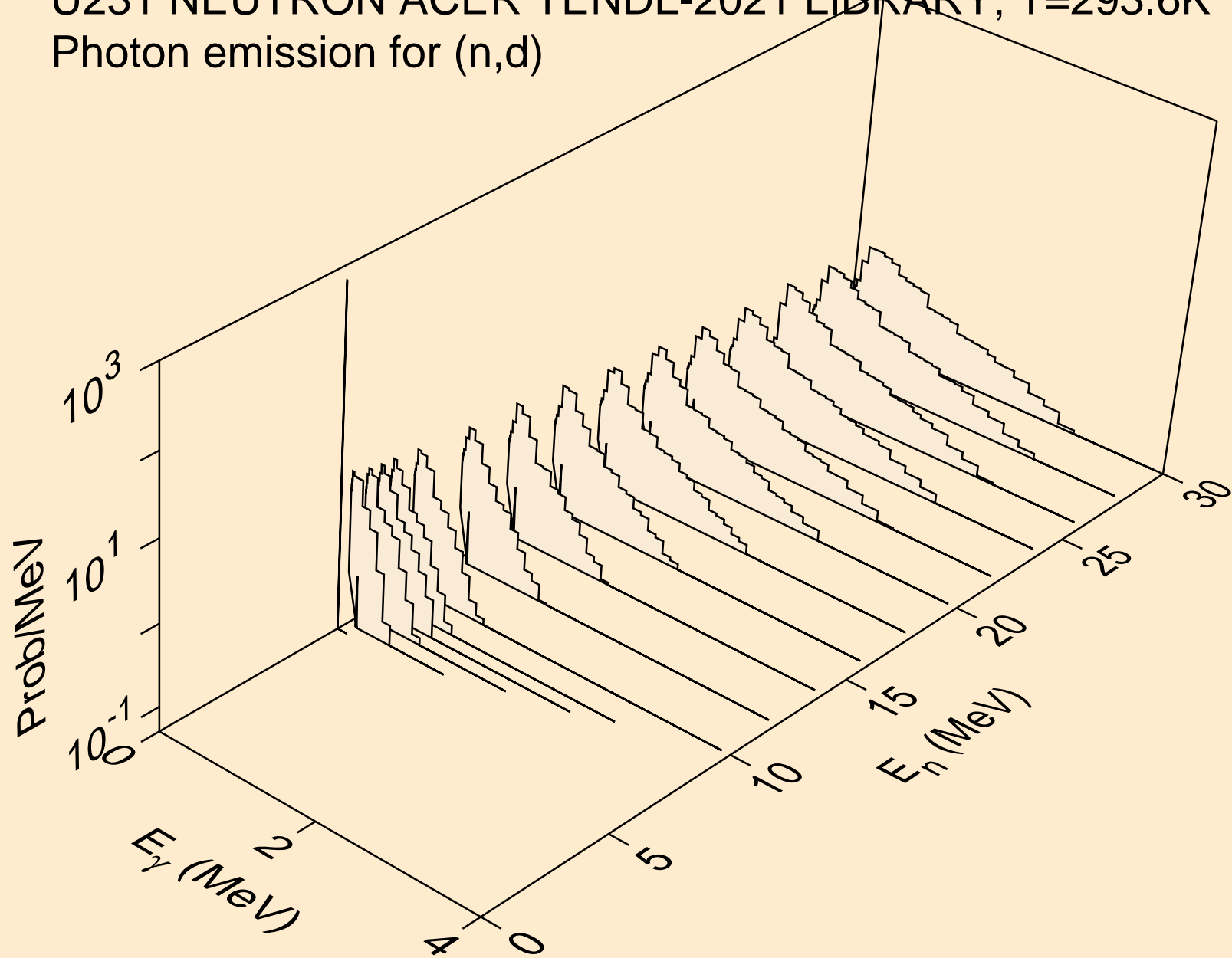

U231 NEUTRON ACER TENDL-2021 LIBRARY; T=293.6K
Photon emission for (n,t)

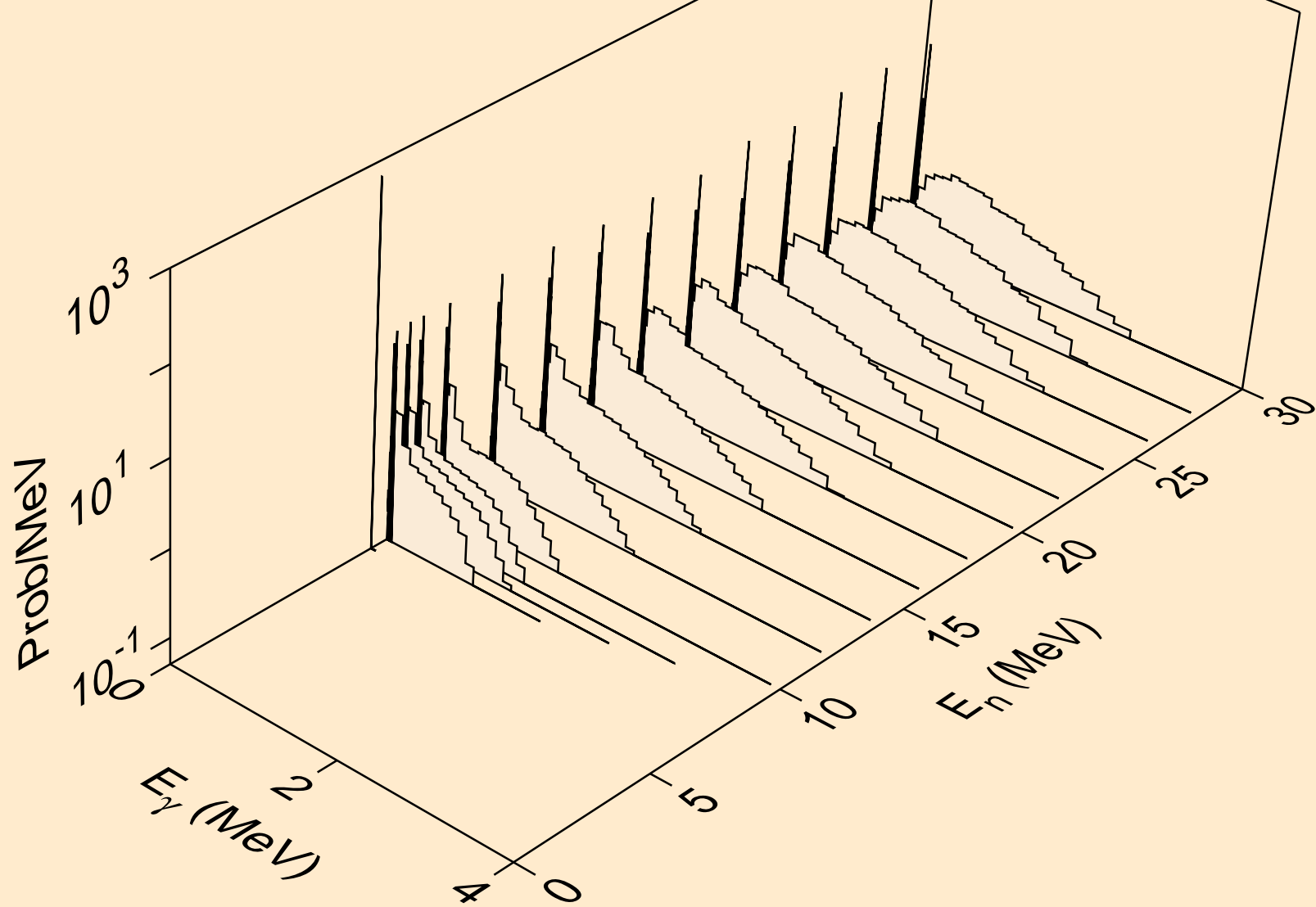

U231 NEUTRON ACER TENDL-2021 LIBRARY; T=293.6K
Photon emission for (n,he3)

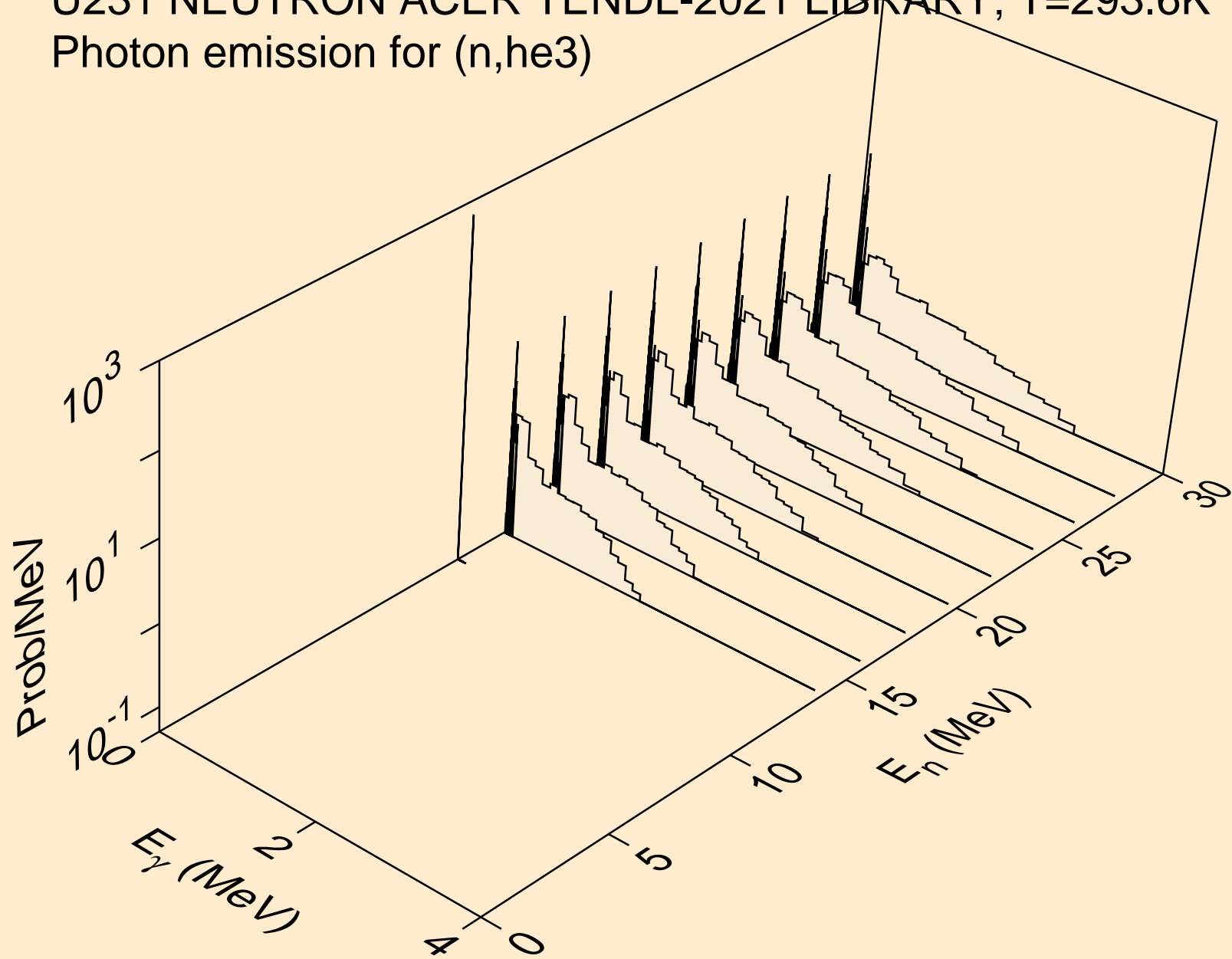

U231 NEUTRON ACER TENDL-2021 LIBRARY; T=293.6K
Photon emission for (n,a)

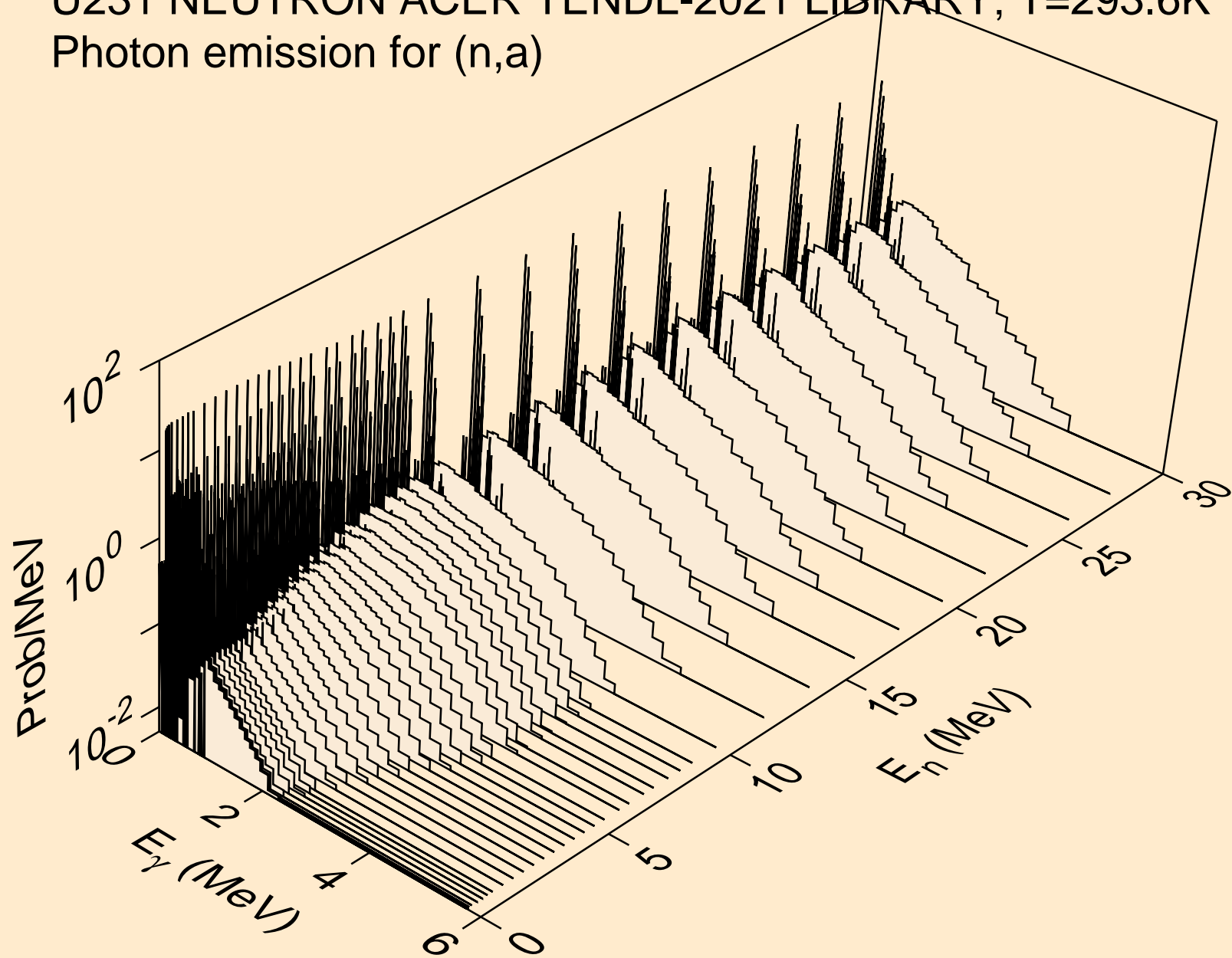

U231 NEUTRON ACER TENDL-2021 LIBRARY; T=293.6K
Photon emission for (n,2a)

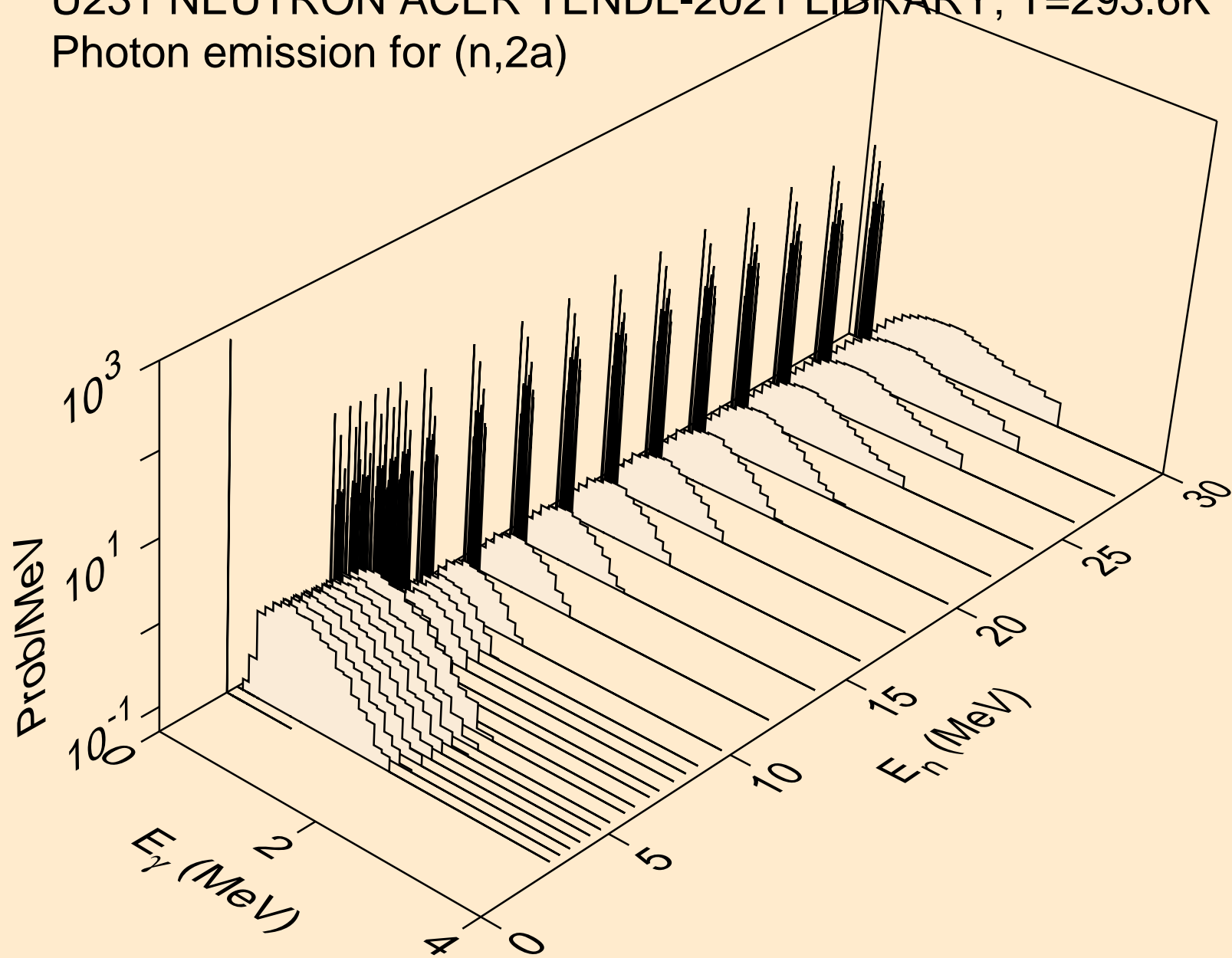

U231 NEUTRON ACER TENDL-2021 LIBRARY; T=293.6K
Photon emission for (n,2p)

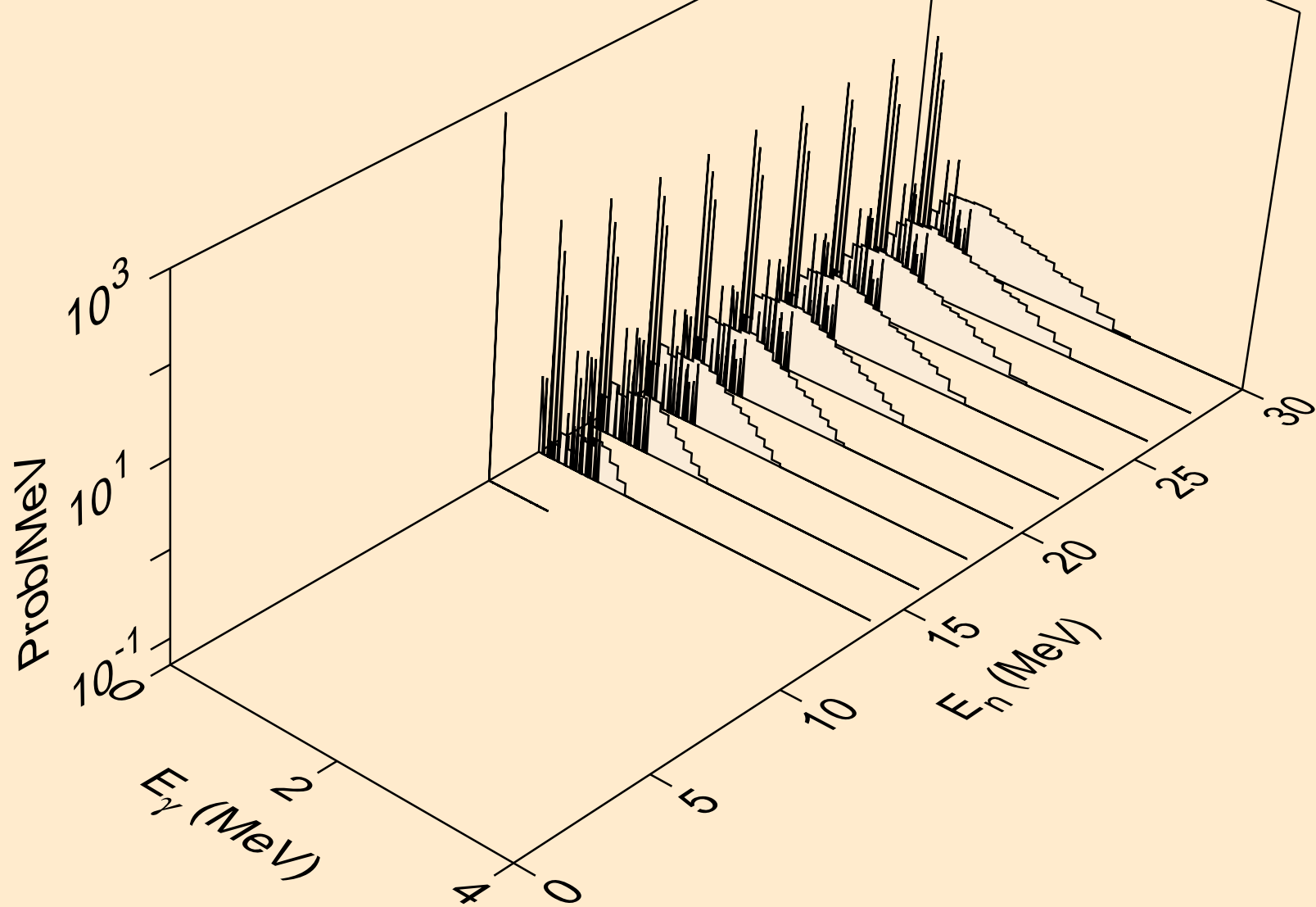

U231 NEUTRON ACER TENDL-2021 LIBRARY; T=293.6K
Photon emission for (n,p α)

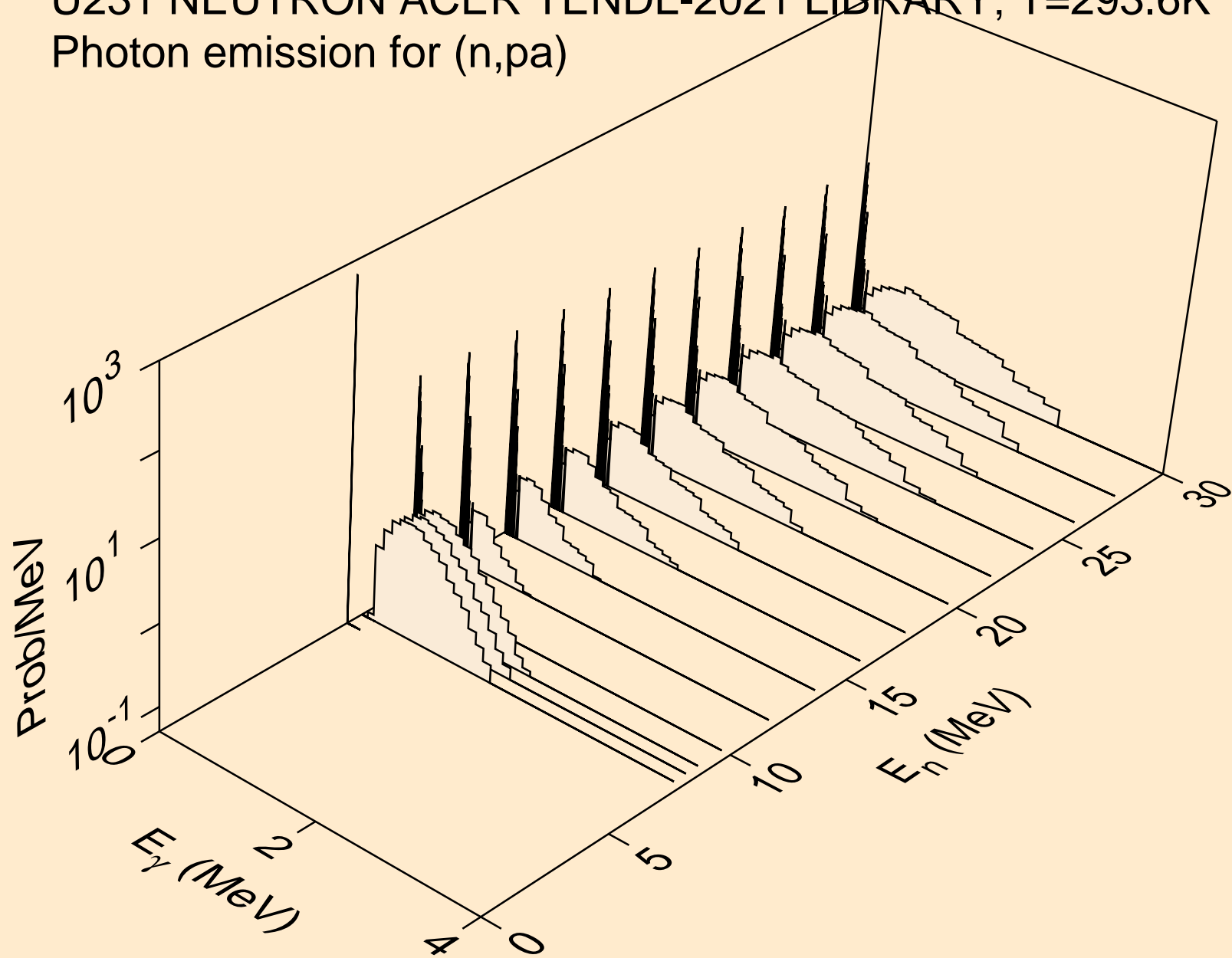

U231 NEUTRON ACER TENDL-2021 LIBRARY; T=293.6K
Photon emission for (n,pd)

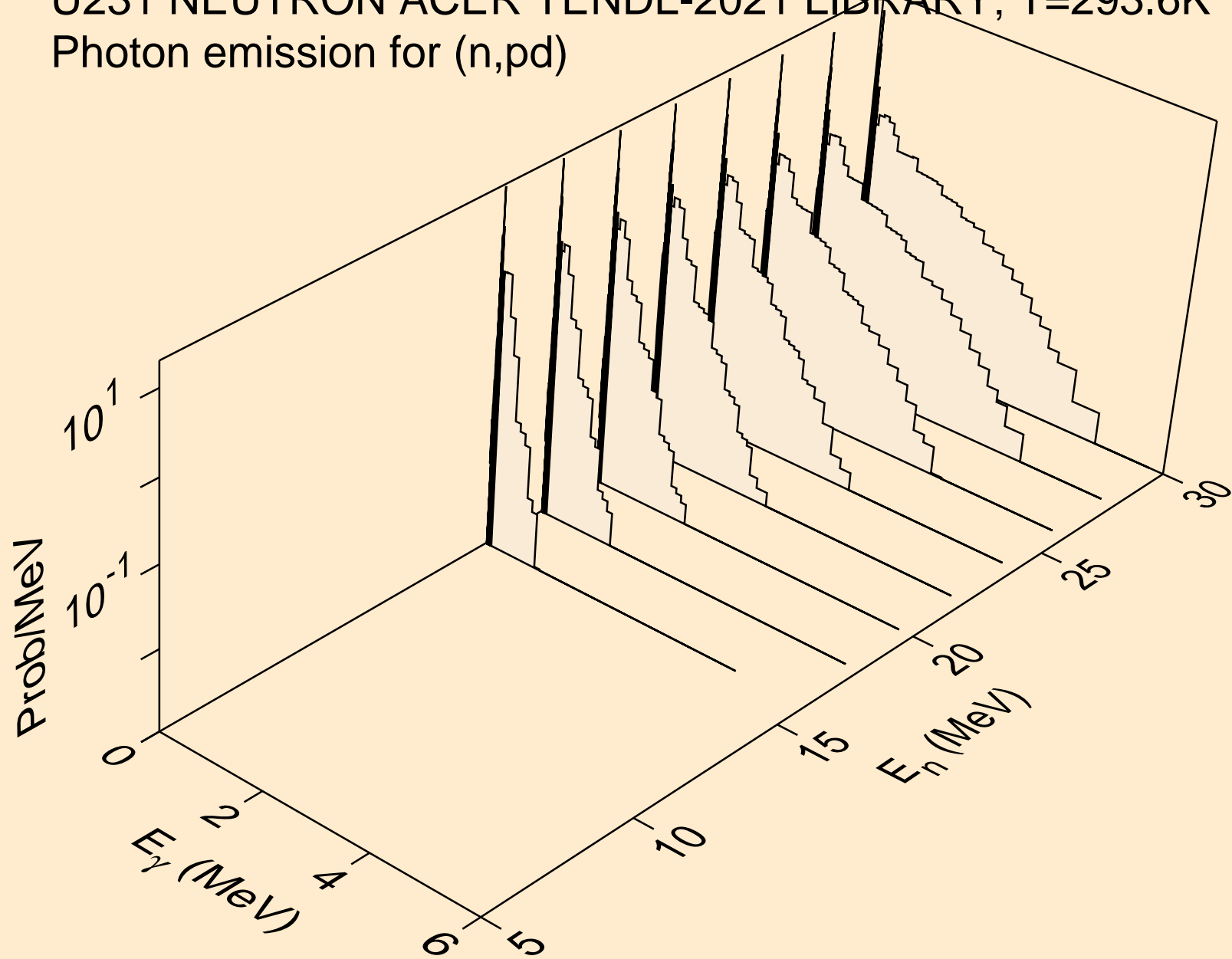

U231 NEUTRON ACER TENDL-2021 LIBRARY; T=293.6K
Photon emission for (n,pt)

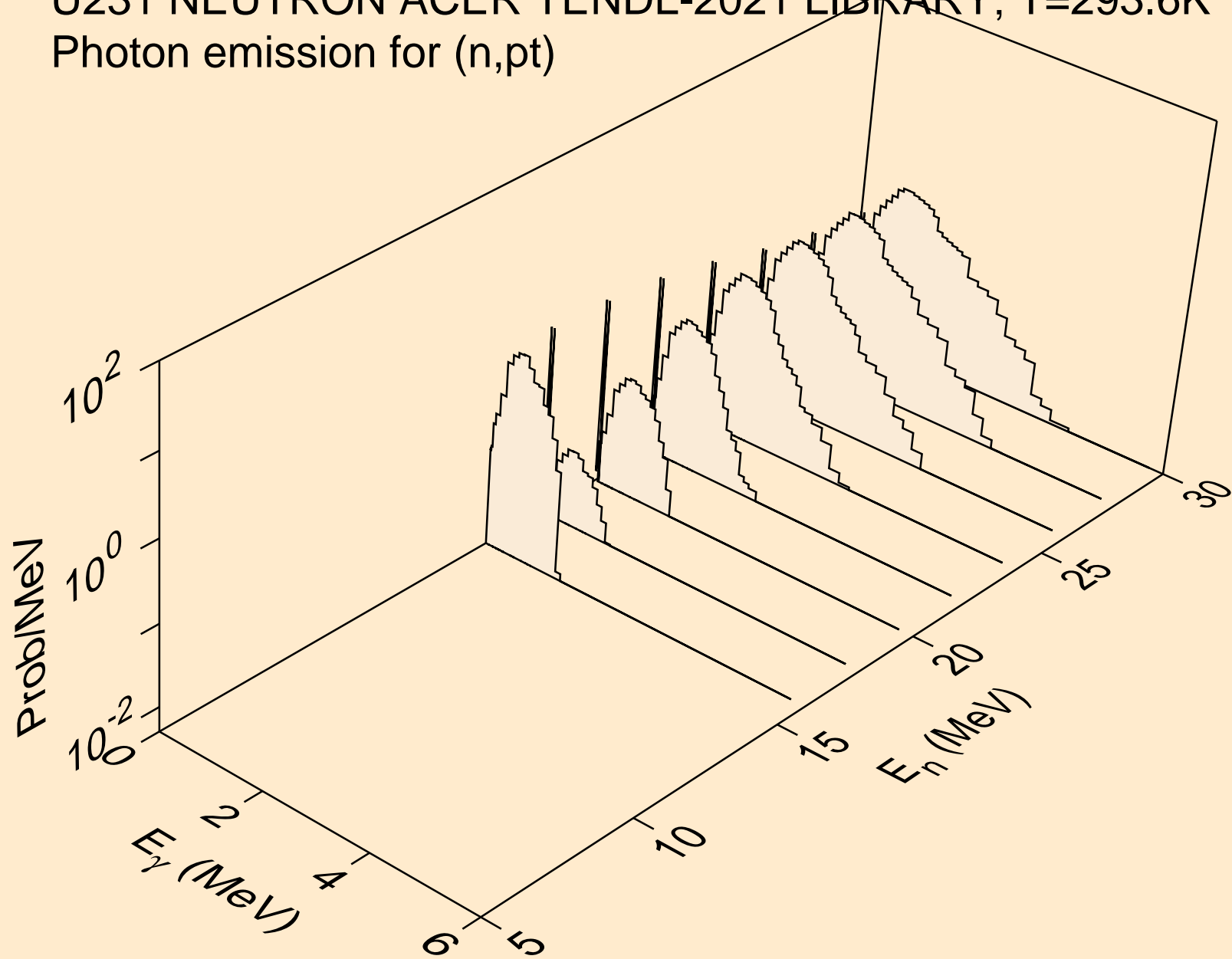

U231 NEUTRON ACER TENDL-2021 LIBRARY; T=293.6K
Photon emission for (n,da)

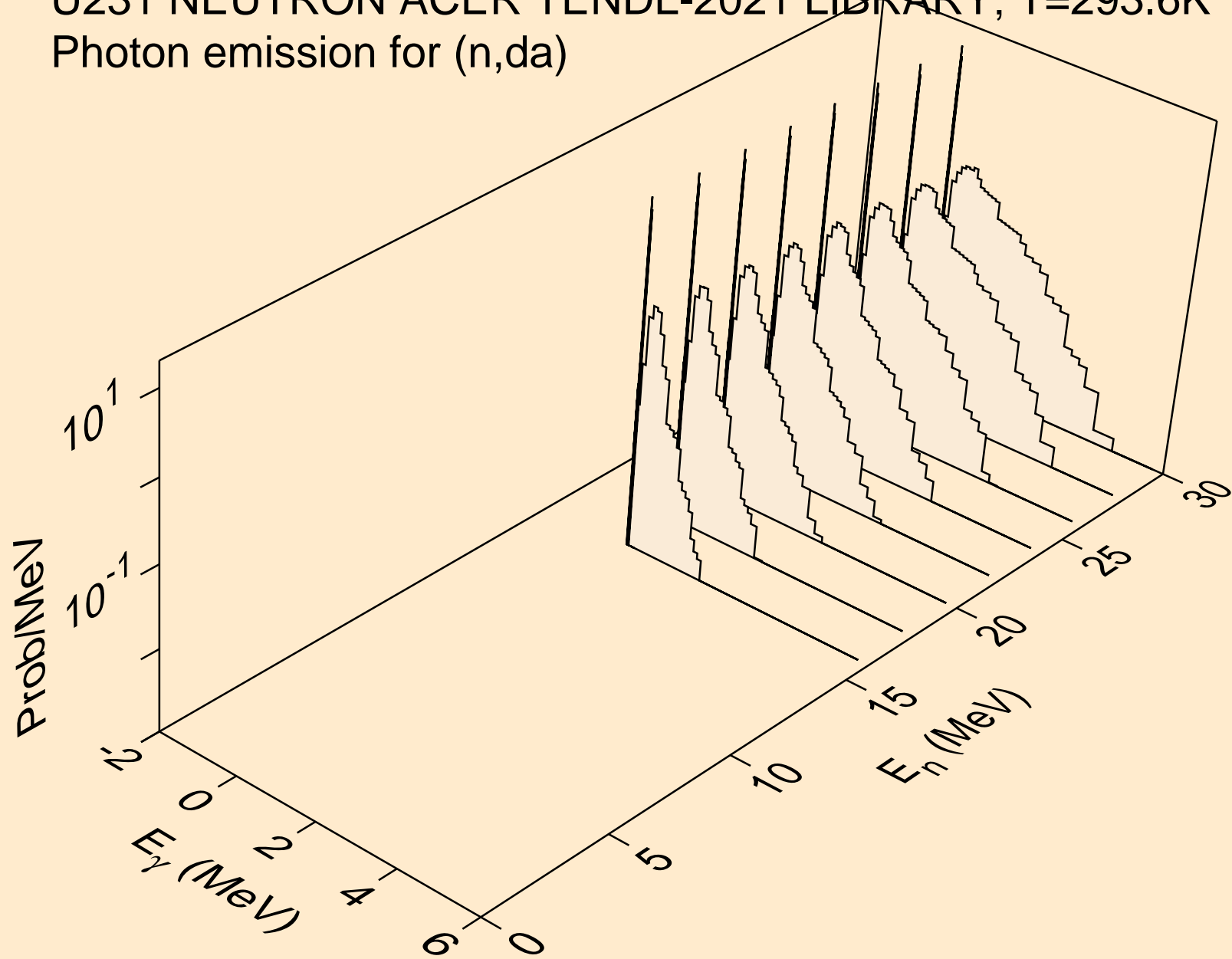

U231 NEUTRON ACER TENDL-2021 LIBRARY; T=293.6K
thermal capture photon spectrum

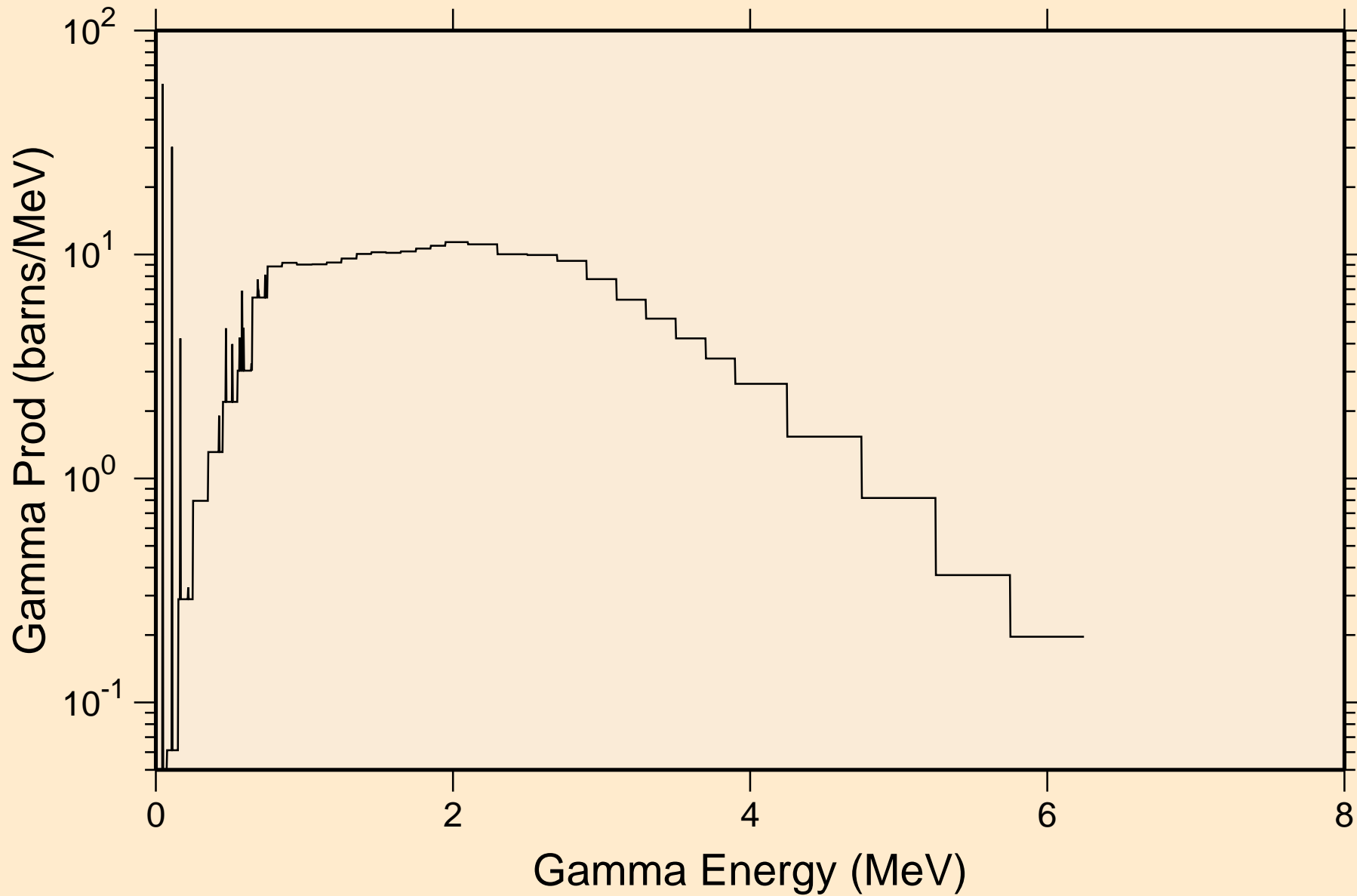

U231 NEUTRON ACER TENDL-2021 LIBRARY; T=293.6K
14 MeV photon spectrum

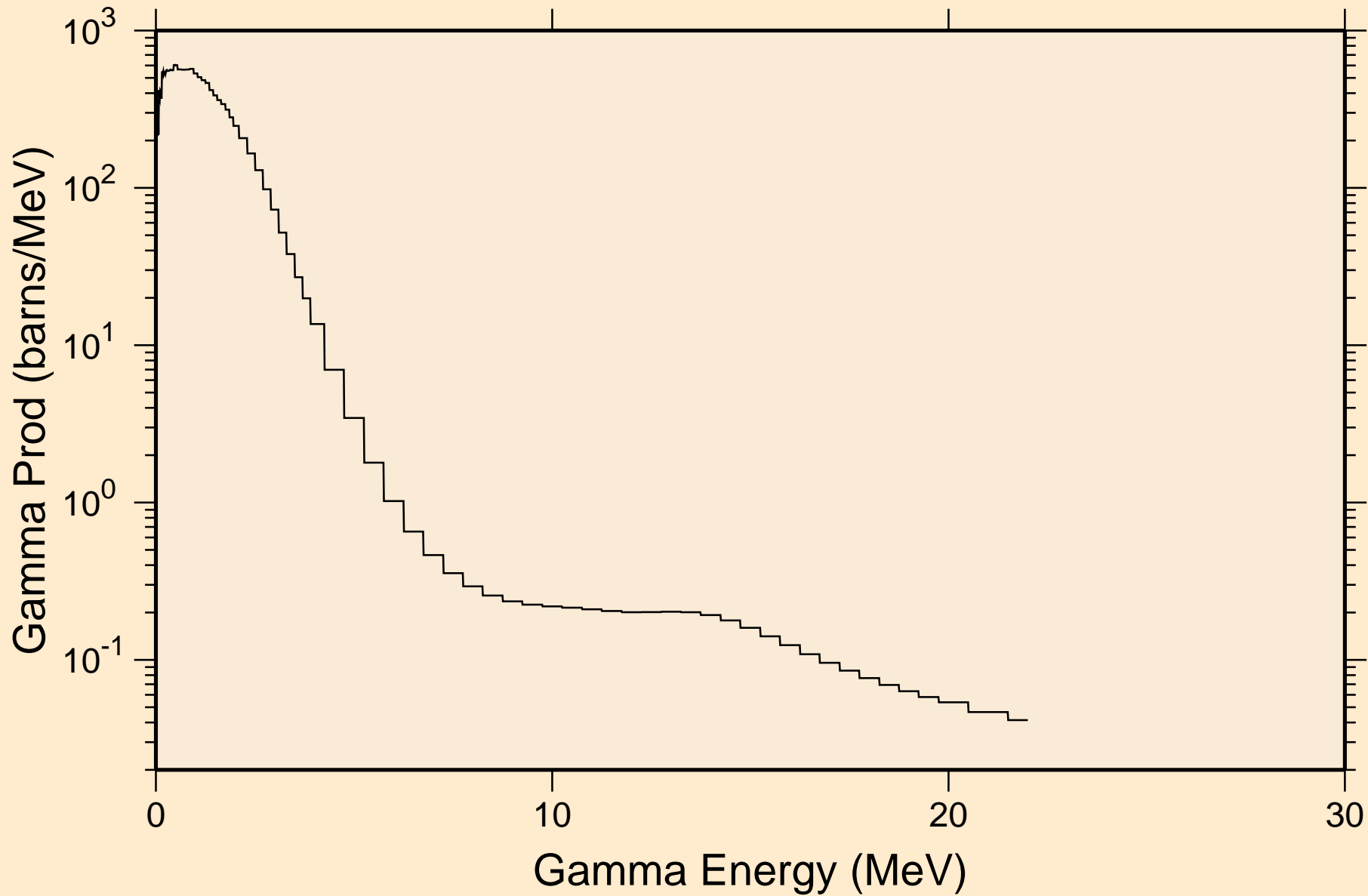

U231 NEUTRON ACER TENDL-2021 LIBRARY; T=293.6K
Particle heating contributions

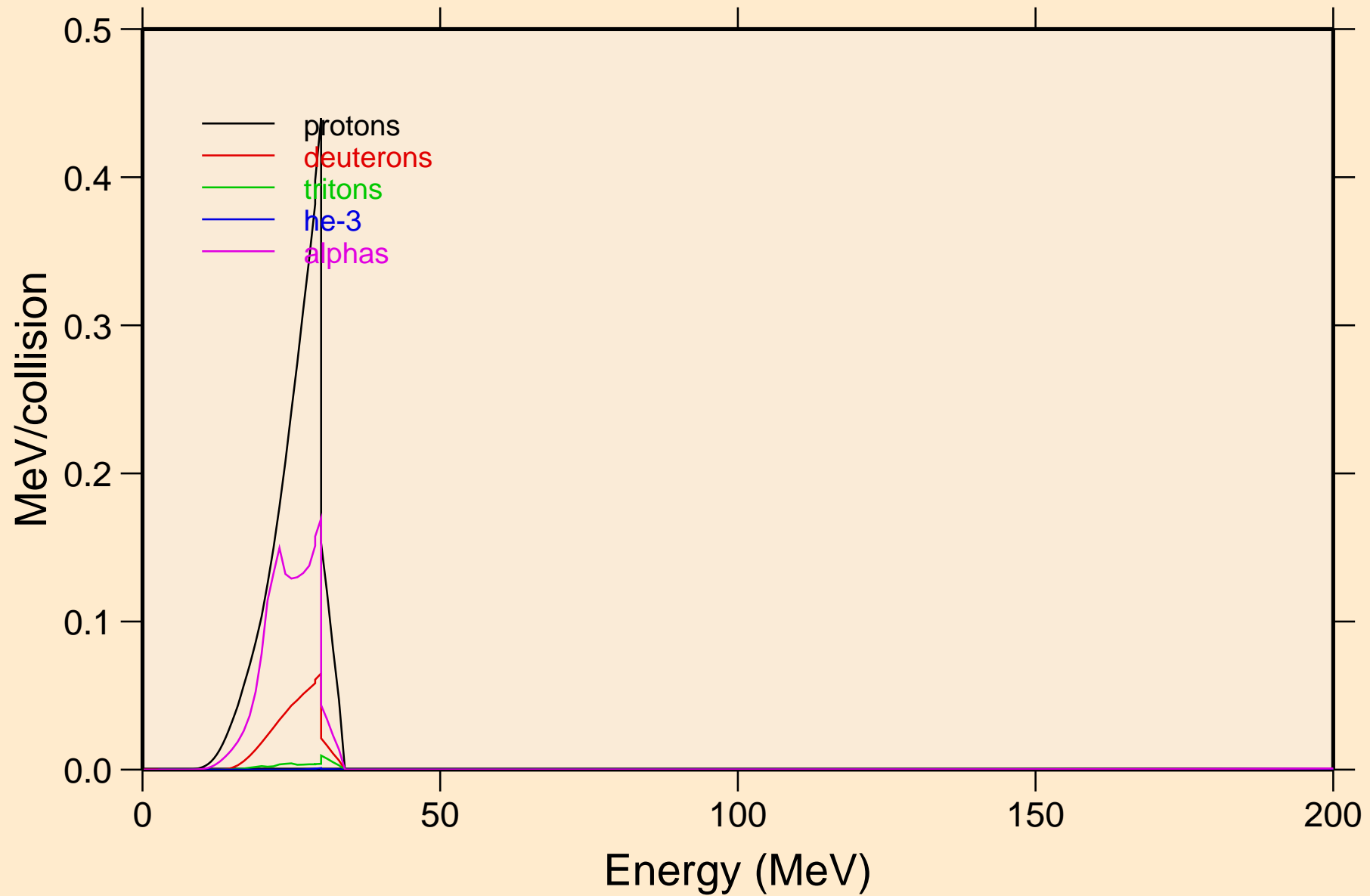

U231 NEUTRON ACER TENDL-2021 LIBRARY; T=293.6K
Recoil Heating

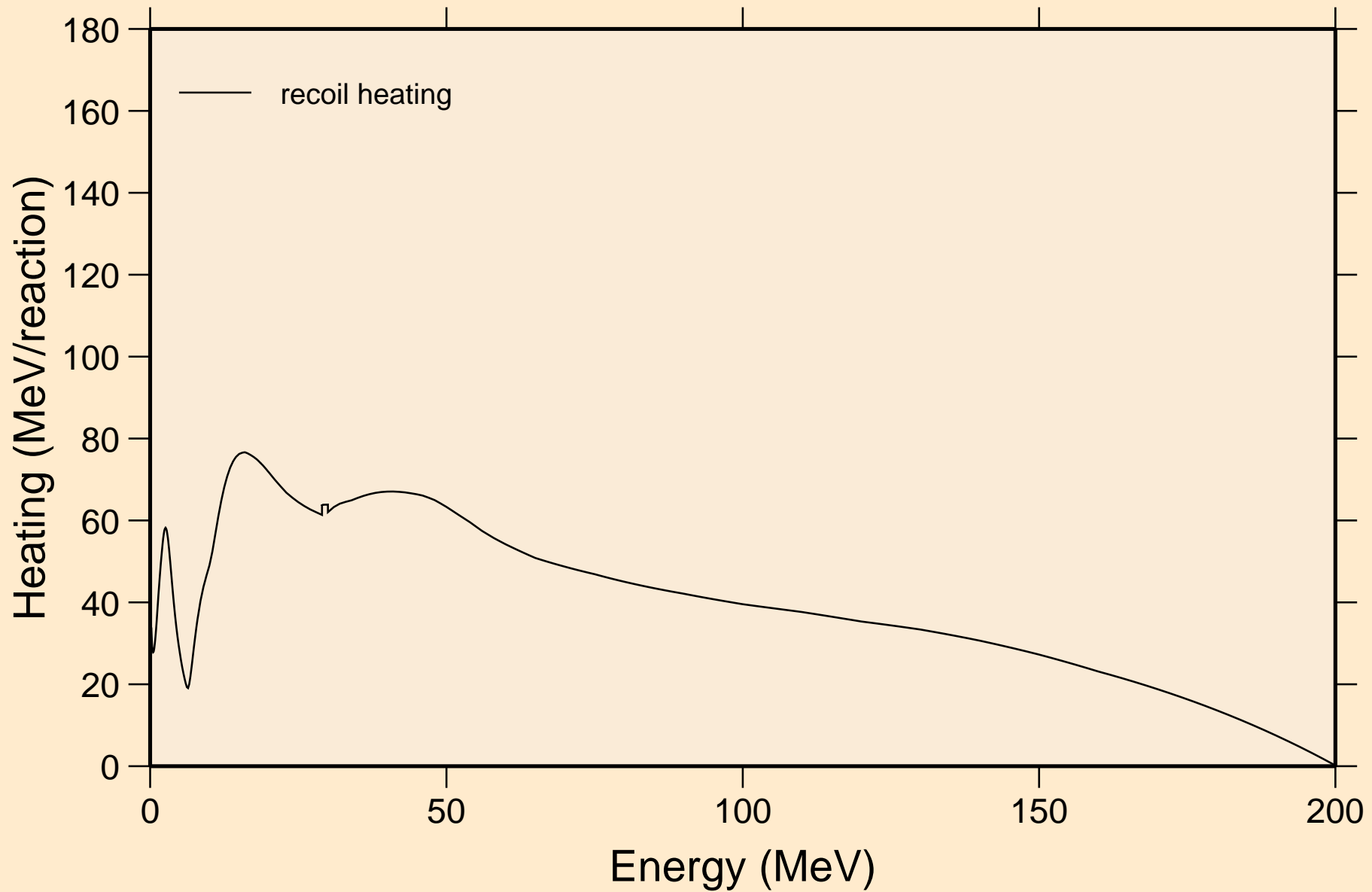

U231 NEUTRON ACER TENDL-2021 LIBRARY; T=293.6K

Particle production cross sections

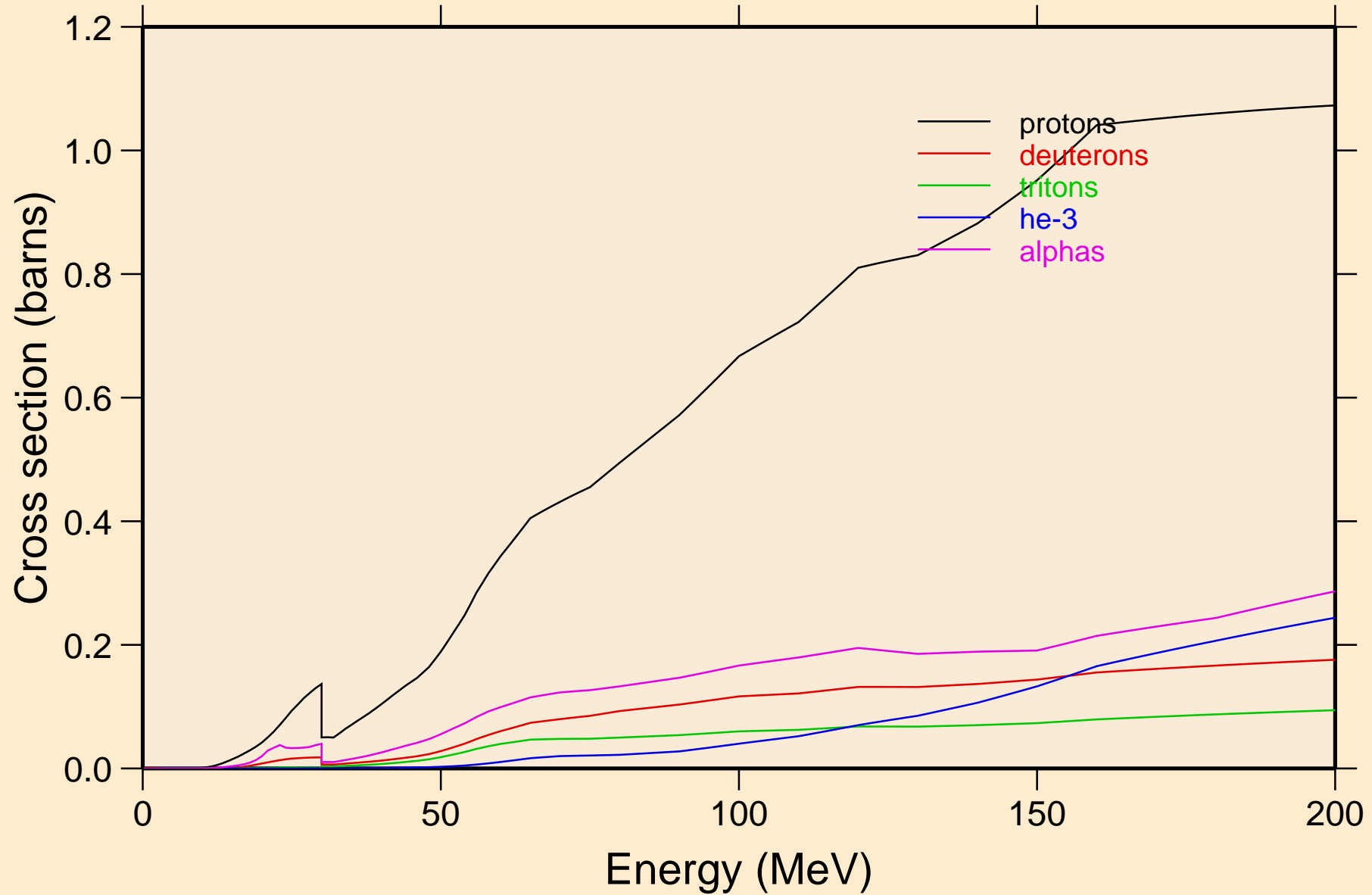

U231 NEUTRON ACER TENDL-2021 LIBRARY; T=293.6K
protons from (n,x)

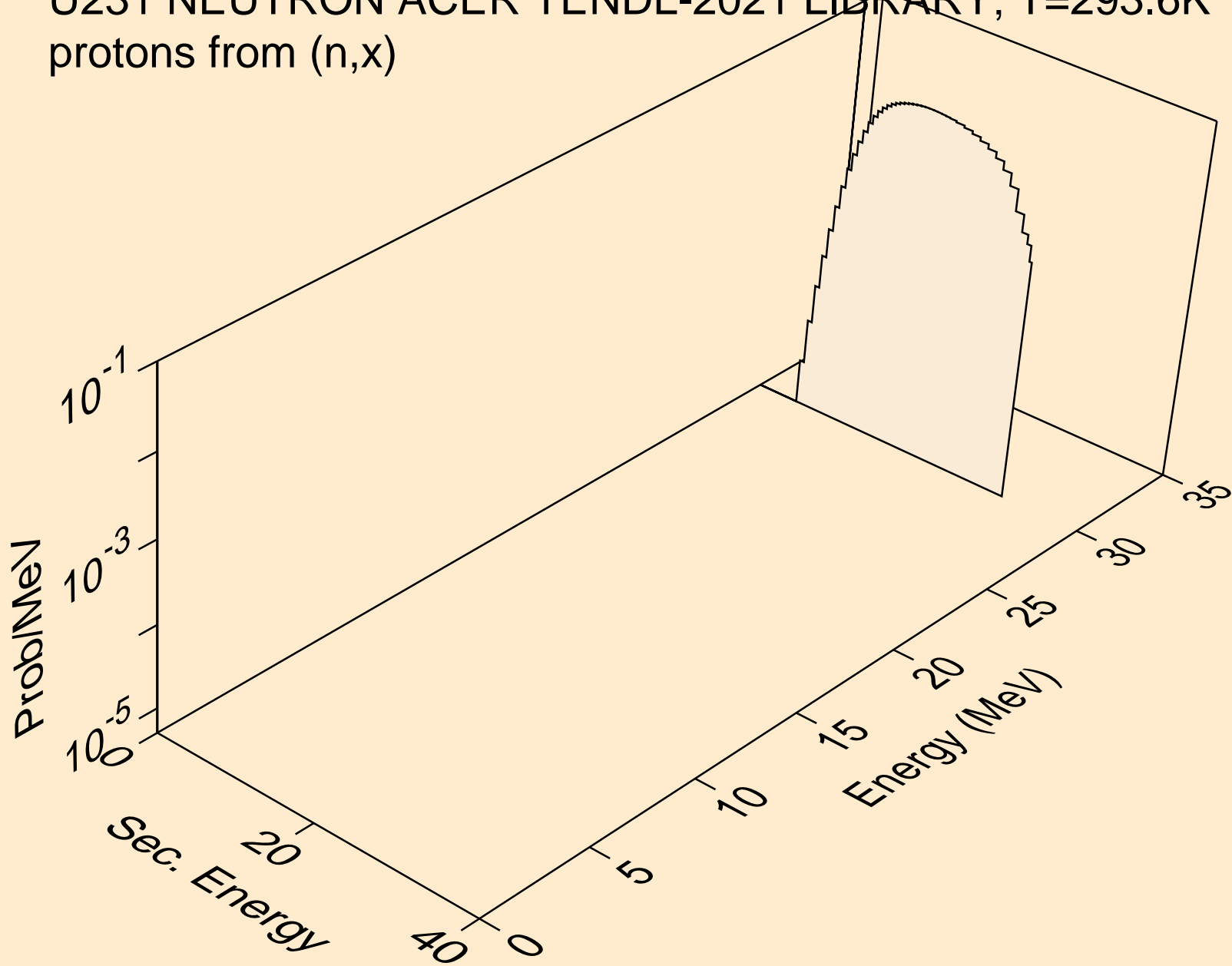

U231 NEUTRON ACER TENDL-2021 LIBRARY; T=293.6K
protons from (n,n*)p

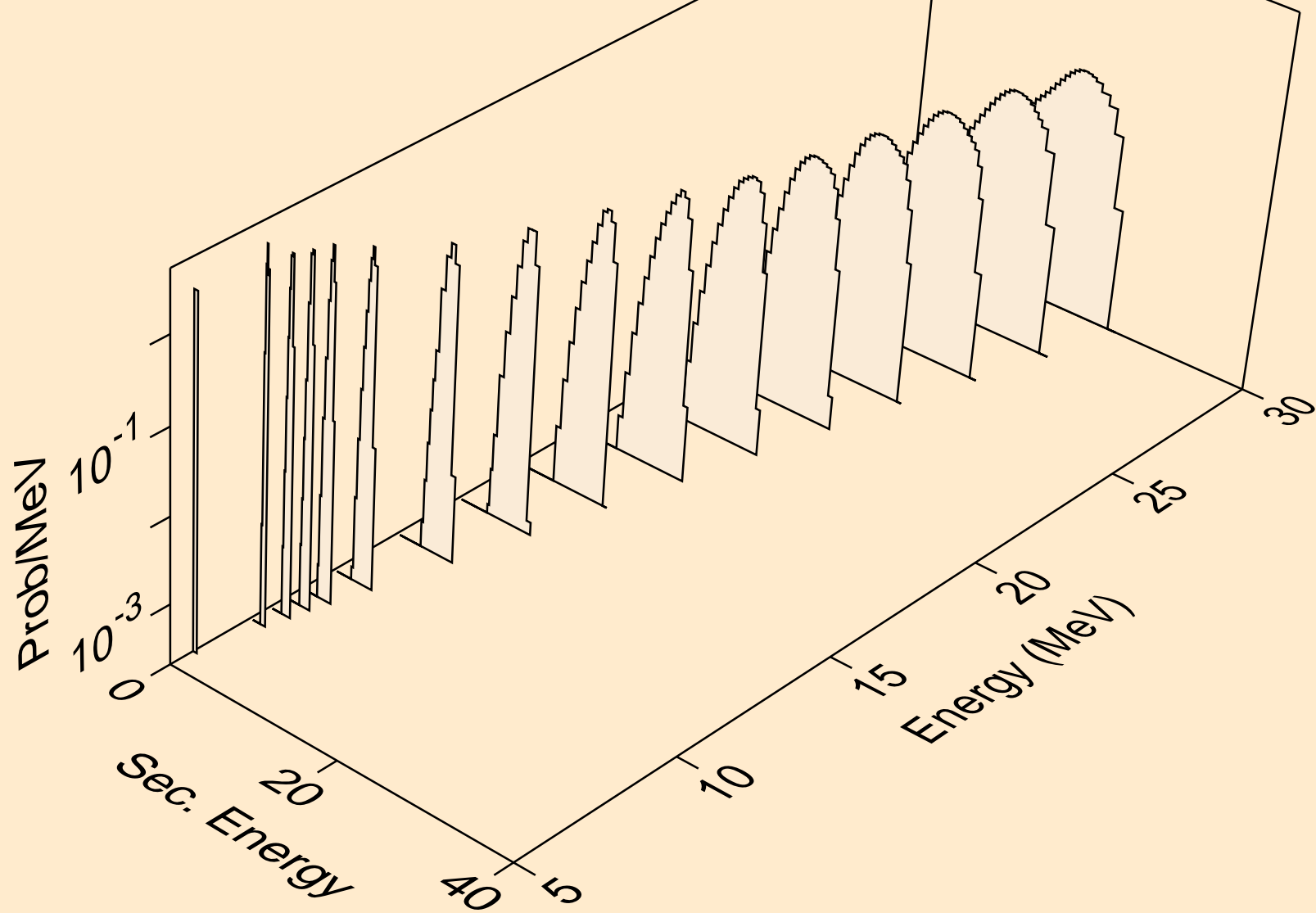

U231 NEUTRON ACER TENDL-2021 LIBRARY; T=293.6K
protons from (n,2np)

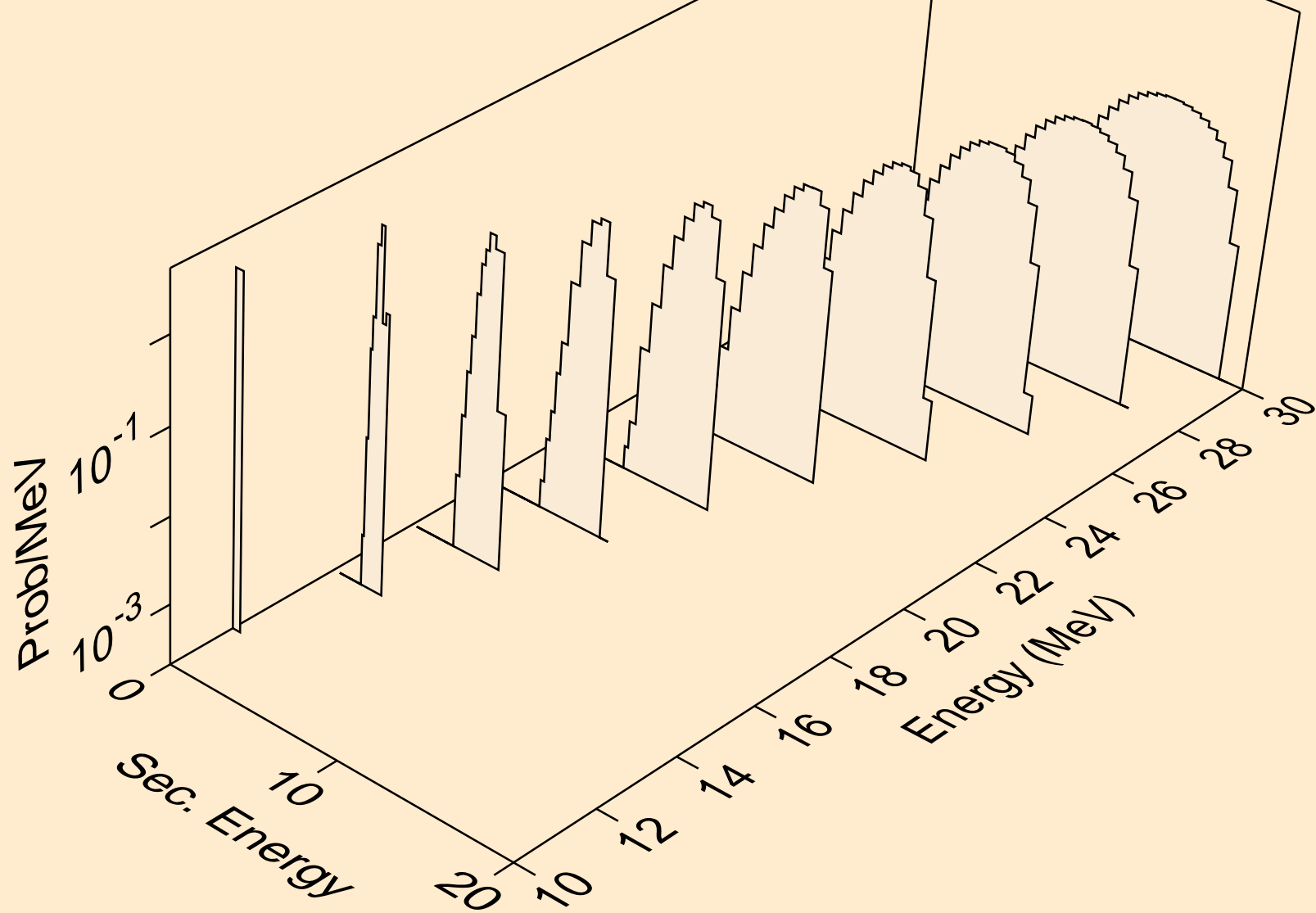

U231 NEUTRON ACER TENDL-2021 LIBRARY; T=293.6K
protons from (n,3np)

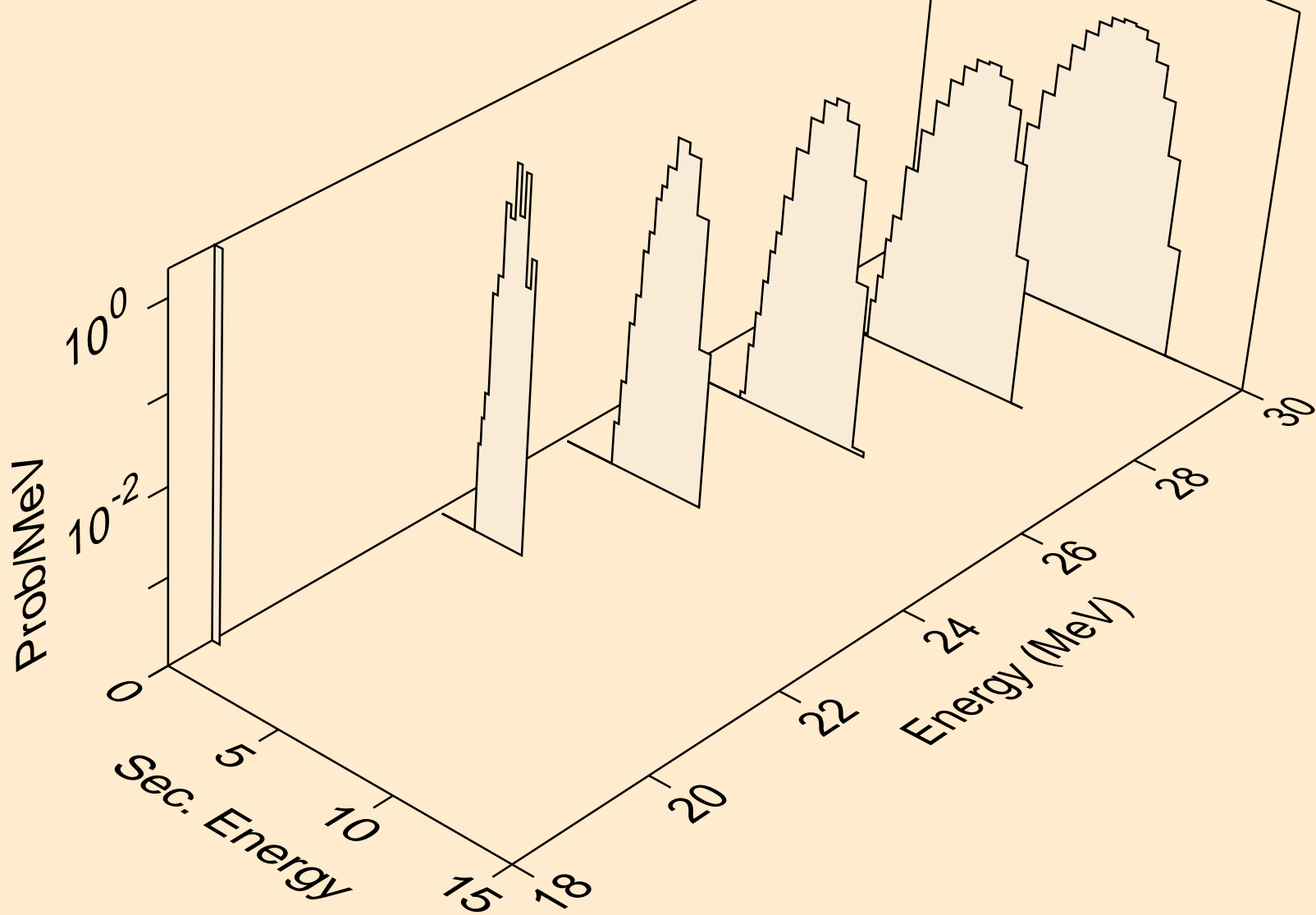

U231 NEUTRON ACER TENDL-2021 LIBRARY; T=293.6K
protons from (n,2np)

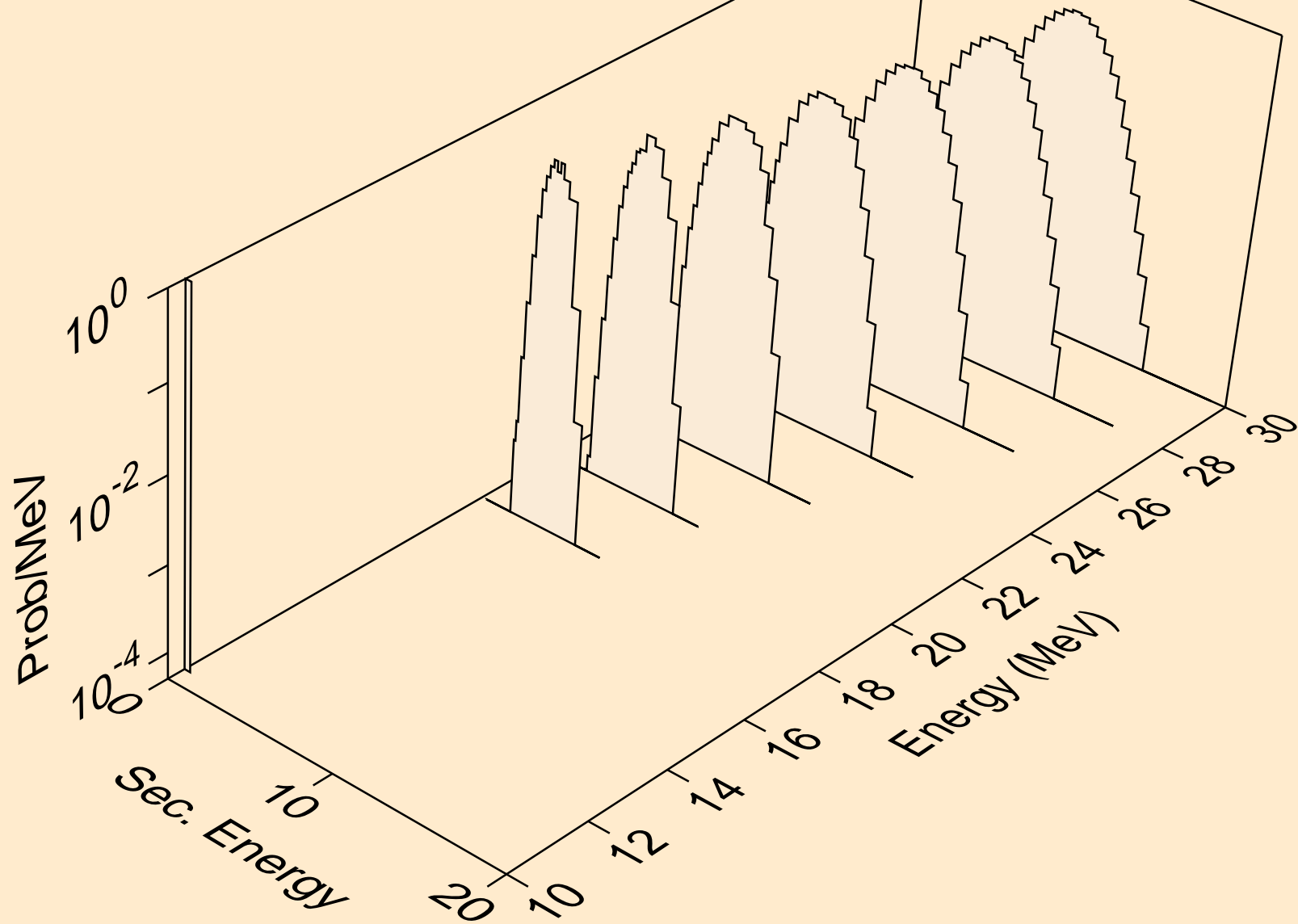

U231 NEUTRON ACER TENDL-2021 LIBRARY; T=293.6K
protons from (n,npa)

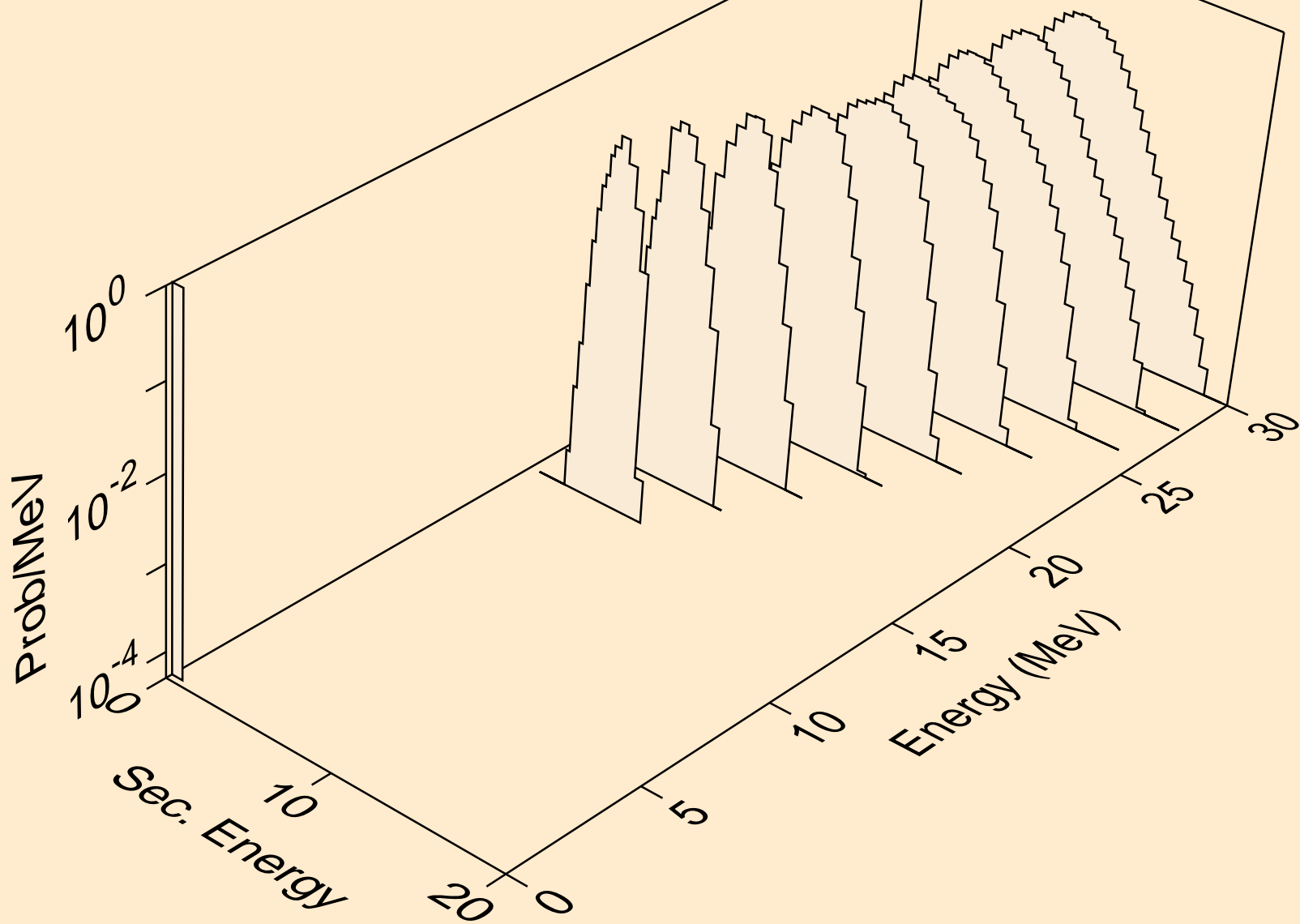

U231 NEUTRON ACER TENDL-2021 LIBRARY; T=293.6K
protons from (n,p)

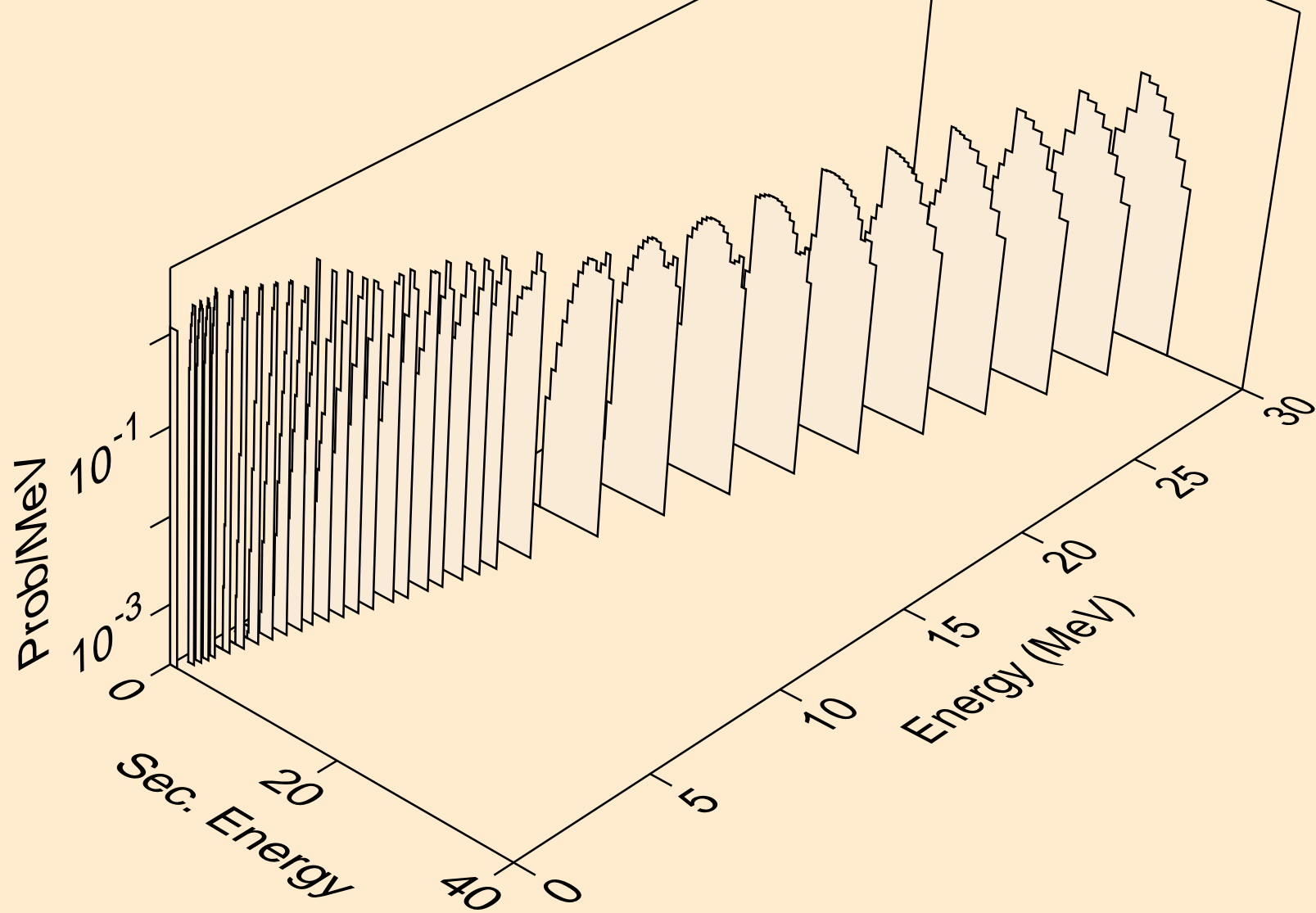

U231 NEUTRON ACER TENDL-2021 LIBRARY; T=293.6K
protons from (n,2p)

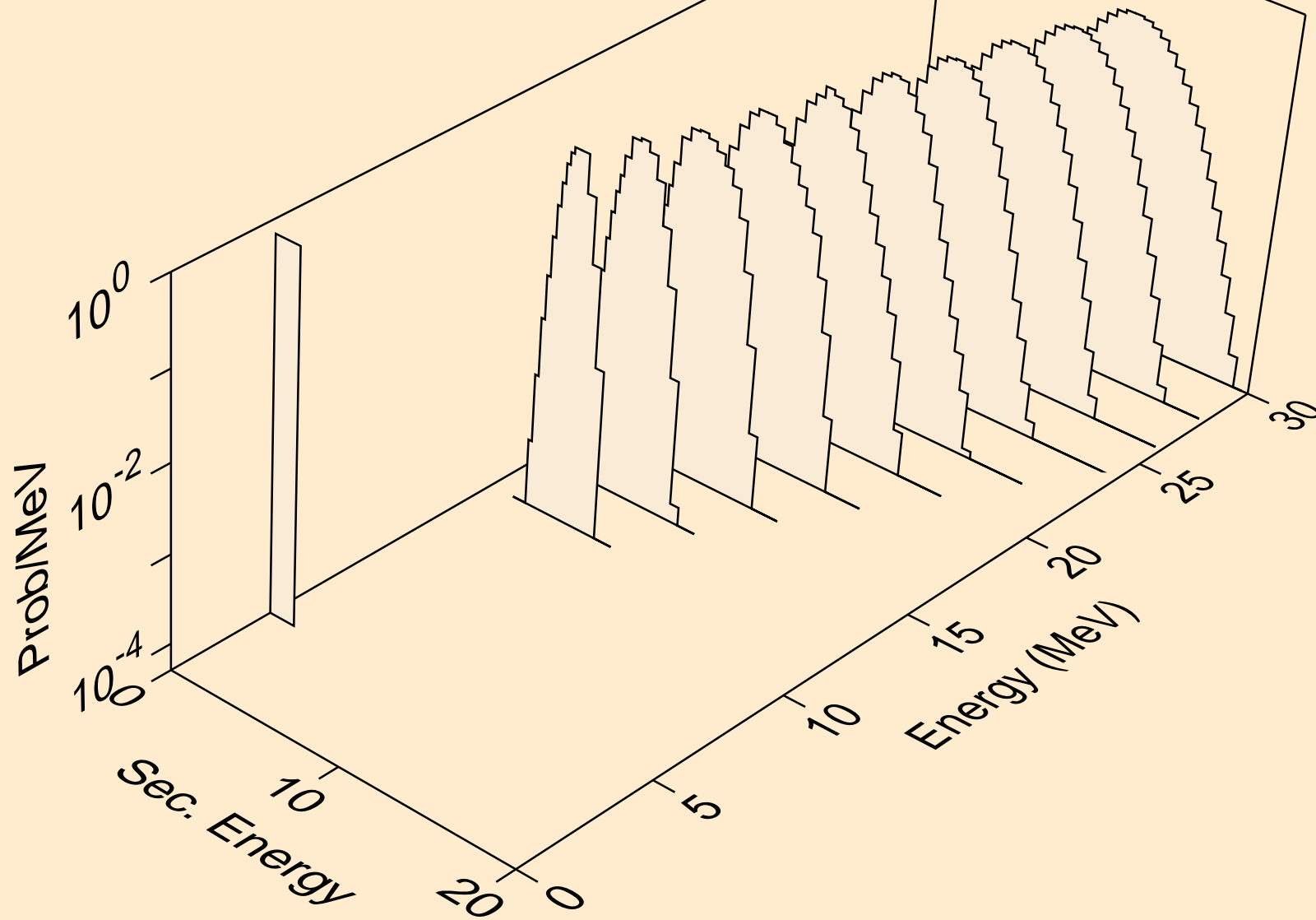

U231 NEUTRON ACER TENDL-2021 LIBRARY; T=293.6K
protons from (n,p)

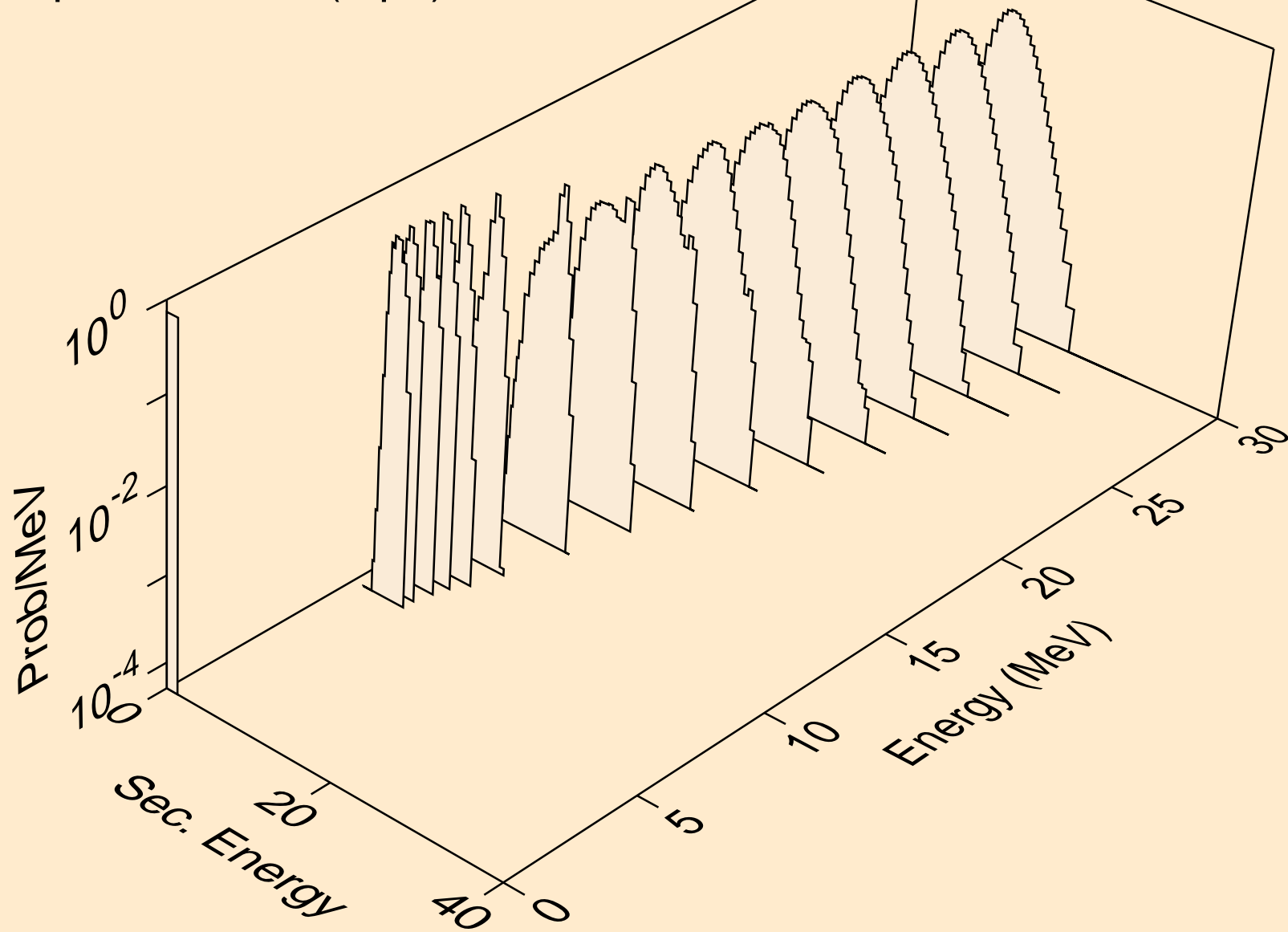

U231 NEUTRON ACER TENDL-2021 LIBRARY; T=293.6K
protons from (n,pd)

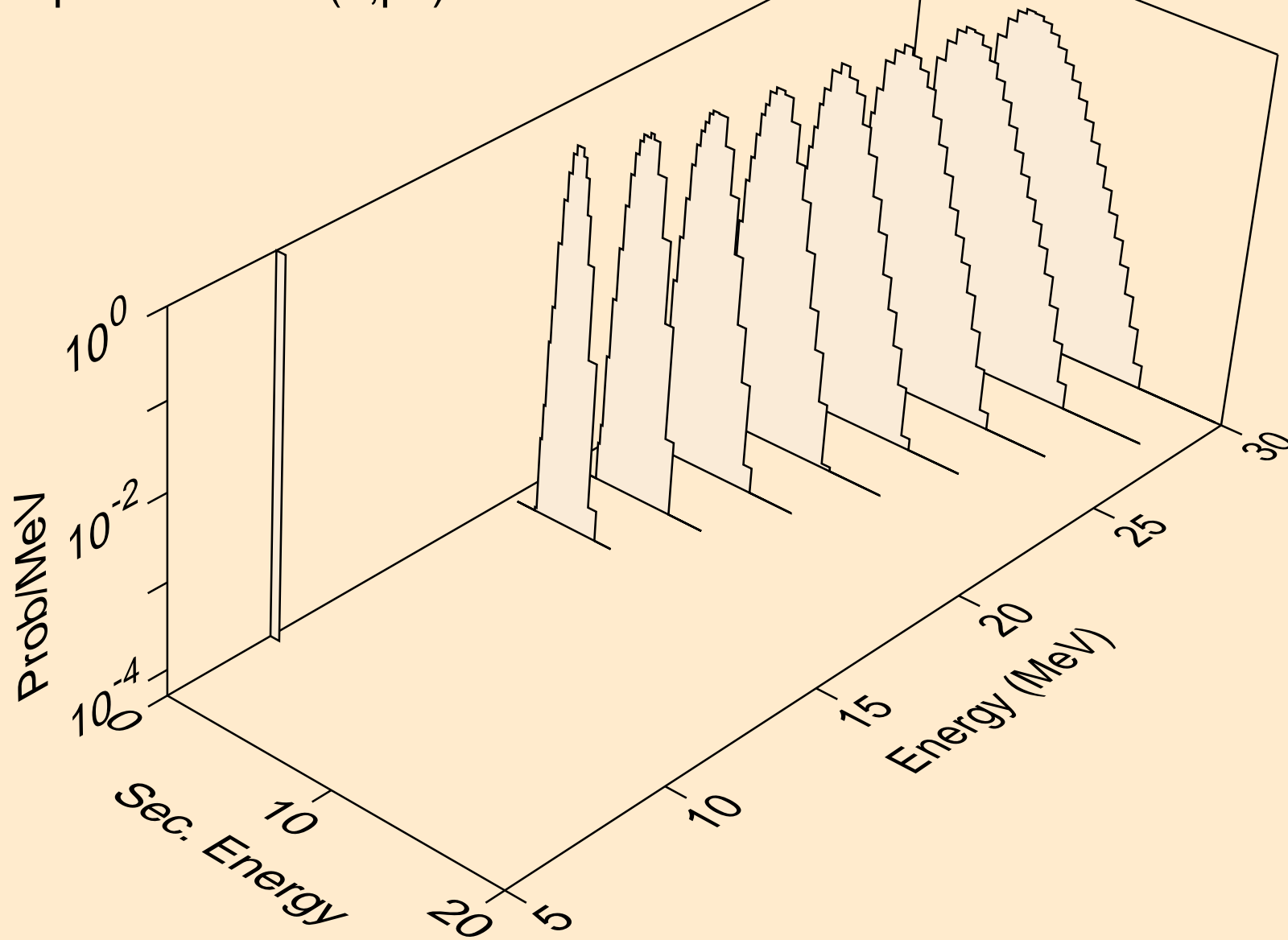

U231 NEUTRON ACER TENDL-2021 LIBRARY; T=293.6K
protons from (n,pt)

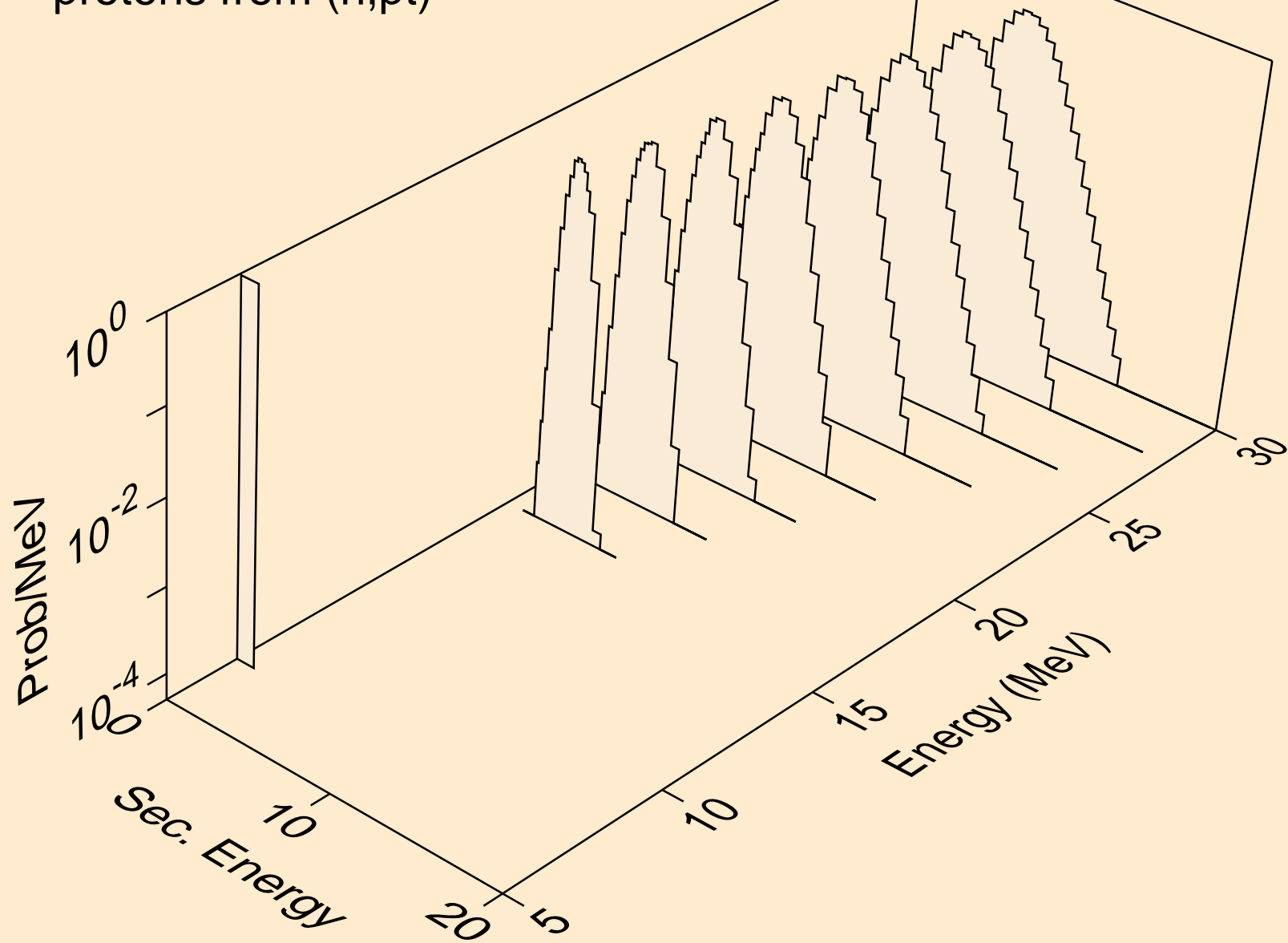

U231 NEUTRON ACER TENDL-2021 LIBRARY; T=293.6K
deuterons from (n,x)

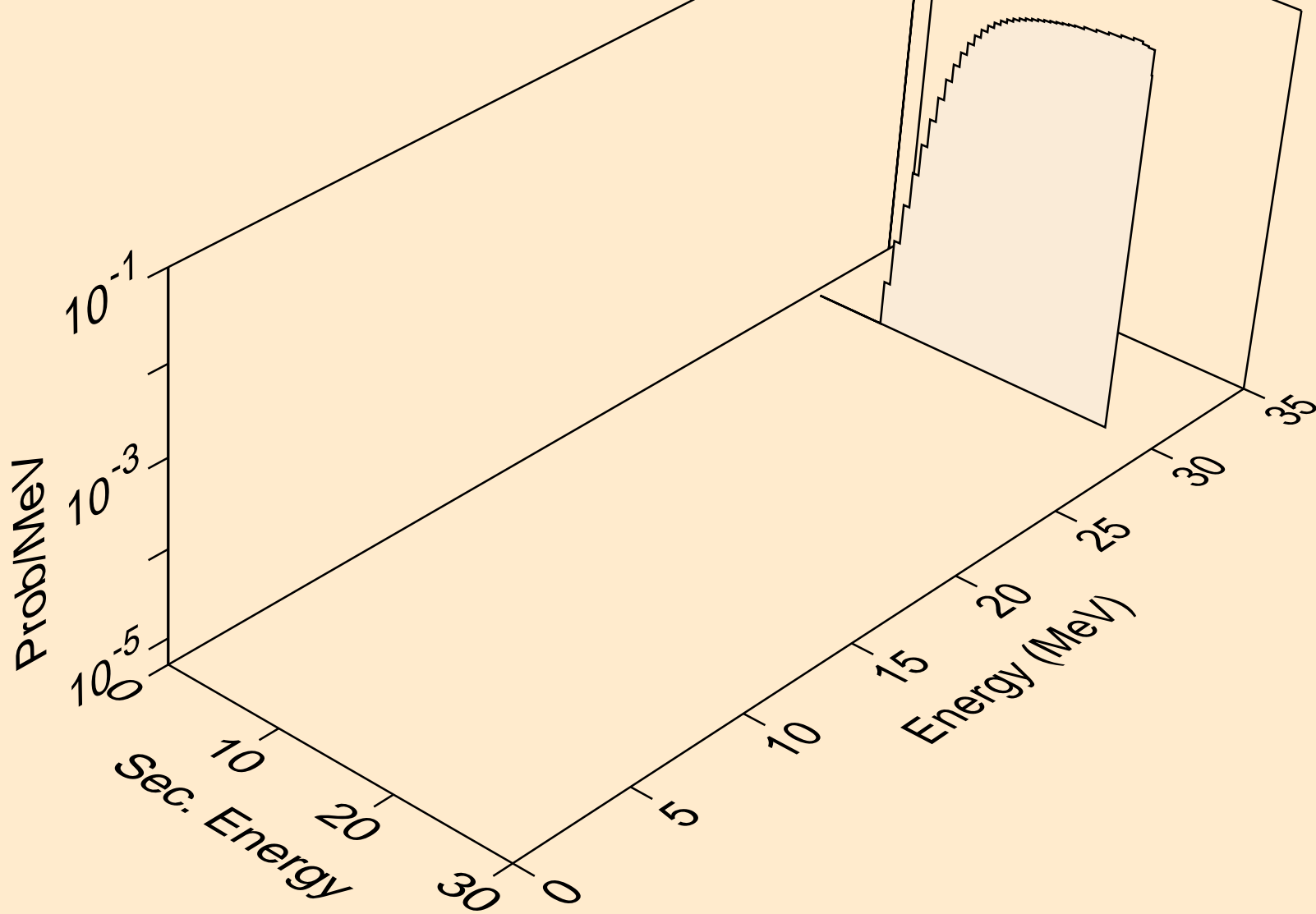

U231 NEUTRON ACER TENDL-2021 LIBRARY; T=293.6K
deuterons from (n,2nd)

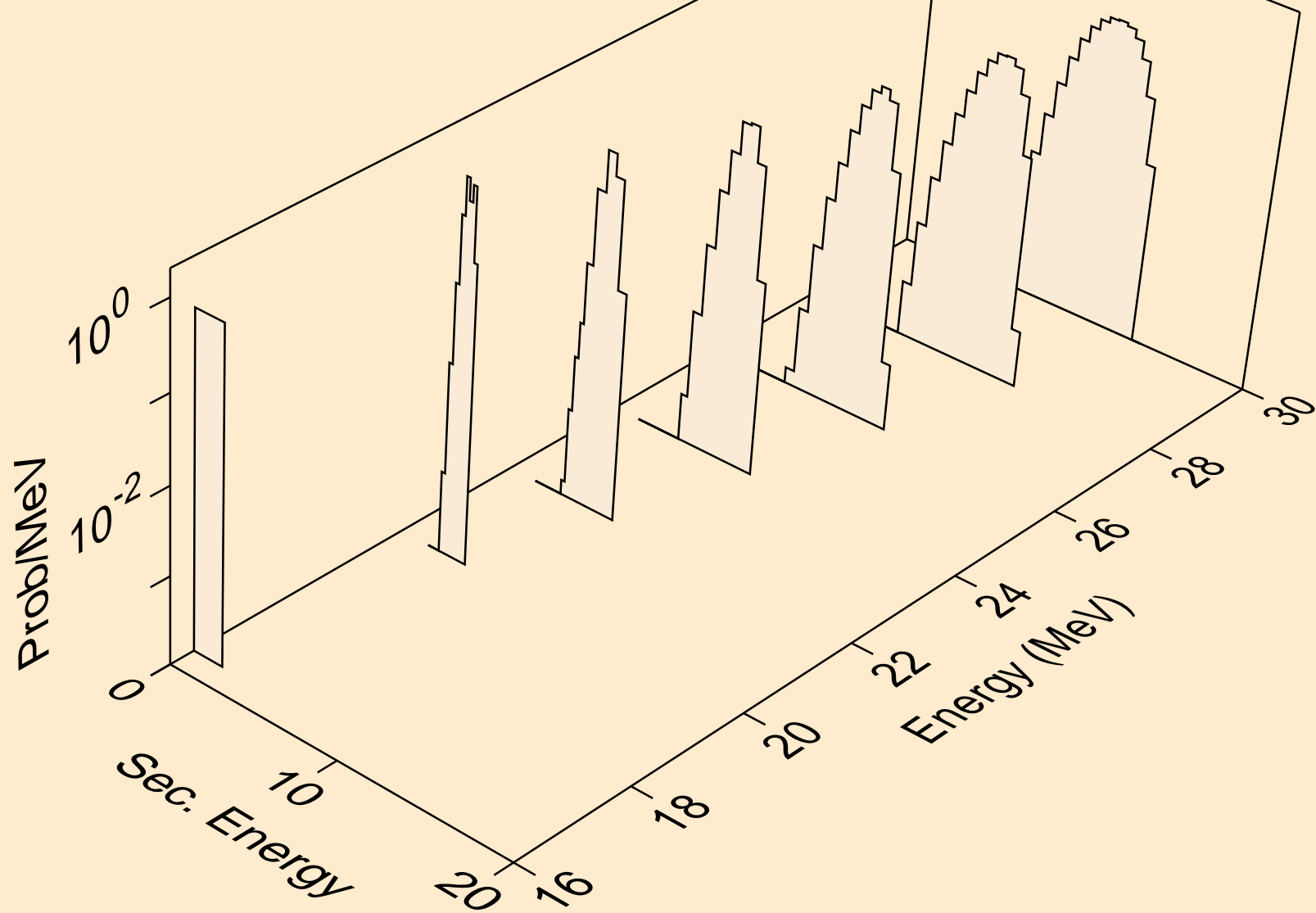

U231 NEUTRON ACER TENDL-2021 LIBRARY; T=293.6K
deuterons from (n,n*)d

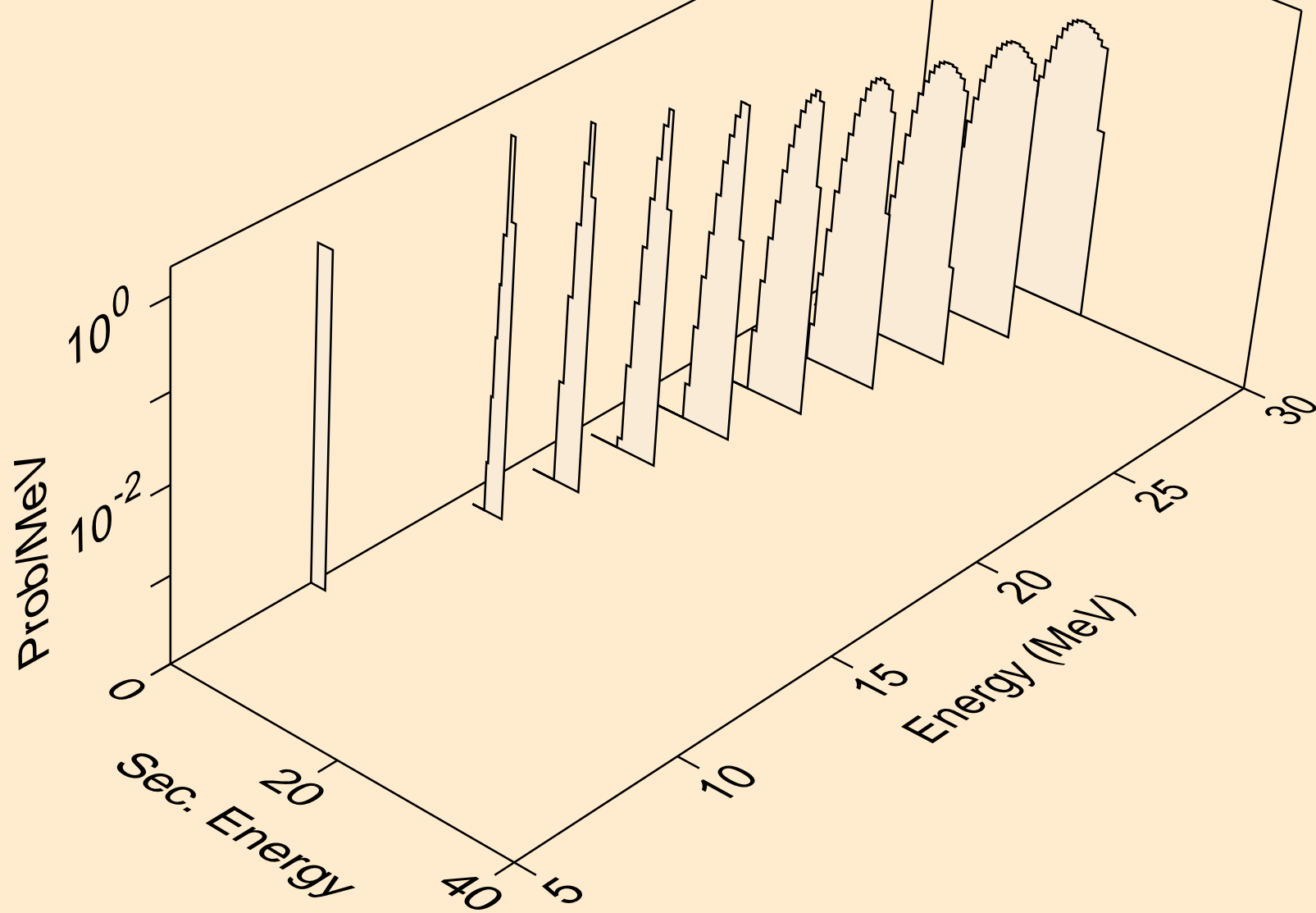

U231 NEUTRON ACER TENDL-2021 LIBRARY; T=293.6K
deuterons from (n,d)

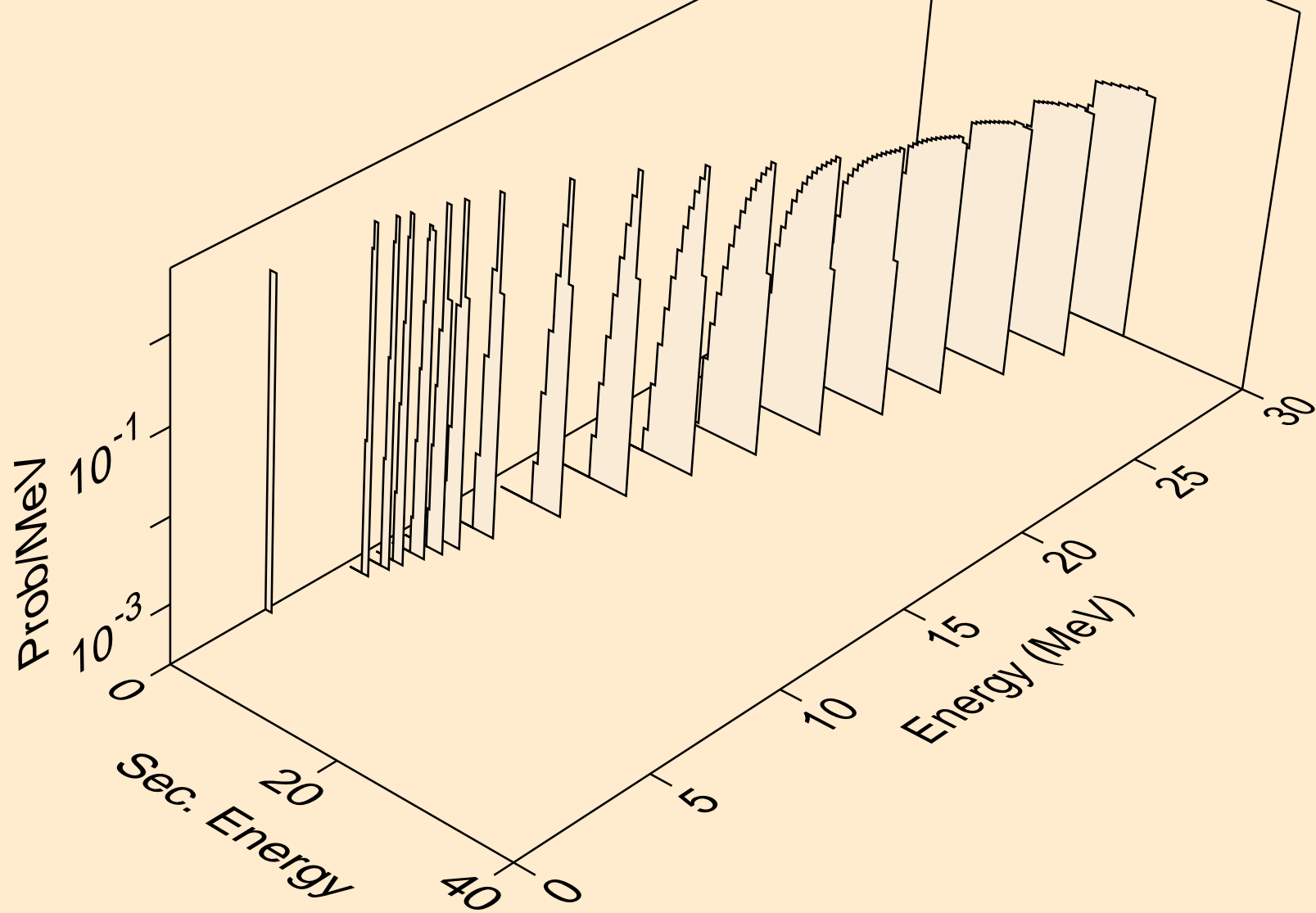

U231 NEUTRON ACER TENDL-2021 LIBRARY; T=293.6K
deuterons from (n,pd)

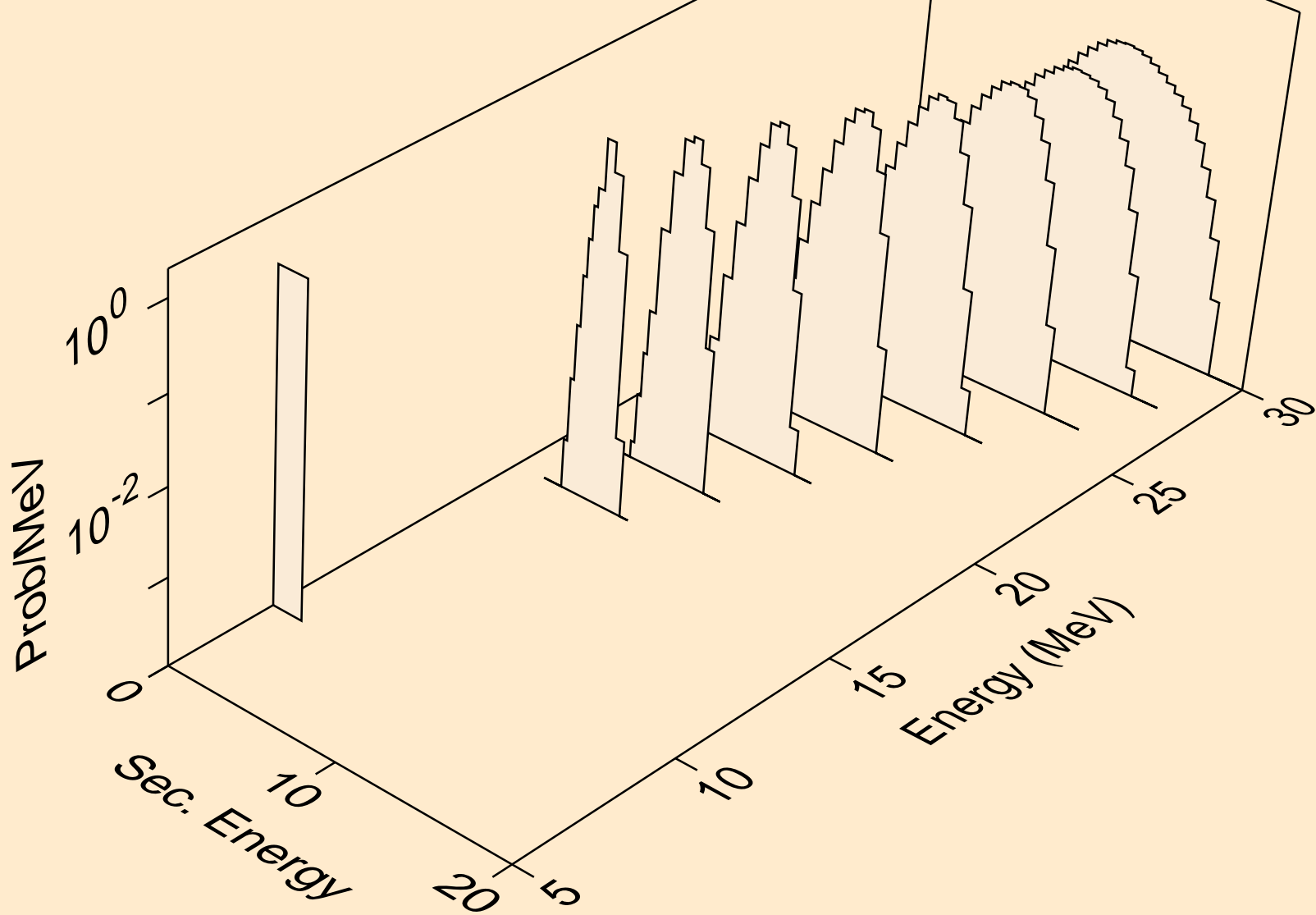

U231 NEUTRON ACER TENDL-2021 LIBRARY; T=293.6K
deuterons from (n,da)

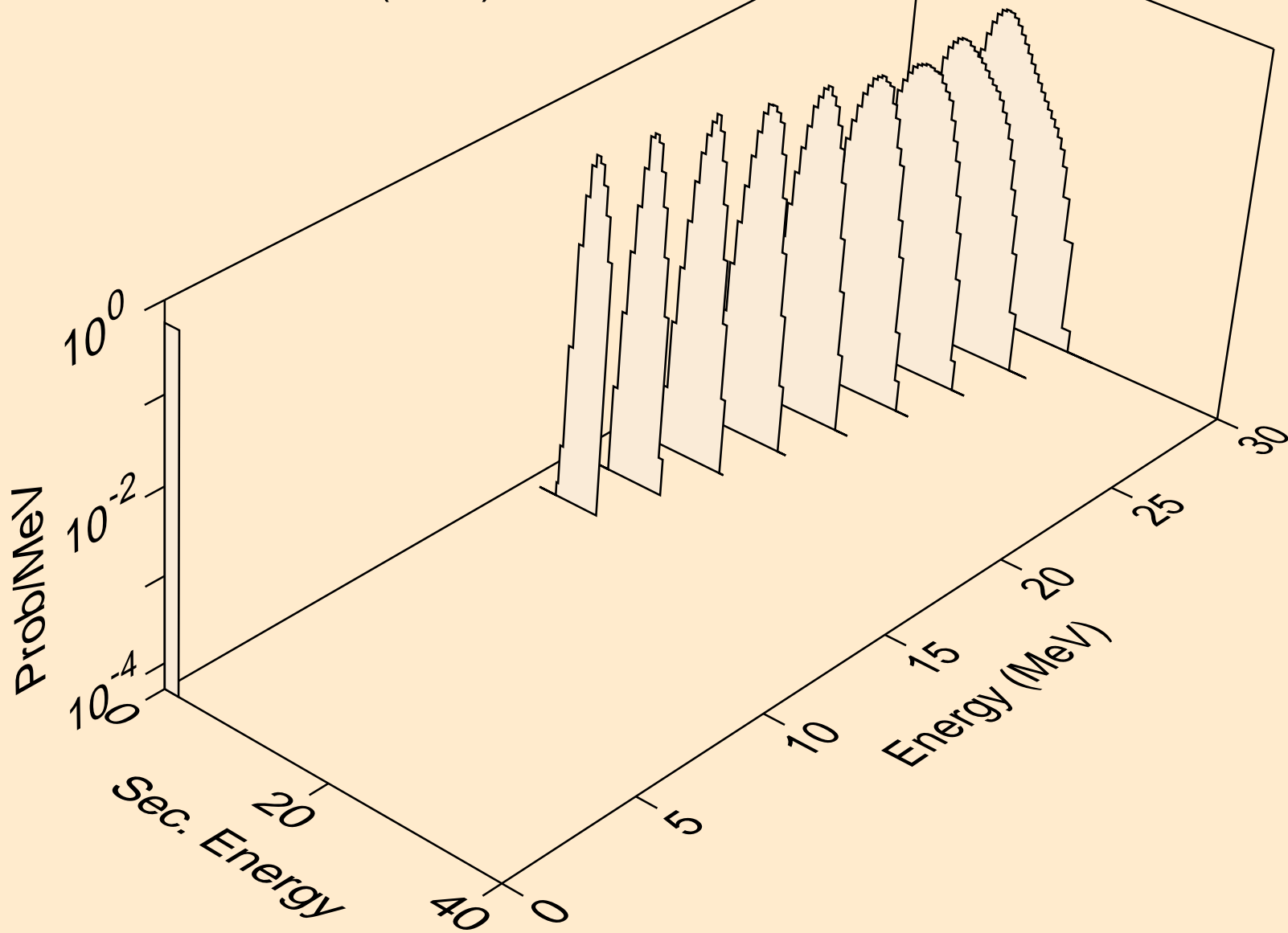

U231 NEUTRON ACER TENDL-2021 LIBRARY; T=293.6K
tritons from (n,x)

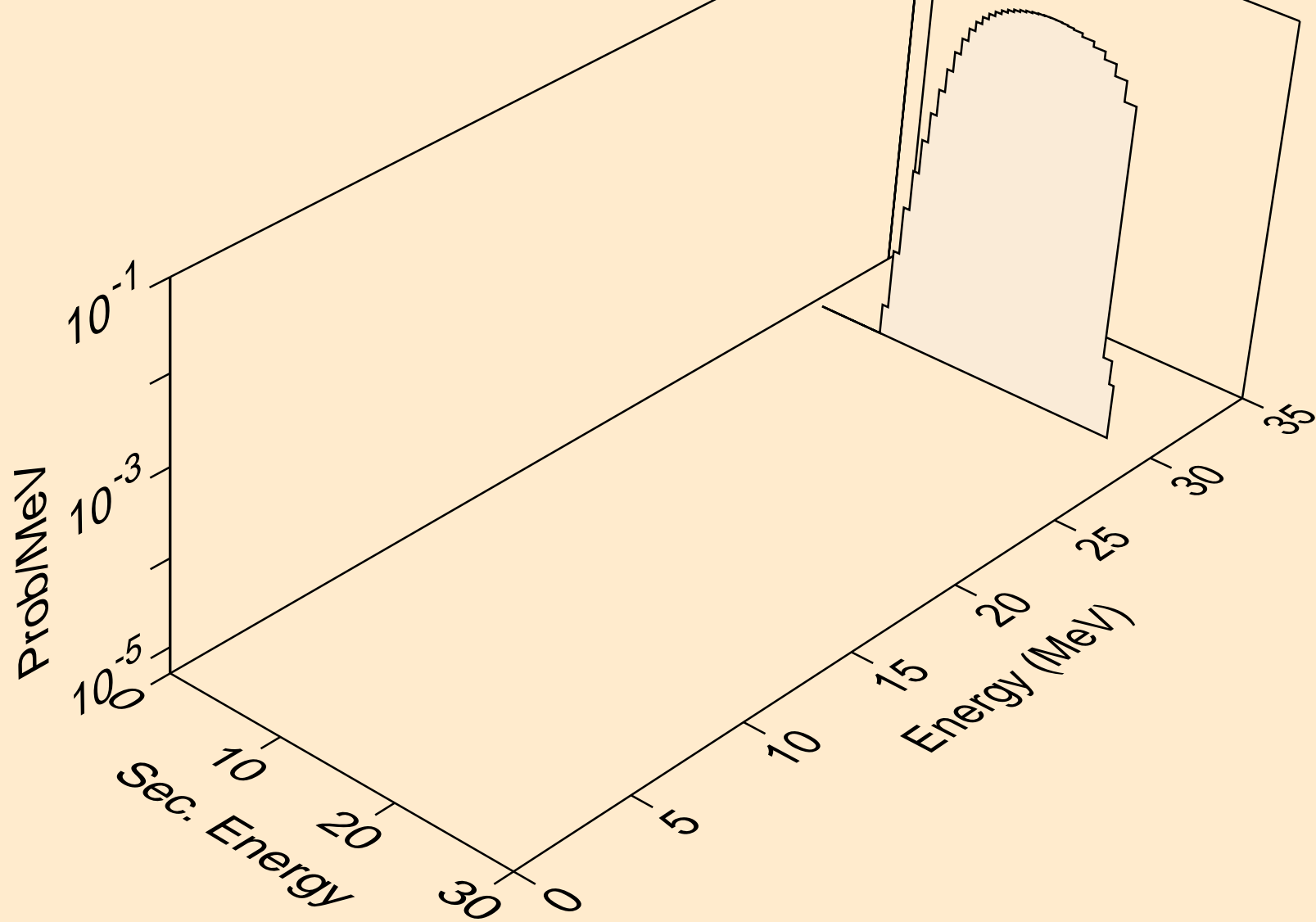

U231 NEUTRON ACER TENDL-2021 LIBRARY; T=293.6K
tritons from (n,n*)t

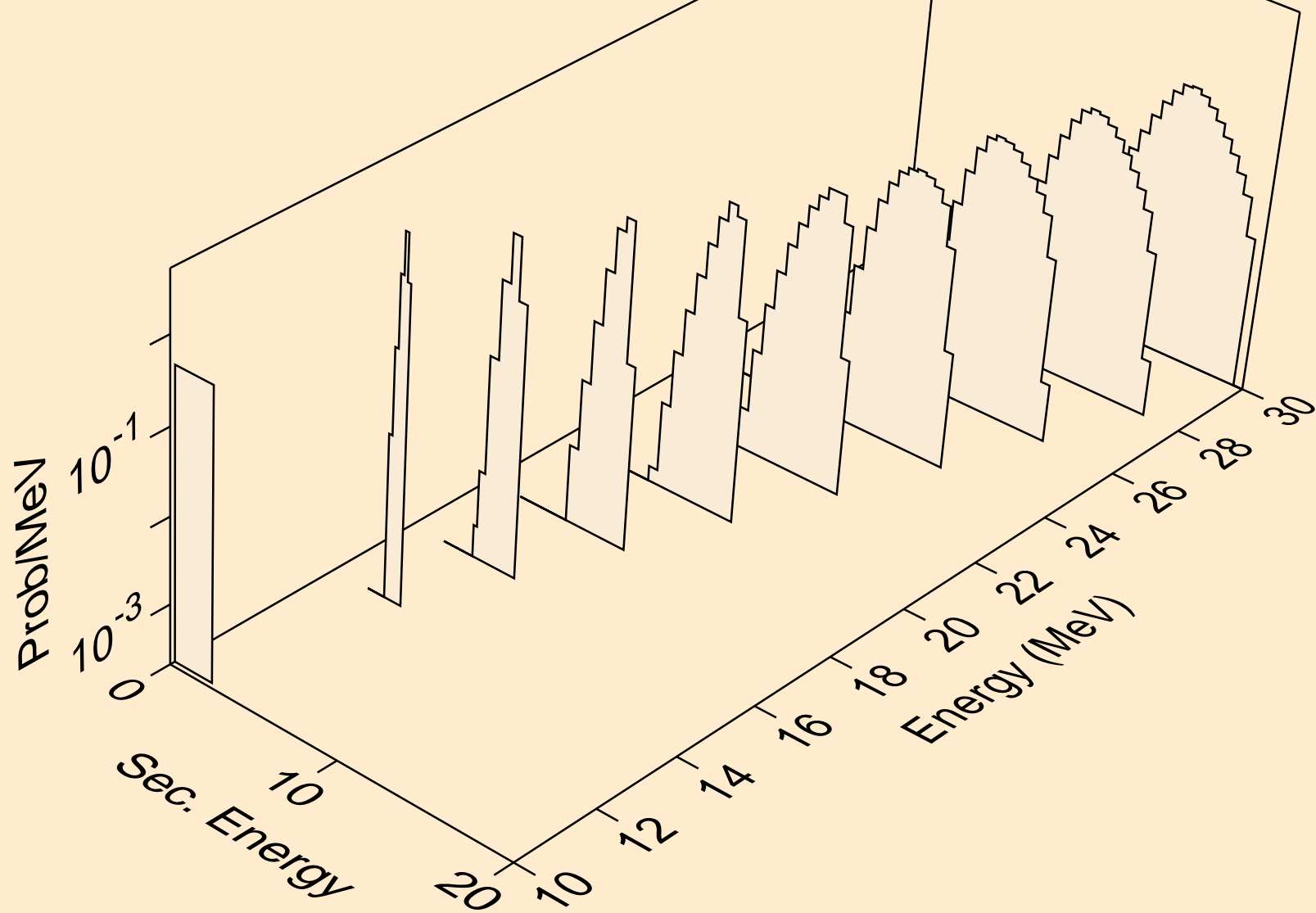

U231 NEUTRON ACER TENDL-2021 LIBRARY; T=293.6K
tritons from (n,t)

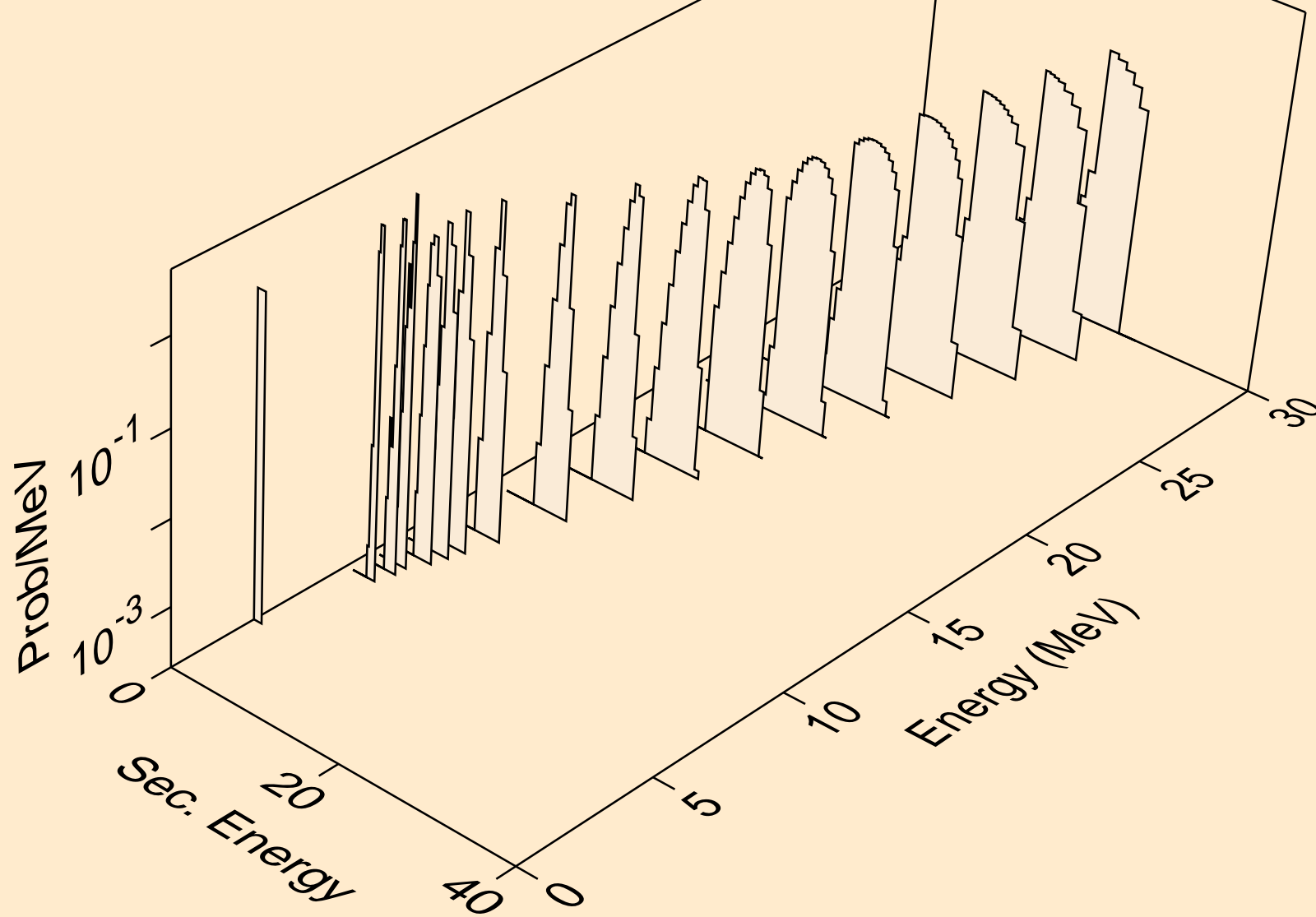

U231 NEUTRON ACER TENDL-2021 LIBRARY; T=293.6K
tritons from (n,pt)

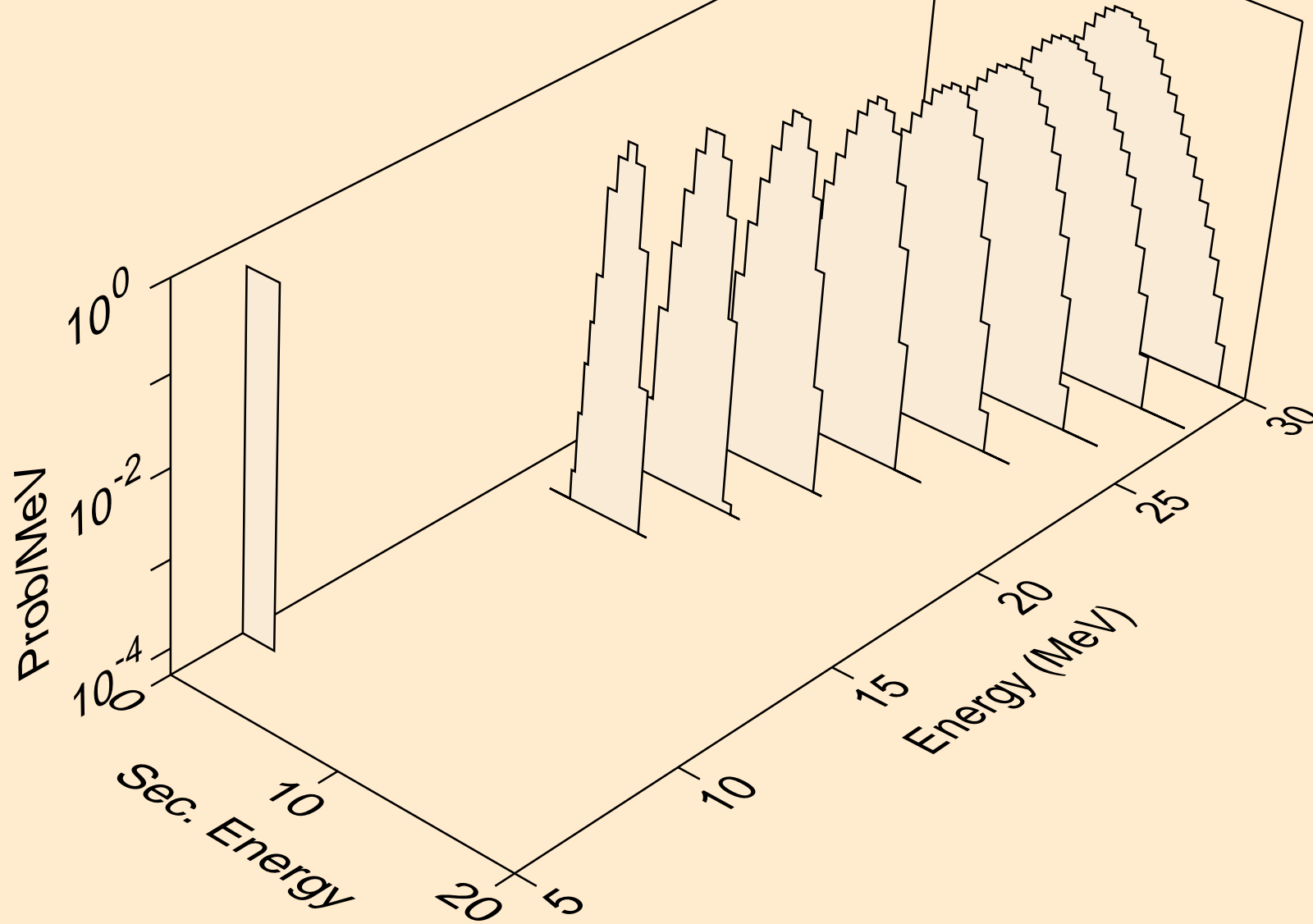

U231 NEUTRON ACER TENDL-2021 LIBRARY; T=293.6K
he3s from (n,x)

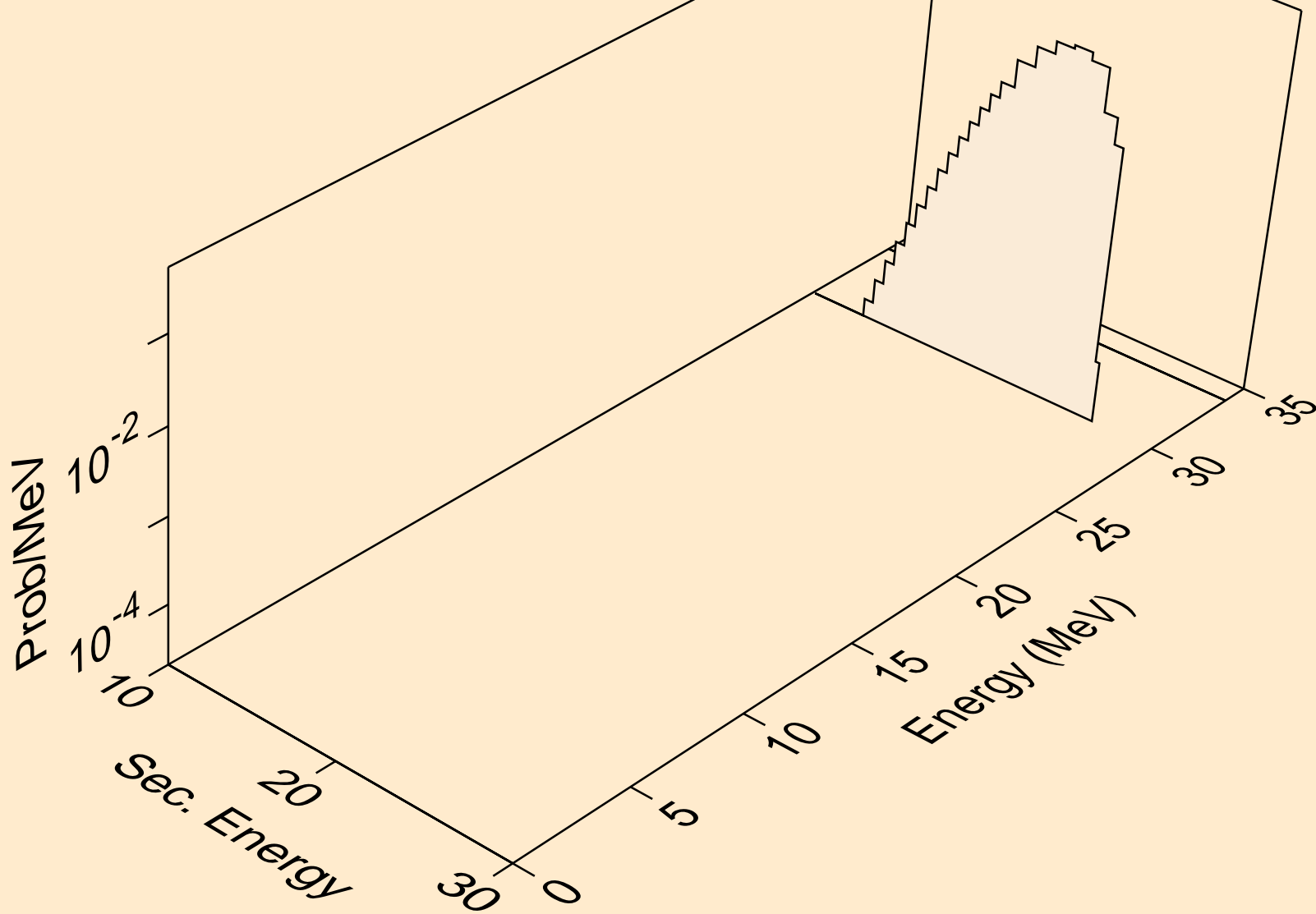

U231 NEUTRON ACER TENDL-2021 LIBRARY; T=293.6K
he3s from (n,n*)he3

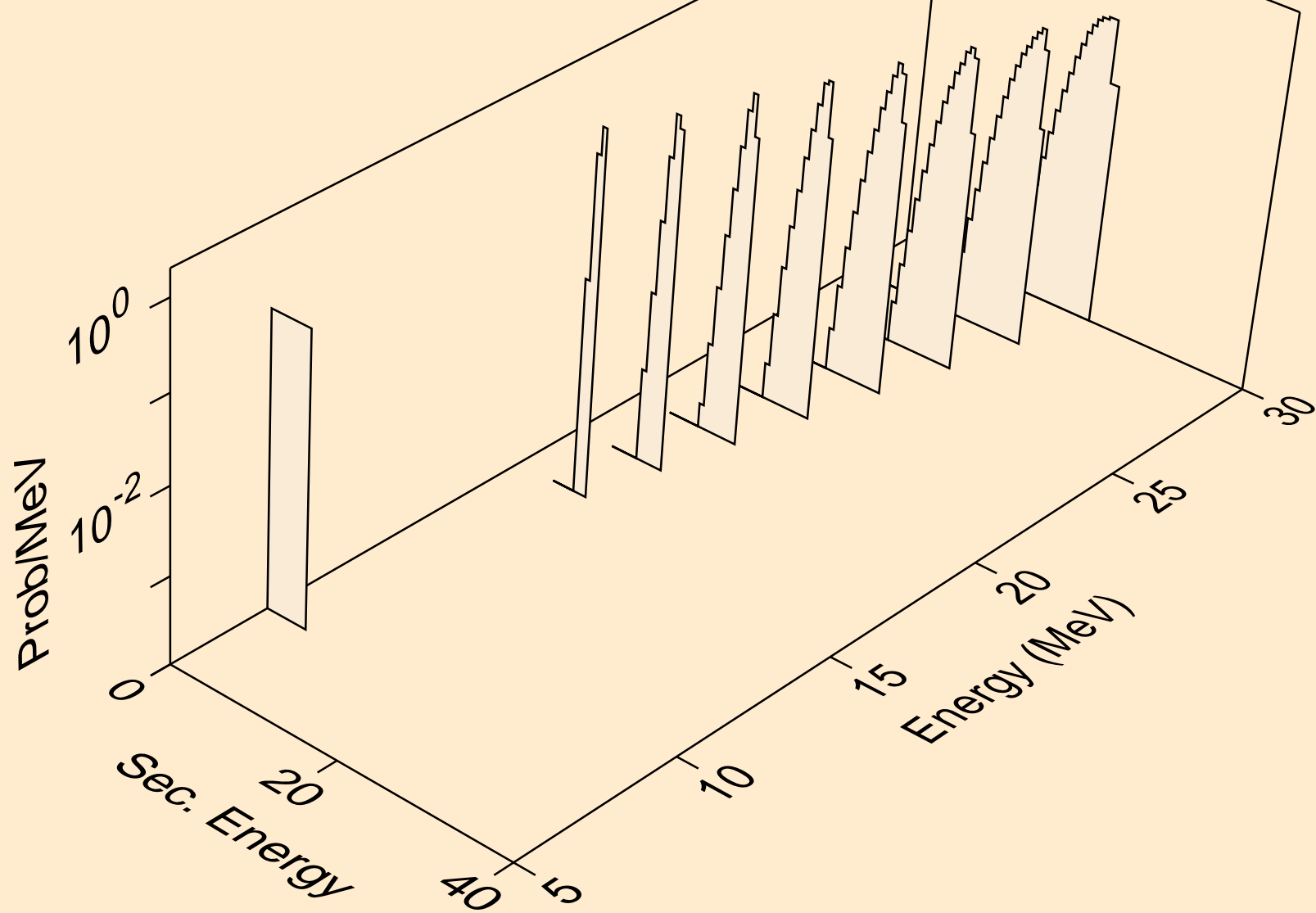

U231 NEUTRON ACER TENDL-2021 LIBRARY; T=293.6K
he3s from (n,he3)

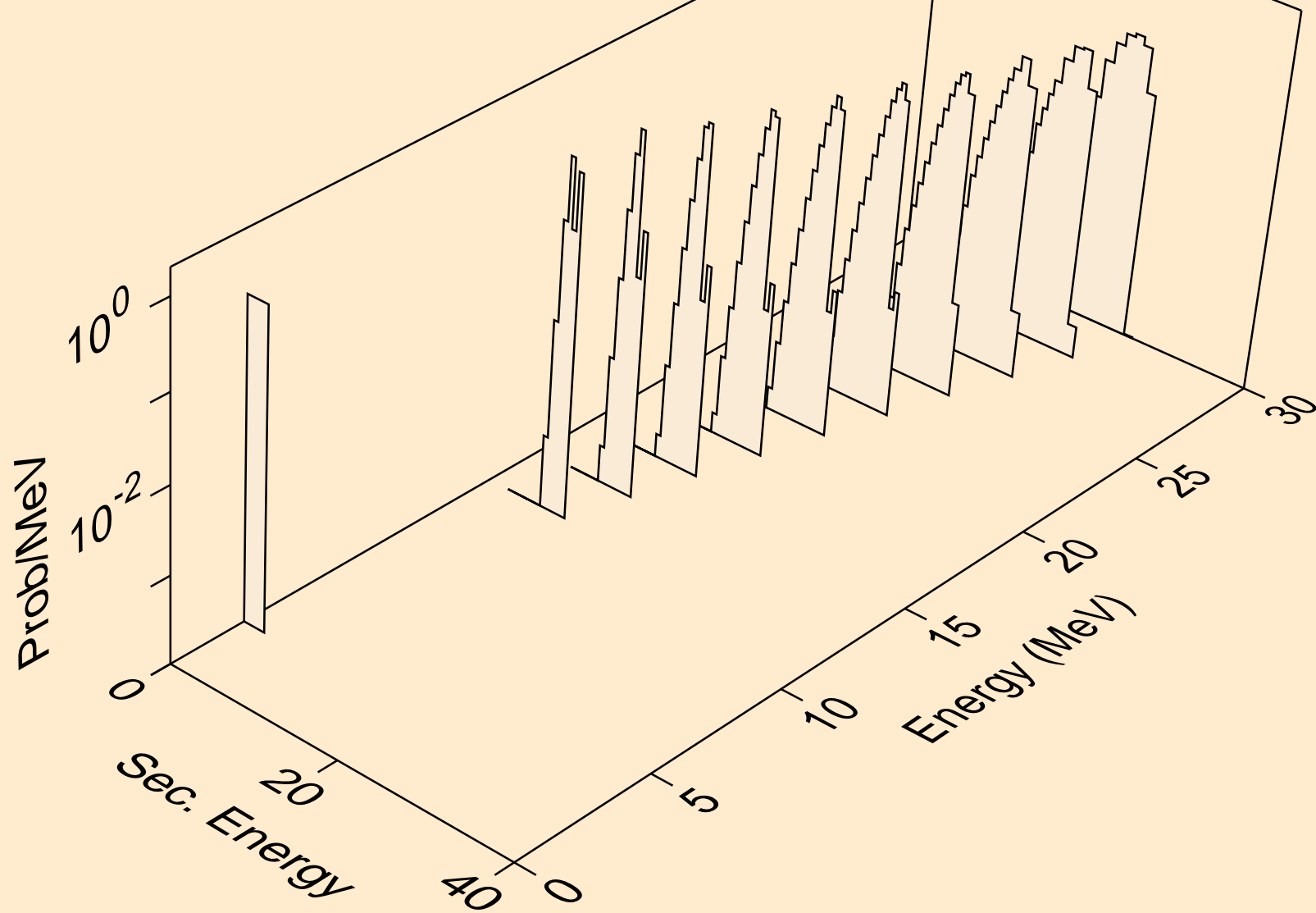

U231 NEUTRON ACER TENDL-2021 LIBRARY; T=293.6K
alphas from (n,x)

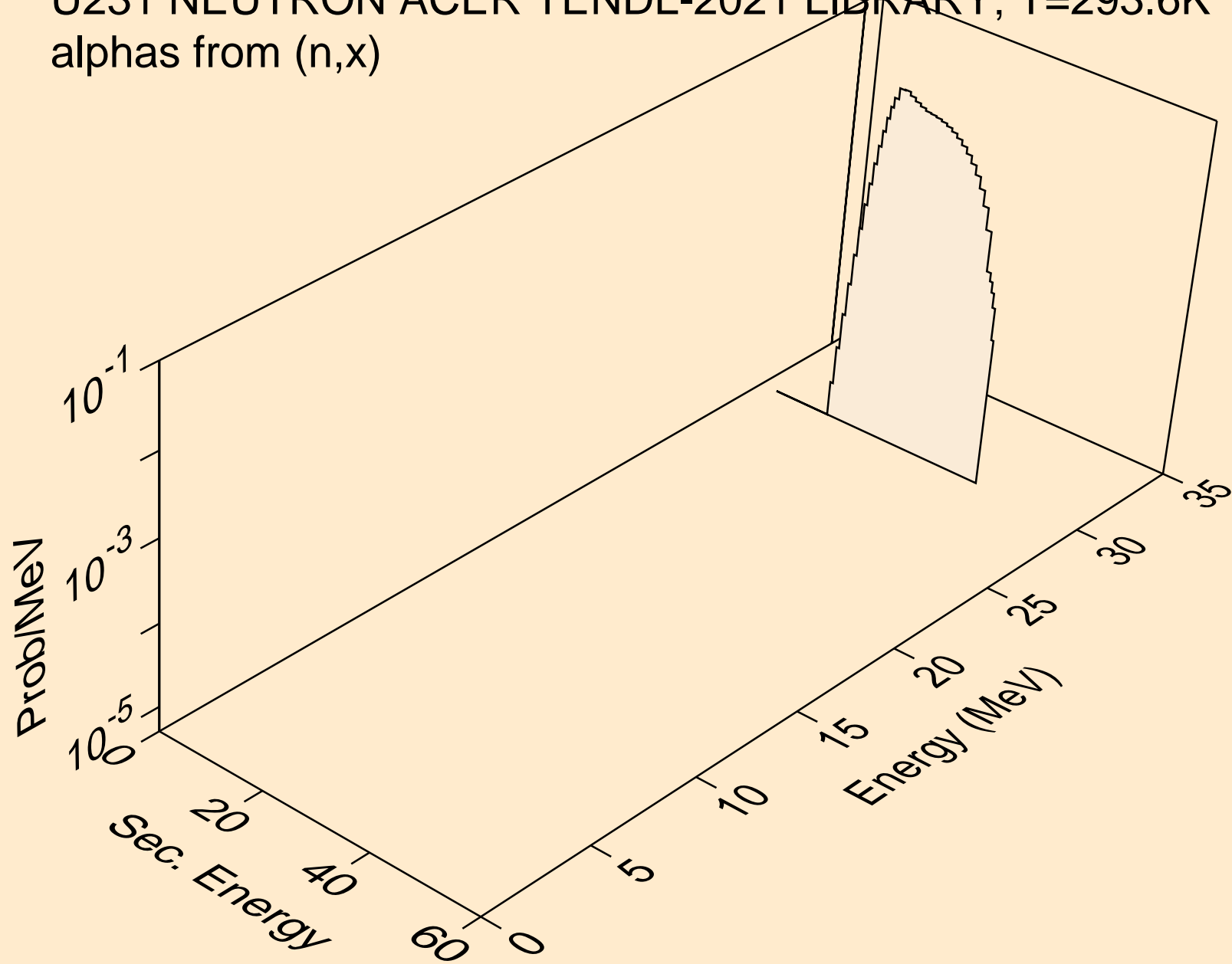

U231 NEUTRON ACER TENDL-2021 LIBRARY; T=293.6K
alphas from (n,n*)a

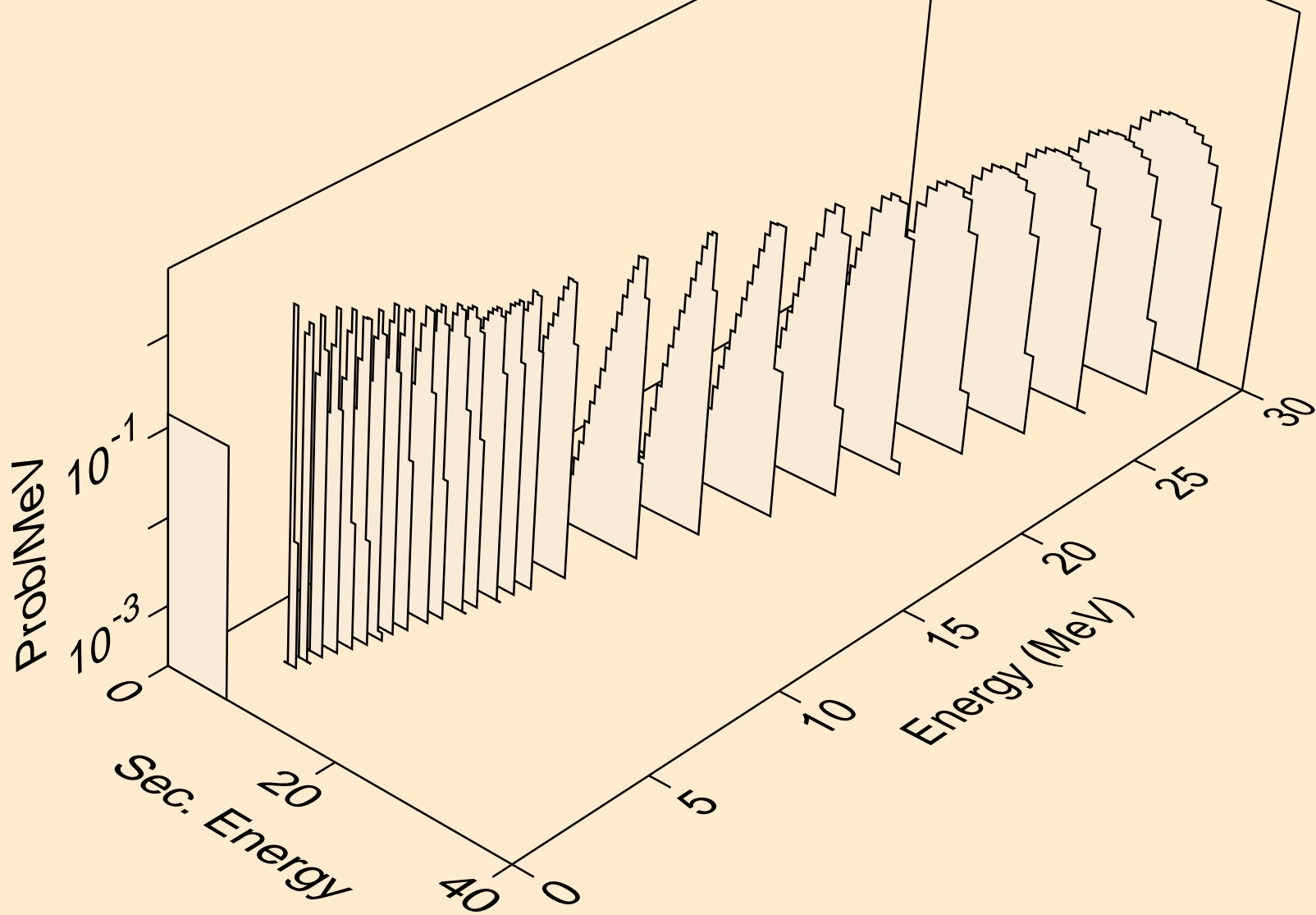

U231 NEUTRON ACER TENDL-2021 LIBRARY; T=293.6K
alphas from (n,2n)a

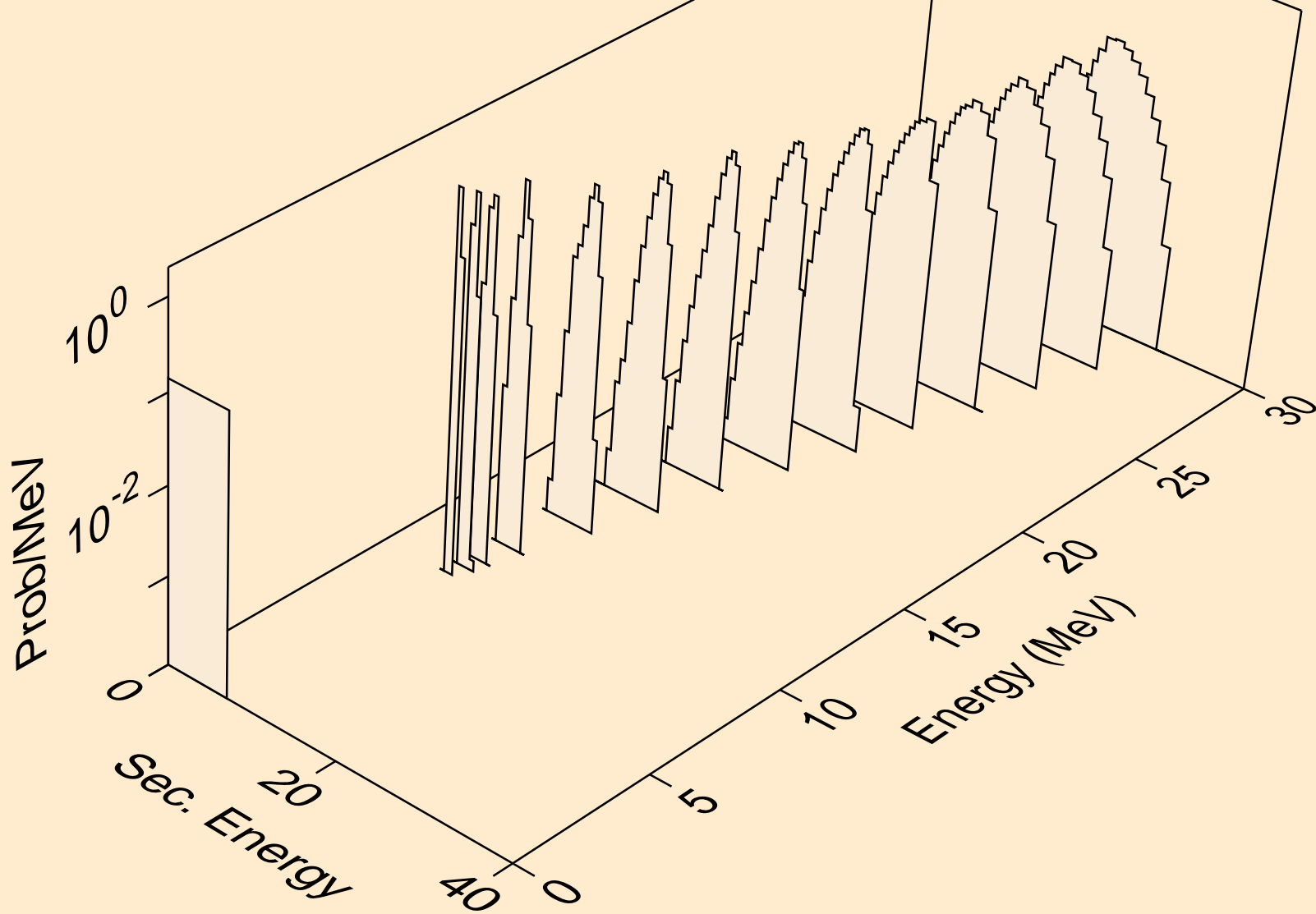

U231 NEUTRON ACER TENDL-2021 LIBRARY; T=293.6K
alphas from (n,3n)a

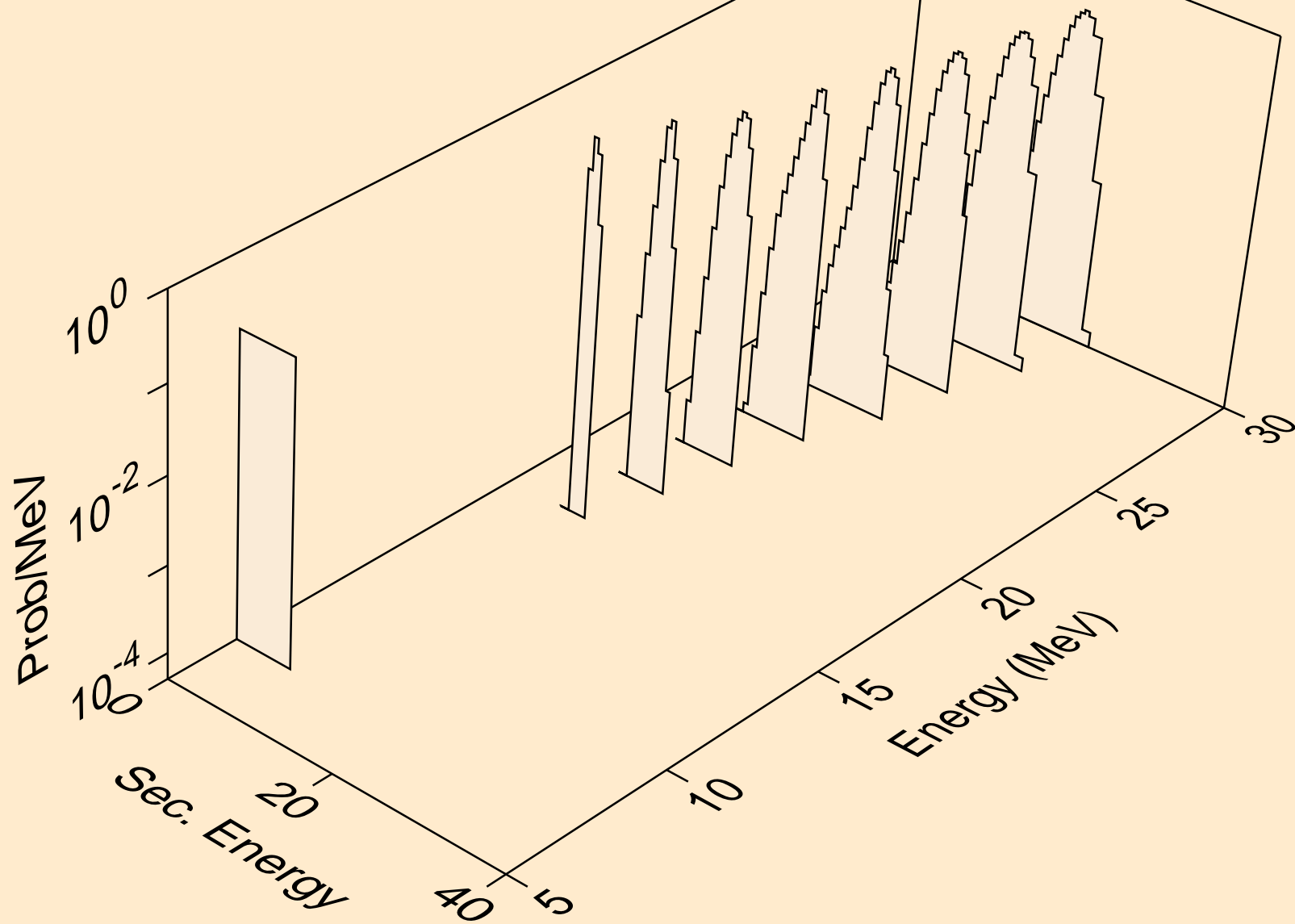

U231 NEUTRON ACER TENDL-2021 LIBRARY; T=293.6K
alphas from (n,n*)2a

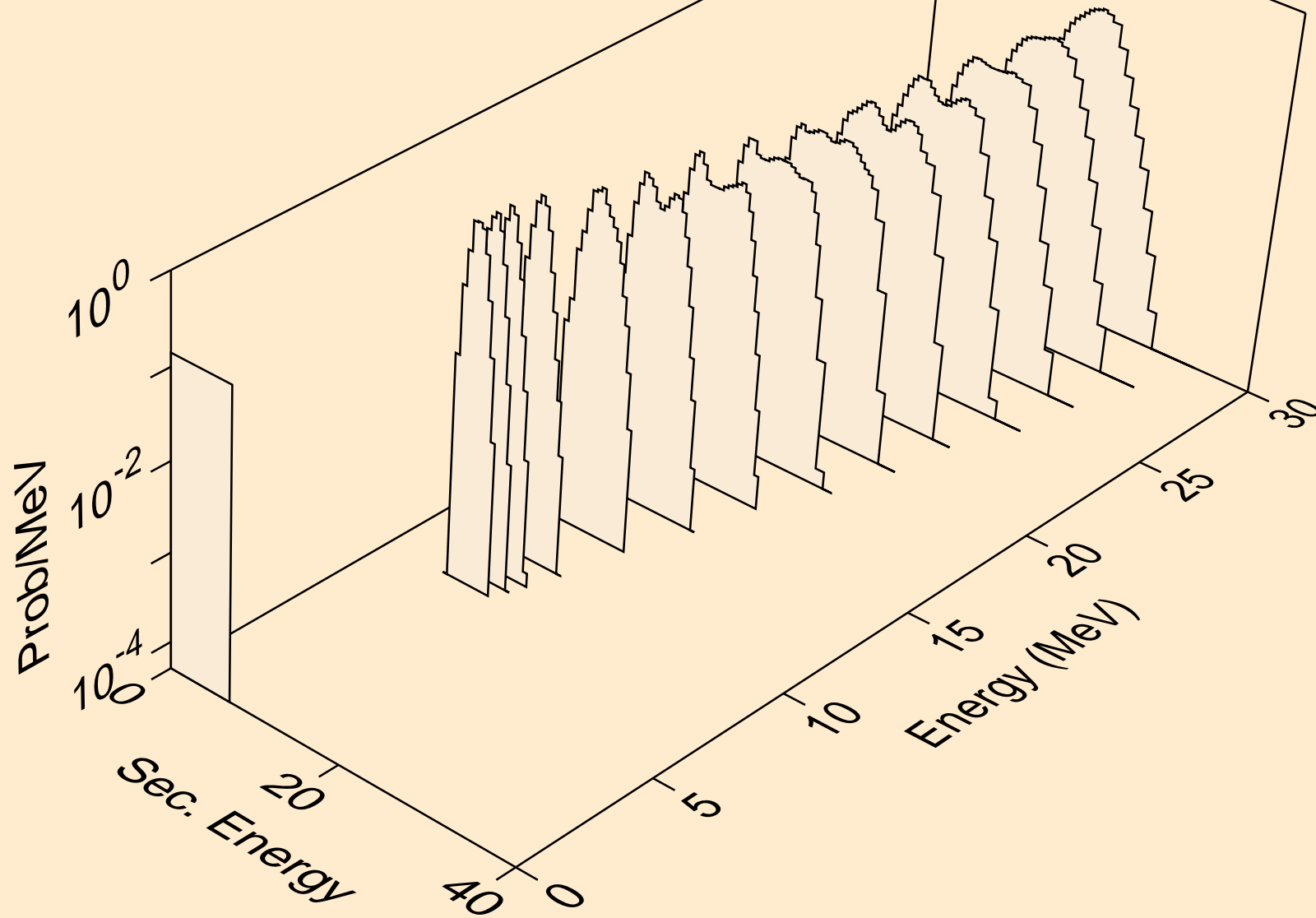

U231 NEUTRON ACER TENDL-2021 LIBRARY; T=293.6K
alphas from (n,2n)2a

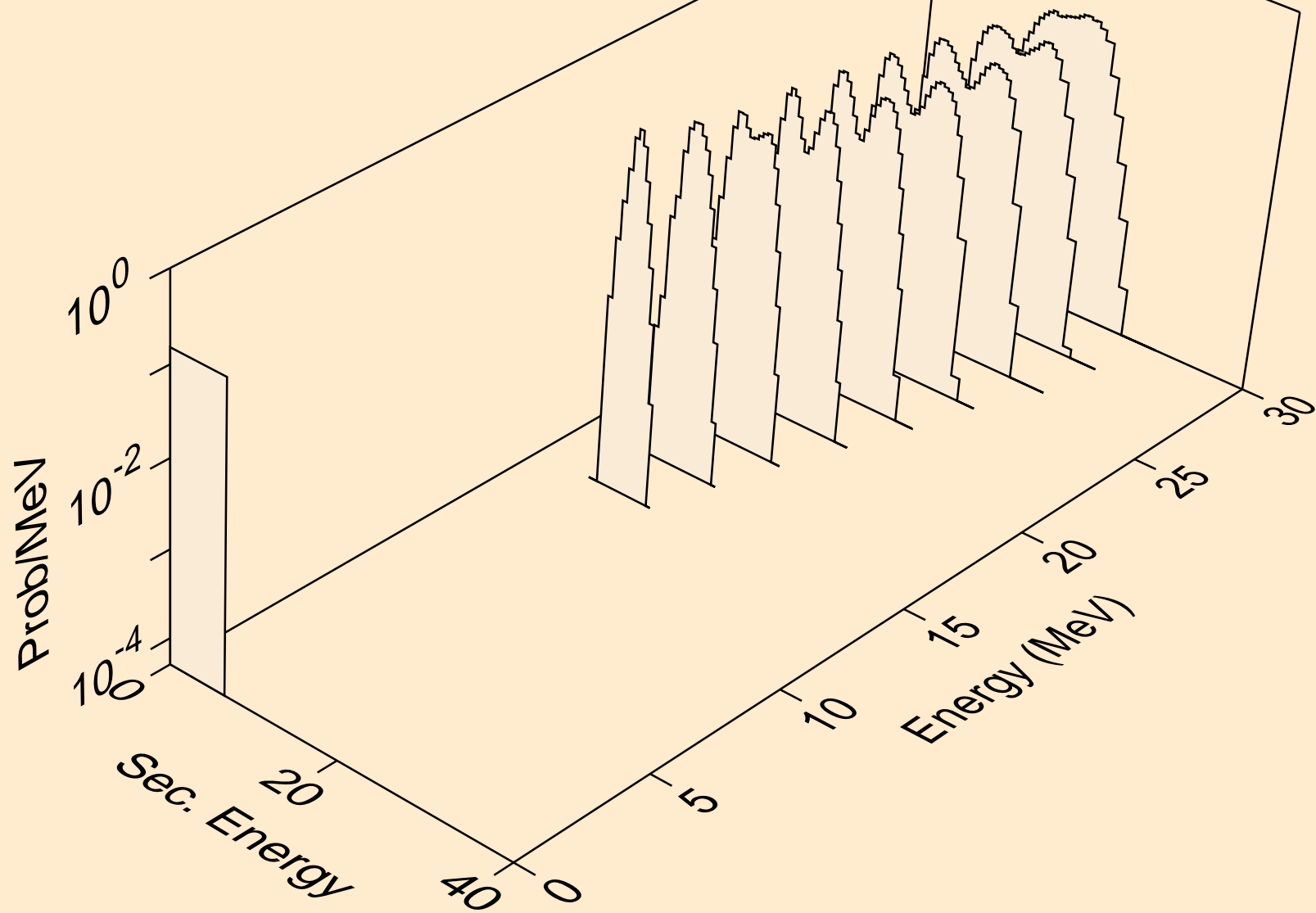

U231 NEUTRON ACER TENDL-2021 LIBRARY; T=293.6K
alphas from (n,npa)

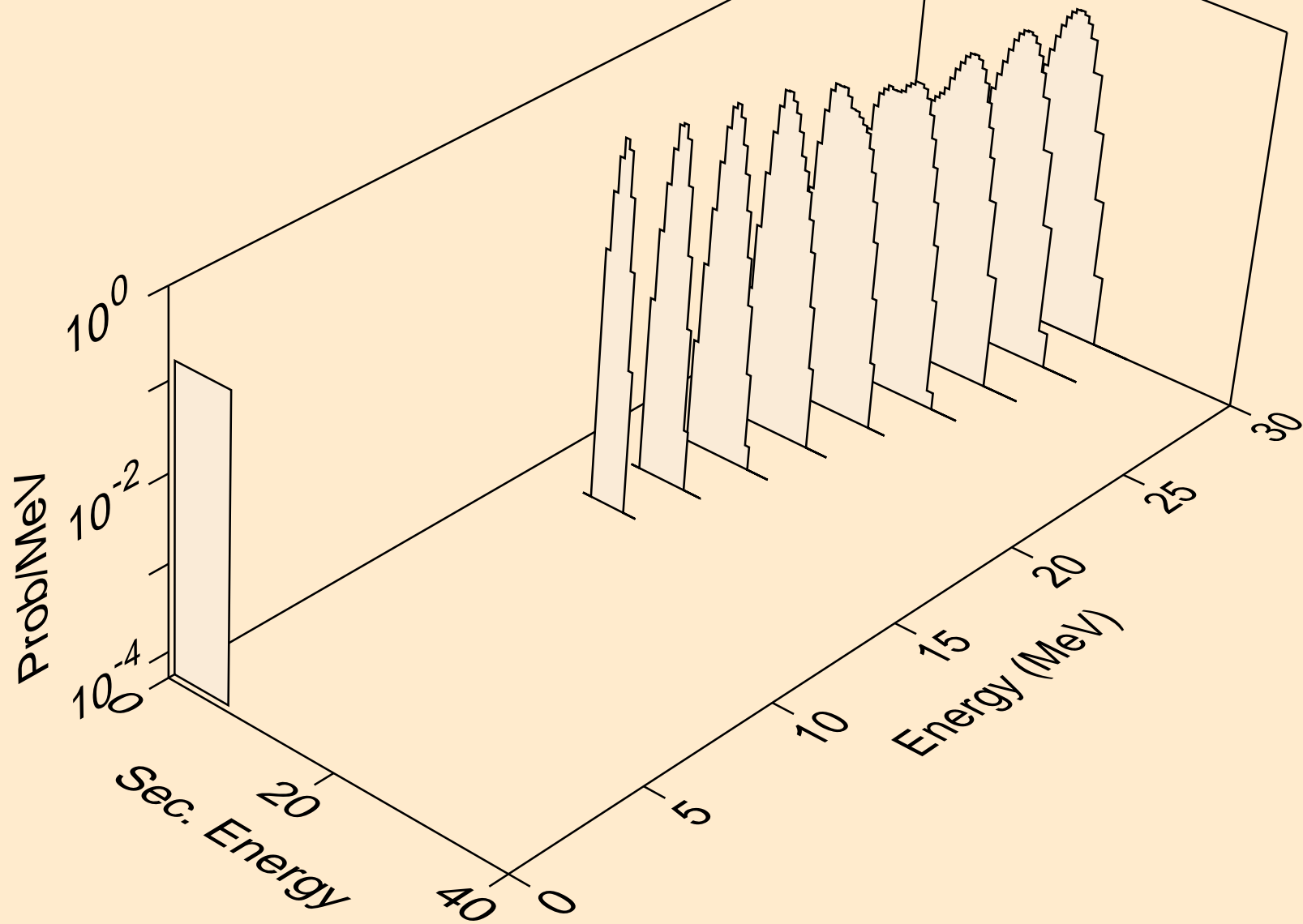

U231 NEUTRON ACER TENDL-2021 LIBRARY; T=293.6K
alphas from (n,a)

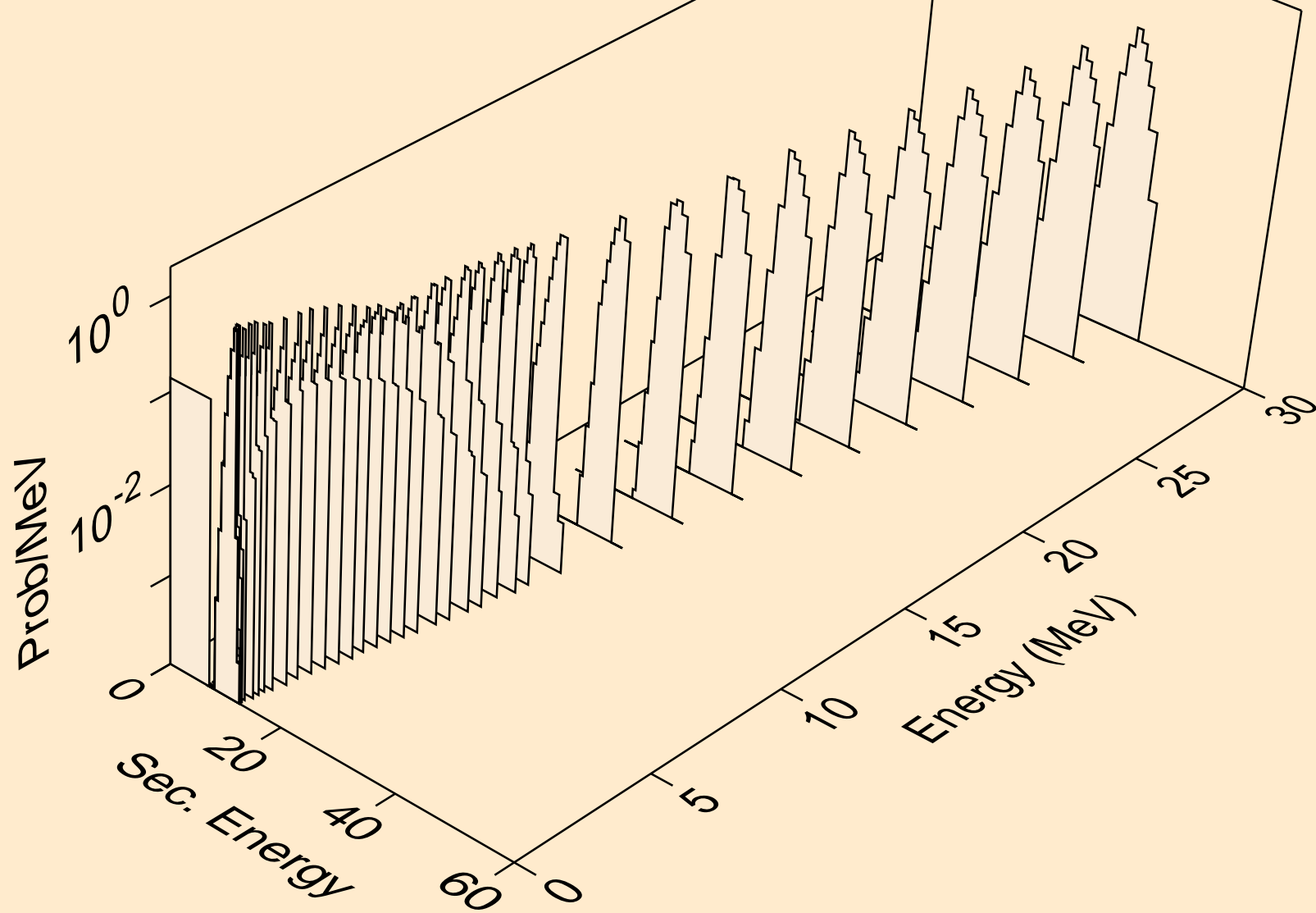

U231 NEUTRON ACER TENDL-2021 LIBRARY; T=293.6K
alphas from (n,2a)

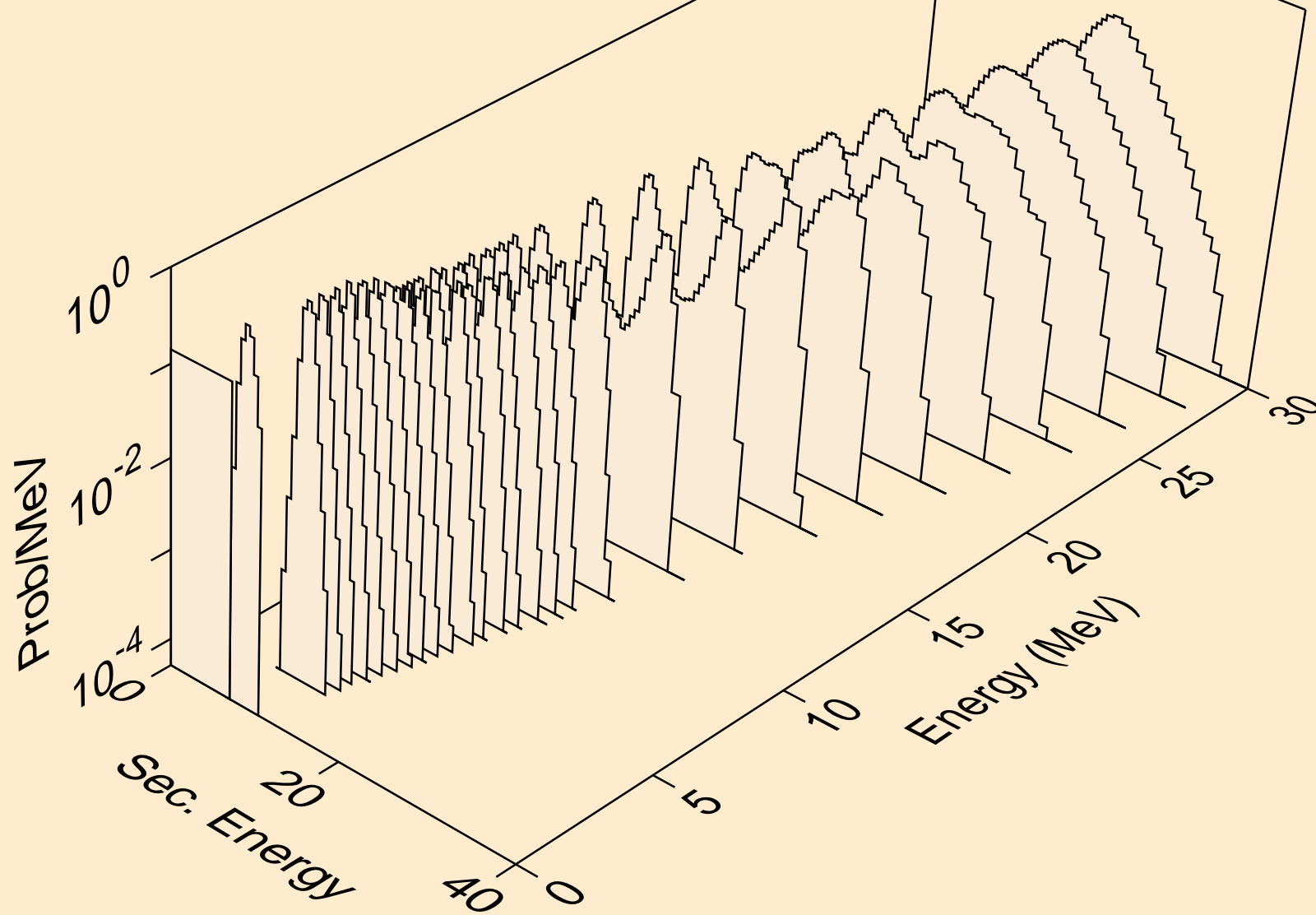

U231 NEUTRON ACER TENDL-2021 LIBRARY; T=293.6K
alphas from (n,pa)

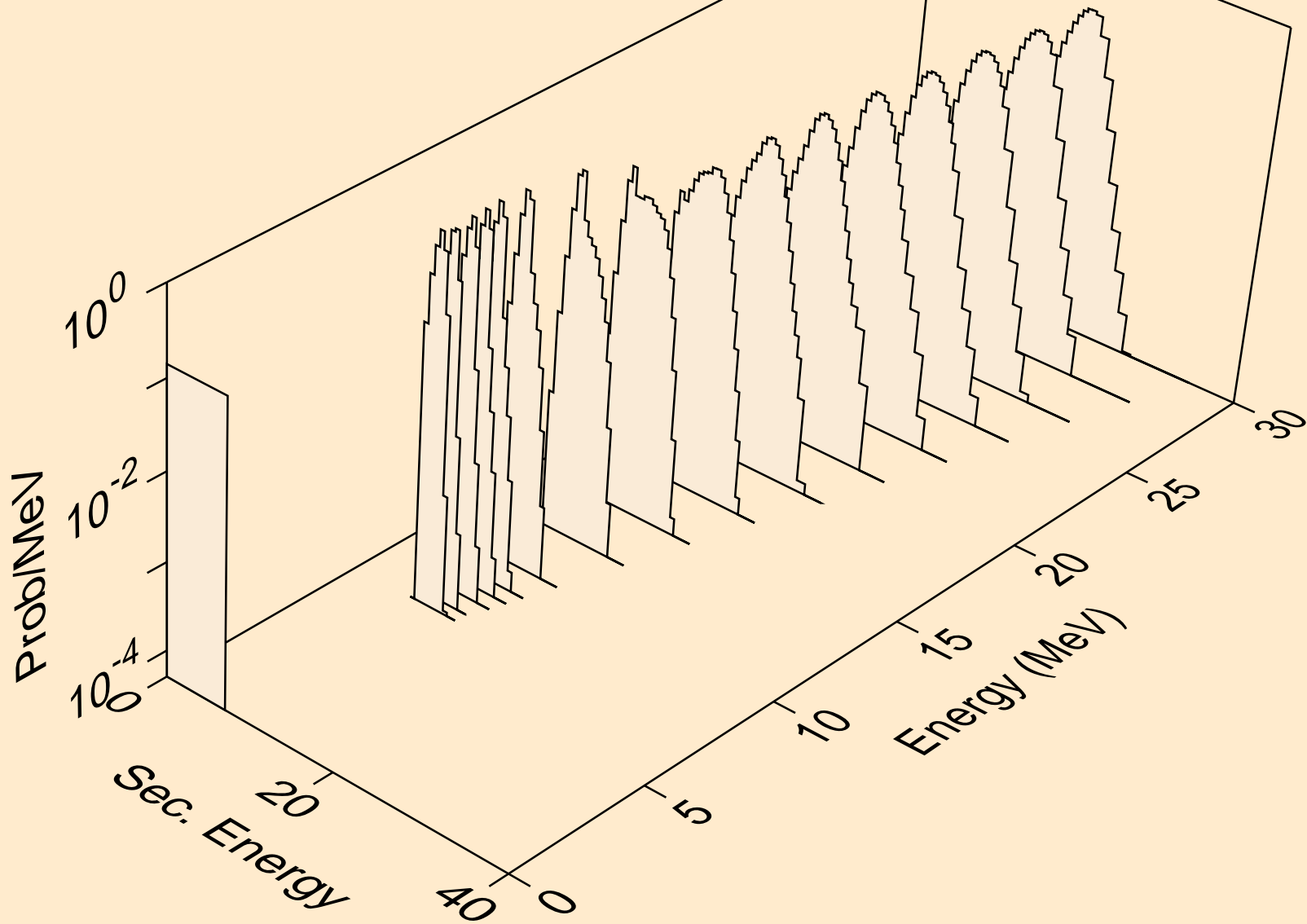

U231 NEUTRON ACER TENDL-2021 LIBRARY; T=293.6K
alphas from (n,da)

