

U241 NEUTRON ACER TENDL-2021 LIBRARY; T=293.6K

Principal cross sections

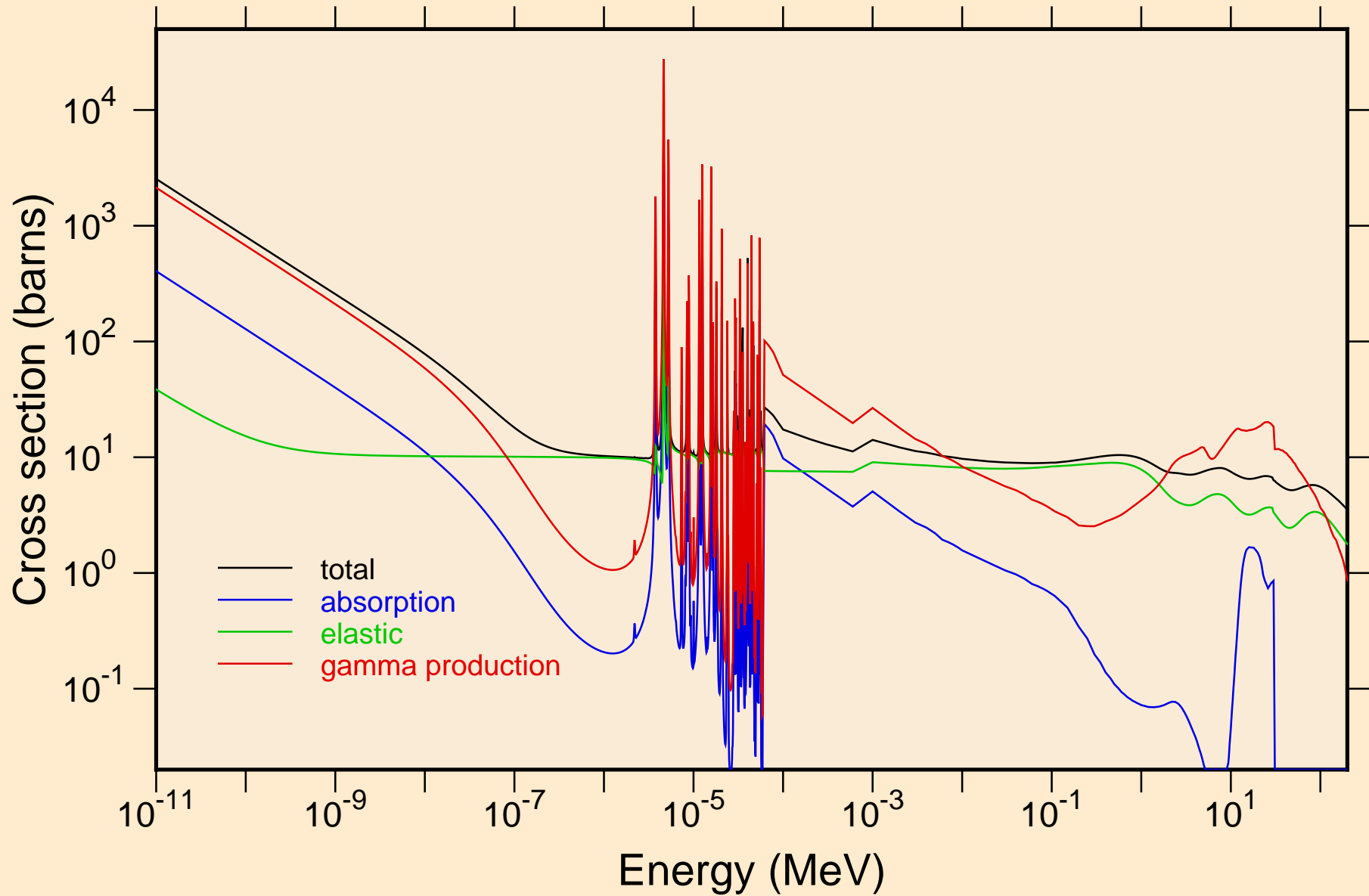

U241 NEUTRON ACER TENDL-2021 LIBRARY; T=293.6K
resonance total cross section

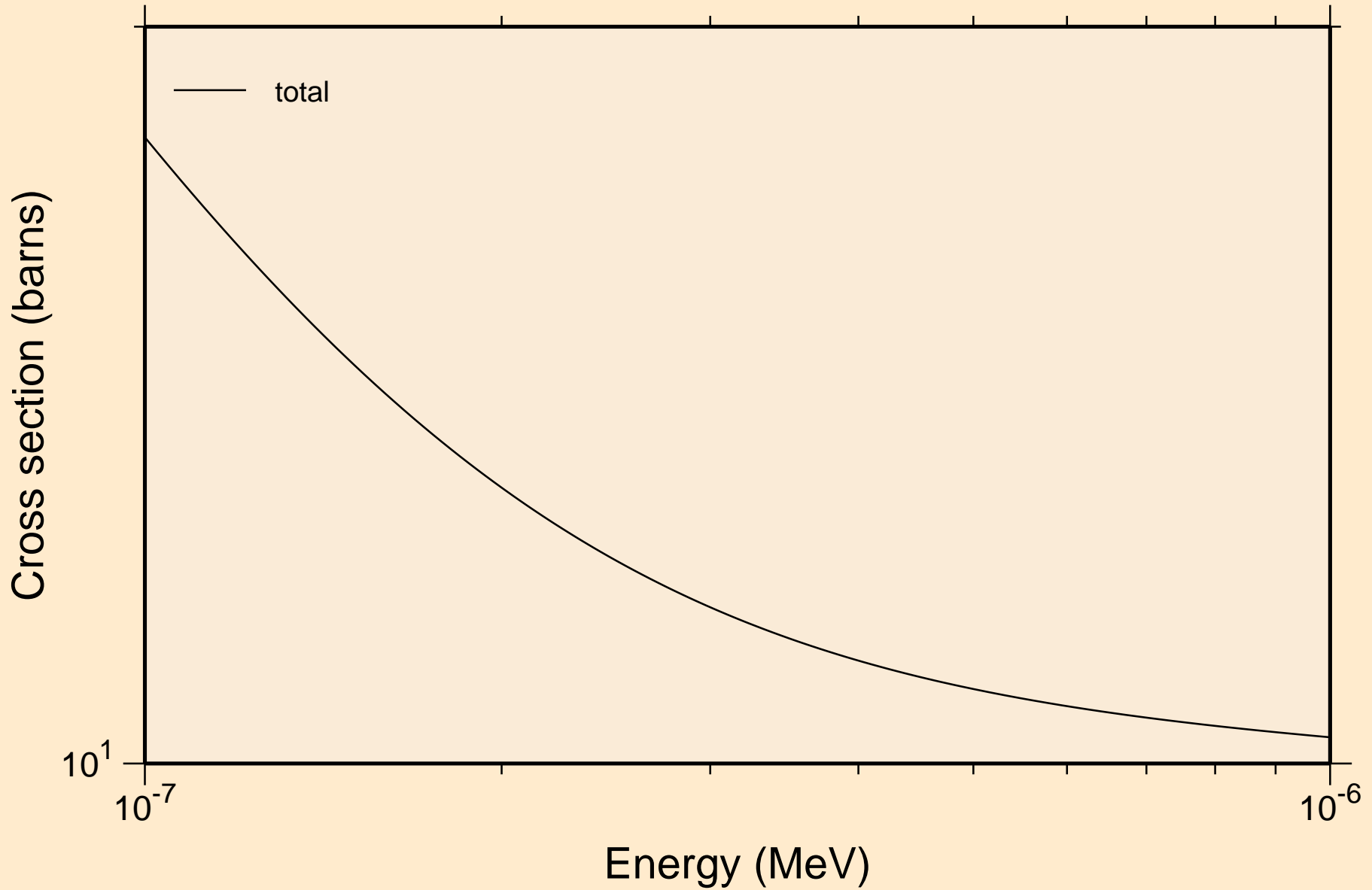

U241 NEUTRON ACER TENDL-2021 LIBRARY; T=293.6K
resonance total cross section

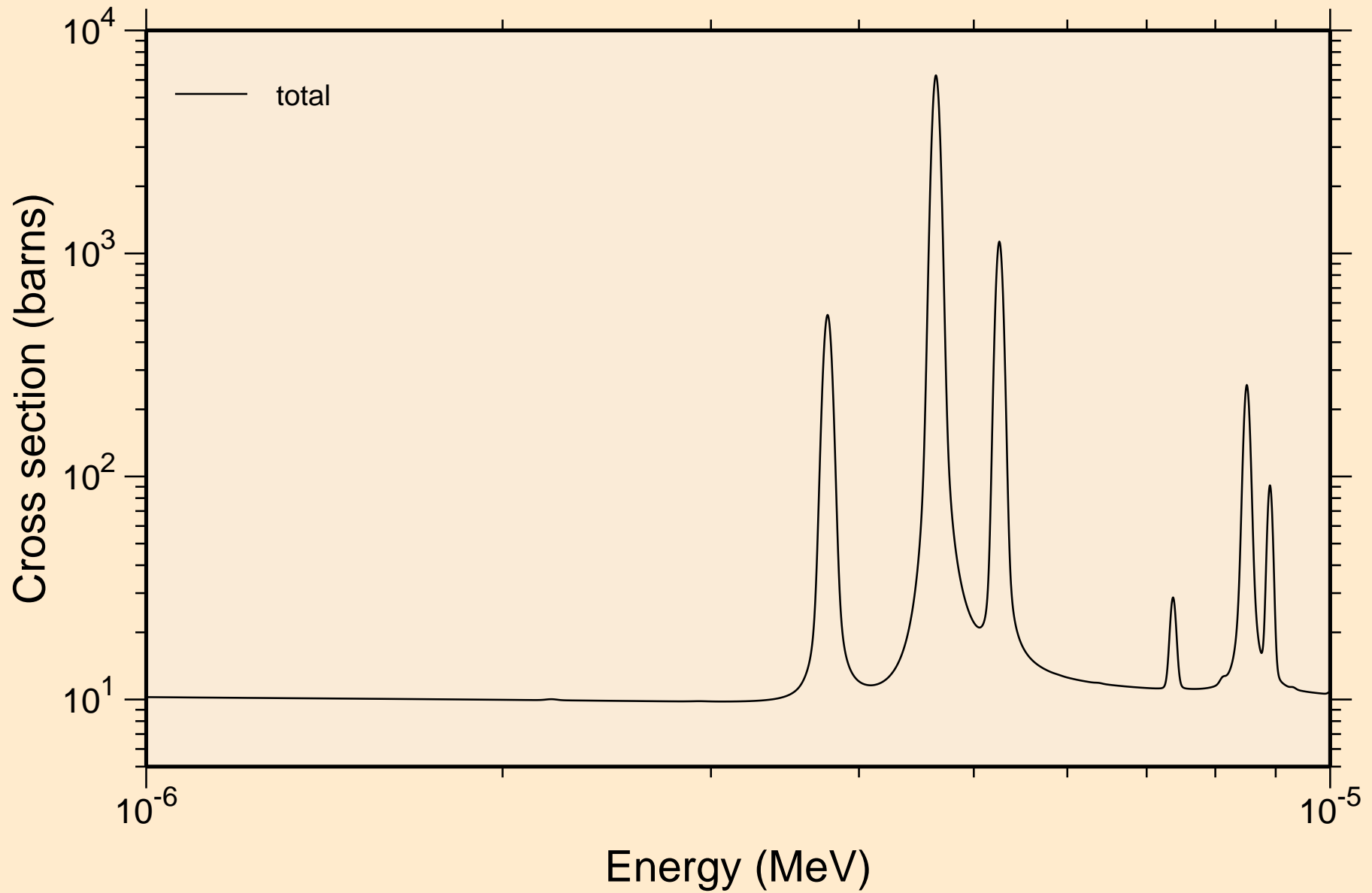

U241 NEUTRON ACER TENDL-2021 LIBRARY; T=293.6K
resonance total cross section

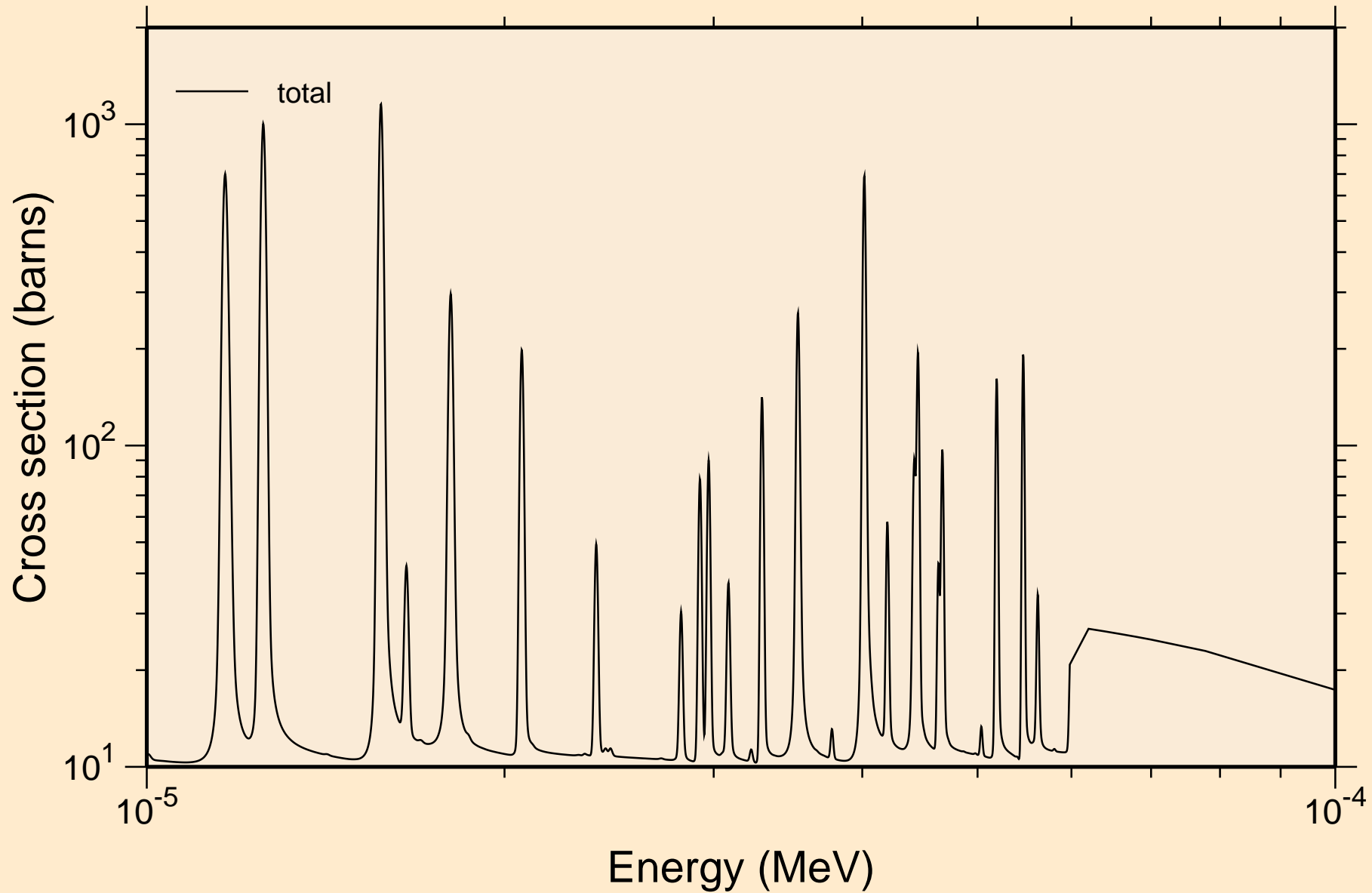

U241 NEUTRON ACER TENDL-2021 LIBRARY; T=293.6K
resonance total cross section

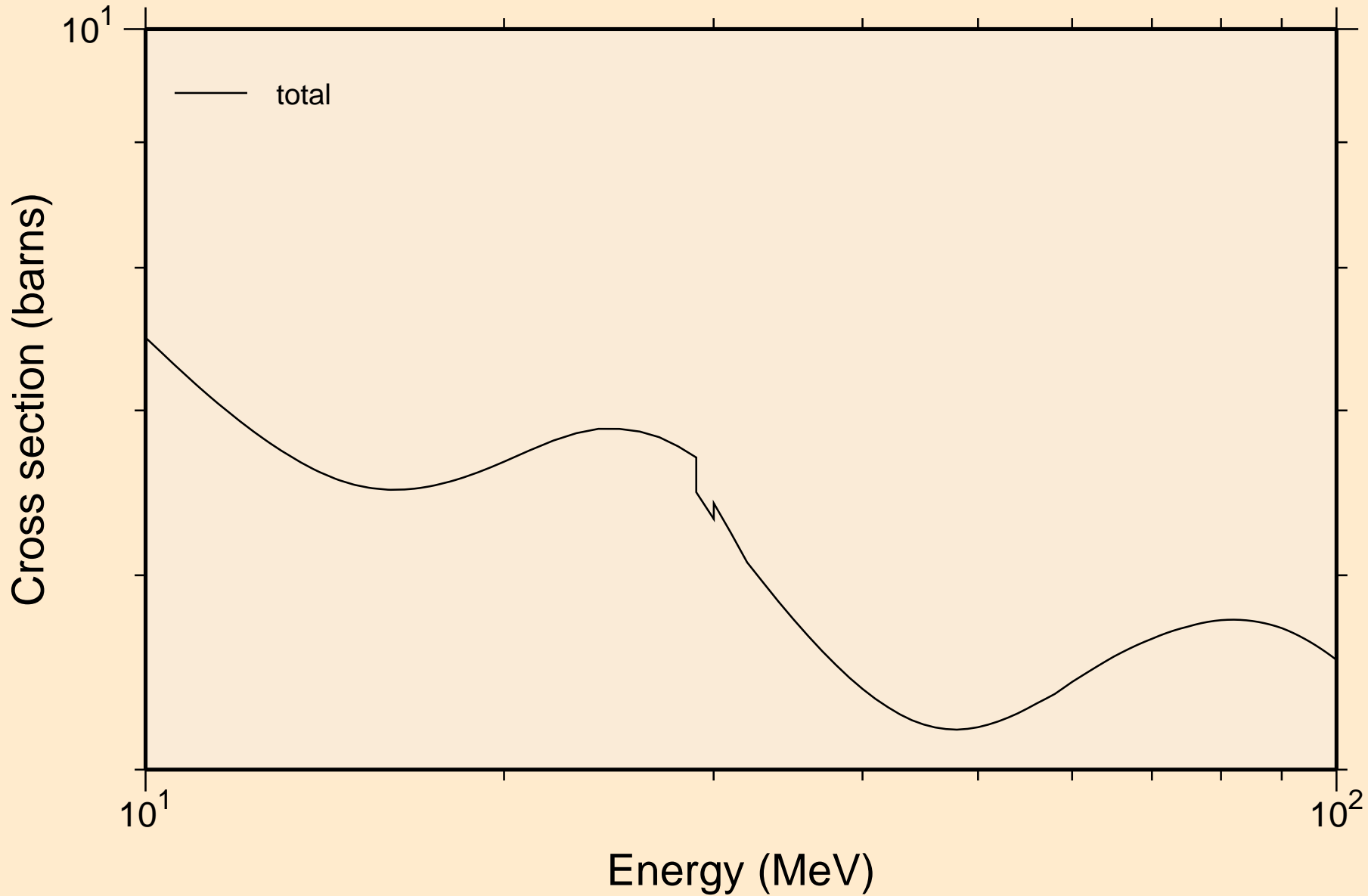

U241 NEUTRON ACER TENDL-2021 LIBRARY; T=293.6K
resonance absorption cross sections

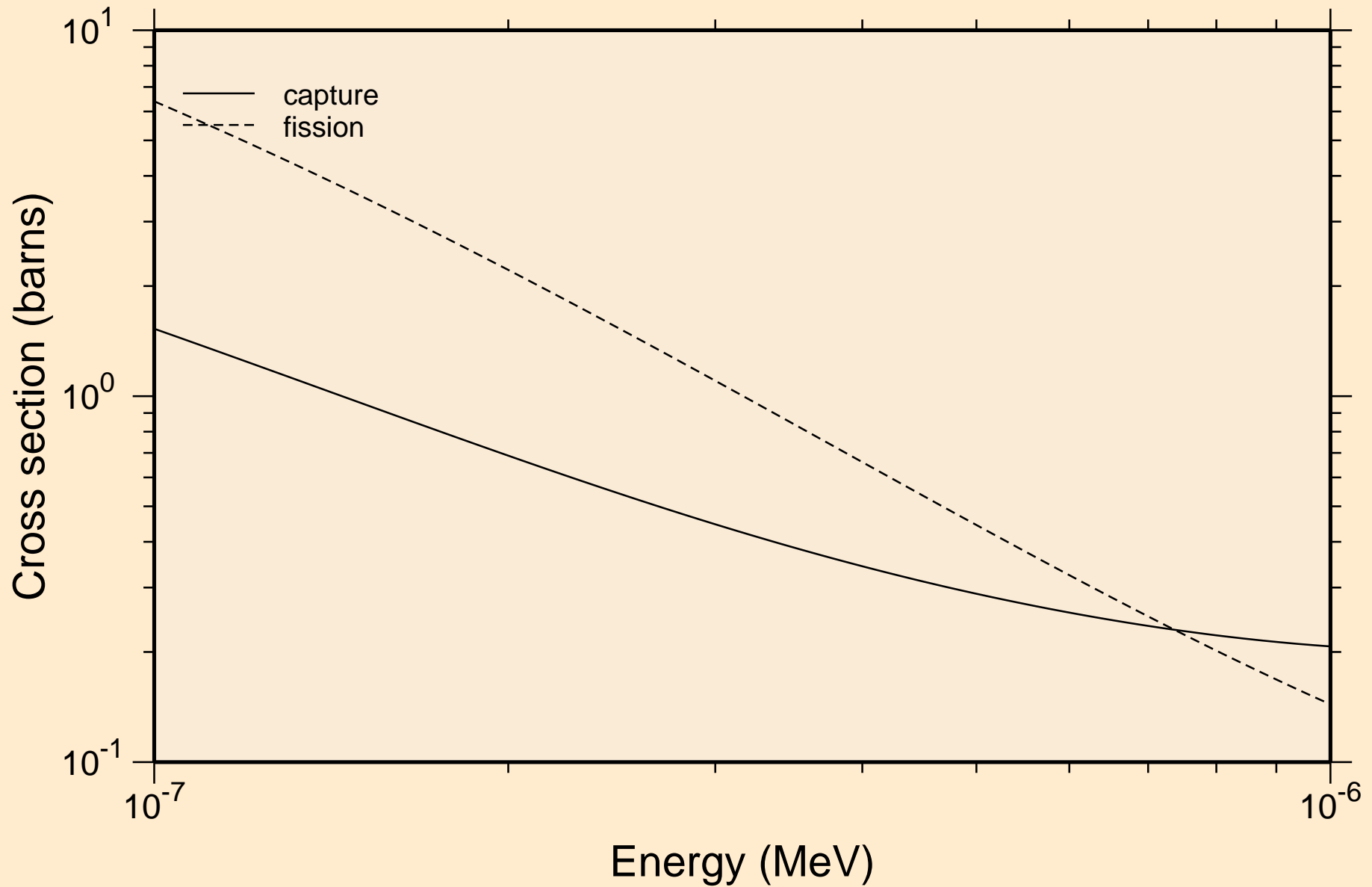

U241 NEUTRON ACER TENDL-2021 LIBRARY; T=293.6K
resonance absorption cross sections

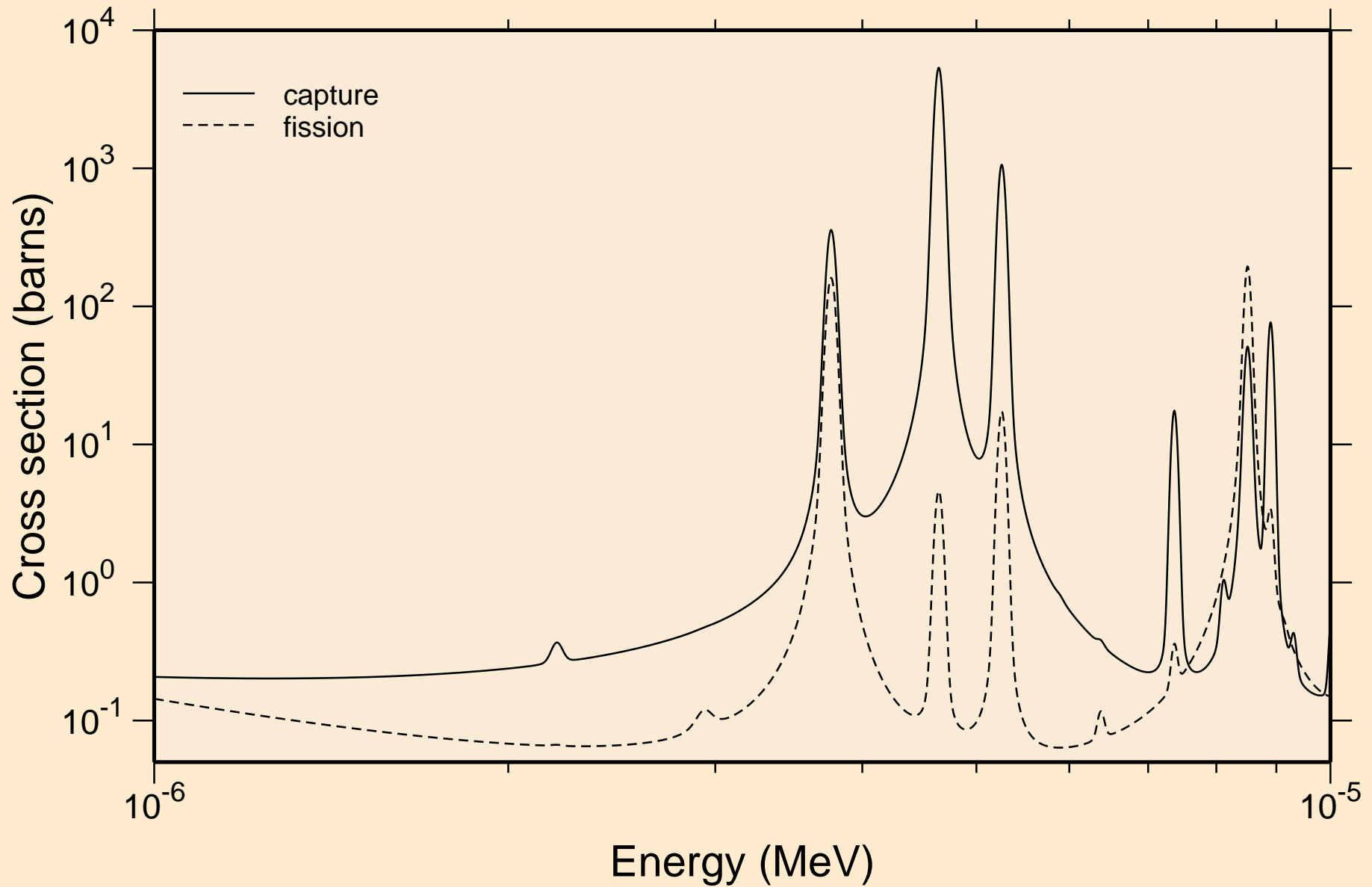

U241 NEUTRON ACER TENDL-2021 LIBRARY; T=293.6K
resonance absorption cross sections

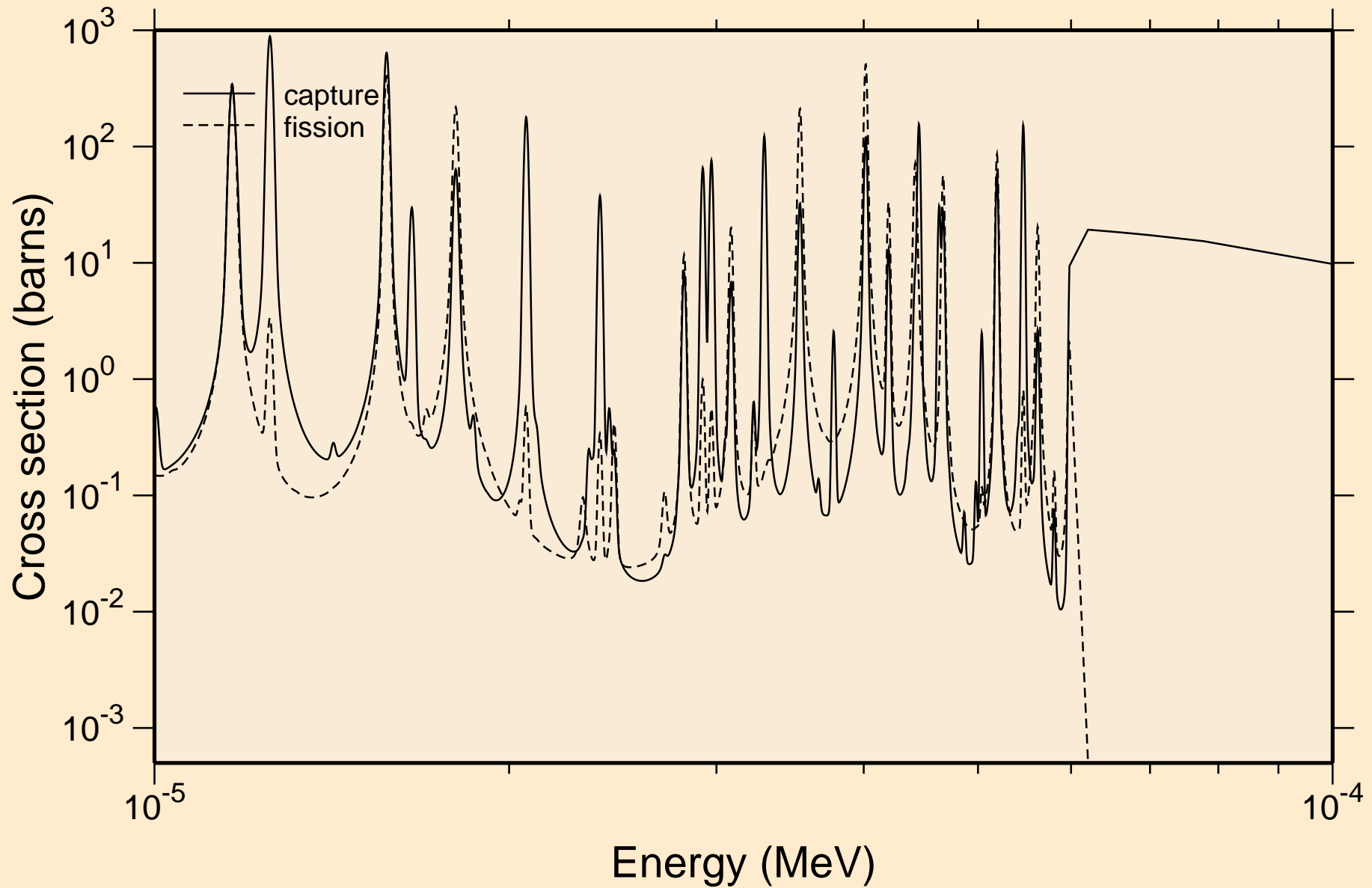

U241 NEUTRON ACER TENDL-2021 LIBRARY; T=293.6K
resonance absorption cross sections

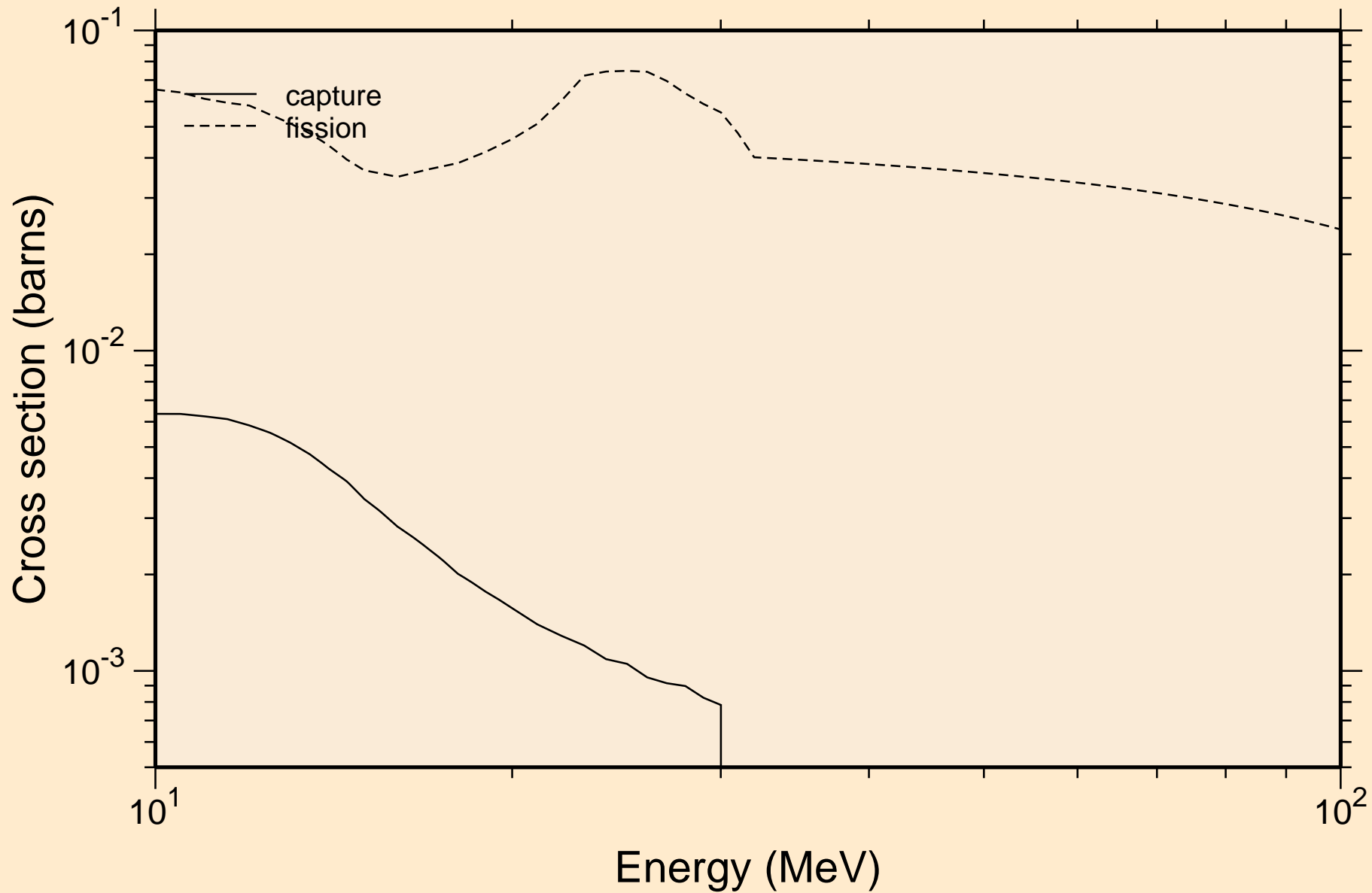

U241 NEUTRON ACER TENDL-2021 LIBRARY; T=293.6K
Heating

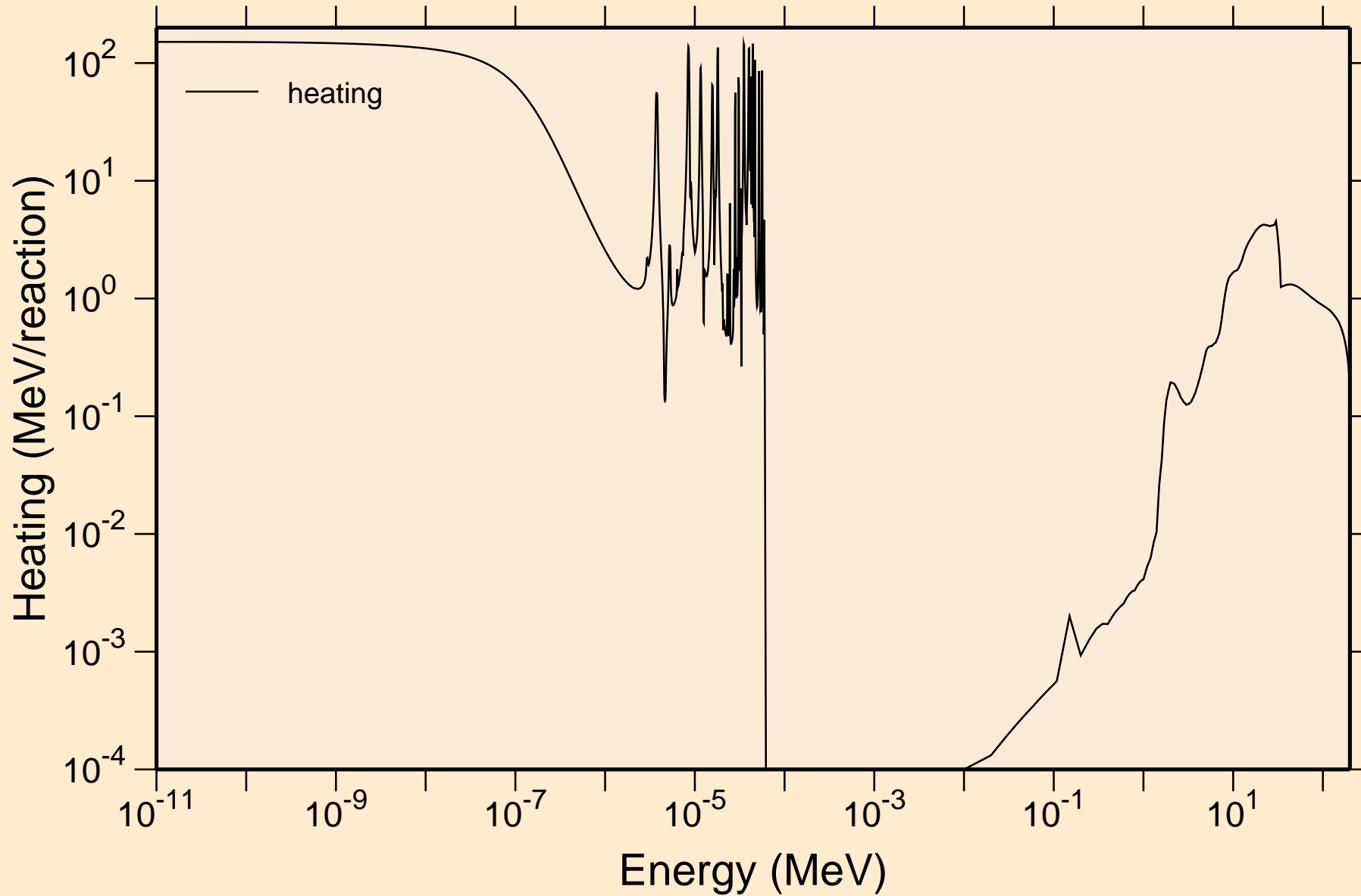

U241 NEUTRON ACER TENDL-2021 LIBRARY; T=293.6K
Damage

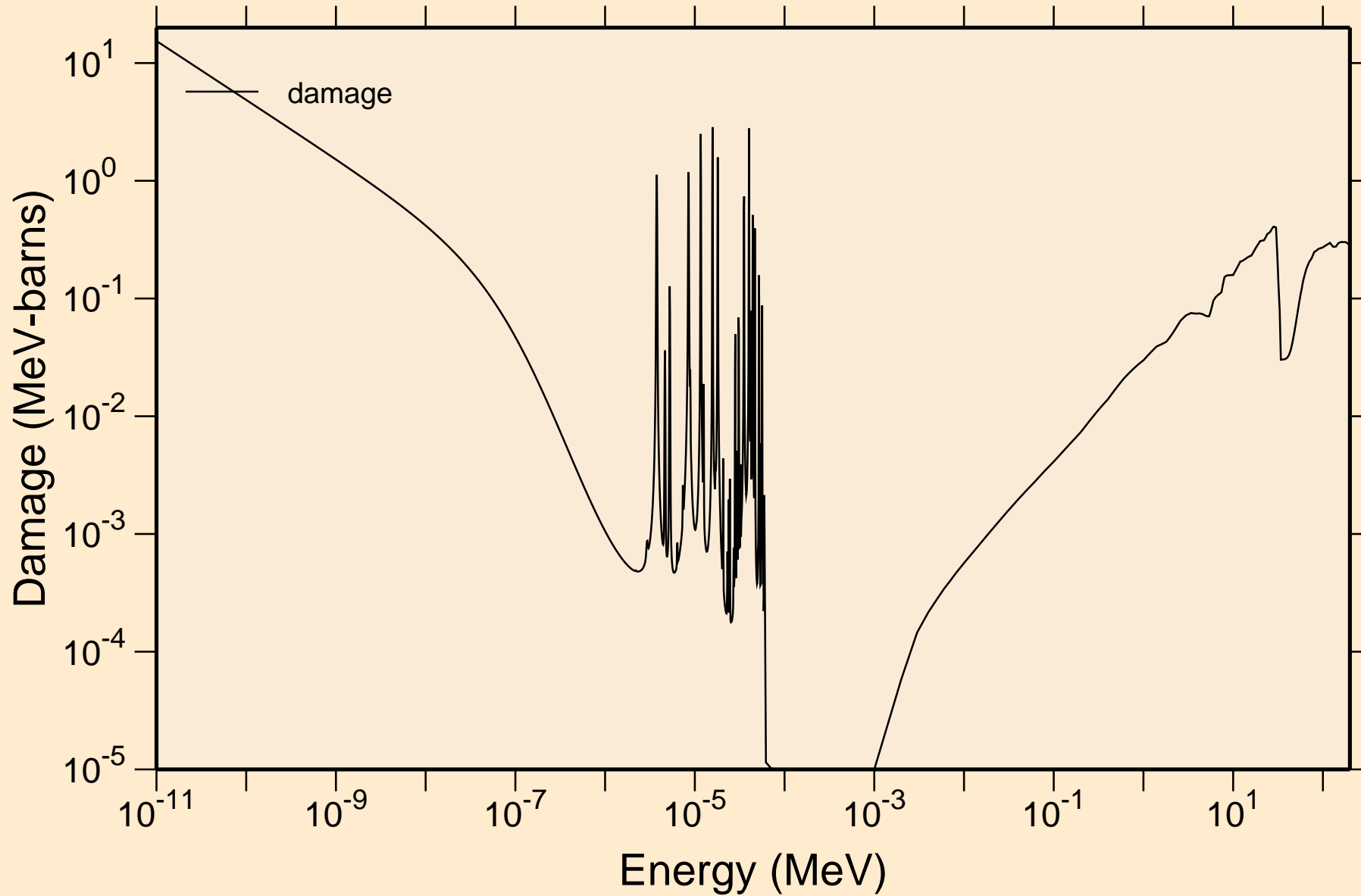

U241 NEUTRON ACER TENDL-2021 LIBRARY; T=293.6K

Non-threshold reactions

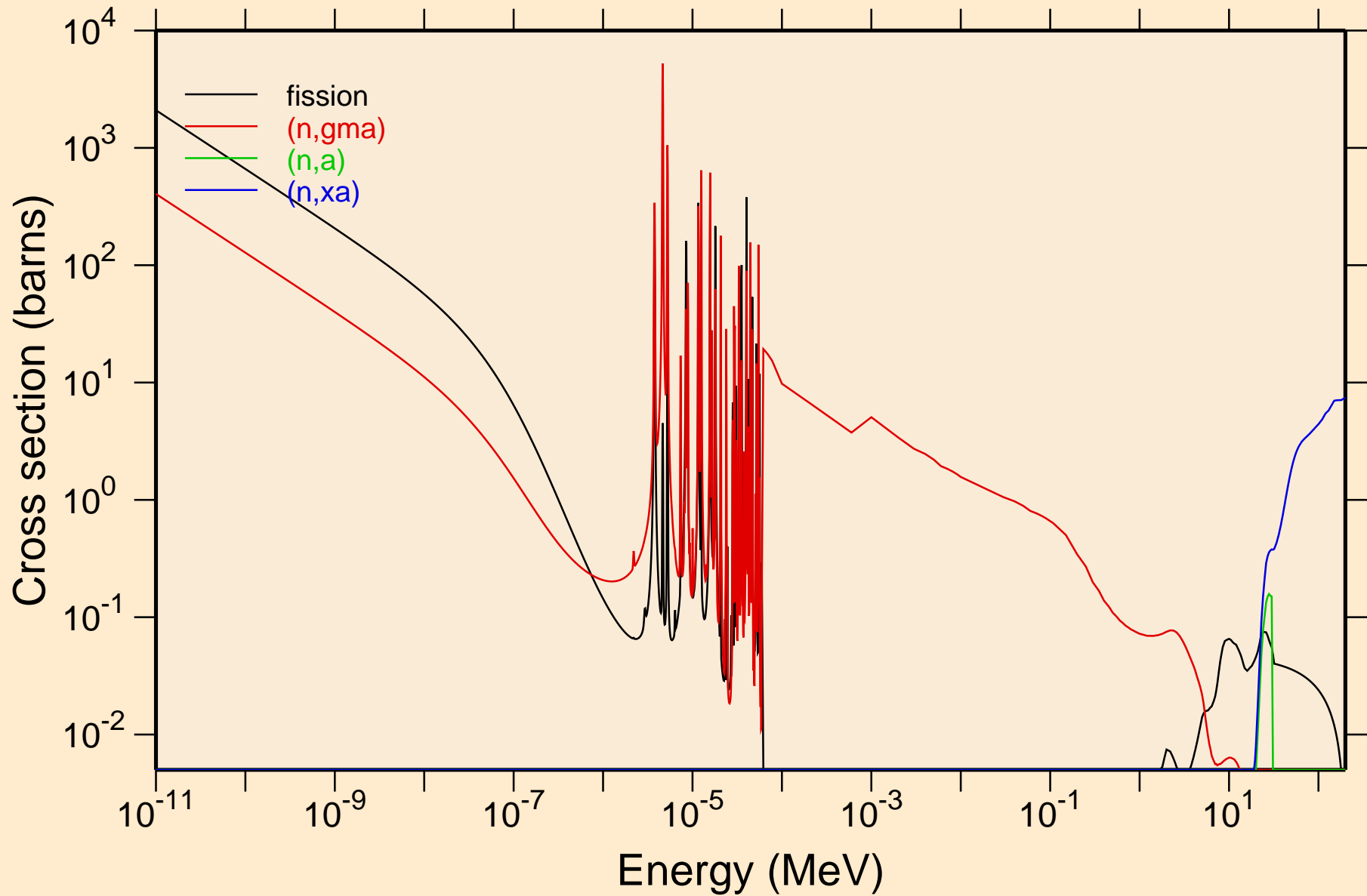

U241 NEUTRON ACER TENDL-2021 LIBRARY; T=293.6K

Principal cross sections

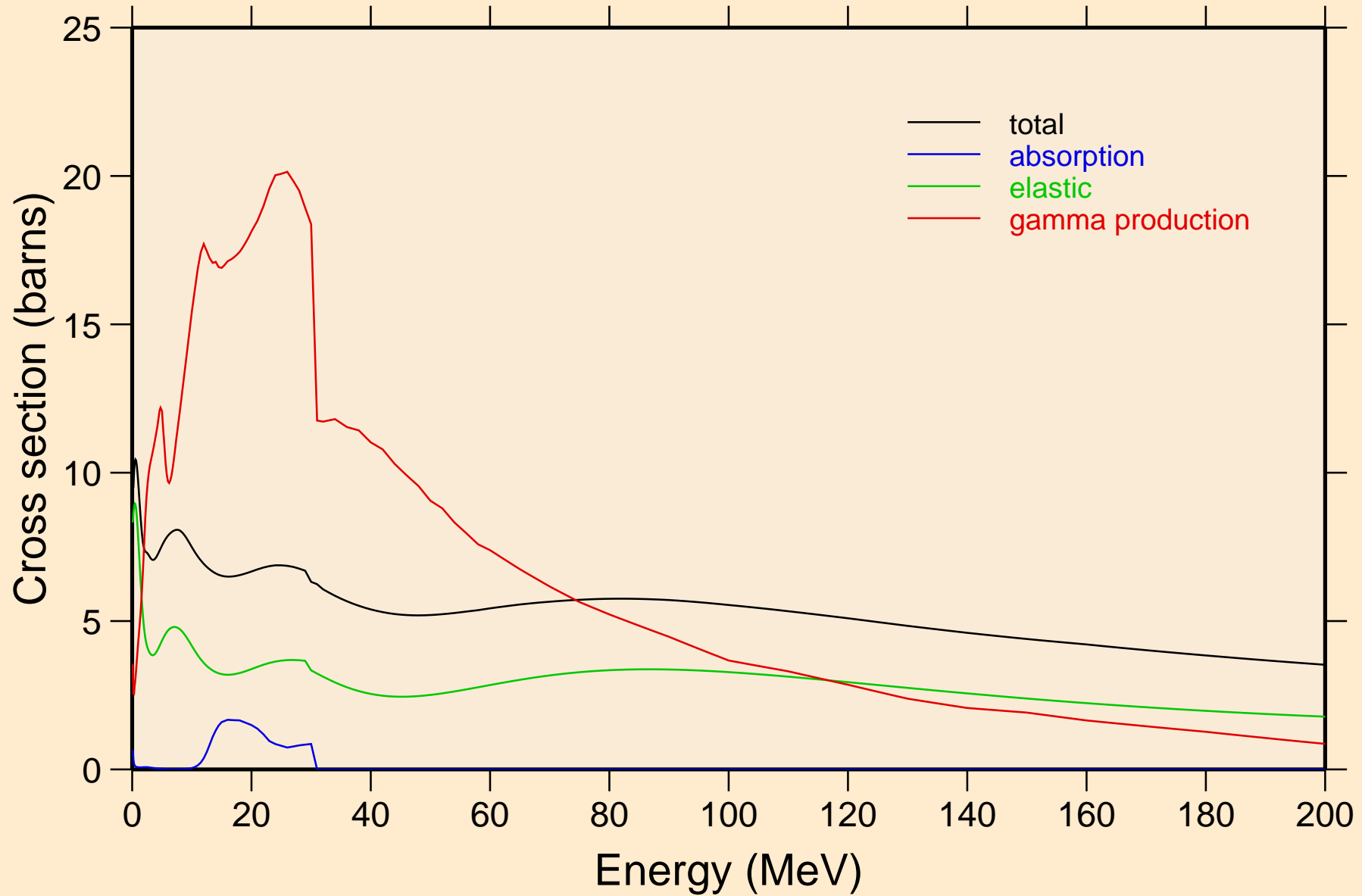

U241 NEUTRON ACER TENDL-2021 LIBRARY; T=293.6K
Heating

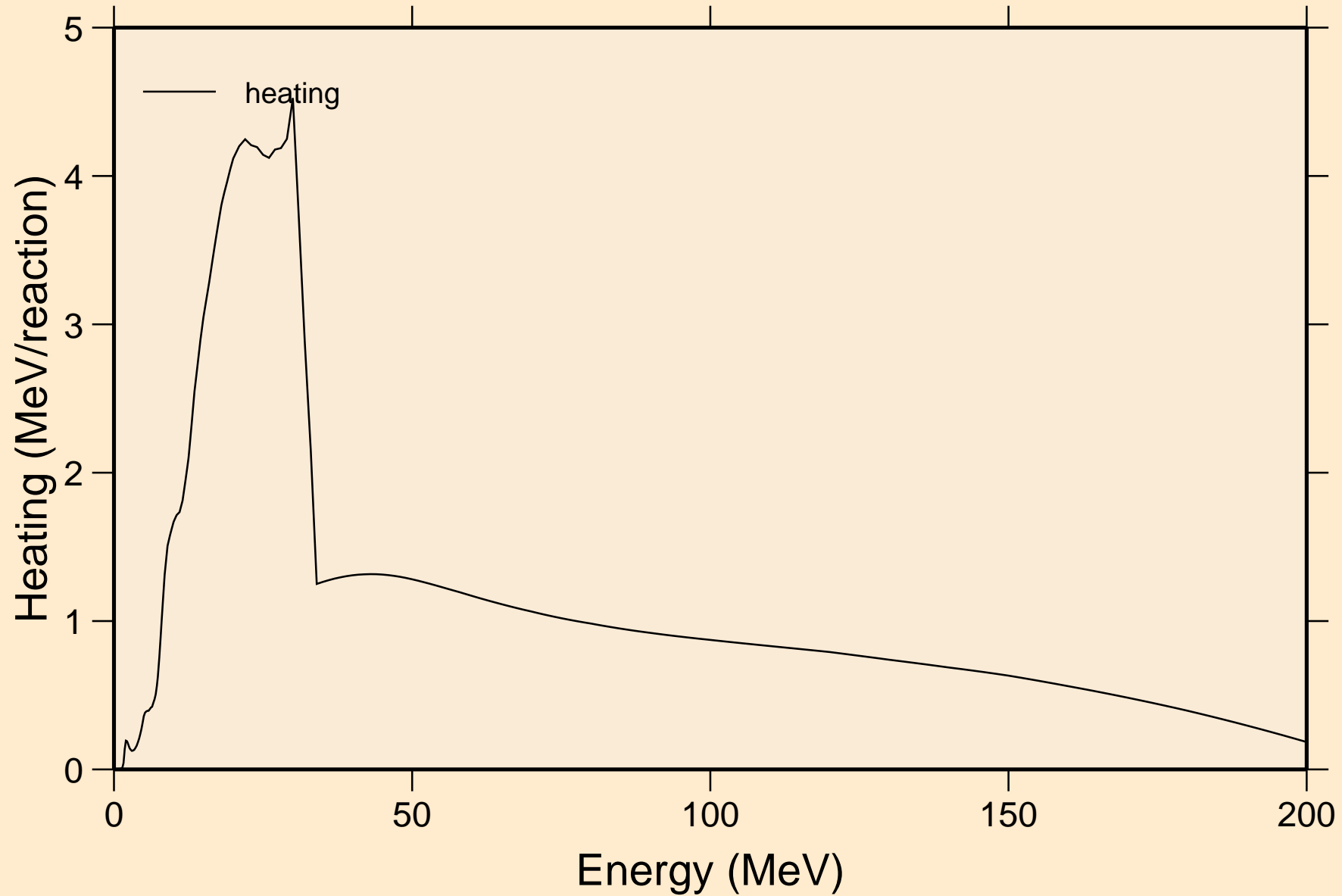

U241 NEUTRON ACER TENDL-2021 LIBRARY; T=293.6K
Damage

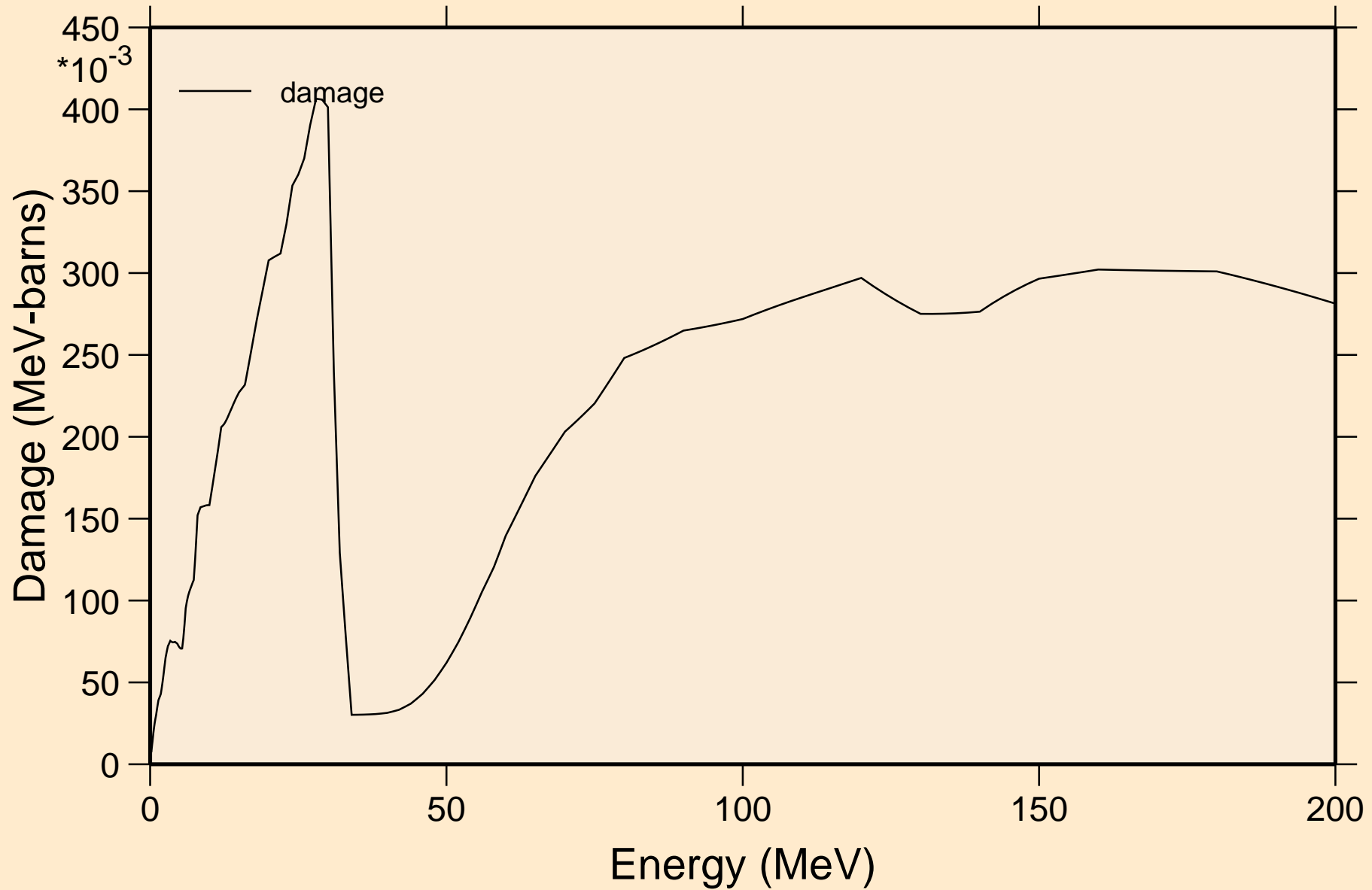

U241 NEUTRON ACER TENDL-2021 LIBRARY; T=293.6K
Non-threshold reactions

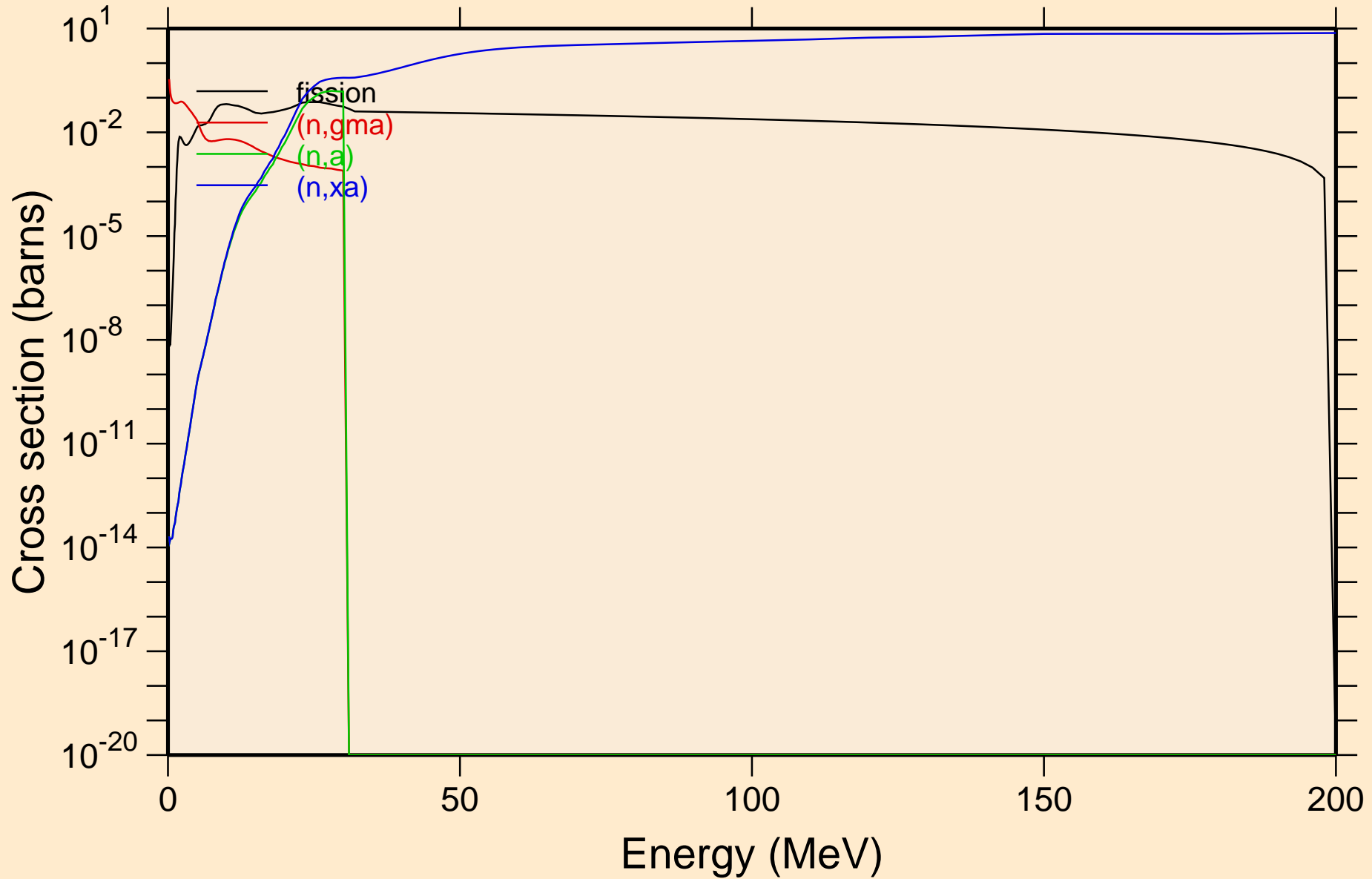

U241 NEUTRON ACER TENDL-2021 LIBRARY; T=293.6K
Inelastic levels

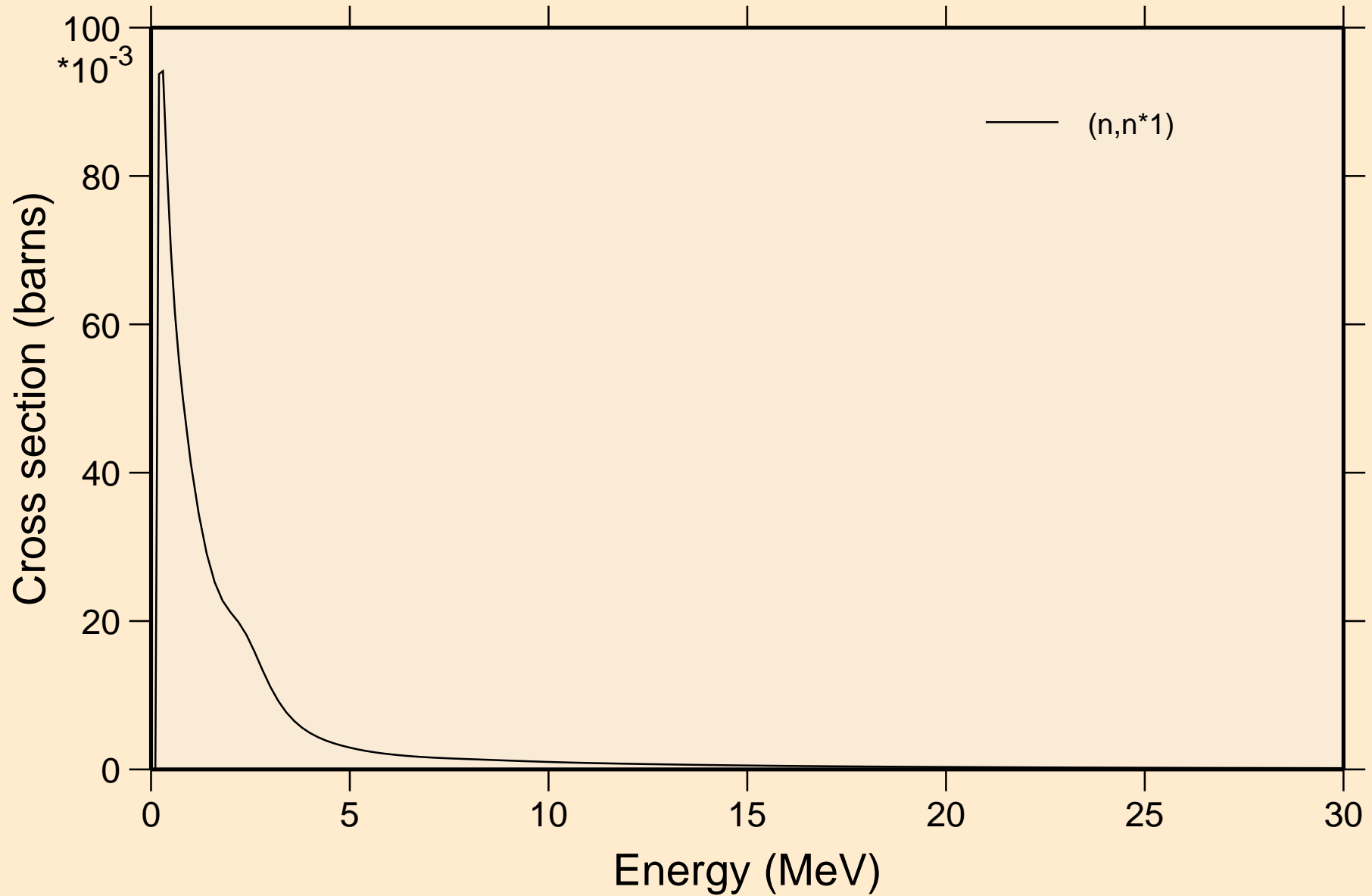

U241 NEUTRON ACER TENDL-2021 LIBRARY; T=293.6K

Threshold reactions

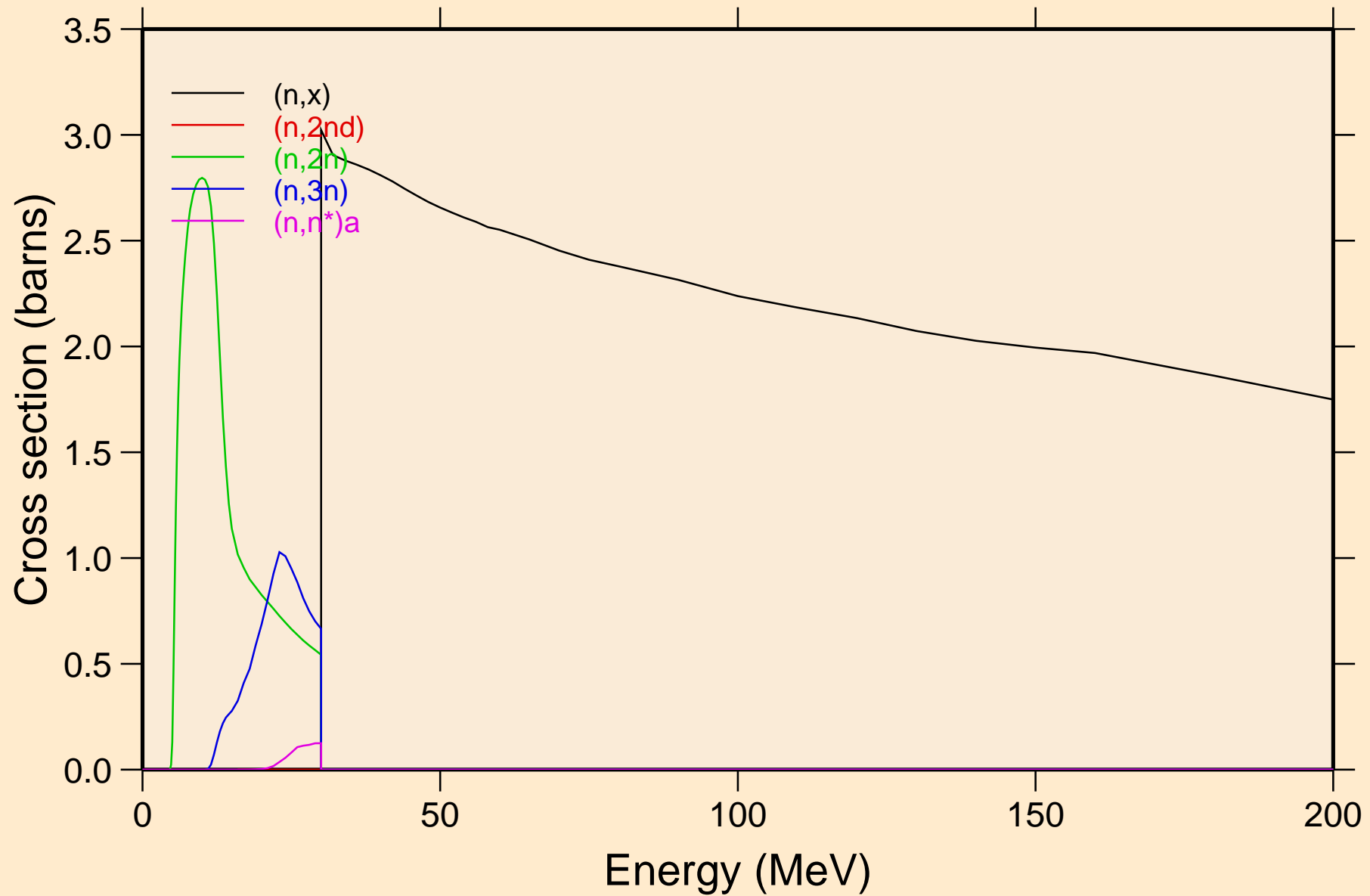

U241 NEUTRON ACER TENDL-2021 LIBRARY; T=293.6K

Threshold reactions

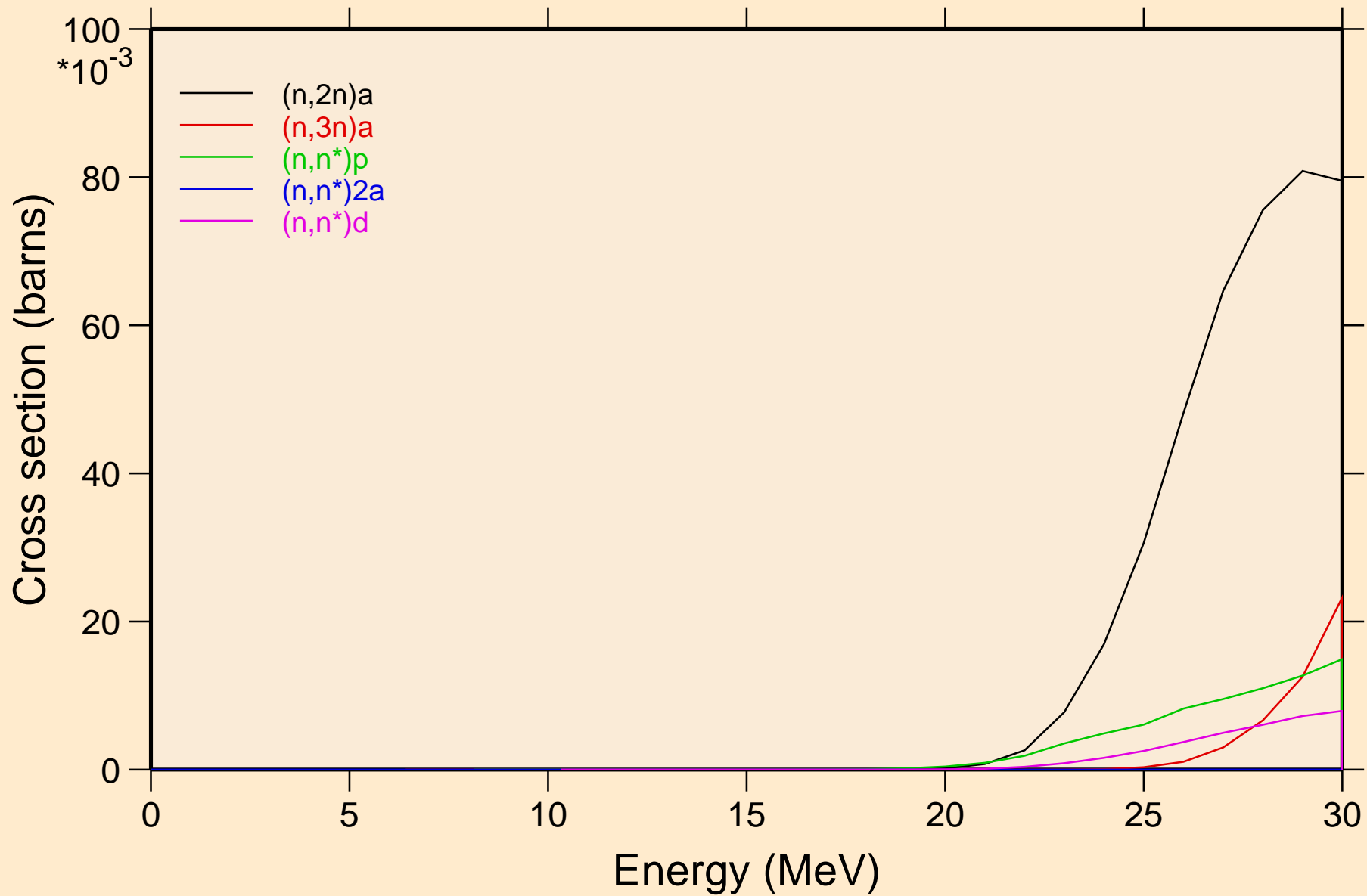

U241 NEUTRON ACER TENDL-2021 LIBRARY; T=293.6K
Threshold reactions

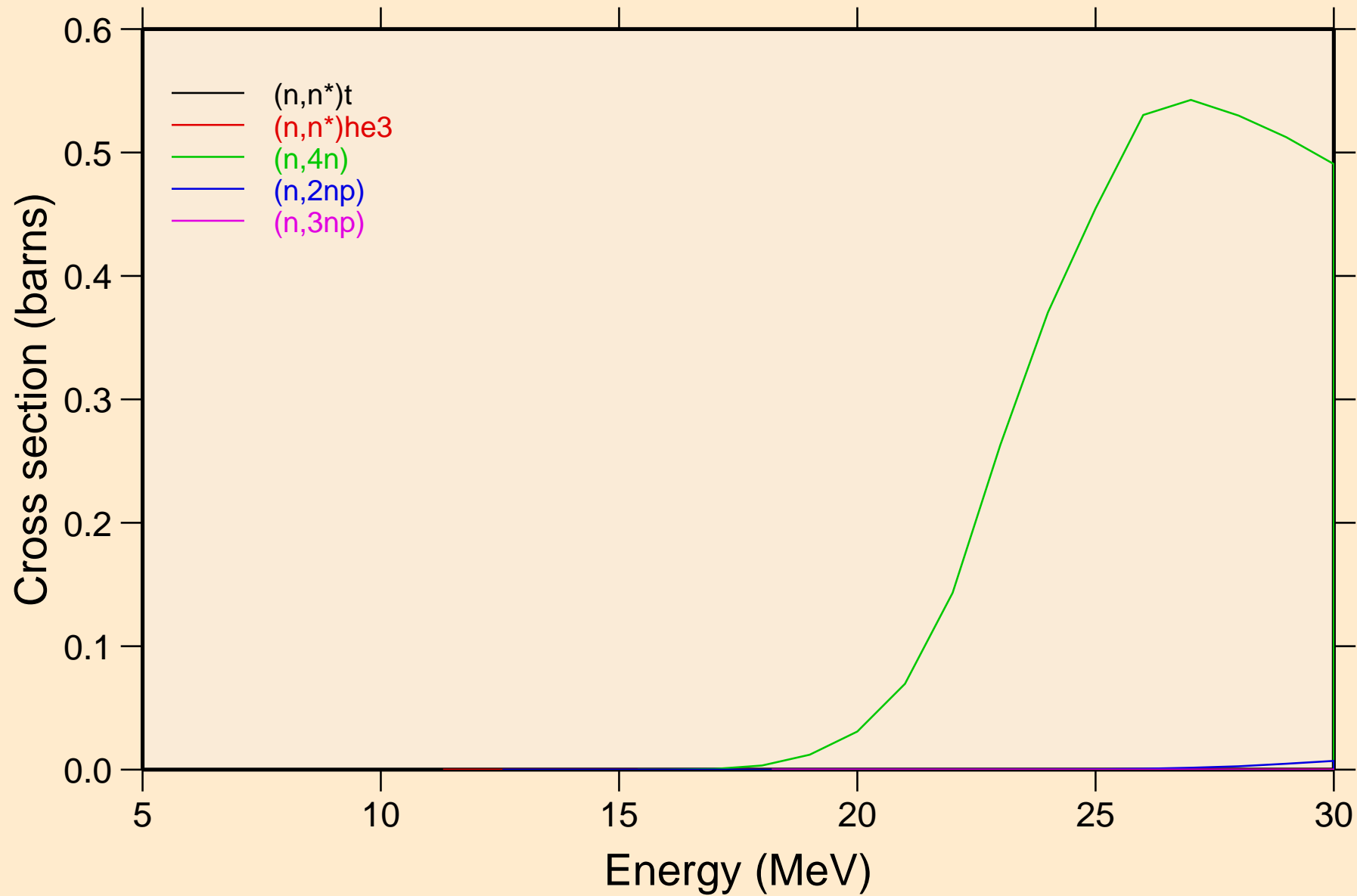

U241 NEUTRON ACER TENDL-2021 LIBRARY; T=293.6K

Threshold reactions

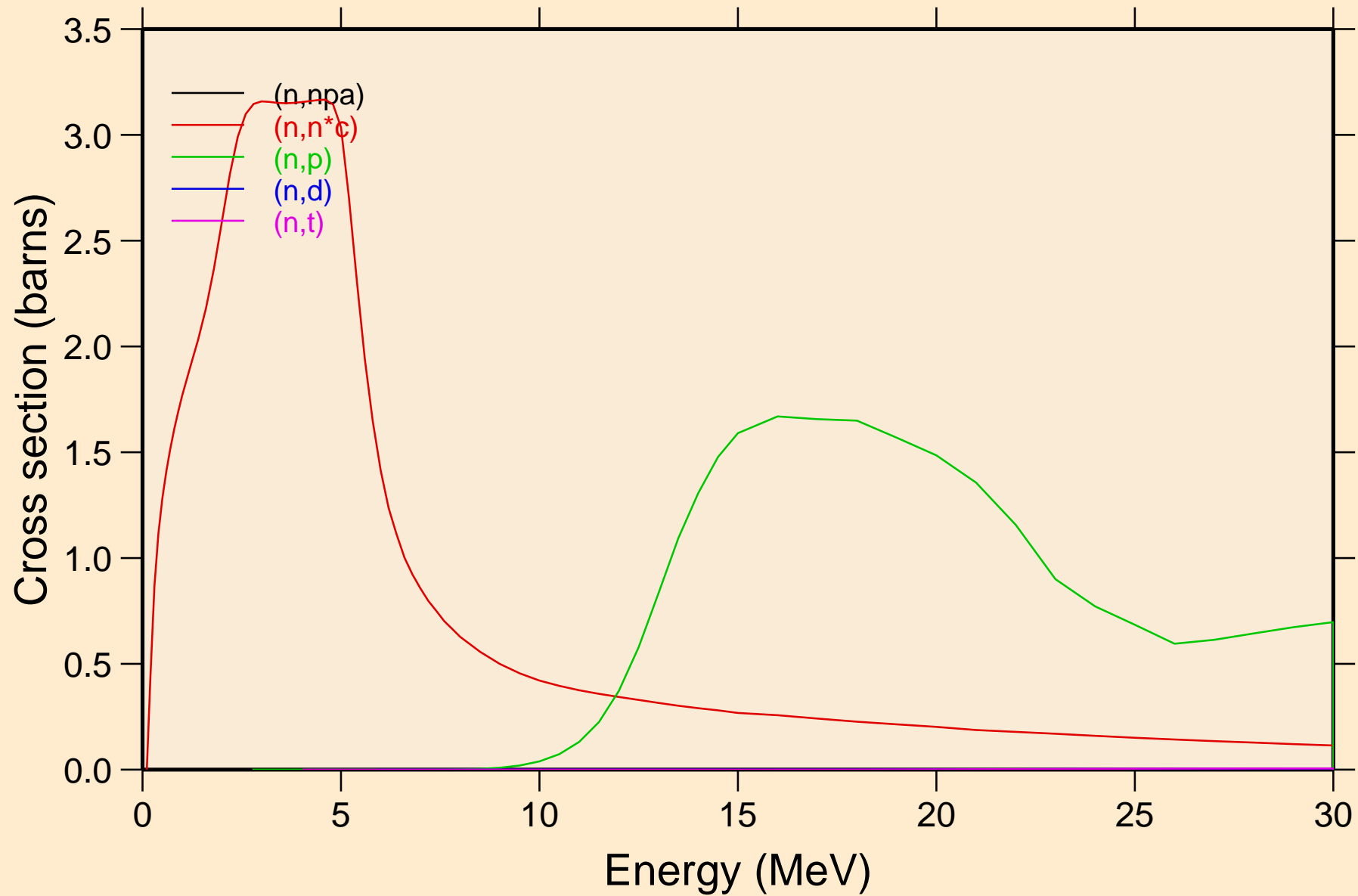

U241 NEUTRON ACER TENDL-2021 LIBRARY; T=293.6K

Threshold reactions

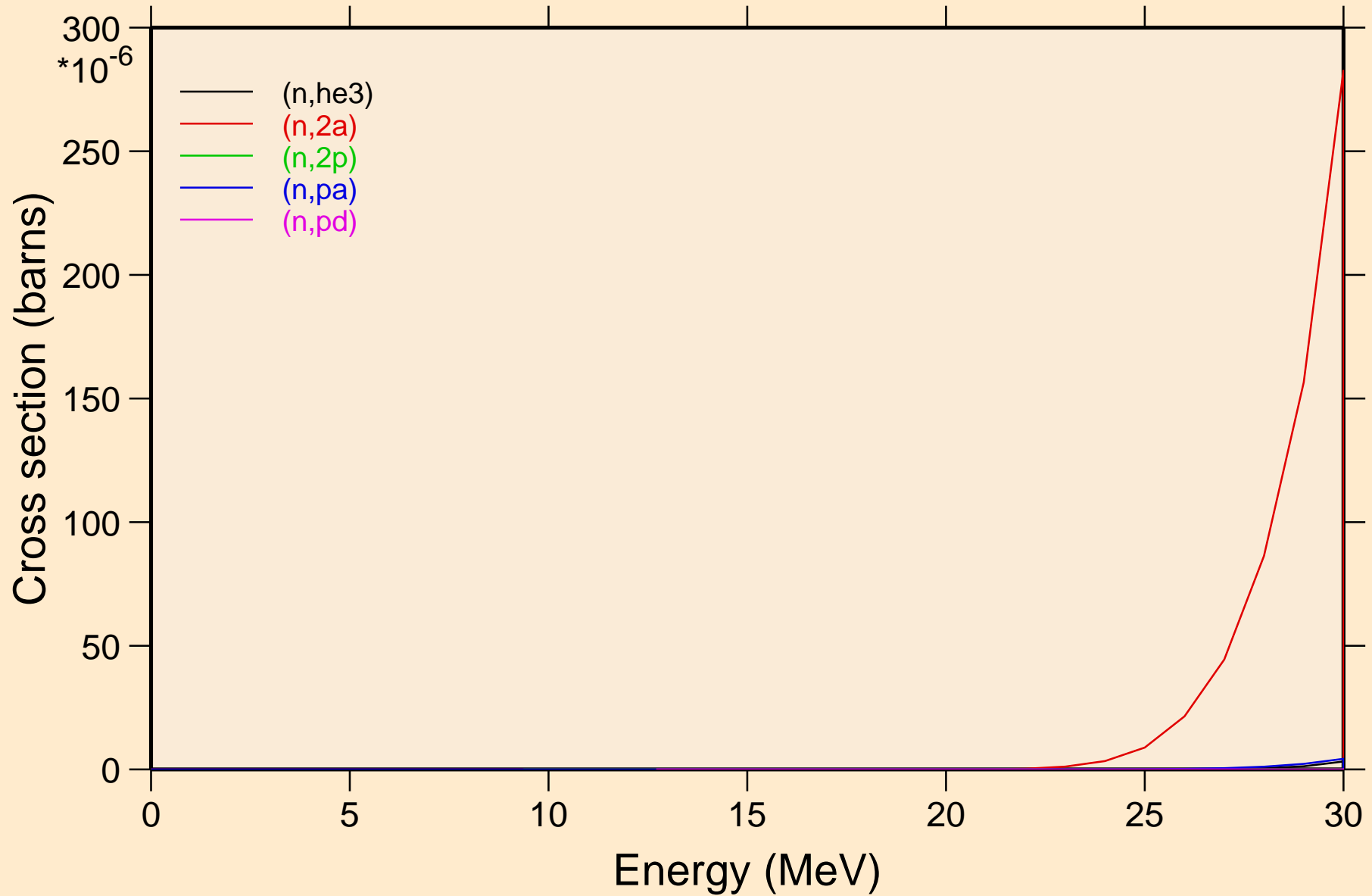

U241 NEUTRON ACER TENDL-2021 LIBRARY; T=293.6K
Threshold reactions

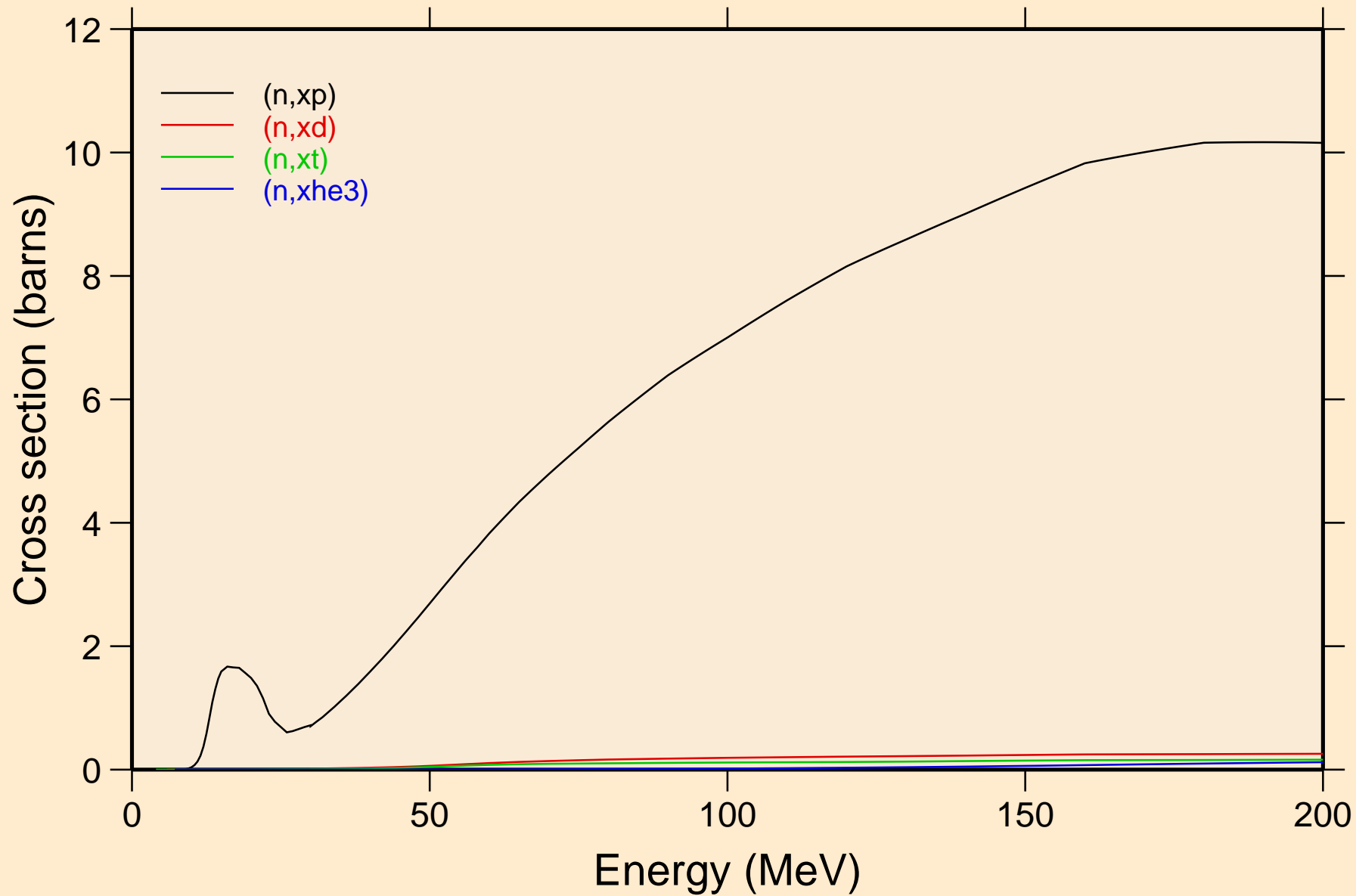

U241 NEUTRON ACER TENDL-2021 LIBRARY; T=293.6K
angular distribution for elastic

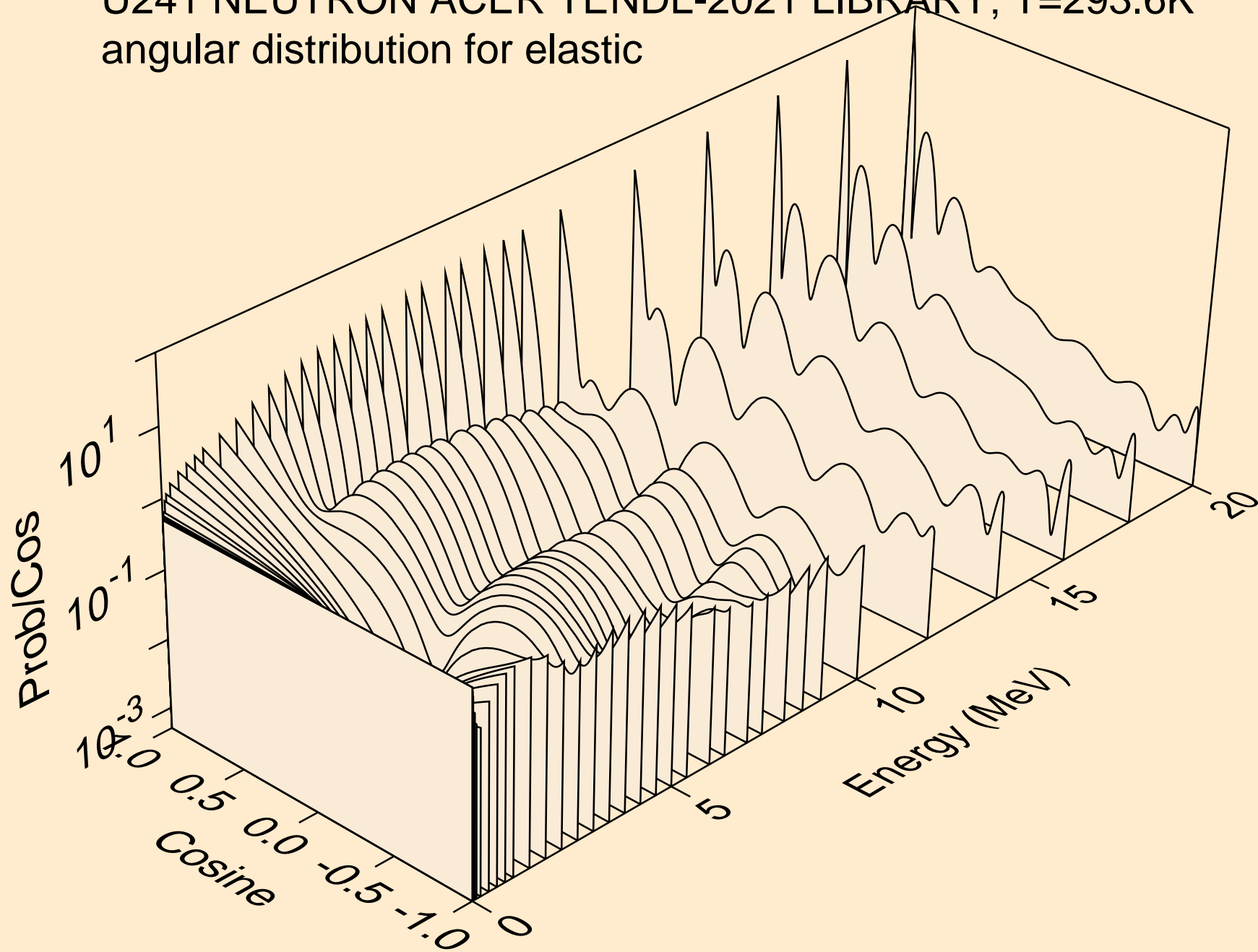

U241 NEUTRON ACER TENDL-2021 LIBRARY; T=293.6K
angular distribution for elastic

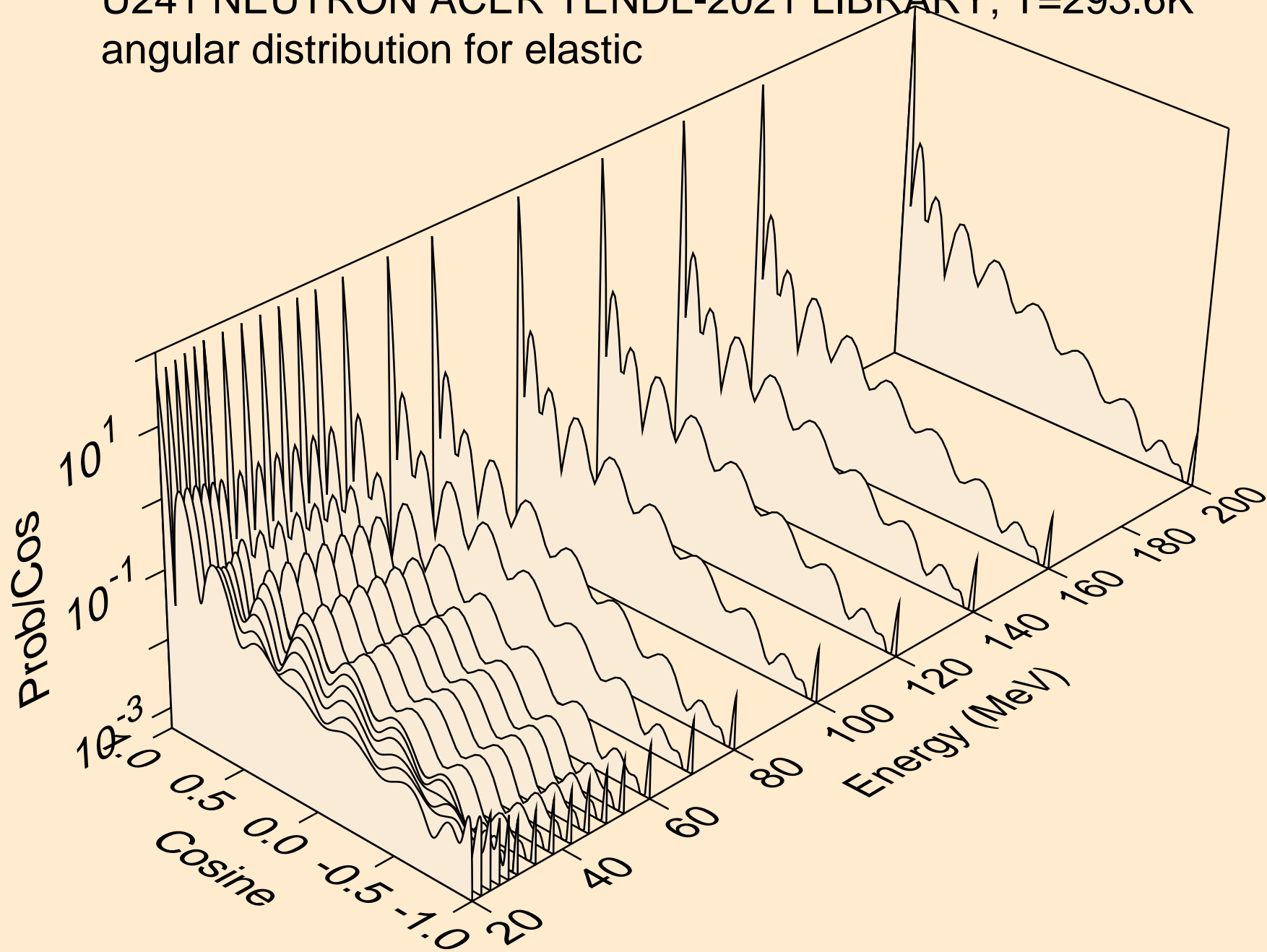

U241 NEUTRON ACER TENDL-2021 LIBRARY; T=293.6K
angular distribution for (n,n*1)

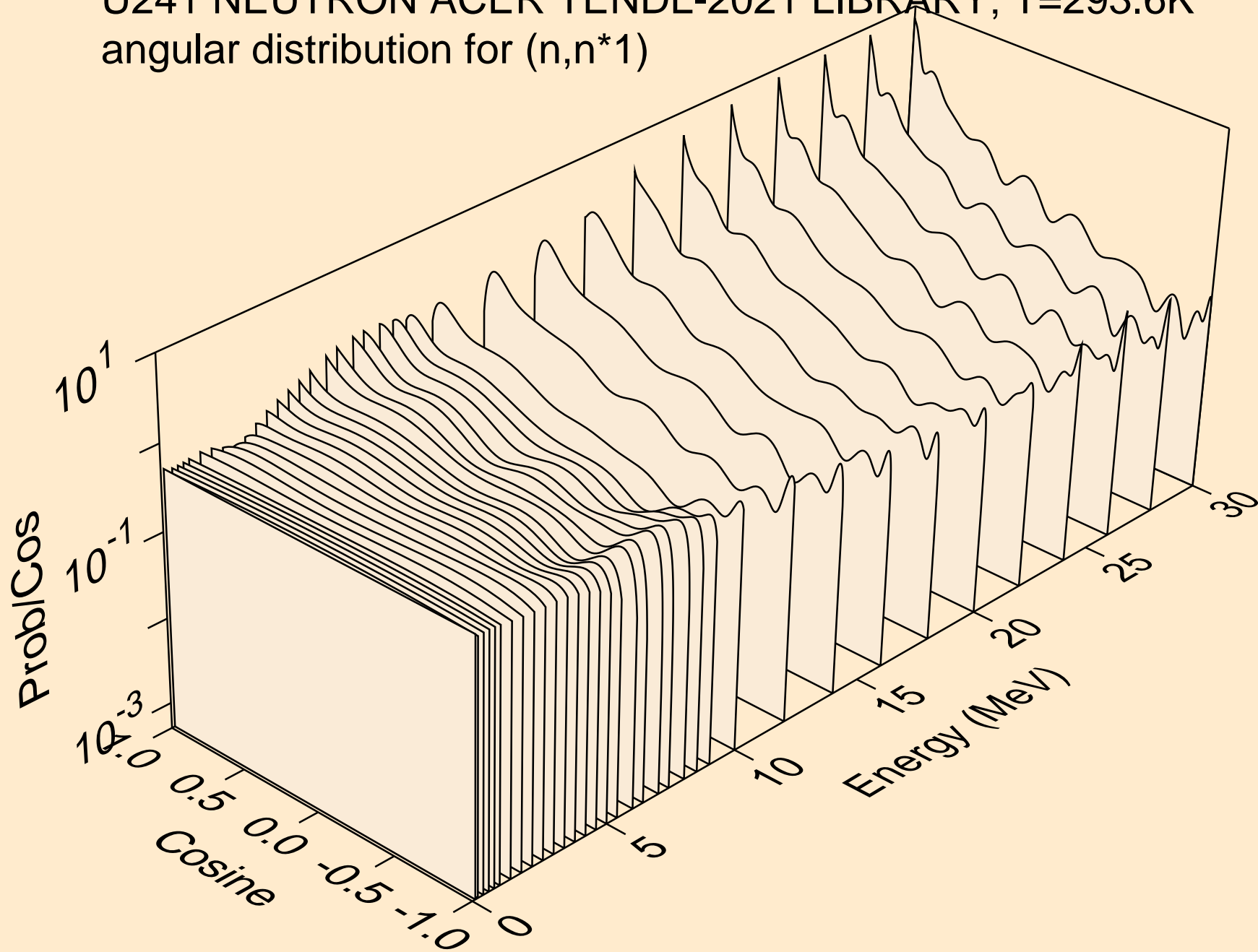

U241 NEUTRON ACER TENDL-2021 LIBRARY; T=293.6K
Total fission nubar

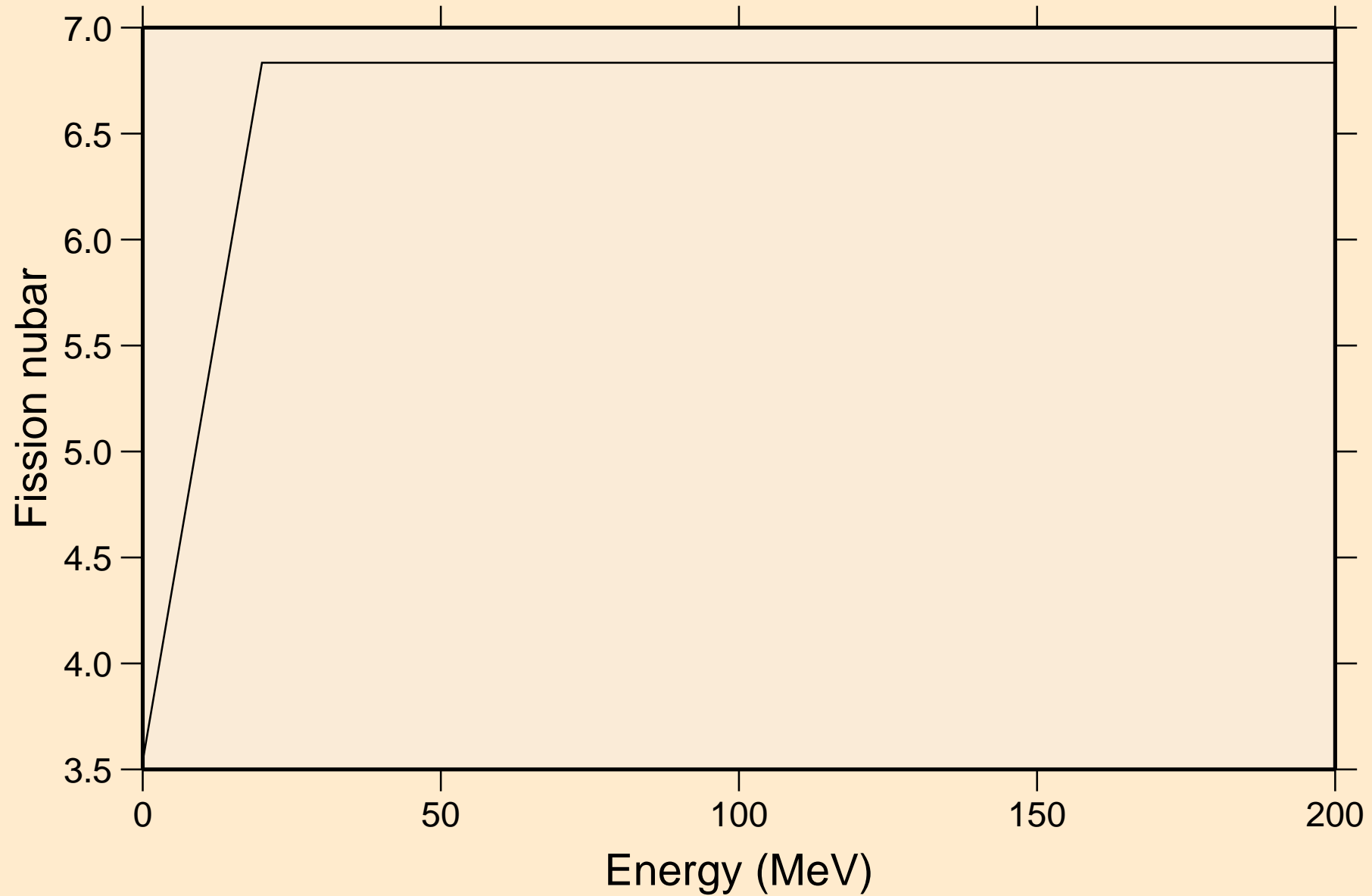

U241 NEUTRON ACER TENDL-2021 LIBRARY; T=293.6K
Neutron emission for (n,x)

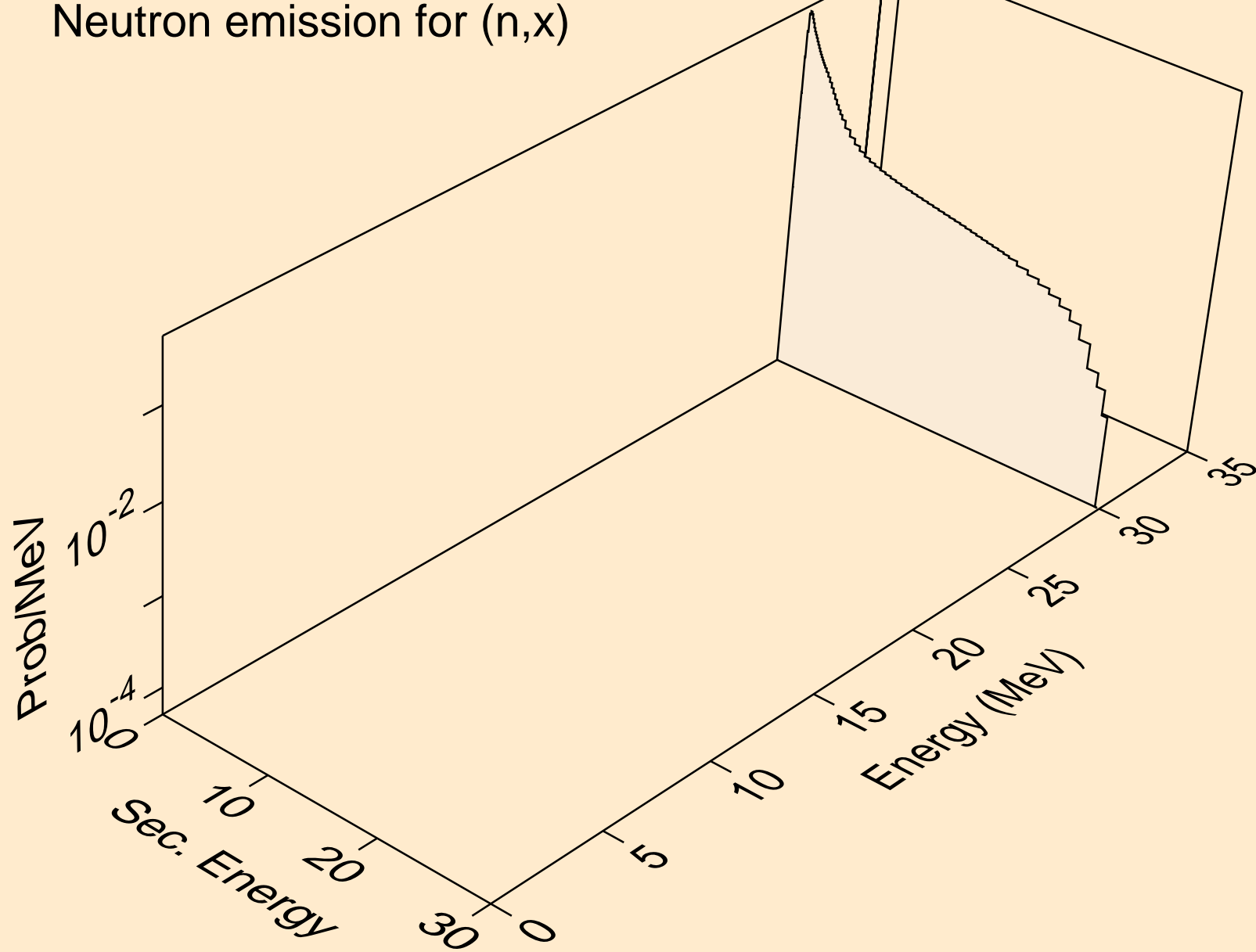

U241 NEUTRON ACER TENDL-2021 LIBRARY; T=293.6K
Neutron emission for (n,2nd)

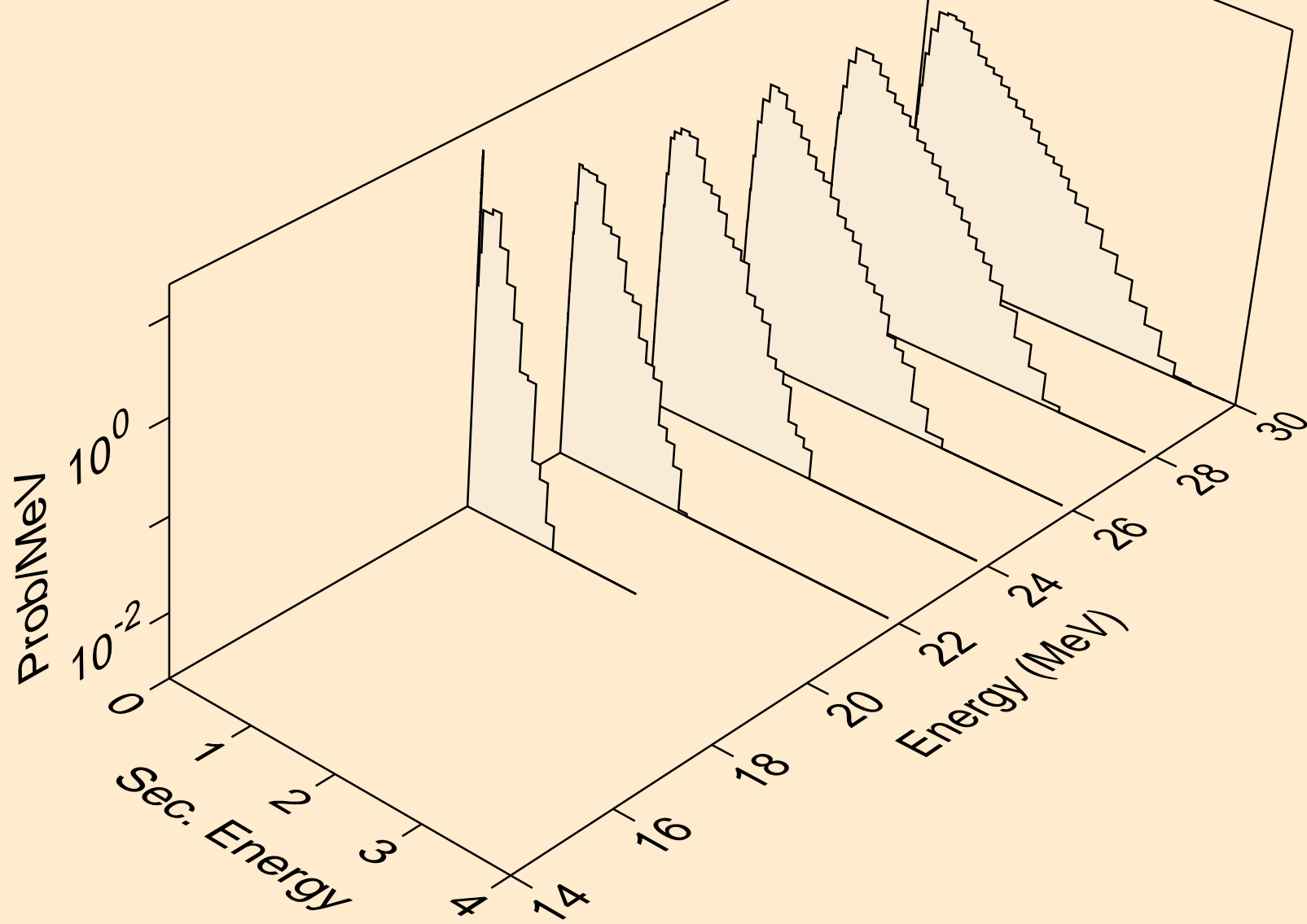

U241 NEUTRON ACER TENDL-2021 LIBRARY; T=293.6K
Neutron emission for (n,2n)

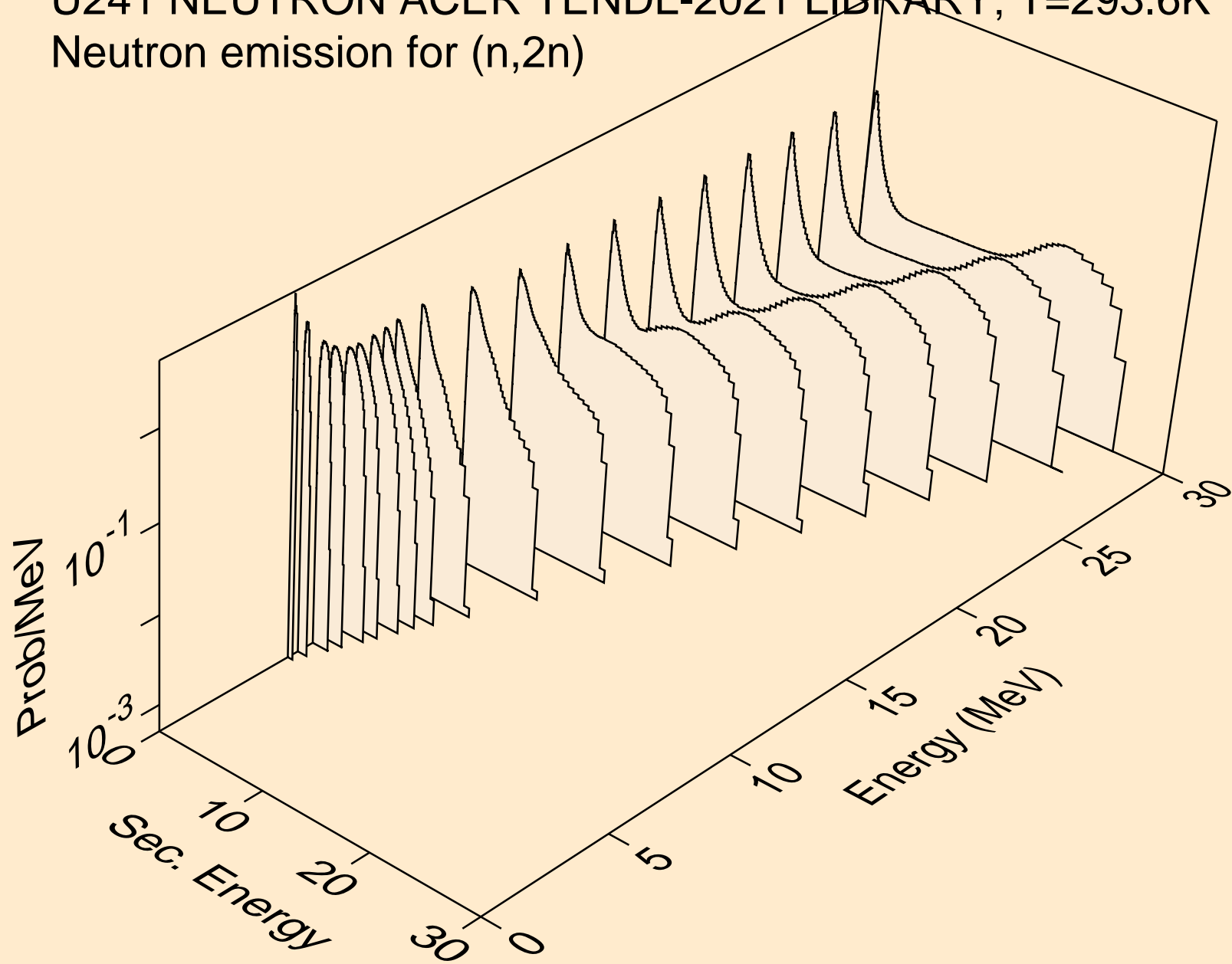

U241 NEUTRON ACER TENDL-2021 LIBRARY; T=293.6K
Neutron emission for (n,3n)

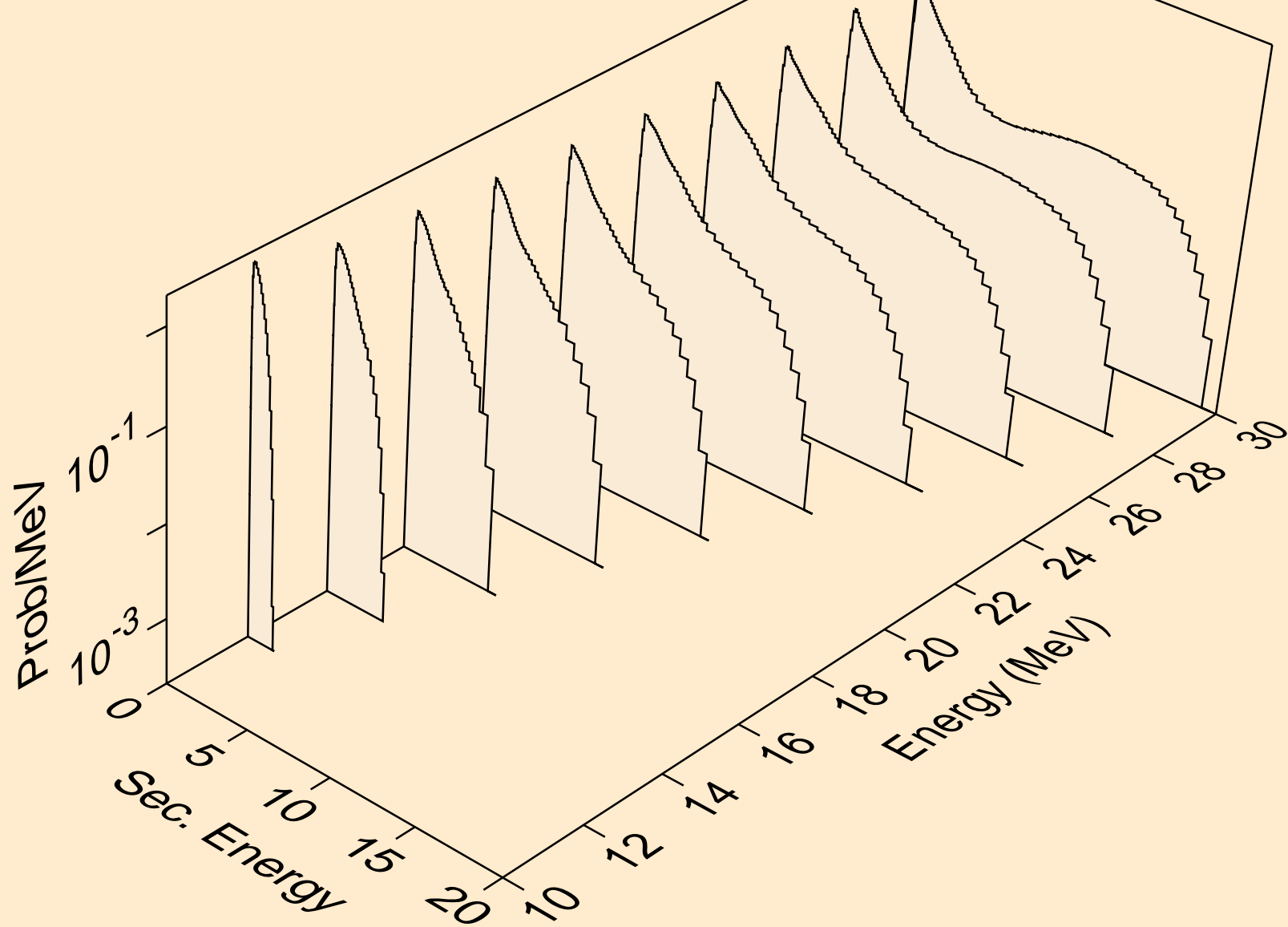

U241 NEUTRON ACER TENDL-2021 LIBRARY; T=293.6K
Neutron emission for fission

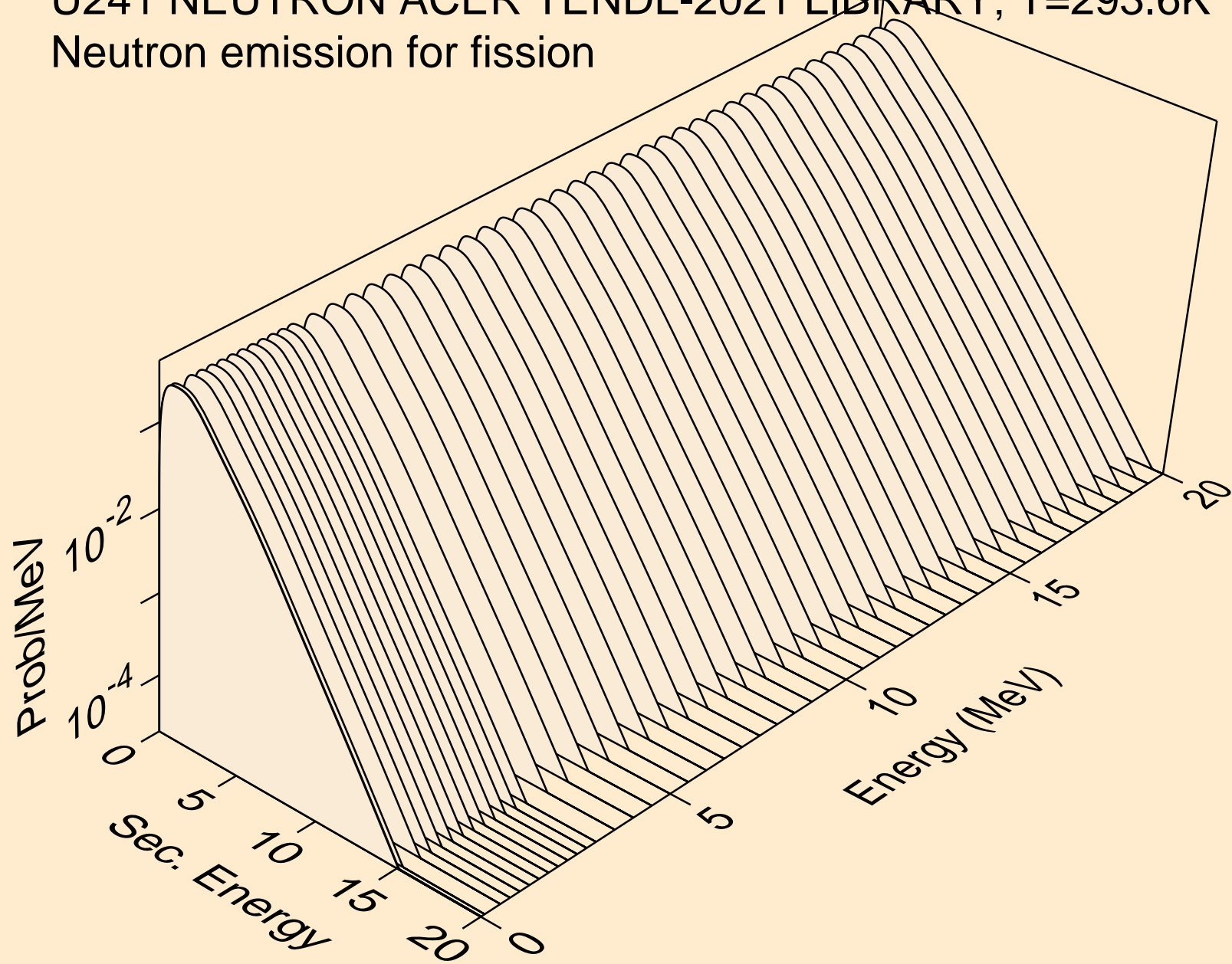

U241 NEUTRON ACER TENDL-2021 LIBRARY; T=293.6K
Neutron emission for (n,n*)a

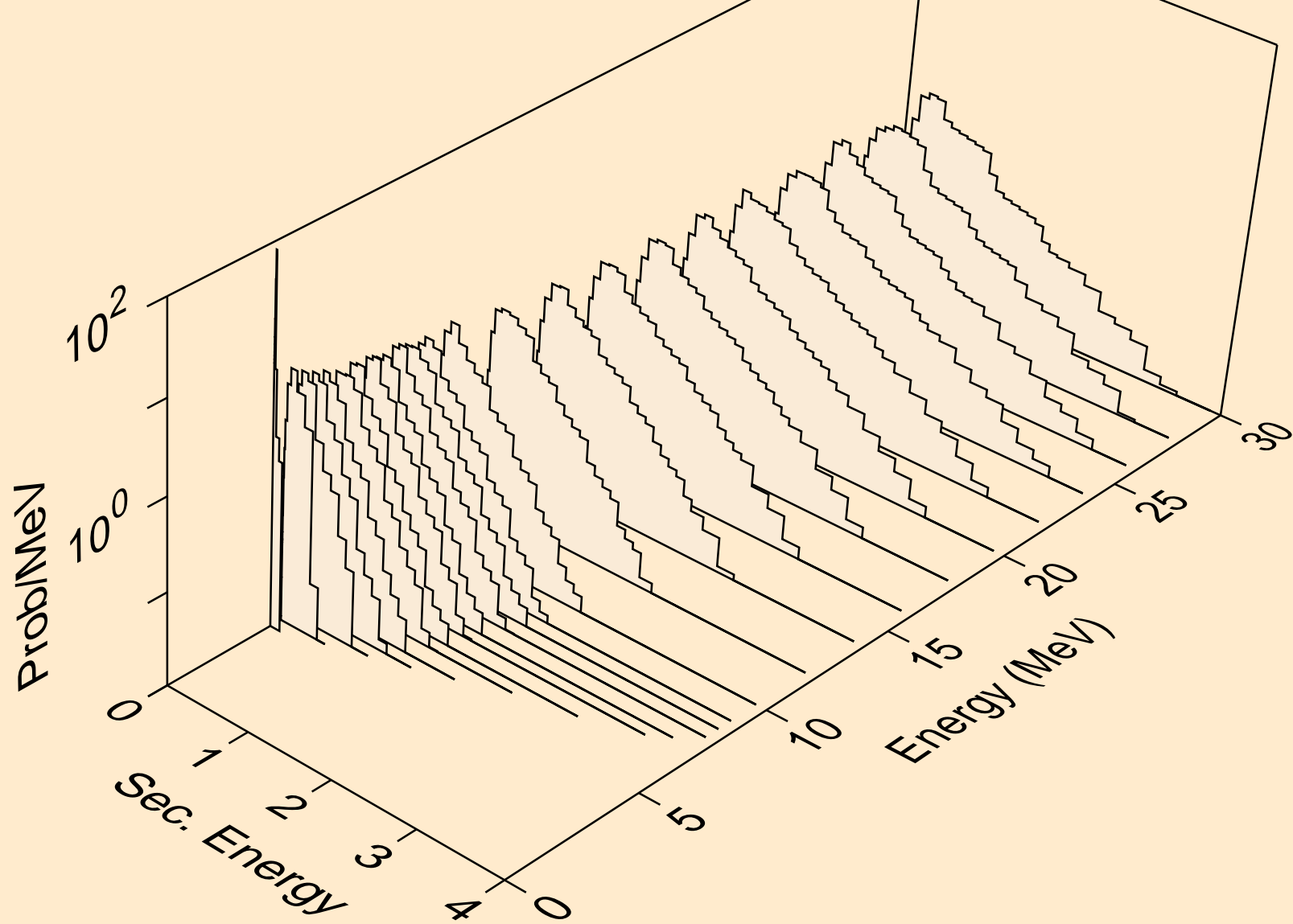

U241 NEUTRON ACER TENDL-2021 LIBRARY; T=293.6K
Neutron emission for (n,2n)a

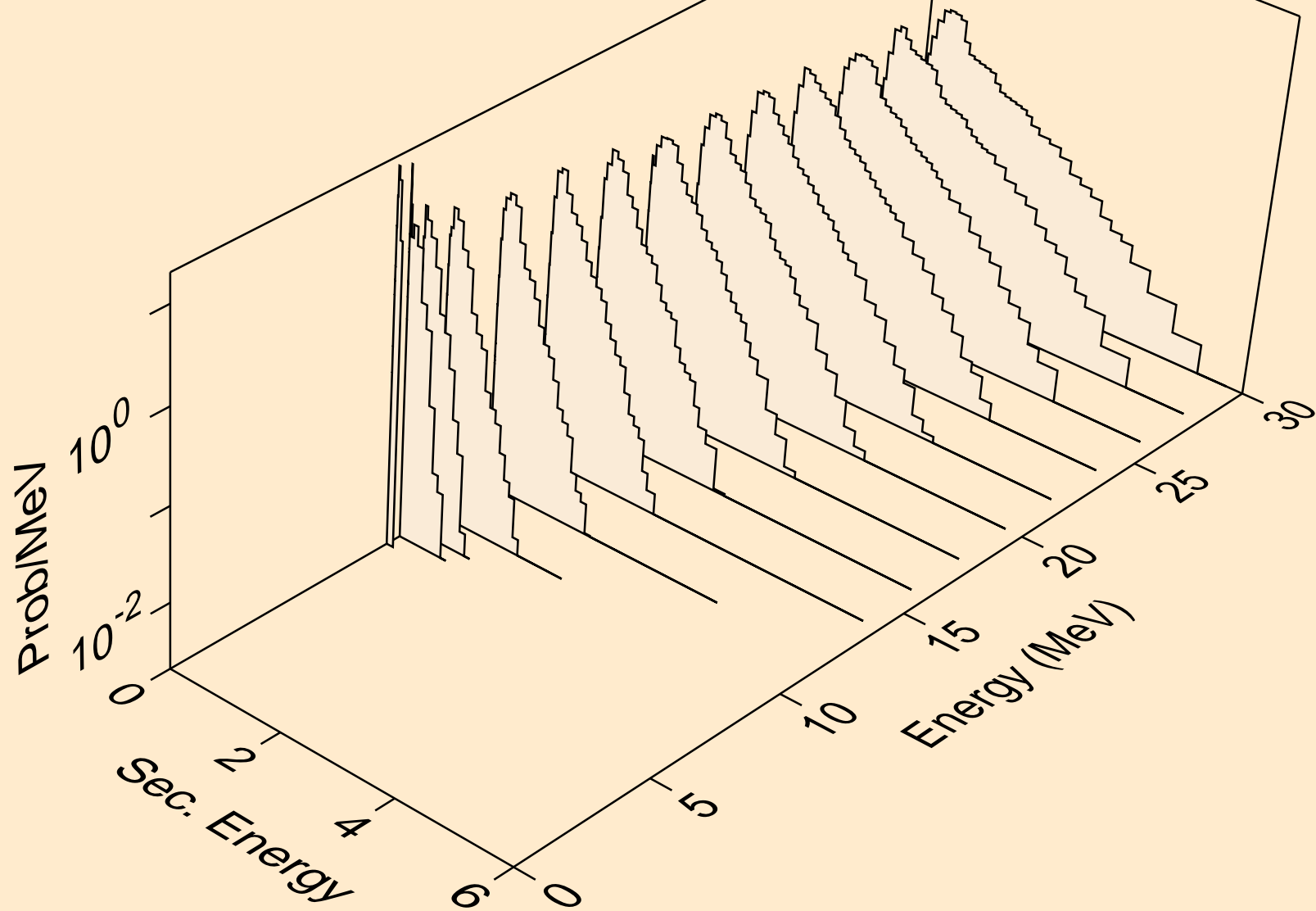

U241 NEUTRON ACER TENDL-2021 LIBRARY; T=293.6K
Neutron emission for (n,3n)a

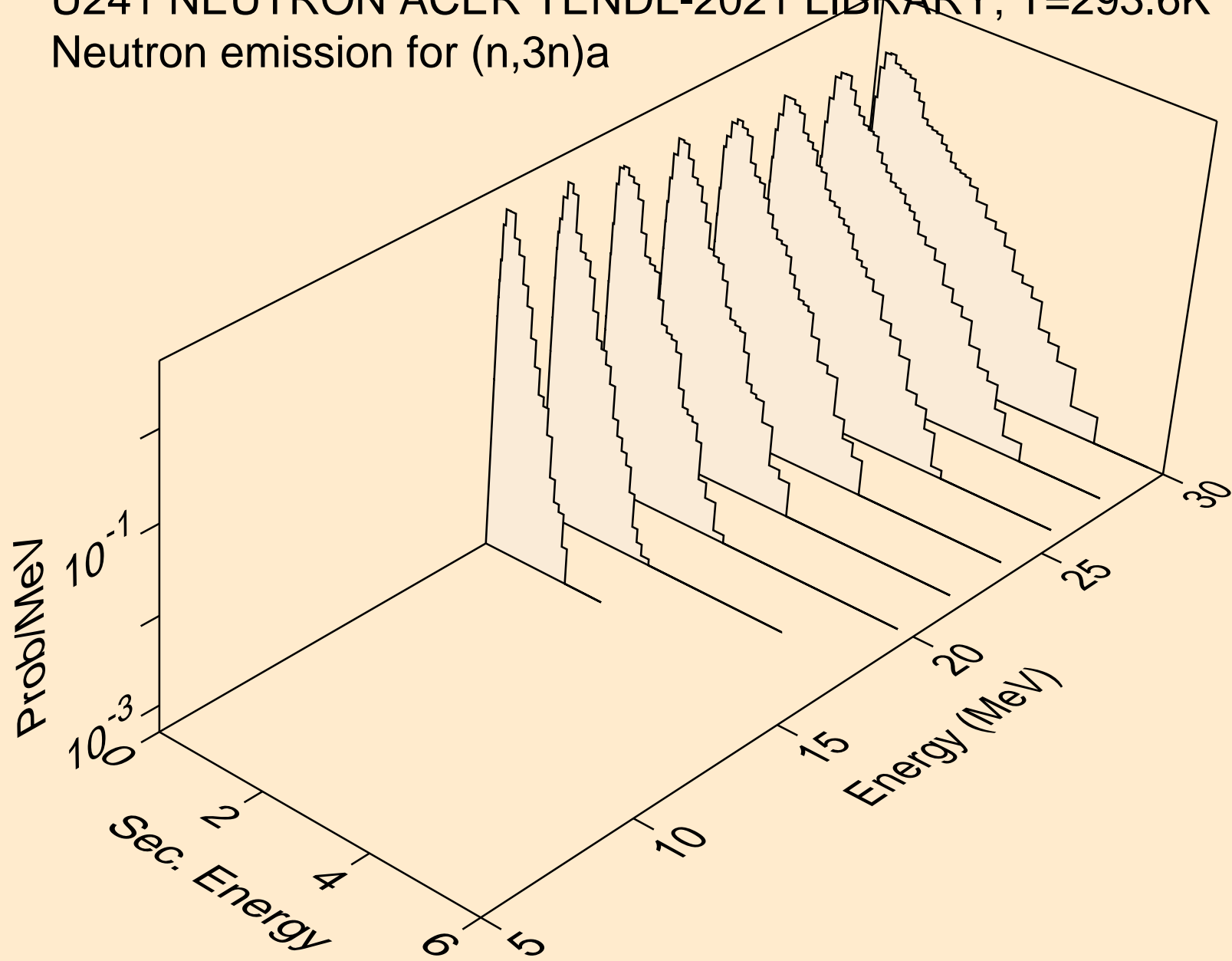

U241 NEUTRON ACER TENDL-2021 LIBRARY; T=293.6K
Neutron emission for (n,n*)p

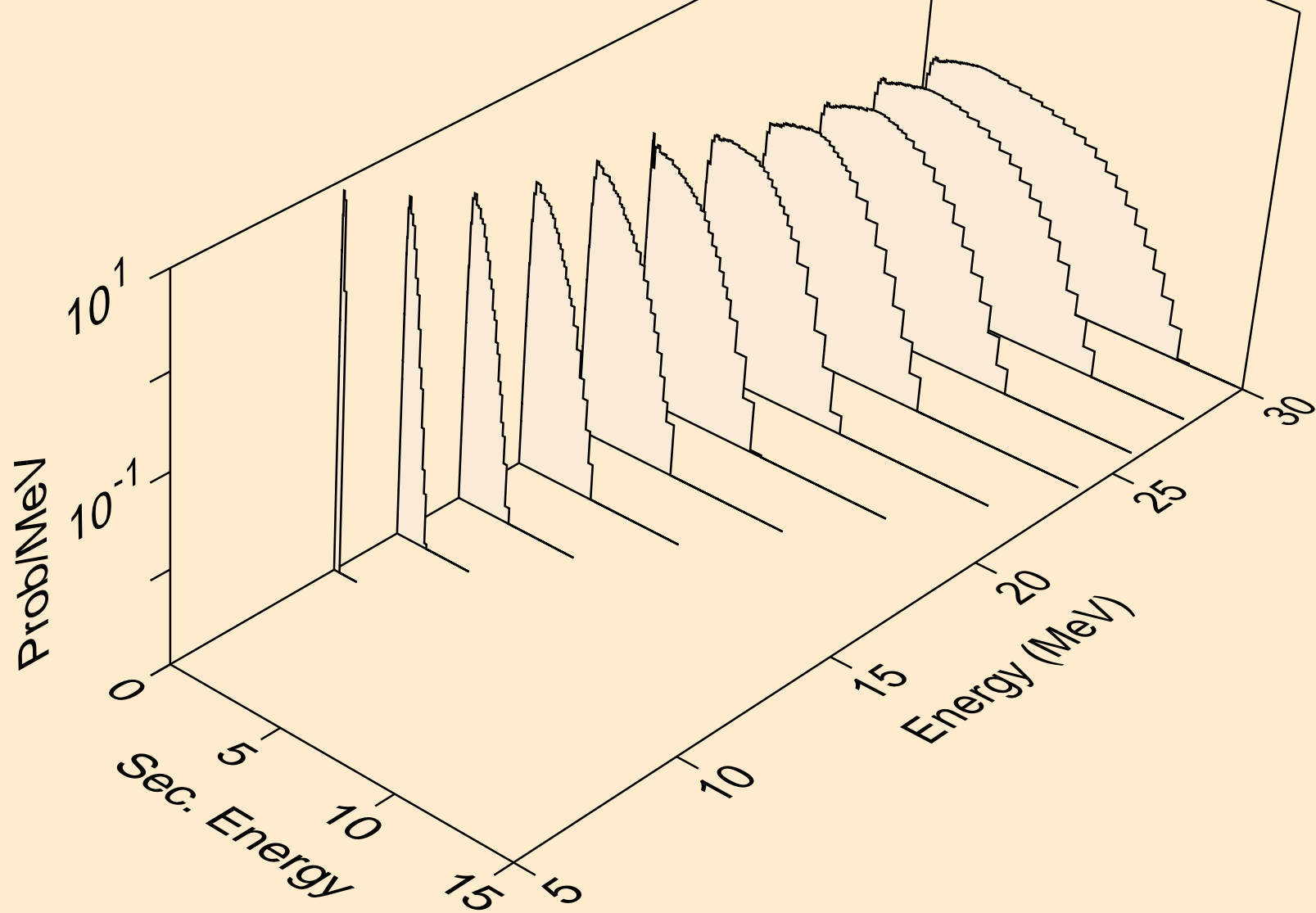

U241 NEUTRON ACER TENDL-2021 LIBRARY; T=293.6K
Neutron emission for (n,n*)2a

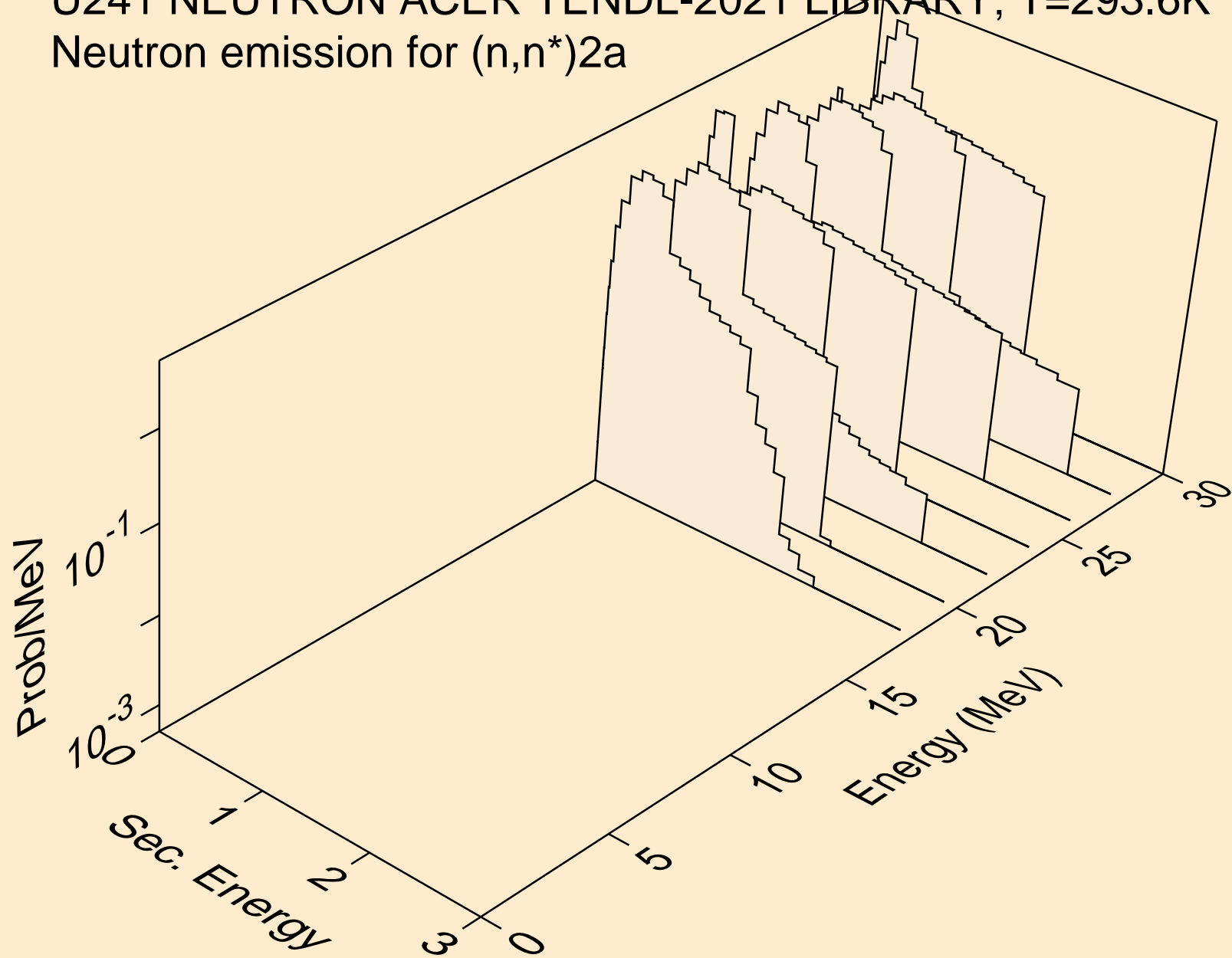

U241 NEUTRON ACER TENDL-2021 LIBRARY; T=293.6K
Neutron emission for (n,n*)d

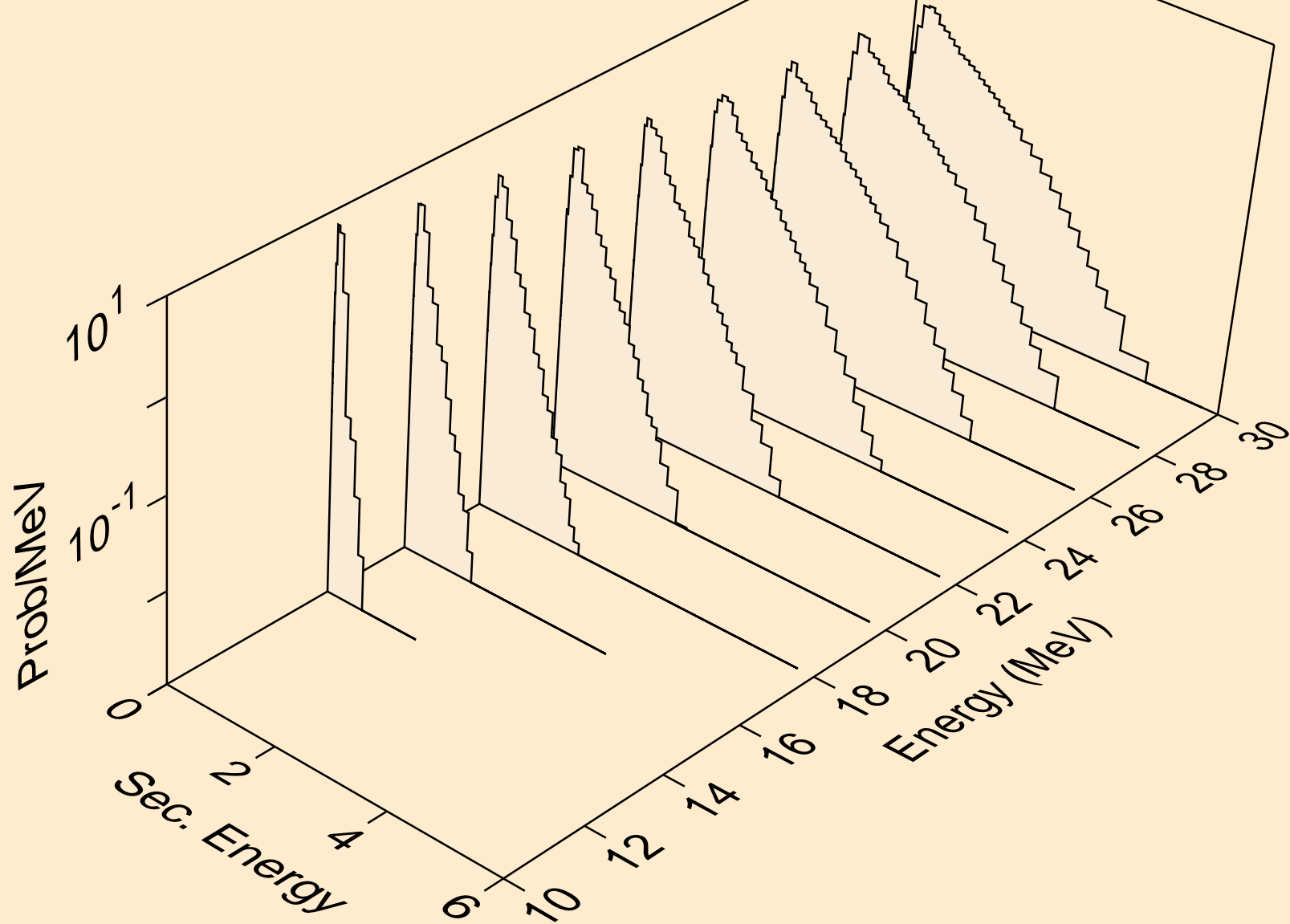

U241 NEUTRON ACER TENDL-2021 LIBRARY; T=293.6K
Neutron emission for (n,n*)t

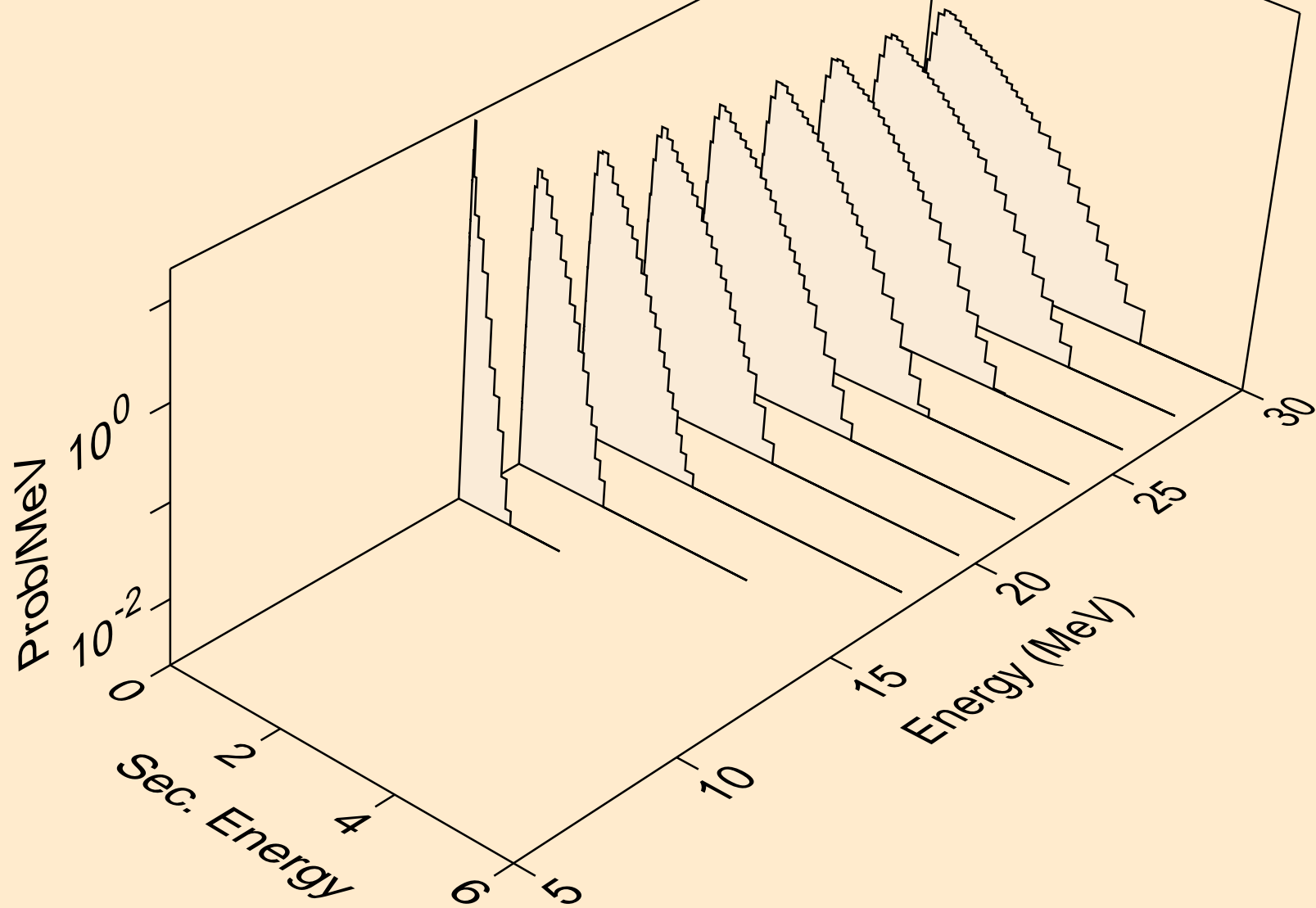

U241 NEUTRON ACER TENDL-2021 LIBRARY; T=293.6K
Neutron emission for (n,n*)he3

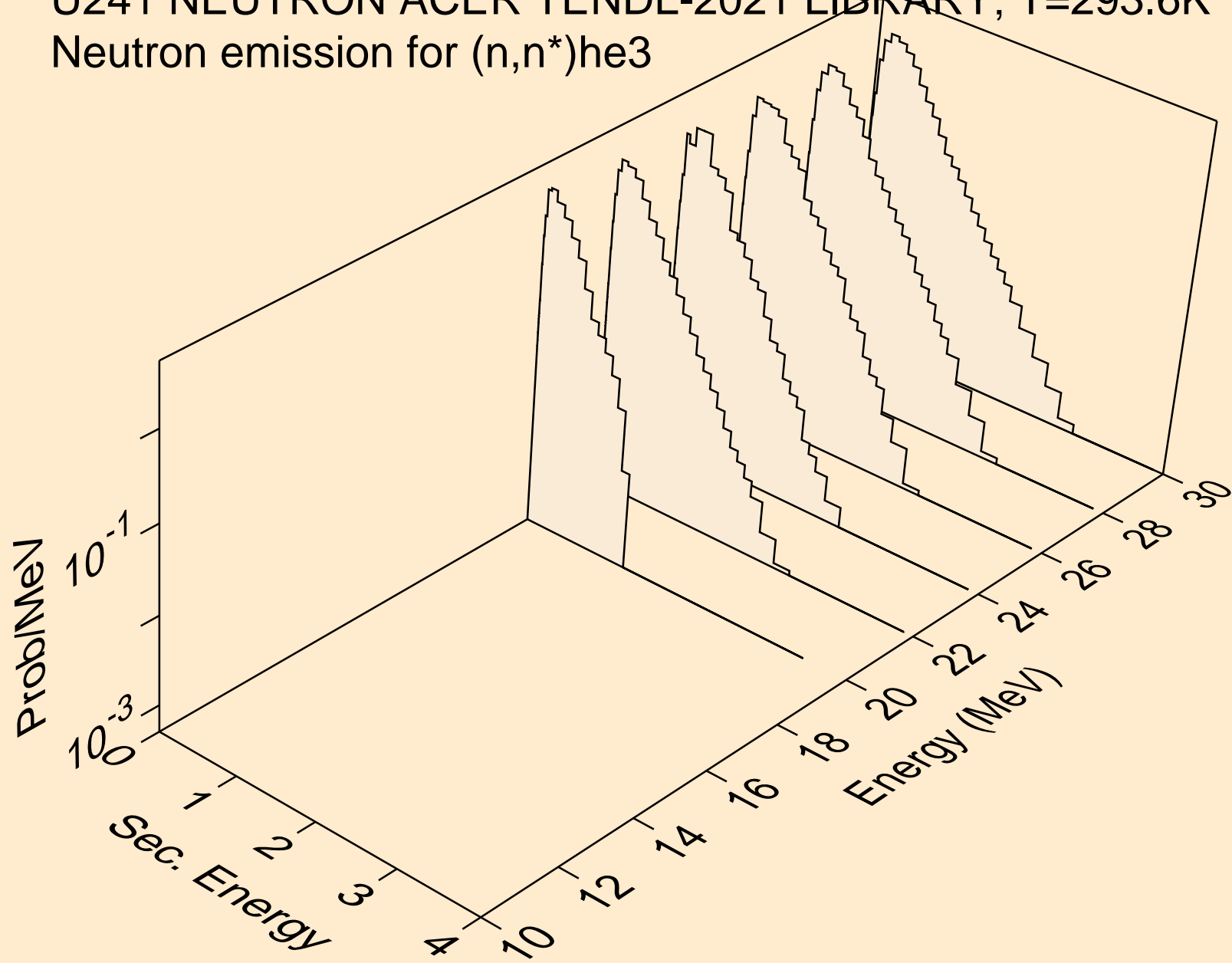

U241 NEUTRON ACER TENDL-2021 LIBRARY; T=293.6K
Neutron emission for (n,4n)

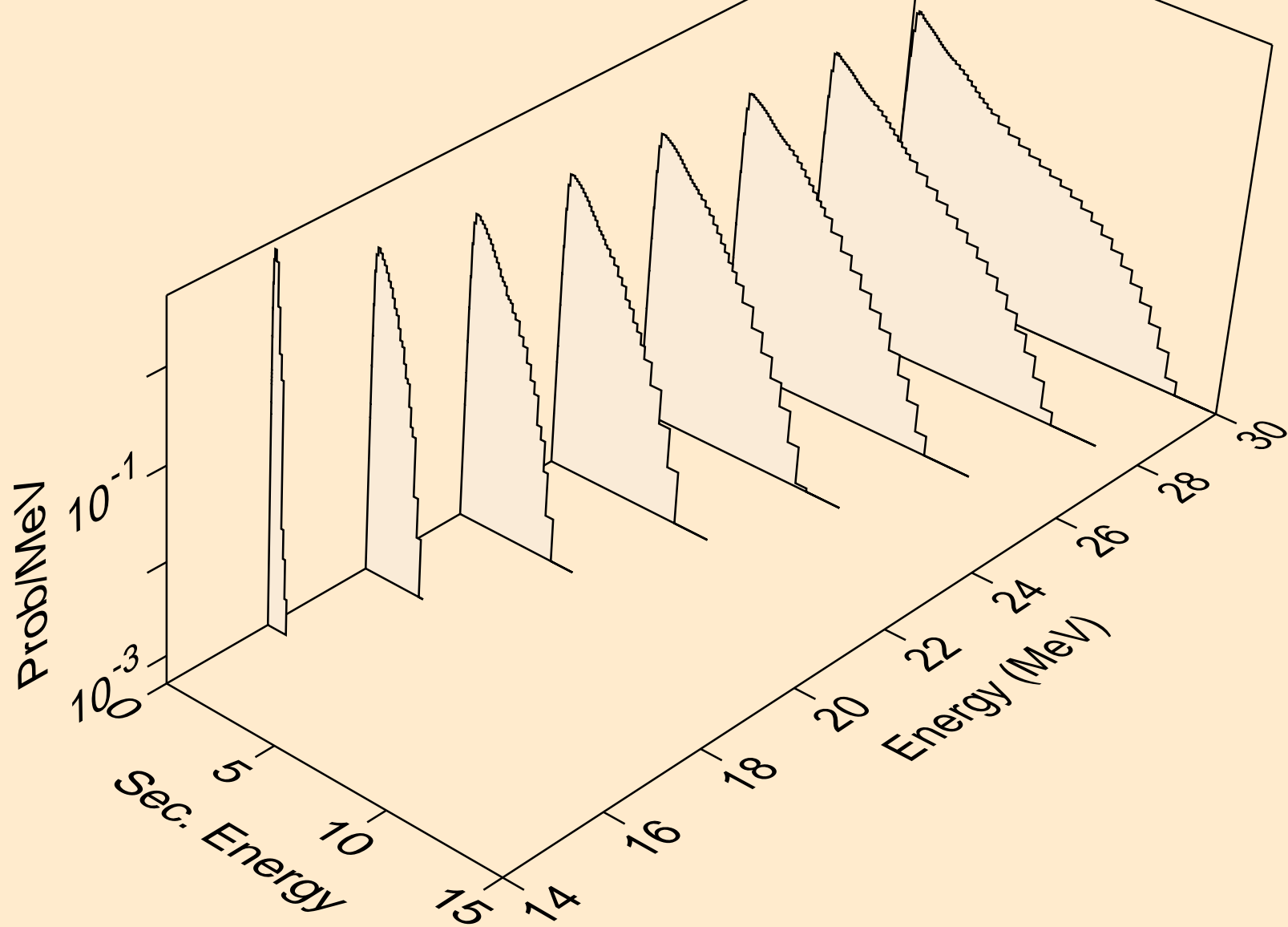

U241 NEUTRON ACER TENDL-2021 LIBRARY; T=293.6K
Neutron emission for (n,2np)

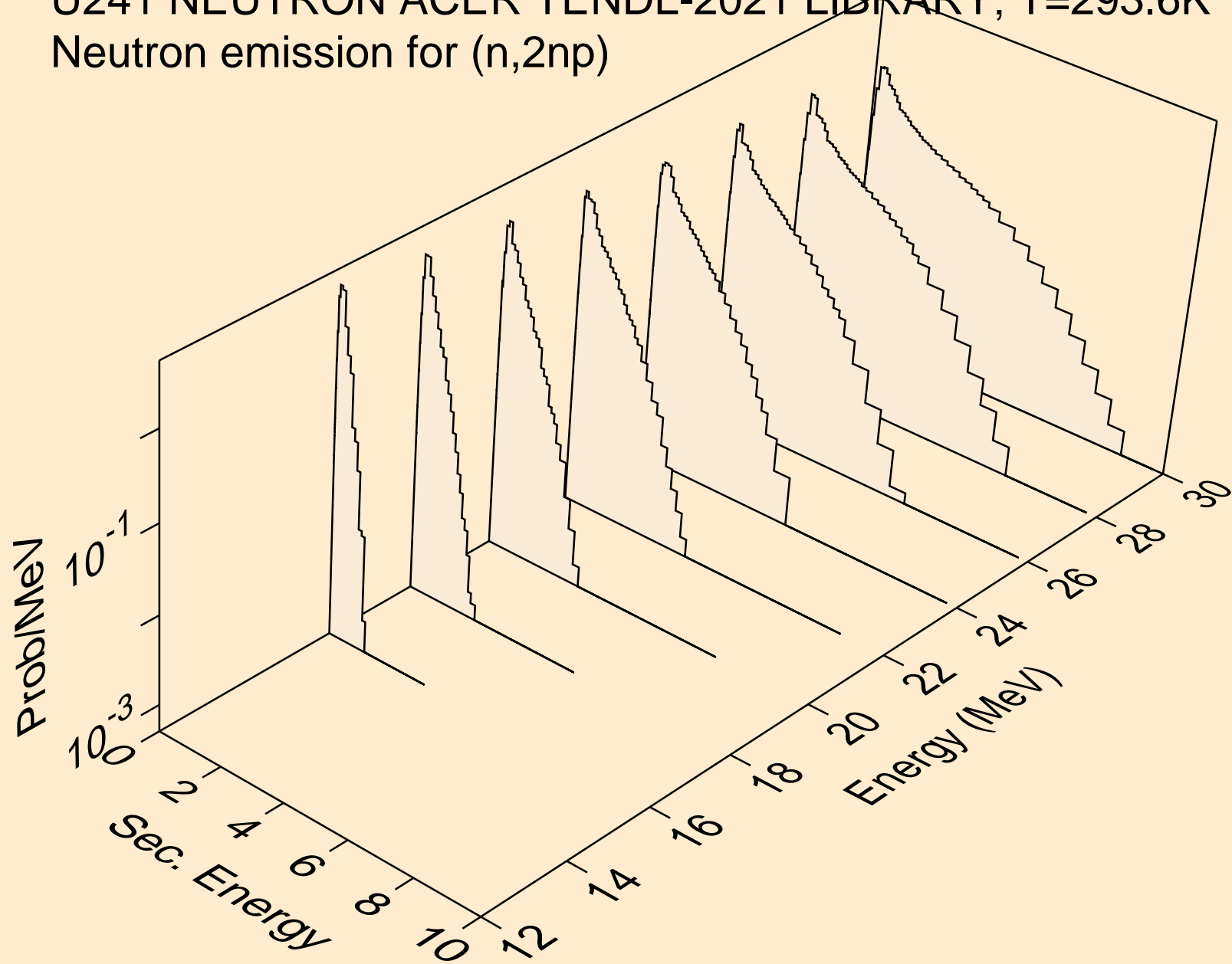

U241 NEUTRON ACER TENDL-2021 LIBRARY; T=293.6K
Neutron emission for (n,3np)

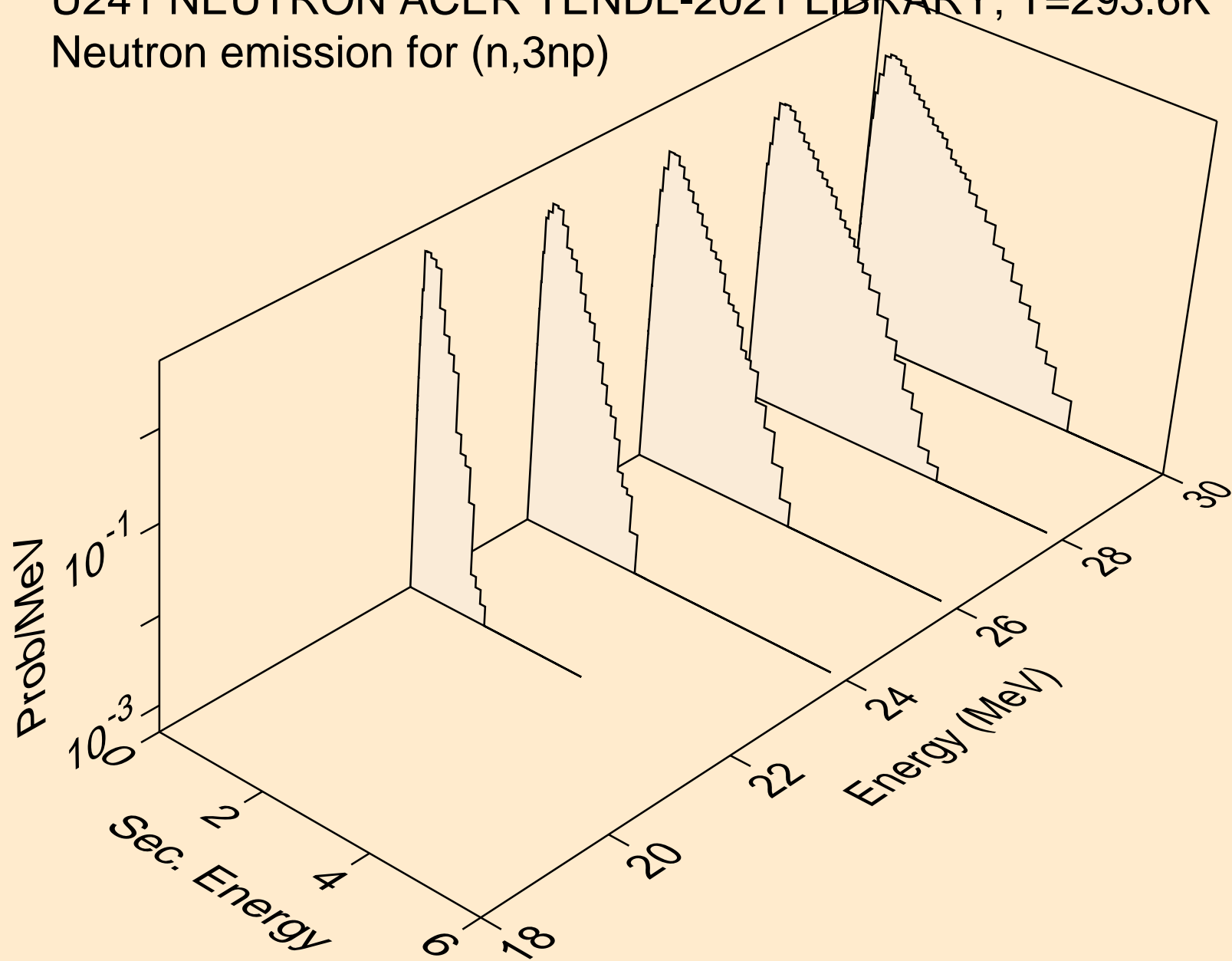

U241 NEUTRON ACER TENDL-2021 LIBRARY; T=293.6K
Neutron emission for (n,npa)

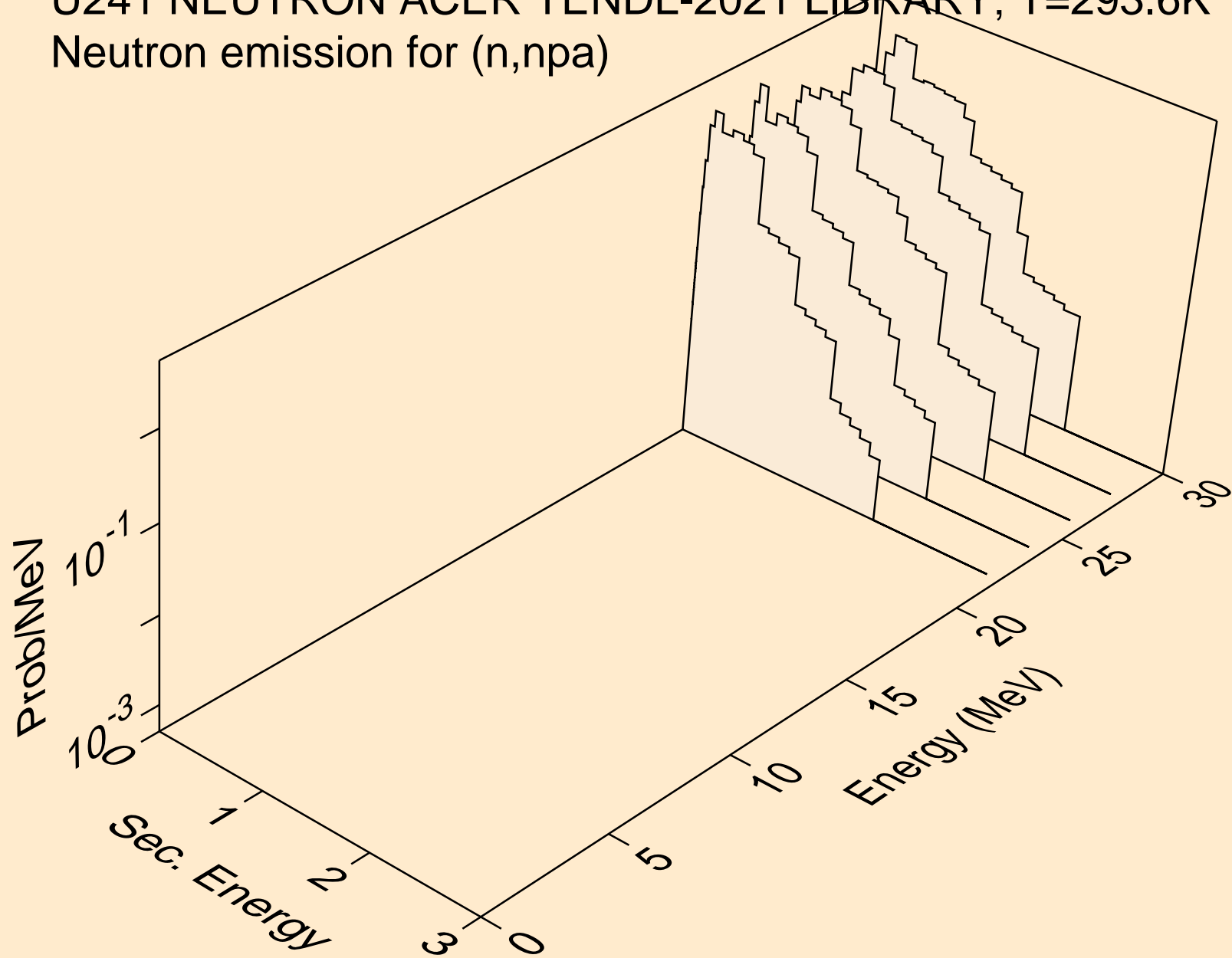

U241 NEUTRON ACER TENDL-2021 LIBRARY; T=293.6K
Neutron emission for (n,n*c)

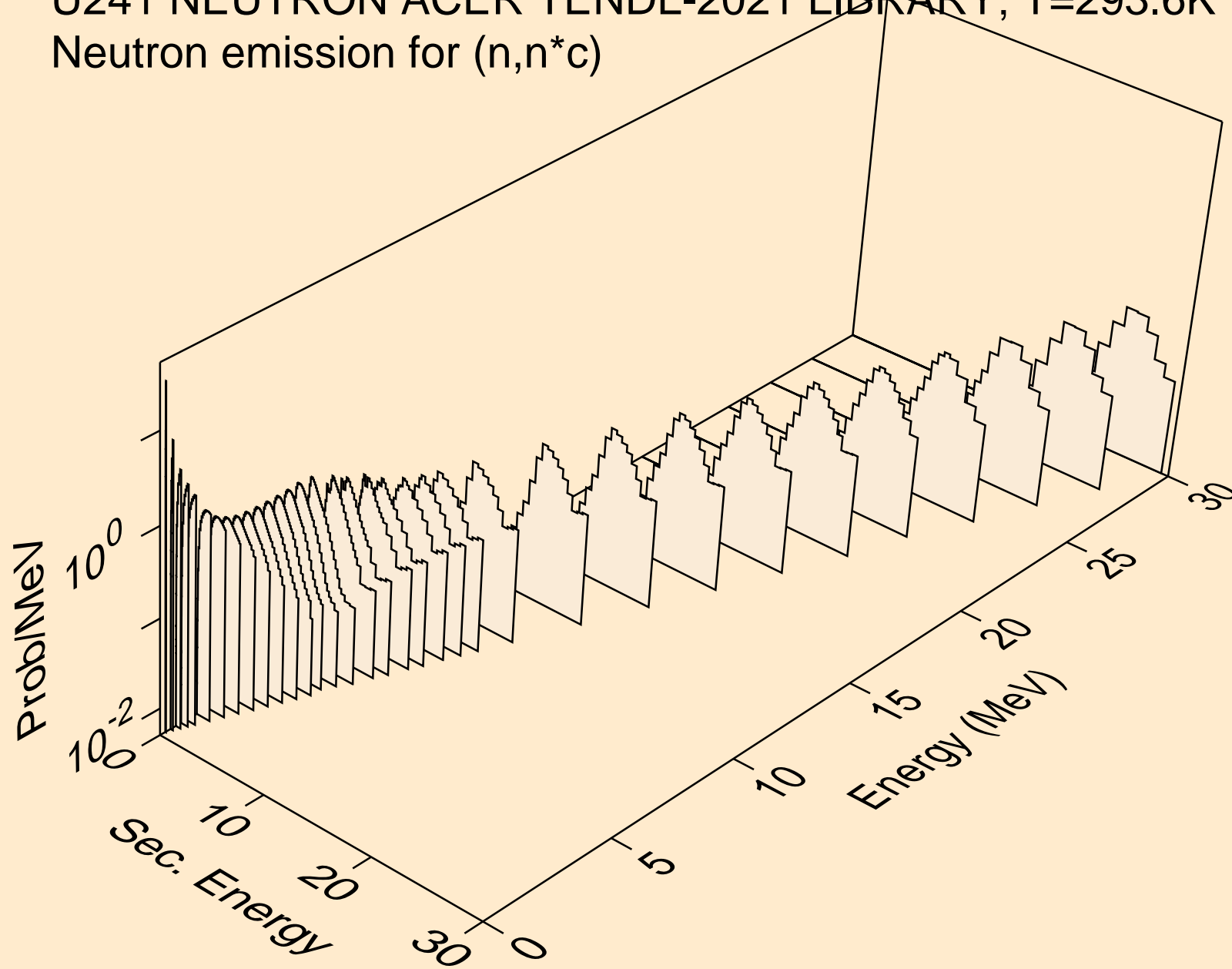

U241 NEUTRON ACER TENDL-2021 LIBRARY; T=293.6K

Delayed nubar

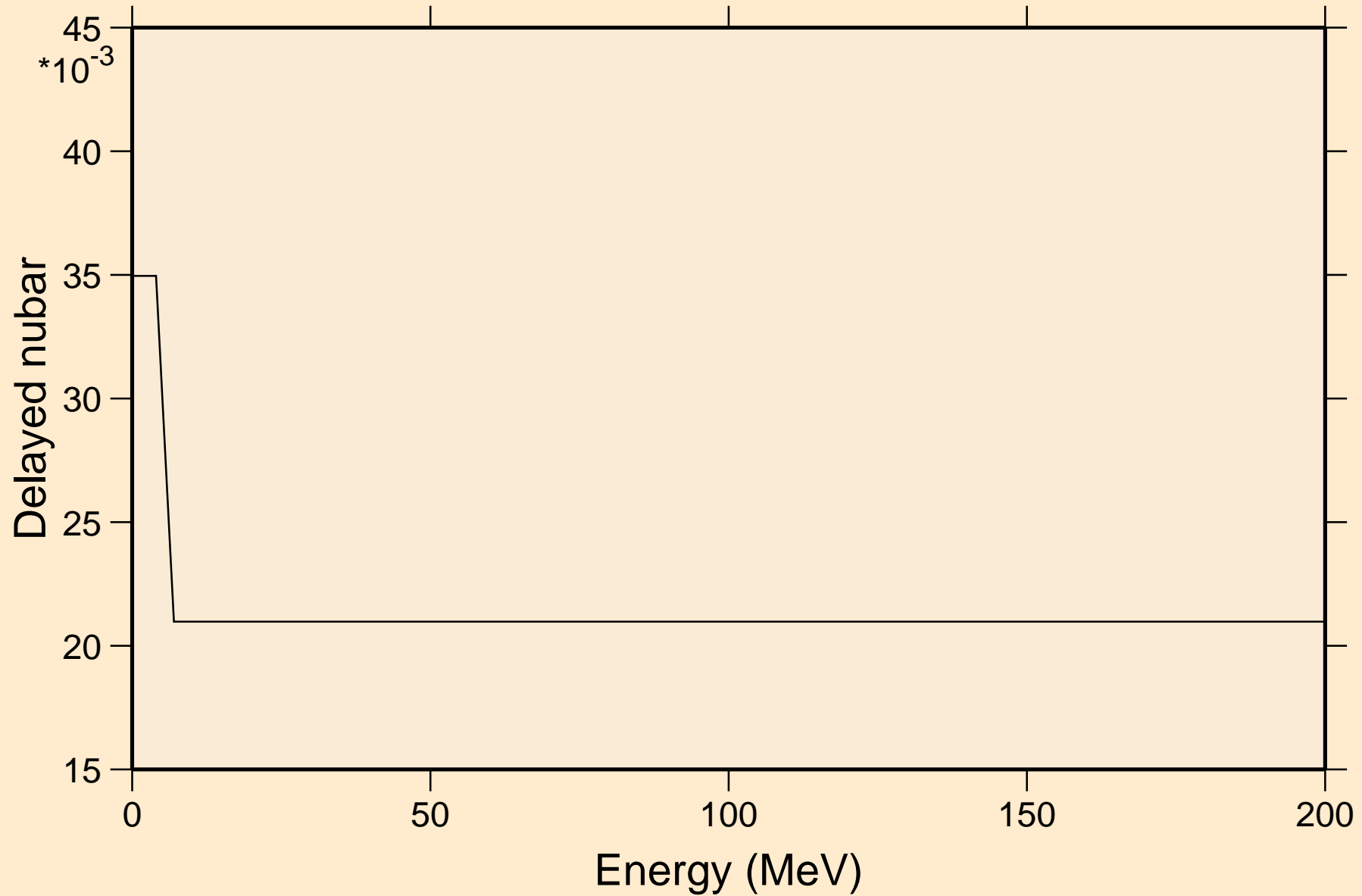

U241 NEUTRON ACER TENDL-2021 LIBRARY; T=293.6K

Delayed neutron spectra

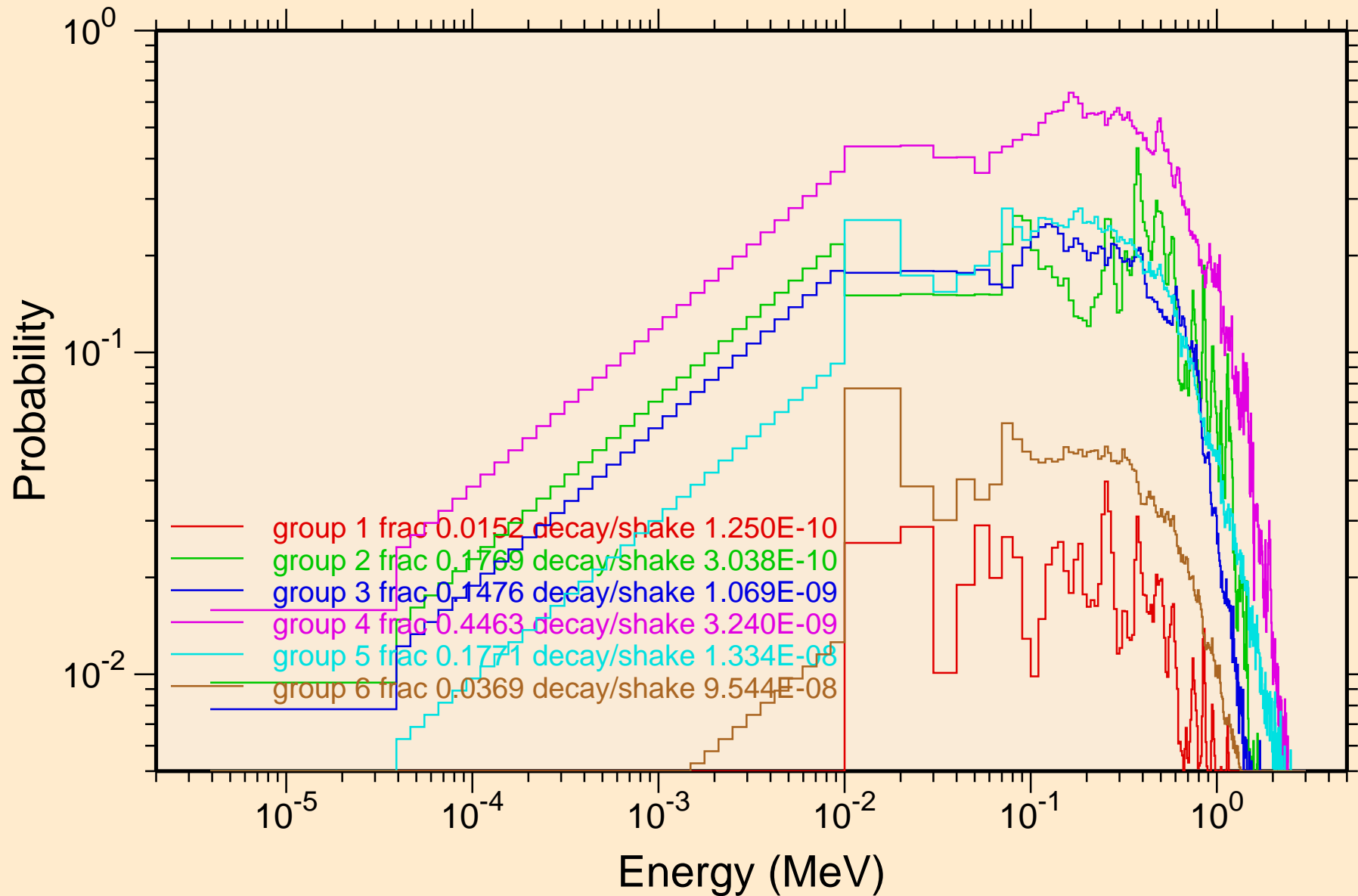

U241 NEUTRON ACER TENDL-2021 LIBRARY; T=293.6K
Photon emission for (n,x)

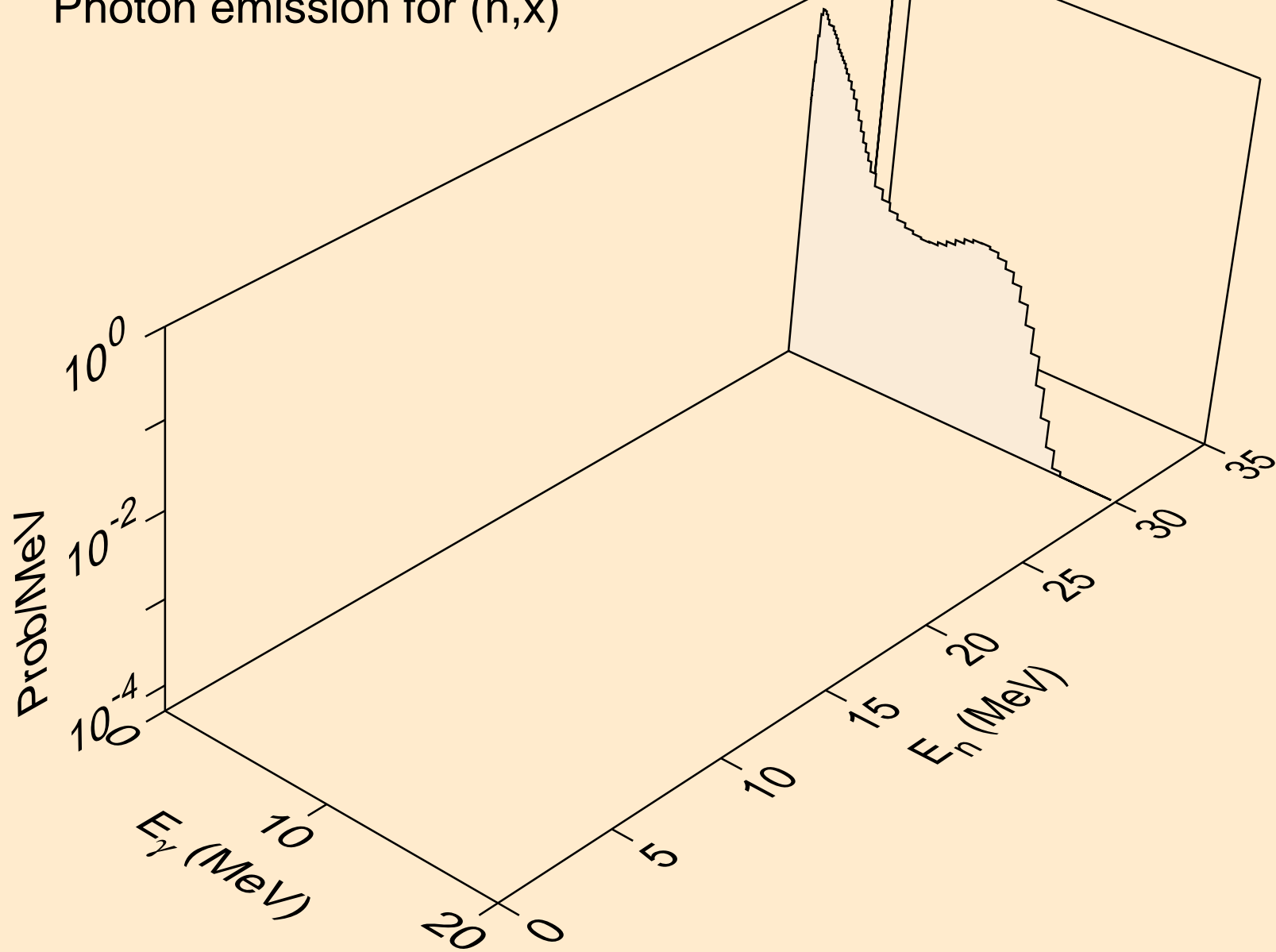

U241 NEUTRON ACER TENDL-2021 LIBRARY; T=293.6K
Photon emission for (n,2nd)

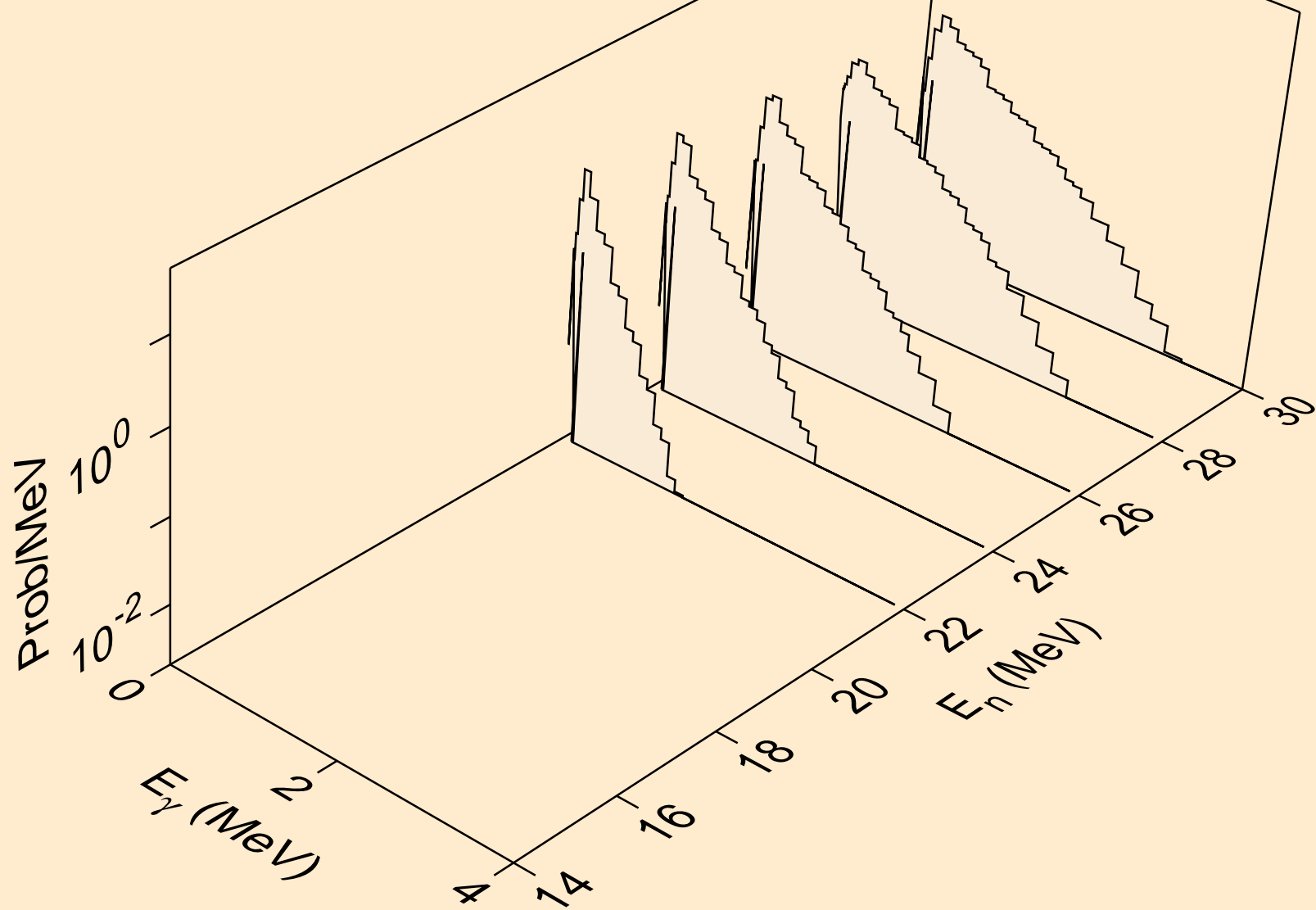

U241 NEUTRON ACER TENDL-2021 LIBRARY; T=293.6K
Photon emission for (n,2n)

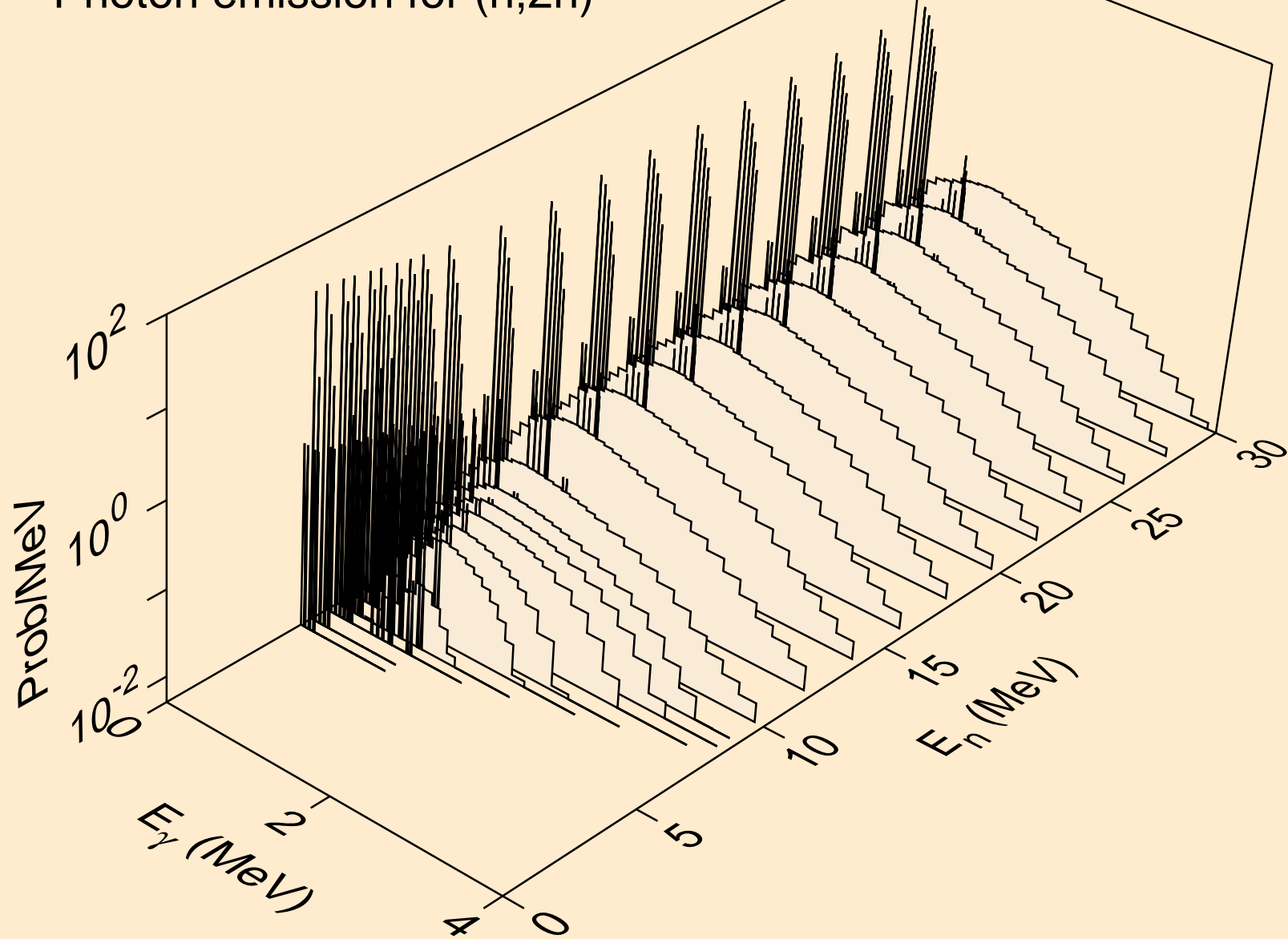

U241 NEUTRON ACER TENDL-2021 LIBRARY; T=293.6K
Photon emission for (n,3n)

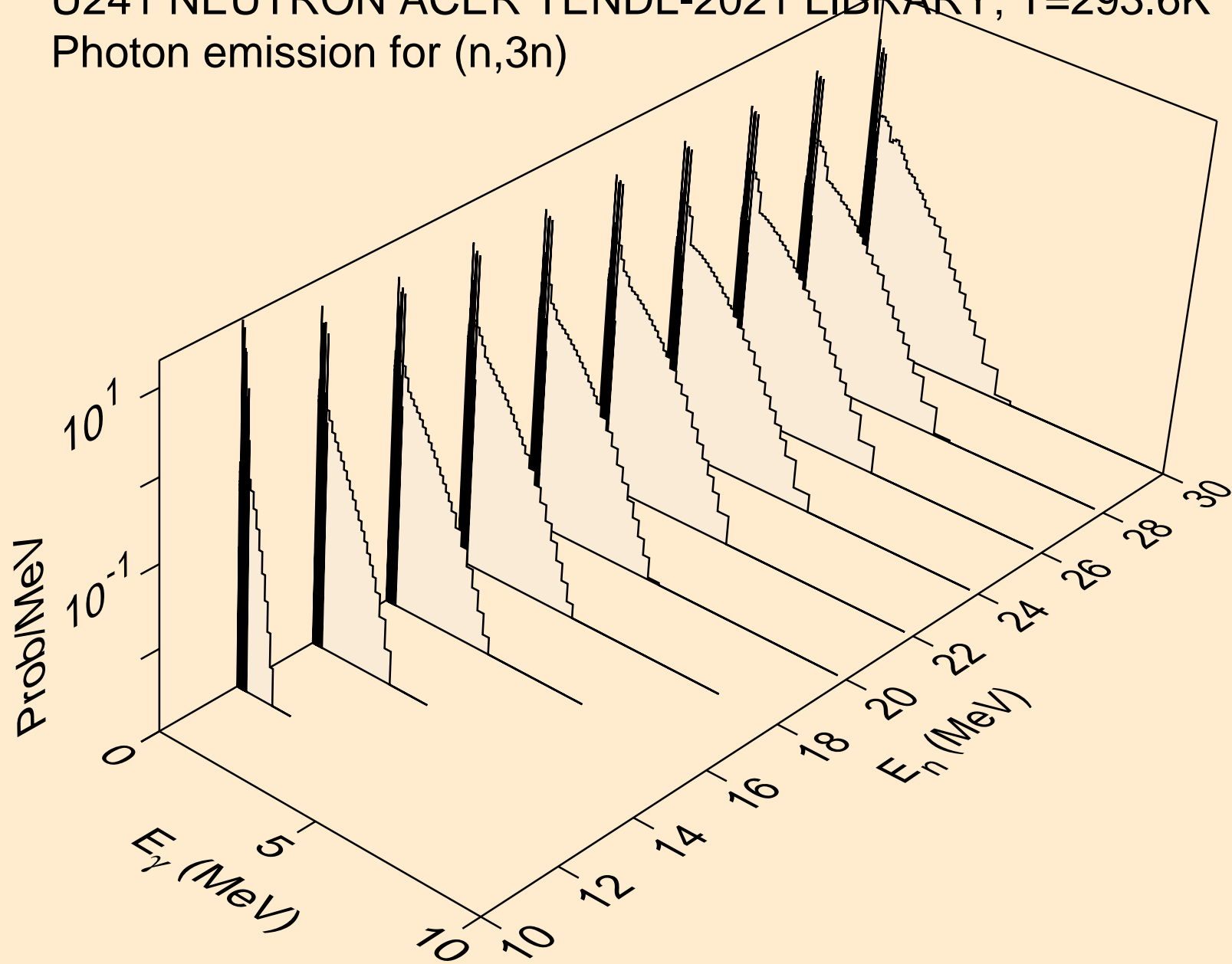

U241 NEUTRON ACER TENDL-2021 LIBRARY; T=293.6K
Photon emission for (n,n*)a

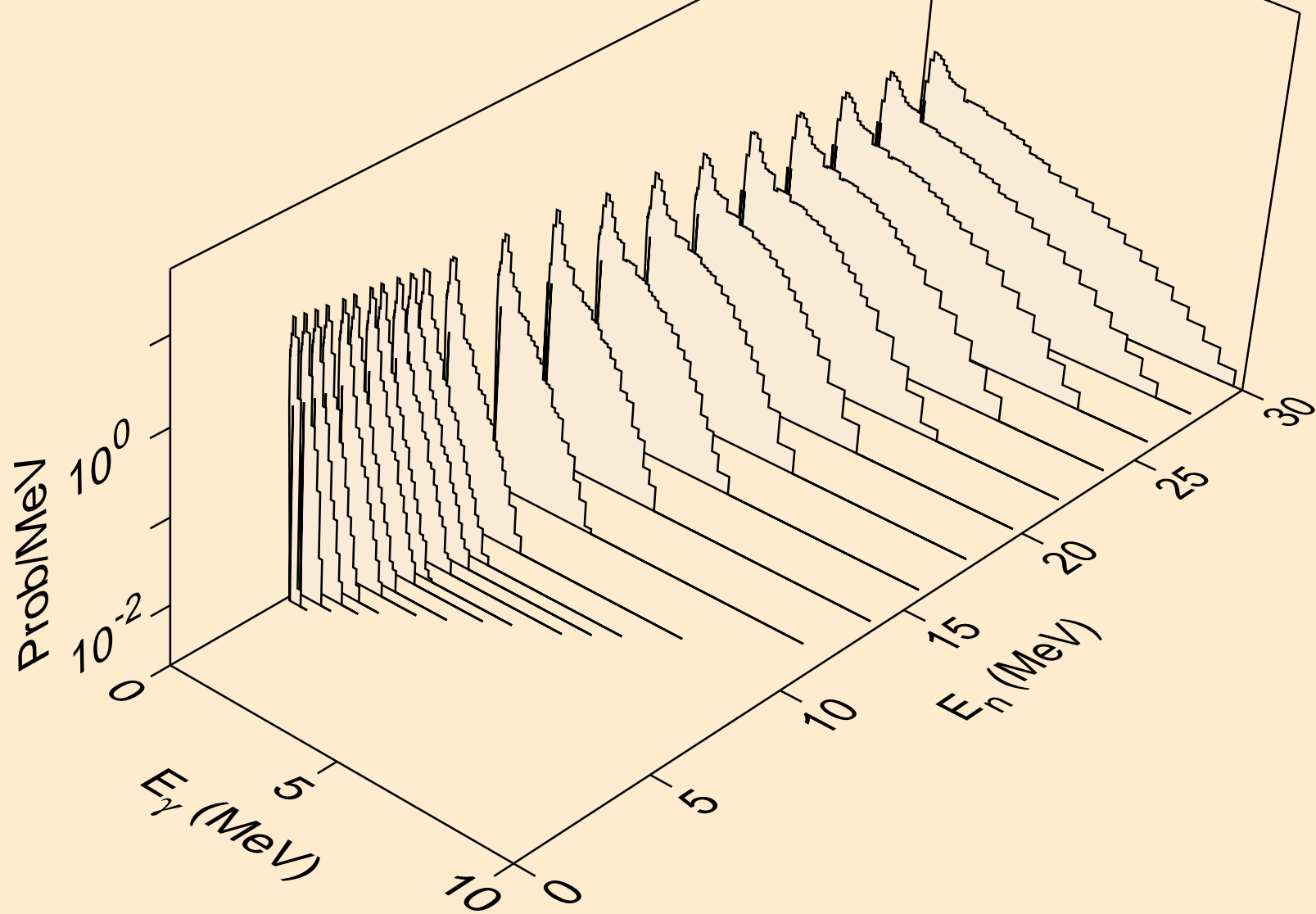

U241 NEUTRON ACER TENDL-2021 LIBRARY; T=293.6K
Photon emission for (n,2n)a

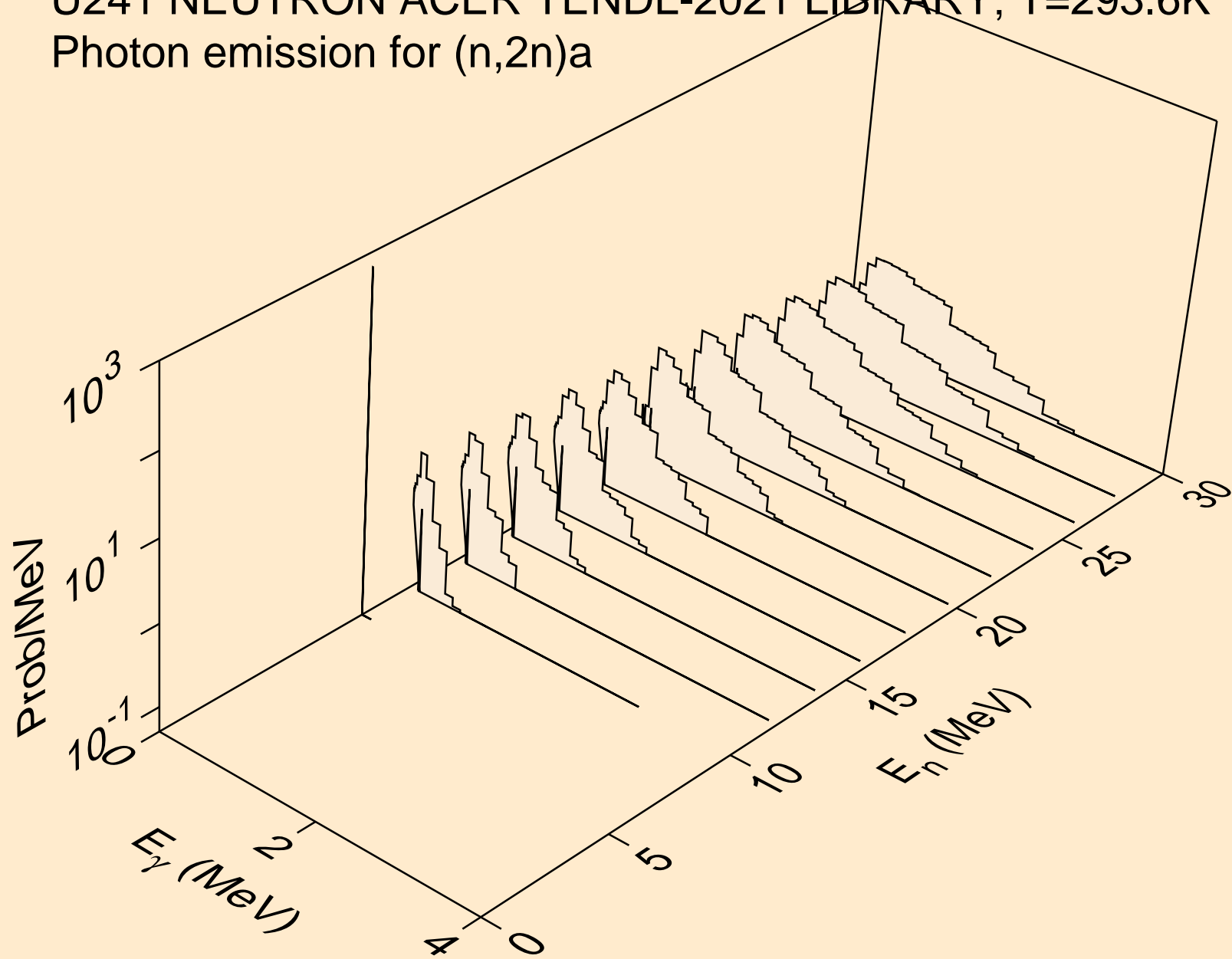

U241 NEUTRON ACER TENDL-2021 LIBRARY; T=293.6K
Photon emission for (n,3n)a

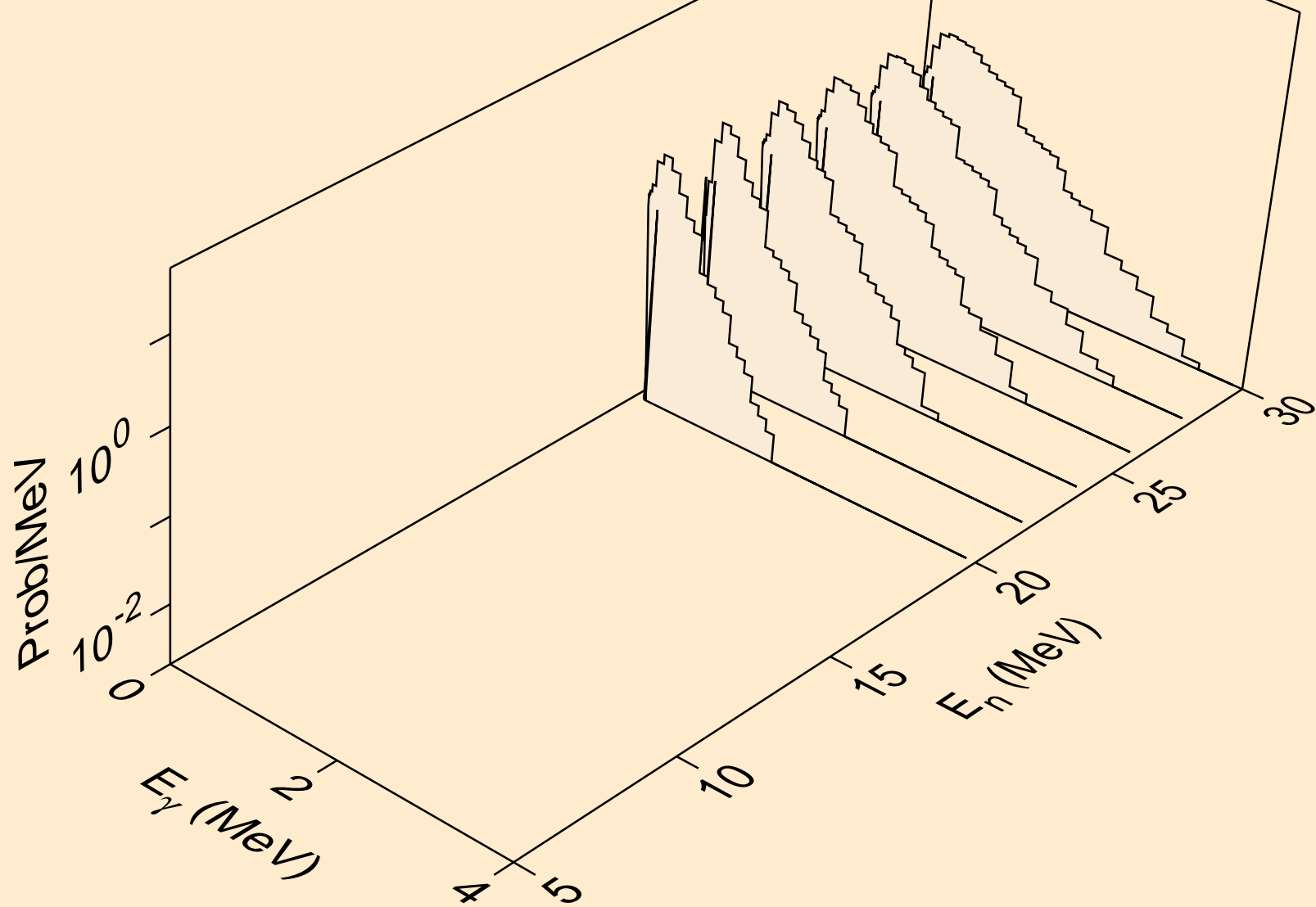

U241 NEUTRON ACER TENDL-2021 LIBRARY; T=293.6K
Photon emission for (n,n*)p

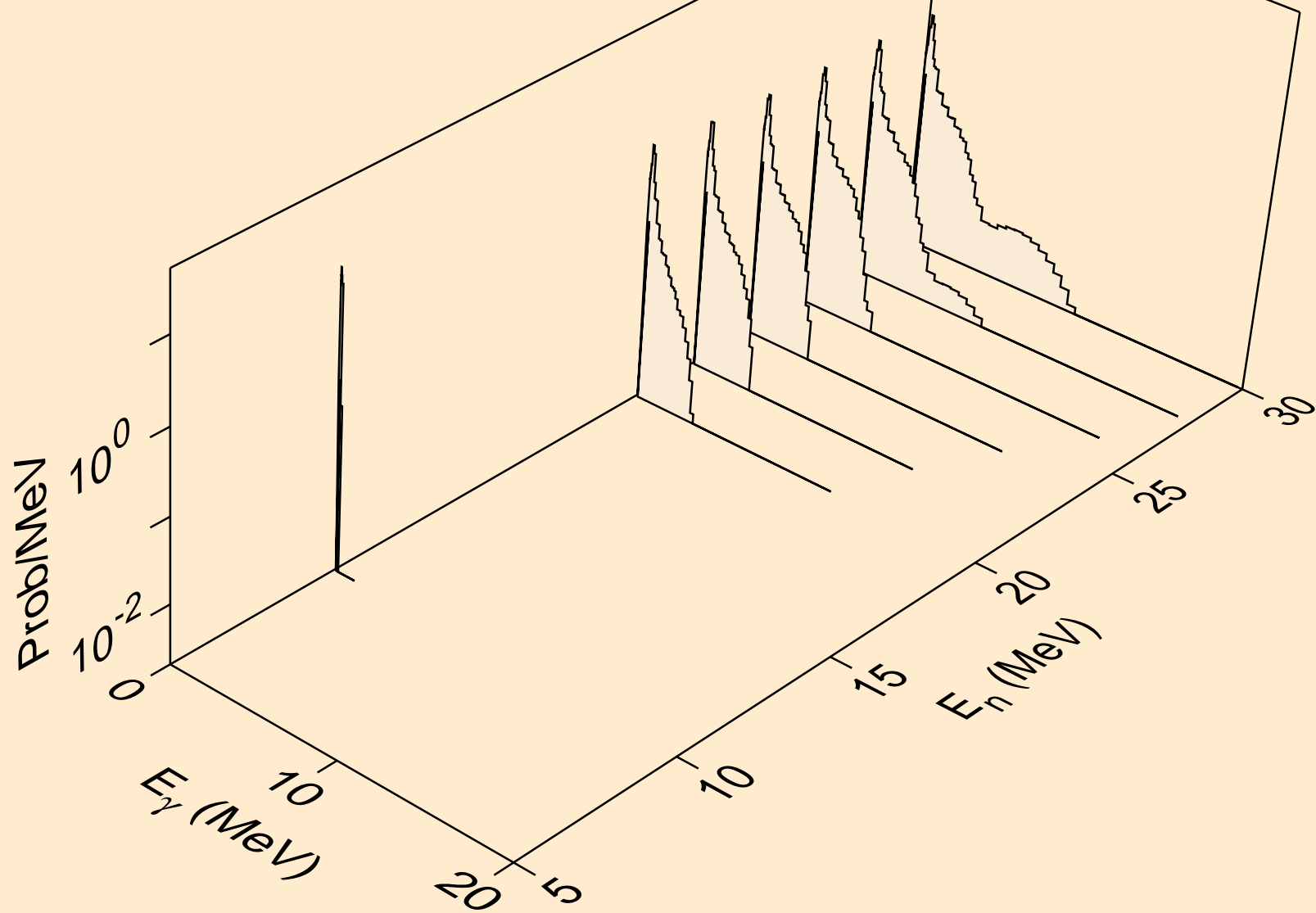

U241 NEUTRON ACER TENDL-2021 LIBRARY; T=293.6K
Photon emission for (n,n*)2a

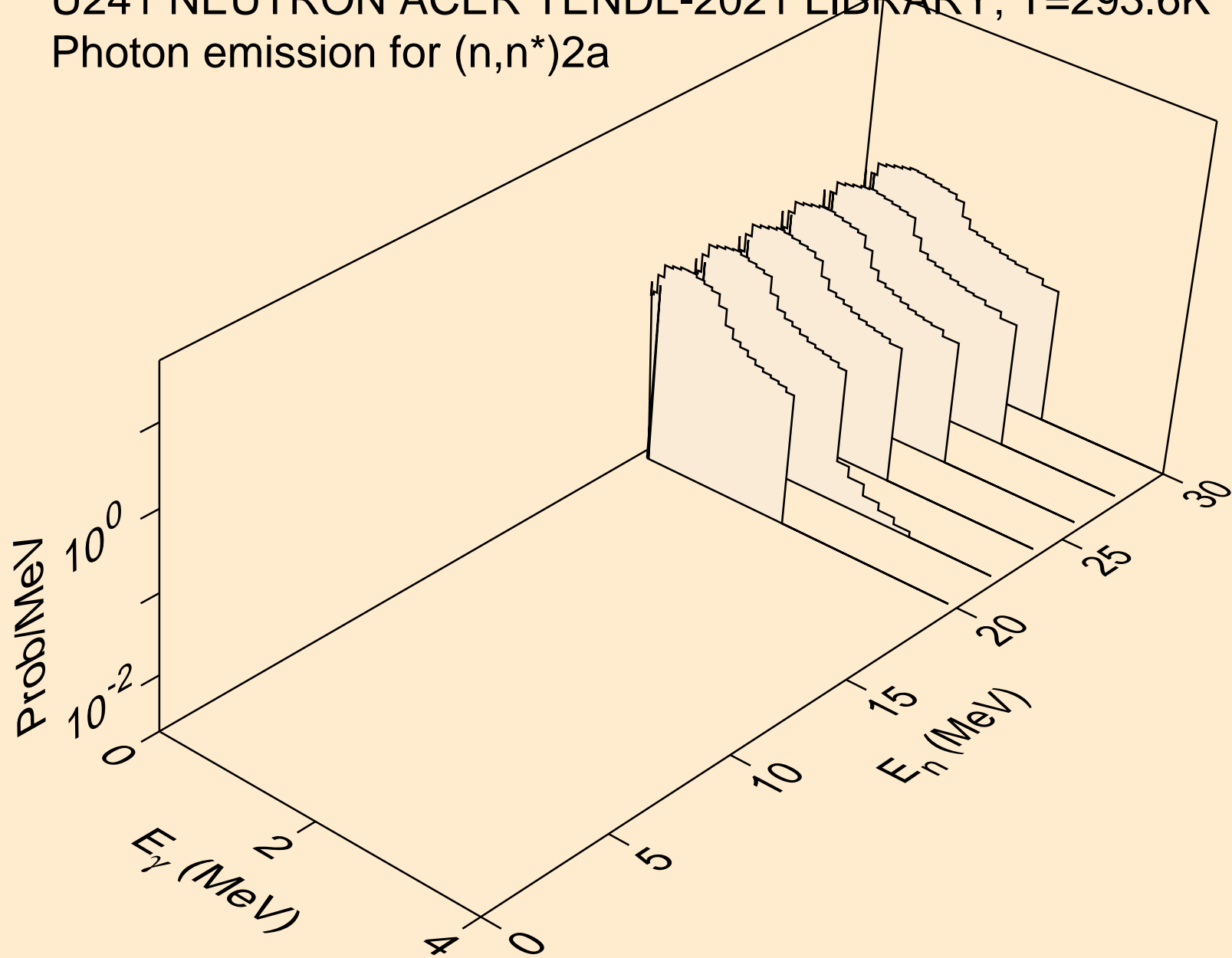

U241 NEUTRON ACER TENDL-2021 LIBRARY; T=293.6K
Photon emission for (n,n*)d

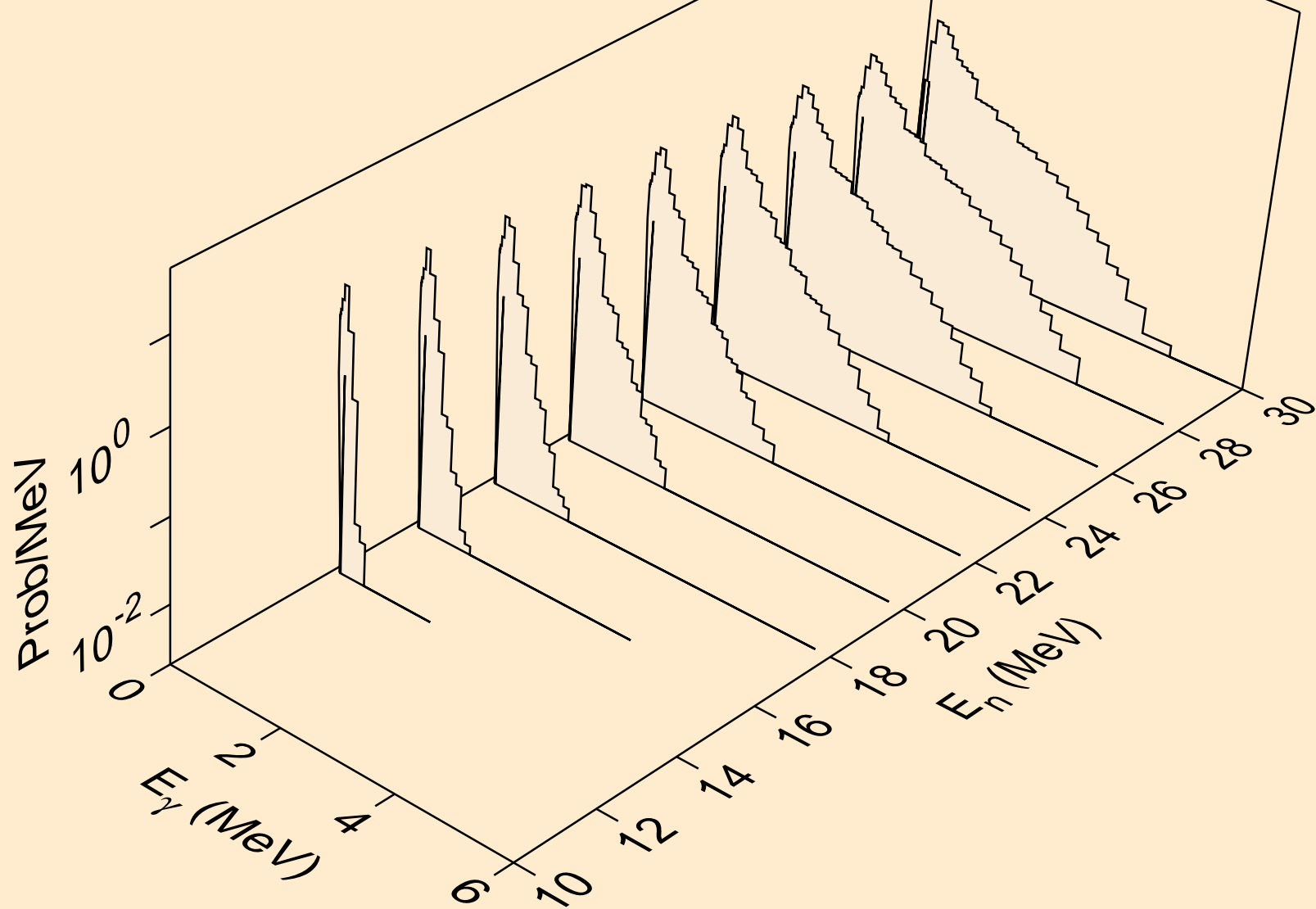

U241 NEUTRON ACER TENDL-2021 LIBRARY; T=293.6K
Photon emission for (n,n*)t

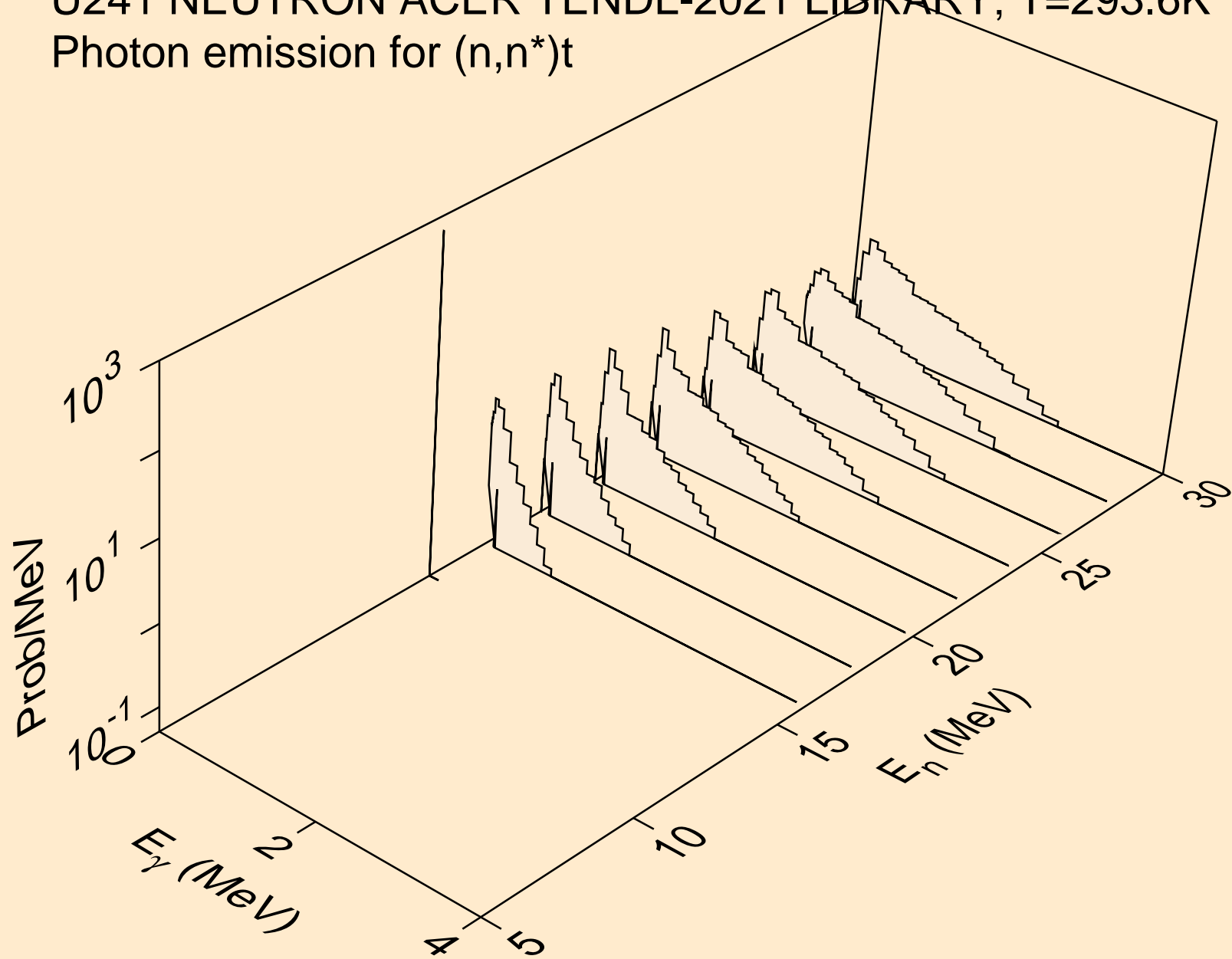

U241 NEUTRON ACER TENDL-2021 LIBRARY; T=293.6K
Photon emission for (n,n*)he3

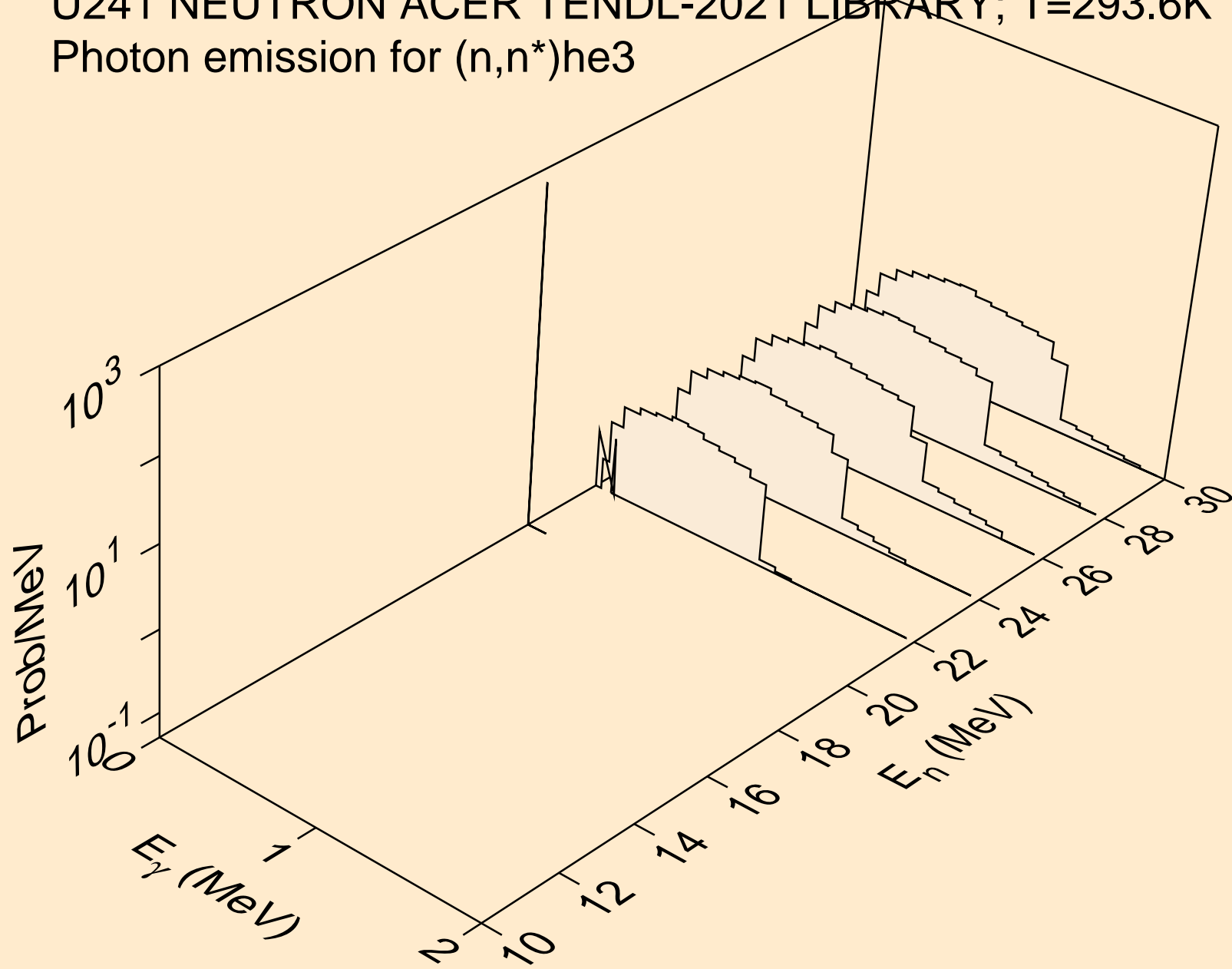

U241 NEUTRON ACER TENDL-2021 LIBRARY; T=293.6K
Photon emission for (n,4n)

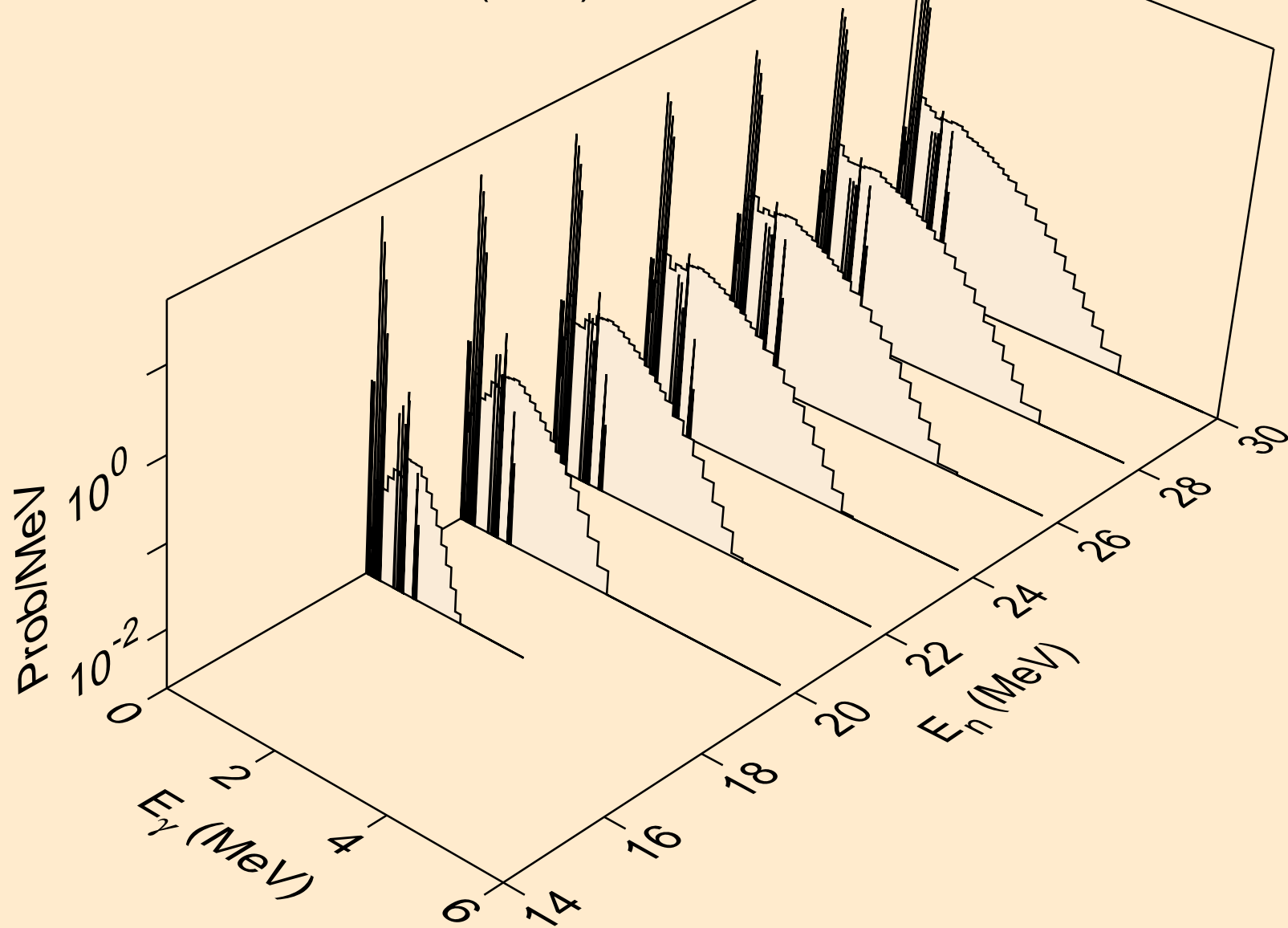

U241 NEUTRON ACER TENDL-2021 LIBRARY; T=293.6K
Photon emission for (n,2np)

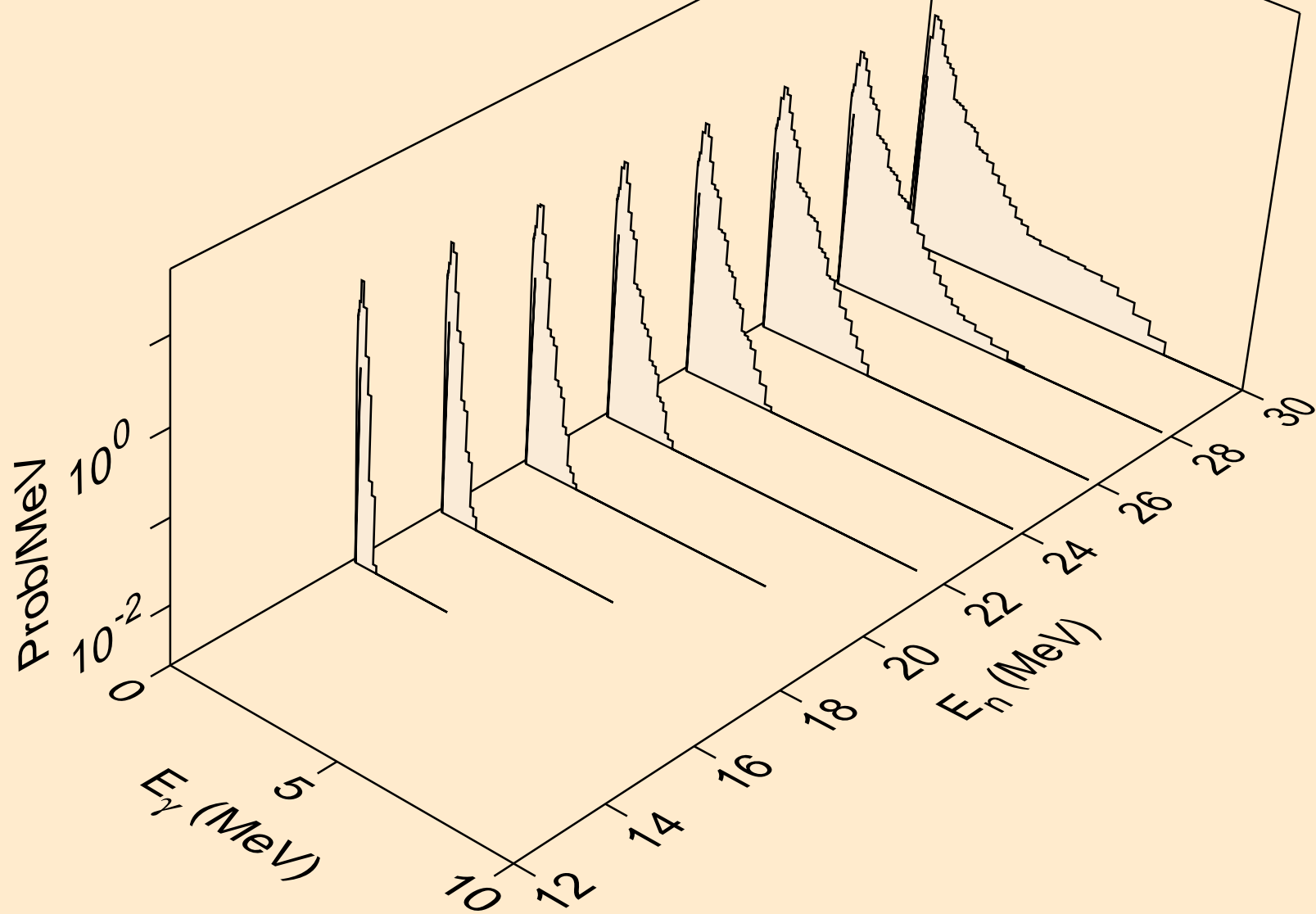

U241 NEUTRON ACER TENDL-2021 LIBRARY; T=293.6K
Photon emission for (n,3np)

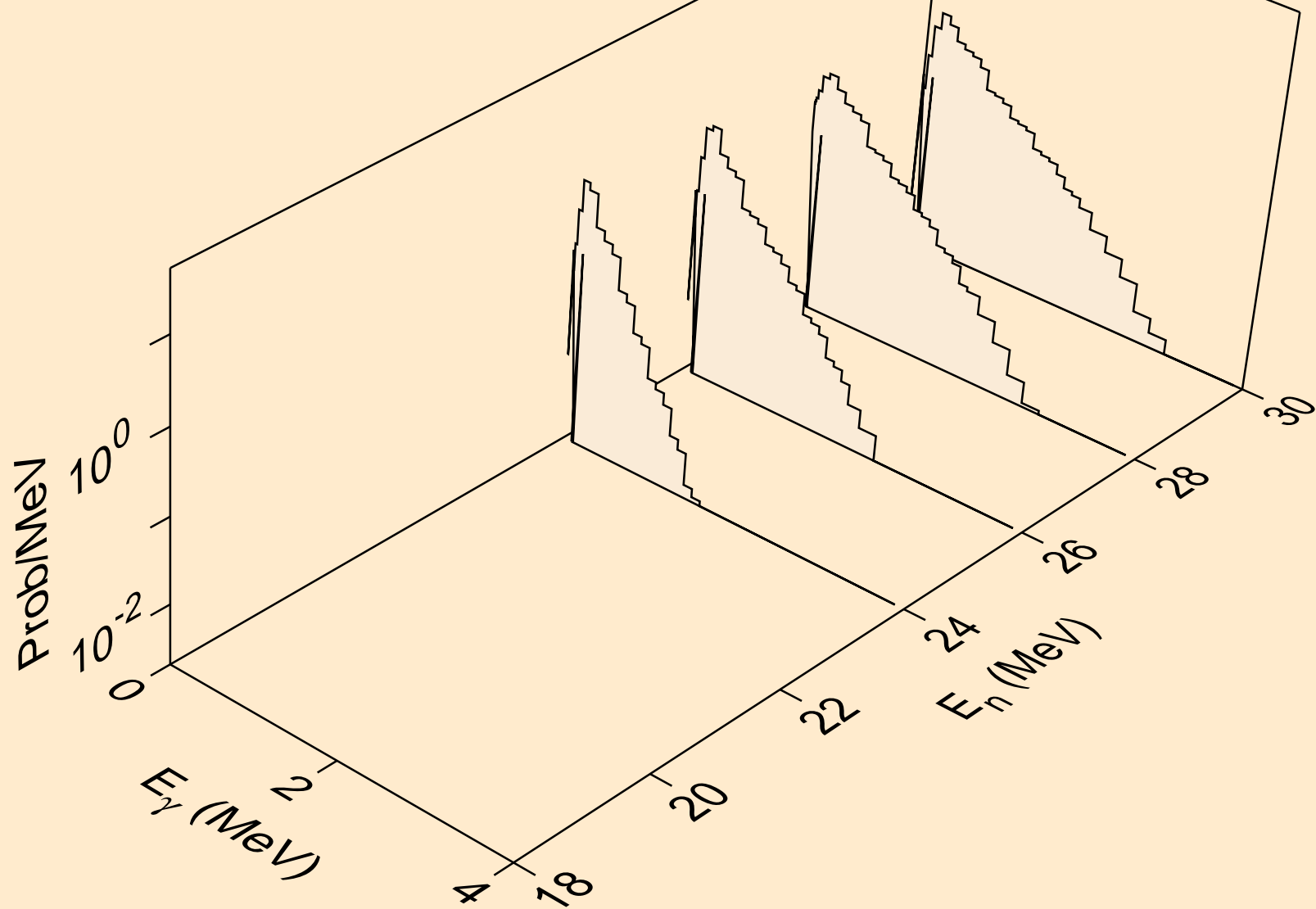

U241 NEUTRON ACER TENDL-2021 LIBRARY; T=293.6K
Photon emission for (n,npa)

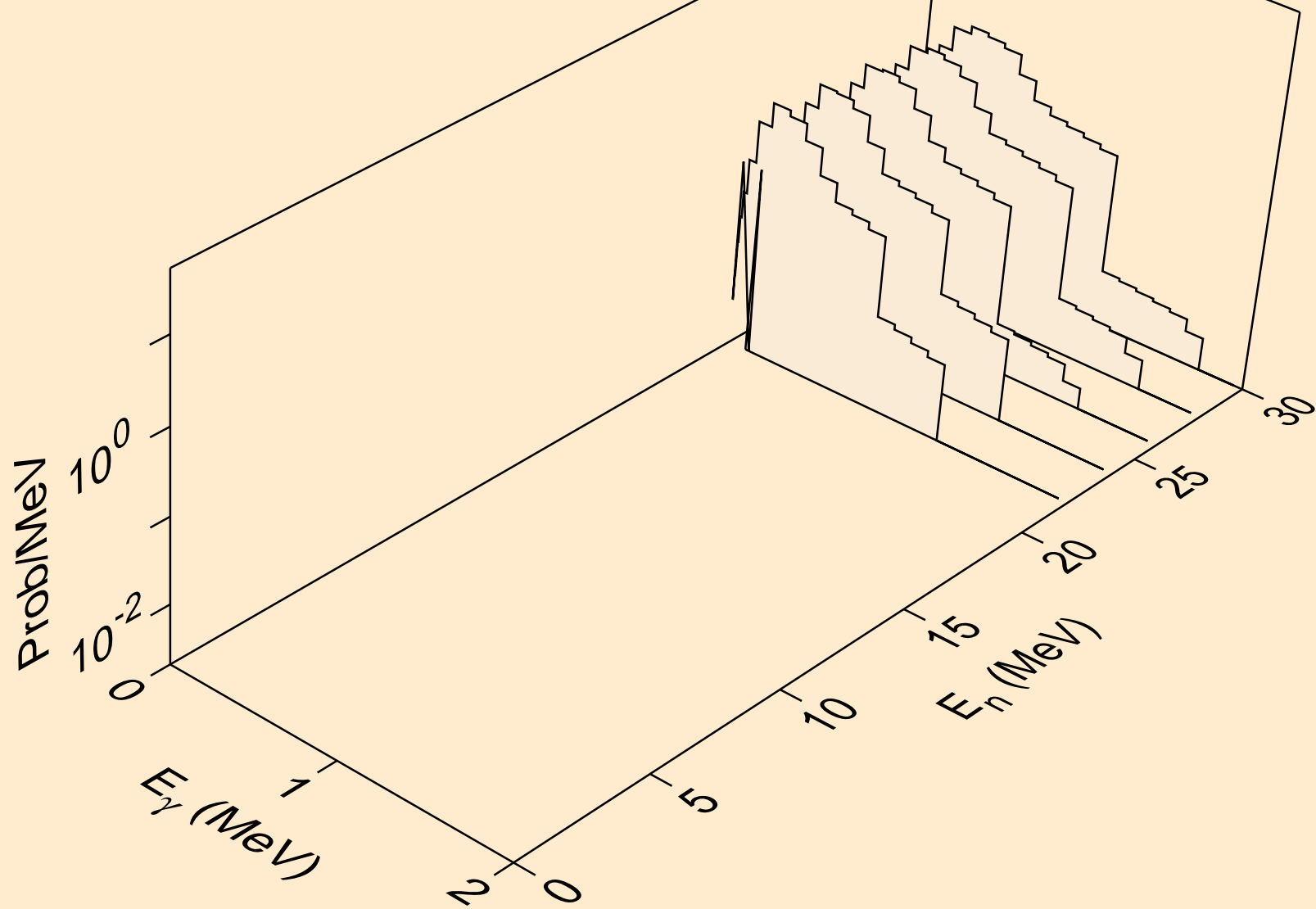

U241 NEUTRON ACER TENDL-2021 LIBRARY; T=293.6K
Photon emission for (n,n*c)

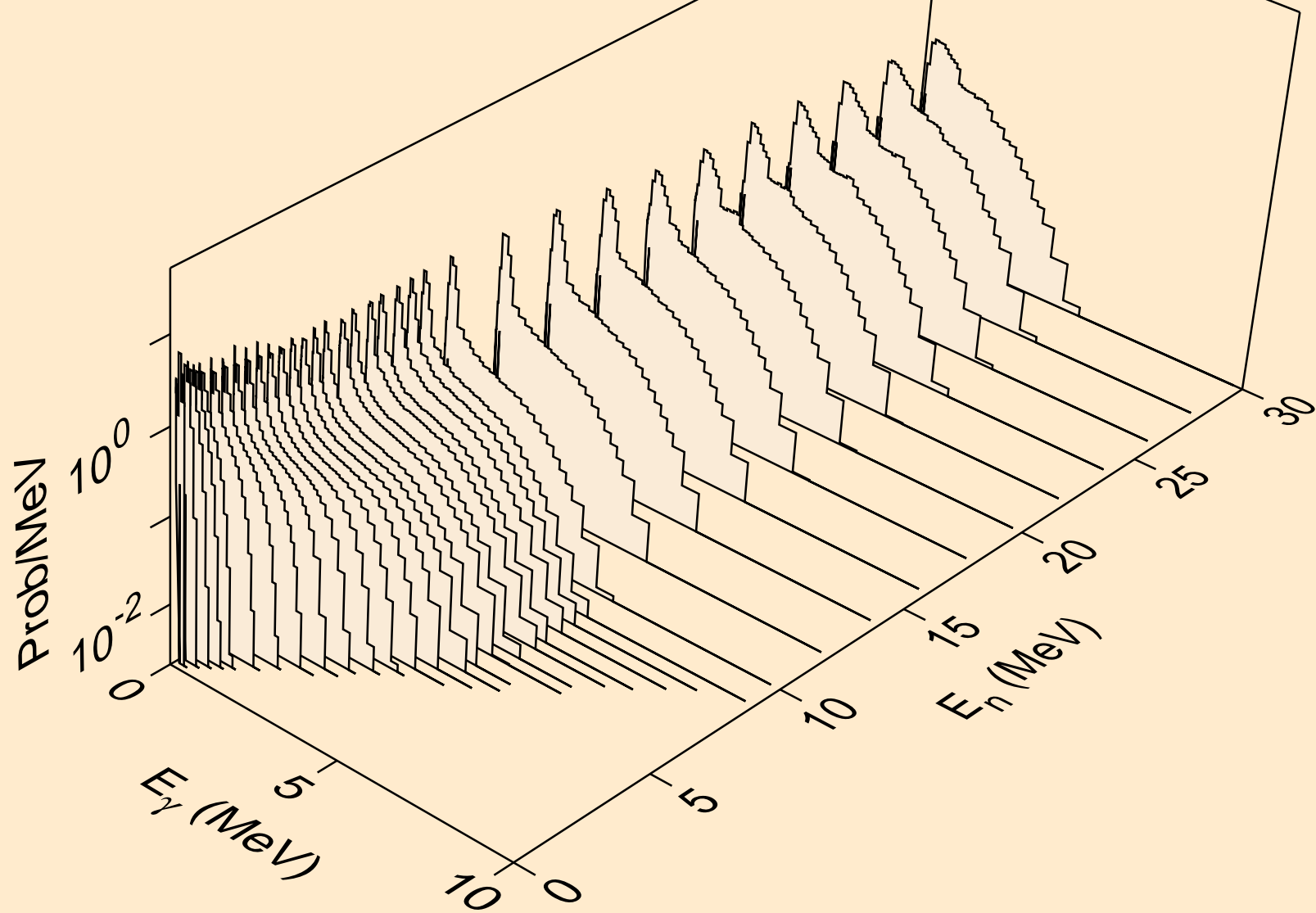

U241 NEUTRON ACER TENDL-2021 LIBRARY; T=293.6K
Photon emission for (n,gma)

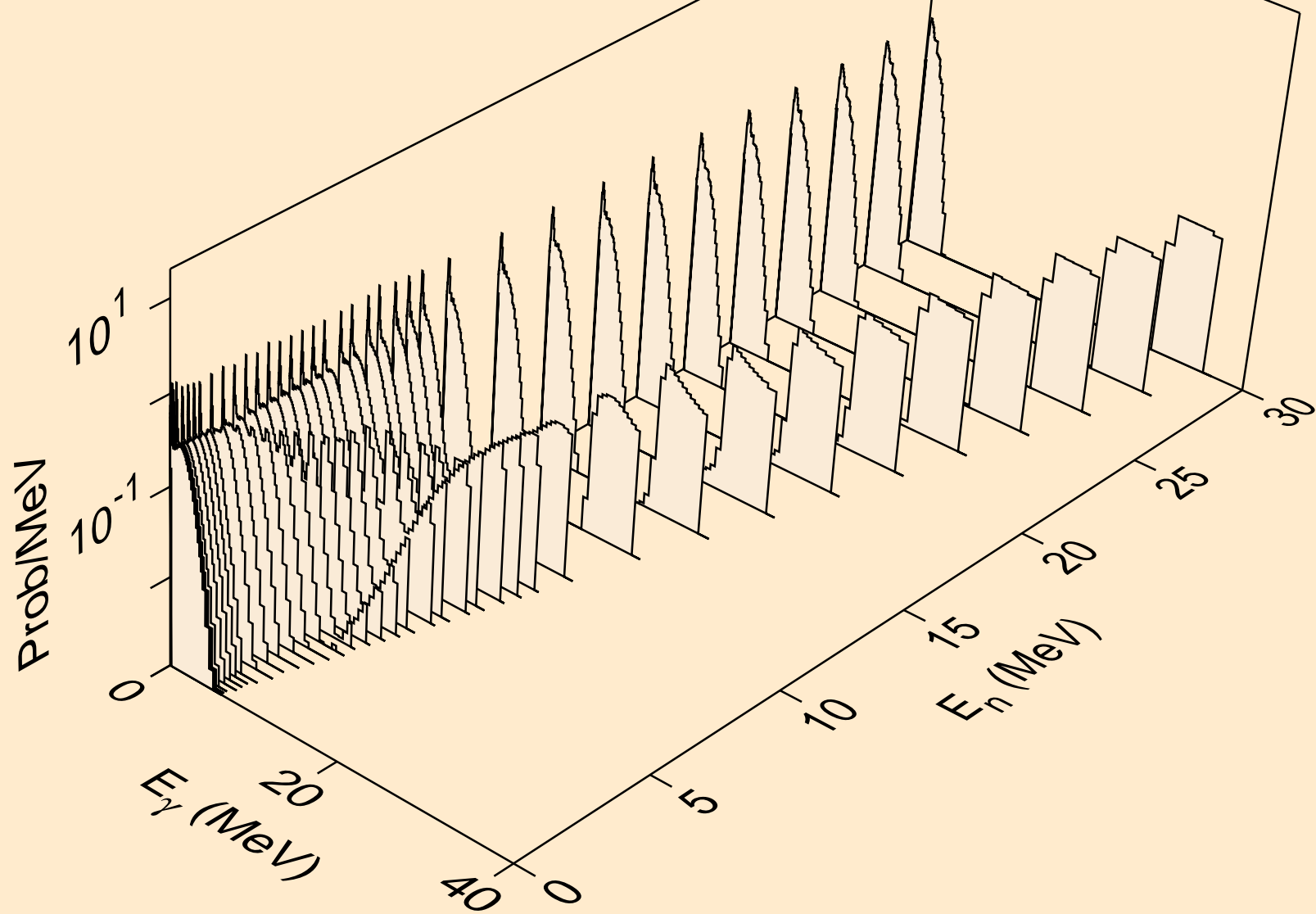

U241 NEUTRON ACER TENDL-2021 LIBRARY; T=293.6K
Photon emission for (n,p)

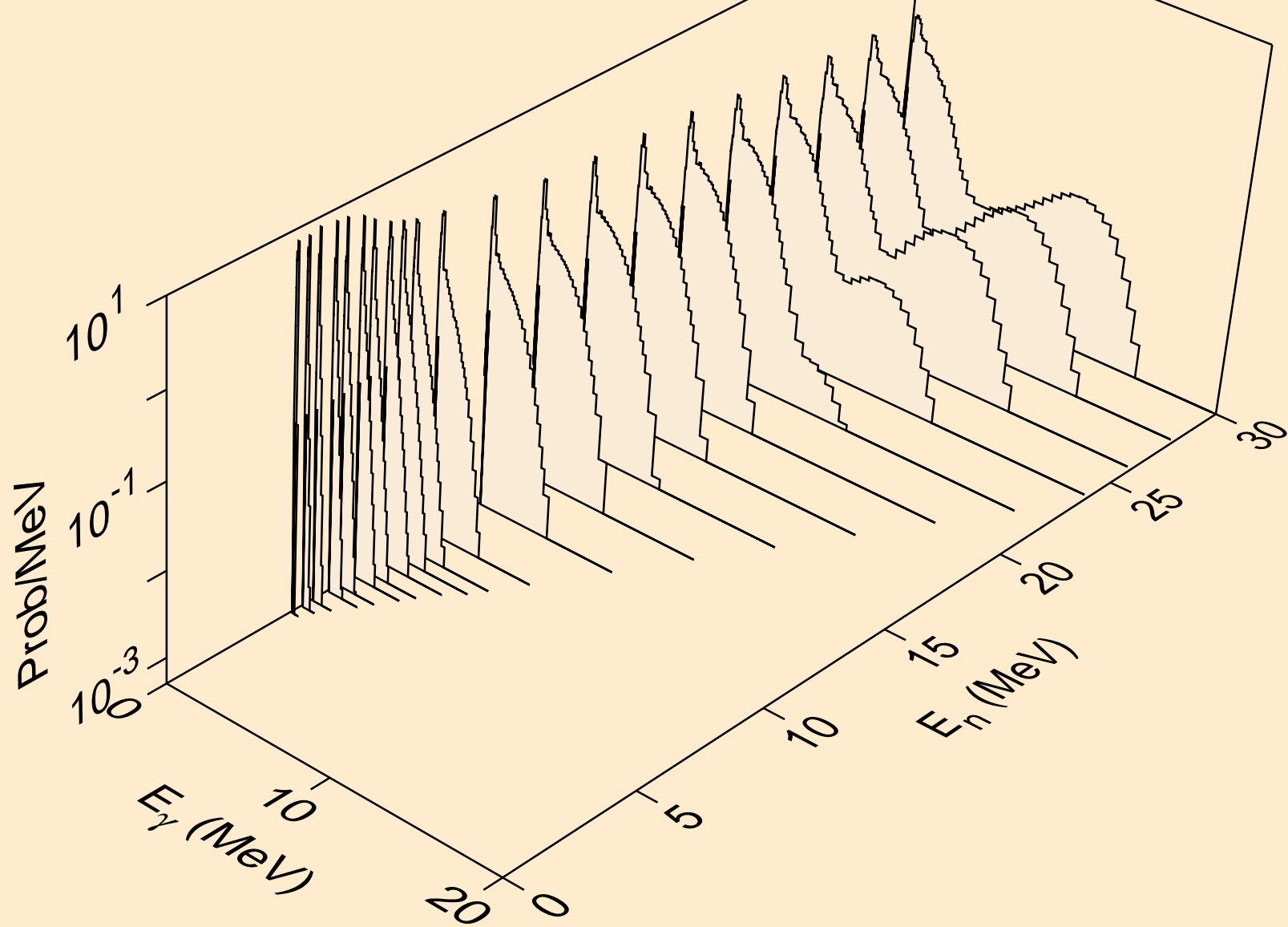

U241 NEUTRON ACER TENDL-2021 LIBRARY; T=293.6K
Photon emission for (n,d)

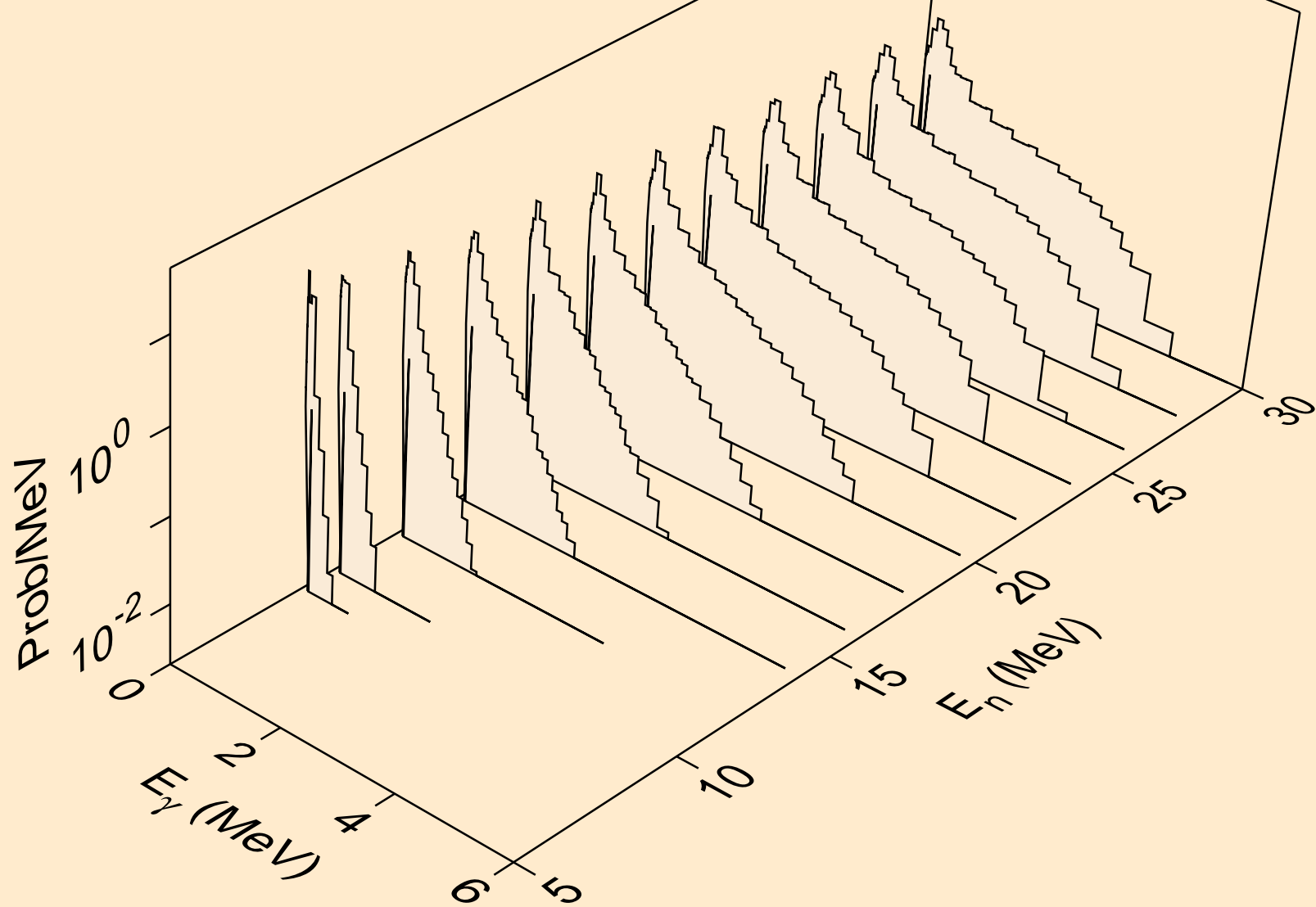

U241 NEUTRON ACER TENDL-2021 LIBRARY; T=293.6K
Photon emission for (n,t)

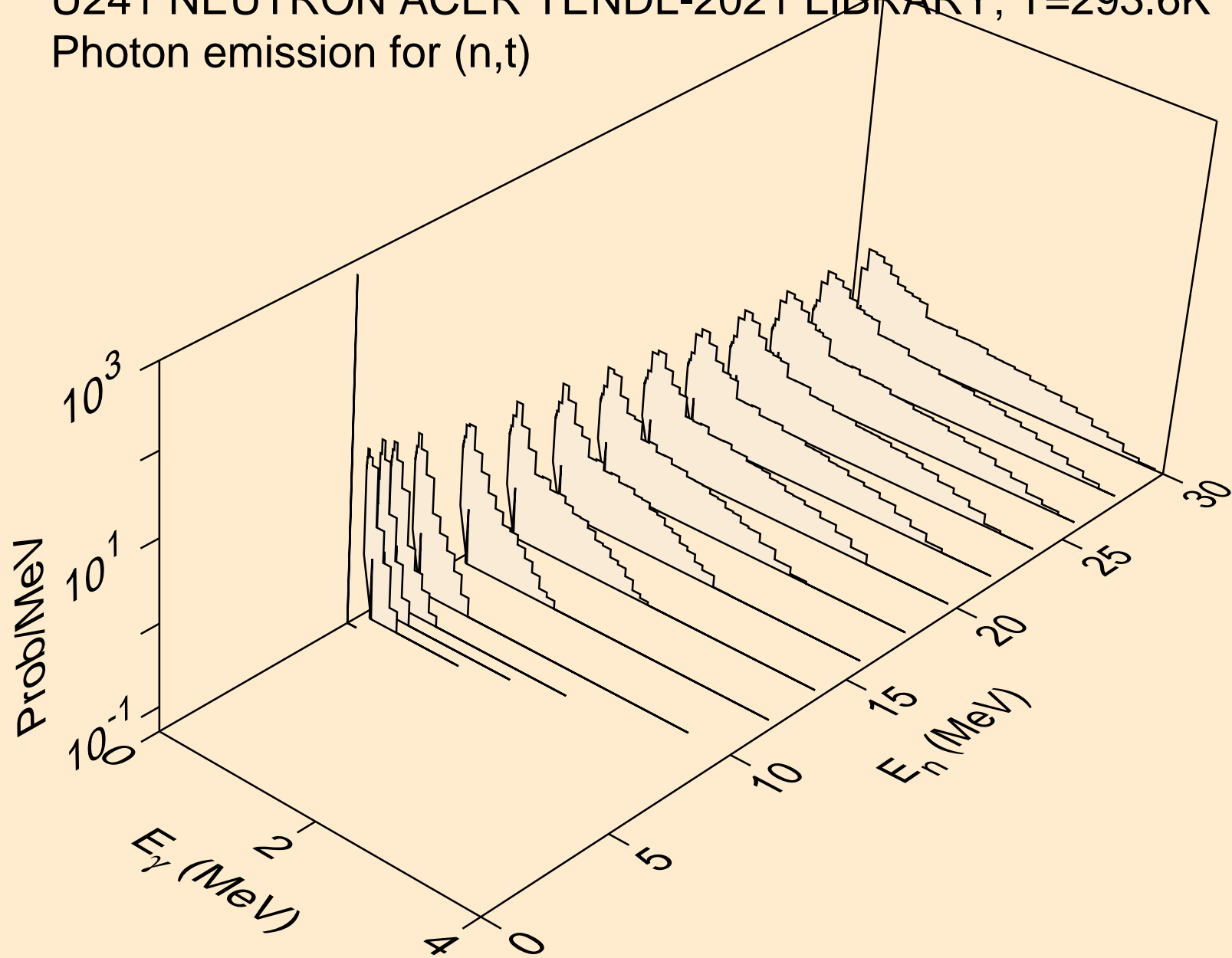

U241 NEUTRON ACER TENDL-2021 LIBRARY; T=293.6K
Photon emission for (n,he3)

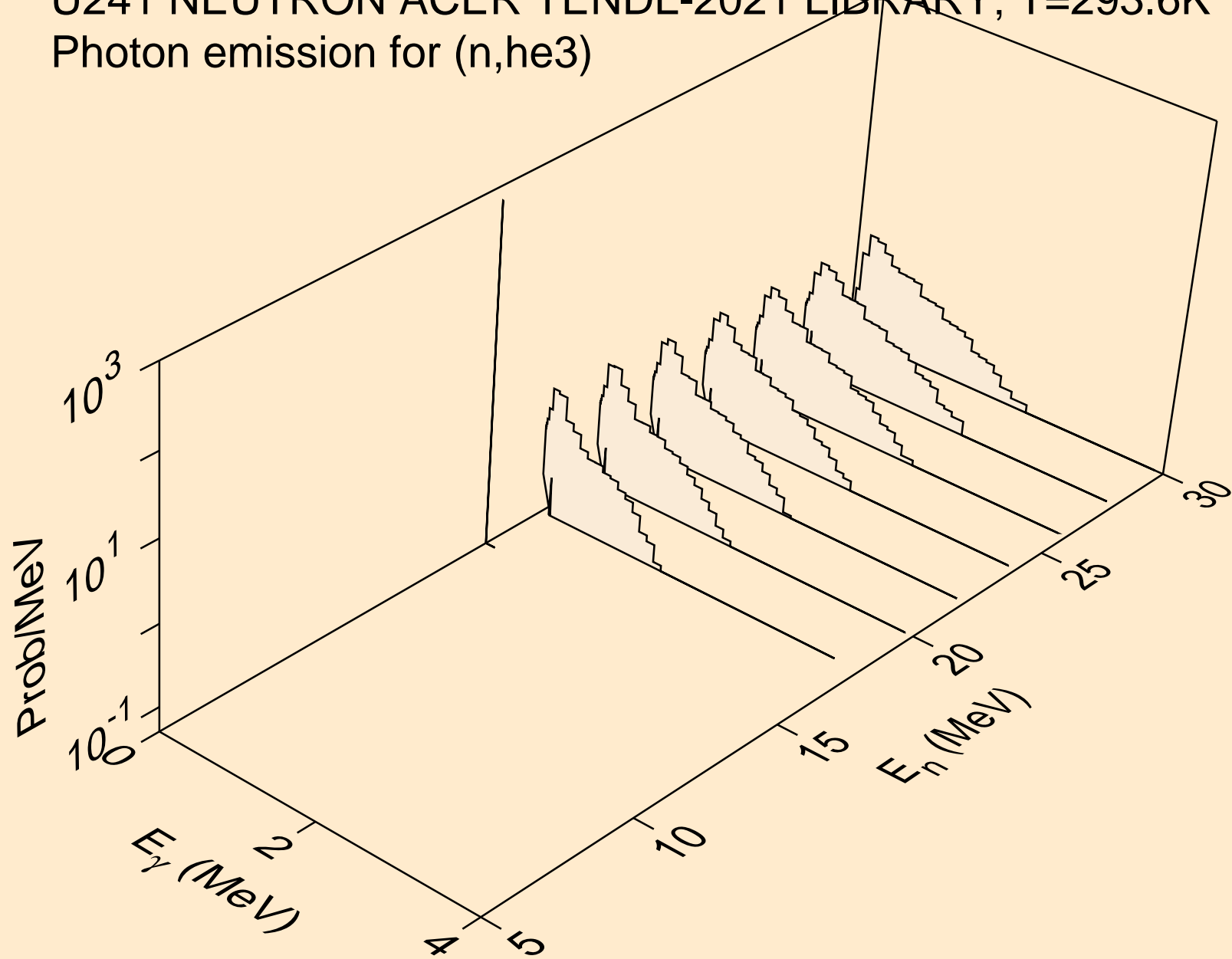

U241 NEUTRON ACER TENDL-2021 LIBRARY; T=293.6K
Photon emission for (n,a)

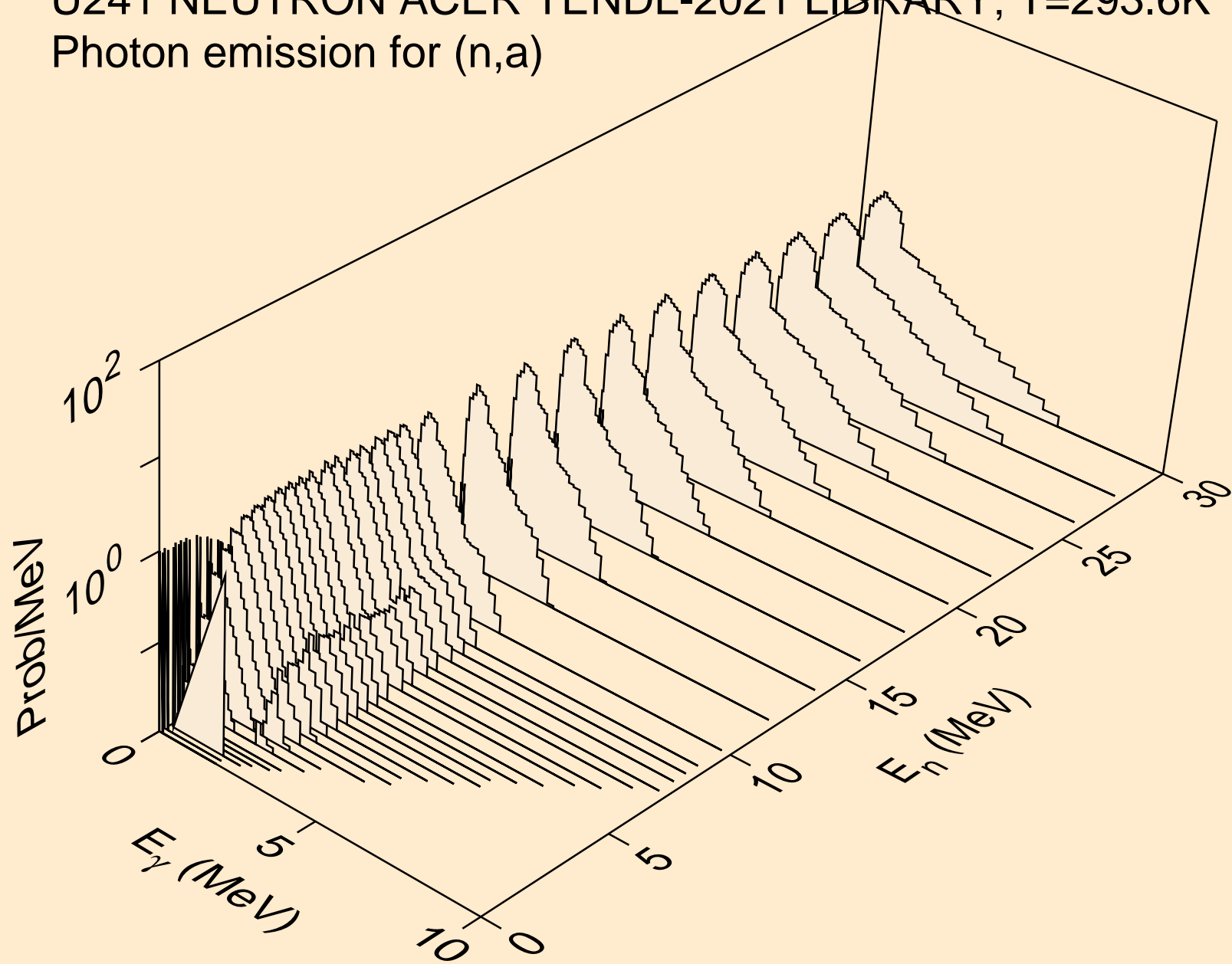

U241 NEUTRON ACER TENDL-2021 LIBRARY; T=293.6K
Photon emission for (n,2a)

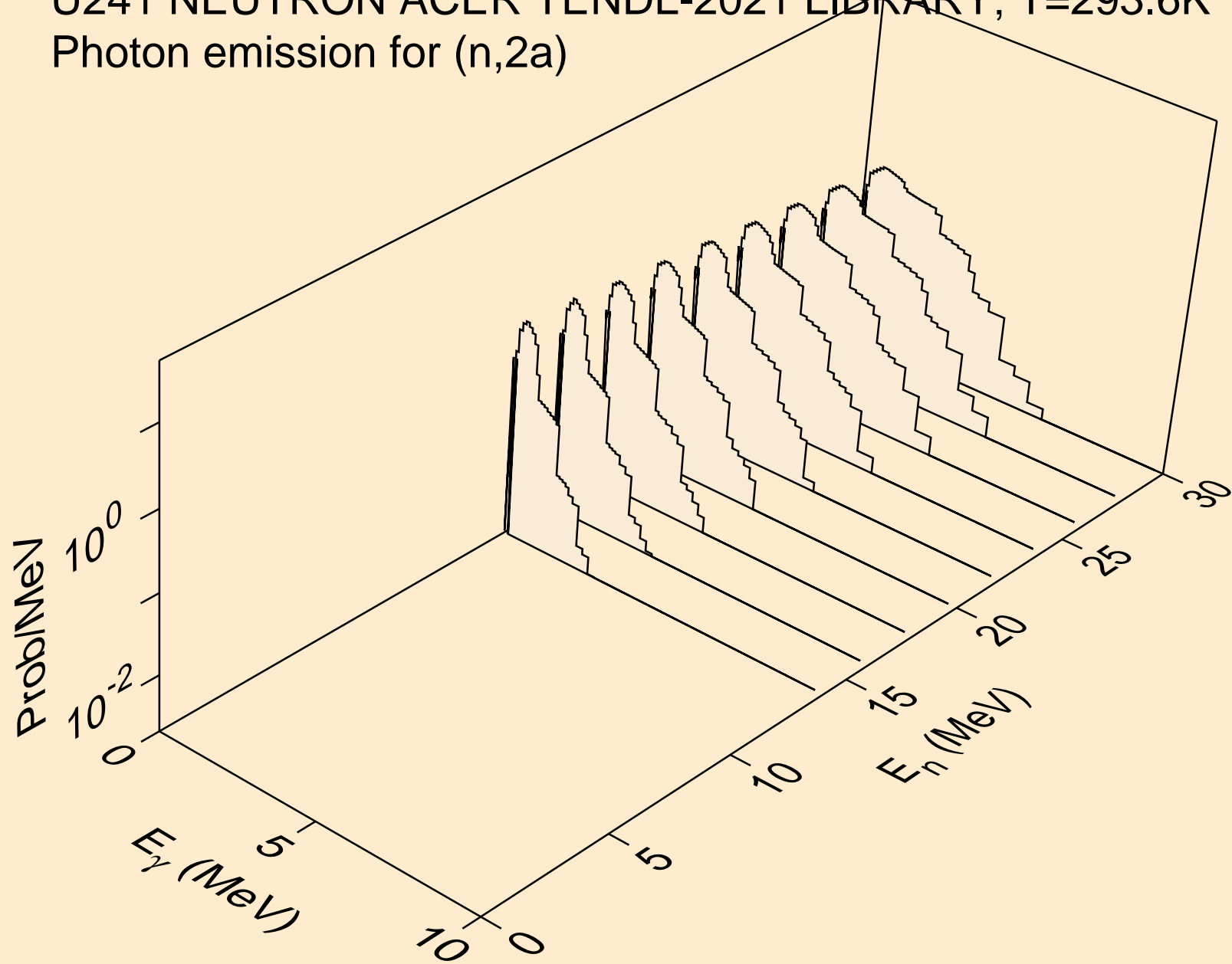

U241 NEUTRON ACER TENDL-2021 LIBRARY; T=293.6K
Photon emission for (n,2p)

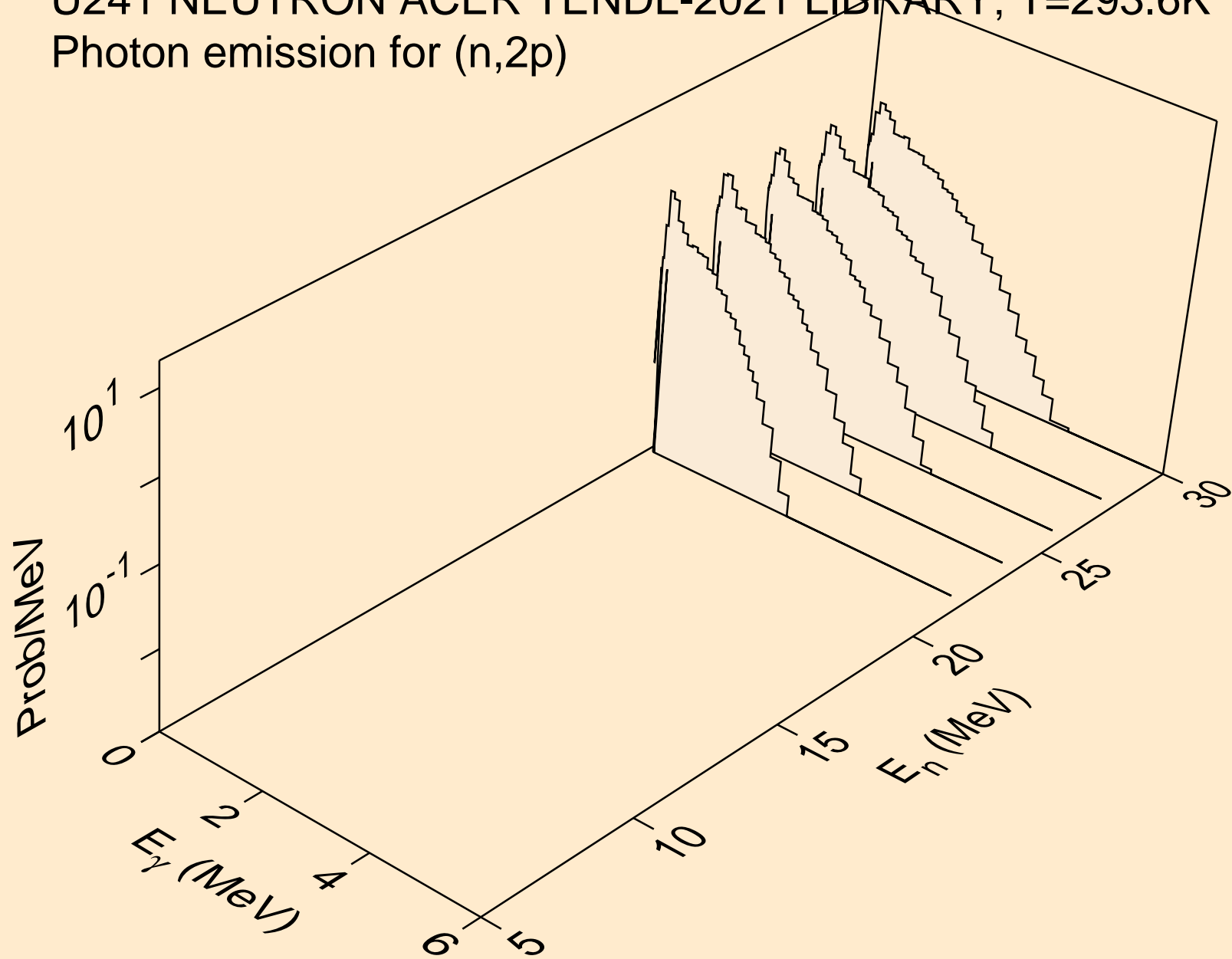

U241 NEUTRON ACER TENDL-2021 LIBRARY; T=293.6K
Photon emission for (n,p α)

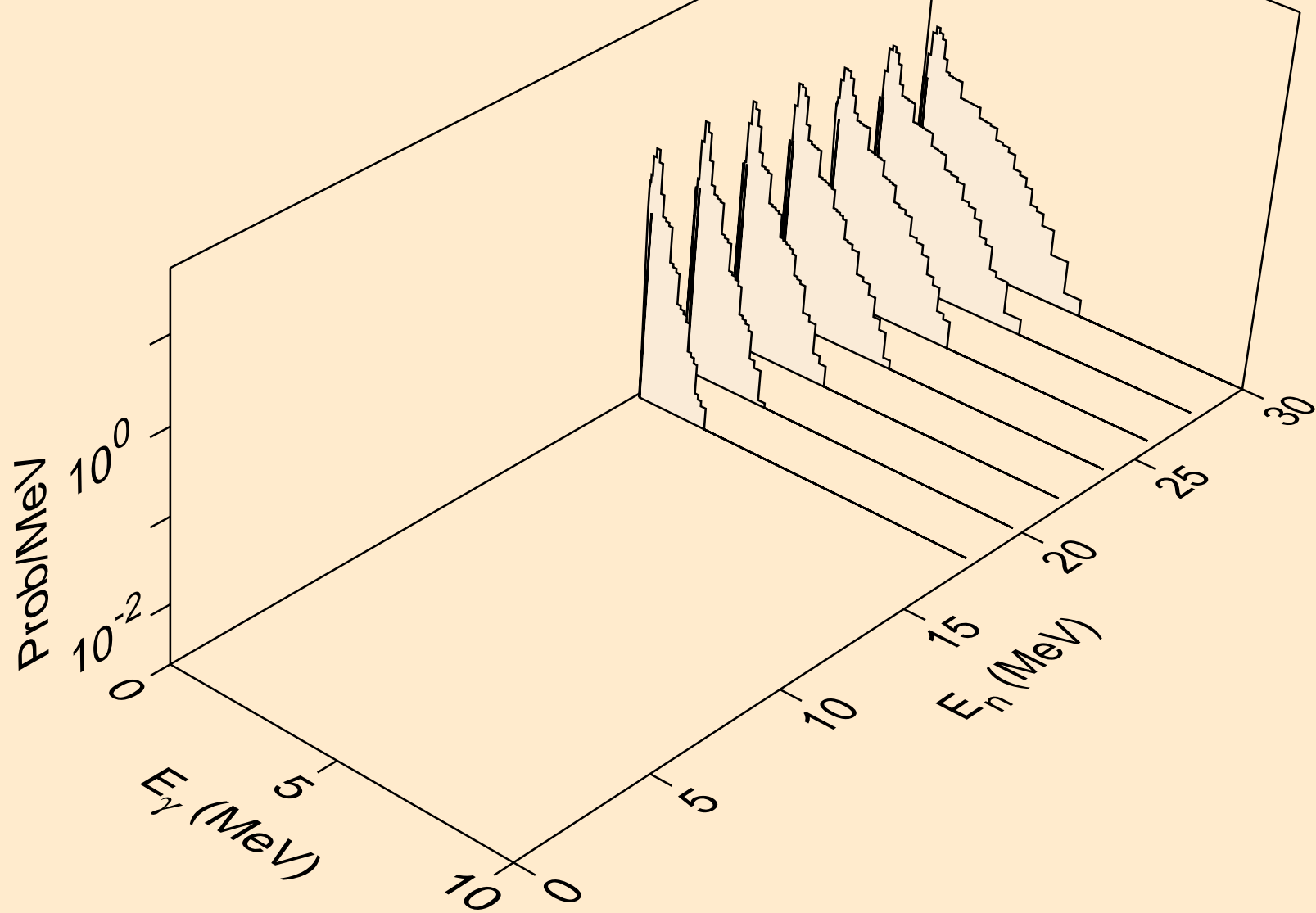

U241 NEUTRON ACER TENDL-2021 LIBRARY; T=293.6K
Photon emission for (n,pd)

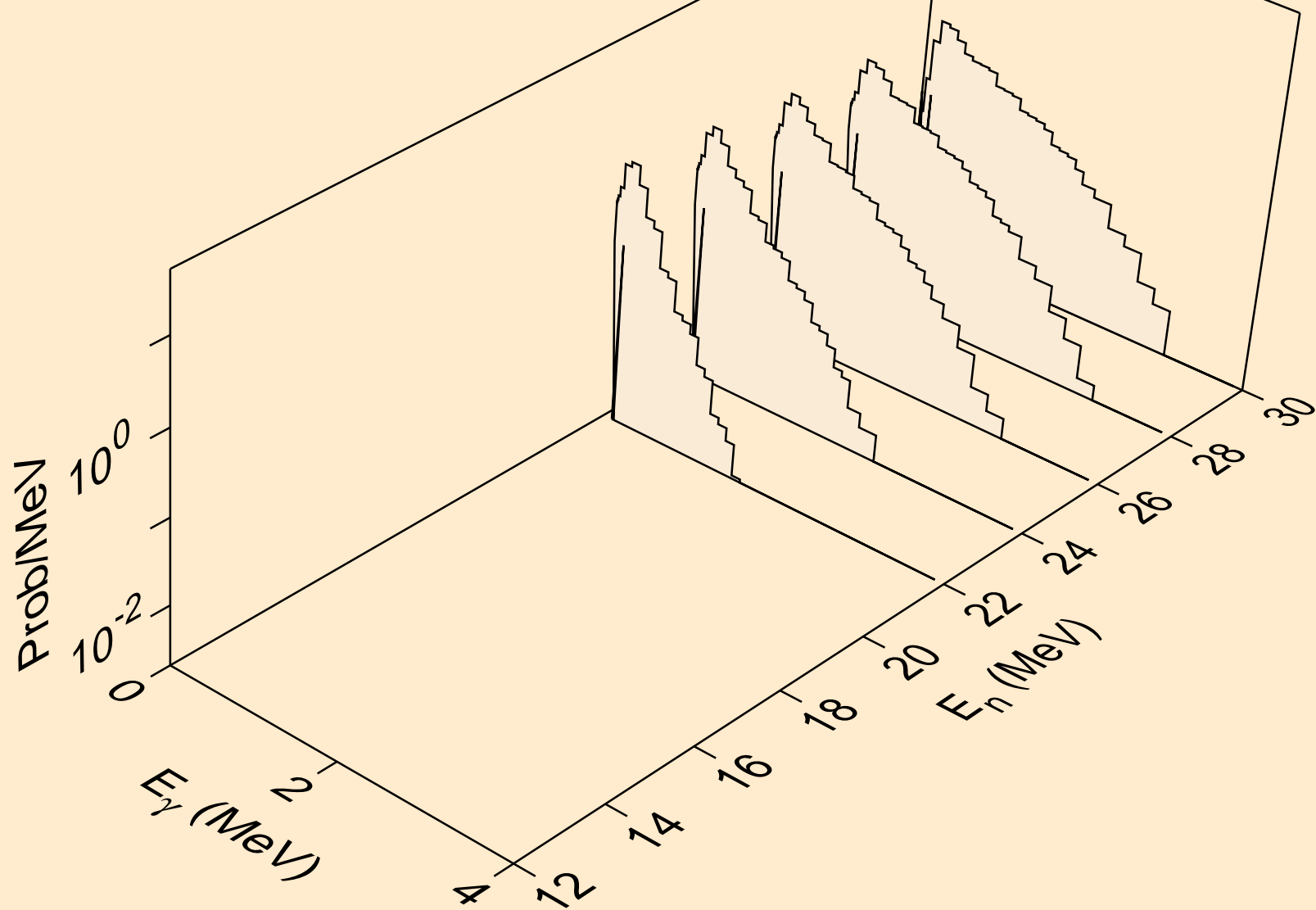

U241 NEUTRON ACER TENDL-2021 LIBRARY; T=293.6K
thermal capture photon spectrum

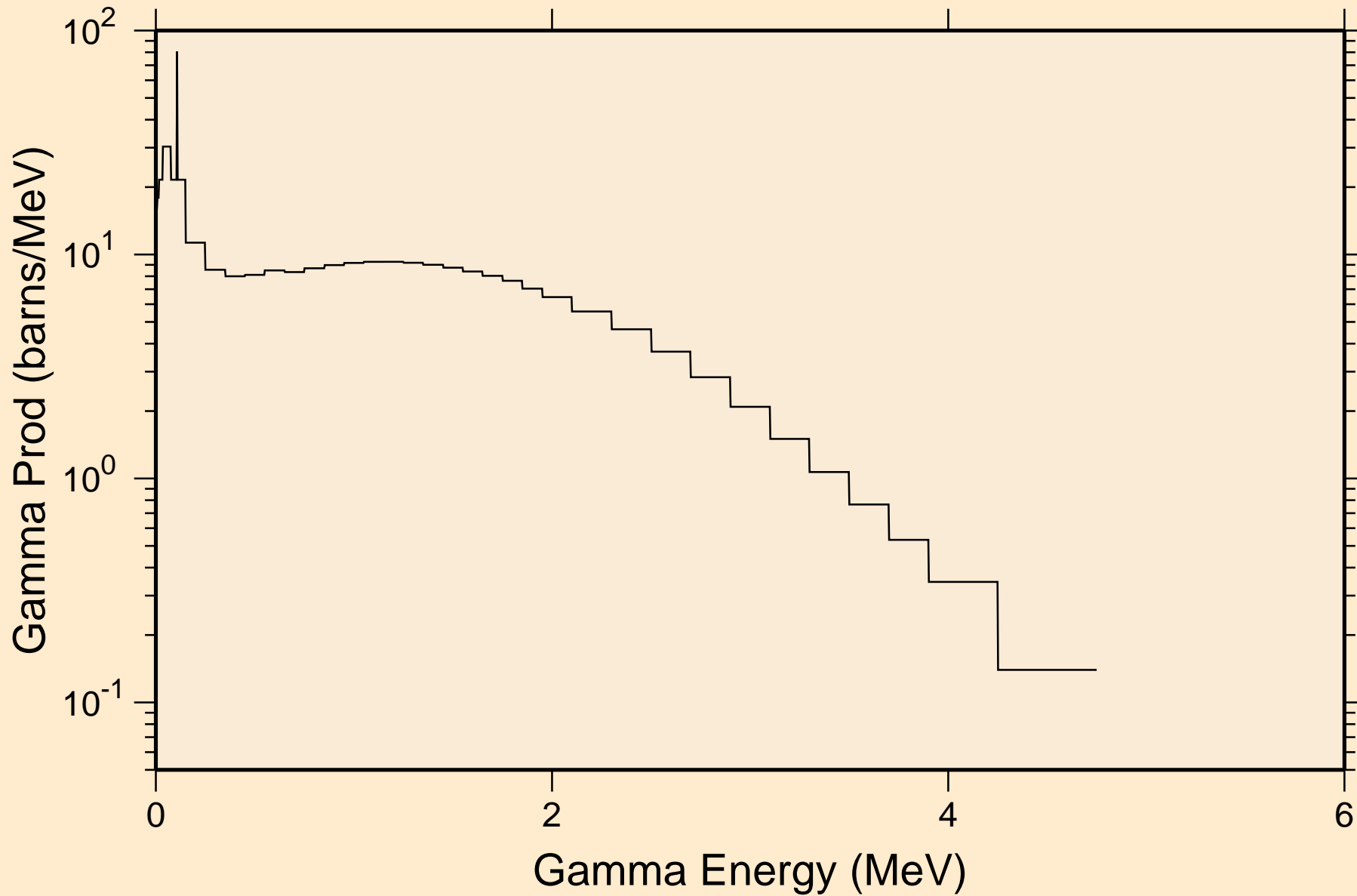

U241 NEUTRON ACER TENDL-2021 LIBRARY; T=293.6K
14 MeV photon spectrum

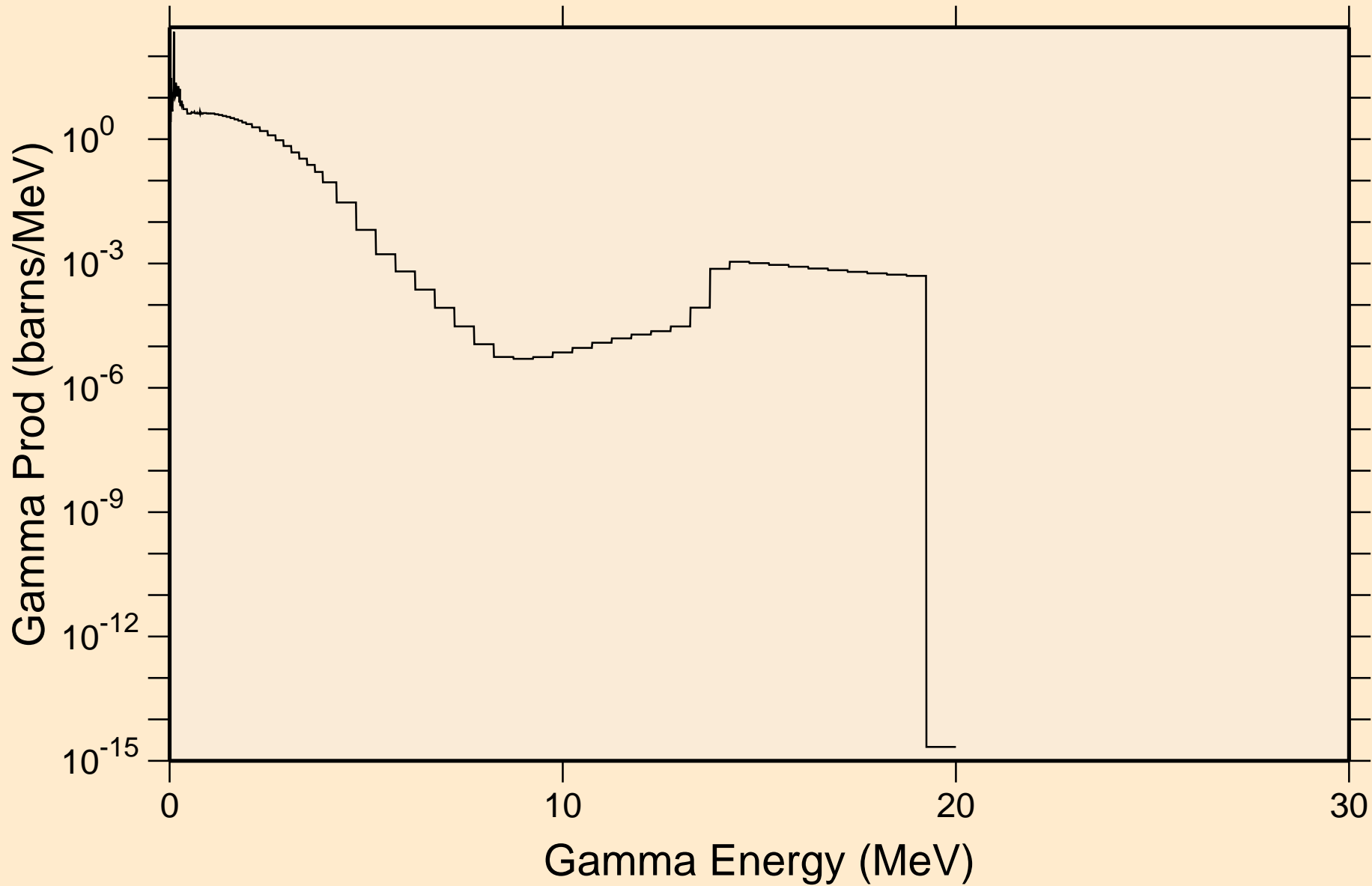

U241 NEUTRON ACER TENDL-2021 LIBRARY; T=293.6K

Particle heating contributions

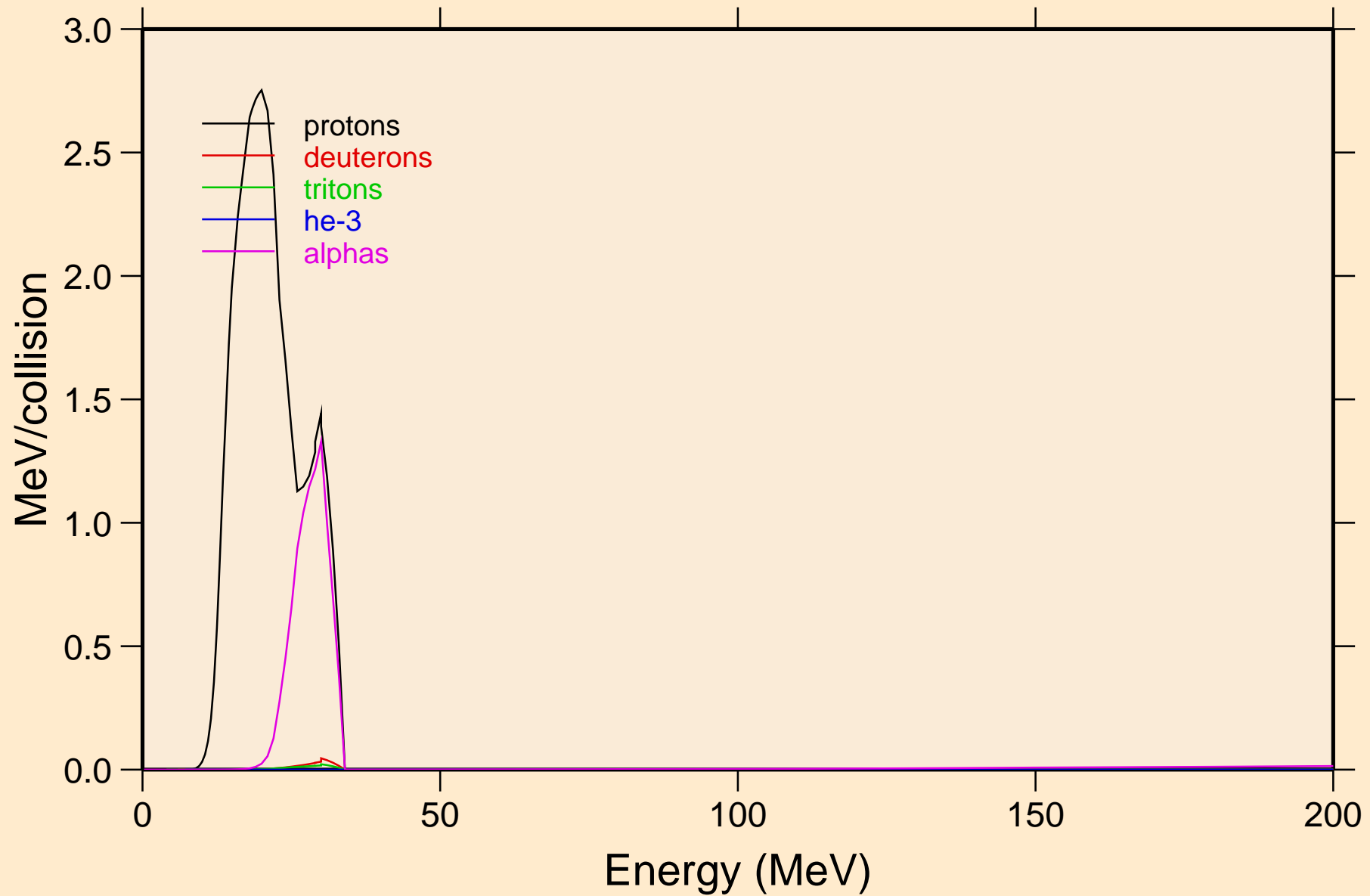

U241 NEUTRON ACER TENDL-2021 LIBRARY; T=293.6K
Recoil Heating

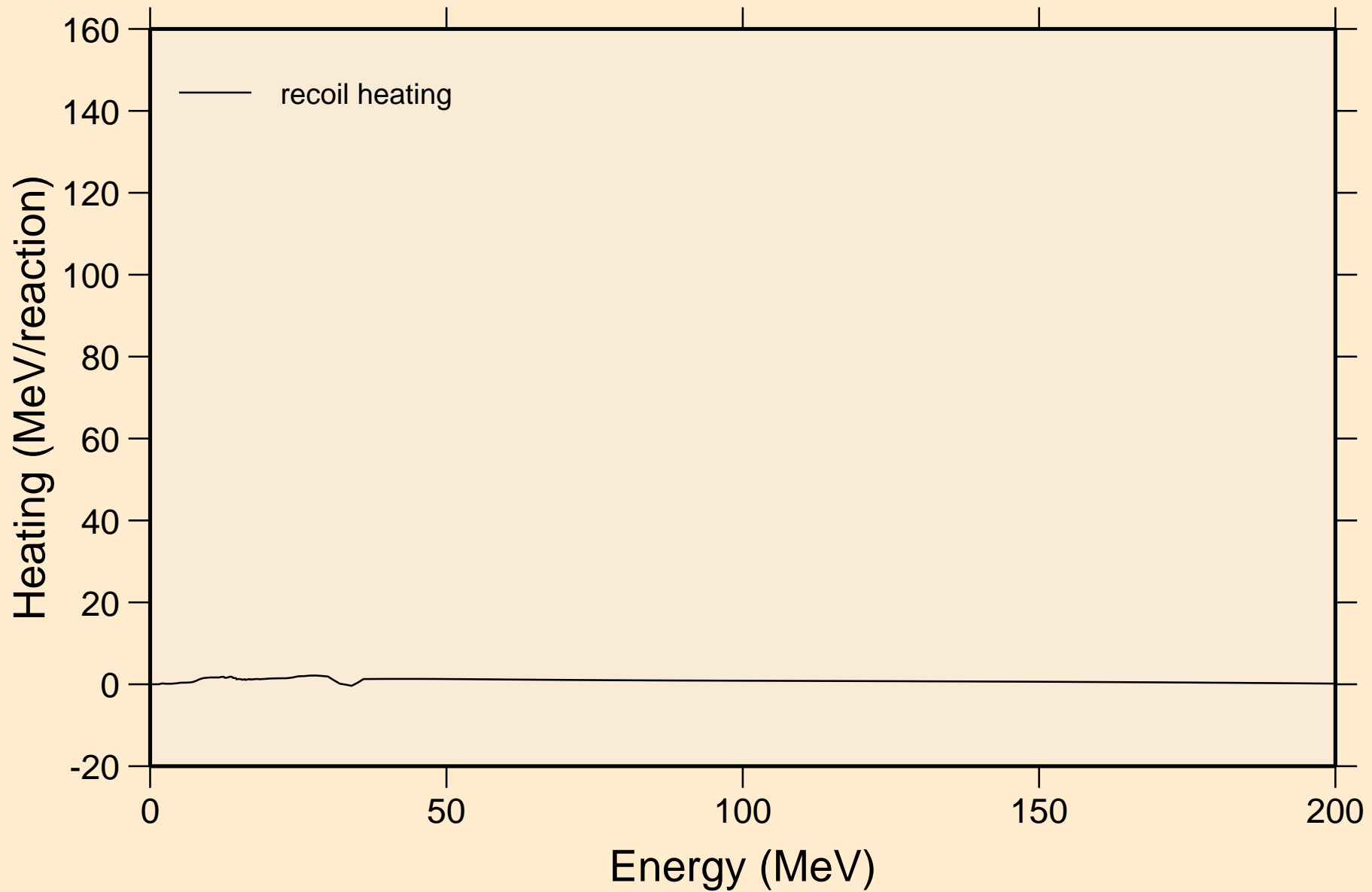

U241 NEUTRON ACER TENDL-2021 LIBRARY; T=293.6K
Particle production cross sections

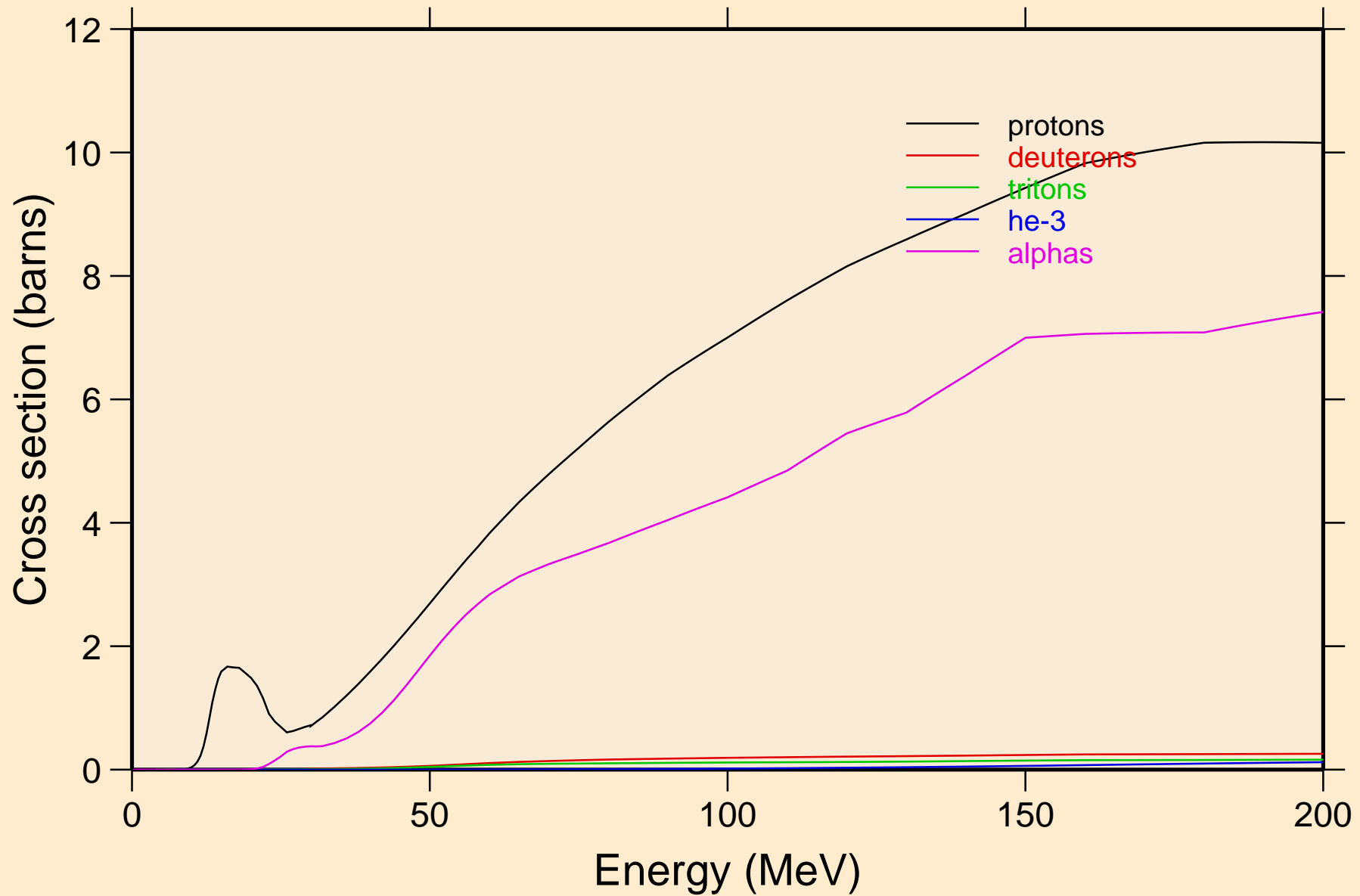

U241 NEUTRON ACER TENDL-2021 LIBRARY; T=293.6K
protons from (n,x)

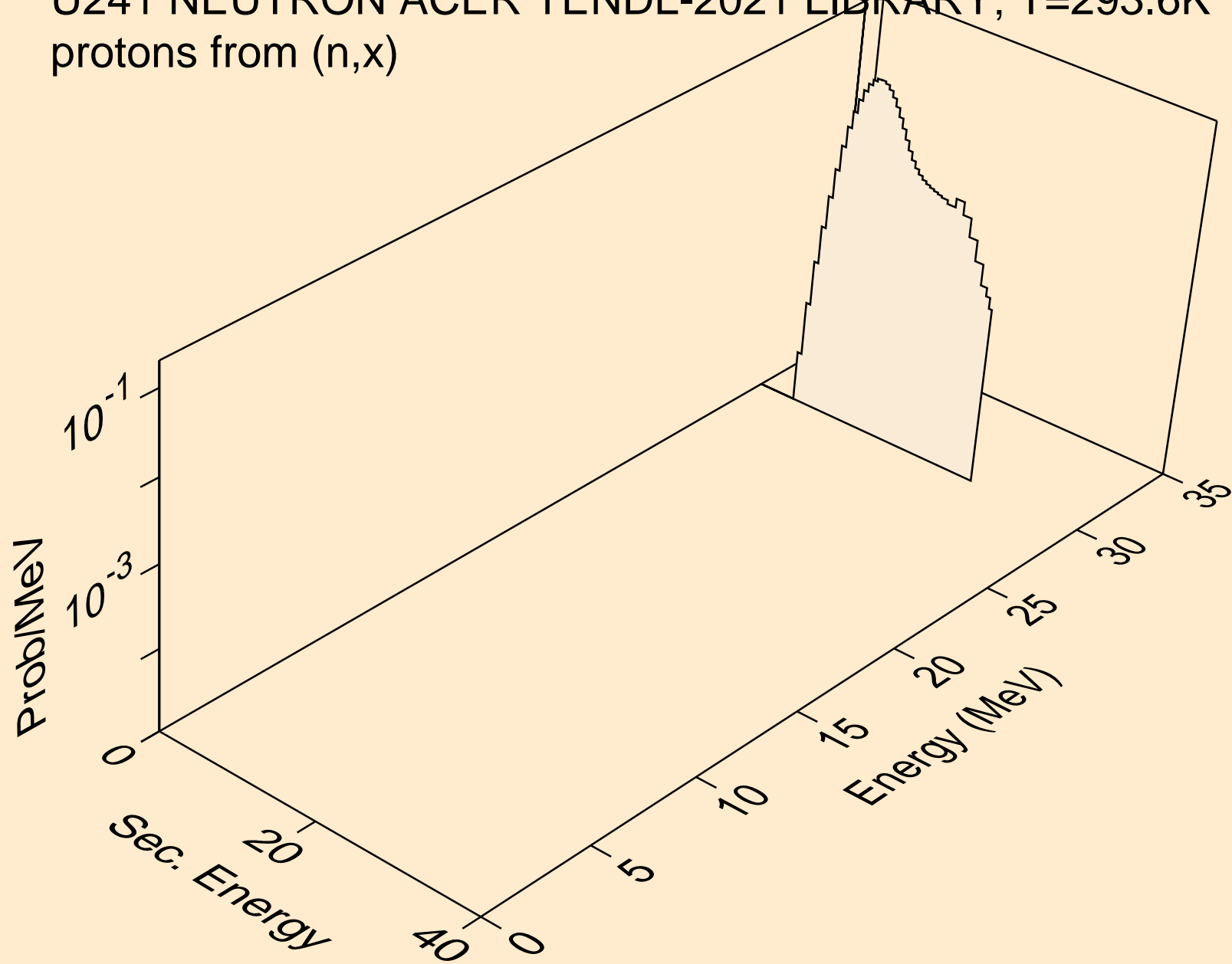

U241 NEUTRON ACER TENDL-2021 LIBRARY; T=293.6K
protons from (n,n*)p

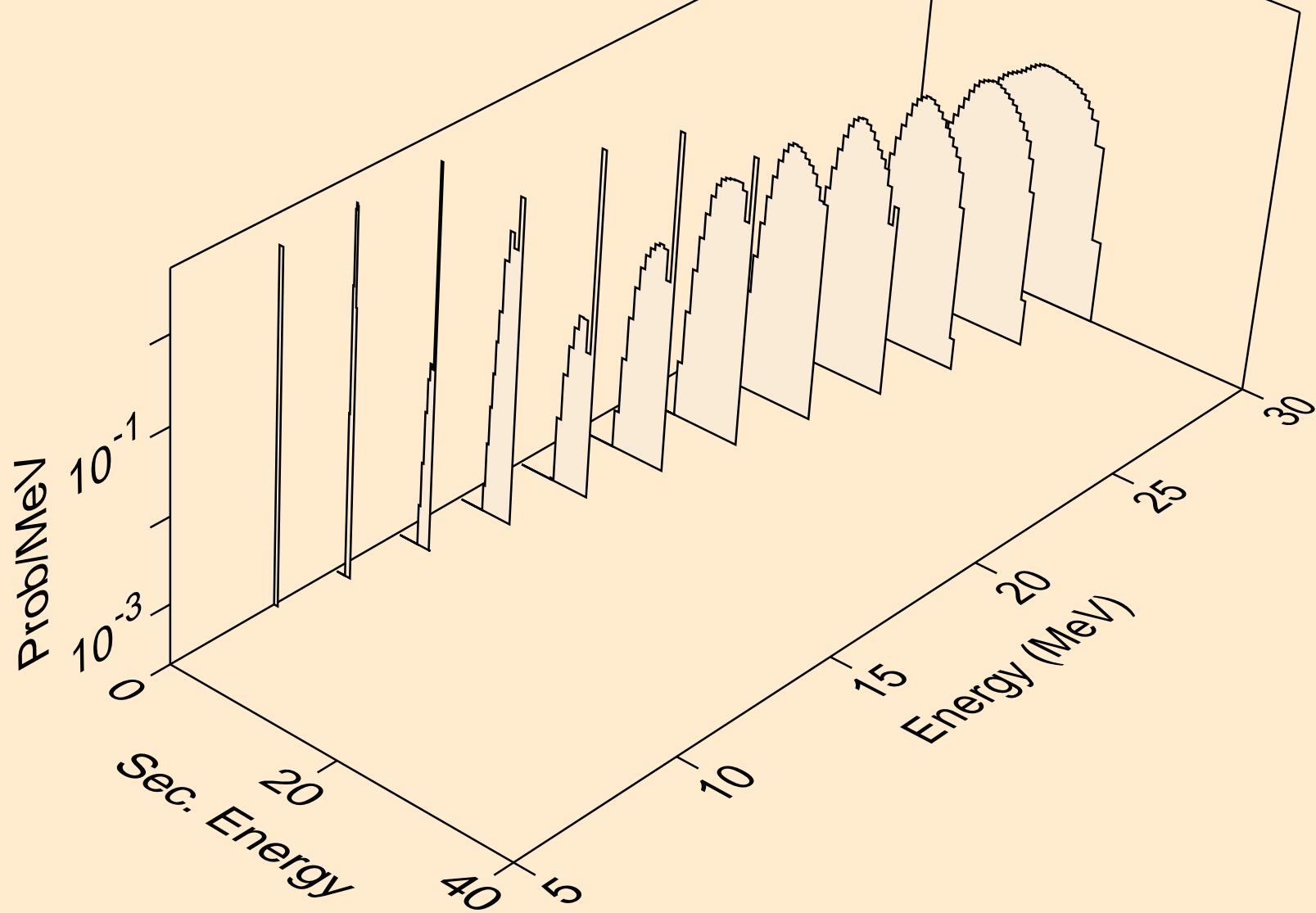

U241 NEUTRON ACER TENDL-2021 LIBRARY; T=293.6K
protons from (n,2np)

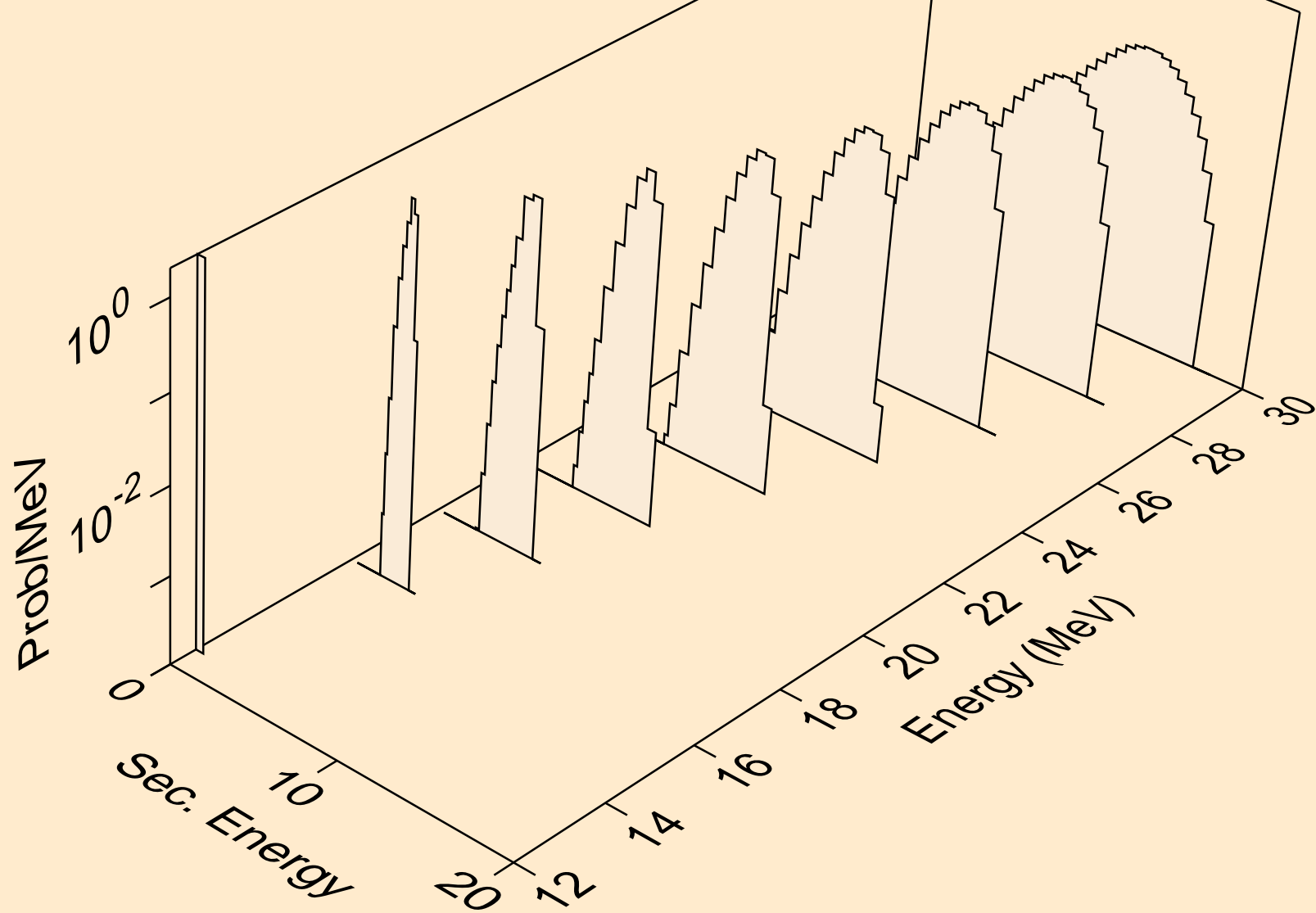

U241 NEUTRON ACER TENDL-2021 LIBRARY; T=293.6K
protons from (n,3np)

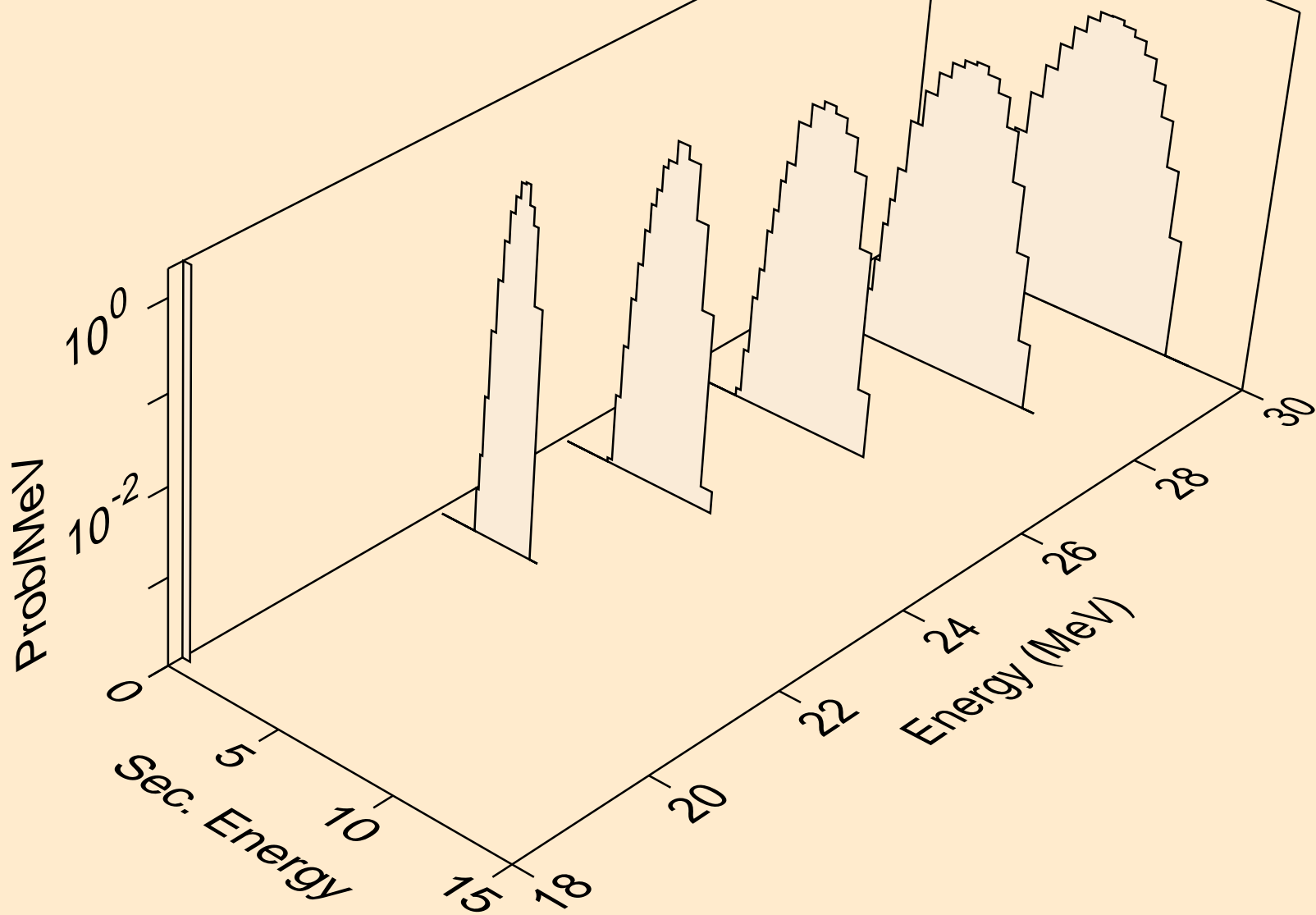

U241 NEUTRON ACER TENDL-2021 LIBRARY; T=293.6K
protons from (n,npa)

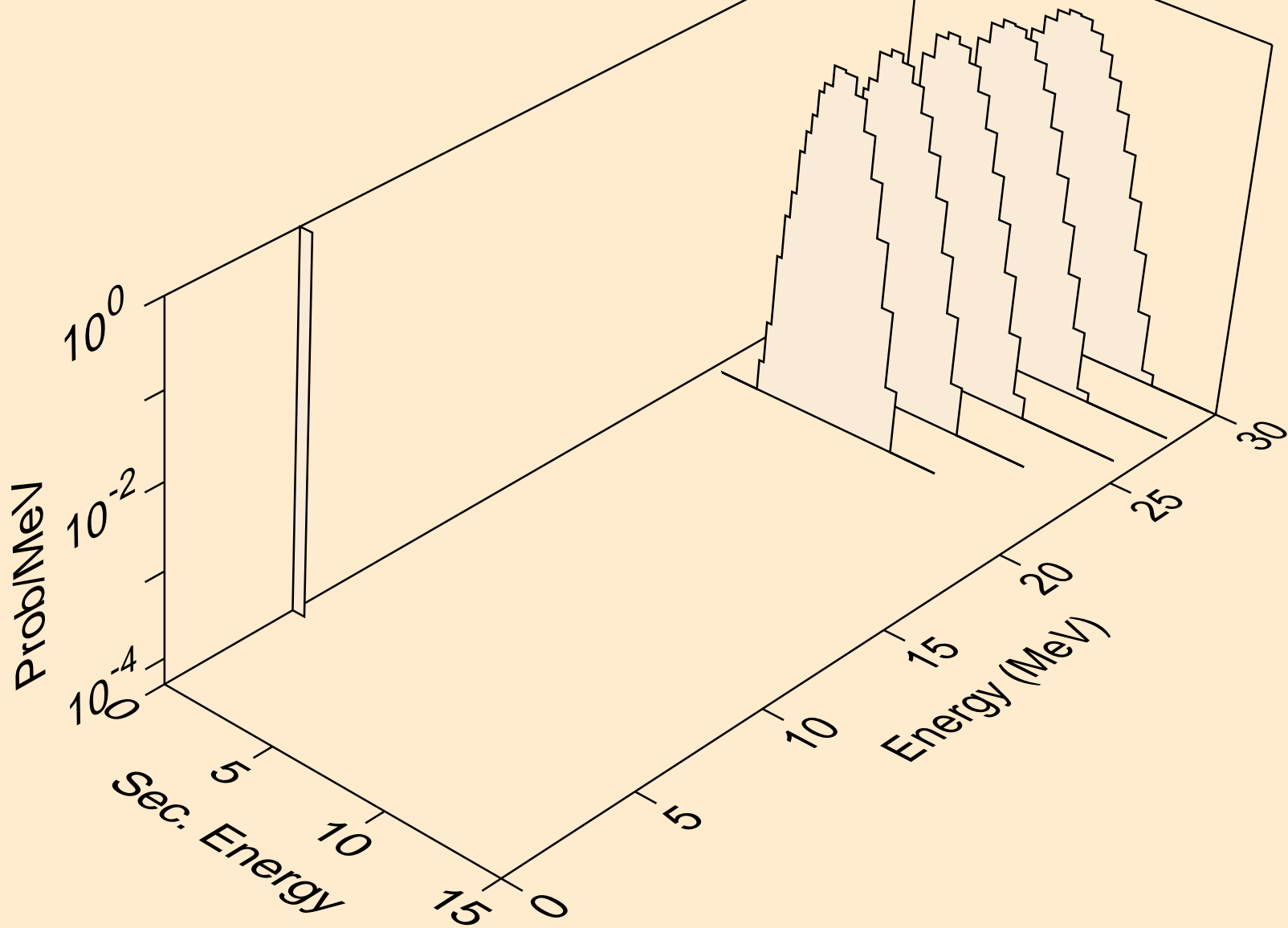

U241 NEUTRON ACER TENDL-2021 LIBRARY; T=293.6K
protons from (n,p)

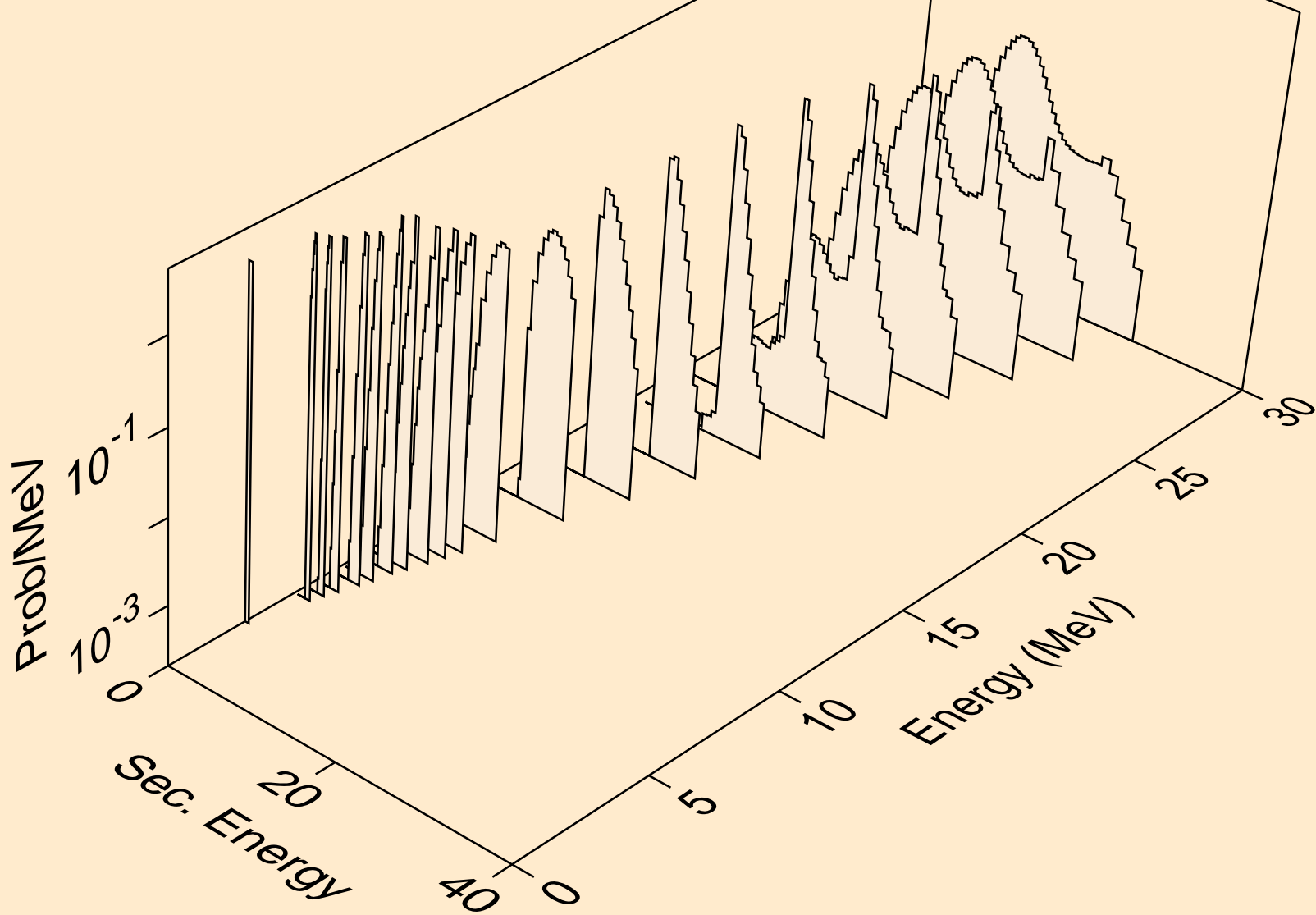

U241 NEUTRON ACER TENDL-2021 LIBRARY; T=293.6K
protons from (n,2p)

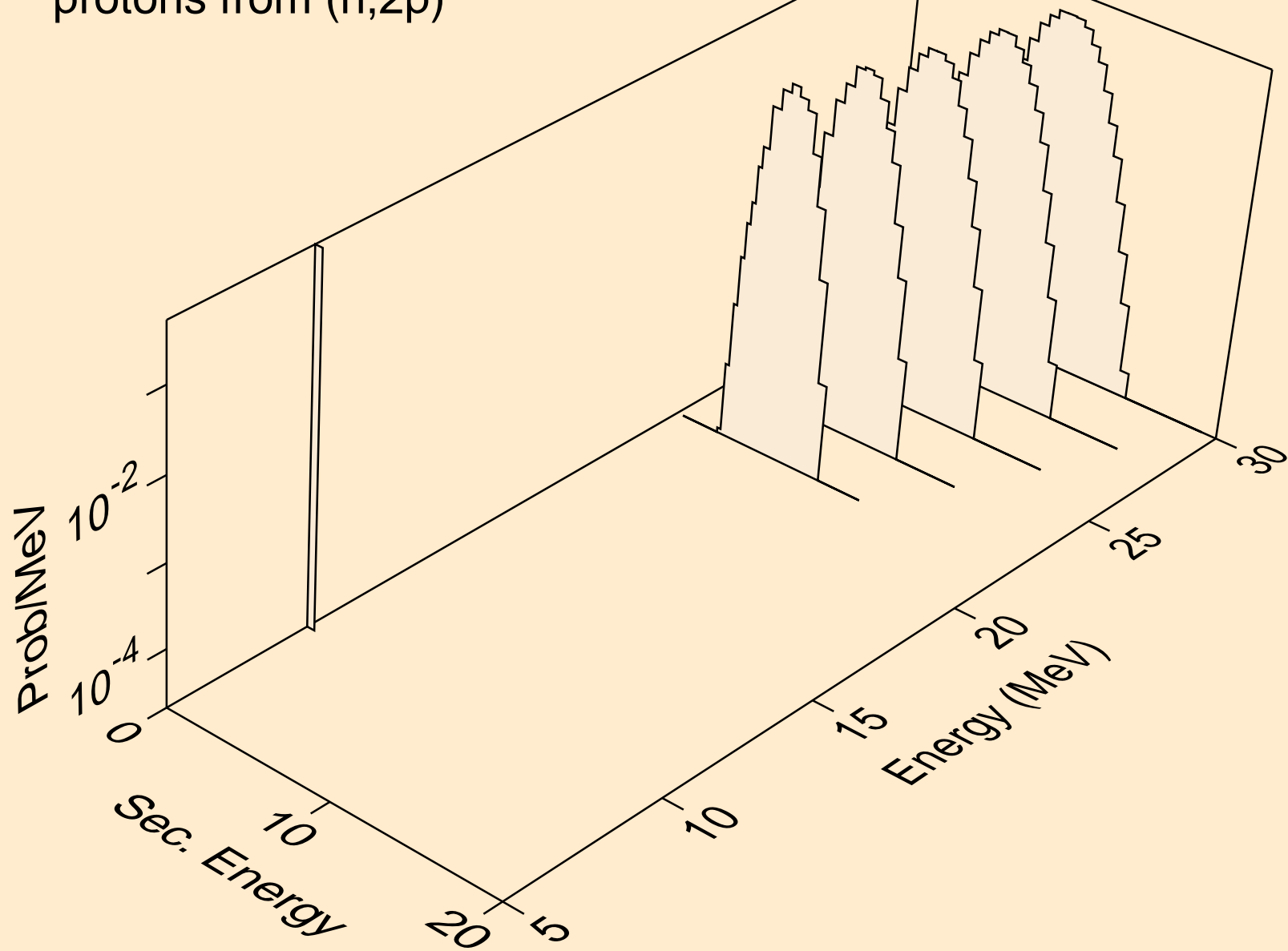

U241 NEUTRON ACER TENDL-2021 LIBRARY; T=293.6K
protons from (n,p)

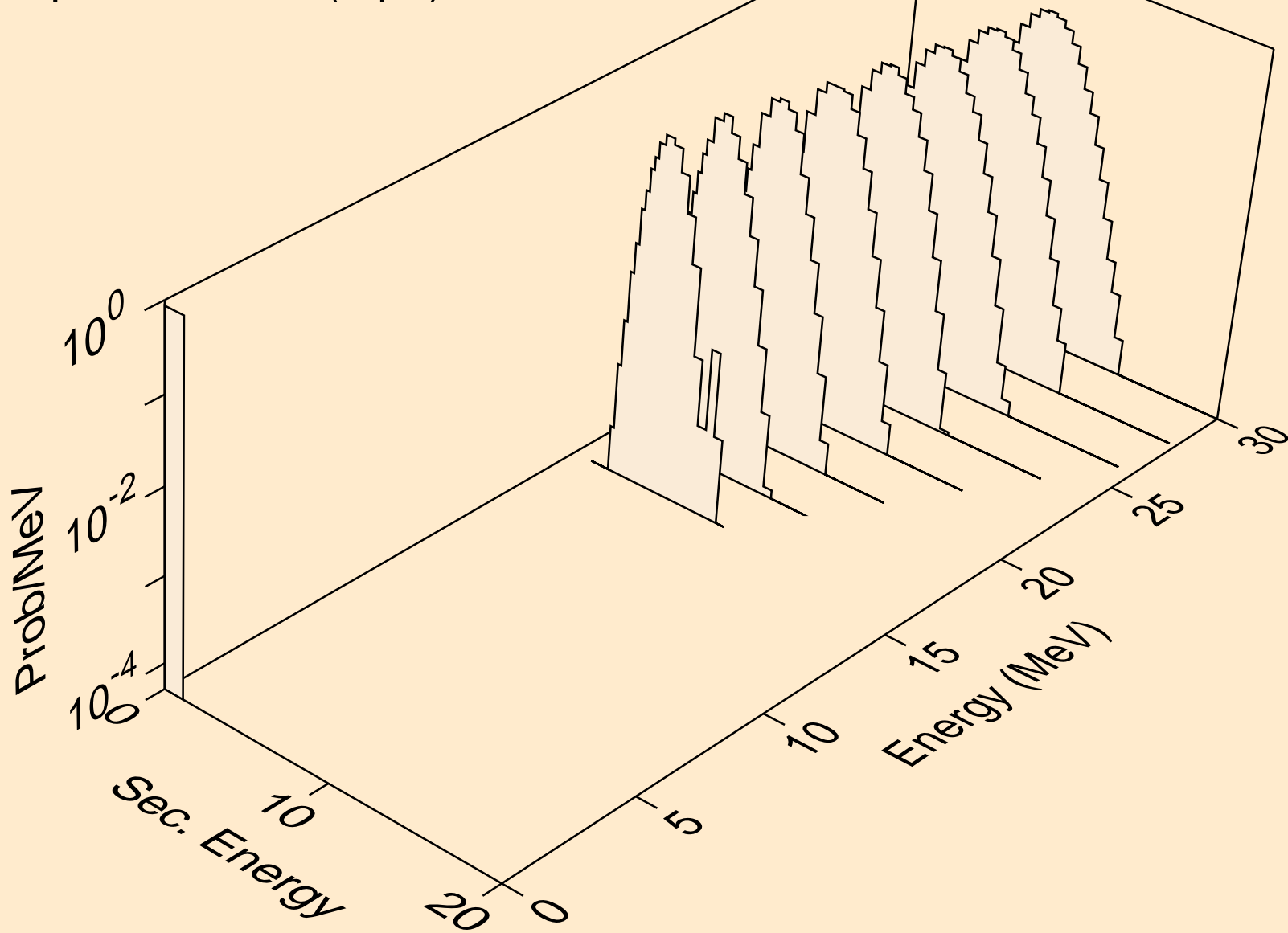

U241 NEUTRON ACER TENDL-2021 LIBRARY; T=293.6K
protons from (n,pd)

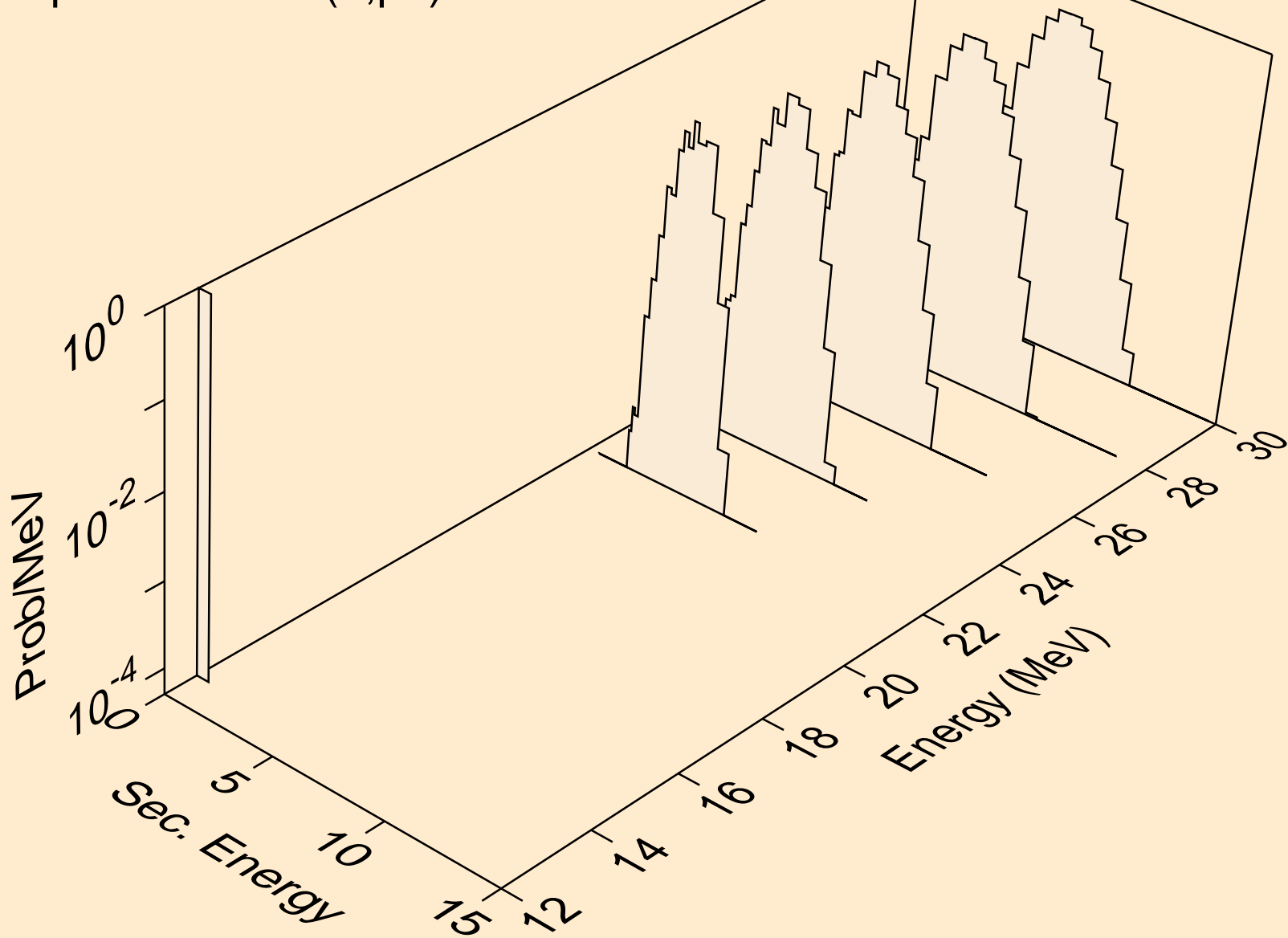

U241 NEUTRON ACER TENDL-2021 LIBRARY; T=293.6K
deuterons from (n,x)

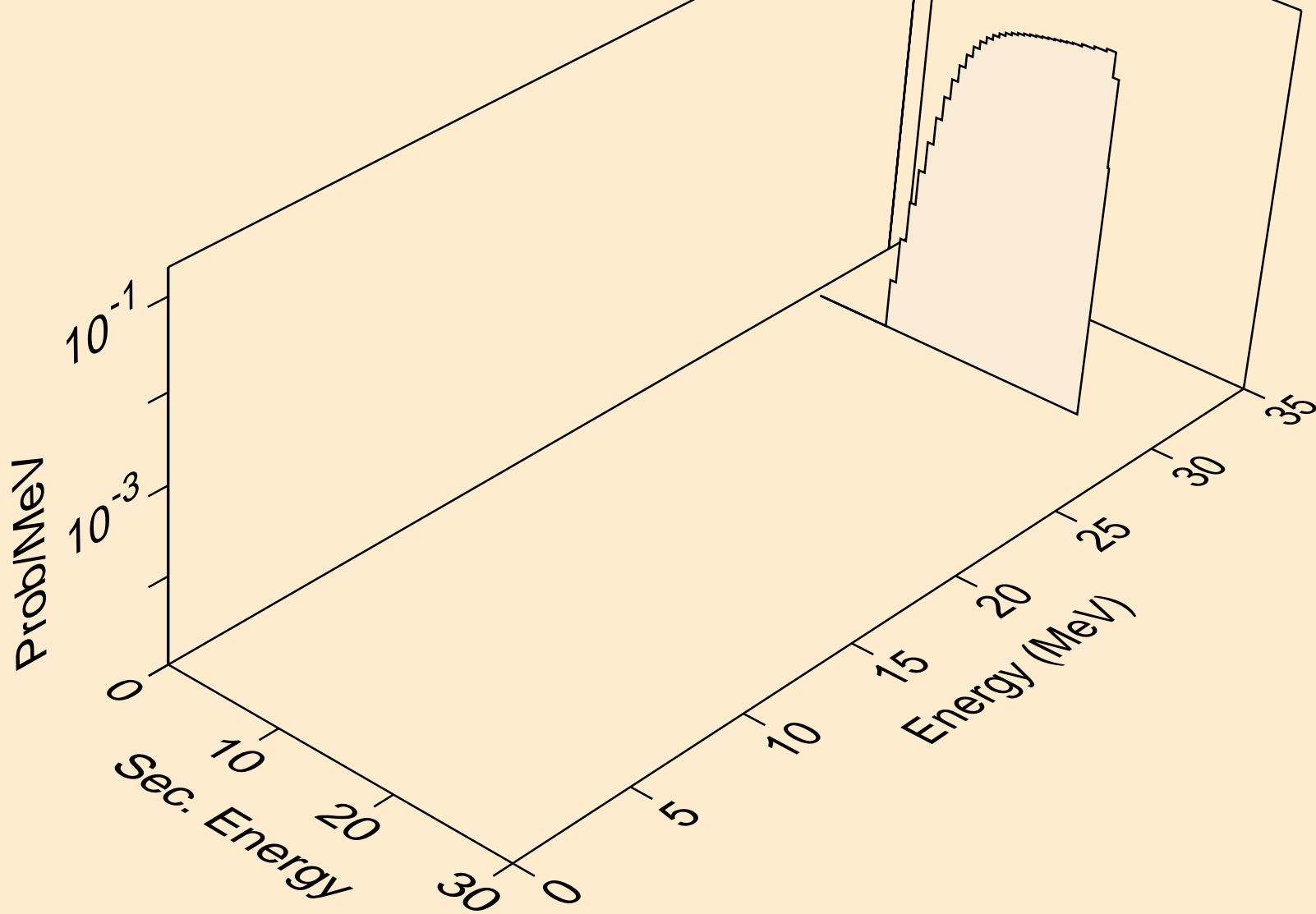

U241 NEUTRON ACER TENDL-2021 LIBRARY; T=293.6K
deuterons from (n,2nd)

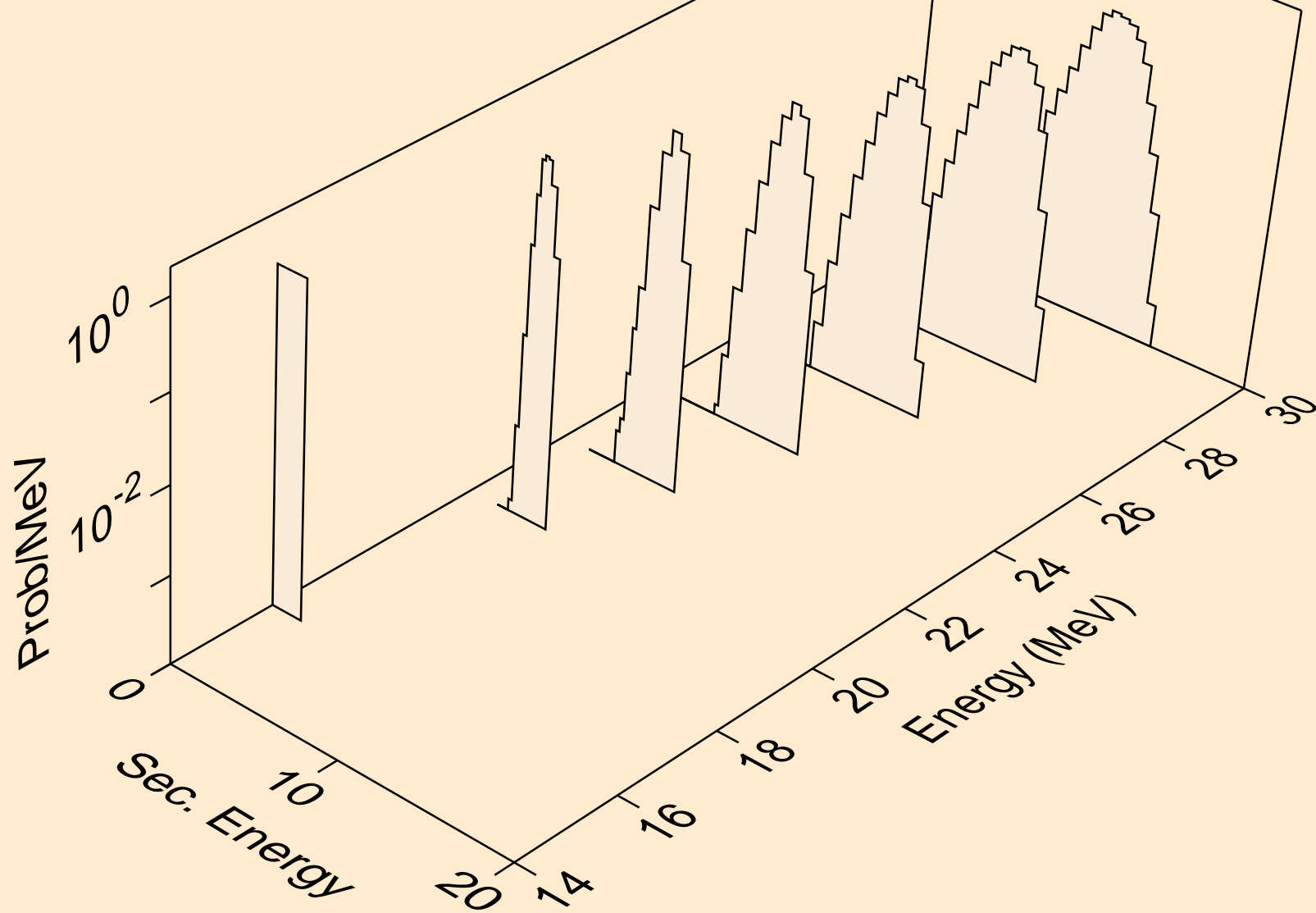

U241 NEUTRON ACER TENDL-2021 LIBRARY; T=293.6K
deuterons from (n,n*)d

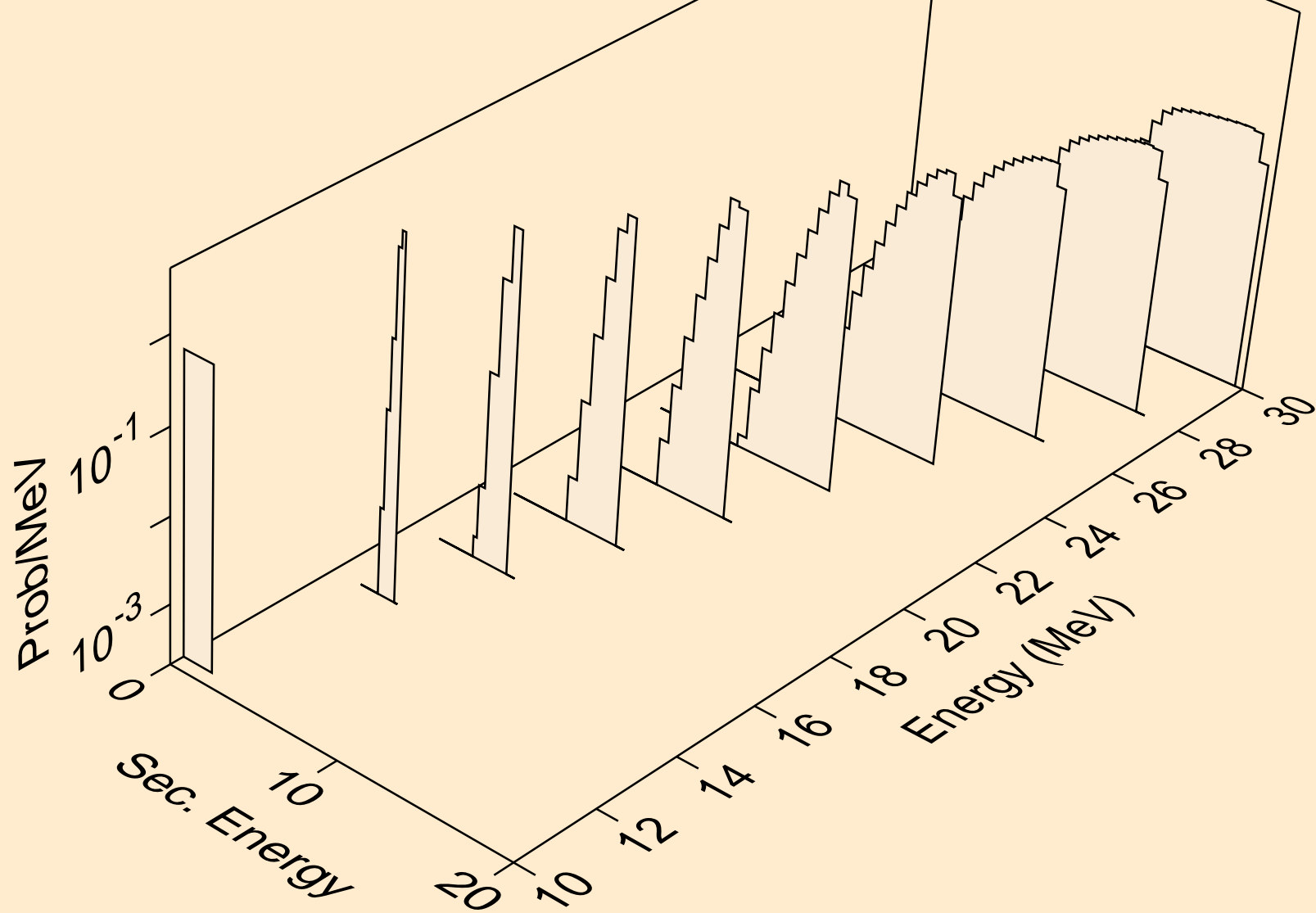

U241 NEUTRON ACER TENDL-2021 LIBRARY; T=293.6K
deuterons from (n,d)

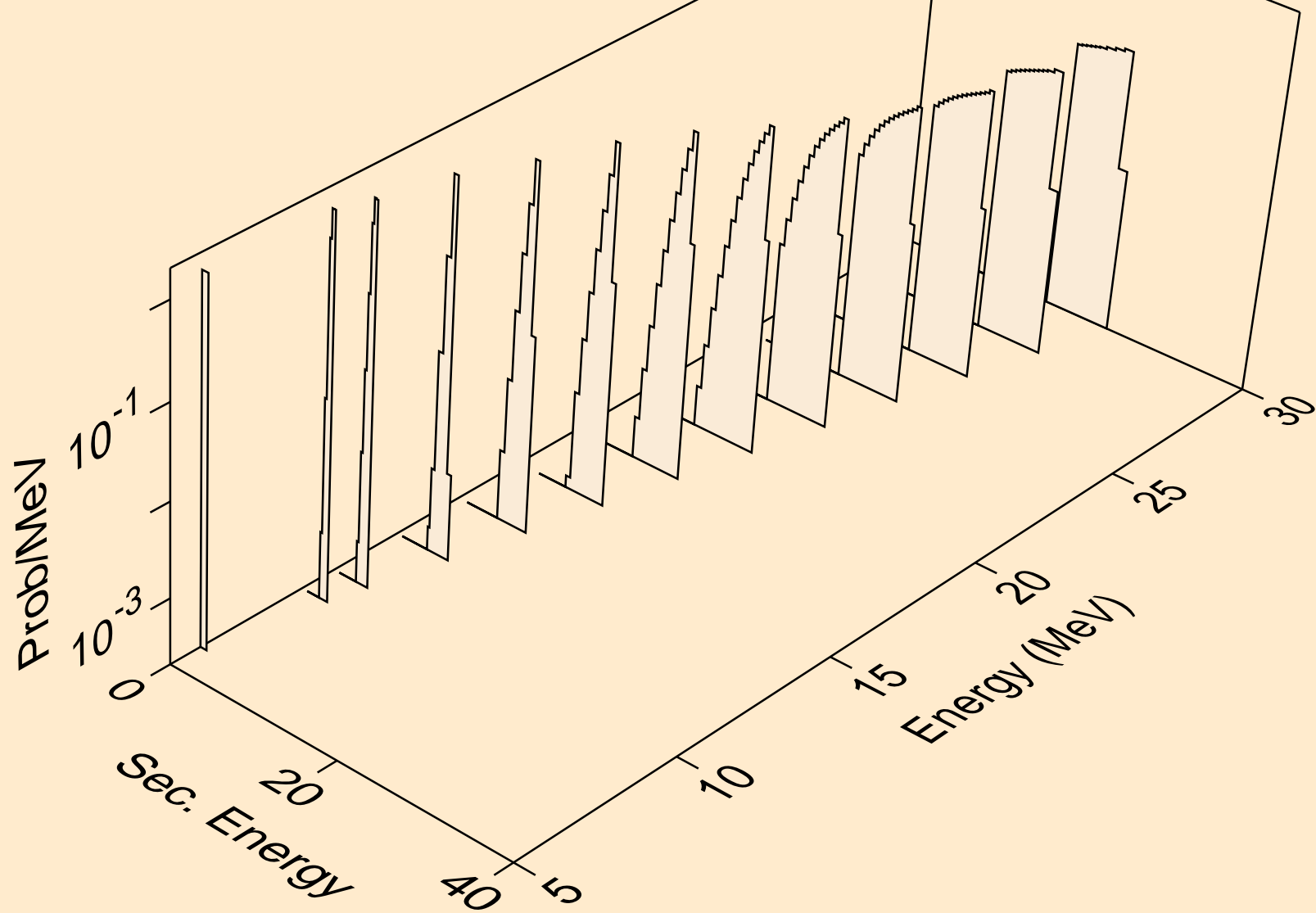

U241 NEUTRON ACER TENDL-2021 LIBRARY; T=293.6K
deuterons from (n,pd)

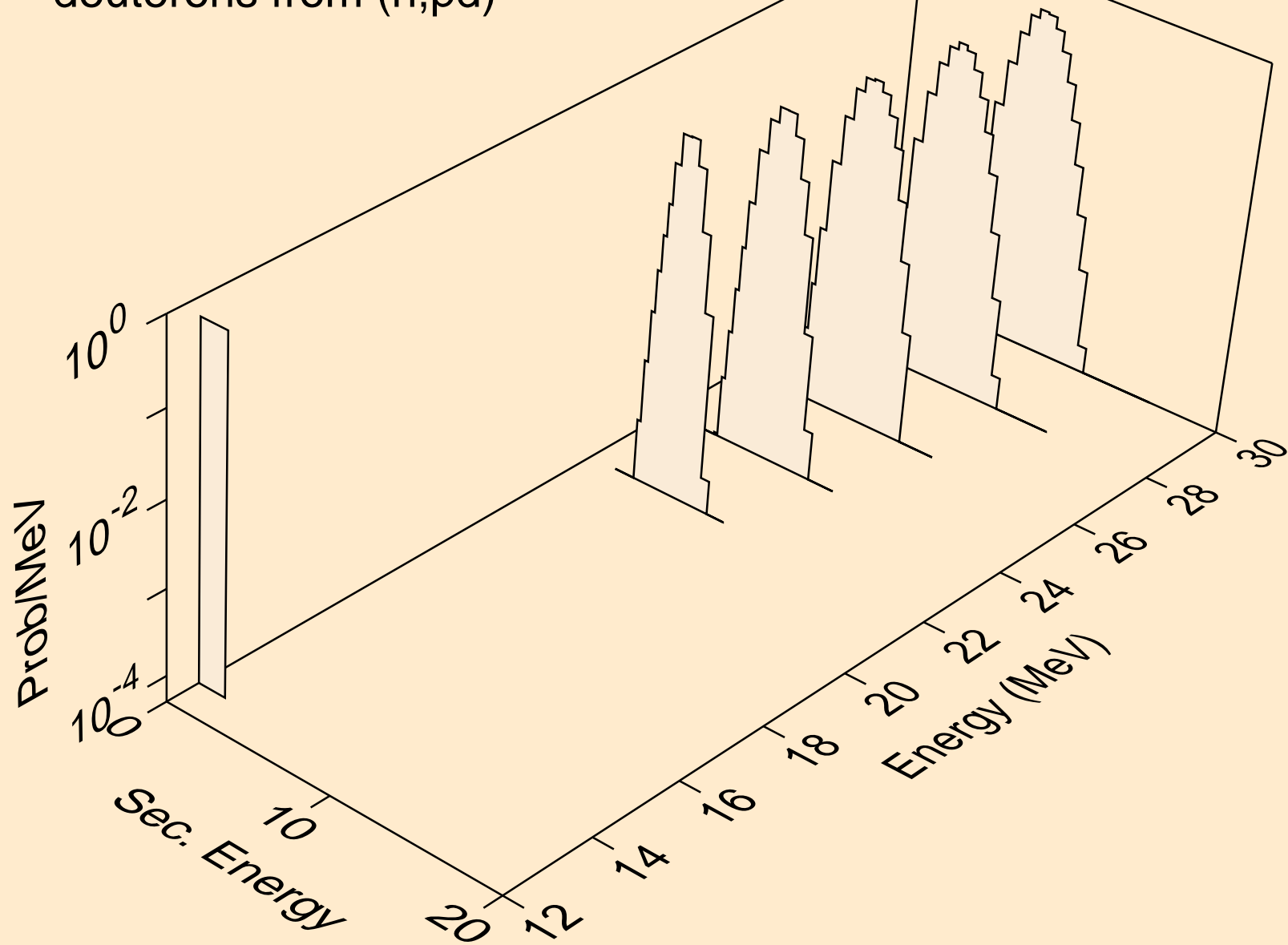

U241 NEUTRON ACER TENDL-2021 LIBRARY; T=293.6K
tritons from (n,x)

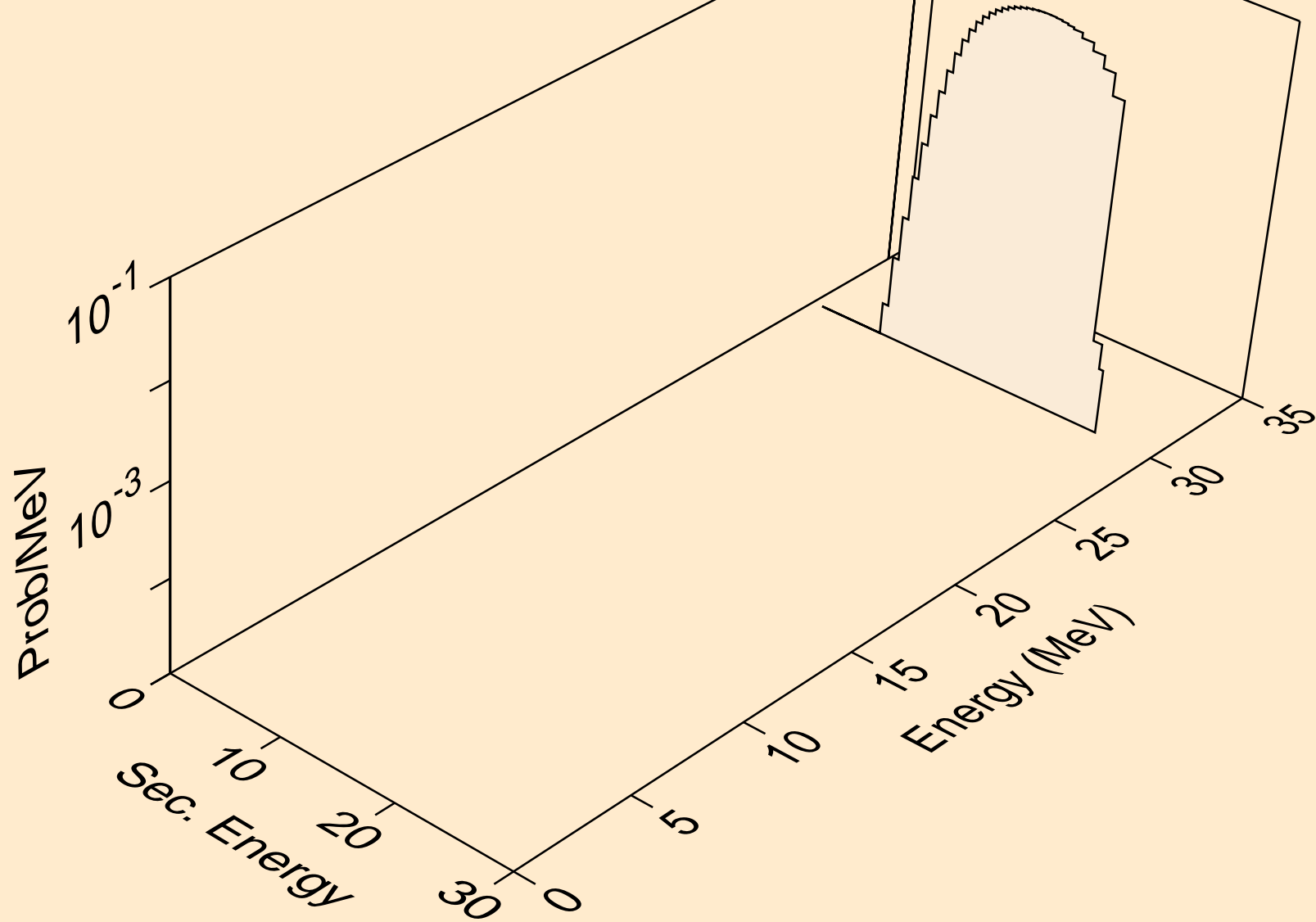

U241 NEUTRON ACER TENDL-2021 LIBRARY; T=293.6K
tritons from (n,n*)t

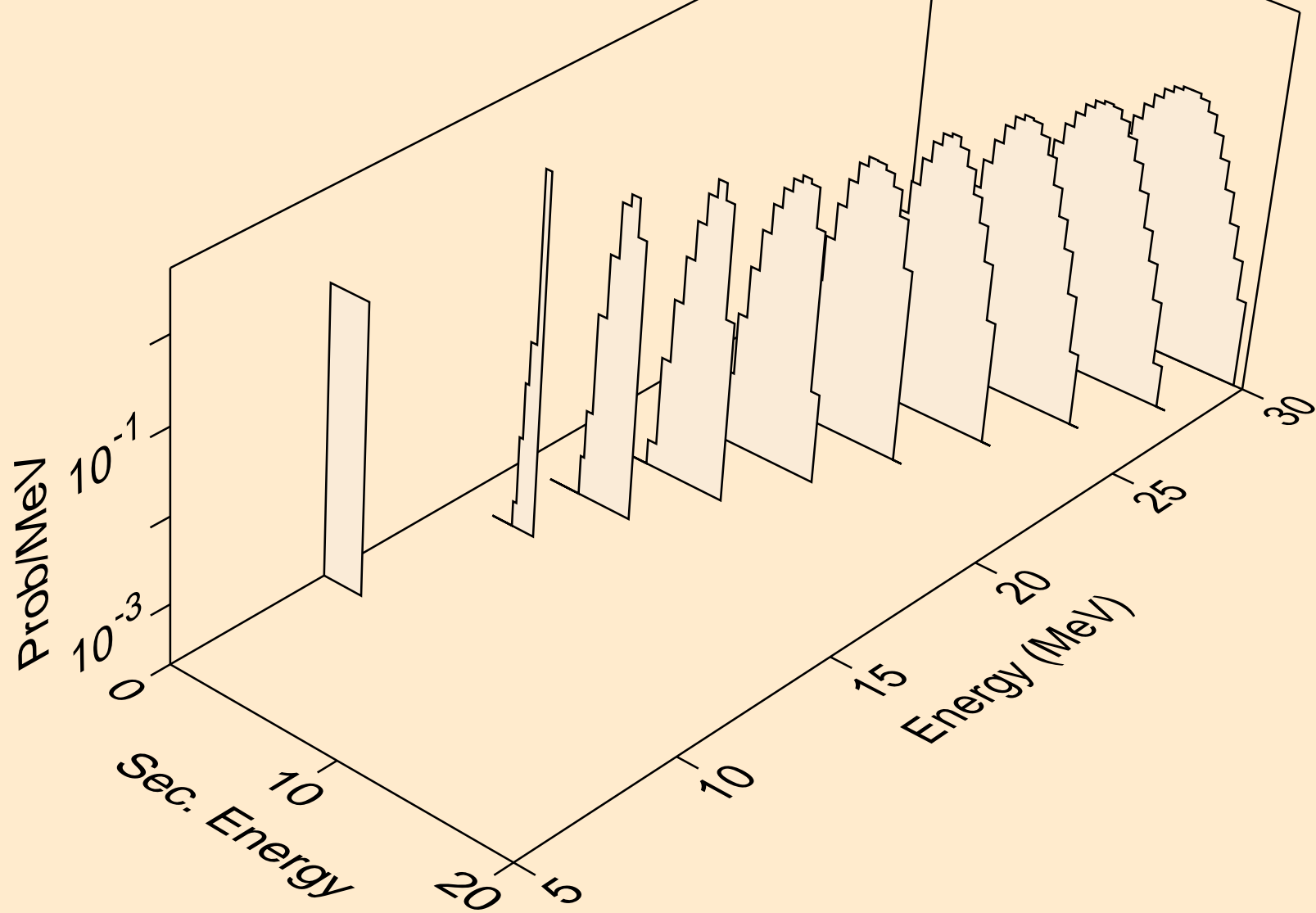

U241 NEUTRON ACER TENDL-2021 LIBRARY; T=293.6K
tritons from (n,t)

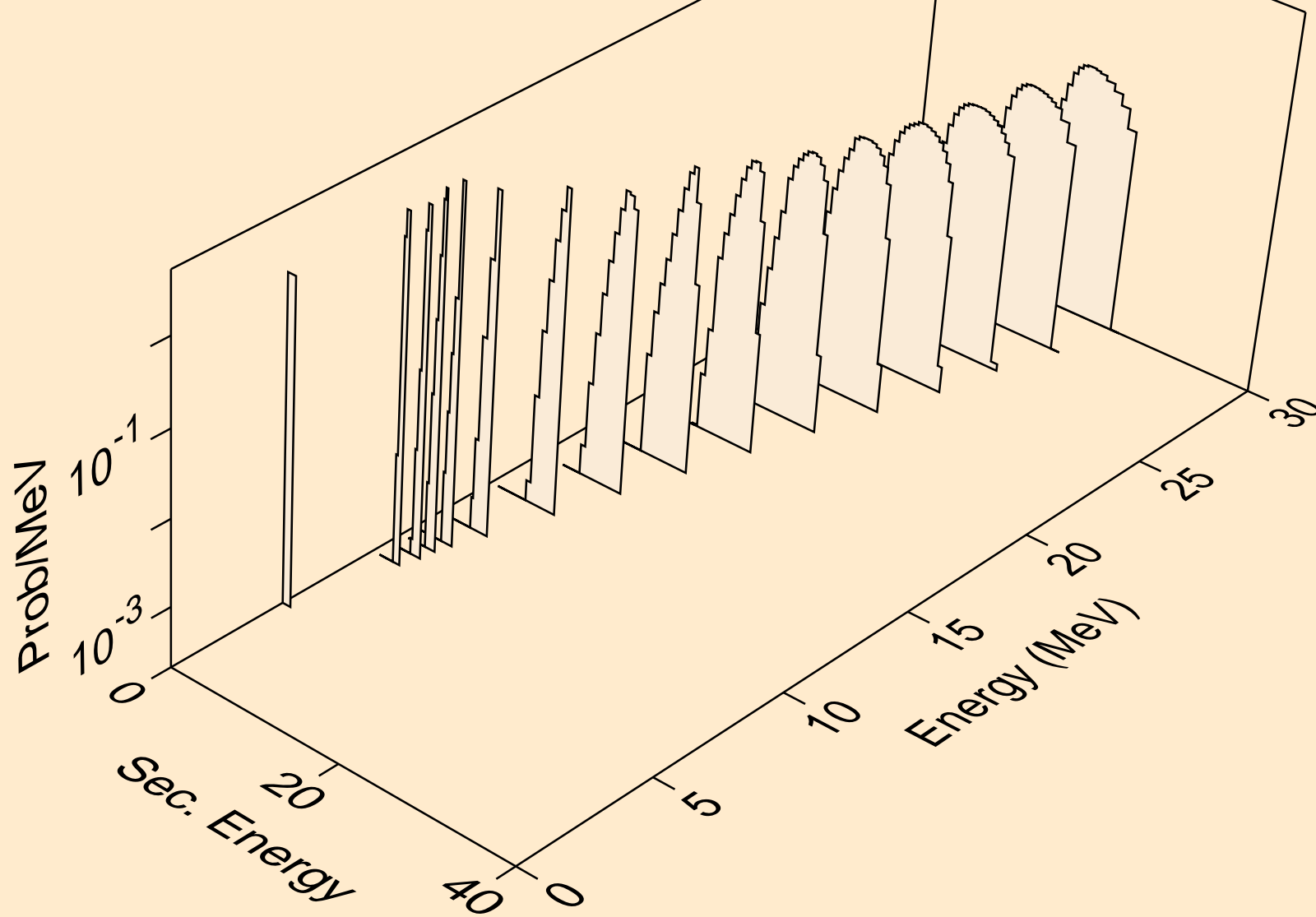

U241 NEUTRON ACER TENDL-2021 LIBRARY; T=293.6K
he3s from (n,x)

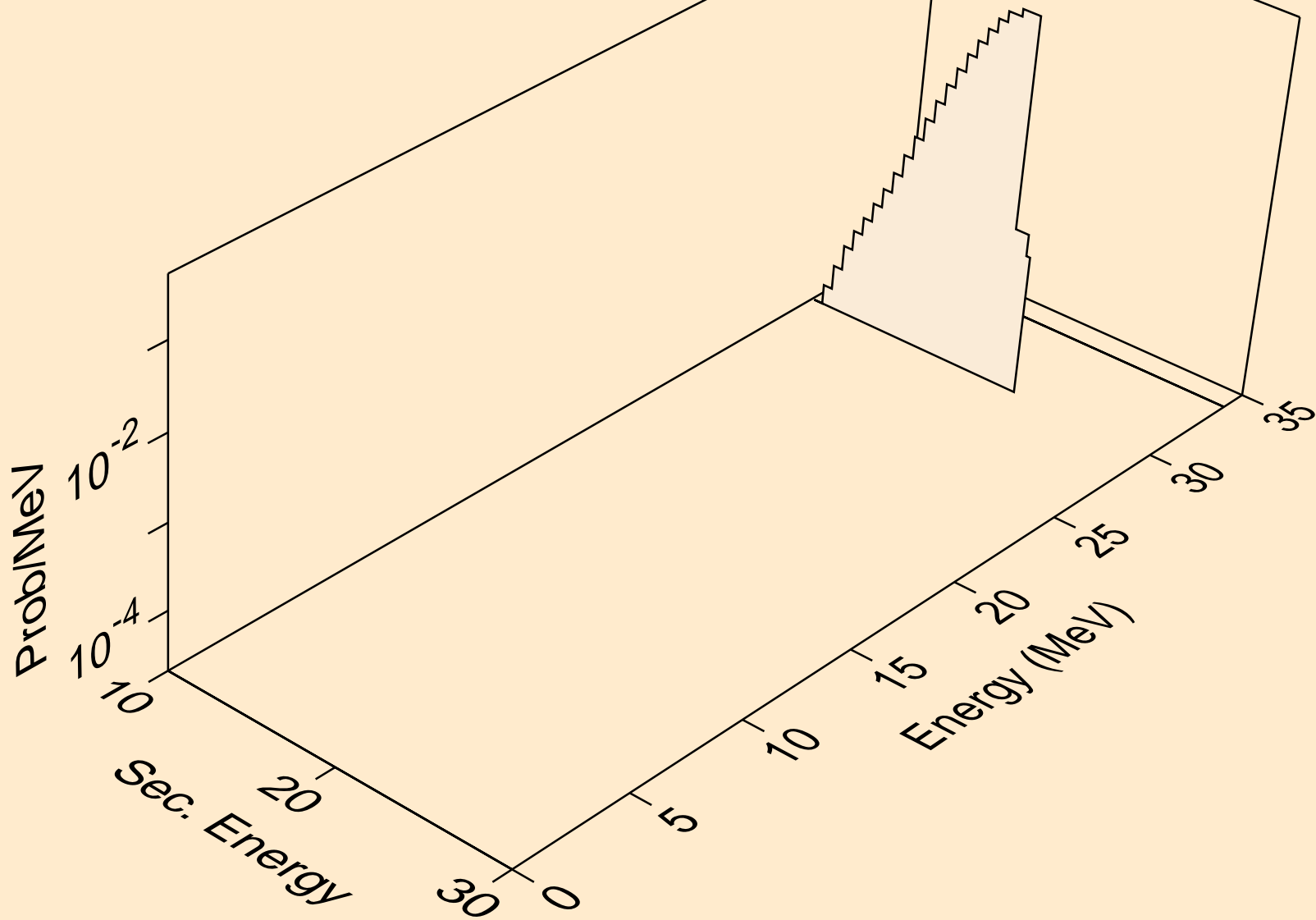

U241 NEUTRON ACER TENDL-2021 LIBRARY; T=293.6K
he3s from (n,n*)he3

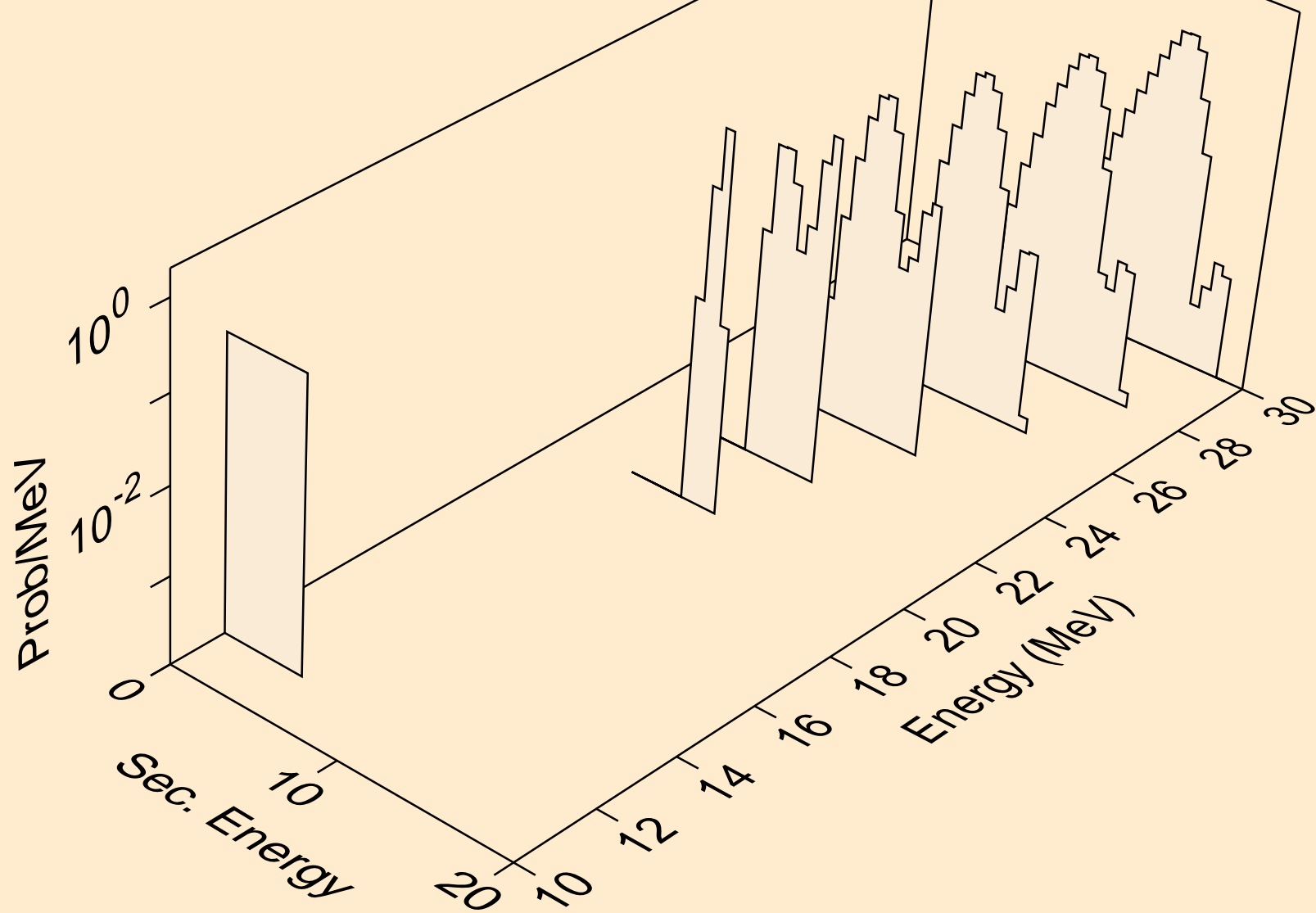

U241 NEUTRON ACER TENDL-2021 LIBRARY; T=293.6K
he3s from (n,he3)

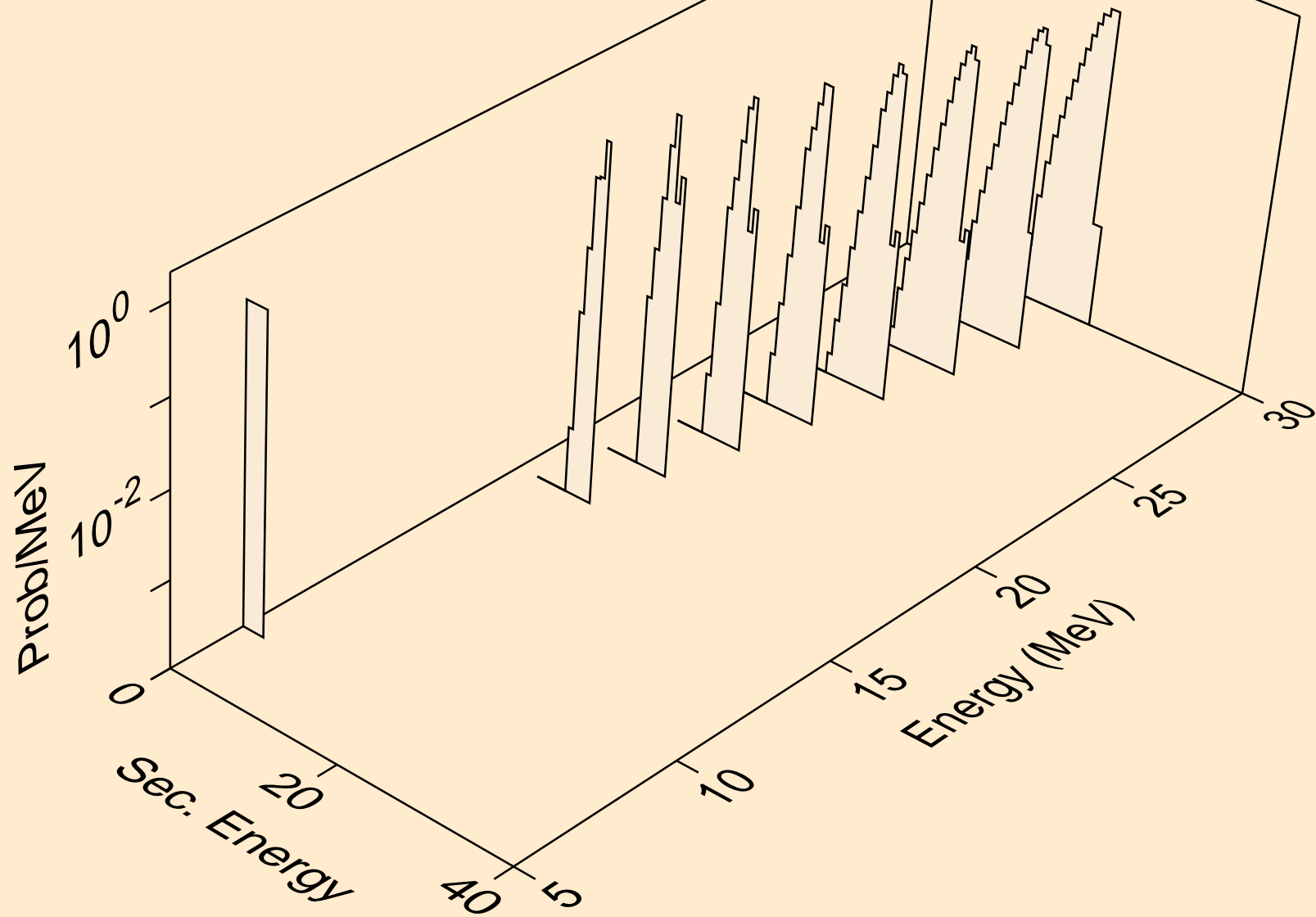

U241 NEUTRON ACER TENDL-2021 LIBRARY; T=293.6K
alphas from (n,x)

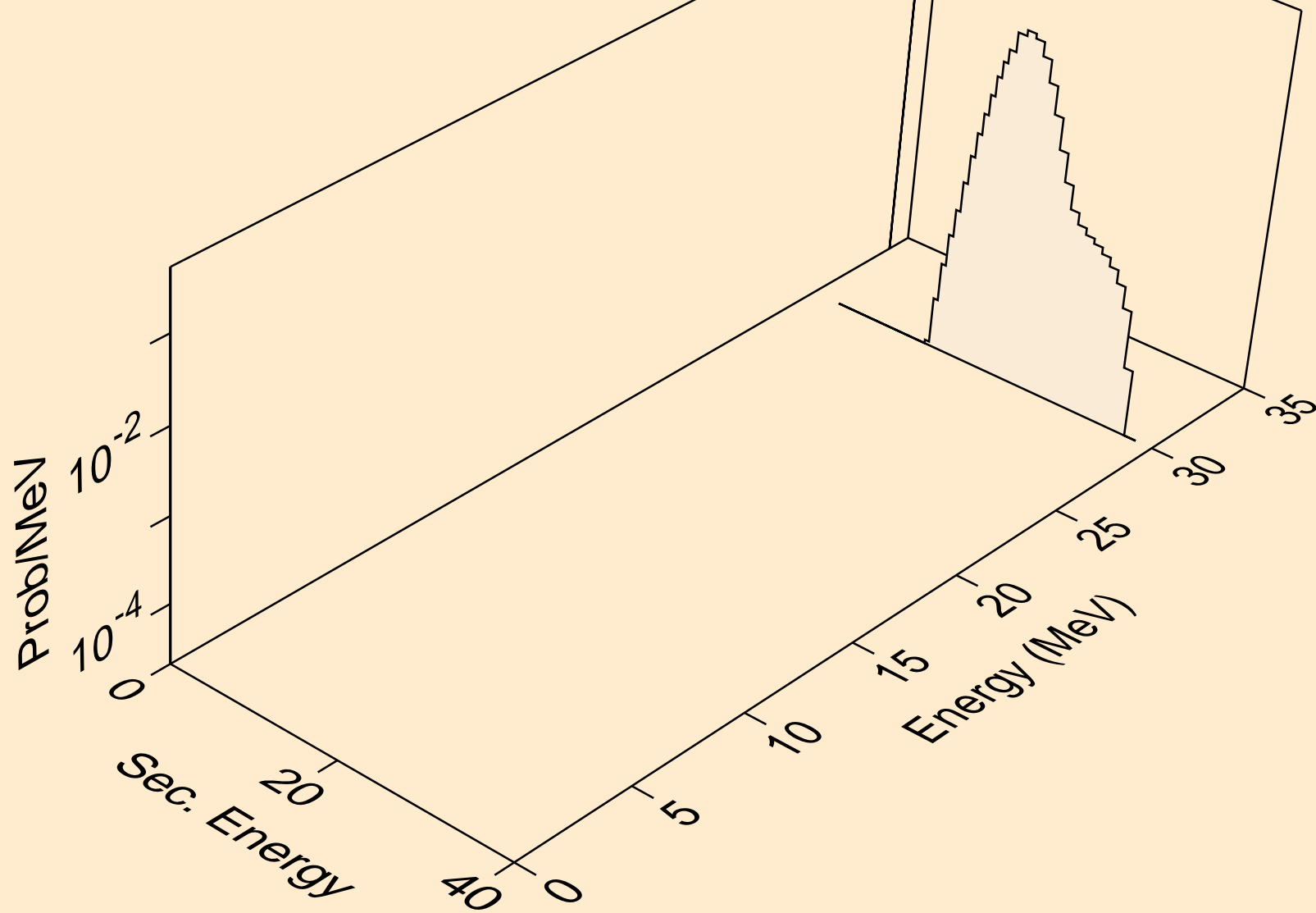

U241 NEUTRON ACER TENDL-2021 LIBRARY; T=293.6K
alphas from (n,n*)a

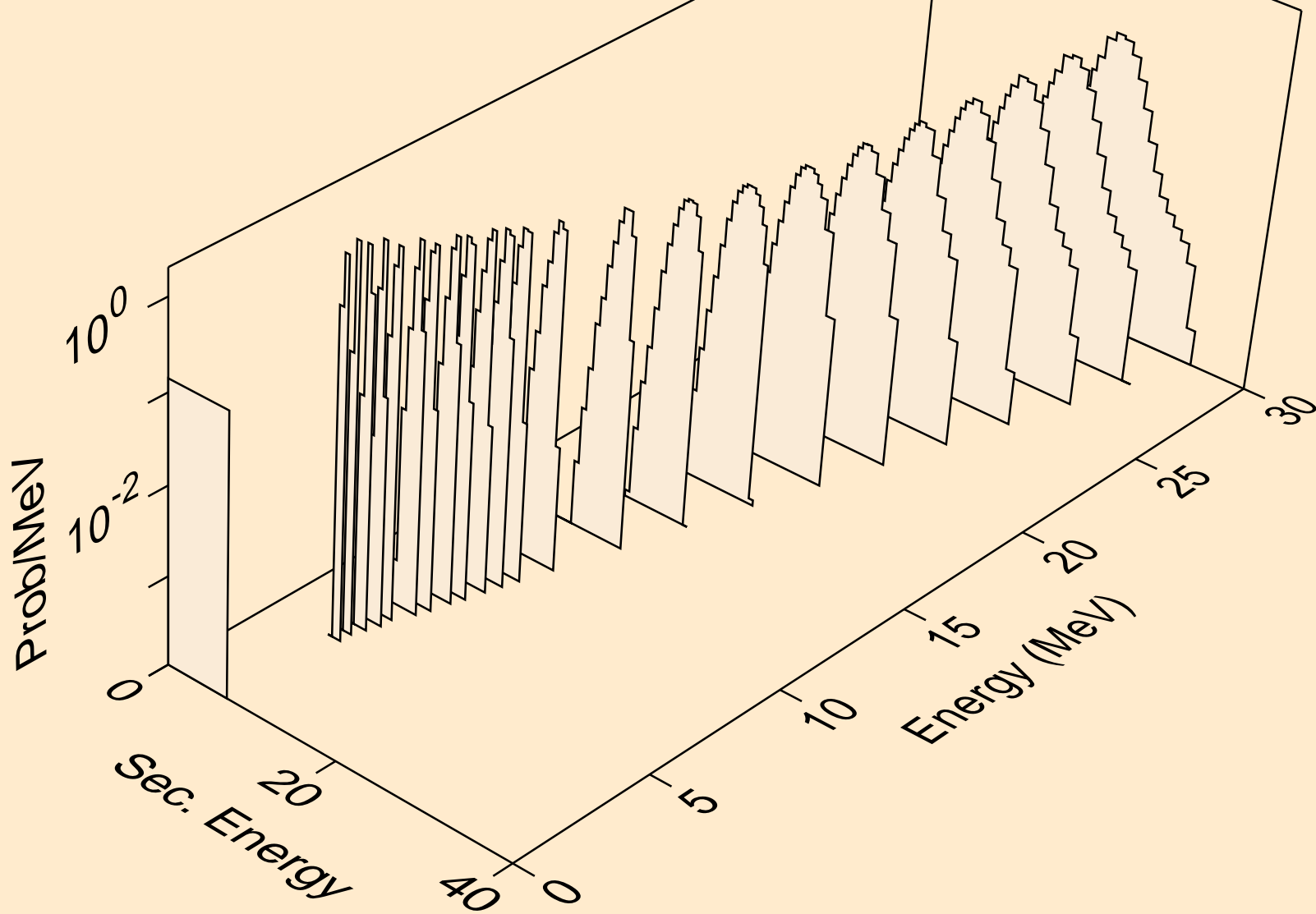

U241 NEUTRON ACER TENDL-2021 LIBRARY; T=293.6K
alphas from (n,2n)a

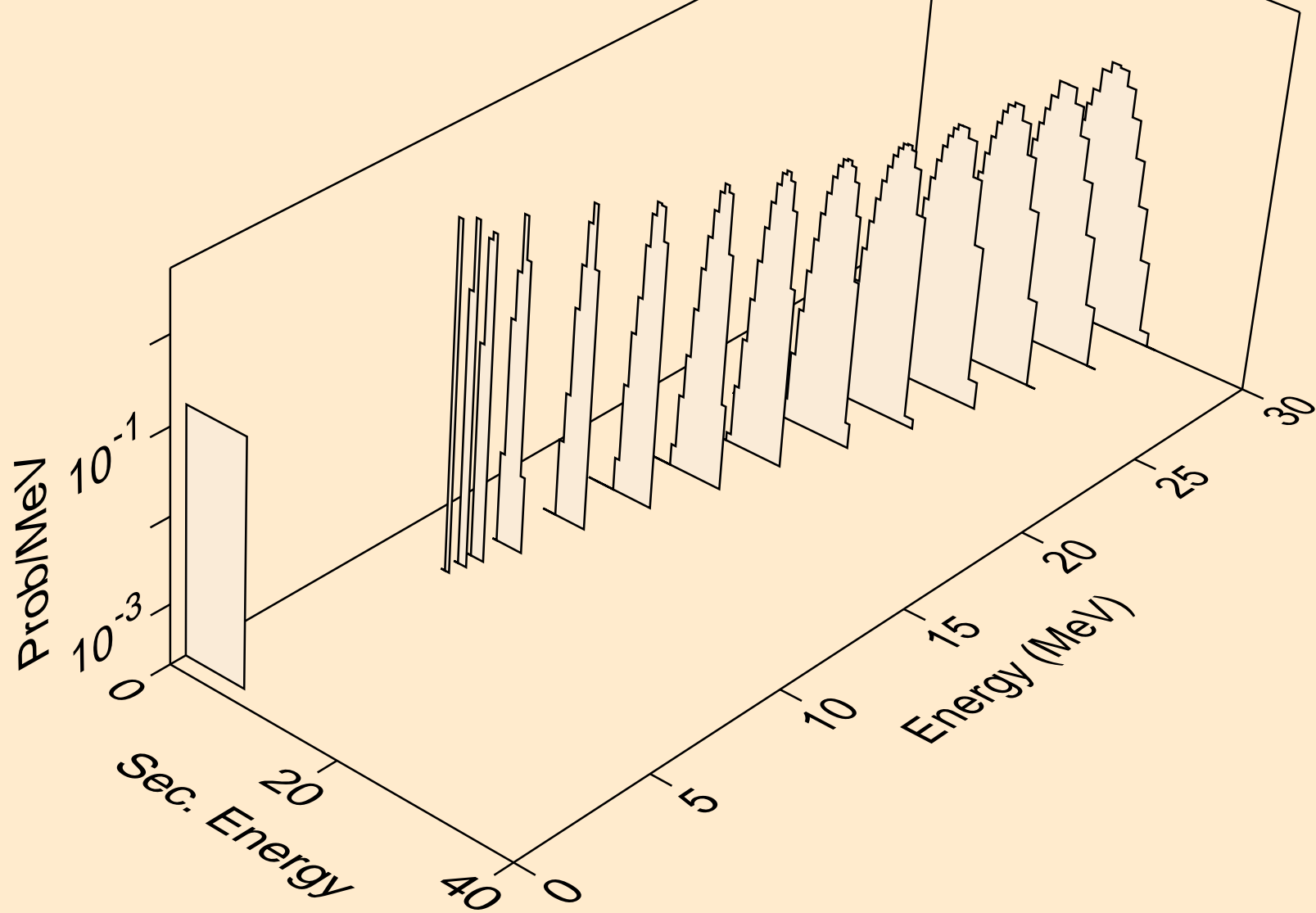

U241 NEUTRON ACER TENDL-2021 LIBRARY; T=293.6K
alphas from (n,3n)a

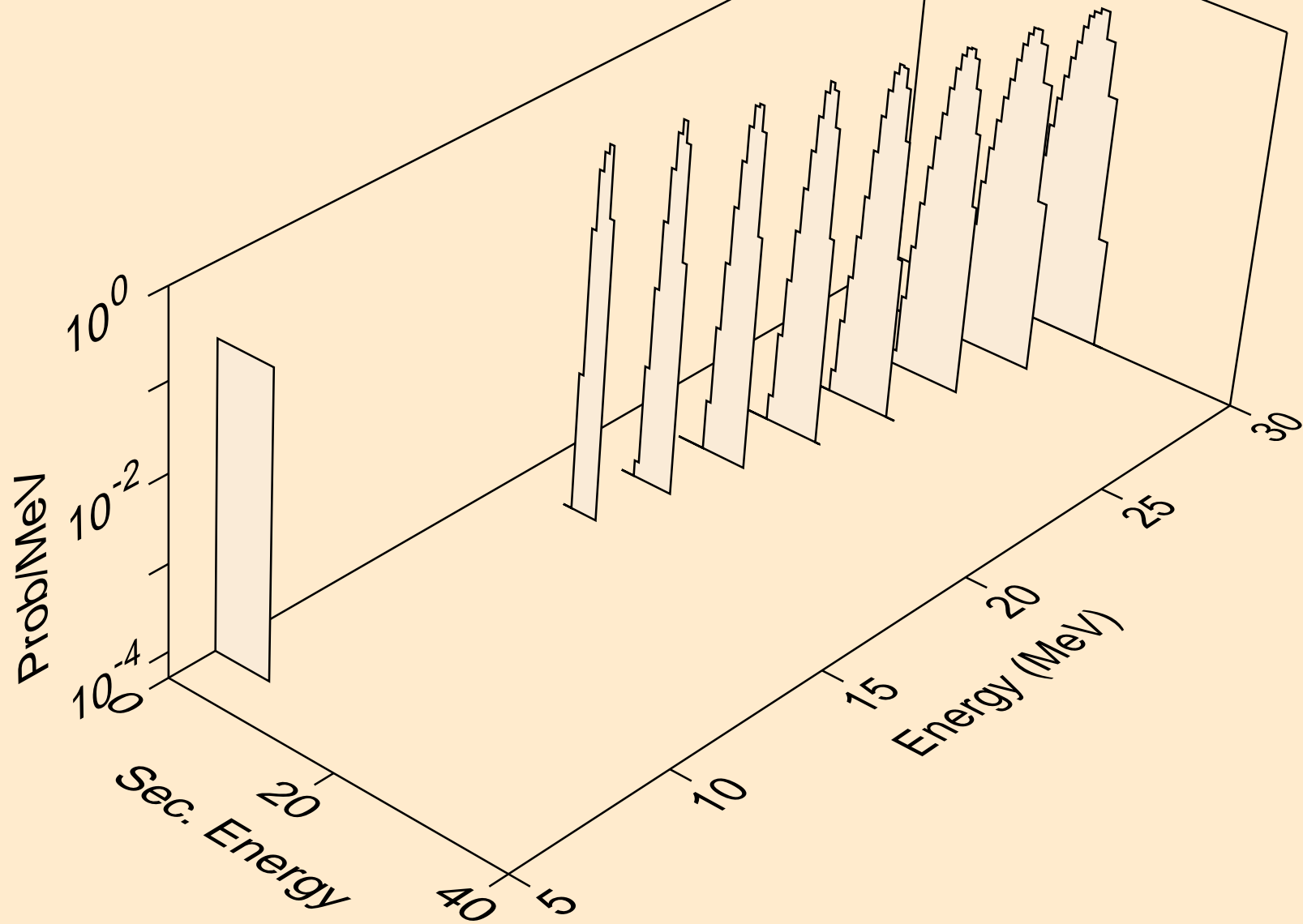

U241 NEUTRON ACER TENDL-2021 LIBRARY; T=293.6K
alphas from (n,n*)2a

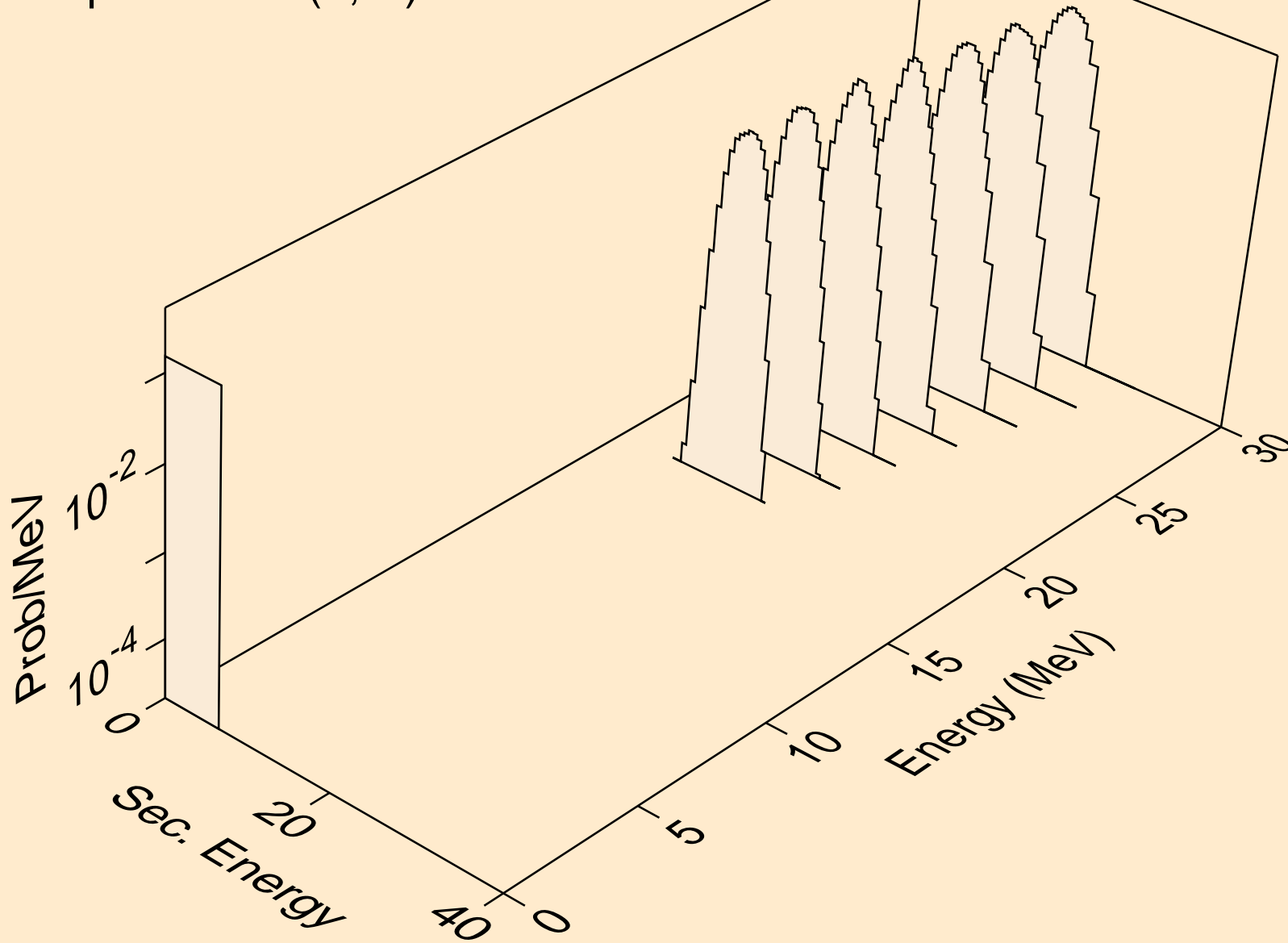

U241 NEUTRON ACER TENDL-2021 LIBRARY; T=293.6K
alphas from (n,npa)

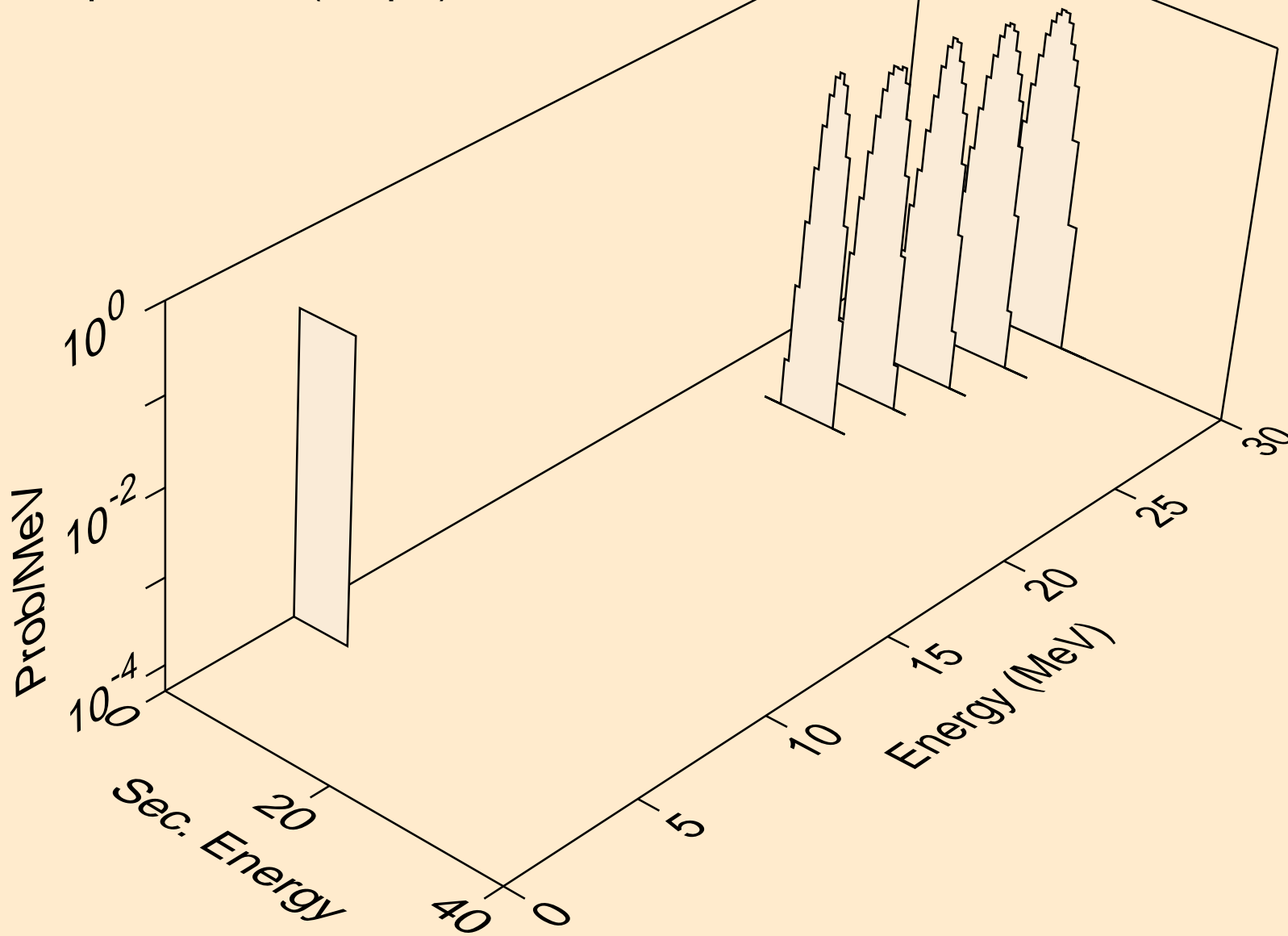

U241 NEUTRON ACER TENDL-2021 LIBRARY; T=293.6K
alphas from (n,a)

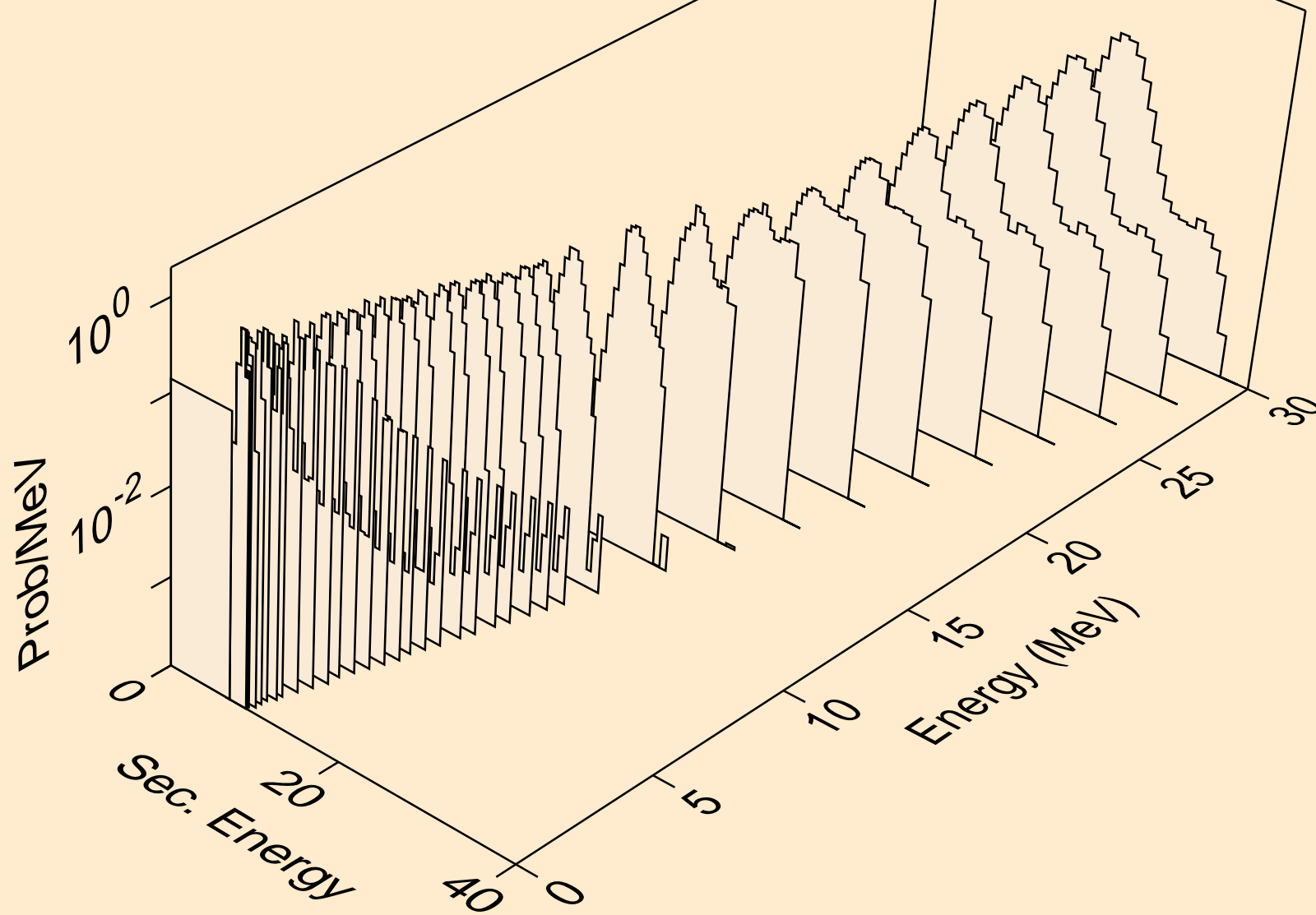

U241 NEUTRON ACER TENDL-2021 LIBRARY; T=293.6K
alphas from (n,2a)

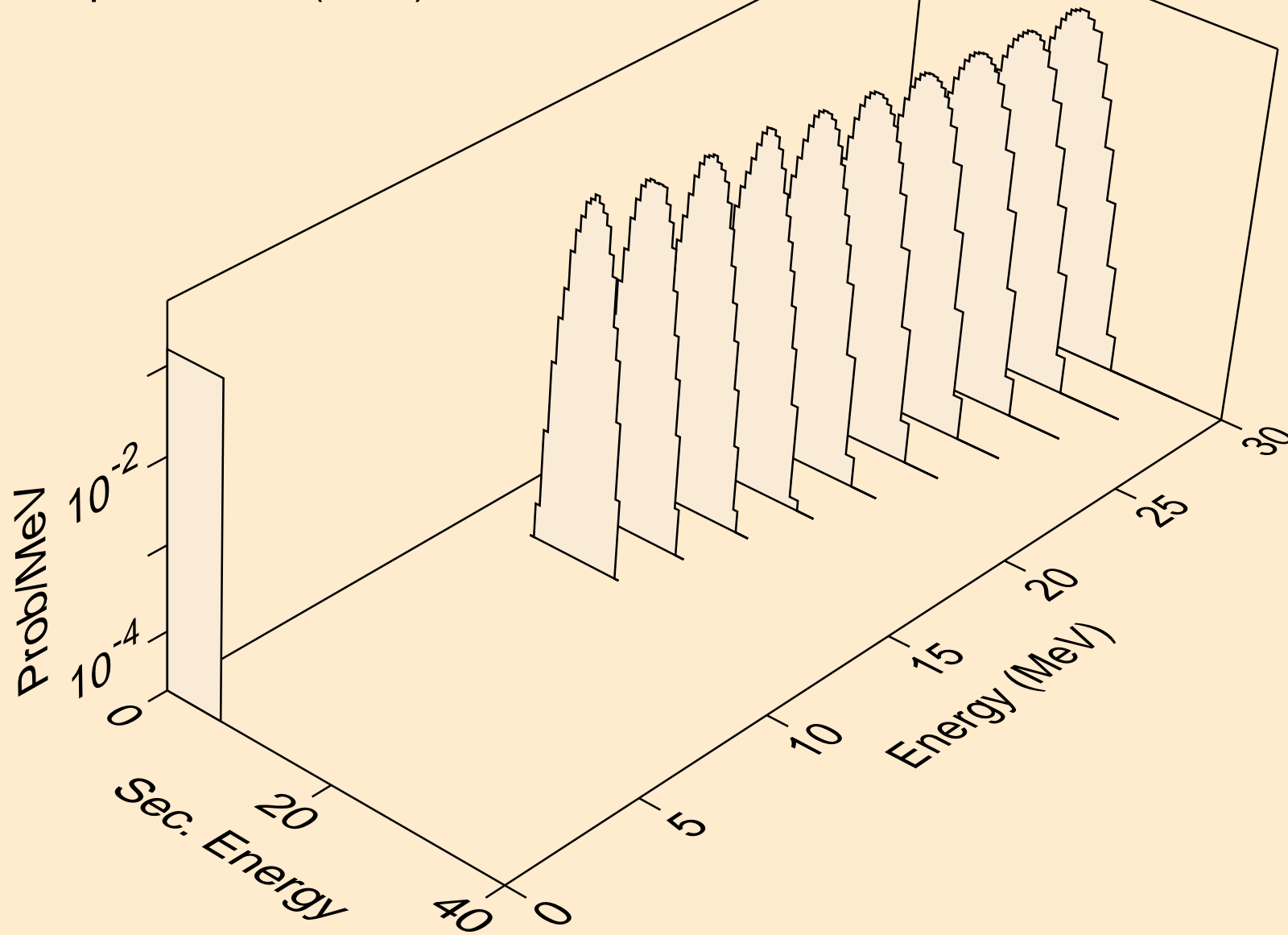

U241 NEUTRON ACER TENDL-2021 LIBRARY; T=293.6K
alphas from (n,pa)

