

V049 NEUTRON ACER TENDL-2021 LIBRARY; T=293.6K  
Principal cross sections

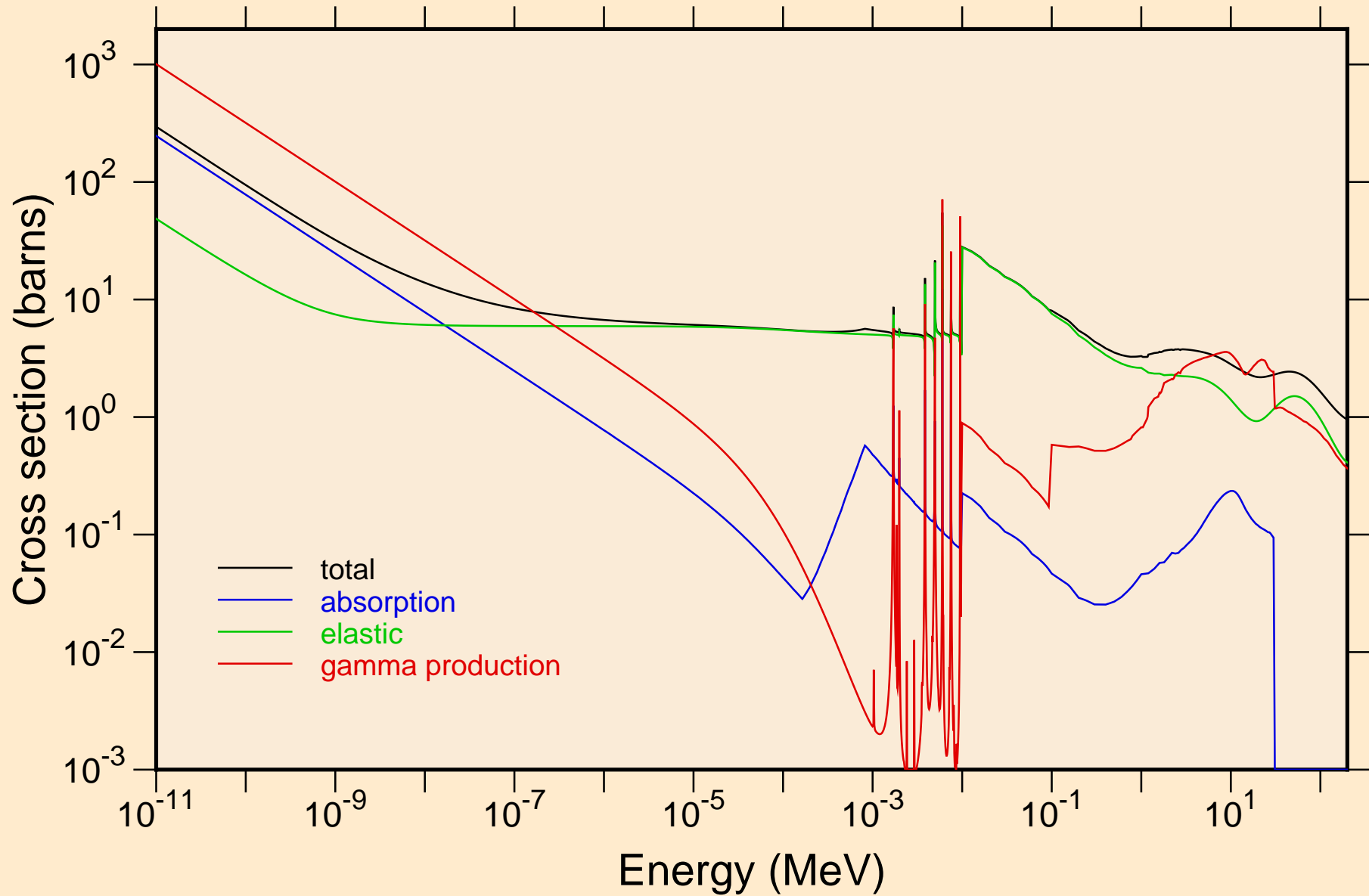

V049 NEUTRON ACER TENDL-2021 LIBRARY; T=293.6K  
resonance total cross section

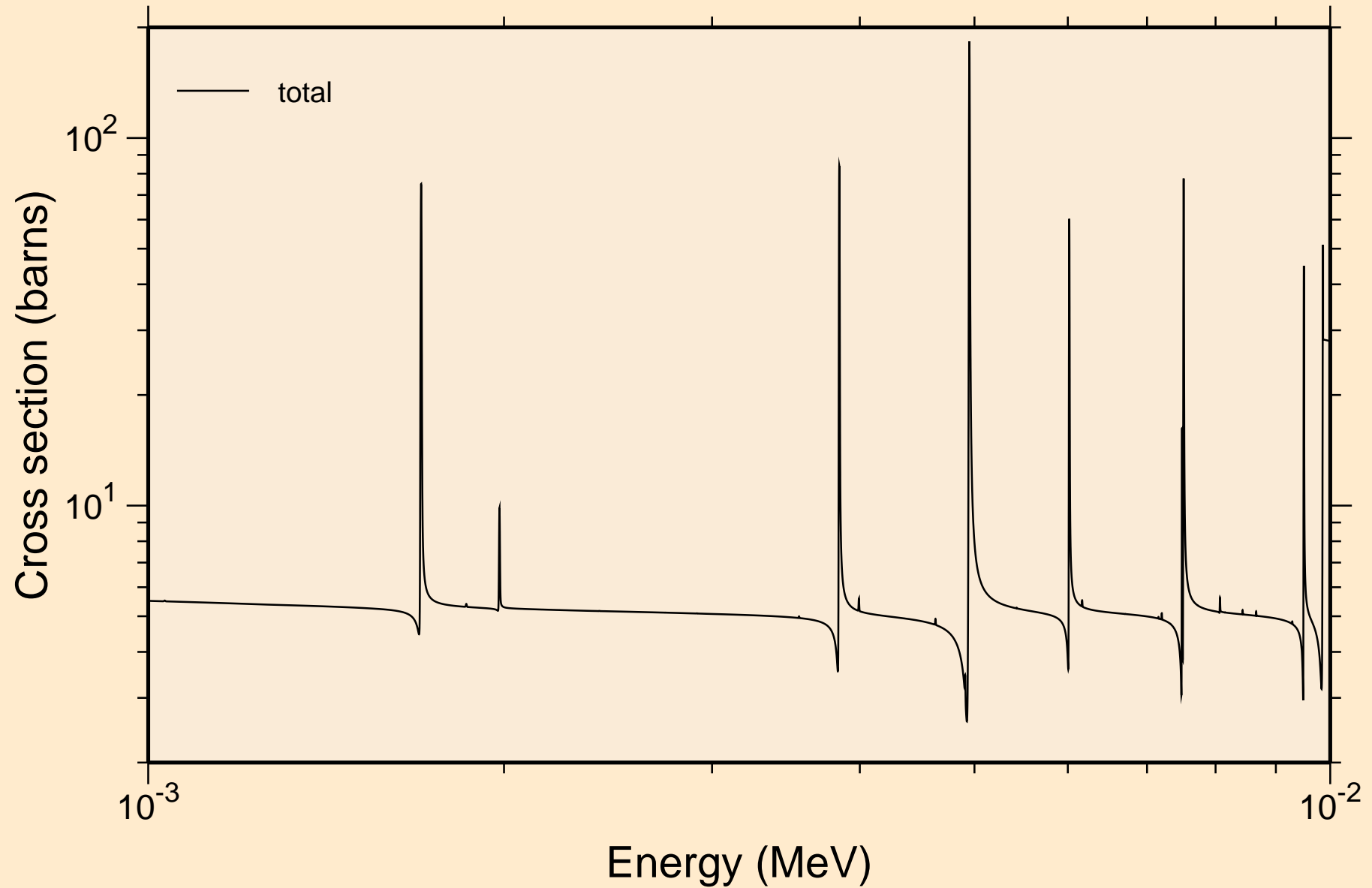

V049 NEUTRON ACER TENDL-2021 LIBRARY; T=293.6K  
resonance total cross section

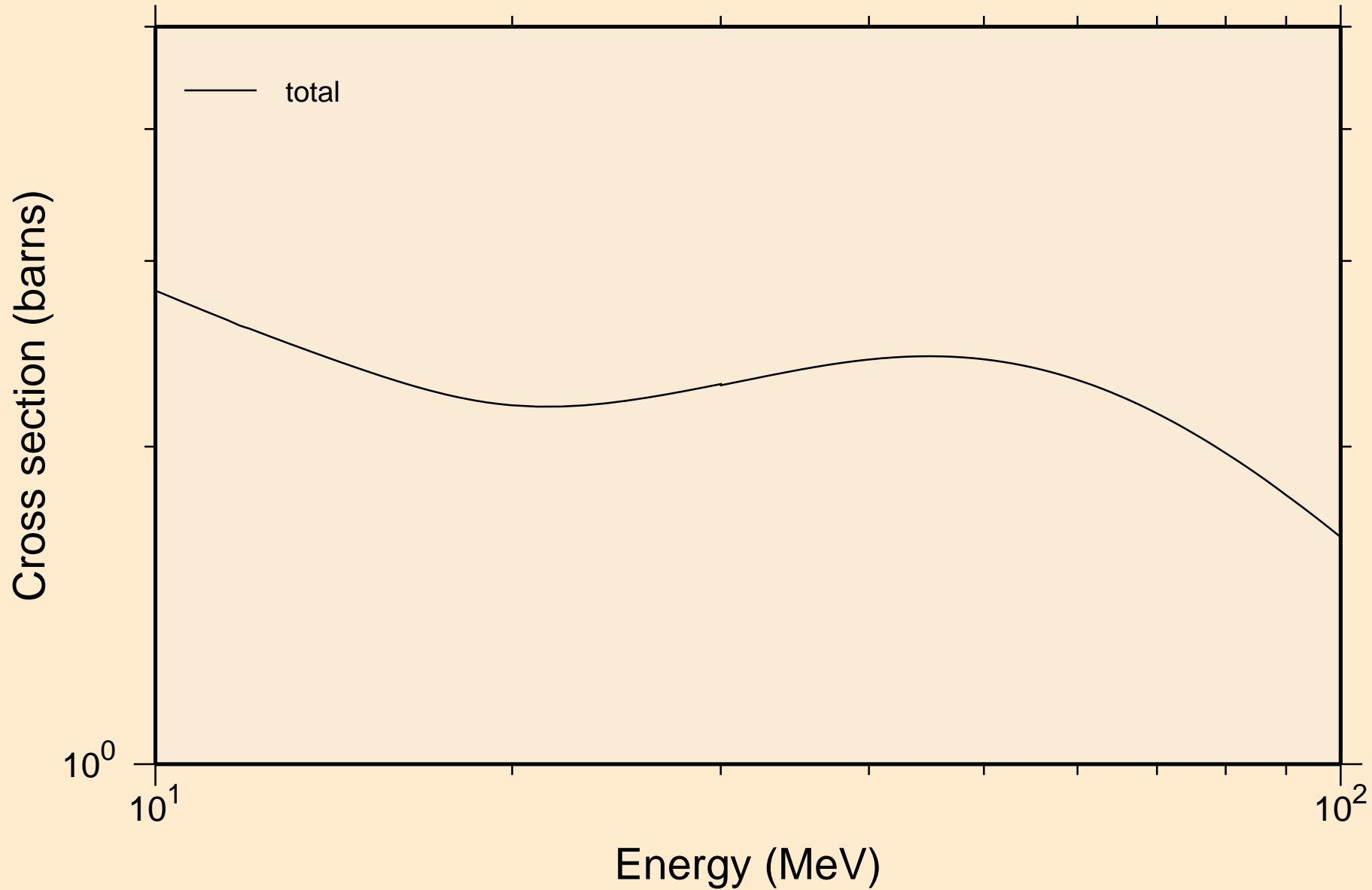

V049 NEUTRON ACER TENDL-2021 LIBRARY; T=293.6K  
resonance absorption cross sections

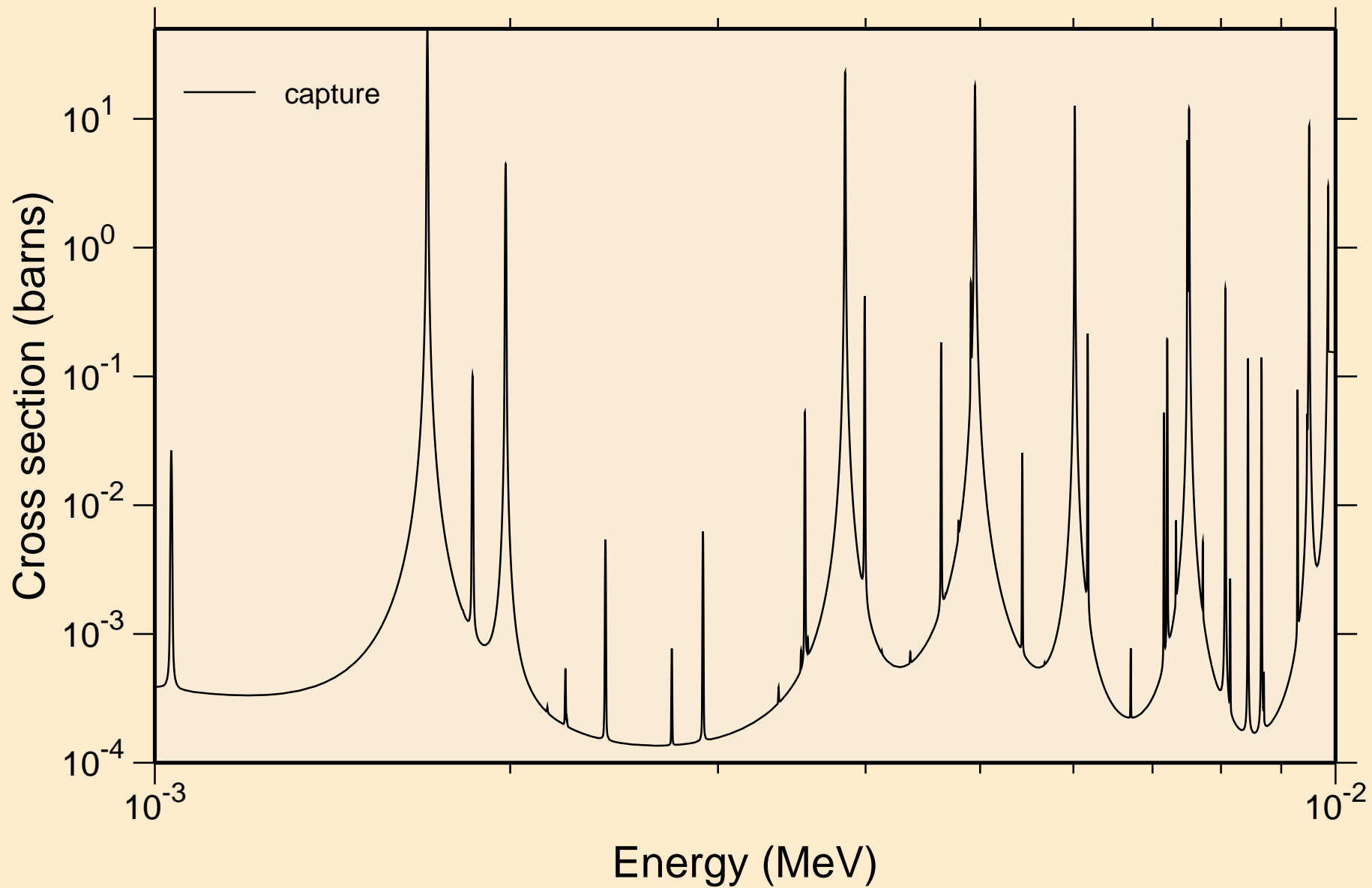

V049 NEUTRON ACER TENDL-2021 LIBRARY; T=293.6K  
resonance absorption cross sections

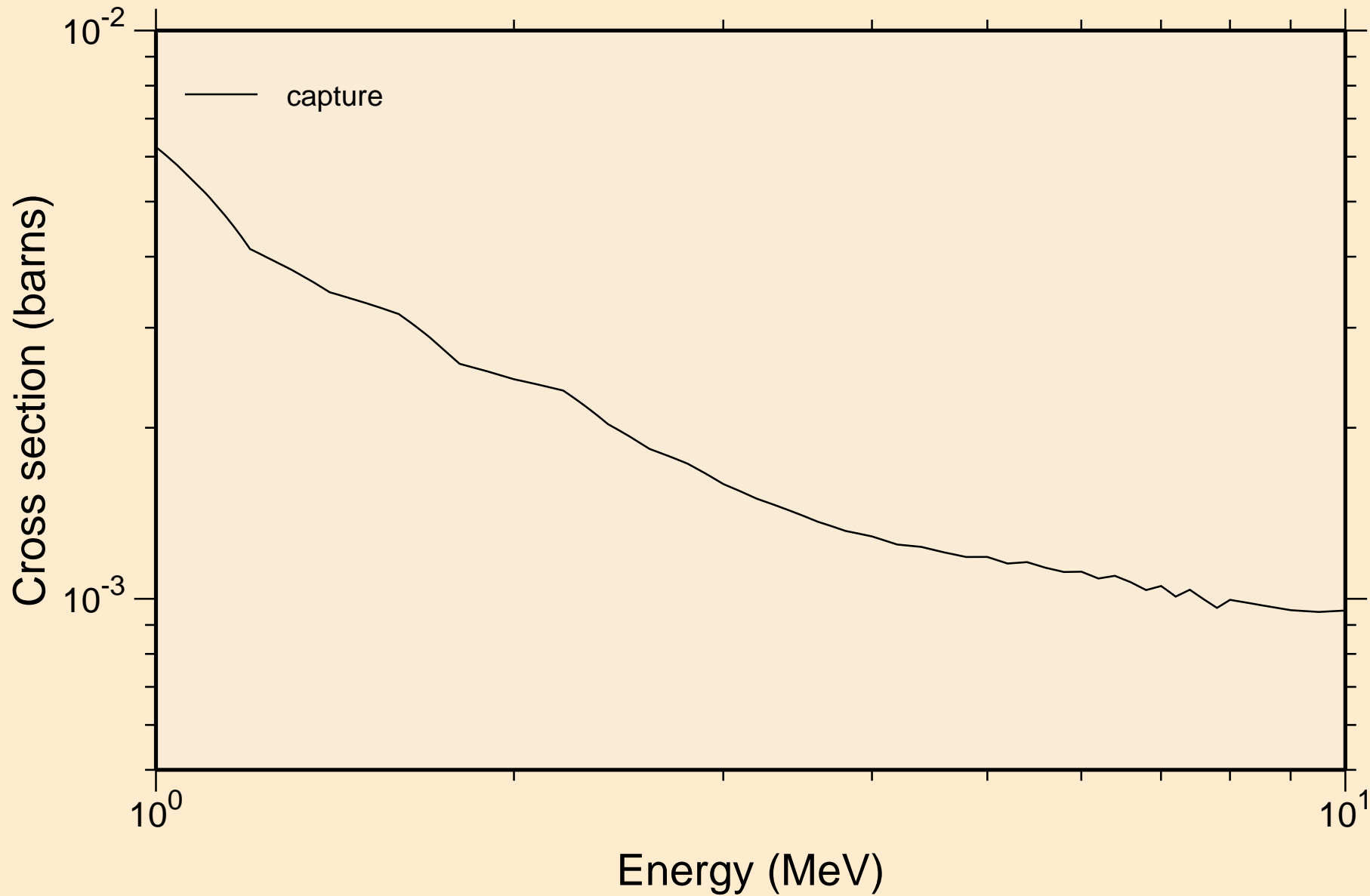

V049 NEUTRON ACER TENDL-2021 LIBRARY; T=293.6K  
Heating

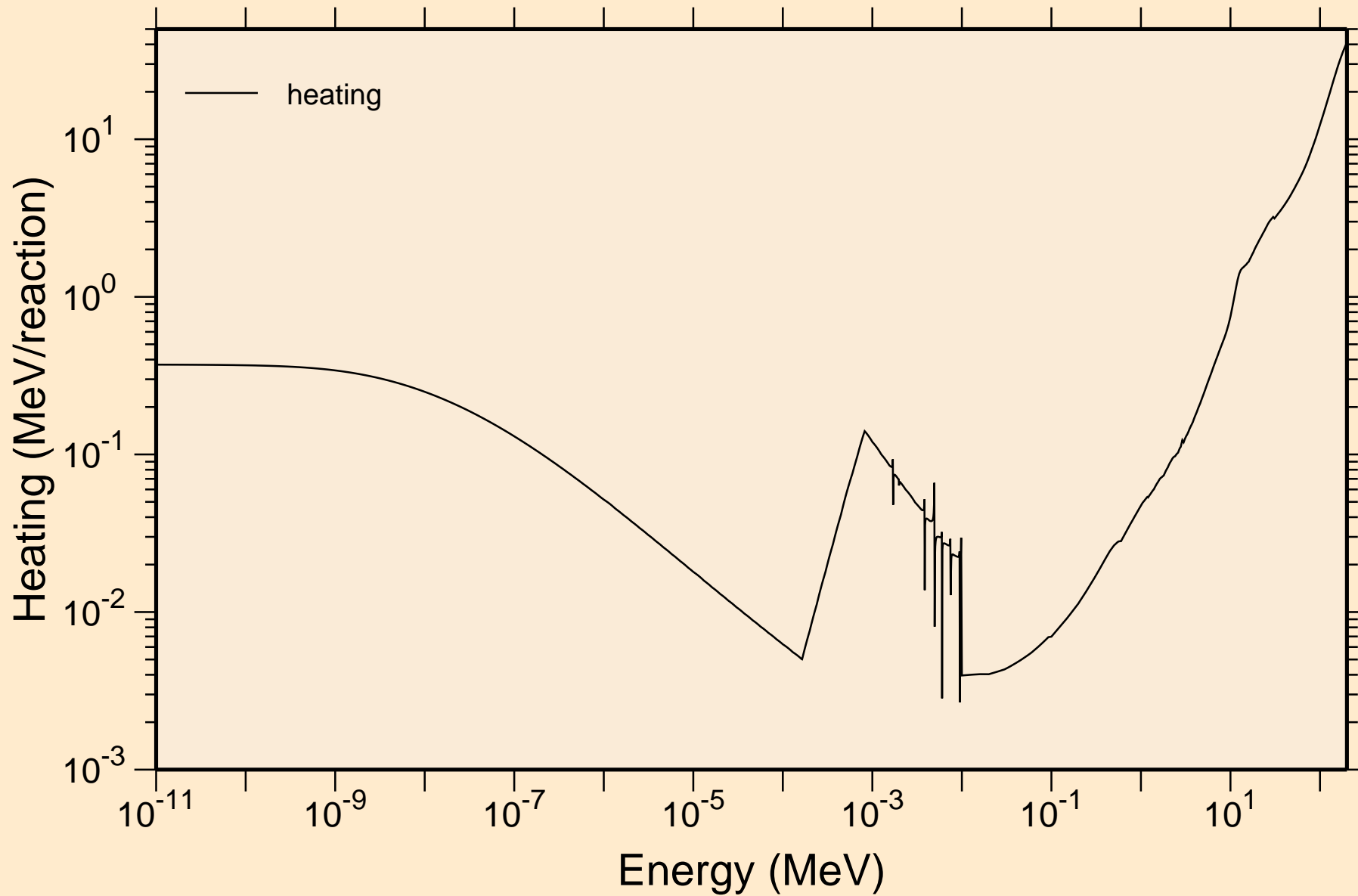

V049 NEUTRON ACER TENDL-2021 LIBRARY; T=293.6K  
Damage

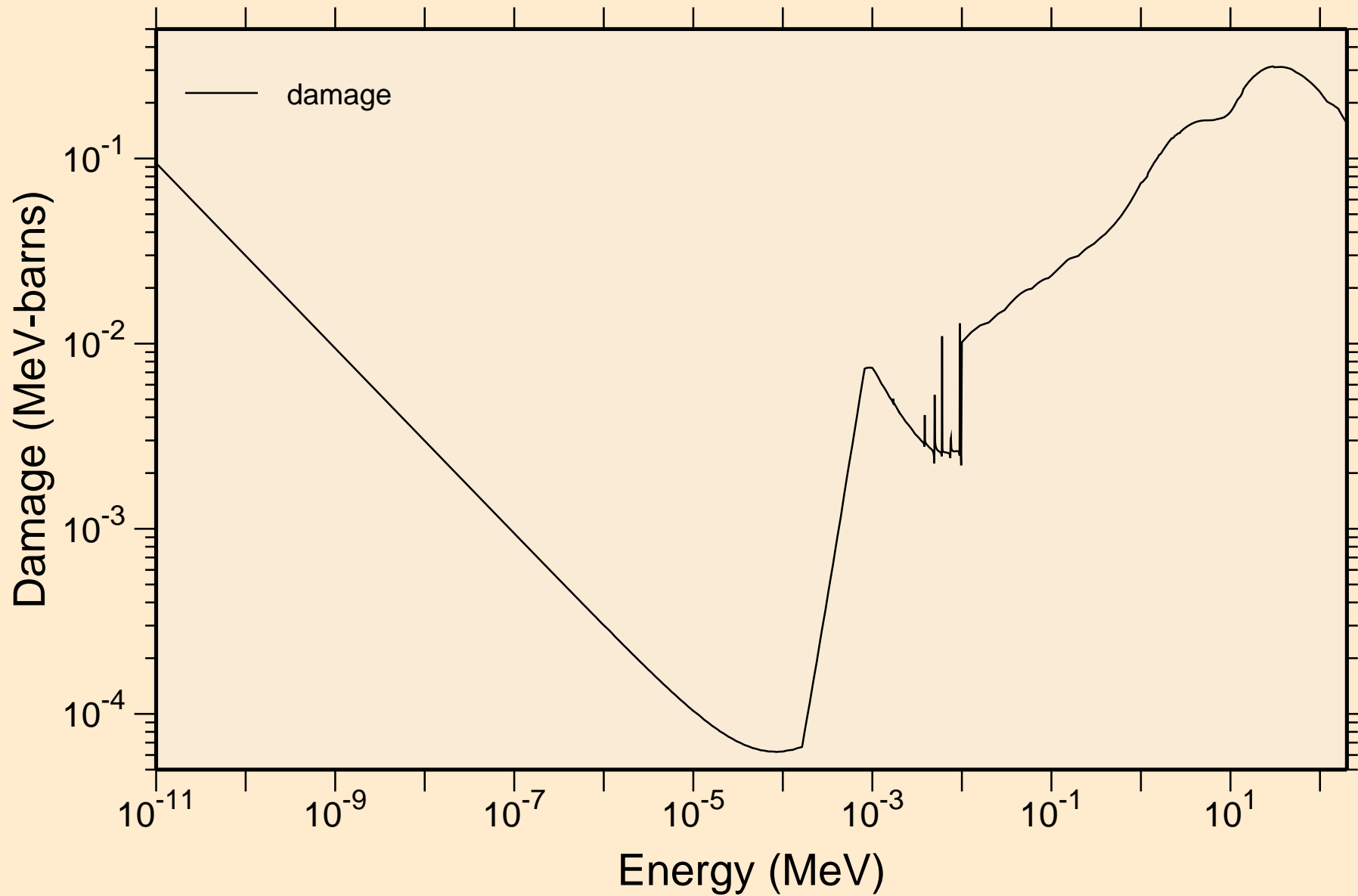

V049 NEUTRON ACER TENDL-2021 LIBRARY; T=293.6K  
Non-threshold reactions

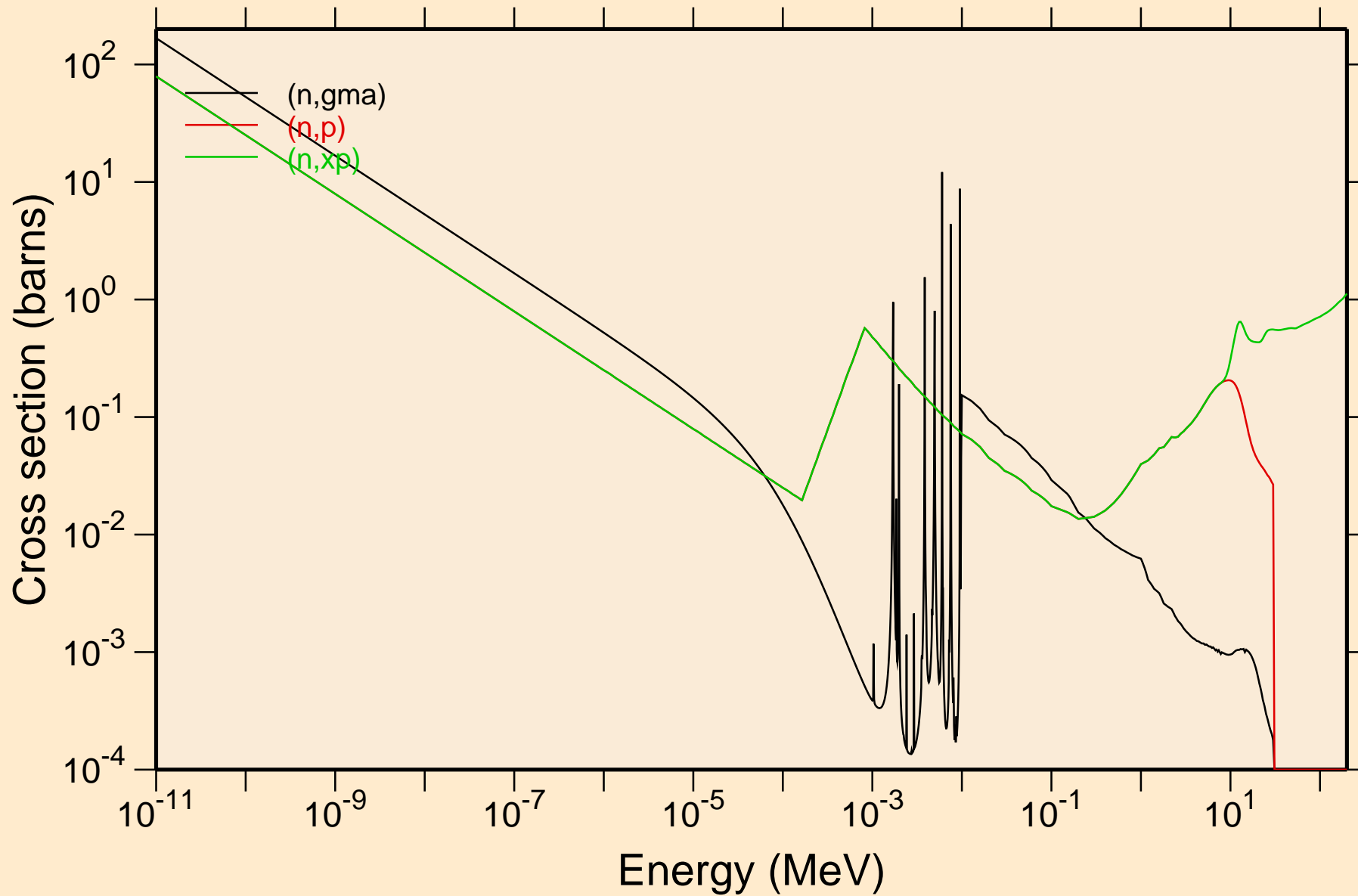



# V049 NEUTRON ACER TENDL-2021 LIBRARY; T=293.6K

## Principal cross sections

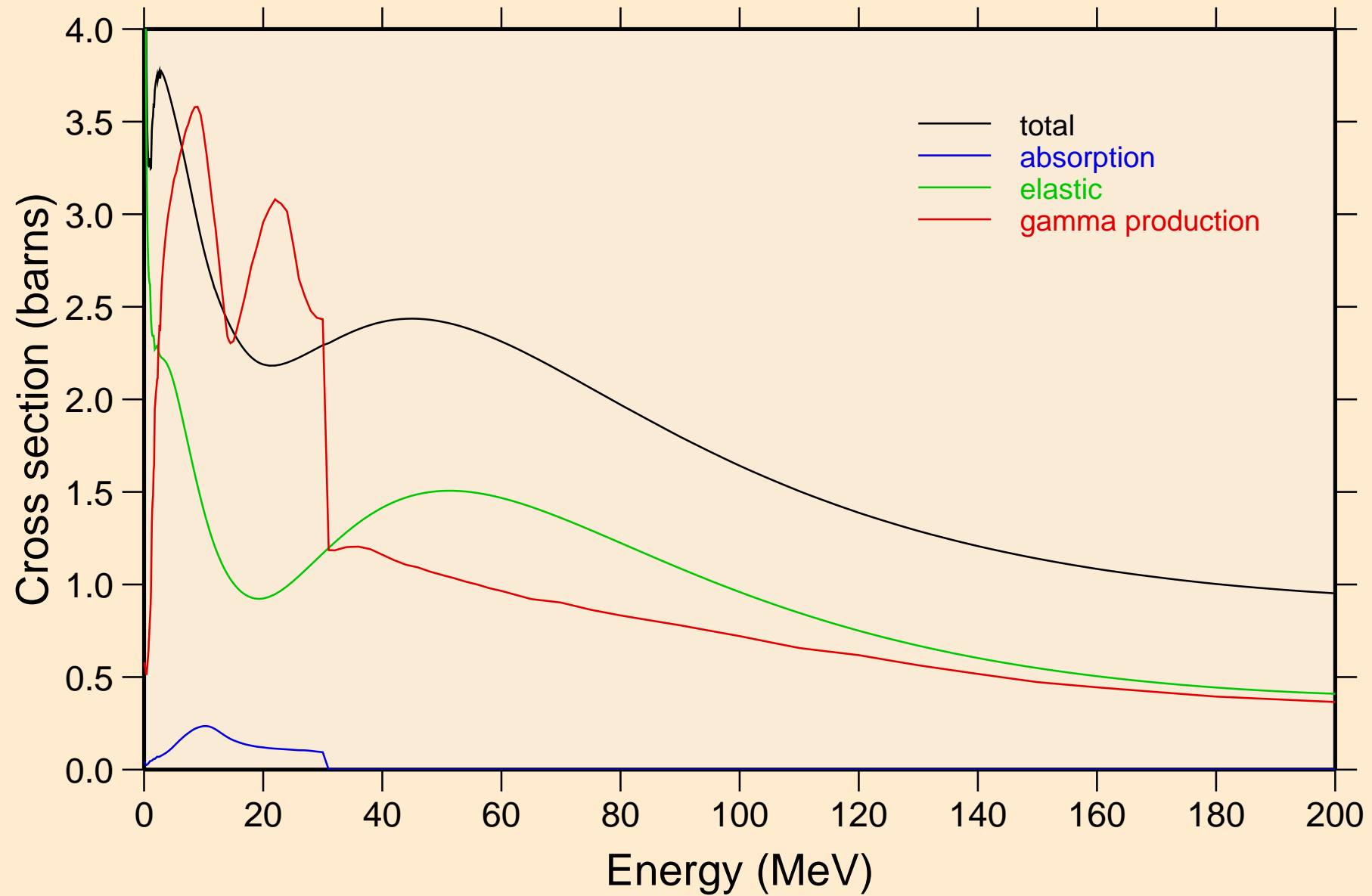

V049 NEUTRON ACER TENDL-2021 LIBRARY; T=293.6K

Heating

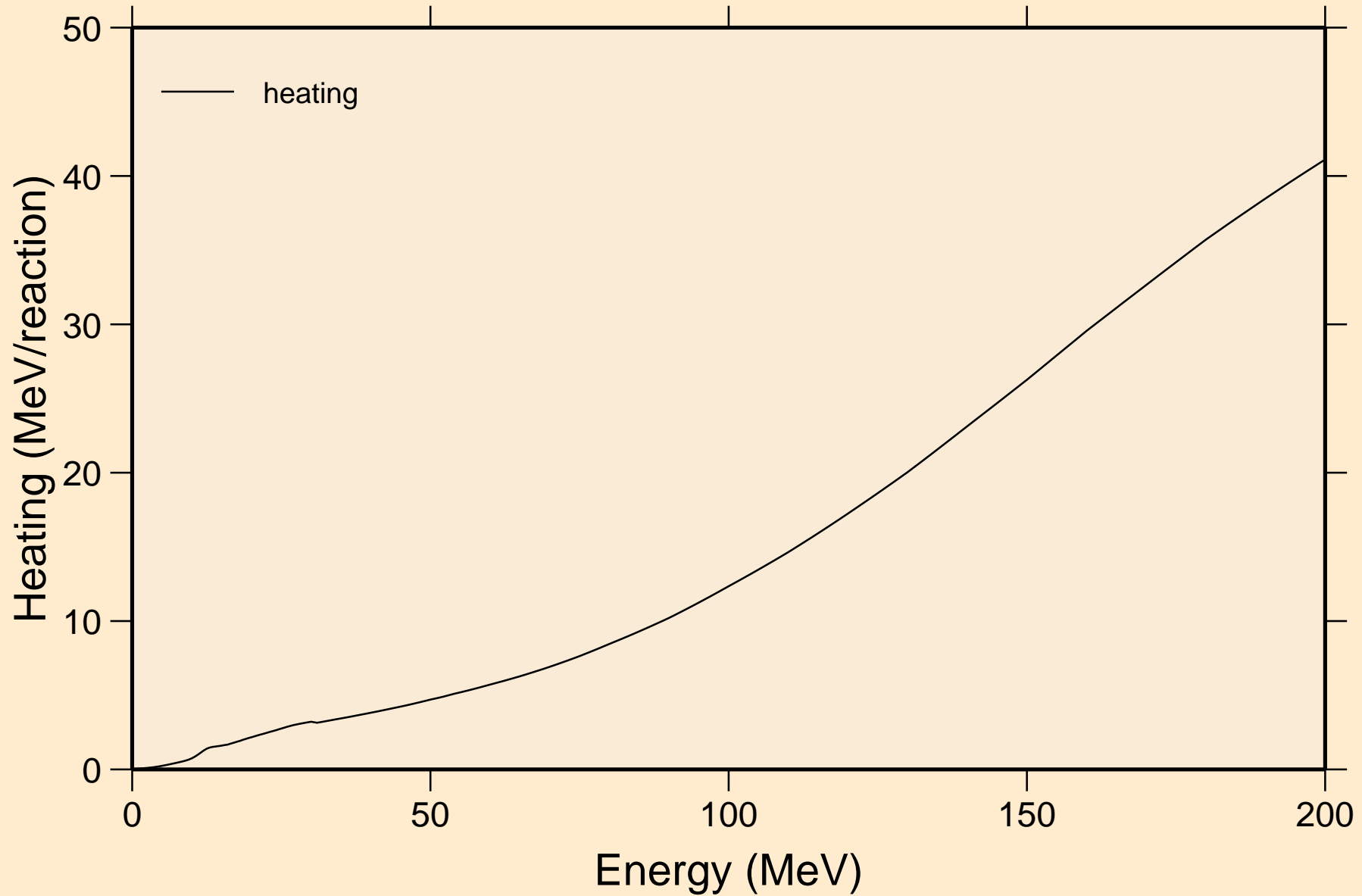

V049 NEUTRON ACER TENDL-2021 LIBRARY; T=293.6K  
Damage

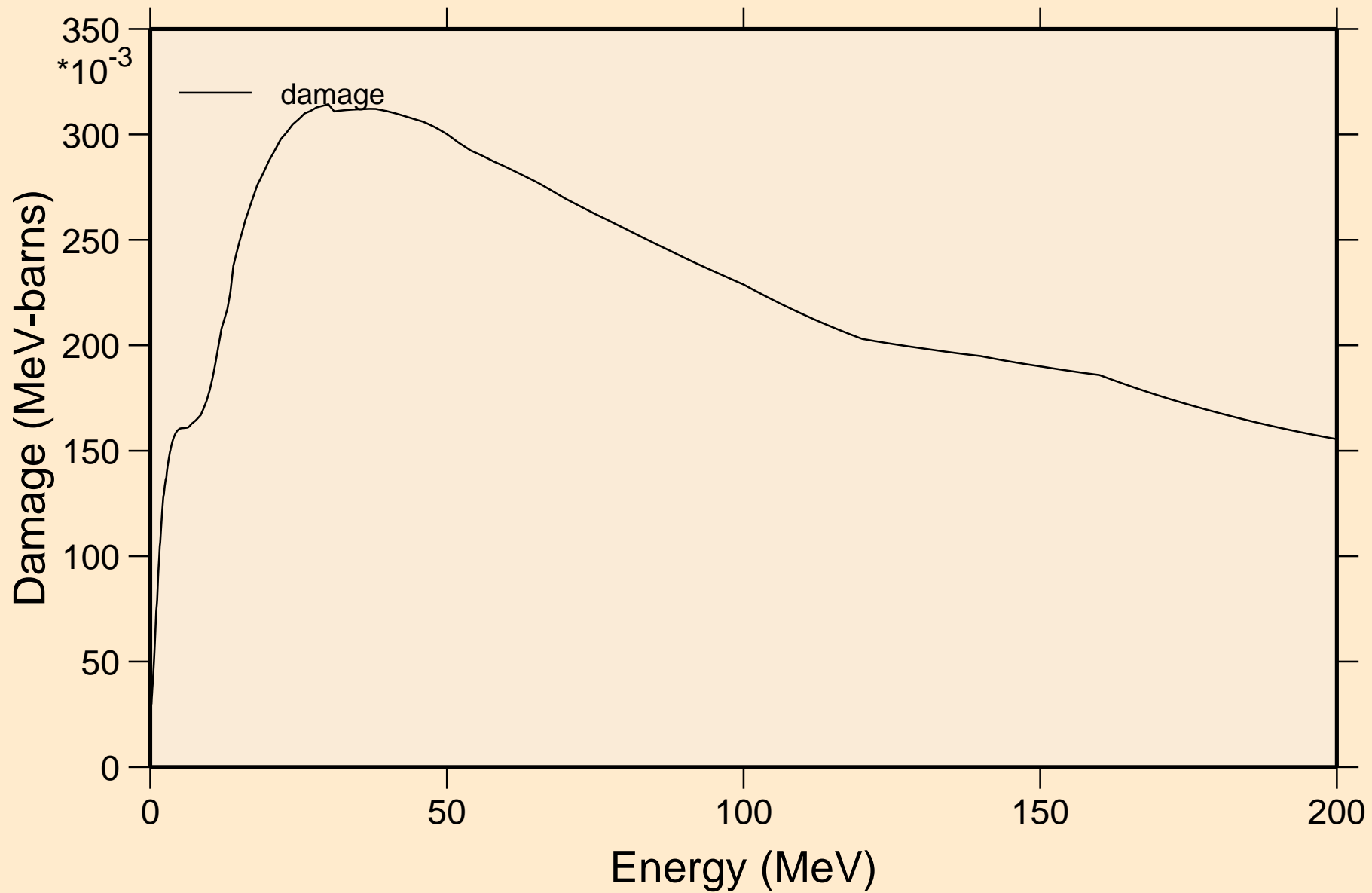

V049 NEUTRON ACER TENDL-2021 LIBRARY; T=293.6K  
Non-threshold reactions

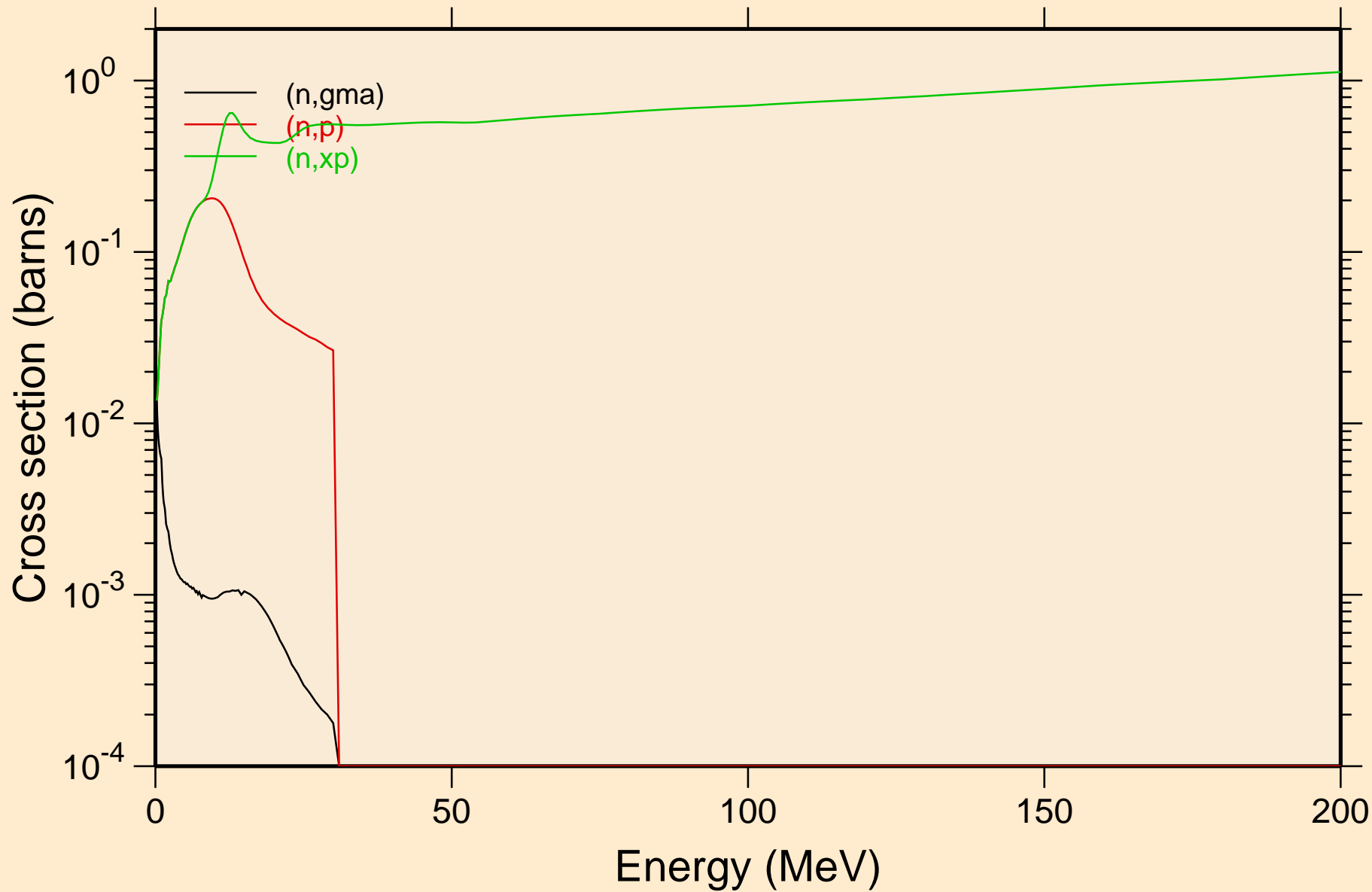

V049 NEUTRON ACER TENDL-2021 LIBRARY; T=293.6K  
Inelastic levels

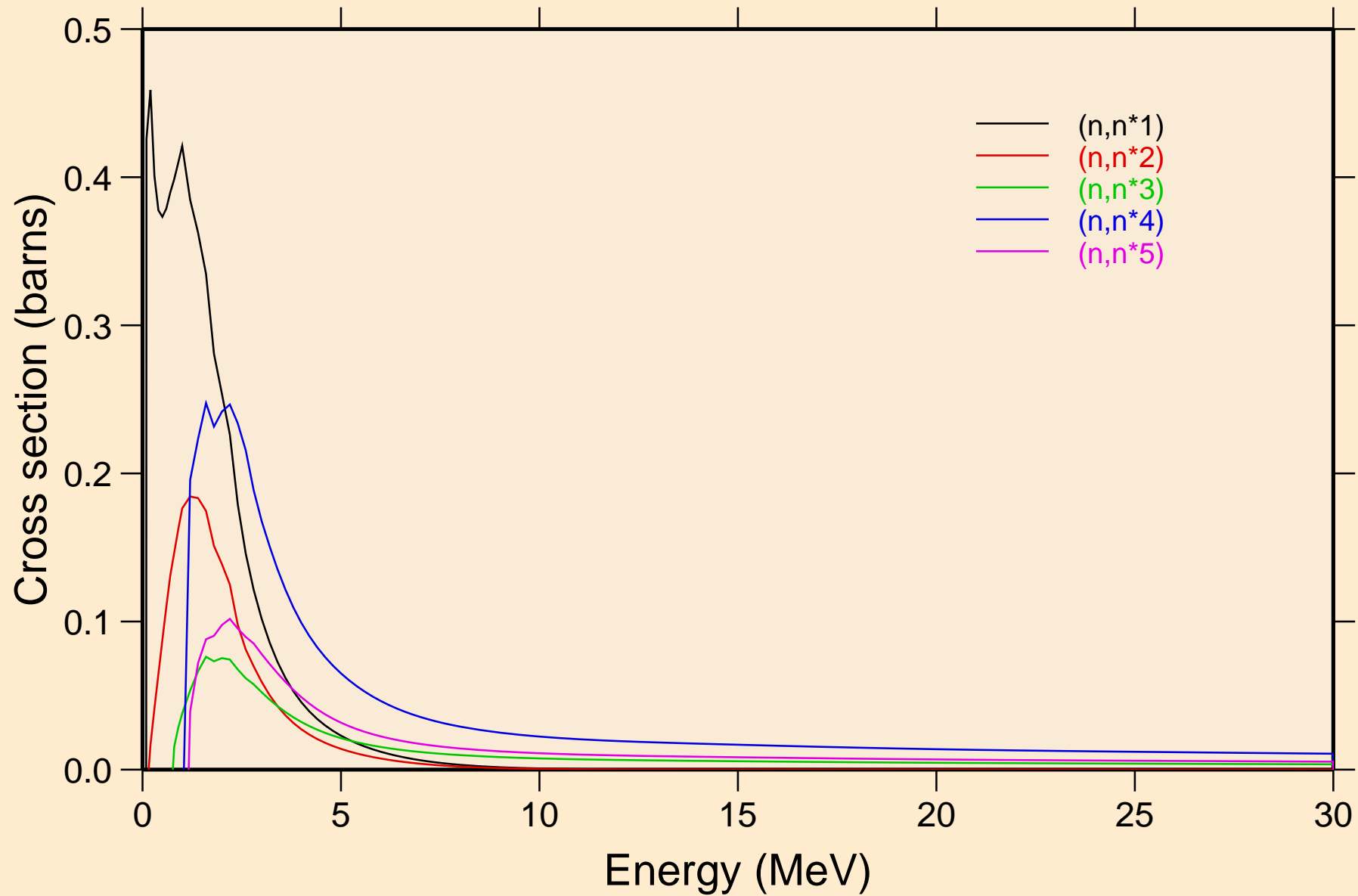

V049 NEUTRON ACER TENDL-2021 LIBRARY; T=293.6K  
Inelastic levels

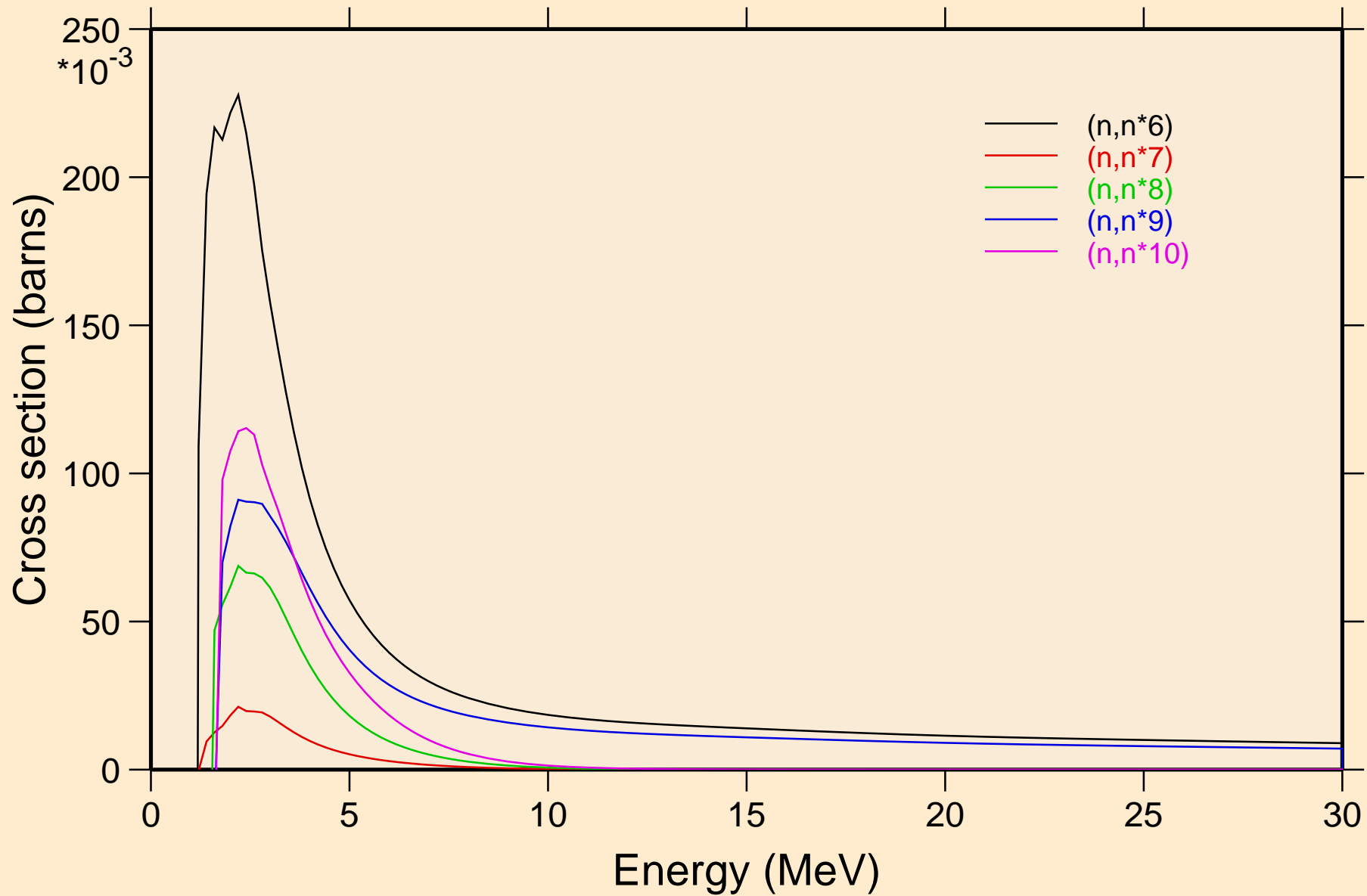

V049 NEUTRON ACER TENDL-2021 LIBRARY; T=293.6K  
Inelastic levels

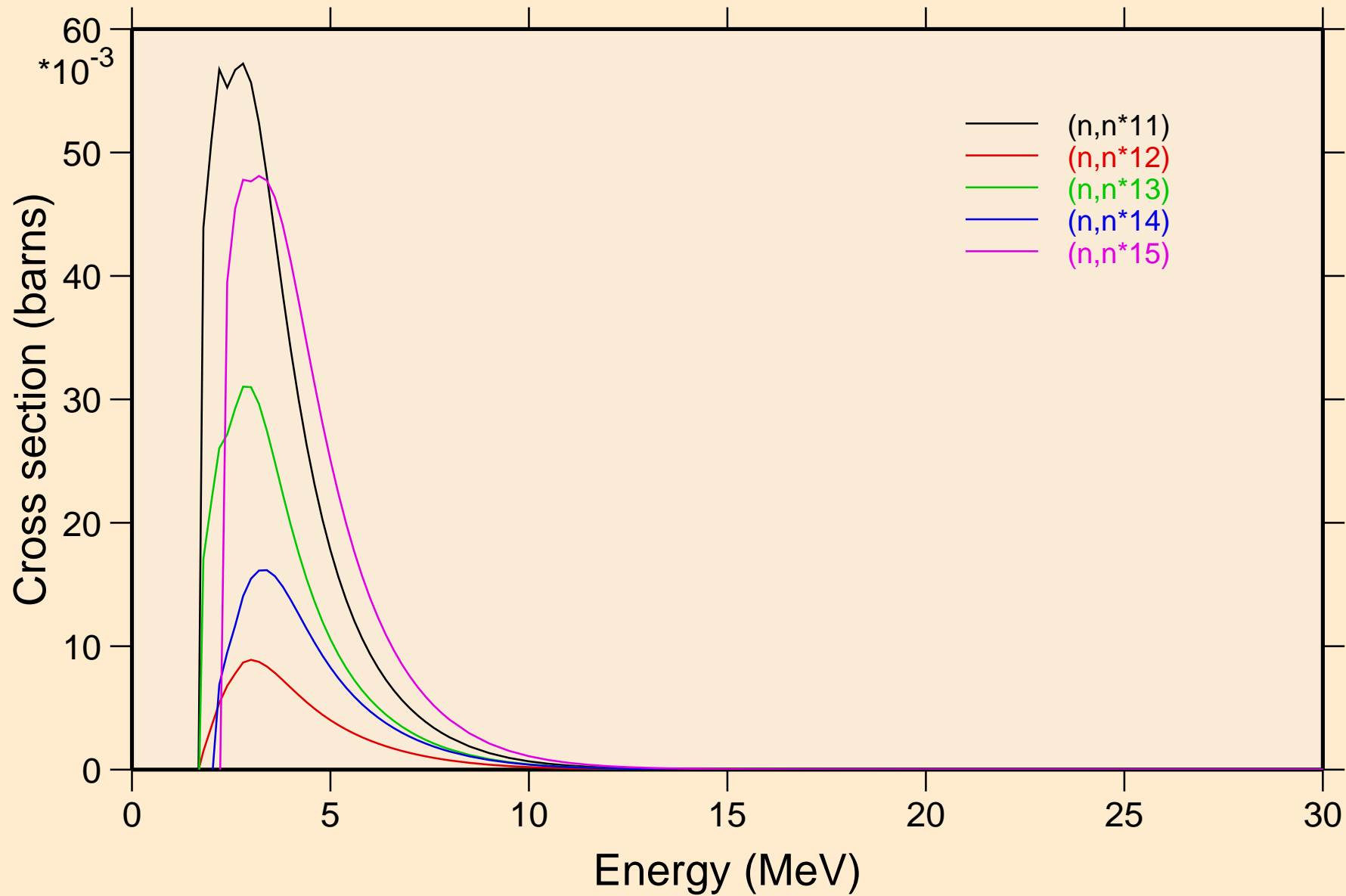

V049 NEUTRON ACER TENDL-2021 LIBRARY; T=293.6K  
Inelastic levels

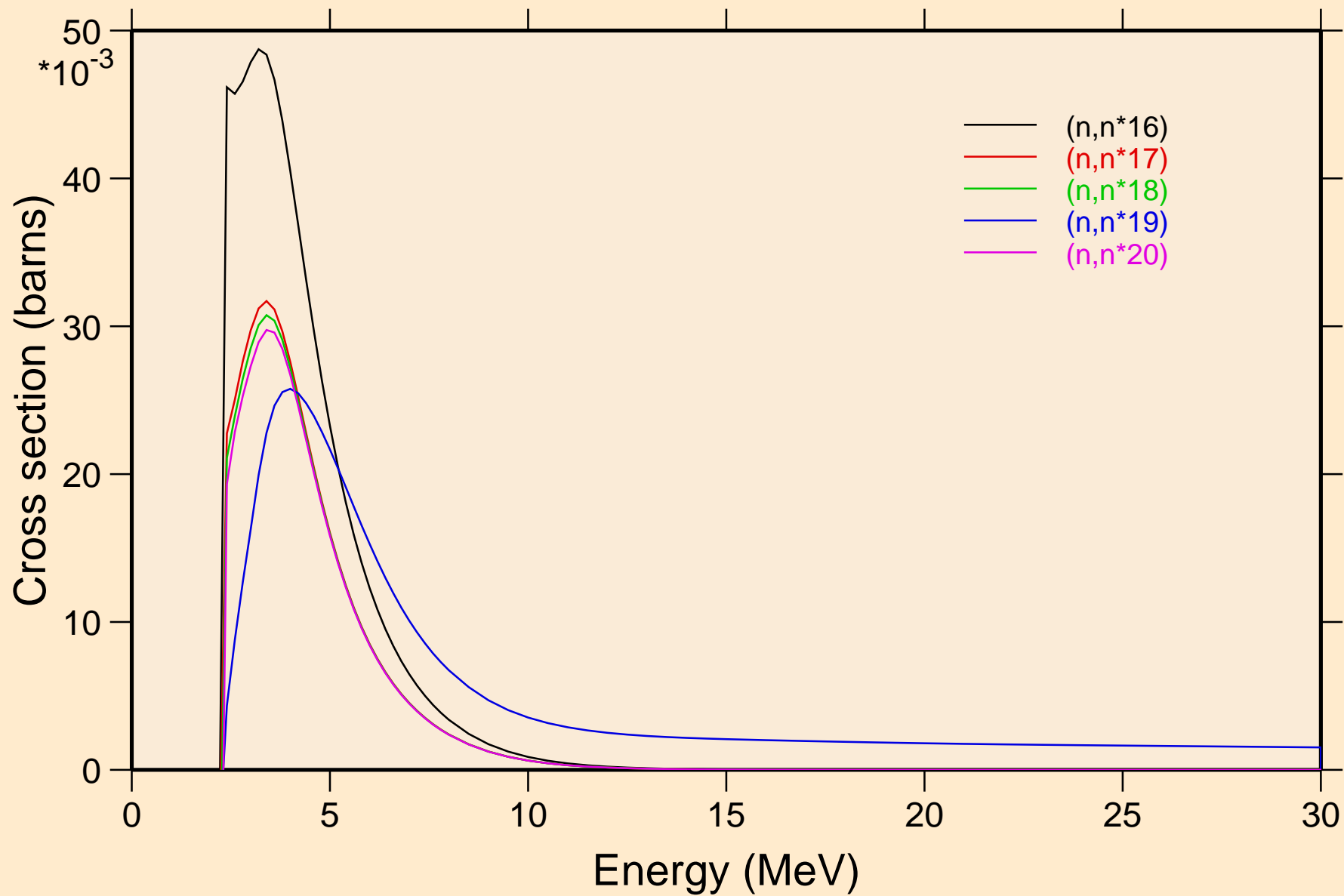



V049 NEUTRON ACER TENDL-2021 LIBRARY; T=293.6K  
Inelastic levels

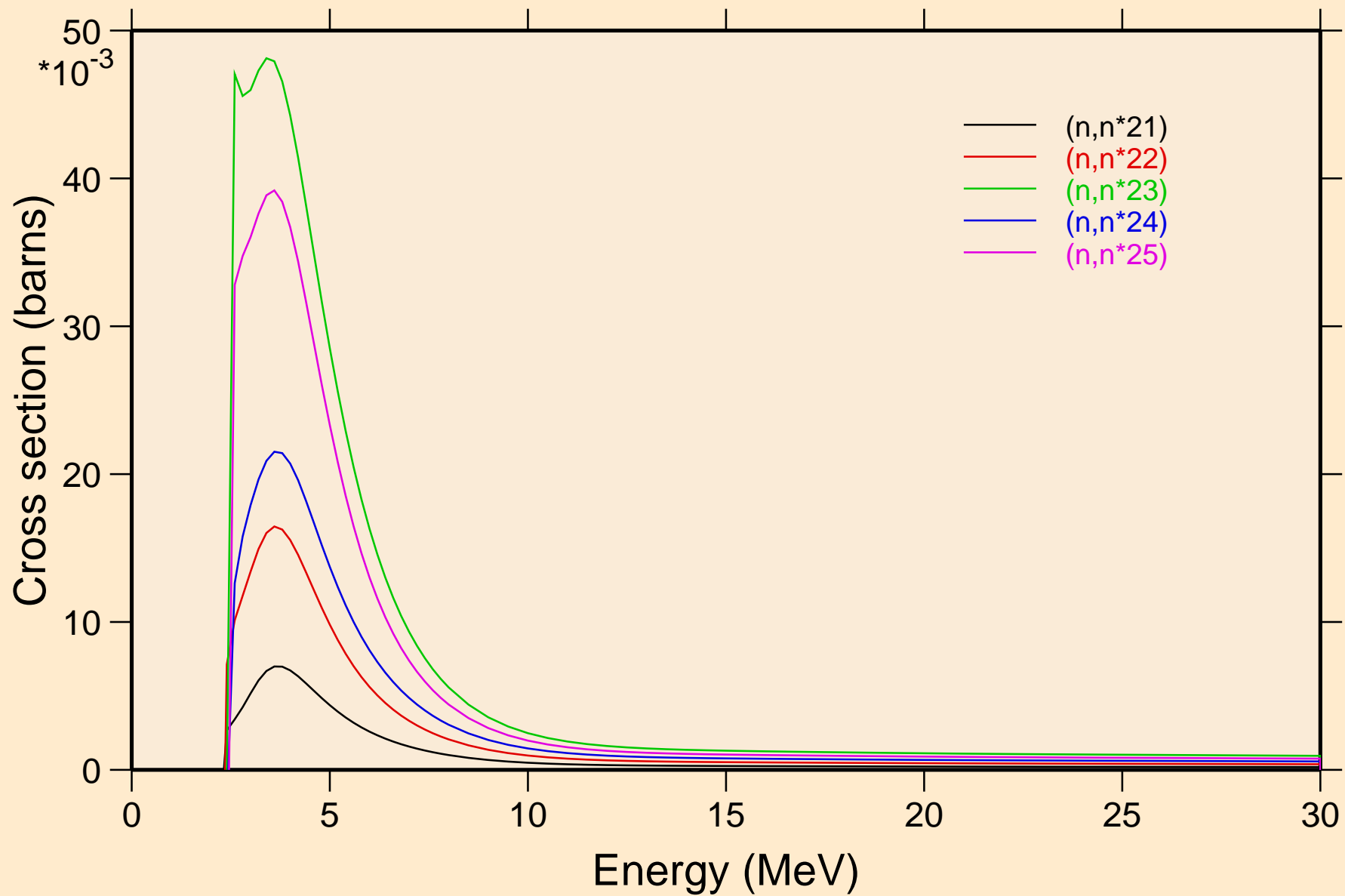

V049 NEUTRON ACER TENDL-2021 LIBRARY; T=293.6K  
Inelastic levels

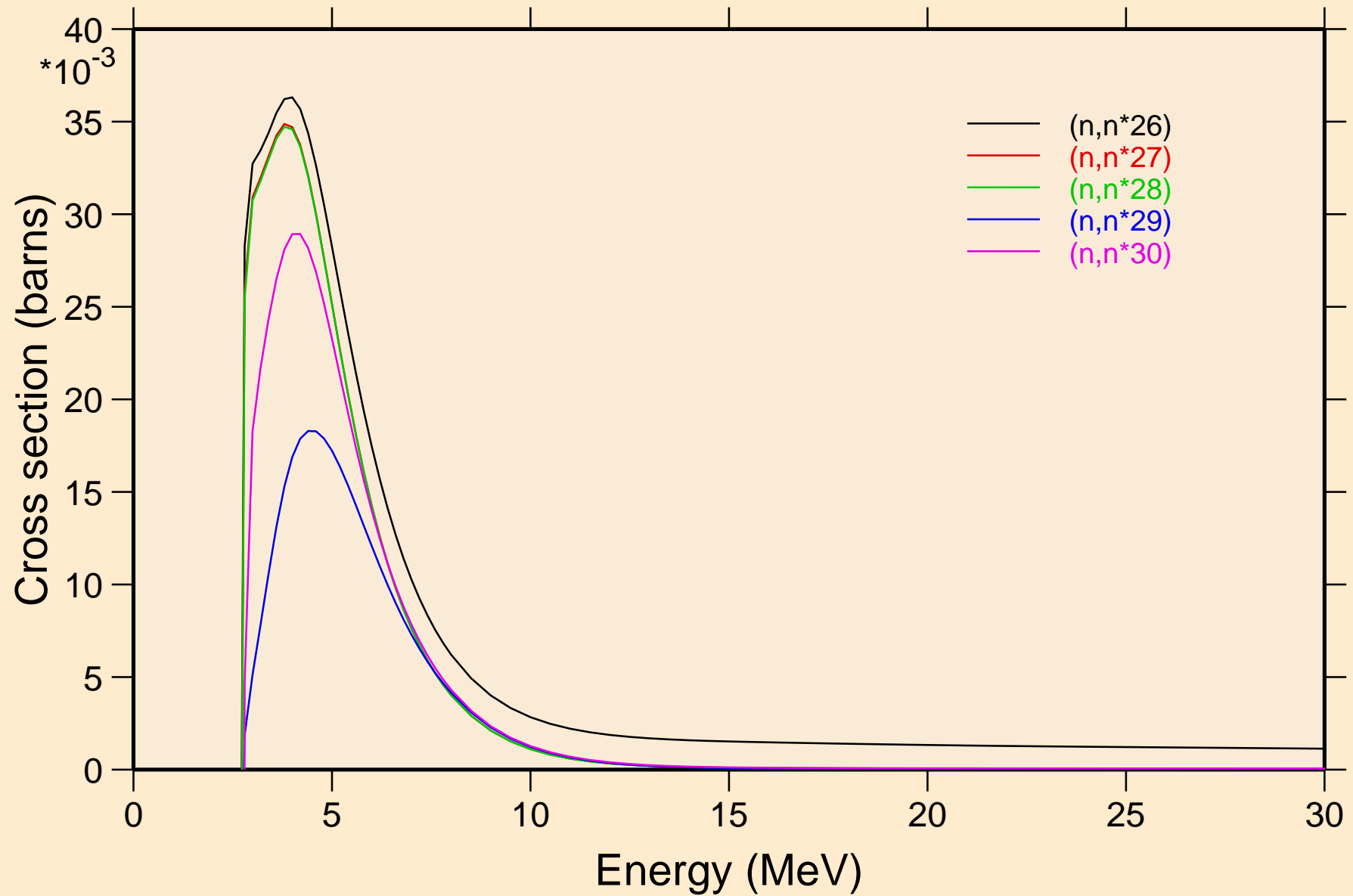

V049 NEUTRON ACER TENDL-2021 LIBRARY; T=293.6K  
Threshold reactions

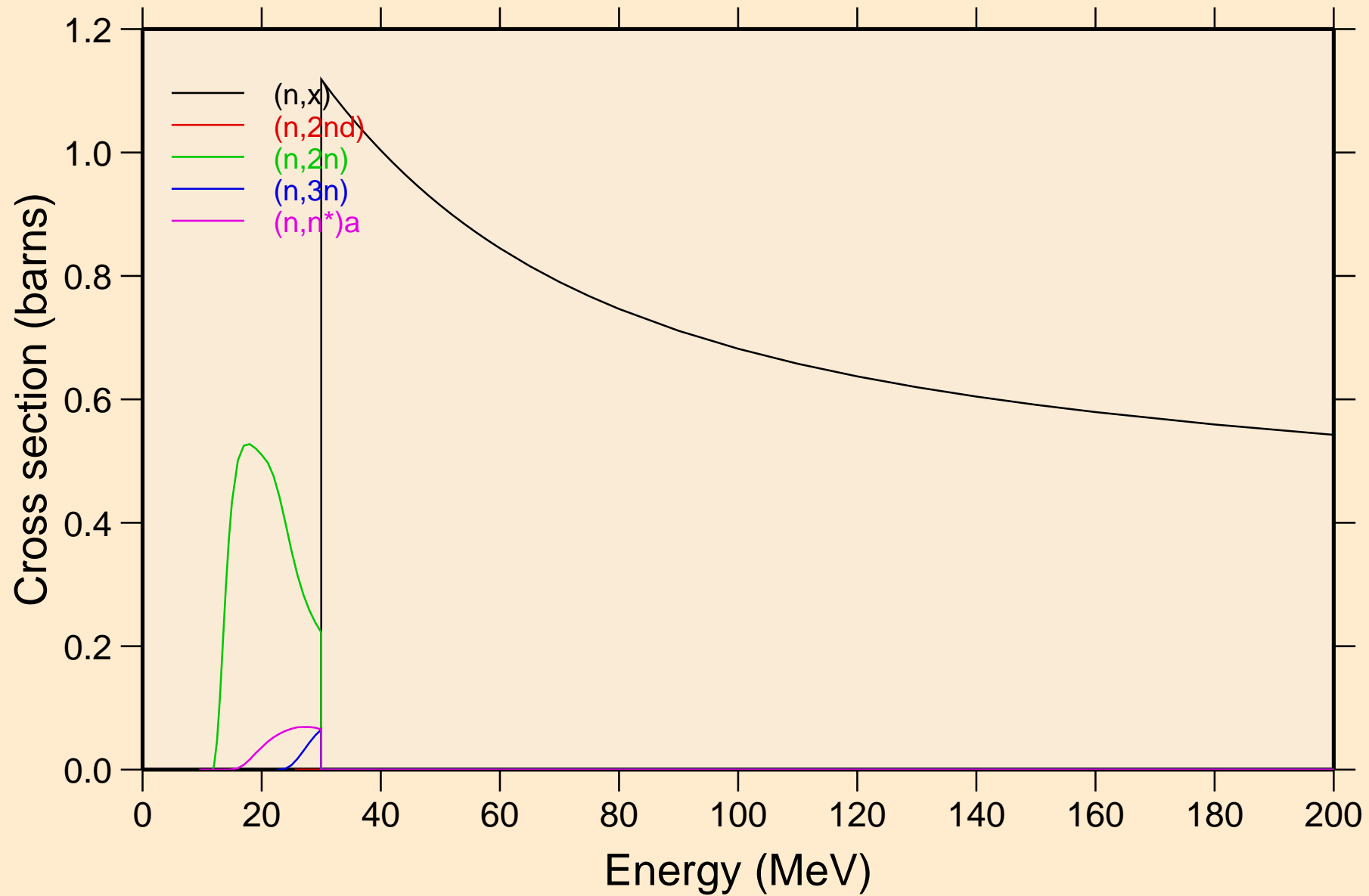

V049 NEUTRON ACER TENDL-2021 LIBRARY; T=293.6K  
Threshold reactions

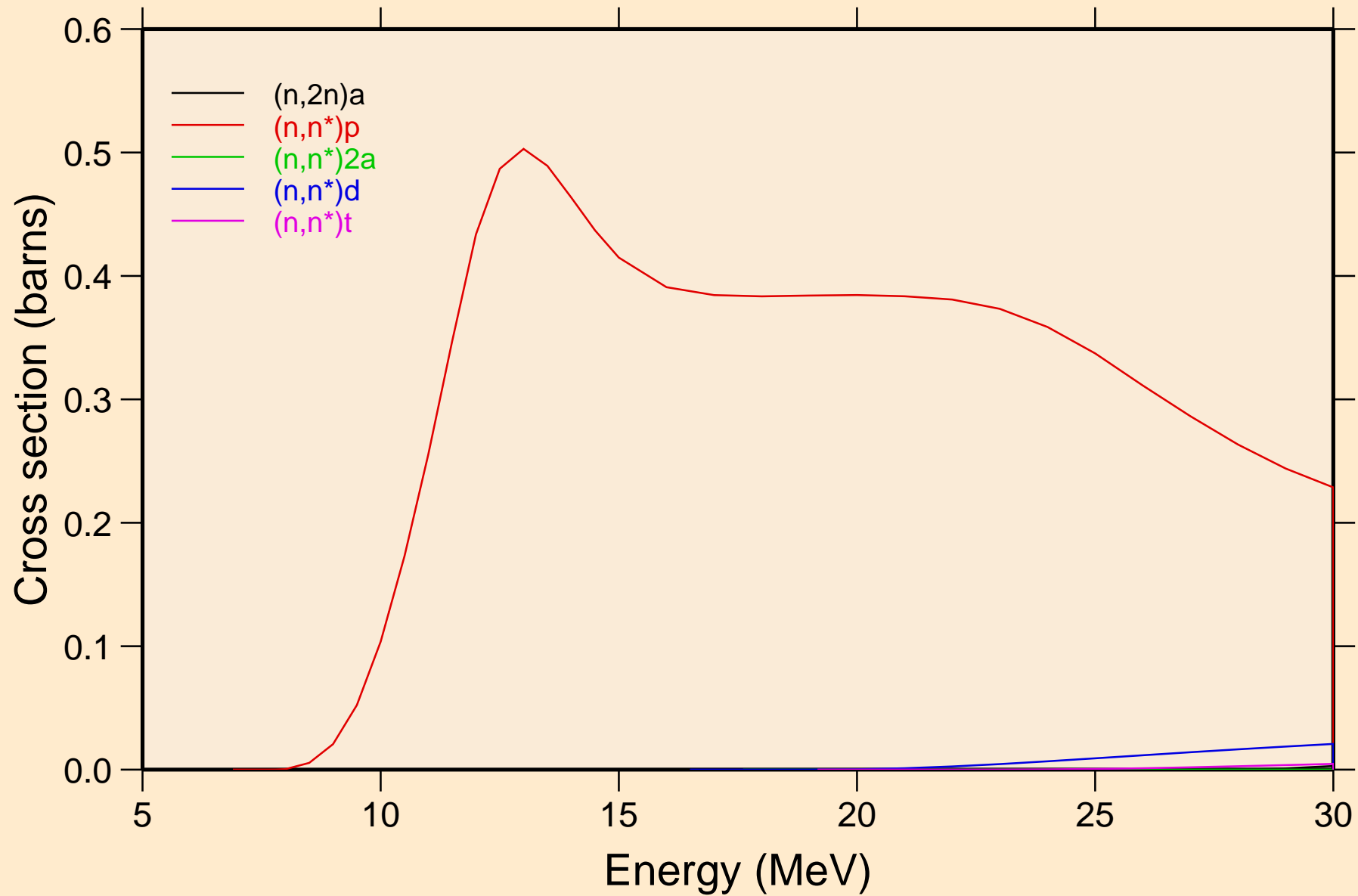

V049 NEUTRON ACER TENDL-2021 LIBRARY; T=293.6K  
Threshold reactions

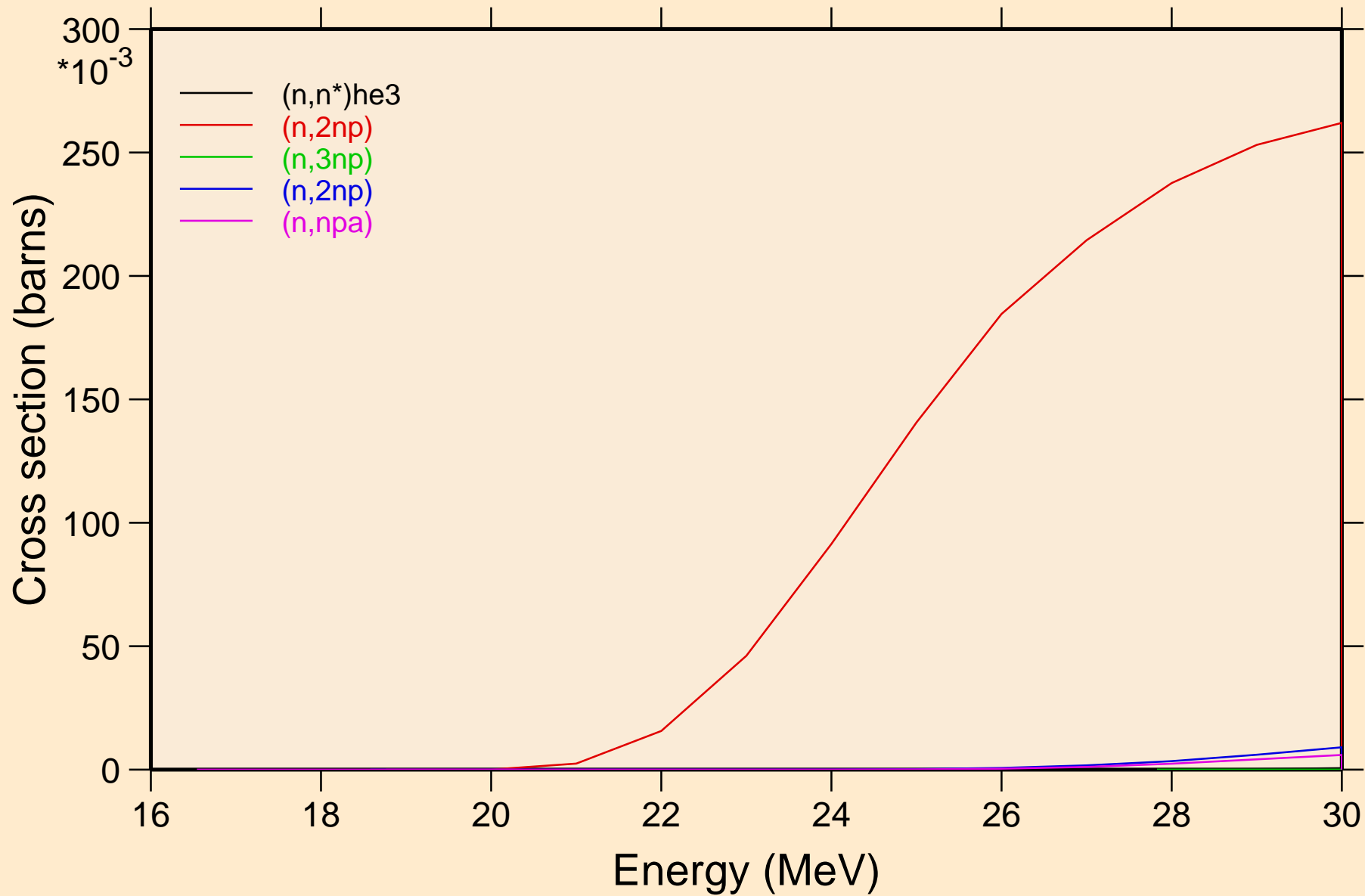

V049 NEUTRON ACER TENDL-2021 LIBRARY; T=293.6K  
Threshold reactions

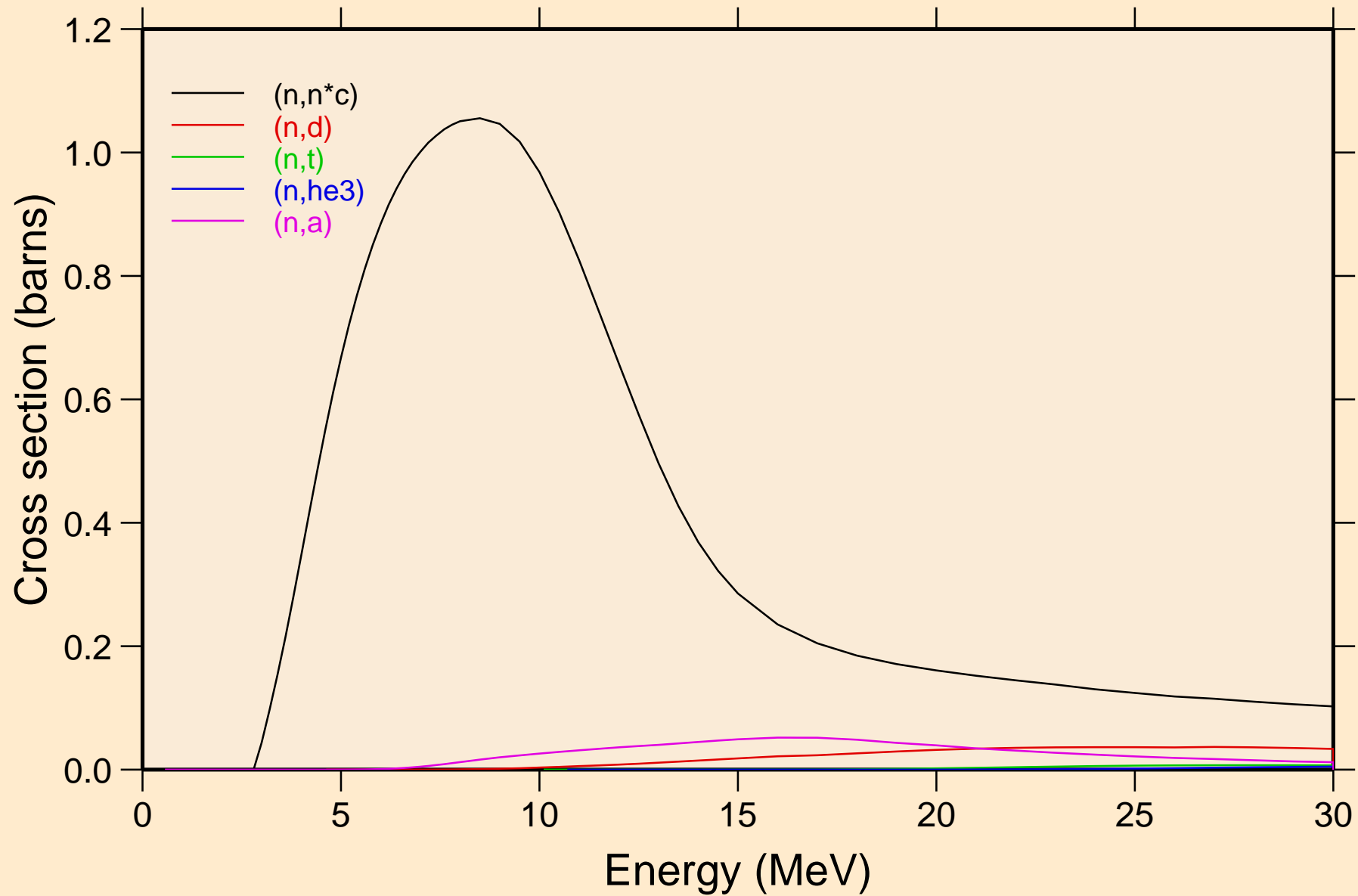

V049 NEUTRON ACER TENDL-2021 LIBRARY; T=293.6K  
Threshold reactions

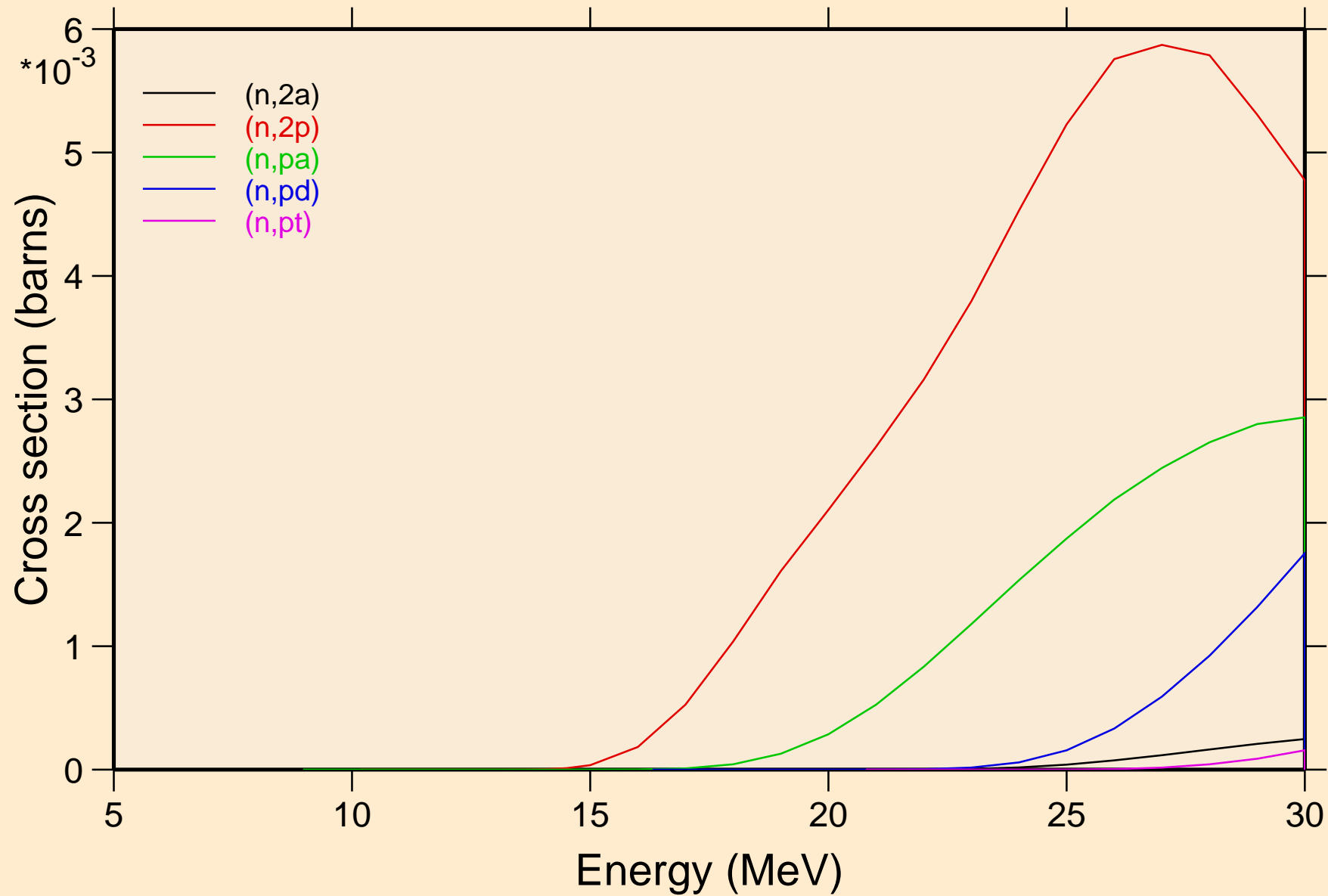

V049 NEUTRON ACER TENDL-2021 LIBRARY; T=293.6K  
Threshold reactions

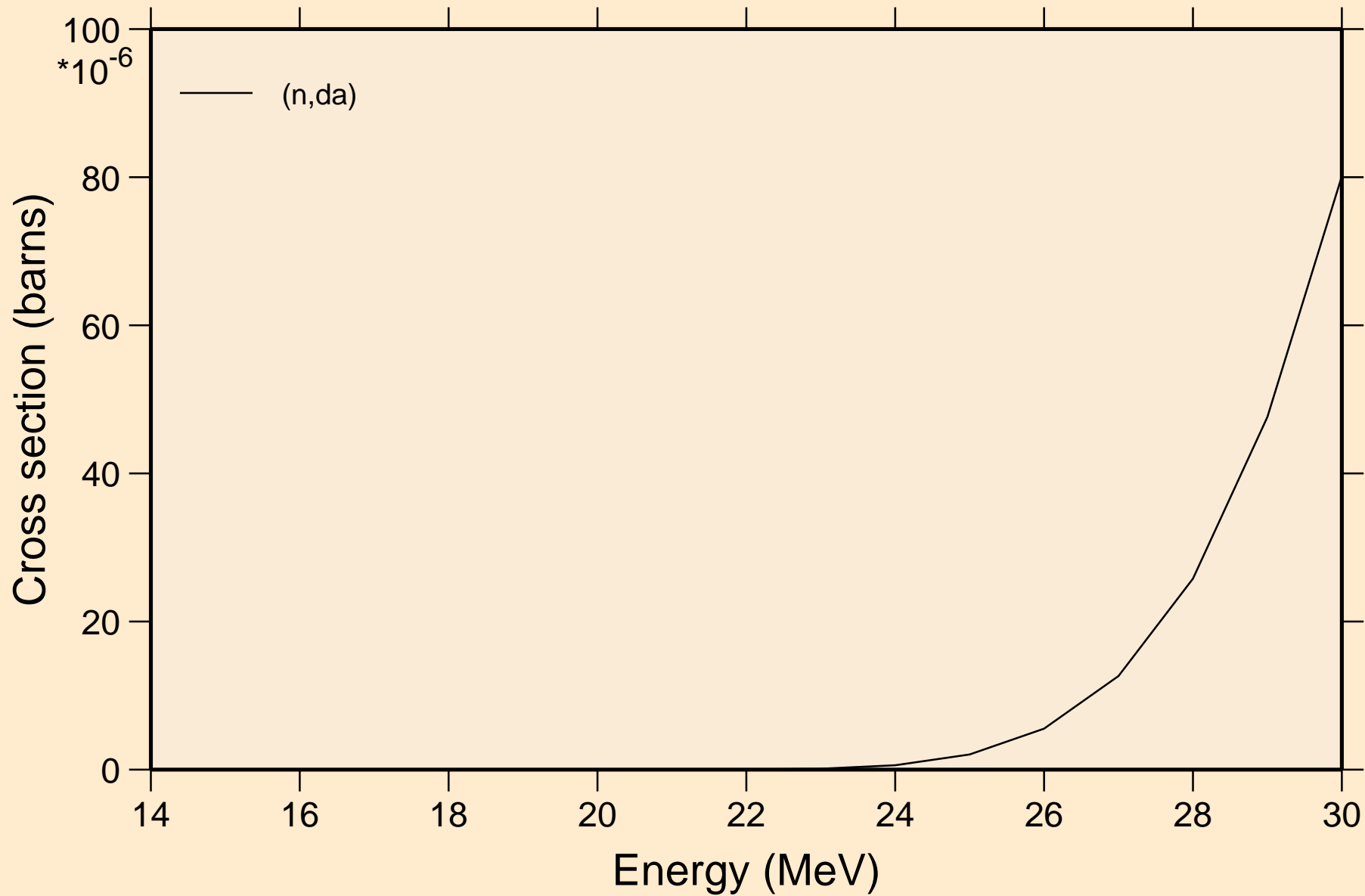



V049 NEUTRON ACER TENDL-2021 LIBRARY; T=293.6K  
Threshold reactions

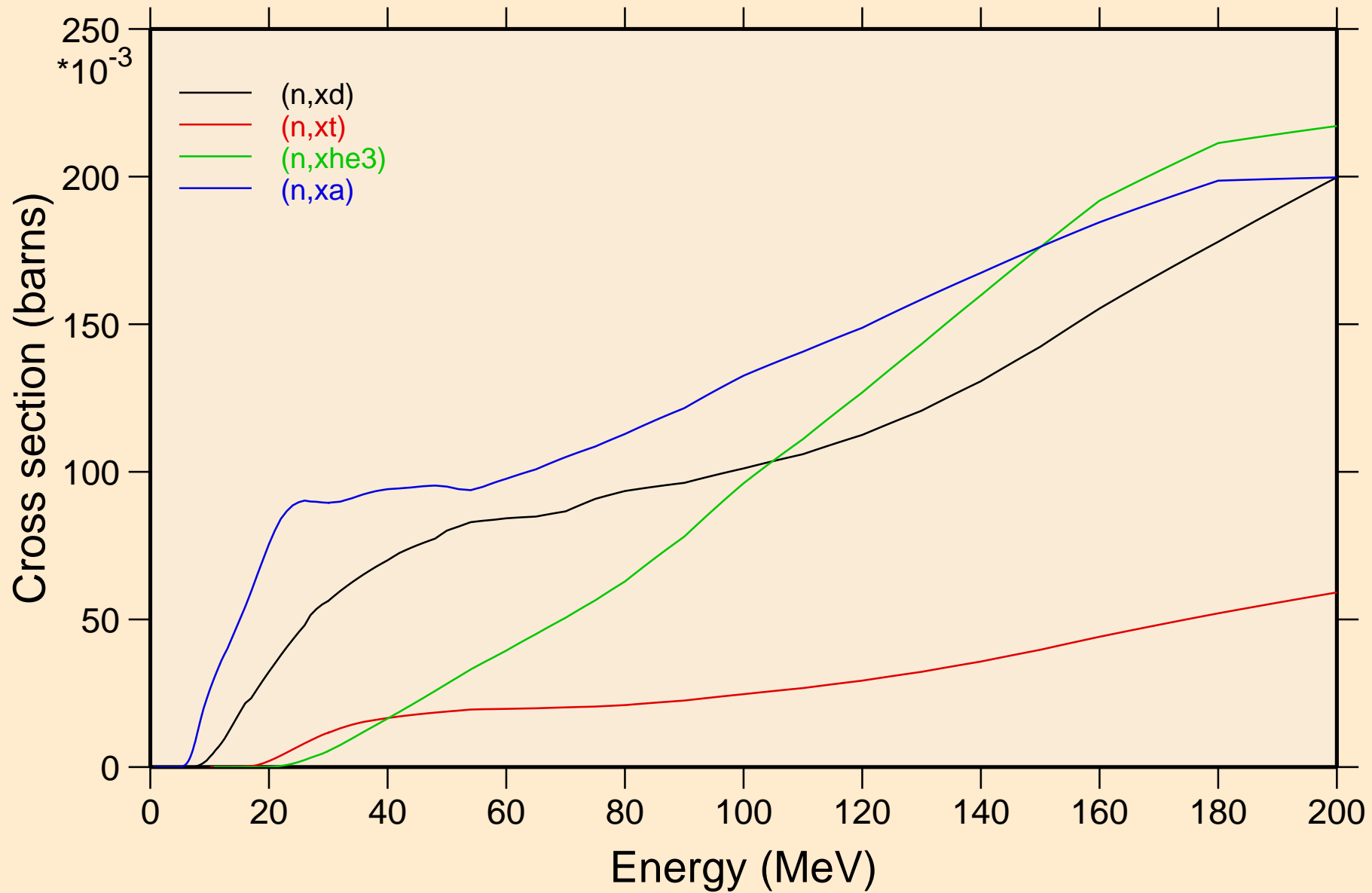

V049 NEUTRON ACER TENDL-2021 LIBRARY; T=293.6K  
angular distribution for elastic

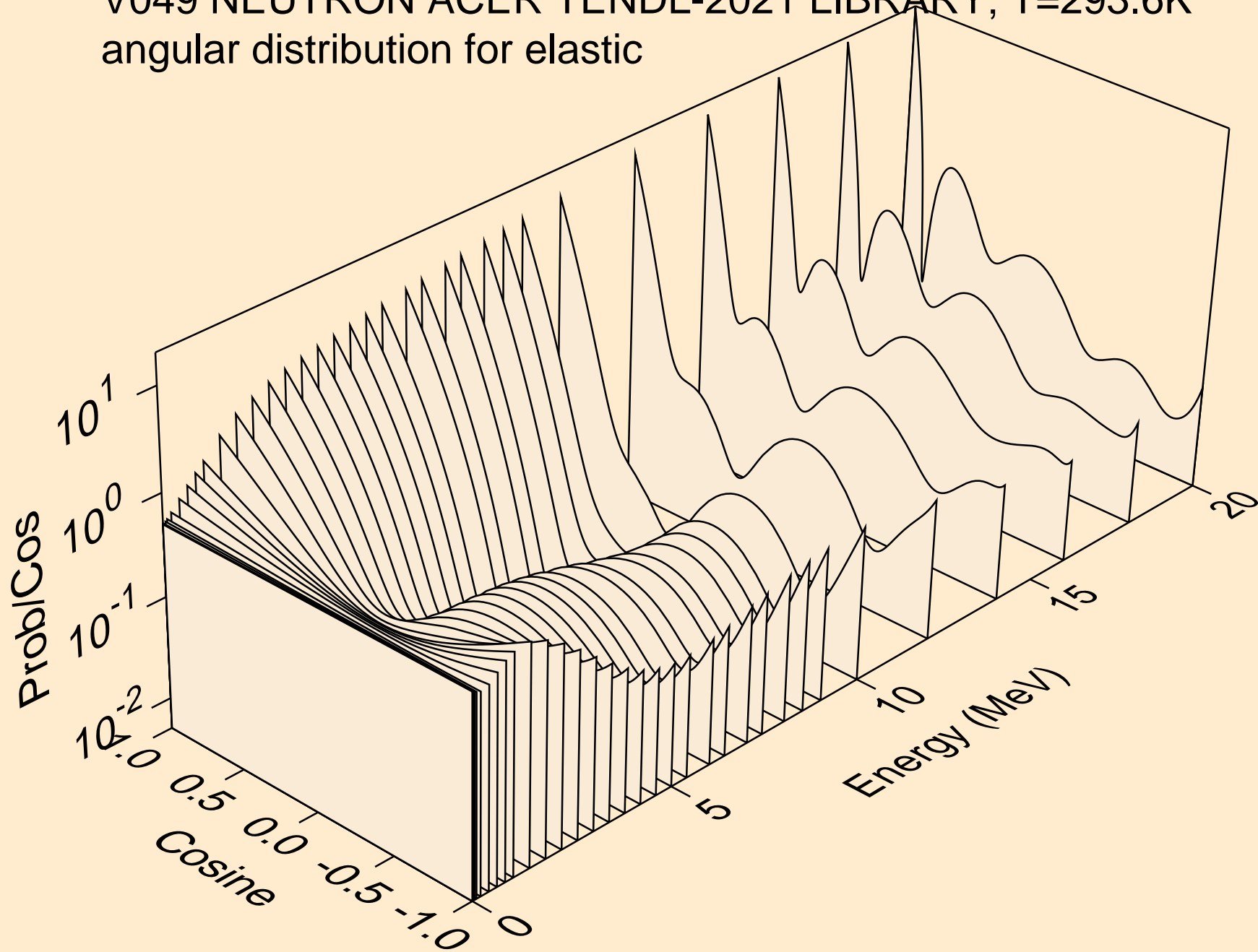

V049 NEUTRON ACER TENDL-2021 LIBRARY; T=293.6K  
angular distribution for elastic

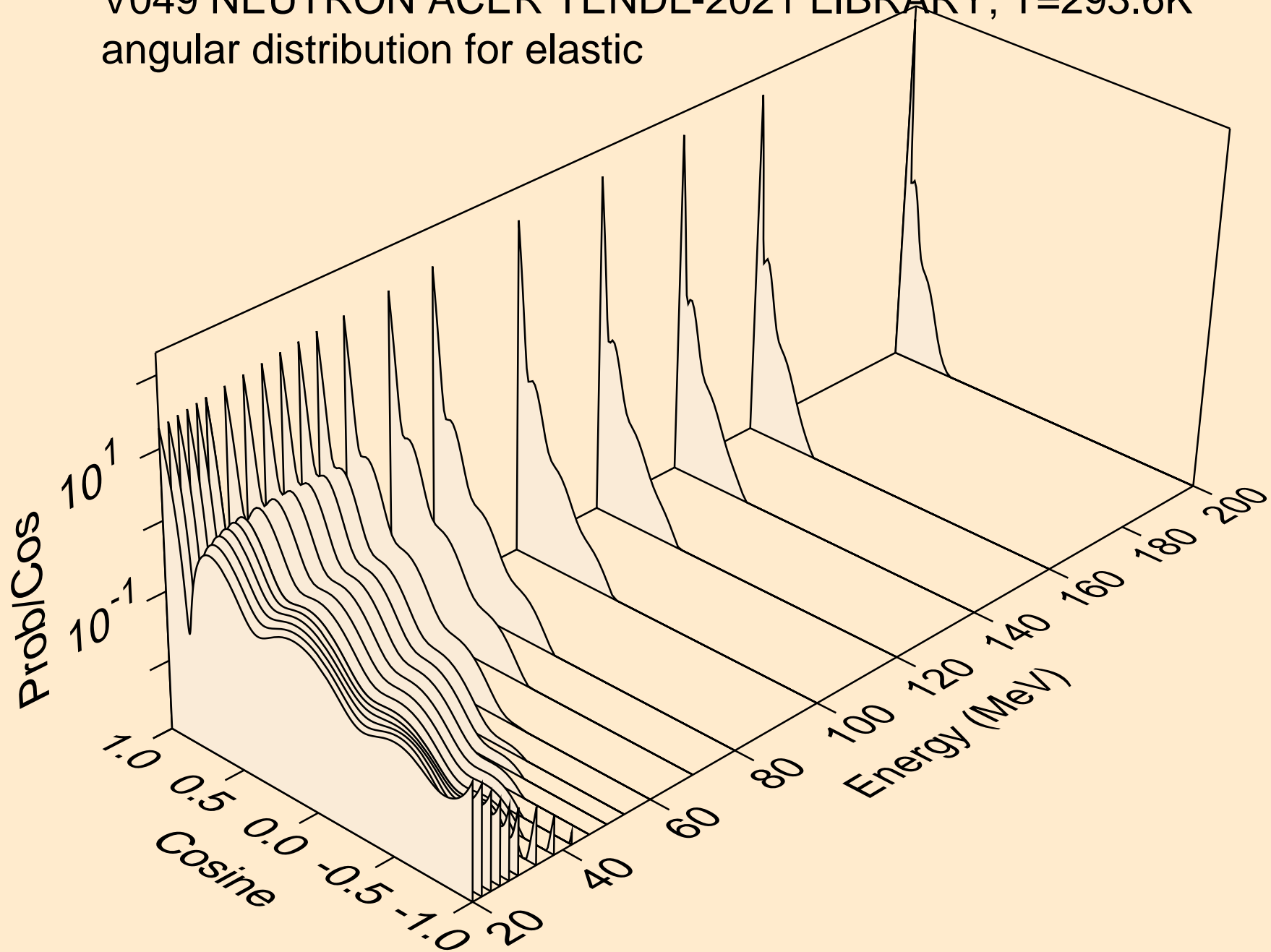

V049 NEUTRON ACER TENDL-2021 LIBRARY; T=293.6K  
angular distribution for (n,n\*1)

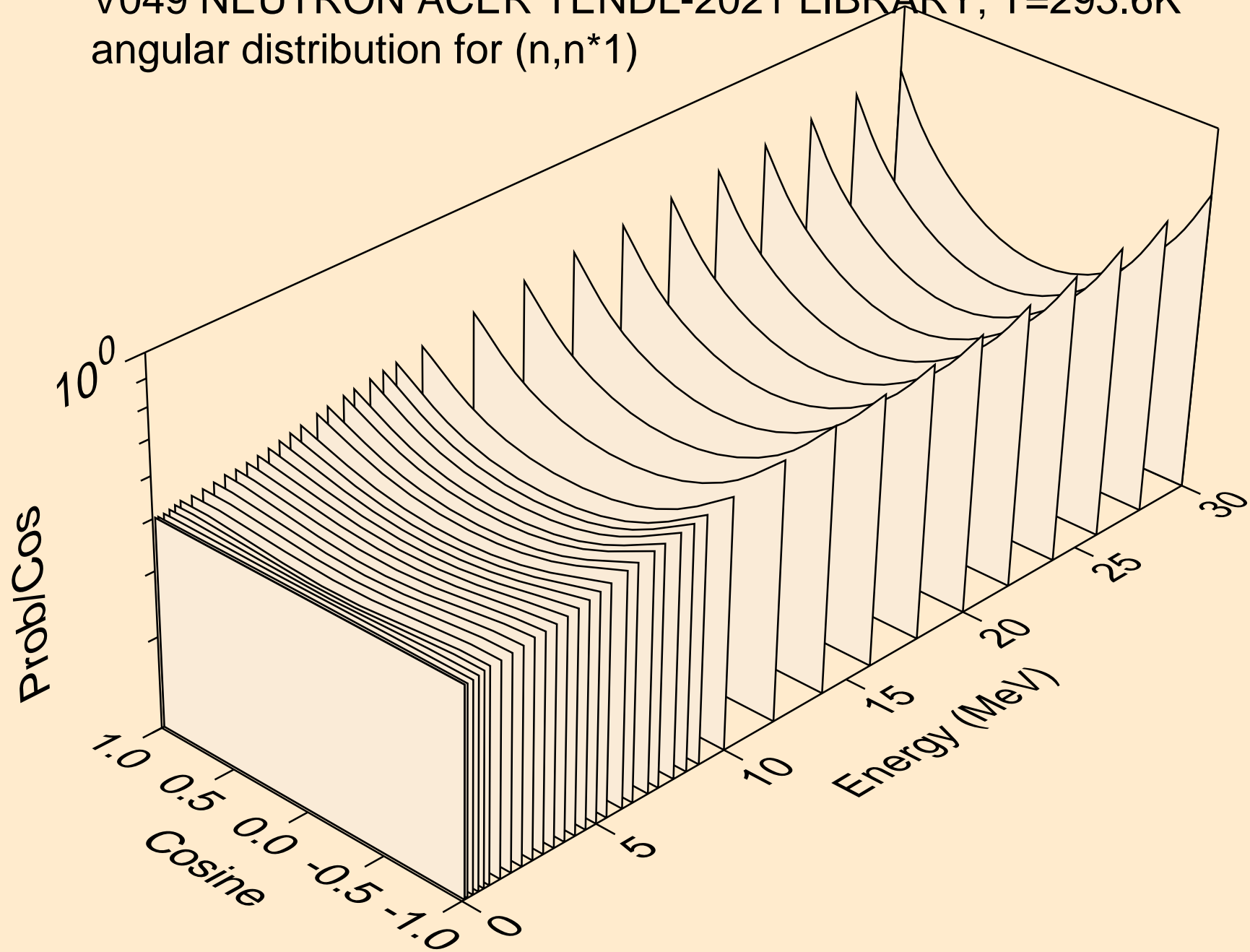

V049 NEUTRON ACER TENDL-2021 LIBRARY; T=293.6K  
angular distribution for (n,n\*2)

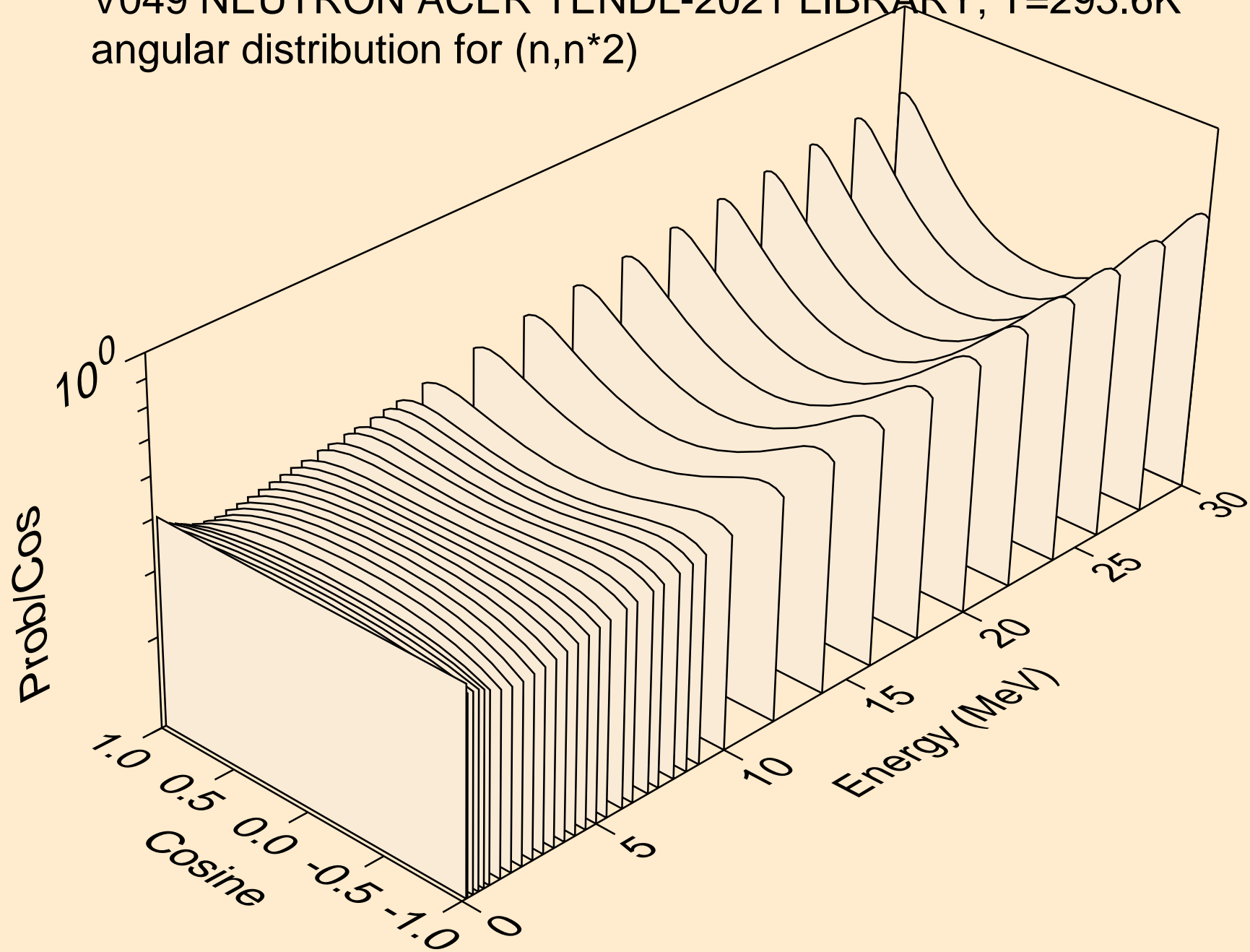

V049 NEUTRON ACER TENDL-2021 LIBRARY; T=293.6K  
angular distribution for (n,n\*3)

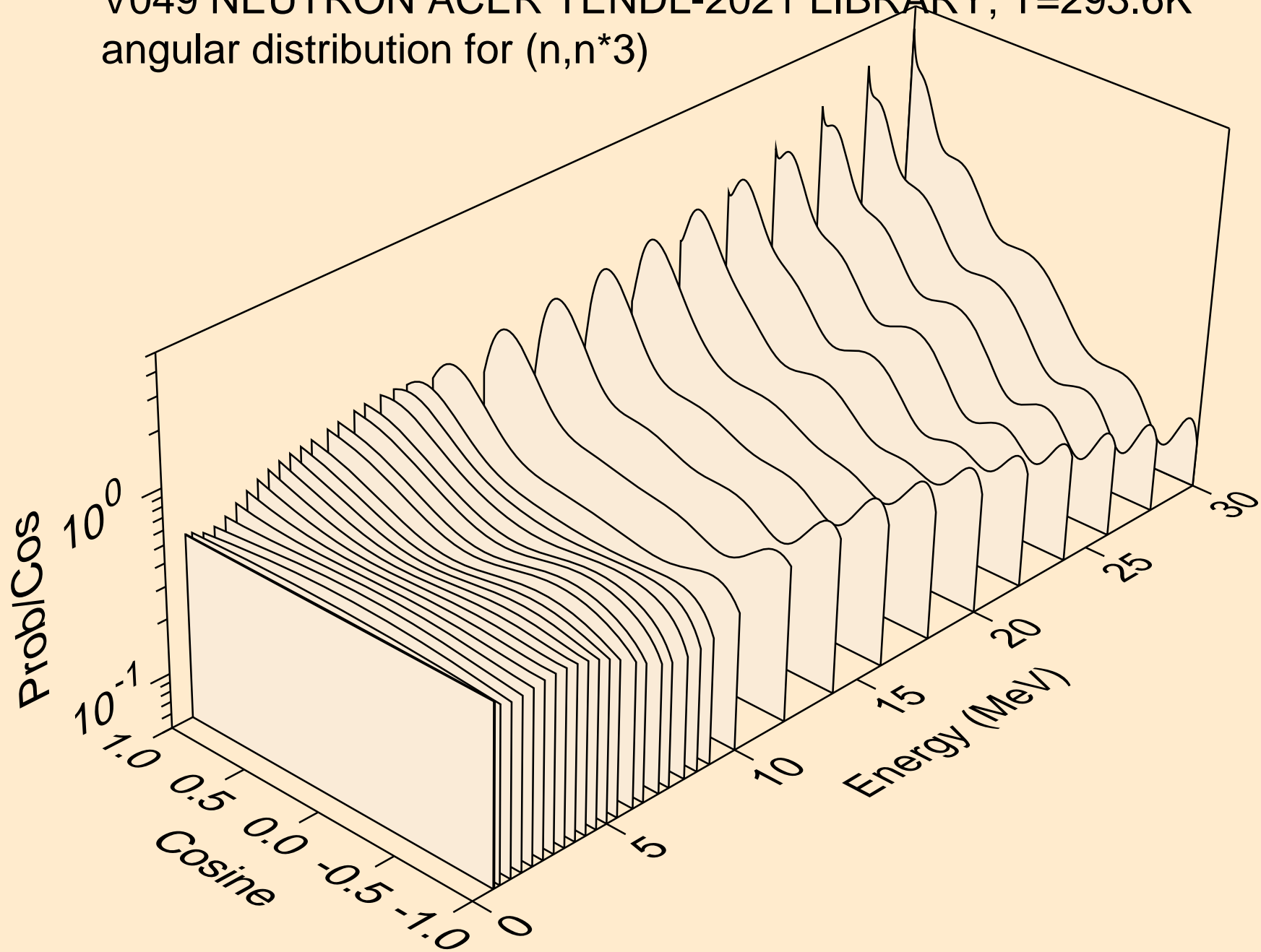

V049 NEUTRON ACER TENDL-2021 LIBRARY; T=293.6K  
angular distribution for (n,n\*4)

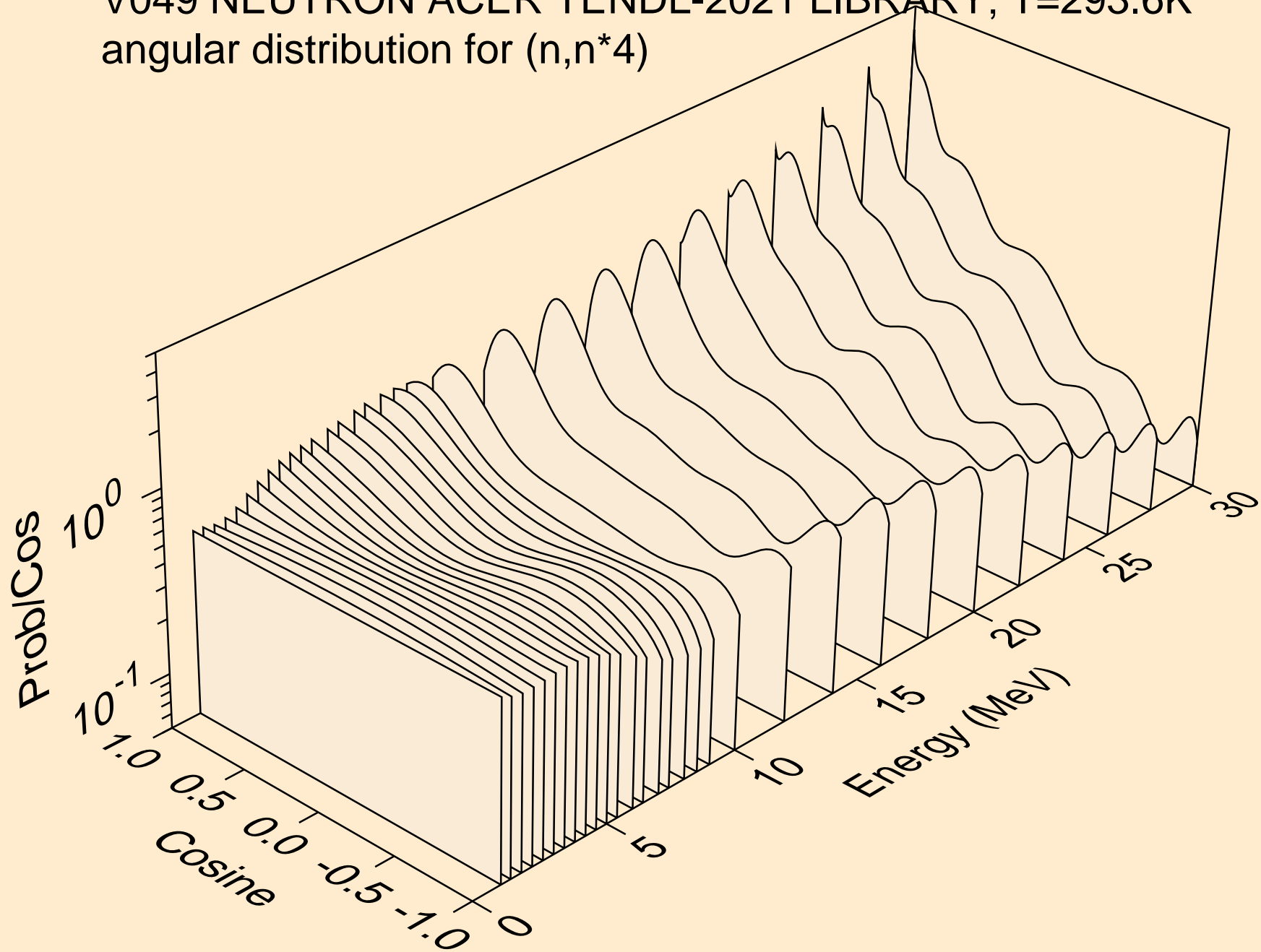

V049 NEUTRON ACER TENDL-2021 LIBRARY; T=293.6K  
angular distribution for (n,n\*5)

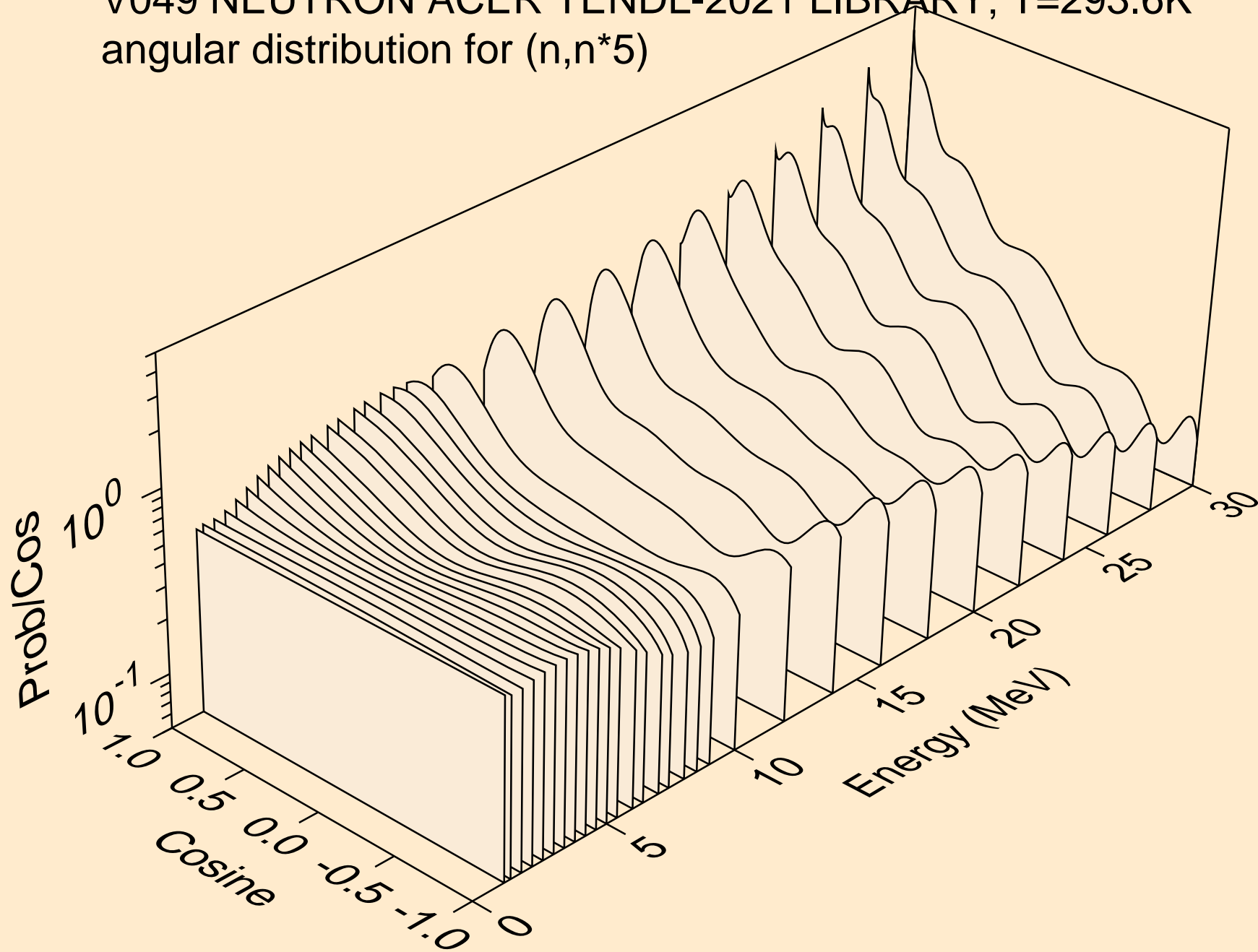



V049 NEUTRON ACER TENDL-2021 LIBRARY; T=293.6K  
angular distribution for (n,n\*6)

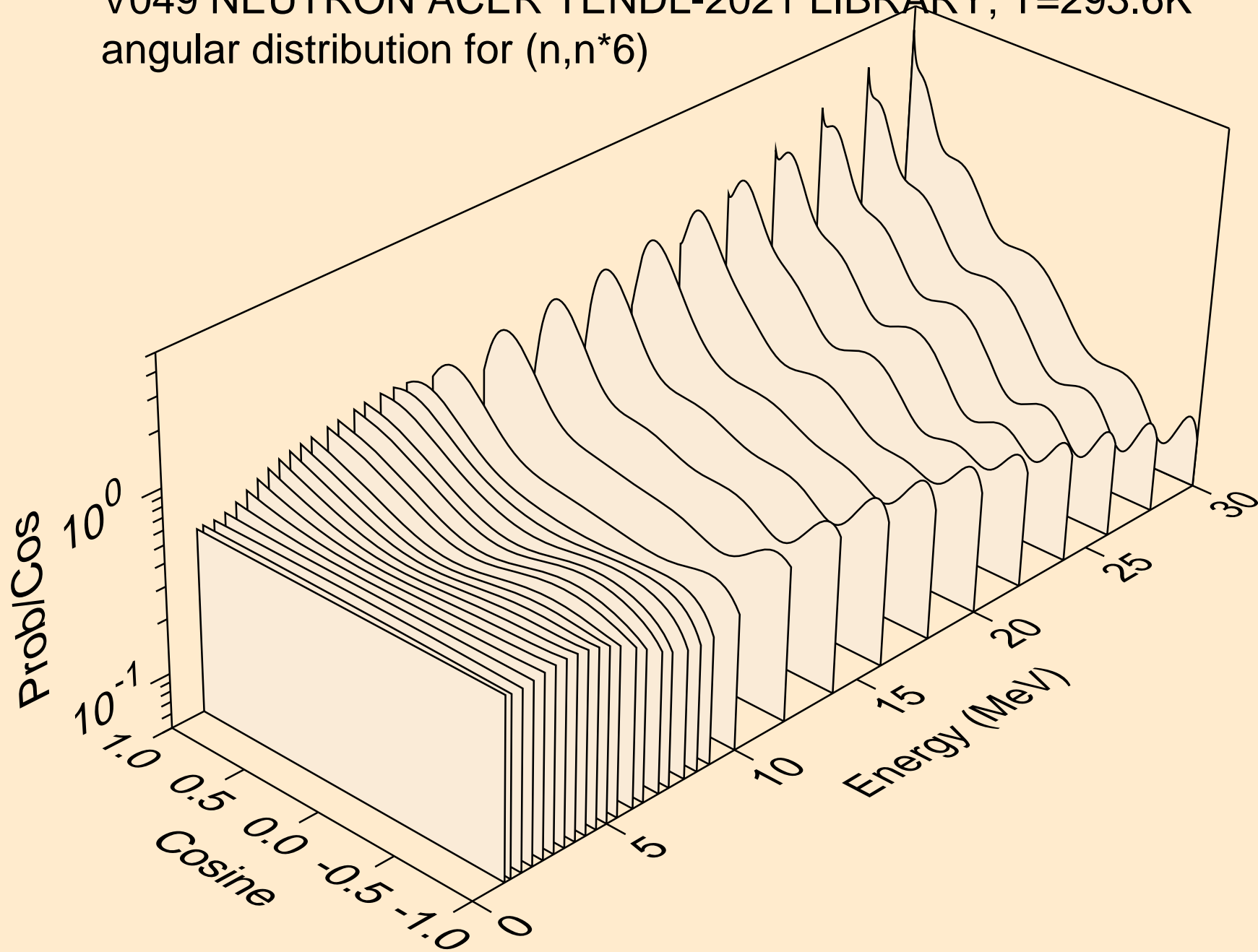

V049 NEUTRON ACER TENDL-2021 LIBRARY; T=293.6K  
angular distribution for (n,n\*7)

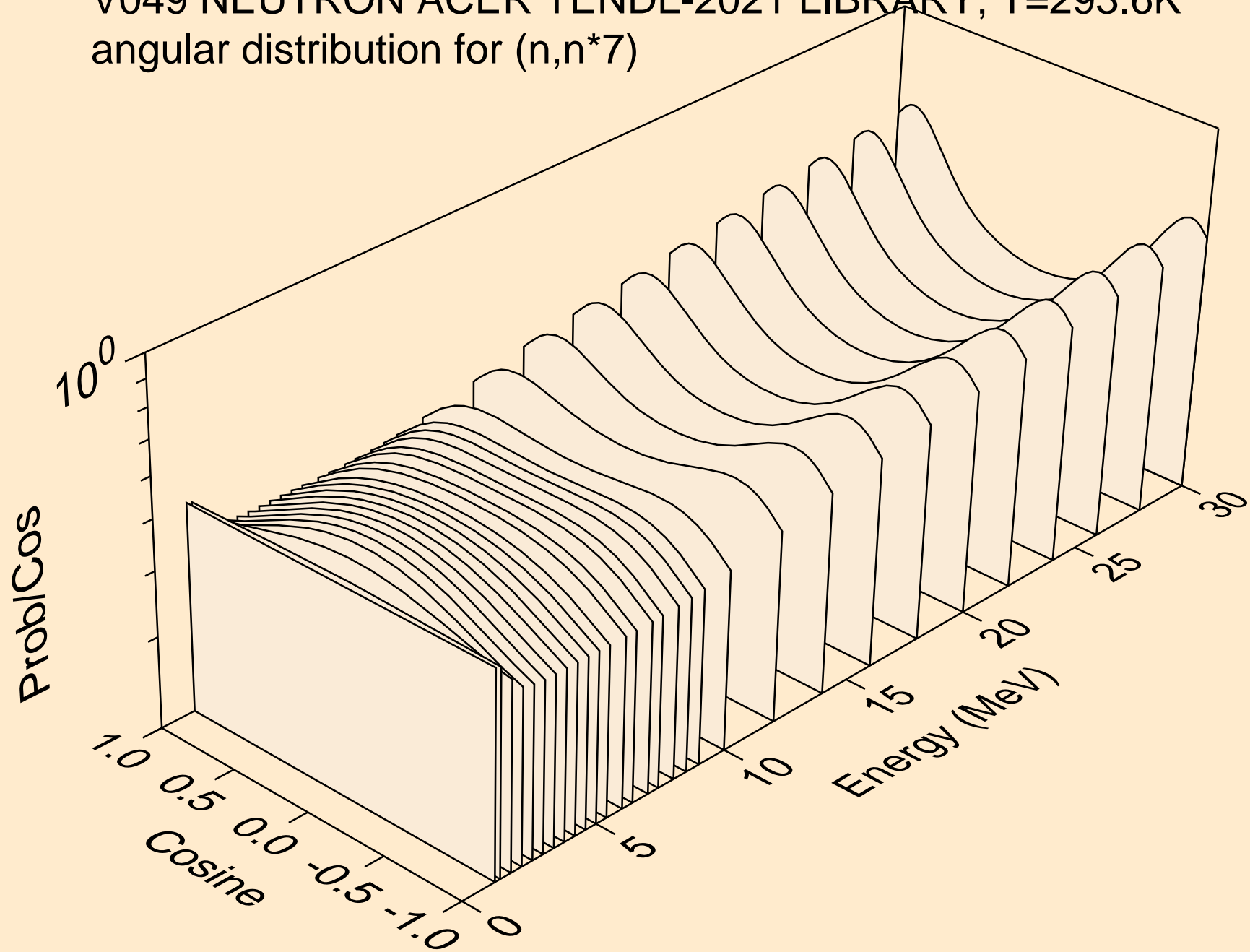

V049 NEUTRON ACER TENDL-2021 LIBRARY; T=293.6K  
angular distribution for (n,n\*8)

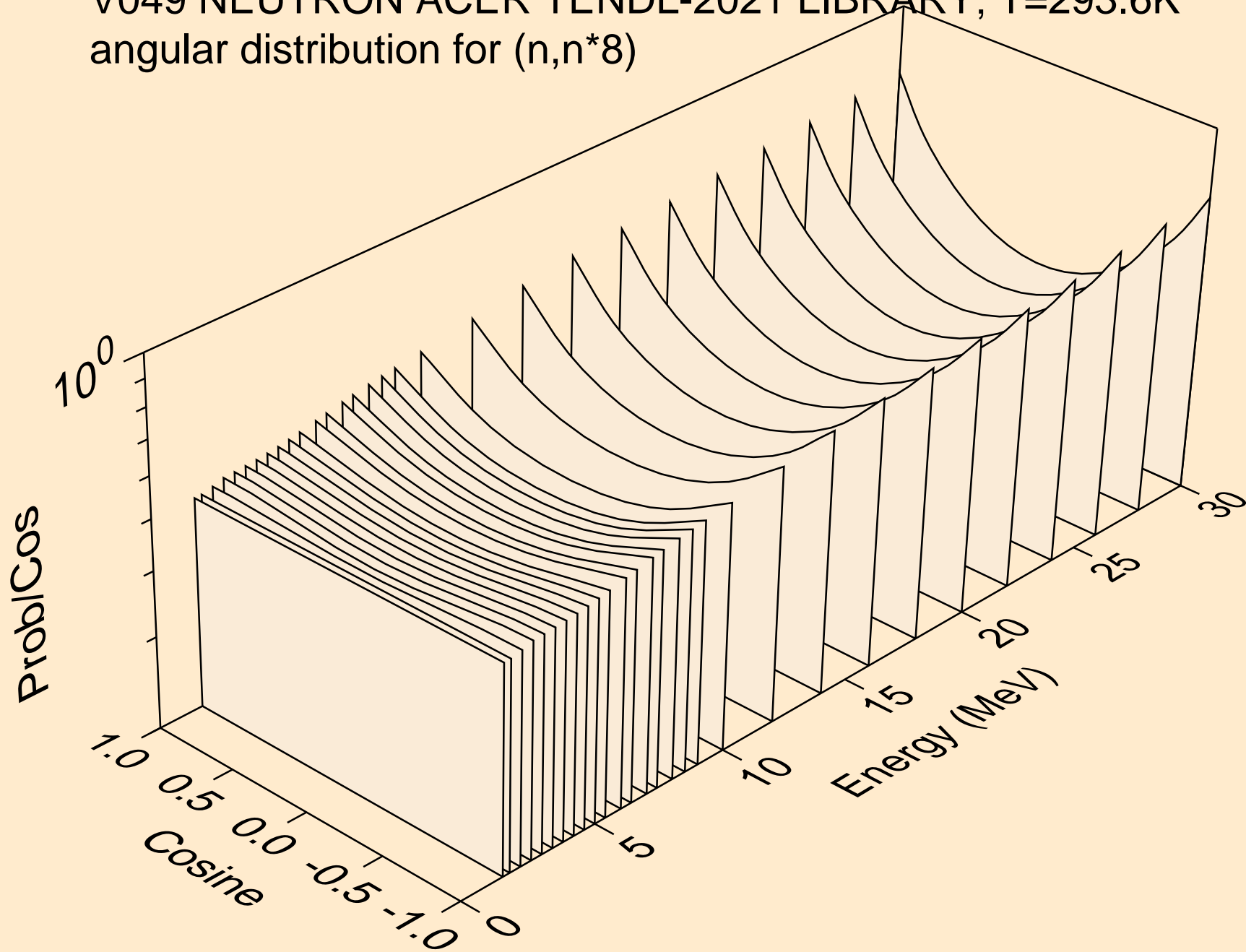

V049 NEUTRON ACER TENDL-2021 LIBRARY; T=293.6K  
angular distribution for (n,n\*9)

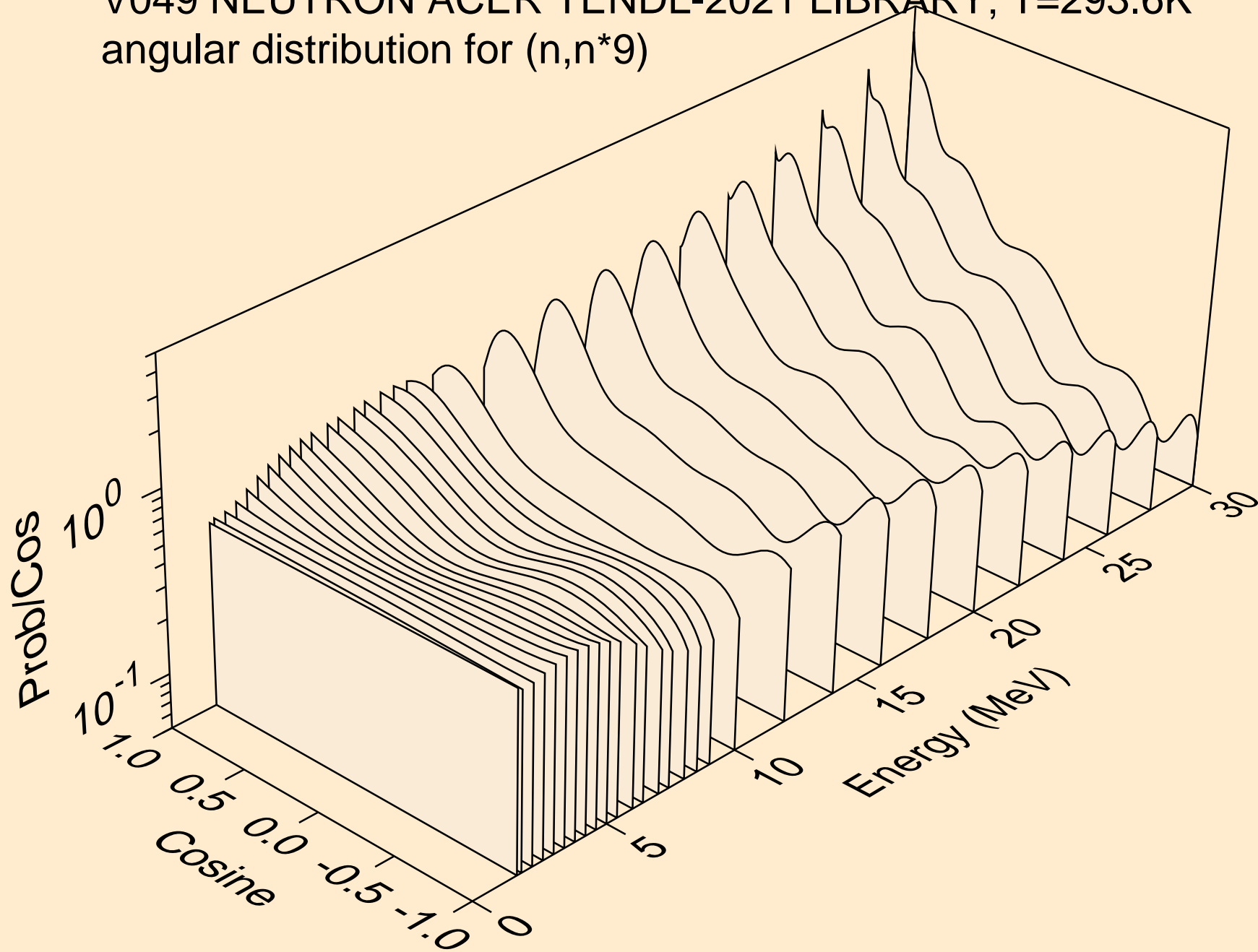

V049 NEUTRON ACER TENDL-2021 LIBRARY; T=293.6K  
angular distribution for (n,n\*10)

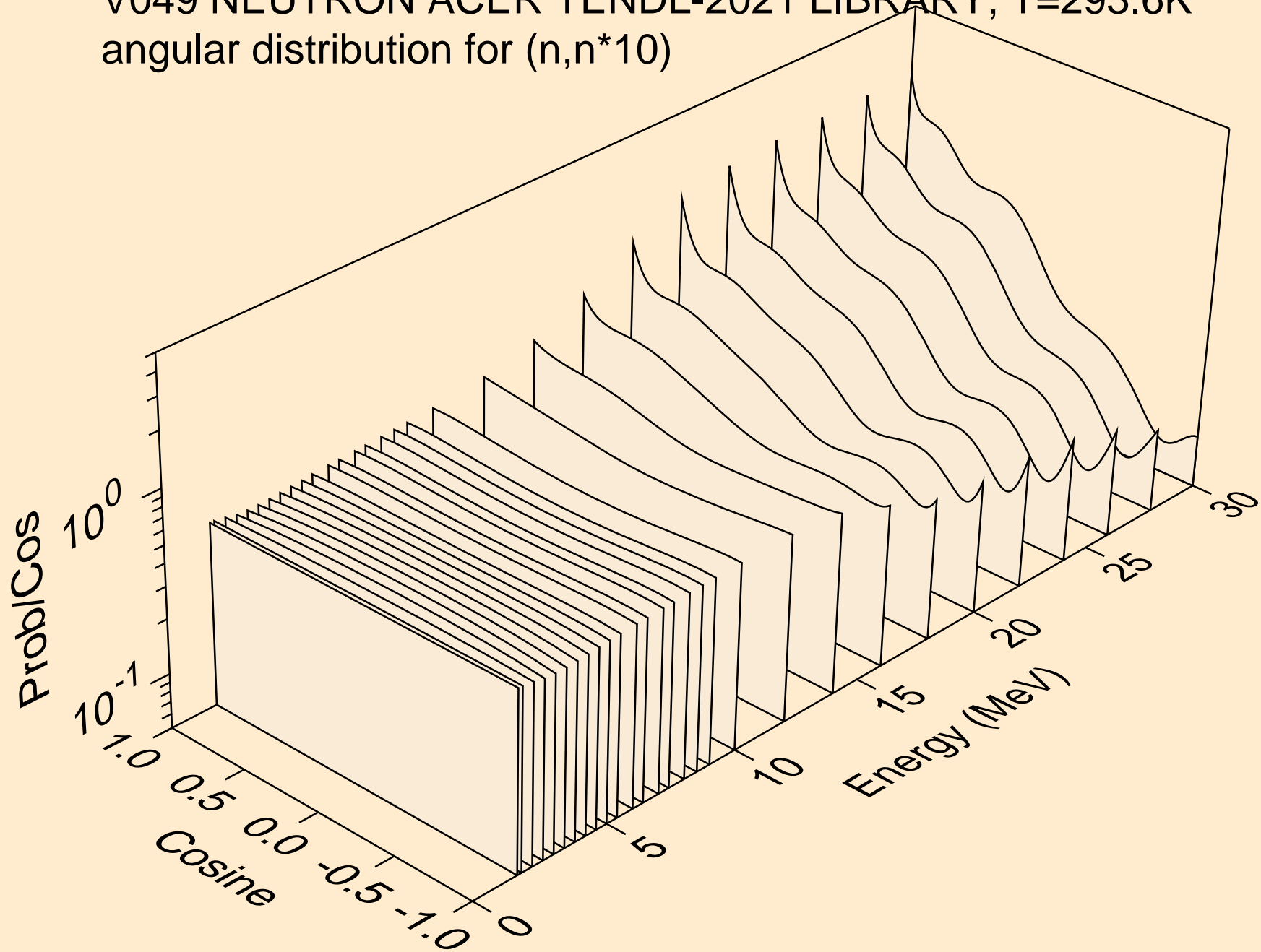

V049 NEUTRON ACER TENDL-2021 LIBRARY; T=293.6K  
angular distribution for (n,n\*11)

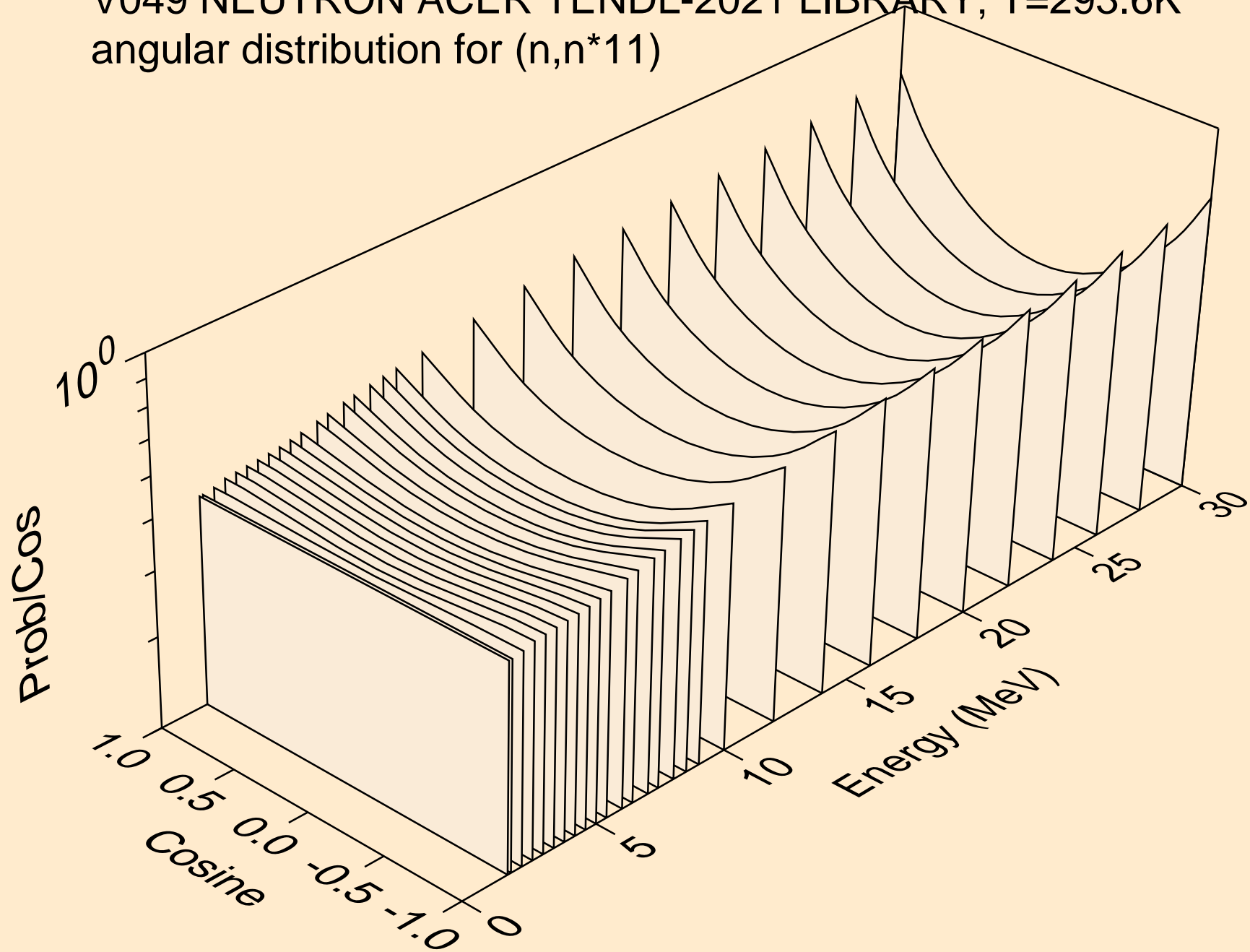

V049 NEUTRON ACER TENDL-2021 LIBRARY; T=293.6K  
angular distribution for (n,n\*12)

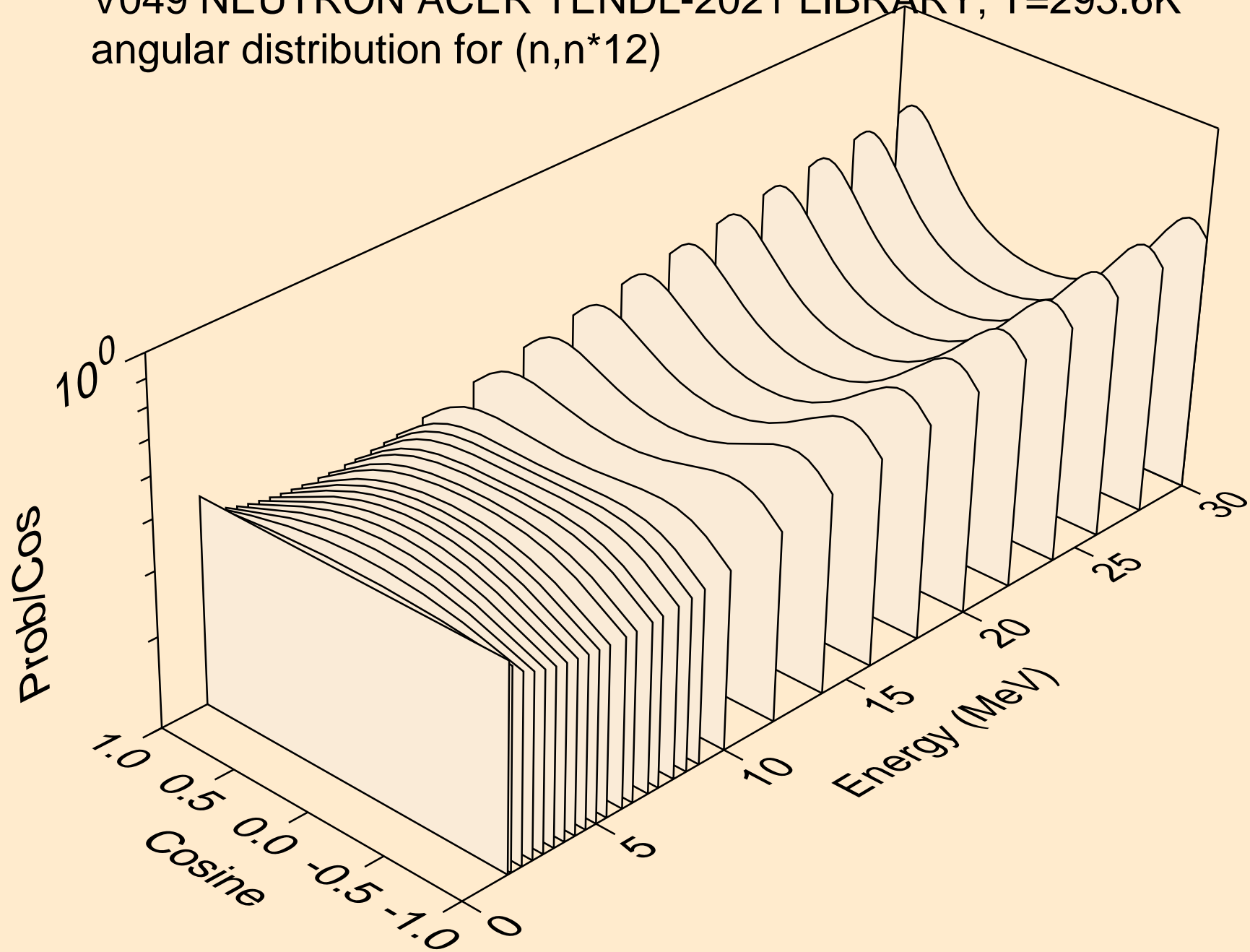

V049 NEUTRON ACER TENDL-2021 LIBRARY; T=293.6K  
angular distribution for (n,n\*13)

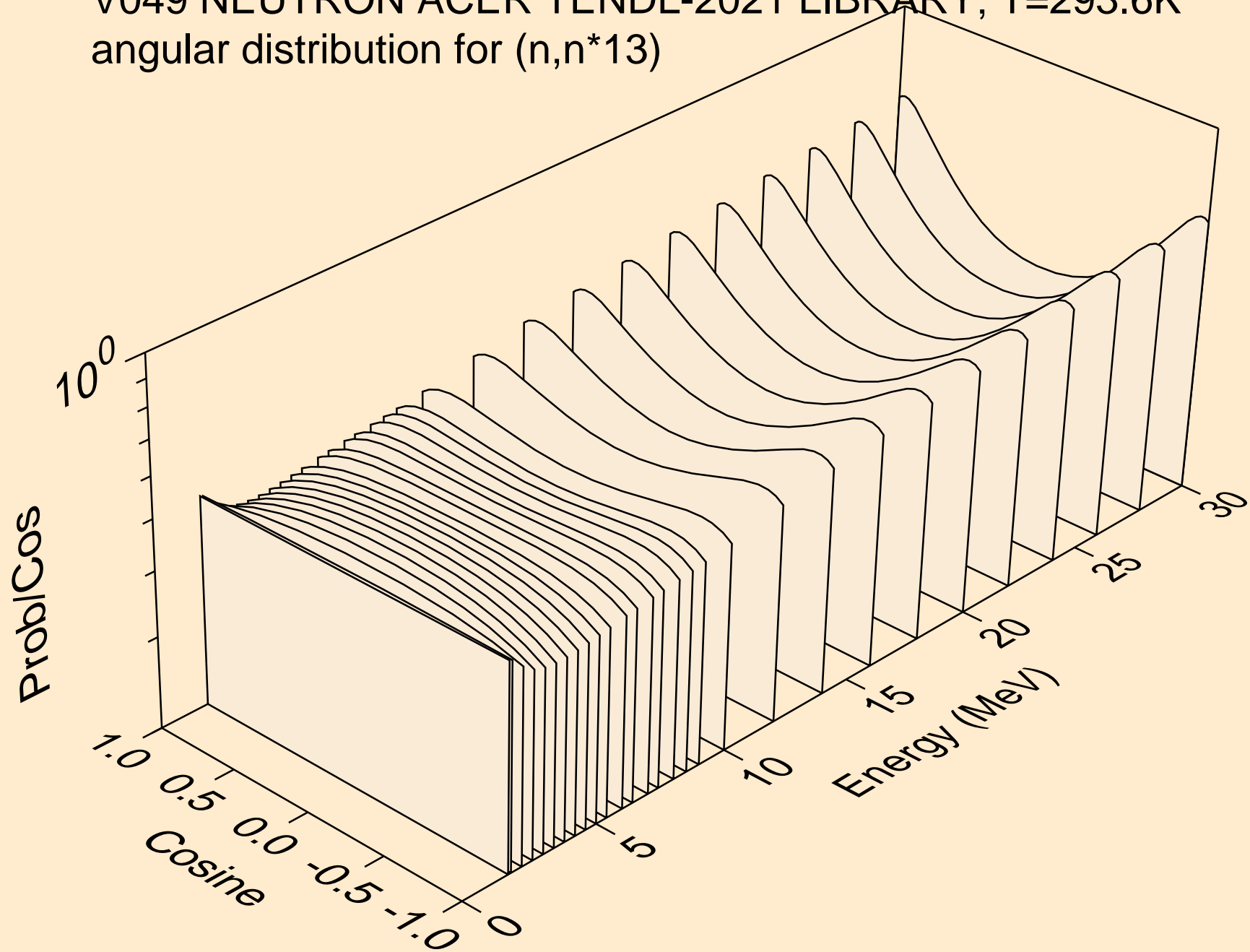



V049 NEUTRON ACER TENDL-2021 LIBRARY; T=293.6K  
angular distribution for (n,n\*14)

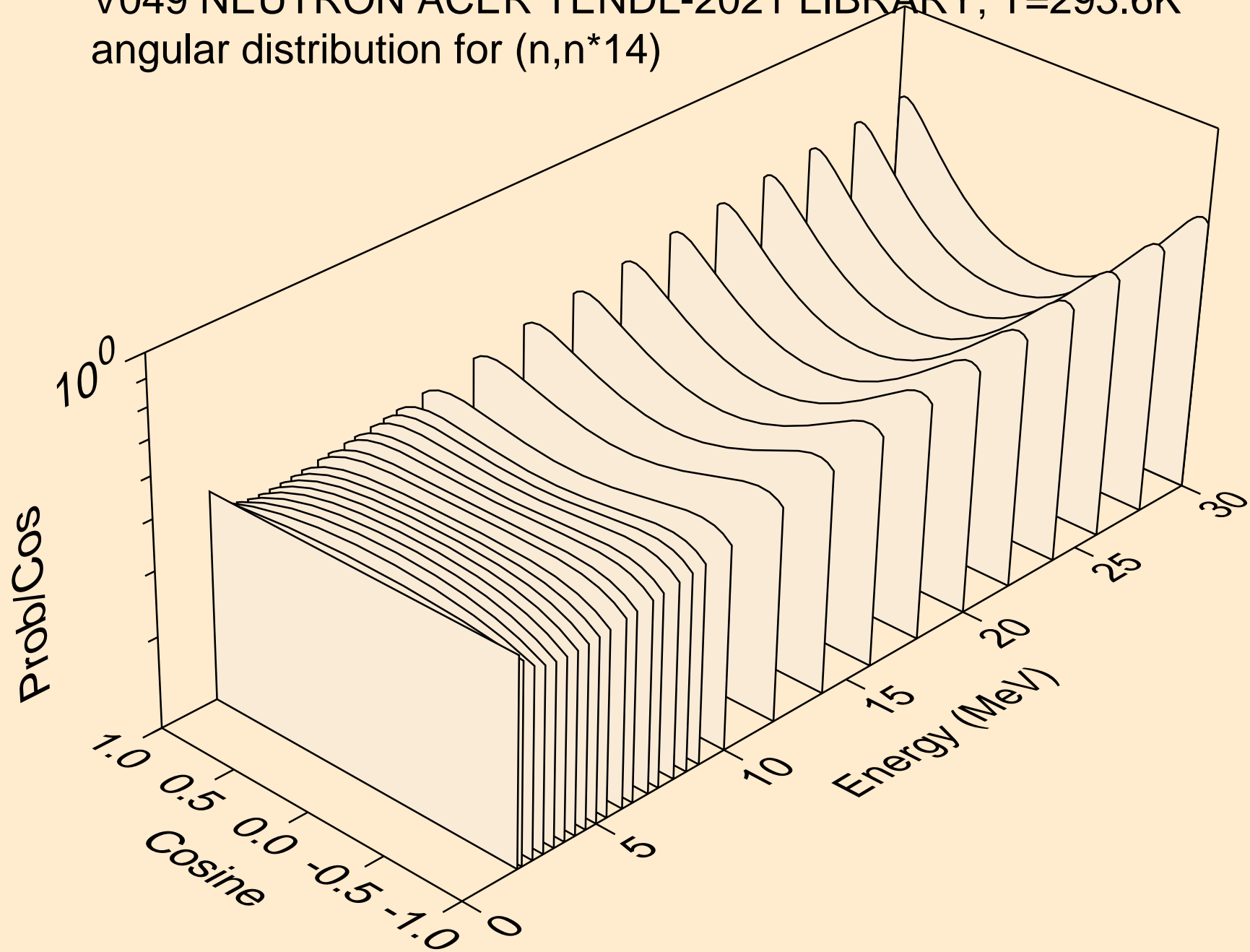

V049 NEUTRON ACER TENDL-2021 LIBRARY; T=293.6K  
angular distribution for (n,n\*15)

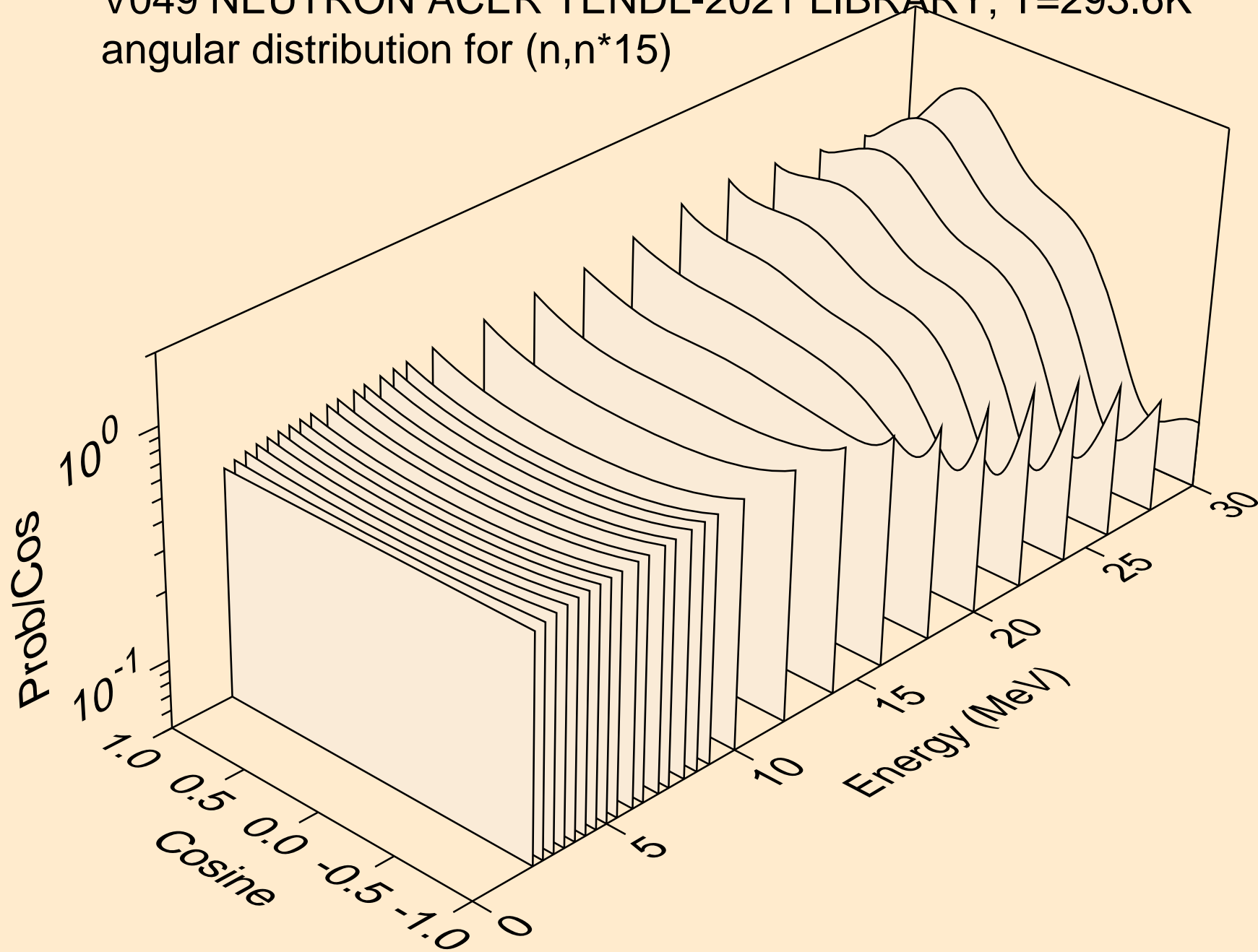

V049 NEUTRON ACER TENDL-2021 LIBRARY; T=293.6K  
angular distribution for (n,n\*16)

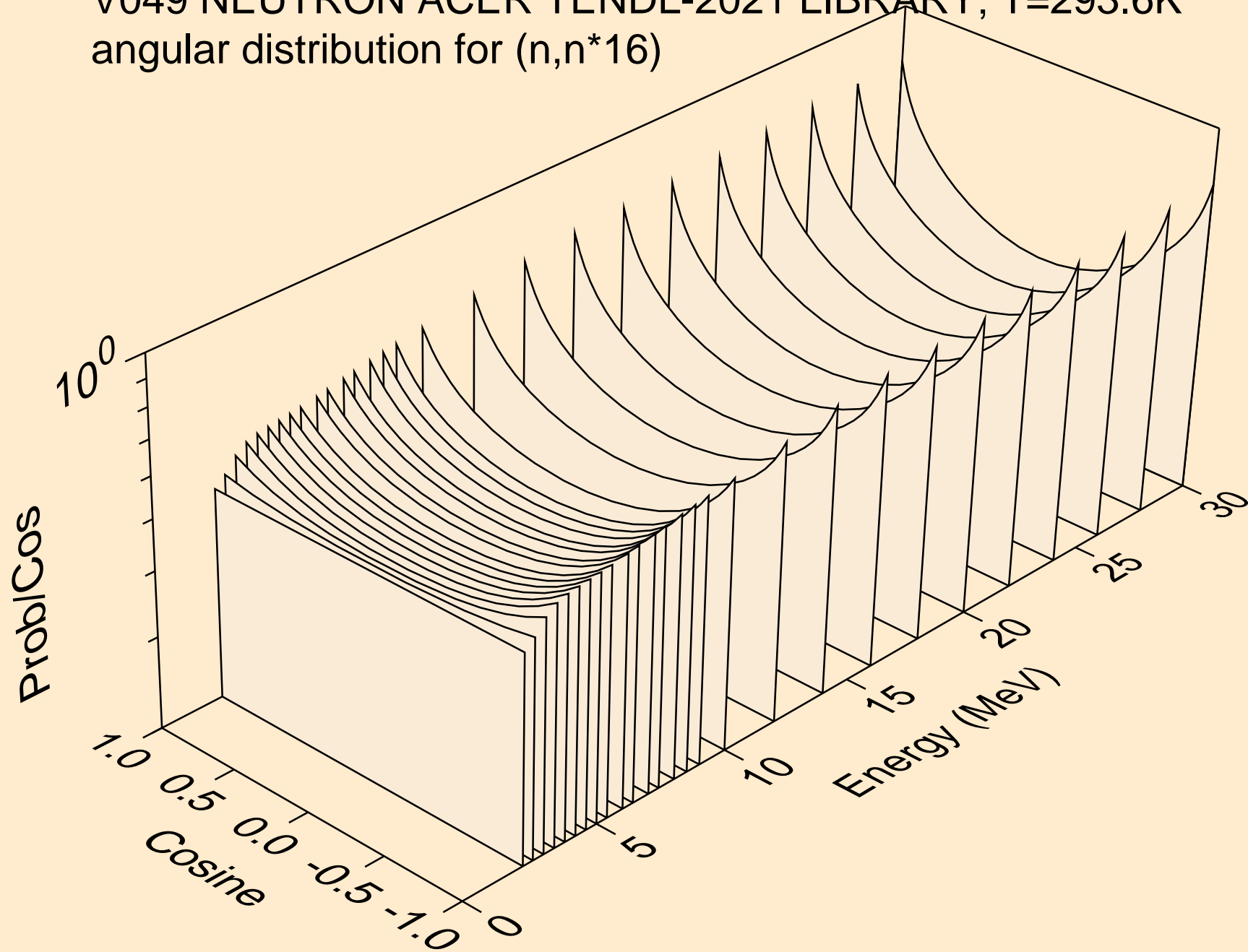

V049 NEUTRON ACER TENDL-2021 LIBRARY; T=293.6K  
angular distribution for (n,n\*17)

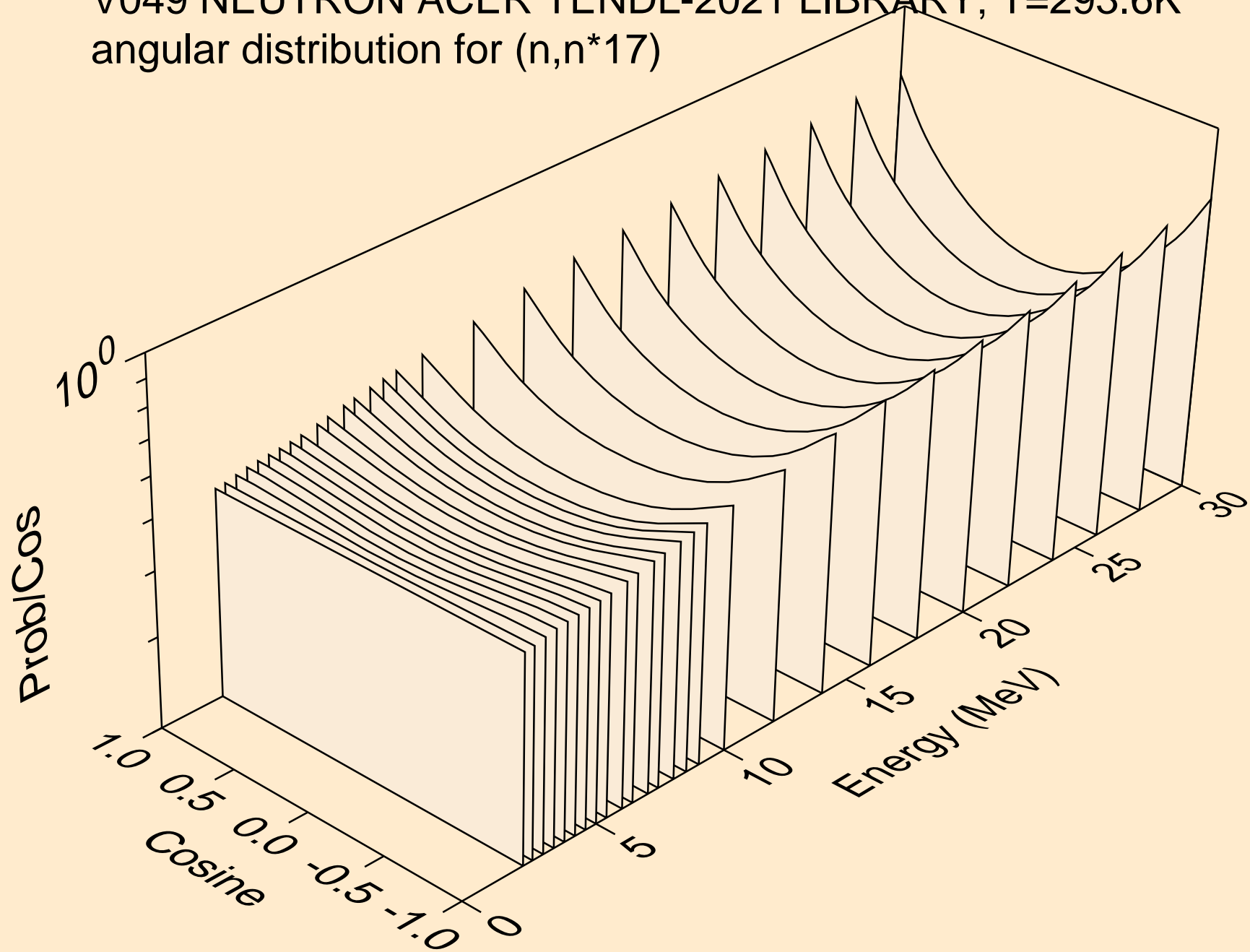

V049 NEUTRON ACER TENDL-2021 LIBRARY; T=293.6K  
angular distribution for (n,n\*18)

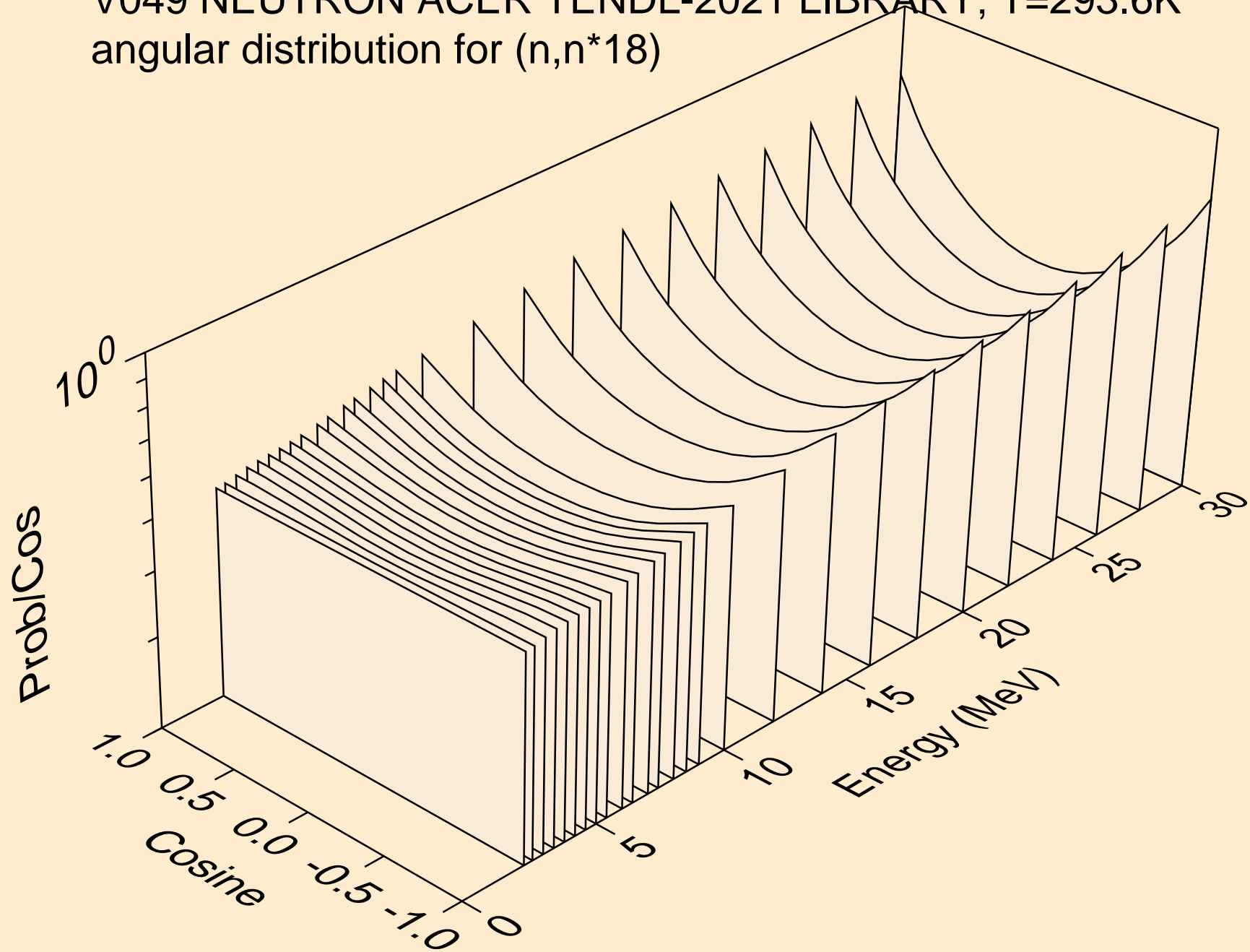

V049 NEUTRON ACER TENDL-2021 LIBRARY; T=293.6K  
angular distribution for (n,n\*19)

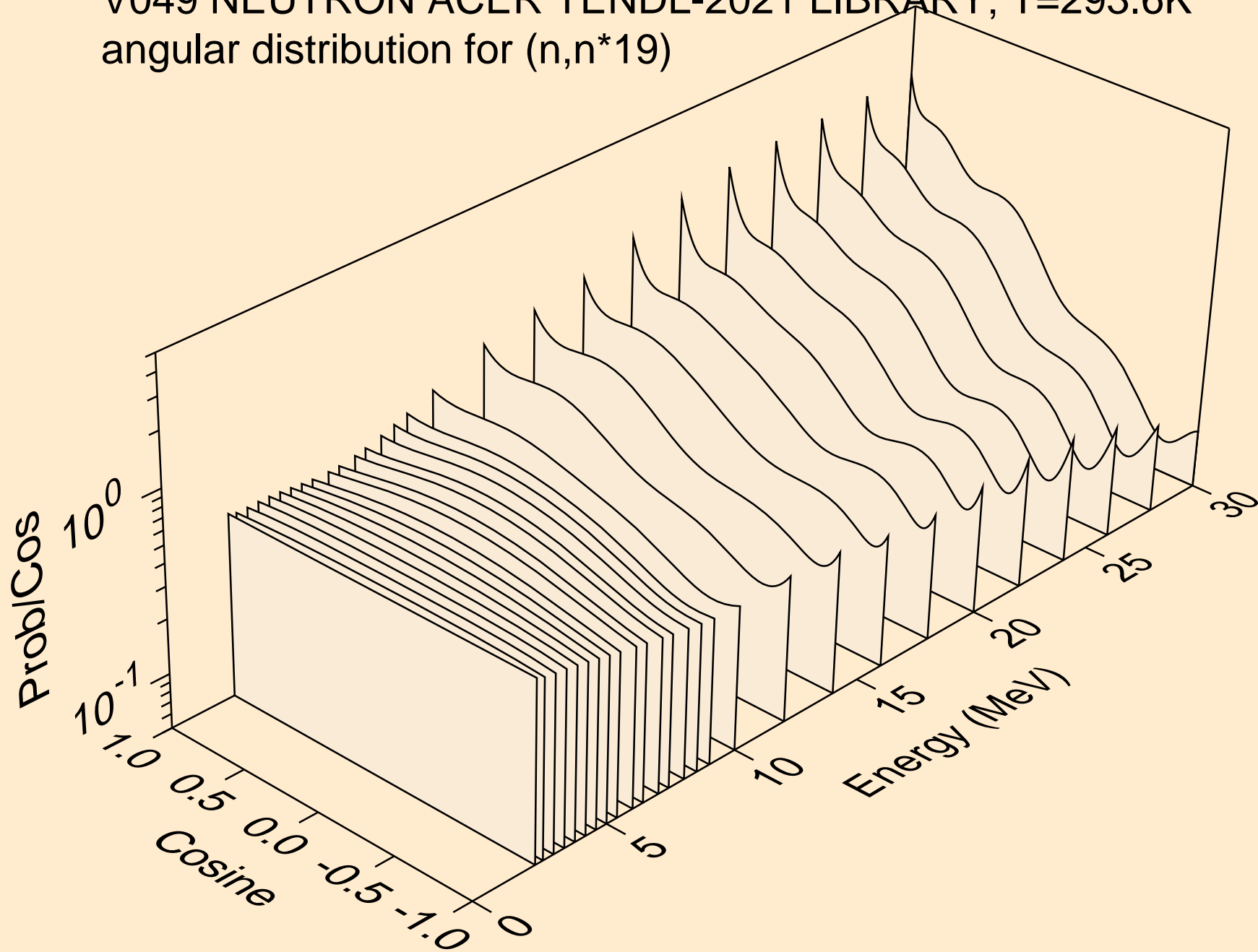

V049 NEUTRON ACER TENDL-2021 LIBRARY; T=293.6K  
angular distribution for (n,n\*20)

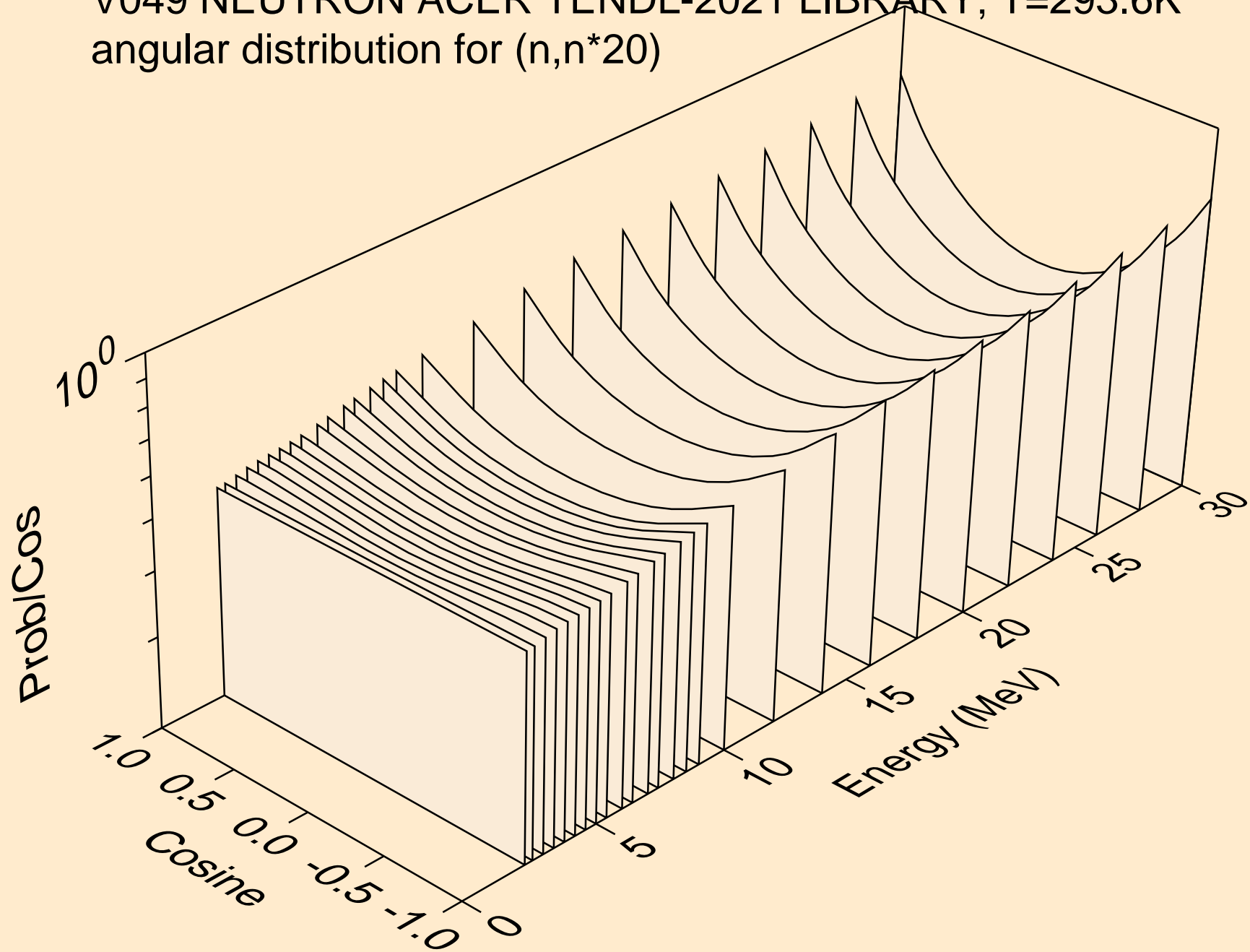

V049 NEUTRON ACER TENDL-2021 LIBRARY; T=293.6K  
angular distribution for (n,n\*21)

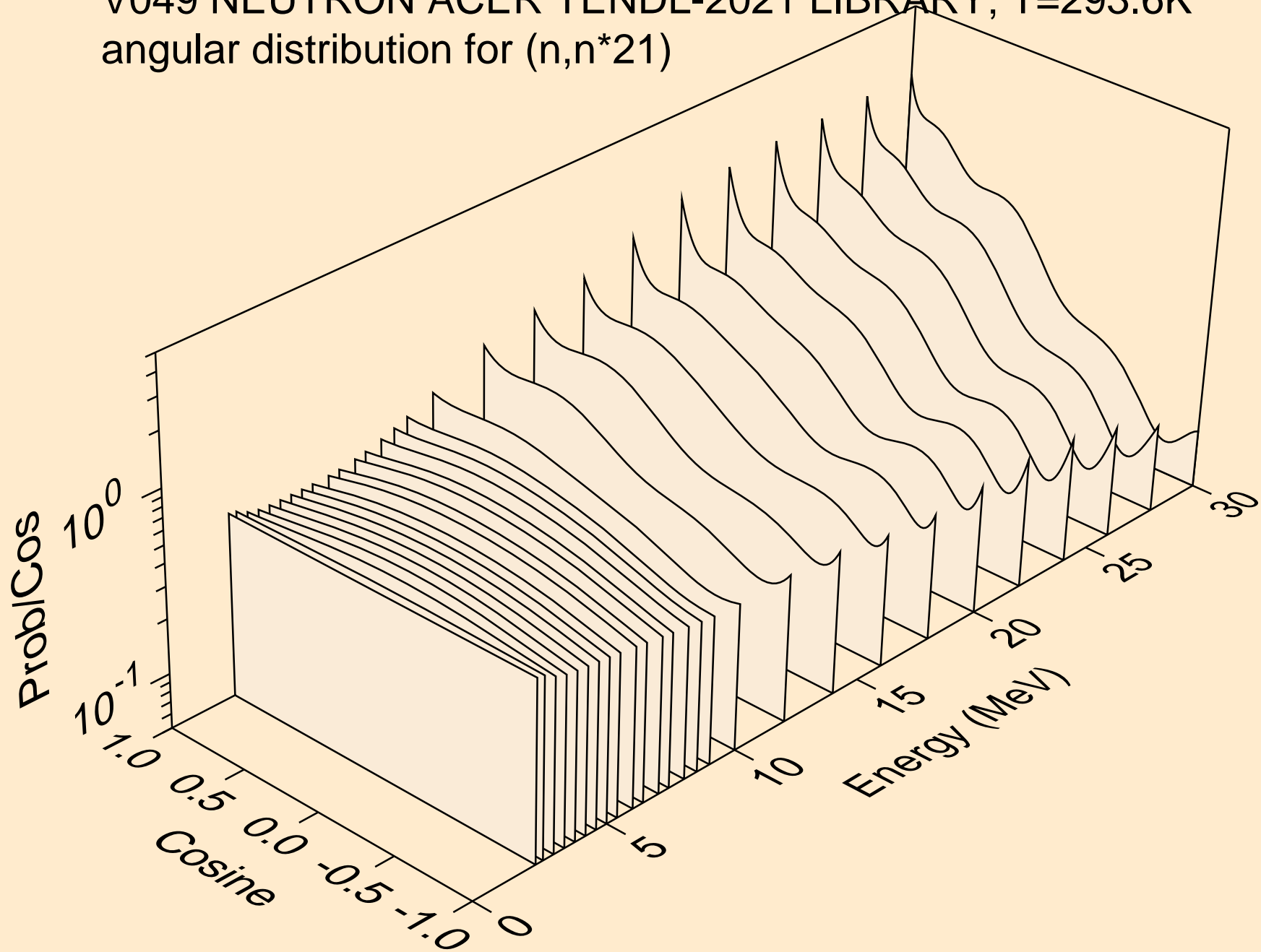



V049 NEUTRON ACER TENDL-2021 LIBRARY; T=293.6K  
angular distribution for (n,n\*22)

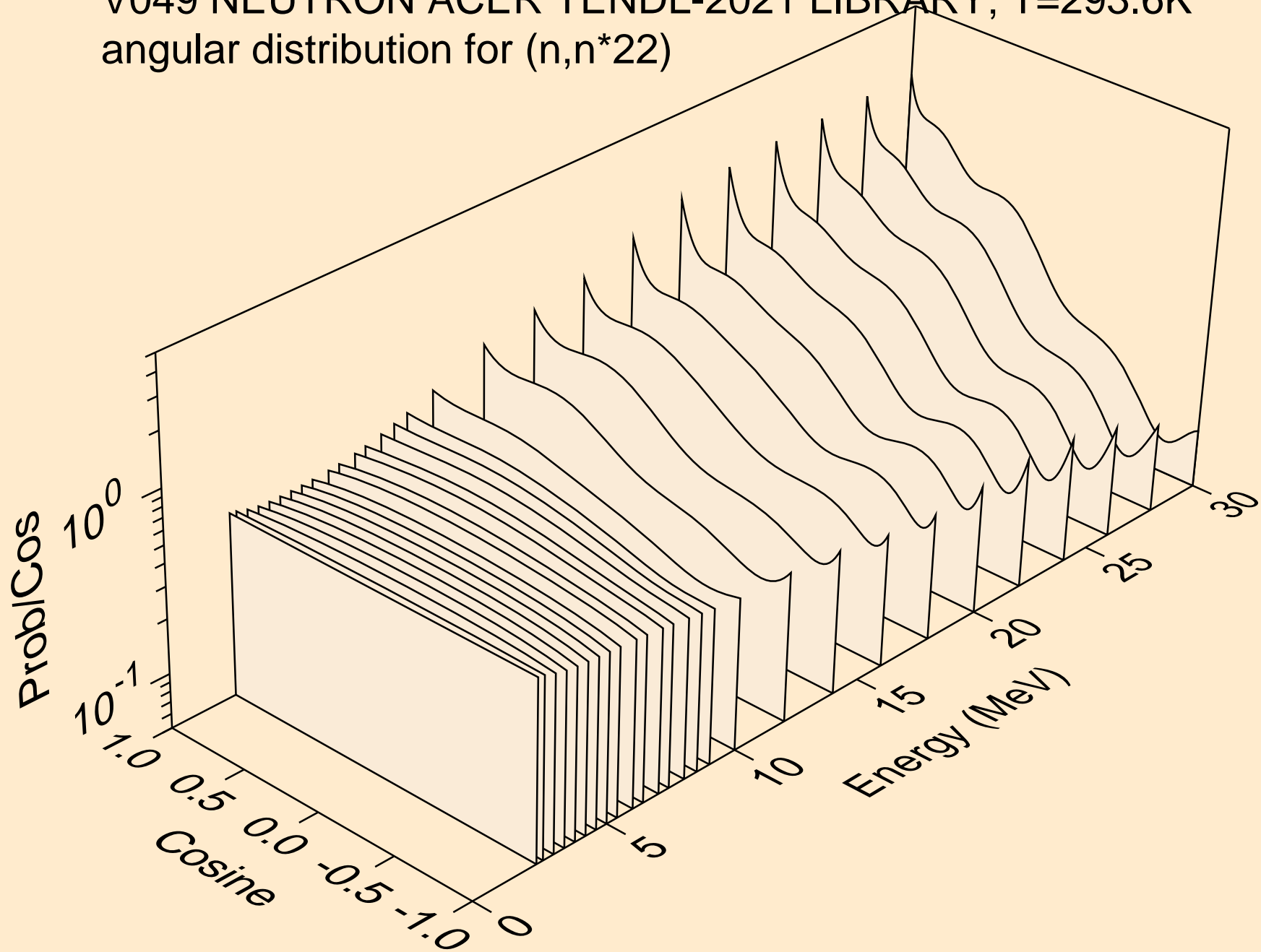

V049 NEUTRON ACER TENDL-2021 LIBRARY; T=293.6K  
angular distribution for (n,n\*23)

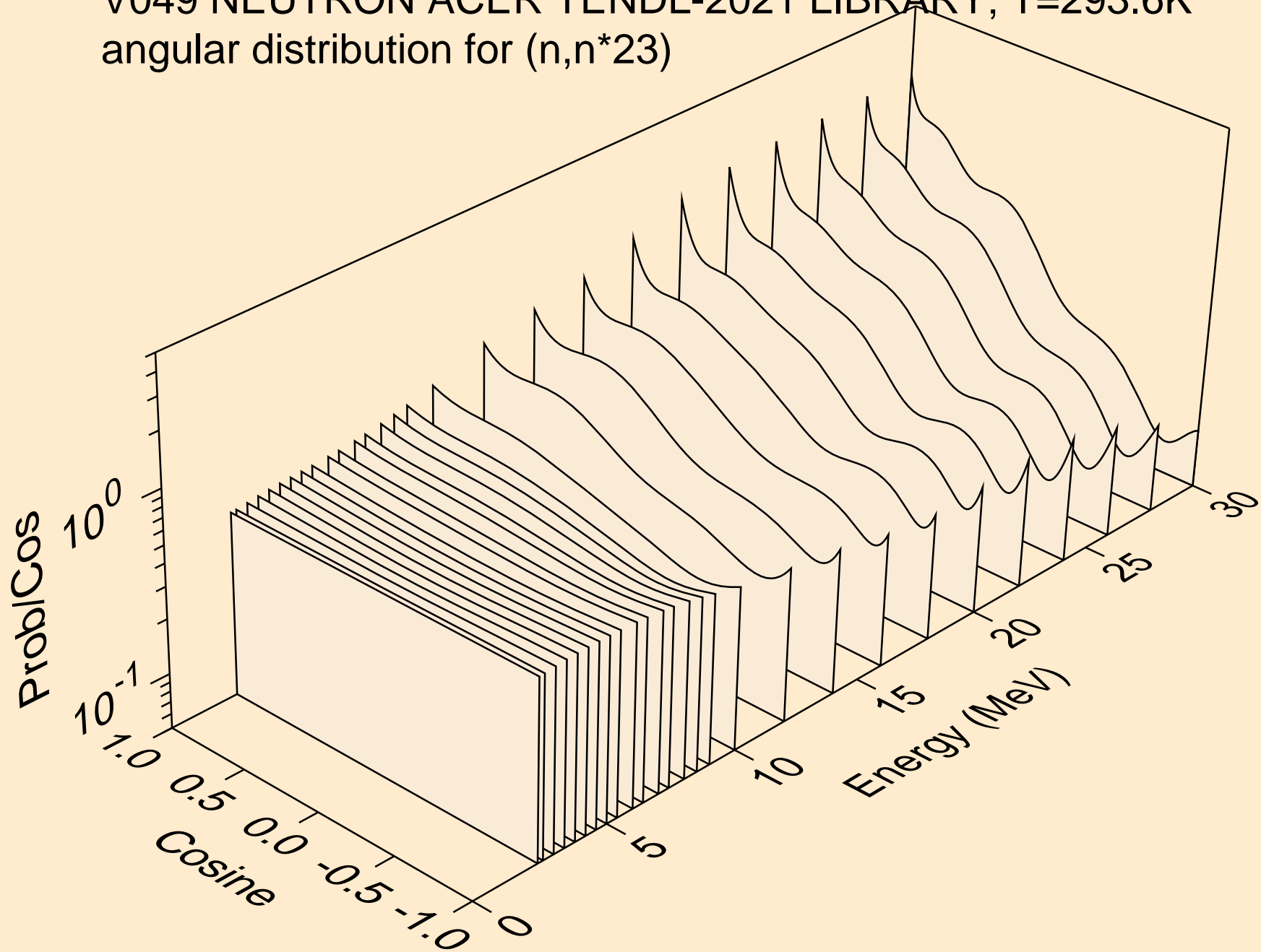

V049 NEUTRON ACER TENDL-2021 LIBRARY; T=293.6K  
angular distribution for (n,n\*24)

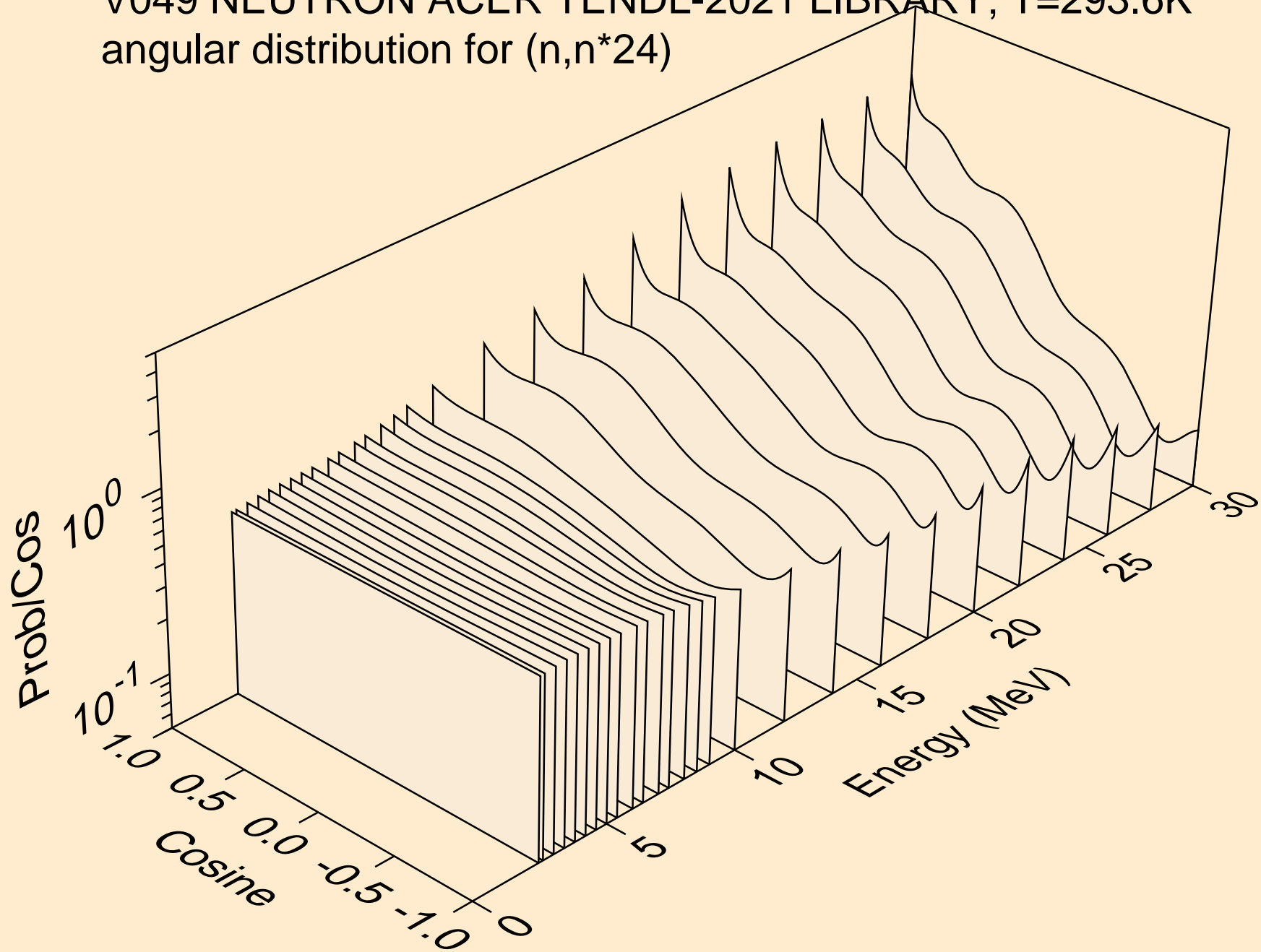

V049 NEUTRON ACER TENDL-2021 LIBRARY; T=293.6K  
angular distribution for (n,n\*25)

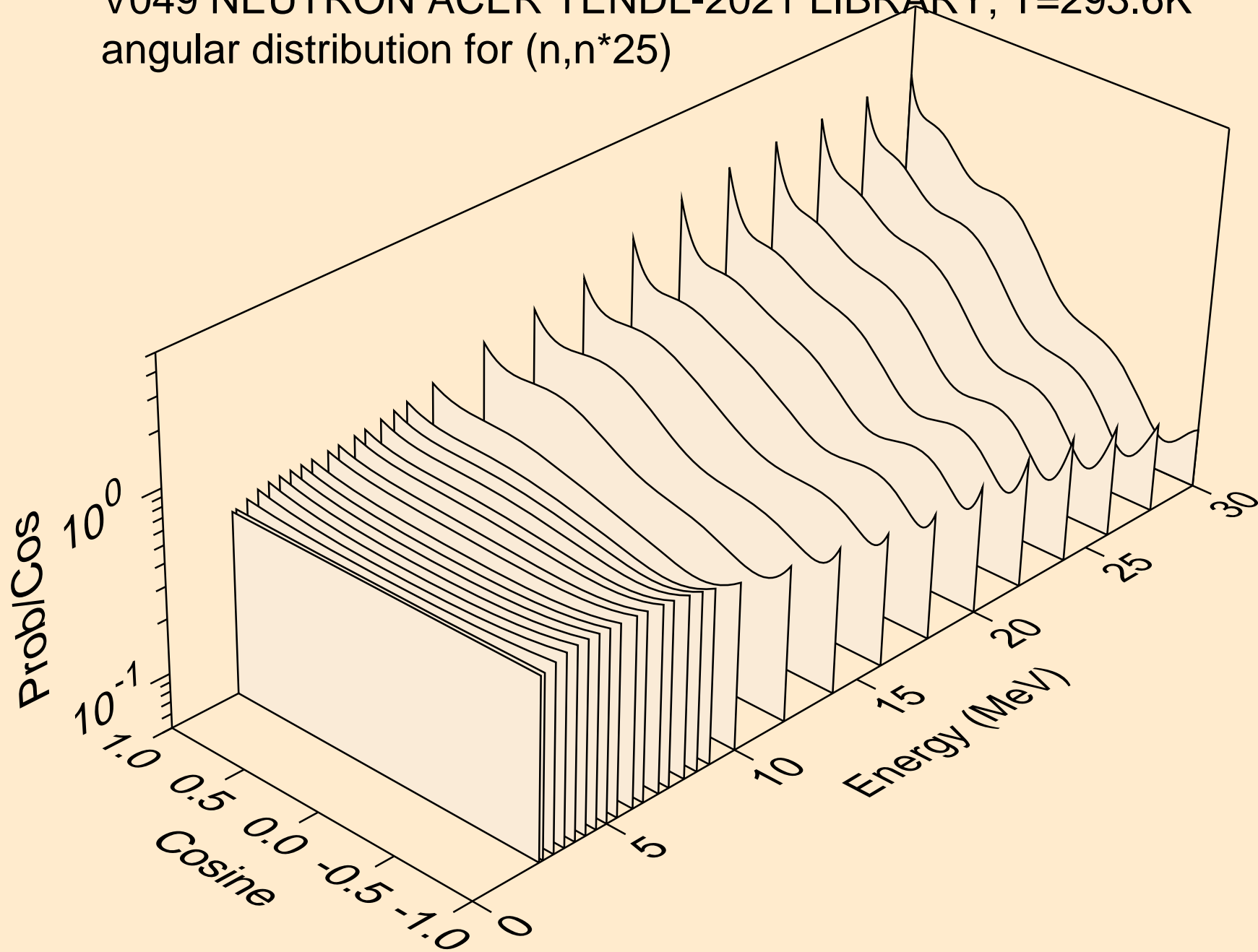

V049 NEUTRON ACER TENDL-2021 LIBRARY; T=293.6K  
angular distribution for (n,n\*26)

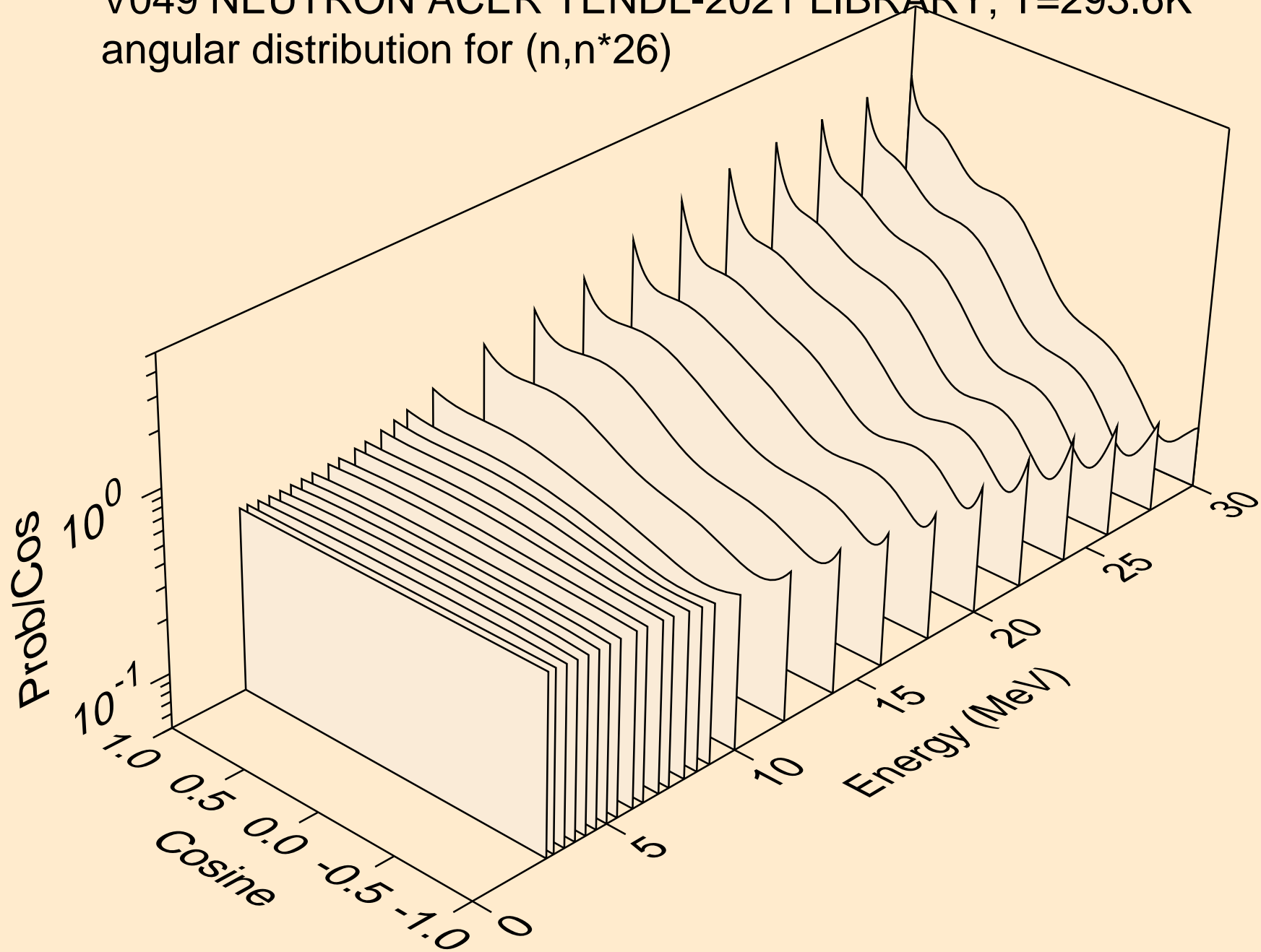

V049 NEUTRON ACER TENDL-2021 LIBRARY; T=293.6K  
angular distribution for (n,n\*27)

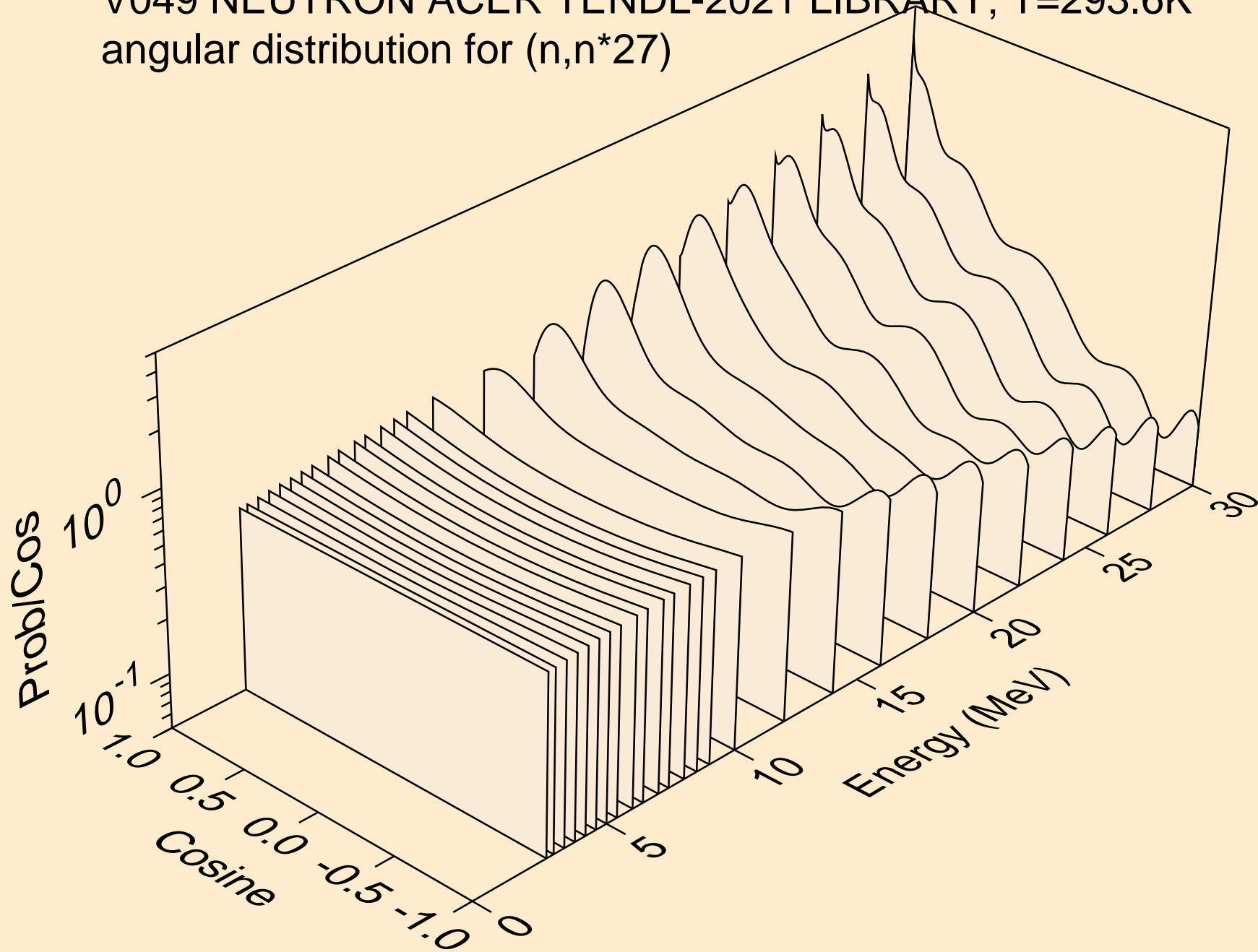

V049 NEUTRON ACER TENDL-2021 LIBRARY; T=293.6K  
angular distribution for (n,n\*28)

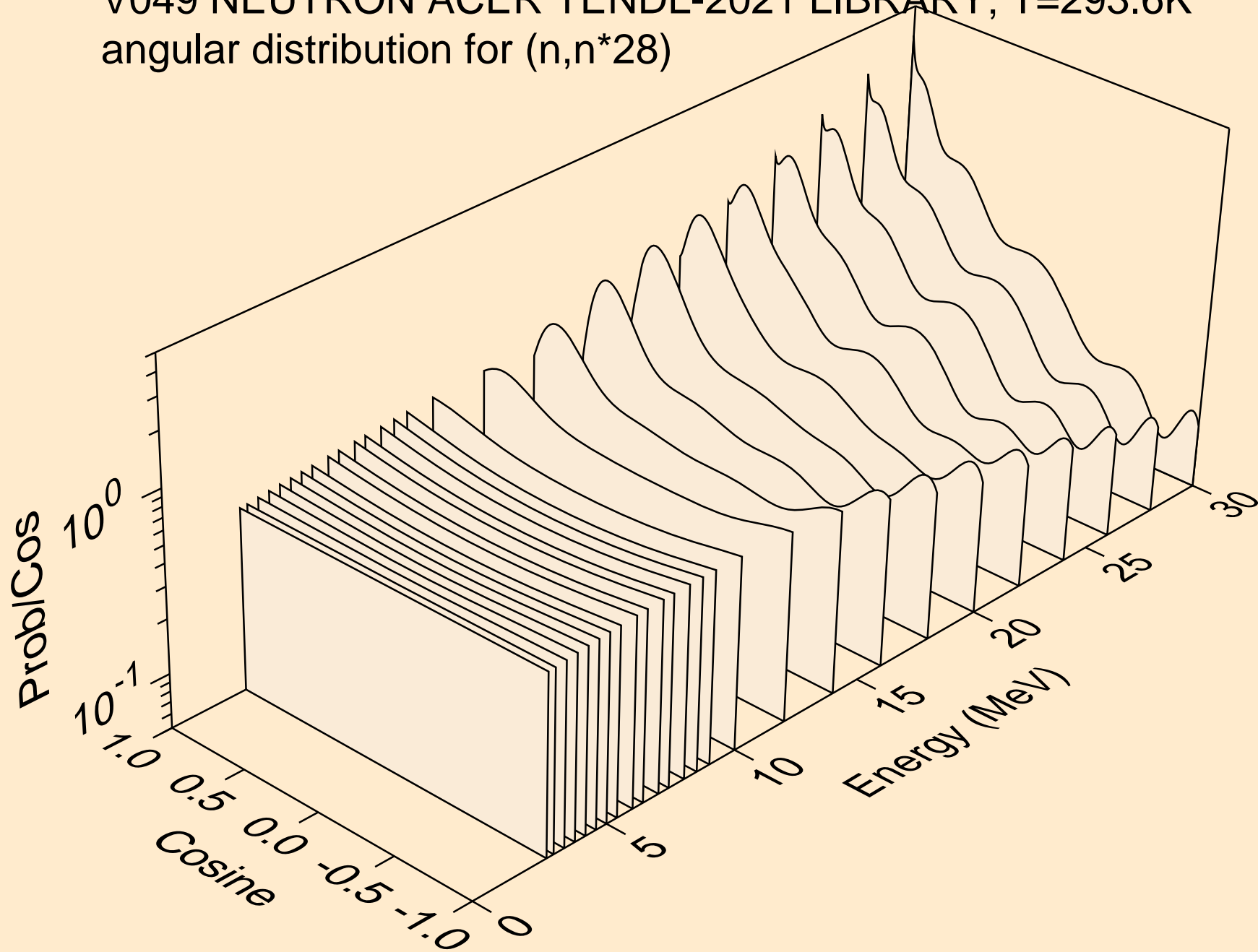

V049 NEUTRON ACER TENDL-2021 LIBRARY; T=293.6K  
angular distribution for (n,n\*29)

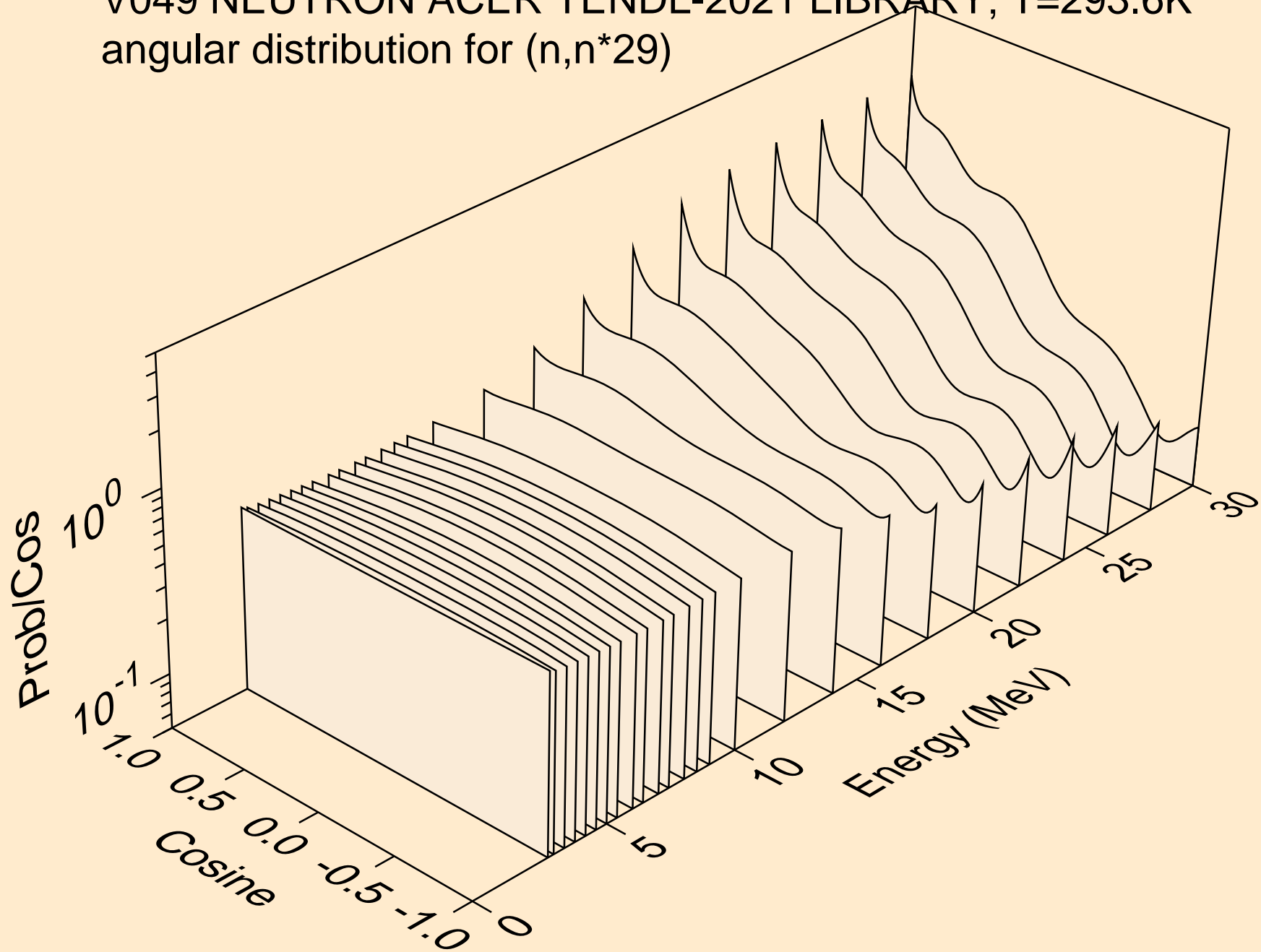



V049 NEUTRON ACER TENDL-2021 LIBRARY; T=293.6K  
angular distribution for (n,n\*30)

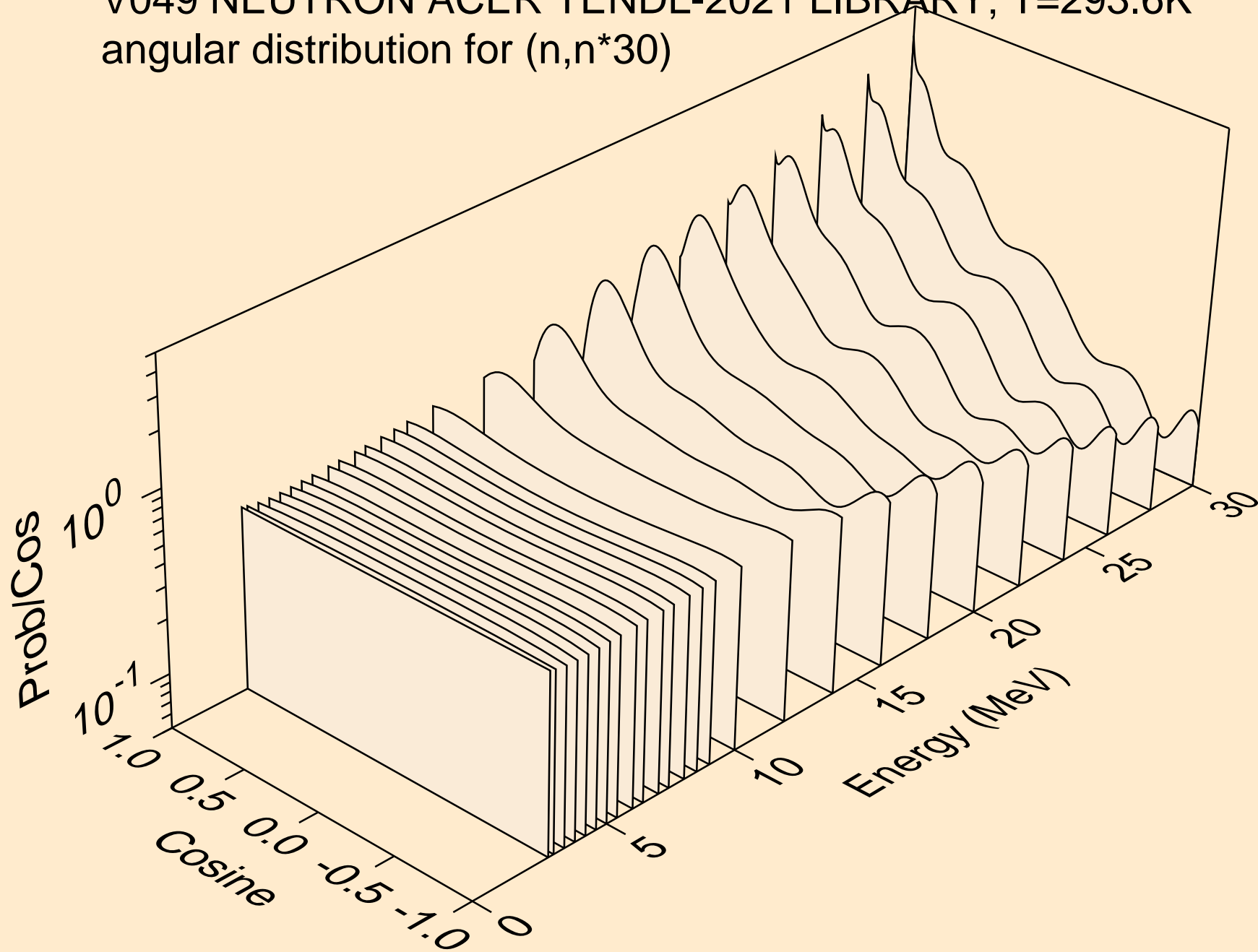

V049 NEUTRON ACER TENDL-2021 LIBRARY; T=293.6K  
Neutron emission for (n,x)

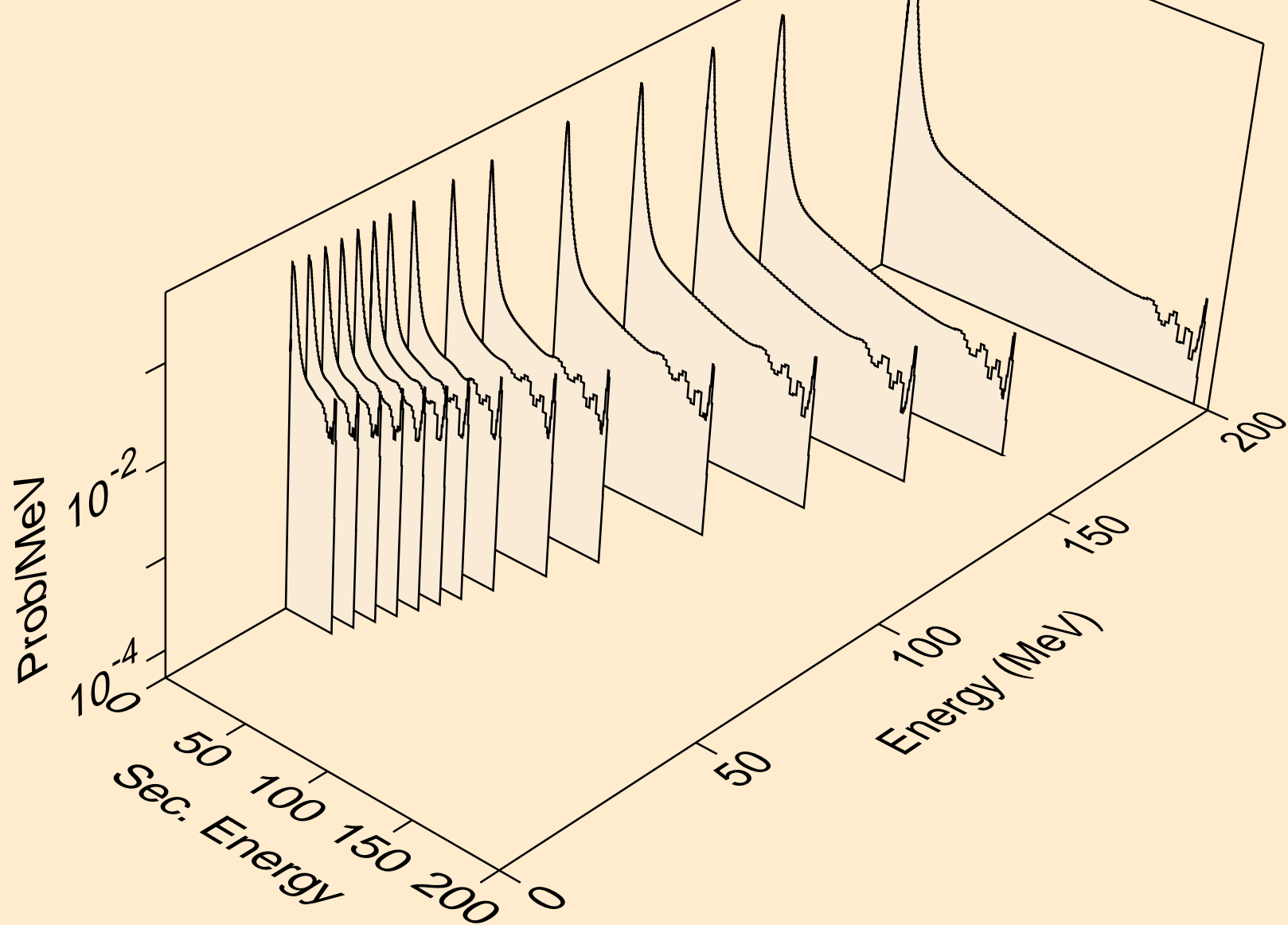

V049 NEUTRON ACER TENDL-2021 LIBRARY; T=293.6K  
Neutron emission for (n,2nd)

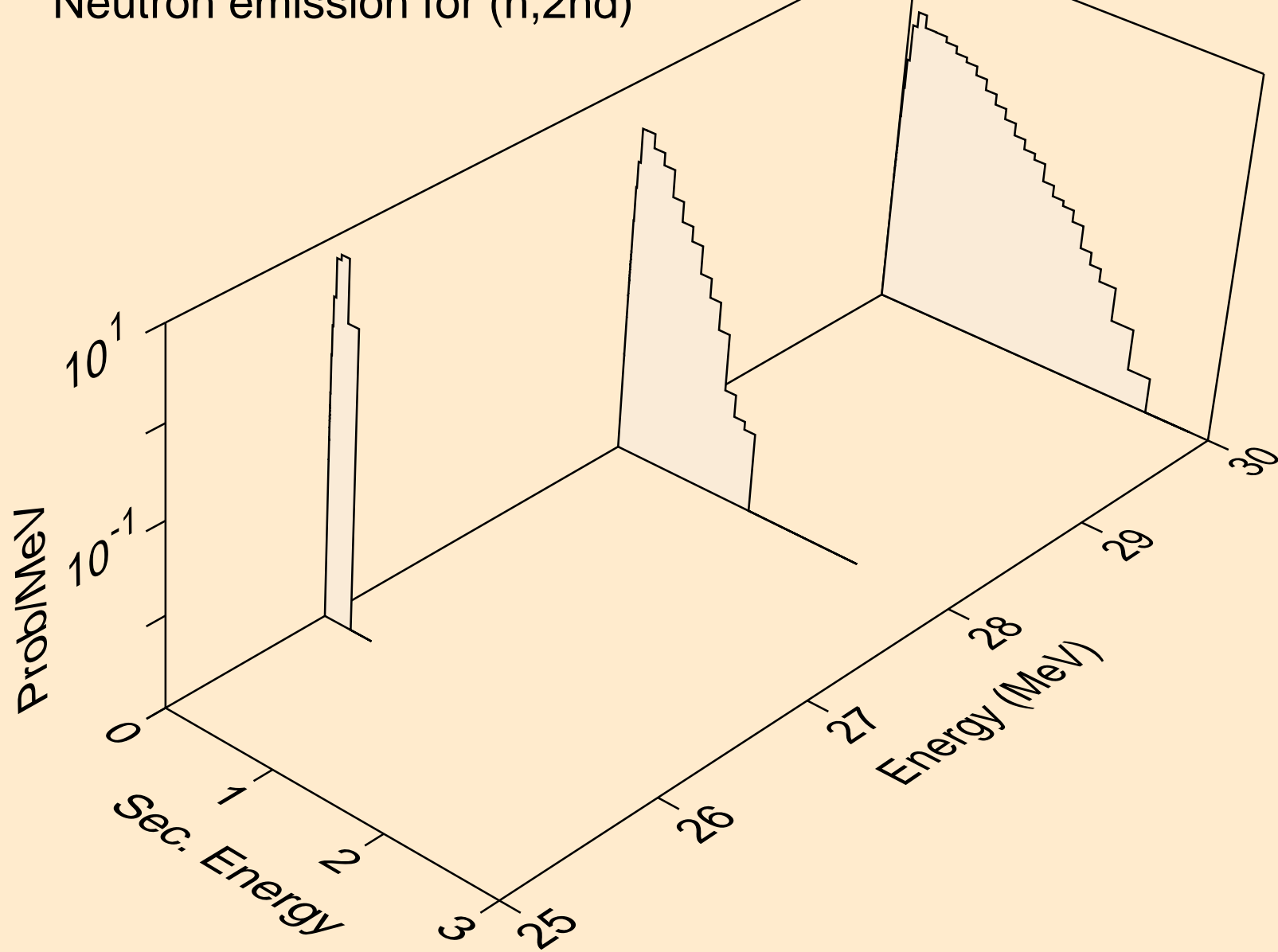

V049 NEUTRON ACER TENDL-2021 LIBRARY; T=293.6K  
Neutron emission for (n,2n)

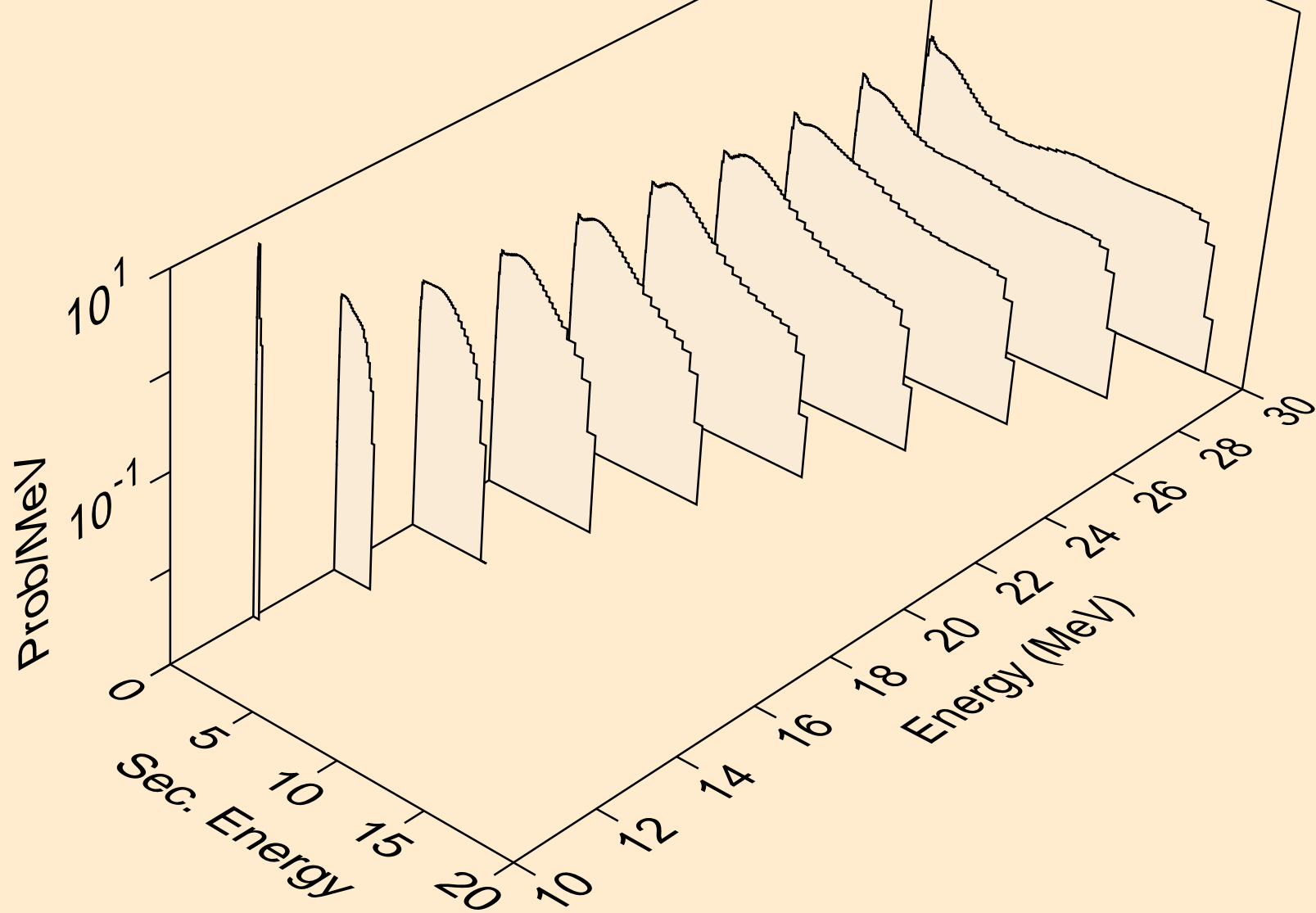

V049 NEUTRON ACER TENDL-2021 LIBRARY; T=293.6K  
Neutron emission for (n,3n)

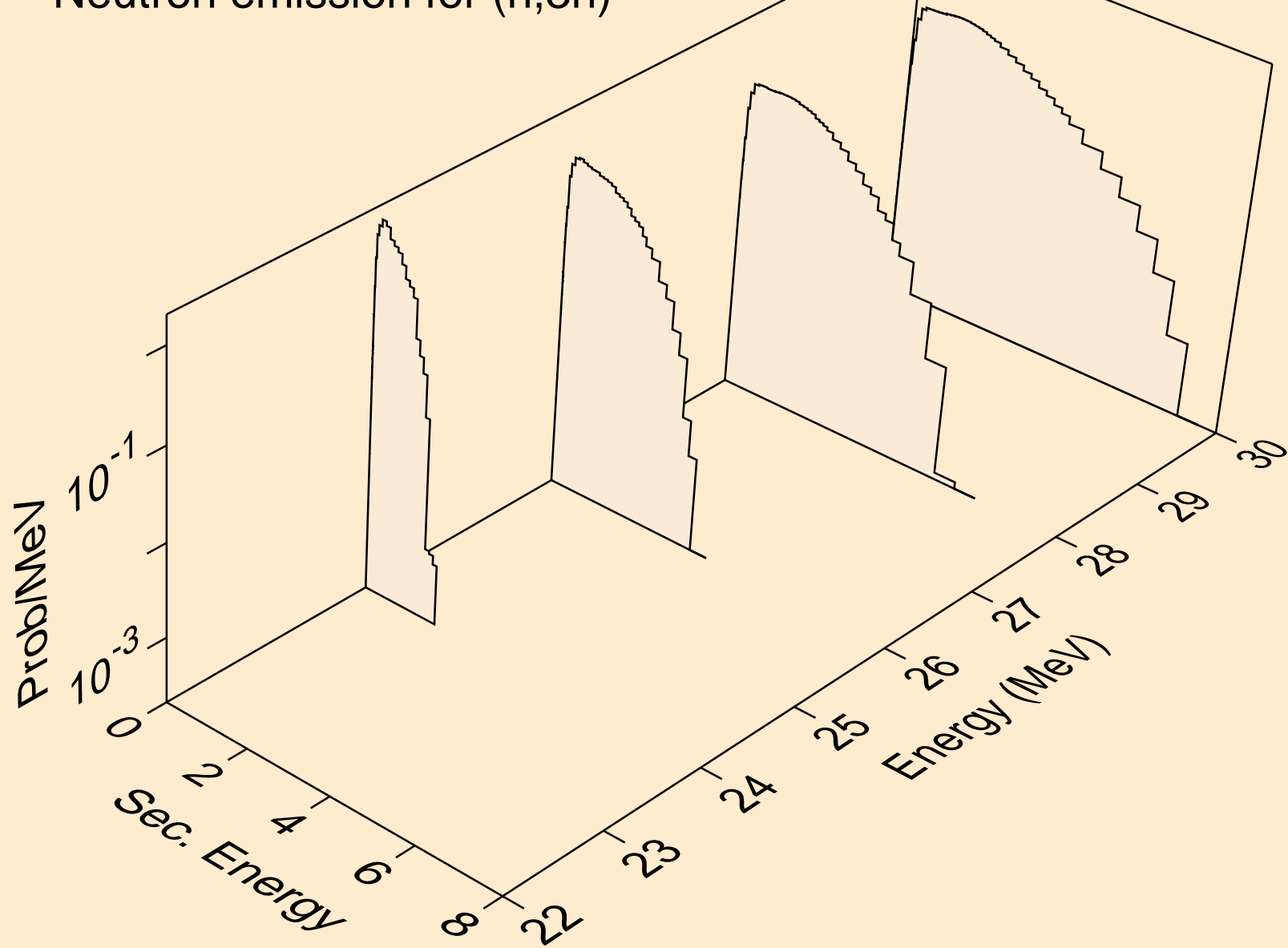

V049 NEUTRON ACER TENDL-2021 LIBRARY; T=293.6K  
Neutron emission for (n,n\*)a

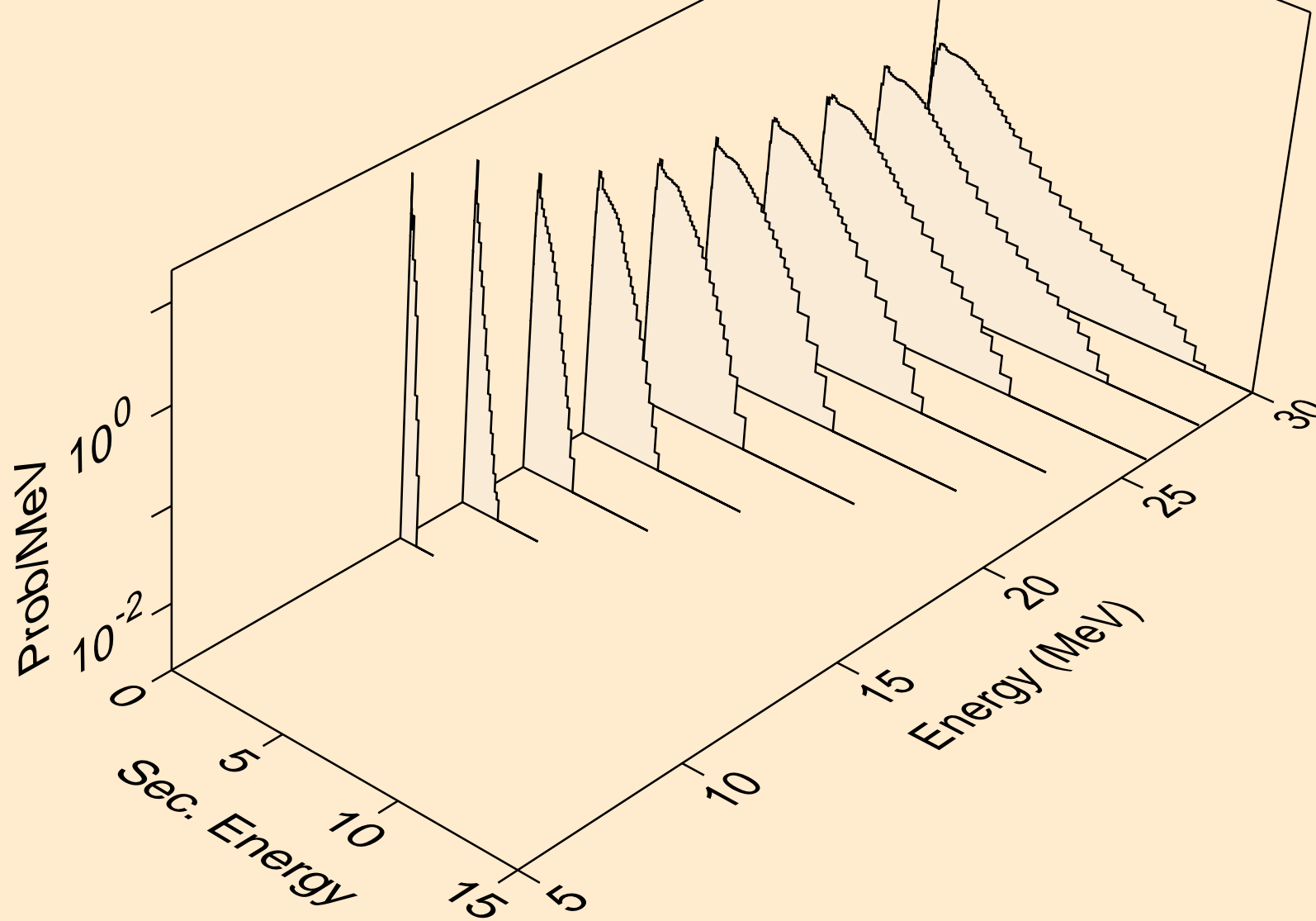

V049 NEUTRON ACER TENDL-2021 LIBRARY; T=293.6K  
Neutron emission for (n,2n)<sub>a</sub>

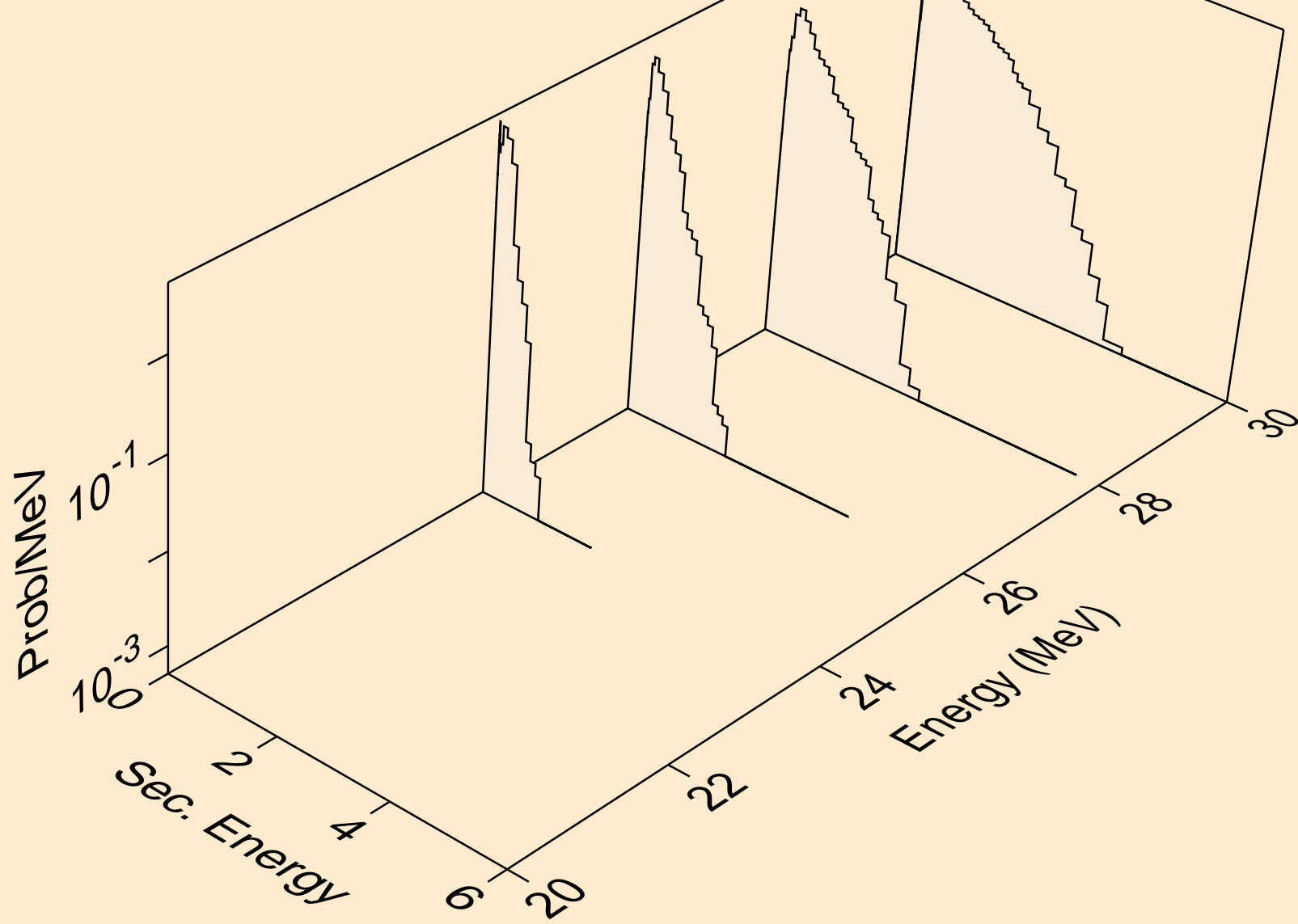

V049 NEUTRON ACER TENDL-2021 LIBRARY; T=293.6K  
Neutron emission for (n,n\*)p

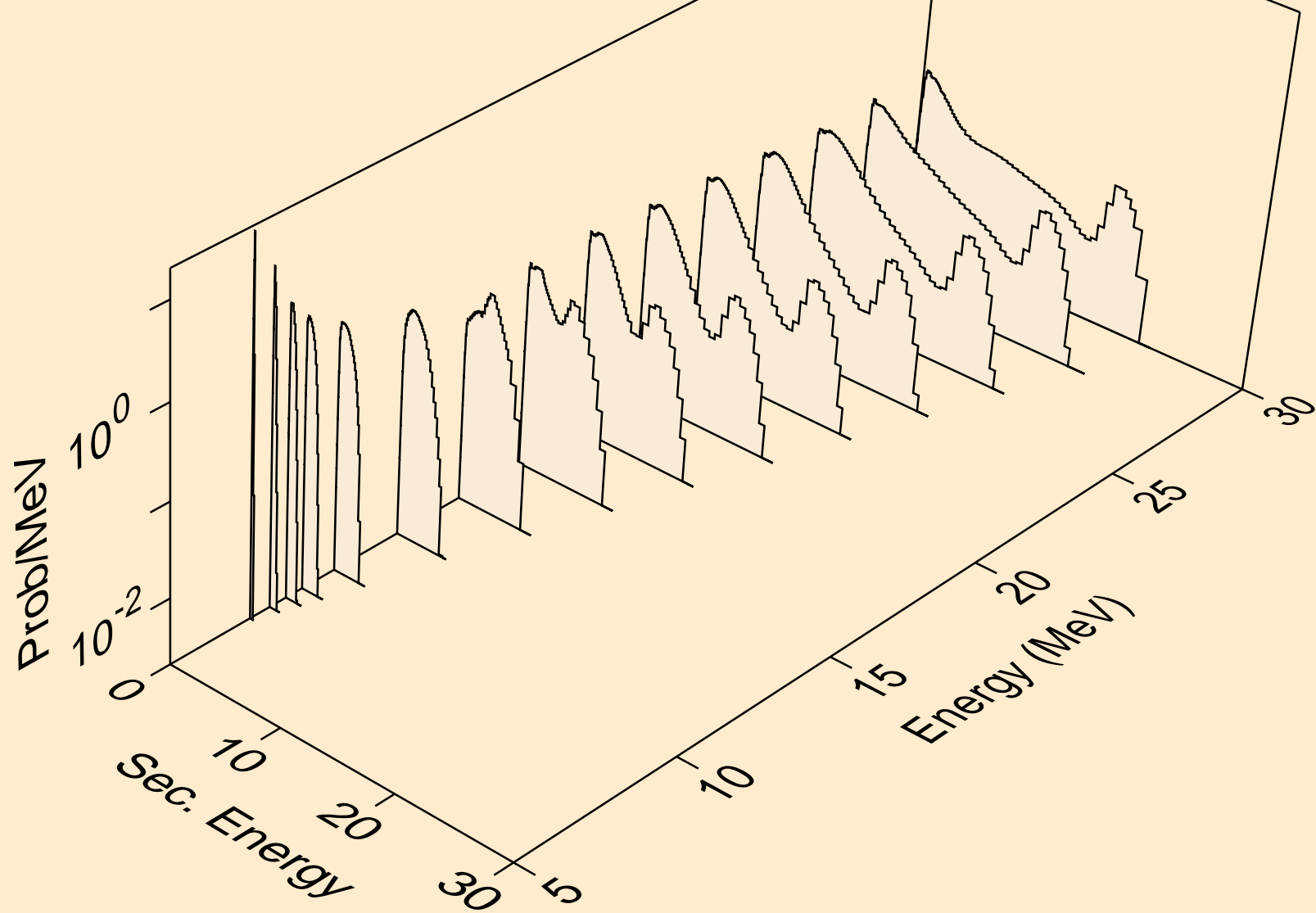



V049 NEUTRON ACER TENDL-2021 LIBRARY; T=293.6K  
Neutron emission for (n,n\*)2a

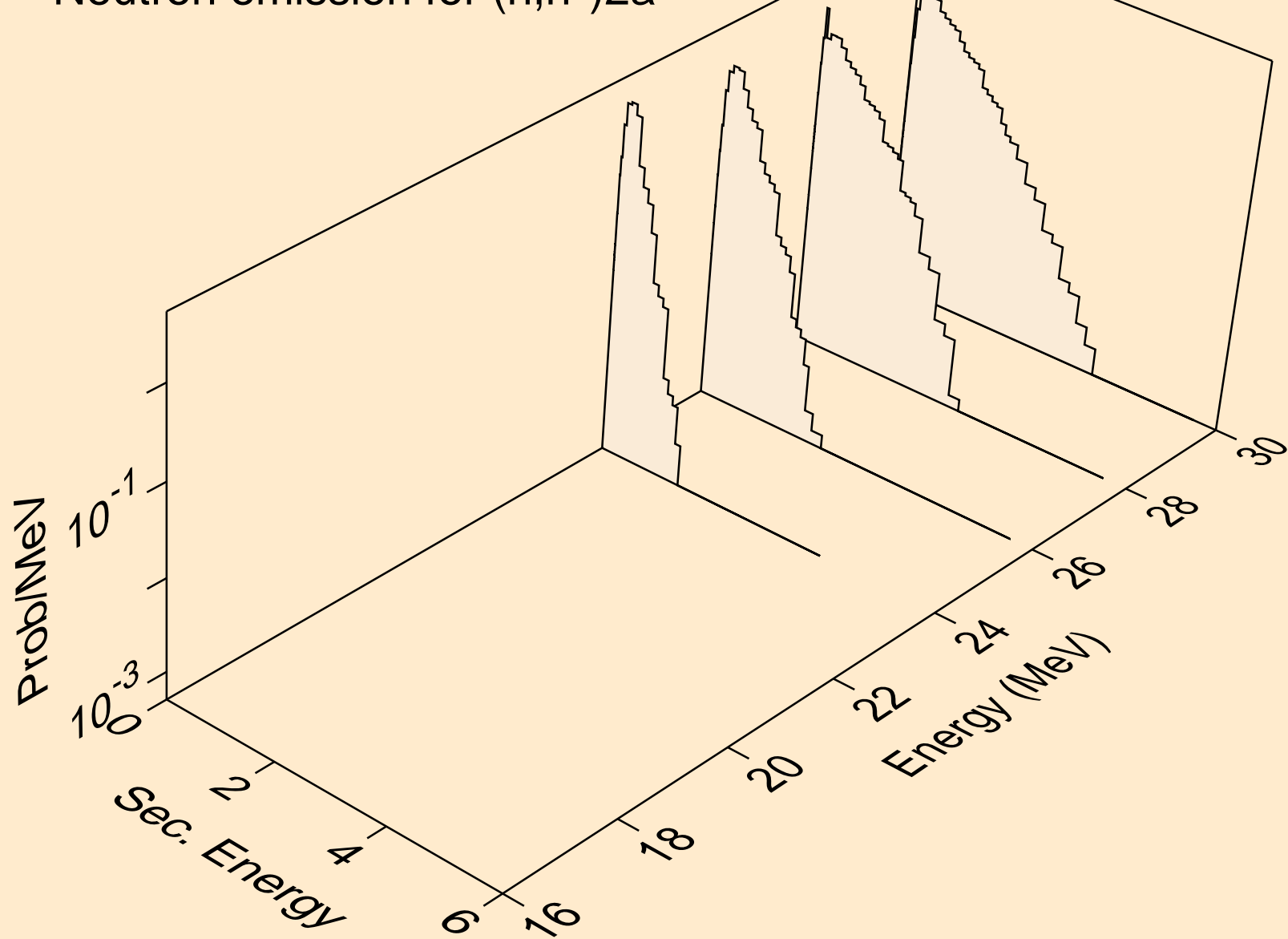

V049 NEUTRON ACER TENDL-2021 LIBRARY; T=293.6K  
Neutron emission for (n,n\*)d

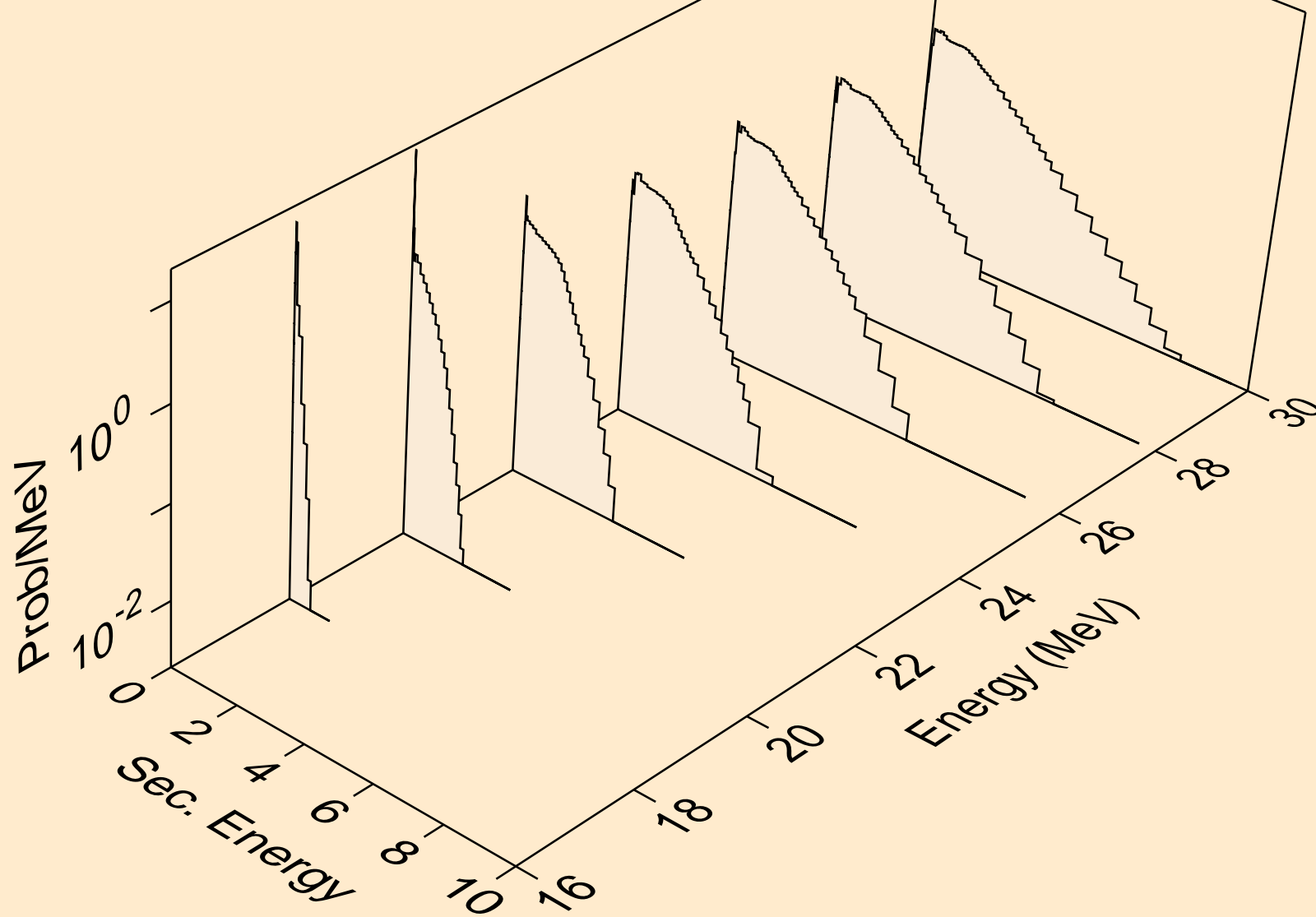

V049 NEUTRON ACER TENDL-2021 LIBRARY; T=293.6K  
Neutron emission for (n,n\*)t

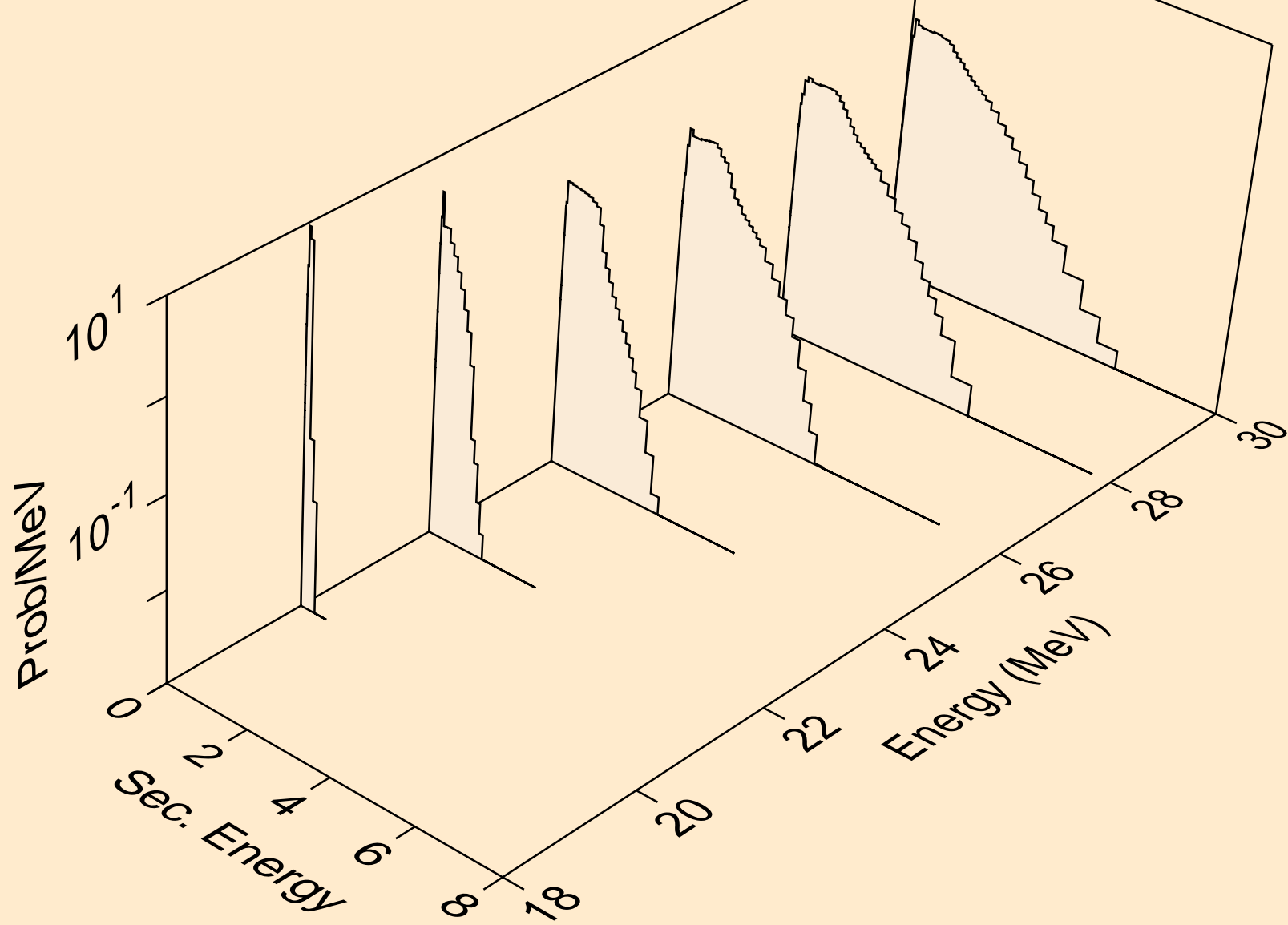

V049 NEUTRON ACER TENDL-2021 LIBRARY; T=293.6K  
Neutron emission for (n,n\*)he3

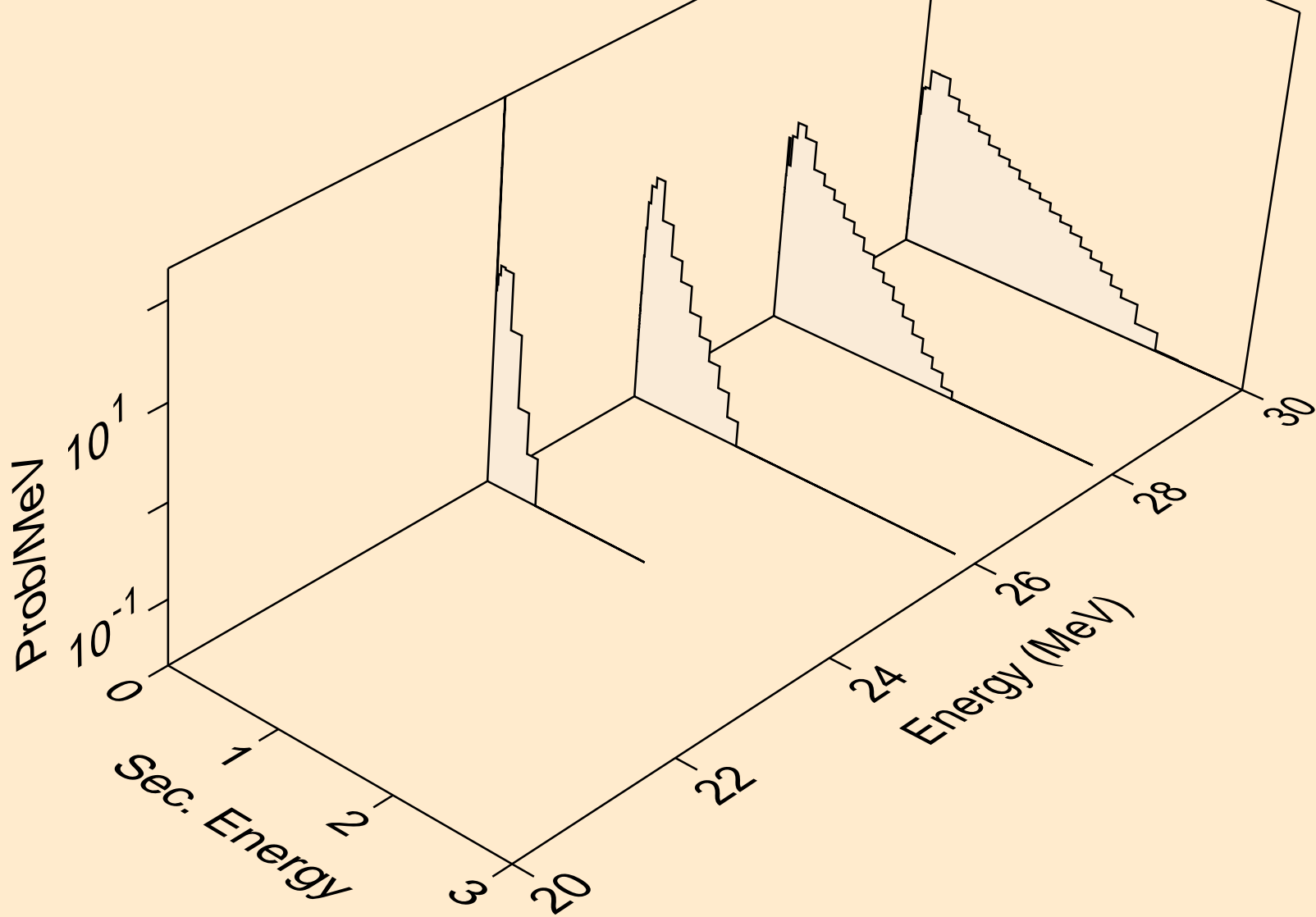

V049 NEUTRON ACER TENDL-2021 LIBRARY; T=293.6K  
Neutron emission for (n,2np)

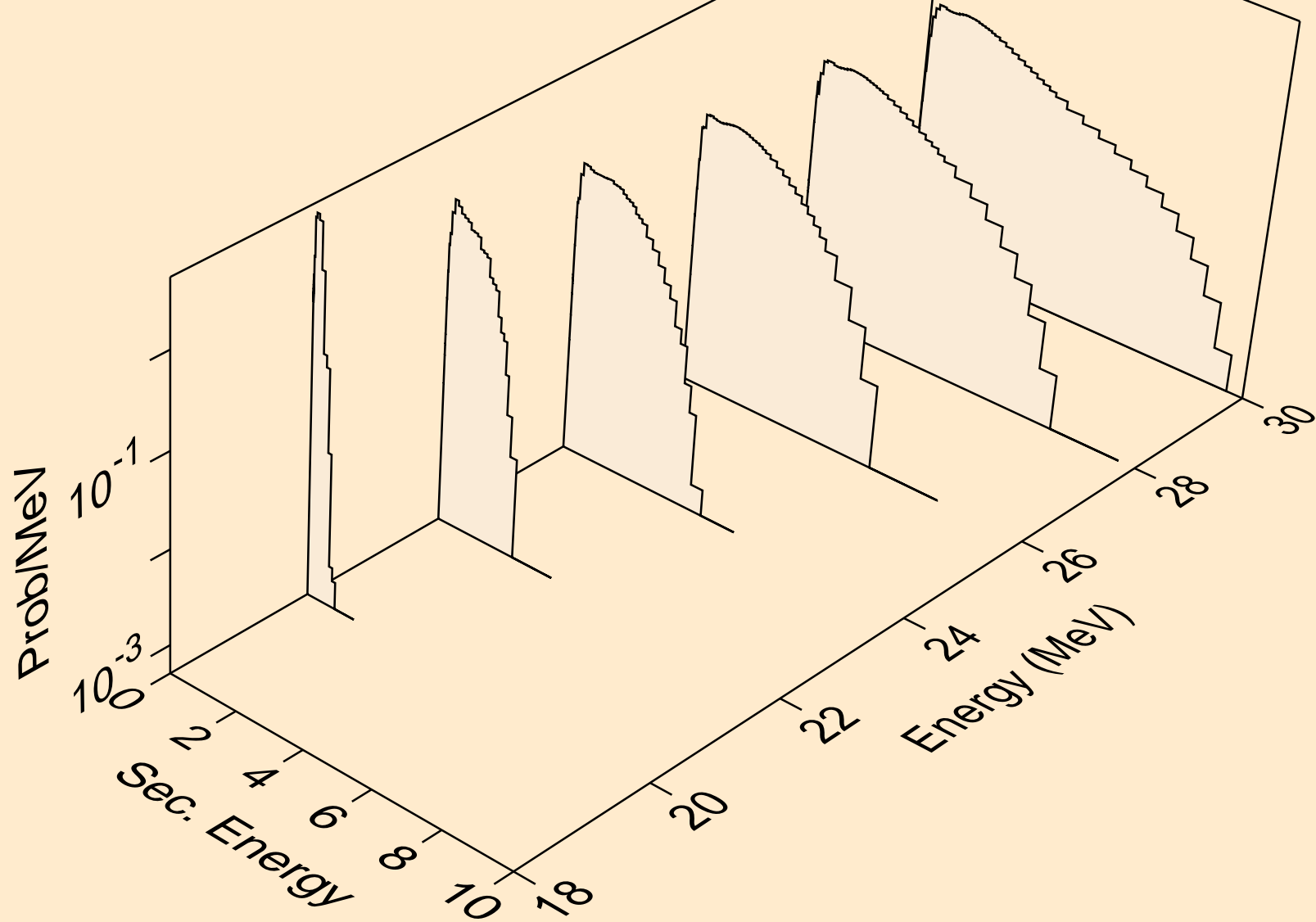

V049 NEUTRON ACER TENDL-2021 LIBRARY; T=293.6K  
Neutron emission for (n,3np)

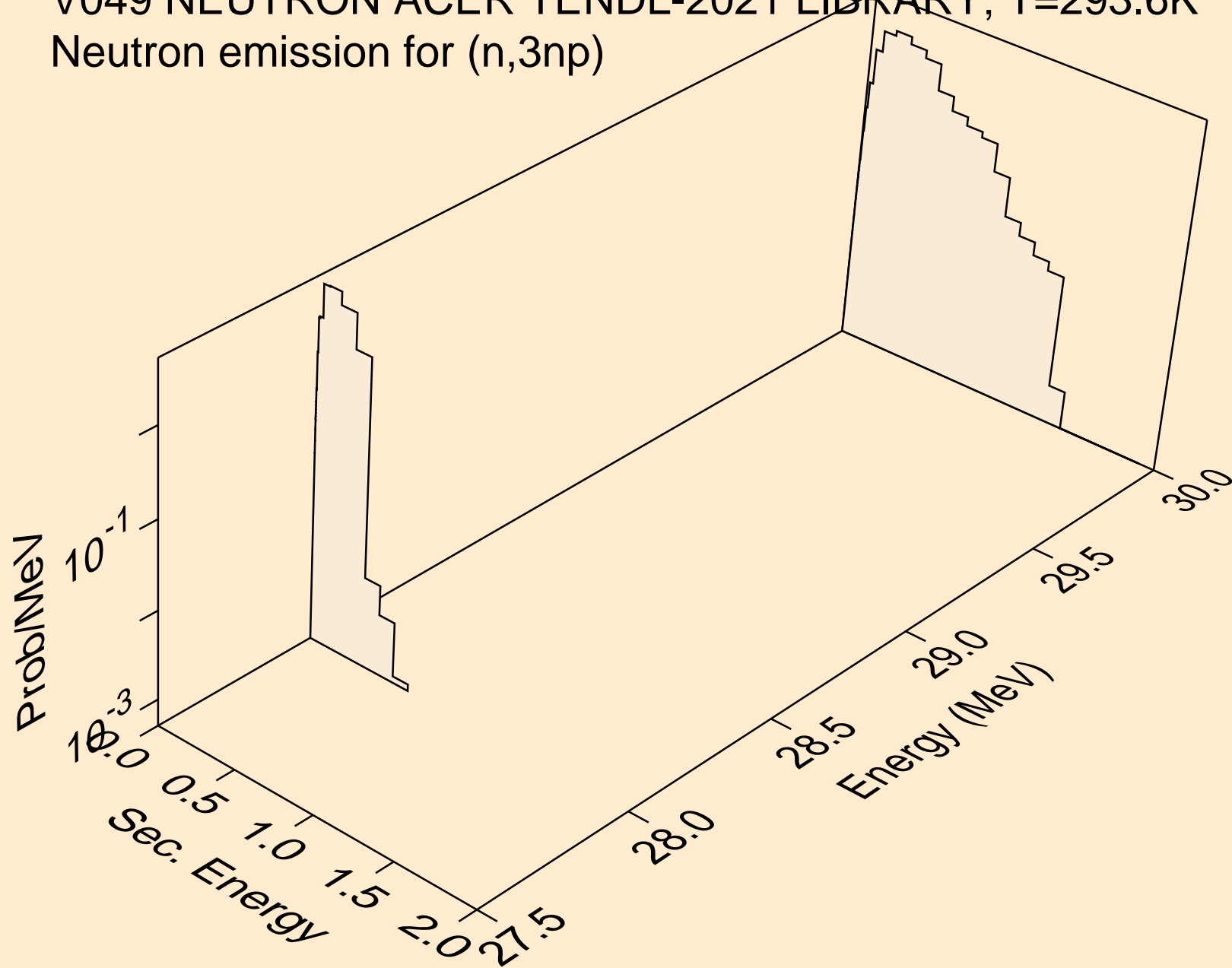

V049 NEUTRON ACER TENDL-2021 LIBRARY; T=293.6K  
Neutron emission for (n,2np)

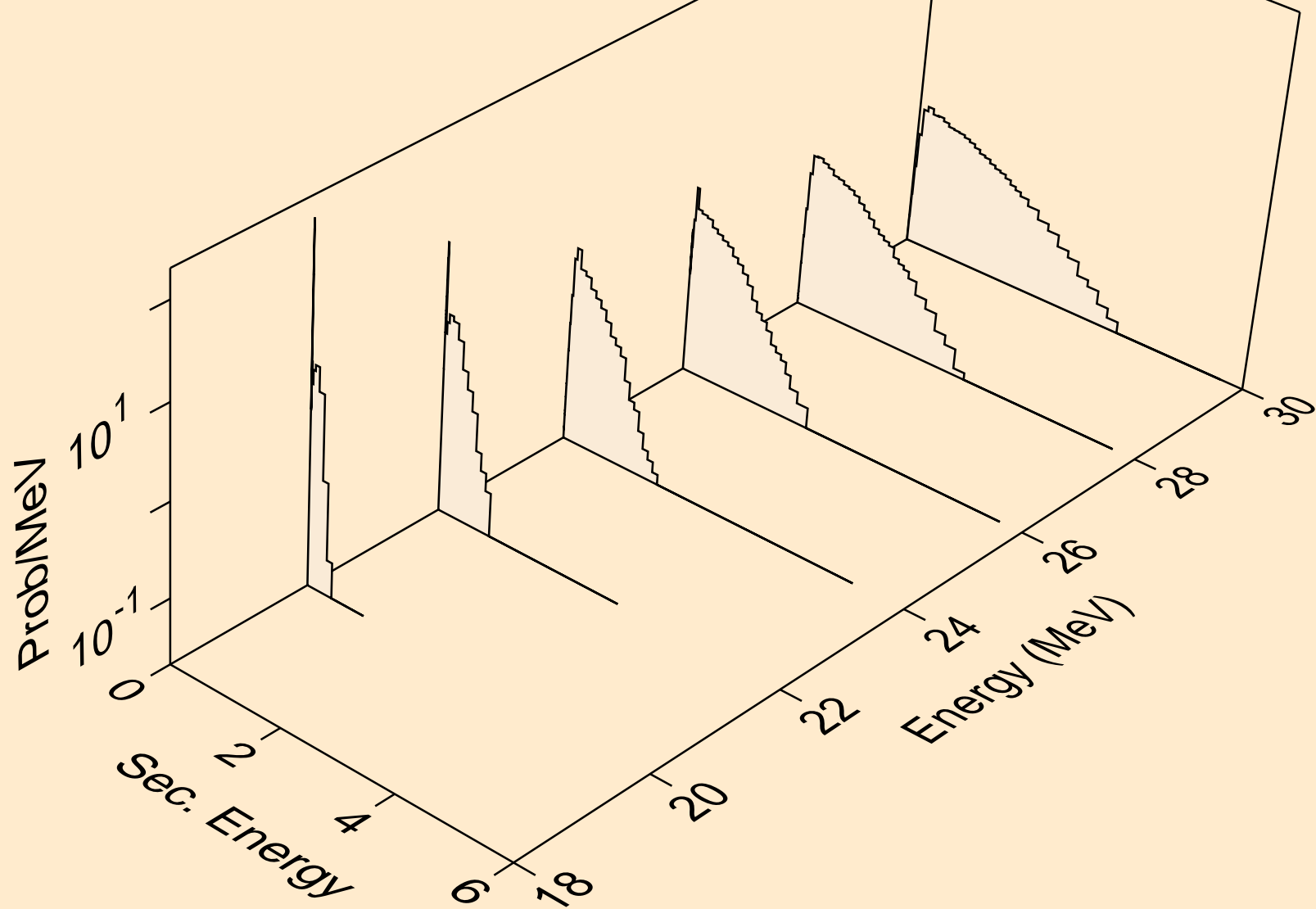

V049 NEUTRON ACER TENDL-2021 LIBRARY; T=293.6K  
Neutron emission for (n,npa)

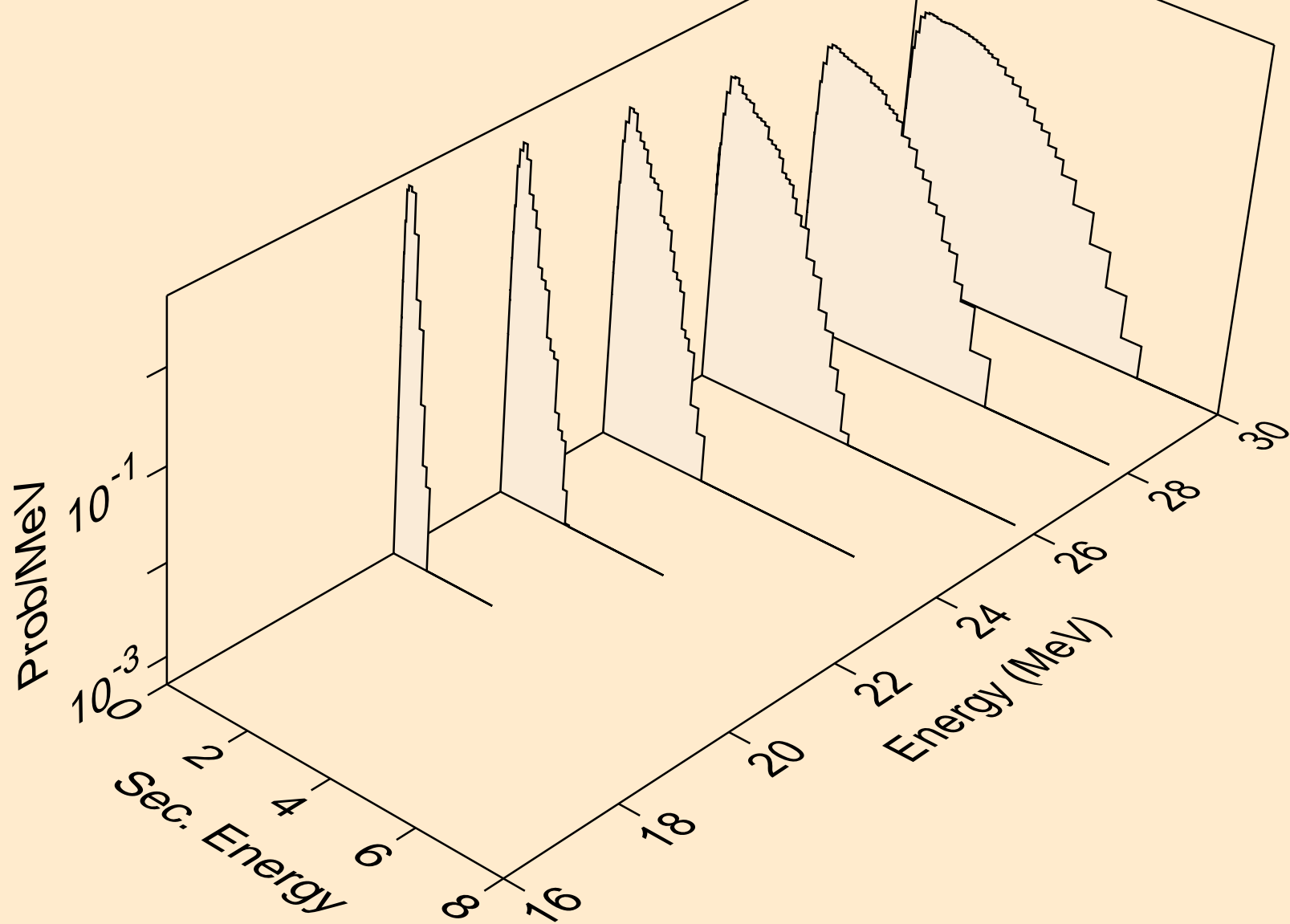



V049 NEUTRON ACER TENDL-2021 LIBRARY; T=293.6K  
Neutron emission for (n,n\*c)

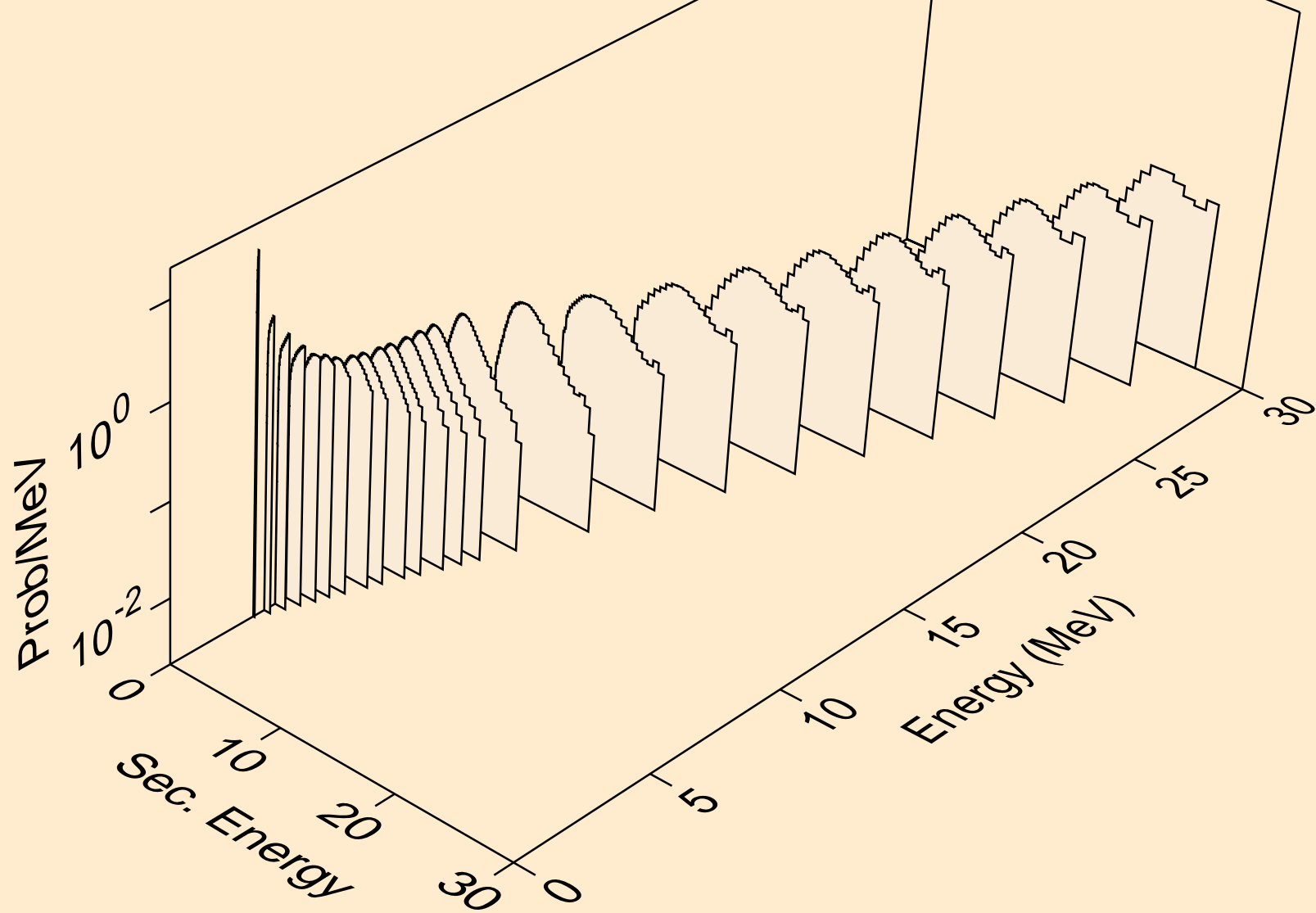

V049 NEUTRON ACER TENDL-2021 LIBRARY; T=293.6K  
Photon emission for (n,x)

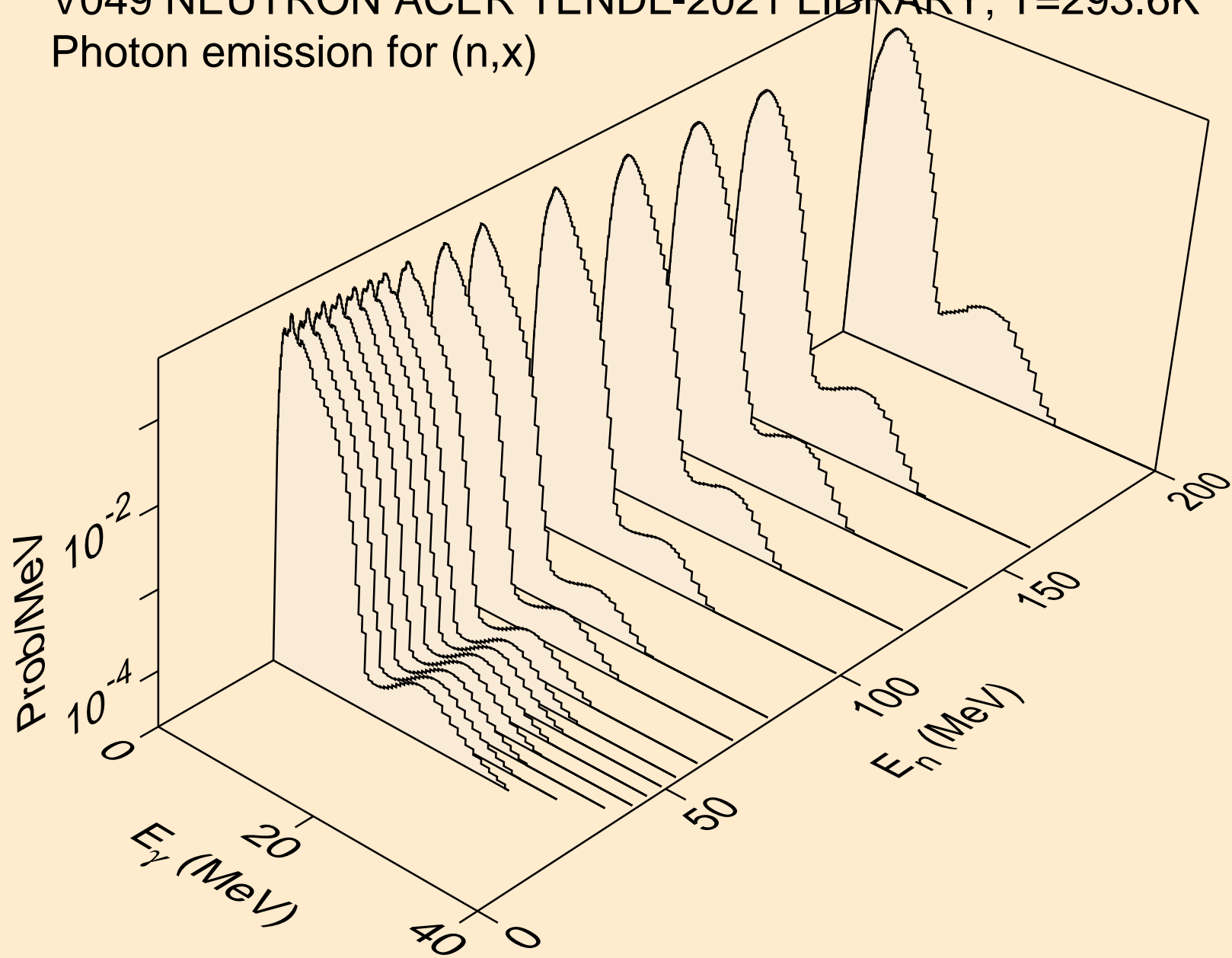

V049 NEUTRON ACER TENDL-2021 LIBRARY; T=293.6K  
Photon emission for (n,2nd)

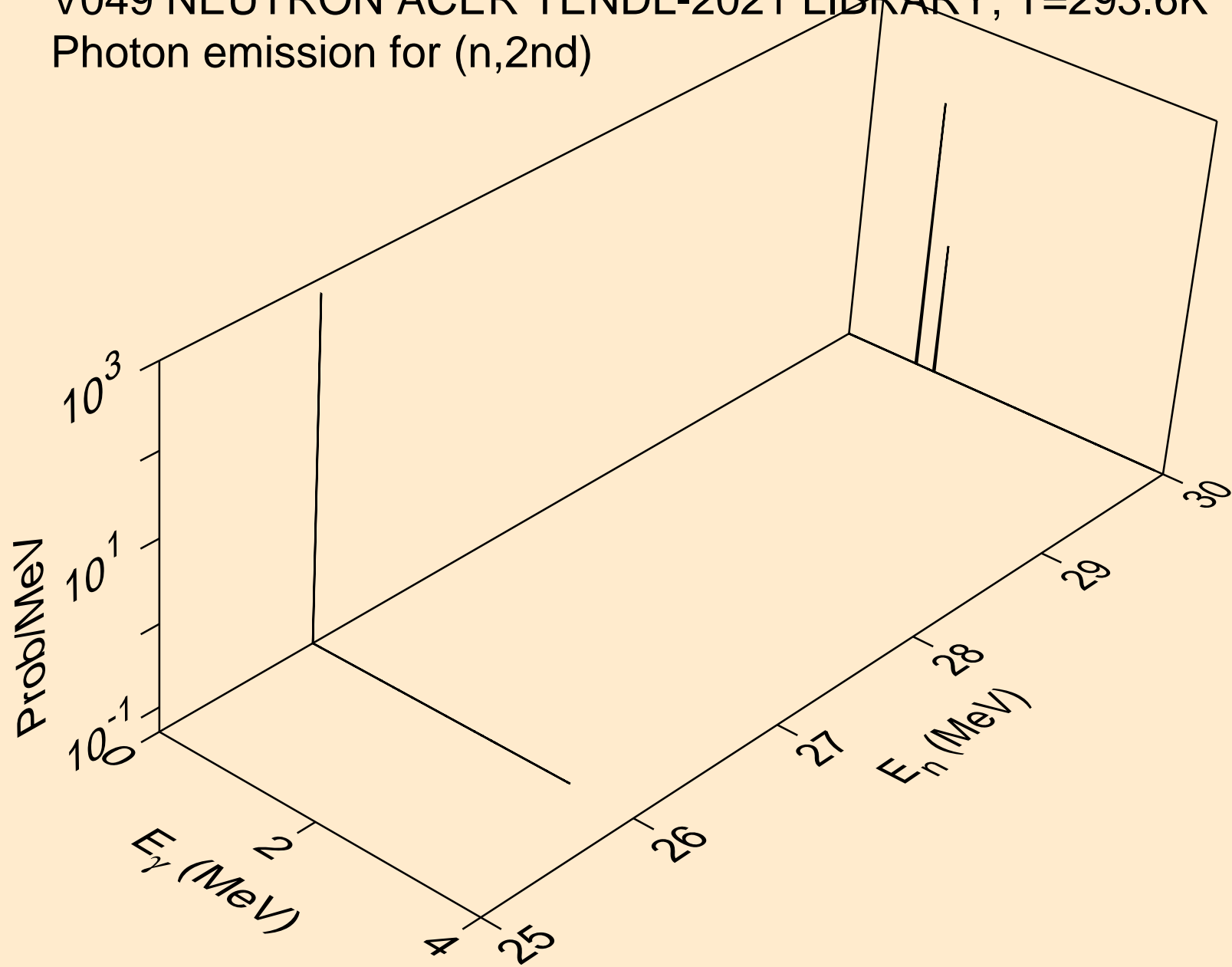

V049 NEUTRON ACER TENDL-2021 LIBRARY; T=293.6K  
Photon emission for (n,2n)

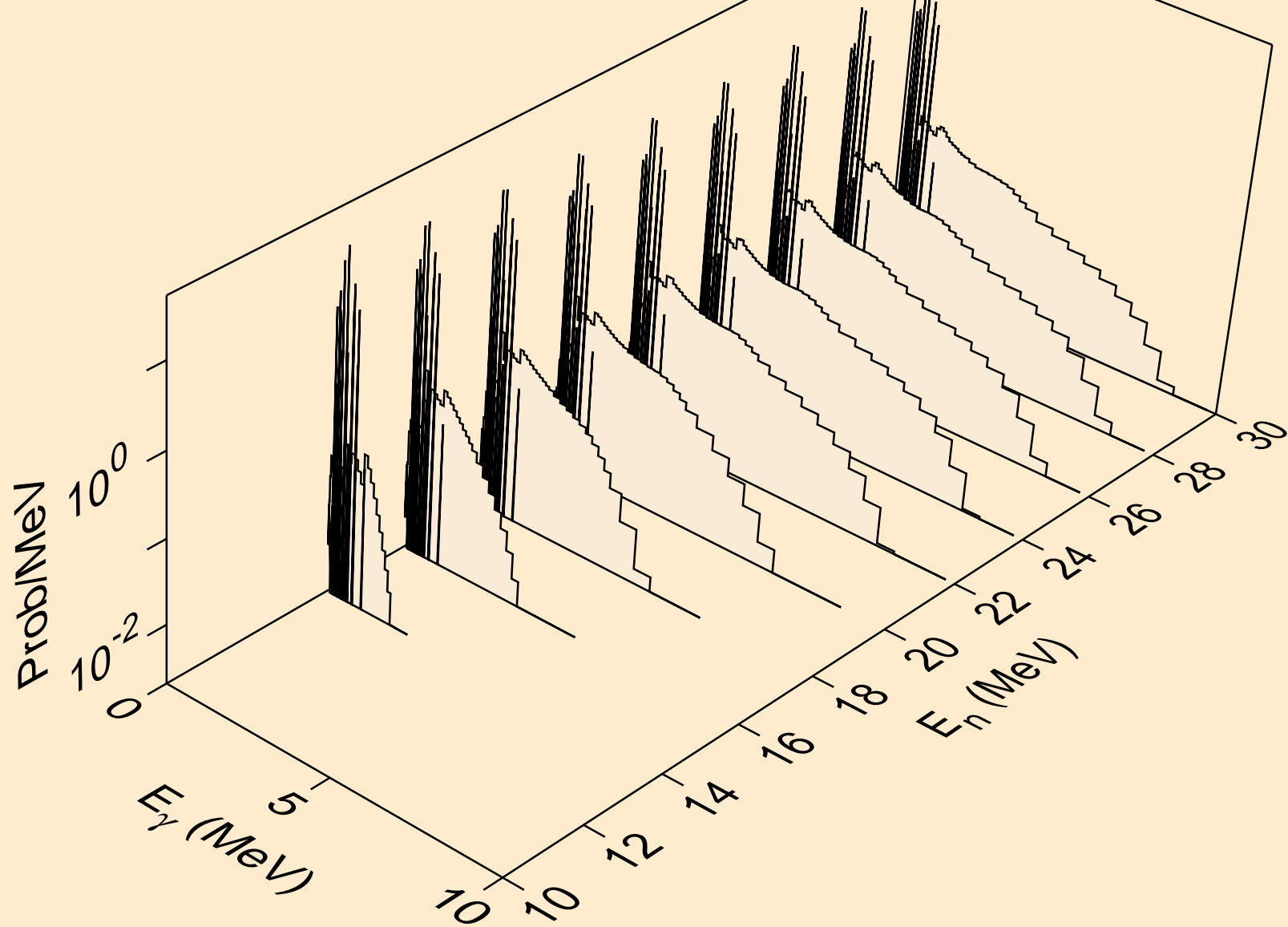

V049 NEUTRON ACER TENDL-2021 LIBRARY; T=293.6K  
Photon emission for (n,3n)

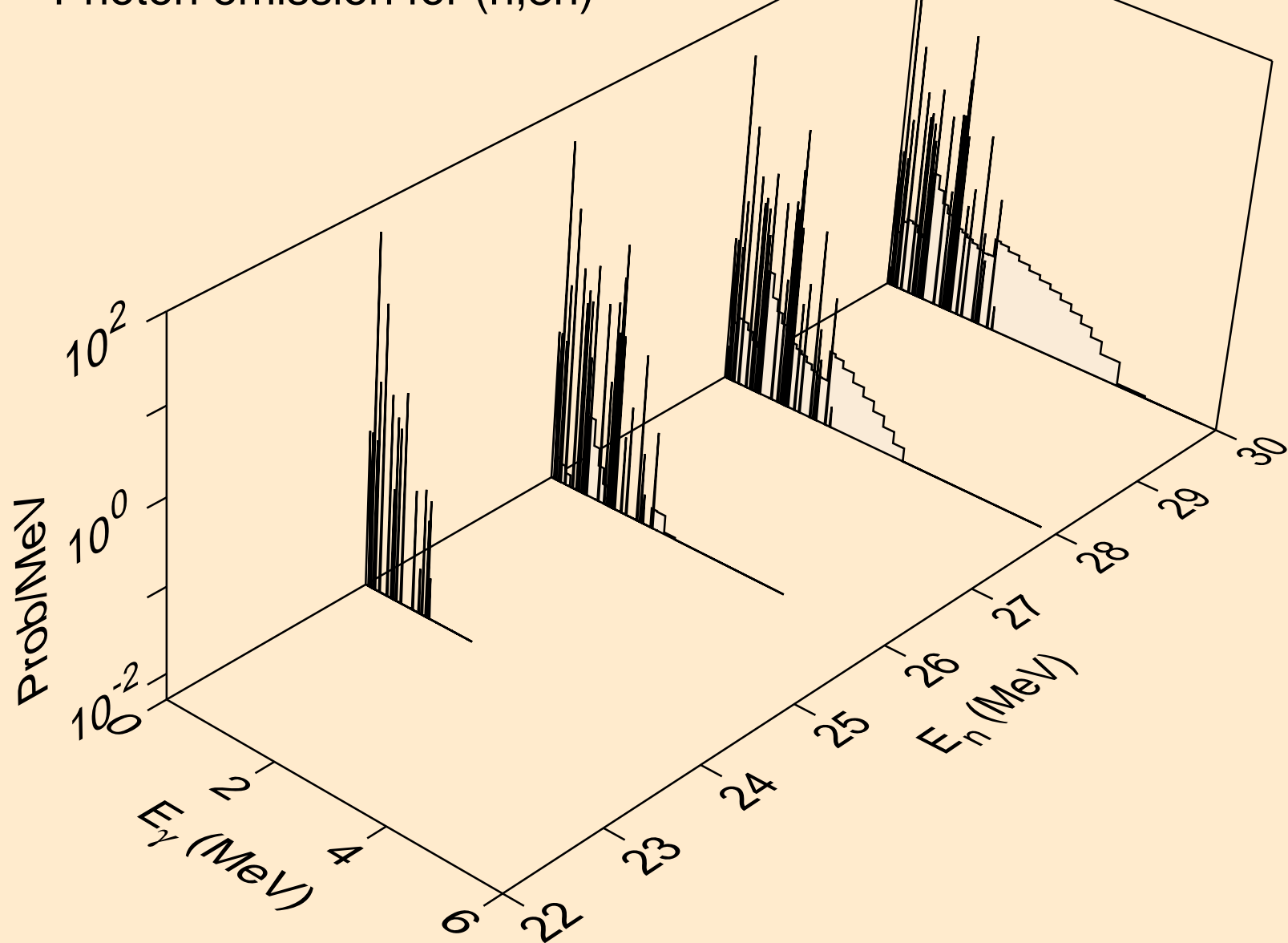

V049 NEUTRON ACER TENDL-2021 LIBRARY; T=293.6K  
Photon emission for (n,n\*)a

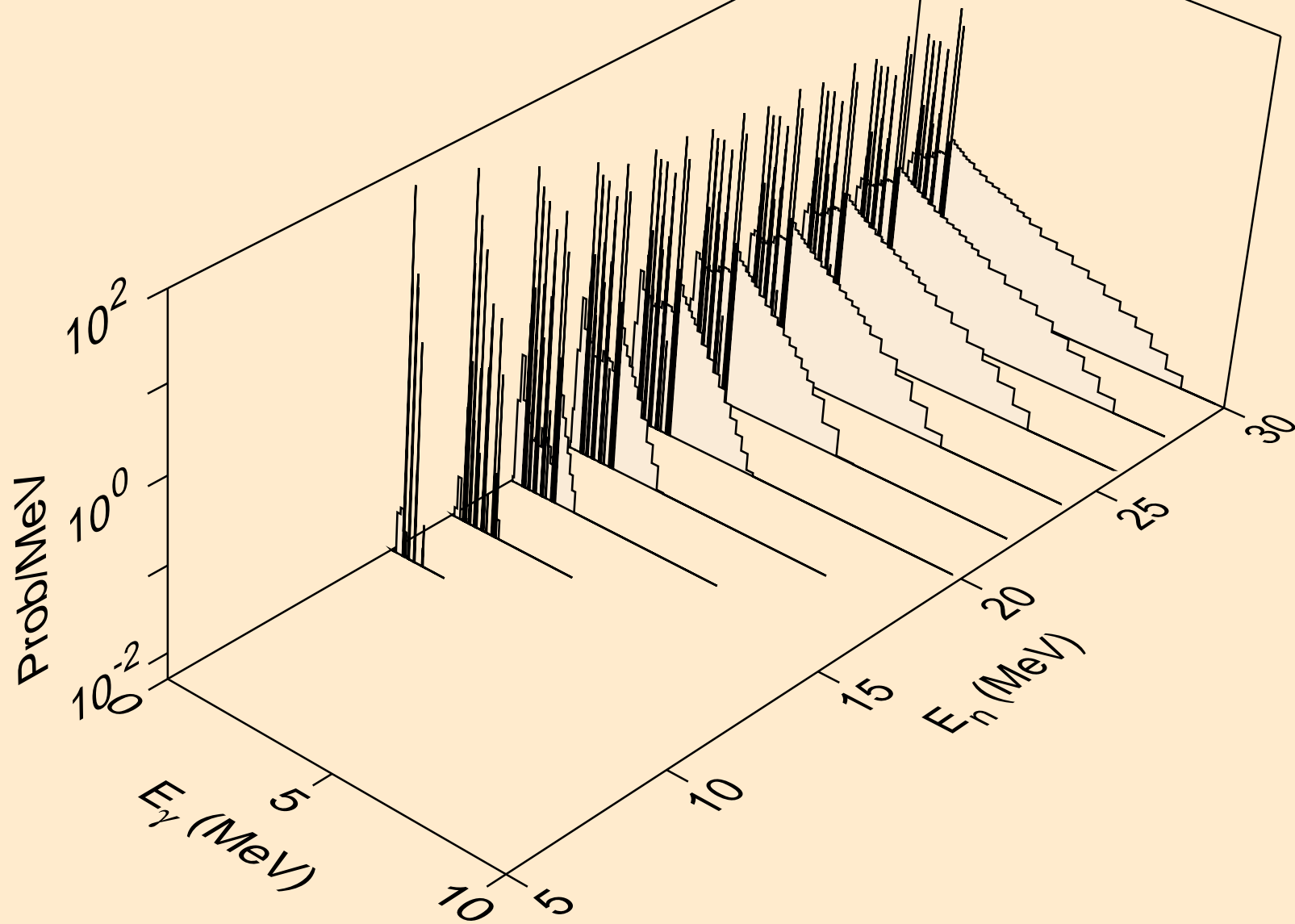

V049 NEUTRON ACER TENDL-2021 LIBRARY; T=293.6K  
Photon emission for (n,2n)a

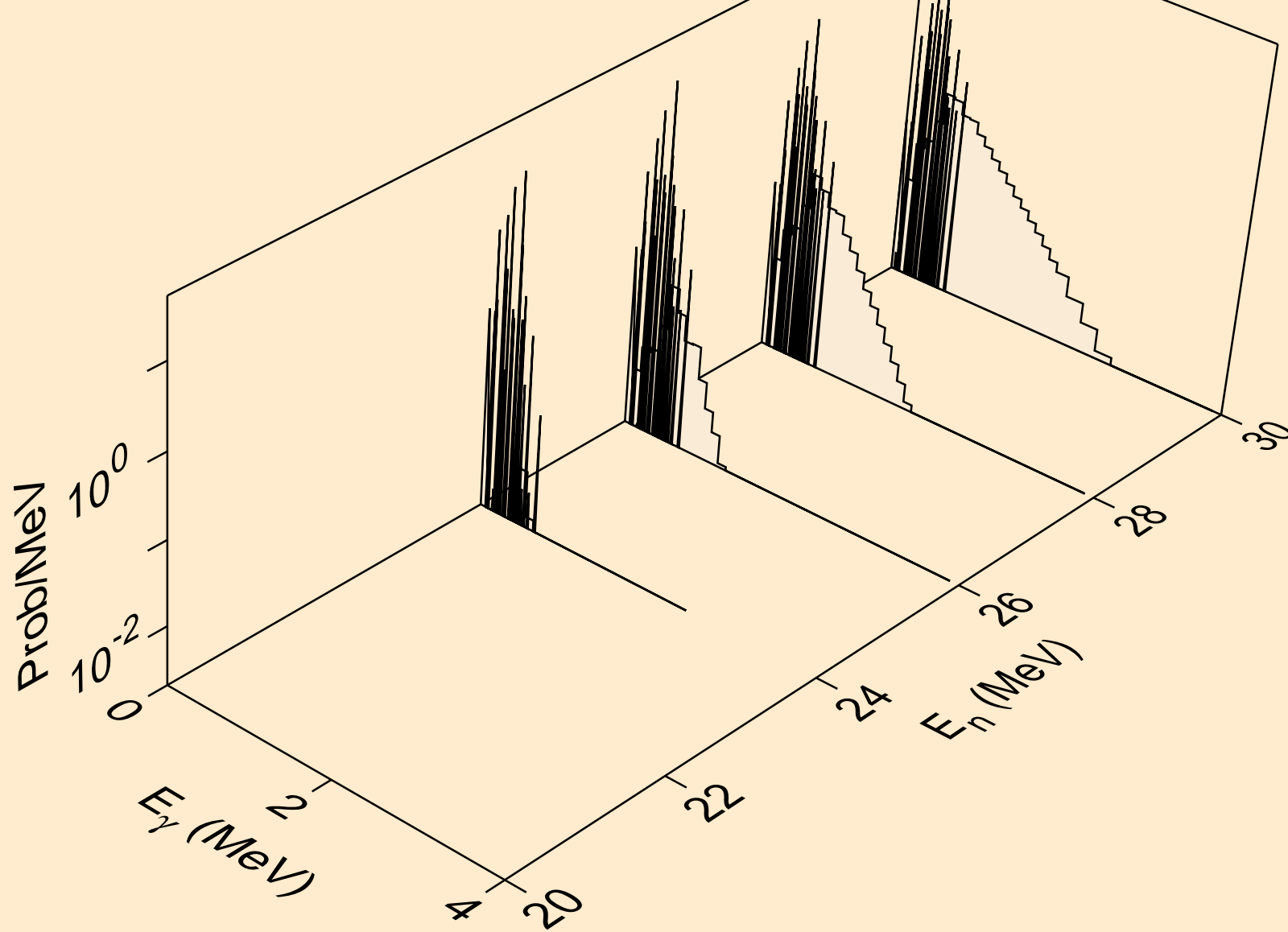

V049 NEUTRON ACER TENDL-2021 LIBRARY; T=293.6K  
Photon emission for (n,n\*)p

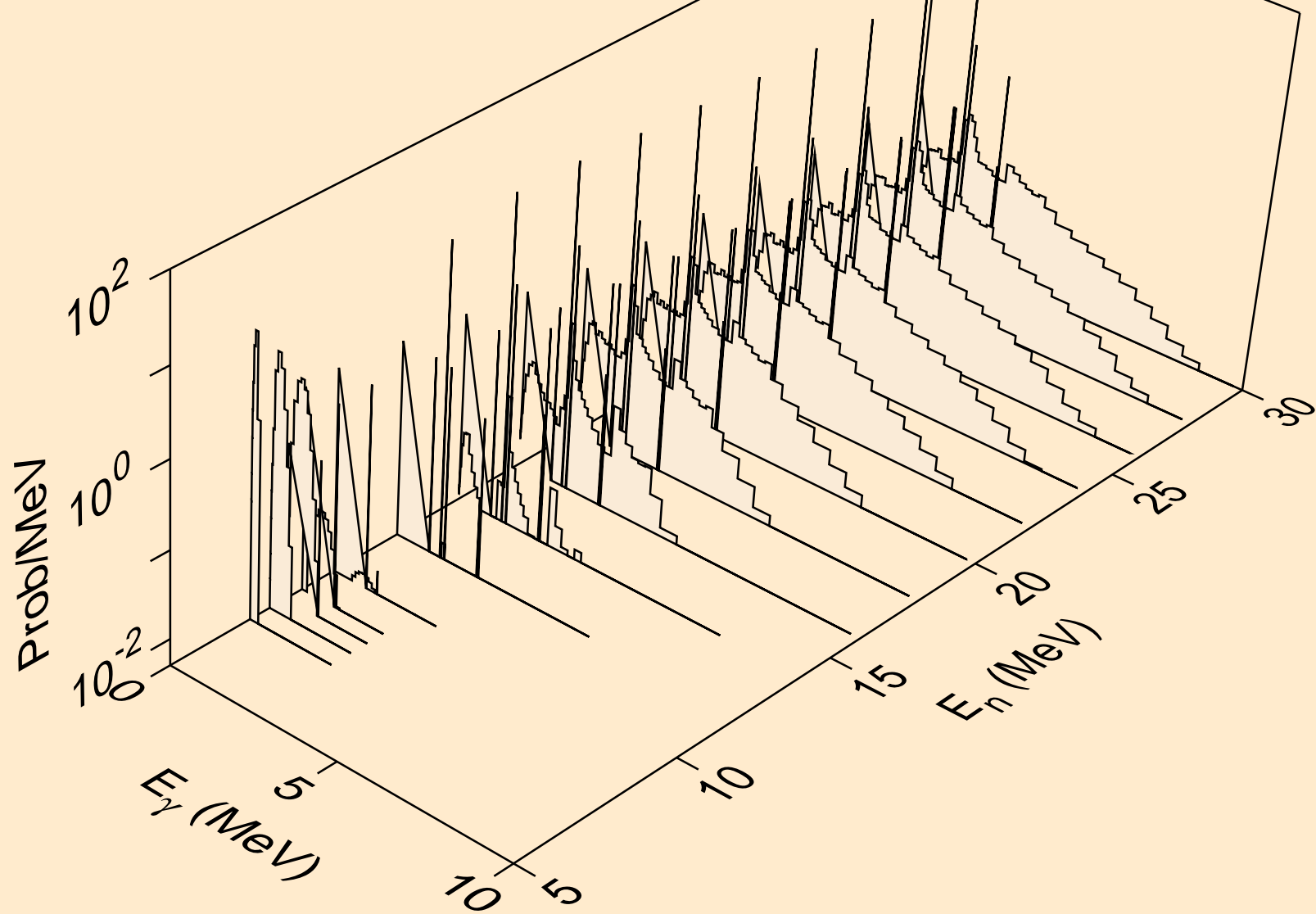



V049 NEUTRON ACER TENDL-2021 LIBRARY; T=293.6K  
Photon emission for (n,n\*)2a

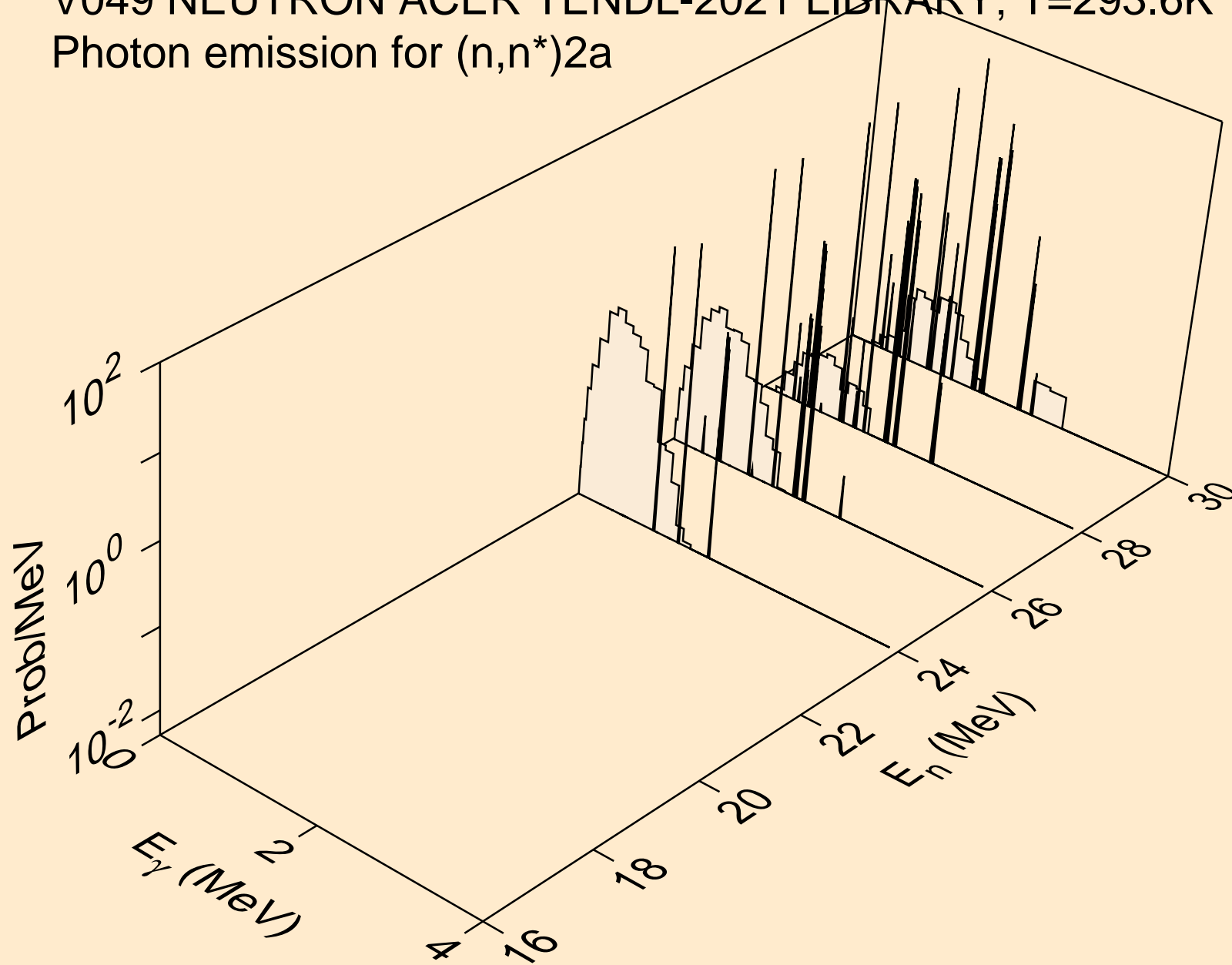

V049 NEUTRON ACER TENDL-2021 LIBRARY; T=293.6K  
Photon emission for (n,n\*)d

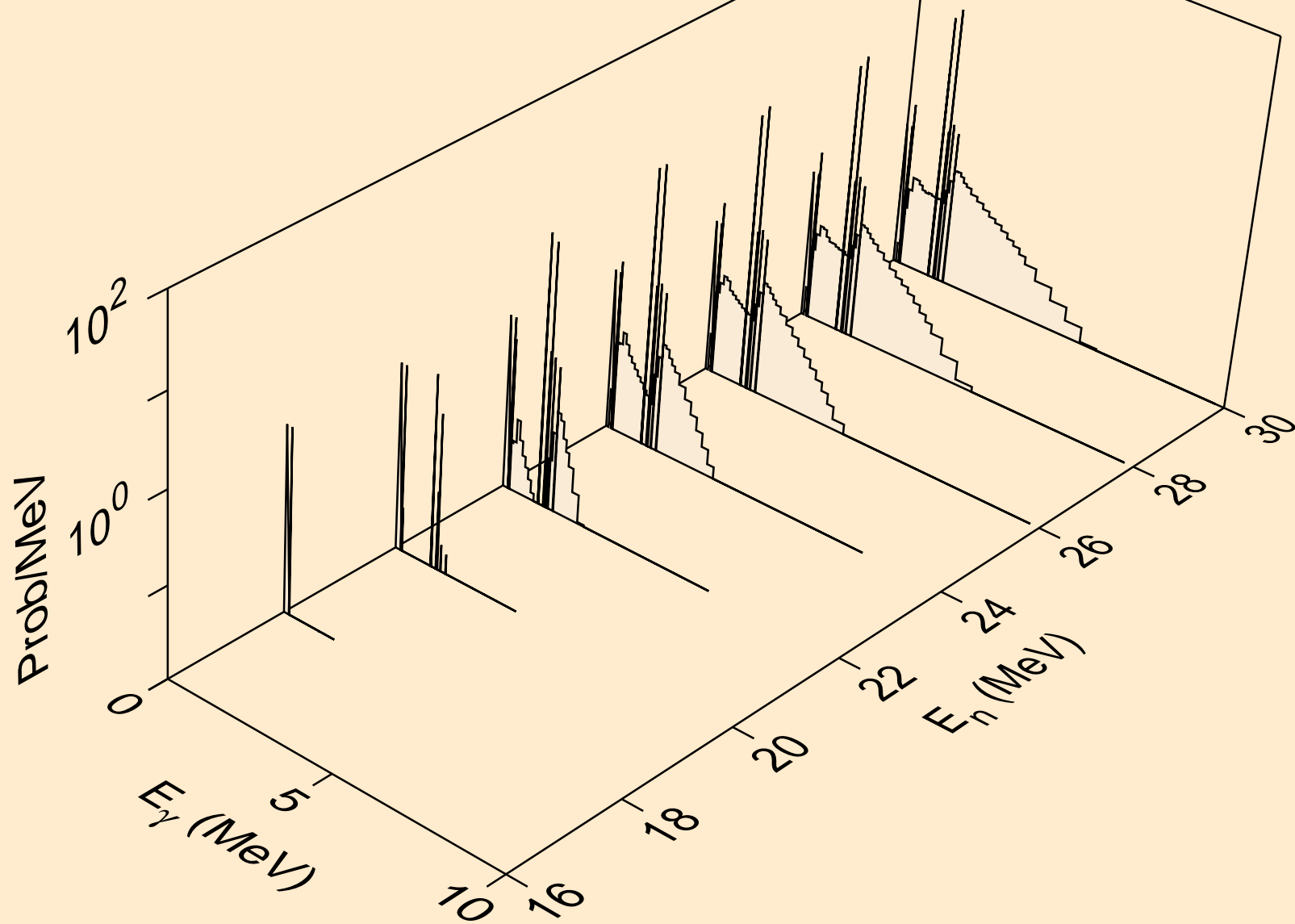

V049 NEUTRON ACER TENDL-2021 LIBRARY; T=293.6K  
Photon emission for (n,n\*)t

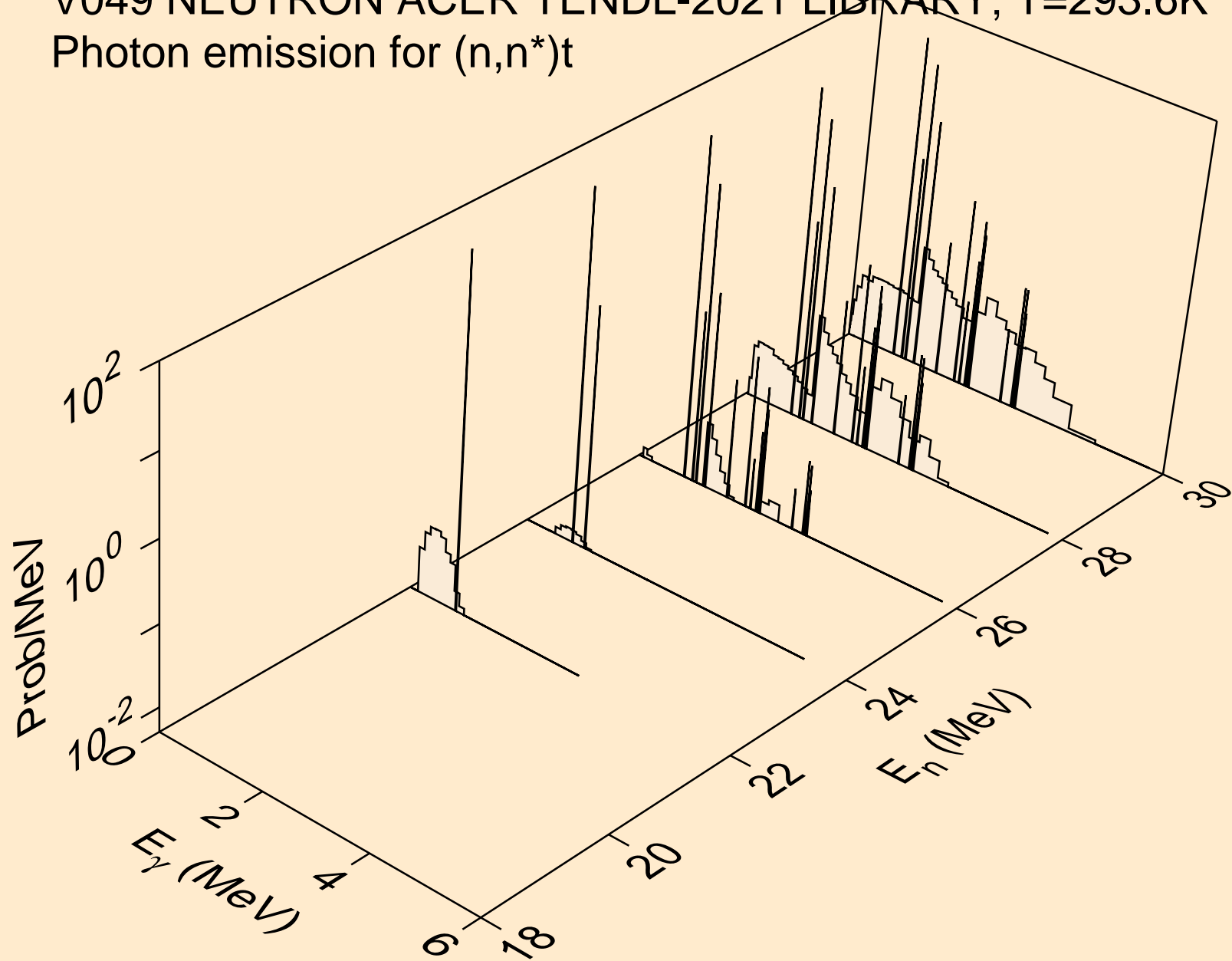

V049 NEUTRON ACER TENDL-2021 LIBRARY; T=293.6K  
Photon emission for (n,n\*)he3

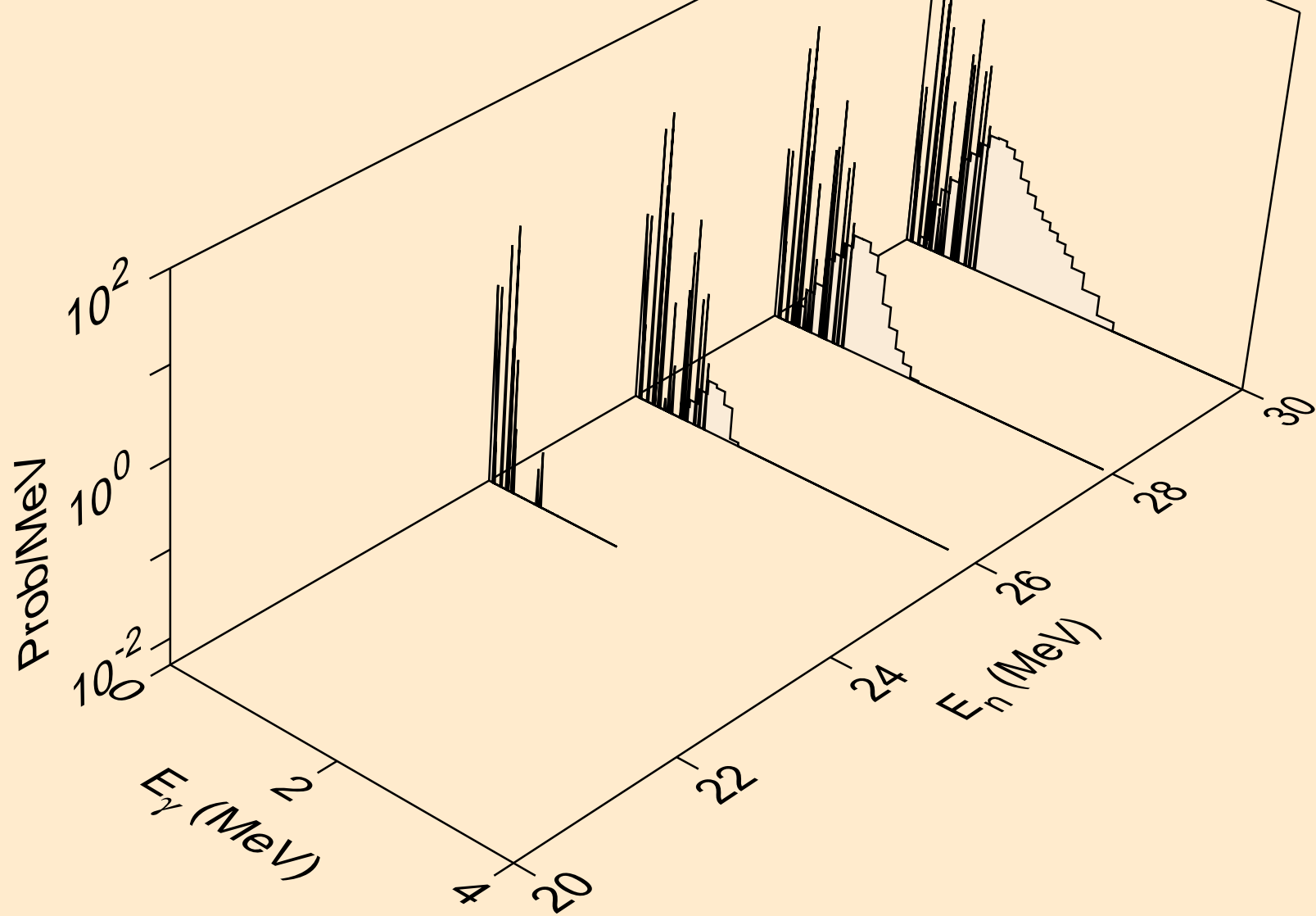

V049 NEUTRON ACER TENDL-2021 LIBRARY; T=293.6K  
Photon emission for (n,2np)

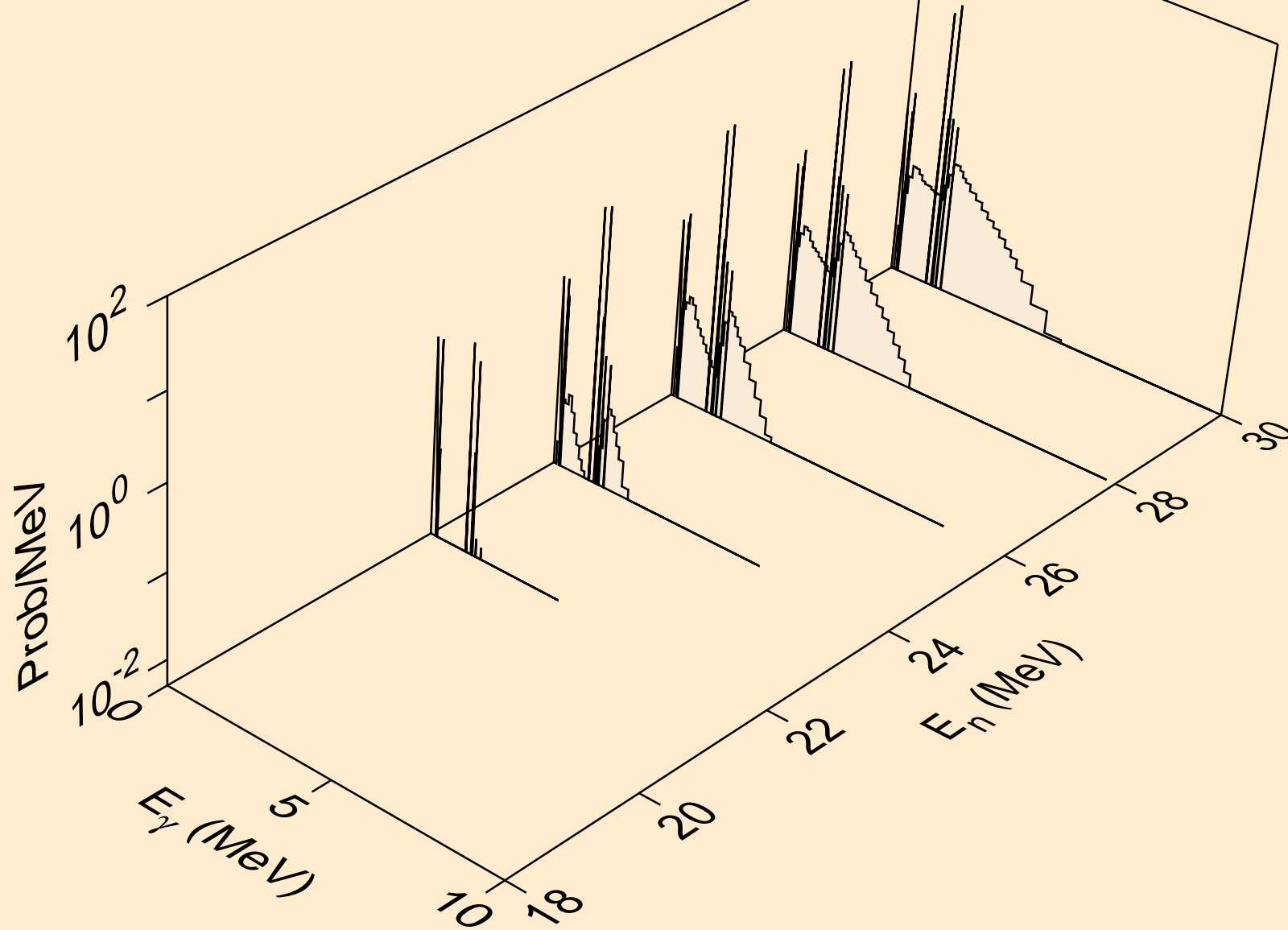

V049 NEUTRON ACER TENDL-2021 LIBRARY; T=293.6K  
Photon emission for (n,3np)

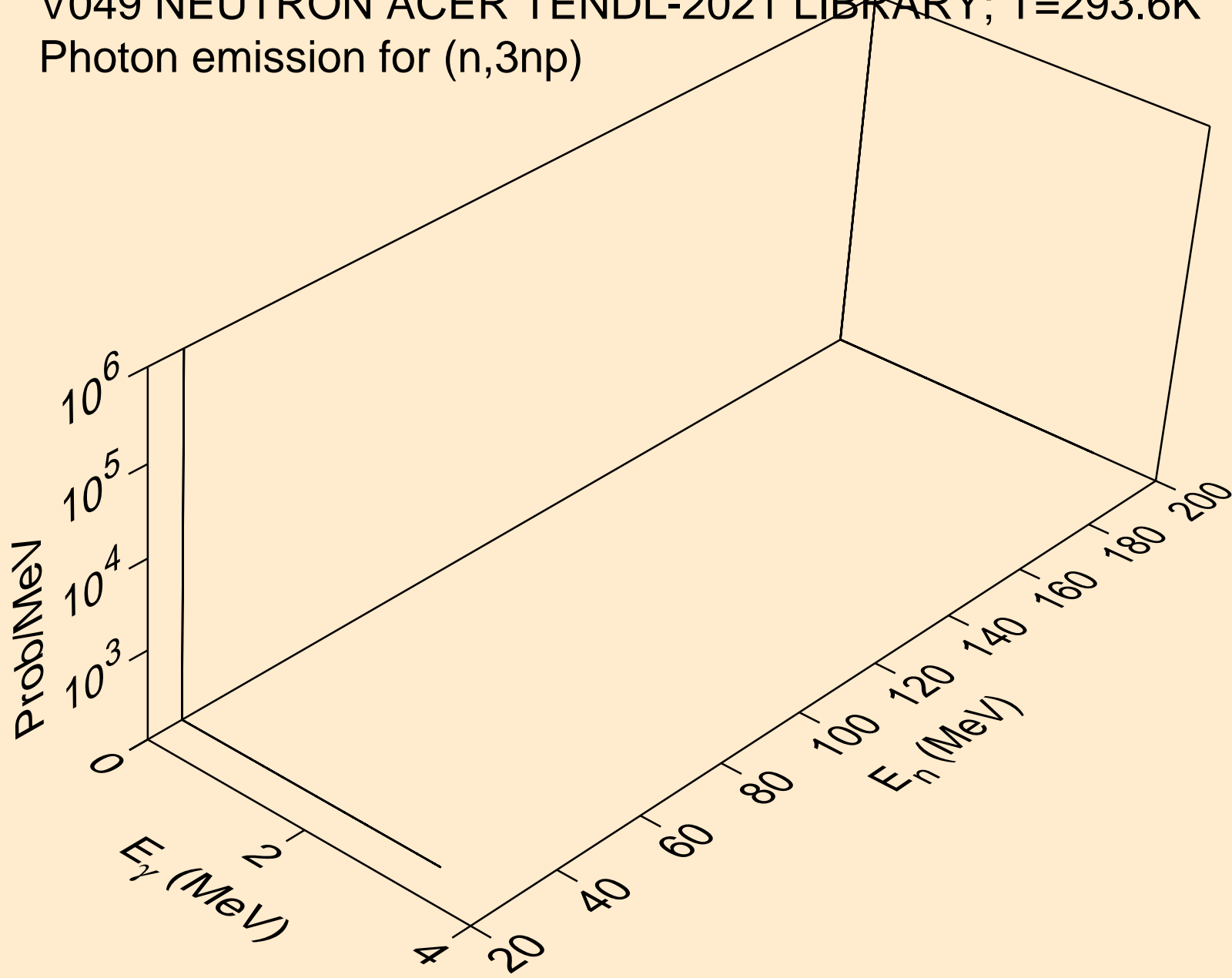

V049 NEUTRON ACER TENDL-2021 LIBRARY; T=293.6K  
Photon emission for (n,2np)

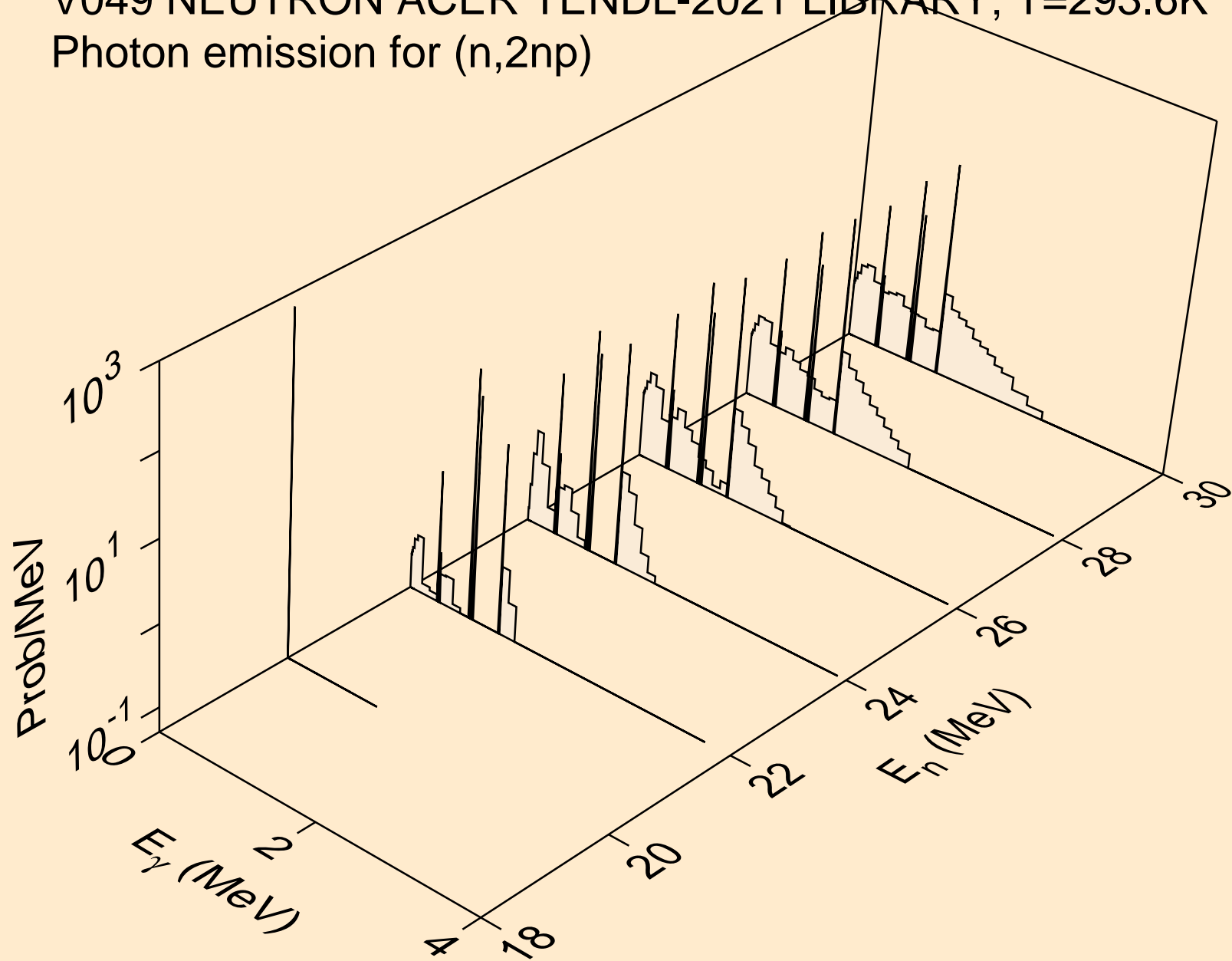

V049 NEUTRON ACER TENDL-2021 LIBRARY; T=293.6K  
Photon emission for (n,npa)

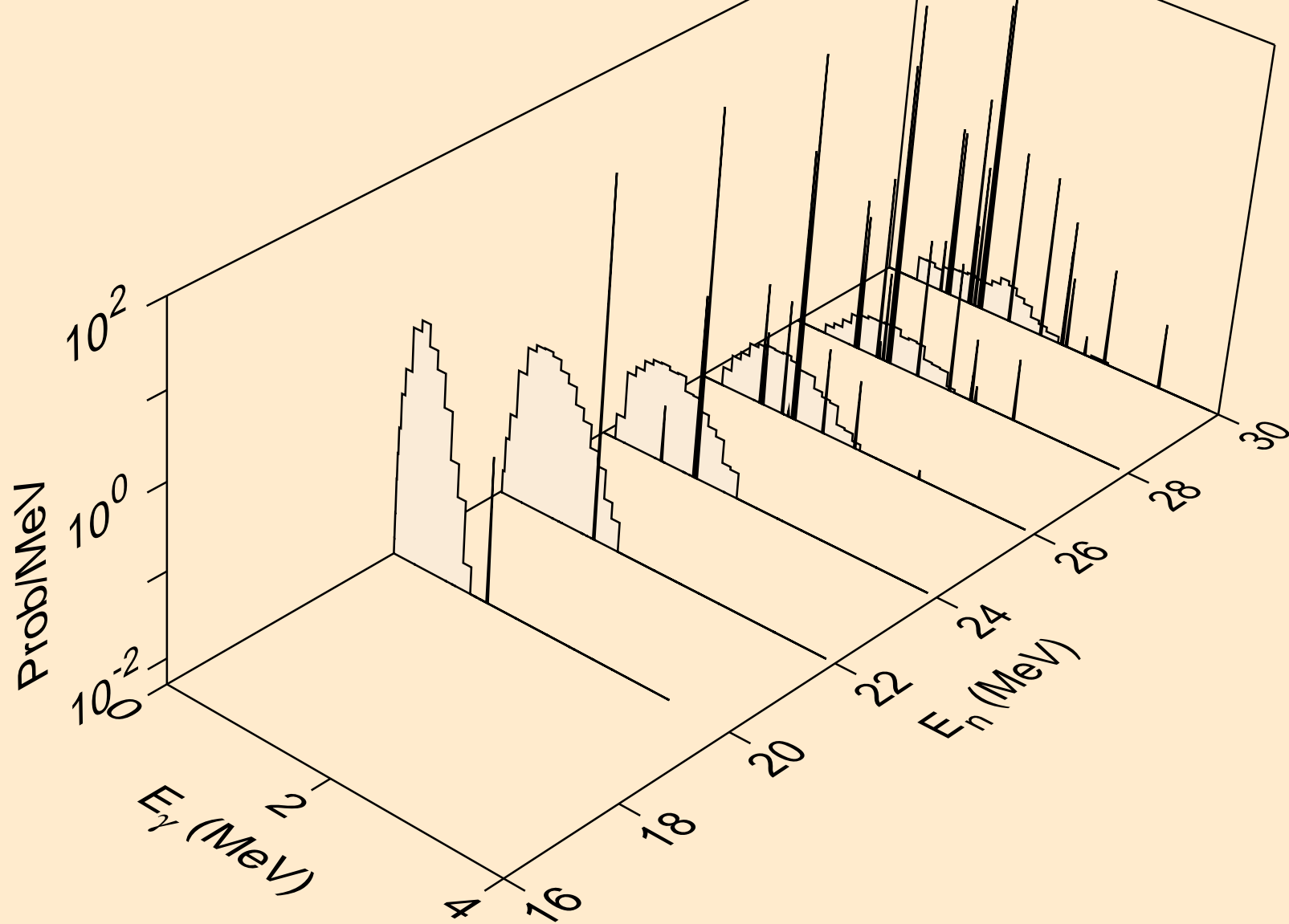



V049 NEUTRON ACER TENDL-2021 LIBRARY; T=293.6K  
Photon emission for (n,n\*c)

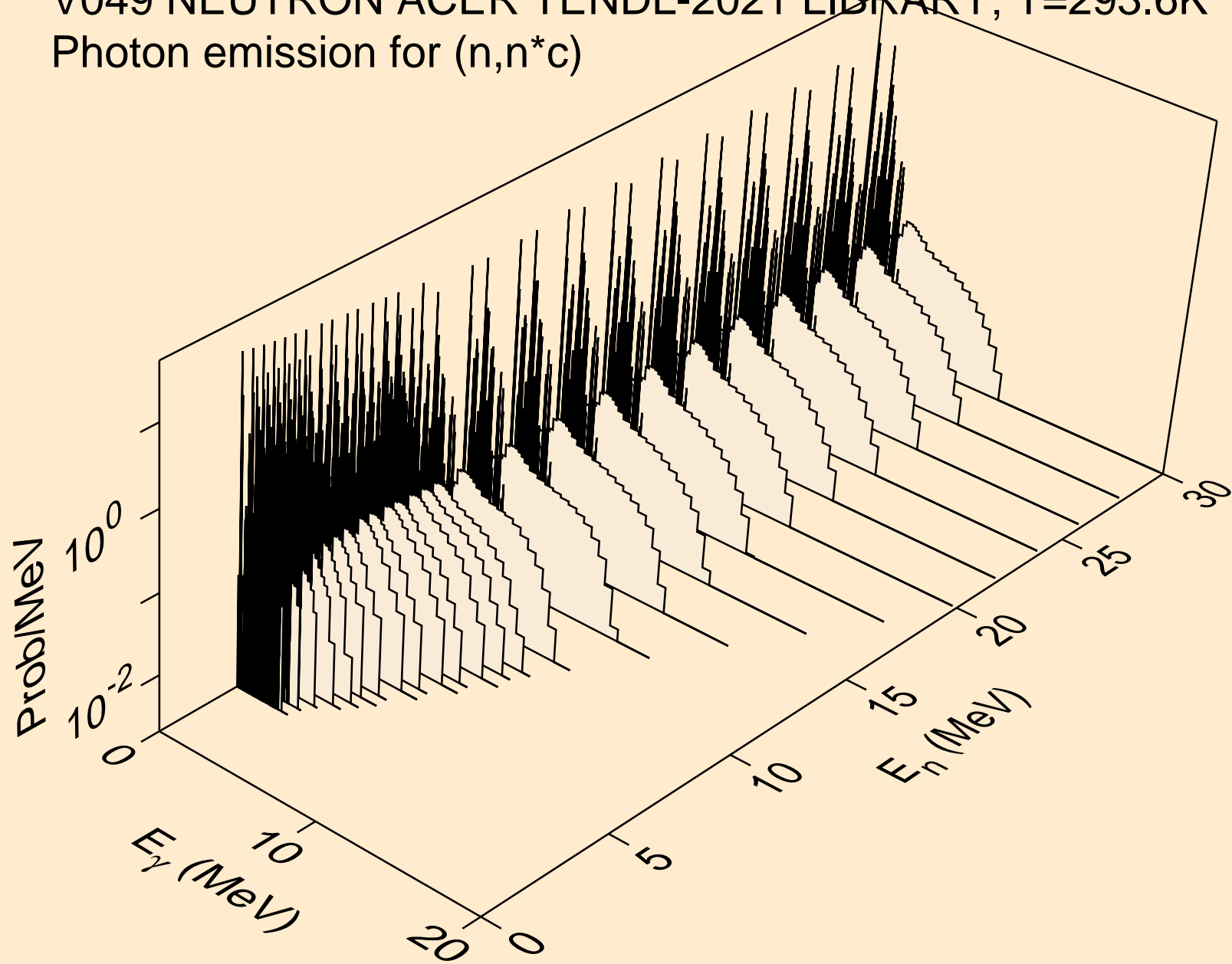

V049 NEUTRON ACER TENDL-2021 LIBRARY; T=293.6K  
Photon emission for (n,gma)

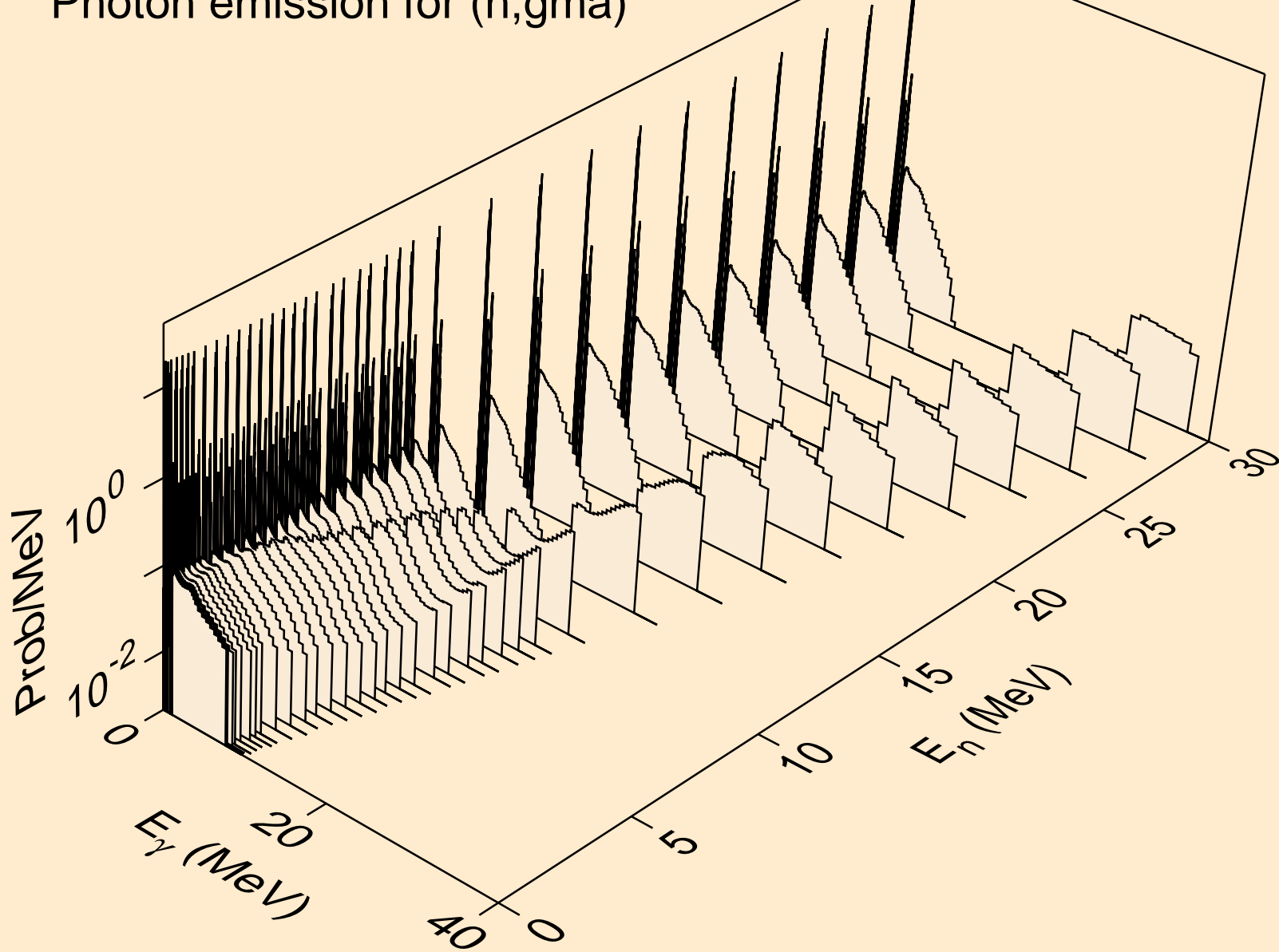

V049 NEUTRON ACER TENDL-2021 LIBRARY; T=293.6K  
Photon emission for (n,p)

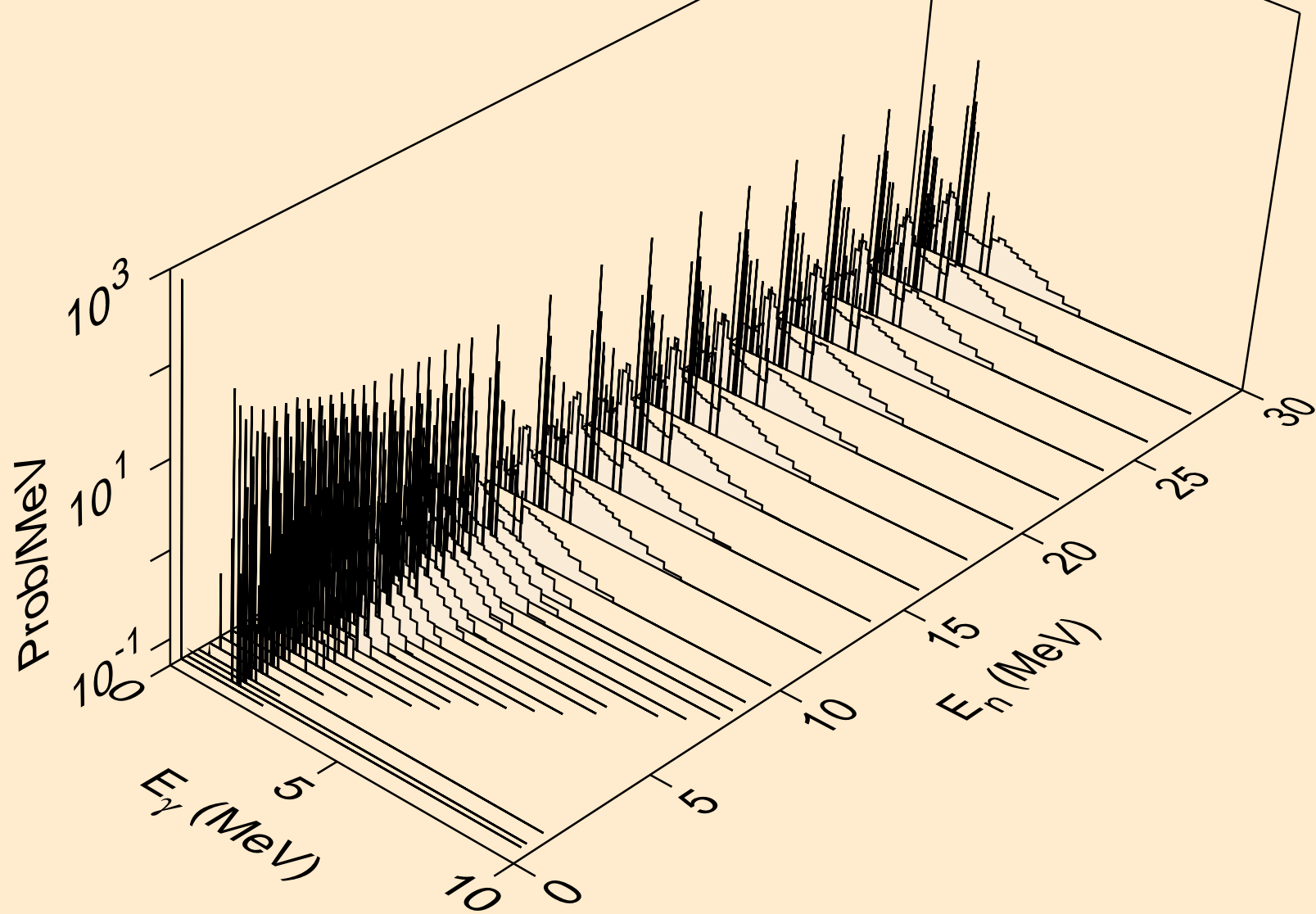

V049 NEUTRON ACER TENDL-2021 LIBRARY; T=293.6K  
Photon emission for (n,d)

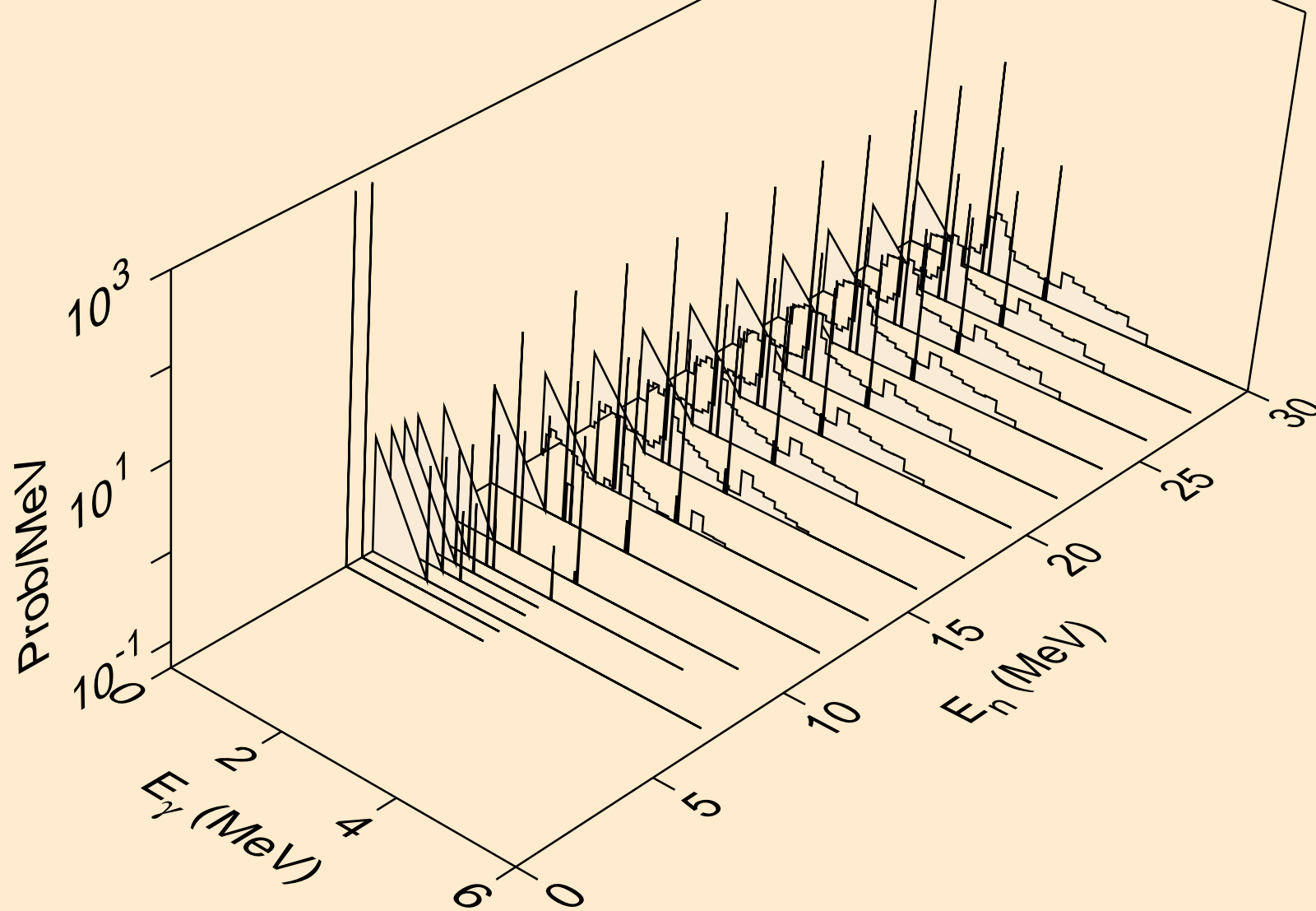

V049 NEUTRON ACER TENDL-2021 LIBRARY; T=293.6K  
Photon emission for (n,t)

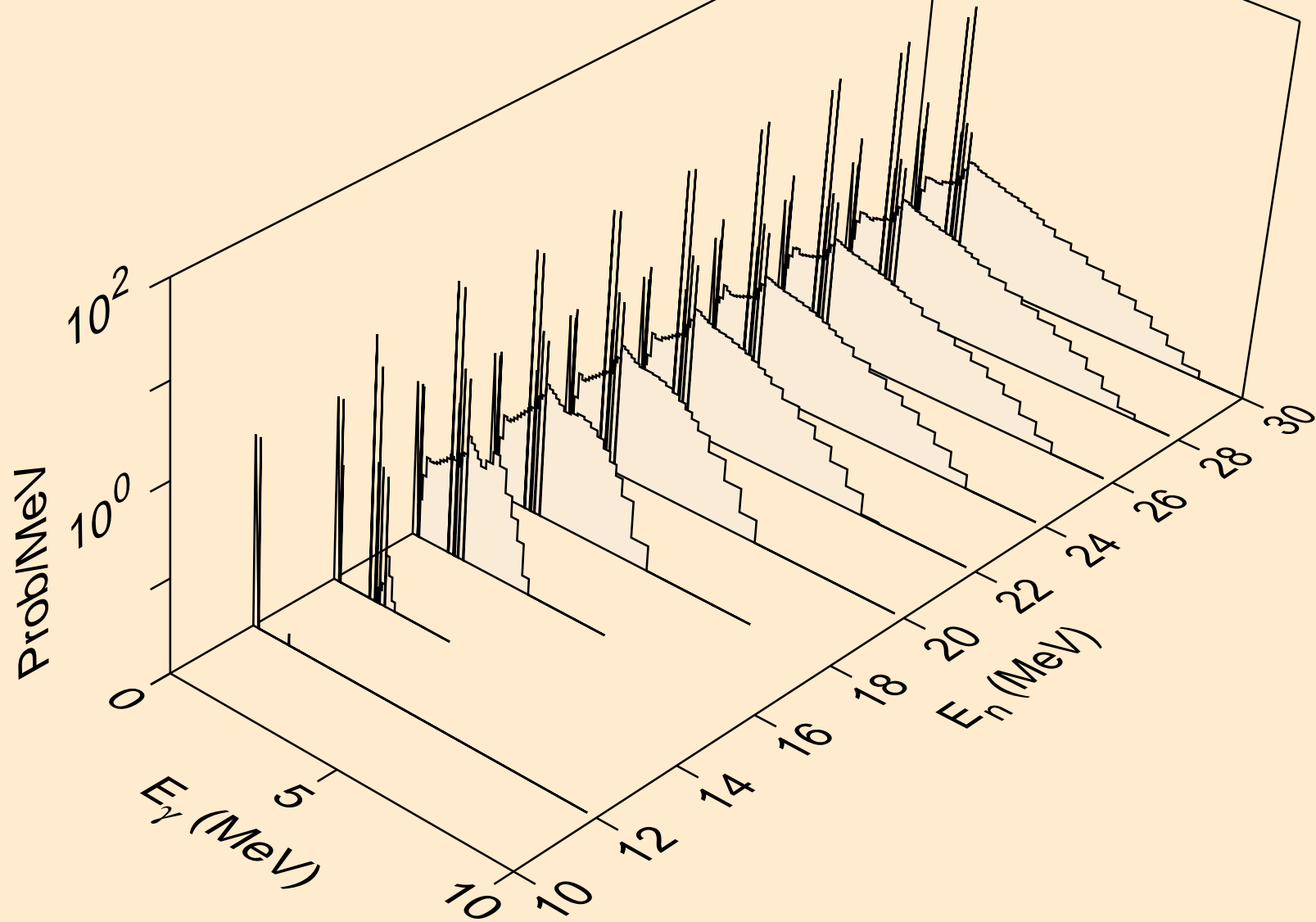

V049 NEUTRON ACER TENDL-2021 LIBRARY; T=293.6K  
Photon emission for (n,he3)

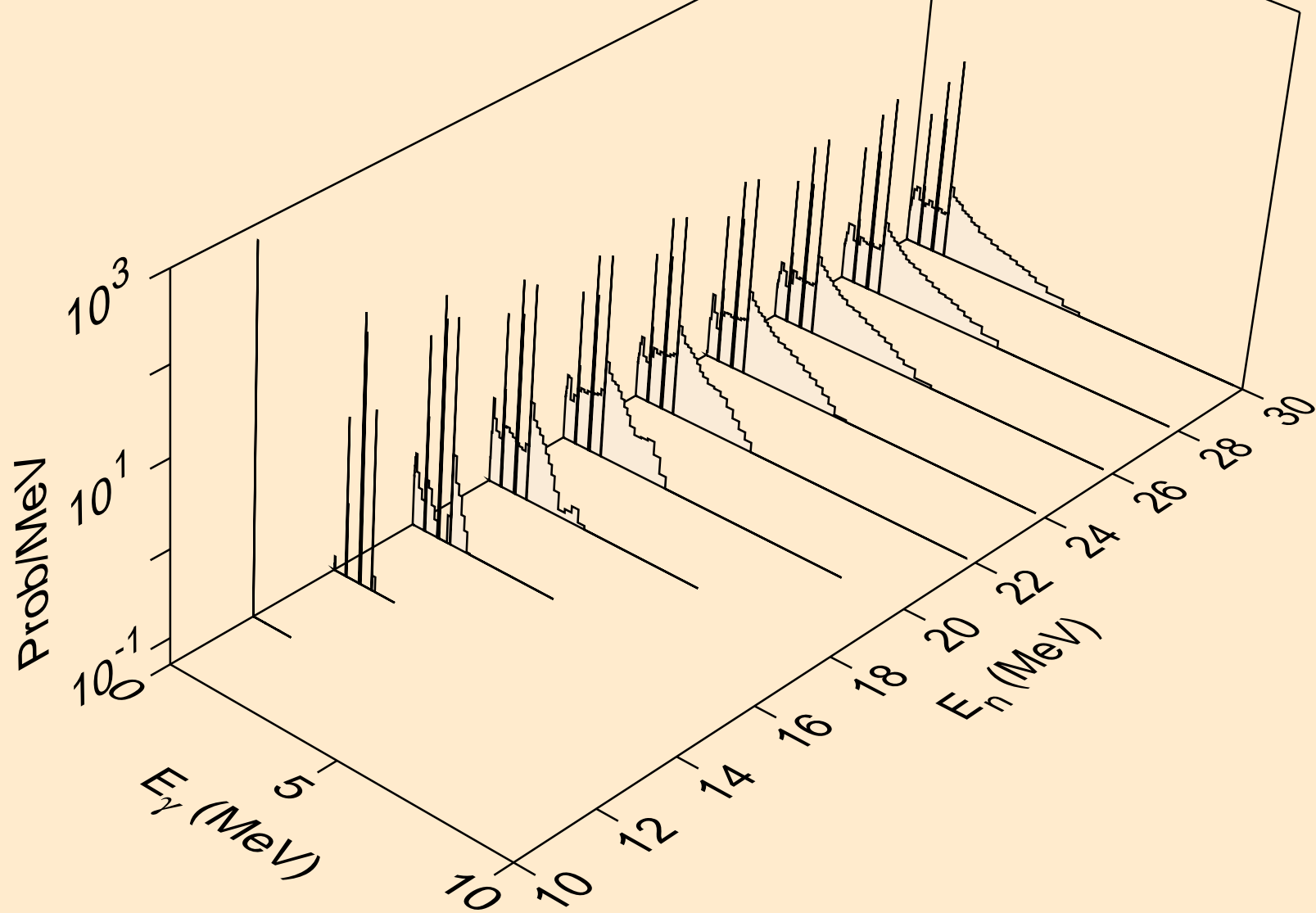

V049 NEUTRON ACER TENDL-2021 LIBRARY; T=293.6K  
Photon emission for (n,a)

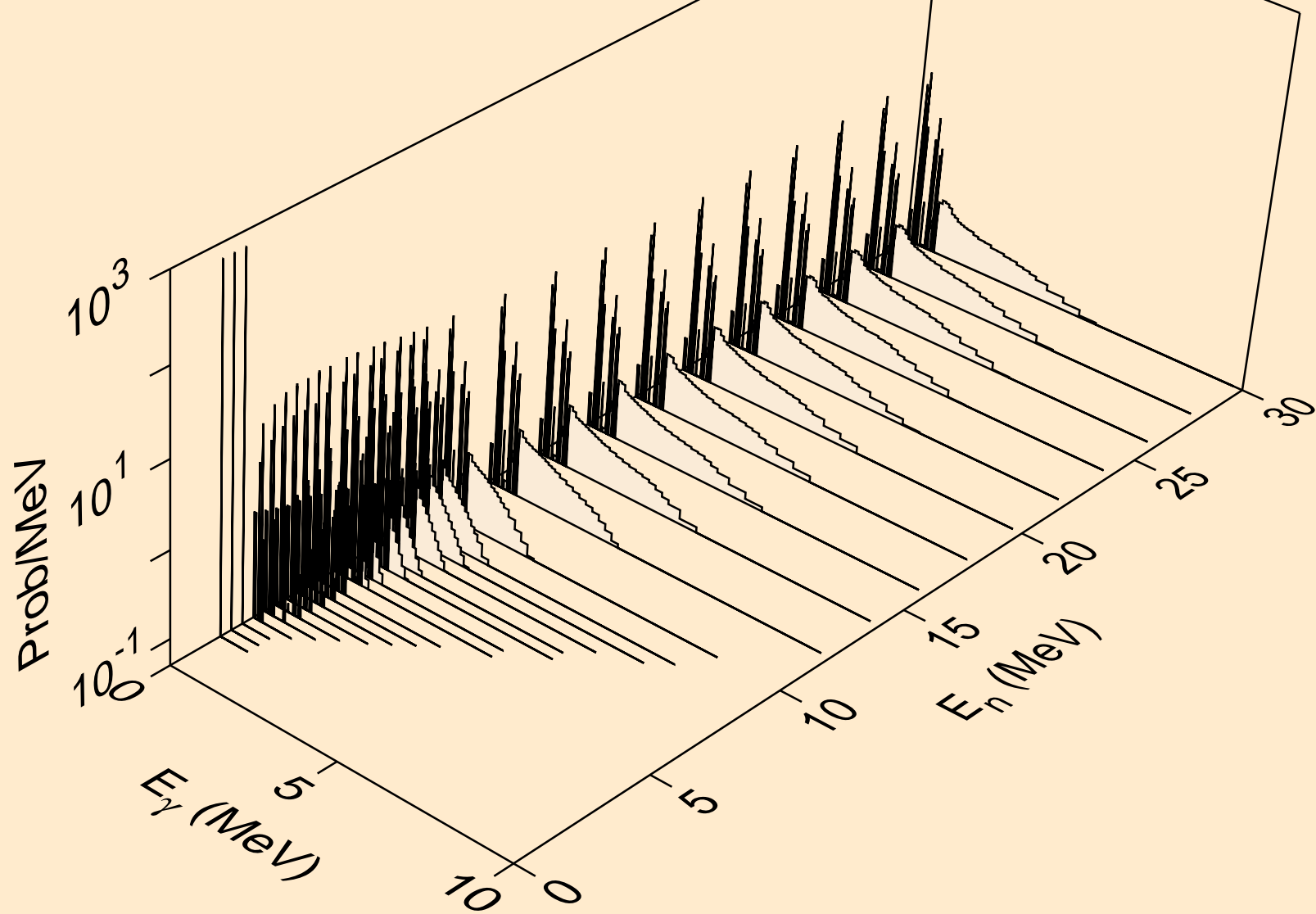

V049 NEUTRON ACER TENDL-2021 LIBRARY; T=293.6K  
Photon emission for (n,2a)

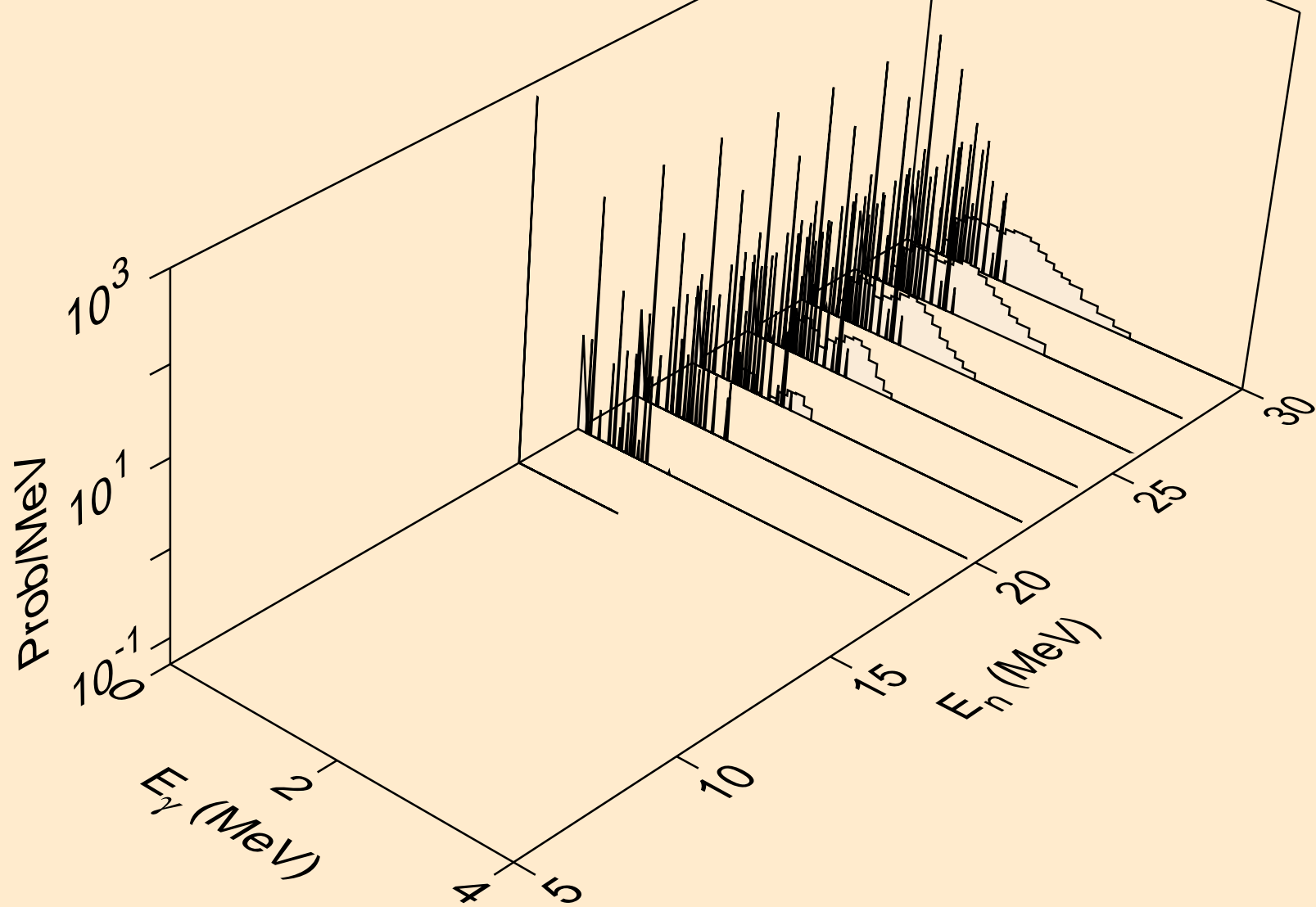



V049 NEUTRON ACER TENDL-2021 LIBRARY; T=293.6K  
Photon emission for (n,2p)

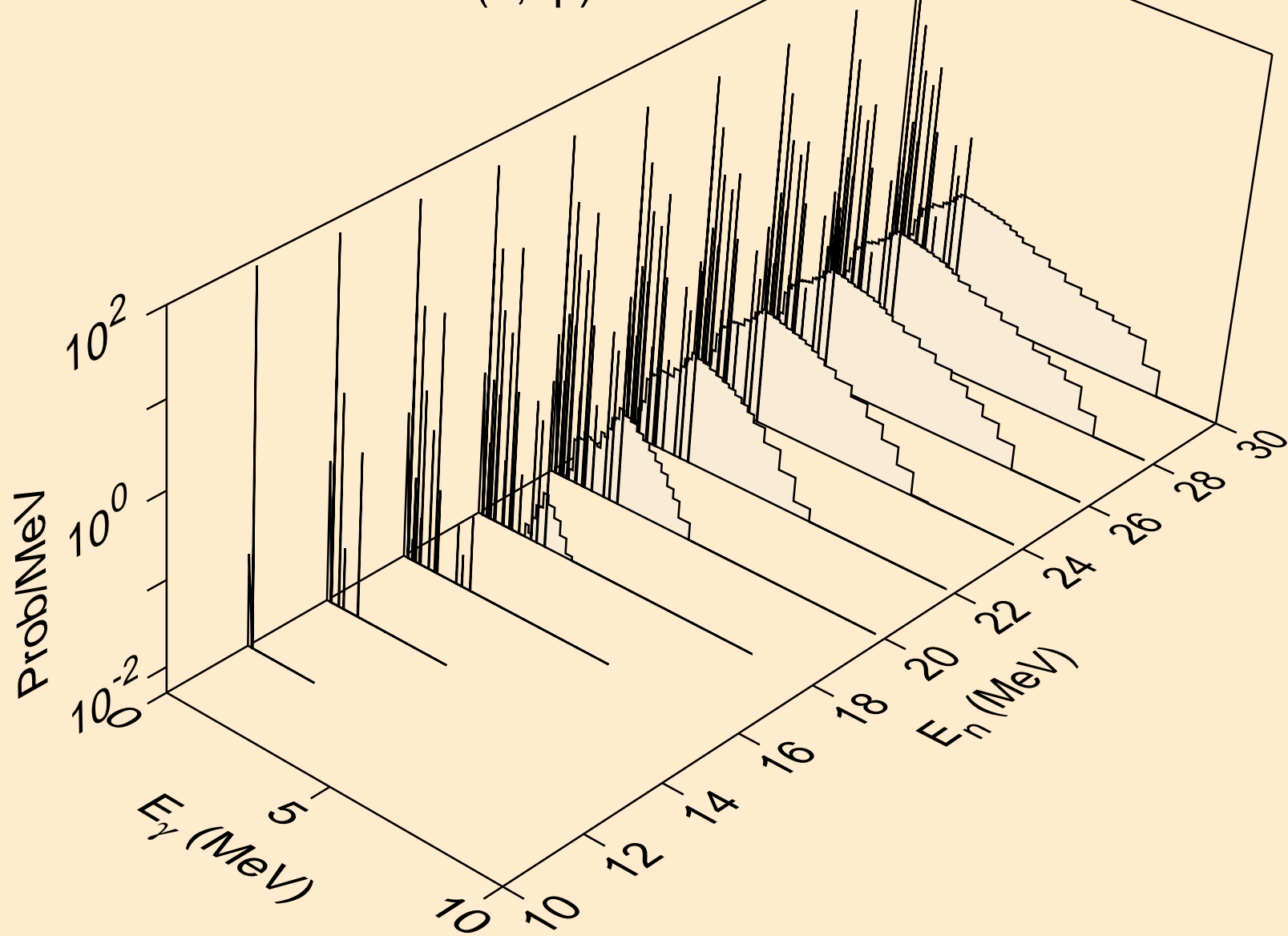

V049 NEUTRON ACER TENDL-2021 LIBRARY; T=293.6K  
Photon emission for (n,p $\alpha$ )

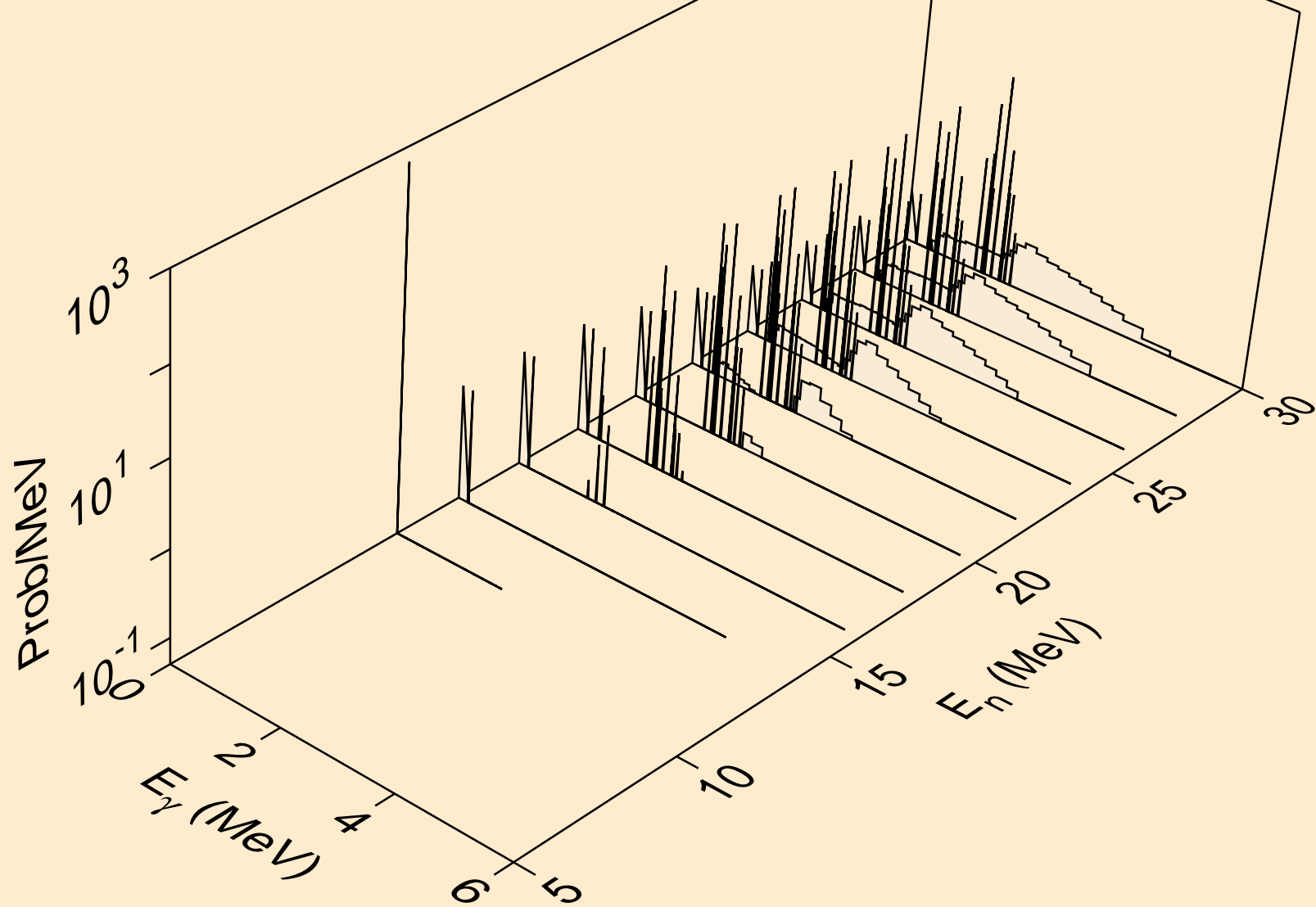

V049 NEUTRON ACER TENDL-2021 LIBRARY; T=293.6K  
Photon emission for (n,pd)

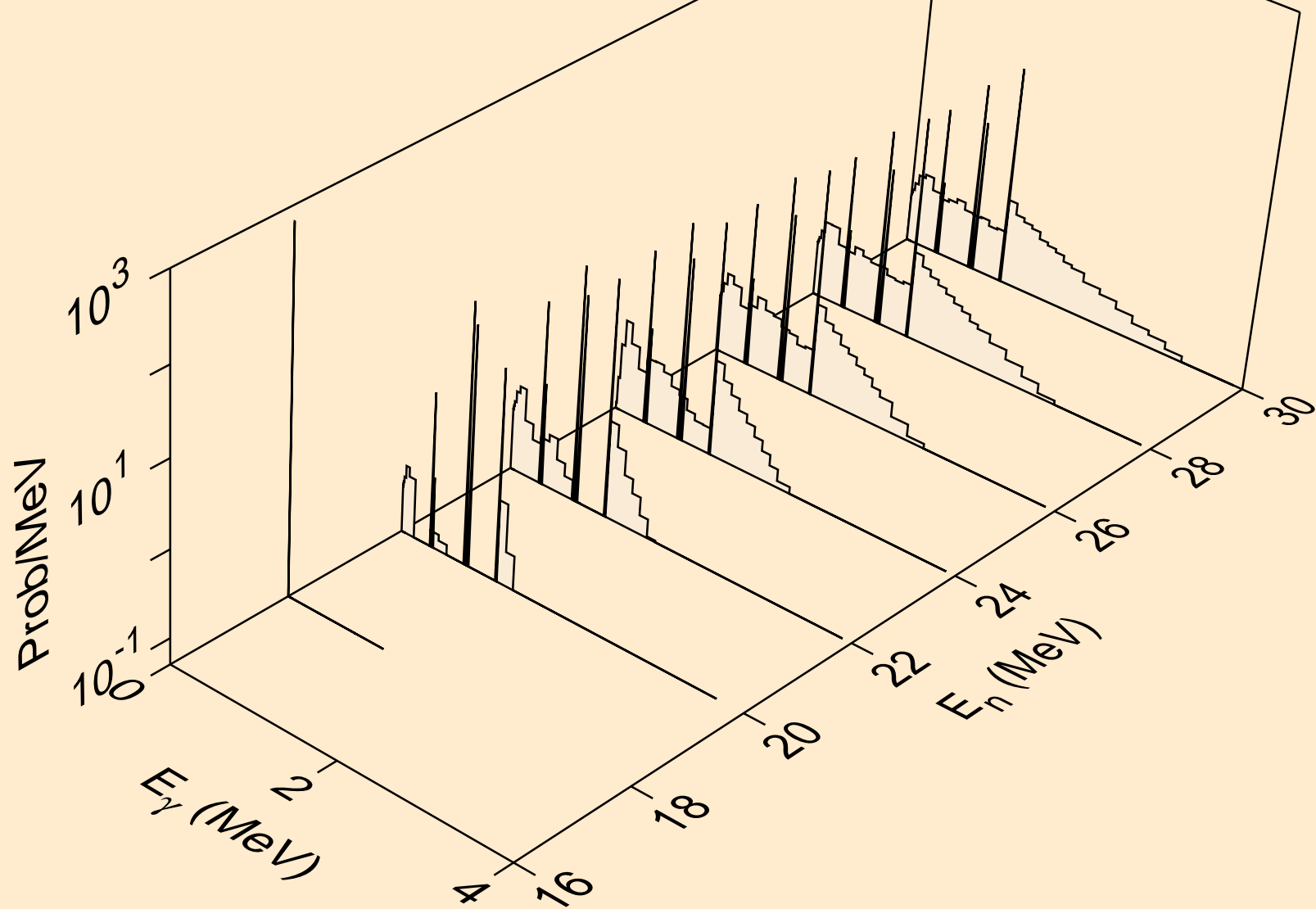

V049 NEUTRON ACER TENDL-2021 LIBRARY; T=293.6K  
Photon emission for (n,pt)

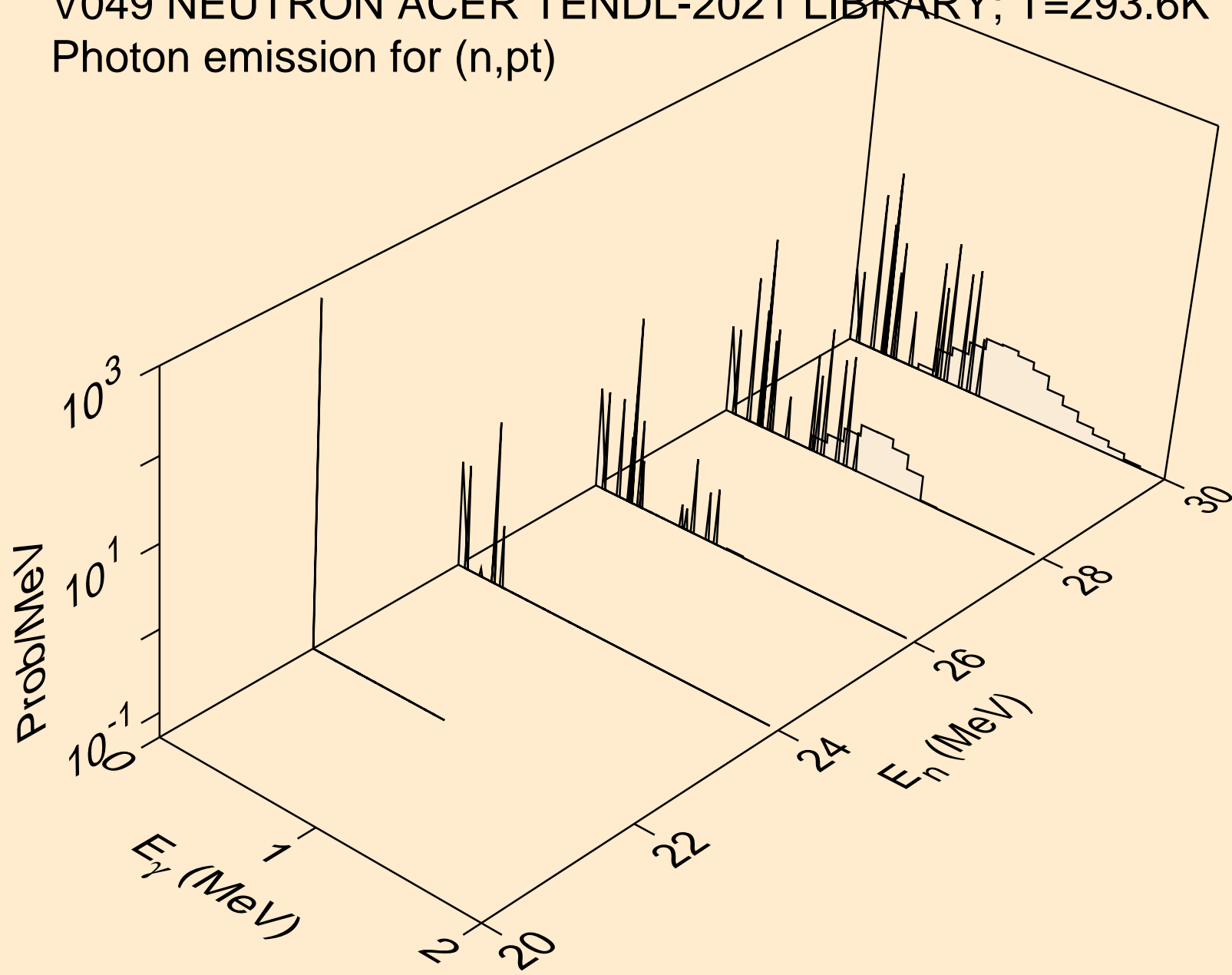

V049 NEUTRON ACER TENDL-2021 LIBRARY; T=293.6K  
Photon emission for (n,da)

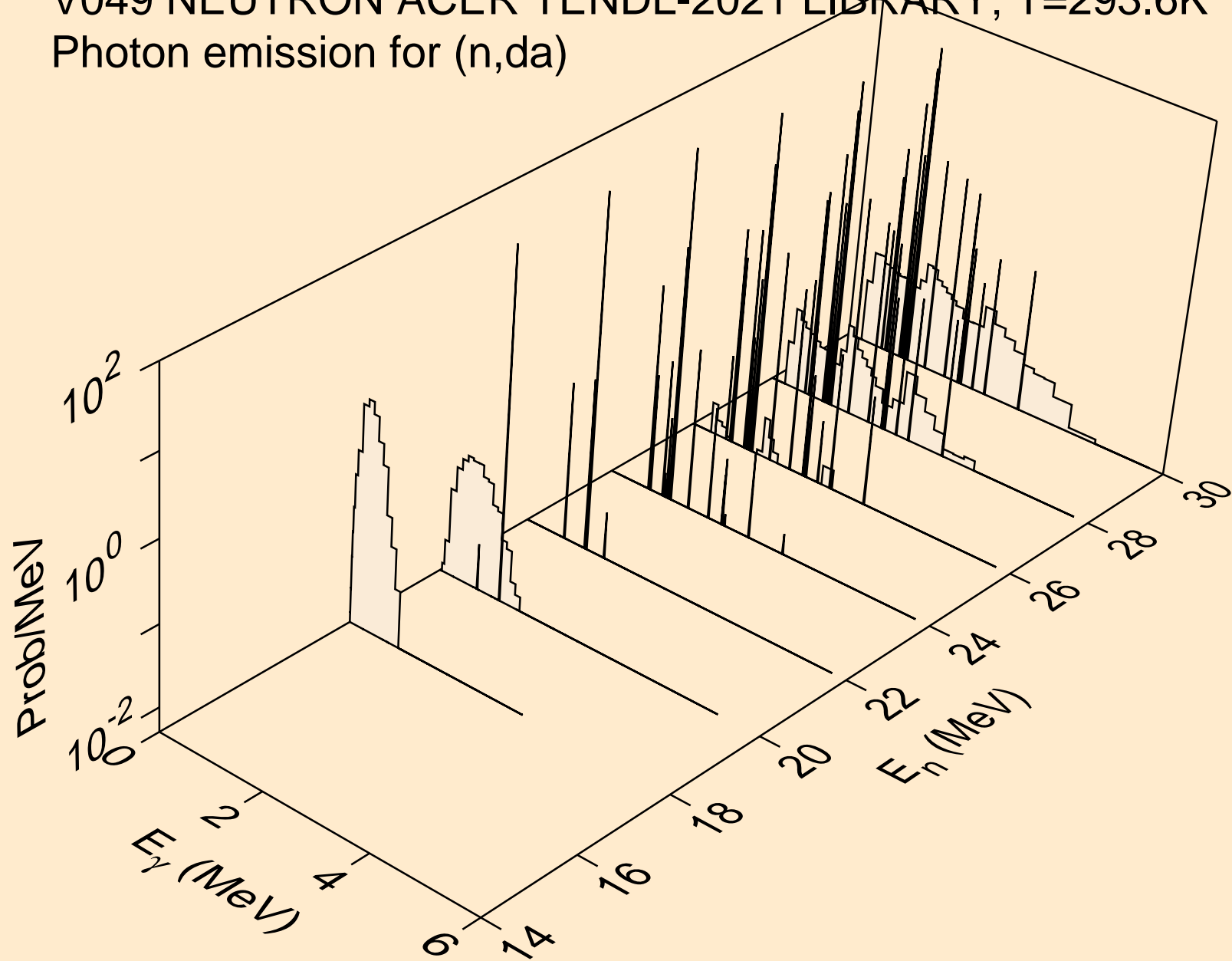

V049 NEUTRON ACER TENDL-2021 LIBRARY; T=293.6K  
thermal capture photon spectrum

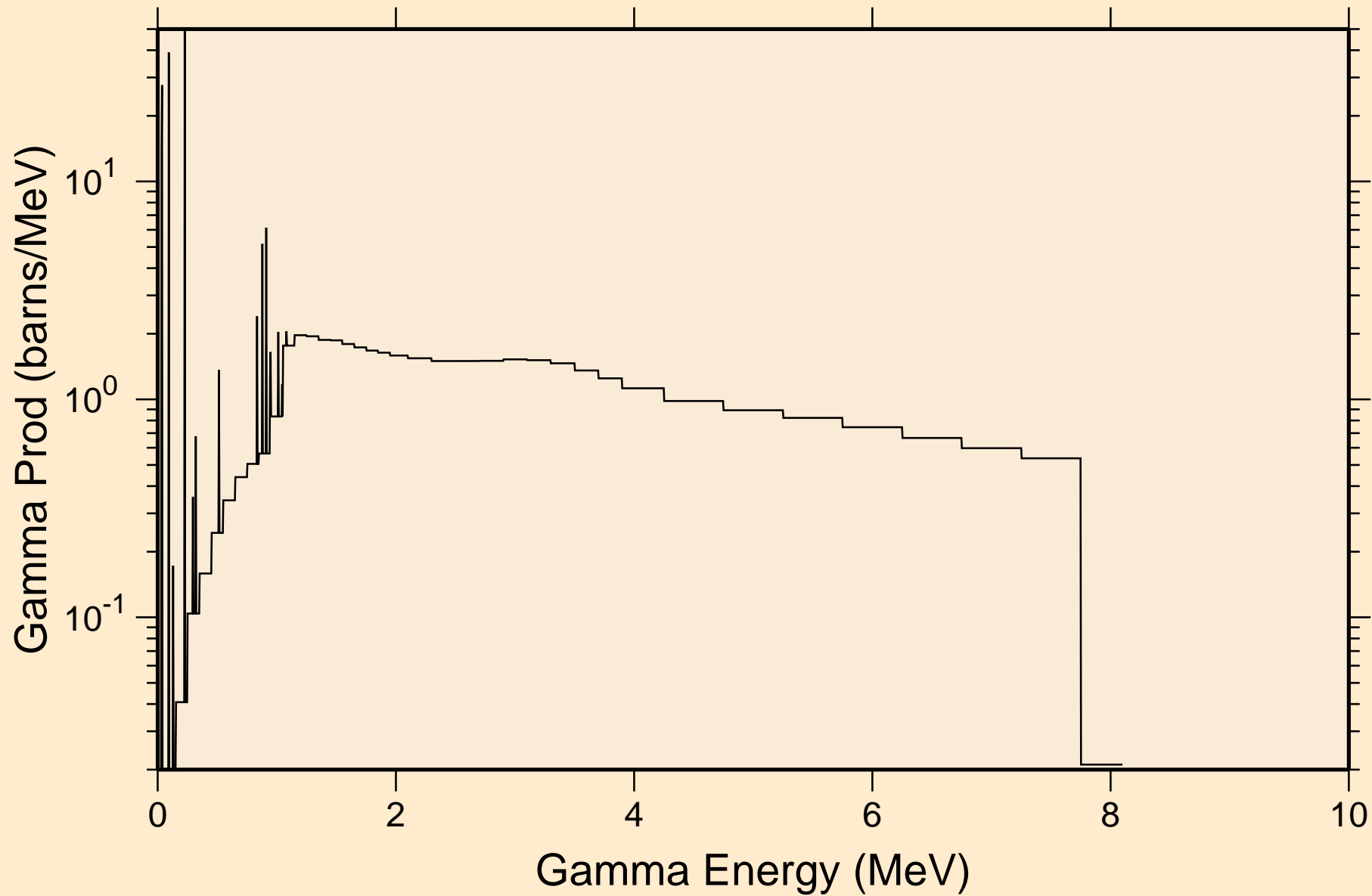

V049 NEUTRON ACER TENDL-2021 LIBRARY; T=293.6K  
14 MeV photon spectrum

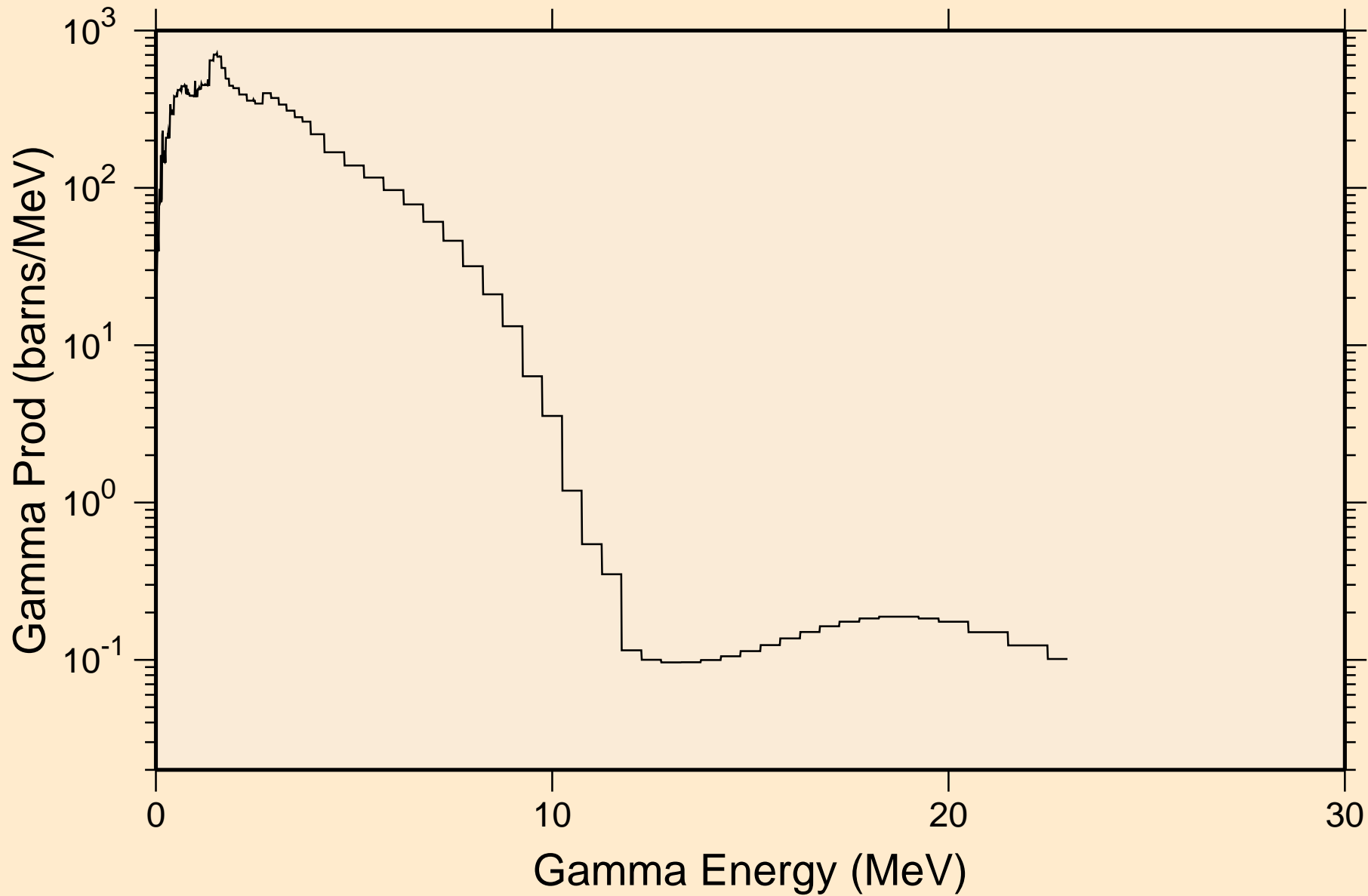

V049 NEUTRON ACER TENDL-2021 LIBRARY; T=293.6K  
Particle heating contributions

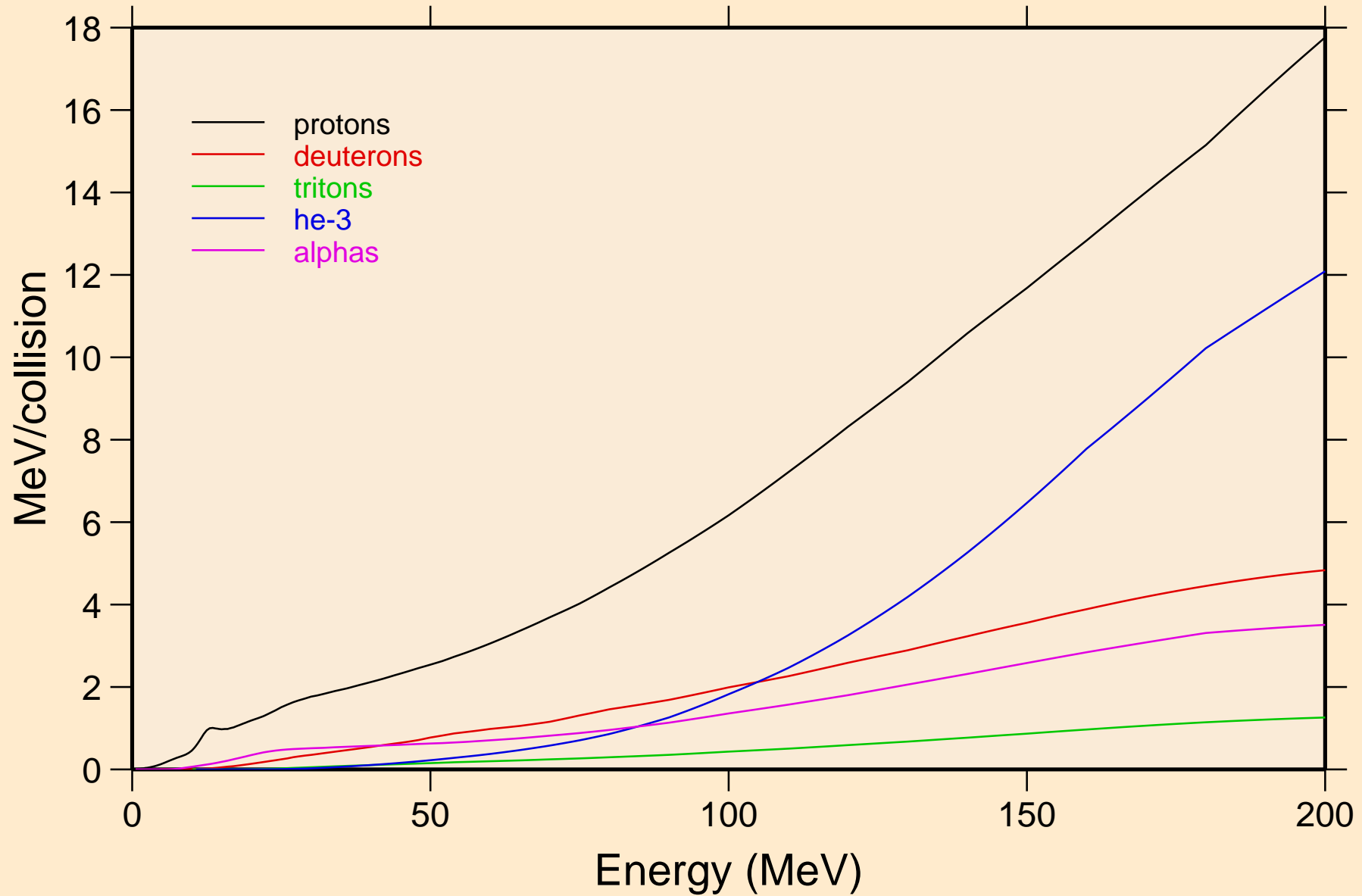



V049 NEUTRON ACER TENDL-2021 LIBRARY; T=293.6K  
Recoil Heating

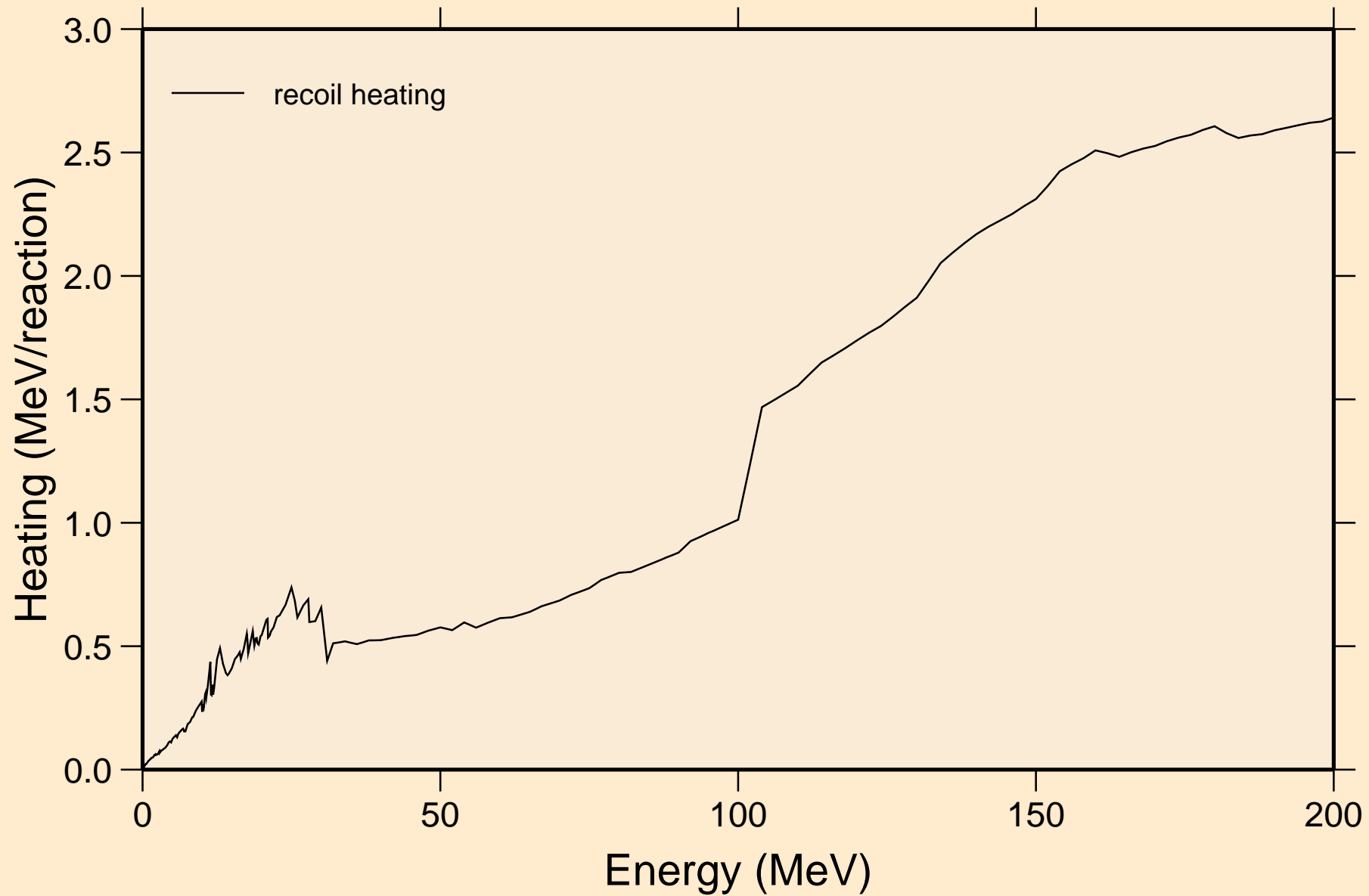

V049 NEUTRON ACER TENDL-2021 LIBRARY; T=293.6K  
Particle production cross sections

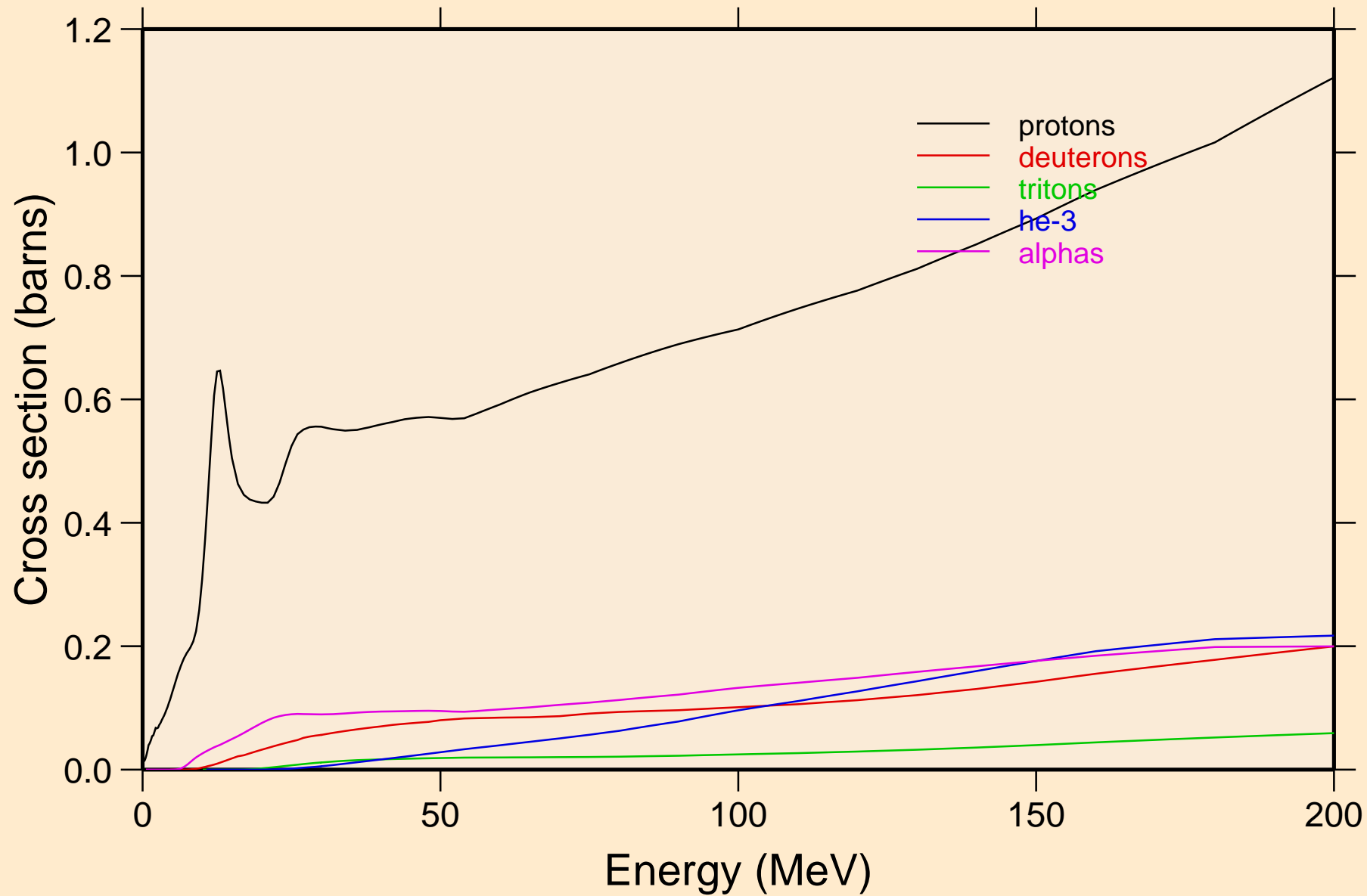

V049 NEUTRON ACER TENDL-2021 LIBRARY; T=293.6K  
protons from (n,x)

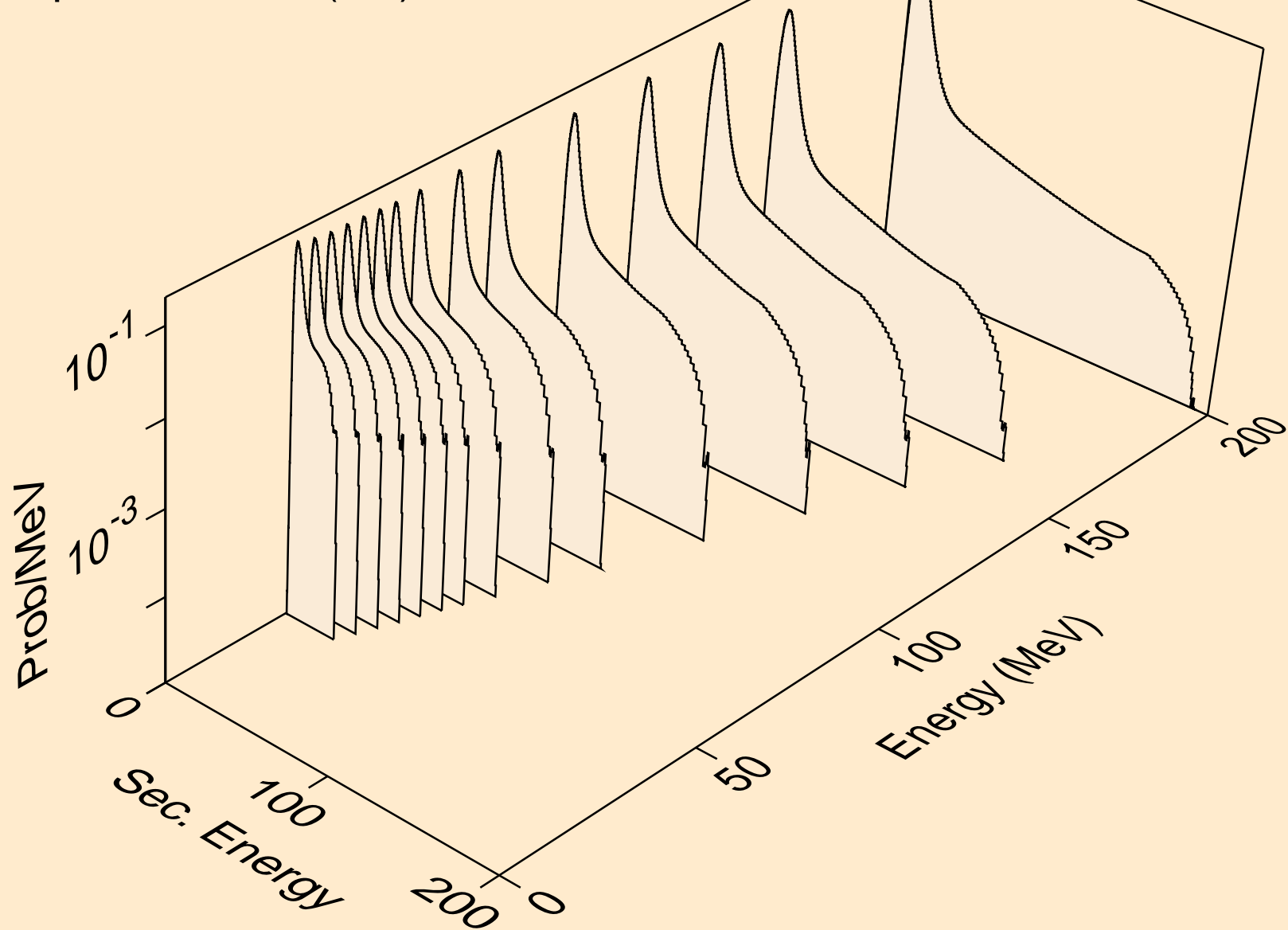

V049 NEUTRON ACER TENDL-2021 LIBRARY; T=293.6K  
protons from (n,n\*)p

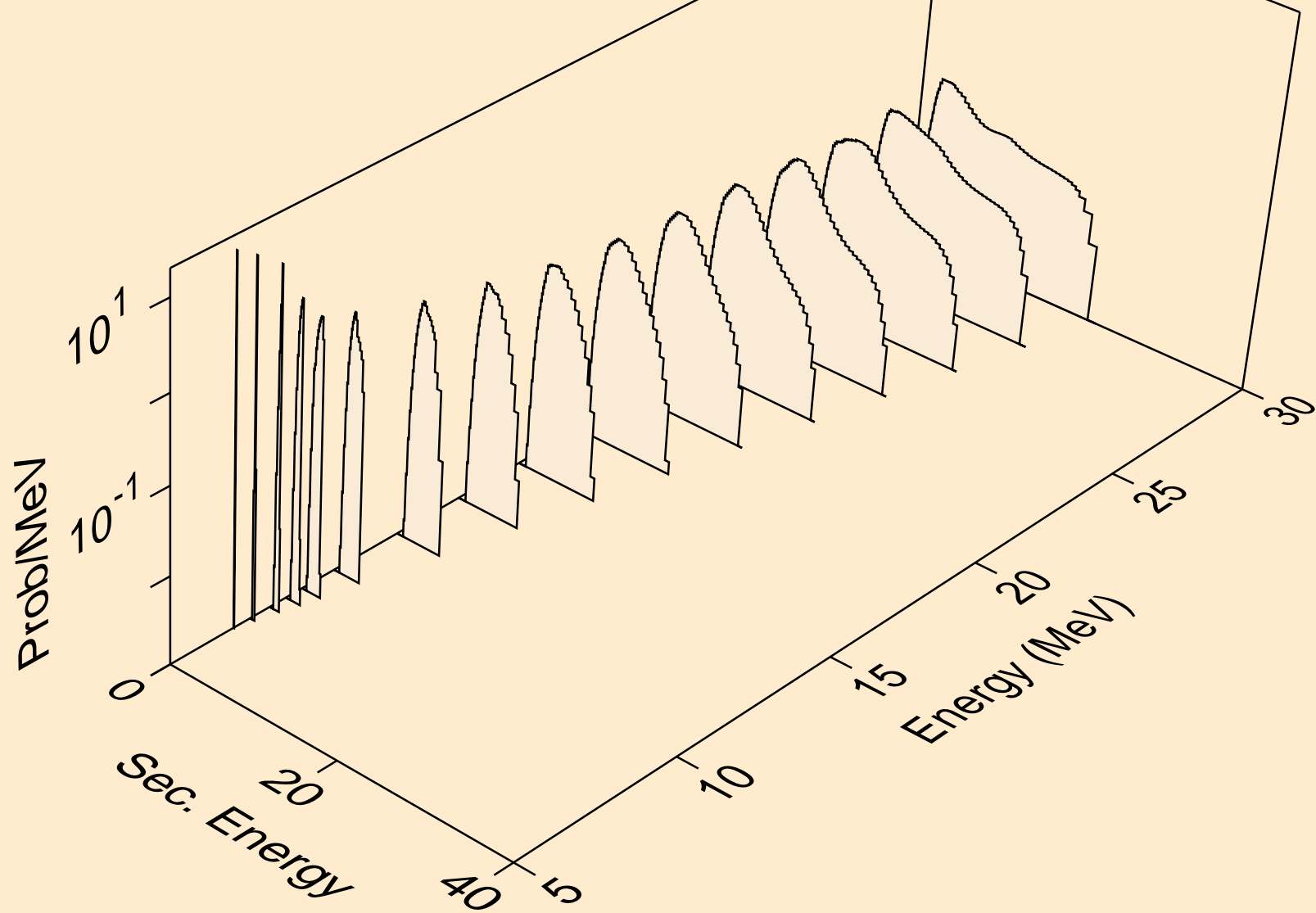

V049 NEUTRON ACER TENDL-2021 LIBRARY; T=293.6K  
protons from (n,2np)

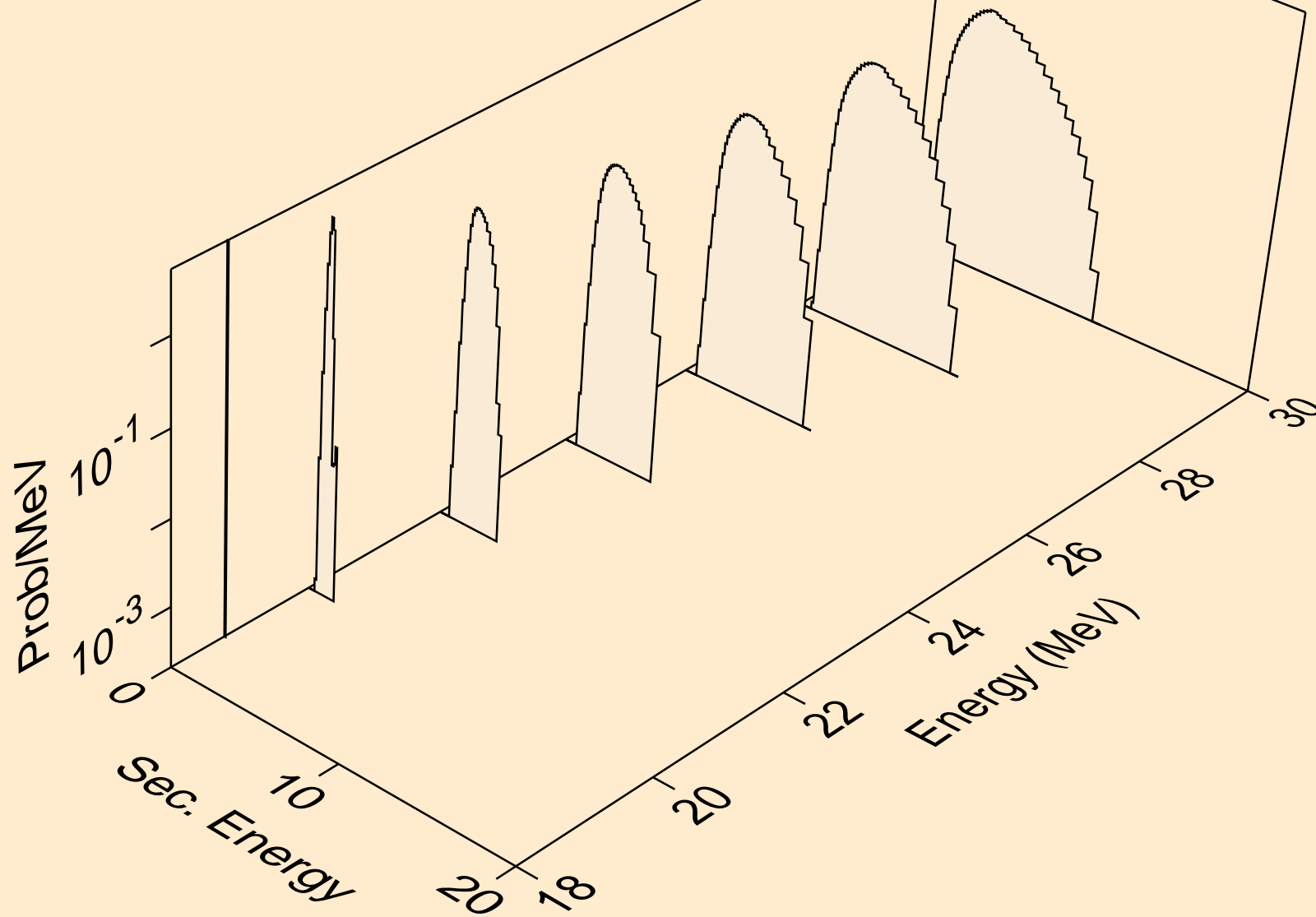

V049 NEUTRON ACER TENDL-2021 LIBRARY; T=293.6K  
protons from (n,3np)

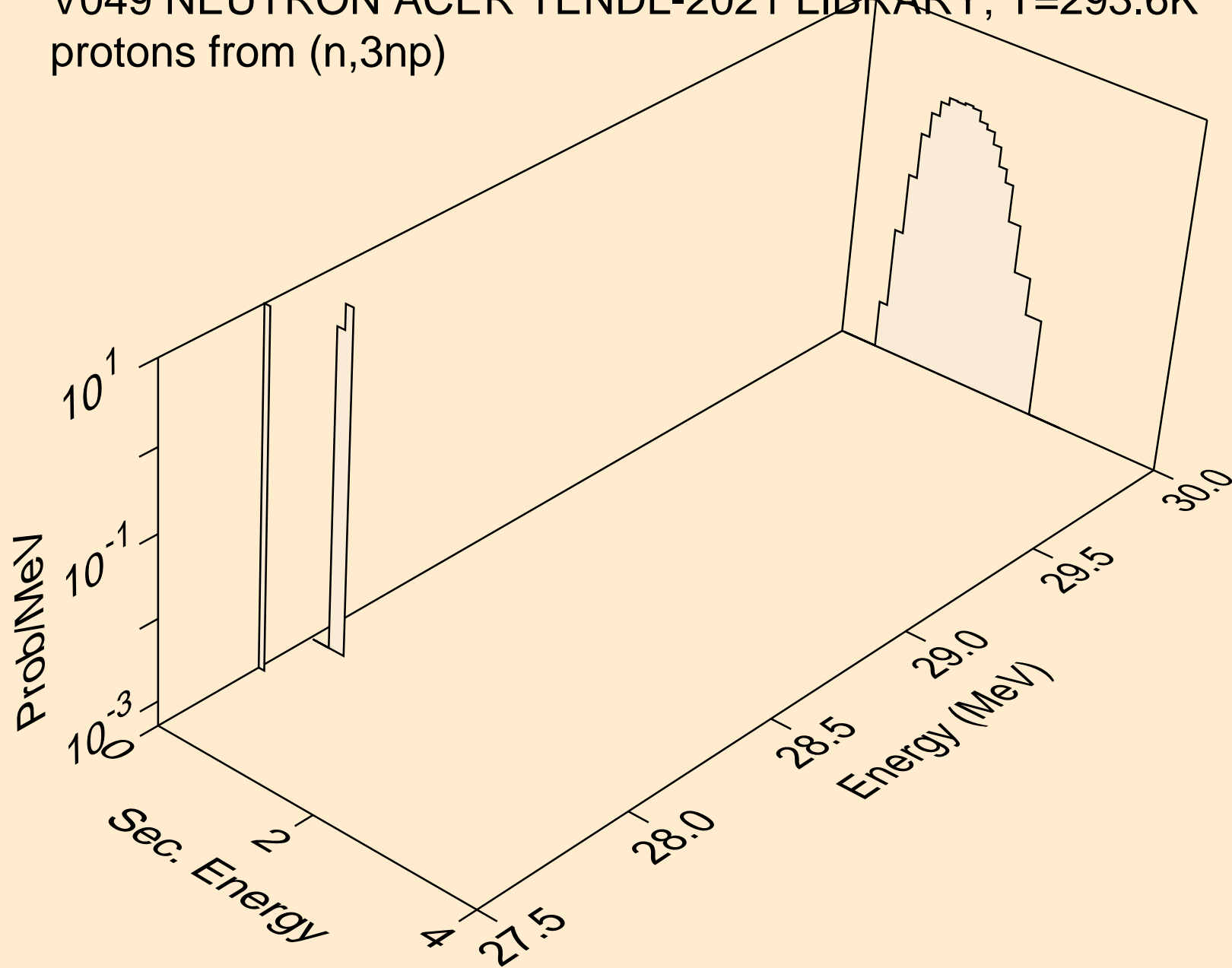

V049 NEUTRON ACER TENDL-2021 LIBRARY; T=293.6K  
protons from (n,2np)

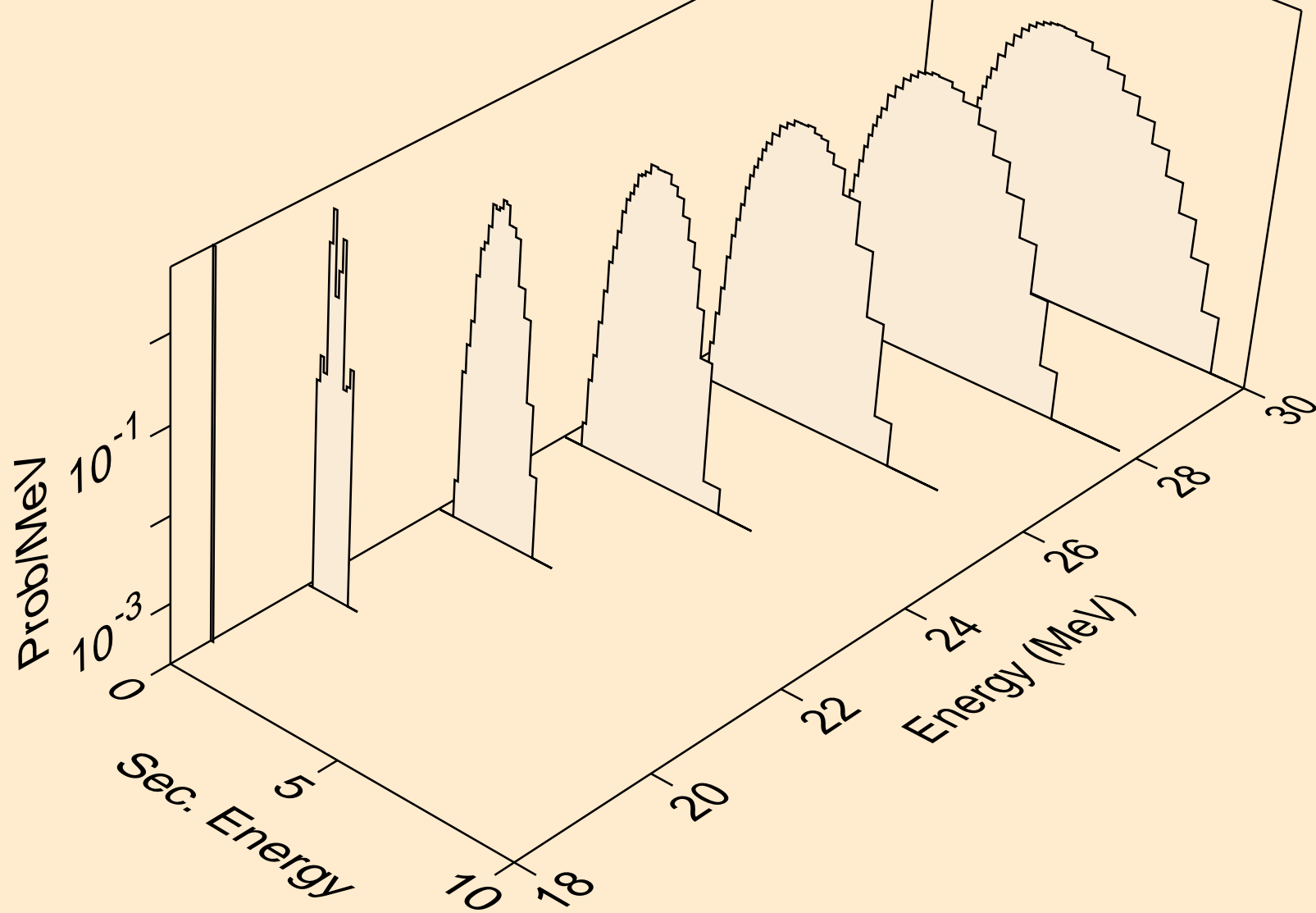

V049 NEUTRON ACER TENDL-2021 LIBRARY; T=293.6K  
protons from (n,npa)

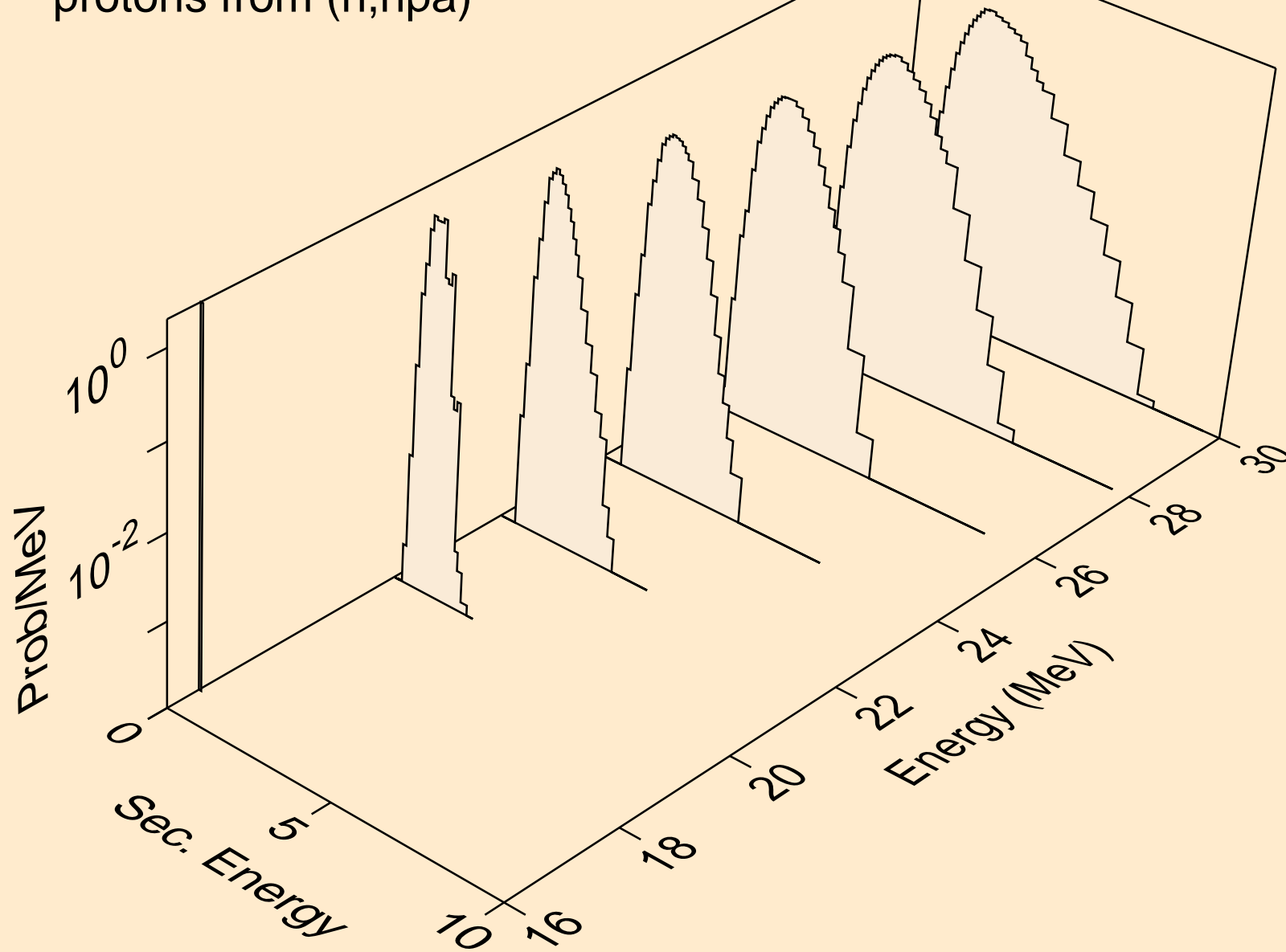



V049 NEUTRON ACER TENDL-2021 LIBRARY; T=293.6K  
protons from (n,p)

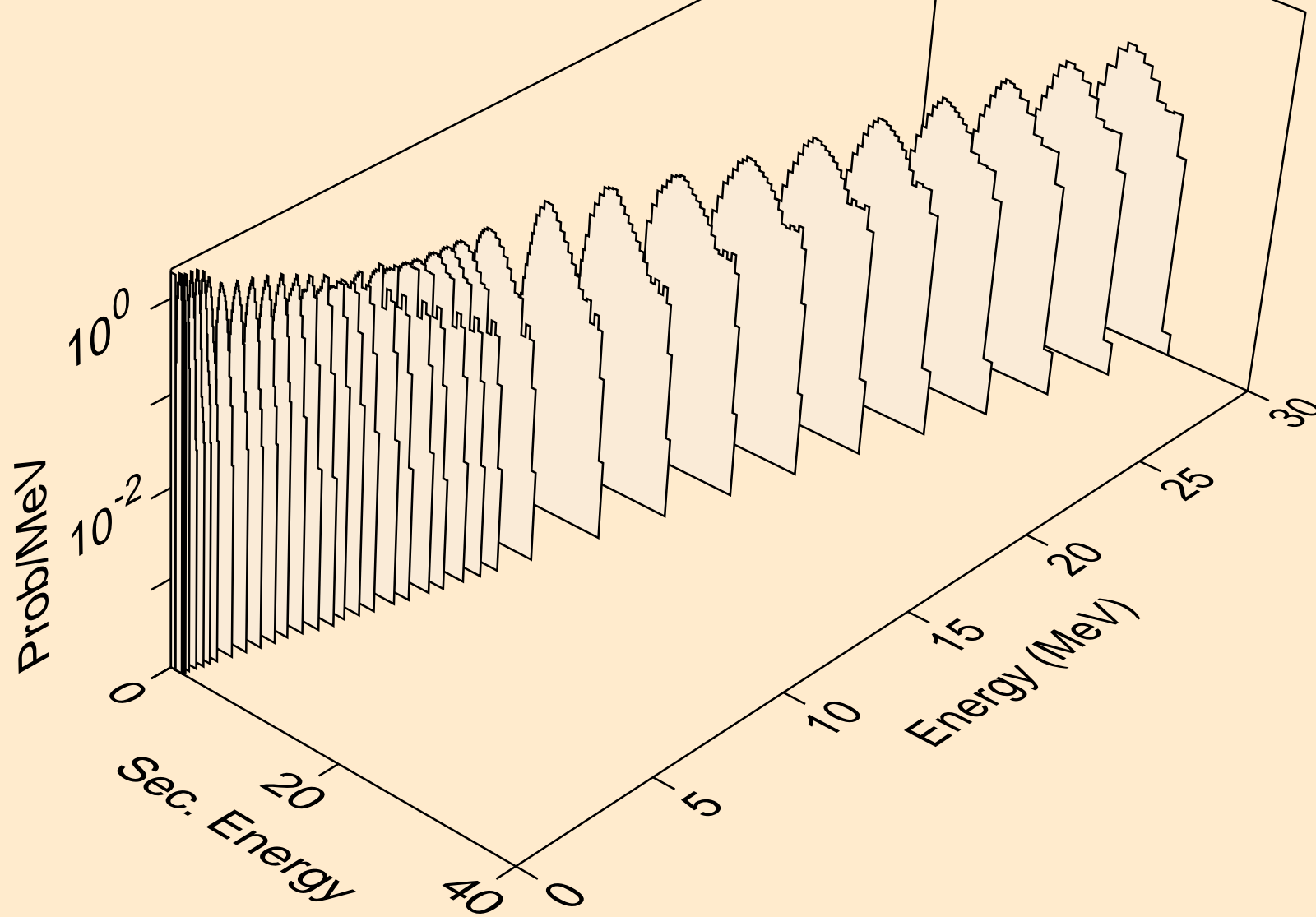

V049 NEUTRON ACER TENDL-2021 LIBRARY; T=293.6K  
protons from (n,2p)

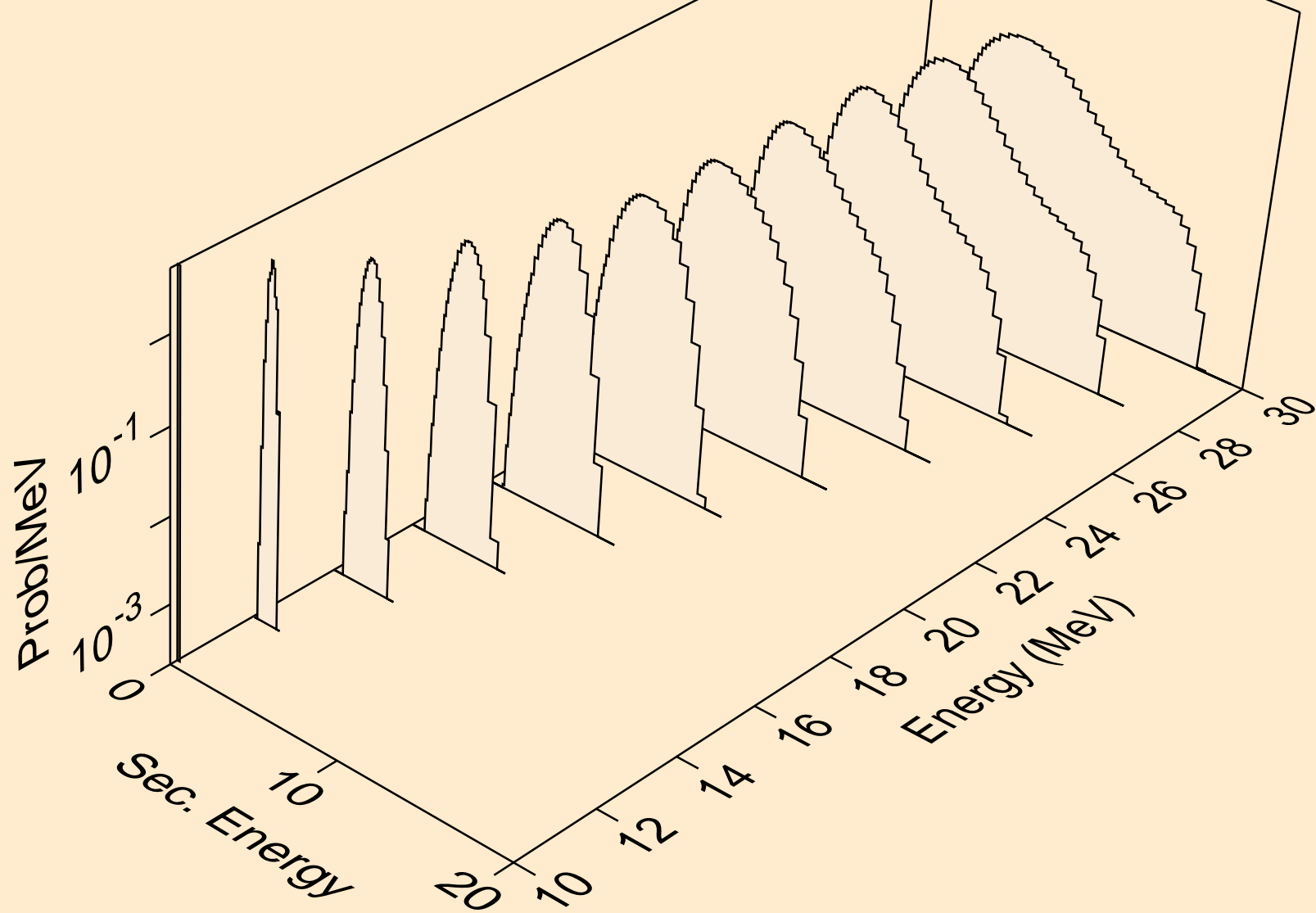

V049 NEUTRON ACER TENDL-2021 LIBRARY; T=293.6K  
protons from (n,p)

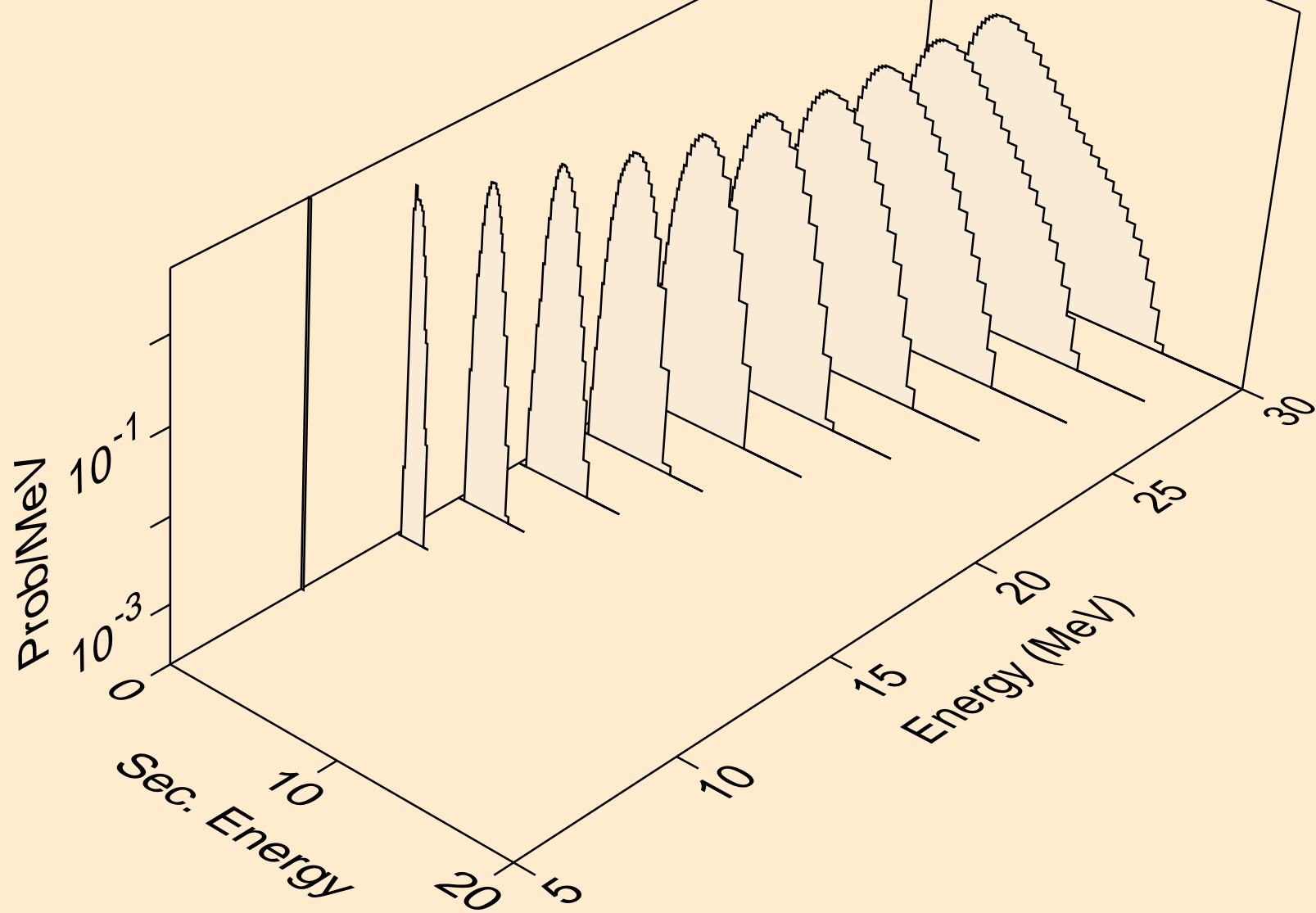

V049 NEUTRON ACER TENDL-2021 LIBRARY; T=293.6K  
protons from (n,pd)

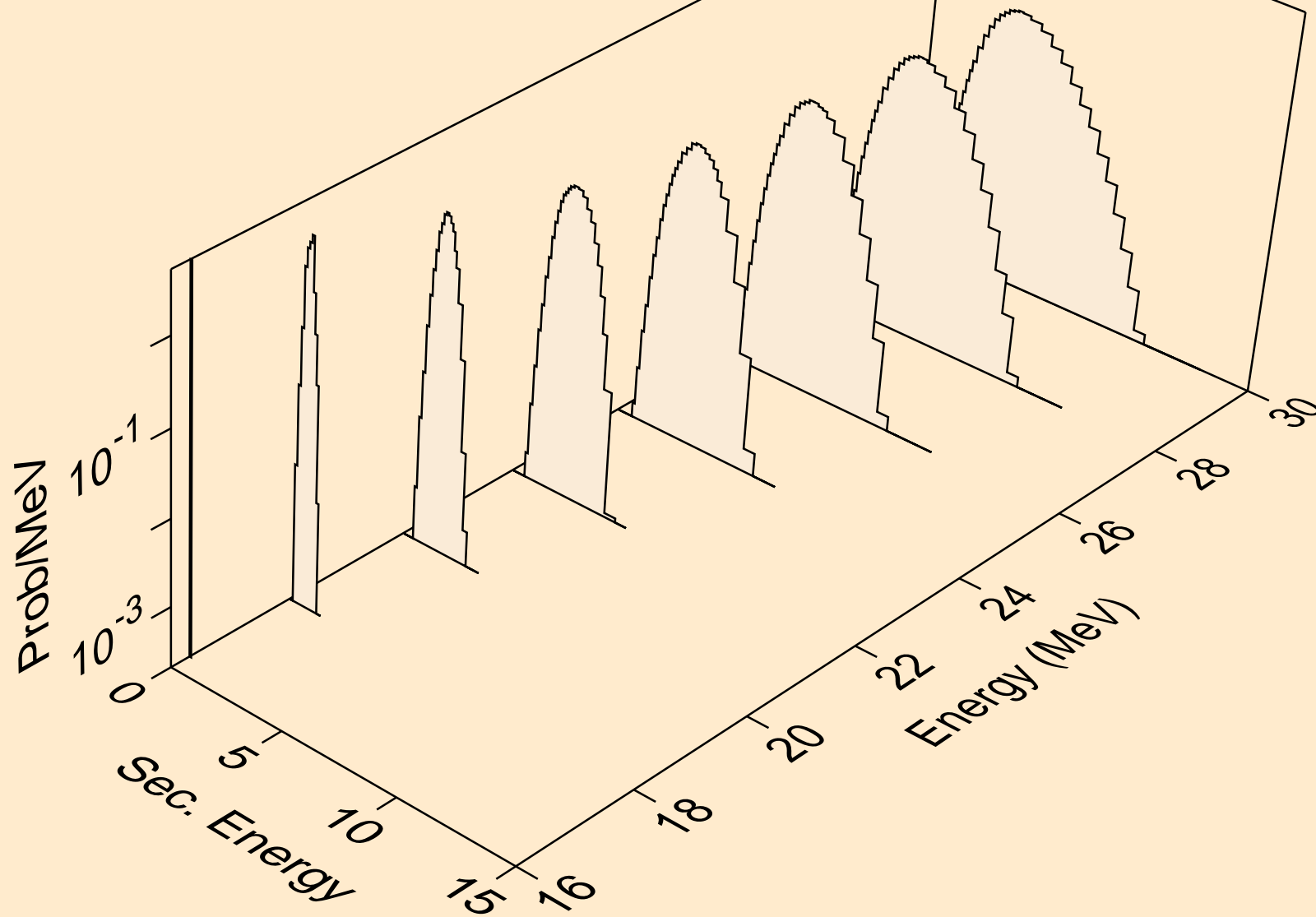

V049 NEUTRON ACER TENDL-2021 LIBRARY; T=293.6K  
protons from (n,pt)

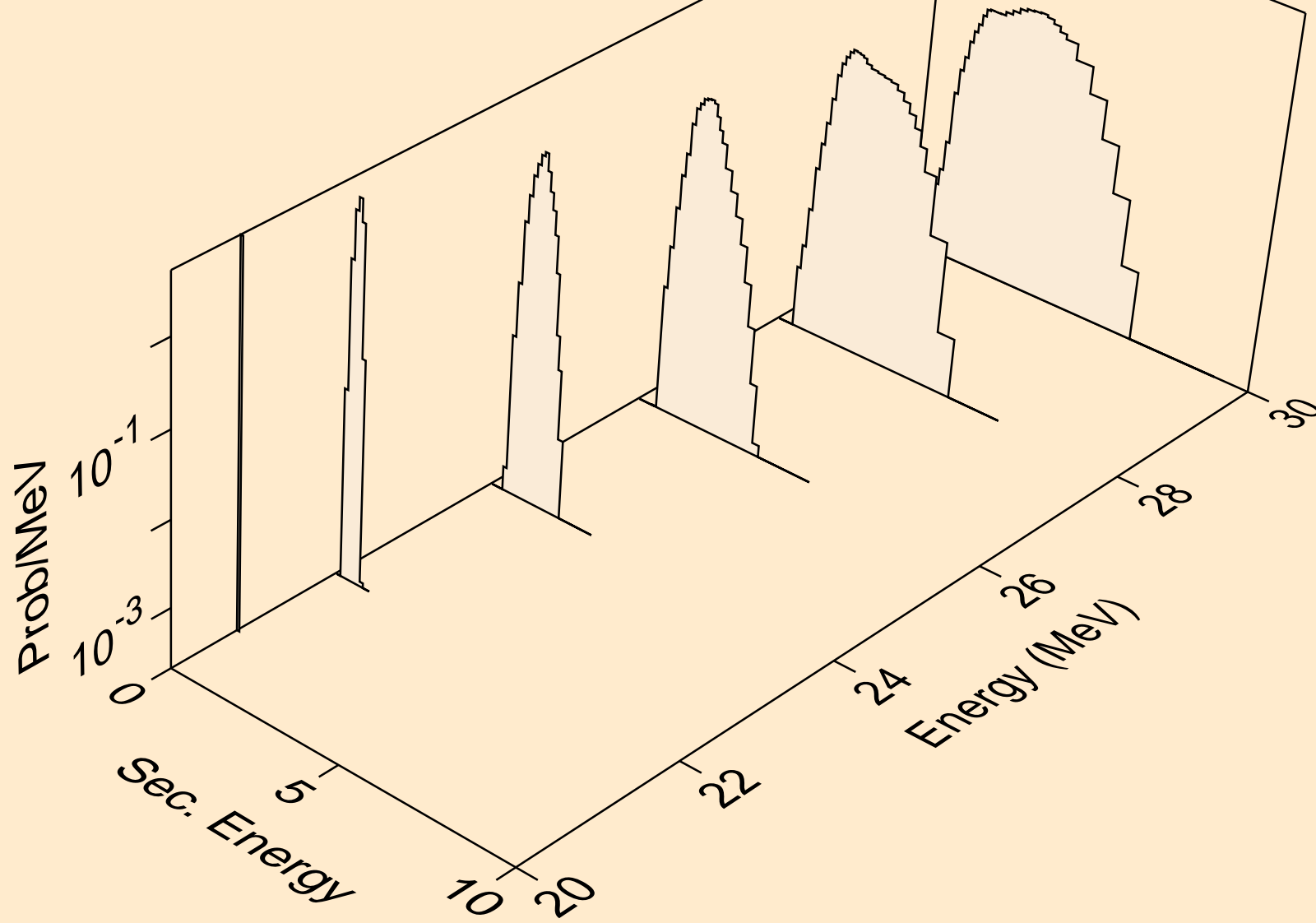

V049 NEUTRON ACER TENDL-2021 LIBRARY; T=293.6K  
deuterons from (n,x)

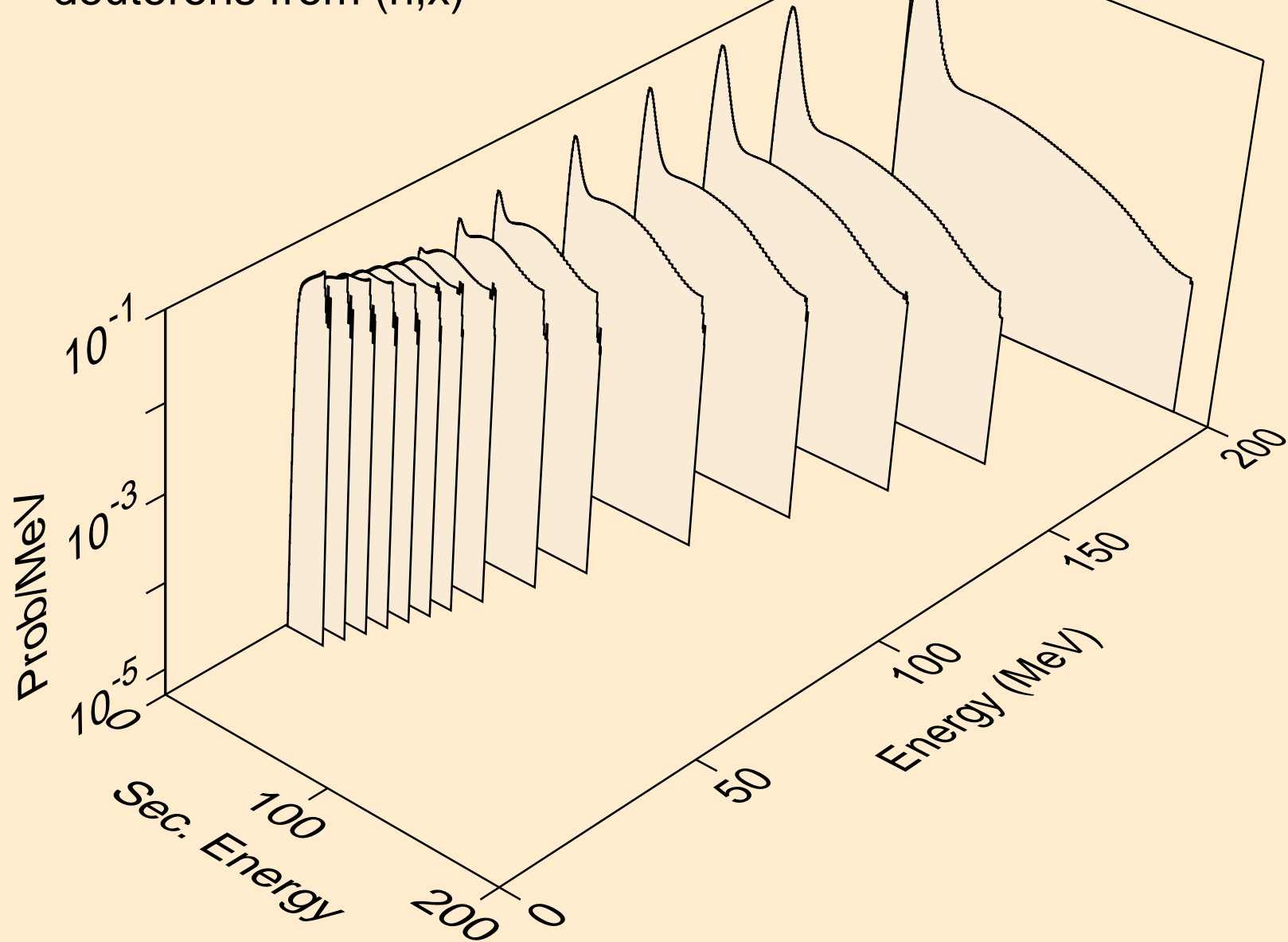

V049 NEUTRON ACER TENDL-2021 LIBRARY; T=293.6K  
deuterons from (n,2nd)

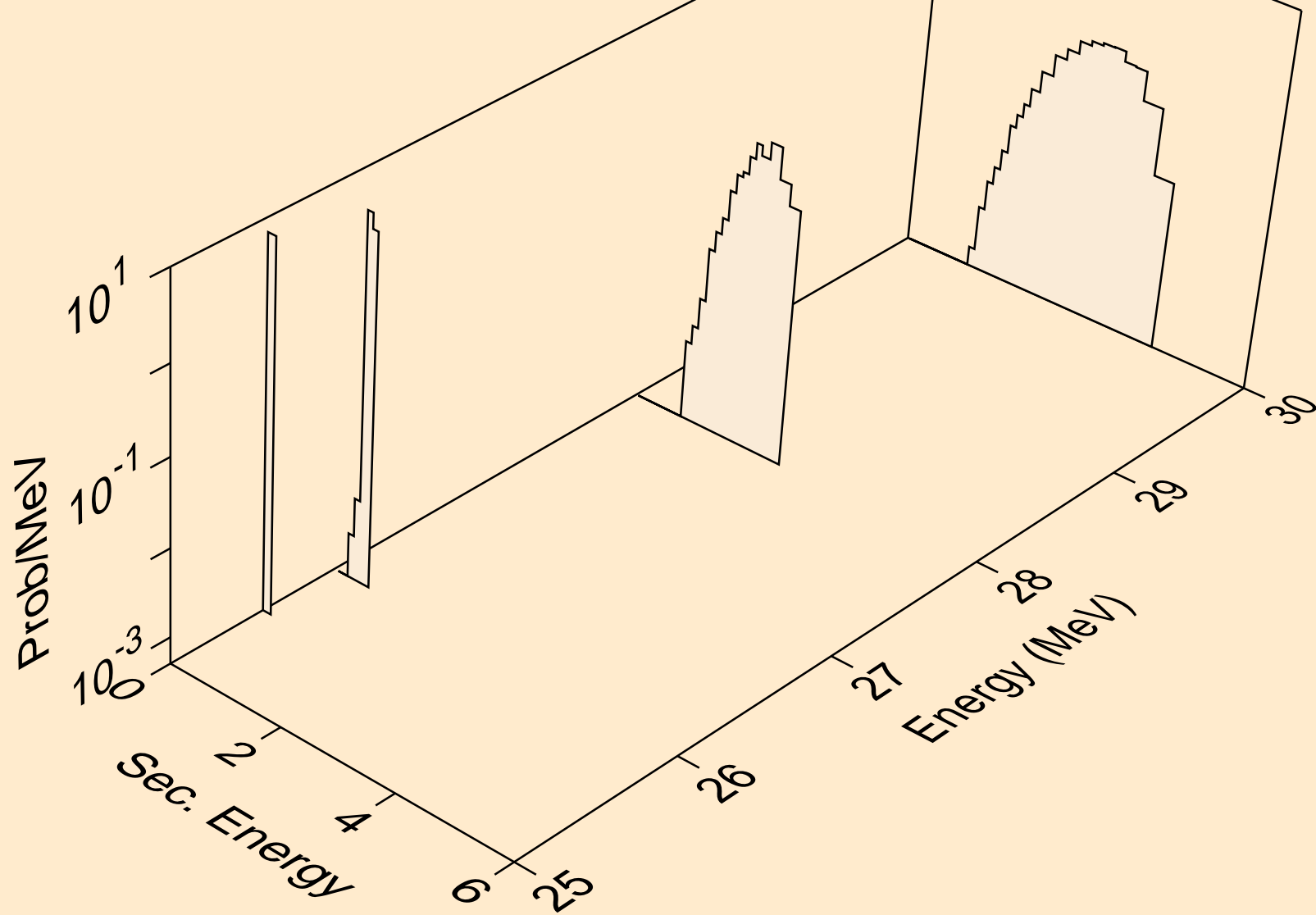

V049 NEUTRON ACER TENDL-2021 LIBRARY; T=293.6K  
deuterons from (n,n\*)d

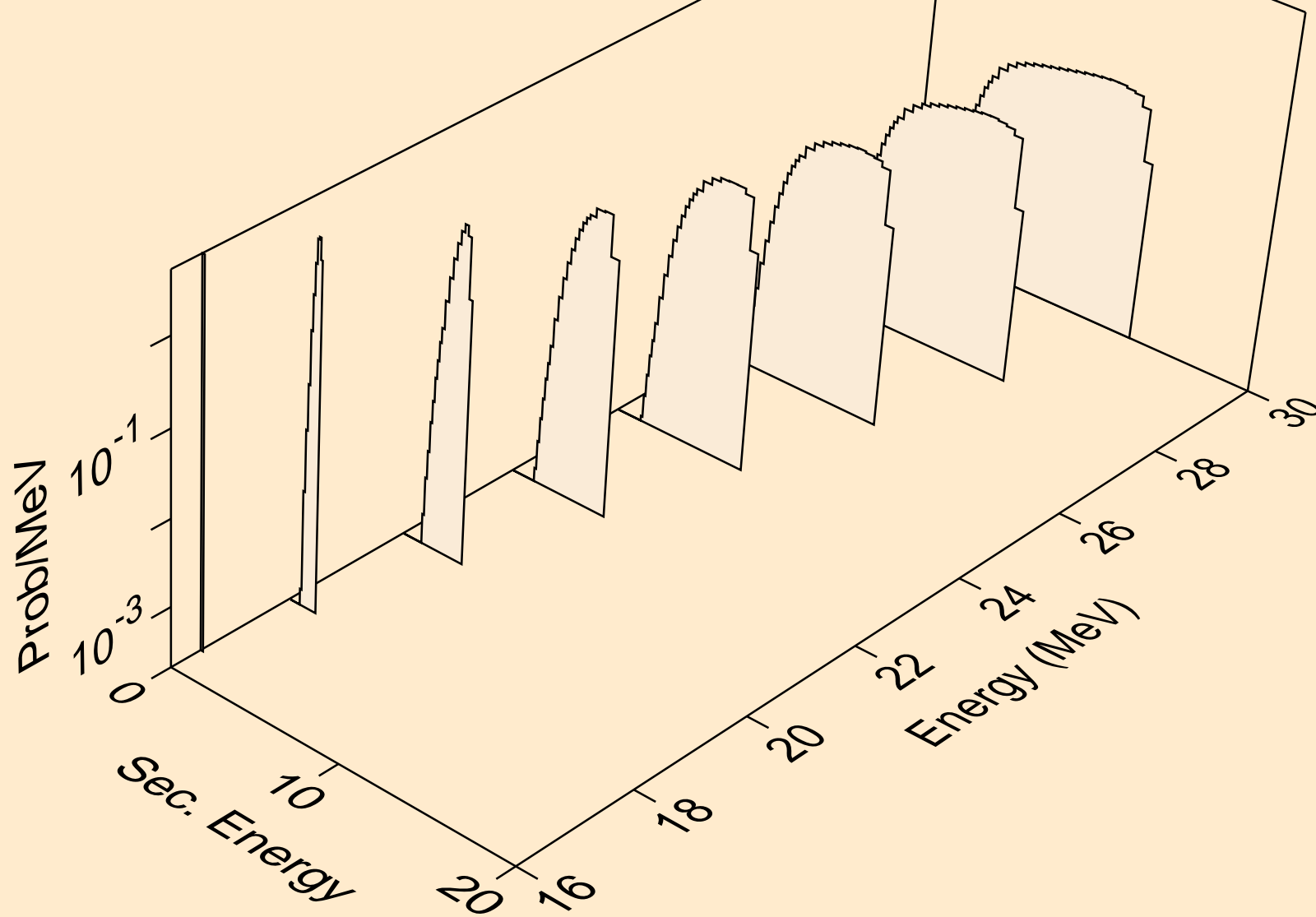



V049 NEUTRON ACER TENDL-2021 LIBRARY; T=293.6K  
deuterons from (n,d)

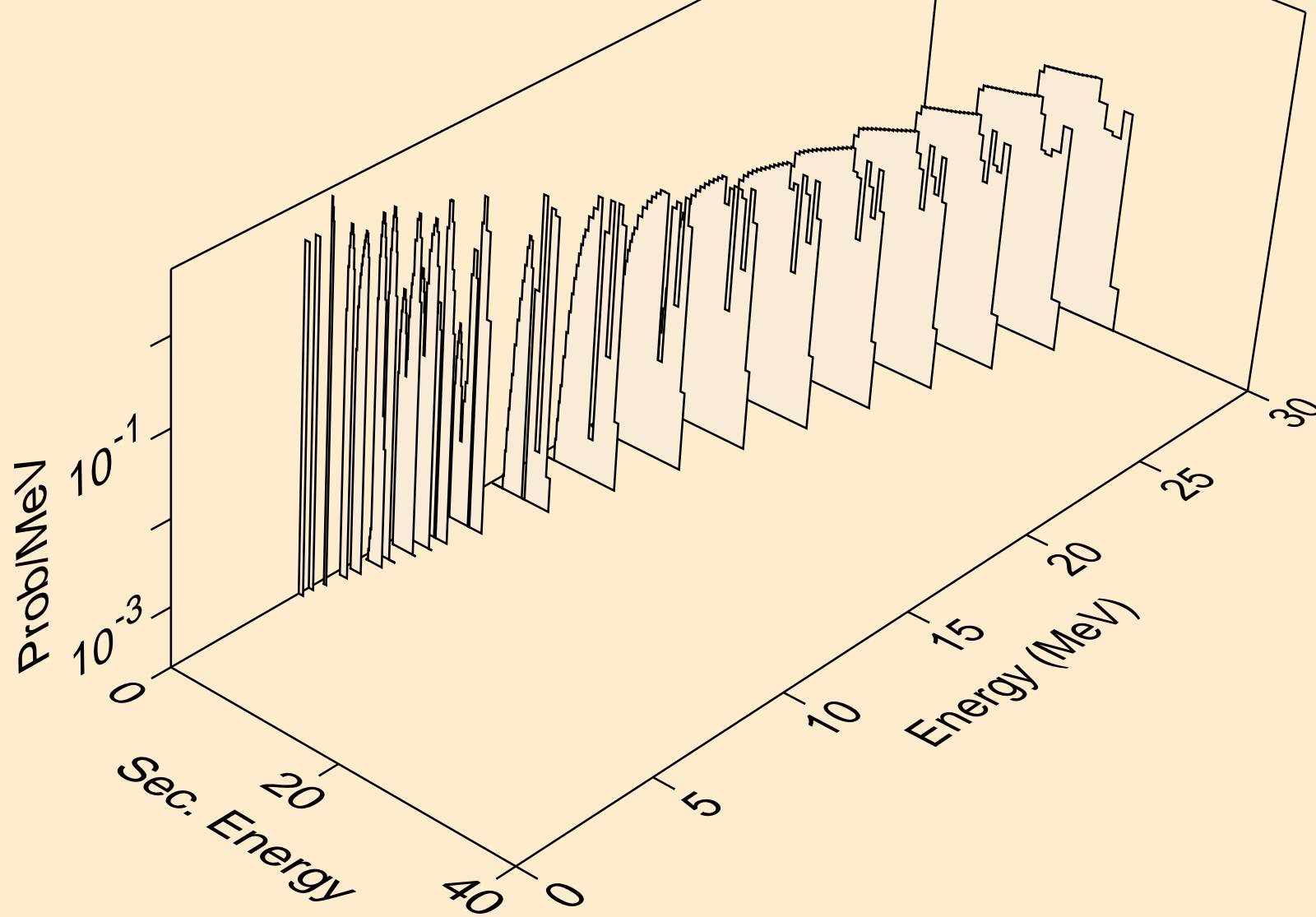

V049 NEUTRON ACER TENDL-2021 LIBRARY; T=293.6K  
deuterons from (n,pd)

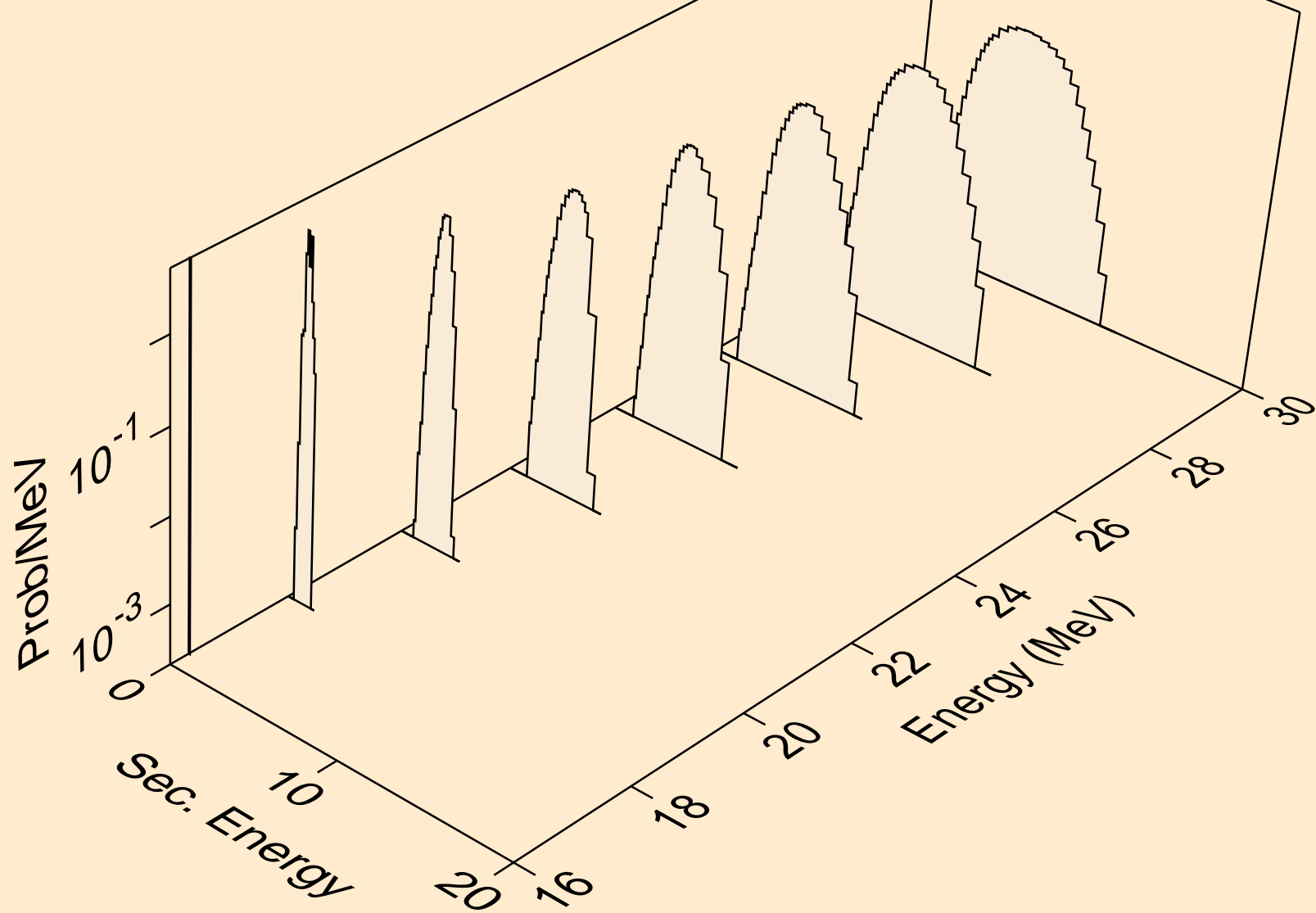

V049 NEUTRON ACER TENDL-2021 LIBRARY; T=293.6K  
deuterons from (n,da)

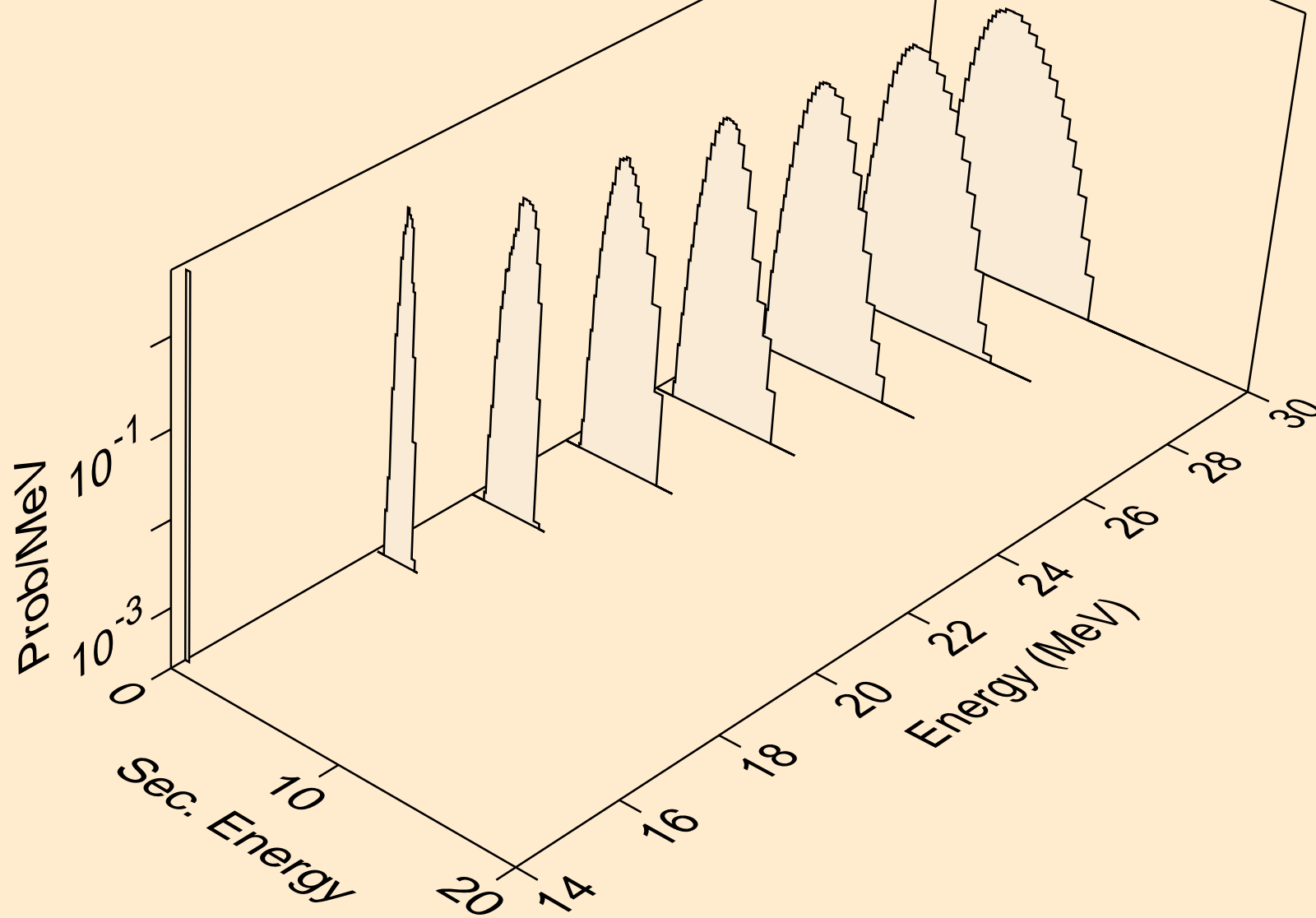

V049 NEUTRON ACER TENDL-2021 LIBRARY; T=293.6K  
tritons from (n,x)

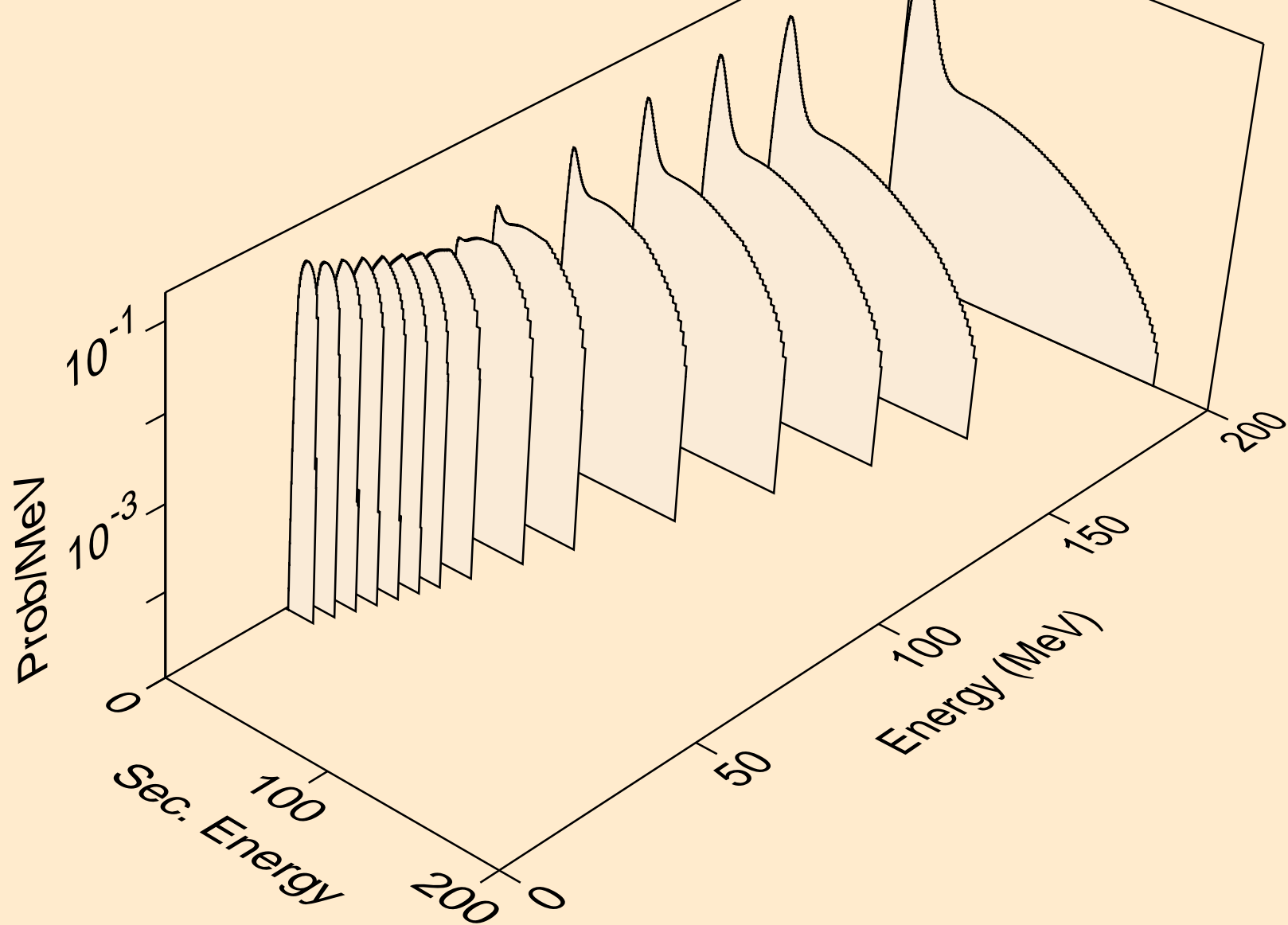

V049 NEUTRON ACER TENDL-2021 LIBRARY; T=293.6K  
tritons from (n,n\*)t

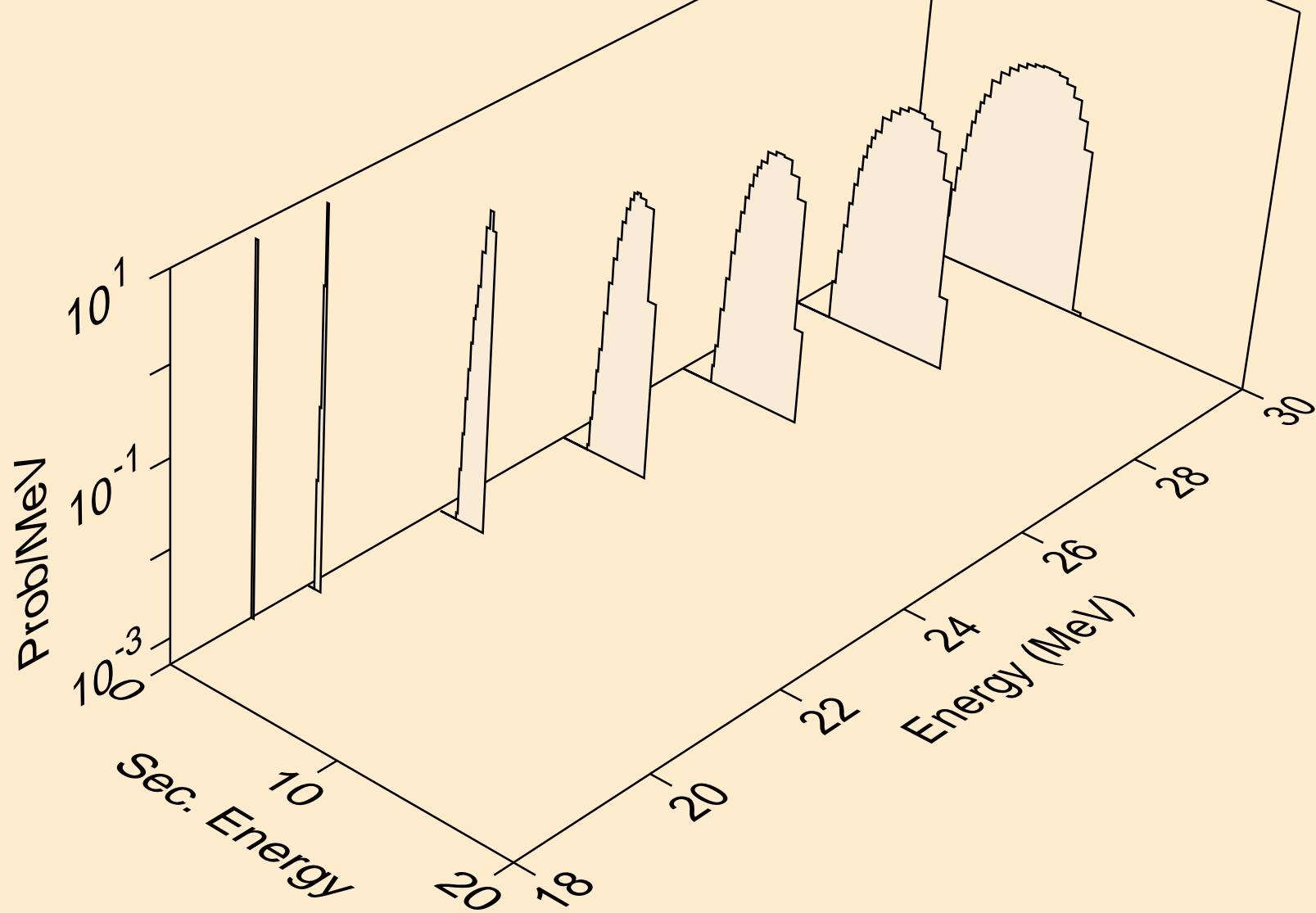

V049 NEUTRON ACER TENDL-2021 LIBRARY; T=293.6K  
tritons from (n,t)

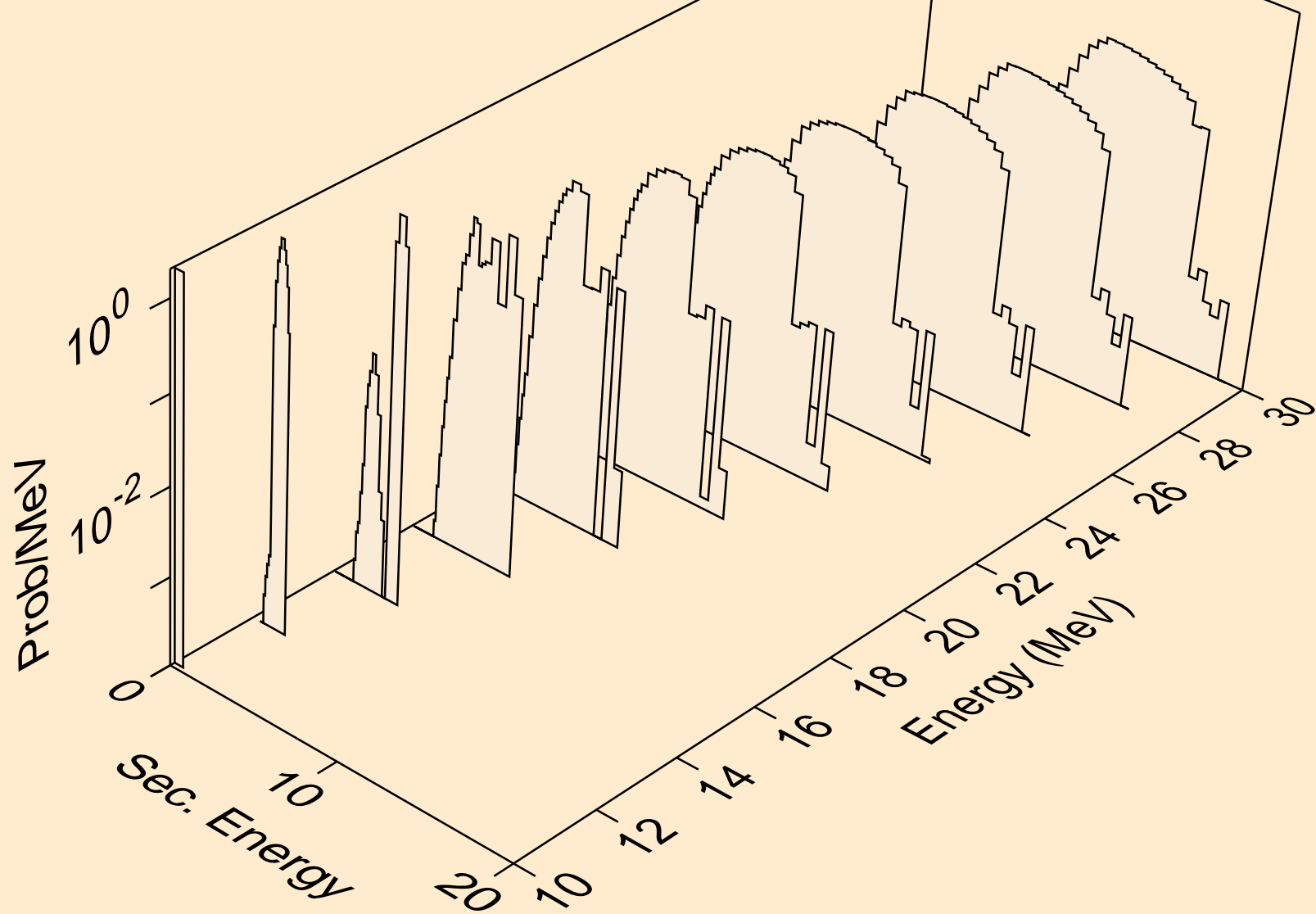

V049 NEUTRON ACER TENDL-2021 LIBRARY; T=293.6K  
tritons from (n,pt)

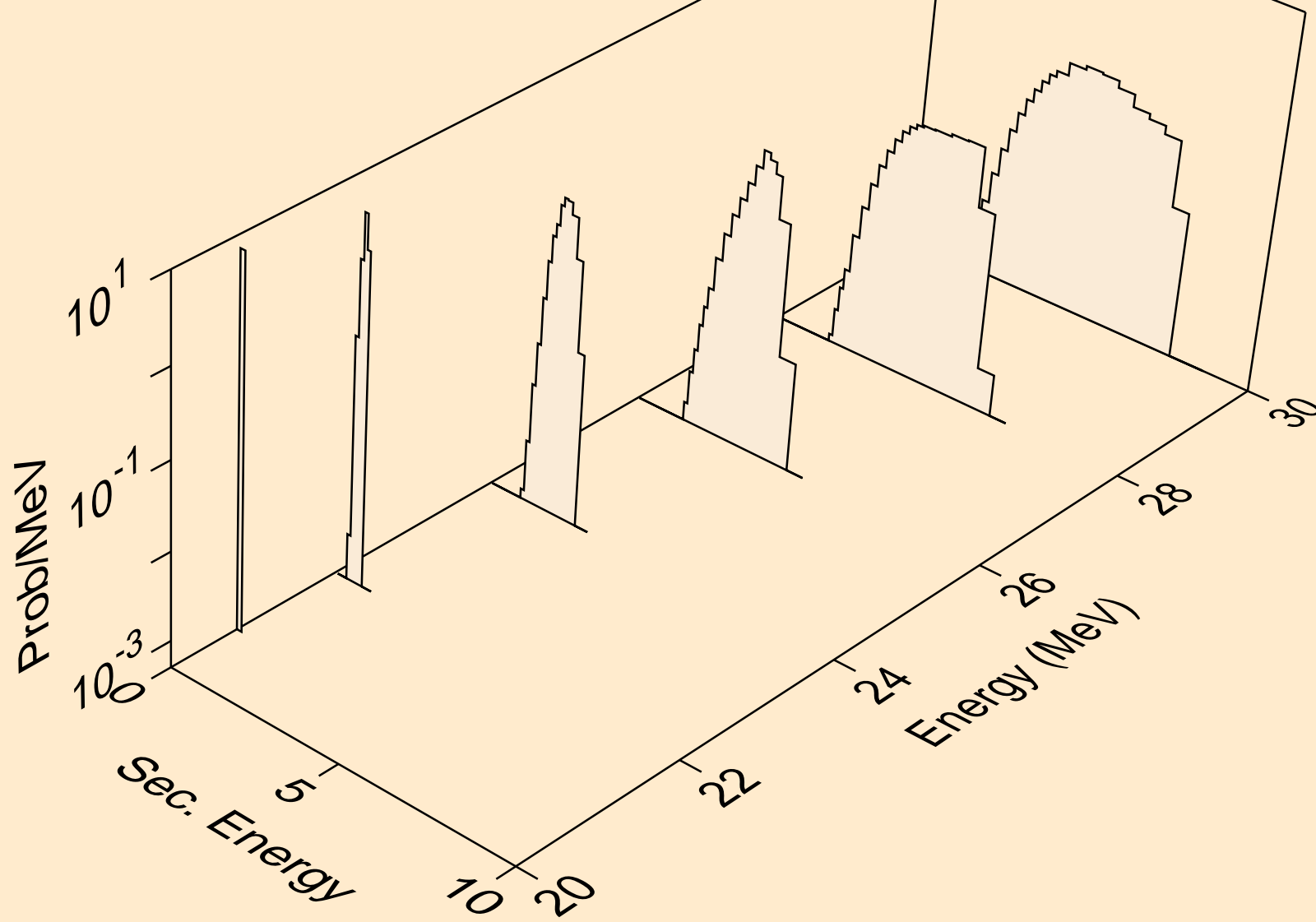

V049 NEUTRON ACER TENDL-2021 LIBRARY; T=293.6K  
he3s from (n,x)

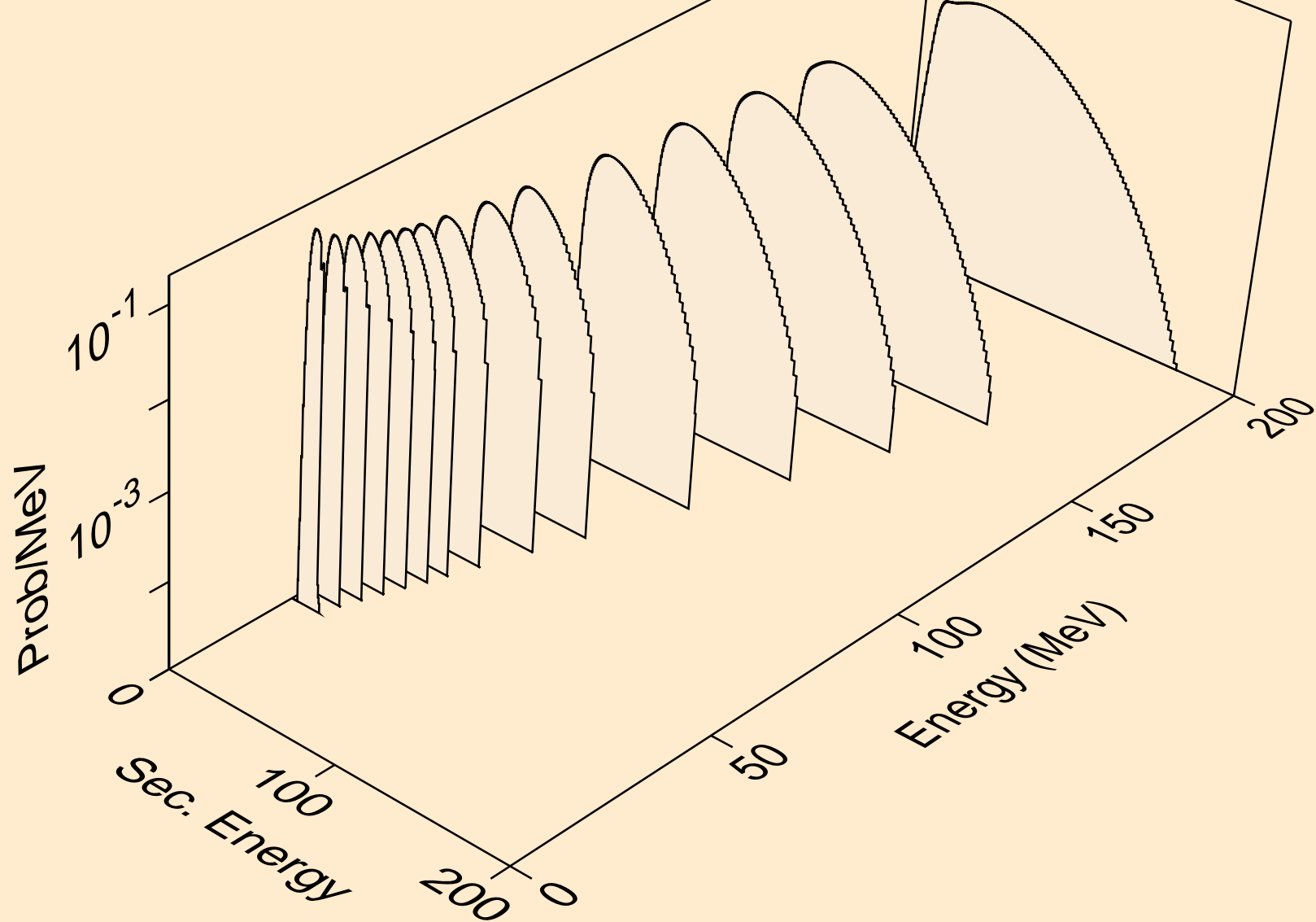



V049 NEUTRON ACER TENDL-2021 LIBRARY; T=293.6K  
he3s from (n,n\*)he3

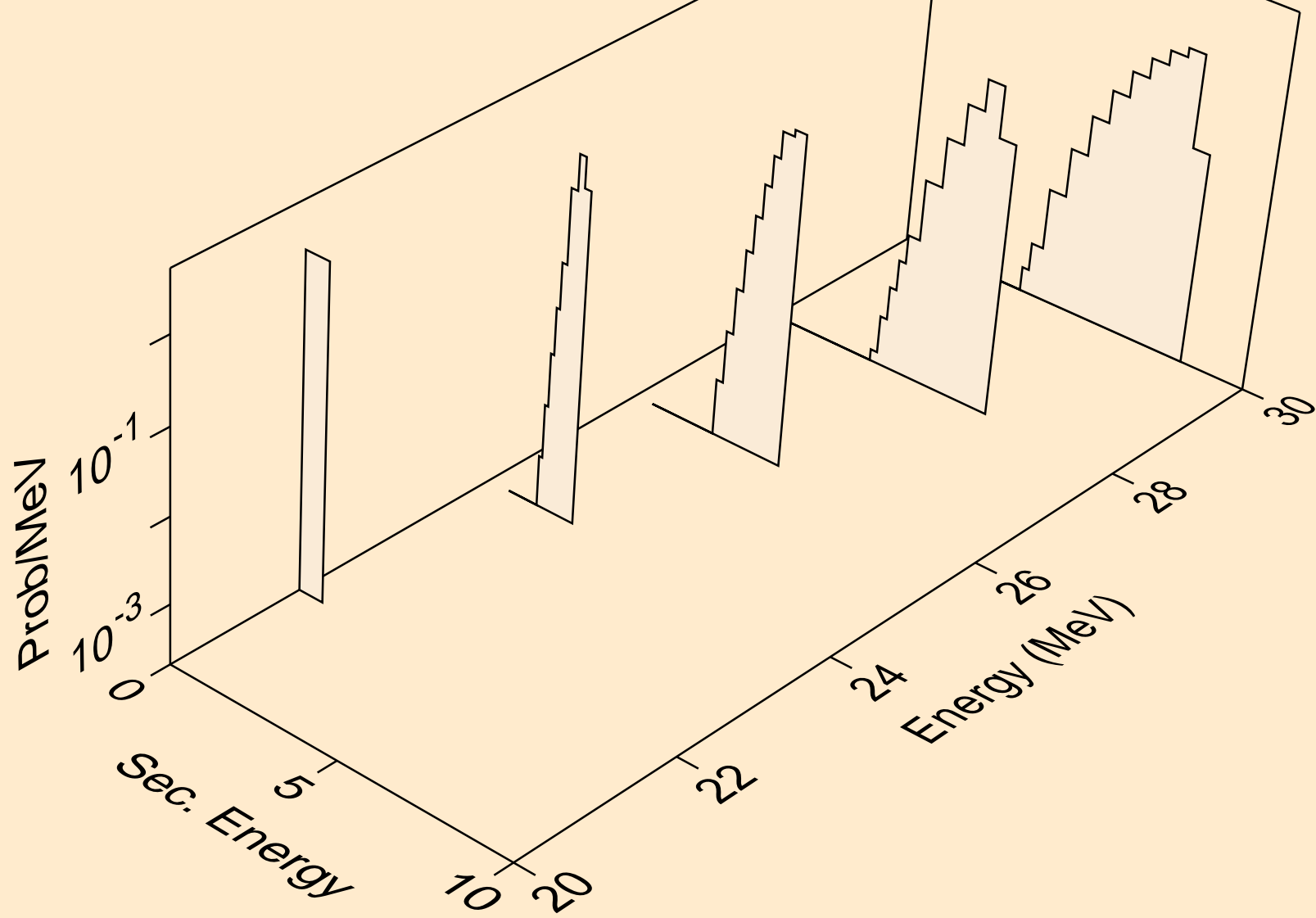

V049 NEUTRON ACER TENDL-2021 LIBRARY; T=293.6K  
he3s from (n,he3)

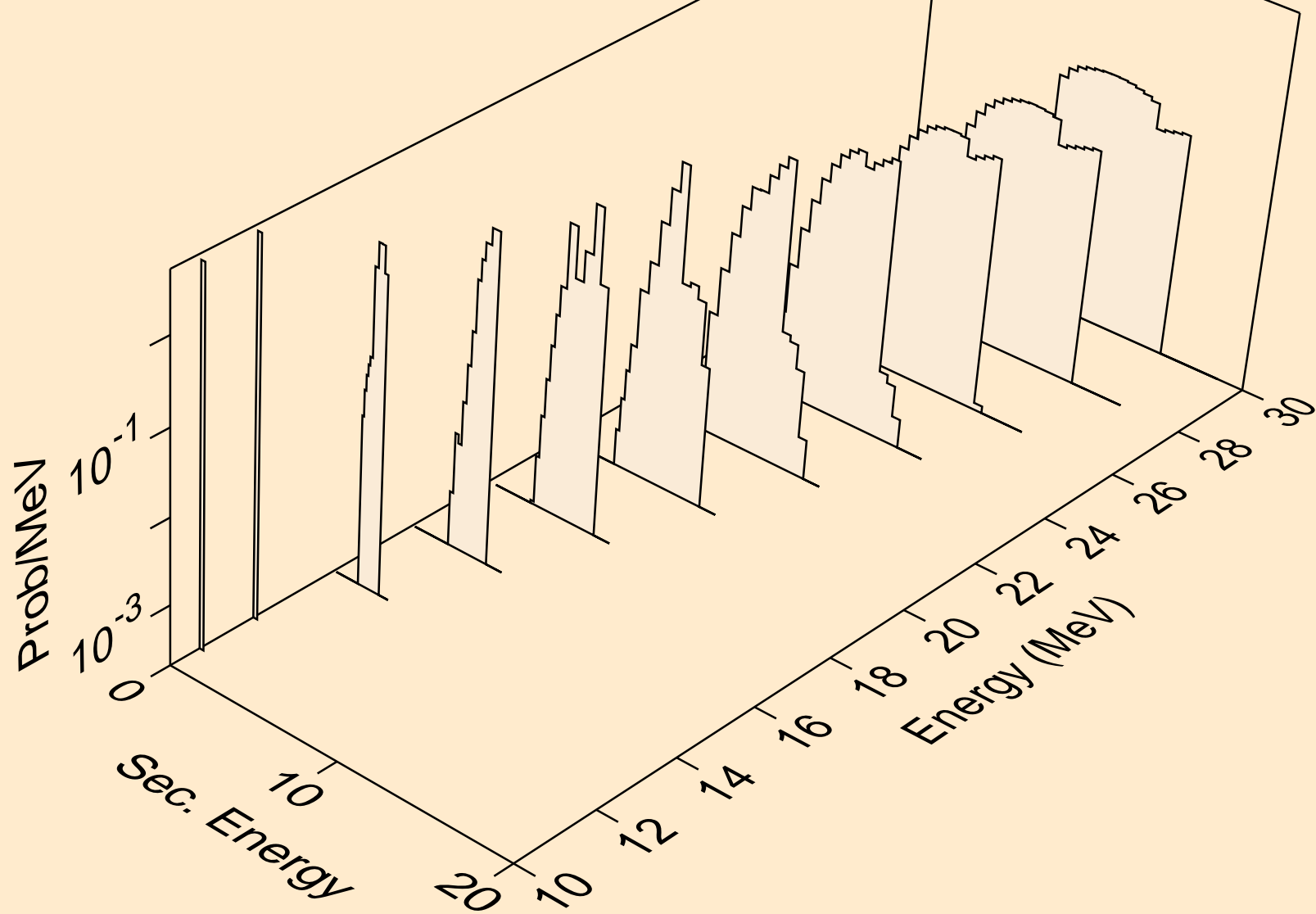

V049 NEUTRON ACER TENDL-2021 LIBRARY; T=293.6K  
alphas from (n,x)

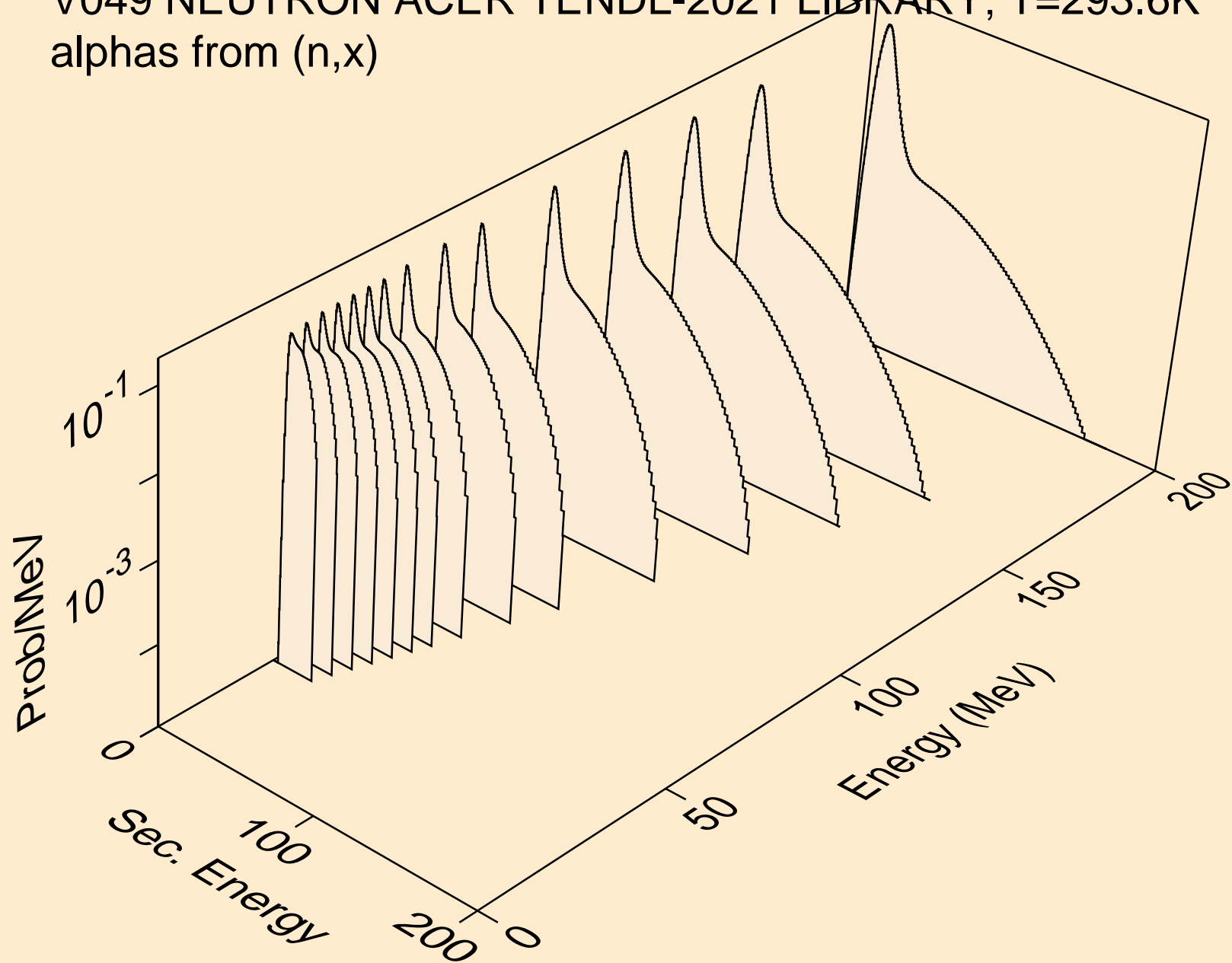

V049 NEUTRON ACER TENDL-2021 LIBRARY; T=293.6K  
alphas from (n,n\*)a

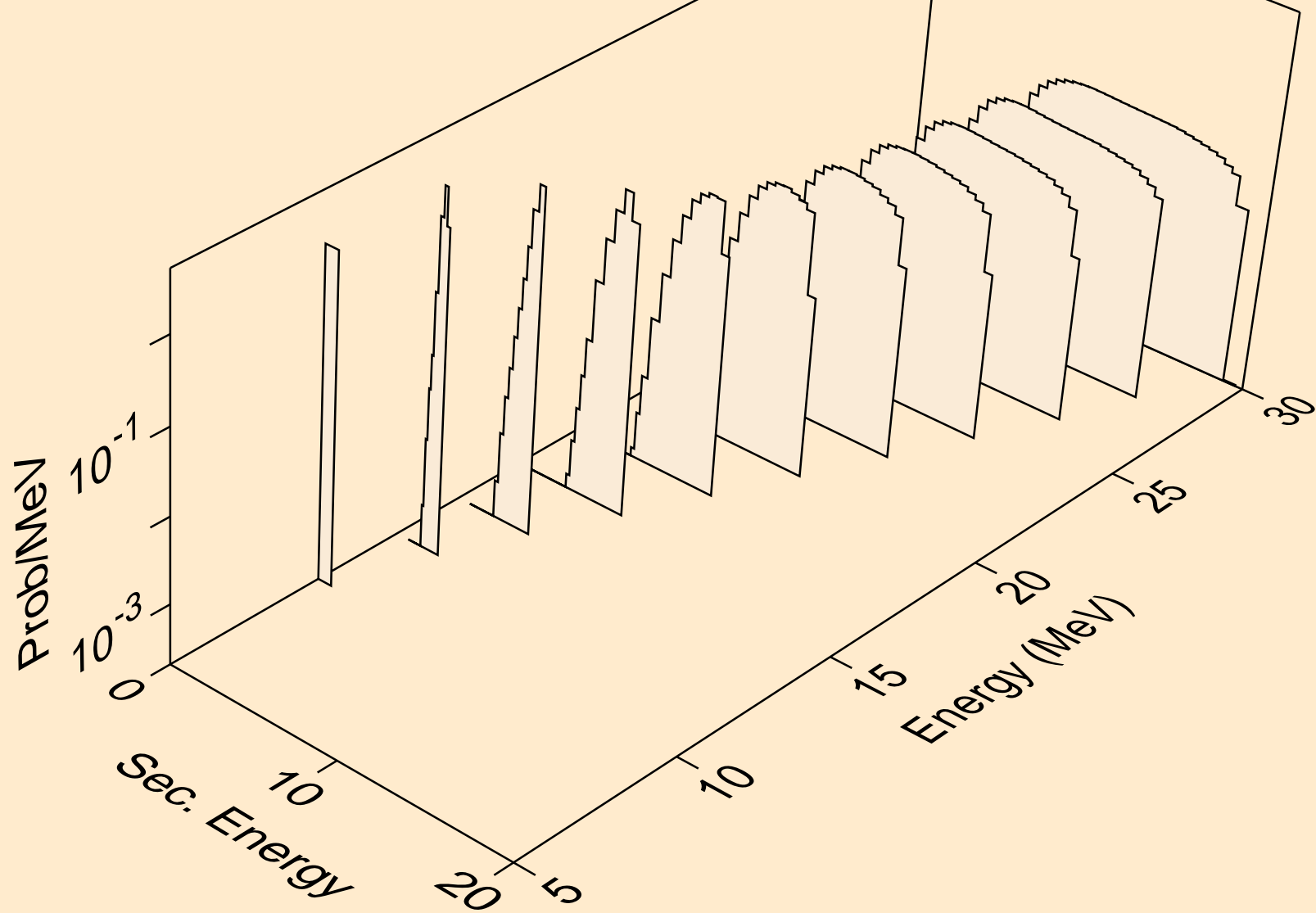

V049 NEUTRON ACER TENDL-2021 LIBRARY; T=293.6K  
alphas from (n,2n)a

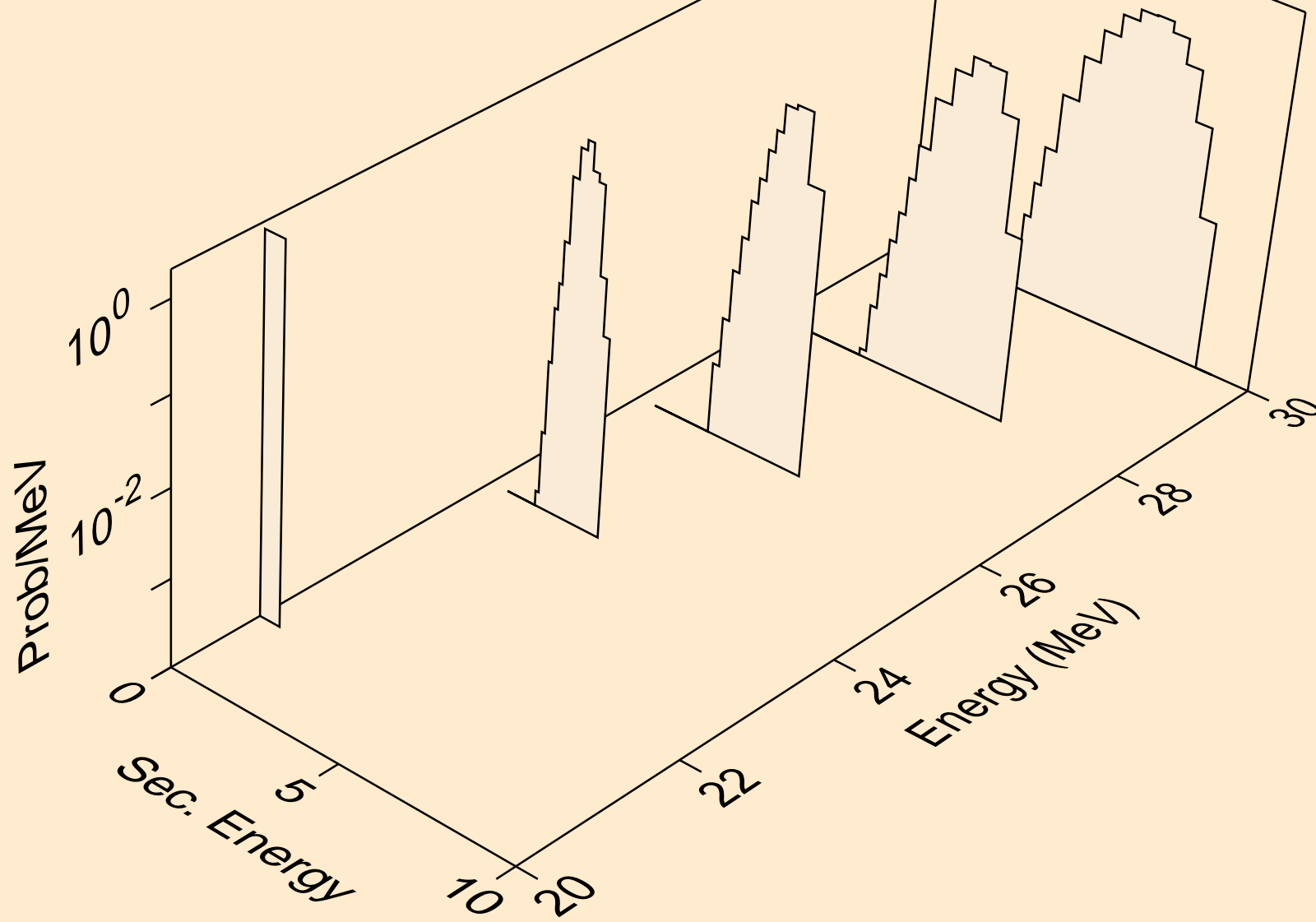

V049 NEUTRON ACER TENDL-2021 LIBRARY; T=293.6K  
alphas from (n,n\*)2a

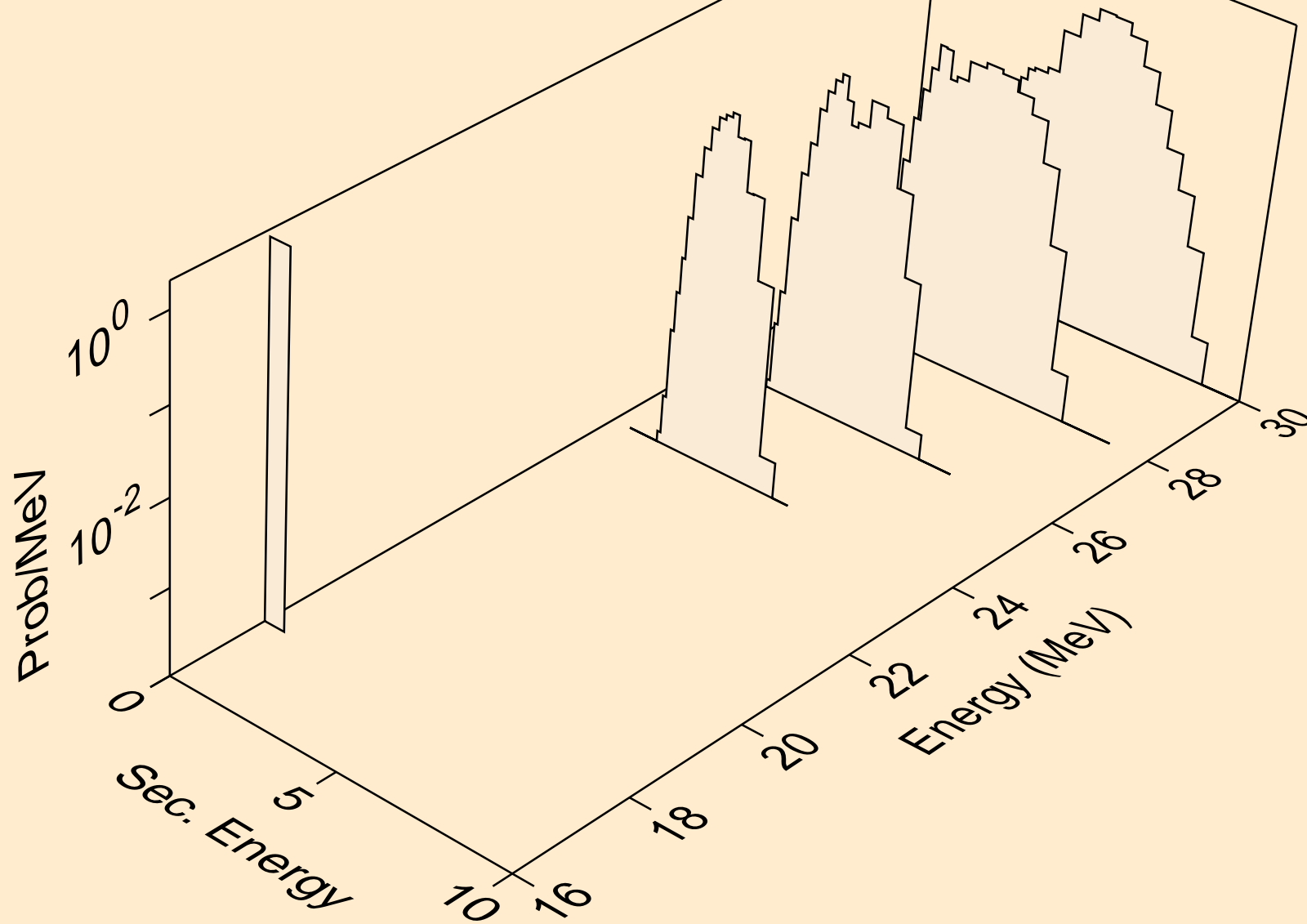

V049 NEUTRON ACER TENDL-2021 LIBRARY; T=293.6K  
alphas from (n,npa)

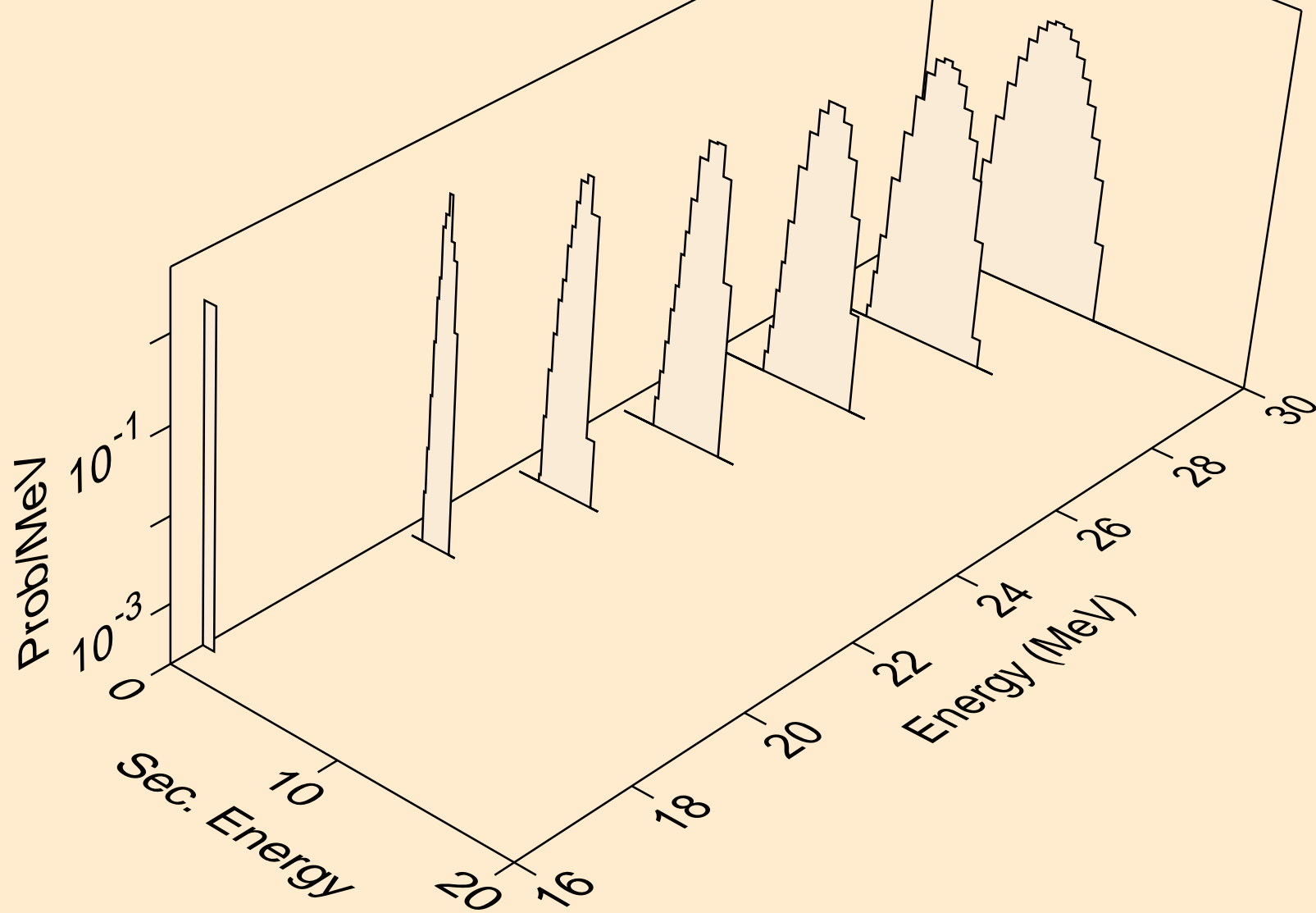

V049 NEUTRON ACER TENDL-2021 LIBRARY; T=293.6K  
alphas from (n,a)

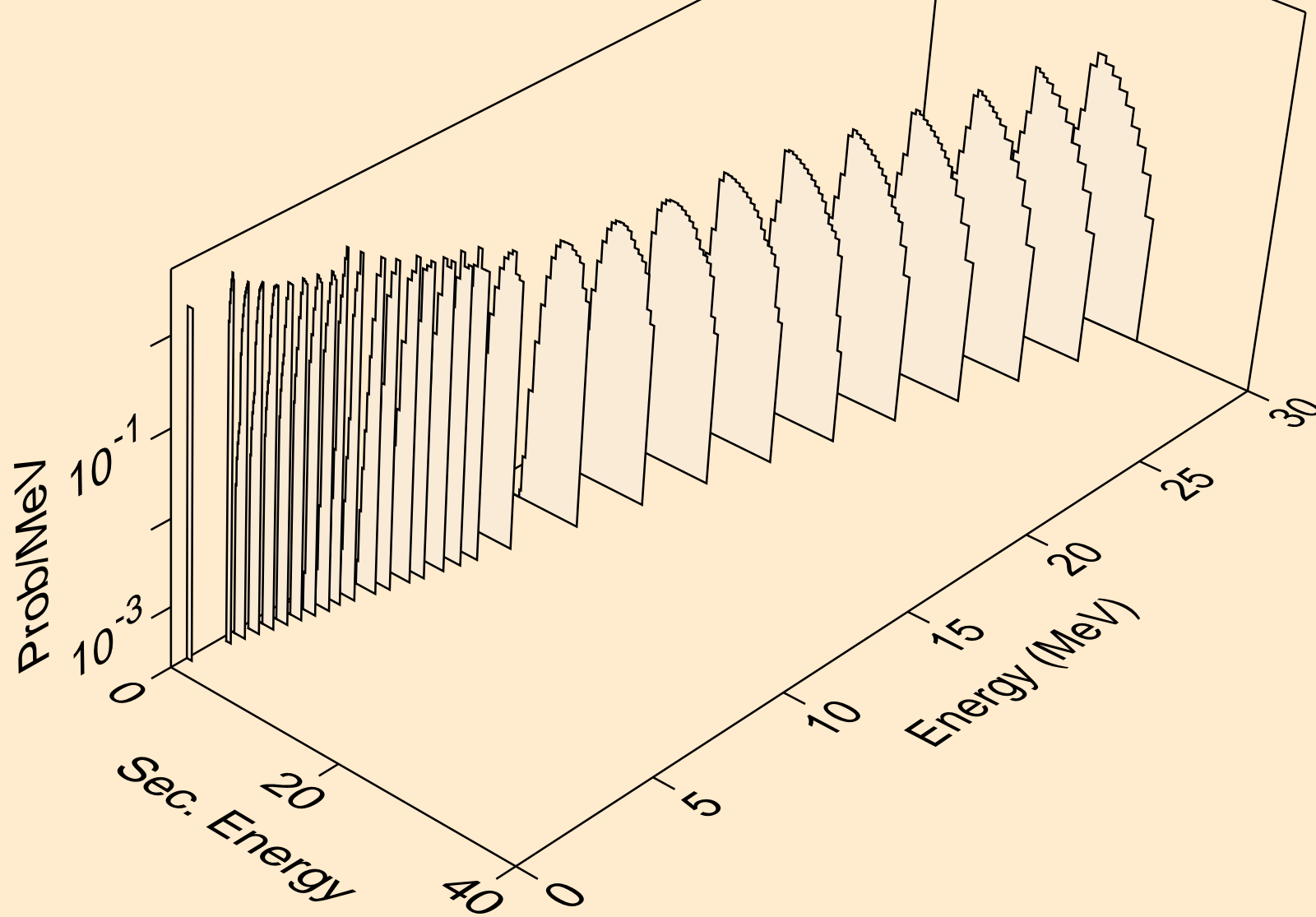



V049 NEUTRON ACER TENDL-2021 LIBRARY; T=293.6K  
alphas from (n,2a)

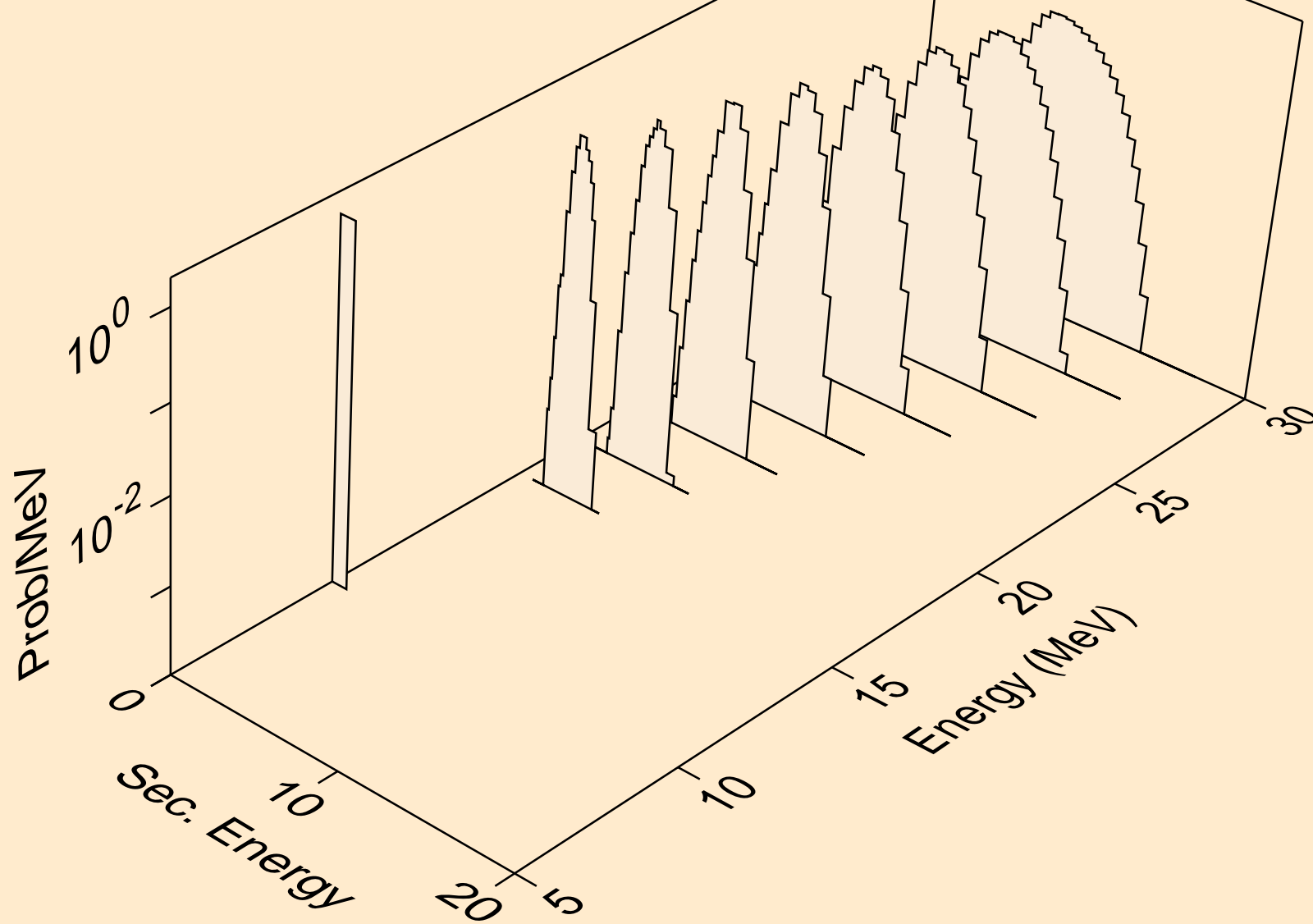

V049 NEUTRON ACER TENDL-2021 LIBRARY; T=293.6K  
alphas from (n,pa)

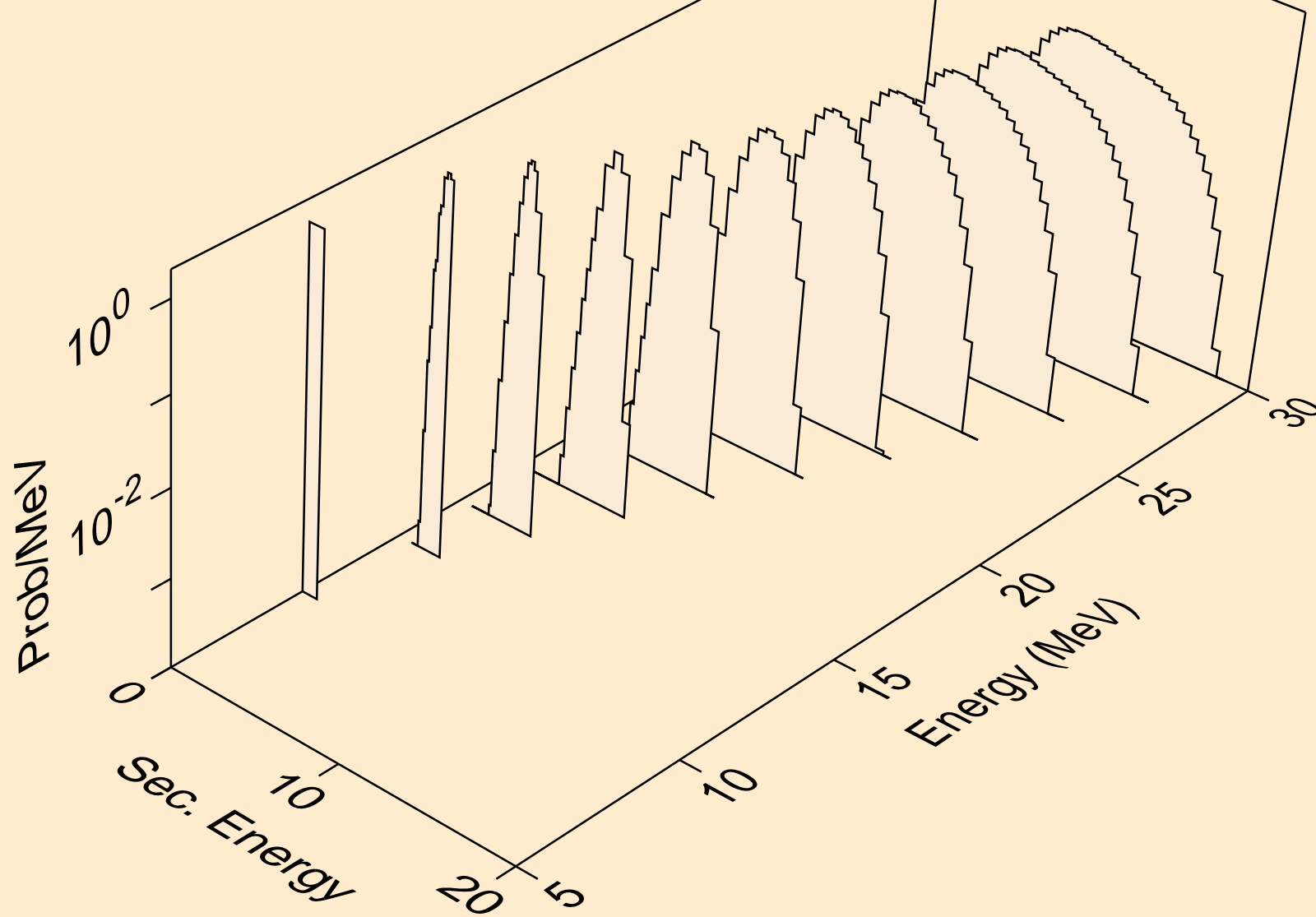

V049 NEUTRON ACER TENDL-2021 LIBRARY; T=293.6K  
alphas from (n,da)

