

W163 NEUTRON ACER TENDL-2021 LIBRARY; T=293.6K

Principal cross sections

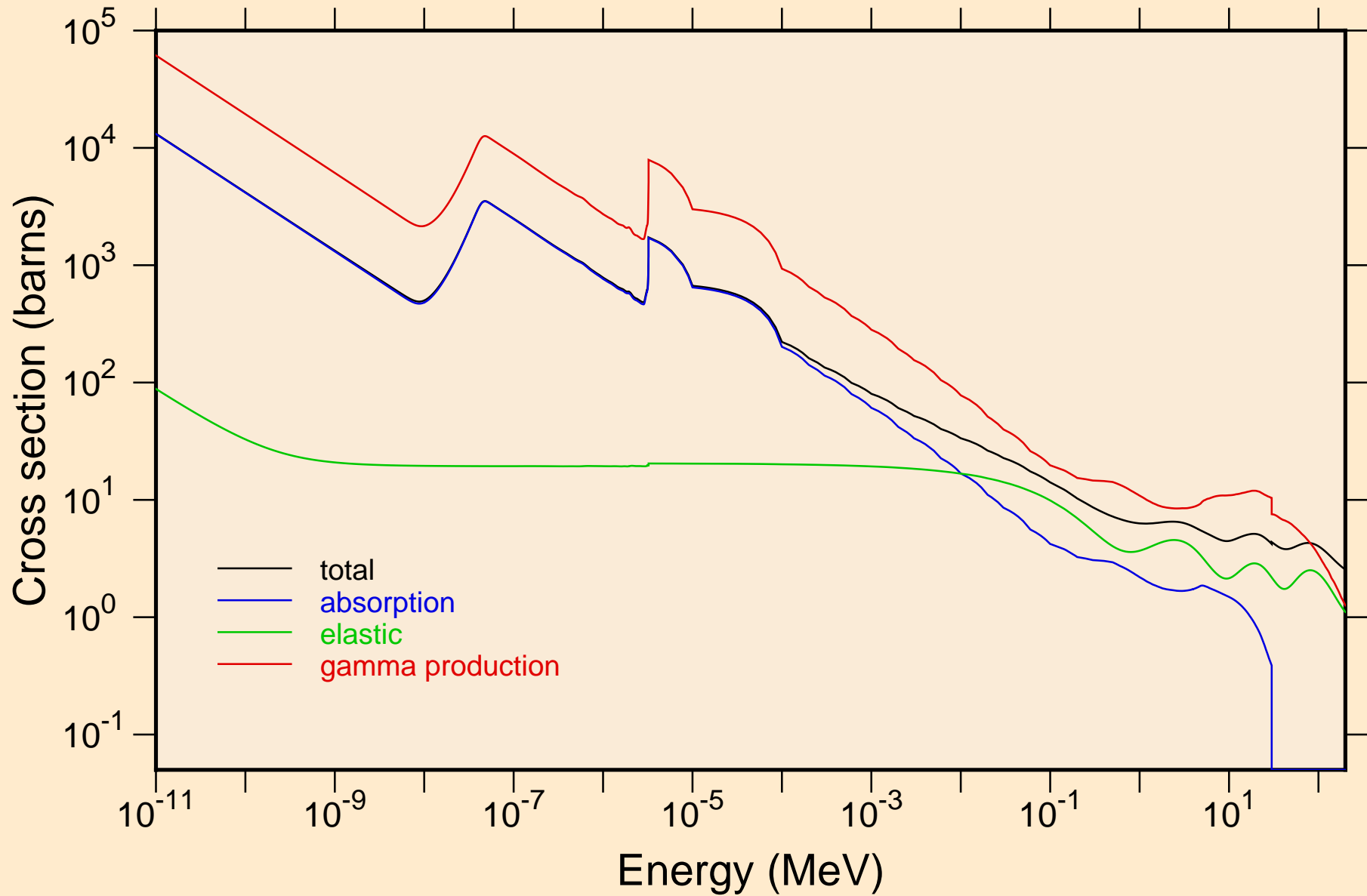

W163 NEUTRON ACER TENDL-2021 LIBRARY; T=293.6K

Heating

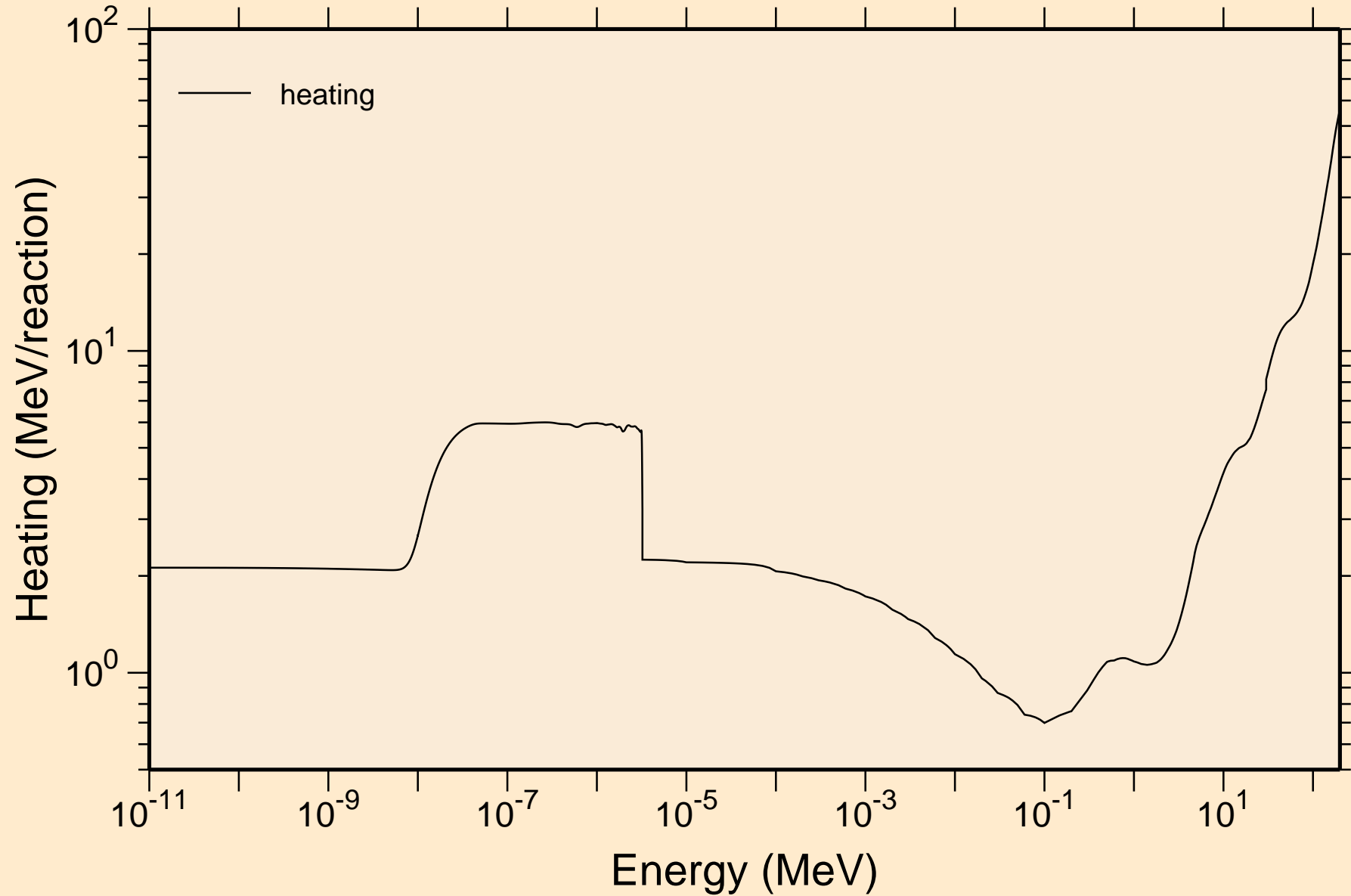

W163 NEUTRON ACER TENDL-2021 LIBRARY; T=293.6K
Damage

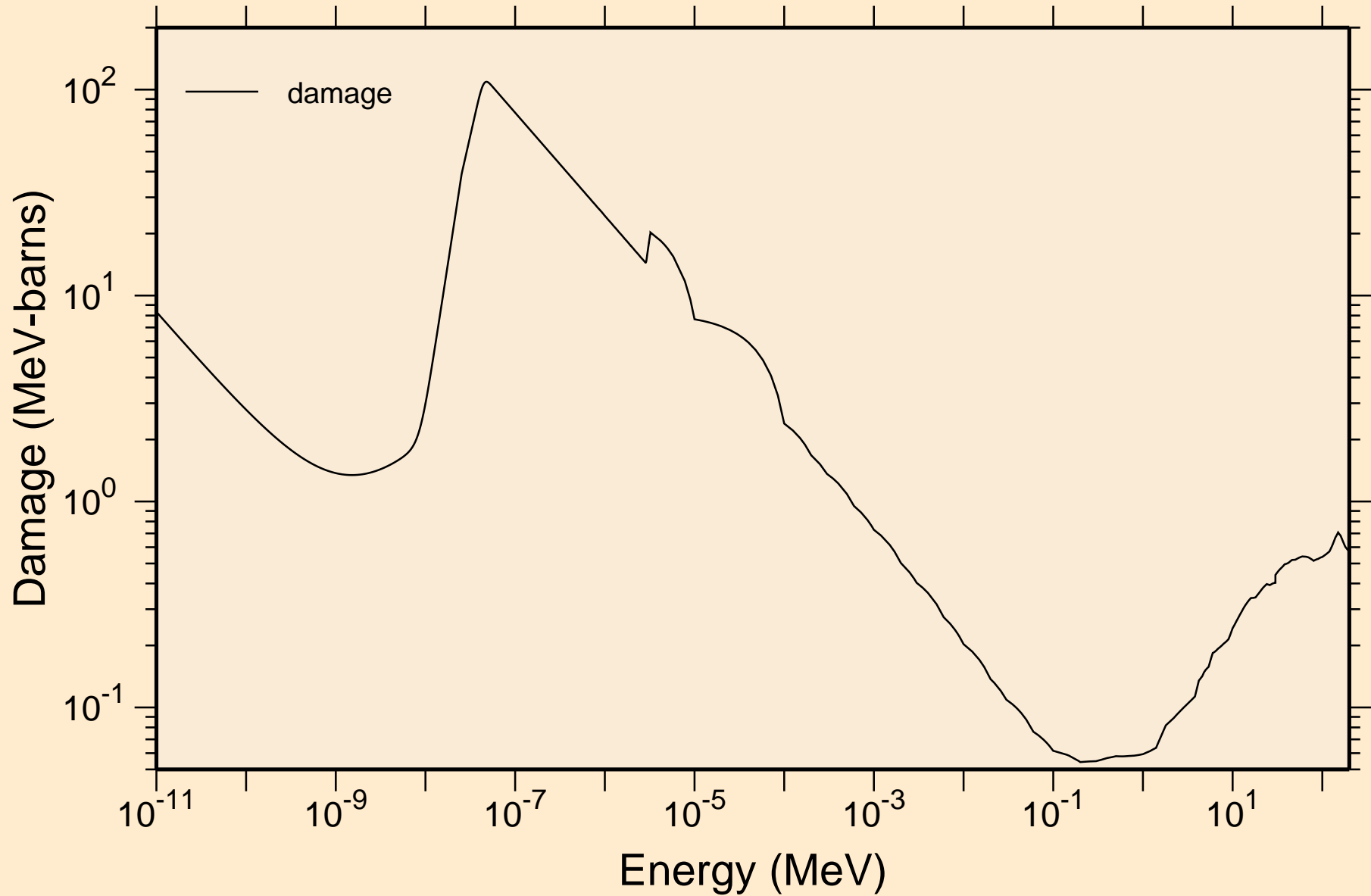

W163 NEUTRON ACER TENDL-2021 LIBRARY; T=293.6K
Non-threshold reactions

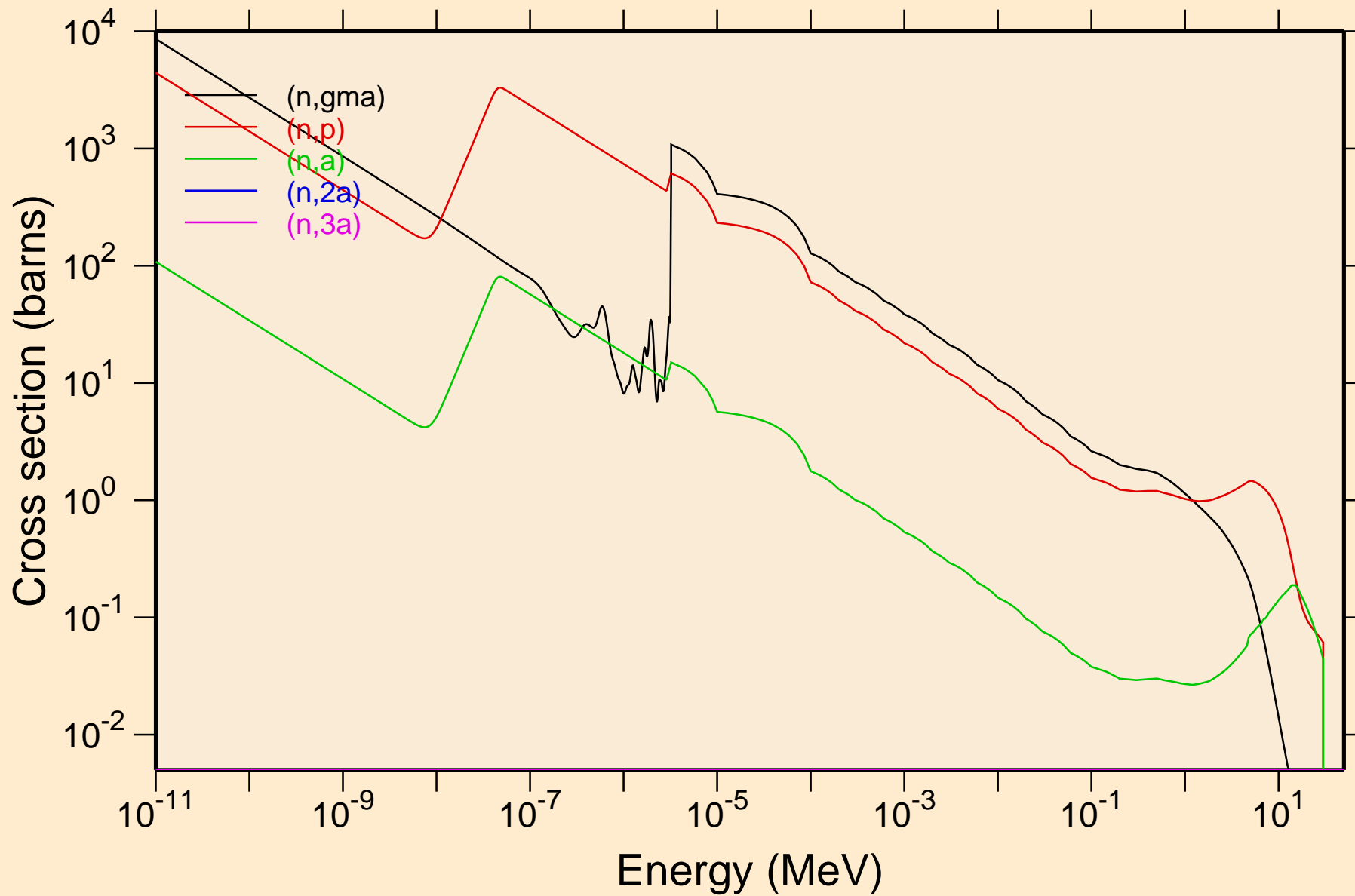

W163 NEUTRON ACER TENDL-2021 LIBRARY; T=293.6K
Non-threshold reactions

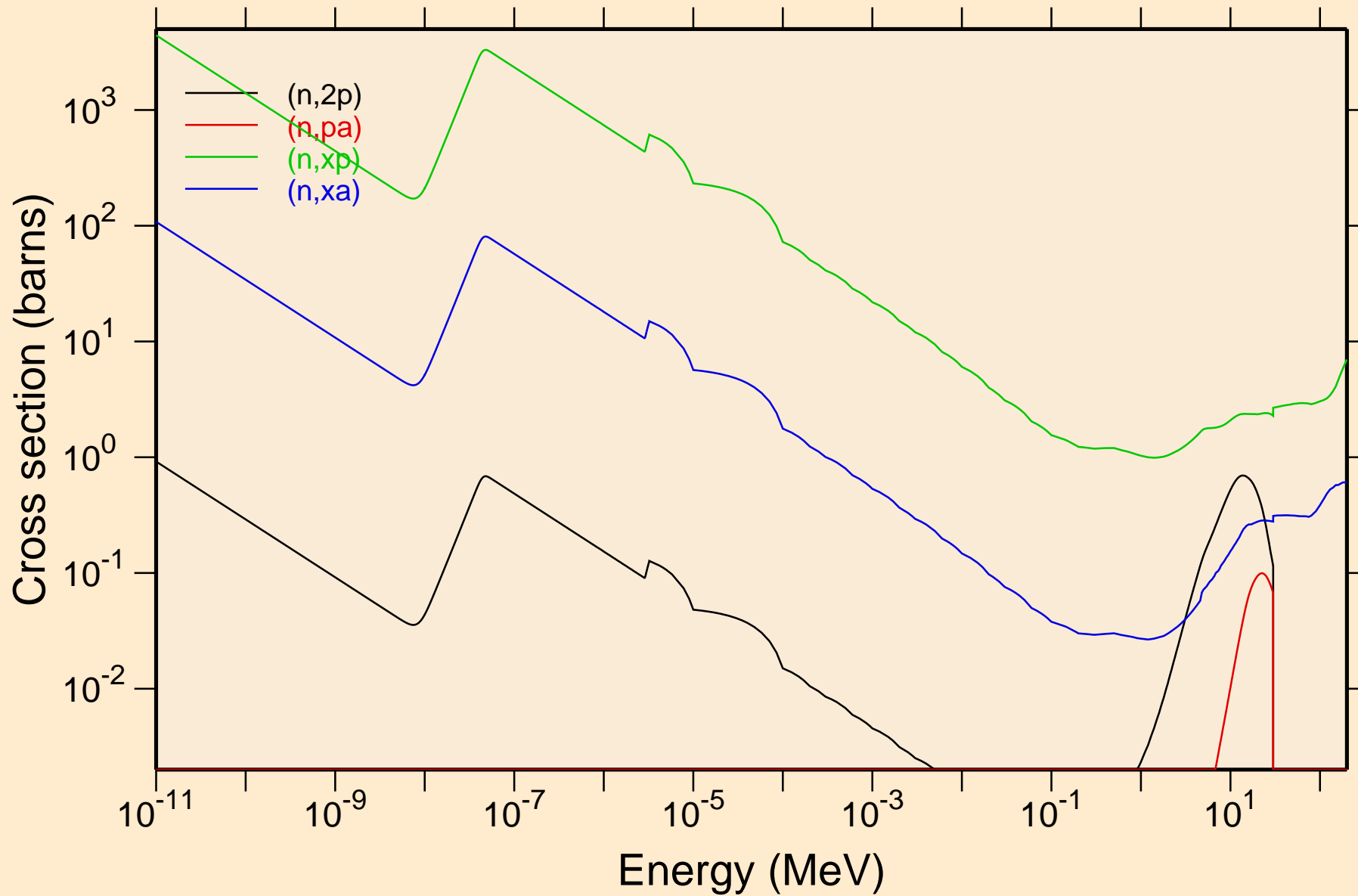

W163 NEUTRON ACER TENDL-2021 LIBRARY; T=293.6K
Principal cross sections

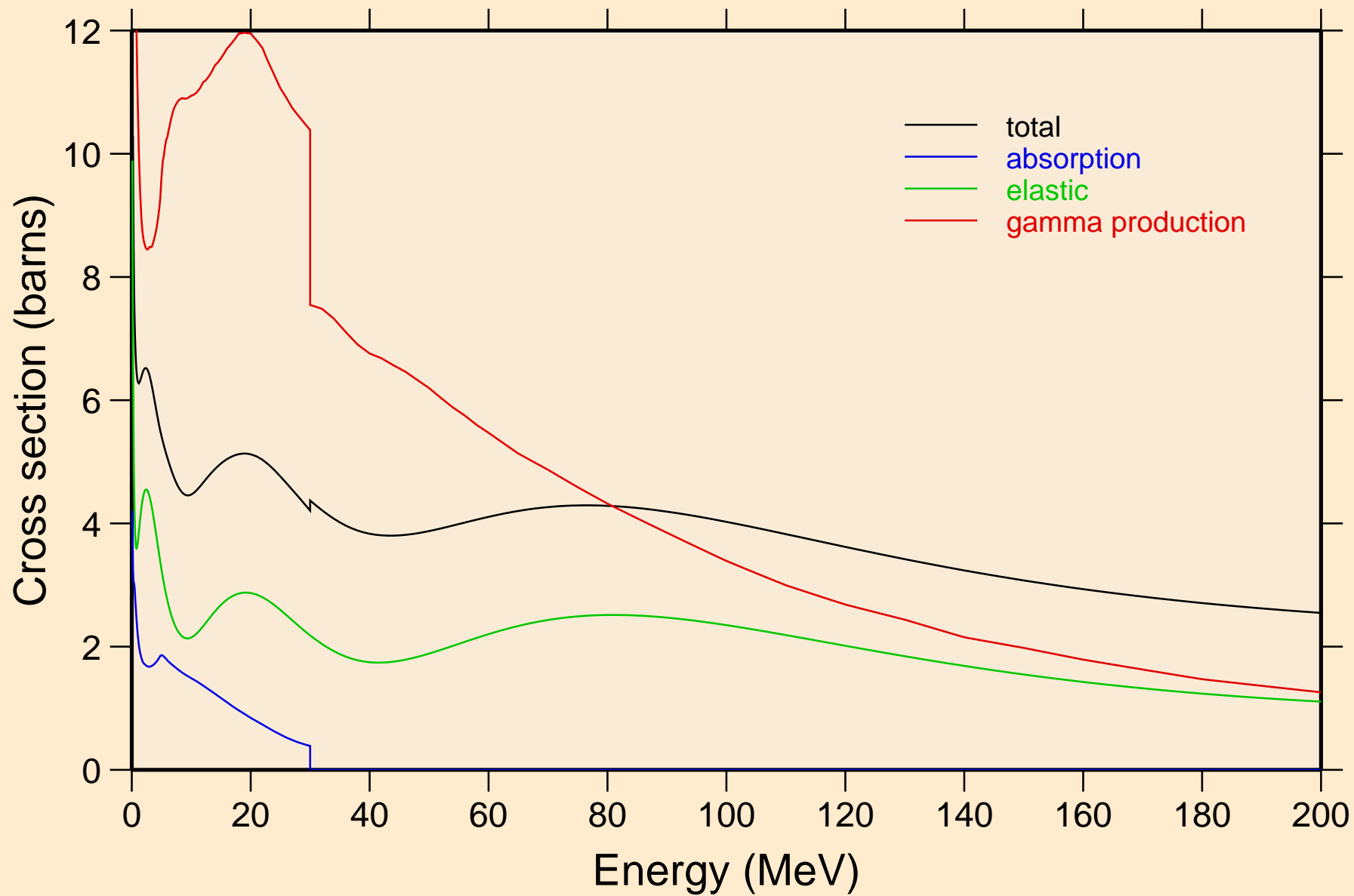

W163 NEUTRON ACER TENDL-2021 LIBRARY; T=293.6K

Heating

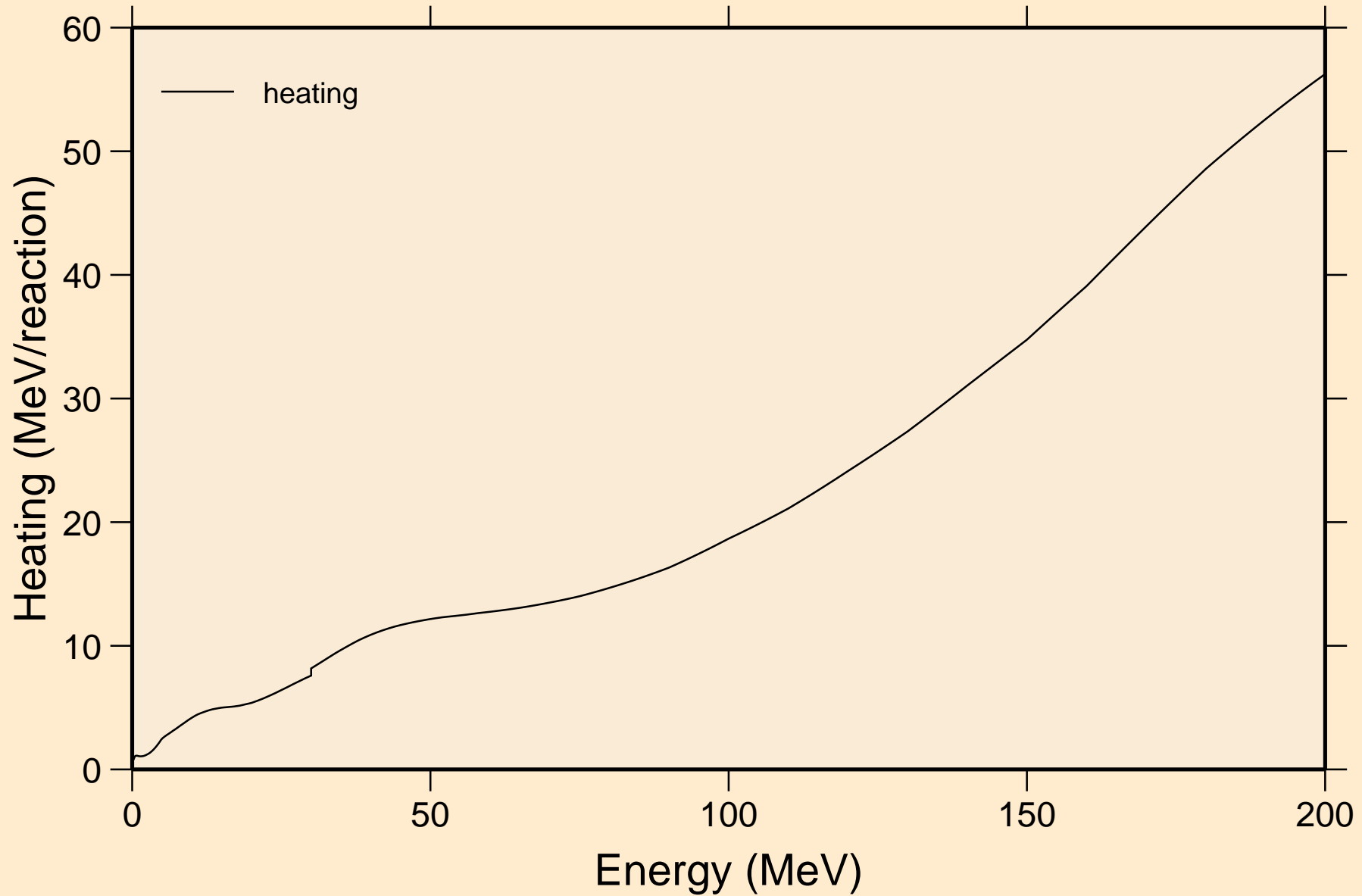

W163 NEUTRON ACER TENDL-2021 LIBRARY; T=293.6K
Damage

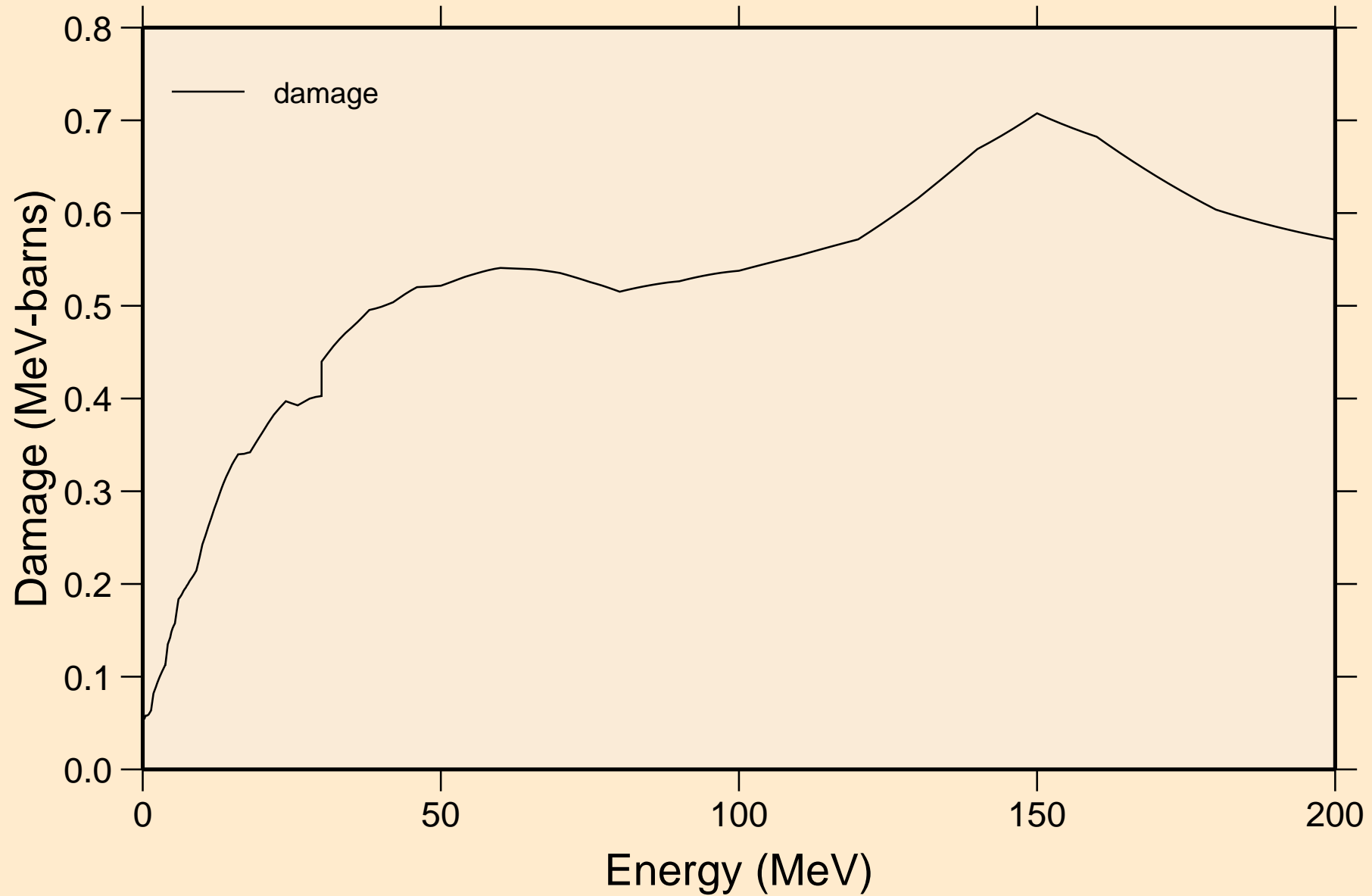

W163 NEUTRON ACER TENDL-2021 LIBRARY; T=293.6K
Non-threshold reactions

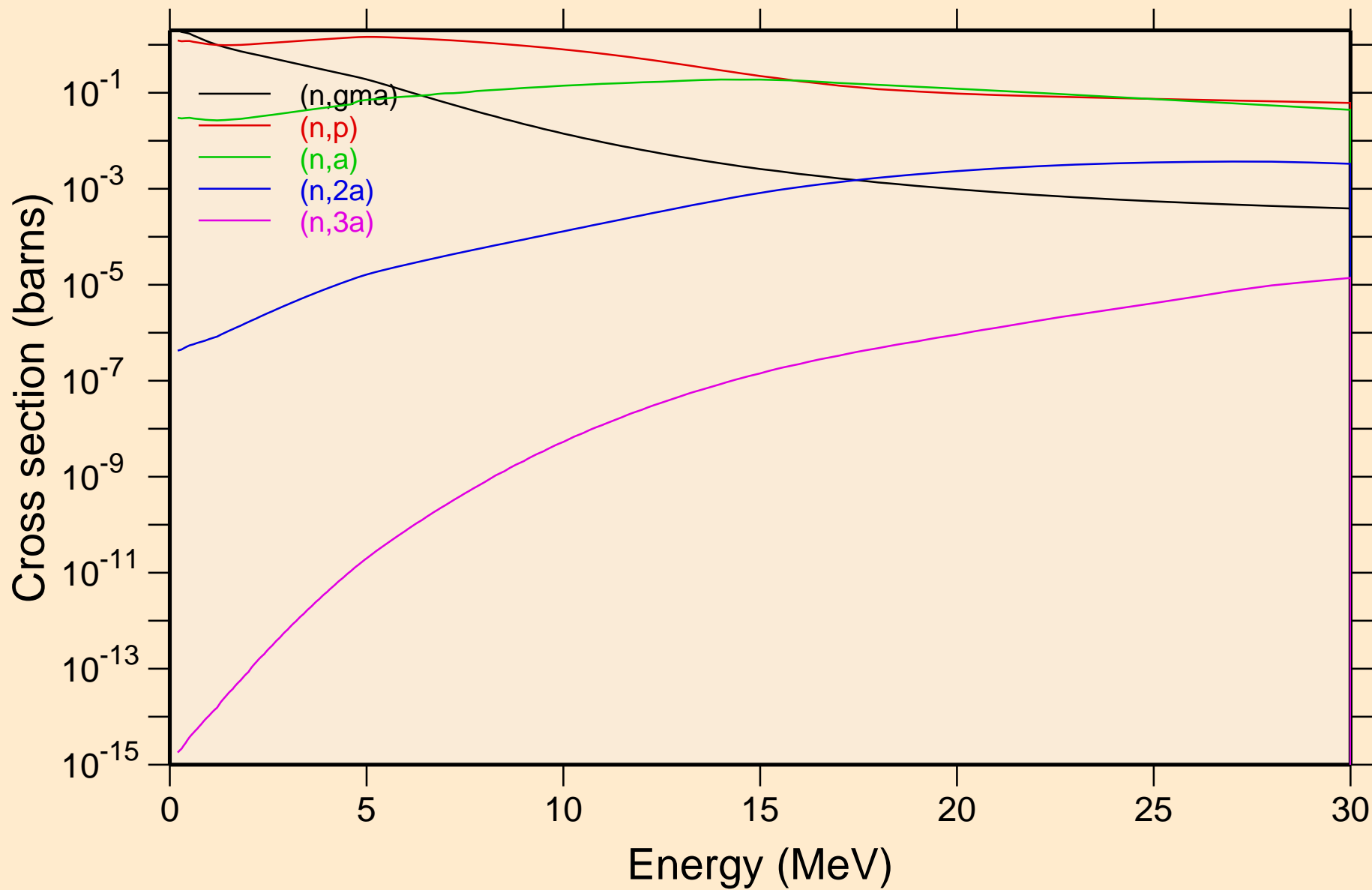

W163 NEUTRON ACER TENDL-2021 LIBRARY; T=293.6K
Non-threshold reactions

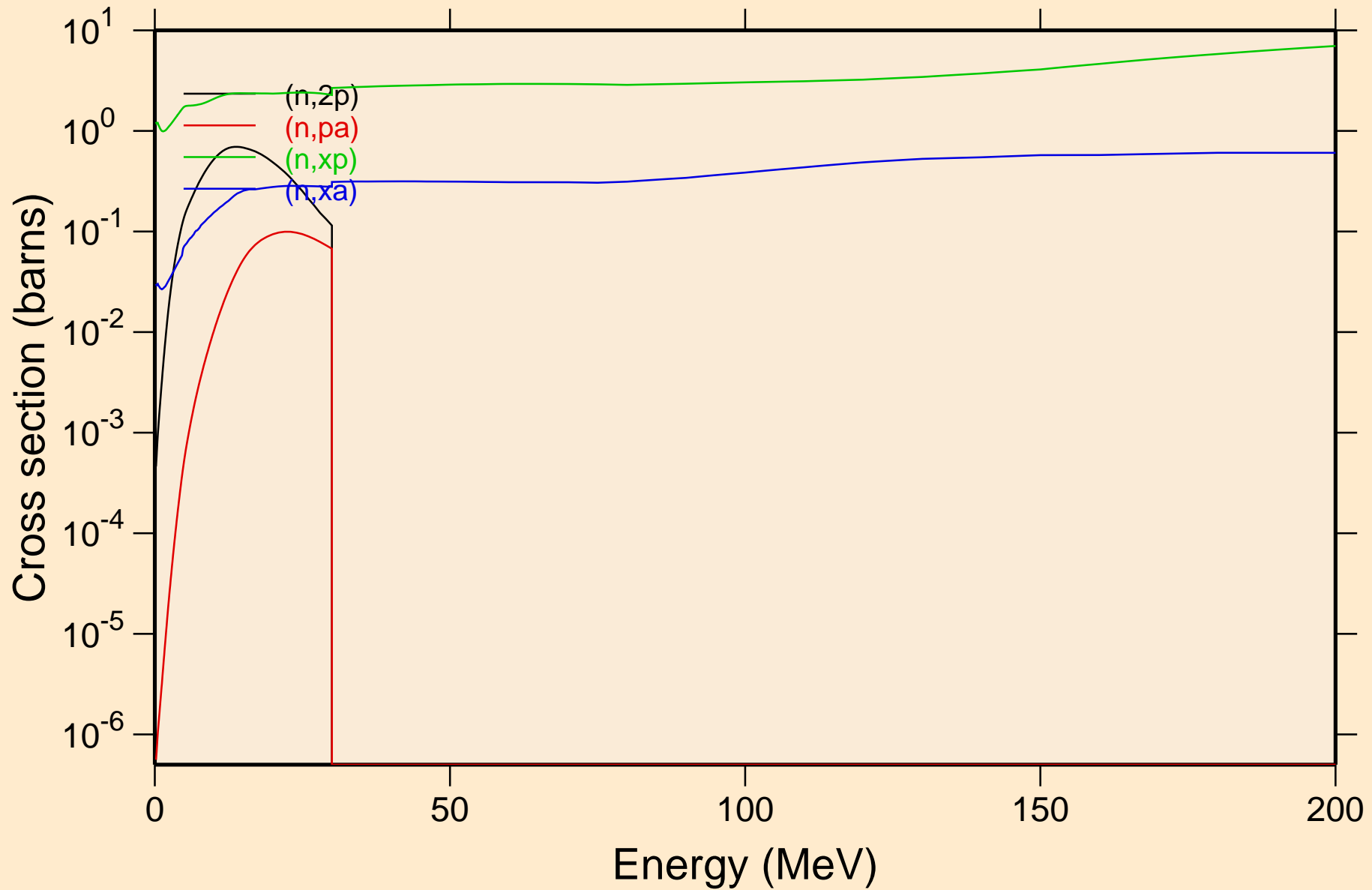

W163 NEUTRON ACER TENDL-2021 LIBRARY; T=293.6K
Inelastic levels

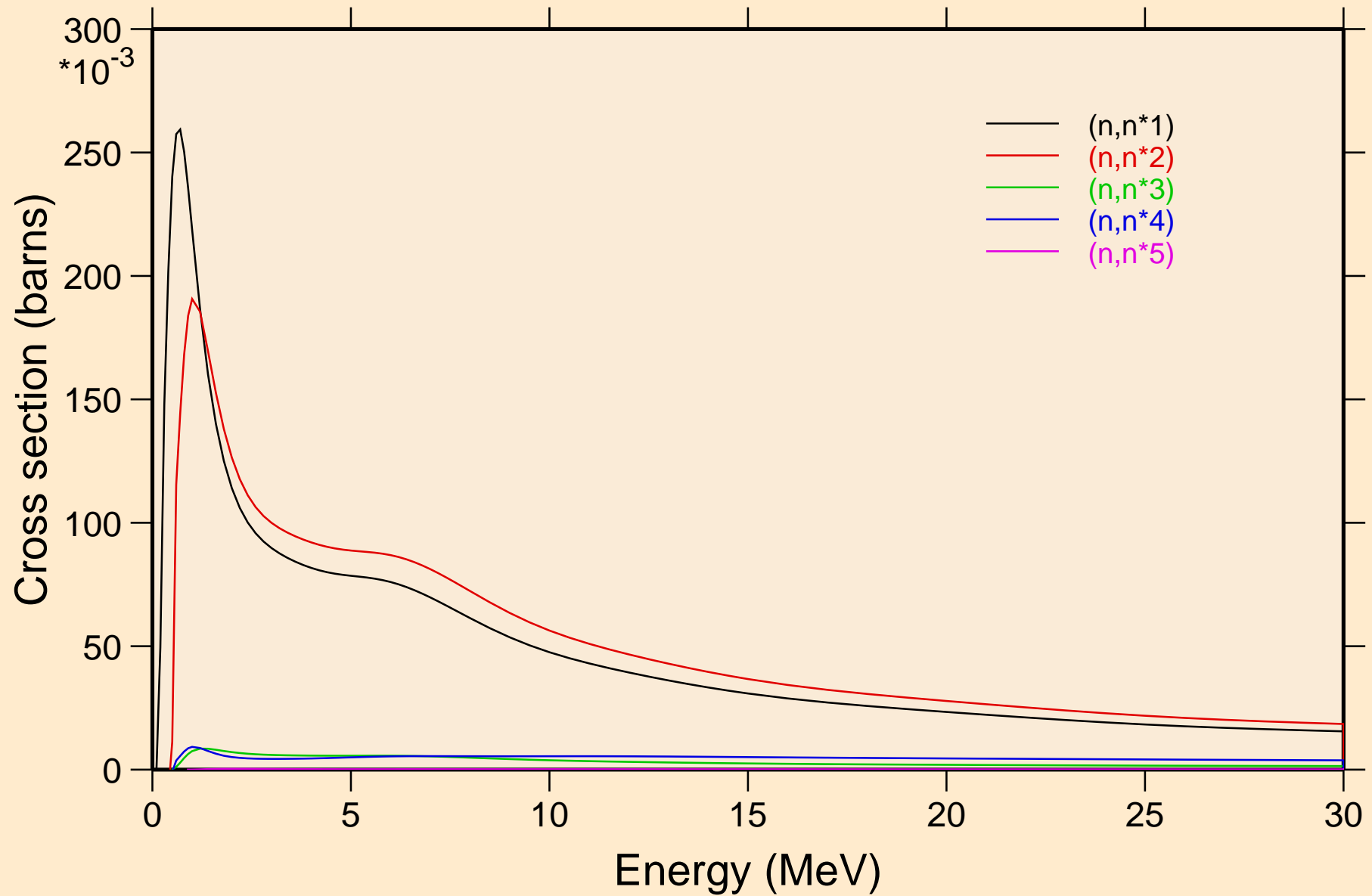

W163 NEUTRON ACER TENDL-2021 LIBRARY; T=293.6K
Inelastic levels

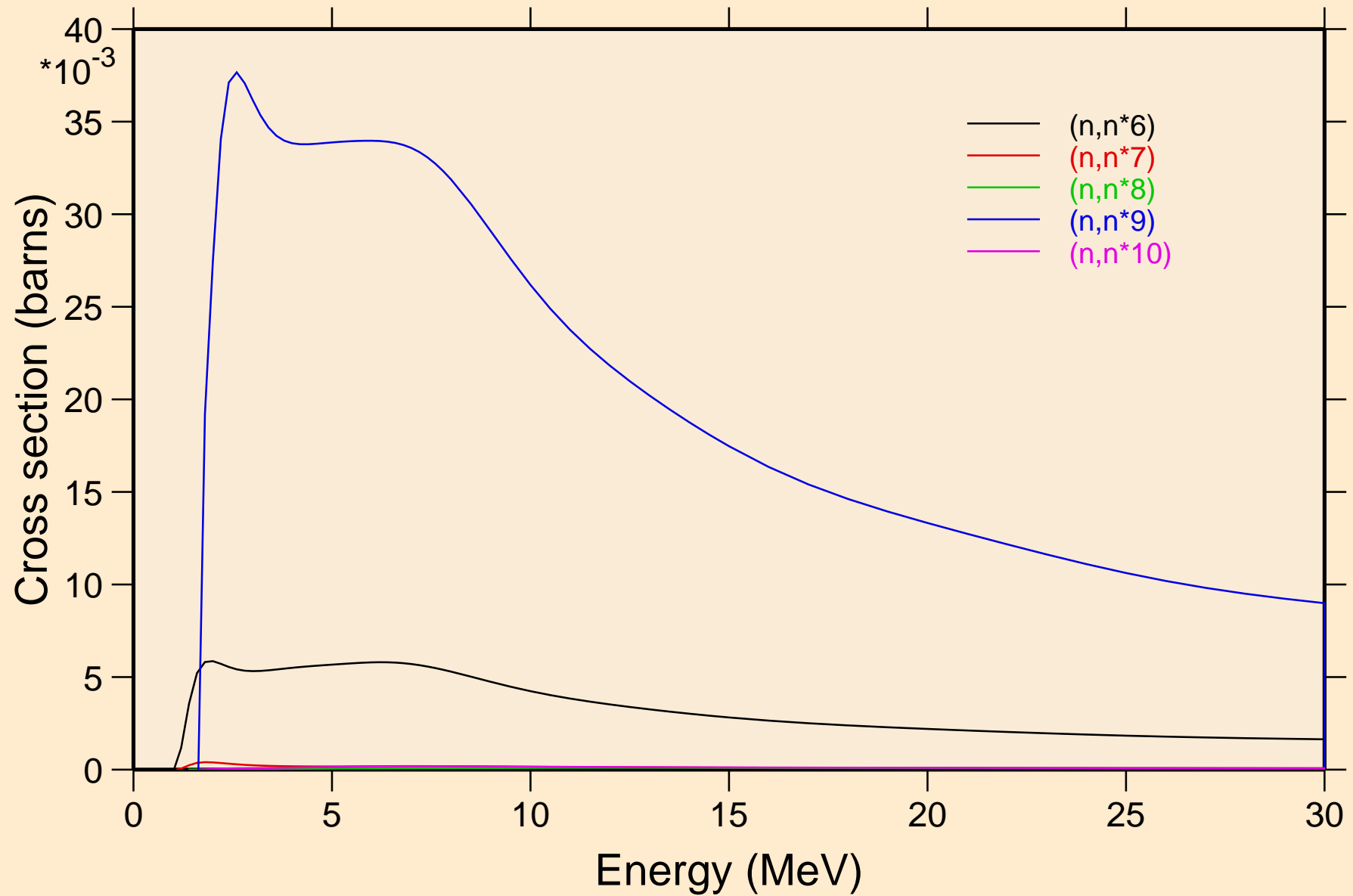

W163 NEUTRON ACER TENDL-2021 LIBRARY; T=293.6K
Inelastic levels

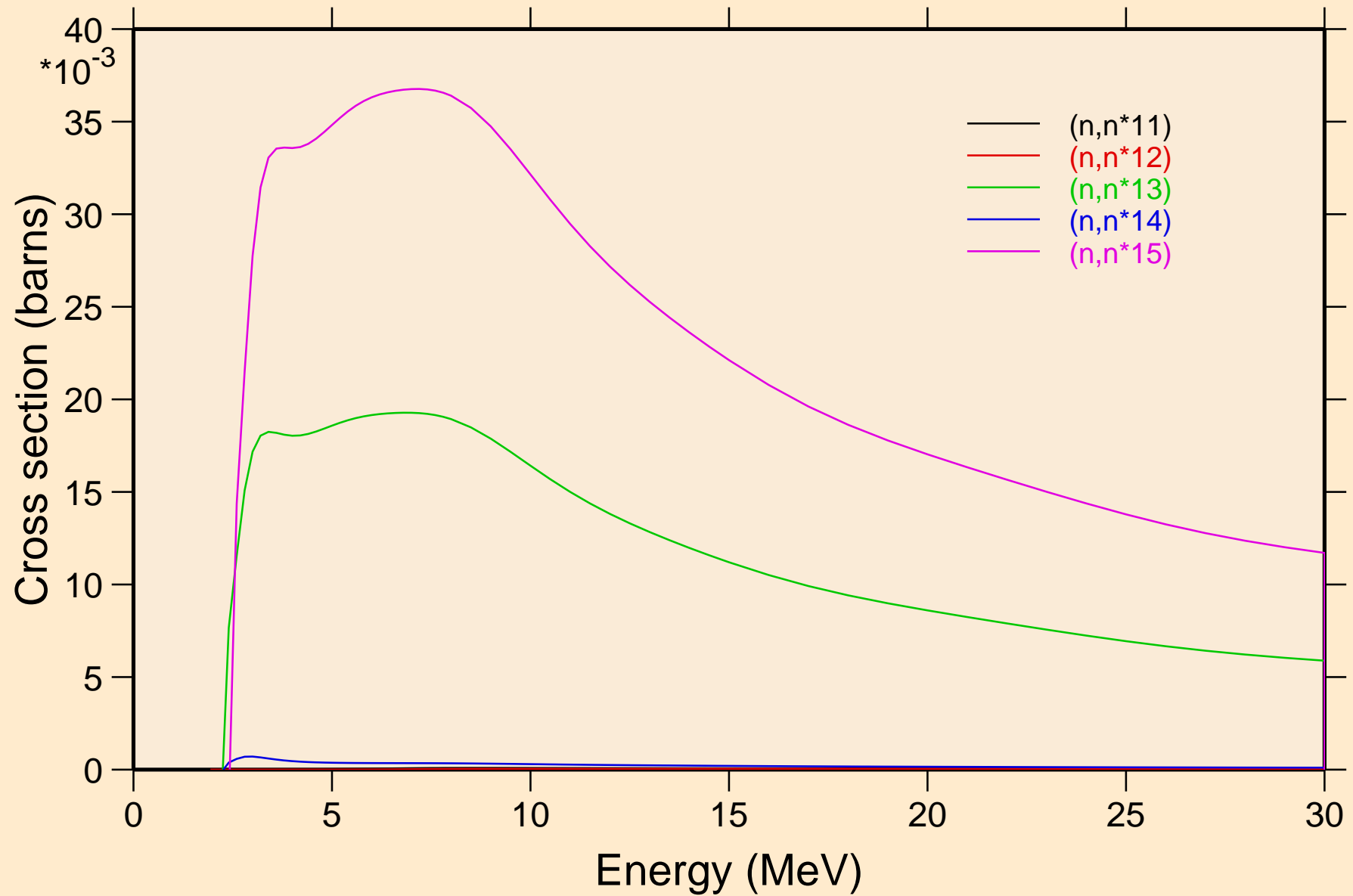

W163 NEUTRON ACER TENDL-2021 LIBRARY; T=293.6K
Threshold reactions

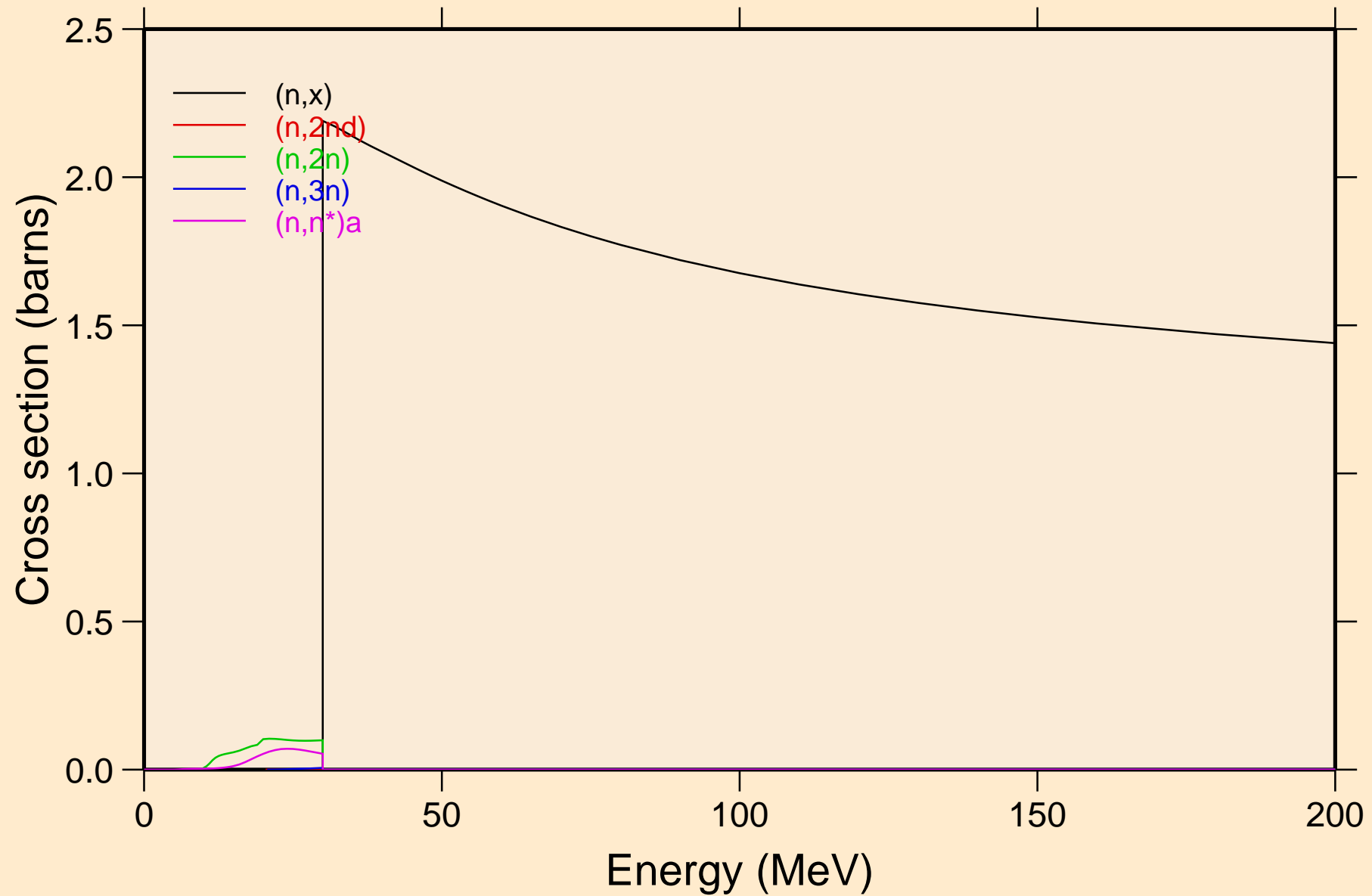

W163 NEUTRON ACER TENDL-2021 LIBRARY; T=293.6K
Threshold reactions

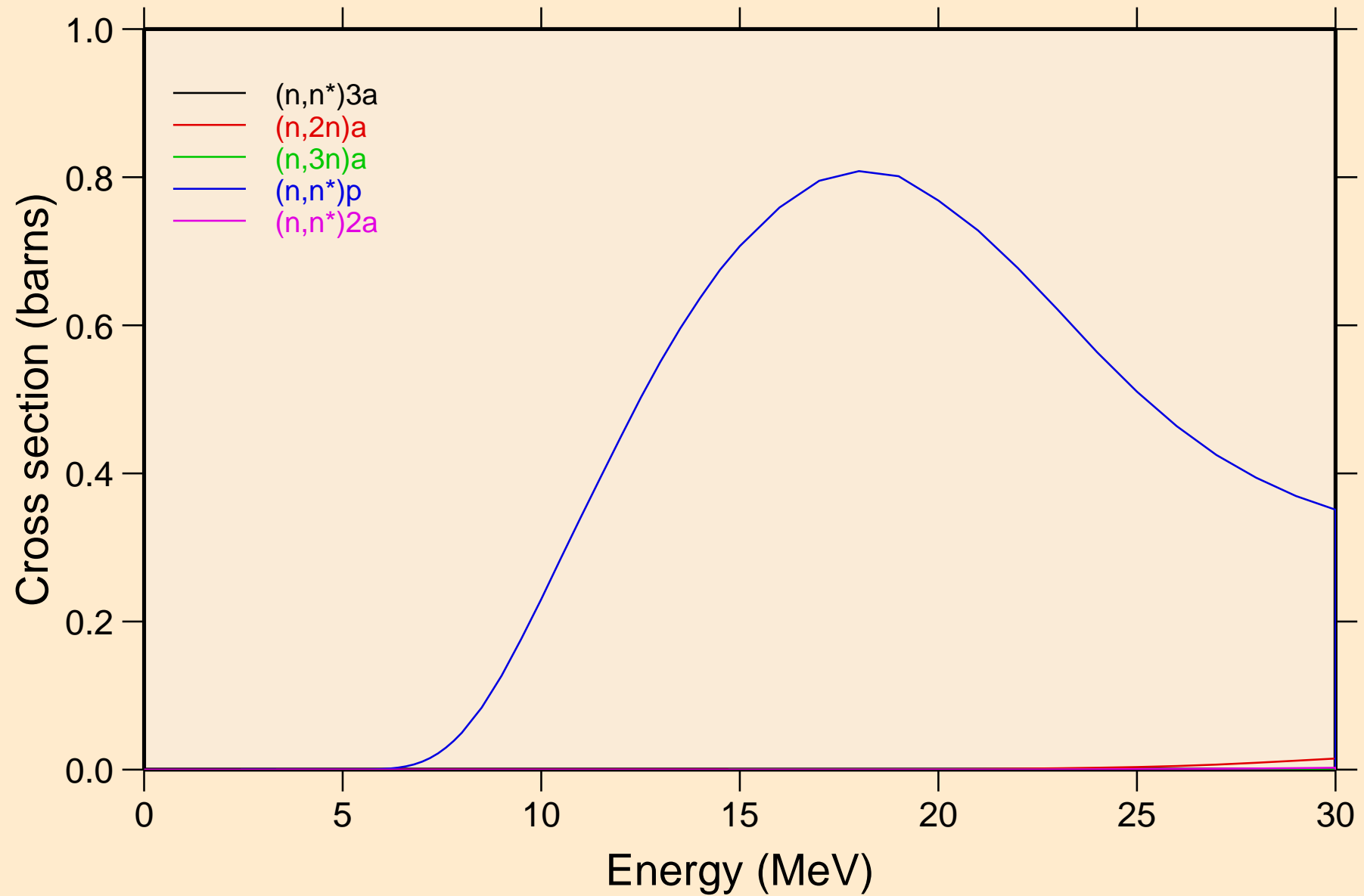

W163 NEUTRON ACER TENDL-2021 LIBRARY; T=293.6K
Threshold reactions

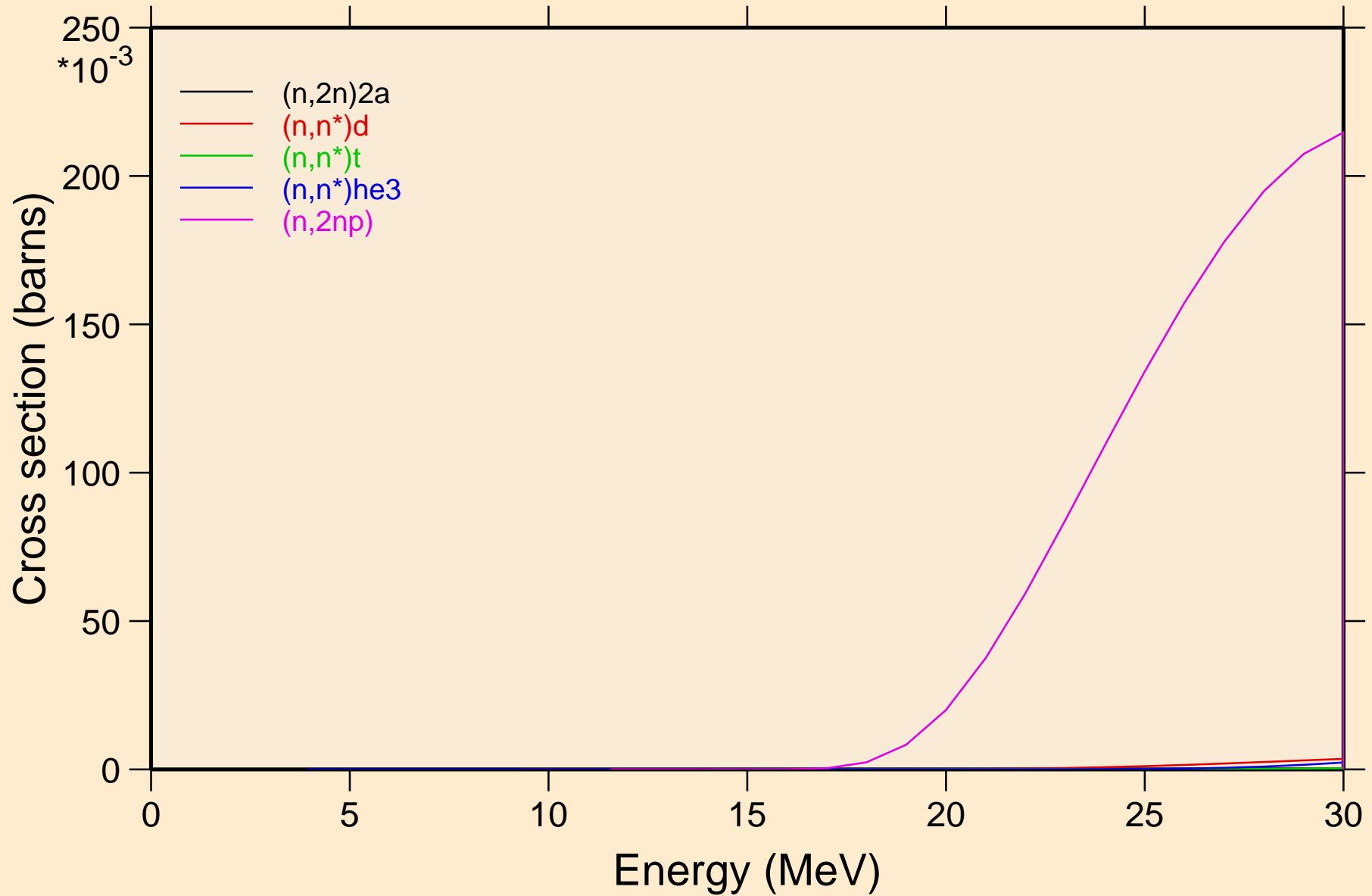

W163 NEUTRON ACER TENDL-2021 LIBRARY; T=293.6K
Threshold reactions

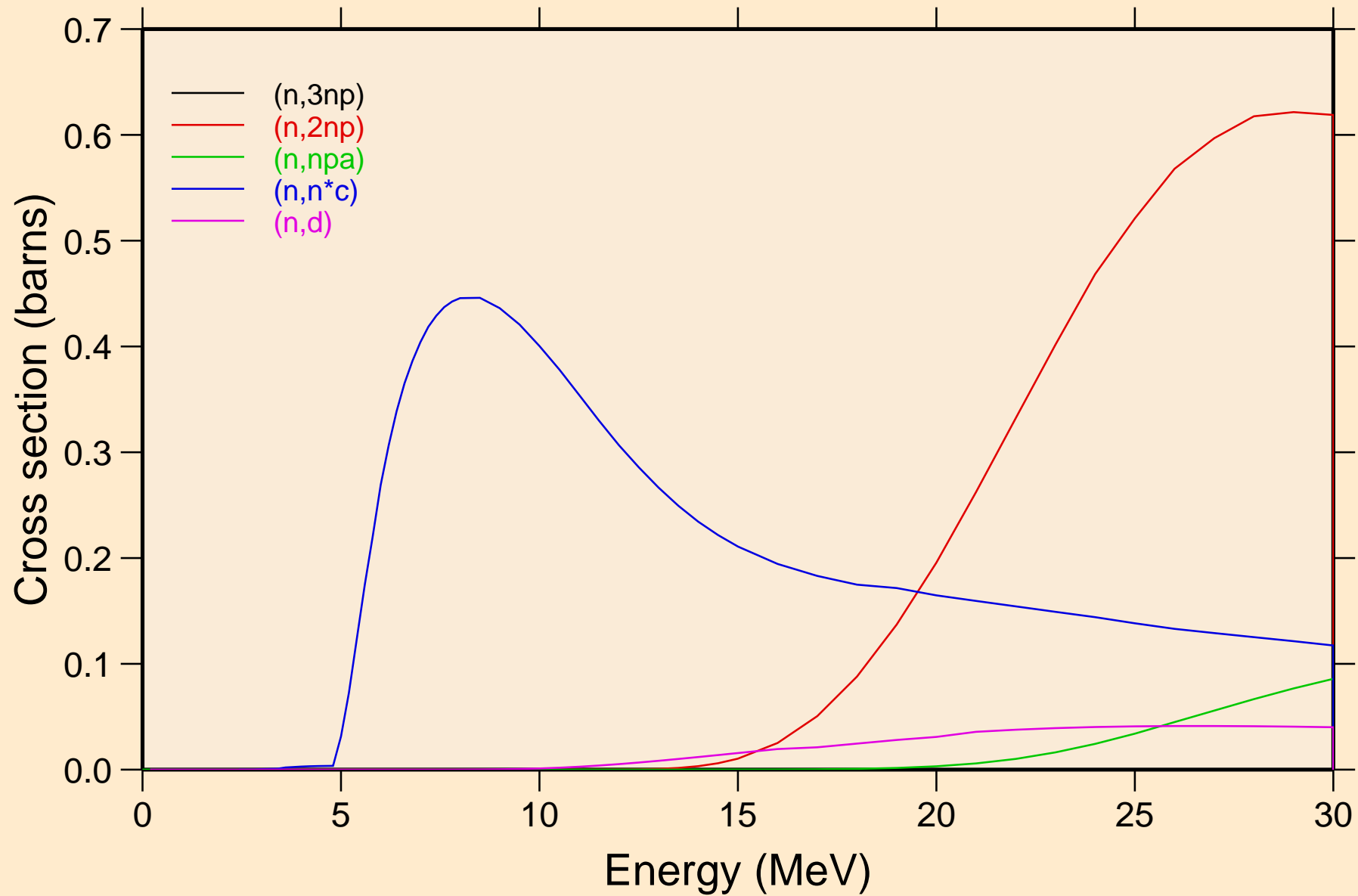

W163 NEUTRON ACER TENDL-2021 LIBRARY; T=293.6K
Threshold reactions

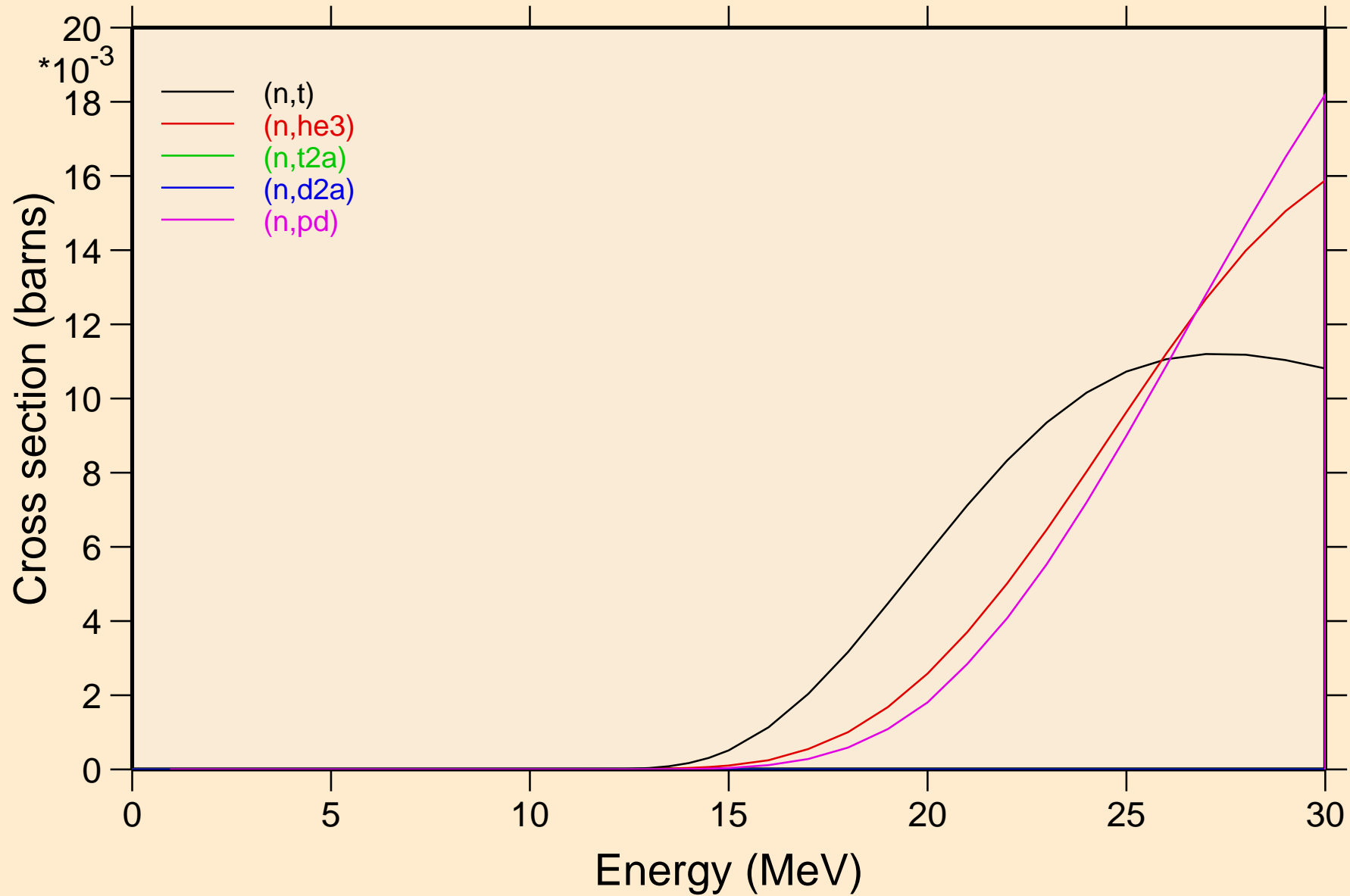

W163 NEUTRON ACER TENDL-2021 LIBRARY; T=293.6K
Threshold reactions

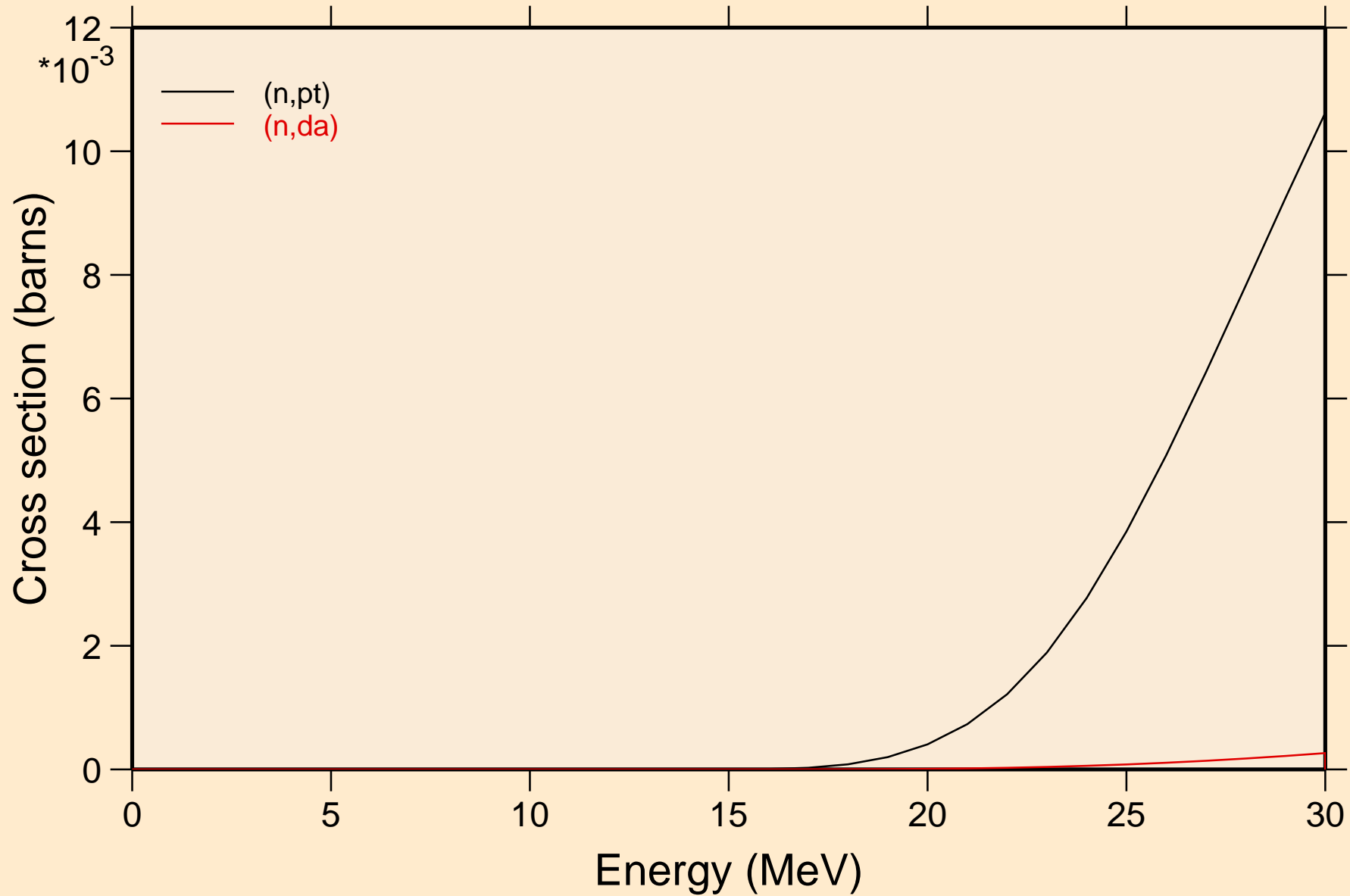

W163 NEUTRON ACER TENDL-2021 LIBRARY; T=293.6K
Threshold reactions

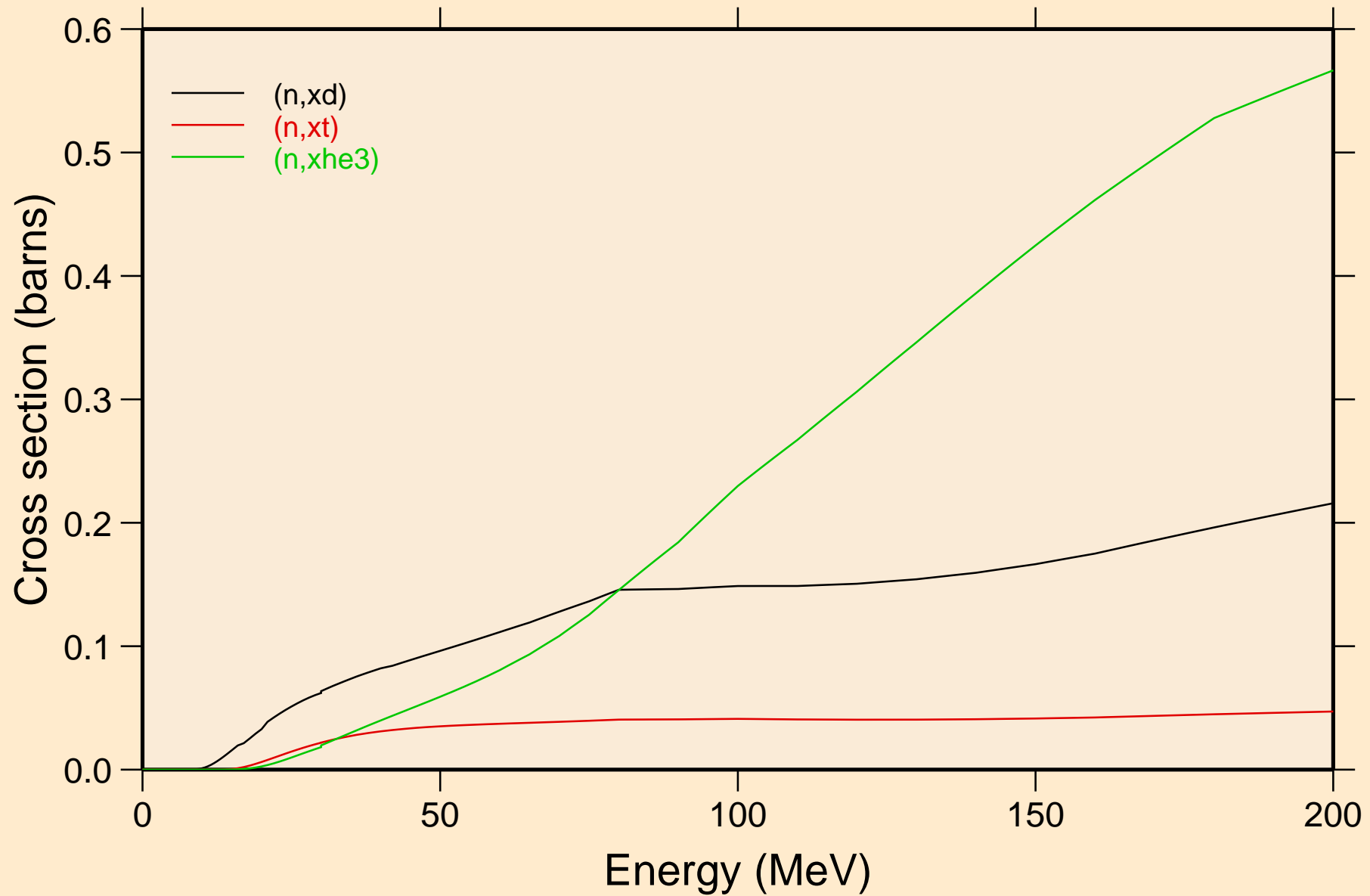

W163 NEUTRON ACER TENDL-2021 LIBRARY; T=293.6K
angular distribution for elastic

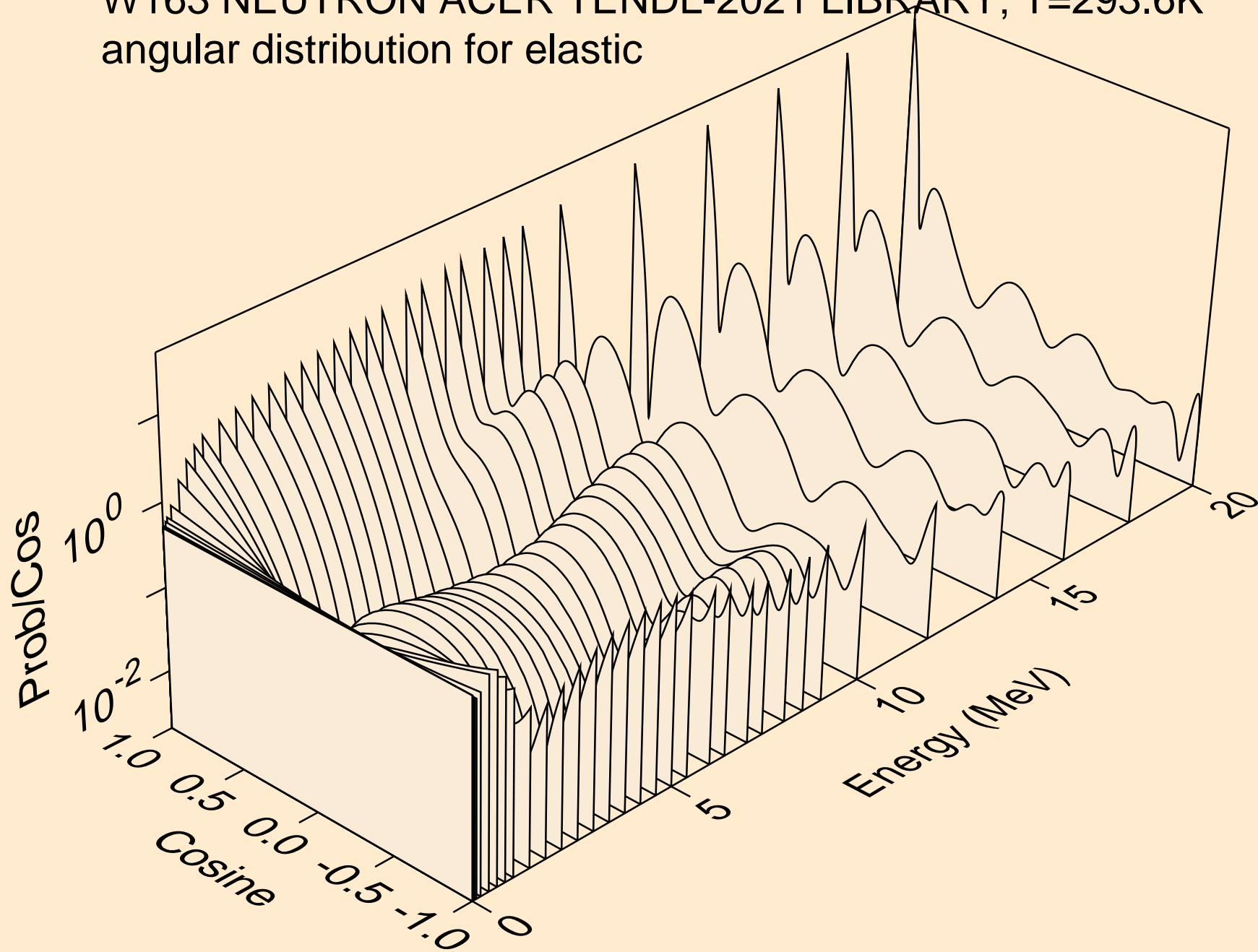

W163 NEUTRON ACER TENDL-2021 LIBRARY; T=293.6K
angular distribution for elastic

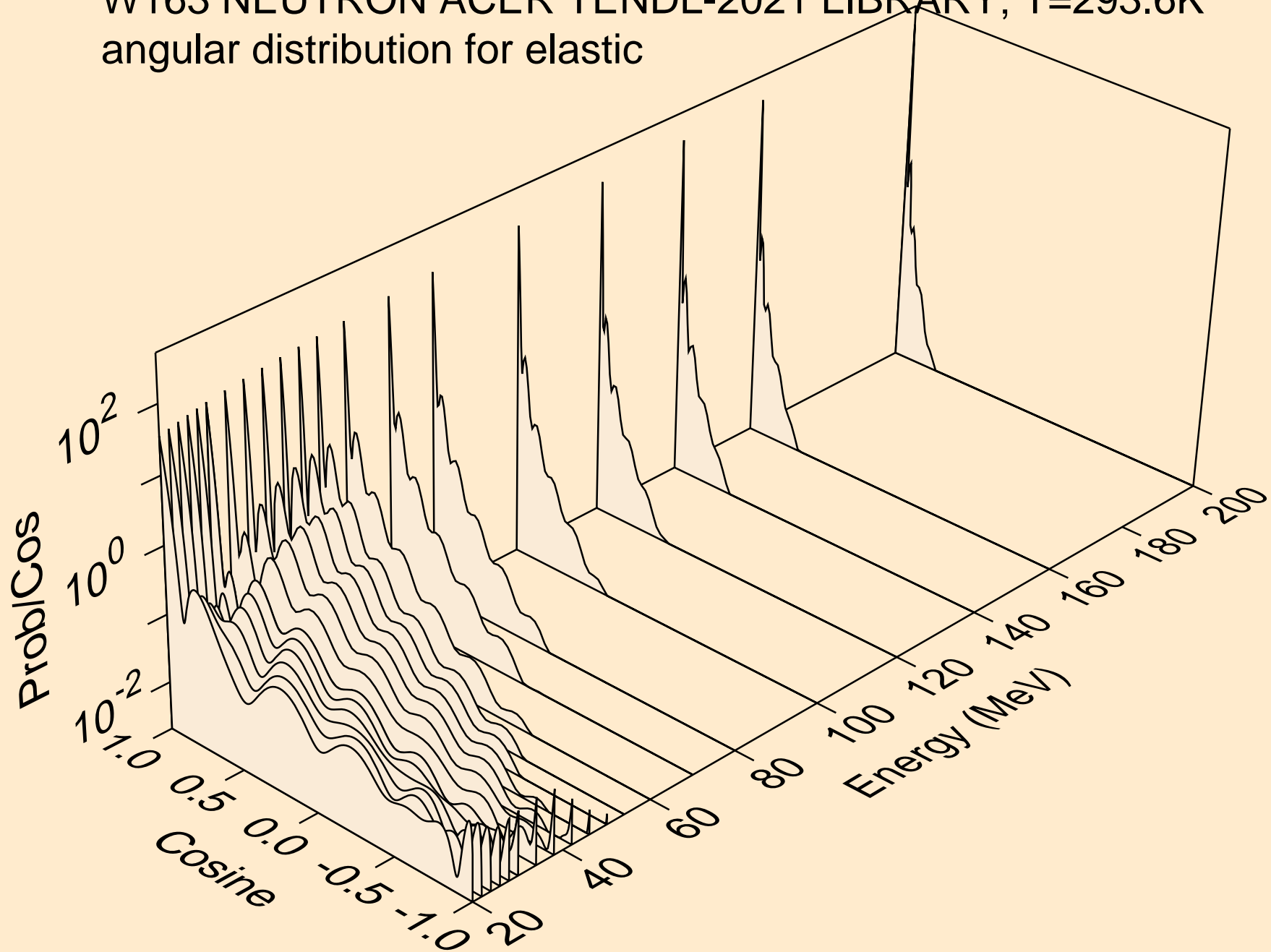

W163 NEUTRON ACER TENDL-2021 LIBRARY; T=293.6K
angular distribution for (n,n*1)

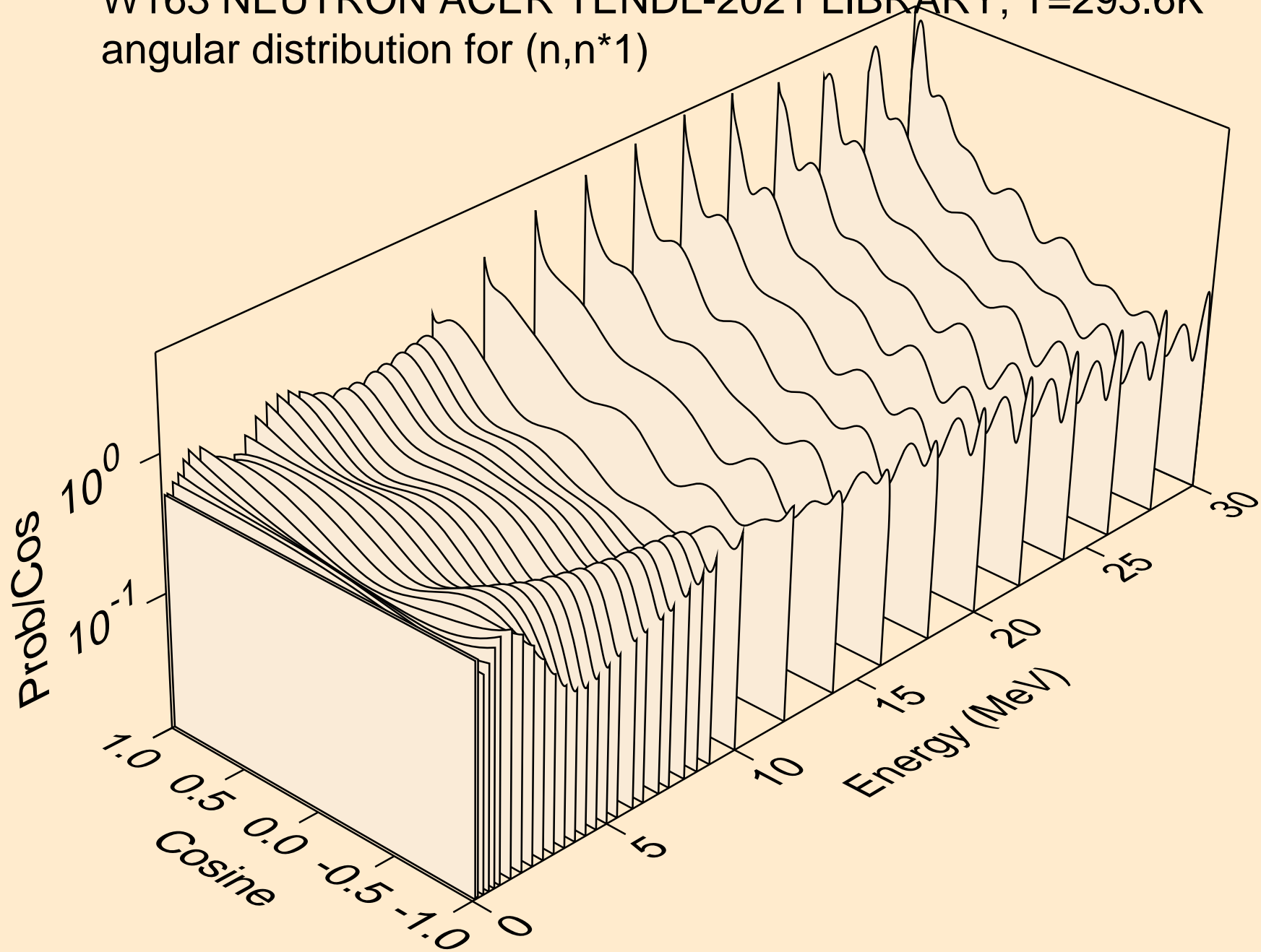

W163 NEUTRON ACER TENDL-2021 LIBRARY; T=293.6K
angular distribution for (n,n*2)

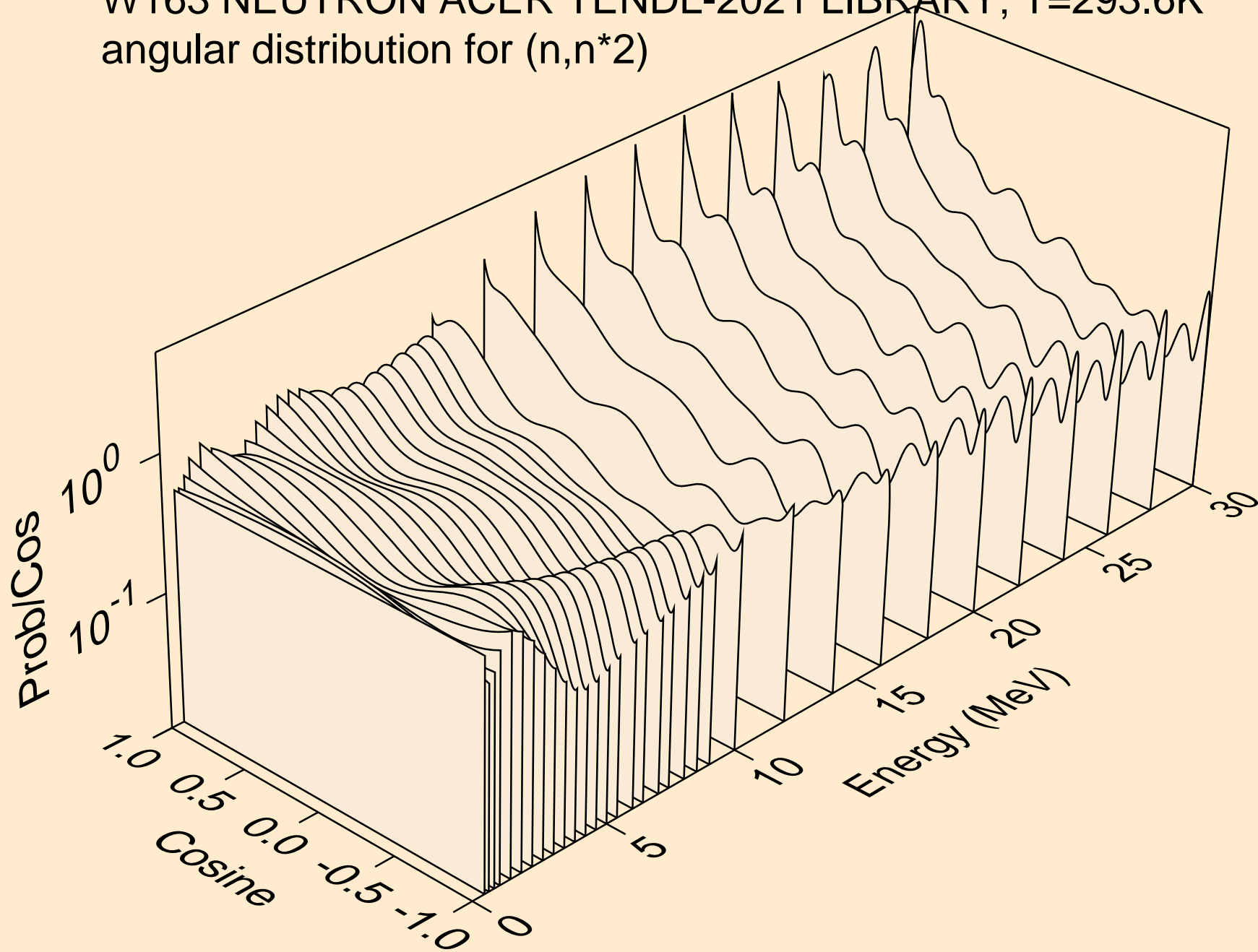

W163 NEUTRON ACER TENDL-2021 LIBRARY; T=293.6K
angular distribution for (n,n*3)

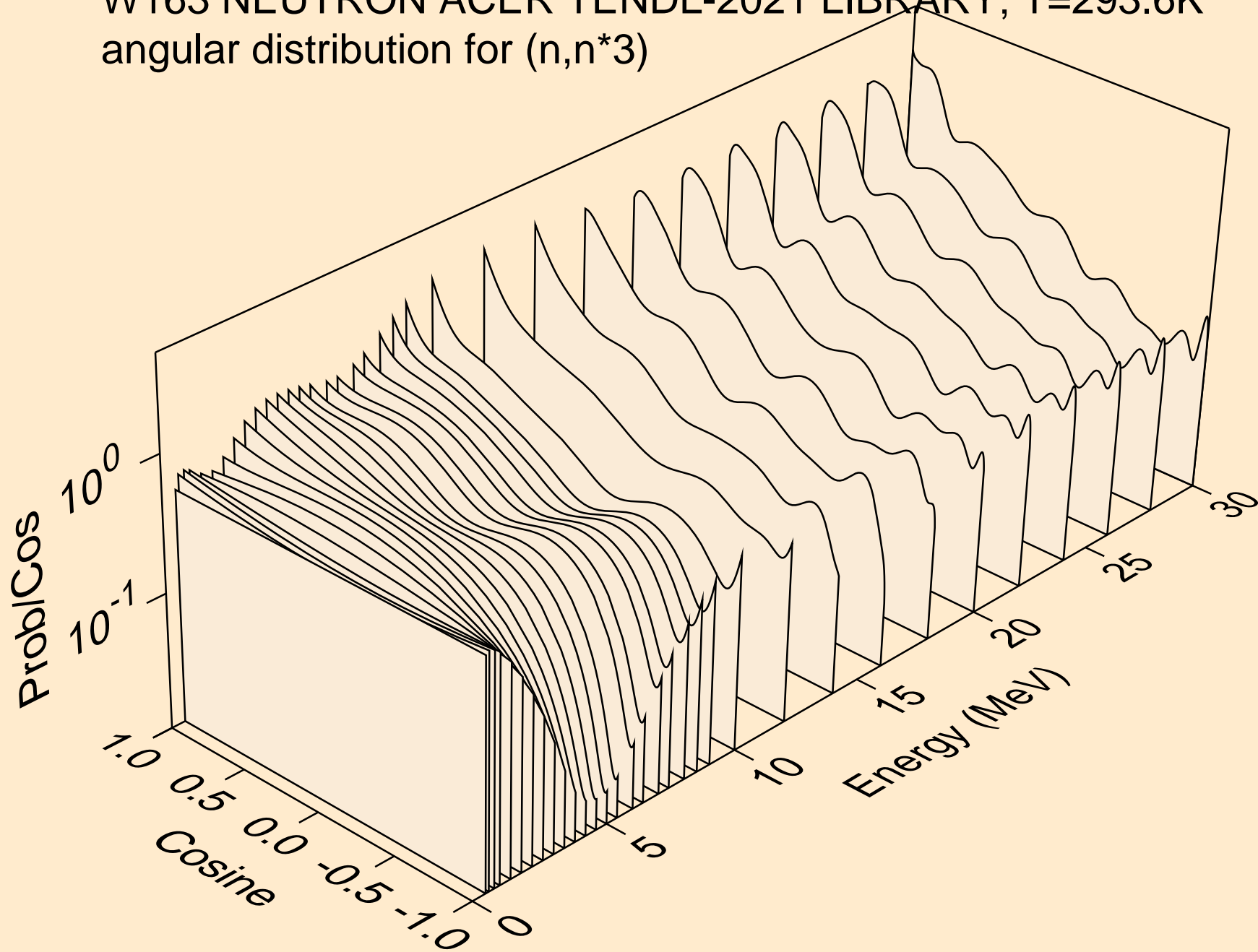

W163 NEUTRON ACER TENDL-2021 LIBRARY; T=293.6K
angular distribution for (n,n*4)

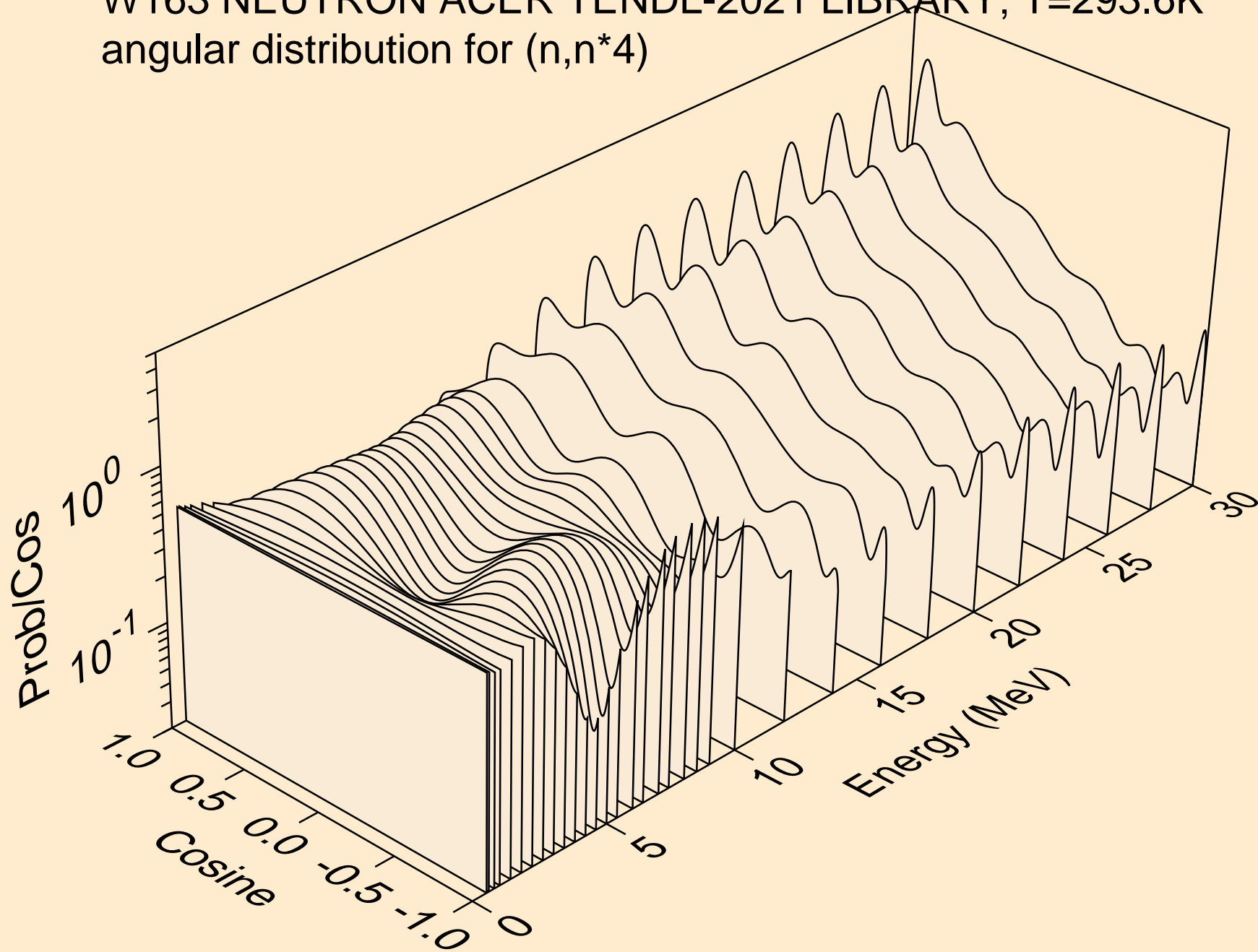

W163 NEUTRON ACER TENDL-2021 LIBRARY; T=293.6K
angular distribution for (n,n*5)

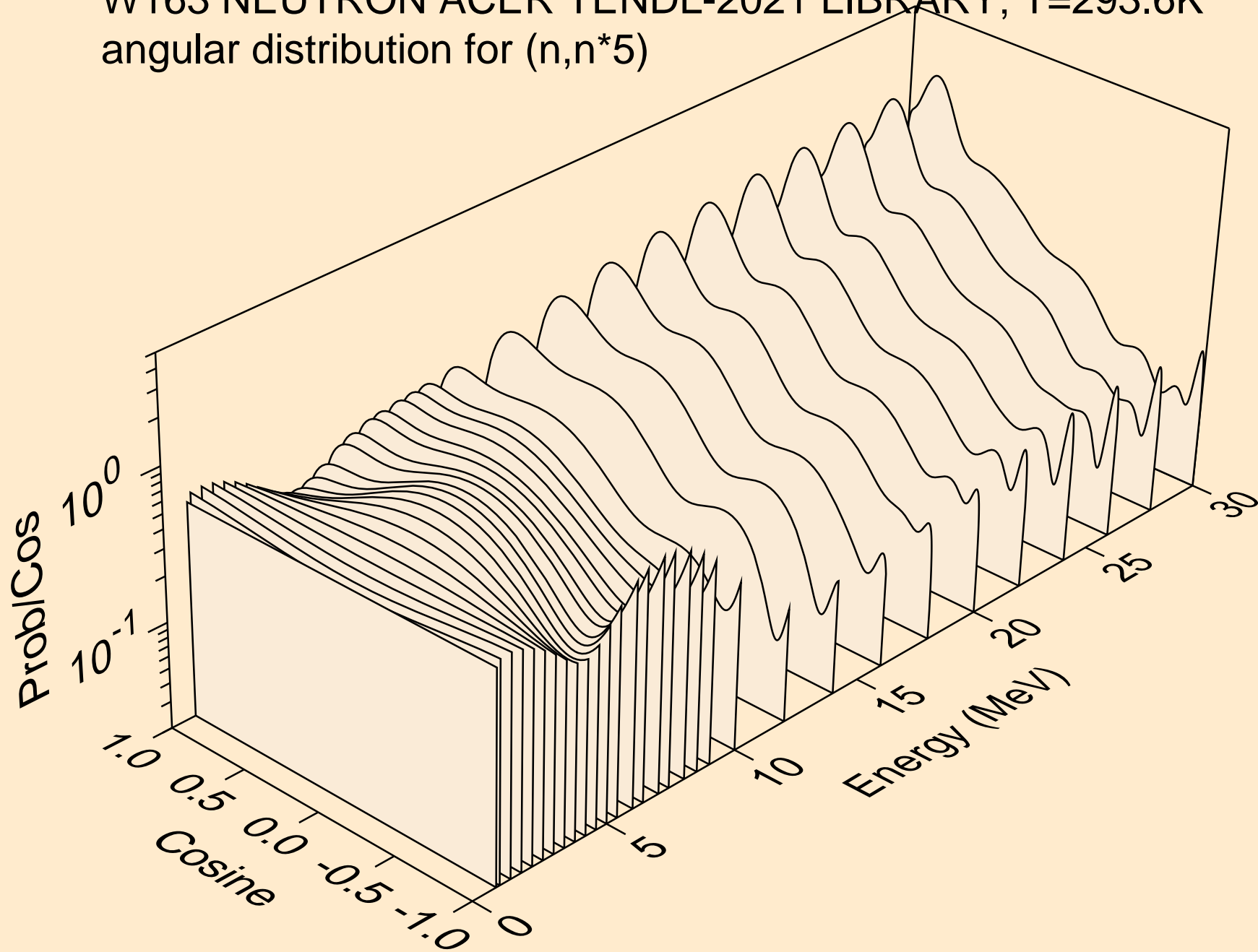

W163 NEUTRON ACER TENDL-2021 LIBRARY; T=293.6K
angular distribution for (n,n*6)

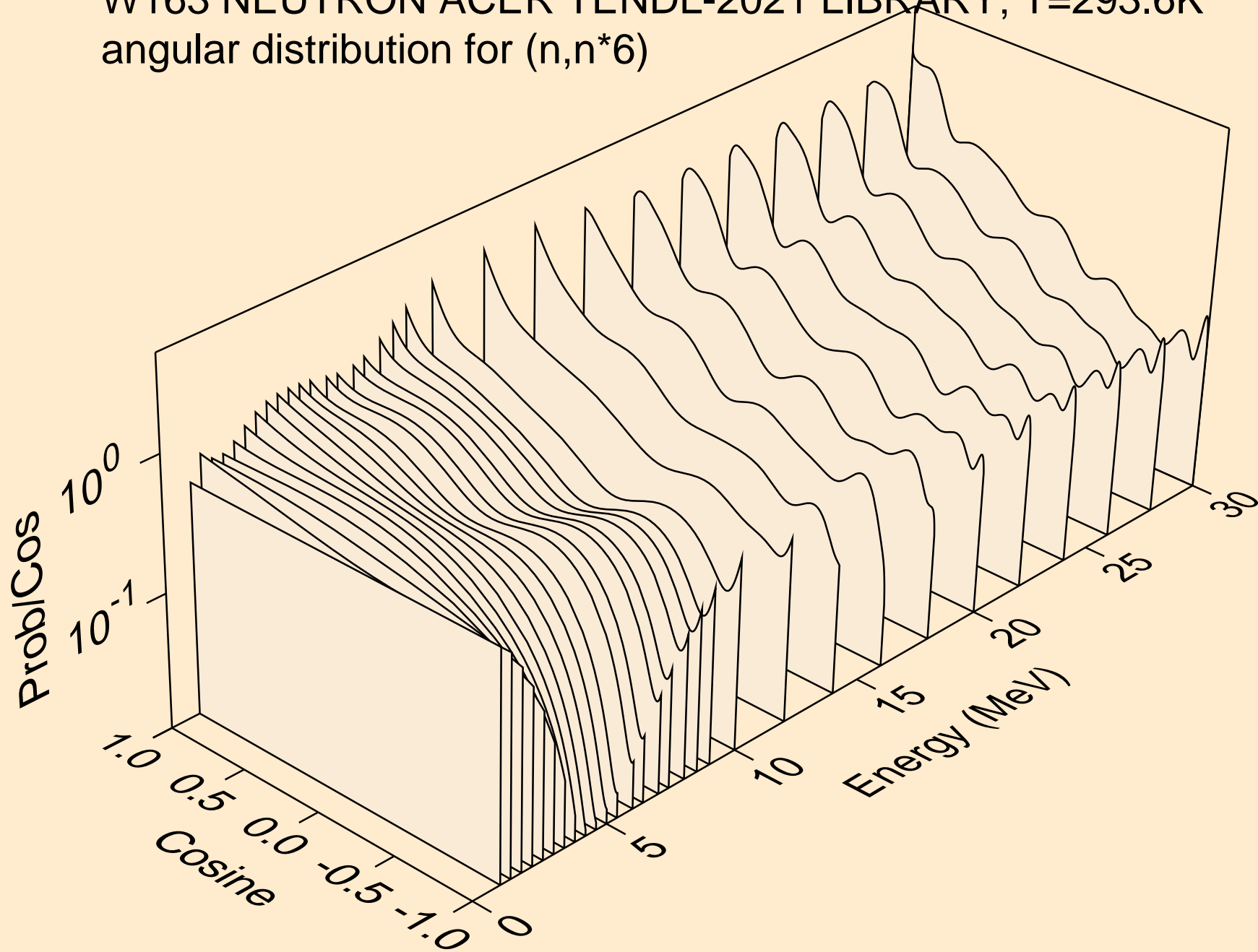

W163 NEUTRON ACER TENDL-2021 LIBRARY; T=293.6K
angular distribution for (n,n*7)

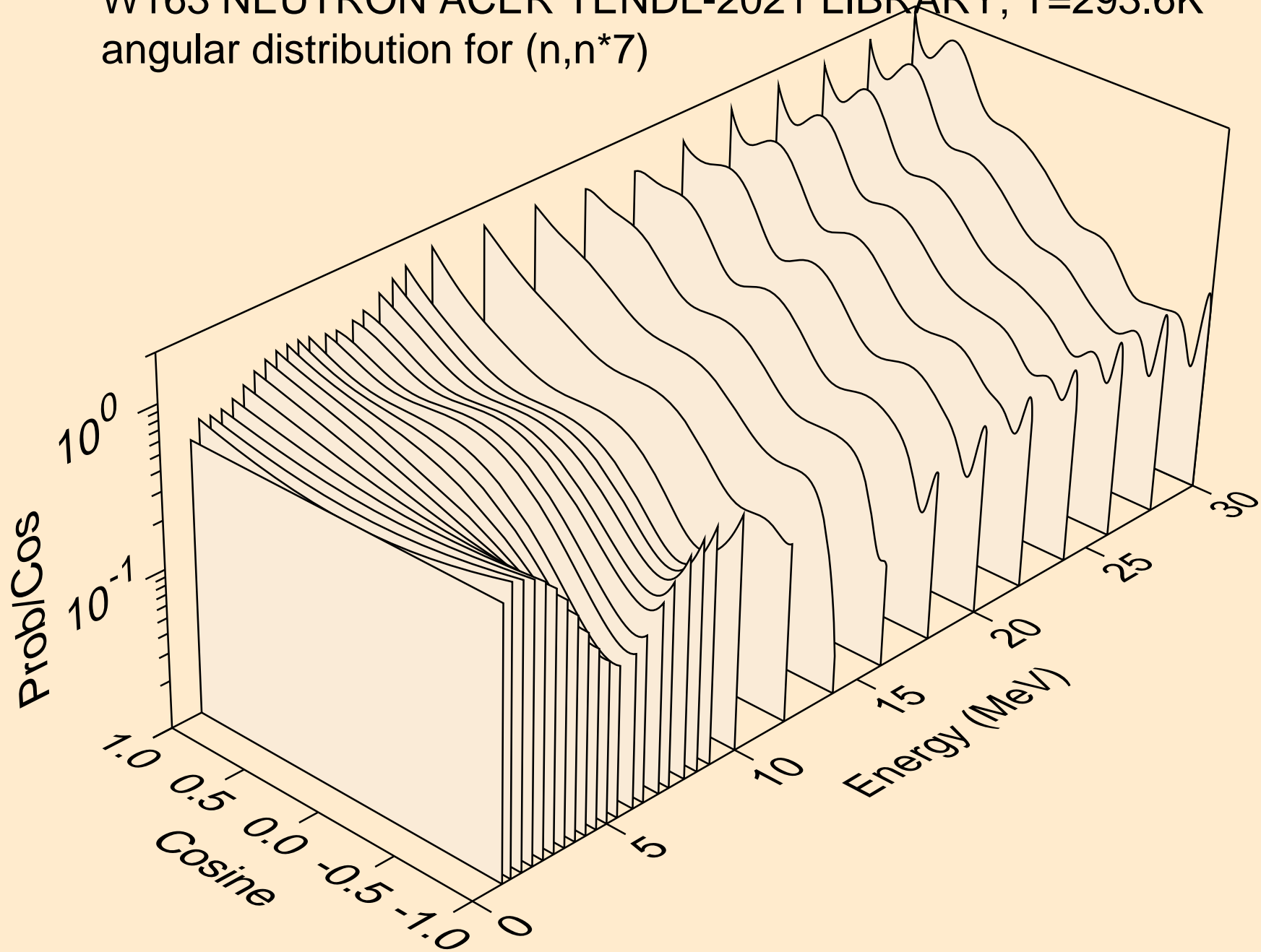

W163 NEUTRON ACER TENDL-2021 LIBRARY; T=293.6K
angular distribution for (n,n*8)

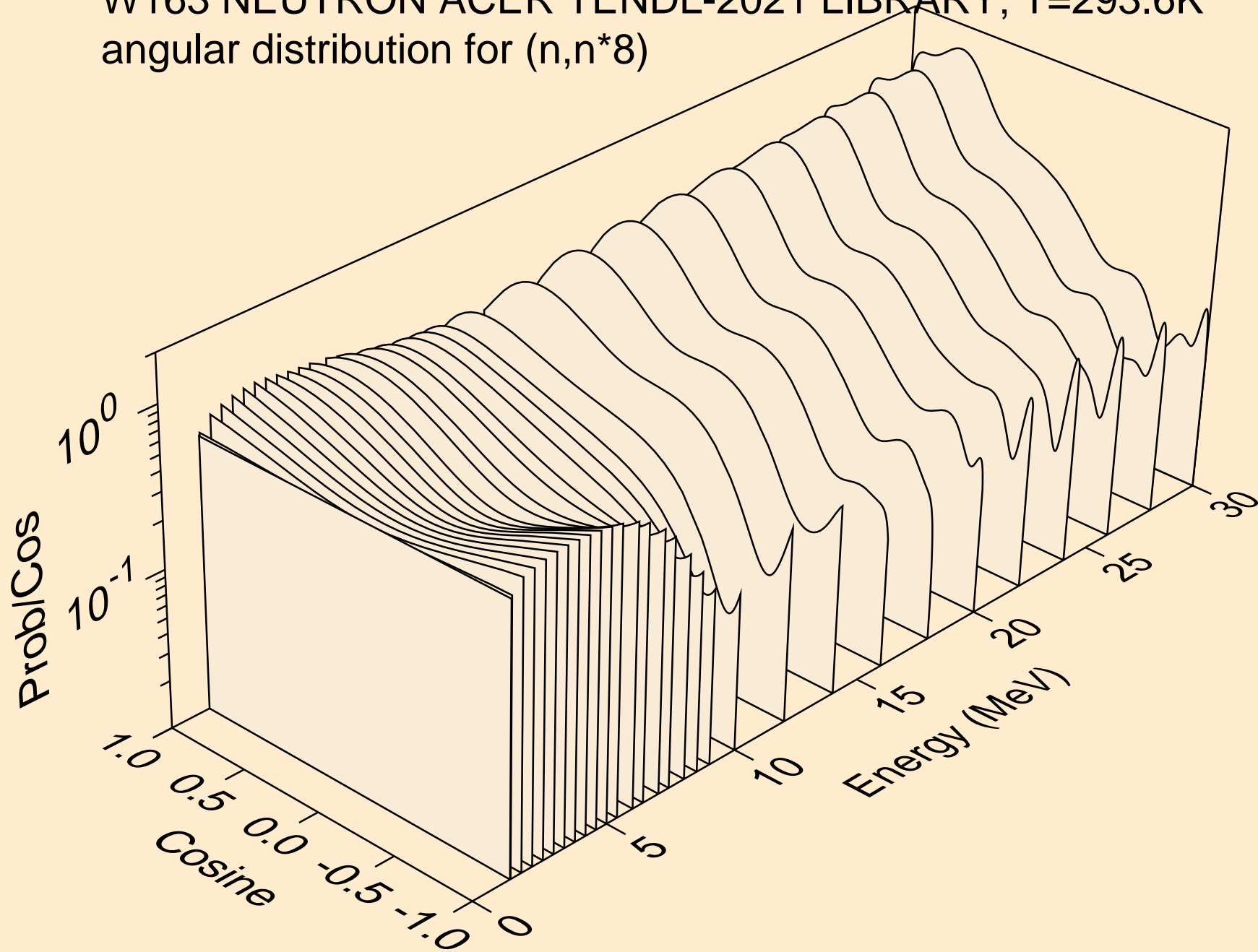

W163 NEUTRON ACER TENDL-2021 LIBRARY; T=293.6K
angular distribution for (n,n*9)

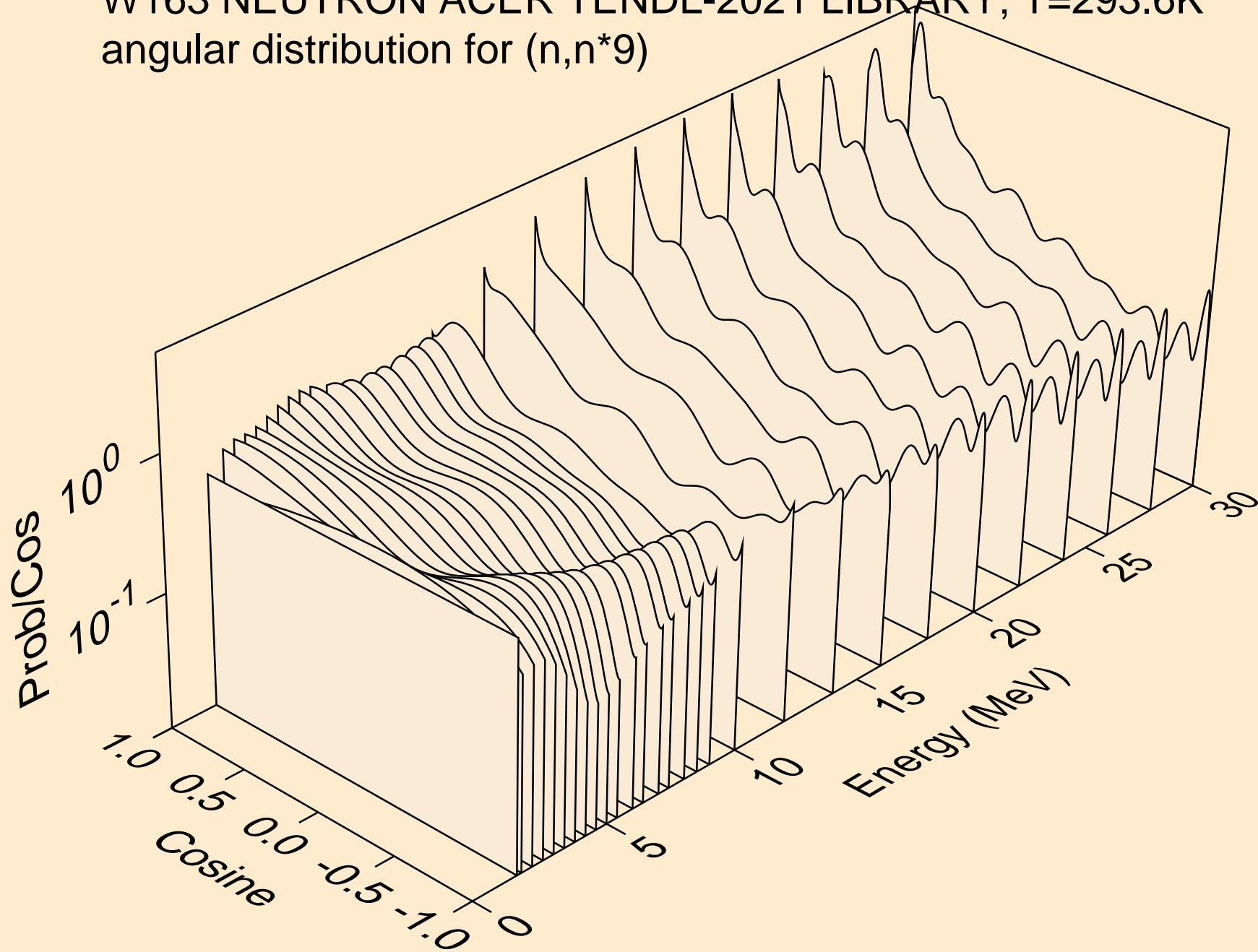

W163 NEUTRON ACER TENDL-2021 LIBRARY; T=293.6K
angular distribution for (n,n*10)

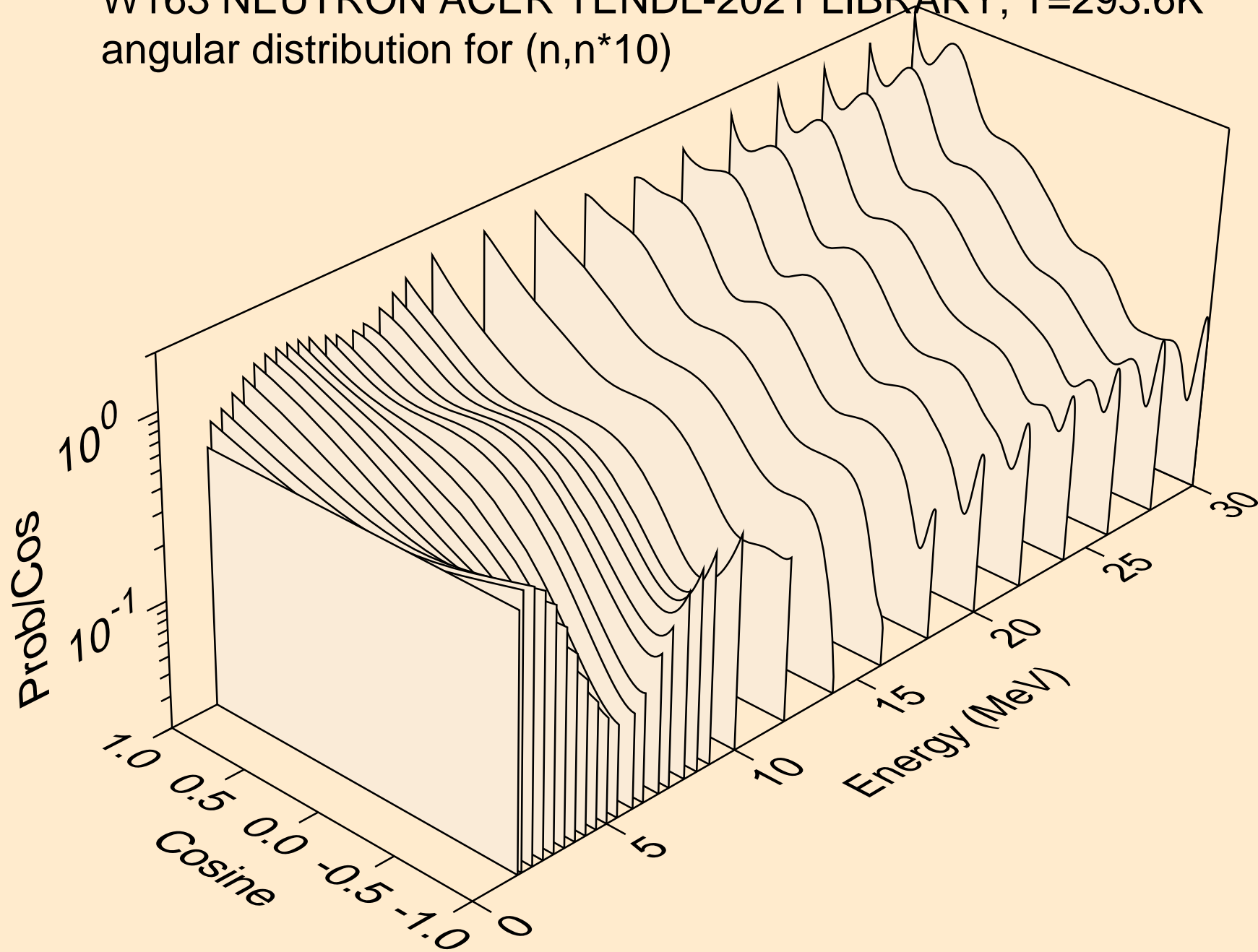

W163 NEUTRON ACER TENDL-2021 LIBRARY; T=293.6K
angular distribution for (n,n*11)

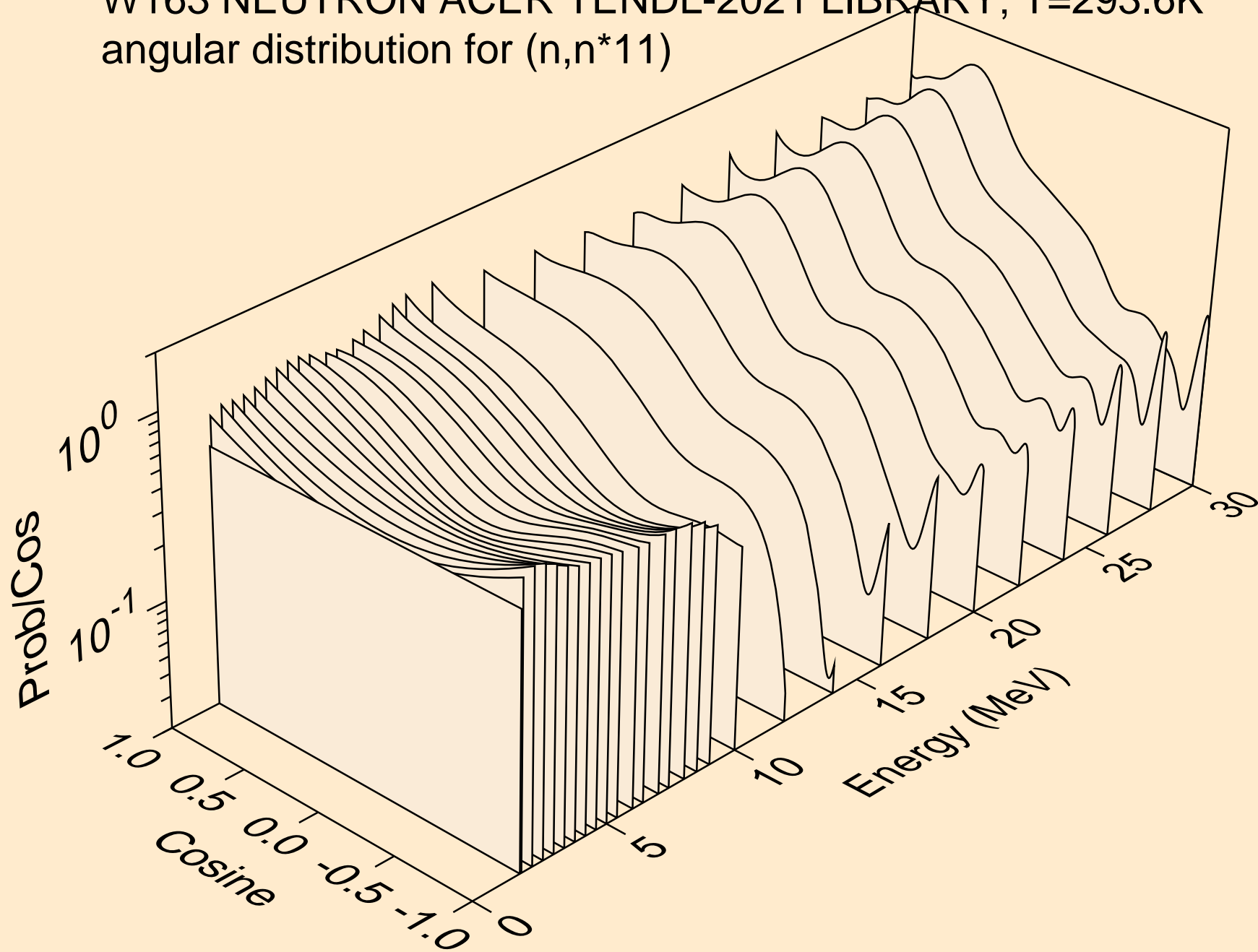

W163 NEUTRON ACER TENDL-2021 LIBRARY; T=293.6K
angular distribution for (n,n*12)

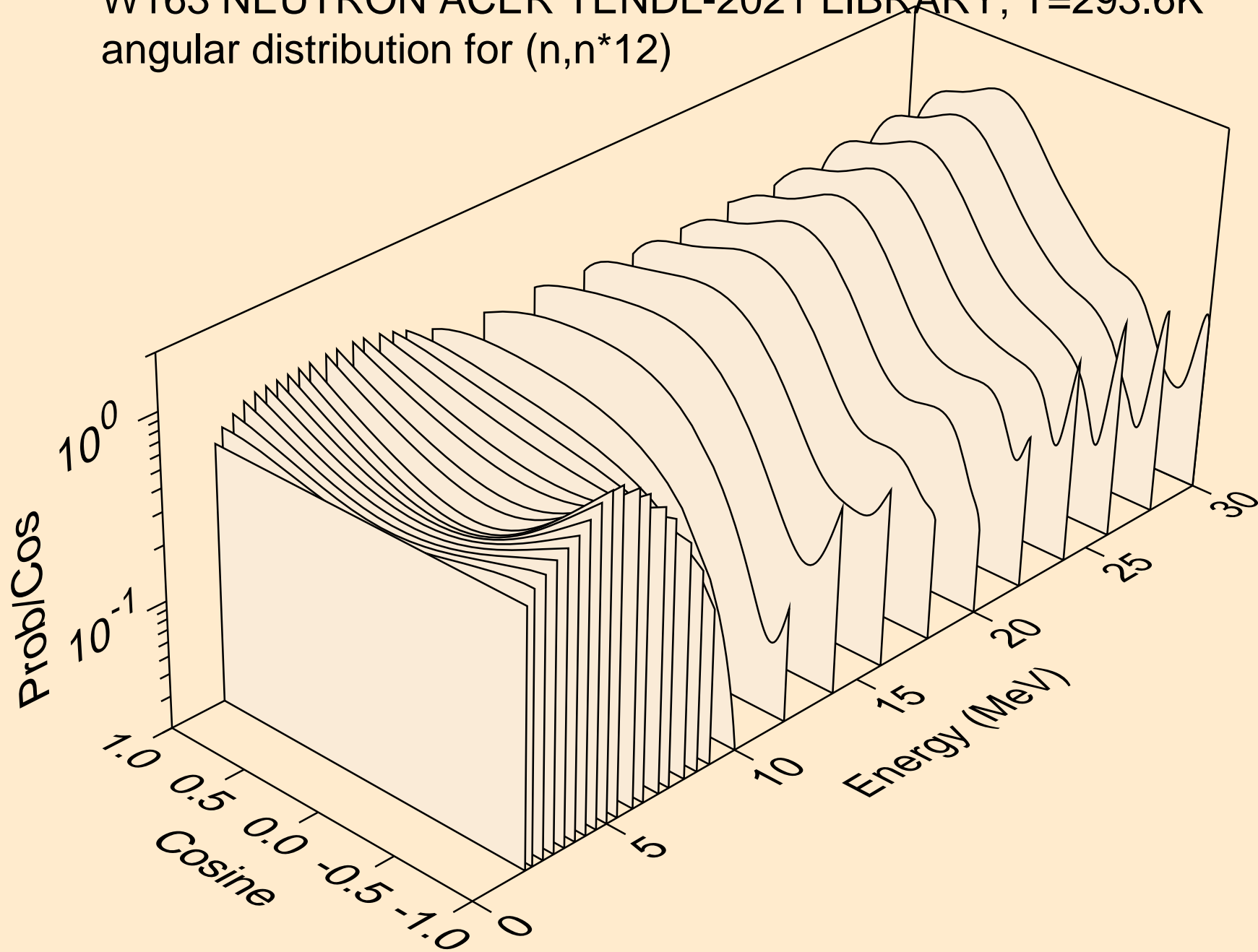

W163 NEUTRON ACER TENDL-2021 LIBRARY; T=293.6K
angular distribution for (n,n*13)

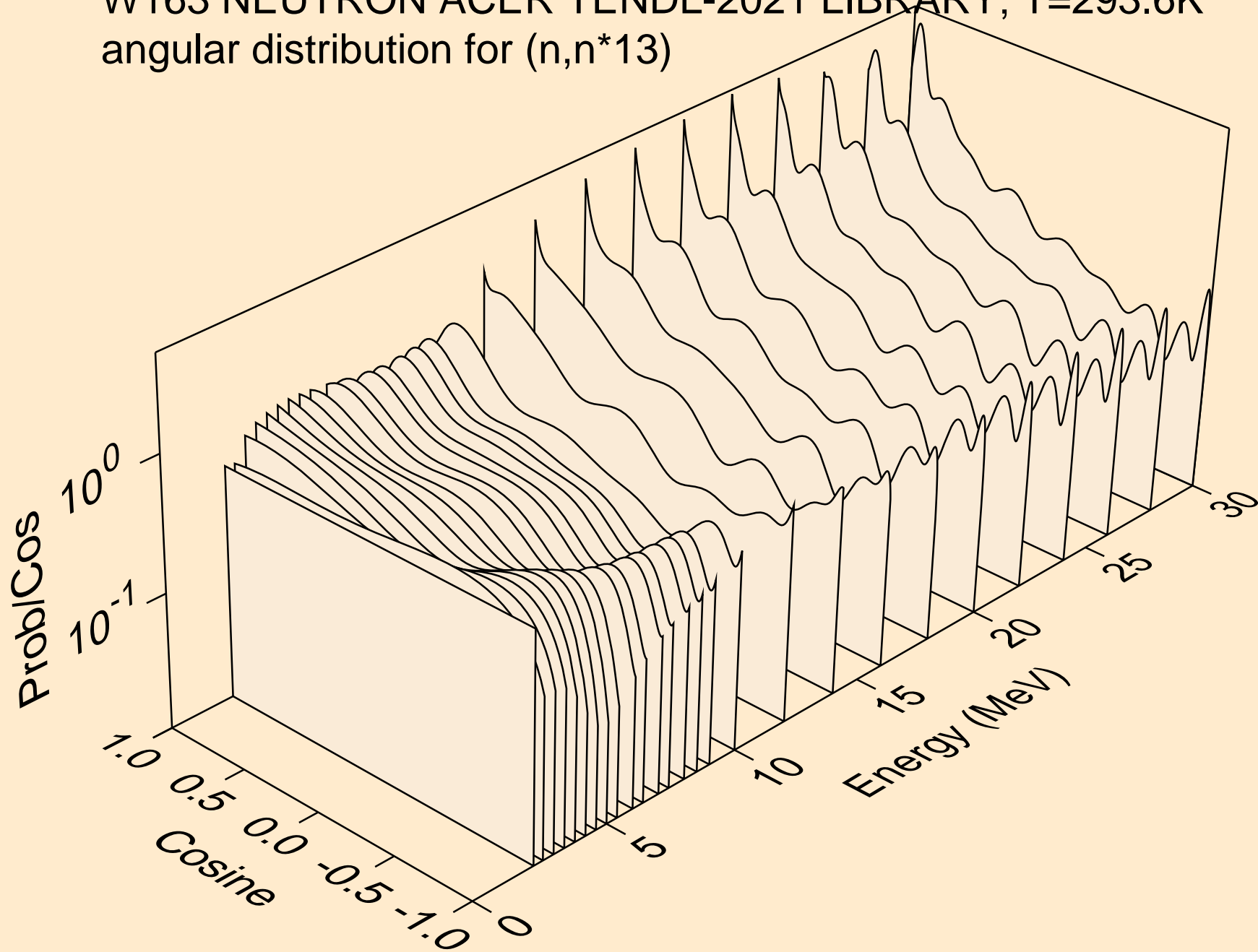

W163 NEUTRON ACER TENDL-2021 LIBRARY; T=293.6K
angular distribution for (n,n*14)

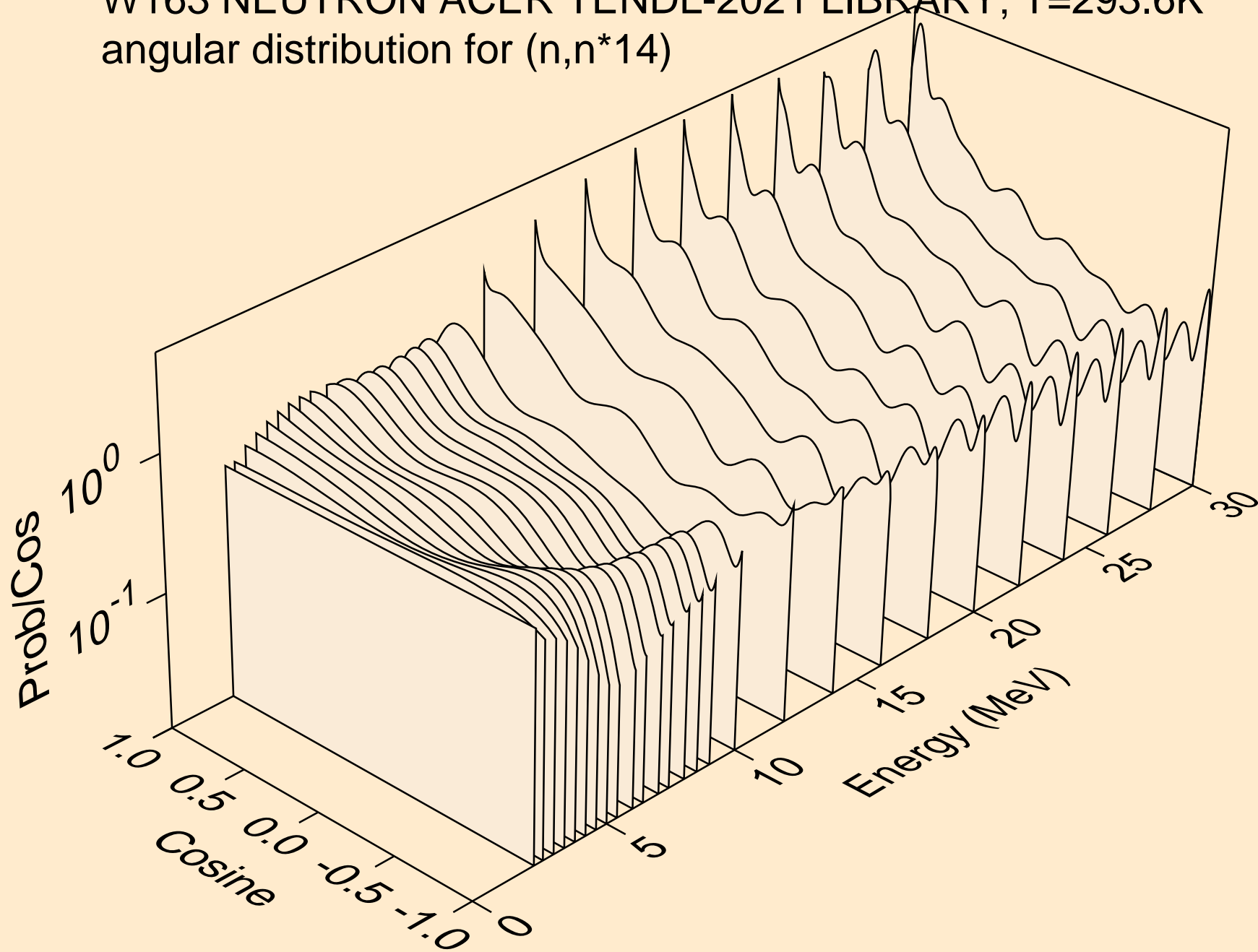

W163 NEUTRON ACER TENDL-2021 LIBRARY; T=293.6K
angular distribution for (n,n*15)

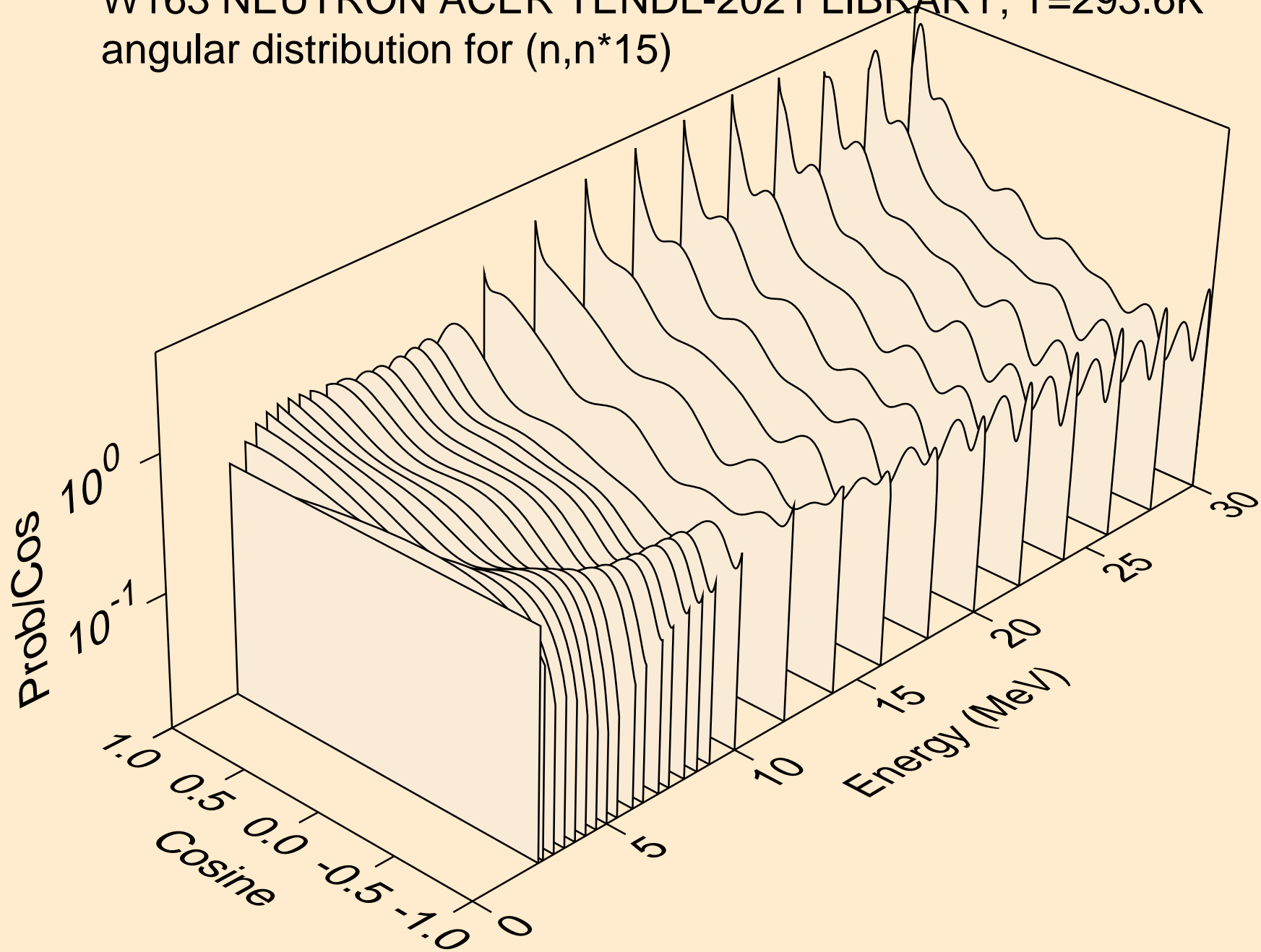

W163 NEUTRON ACER TENDL-2021 LIBRARY; T=293.6K
Neutron emission for (n,x)

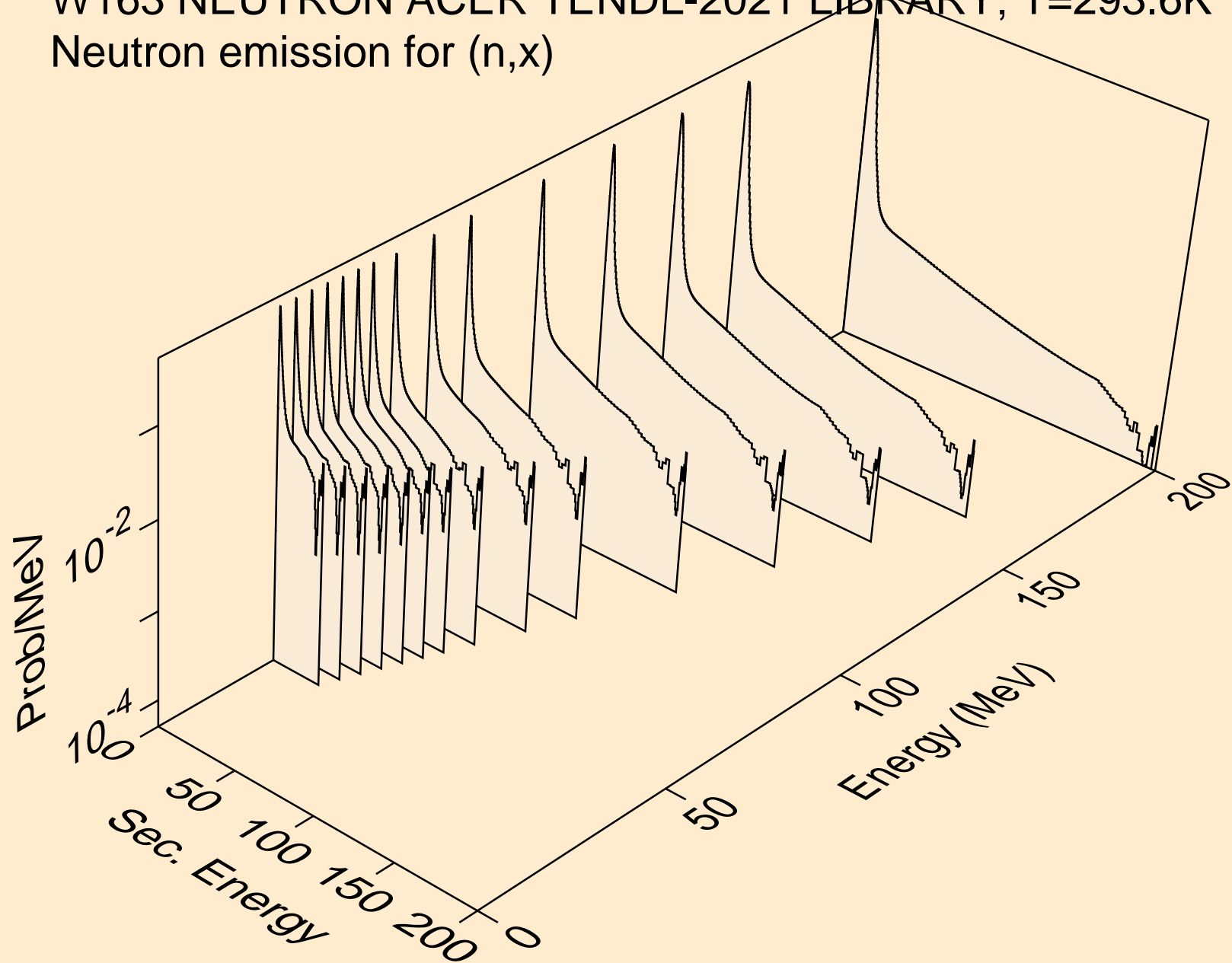

W163 NEUTRON ACER TENDL-2021 LIBRARY; T=293.6K
Neutron emission for (n,2nd)

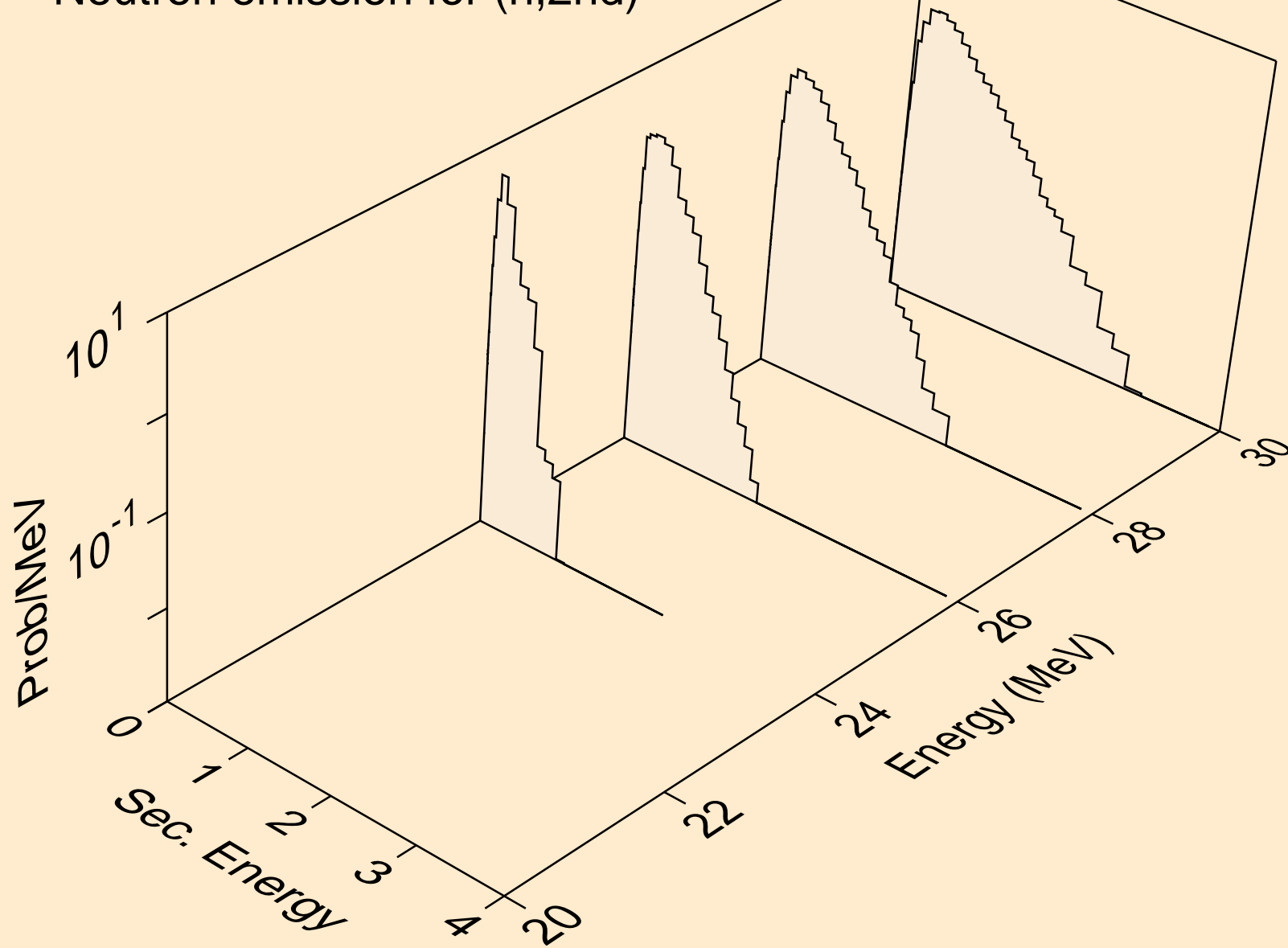

W163 NEUTRON ACER TENDL-2021 LIBRARY; T=293.6K
Neutron emission for (n,2n)

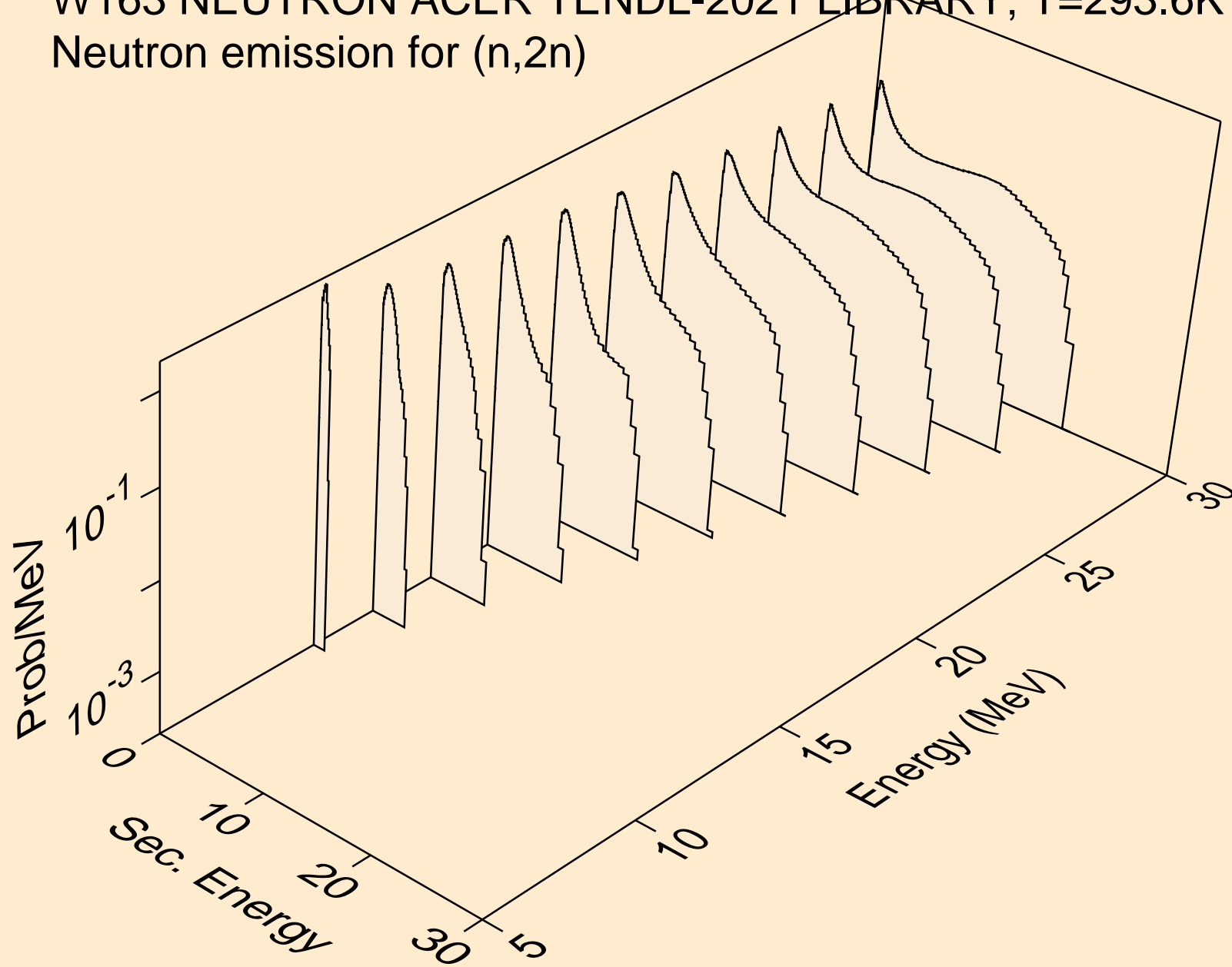

W163 NEUTRON ACER TENDL-2021 LIBRARY; T=293.6K
Neutron emission for (n,3n)

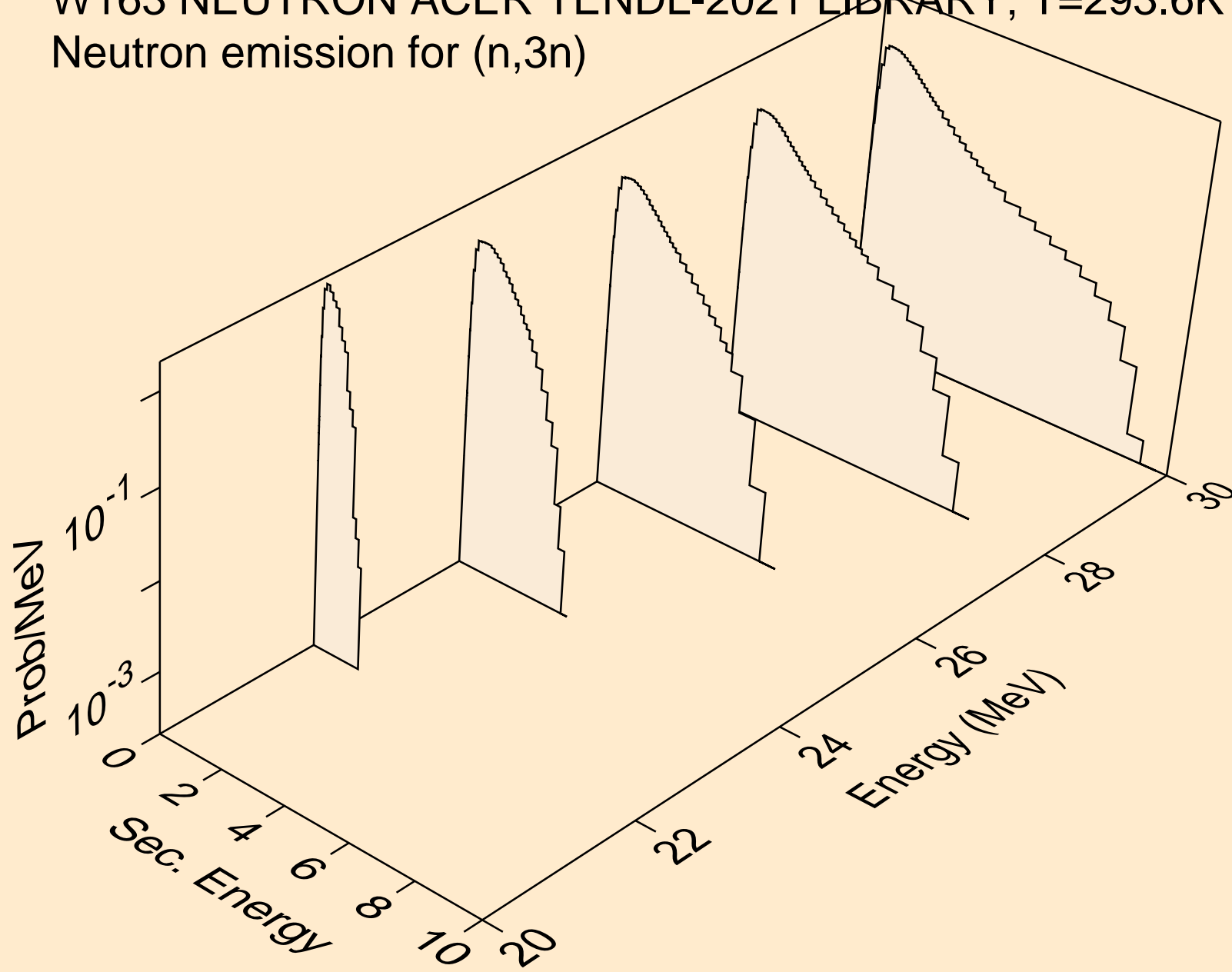

W163 NEUTRON ACER TENDL-2021 LIBRARY; T=293.6K
Neutron emission for (n,n*)a

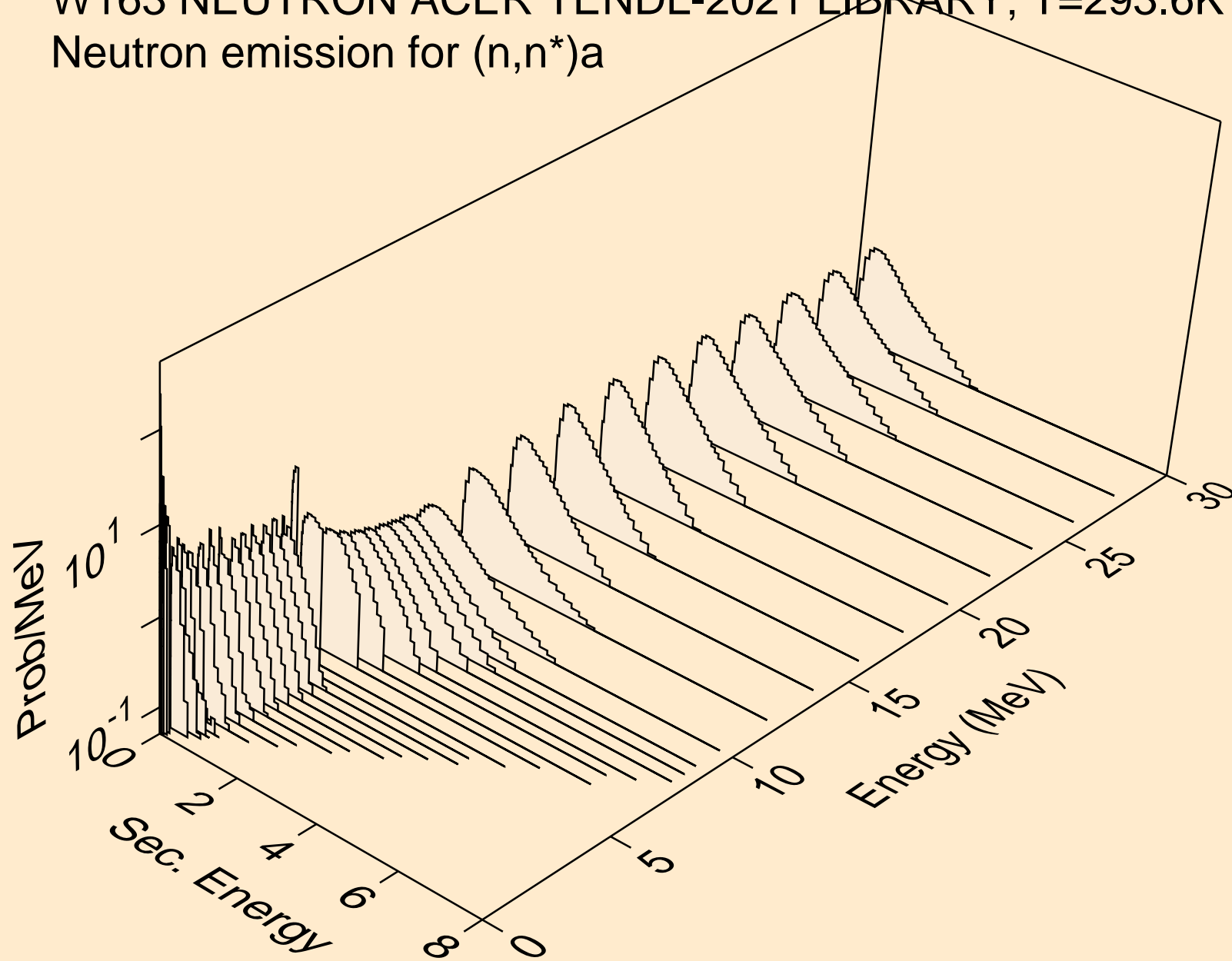

W163 NEUTRON ACER TENDL-2021 LIBRARY; T=293.6K
Neutron emission for (n,n*)3a

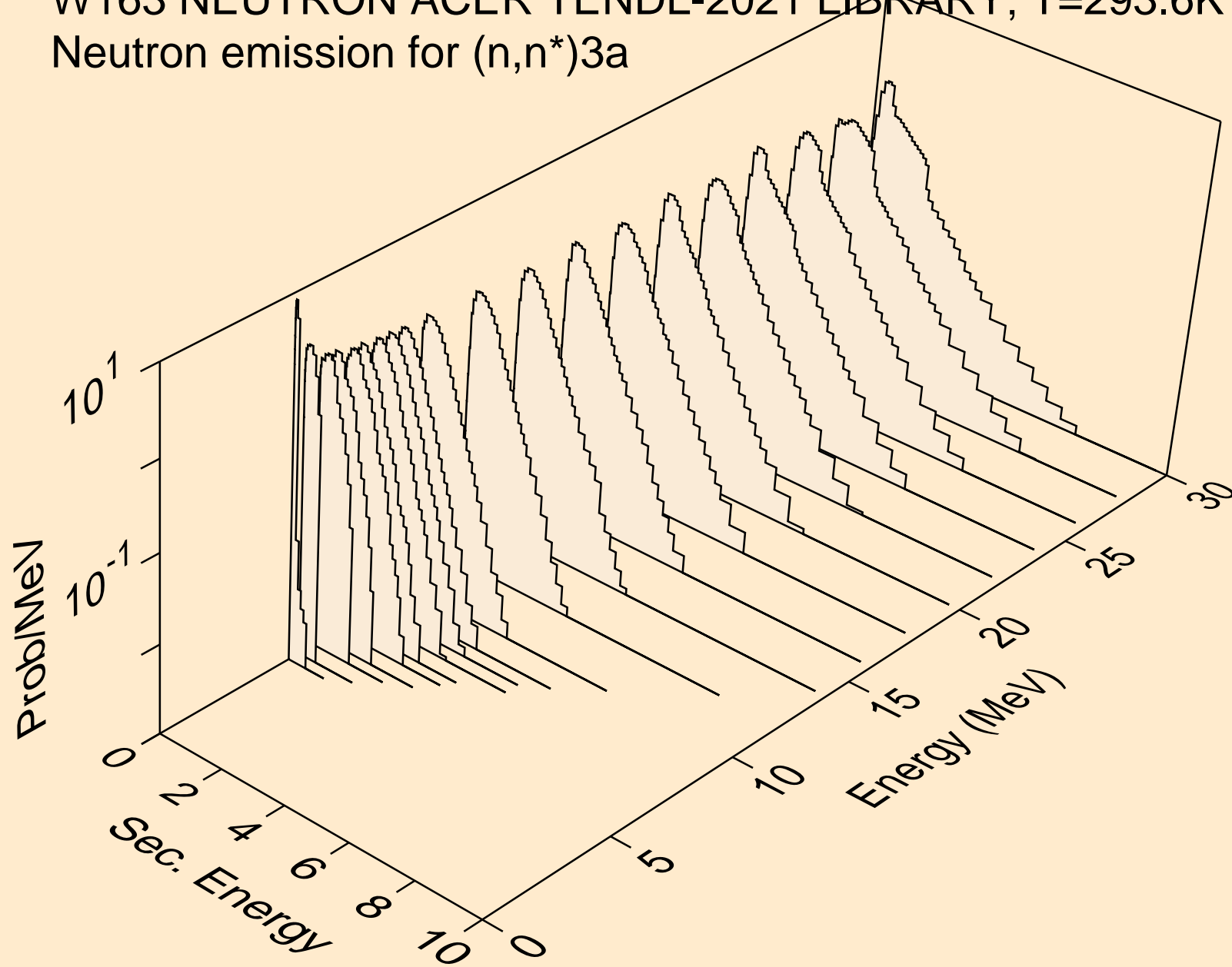

W163 NEUTRON ACER TENDL-2021 LIBRARY; T=293.6K
Neutron emission for (n,2n)a

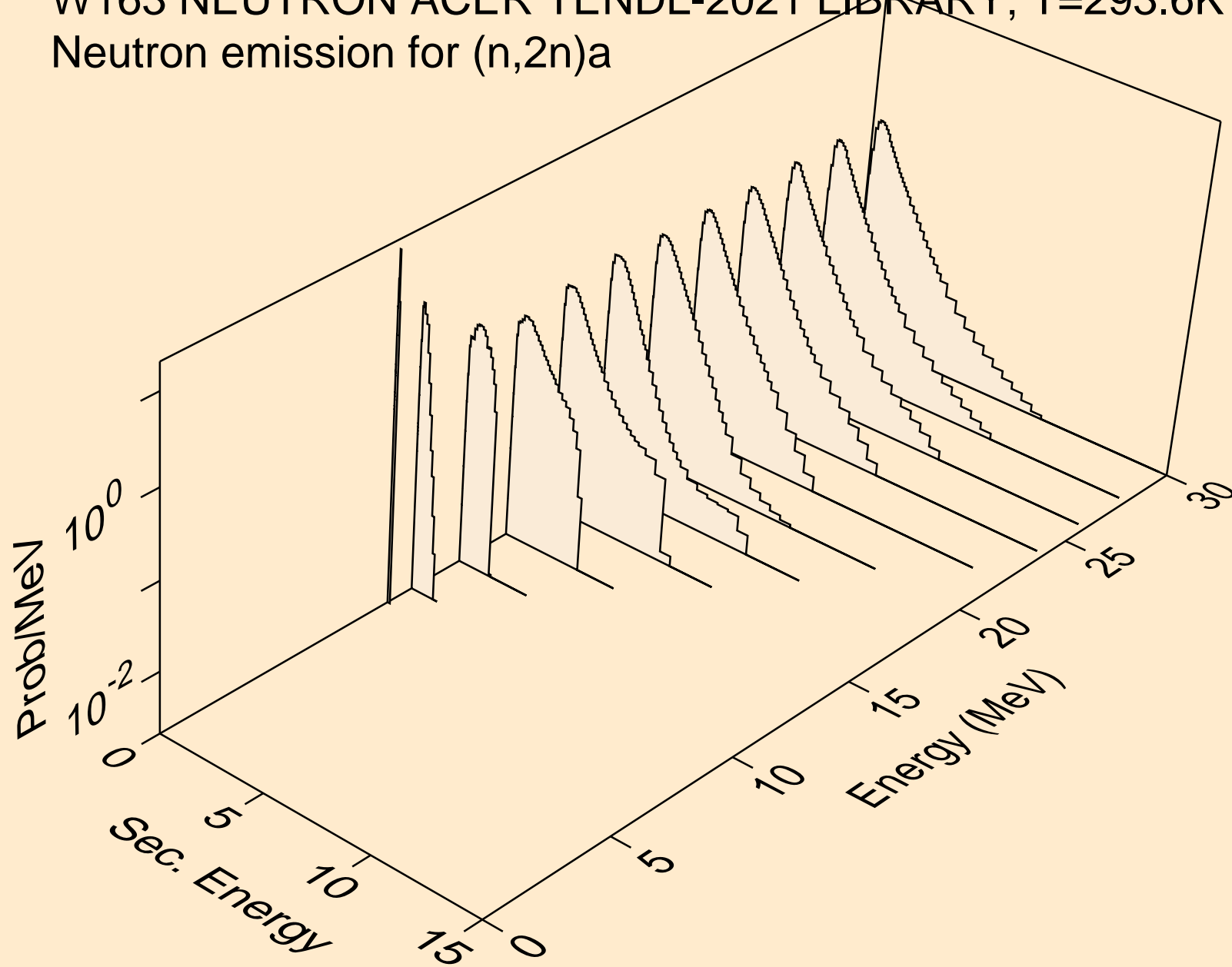

W163 NEUTRON ACER TENDL-2021 LIBRARY; T=293.6K
Neutron emission for (n,3n)a

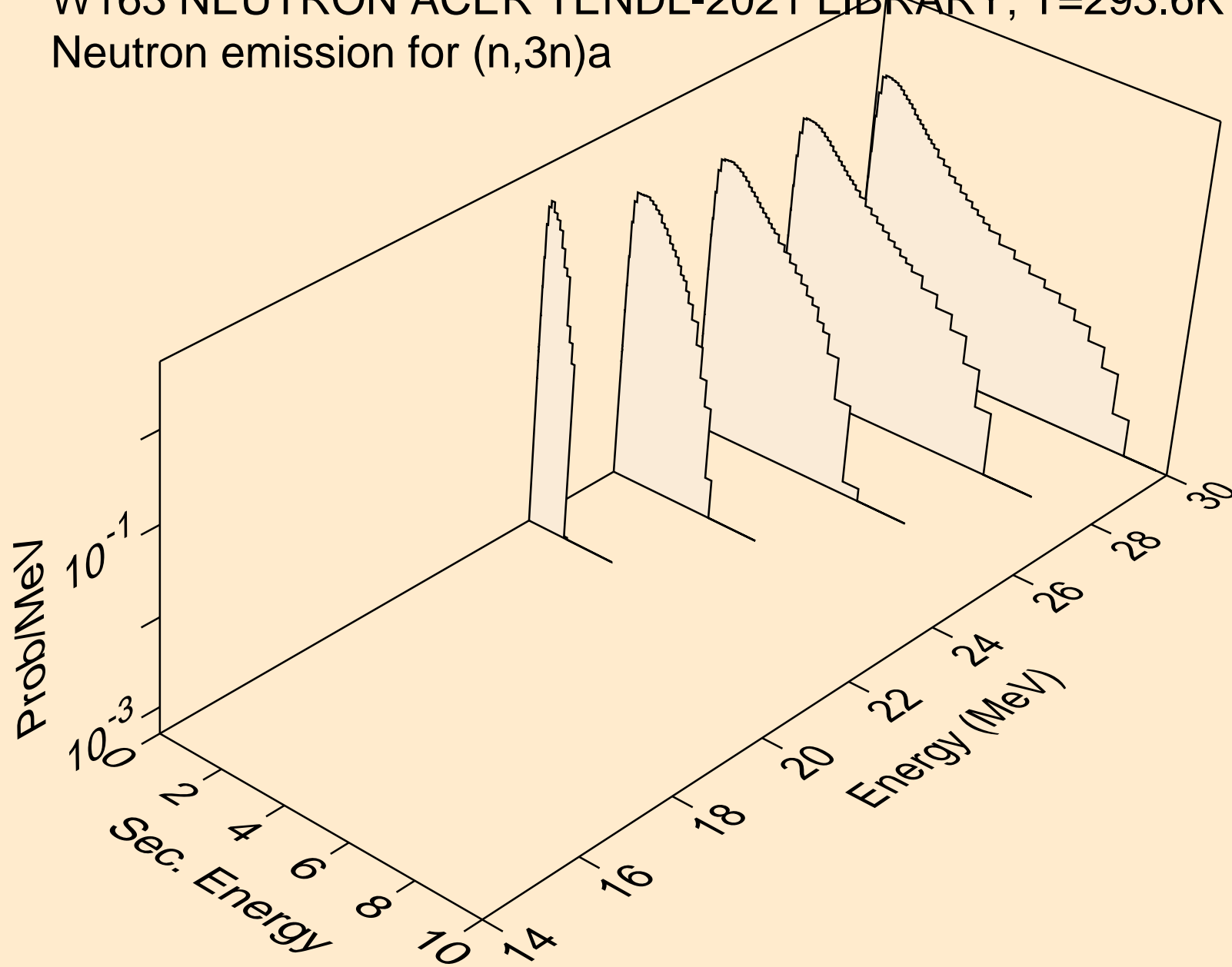

W163 NEUTRON ACER TENDL-2021 LIBRARY; T=293.6K
Neutron emission for (n,n*)p

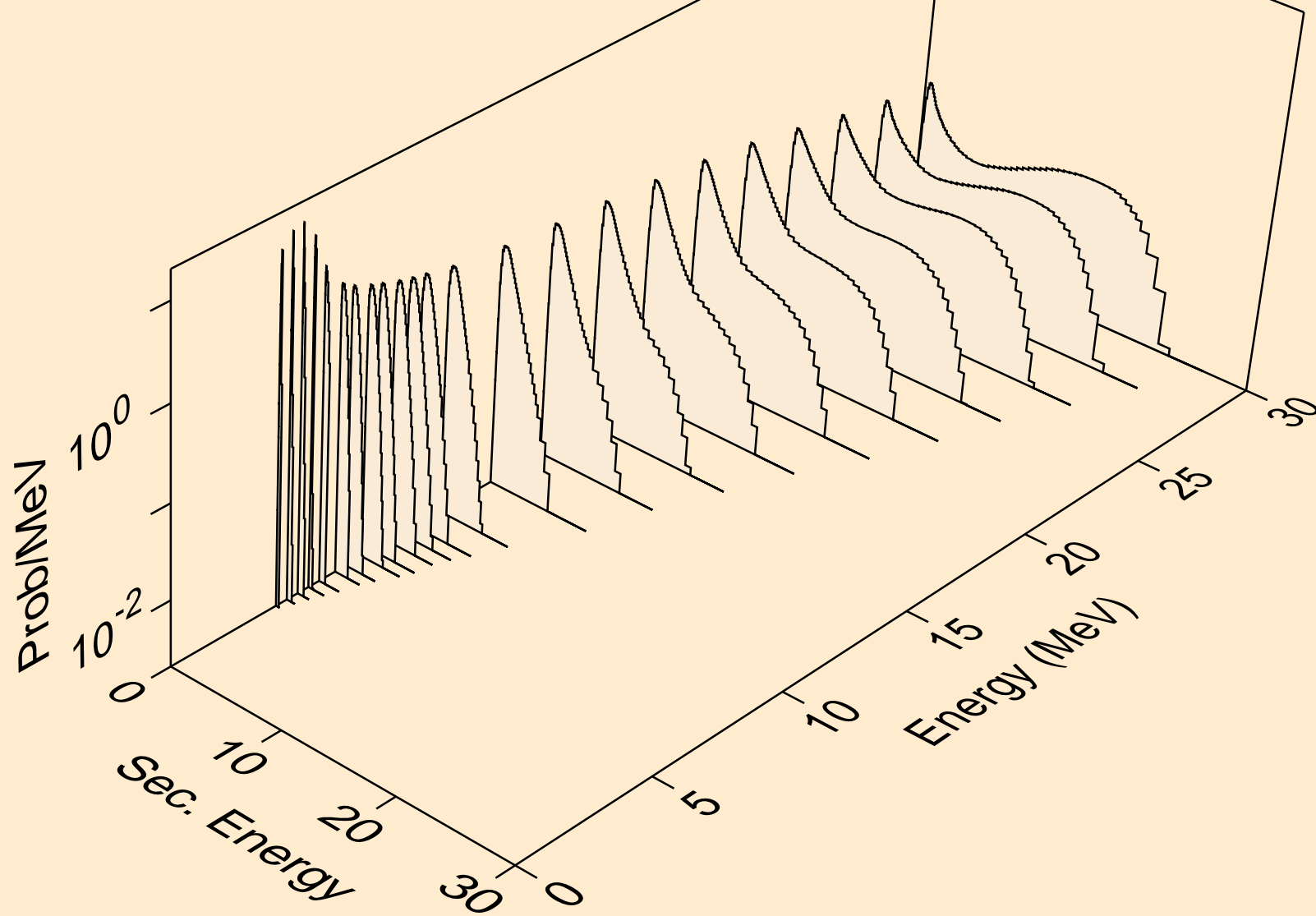

W163 NEUTRON ACER TENDL-2021 LIBRARY; T=293.6K
Neutron emission for (n,n*)2a

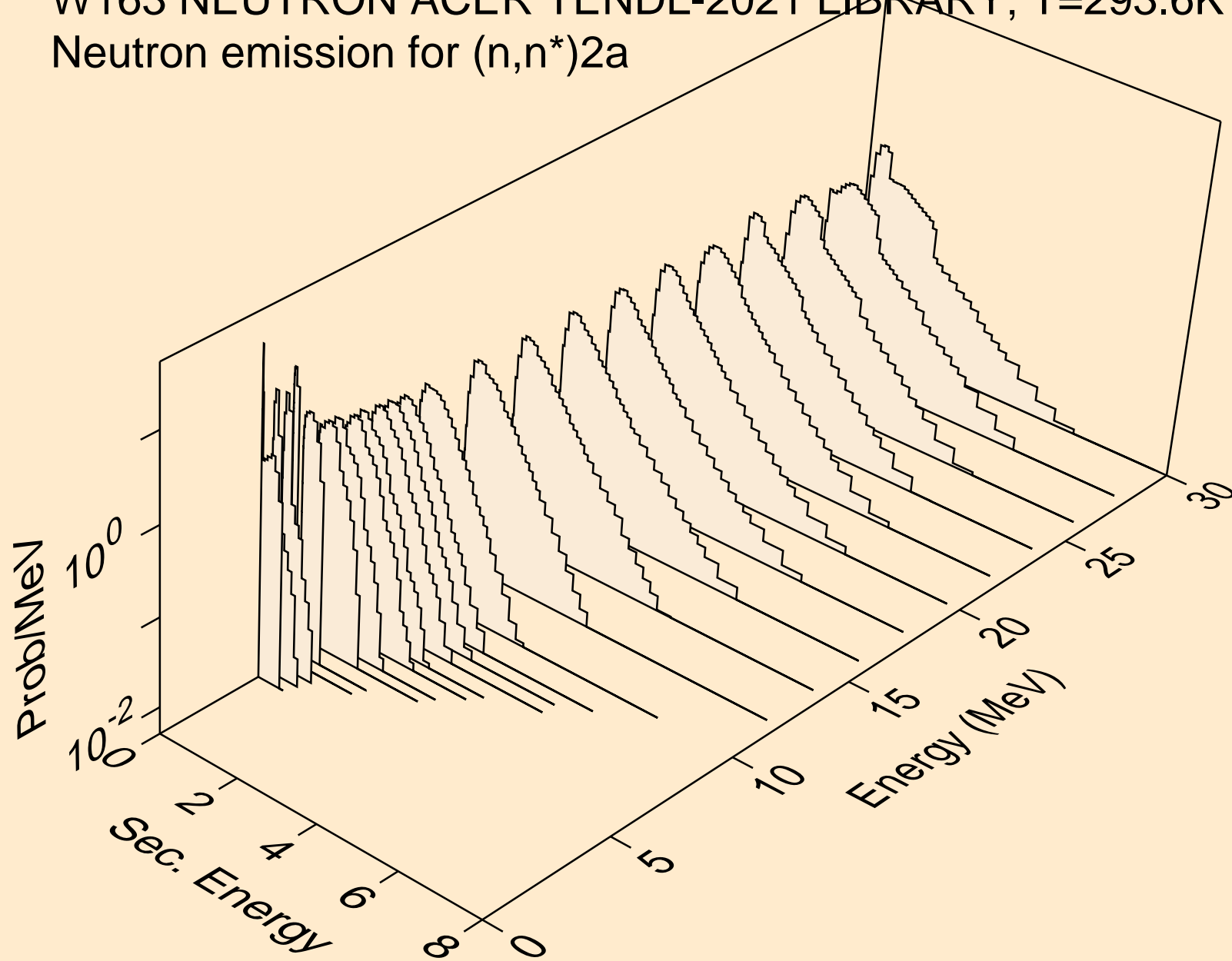

W163 NEUTRON ACER TENDL-2021 LIBRARY; T=293.6K
Neutron emission for (n,2n)2a

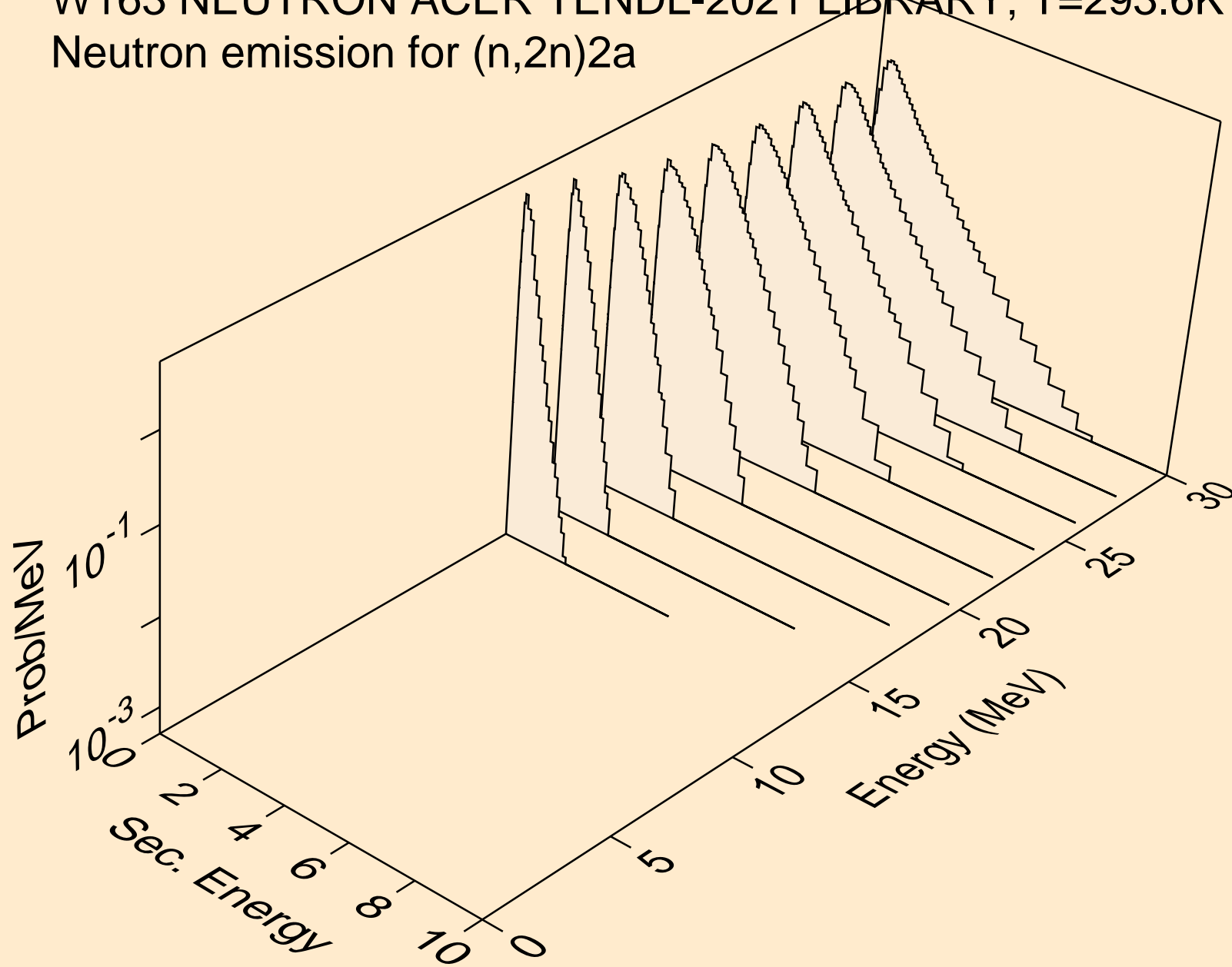

W163 NEUTRON ACER TENDL-2021 LIBRARY; T=293.6K
Neutron emission for (n,n*)d

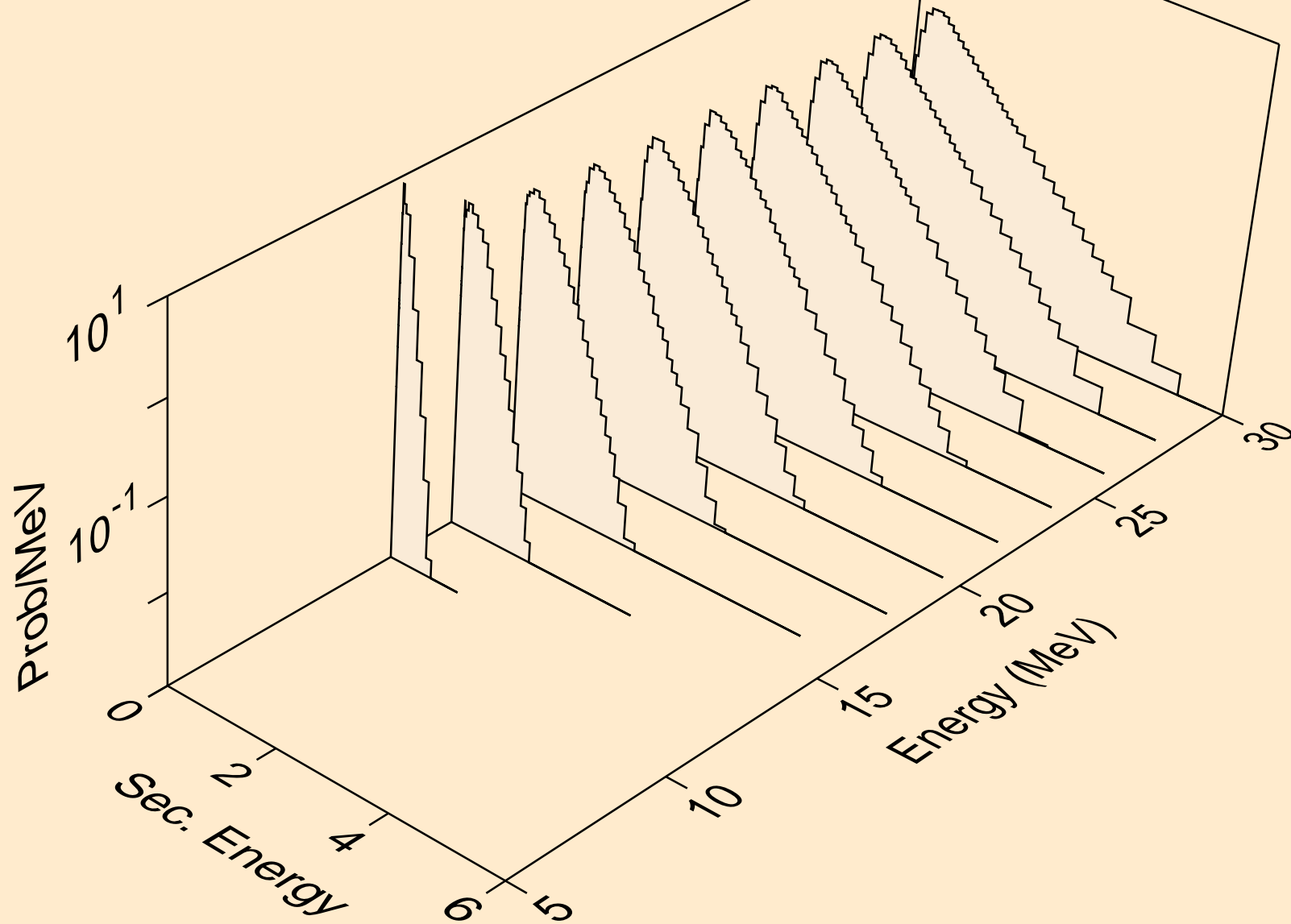

W163 NEUTRON ACER TENDL-2021 LIBRARY; T=293.6K
Neutron emission for (n,n*)t

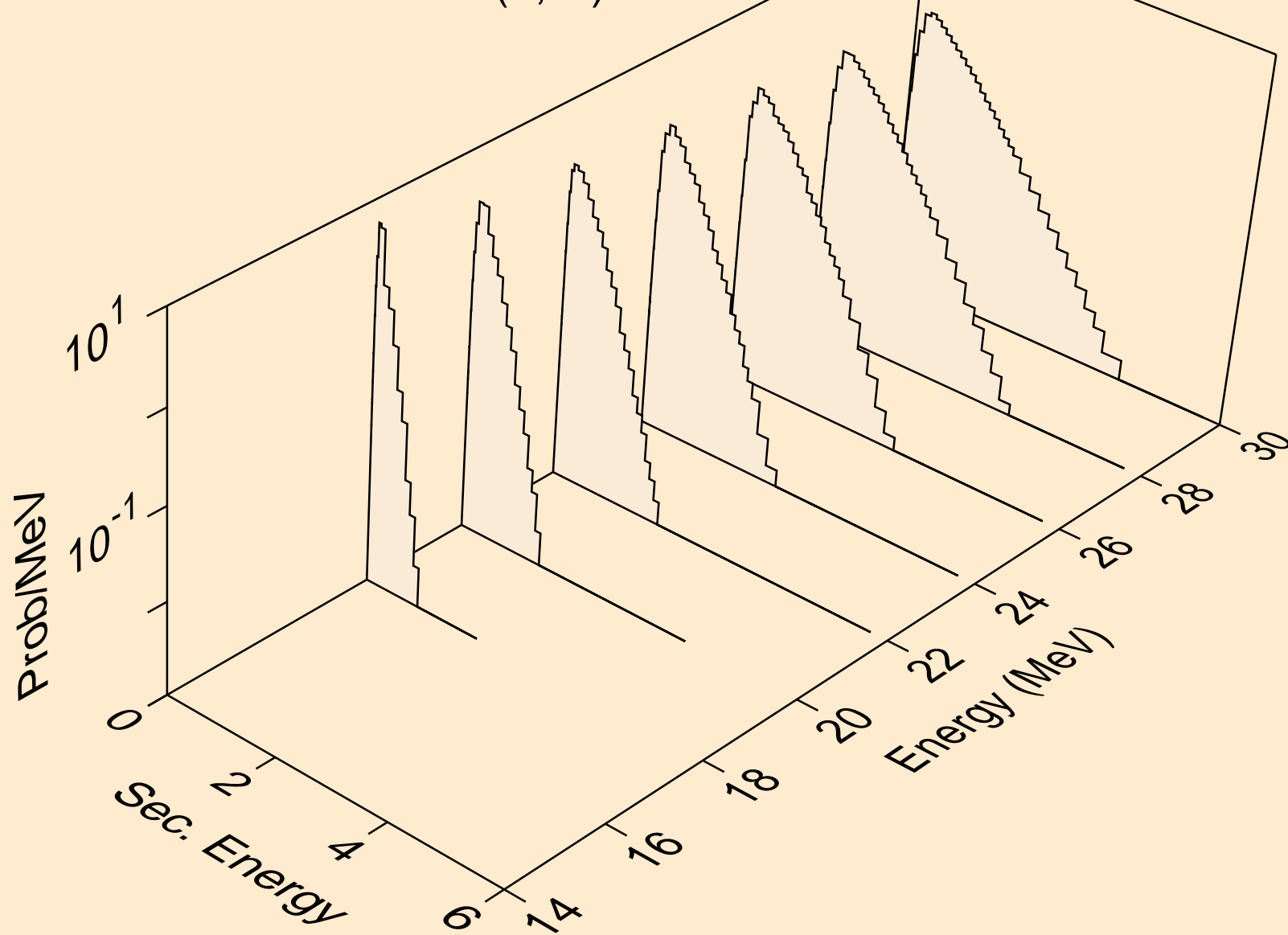

W163 NEUTRON ACER TENDL-2021 LIBRARY; T=293.6K
Neutron emission for (n,n*)he3

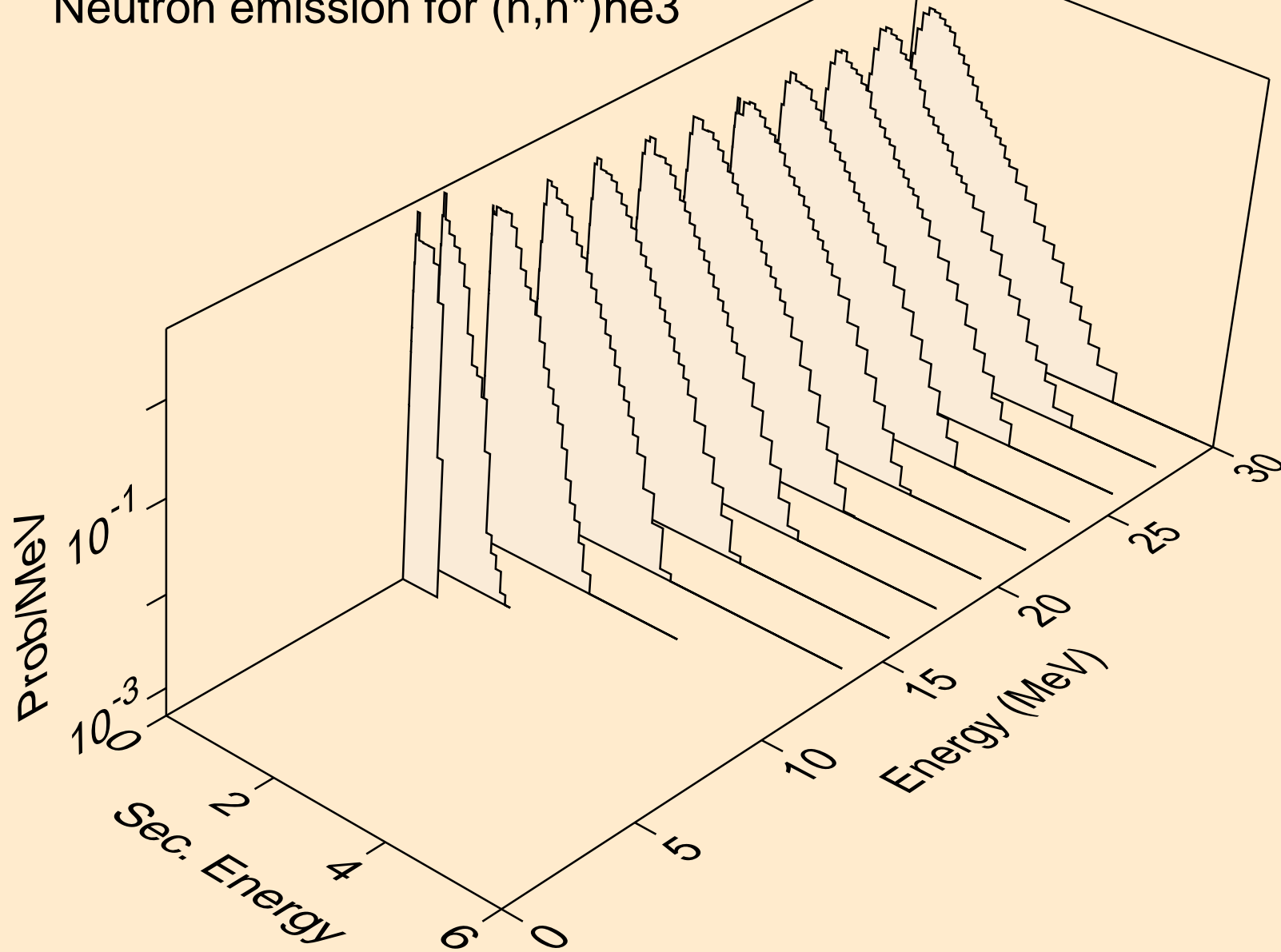

W163 NEUTRON ACER TENDL-2021 LIBRARY; T=293.6K
Neutron emission for (n,2np)

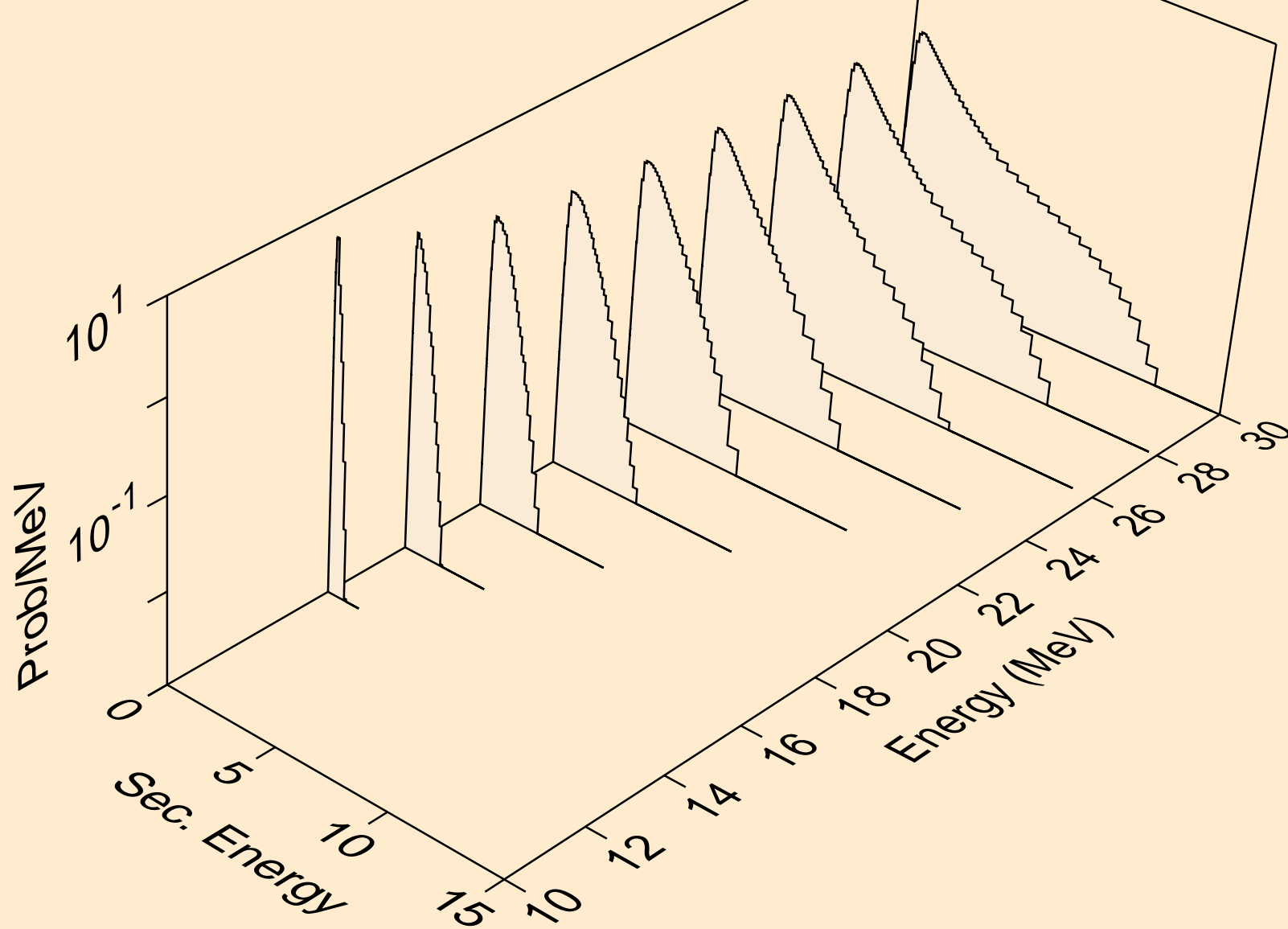

W163 NEUTRON ACER TENDL-2021 LIBRARY; T=293.6K
Neutron emission for (n,3np)

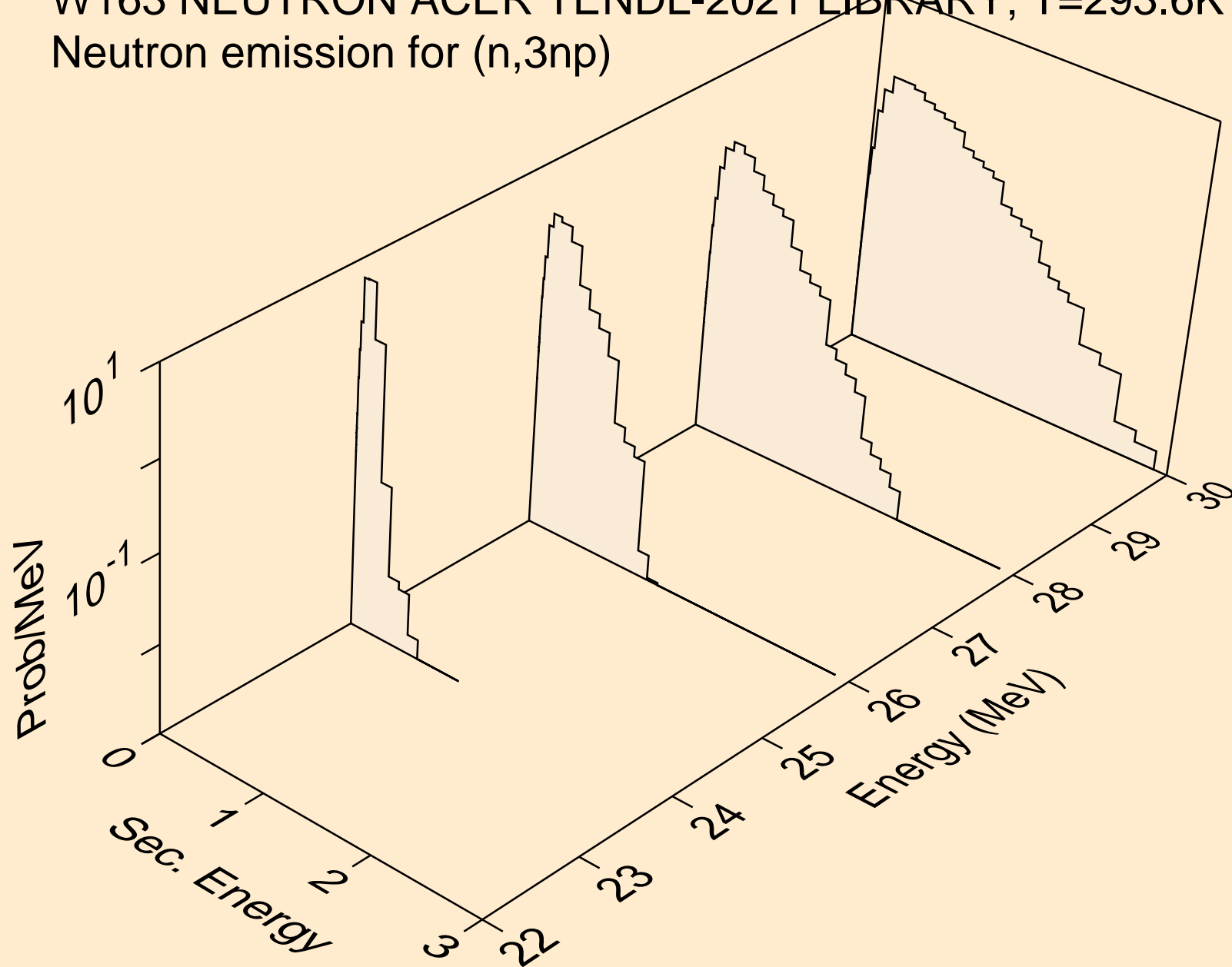

W163 NEUTRON ACER TENDL-2021 LIBRARY; T=293.6K
Neutron emission for (n,2np)

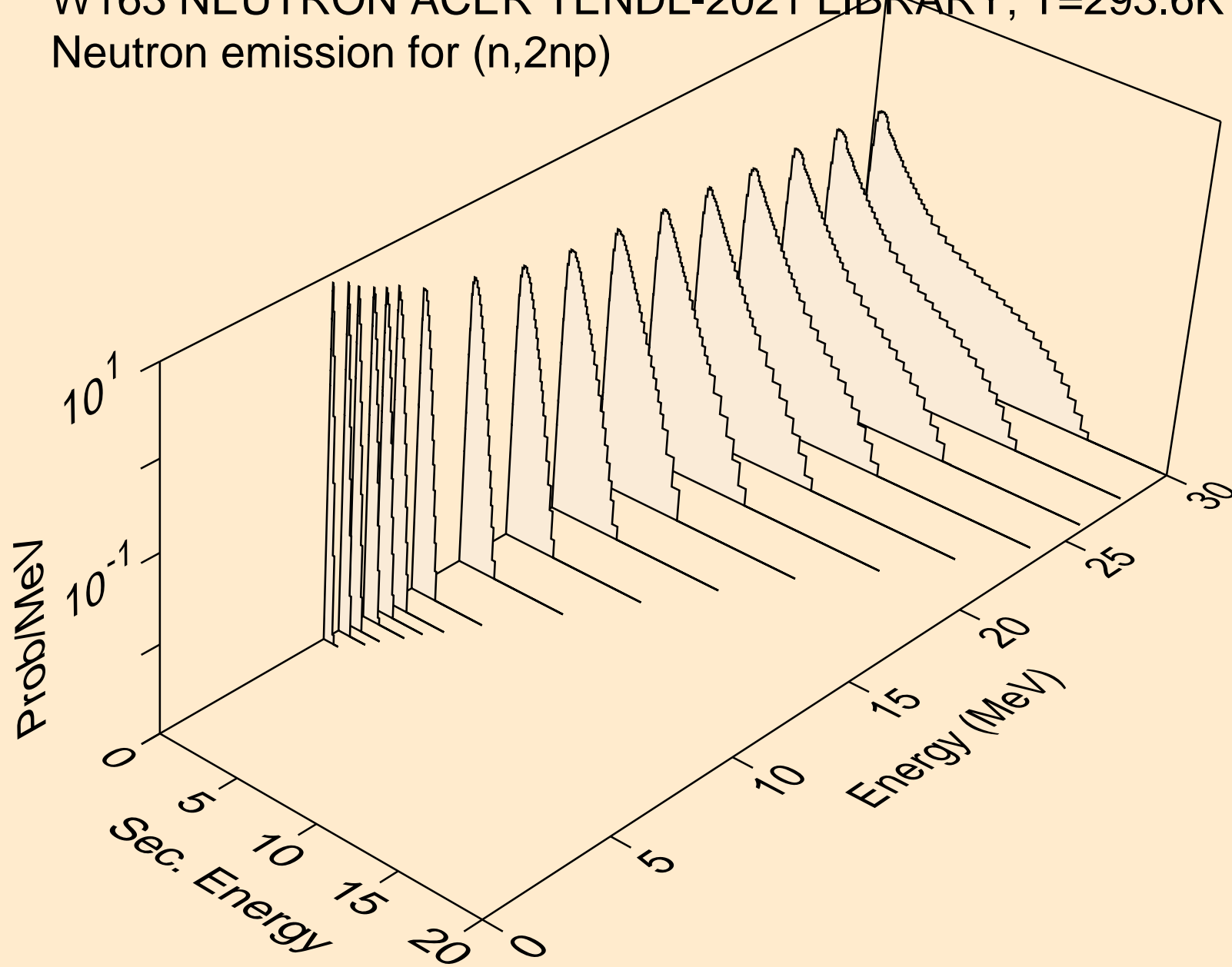

W163 NEUTRON ACER TENDL-2021 LIBRARY; T=293.6K
Neutron emission for (n,npa)

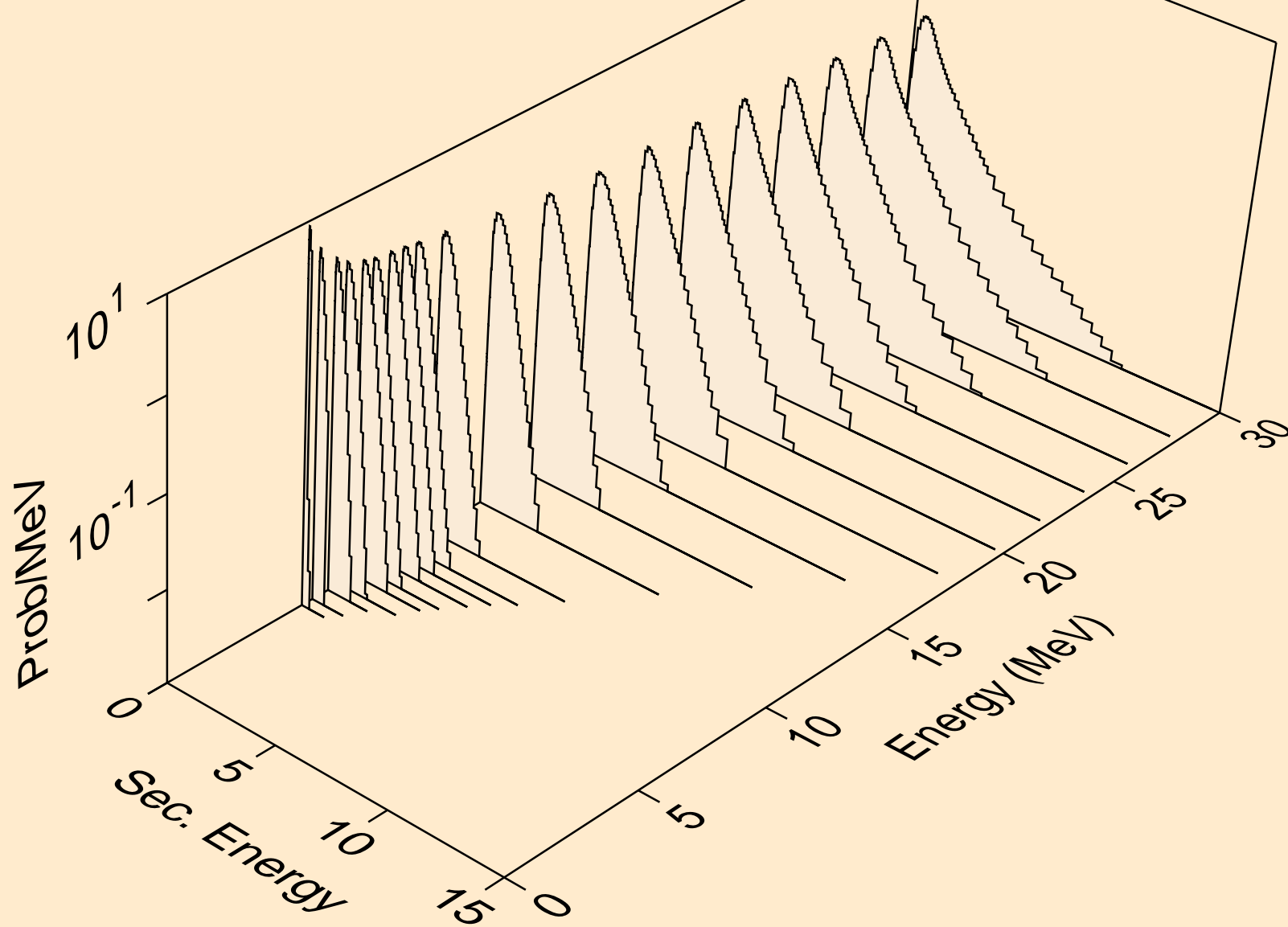

W163 NEUTRON ACER TENDL-2021 LIBRARY; T=293.6K
Neutron emission for (n,n*c)

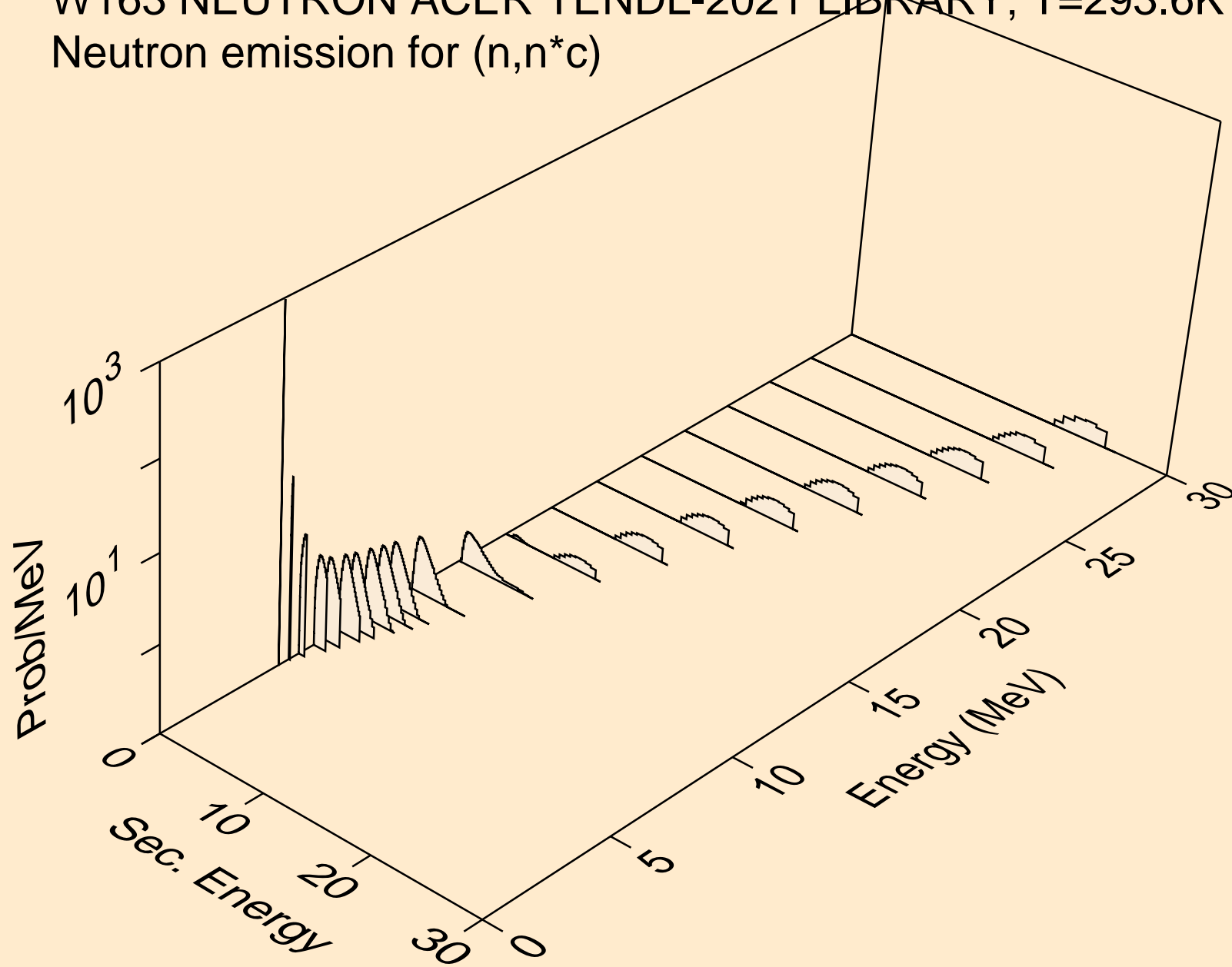

W163 NEUTRON ACER TENDL-2021 LIBRARY; T=293.6K
Photon emission for (n,x)

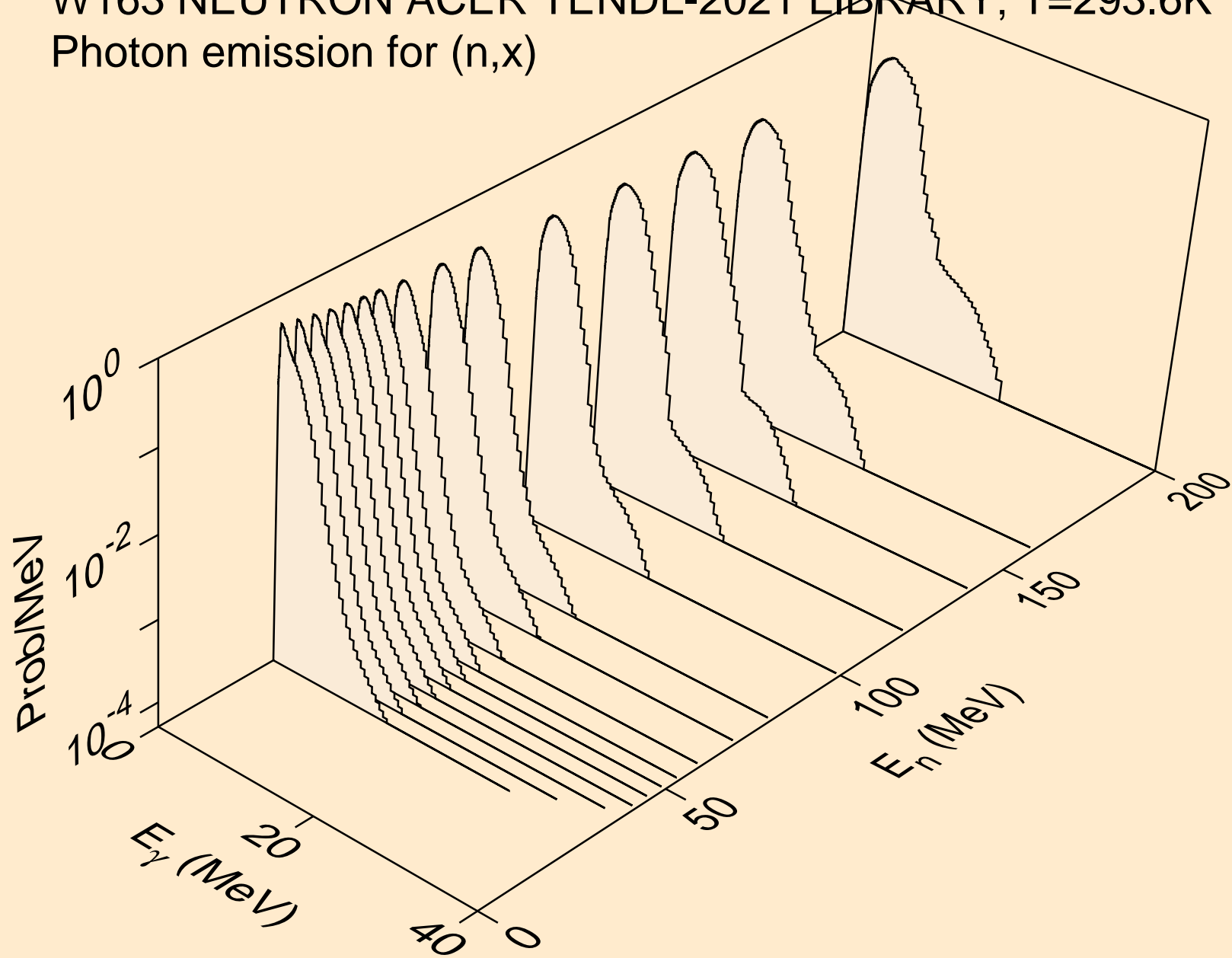

W163 NEUTRON ACER TENDL-2021 LIBRARY; T=293.6K
Photon emission for (n,2nd)

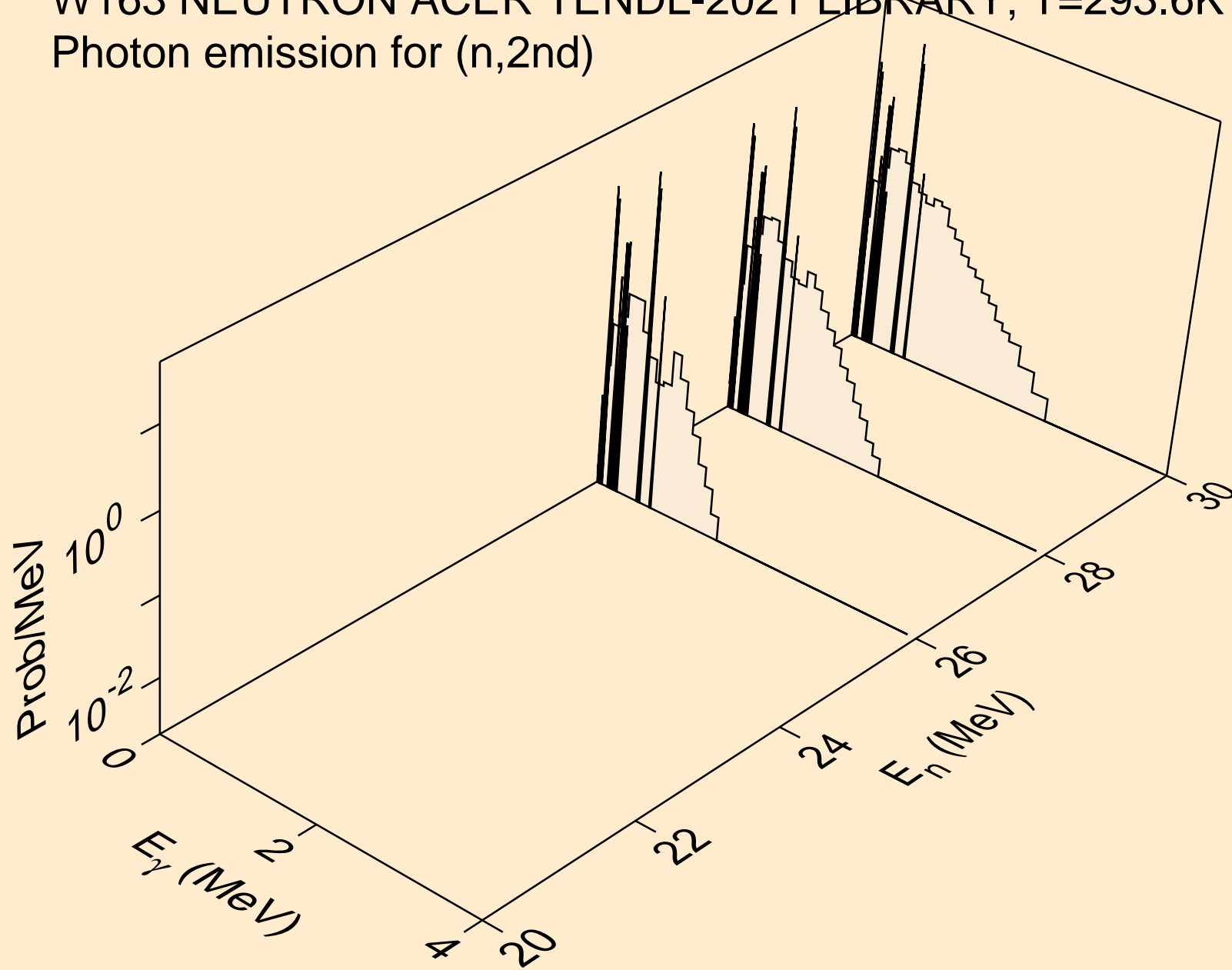

W163 NEUTRON ACER TENDL-2021 LIBRARY; T=293.6K
Photon emission for (n,2n)

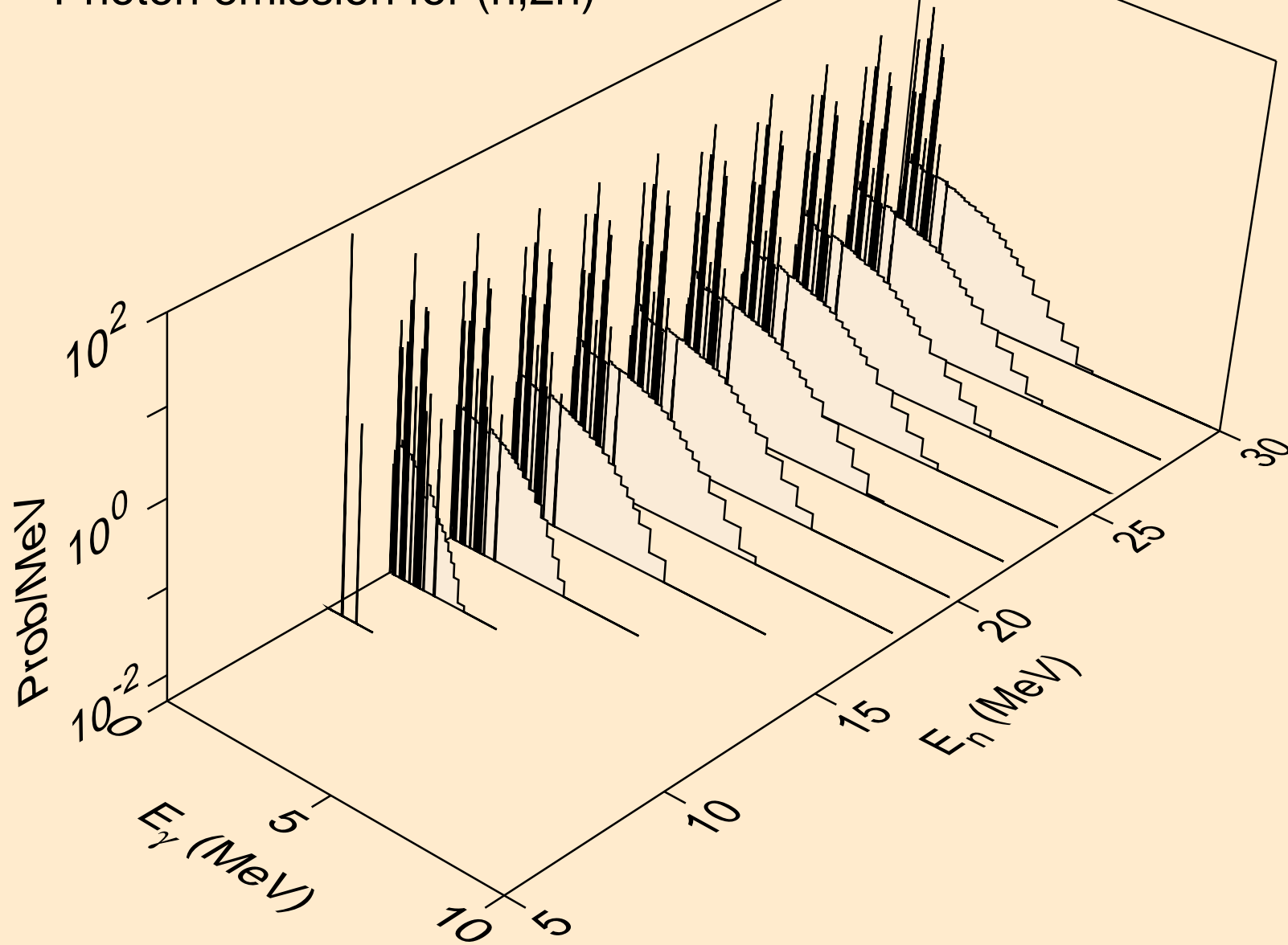

W163 NEUTRON ACER TENDL-2021 LIBRARY; T=293.6K
Photon emission for (n,3n)

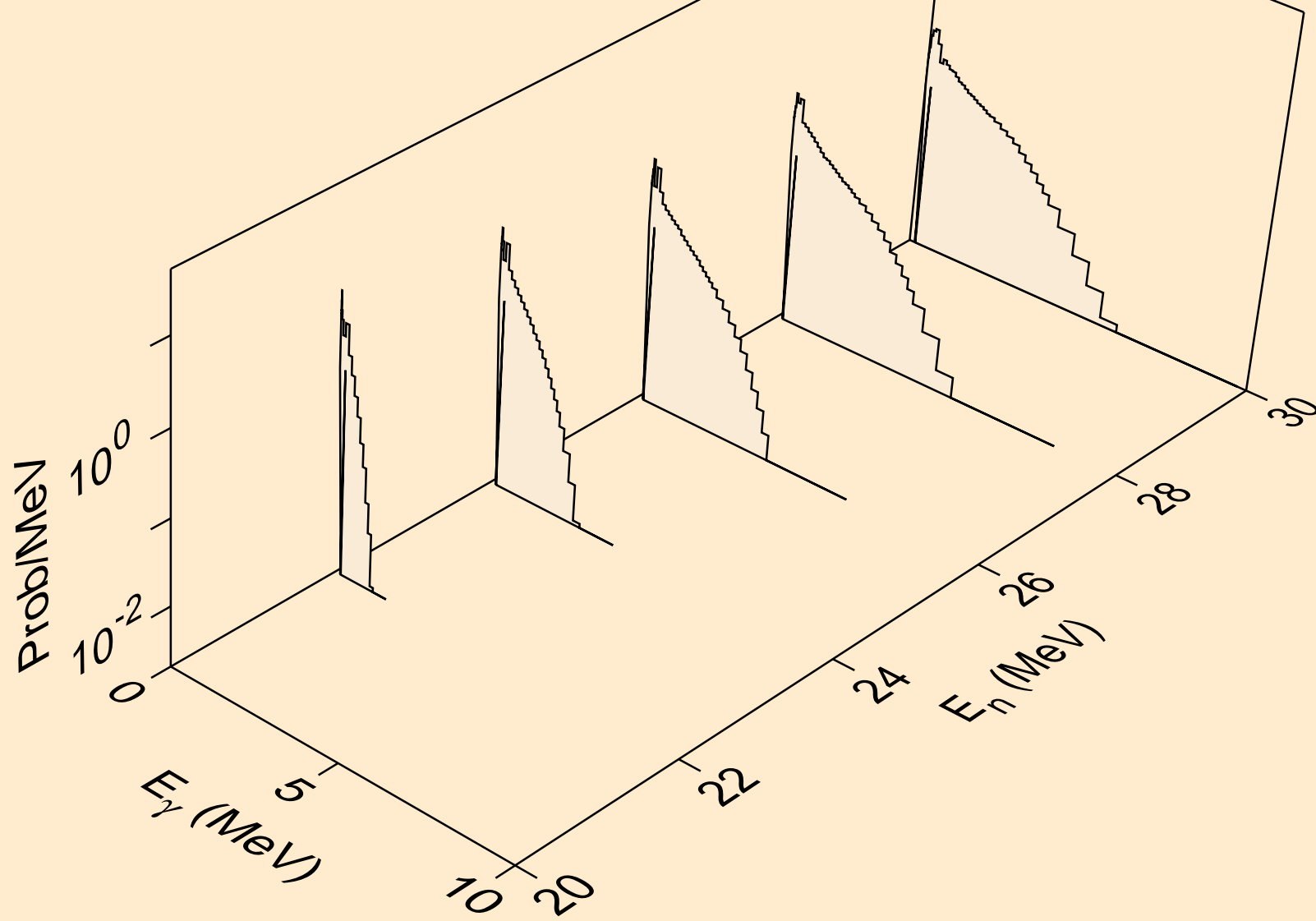

W163 NEUTRON ACER TENDL-2021 LIBRARY; T=293.6K
Photon emission for (n,n*)a

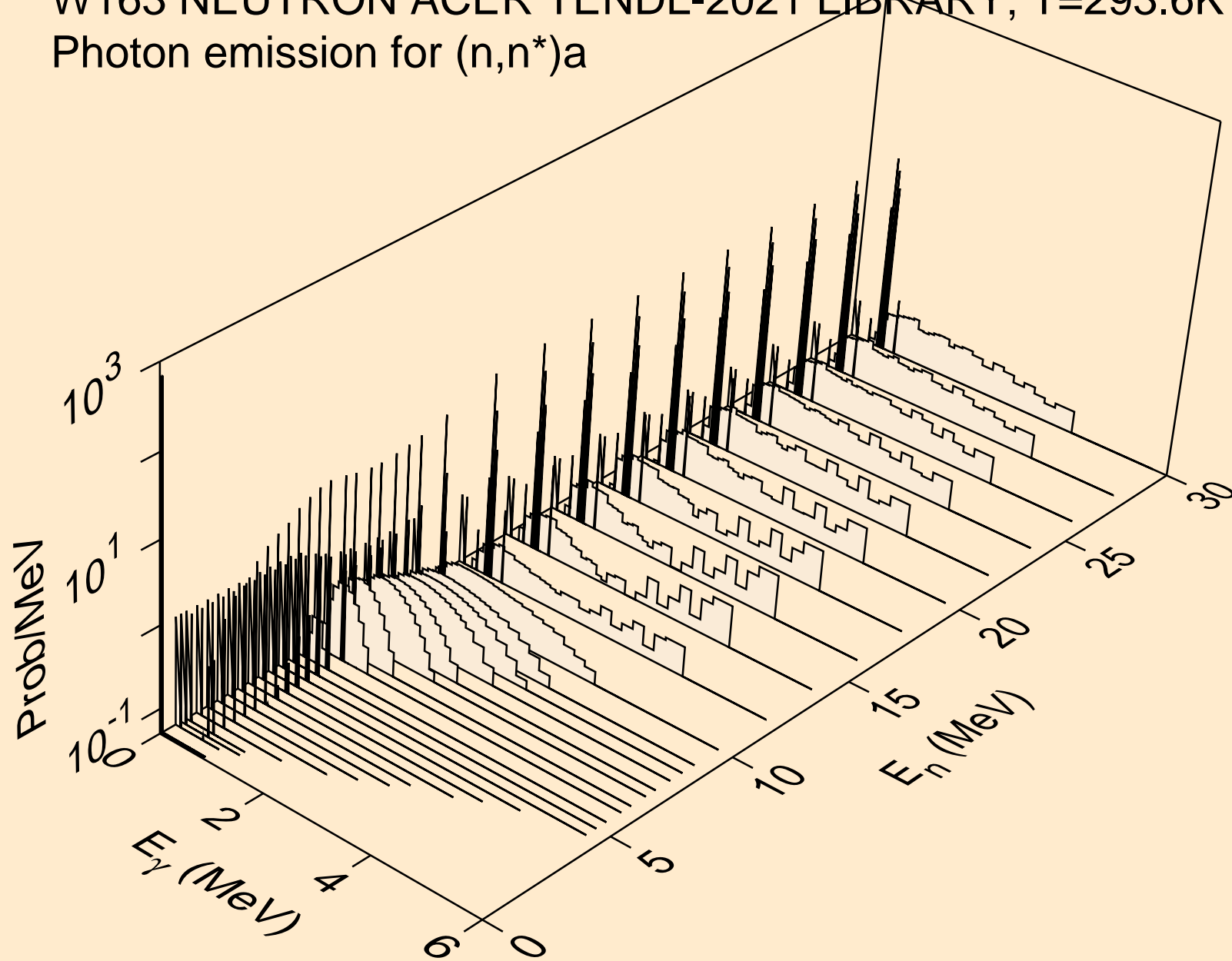

W163 NEUTRON ACER TENDL-2021 LIBRARY; T=293.6K
Photon emission for (n,n*)3a

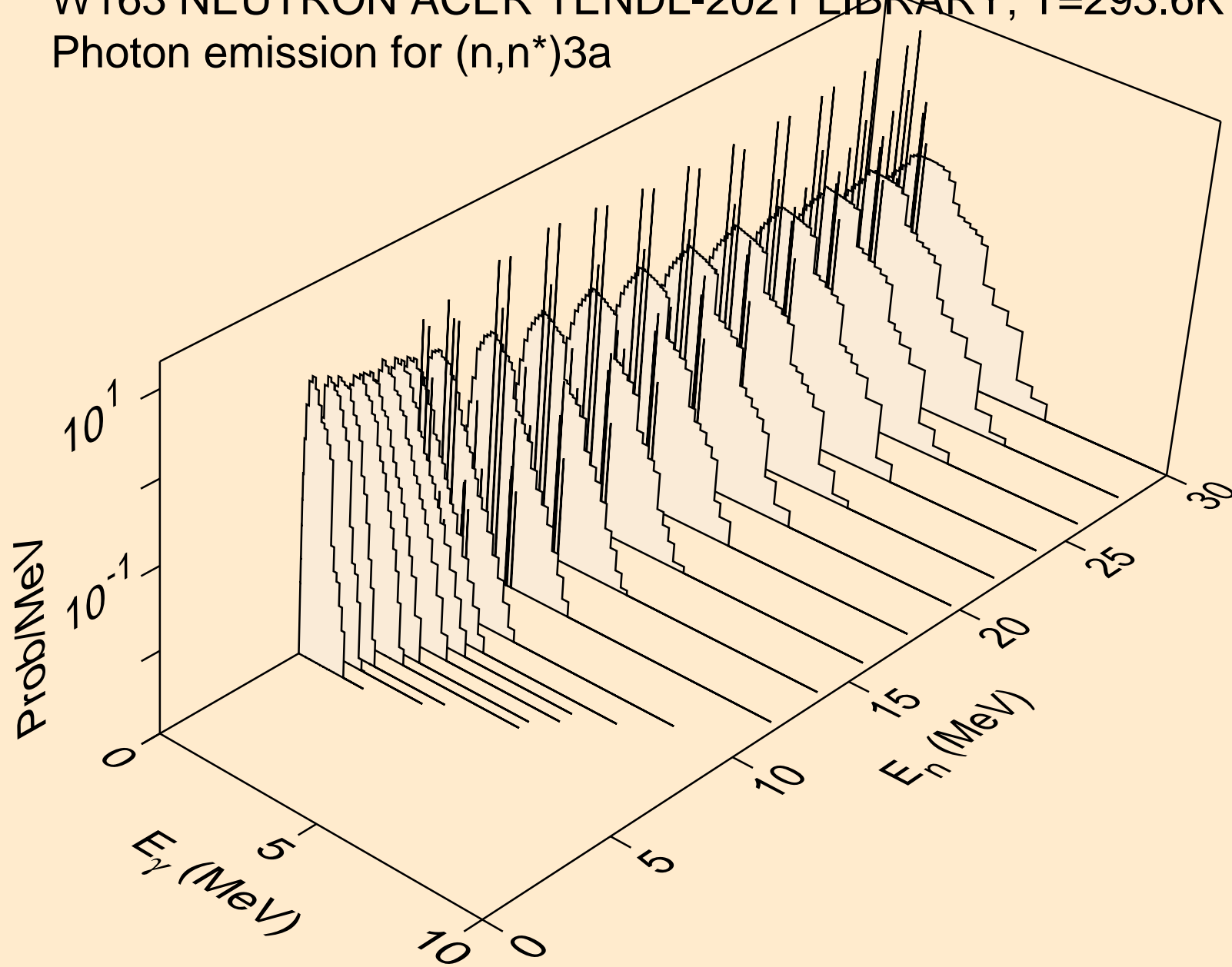

W163 NEUTRON ACER TENDL-2021 LIBRARY; T=293.6K
Photon emission for (n,2n)a

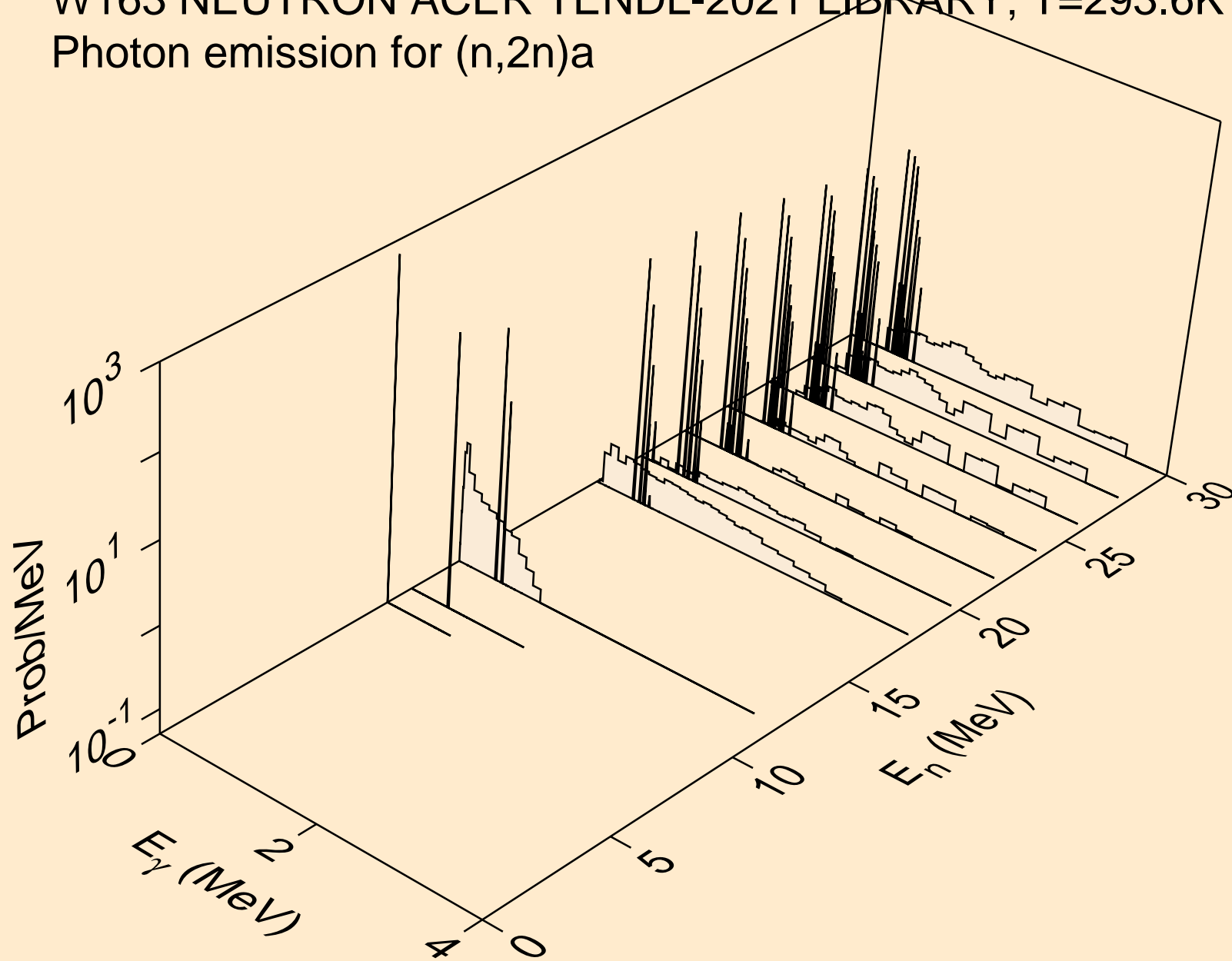

W163 NEUTRON ACER TENDL-2021 LIBRARY; T=293.6K
Photon emission for (n,3n)a

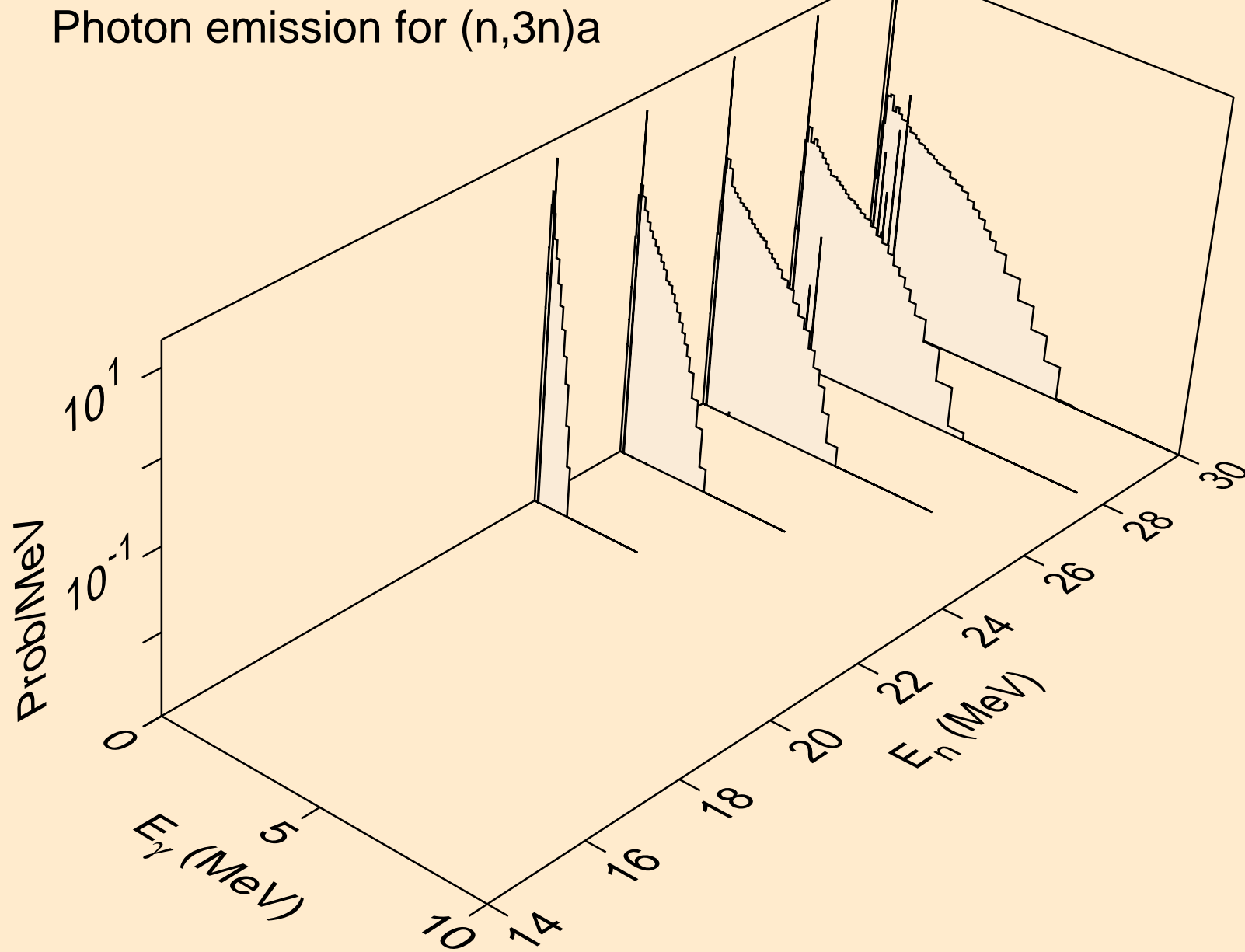

W163 NEUTRON ACER TENDL-2021 LIBRARY; T=293.6K
Photon emission for (n,n*)p

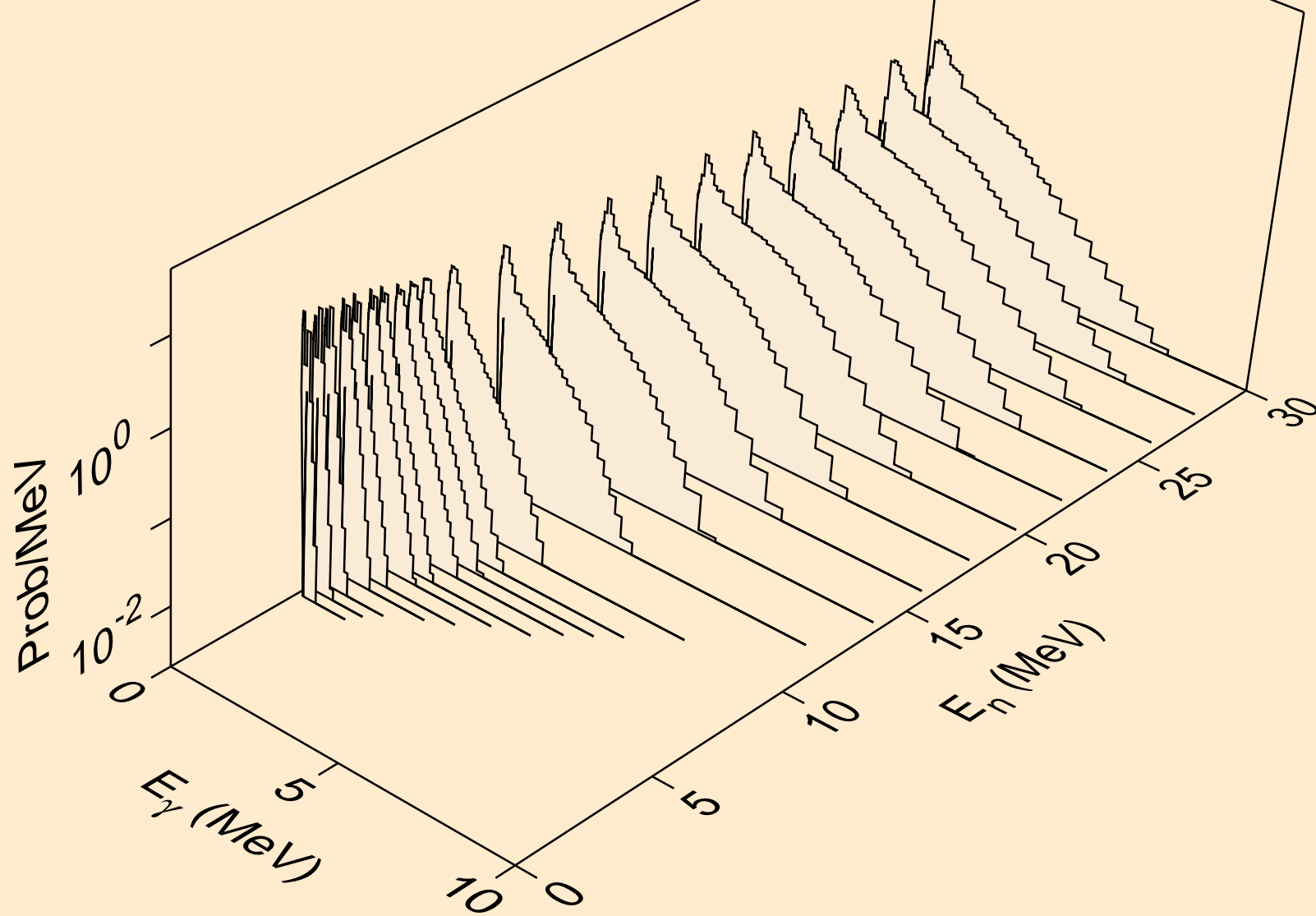

W163 NEUTRON ACER TENDL-2021 LIBRARY; T=293.6K
Photon emission for (n,n*)2a

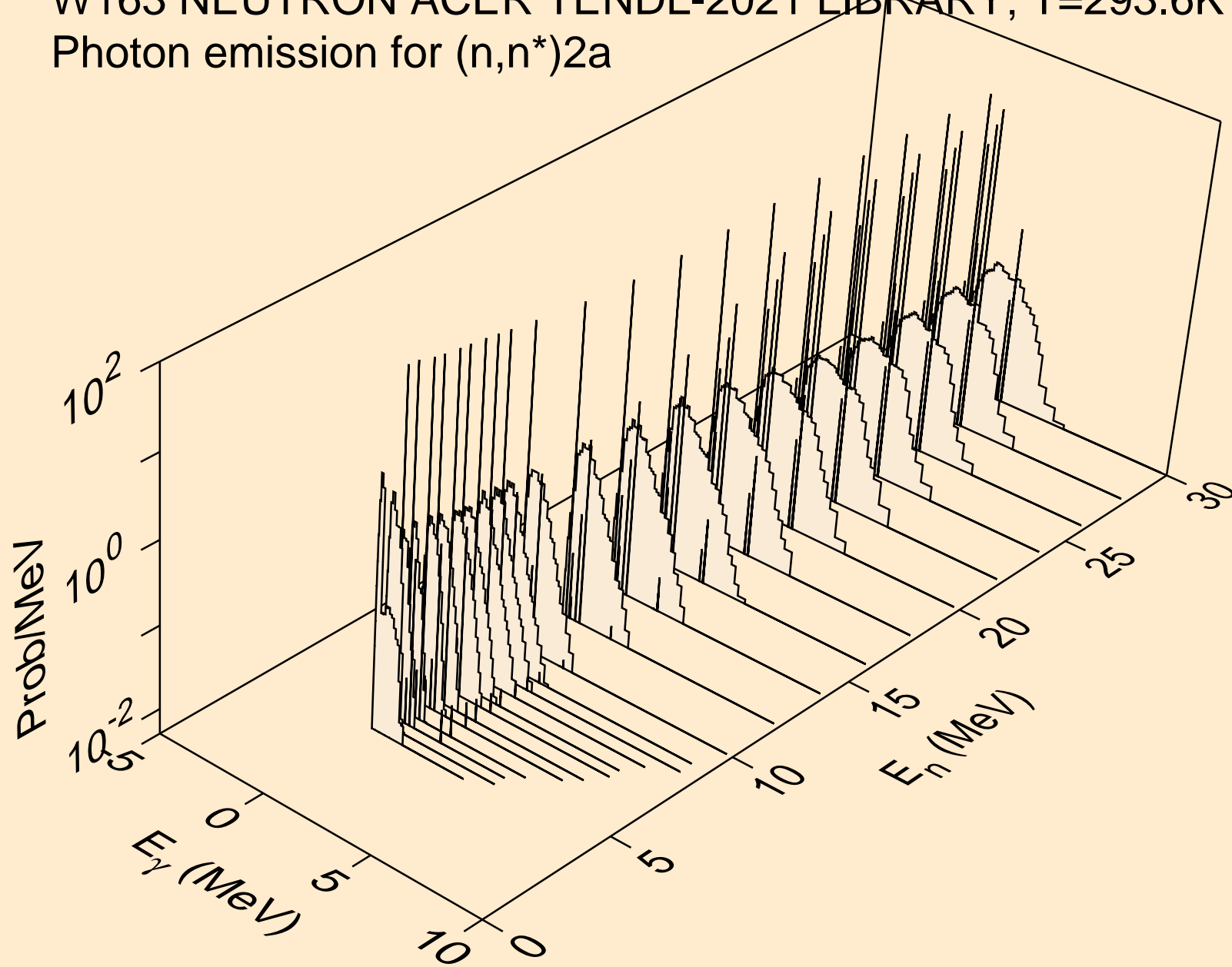

W163 NEUTRON ACER TENDL-2021 LIBRARY; T=293.6K
Photon emission for (n,2n)2a

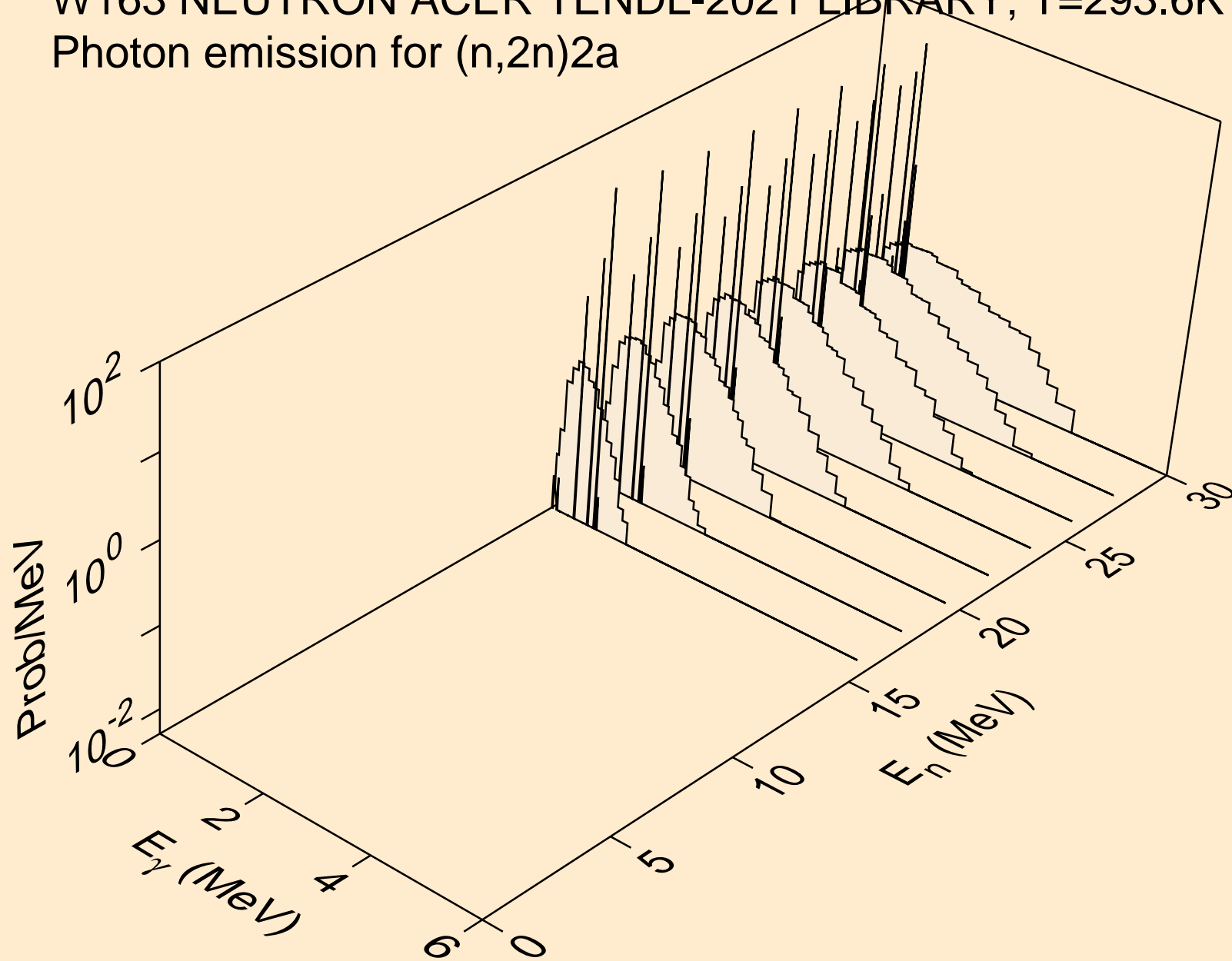

W163 NEUTRON ACER TENDL-2021 LIBRARY; T=293.6K
Photon emission for (n,n*)d

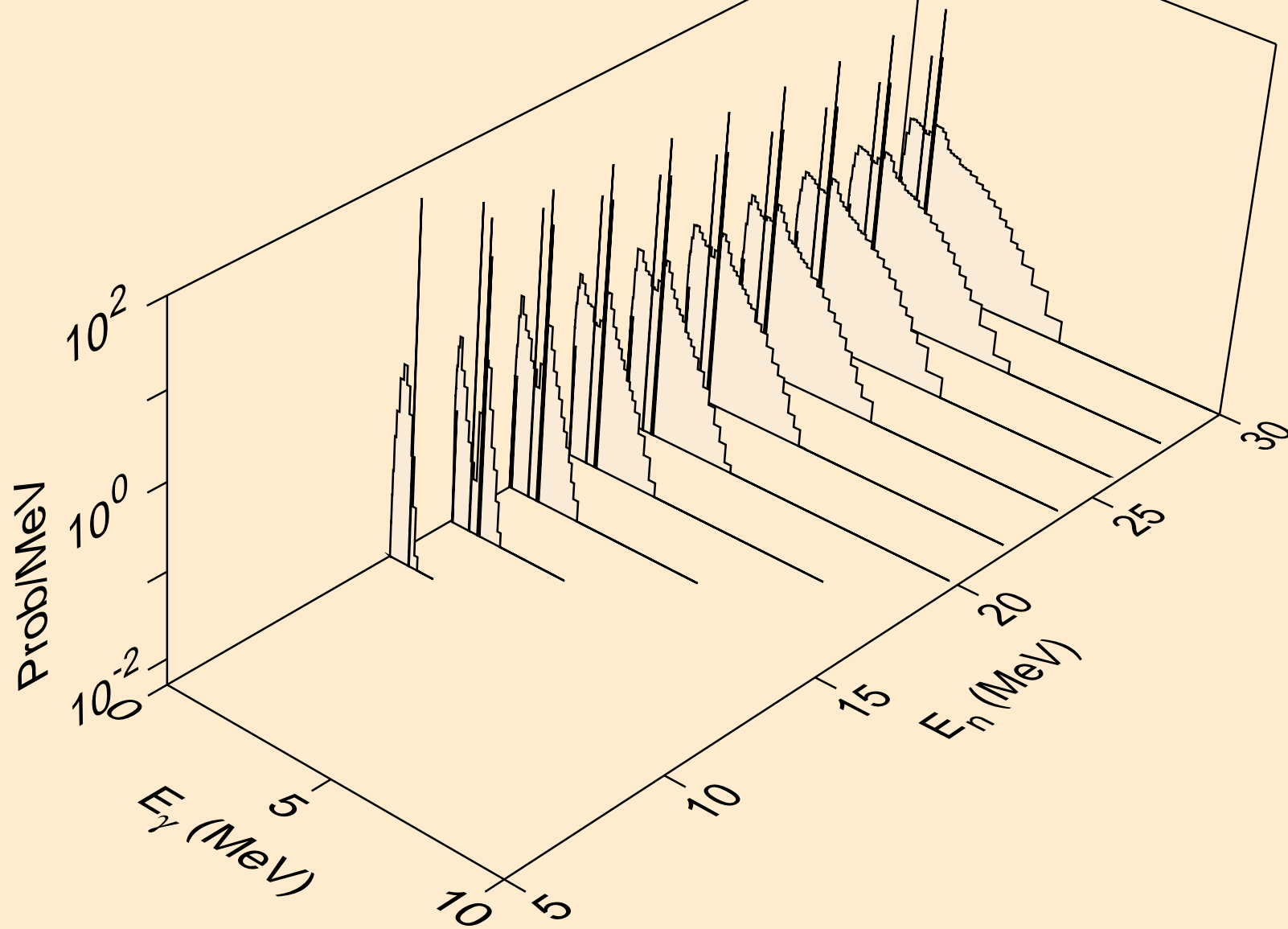

W163 NEUTRON ACER TENDL-2021 LIBRARY; T=293.6K
Photon emission for (n,n*)t

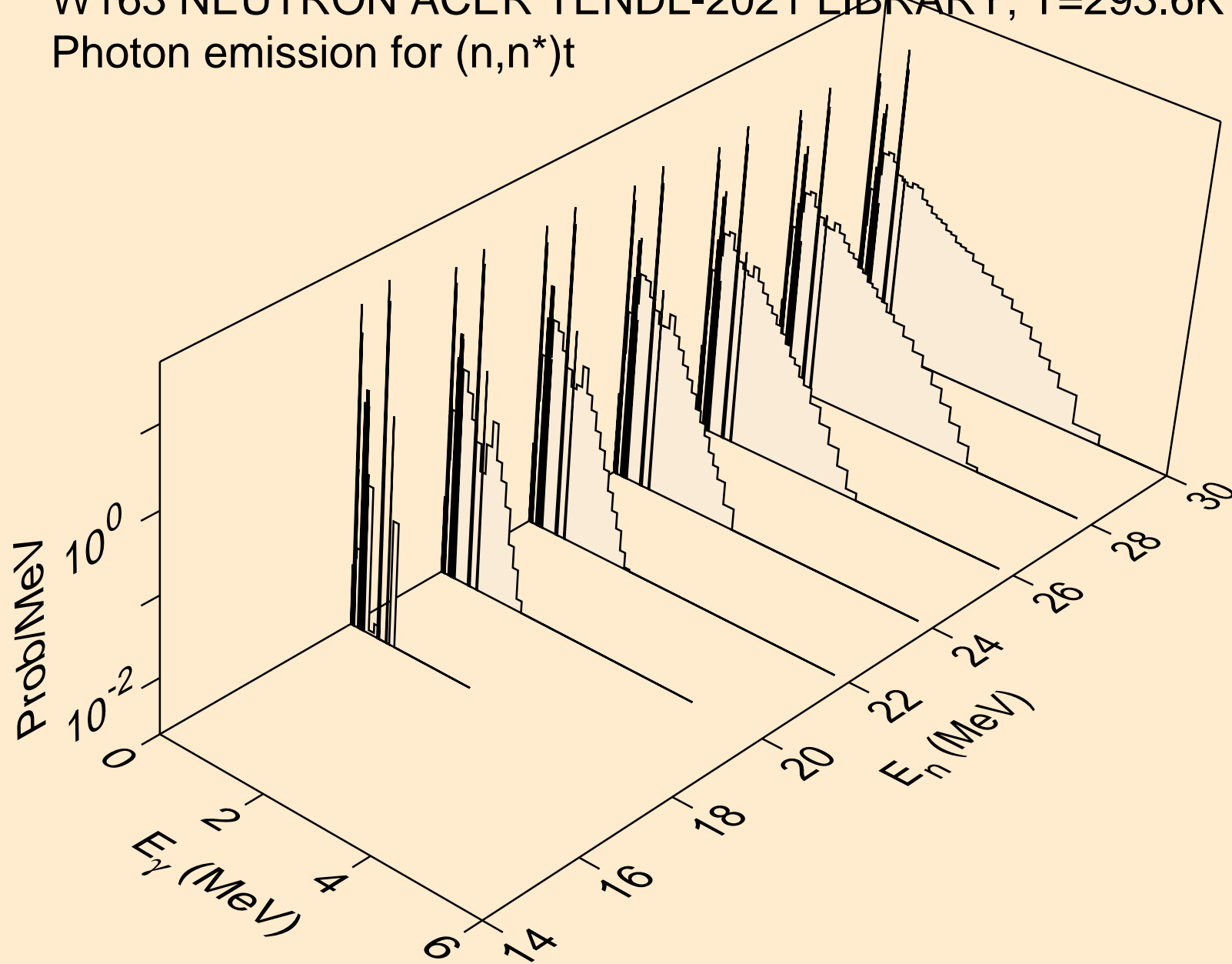

W163 NEUTRON ACER TENDL-2021 LIBRARY; T=293.6K
Photon emission for (n,n*)he3

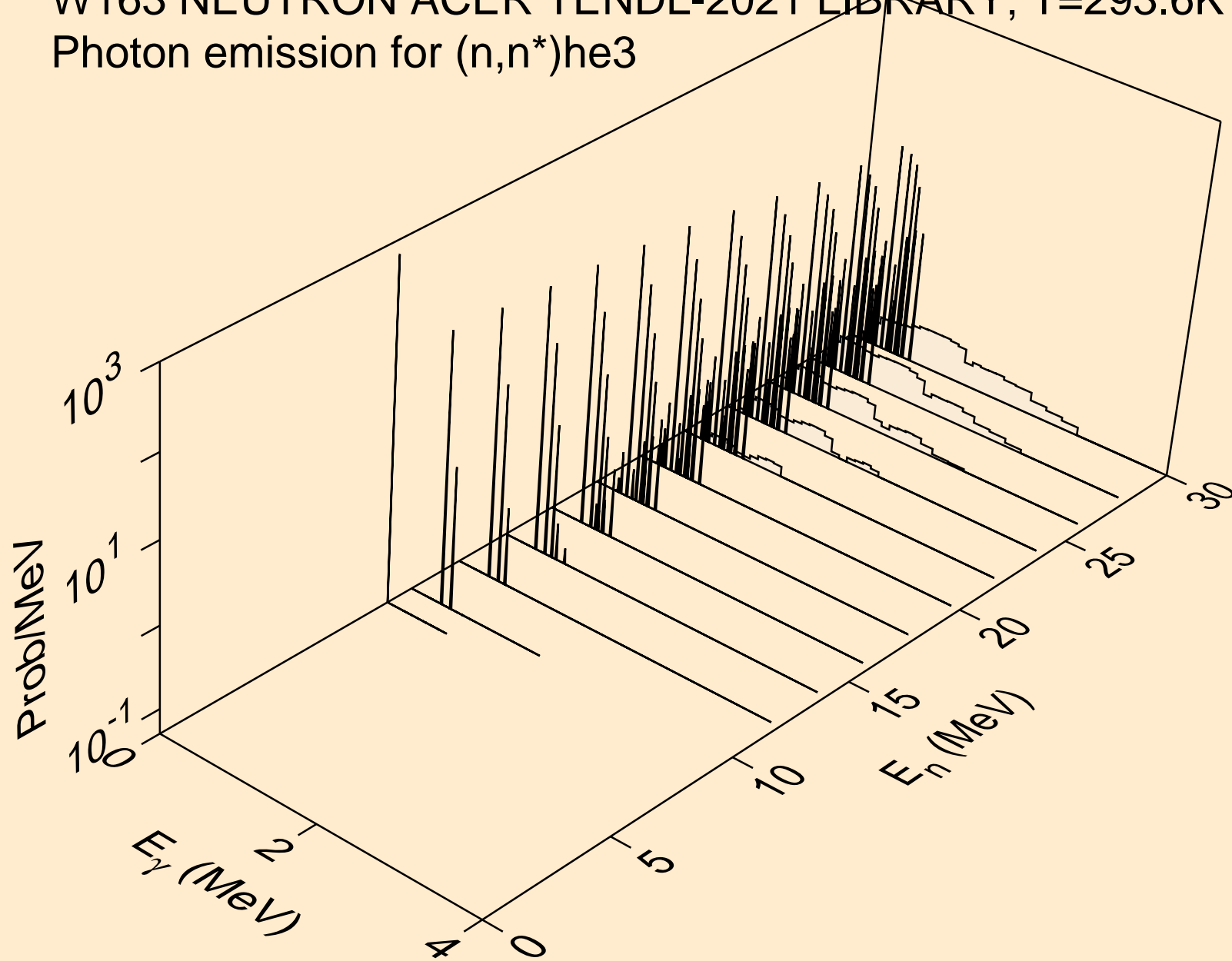

W163 NEUTRON ACER TENDL-2021 LIBRARY; T=293.6K
Photon emission for (n,2np)

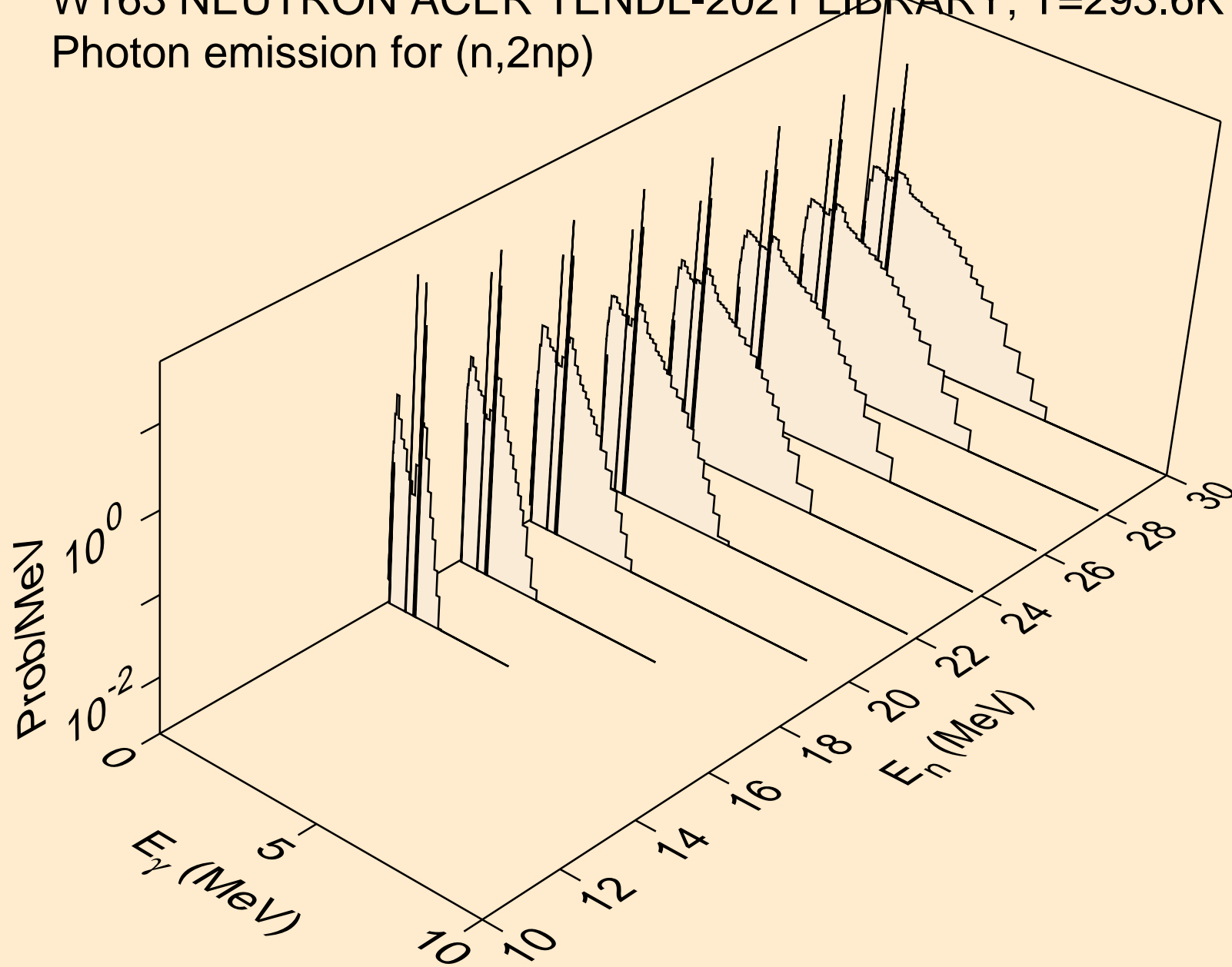

W163 NEUTRON ACER TENDL-2021 LIBRARY; T=293.6K
Photon emission for (n,3np)

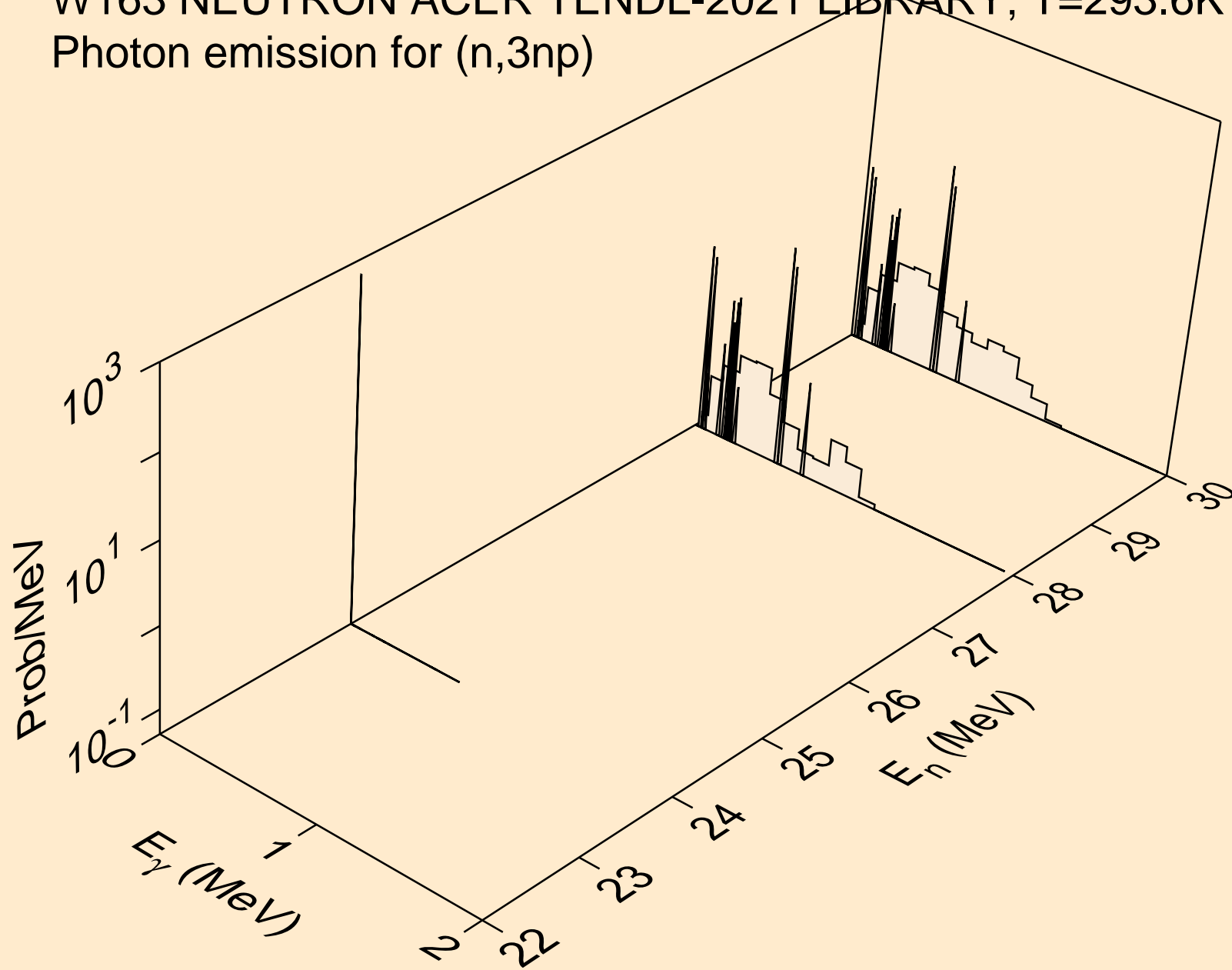

W163 NEUTRON ACER TENDL-2021 LIBRARY; T=293.6K
Photon emission for (n,2np)

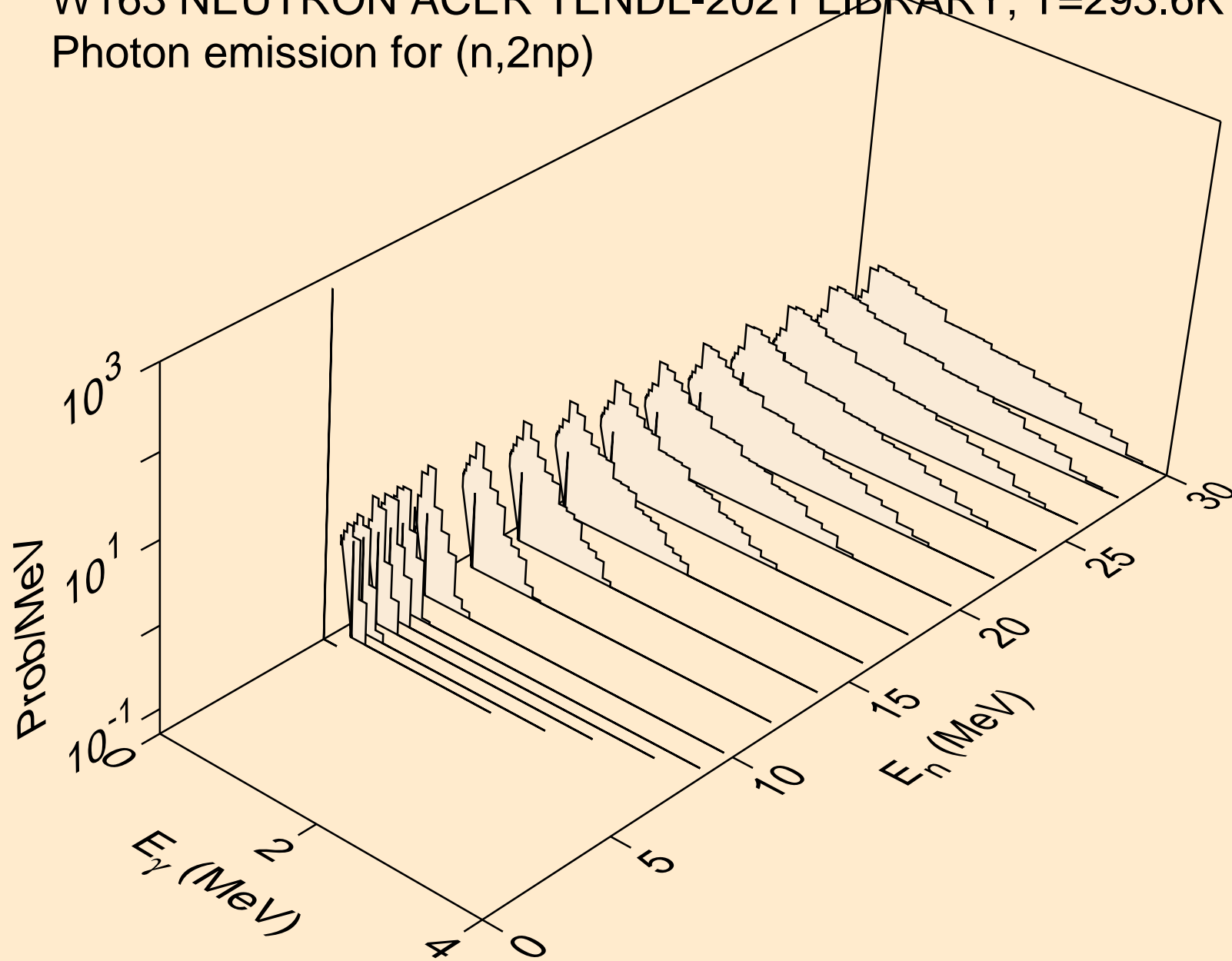

W163 NEUTRON ACER TENDL-2021 LIBRARY; T=293.6K
Photon emission for (n,npa)

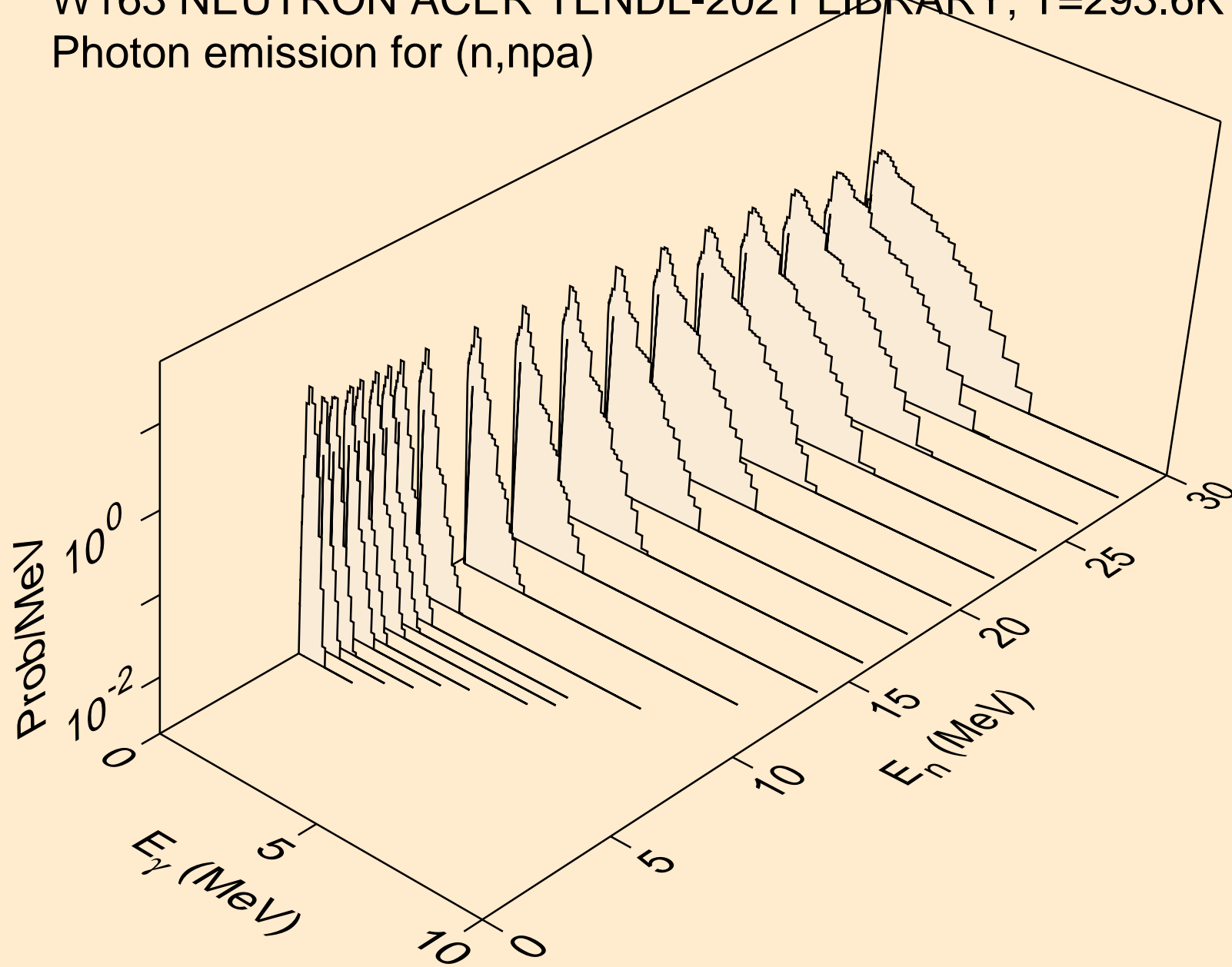

W163 NEUTRON ACER TENDL-2021 LIBRARY; T=293.6K
Photon emission for (n,n*c)

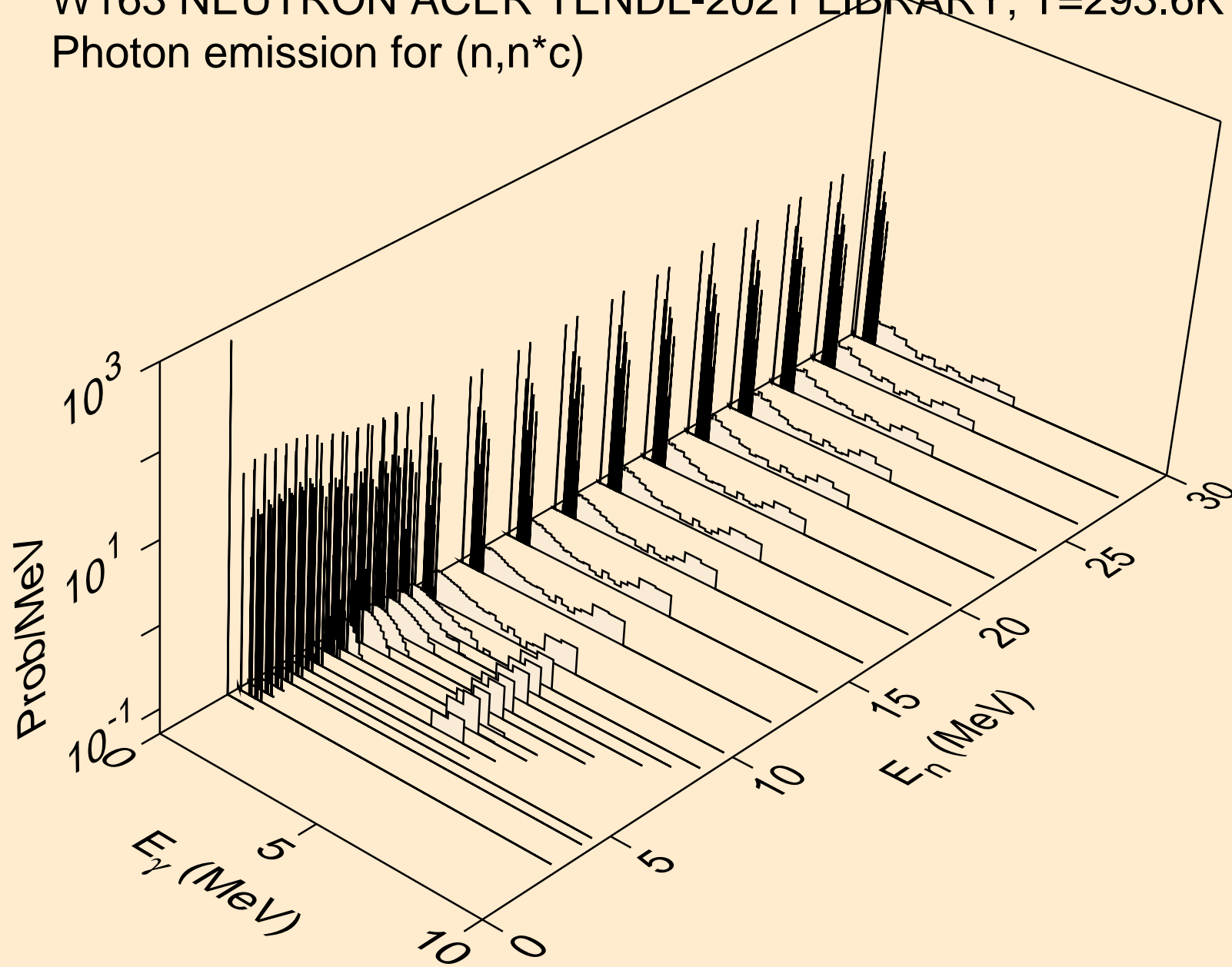

W163 NEUTRON ACER TENDL-2021 LIBRARY; T=293.6K
Photon emission for (n,gma)

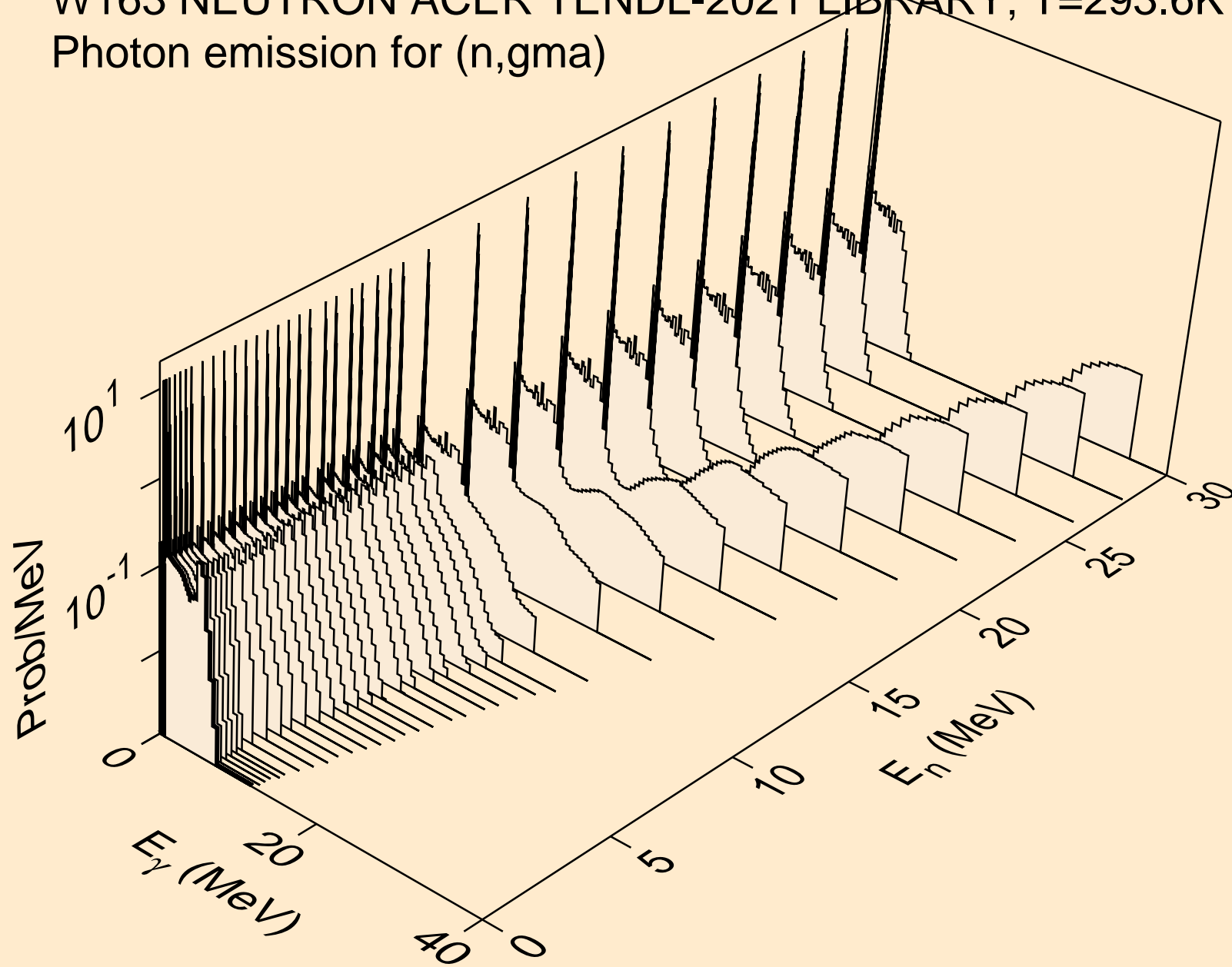

W163 NEUTRON ACER TENDL-2021 LIBRARY; T=293.6K
Photon emission for (n,p)

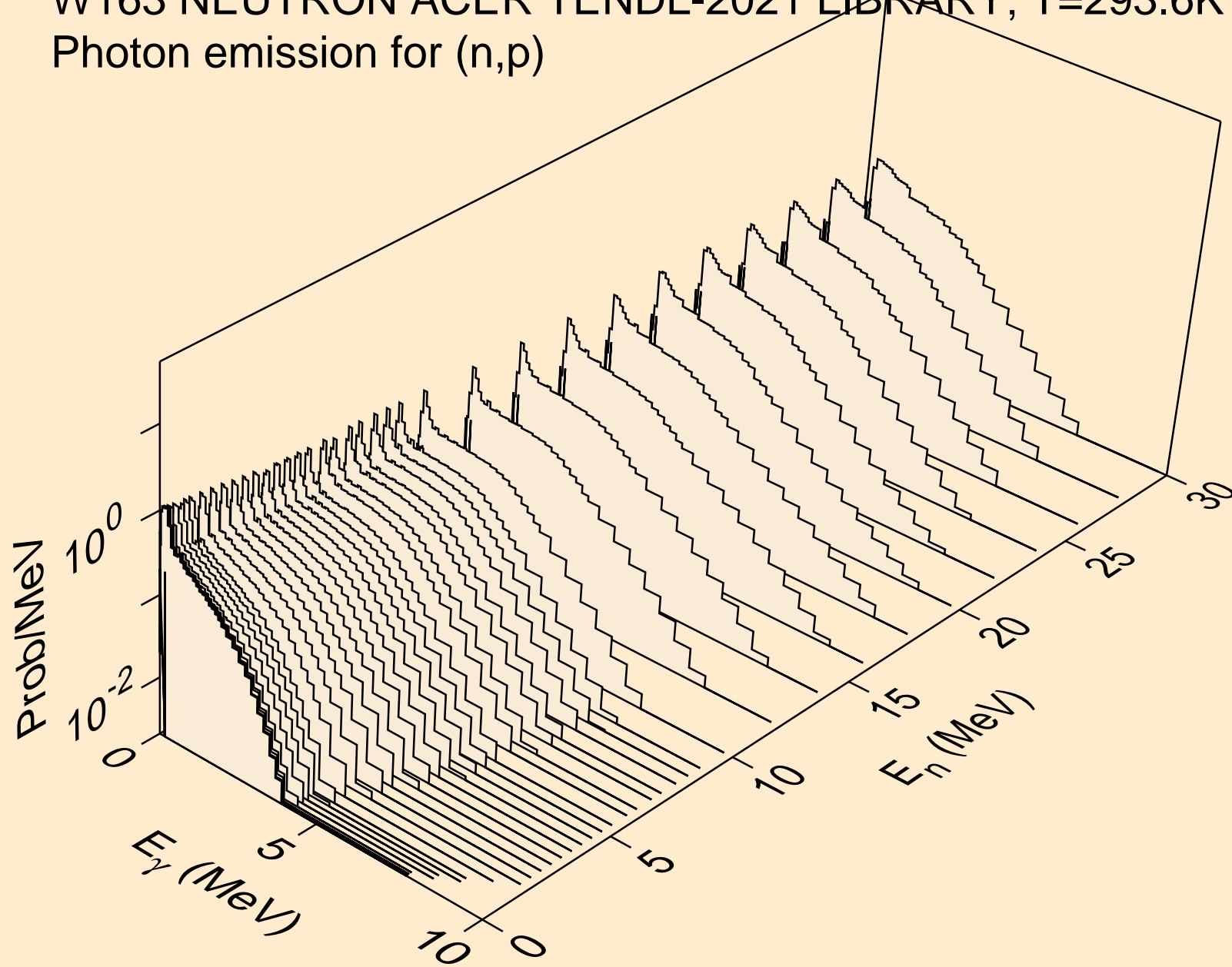

W163 NEUTRON ACER TENDL-2021 LIBRARY; T=293.6K
Photon emission for (n,d)

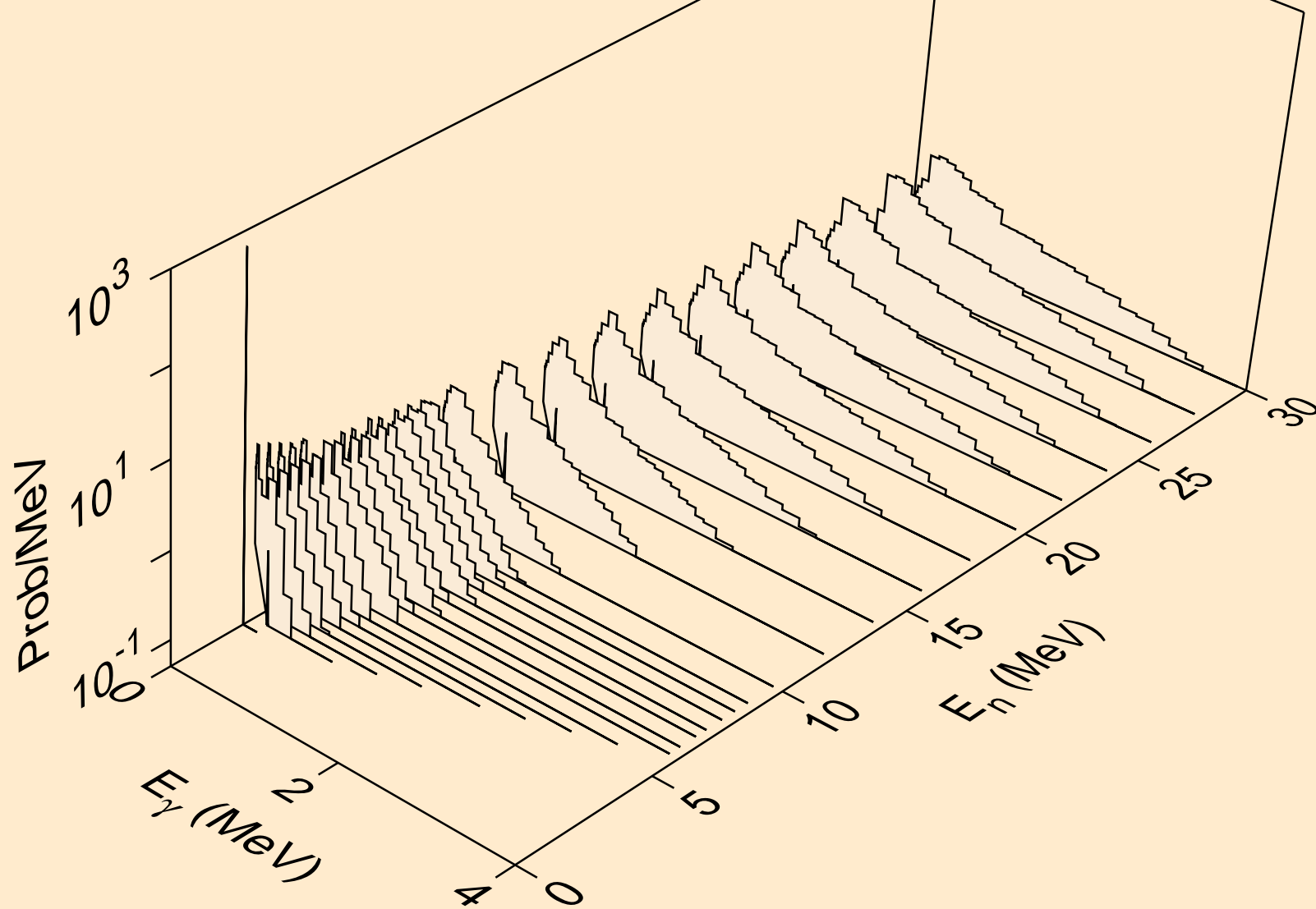

W163 NEUTRON ACER TENDL-2021 LIBRARY; T=293.6K
Photon emission for (n,t)

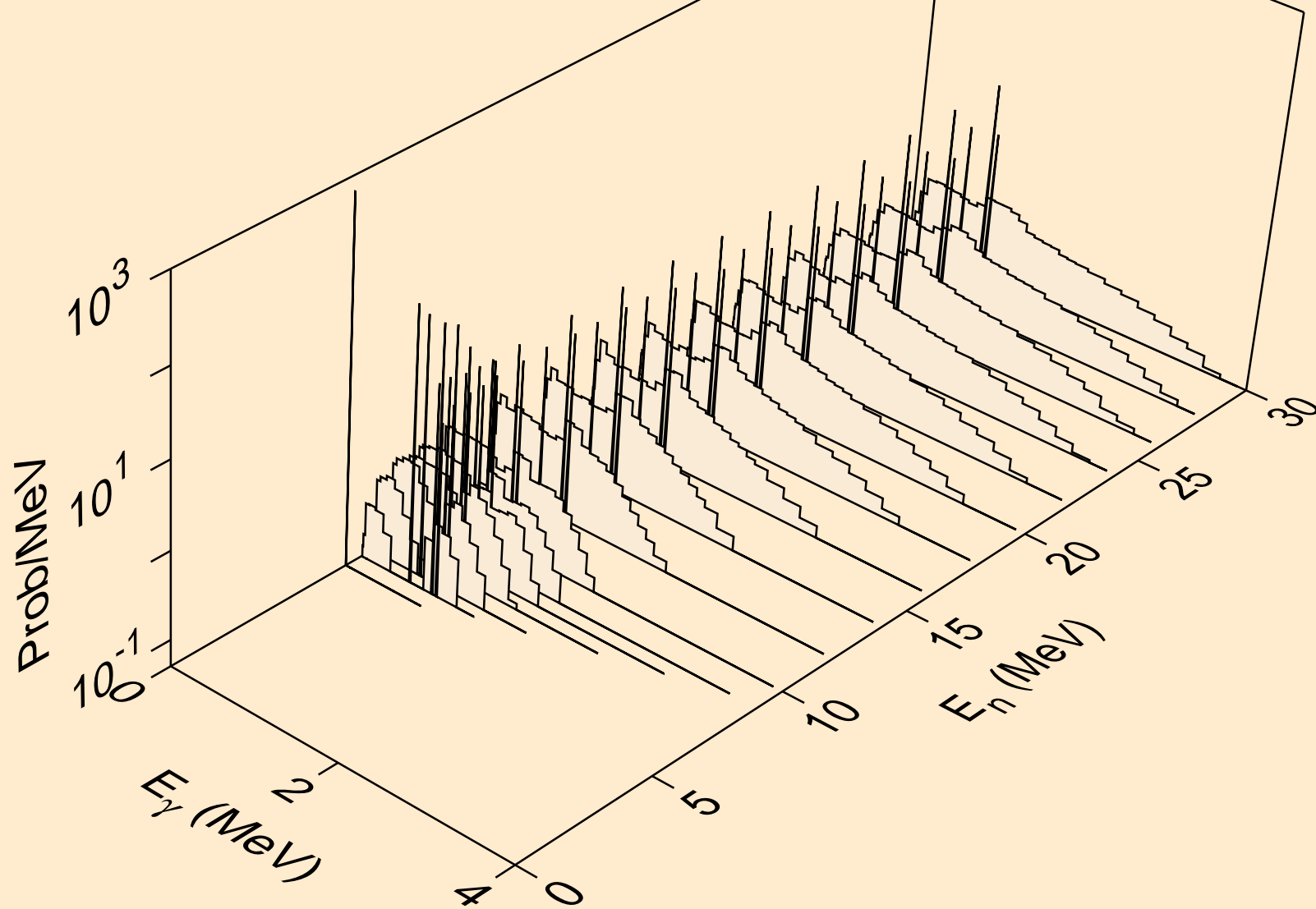

W163 NEUTRON ACER TENDL-2021 LIBRARY; T=293.6K
Photon emission for (n,he3)

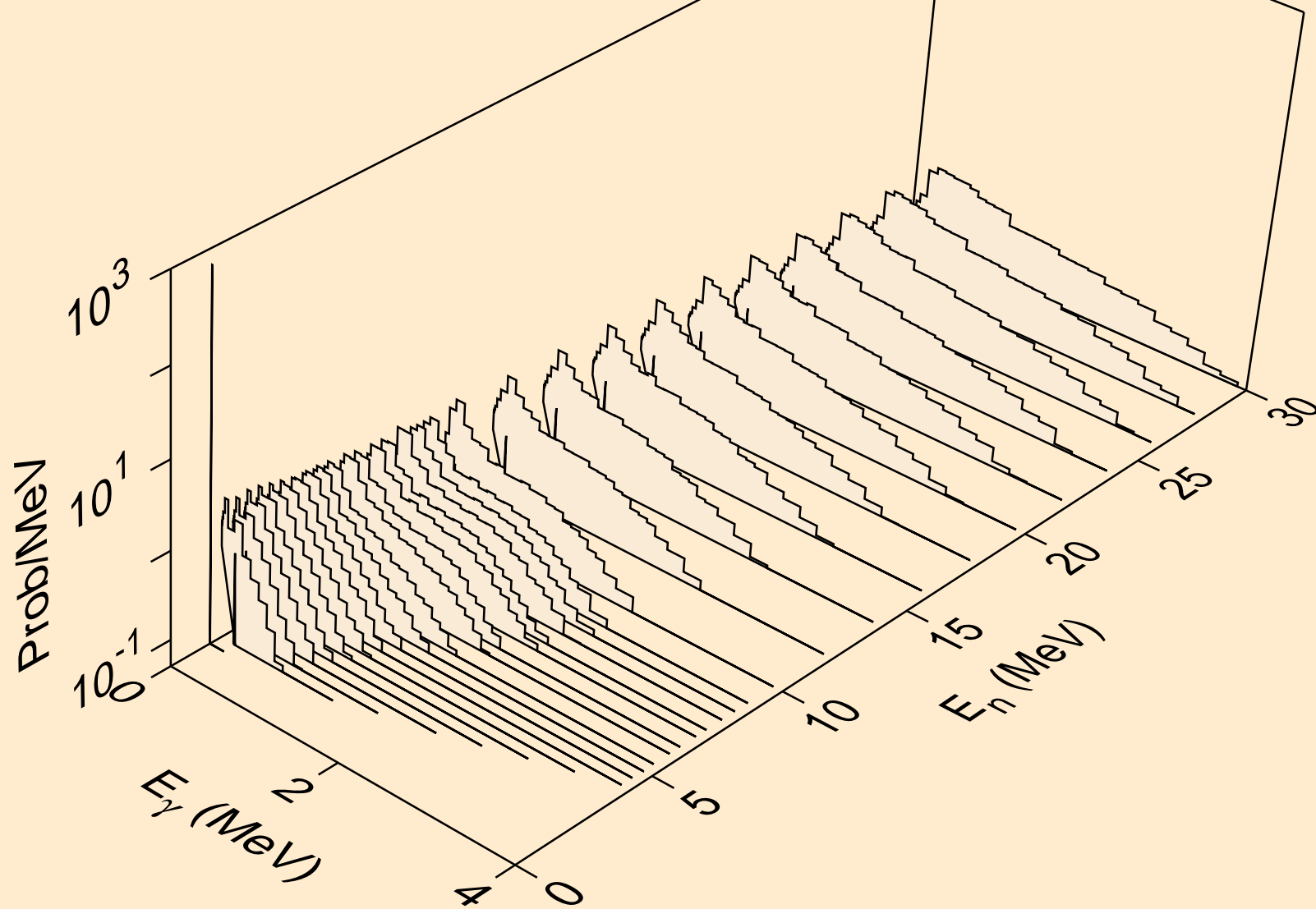

W163 NEUTRON ACER TENDL-2021 LIBRARY; T=293.6K
Photon emission for (n,a)

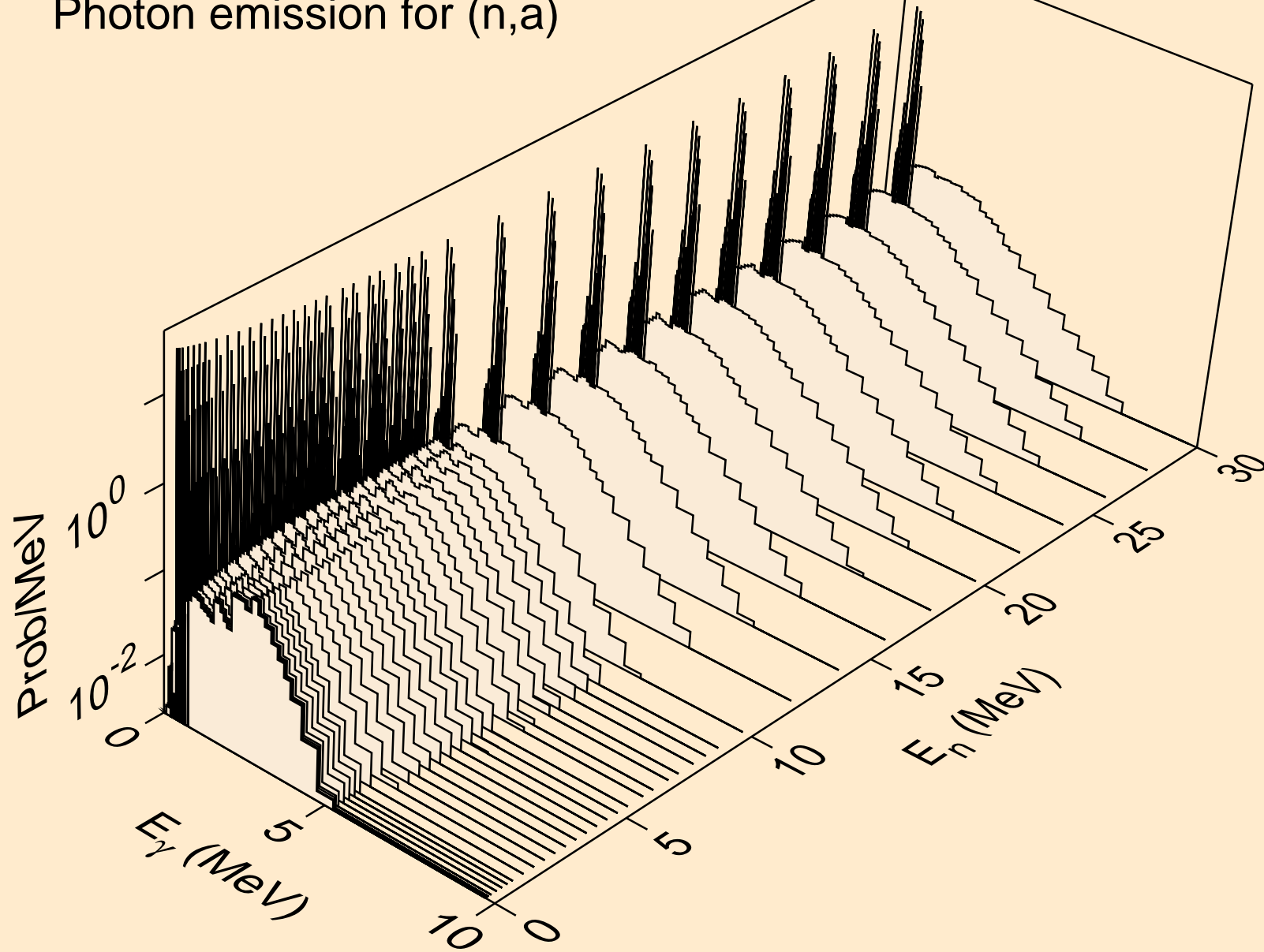

W163 NEUTRON ACER TENDL-2021 LIBRARY; T=293.6K
Photon emission for (n,2a)

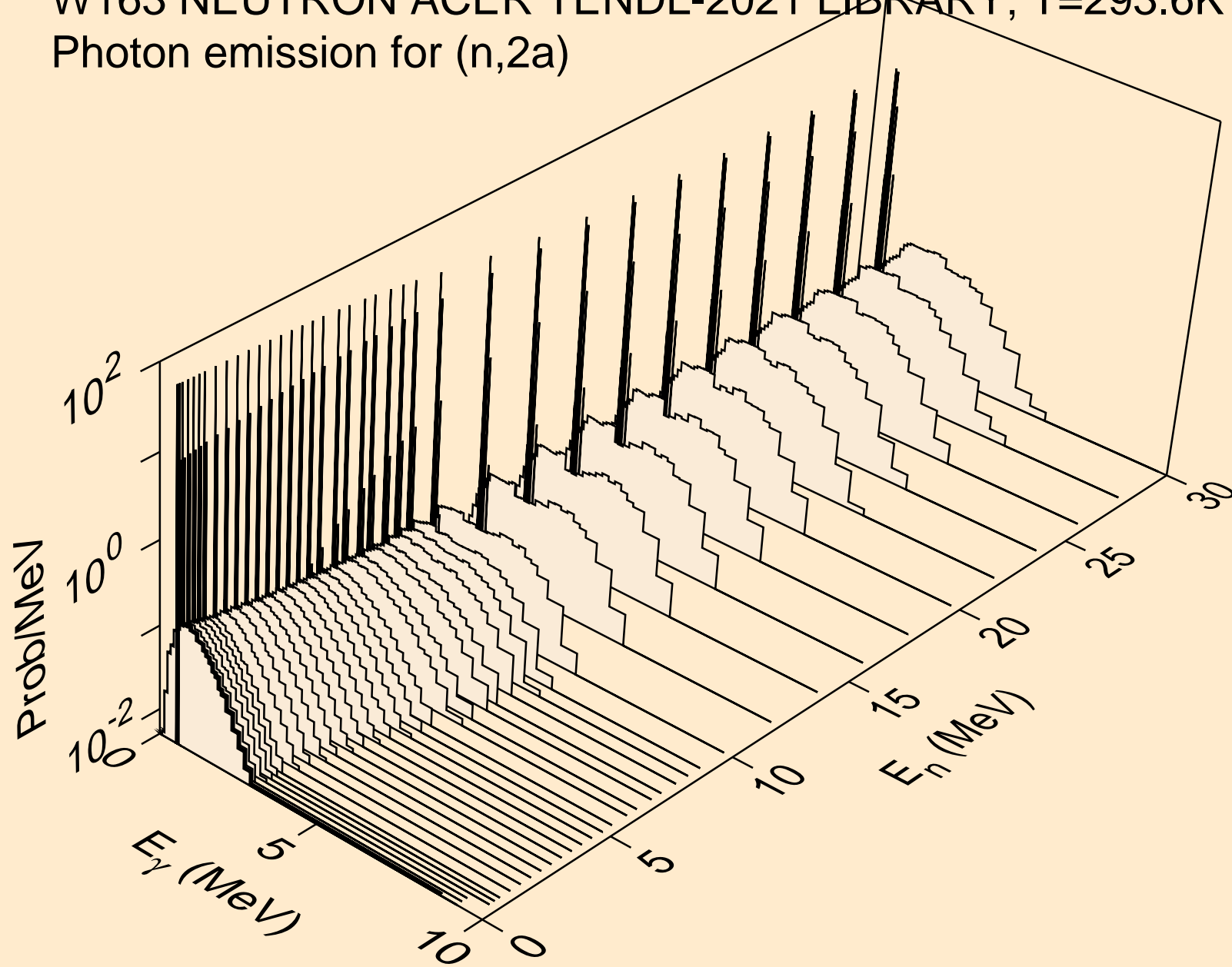

W163 NEUTRON ACER TENDL-2021 LIBRARY; T=293.6K
Photon emission for (n,3a)

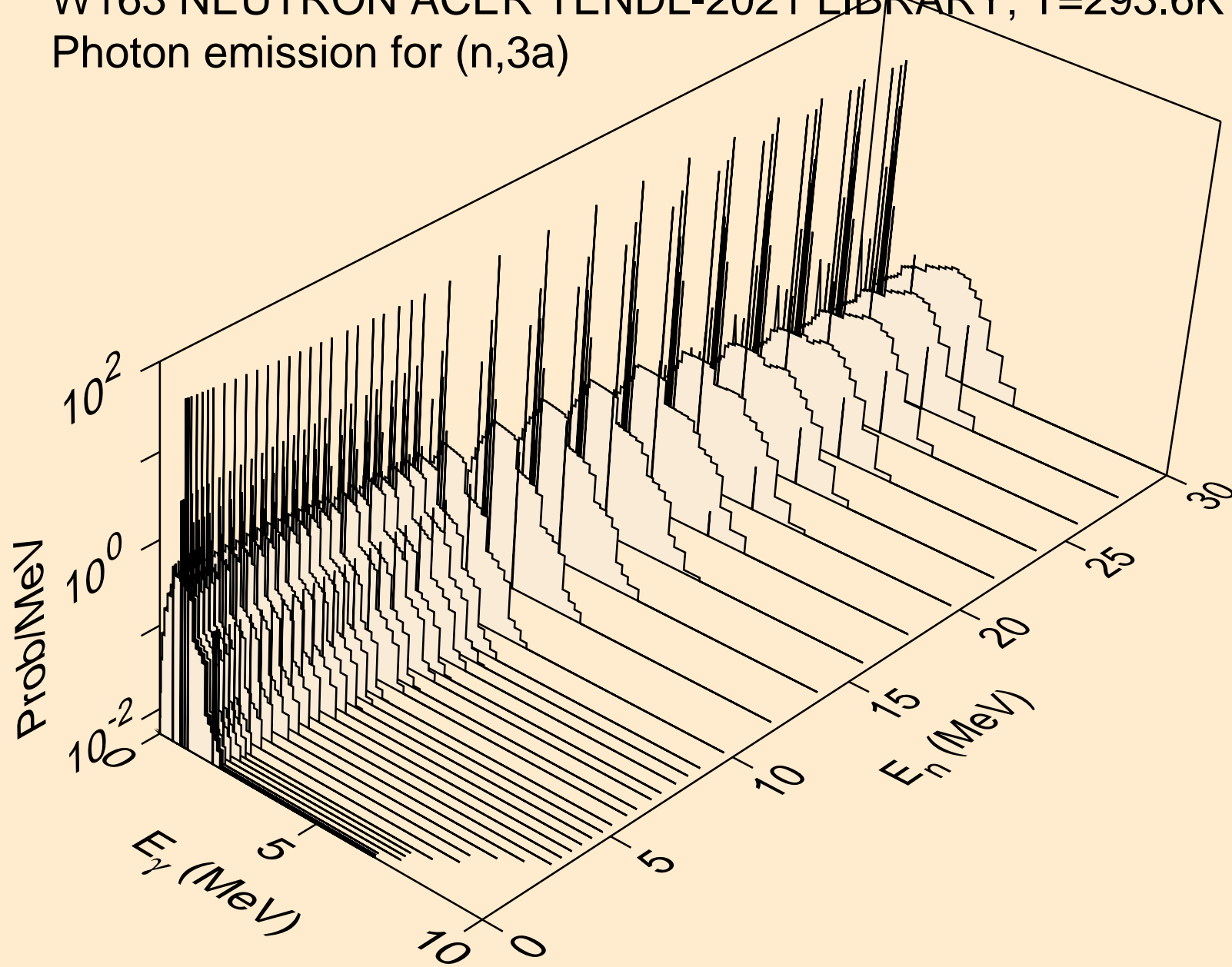

W163 NEUTRON ACER TENDL-2021 LIBRARY; T=293.6K
Photon emission for (n,2p)

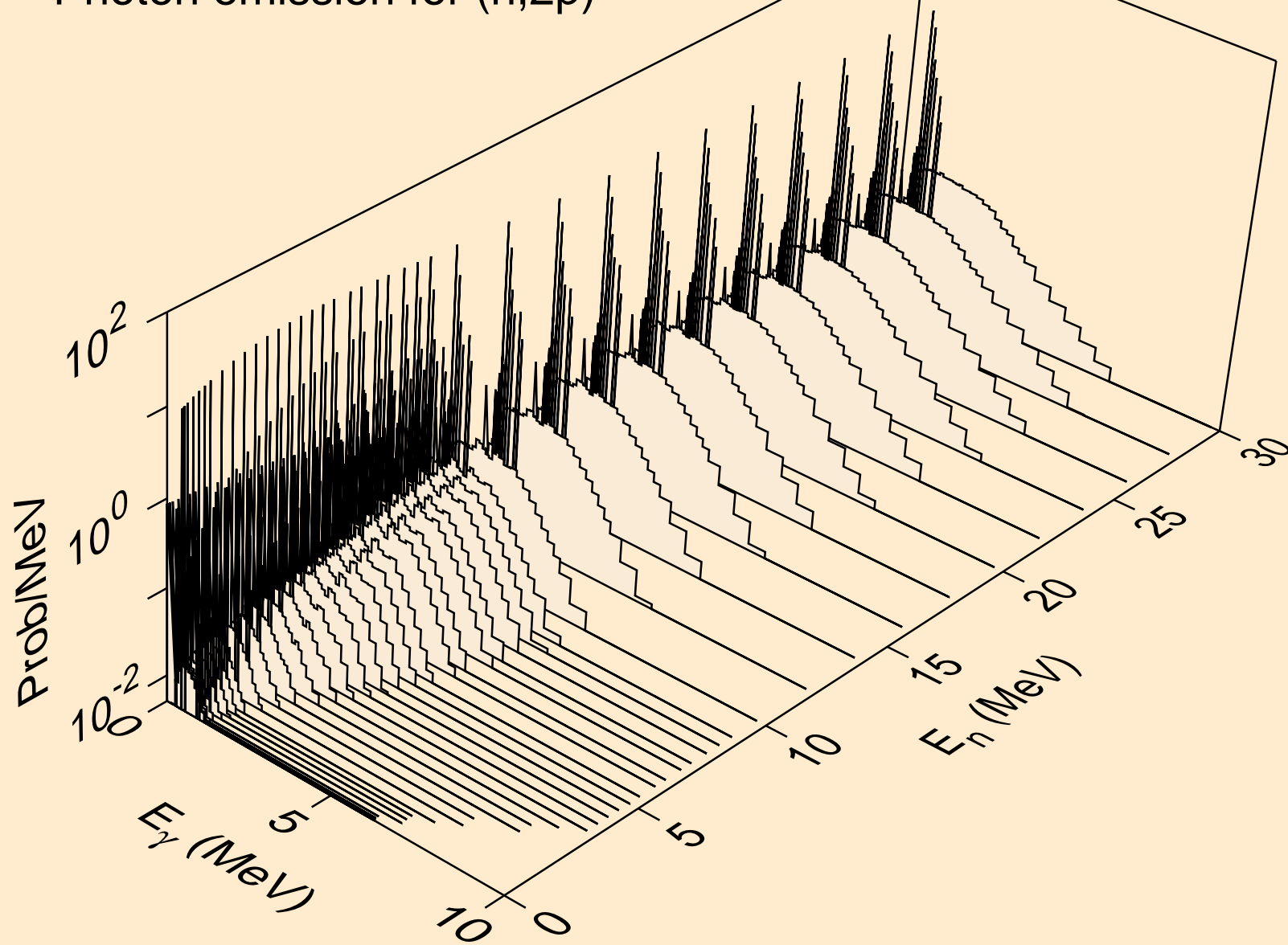

W163 NEUTRON ACER TENDL-2021 LIBRARY; T=293.6K
Photon emission for (n,p)

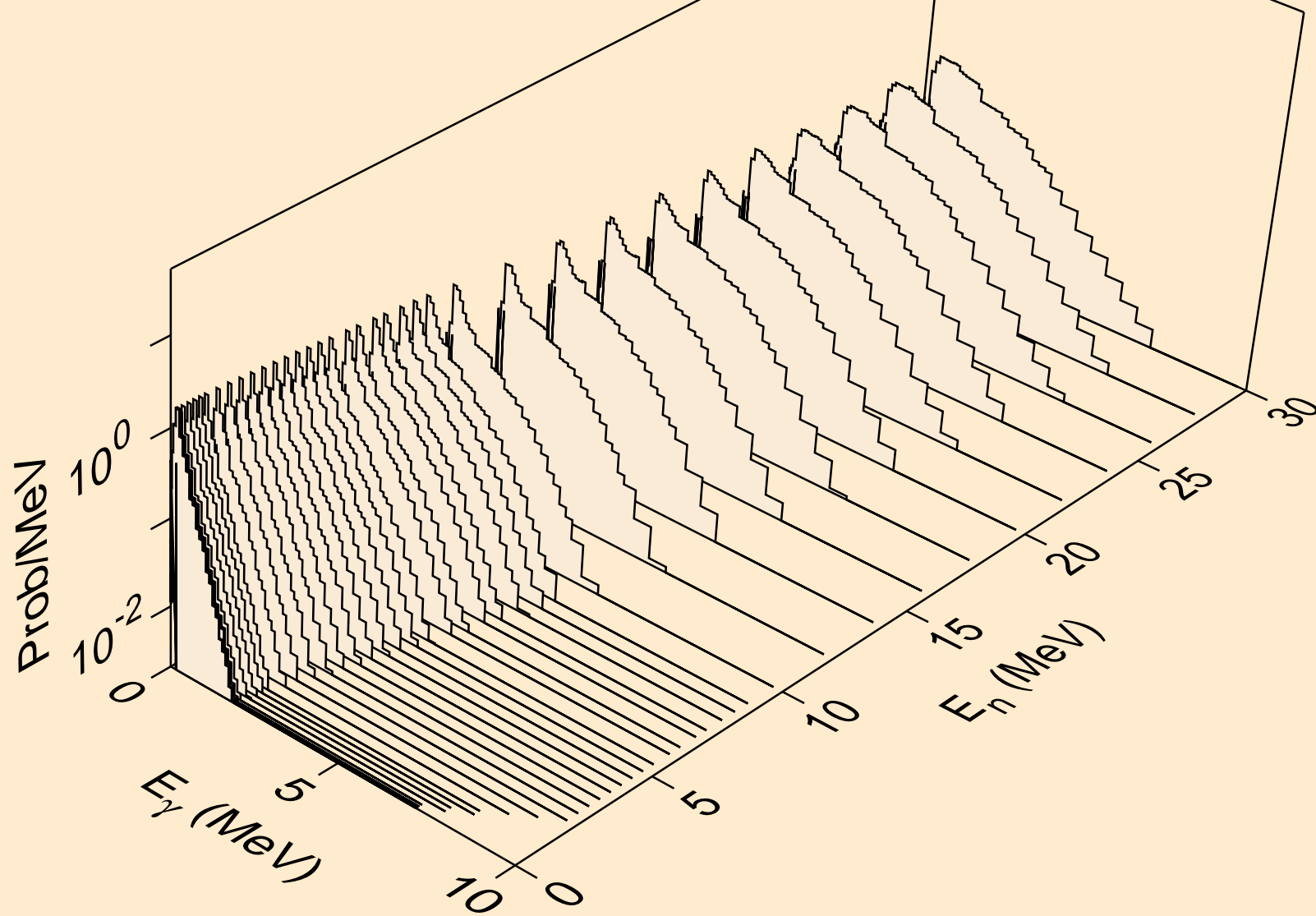

W163 NEUTRON ACER TENDL-2021 LIBRARY; T=293.6K
Photon emission for (n,t2a)

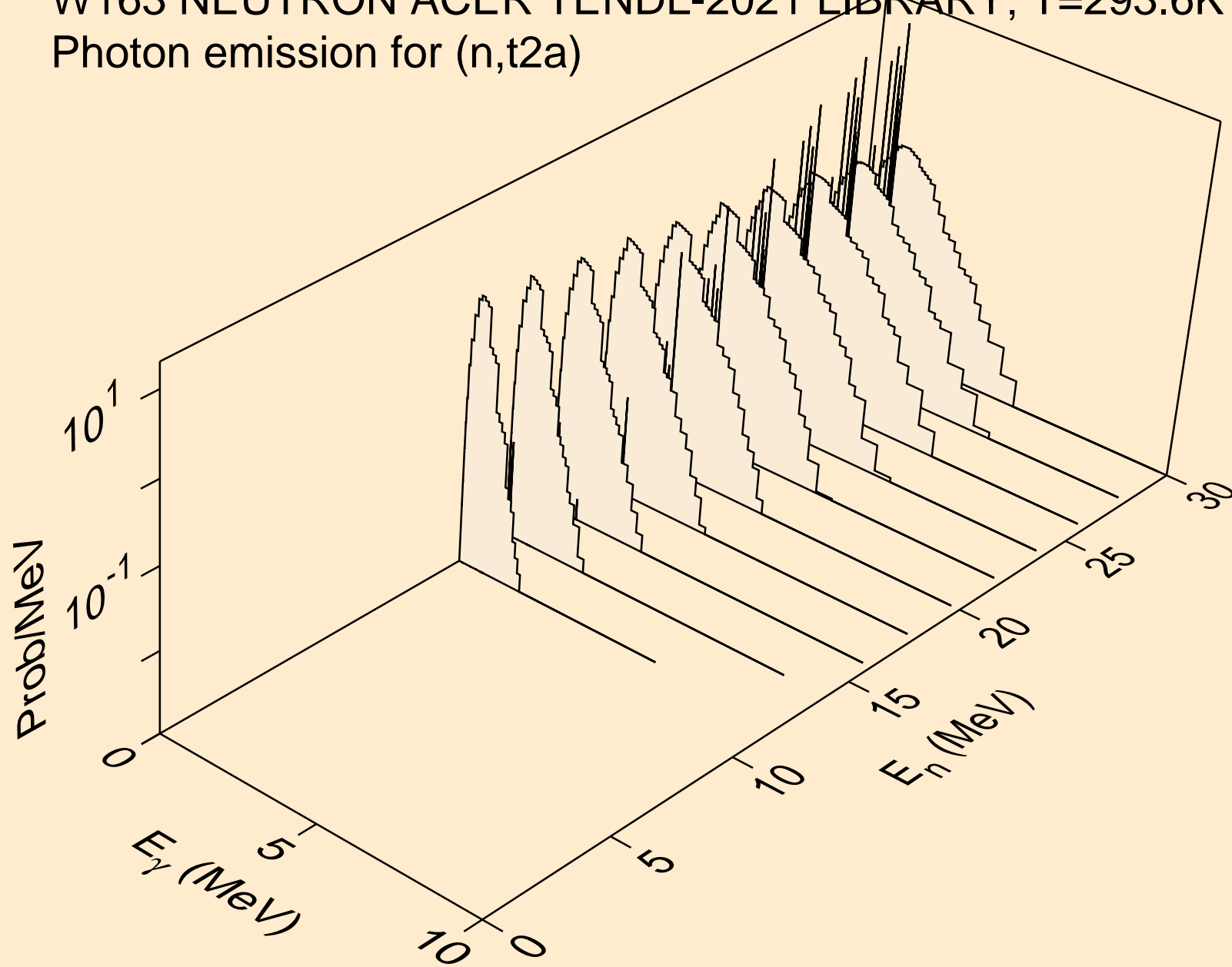

W163 NEUTRON ACER TENDL-2021 LIBRARY; T=293.6K
Photon emission for (n,d2a)

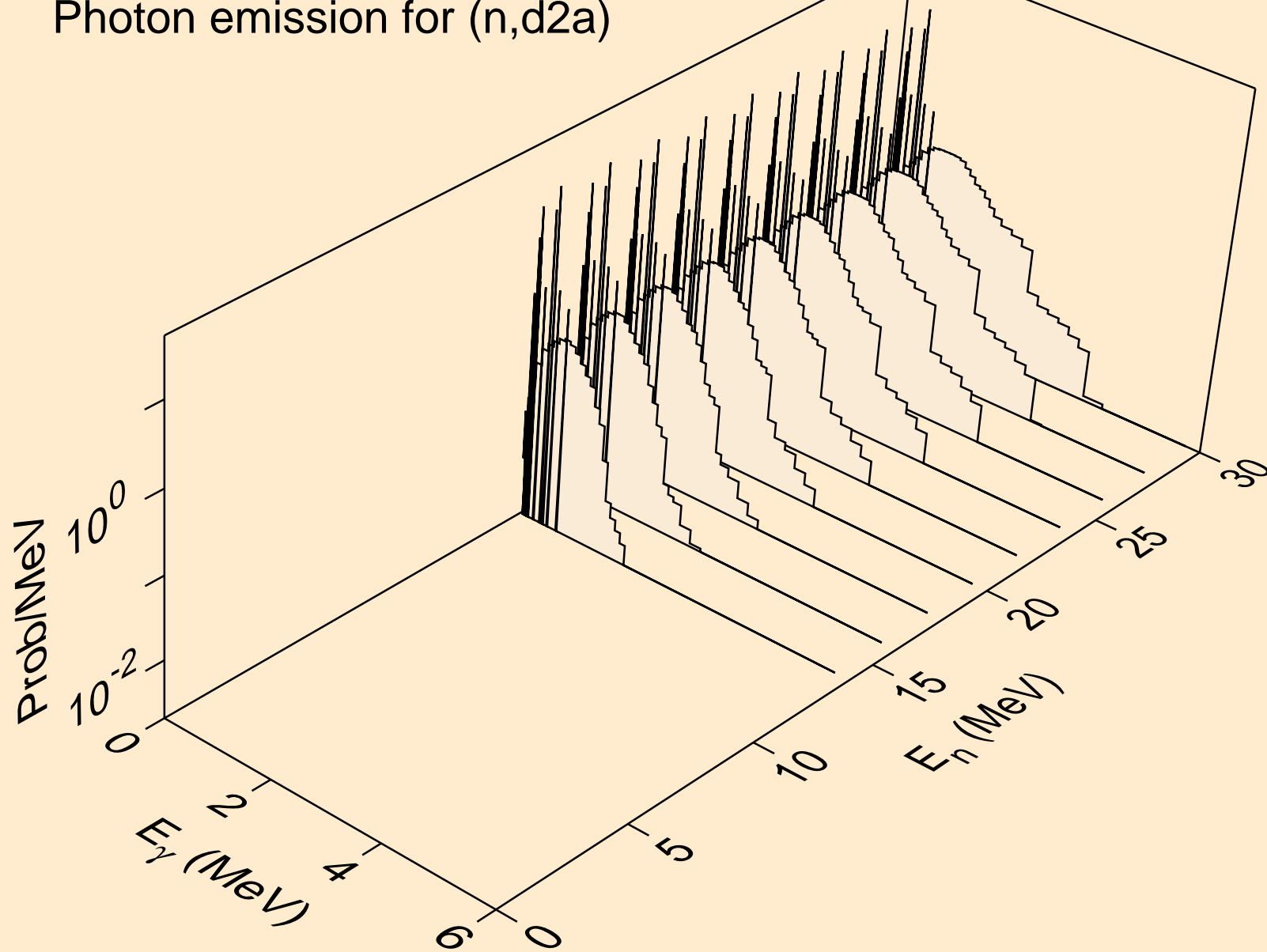

W163 NEUTRON ACER TENDL-2021 LIBRARY; T=293.6K
Photon emission for (n,pd)

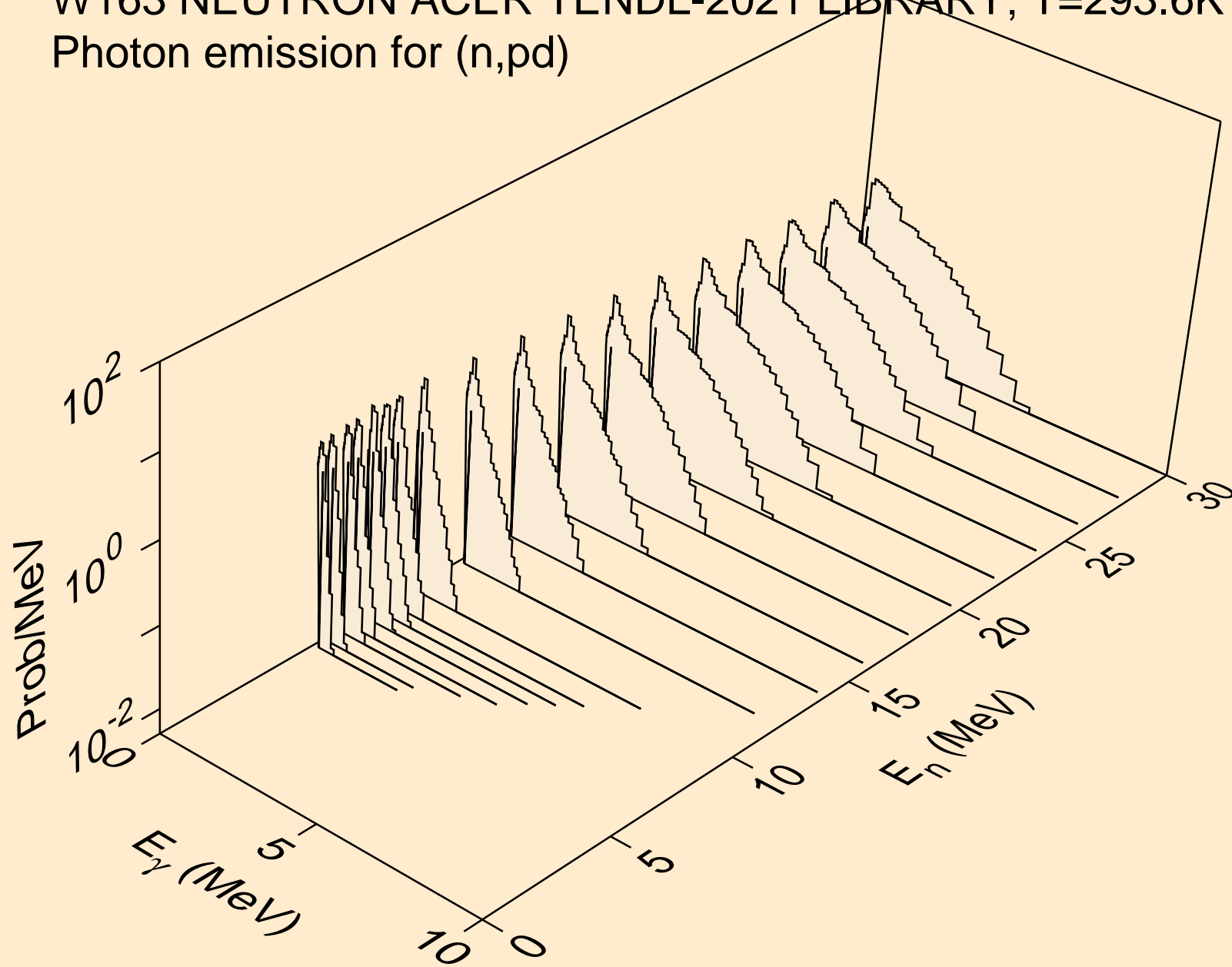

W163 NEUTRON ACER TENDL-2021 LIBRARY; T=293.6K
Photon emission for (n,pt)

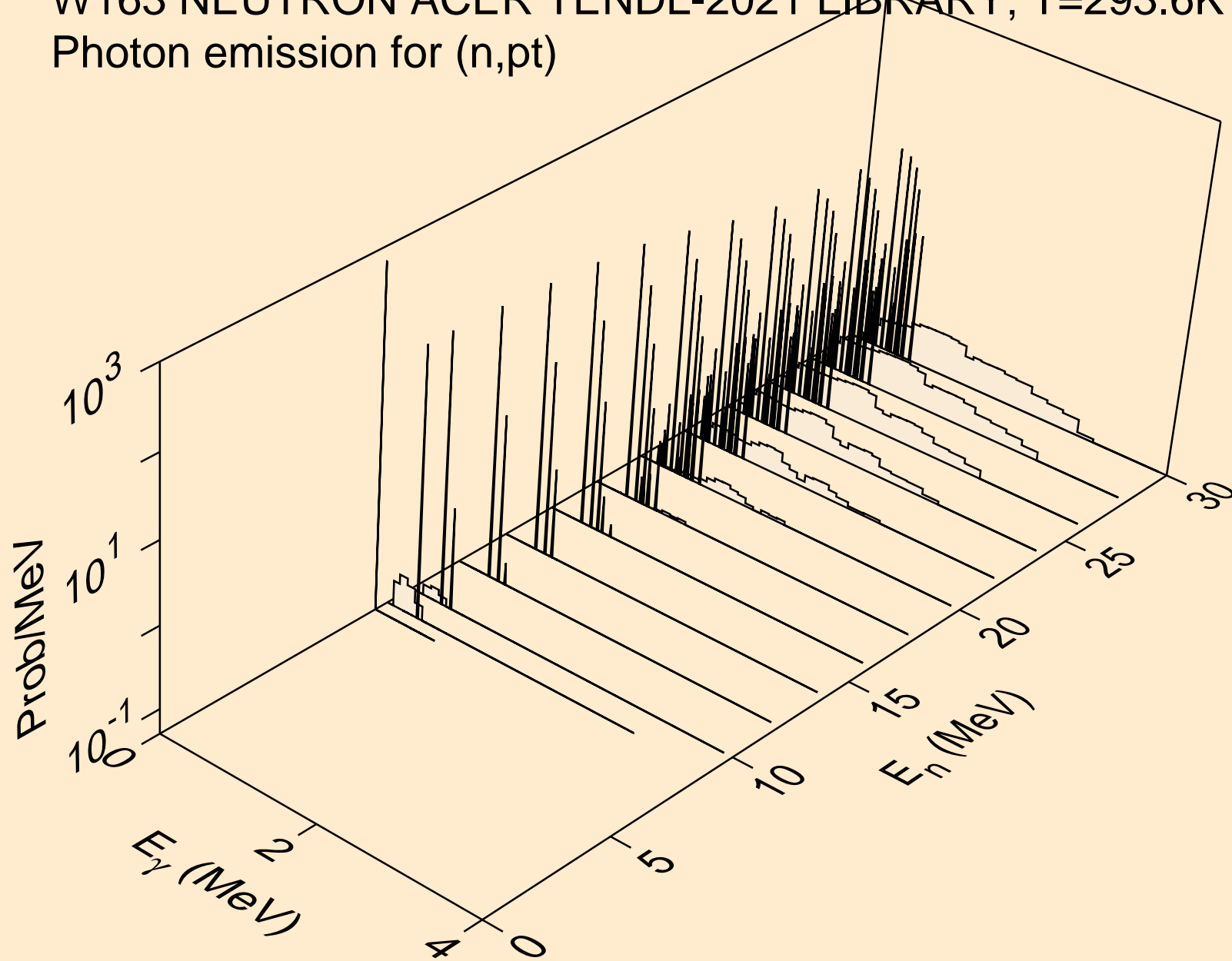

W163 NEUTRON ACER TENDL-2021 LIBRARY; T=293.6K
Photon emission for (n,da)

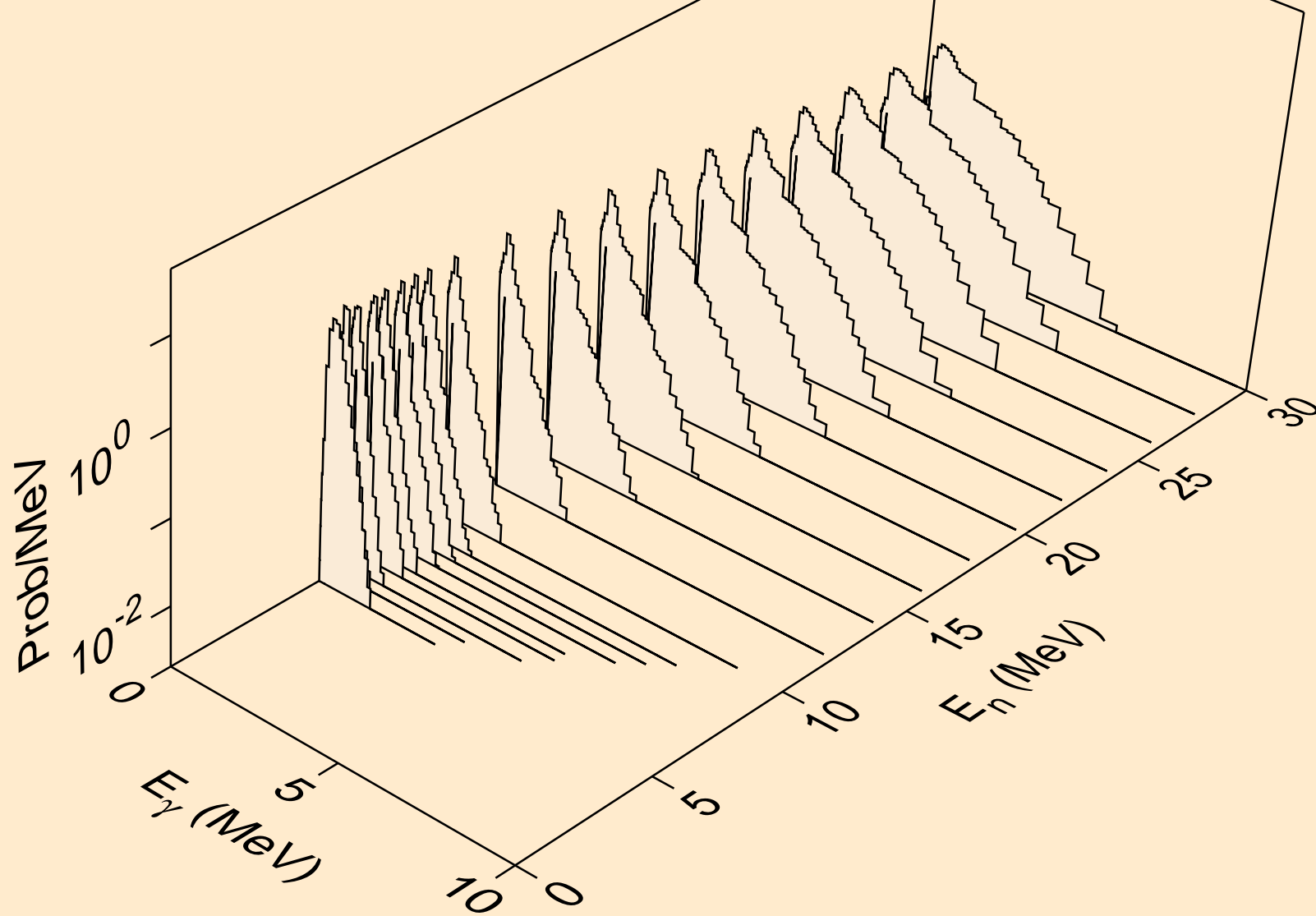

W163 NEUTRON ACER TENDL-2021 LIBRARY; T=293.6K
thermal capture photon spectrum

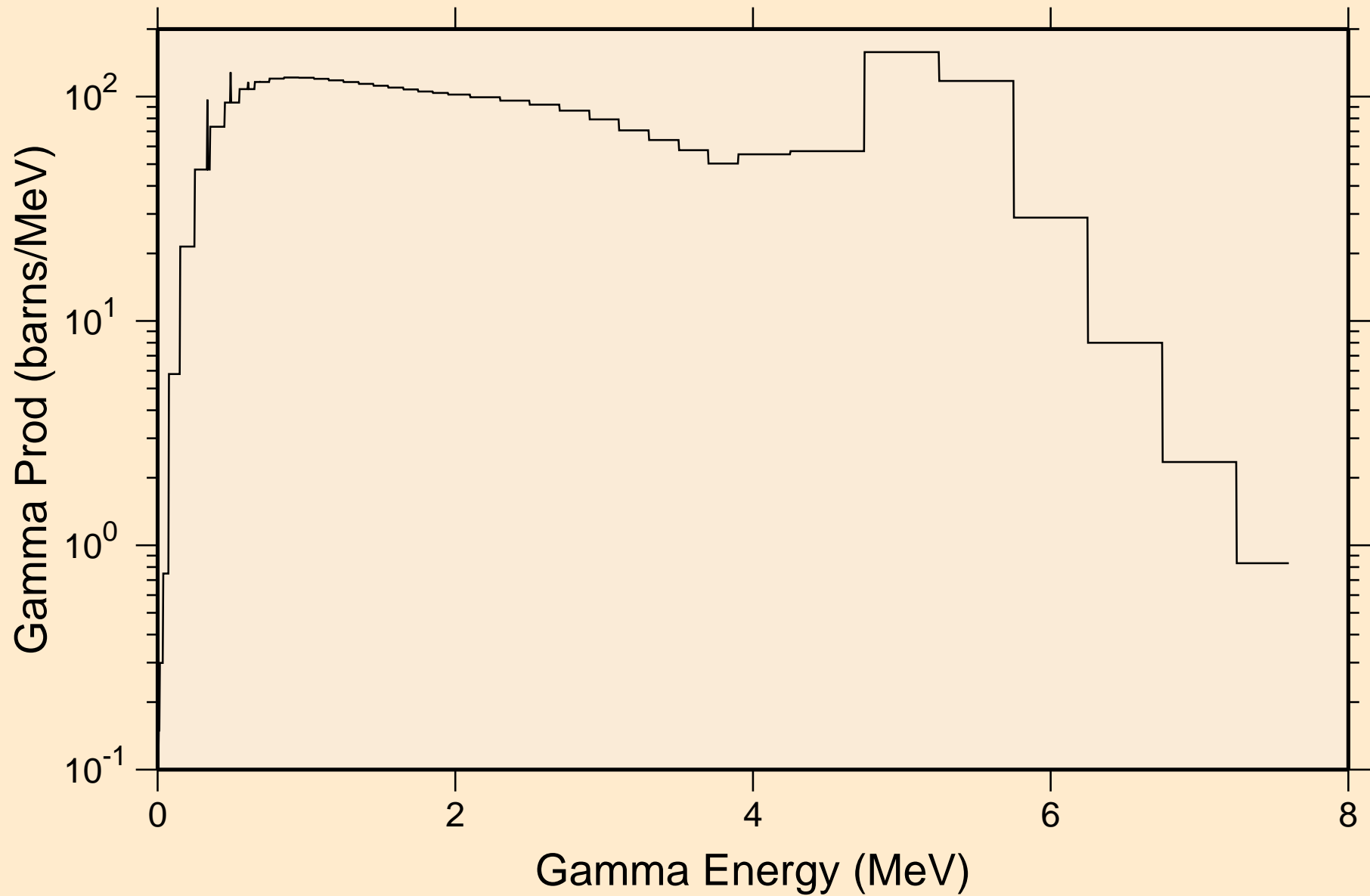

W163 NEUTRON ACER TENDL-2021 LIBRARY; T=293.6K
14 MeV photon spectrum

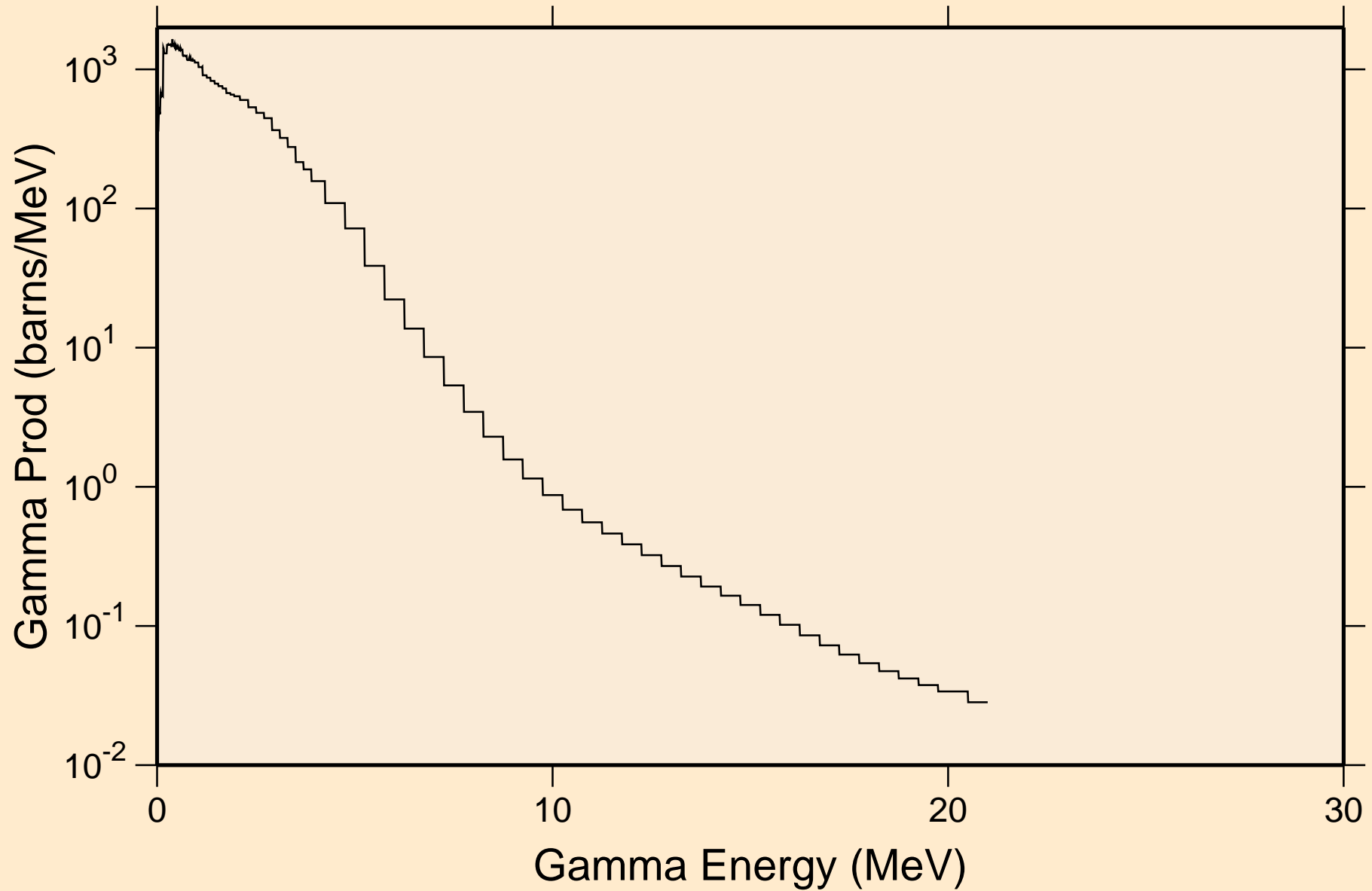

W163 NEUTRON ACER TENDL-2021 LIBRARY; T=293.6K
Particle heating contributions

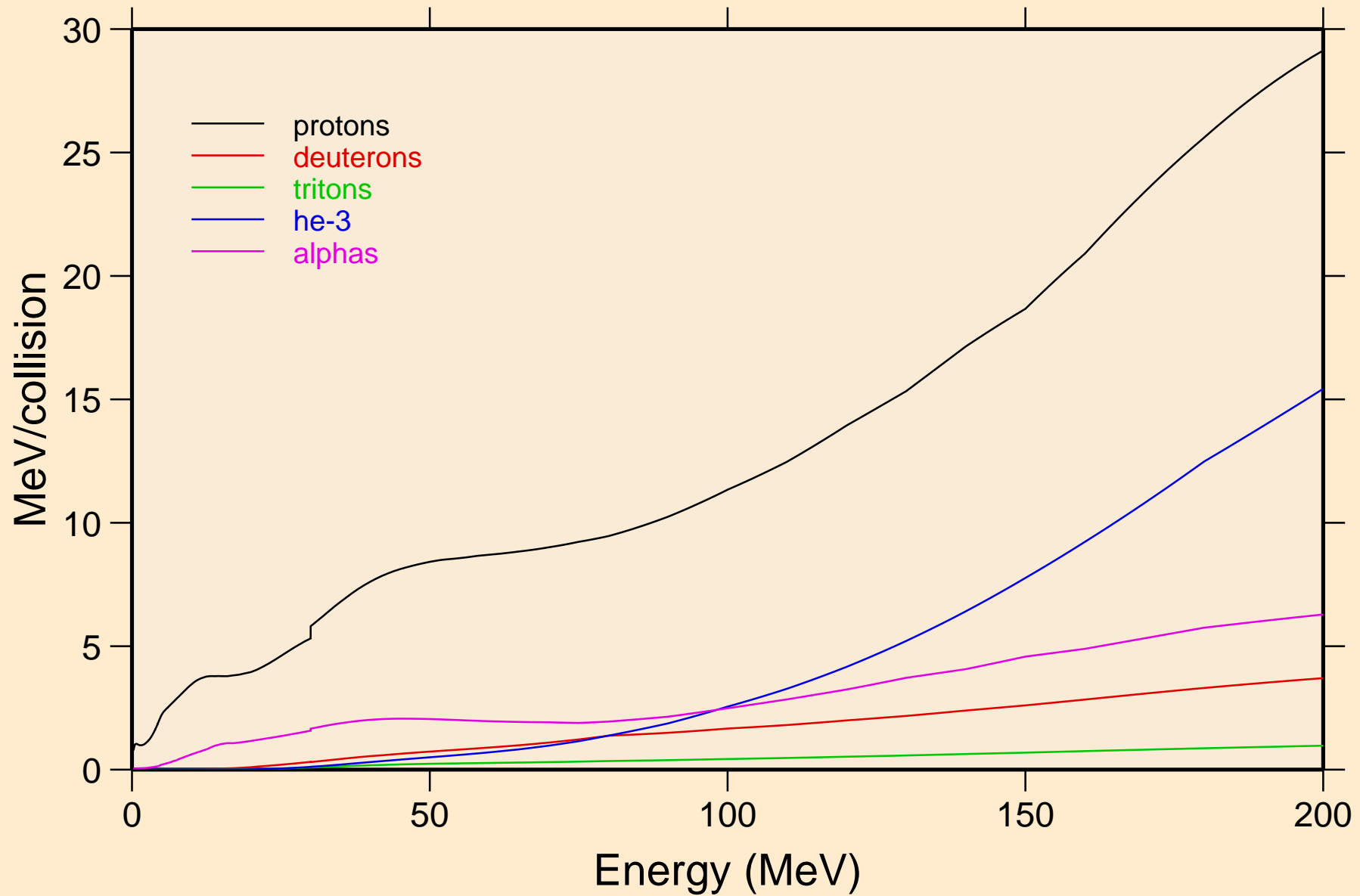

W163 NEUTRON ACER TENDL-2021 LIBRARY; T=293.6K
Recoil Heating

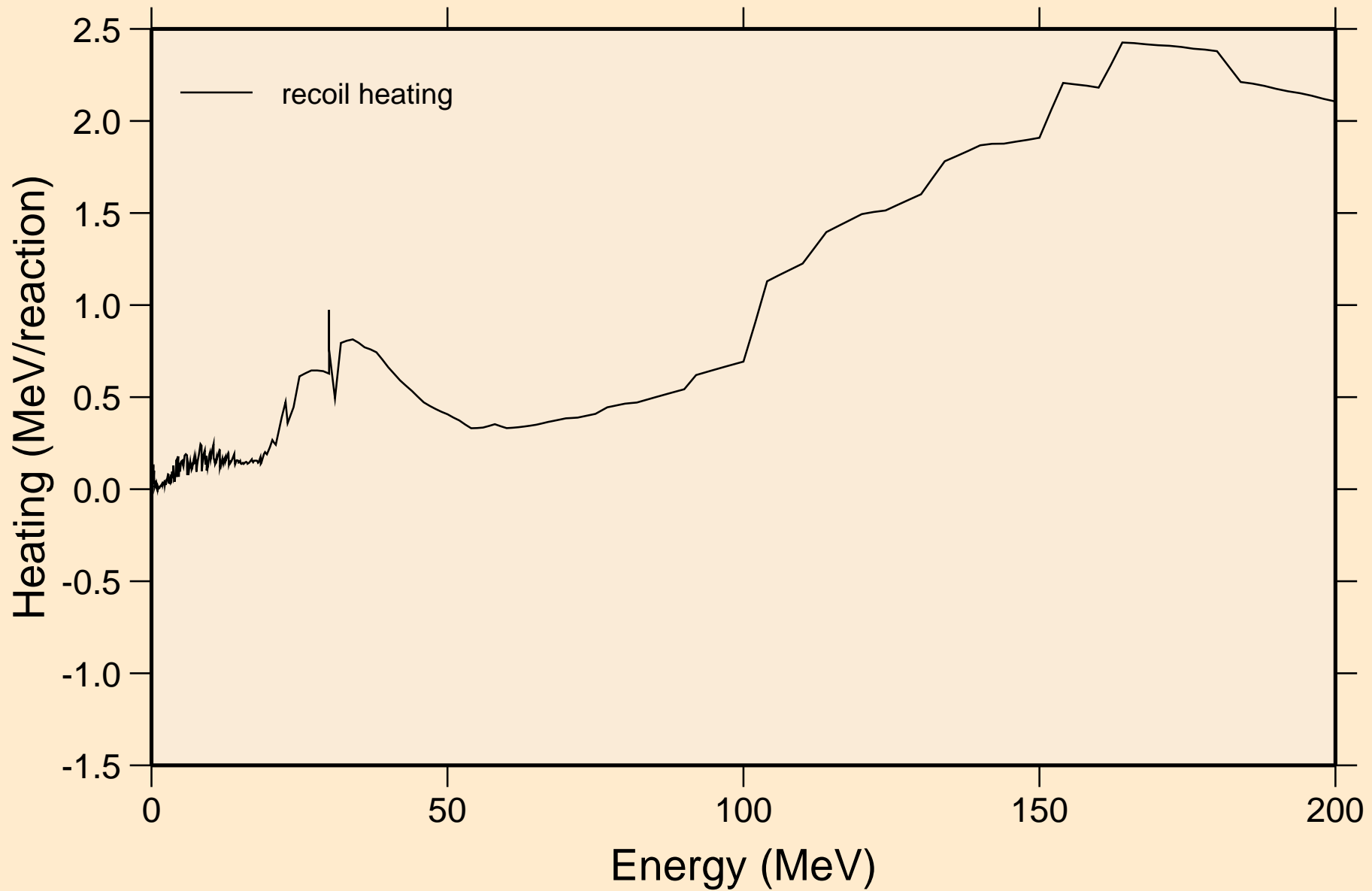

W163 NEUTRON ACER TENDL-2021 LIBRARY; T=293.6K
Particle production cross sections

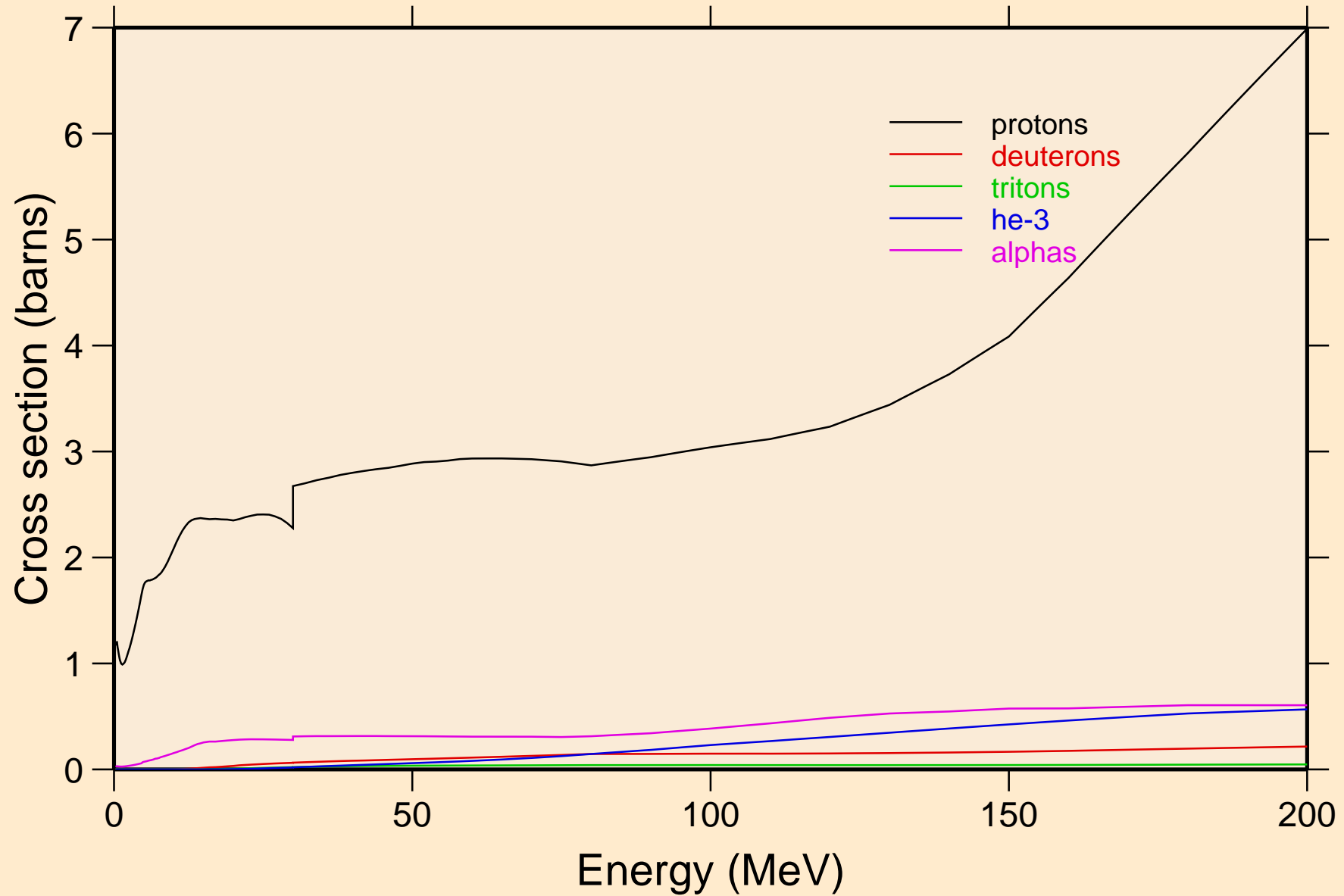

W163 NEUTRON ACER TENDL-2021 LIBRARY; T=293.6K
protons from (n,x)

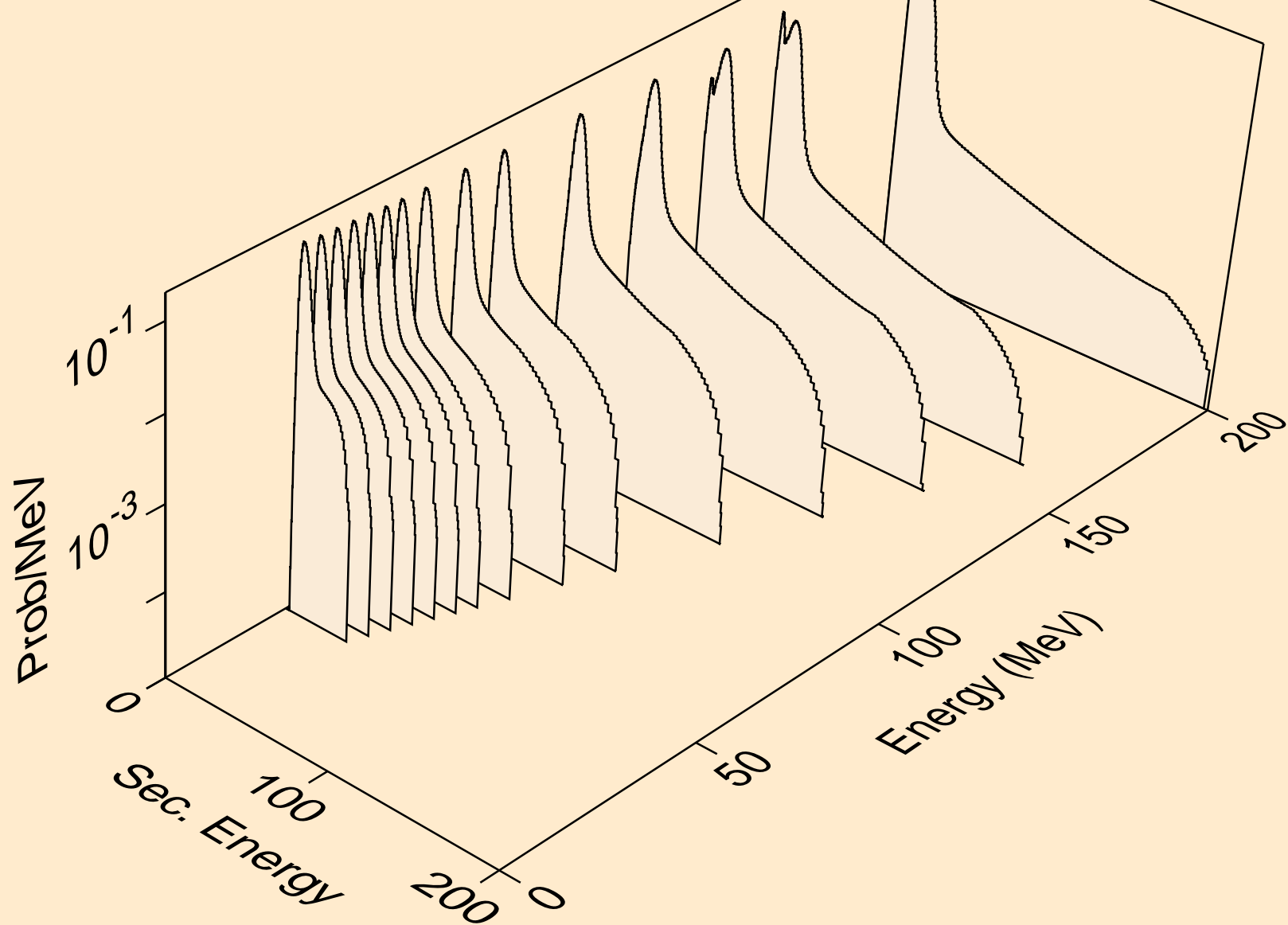

W163 NEUTRON ACER TENDL-2021 LIBRARY; T=293.6K
protons from (n,n*)p

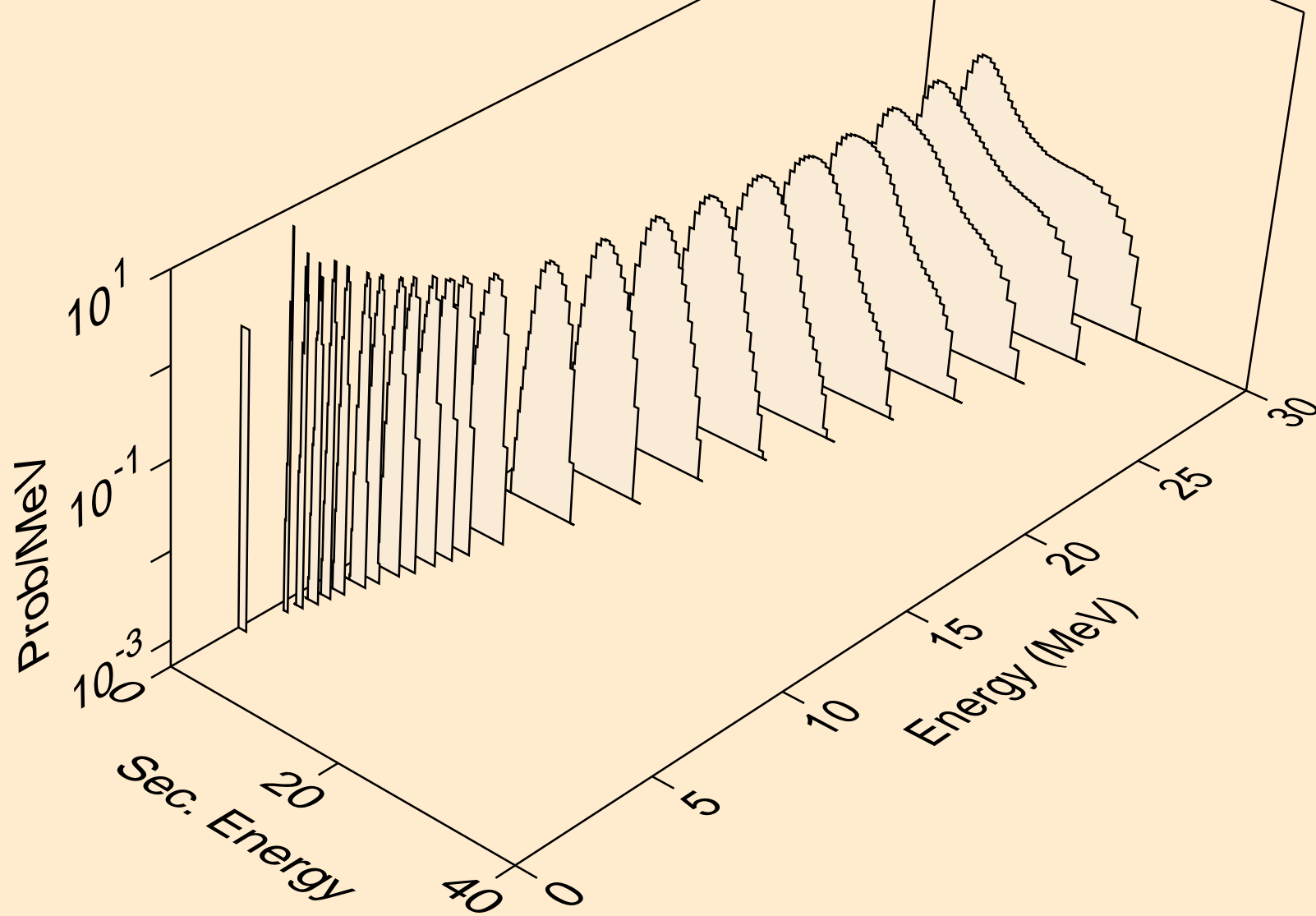

W163 NEUTRON ACER TENDL-2021 LIBRARY; T=293.6K
protons from (n,2np)

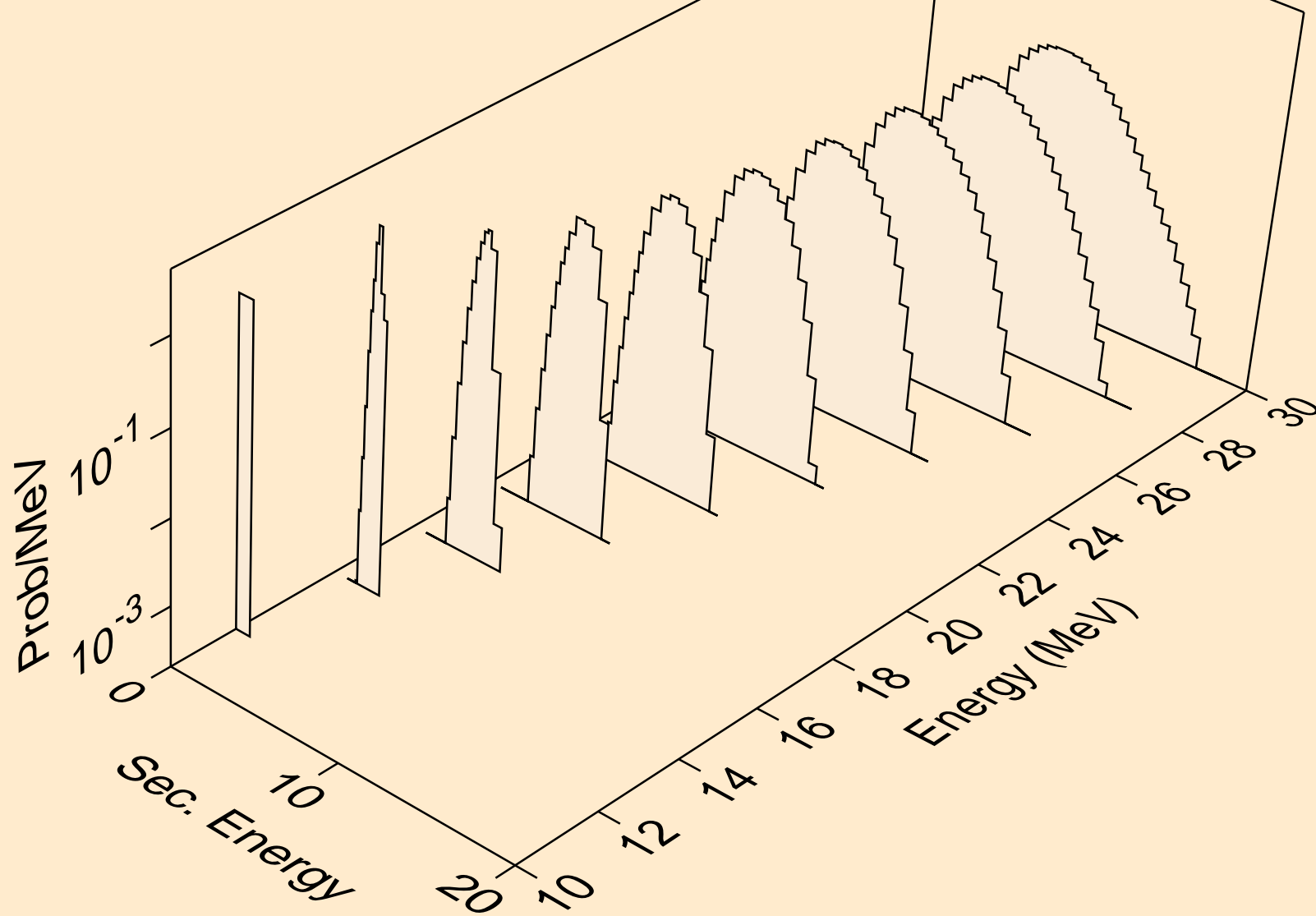

W163 NEUTRON ACER TENDL-2021 LIBRARY; T=293.6K
protons from (n,3np)

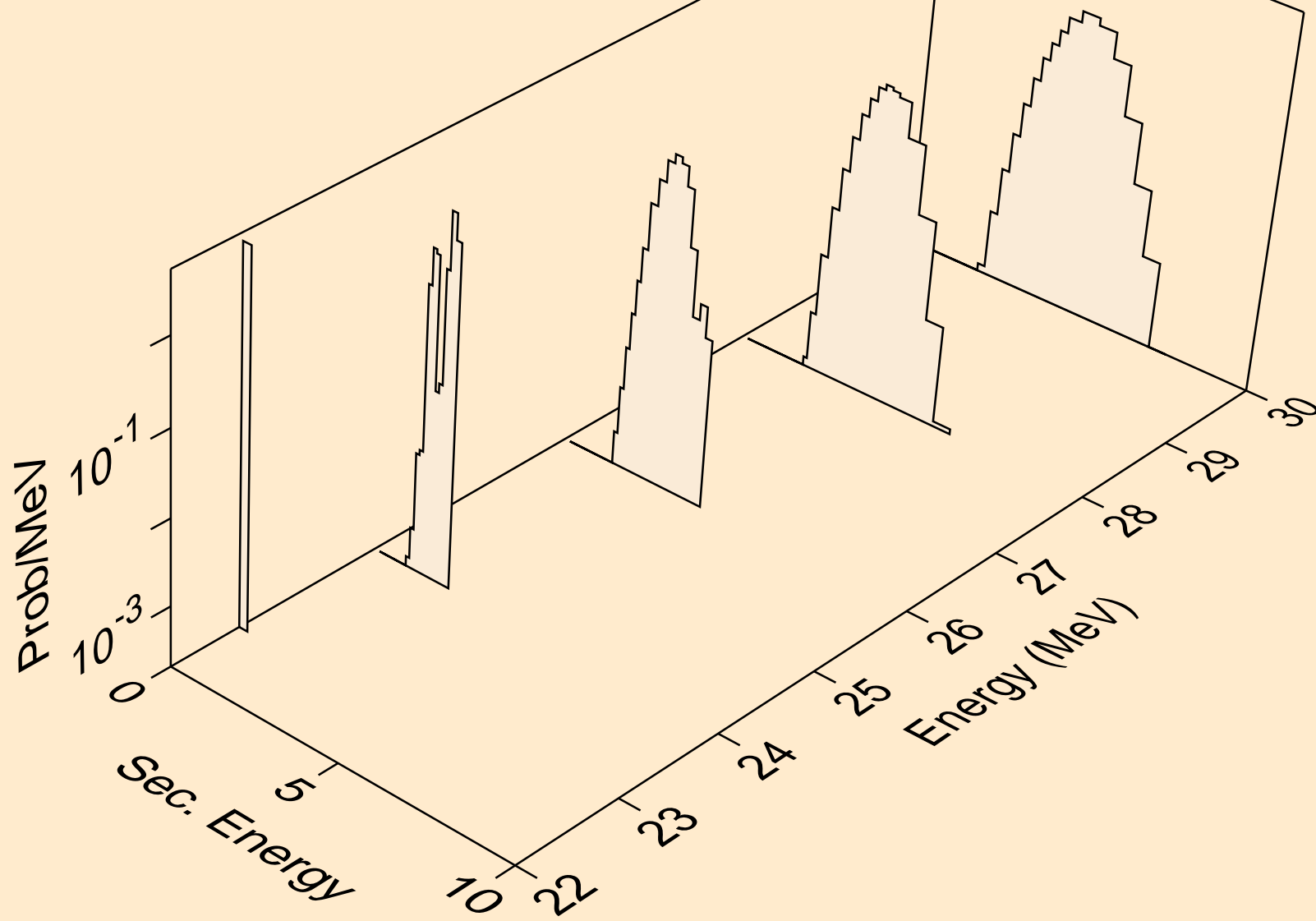

W163 NEUTRON ACER TENDL-2021 LIBRARY; T=293.6K
protons from (n,2np)

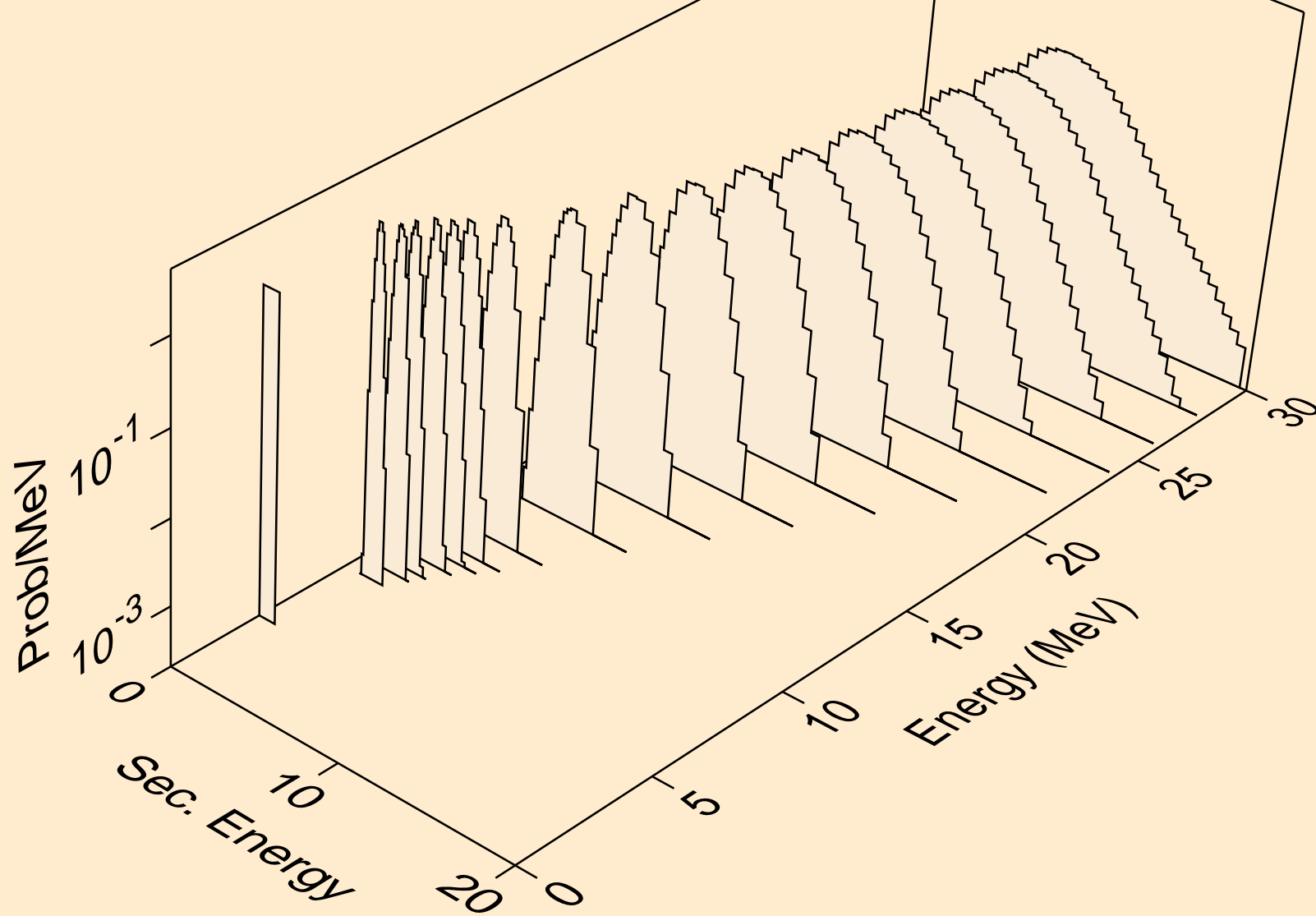

W163 NEUTRON ACER TENDL-2021 LIBRARY; T=293.6K
protons from (n,npa)

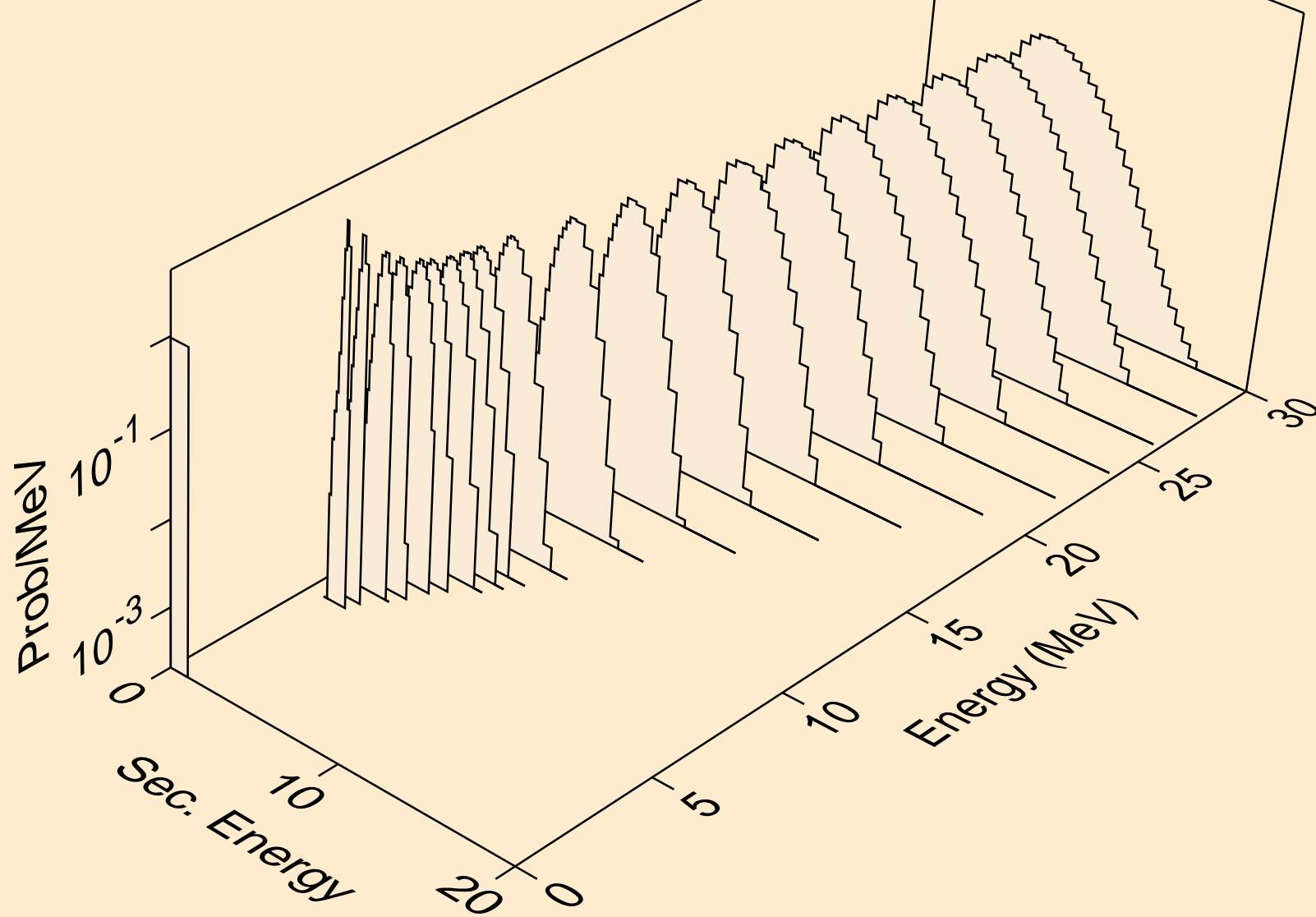

W163 NEUTRON ACER TENDL-2021 LIBRARY; T=293.6K
protons from (n,p)

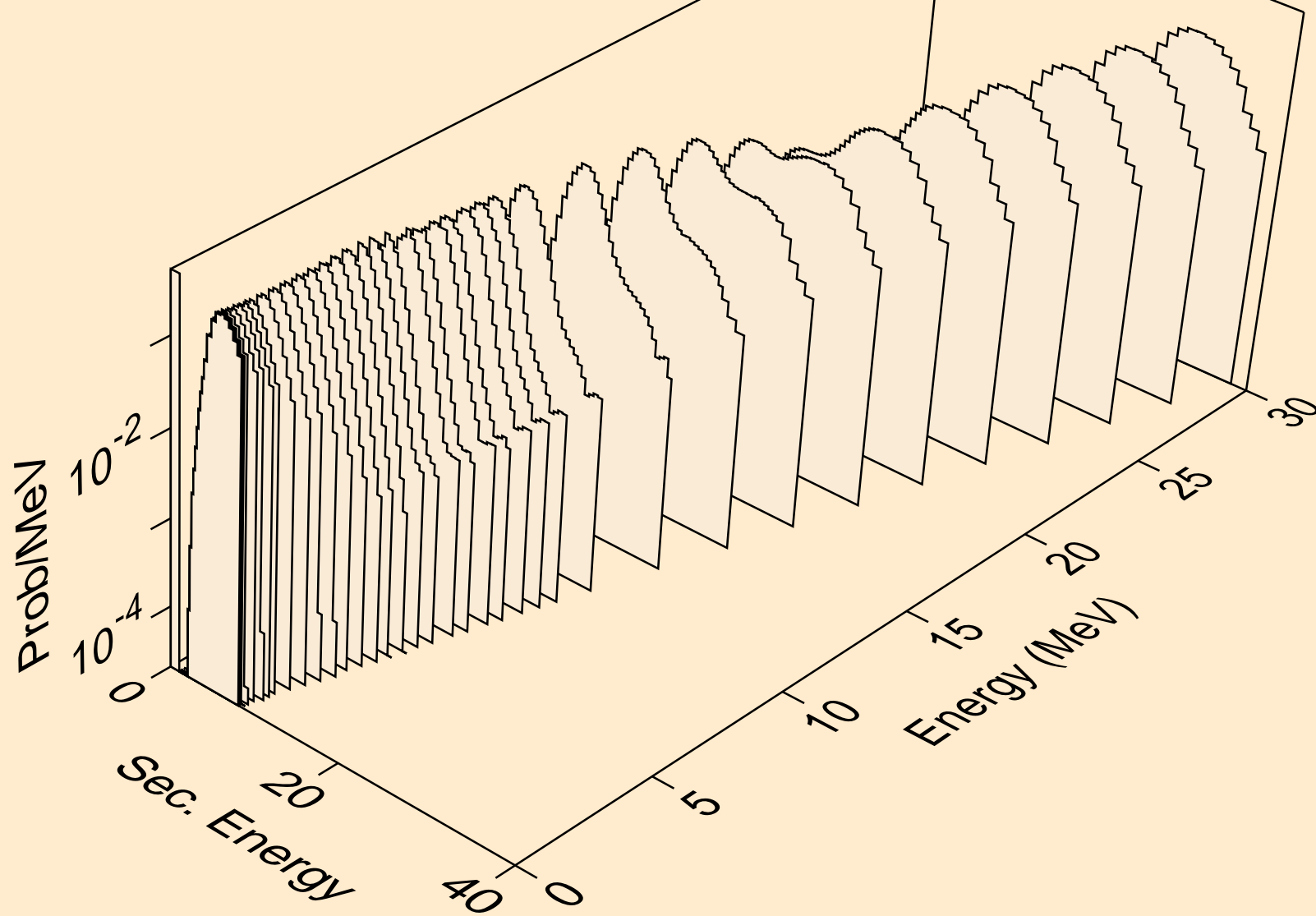

W163 NEUTRON ACER TENDL-2021 LIBRARY; T=293.6K
protons from (n,2p)

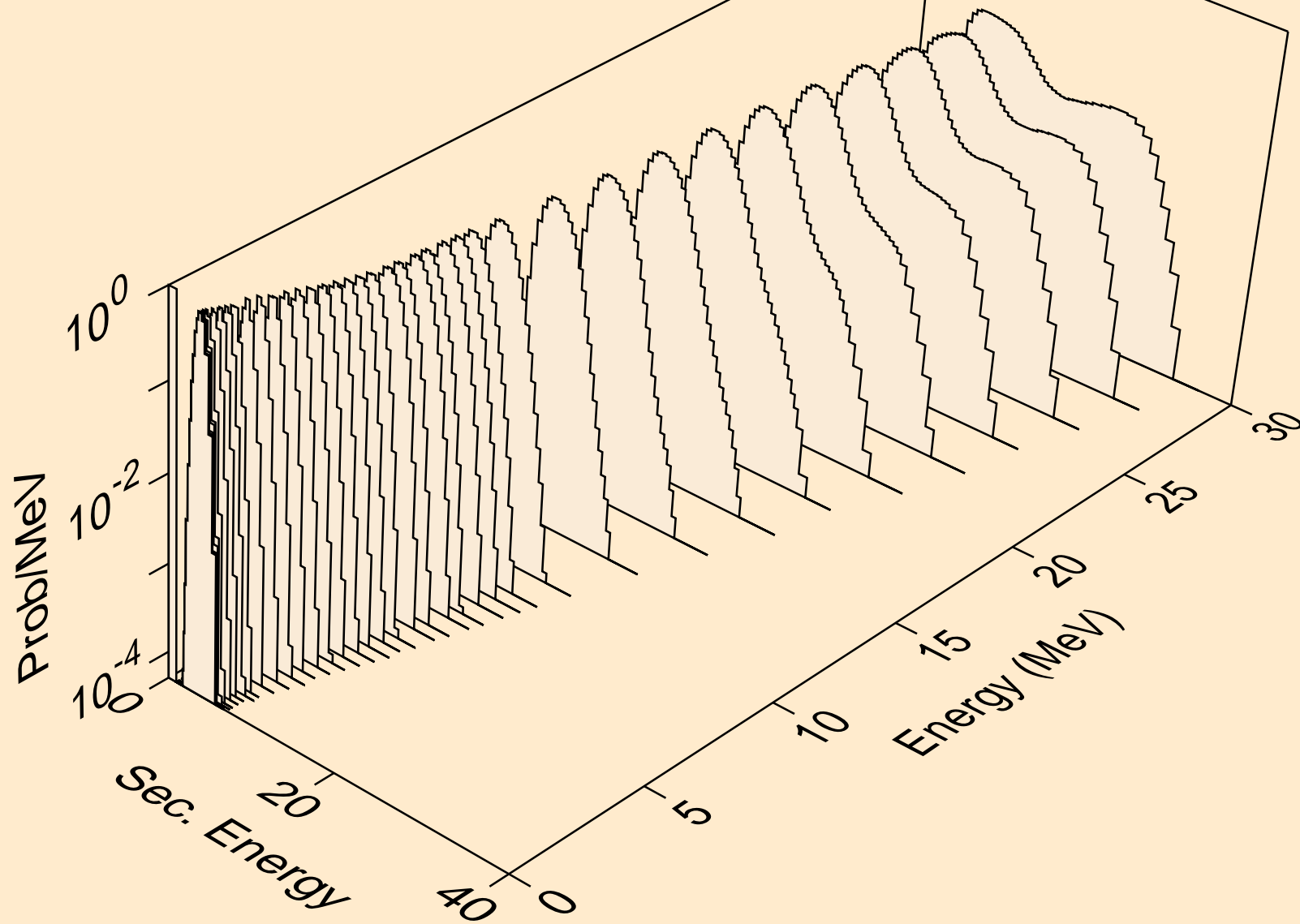

W163 NEUTRON ACER TENDL-2021 LIBRARY; T=293.6K
protons from (n,p)

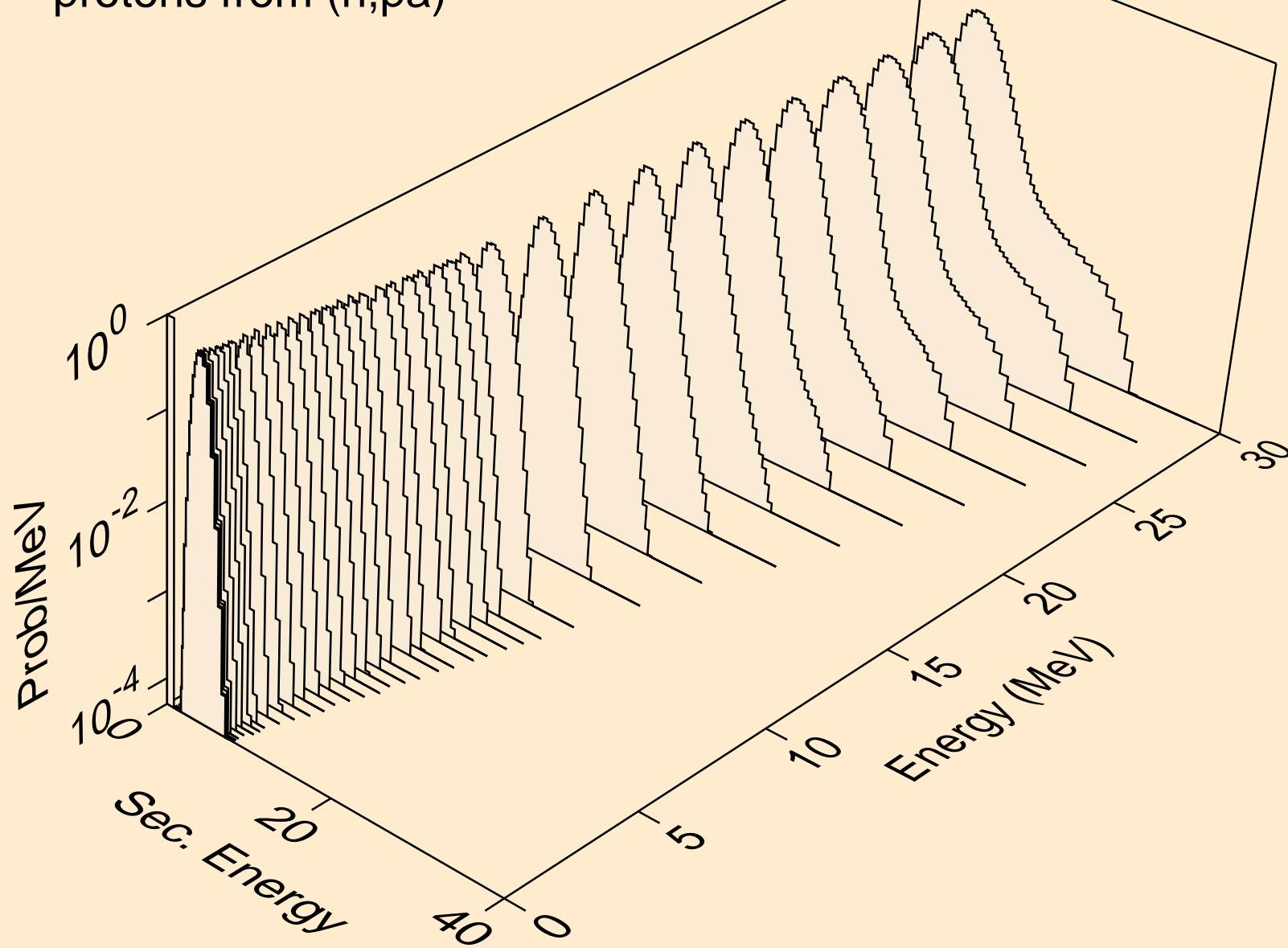

W163 NEUTRON ACER TENDL-2021 LIBRARY; T=293.6K
protons from (n,pd)

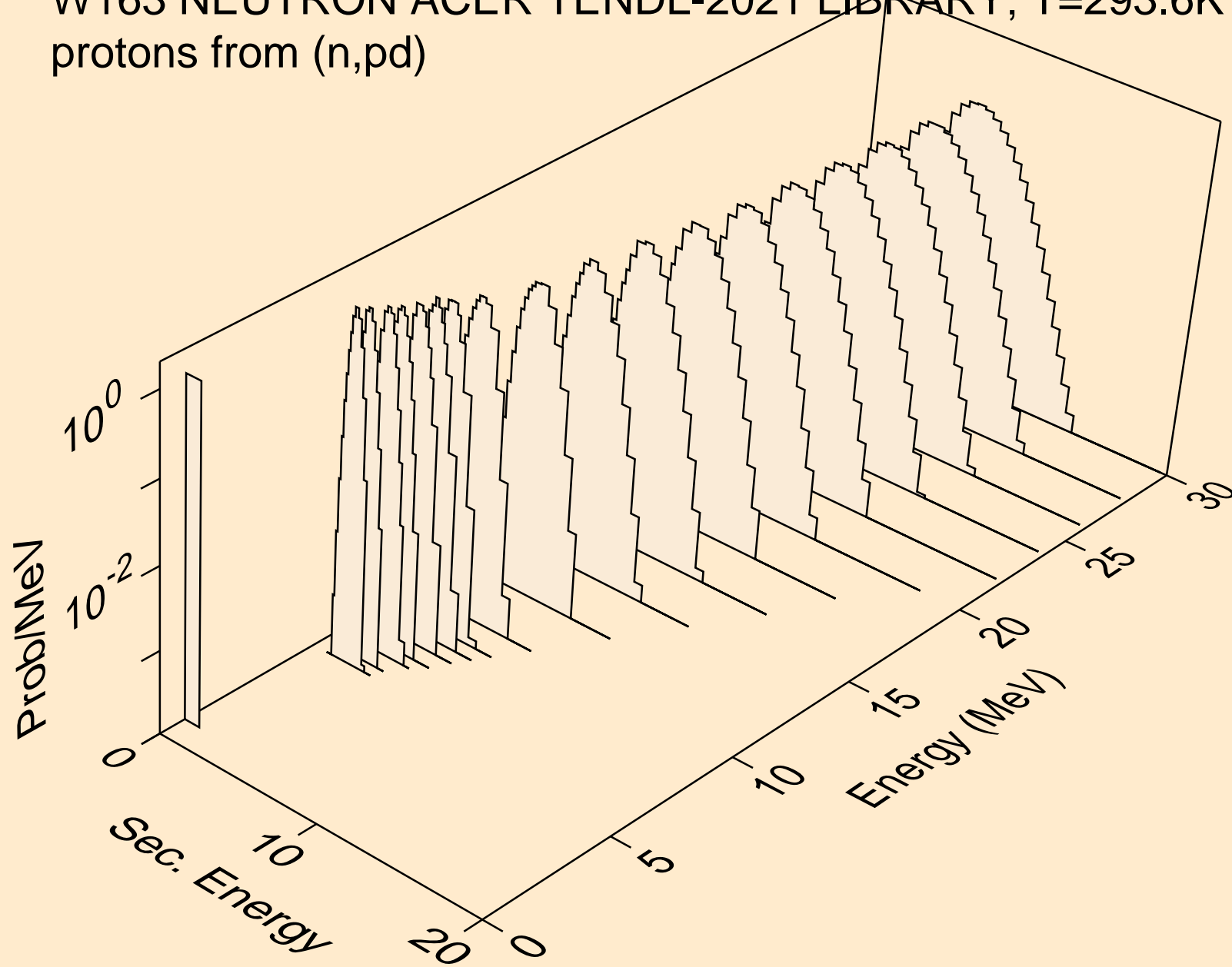

W163 NEUTRON ACER TENDL-2021 LIBRARY; T=293.6K
protons from (n,pt)

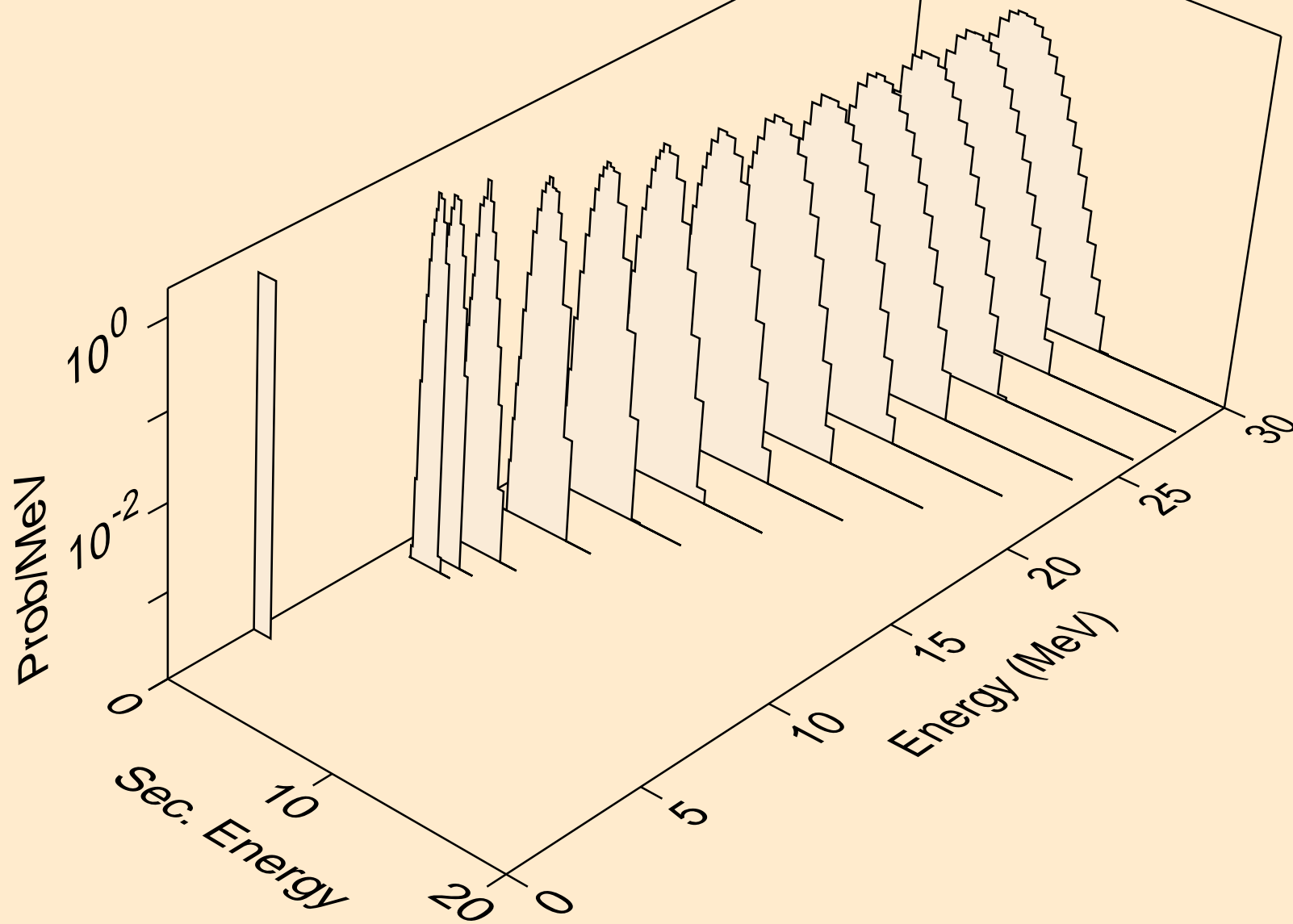

W163 NEUTRON ACER TENDL-2021 LIBRARY; T=293.6K
deuterons from (n,x)

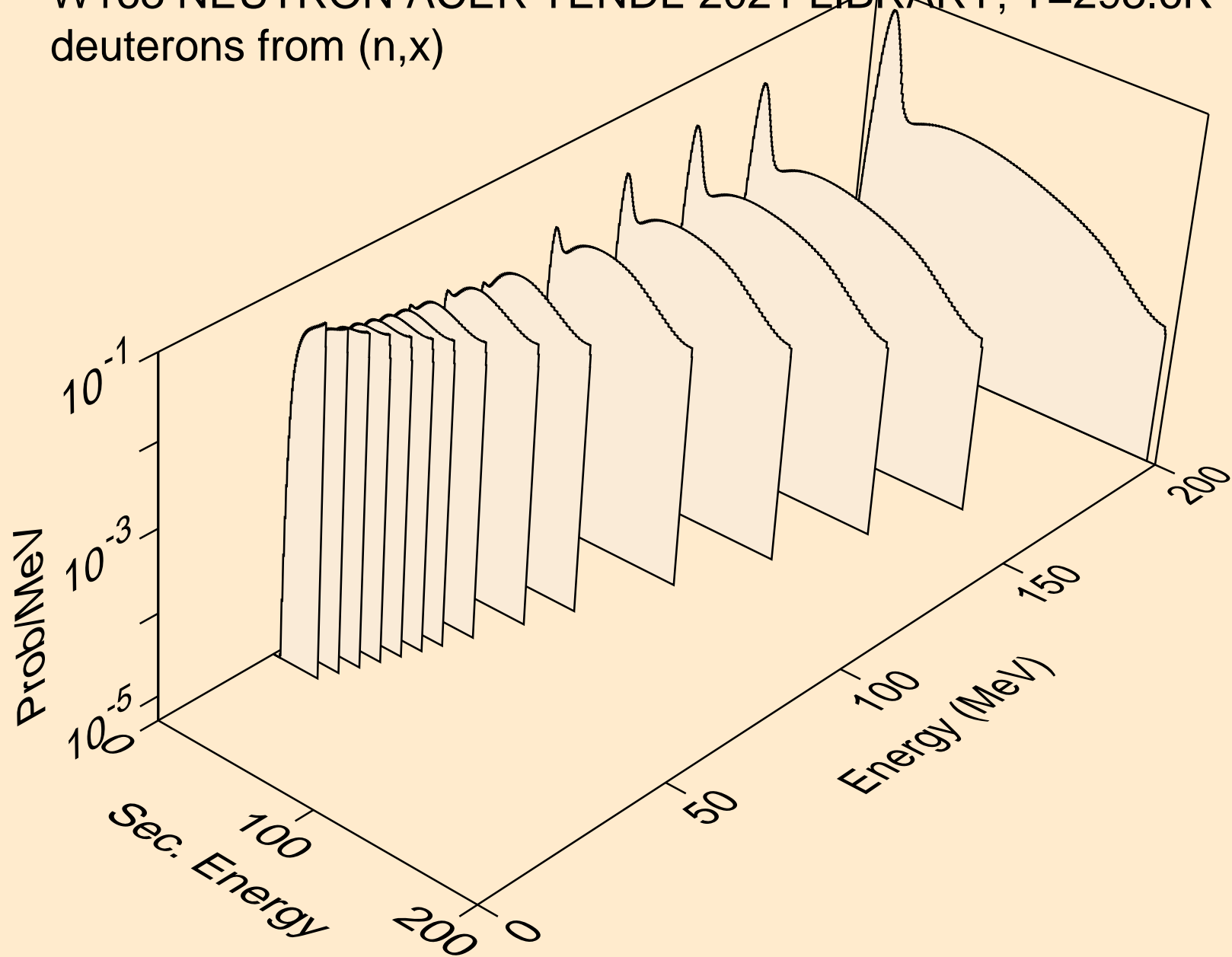

W163 NEUTRON ACER TENDL-2021 LIBRARY; T=293.6K
deuterons from (n,2nd)

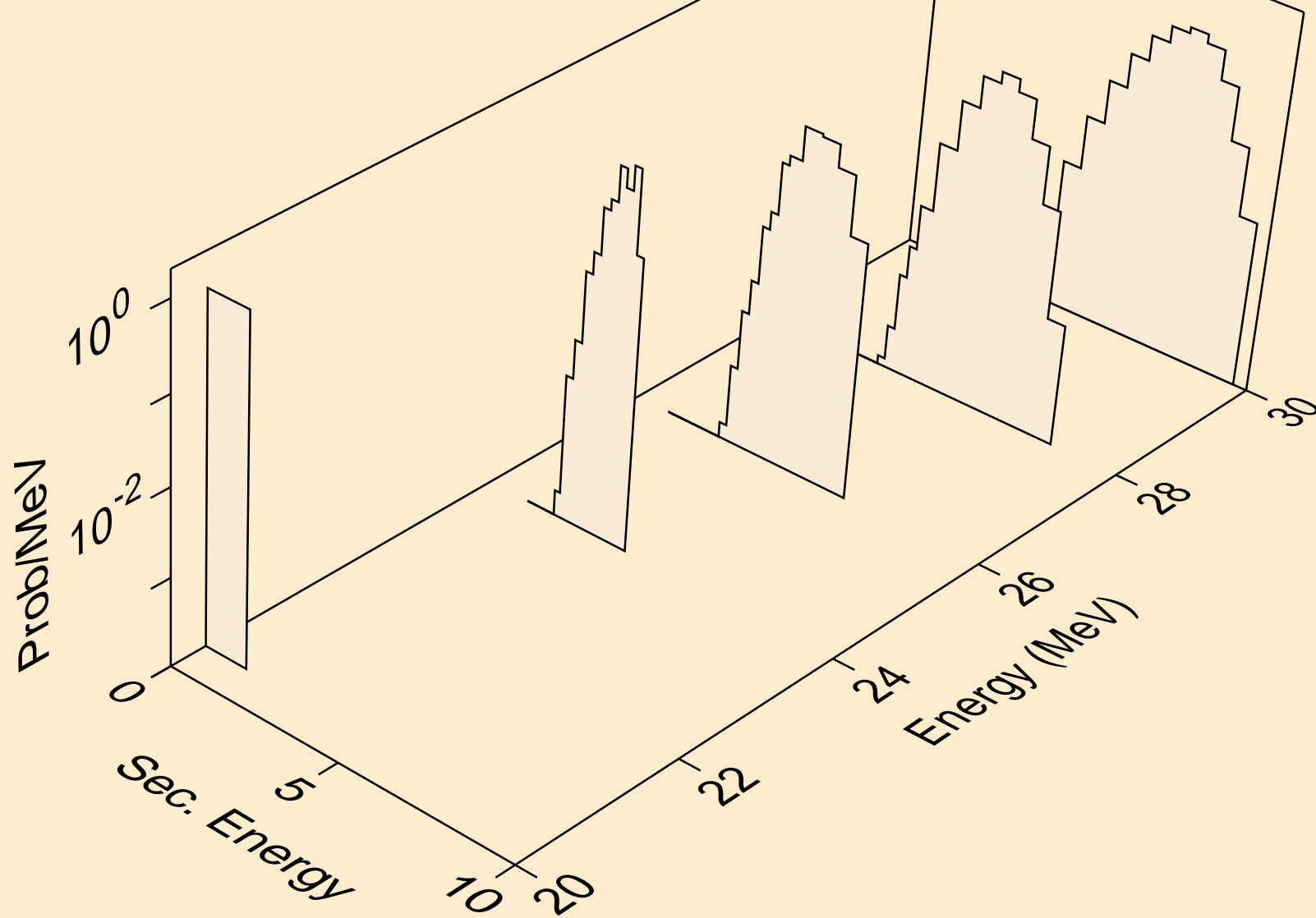

W163 NEUTRON ACER TENDL-2021 LIBRARY; T=293.6K
deuterons from (n,n*)d

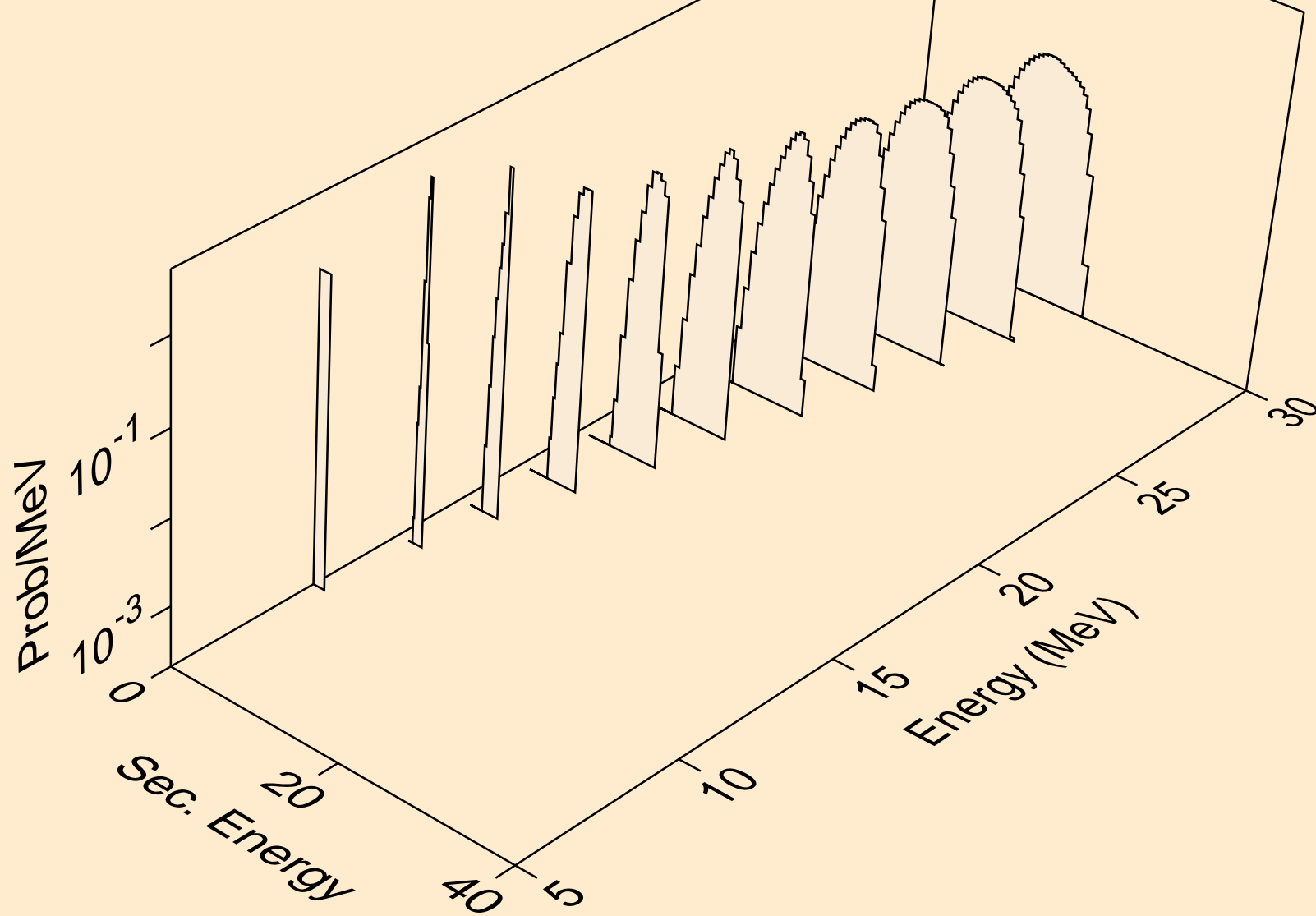

W163 NEUTRON ACER TENDL-2021 LIBRARY; T=293.6K
deuterons from (n,d)

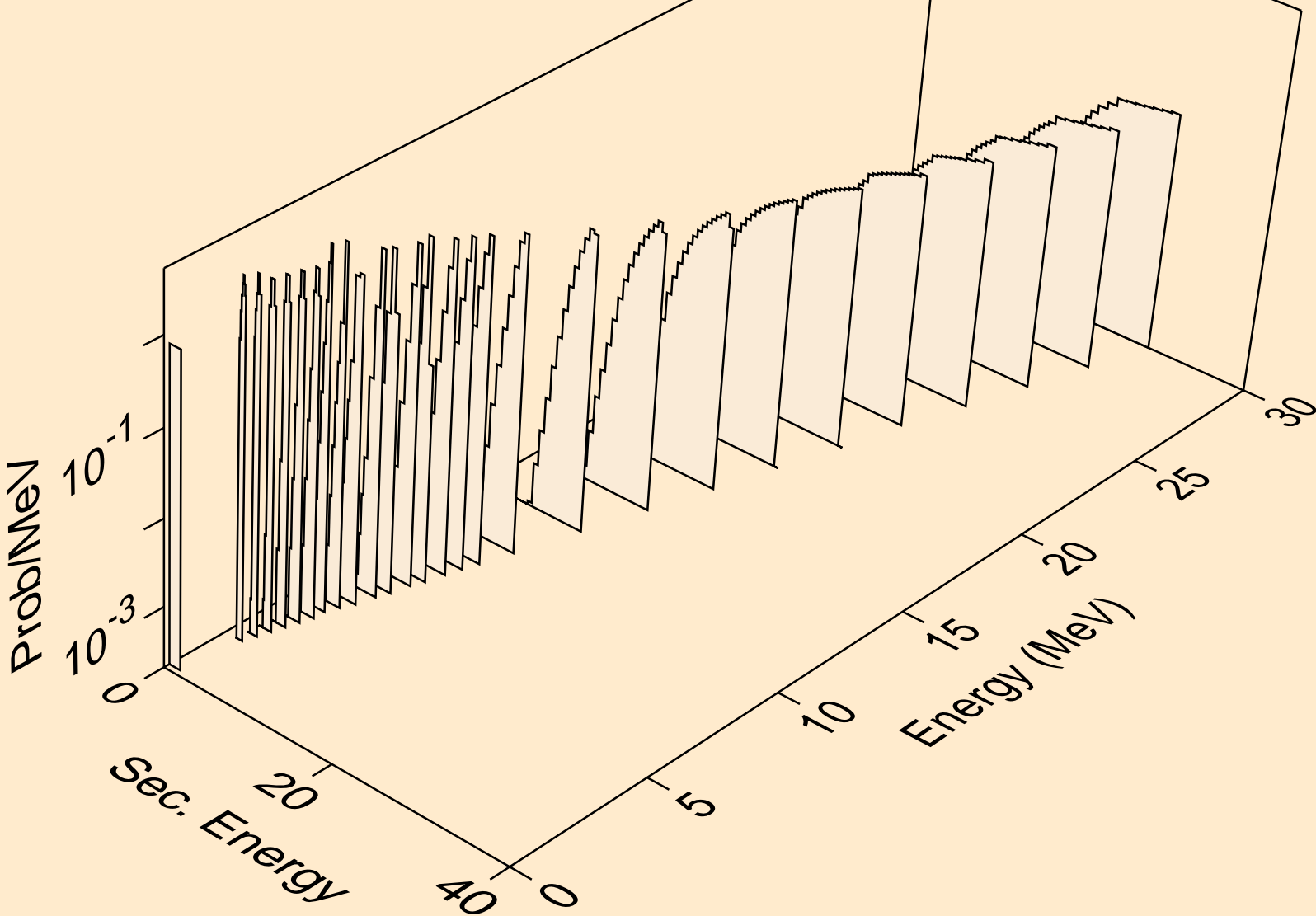

W163 NEUTRON ACER TENDL-2021 LIBRARY; T=293.6K
deuterons from (n,d2a)

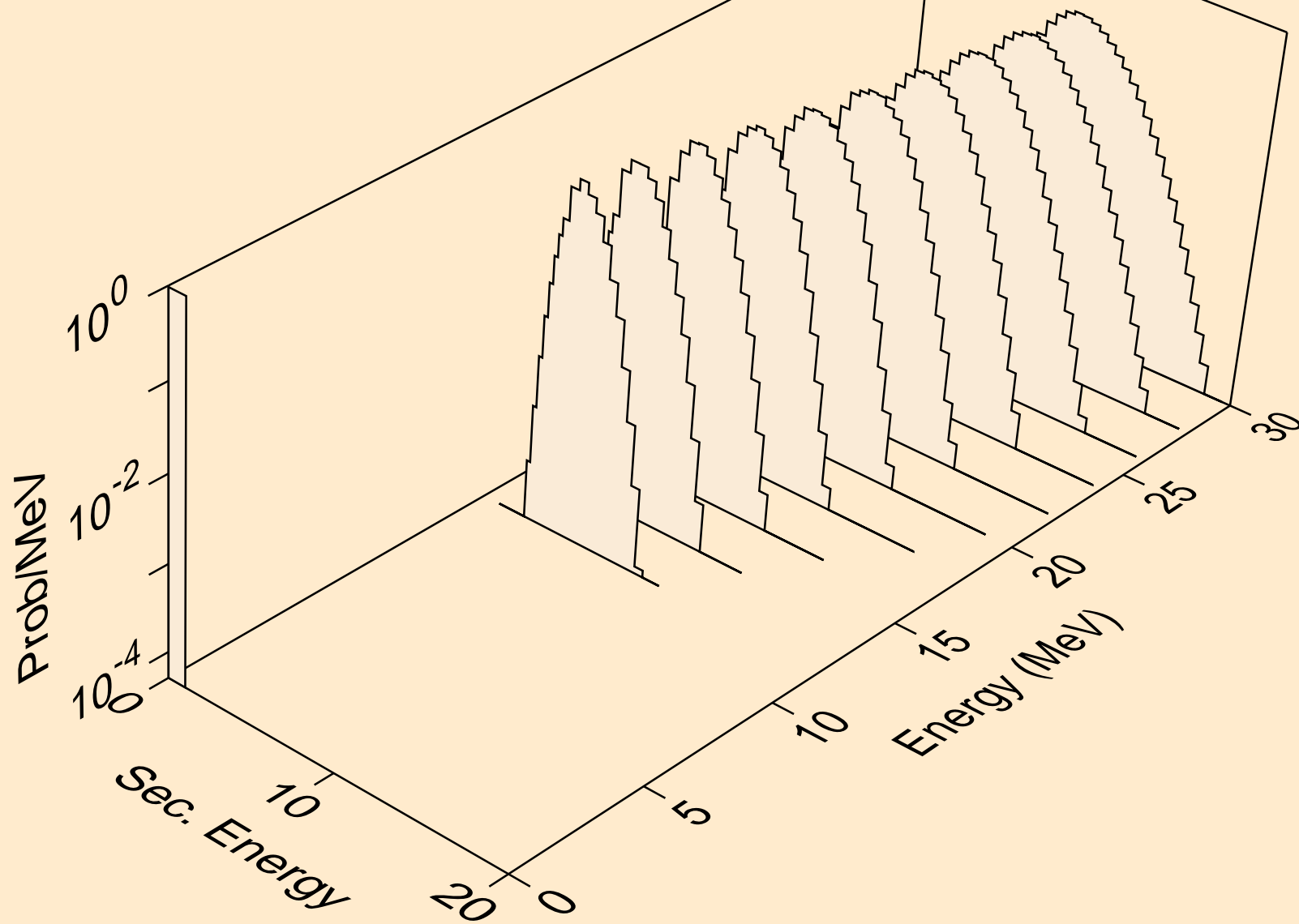

W163 NEUTRON ACER TENDL-2021 LIBRARY; T=293.6K
deuterons from (n,pd)

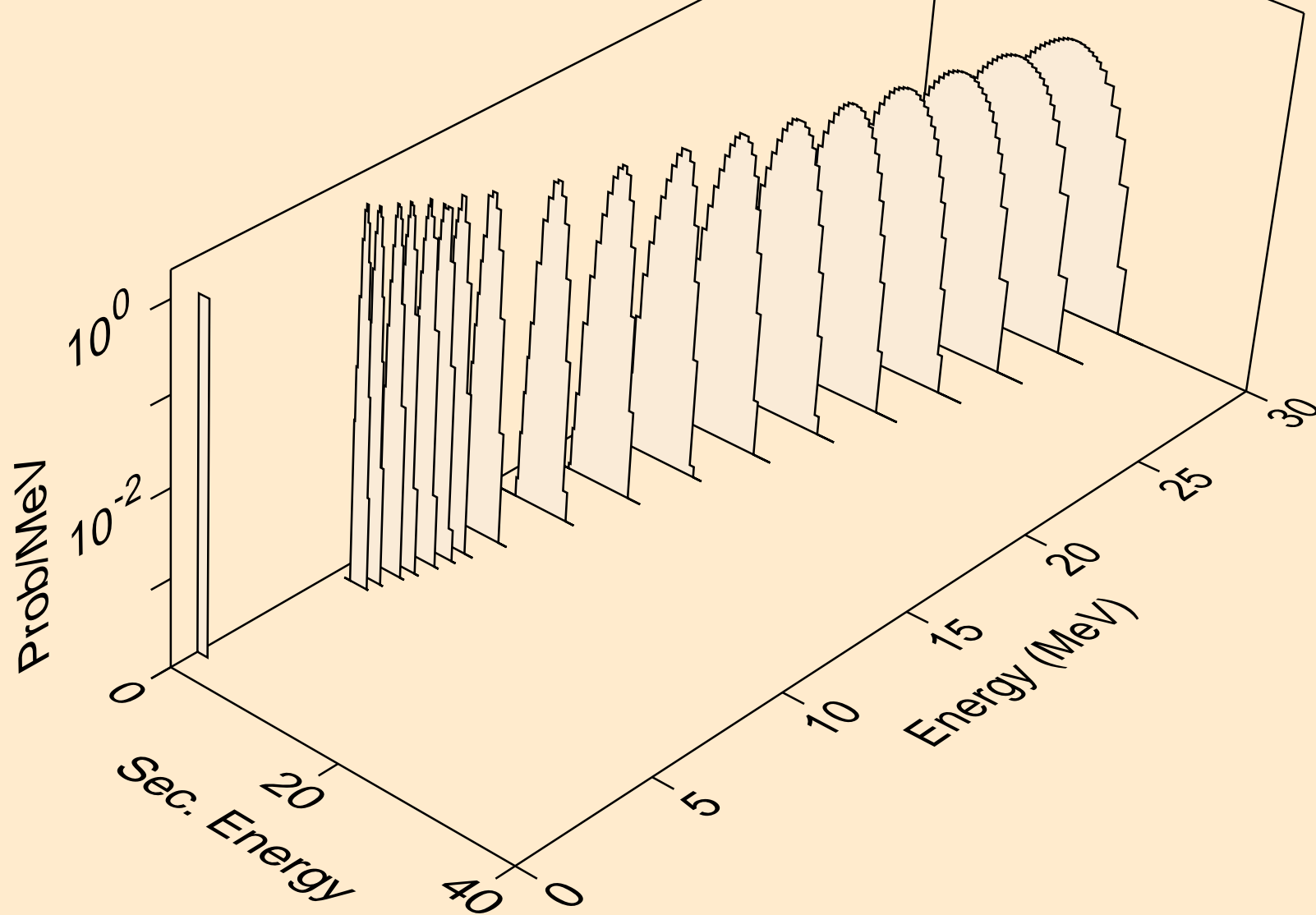

W163 NEUTRON ACER TENDL-2021 LIBRARY; T=293.6K
deuterons from (n,da)

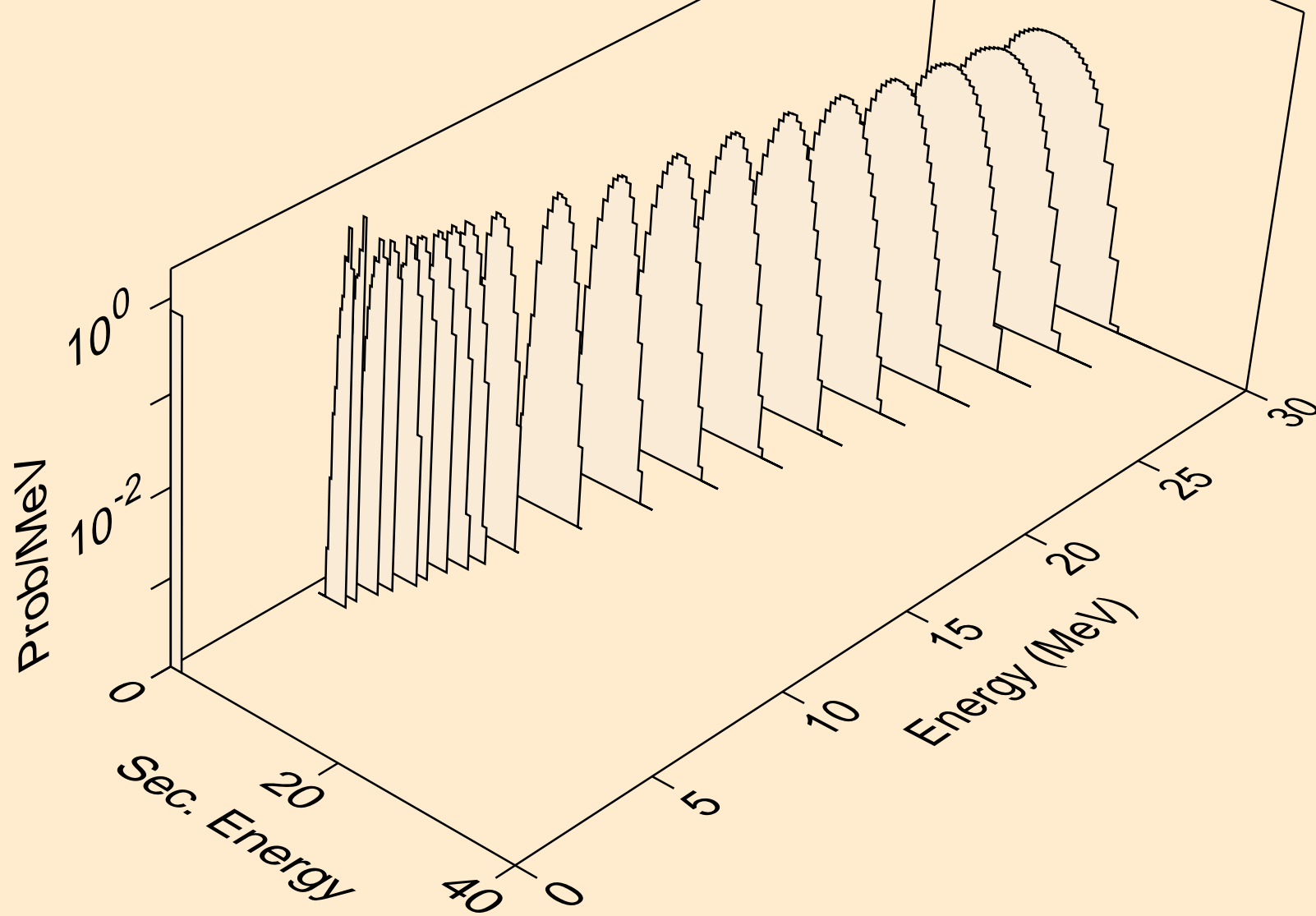

W163 NEUTRON ACER TENDL-2021 LIBRARY; T=293.6K
tritons from (n,x)

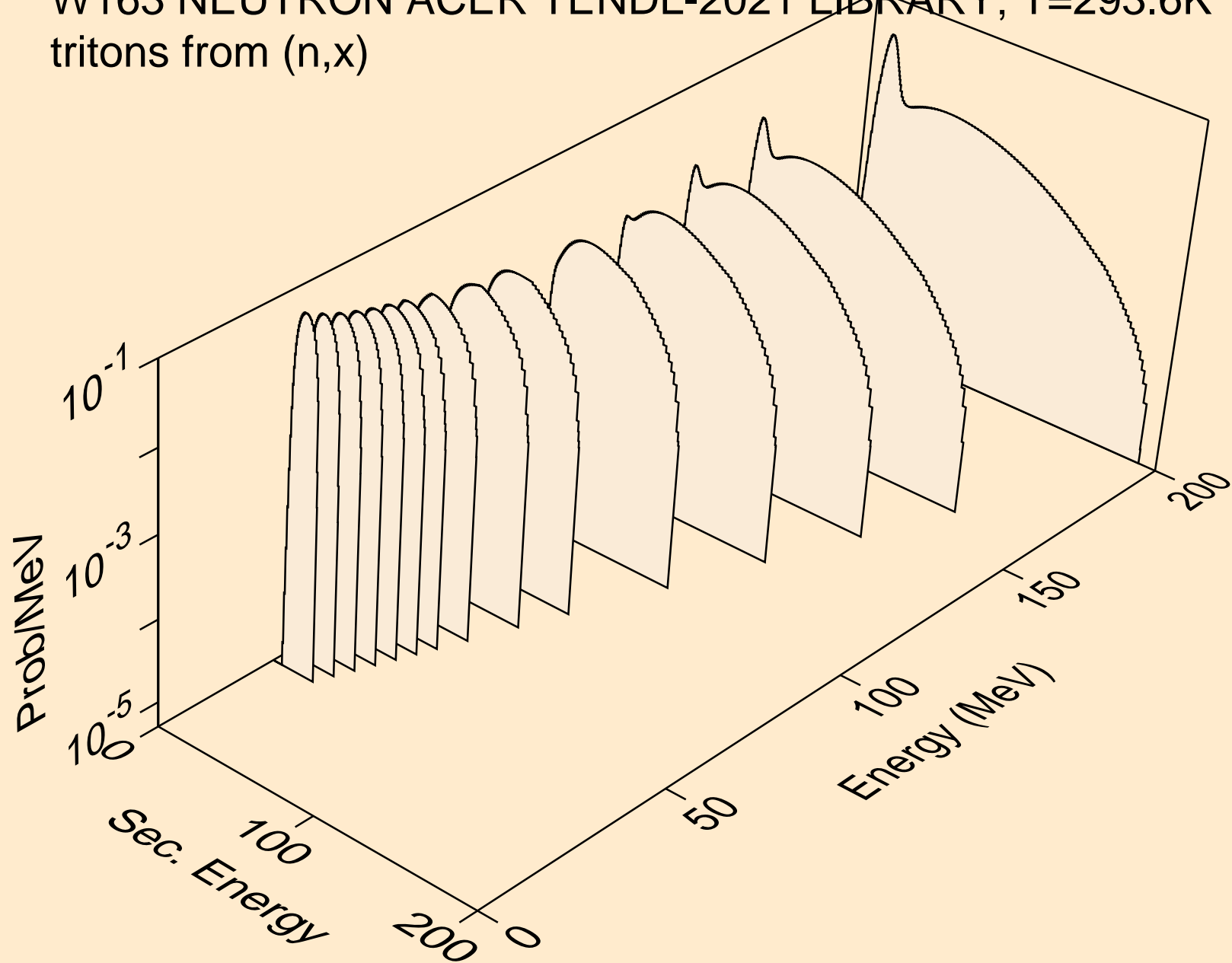

W163 NEUTRON ACER TENDL-2021 LIBRARY; T=293.6K
tritons from (n,n*)t

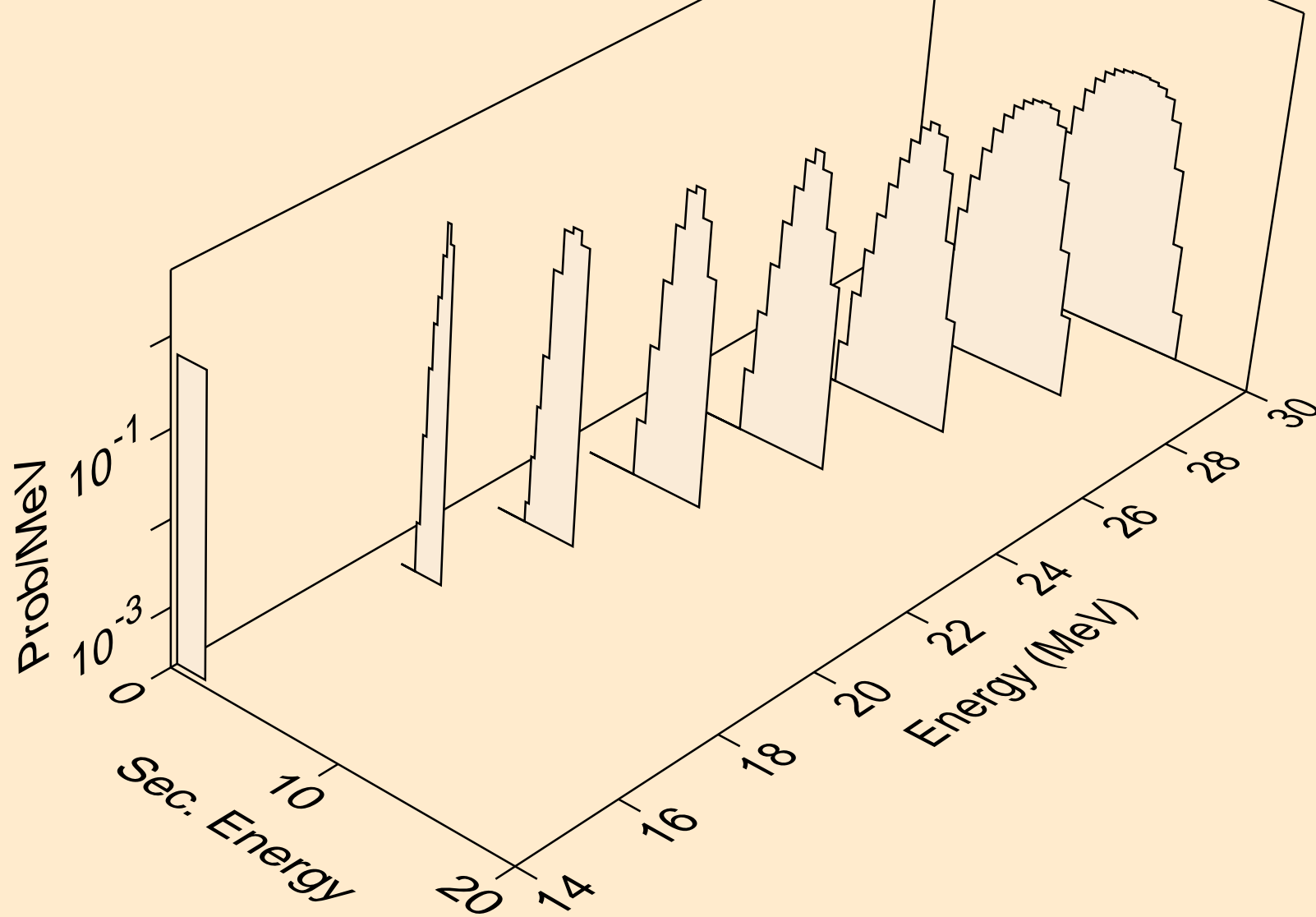

W163 NEUTRON ACER TENDL-2021 LIBRARY; T=293.6K
tritons from (n,t)

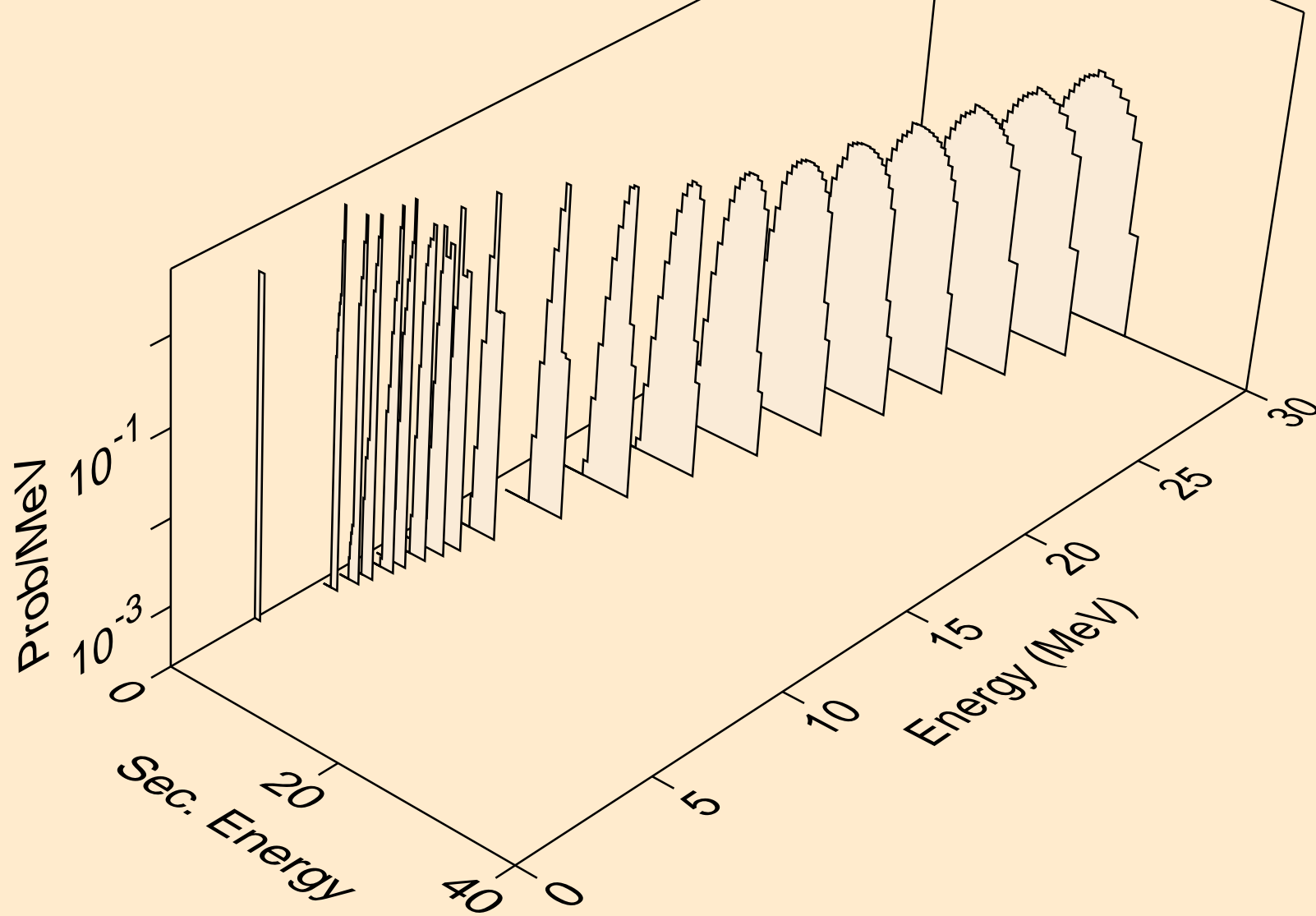

W163 NEUTRON ACER TENDL-2021 LIBRARY; T=293.6K
tritons from (n,t2a)

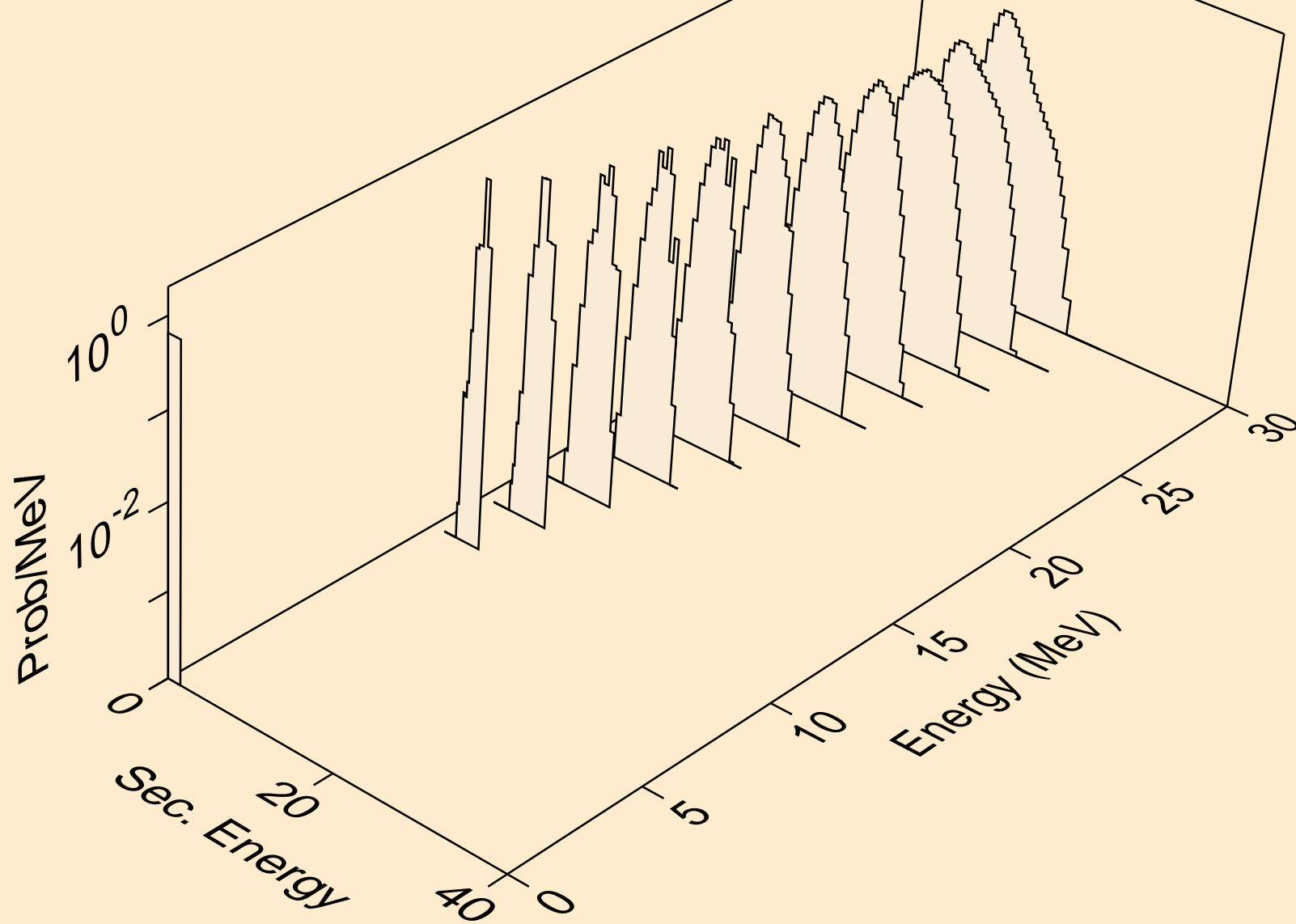

W163 NEUTRON ACER TENDL-2021 LIBRARY; T=293.6K
tritons from (n,pt)

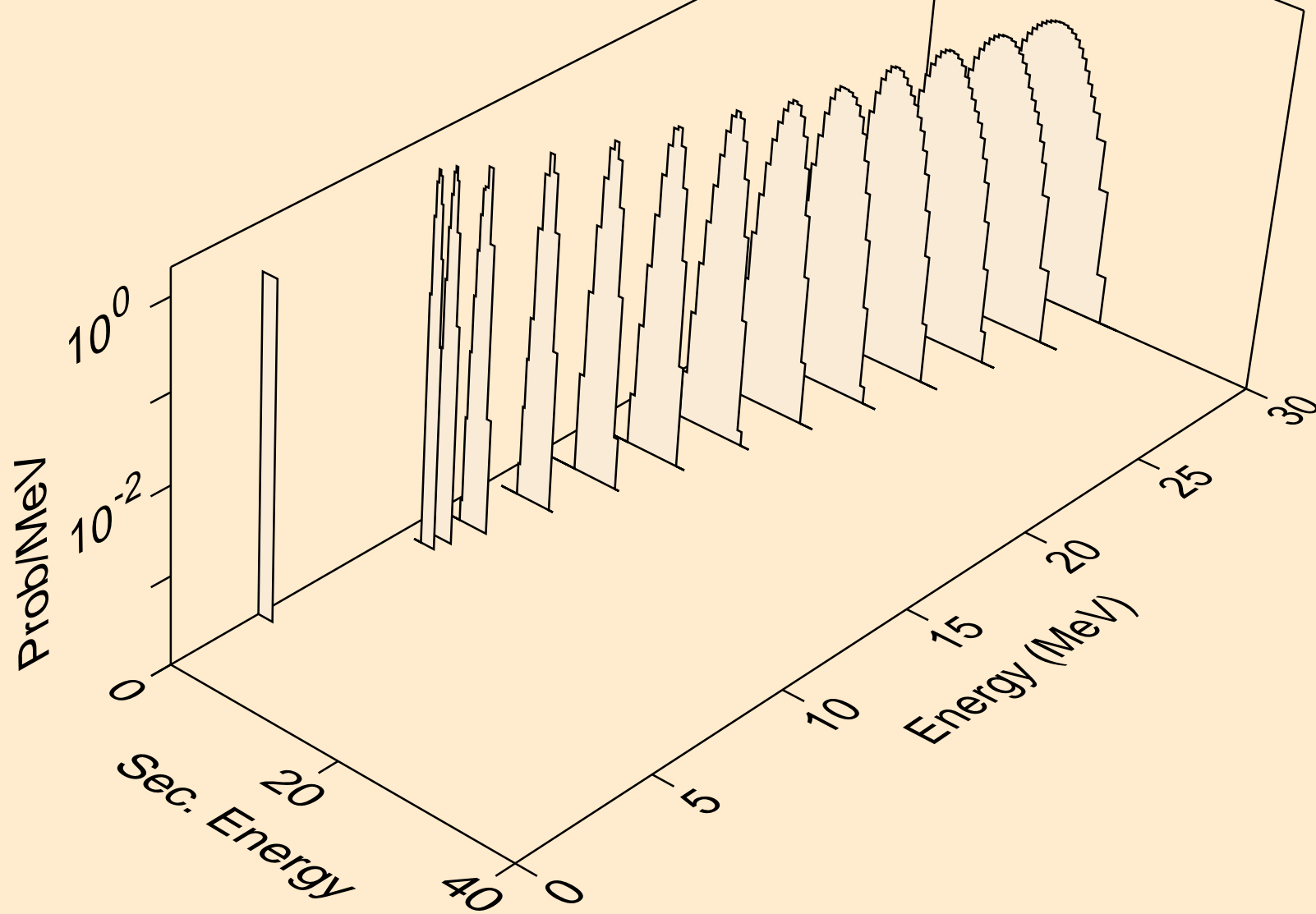

W163 NEUTRON ACER TENDL-2021 LIBRARY; T=293.6K
he3s from (n,x)

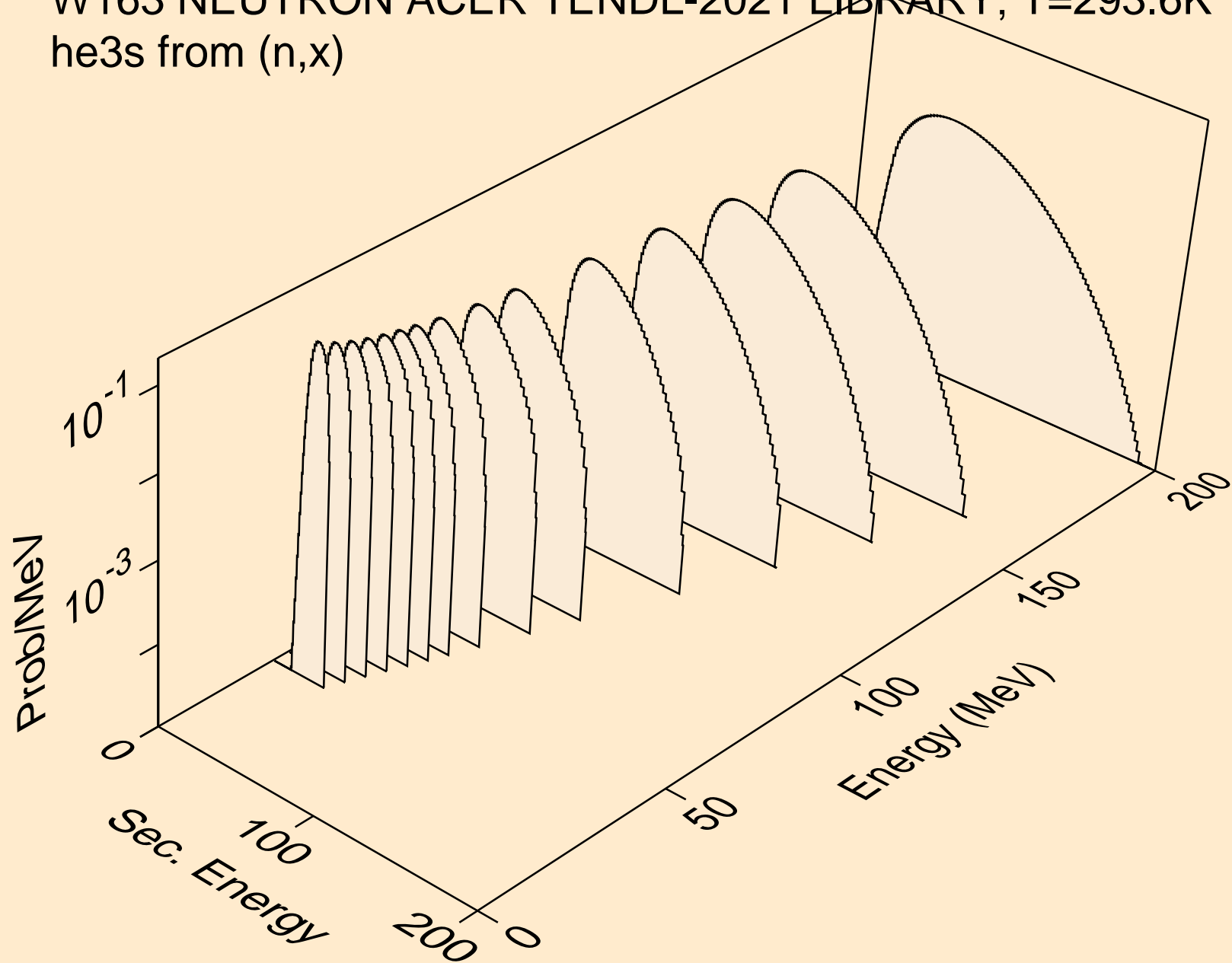

W163 NEUTRON ACER TENDL-2021 LIBRARY; T=293.6K
he3s from (n,n*)he3

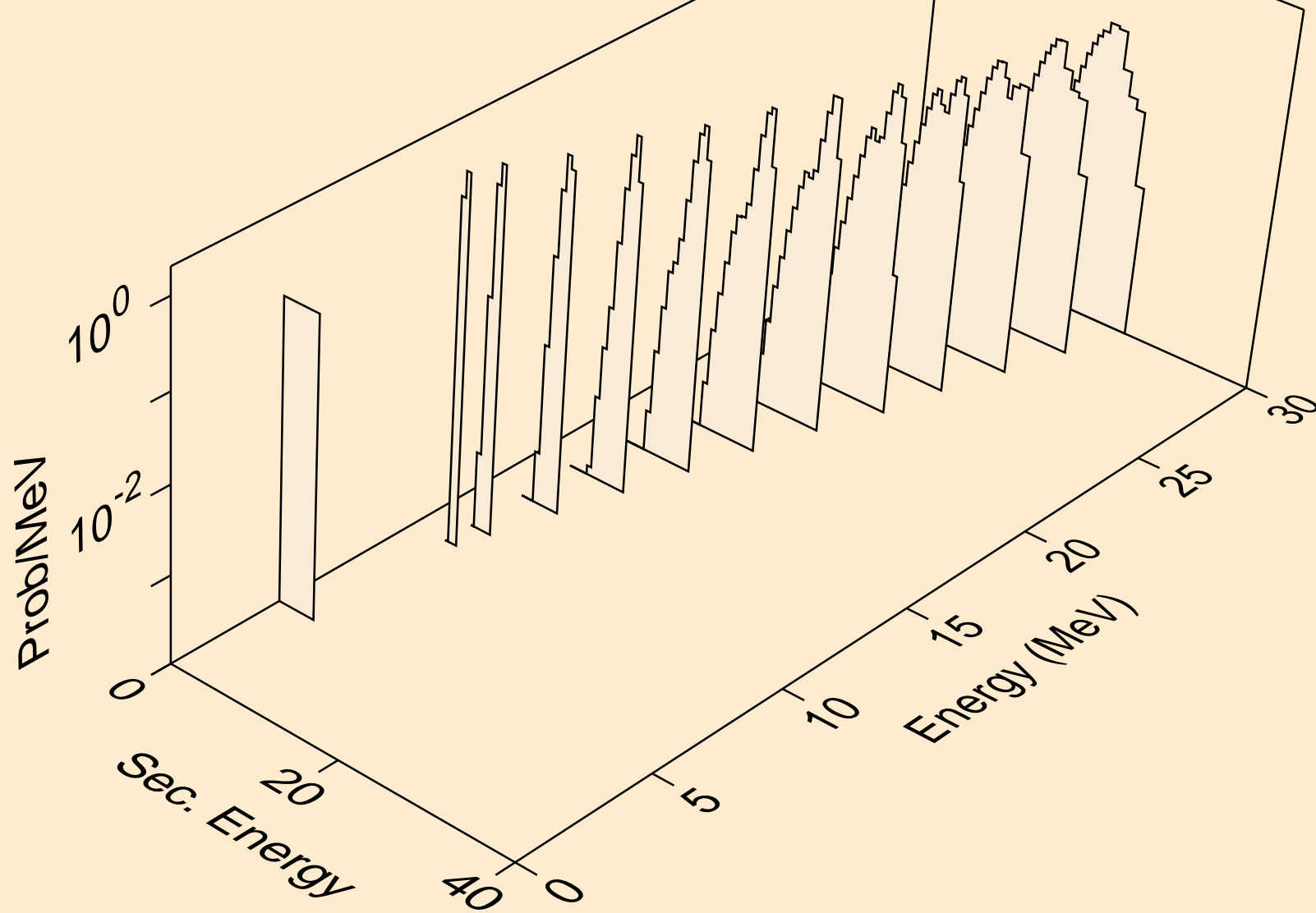

W163 NEUTRON ACER TENDL-2021 LIBRARY; T=293.6K
he3s from (n,he3)

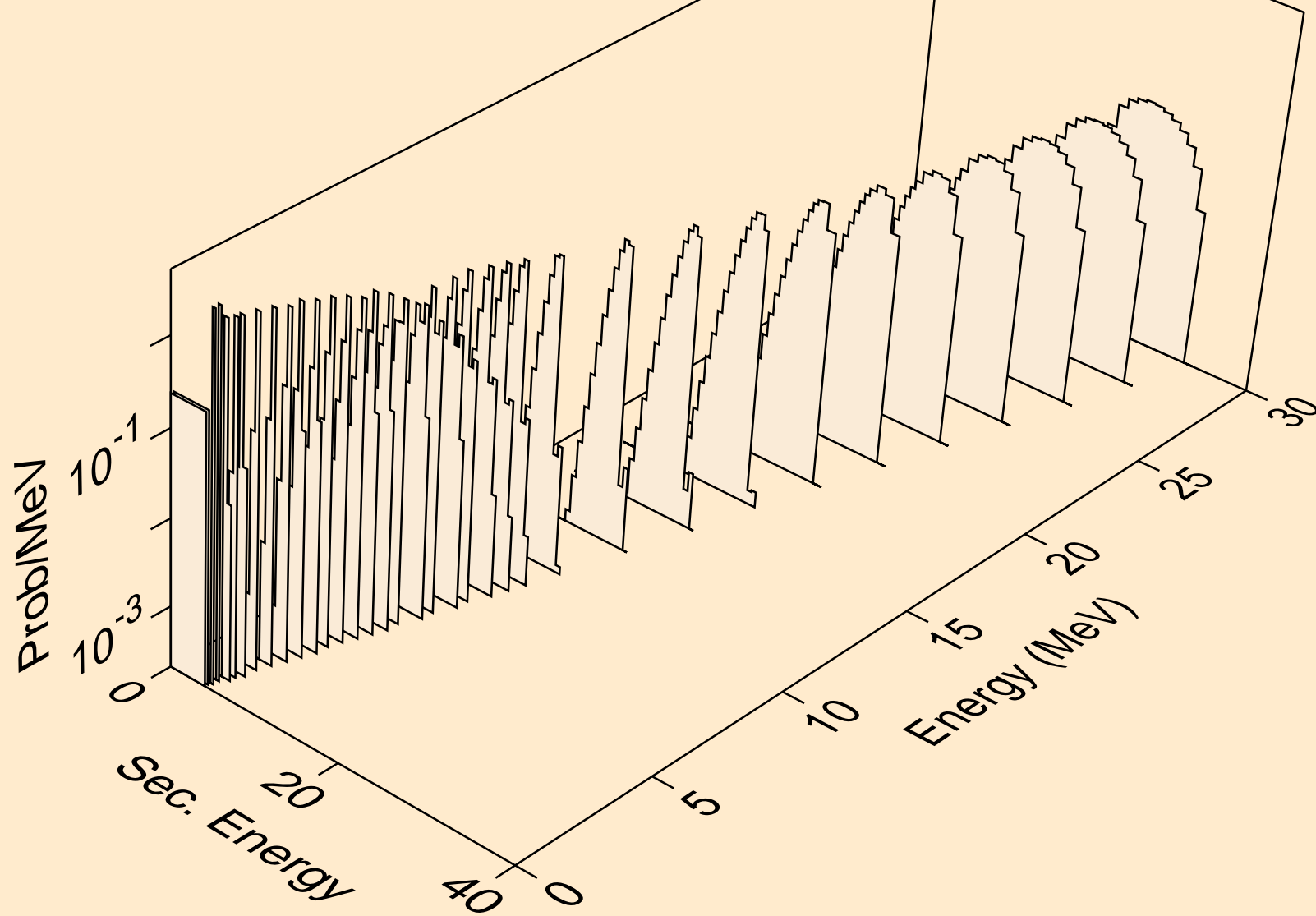

W163 NEUTRON ACER TENDL-2021 LIBRARY; T=293.6K
alphas from (n,x)

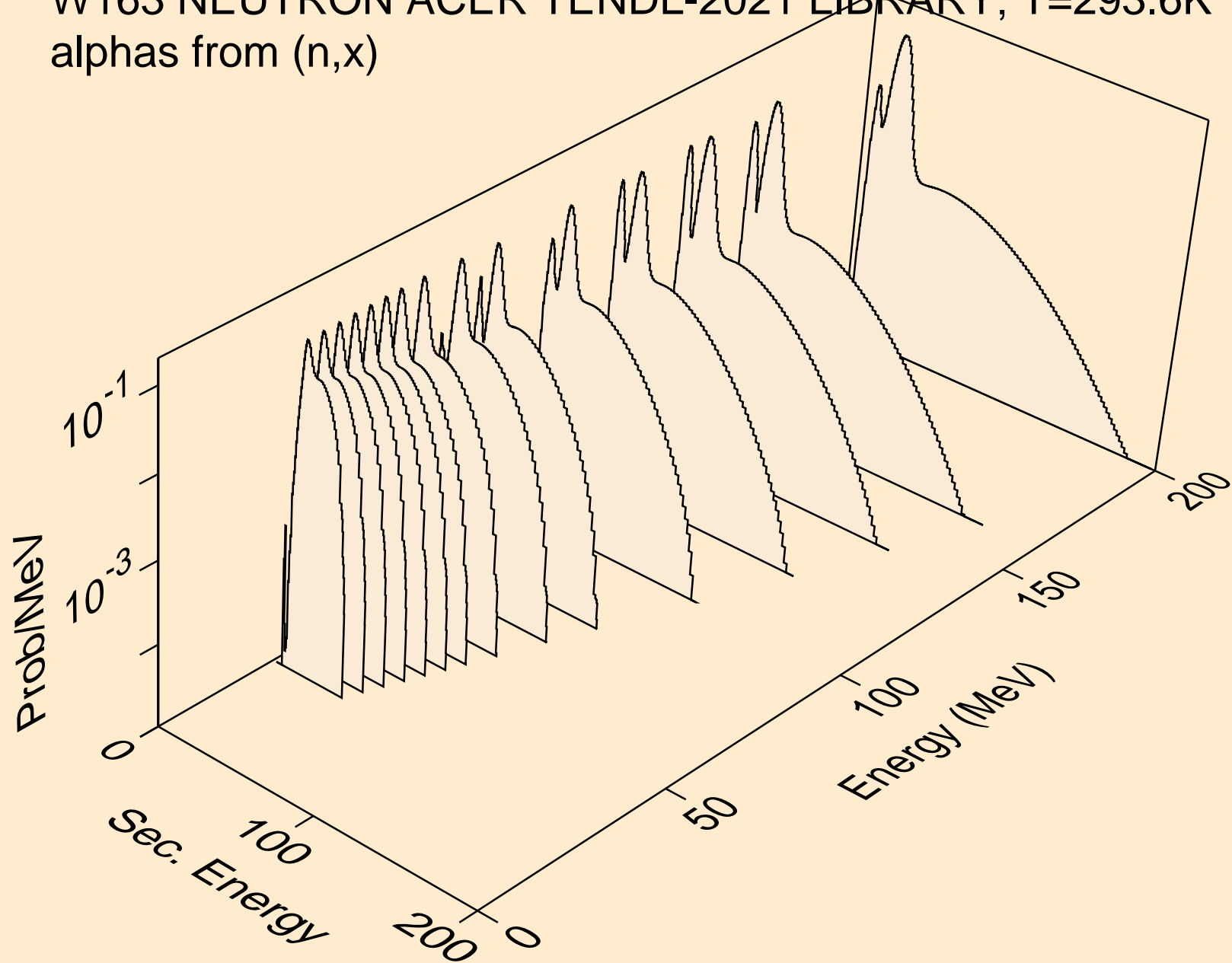

W163 NEUTRON ACER TENDL-2021 LIBRARY; T=293.6K
alphas from (n,n*)a

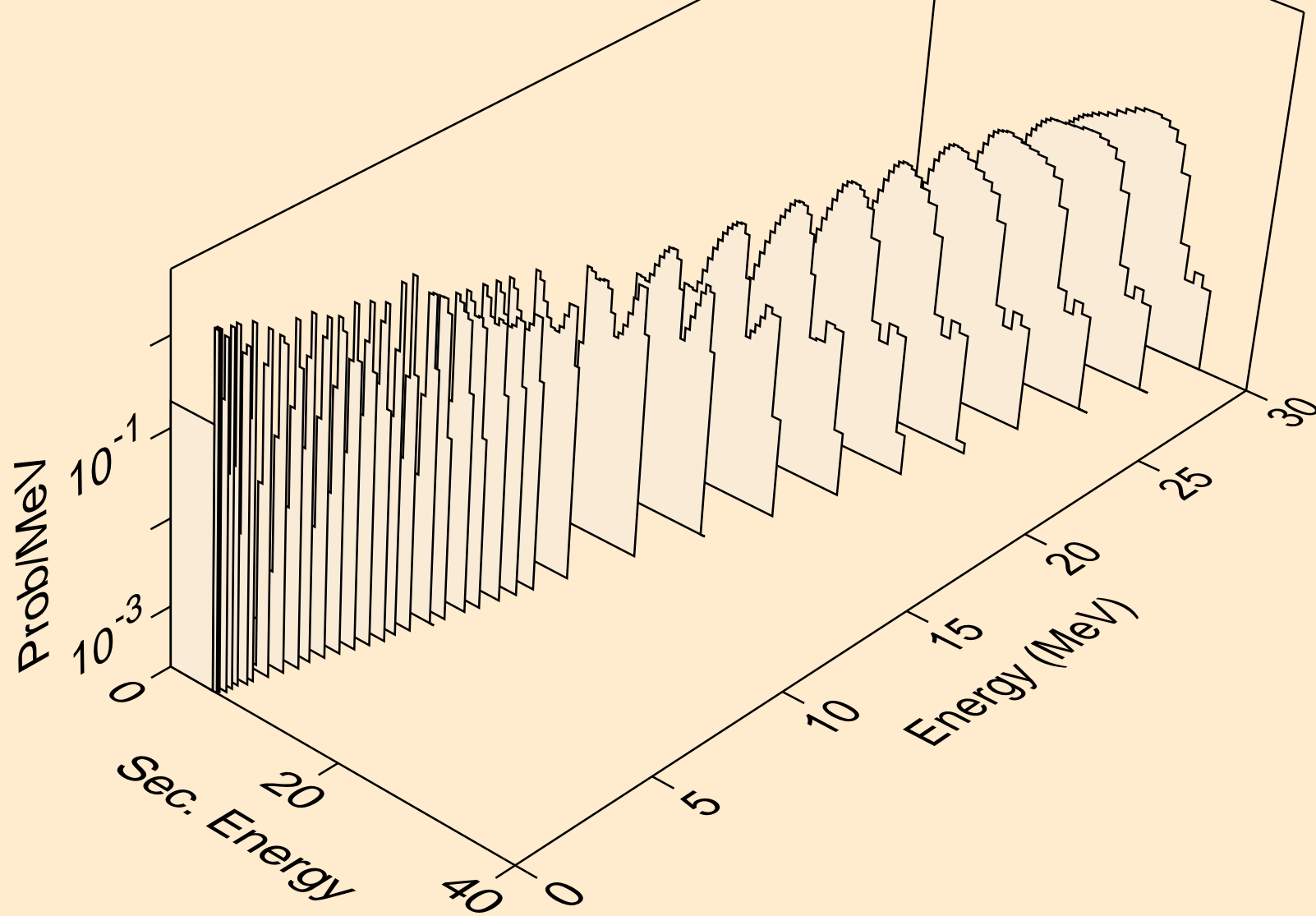

W163 NEUTRON ACER TENDL-2021 LIBRARY; T=293.6K
alphas from (n,n*)3a

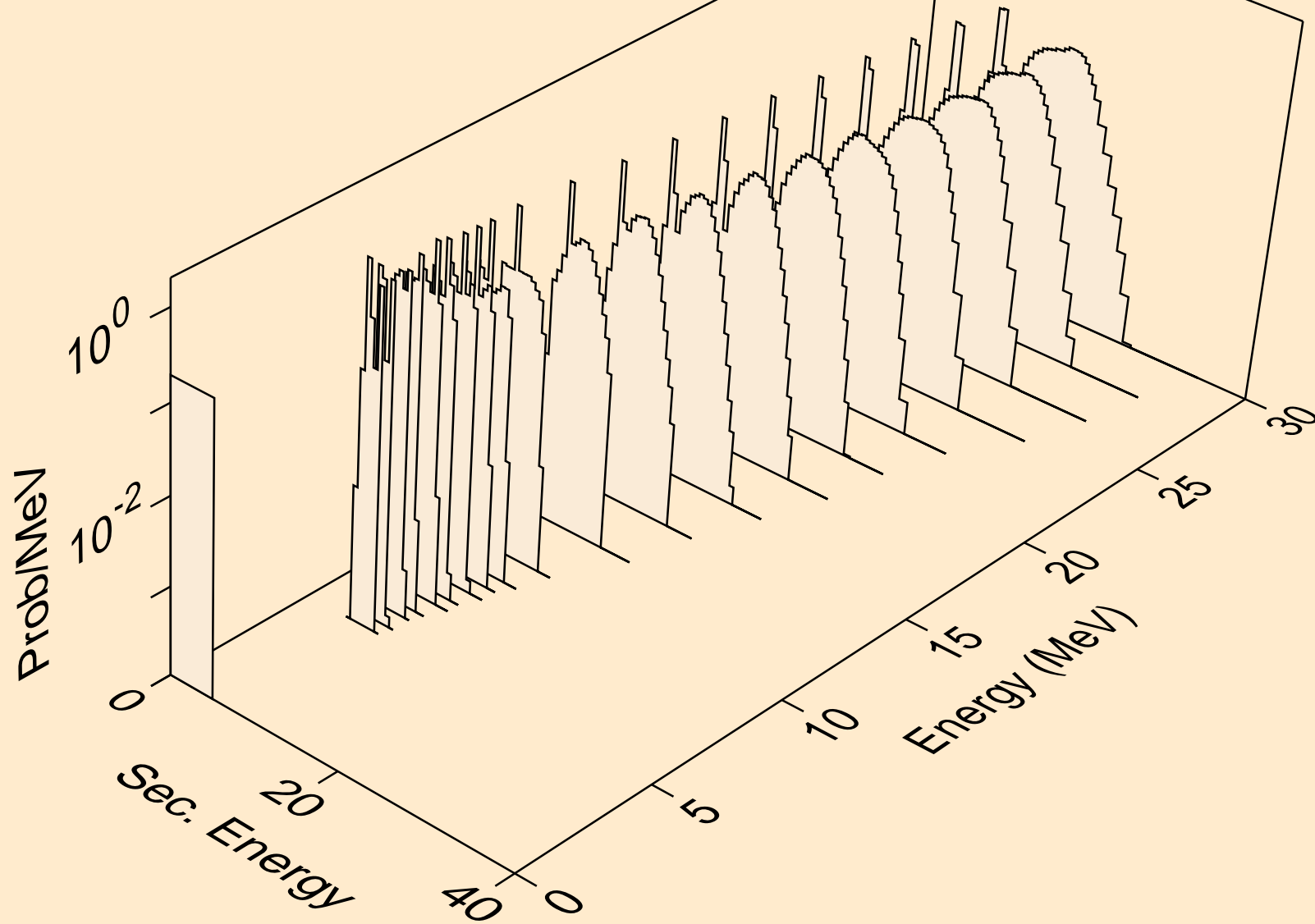

W163 NEUTRON ACER TENDL-2021 LIBRARY; T=293.6K
alphas from (n,2n)a

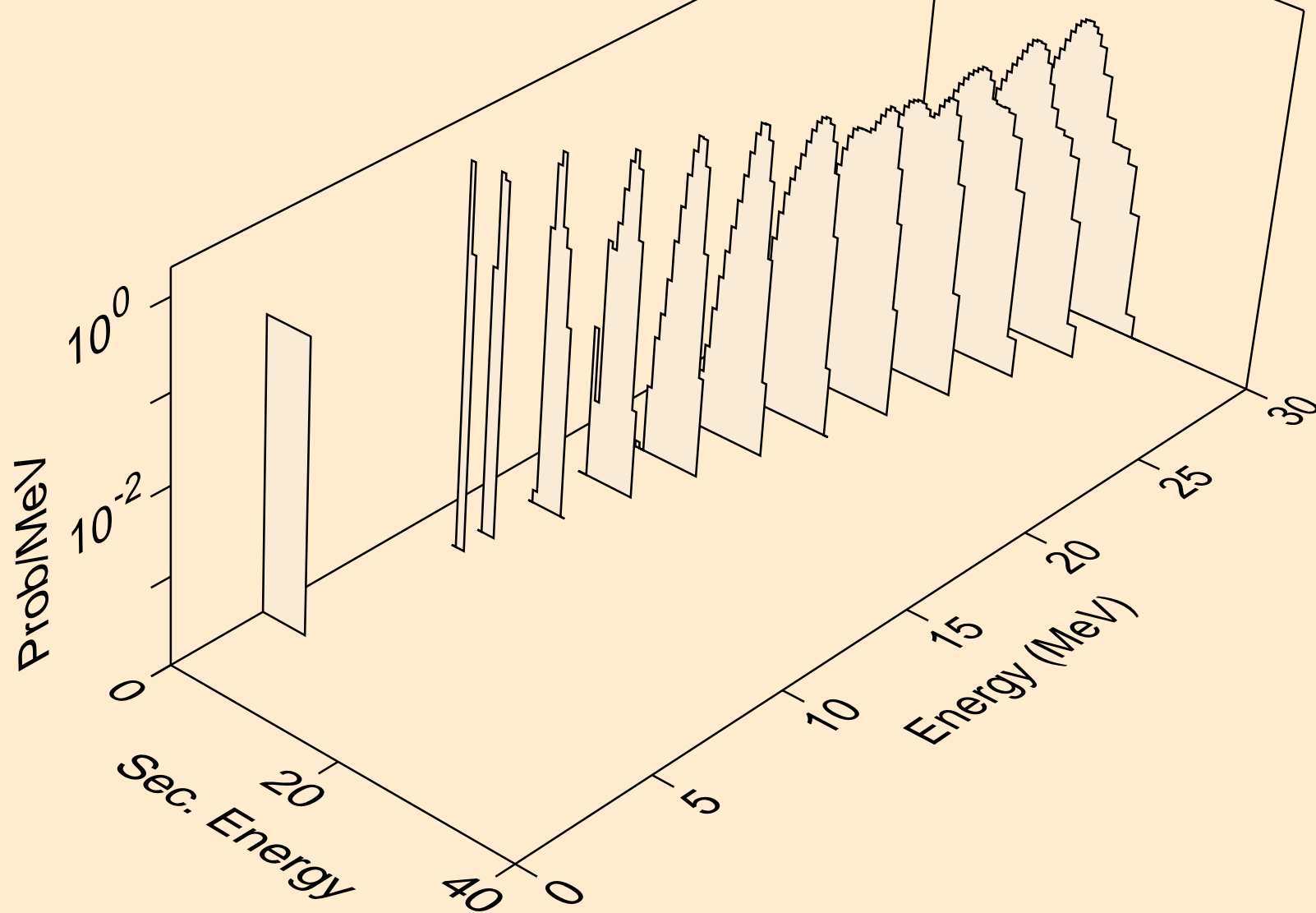

W163 NEUTRON ACER TENDL-2021 LIBRARY; T=293.6K
alphas from (n,3n)a

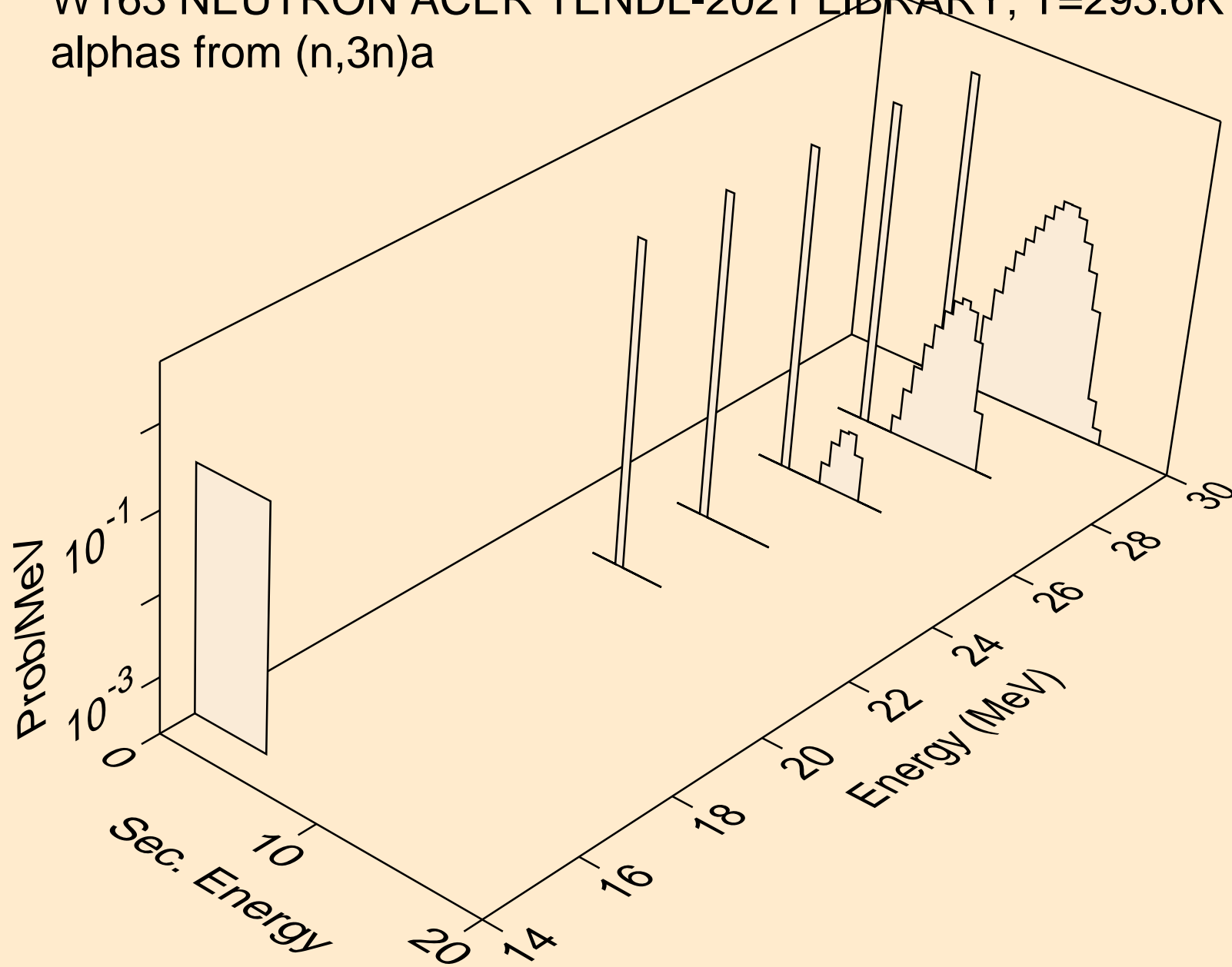

W163 NEUTRON ACER TENDL-2021 LIBRARY; T=293.6K
alphas from (n,n*)2a

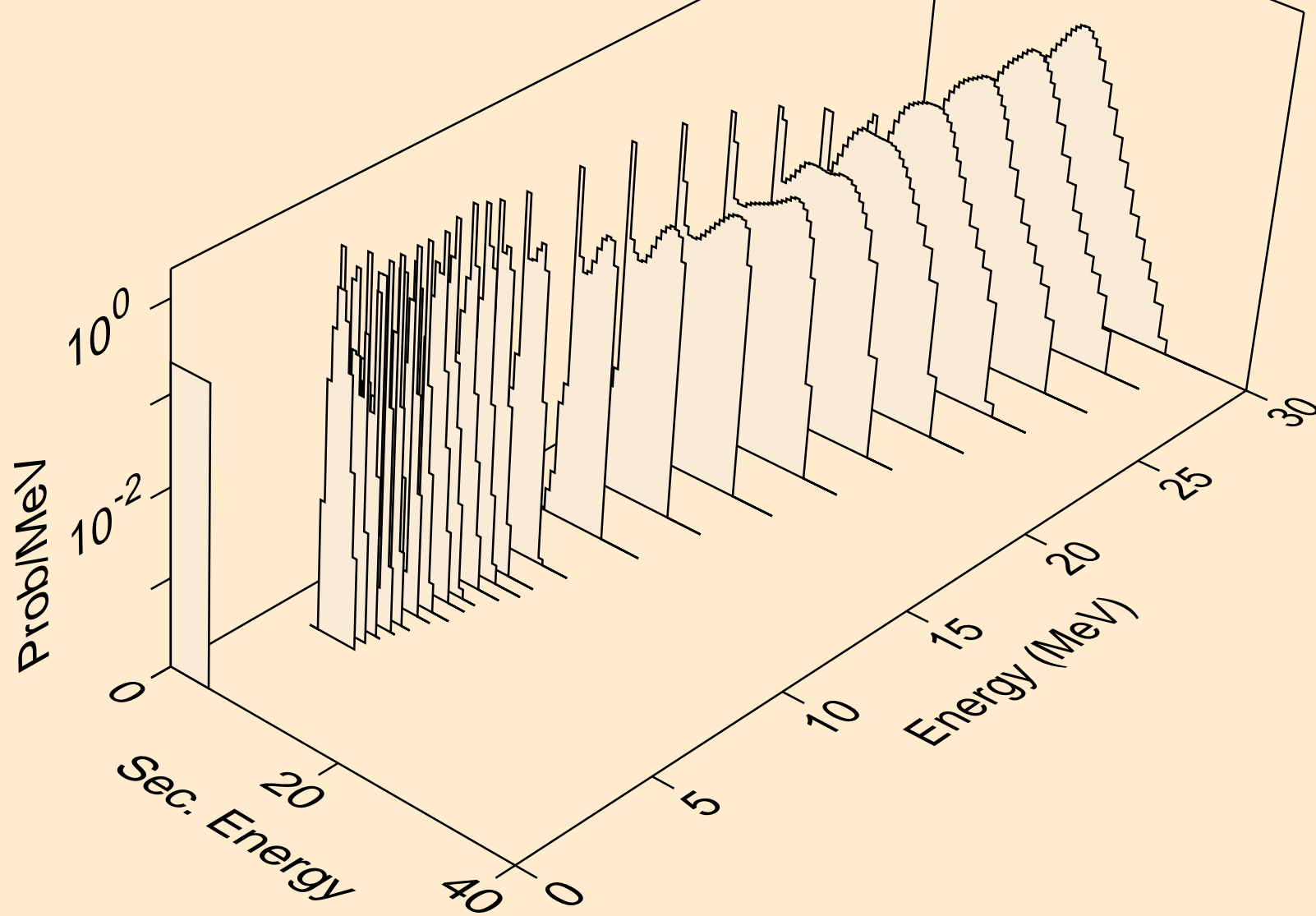

W163 NEUTRON ACER TENDL-2021 LIBRARY; T=293.6K
alphas from (n,2n)2a

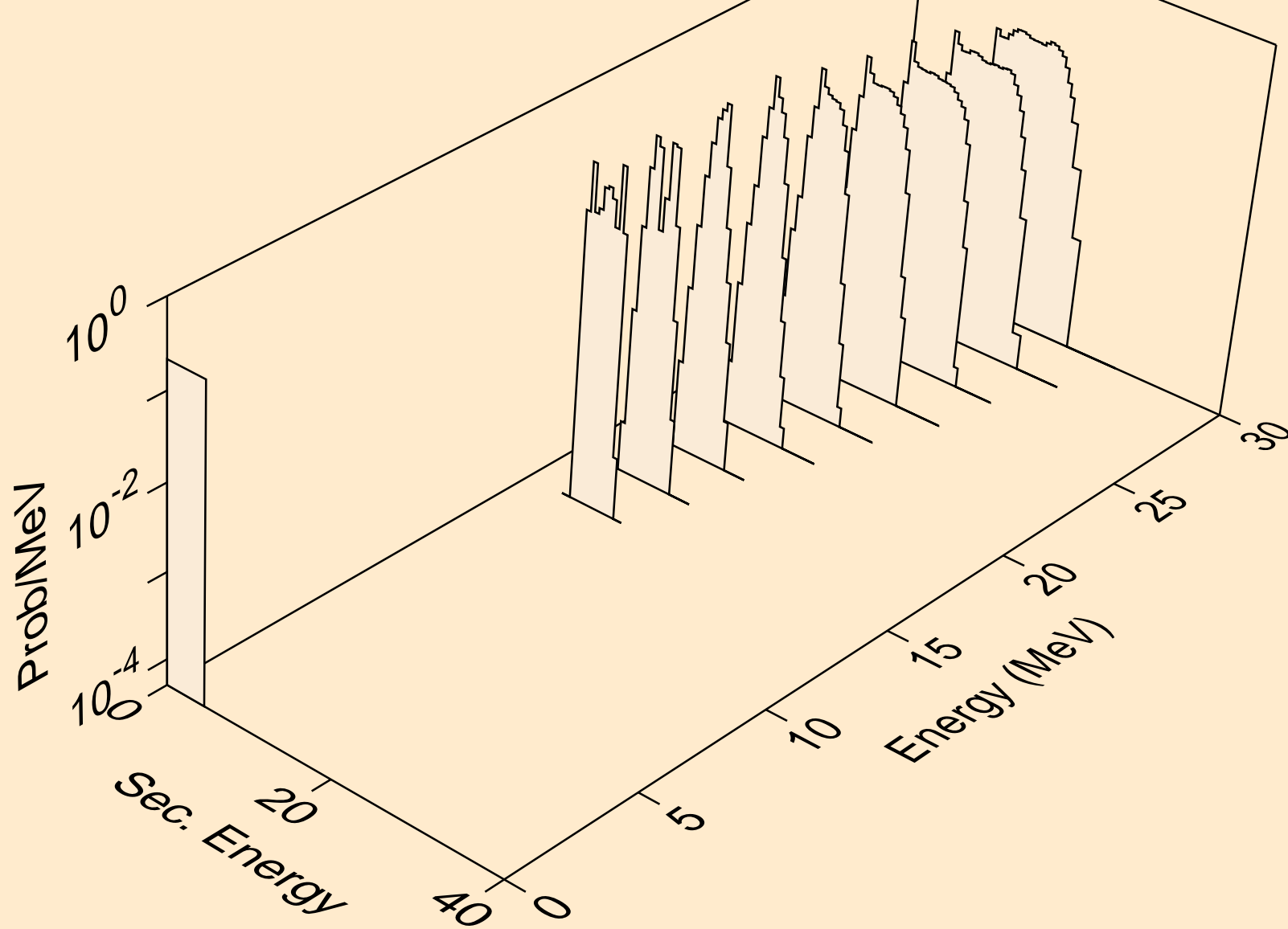

W163 NEUTRON ACER TENDL-2021 LIBRARY; T=293.6K
alphas from (n,npa)

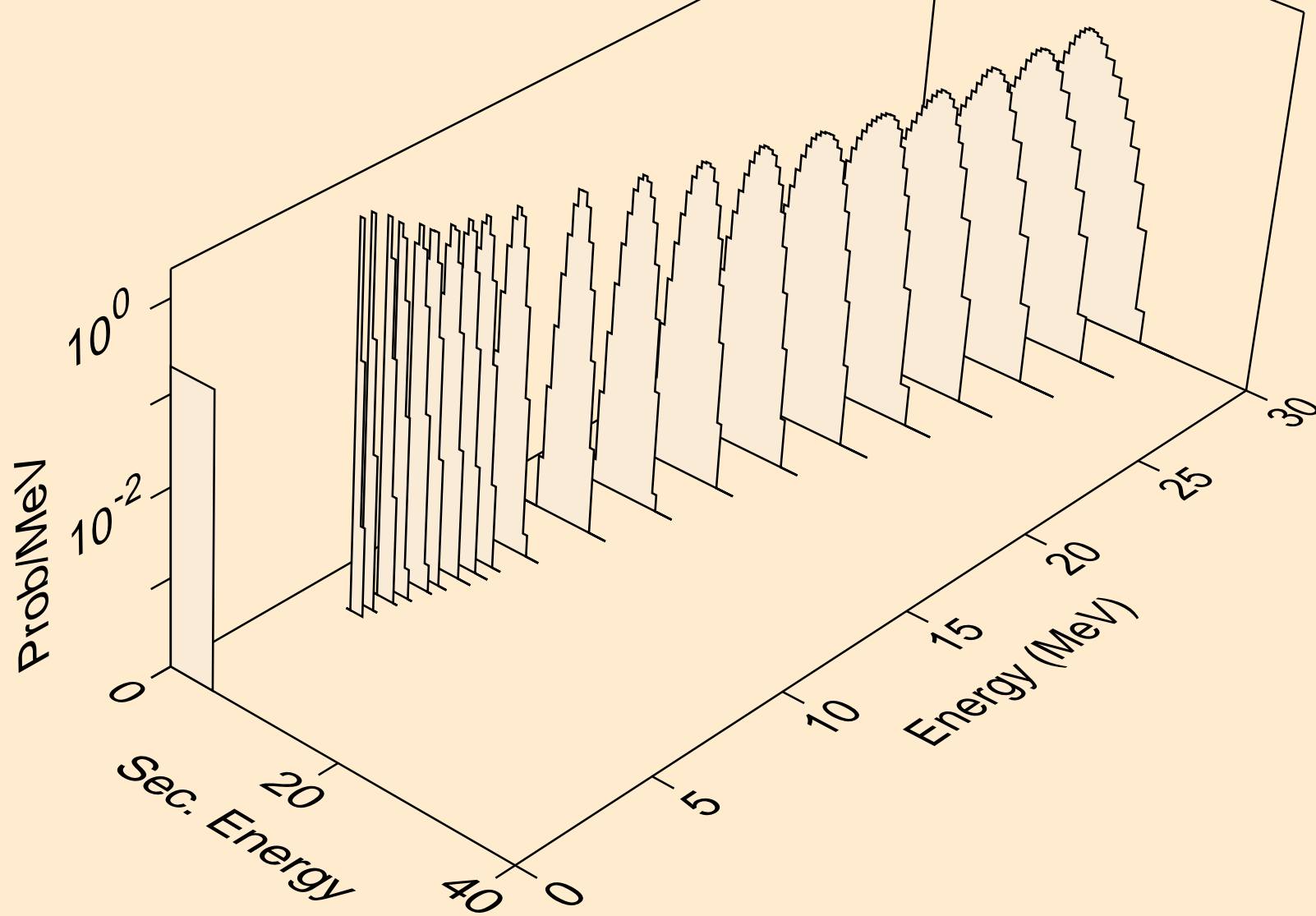

W163 NEUTRON ACER TENDL-2021 LIBRARY; T=293.6K
alphas from (n,a)

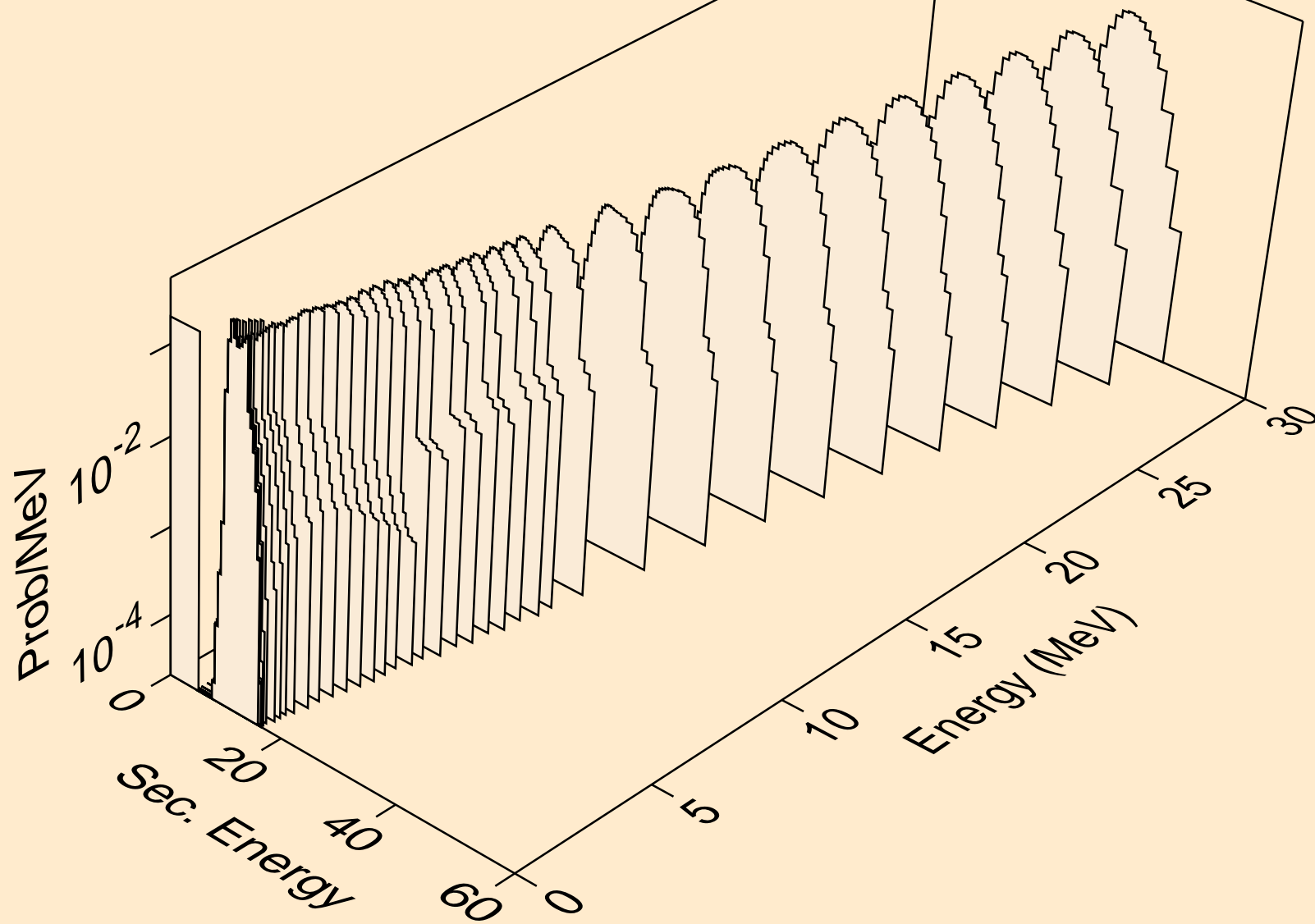

W163 NEUTRON ACER TENDL-2021 LIBRARY; T=293.6K
alphas from (n,2a)

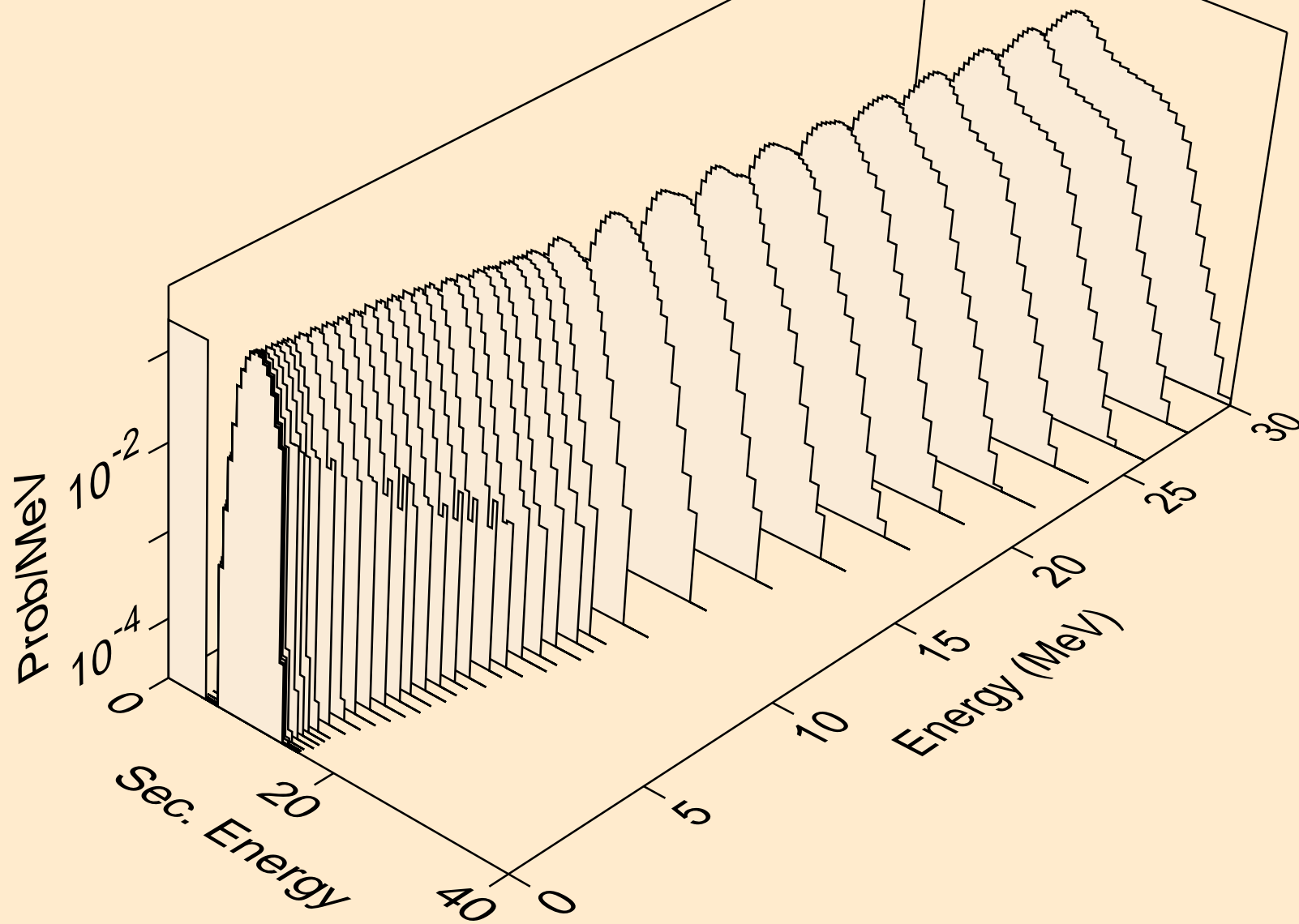

W163 NEUTRON ACER TENDL-2021 LIBRARY; T=293.6K
alphas from (n,3a)

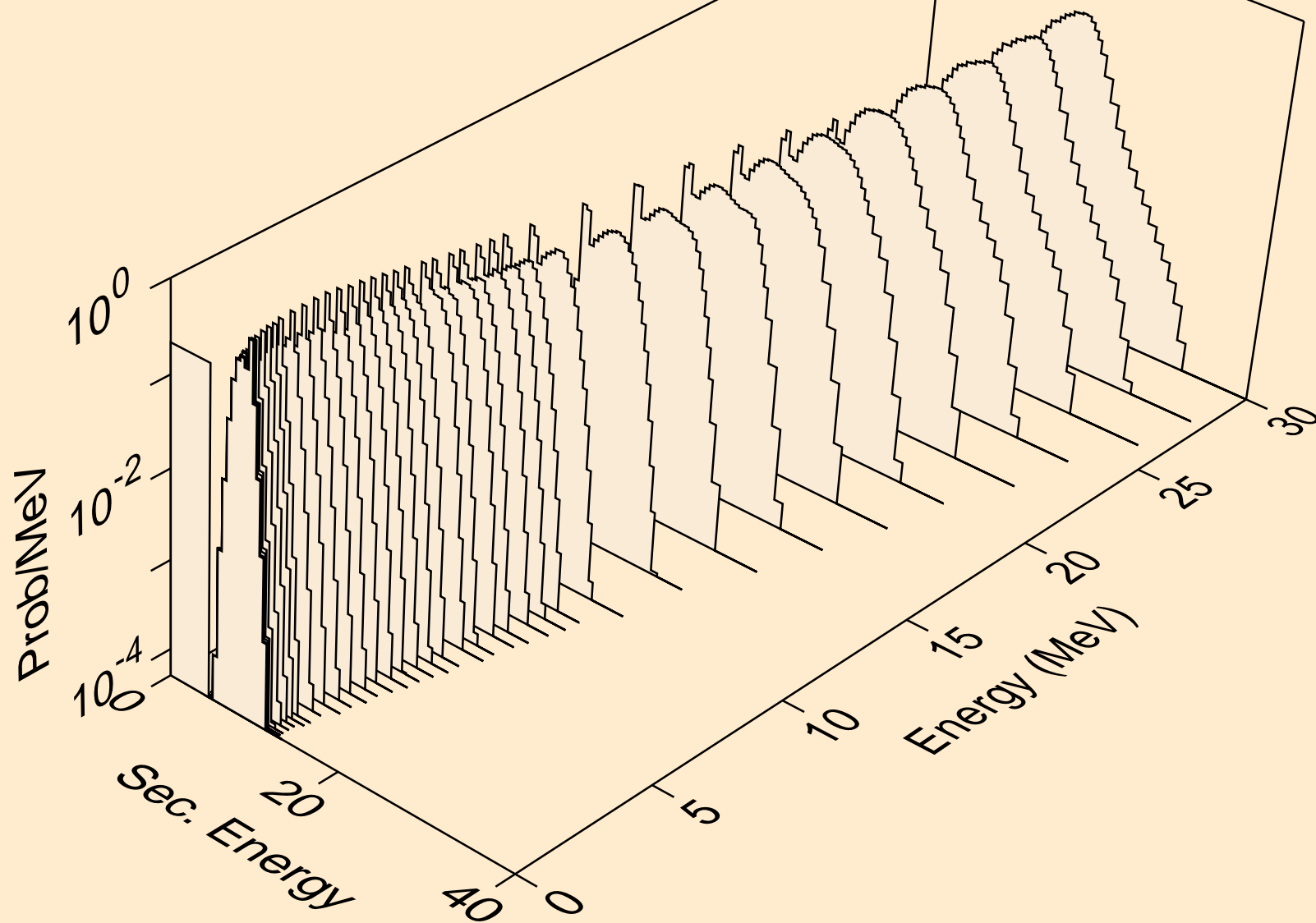

W163 NEUTRON ACER TENDL-2021 LIBRARY; T=293.6K
alphas from (n,pa)

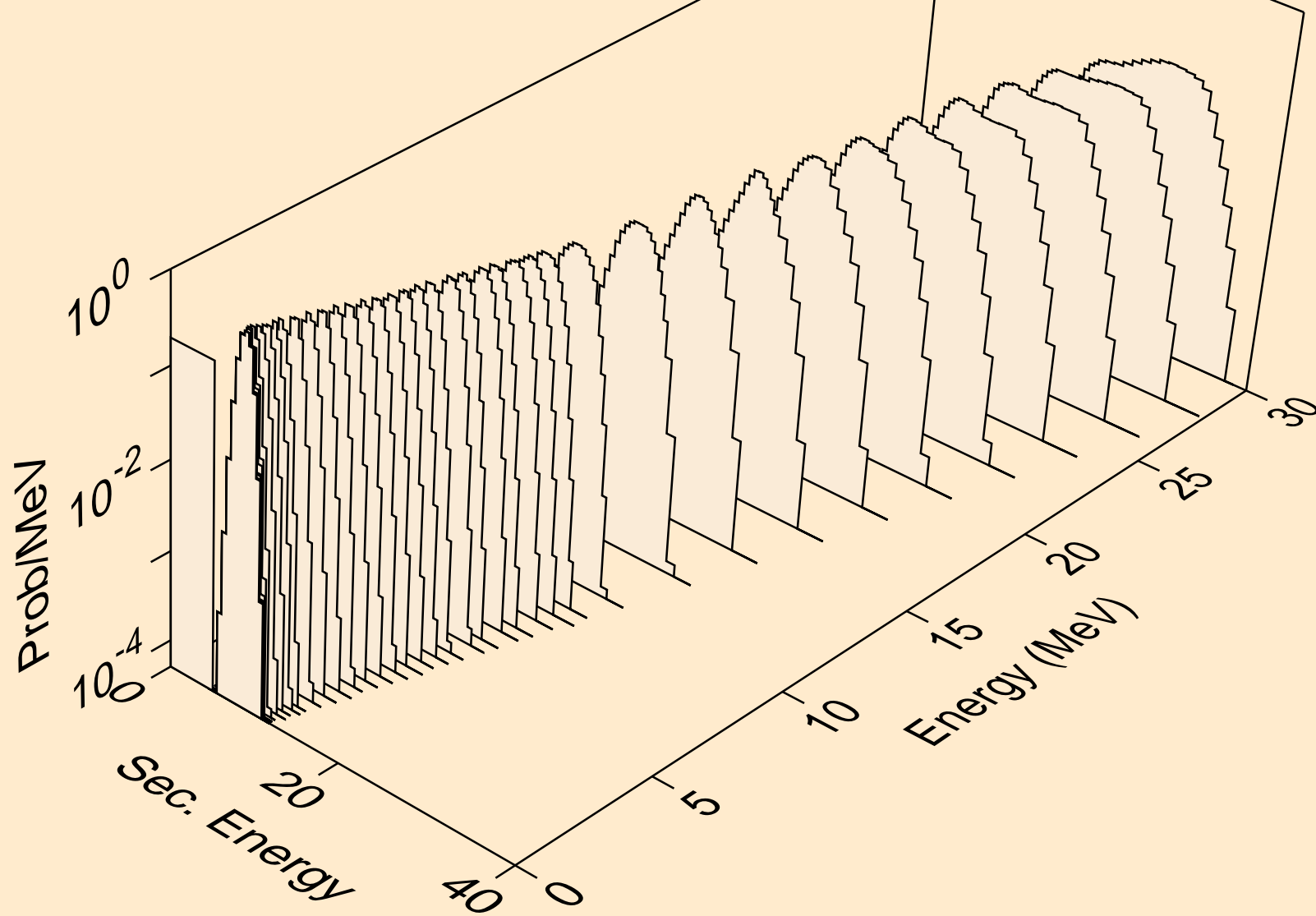

W163 NEUTRON ACER TENDL-2021 LIBRARY; T=293.6K
alphas from (n,t2a)

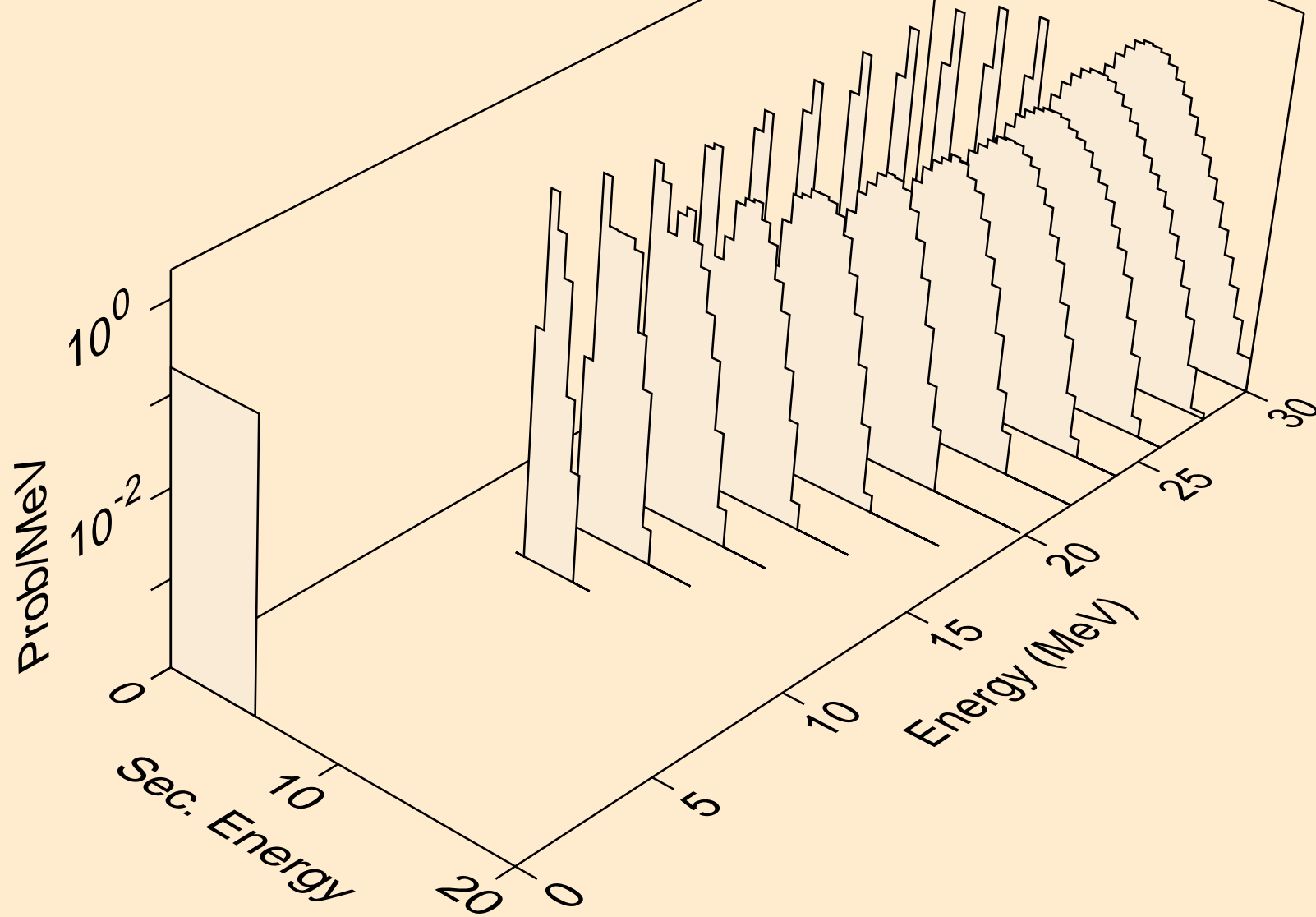

W163 NEUTRON ACER TENDL-2021 LIBRARY; T=293.6K
alphas from (n,d2a)

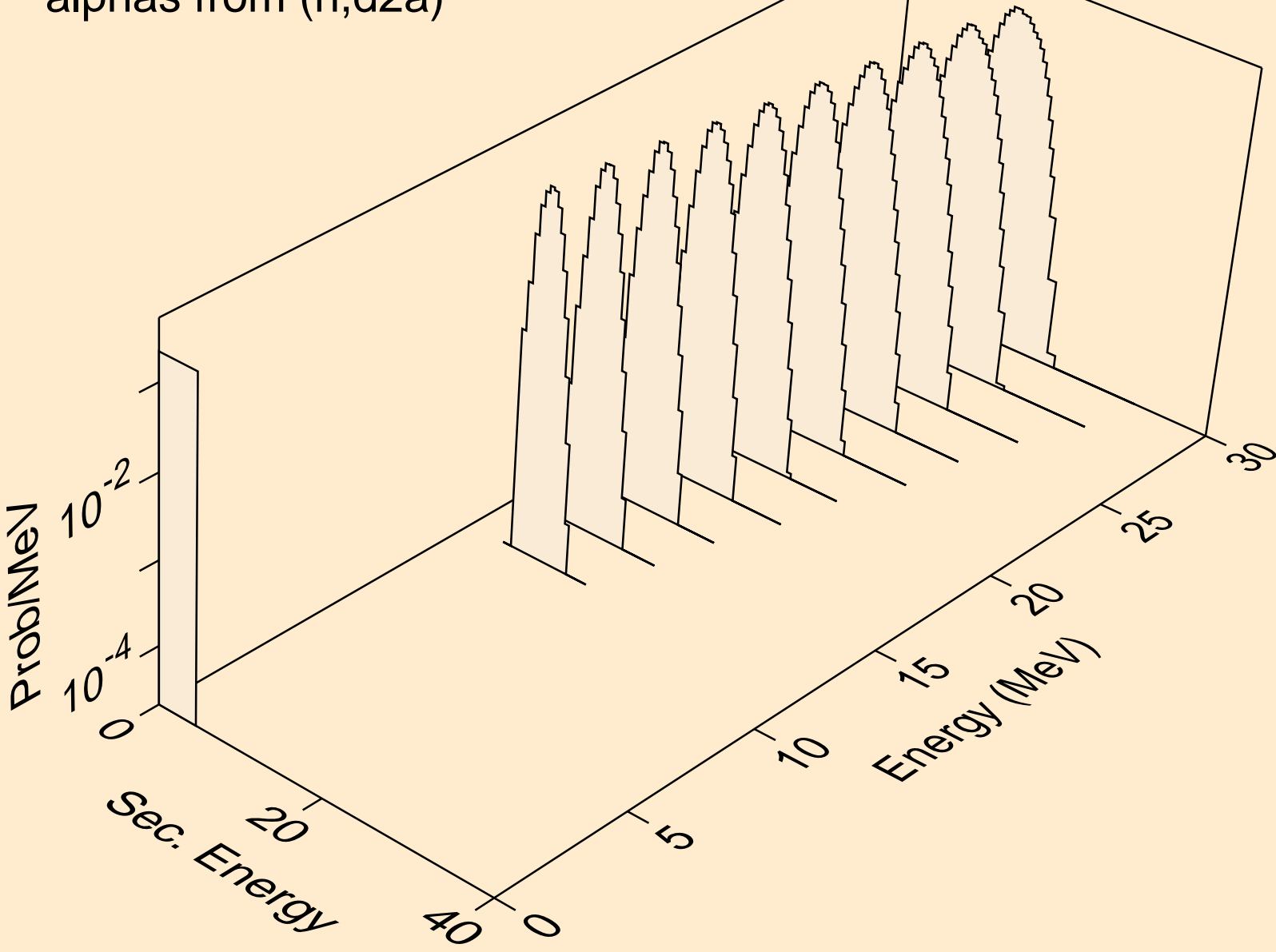

W163 NEUTRON ACER TENDL-2021 LIBRARY; T=293.6K
alphas from (n,da)

