

# W165 NEUTRON ACER TENDL-2021 LIBRARY; T=293.6K

## Principal cross sections

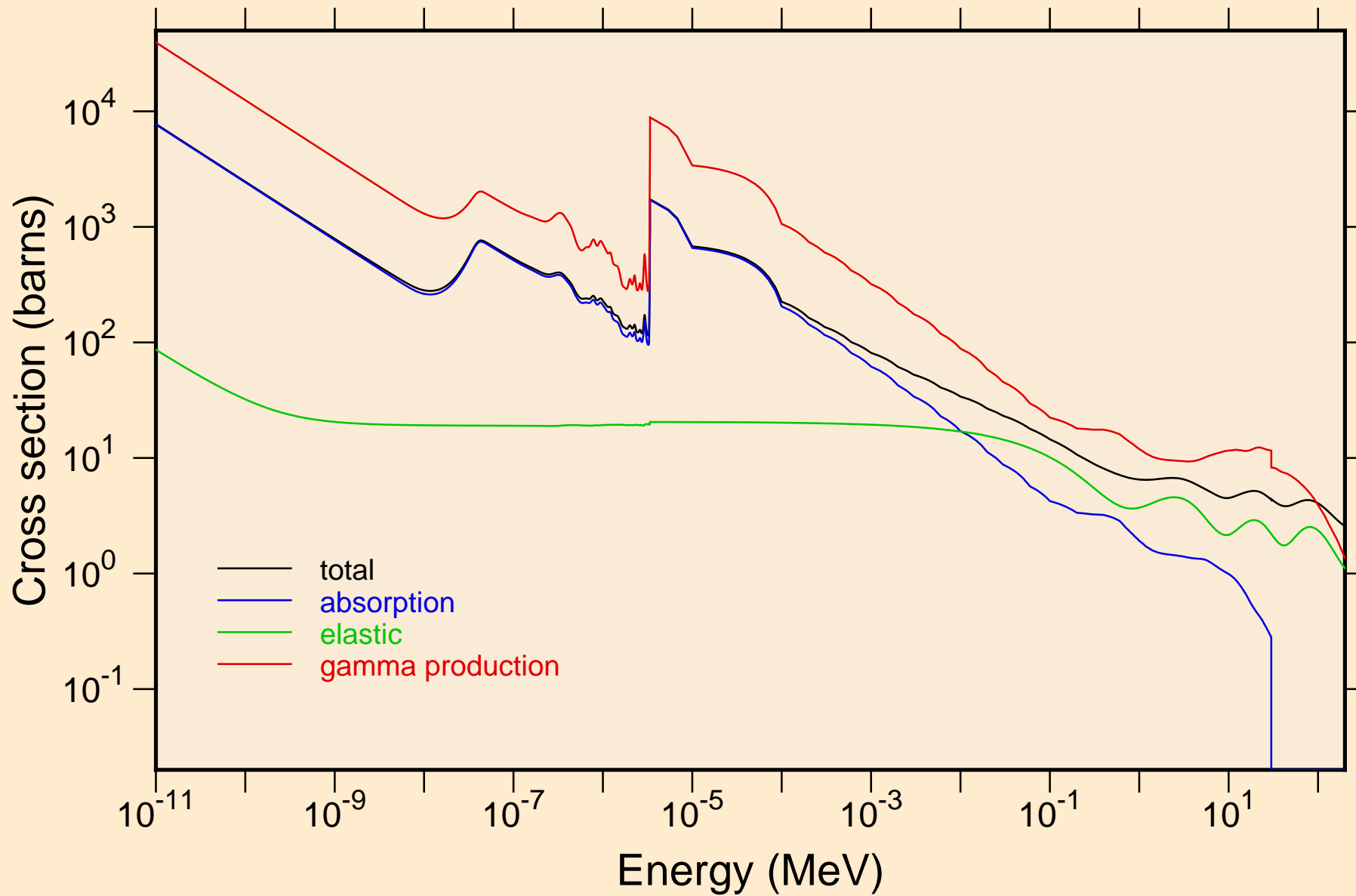

W165 NEUTRON ACER TENDL-2021 LIBRARY; T=293.6K  
Heating

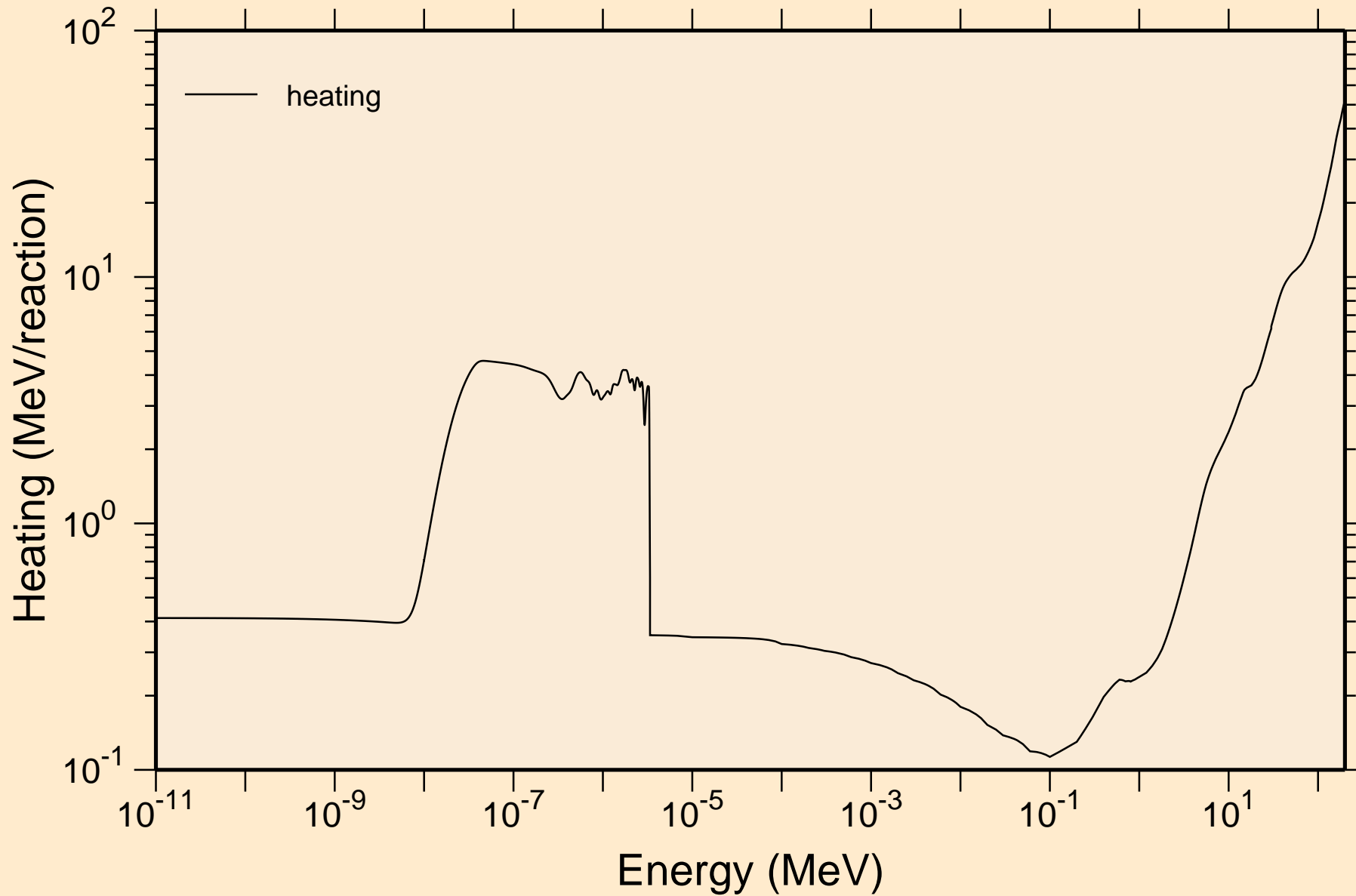

W165 NEUTRON ACER TENDL-2021 LIBRARY; T=293.6K  
Damage

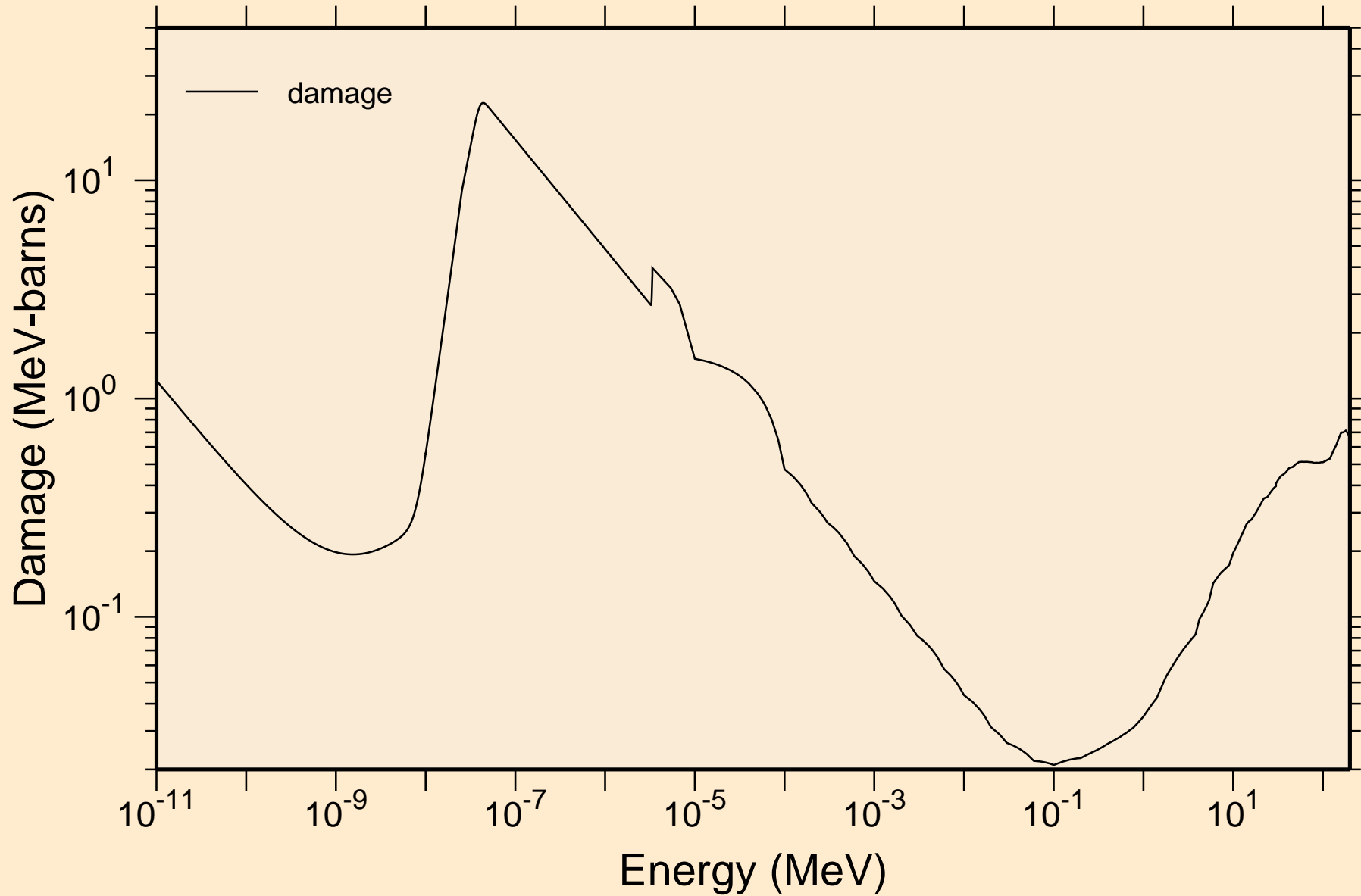

W165 NEUTRON ACER TENDL-2021 LIBRARY; T=293.6K  
Non-threshold reactions

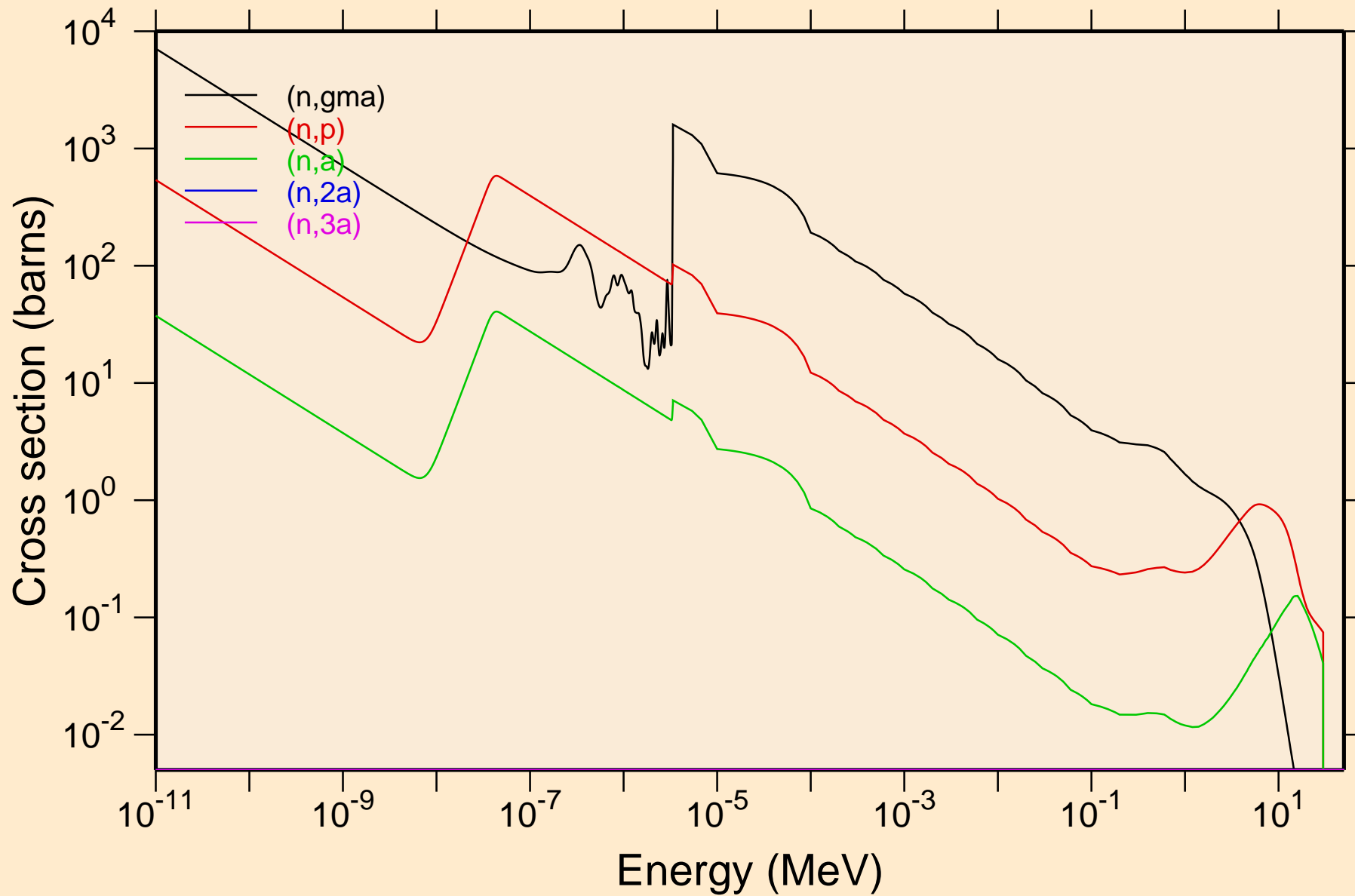

W165 NEUTRON ACER TENDL-2021 LIBRARY; T=293.6K  
Non-threshold reactions

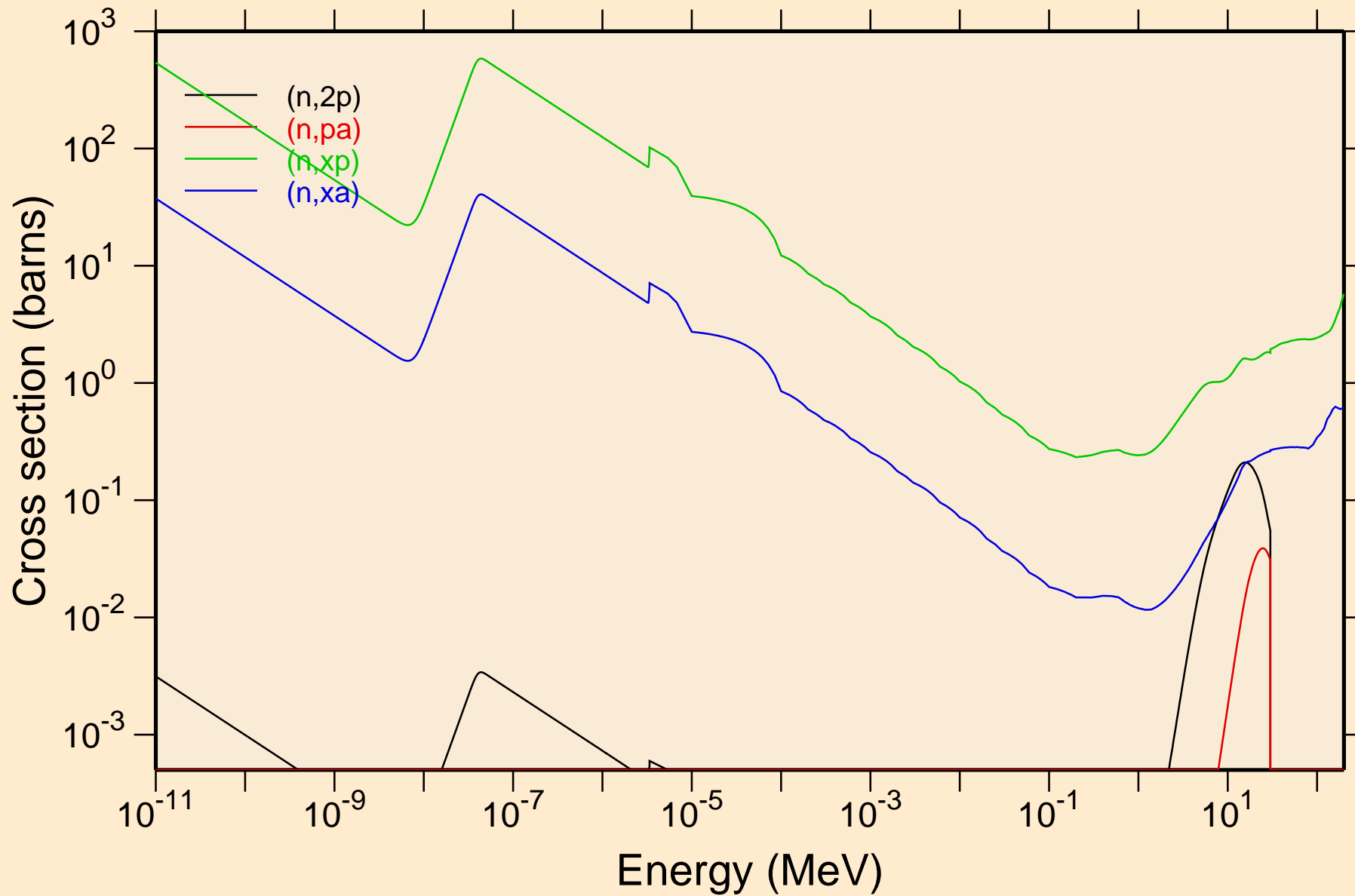

W165 NEUTRON ACER TENDL-2021 LIBRARY; T=293.6K  
Principal cross sections

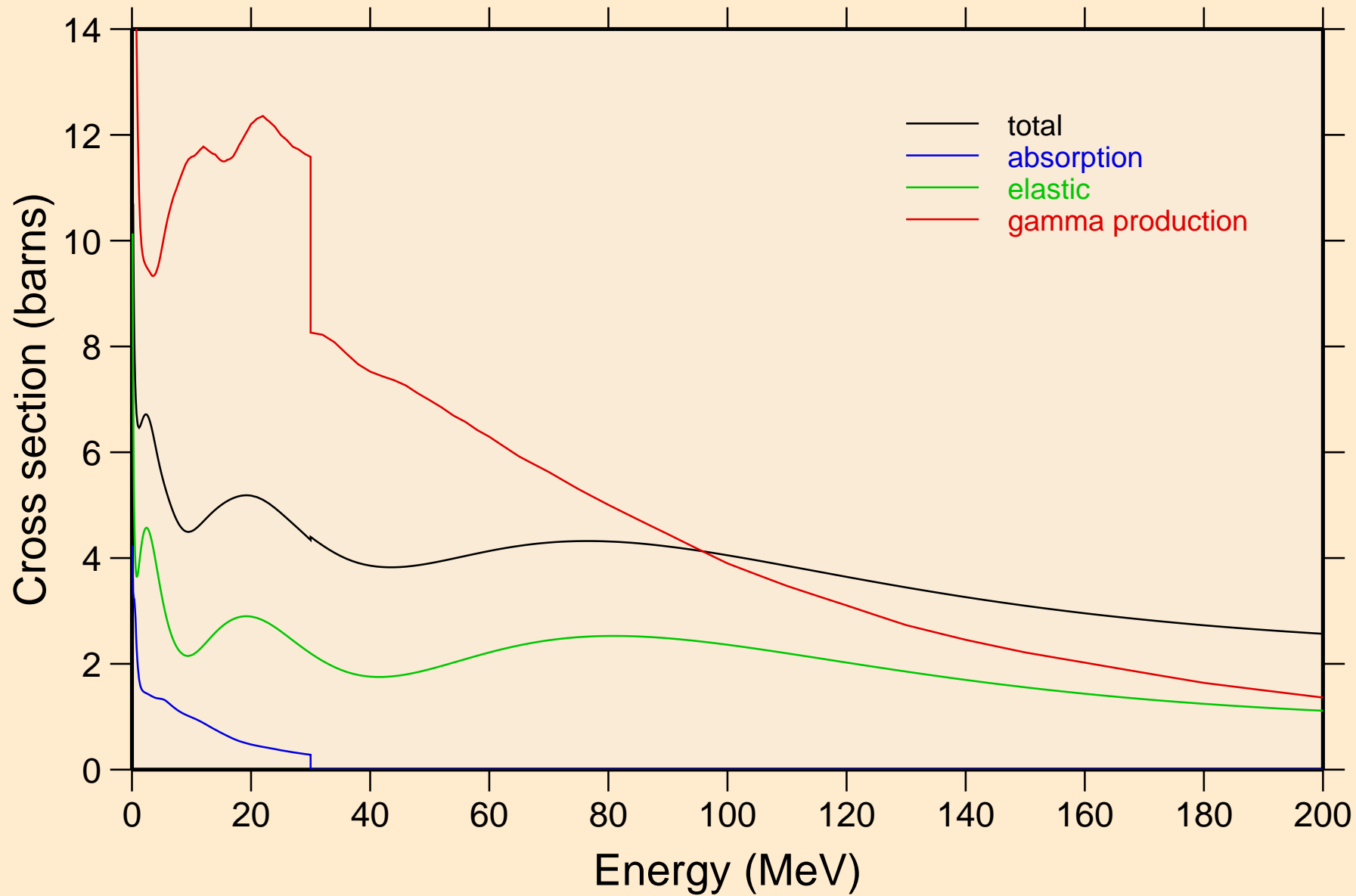

W165 NEUTRON ACER TENDL-2021 LIBRARY; T=293.6K

Heating

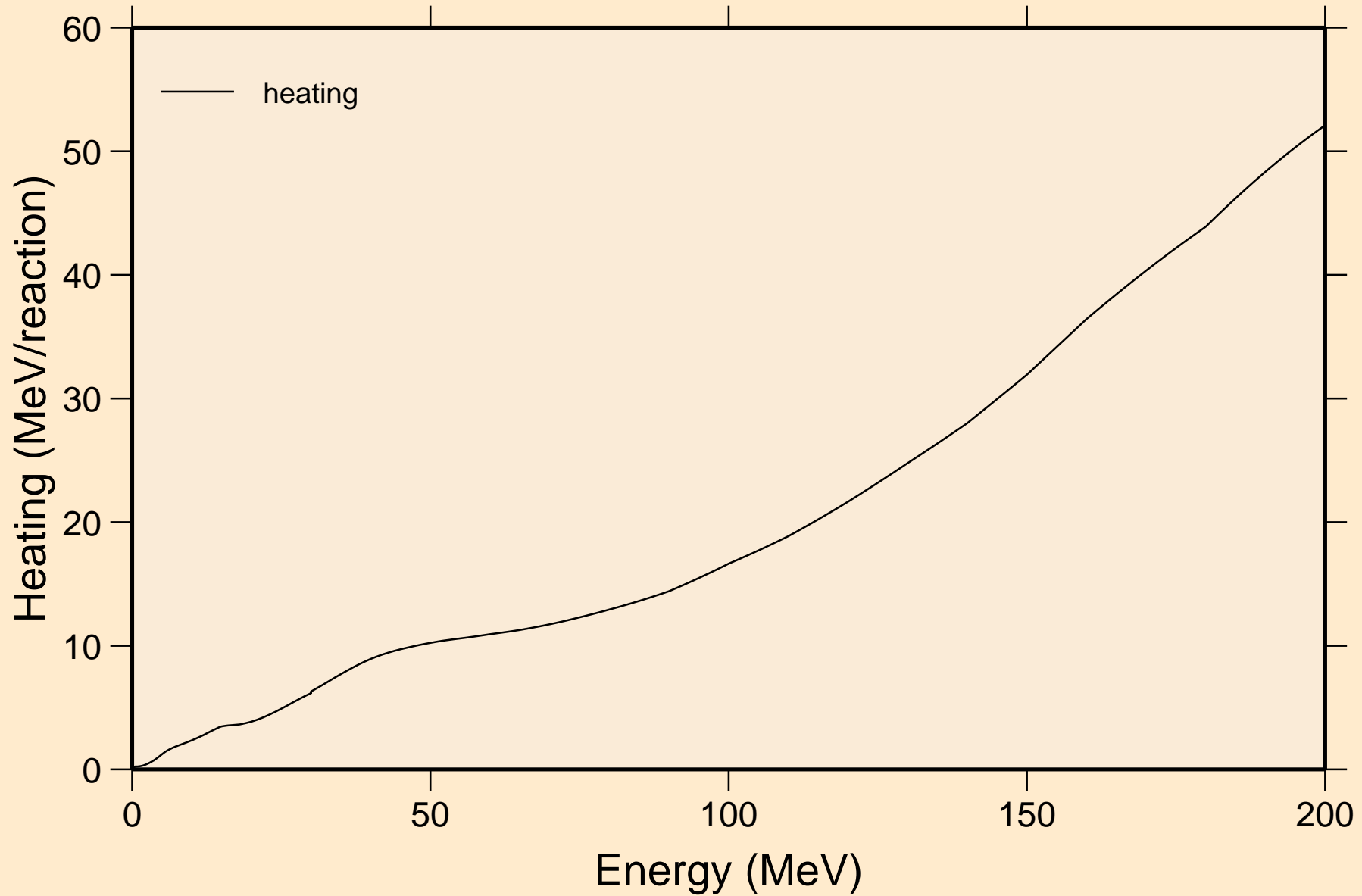

W165 NEUTRON ACER TENDL-2021 LIBRARY; T=293.6K  
Damage

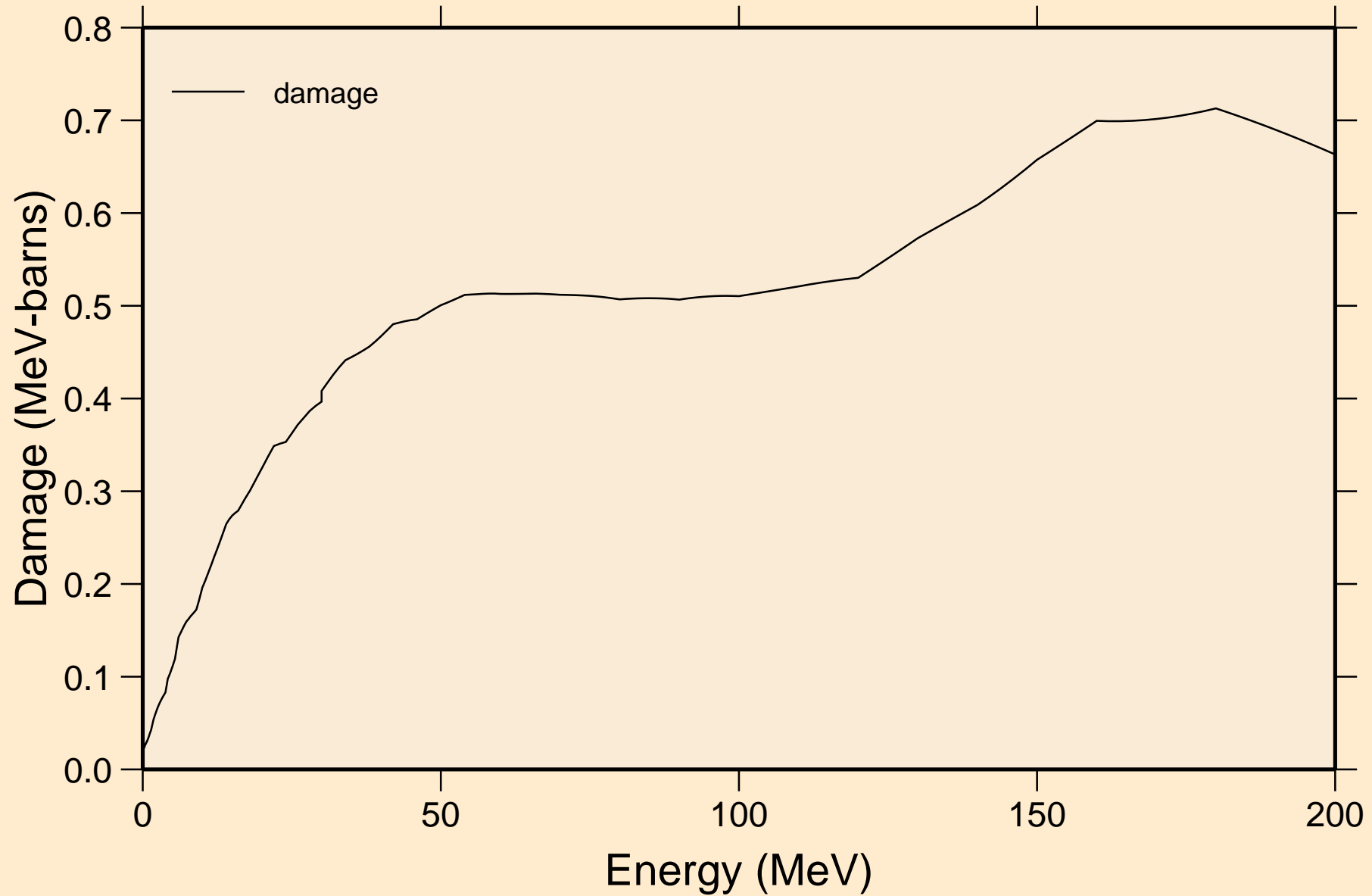



W165 NEUTRON ACER TENDL-2021 LIBRARY; T=293.6K  
Non-threshold reactions

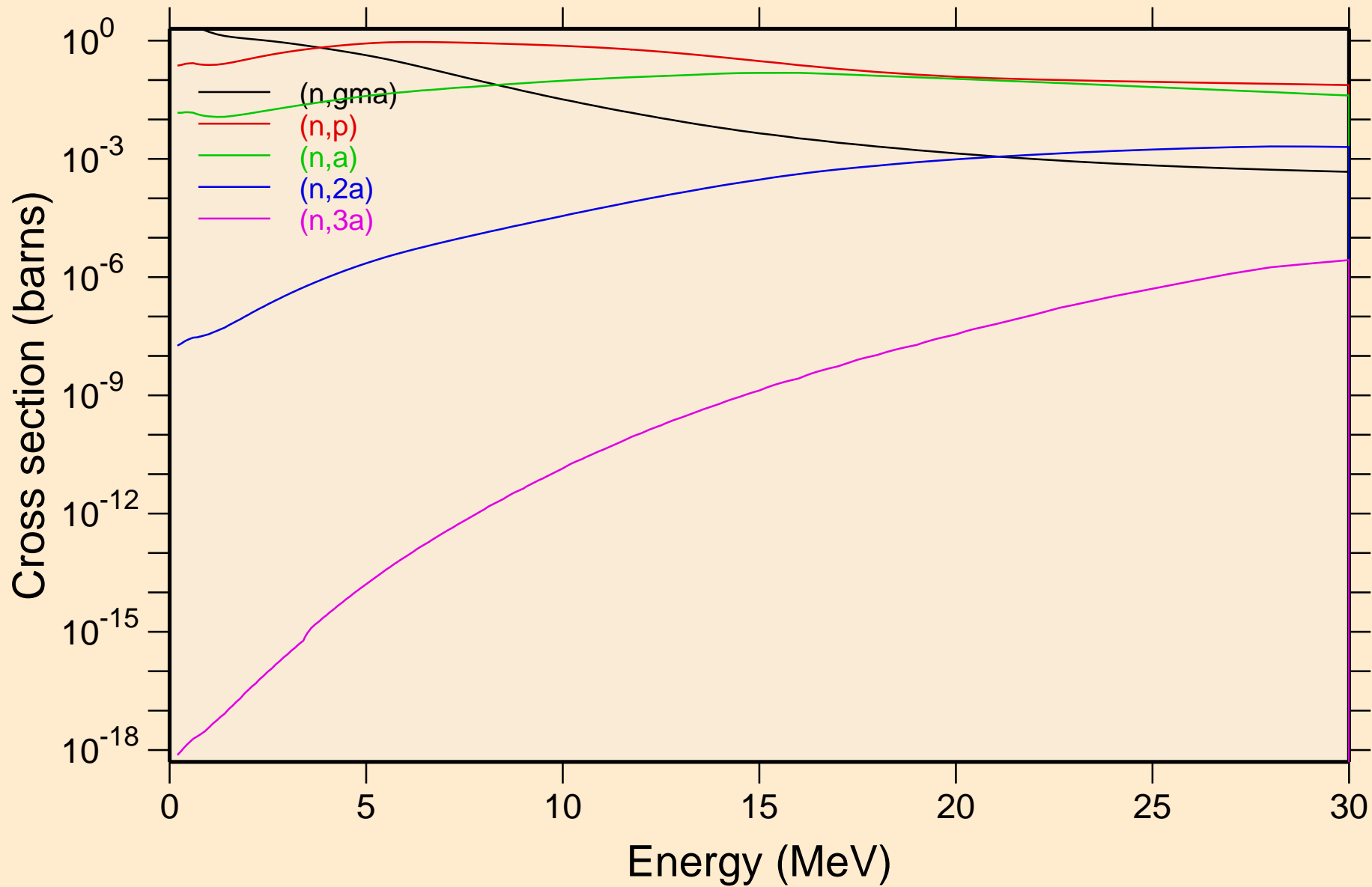

W165 NEUTRON ACER TENDL-2021 LIBRARY; T=293.6K  
Non-threshold reactions

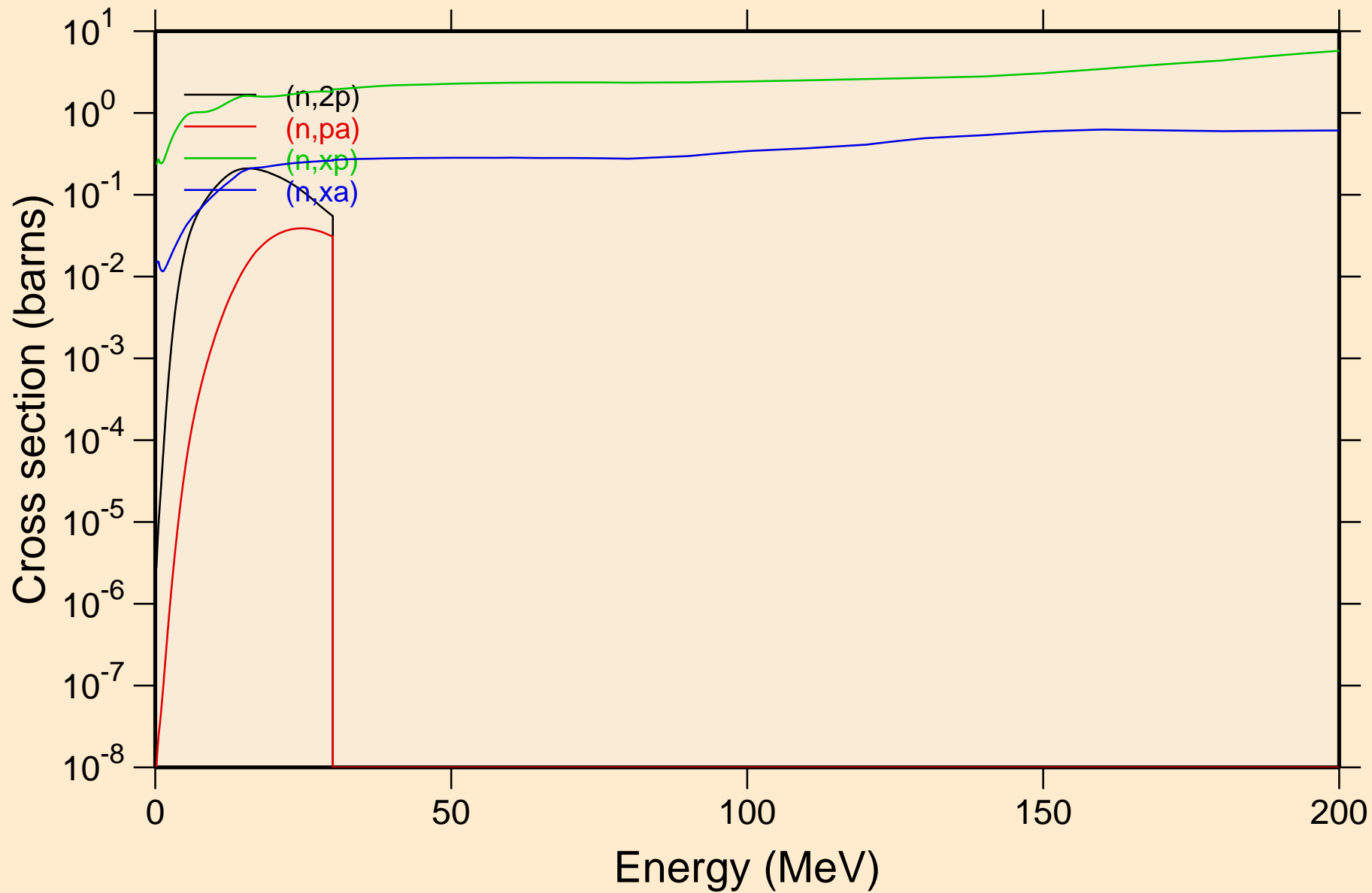

W165 NEUTRON ACER TENDL-2021 LIBRARY; T=293.6K  
Inelastic levels

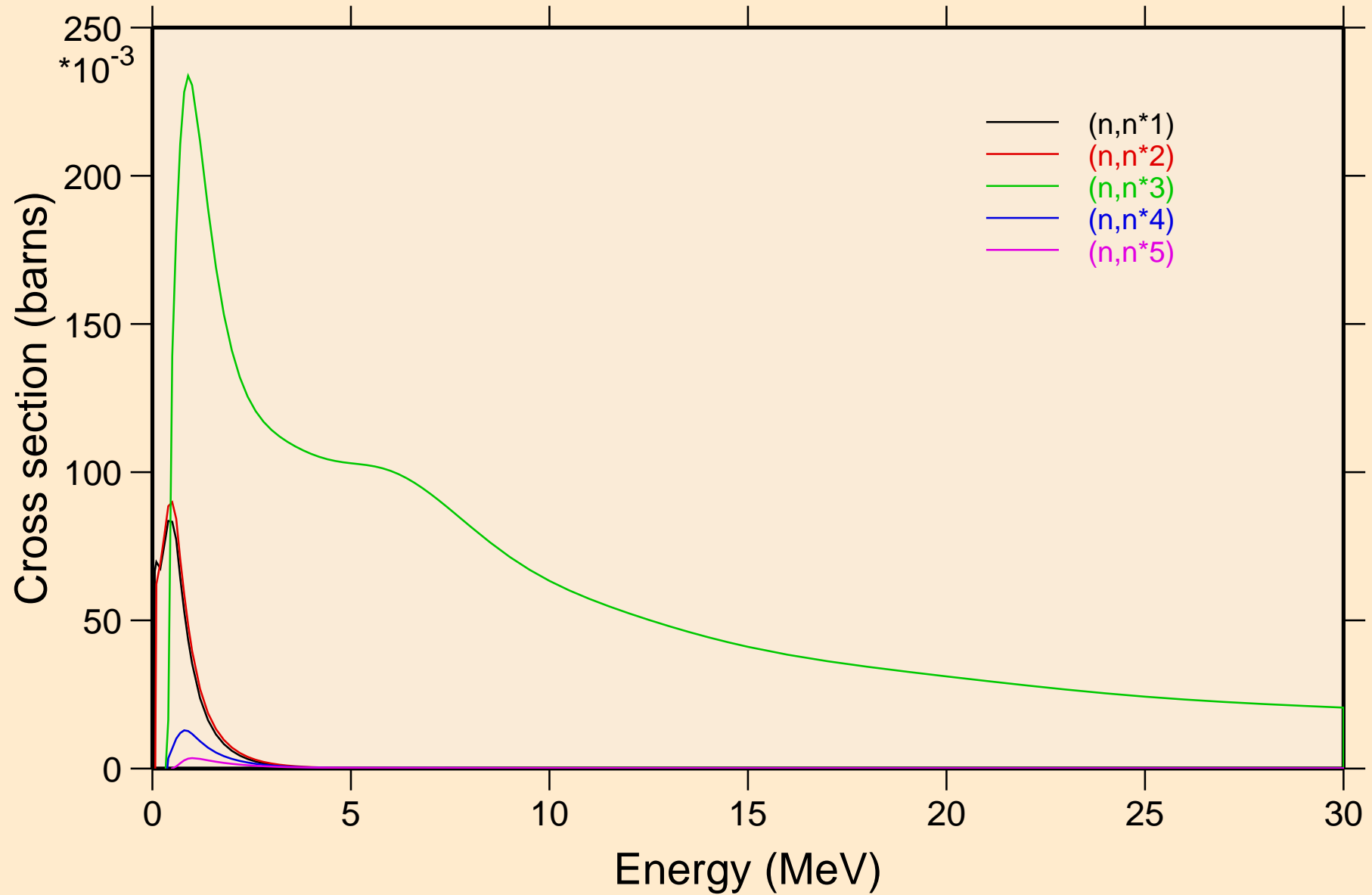

W165 NEUTRON ACER TENDL-2021 LIBRARY; T=293.6K  
Inelastic levels

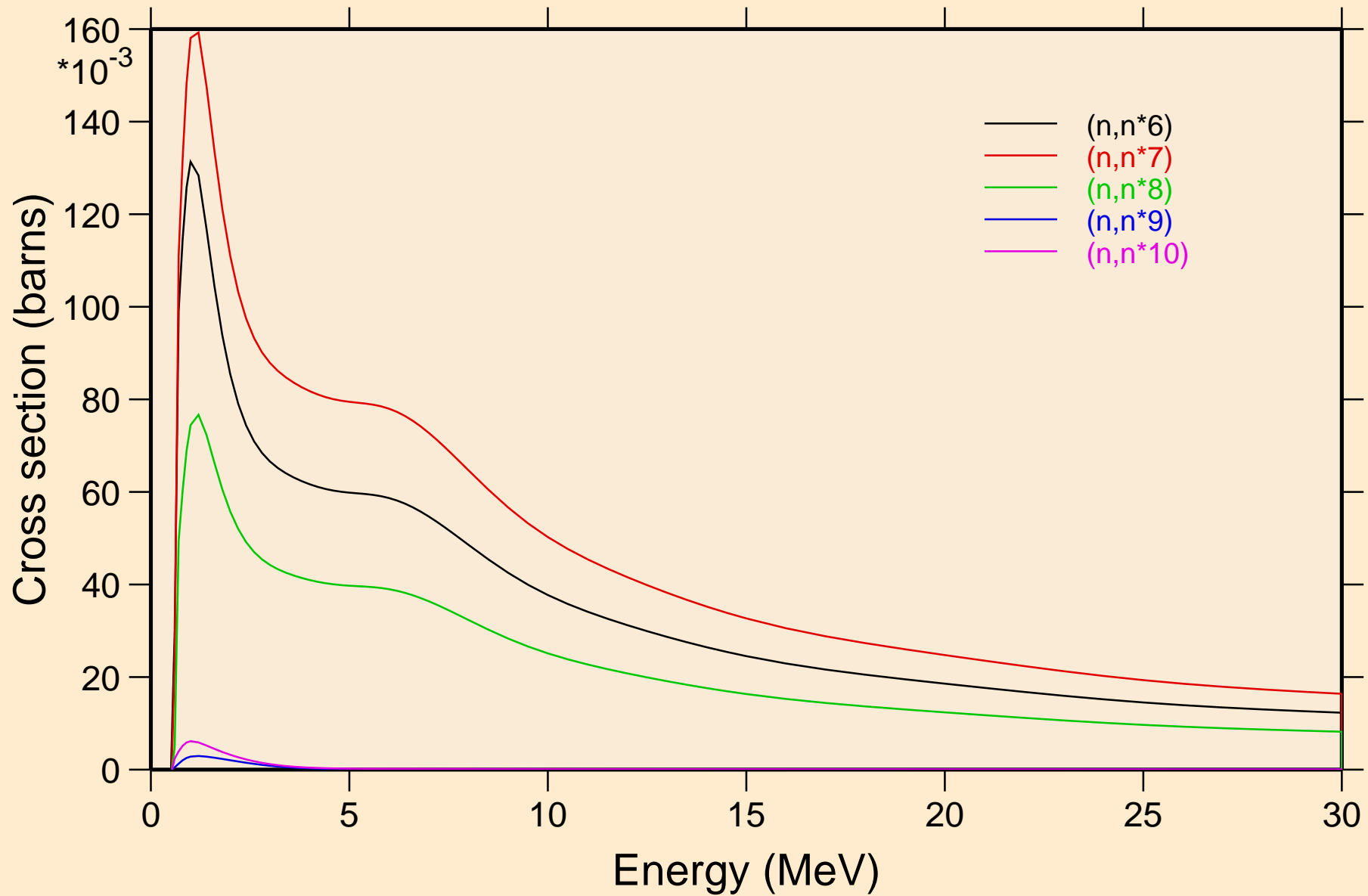

W165 NEUTRON ACER TENDL-2021 LIBRARY; T=293.6K  
Inelastic levels

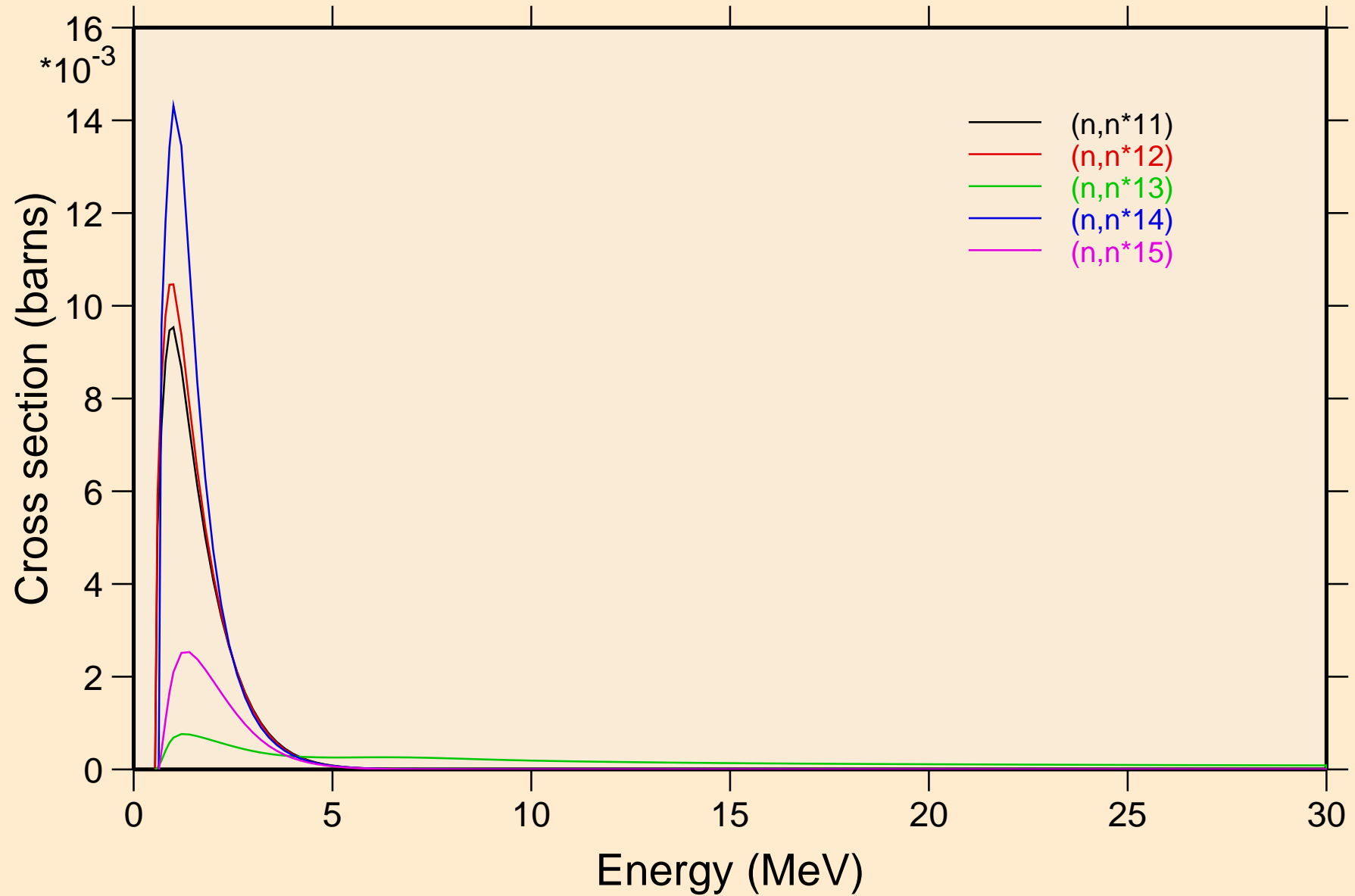

W165 NEUTRON ACER TENDL-2021 LIBRARY; T=293.6K  
Inelastic levels

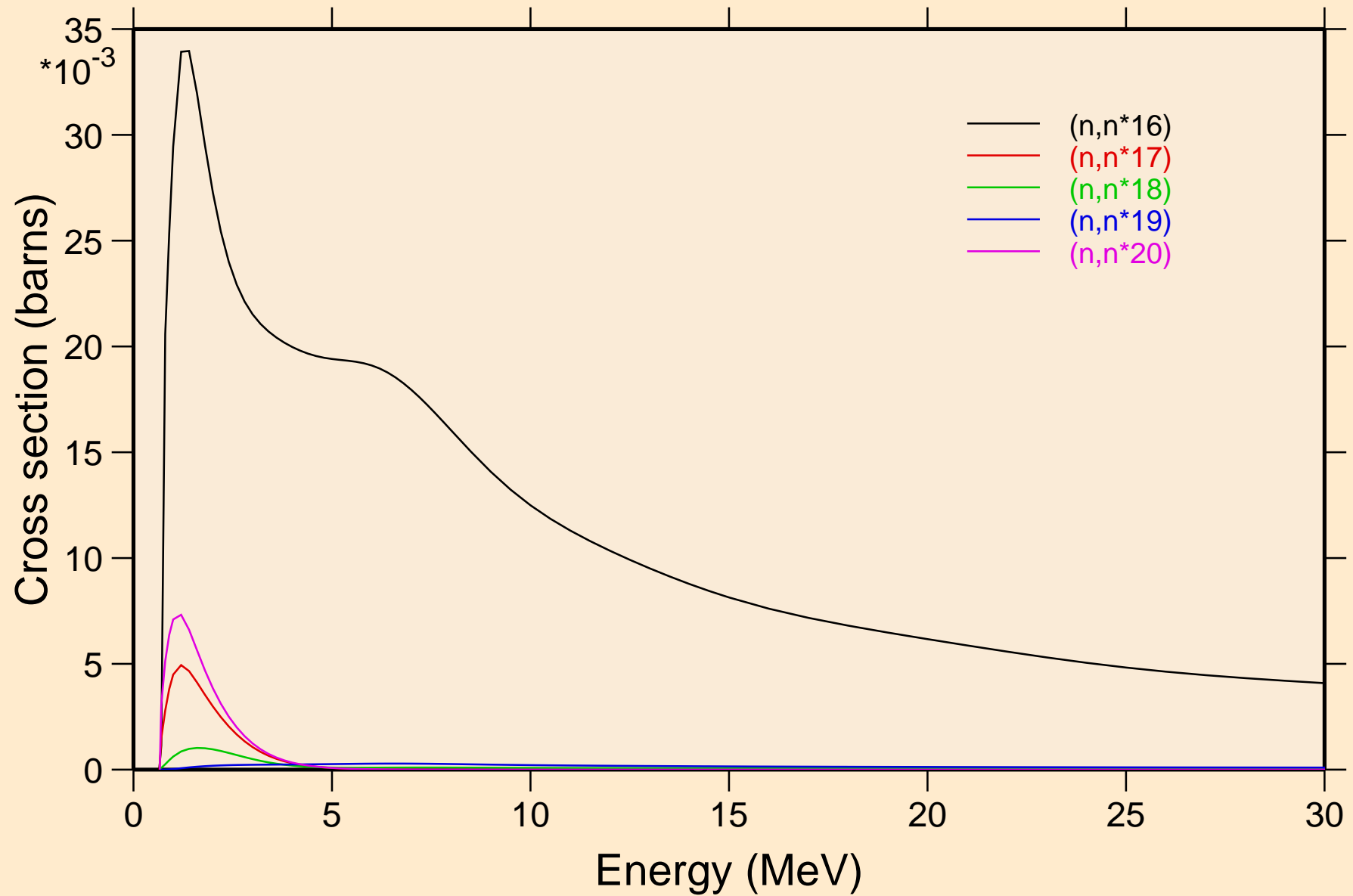

W165 NEUTRON ACER TENDL-2021 LIBRARY; T=293.6K  
Inelastic levels

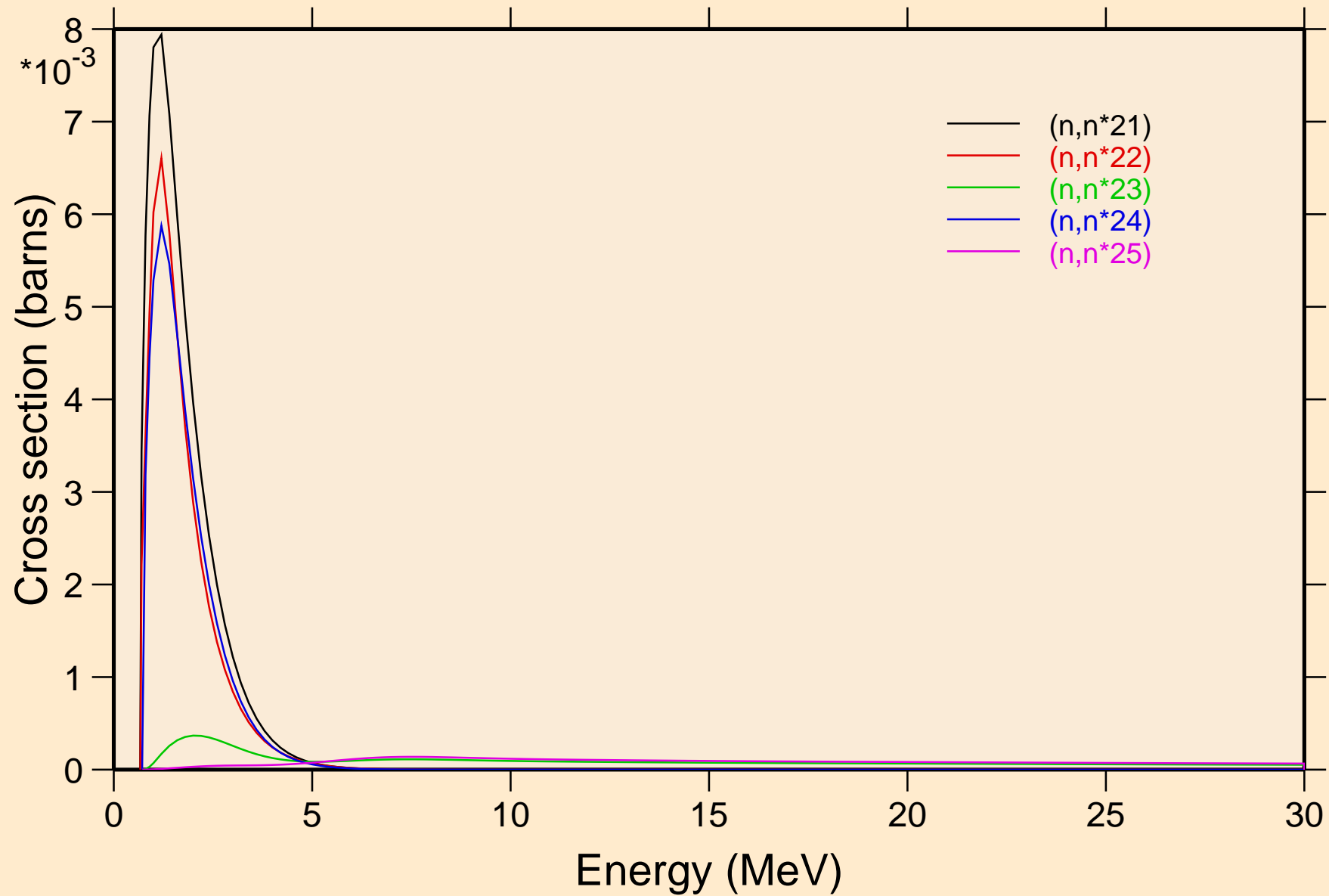

W165 NEUTRON ACER TENDL-2021 LIBRARY; T=293.6K  
Inelastic levels

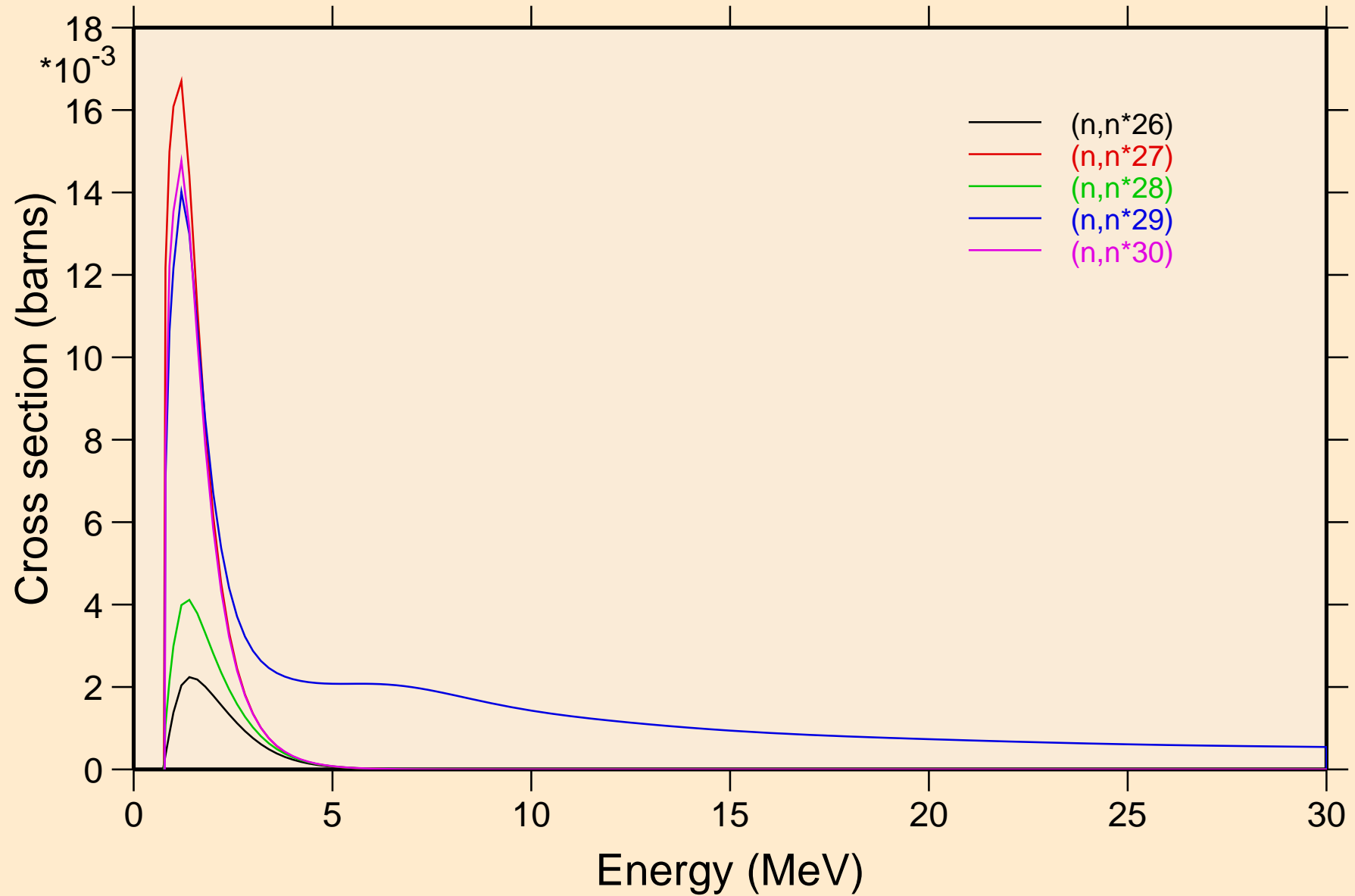



W165 NEUTRON ACER TENDL-2021 LIBRARY; T=293.6K  
Threshold reactions

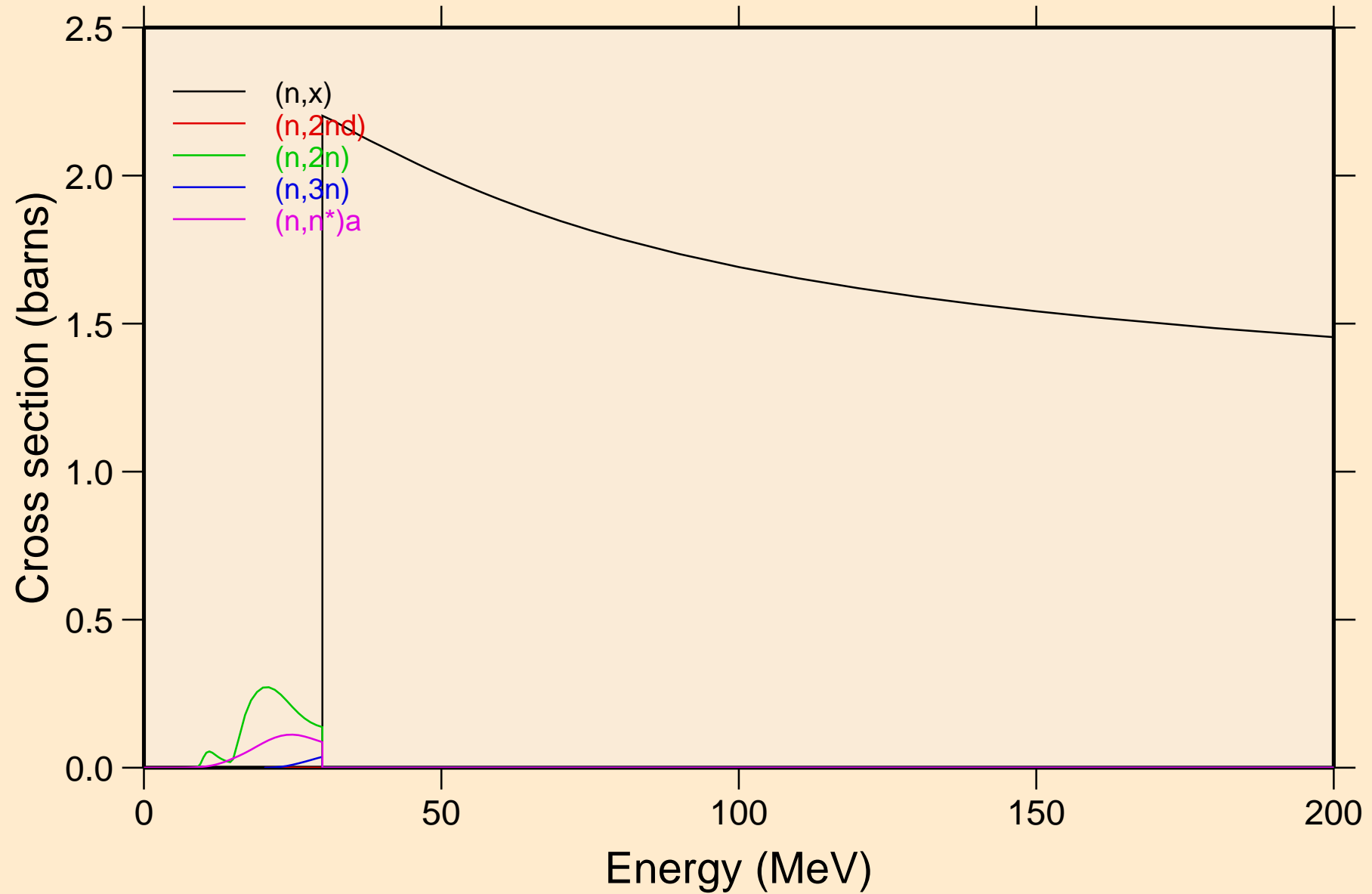

W165 NEUTRON ACER TENDL-2021 LIBRARY; T=293.6K  
Threshold reactions

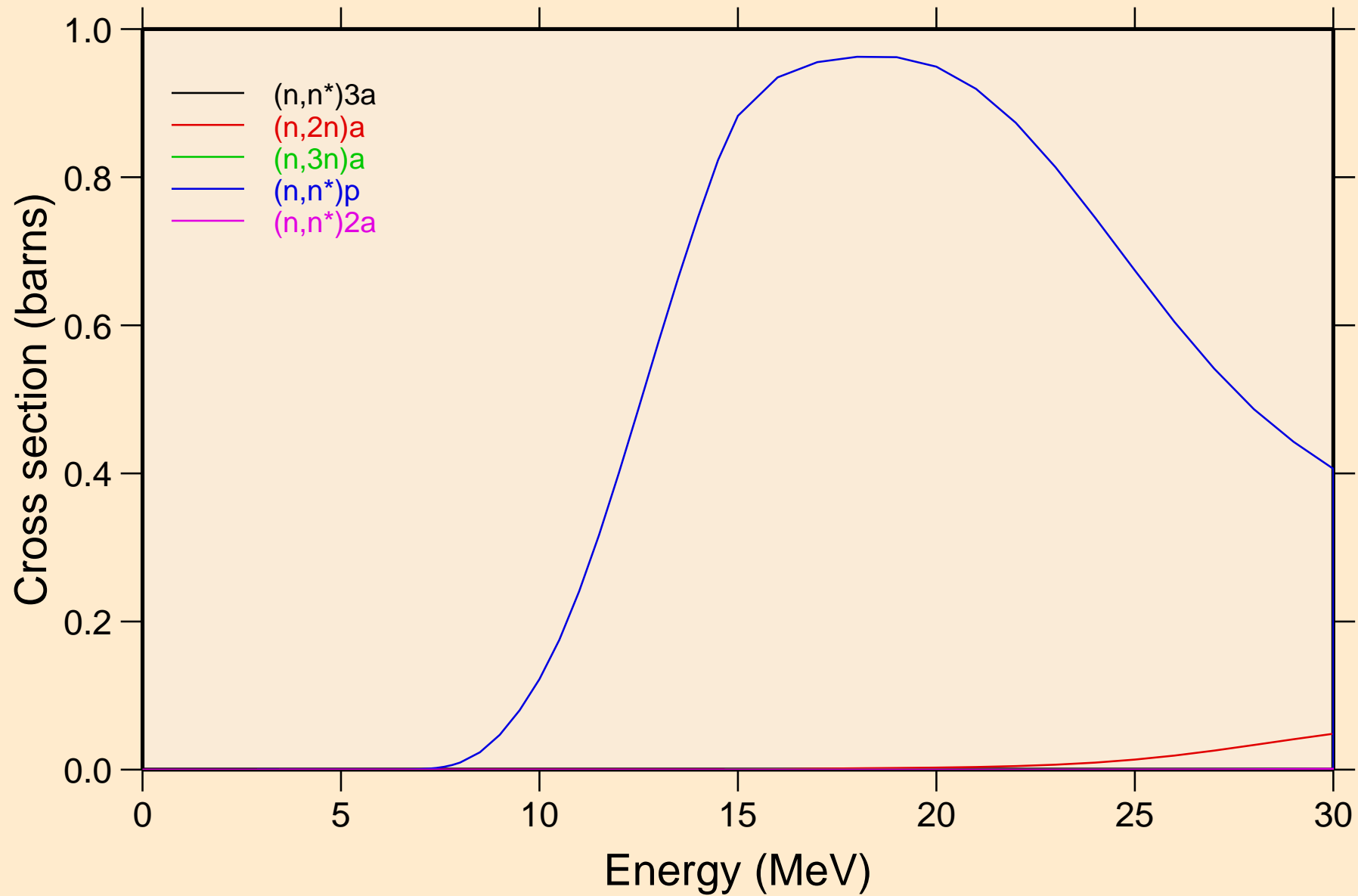

W165 NEUTRON ACER TENDL-2021 LIBRARY; T=293.6K  
Threshold reactions

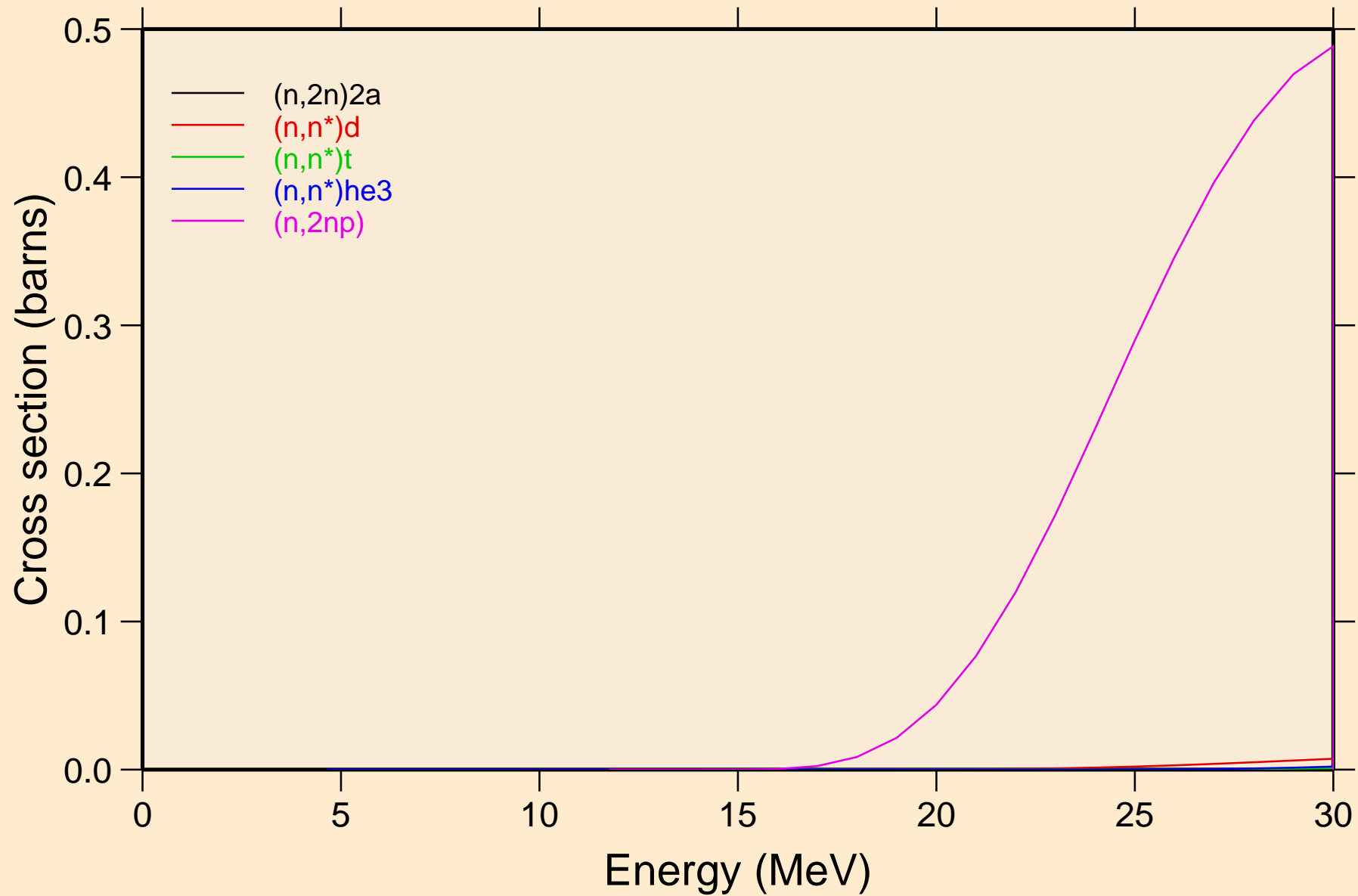

W165 NEUTRON ACER TENDL-2021 LIBRARY; T=293.6K  
Threshold reactions

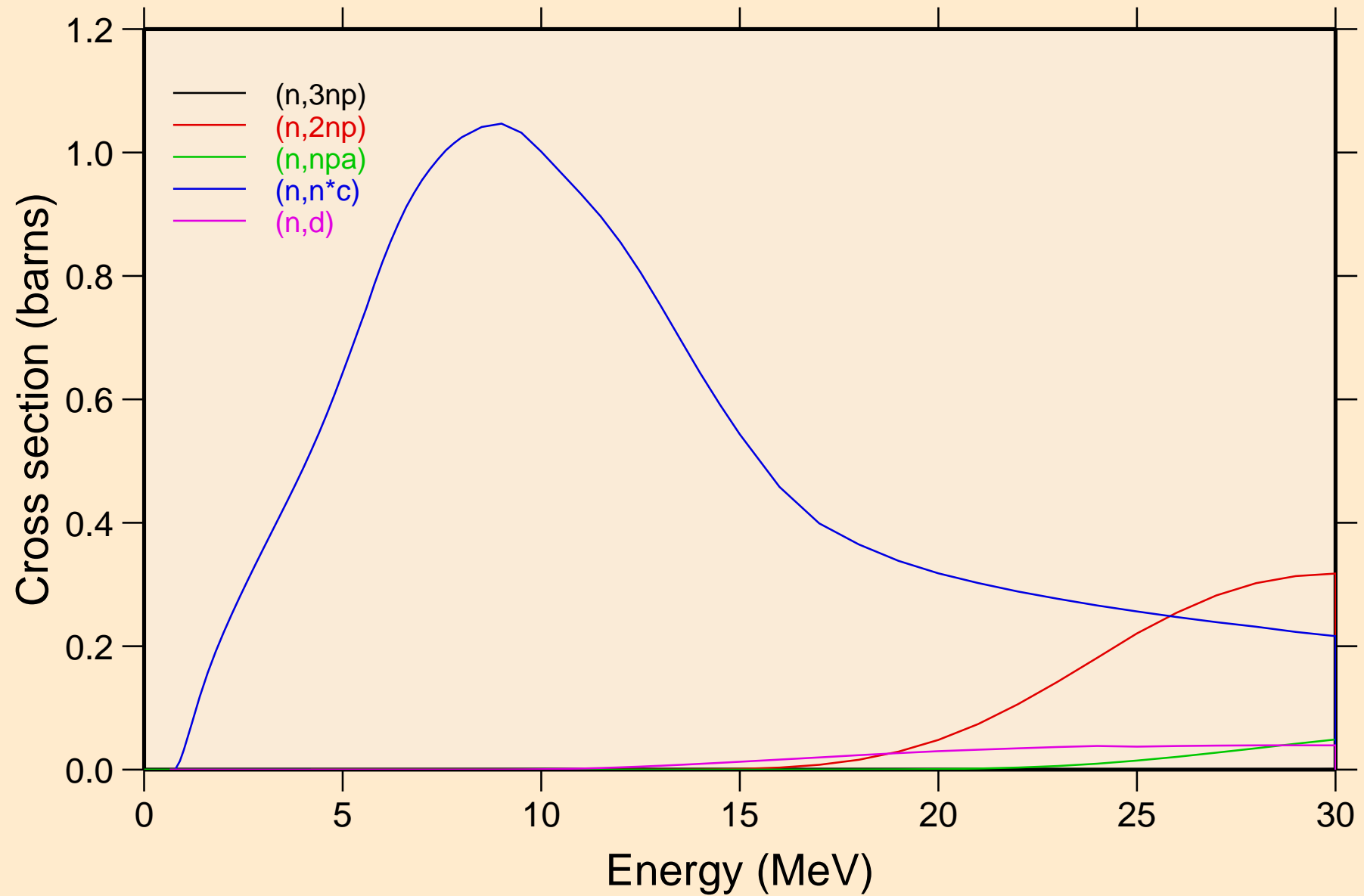

W165 NEUTRON ACER TENDL-2021 LIBRARY; T=293.6K  
Threshold reactions

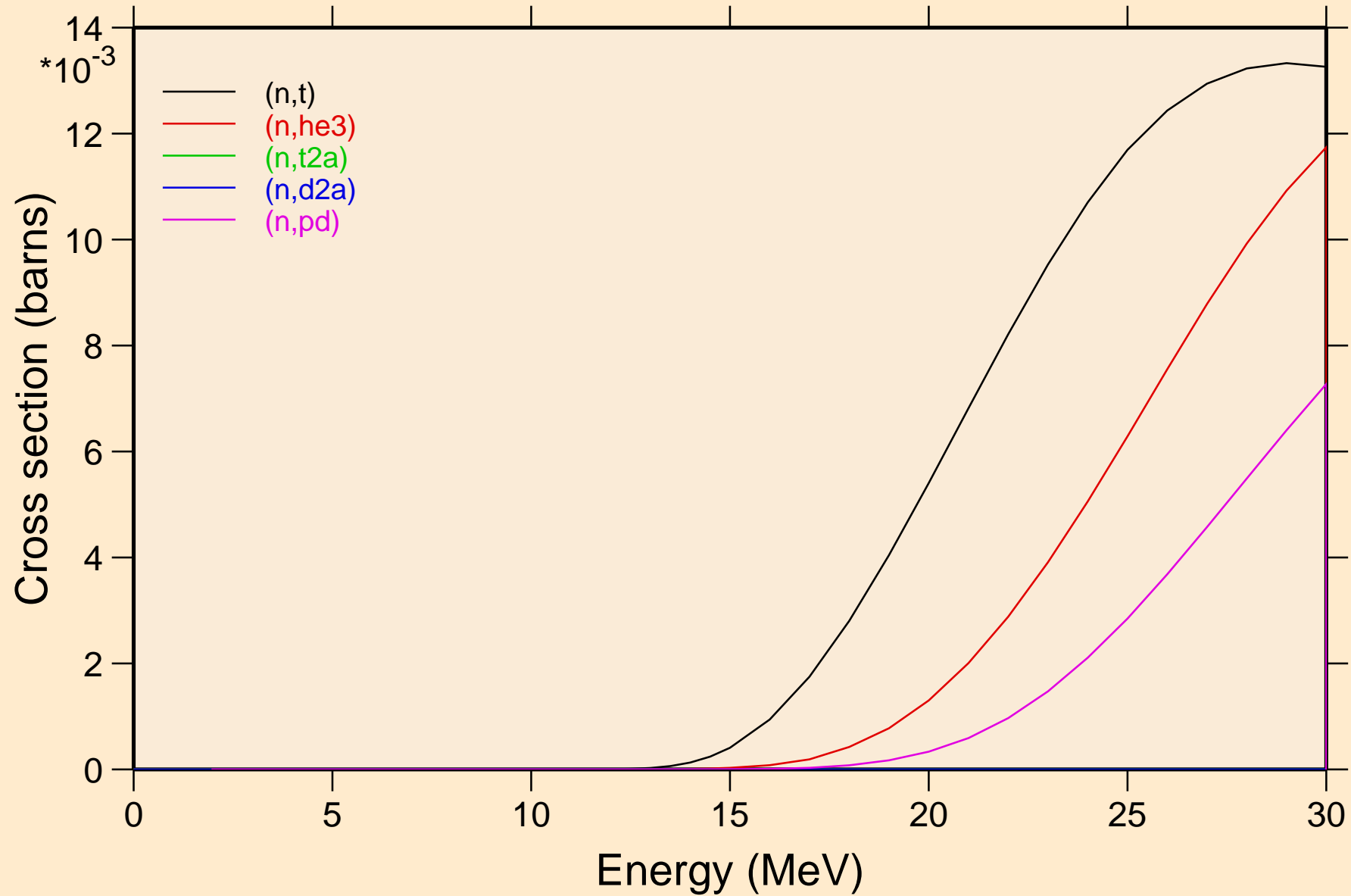

W165 NEUTRON ACER TENDL-2021 LIBRARY; T=293.6K  
Threshold reactions

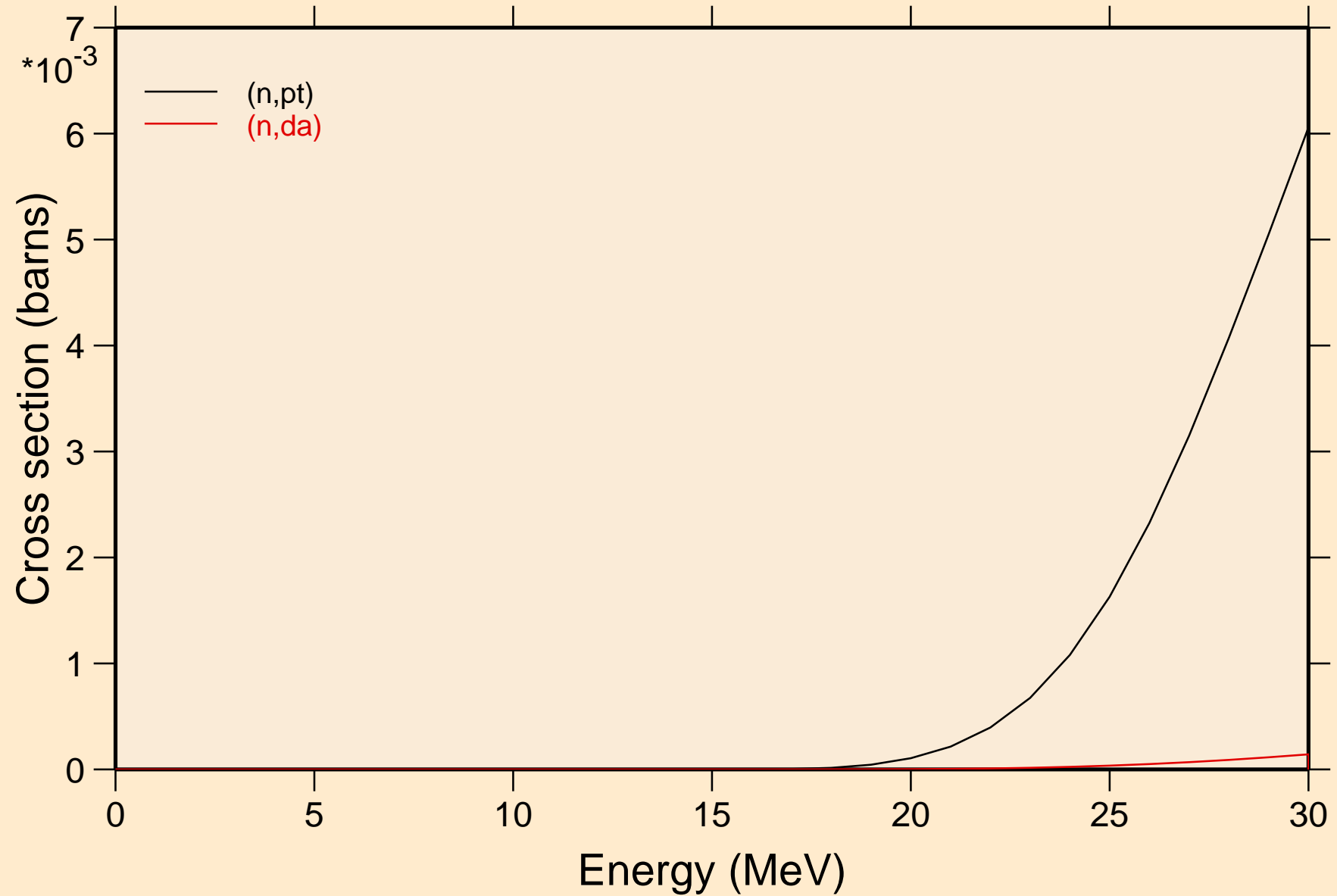

W165 NEUTRON ACER TENDL-2021 LIBRARY; T=293.6K  
Threshold reactions

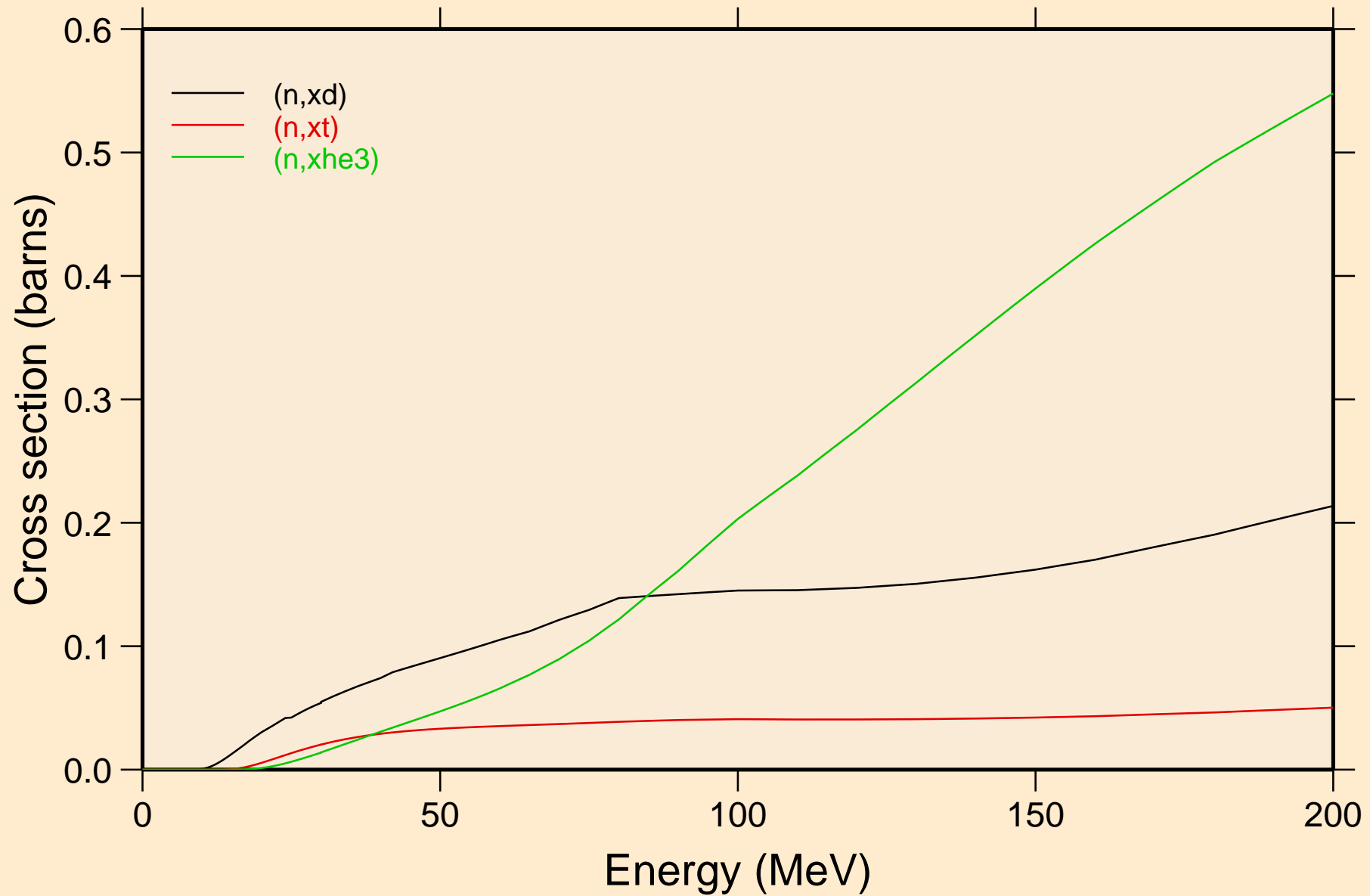

W165 NEUTRON ACER TENDL-2021 LIBRARY; T=293.6K  
angular distribution for elastic

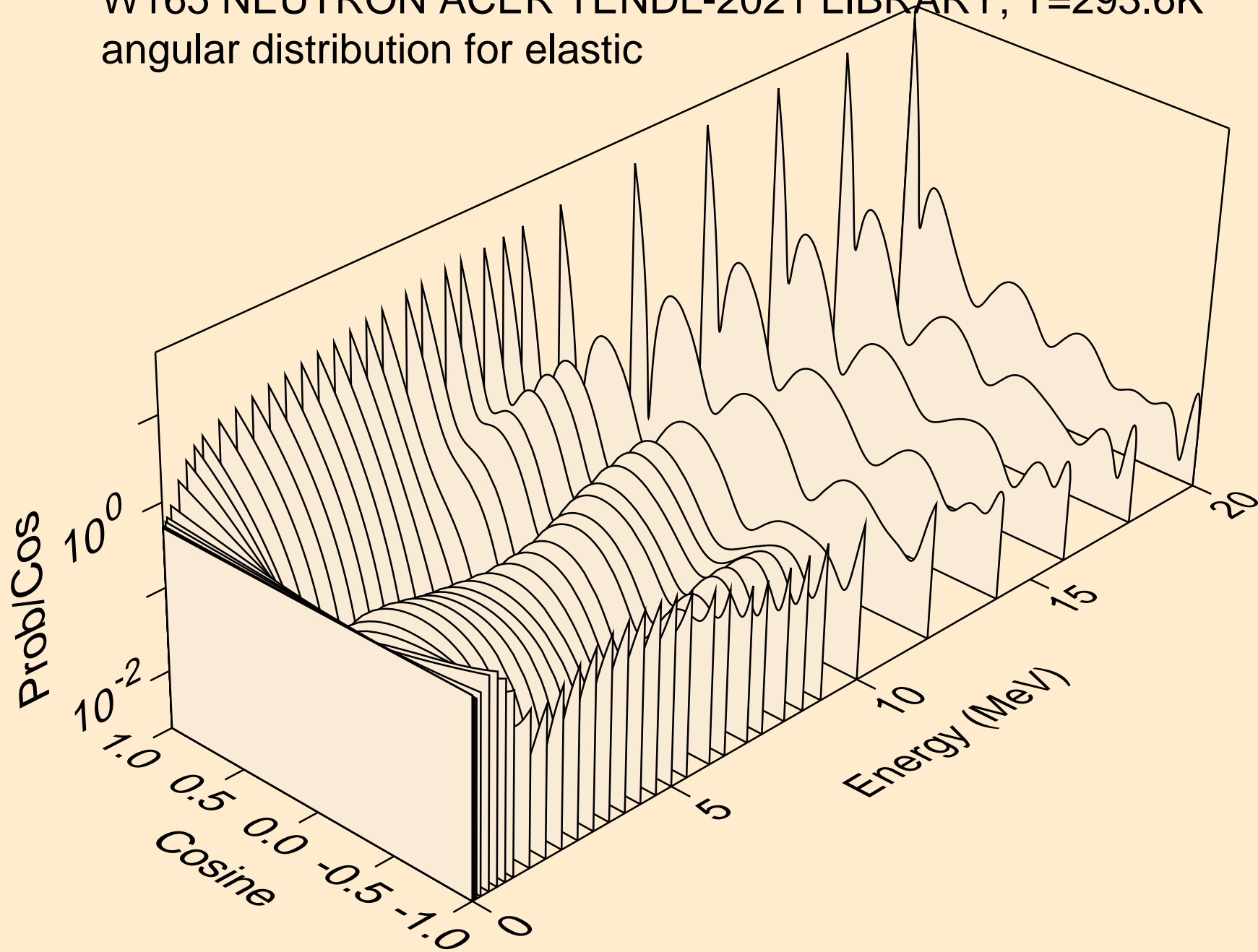



W165 NEUTRON ACER TENDL-2021 LIBRARY; T=293.6K  
angular distribution for elastic

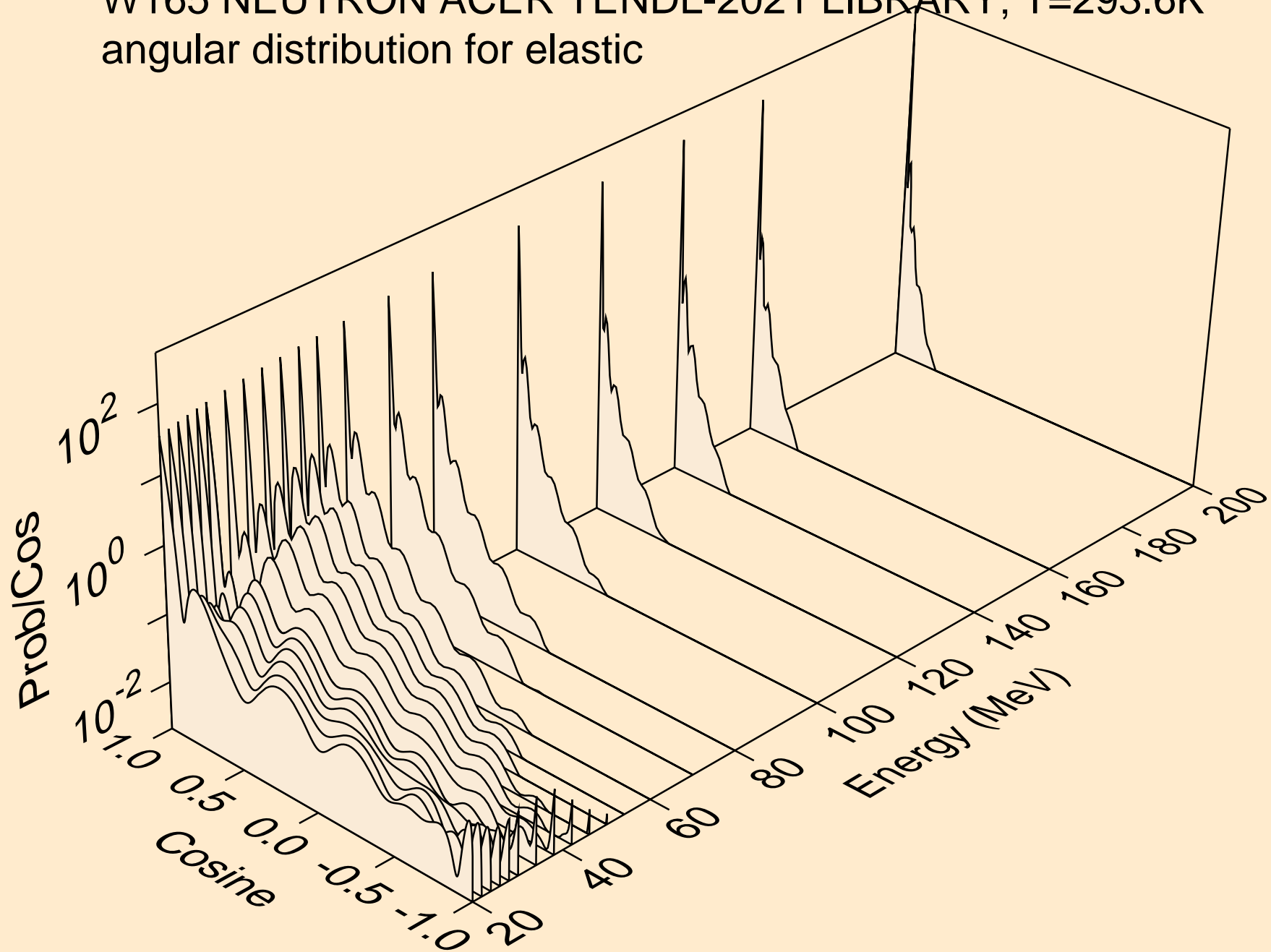

W165 NEUTRON ACER TENDL-2021 LIBRARY; T=293.6K  
angular distribution for (n,n\*1)

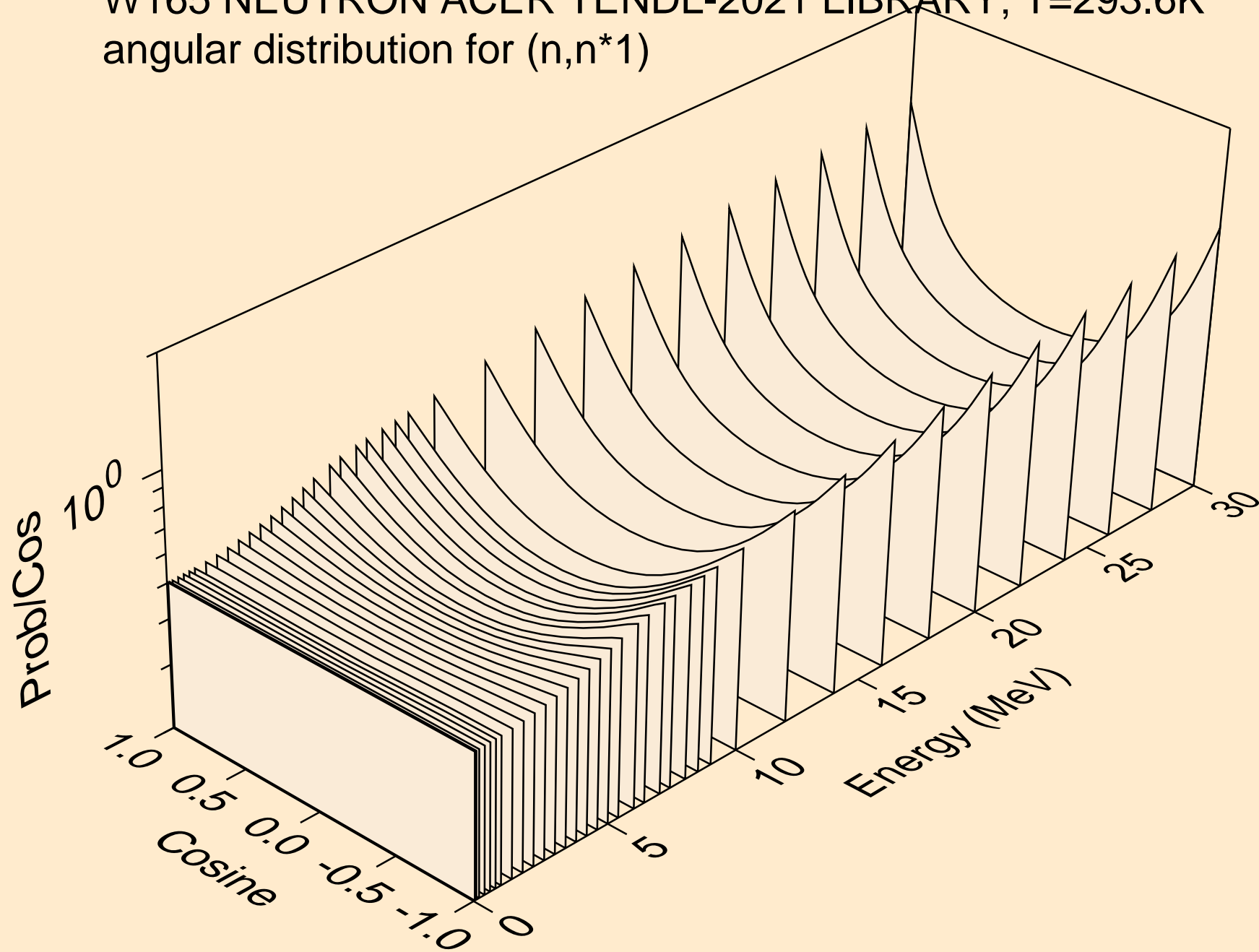

W165 NEUTRON ACER TENDL-2021 LIBRARY; T=293.6K  
angular distribution for (n,n\*2)

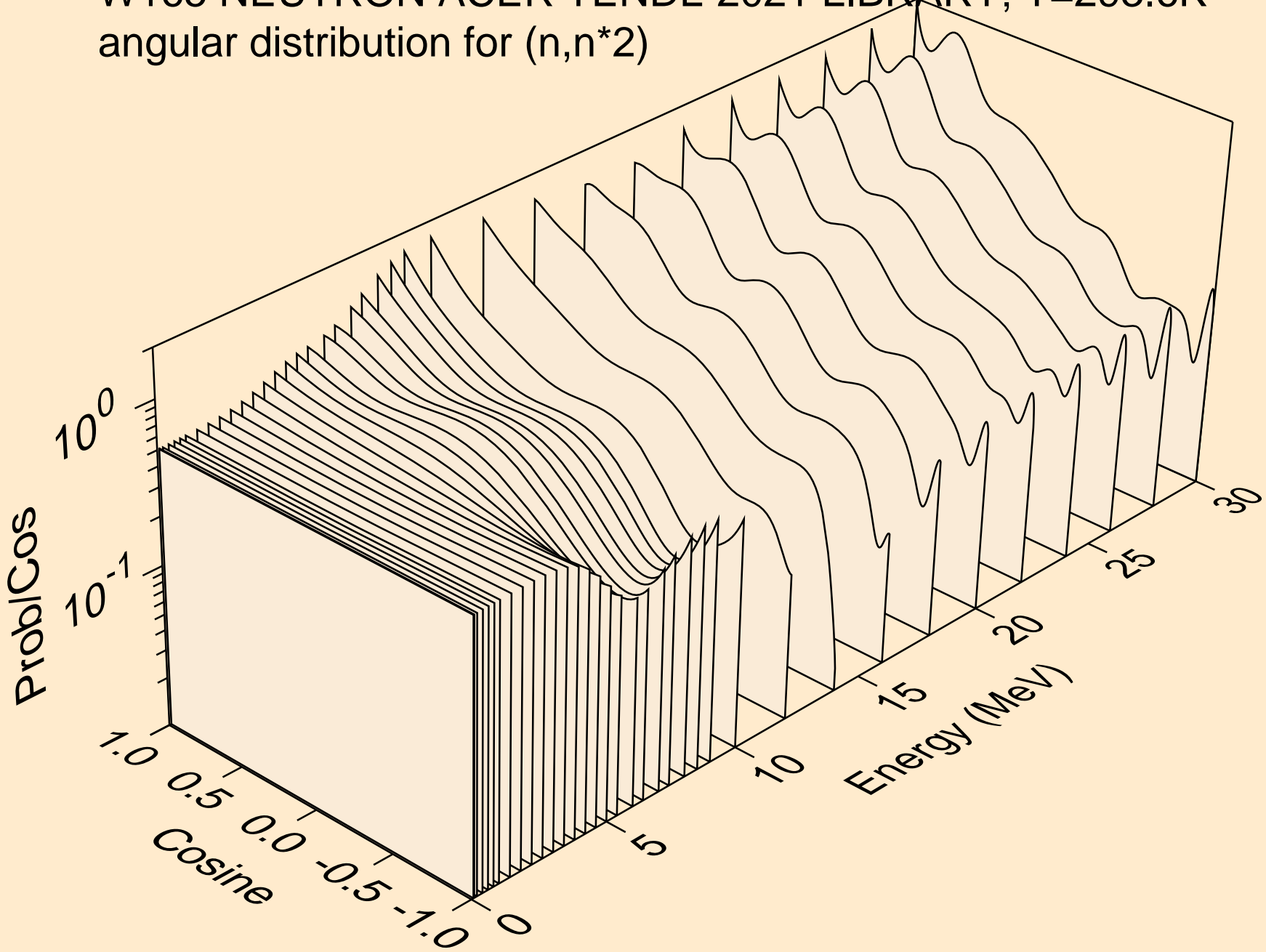

W165 NEUTRON ACER TENDL-2021 LIBRARY; T=293.6K  
angular distribution for (n,n\*3)

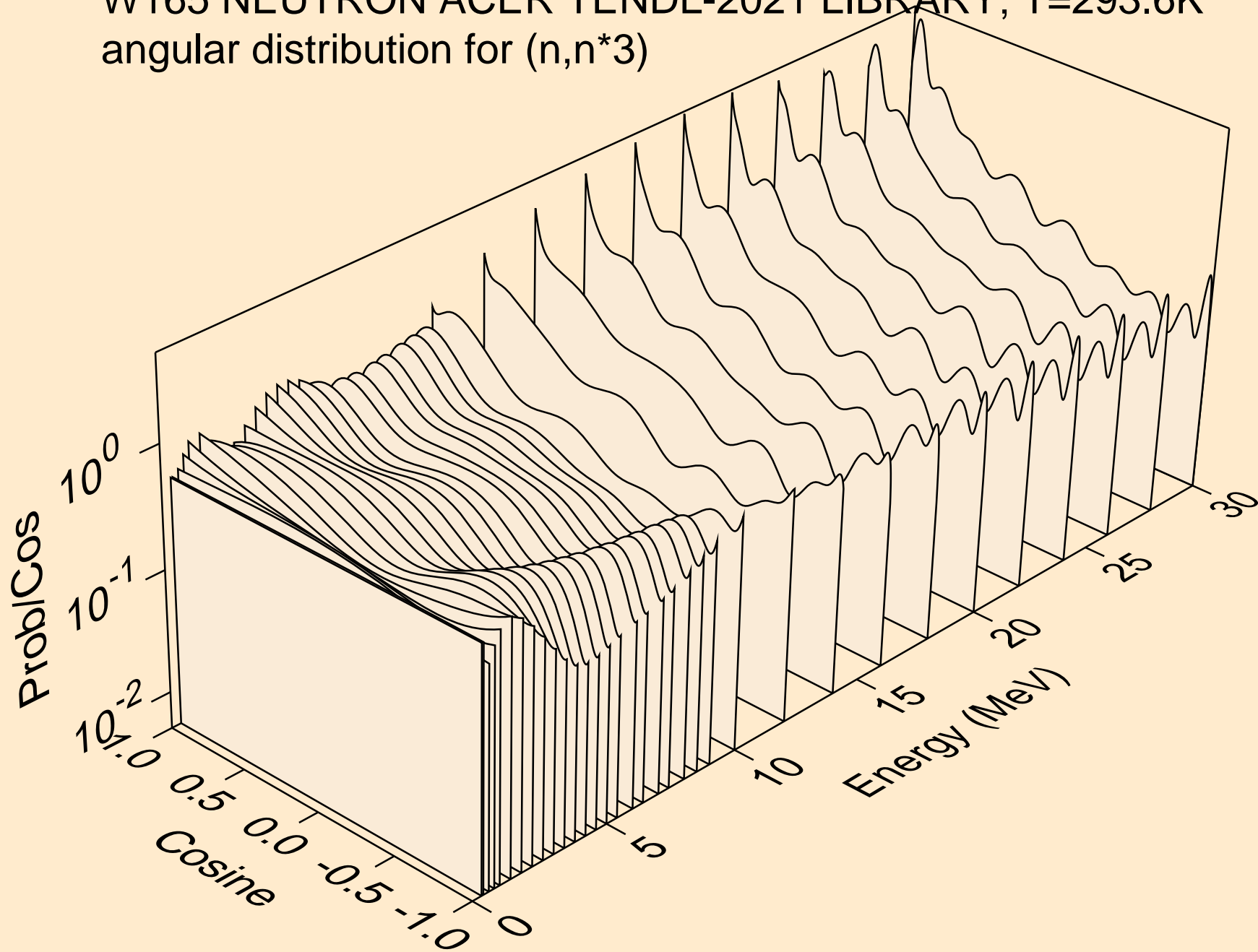

W165 NEUTRON ACER TENDL-2021 LIBRARY; T=293.6K  
angular distribution for (n,n\*4)

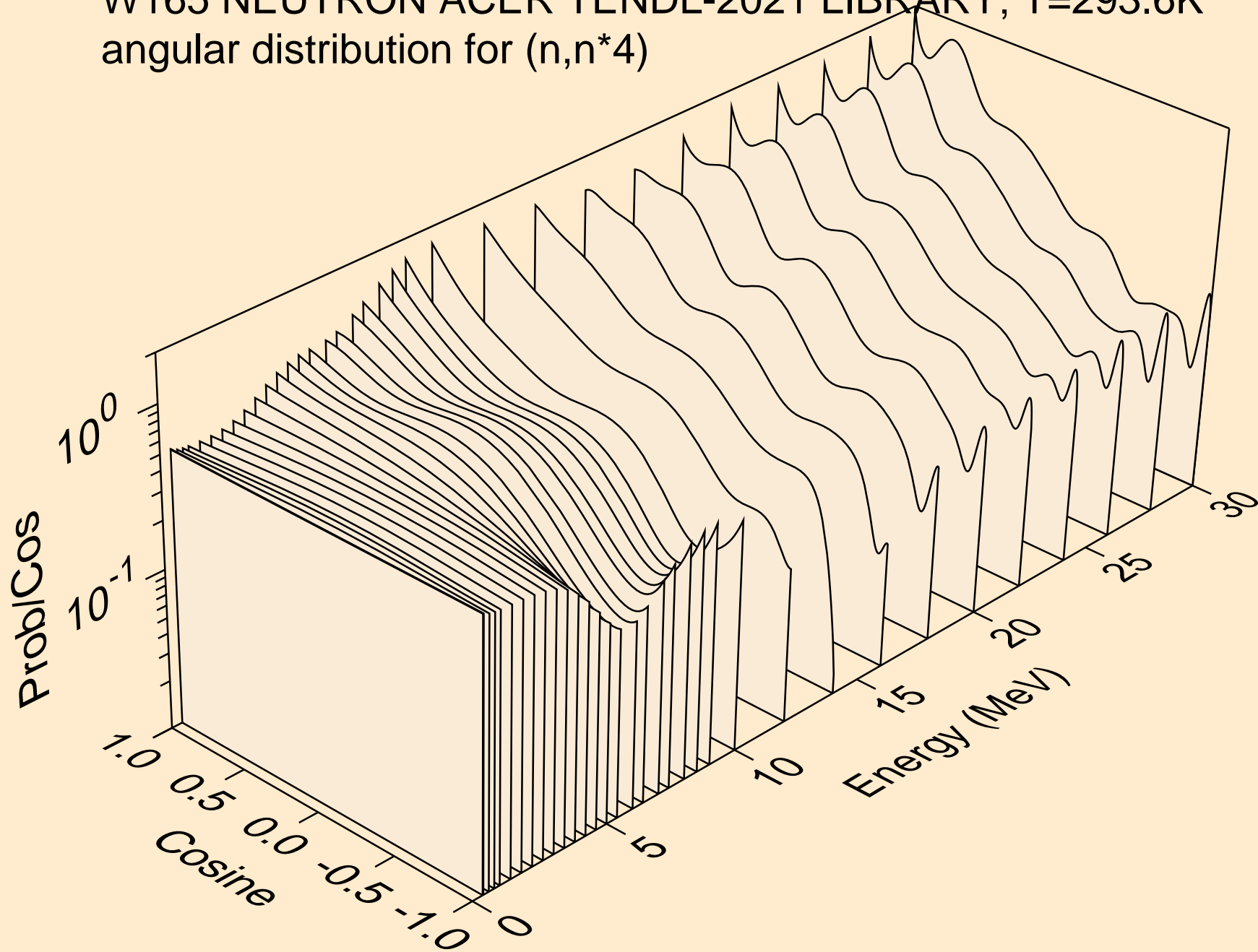

W165 NEUTRON ACER TENDL-2021 LIBRARY; T=293.6K  
angular distribution for (n,n\*5)

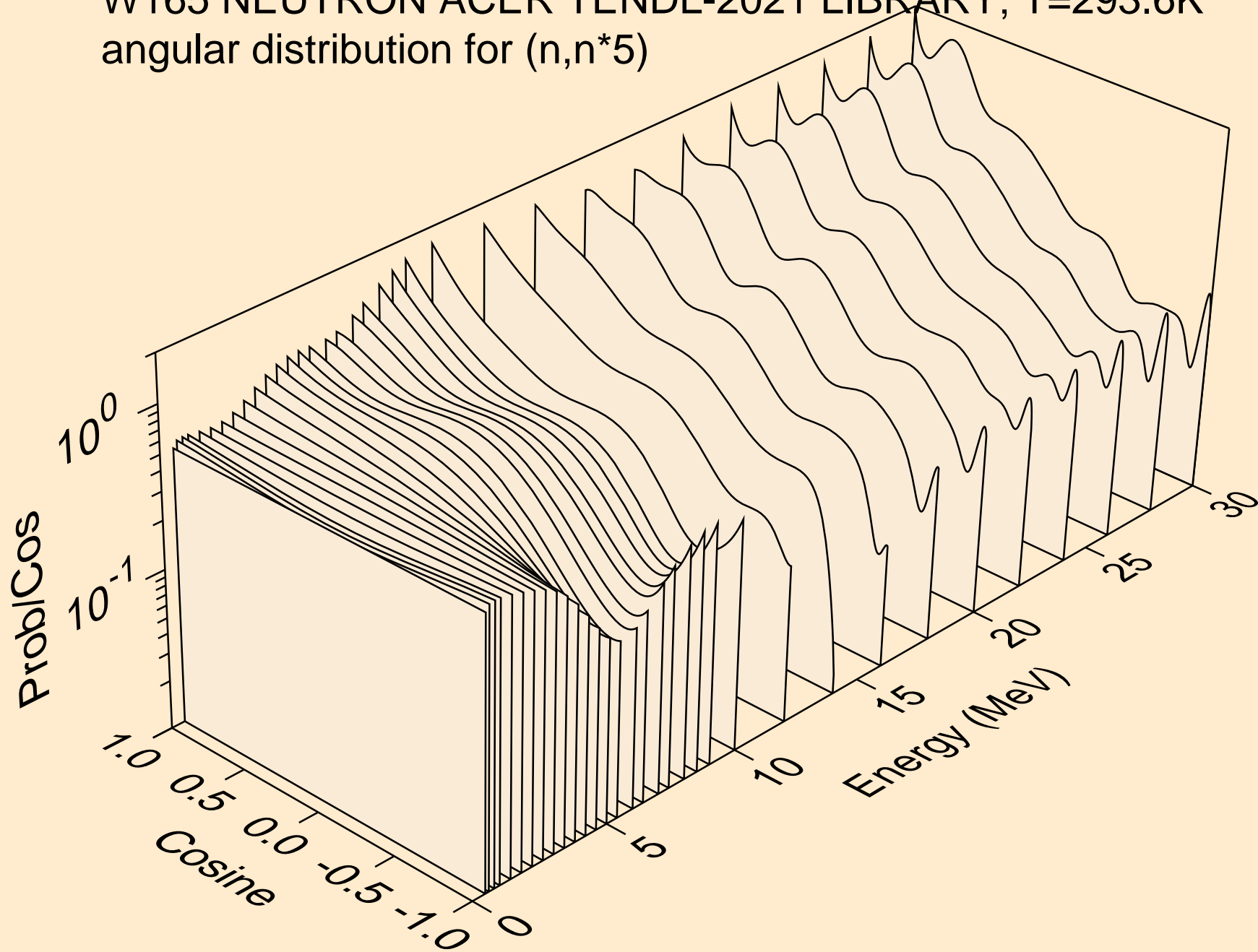

W165 NEUTRON ACER TENDL-2021 LIBRARY; T=293.6K  
angular distribution for (n,n\*6)

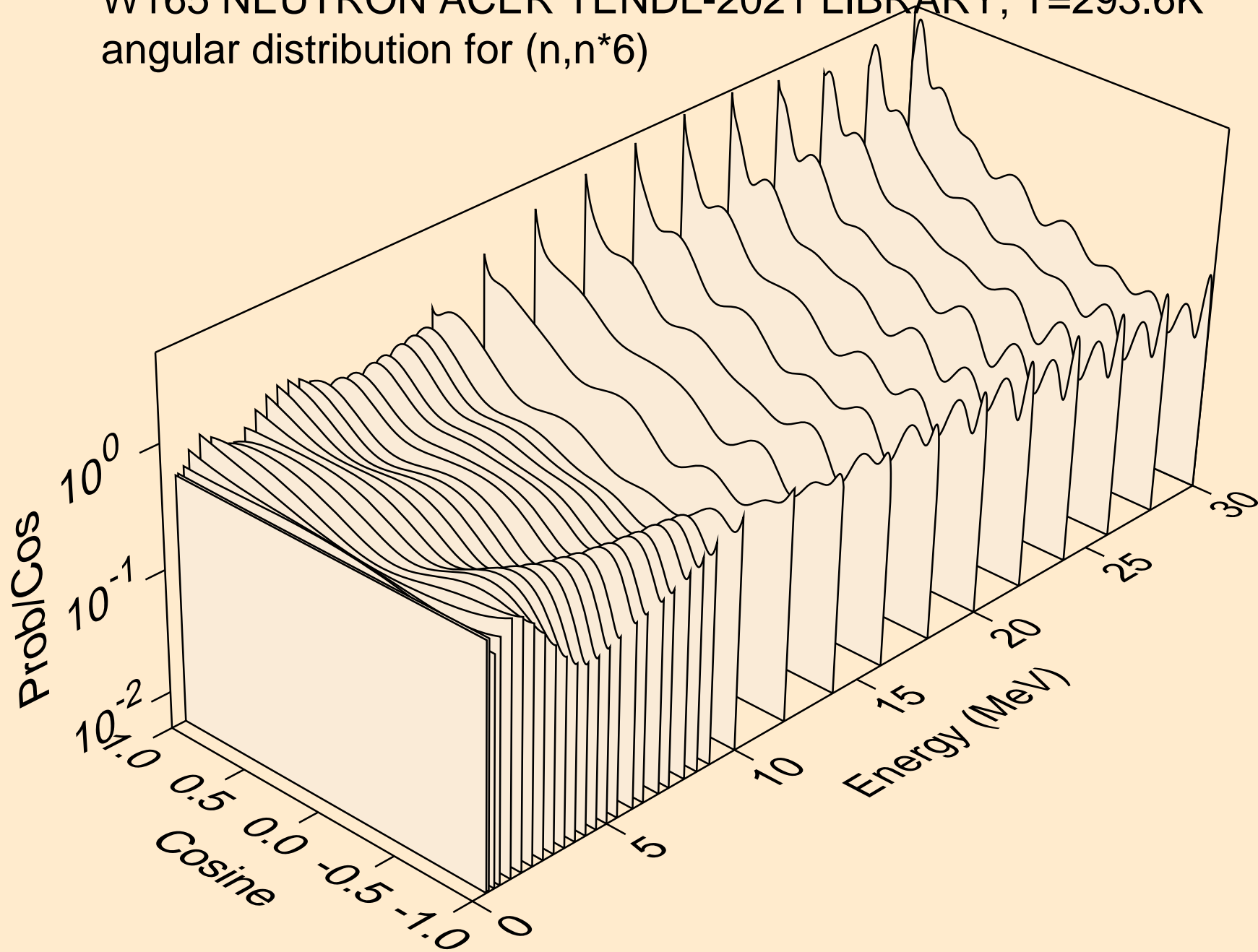

W165 NEUTRON ACER TENDL-2021 LIBRARY; T=293.6K  
angular distribution for (n,n\*7)

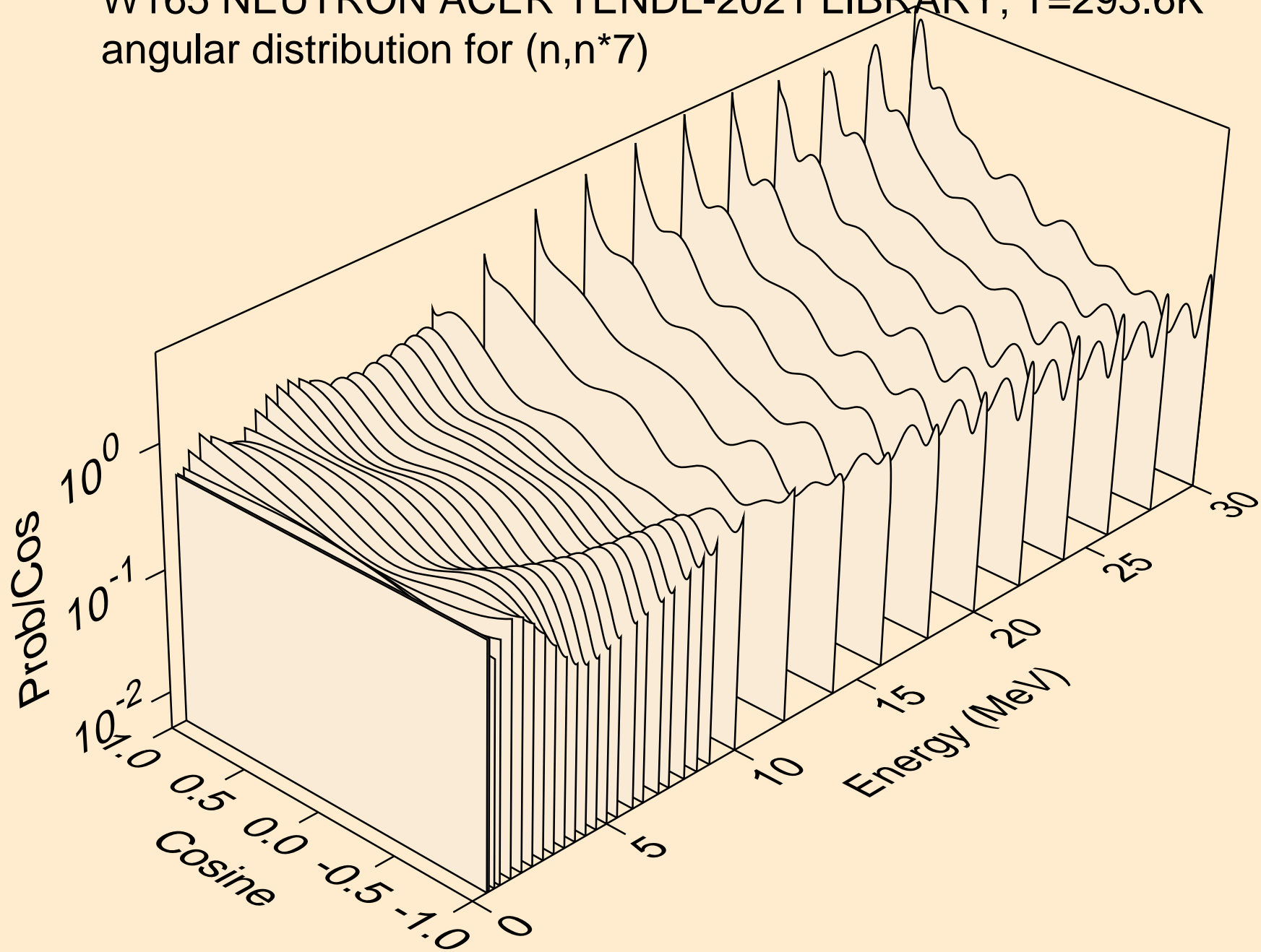



W165 NEUTRON ACER TENDL-2021 LIBRARY; T=293.6K  
angular distribution for (n,n\*8)

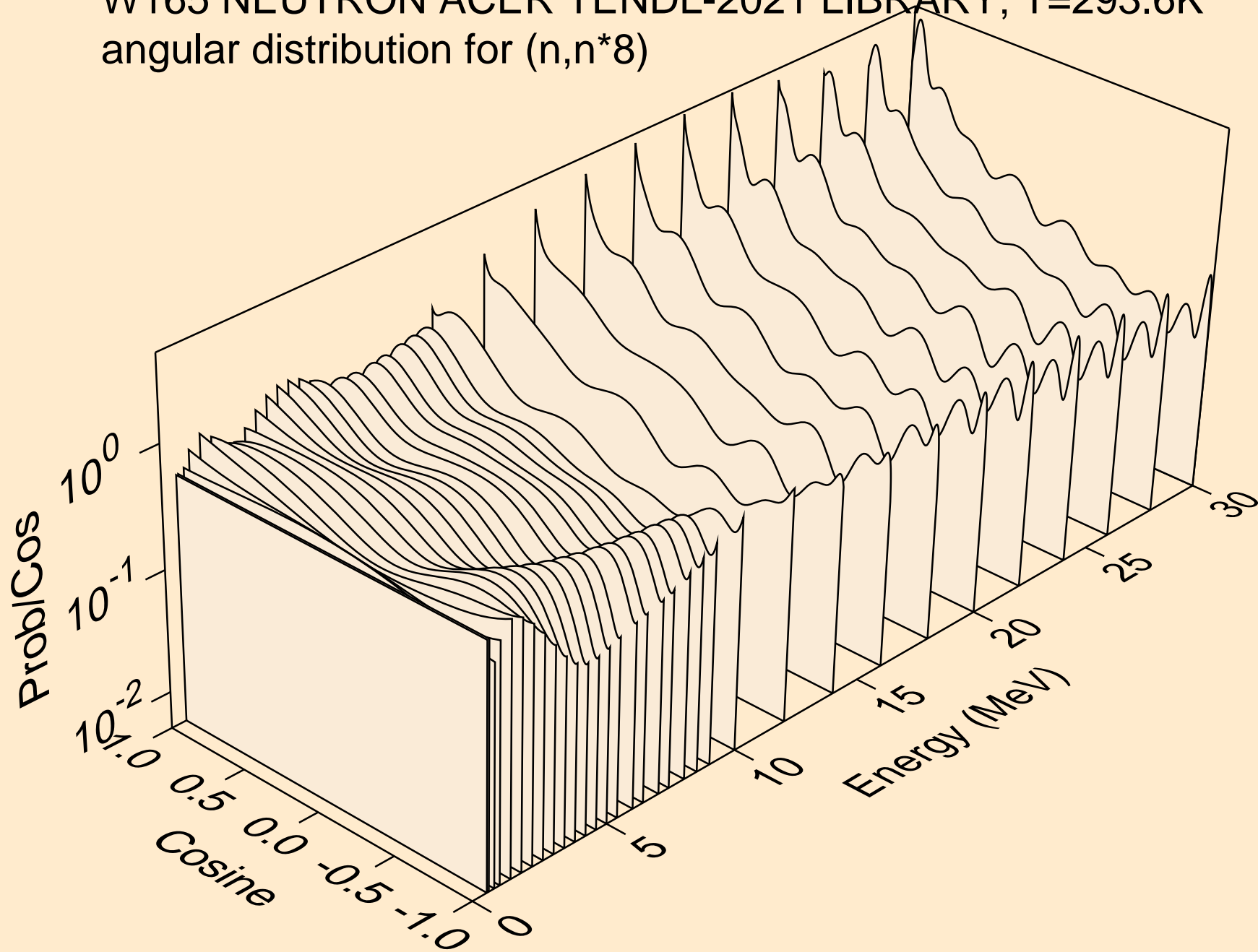

W165 NEUTRON ACER TENDL-2021 LIBRARY; T=293.6K  
angular distribution for (n,n\*9)

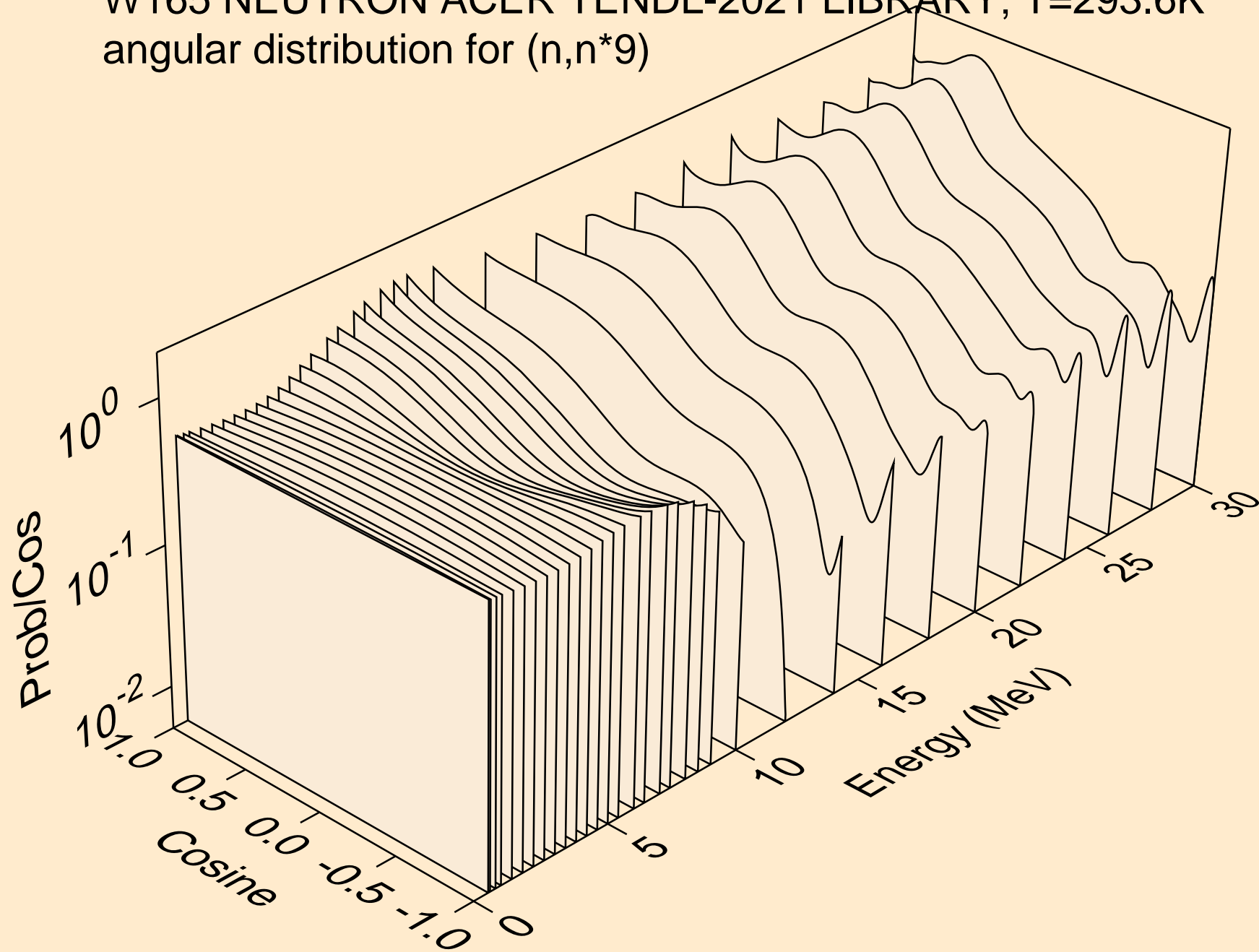

W165 NEUTRON ACER TENDL-2021 LIBRARY; T=293.6K  
angular distribution for (n,n\*10)

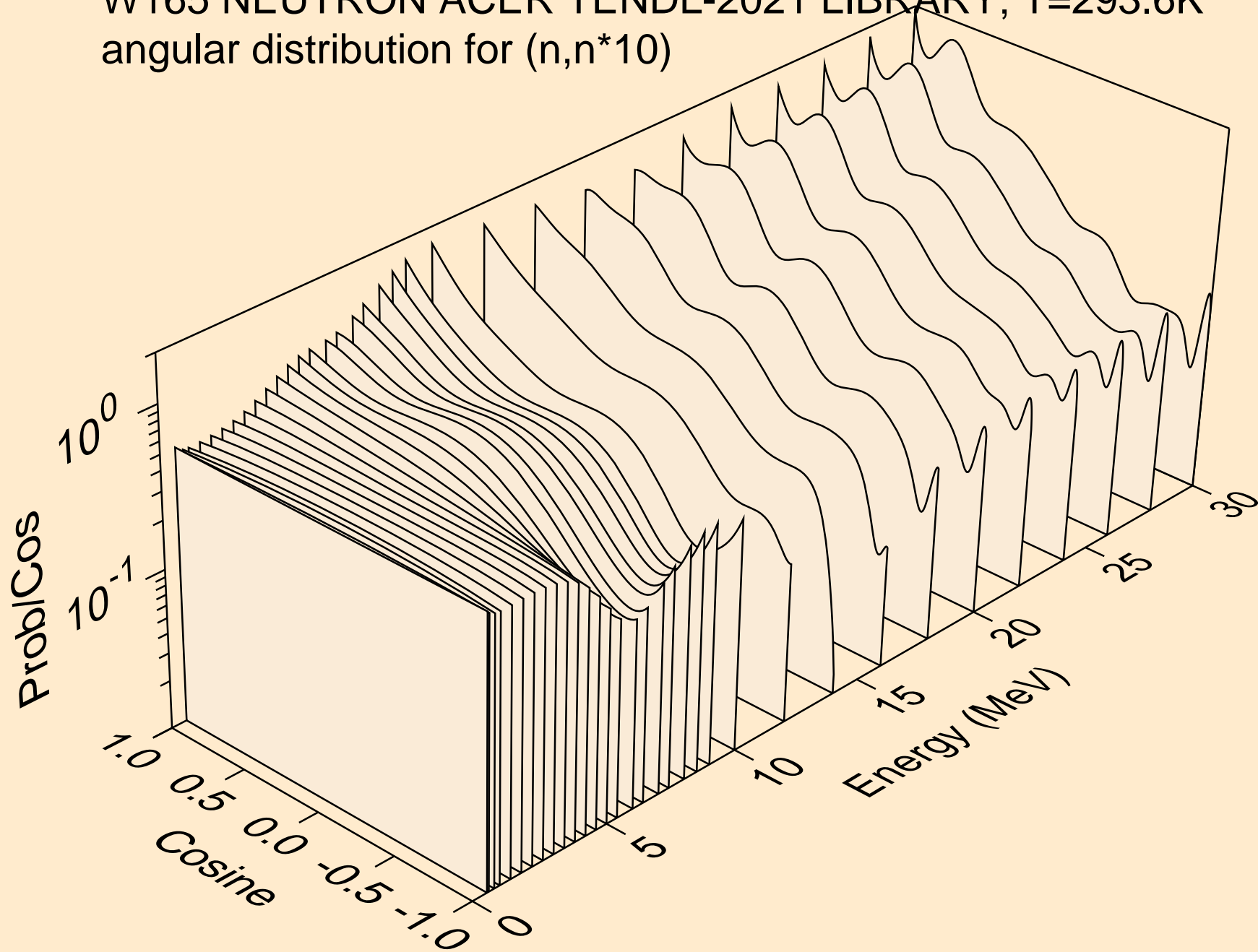

W165 NEUTRON ACER TENDL-2021 LIBRARY; T=293.6K  
angular distribution for (n,n\*11)

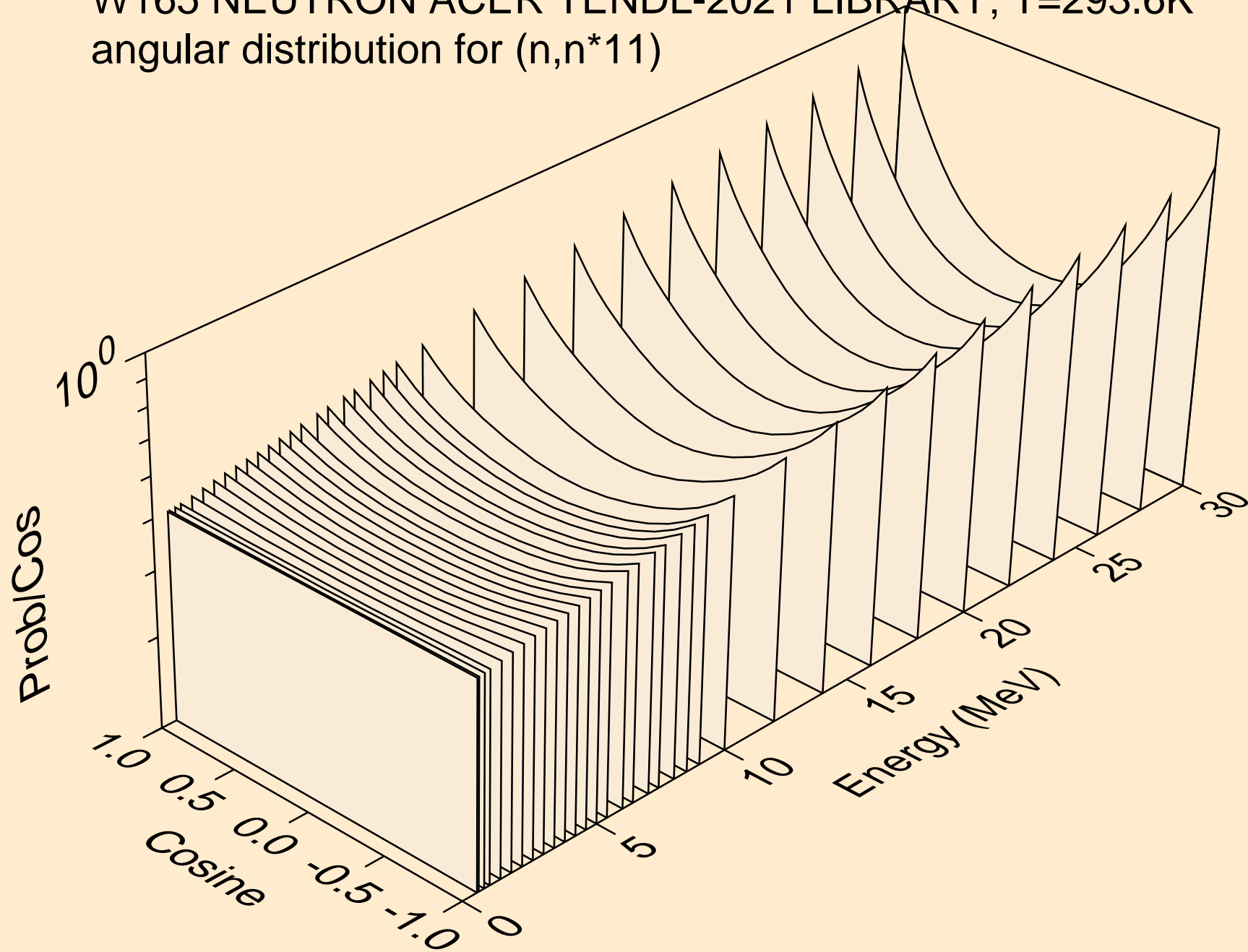

W165 NEUTRON ACER TENDL-2021 LIBRARY; T=293.6K  
angular distribution for (n,n\*12)

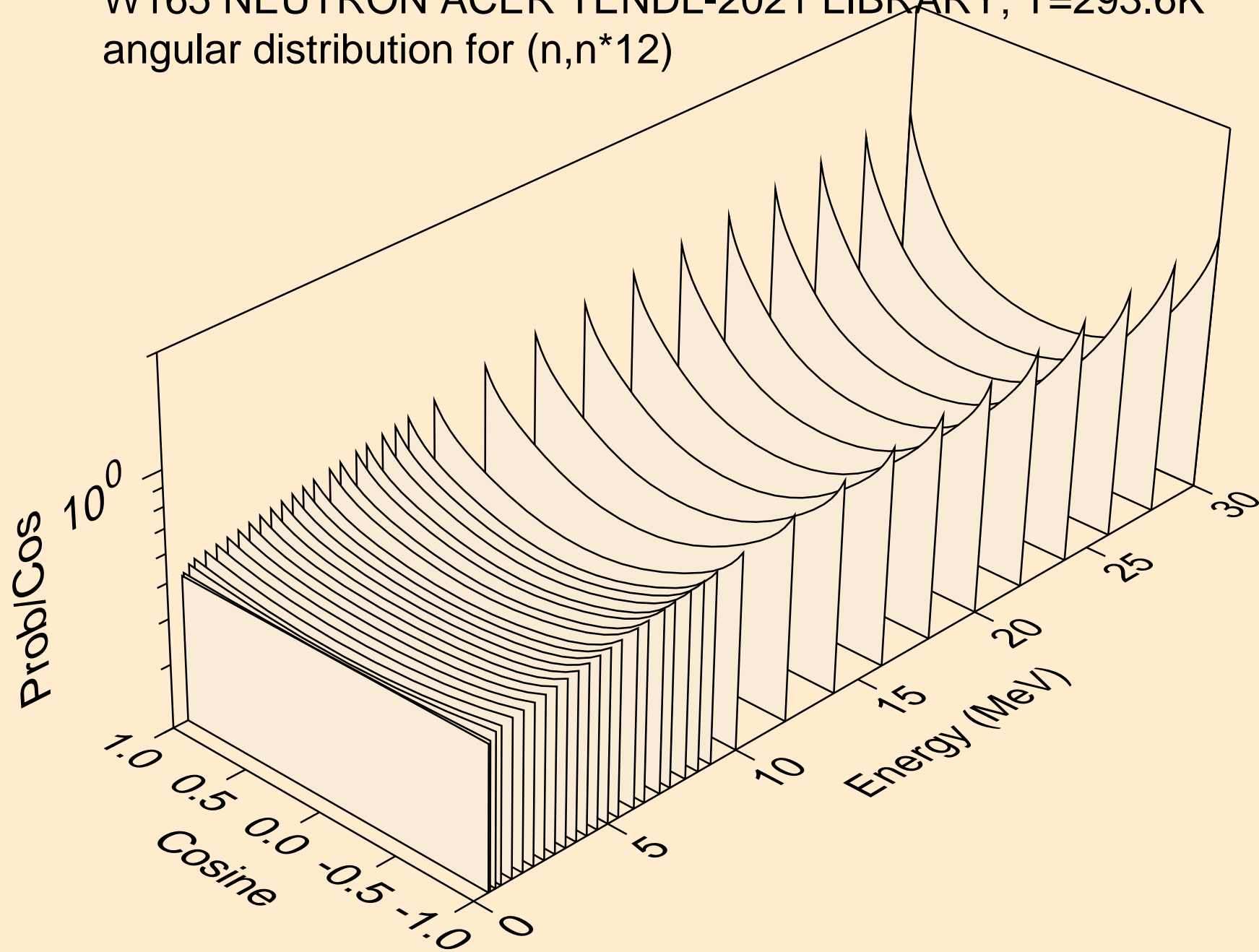

W165 NEUTRON ACER TENDL-2021 LIBRARY; T=293.6K  
angular distribution for (n,n\*13)

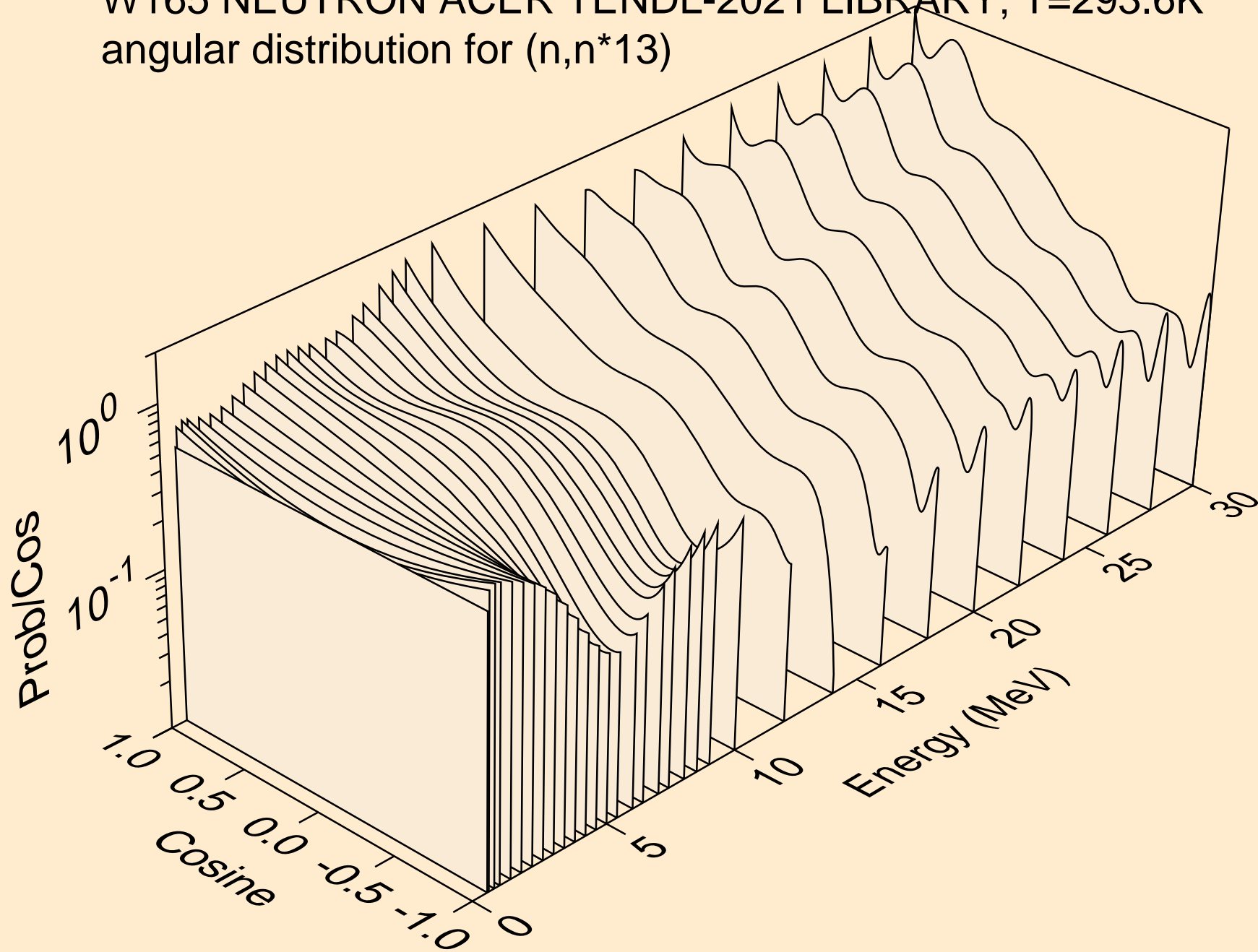

W165 NEUTRON ACER TENDL-2021 LIBRARY; T=293.6K  
angular distribution for (n,n\*14)

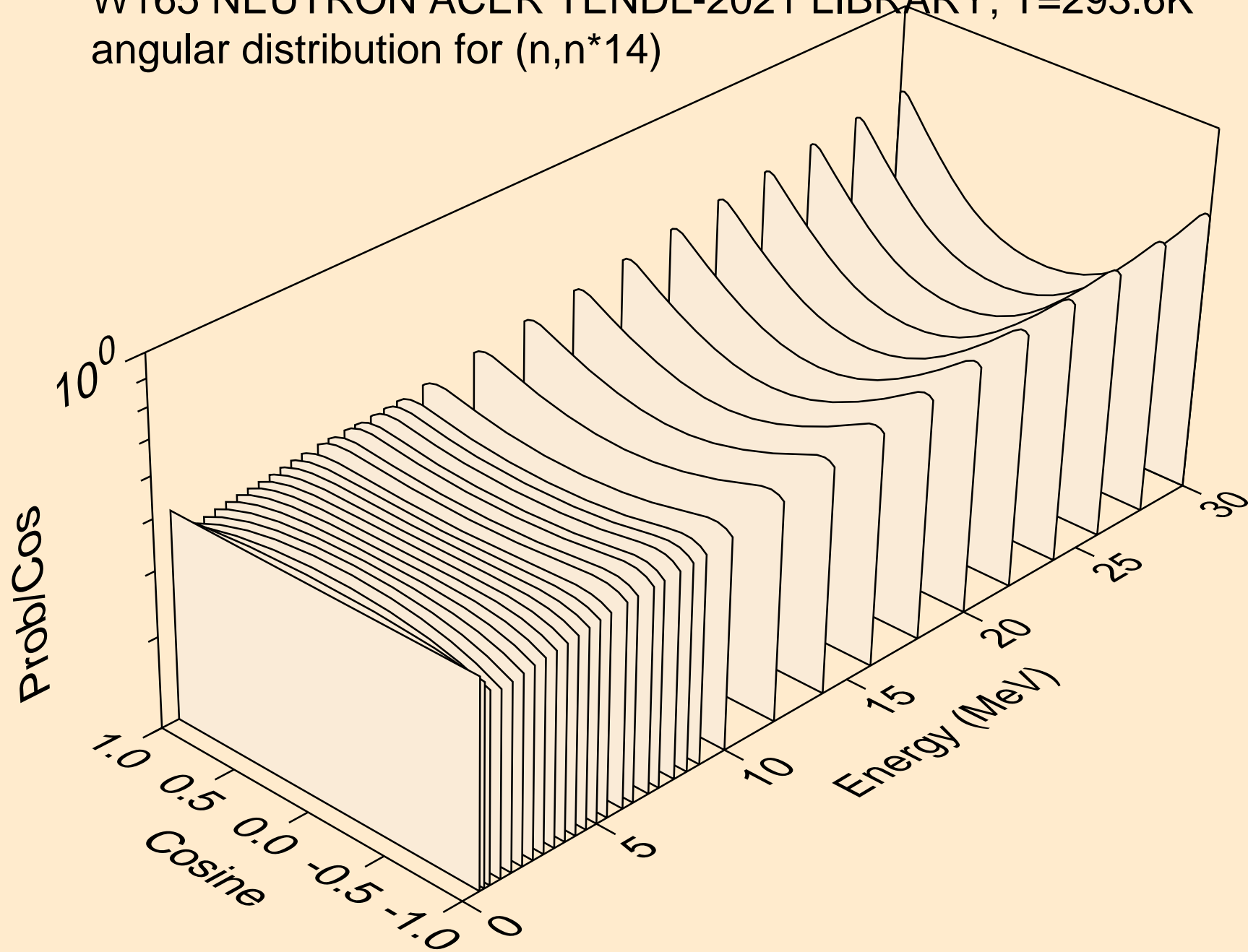

W165 NEUTRON ACER TENDL-2021 LIBRARY; T=293.6K  
angular distribution for (n,n\*15)

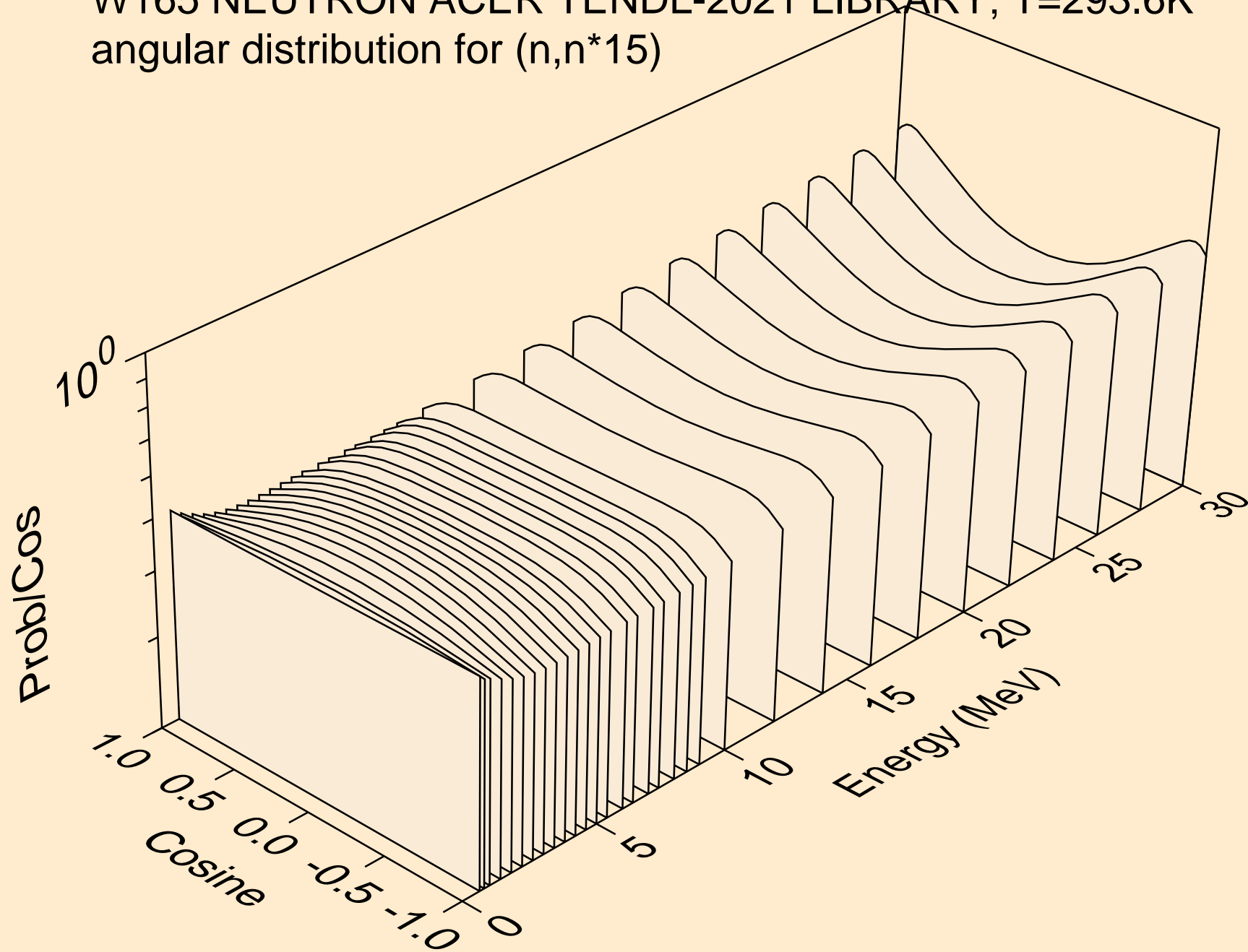



W165 NEUTRON ACER TENDL-2021 LIBRARY; T=293.6K  
angular distribution for (n,n\*16)

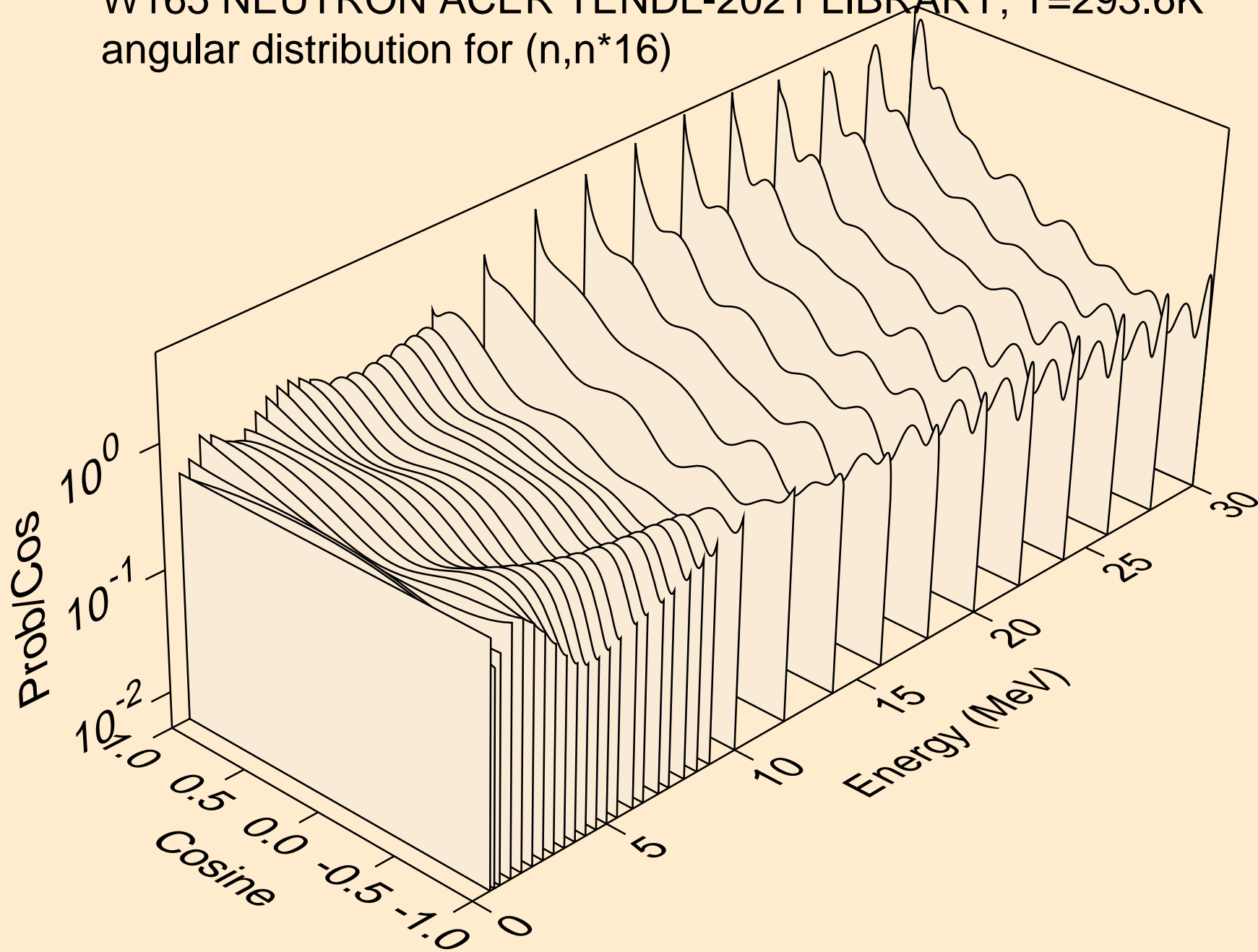

W165 NEUTRON ACER TENDL-2021 LIBRARY; T=293.6K  
angular distribution for (n,n\*17)

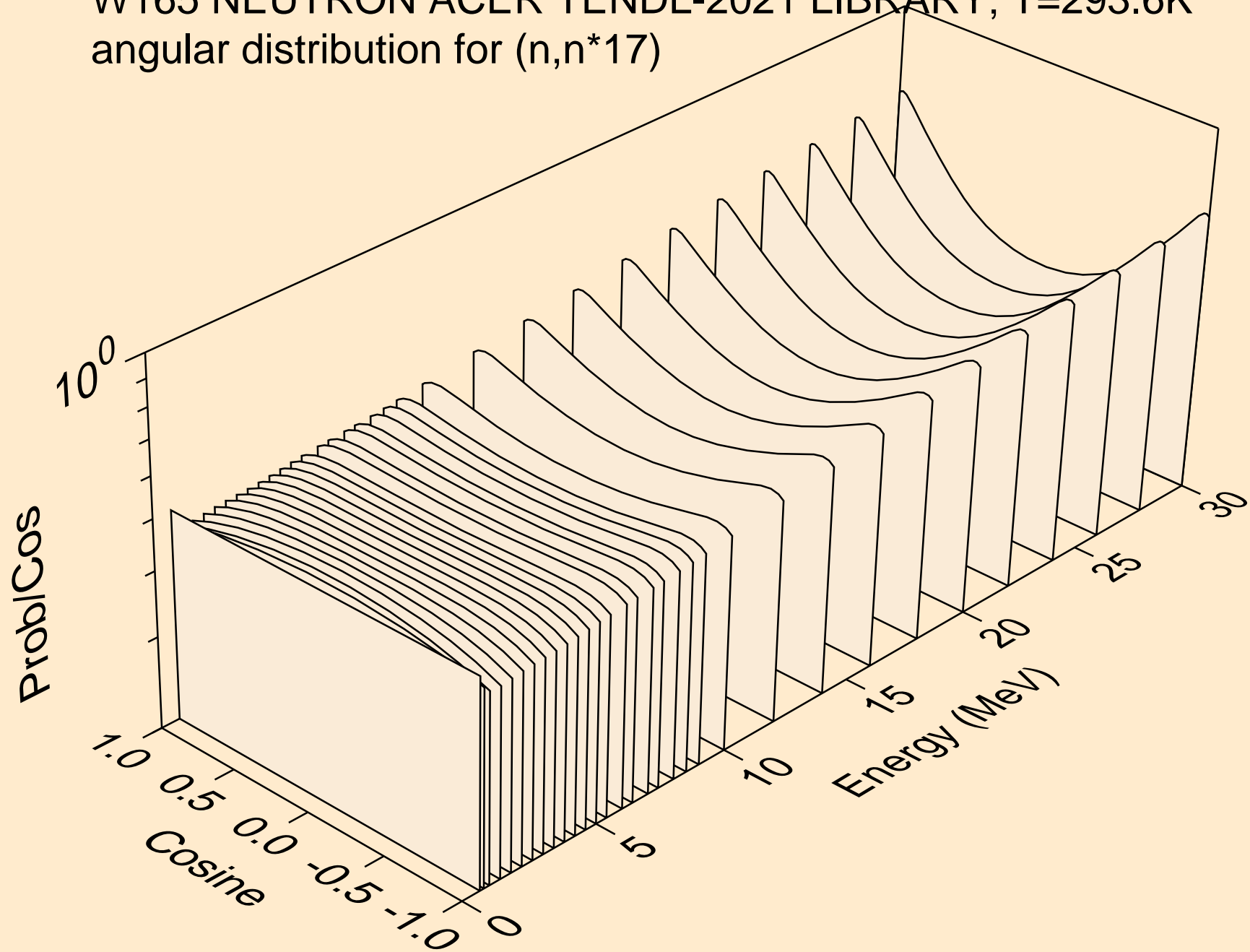

W165 NEUTRON ACER TENDL-2021 LIBRARY; T=293.6K  
angular distribution for (n,n\*18)

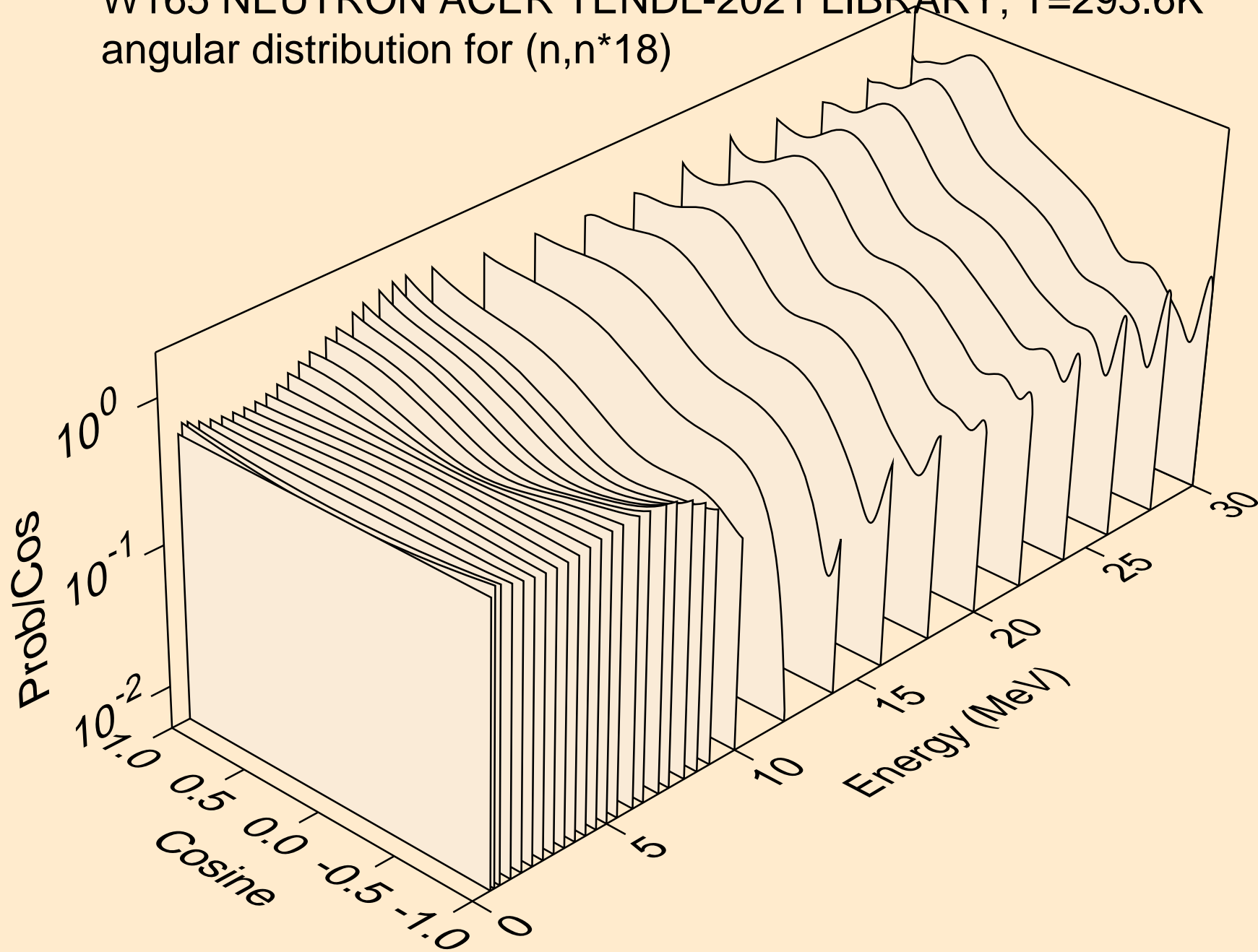

W165 NEUTRON ACER TENDL-2021 LIBRARY; T=293.6K  
angular distribution for (n,n\*19)

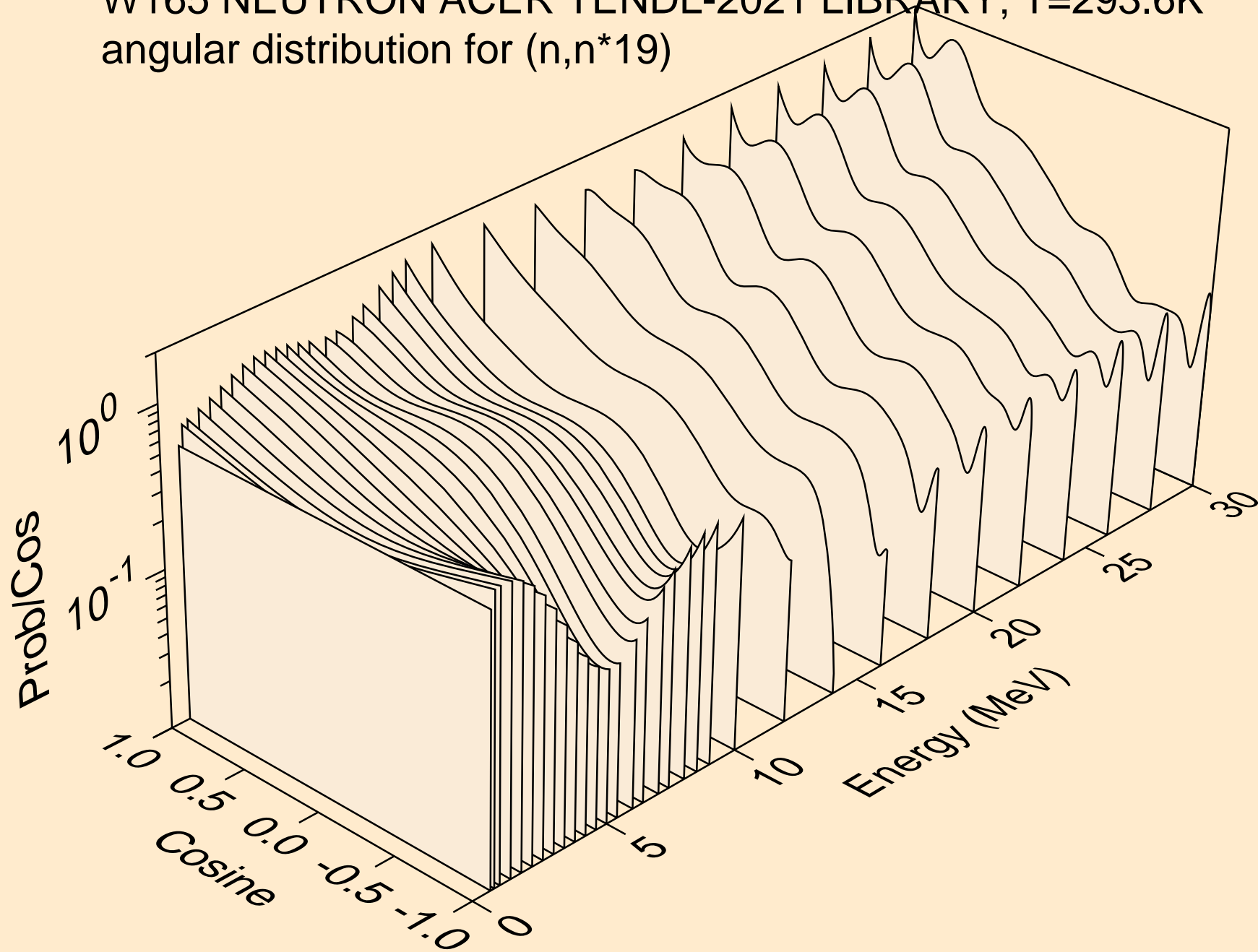

W165 NEUTRON ACER TENDL-2021 LIBRARY; T=293.6K  
angular distribution for (n,n\*20)

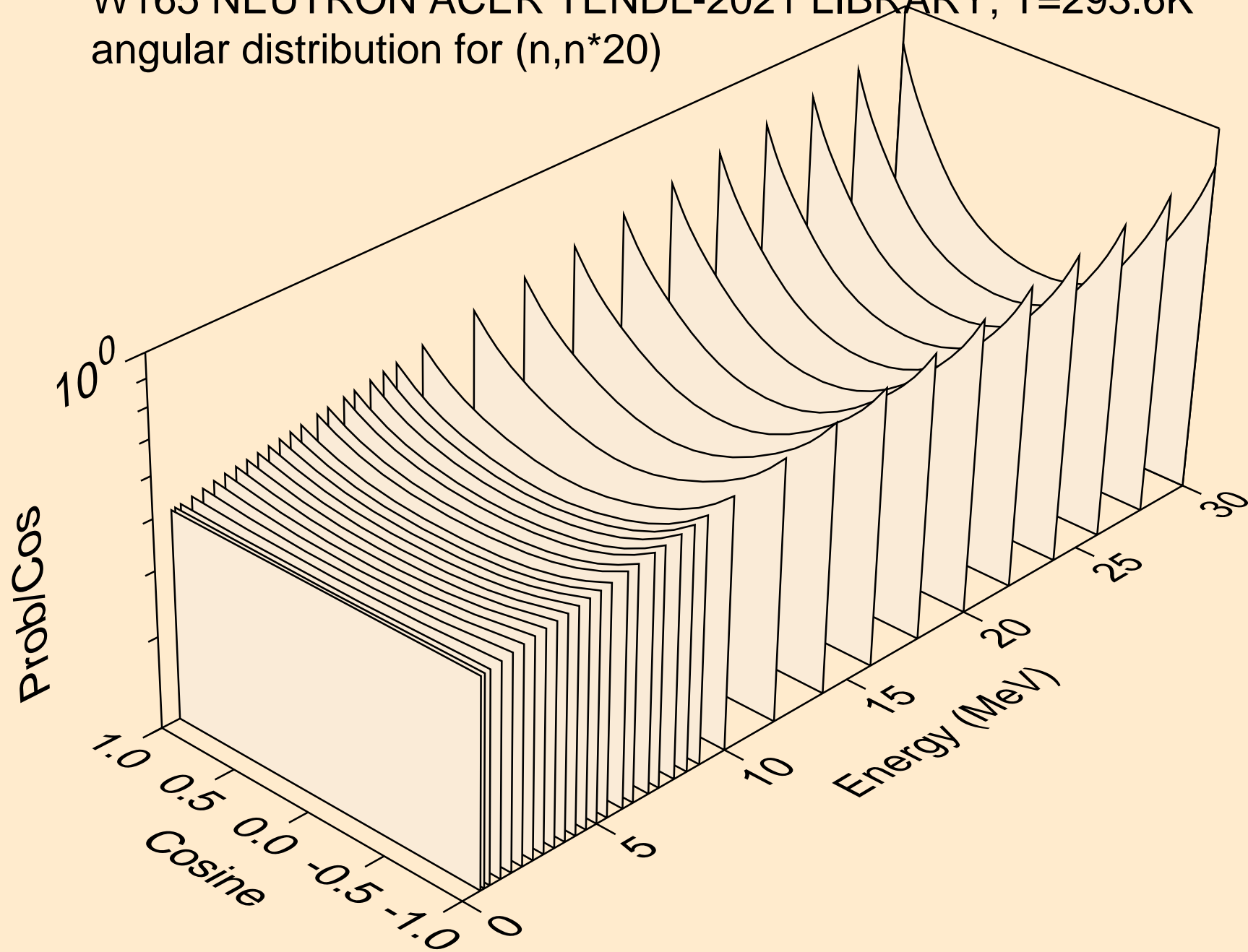

W165 NEUTRON ACER TENDL-2021 LIBRARY; T=293.6K  
angular distribution for (n,n\*21)

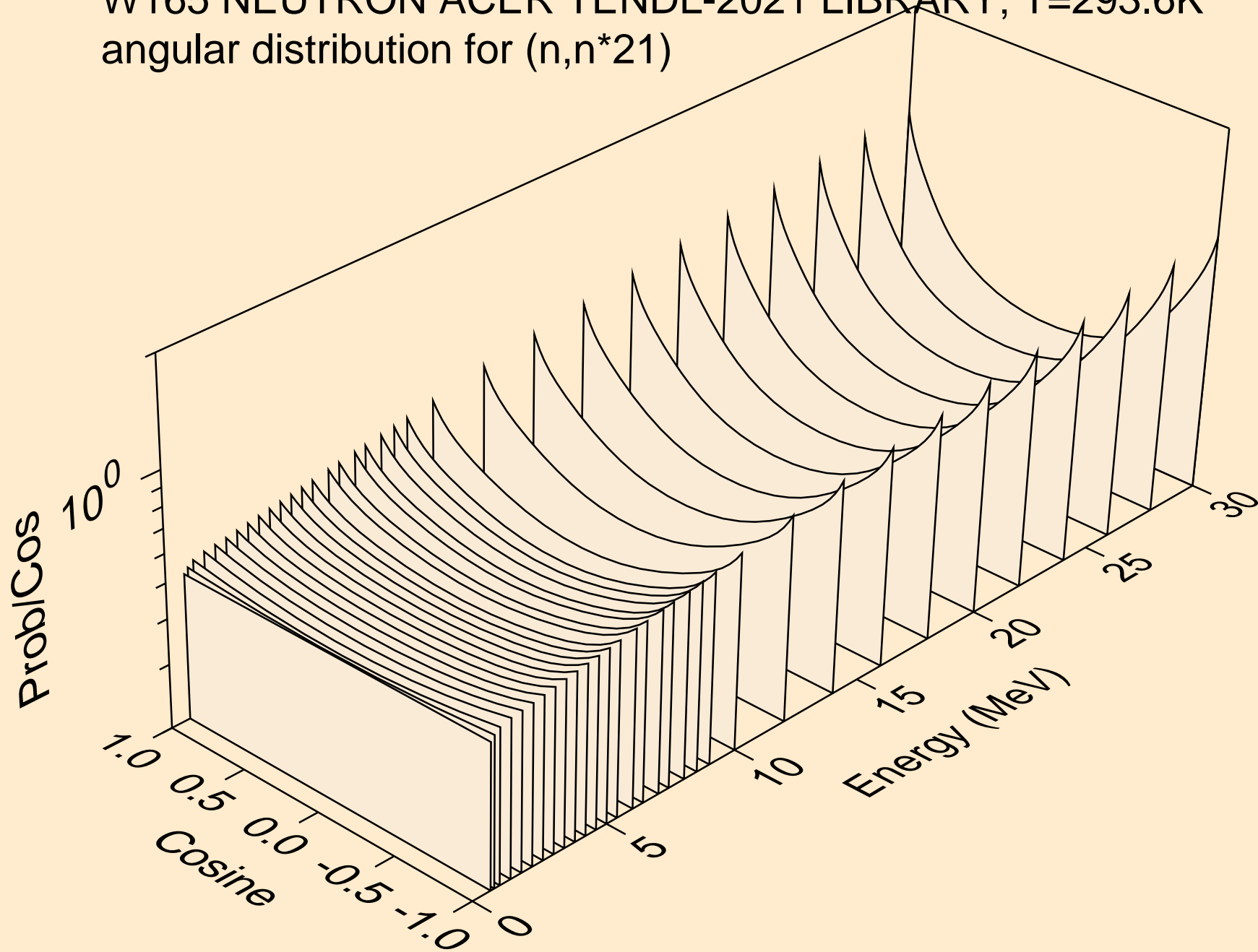

W165 NEUTRON ACER TENDL-2021 LIBRARY; T=293.6K  
angular distribution for (n,n\*22)

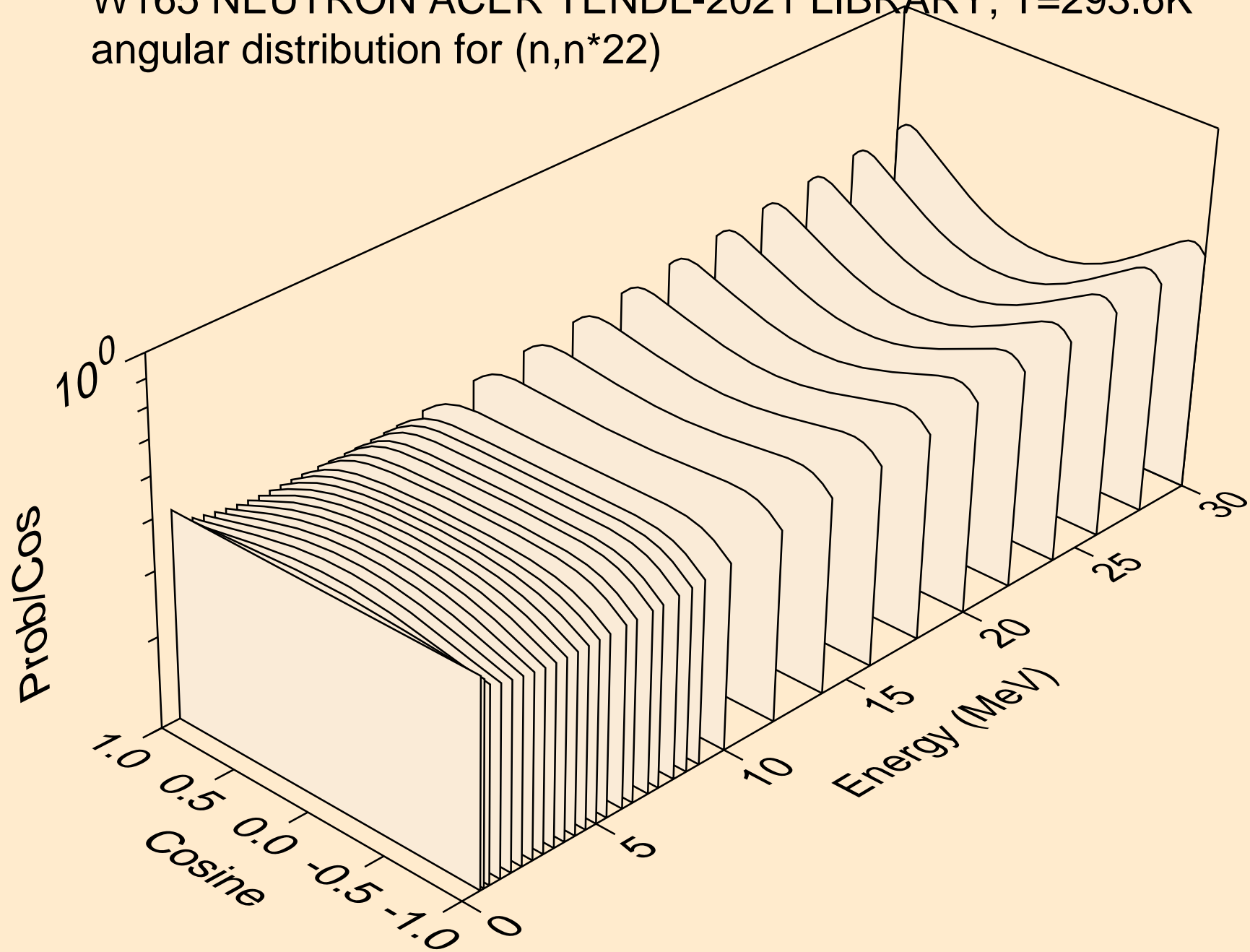

W165 NEUTRON ACER TENDL-2021 LIBRARY; T=293.6K  
angular distribution for (n,n\*23)

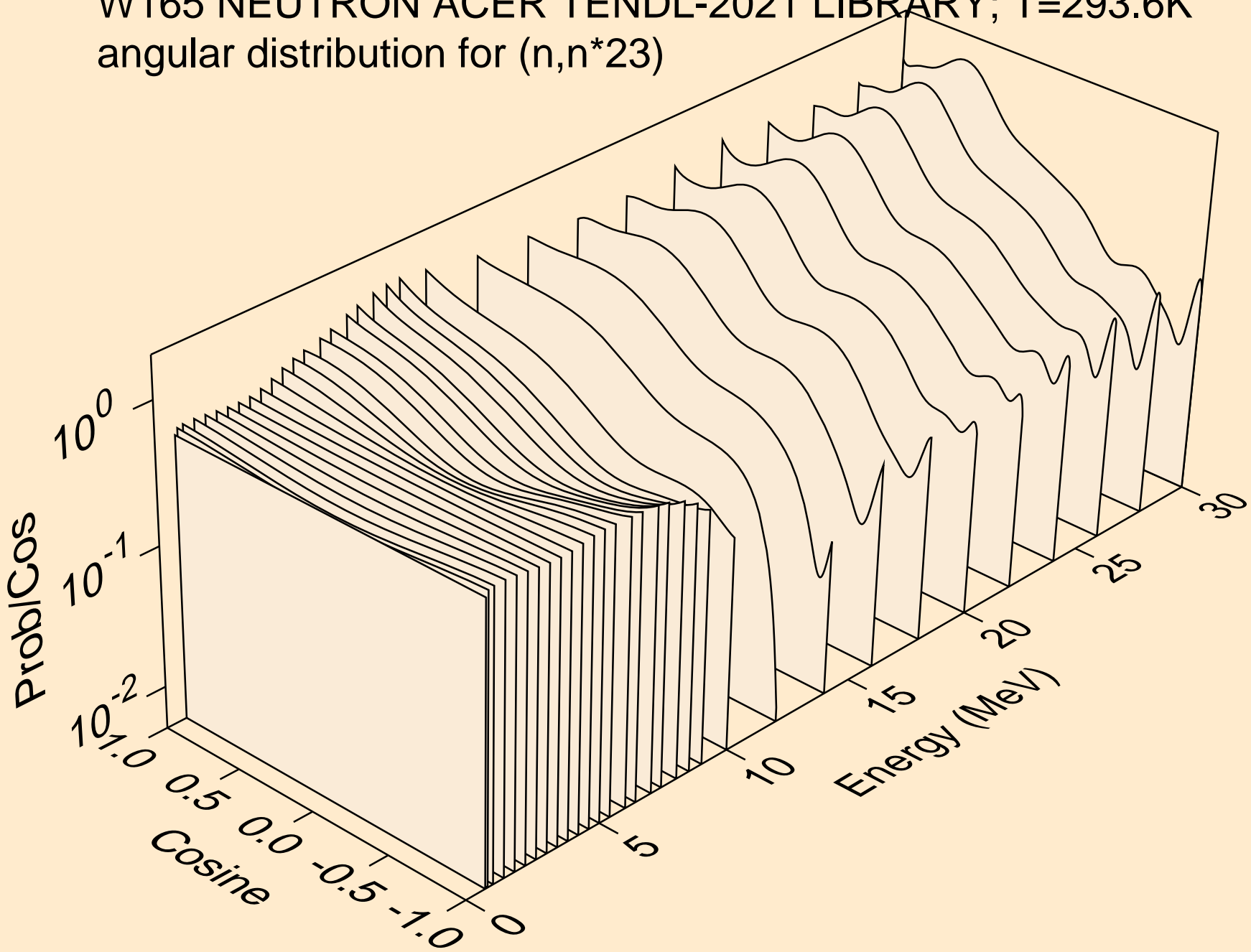



W165 NEUTRON ACER TENDL-2021 LIBRARY; T=293.6K  
angular distribution for (n,n\*24)

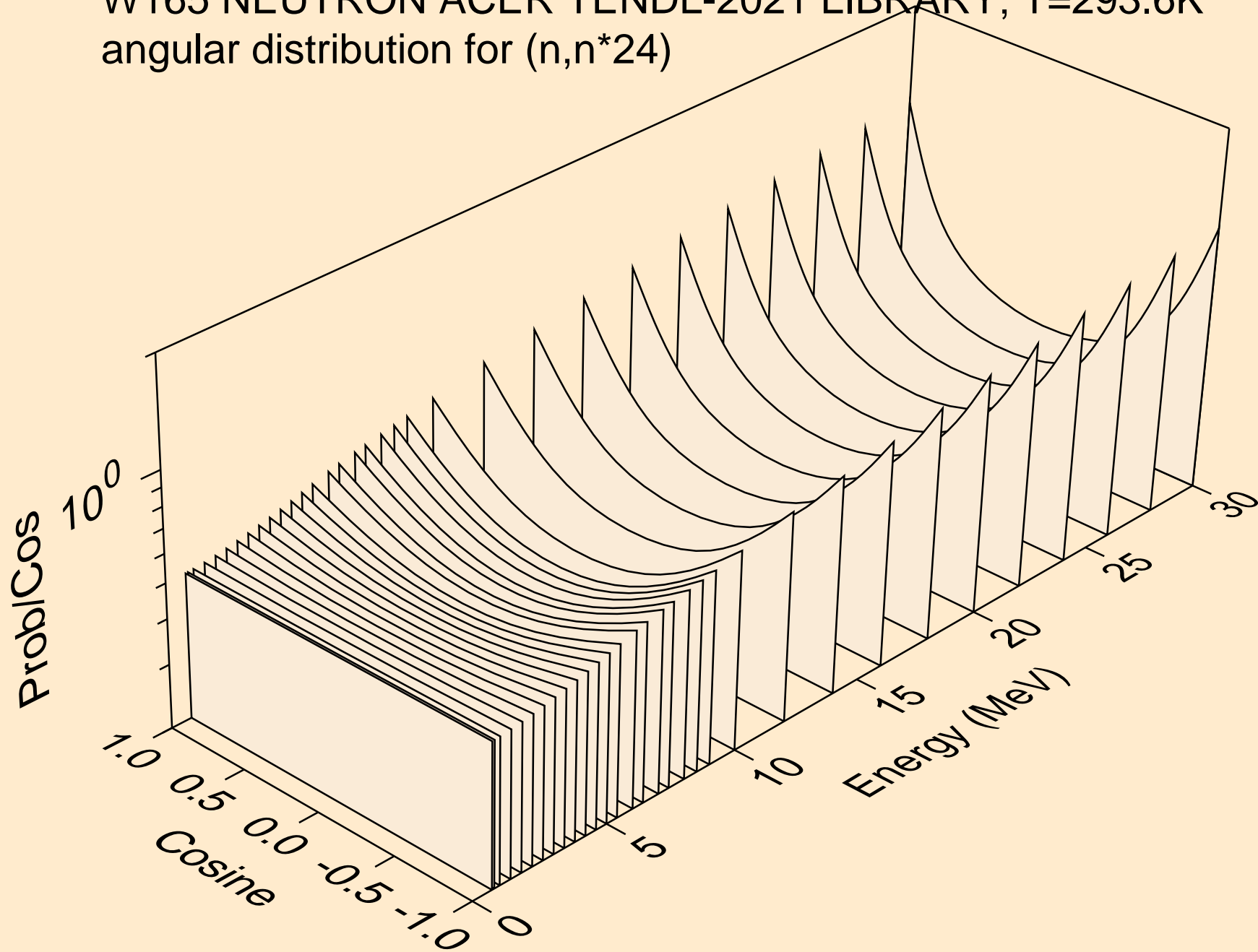

W165 NEUTRON ACER TENDL-2021 LIBRARY; T=293.6K  
angular distribution for (n,n\*25)

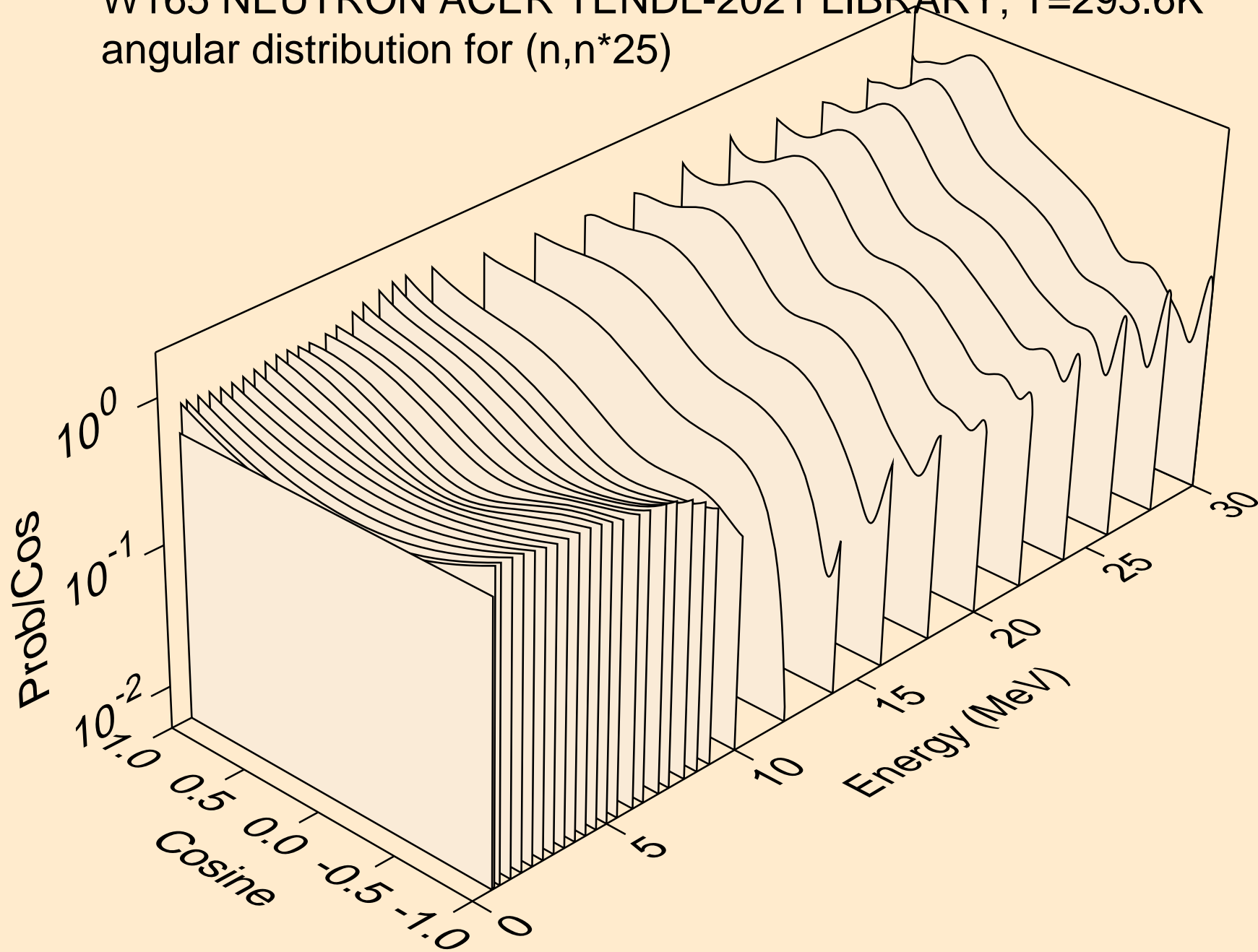

W165 NEUTRON ACER TENDL-2021 LIBRARY; T=293.6K  
angular distribution for (n,n\*26)

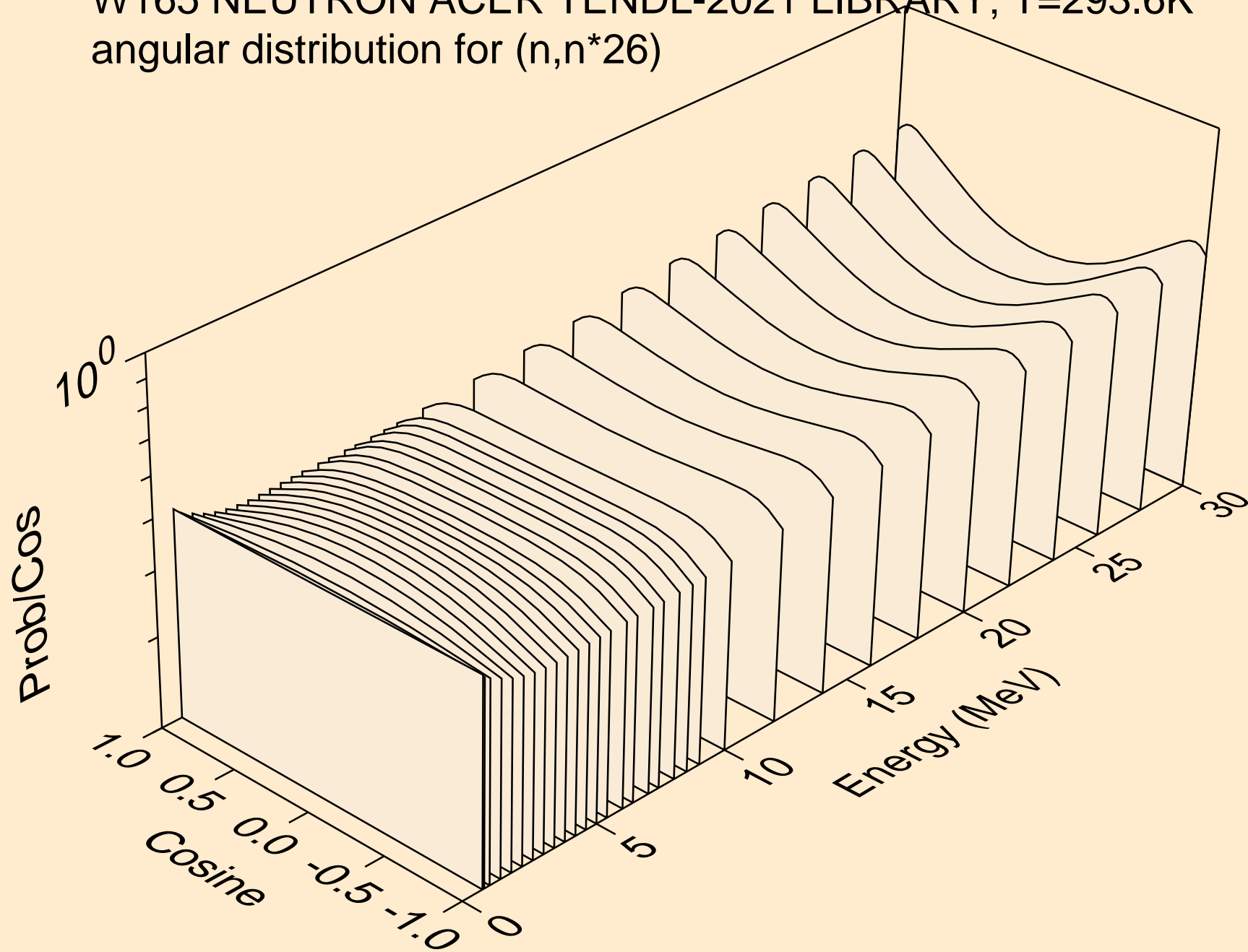

W165 NEUTRON ACER TENDL-2021 LIBRARY; T=293.6K  
angular distribution for (n,n\*27)

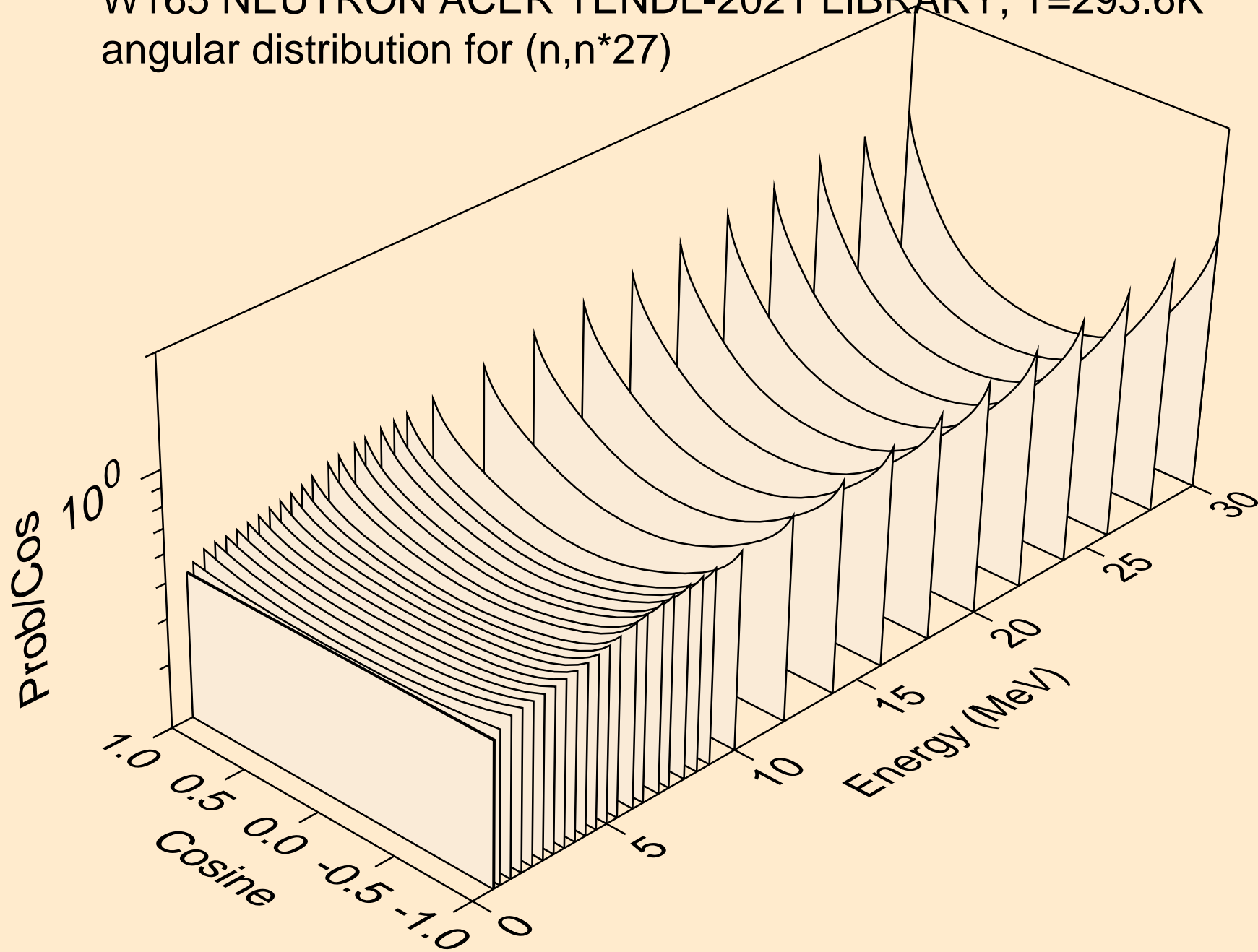

W165 NEUTRON ACER TENDL-2021 LIBRARY; T=293.6K  
angular distribution for (n,n\*28)

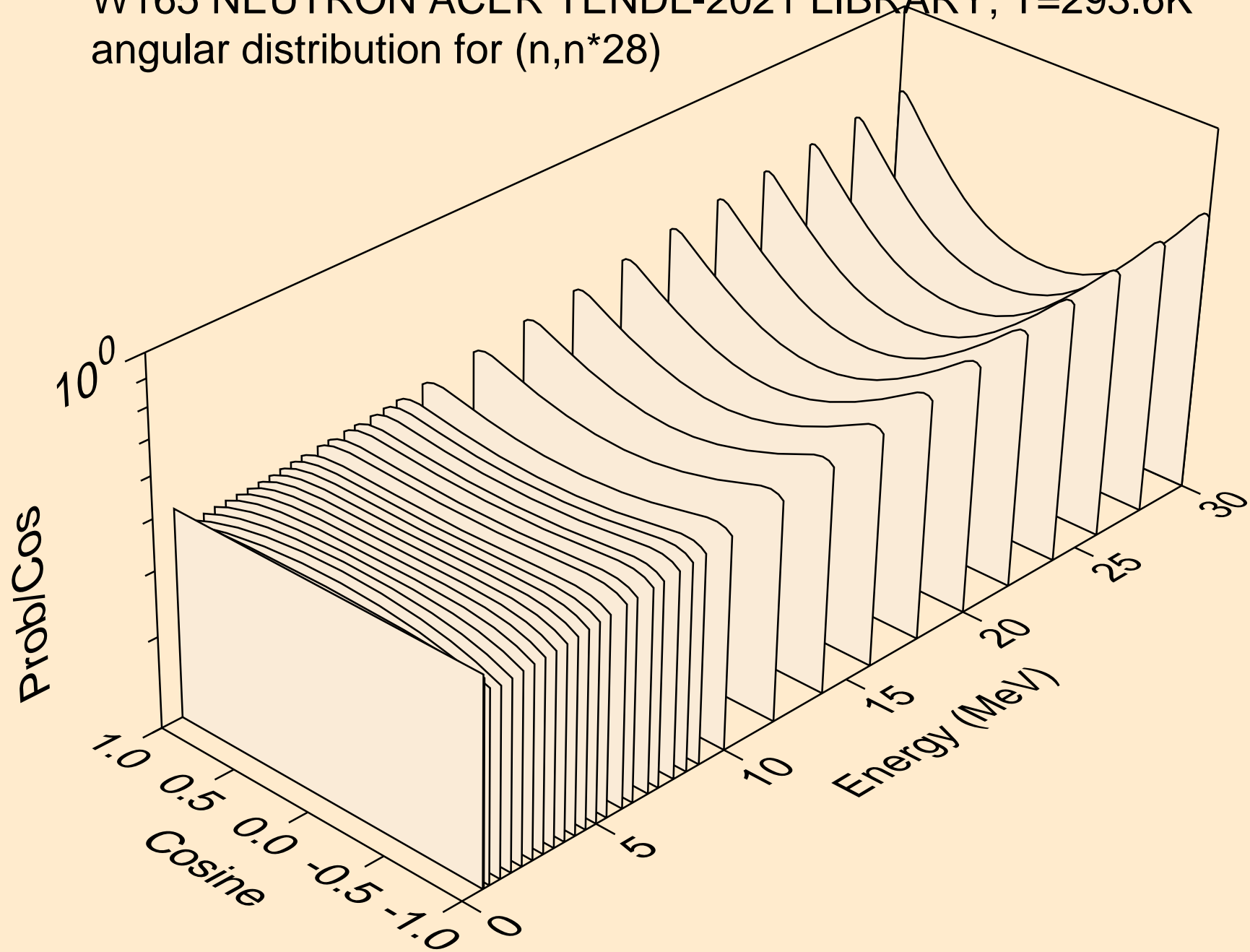

W165 NEUTRON ACER TENDL-2021 LIBRARY; T=293.6K  
angular distribution for (n,n\*29)

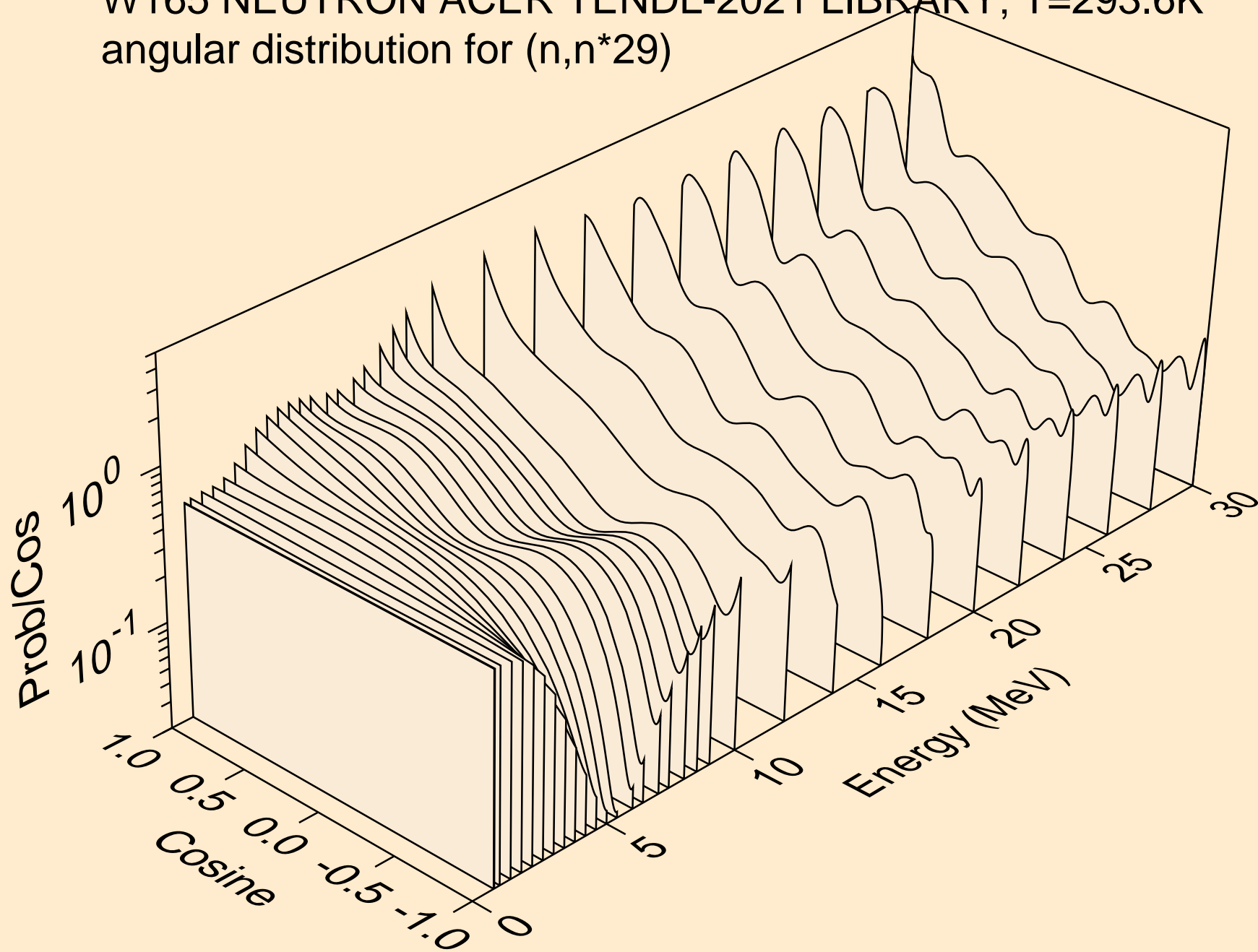

W165 NEUTRON ACER TENDL-2021 LIBRARY; T=293.6K  
angular distribution for (n,n\*30)

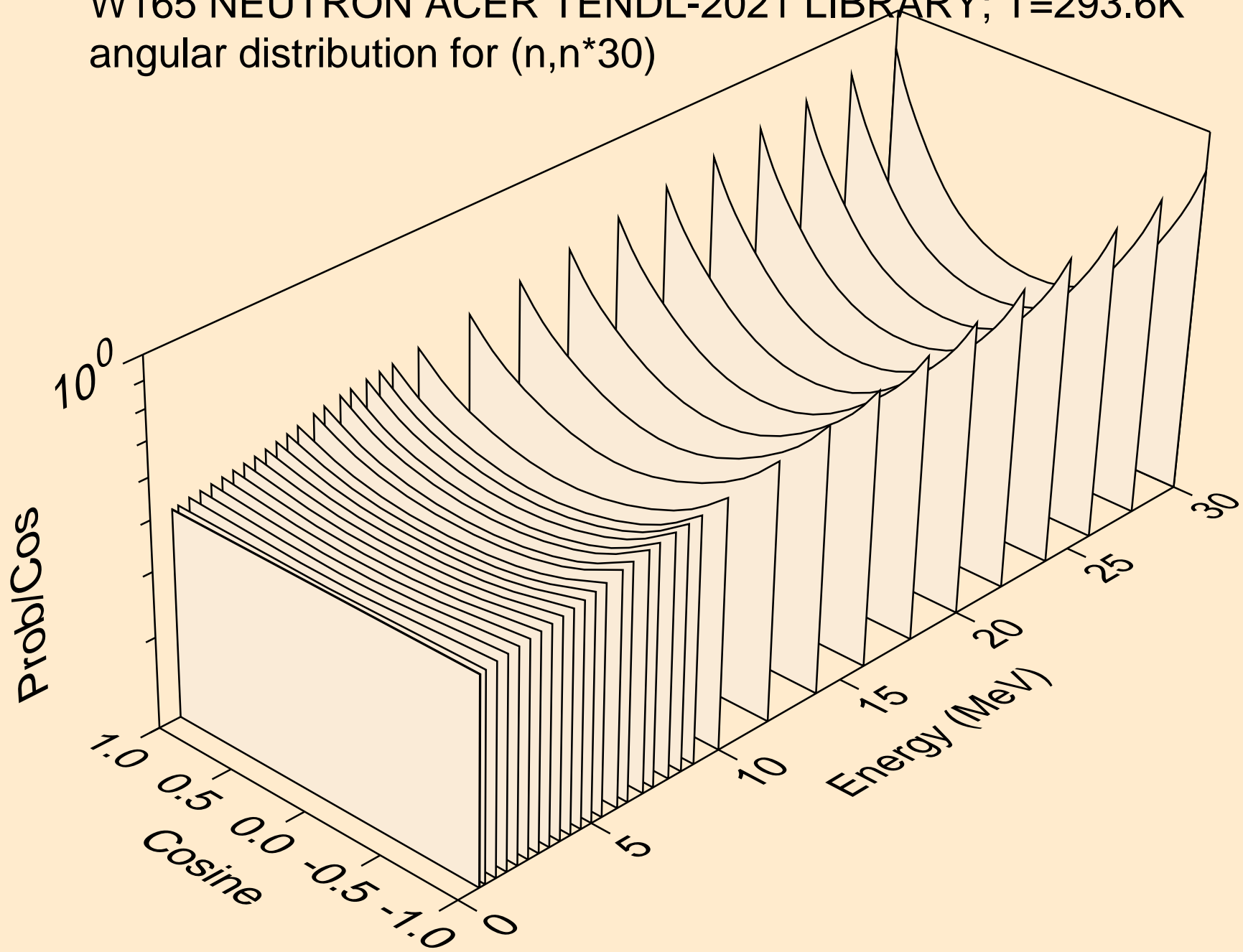

W165 NEUTRON ACER TENDL-2021 LIBRARY; T=293.6K  
Neutron emission for (n,x)

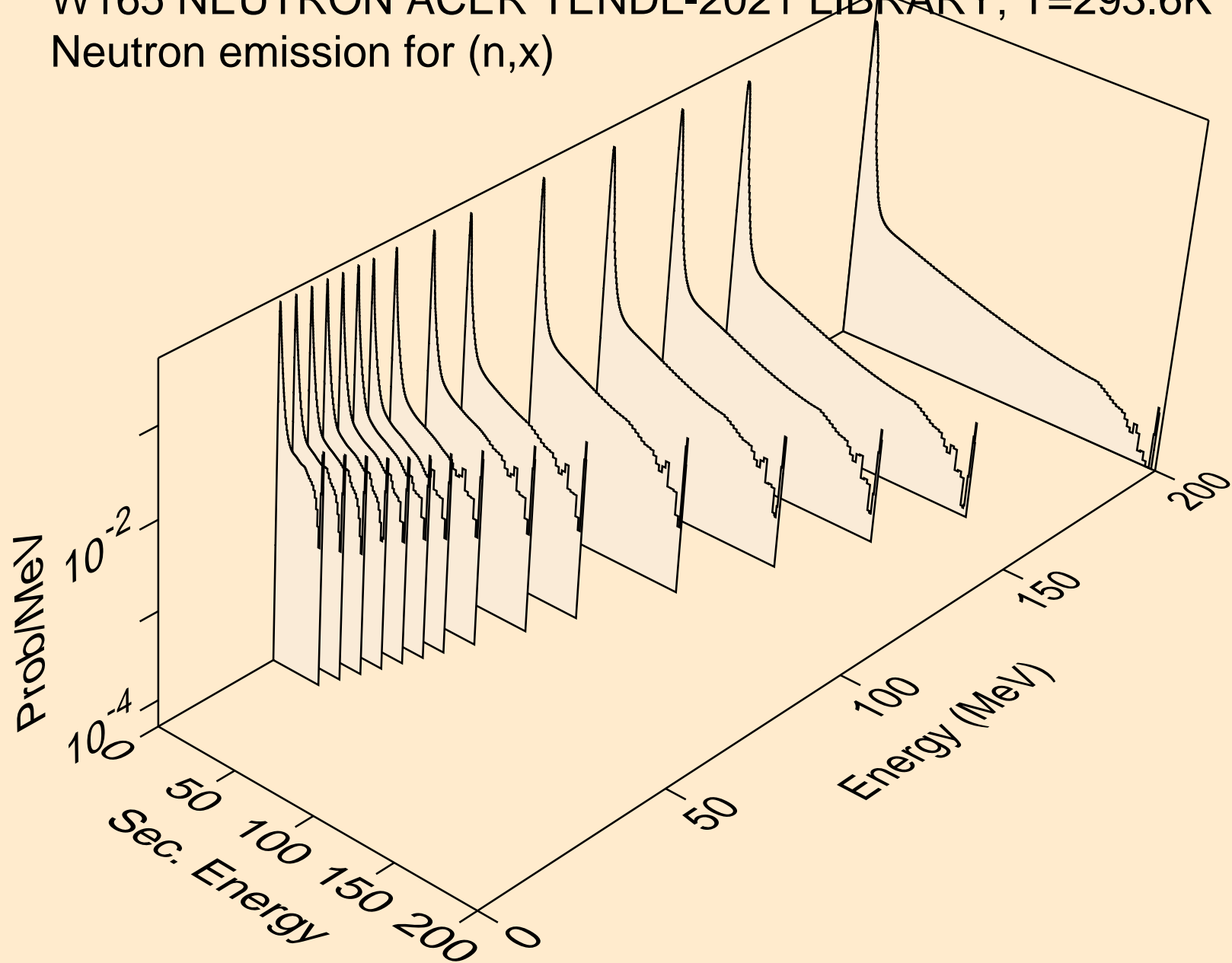



W165 NEUTRON ACER TENDL-2021 LIBRARY; T=293.6K  
Neutron emission for (n,2nd)

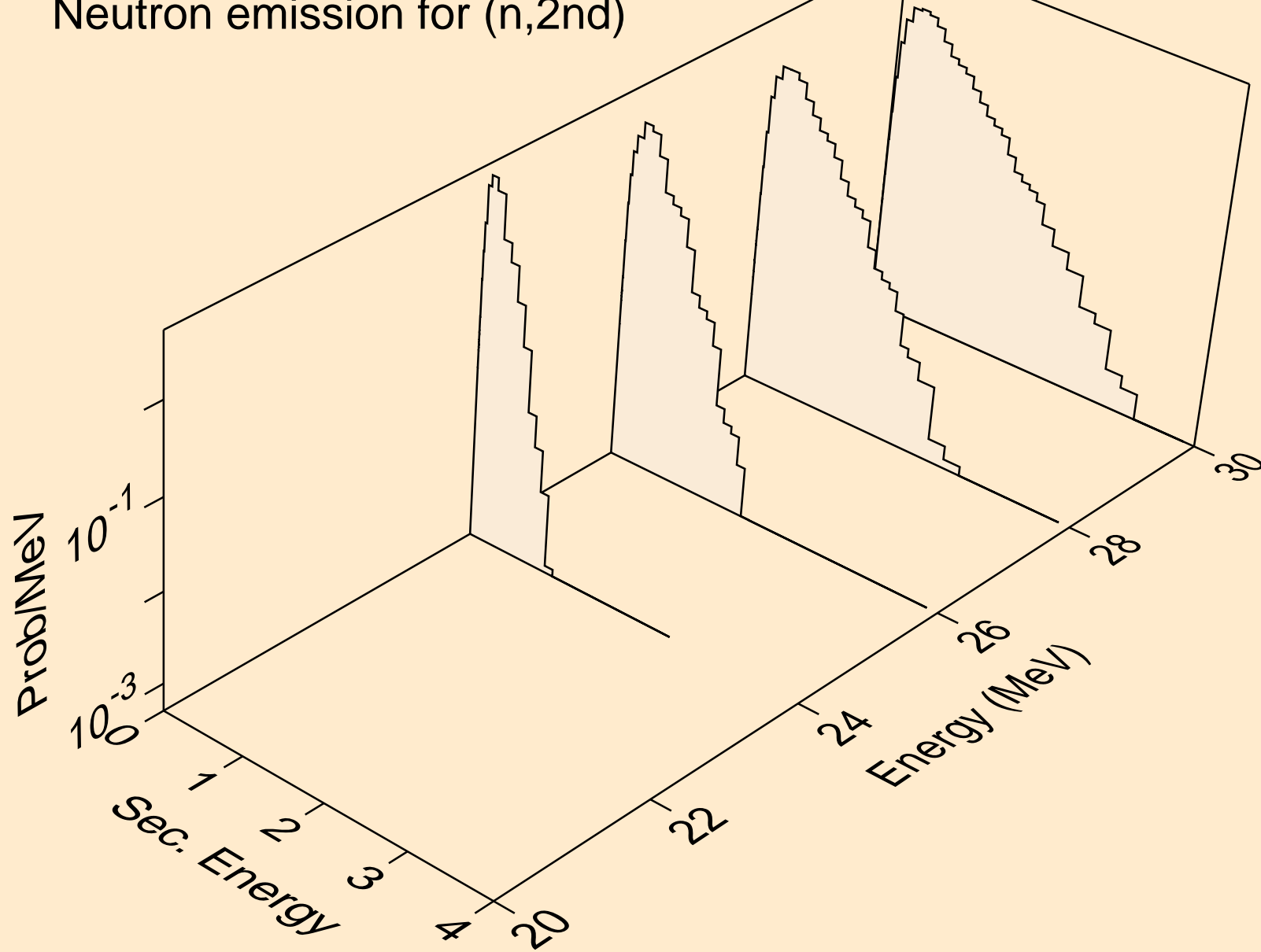

W165 NEUTRON ACER TENDL-2021 LIBRARY; T=293.6K  
Neutron emission for (n,2n)

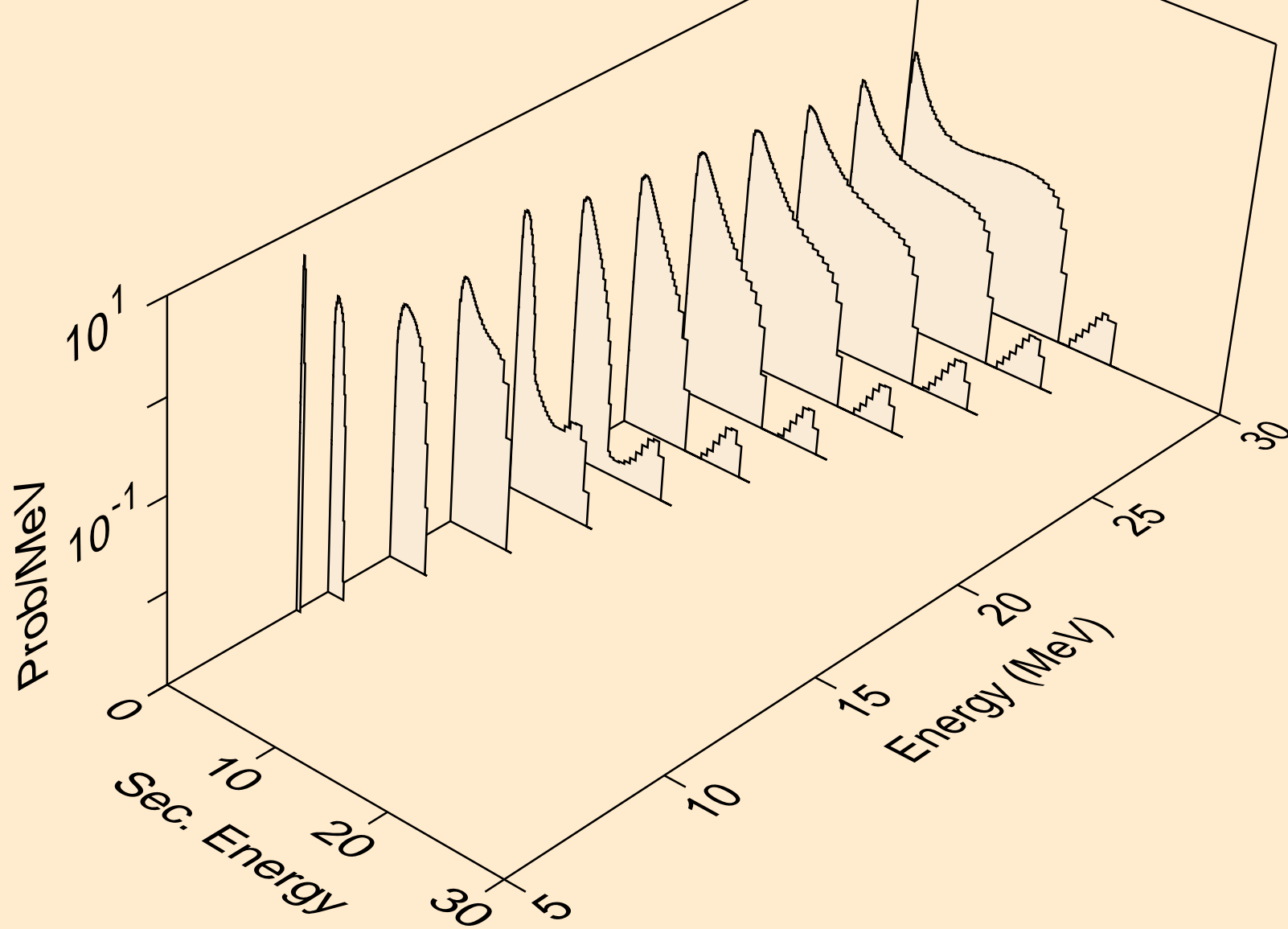

W165 NEUTRON ACER TENDL-2021 LIBRARY; T=293.6K  
Neutron emission for (n,3n)

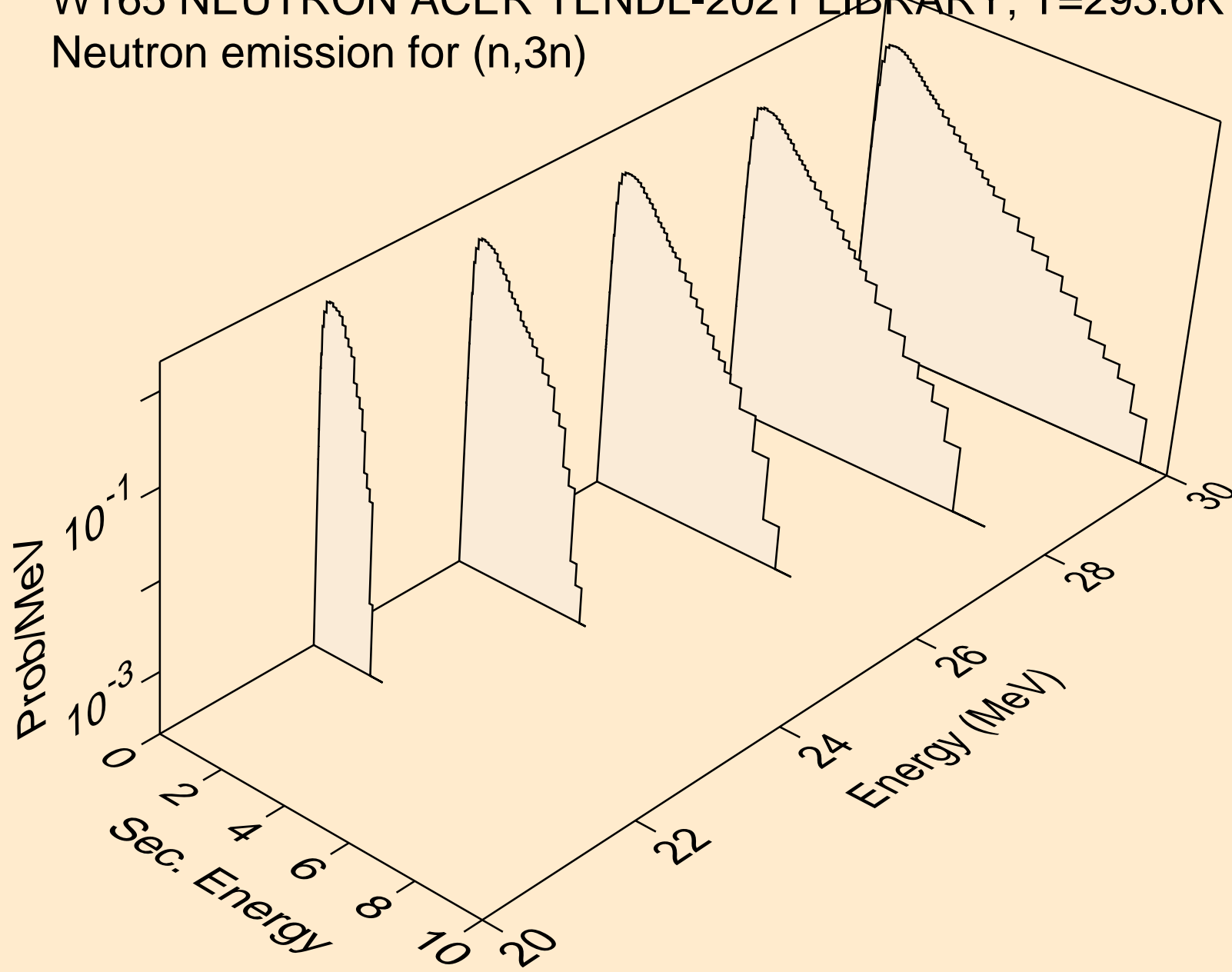

W165 NEUTRON ACER TENDL-2021 LIBRARY; T=293.6K  
Neutron emission for (n,n\*)a

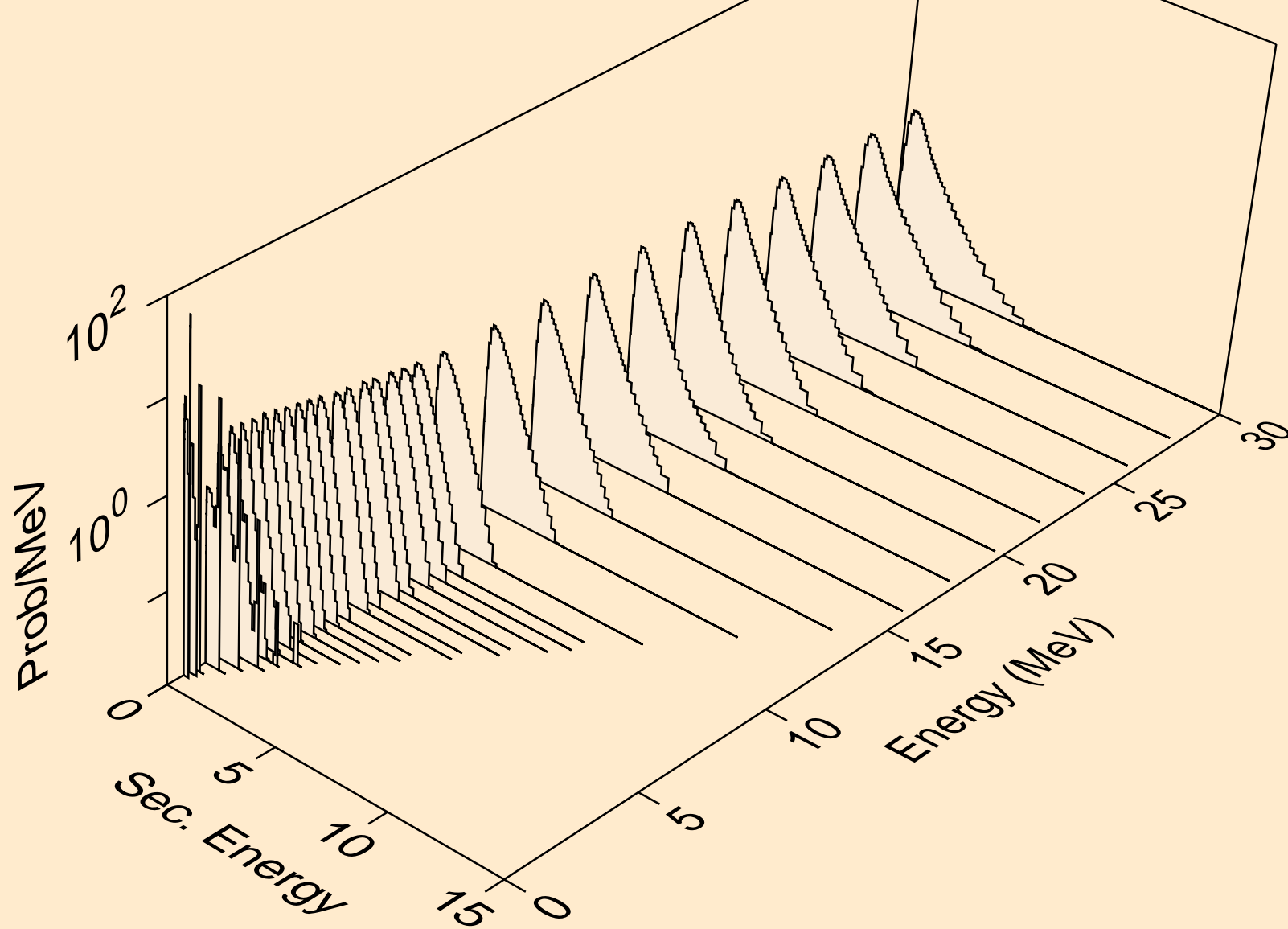

W165 NEUTRON ACER TENDL-2021 LIBRARY; T=293.6K  
Neutron emission for (n,n\*)3a

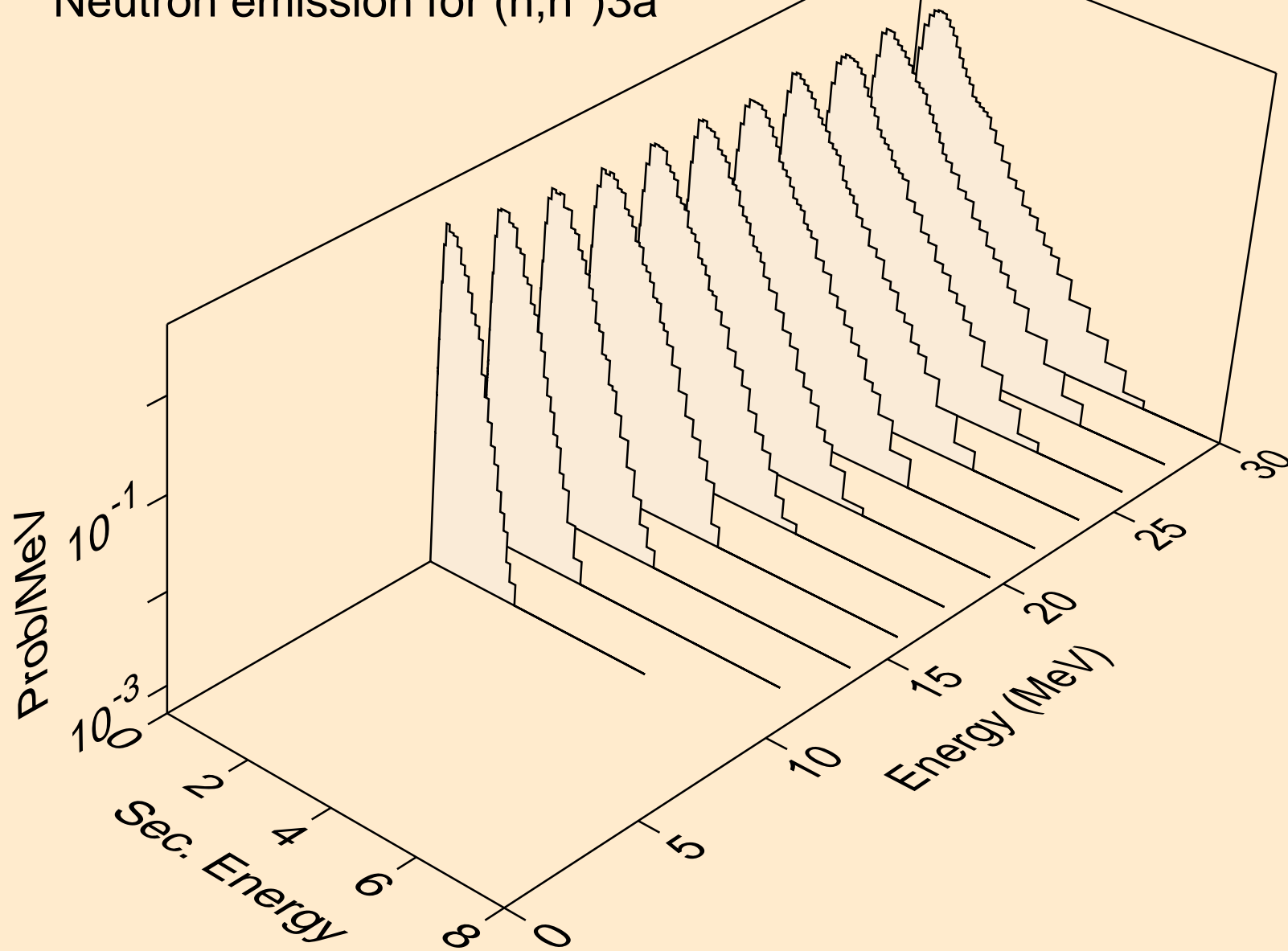

W165 NEUTRON ACER TENDL-2021 LIBRARY; T=293.6K  
Neutron emission for (n,2n)a

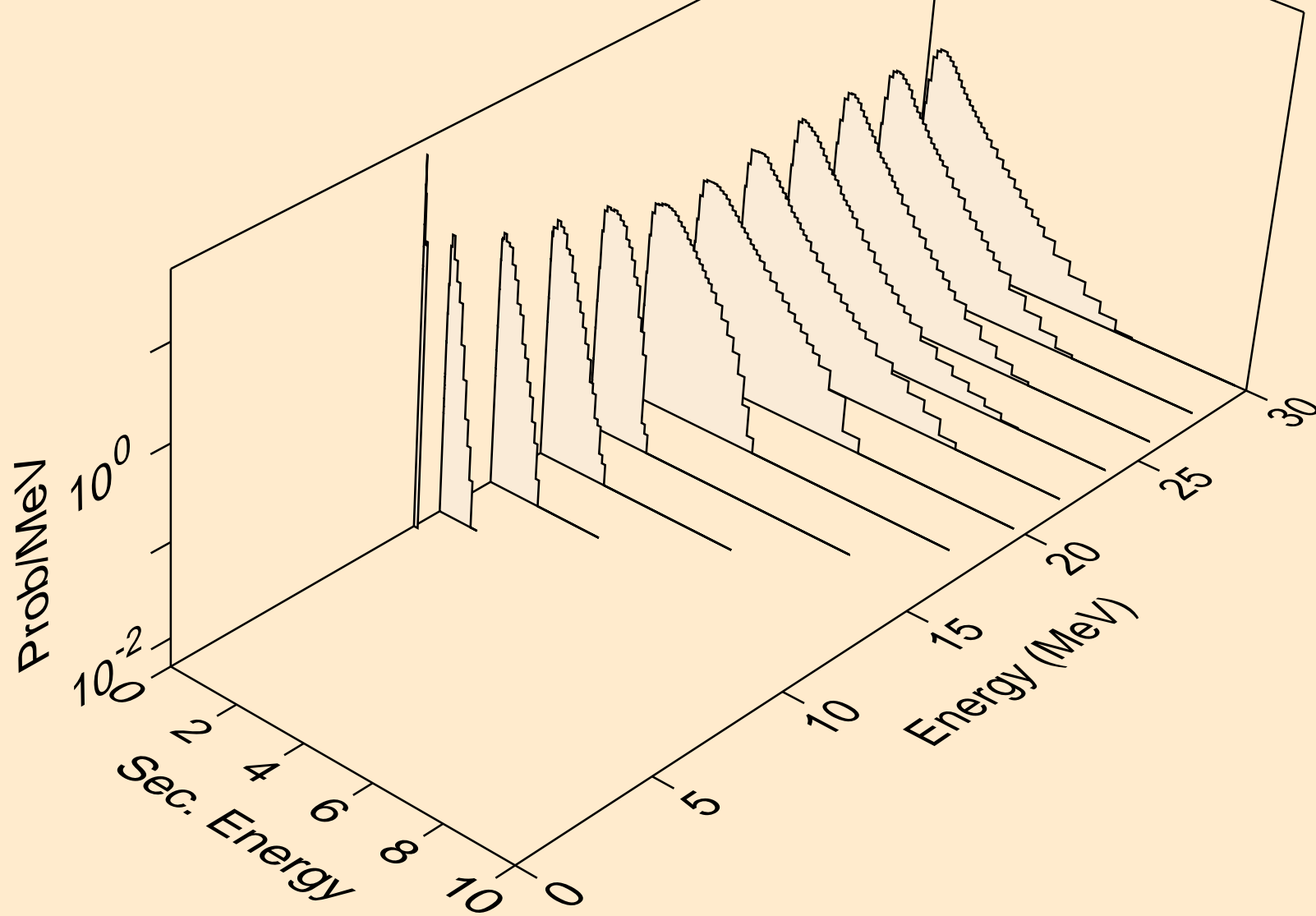

W165 NEUTRON ACER TENDL-2021 LIBRARY; T=293.6K  
Neutron emission for (n,3n)a

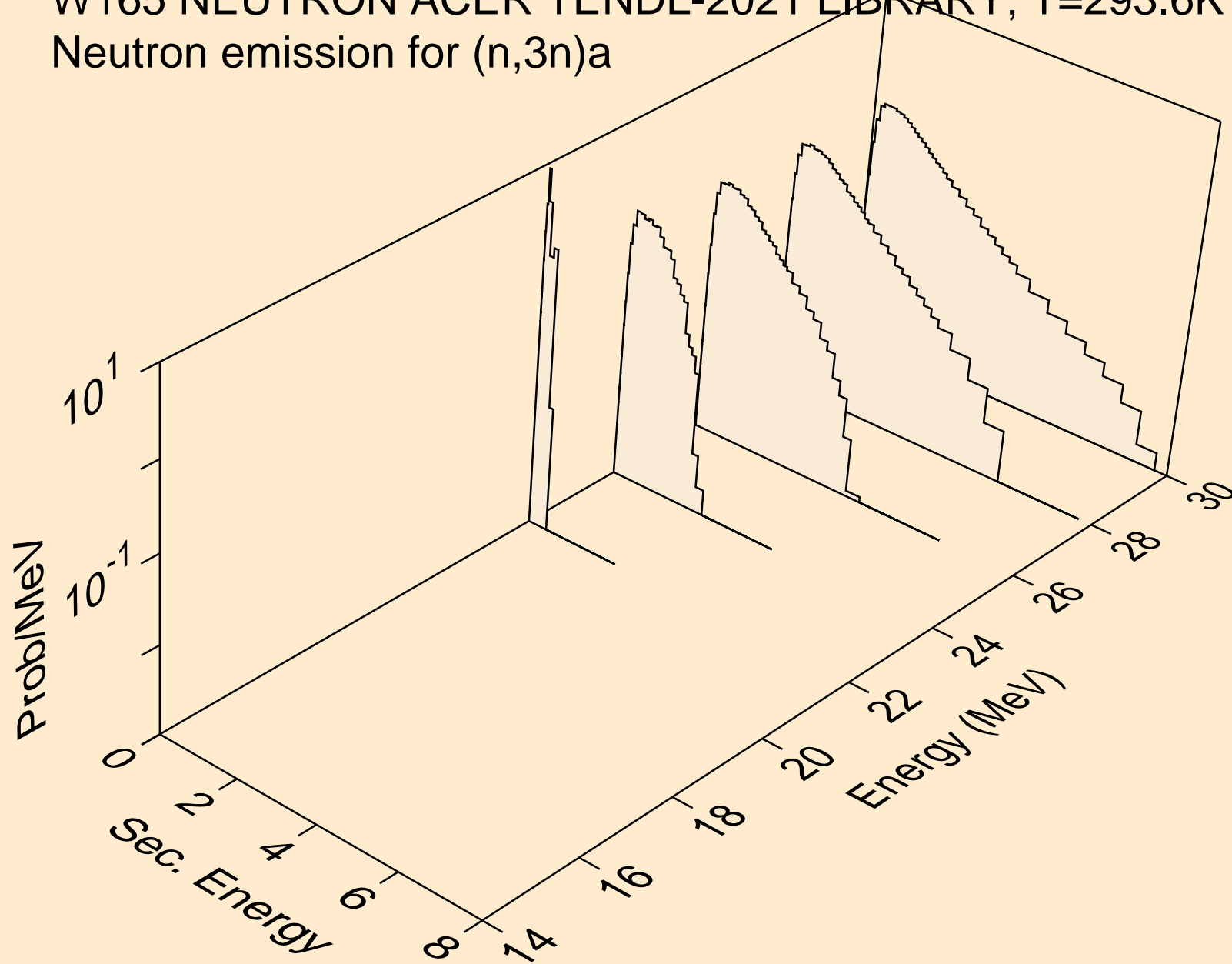

W165 NEUTRON ACER TENDL-2021 LIBRARY; T=293.6K  
Neutron emission for (n,n\*)p

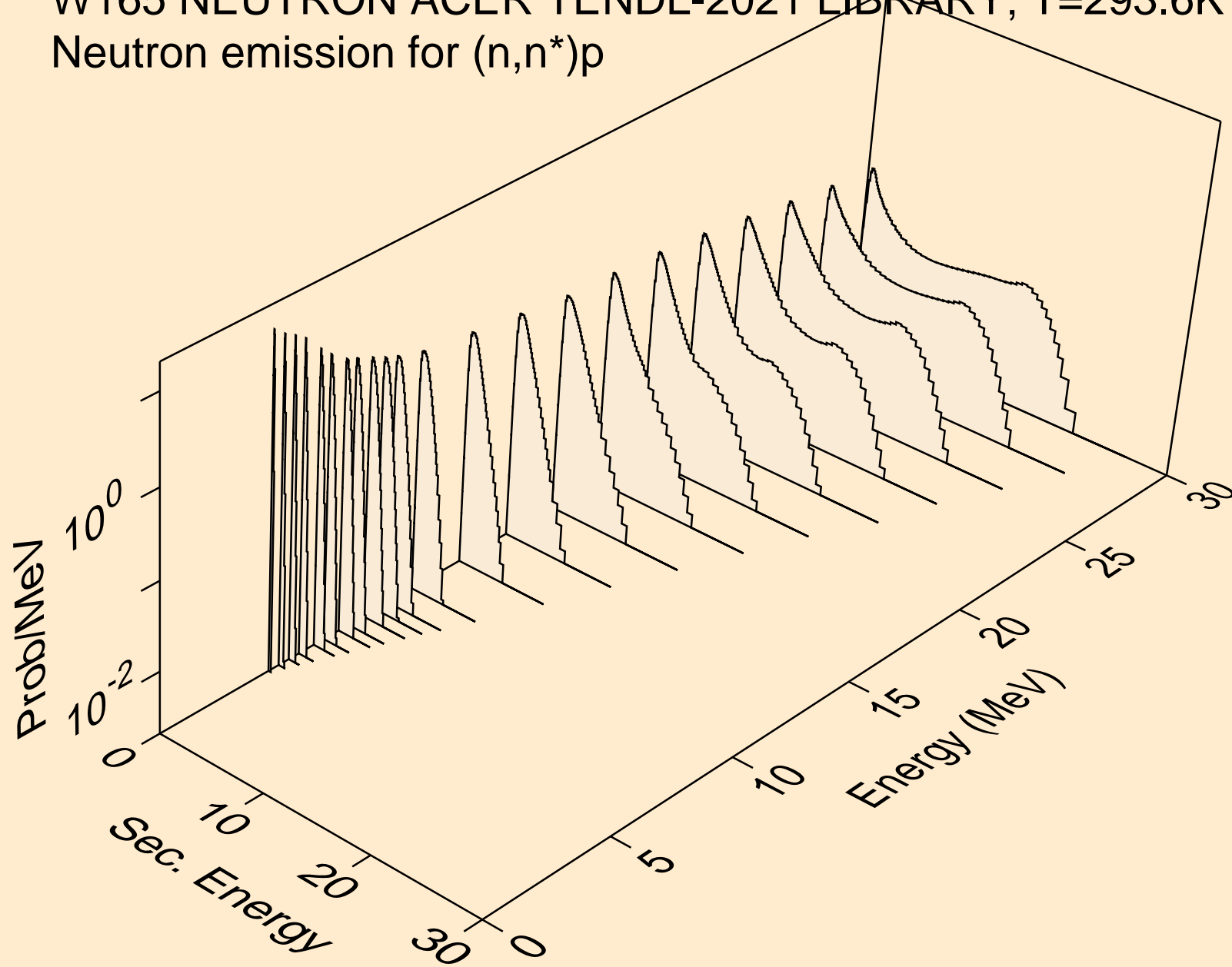



W165 NEUTRON ACER TENDL-2021 LIBRARY; T=293.6K  
Neutron emission for (n,n\*)2a

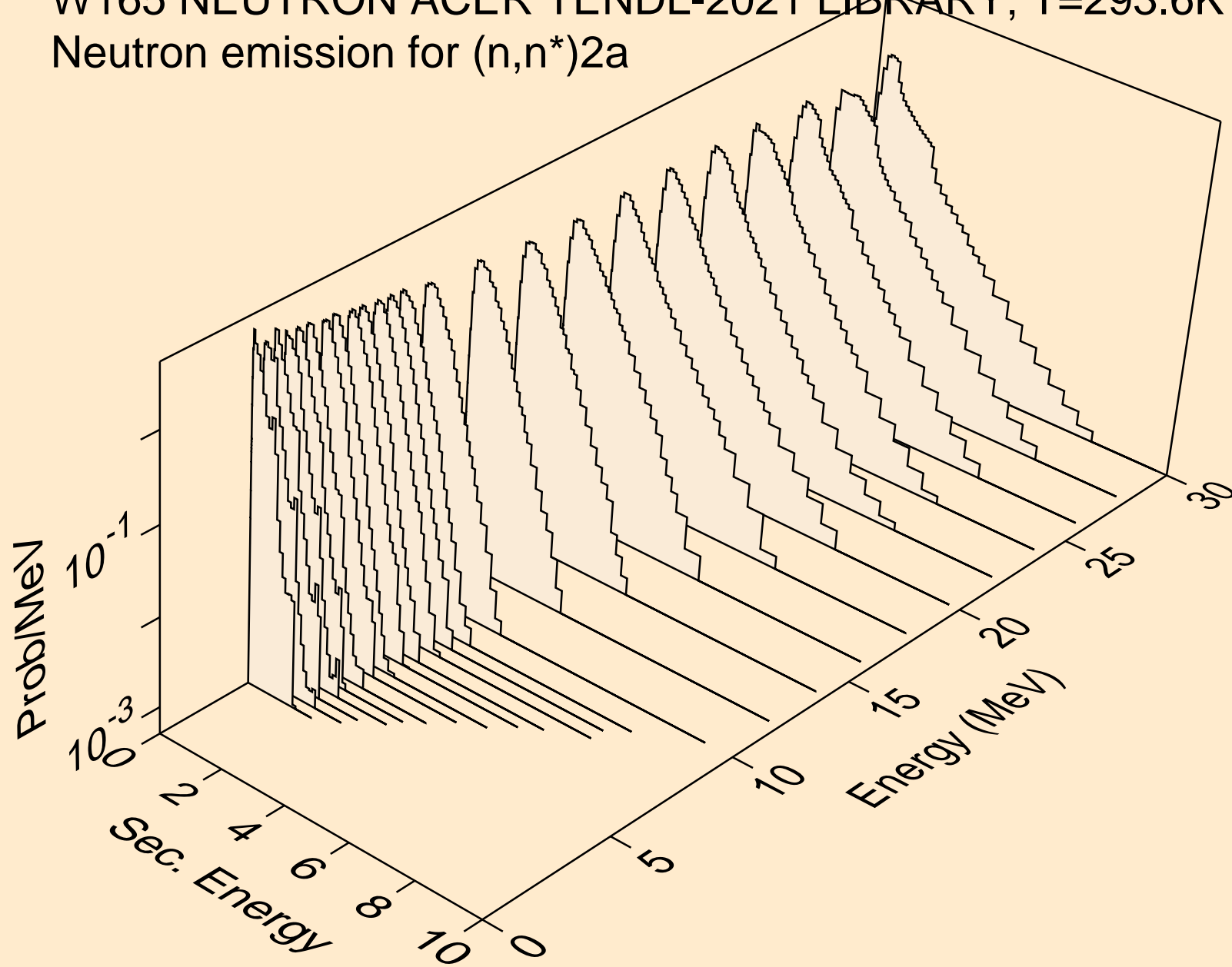

W165 NEUTRON ACER TENDL-2021 LIBRARY; T=293.6K  
Neutron emission for (n,2n)2a

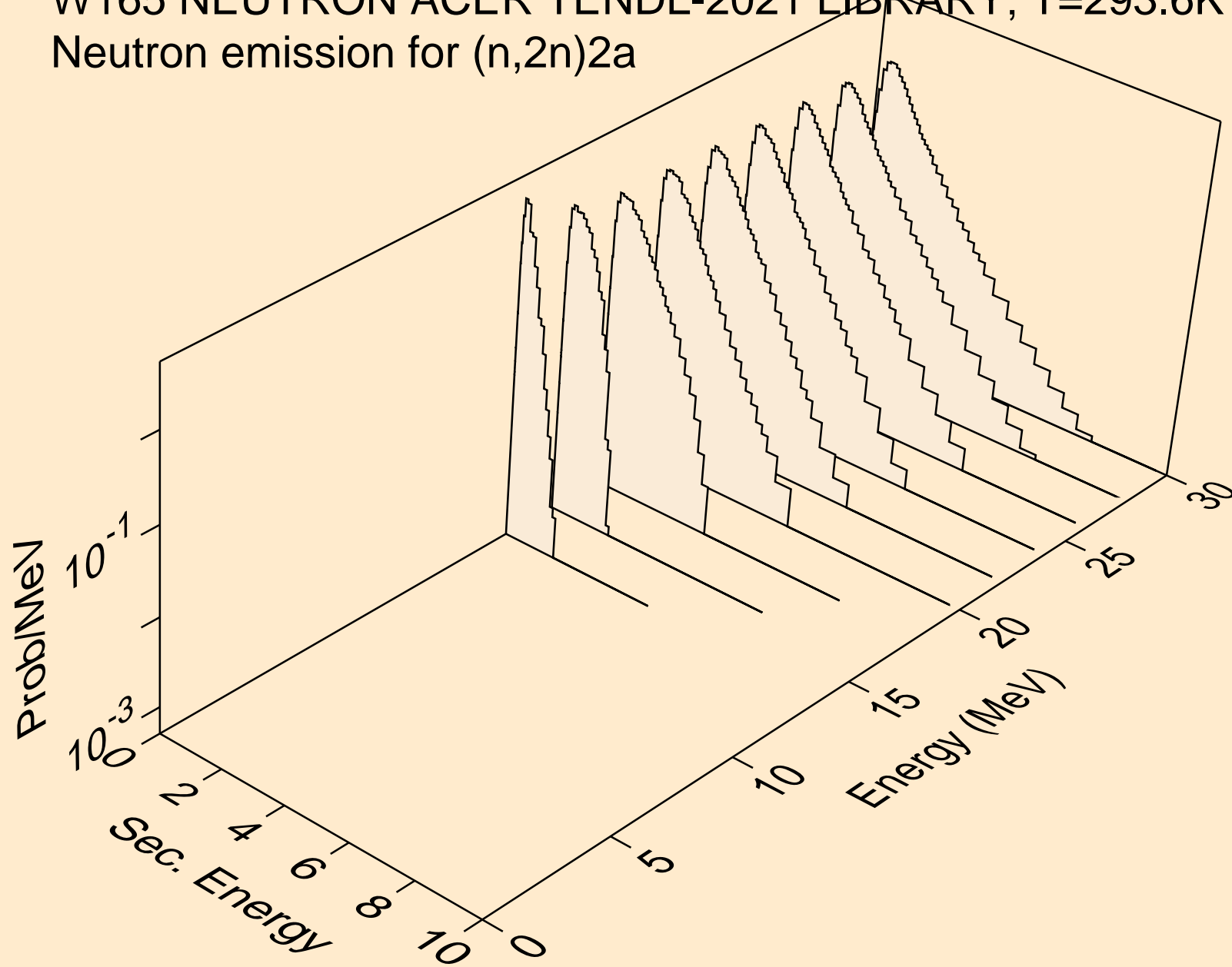

W165 NEUTRON ACER TENDL-2021 LIBRARY; T=293.6K  
Neutron emission for (n,n\*)d

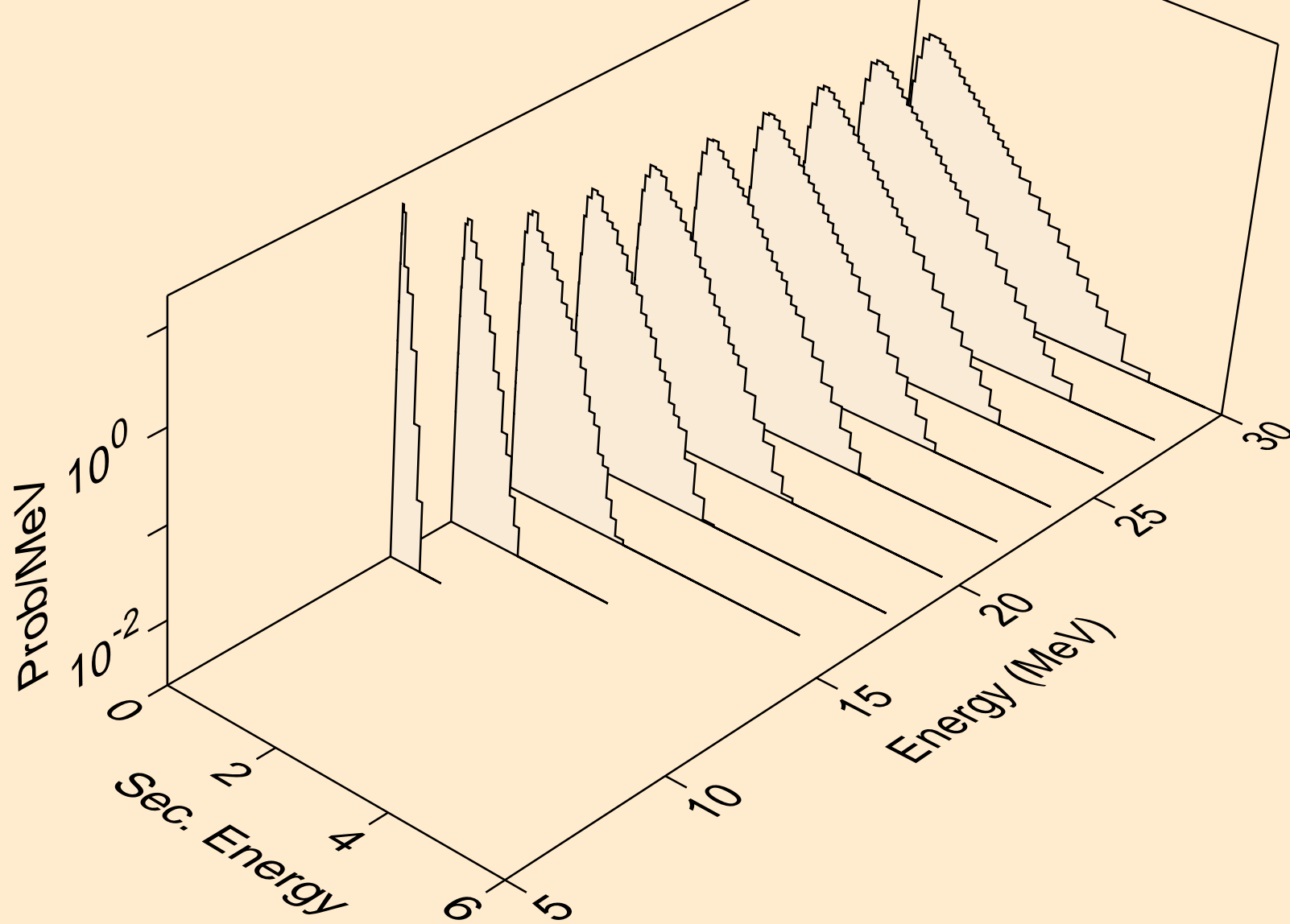

W165 NEUTRON ACER TENDL-2021 LIBRARY; T=293.6K  
Neutron emission for (n,n\*)t

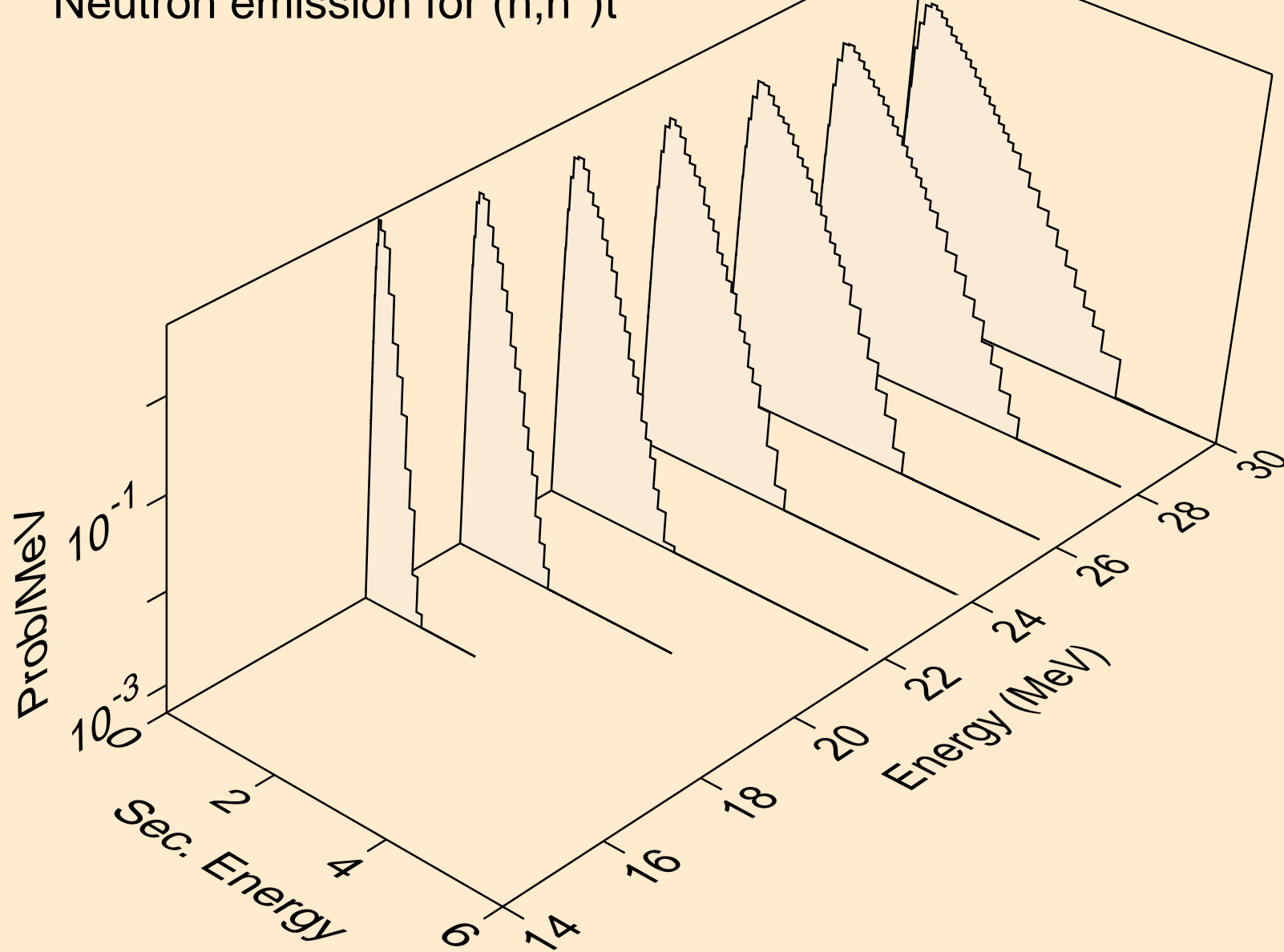

W165 NEUTRON ACER TENDL-2021 LIBRARY; T=293.6K  
Neutron emission for (n,n\*)he3

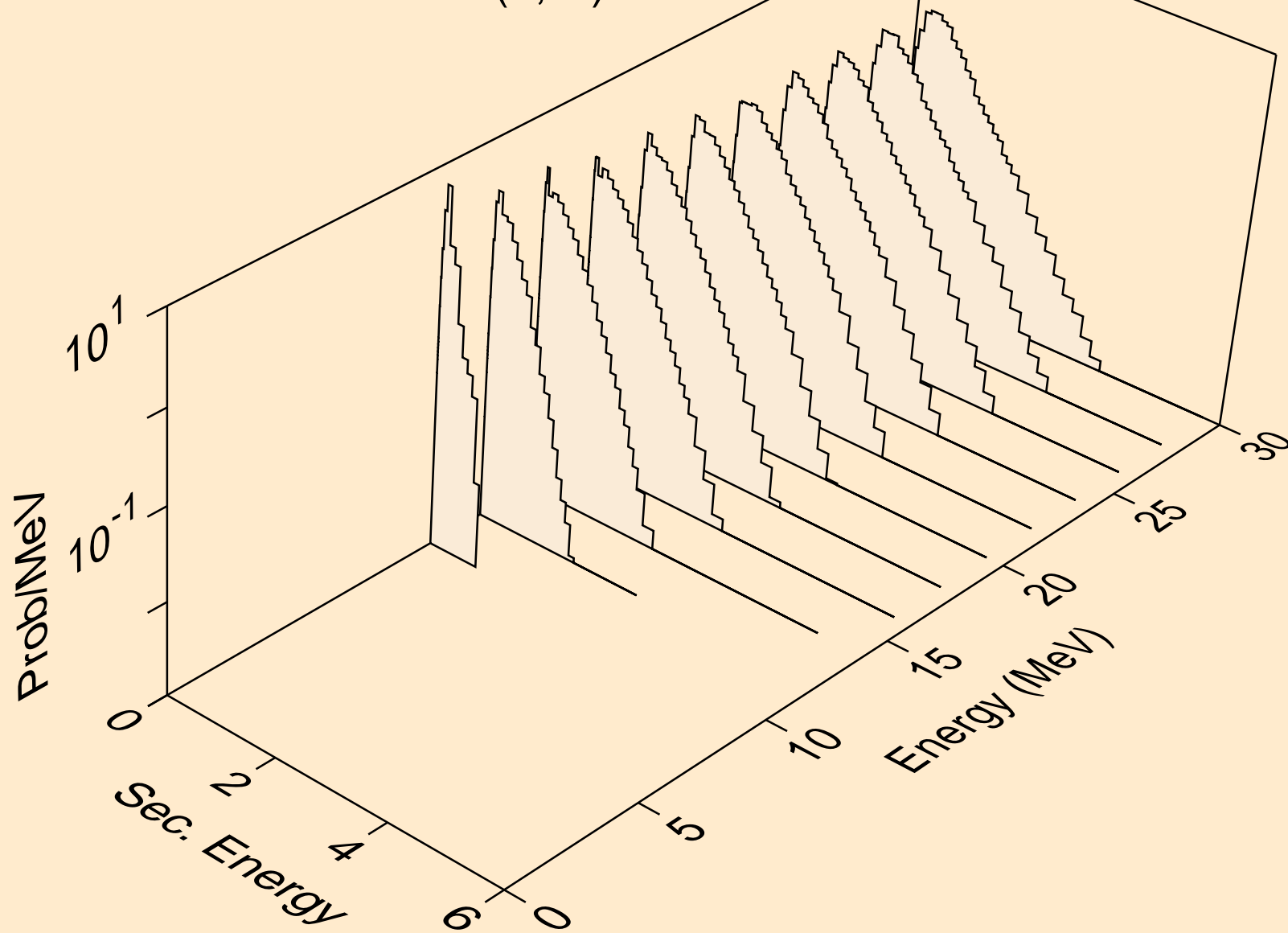

W165 NEUTRON ACER TENDL-2021 LIBRARY; T=293.6K  
Neutron emission for (n,2np)

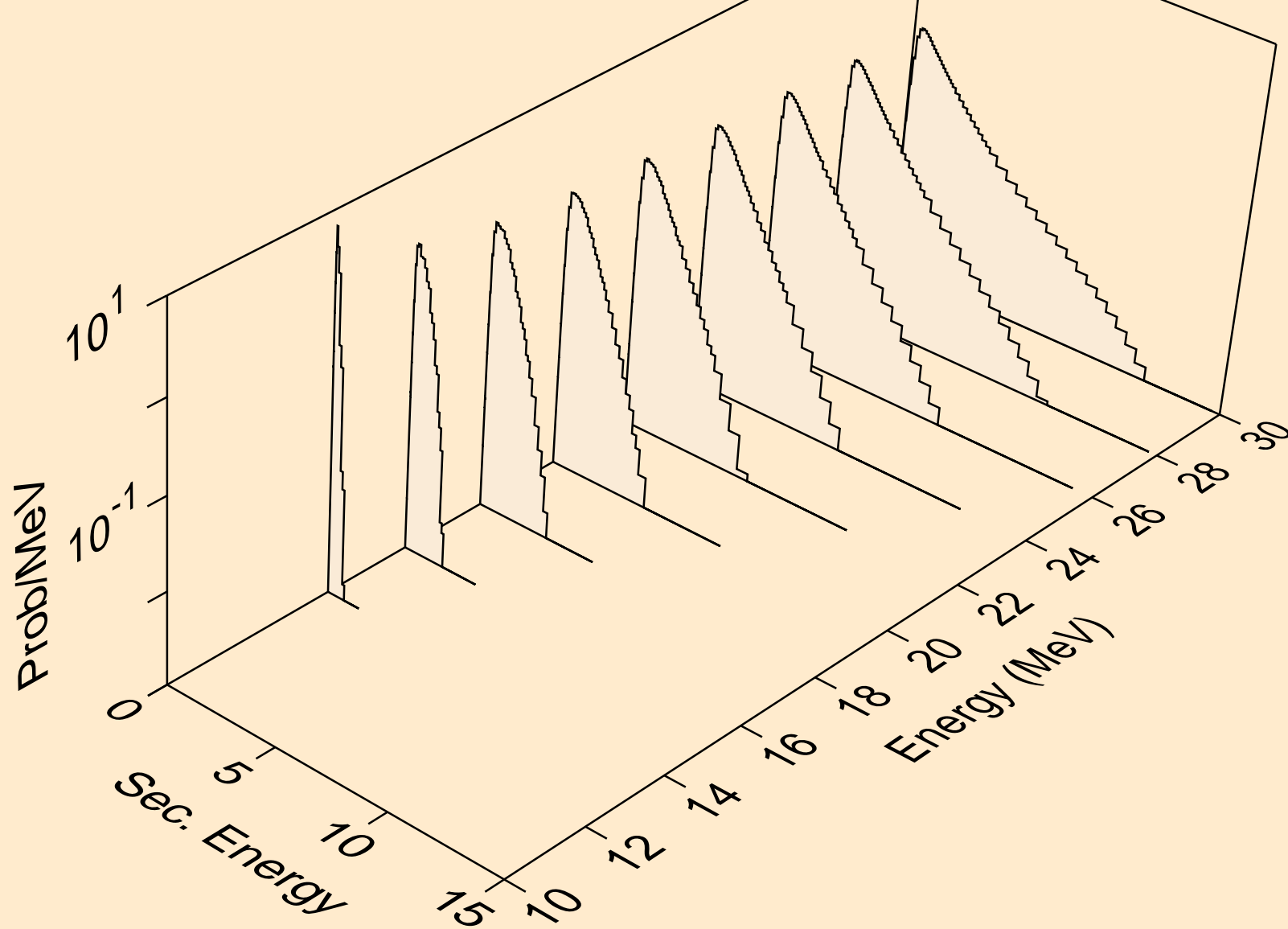

W165 NEUTRON ACER TENDL-2021 LIBRARY; T=293.6K  
Neutron emission for (n,3np)

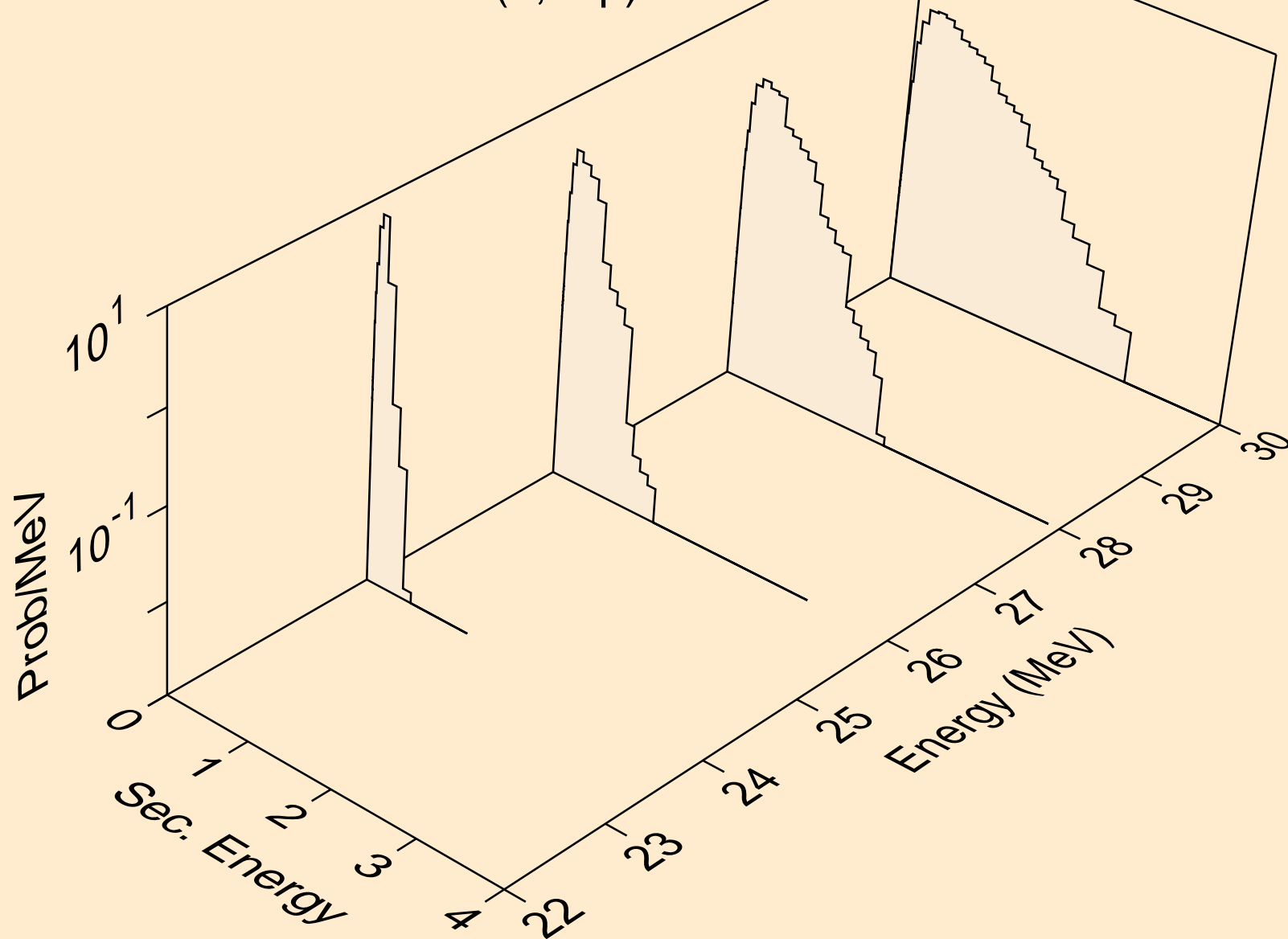

W165 NEUTRON ACER TENDL-2021 LIBRARY; T=293.6K  
Neutron emission for (n,2np)

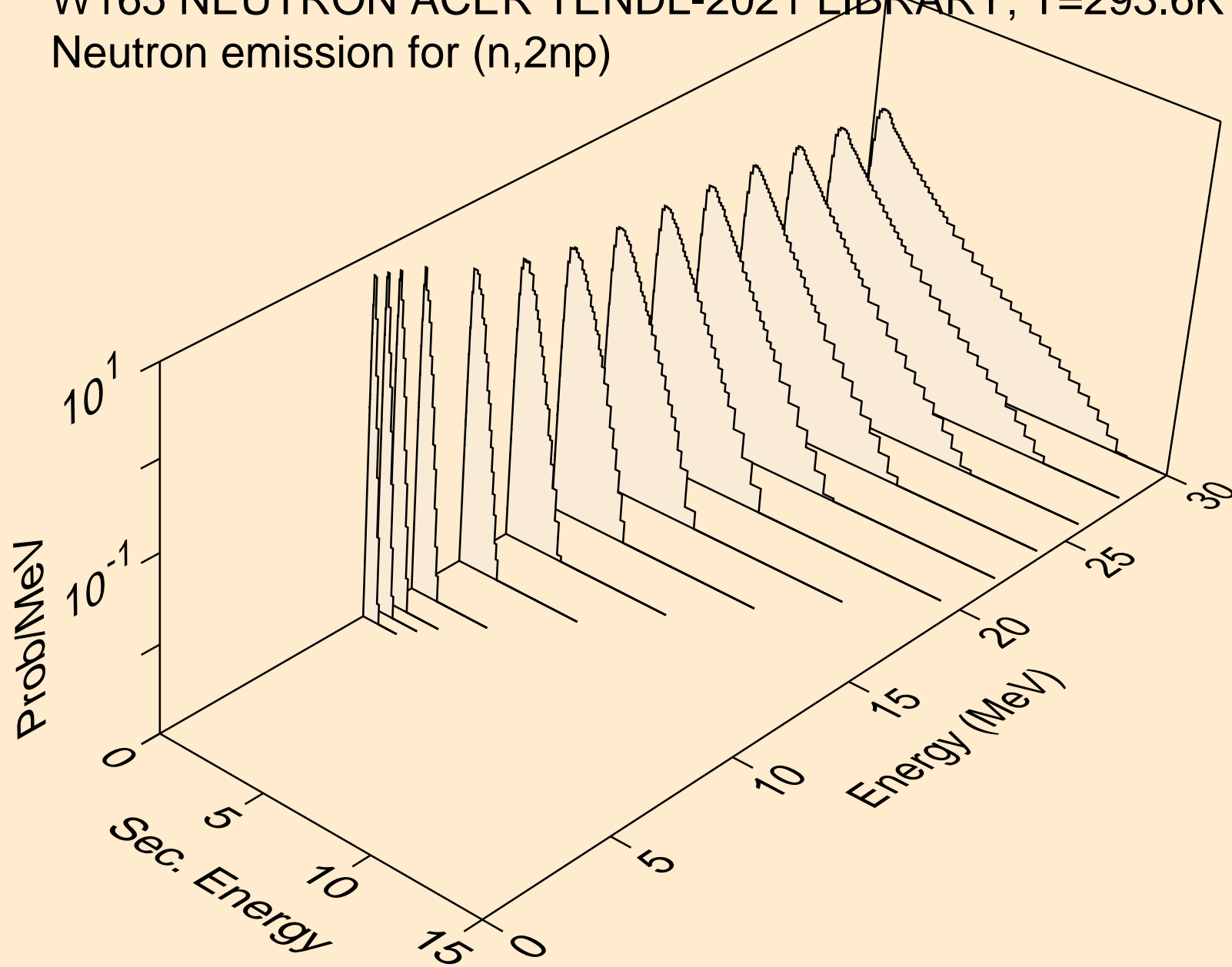



W165 NEUTRON ACER TENDL-2021 LIBRARY; T=293.6K  
Neutron emission for (n,npa)

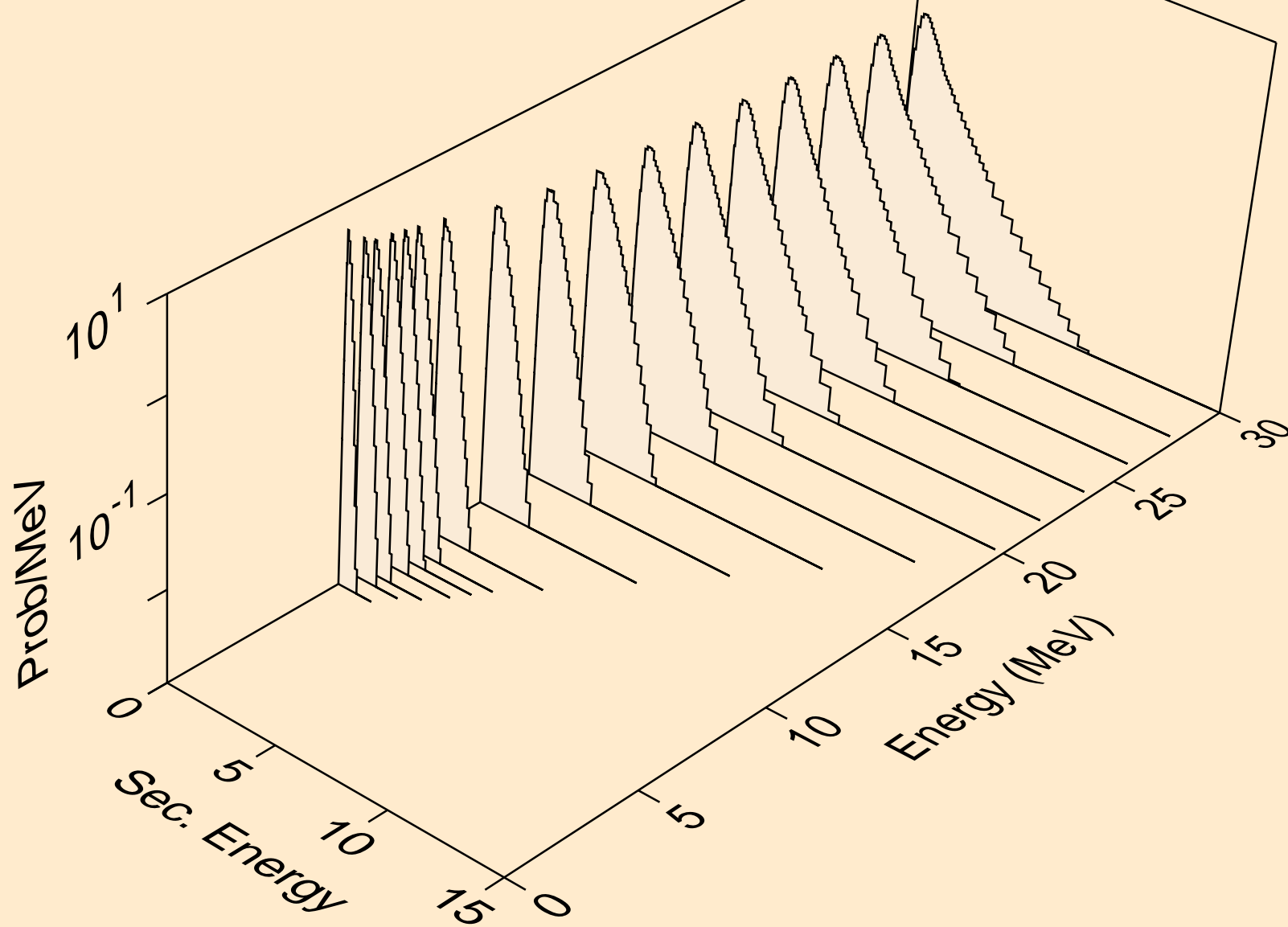

W165 NEUTRON ACER TENDL-2021 LIBRARY; T=293.6K  
Neutron emission for (n,n\*c)

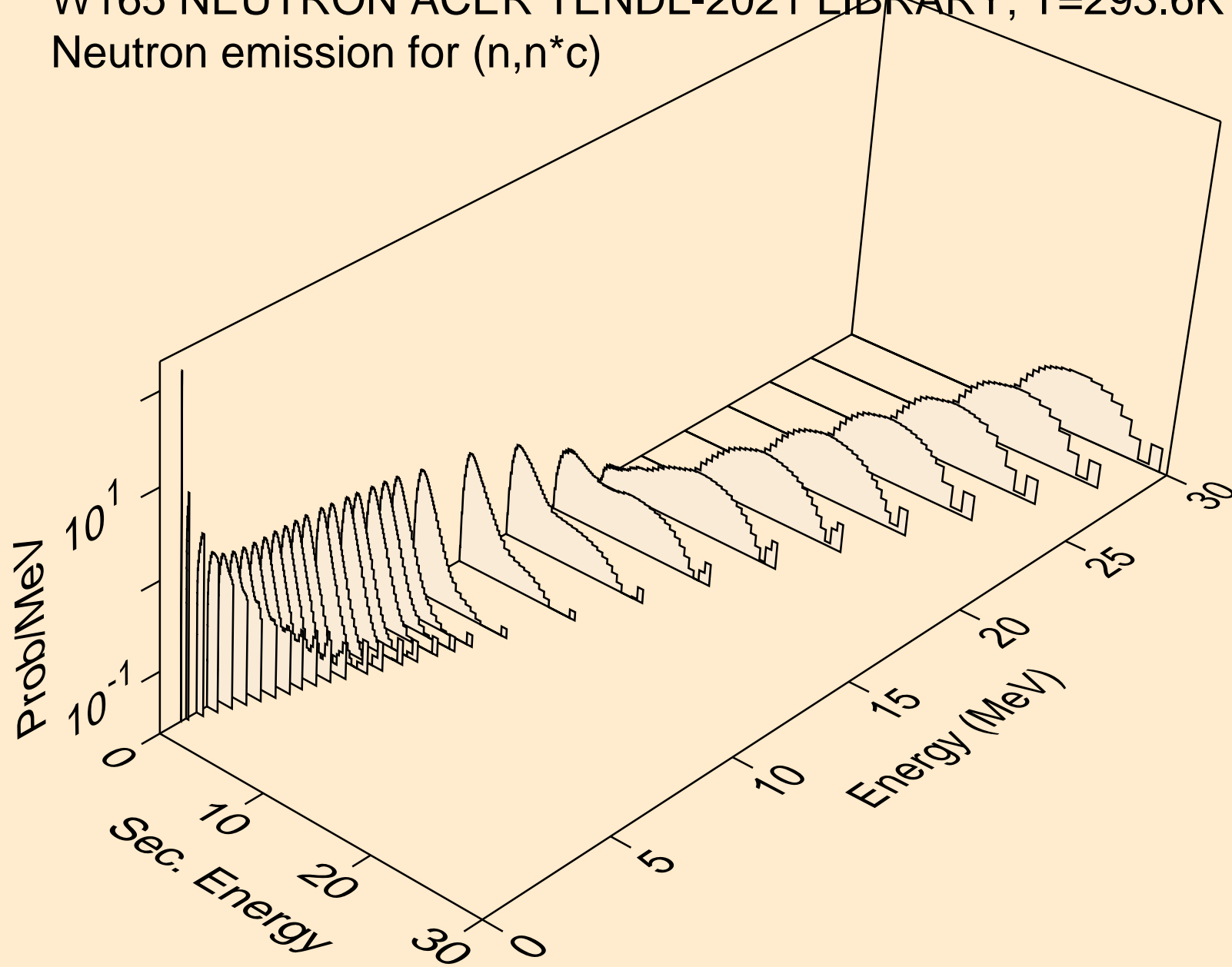

W165 NEUTRON ACER TENDL-2021 LIBRARY; T=293.6K  
Photon emission for (n,x)

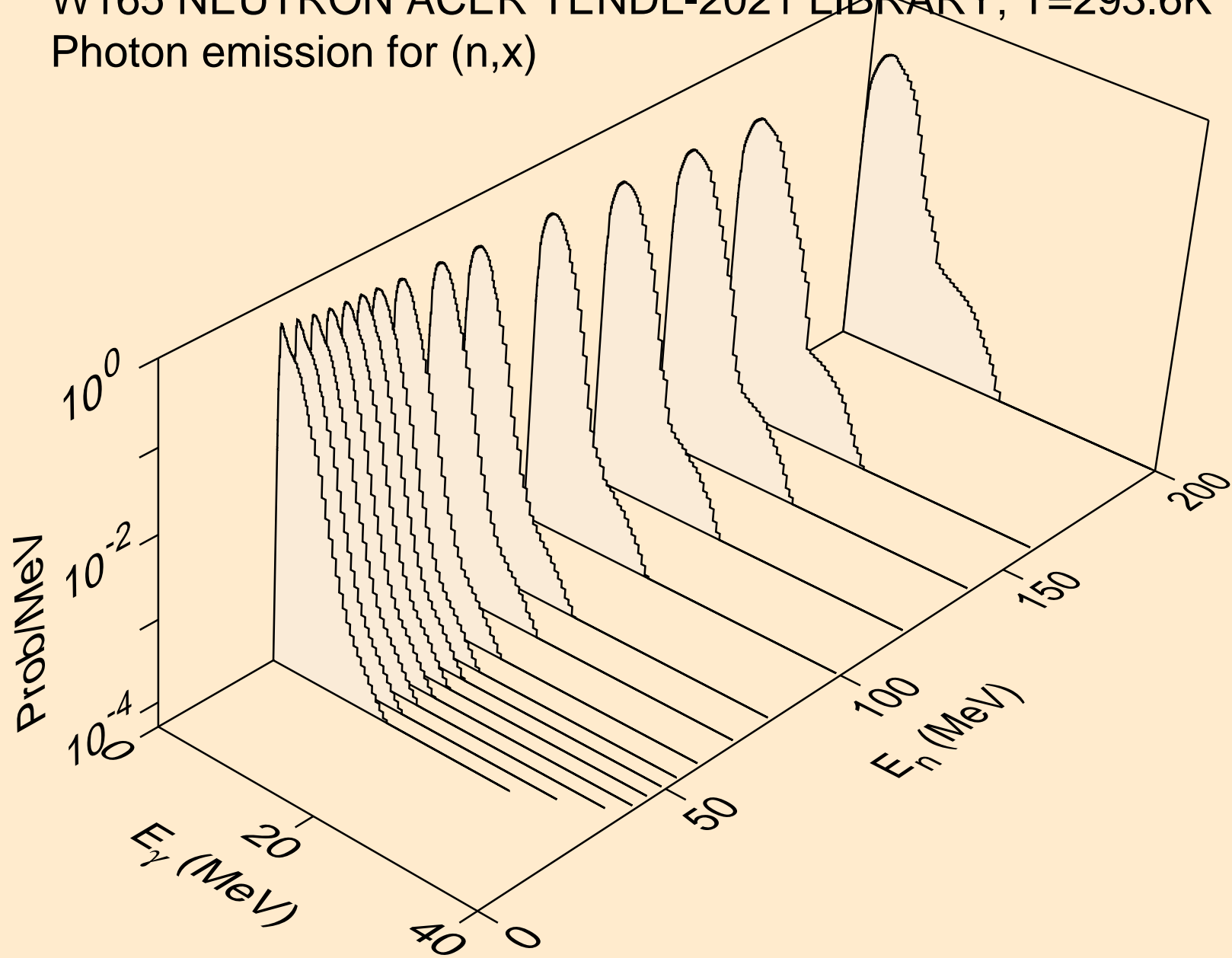

W165 NEUTRON ACER TENDL-2021 LIBRARY; T=293.6K  
Photon emission for (n,2nd)

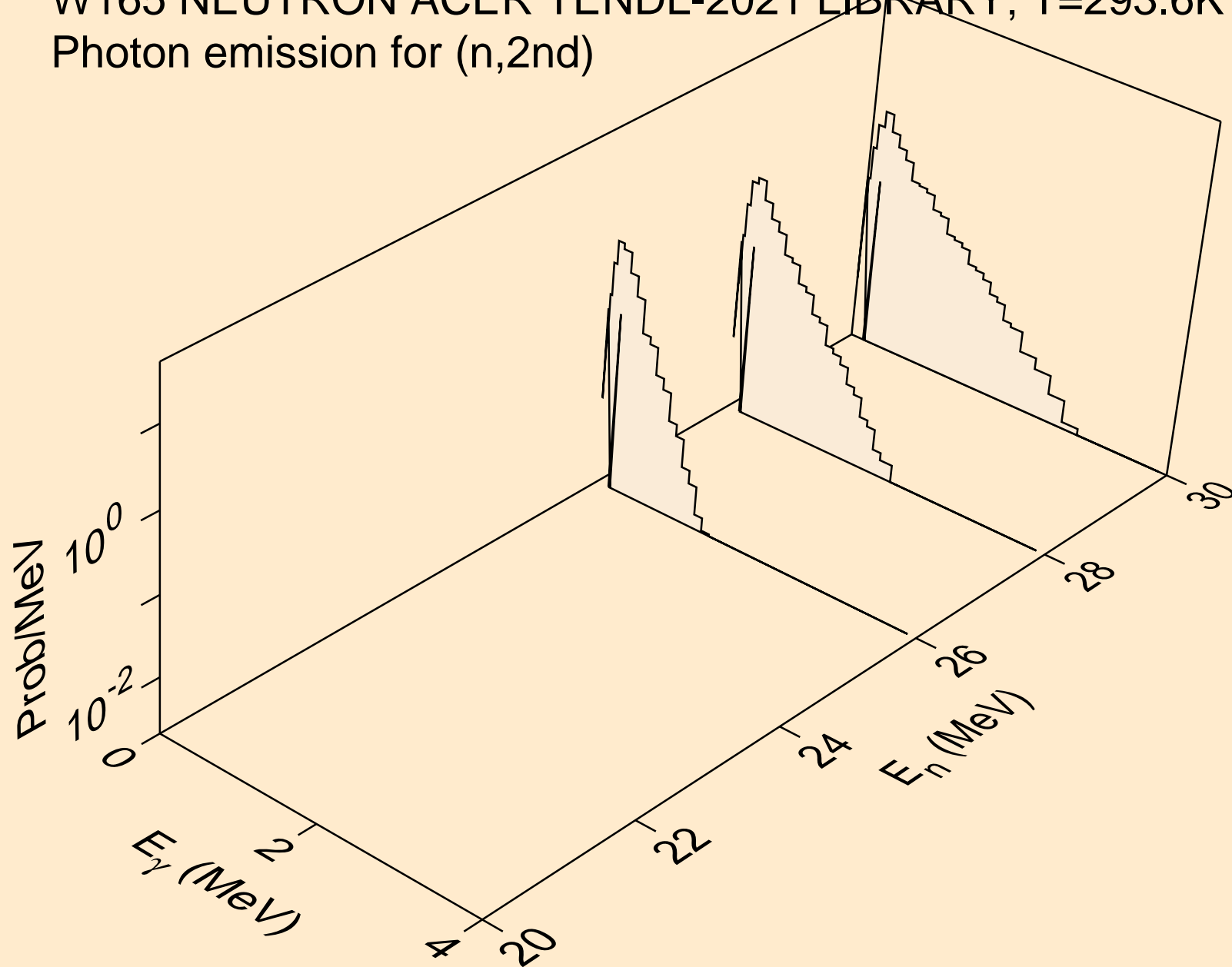

W165 NEUTRON ACER TENDL-2021 LIBRARY; T=293.6K  
Photon emission for (n,2n)

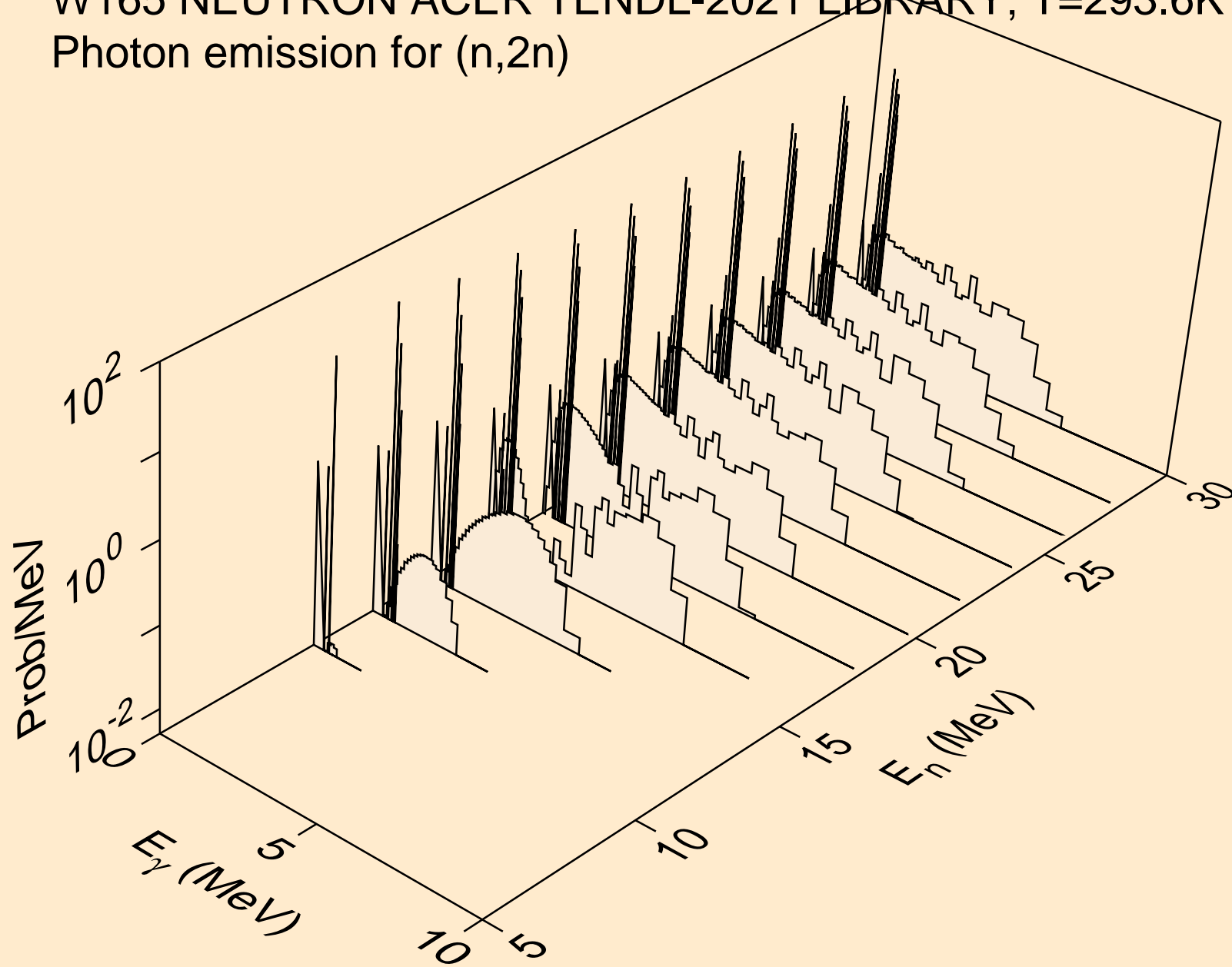

W165 NEUTRON ACER TENDL-2021 LIBRARY; T=293.6K  
Photon emission for (n,3n)

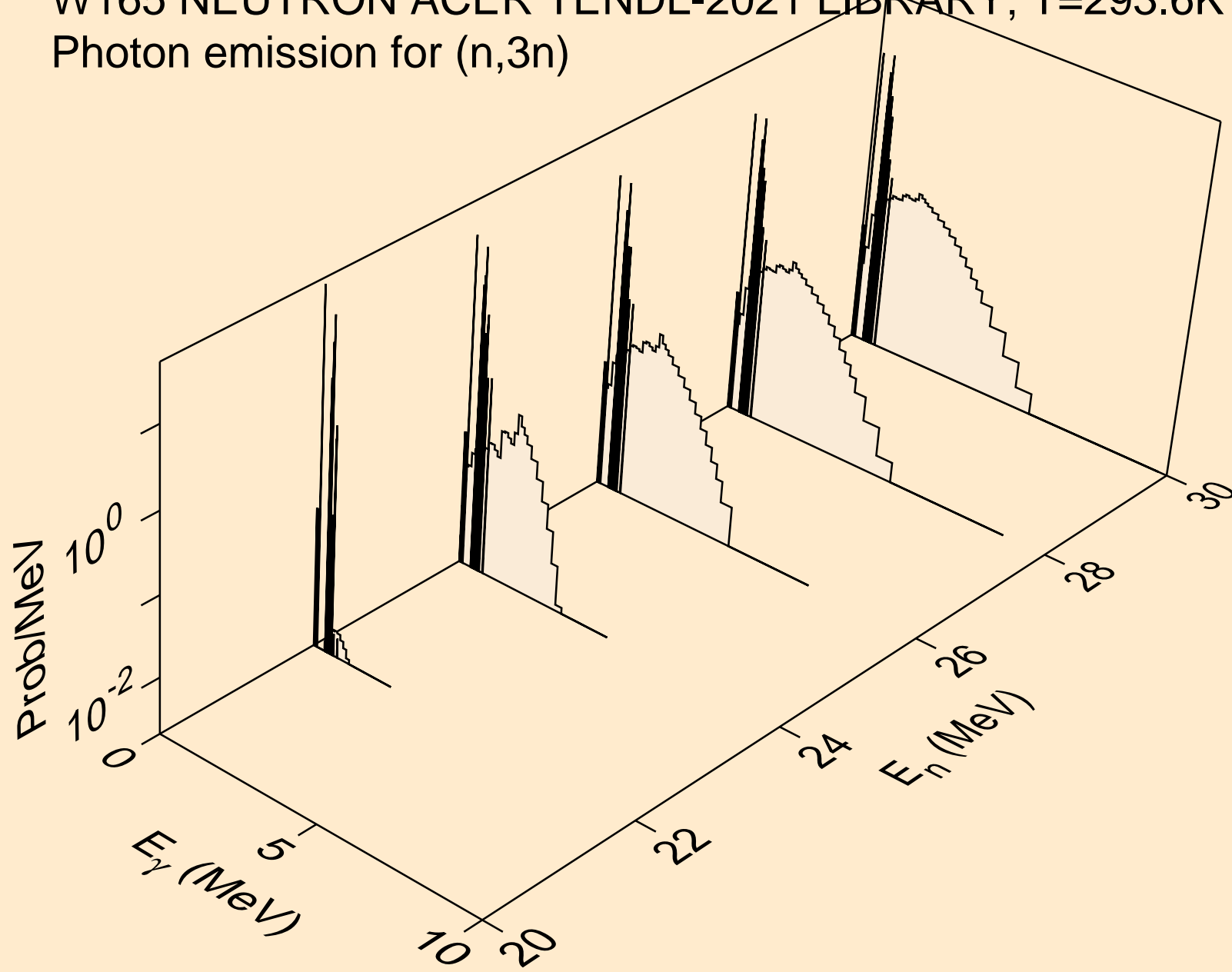

W165 NEUTRON ACER TENDL-2021 LIBRARY; T=293.6K  
Photon emission for (n,n\*)a

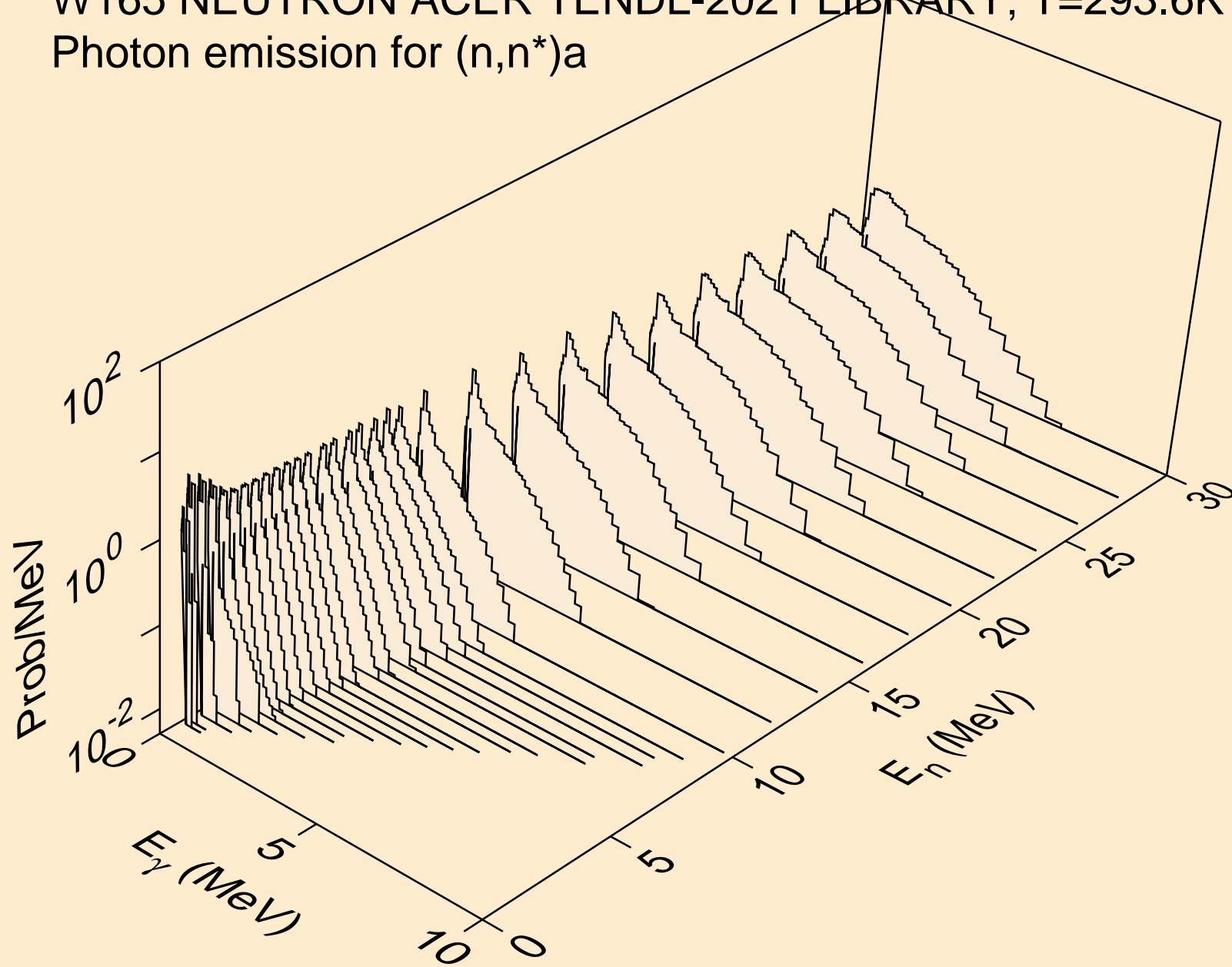

W165 NEUTRON ACER TENDL-2021 LIBRARY; T=293.6K  
Photon emission for (n,n\*)3a

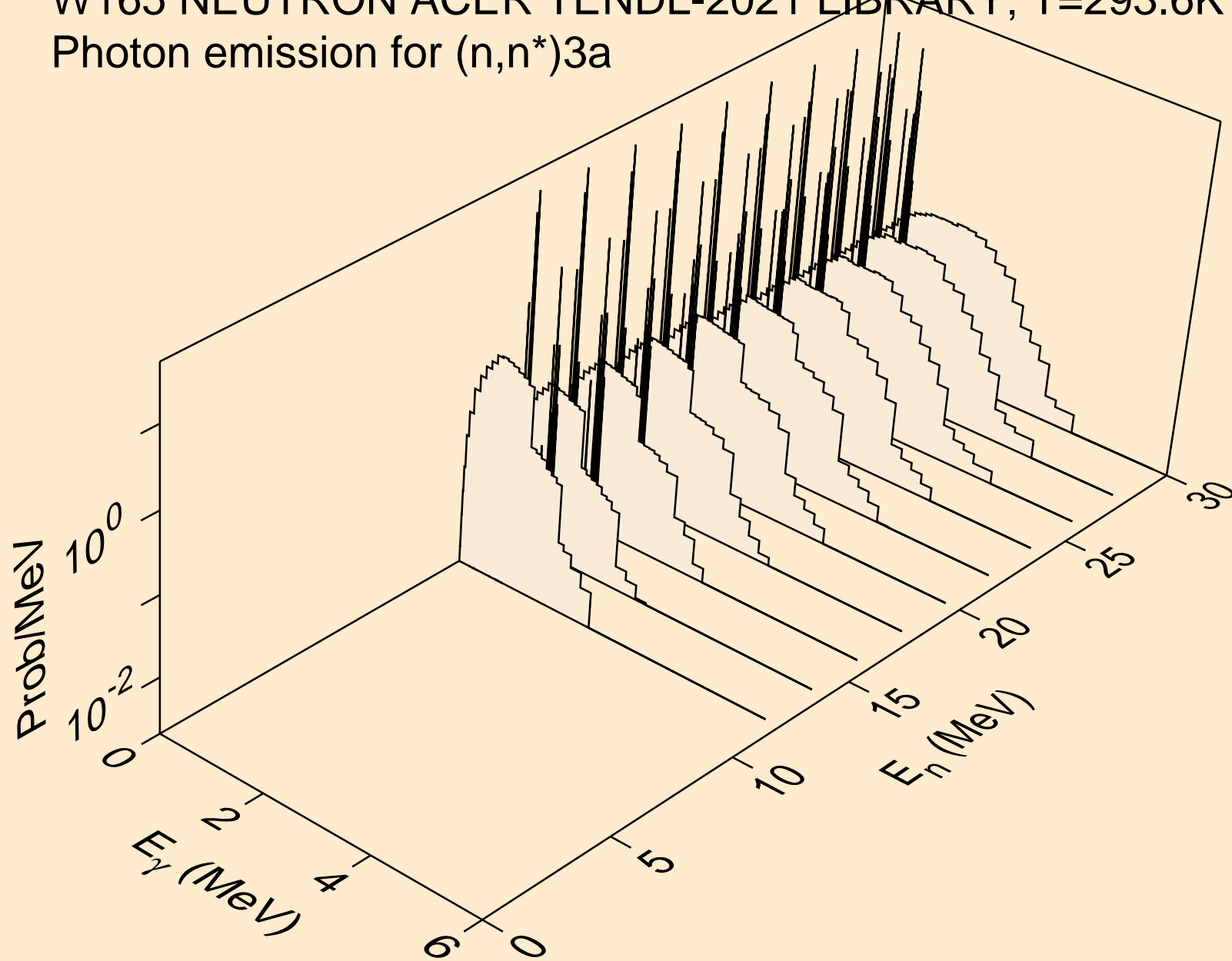



W165 NEUTRON ACER TENDL-2021 LIBRARY; T=293.6K  
Photon emission for (n,2n)a

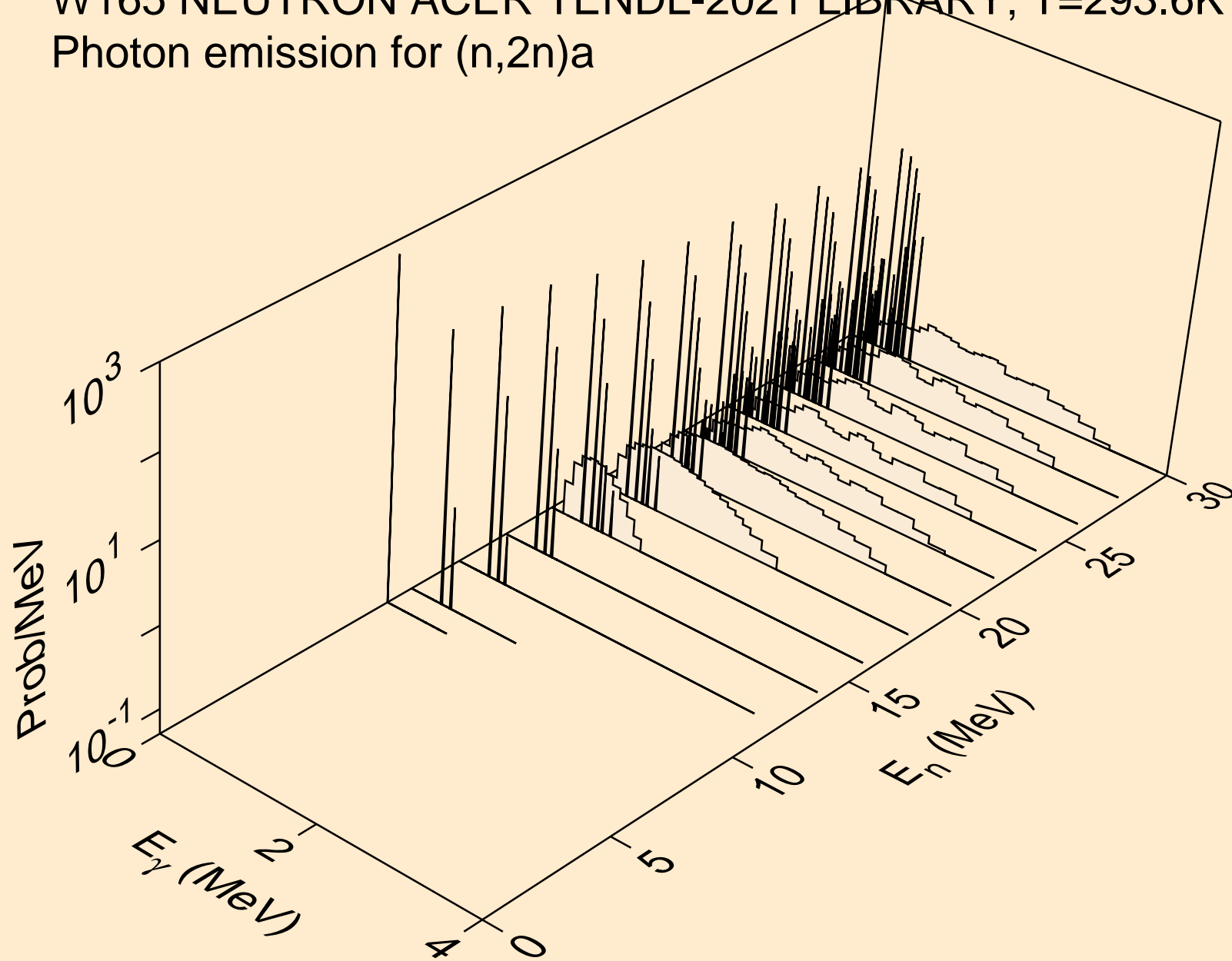

W165 NEUTRON ACER TENDL-2021 LIBRARY; T=293.6K  
Photon emission for (n,3n)a

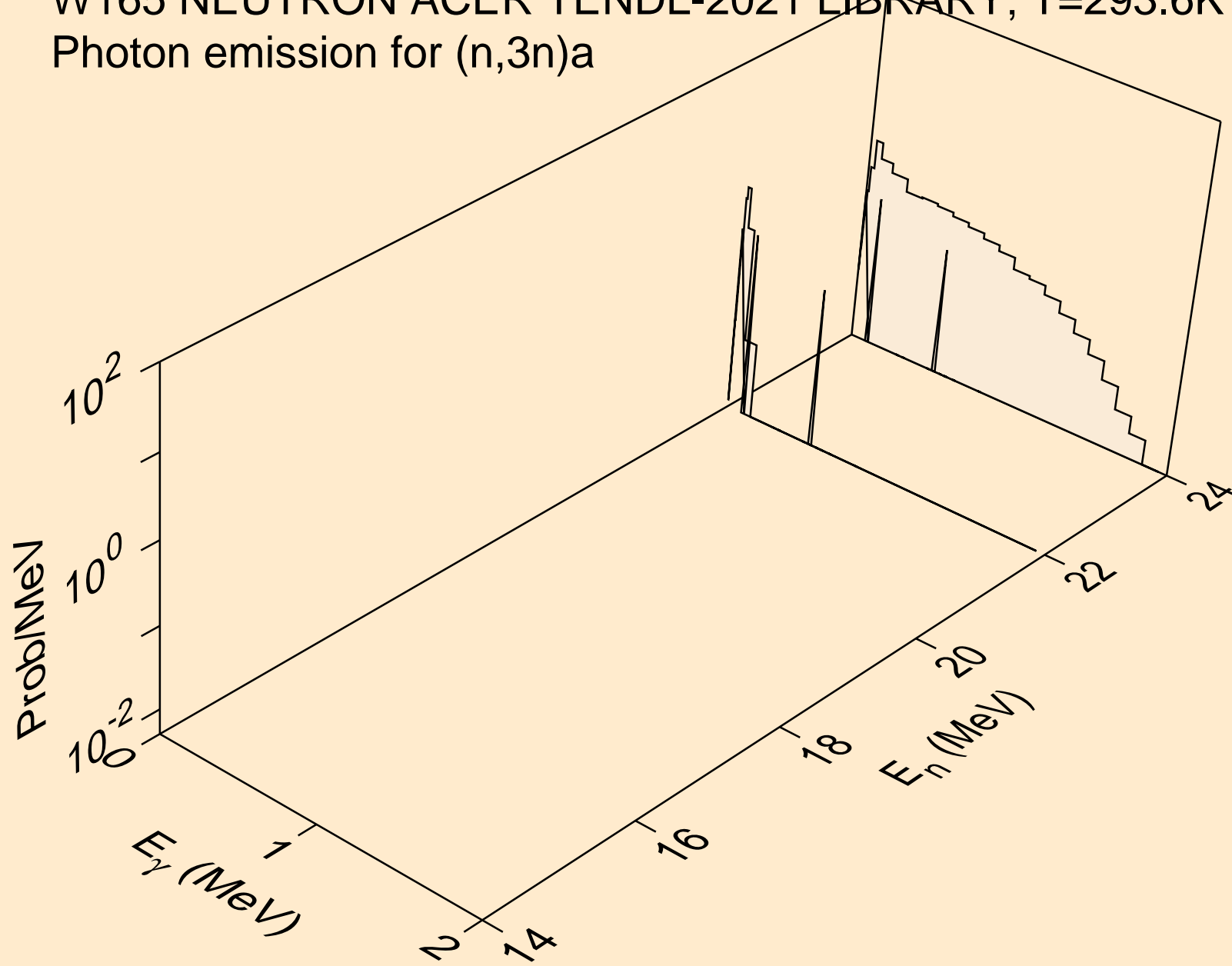

W165 NEUTRON ACER TENDL-2021 LIBRARY; T=293.6K  
Photon emission for (n,n\*)p

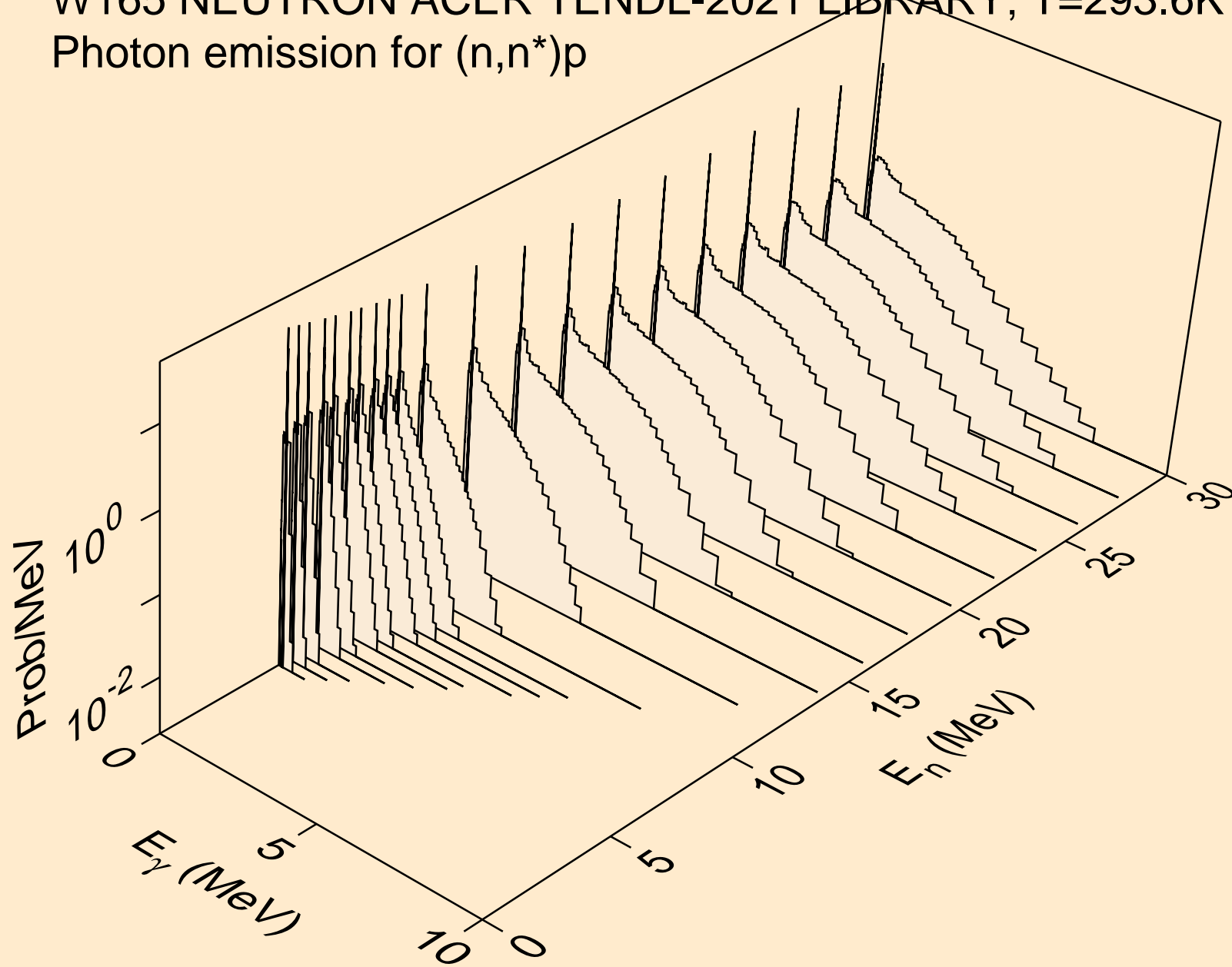

W165 NEUTRON ACER TENDL-2021 LIBRARY; T=293.6K  
Photon emission for (n,n\*)2a

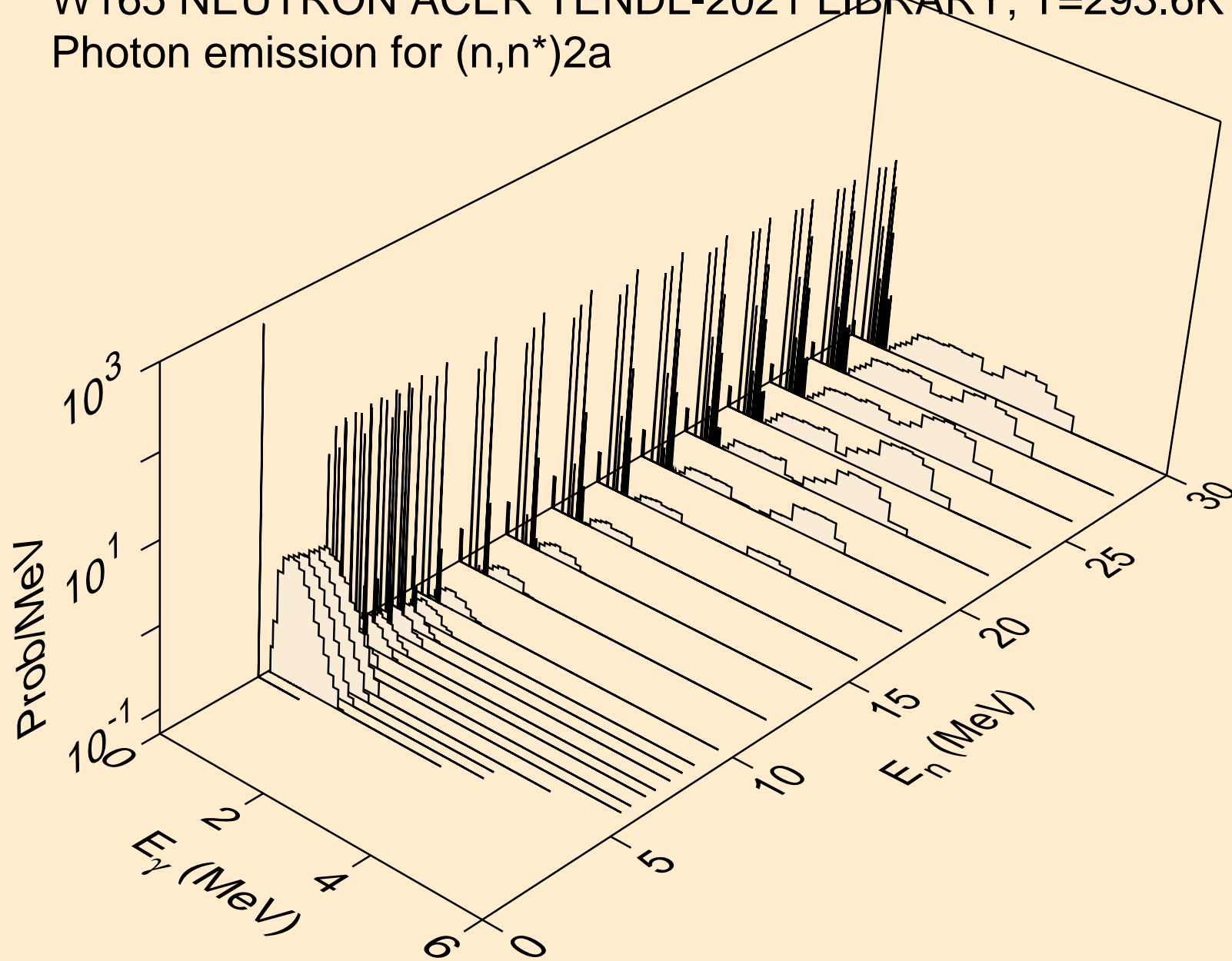

W165 NEUTRON ACER TENDL-2021 LIBRARY; T=293.6K  
Photon emission for (n,2n)2a

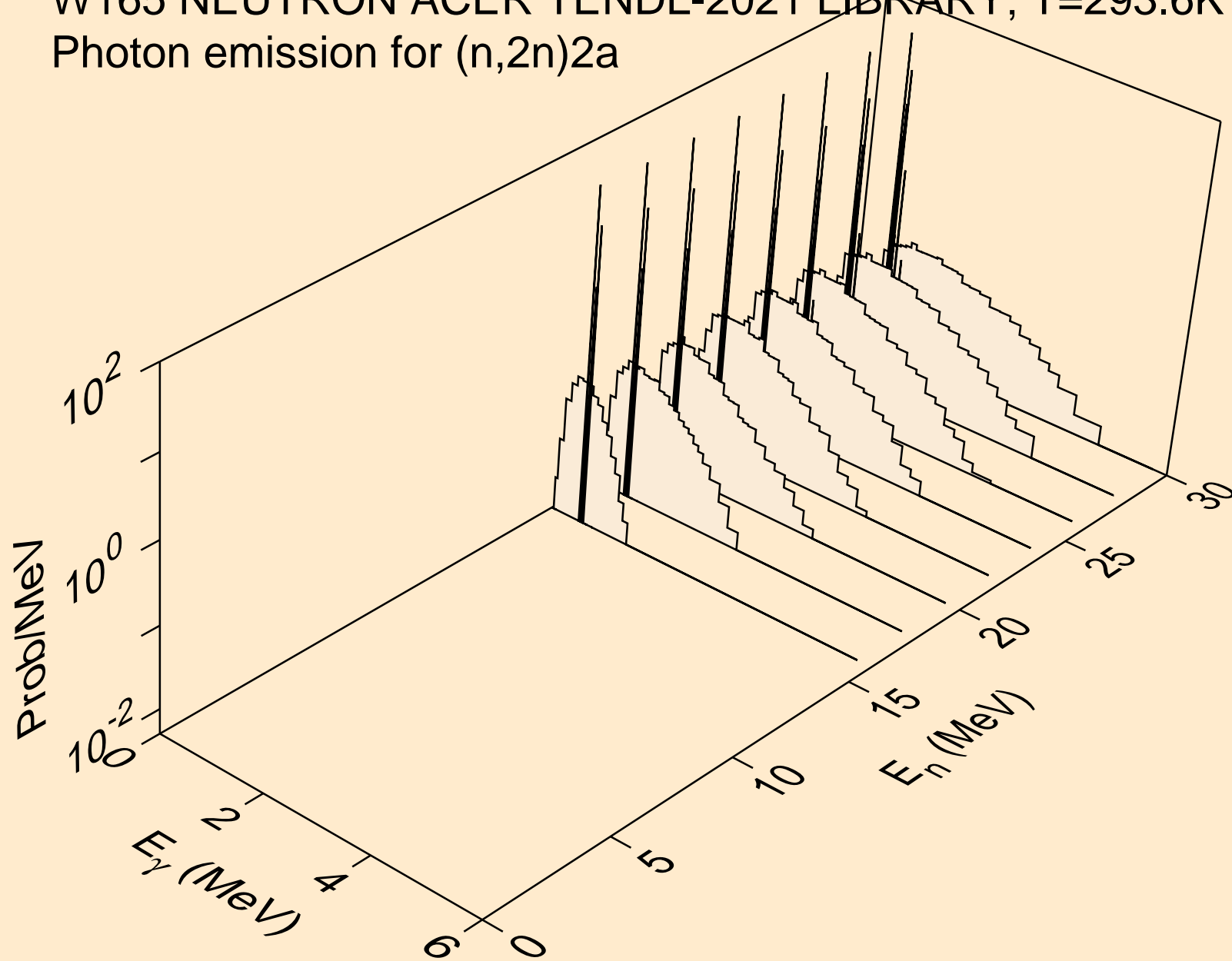

W165 NEUTRON ACER TENDL-2021 LIBRARY; T=293.6K  
Photon emission for (n,n\*)d

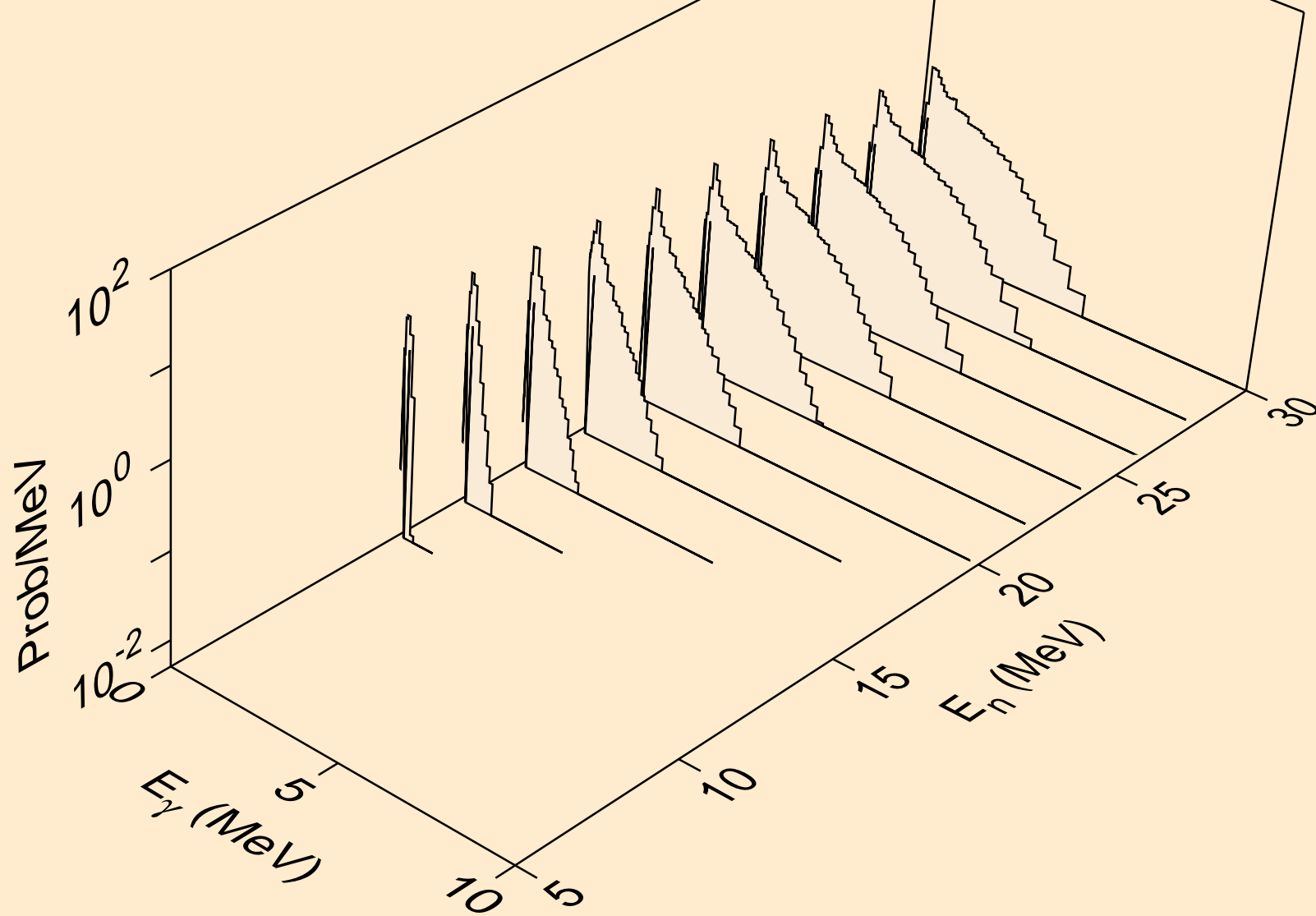

W165 NEUTRON ACER TENDL-2021 LIBRARY; T=293.6K  
Photon emission for (n,n\*)t

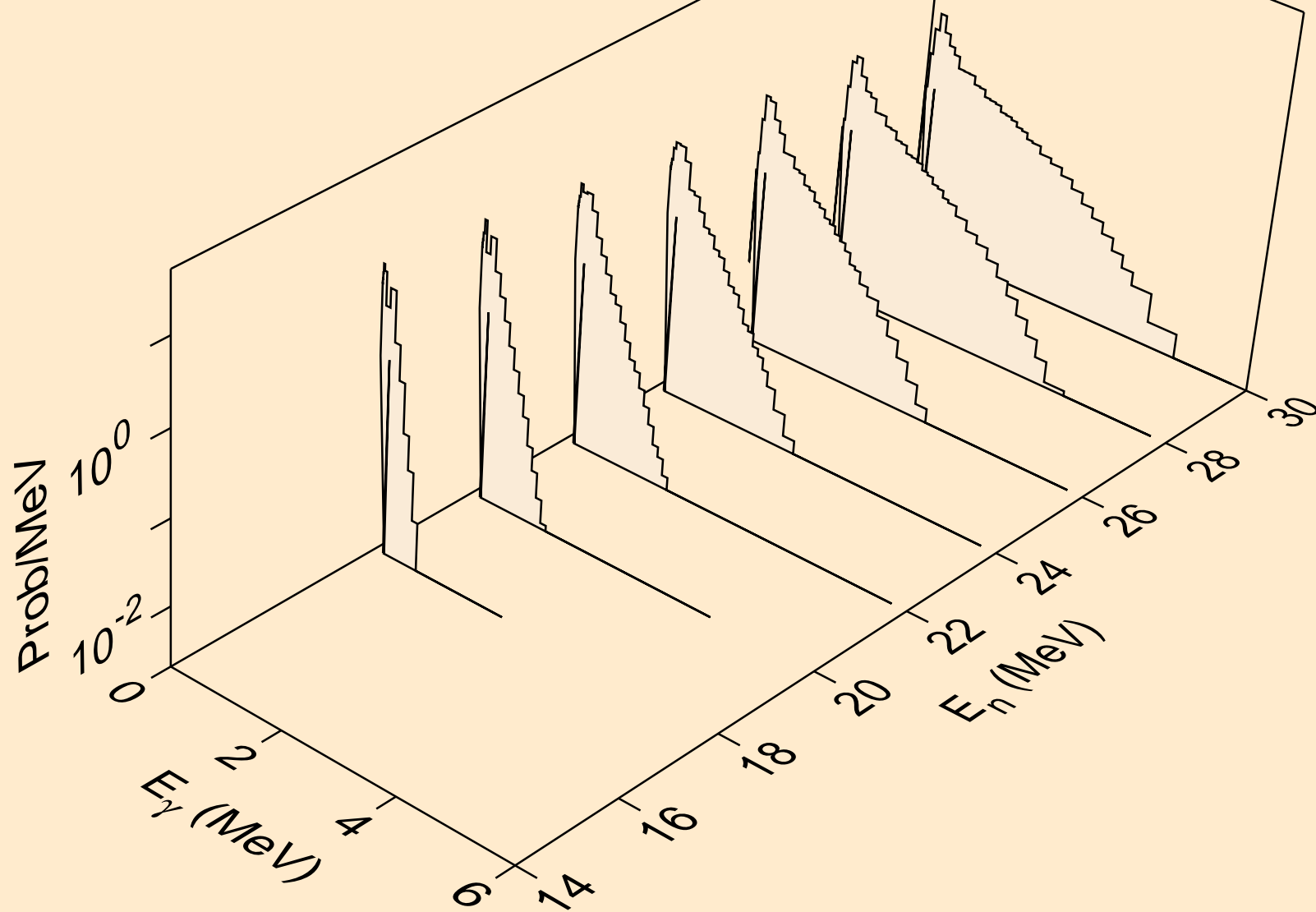

W165 NEUTRON ACER TENDL-2021 LIBRARY; T=293.6K  
Photon emission for (n,n\*)he3

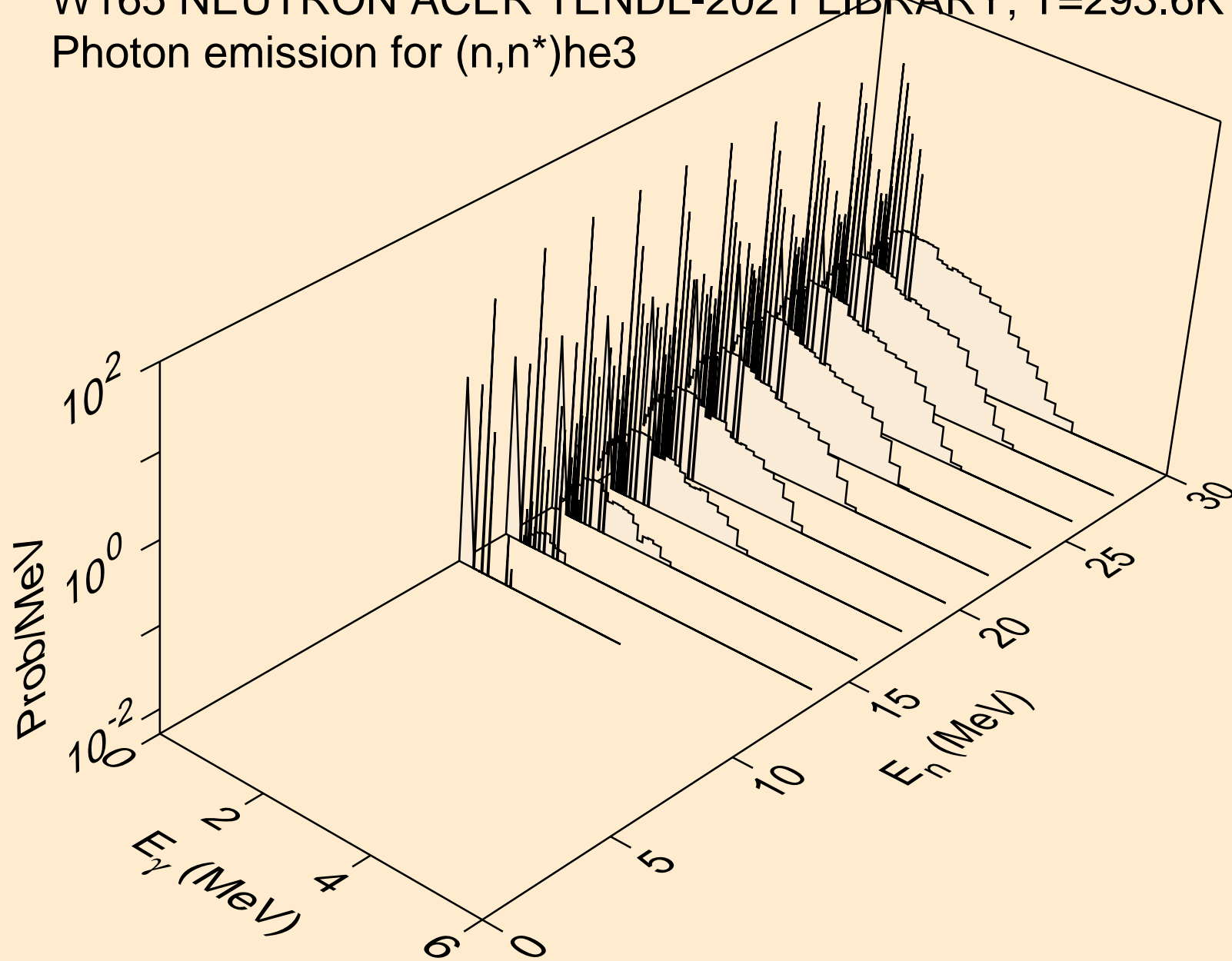



W165 NEUTRON ACER TENDL-2021 LIBRARY; T=293.6K  
Photon emission for (n,2np)

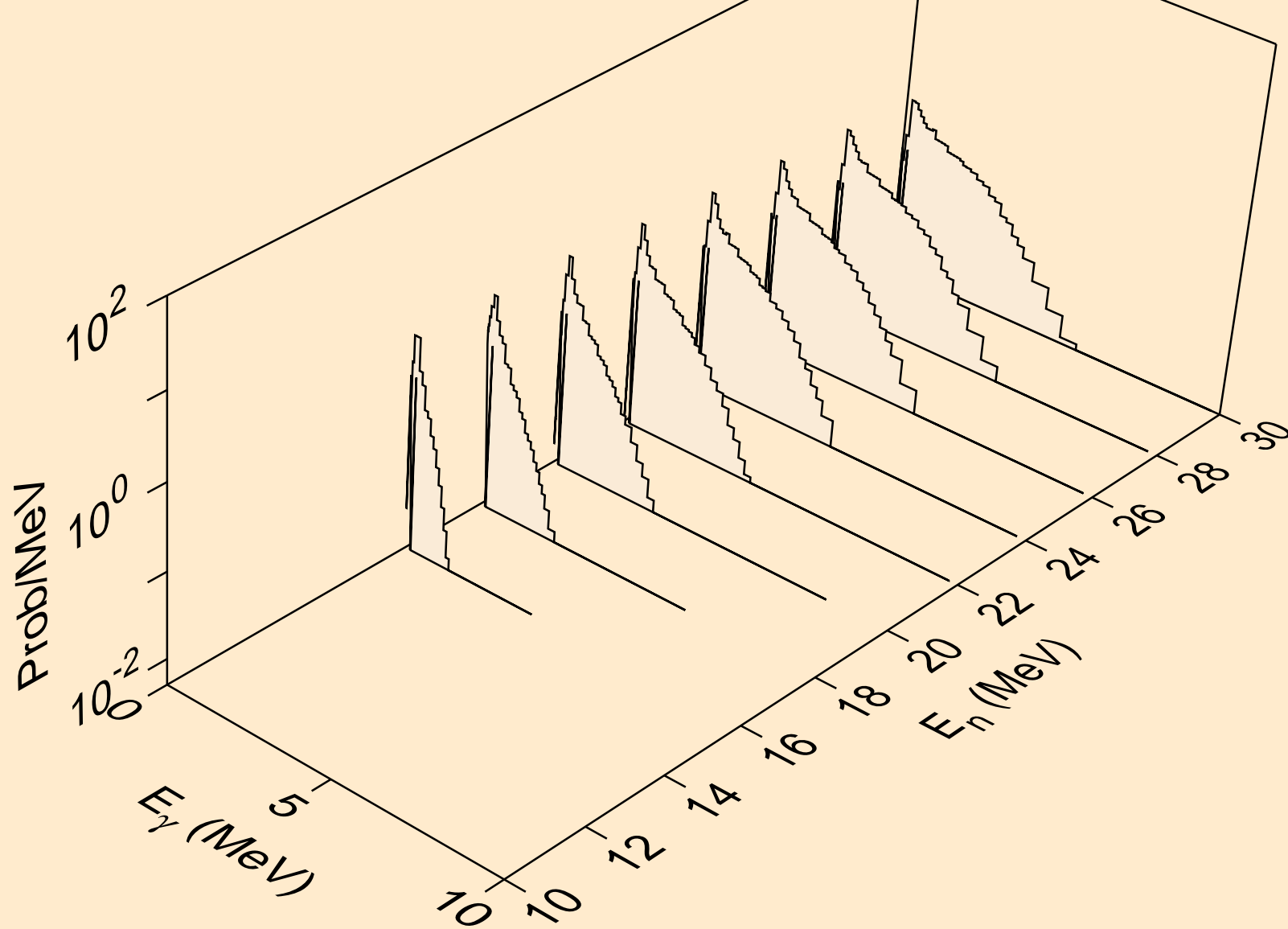

W165 NEUTRON ACER TENDL-2021 LIBRARY; T=293.6K  
Photon emission for (n,3np)

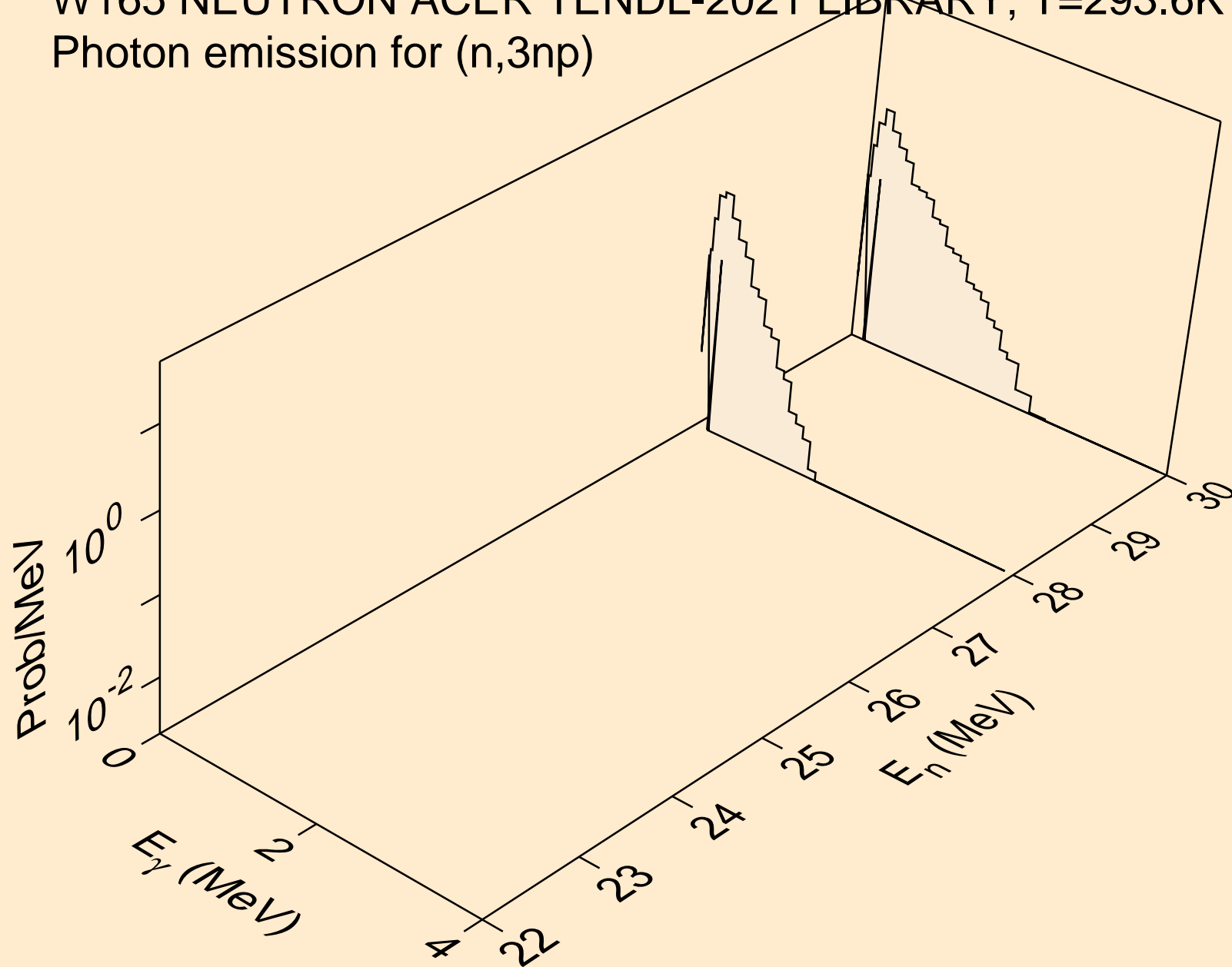

W165 NEUTRON ACER TENDL-2021 LIBRARY; T=293.6K  
Photon emission for (n,2np)

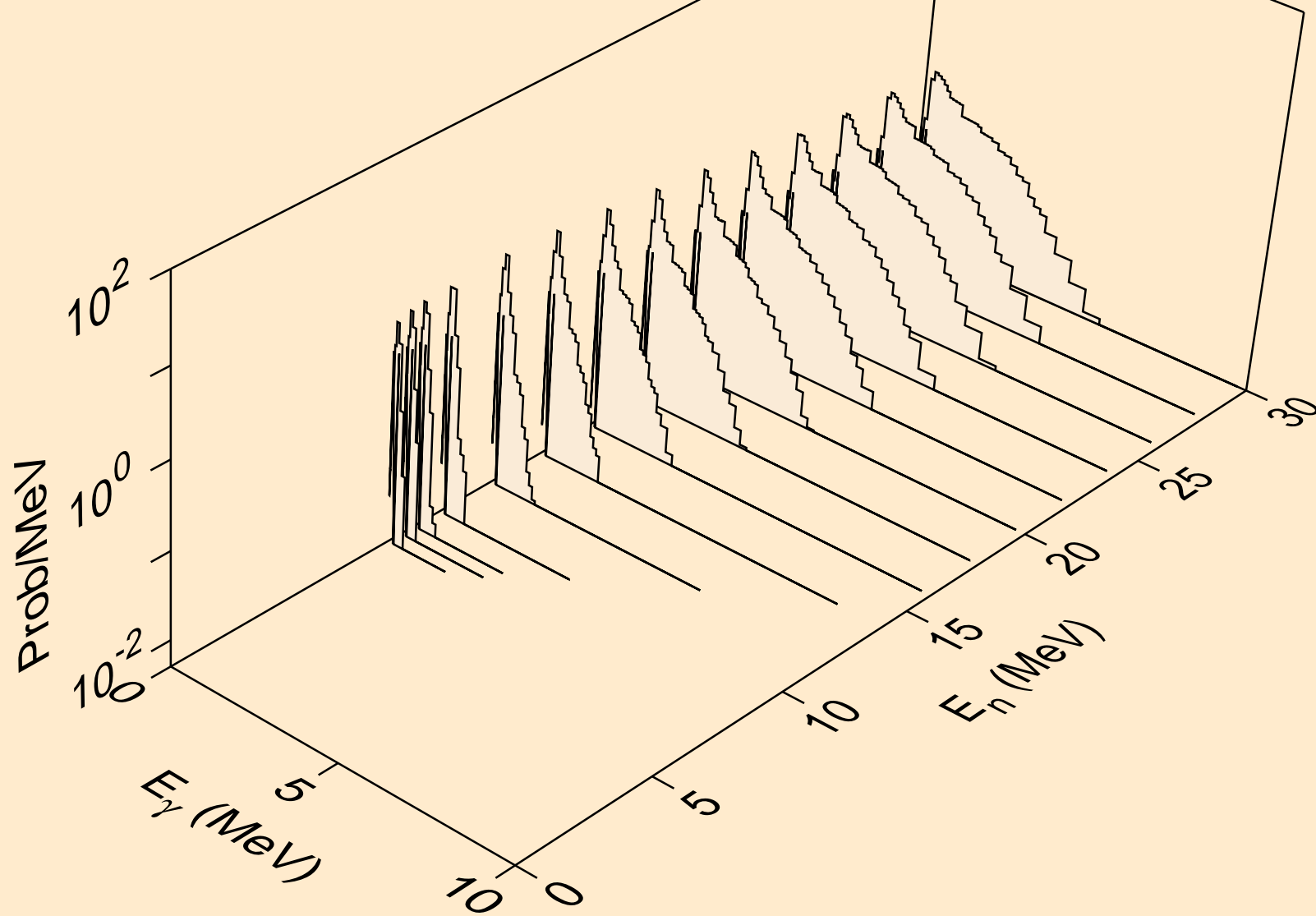

W165 NEUTRON ACER TENDL-2021 LIBRARY; T=293.6K  
Photon emission for (n,npa)

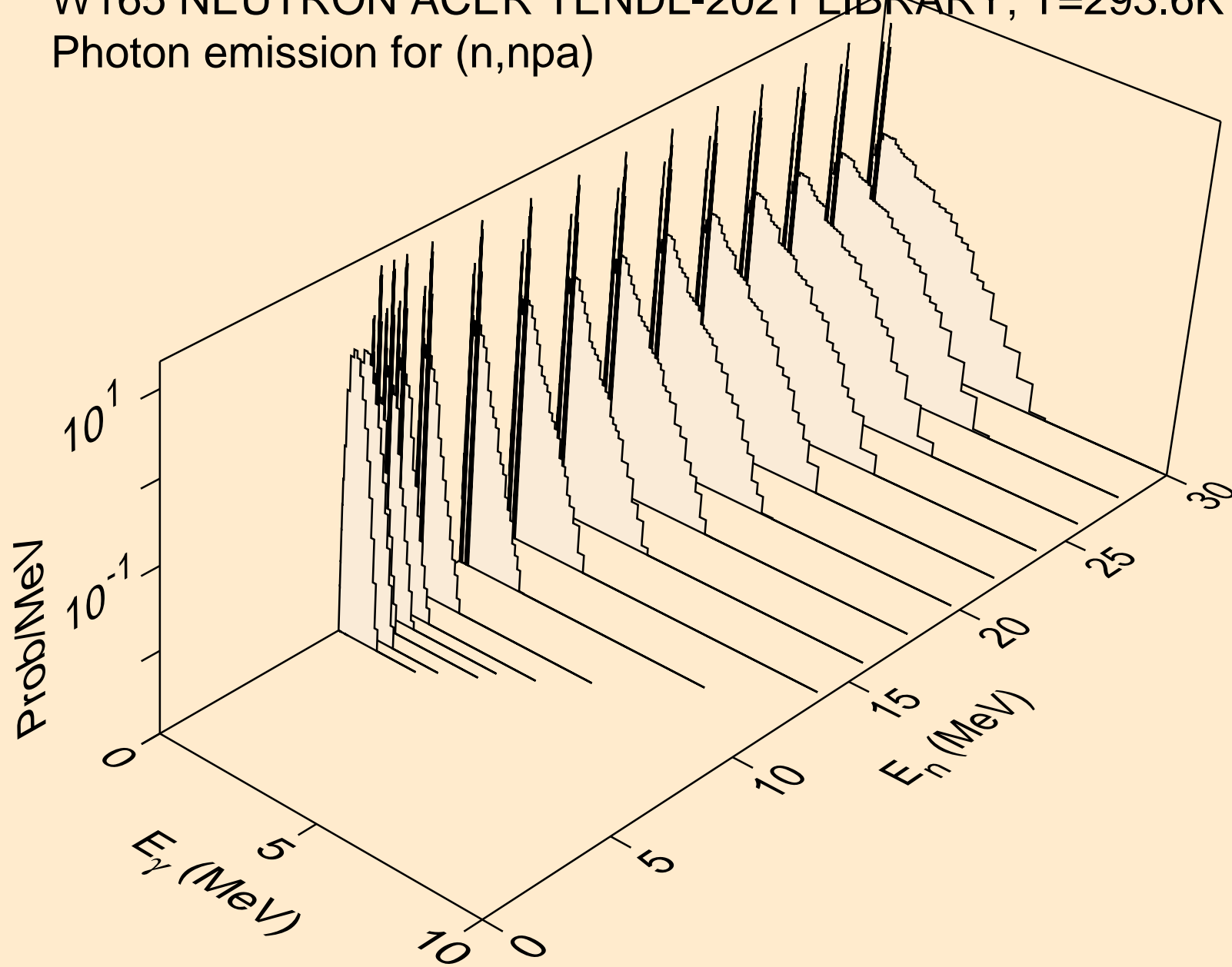

W165 NEUTRON ACER TENDL-2021 LIBRARY; T=293.6K  
Photon emission for (n,n\*c)

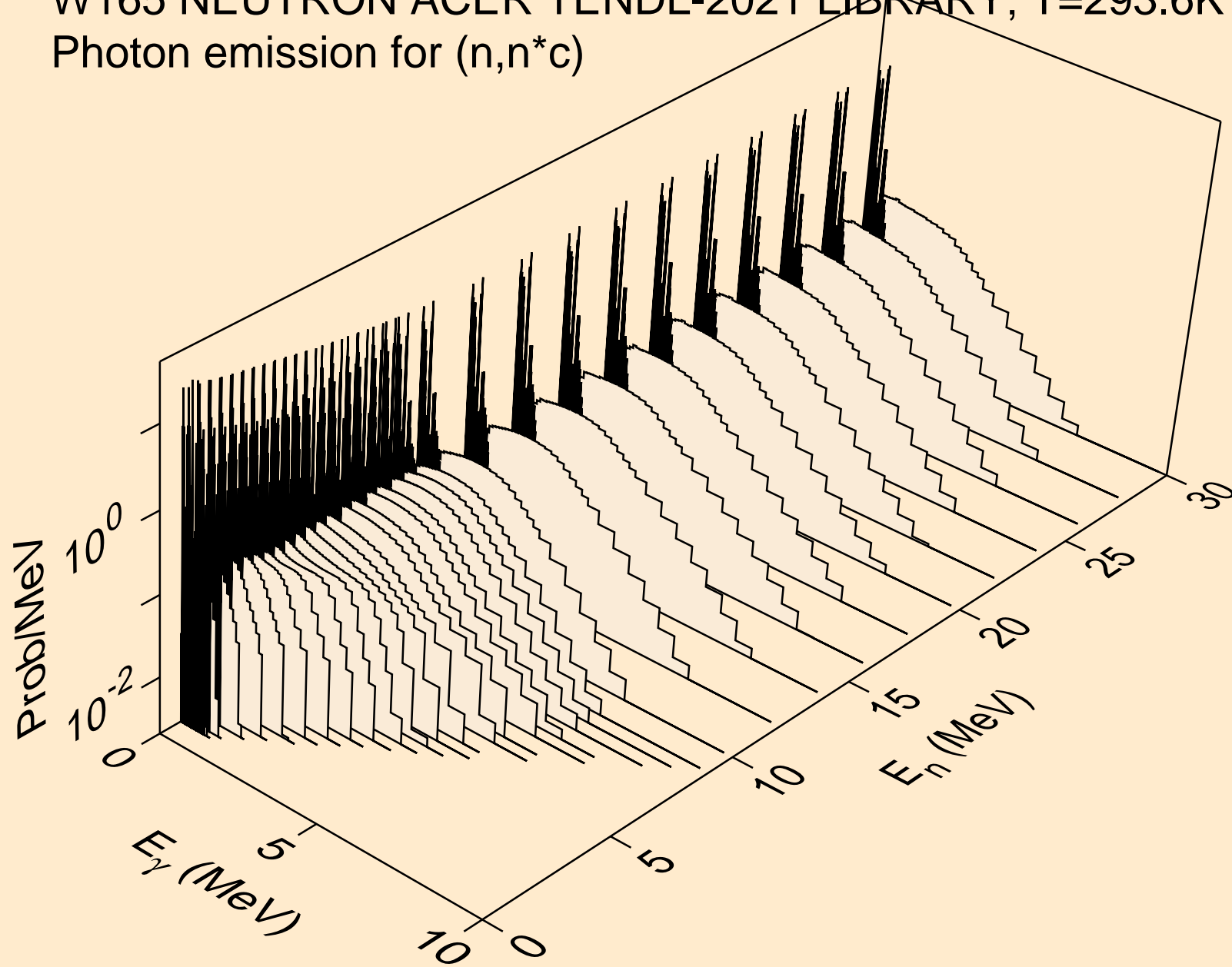

W165 NEUTRON ACER TENDL-2021 LIBRARY; T=293.6K  
Photon emission for (n,gma)

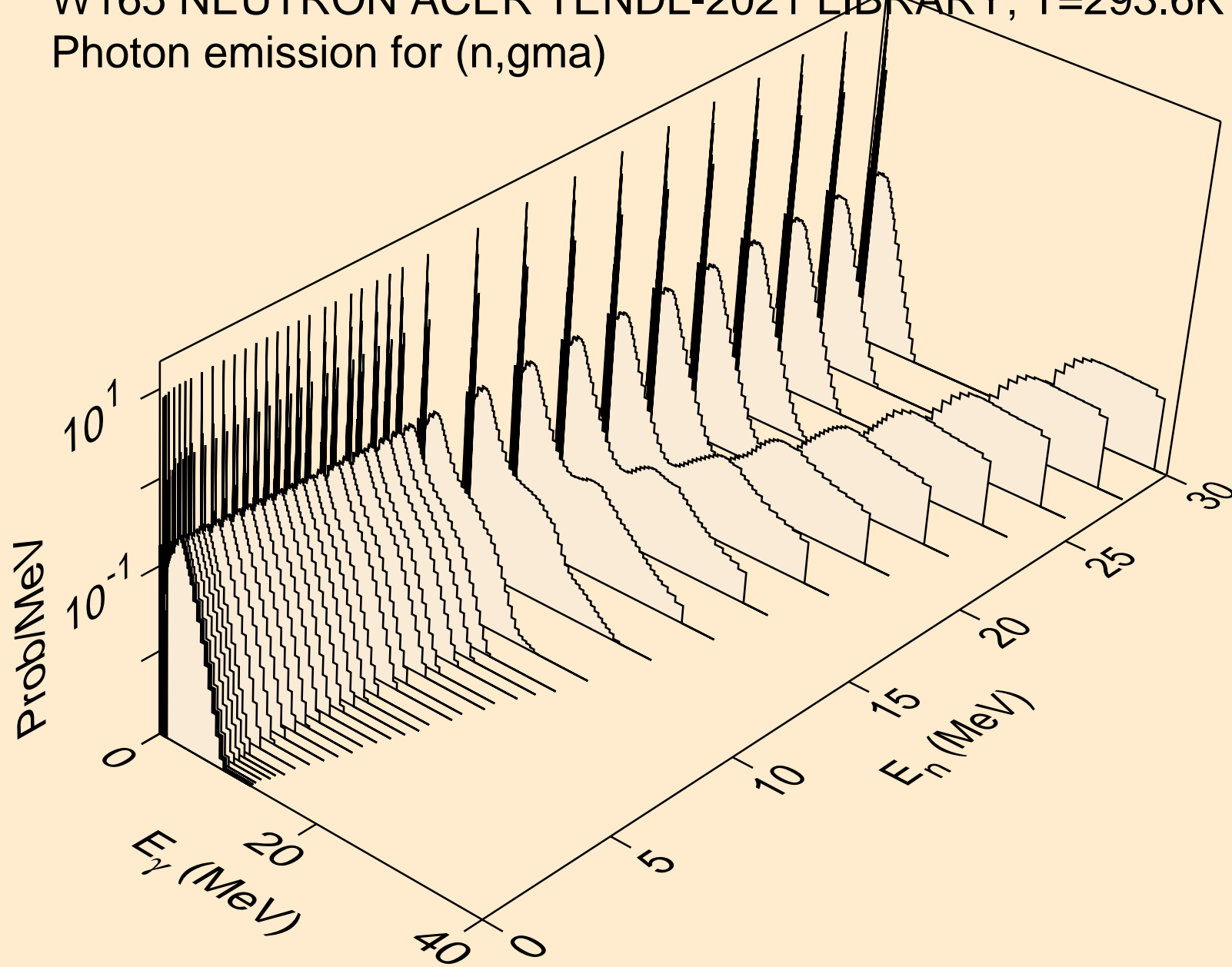

W165 NEUTRON ACER TENDL-2021 LIBRARY; T=293.6K  
Photon emission for (n,p)

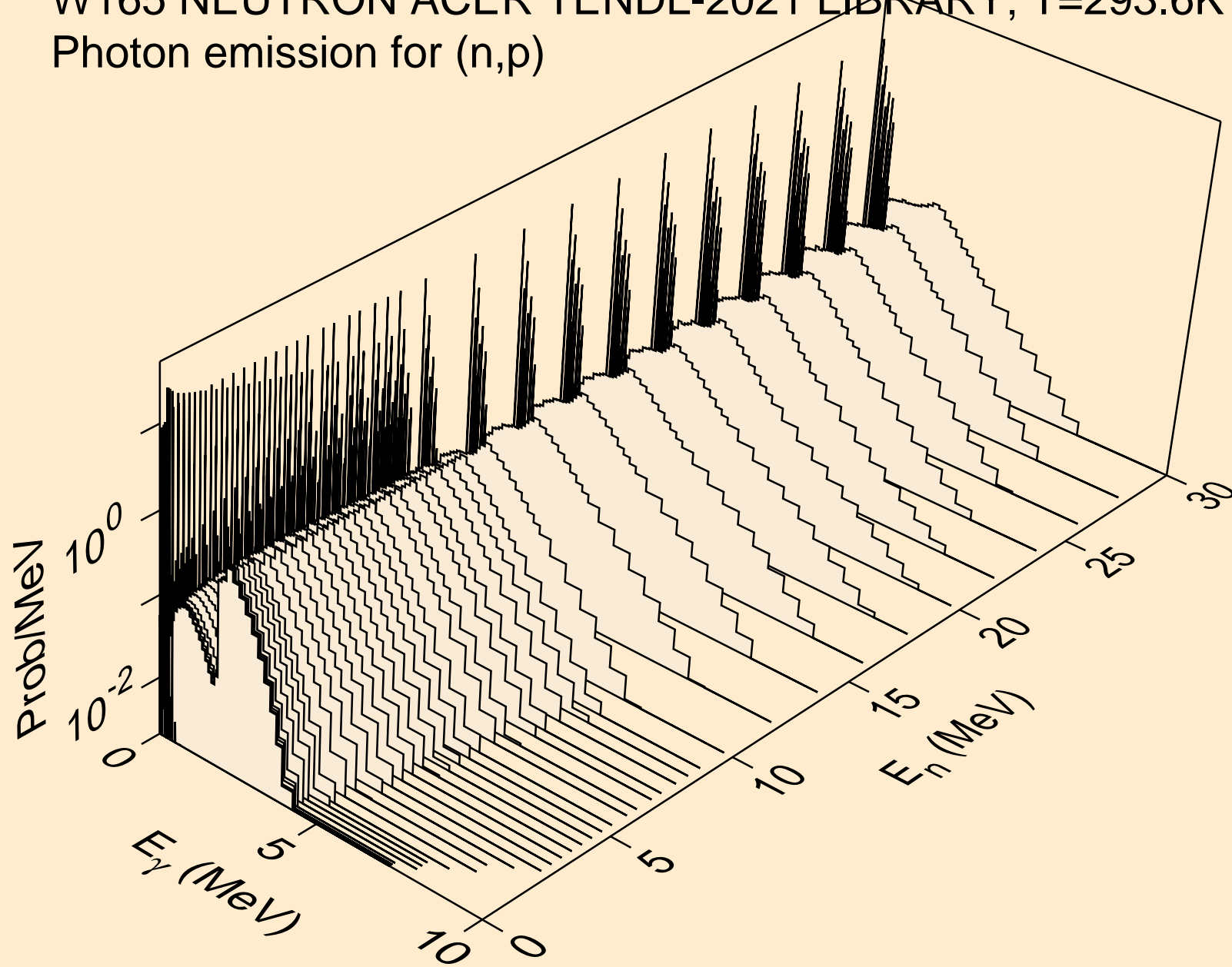

W165 NEUTRON ACER TENDL-2021 LIBRARY; T=293.6K  
Photon emission for (n,d)

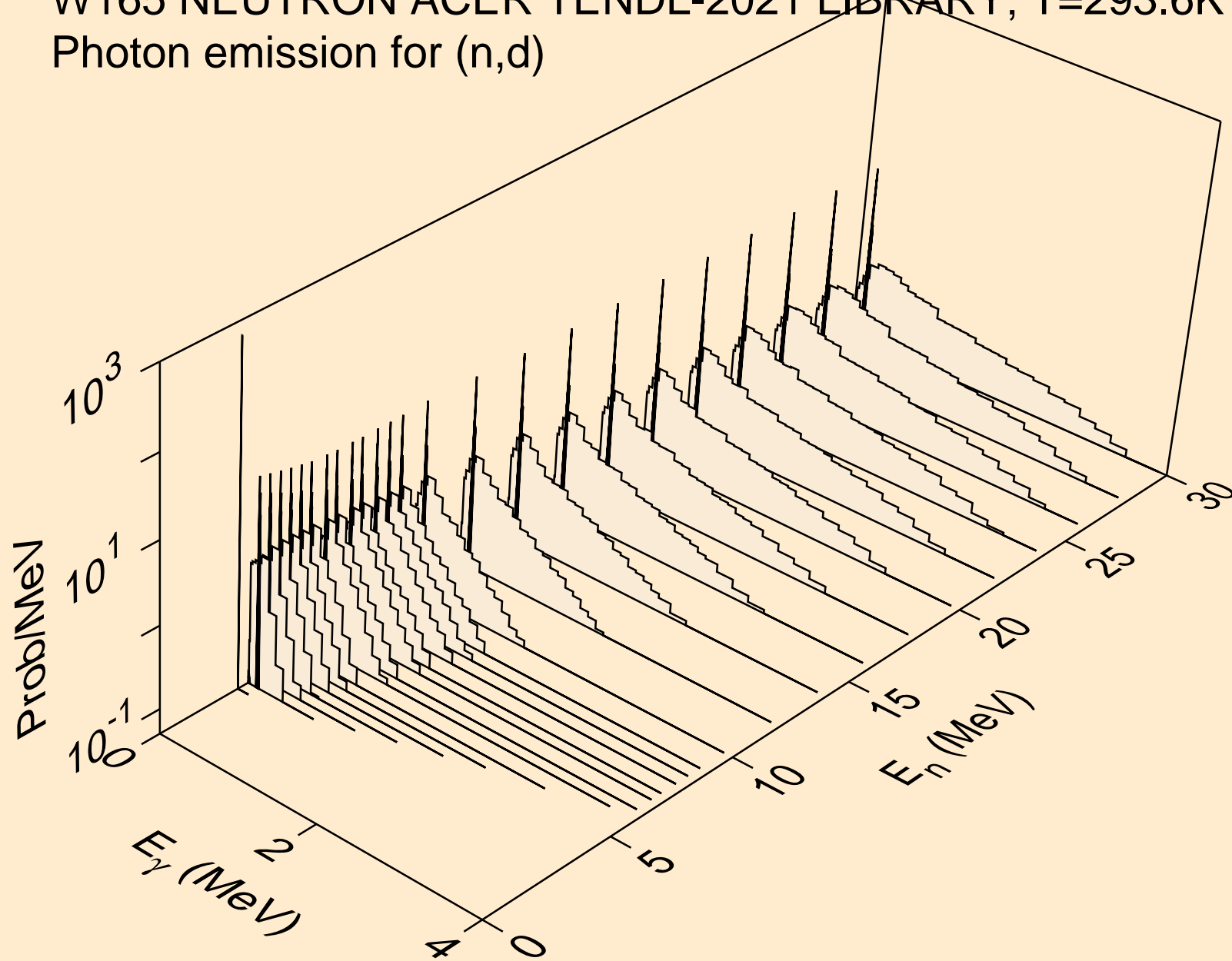



W165 NEUTRON ACER TENDL-2021 LIBRARY; T=293.6K  
Photon emission for (n,t)

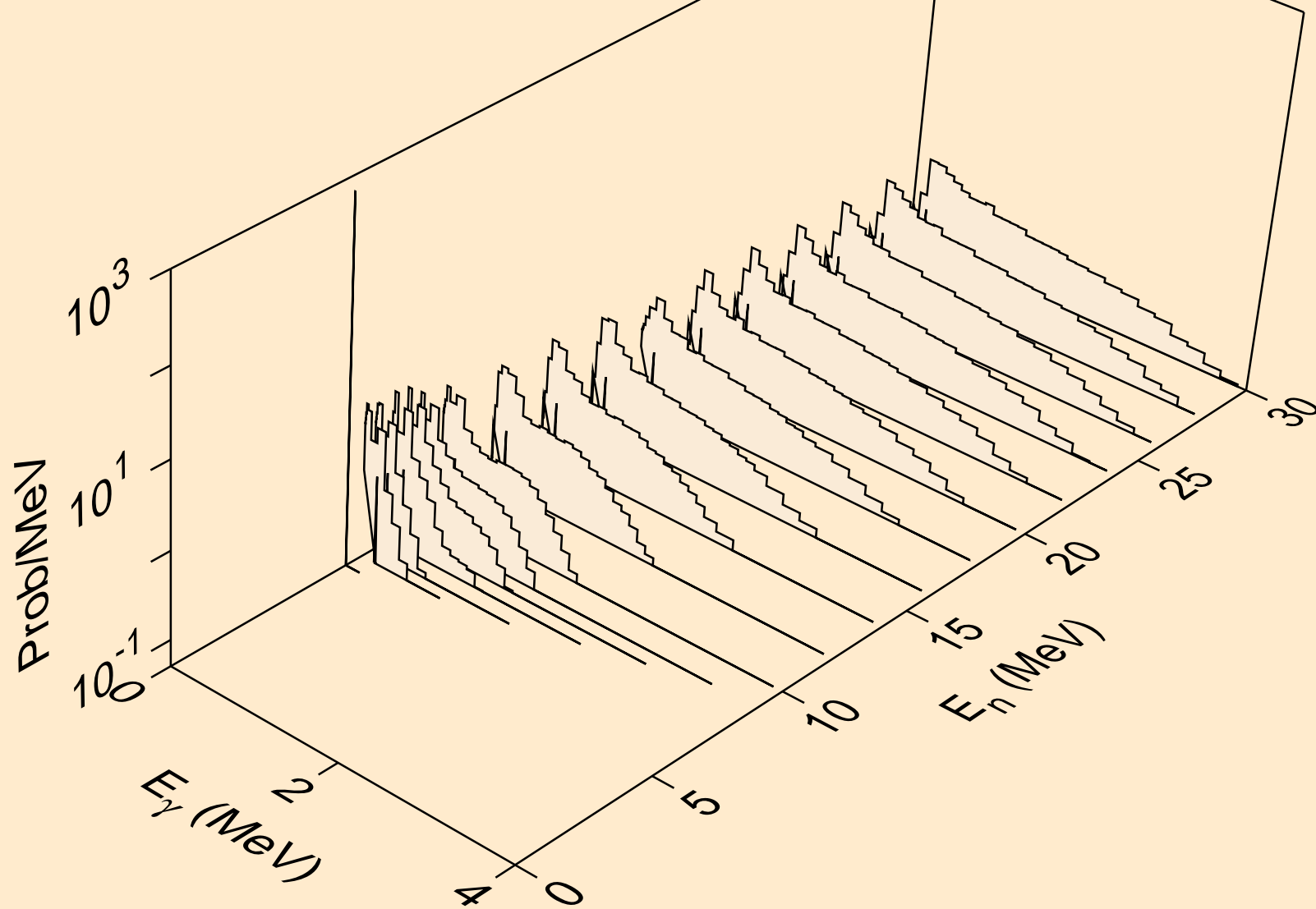

W165 NEUTRON ACER TENDL-2021 LIBRARY; T=293.6K  
Photon emission for (n,he3)

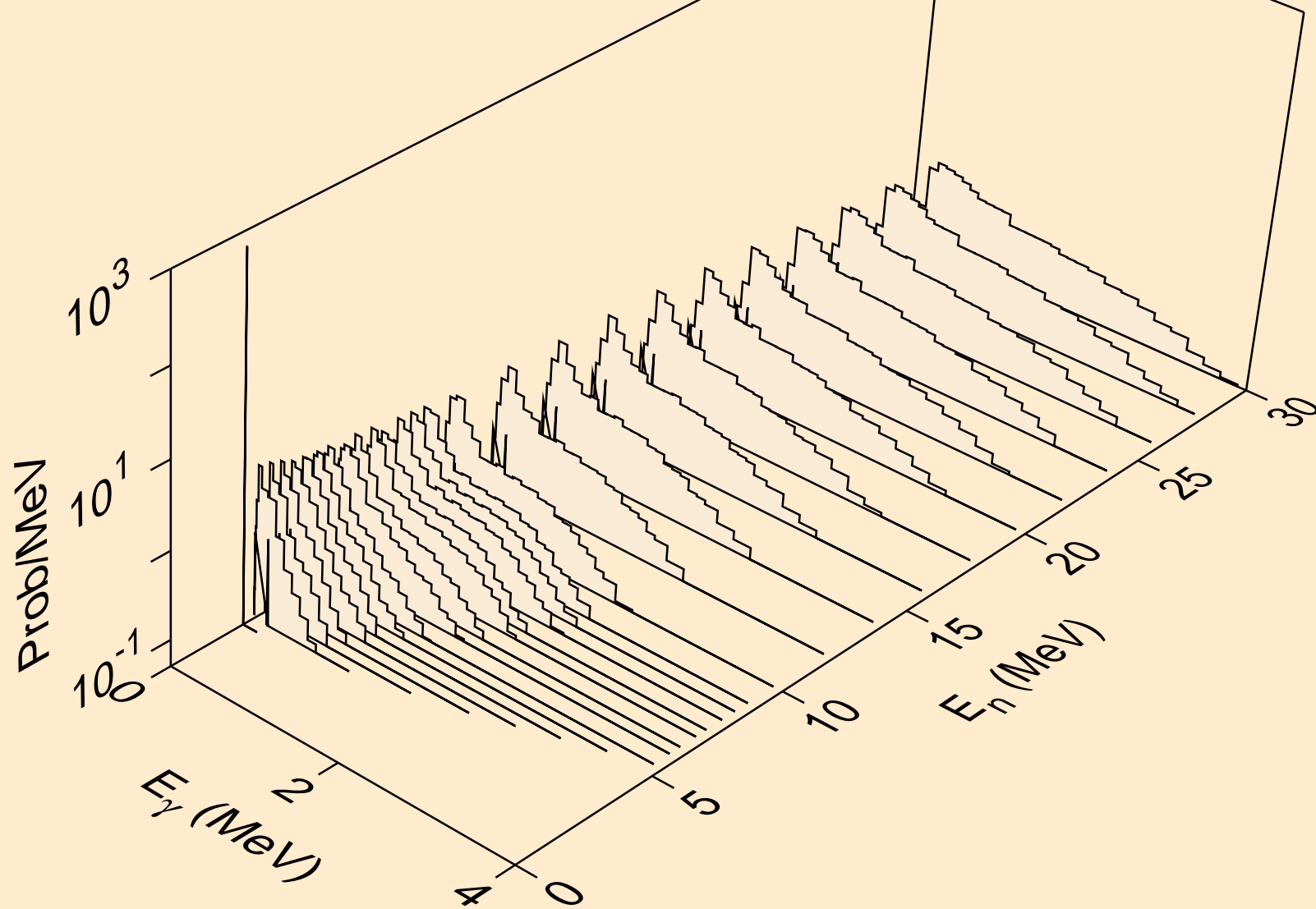

W165 NEUTRON ACER TENDL-2021 LIBRARY; T=293.6K  
Photon emission for (n,a)

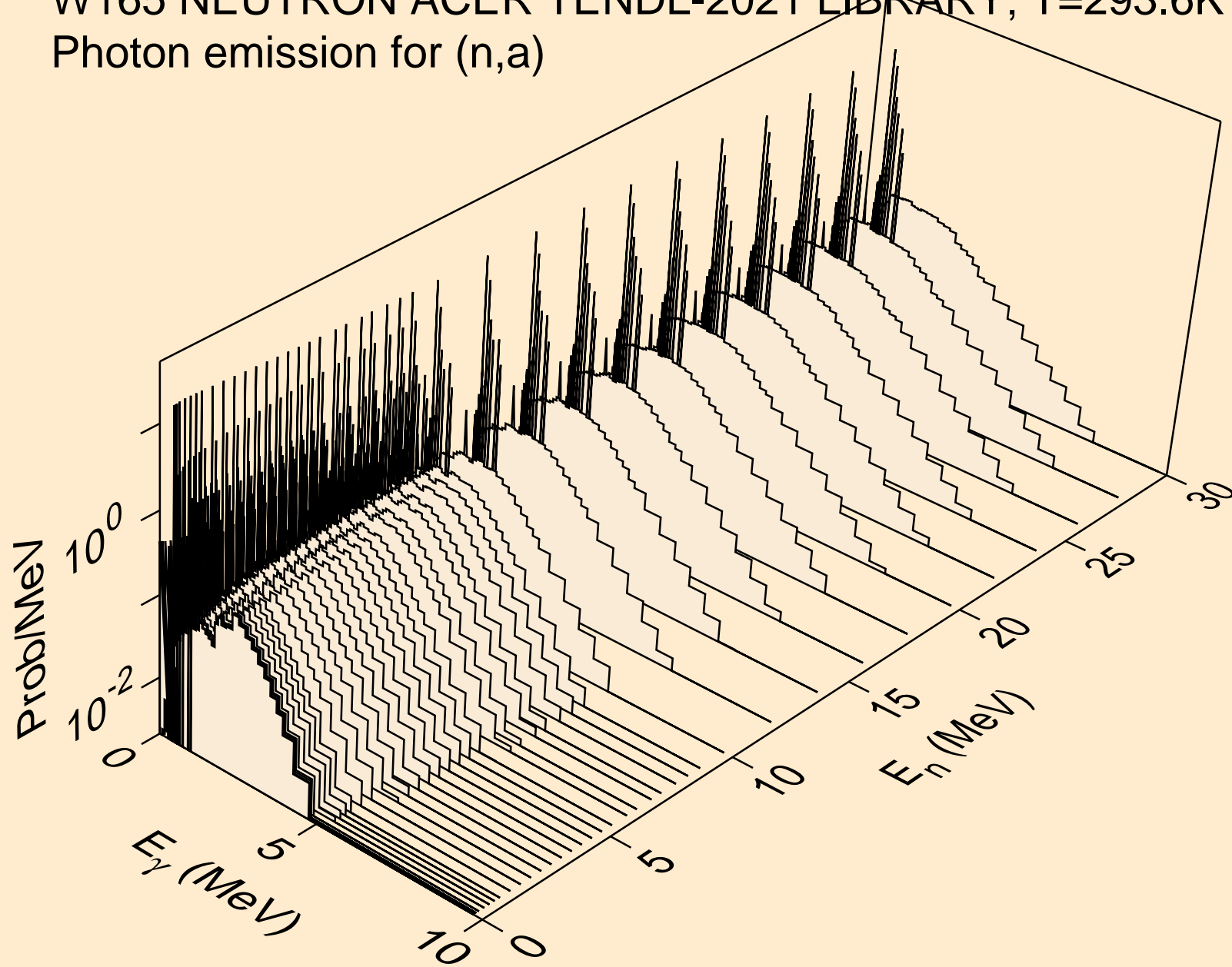

W165 NEUTRON ACER TENDL-2021 LIBRARY; T=293.6K  
Photon emission for (n,2a)

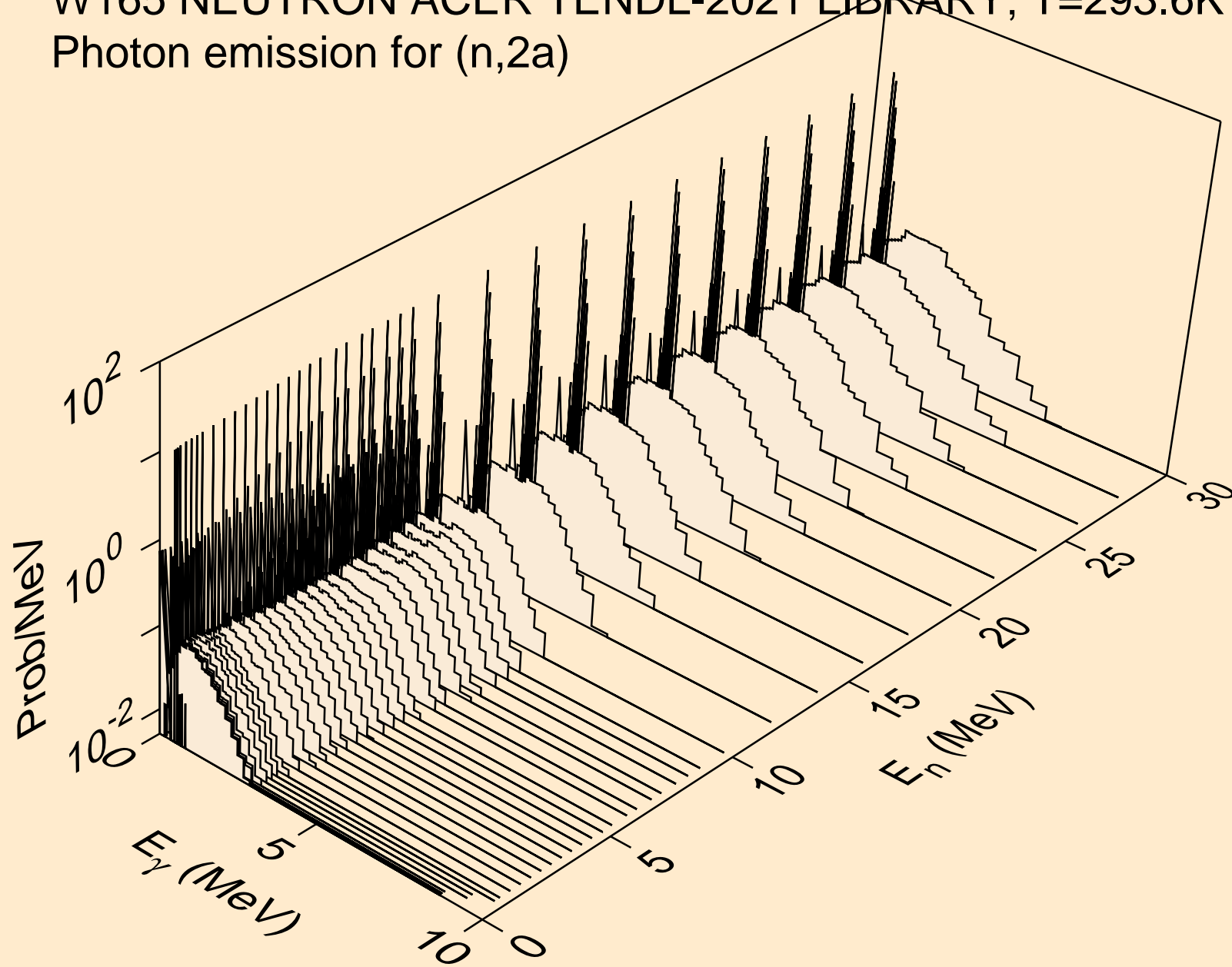

W165 NEUTRON ACER TENDL-2021 LIBRARY; T=293.6K  
Photon emission for (n,3a)

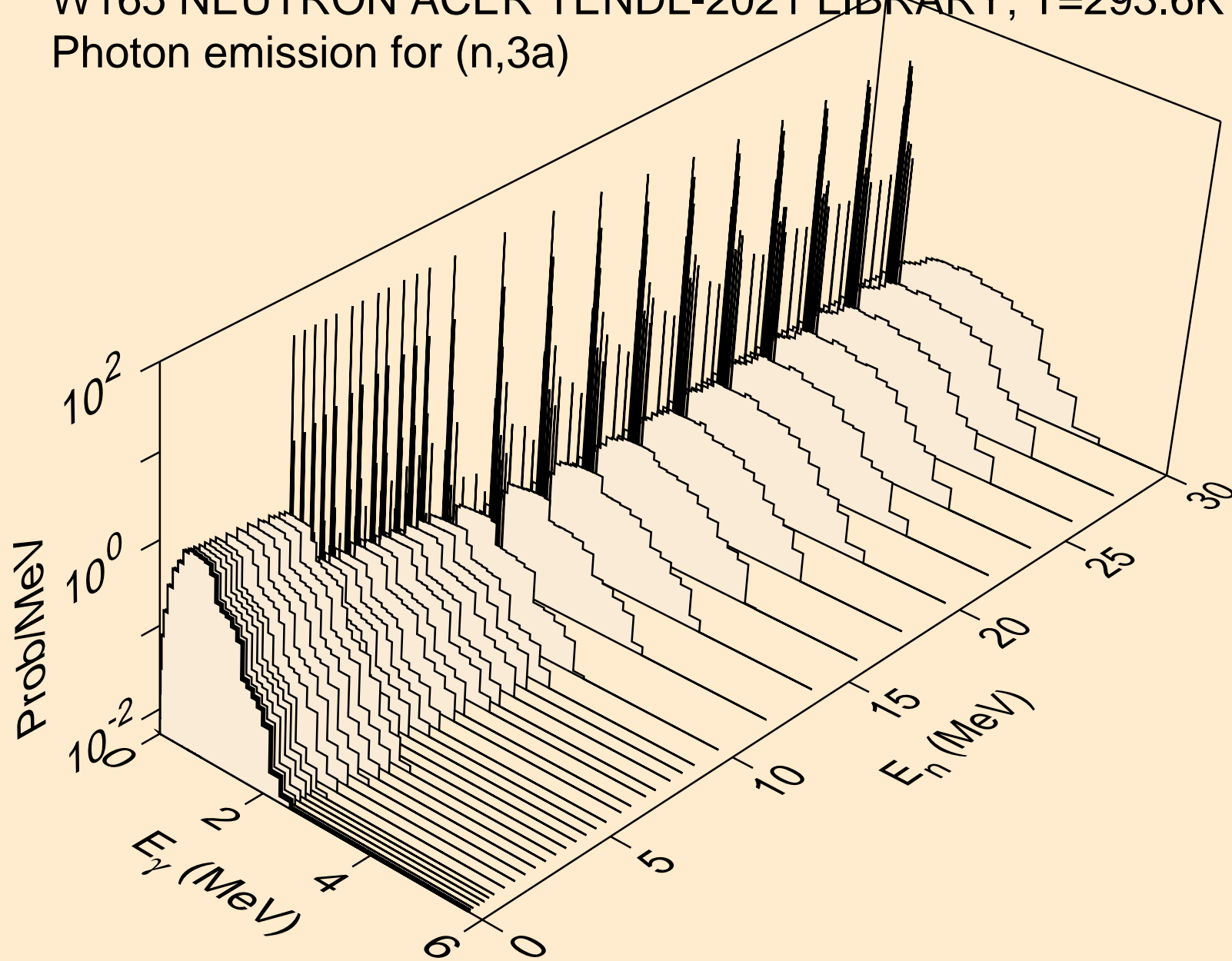

W165 NEUTRON ACER TENDL-2021 LIBRARY; T=293.6K  
Photon emission for (n,2p)

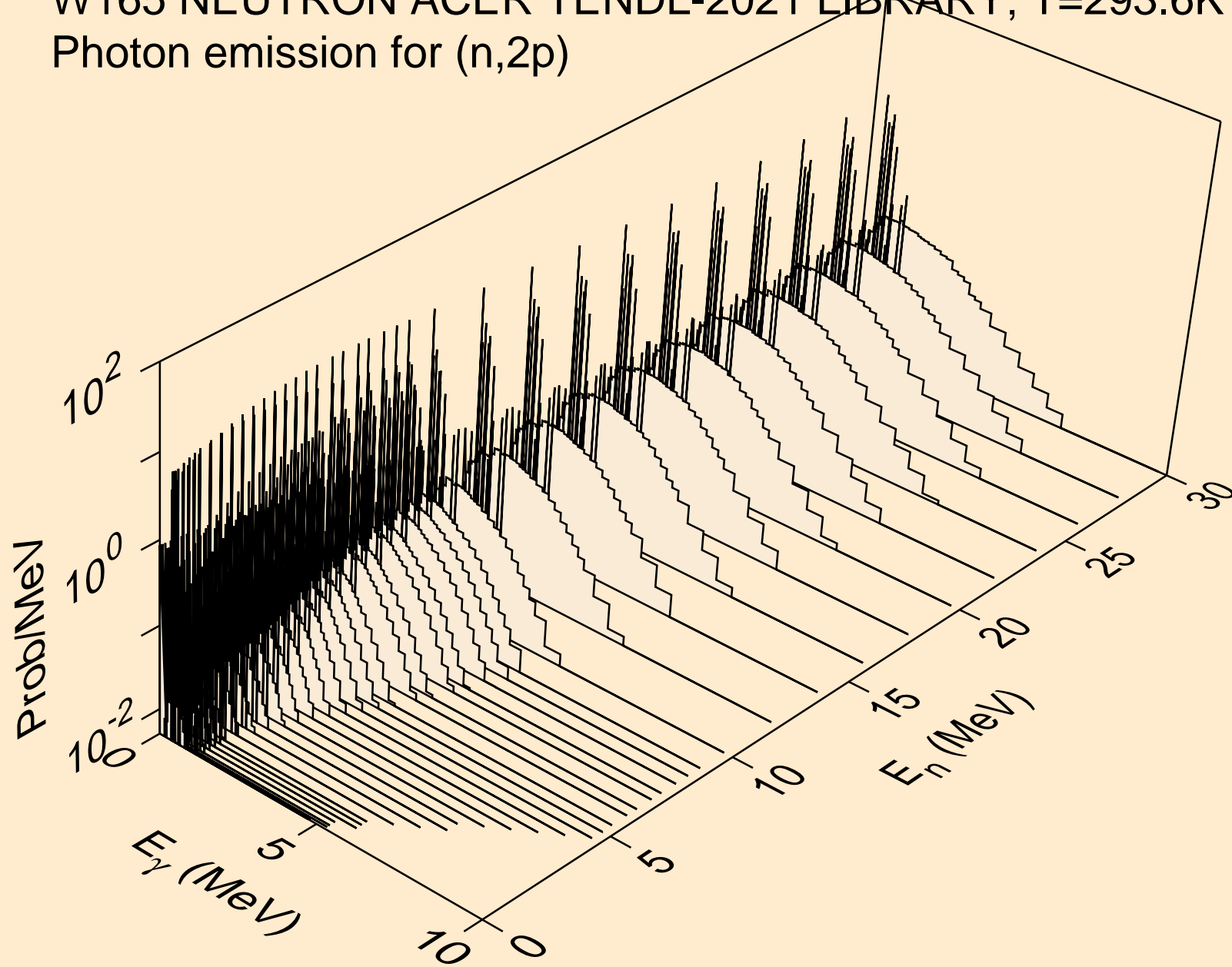

W165 NEUTRON ACER TENDL-2021 LIBRARY; T=293.6K  
Photon emission for (n,p $\alpha$ )

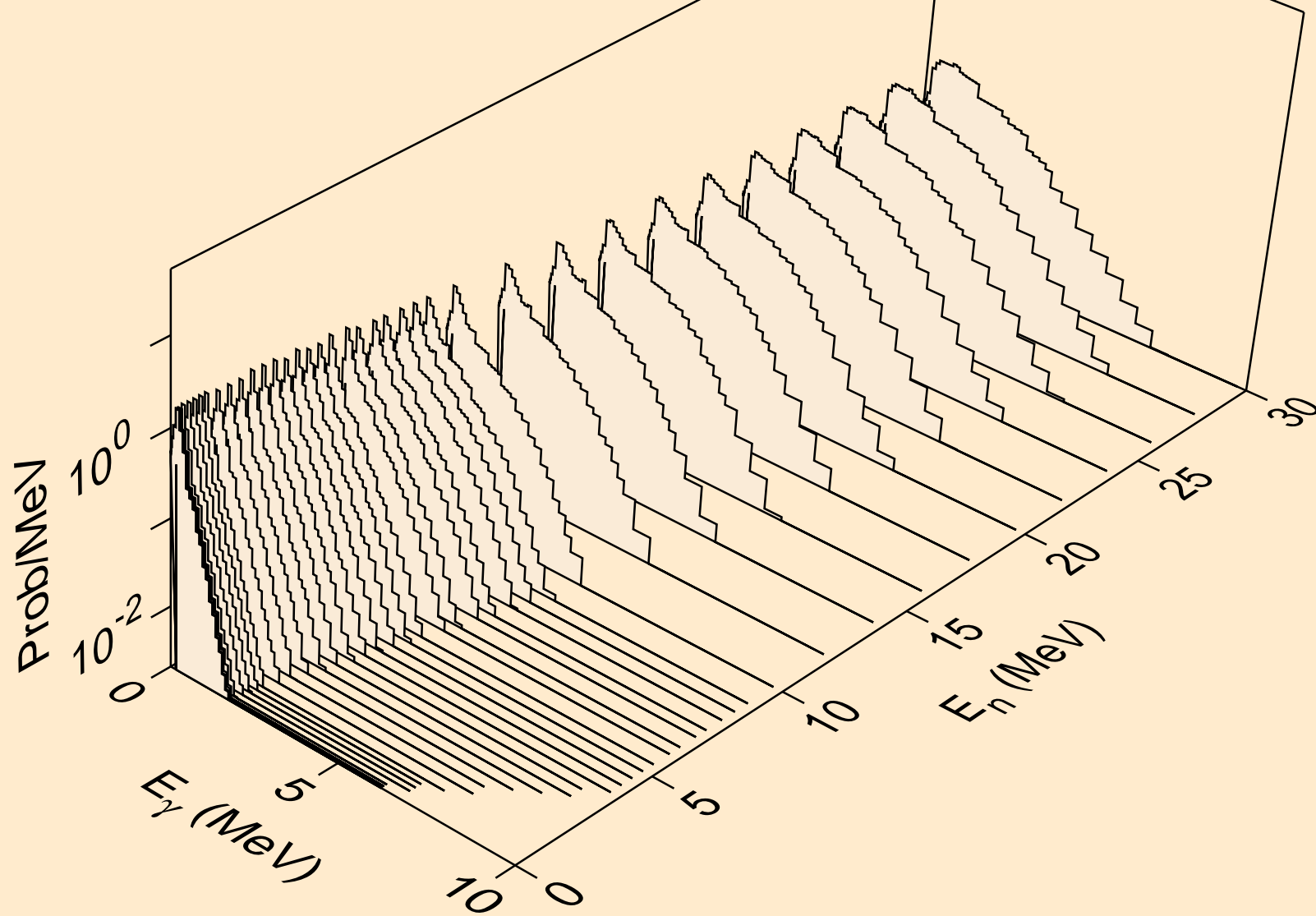

W165 NEUTRON ACER TENDL-2021 LIBRARY; T=293.6K  
Photon emission for (n,t2a)

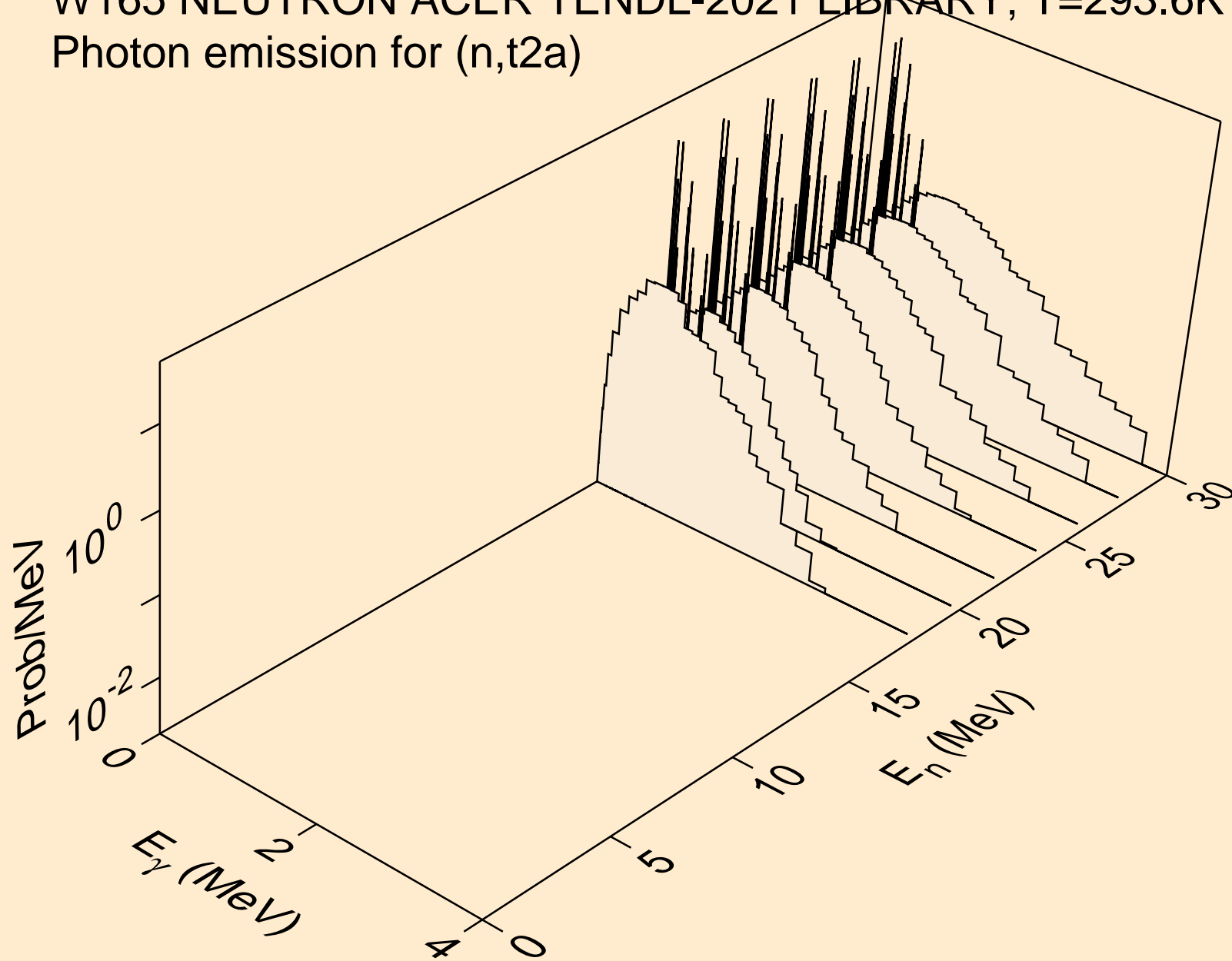



W165 NEUTRON ACER TENDL-2021 LIBRARY; T=293.6K  
Photon emission for (n,d2a)

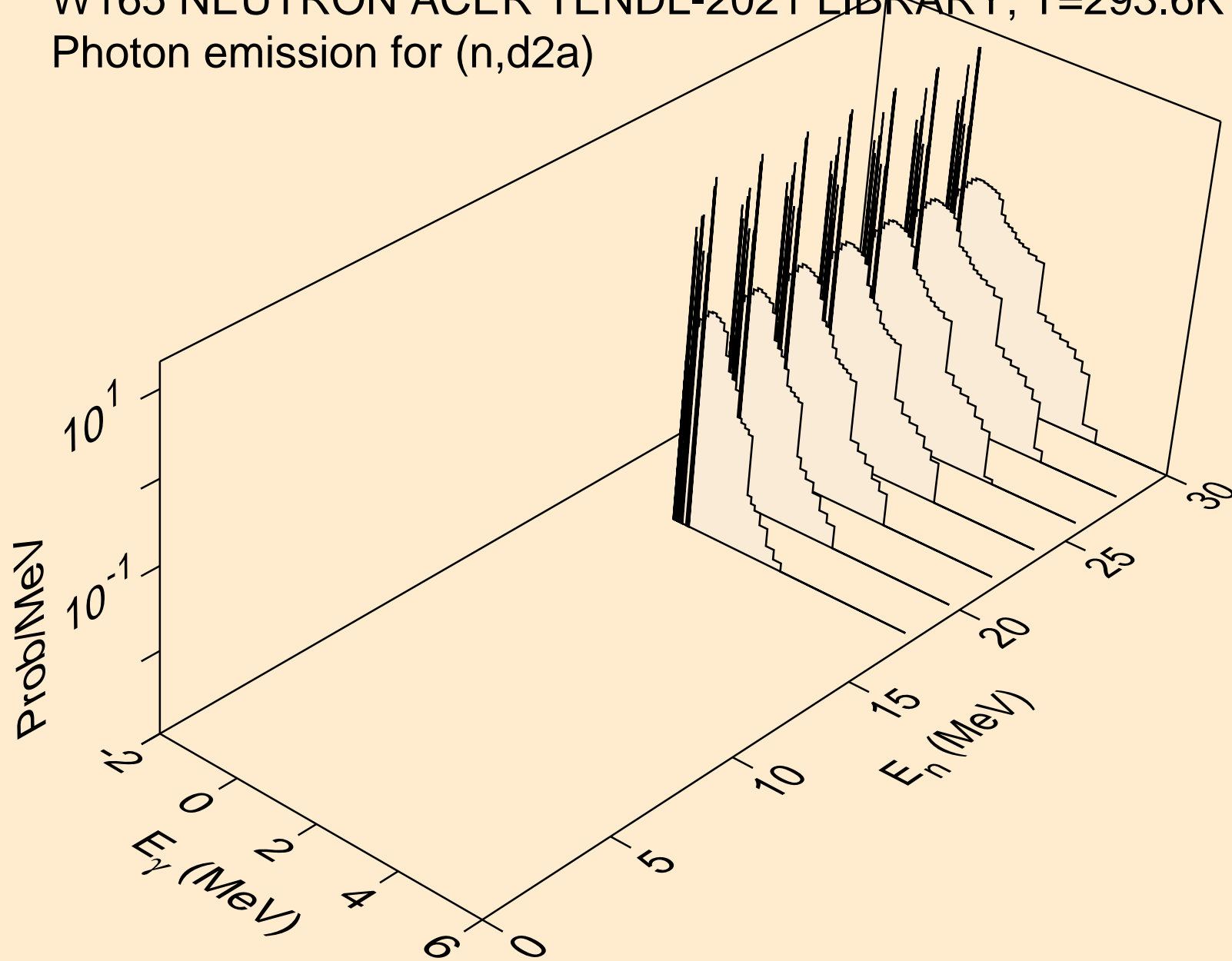

W165 NEUTRON ACER TENDL-2021 LIBRARY; T=293.6K  
Photon emission for (n,pd)

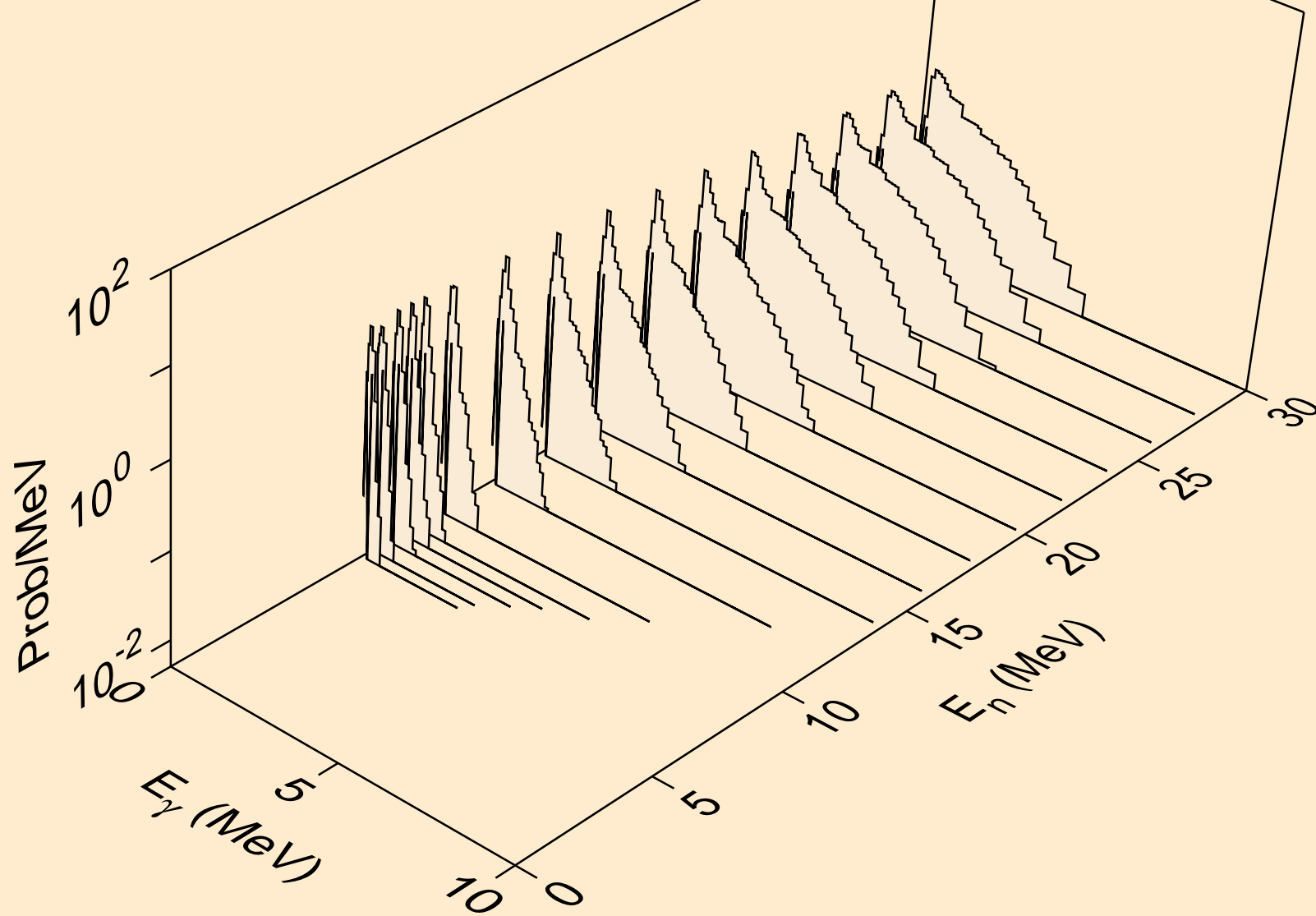

W165 NEUTRON ACER TENDL-2021 LIBRARY; T=293.6K  
Photon emission for (n,pt)

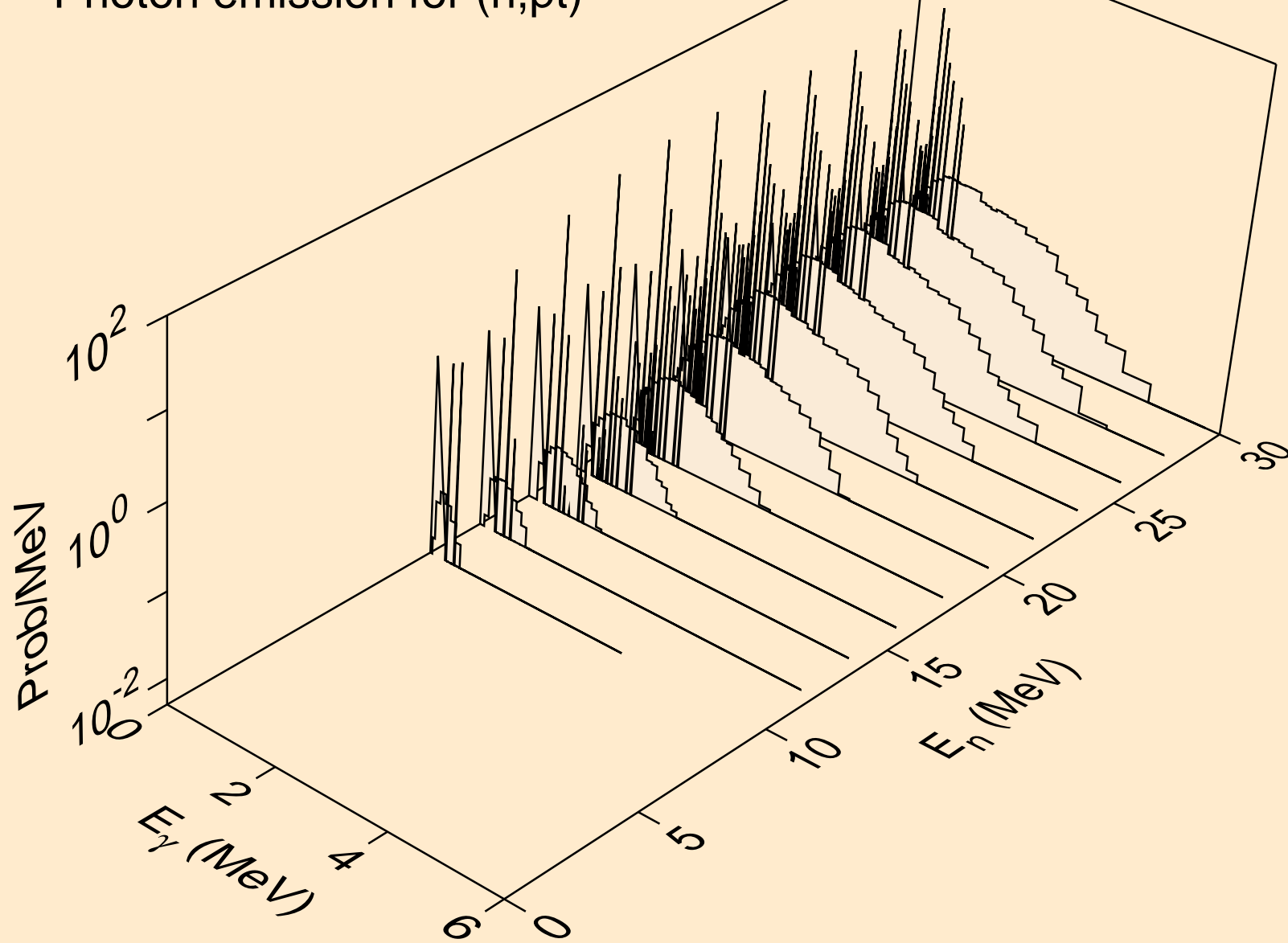

W165 NEUTRON ACER TENDL-2021 LIBRARY; T=293.6K  
Photon emission for (n,da)

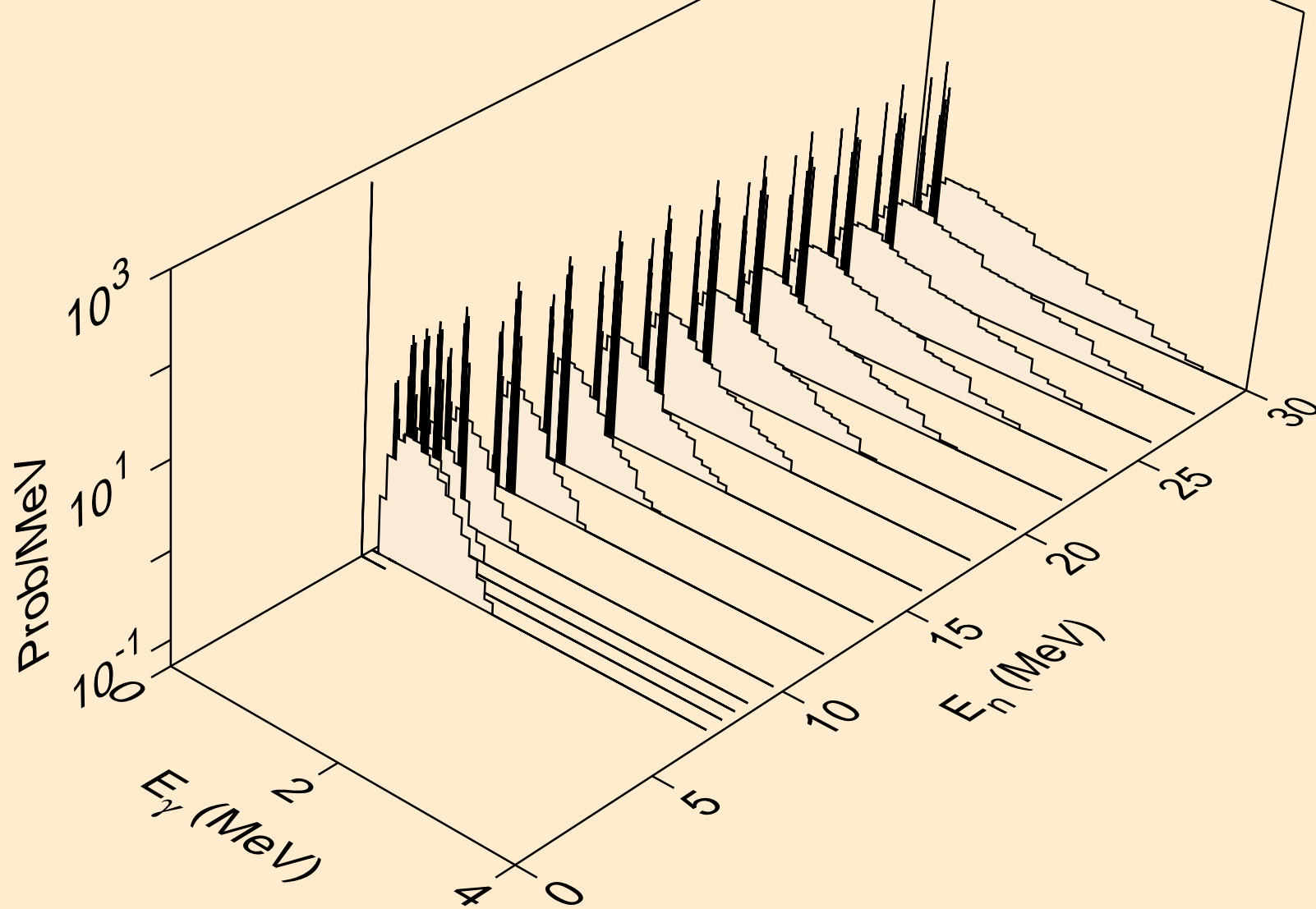

W165 NEUTRON ACER TENDL-2021 LIBRARY; T=293.6K  
thermal capture photon spectrum

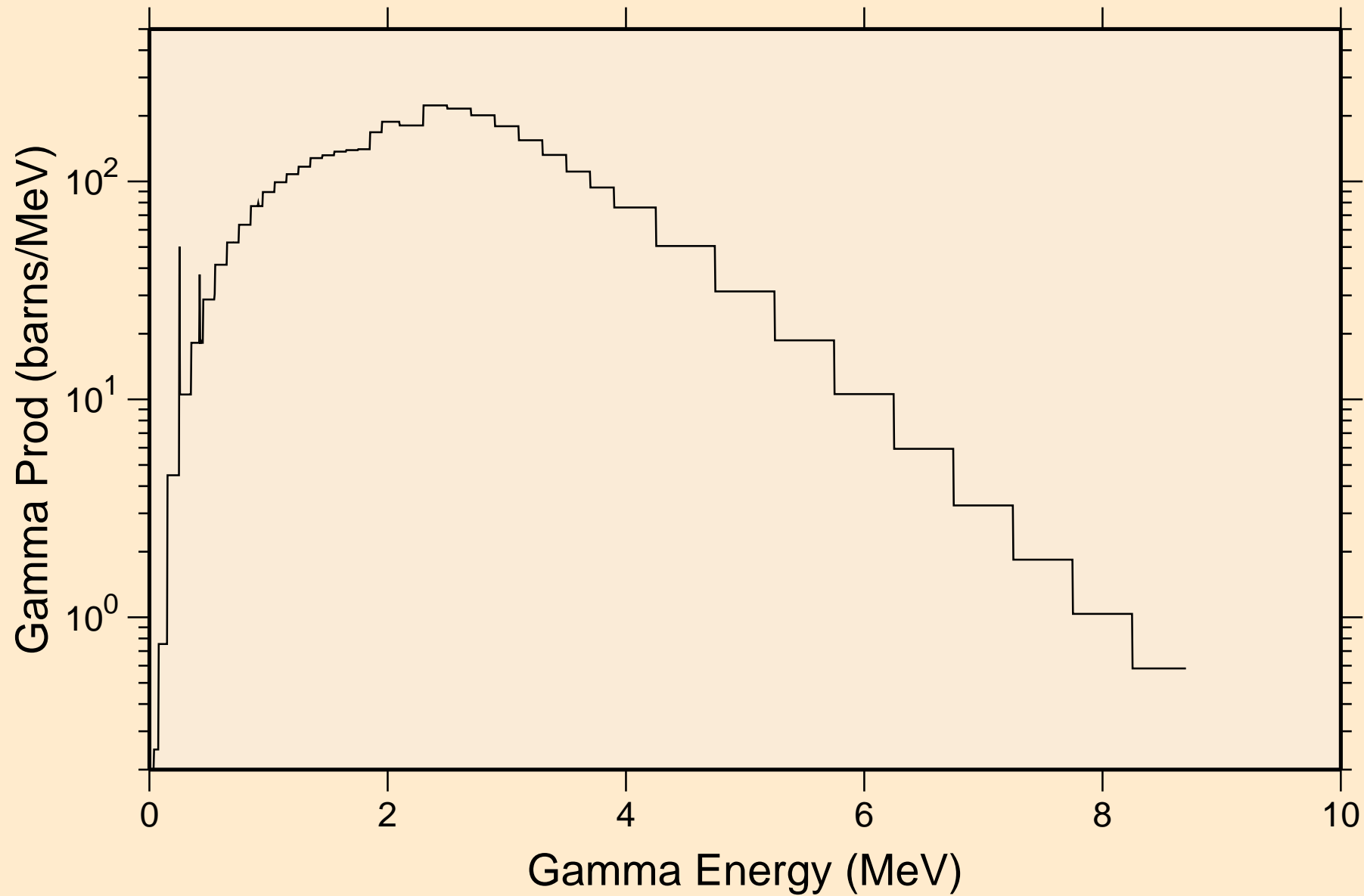

W165 NEUTRON ACER TENDL-2021 LIBRARY; T=293.6K  
14 MeV photon spectrum

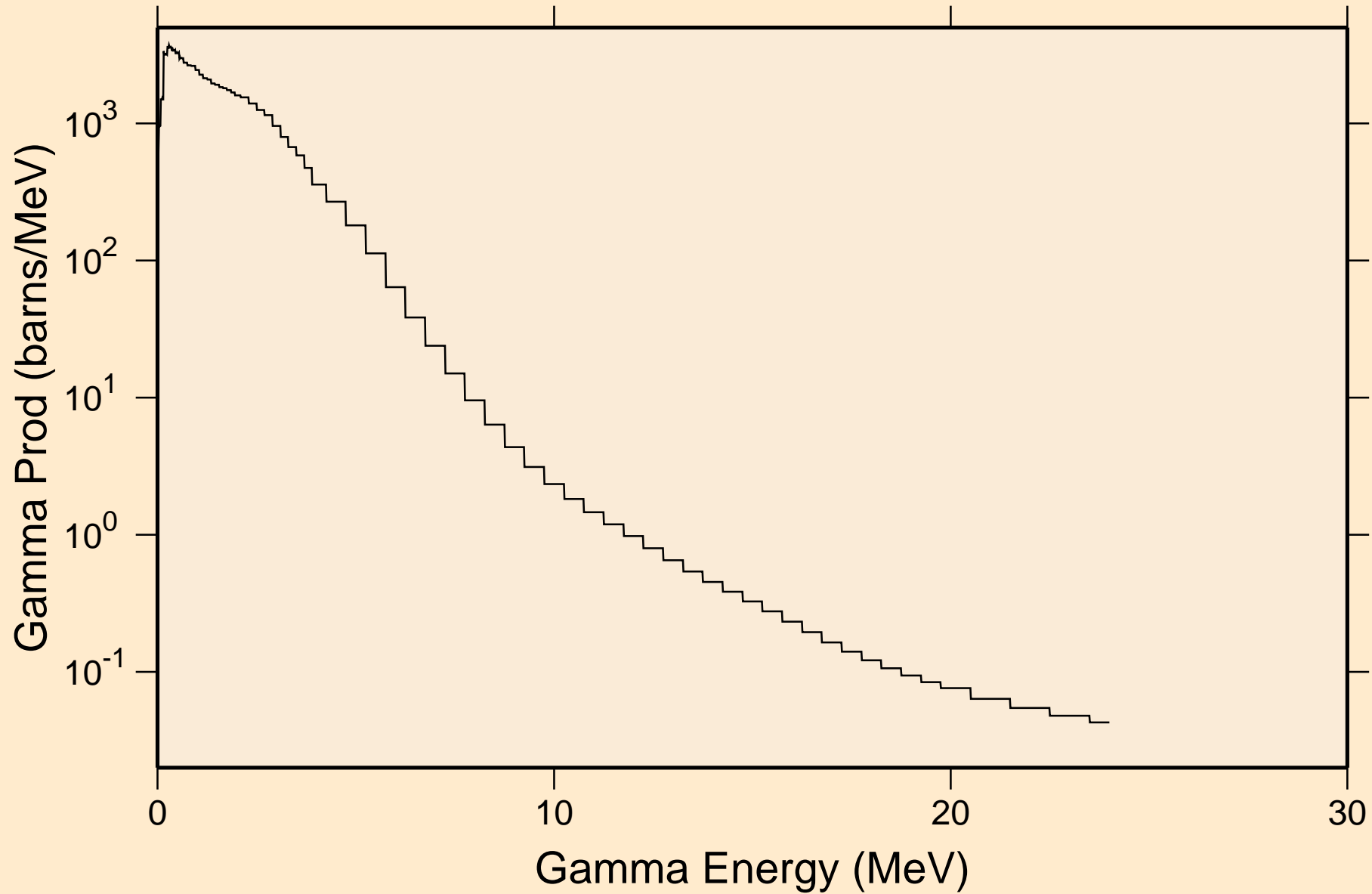

# W165 NEUTRON ACER TENDL-2021 LIBRARY; T=293.6K

## Particle heating contributions

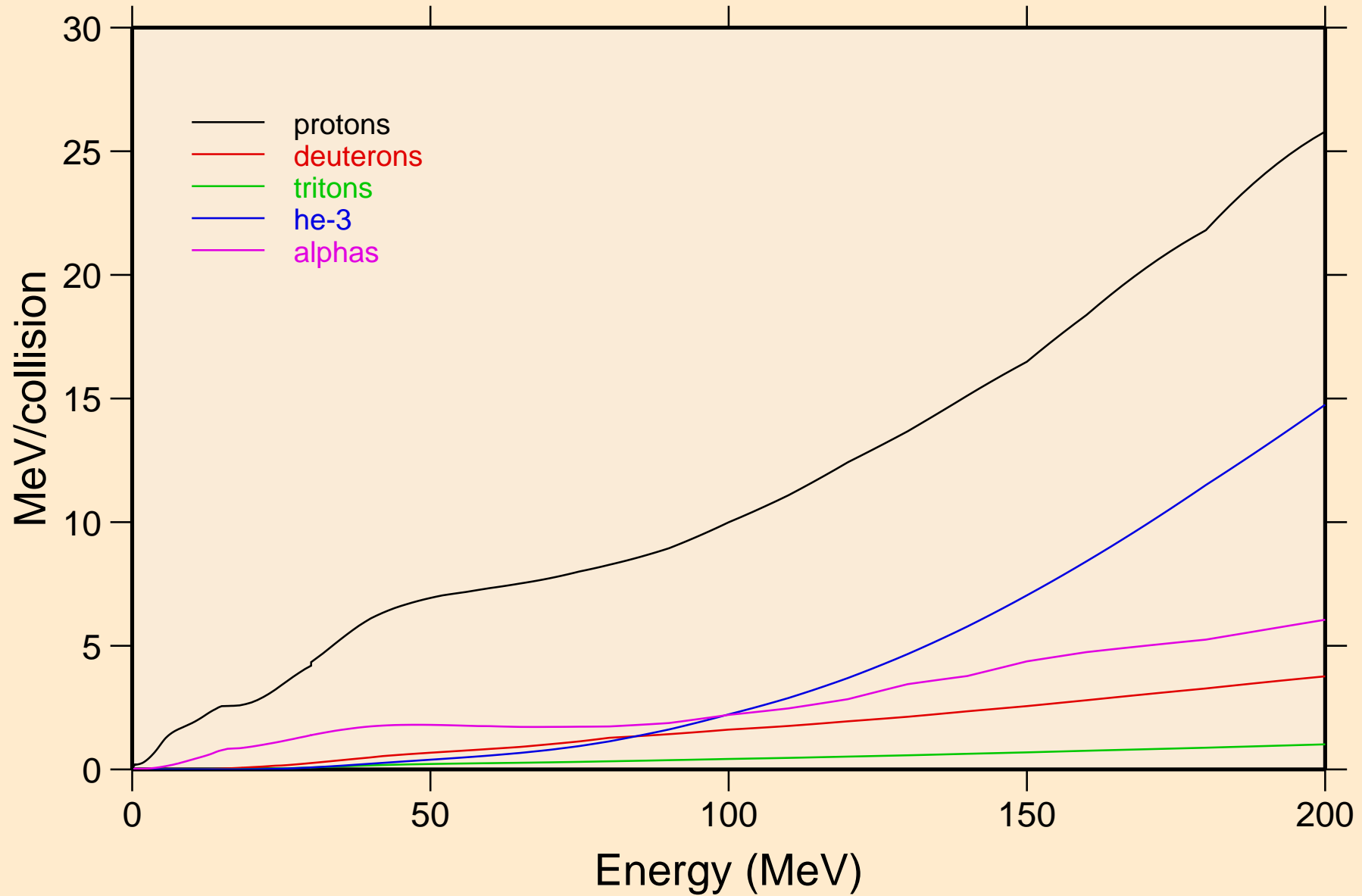

W165 NEUTRON ACER TENDL-2021 LIBRARY; T=293.6K  
Recoil Heating

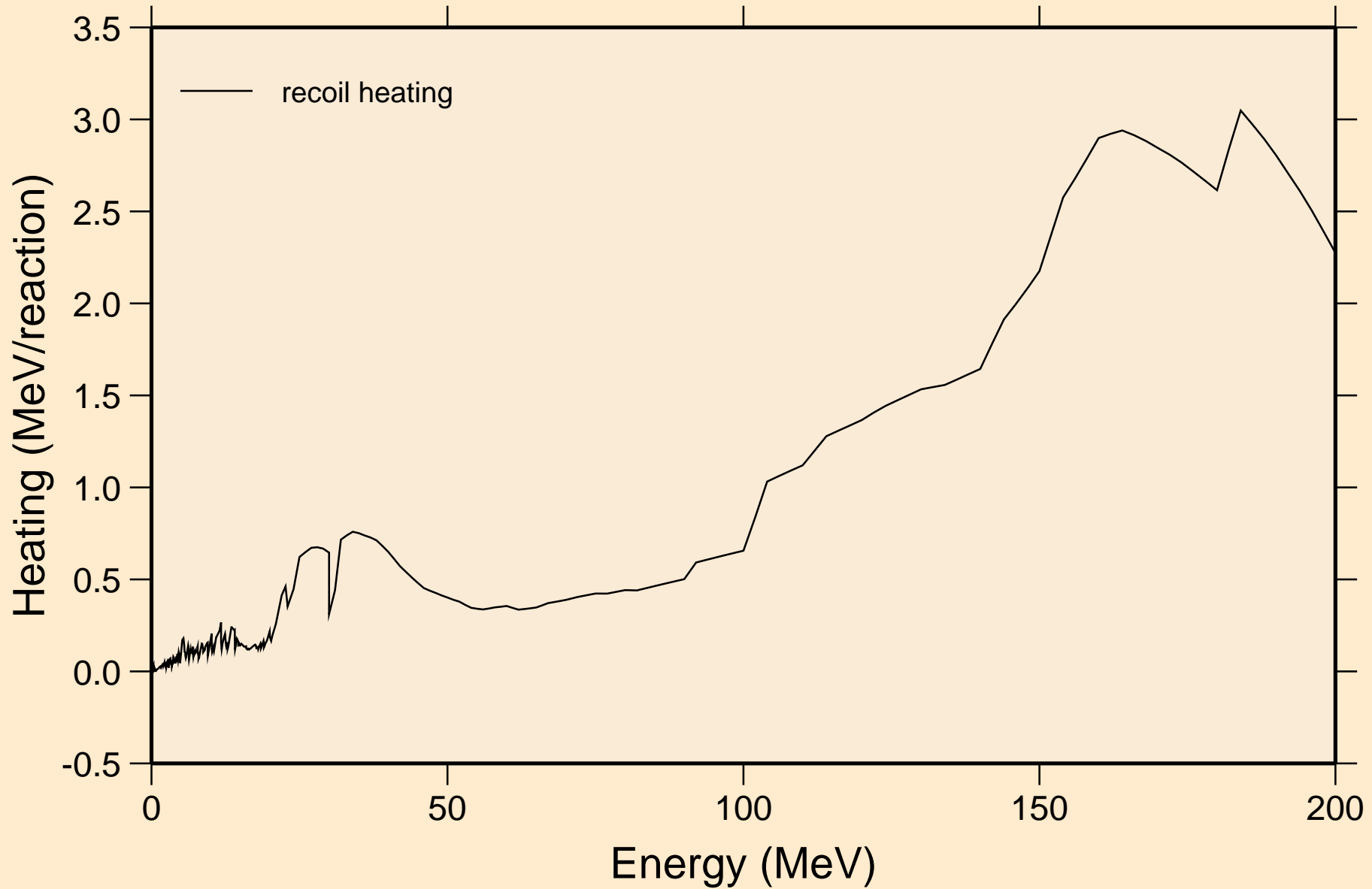



W165 NEUTRON ACER TENDL-2021 LIBRARY; T=293.6K  
Particle production cross sections

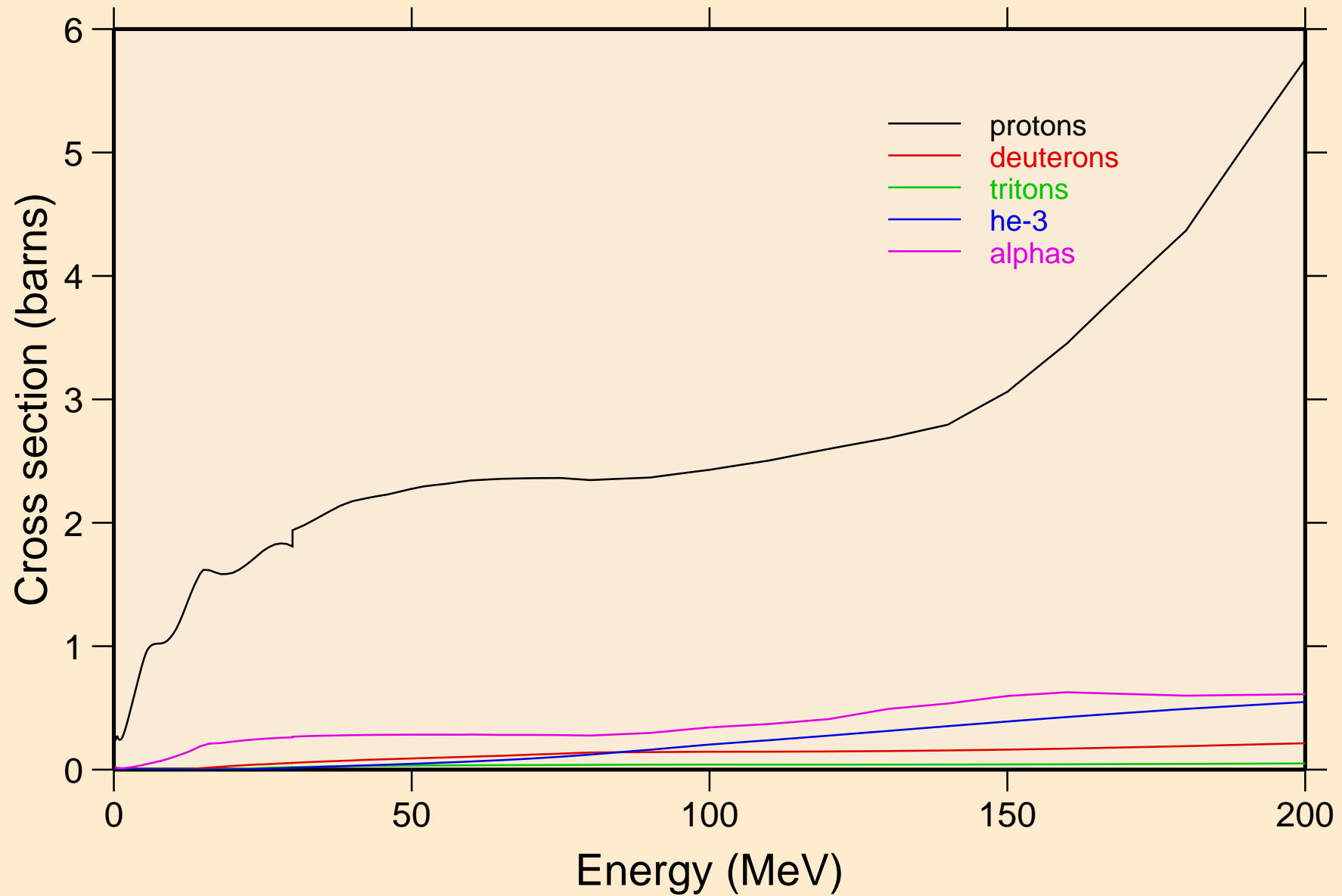

W165 NEUTRON ACER TENDL-2021 LIBRARY; T=293.6K  
protons from (n,x)

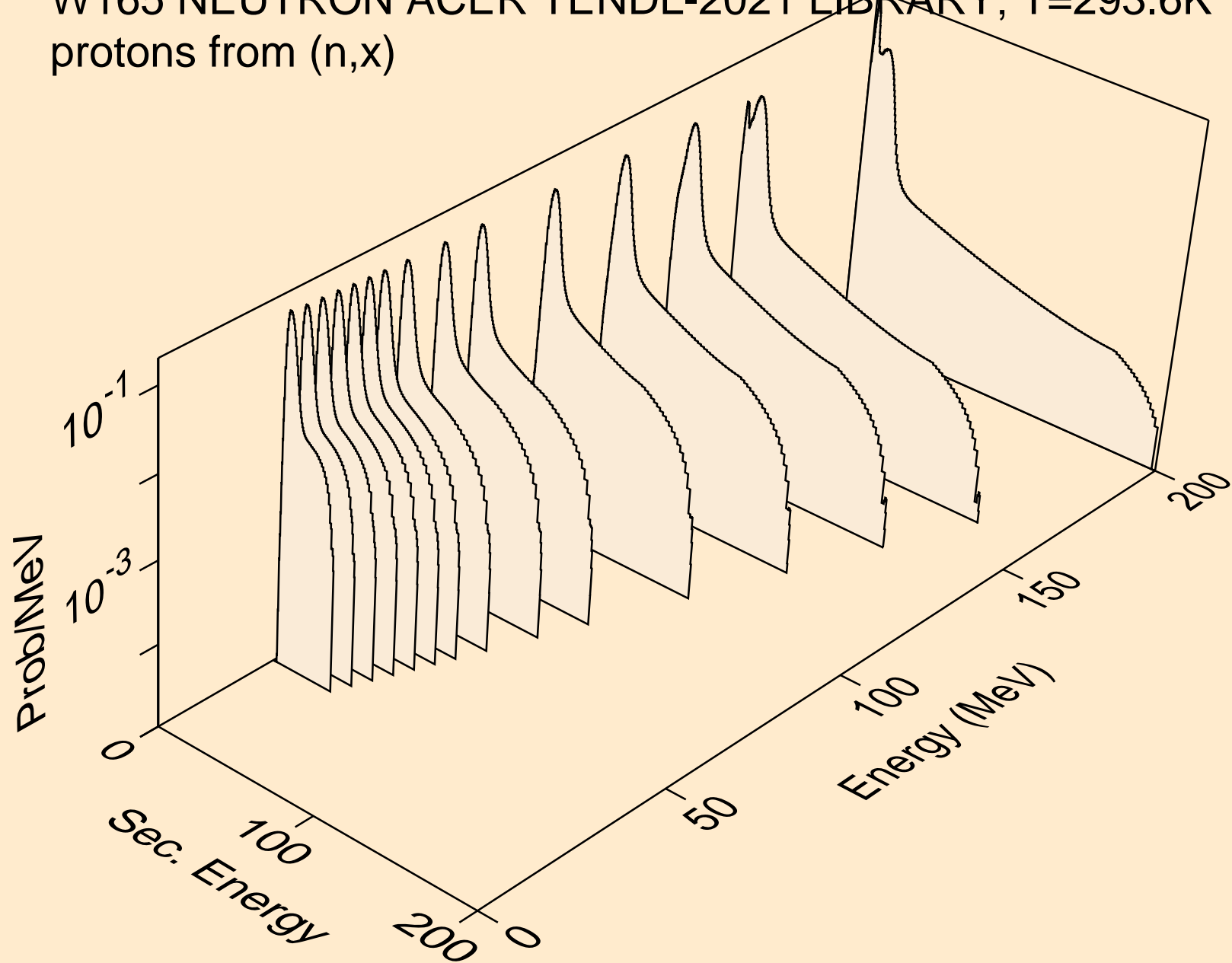

W165 NEUTRON ACER TENDL-2021 LIBRARY; T=293.6K  
protons from (n,n\*)p

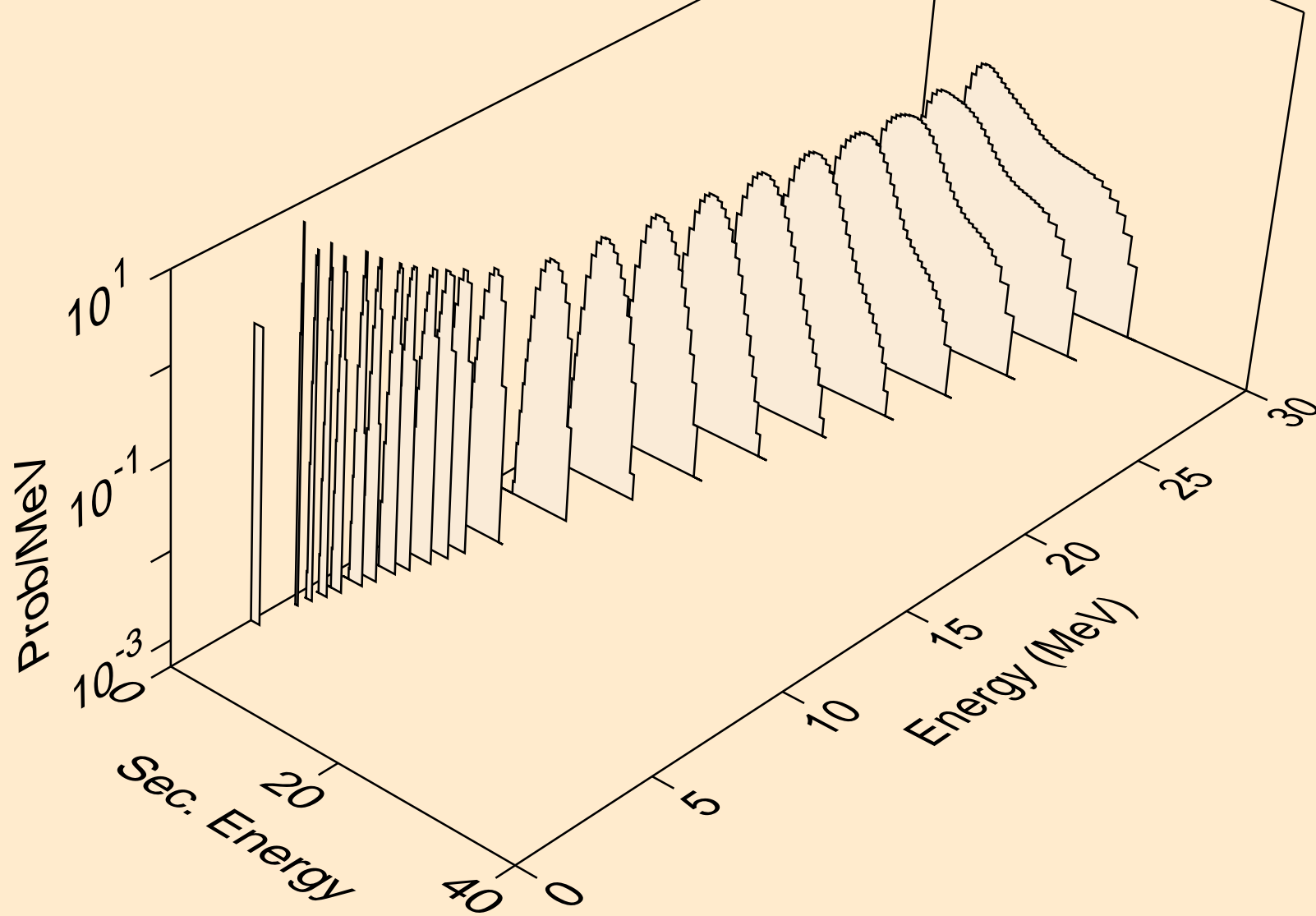

W165 NEUTRON ACER TENDL-2021 LIBRARY; T=293.6K  
protons from (n,2np)

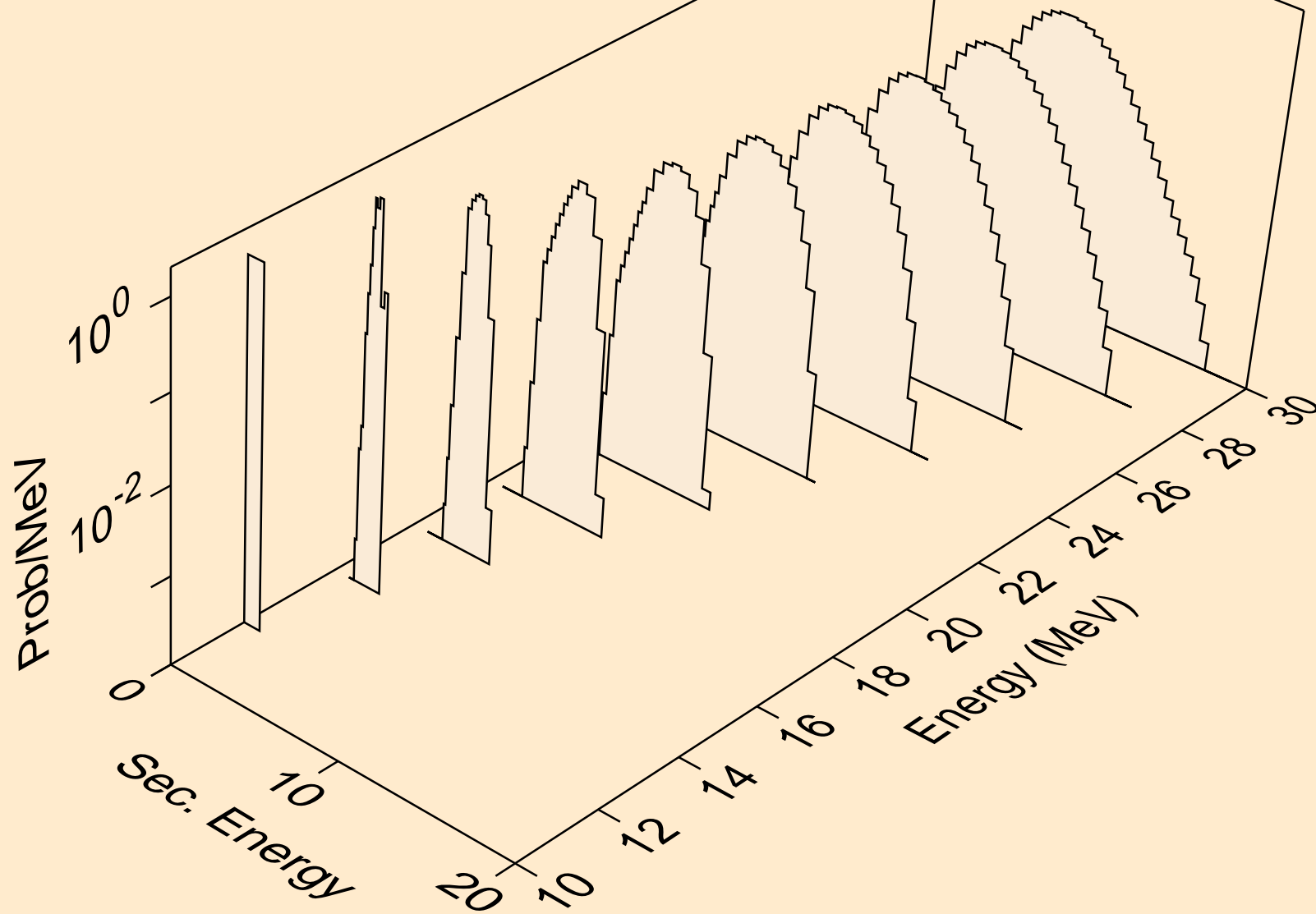

W165 NEUTRON ACER TENDL-2021 LIBRARY; T=293.6K  
protons from (n,3np)

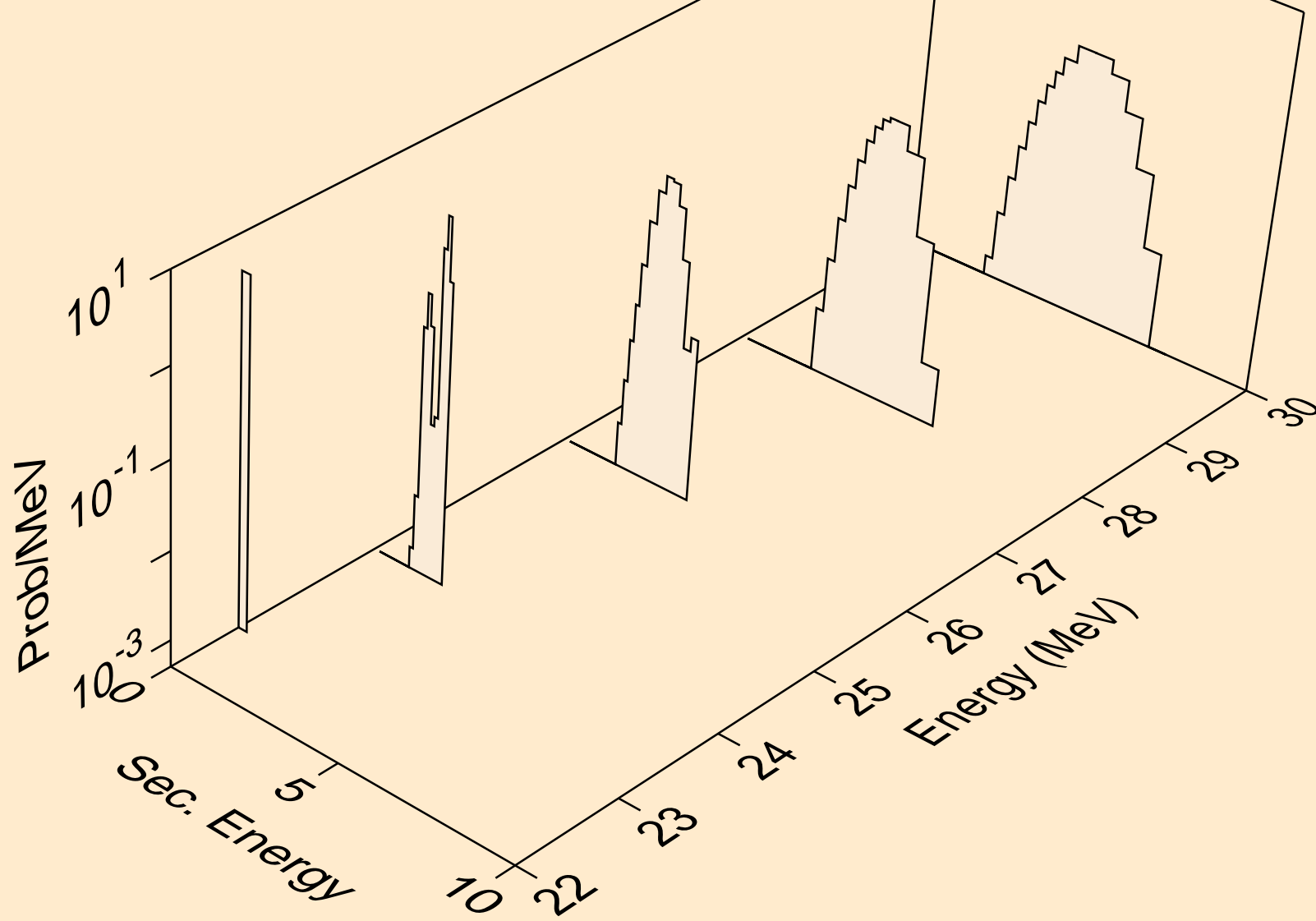

W165 NEUTRON ACER TENDL-2021 LIBRARY; T=293.6K  
protons from (n,2np)

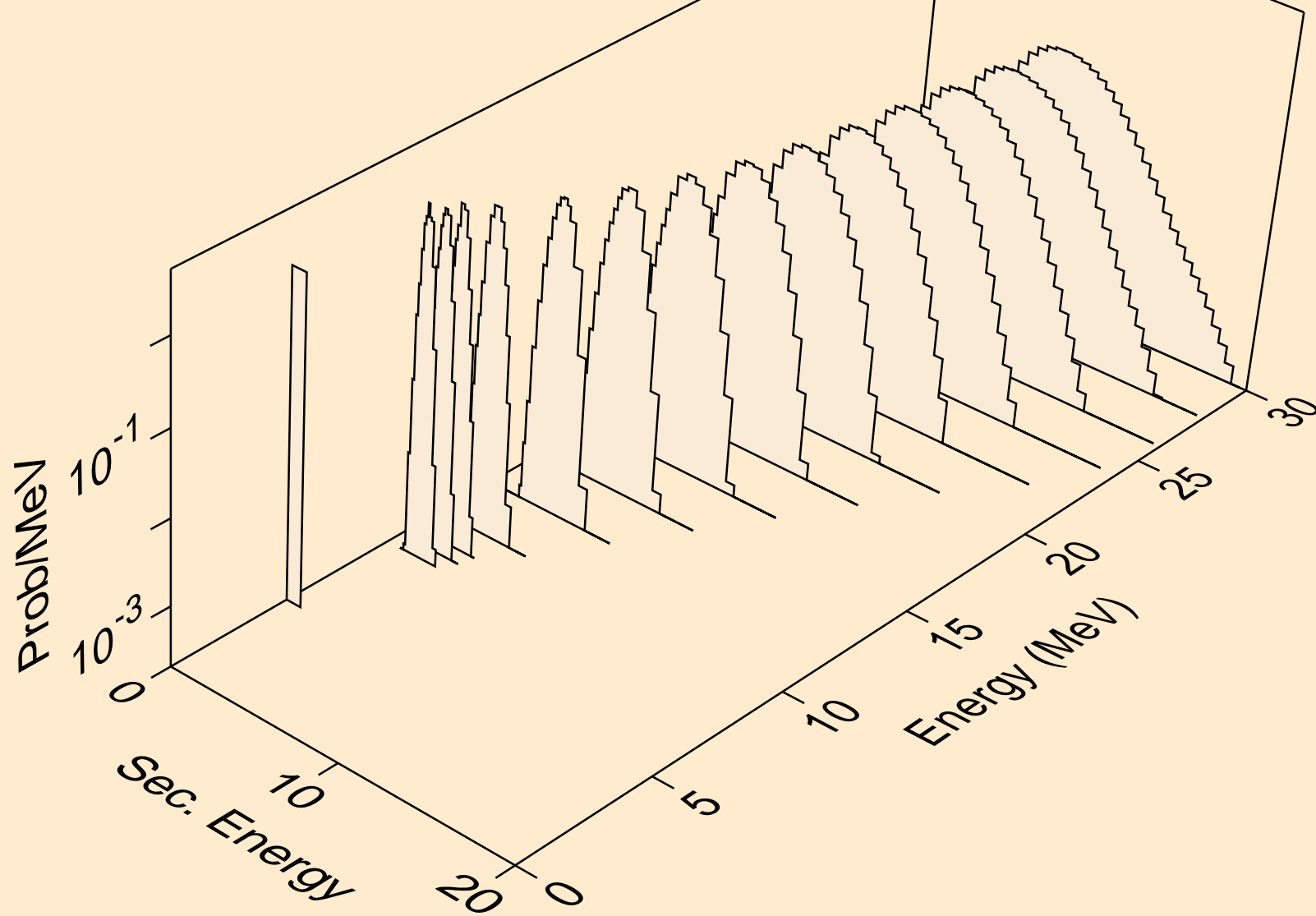

W165 NEUTRON ACER TENDL-2021 LIBRARY; T=293.6K  
protons from (n,npa)

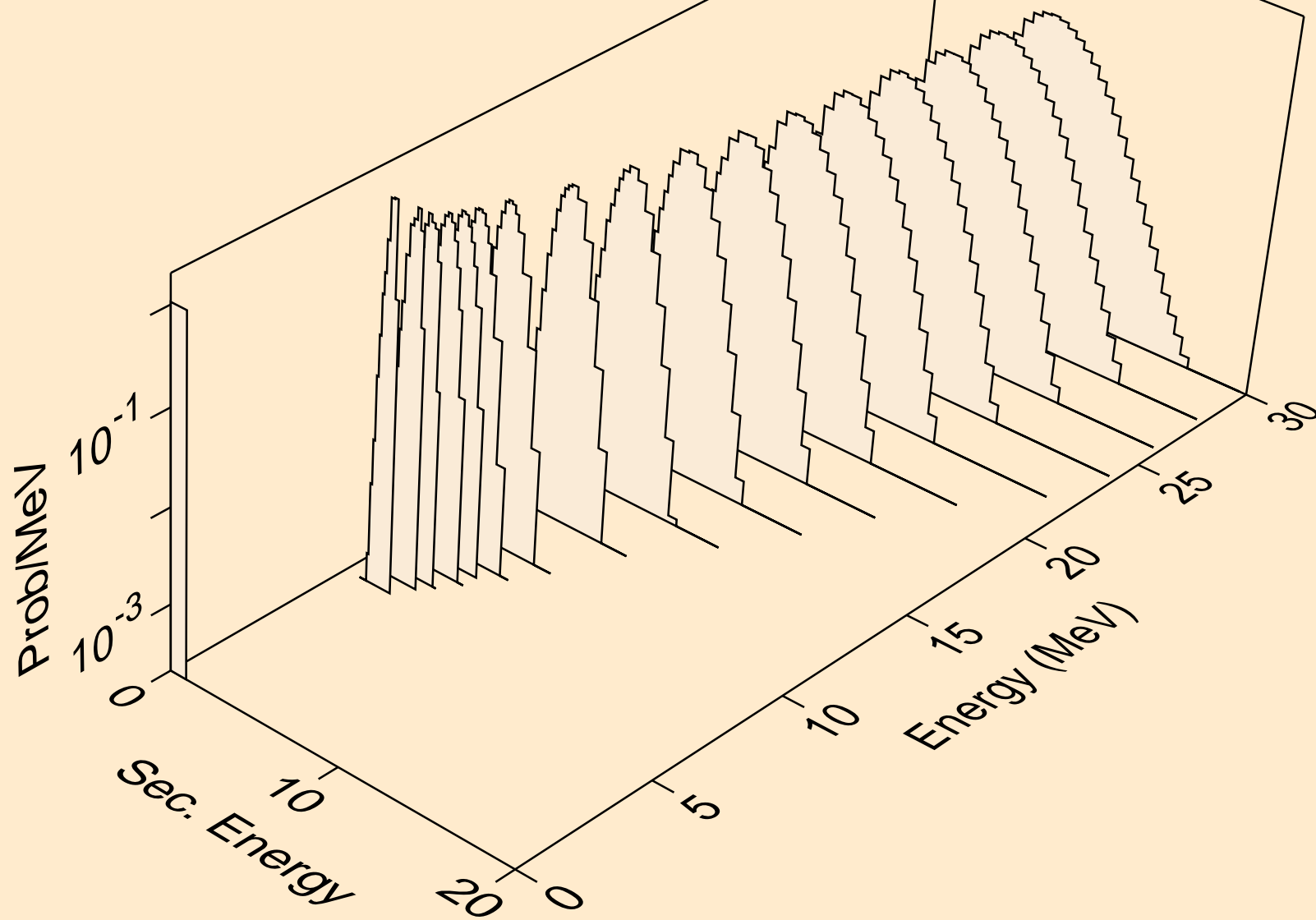

W165 NEUTRON ACER TENDL-2021 LIBRARY; T=293.6K  
protons from (n,p)

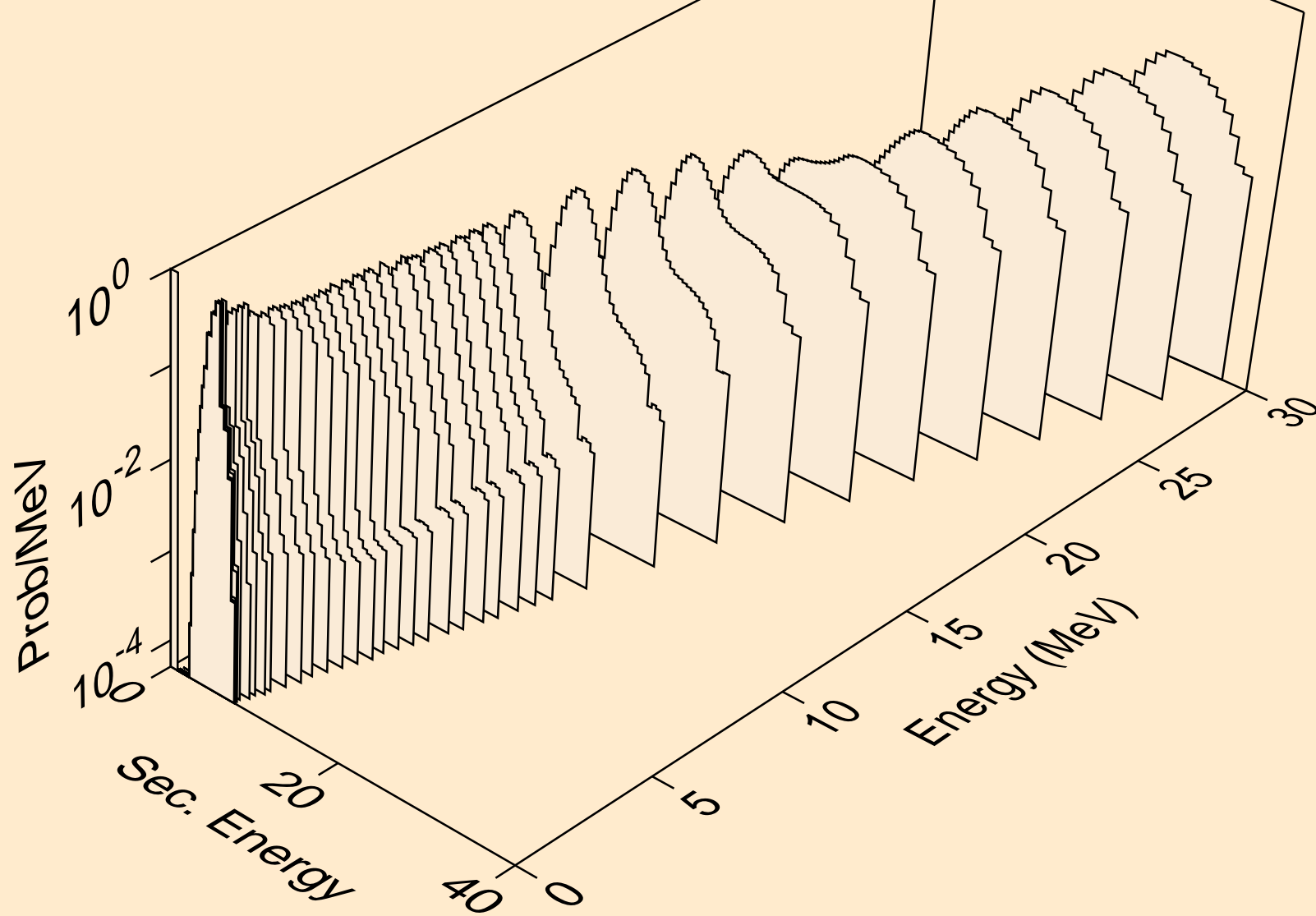



W165 NEUTRON ACER TENDL-2021 LIBRARY; T=293.6K  
protons from (n,2p)

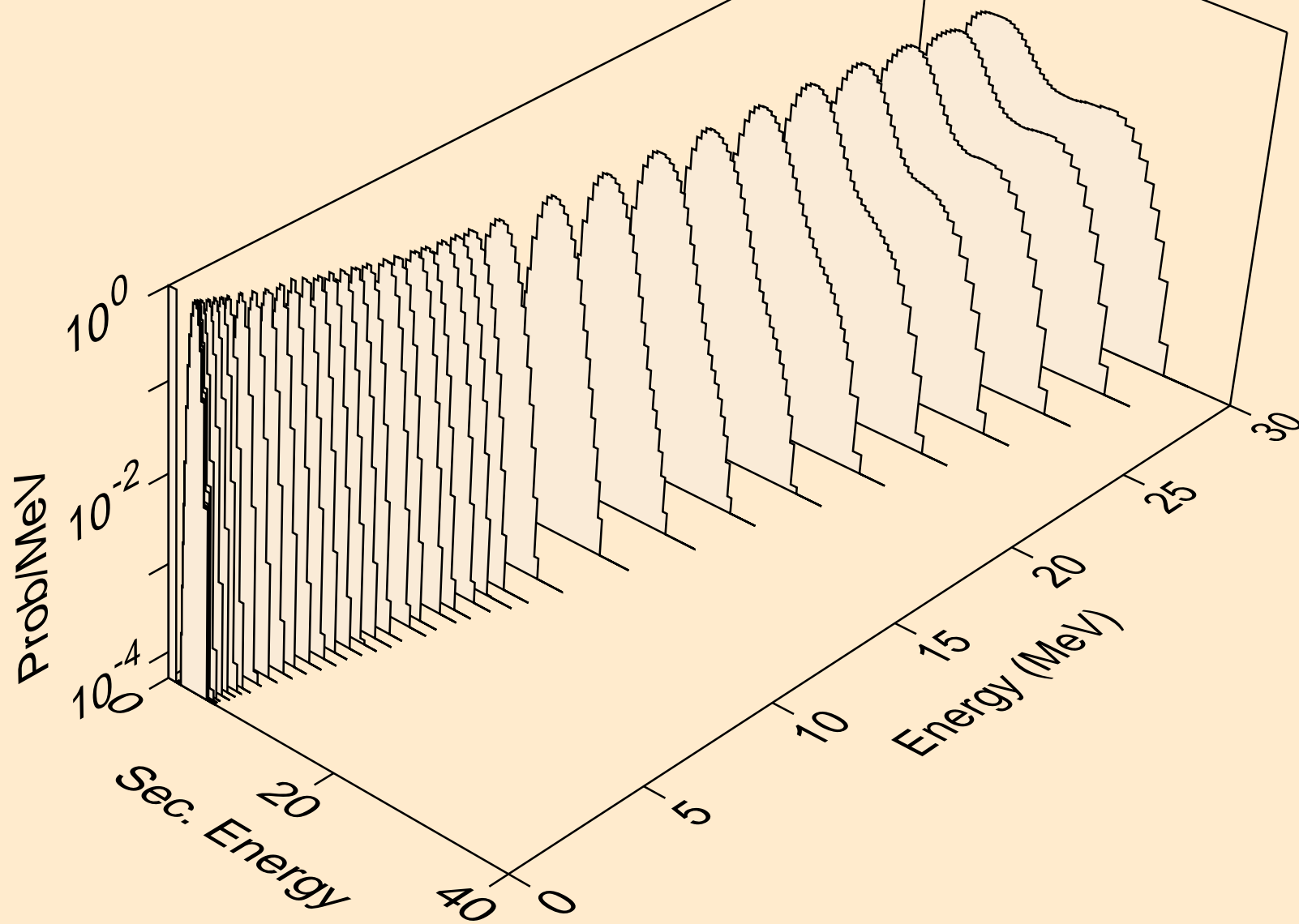

W165 NEUTRON ACER TENDL-2021 LIBRARY; T=293.6K  
protons from (n,p)

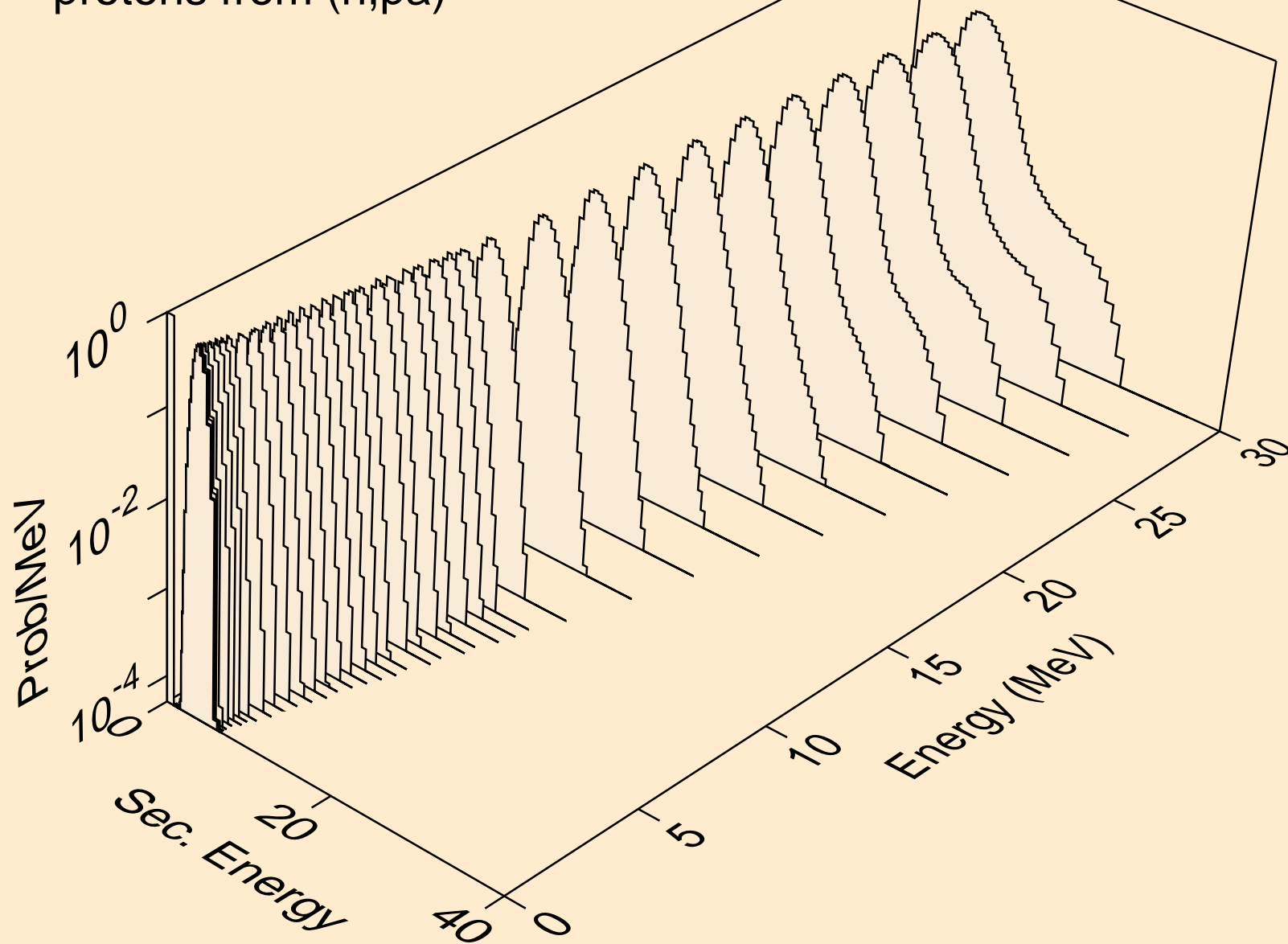

W165 NEUTRON ACER TENDL-2021 LIBRARY; T=293.6K  
protons from (n,pd)

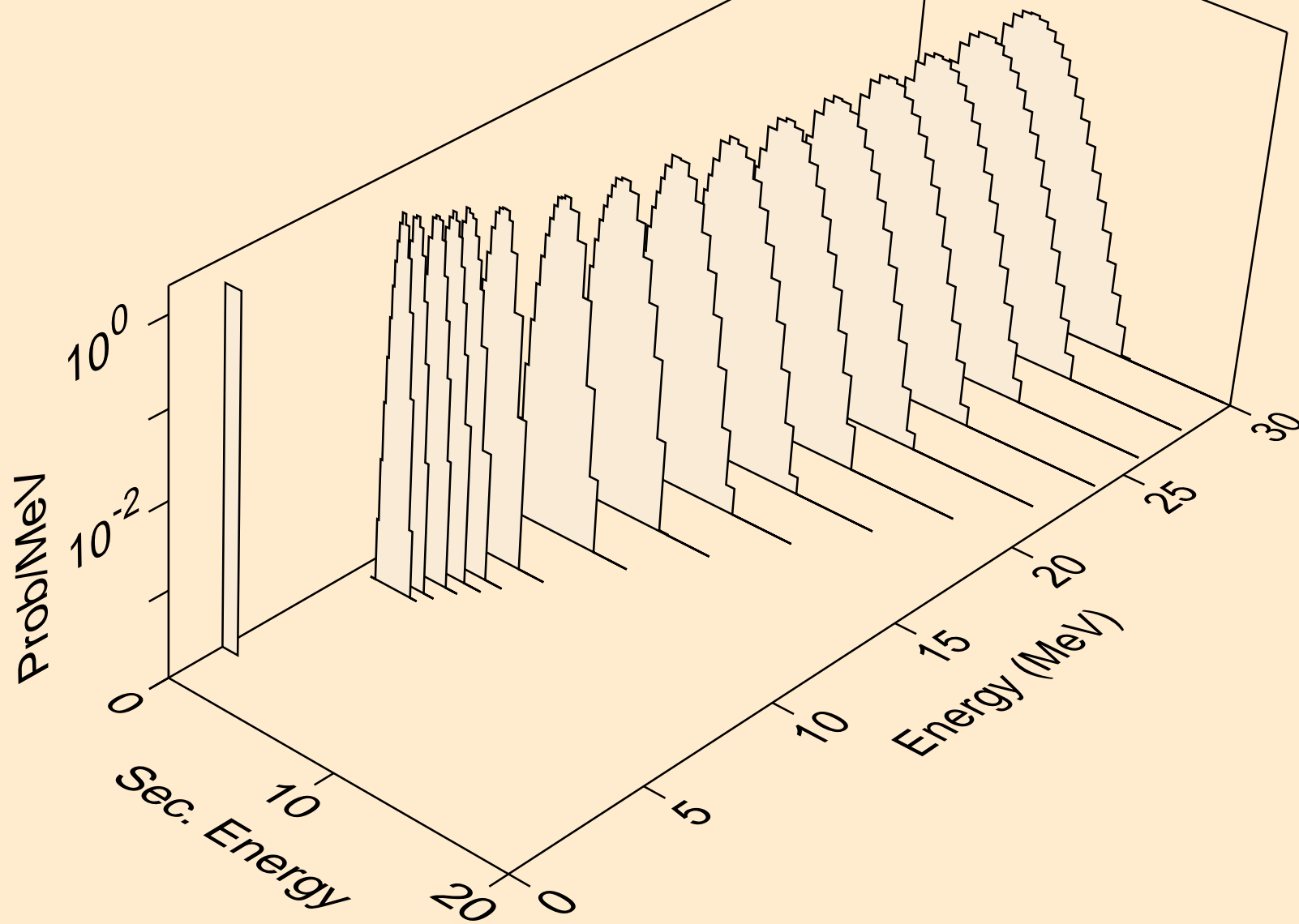

W165 NEUTRON ACER TENDL-2021 LIBRARY; T=293.6K  
protons from (n,pt)

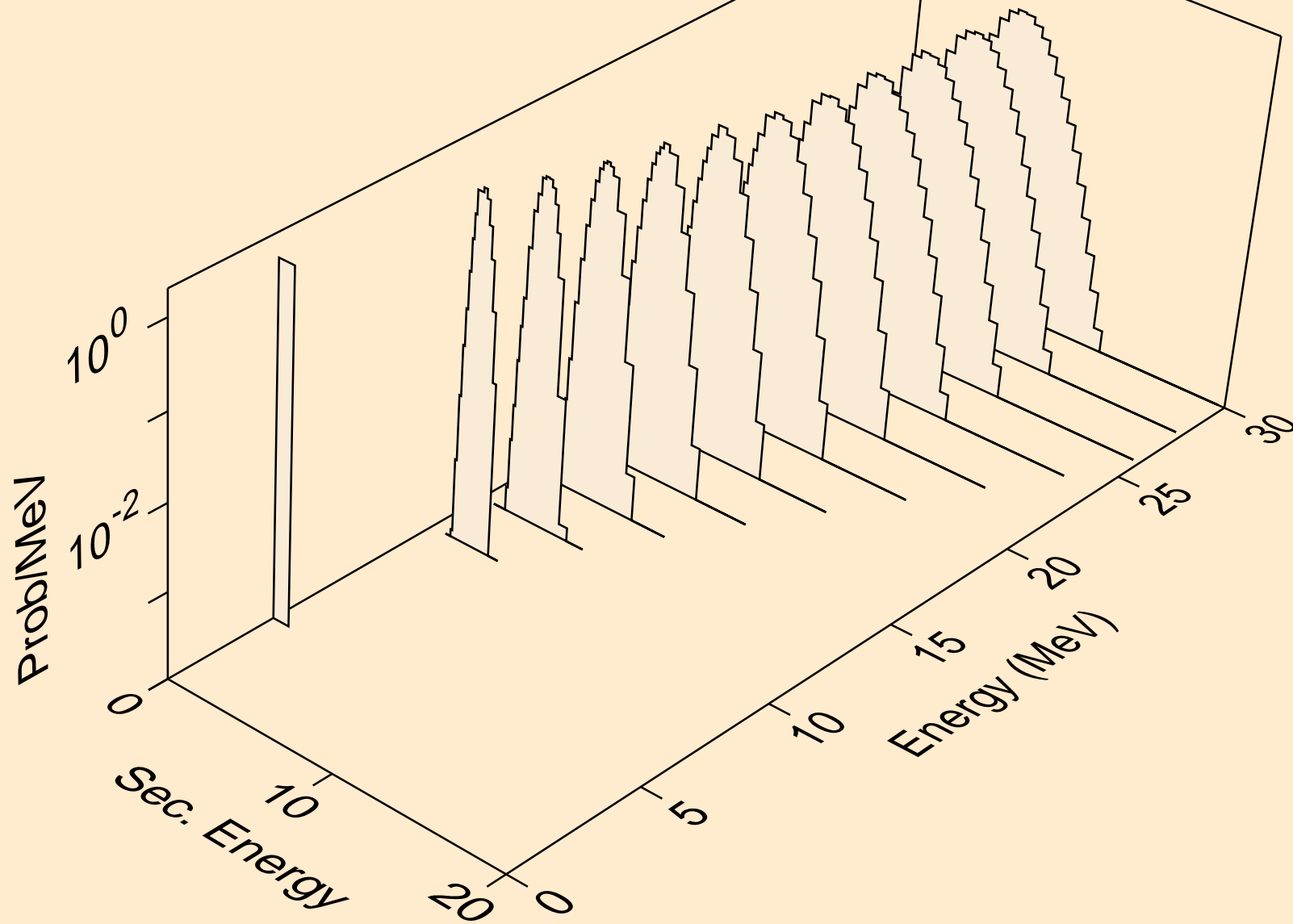

W165 NEUTRON ACER TENDL-2021 LIBRARY; T=293.6K  
deuterons from (n,x)

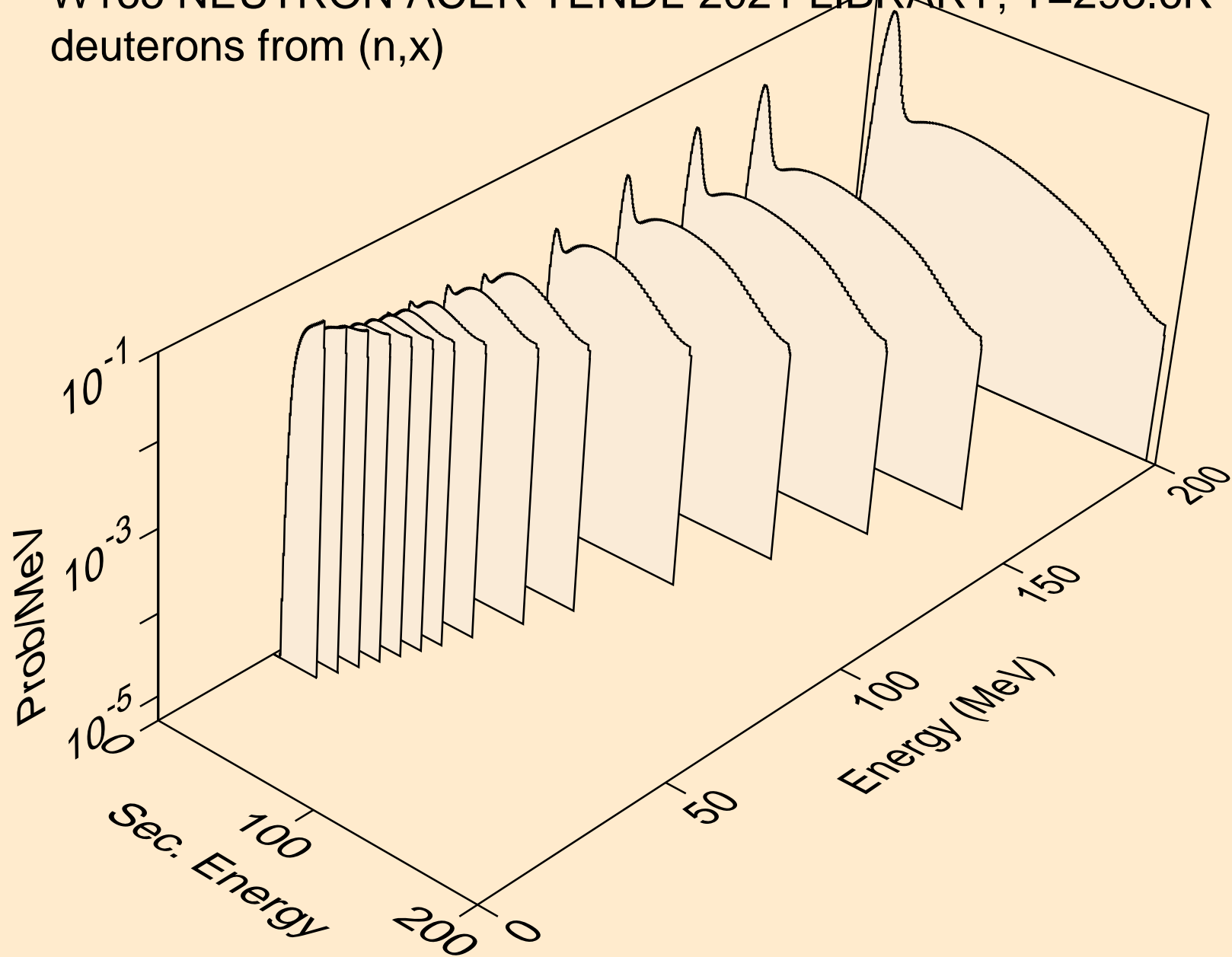

W165 NEUTRON ACER TENDL-2021 LIBRARY; T=293.6K  
deuterons from (n,2nd)

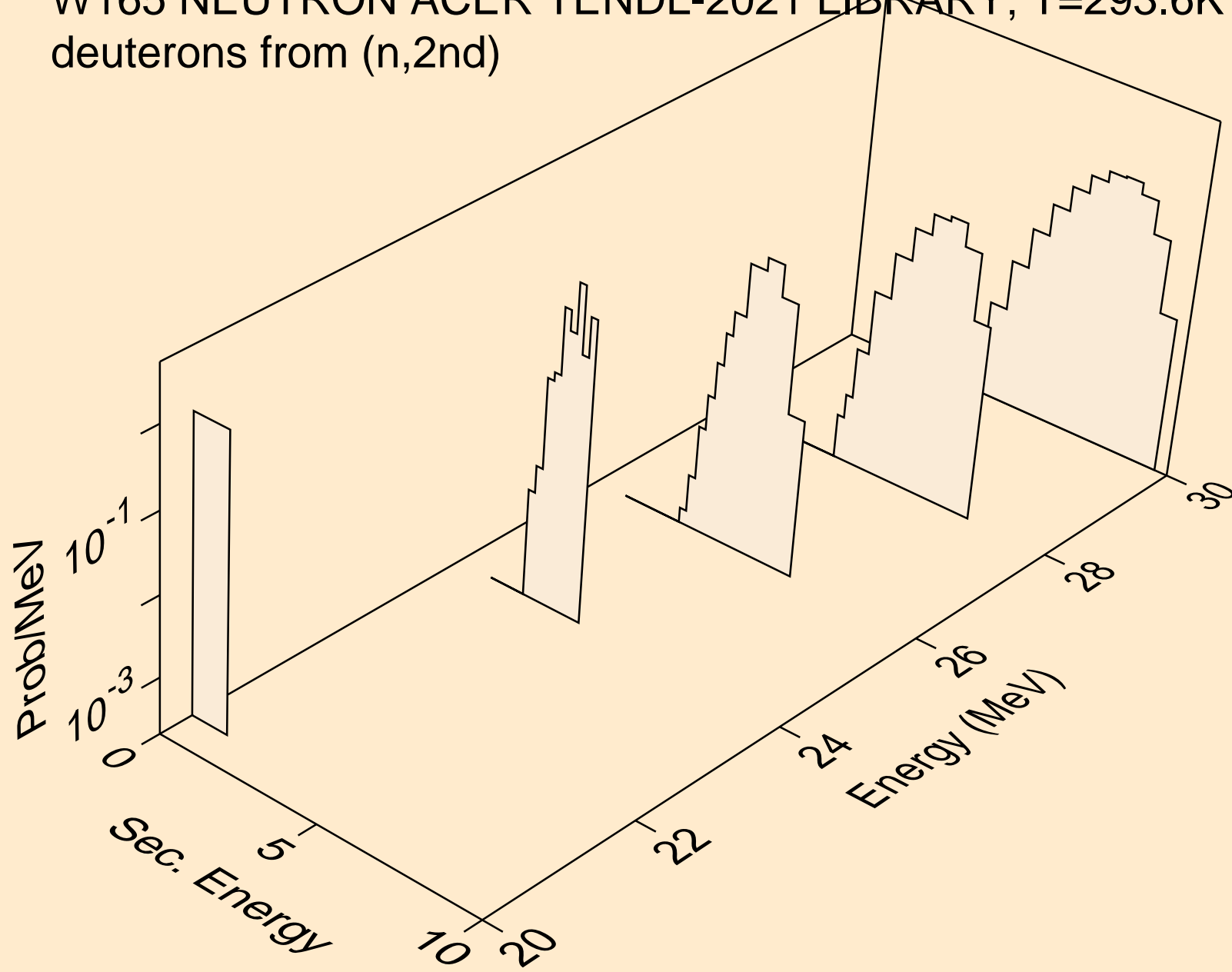

W165 NEUTRON ACER TENDL-2021 LIBRARY; T=293.6K  
deuterons from (n,n\*)d

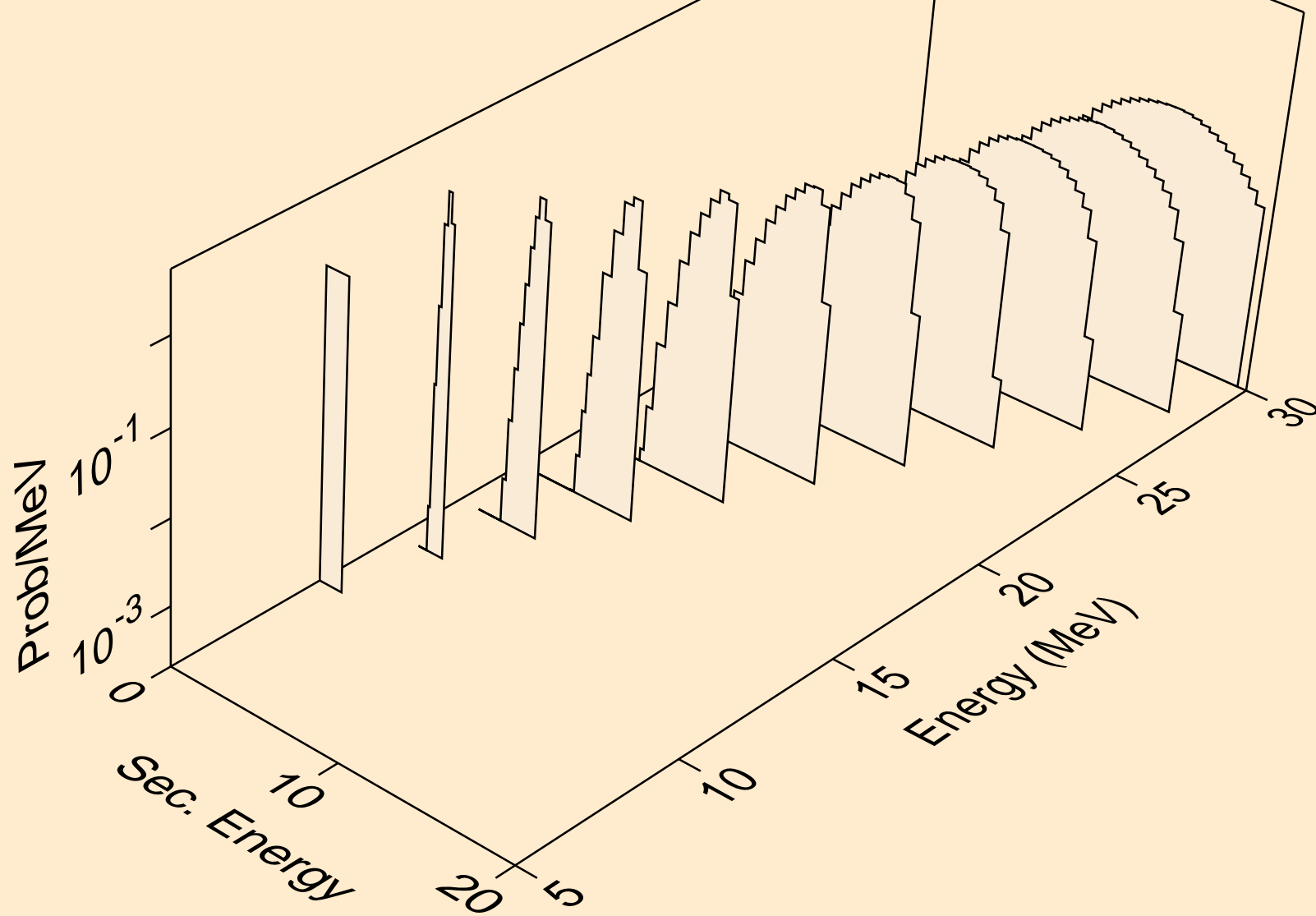

W165 NEUTRON ACER TENDL-2021 LIBRARY; T=293.6K  
deuterons from (n,d)

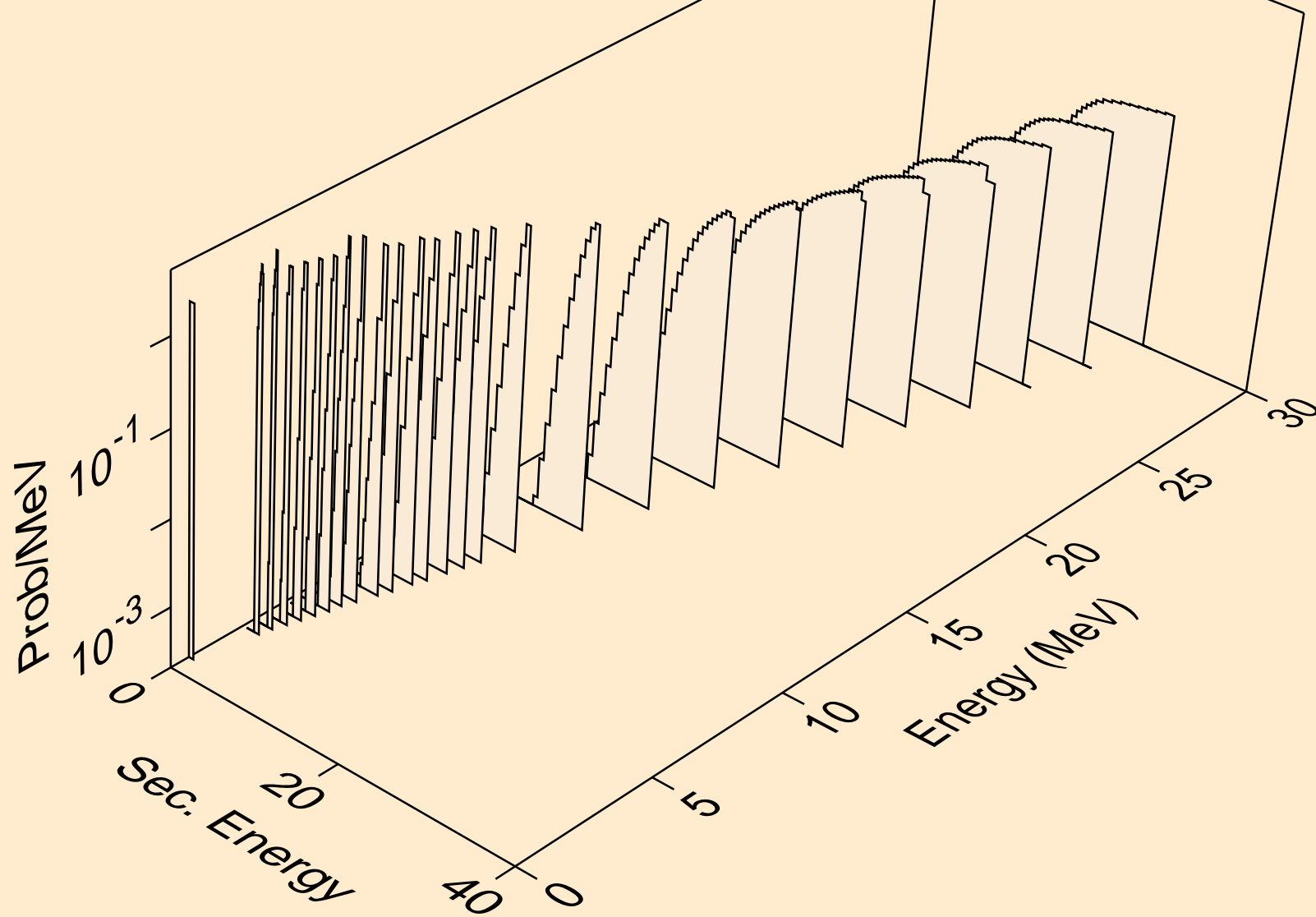



W165 NEUTRON ACER TENDL-2021 LIBRARY; T=293.6K  
deuterons from (n,d2a)

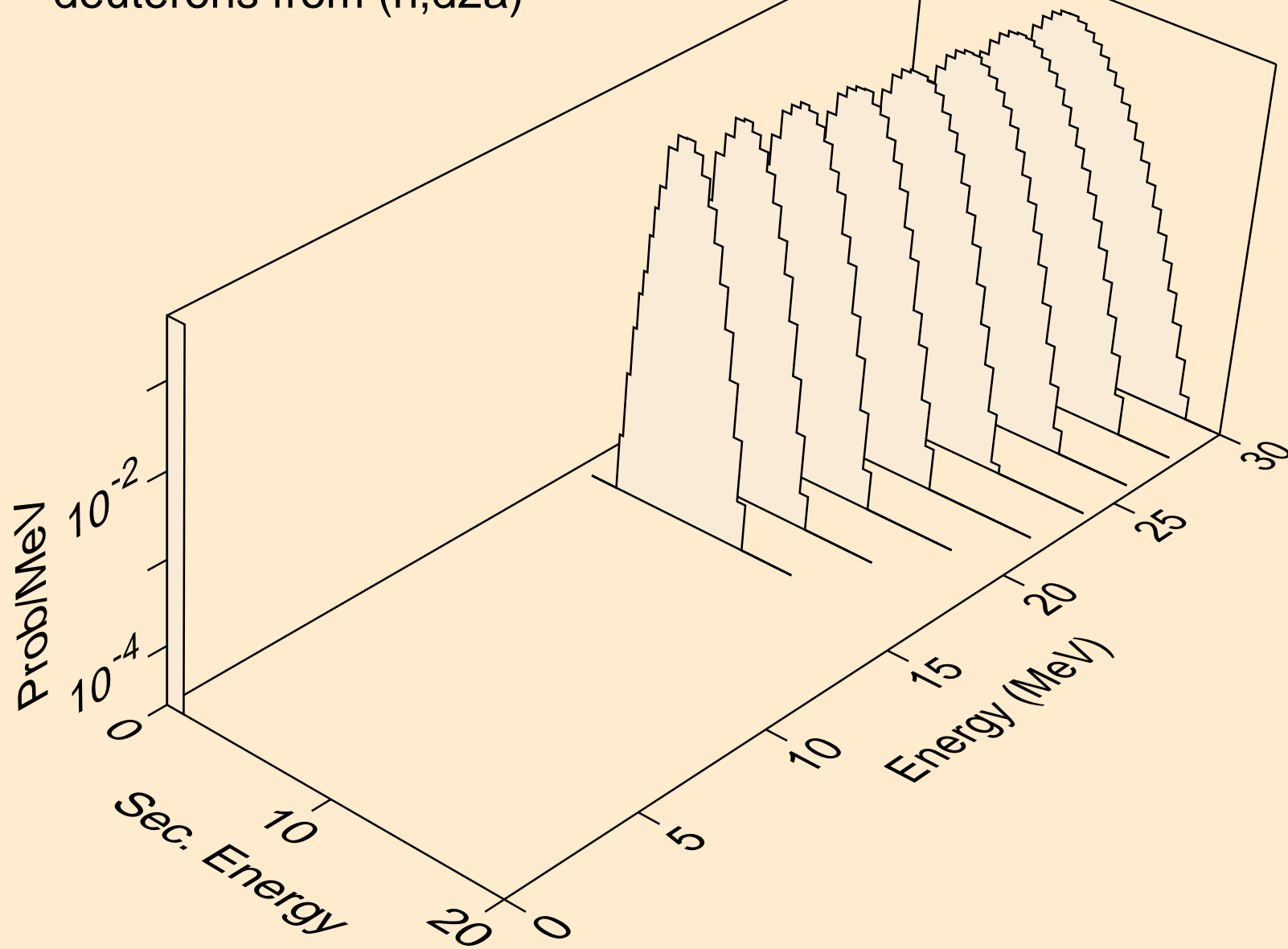

W165 NEUTRON ACER TENDL-2021 LIBRARY; T=293.6K  
deuterons from (n,pd)

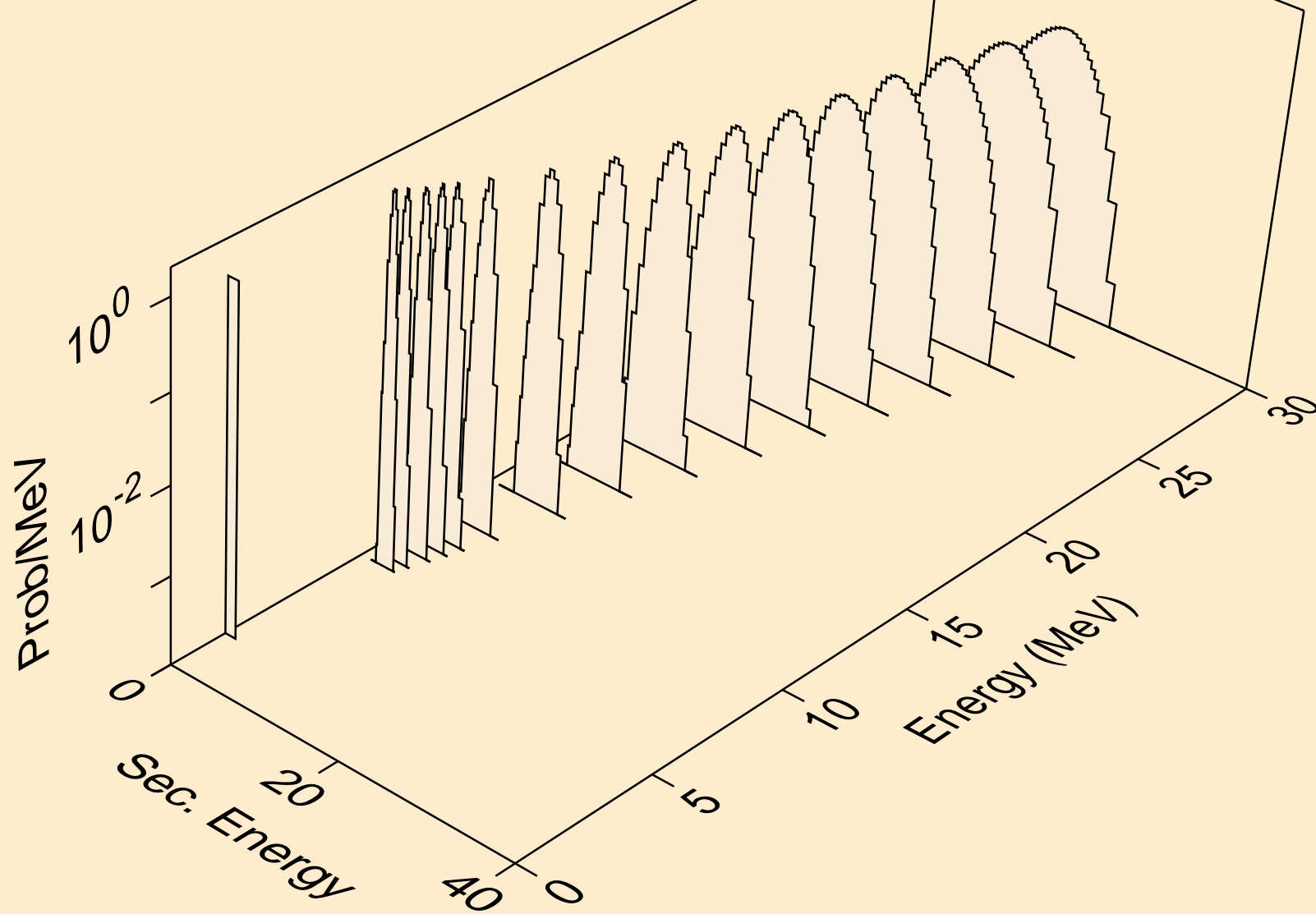

W165 NEUTRON ACER TENDL-2021 LIBRARY; T=293.6K  
deuterons from (n,da)

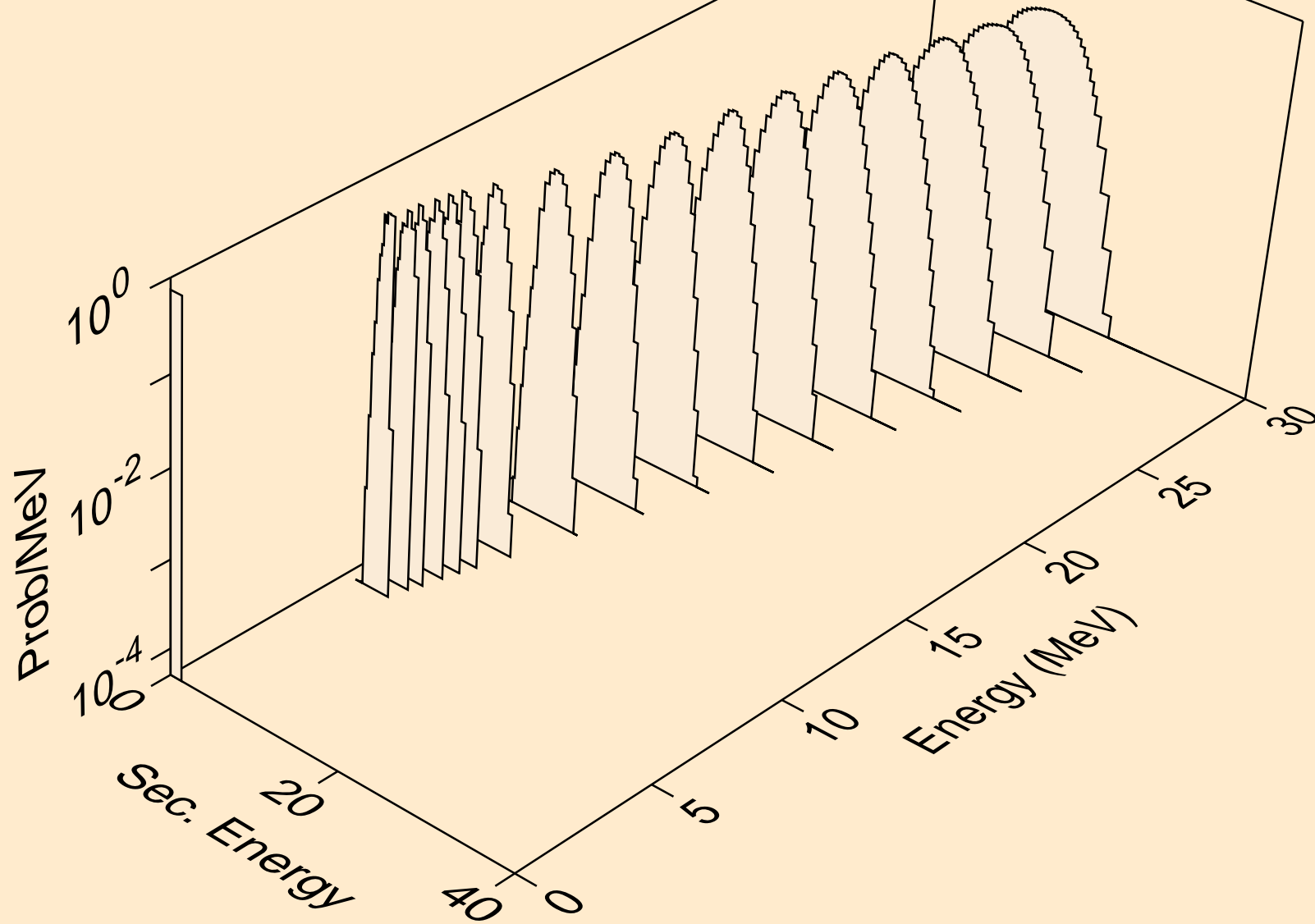

W165 NEUTRON ACER TENDL-2021 LIBRARY; T=293.6K  
tritons from (n,x)

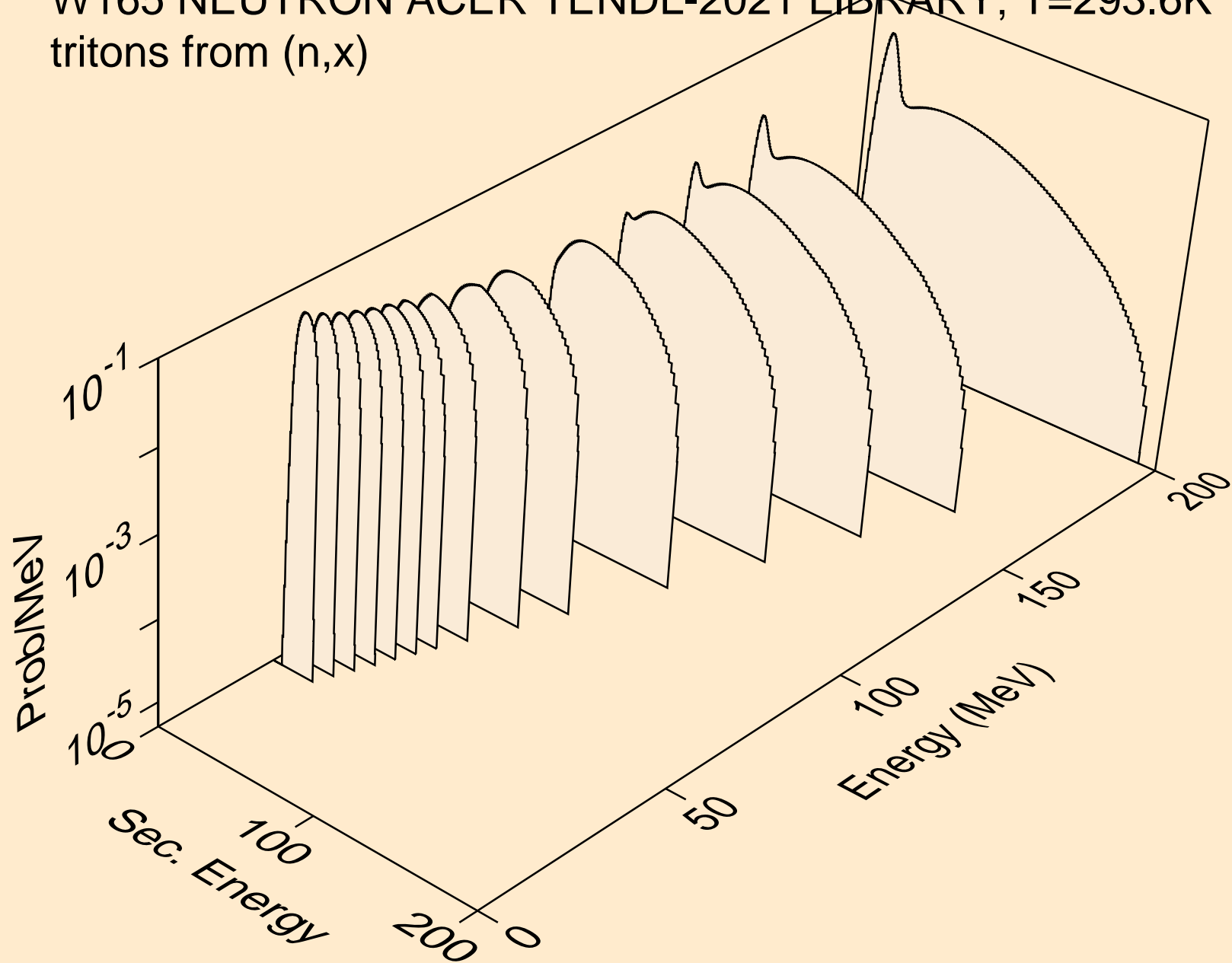

W165 NEUTRON ACER TENDL-2021 LIBRARY; T=293.6K  
tritons from (n,n\*)t

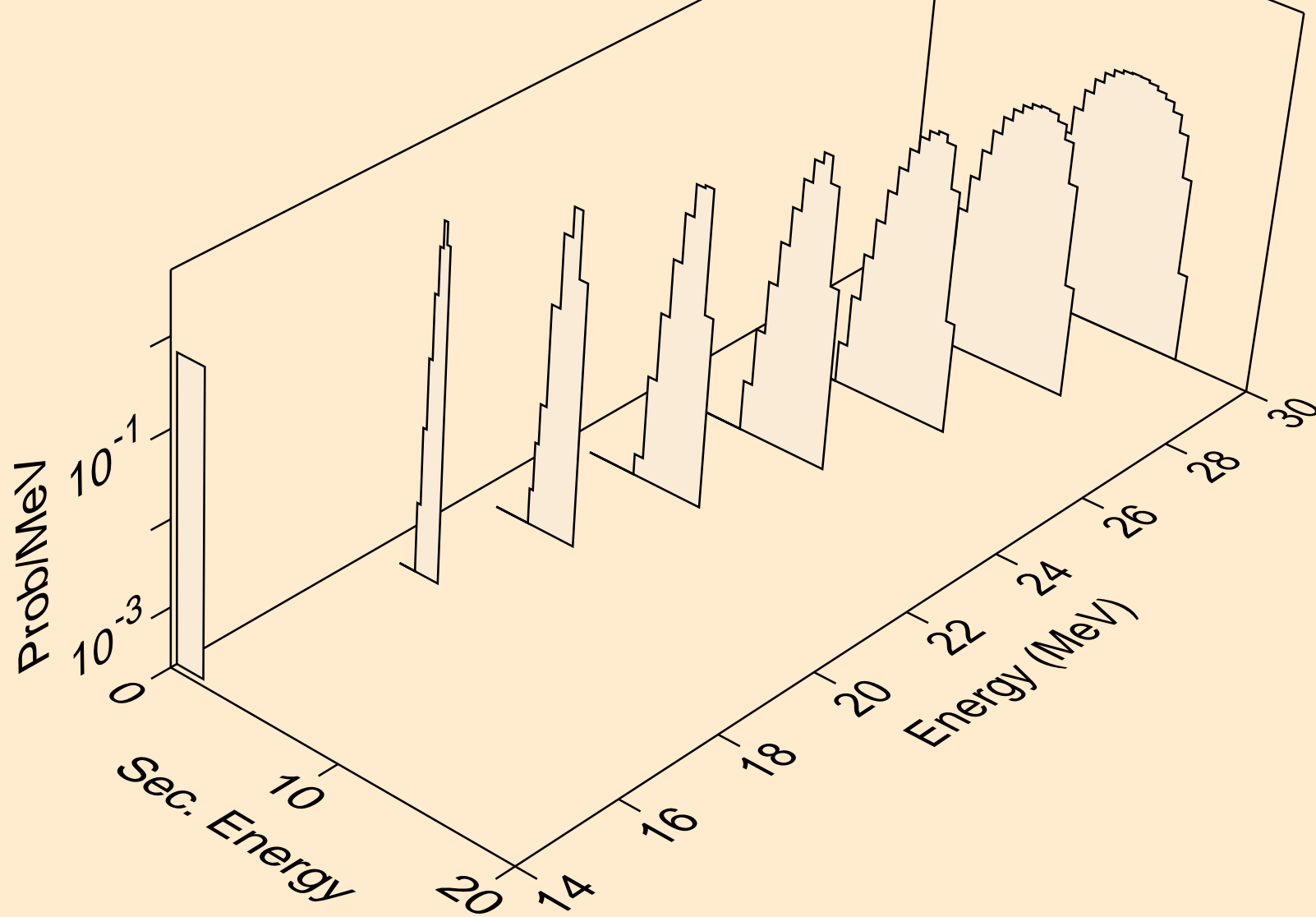

W165 NEUTRON ACER TENDL-2021 LIBRARY; T=293.6K  
tritons from (n,t)

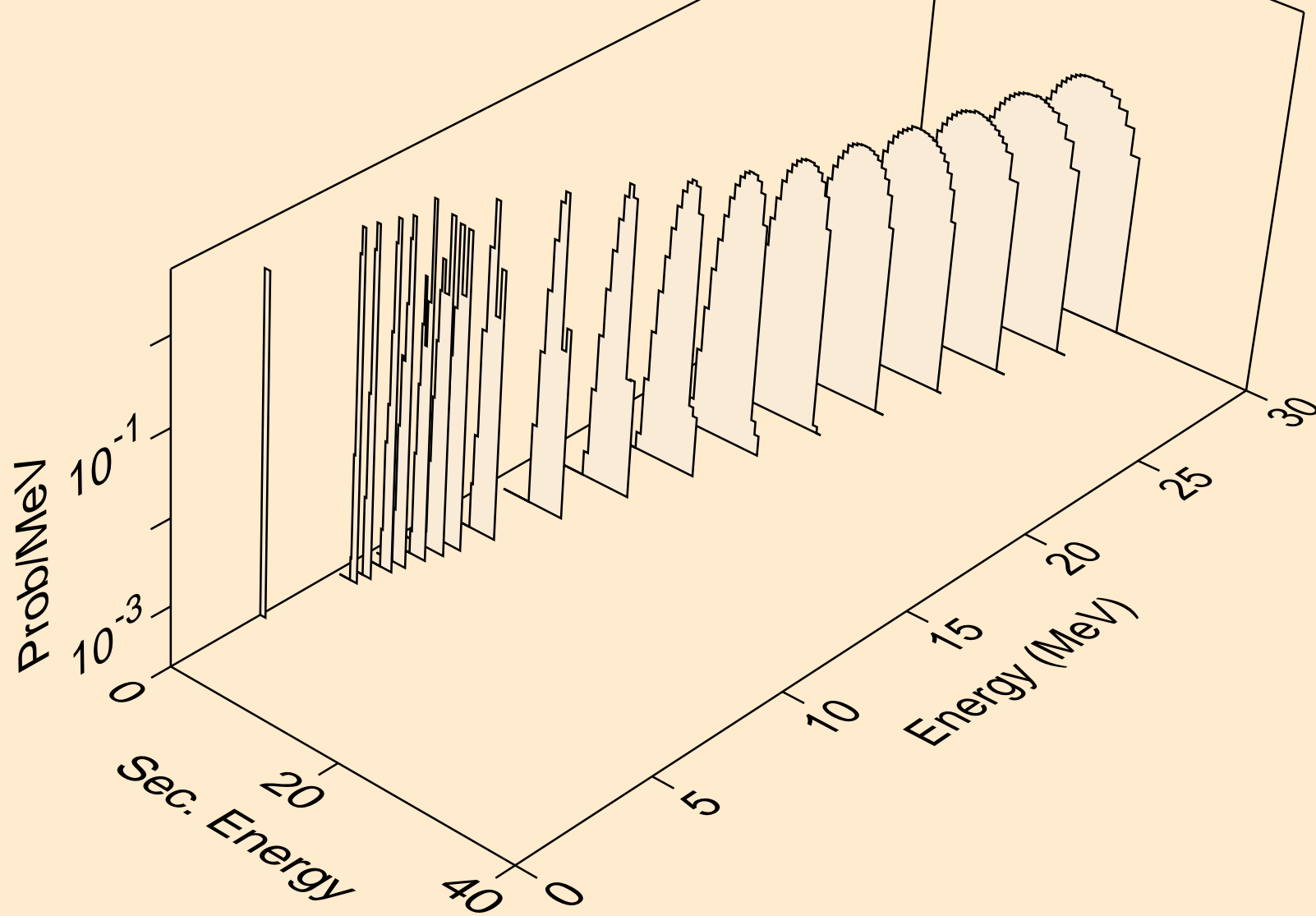

W165 NEUTRON ACER TENDL-2021 LIBRARY; T=293.6K  
tritons from (n,t2a)

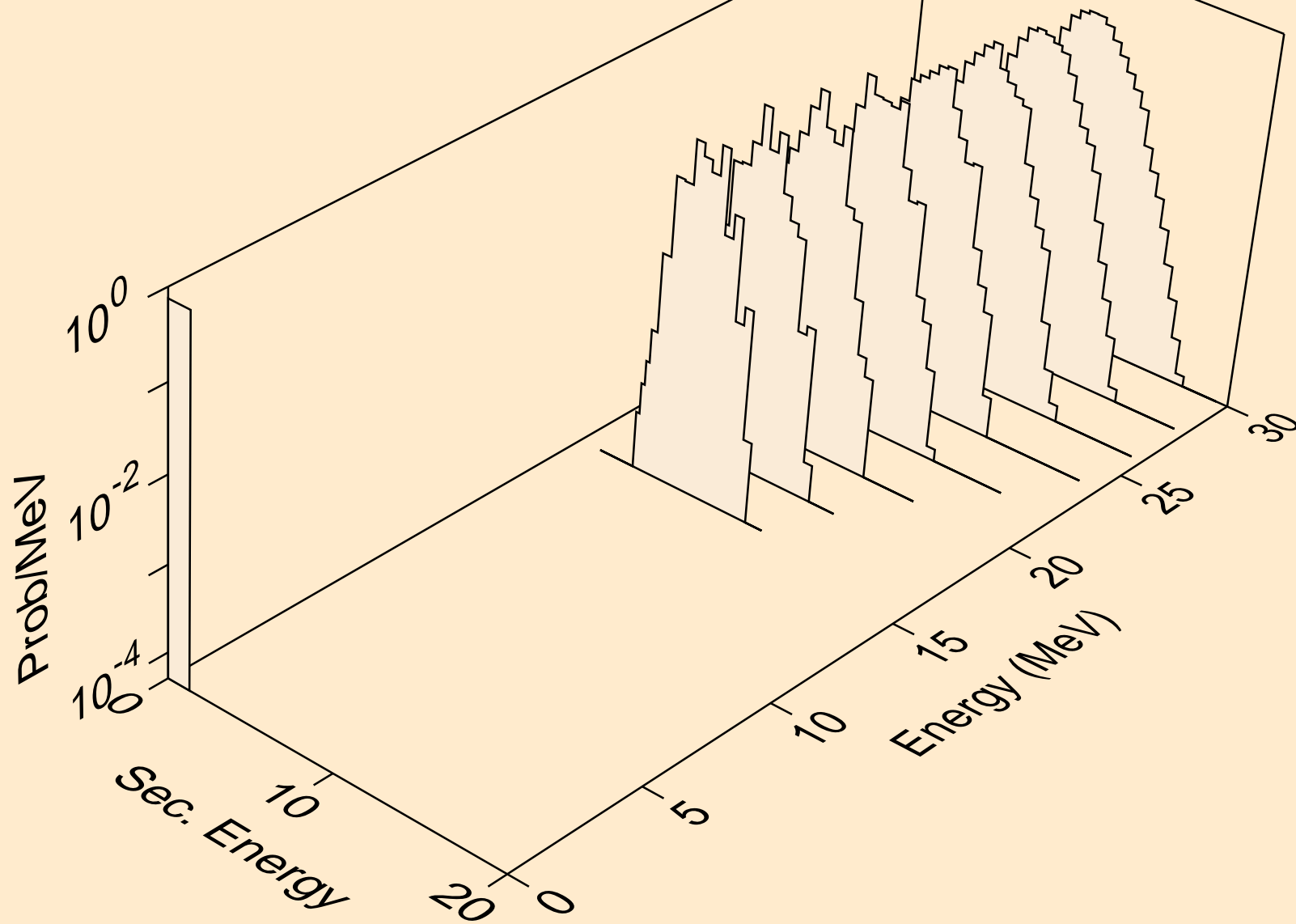

W165 NEUTRON ACER TENDL-2021 LIBRARY; T=293.6K  
tritons from (n,pt)

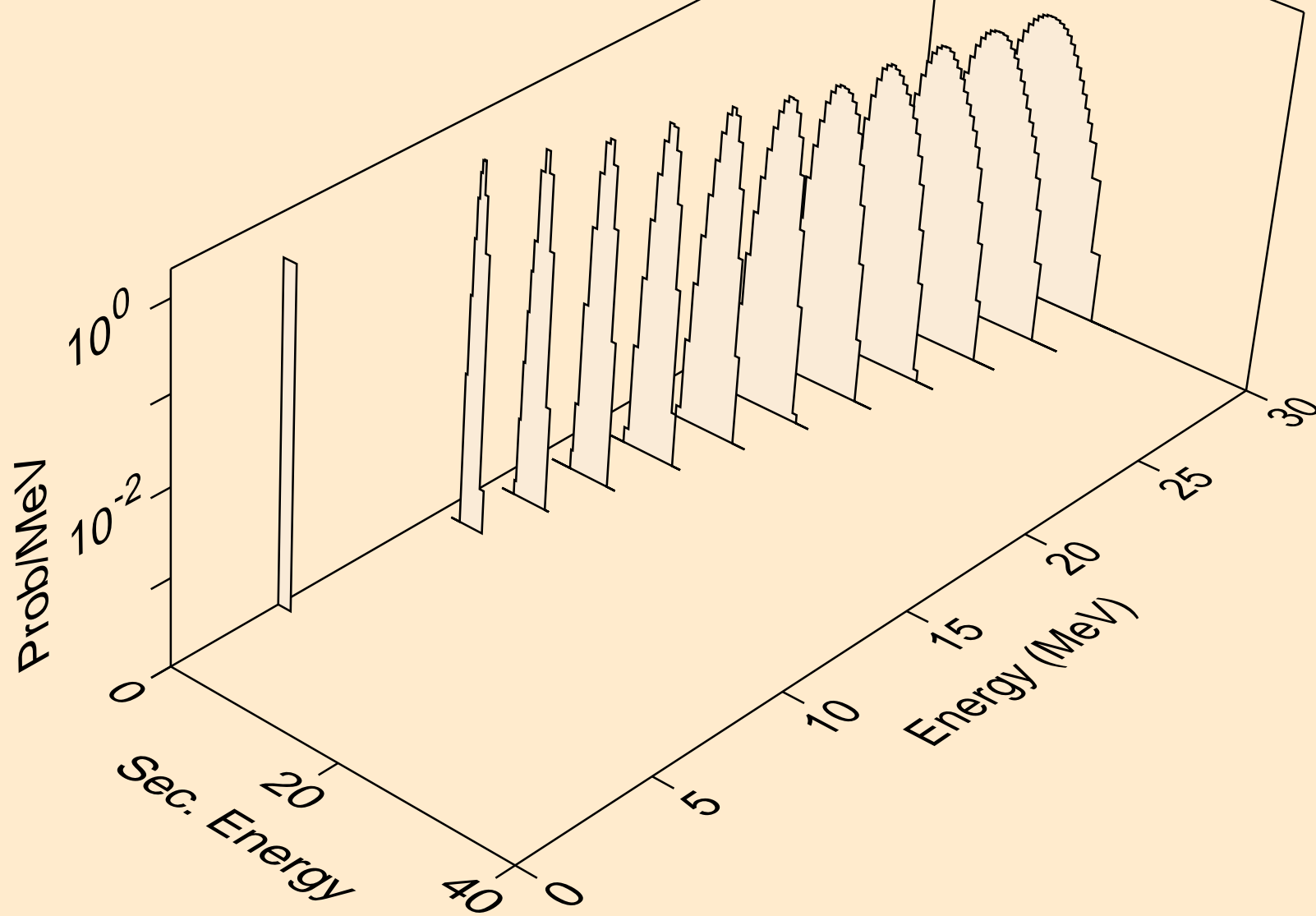



W165 NEUTRON ACER TENDL-2021 LIBRARY; T=293.6K  
he3s from (n,x)

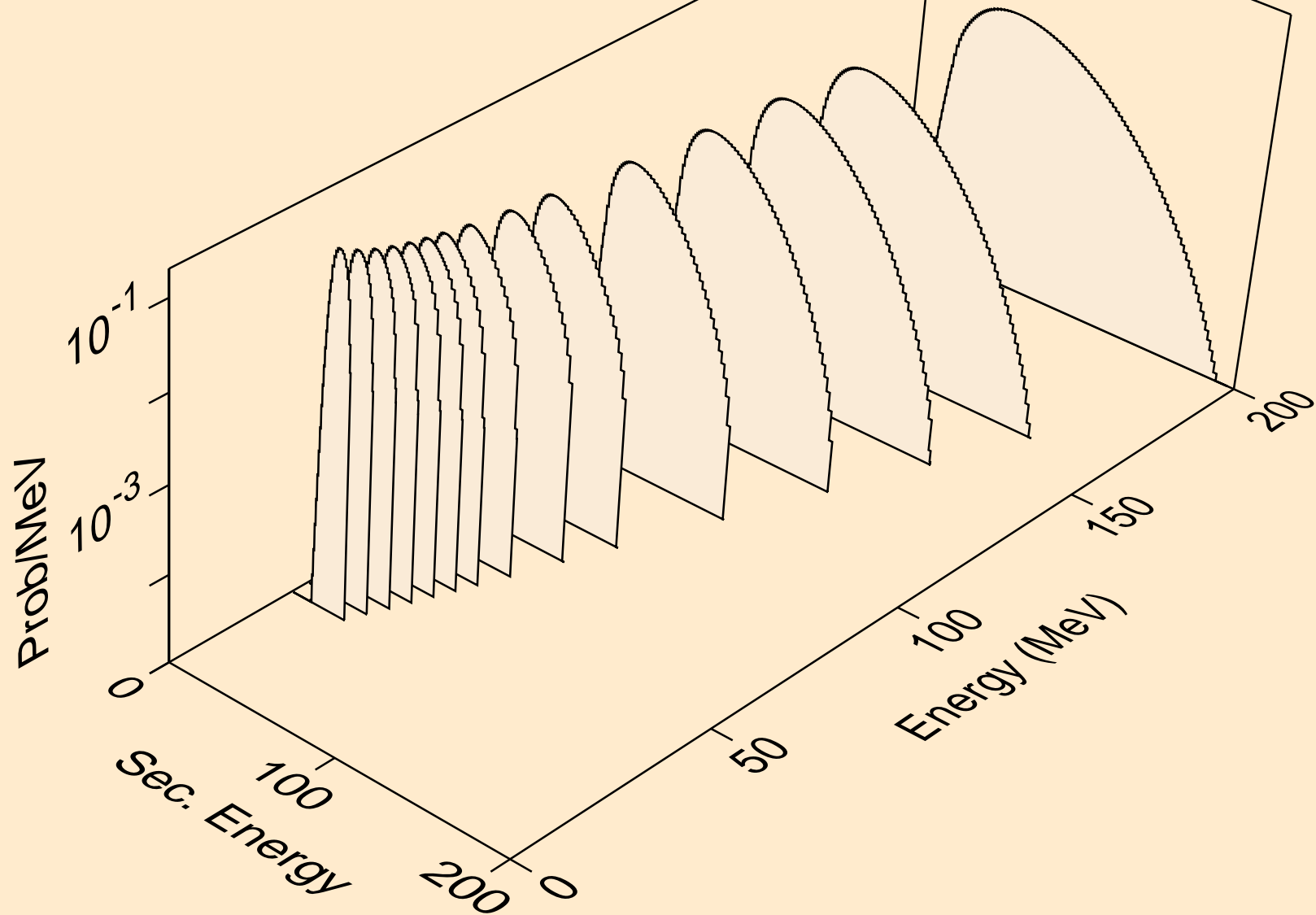

W165 NEUTRON ACER TENDL-2021 LIBRARY; T=293.6K  
he3s from (n,n\*)he3

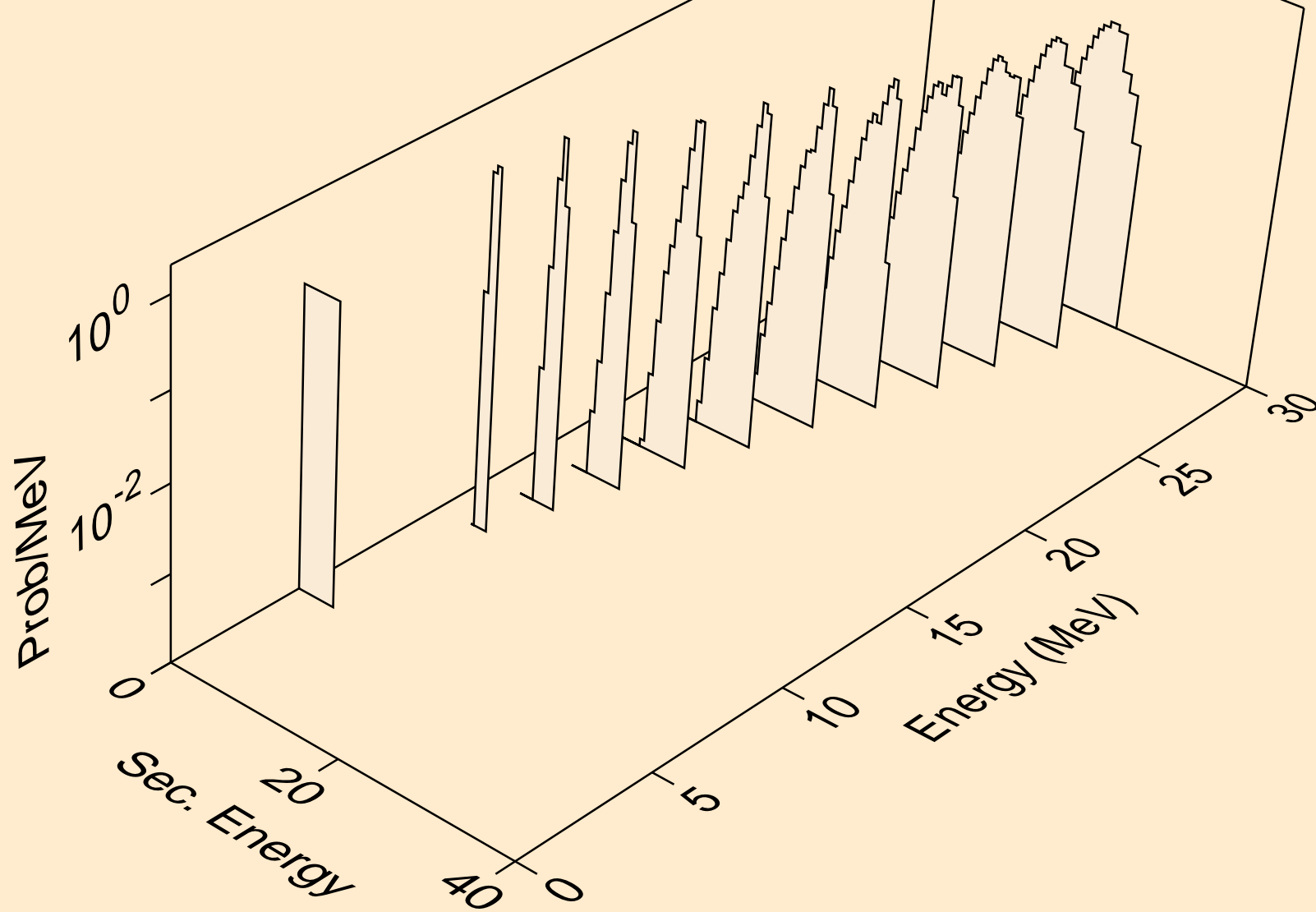

W165 NEUTRON ACER TENDL-2021 LIBRARY; T=293.6K  
he3s from (n,he3)

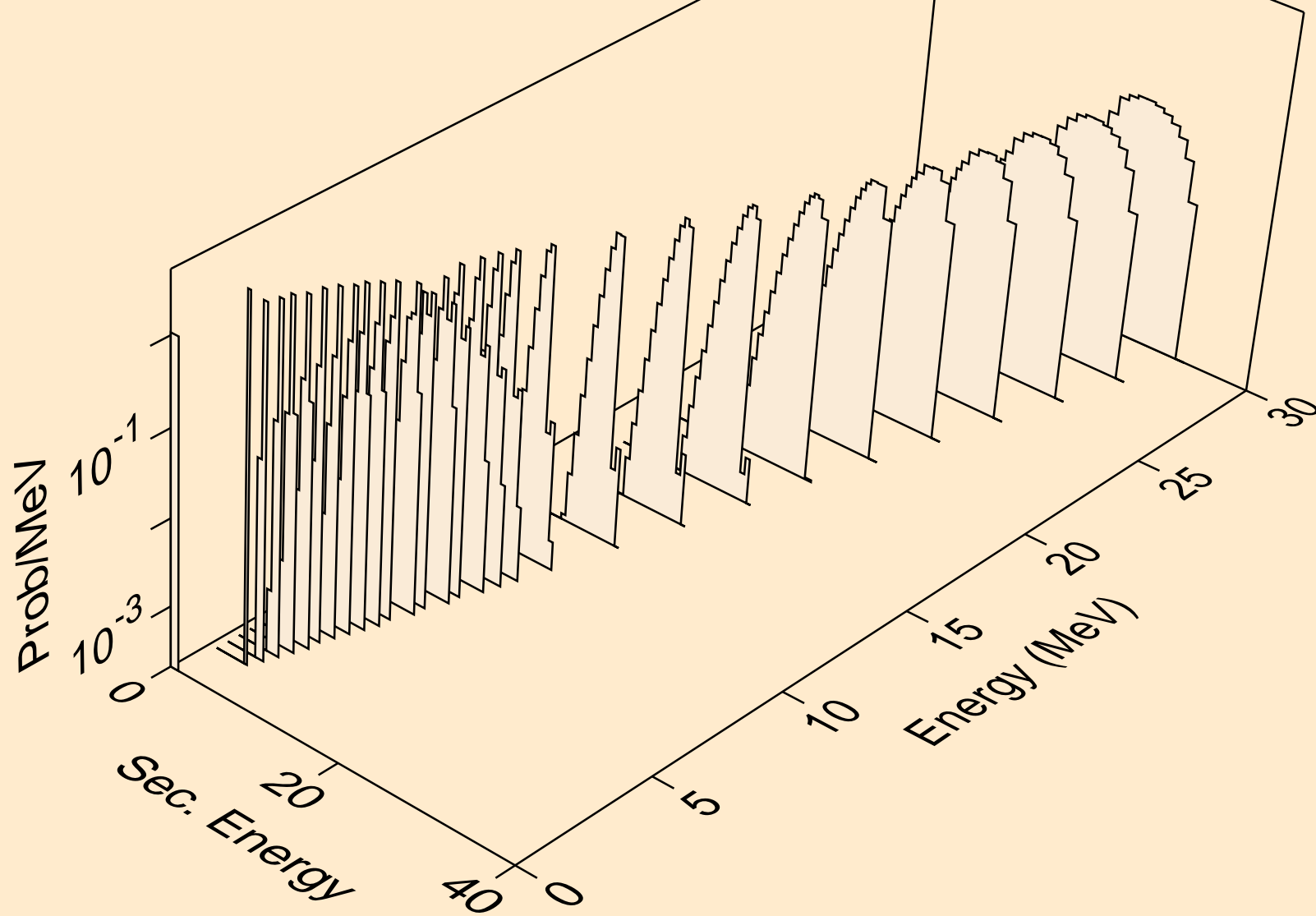

W165 NEUTRON ACER TENDL-2021 LIBRARY; T=293.6K  
alphas from (n,x)

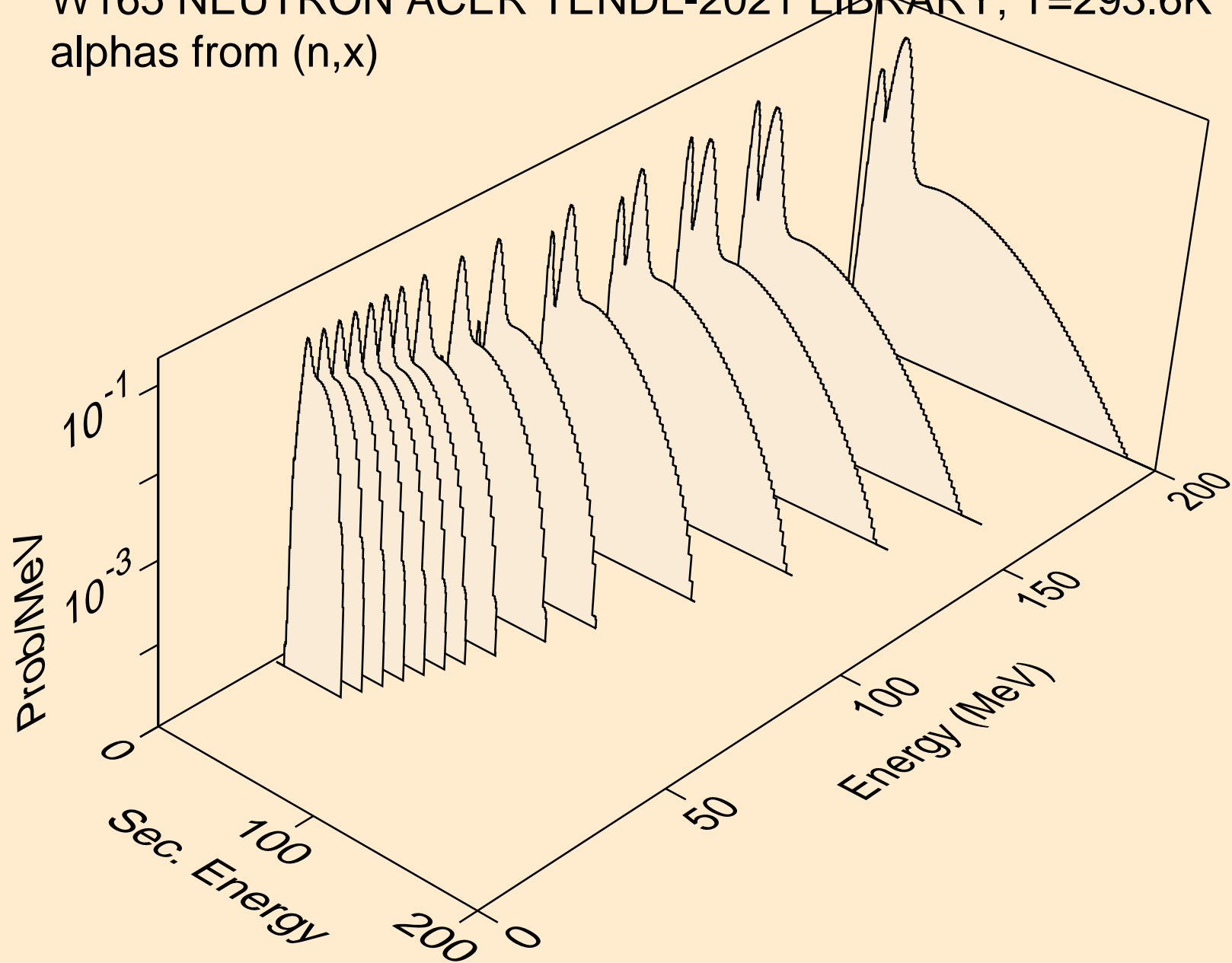

W165 NEUTRON ACER TENDL-2021 LIBRARY; T=293.6K  
alphas from (n,n\*)a

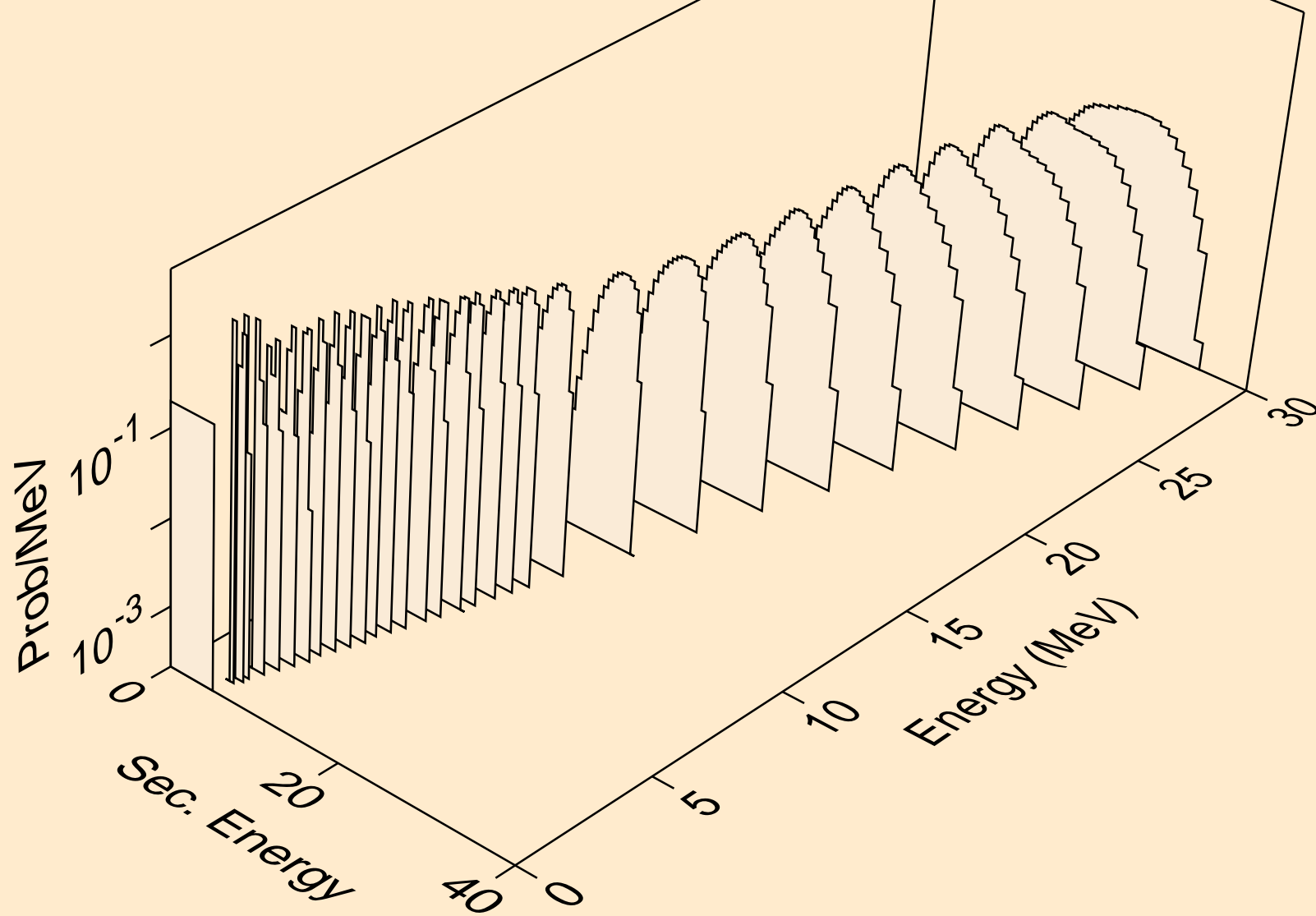

W165 NEUTRON ACER TENDL-2021 LIBRARY; T=293.6K  
alphas from (n,n\*)3a

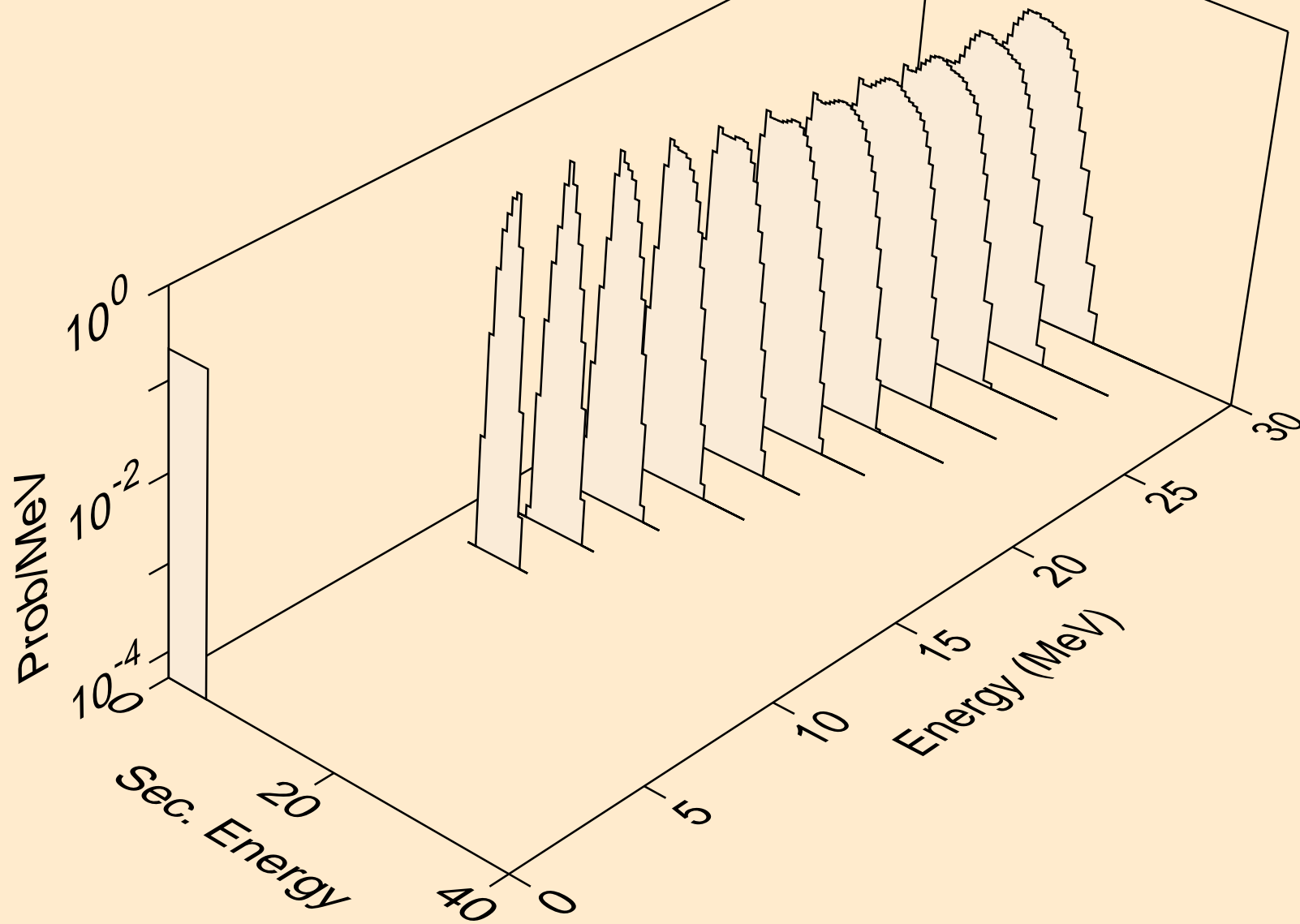

W165 NEUTRON ACER TENDL-2021 LIBRARY; T=293.6K  
alphas from (n,2n)a

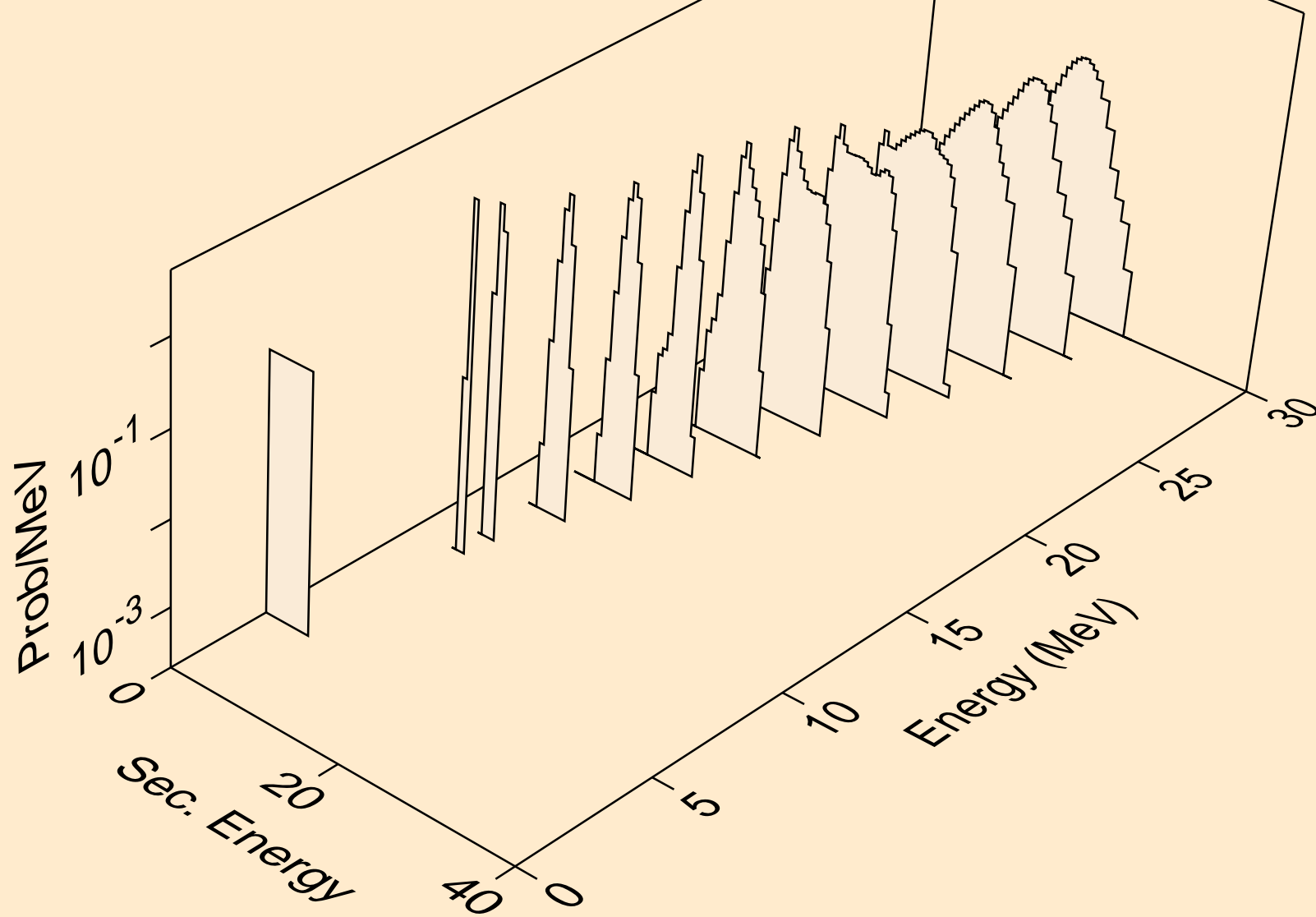

W165 NEUTRON ACER TENDL-2021 LIBRARY; T=293.6K  
alphas from (n,3n)a

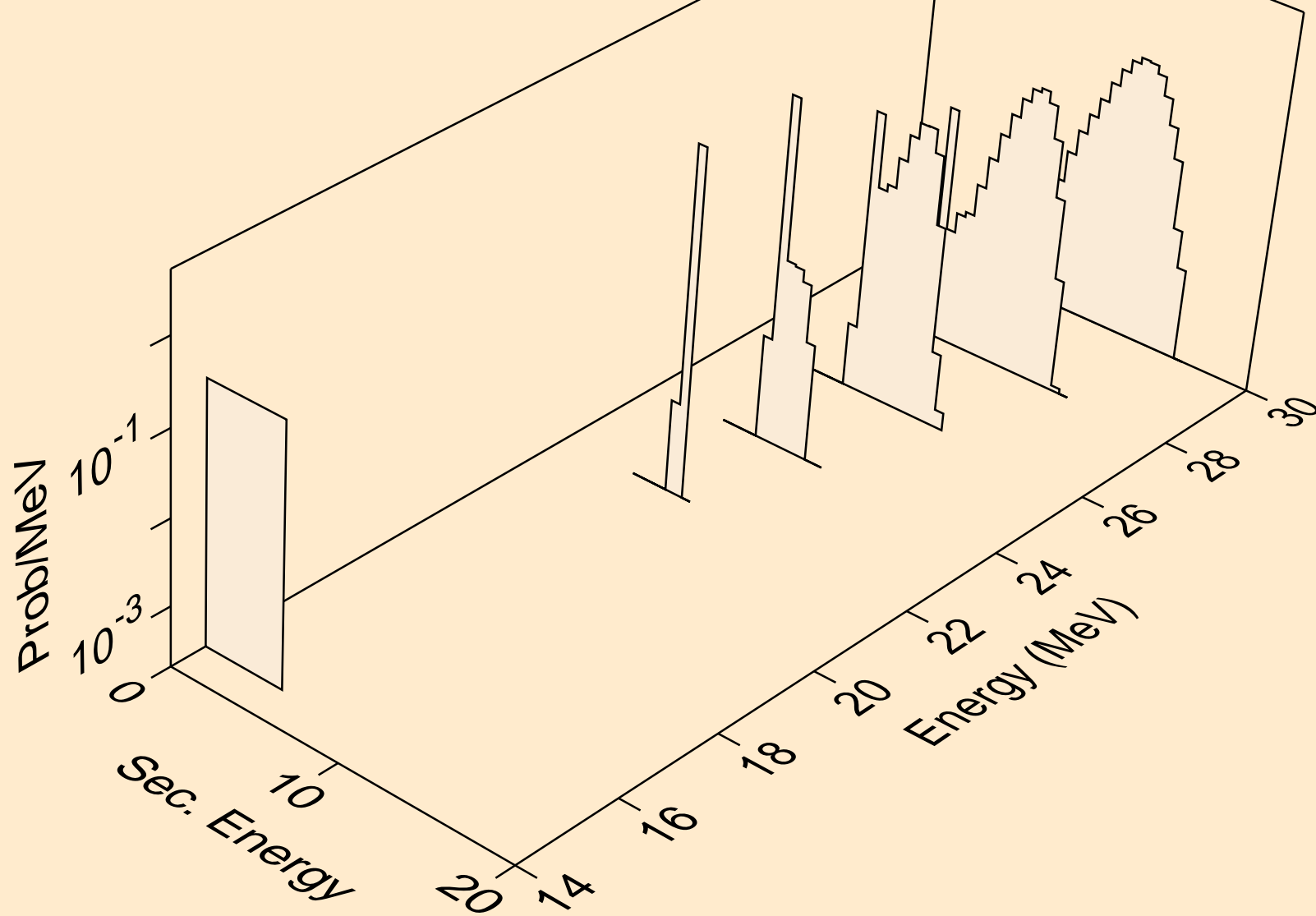



W165 NEUTRON ACER TENDL-2021 LIBRARY; T=293.6K  
alphas from (n,n\*)2a

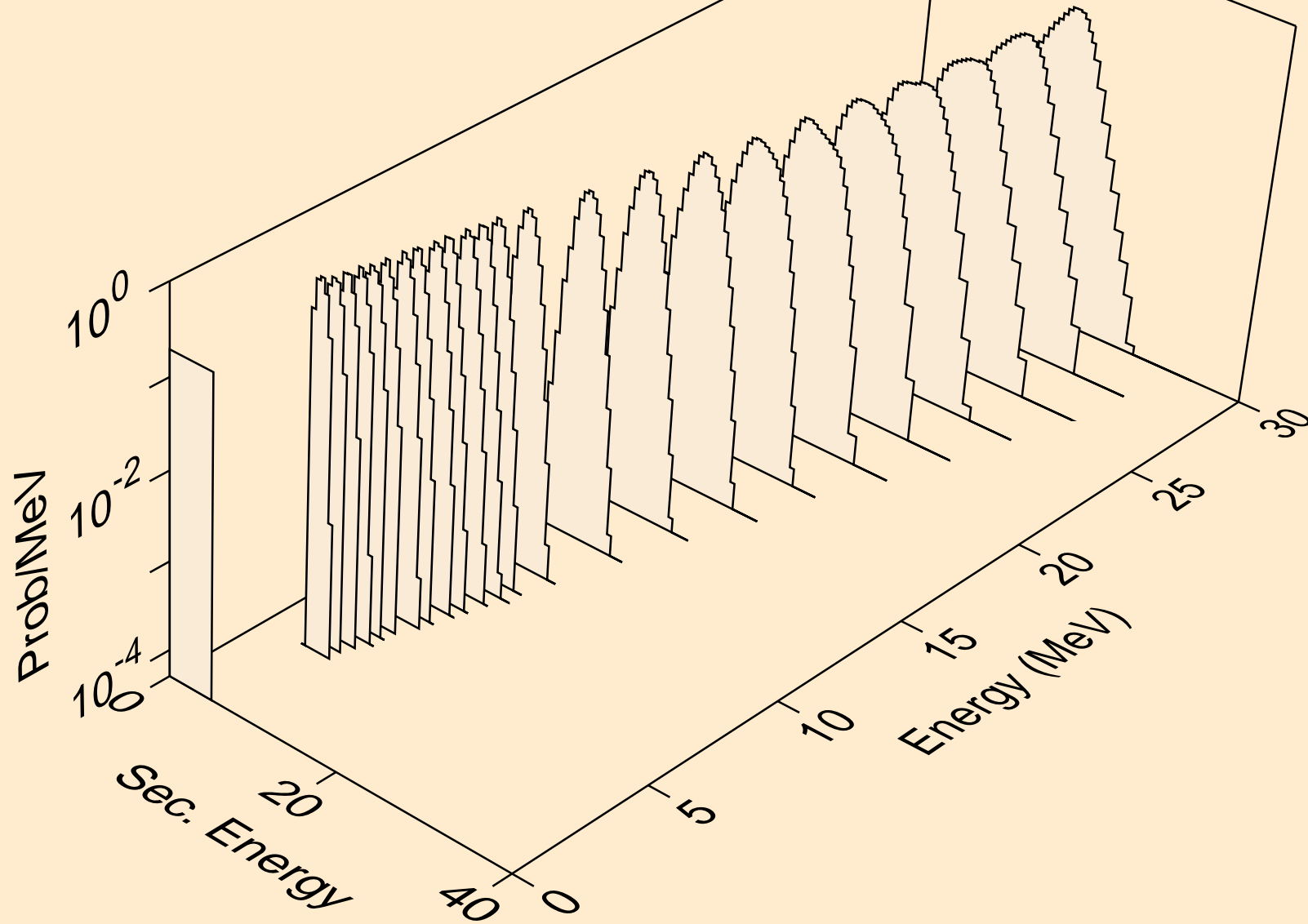

W165 NEUTRON ACER TENDL-2021 LIBRARY; T=293.6K  
alphas from (n,2n)2a

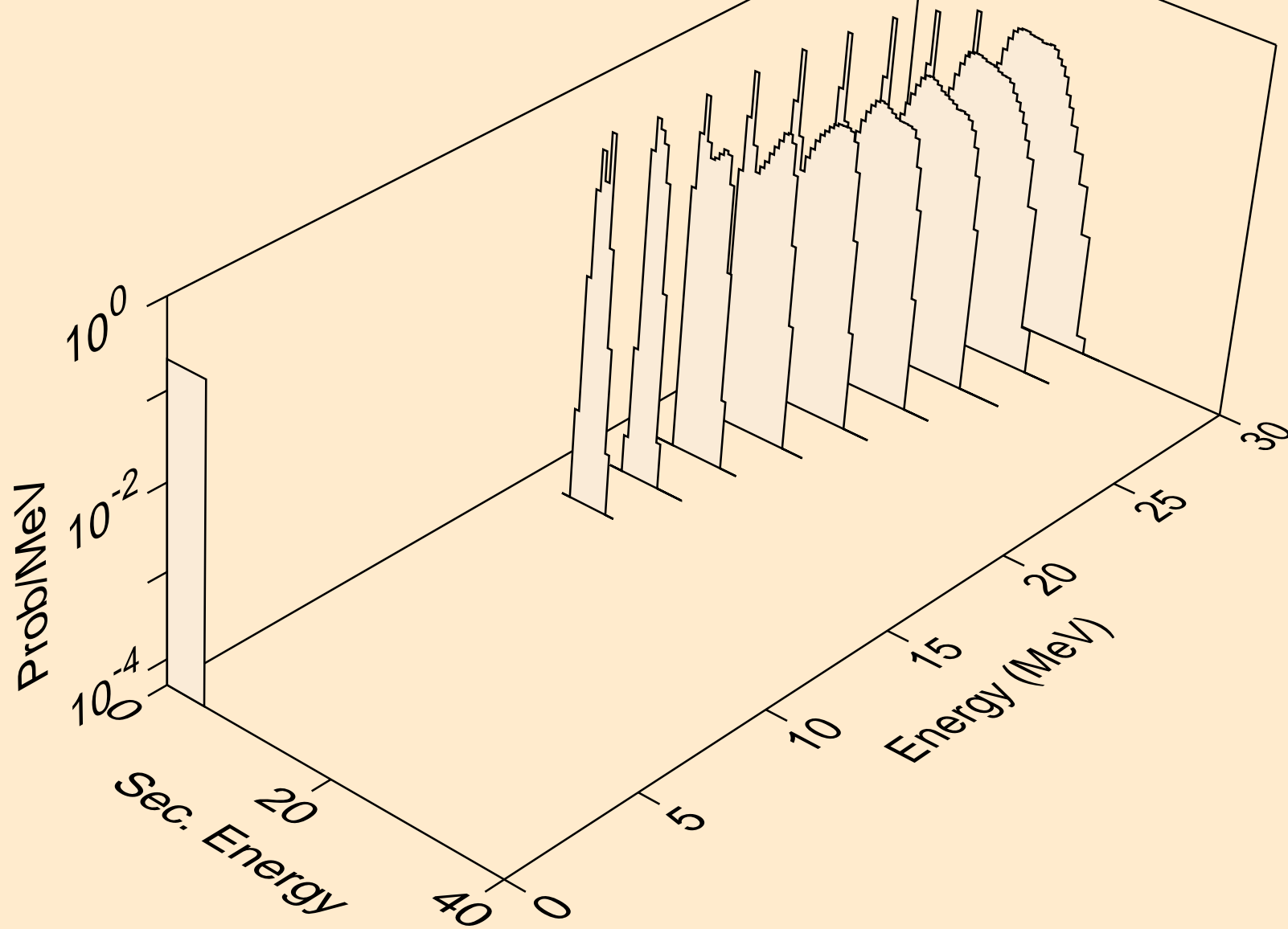

W165 NEUTRON ACER TENDL-2021 LIBRARY; T=293.6K  
alphas from (n,npa)

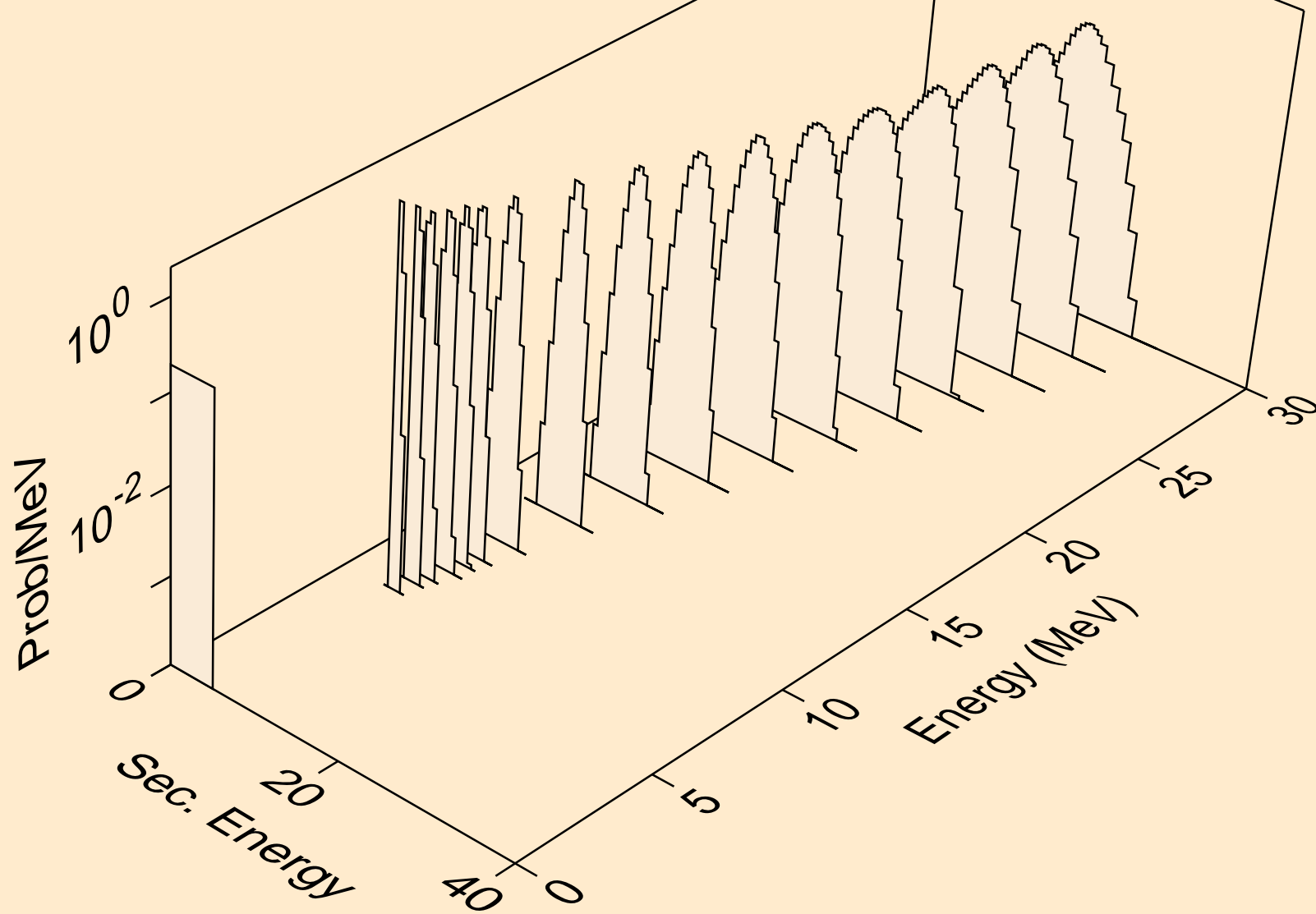

W165 NEUTRON ACER TENDL-2021 LIBRARY; T=293.6K  
alphas from (n,a)

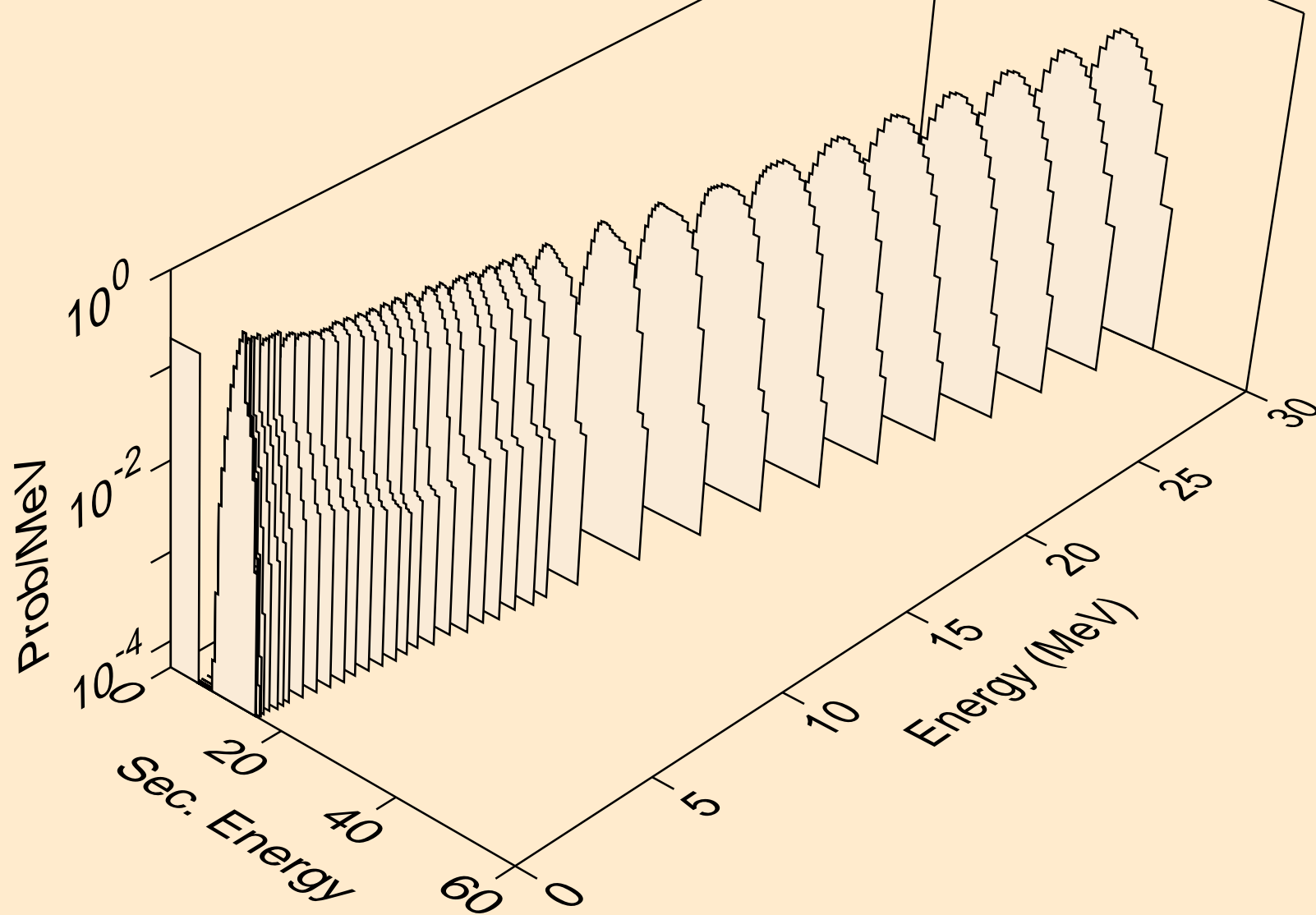

W165 NEUTRON ACER TENDL-2021 LIBRARY; T=293.6K  
alphas from (n,2a)

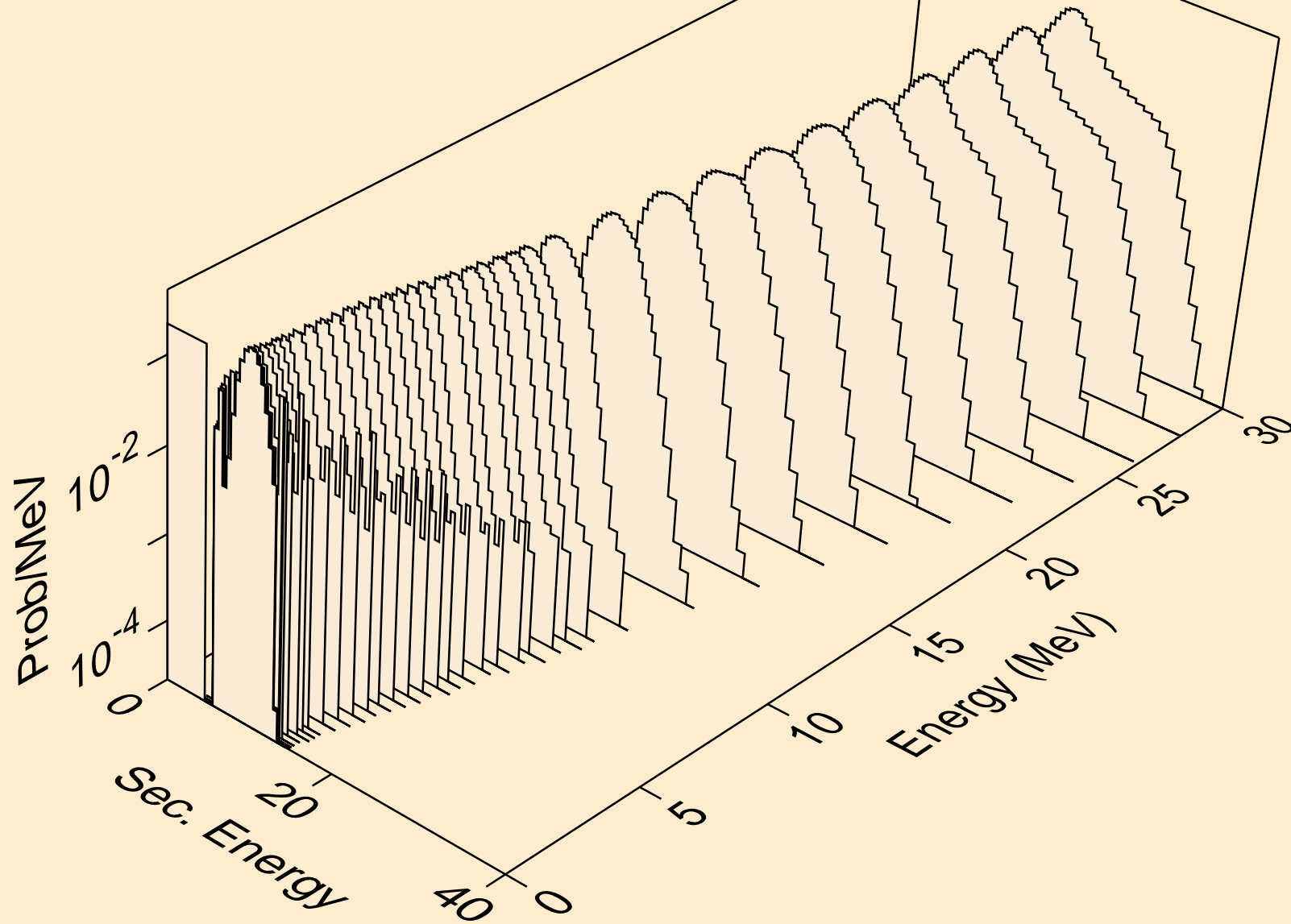

W165 NEUTRON ACER TENDL-2021 LIBRARY; T=293.6K  
alphas from (n,3a)

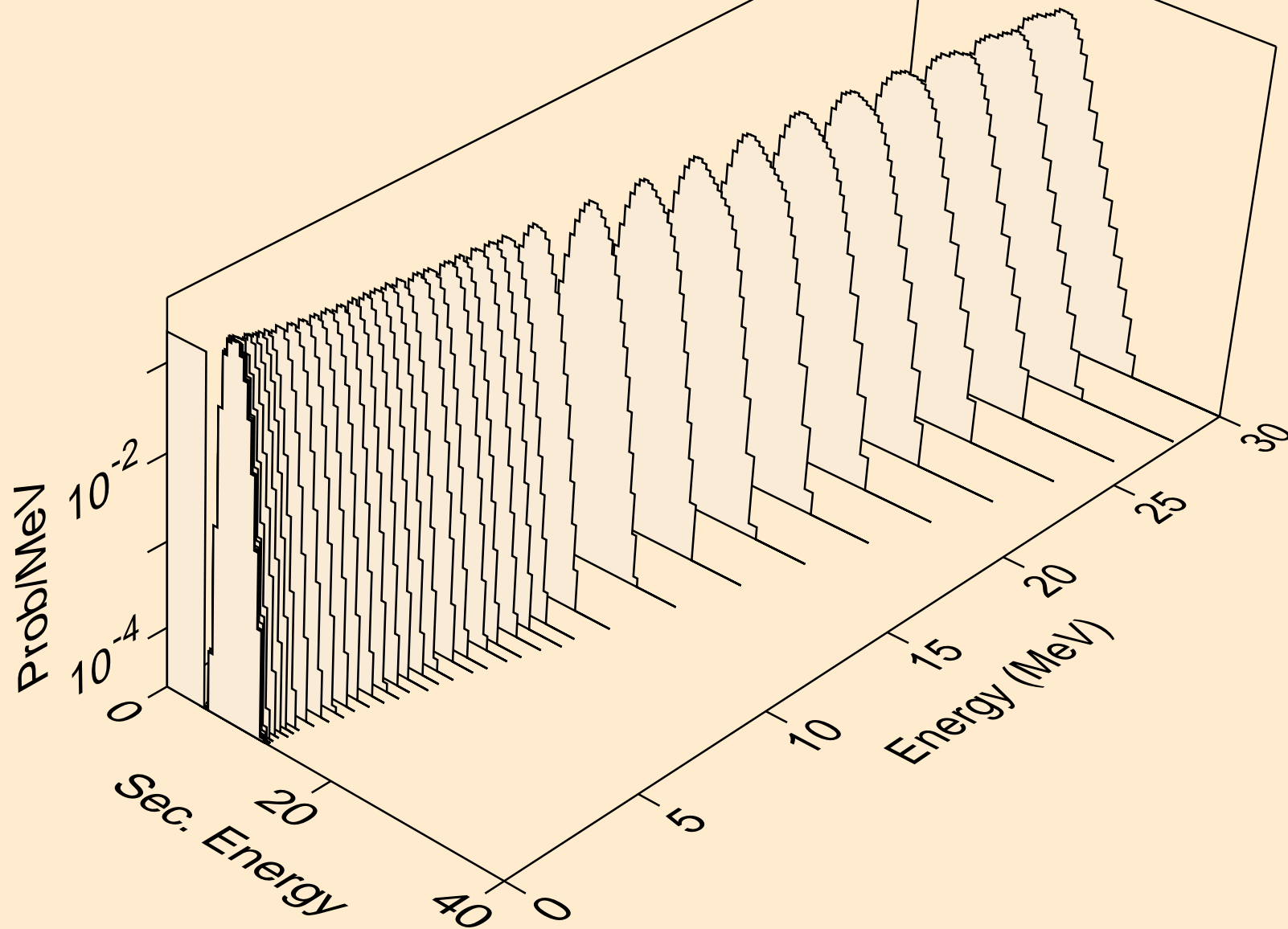

W165 NEUTRON ACER TENDL-2021 LIBRARY; T=293.6K  
alphas from (n,pa)

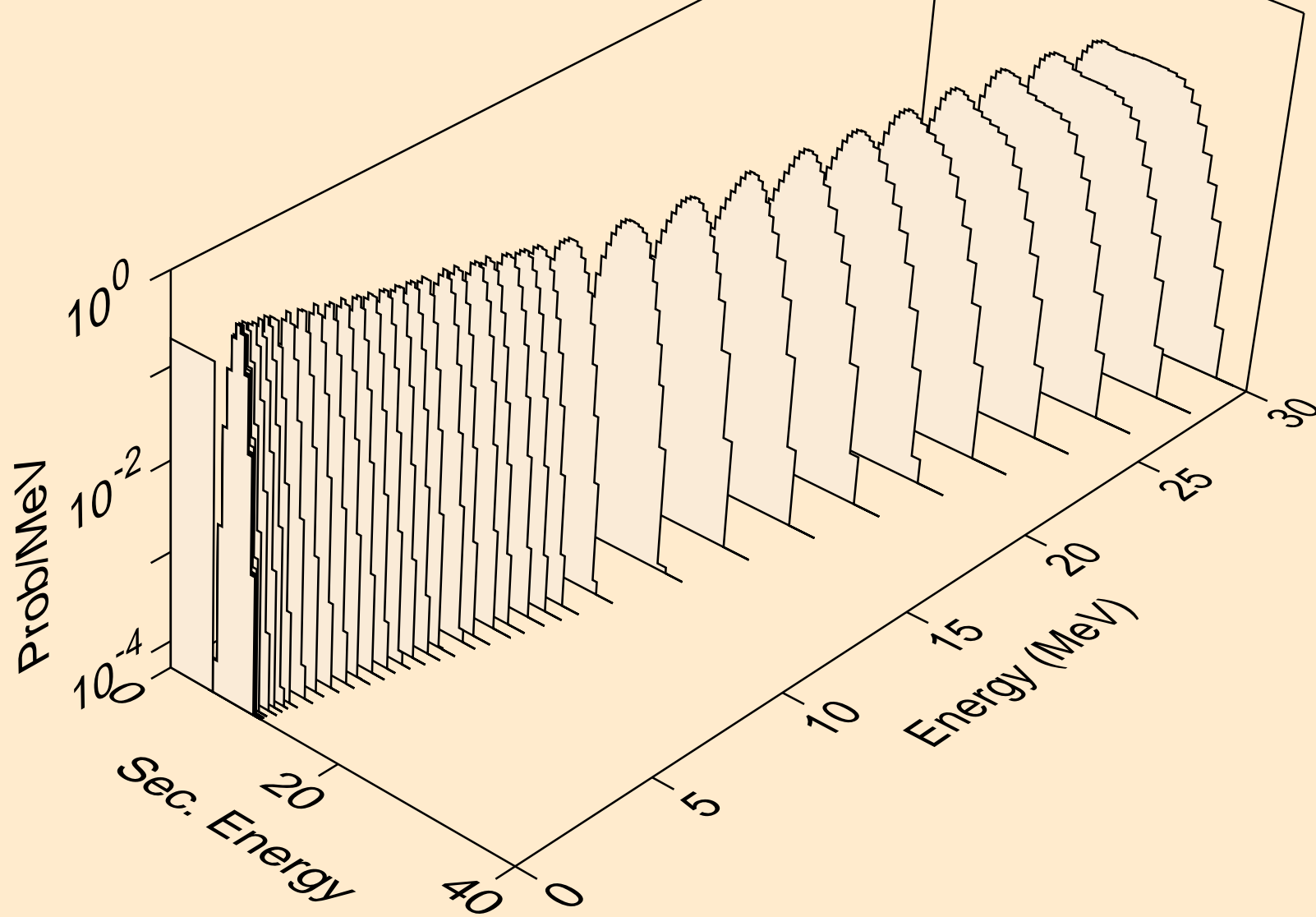

W165 NEUTRON ACER TENDL-2021 LIBRARY; T=293.6K  
alphas from (n,t2a)

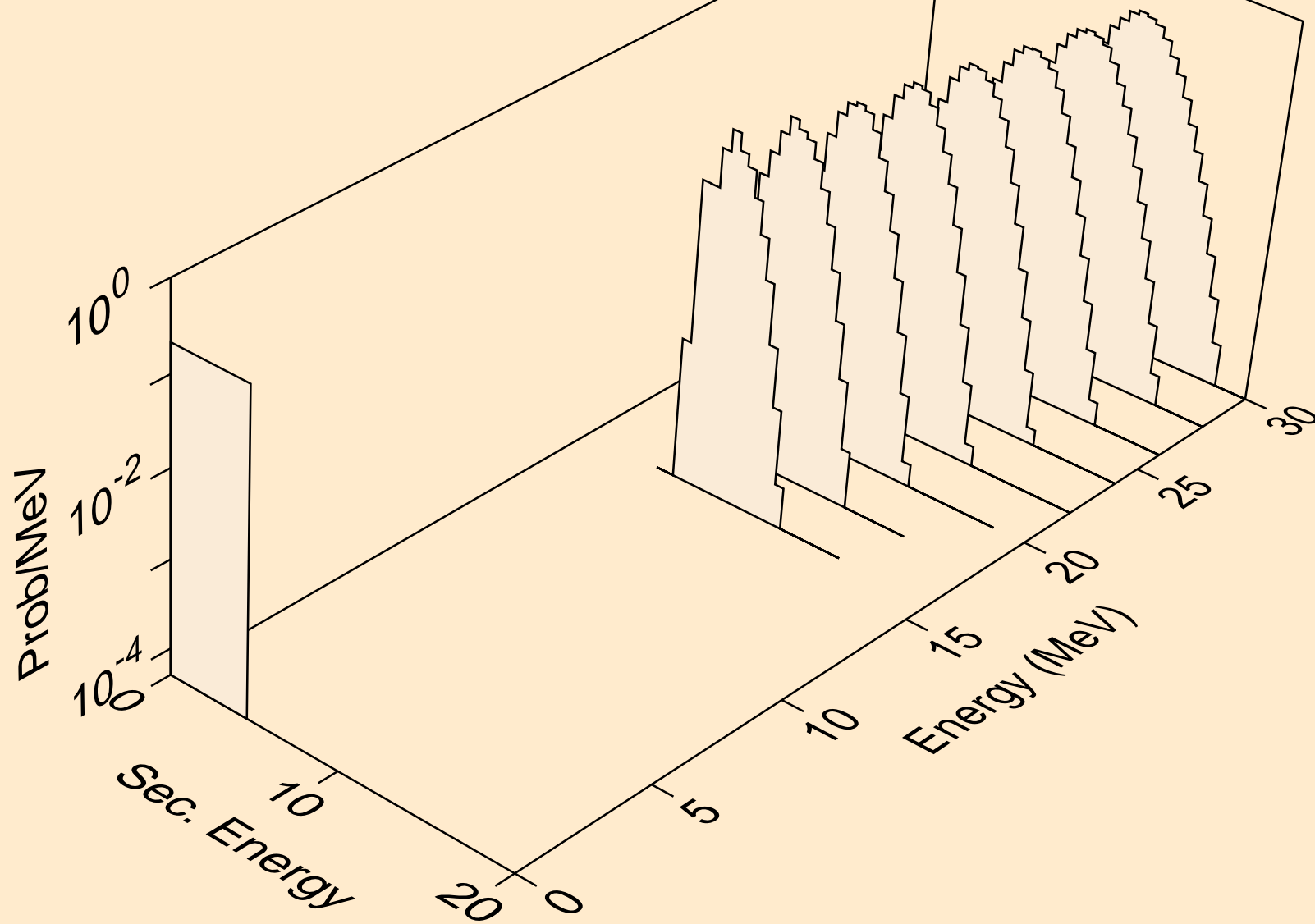



W165 NEUTRON ACER TENDL-2021 LIBRARY; T=293.6K  
alphas from (n,d2a)

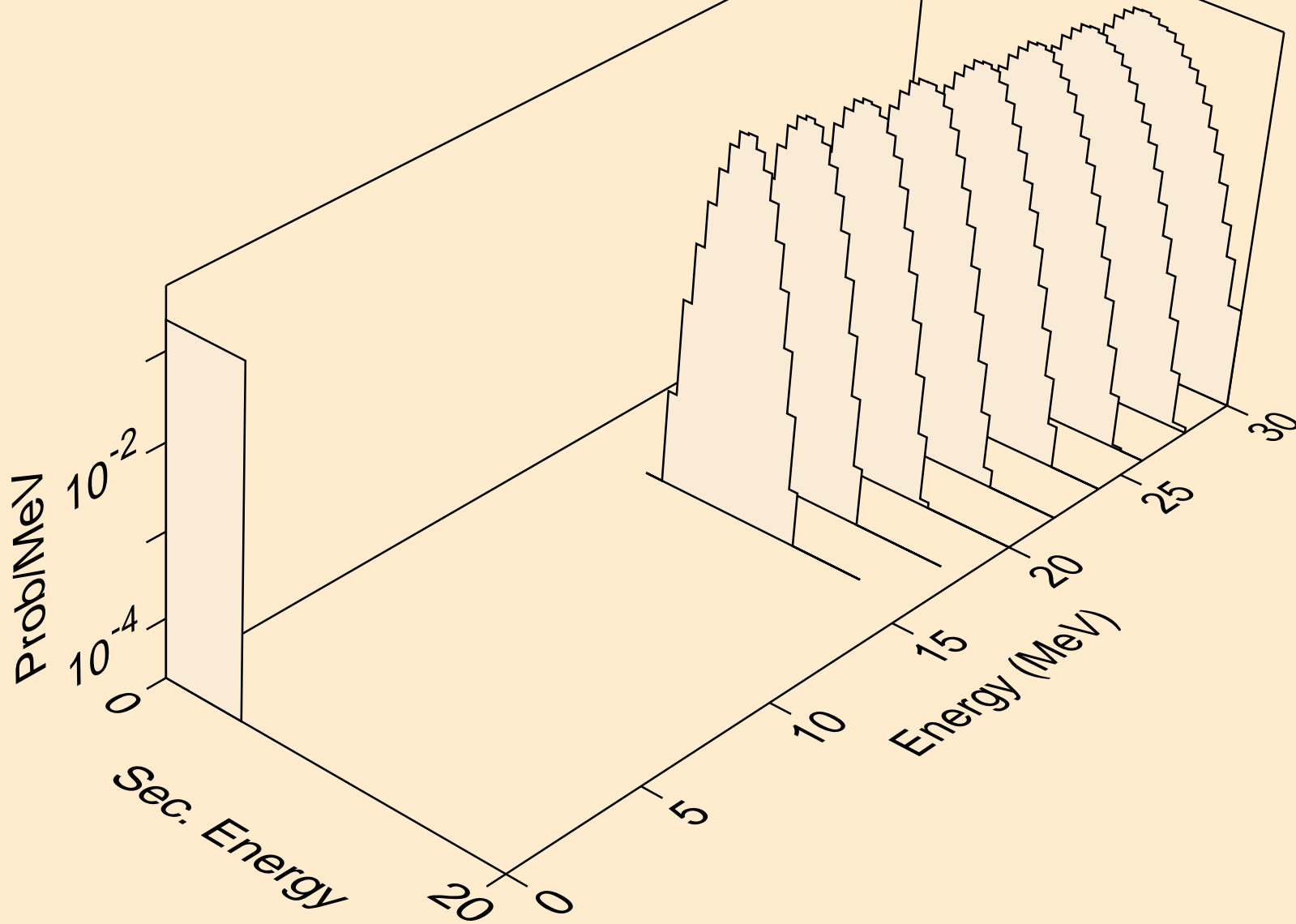

W165 NEUTRON ACER TENDL-2021 LIBRARY; T=293.6K  
alphas from (n,da)

