

W171 NEUTRON ACER TENDL-2021 LIBRARY; T=293.6K
Principal cross sections

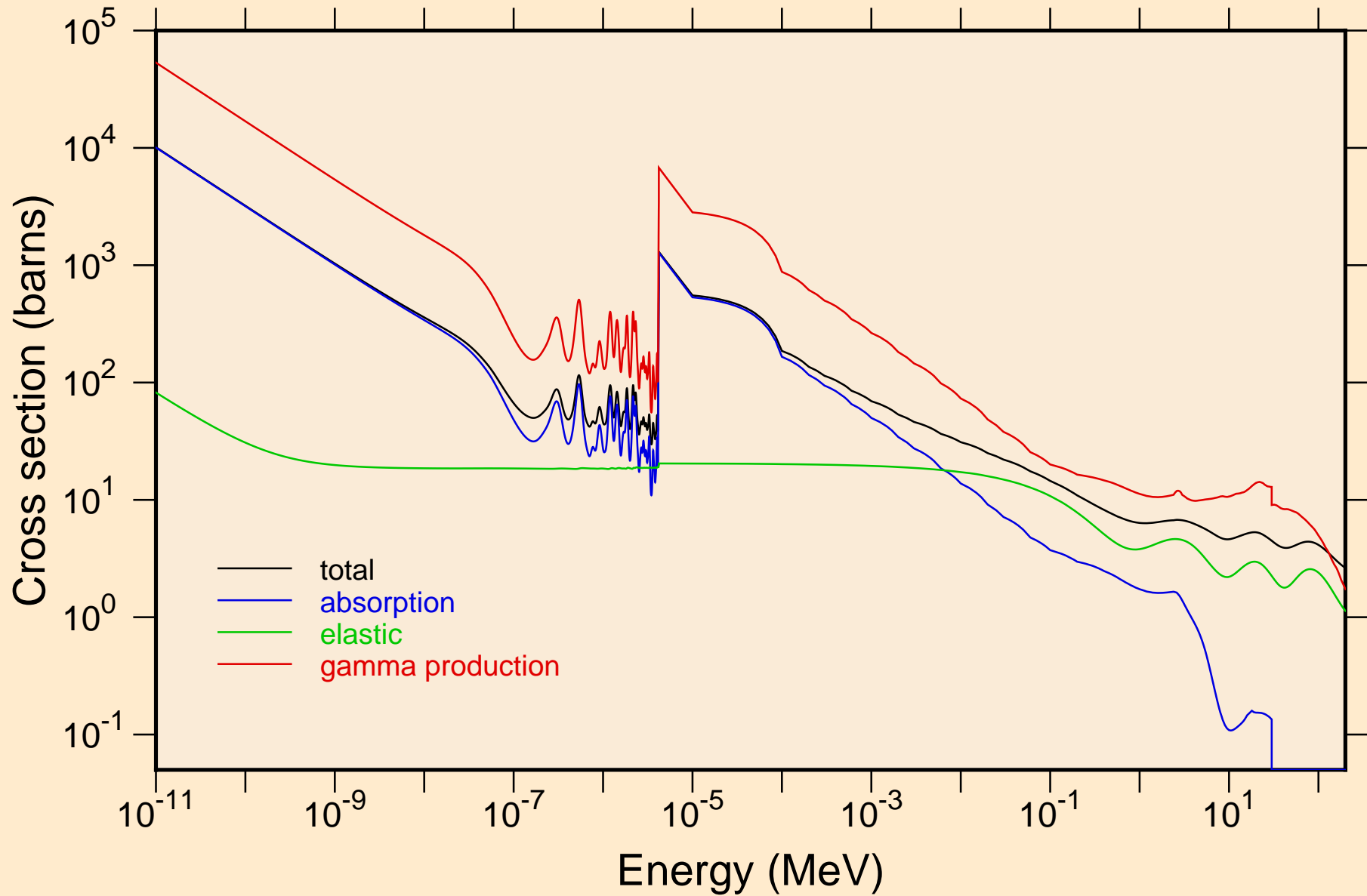

W171 NEUTRON ACER TENDL-2021 LIBRARY; T=293.6K
resonance total cross section

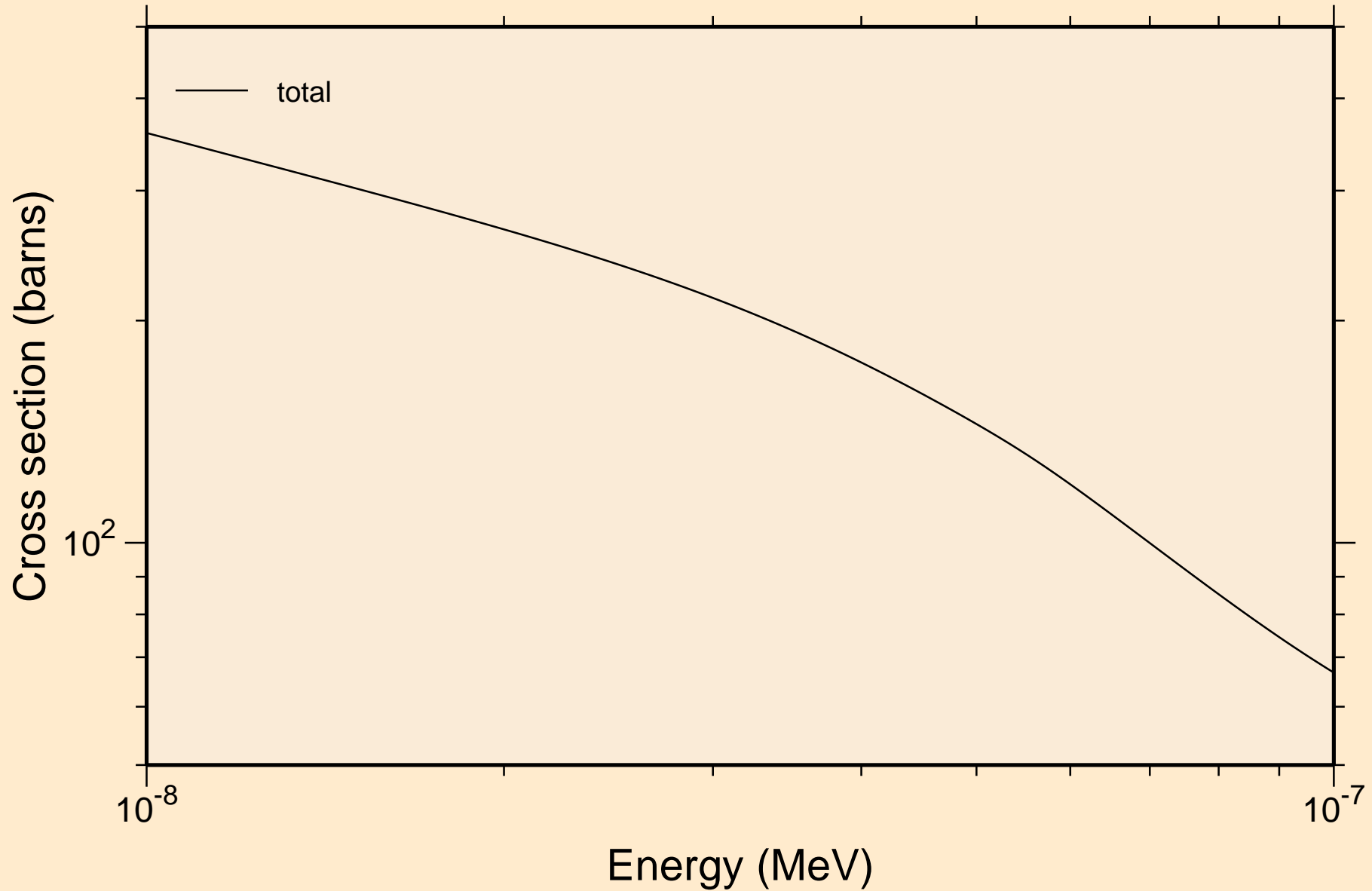

W171 NEUTRON ACER TENDL-2021 LIBRARY; T=293.6K
resonance total cross section

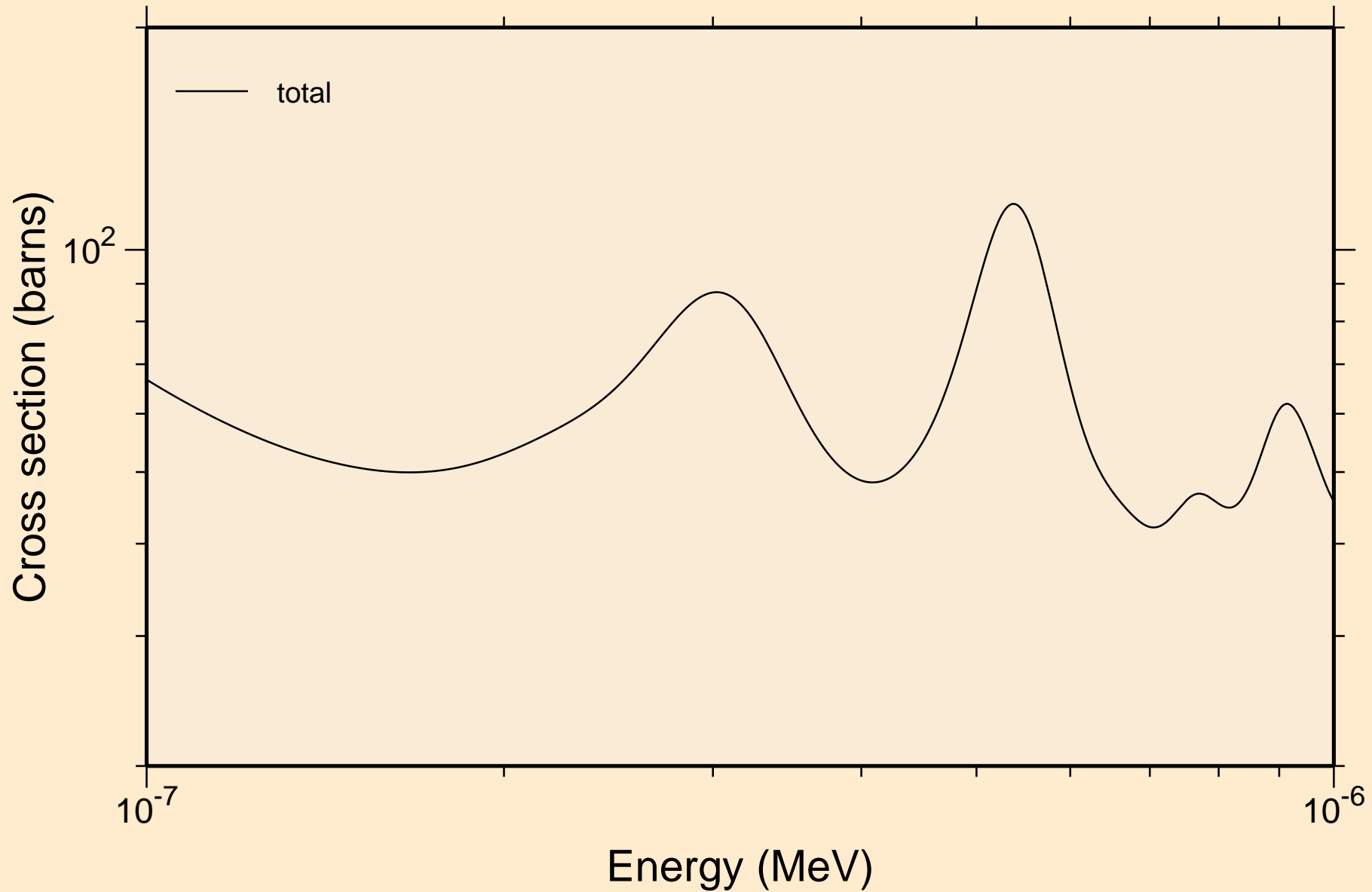

W171 NEUTRON ACER TENDL-2021 LIBRARY; T=293.6K
resonance total cross section

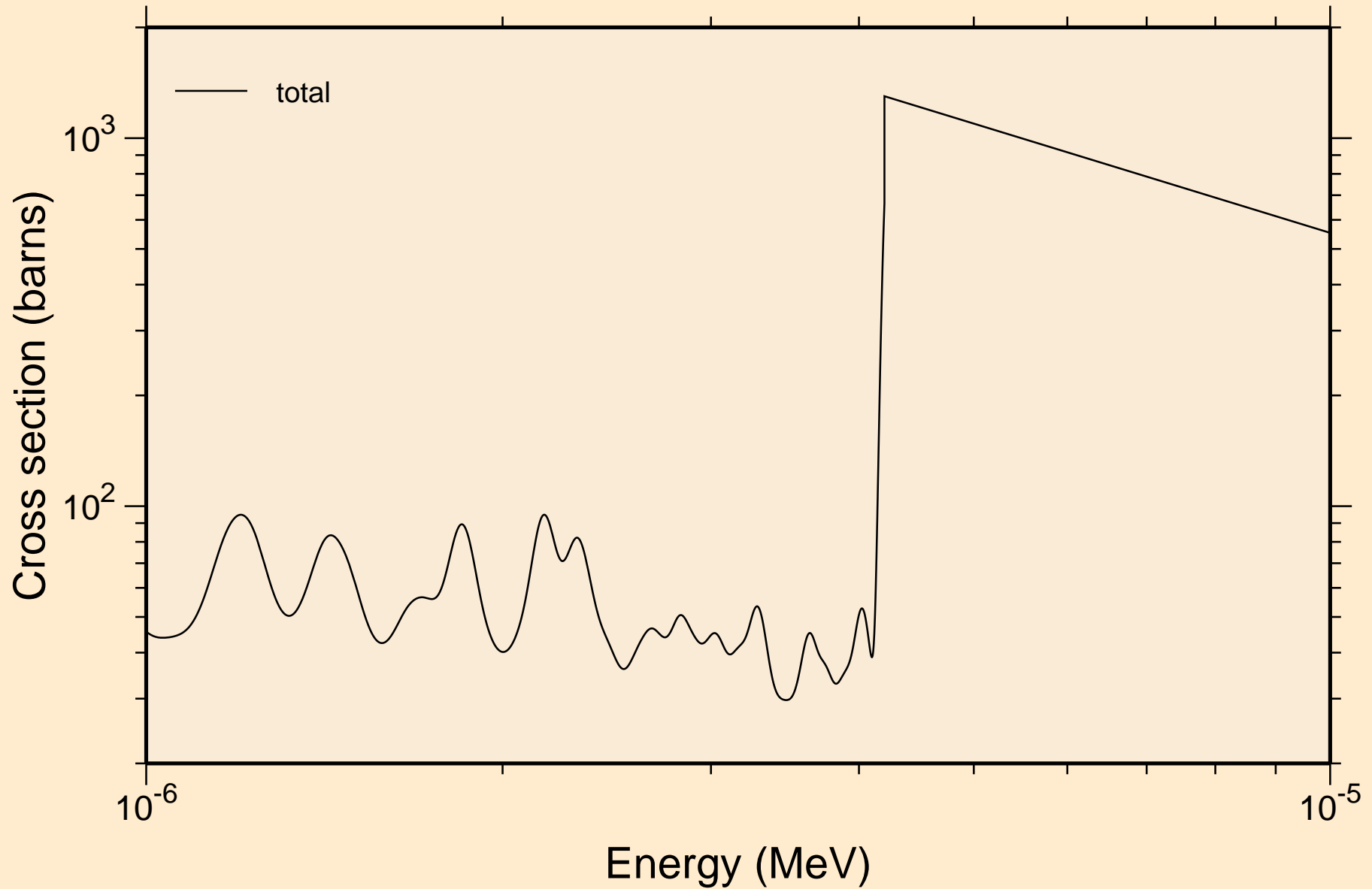

W171 NEUTRON ACER TENDL-2021 LIBRARY; T=293.6K
resonance total cross section

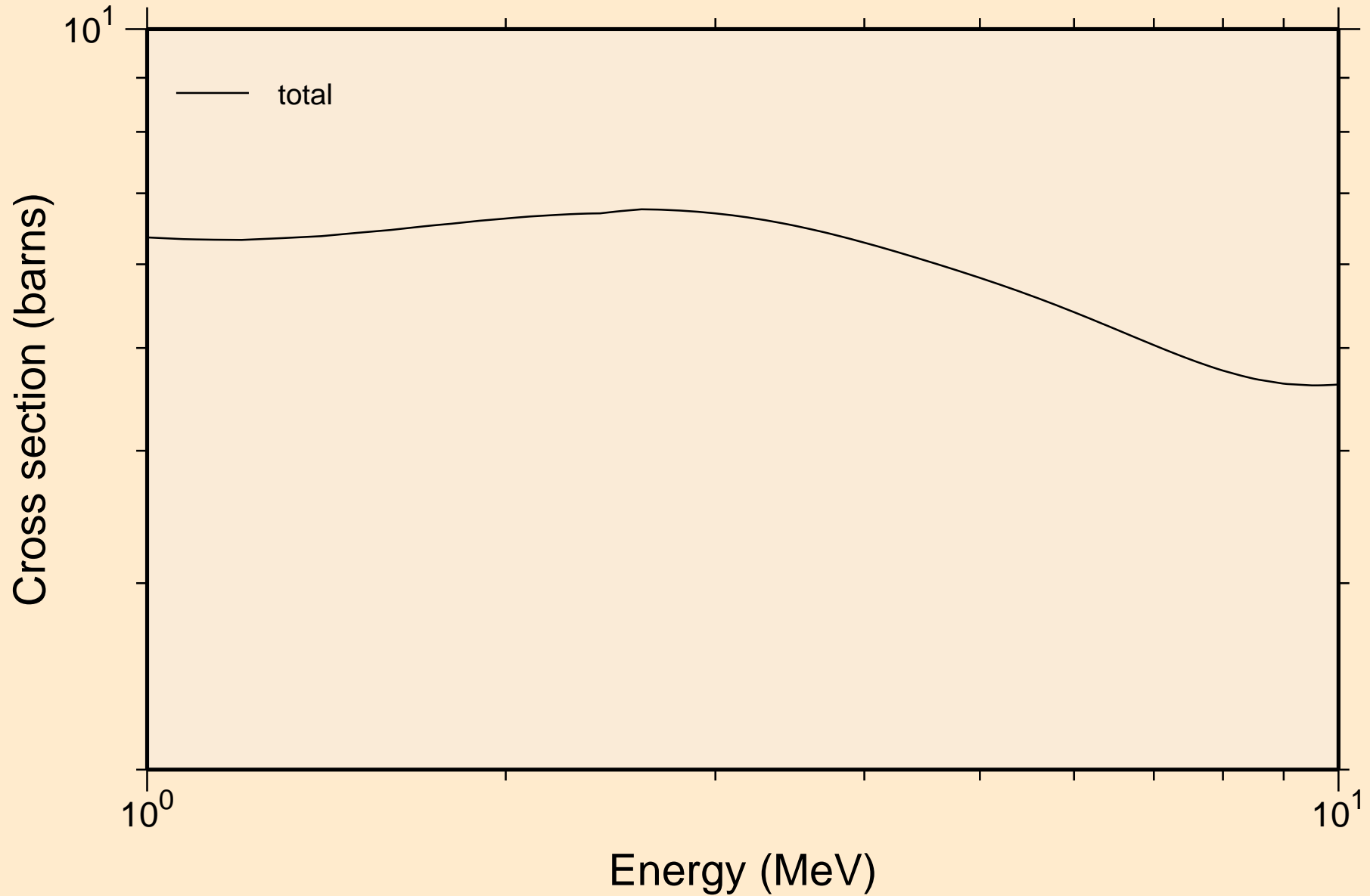

W171 NEUTRON ACER TENDL-2021 LIBRARY; T=293.6K
resonance absorption cross sections

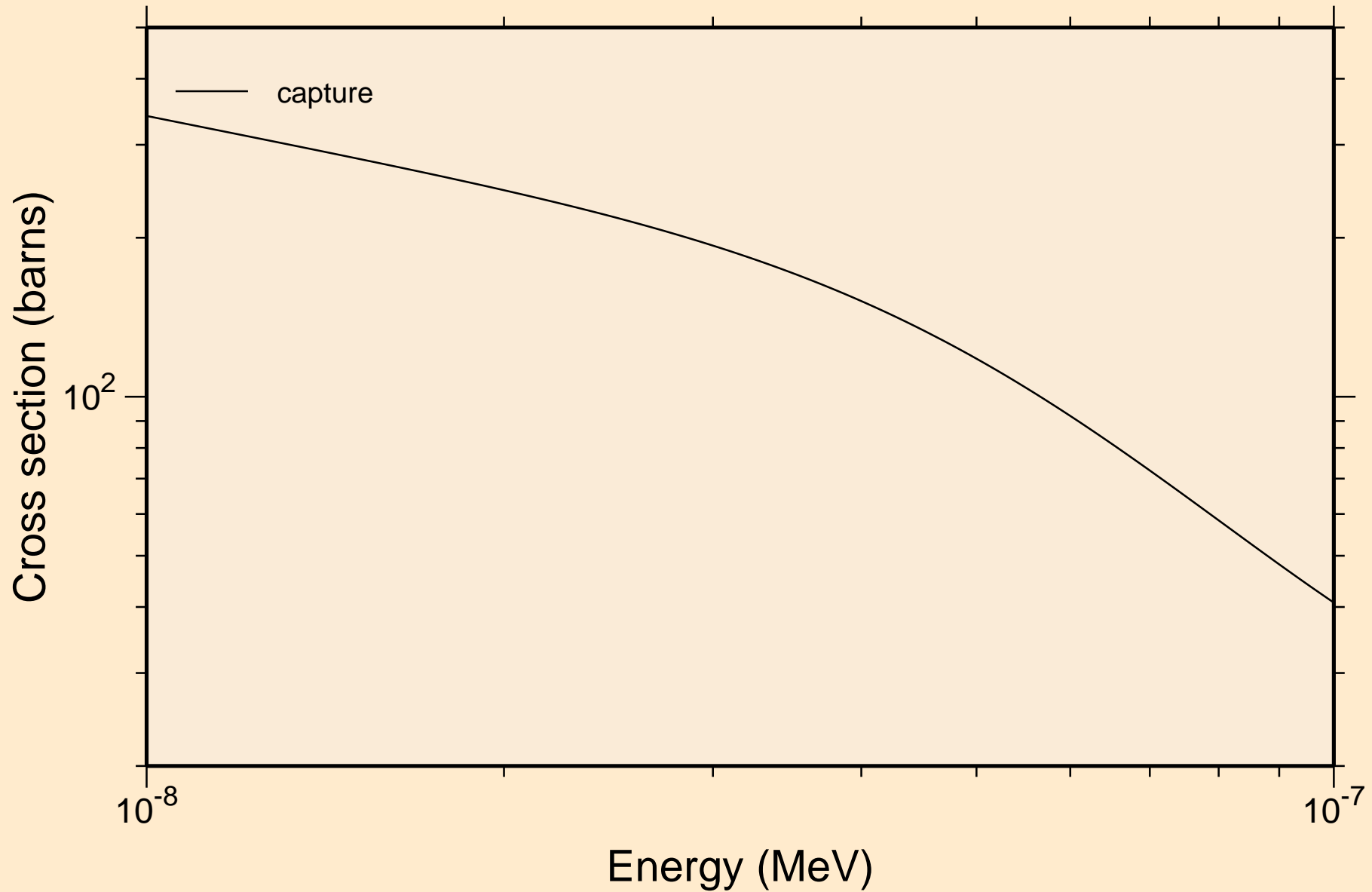

W171 NEUTRON ACER TENDL-2021 LIBRARY; T=293.6K
resonance absorption cross sections

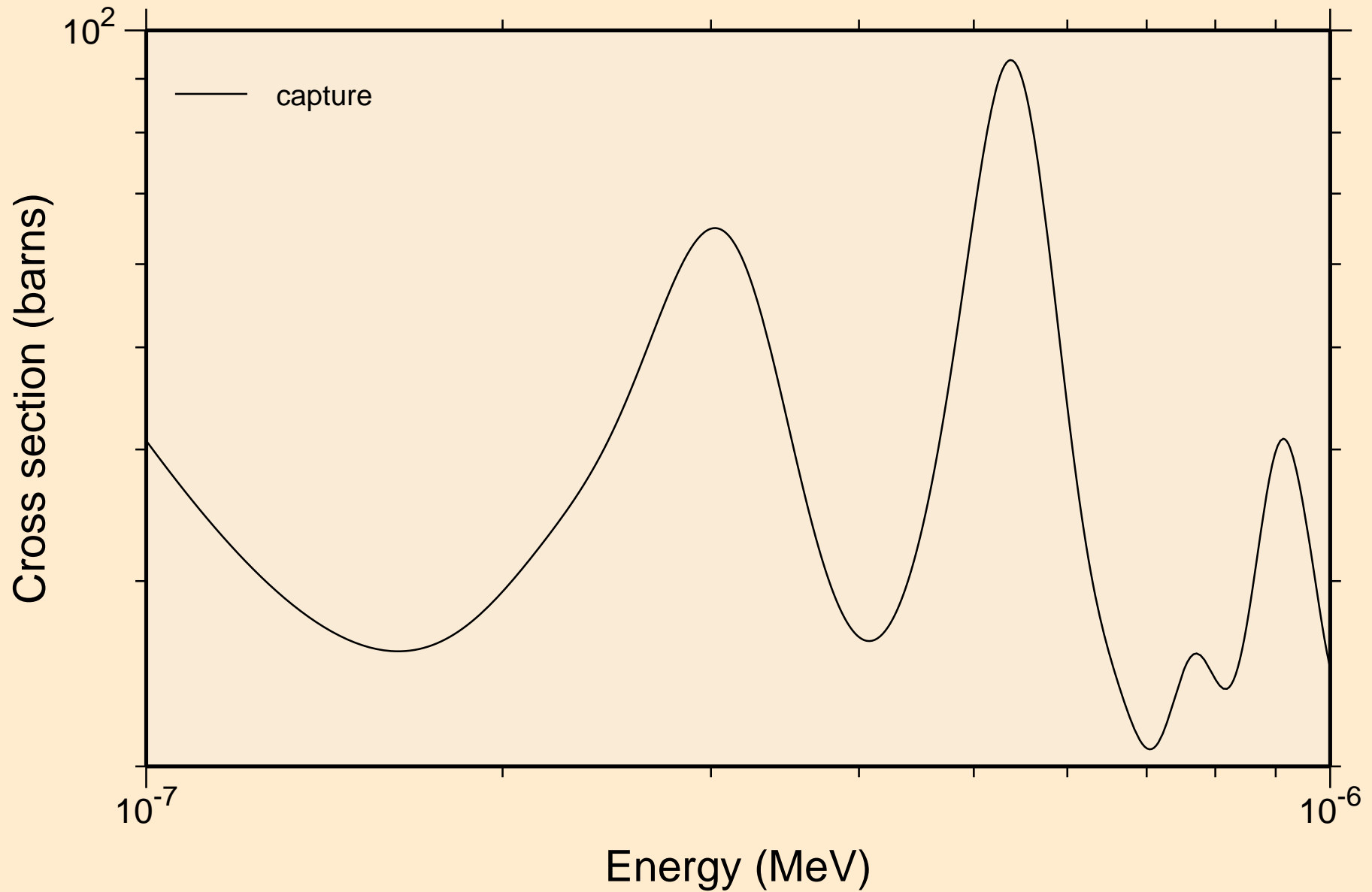

W171 NEUTRON ACER TENDL-2021 LIBRARY; T=293.6K
resonance absorption cross sections

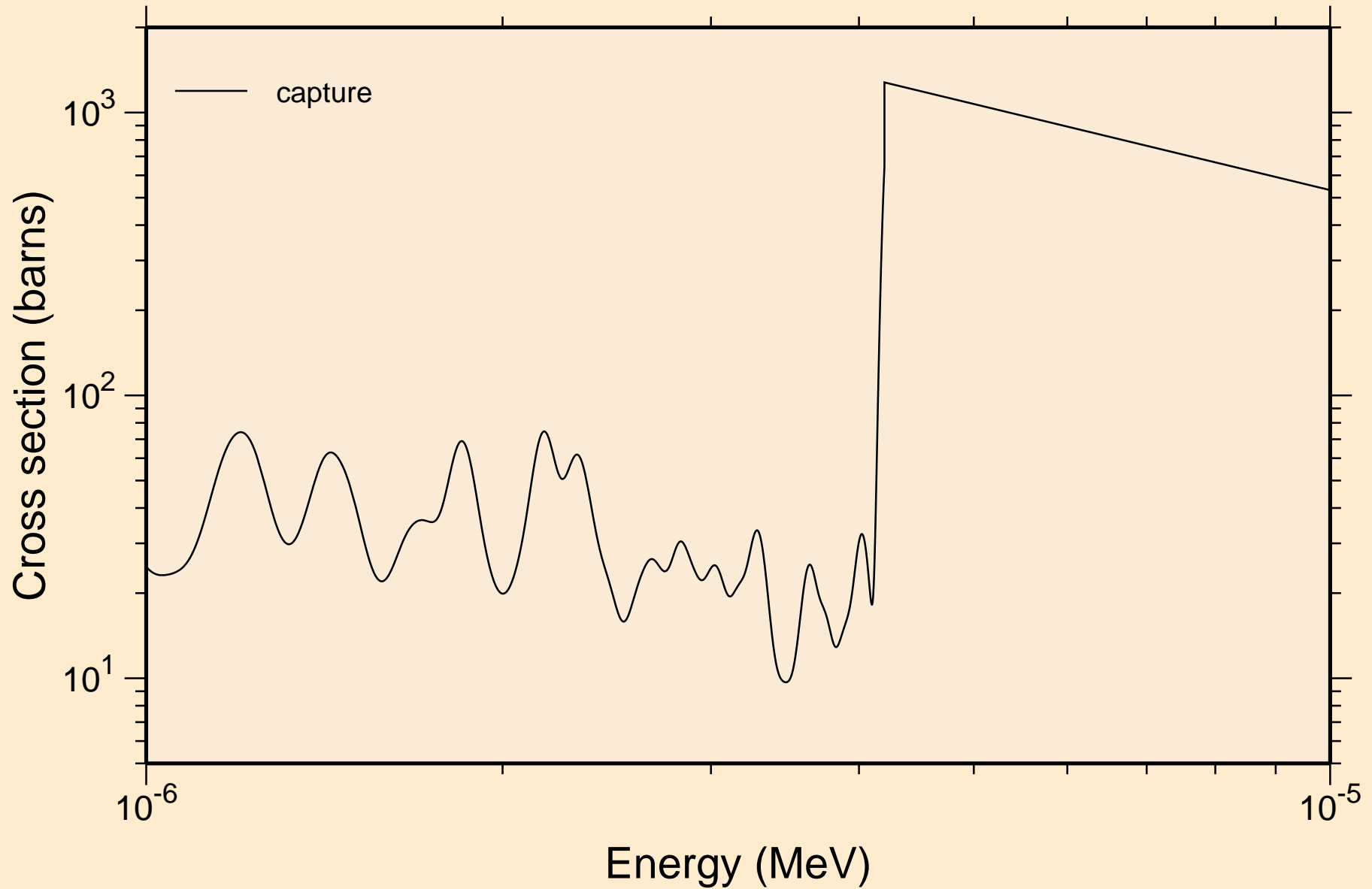

W171 NEUTRON ACER TENDL-2021 LIBRARY; T=293.6K
resonance absorption cross sections

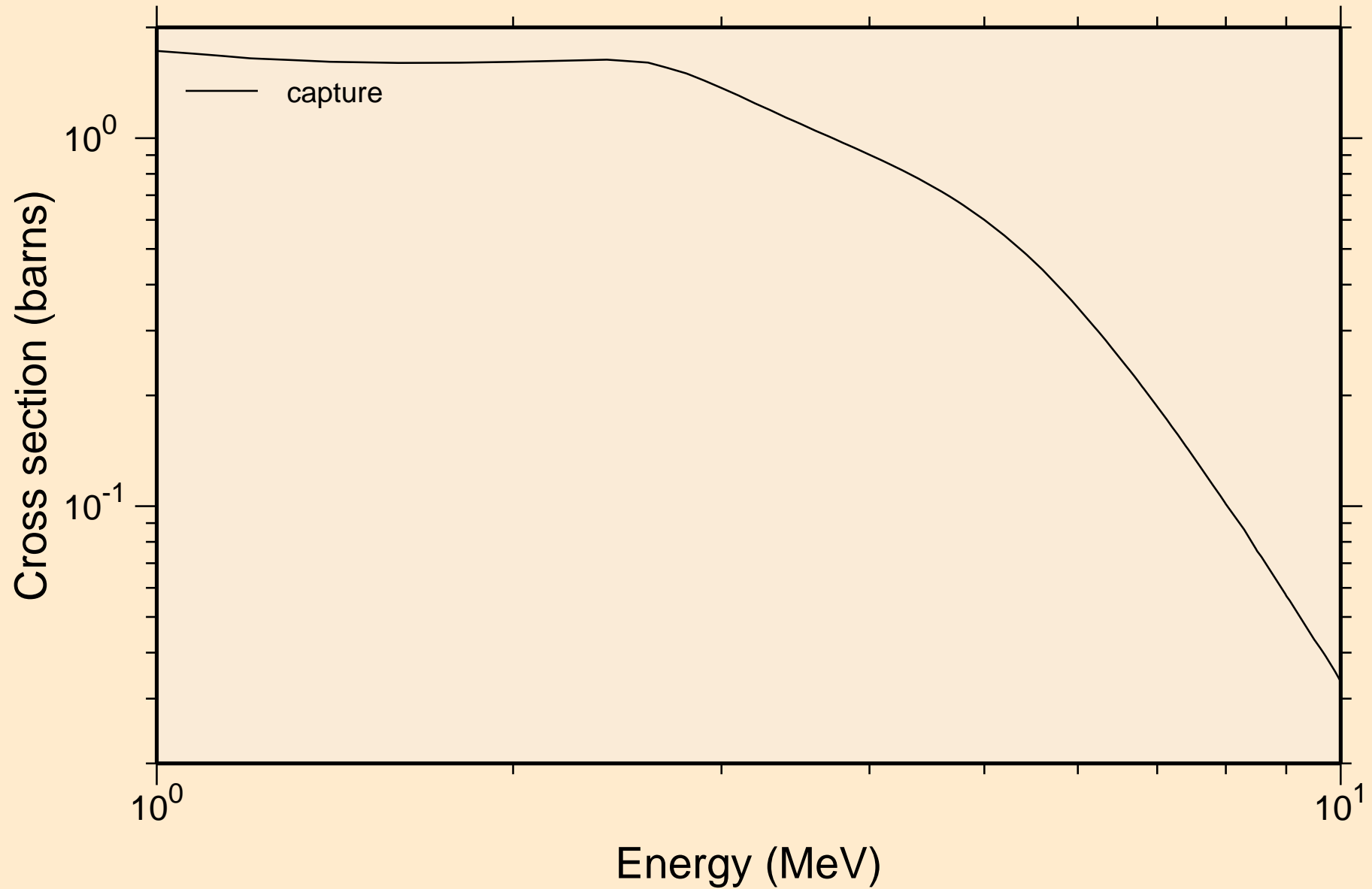

W171 NEUTRON ACER TENDL-2021 LIBRARY; T=293.6K
Heating

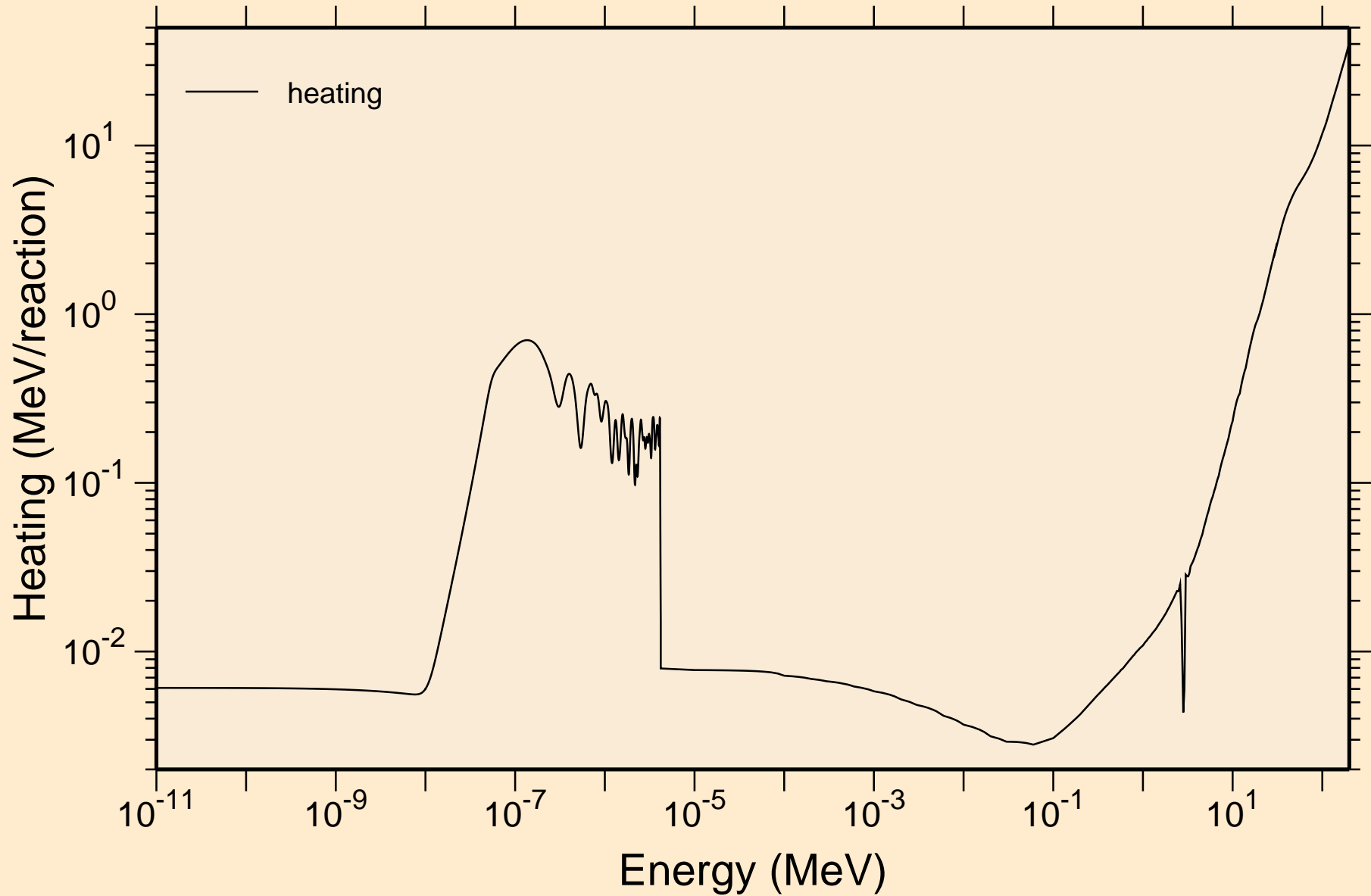

W171 NEUTRON ACER TENDL-2021 LIBRARY; T=293.6K

Damage

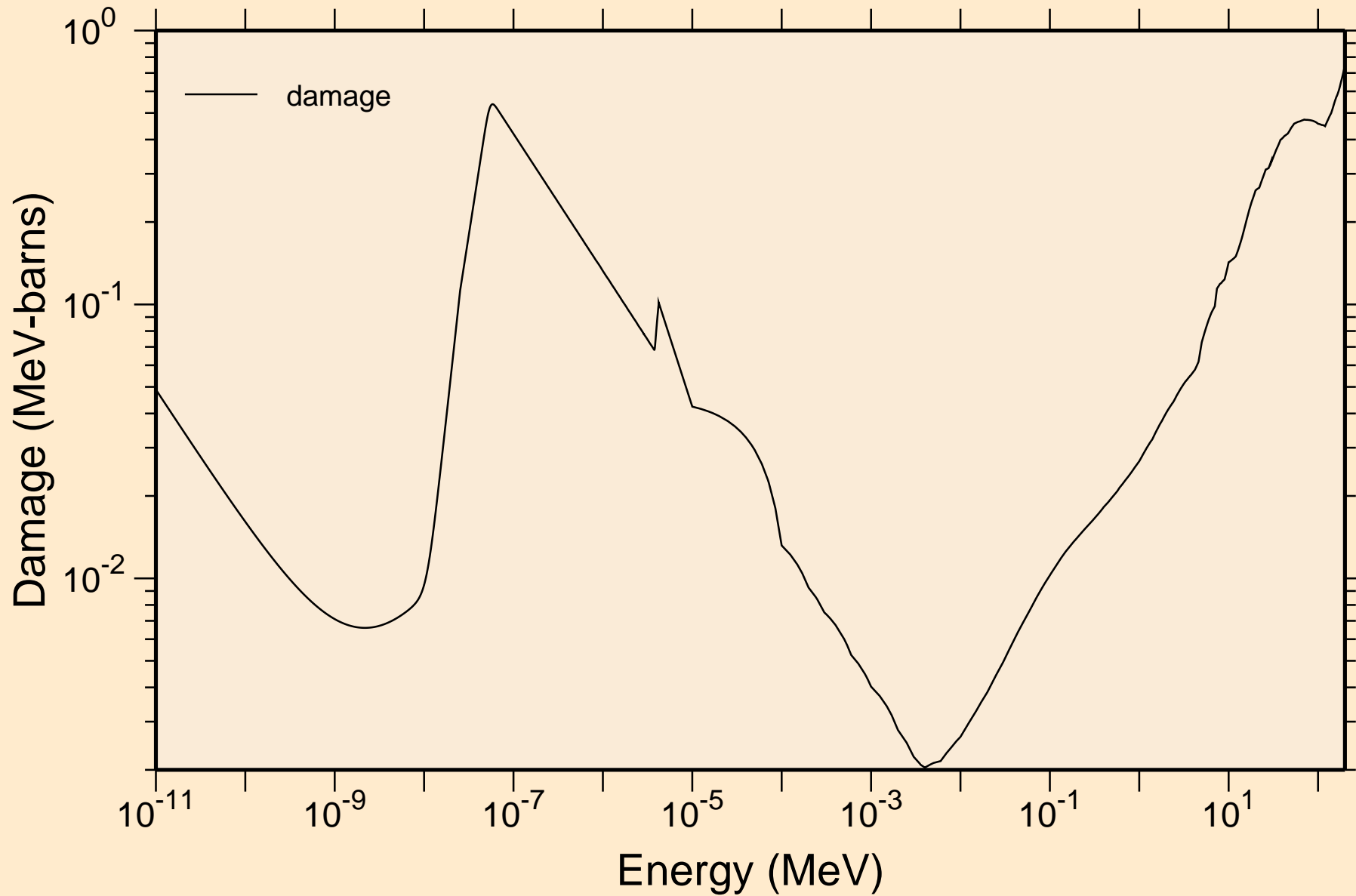

W171 NEUTRON ACER TENDL-2021 LIBRARY; T=293.6K
Non-threshold reactions

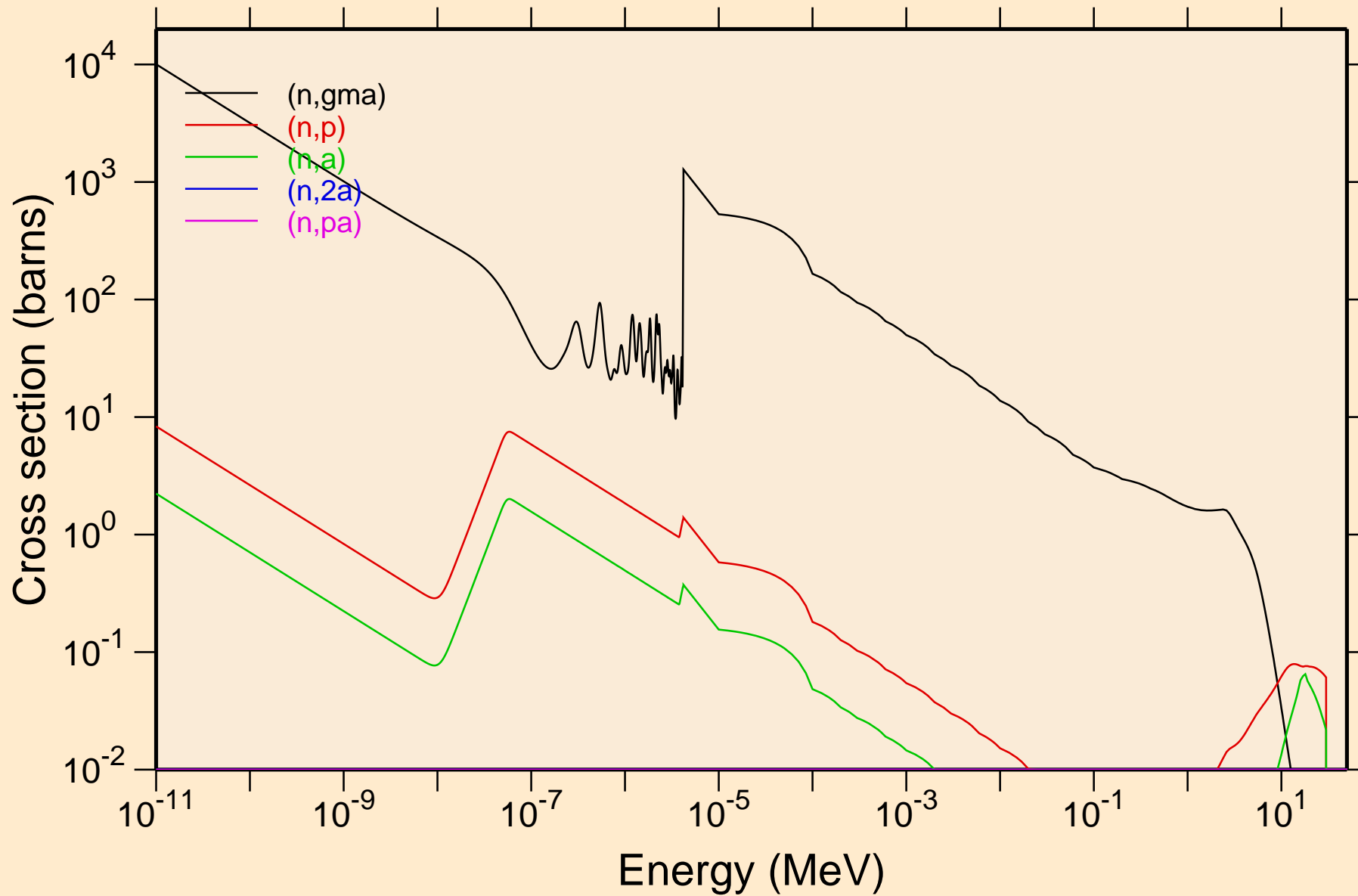

W171 NEUTRON ACER TENDL-2021 LIBRARY; T=293.6K
Non-threshold reactions

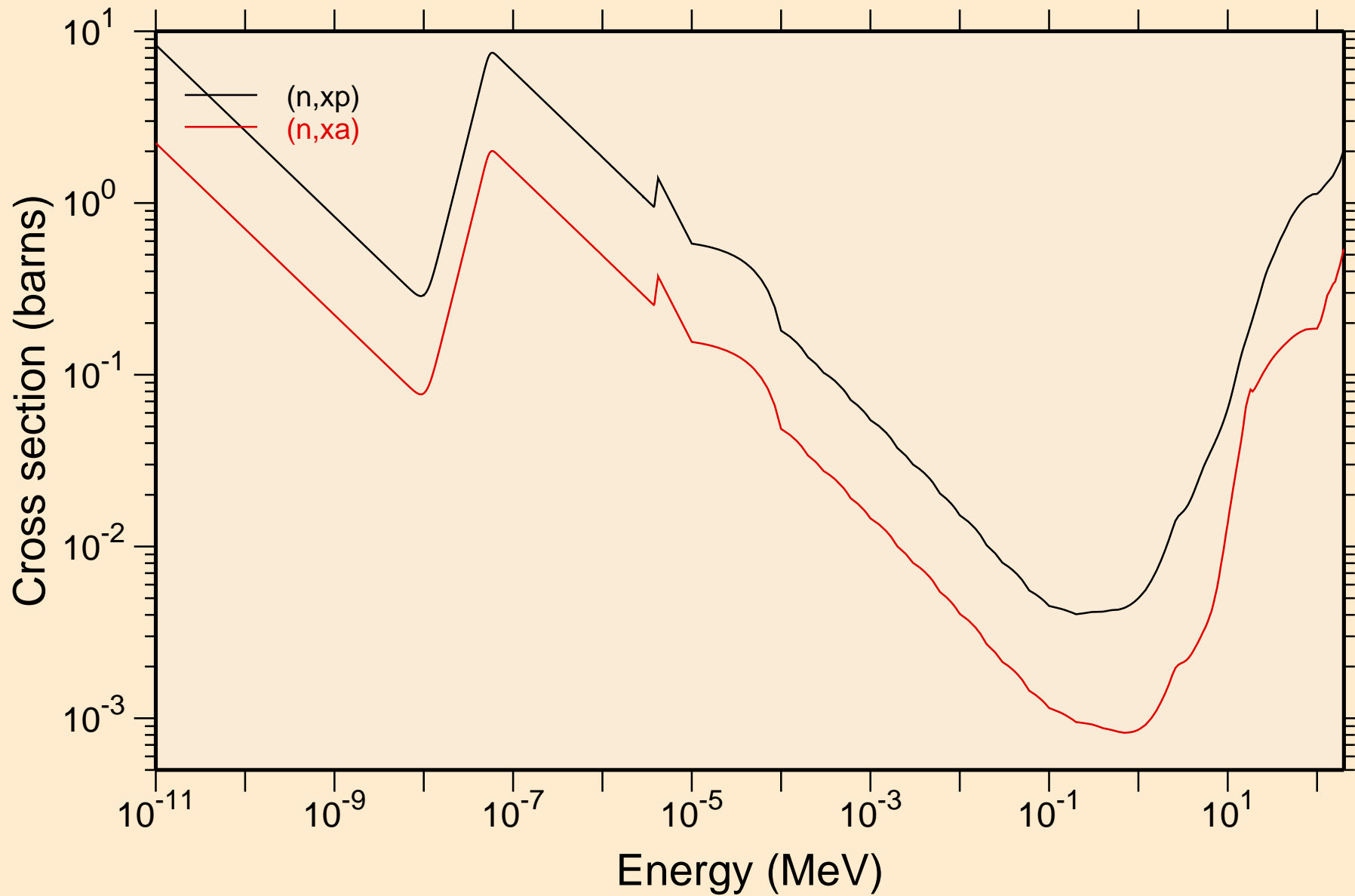

W171 NEUTRON ACER TENDL-2021 LIBRARY; T=293.6K
Principal cross sections

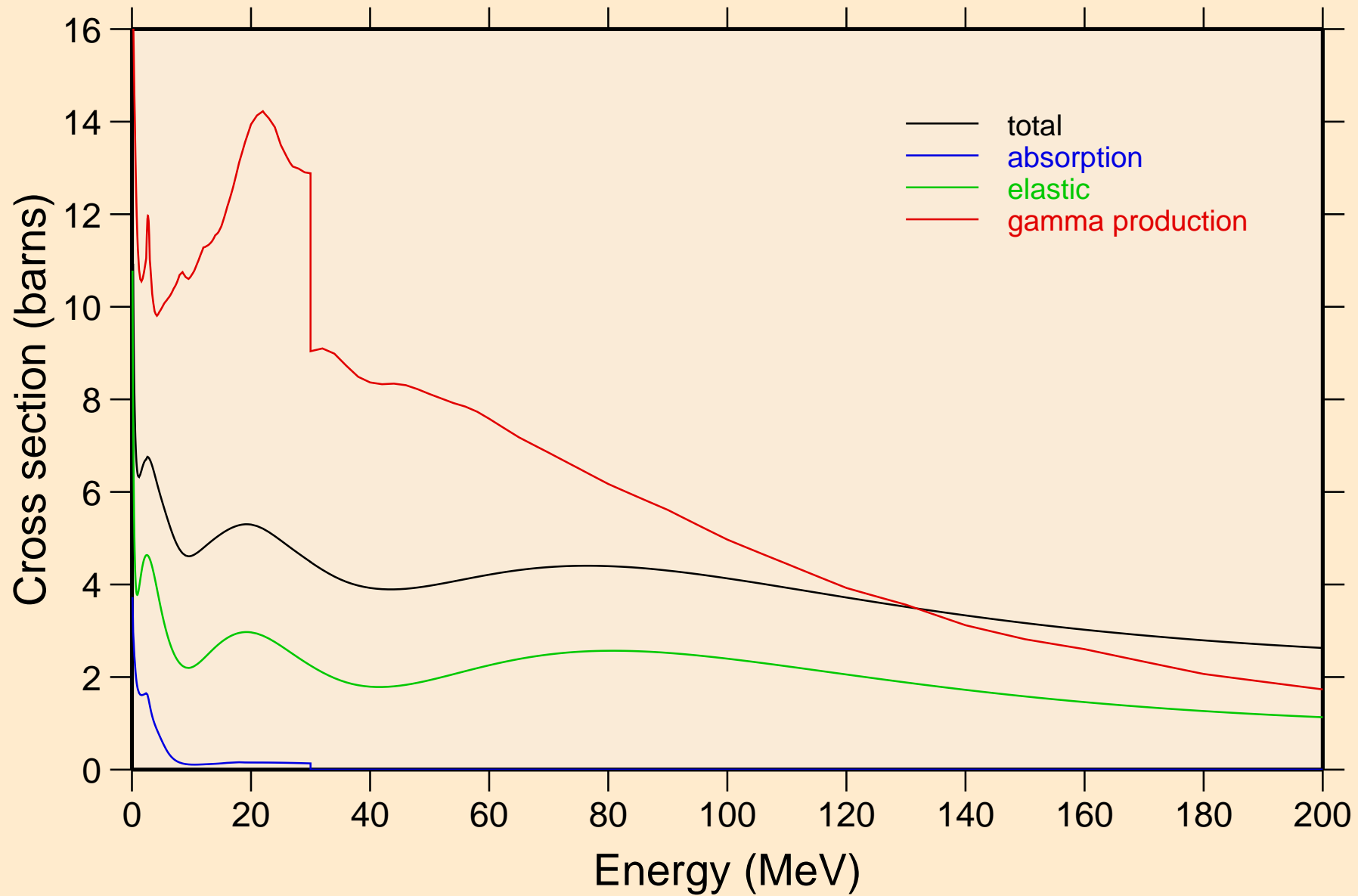

W171 NEUTRON ACER TENDL-2021 LIBRARY; T=293.6K

Heating

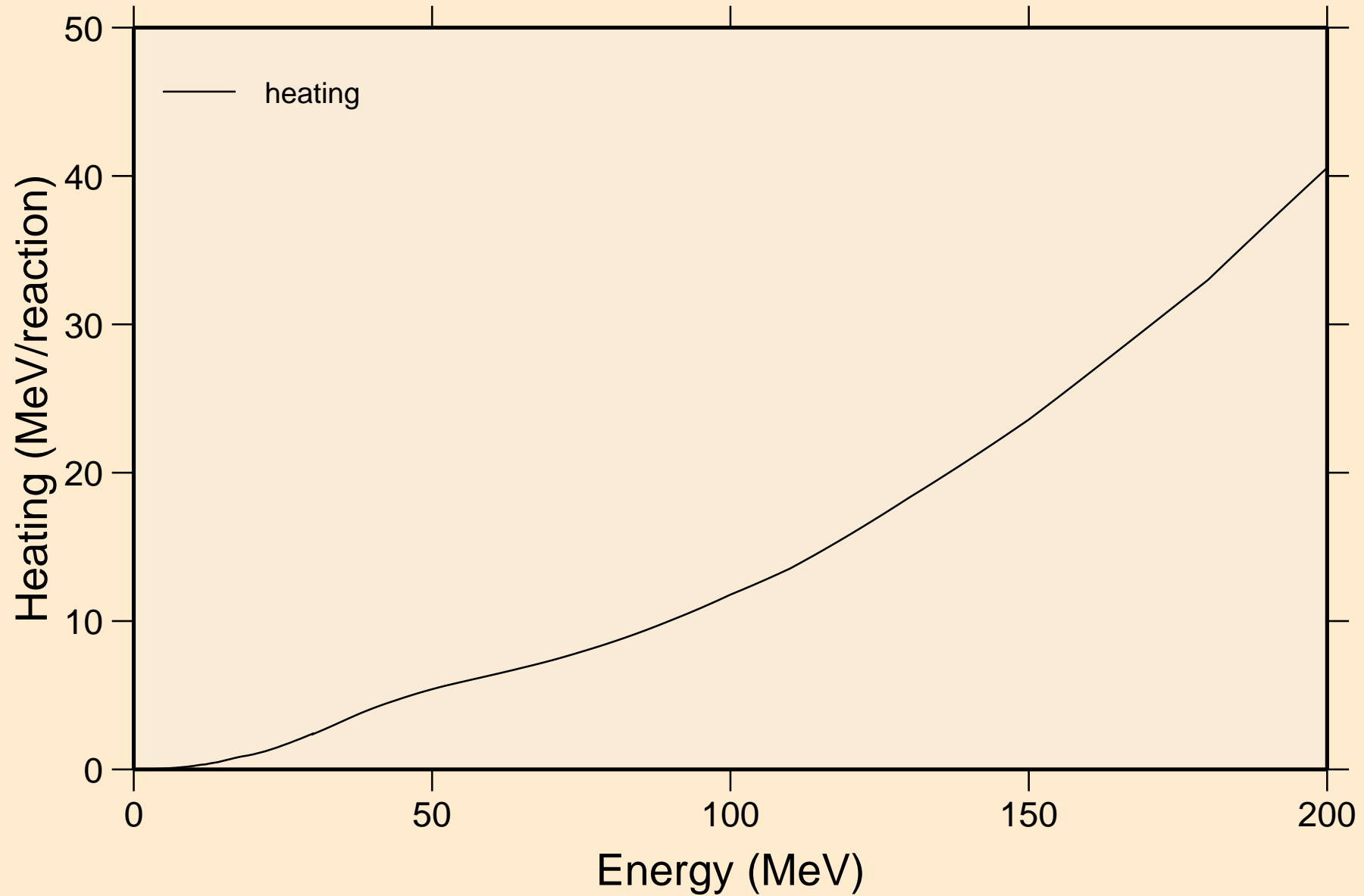

W171 NEUTRON ACER TENDL-2021 LIBRARY; T=293.6K
Damage

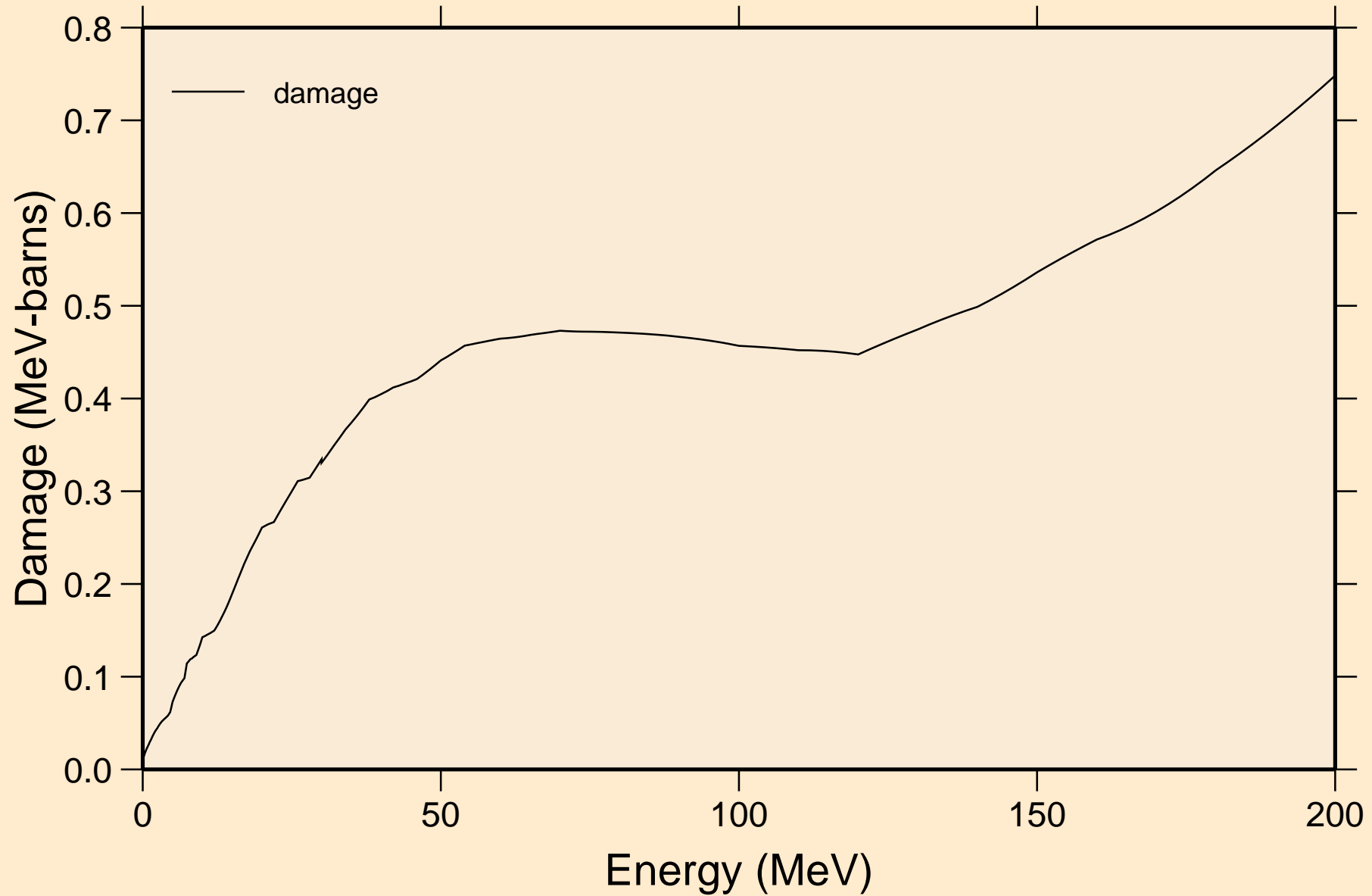

W171 NEUTRON ACER TENDL-2021 LIBRARY; T=293.6K
Non-threshold reactions

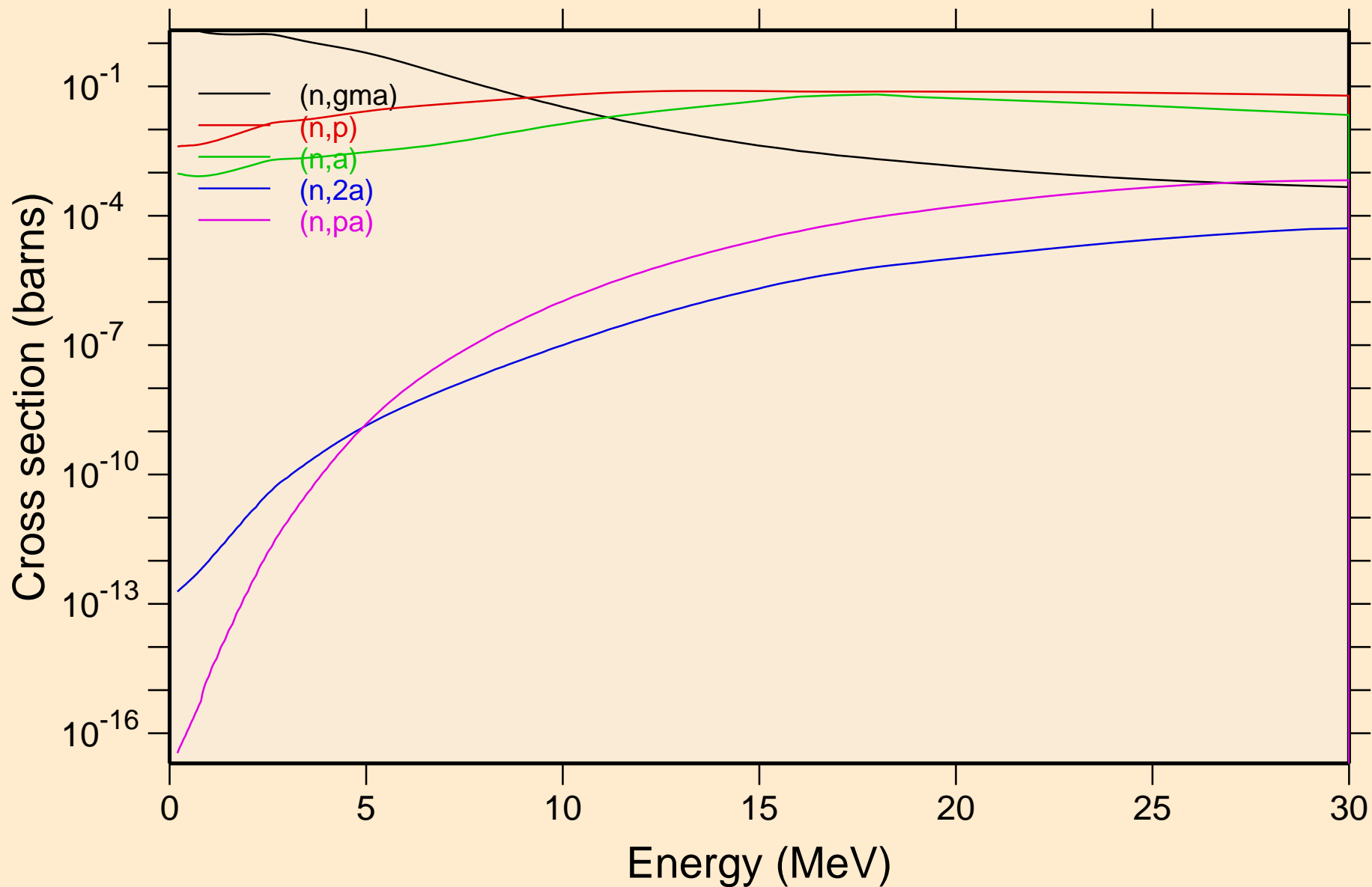

W171 NEUTRON ACER TENDL-2021 LIBRARY; T=293.6K
Non-threshold reactions

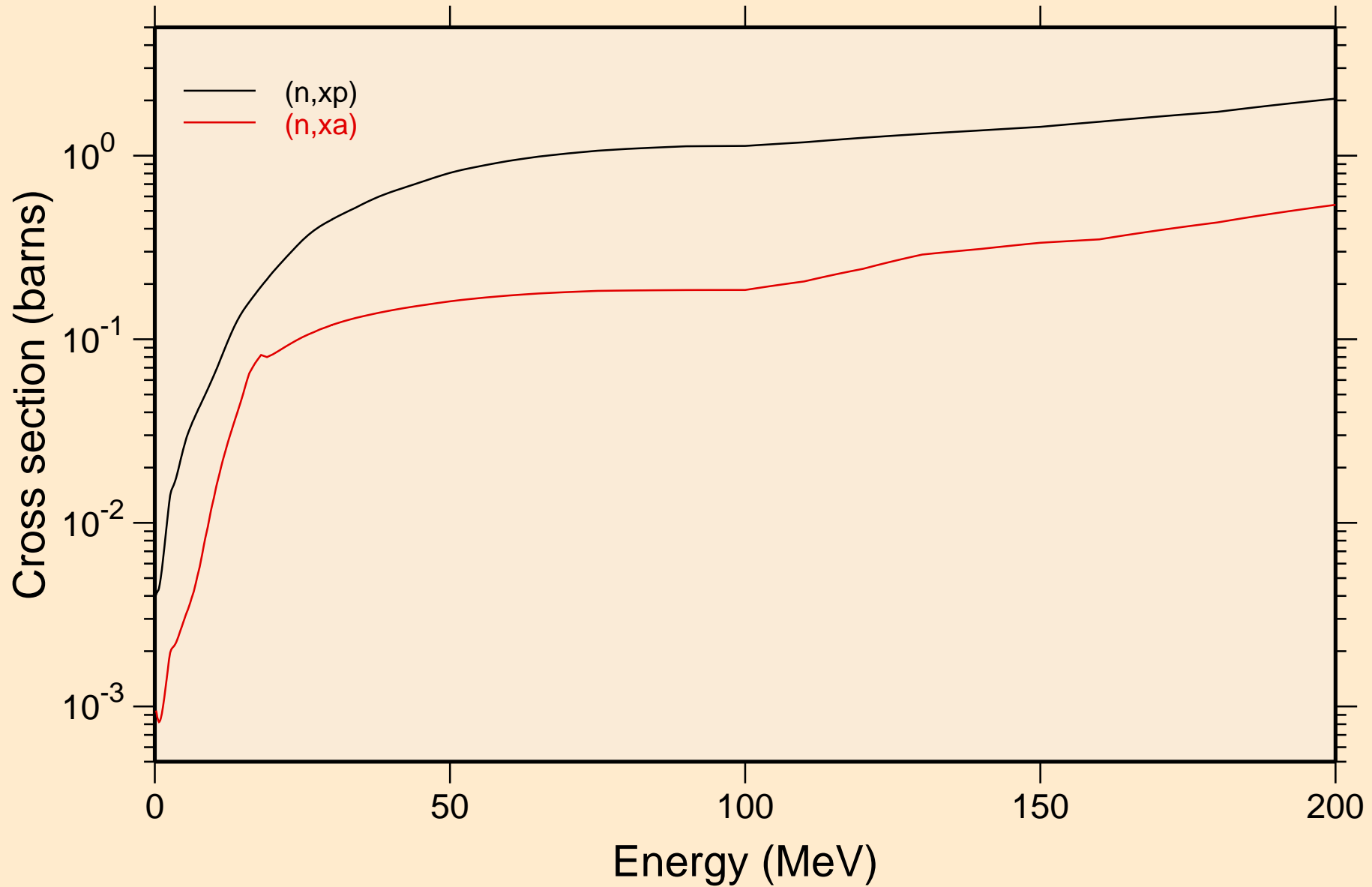

W171 NEUTRON ACER TENDL-2021 LIBRARY; T=293.6K
Inelastic levels

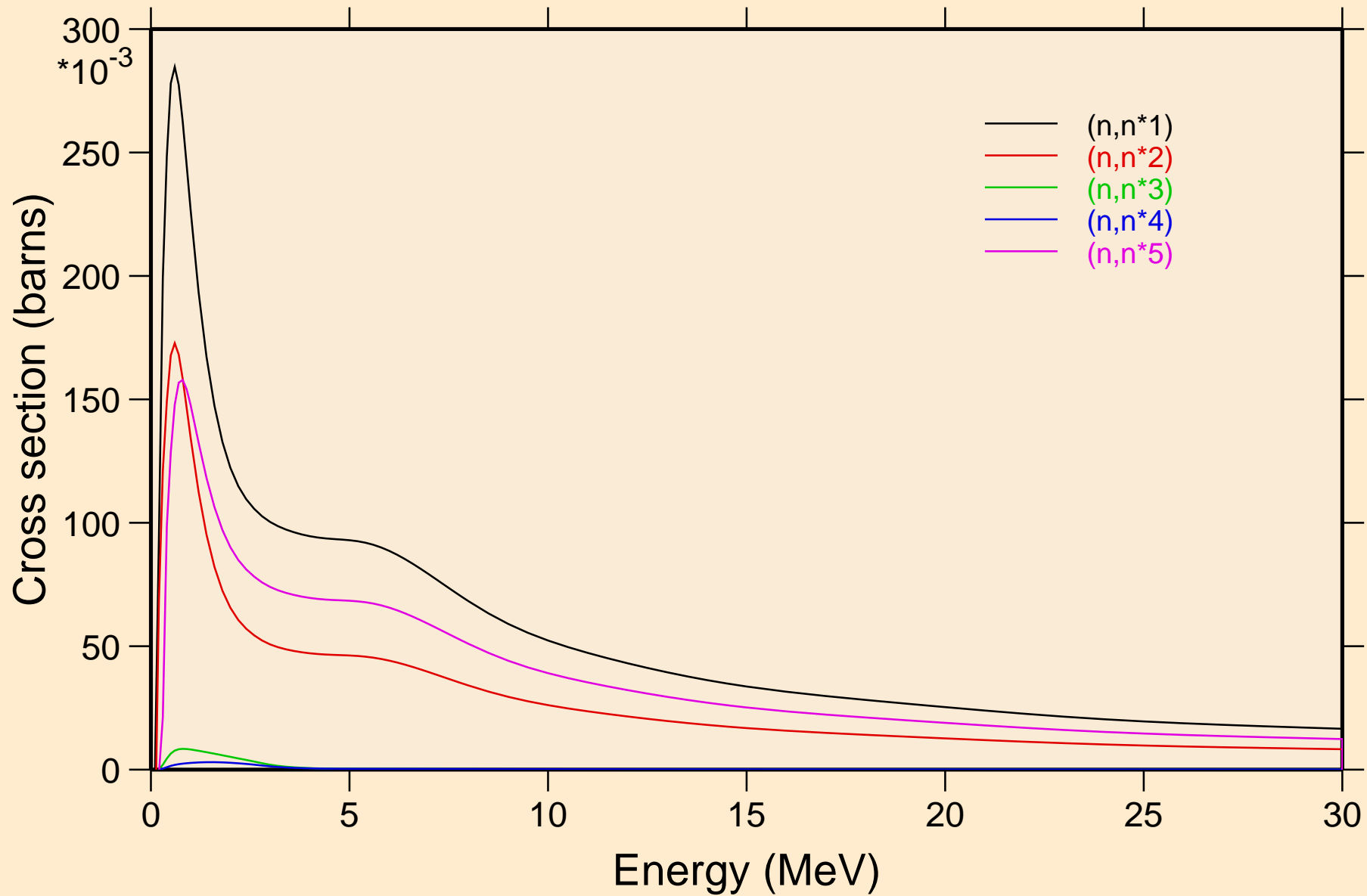

W171 NEUTRON ACER TENDL-2021 LIBRARY; T=293.6K
Inelastic levels

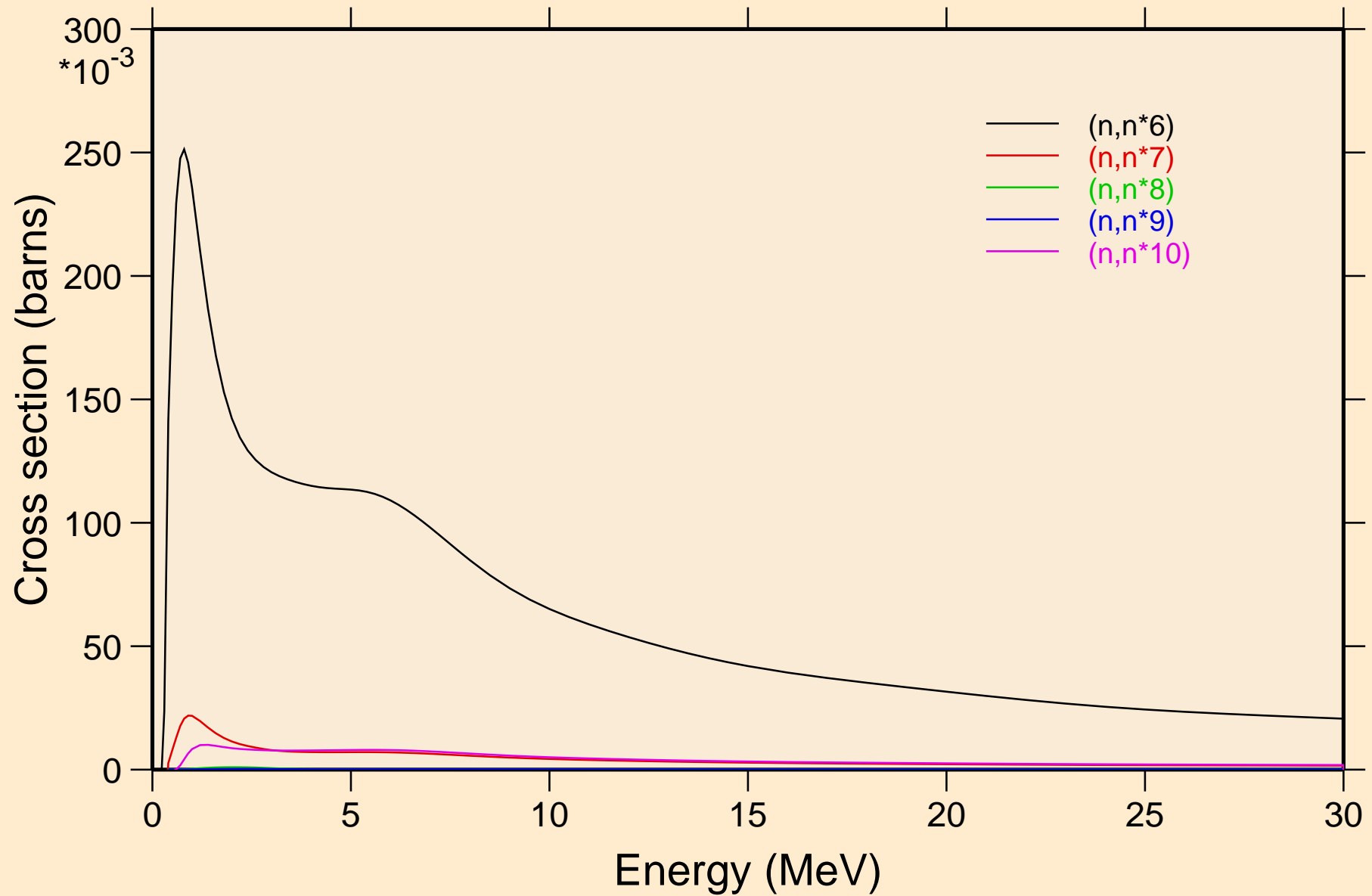

W171 NEUTRON ACER TENDL-2021 LIBRARY; T=293.6K
Inelastic levels

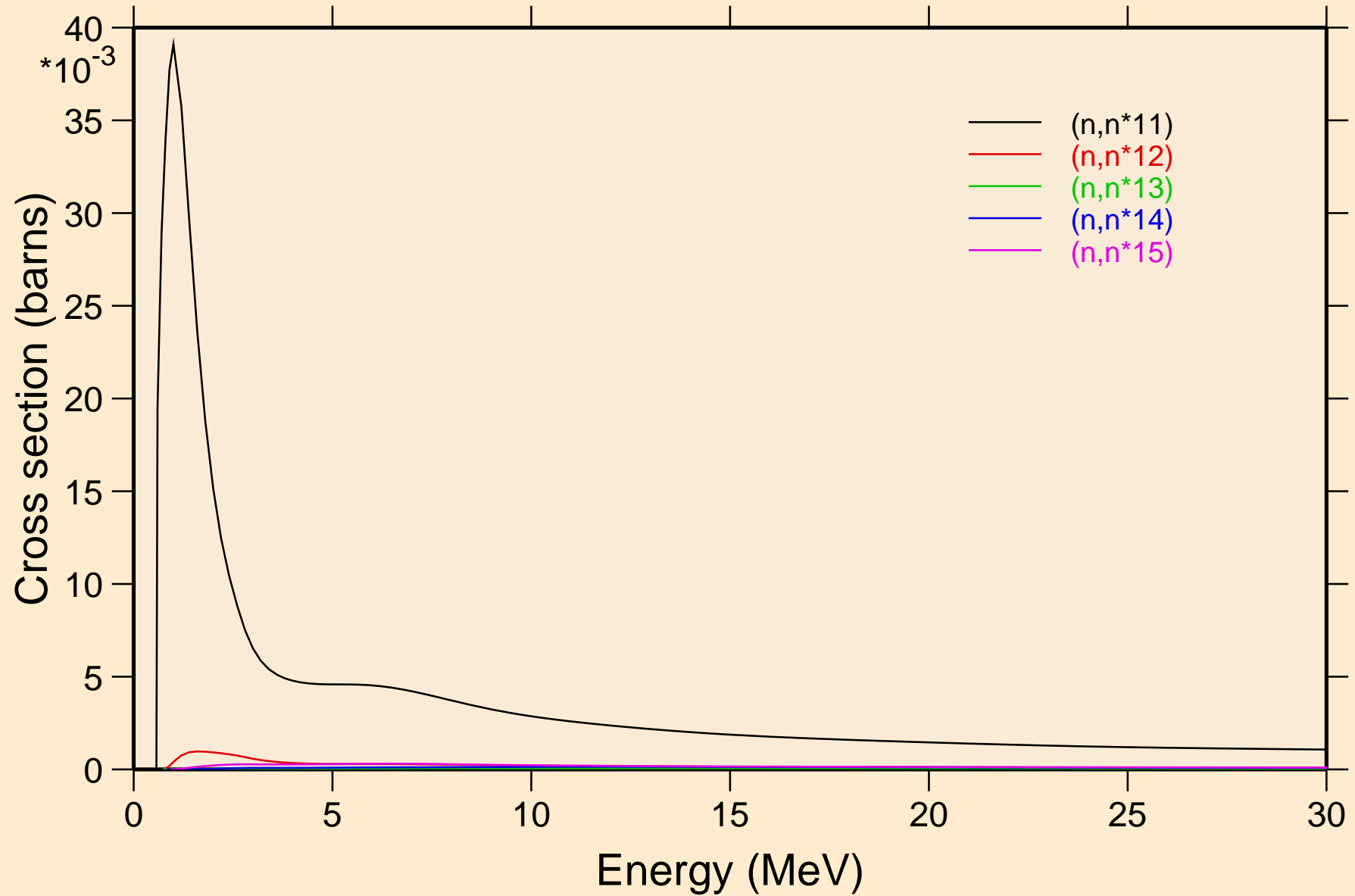

W171 NEUTRON ACER TENDL-2021 LIBRARY; T=293.6K
Inelastic levels

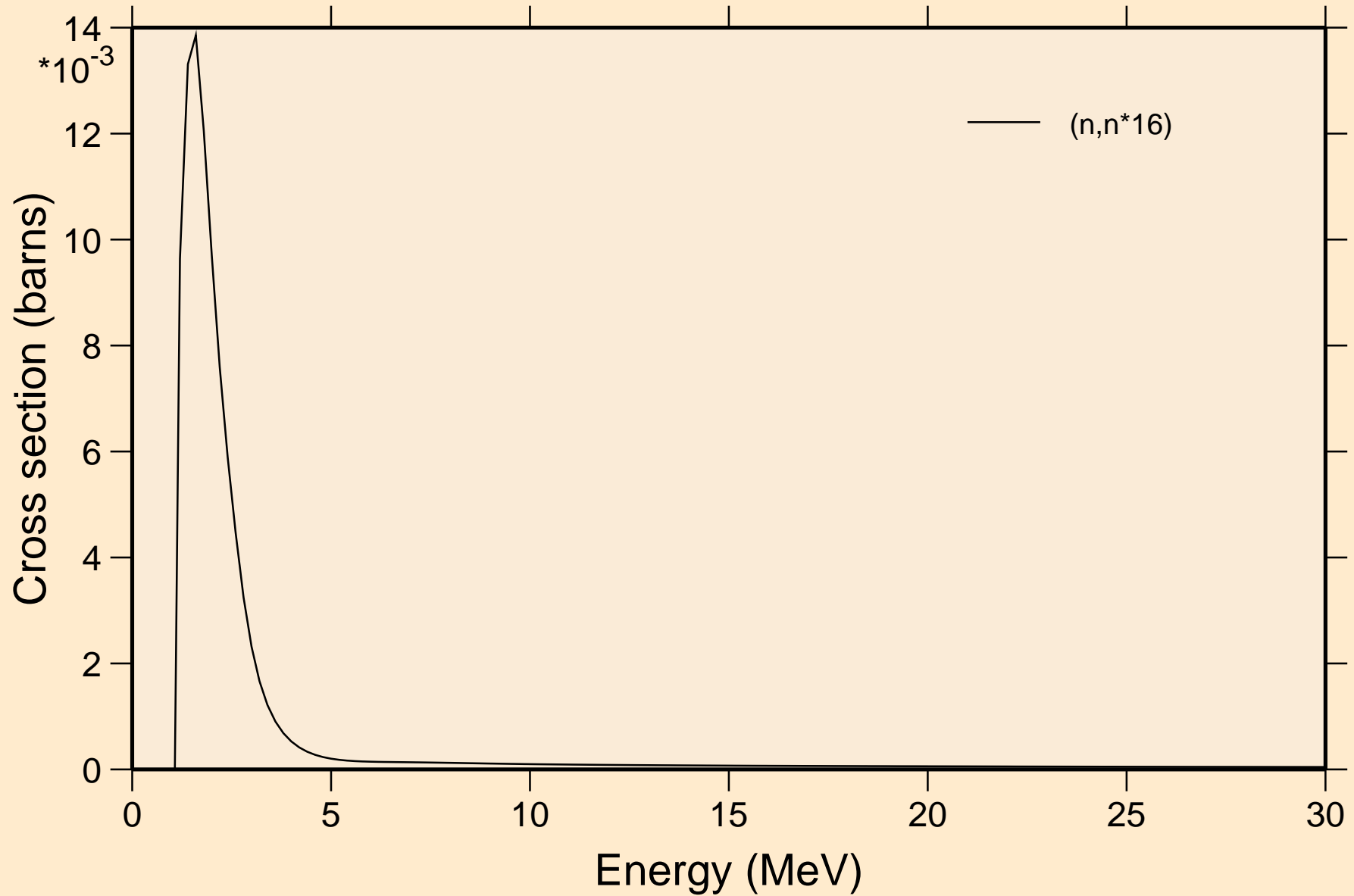

W171 NEUTRON ACER TENDL-2021 LIBRARY; T=293.6K
Threshold reactions

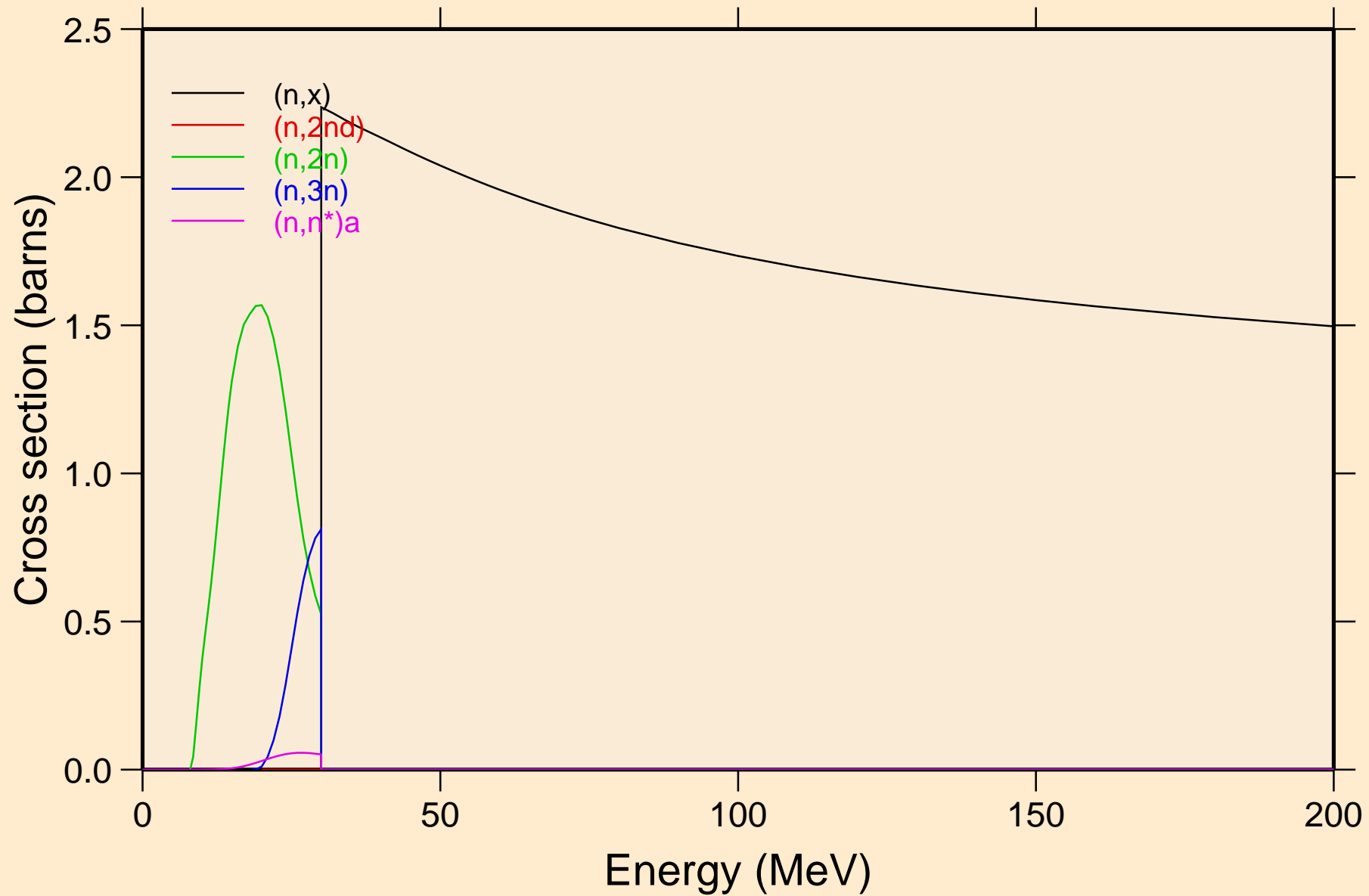

W171 NEUTRON ACER TENDL-2021 LIBRARY; T=293.6K
Threshold reactions

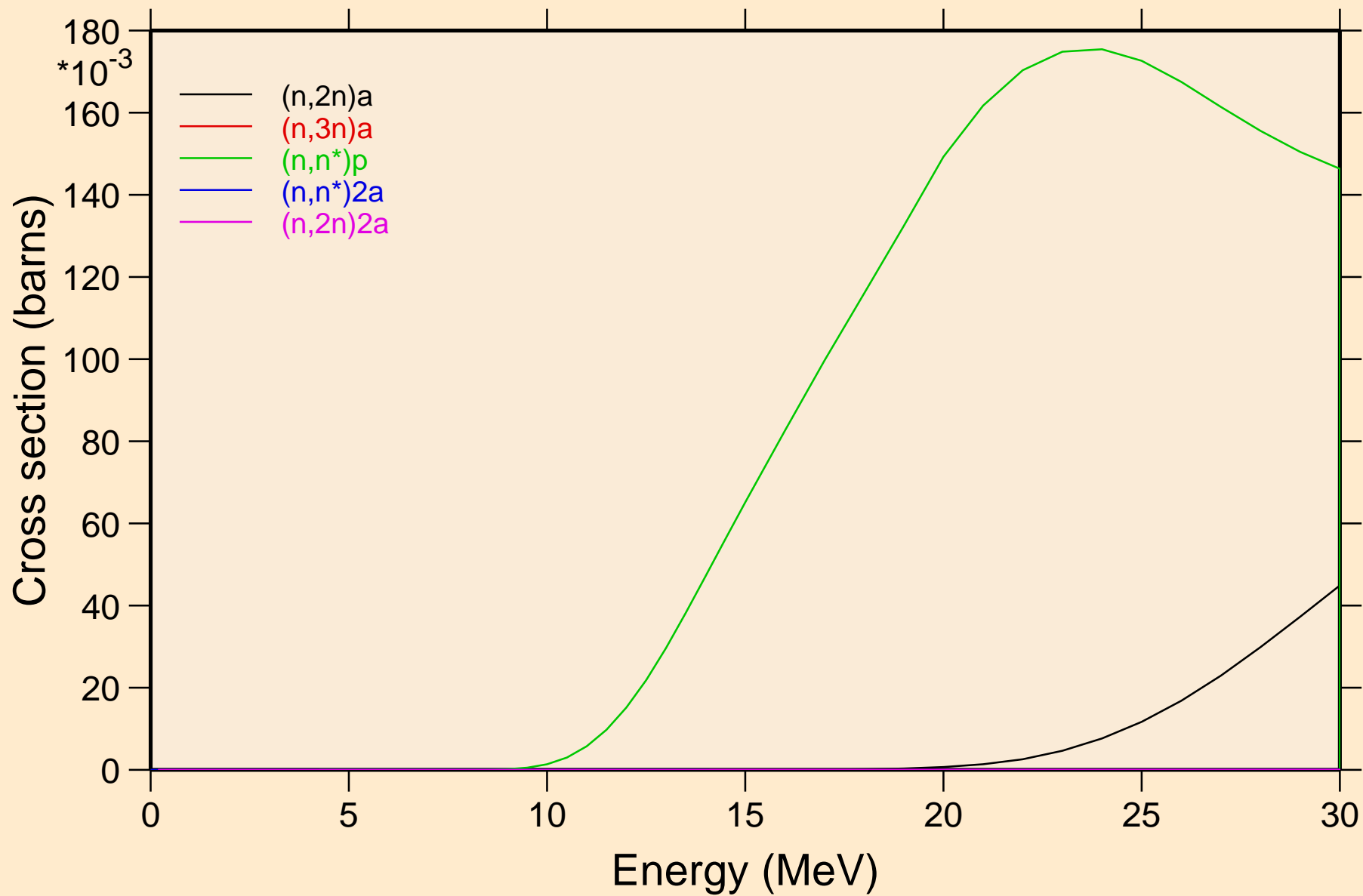

W171 NEUTRON ACER TENDL-2021 LIBRARY; T=293.6K
Threshold reactions

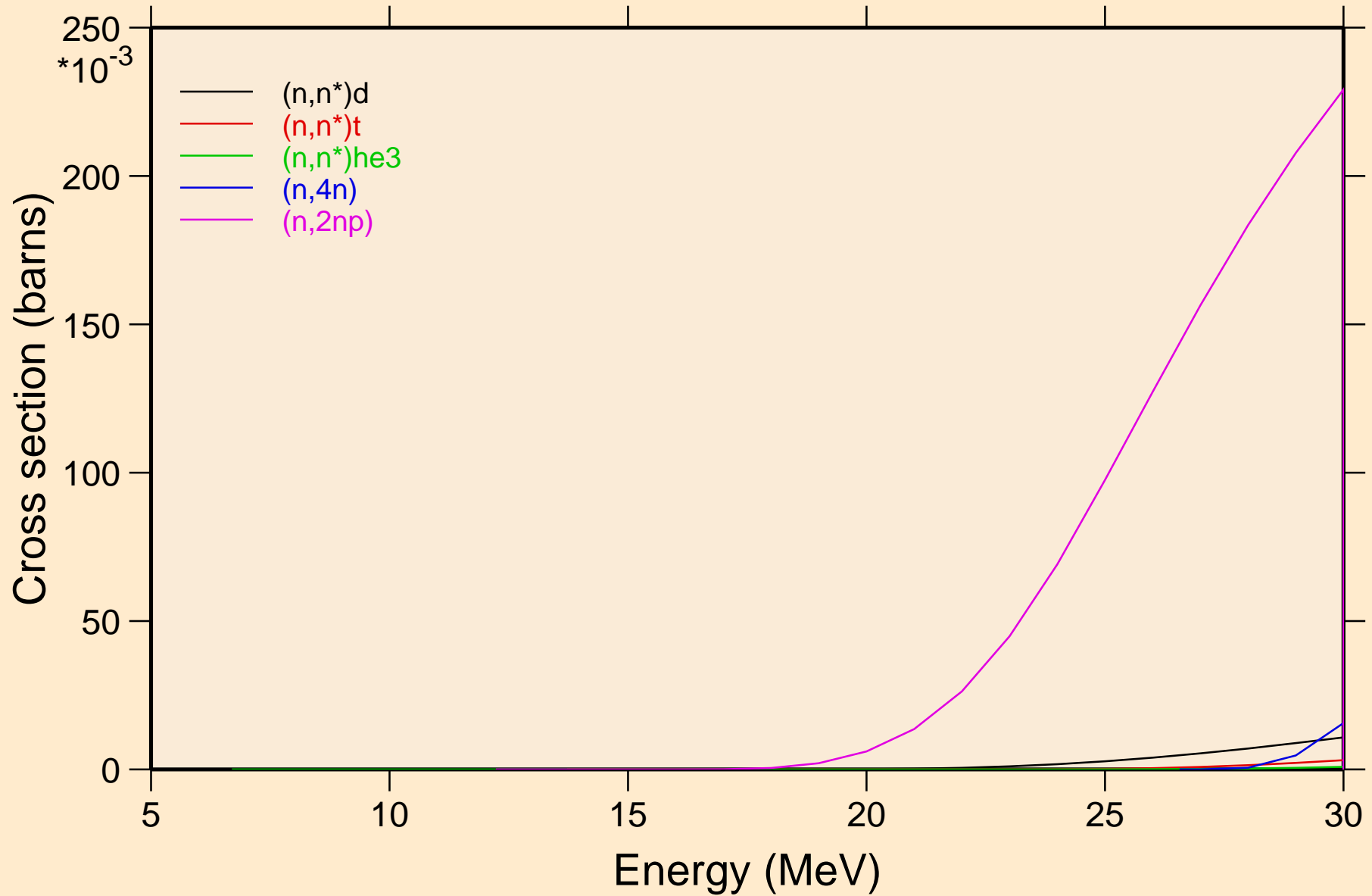

W171 NEUTRON ACER TENDL-2021 LIBRARY; T=293.6K
Threshold reactions

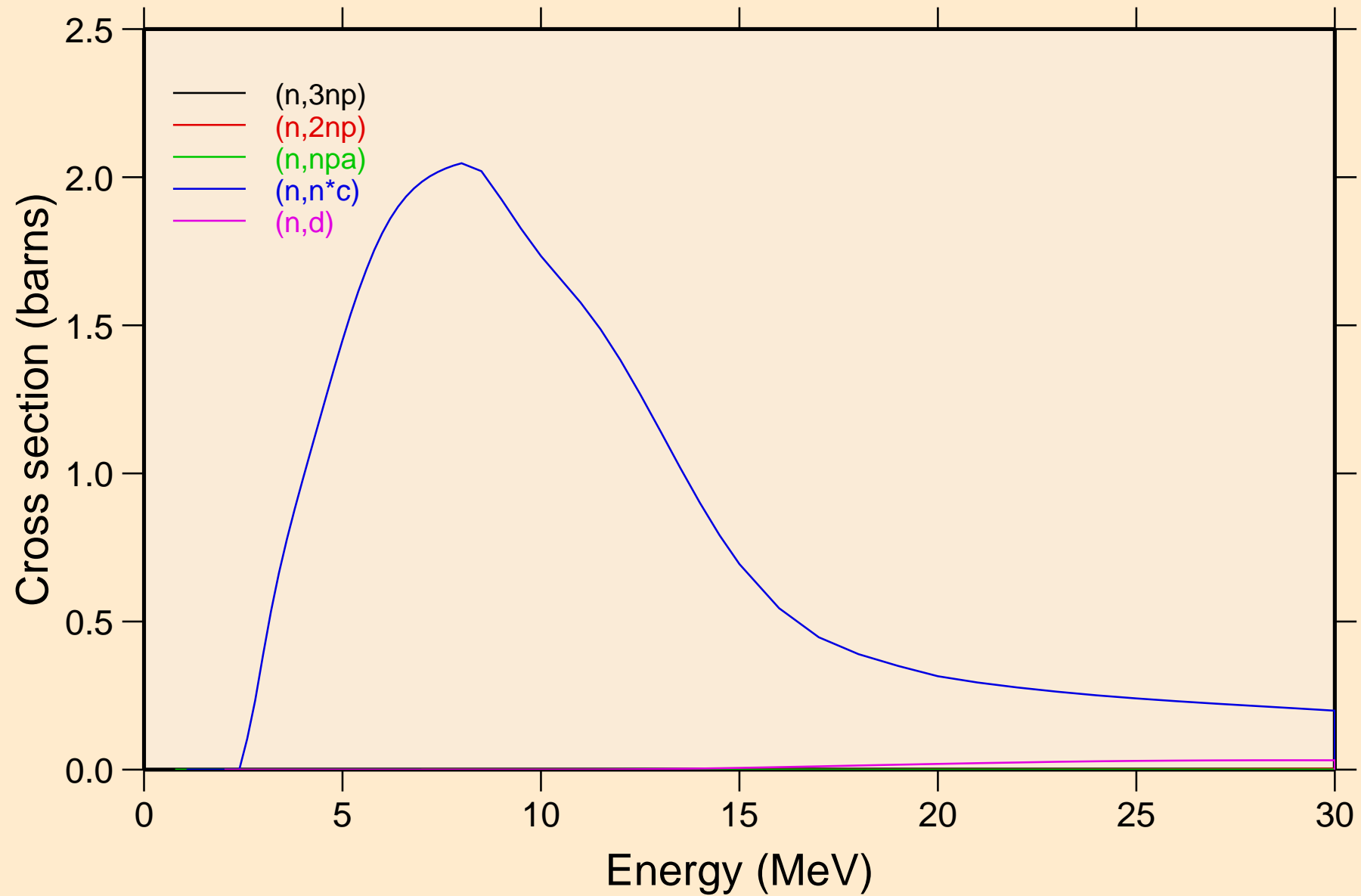

W171 NEUTRON ACER TENDL-2021 LIBRARY; T=293.6K
Threshold reactions

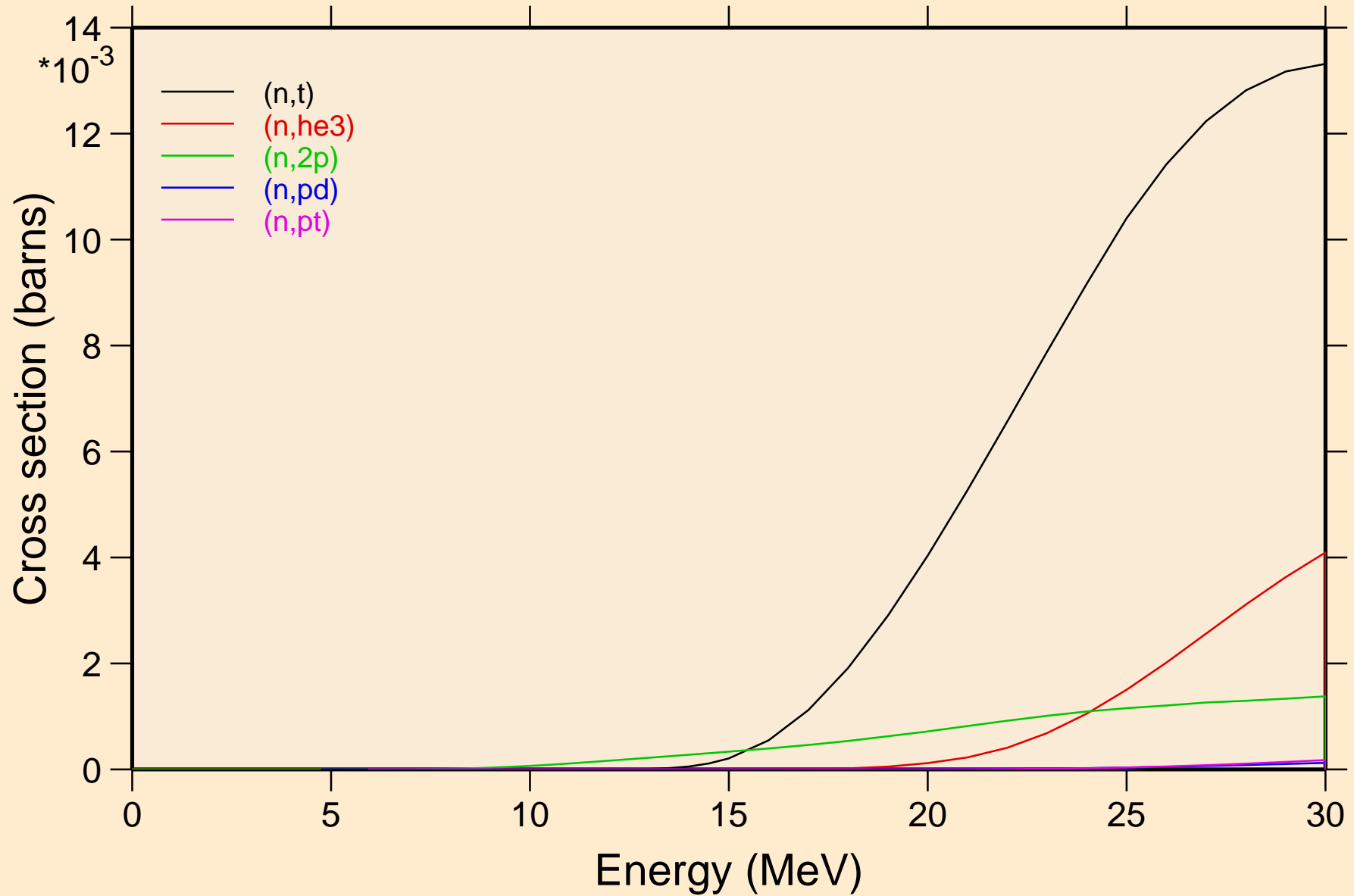

W171 NEUTRON ACER TENDL-2021 LIBRARY; T=293.6K
Threshold reactions

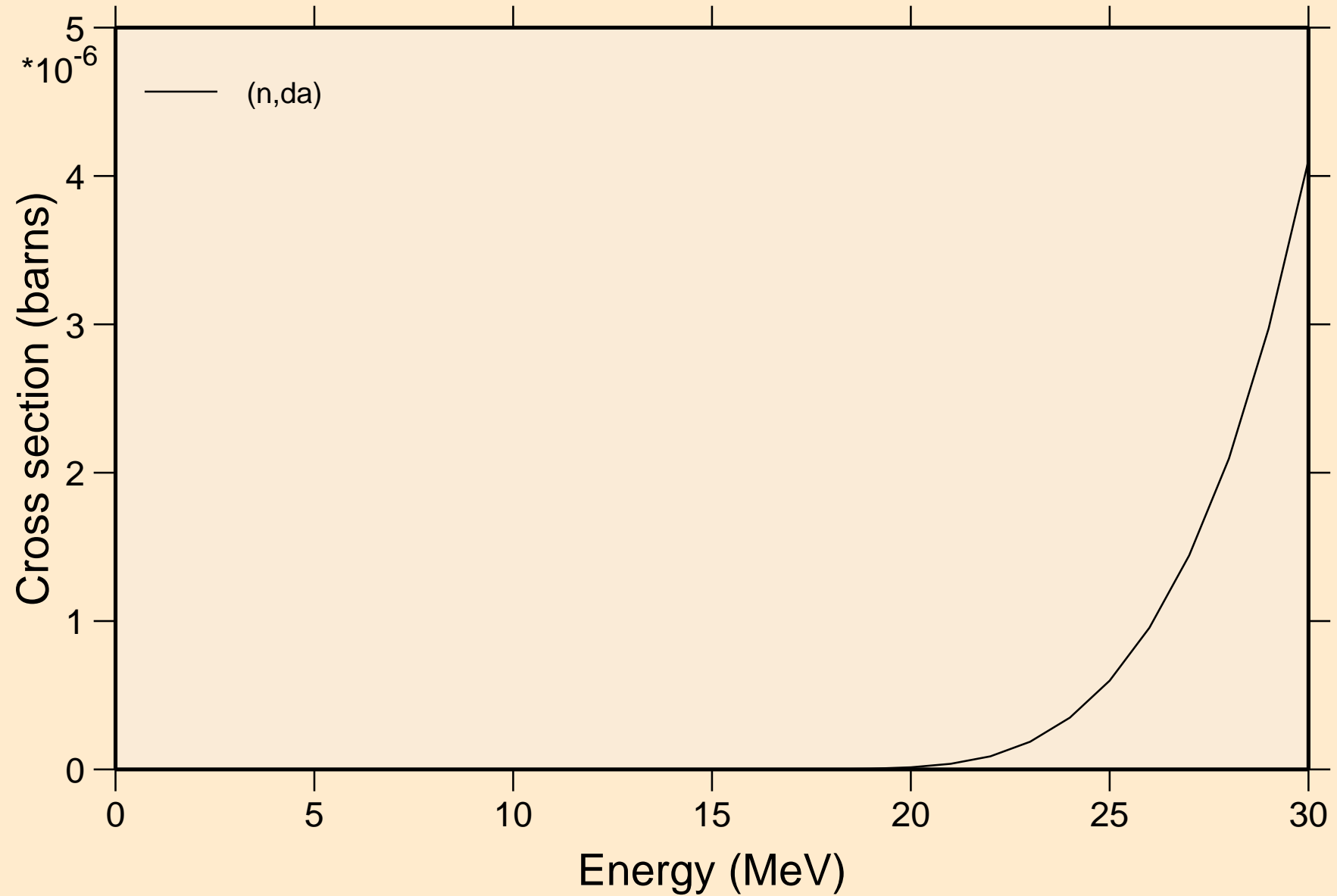

W171 NEUTRON ACER TENDL-2021 LIBRARY; T=293.6K
Threshold reactions

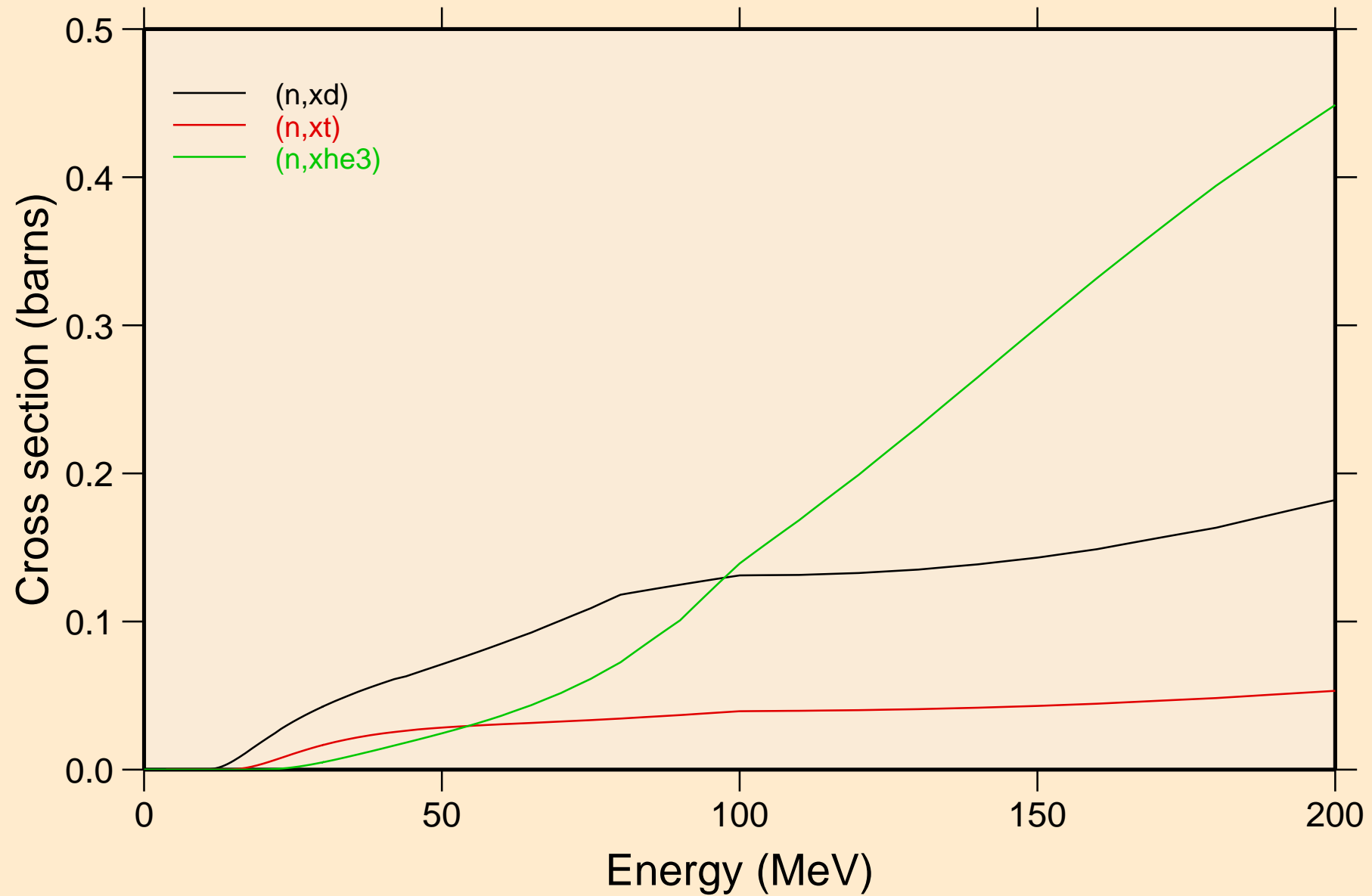

W171 NEUTRON ACER TENDL-2021 LIBRARY; T=293.6K
angular distribution for elastic

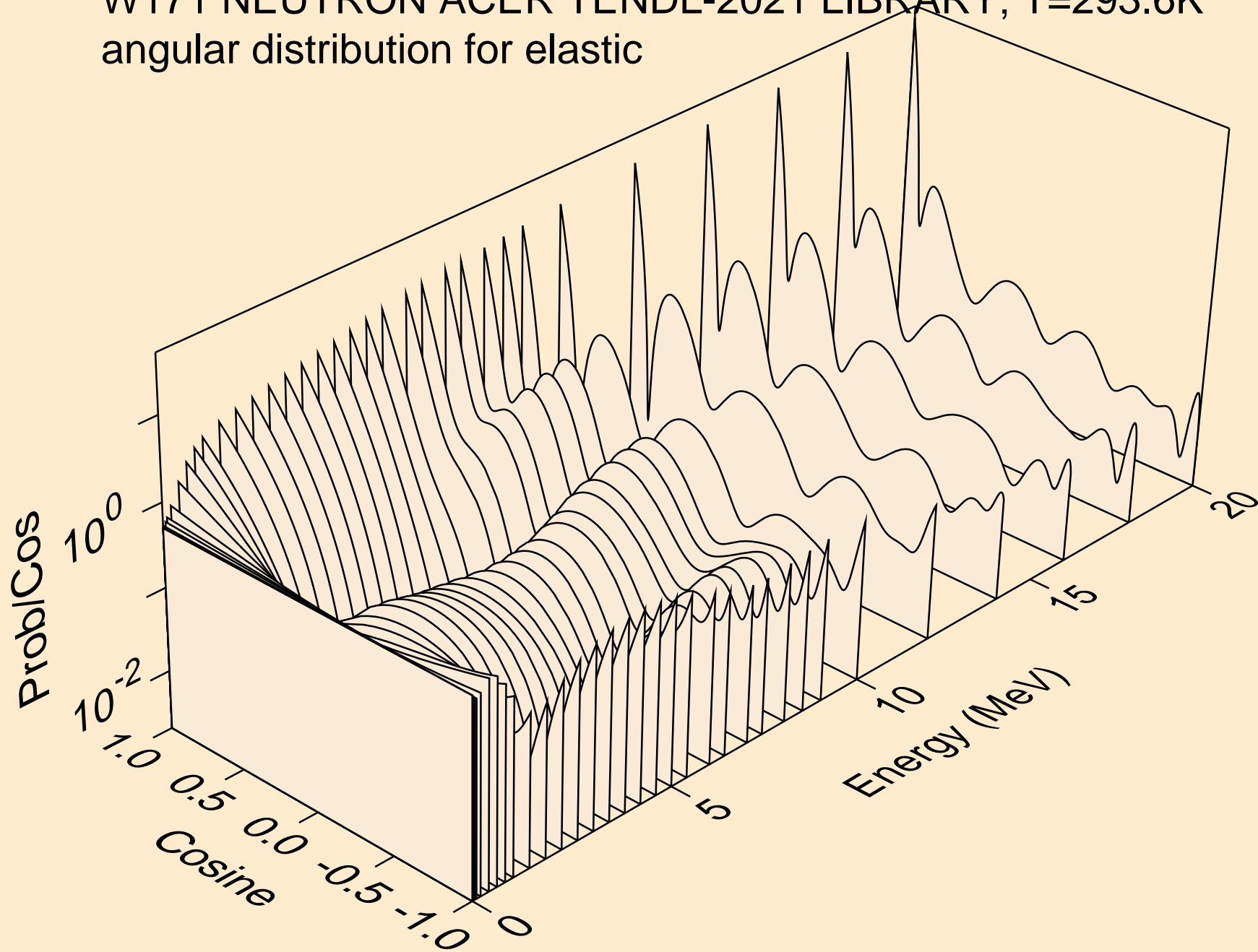

W171 NEUTRON ACER TENDL-2021 LIBRARY; T=293.6K
angular distribution for elastic

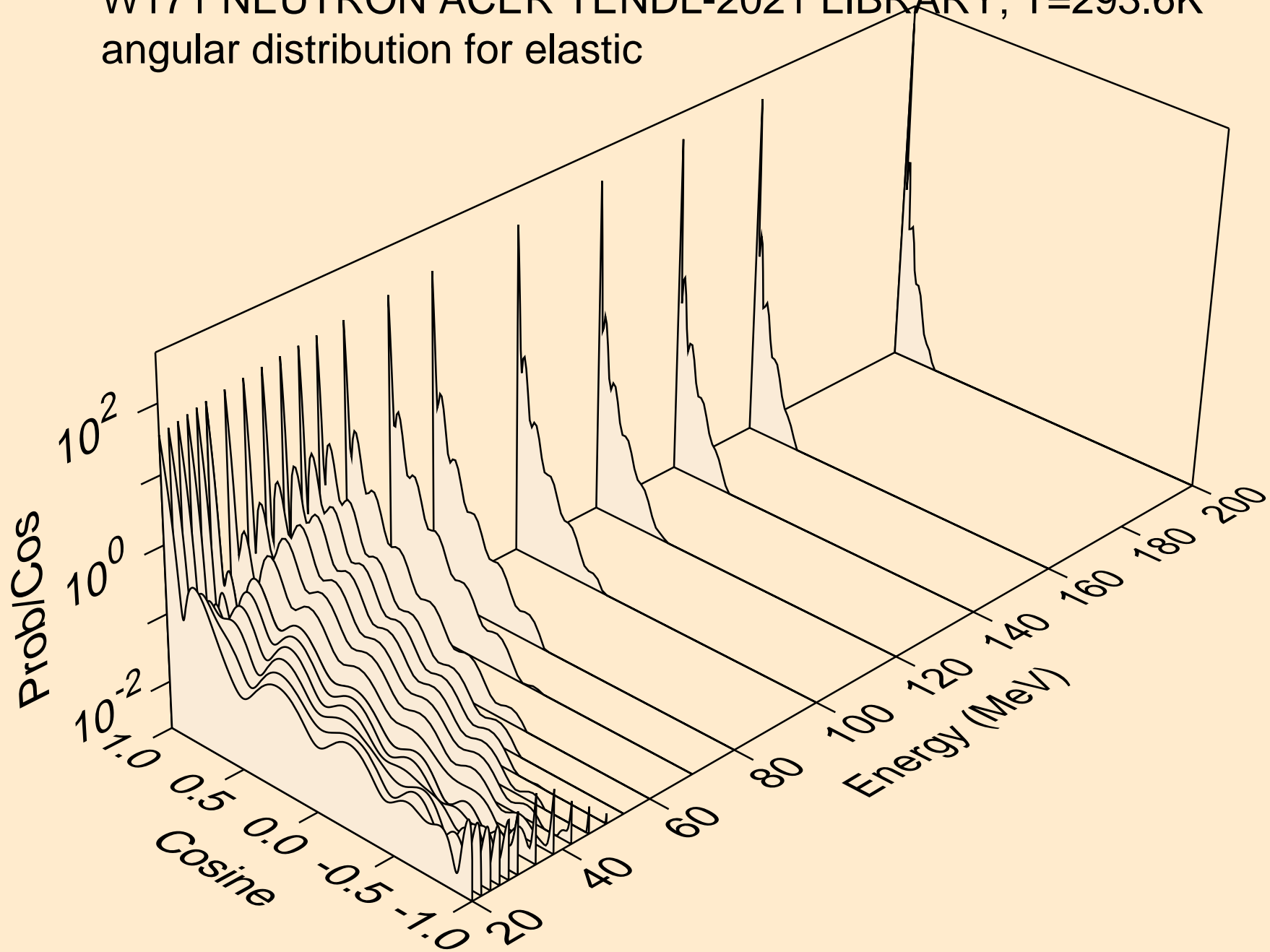

W171 NEUTRON ACER TENDL-2021 LIBRARY; T=293.6K
angular distribution for (n,n*1)

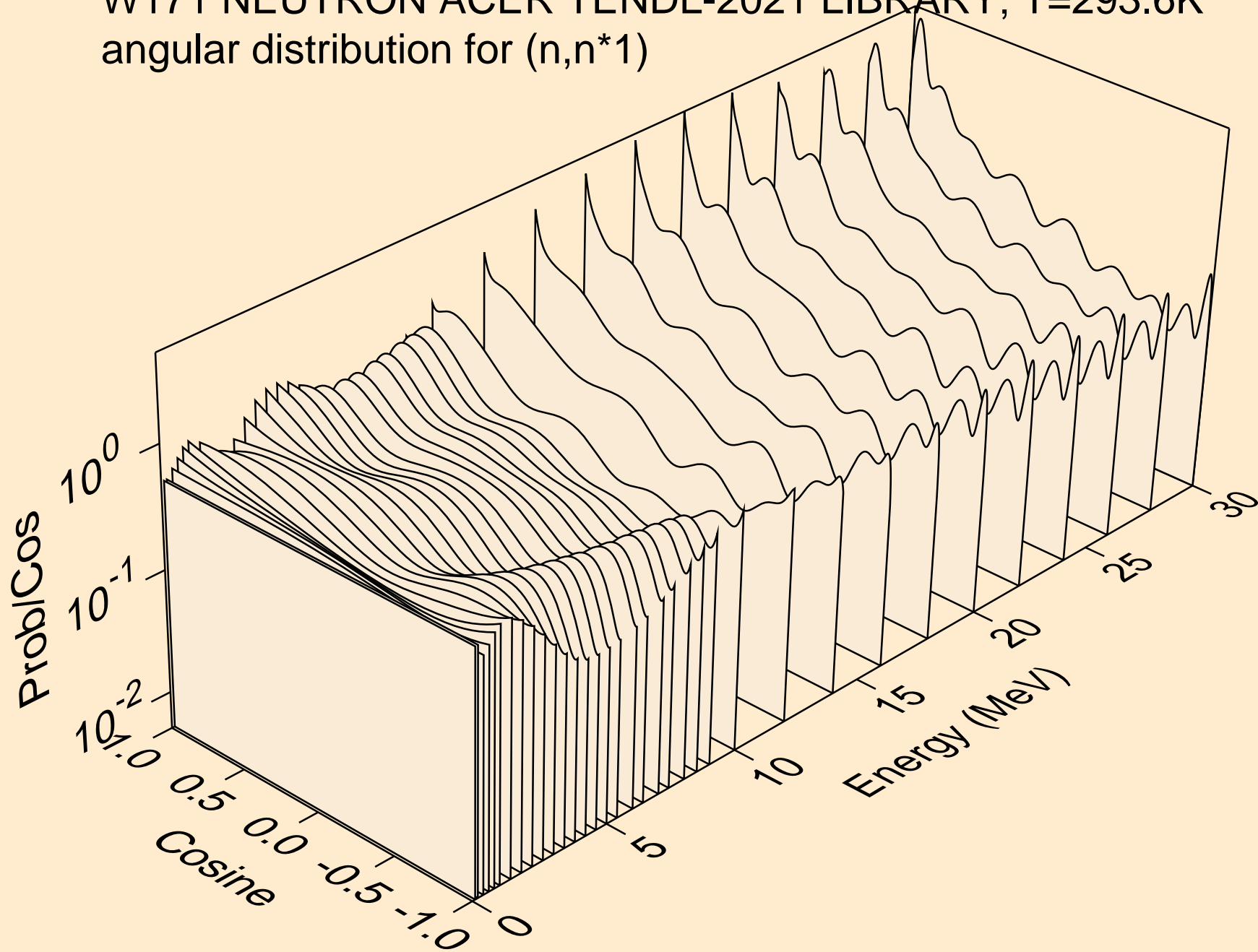

W171 NEUTRON ACER TENDL-2021 LIBRARY; T=293.6K
angular distribution for (n,n*2)

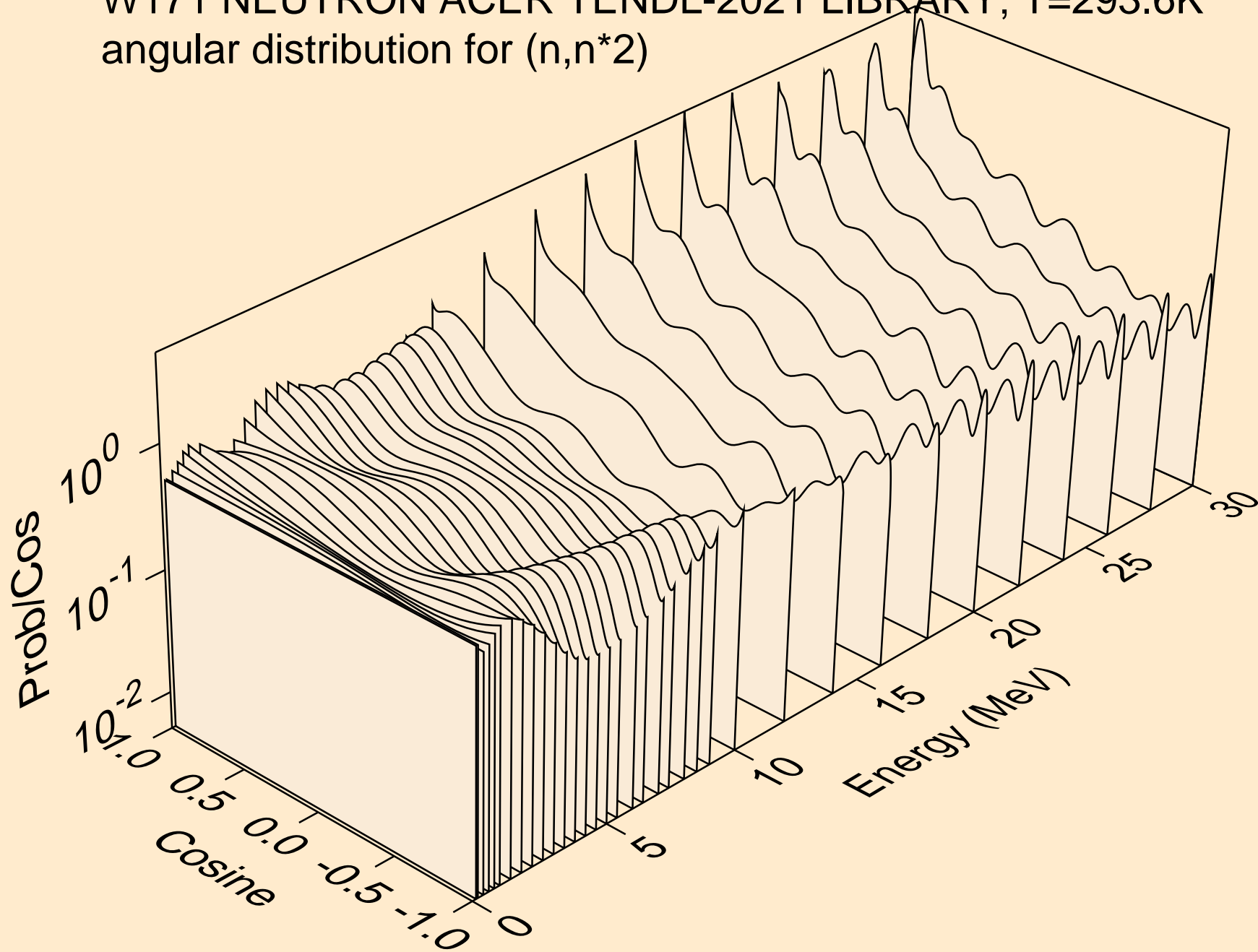

W171 NEUTRON ACER TENDL-2021 LIBRARY; T=293.6K
angular distribution for (n,n*3)

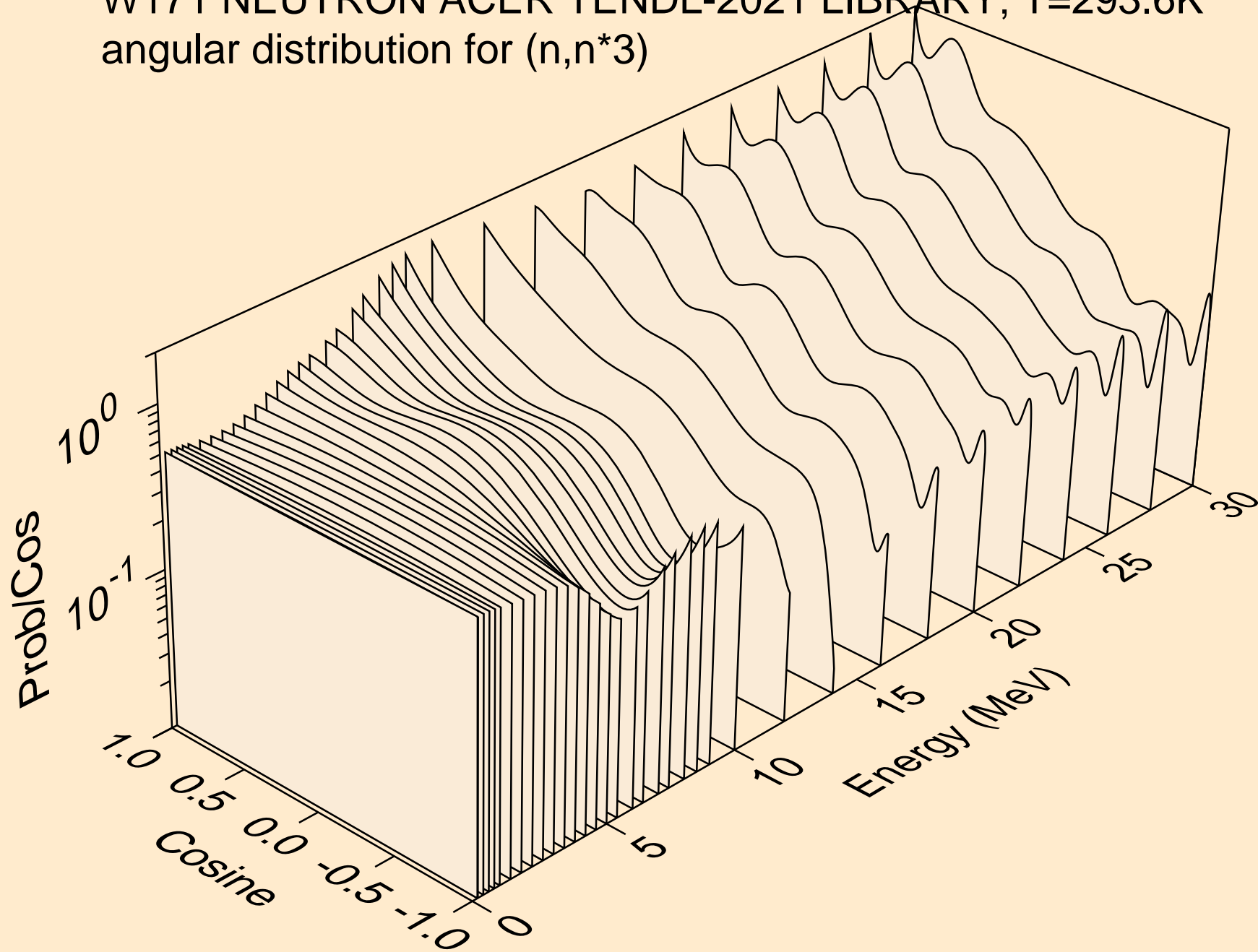

W171 NEUTRON ACER TENDL-2021 LIBRARY; T=293.6K
angular distribution for (n,n*4)

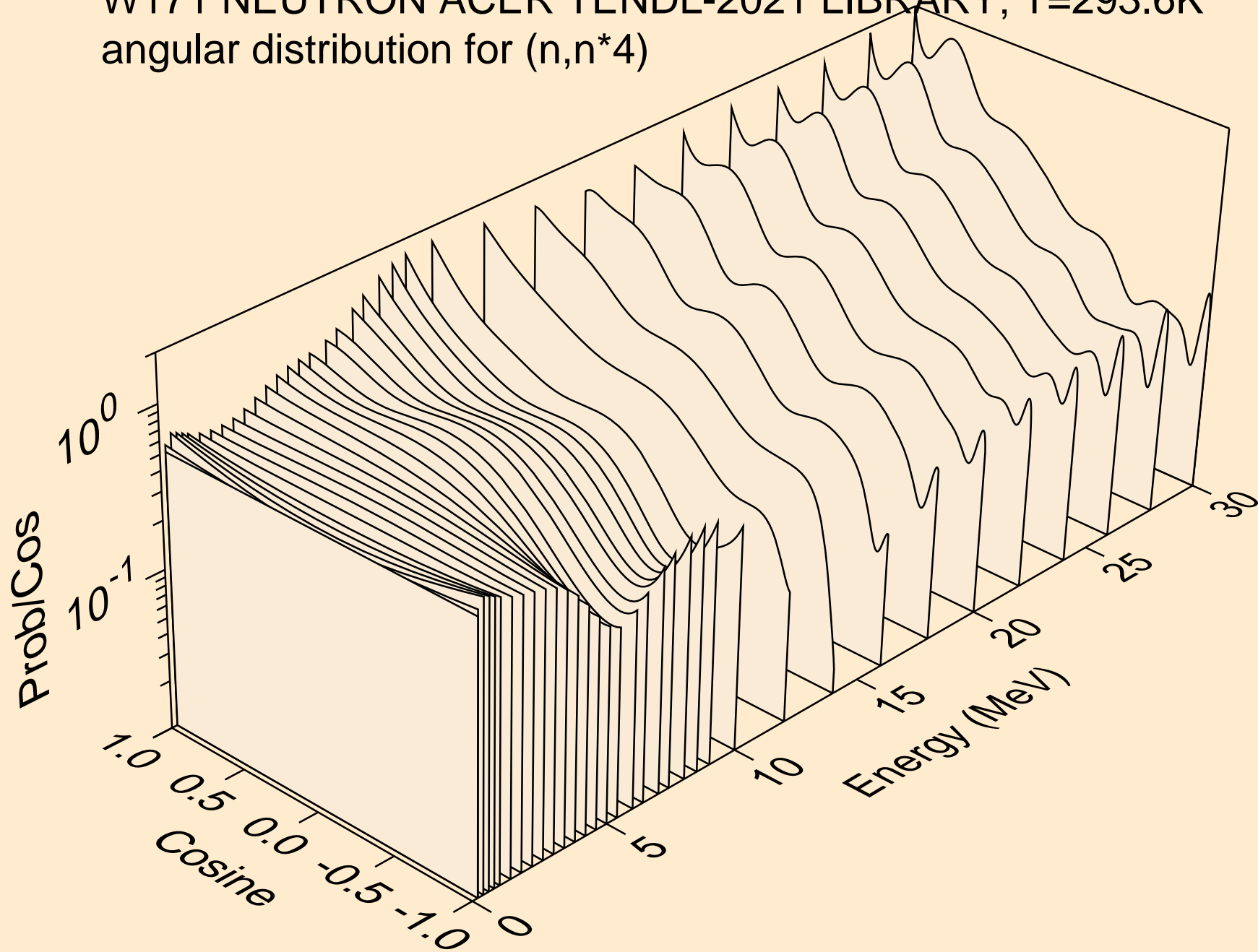

W171 NEUTRON ACER TENDL-2021 LIBRARY; T=293.6K
angular distribution for (n,n*5)

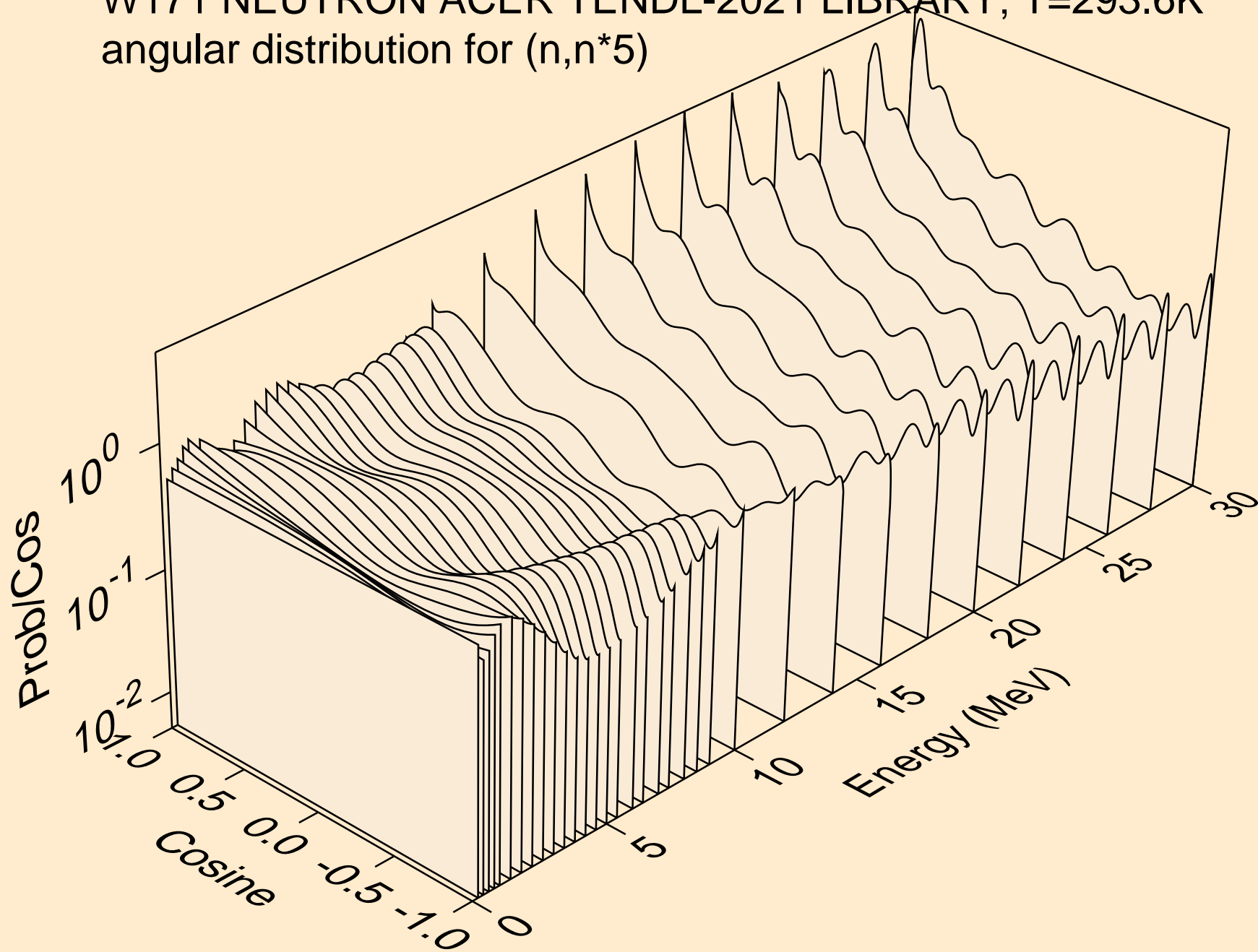

W171 NEUTRON ACER TENDL-2021 LIBRARY; T=293.6K
angular distribution for (n,n*6)

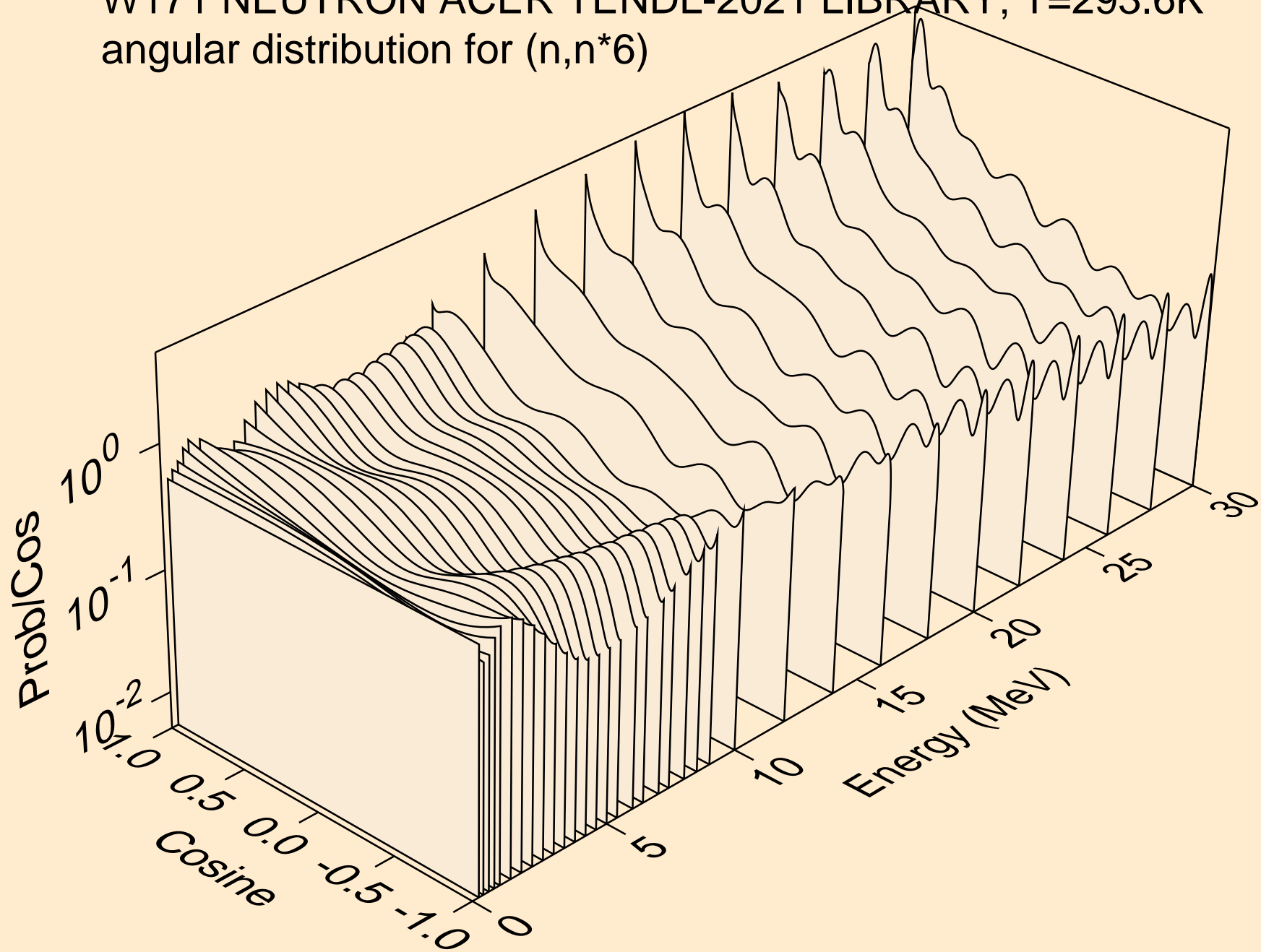

W171 NEUTRON ACER TENDL-2021 LIBRARY; T=293.6K
angular distribution for (n,n*7)

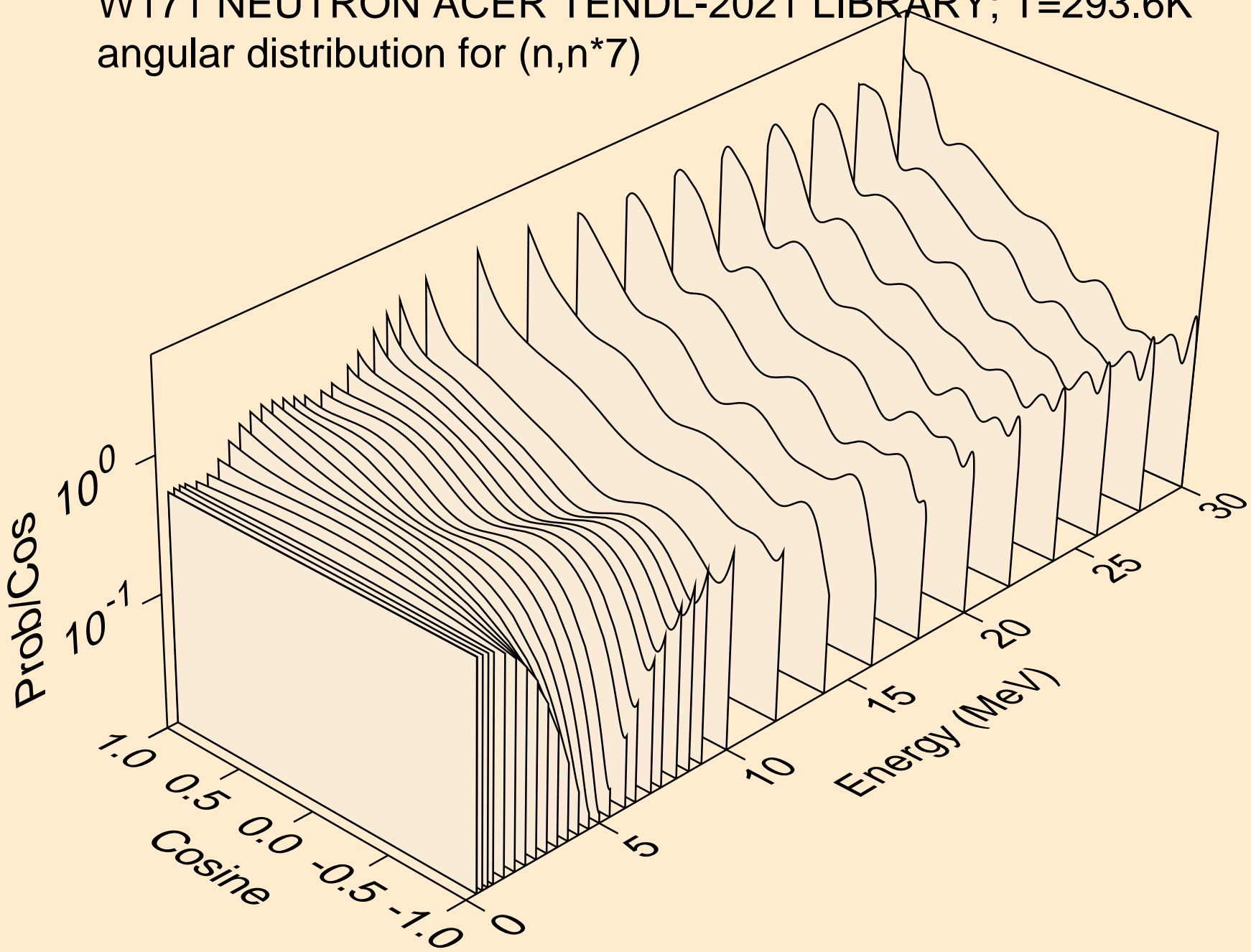

W171 NEUTRON ACER TENDL-2021 LIBRARY; T=293.6K
angular distribution for (n,n*8)

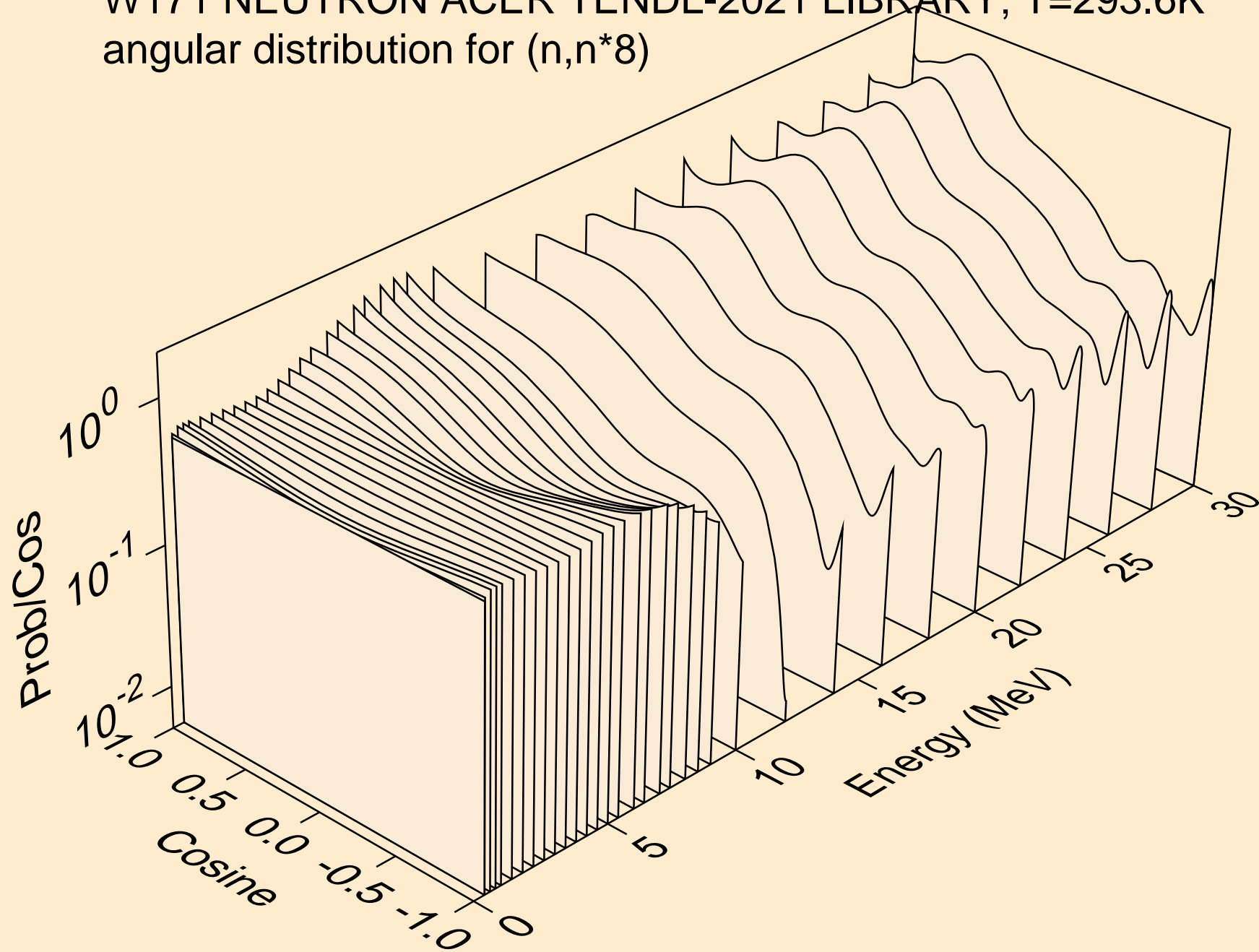

W171 NEUTRON ACER TENDL-2021 LIBRARY; T=293.6K
angular distribution for (n,n*9)

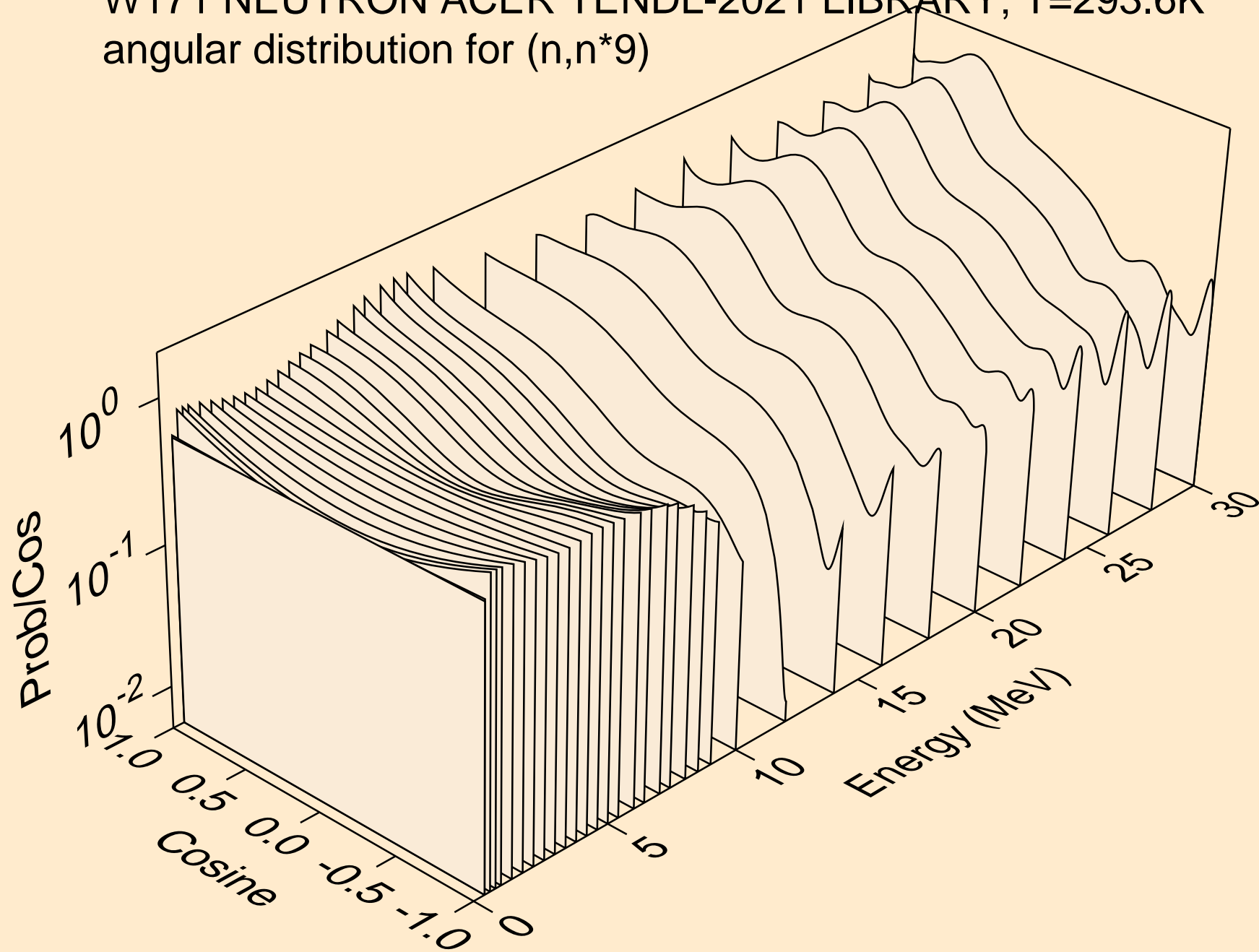

W171 NEUTRON ACER TENDL-2021 LIBRARY; T=293.6K
angular distribution for (n,n*10)

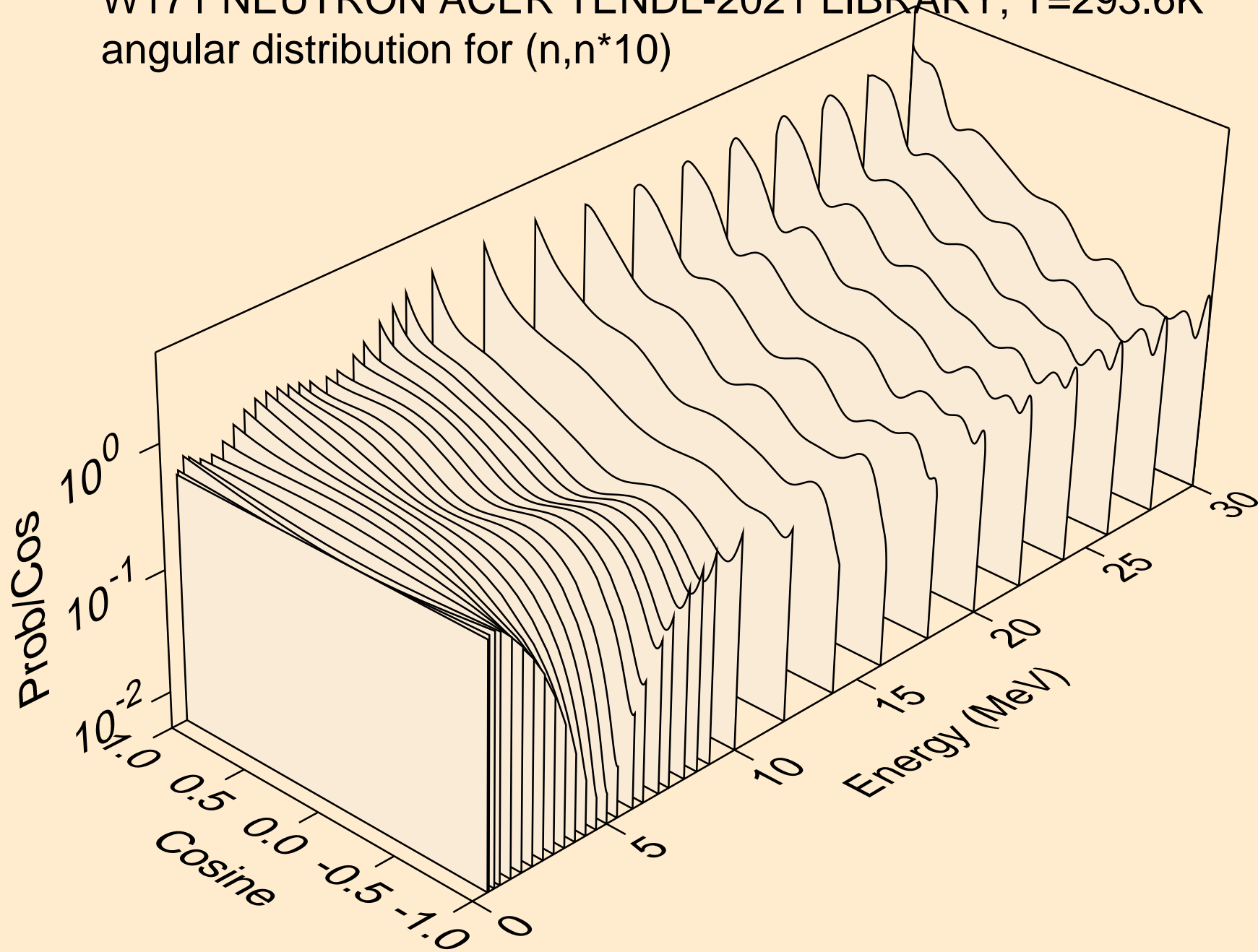

W171 NEUTRON ACER TENDL-2021 LIBRARY; T=293.6K
angular distribution for (n,n*11)

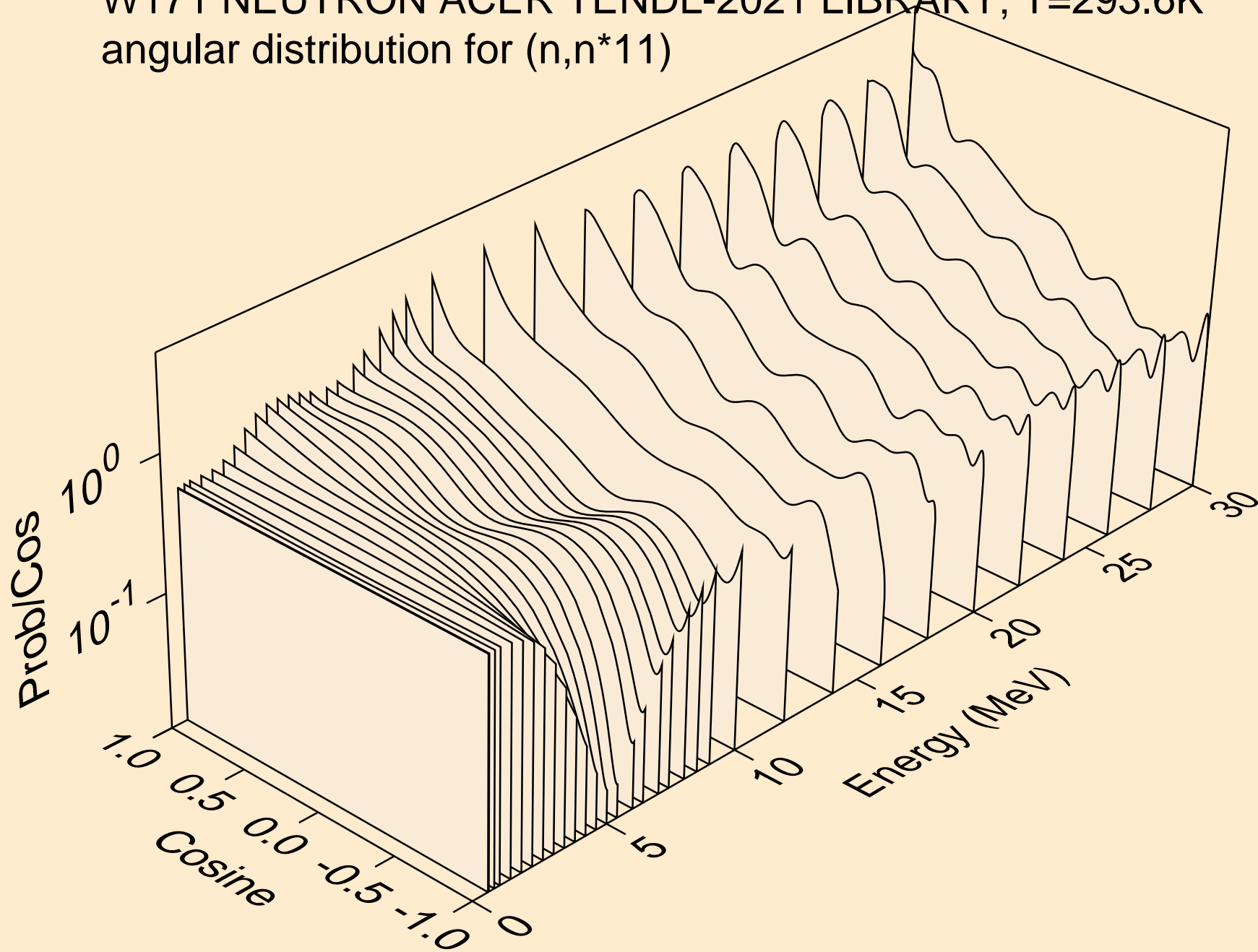

W171 NEUTRON ACER TENDL-2021 LIBRARY; T=293.6K
angular distribution for (n,n*12)

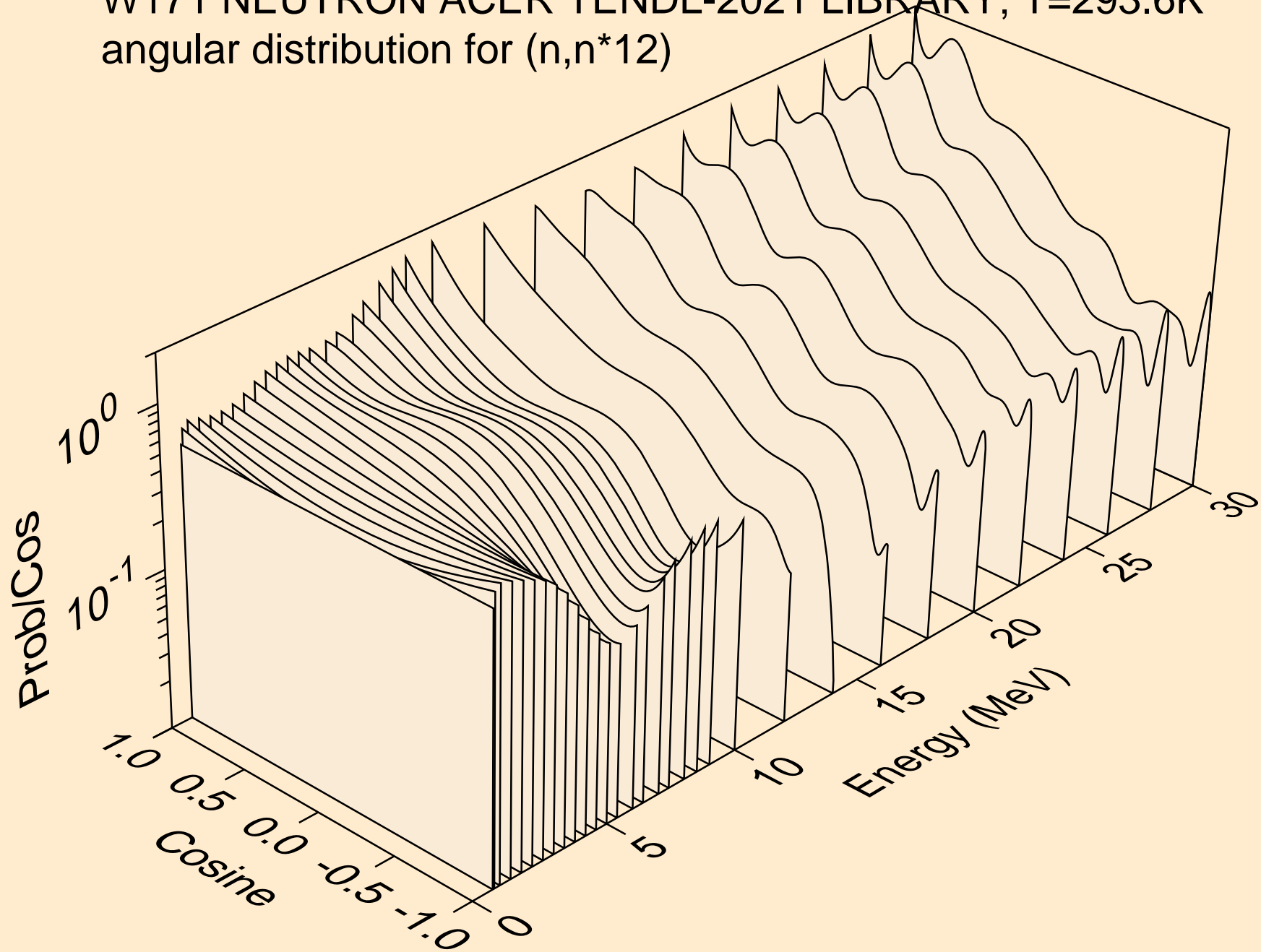

W171 NEUTRON ACER TENDL-2021 LIBRARY; T=293.6K
angular distribution for (n,n*13)

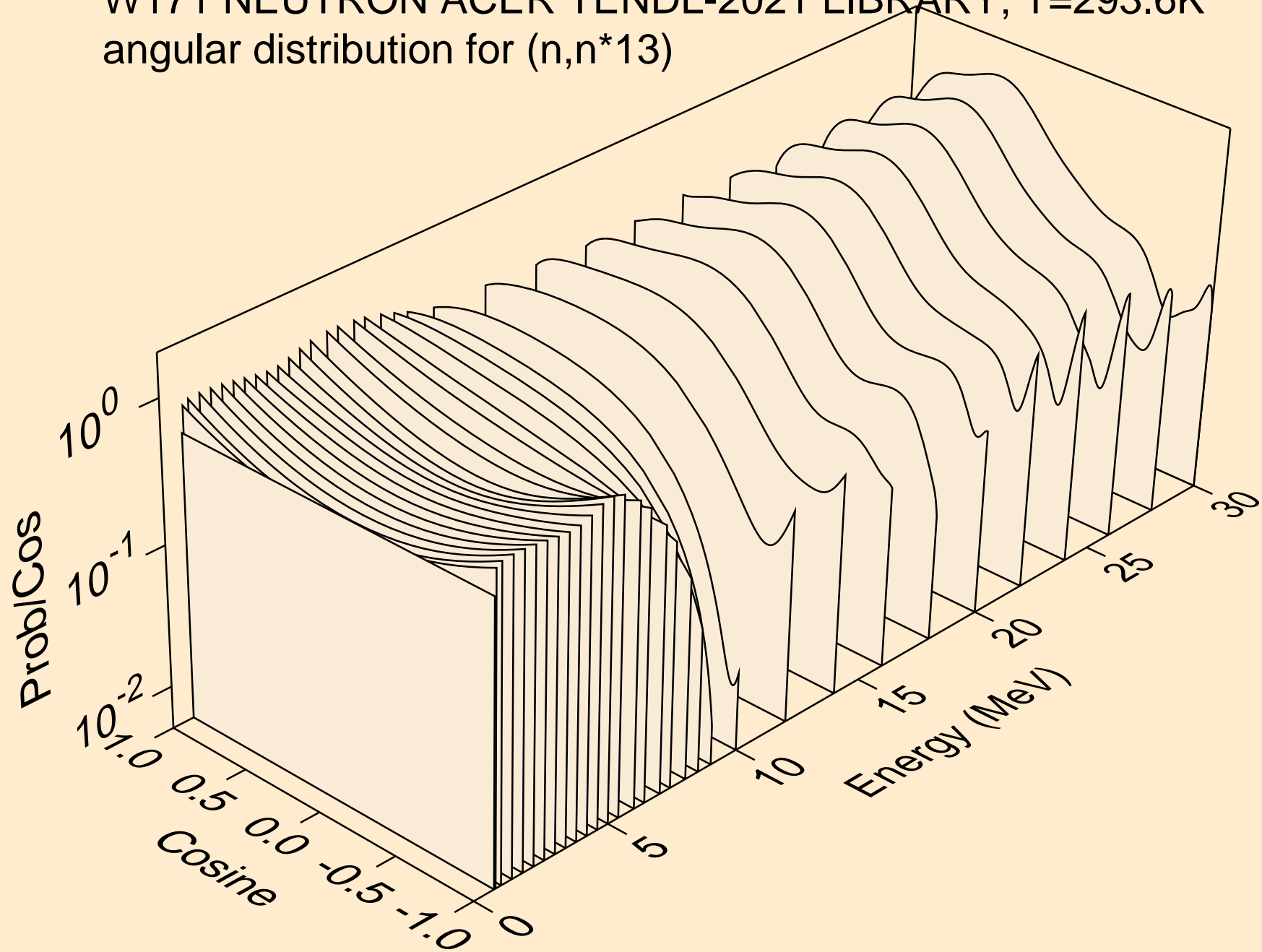

W171 NEUTRON ACER TENDL-2021 LIBRARY; T=293.6K
angular distribution for (n,n*14)

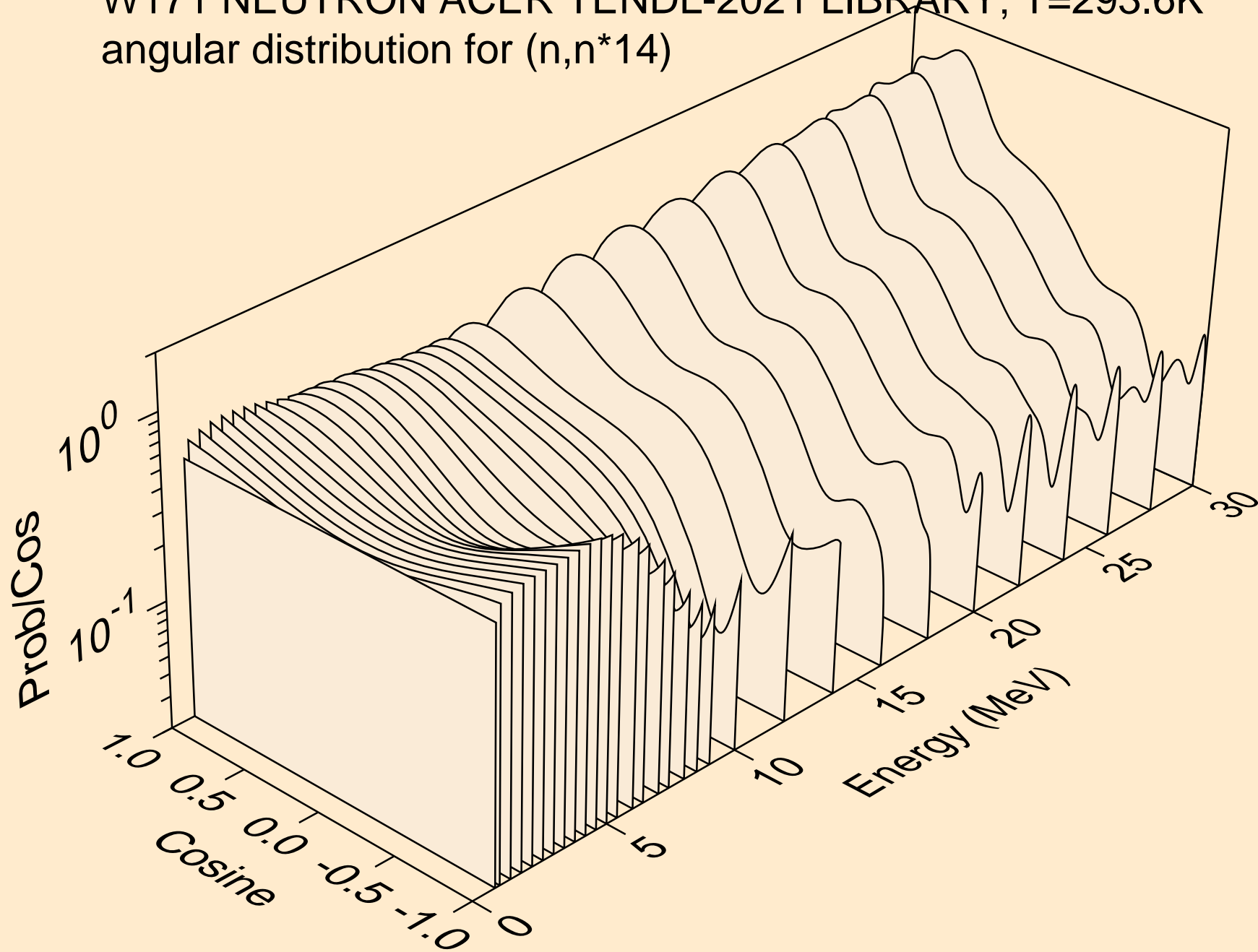

W171 NEUTRON ACER TENDL-2021 LIBRARY; T=293.6K
angular distribution for (n,n*15)

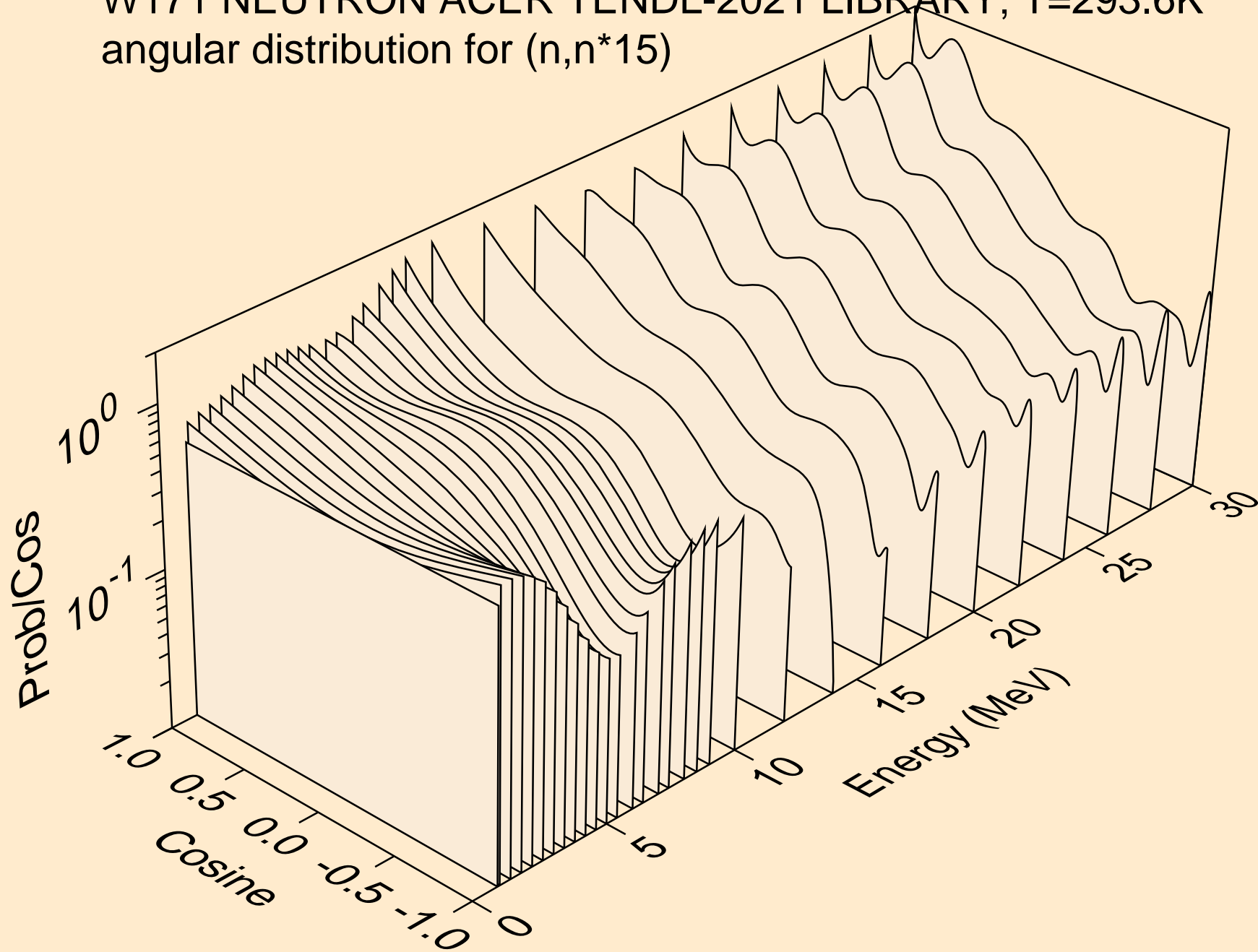

W171 NEUTRON ACER TENDL-2021 LIBRARY; T=293.6K
angular distribution for (n,n*16)

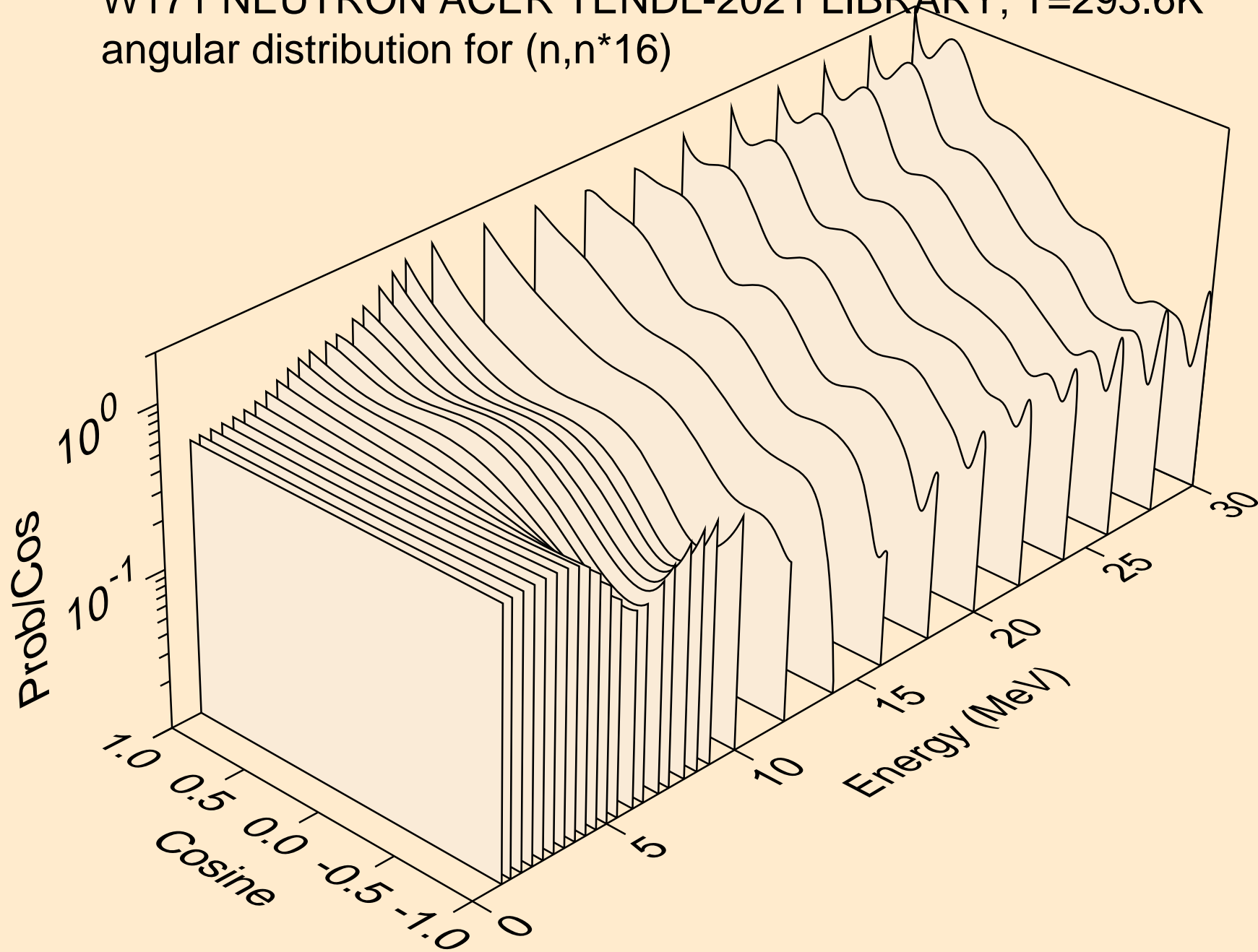

W171 NEUTRON ACER TENDL-2021 LIBRARY; T=293.6K
Neutron emission for (n,x)

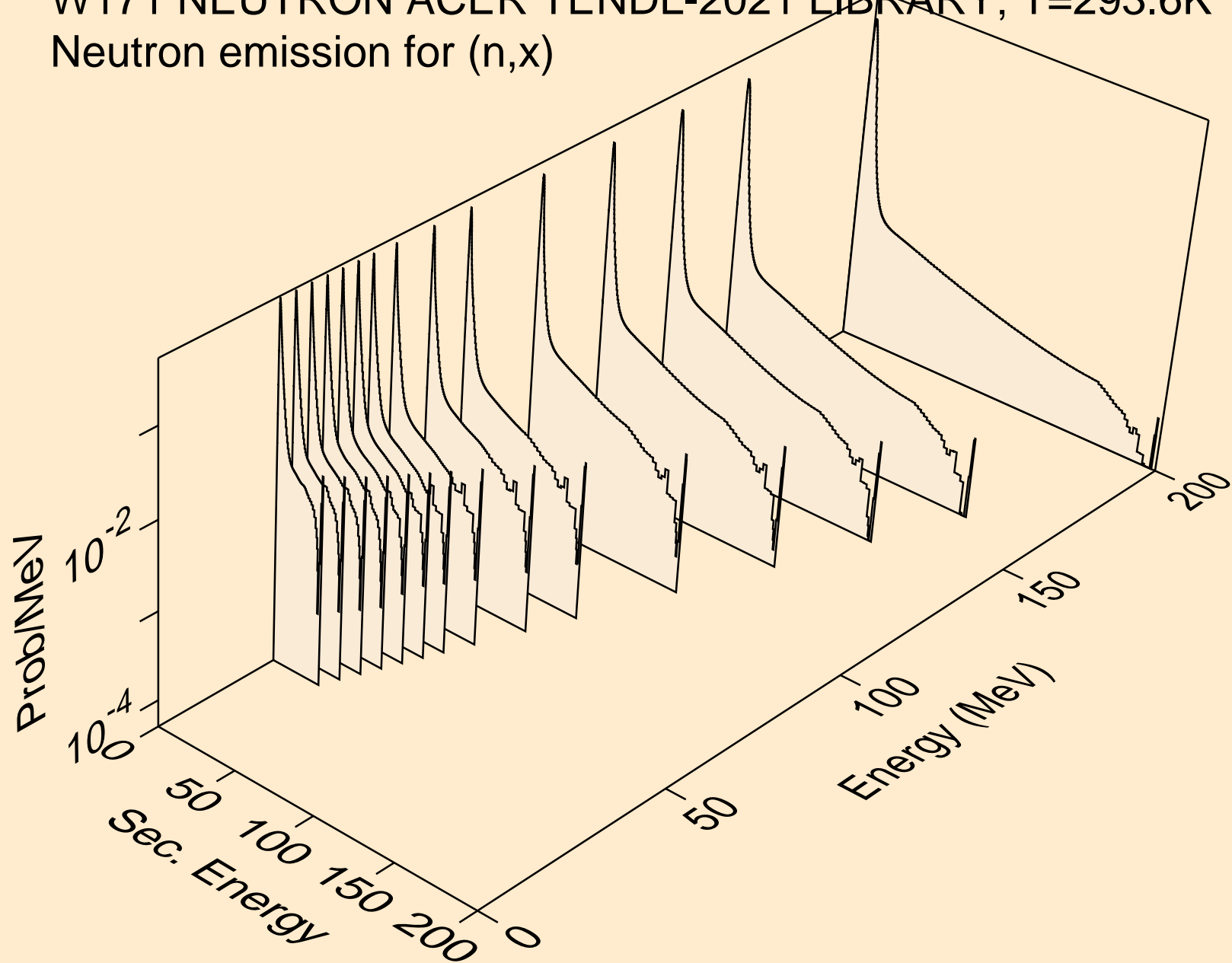

W171 NEUTRON ACER TENDL-2021 LIBRARY; T=293.6K
Neutron emission for (n,2nd)

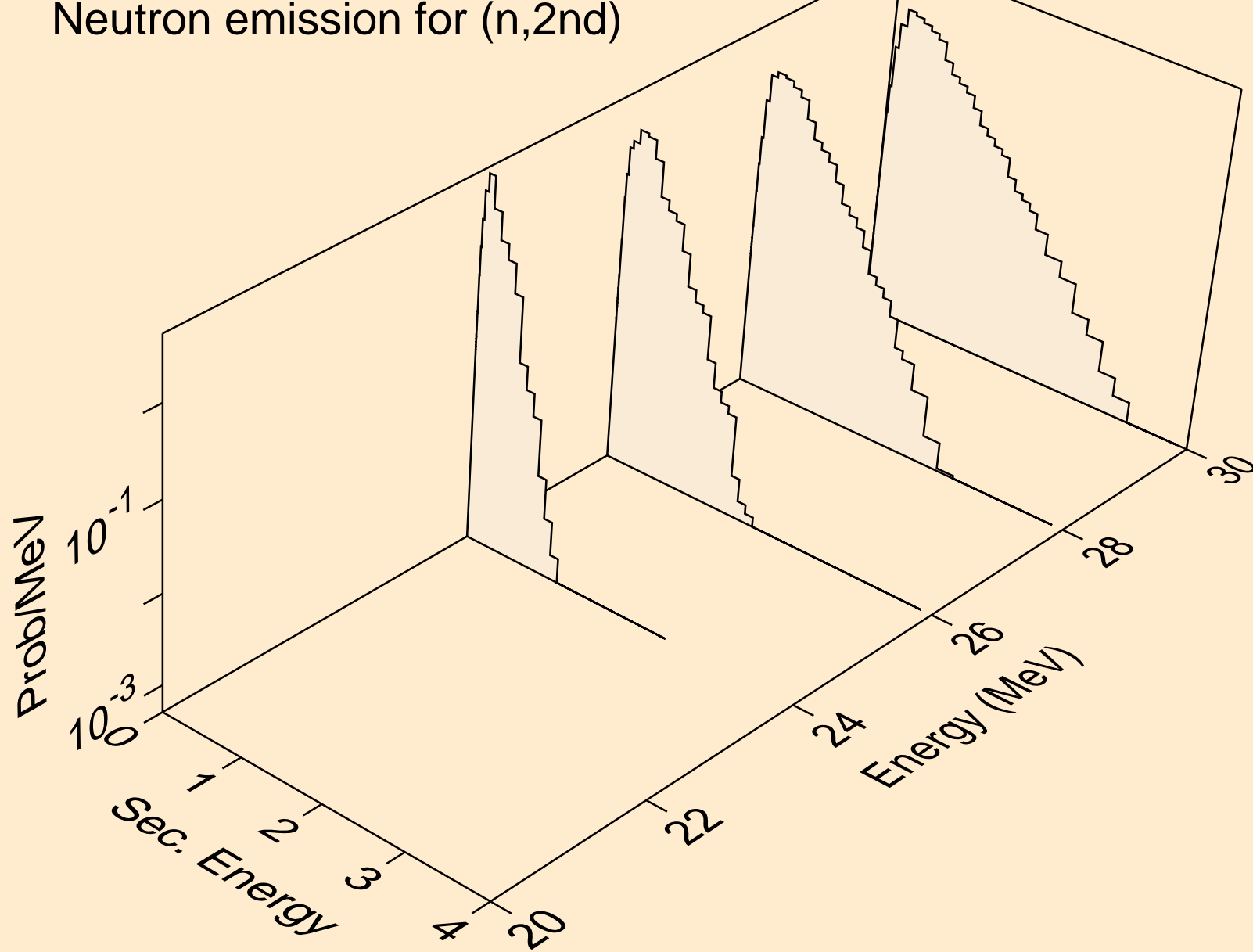

W171 NEUTRON ACER TENDL-2021 LIBRARY; T=293.6K
Neutron emission for (n,2n)

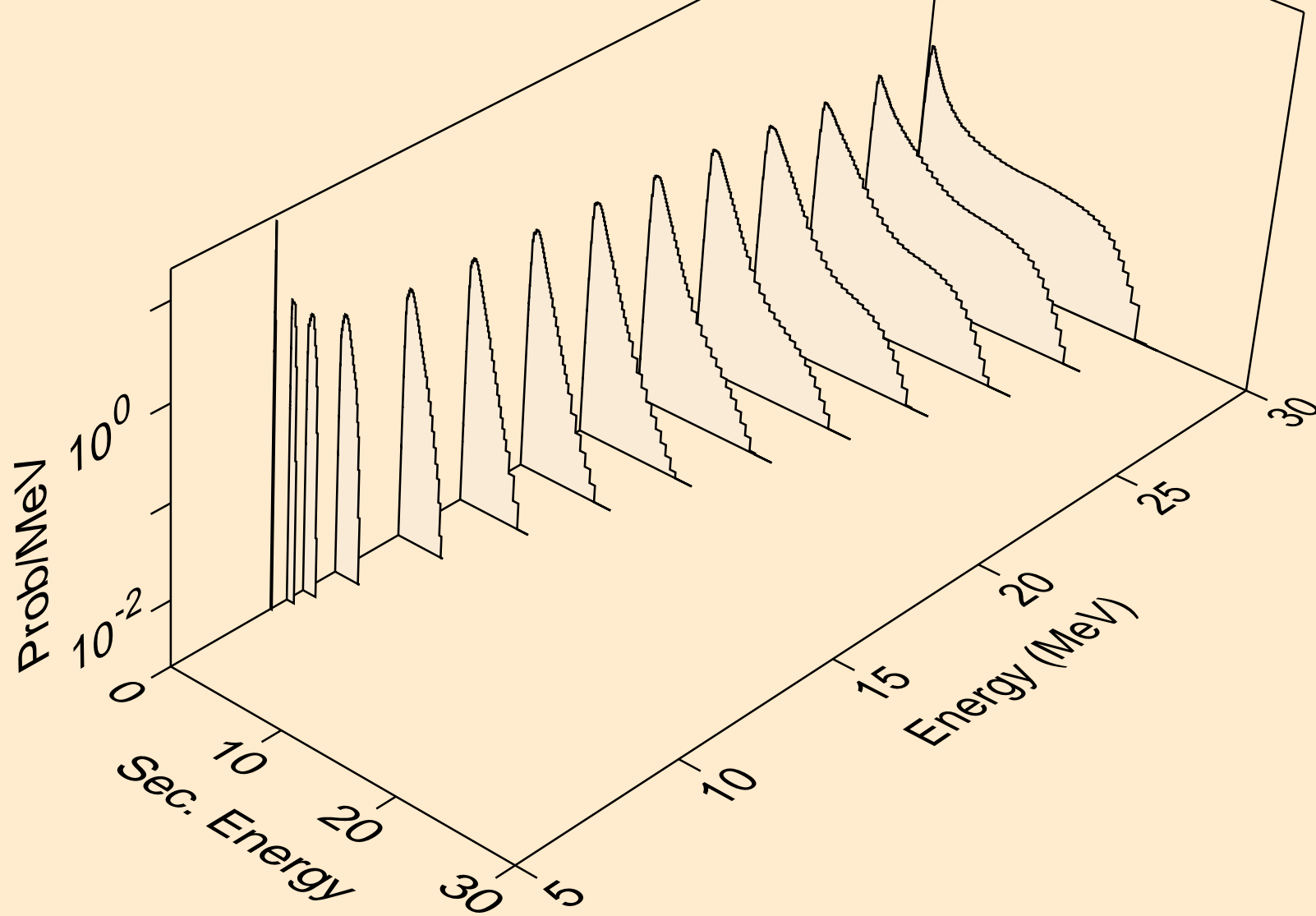

W171 NEUTRON ACER TENDL-2021 LIBRARY; T=293.6K
Neutron emission for (n,3n)

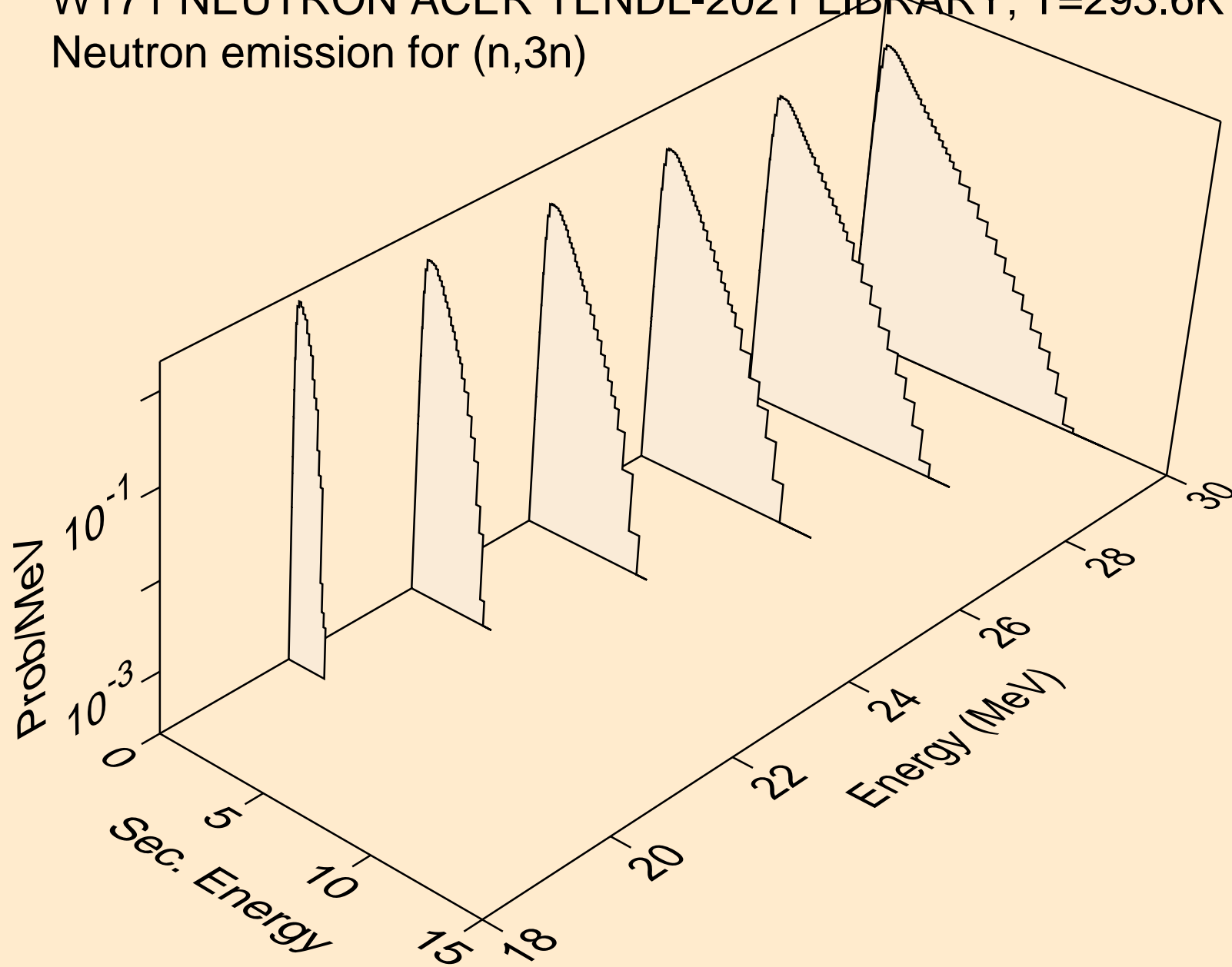

W171 NEUTRON ACER TENDL-2021 LIBRARY; T=293.6K
Neutron emission for (n,n*)a

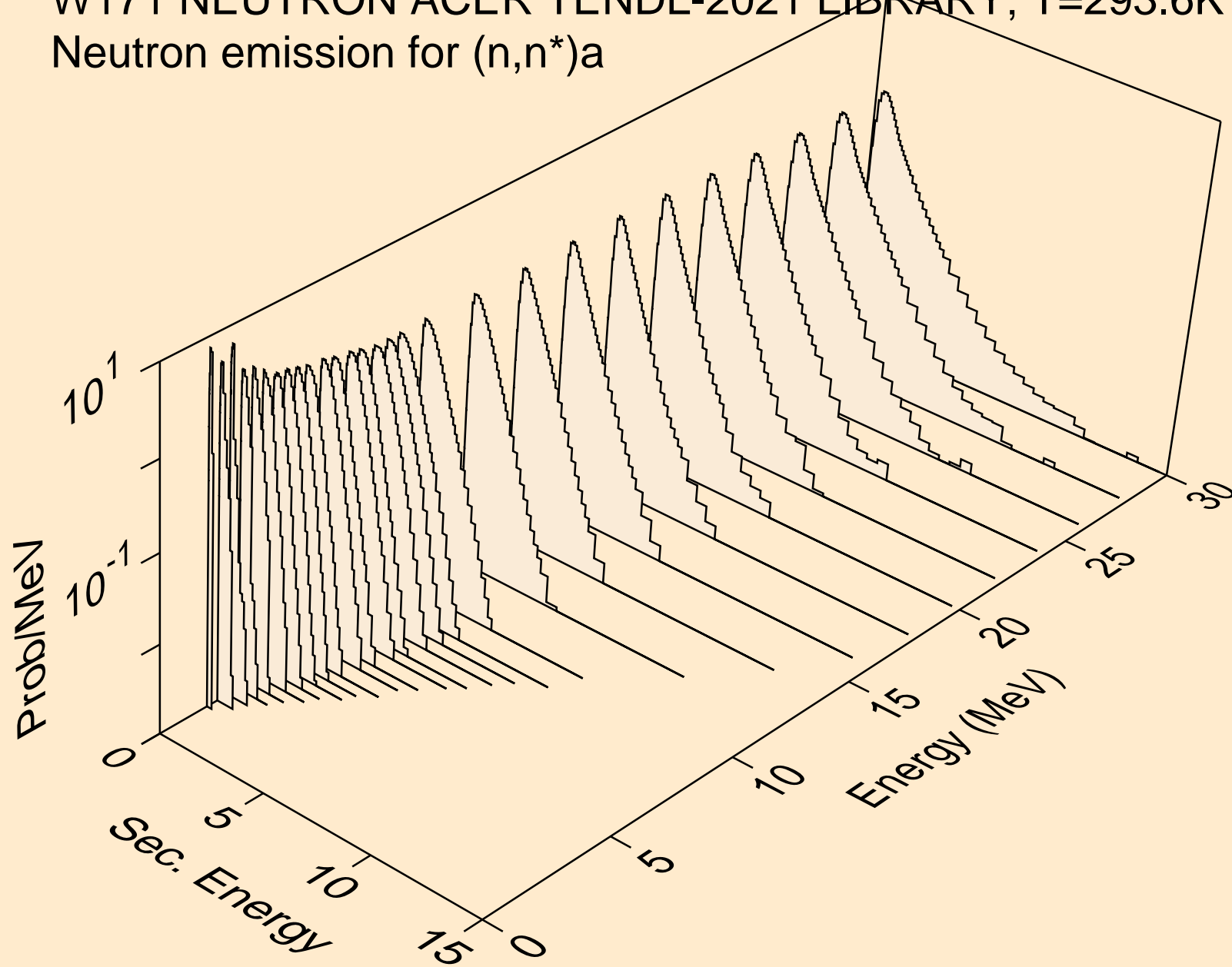

W171 NEUTRON ACER TENDL-2021 LIBRARY; T=293.6K
Neutron emission for (n,2n)a

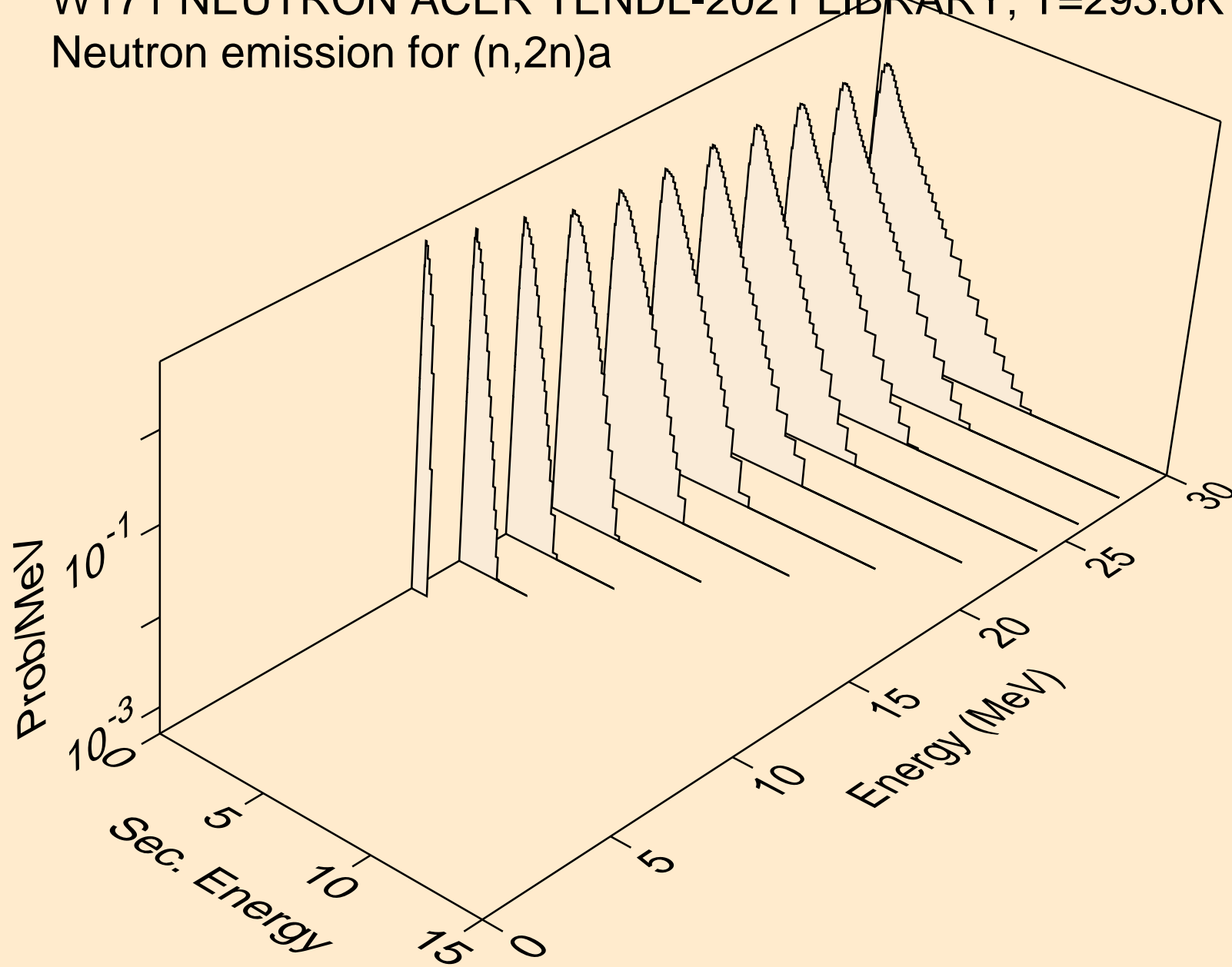

W171 NEUTRON ACER TENDL-2021 LIBRARY; T=293.6K
Neutron emission for (n,3n)a

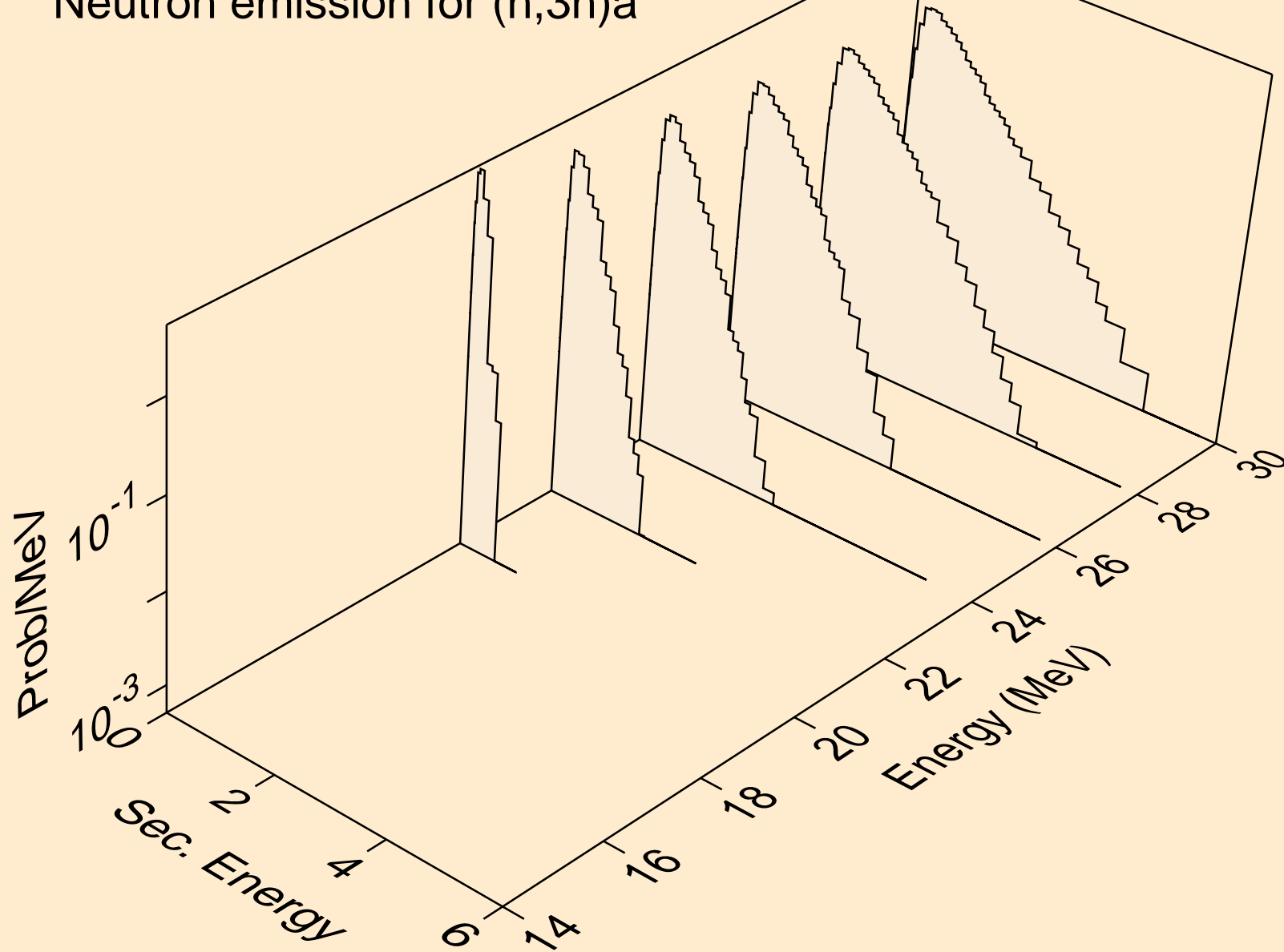

W171 NEUTRON ACER TENDL-2021 LIBRARY; T=293.6K
Neutron emission for (n,n*)p

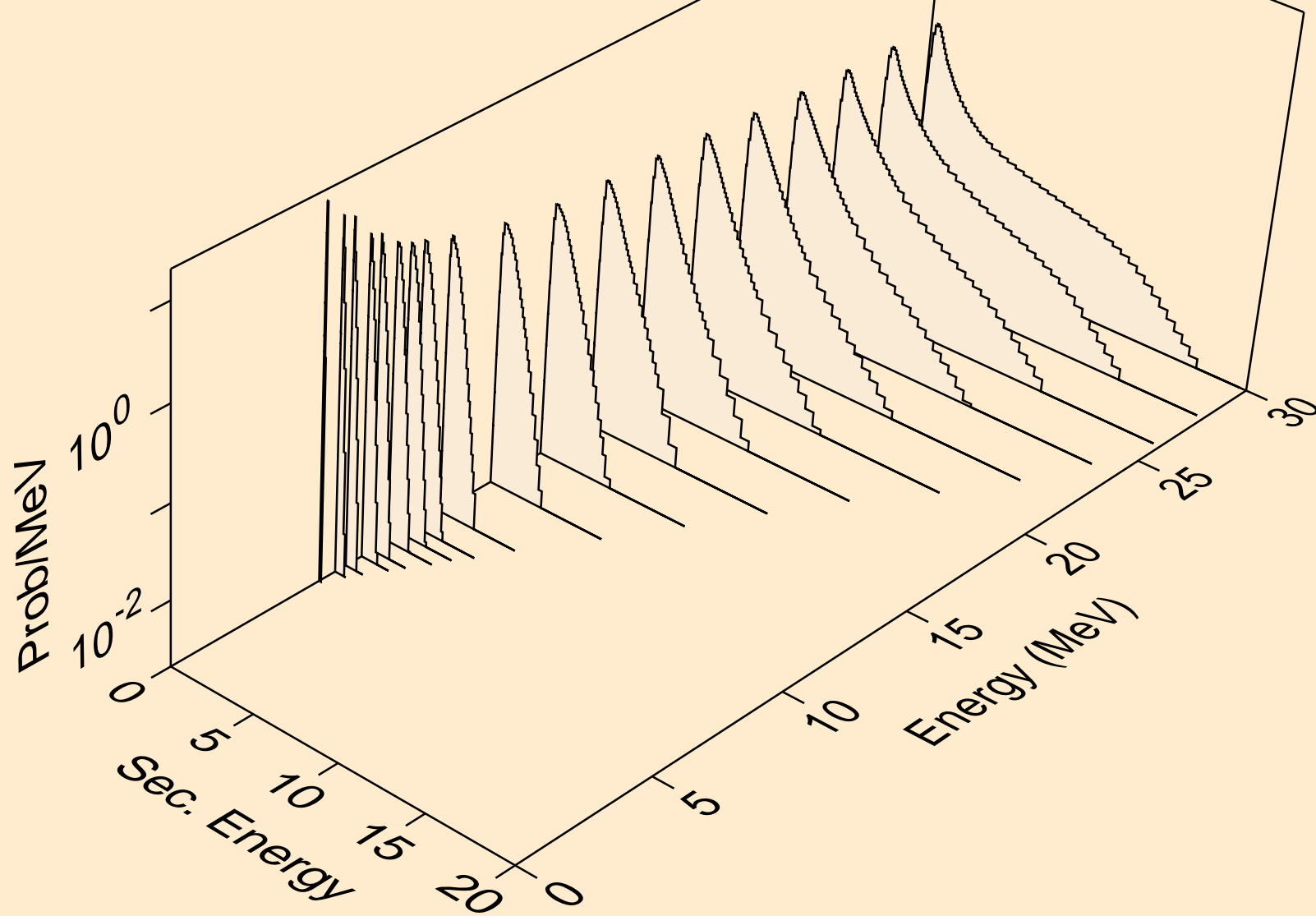

W171 NEUTRON ACER TENDL-2021 LIBRARY; T=293.6K
Neutron emission for (n,n*)2a

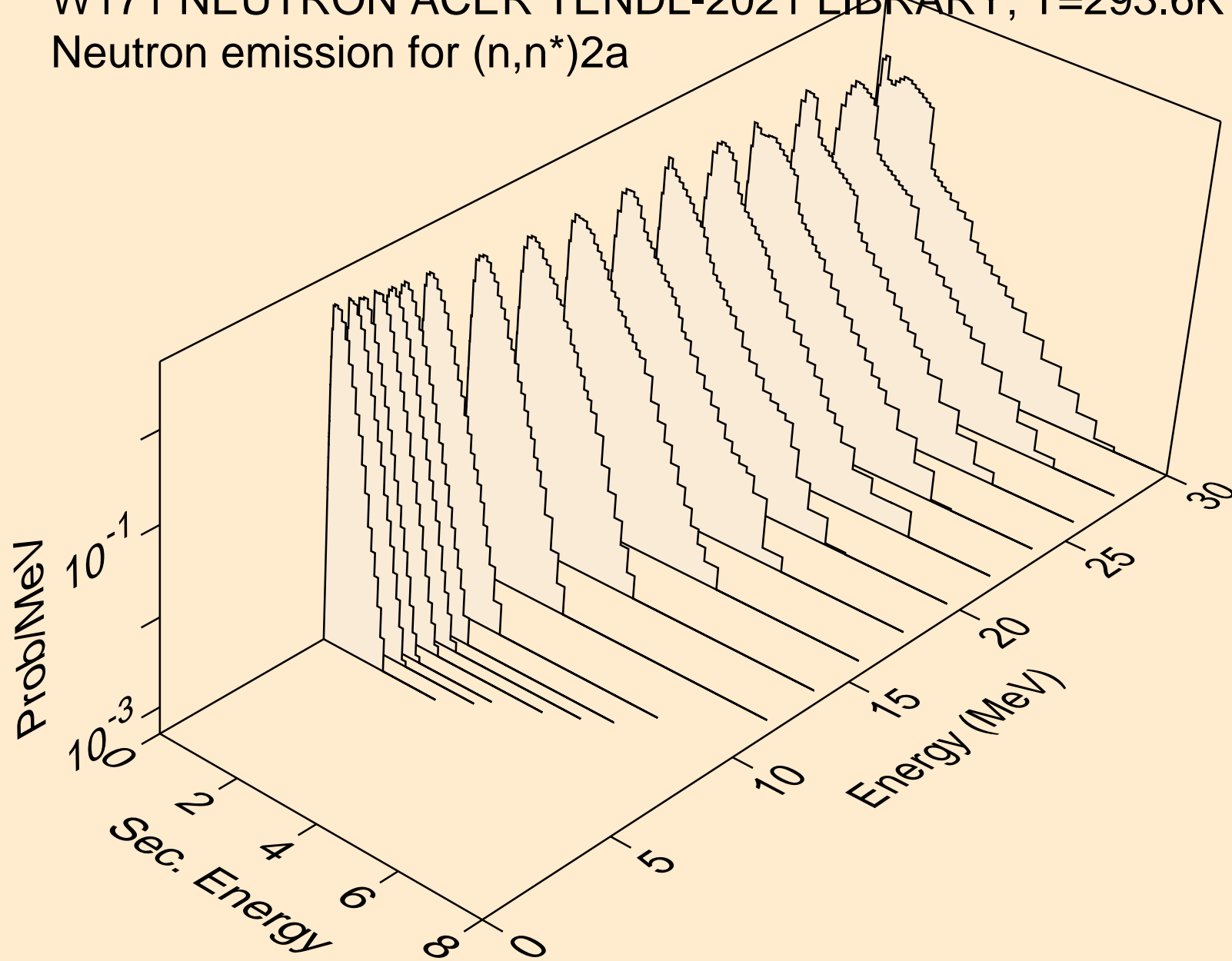

W171 NEUTRON ACER TENDL-2021 LIBRARY; T=293.6K
Neutron emission for (n,2n)2a

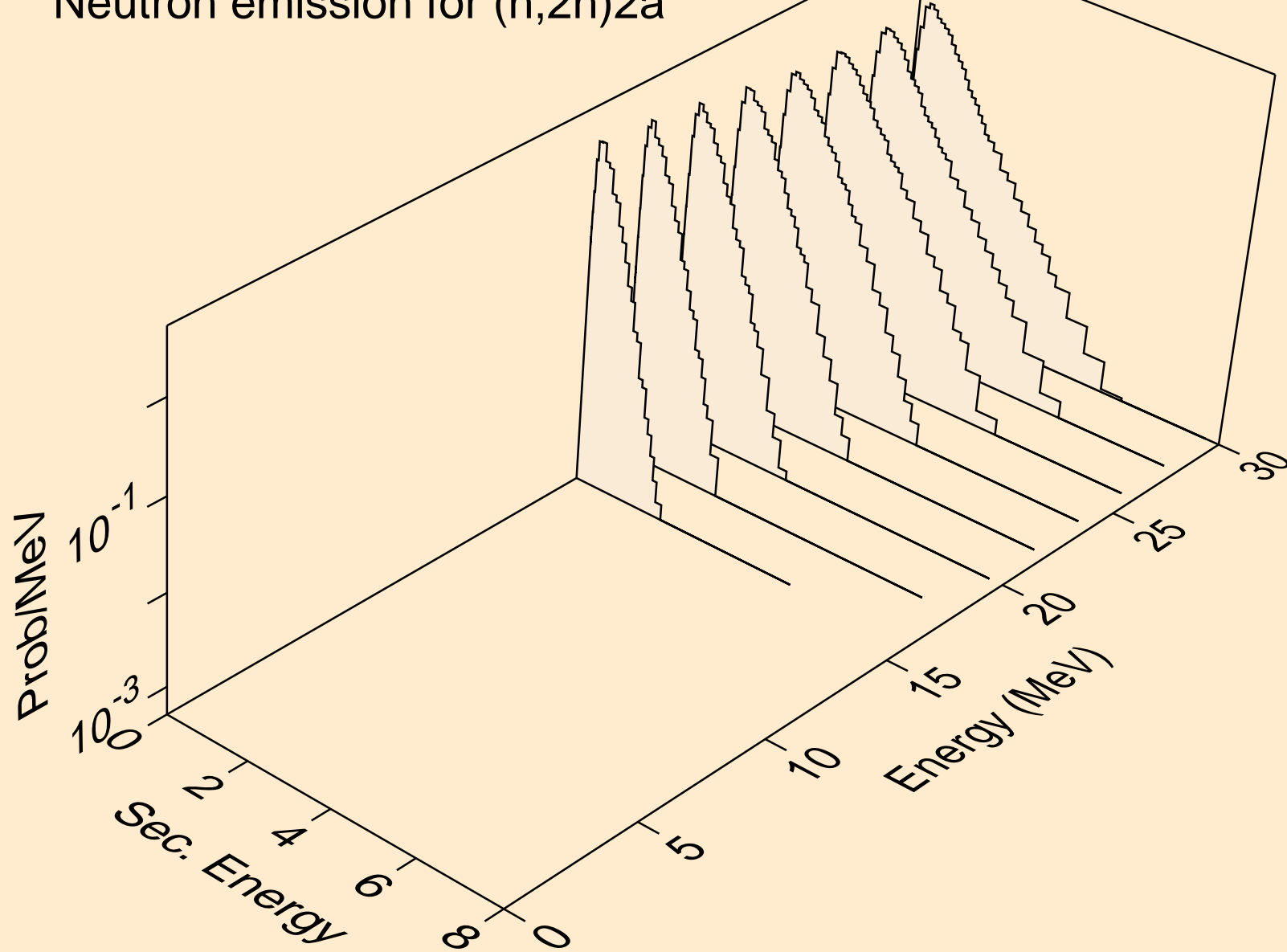

W171 NEUTRON ACER TENDL-2021 LIBRARY; T=293.6K
Neutron emission for (n,n*)d

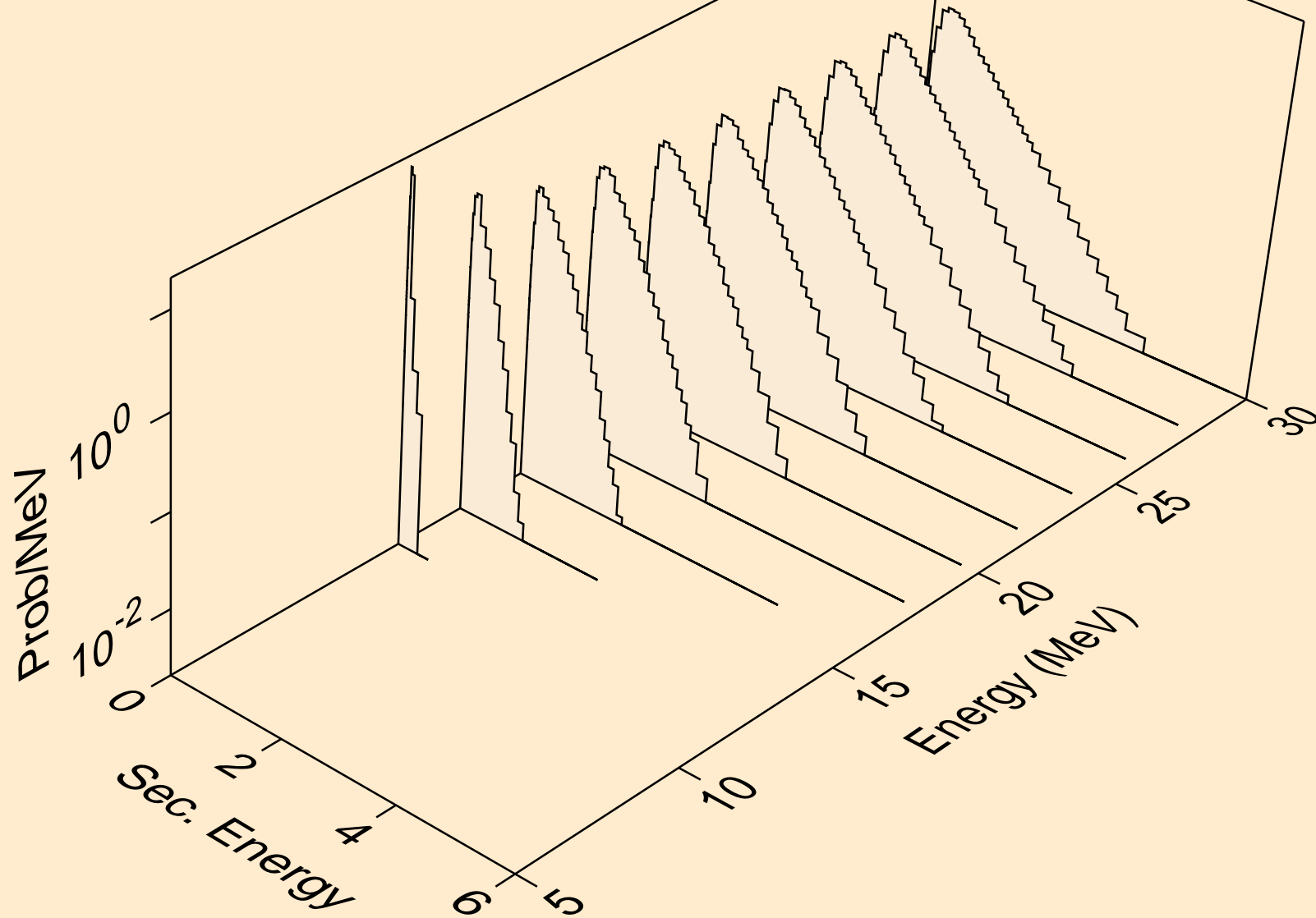

W171 NEUTRON ACER TENDL-2021 LIBRARY; T=293.6K
Neutron emission for (n,n*)t

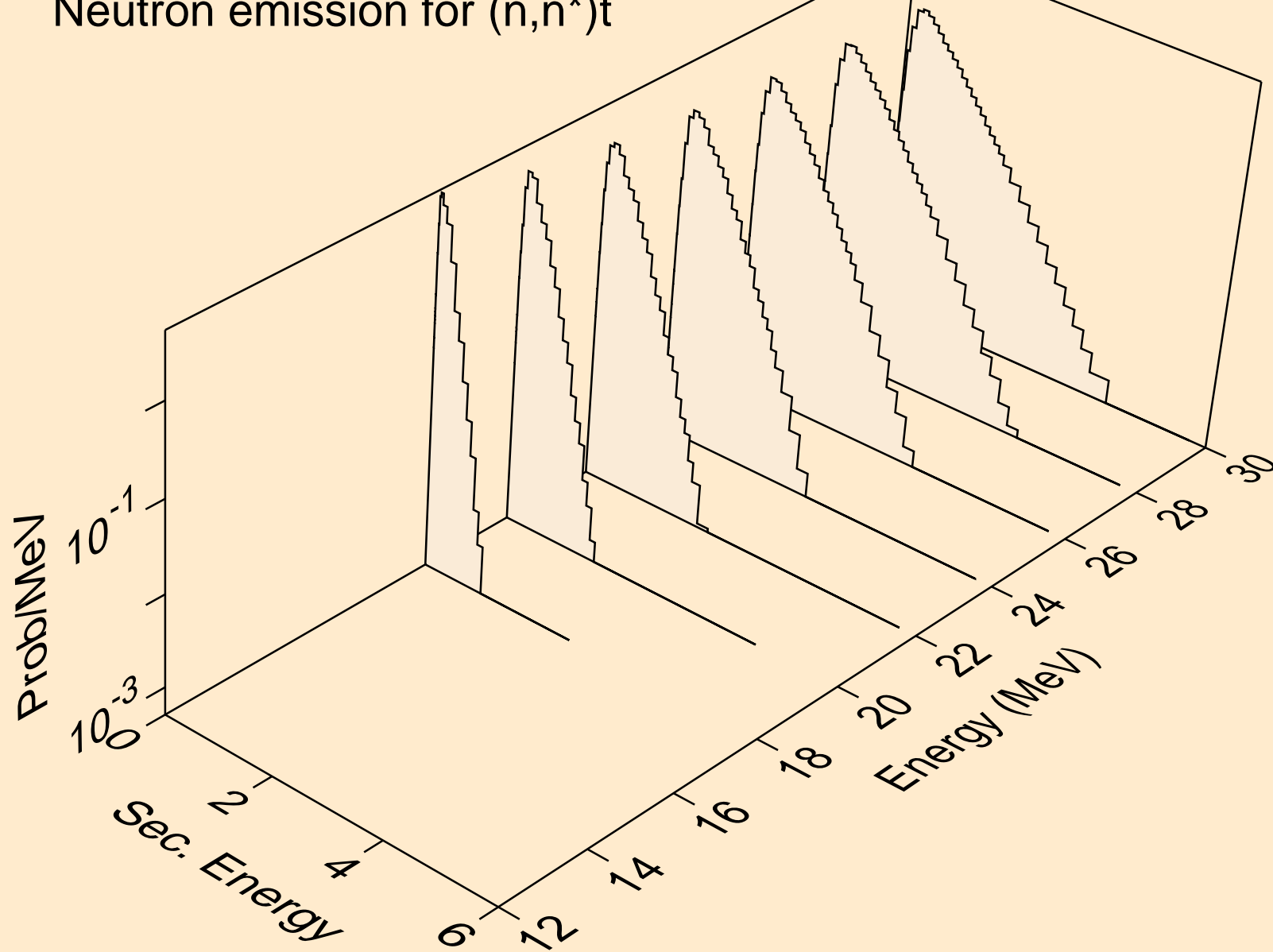

W171 NEUTRON ACER TENDL-2021 LIBRARY; T=293.6K
Neutron emission for (n,n*)he3

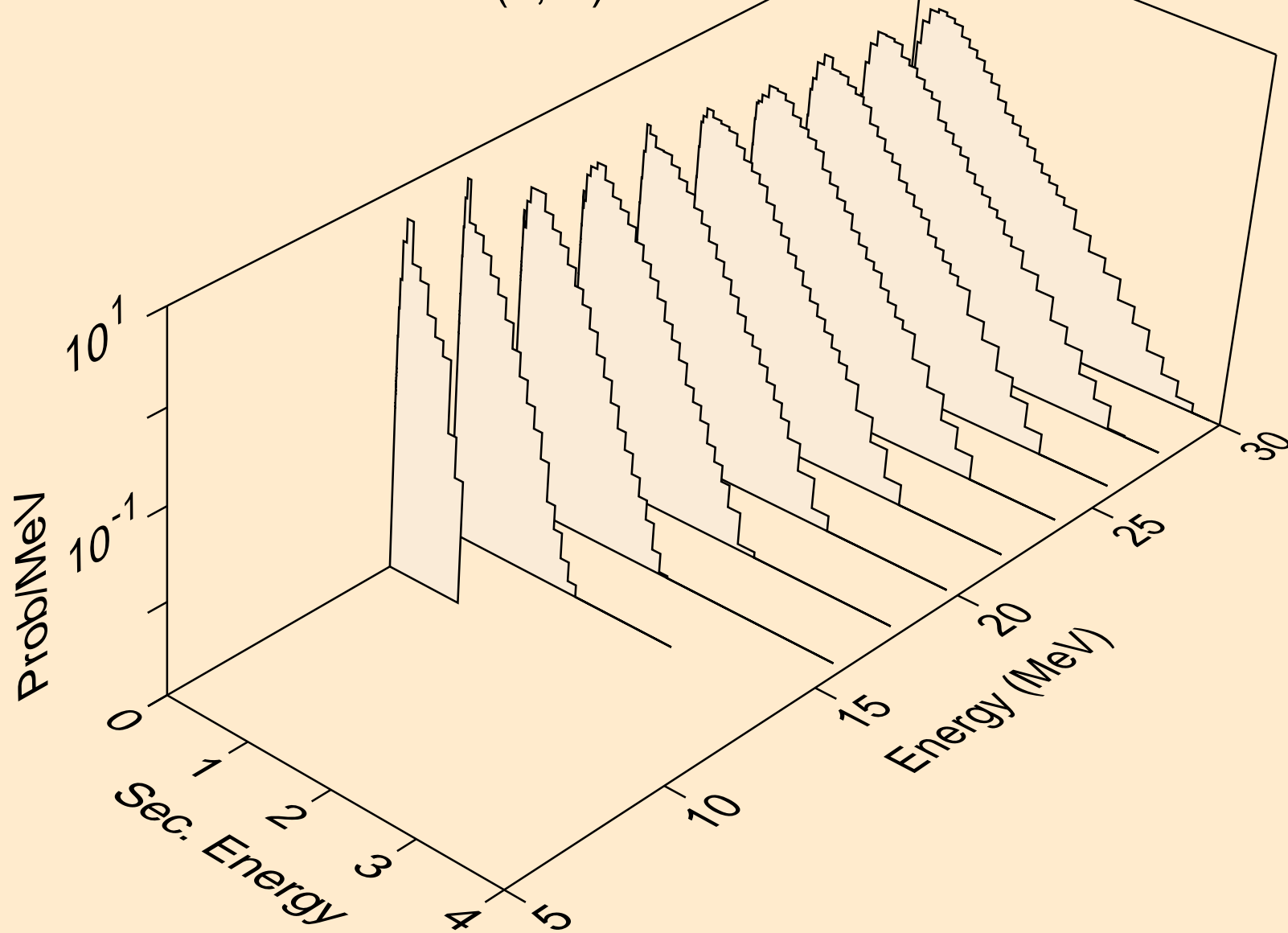

W171 NEUTRON ACER TENDL-2021 LIBRARY; T=293.6K
Neutron emission for (n,4n)

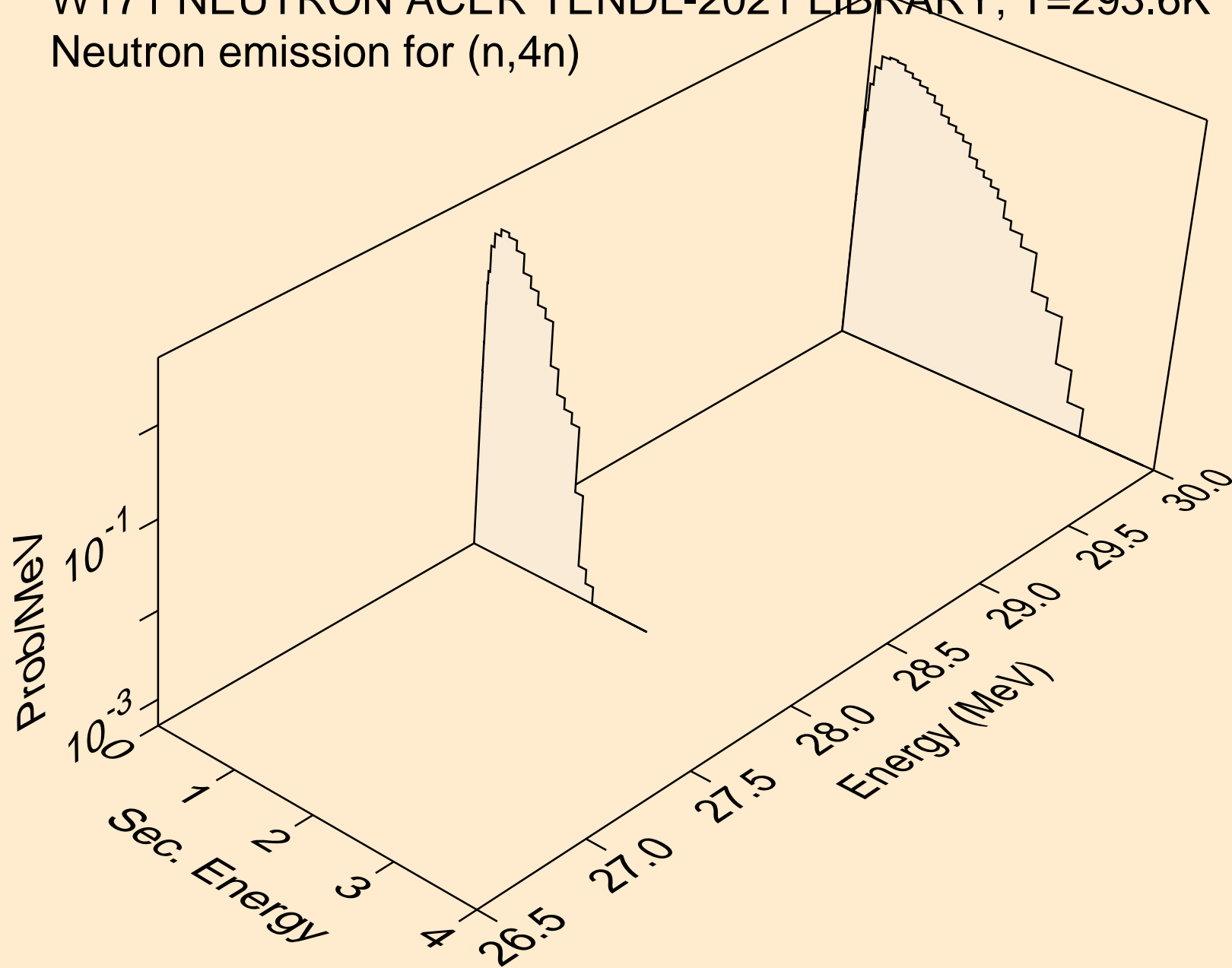

W171 NEUTRON ACER TENDL-2021 LIBRARY; T=293.6K
Neutron emission for (n,2np)

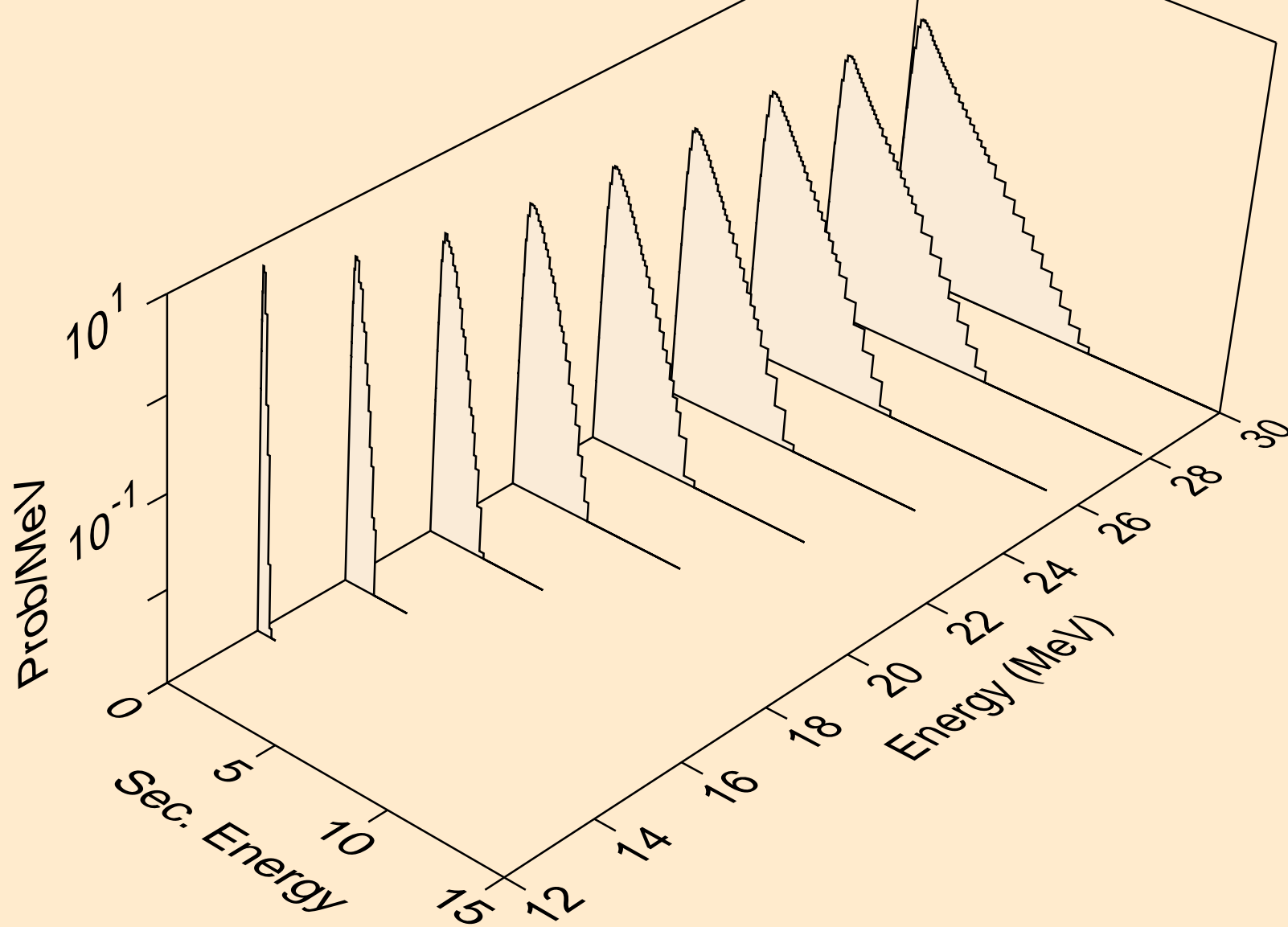

W171 NEUTRON ACER TENDL-2021 LIBRARY; T=293.6K
Neutron emission for (n,3np)

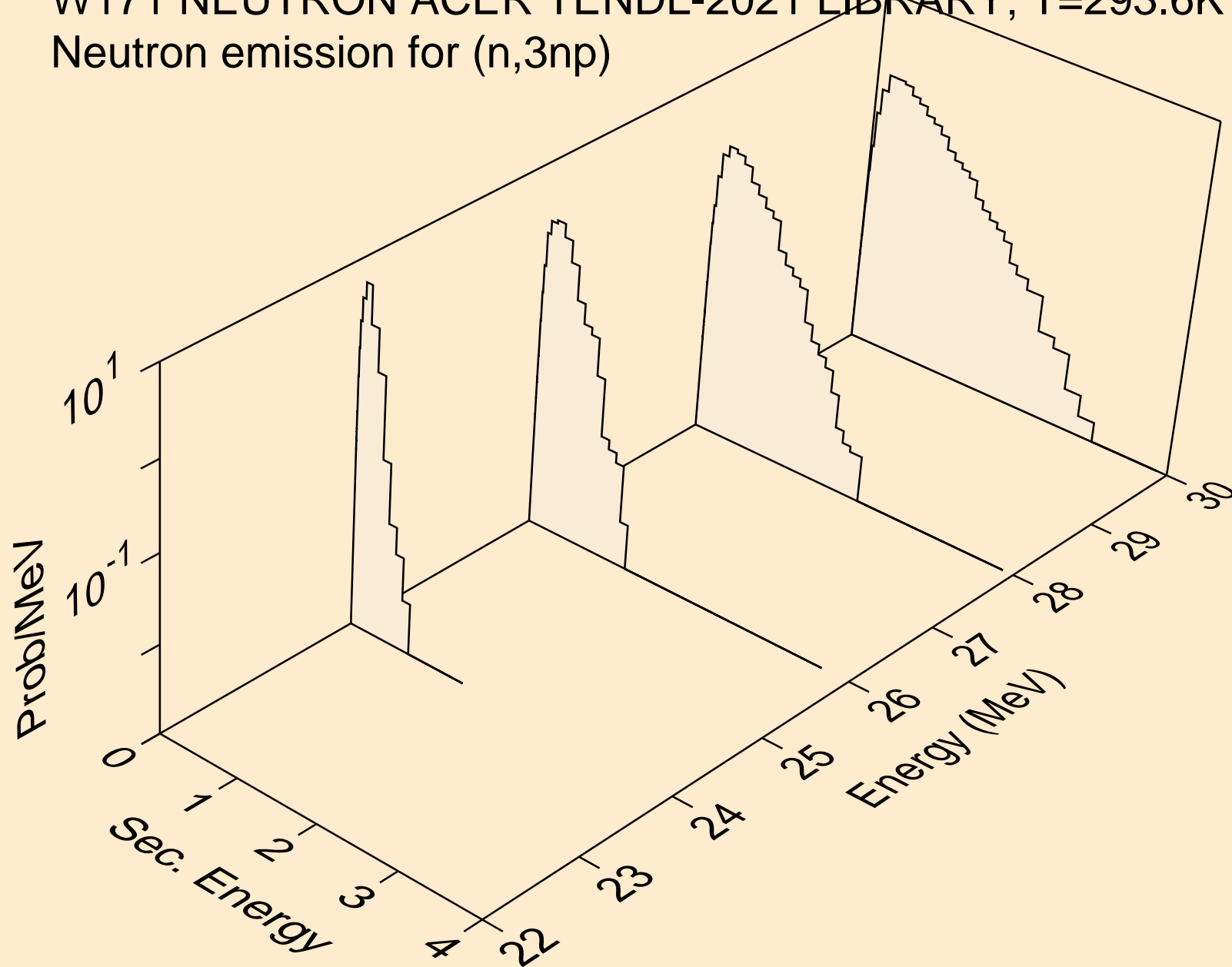

W171 NEUTRON ACER TENDL-2021 LIBRARY; T=293.6K
Neutron emission for (n,2np)

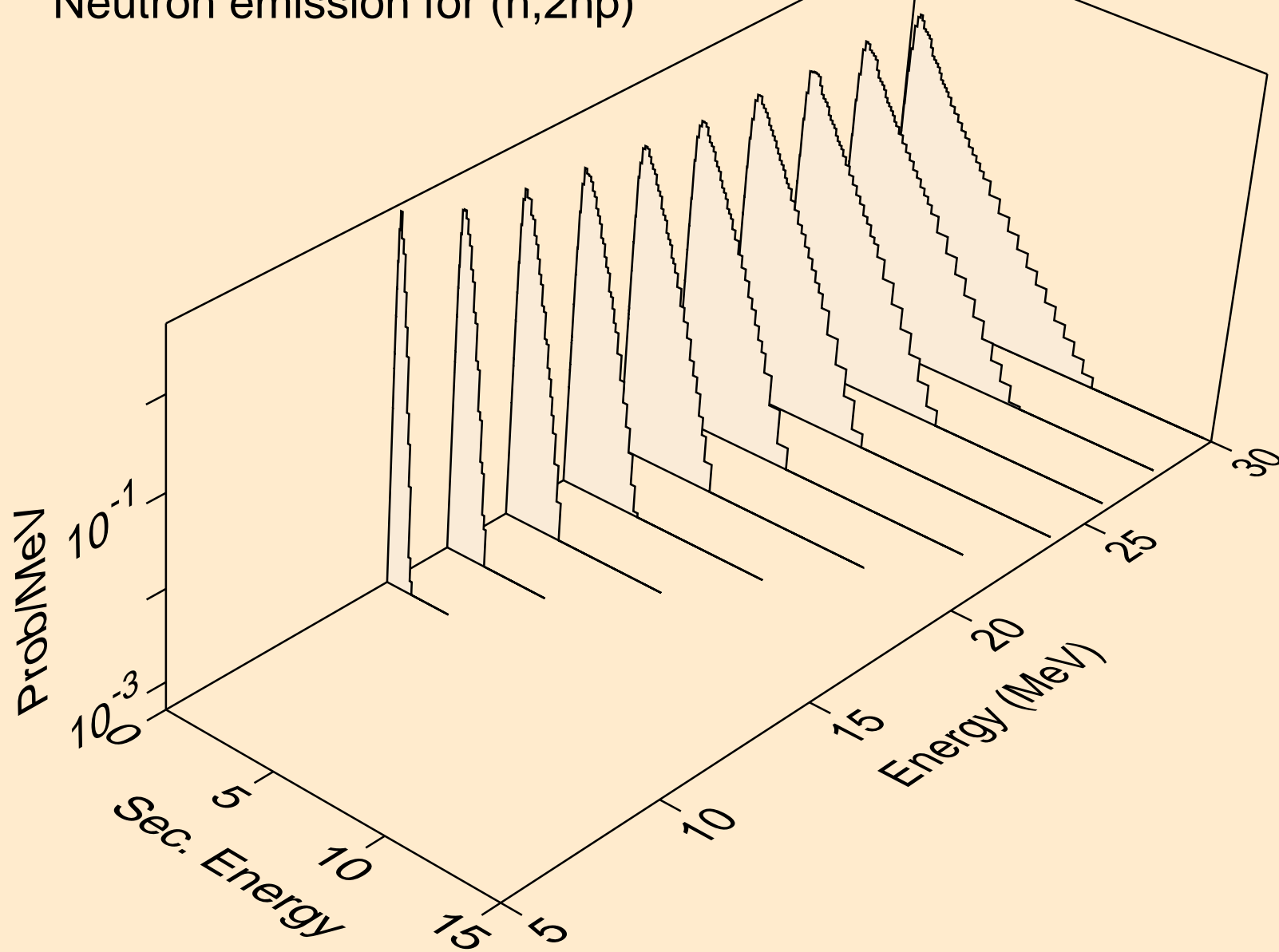

W171 NEUTRON ACER TENDL-2021 LIBRARY; T=293.6K
Neutron emission for (n,npa)

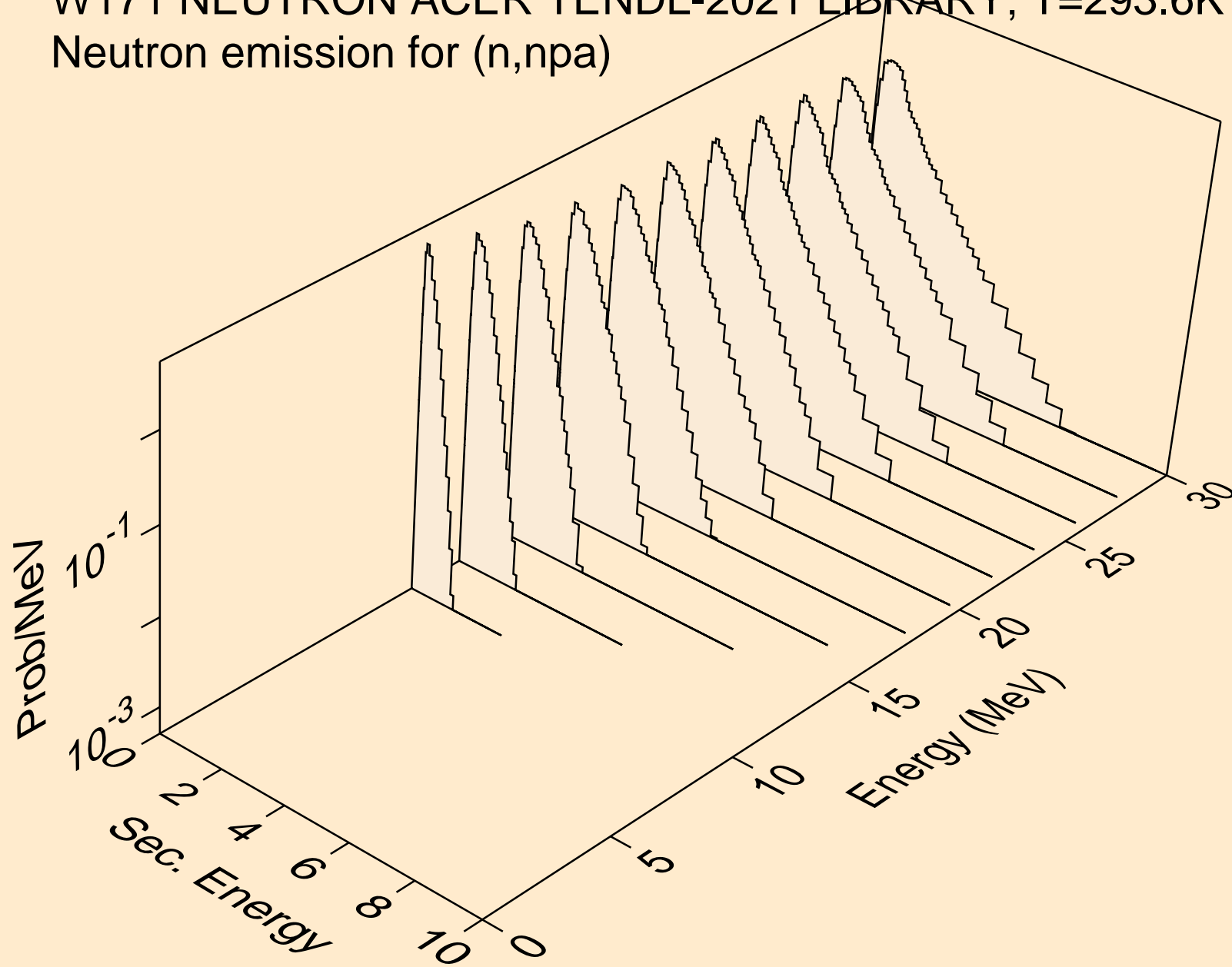

W171 NEUTRON ACER TENDL-2021 LIBRARY; T=293.6K
Neutron emission for (n,n*c)

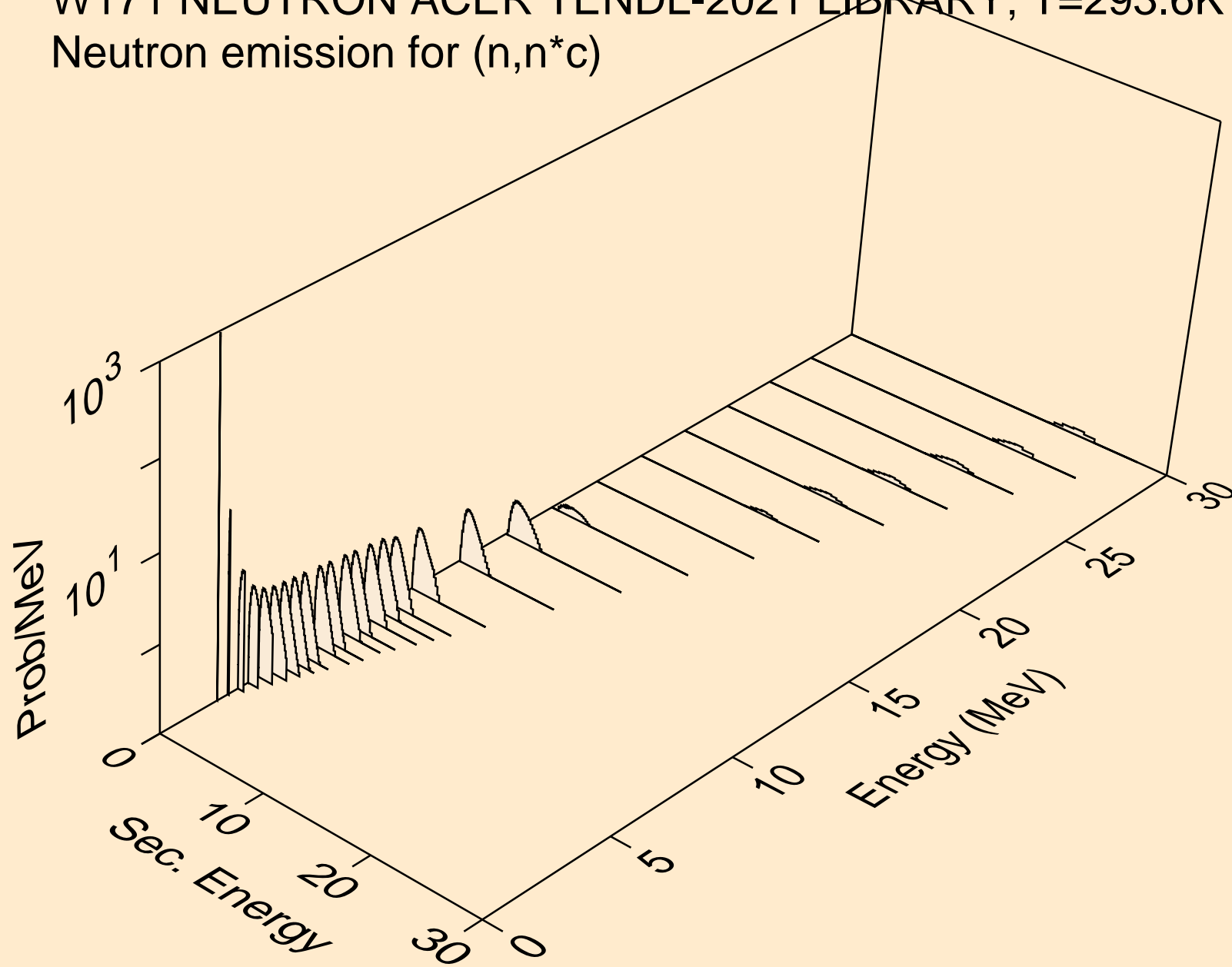

W171 NEUTRON ACER TENDL-2021 LIBRARY; T=293.6K
Photon emission for (n,x)

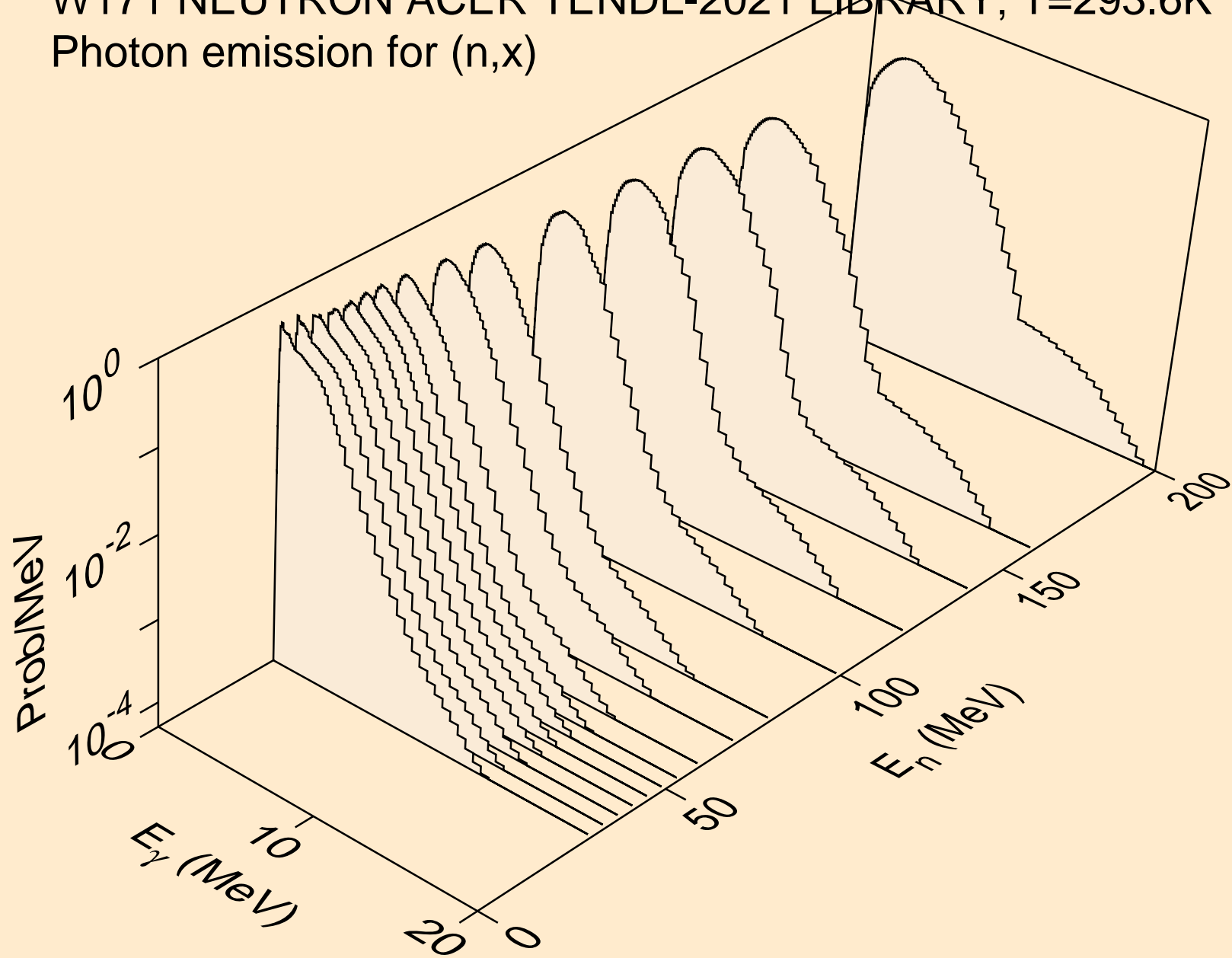

W171 NEUTRON ACER TENDL-2021 LIBRARY; T=293.6K
Photon emission for (n,2nd)

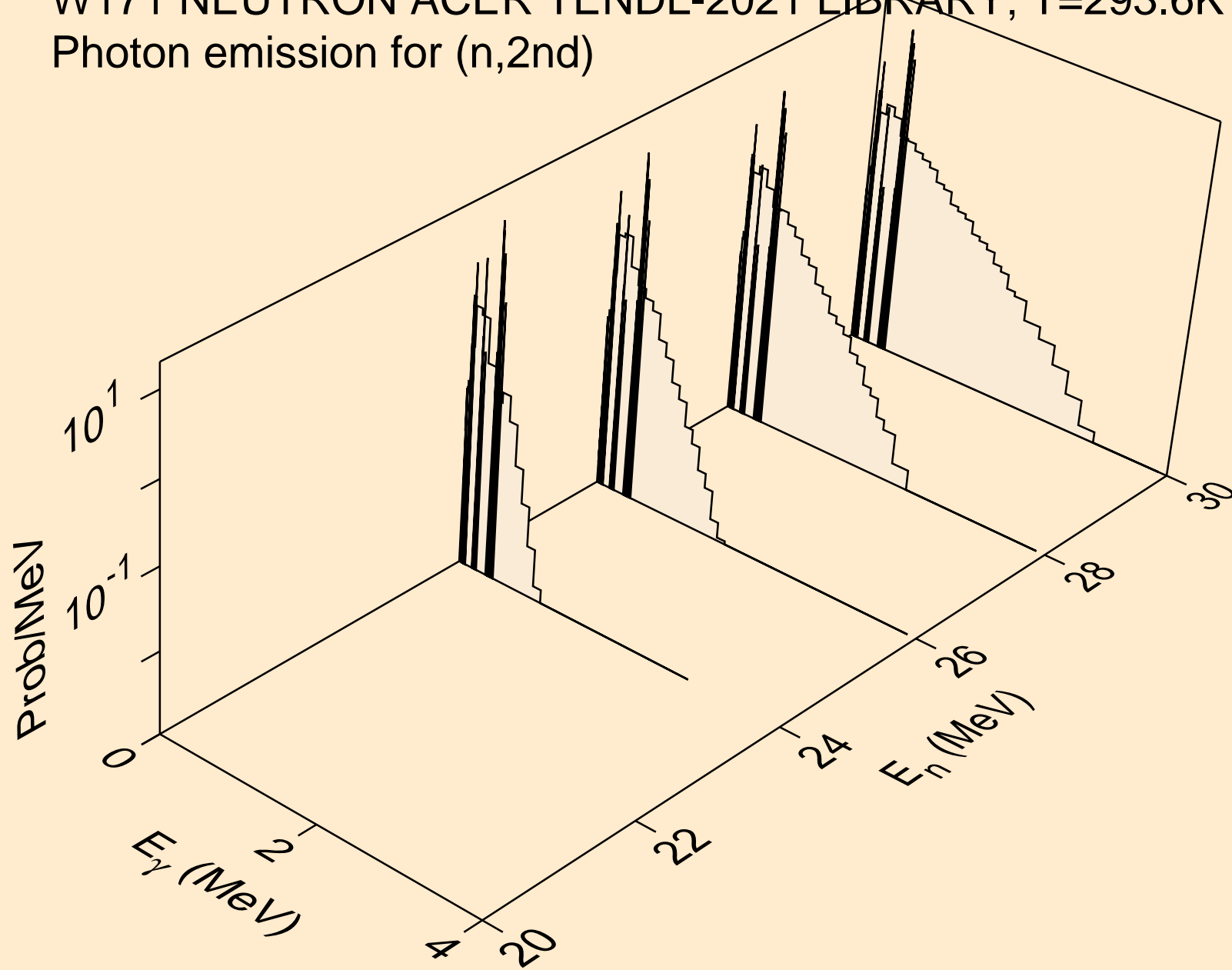

W171 NEUTRON ACER TENDL-2021 LIBRARY; T=293.6K
Photon emission for (n,2n)

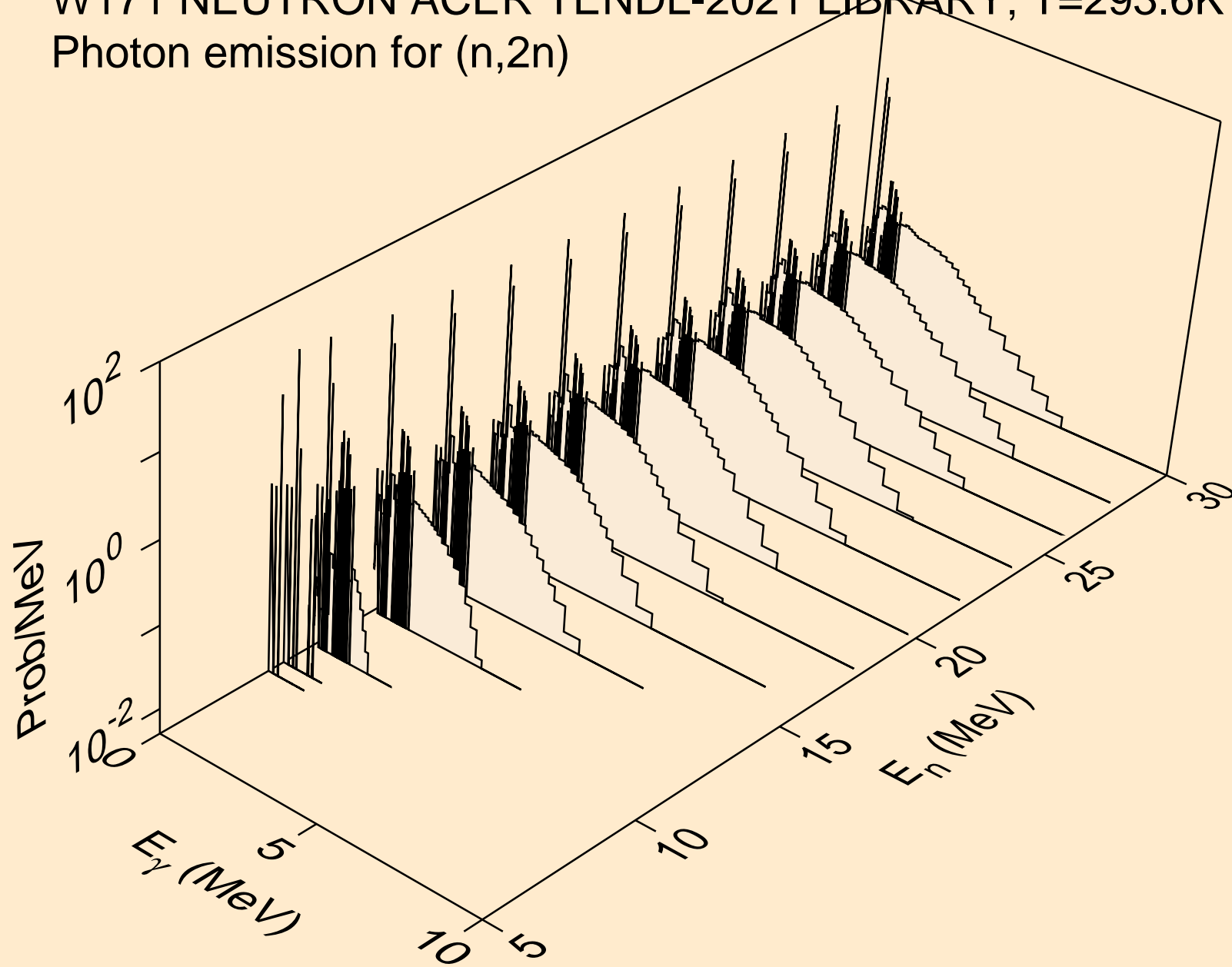

W171 NEUTRON ACER TENDL-2021 LIBRARY; T=293.6K
Photon emission for (n,3n)

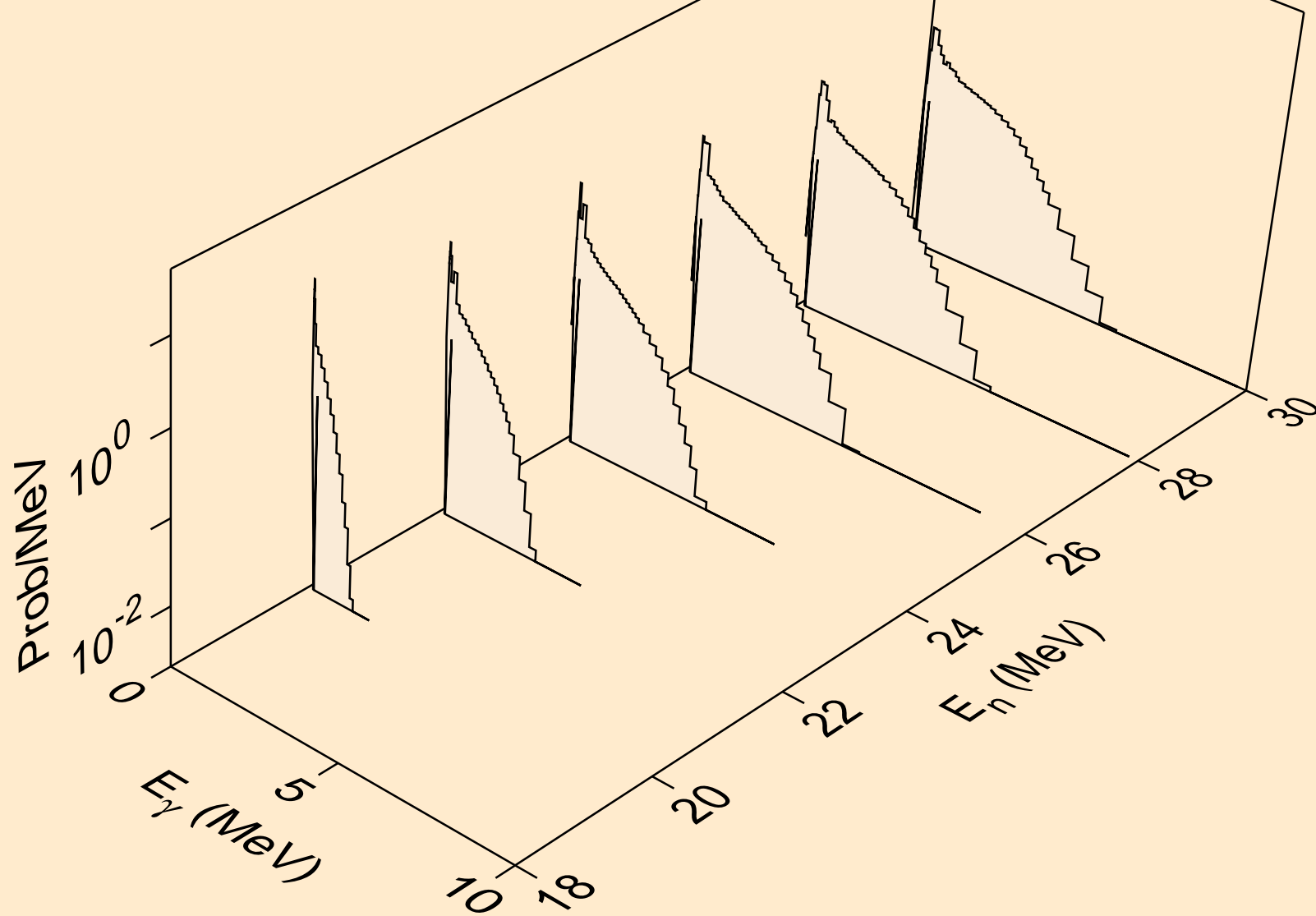

W171 NEUTRON ACER TENDL-2021 LIBRARY; T=293.6K
Photon emission for (n,n*)a

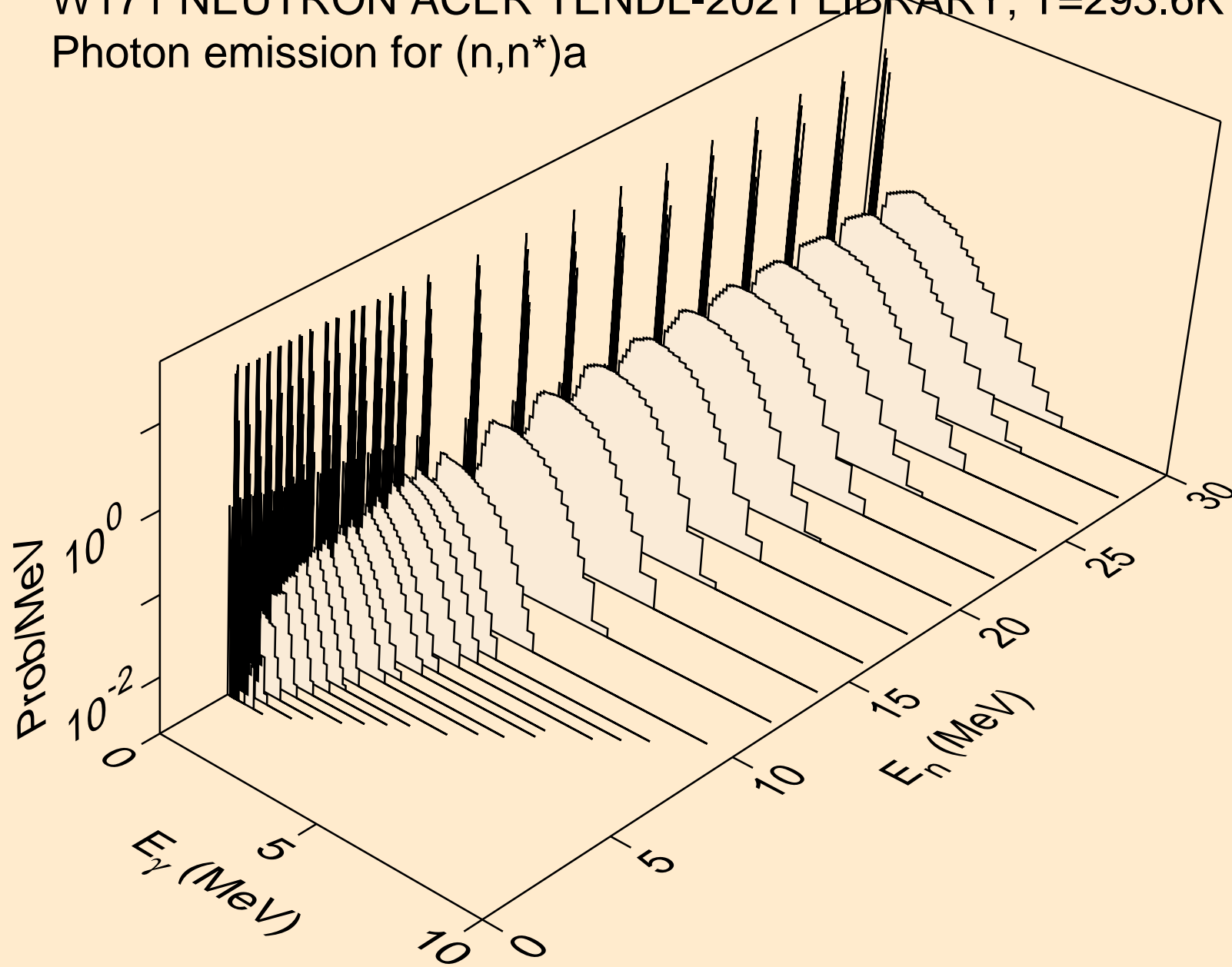

W171 NEUTRON ACER TENDL-2021 LIBRARY; T=293.6K
Photon emission for (n,2n)a

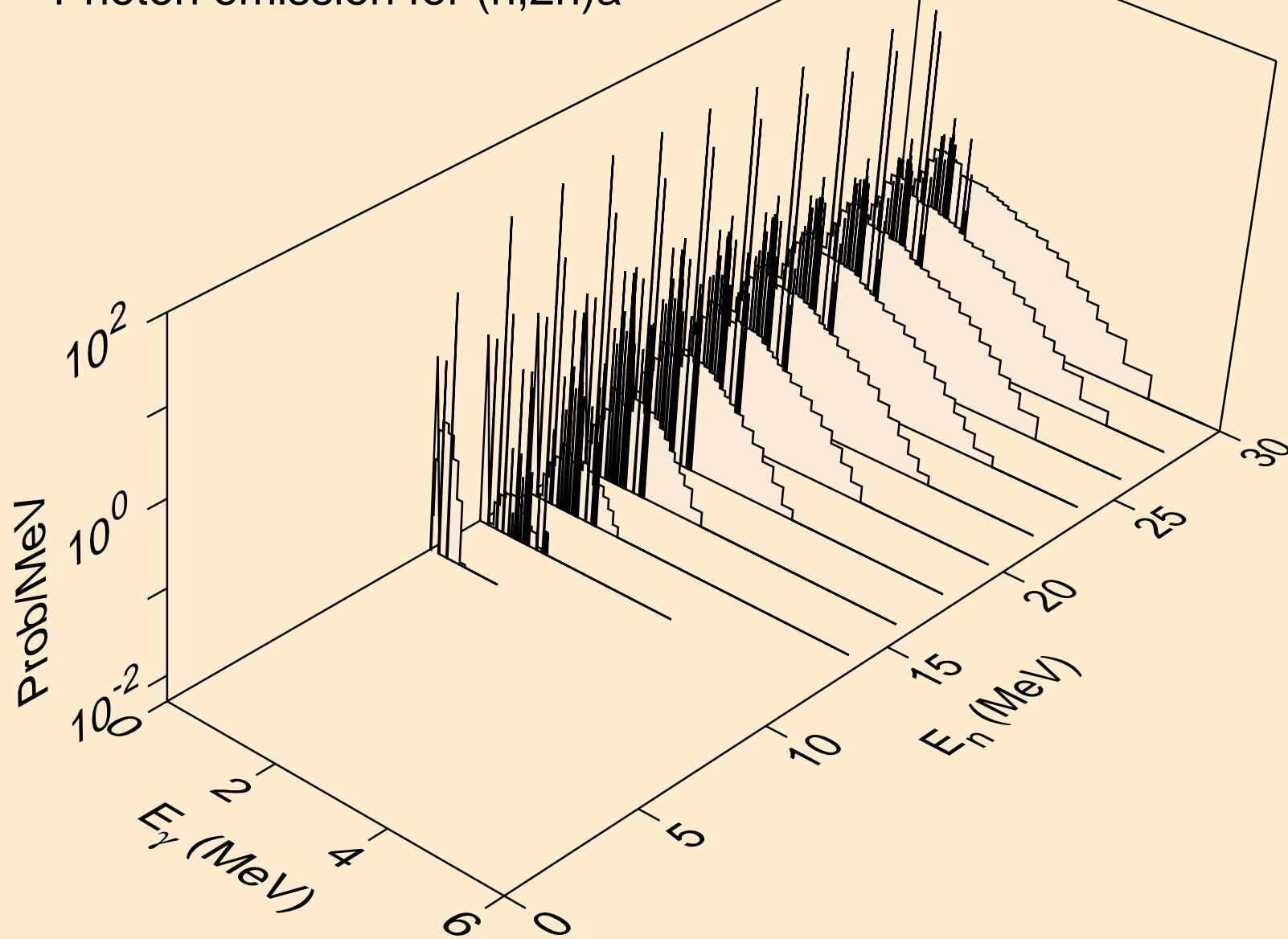

W171 NEUTRON ACER TENDL-2021 LIBRARY; T=293.6K
Photon emission for (n,3n)a

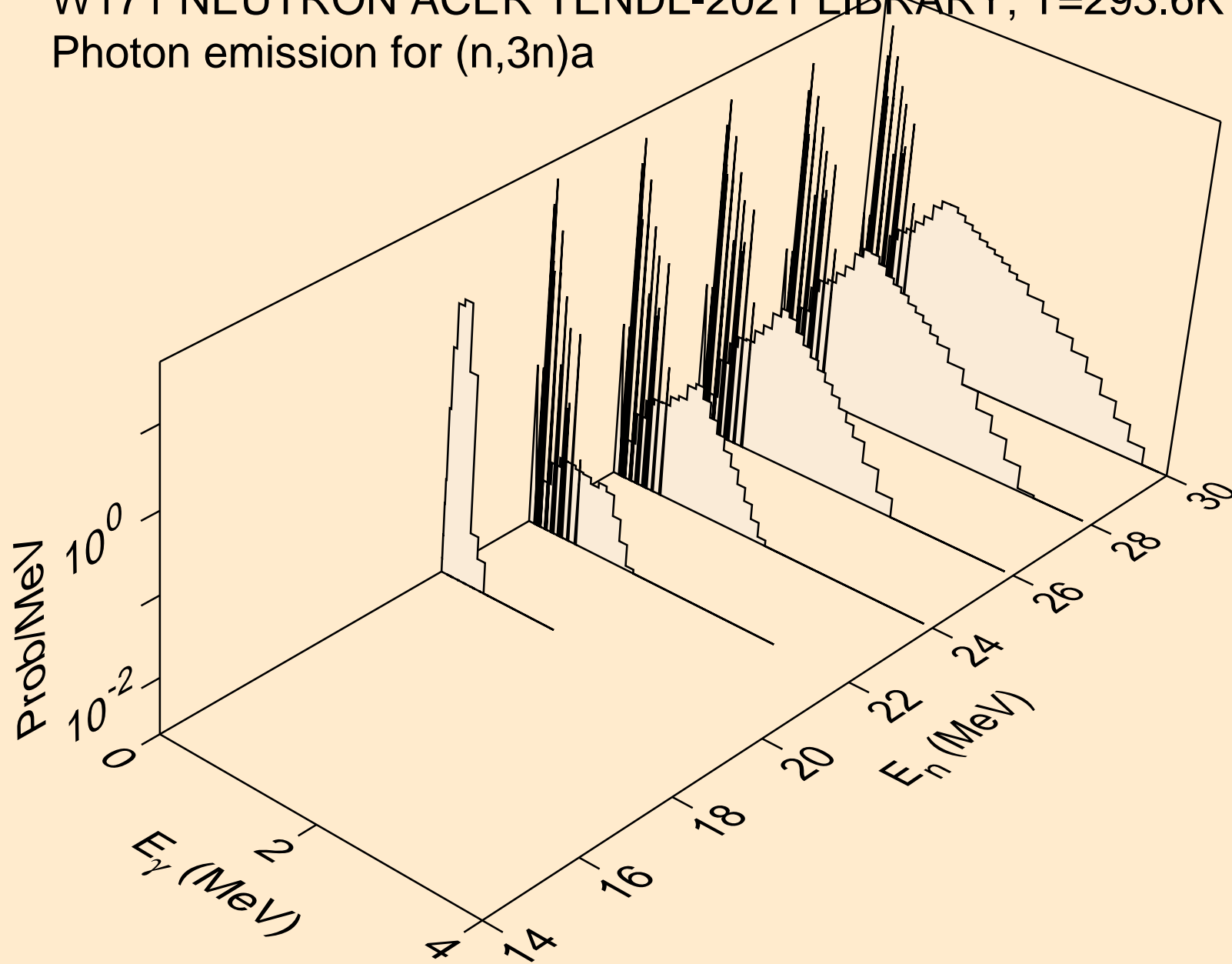

W171 NEUTRON ACER TENDL-2021 LIBRARY; T=293.6K
Photon emission for (n,n*)p

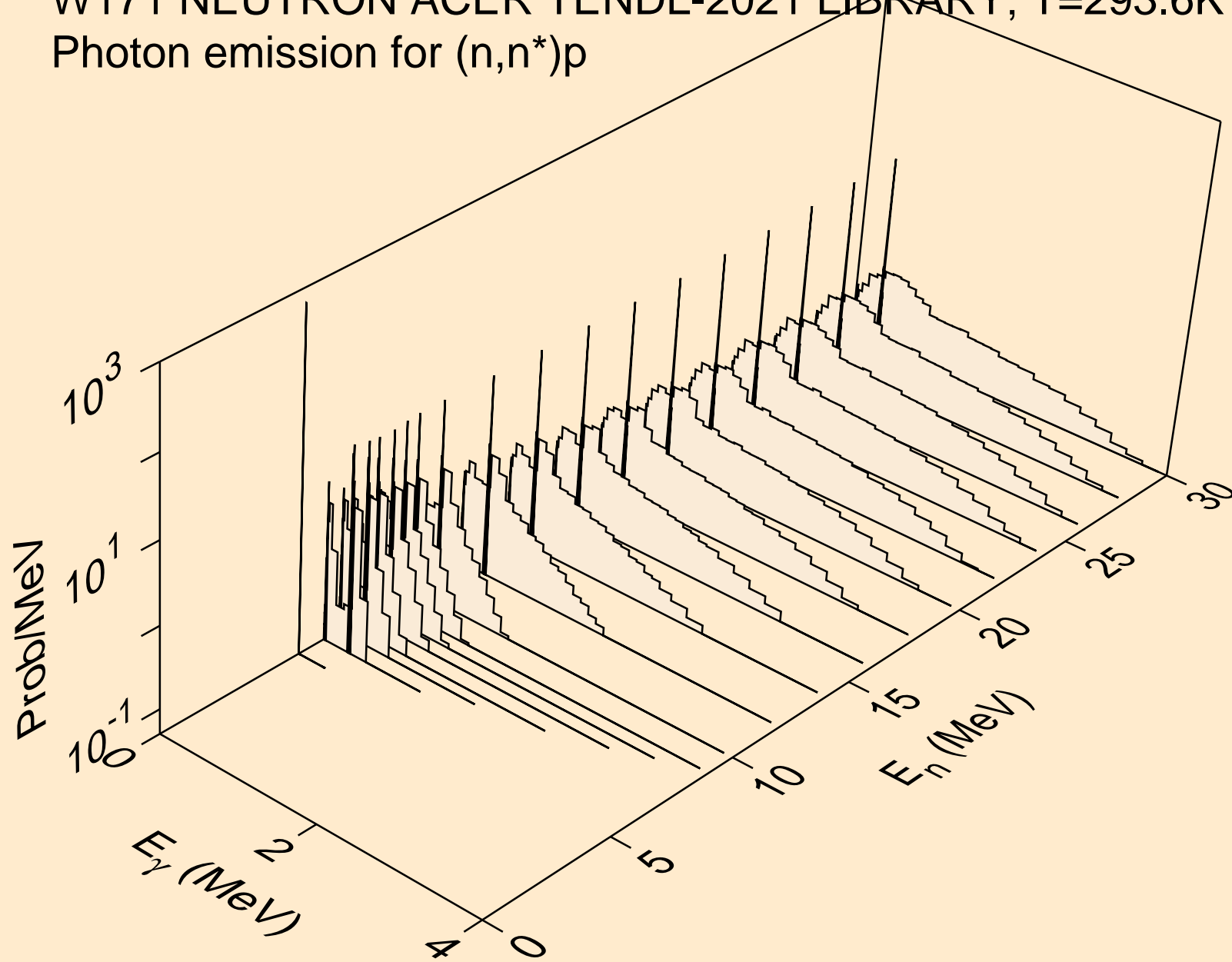

W171 NEUTRON ACER TENDL-2021 LIBRARY; T=293.6K
Photon emission for (n,n*)2a

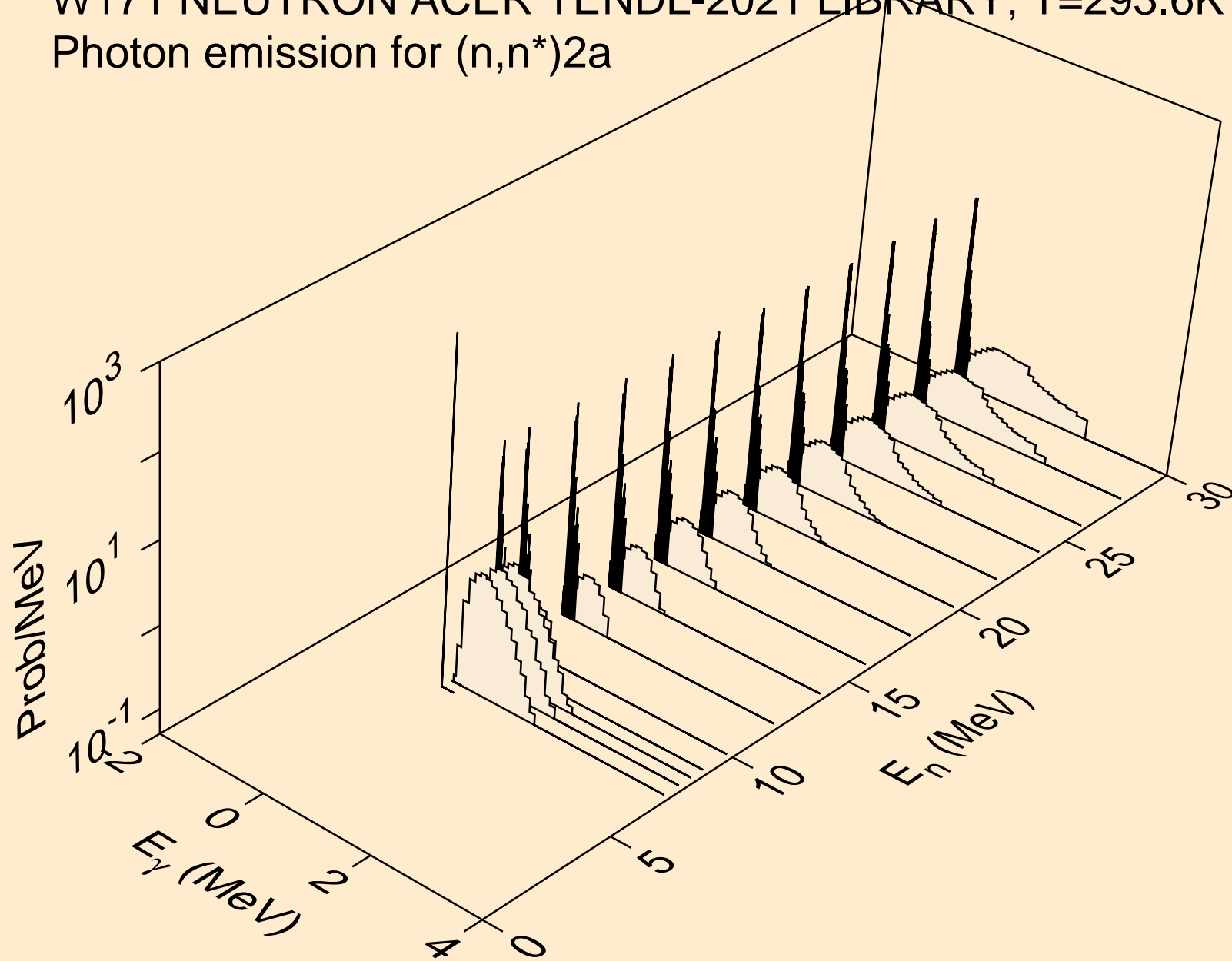

W171 NEUTRON ACER TENDL-2021 LIBRARY; T=293.6K
Photon emission for (n,2n)2a

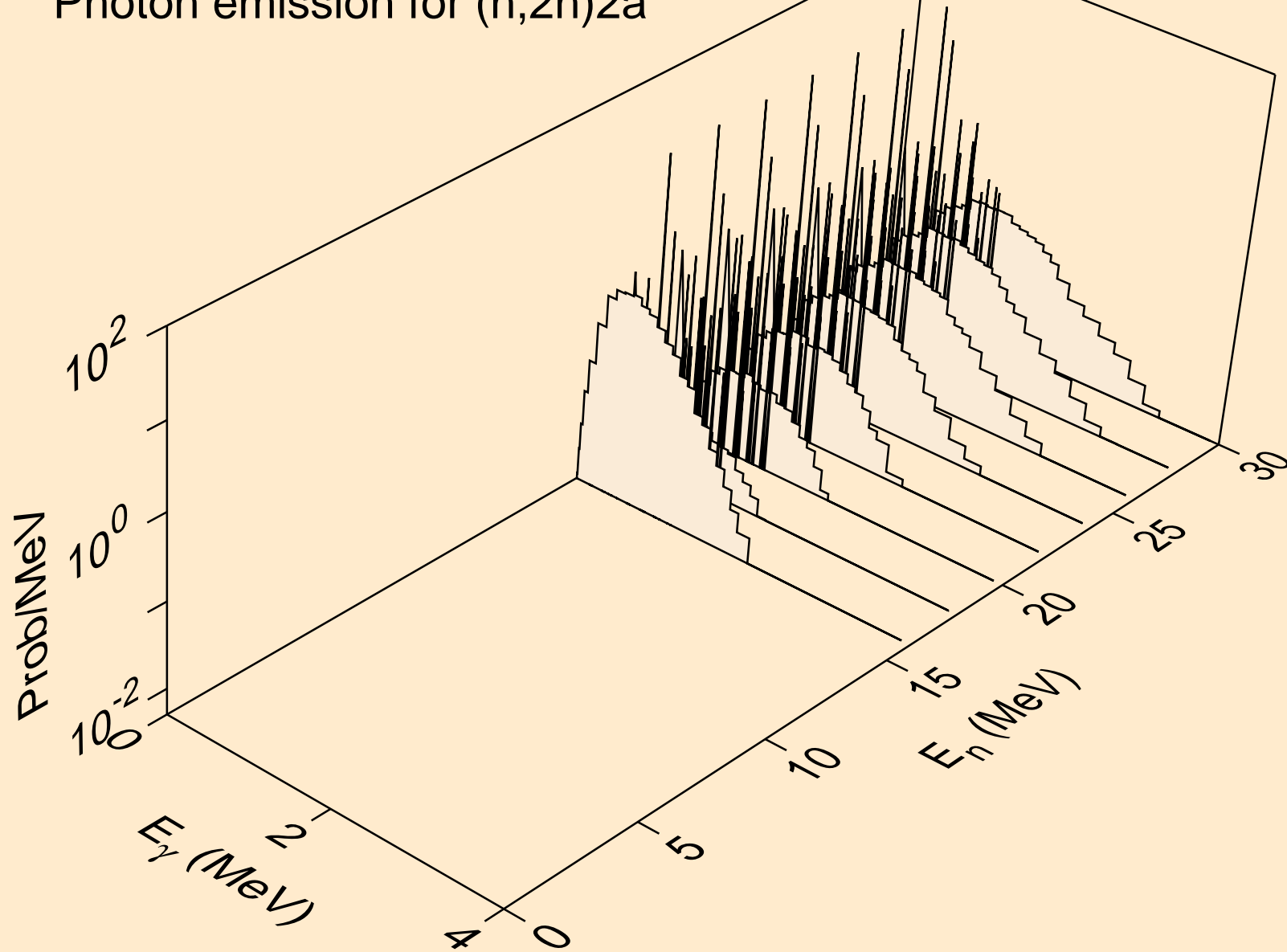

W171 NEUTRON ACER TENDL-2021 LIBRARY; T=293.6K
Photon emission for (n,n*)d

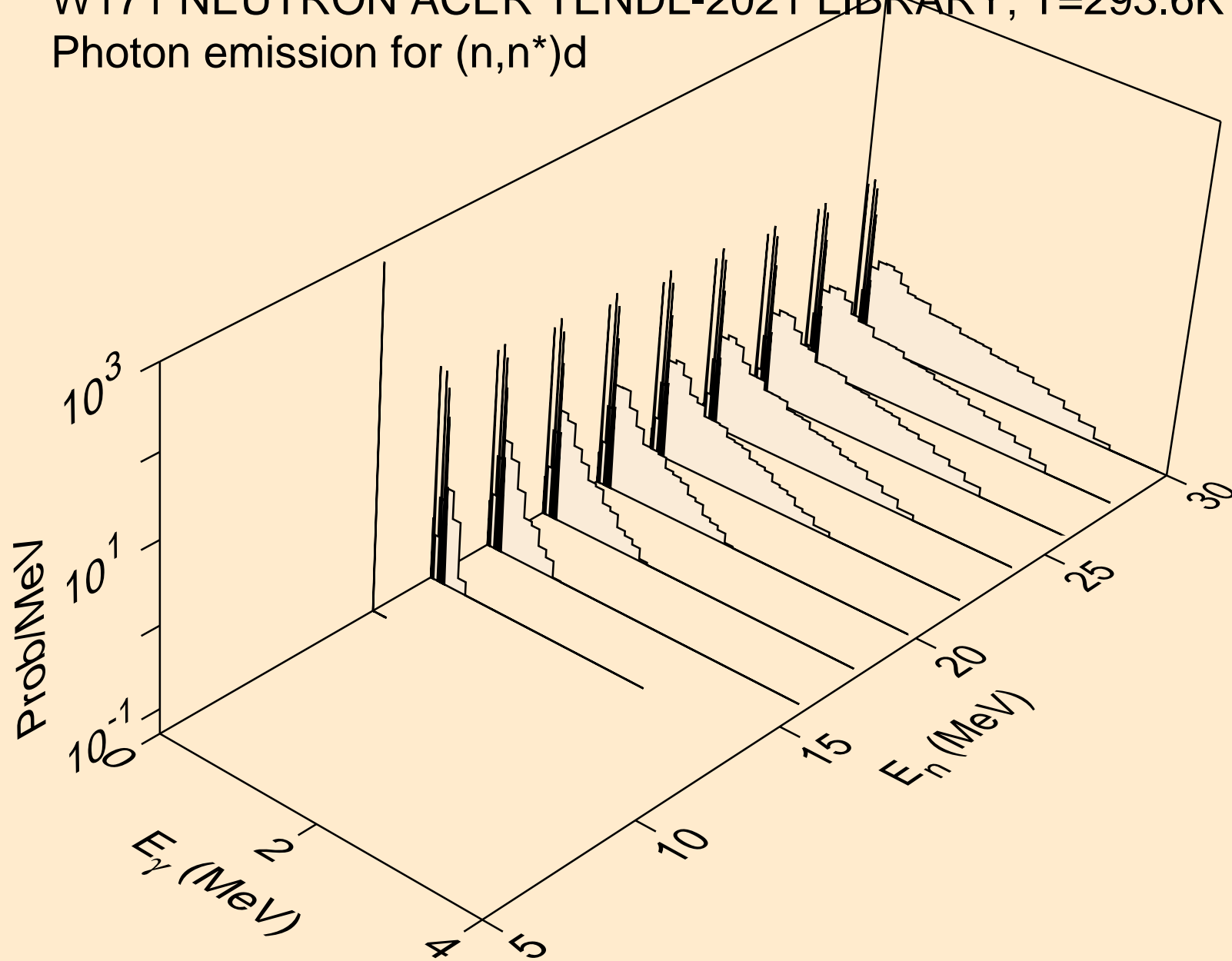

W171 NEUTRON ACER TENDL-2021 LIBRARY; T=293.6K
Photon emission for (n,n*)t

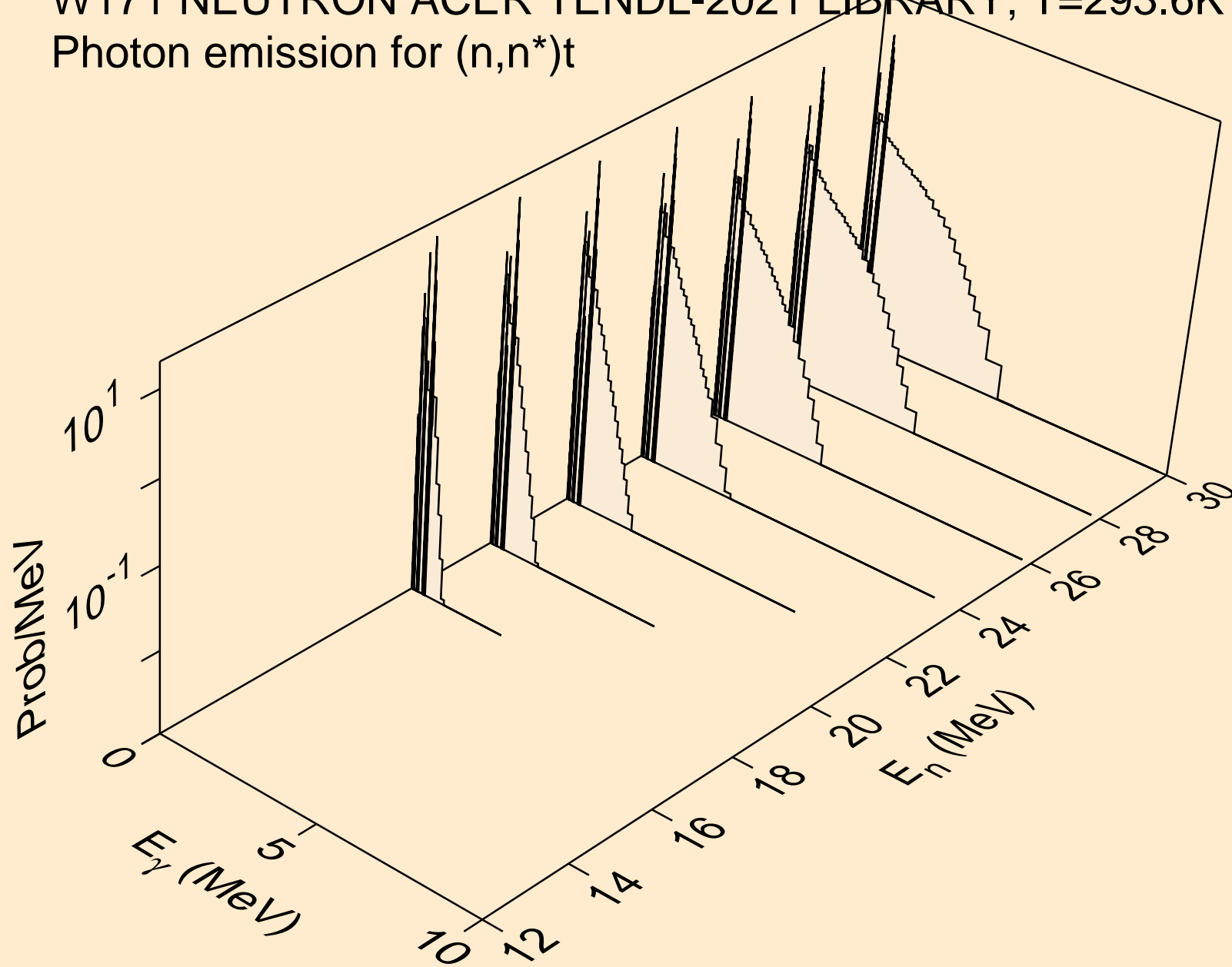

W171 NEUTRON ACER TENDL-2021 LIBRARY; T=293.6K
Photon emission for (n,n*)he3

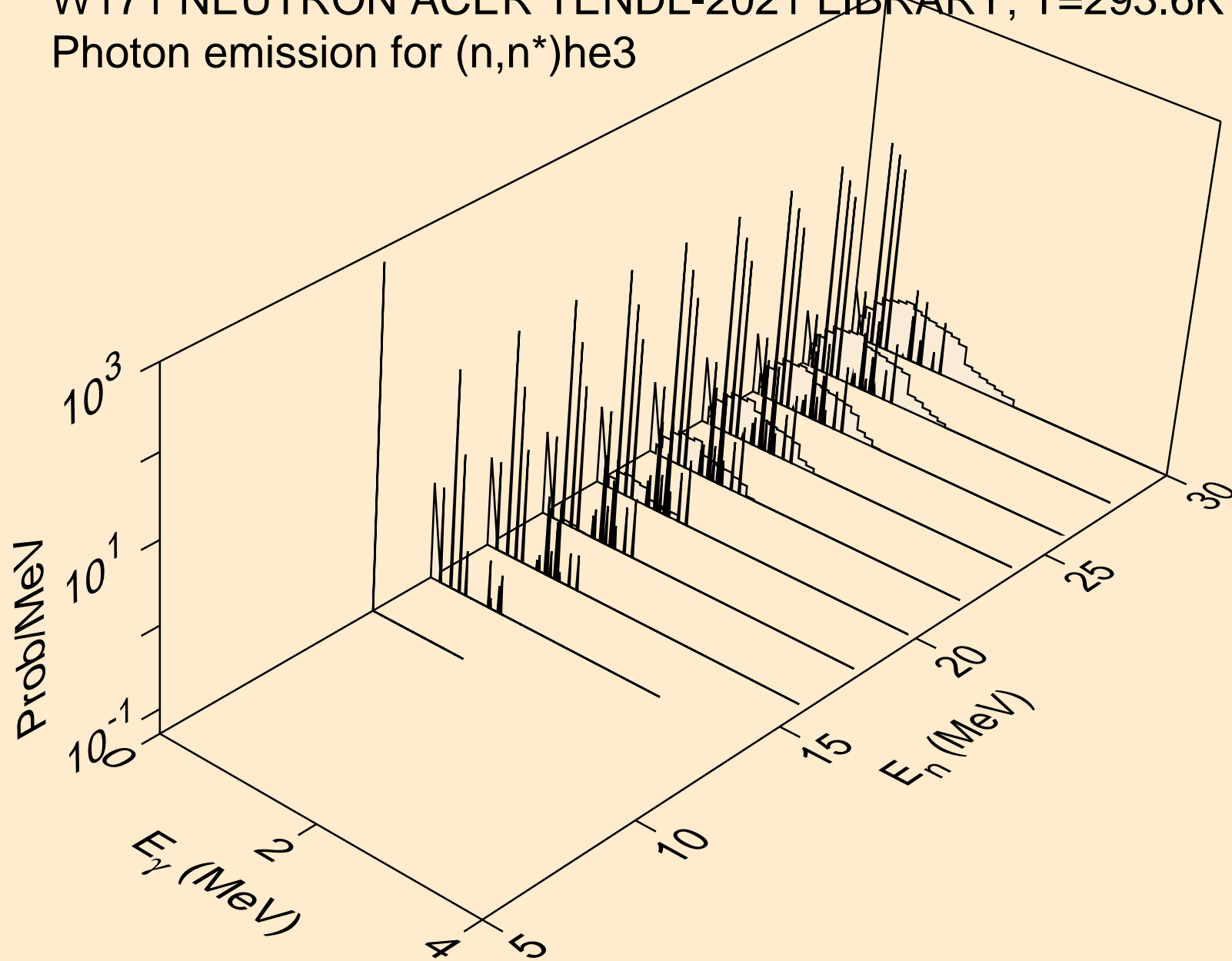

W171 NEUTRON ACER TENDL-2021 LIBRARY; T=293.6K
Photon emission for (n,4n)

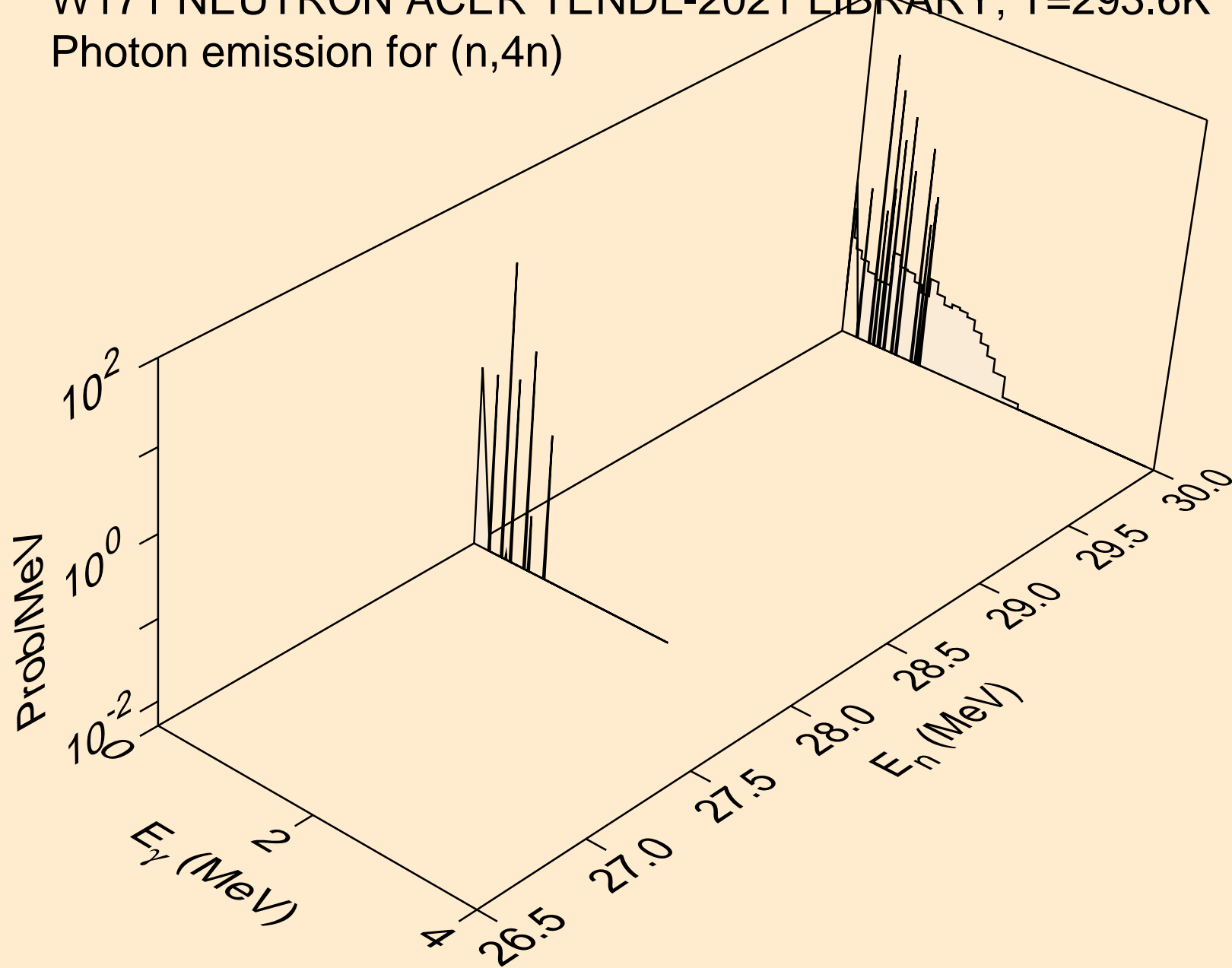

W171 NEUTRON ACER TENDL-2021 LIBRARY; T=293.6K
Photon emission for (n,2np)

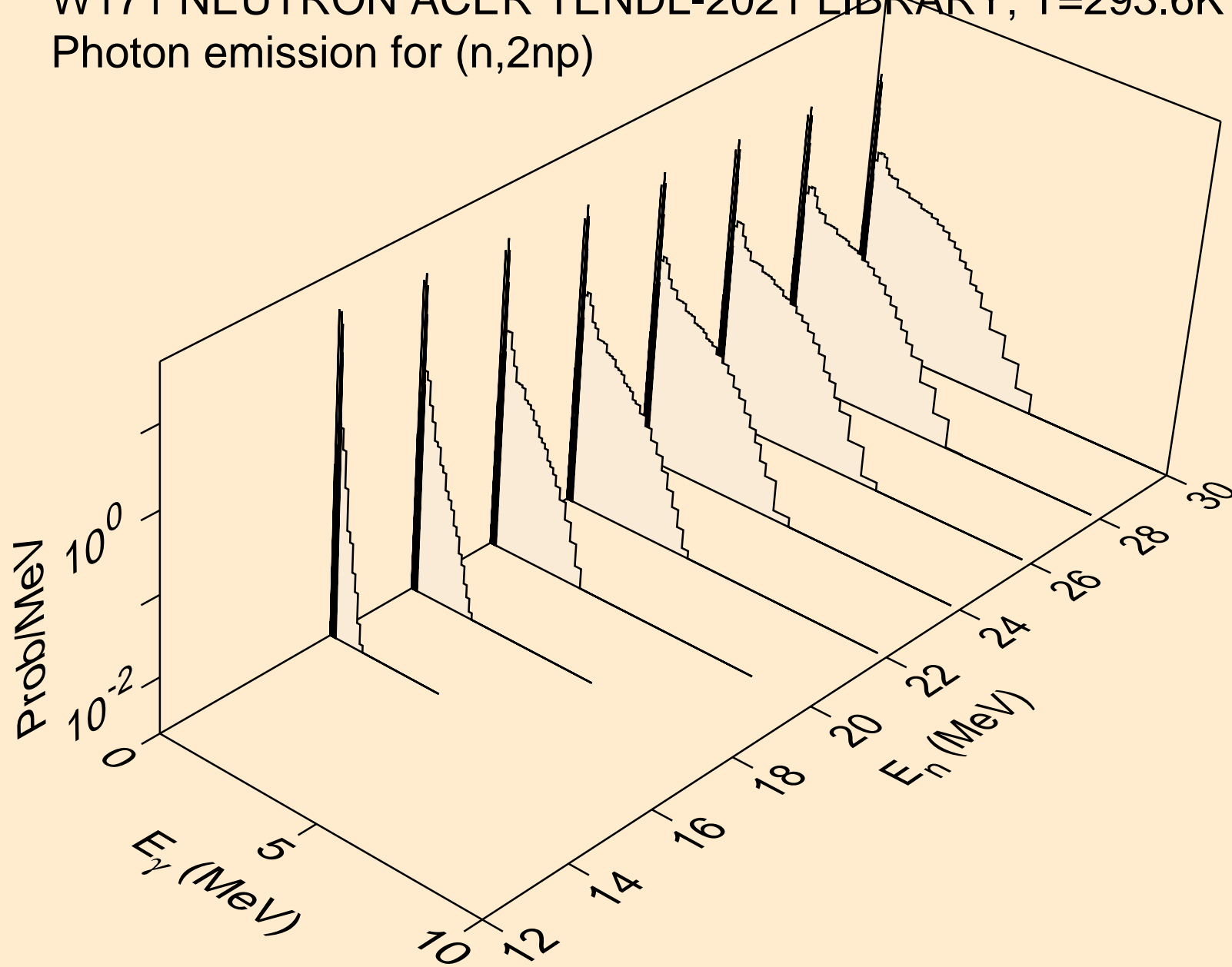

W171 NEUTRON ACER TENDL-2021 LIBRARY; T=293.6K
Photon emission for (n,3np)

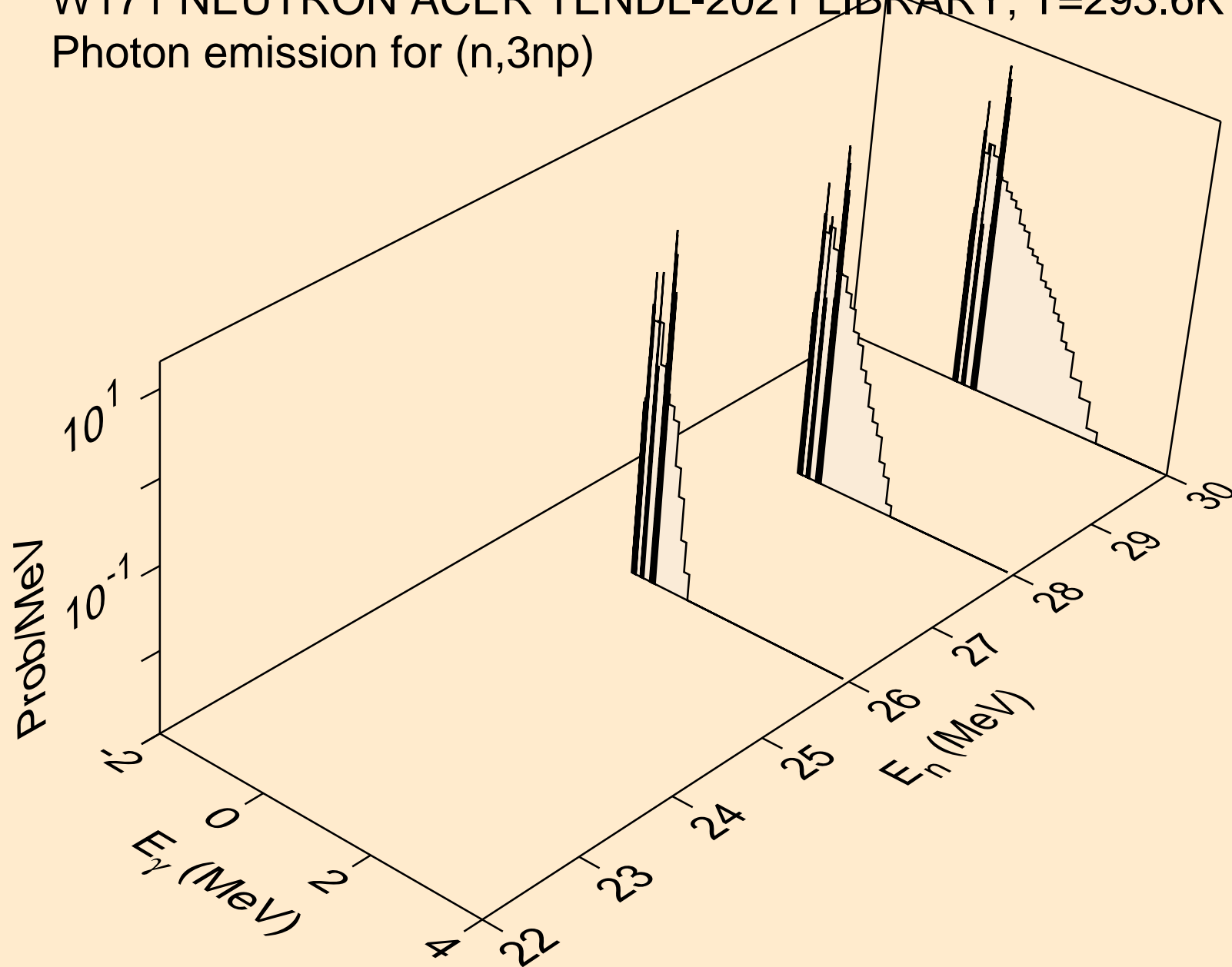

W171 NEUTRON ACER TENDL-2021 LIBRARY; T=293.6K
Photon emission for (n,2np)

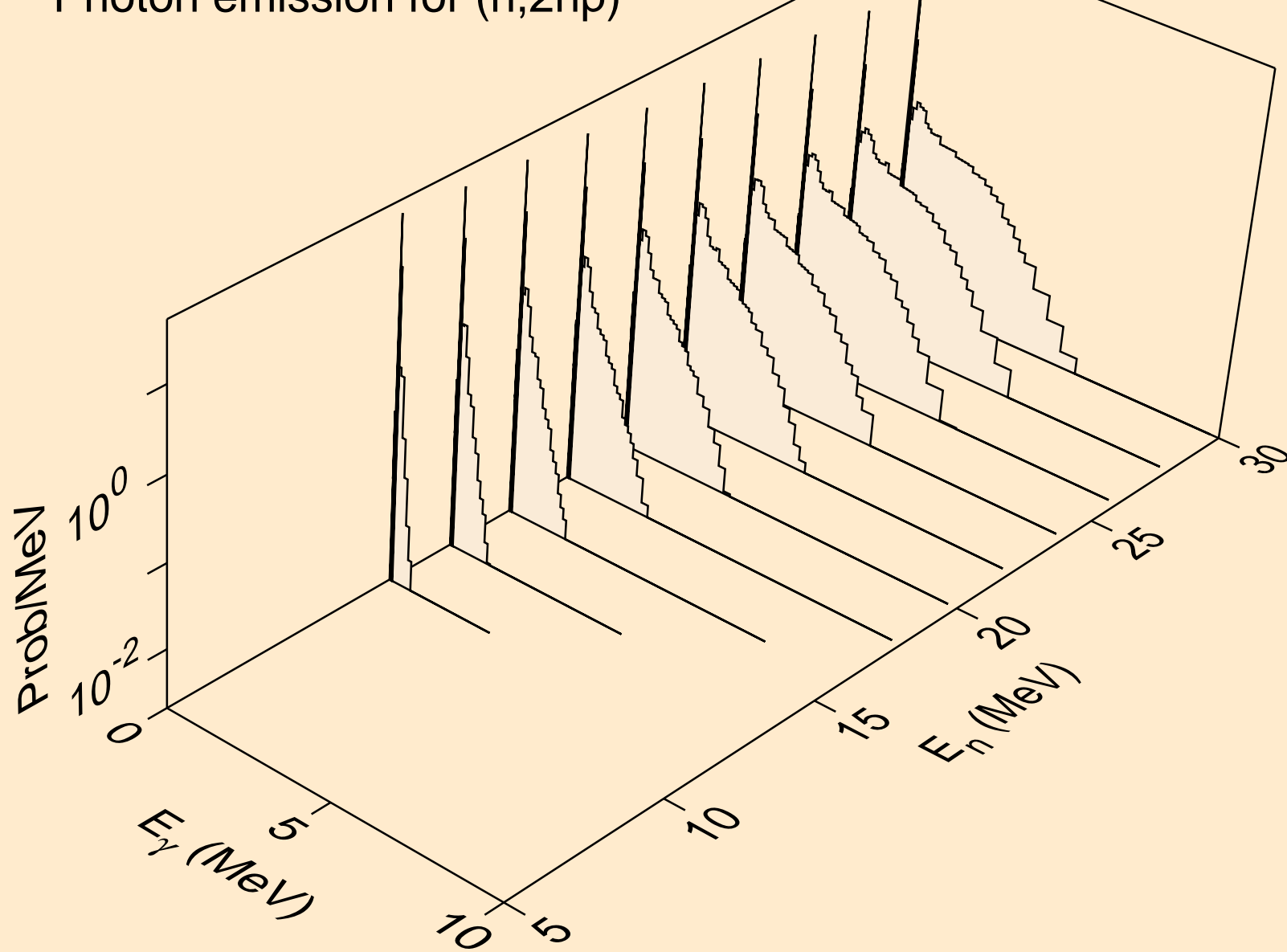

W171 NEUTRON ACER TENDL-2021 LIBRARY; T=293.6K
Photon emission for (n,npa)

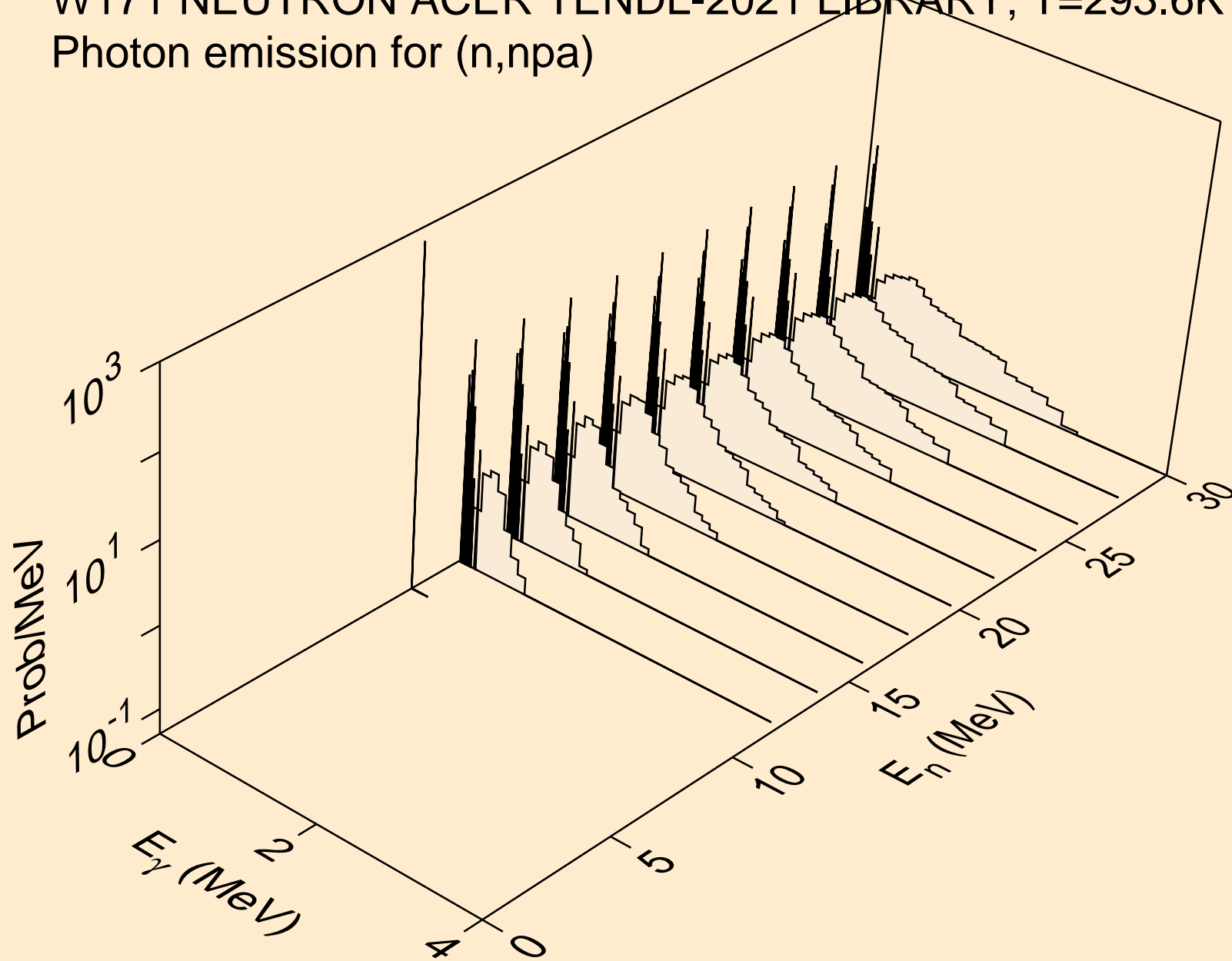

W171 NEUTRON ACER TENDL-2021 LIBRARY; T=293.6K
Photon emission for (n,n*c)

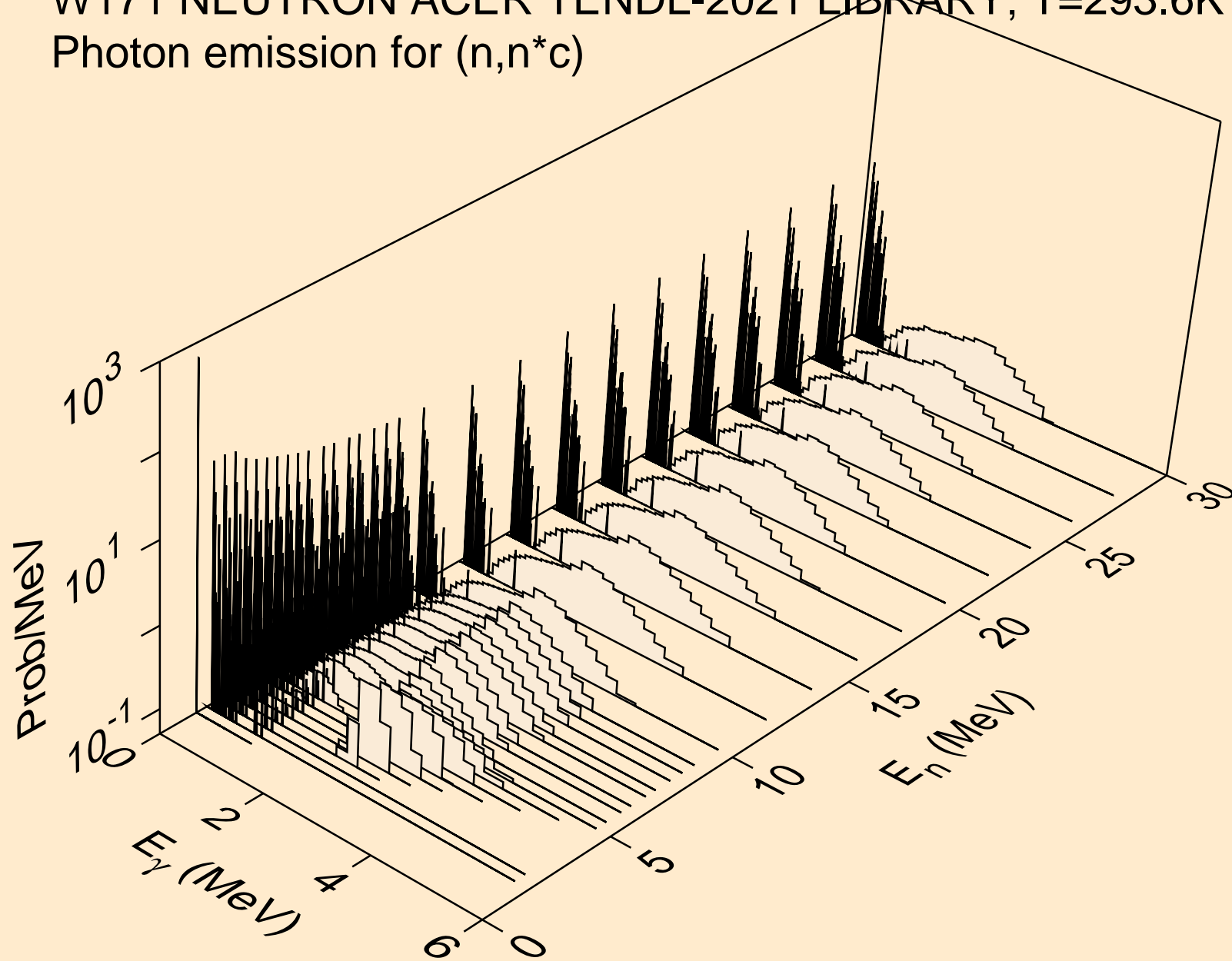

W171 NEUTRON ACER TENDL-2021 LIBRARY; T=293.6K
Photon emission for (n,gma)

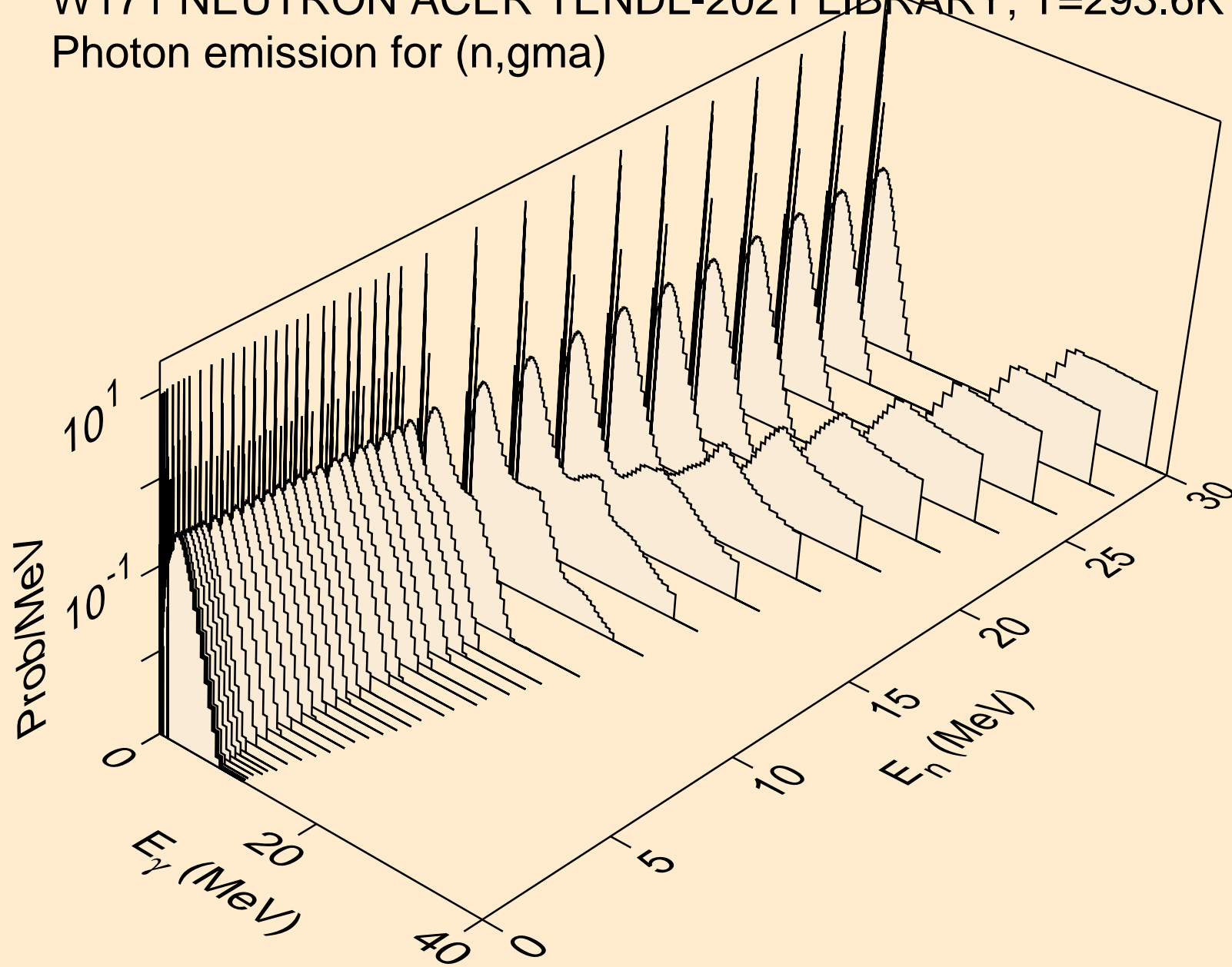

W171 NEUTRON ACER TENDL-2021 LIBRARY; T=293.6K
Photon emission for (n,p)

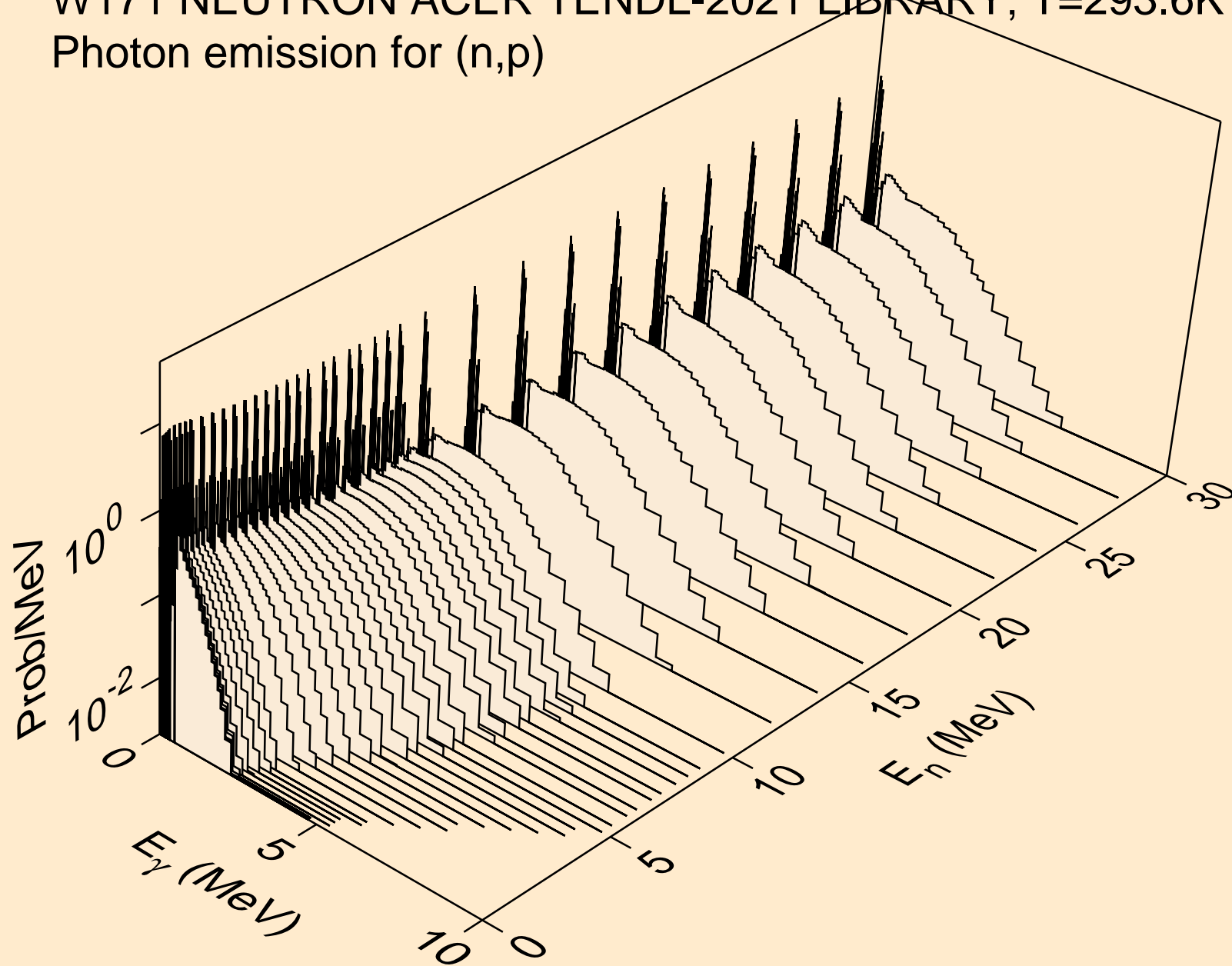

W171 NEUTRON ACER TENDL-2021 LIBRARY; T=293.6K
Photon emission for (n,d)

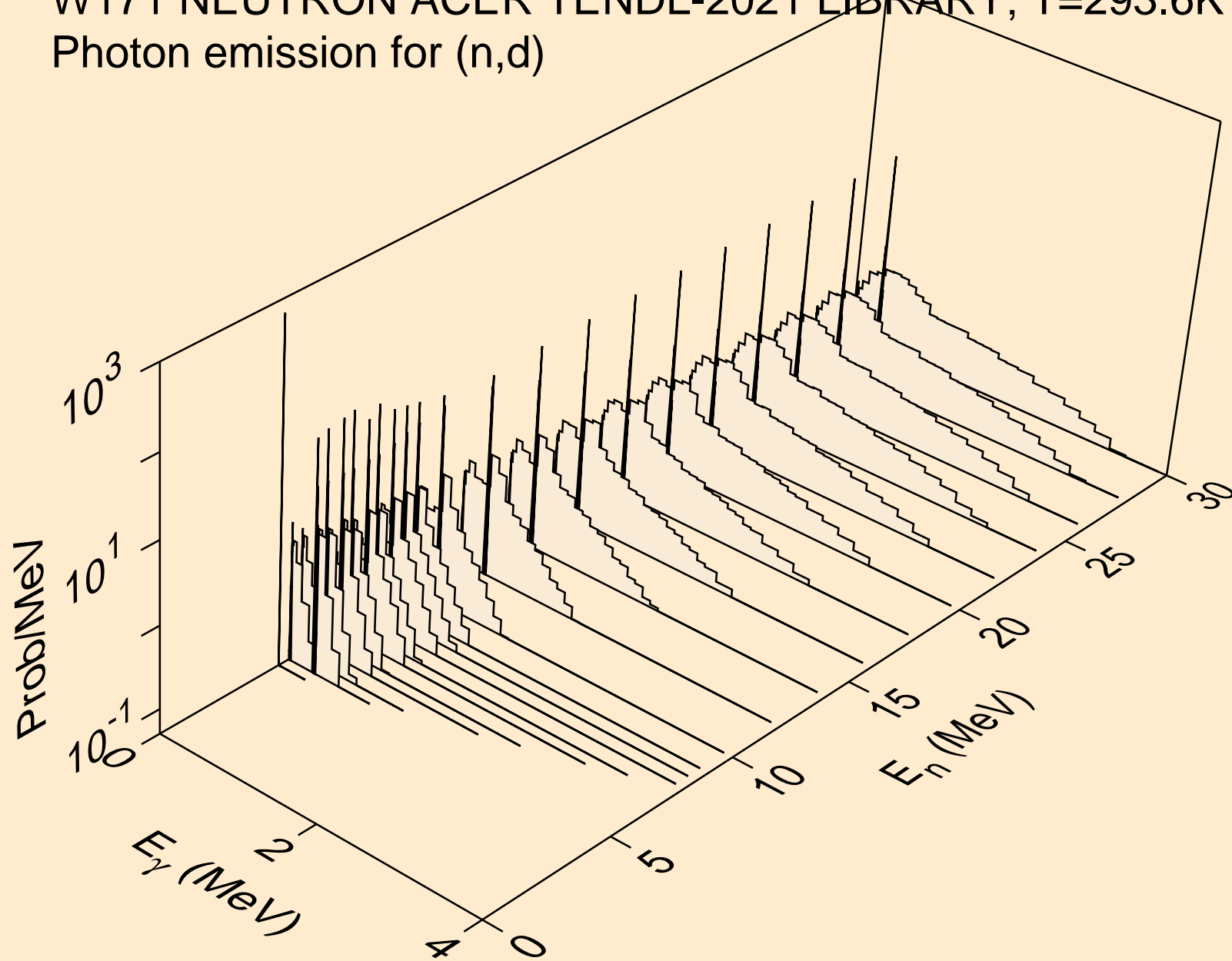

W171 NEUTRON ACER TENDL-2021 LIBRARY; T=293.6K
Photon emission for (n,t)

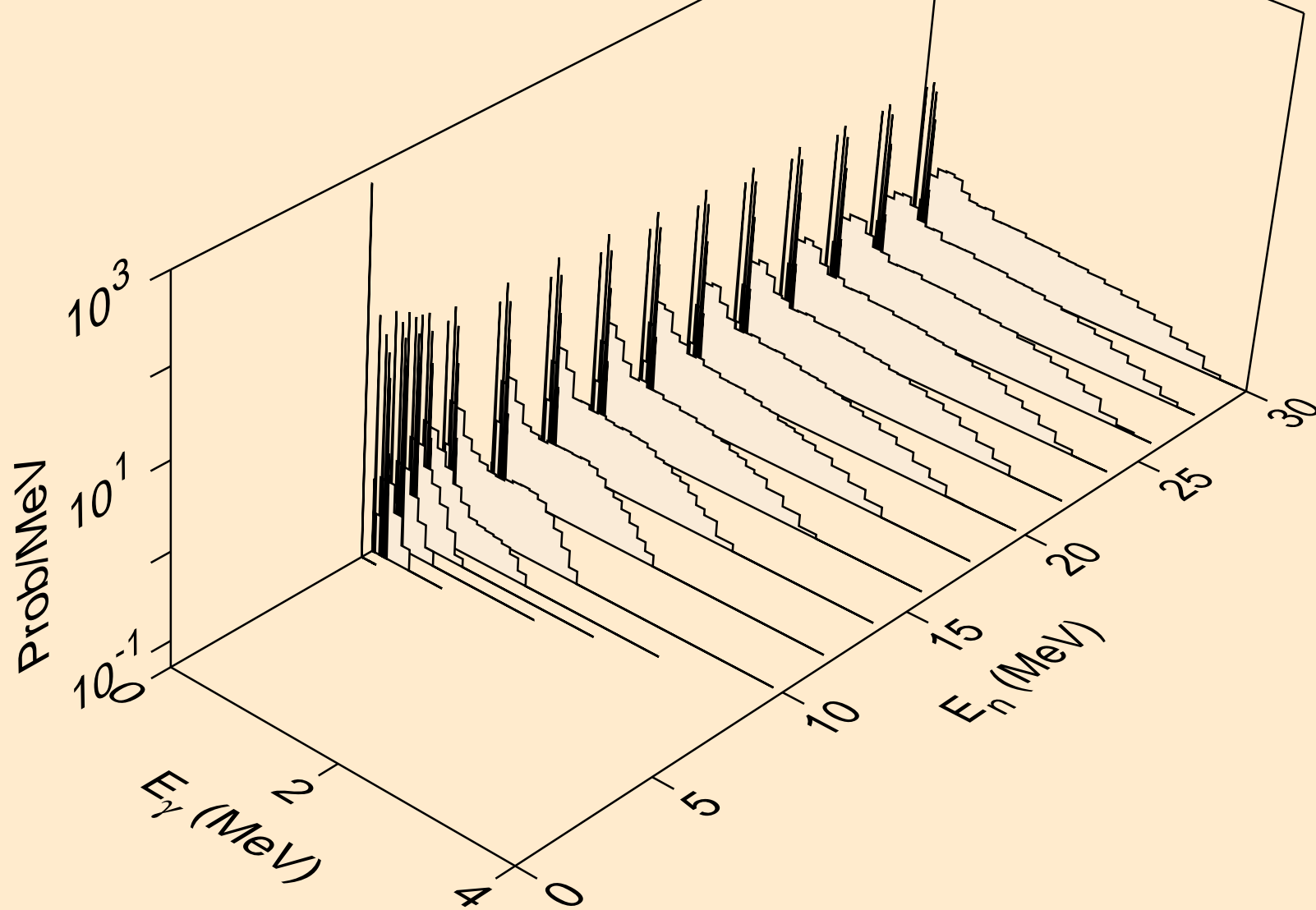

W171 NEUTRON ACER TENDL-2021 LIBRARY; T=293.6K
Photon emission for (n,he3)

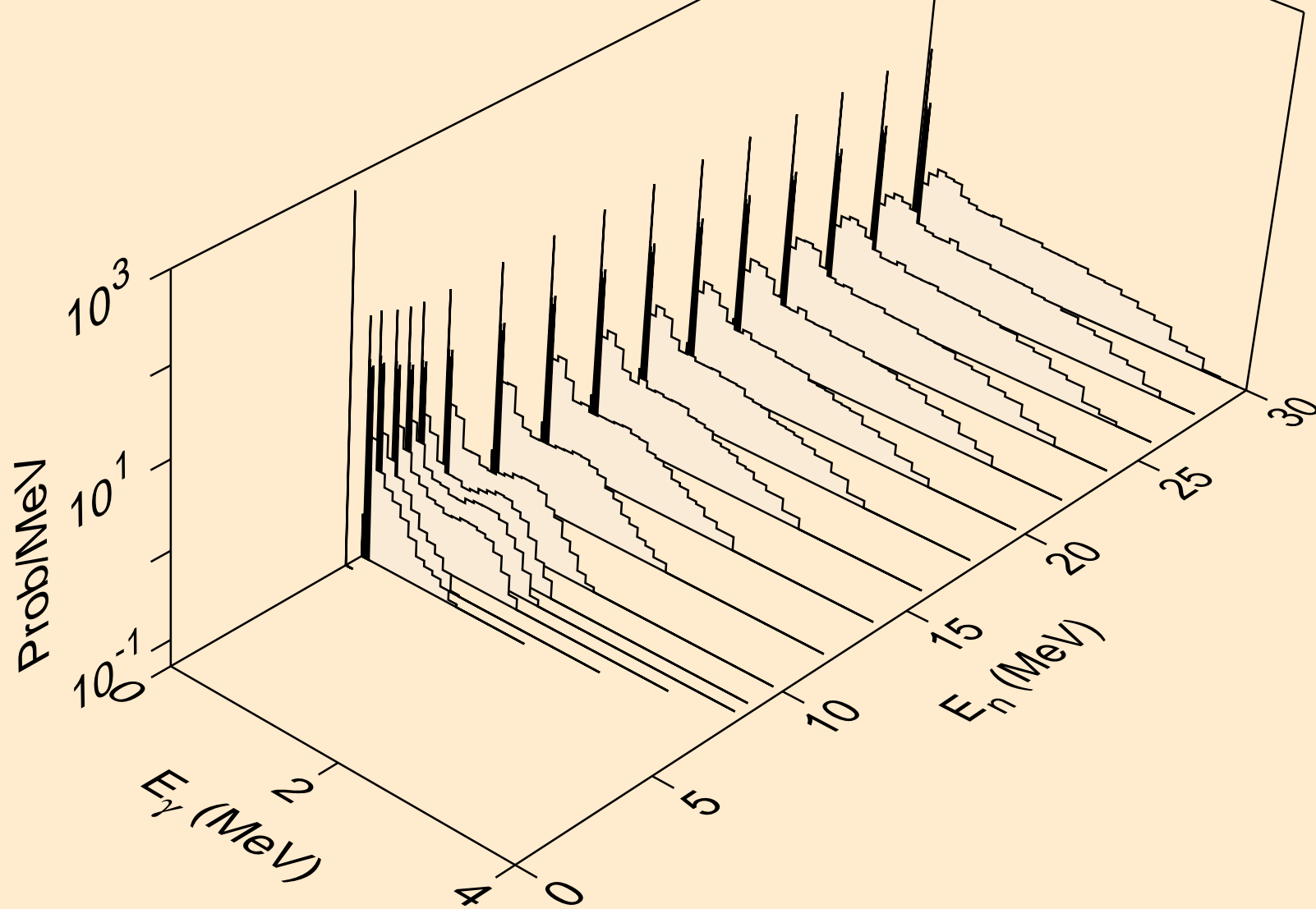

W171 NEUTRON ACER TENDL-2021 LIBRARY; T=293.6K
Photon emission for (n,a)

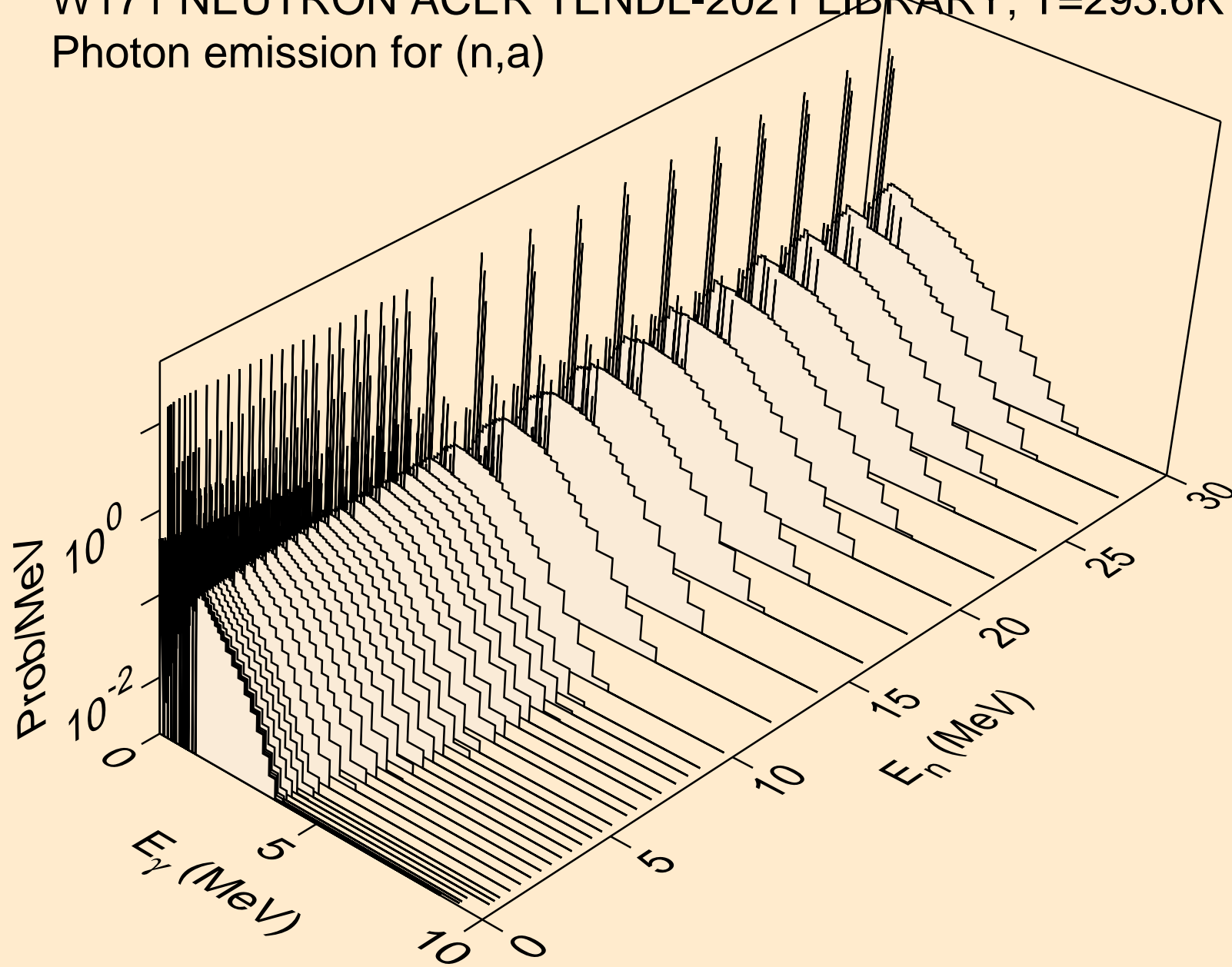

W171 NEUTRON ACER TENDL-2021 LIBRARY; T=293.6K
Photon emission for (n,2a)

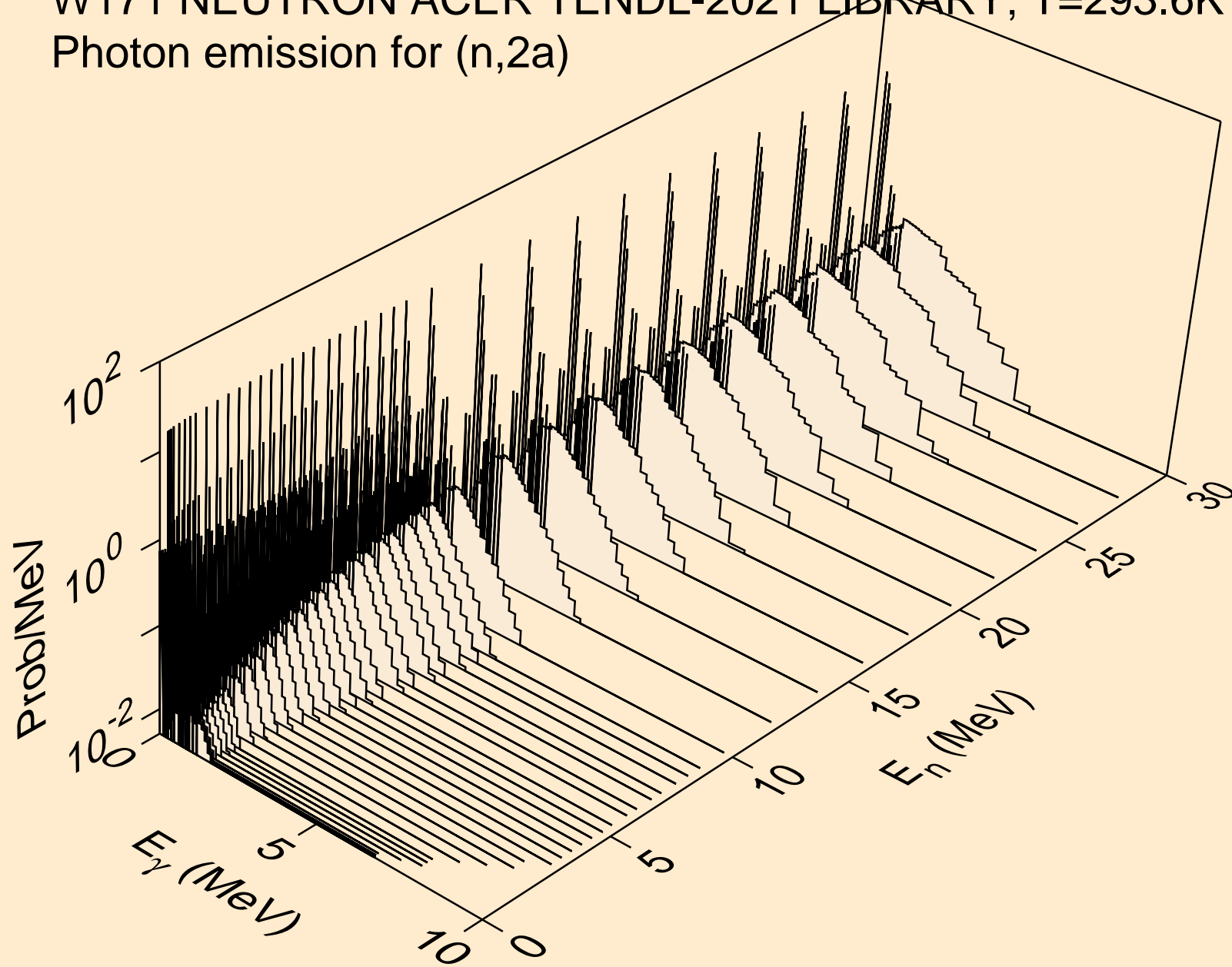

W171 NEUTRON ACER TENDL-2021 LIBRARY; T=293.6K
Photon emission for (n,2p)

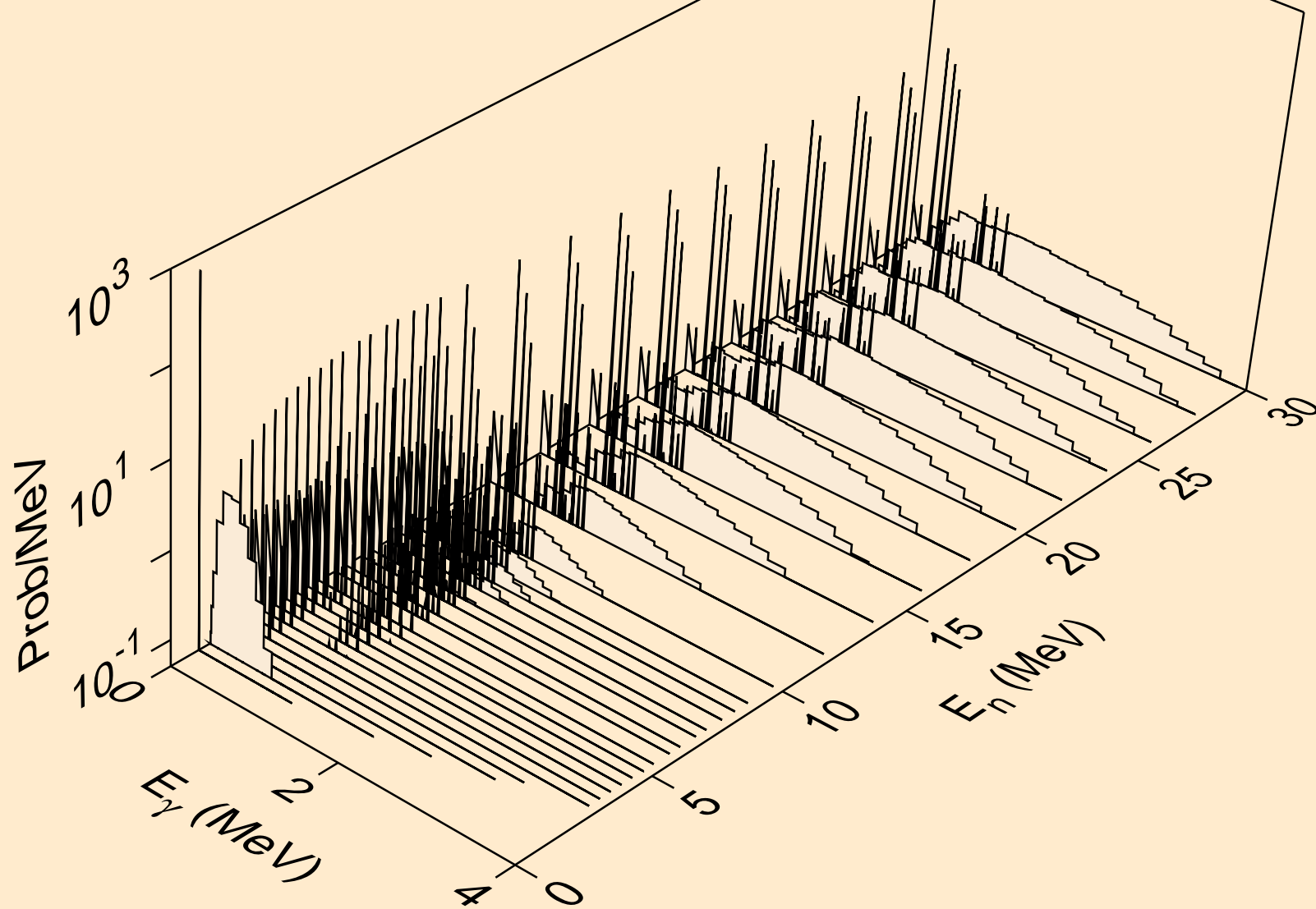

W171 NEUTRON ACER TENDL-2021 LIBRARY; T=293.6K
Photon emission for (n,p α)

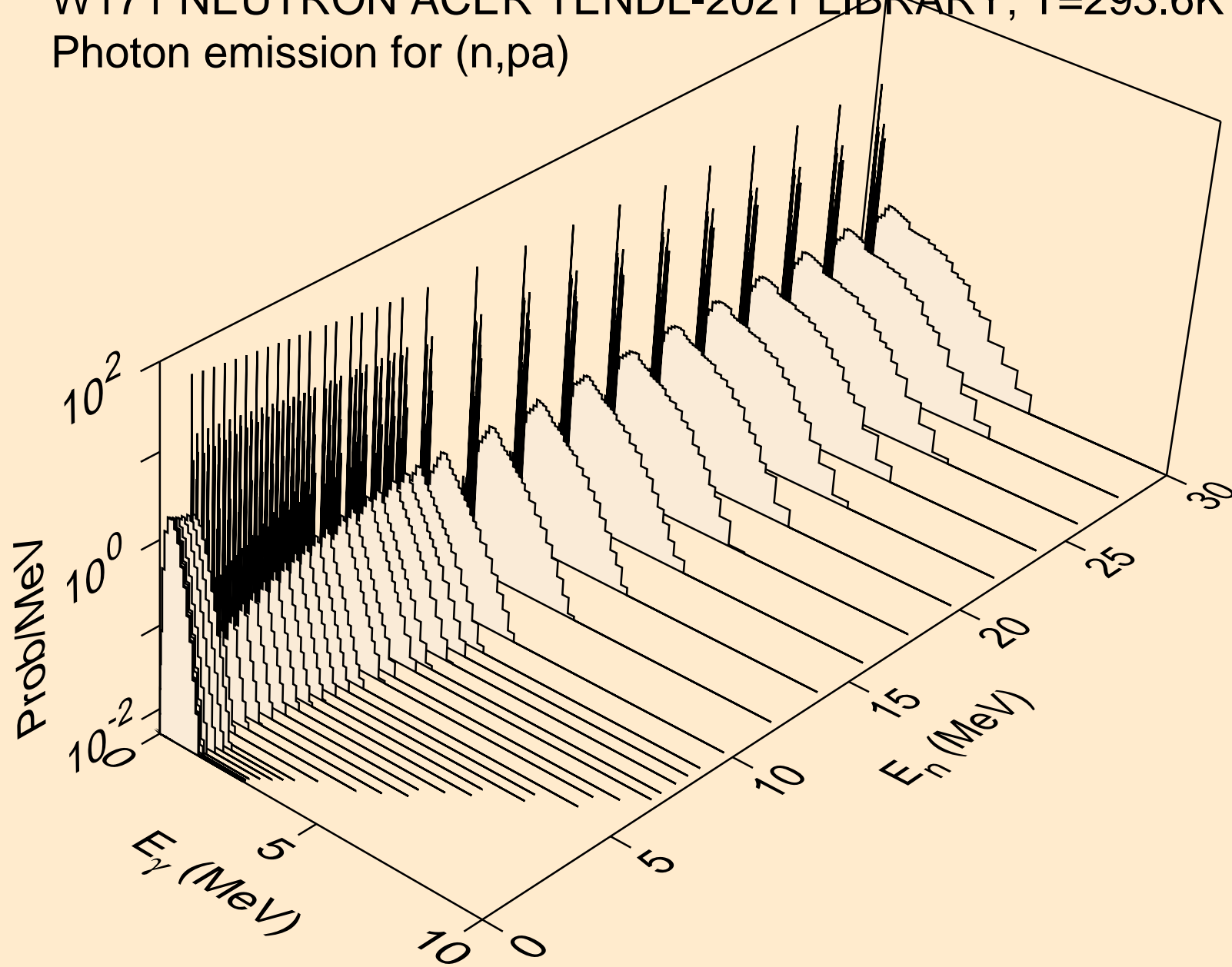

W171 NEUTRON ACER TENDL-2021 LIBRARY; T=293.6K
Photon emission for (n,pd)

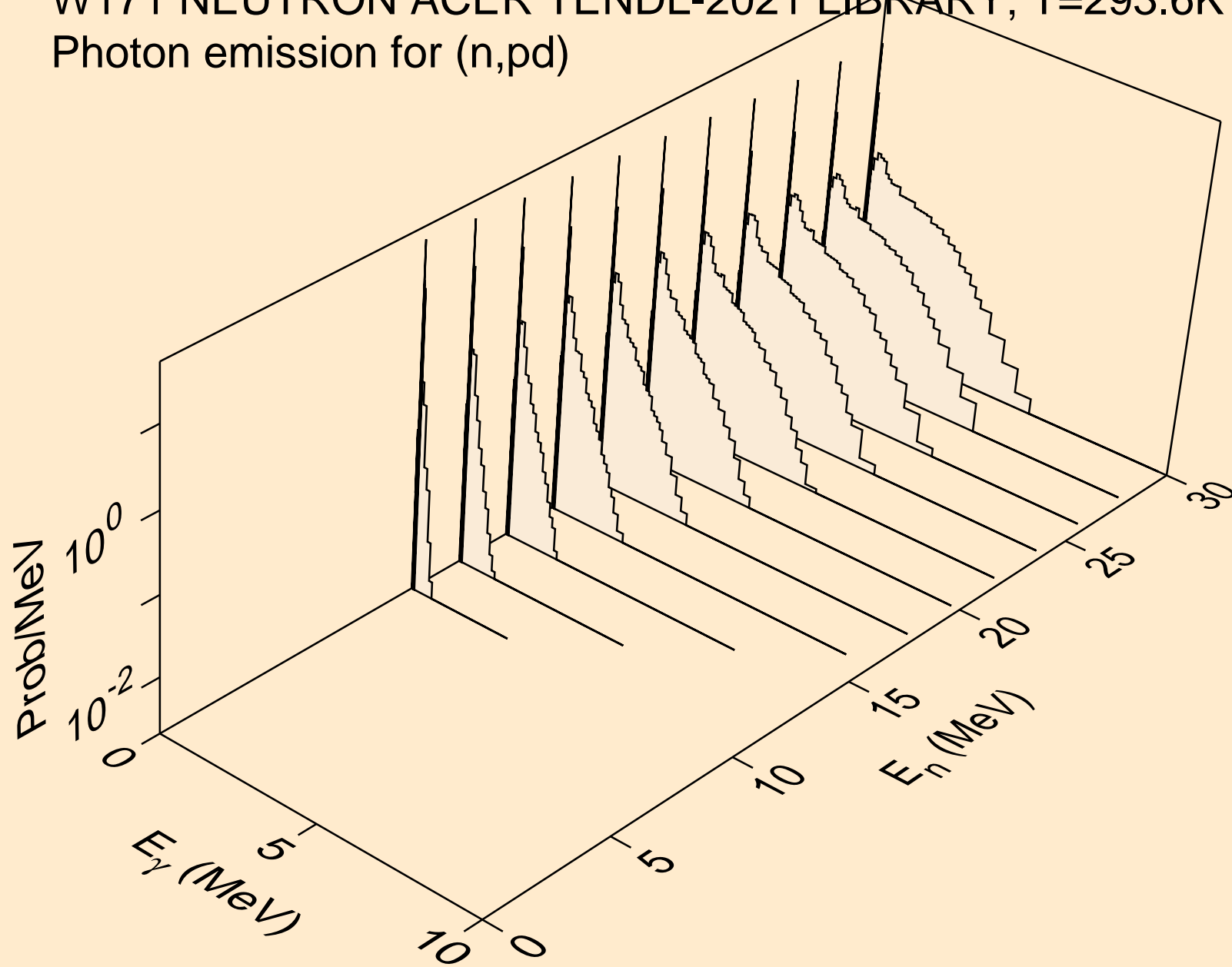

W171 NEUTRON ACER TENDL-2021 LIBRARY; T=293.6K
Photon emission for (n,pt)

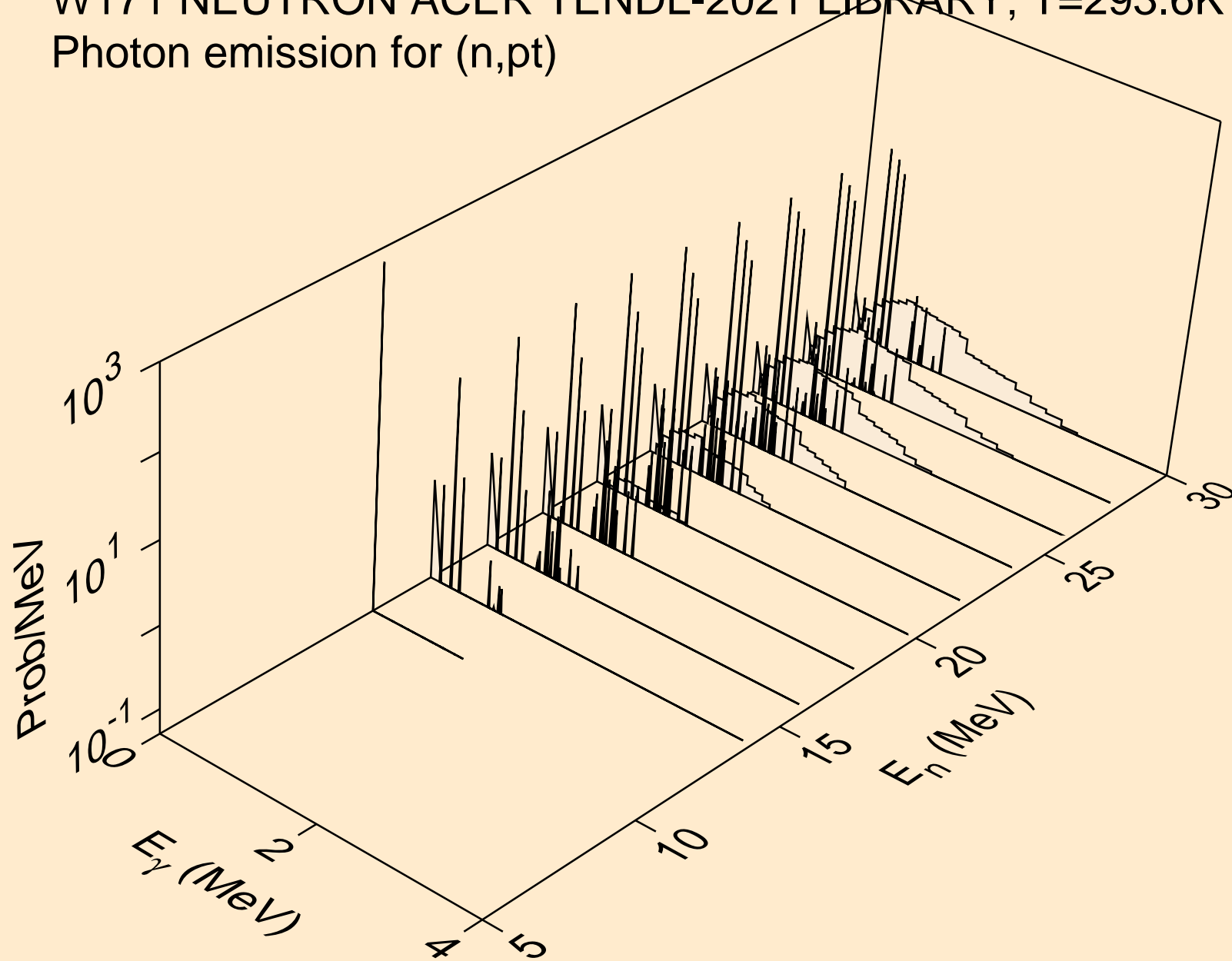

W171 NEUTRON ACER TENDL-2021 LIBRARY; T=293.6K
Photon emission for (n,da)

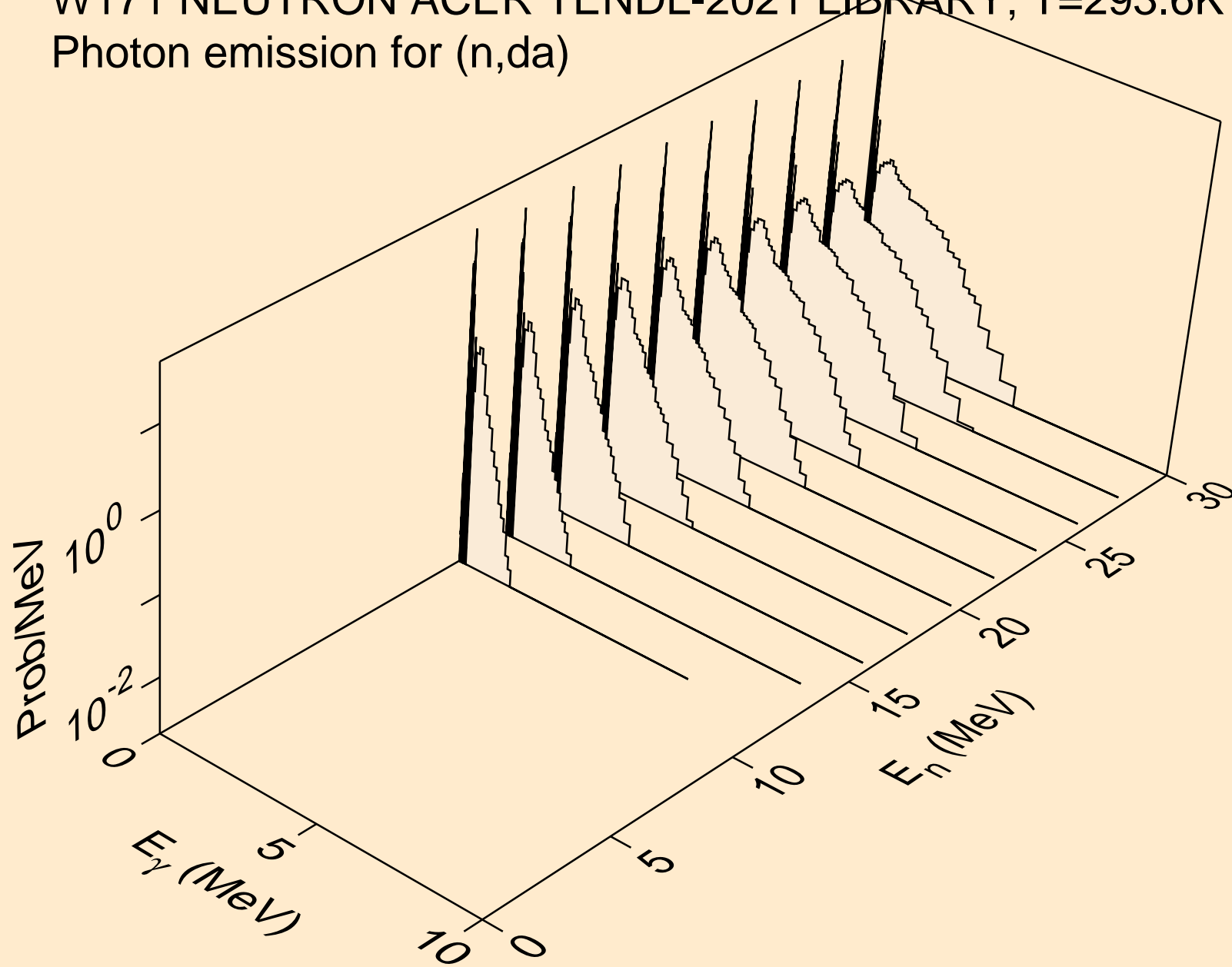

W171 NEUTRON ACER TENDL-2021 LIBRARY; T=293.6K
thermal capture photon spectrum

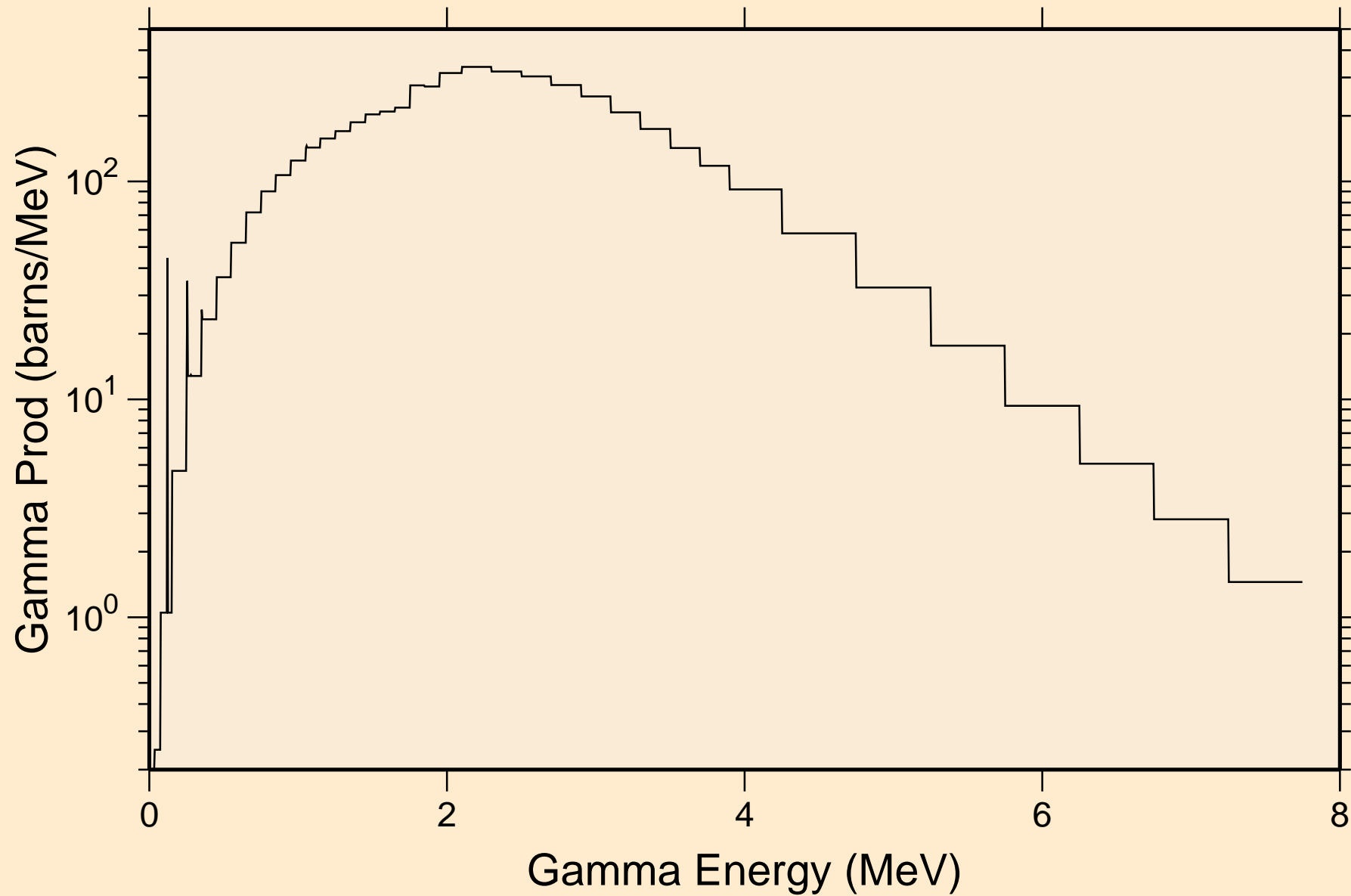

W171 NEUTRON ACER TENDL-2021 LIBRARY; T=293.6K
14 MeV photon spectrum

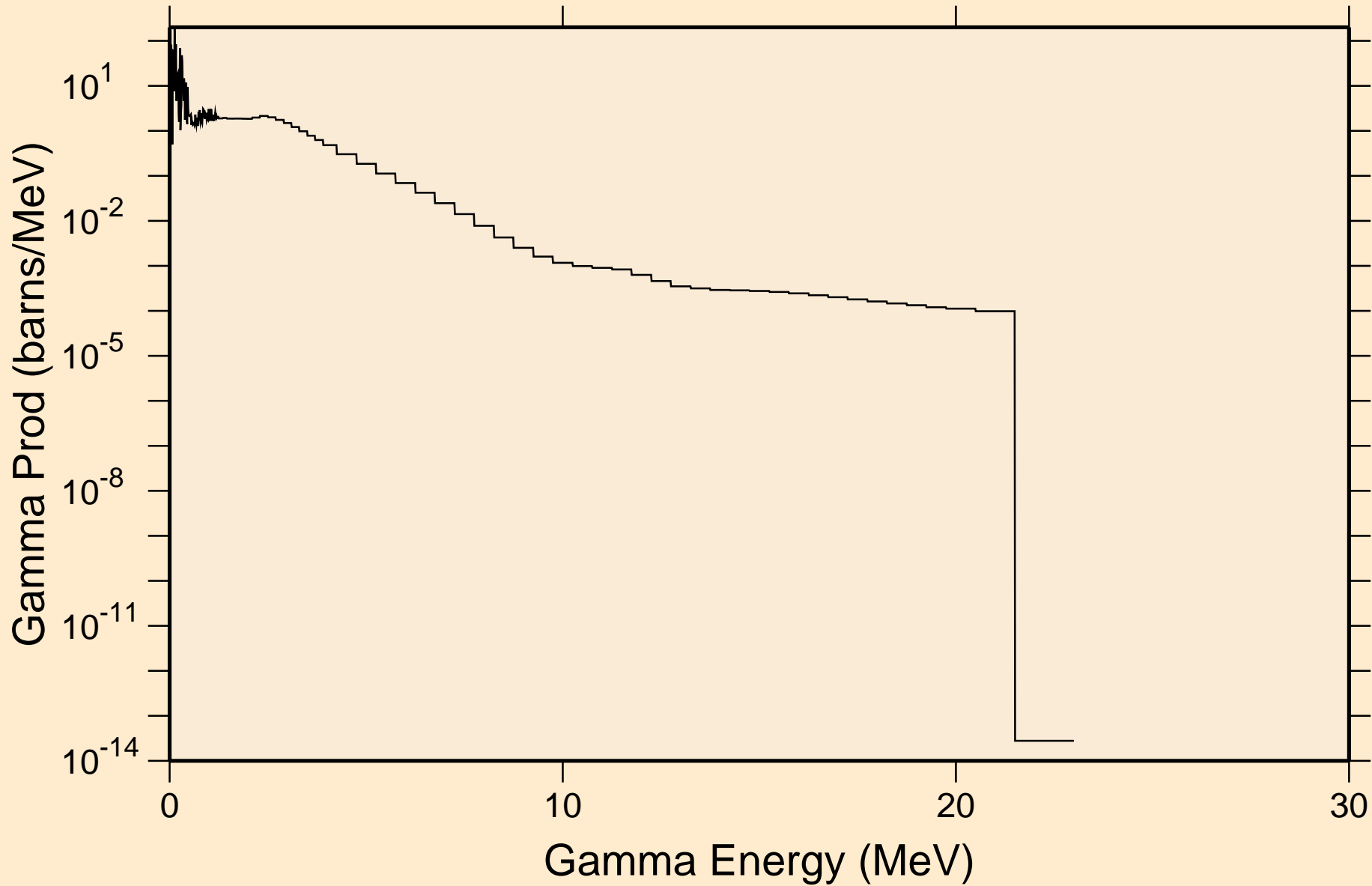

W171 NEUTRON ACER TENDL-2021 LIBRARY; T=293.6K
Particle heating contributions

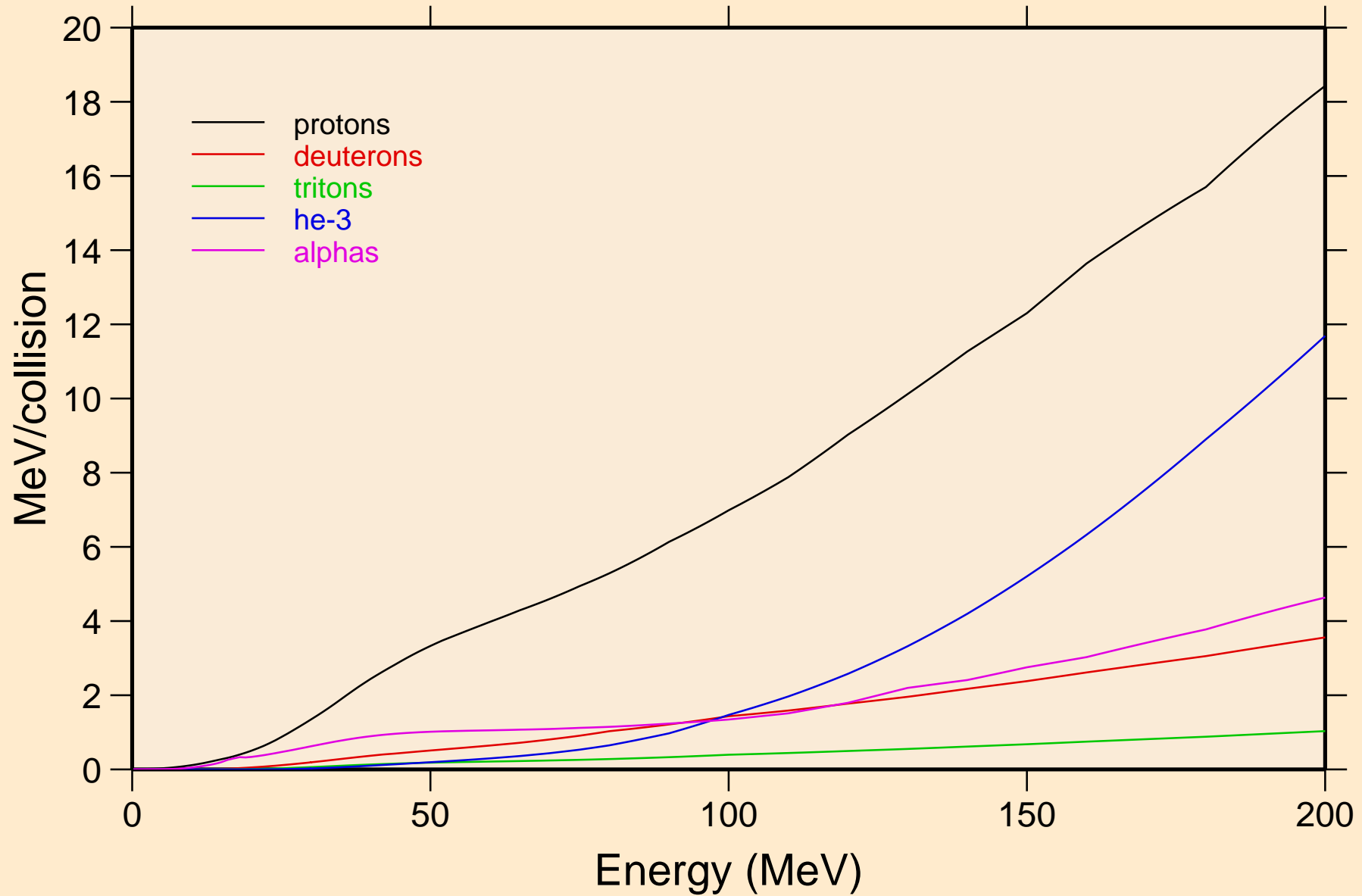

W171 NEUTRON ACER TENDL-2021 LIBRARY; T=293.6K
Recoil Heating

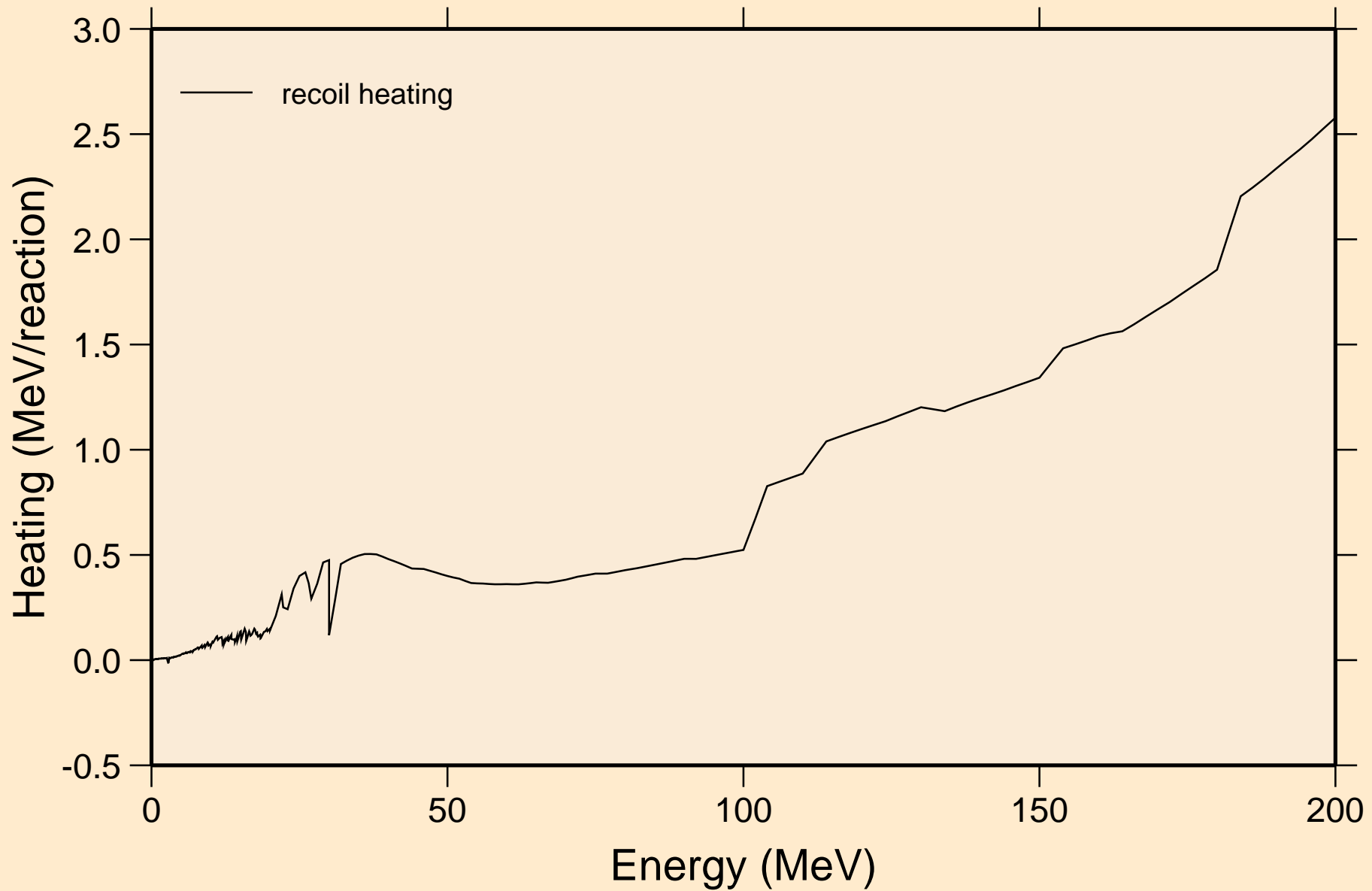

W171 NEUTRON ACER TENDL-2021 LIBRARY; T=293.6K
Particle production cross sections

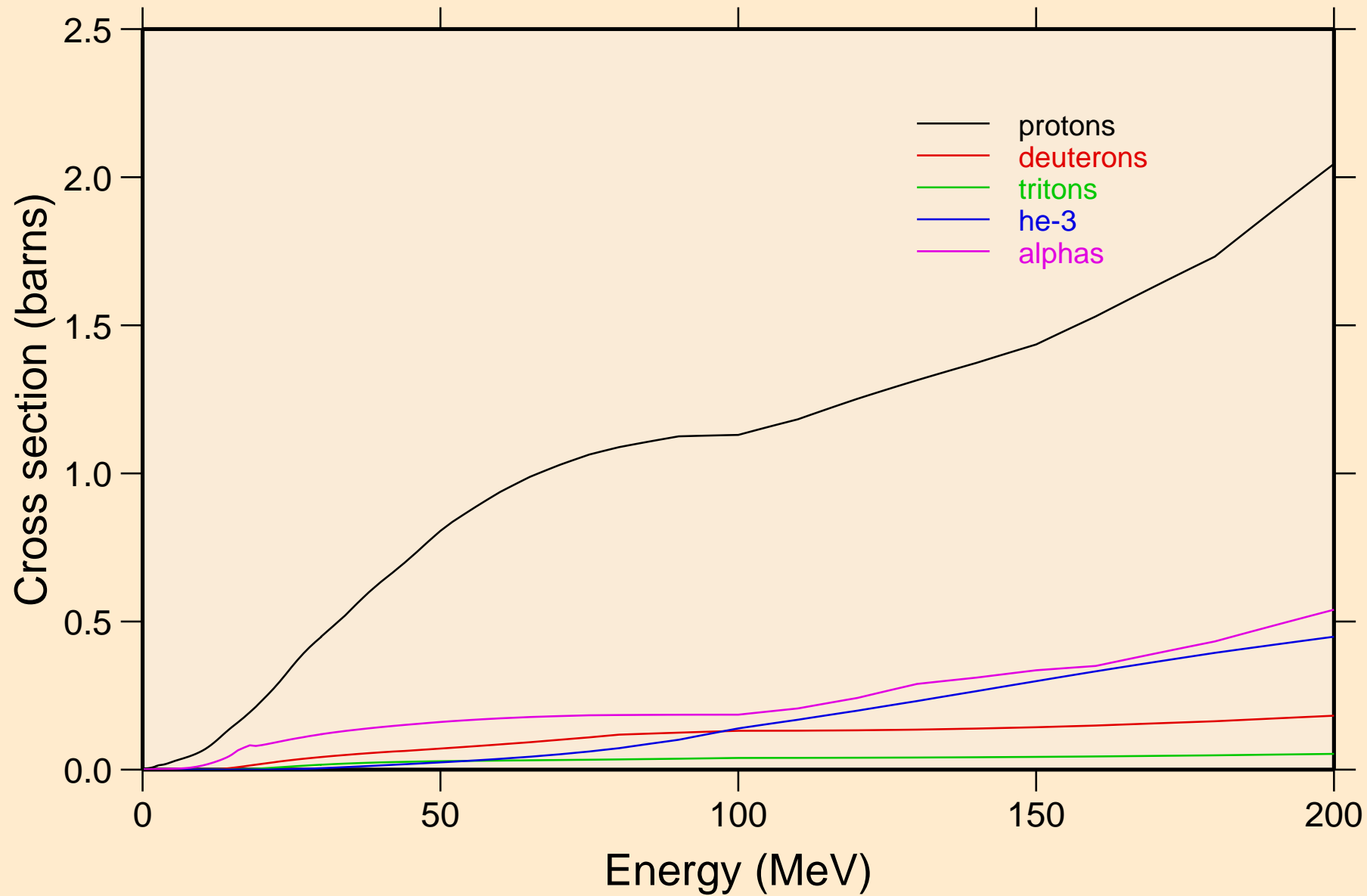

W171 NEUTRON ACER TENDL-2021 LIBRARY; T=293.6K
protons from (n,x)

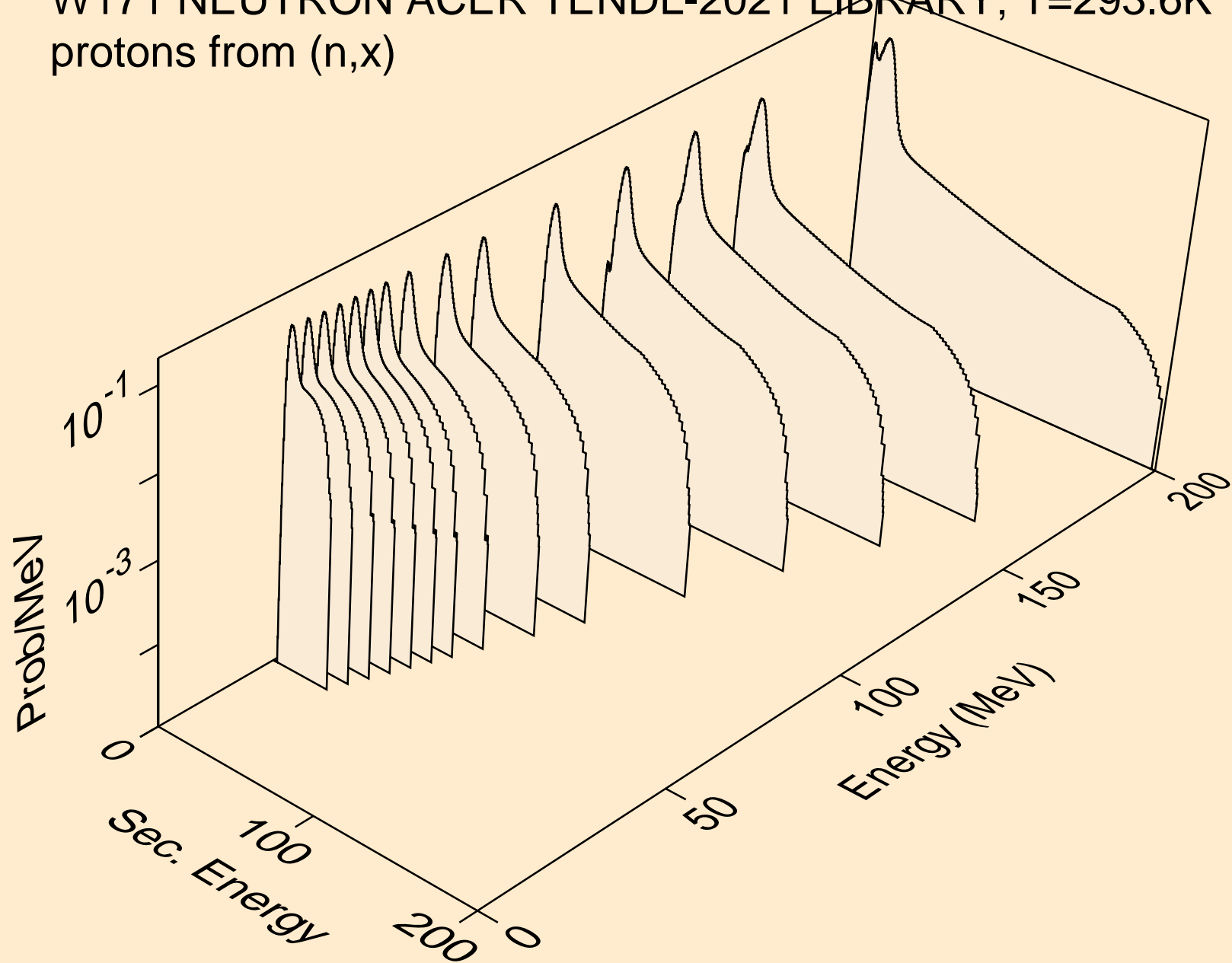

W171 NEUTRON ACER TENDL-2021 LIBRARY; T=293.6K
protons from (n,n*)p

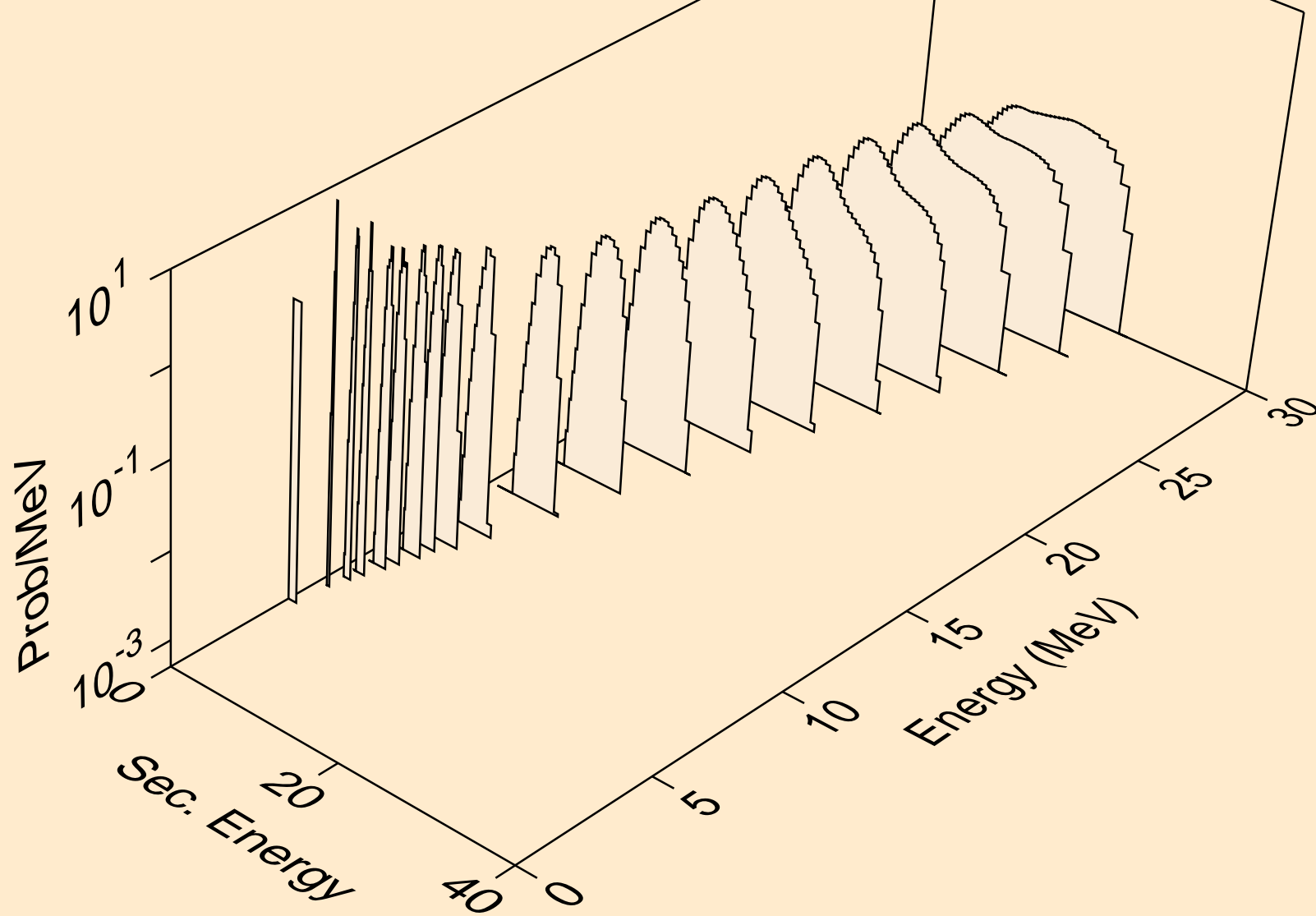

W171 NEUTRON ACER TENDL-2021 LIBRARY; T=293.6K
protons from (n,2np)

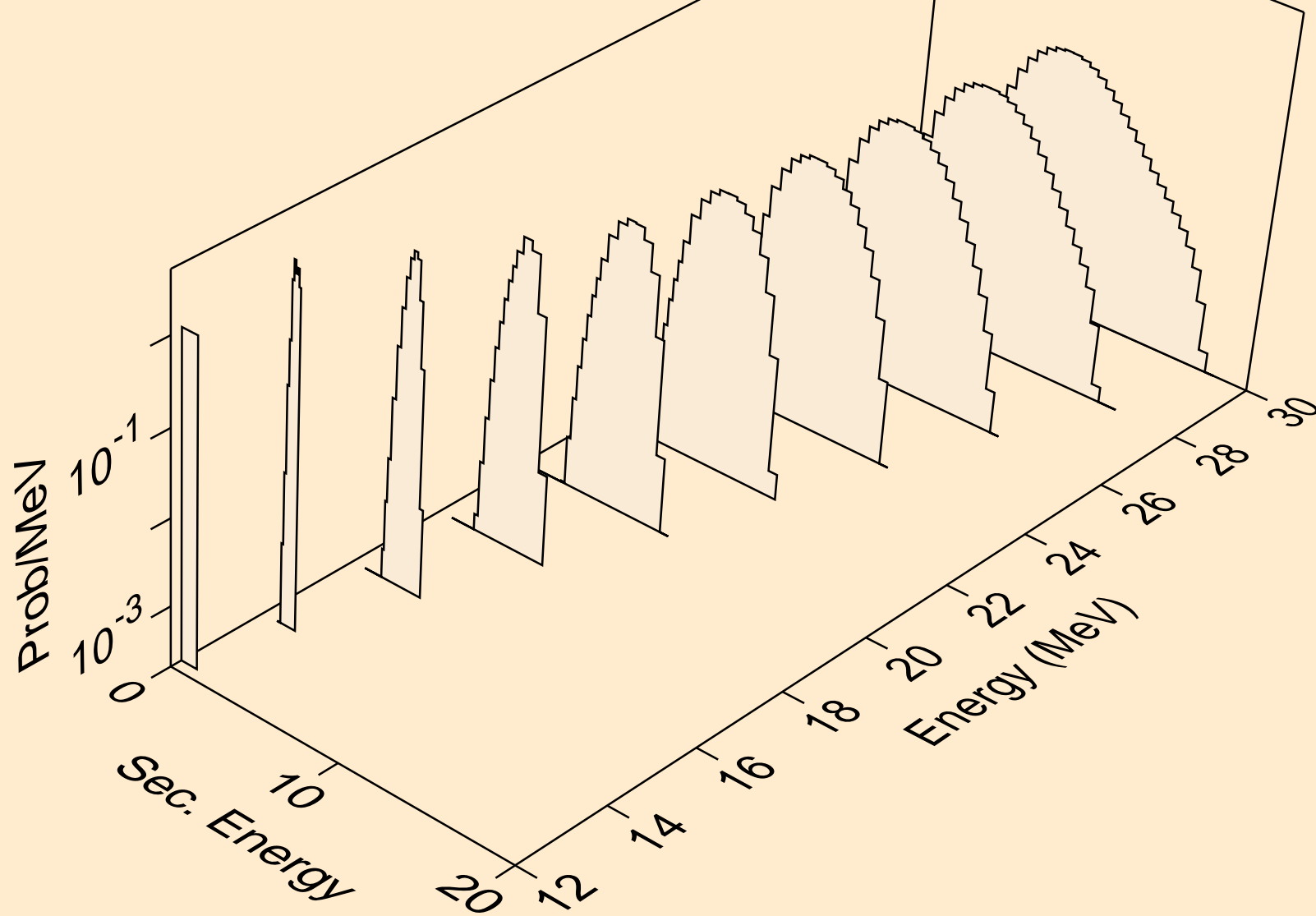

W171 NEUTRON ACER TENDL-2021 LIBRARY; T=293.6K
protons from (n,3np)

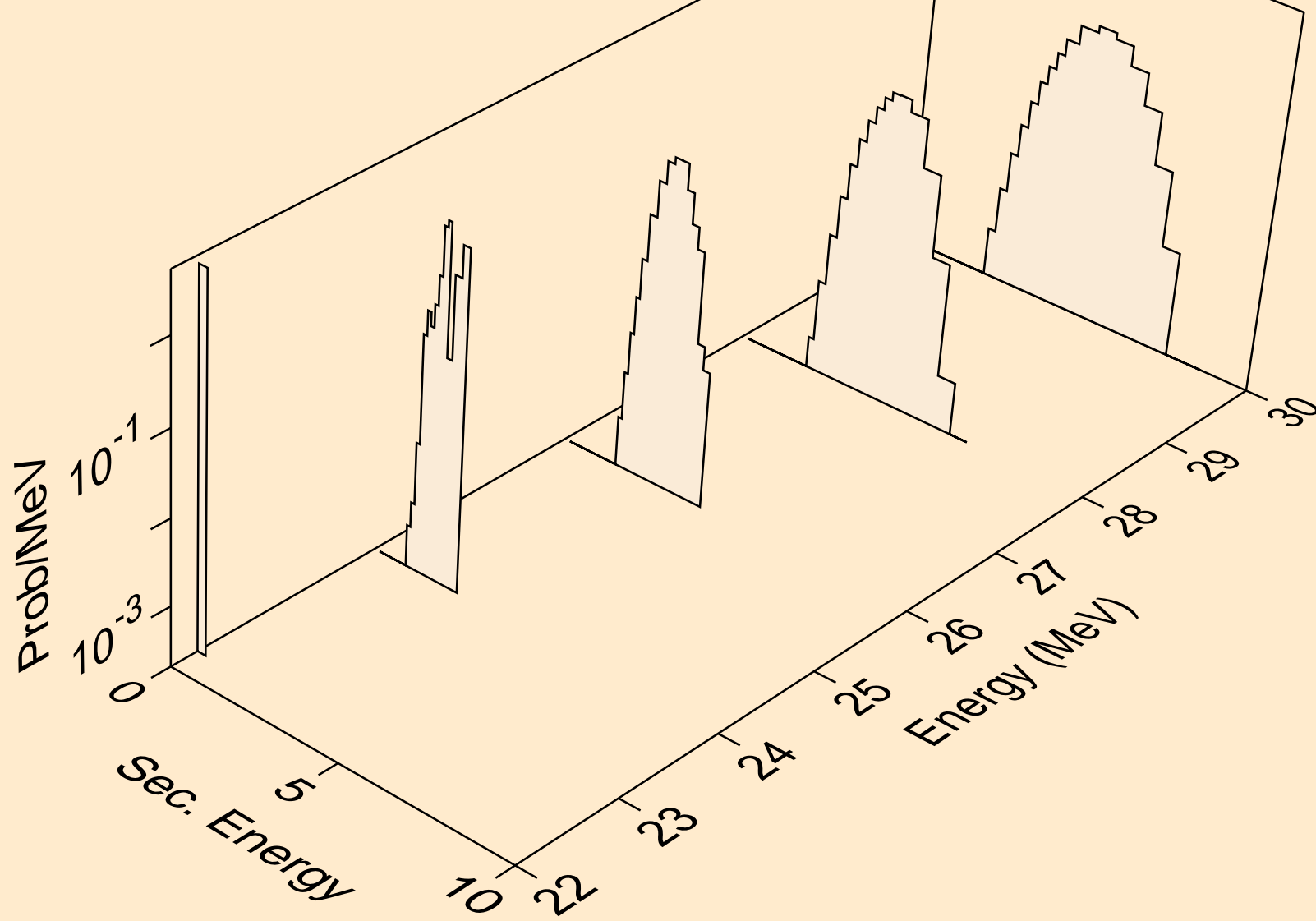

W171 NEUTRON ACER TENDL-2021 LIBRARY; T=293.6K
protons from (n,2np)

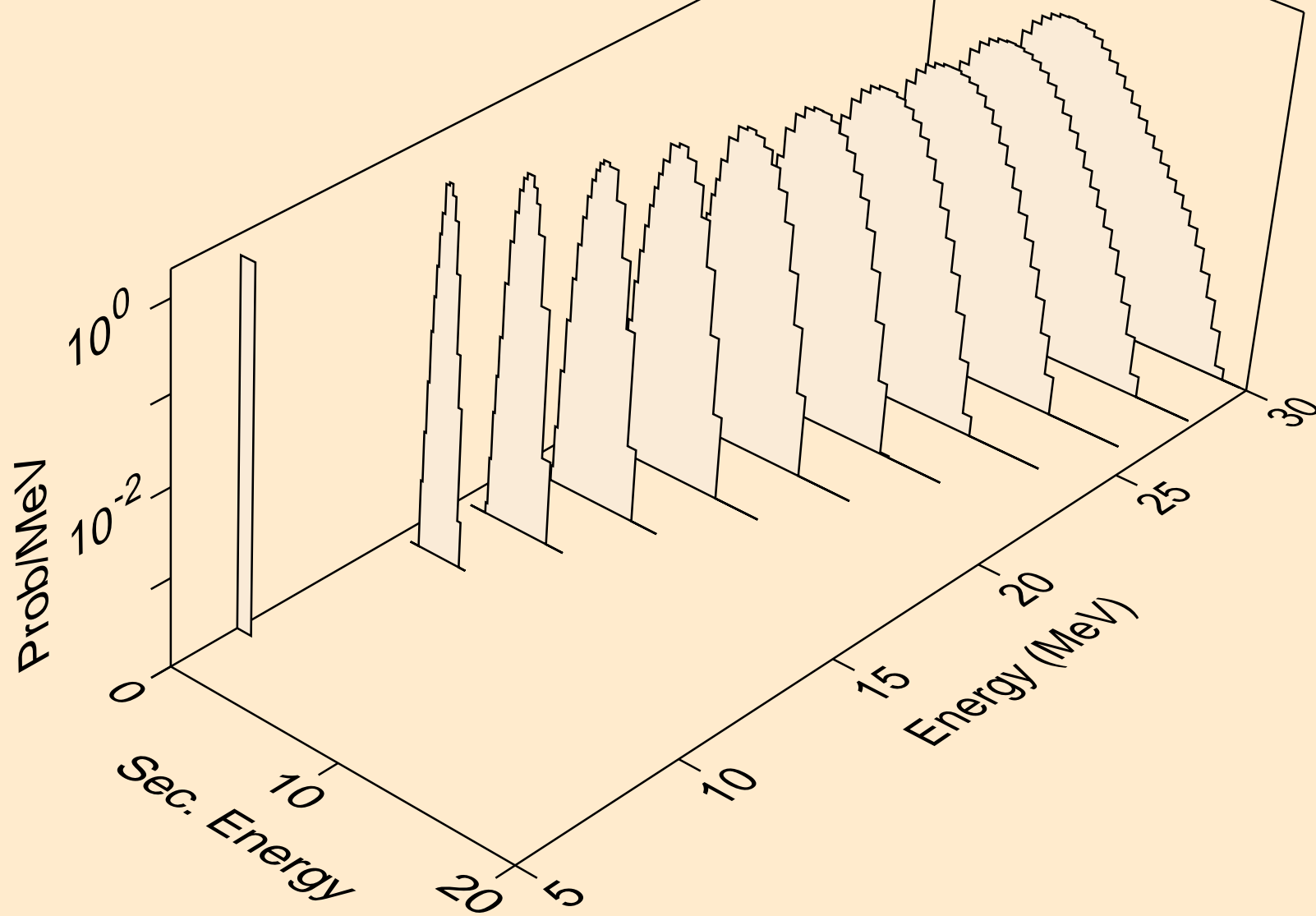

W171 NEUTRON ACER TENDL-2021 LIBRARY; T=293.6K
protons from (n,npa)

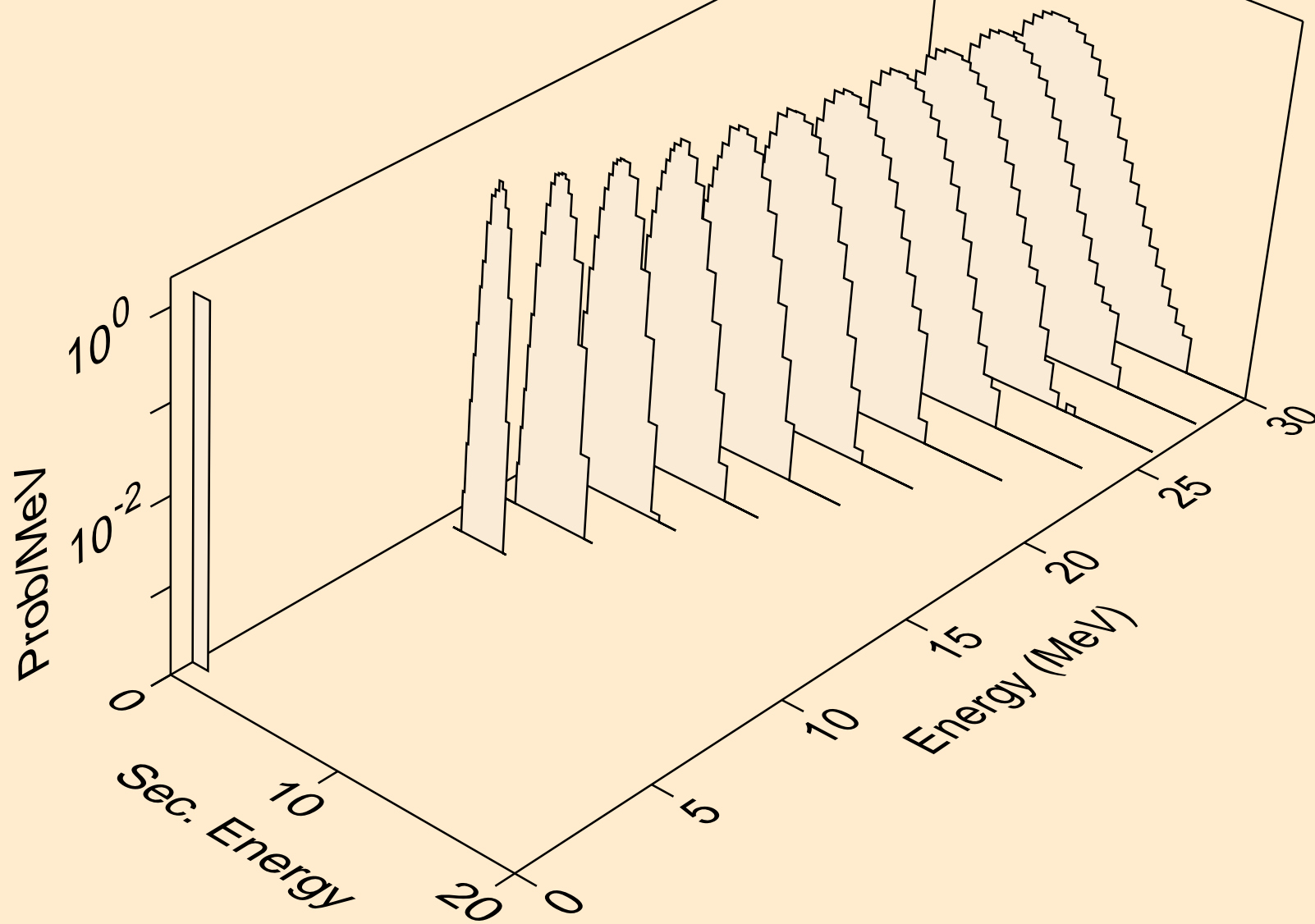

W171 NEUTRON ACER TENDL-2021 LIBRARY; T=293.6K
protons from (n,p)

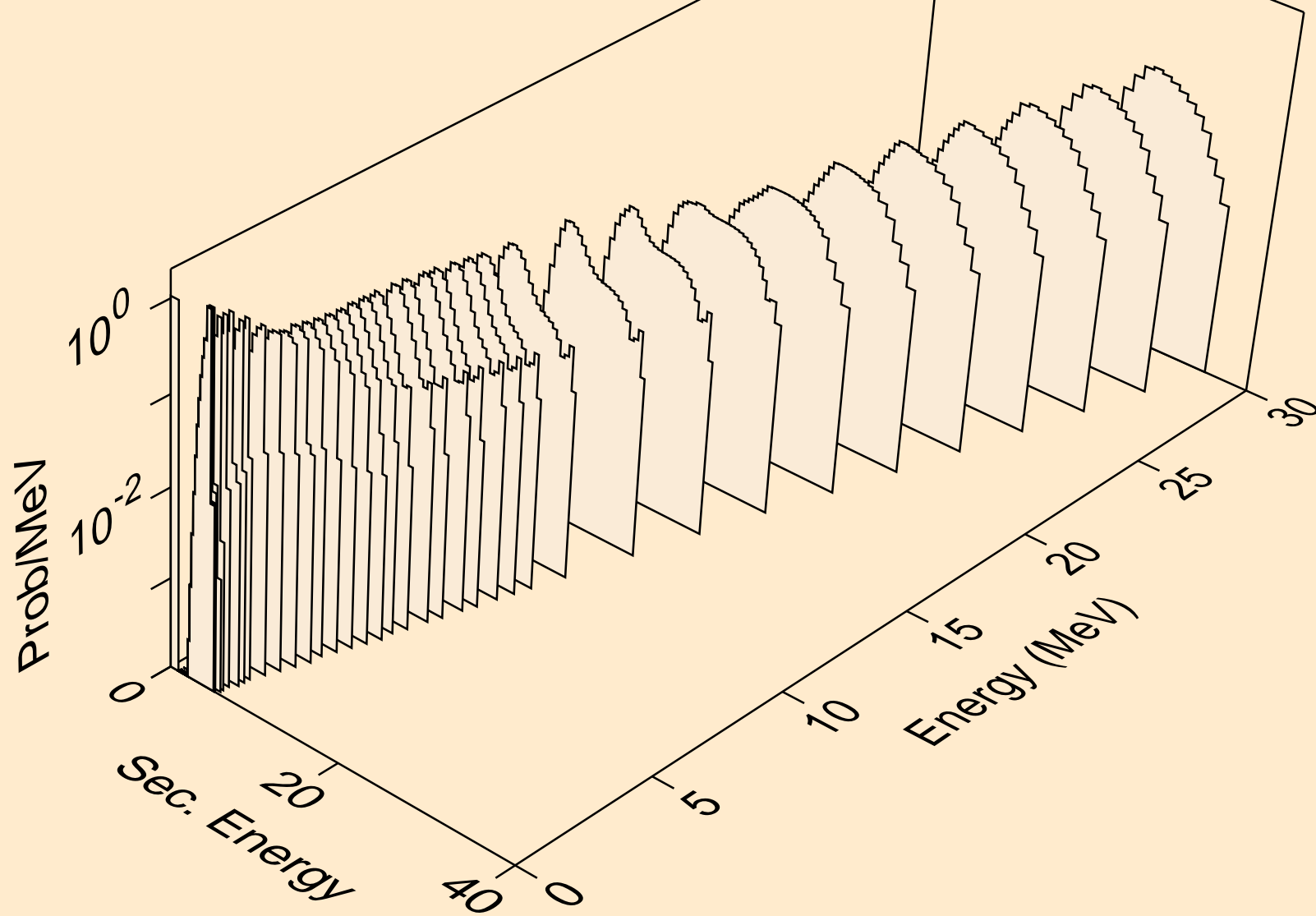

W171 NEUTRON ACER TENDL-2021 LIBRARY; T=293.6K
protons from (n,2p)

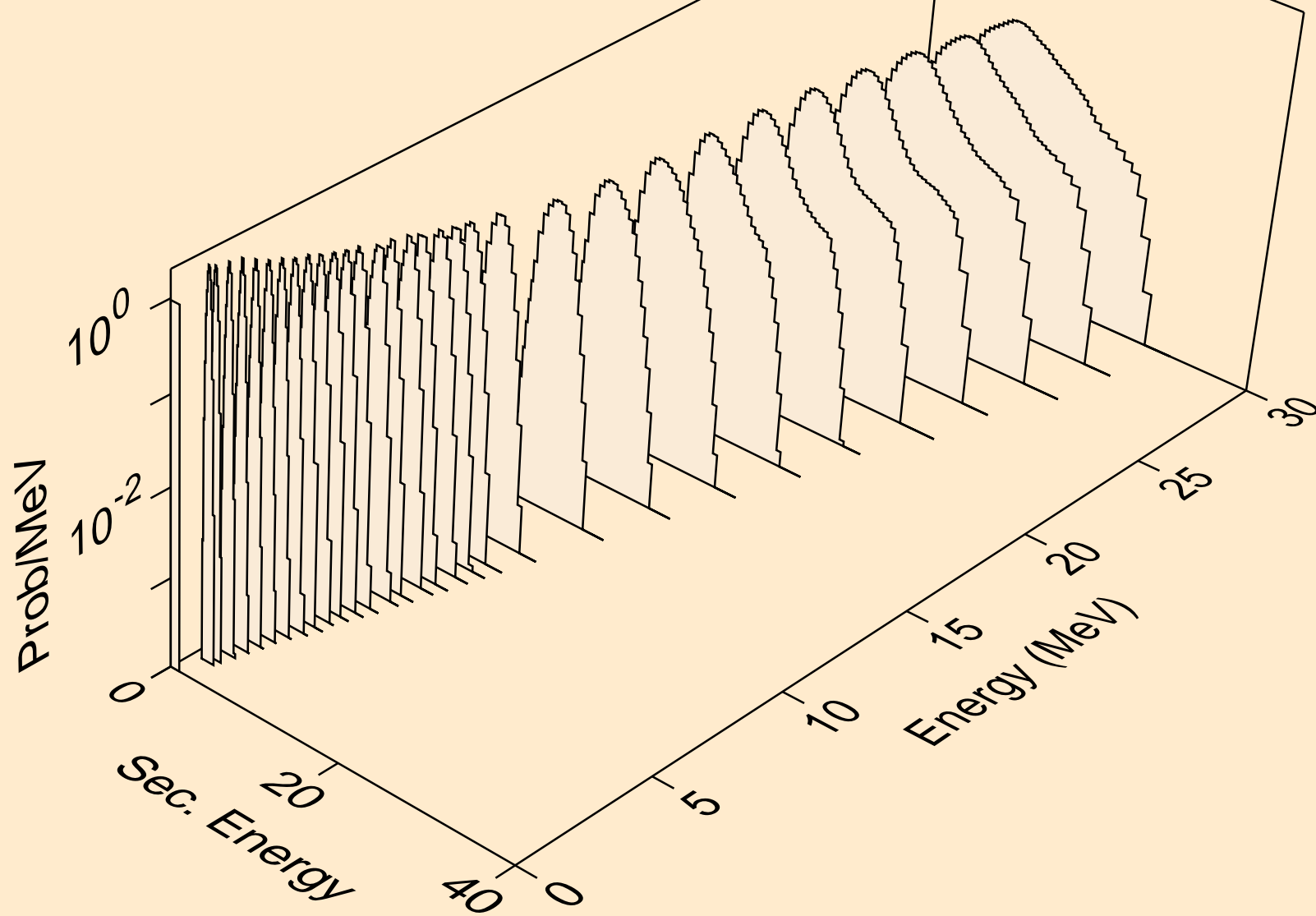

W171 NEUTRON ACER TENDL-2021 LIBRARY; T=293.6K
protons from (n,p)

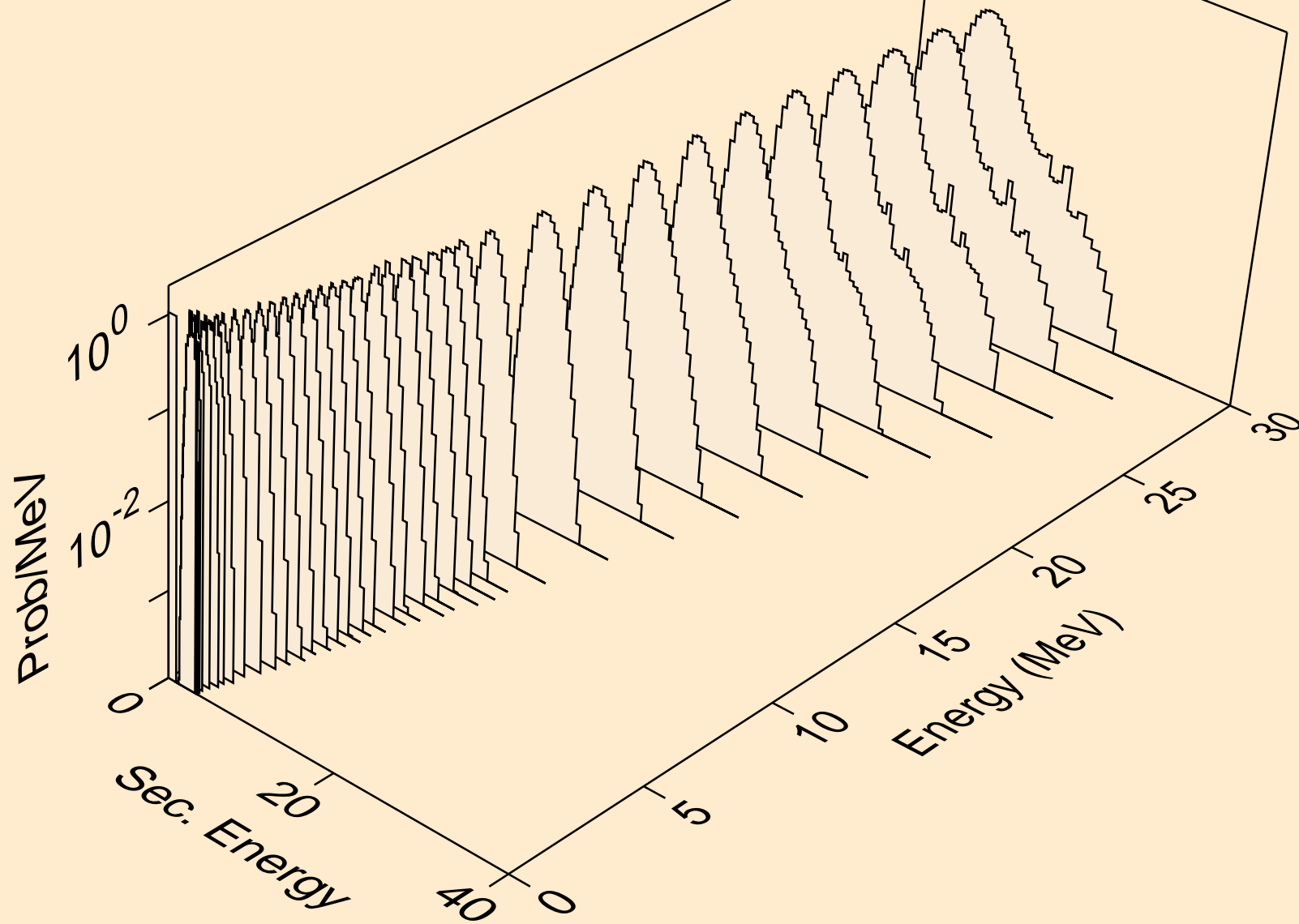

W171 NEUTRON ACER TENDL-2021 LIBRARY; T=293.6K
protons from (n,pd)

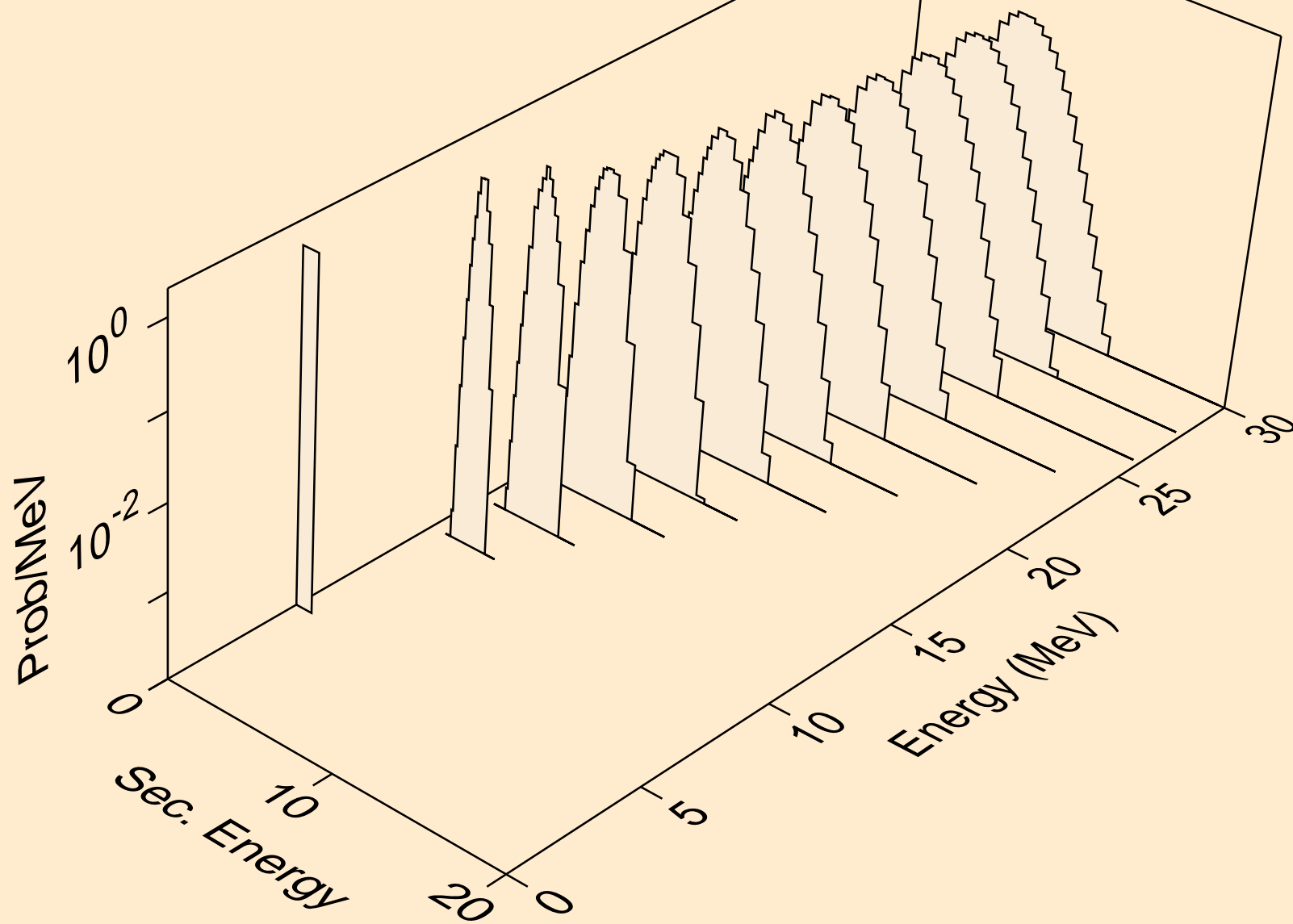

W171 NEUTRON ACER TENDL-2021 LIBRARY; T=293.6K
protons from (n,pt)

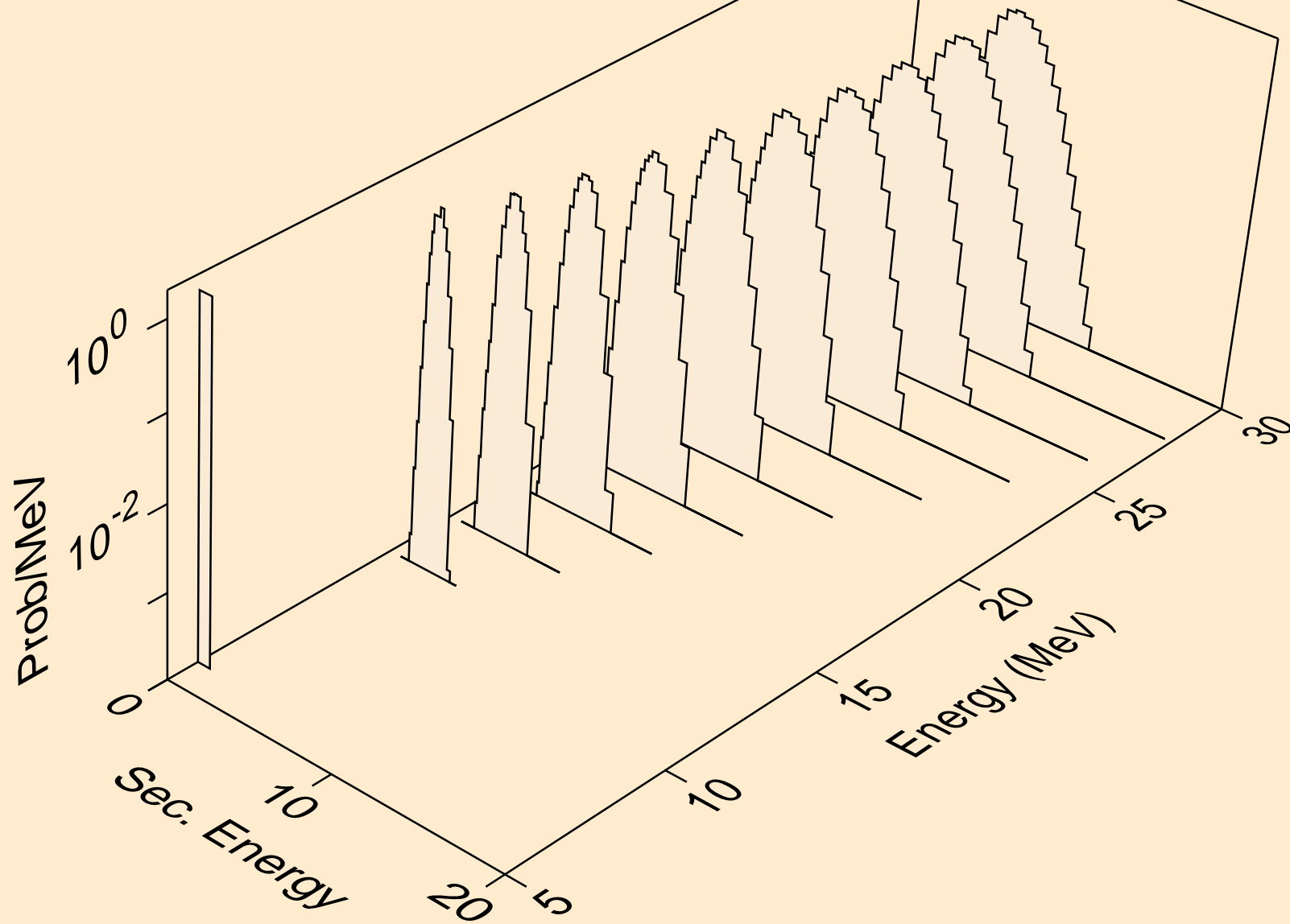

W171 NEUTRON ACER TENDL-2021 LIBRARY; T=293.6K
deuterons from (n,x)

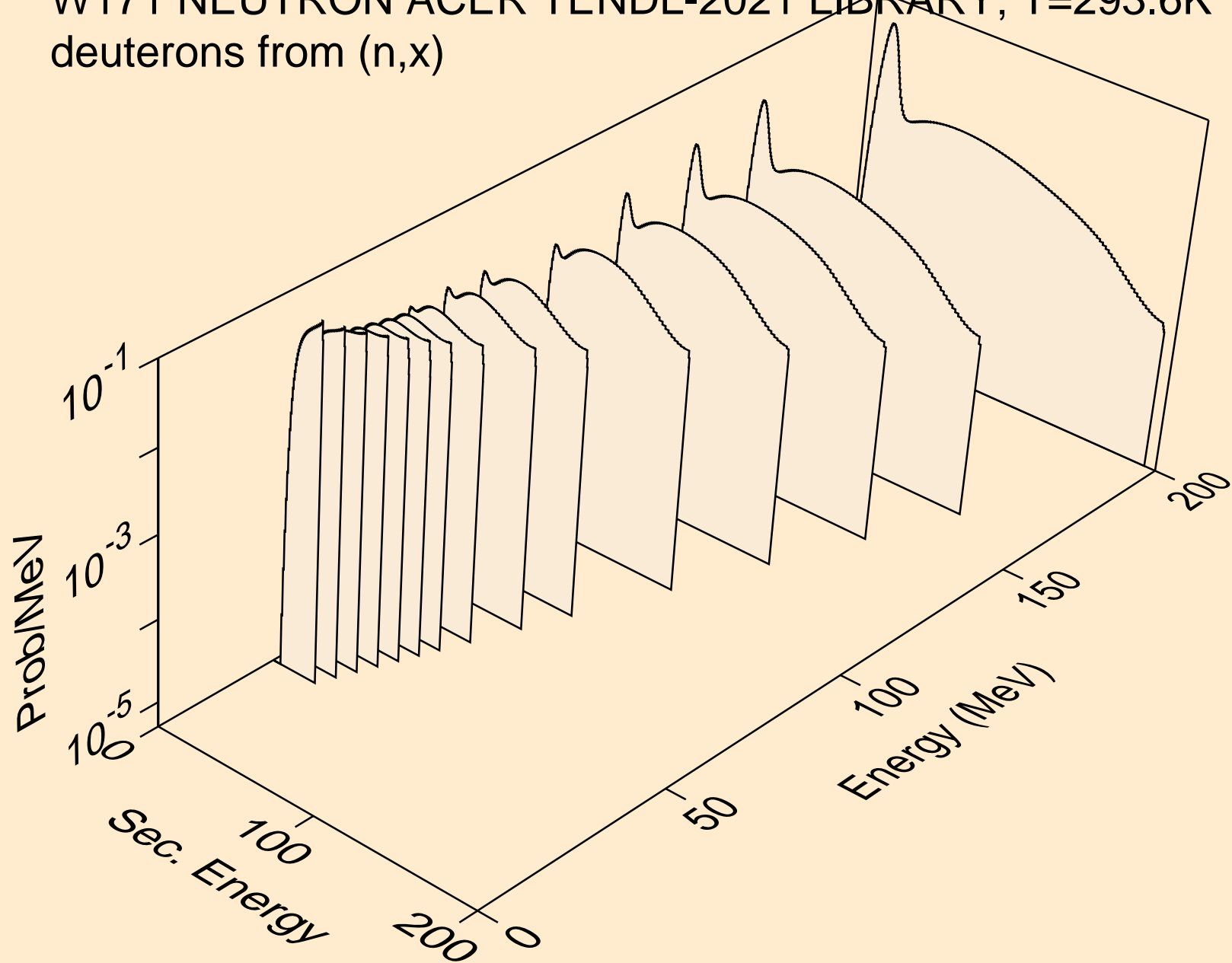

W171 NEUTRON ACER TENDL-2021 LIBRARY; T=293.6K
deuterons from (n,2nd)

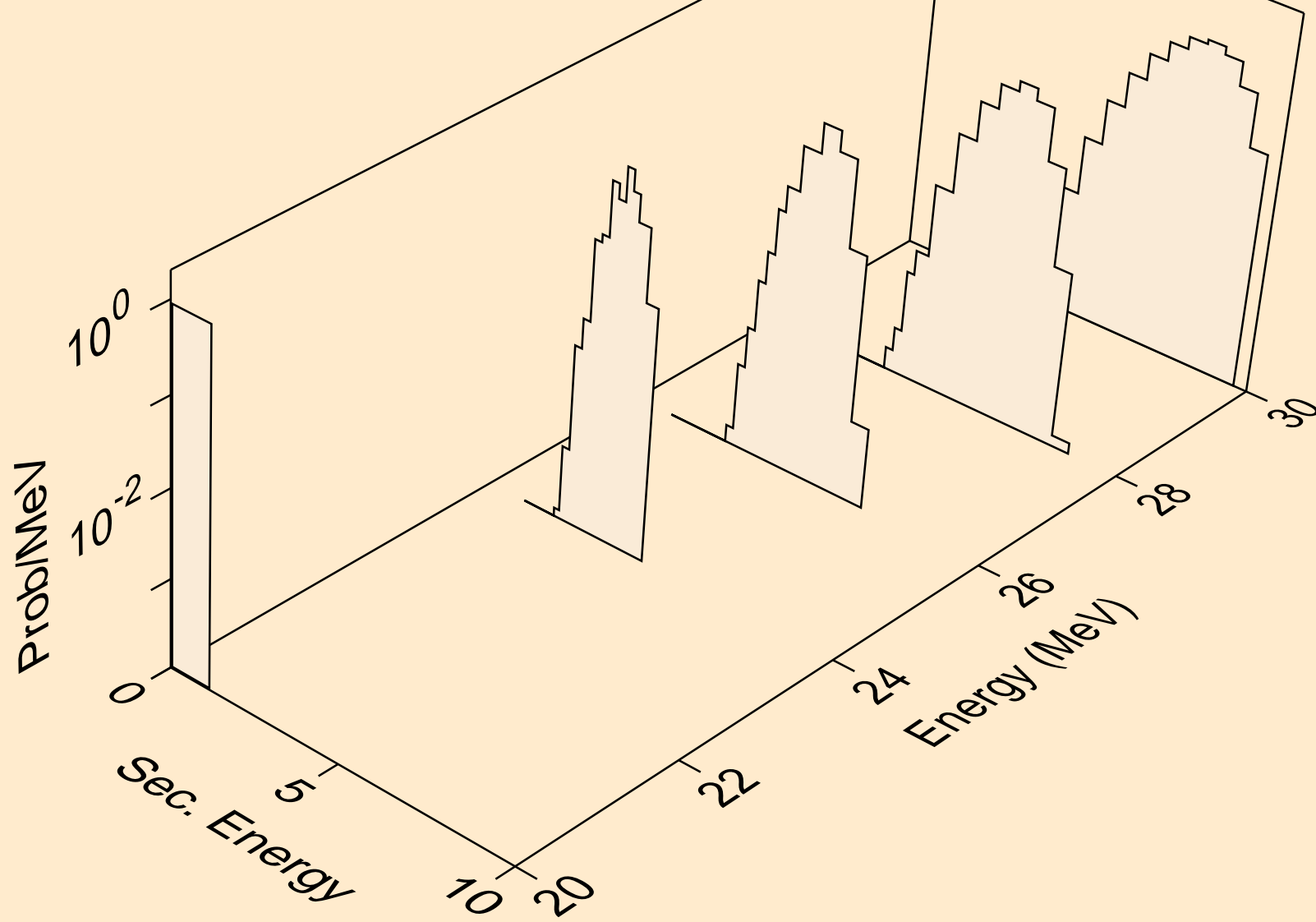

W171 NEUTRON ACER TENDL-2021 LIBRARY; T=293.6K
deuterons from (n,n*)d

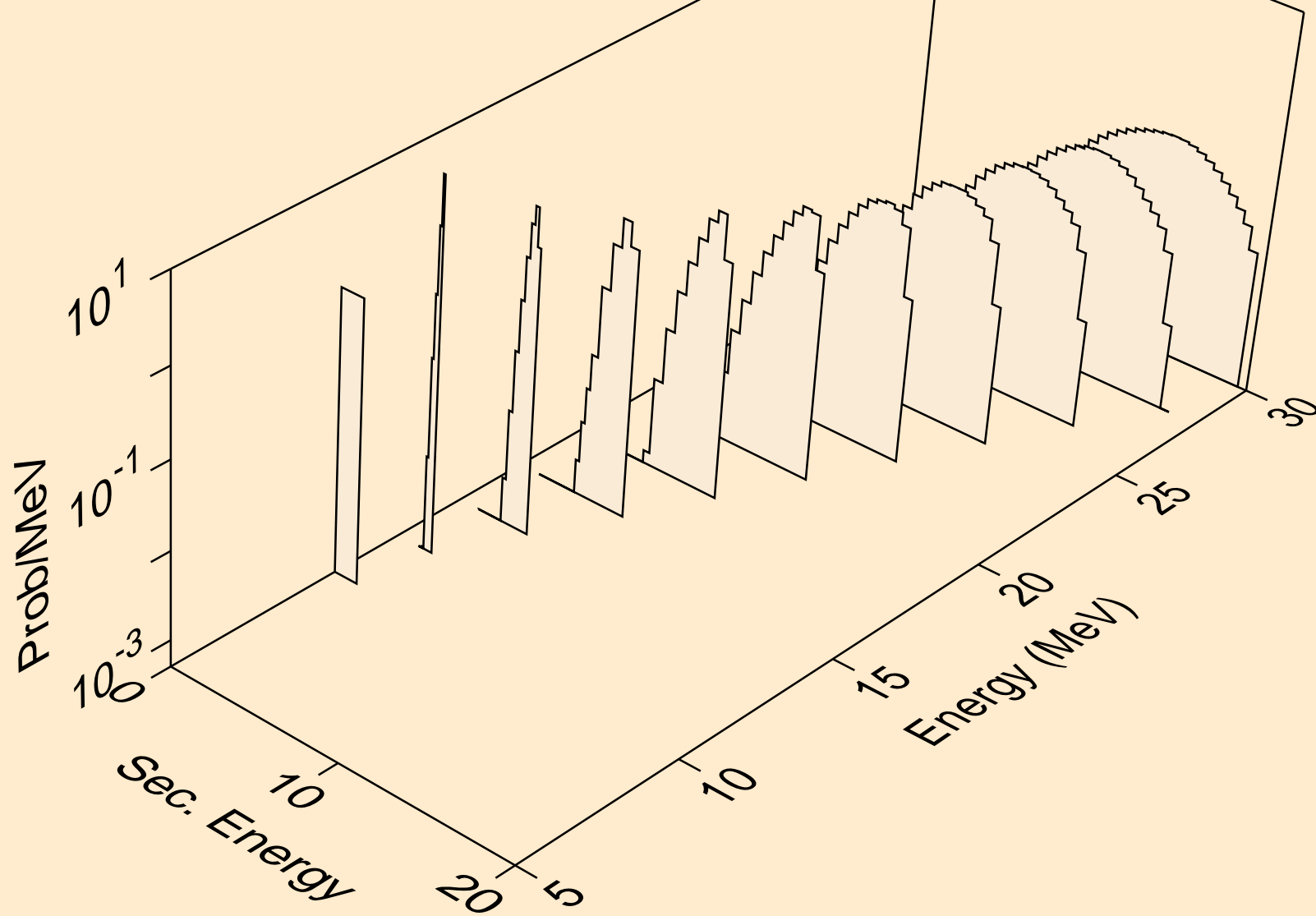

W171 NEUTRON ACER TENDL-2021 LIBRARY; T=293.6K
deuterons from (n,d)

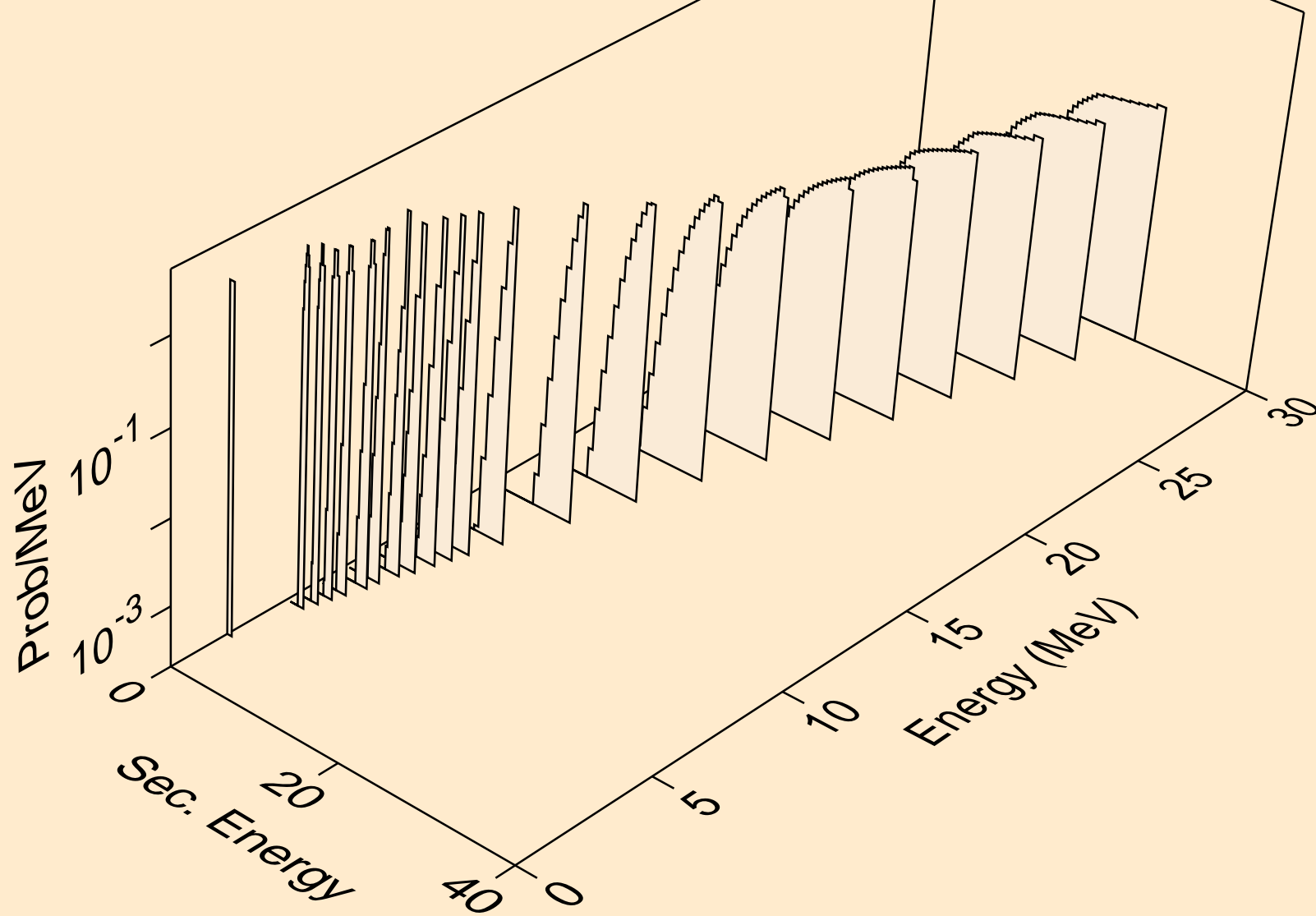

W171 NEUTRON ACER TENDL-2021 LIBRARY; T=293.6K
deuterons from (n,pd)

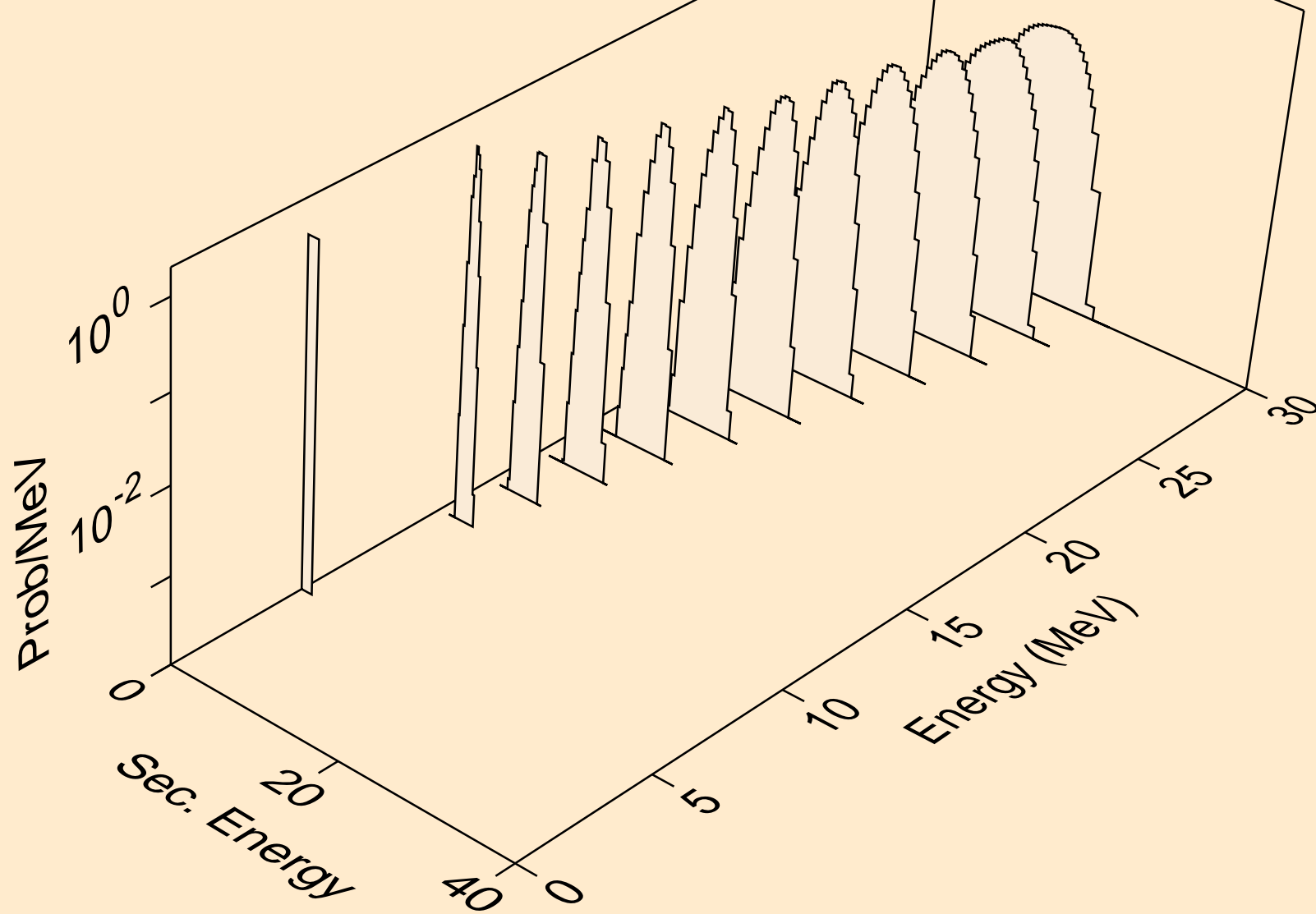

W171 NEUTRON ACER TENDL-2021 LIBRARY; T=293.6K
deuterons from (n,da)

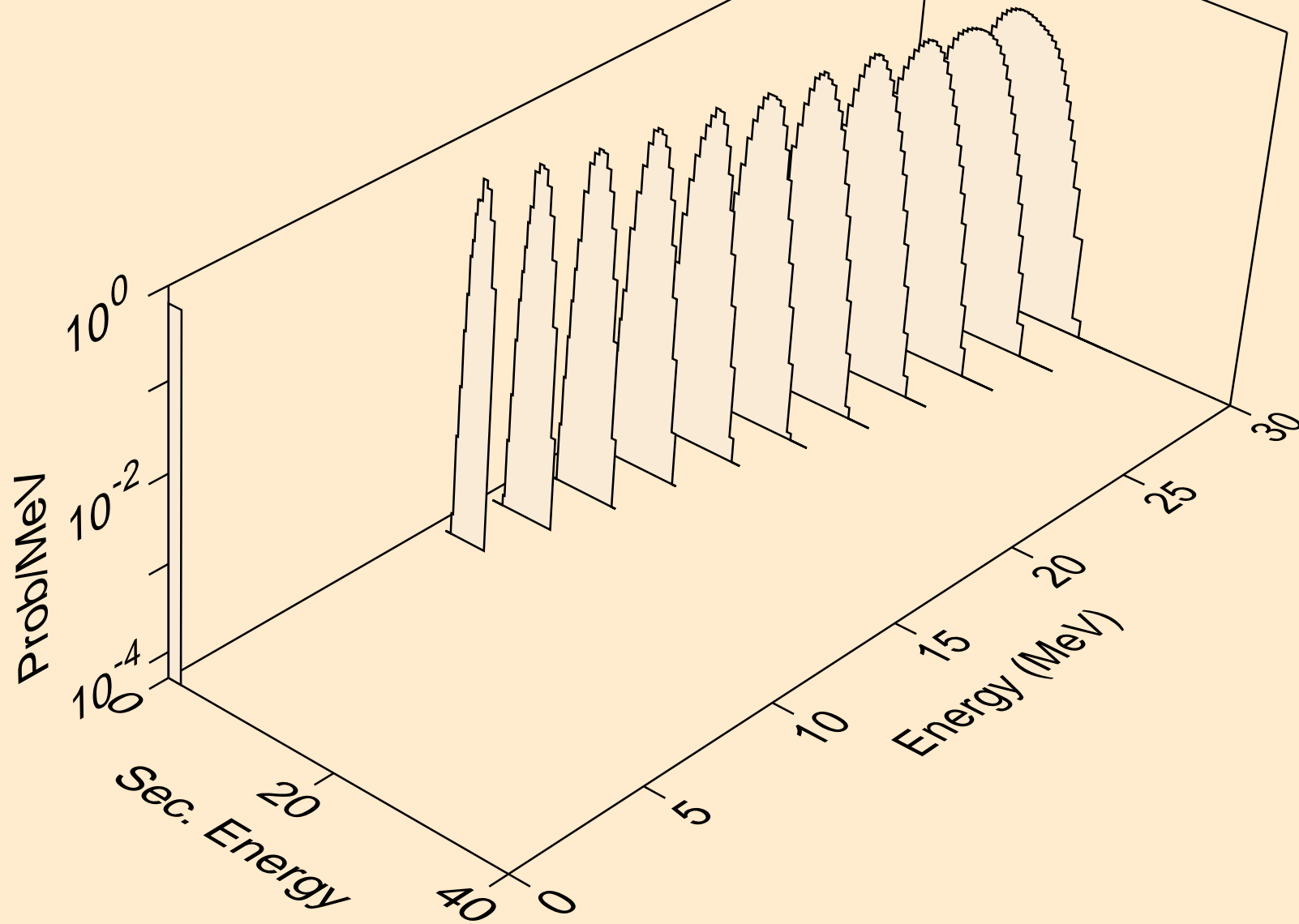

W171 NEUTRON ACER TENDL-2021 LIBRARY; T=293.6K
tritons from (n,x)

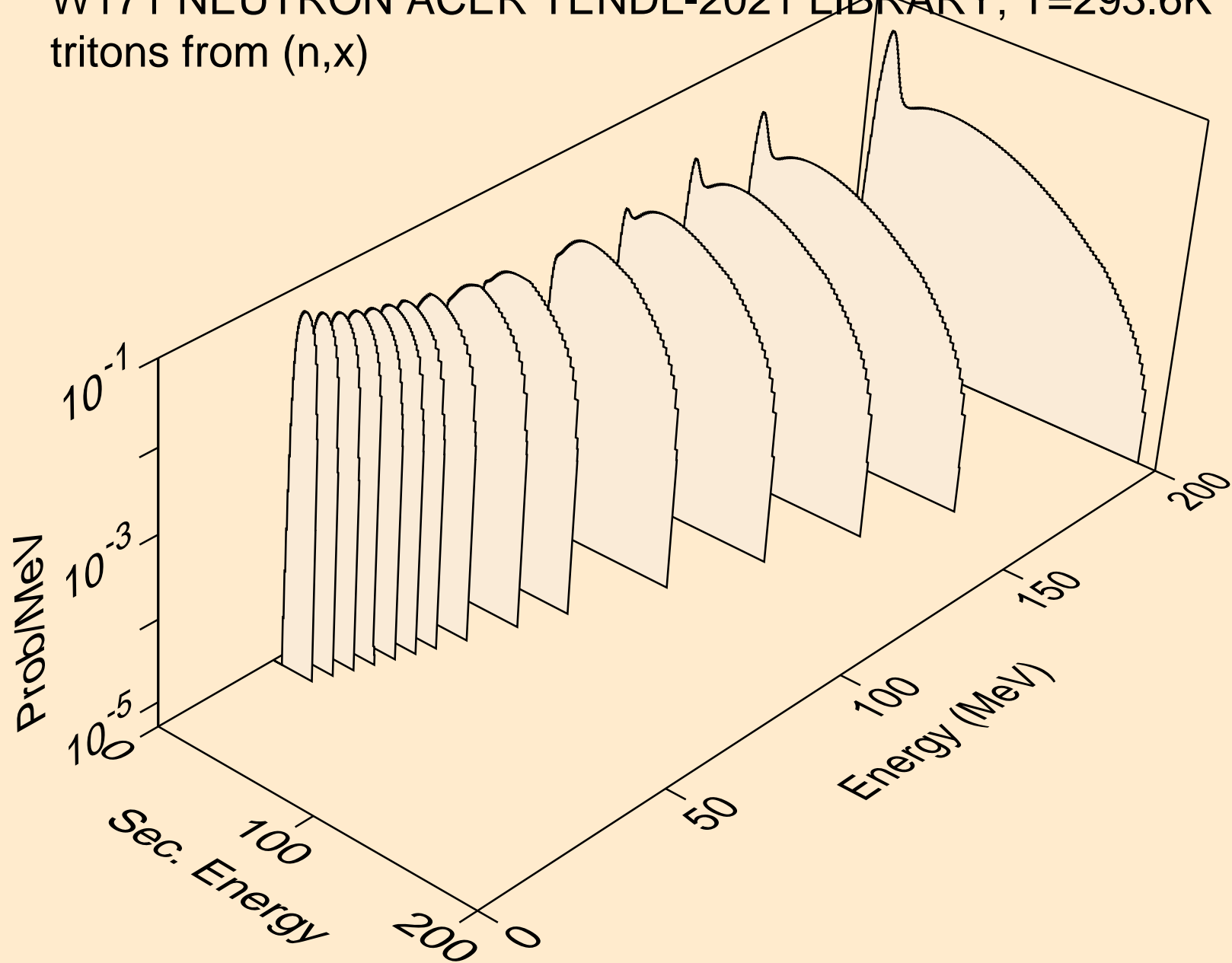

W171 NEUTRON ACER TENDL-2021 LIBRARY; T=293.6K
tritons from (n,n*)t

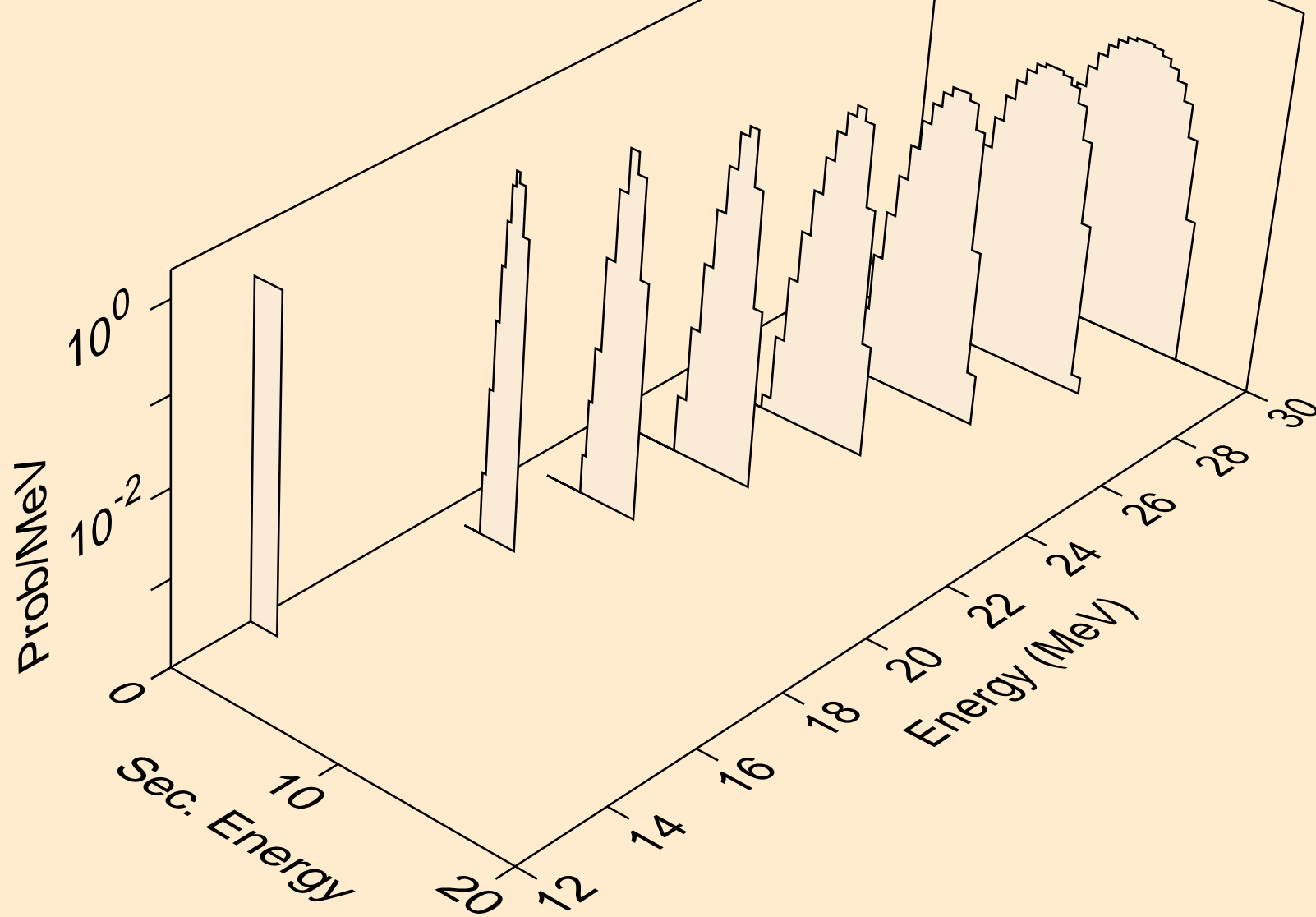

W171 NEUTRON ACER TENDL-2021 LIBRARY; T=293.6K
tritons from (n,t)

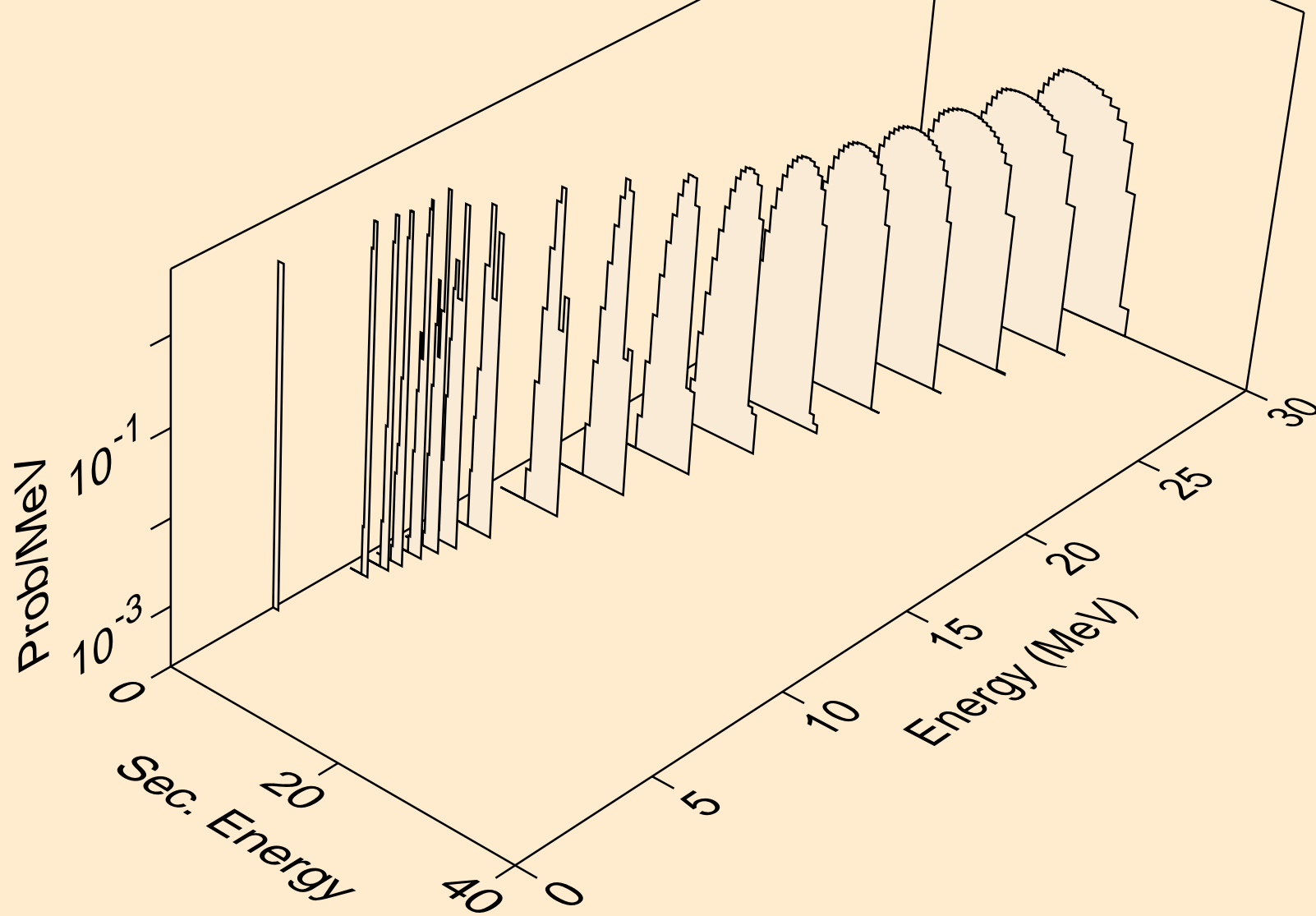

W171 NEUTRON ACER TENDL-2021 LIBRARY; T=293.6K
tritons from (n,pt)

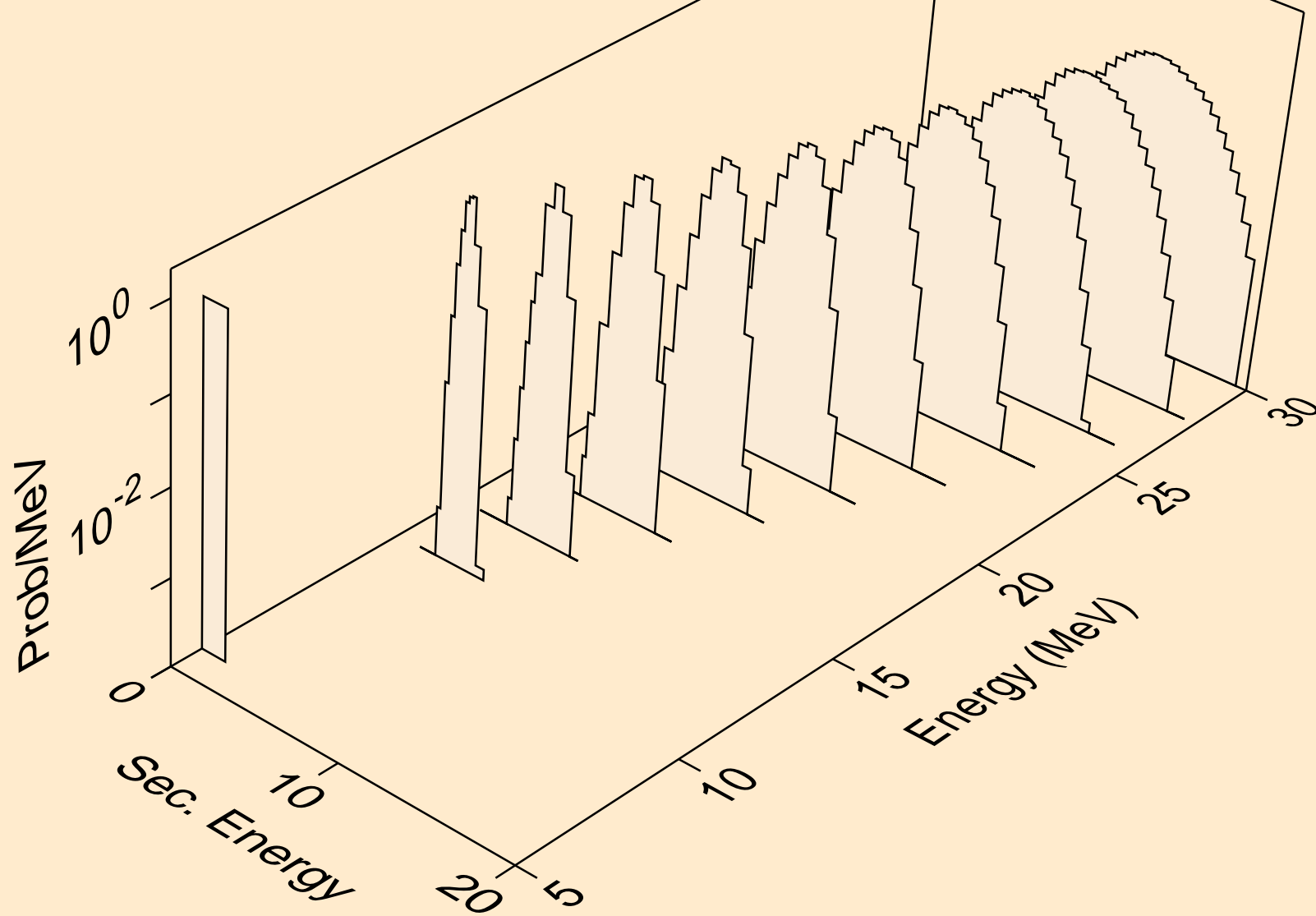

W171 NEUTRON ACER TENDL-2021 LIBRARY; T=293.6K
he3s from (n,x)

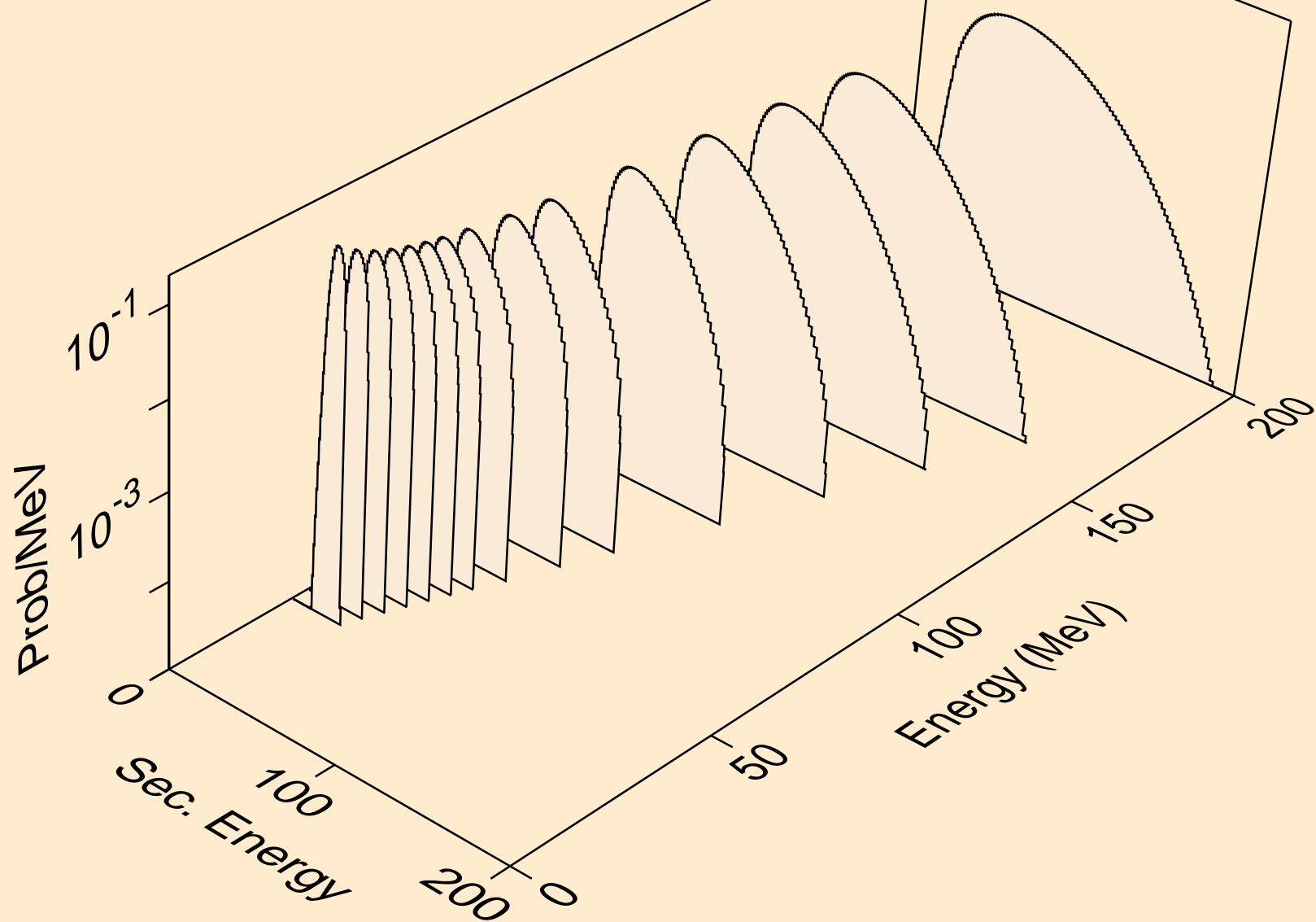

W171 NEUTRON ACER TENDL-2021 LIBRARY; T=293.6K
he3s from (n,n*)he3

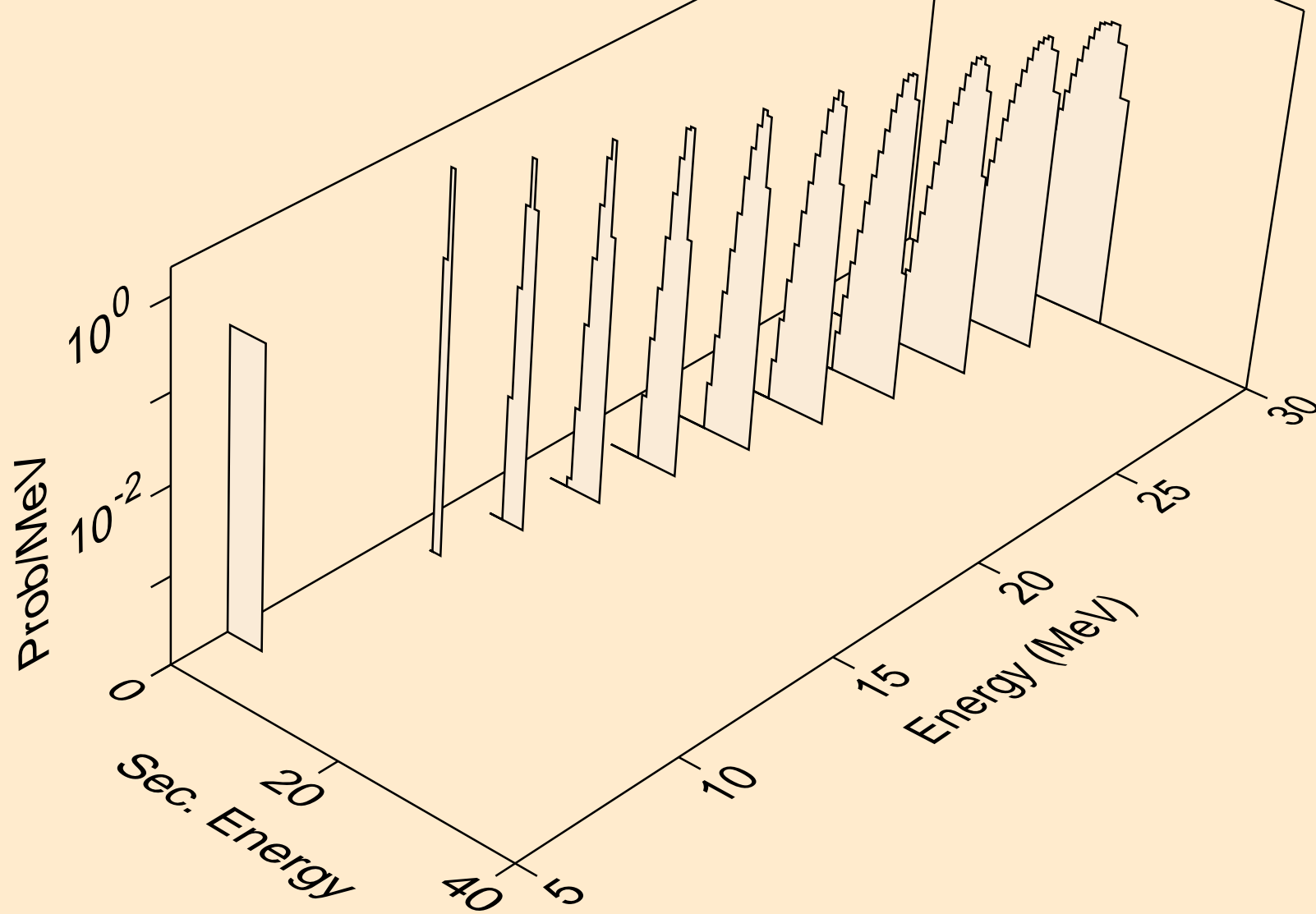

W171 NEUTRON ACER TENDL-2021 LIBRARY; T=293.6K
he3s from (n,he3)

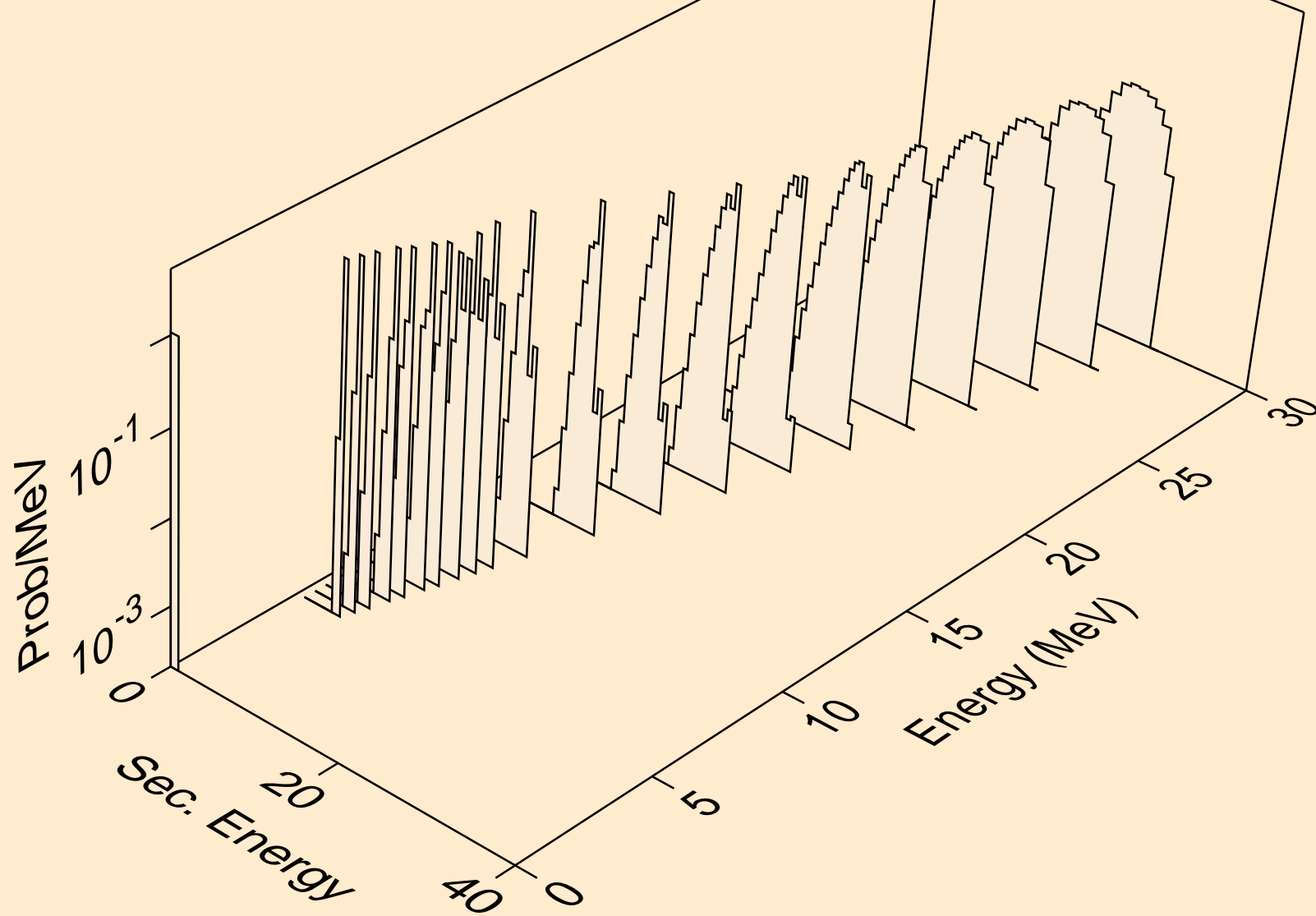

W171 NEUTRON ACER TENDL-2021 LIBRARY; T=293.6K
alphas from (n,x)

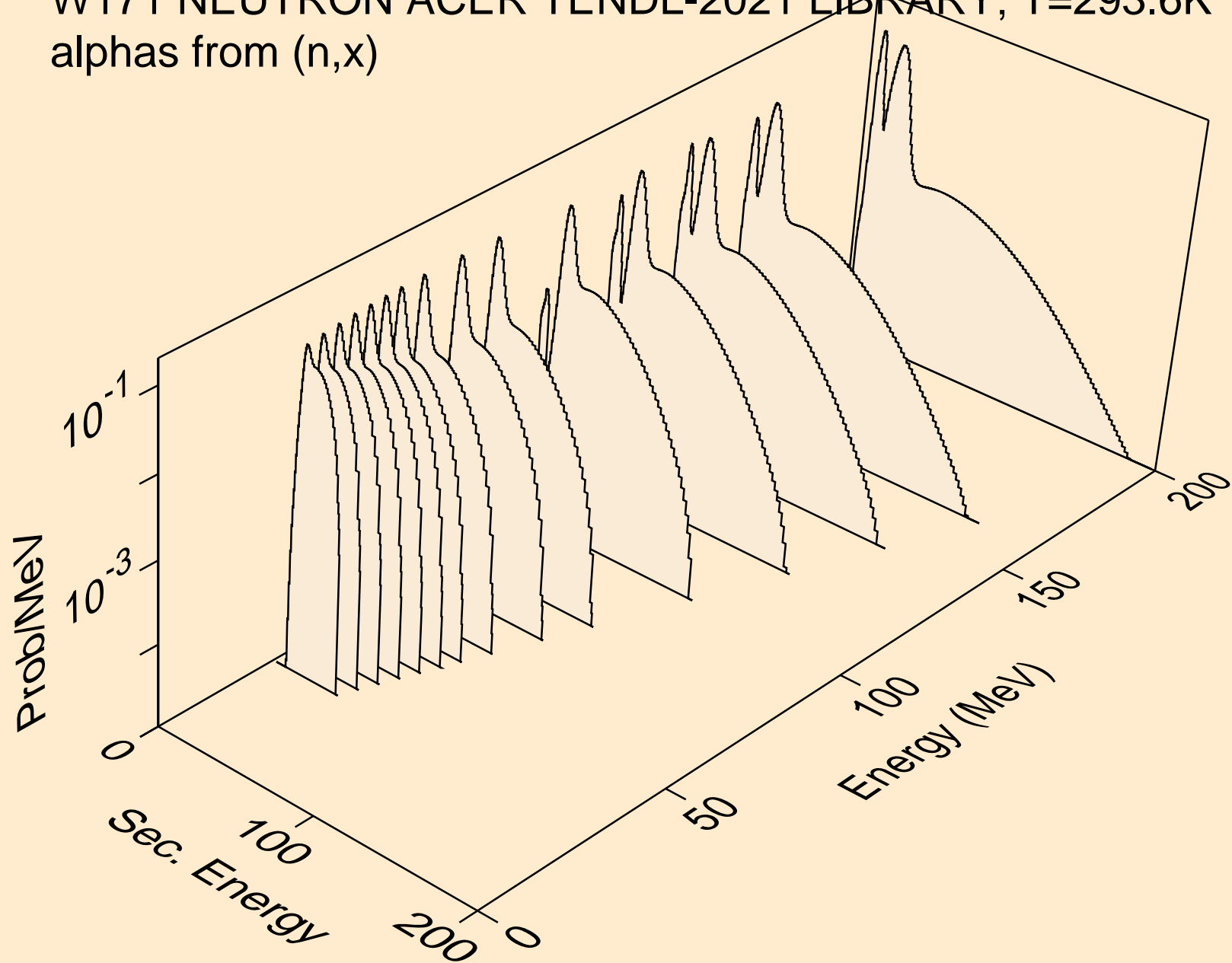

W171 NEUTRON ACER TENDL-2021 LIBRARY; T=293.6K
alphas from (n,n*)a

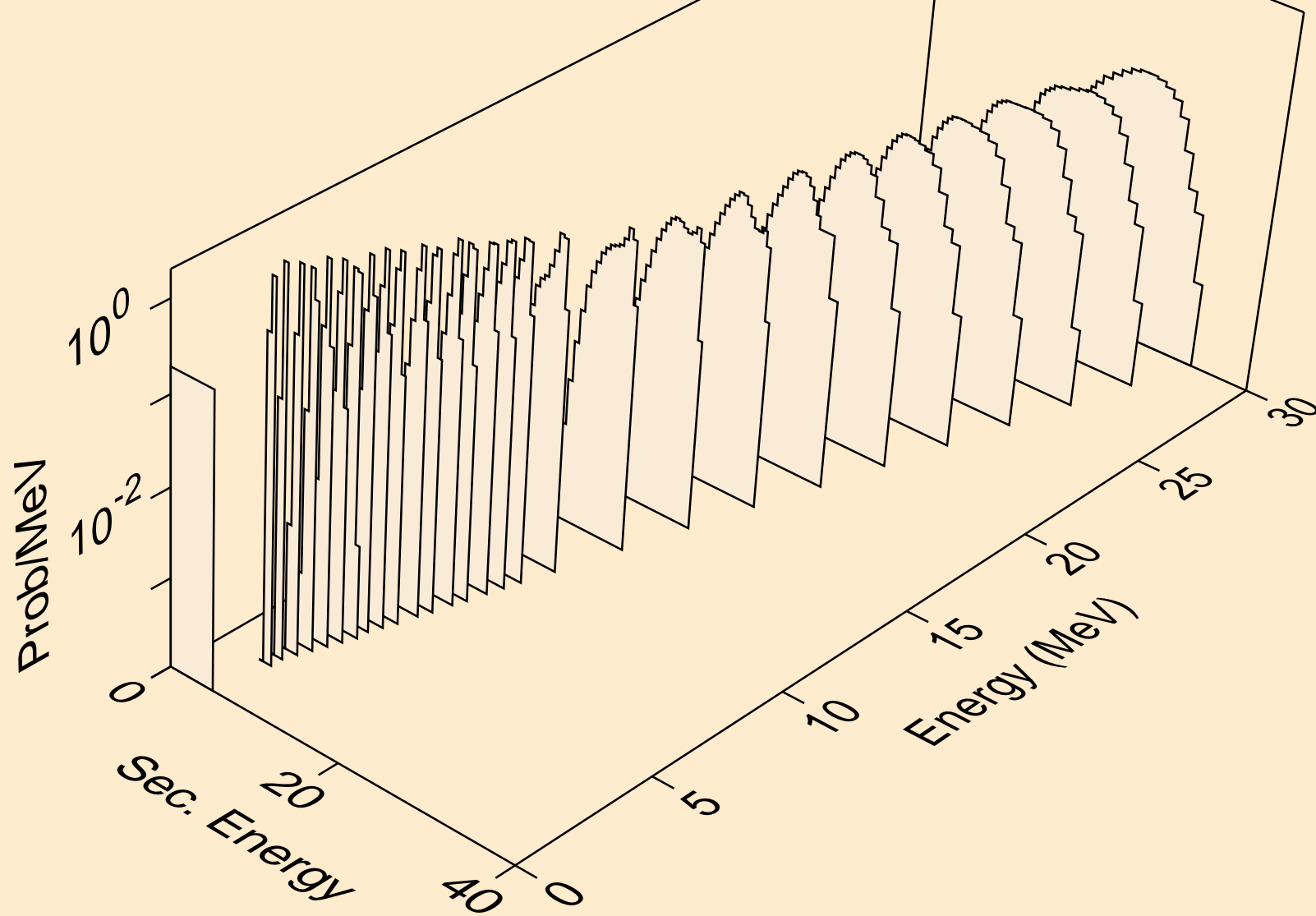

W171 NEUTRON ACER TENDL-2021 LIBRARY; T=293.6K
alphas from (n,2n)a

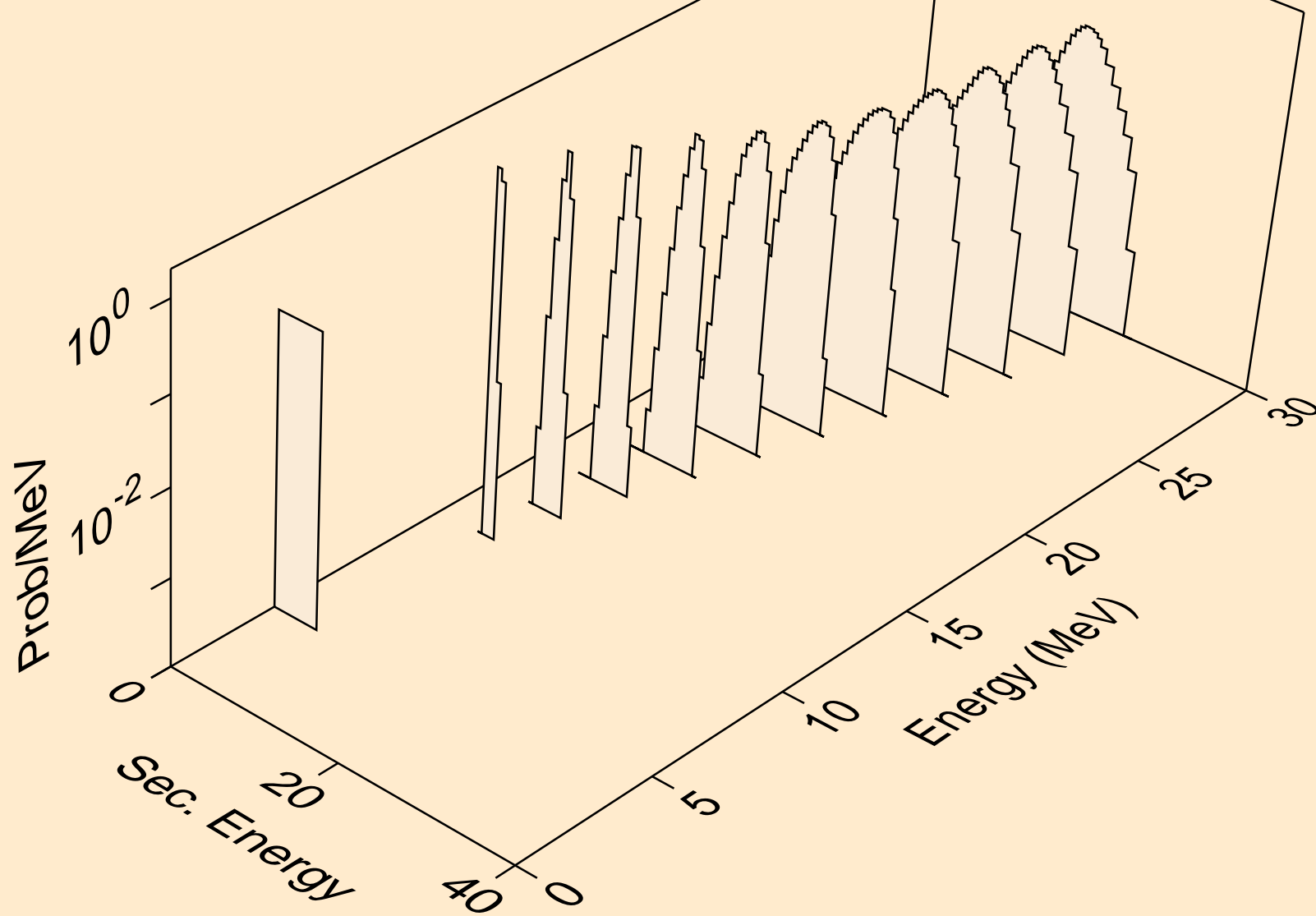

W171 NEUTRON ACER TENDL-2021 LIBRARY; T=293.6K
alphas from (n,3n)a

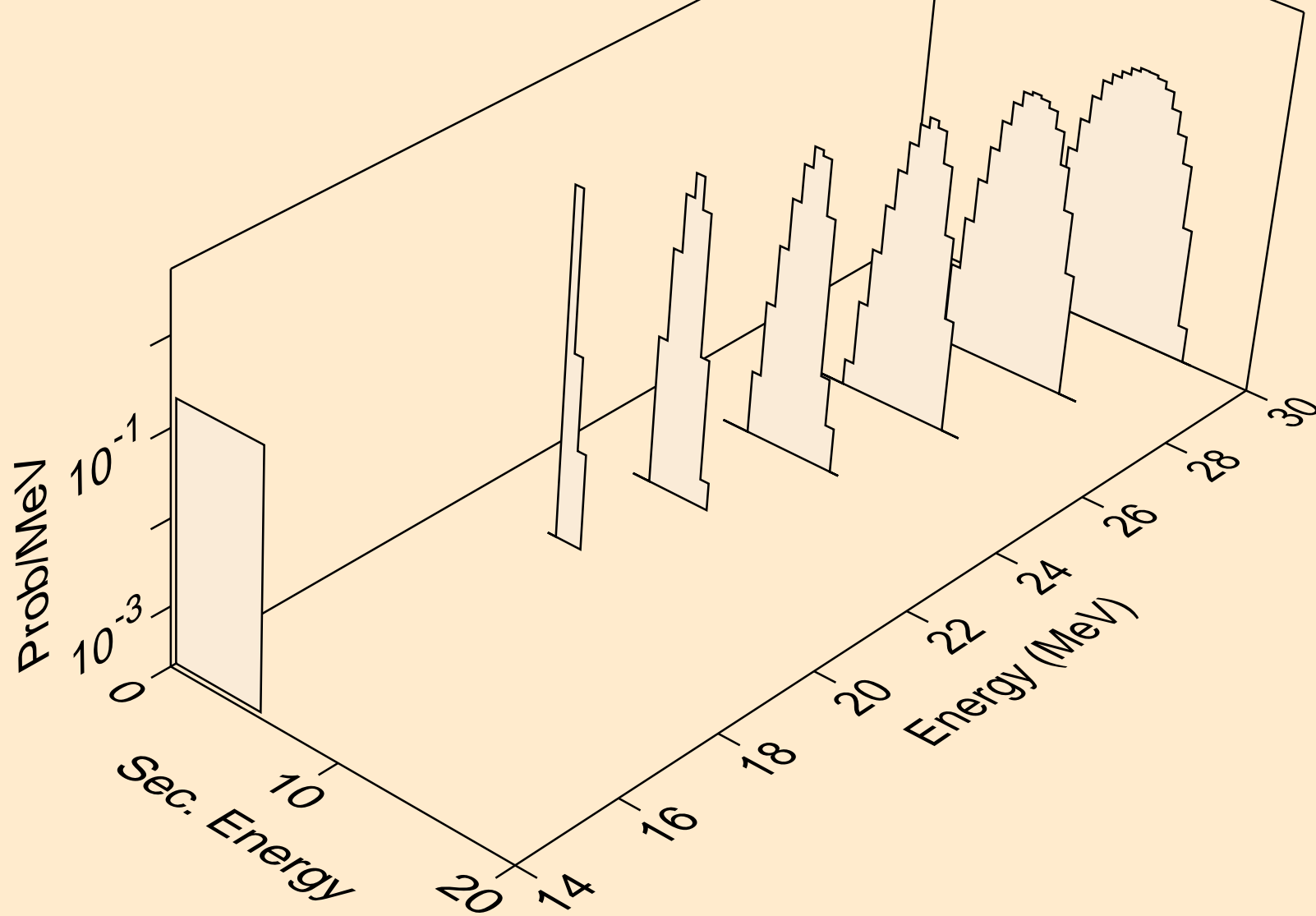

W171 NEUTRON ACER TENDL-2021 LIBRARY; T=293.6K
alphas from (n,n*)2a

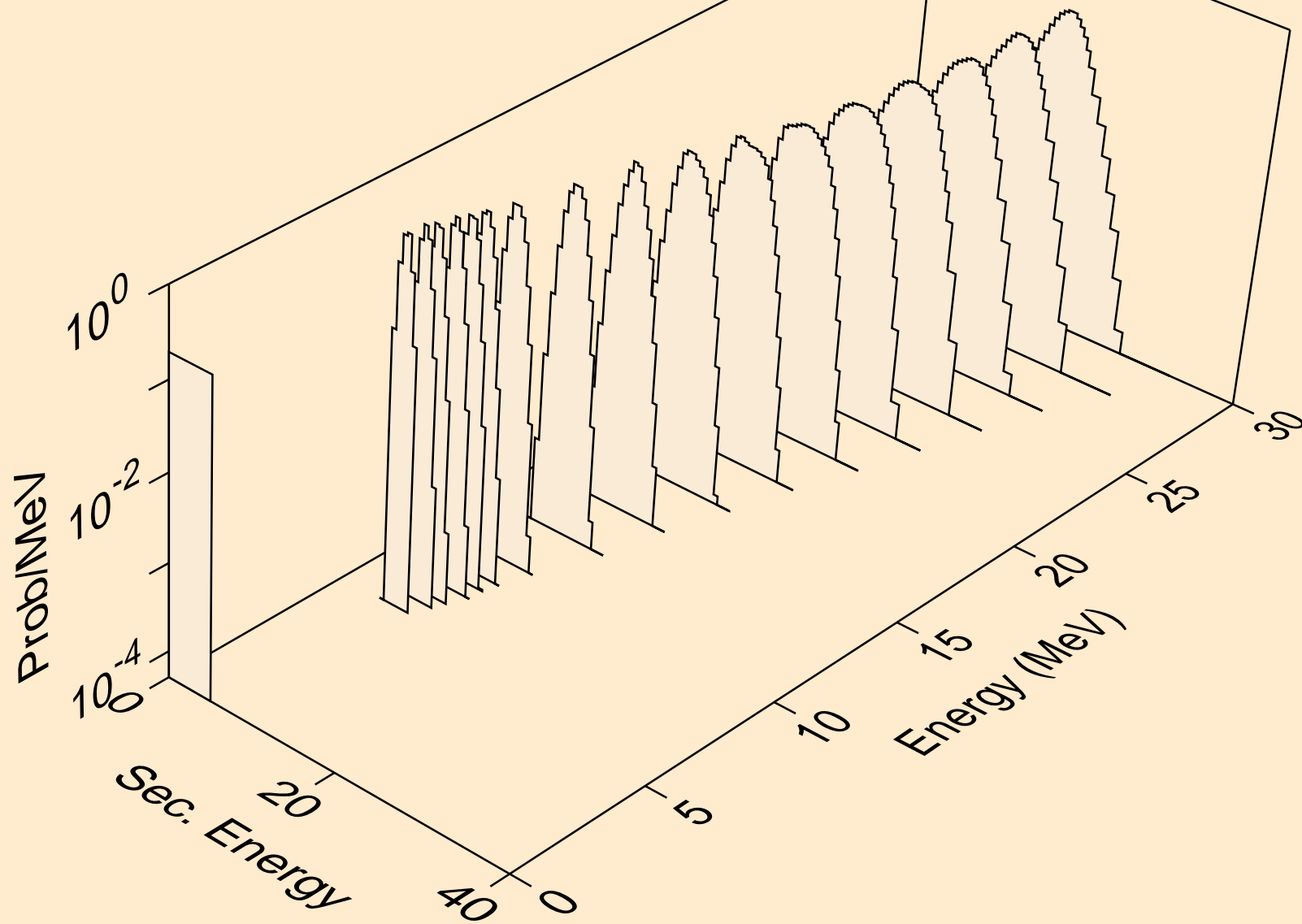

W171 NEUTRON ACER TENDL-2021 LIBRARY; T=293.6K
alphas from (n,2n)2a

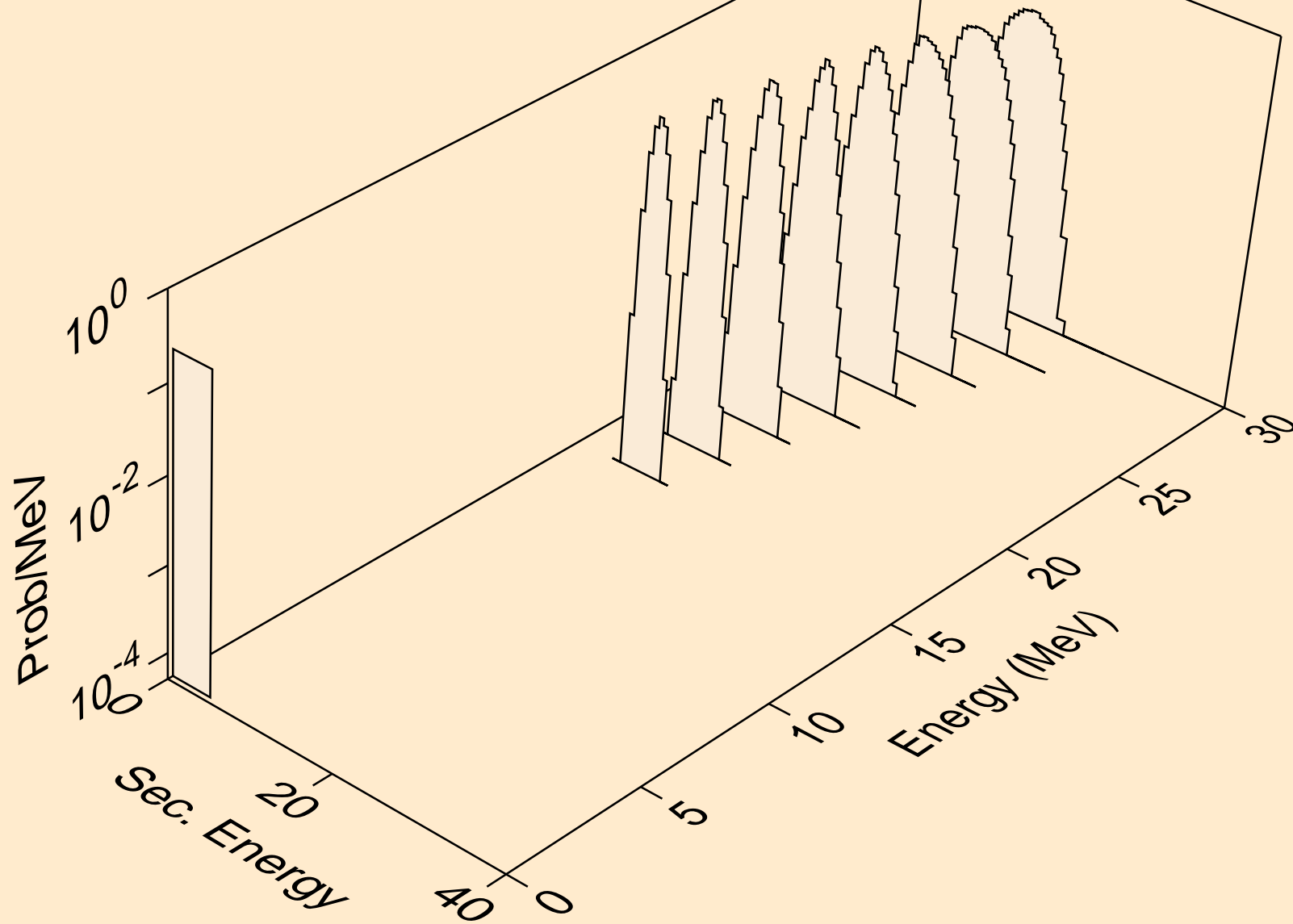

W171 NEUTRON ACER TENDL-2021 LIBRARY; T=293.6K
alphas from (n,npa)

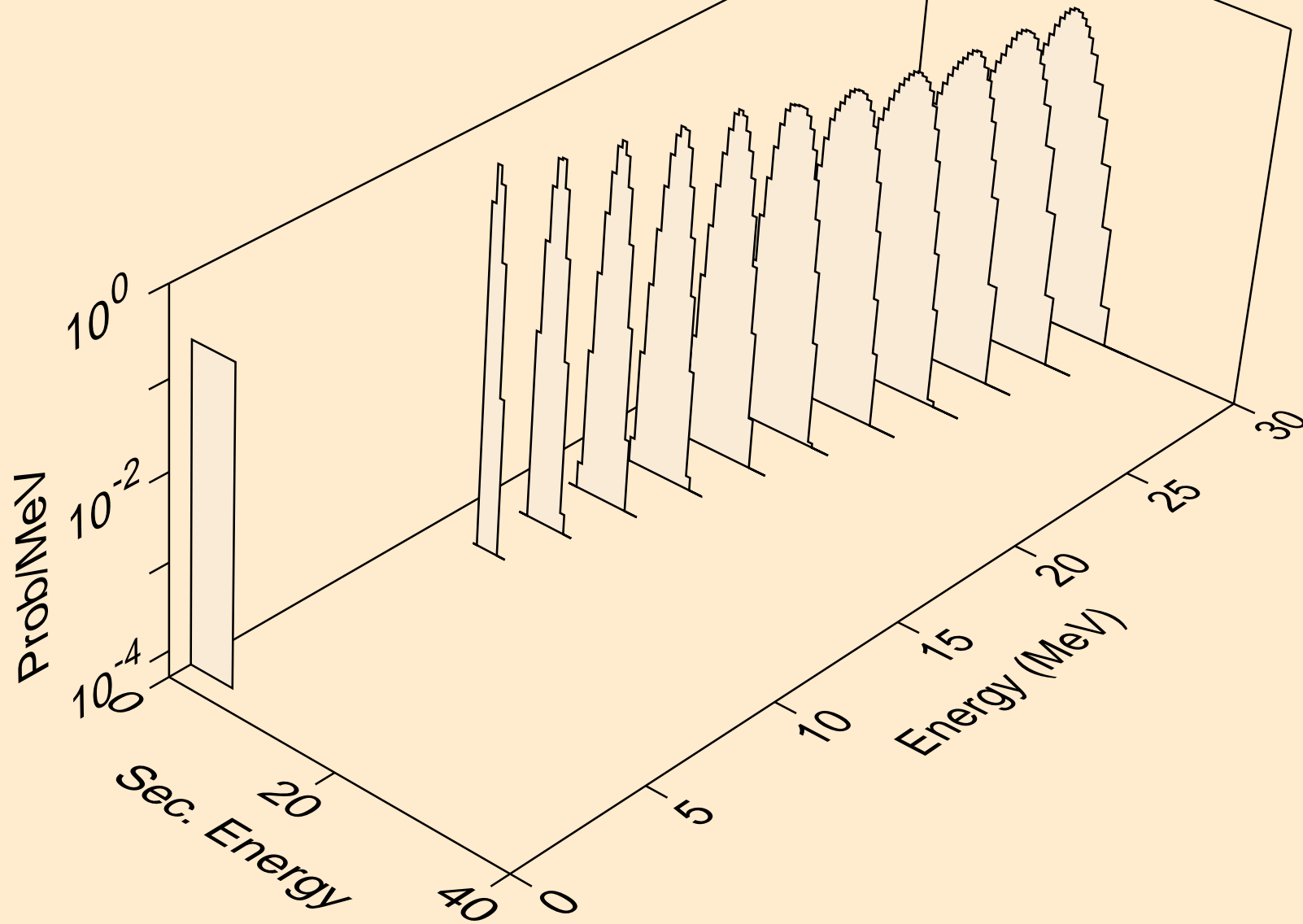

W171 NEUTRON ACER TENDL-2021 LIBRARY; T=293.6K
alphas from (n,a)

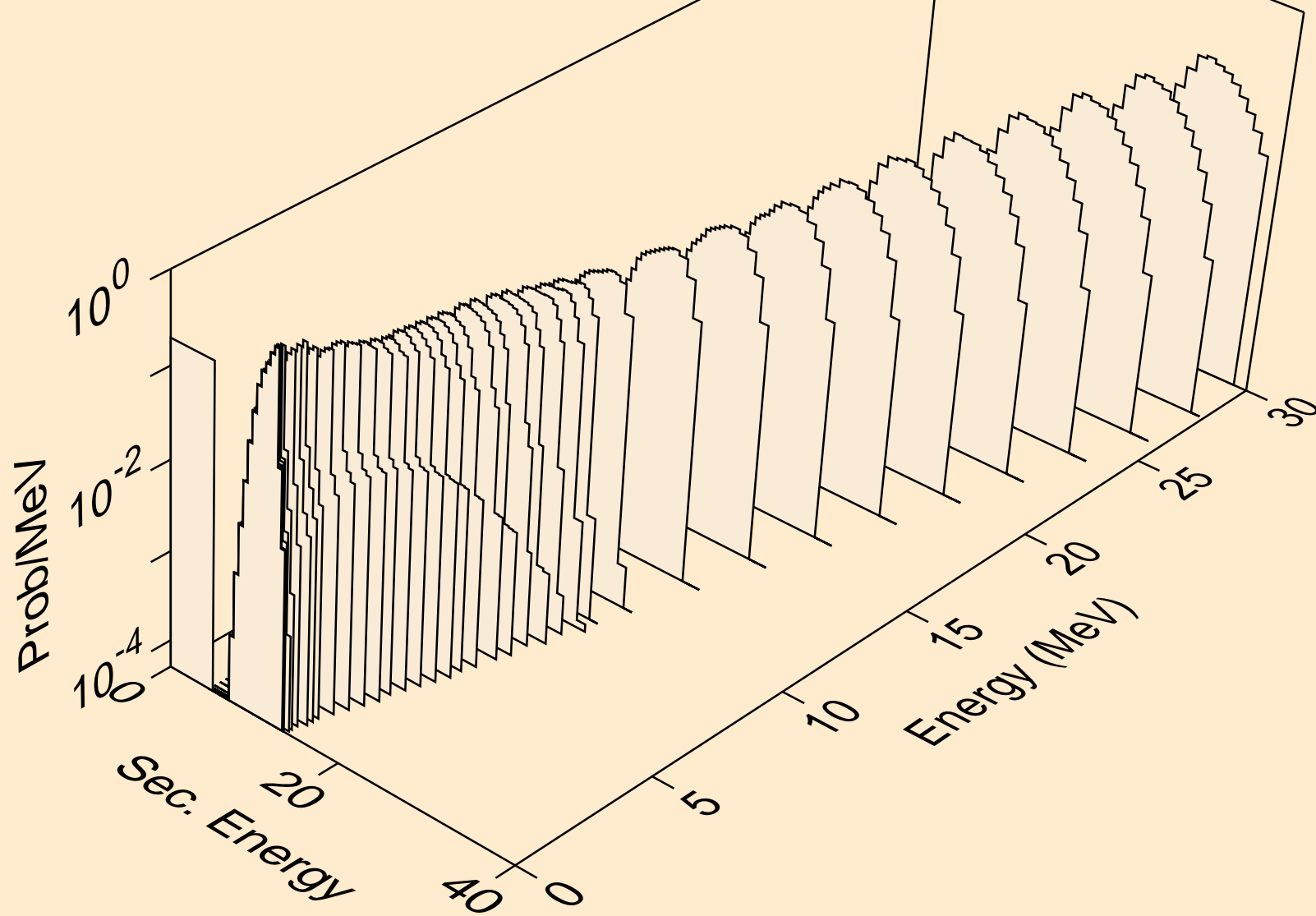

W171 NEUTRON ACER TENDL-2021 LIBRARY; T=293.6K
alphas from (n,2a)

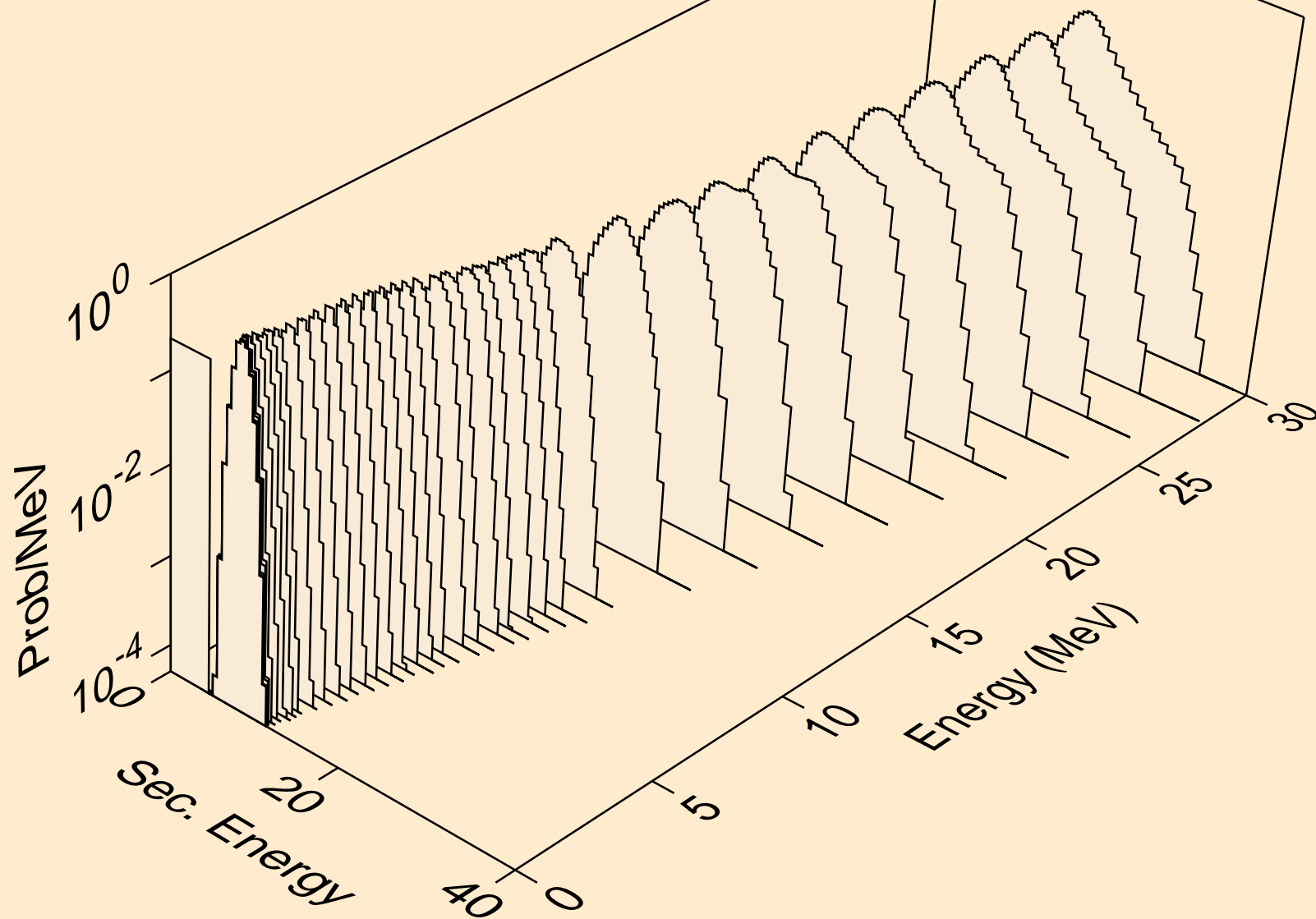

W171 NEUTRON ACER TENDL-2021 LIBRARY; T=293.6K
alphas from (n,pa)

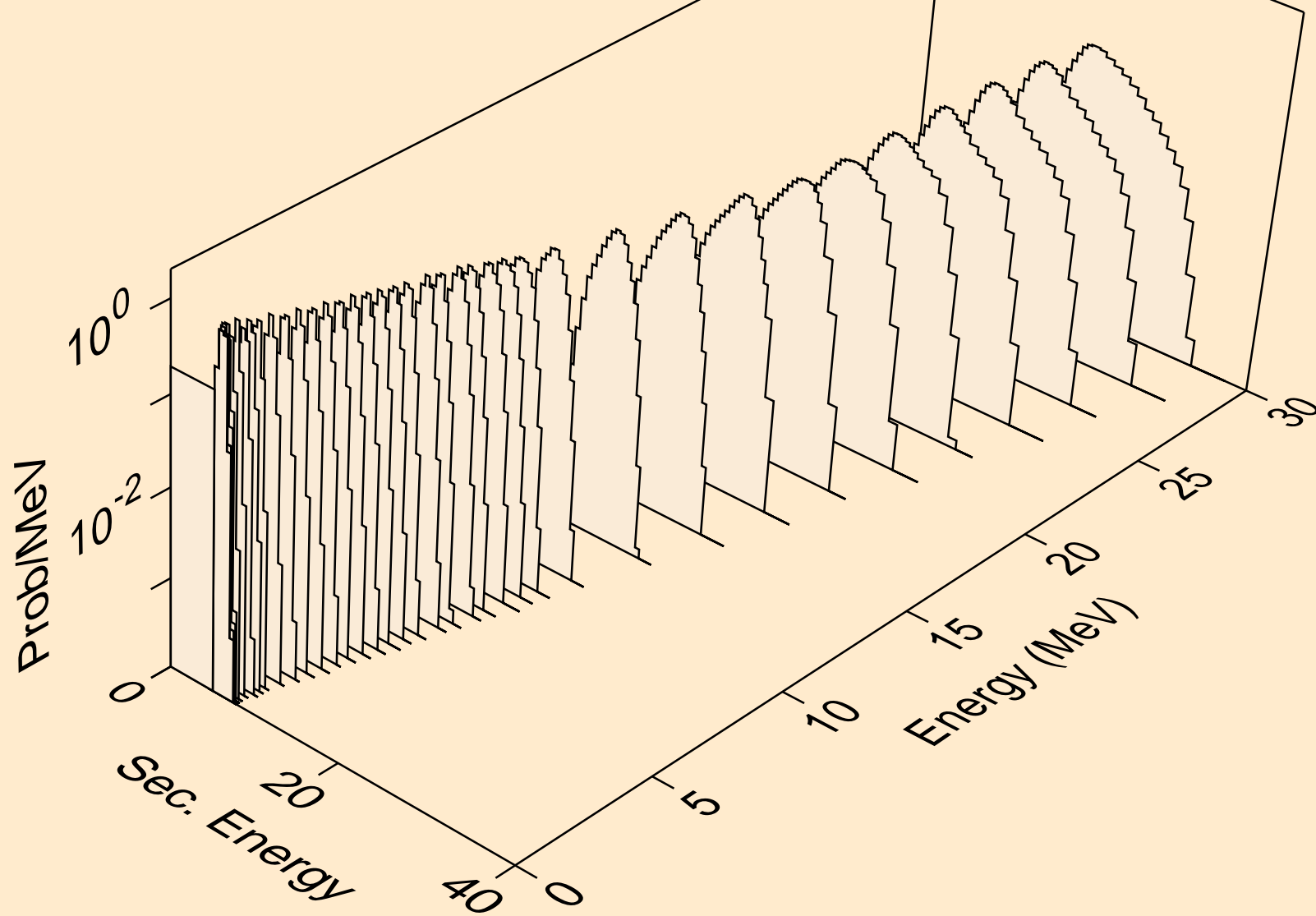

W171 NEUTRON ACER TENDL-2021 LIBRARY; T=293.6K
alphas from (n,da)

