

W181 NEUTRON ACER TENDL-2021 LIBRARY; T=293.6K  
Principal cross sections

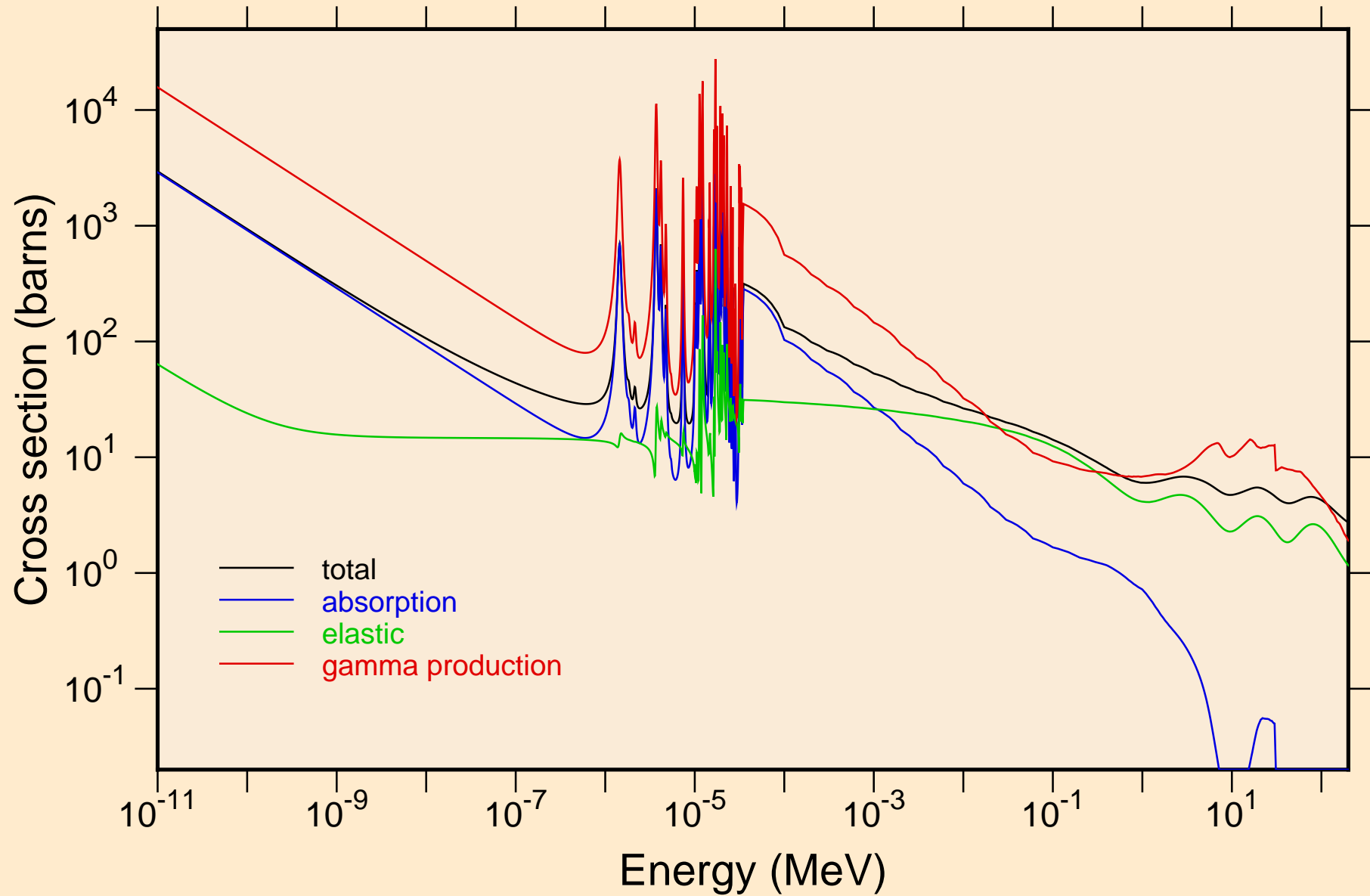

W181 NEUTRON ACER TENDL-2021 LIBRARY; T=293.6K  
resonance total cross section

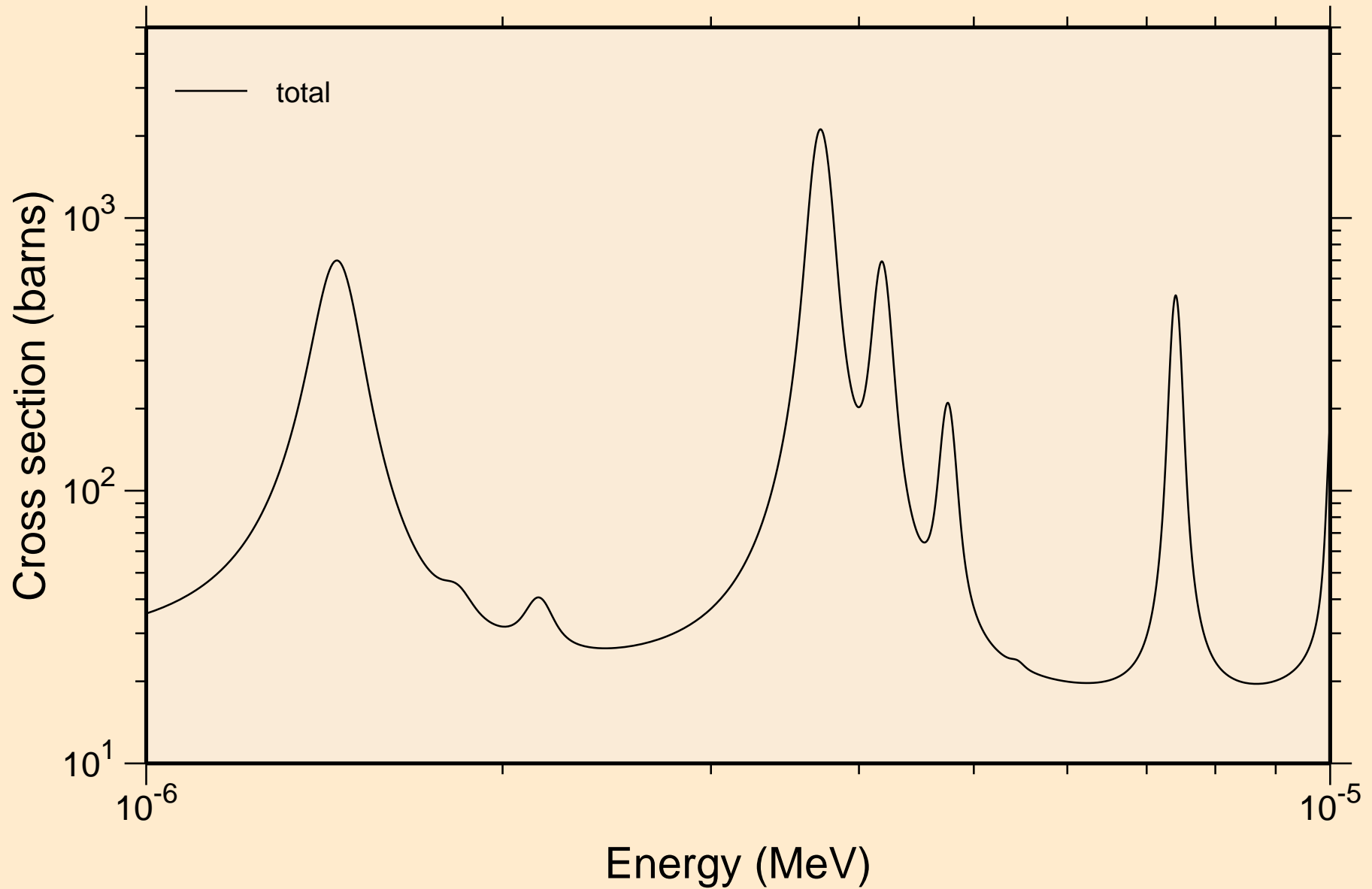

W181 NEUTRON ACER TENDL-2021 LIBRARY; T=293.6K  
resonance total cross section

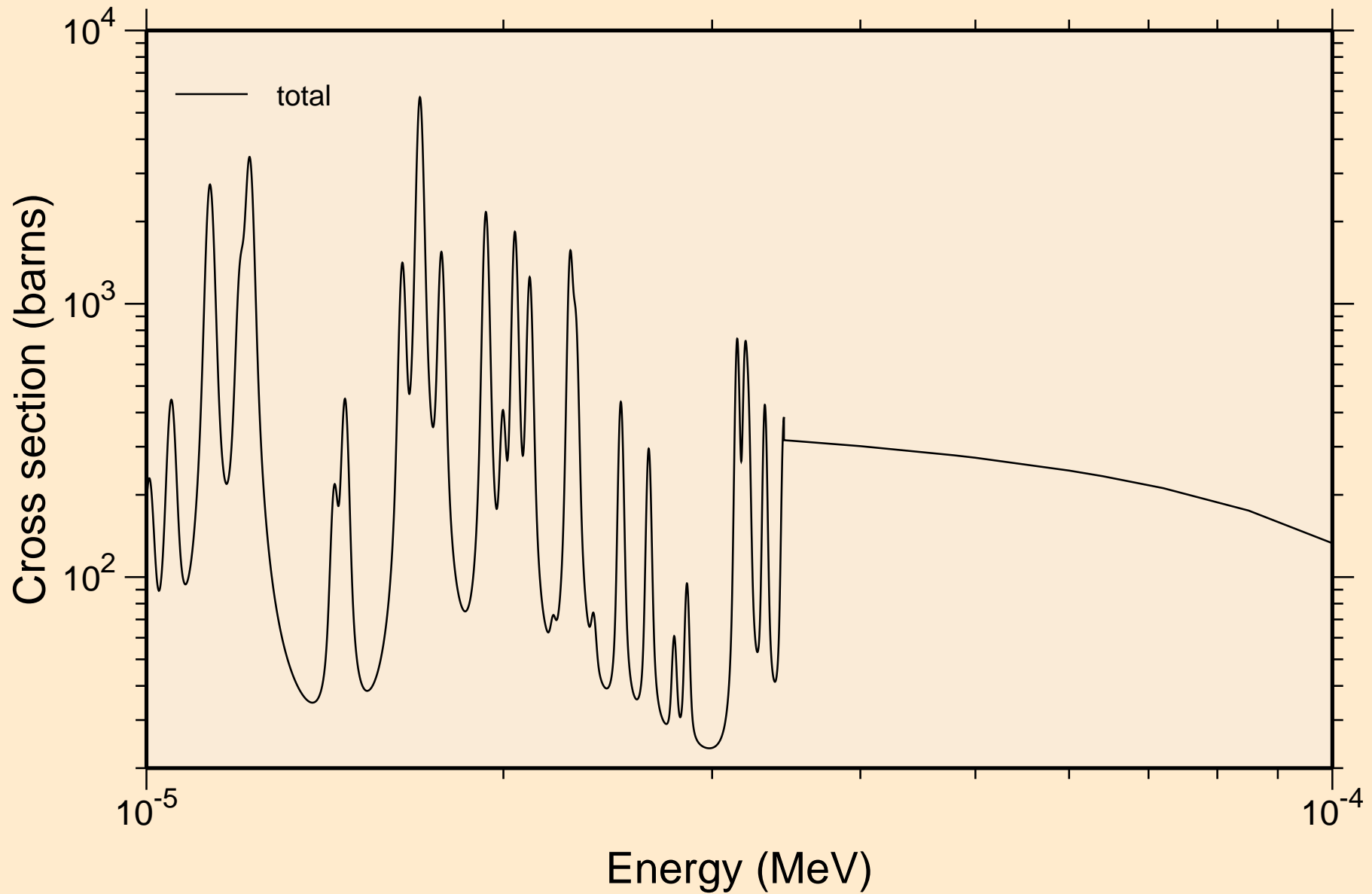

W181 NEUTRON ACER TENDL-2021 LIBRARY; T=293.6K  
resonance total cross section

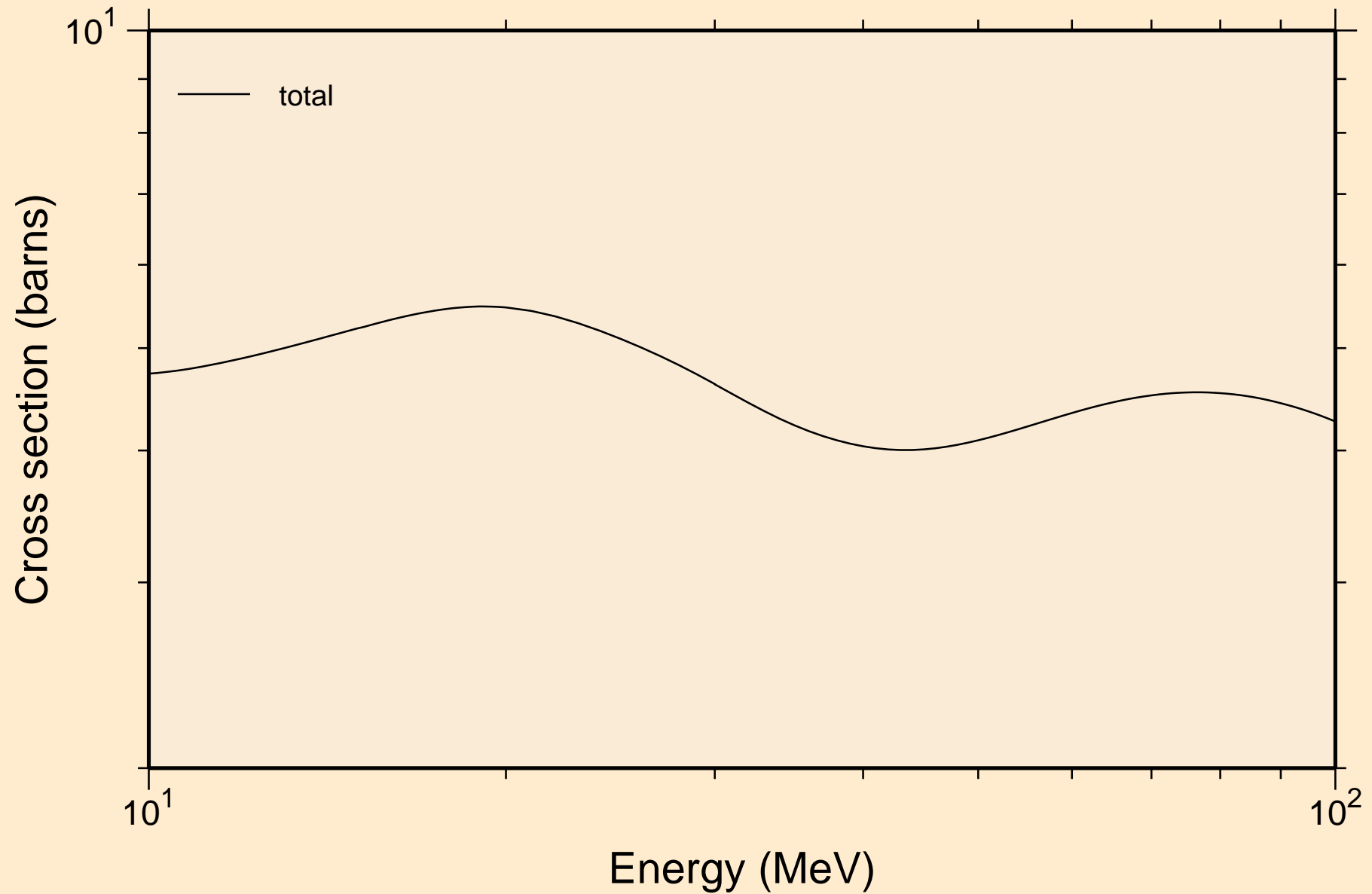

W181 NEUTRON ACER TENDL-2021 LIBRARY; T=293.6K  
resonance absorption cross sections

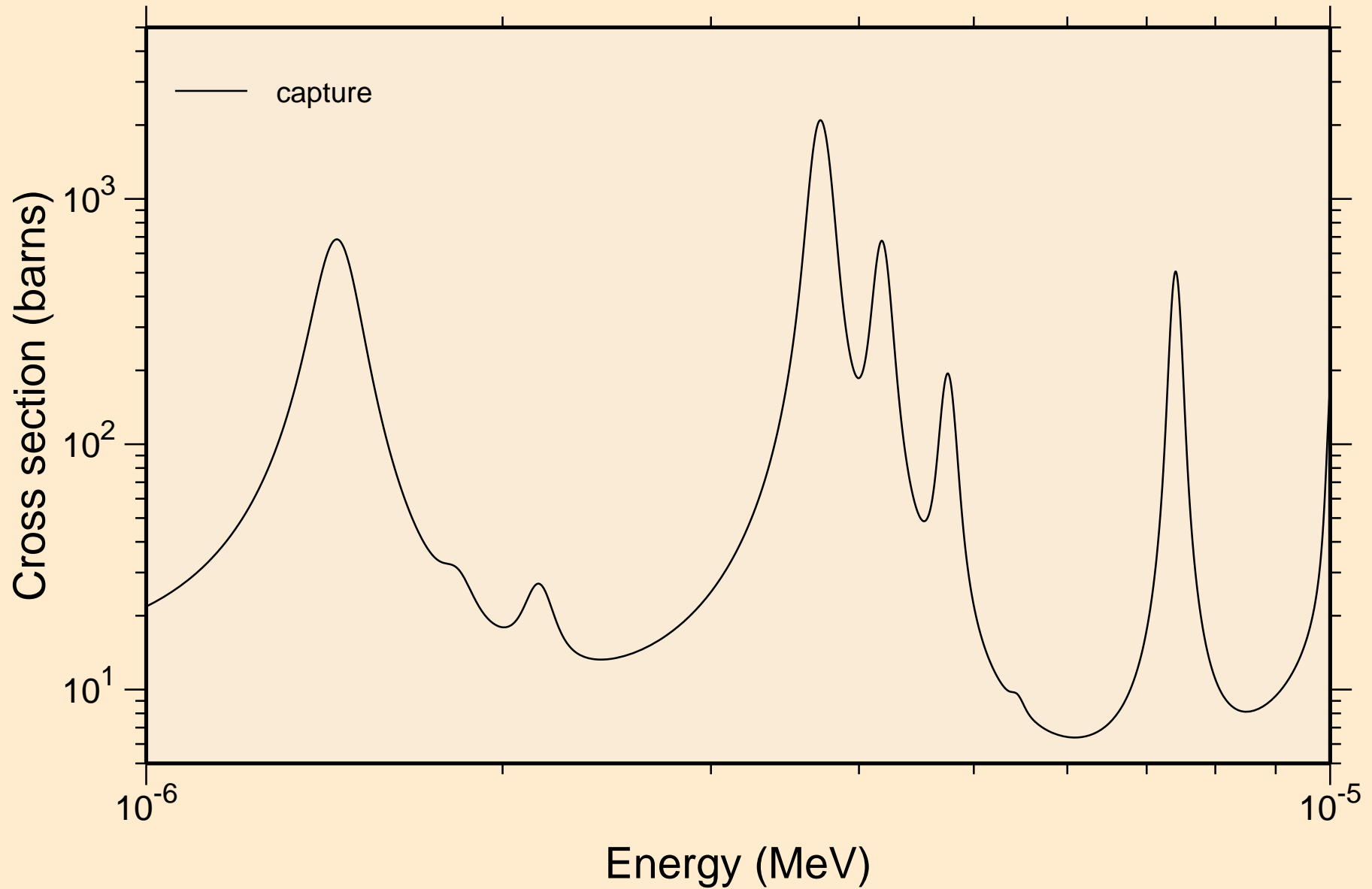

W181 NEUTRON ACER TENDL-2021 LIBRARY; T=293.6K  
resonance absorption cross sections

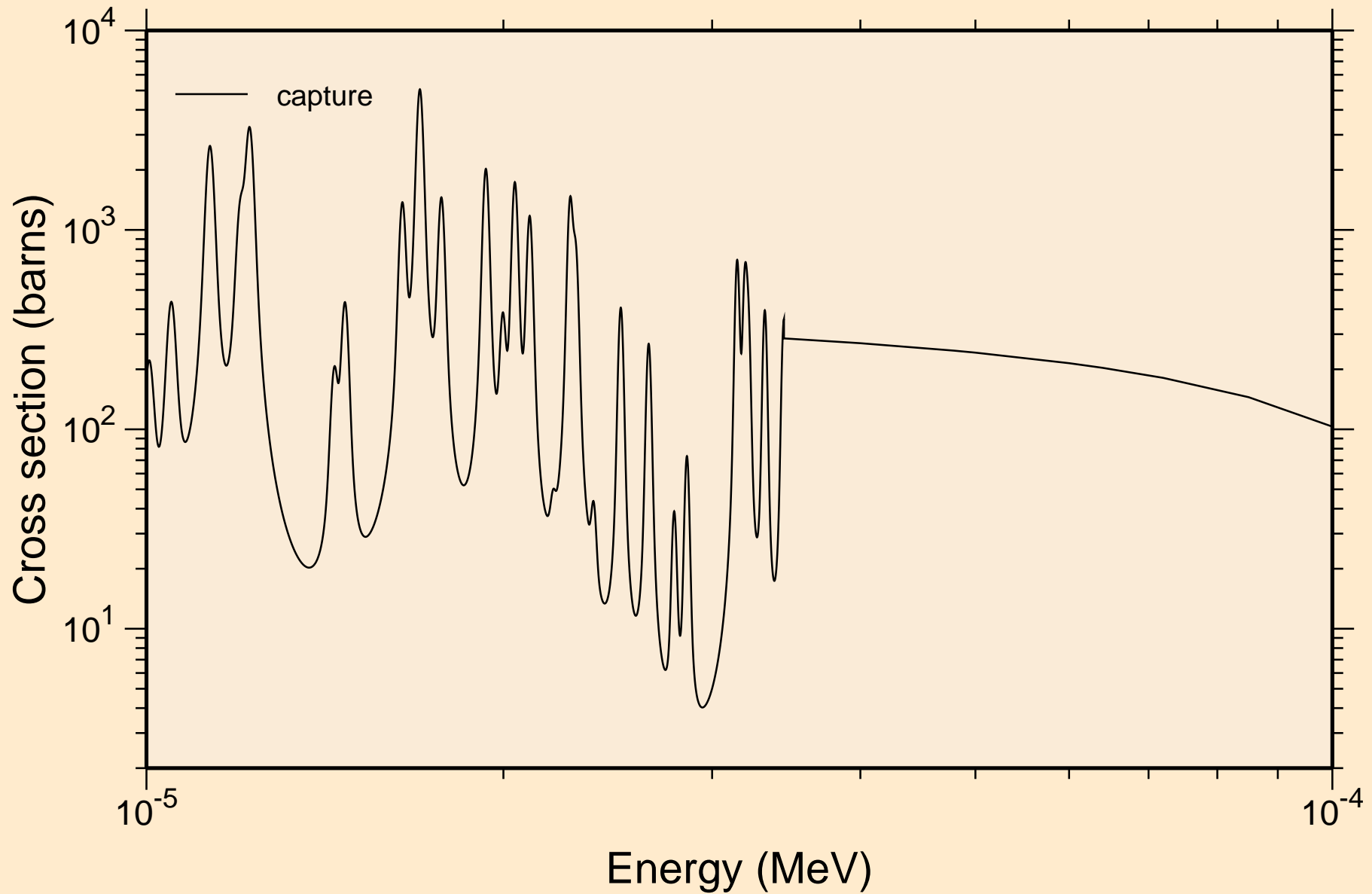

W181 NEUTRON ACER TENDL-2021 LIBRARY; T=293.6K  
resonance absorption cross sections

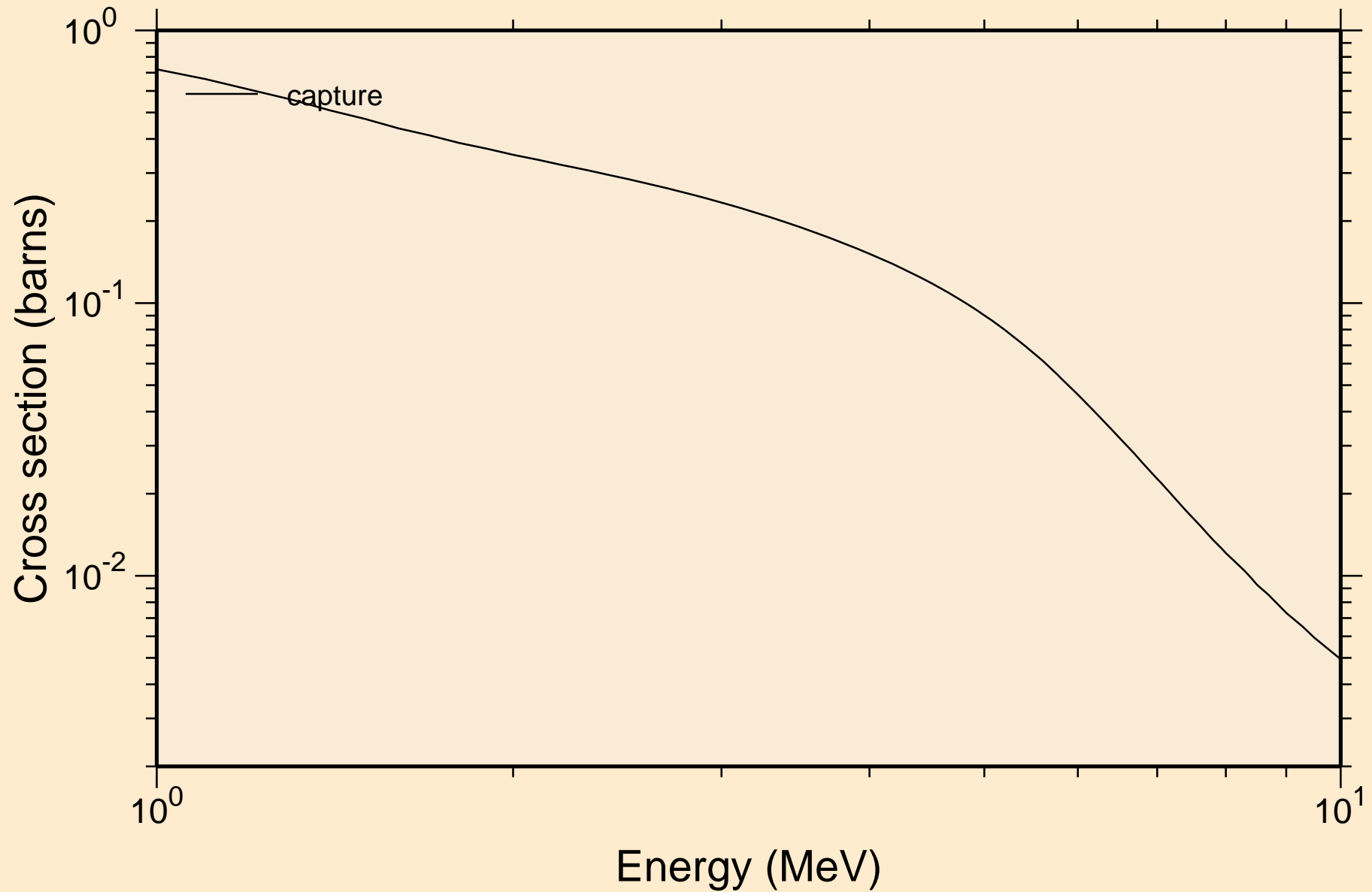

W181 NEUTRON ACER TENDL-2021 LIBRARY; T=293.6K  
Heating

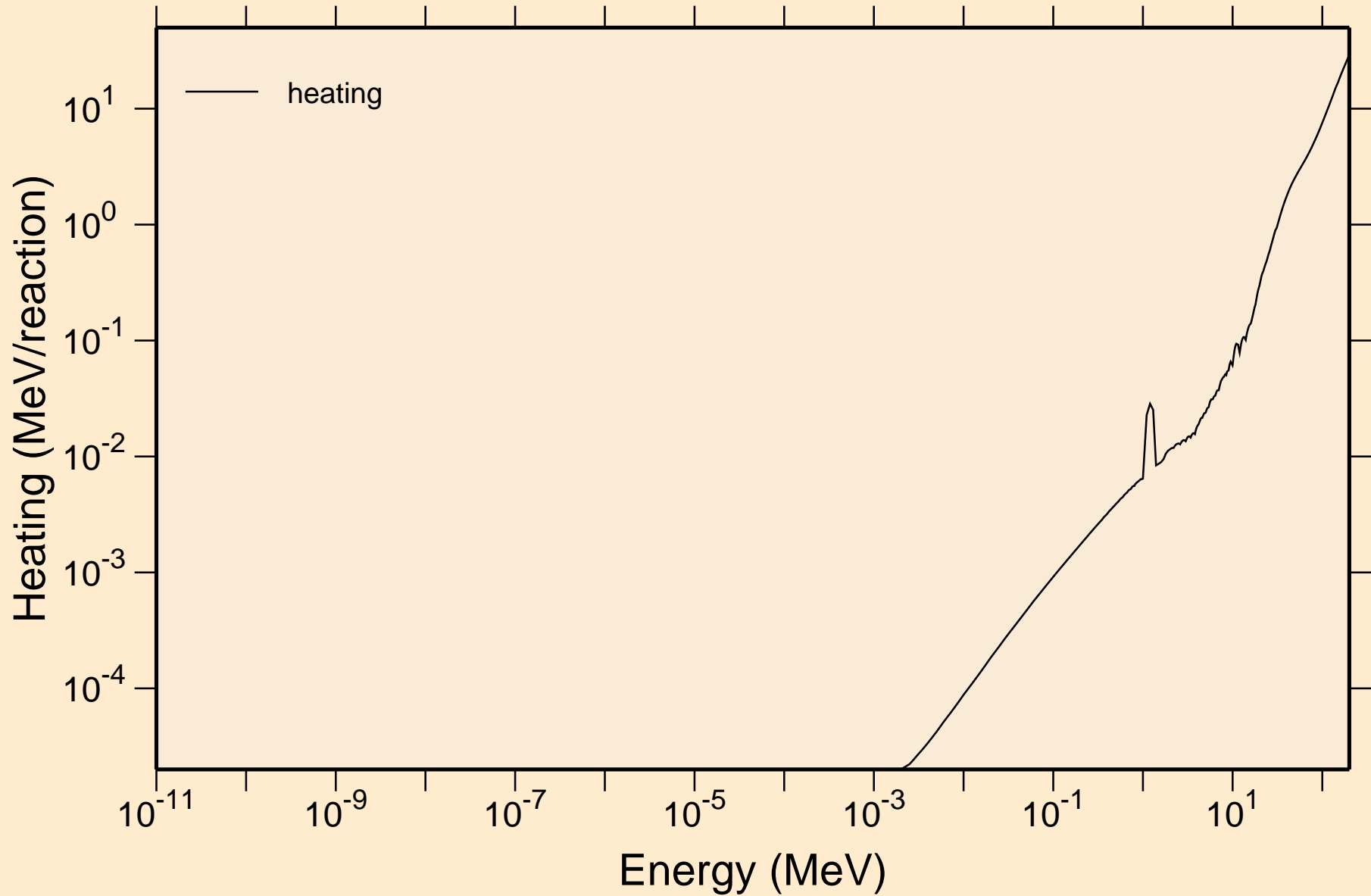



W181 NEUTRON ACER TENDL-2021 LIBRARY; T=293.6K  
Damage

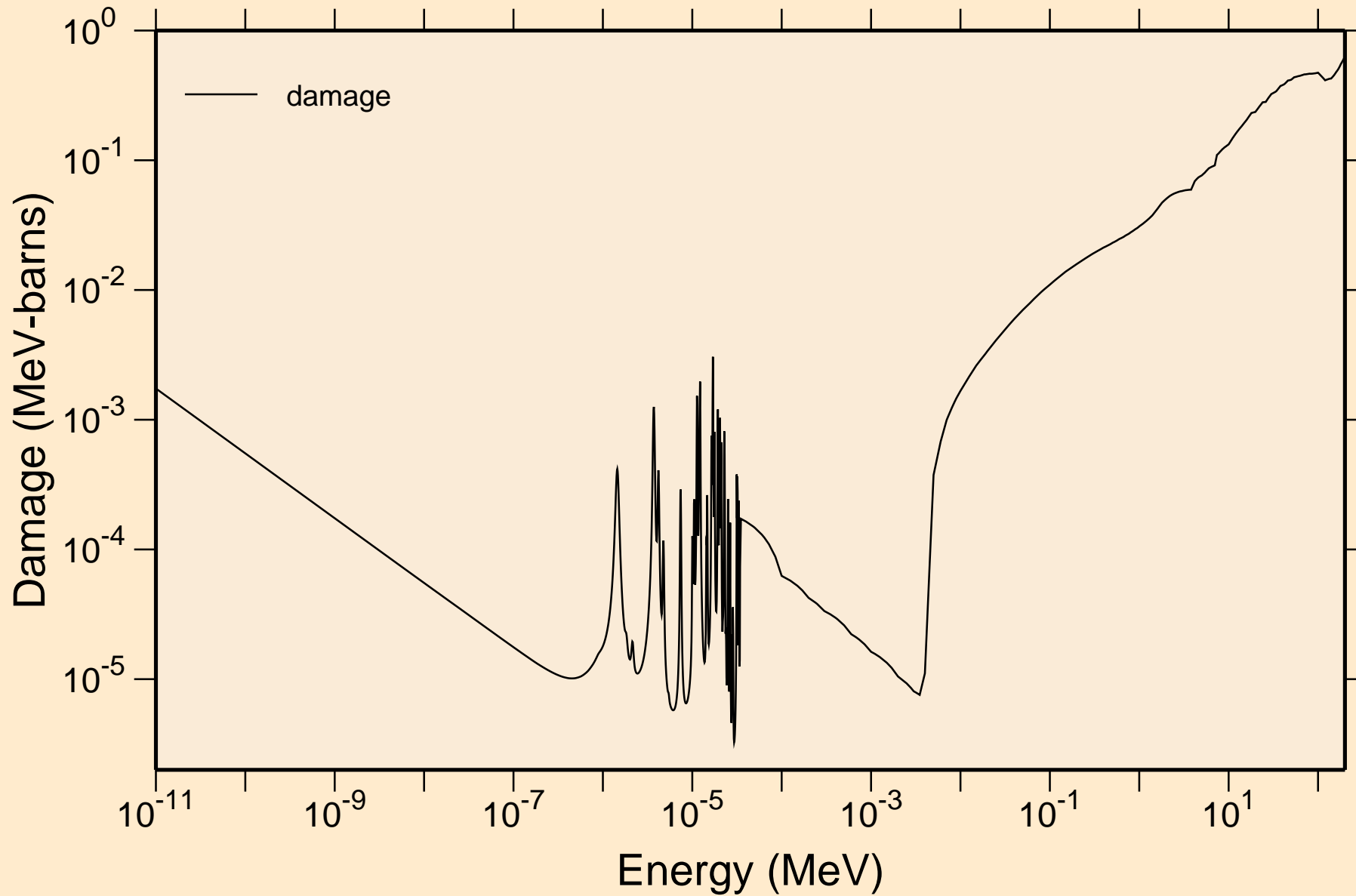

W181 NEUTRON ACER TENDL-2021 LIBRARY; T=293.6K  
Non-threshold reactions

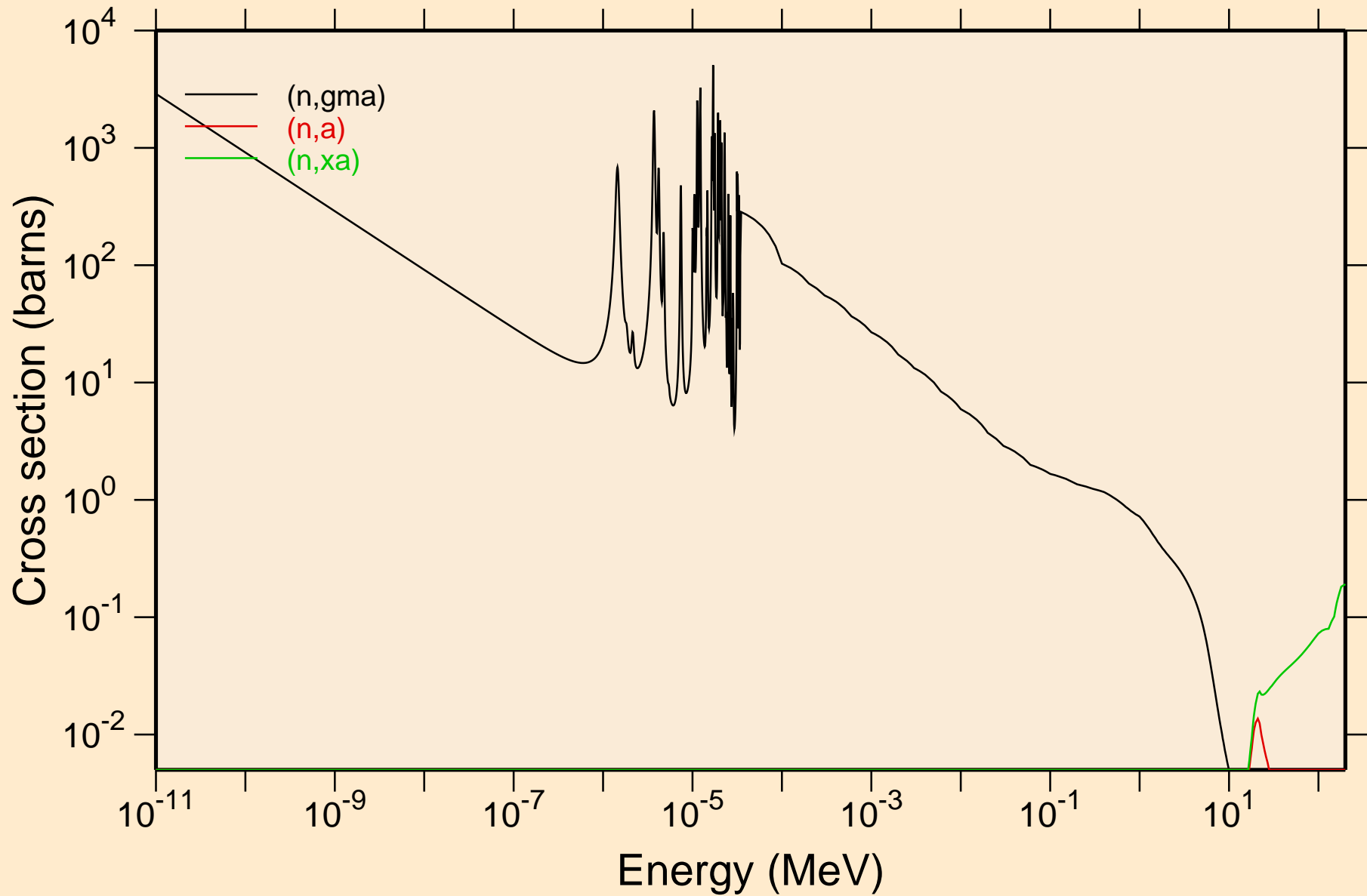

W181 NEUTRON ACER TENDL-2021 LIBRARY; T=293.6K  
Principal cross sections

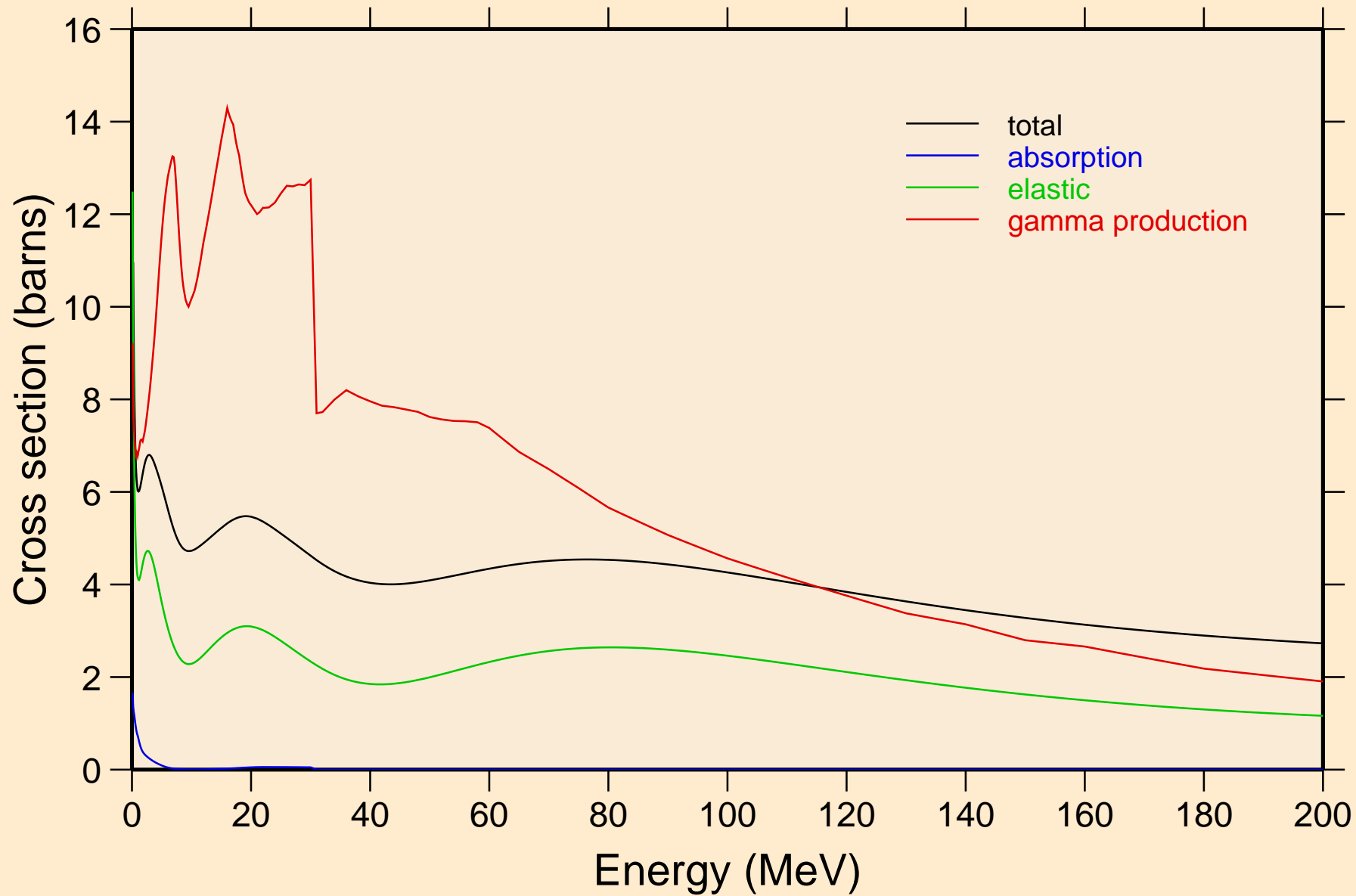

W181 NEUTRON ACER TENDL-2021 LIBRARY; T=293.6K  
Heating

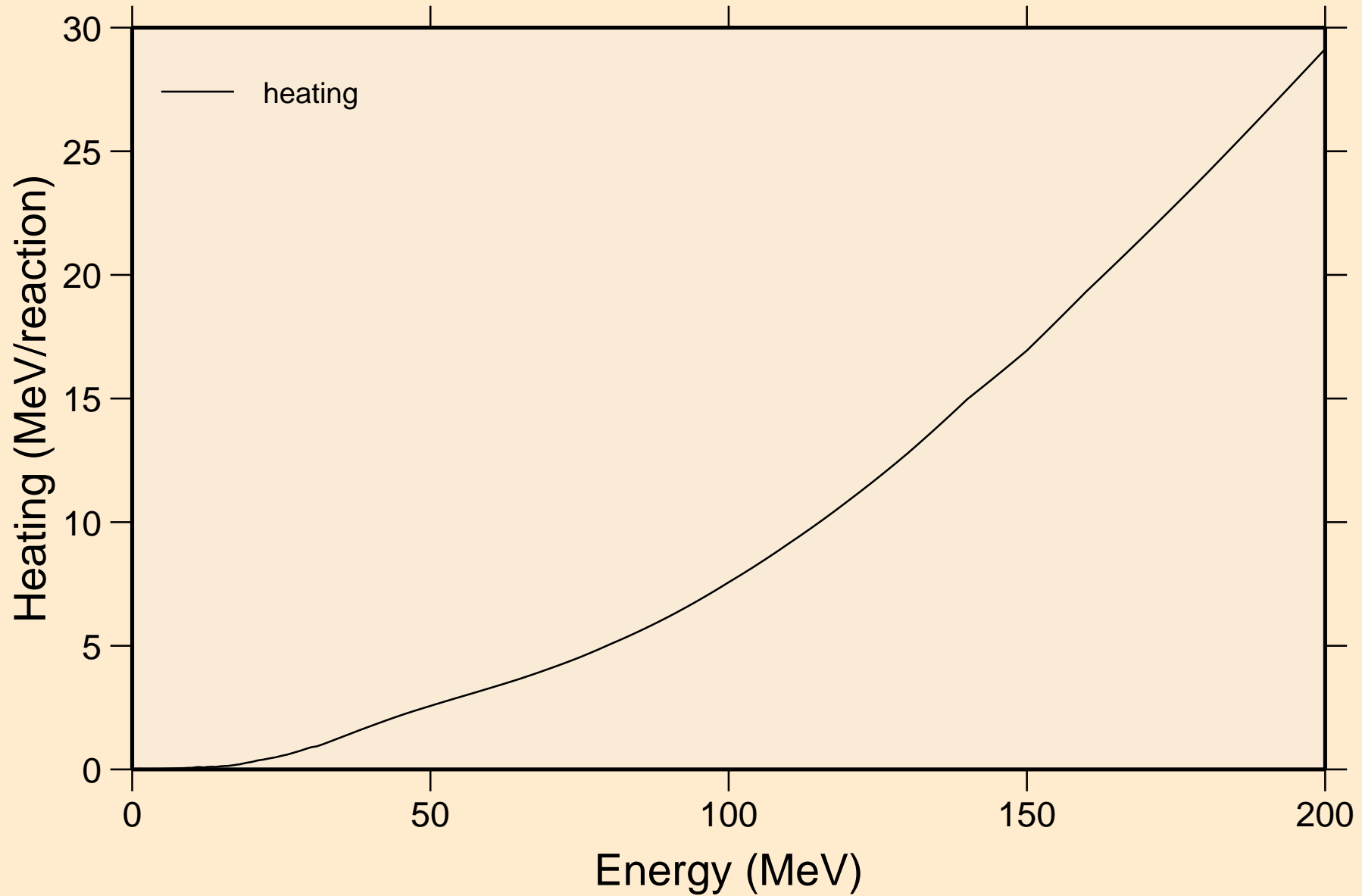

W181 NEUTRON ACER TENDL-2021 LIBRARY; T=293.6K  
Damage

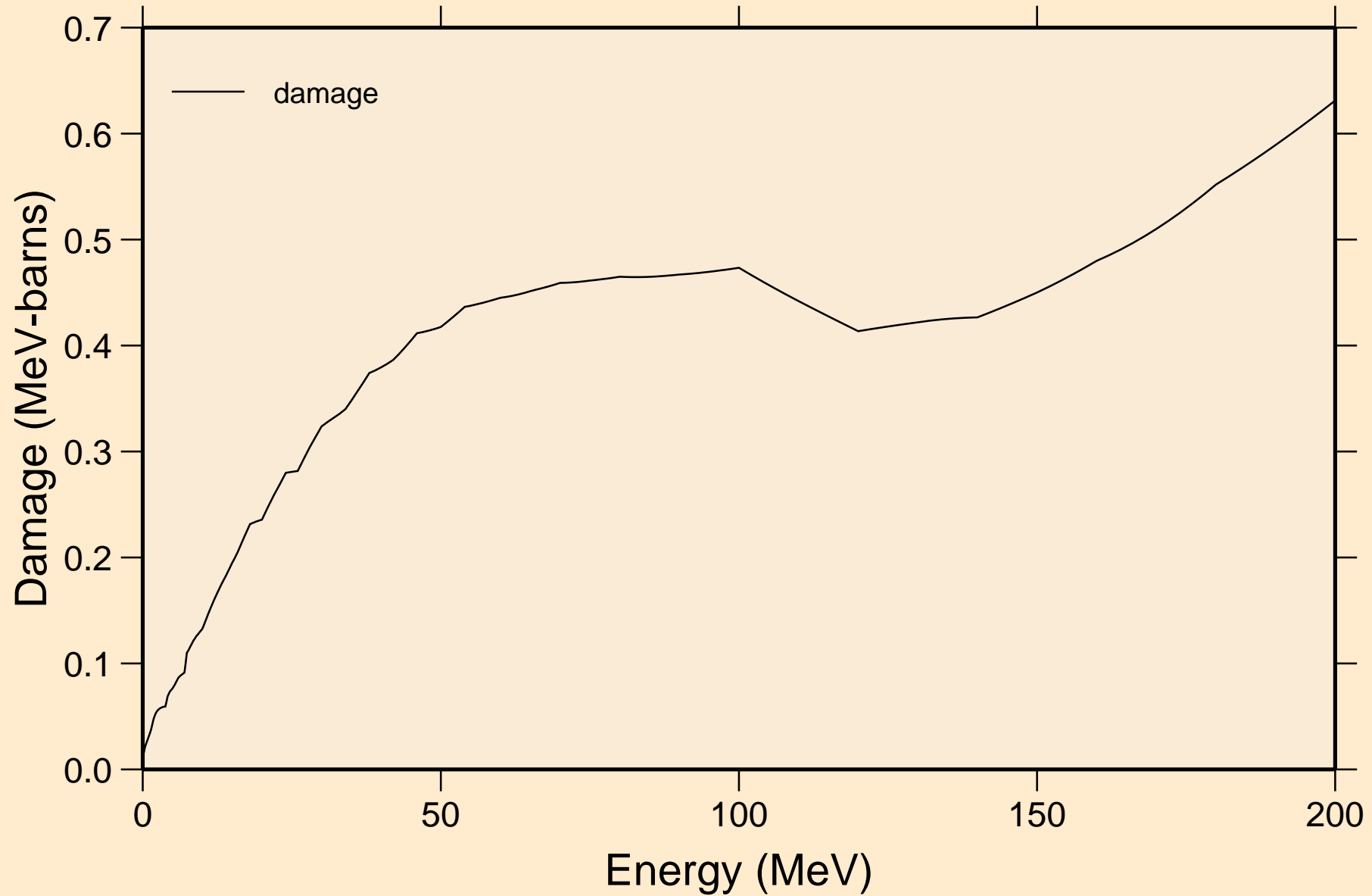

W181 NEUTRON ACER TENDL-2021 LIBRARY; T=293.6K  
Non-threshold reactions

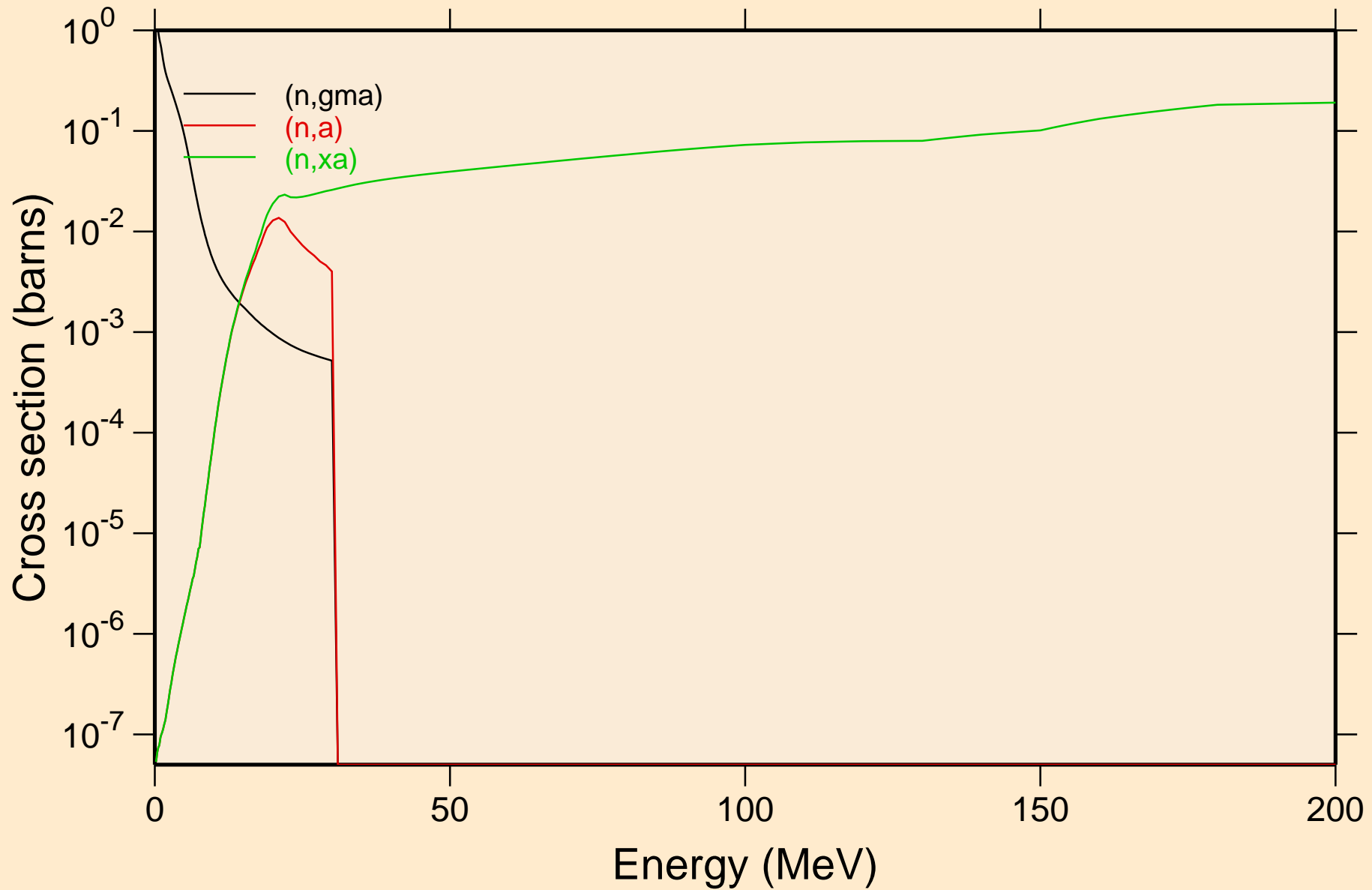

W181 NEUTRON ACER TENDL-2021 LIBRARY; T=293.6K  
Inelastic levels

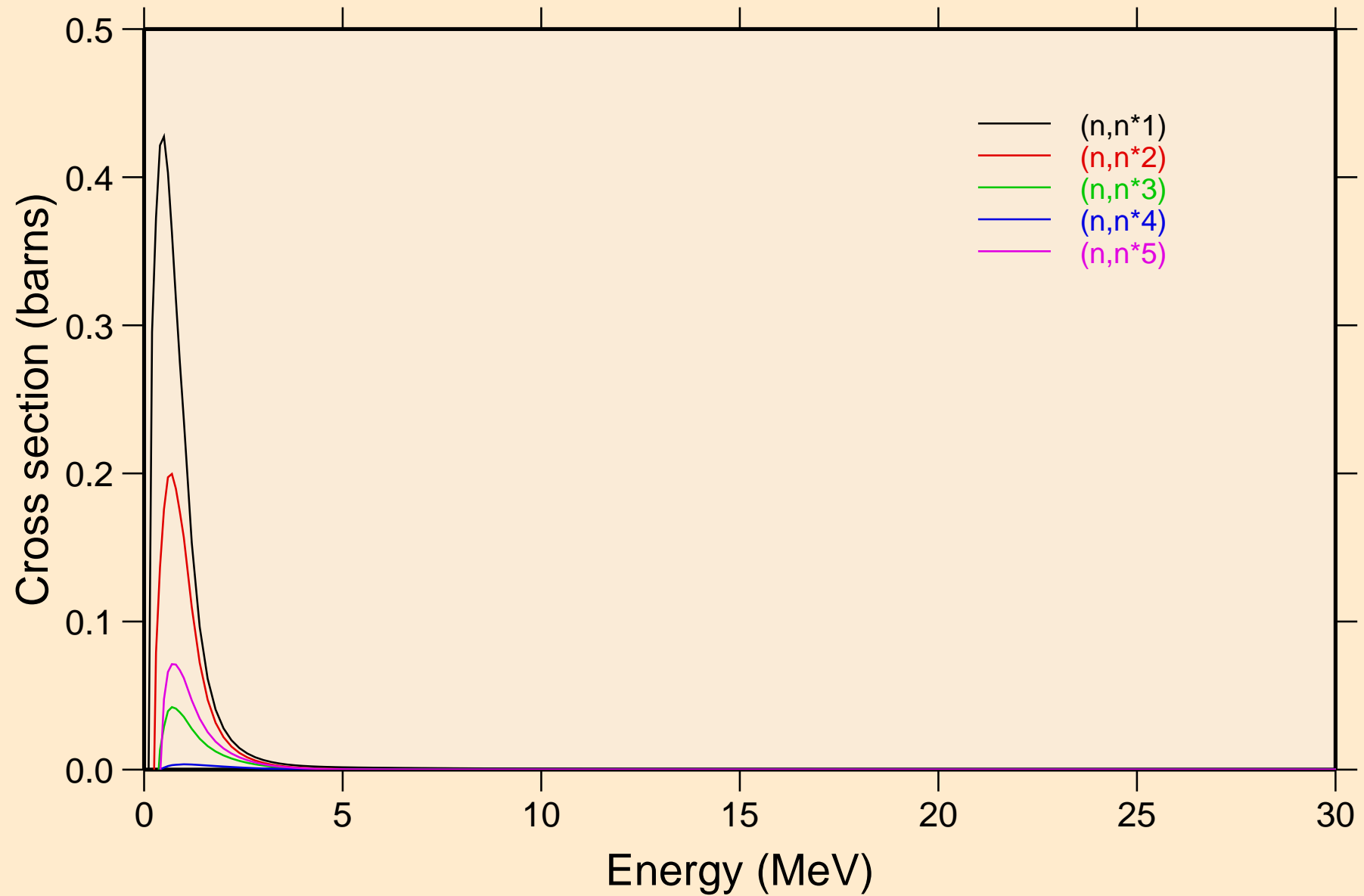

W181 NEUTRON ACER TENDL-2021 LIBRARY; T=293.6K  
Inelastic levels

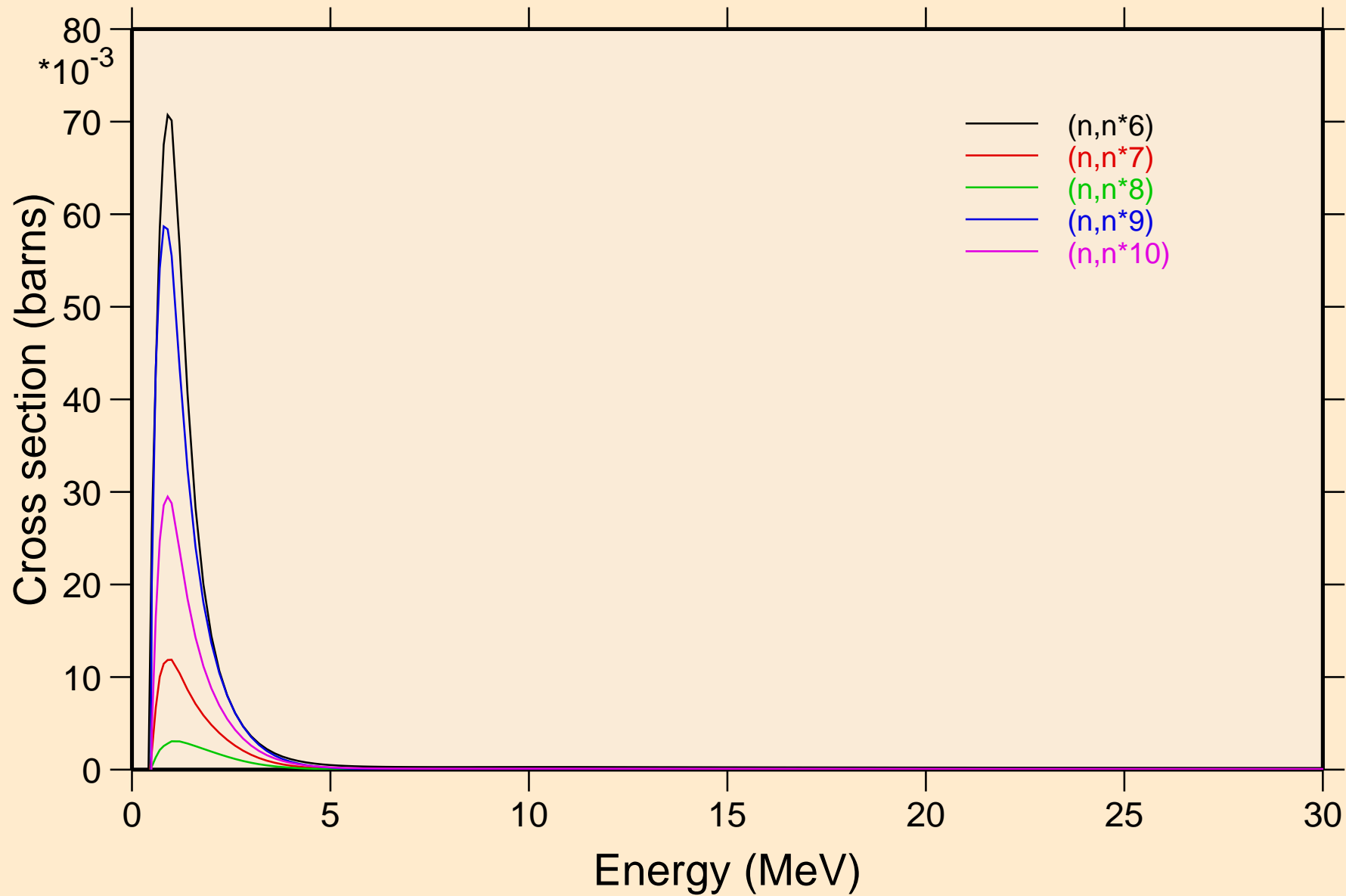



W181 NEUTRON ACER TENDL-2021 LIBRARY; T=293.6K  
Inelastic levels

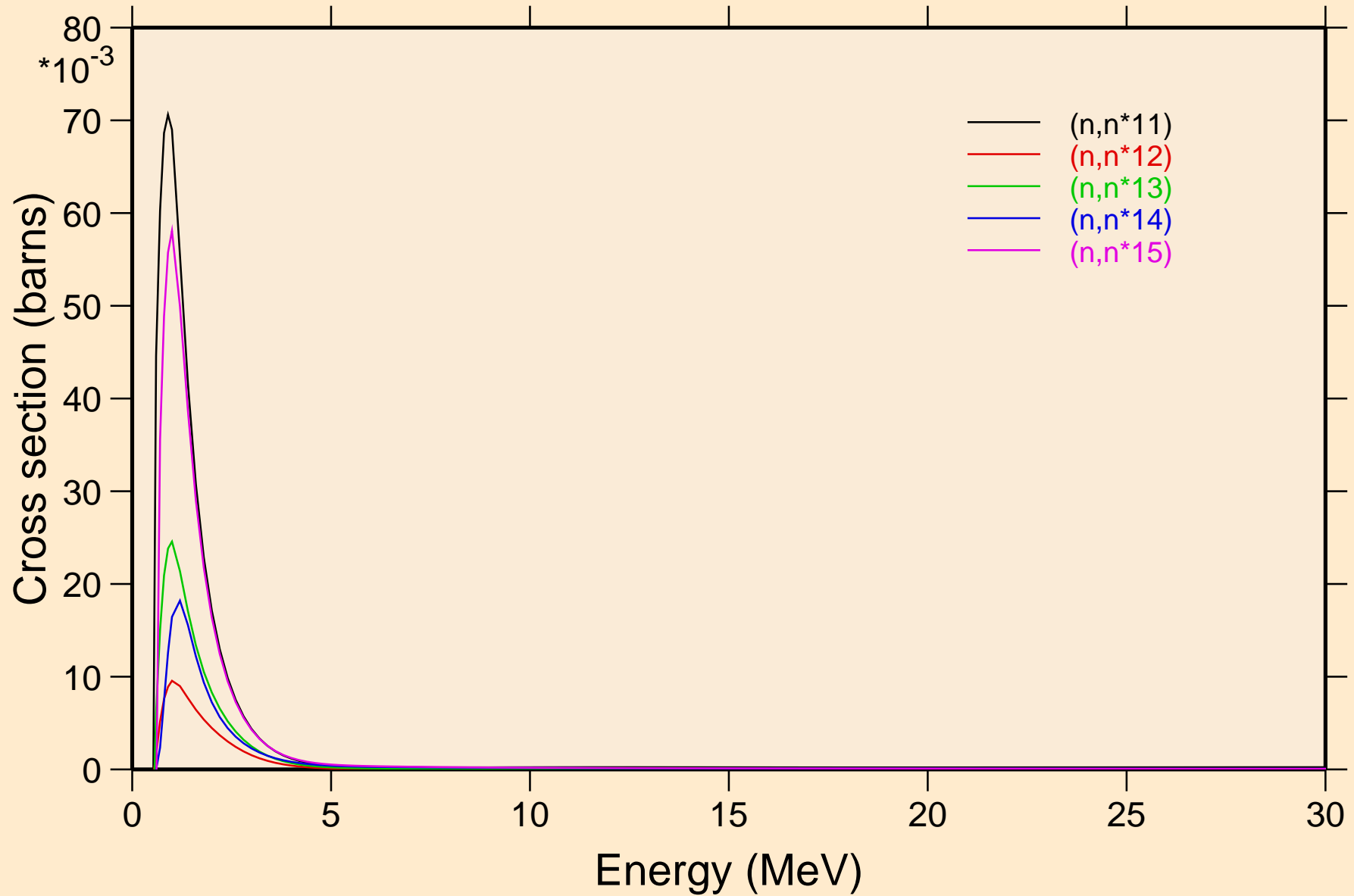

W181 NEUTRON ACER TENDL-2021 LIBRARY; T=293.6K  
Inelastic levels

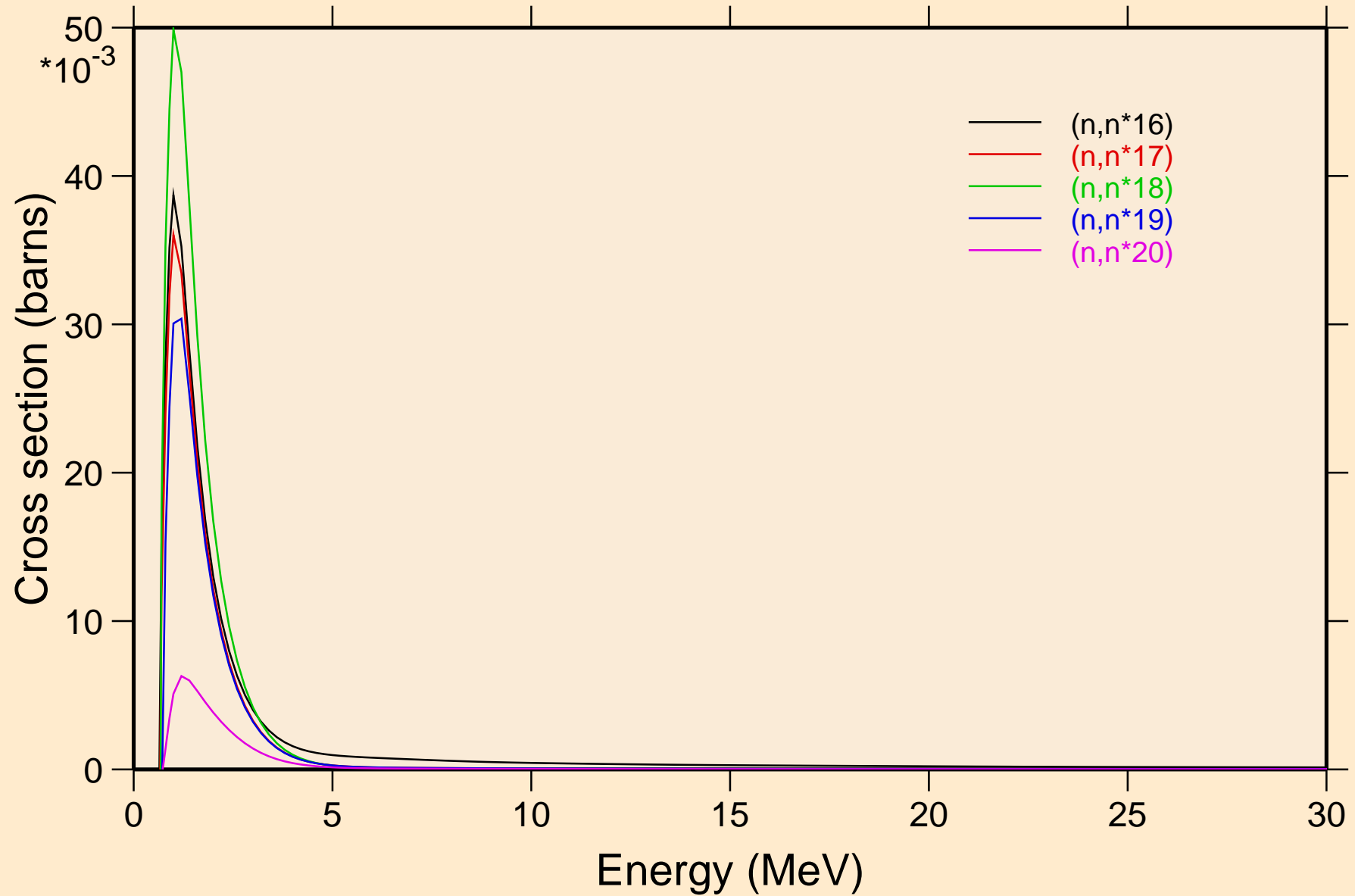

W181 NEUTRON ACER TENDL-2021 LIBRARY; T=293.6K  
Inelastic levels

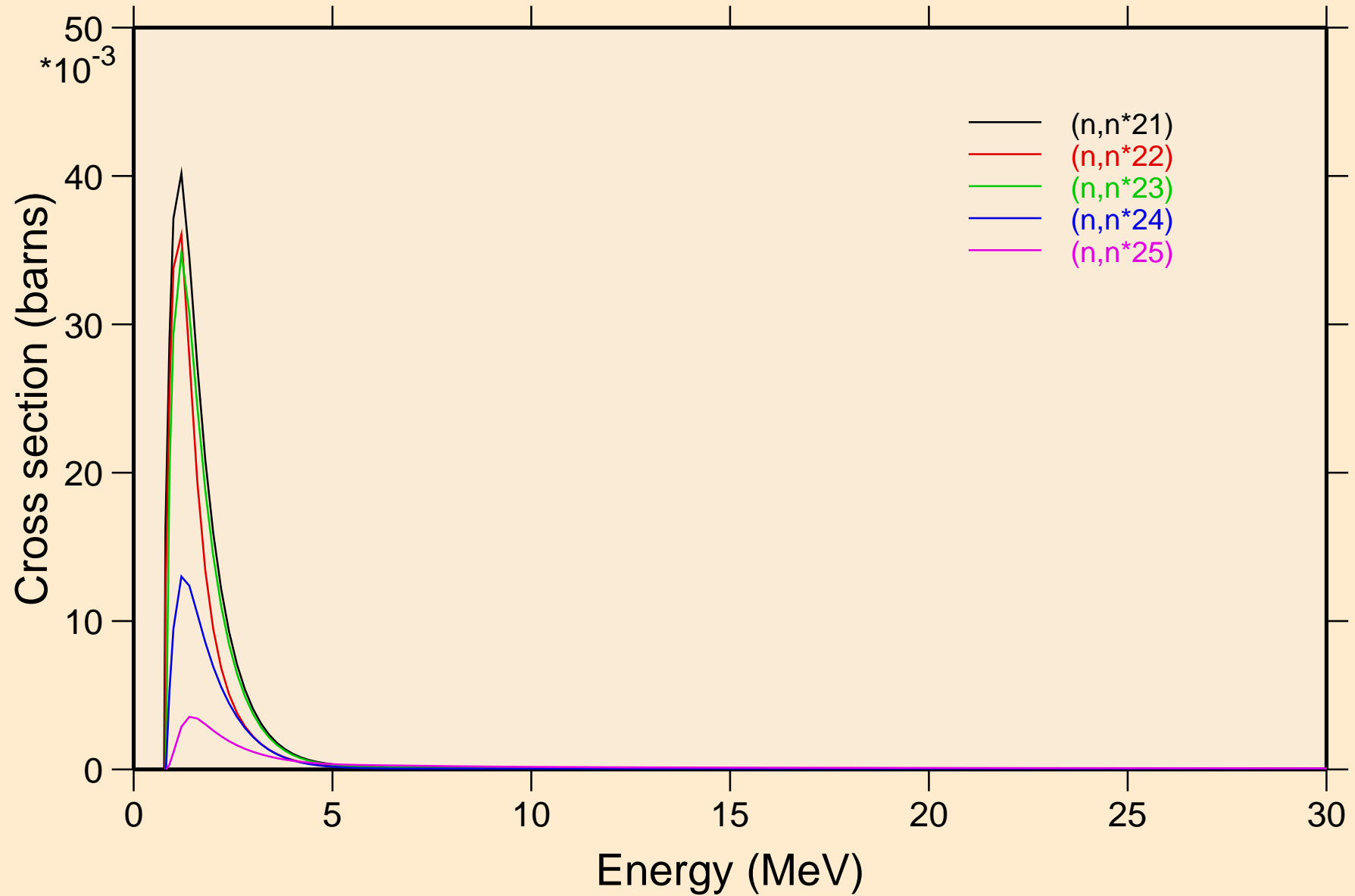

W181 NEUTRON ACER TENDL-2021 LIBRARY; T=293.6K  
Inelastic levels

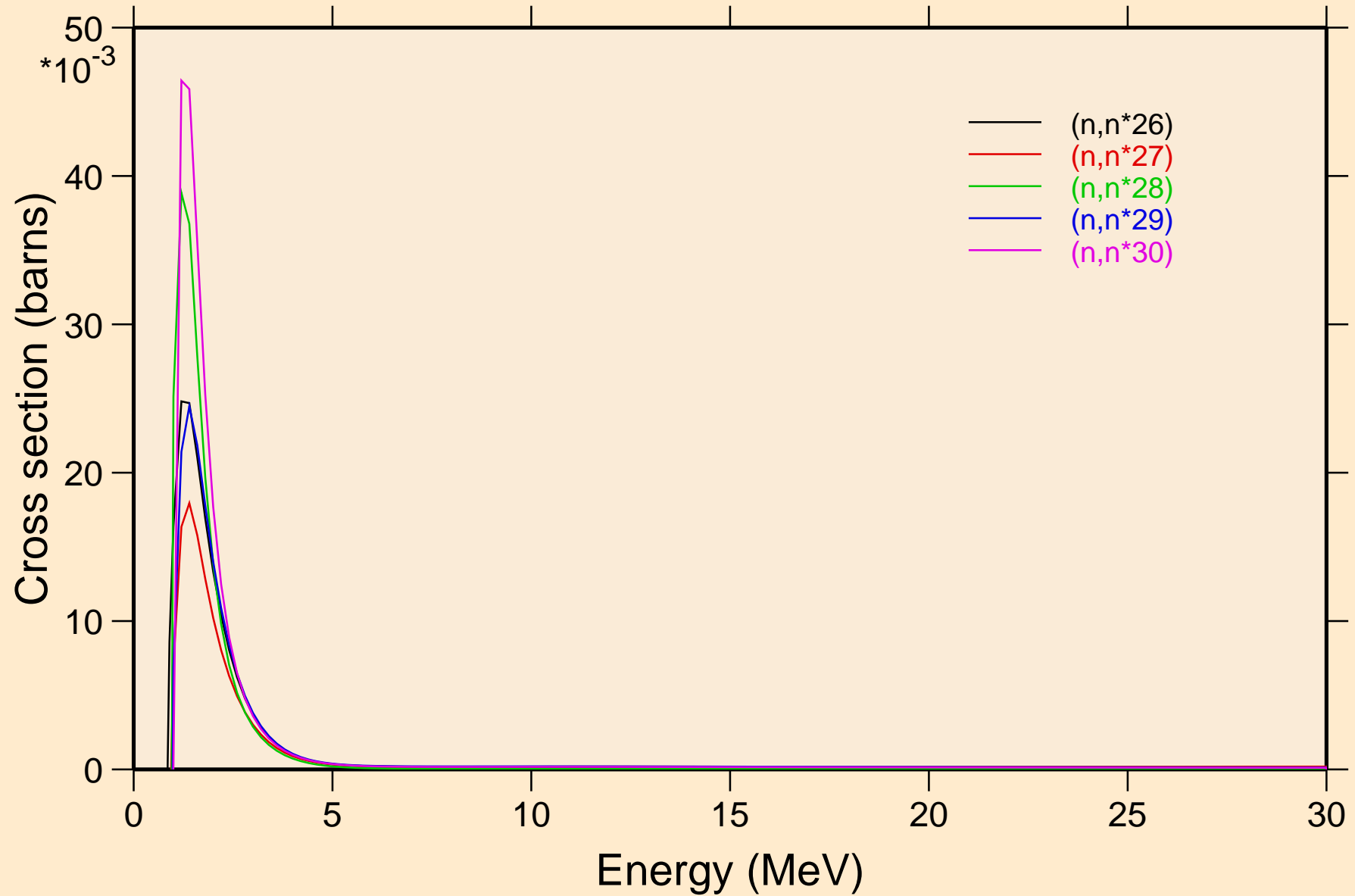

W181 NEUTRON ACER TENDL-2021 LIBRARY; T=293.6K  
Threshold reactions

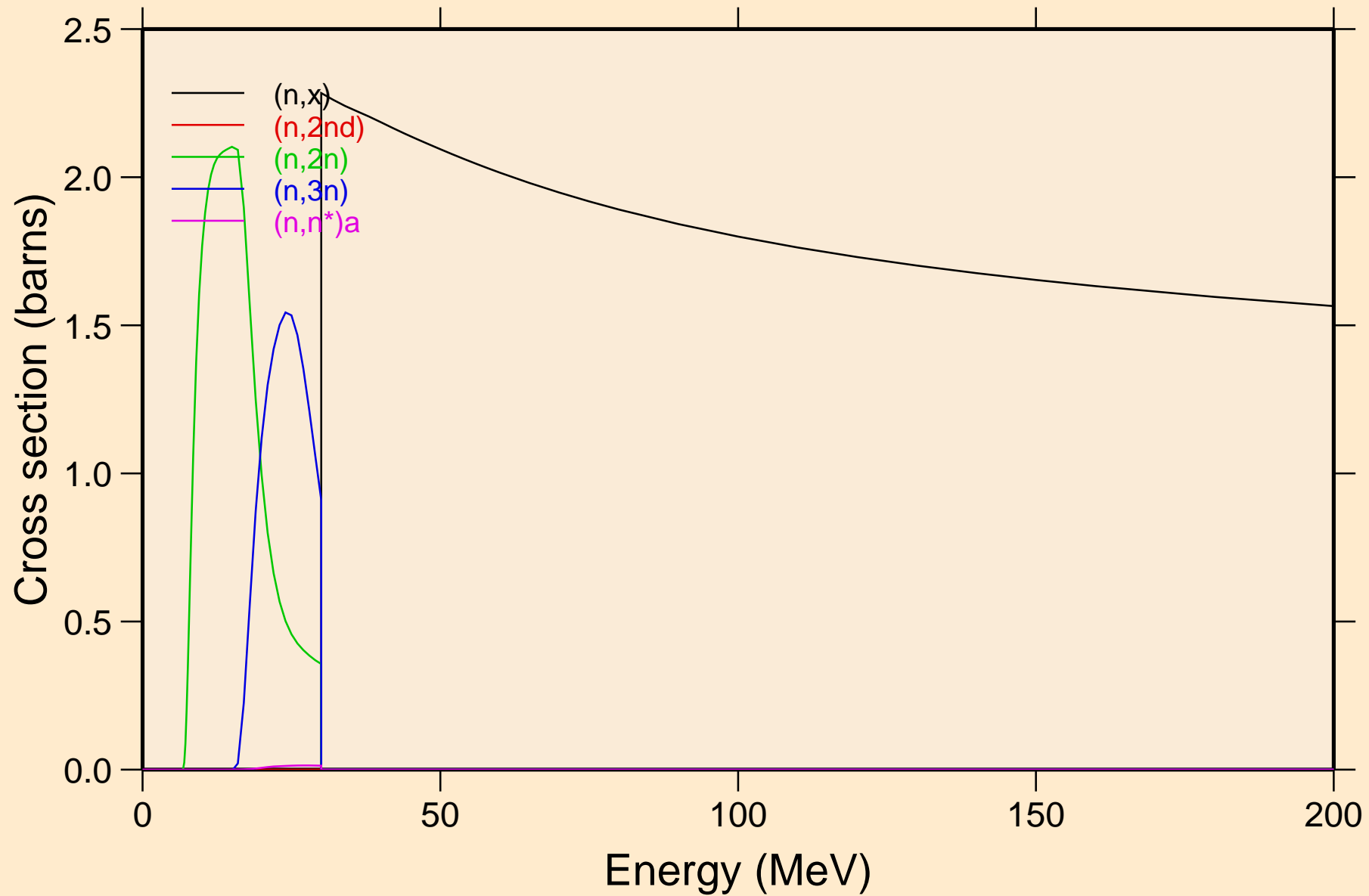

W181 NEUTRON ACER TENDL-2021 LIBRARY; T=293.6K  
Threshold reactions

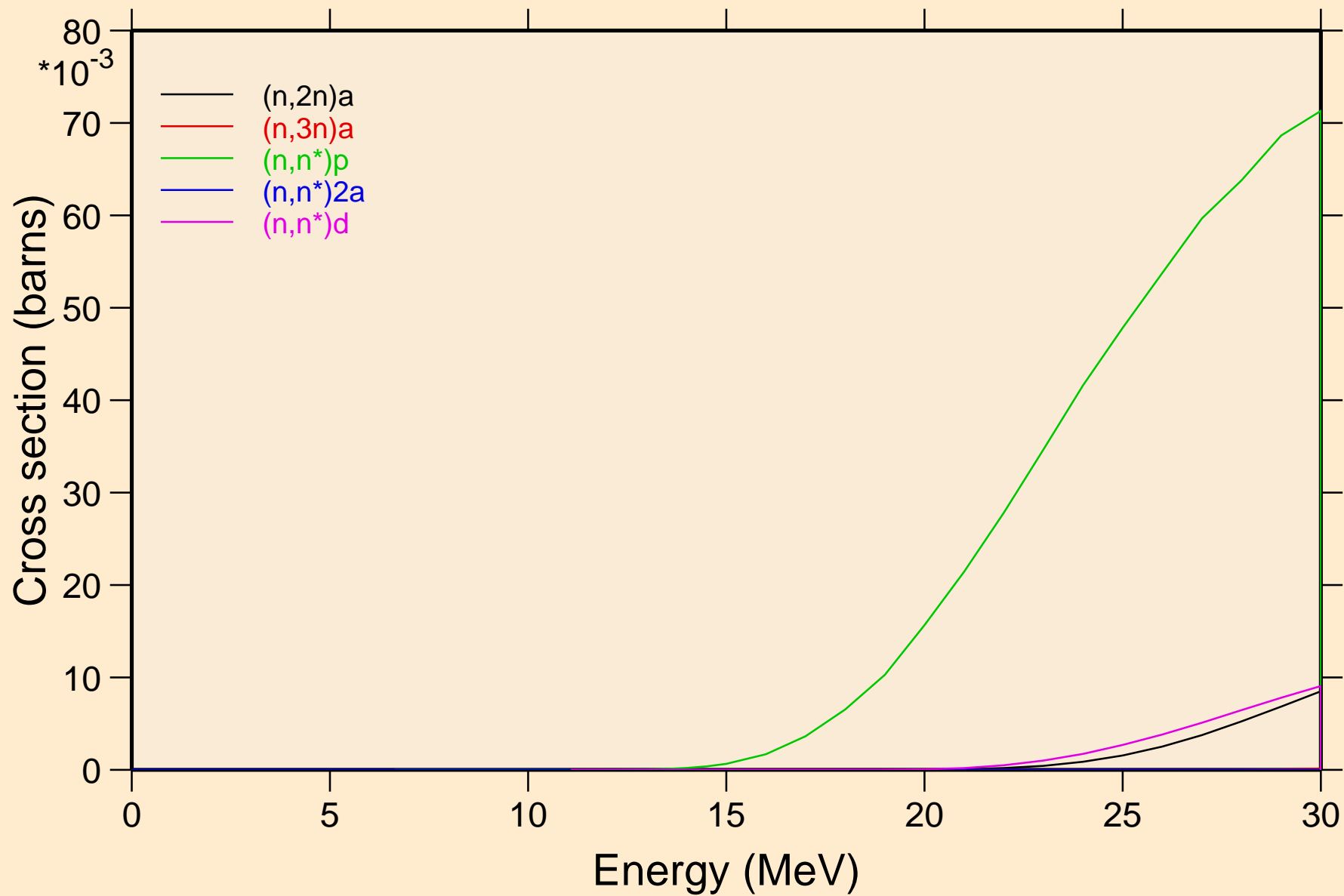

W181 NEUTRON ACER TENDL-2021 LIBRARY; T=293.6K  
Threshold reactions

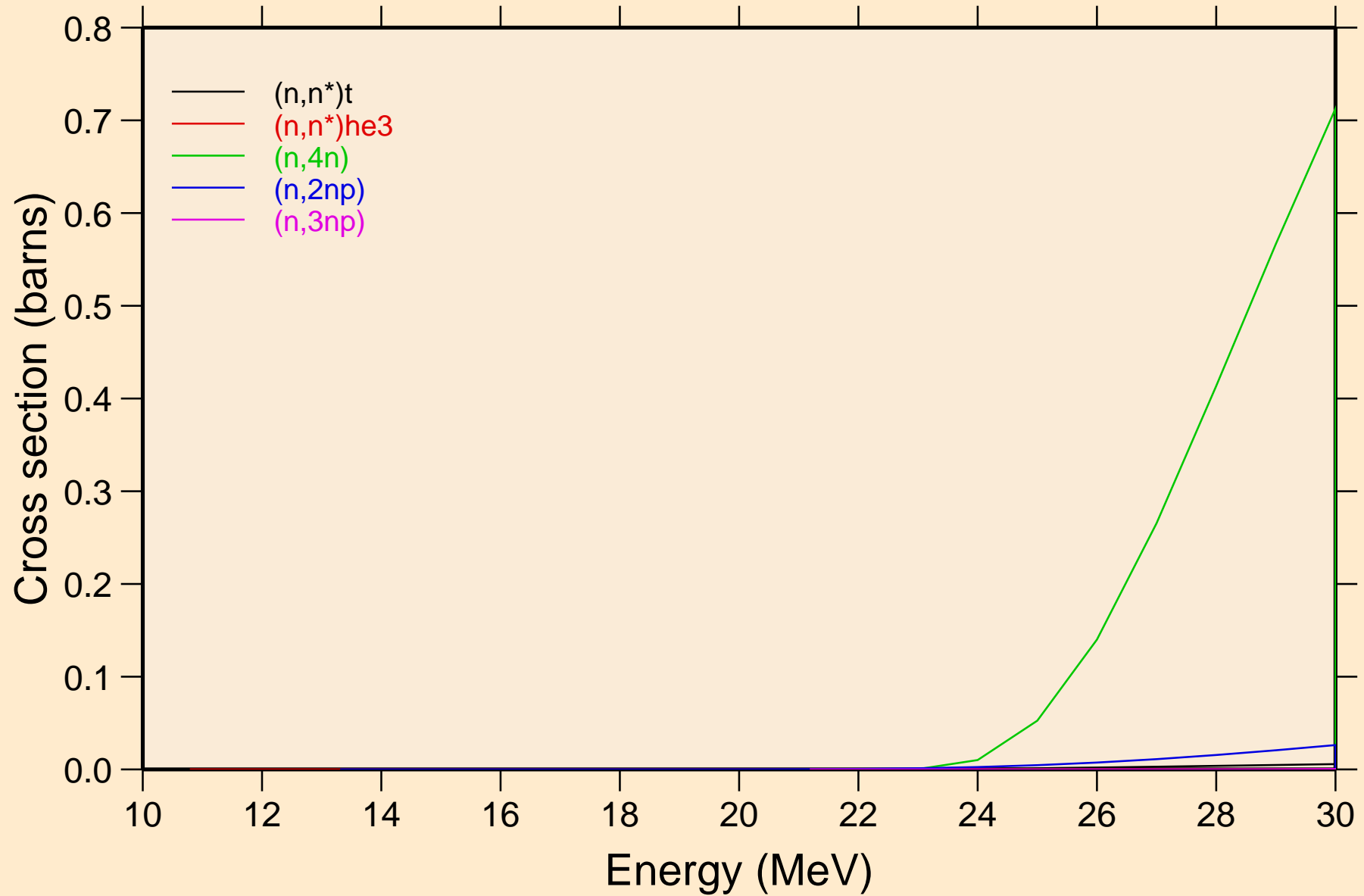

W181 NEUTRON ACER TENDL-2021 LIBRARY; T=293.6K  
Threshold reactions

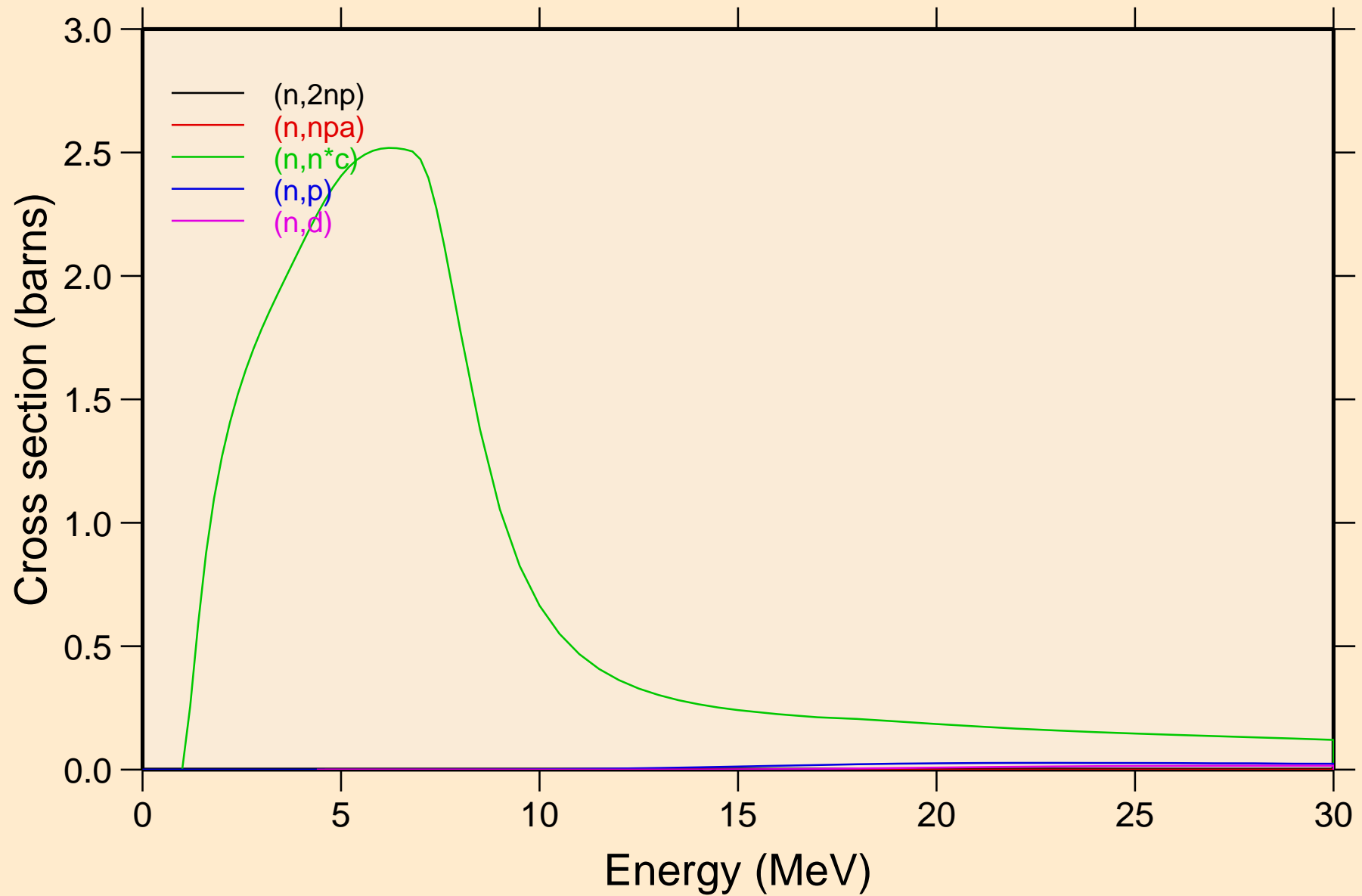



W181 NEUTRON ACER TENDL-2021 LIBRARY; T=293.6K  
Threshold reactions

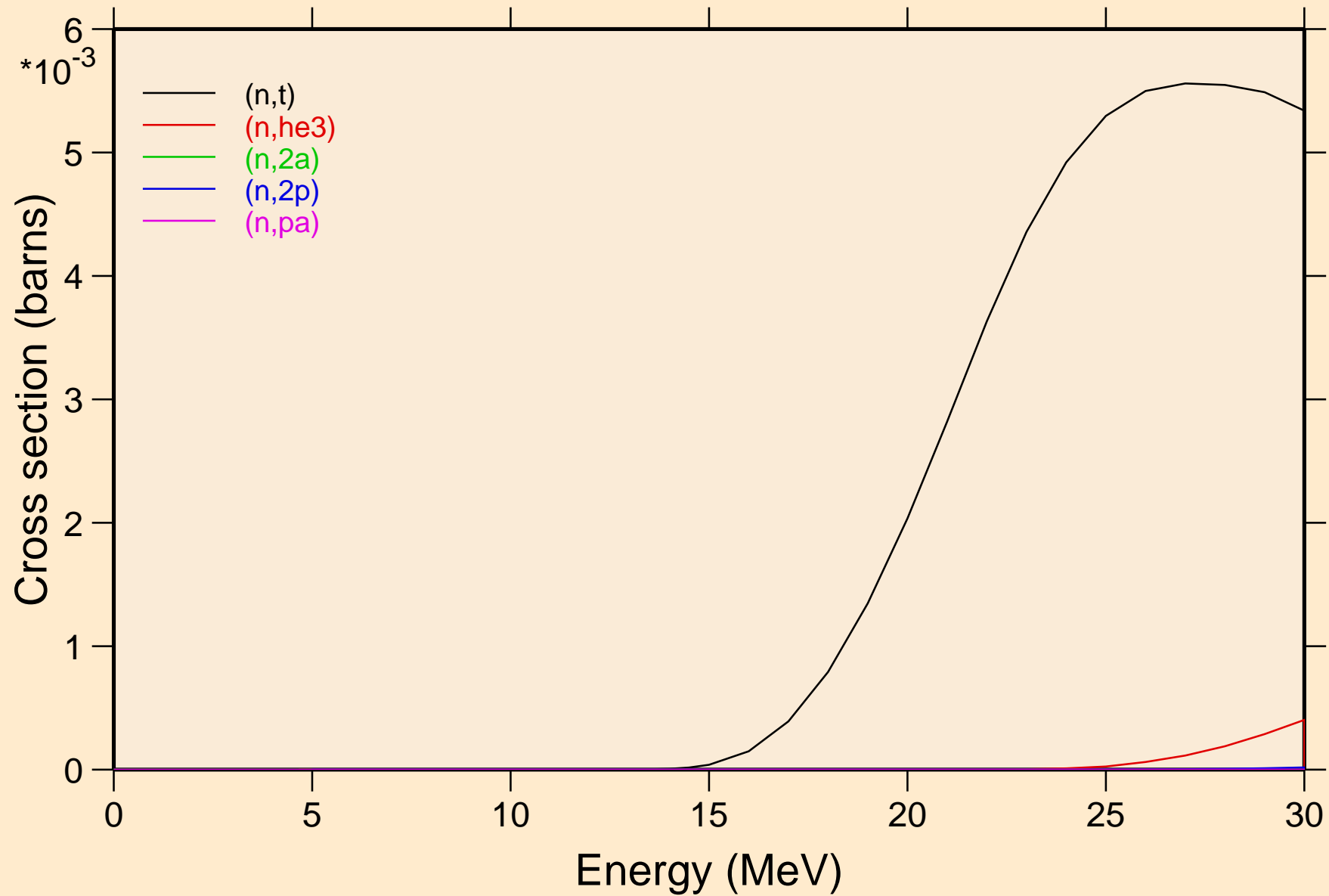

W181 NEUTRON ACER TENDL-2021 LIBRARY; T=293.6K  
Threshold reactions

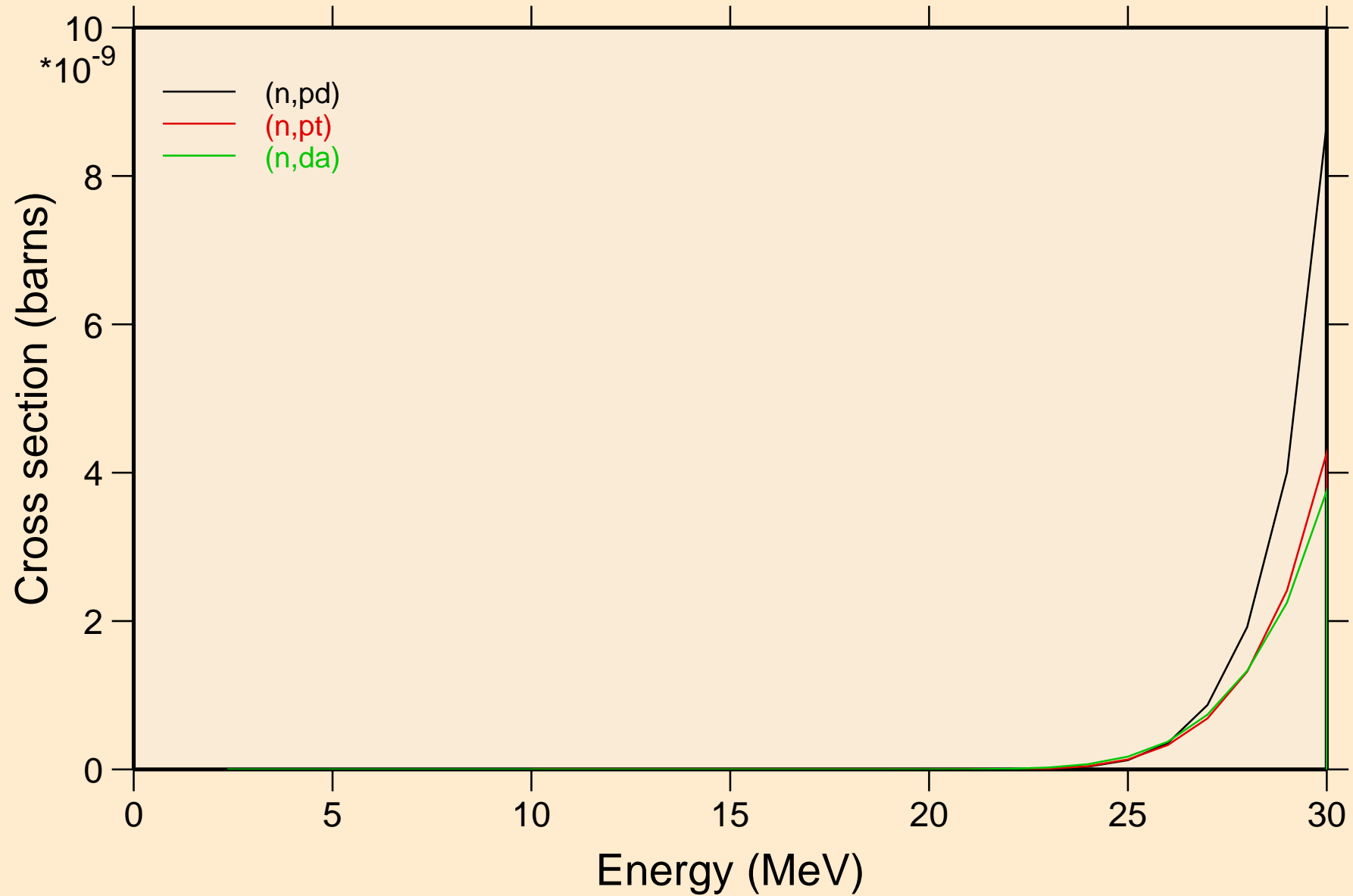

W181 NEUTRON ACER TENDL-2021 LIBRARY; T=293.6K  
Threshold reactions

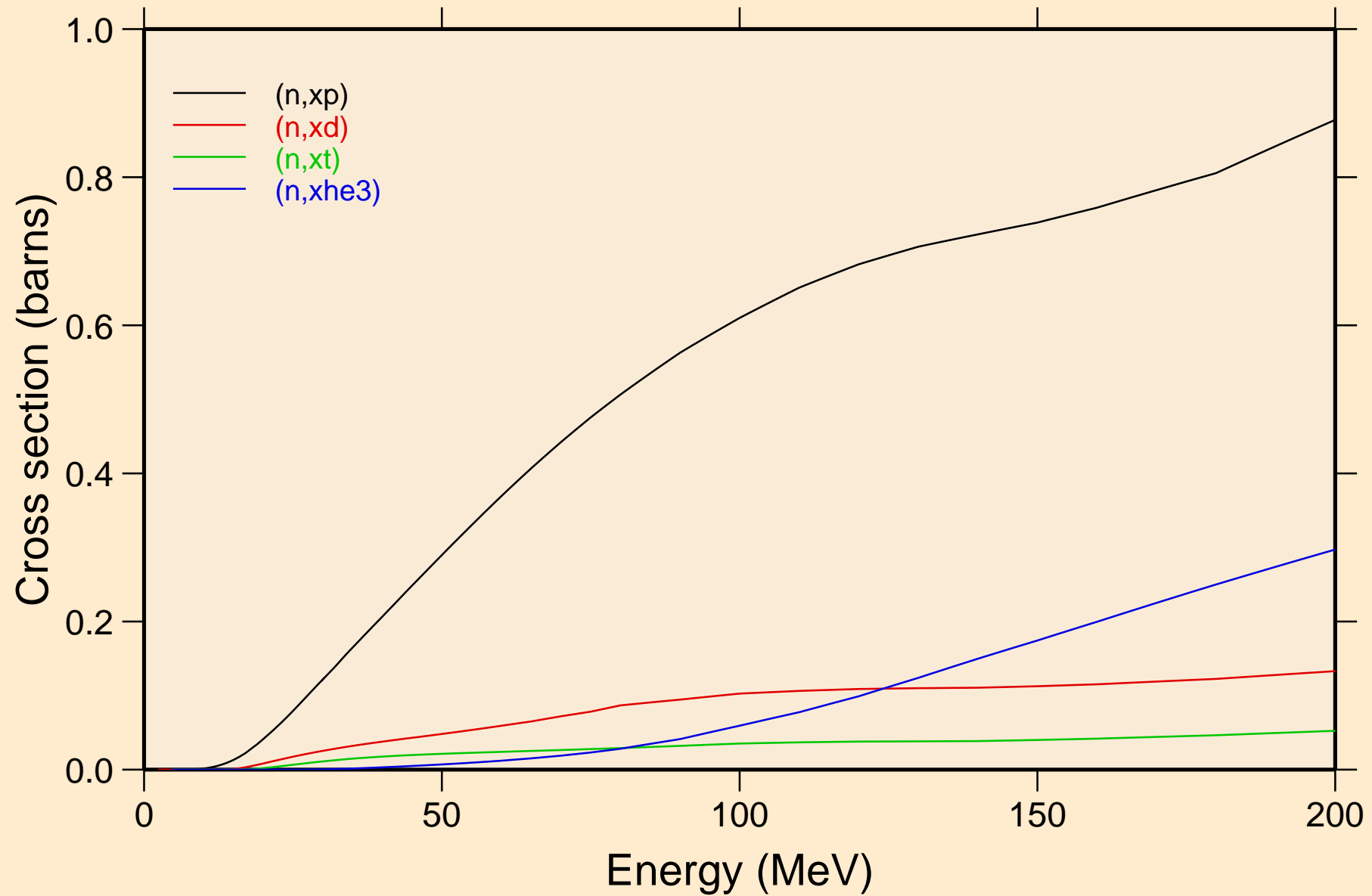

W181 NEUTRON ACER TENDL-2021 LIBRARY; T=293.6K  
angular distribution for elastic

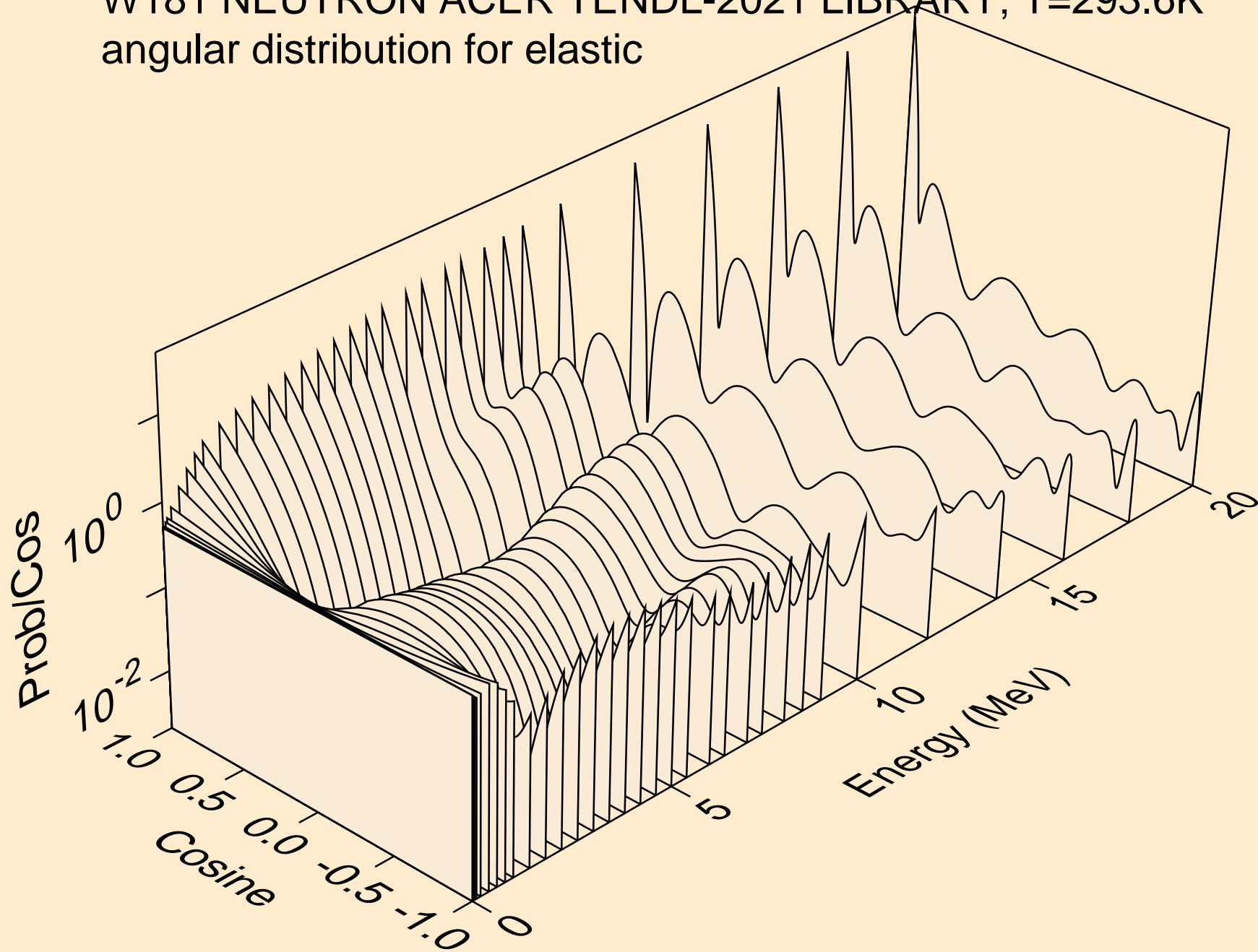

W181 NEUTRON ACER TENDL-2021 LIBRARY; T=293.6K  
angular distribution for elastic

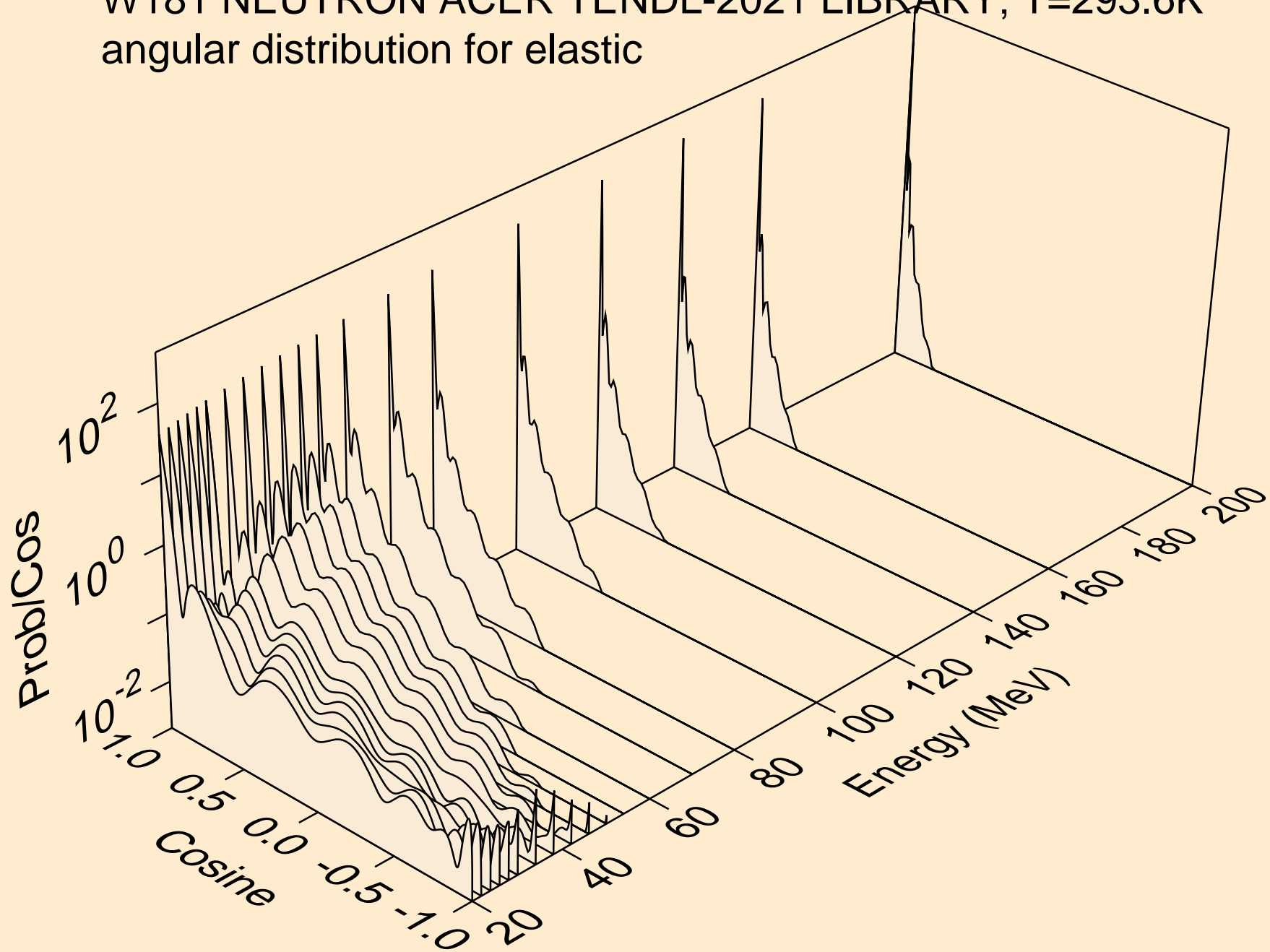

W181 NEUTRON ACER TENDL-2021 LIBRARY; T=293.6K  
angular distribution for (n,n\*1)

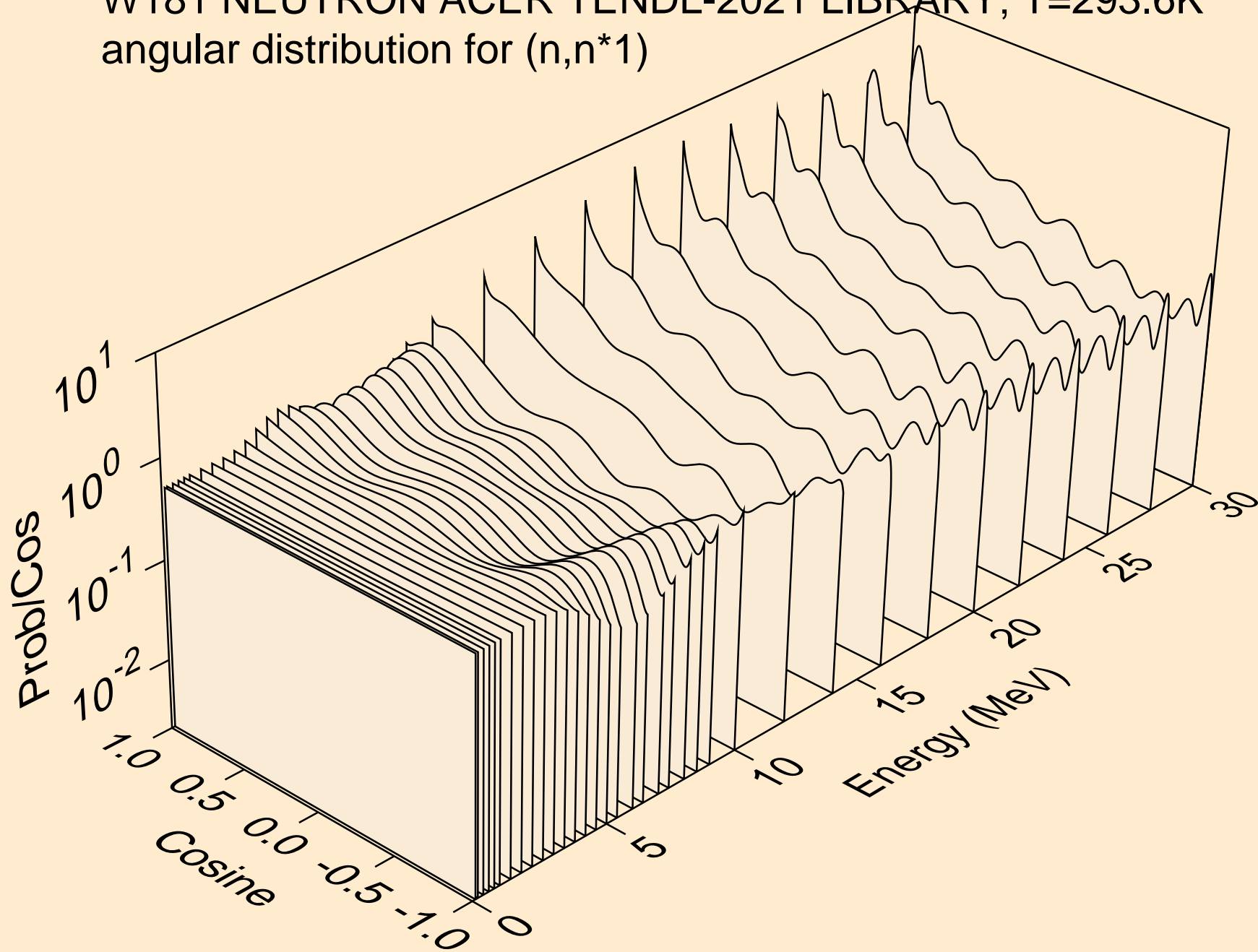

W181 NEUTRON ACER TENDL-2021 LIBRARY; T=293.6K  
angular distribution for (n,n\*2)

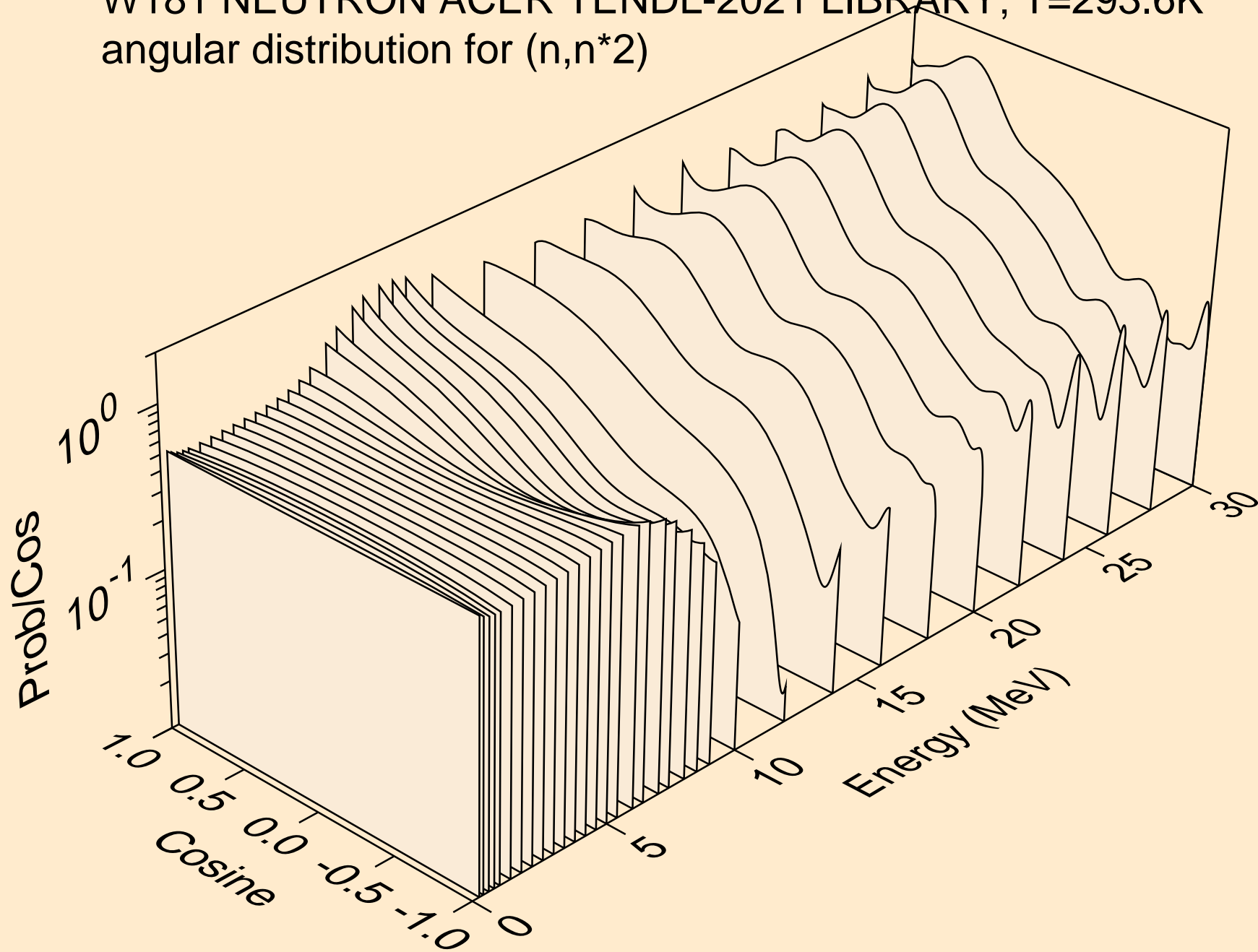

W181 NEUTRON ACER TENDL-2021 LIBRARY; T=293.6K  
angular distribution for (n,n\*3)

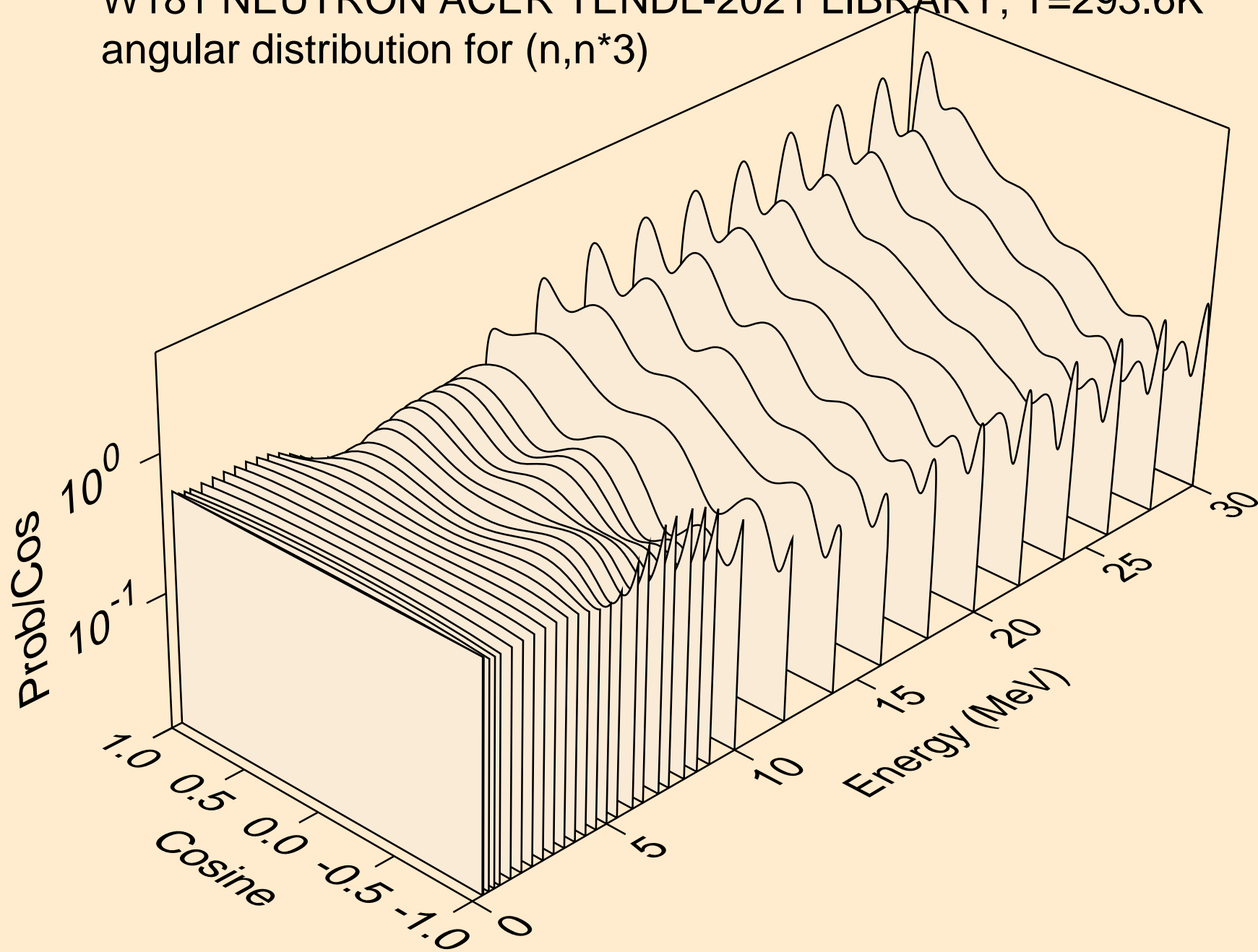



W181 NEUTRON ACER TENDL-2021 LIBRARY; T=293.6K  
angular distribution for (n,n\*4)

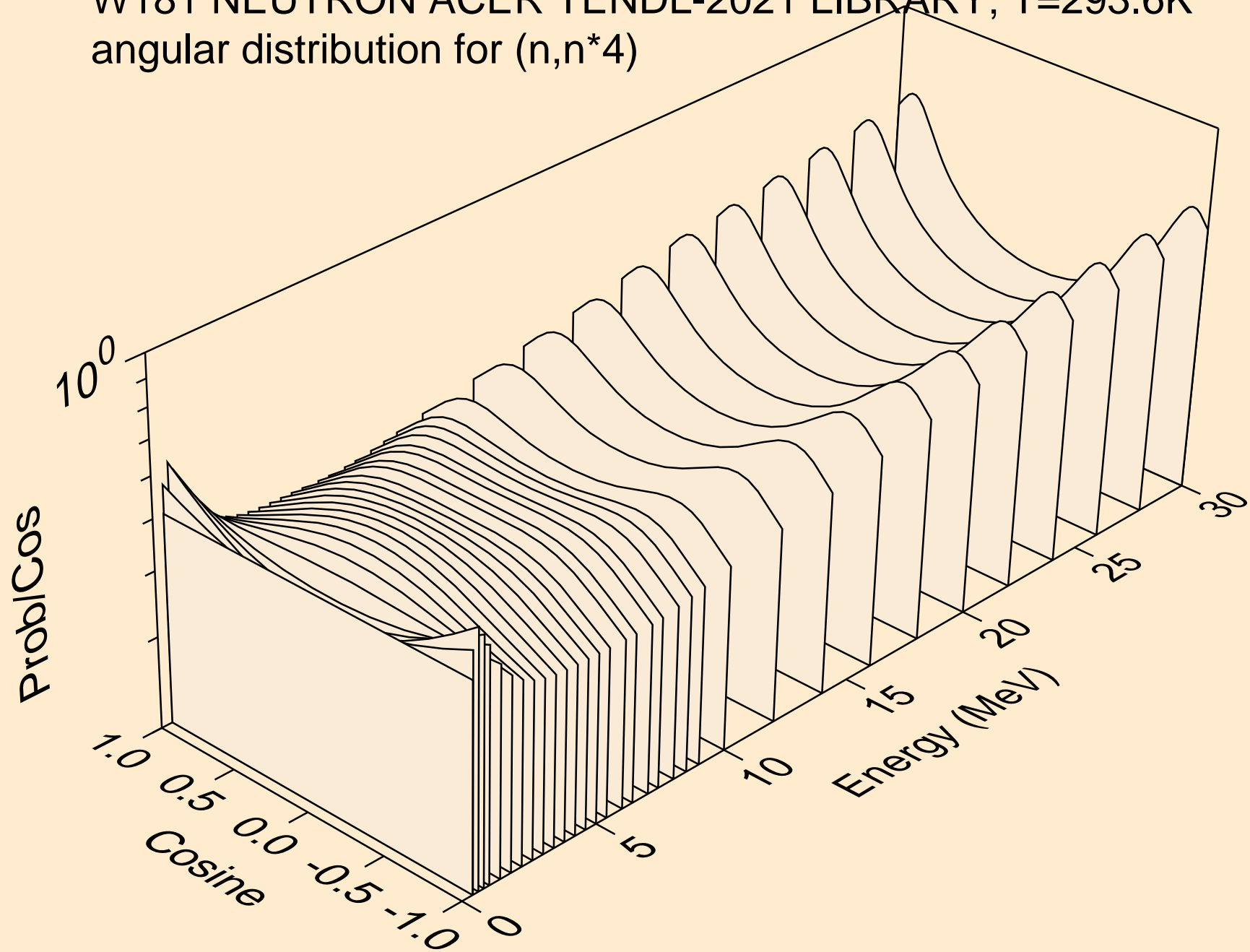

W181 NEUTRON ACER TENDL-2021 LIBRARY; T=293.6K  
angular distribution for (n,n\*5)

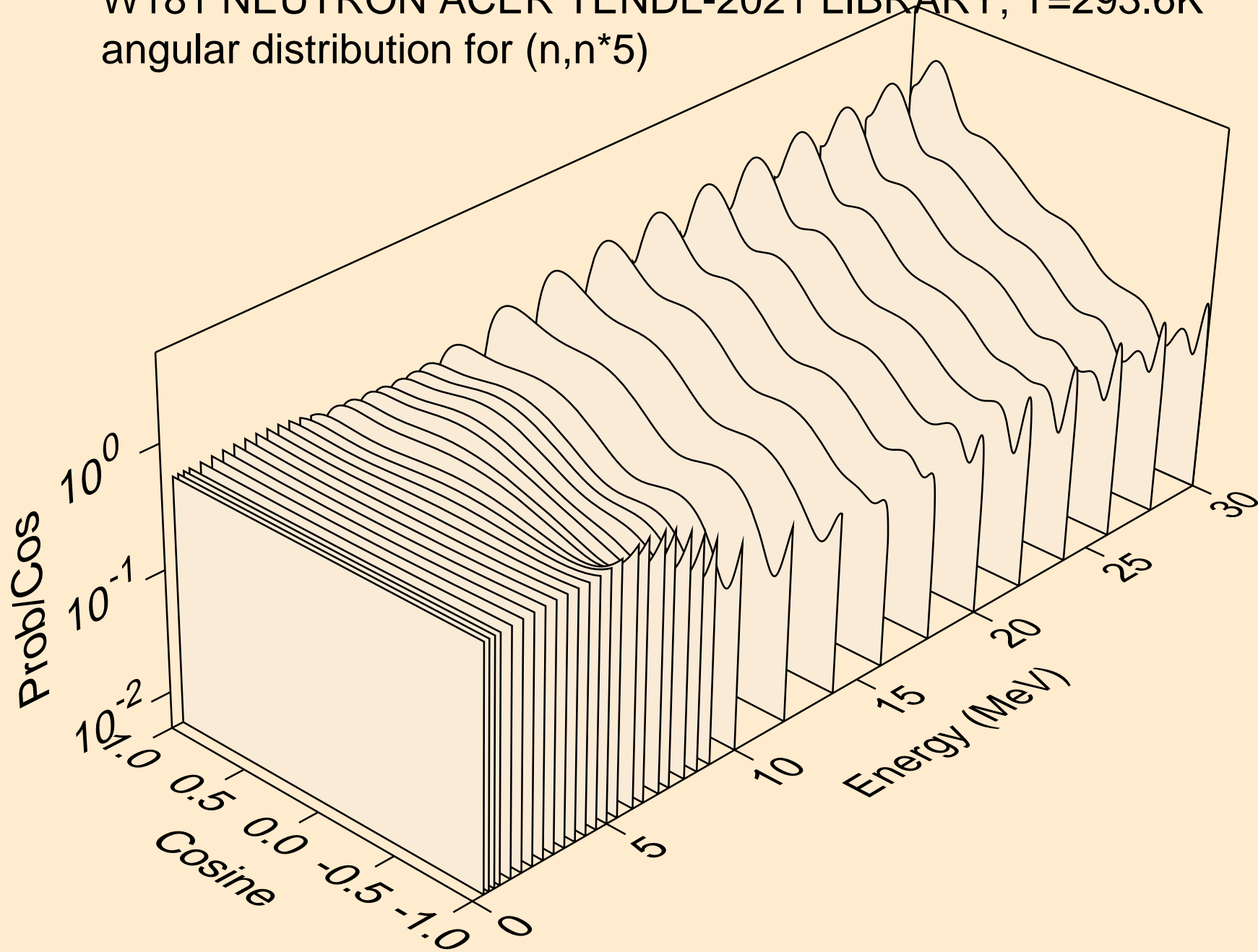

W181 NEUTRON ACER TENDL-2021 LIBRARY; T=293.6K  
angular distribution for (n,n\*6)

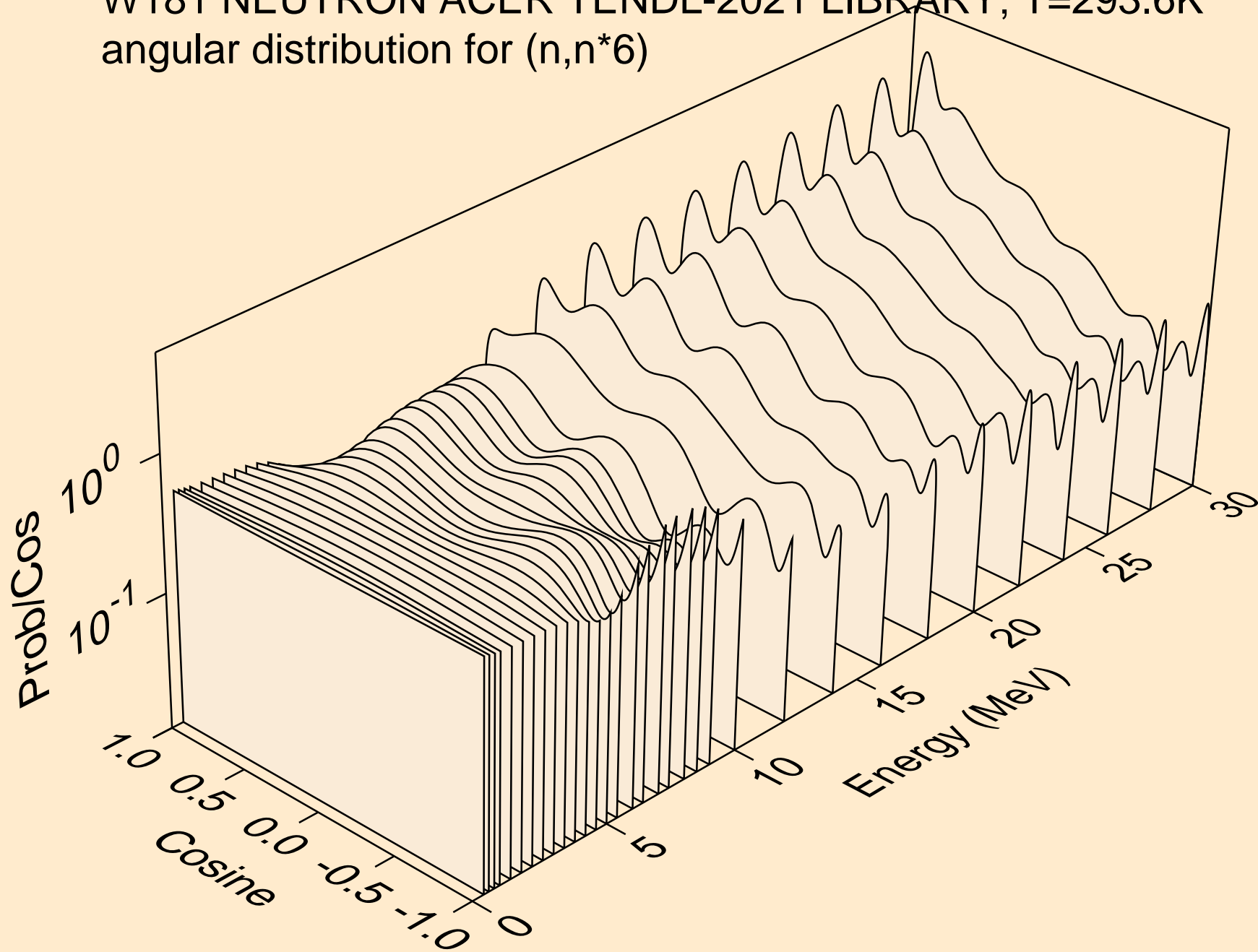

W181 NEUTRON ACER TENDL-2021 LIBRARY; T=293.6K  
angular distribution for (n,n\*7)

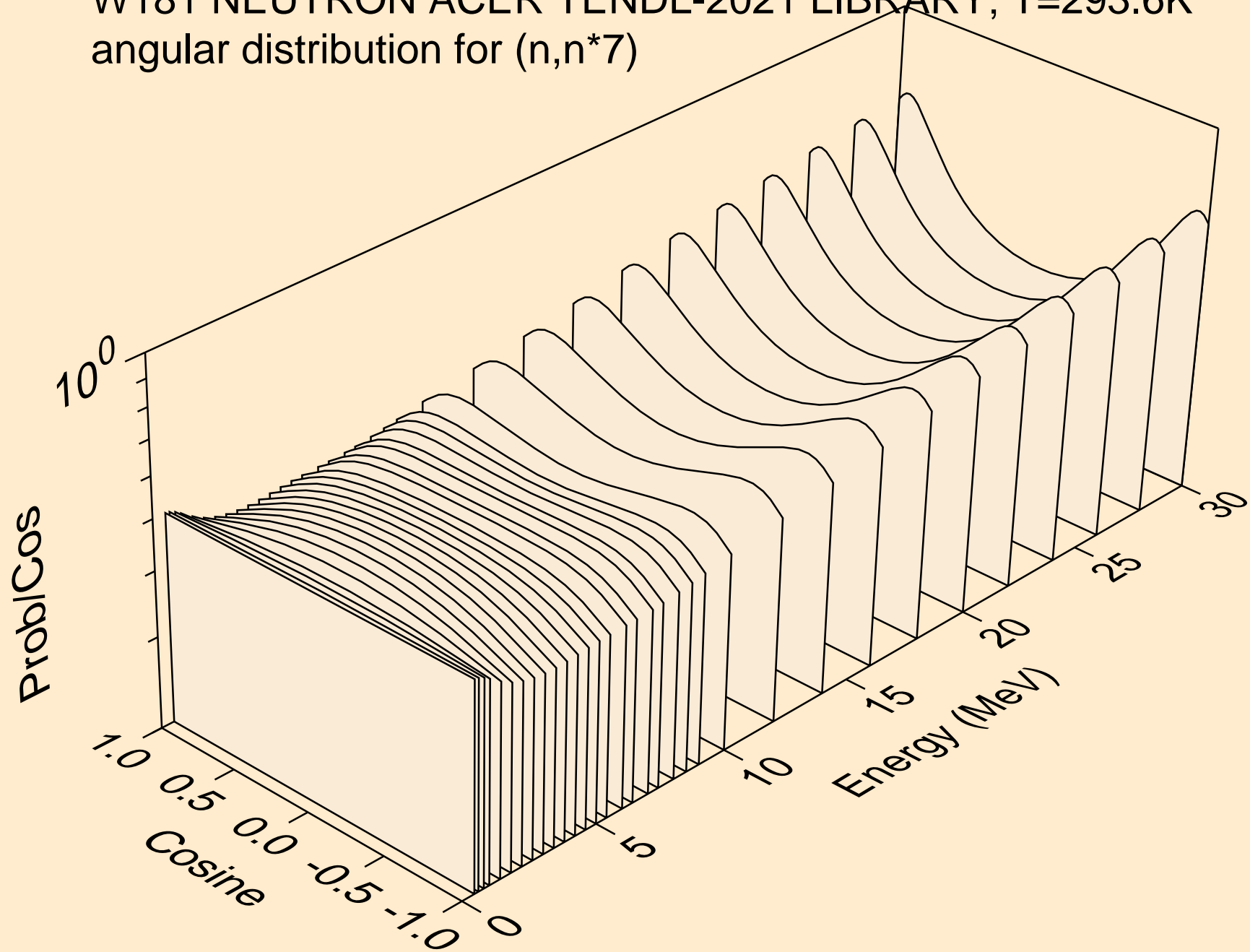

W181 NEUTRON ACER TENDL-2021 LIBRARY; T=293.6K  
angular distribution for (n,n\*8)

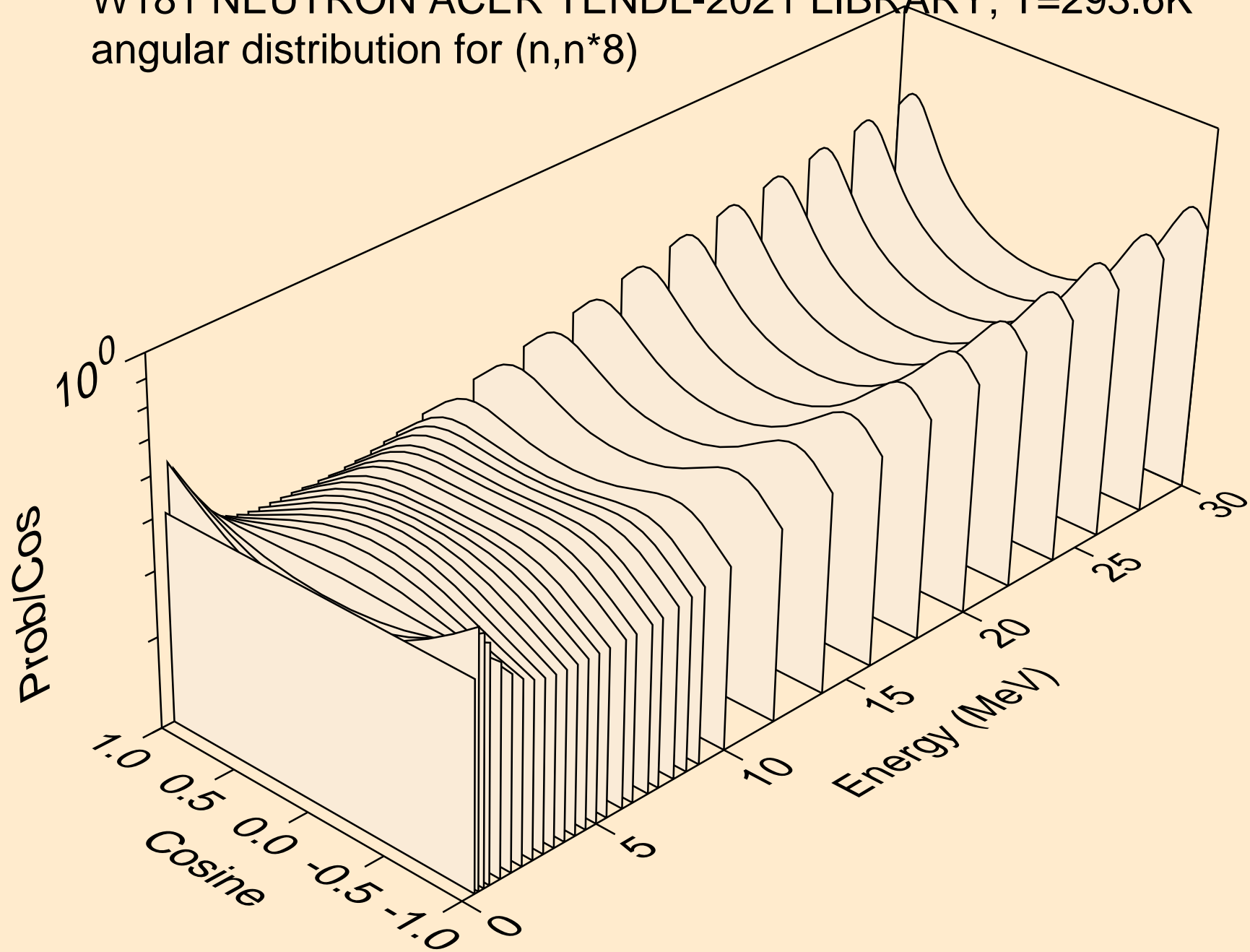

W181 NEUTRON ACER TENDL-2021 LIBRARY; T=293.6K  
angular distribution for (n,n\*9)

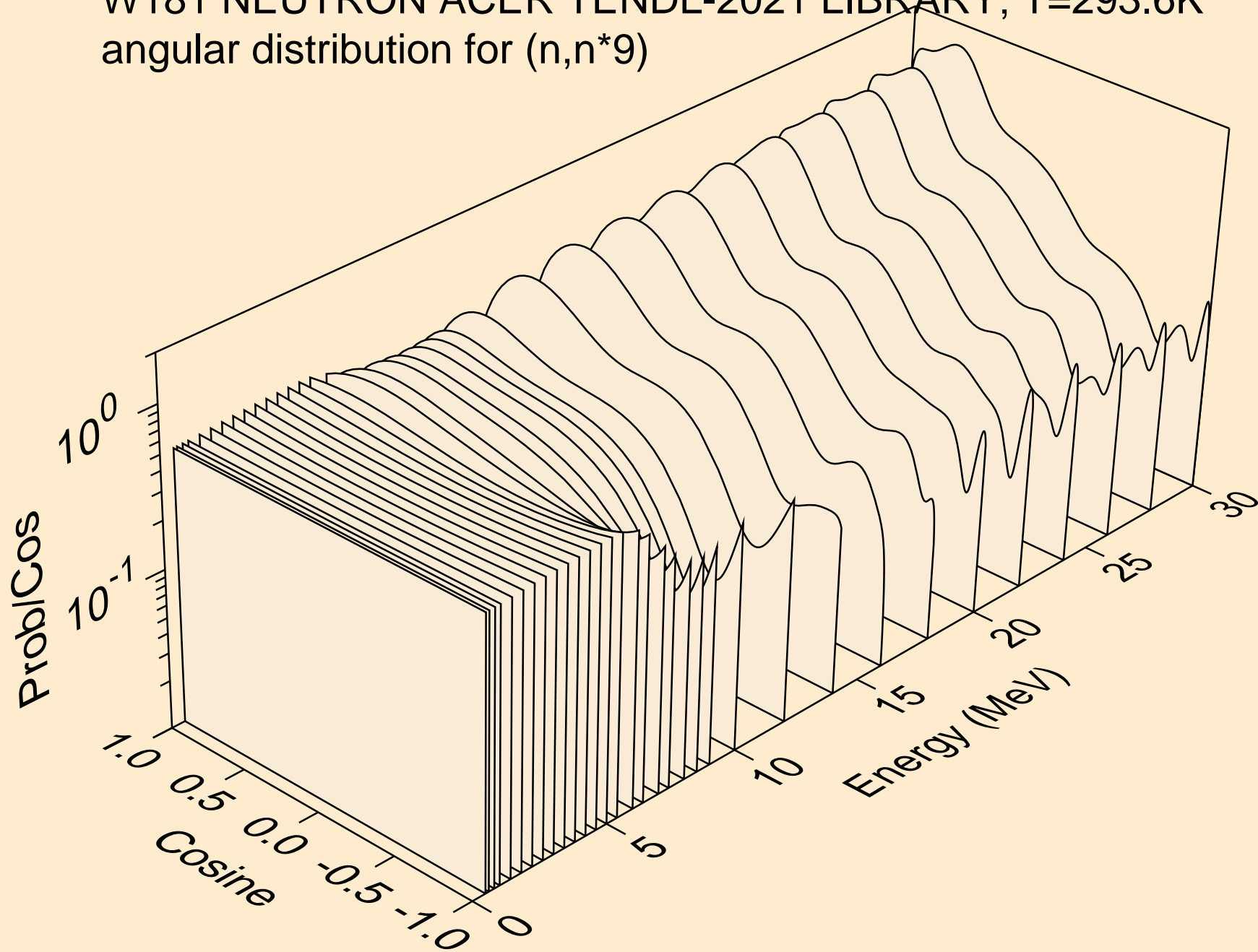

W181 NEUTRON ACER TENDL-2021 LIBRARY; T=293.6K  
angular distribution for (n,n\*10)

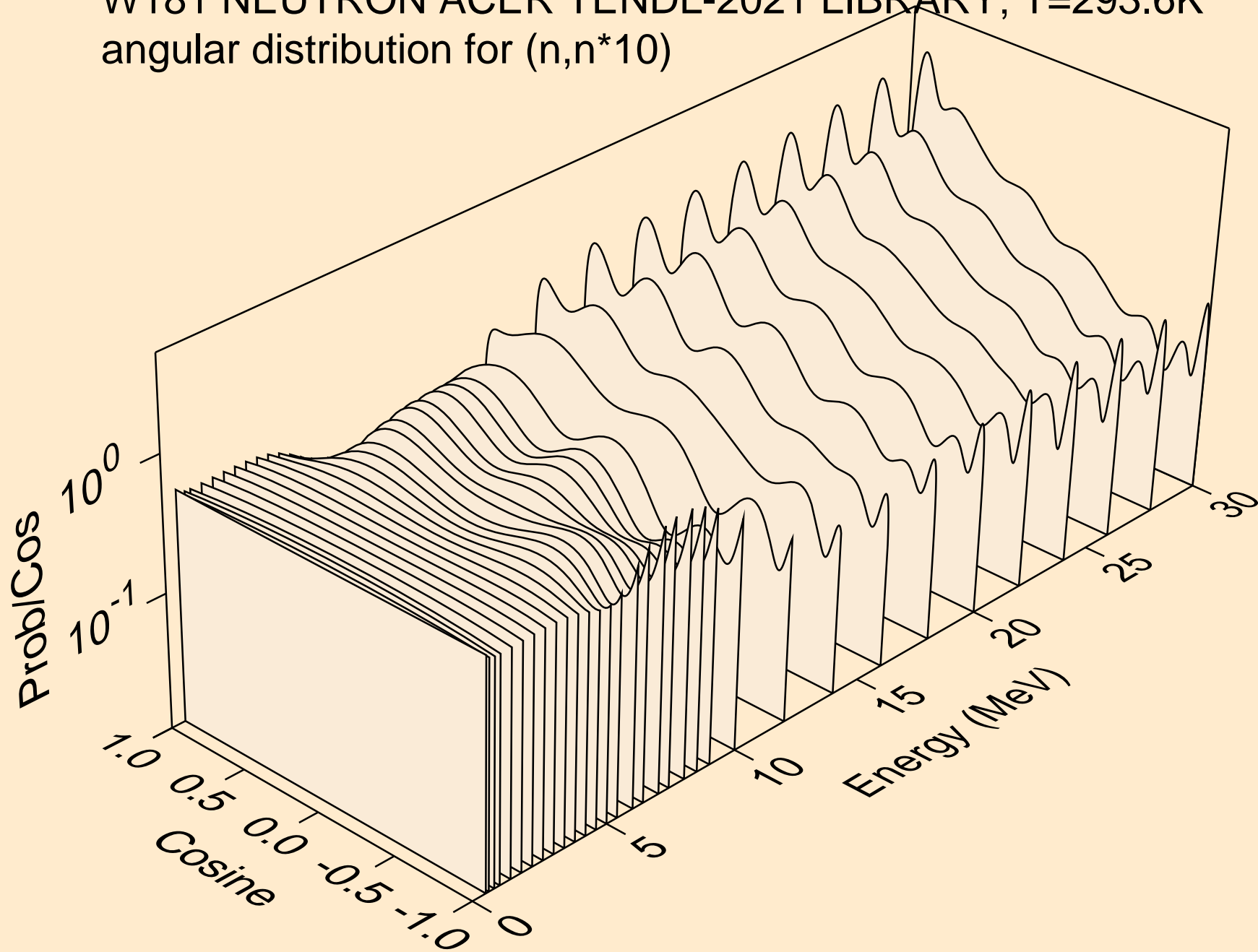

W181 NEUTRON ACER TENDL-2021 LIBRARY; T=293.6K  
angular distribution for (n,n\*11)

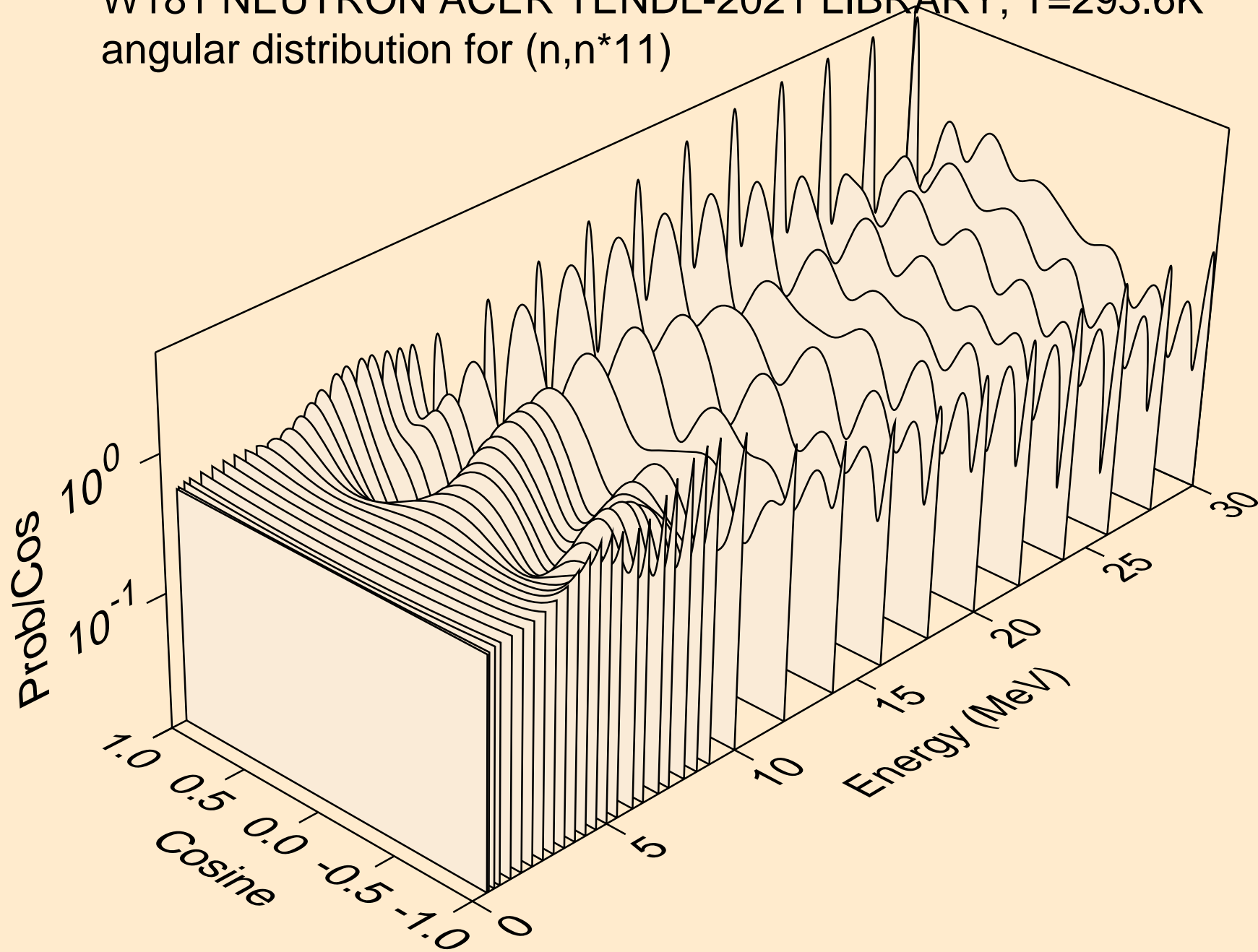



W181 NEUTRON ACER TENDL-2021 LIBRARY; T=293.6K  
angular distribution for (n,n\*12)

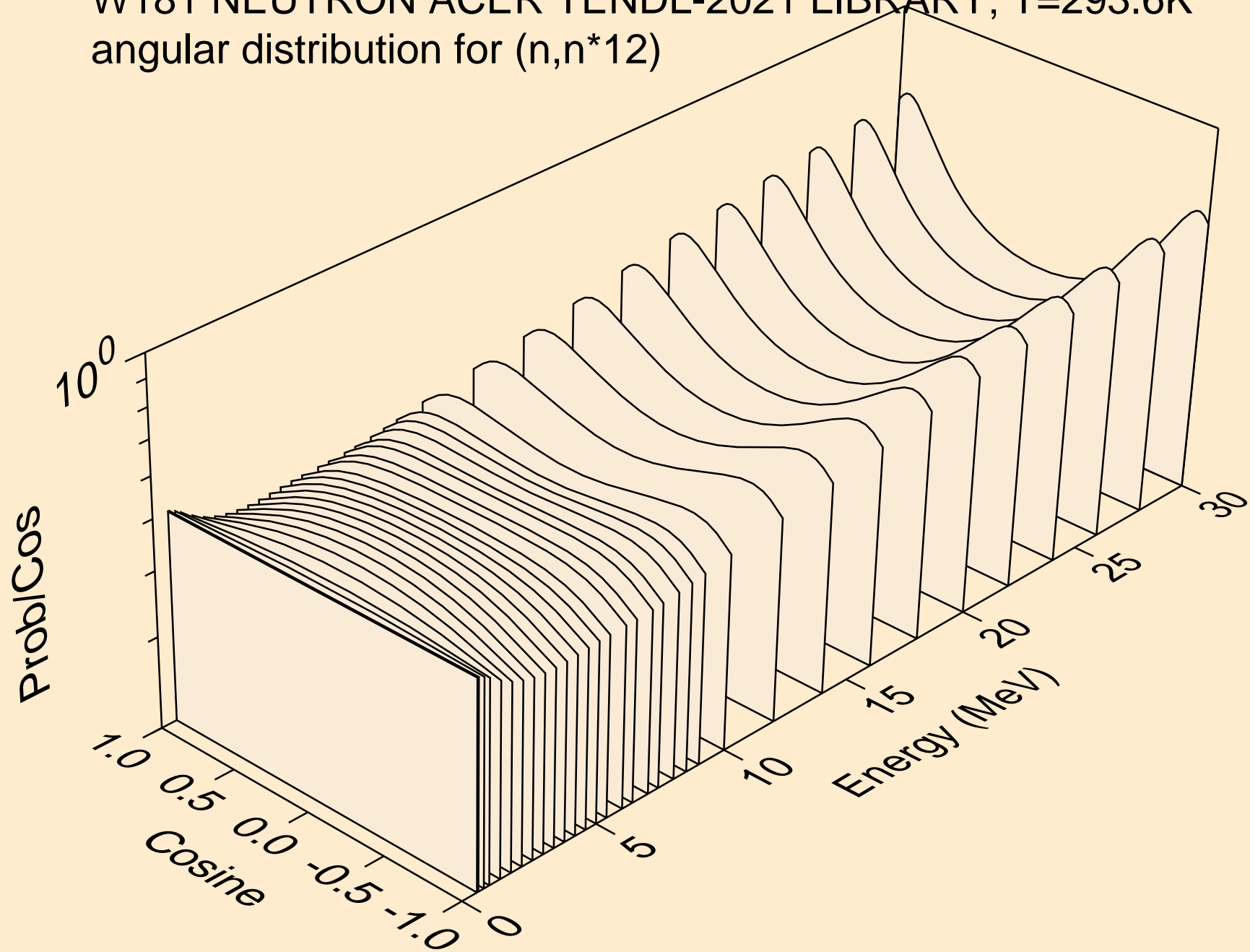

W181 NEUTRON ACER TENDL-2021 LIBRARY; T=293.6K  
angular distribution for (n,n\*13)

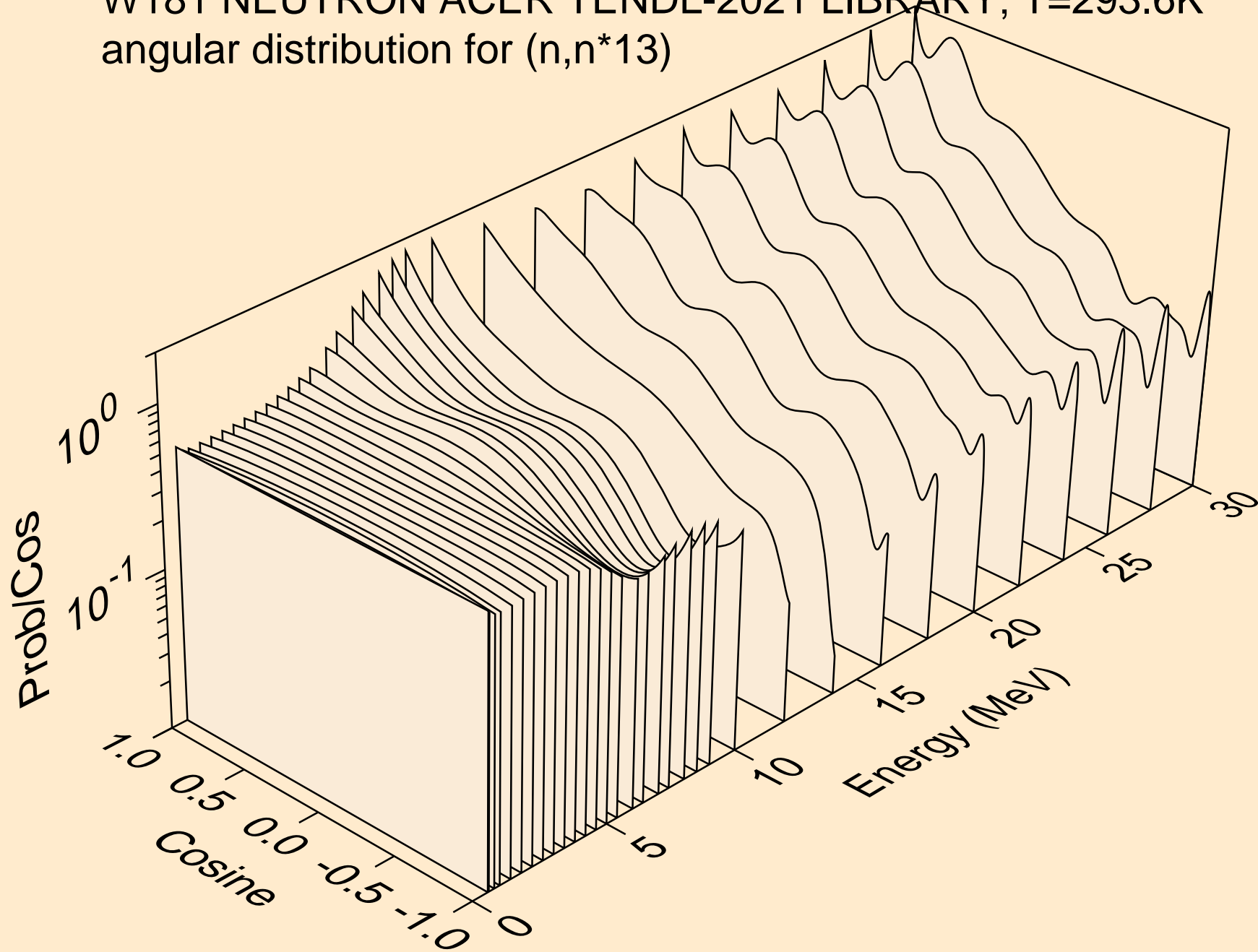

W181 NEUTRON ACER TENDL-2021 LIBRARY; T=293.6K  
angular distribution for (n,n\*14)

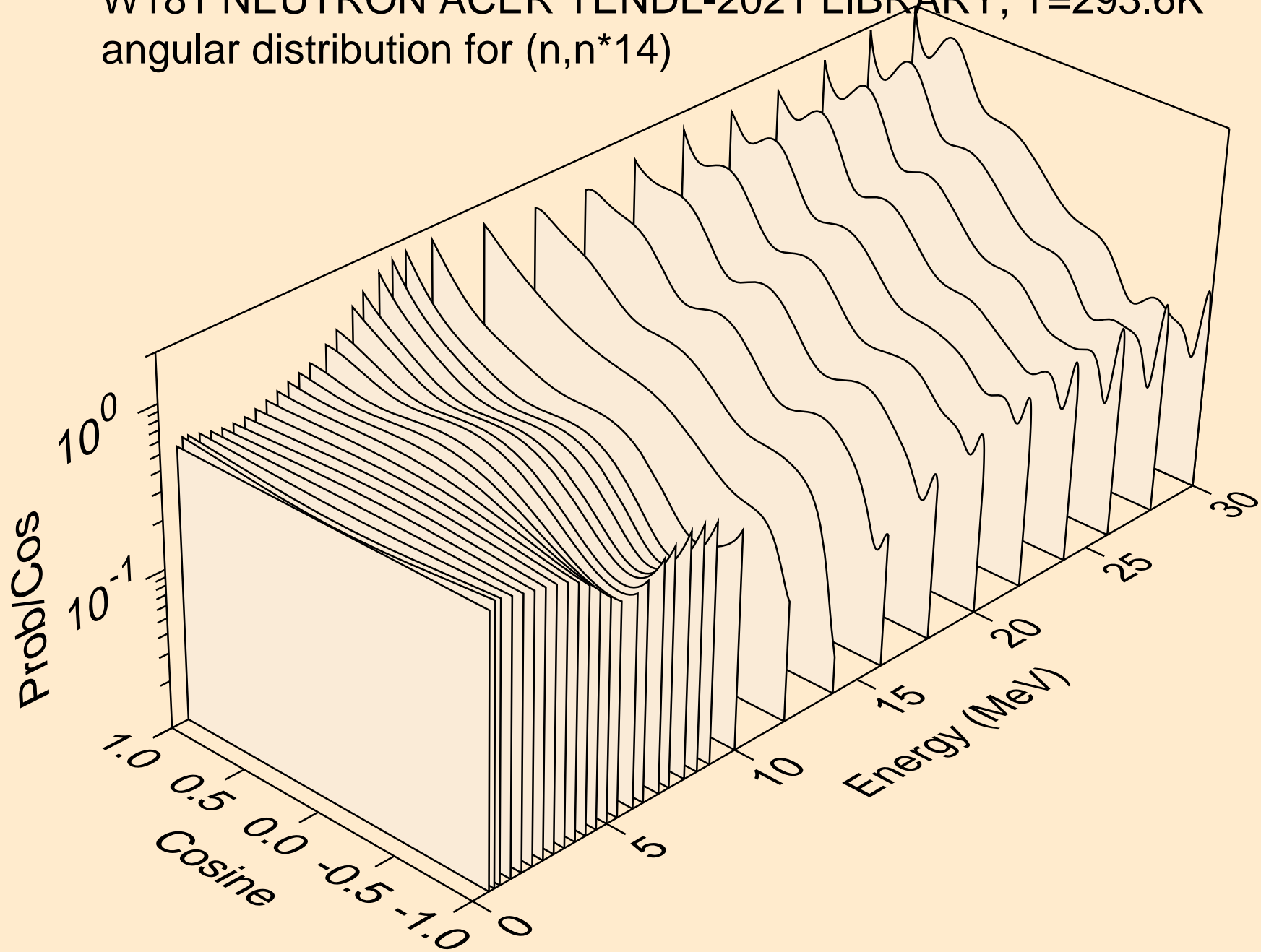

W181 NEUTRON ACER TENDL-2021 LIBRARY; T=293.6K  
angular distribution for (n,n\*15)

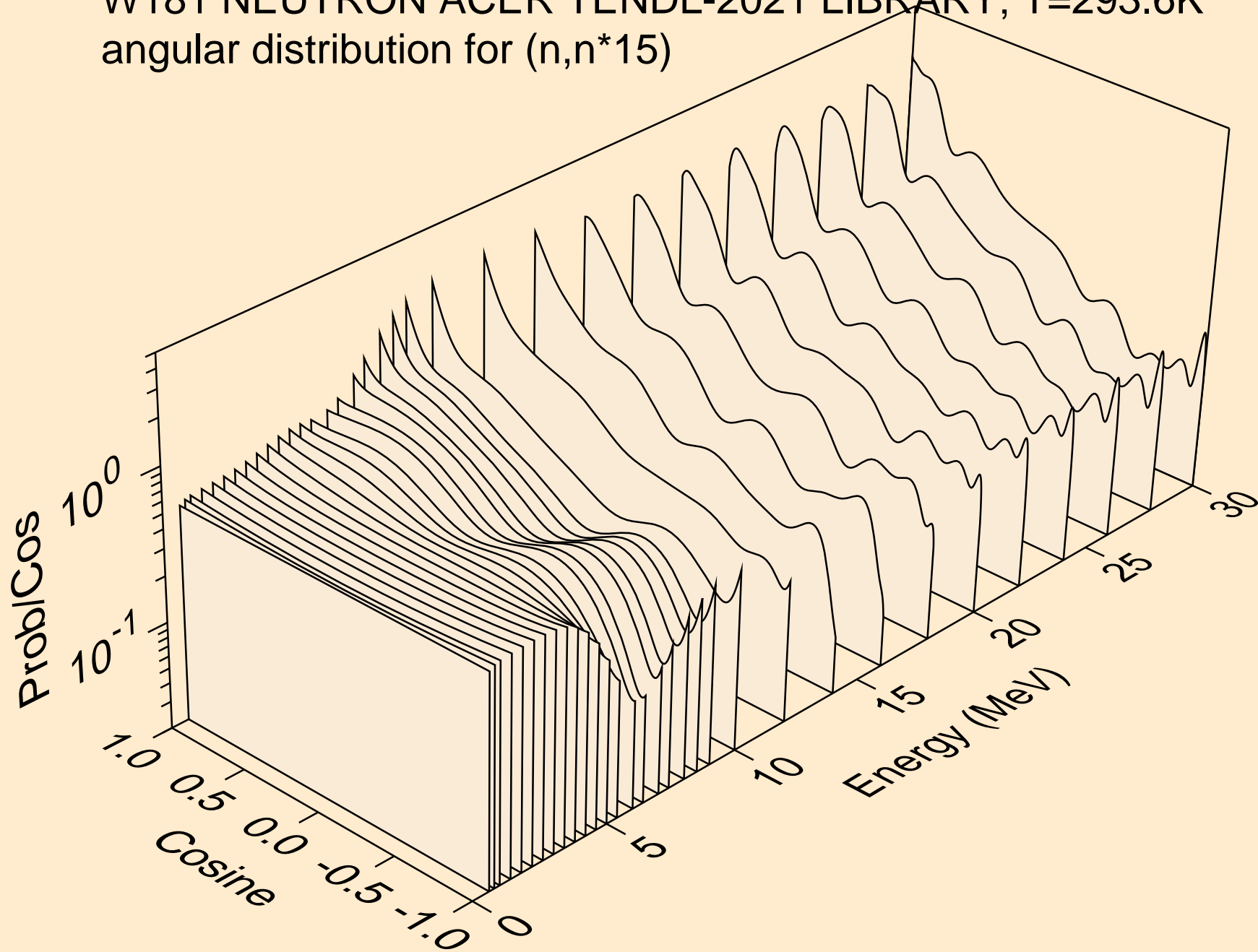

W181 NEUTRON ACER TENDL-2021 LIBRARY; T=293.6K  
angular distribution for (n,n\*16)

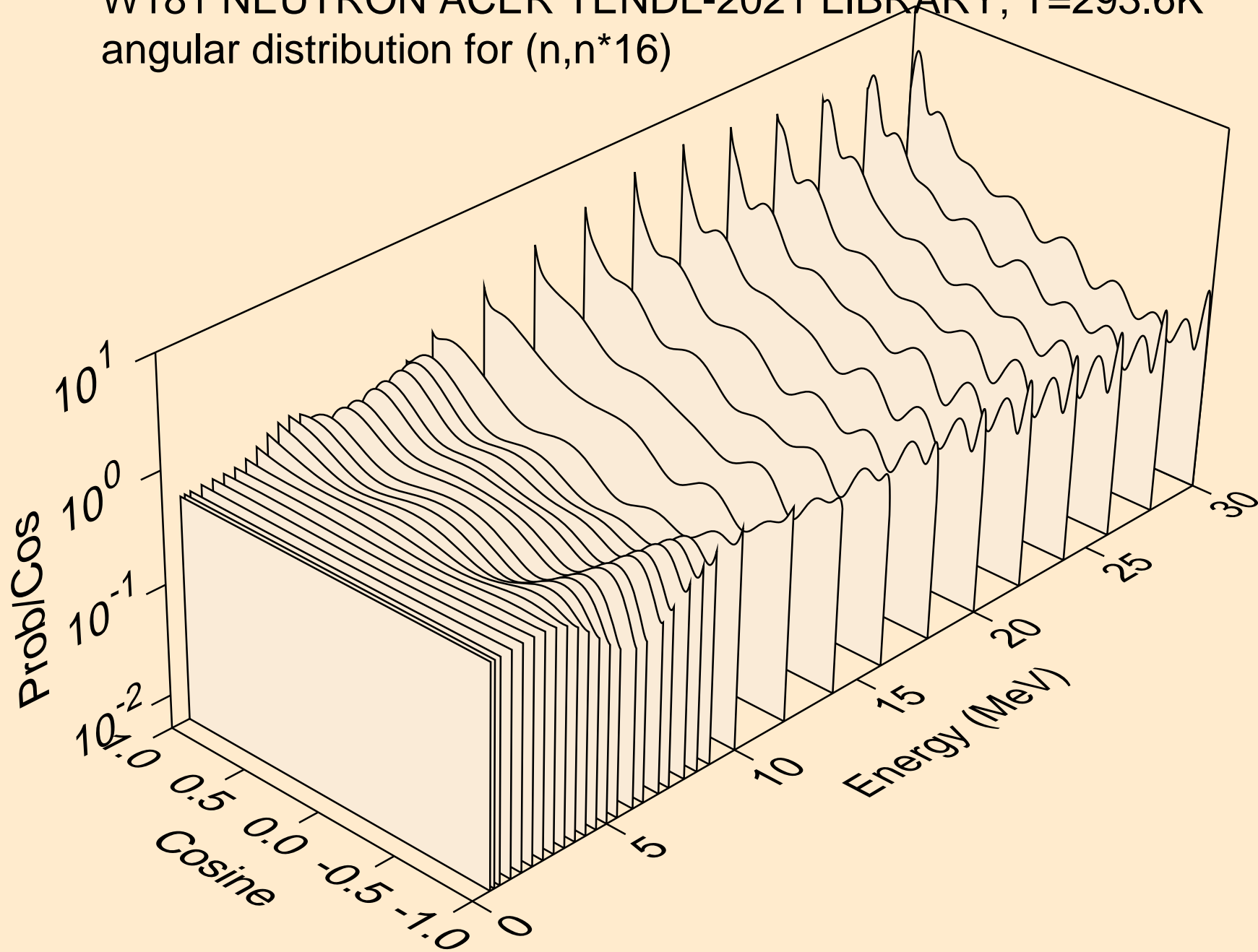

W181 NEUTRON ACER TENDL-2021 LIBRARY; T=293.6K  
angular distribution for (n,n\*17)

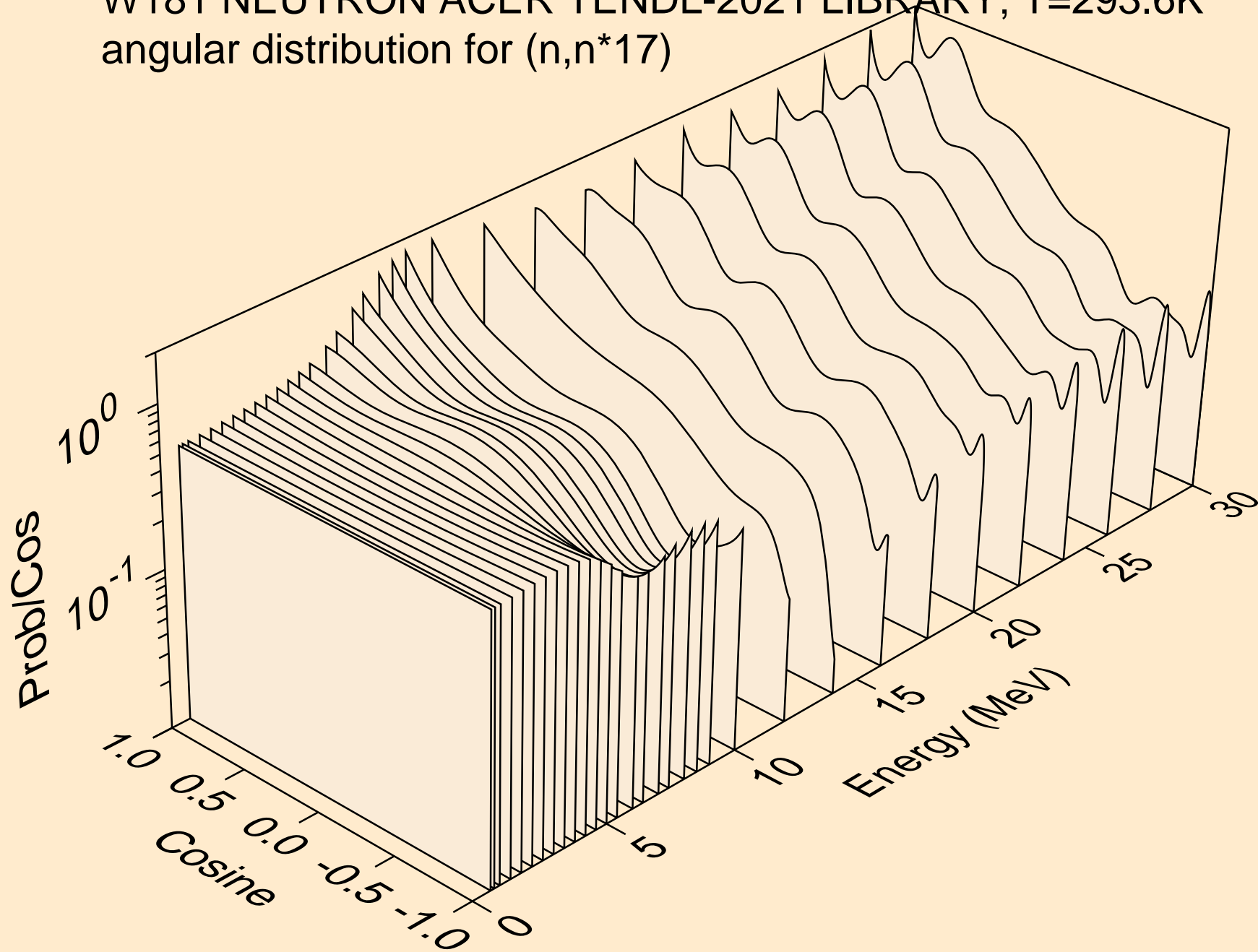

W181 NEUTRON ACER TENDL-2021 LIBRARY; T=293.6K  
angular distribution for (n,n\*18)

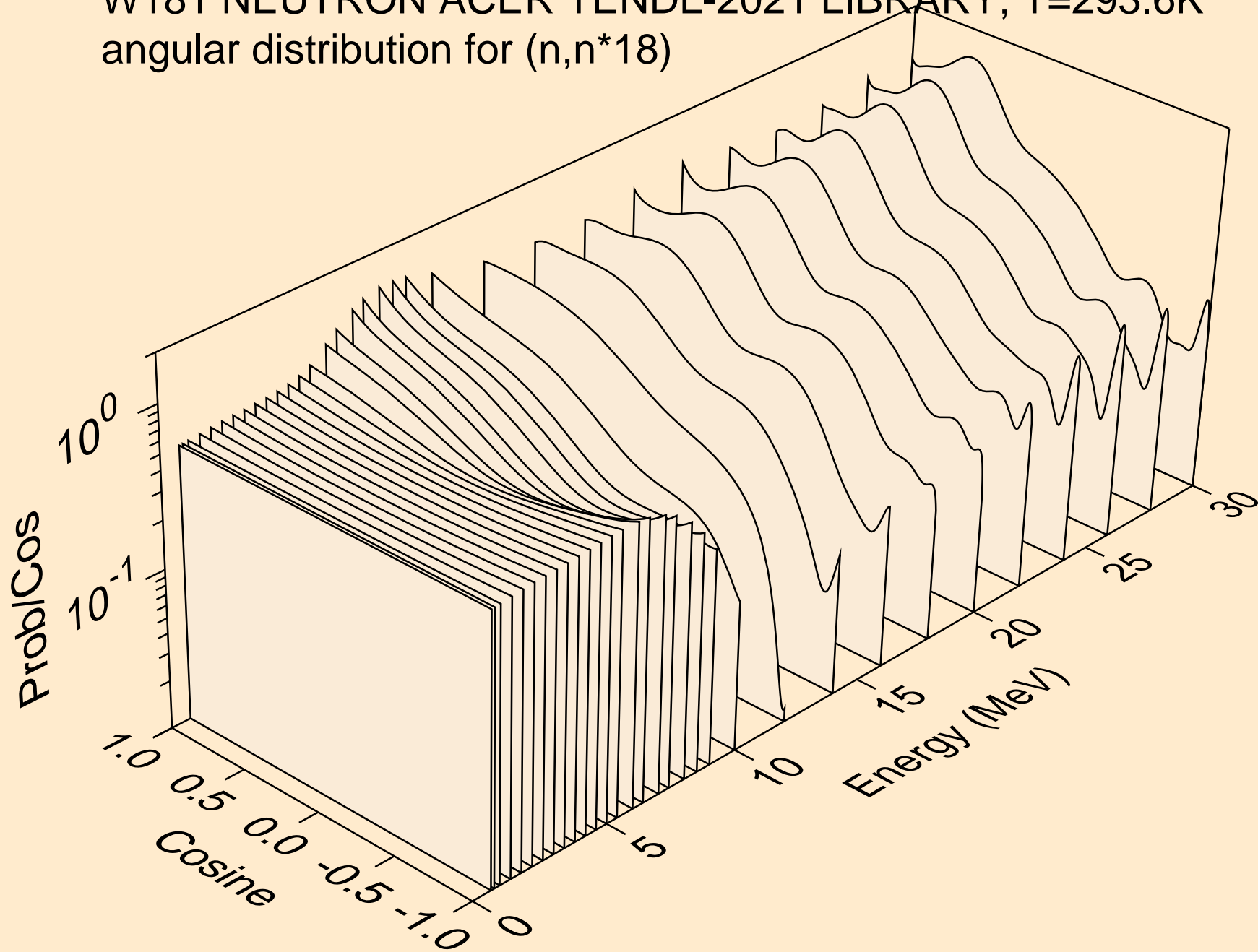

W181 NEUTRON ACER TENDL-2021 LIBRARY; T=293.6K  
angular distribution for (n,n\*19)

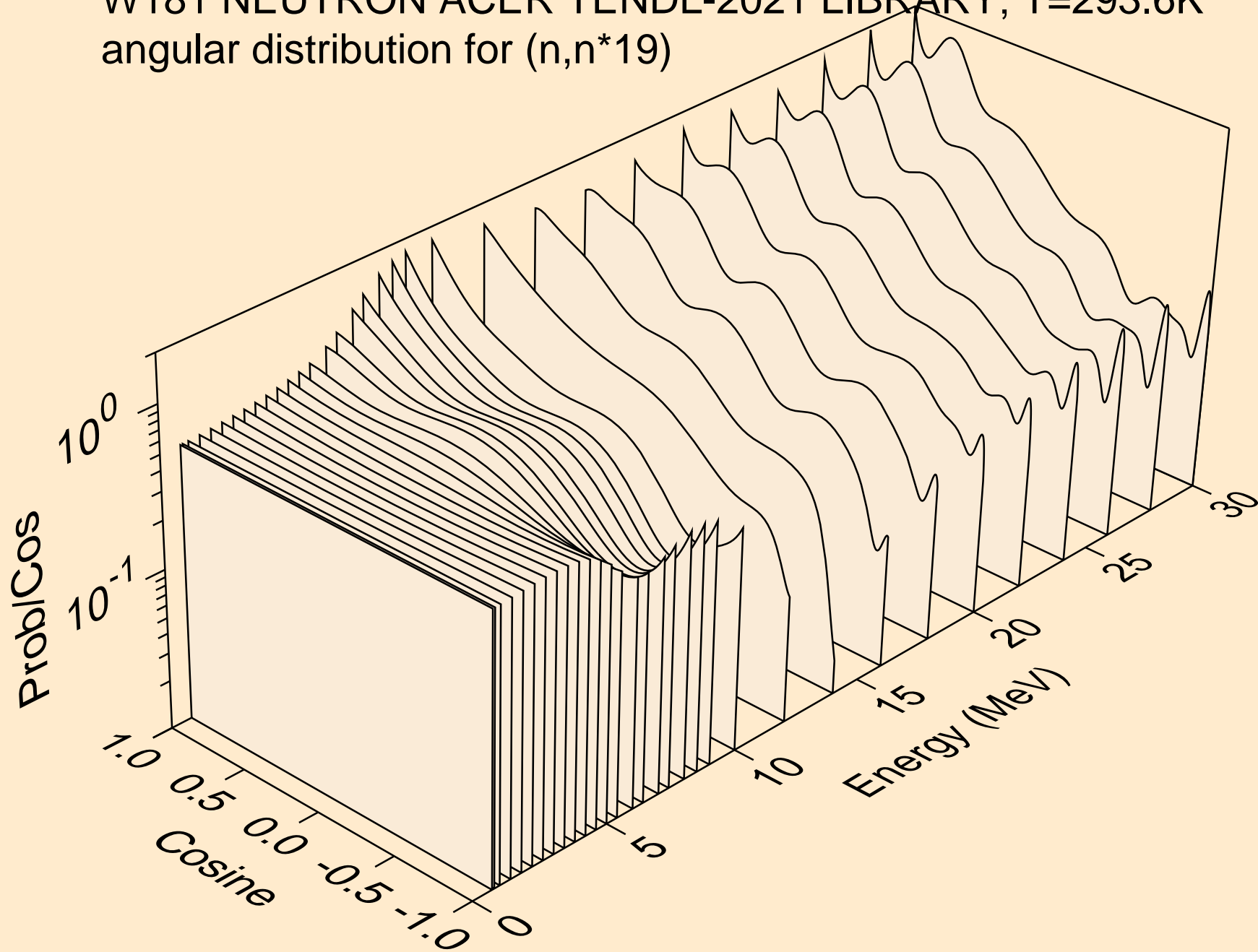



W181 NEUTRON ACER TENDL-2021 LIBRARY; T=293.6K  
angular distribution for (n,n\*20)

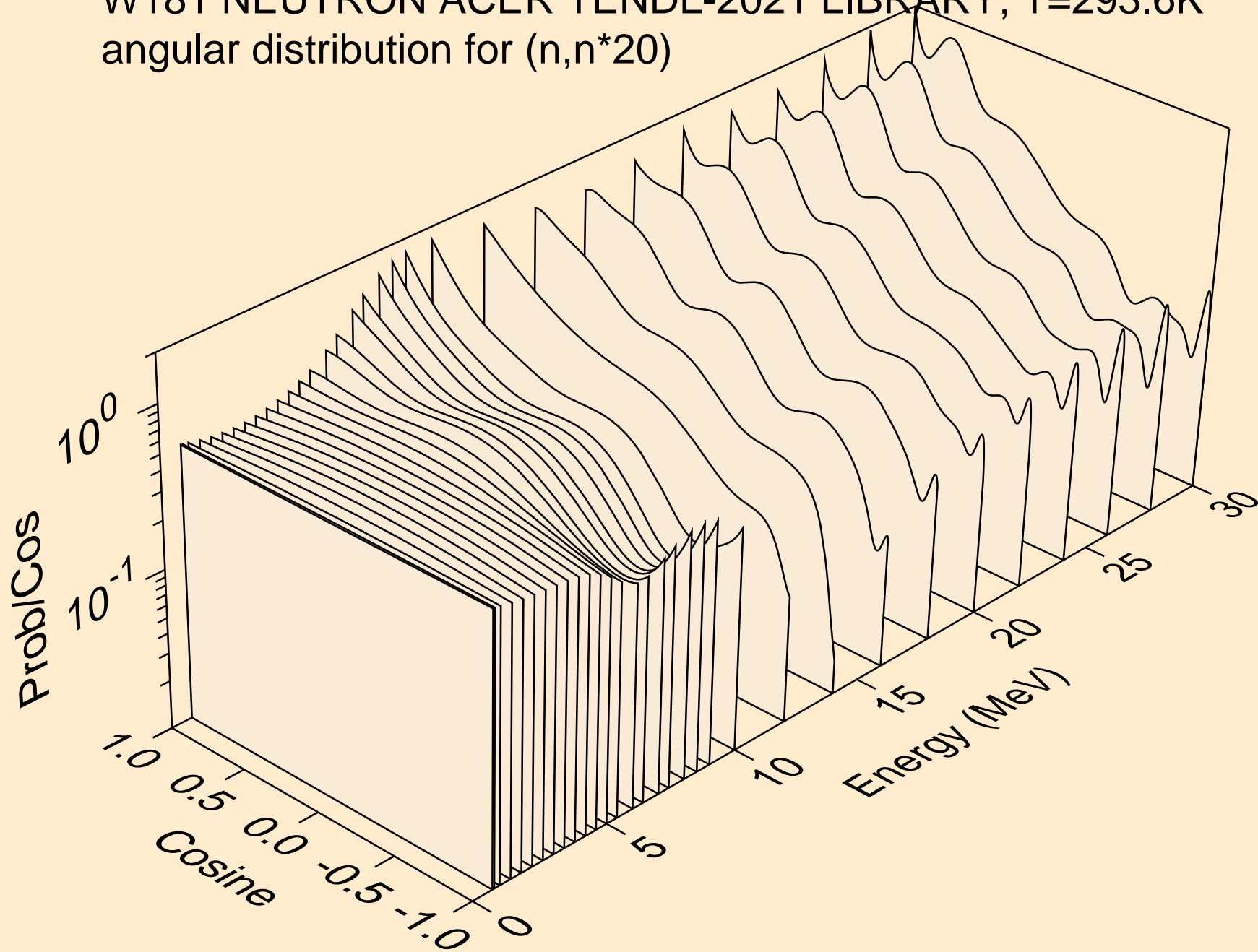

W181 NEUTRON ACER TENDL-2021 LIBRARY; T=293.6K  
angular distribution for (n,n\*21)

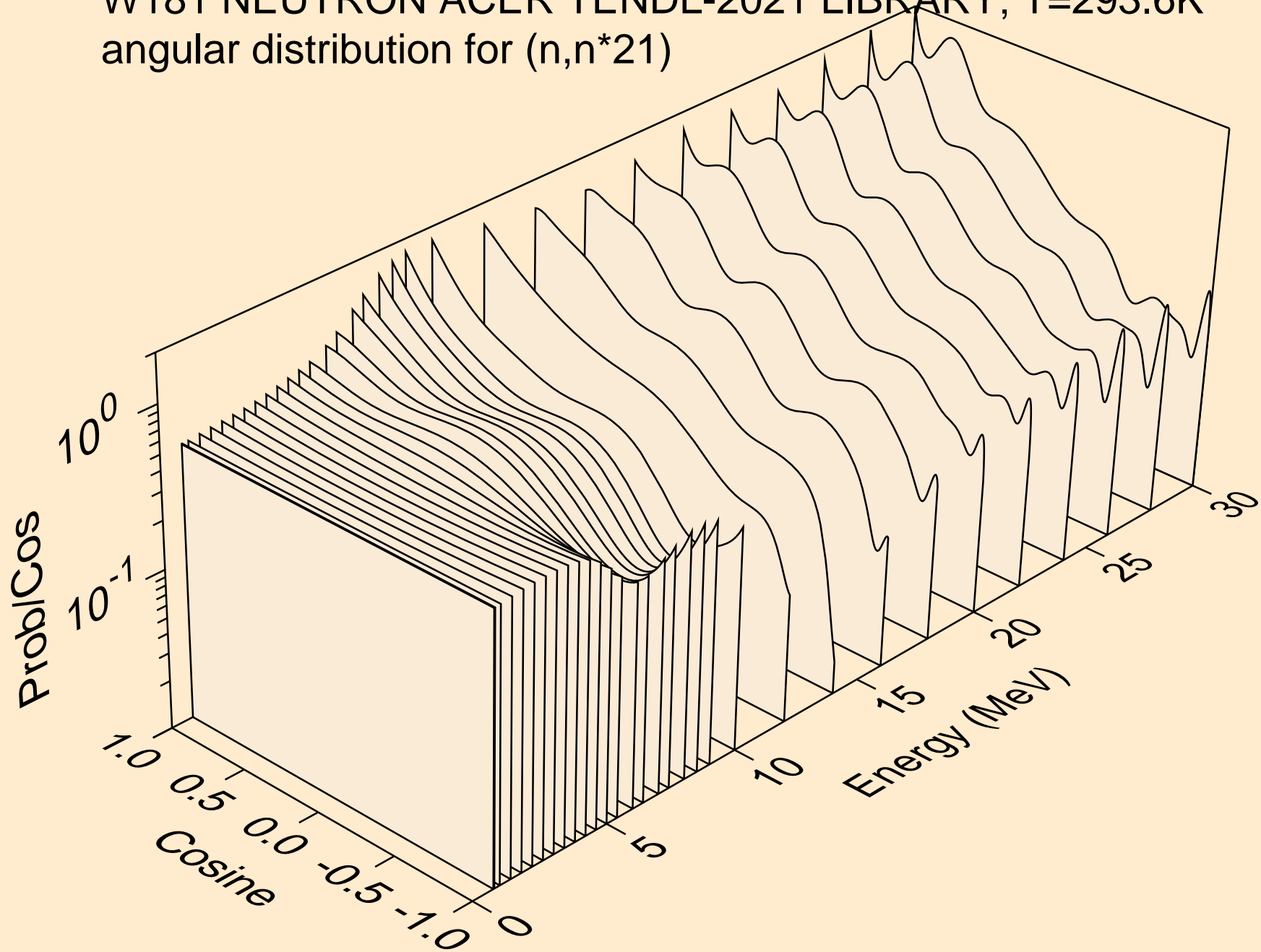

W181 NEUTRON ACER TENDL-2021 LIBRARY; T=293.6K  
angular distribution for (n,n\*22)

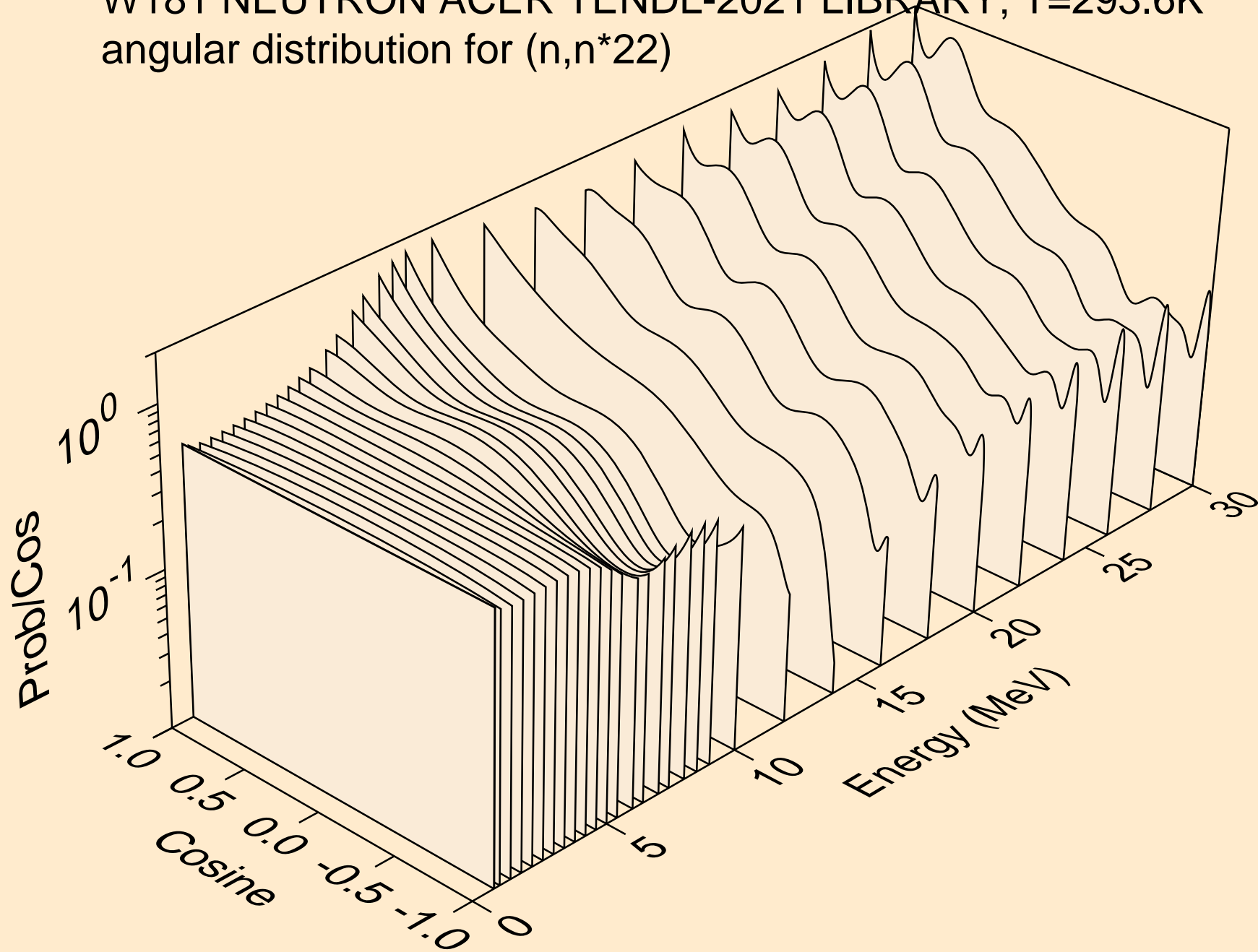

W181 NEUTRON ACER TENDL-2021 LIBRARY; T=293.6K  
angular distribution for (n,n\*23)

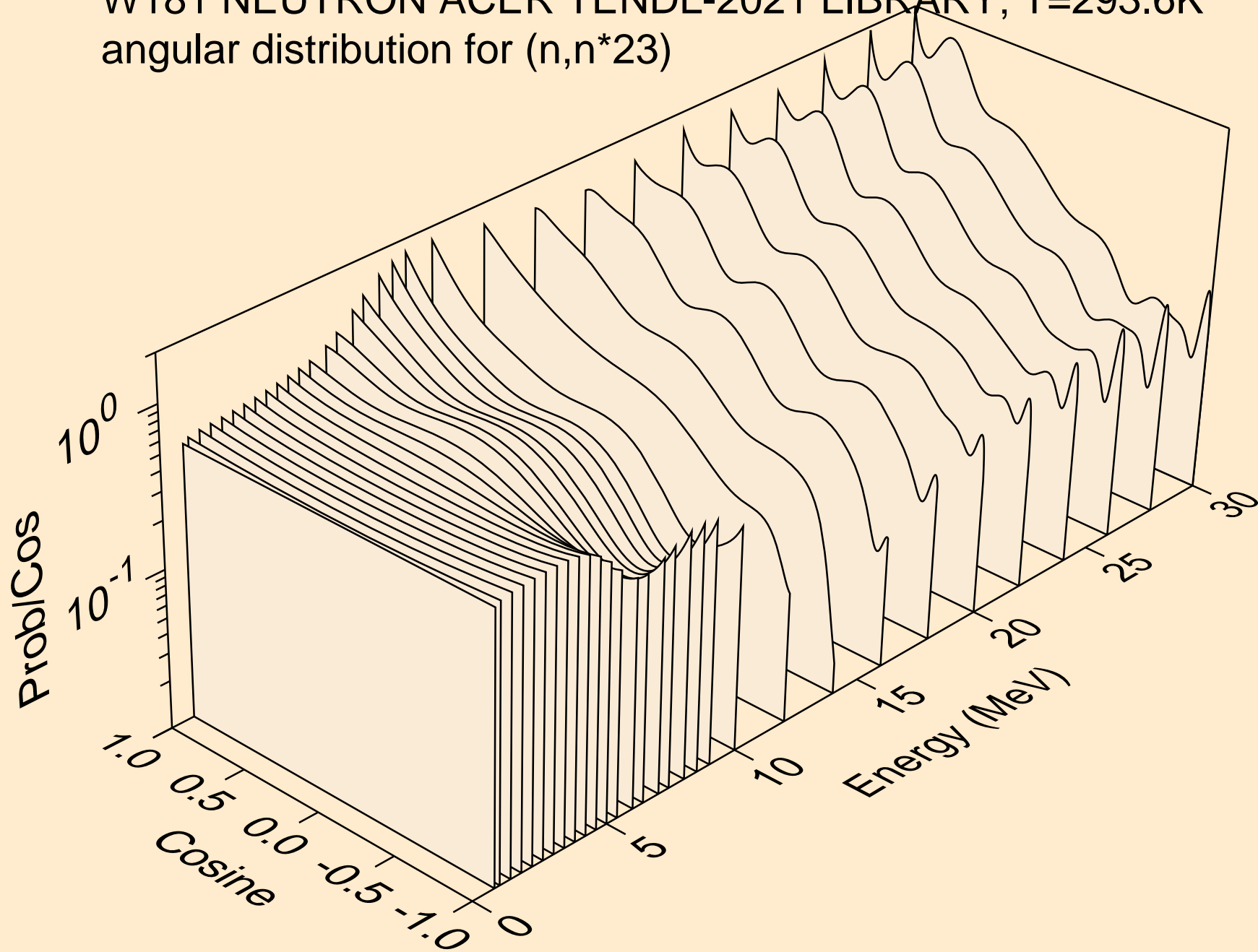

W181 NEUTRON ACER TENDL-2021 LIBRARY; T=293.6K  
angular distribution for (n,n\*24)

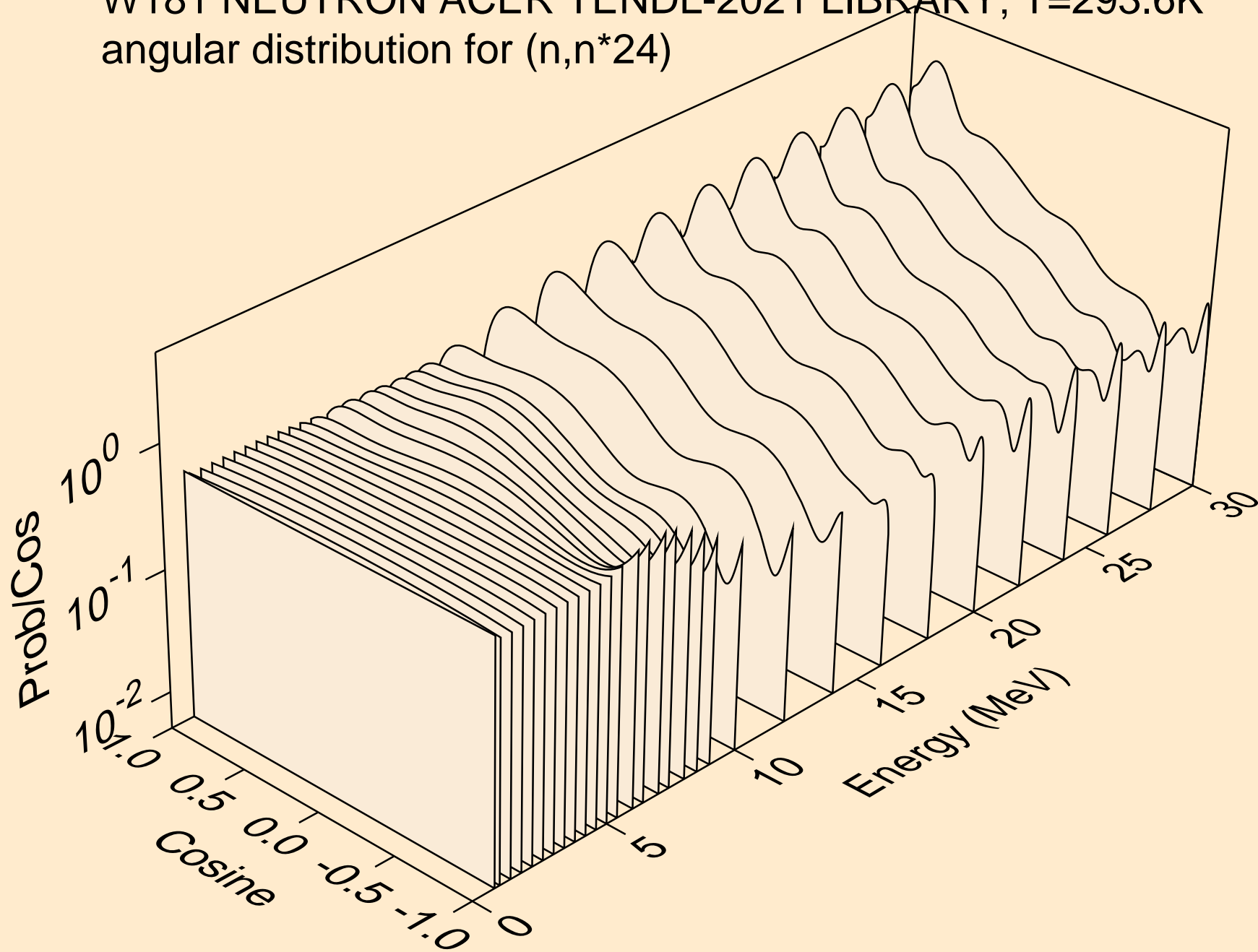

W181 NEUTRON ACER TENDL-2021 LIBRARY; T=293.6K  
angular distribution for (n,n\*25)

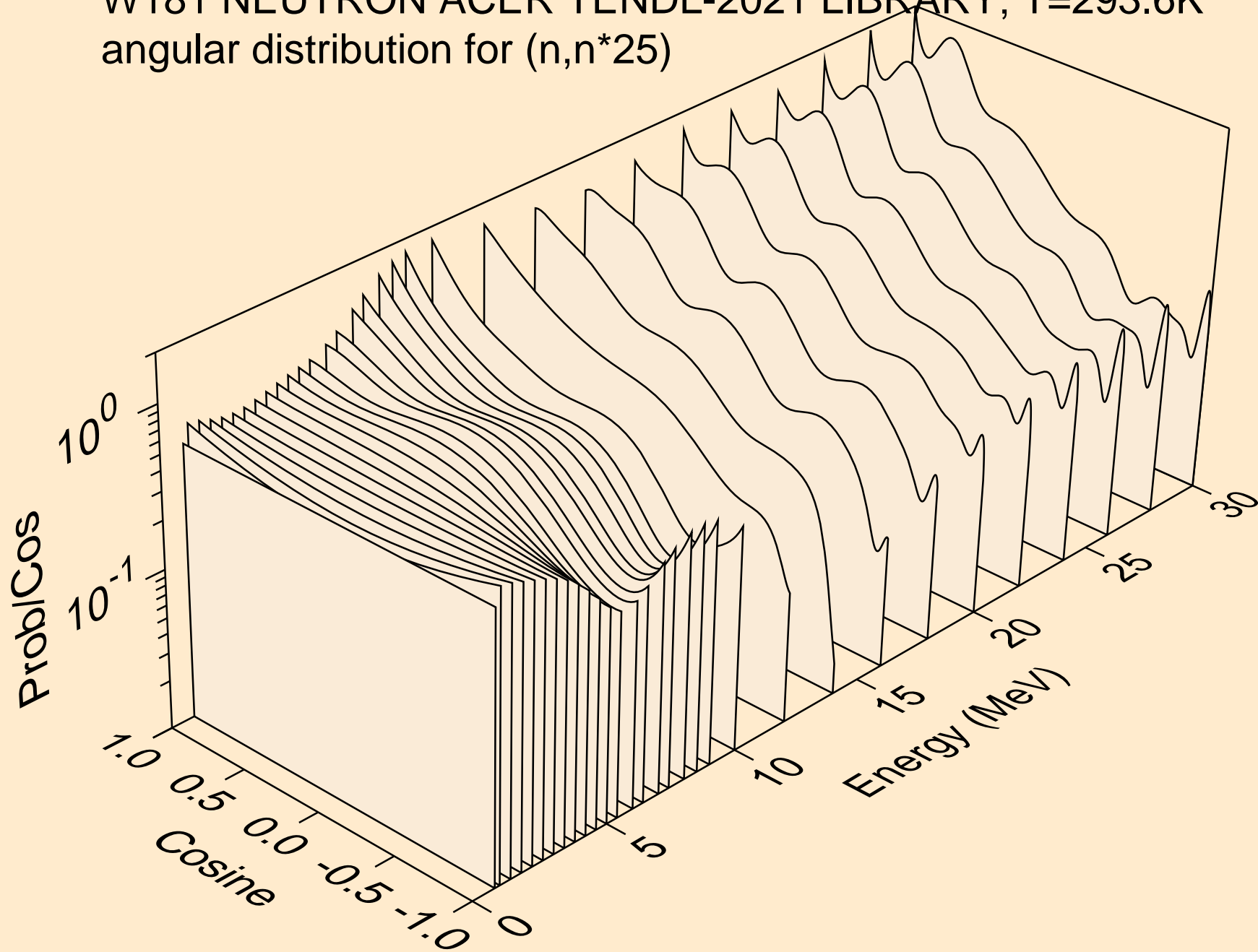

W181 NEUTRON ACER TENDL-2021 LIBRARY; T=293.6K  
angular distribution for (n,n\*26)

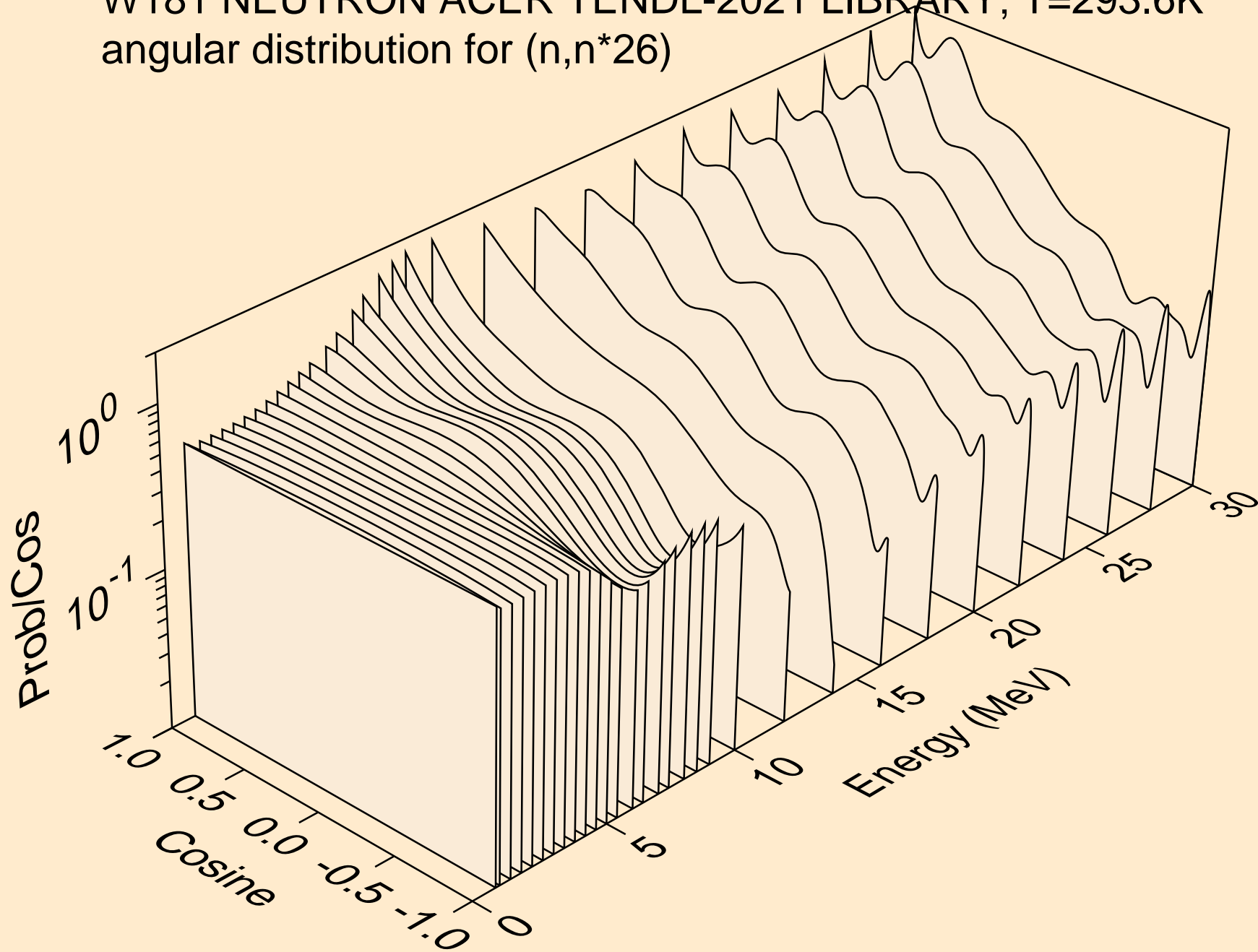



W181 NEUTRON ACER TENDL-2021 LIBRARY; T=293.6K  
angular distribution for (n,n\*27)

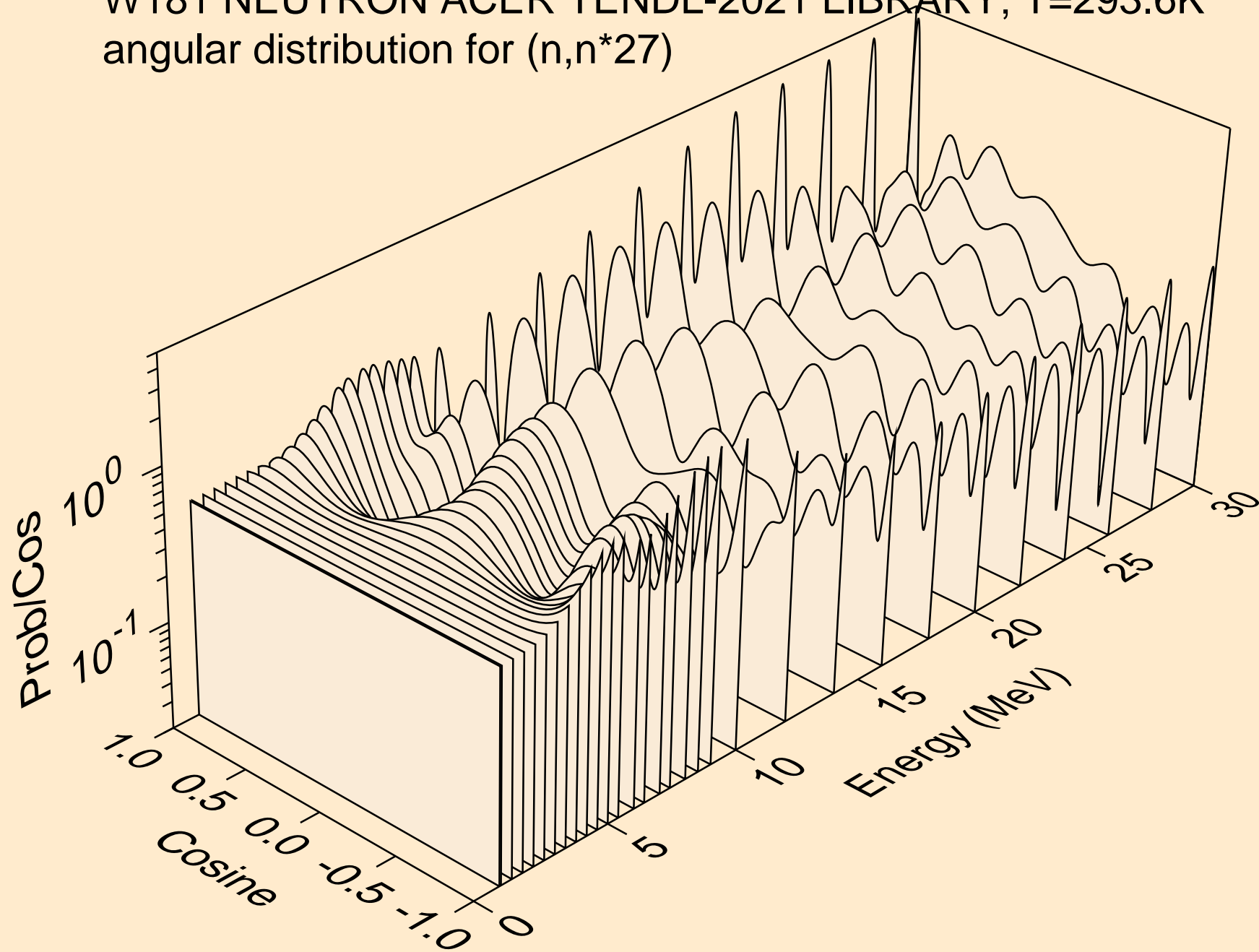



W181 NEUTRON ACER TENDL-2021 LIBRARY; T=293.6K  
angular distribution for (n,n\*28)

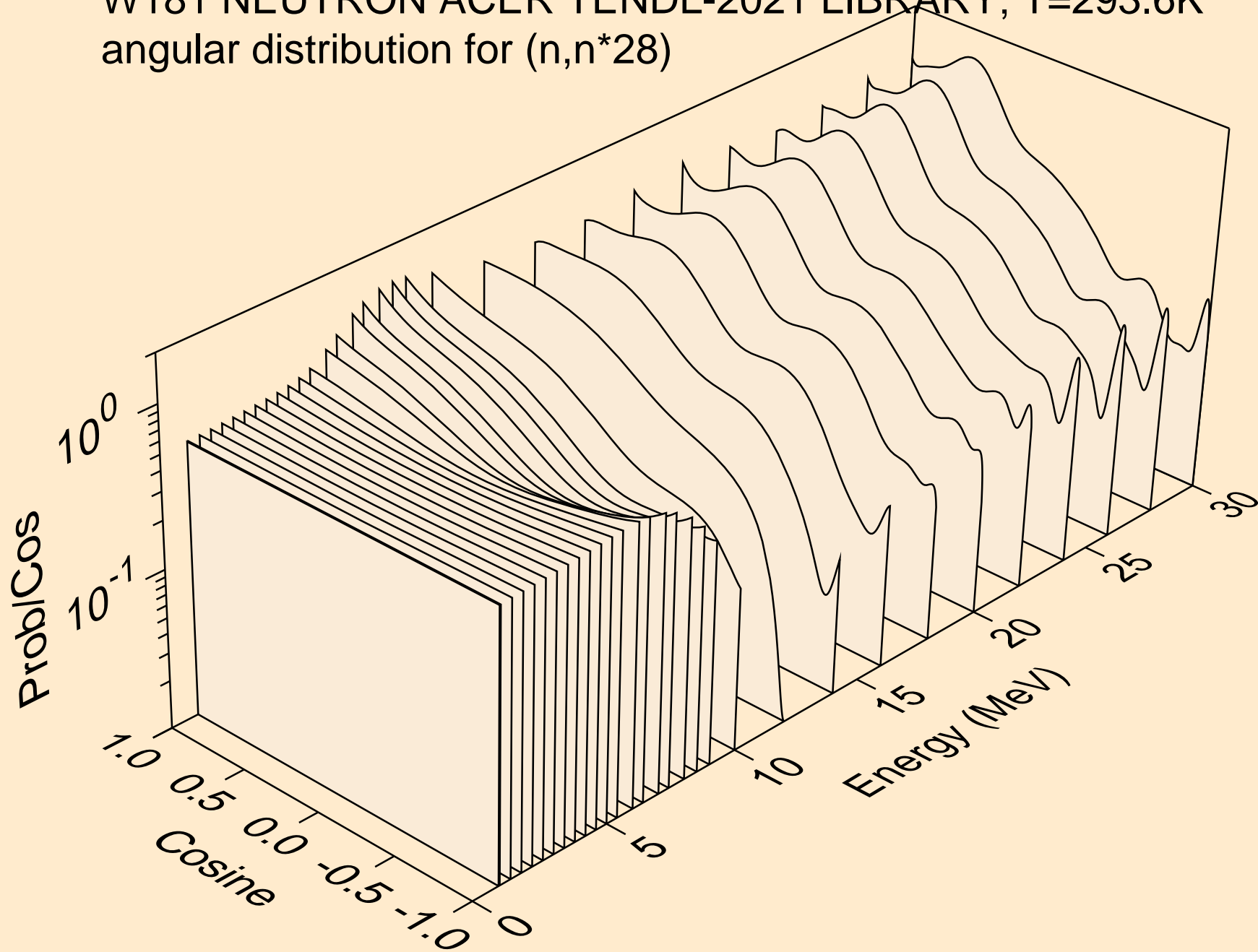

W181 NEUTRON ACER TENDL-2021 LIBRARY; T=293.6K  
angular distribution for (n,n\*29)

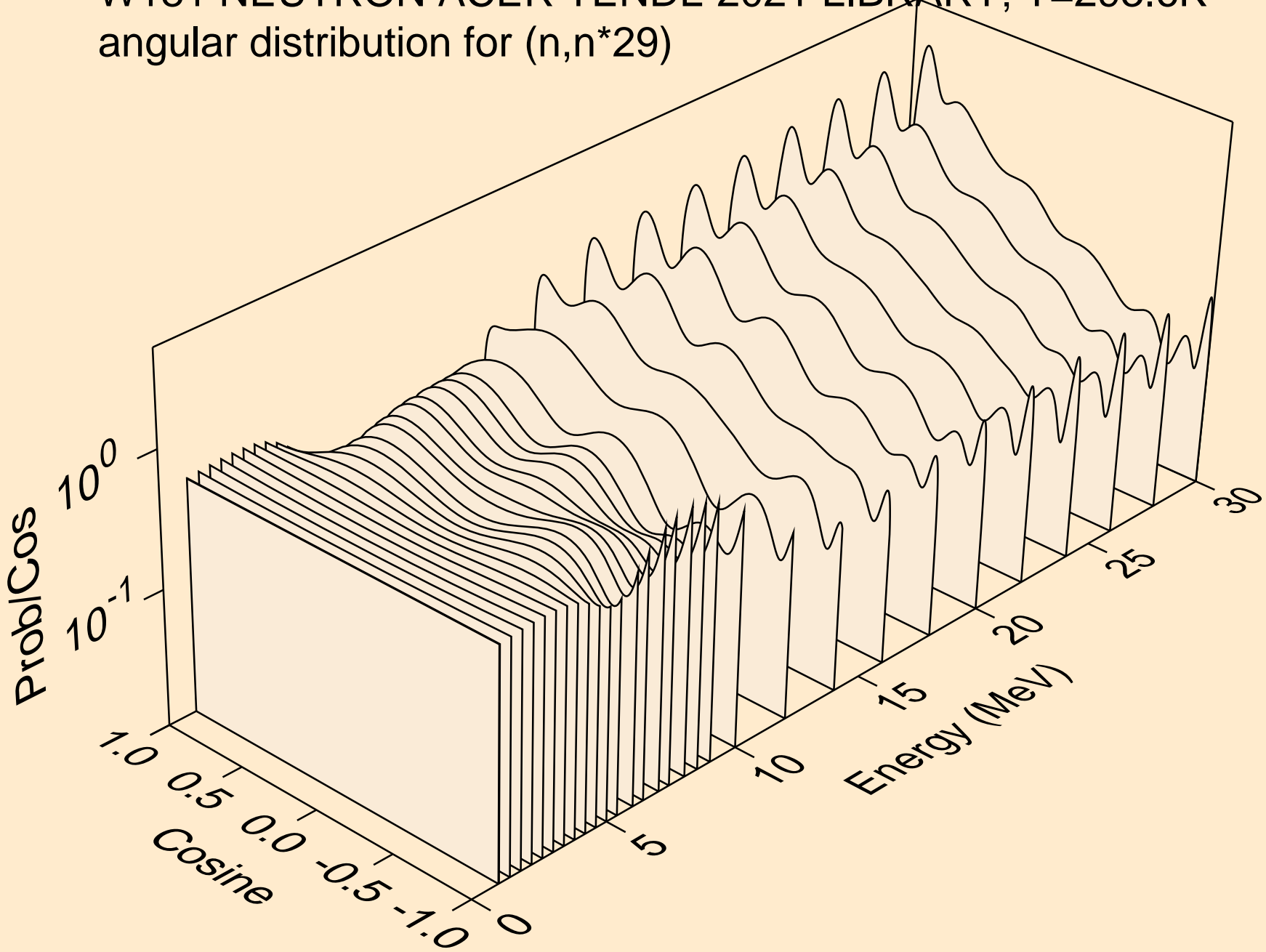

W181 NEUTRON ACER TENDL-2021 LIBRARY; T=293.6K  
angular distribution for (n,n\*30)

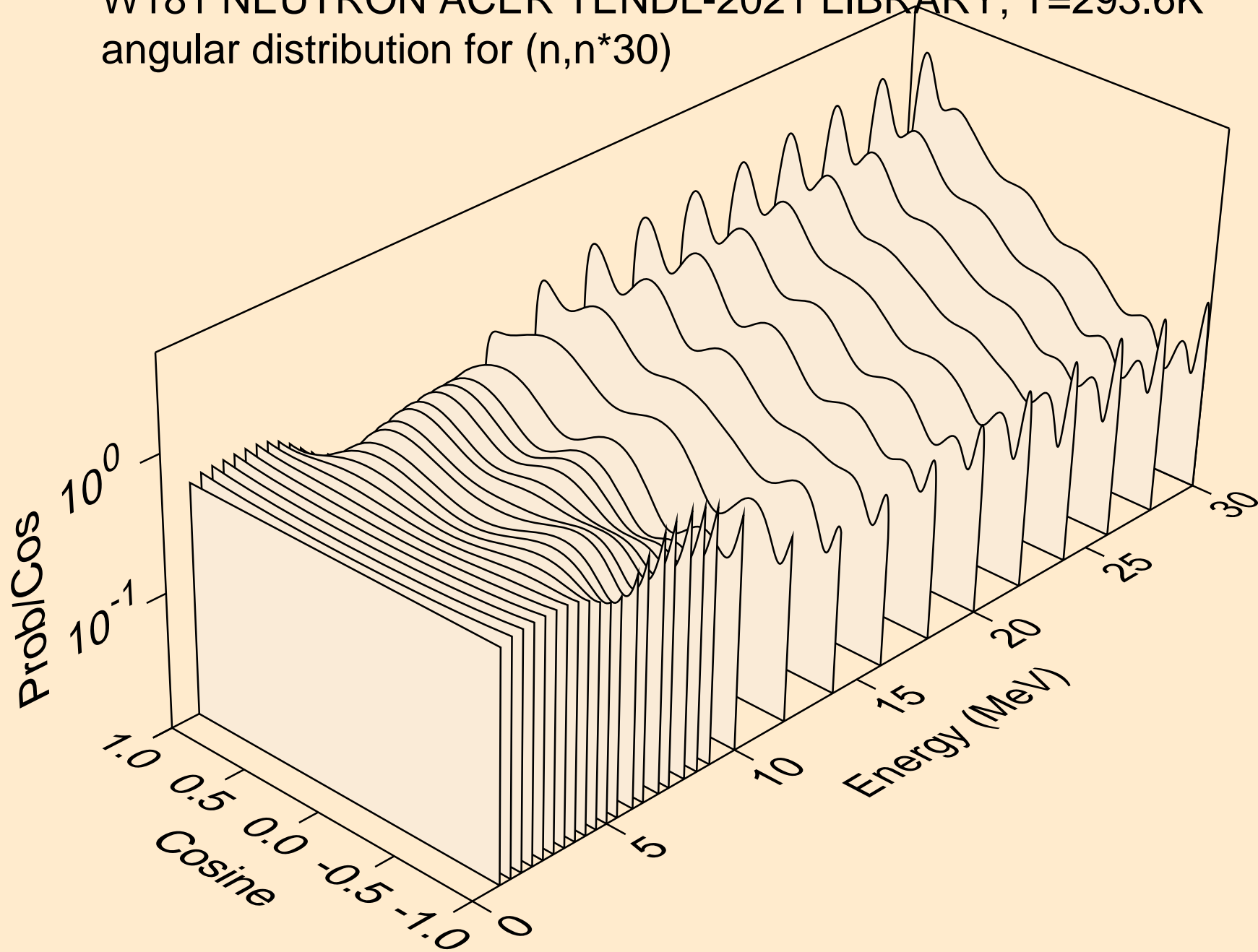

W181 NEUTRON ACER TENDL-2021 LIBRARY; T=293.6K  
Neutron emission for (n,x)

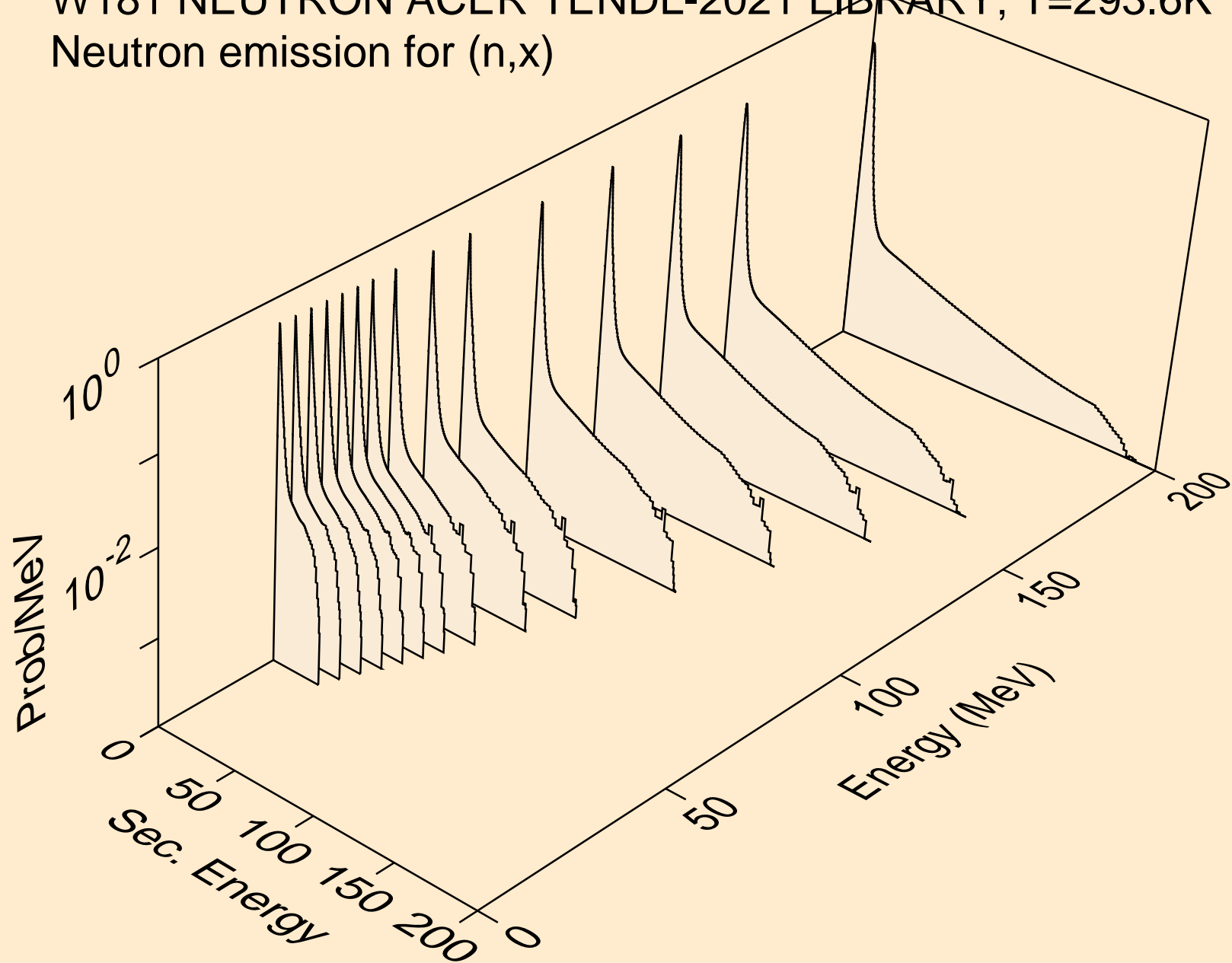

W181 NEUTRON ACER TENDL-2021 LIBRARY; T=293.6K  
Neutron emission for (n,2nd)

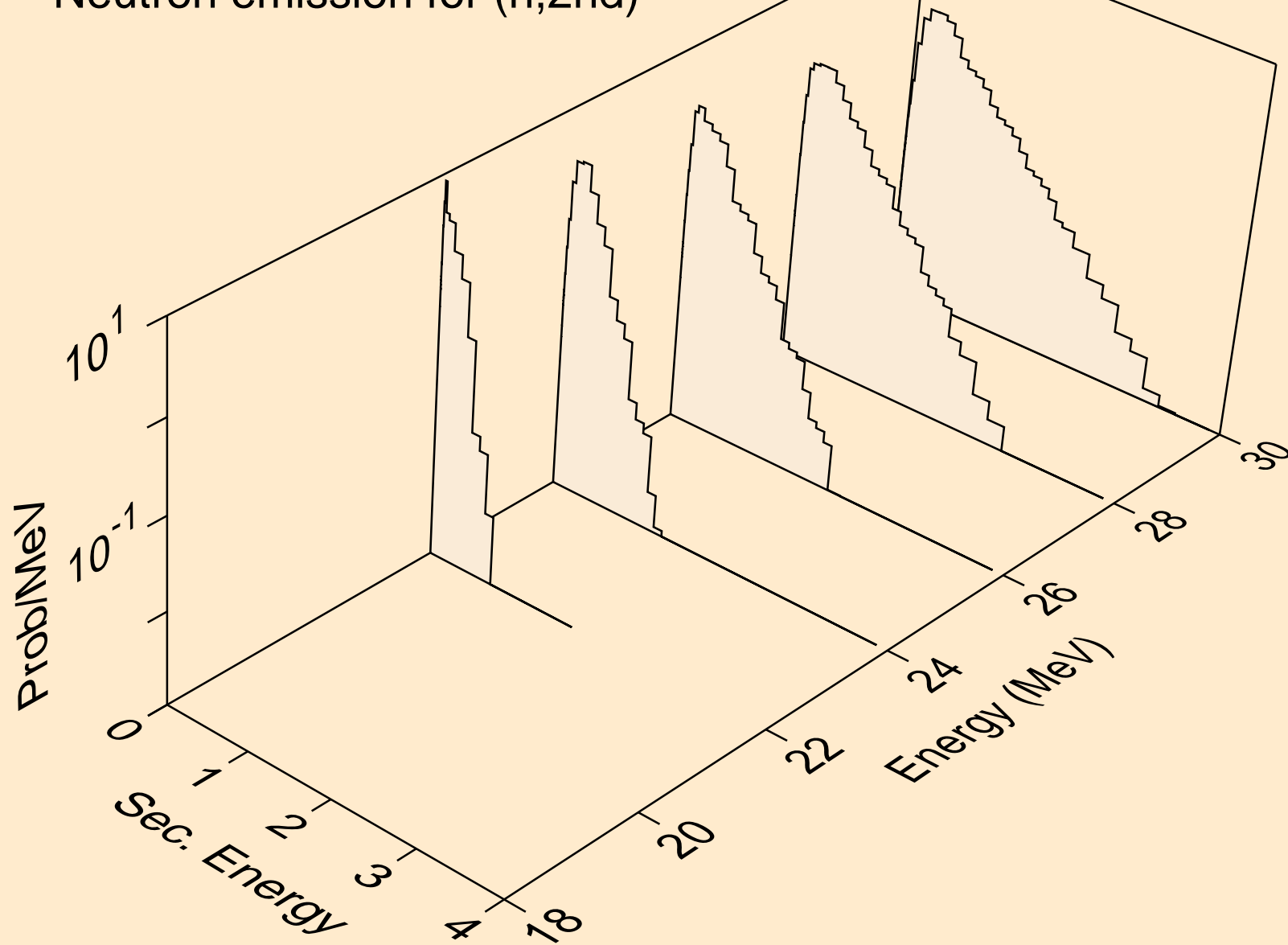

W181 NEUTRON ACER TENDL-2021 LIBRARY; T=293.6K  
Neutron emission for (n,2n)

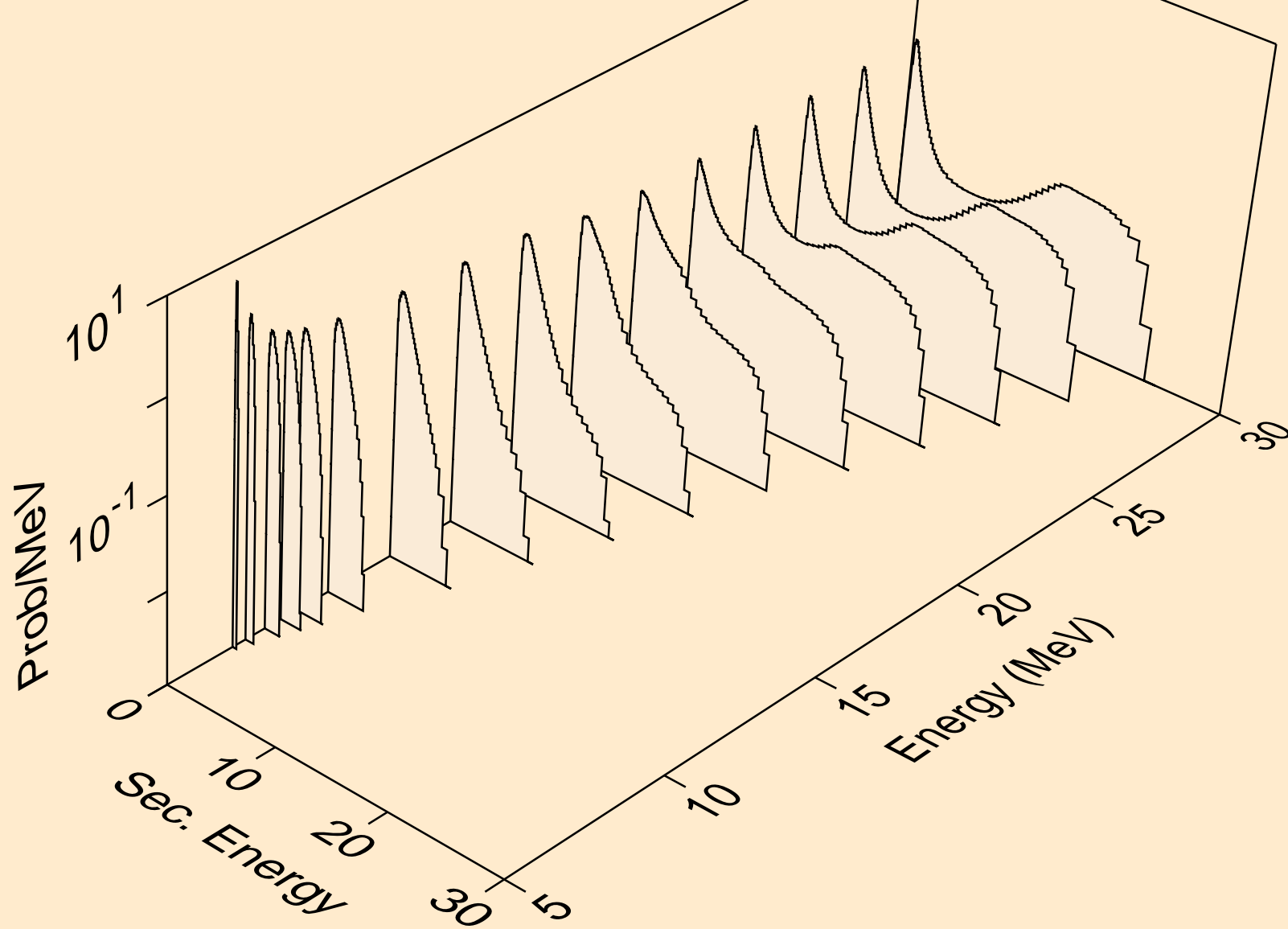

W181 NEUTRON ACER TENDL-2021 LIBRARY; T=293.6K  
Neutron emission for (n,3n)

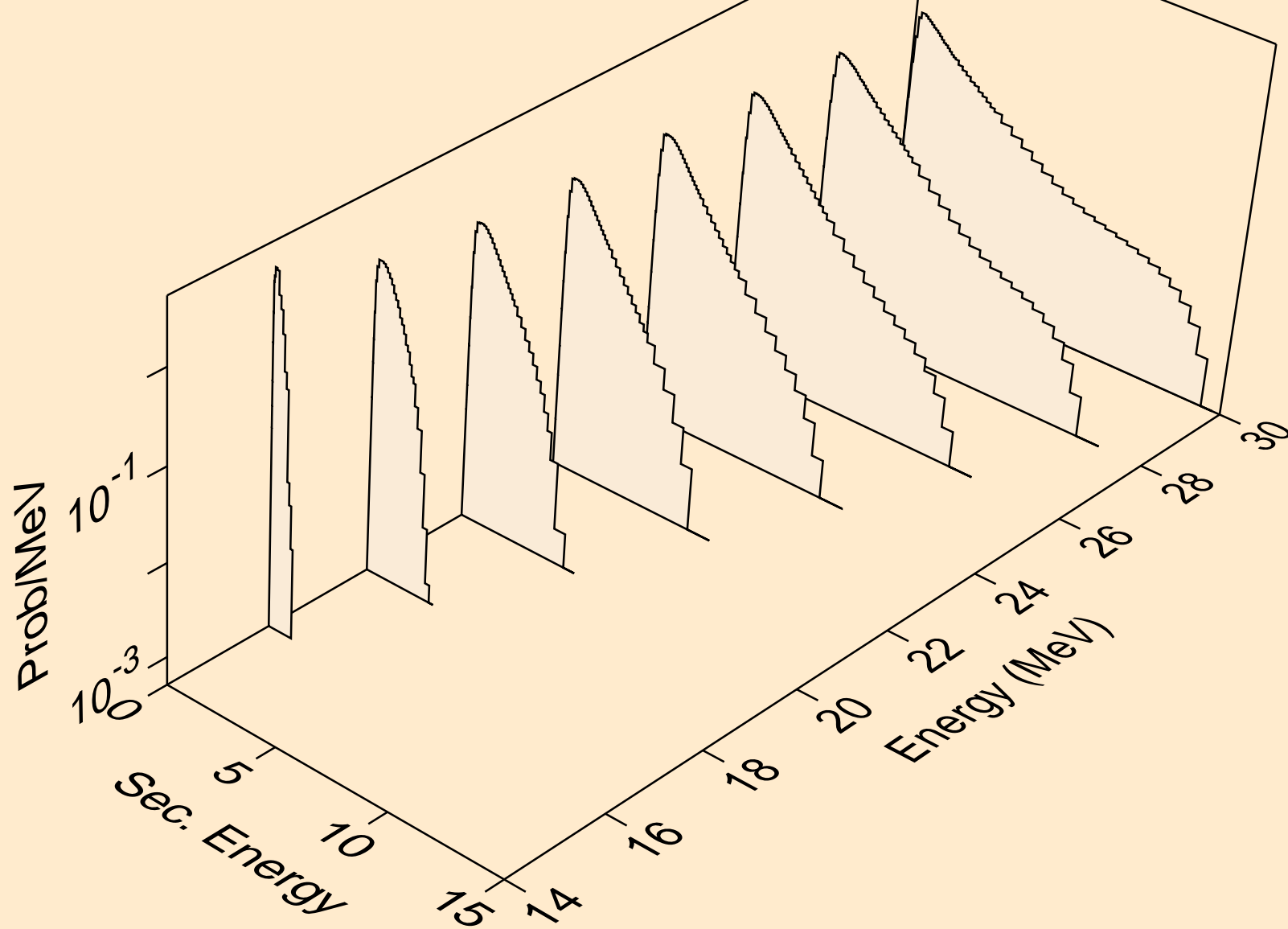

W181 NEUTRON ACER TENDL-2021 LIBRARY; T=293.6K  
Neutron emission for (n,n\*)a

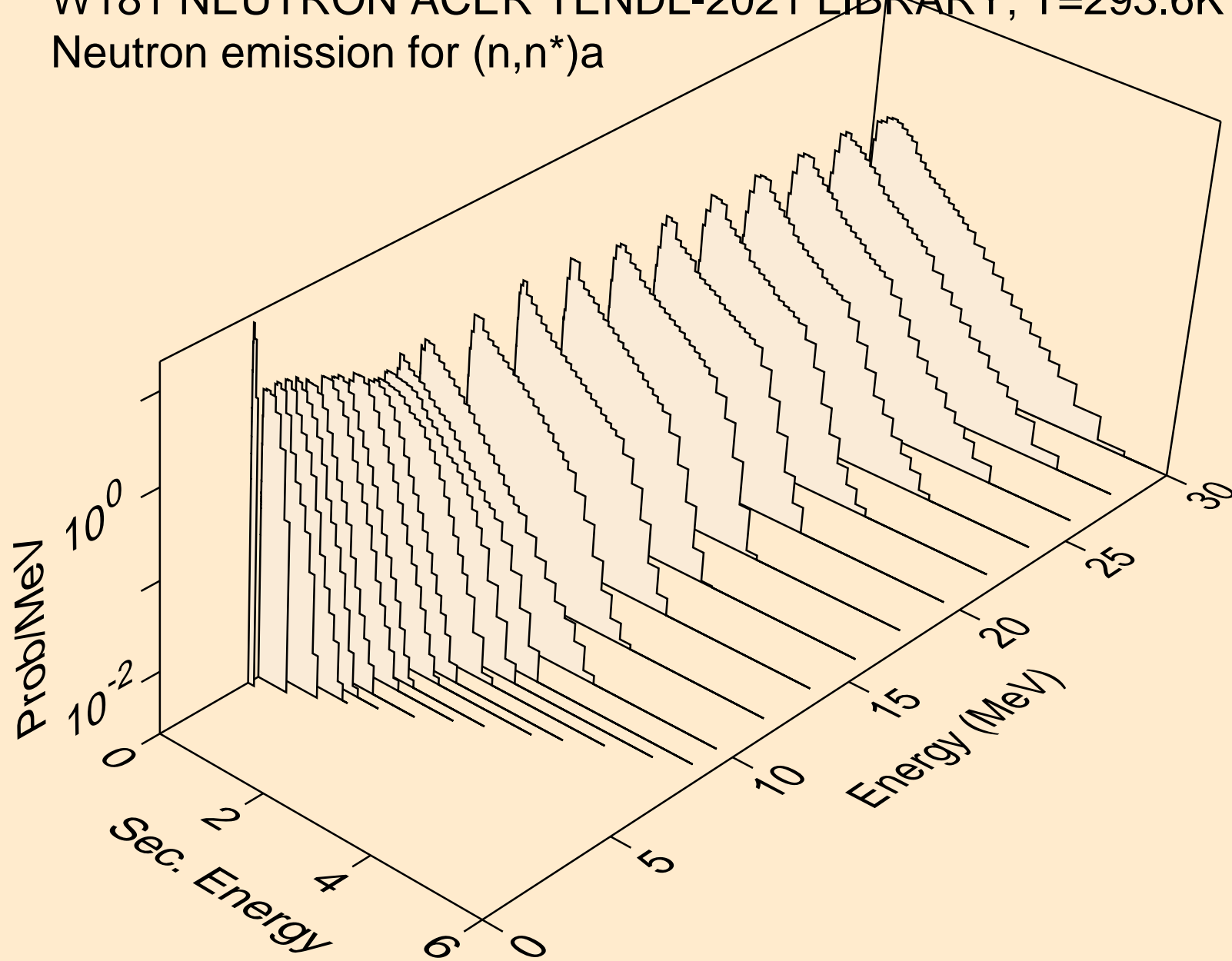



W181 NEUTRON ACER TENDL-2021 LIBRARY; T=293.6K  
Neutron emission for (n,2n)a

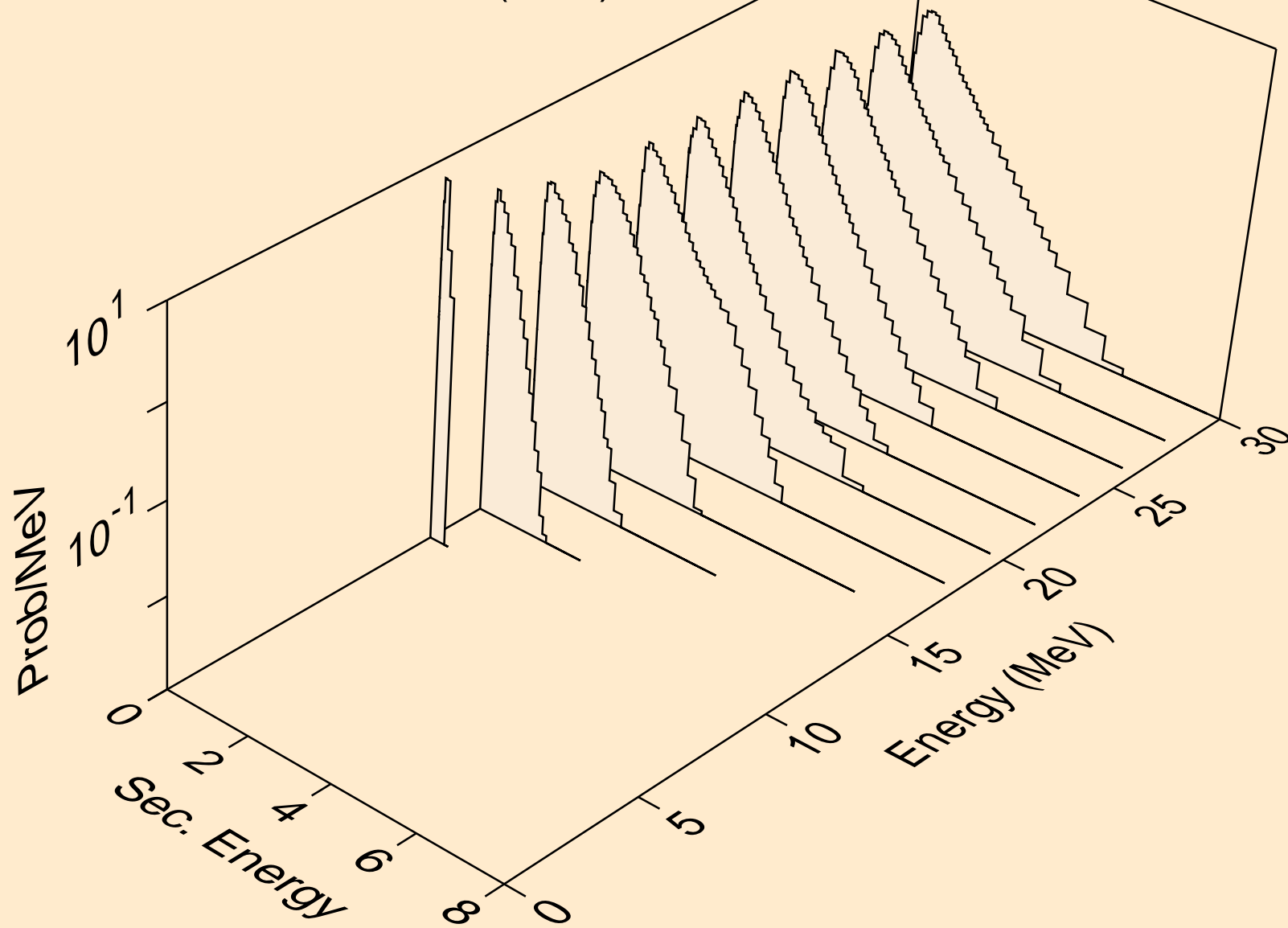

W181 NEUTRON ACER TENDL-2021 LIBRARY; T=293.6K  
Neutron emission for (n,3n)a

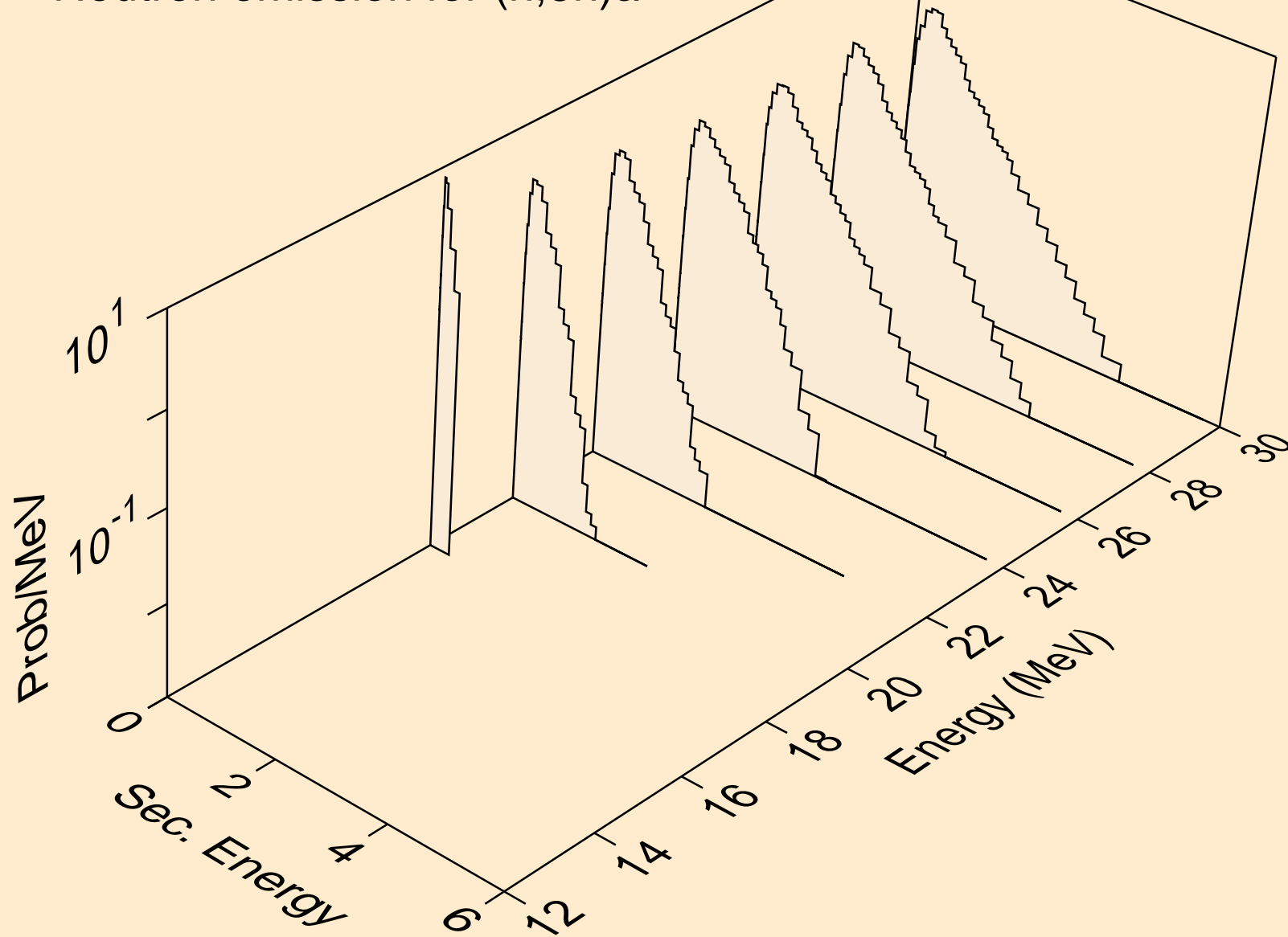

W181 NEUTRON ACER TENDL-2021 LIBRARY; T=293.6K  
Neutron emission for (n,n\*)p

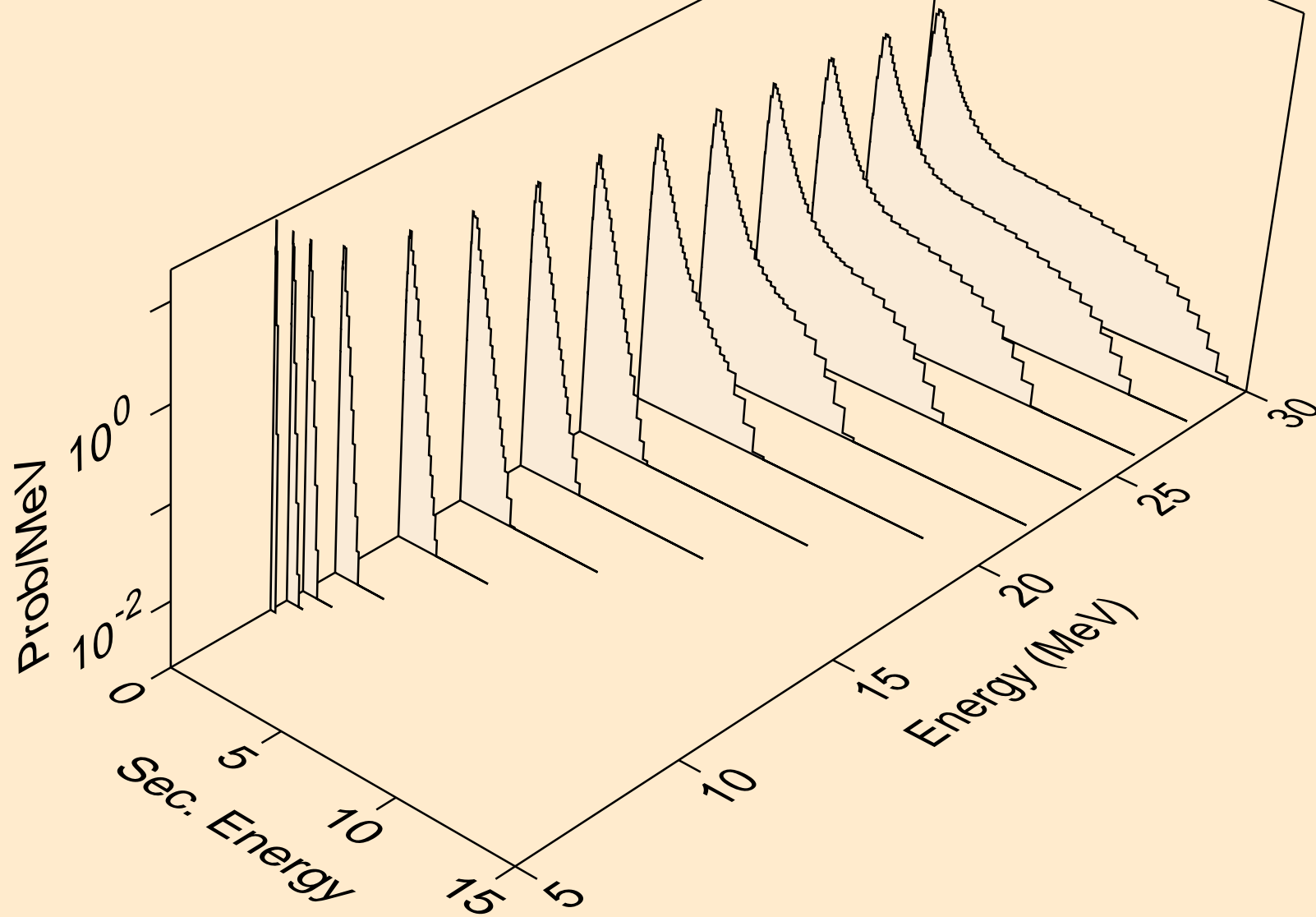

W181 NEUTRON ACER TENDL-2021 LIBRARY; T=293.6K  
Neutron emission for (n,n\*)2a

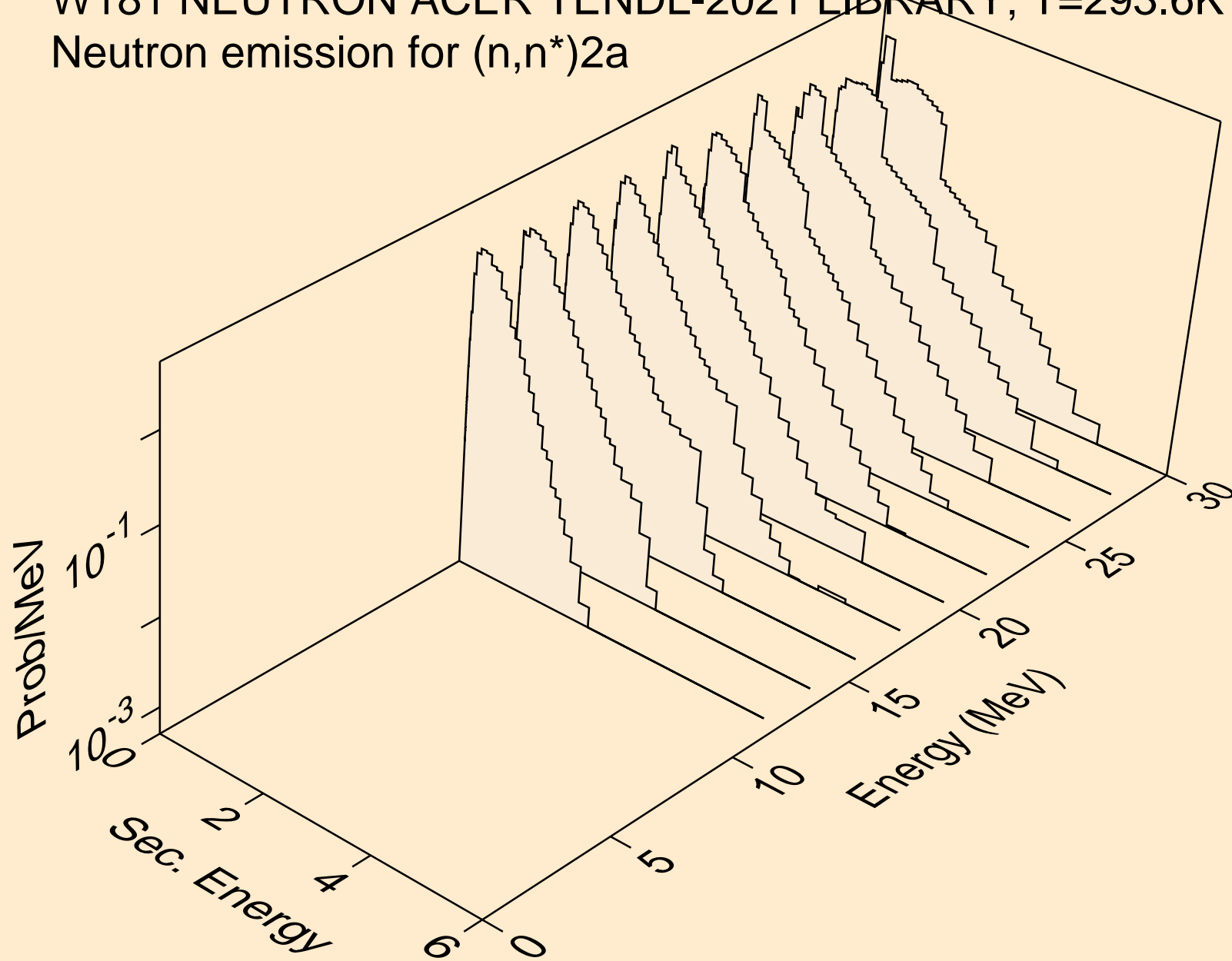

W181 NEUTRON ACER TENDL-2021 LIBRARY; T=293.6K  
Neutron emission for (n,n\*)d

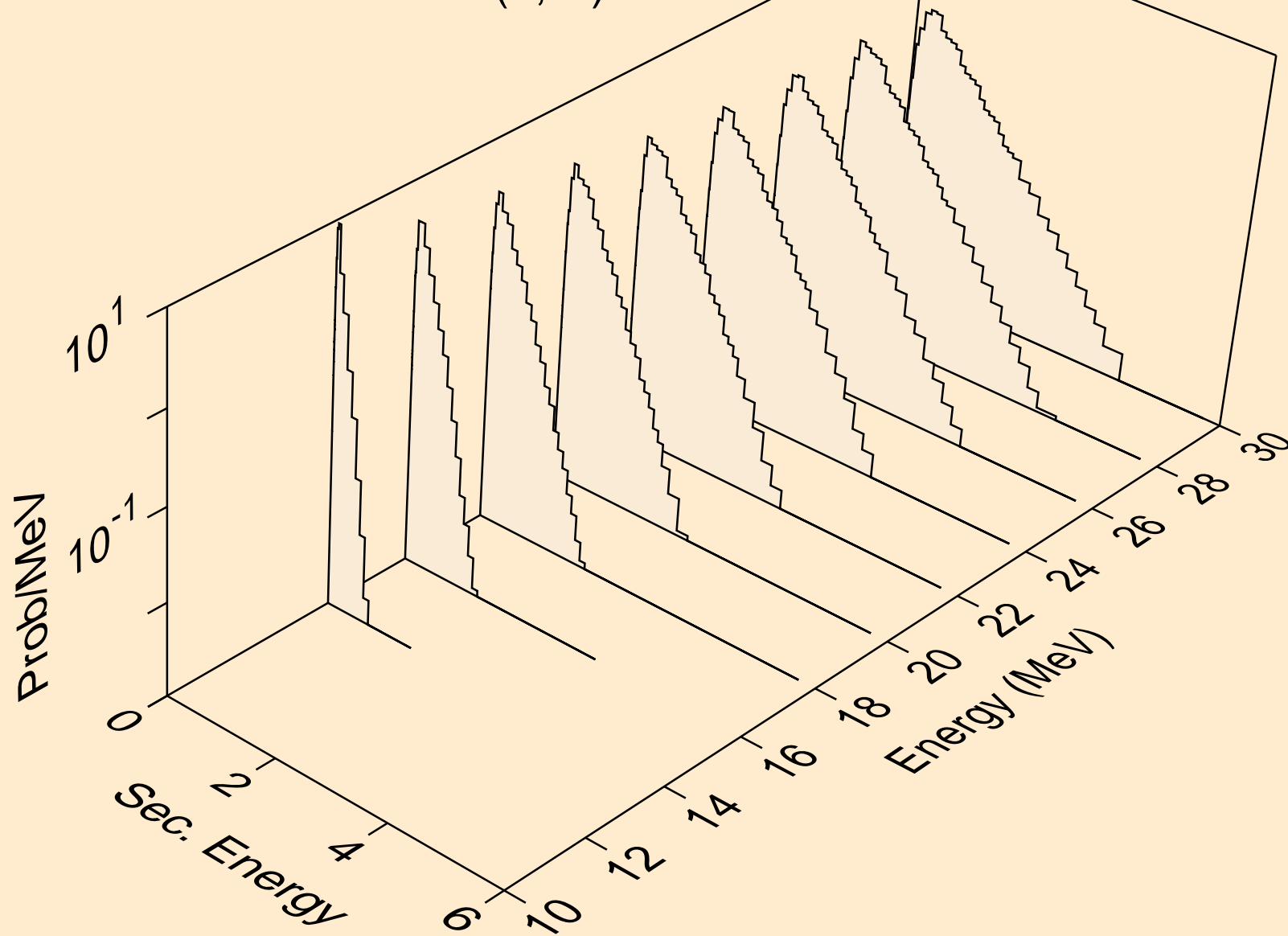

W181 NEUTRON ACER TENDL-2021 LIBRARY; T=293.6K  
Neutron emission for (n,n\*)t

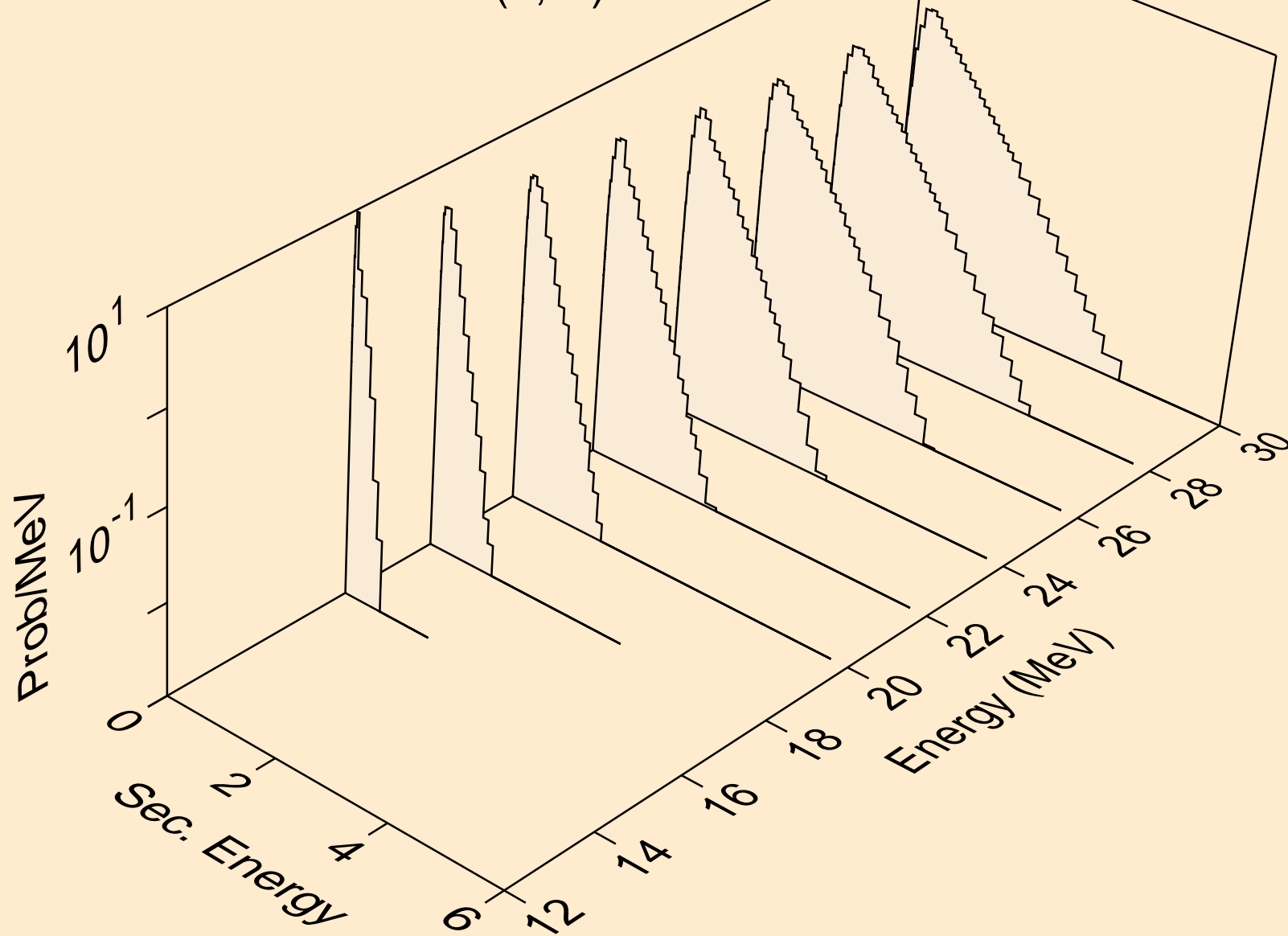

W181 NEUTRON ACER TENDL-2021 LIBRARY; T=293.6K  
Neutron emission for (n,n\*)he3

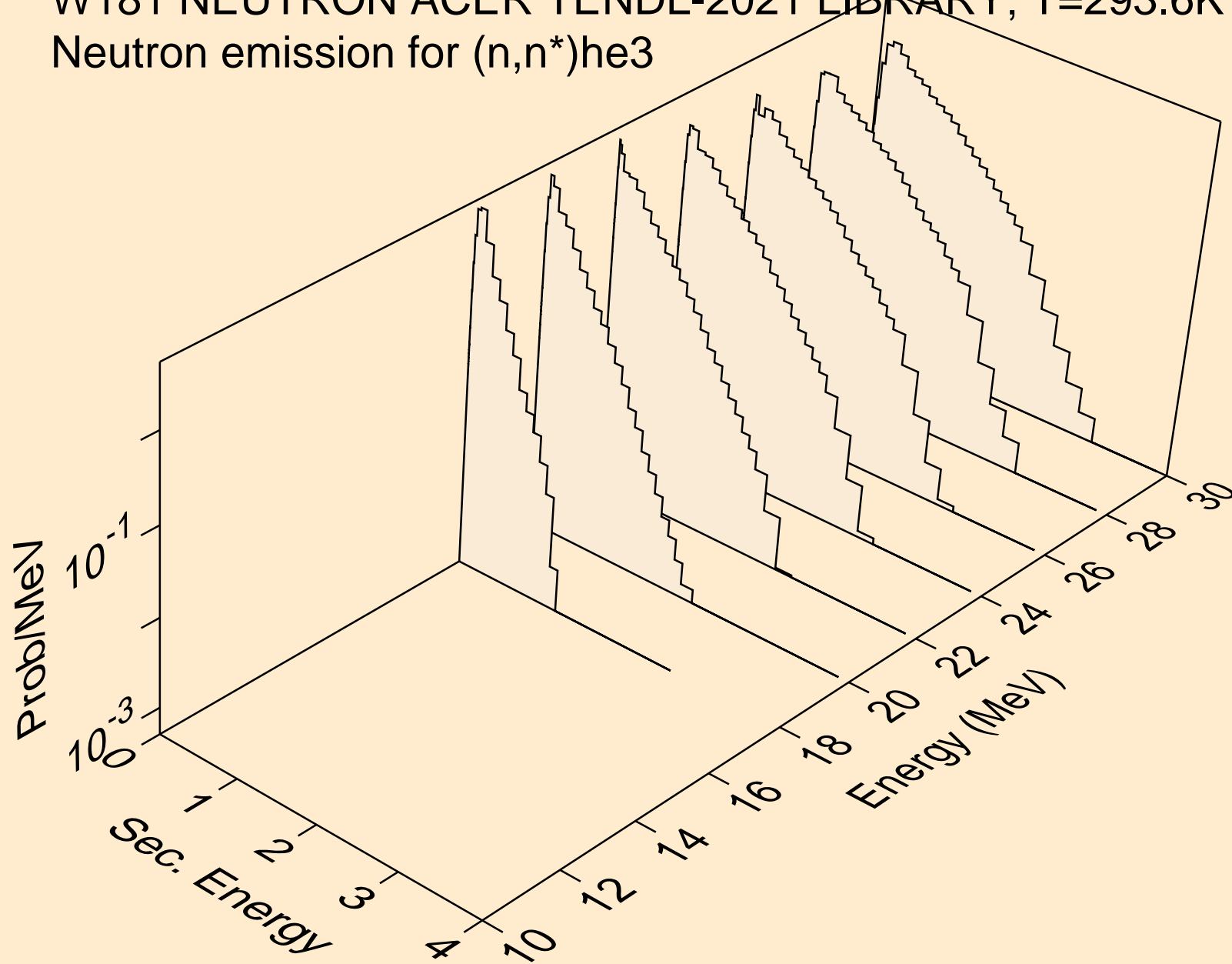

W181 NEUTRON ACER TENDL-2021 LIBRARY; T=293.6K  
Neutron emission for (n,4n)

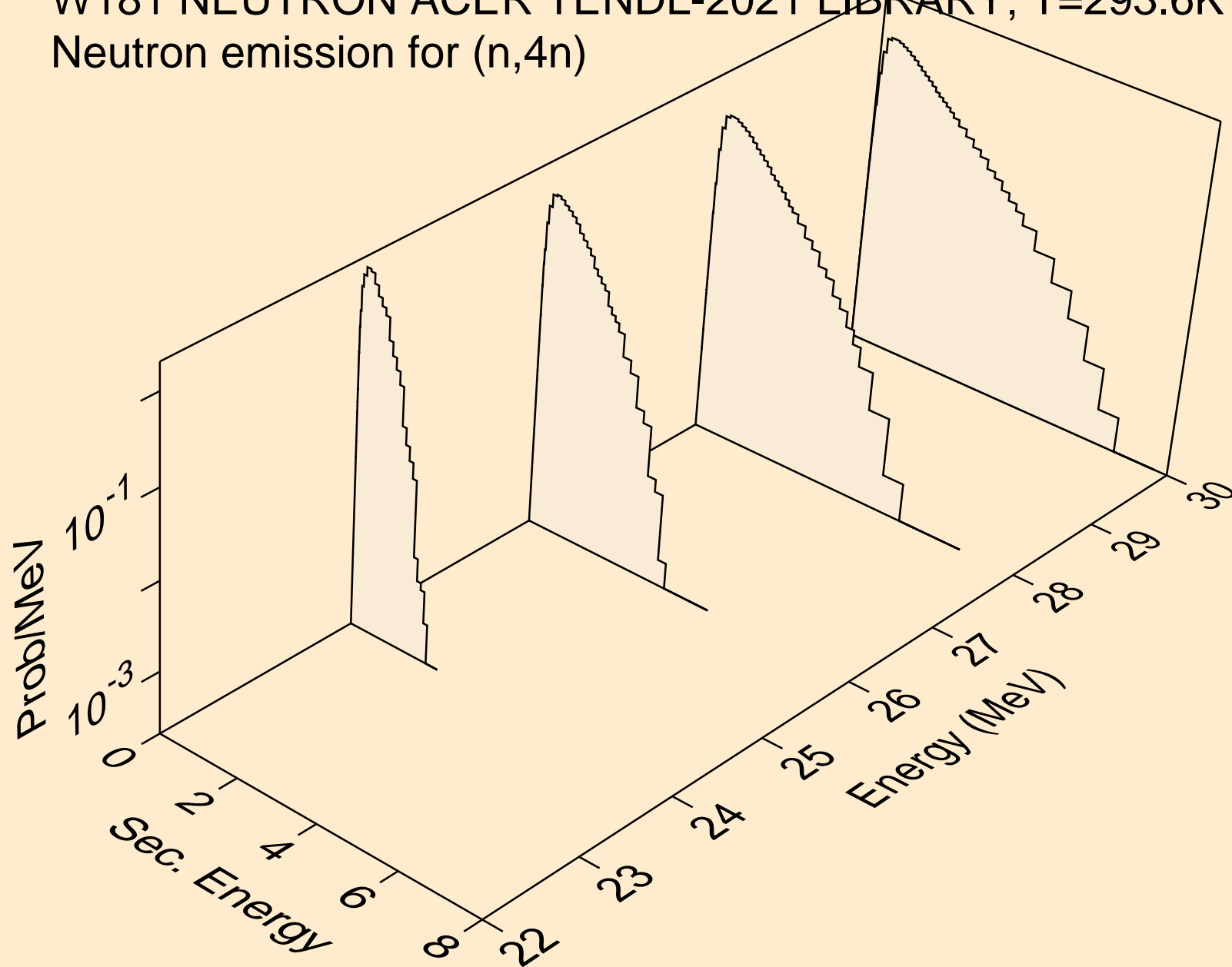



W181 NEUTRON ACER TENDL-2021 LIBRARY; T=293.6K  
Neutron emission for (n,2np)

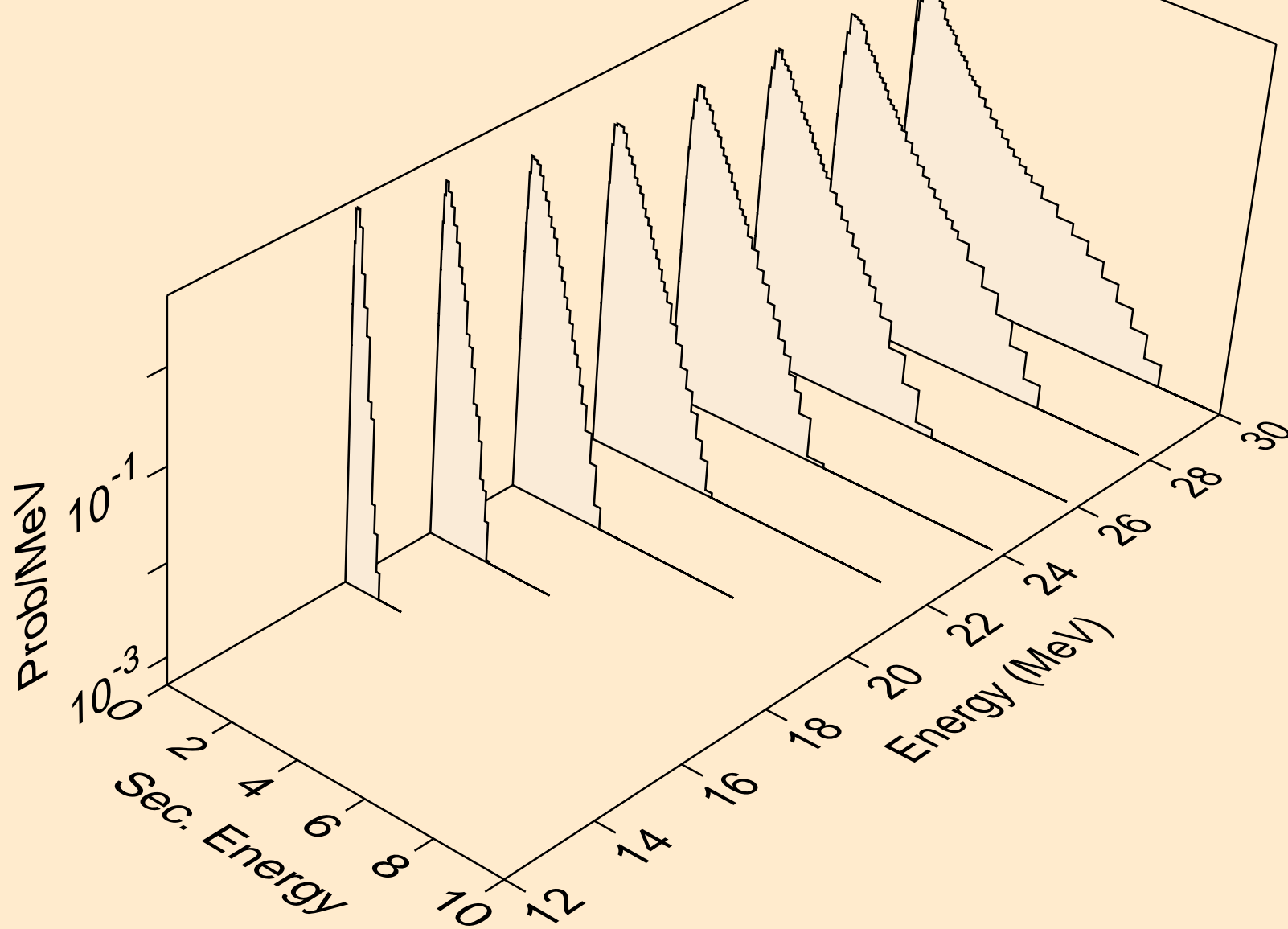

W181 NEUTRON ACER TENDL-2021 LIBRARY; T=293.6K  
Neutron emission for (n,3np)

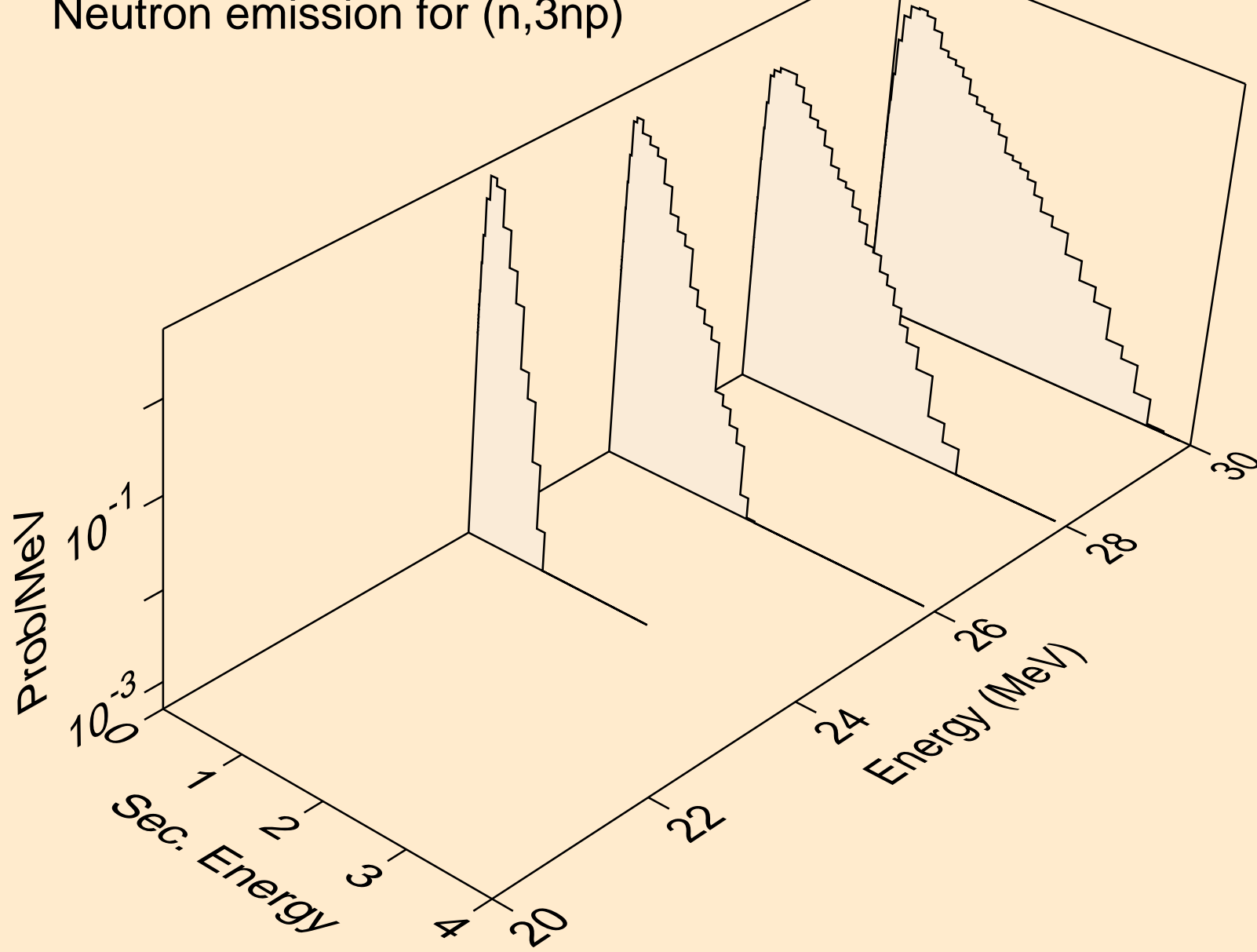

W181 NEUTRON ACER TENDL-2021 LIBRARY; T=293.6K  
Neutron emission for (n,2np)

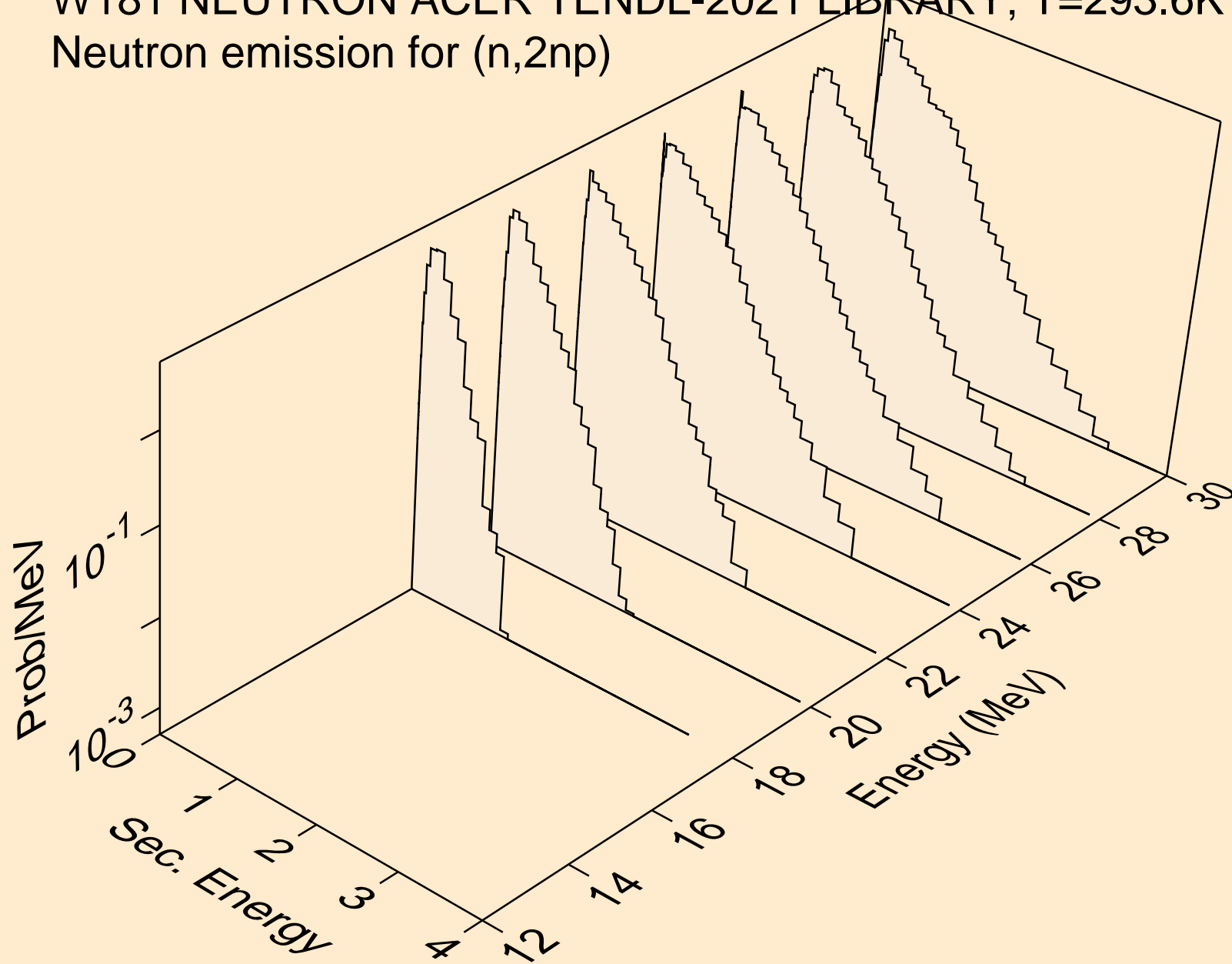

W181 NEUTRON ACER TENDL-2021 LIBRARY; T=293.6K  
Neutron emission for (n,npa)

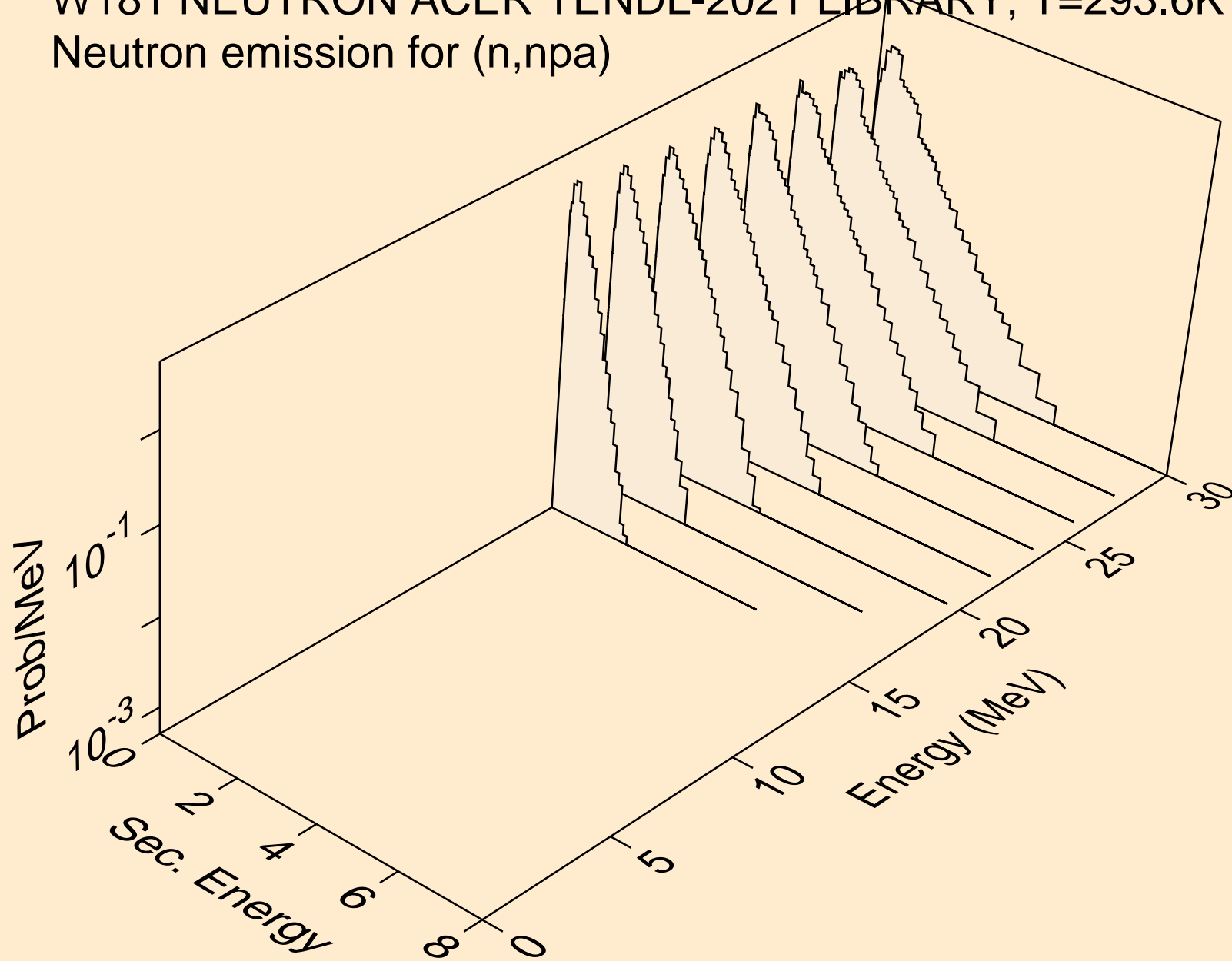

W181 NEUTRON ACER TENDL-2021 LIBRARY; T=293.6K  
Neutron emission for (n,n\*c)

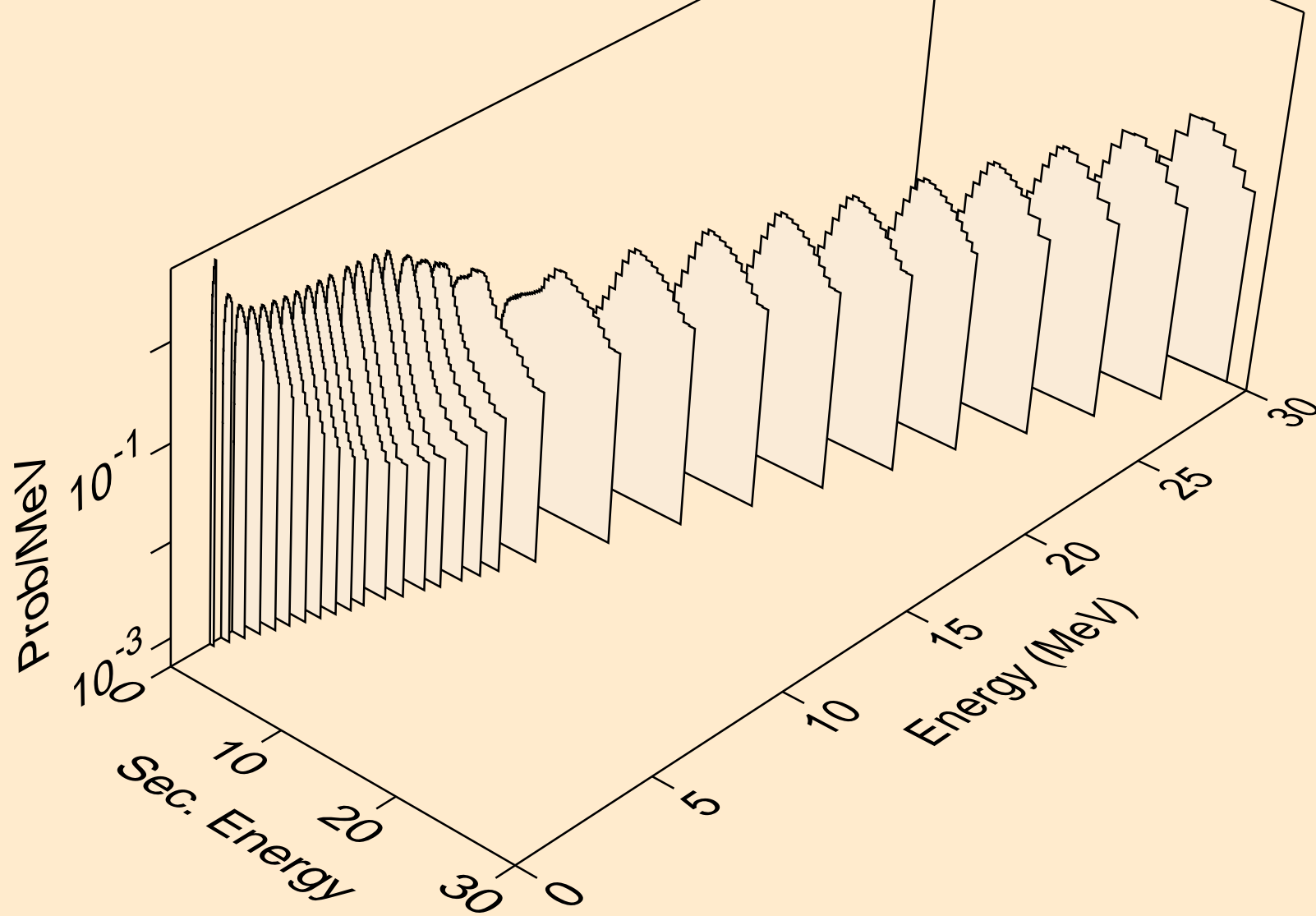

W181 NEUTRON ACER TENDL-2021 LIBRARY; T=293.6K  
Photon emission for (n,x)

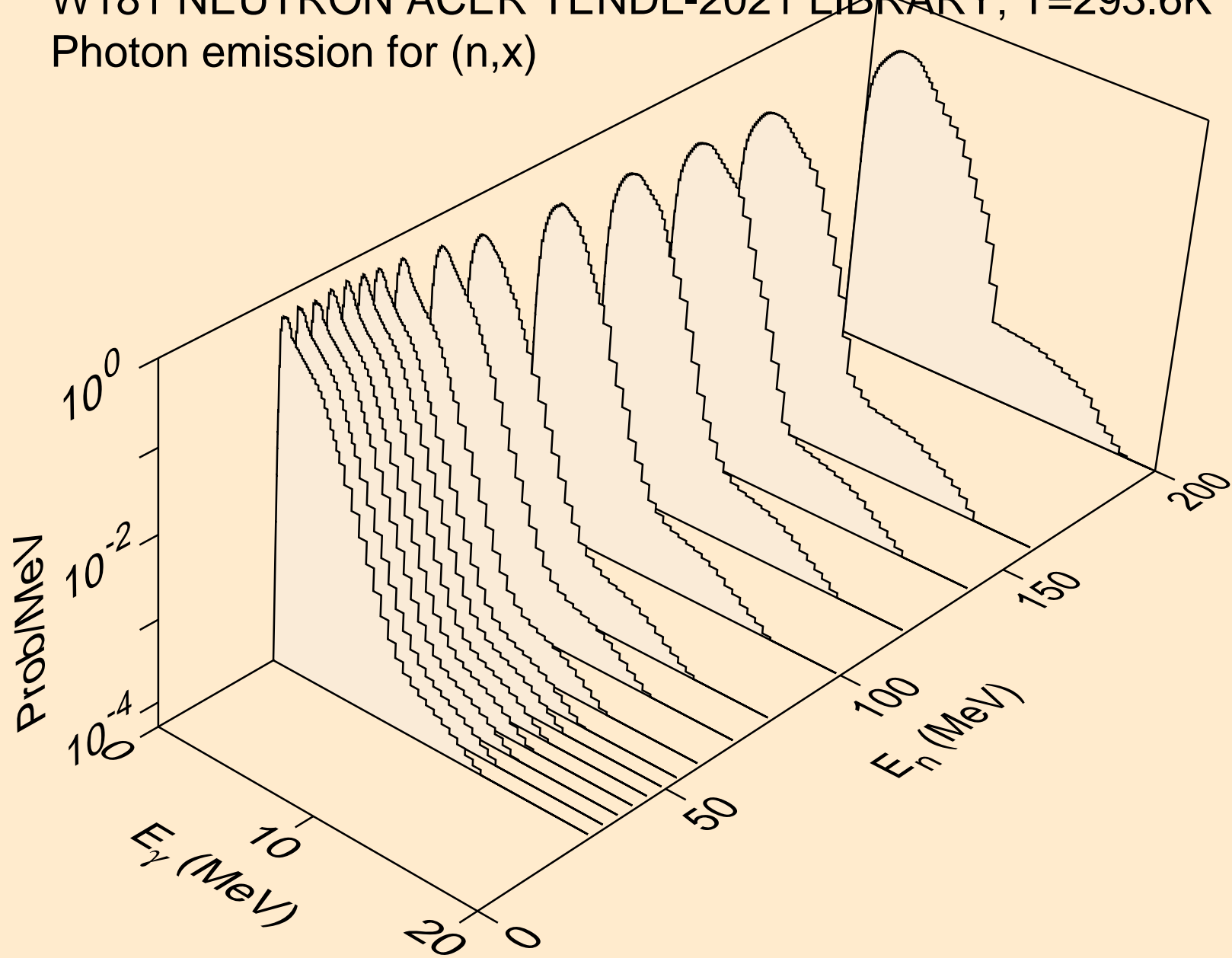

W181 NEUTRON ACER TENDL-2021 LIBRARY; T=293.6K  
Photon emission for (n,2nd)

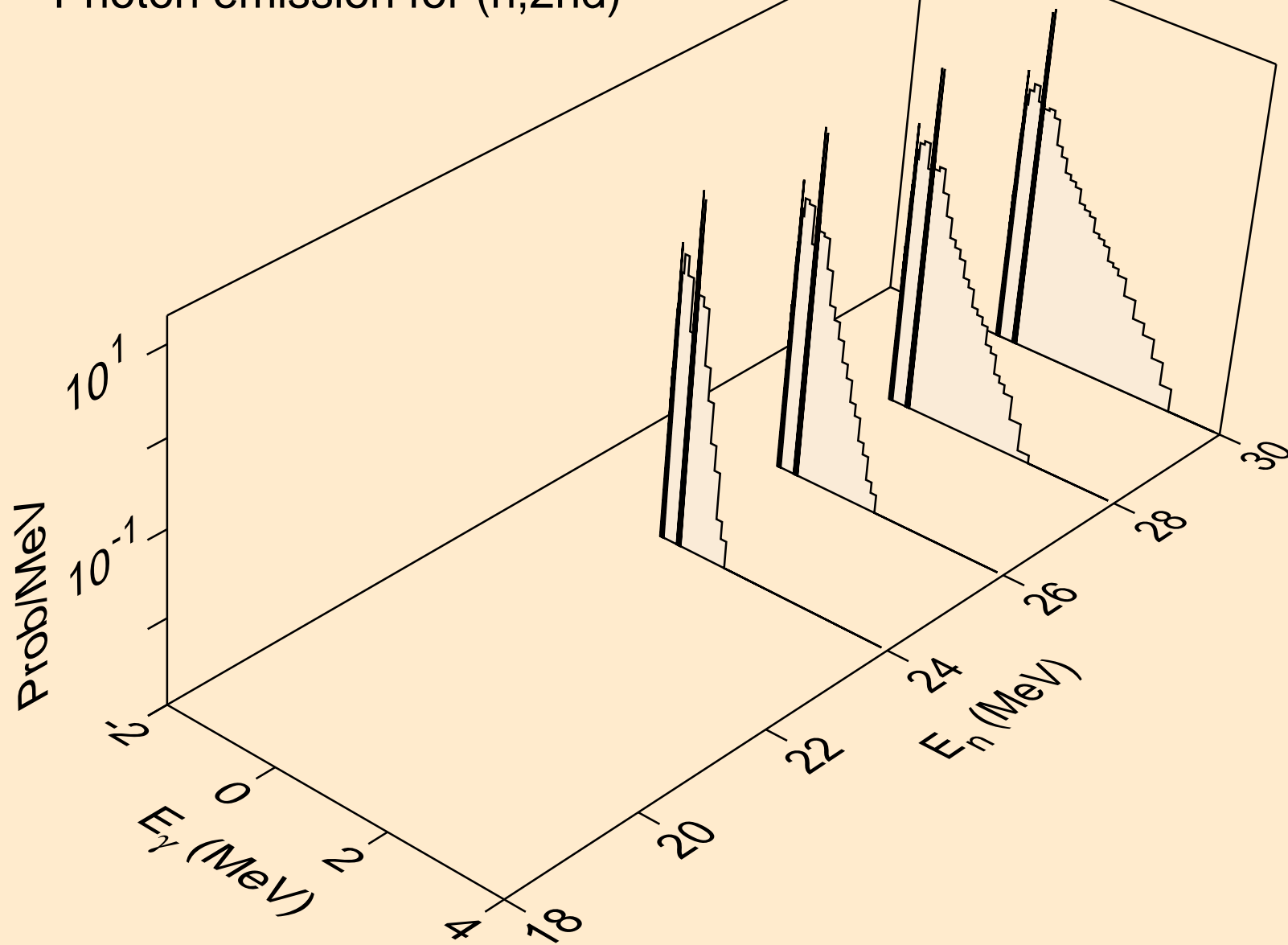

W181 NEUTRON ACER TENDL-2021 LIBRARY; T=293.6K  
Photon emission for (n,2n)

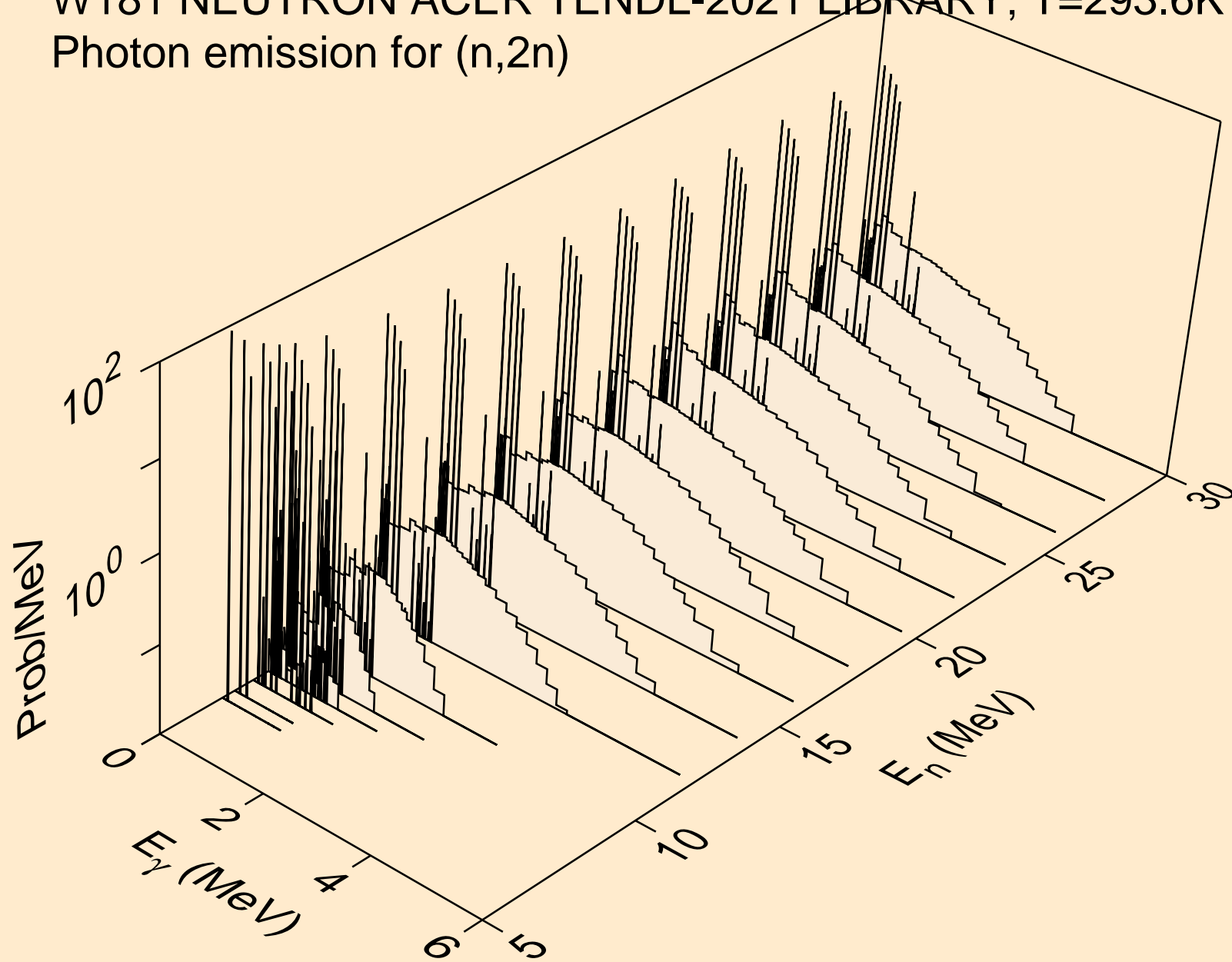



W181 NEUTRON ACER TENDL-2021 LIBRARY; T=293.6K  
Photon emission for (n,3n)

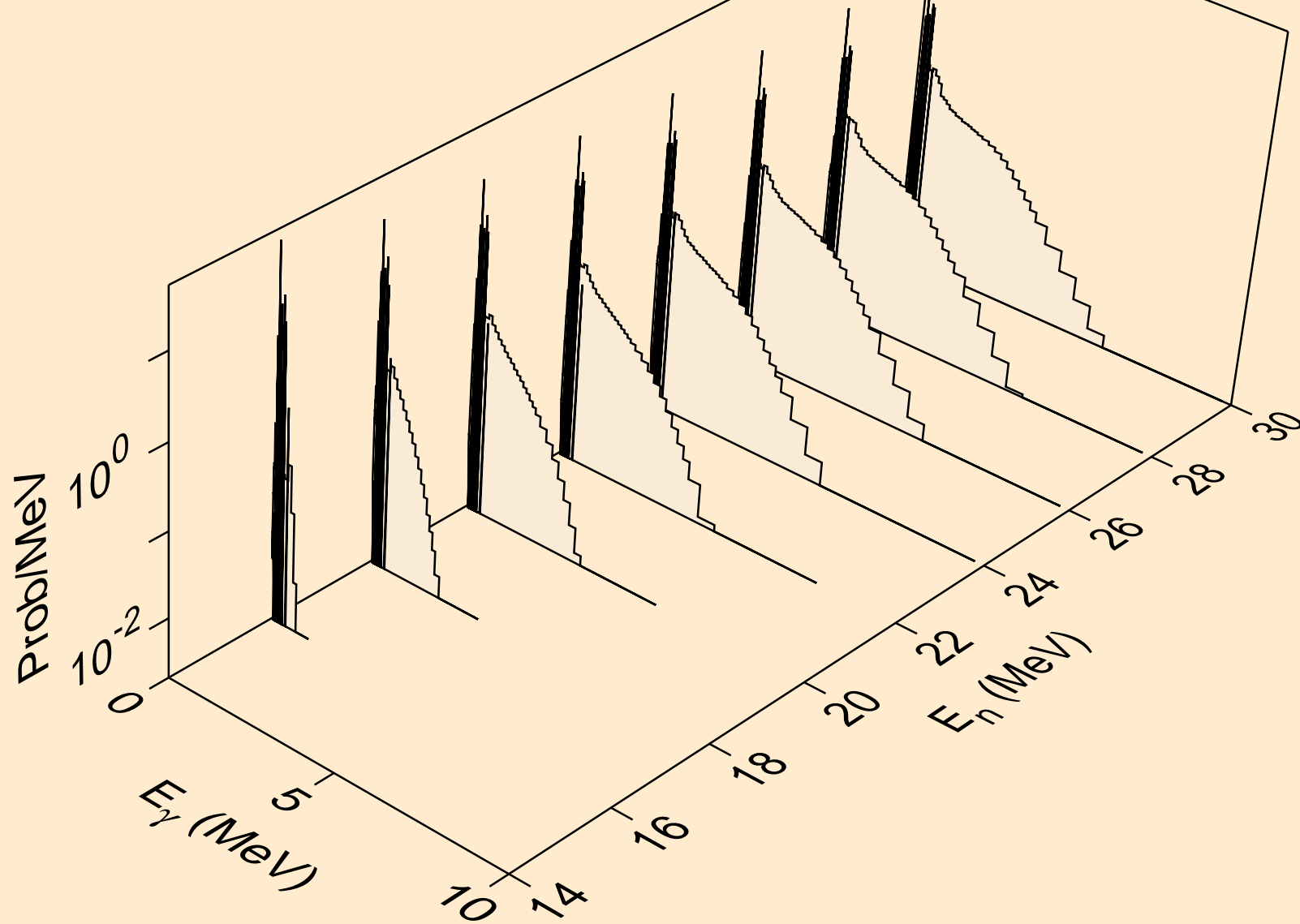

W181 NEUTRON ACER TENDL-2021 LIBRARY; T=293.6K  
Photon emission for (n,n\*)a

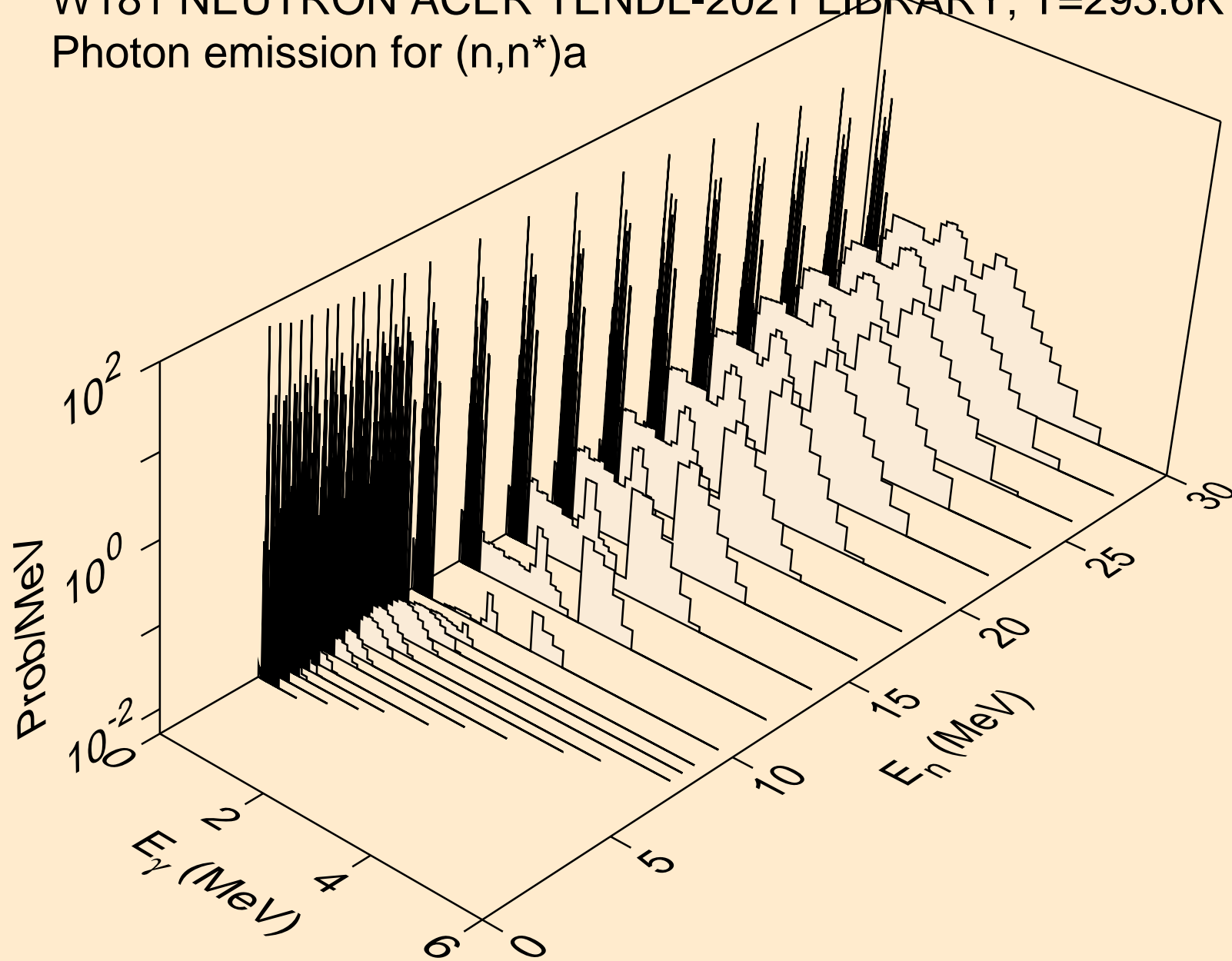

W181 NEUTRON ACER TENDL-2021 LIBRARY; T=293.6K  
Photon emission for (n,2n)a

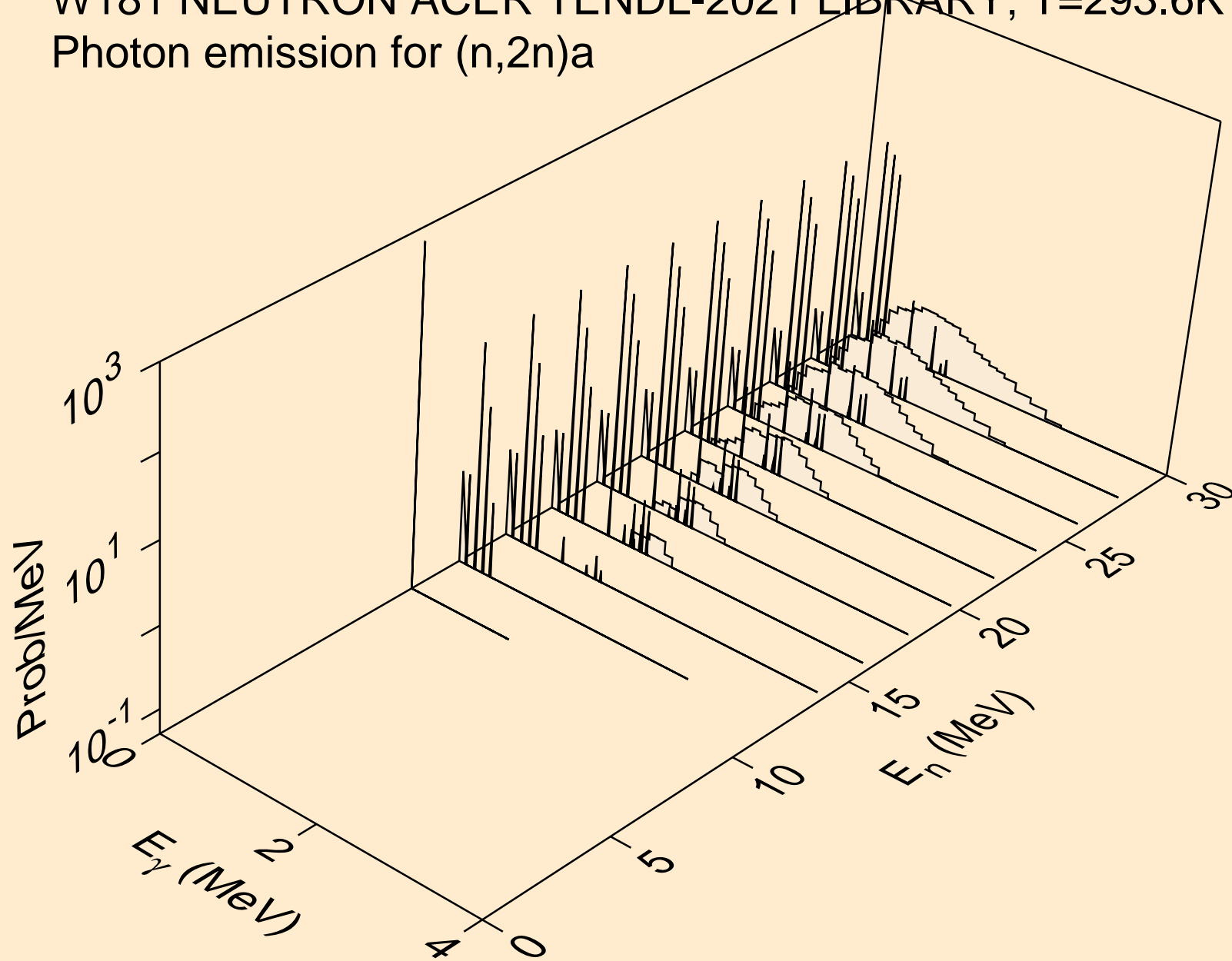

W181 NEUTRON ACER TENDL-2021 LIBRARY; T=293.6K  
Photon emission for (n,3n)a

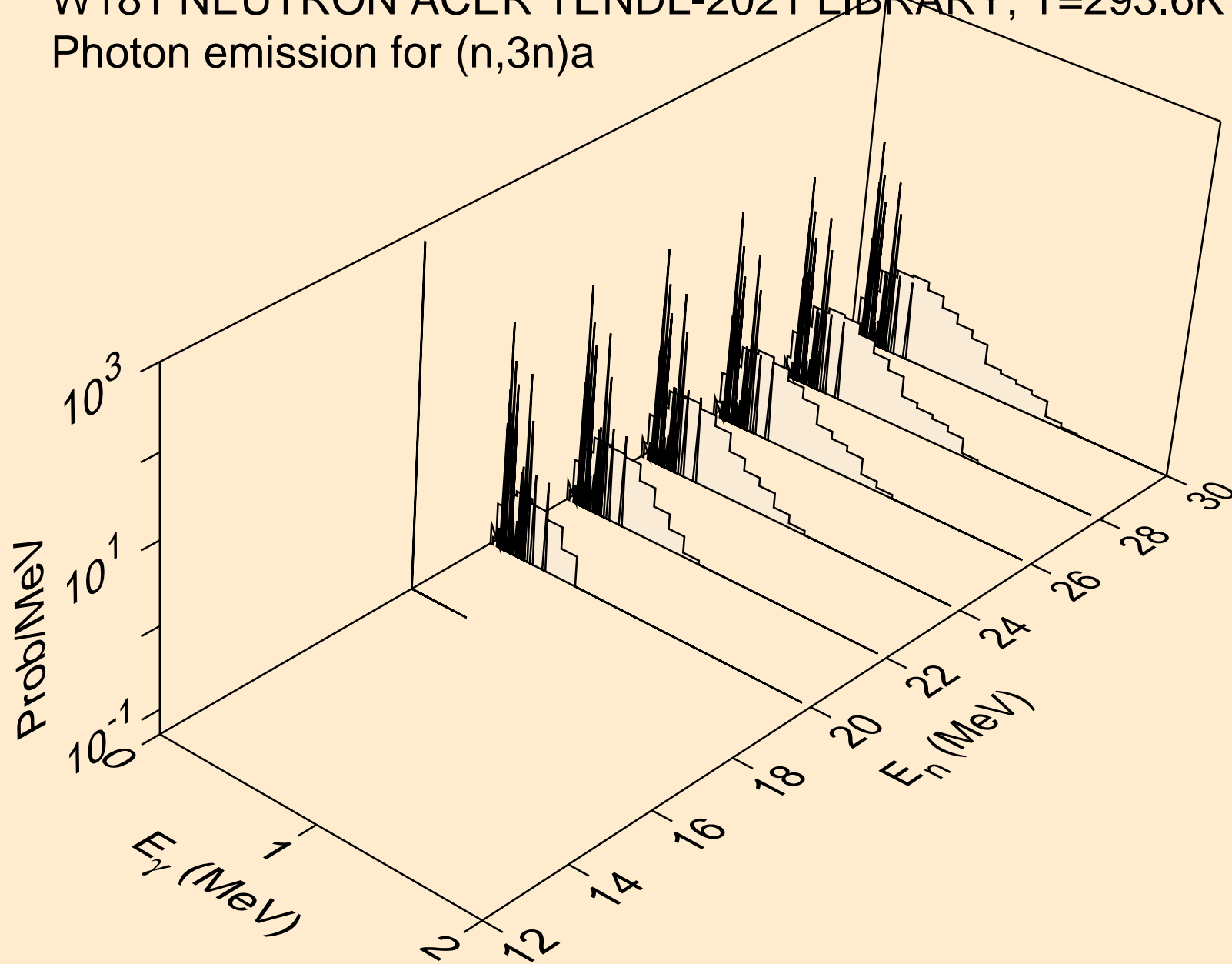

W181 NEUTRON ACER TENDL-2021 LIBRARY; T=293.6K  
Photon emission for (n,n\*)p

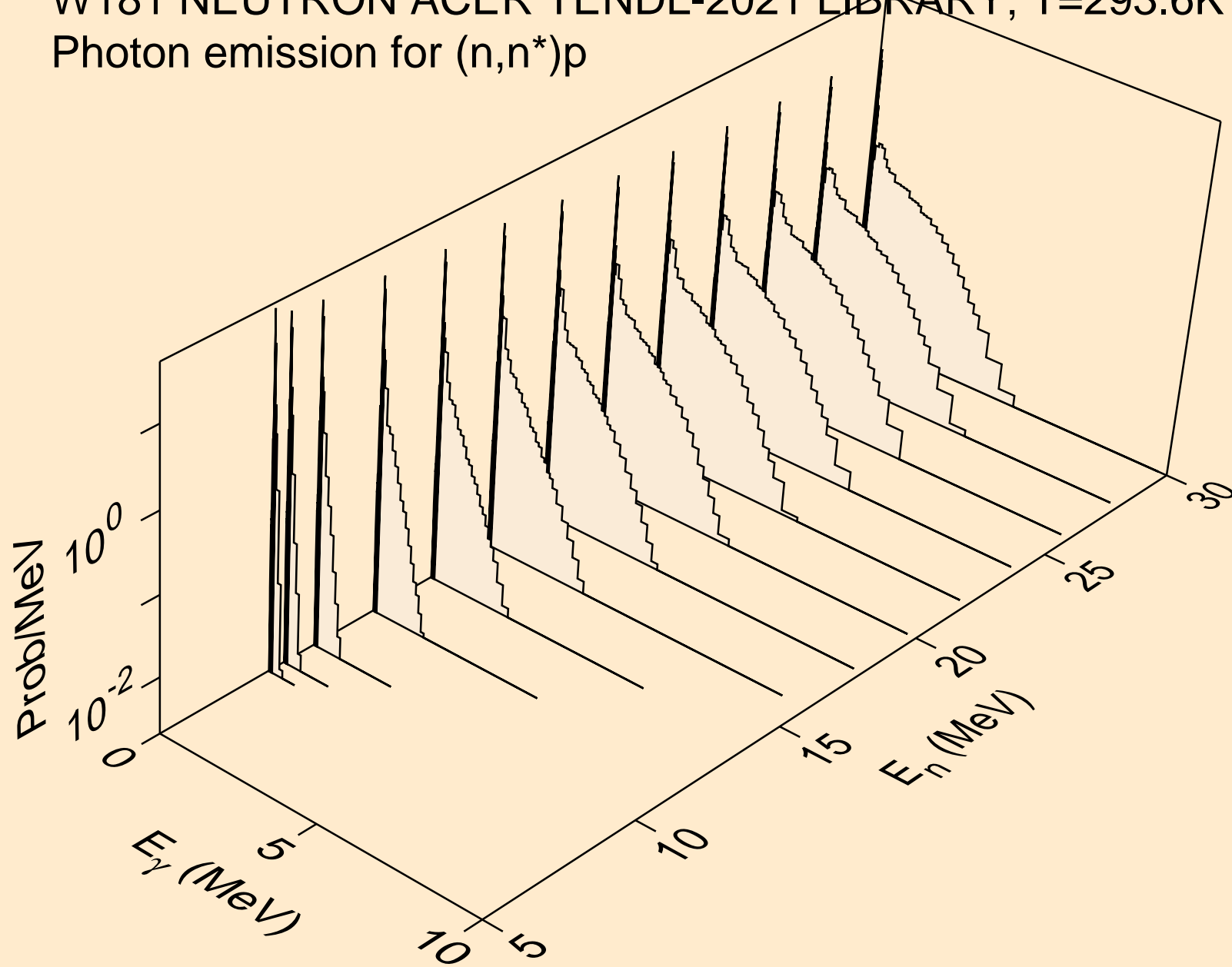

W181 NEUTRON ACER TENDL-2021 LIBRARY; T=293.6K  
Photon emission for (n,n\*)2a

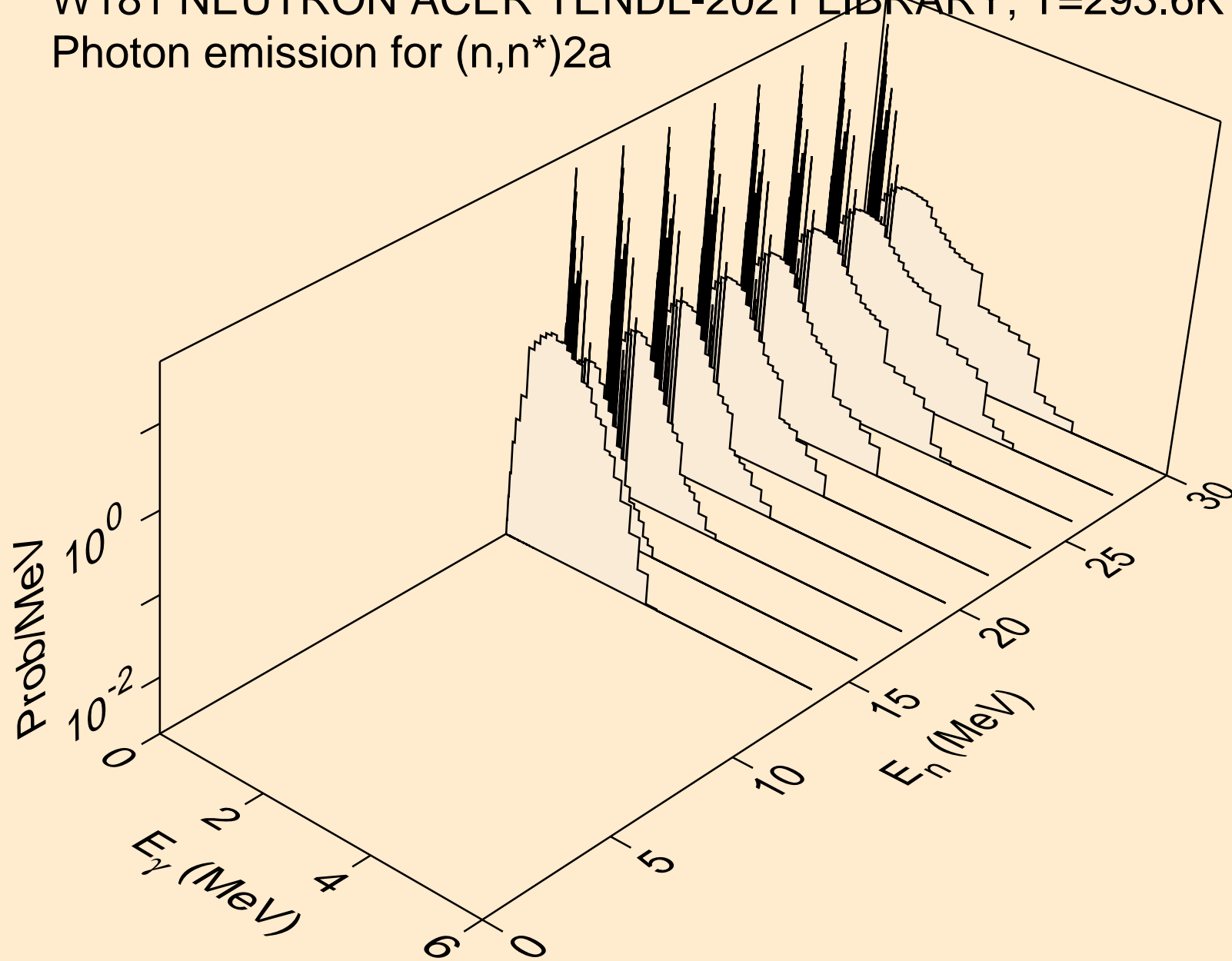

W181 NEUTRON ACER TENDL-2021 LIBRARY; T=293.6K  
Photon emission for (n,n\*)d

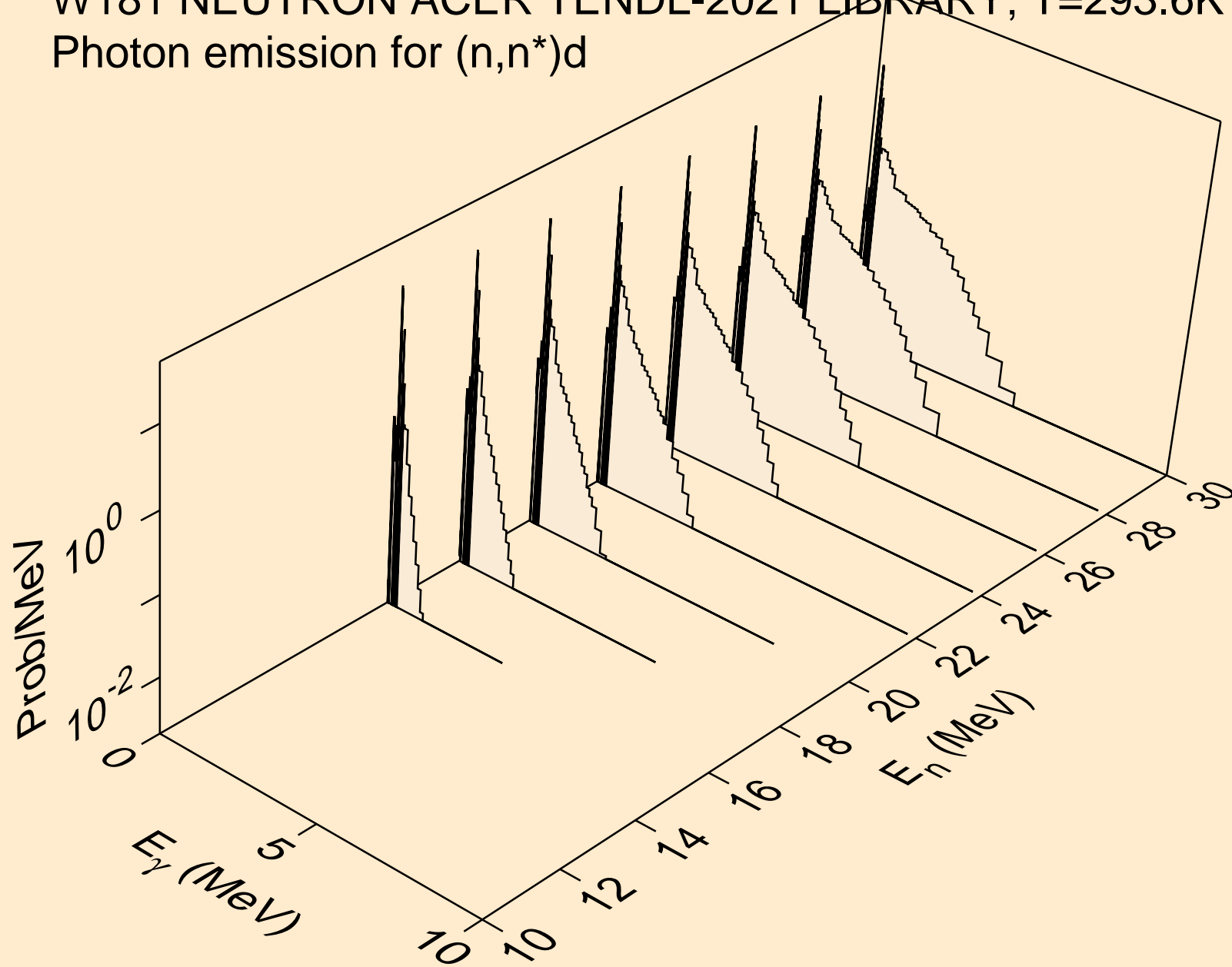

W181 NEUTRON ACER TENDL-2021 LIBRARY; T=293.6K  
Photon emission for (n,n\*)t

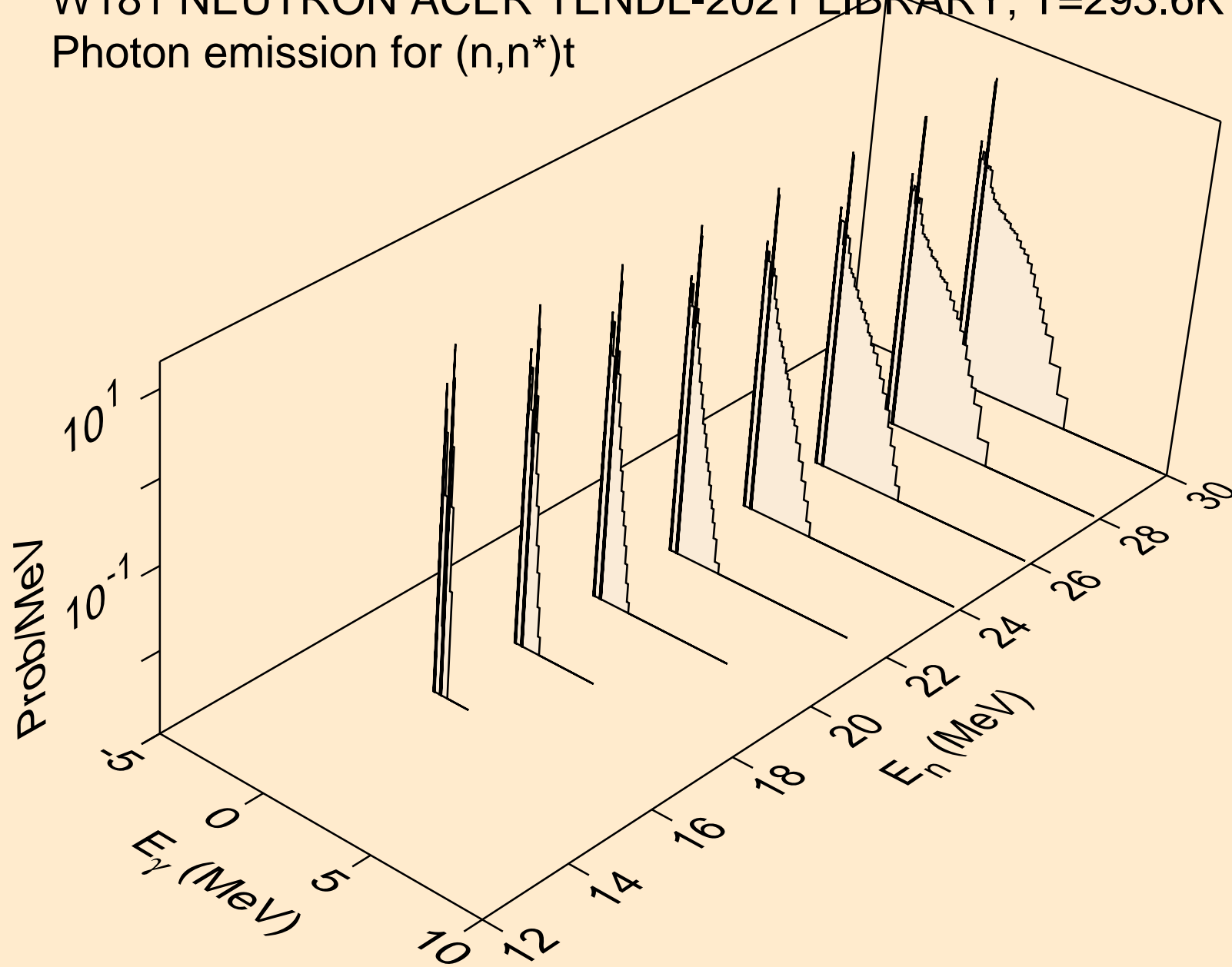



W181 NEUTRON ACER TENDL-2021 LIBRARY; T=293.6K  
Photon emission for (n,n\*)he3

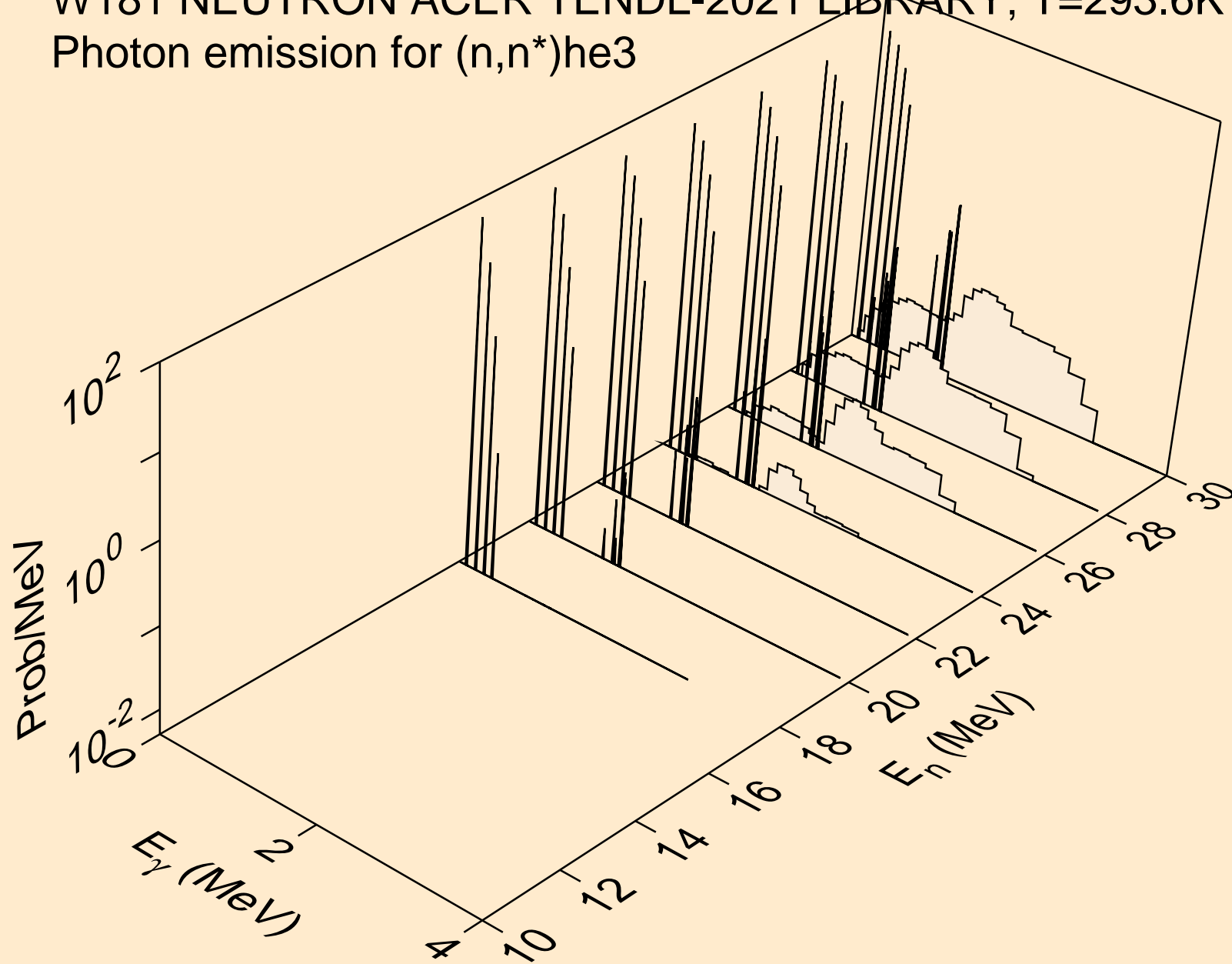

W181 NEUTRON ACER TENDL-2021 LIBRARY; T=293.6K  
Photon emission for (n,4n)

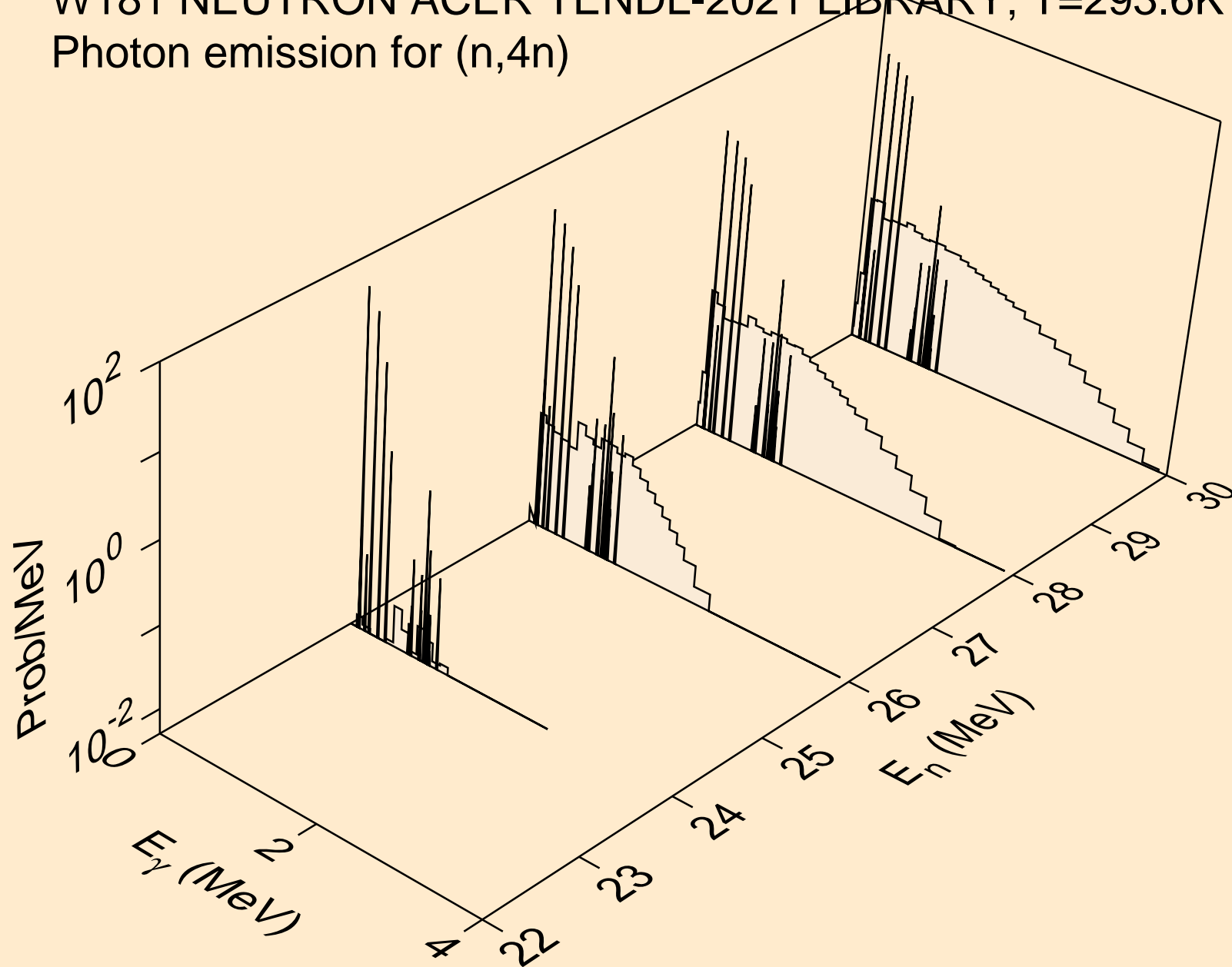

W181 NEUTRON ACER TENDL-2021 LIBRARY; T=293.6K  
Photon emission for (n,2np)

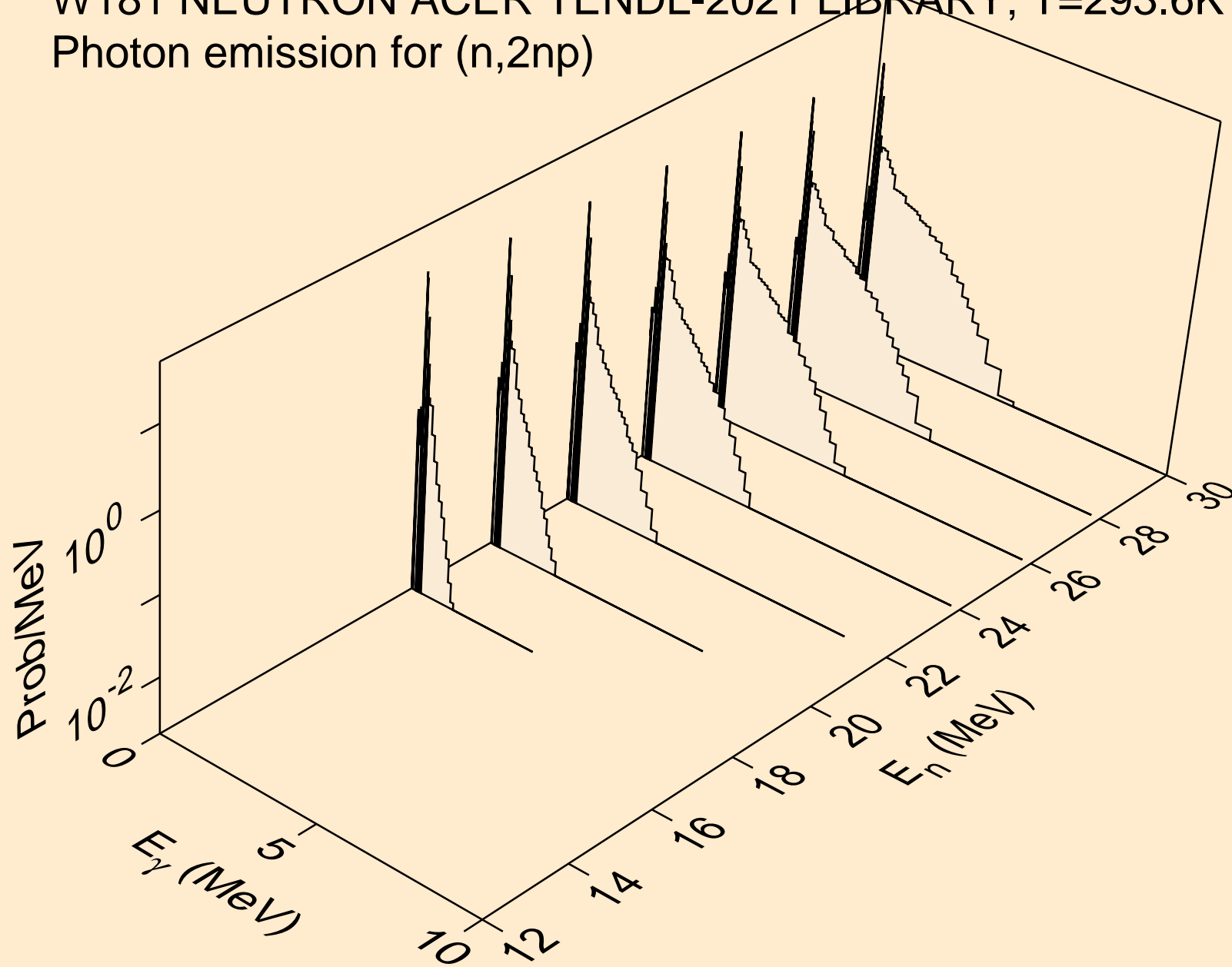

W181 NEUTRON ACER TENDL-2021 LIBRARY; T=293.6K  
Photon emission for (n,3np)

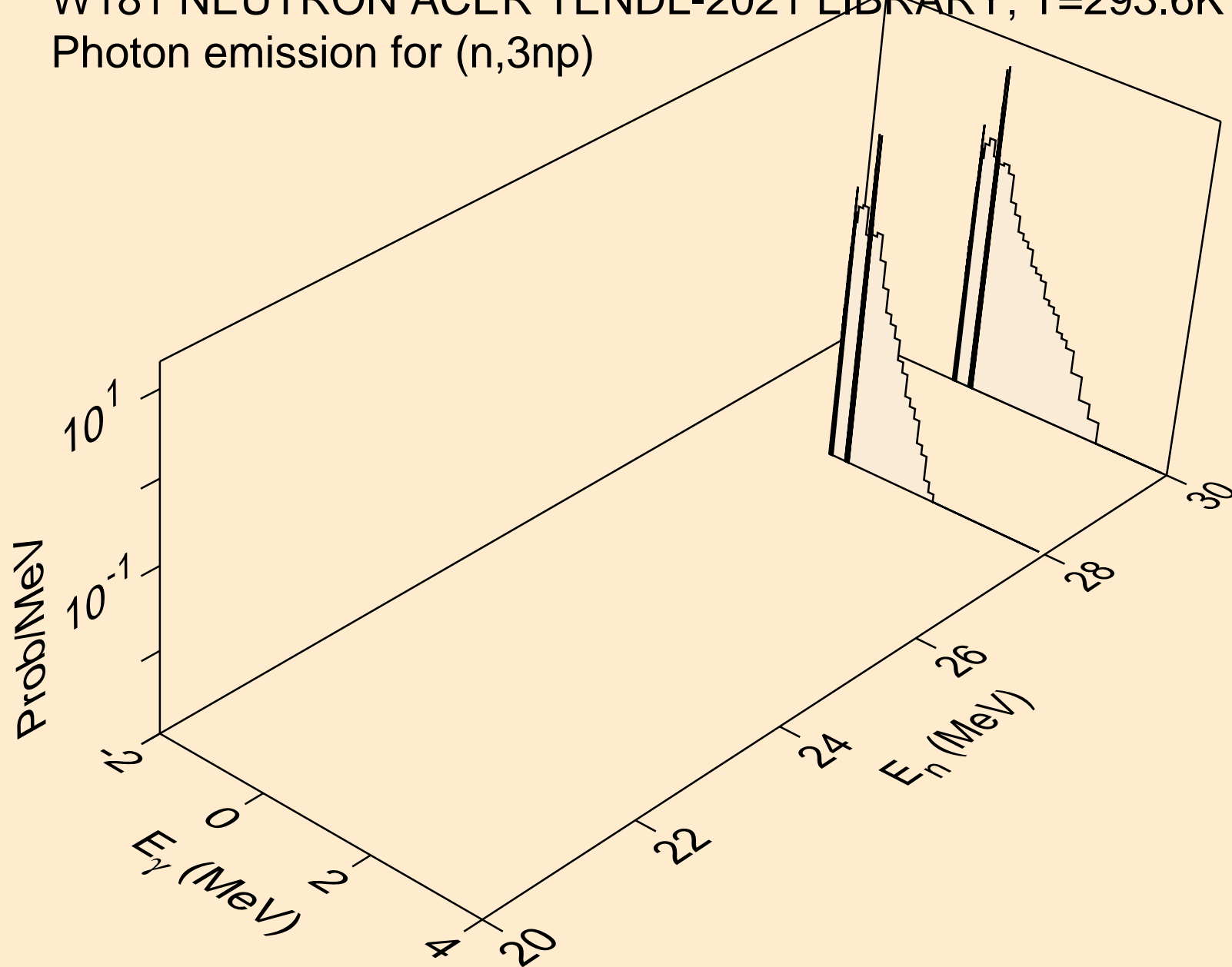

W181 NEUTRON ACER TENDL-2021 LIBRARY; T=293.6K  
Photon emission for (n,2np)

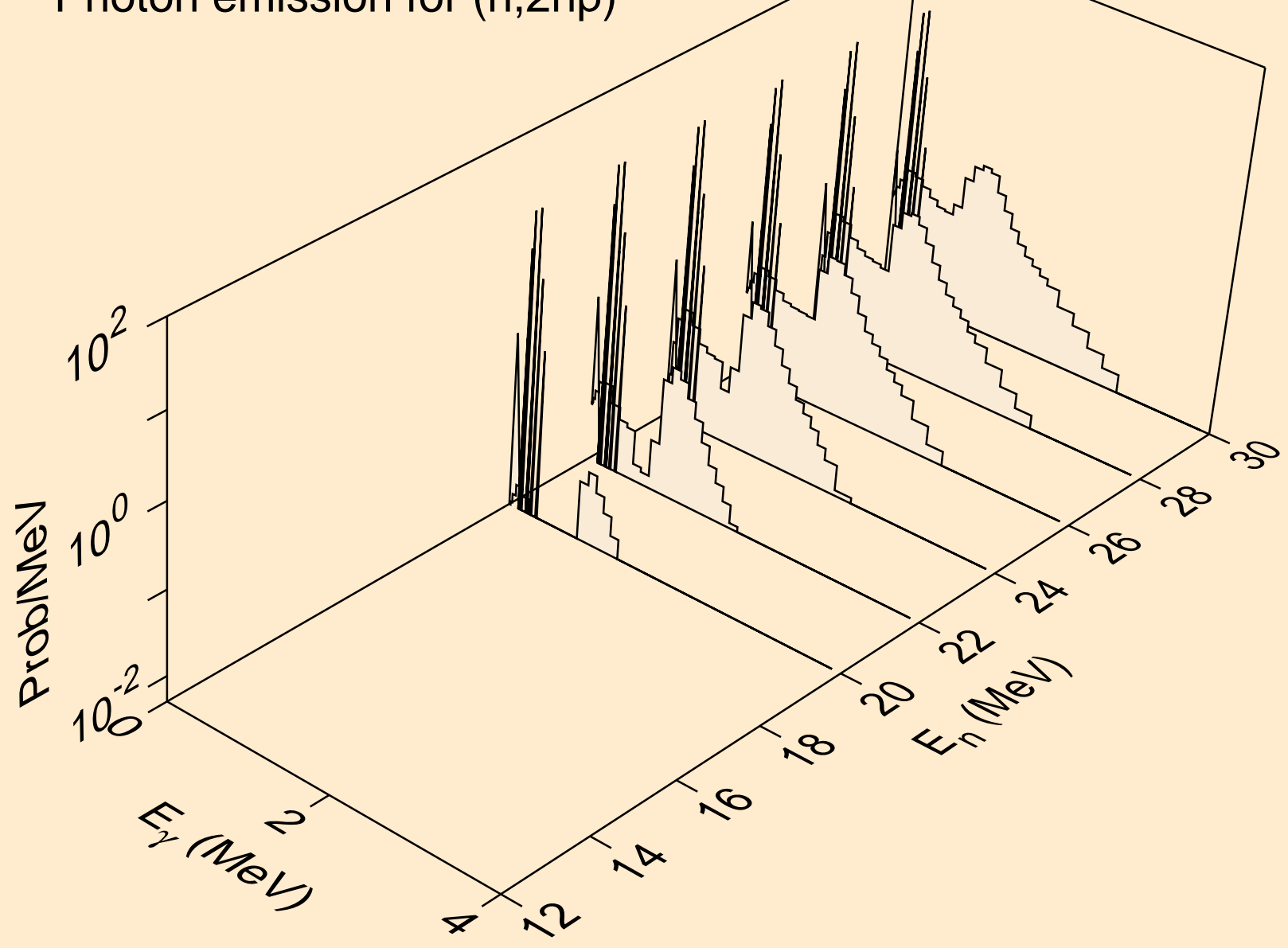

W181 NEUTRON ACER TENDL-2021 LIBRARY; T=293.6K  
Photon emission for (n,npa)

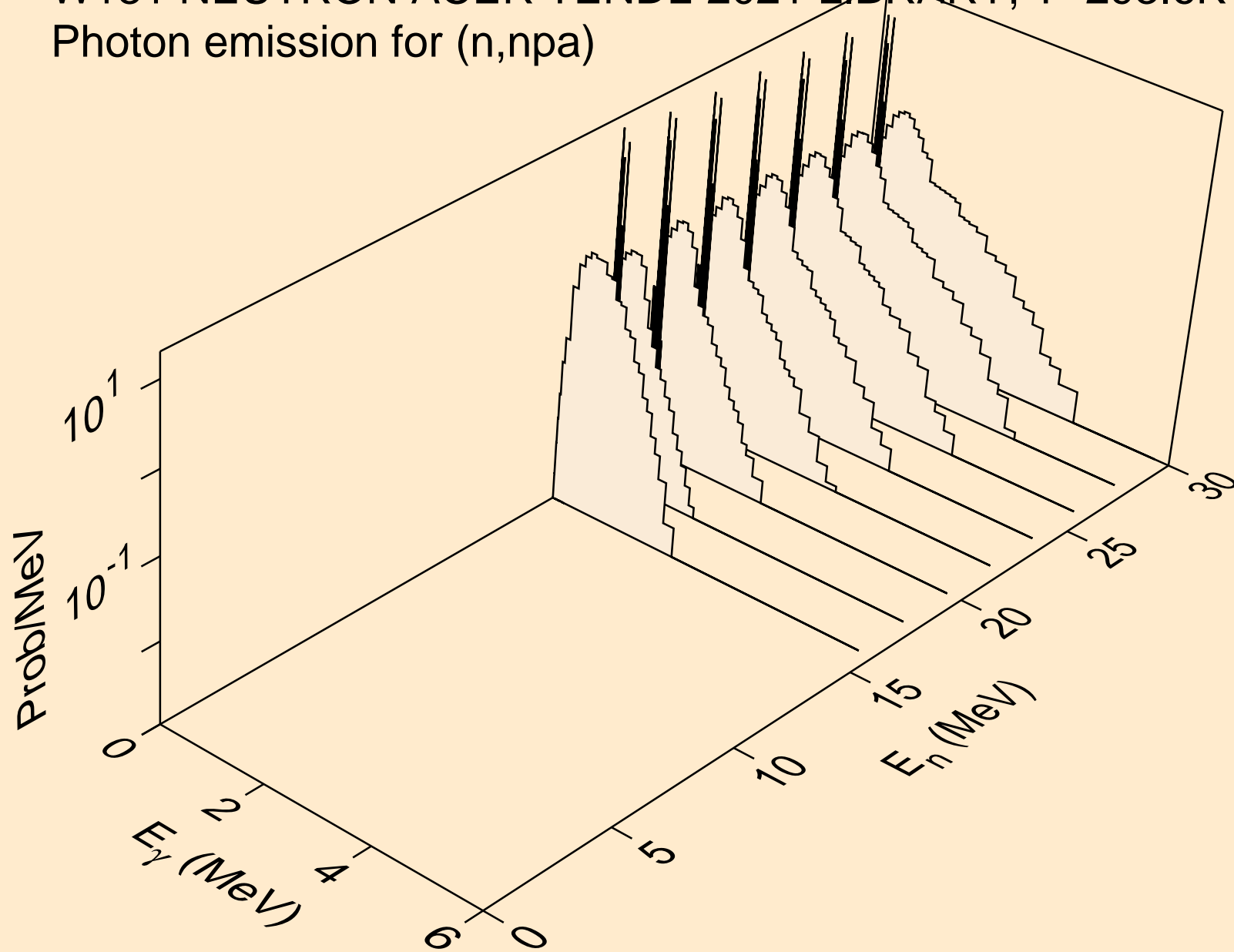

W181 NEUTRON ACER TENDL-2021 LIBRARY; T=293.6K  
Photon emission for (n,n\*c)

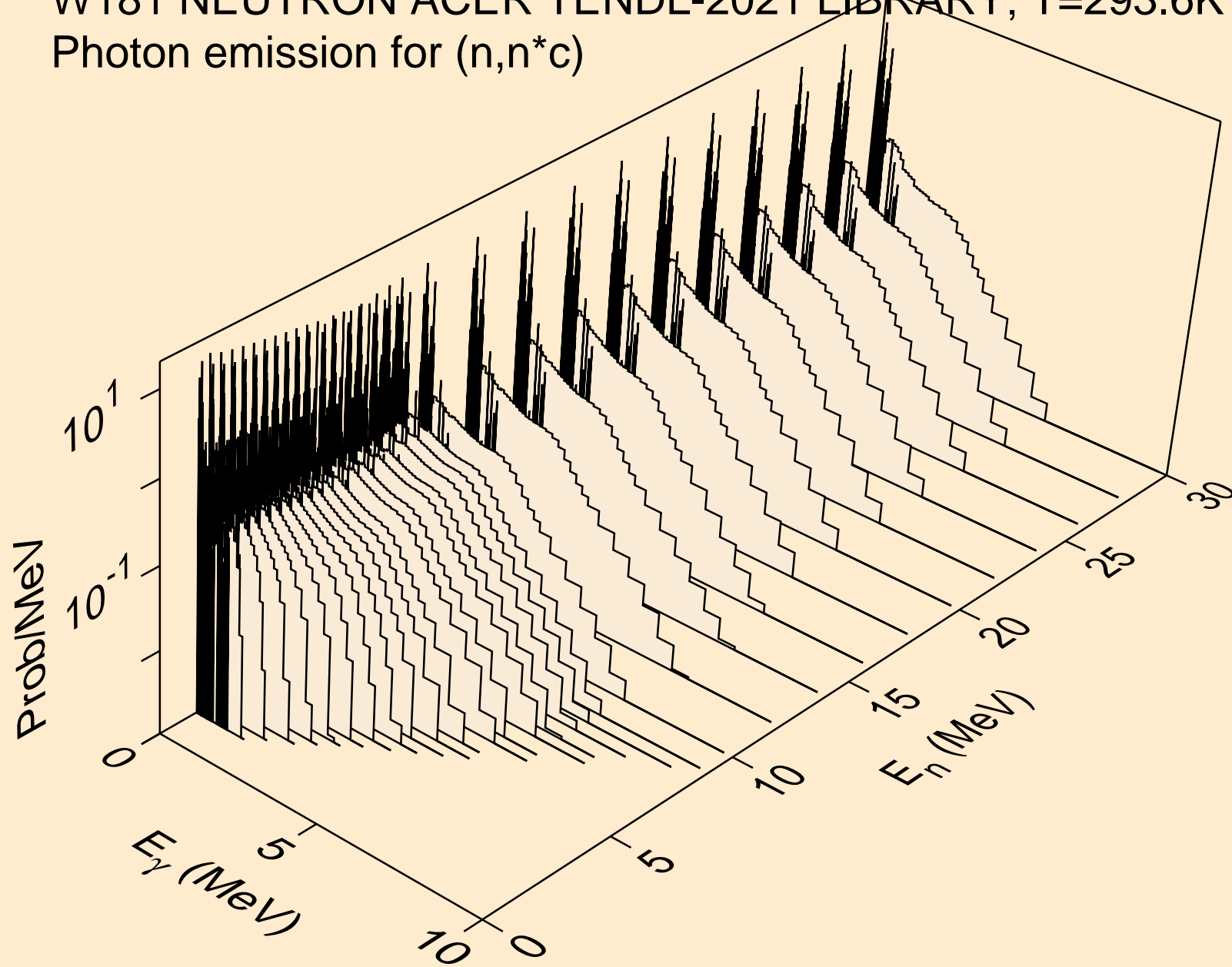

W181 NEUTRON ACER TENDL-2021 LIBRARY; T=293.6K  
Photon emission for (n,gma)

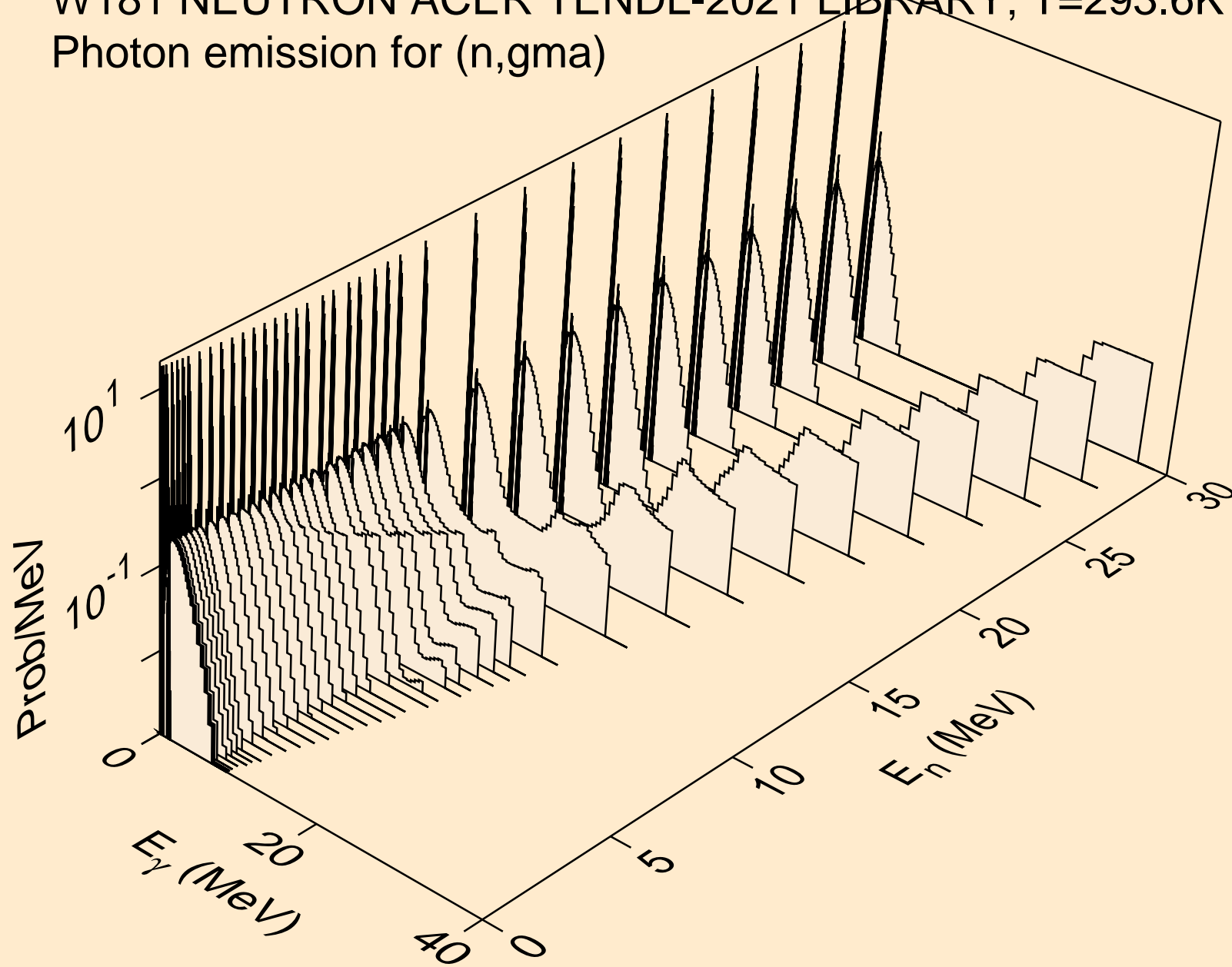



W181 NEUTRON ACER TENDL-2021 LIBRARY; T=293.6K  
Photon emission for (n,p)

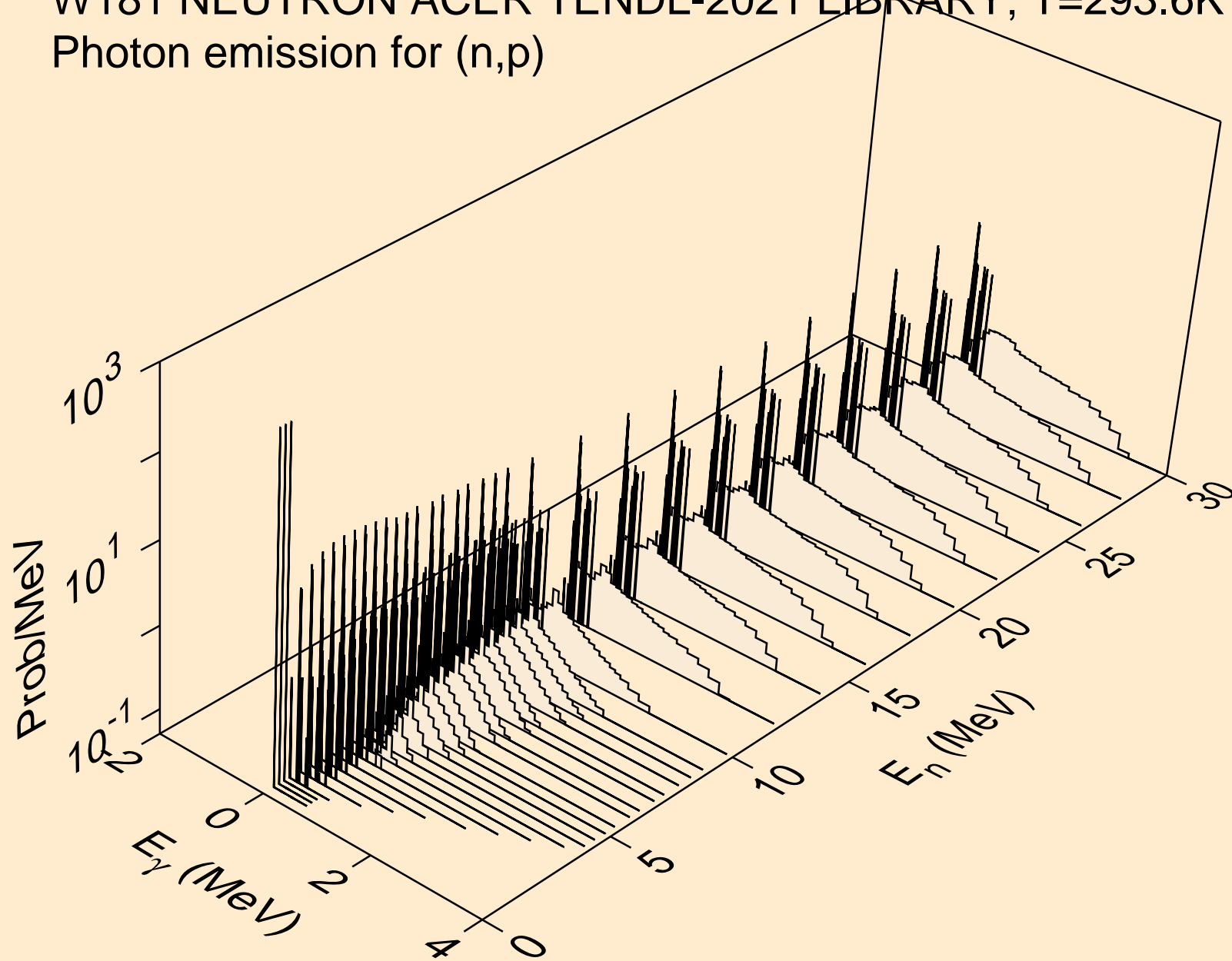

W181 NEUTRON ACER TENDL-2021 LIBRARY; T=293.6K  
Photon emission for (n,d)

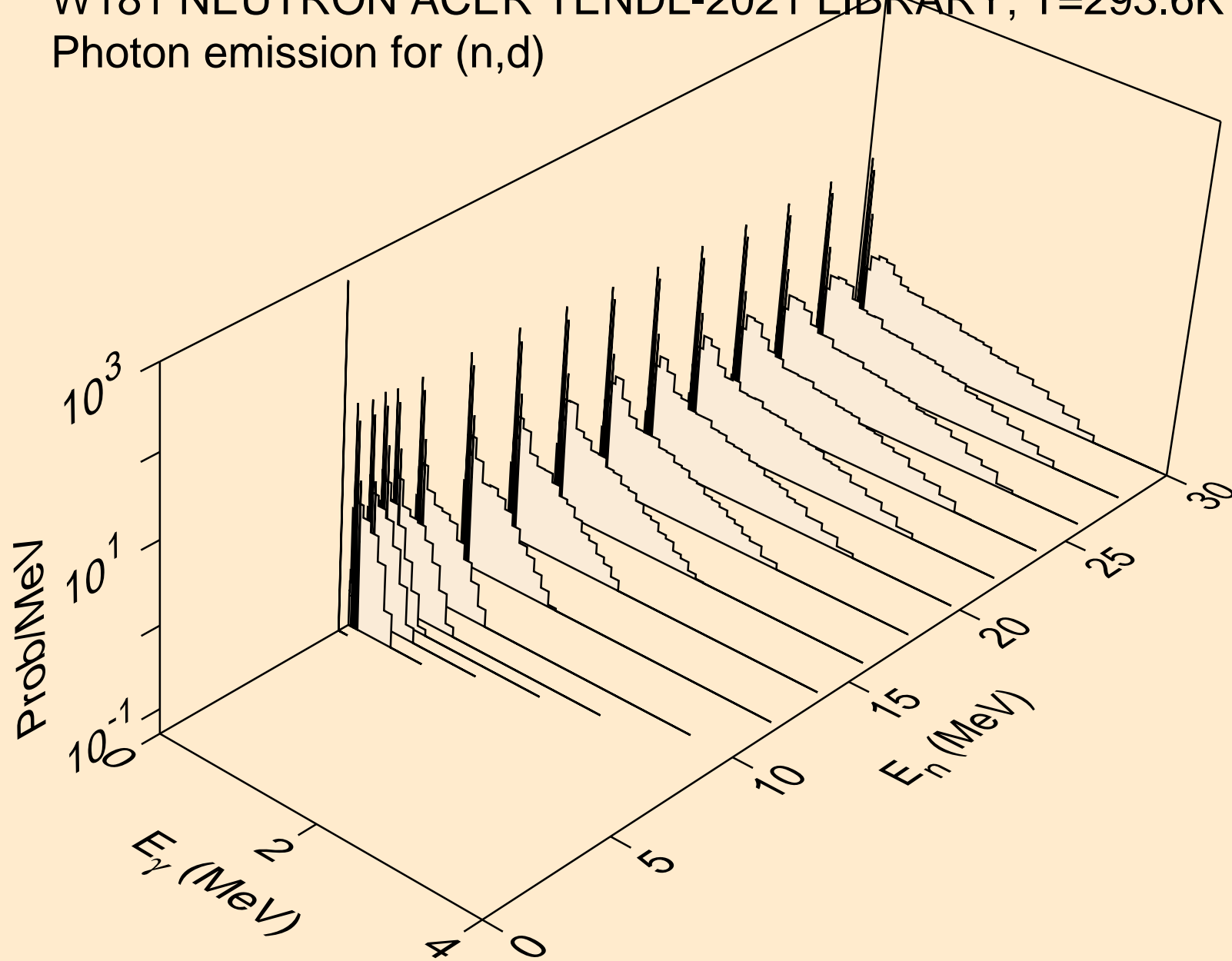

W181 NEUTRON ACER TENDL-2021 LIBRARY; T=293.6K  
Photon emission for (n,t)

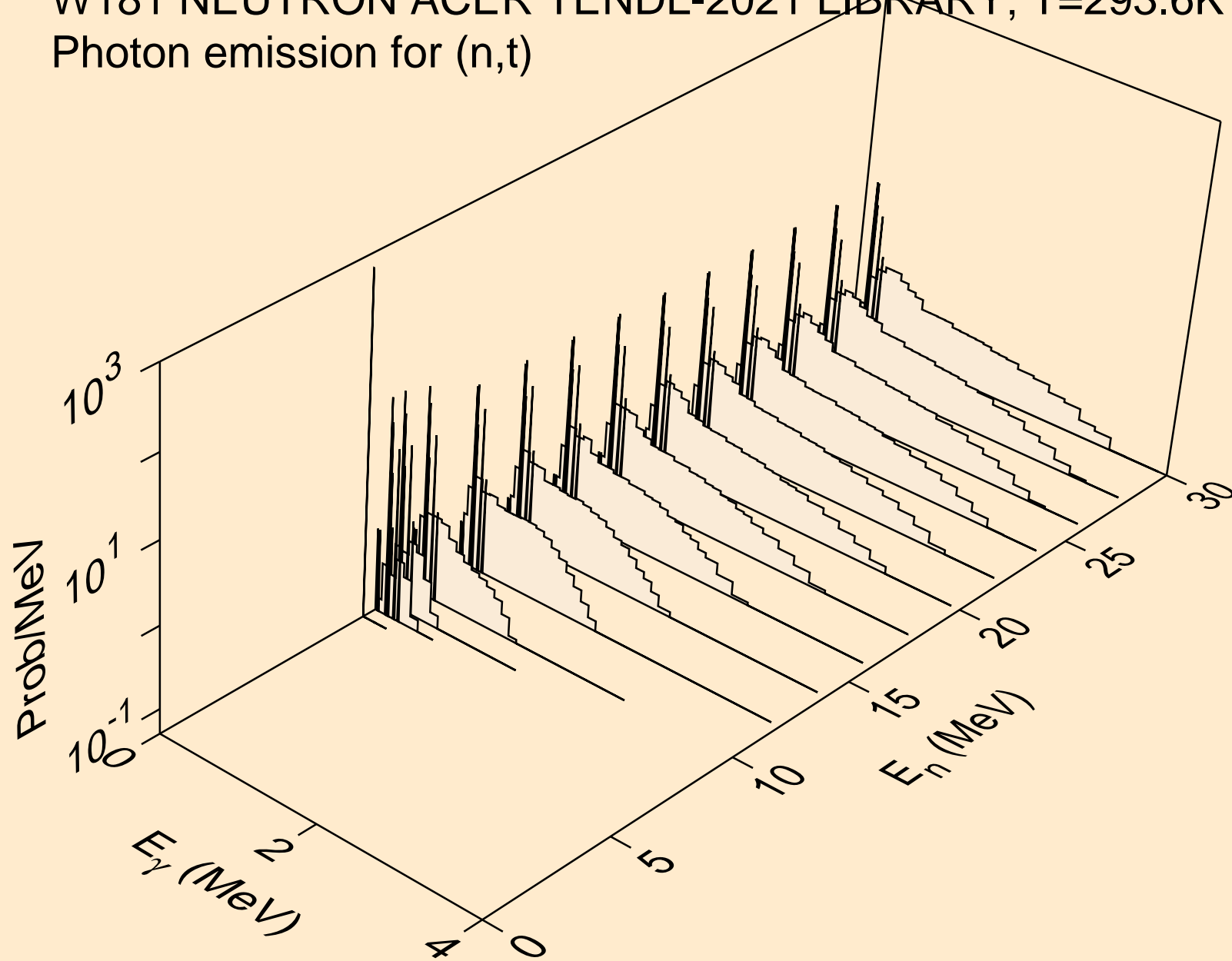

W181 NEUTRON ACER TENDL-2021 LIBRARY; T=293.6K  
Photon emission for (n,he3)

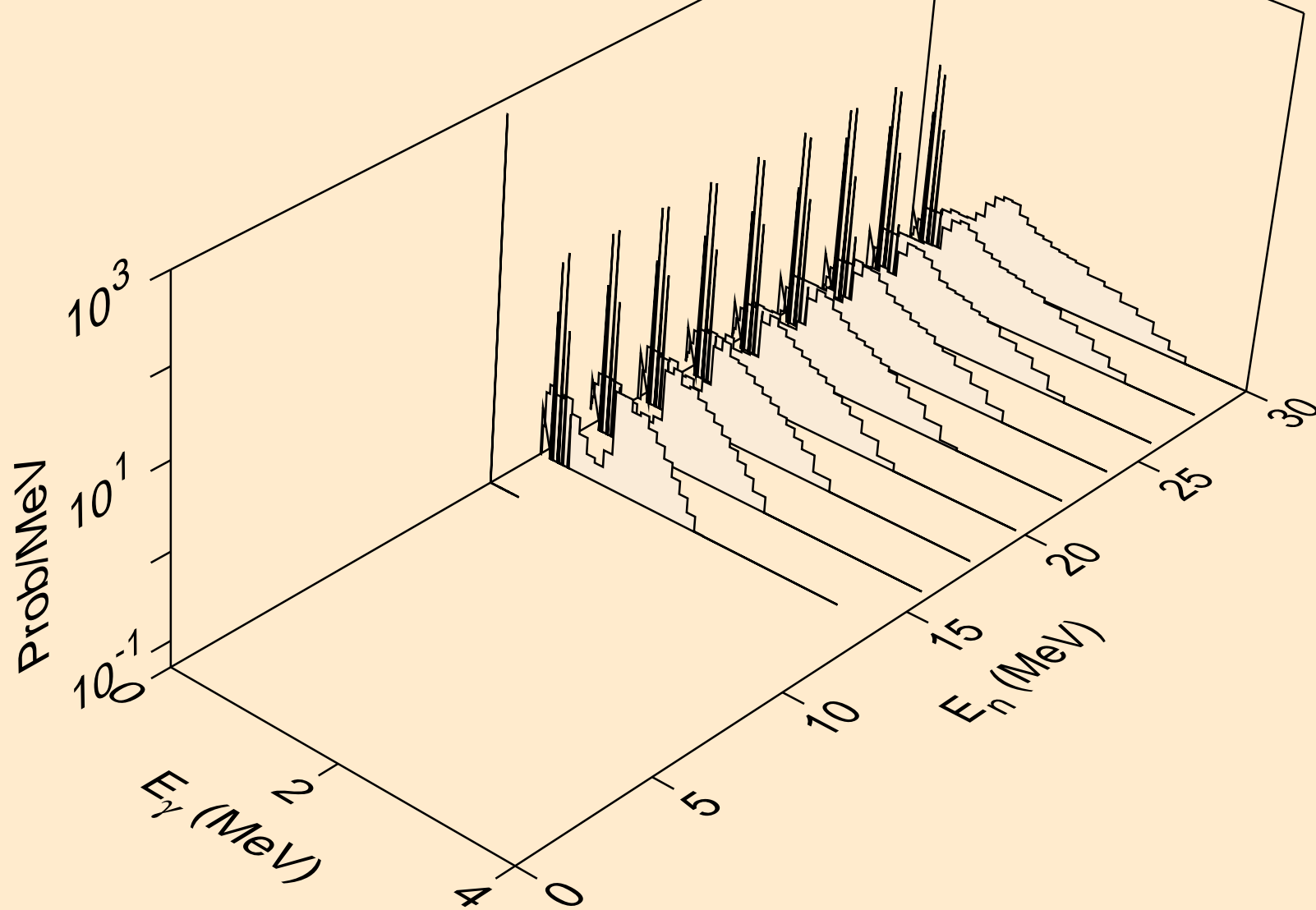

W181 NEUTRON ACER TENDL-2021 LIBRARY; T=293.6K  
Photon emission for (n,a)

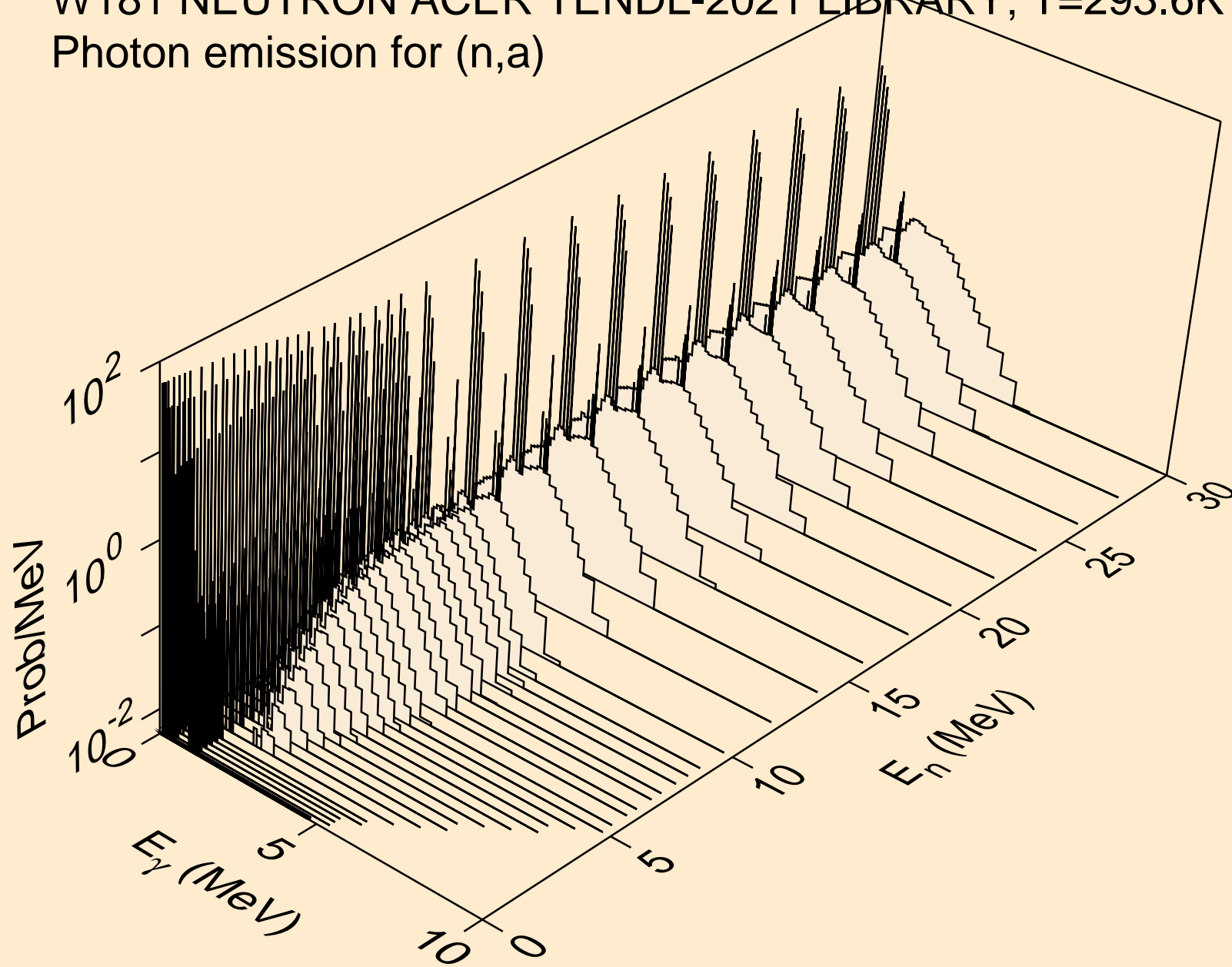

W181 NEUTRON ACER TENDL-2021 LIBRARY; T=293.6K  
Photon emission for (n,2a)

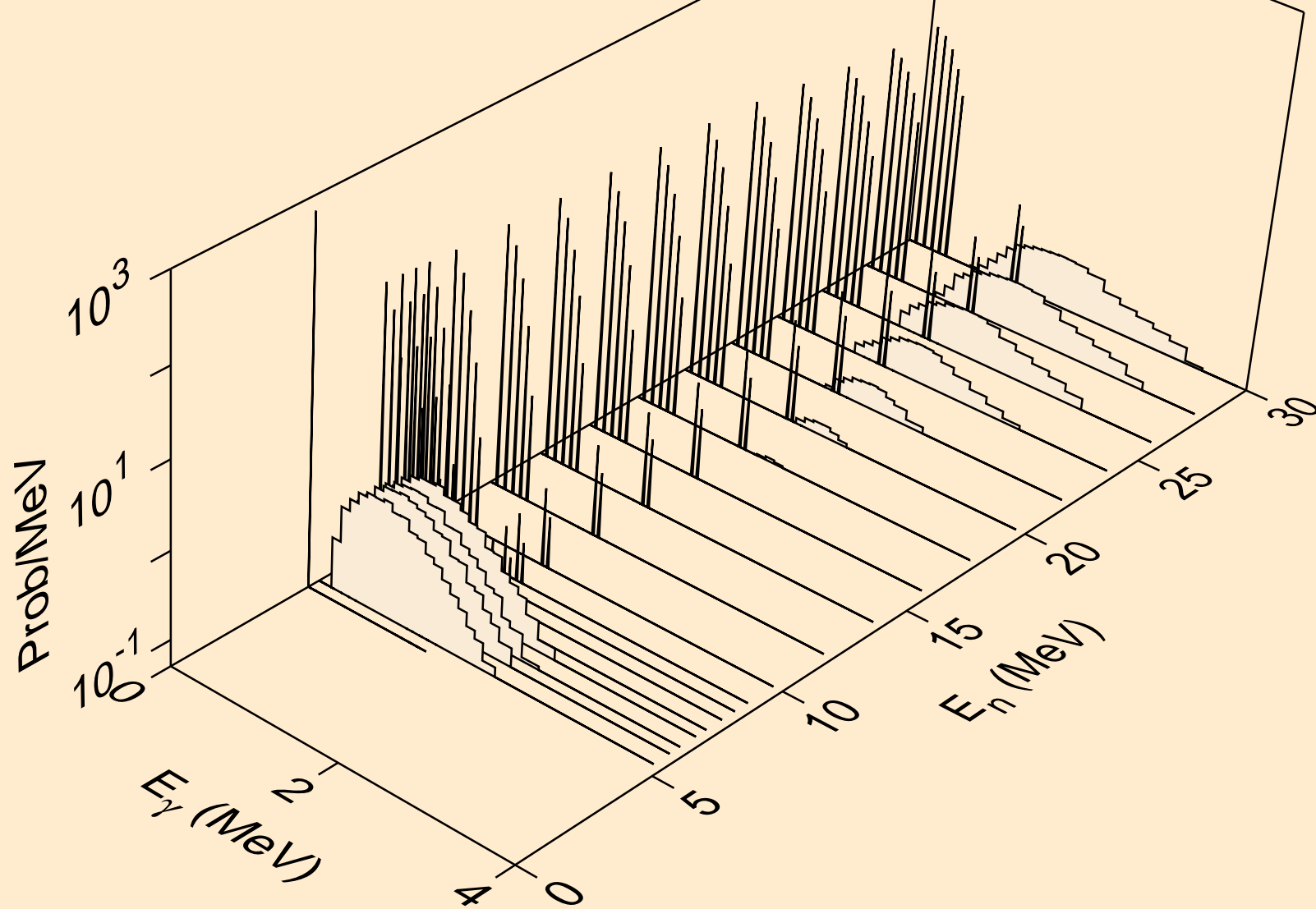

W181 NEUTRON ACER TENDL-2021 LIBRARY; T=293.6K  
Photon emission for (n,2p)

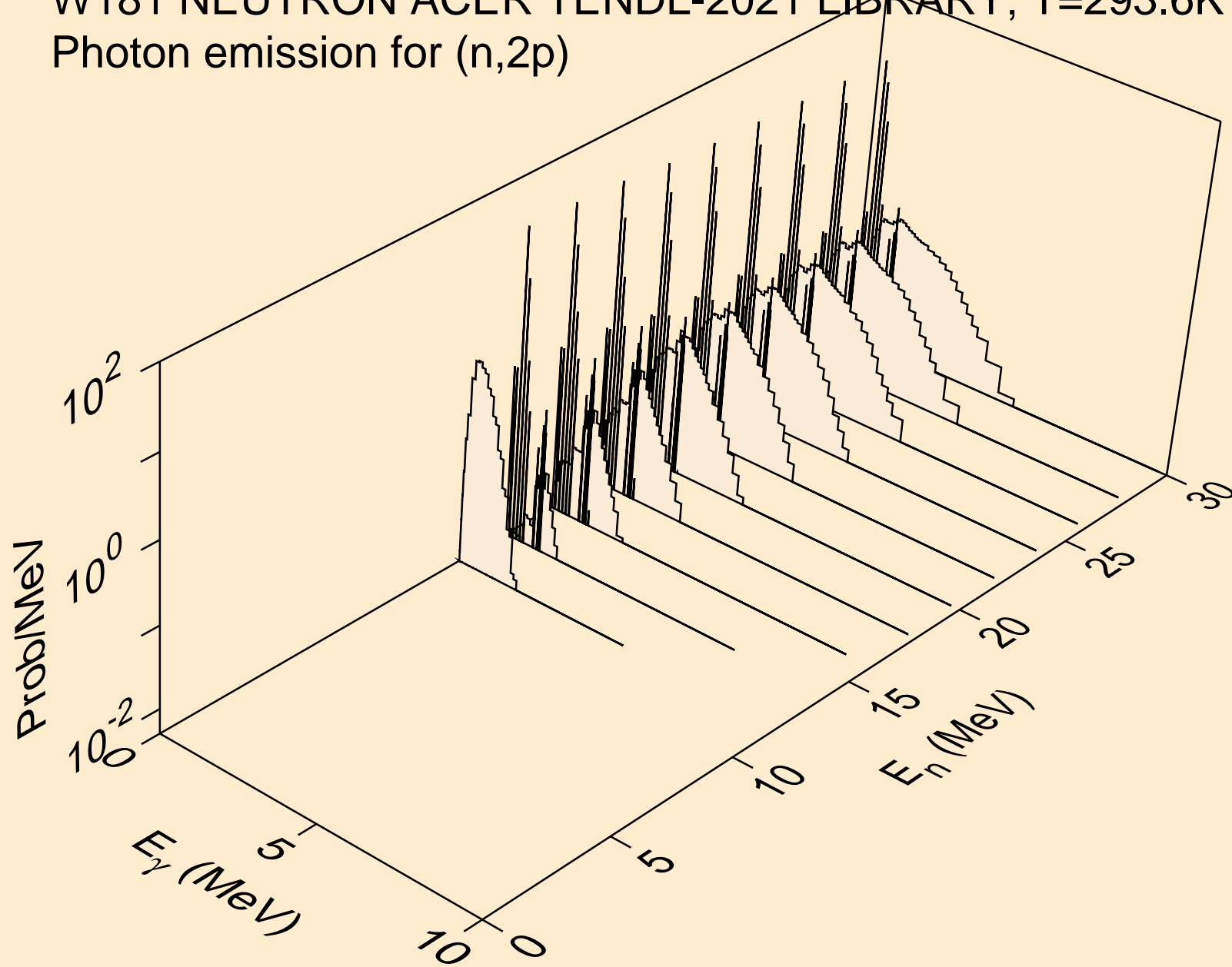

W181 NEUTRON ACER TENDL-2021 LIBRARY; T=293.6K  
Photon emission for (n,p $\alpha$ )

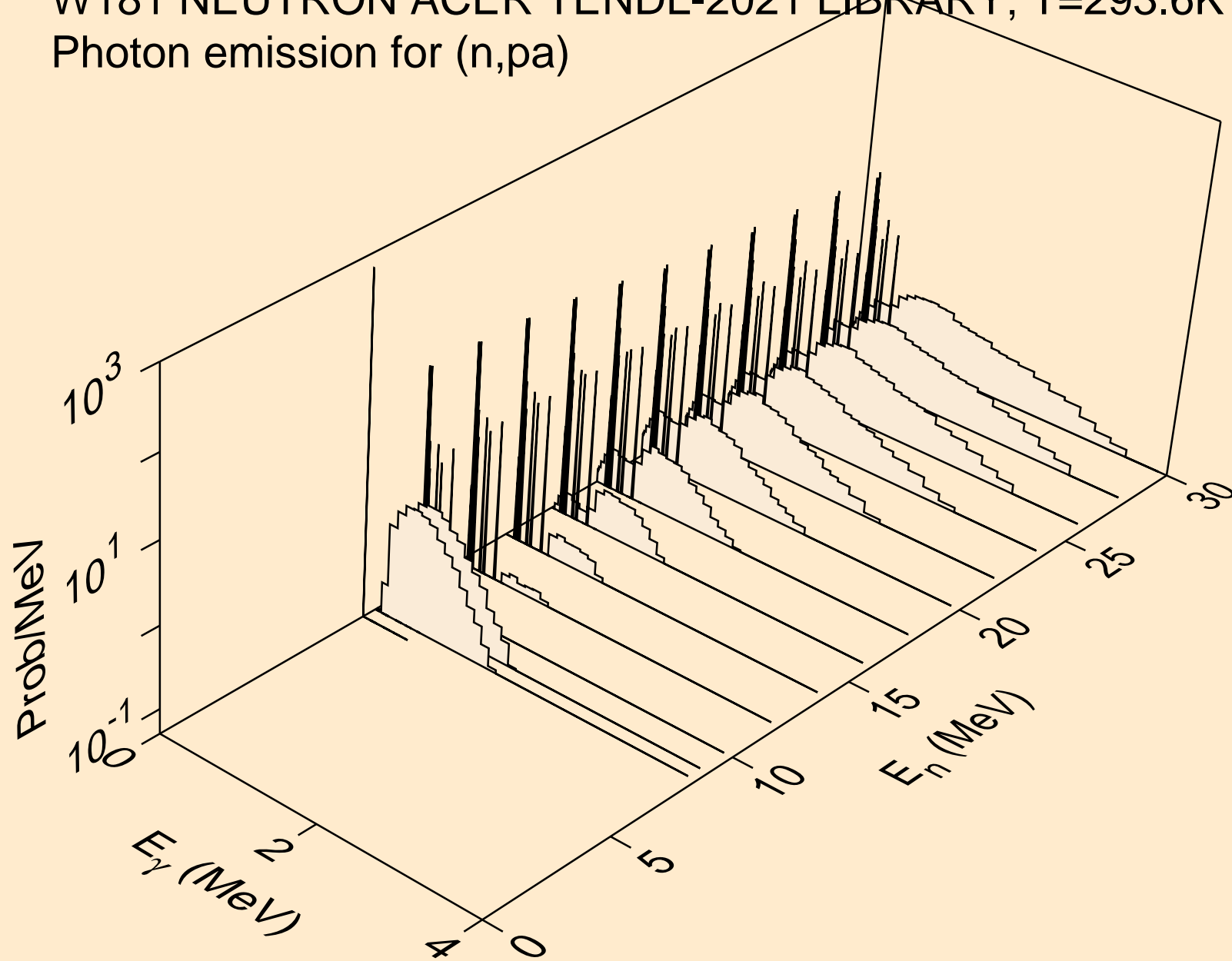



W181 NEUTRON ACER TENDL-2021 LIBRARY; T=293.6K  
Photon emission for (n,pd)

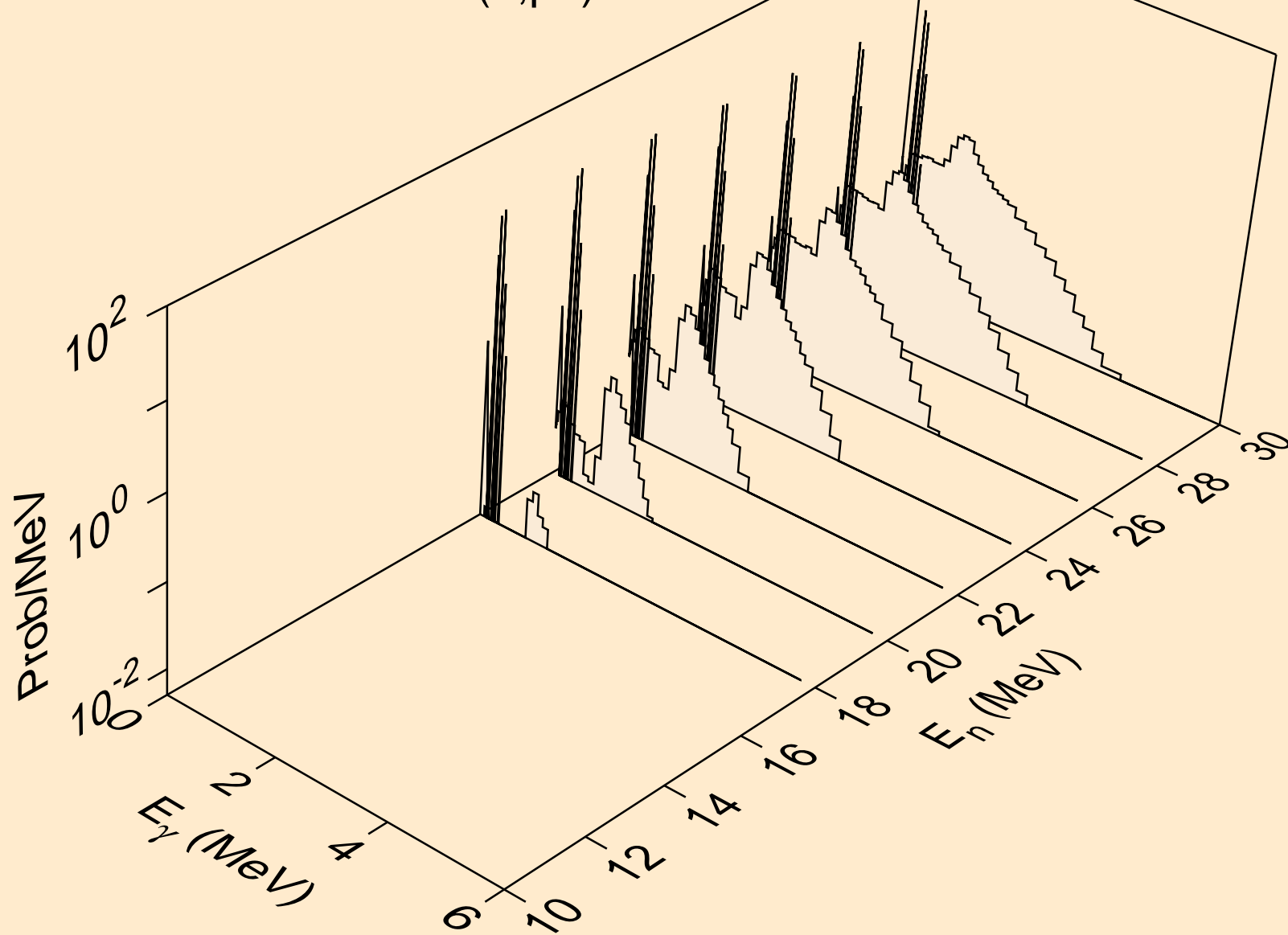

W181 NEUTRON ACER TENDL-2021 LIBRARY; T=293.6K  
Photon emission for (n,pt)

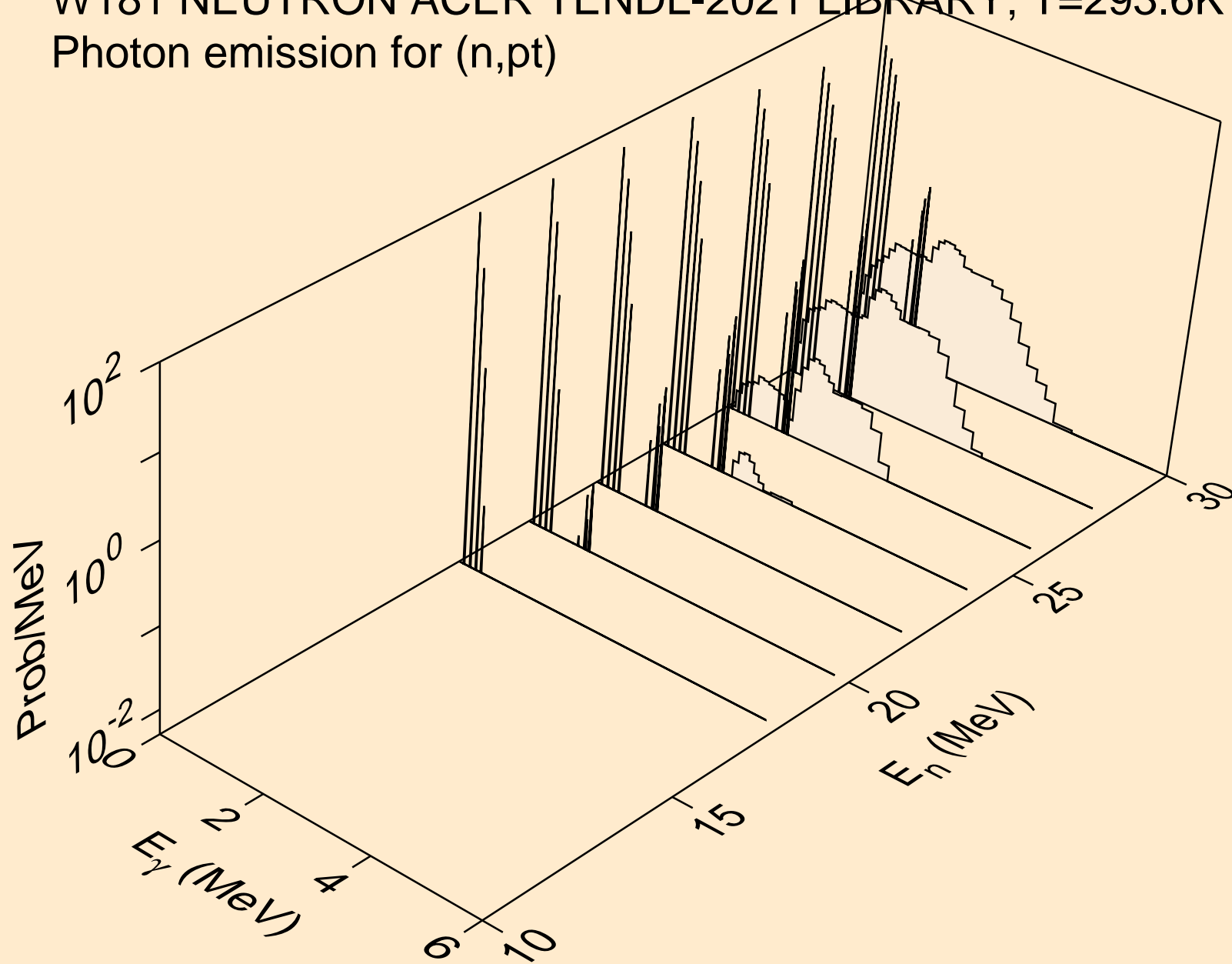

W181 NEUTRON ACER TENDL-2021 LIBRARY; T=293.6K  
Photon emission for (n,da)

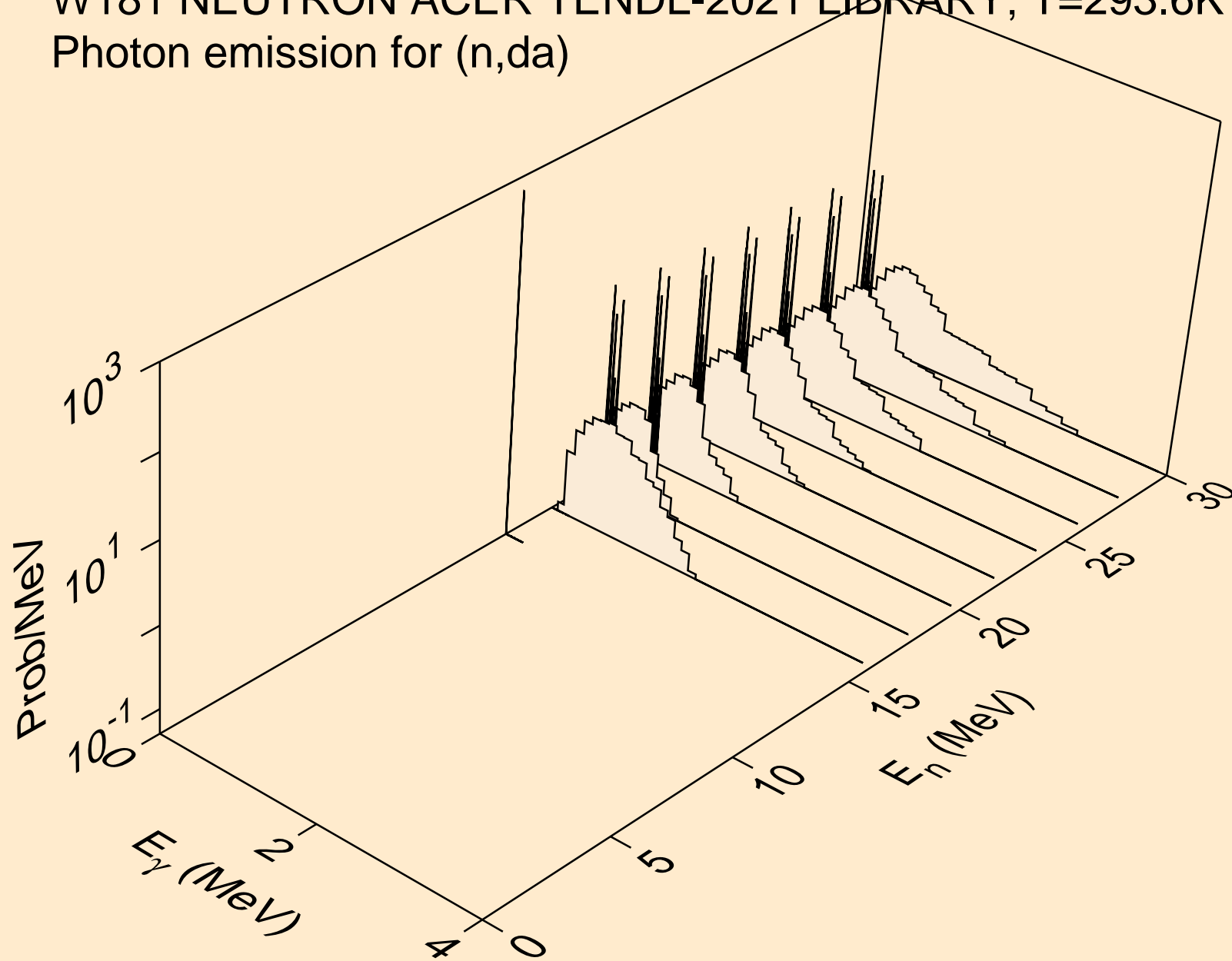

W181 NEUTRON ACER TENDL-2021 LIBRARY; T=293.6K  
thermal capture photon spectrum

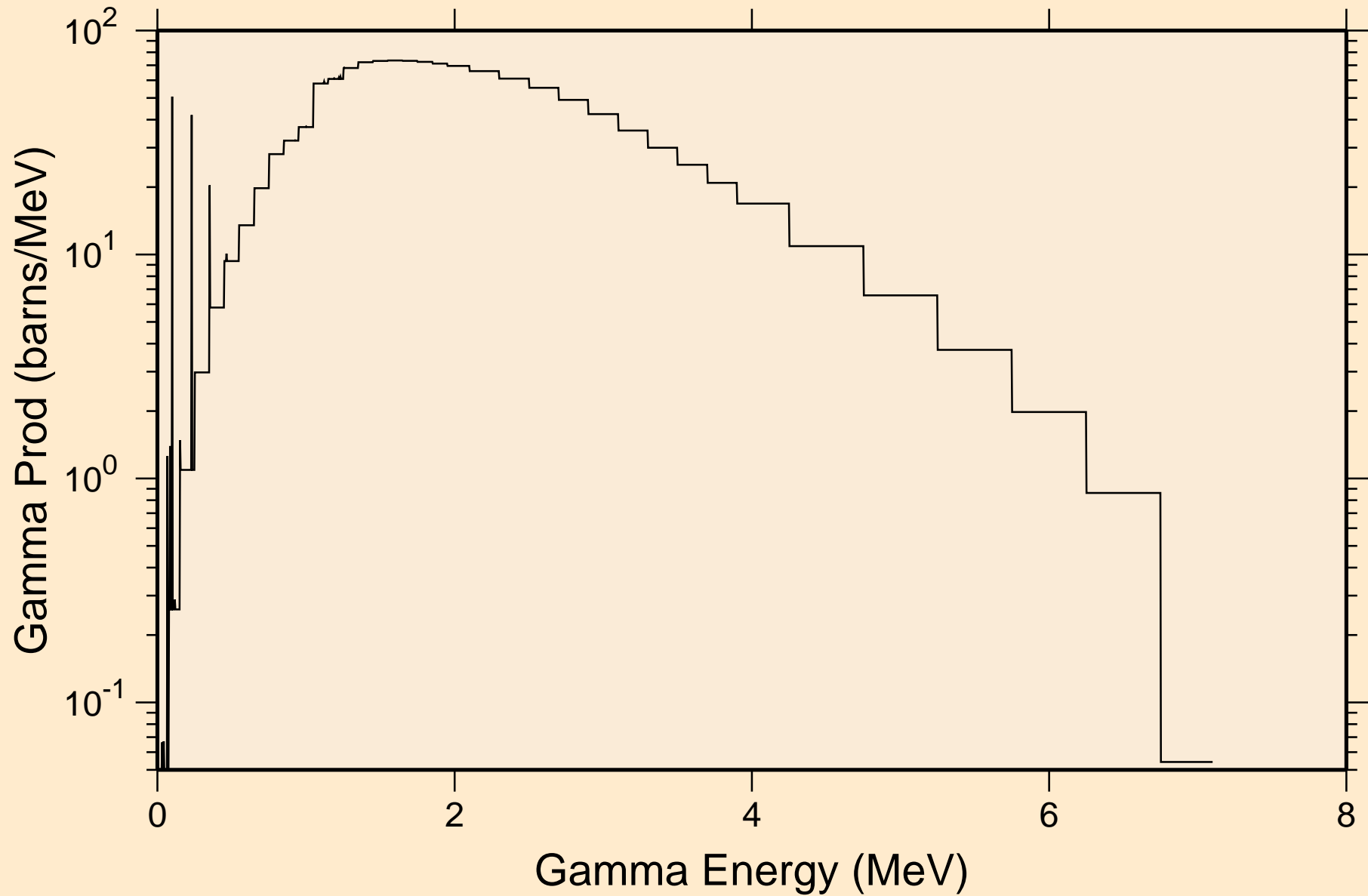

W181 NEUTRON ACER TENDL-2021 LIBRARY; T=293.6K  
14 MeV photon spectrum

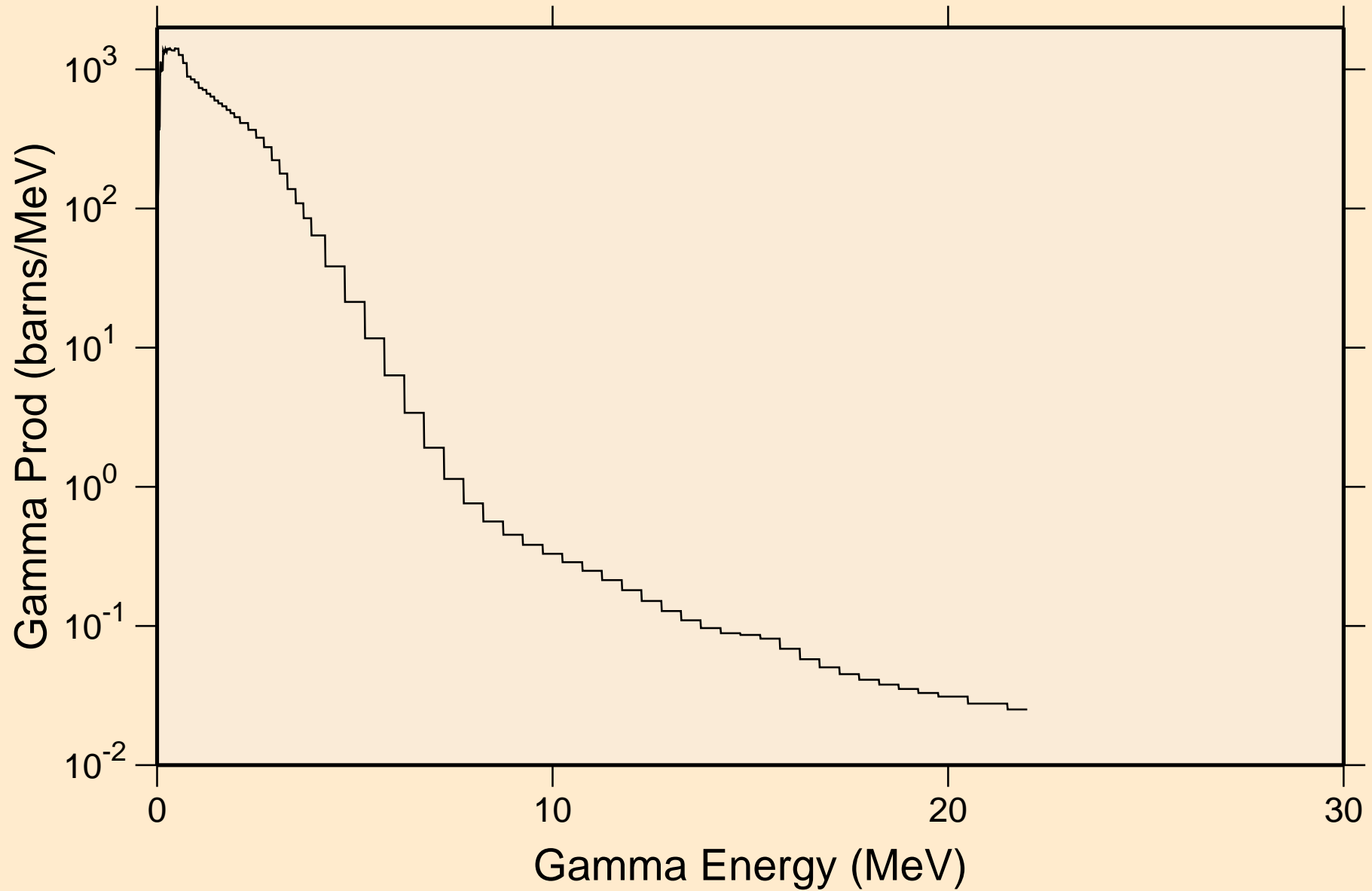

# W181 NEUTRON ACER TENDL-2021 LIBRARY; T=293.6K

## Particle heating contributions

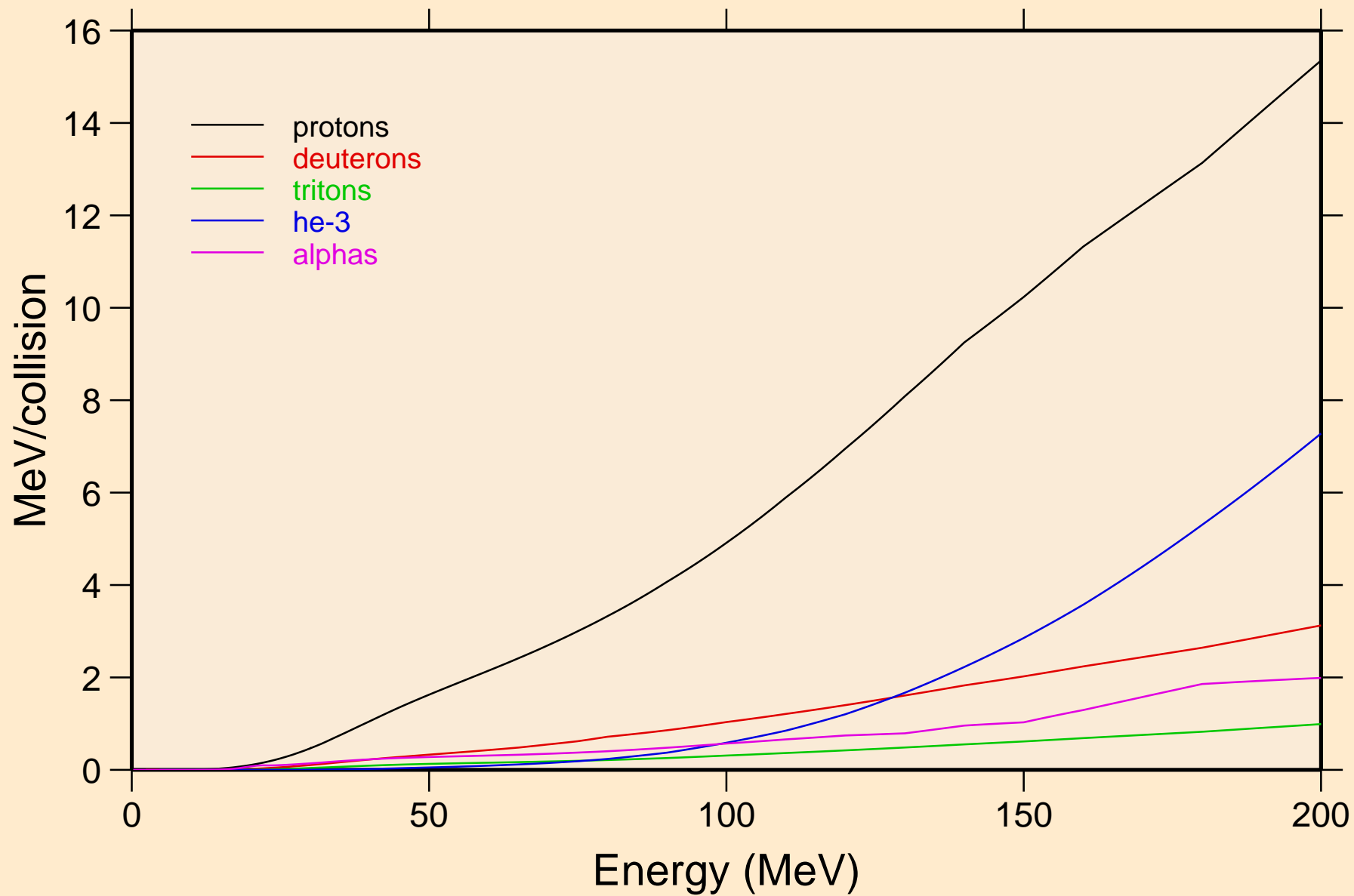

W181 NEUTRON ACER TENDL-2021 LIBRARY; T=293.6K  
Recoil Heating

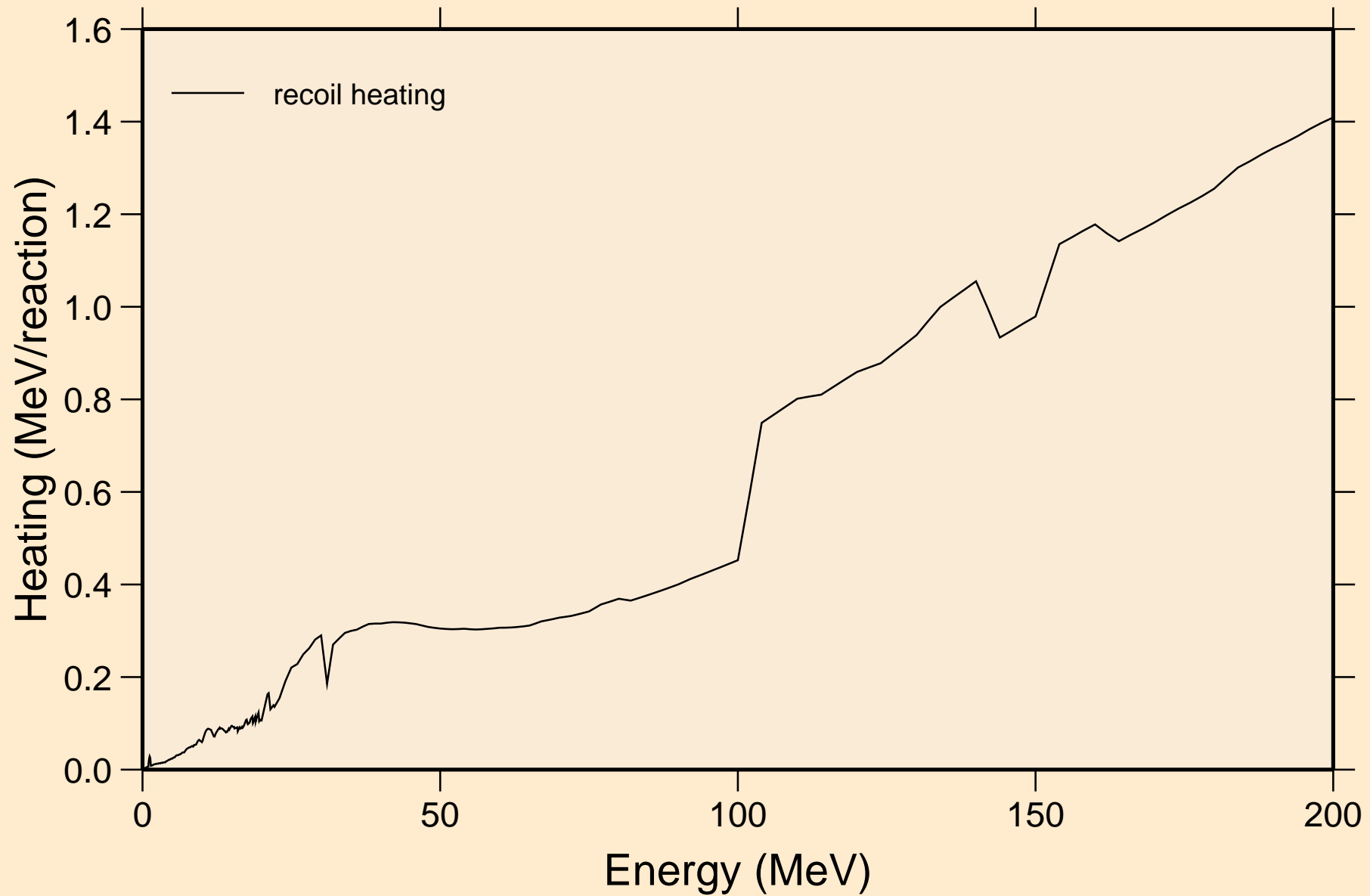

W181 NEUTRON ACER TENDL-2021 LIBRARY; T=293.6K  
Particle production cross sections

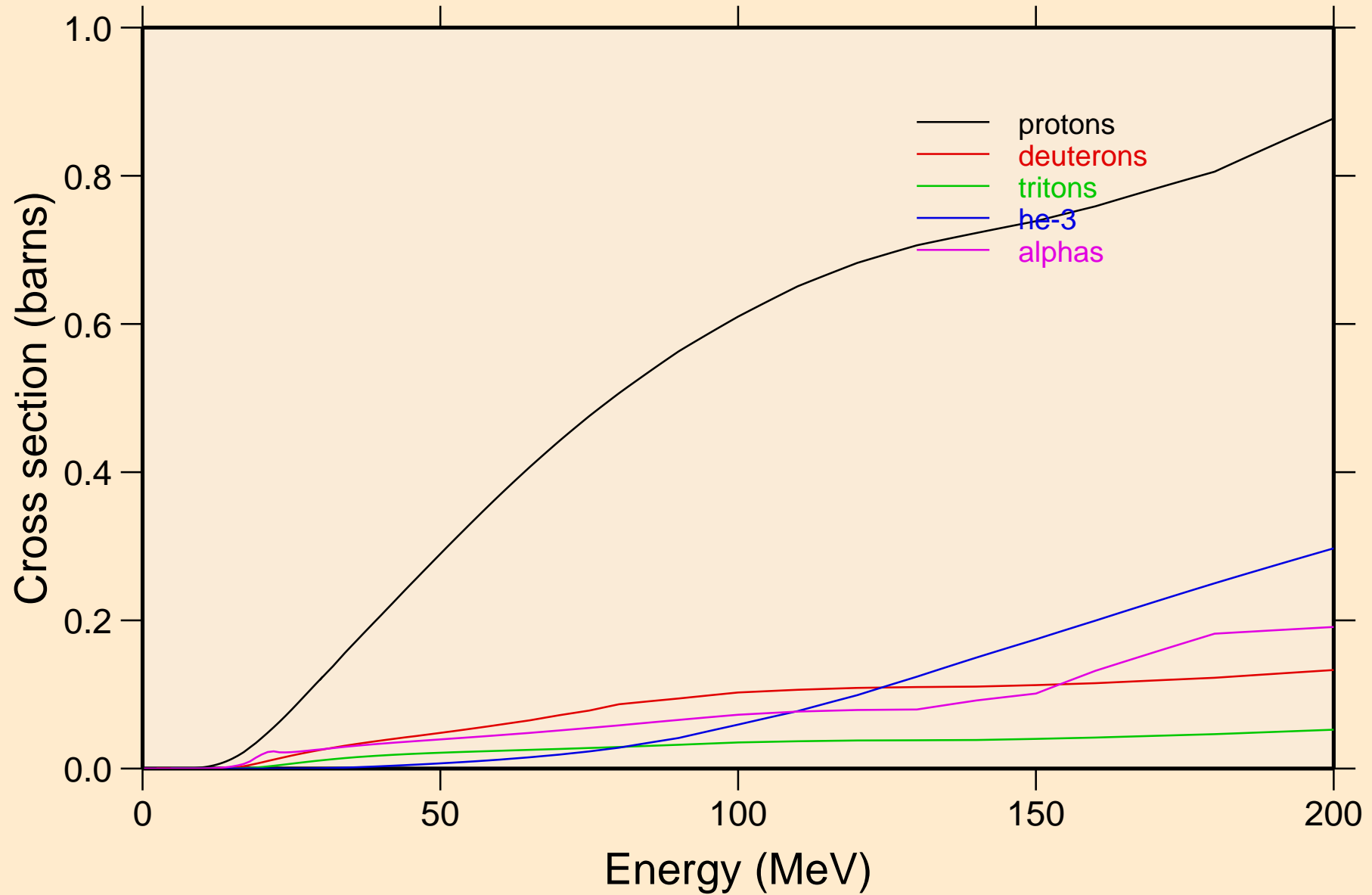



W181 NEUTRON ACER TENDL-2021 LIBRARY; T=293.6K  
protons from (n,x)

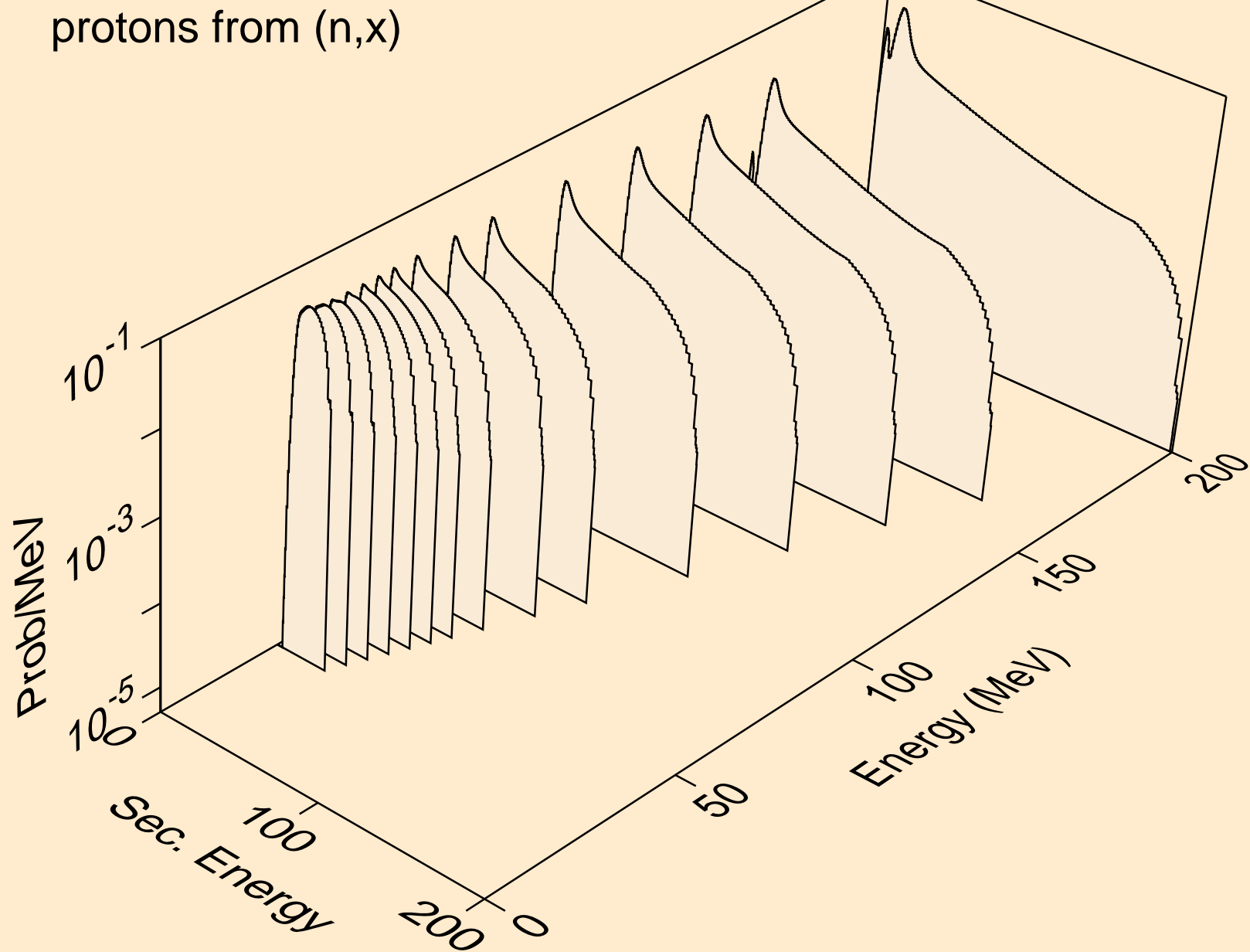

W181 NEUTRON ACER TENDL-2021 LIBRARY; T=293.6K  
protons from (n,n\*)p

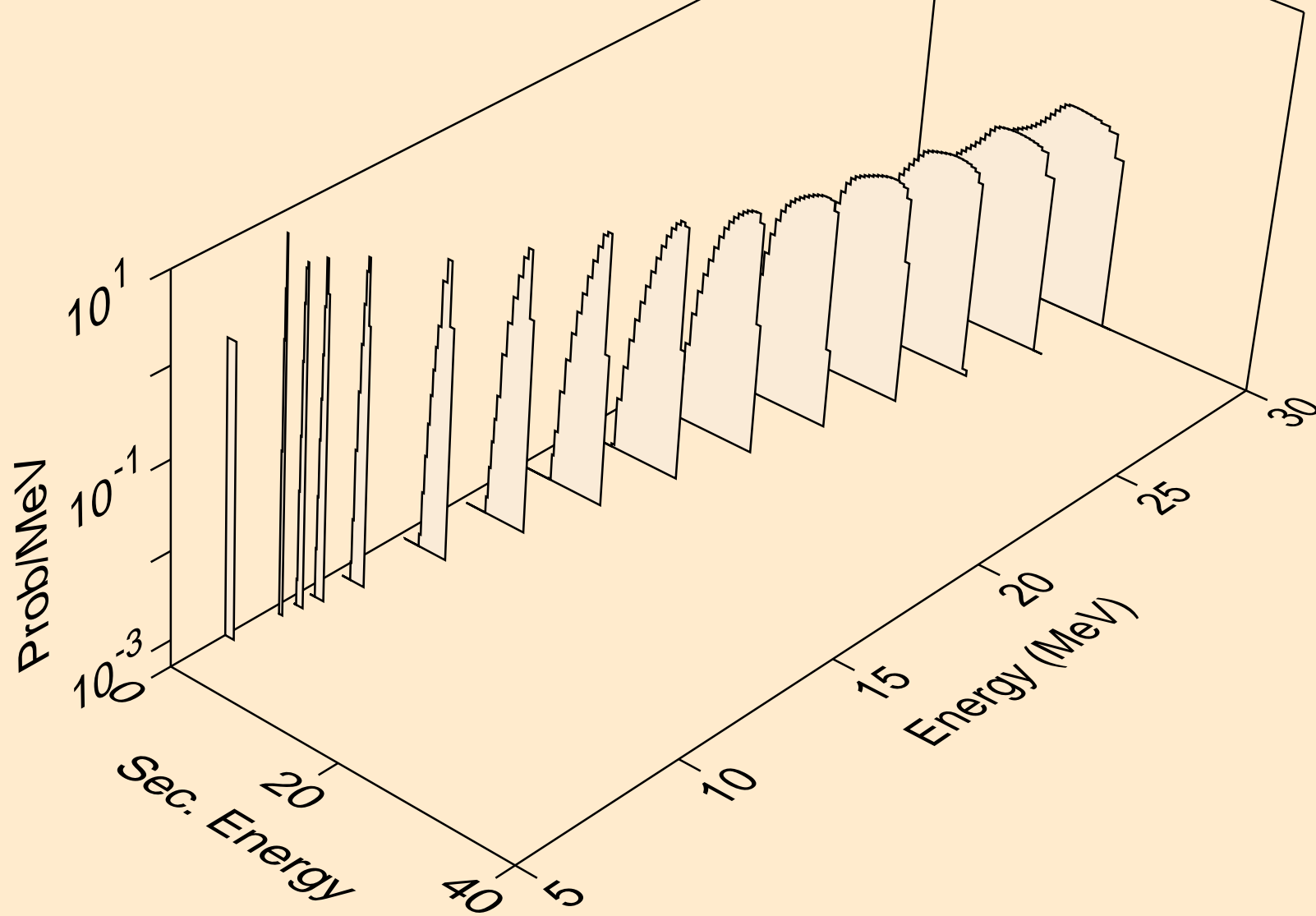

W181 NEUTRON ACER TENDL-2021 LIBRARY; T=293.6K  
protons from (n,2np)

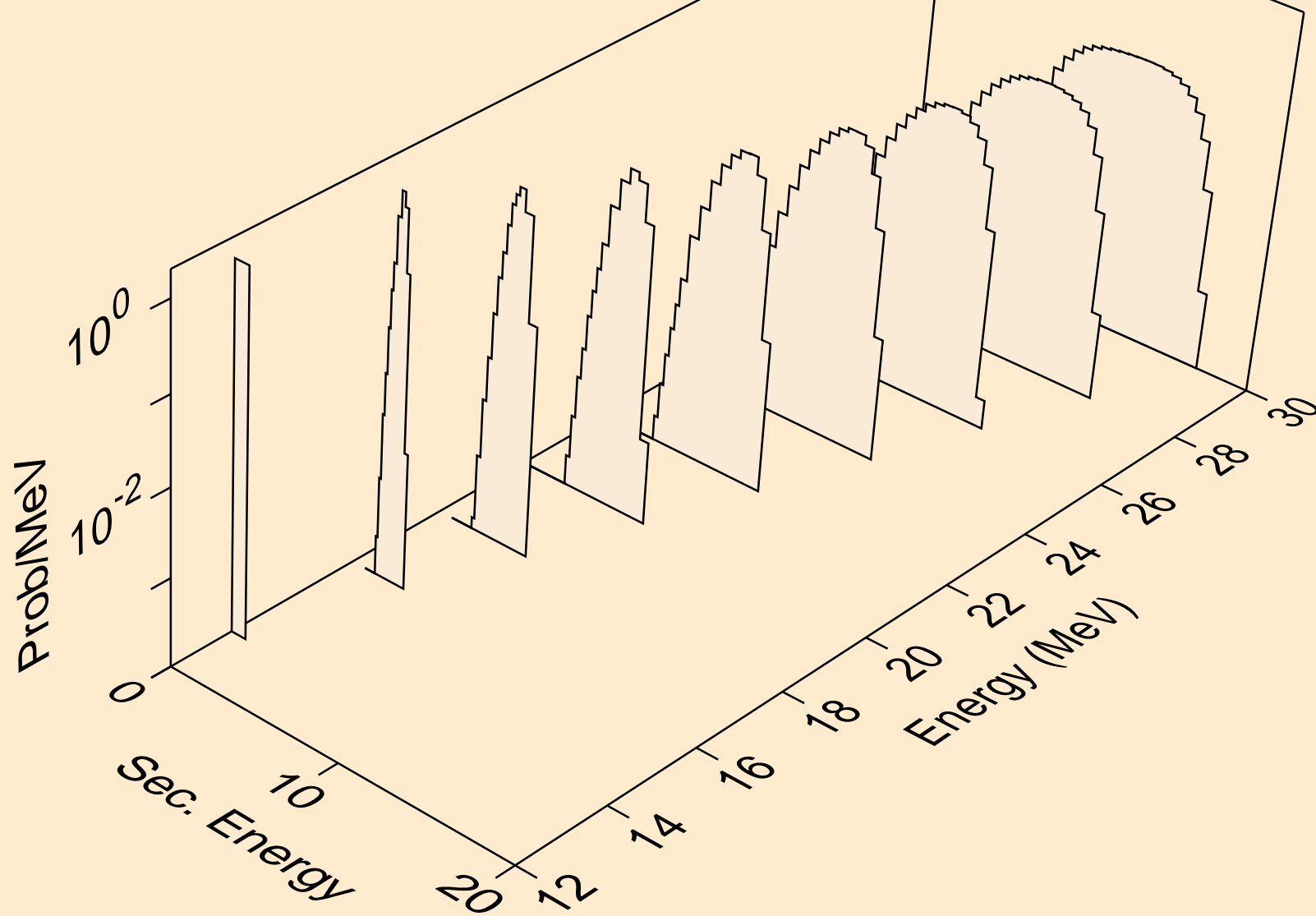

W181 NEUTRON ACER TENDL-2021 LIBRARY; T=293.6K  
protons from (n,3np)

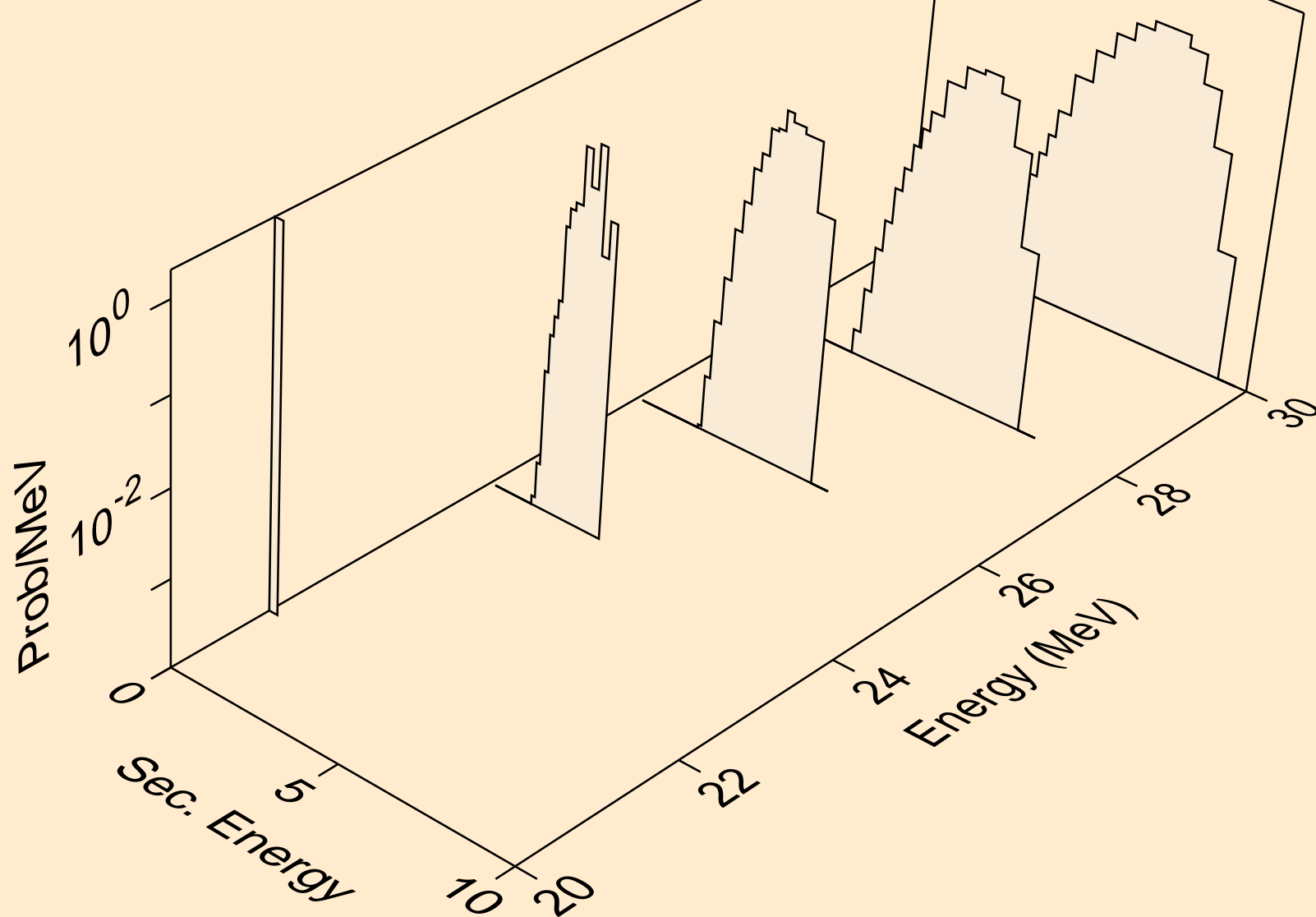

W181 NEUTRON ACER TENDL-2021 LIBRARY; T=293.6K  
protons from (n,2np)

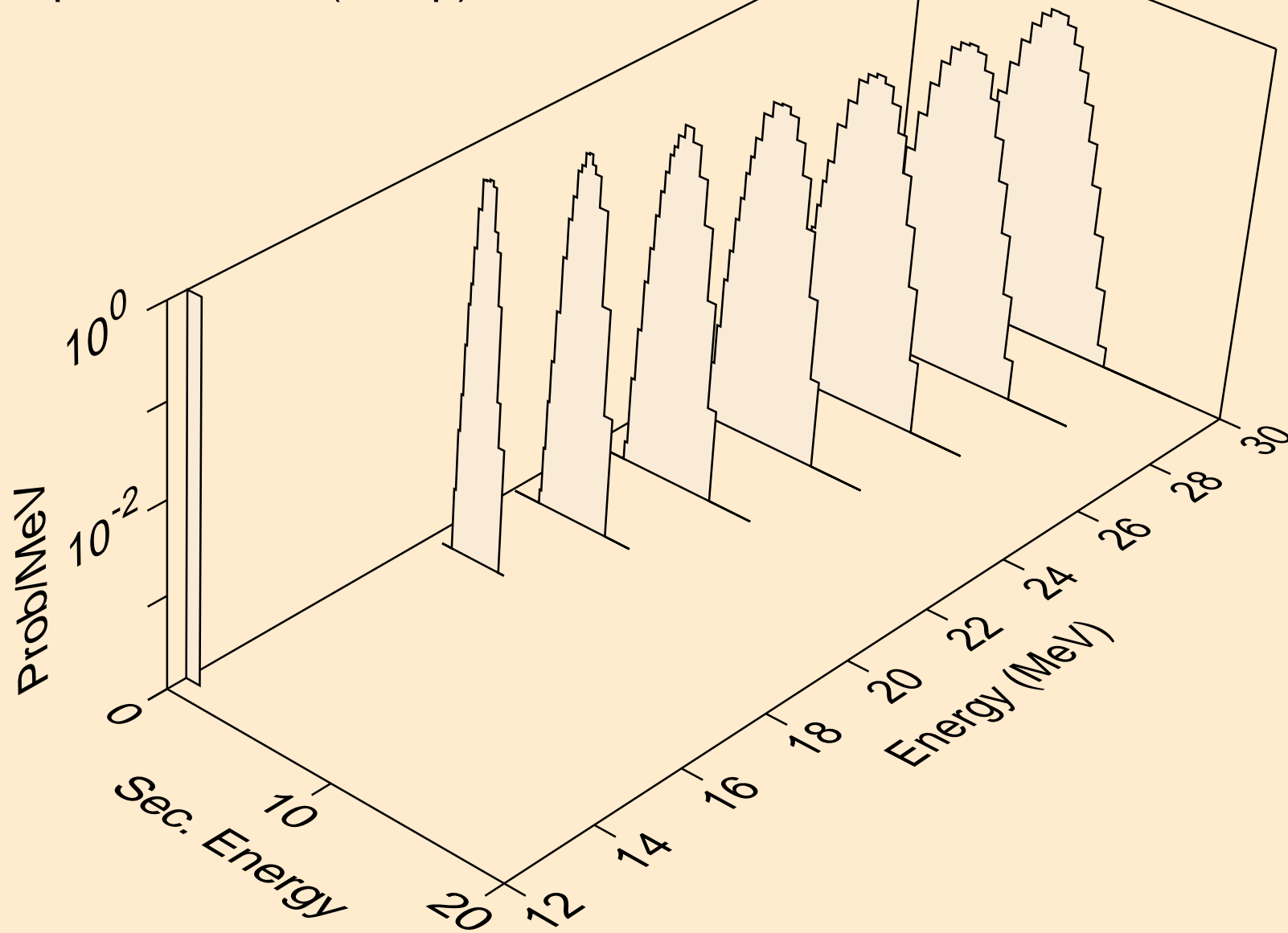

W181 NEUTRON ACER TENDL-2021 LIBRARY; T=293.6K  
protons from (n,npa)

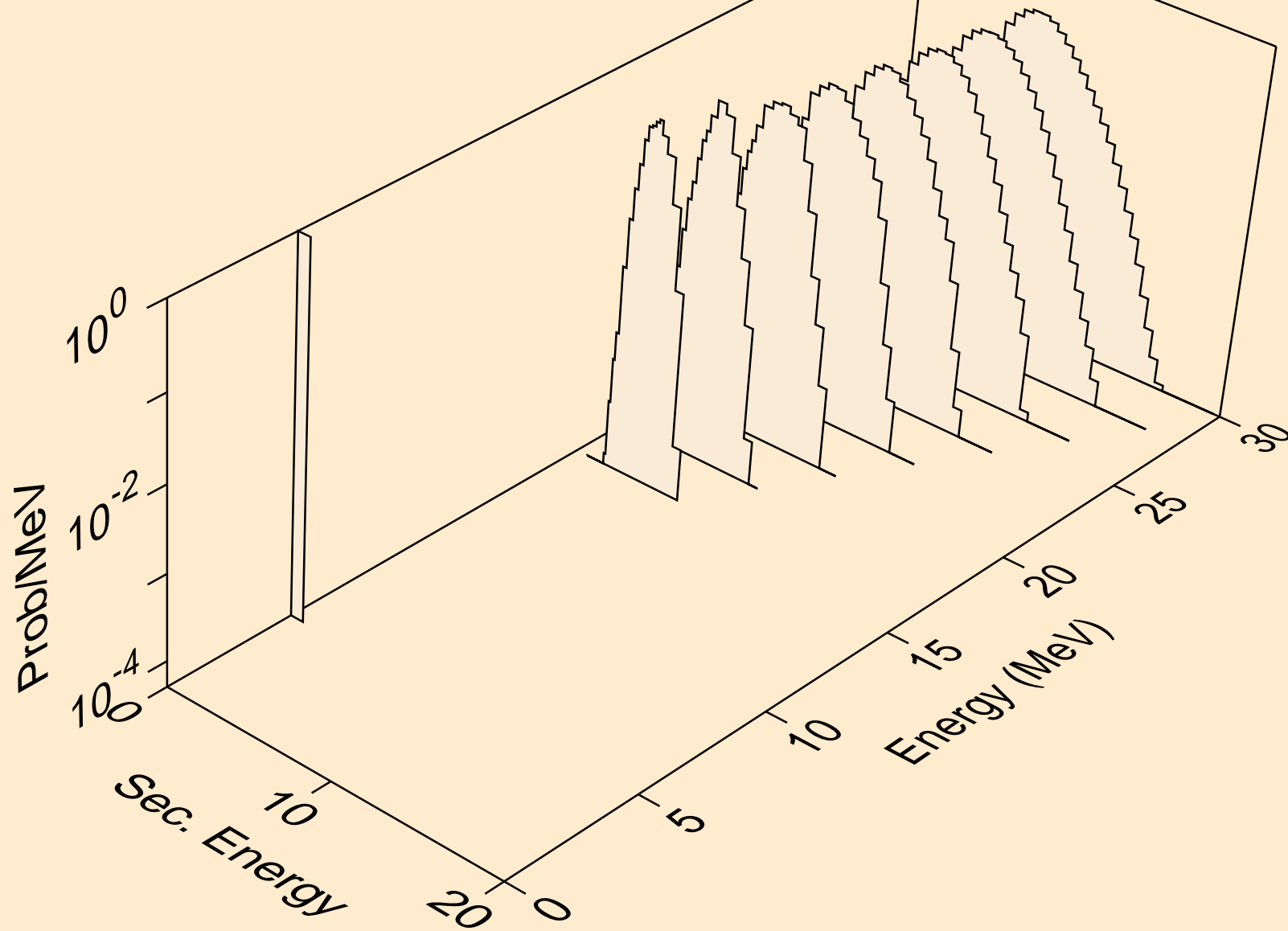

W181 NEUTRON ACER TENDL-2021 LIBRARY; T=293.6K  
protons from (n,p)

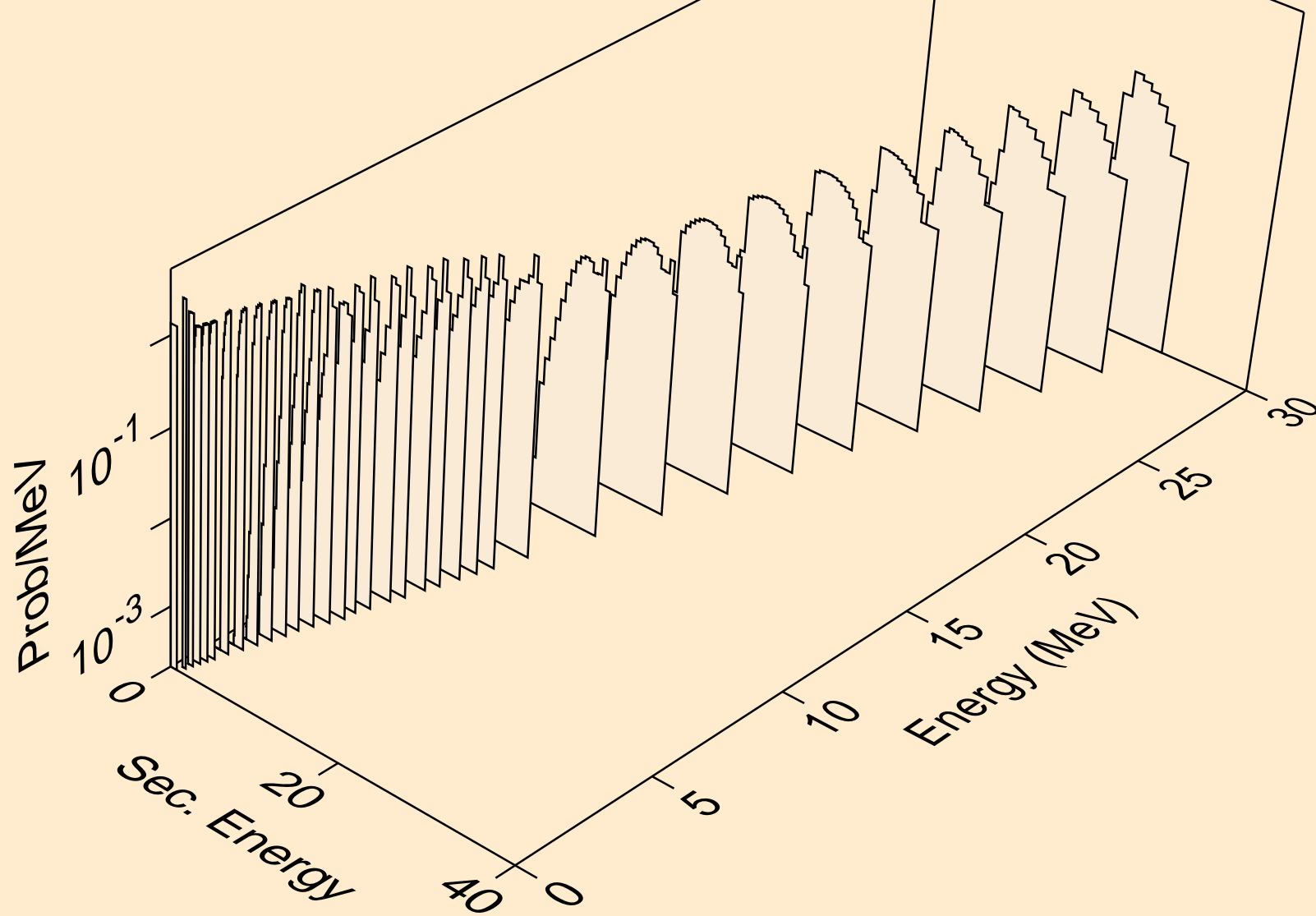

W181 NEUTRON ACER TENDL-2021 LIBRARY; T=293.6K  
protons from (n,2p)

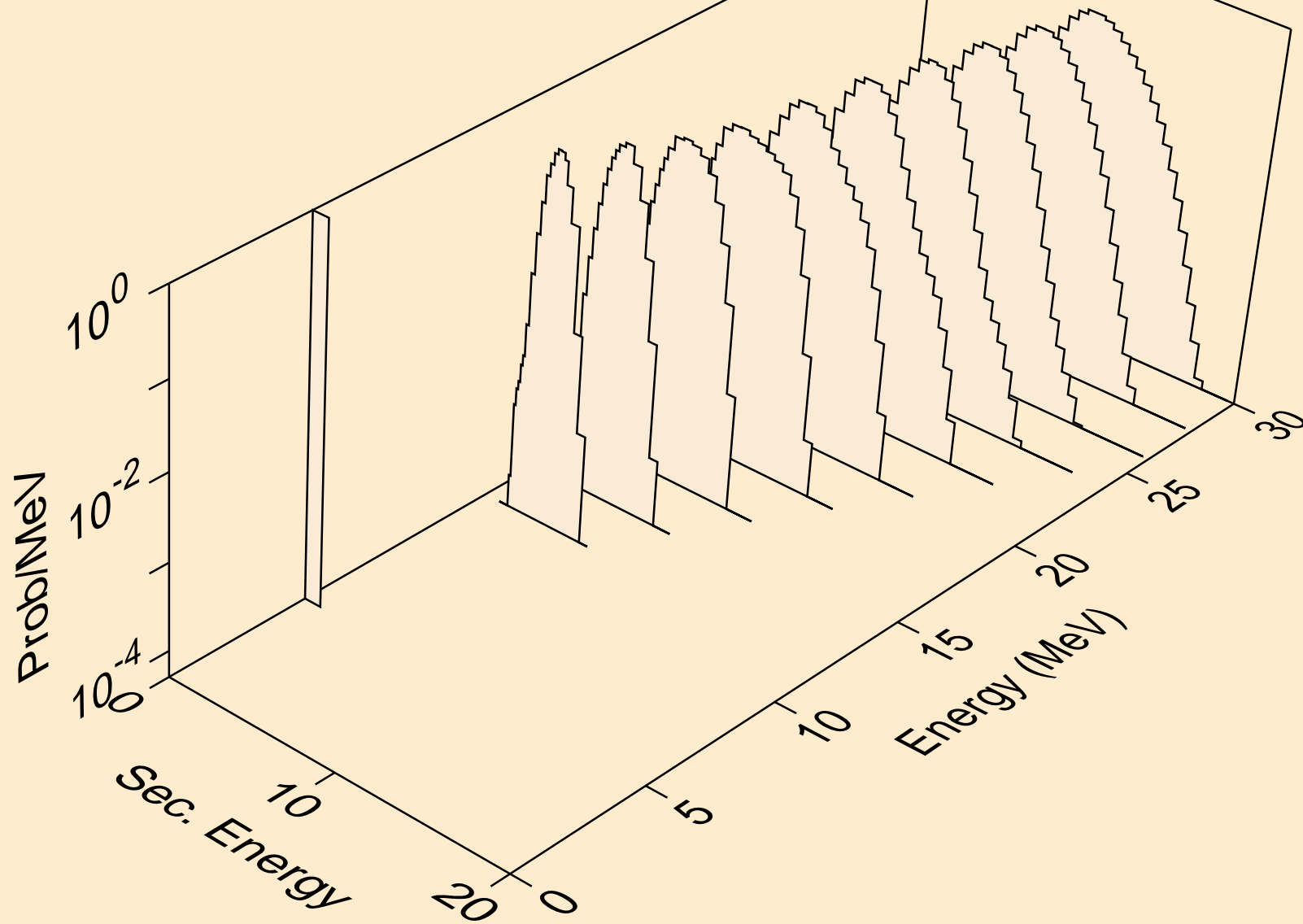



W181 NEUTRON ACER TENDL-2021 LIBRARY; T=293.6K  
protons from (n,p)

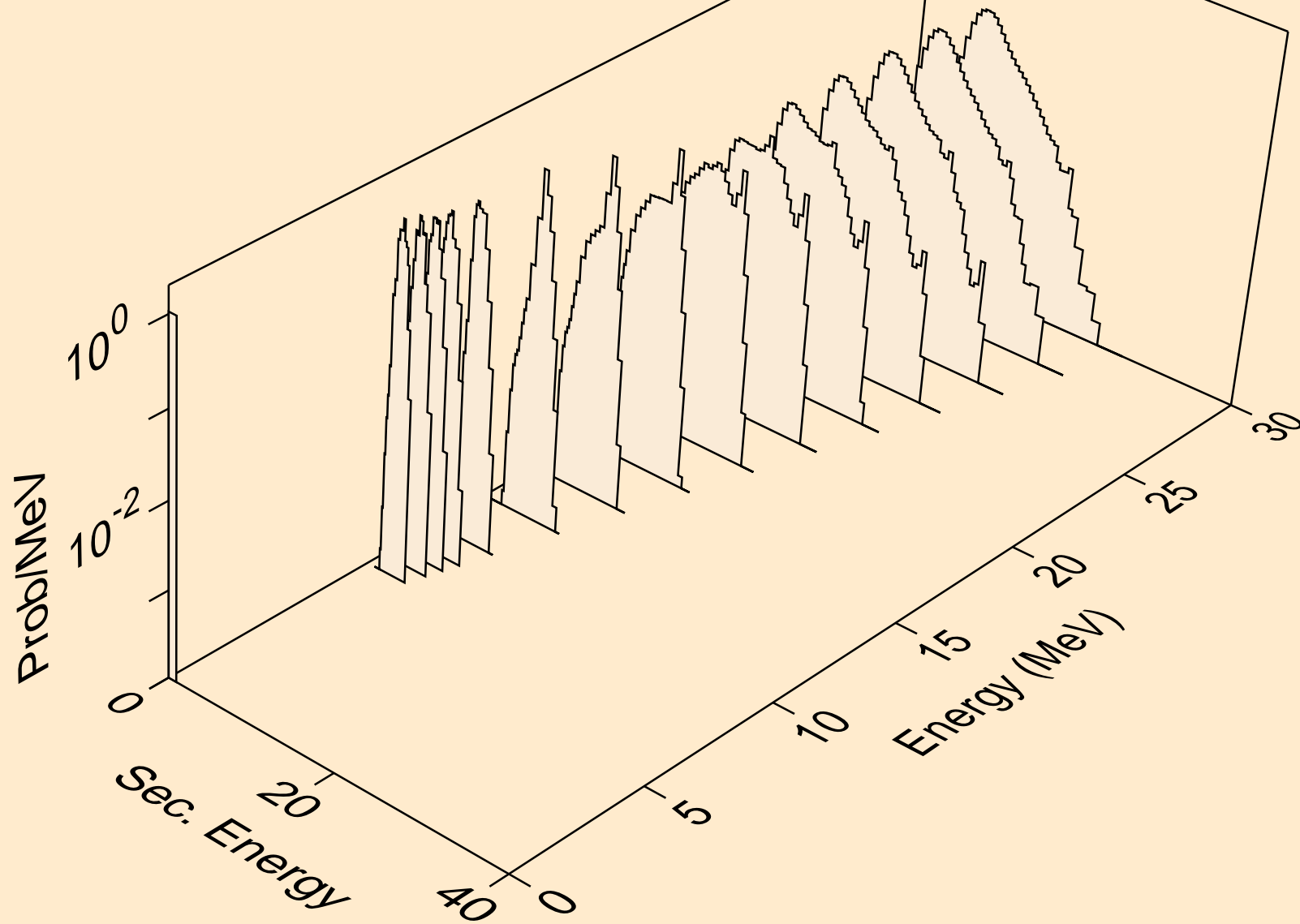

W181 NEUTRON ACER TENDL-2021 LIBRARY; T=293.6K  
protons from (n,pd)

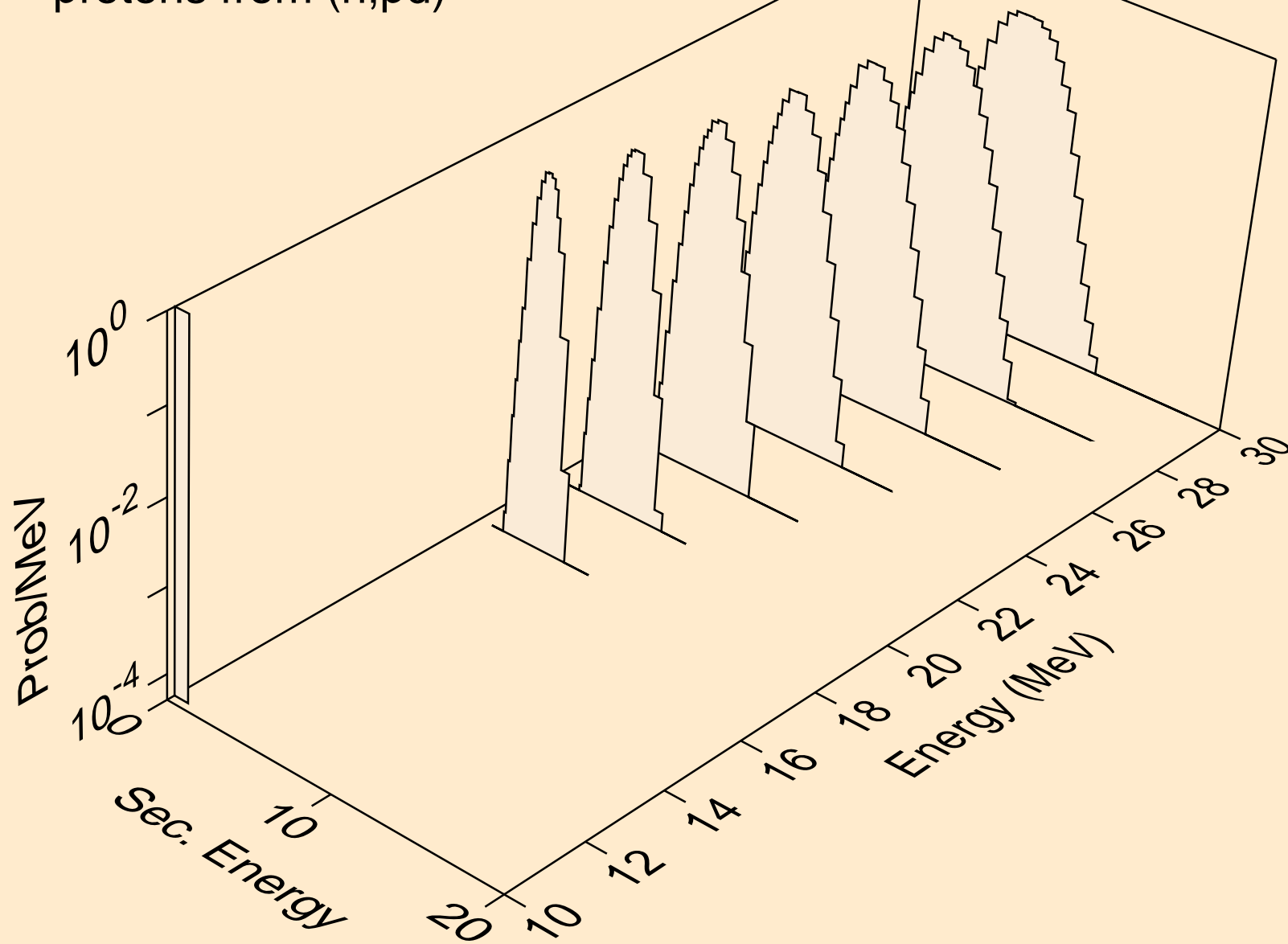

W181 NEUTRON ACER TENDL-2021 LIBRARY; T=293.6K  
protons from (n,pt)

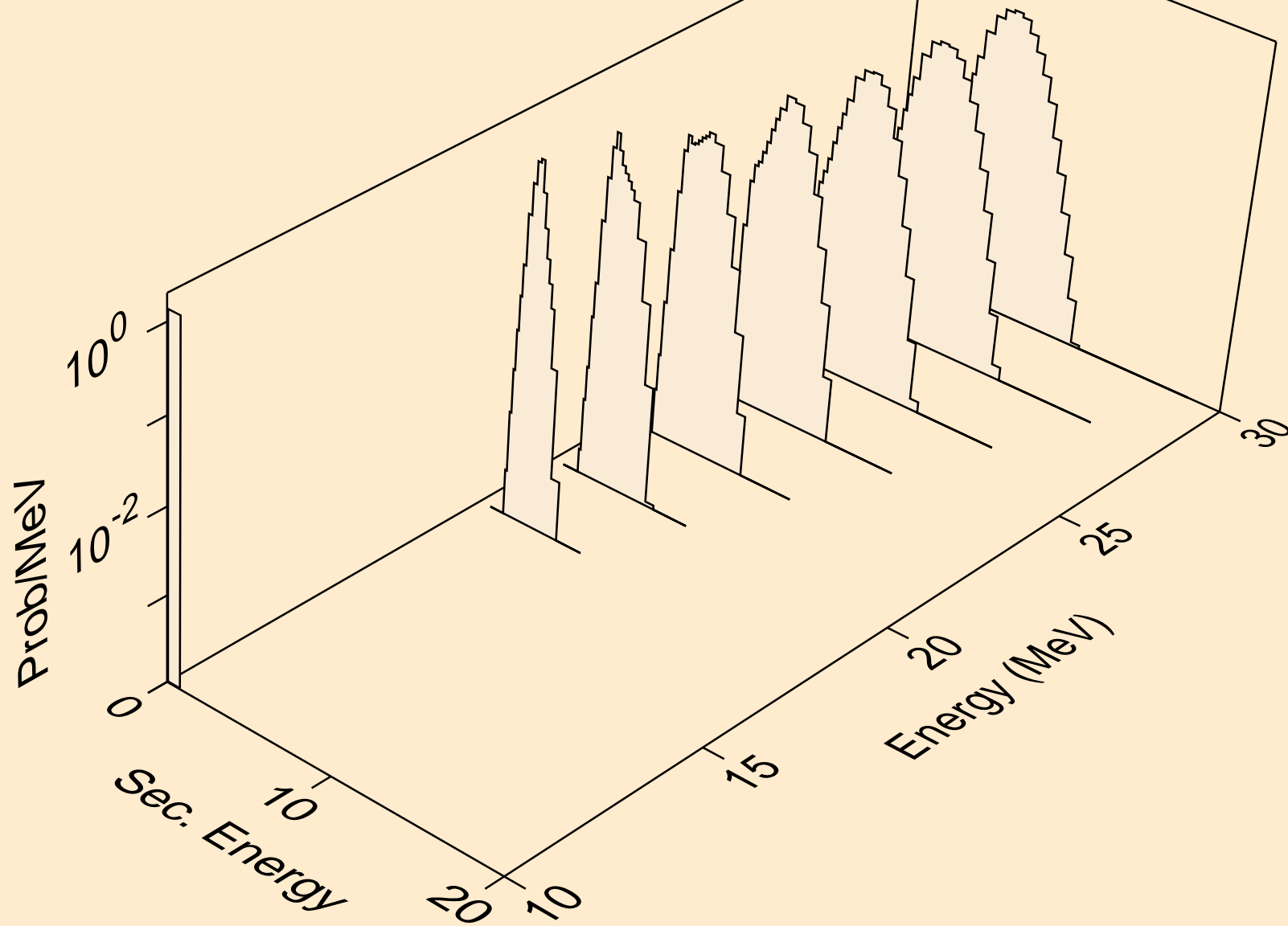

W181 NEUTRON ACER TENDL-2021 LIBRARY; T=293.6K  
deuterons from (n,x)

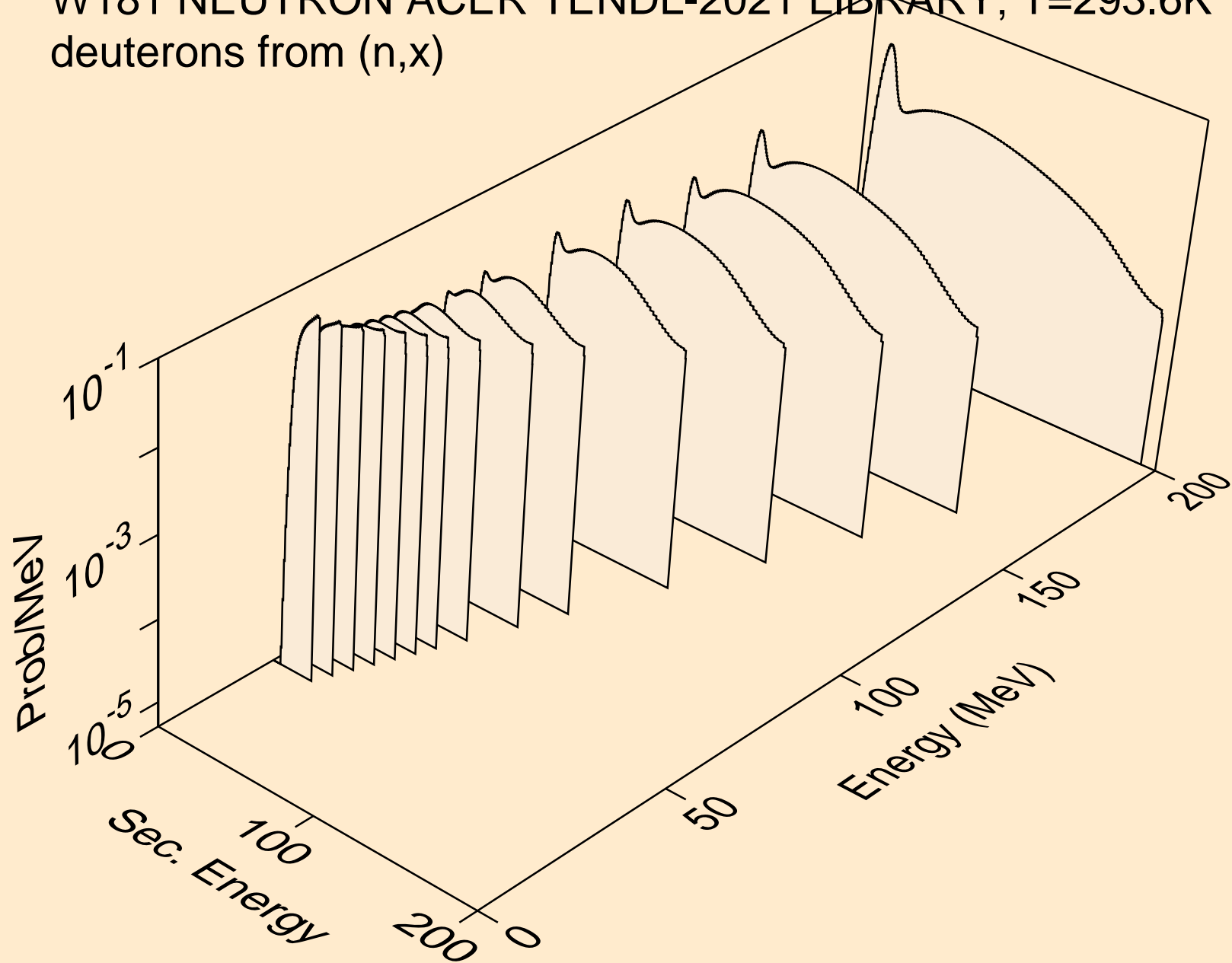

W181 NEUTRON ACER TENDL-2021 LIBRARY; T=293.6K  
deuterons from (n,2nd)

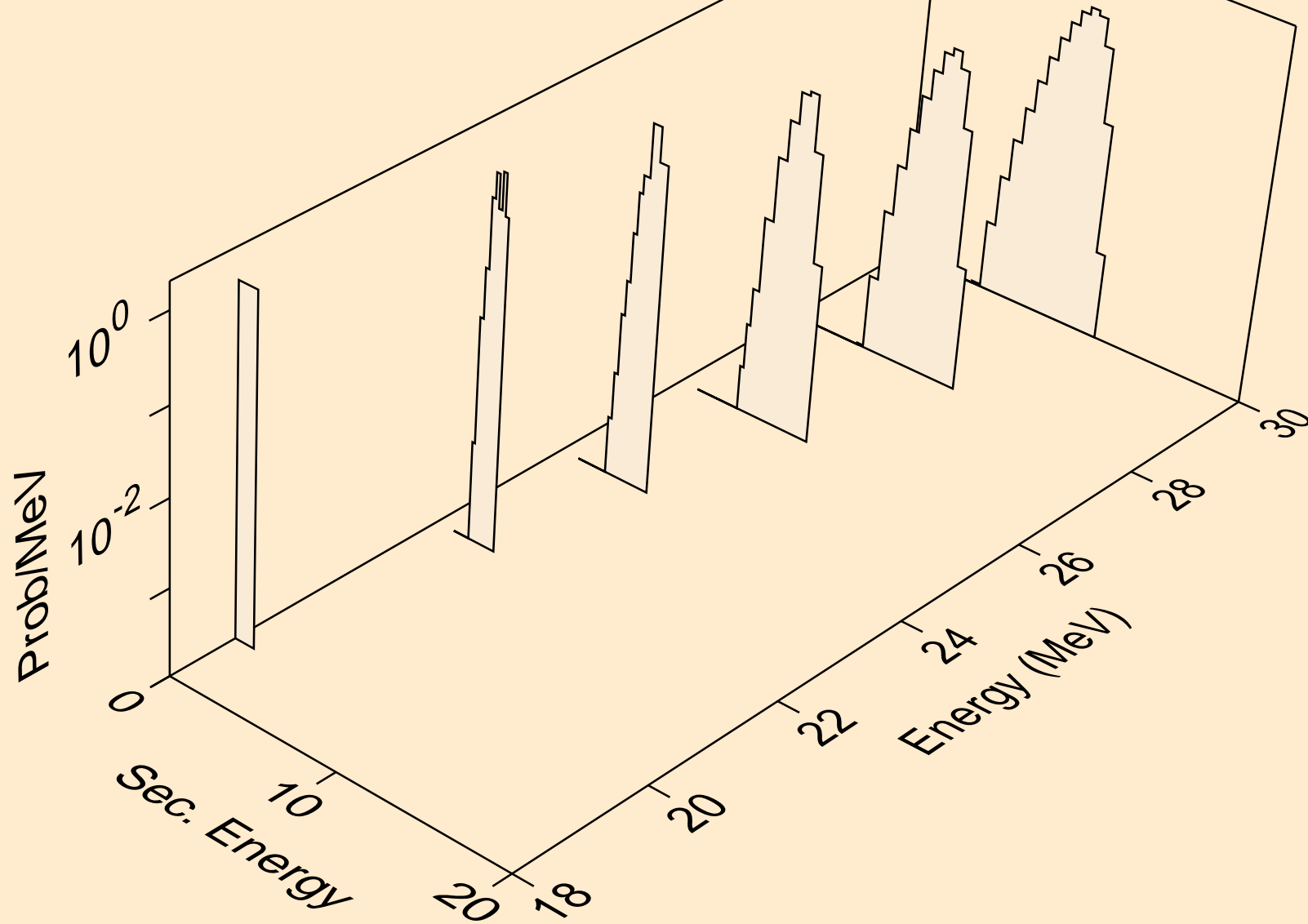

W181 NEUTRON ACER TENDL-2021 LIBRARY; T=293.6K  
deuterons from (n,n\*)d

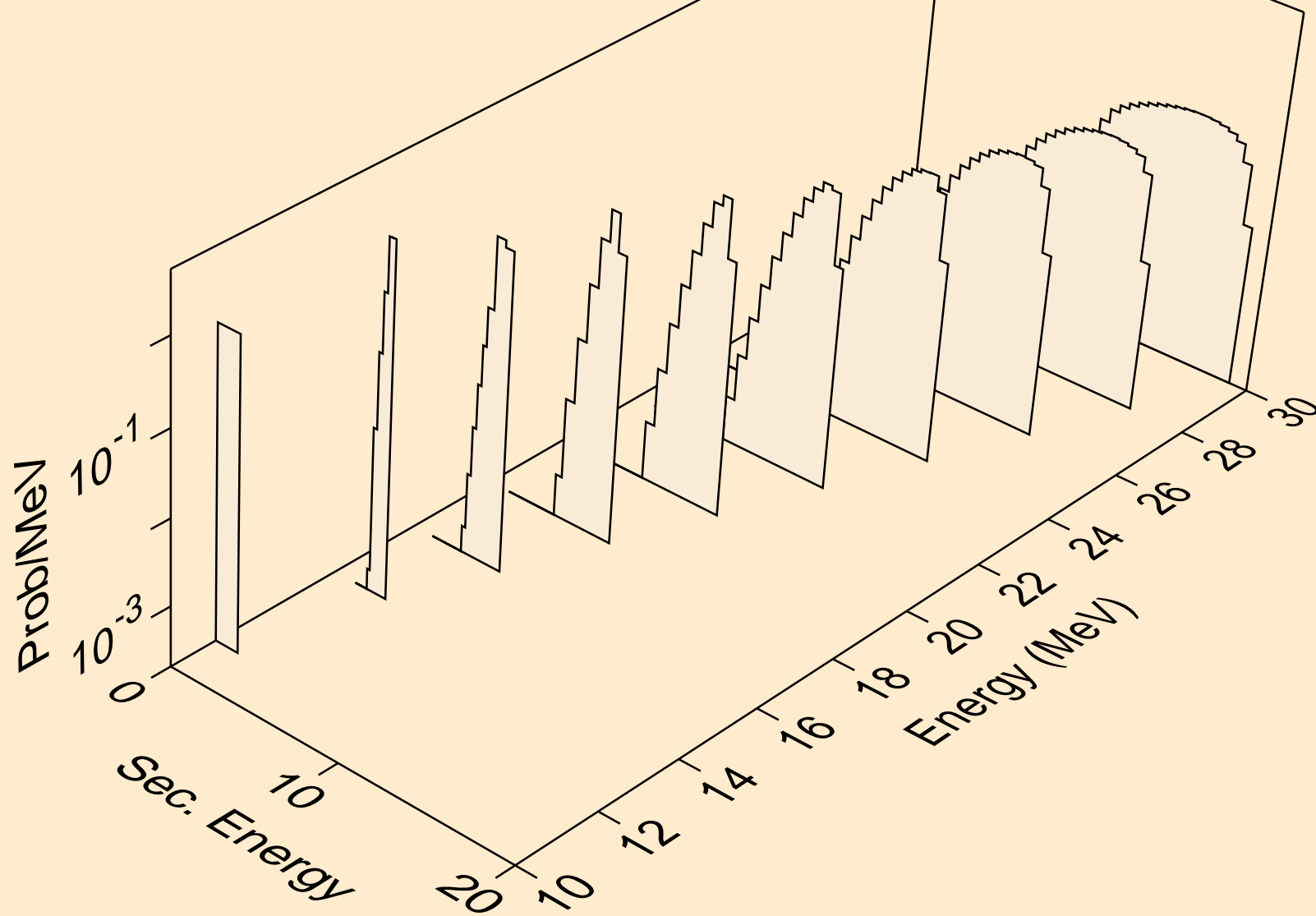

W181 NEUTRON ACER TENDL-2021 LIBRARY; T=293.6K  
deuterons from (n,d)

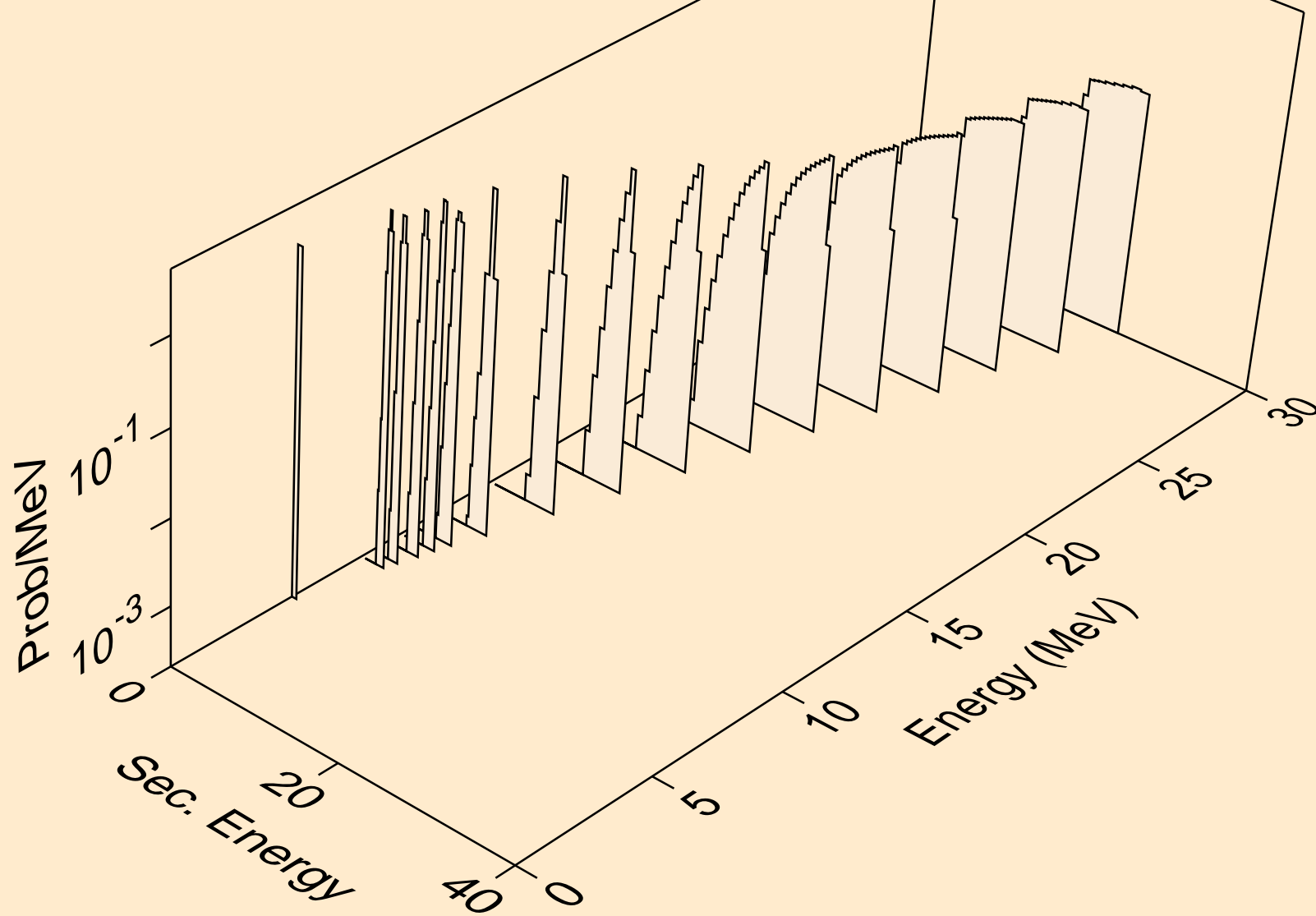

W181 NEUTRON ACER TENDL-2021 LIBRARY; T=293.6K  
deuterons from (n,pd)

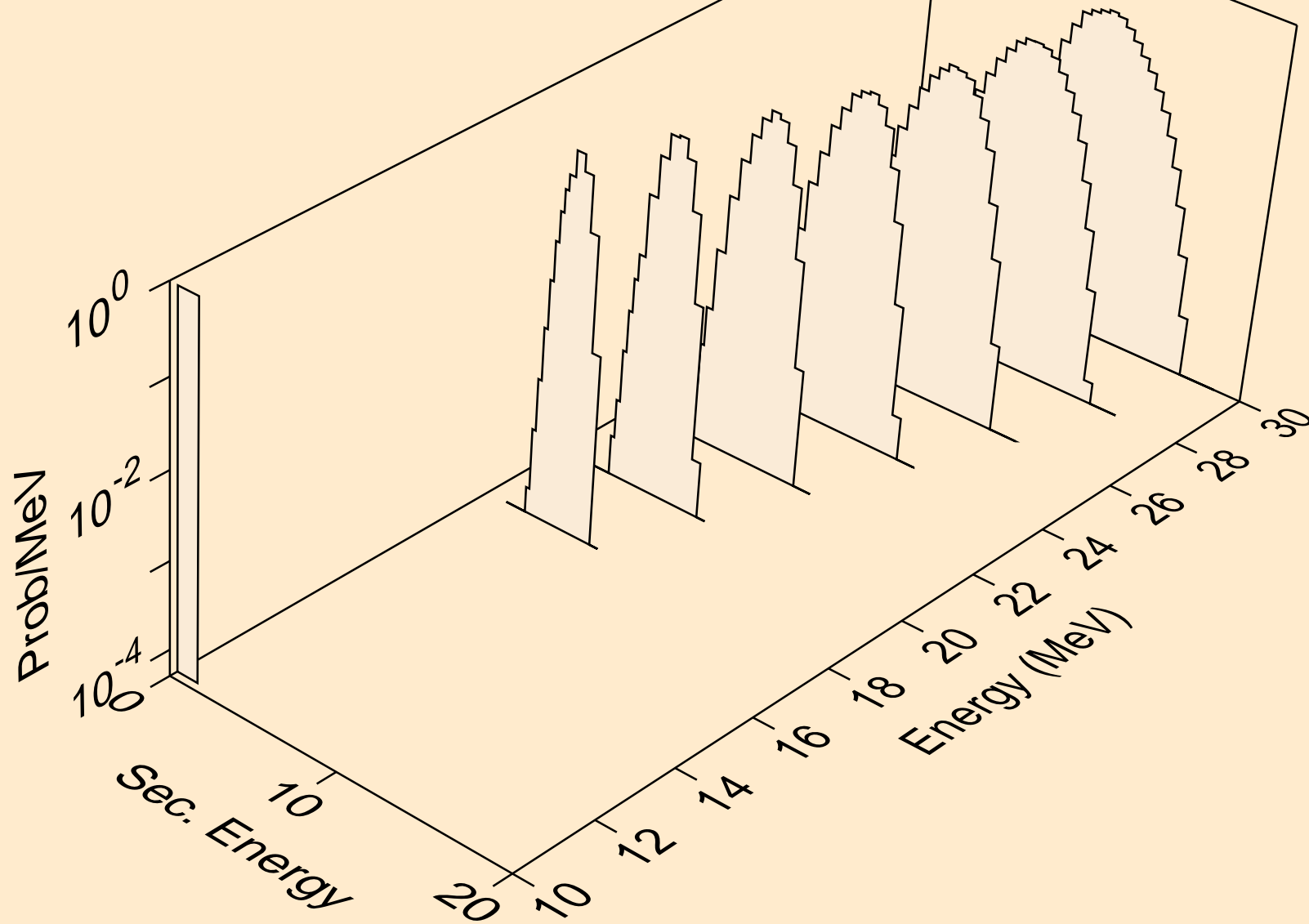



W181 NEUTRON ACER TENDL-2021 LIBRARY; T=293.6K  
deuterons from (n,da)

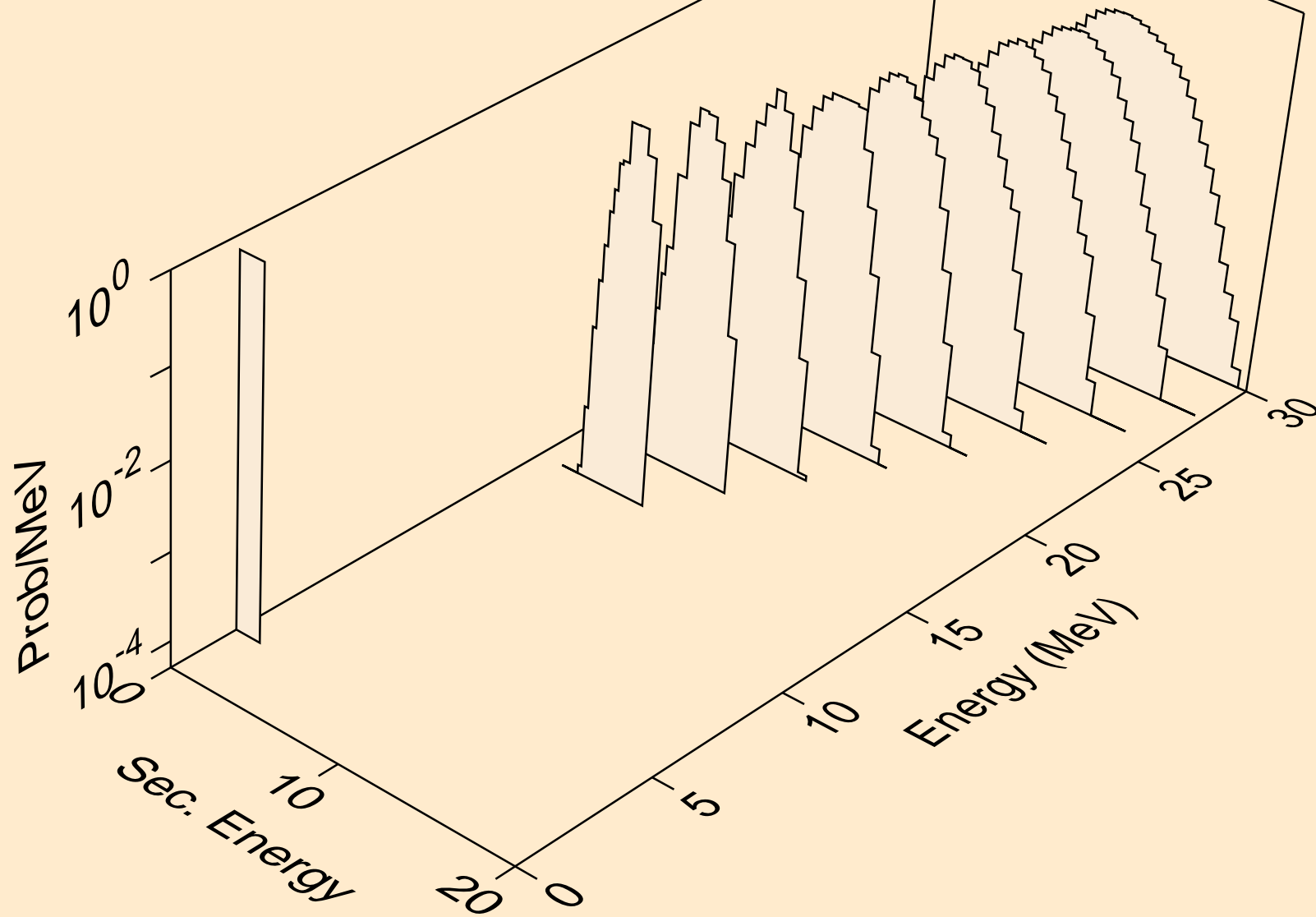

W181 NEUTRON ACER TENDL-2021 LIBRARY; T=293.6K  
tritons from (n,x)

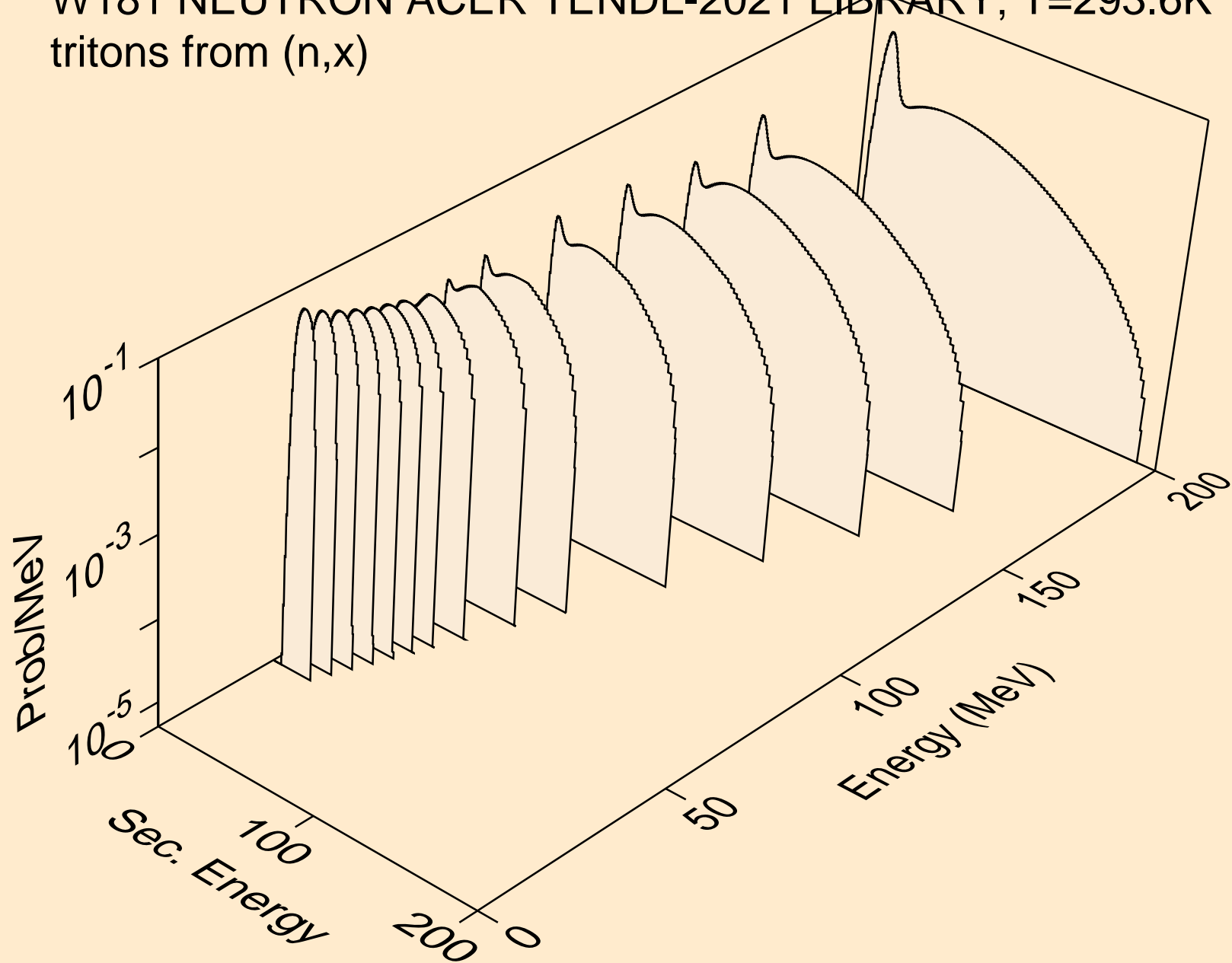

W181 NEUTRON ACER TENDL-2021 LIBRARY; T=293.6K  
tritons from (n,n\*)t

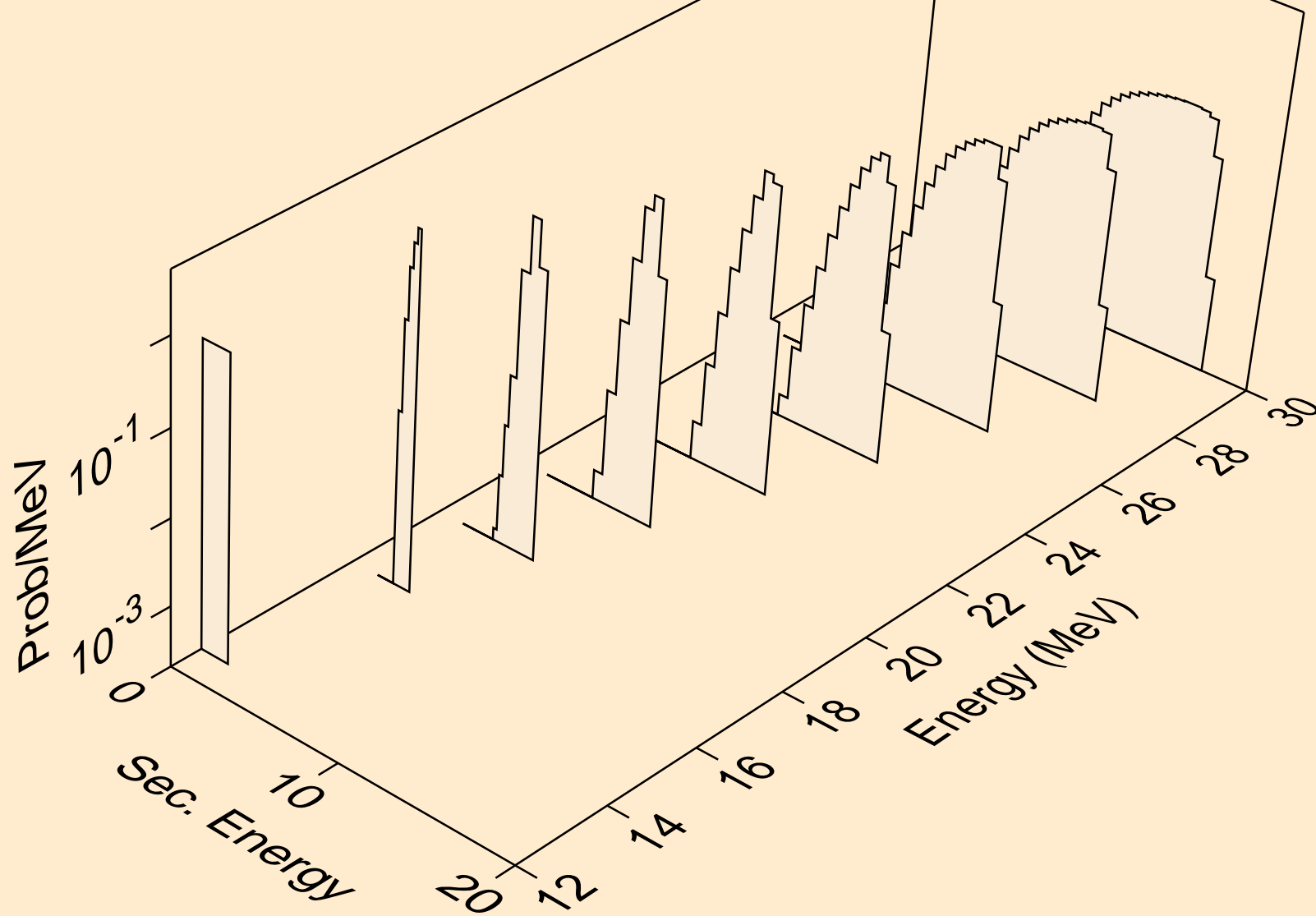

W181 NEUTRON ACER TENDL-2021 LIBRARY; T=293.6K  
tritons from (n,t)

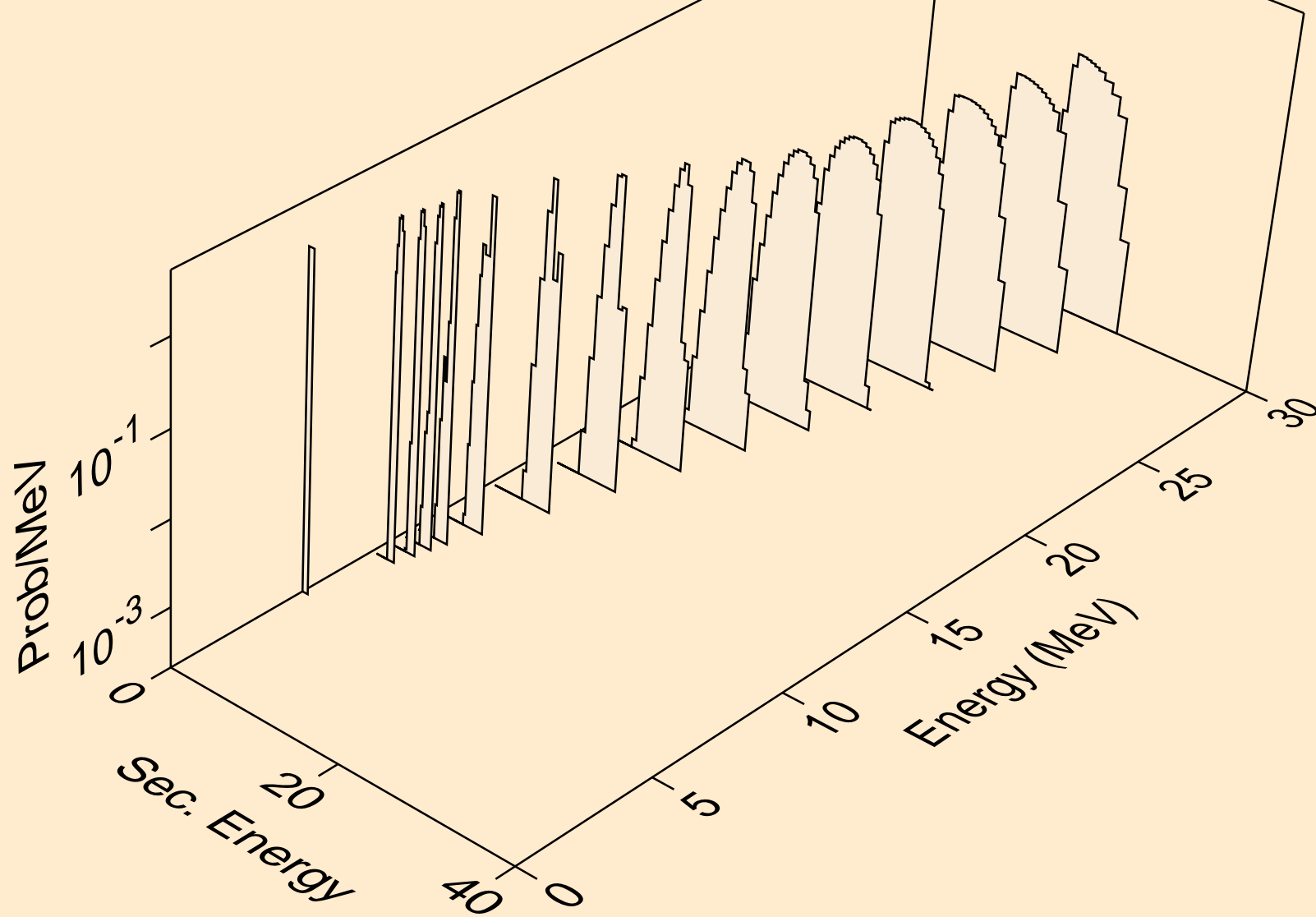

W181 NEUTRON ACER TENDL-2021 LIBRARY; T=293.6K  
tritons from (n,pt)

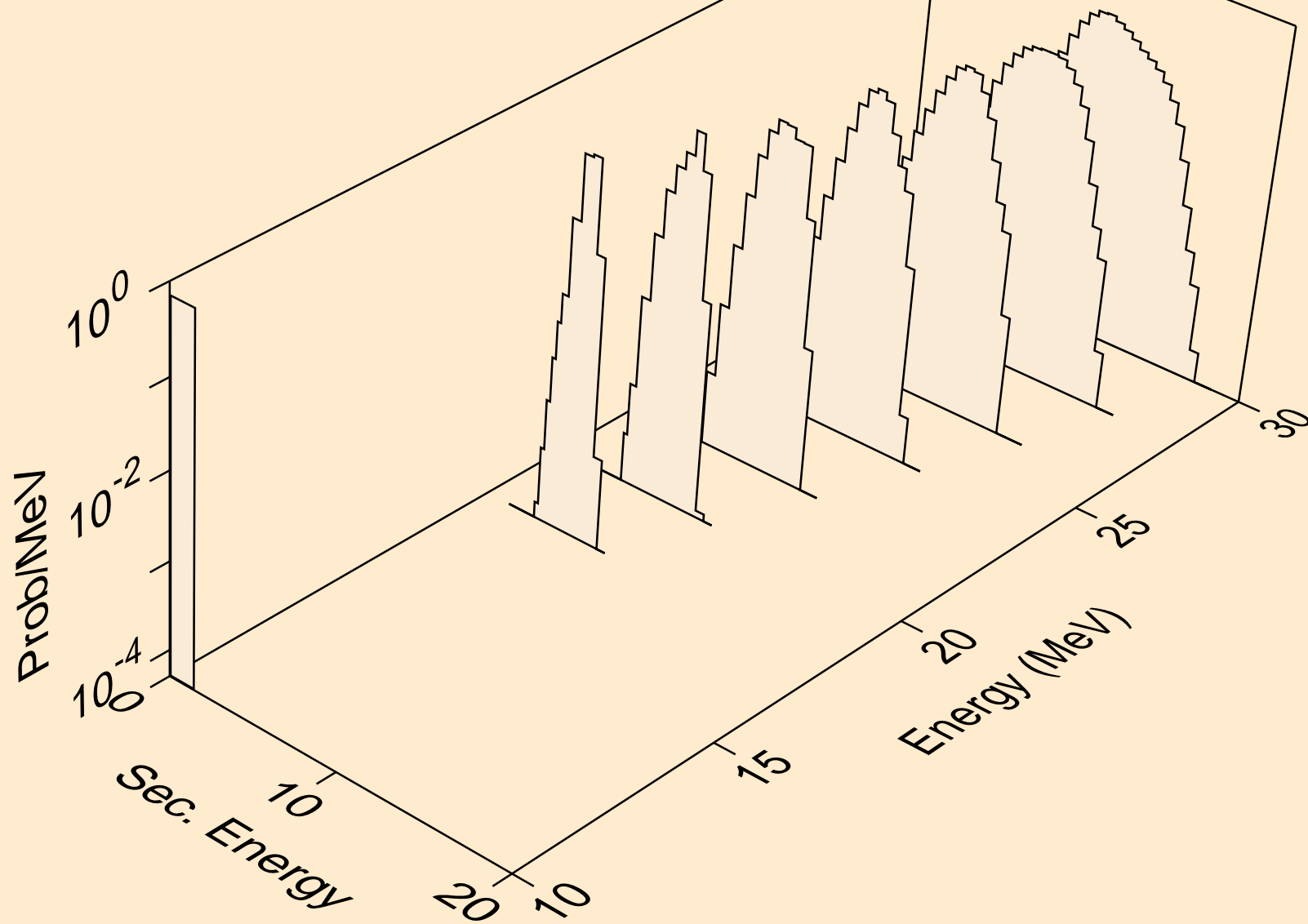

W181 NEUTRON ACER TENDL-2021 LIBRARY; T=293.6K  
he3s from (n,x)

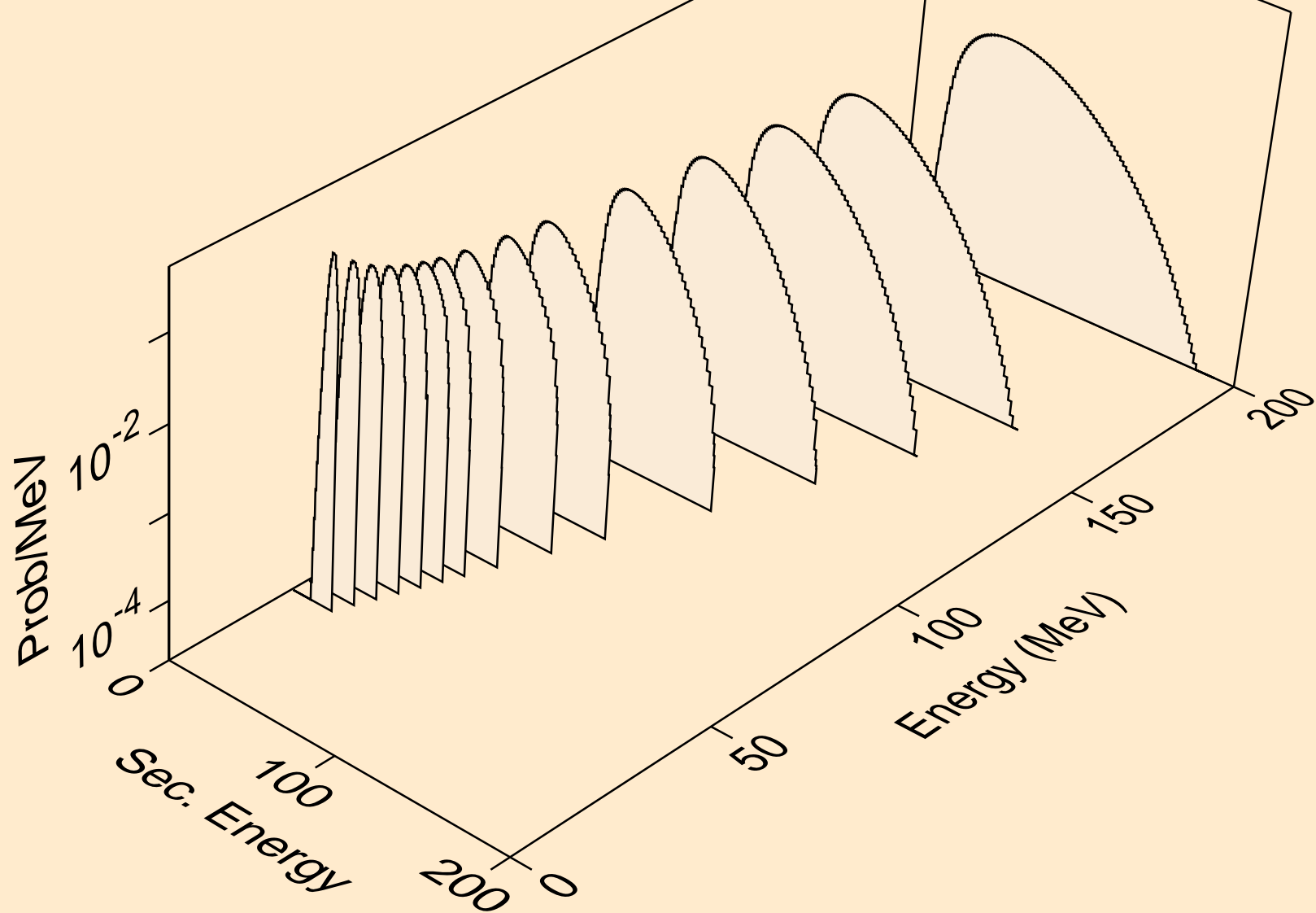

W181 NEUTRON ACER TENDL-2021 LIBRARY; T=293.6K  
he3s from (n,n\*)he3

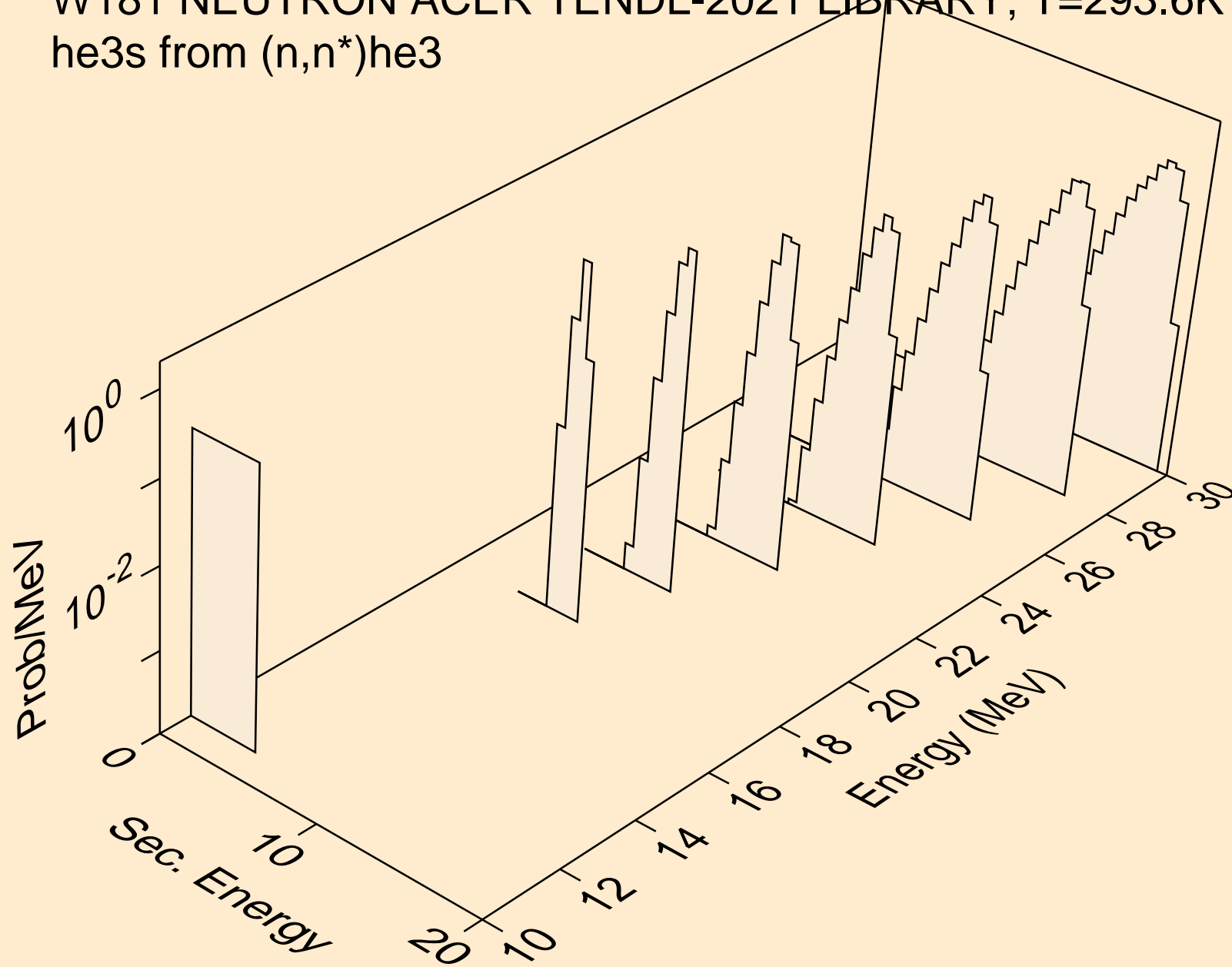

W181 NEUTRON ACER TENDL-2021 LIBRARY; T=293.6K  
he3s from (n,he3)

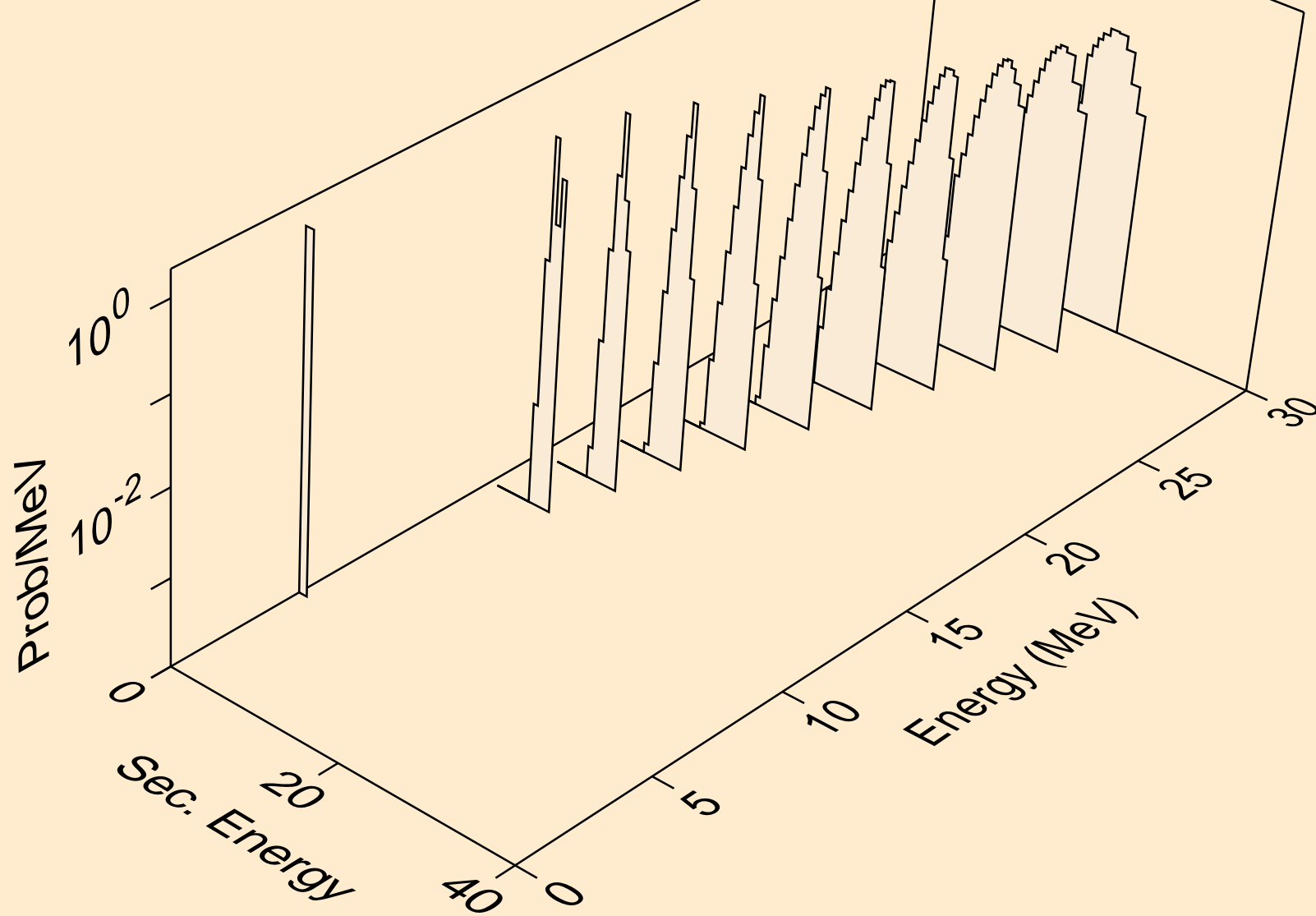



W181 NEUTRON ACER TENDL-2021 LIBRARY; T=293.6K  
alphas from (n,x)

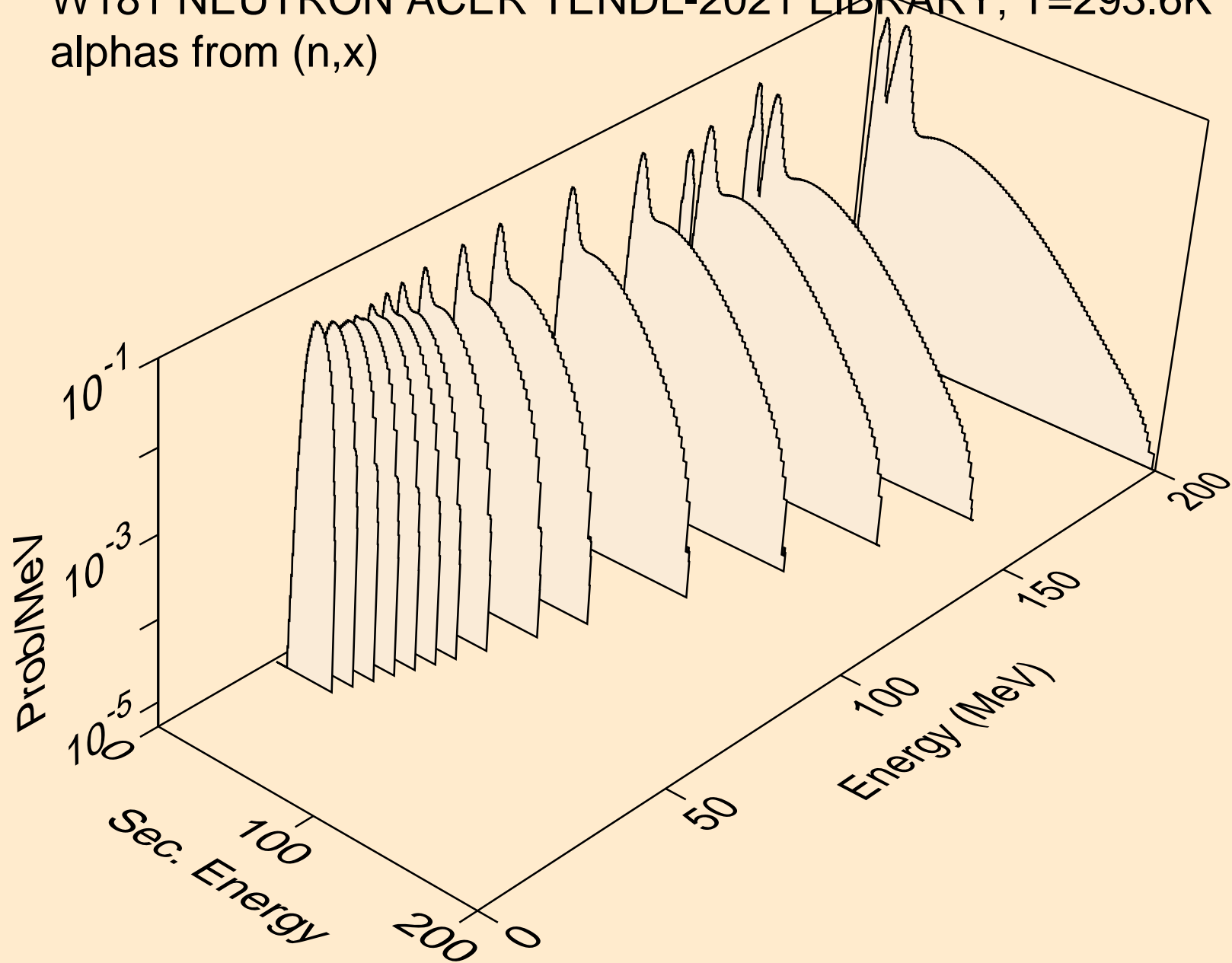

W181 NEUTRON ACER TENDL-2021 LIBRARY; T=293.6K  
alphas from (n,n\*)a

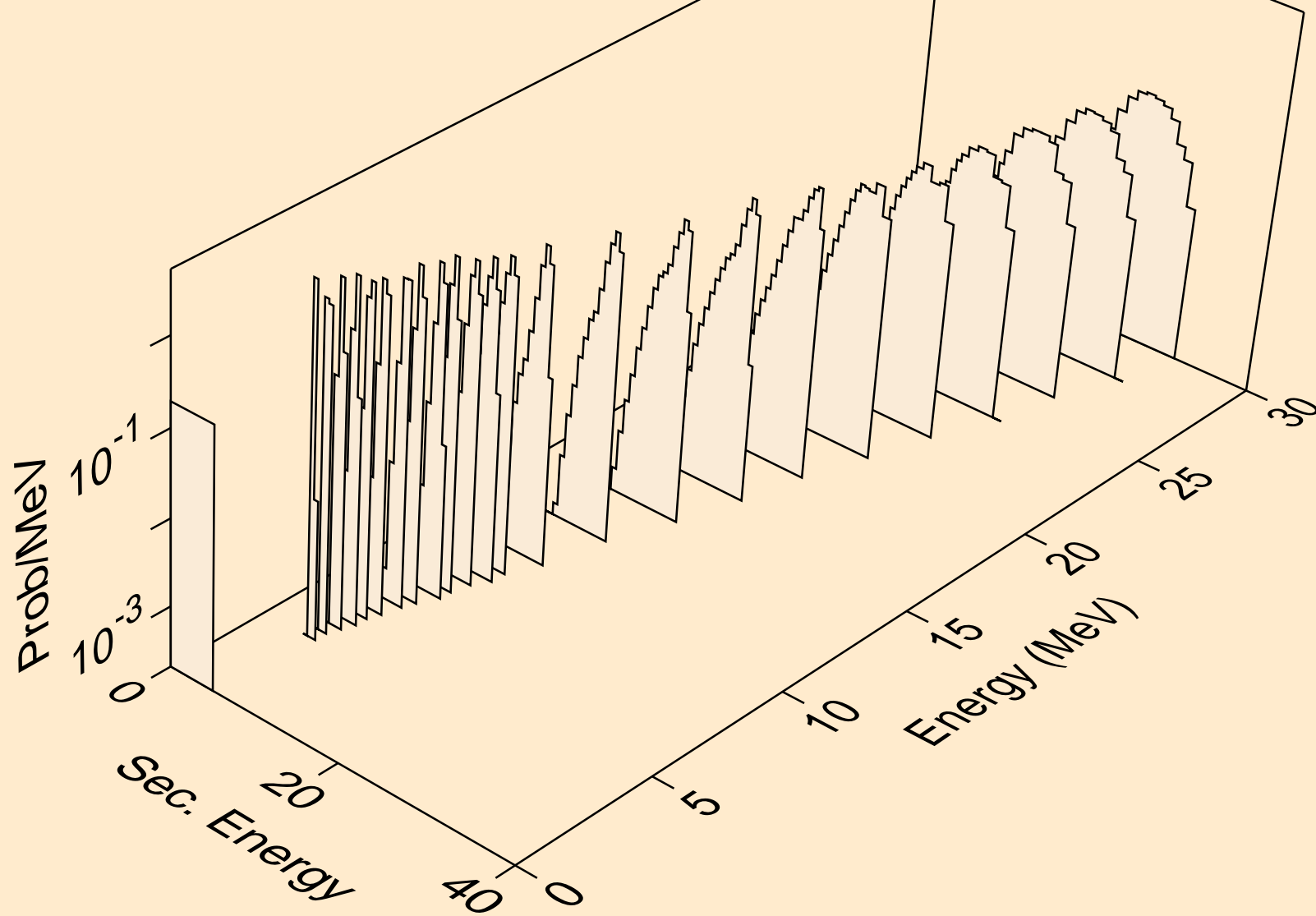

W181 NEUTRON ACER TENDL-2021 LIBRARY; T=293.6K  
alphas from (n,2n)a

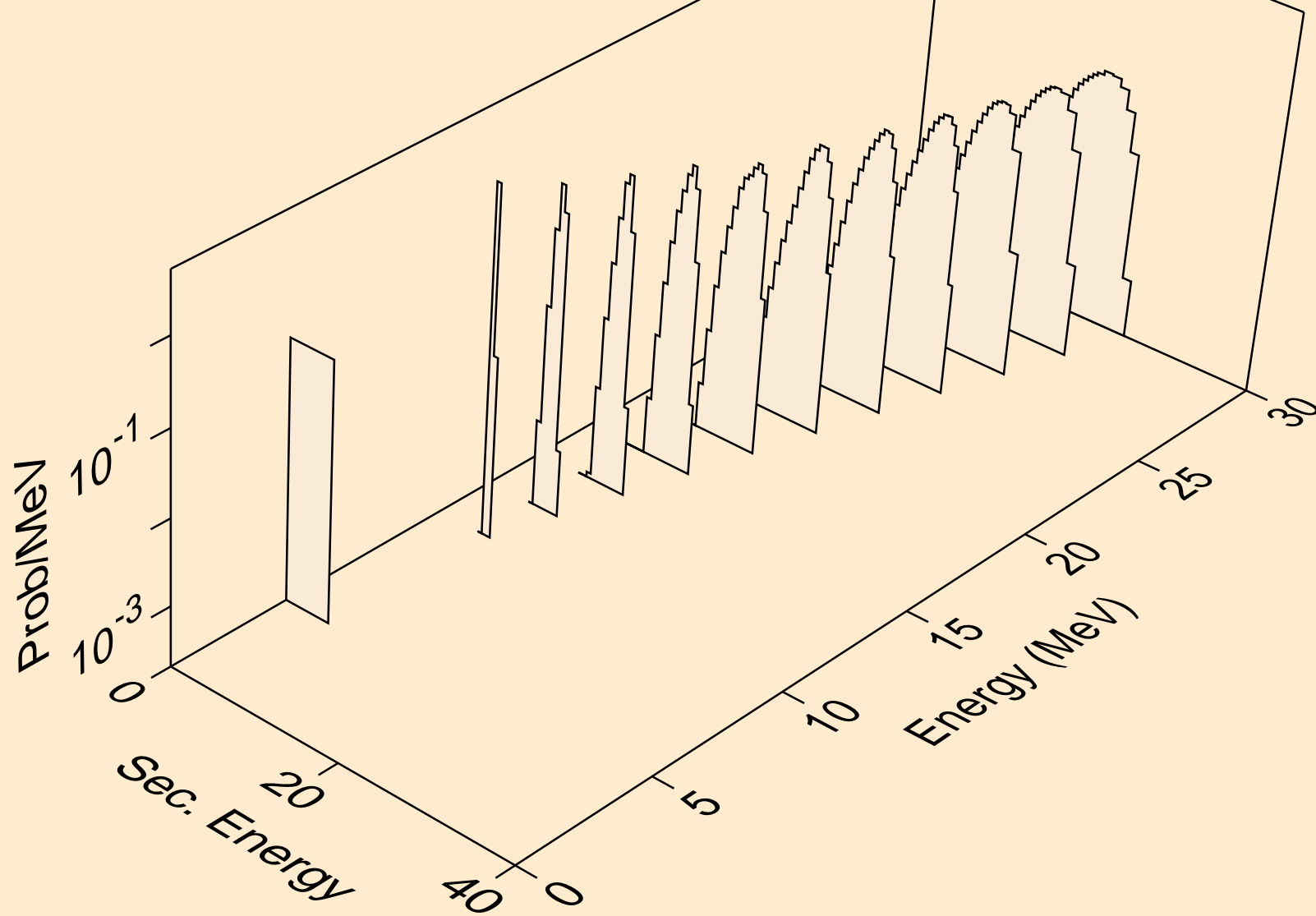

W181 NEUTRON ACER TENDL-2021 LIBRARY; T=293.6K  
alphas from (n,3n)a

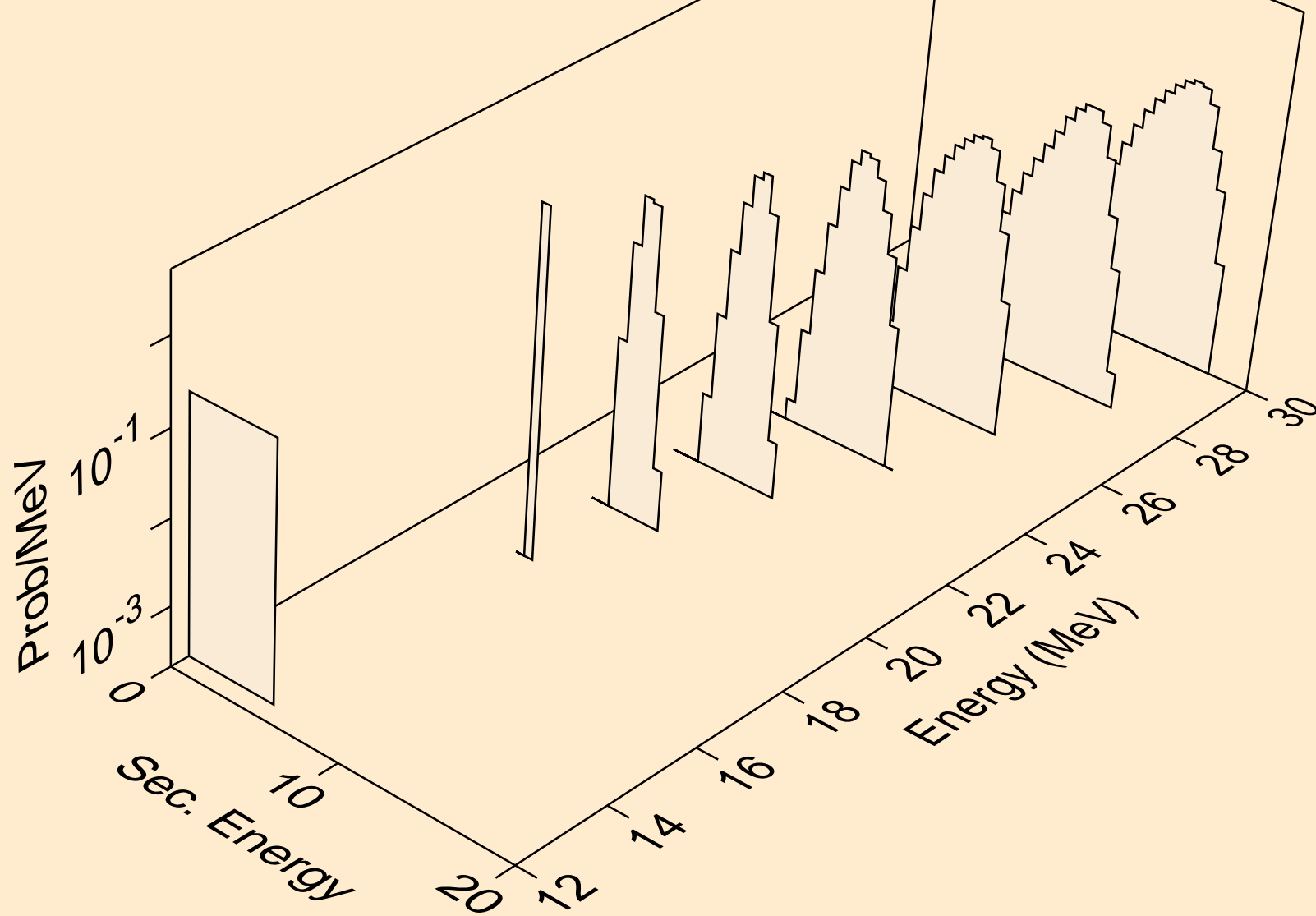

W181 NEUTRON ACER TENDL-2021 LIBRARY; T=293.6K  
alphas from (n,n\*)2a

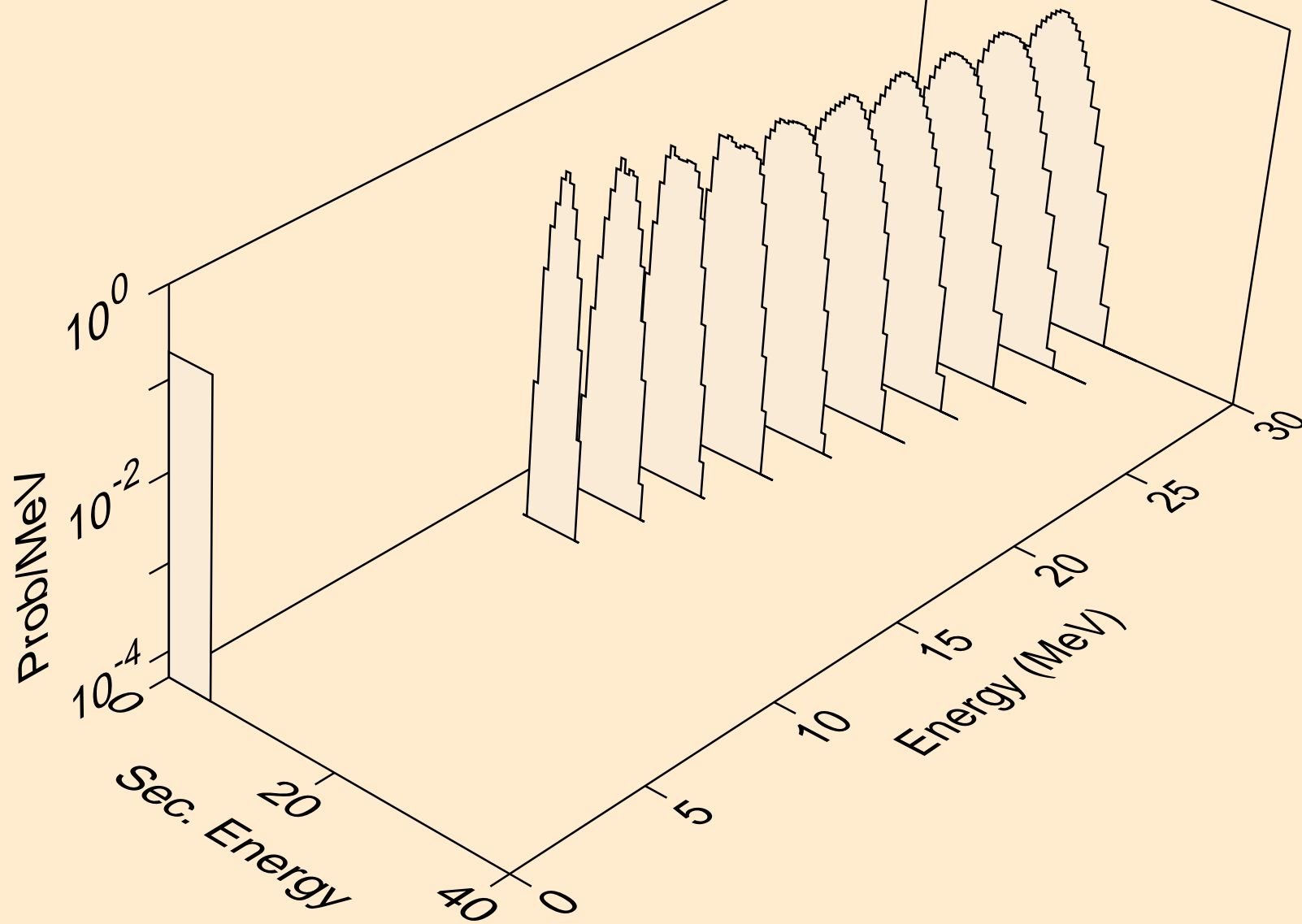

W181 NEUTRON ACER TENDL-2021 LIBRARY; T=293.6K  
alphas from (n,npa)

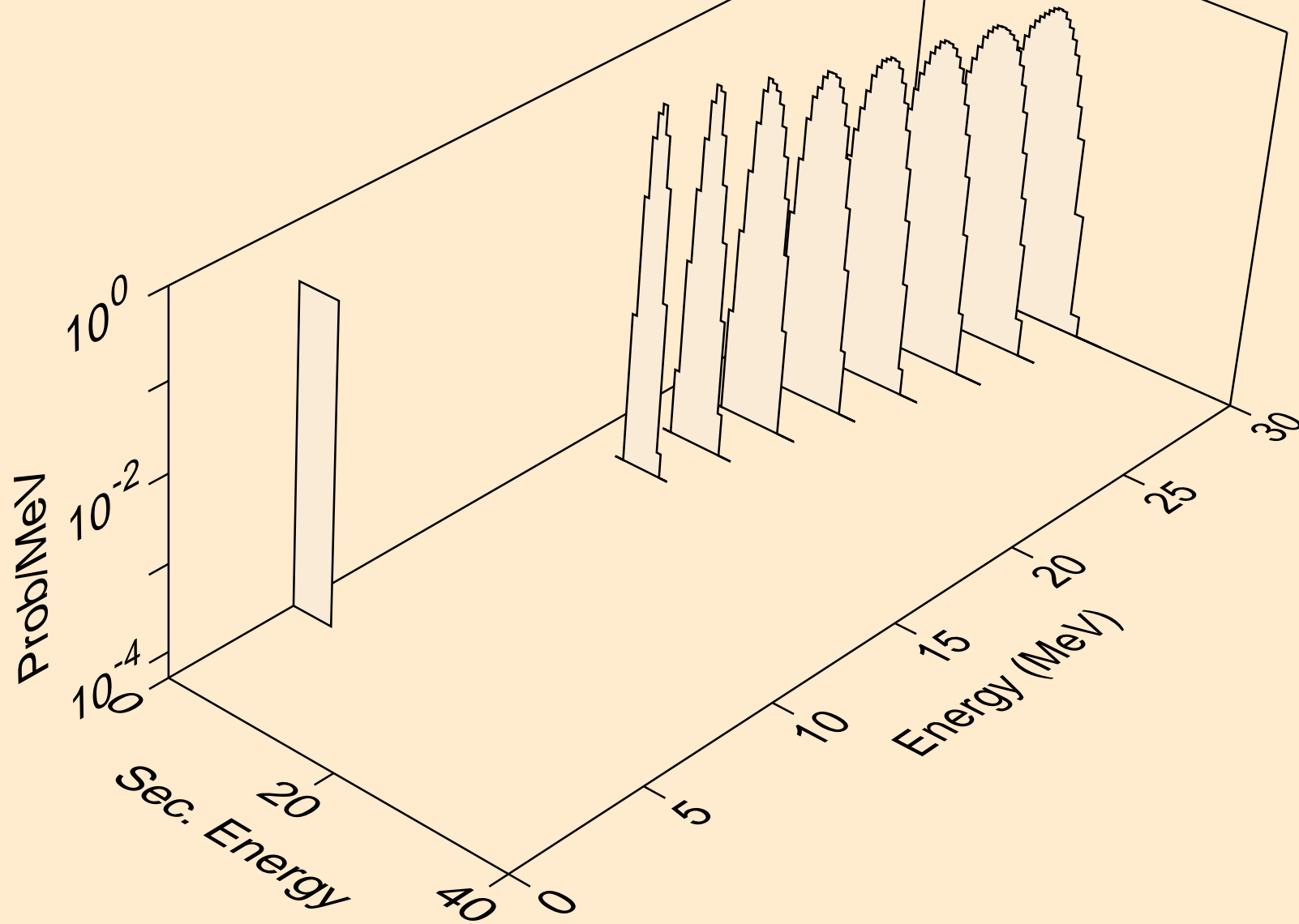

W181 NEUTRON ACER TENDL-2021 LIBRARY; T=293.6K  
alphas from (n,a)

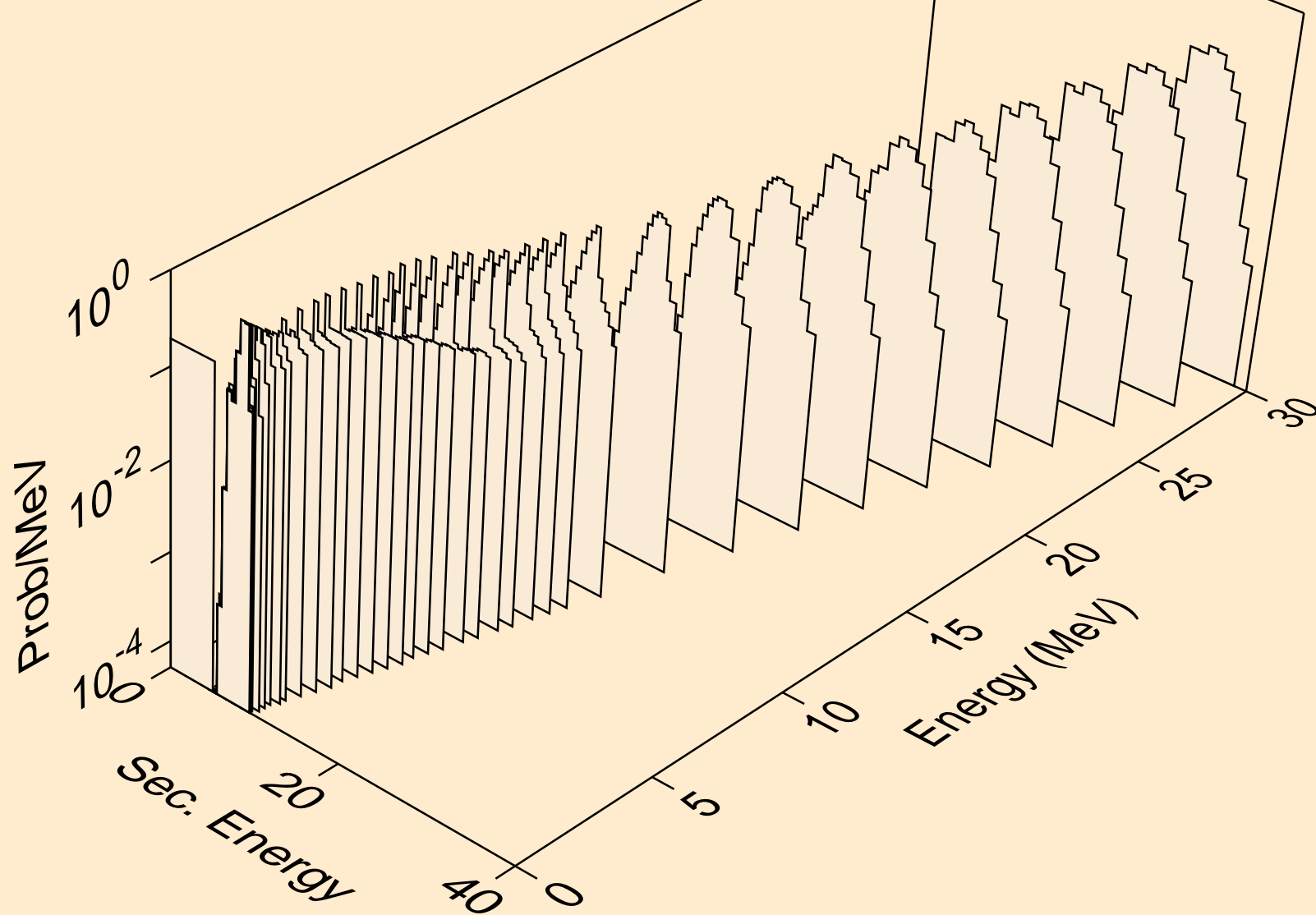

W181 NEUTRON ACER TENDL-2021 LIBRARY; T=293.6K  
alphas from (n,2a)

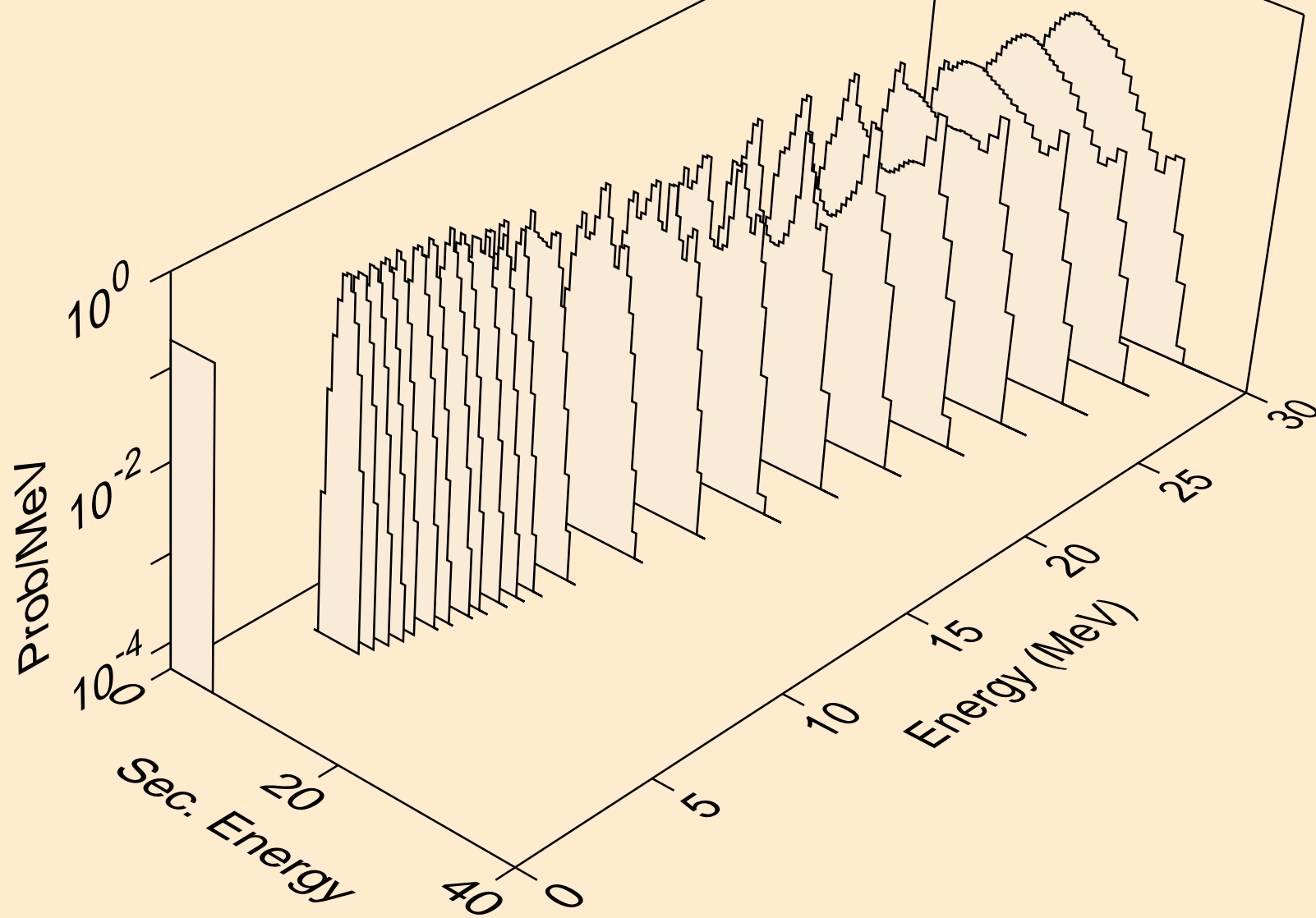



W181 NEUTRON ACER TENDL-2021 LIBRARY; T=293.6K  
alphas from (n,pa)

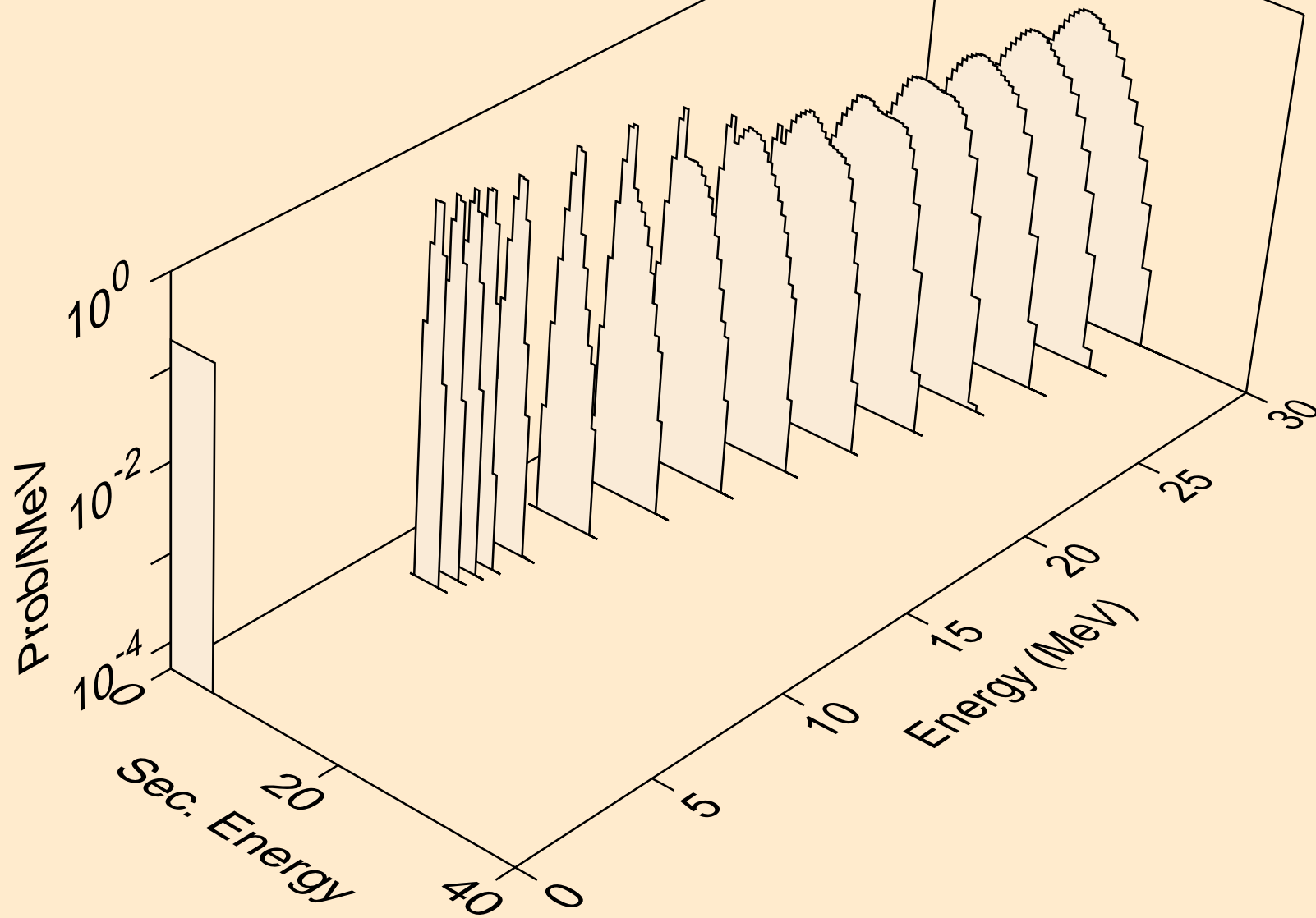

W181 NEUTRON ACER TENDL-2021 LIBRARY; T=293.6K  
alphas from (n,da)

