

W193 NEUTRON ACER TENDL-2021 LIBRARY; T=293.6K

Principal cross sections

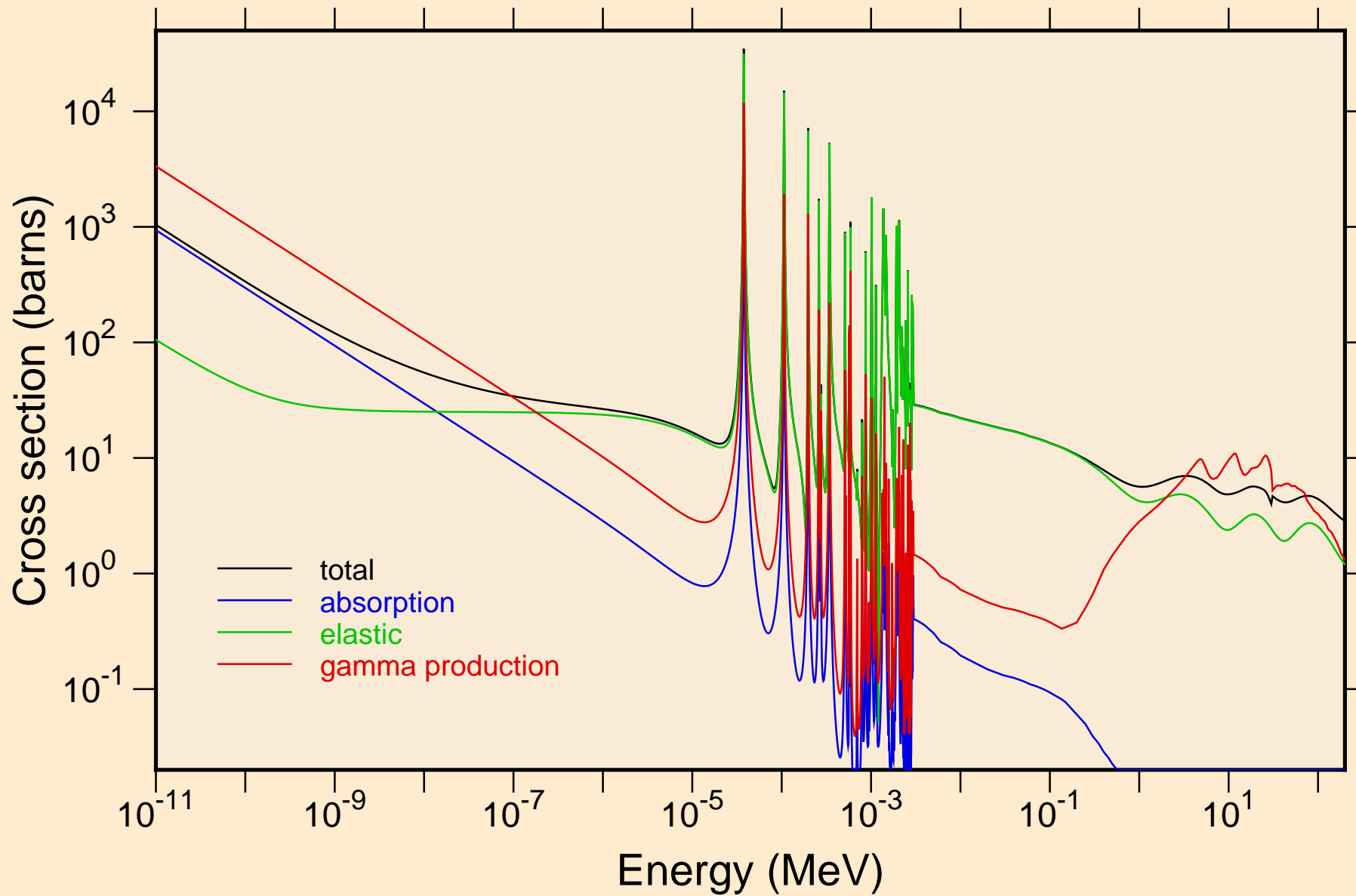

W193 NEUTRON ACER TENDL-2021 LIBRARY; T=293.6K
resonance total cross section

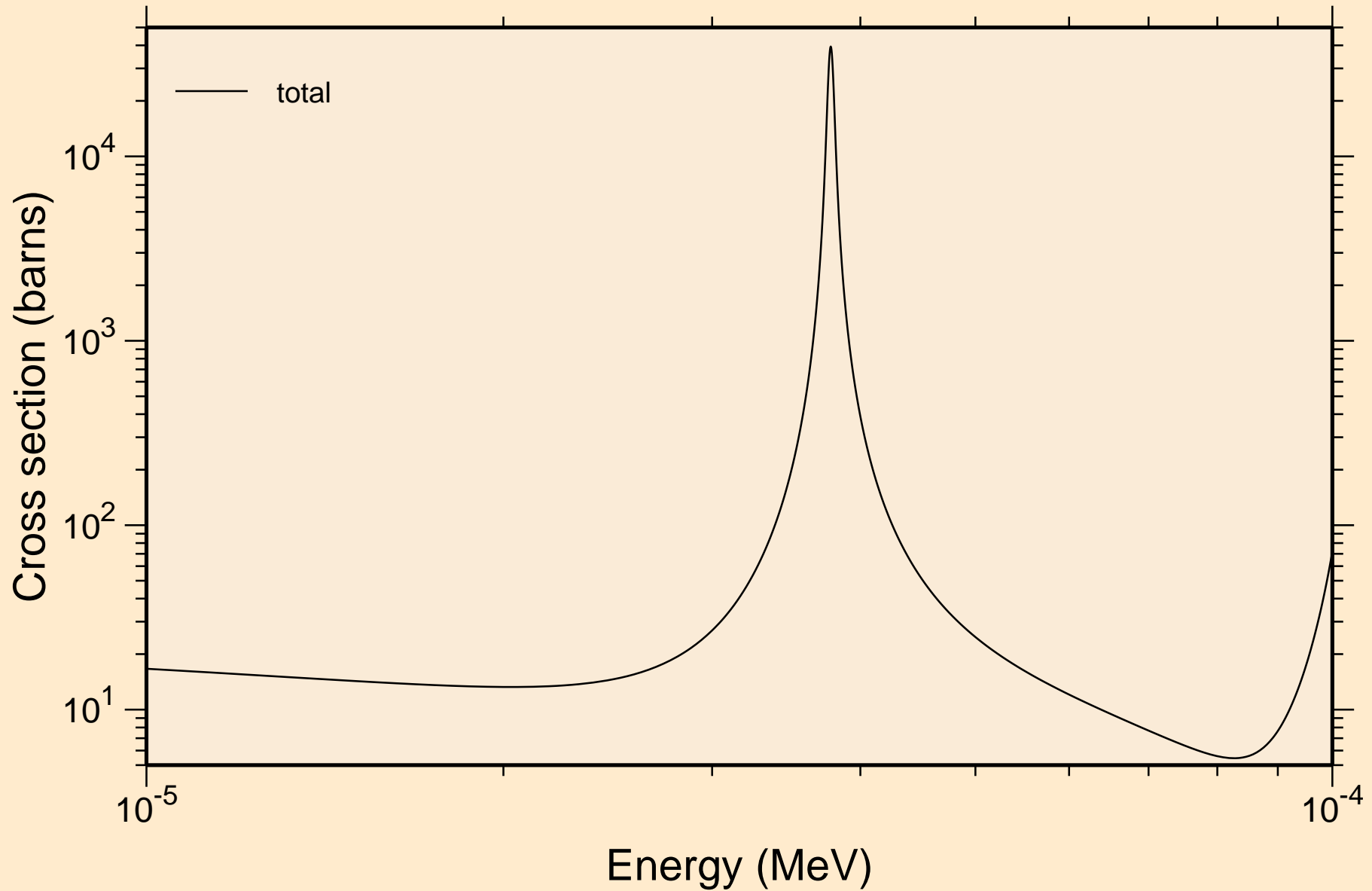

W193 NEUTRON ACER TENDL-2021 LIBRARY; T=293.6K
resonance total cross section

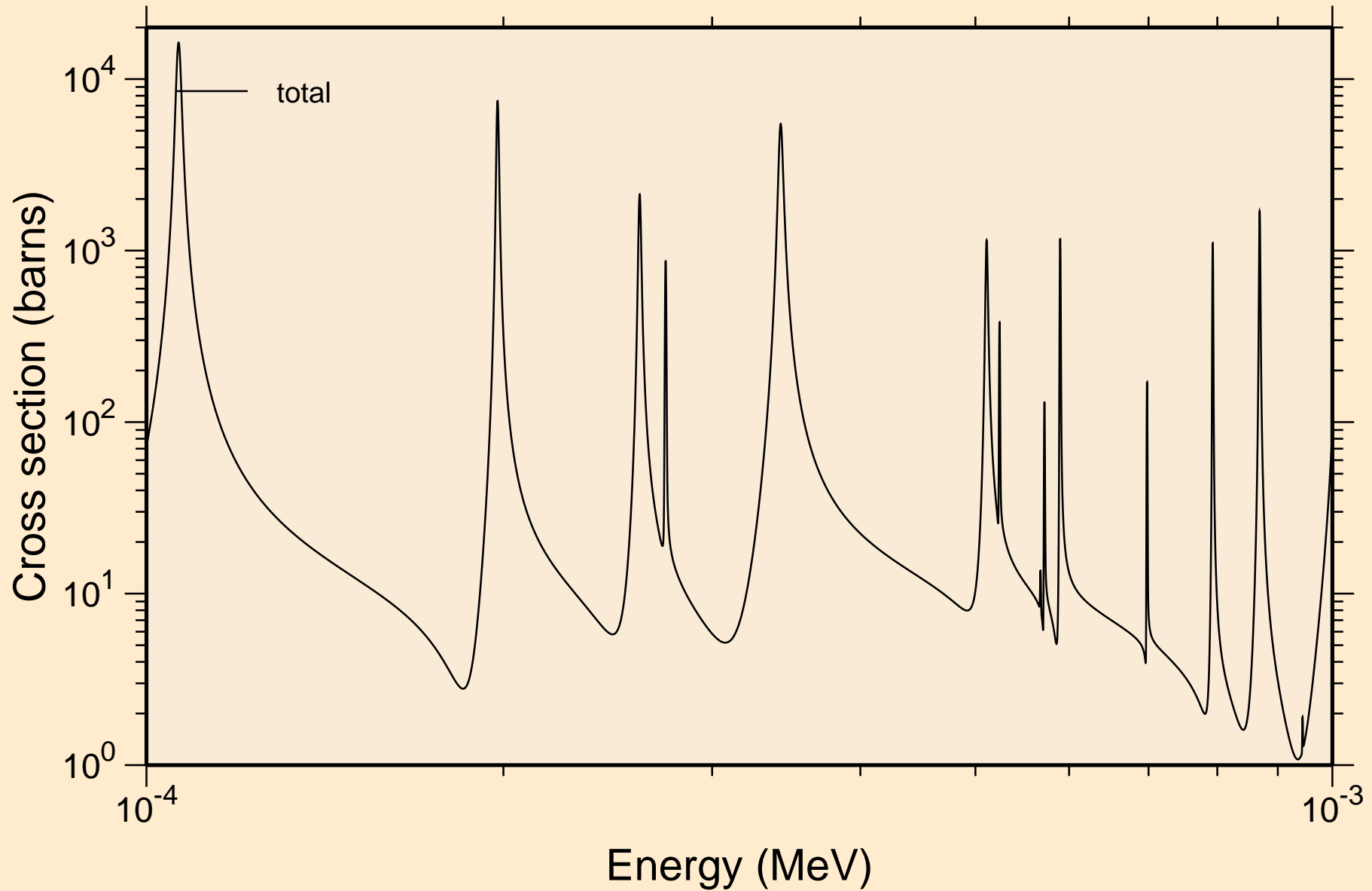

W193 NEUTRON ACER TENDL-2021 LIBRARY; T=293.6K
resonance total cross section

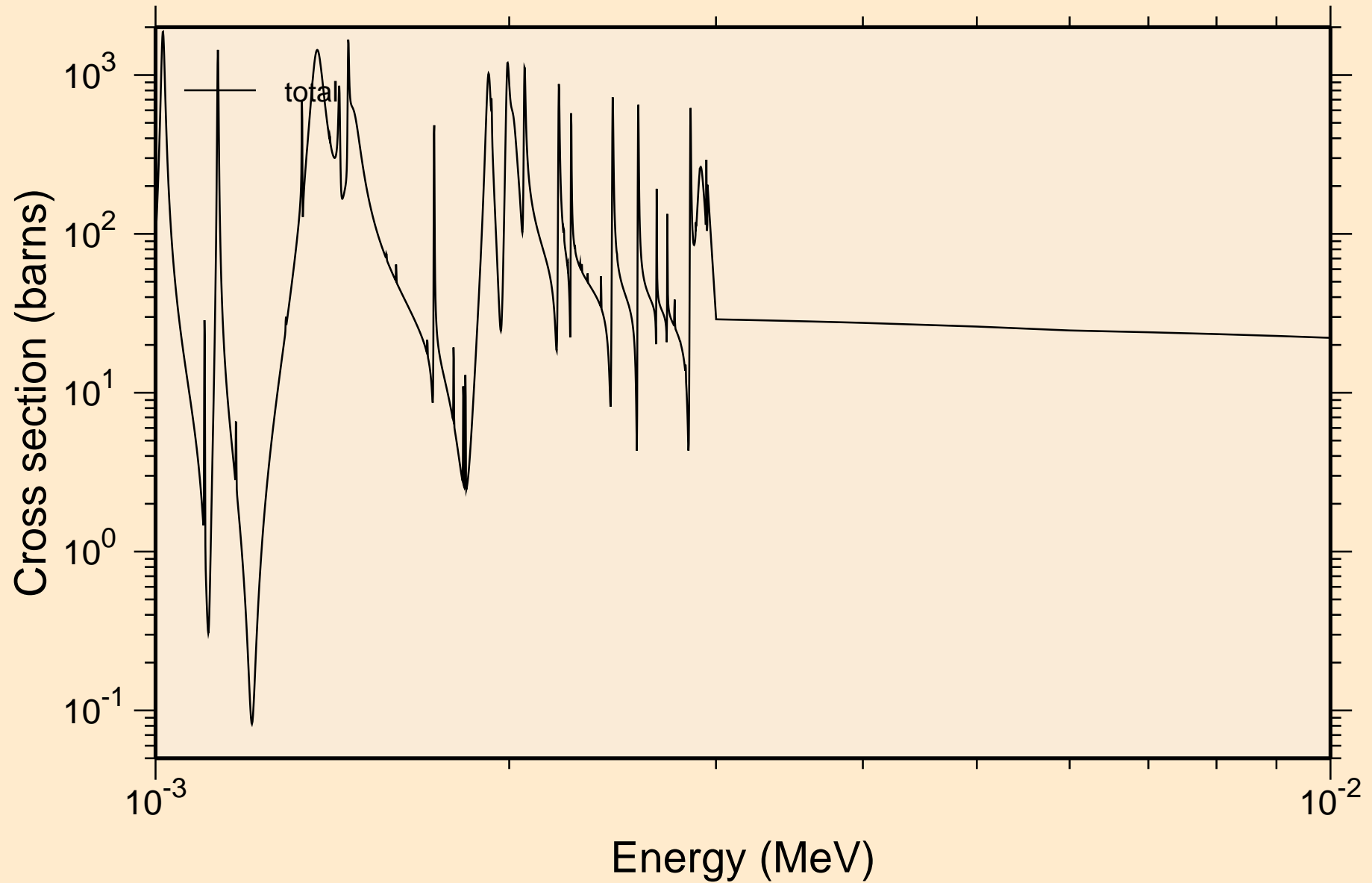

W193 NEUTRON ACER TENDL-2021 LIBRARY; T=293.6K
resonance total cross section

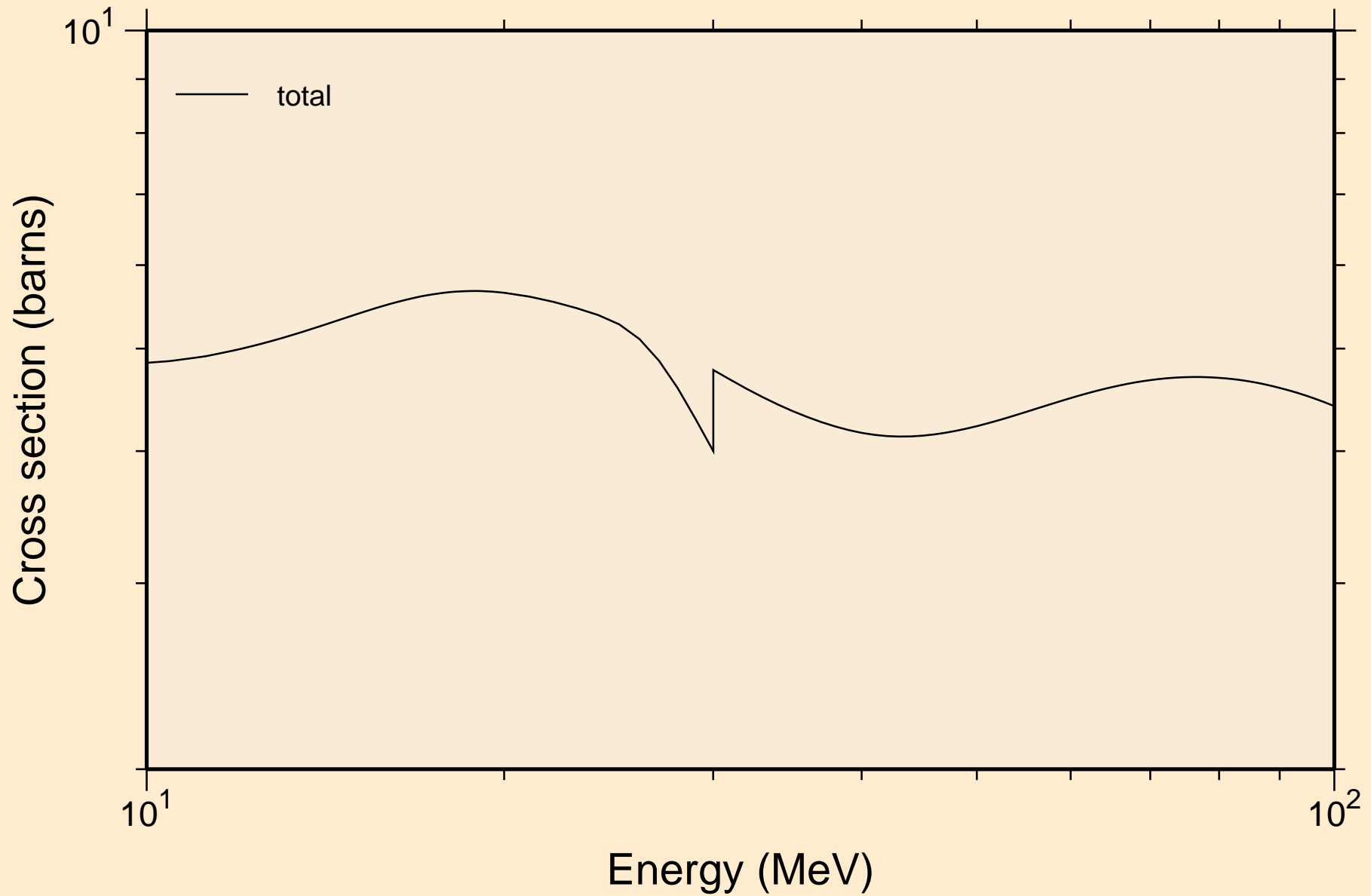

W193 NEUTRON ACER TENDL-2021 LIBRARY; T=293.6K
resonance absorption cross sections

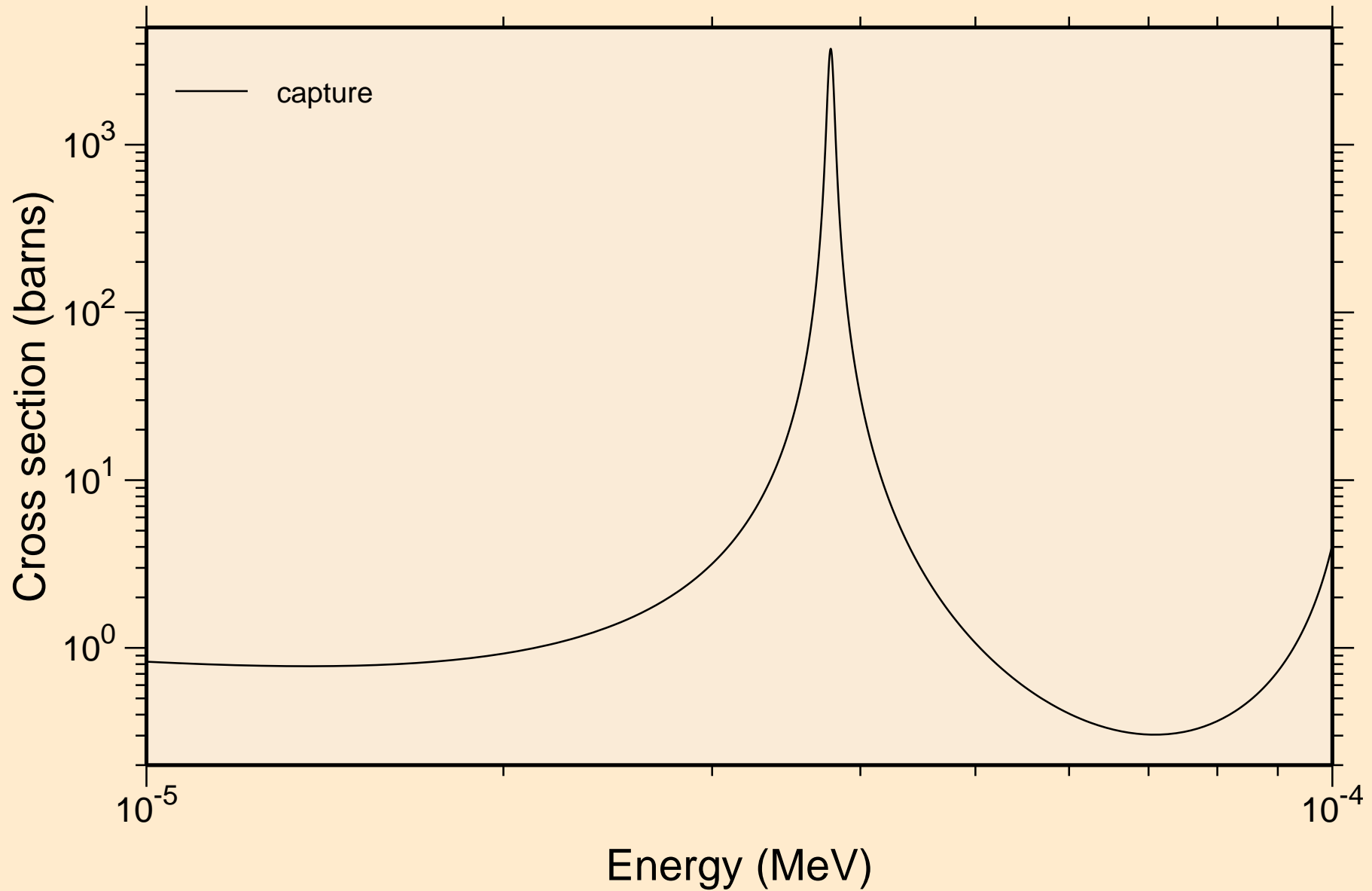

W193 NEUTRON ACER TENDL-2021 LIBRARY; T=293.6K
resonance absorption cross sections

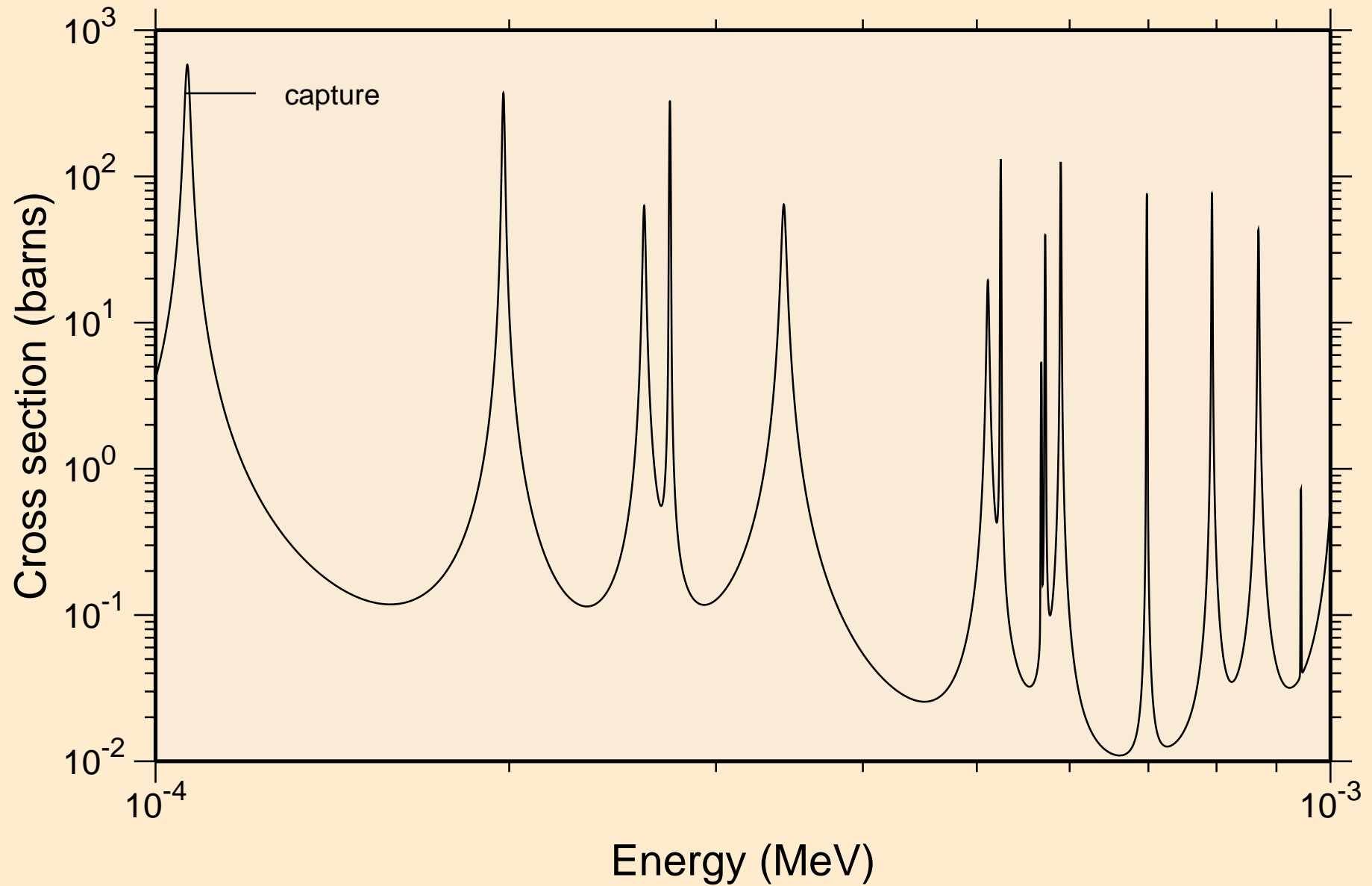

W193 NEUTRON ACER TENDL-2021 LIBRARY; T=293.6K
resonance absorption cross sections

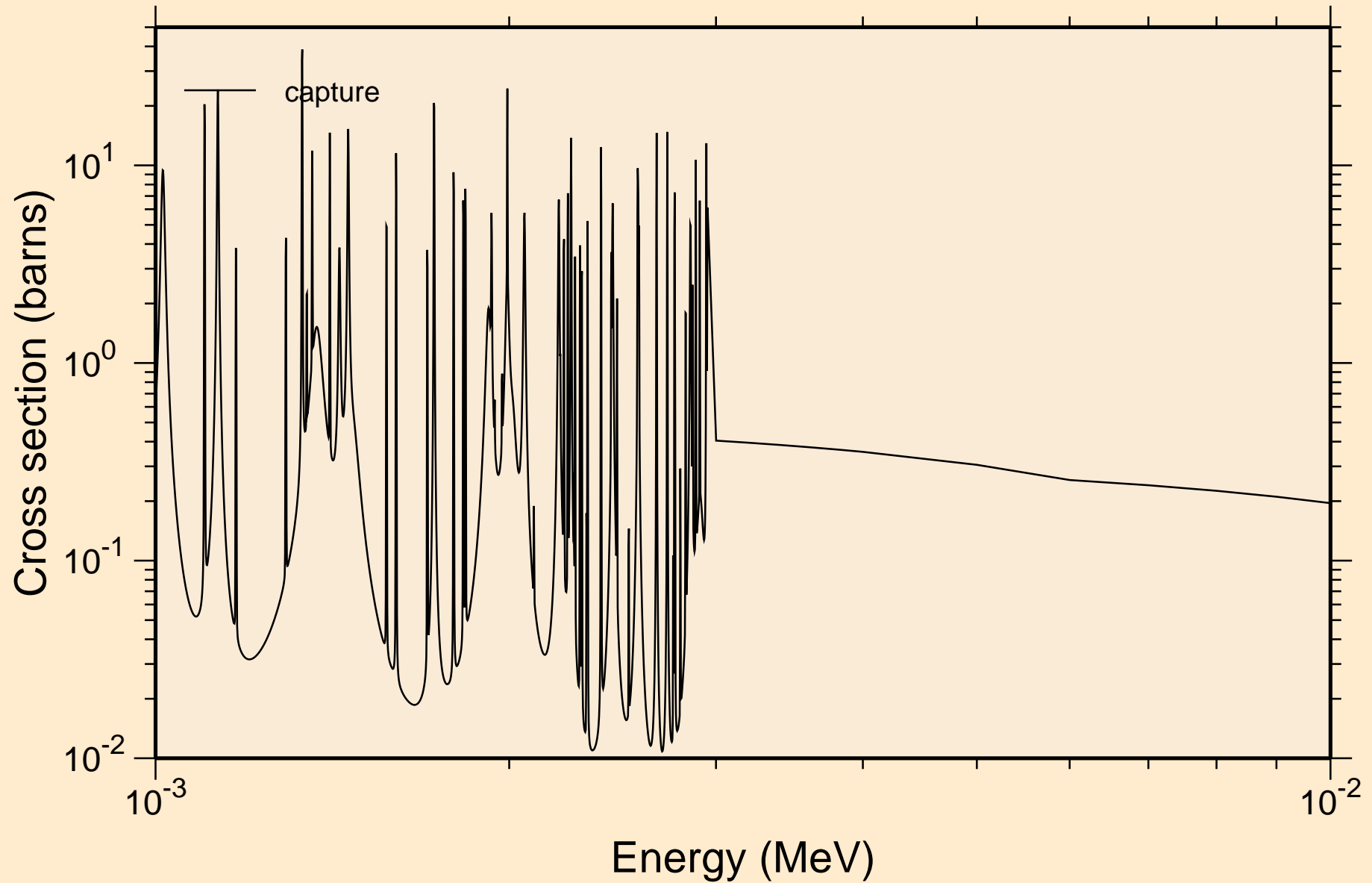

W193 NEUTRON ACER TENDL-2021 LIBRARY; T=293.6K
resonance absorption cross sections

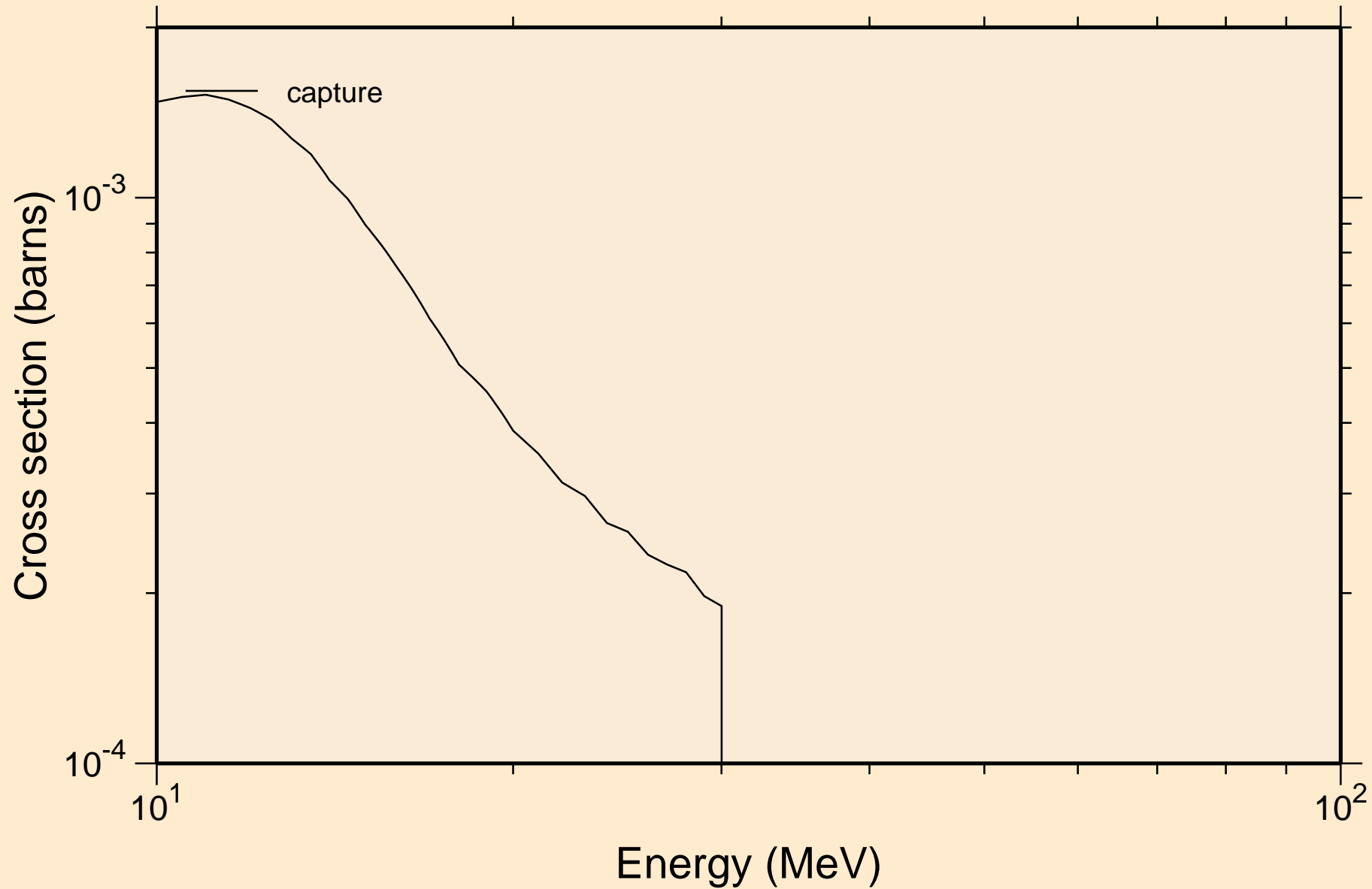

W193 NEUTRON ACER TENDL-2021 LIBRARY; T=293.6K
Heating

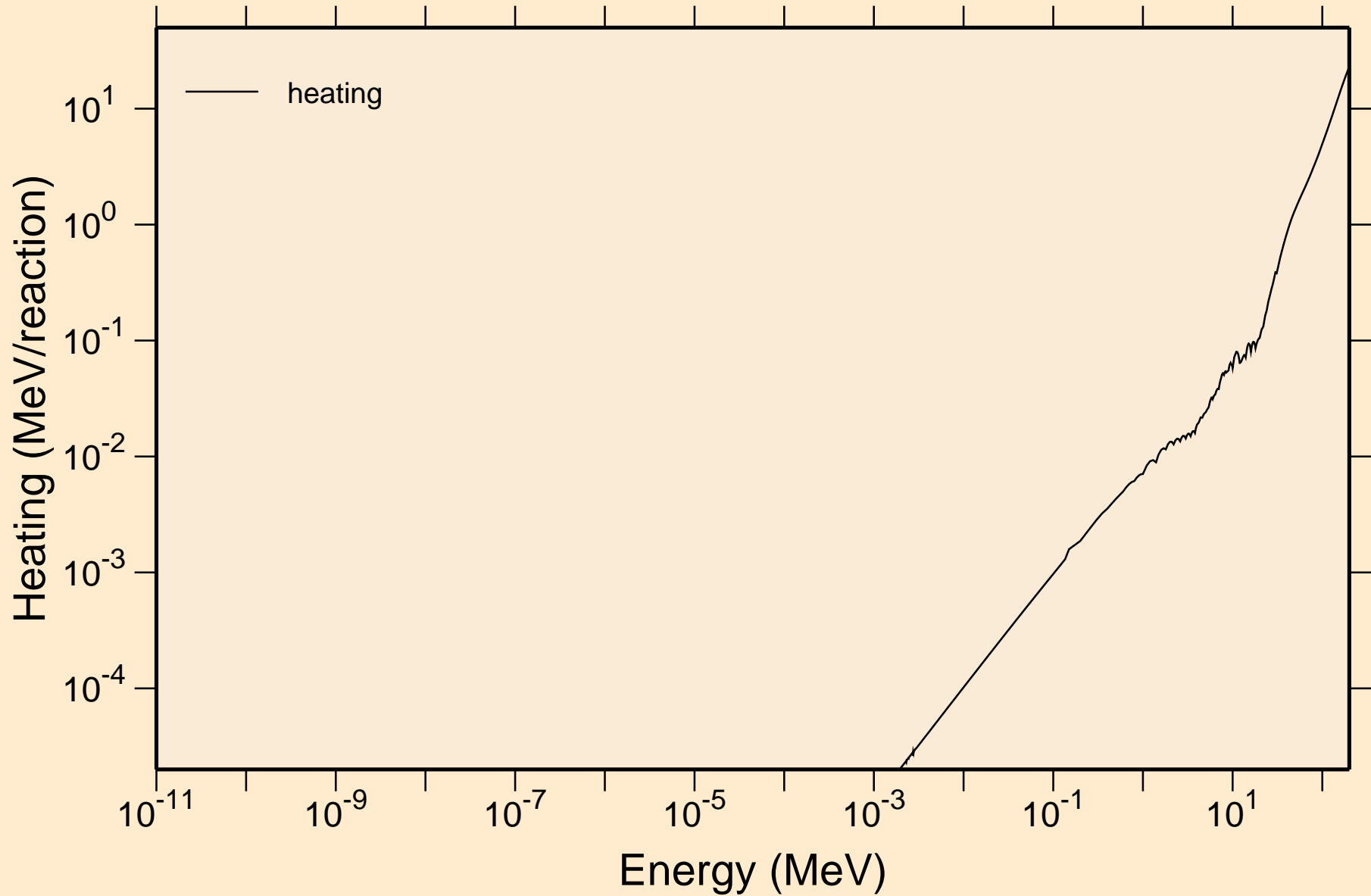

W193 NEUTRON ACER TENDL-2021 LIBRARY; T=293.6K

Damage

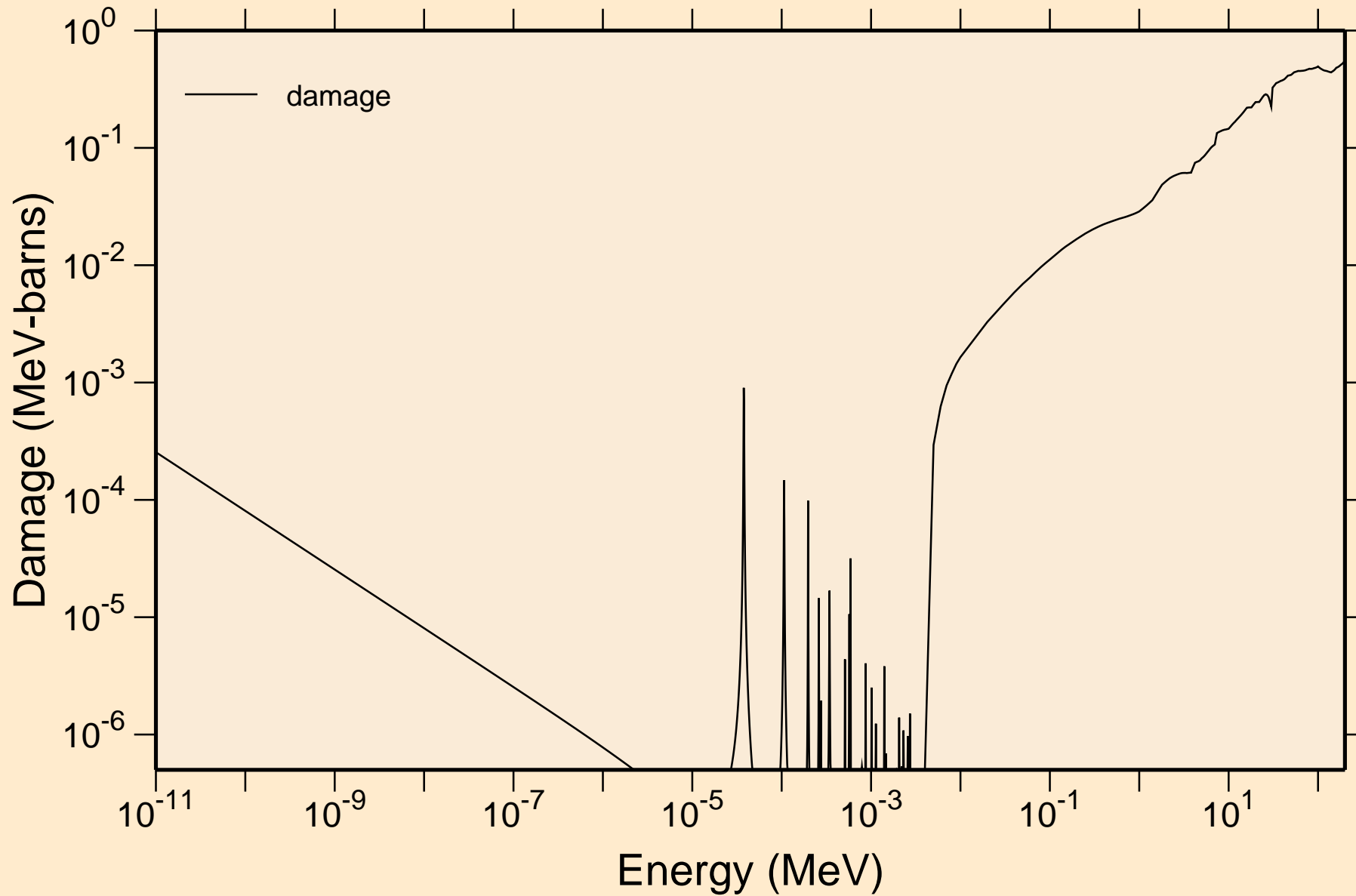

W193 NEUTRON ACER TENDL-2021 LIBRARY; T=293.6K
Non-threshold reactions

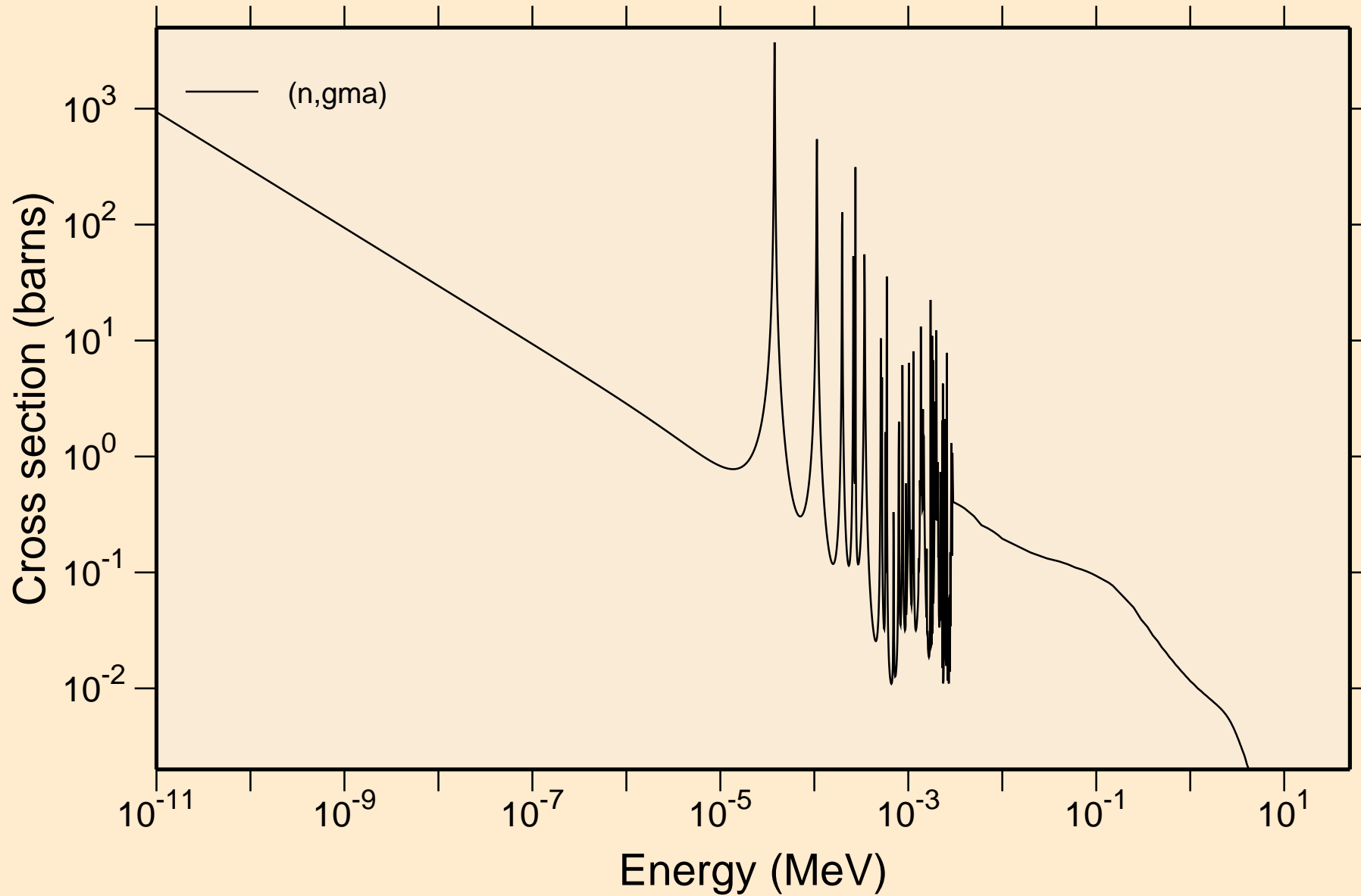

W193 NEUTRON ACER TENDL-2021 LIBRARY; T=293.6K
Principal cross sections

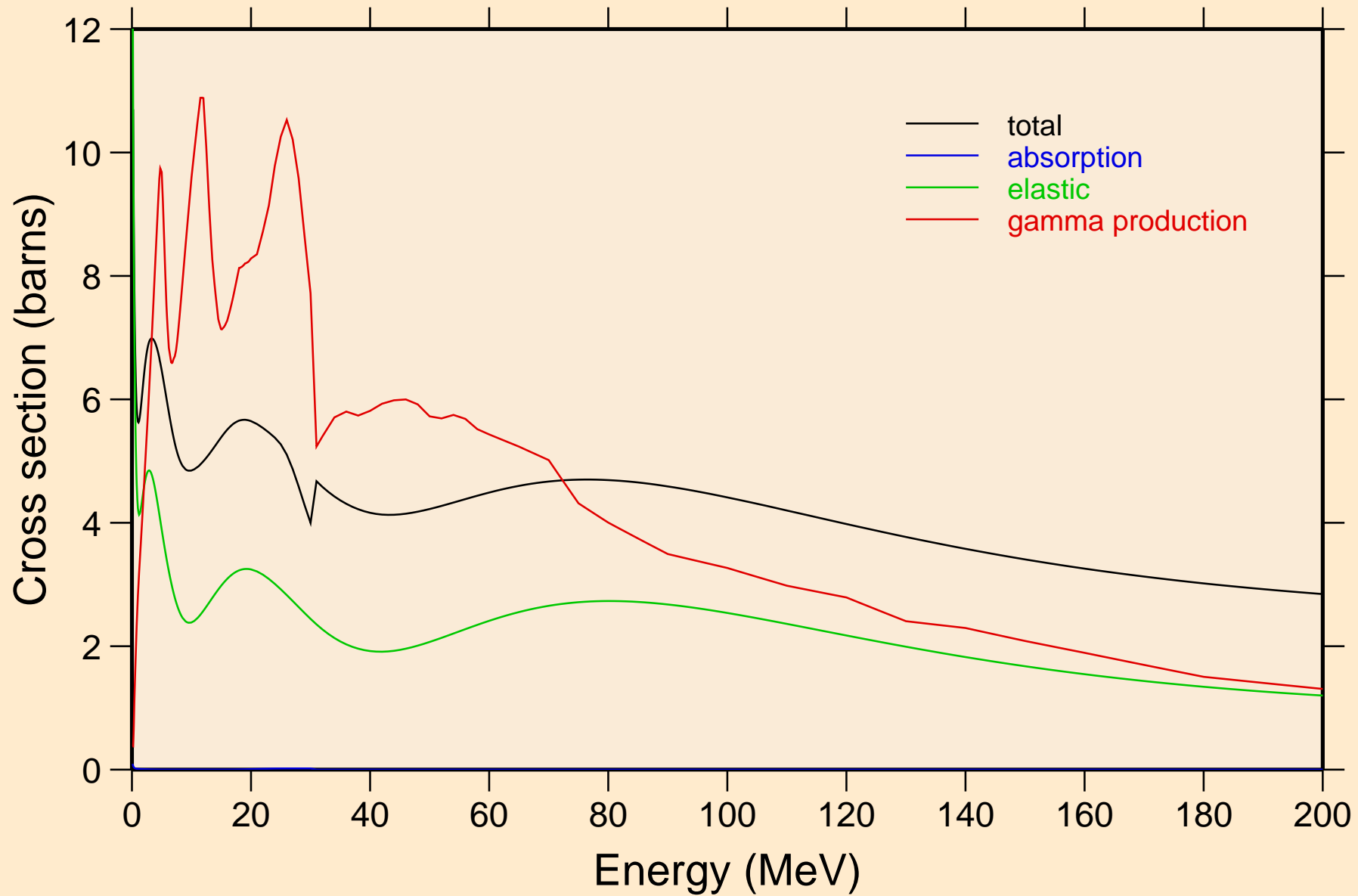

W193 NEUTRON ACER TENDL-2021 LIBRARY; T=293.6K
Heating

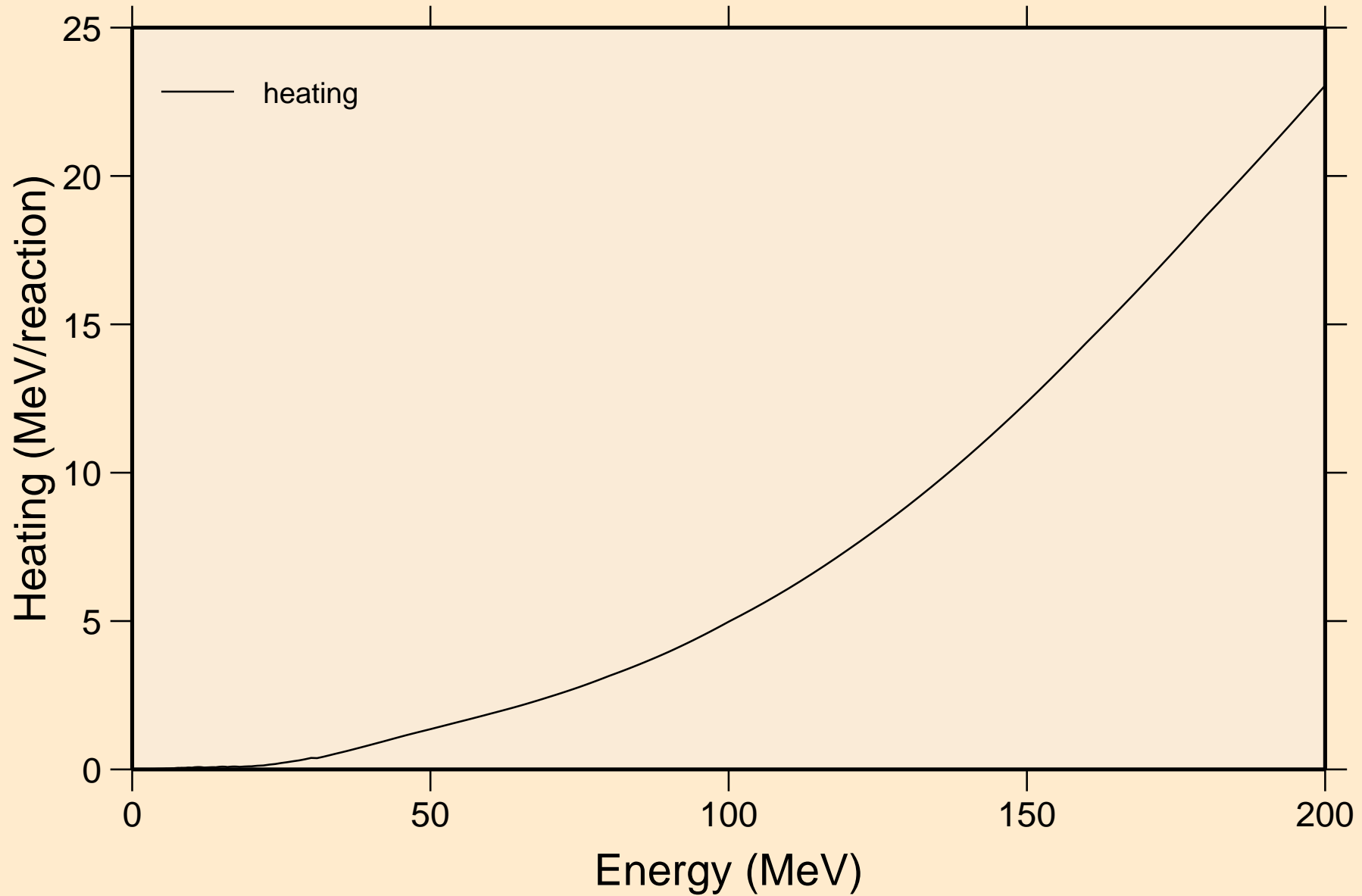

W193 NEUTRON ACER TENDL-2021 LIBRARY; T=293.6K
Damage

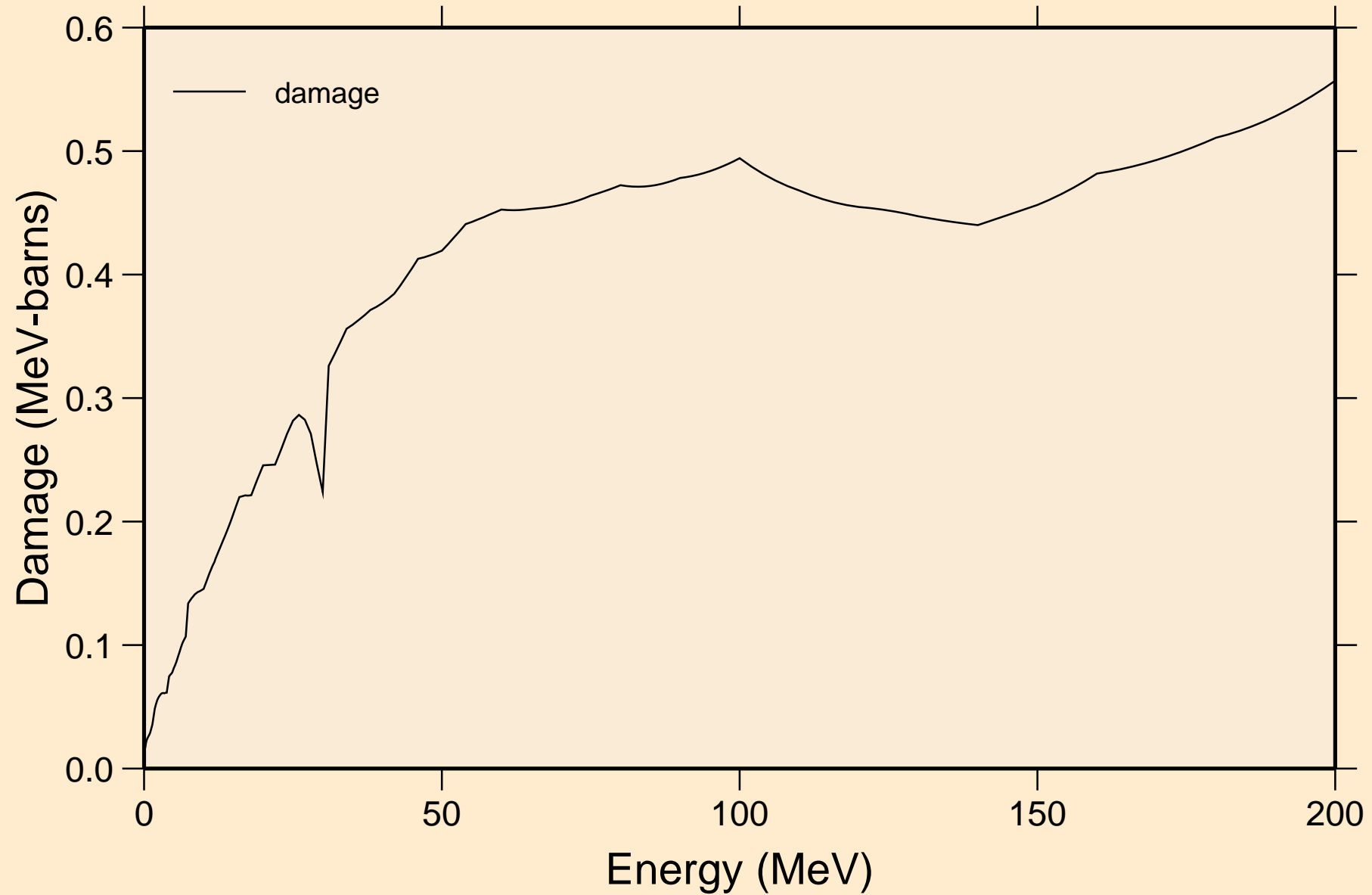

W193 NEUTRON ACER TENDL-2021 LIBRARY; T=293.6K
Non-threshold reactions

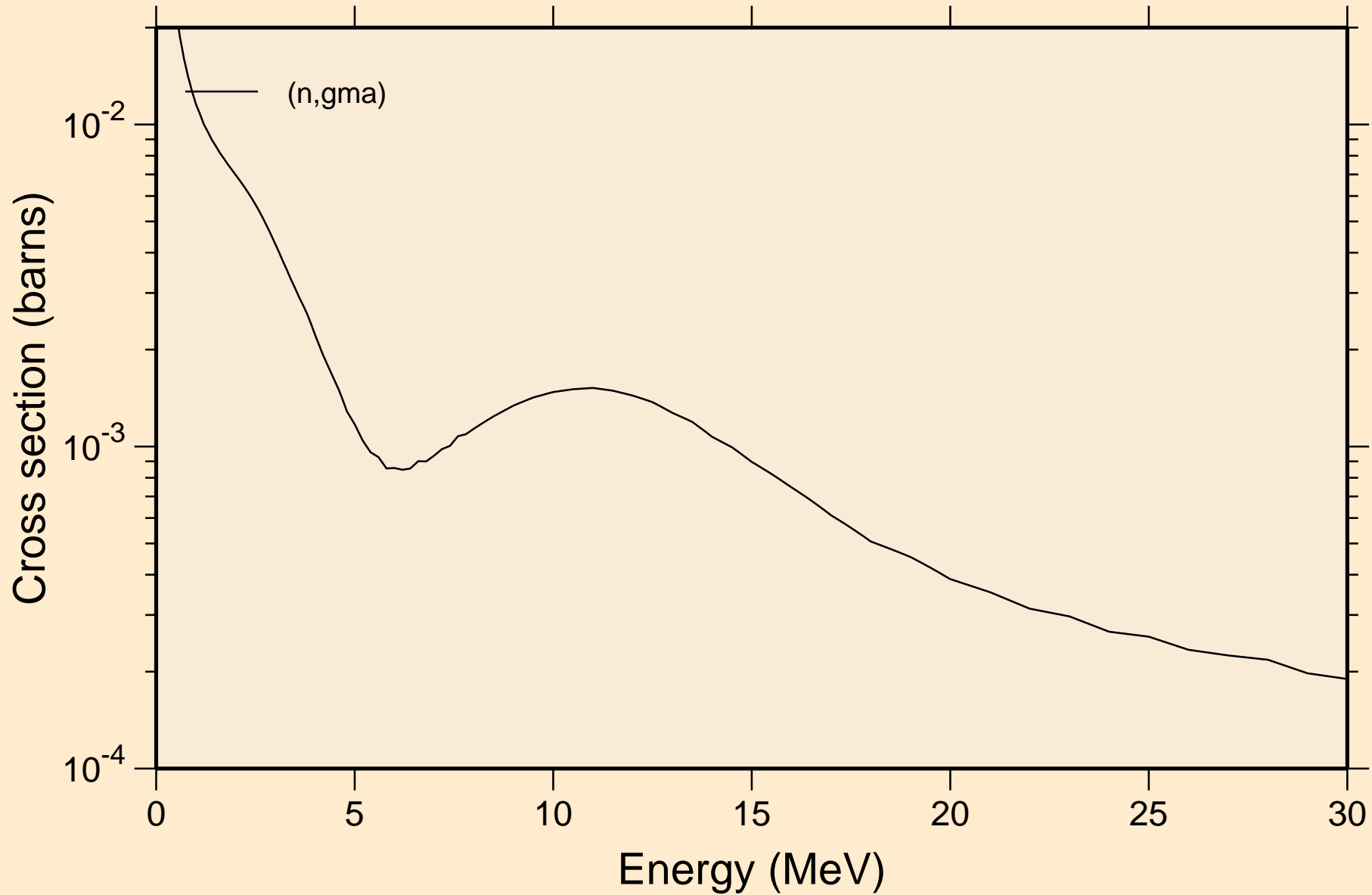

W193 NEUTRON ACER TENDL-2021 LIBRARY; T=293.6K
Inelastic levels

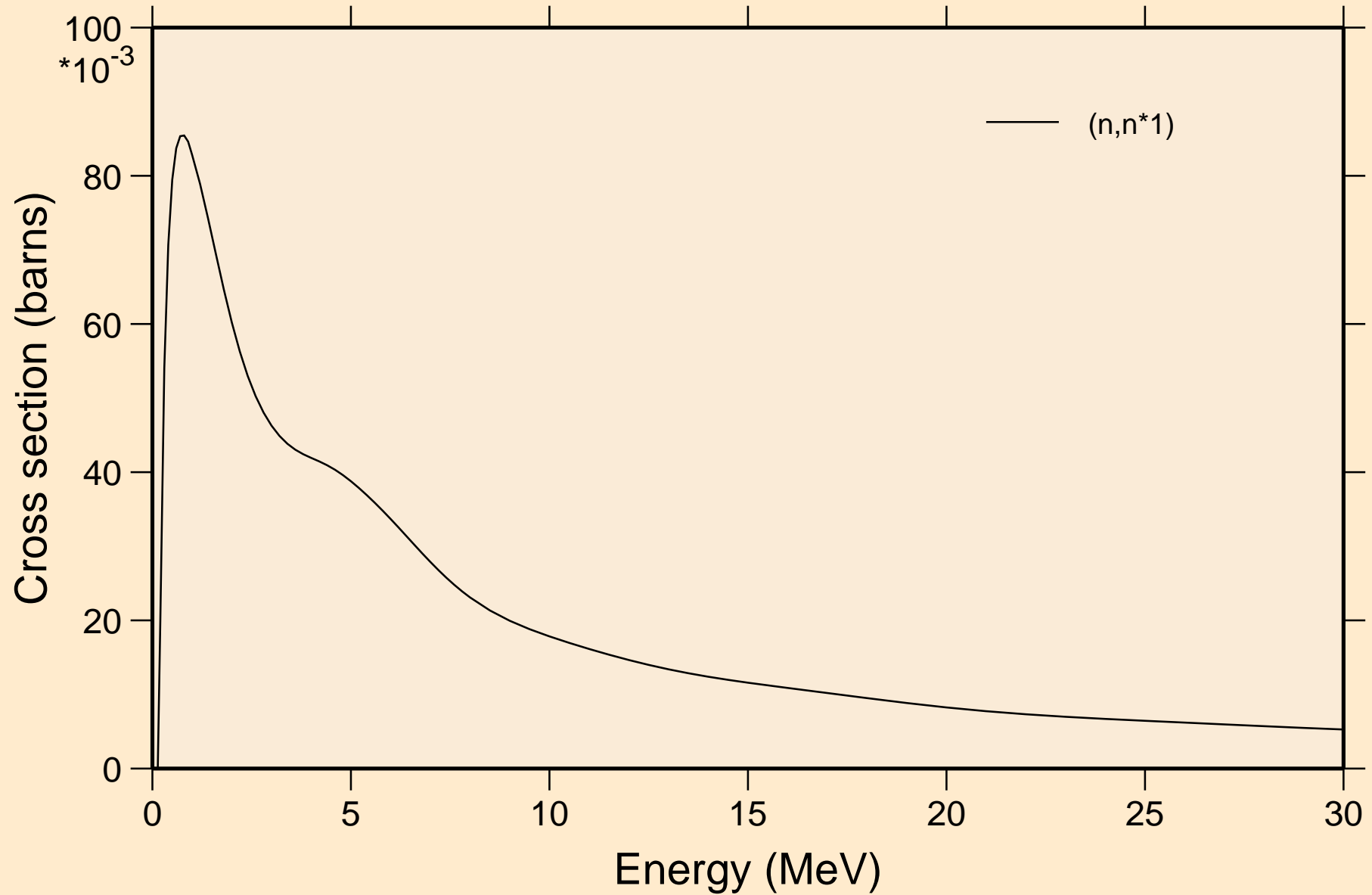

W193 NEUTRON ACER TENDL-2021 LIBRARY; T=293.6K
Threshold reactions

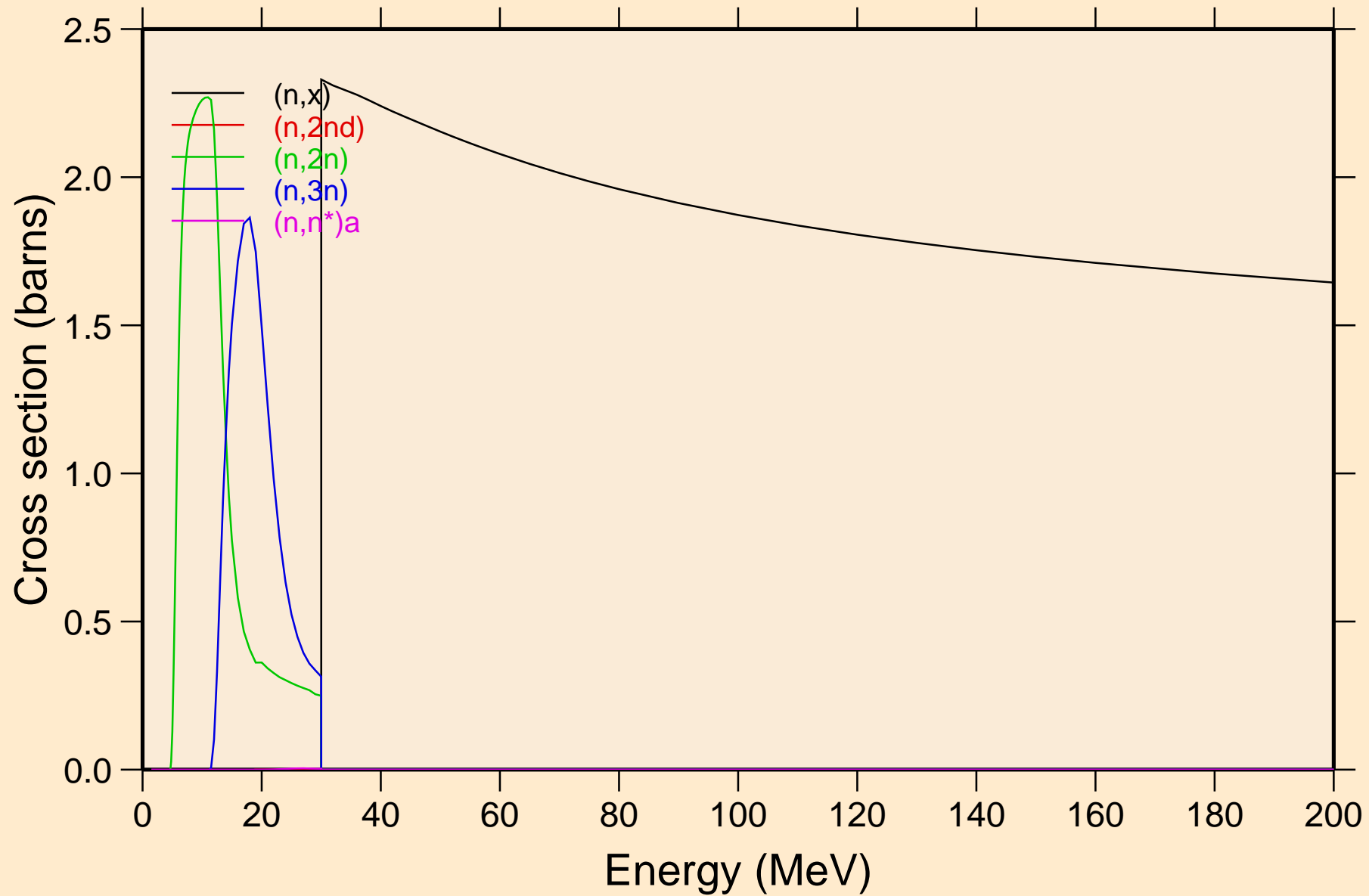

W193 NEUTRON ACER TENDL-2021 LIBRARY; T=293.6K
Threshold reactions

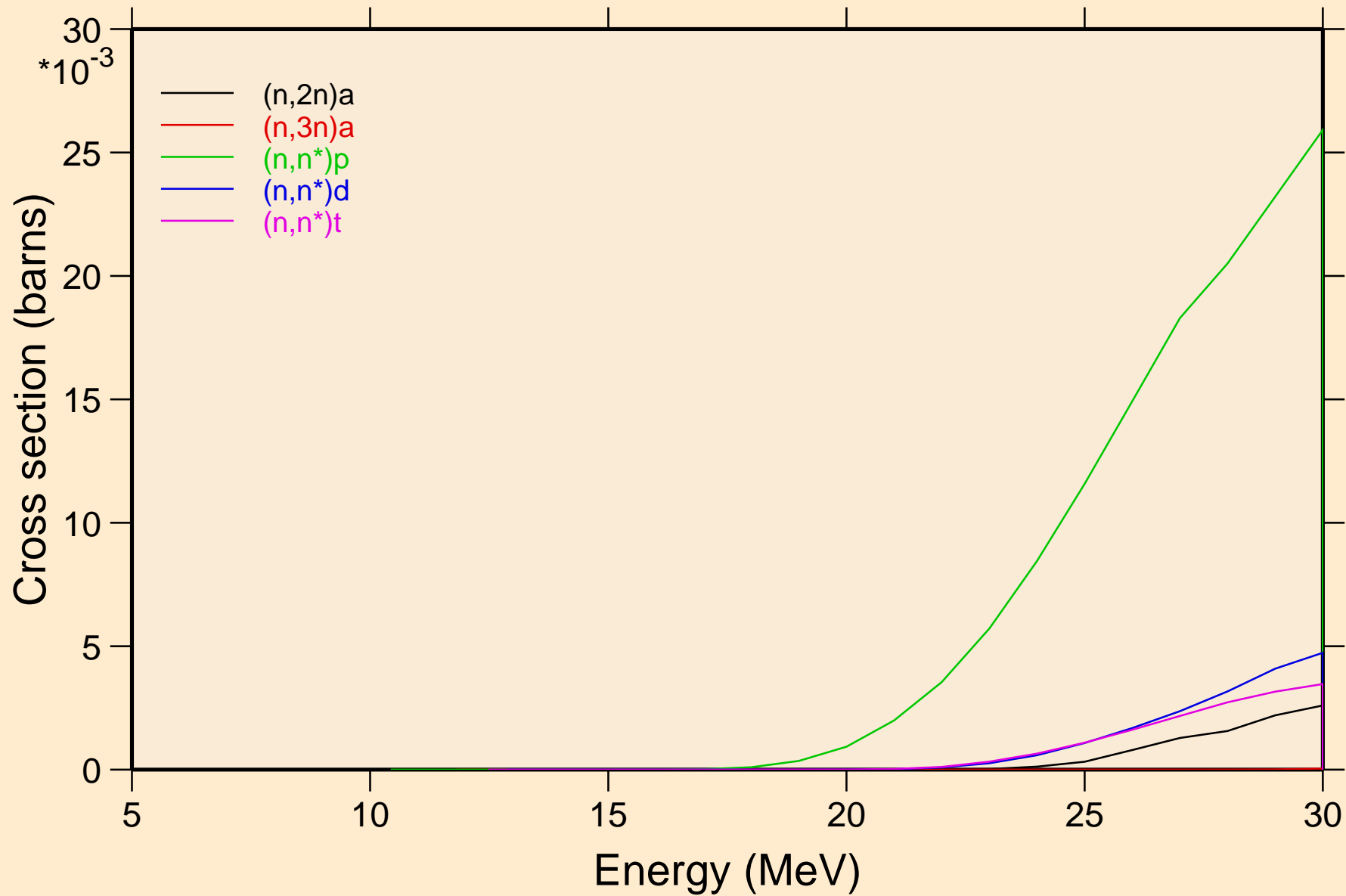

W193 NEUTRON ACER TENDL-2021 LIBRARY; T=293.6K
Threshold reactions

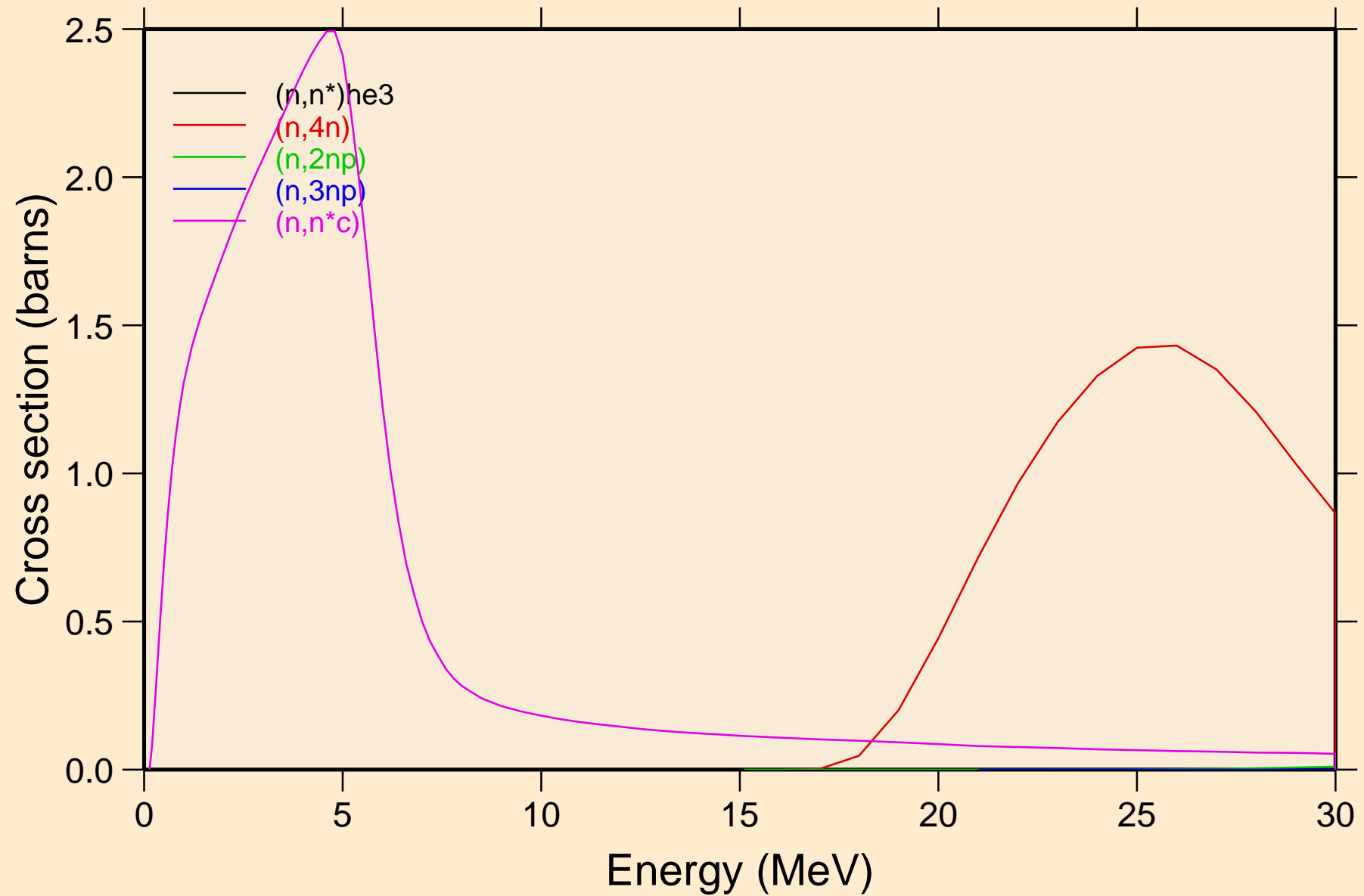

W193 NEUTRON ACER TENDL-2021 LIBRARY; T=293.6K
Threshold reactions

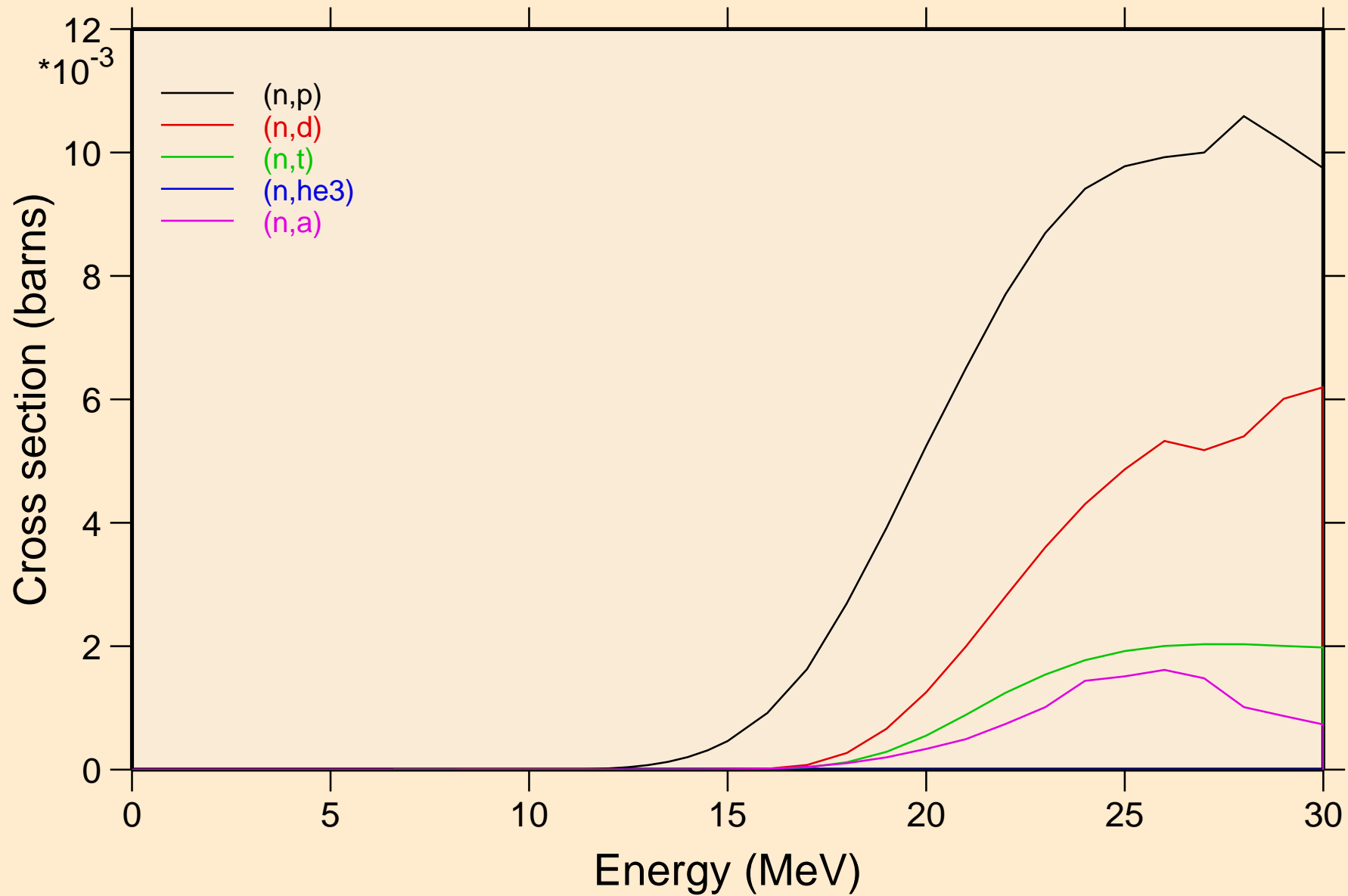

W193 NEUTRON ACER TENDL-2021 LIBRARY; T=293.6K
Threshold reactions

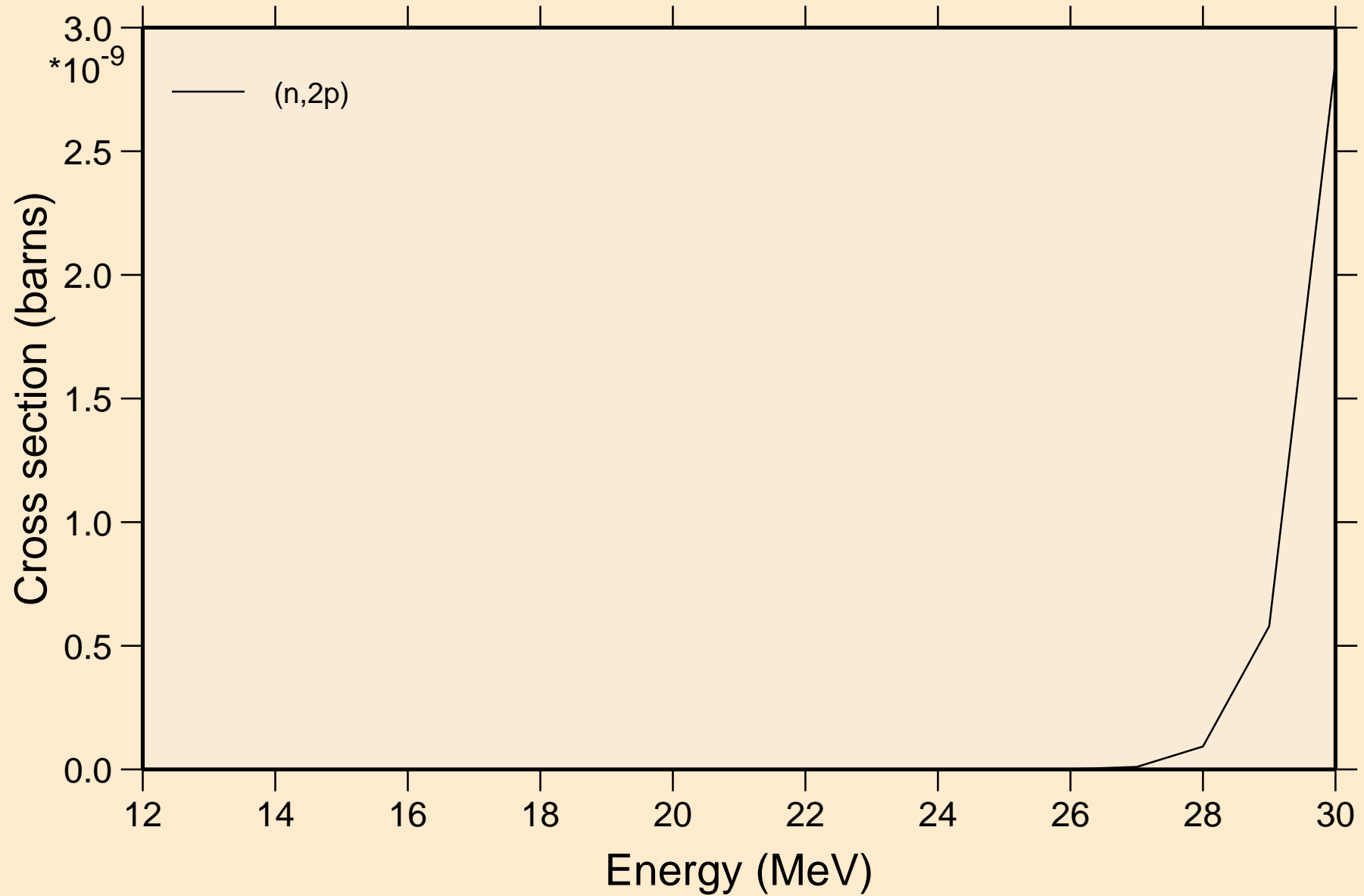

W193 NEUTRON ACER TENDL-2021 LIBRARY; T=293.6K
Threshold reactions

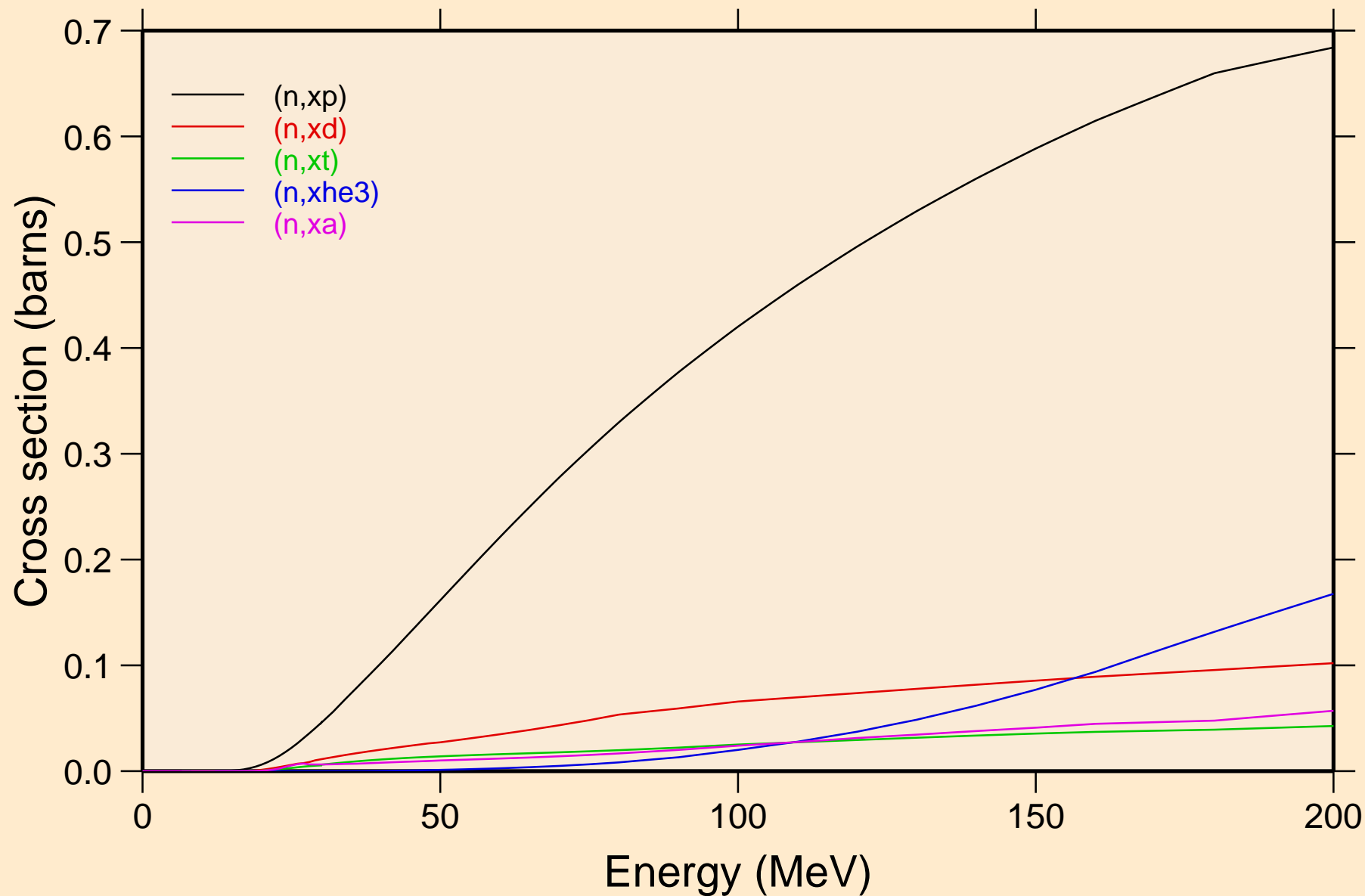

W193 NEUTRON ACER TENDL-2021 LIBRARY; T=293.6K
angular distribution for elastic

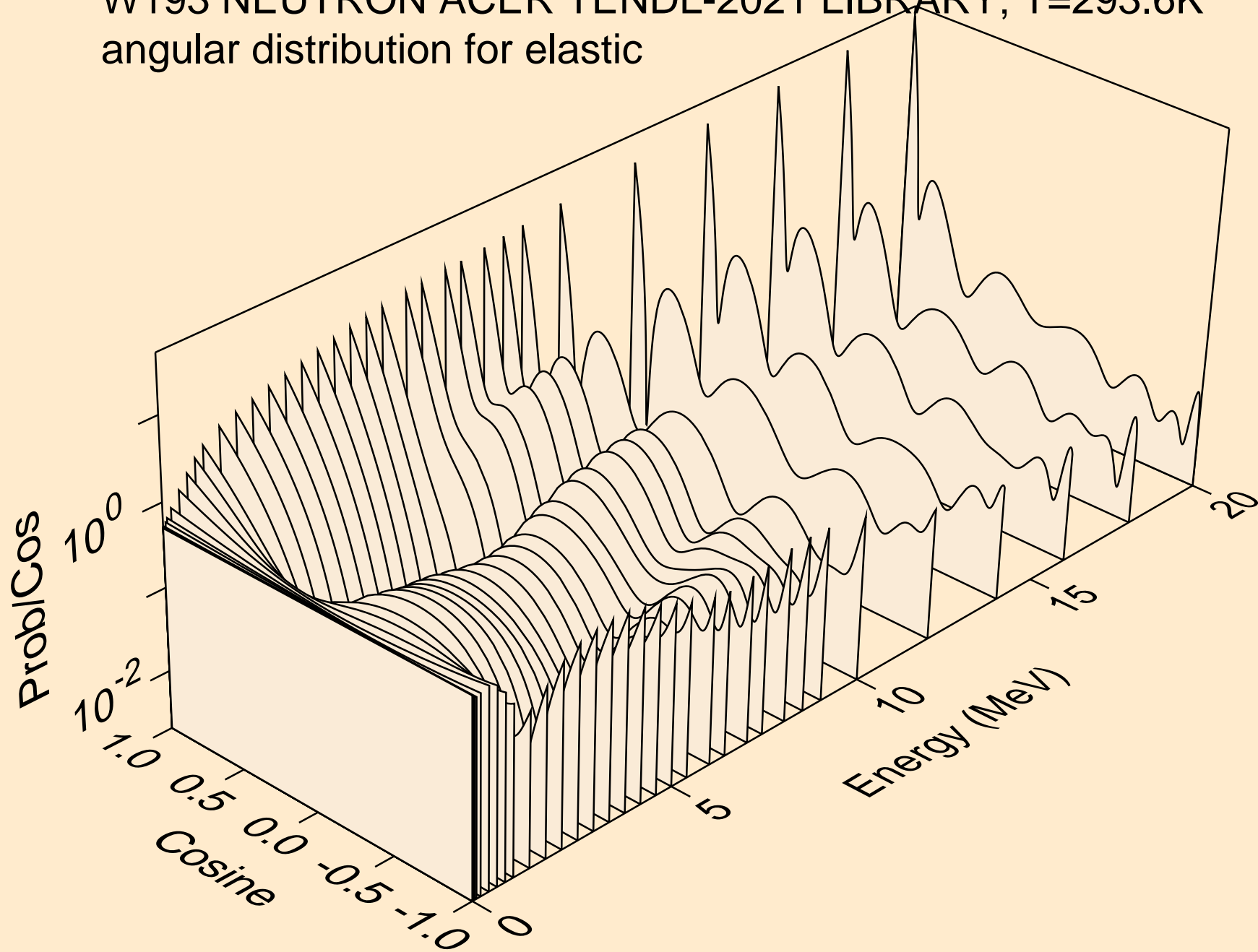

W193 NEUTRON ACER TENDL-2021 LIBRARY; T=293.6K
angular distribution for elastic

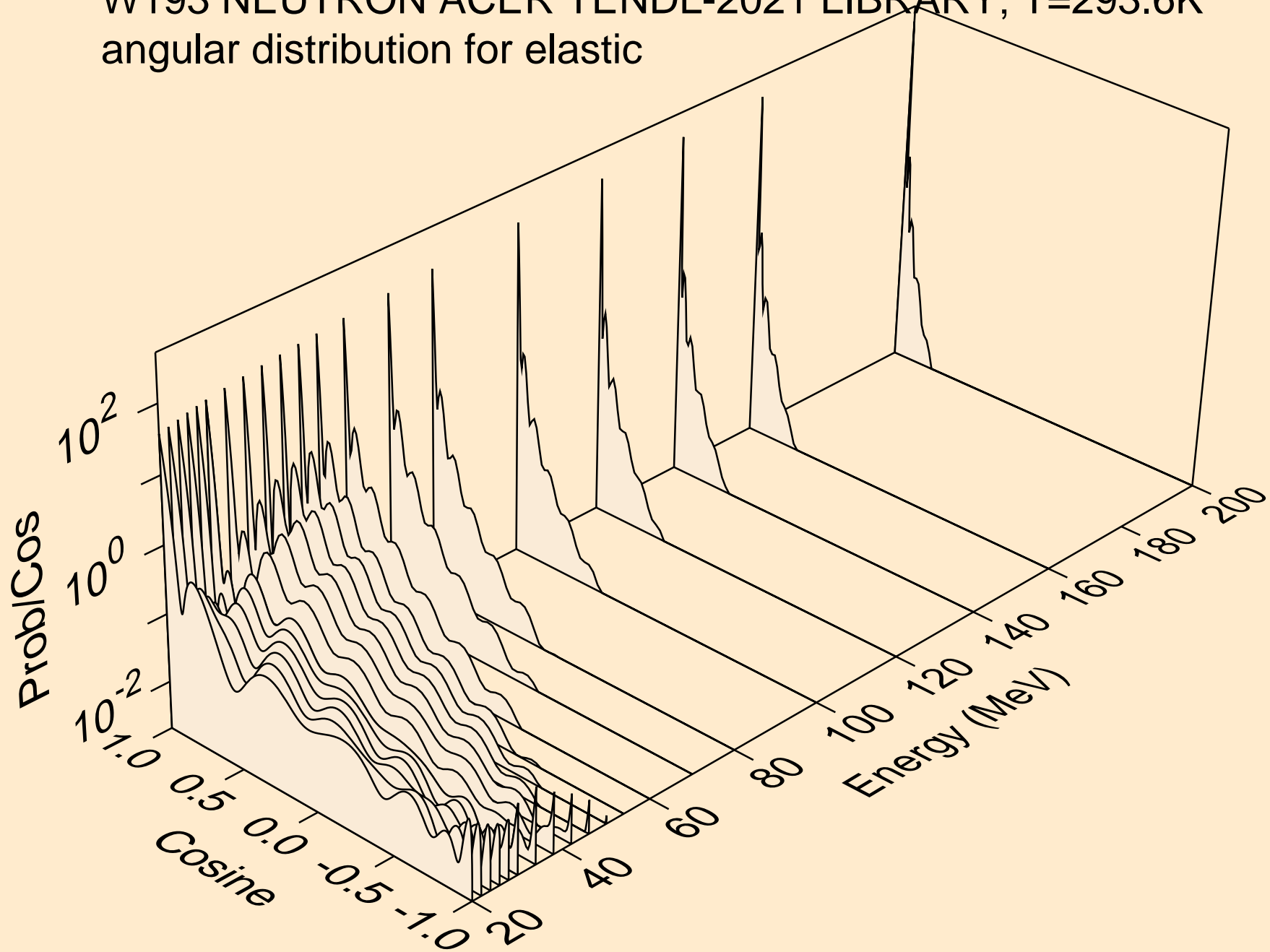

W193 NEUTRON ACER TENDL-2021 LIBRARY; T=293.6K
angular distribution for (n,n*1)

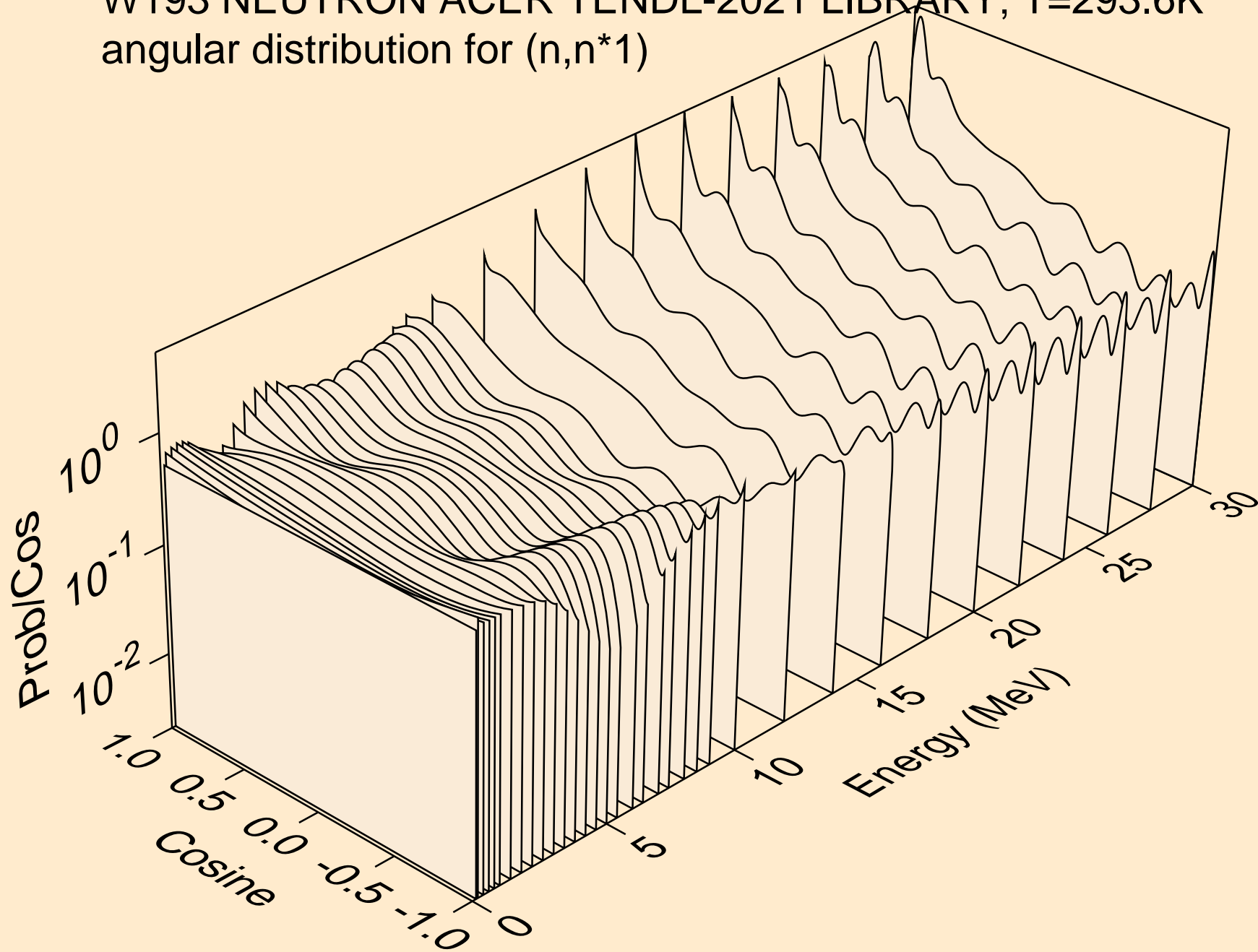

W193 NEUTRON ACER TENDL-2021 LIBRARY; T=293.6K
Neutron emission for (n,x)

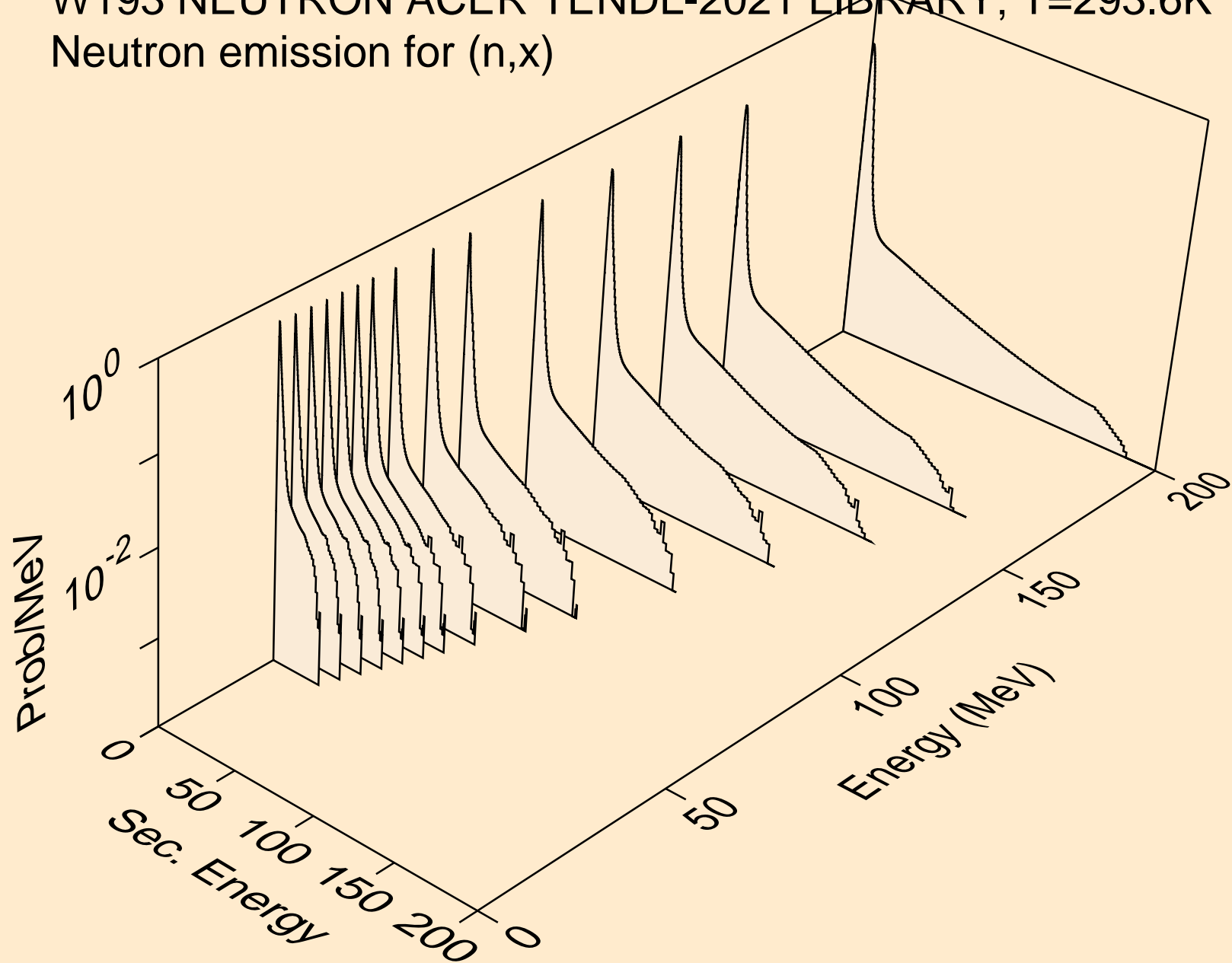

W193 NEUTRON ACER TENDL-2021 LIBRARY; T=293.6K
Neutron emission for (n,2nd)

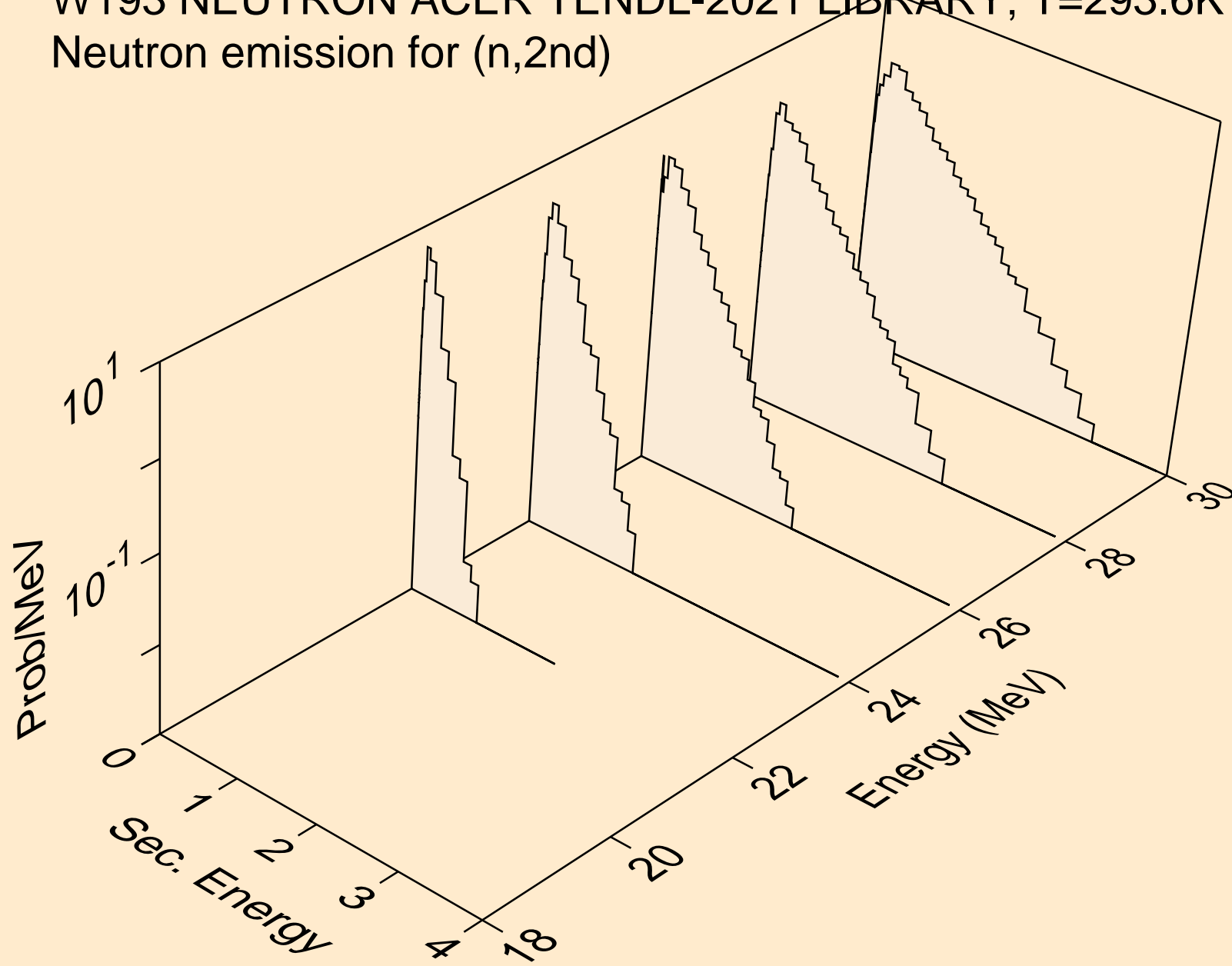

W193 NEUTRON ACER TENDL-2021 LIBRARY; T=293.6K
Neutron emission for (n,2n)

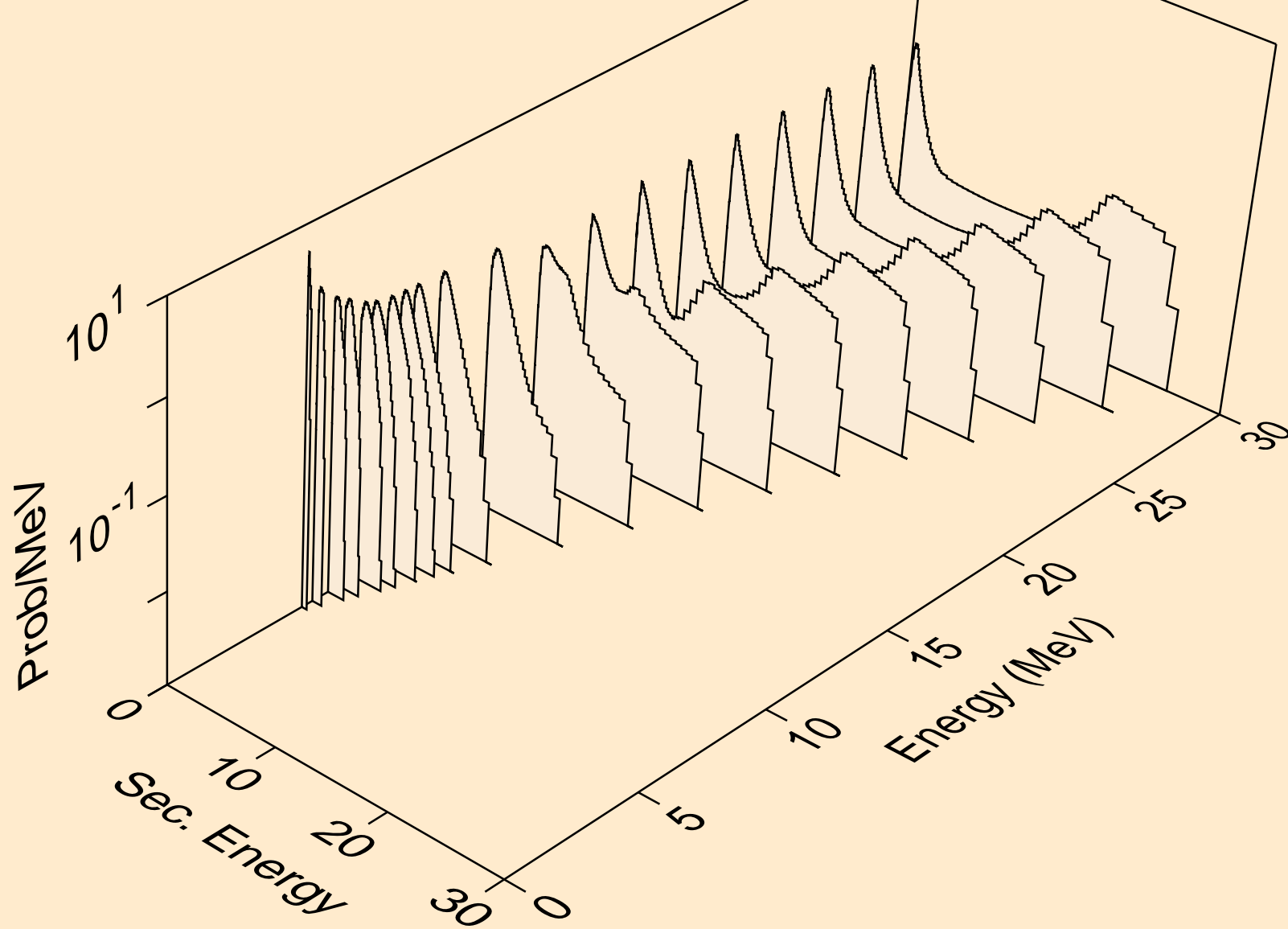

W193 NEUTRON ACER TENDL-2021 LIBRARY; T=293.6K
Neutron emission for (n,3n)

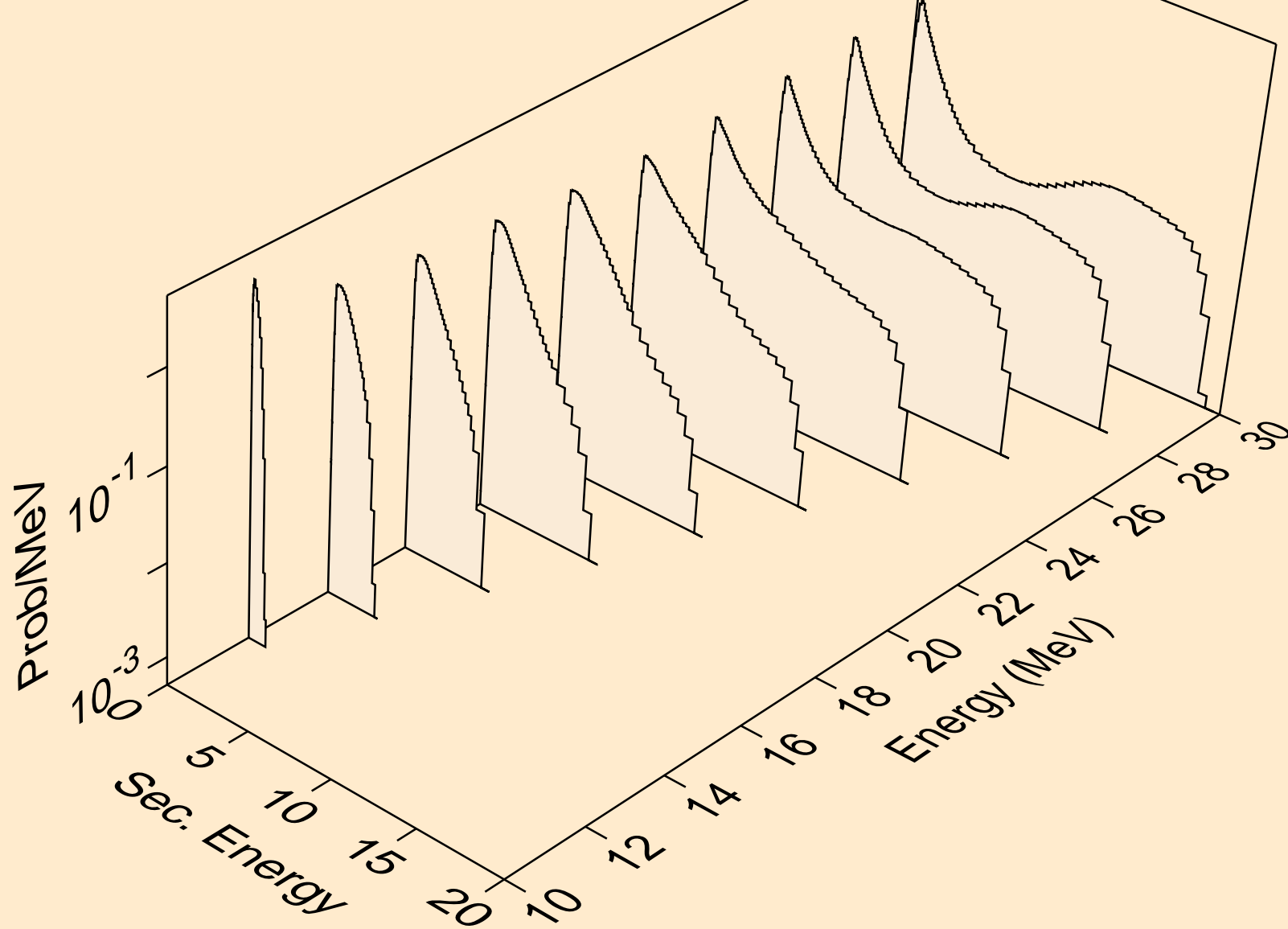

W193 NEUTRON ACER TENDL-2021 LIBRARY; T=293.6K
Neutron emission for (n,n*)a

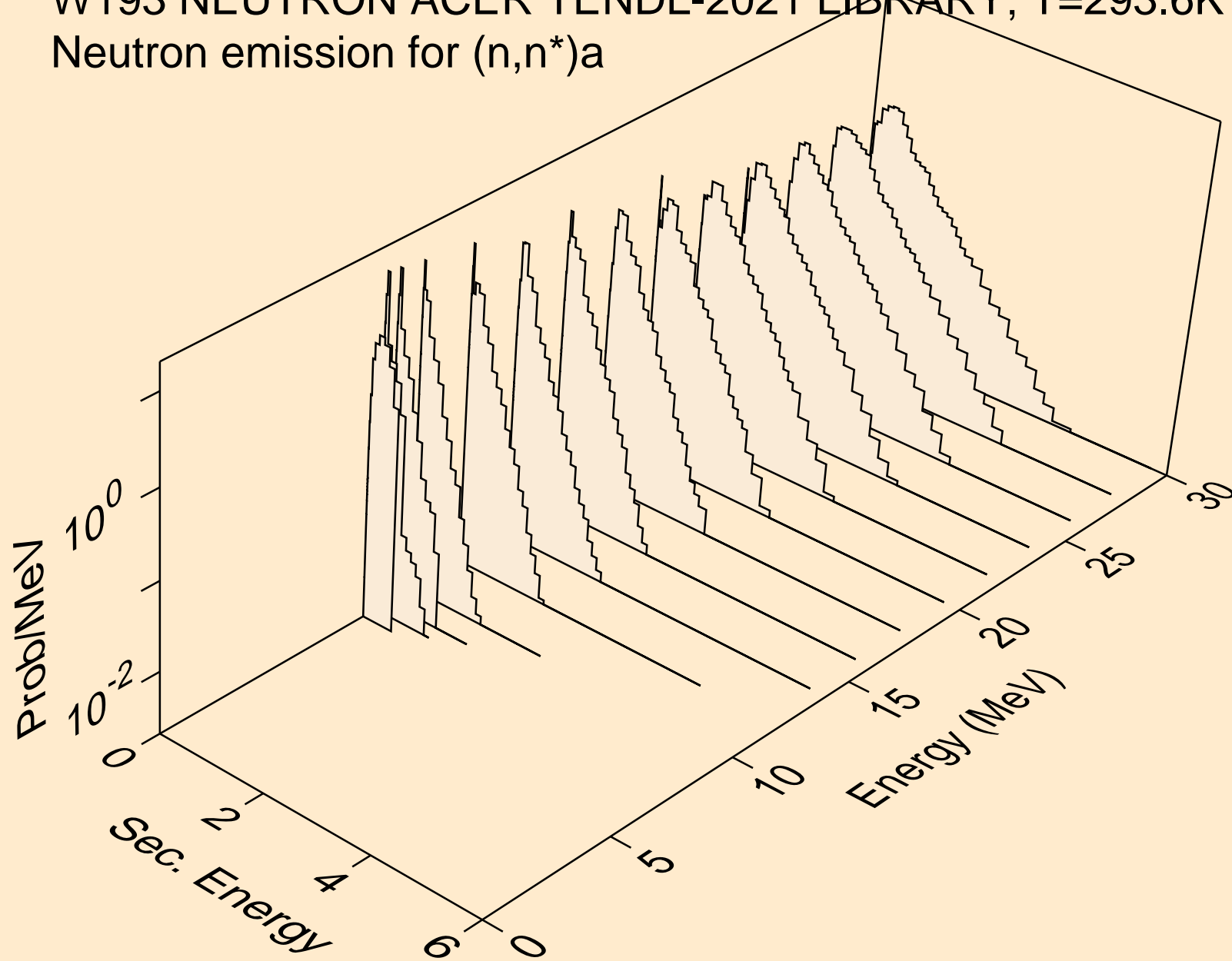

W193 NEUTRON ACER TENDL-2021 LIBRARY; T=293.6K
Neutron emission for (n,2n)a

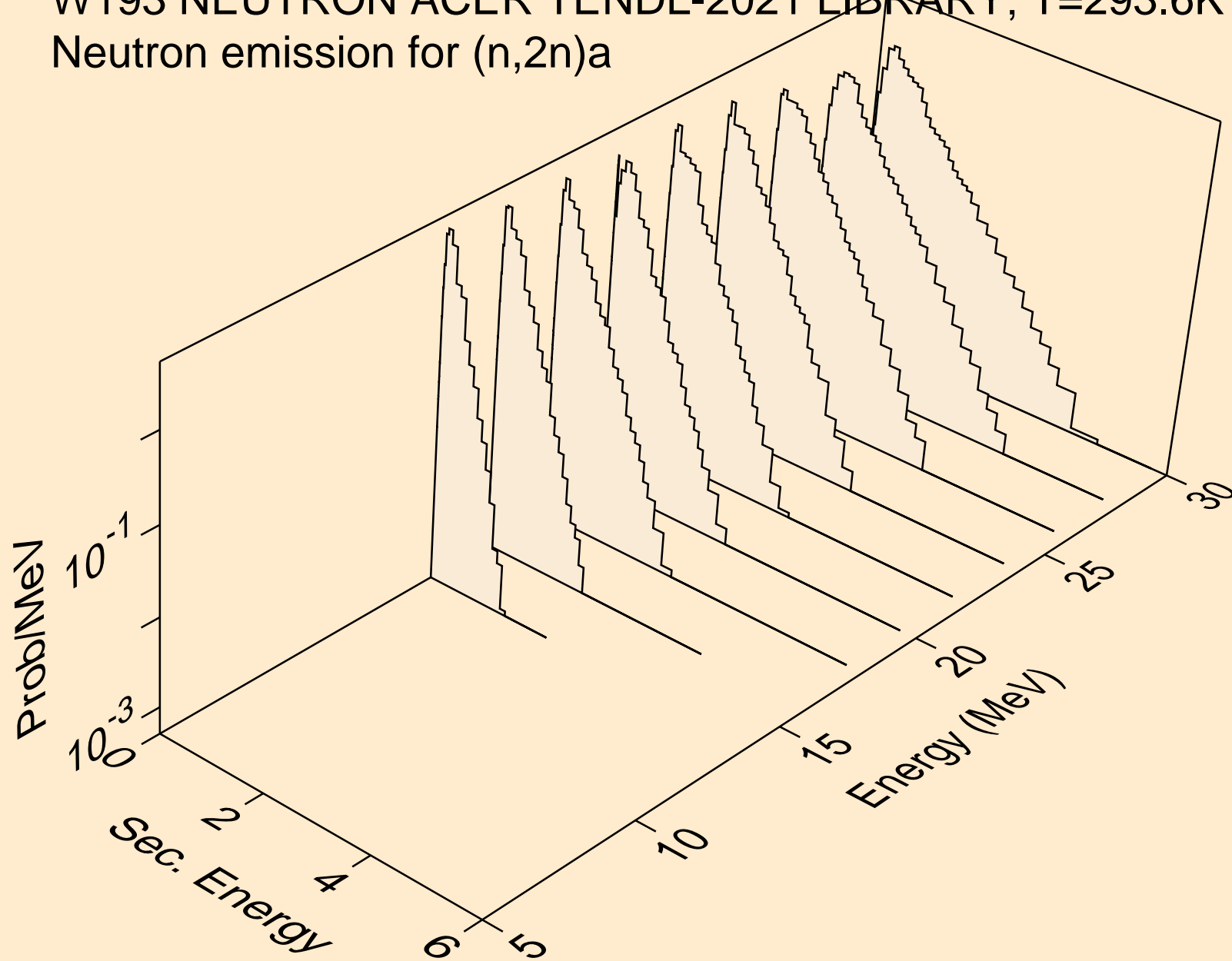

W193 NEUTRON ACER TENDL-2021 LIBRARY; T=293.6K
Neutron emission for (n,3n)a

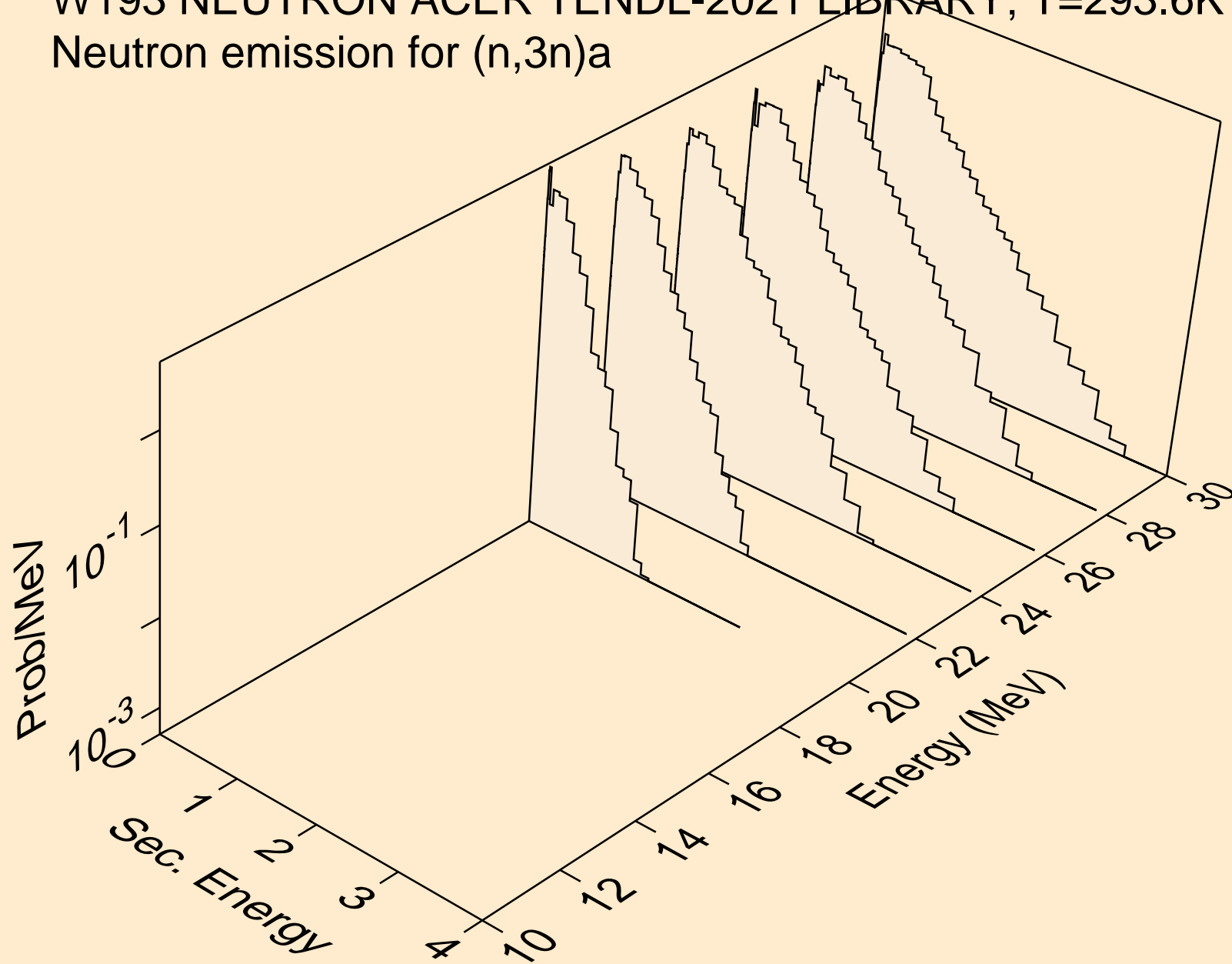

W193 NEUTRON ACER TENDL-2021 LIBRARY; T=293.6K
Neutron emission for (n,n*)p

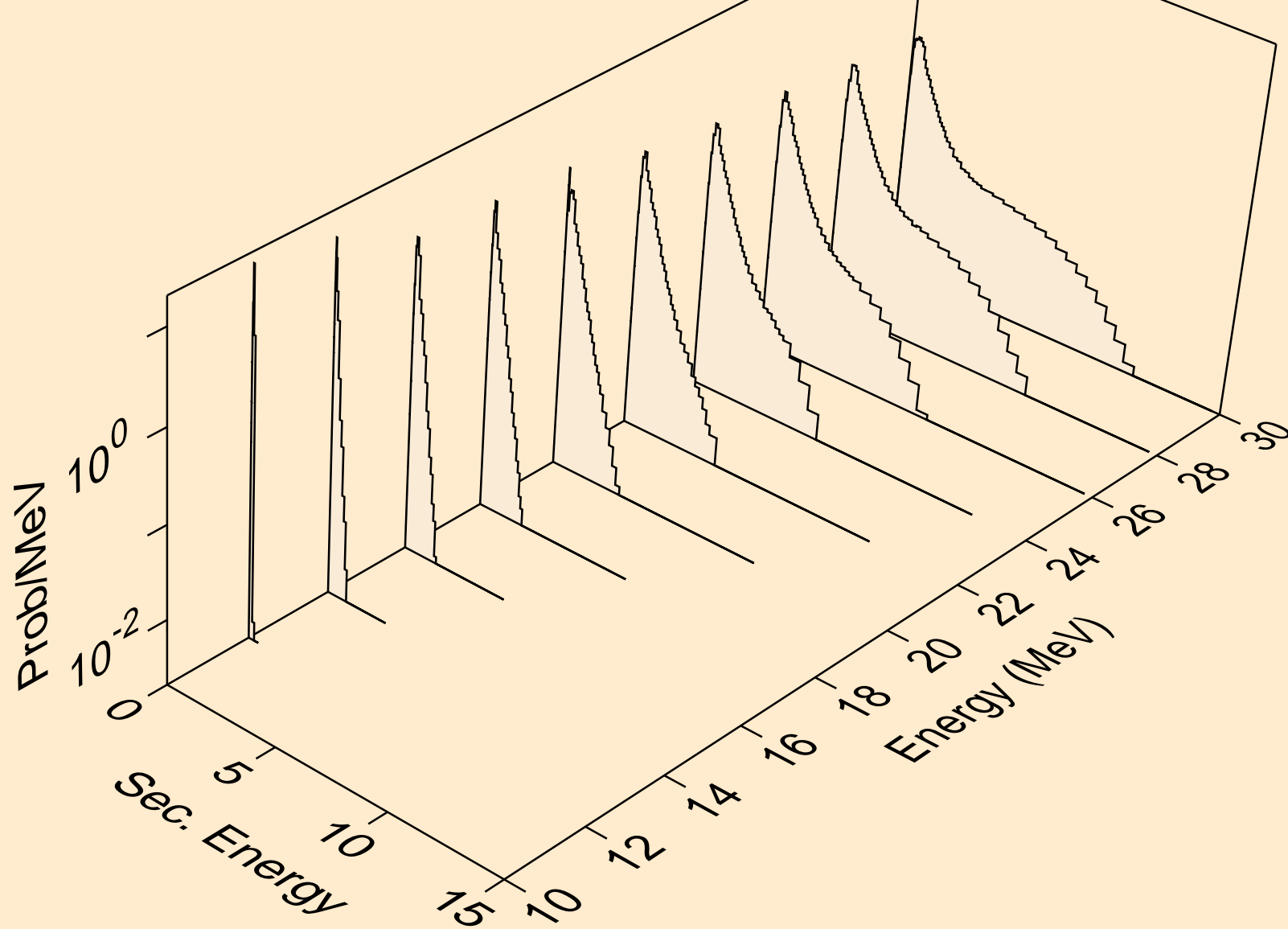

W193 NEUTRON ACER TENDL-2021 LIBRARY; T=293.6K
Neutron emission for (n,n*)d

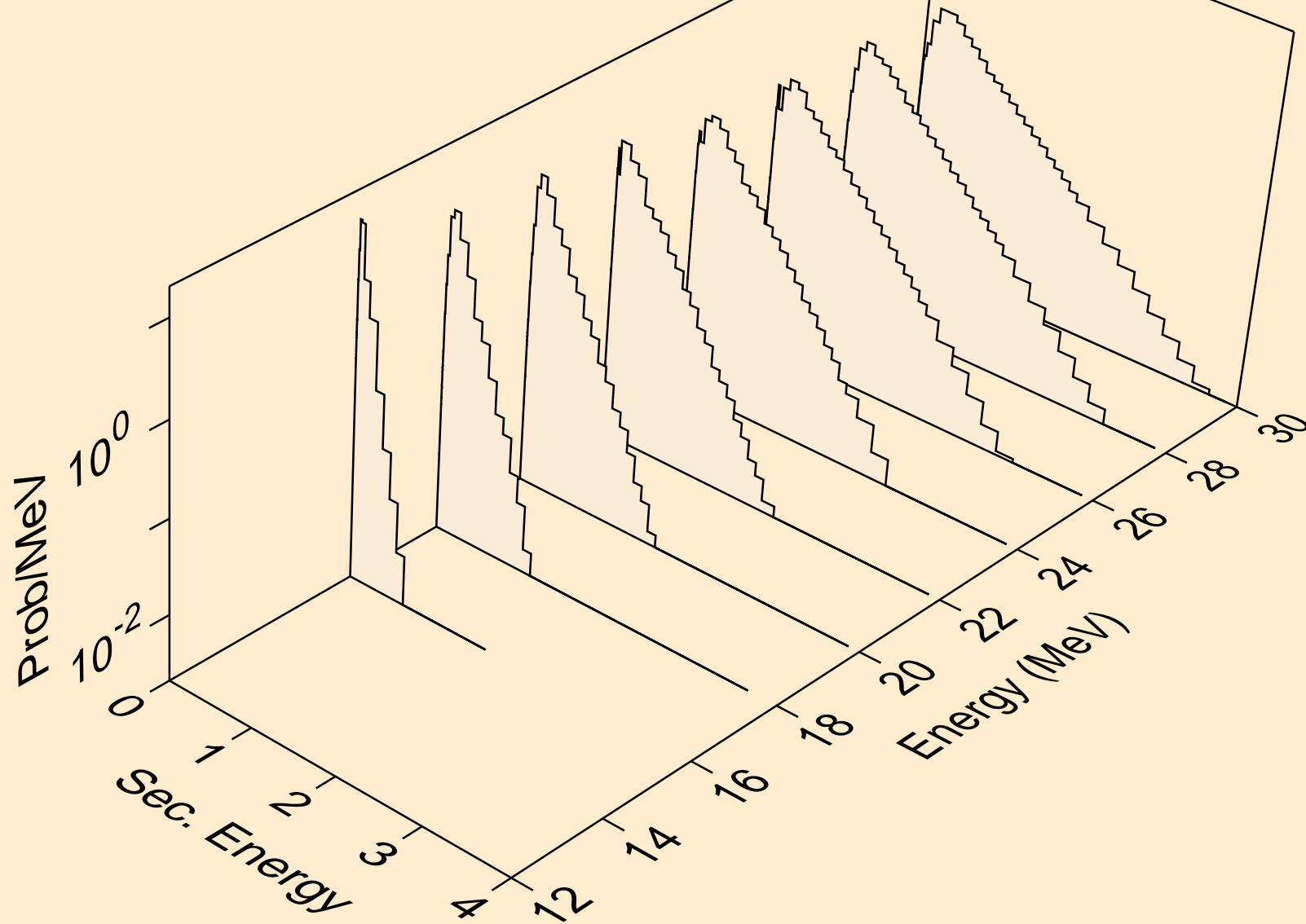

W193 NEUTRON ACER TENDL-2021 LIBRARY; T=293.6K
Neutron emission for (n,n*)t

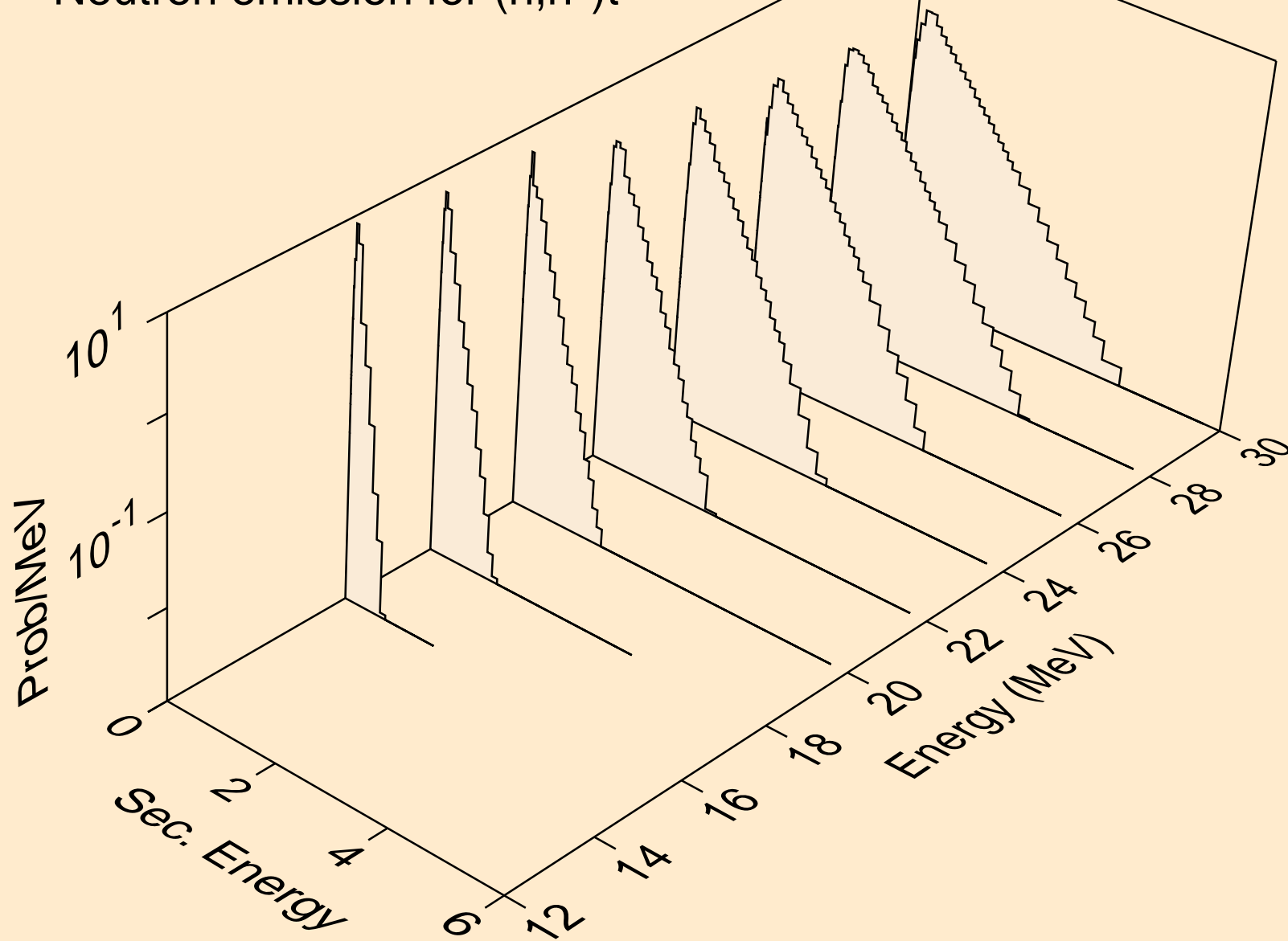

W193 NEUTRON ACER TENDL-2021 LIBRARY; T=293.6K
Neutron emission for (n,n*)he3

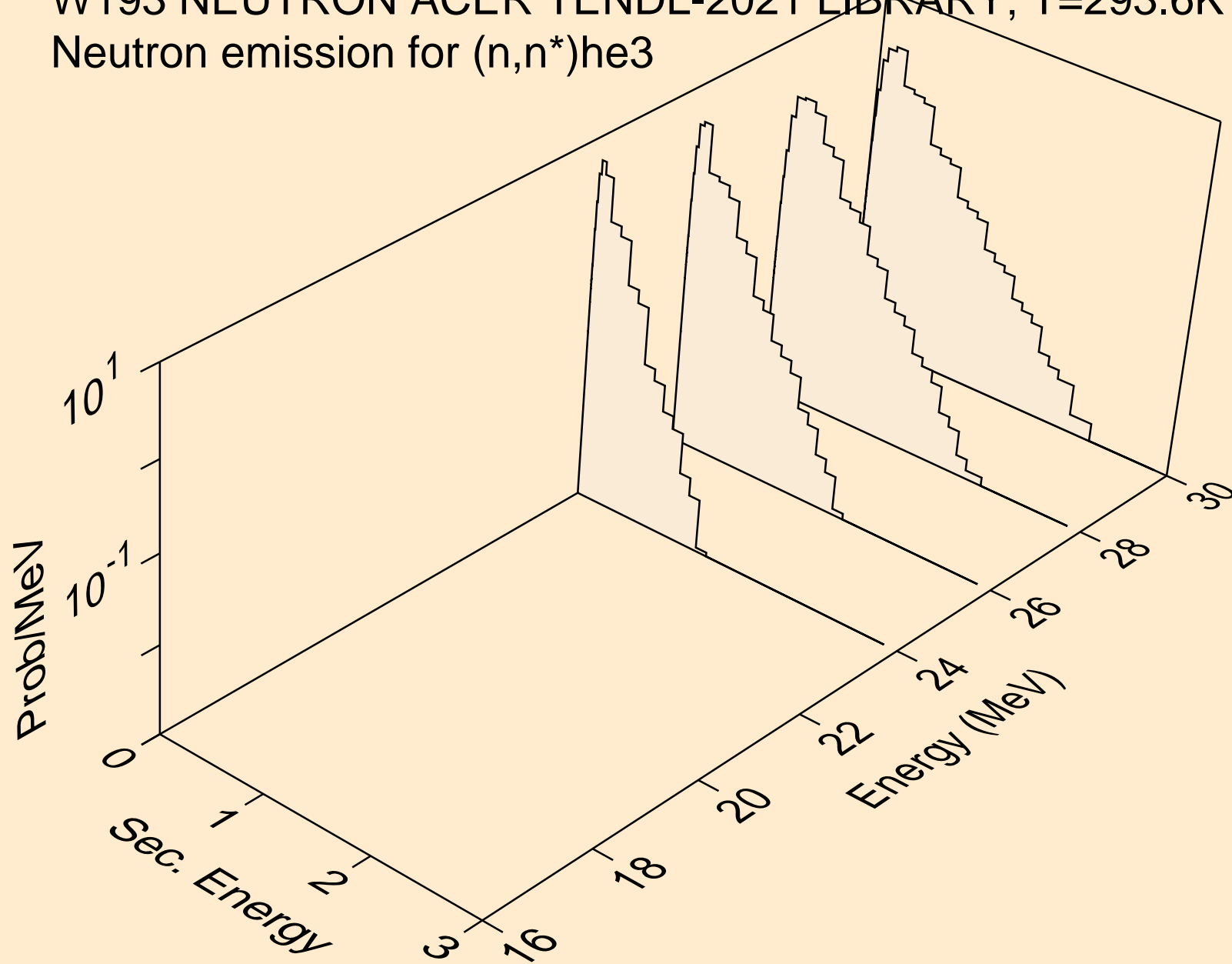

W193 NEUTRON ACER TENDL-2021 LIBRARY; T=293.6K
Neutron emission for (n,4n)

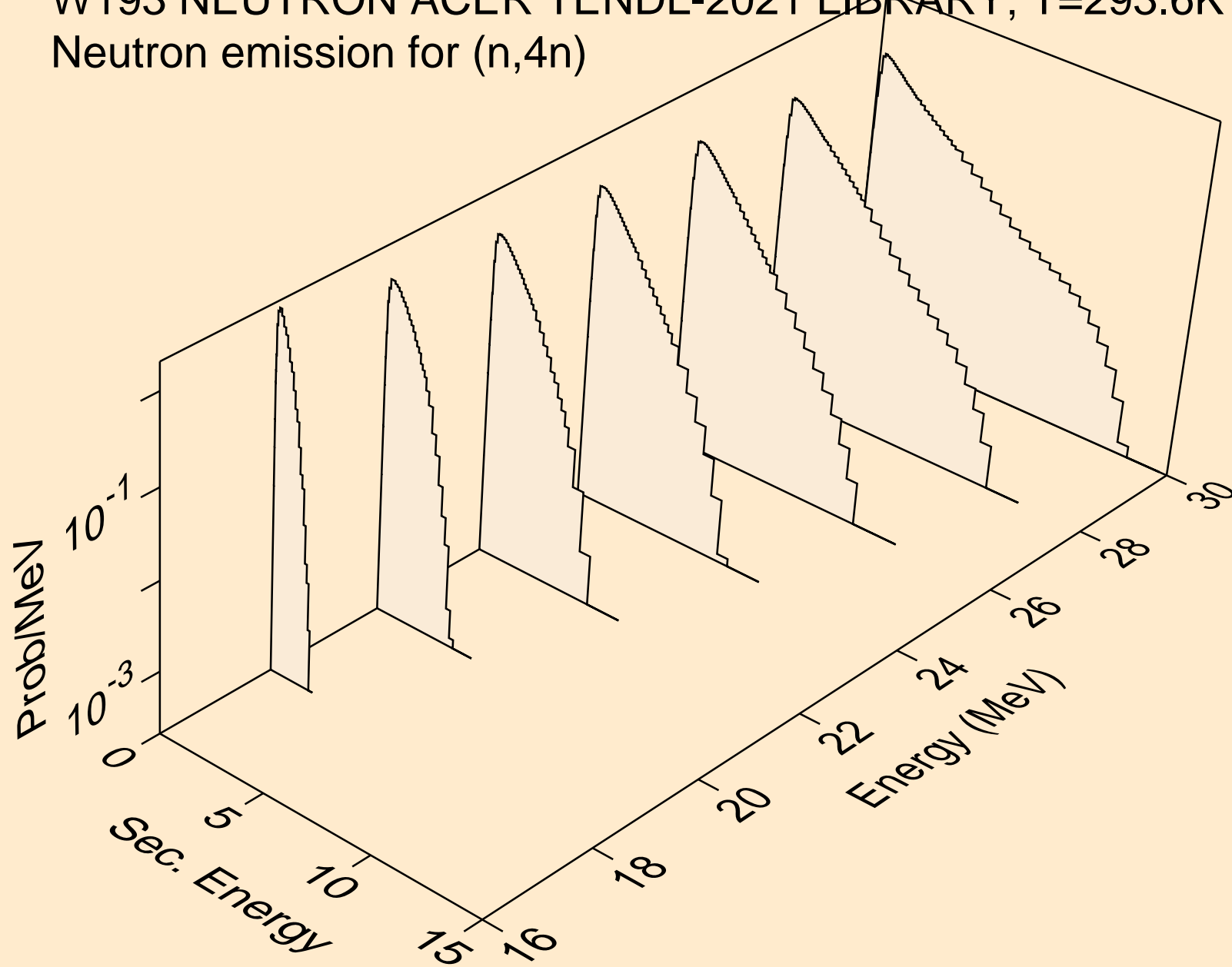

W193 NEUTRON ACER TENDL-2021 LIBRARY; T=293.6K
Neutron emission for (n,2np)

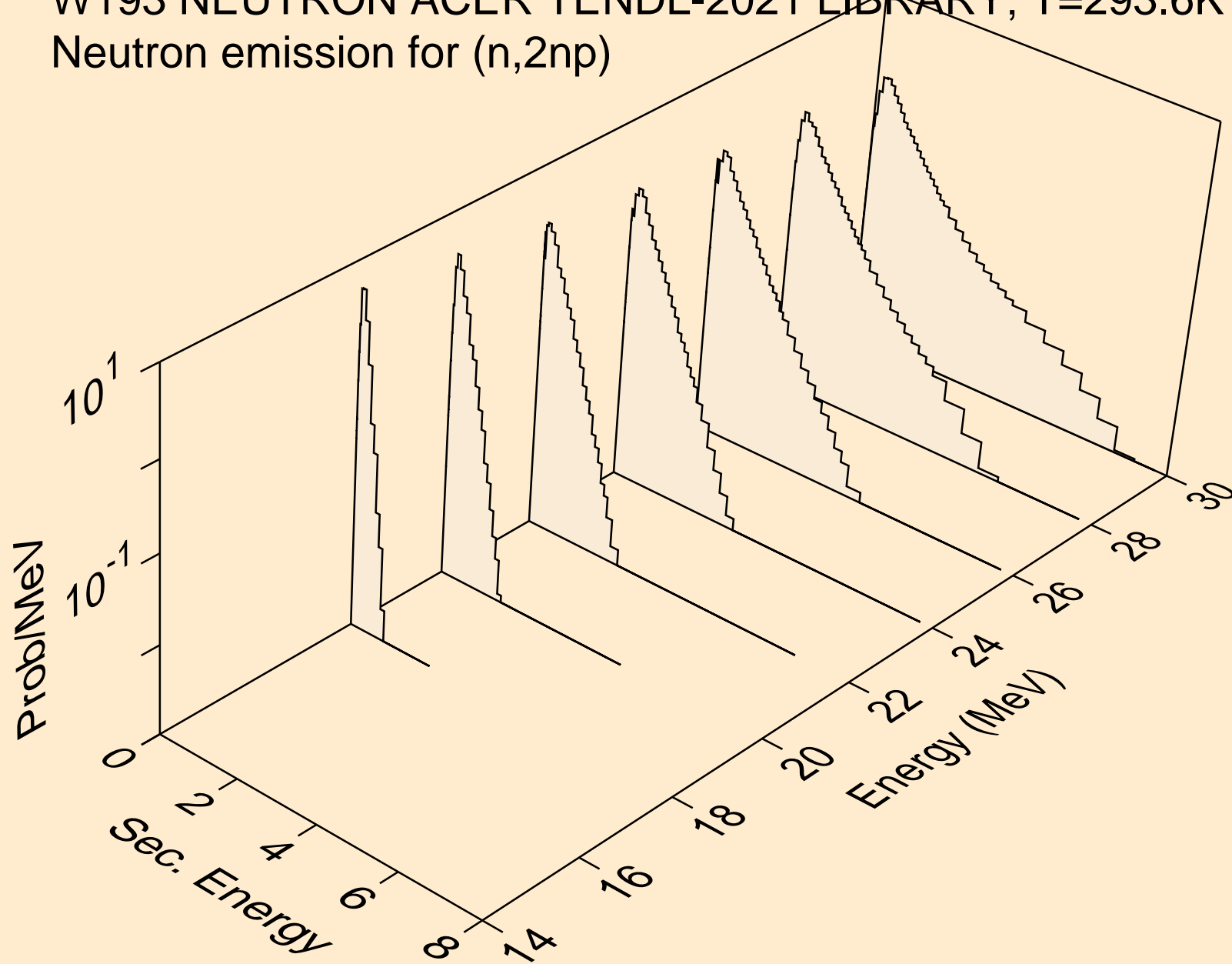

W193 NEUTRON ACER TENDL-2021 LIBRARY; T=293.6K
Neutron emission for (n,3np)

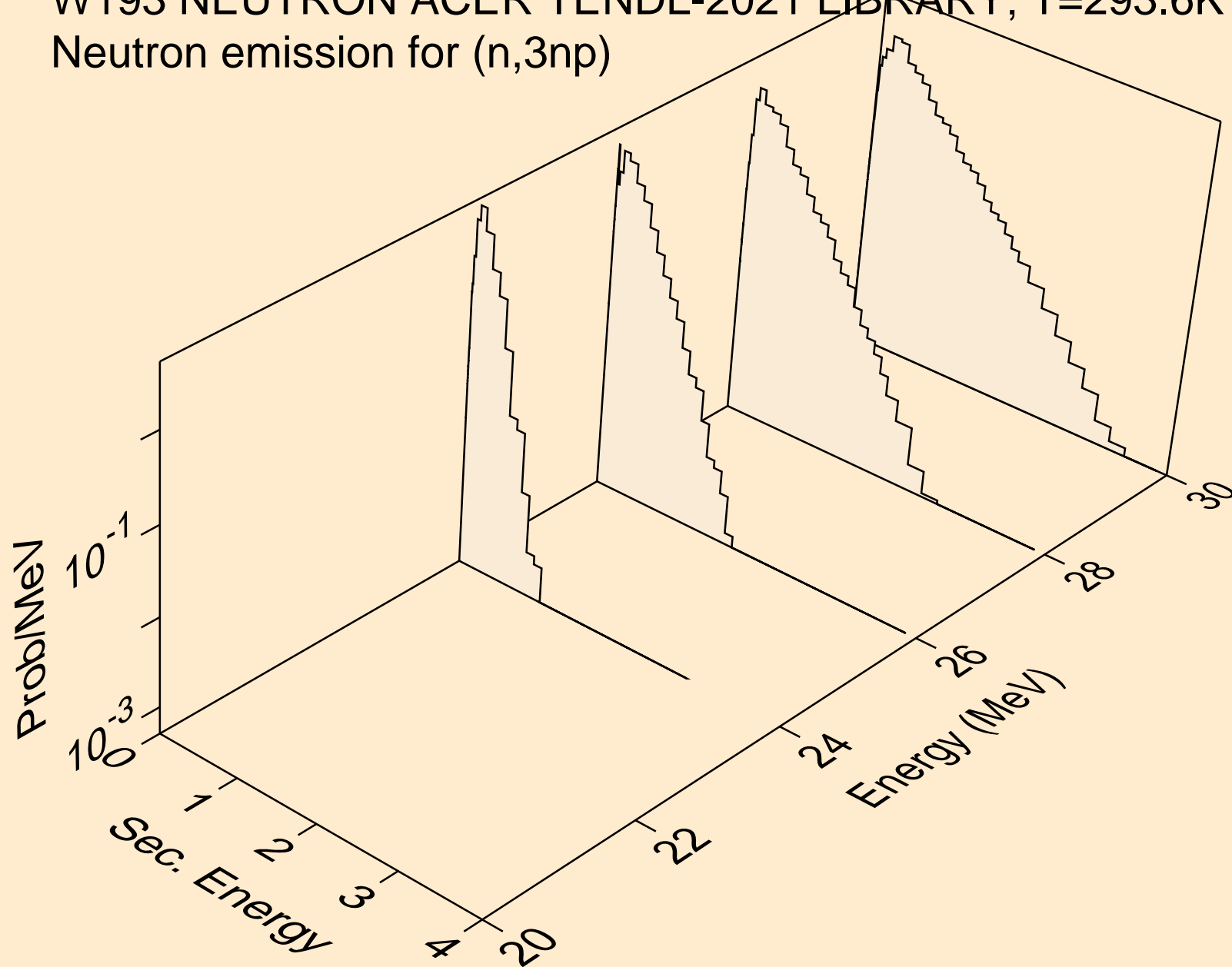

W193 NEUTRON ACER TENDL-2021 LIBRARY; T=293.6K
Neutron emission for (n,n*c)

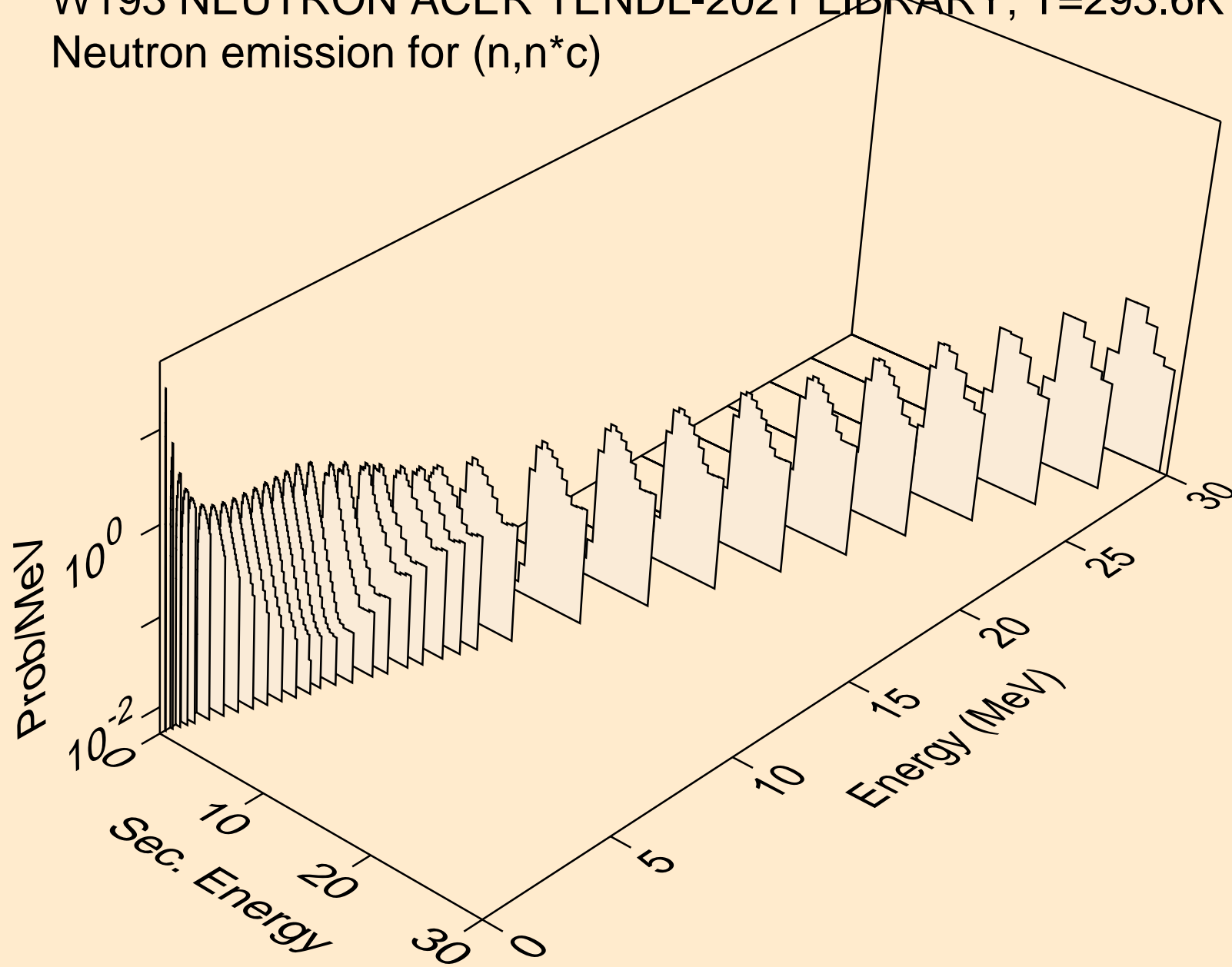

W193 NEUTRON ACER TENDL-2021 LIBRARY; T=293.6K
Photon emission for (n,x)

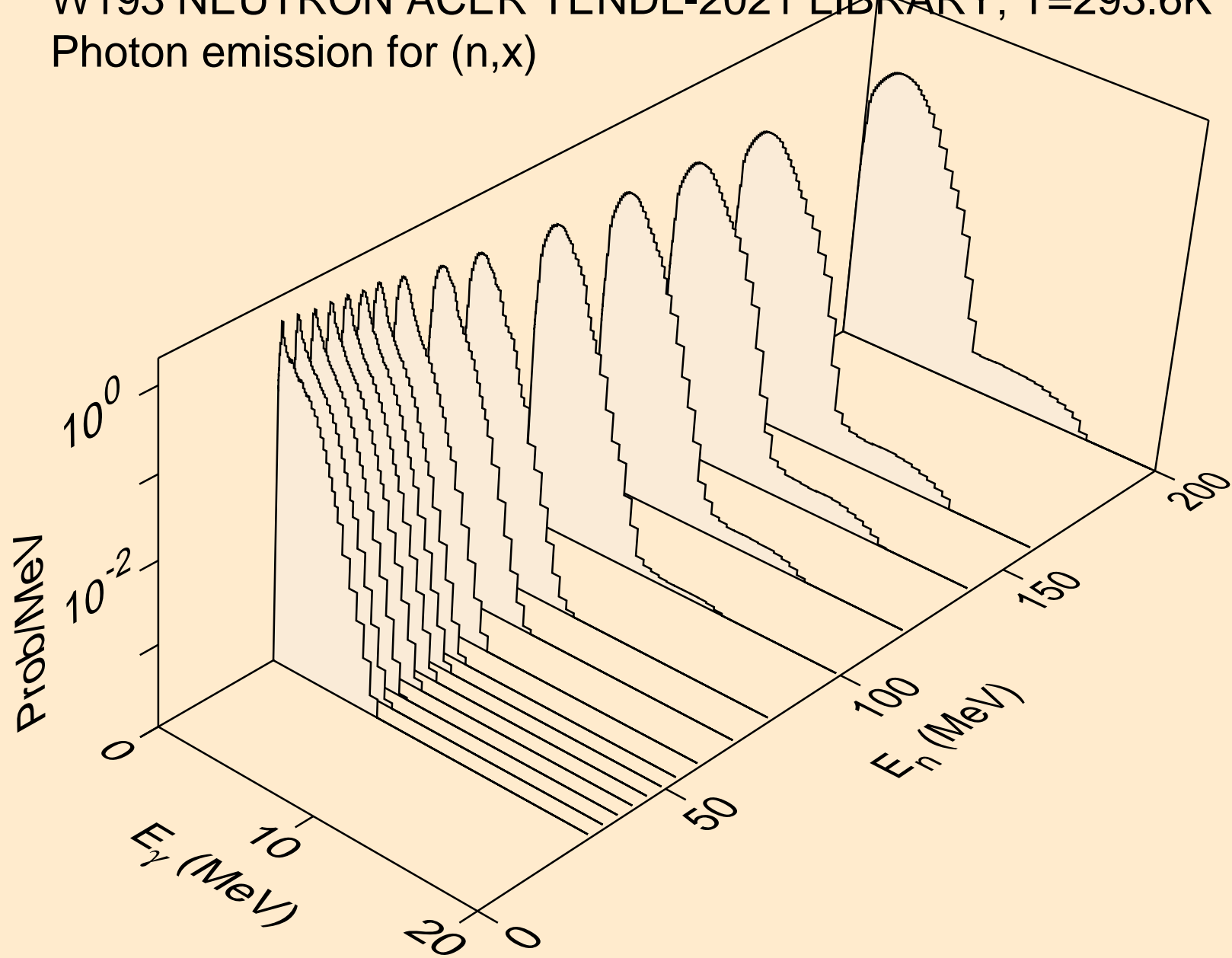

W193 NEUTRON ACER TENDL-2021 LIBRARY; T=293.6K
Photon emission for (n,2nd)

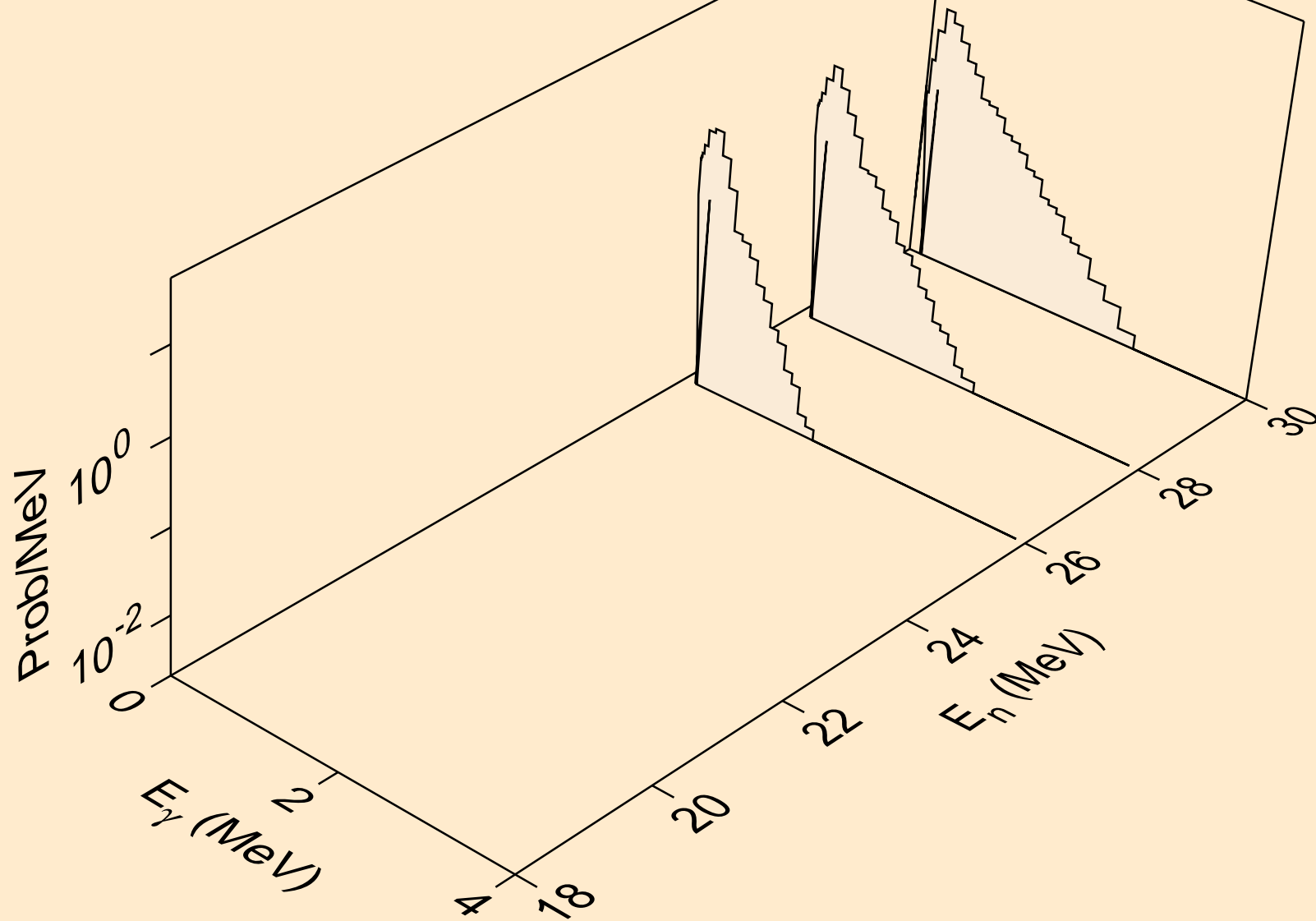

W193 NEUTRON ACER TENDL-2021 LIBRARY; T=293.6K
Photon emission for (n,2n)

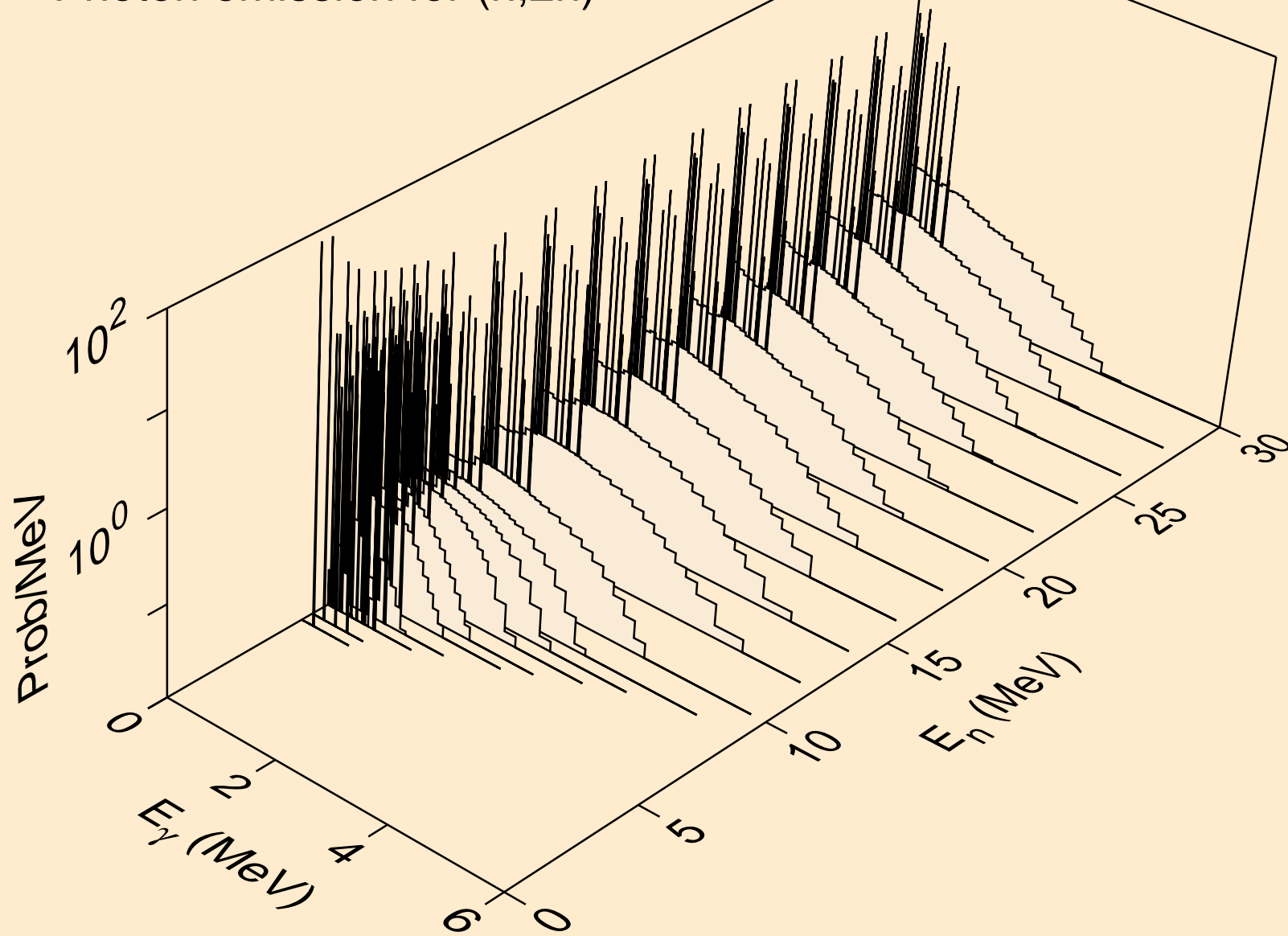

W193 NEUTRON ACER TENDL-2021 LIBRARY; T=293.6K
Photon emission for (n,3n)

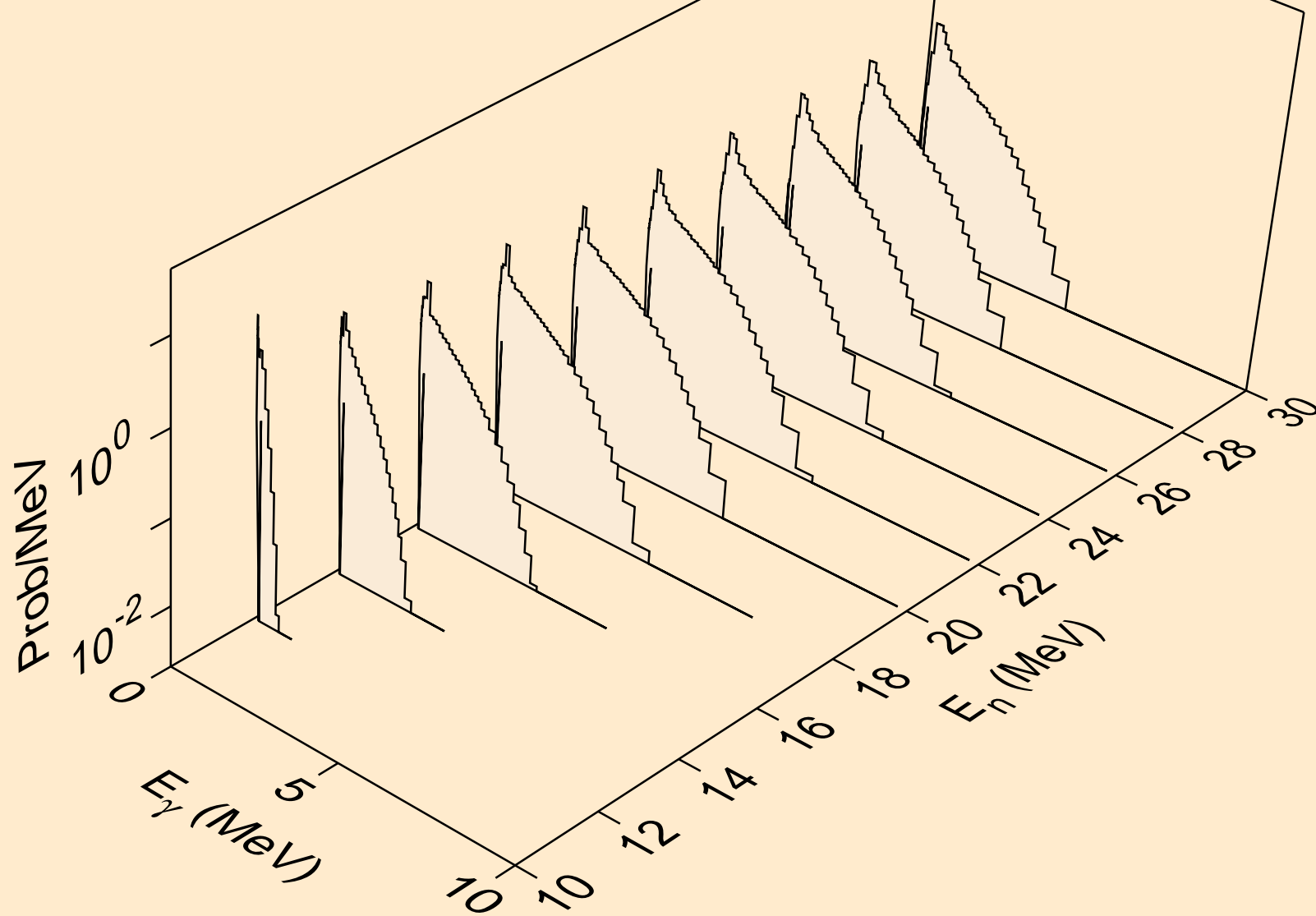

W193 NEUTRON ACER TENDL-2021 LIBRARY; T=293.6K
Photon emission for (n,n*)a

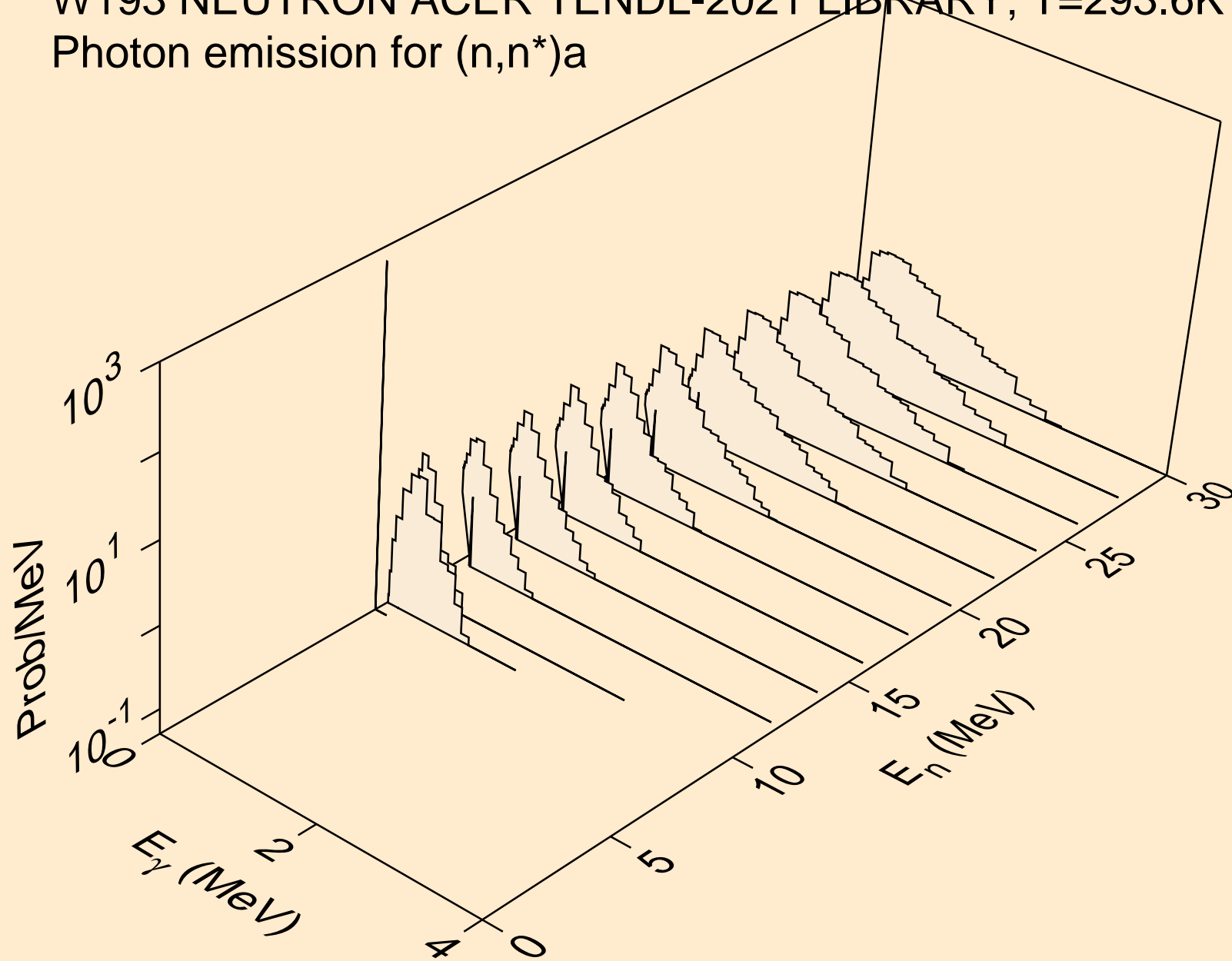

W193 NEUTRON ACER TENDL-2021 LIBRARY; T=293.6K
Photon emission for (n,2n)a

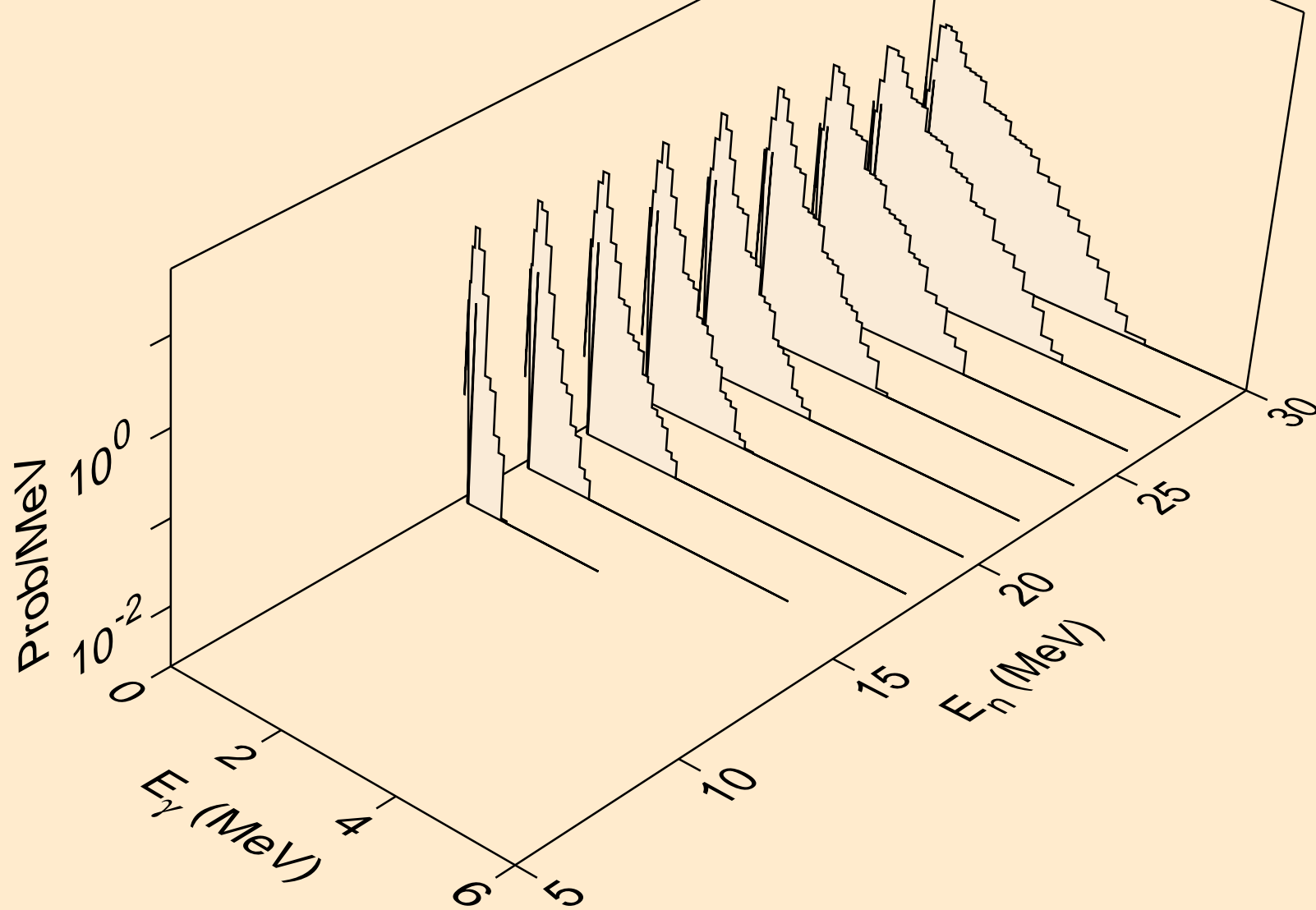

W193 NEUTRON ACER TENDL-2021 LIBRARY; T=293.6K
Photon emission for (n,3n)a

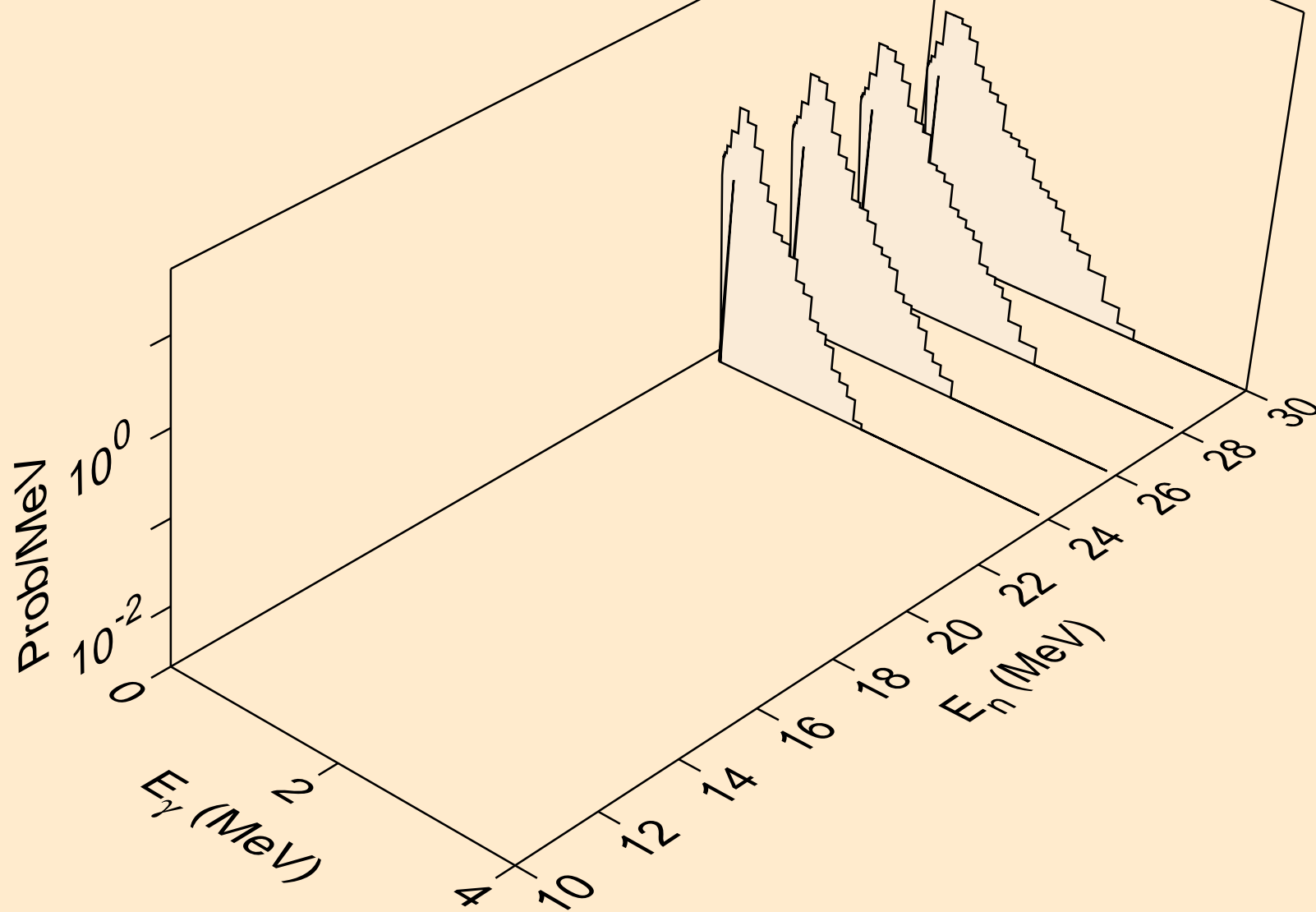

W193 NEUTRON ACER TENDL-2021 LIBRARY; T=293.6K
Photon emission for (n,n*)p

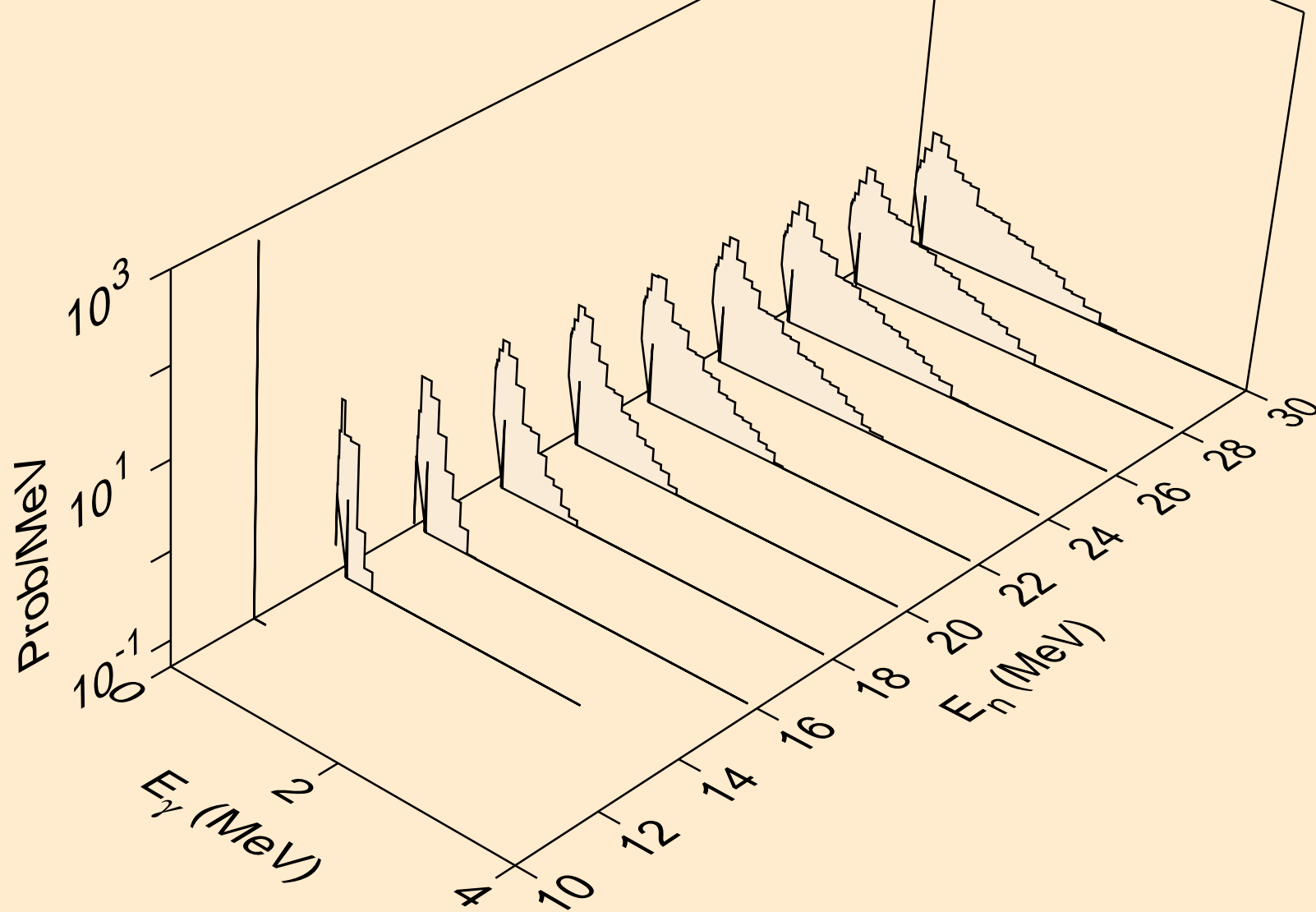

W193 NEUTRON ACER TENDL-2021 LIBRARY; T=293.6K
Photon emission for (n,n*)d

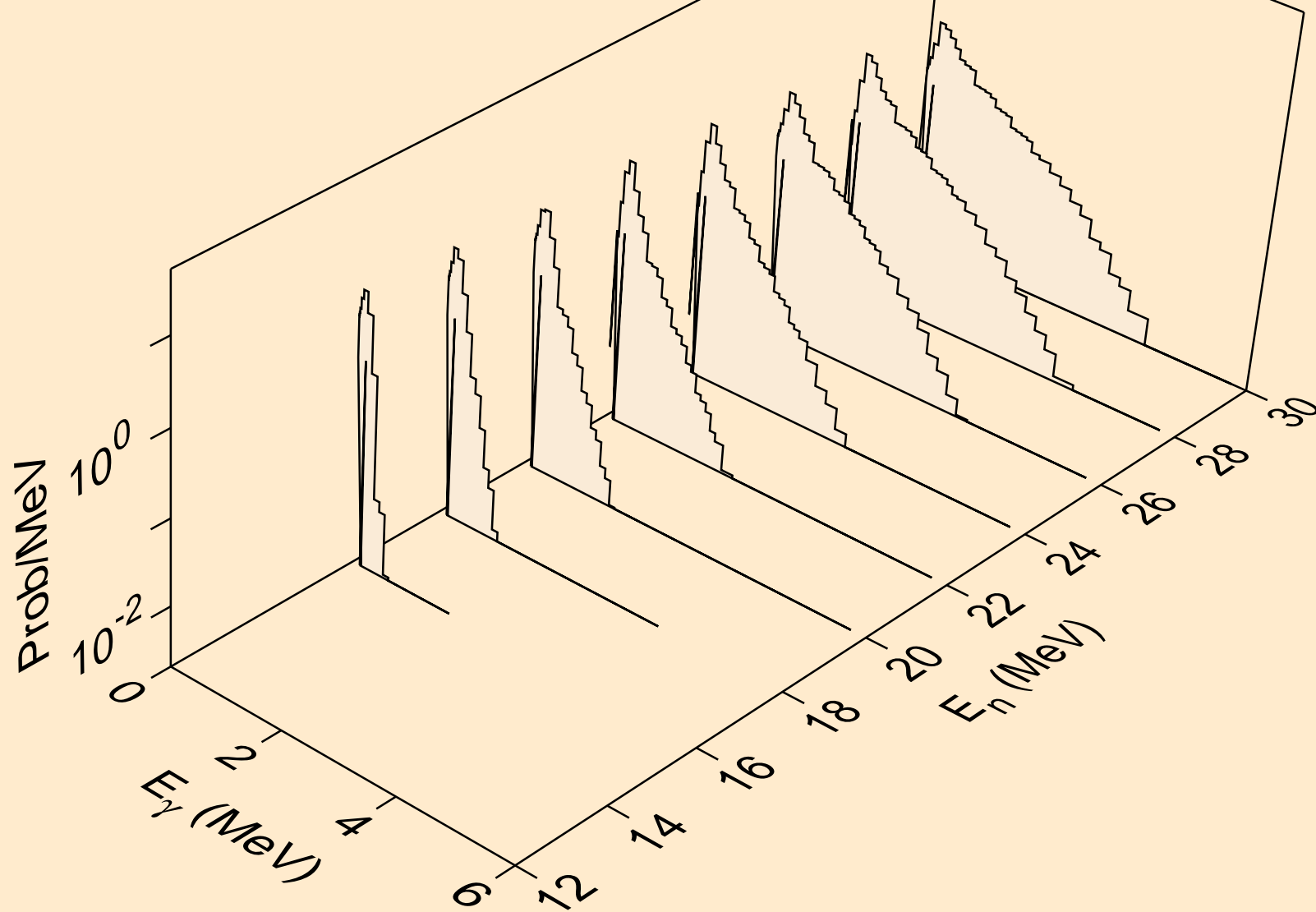

W193 NEUTRON ACER TENDL-2021 LIBRARY; T=293.6K
Photon emission for (n,n*)t

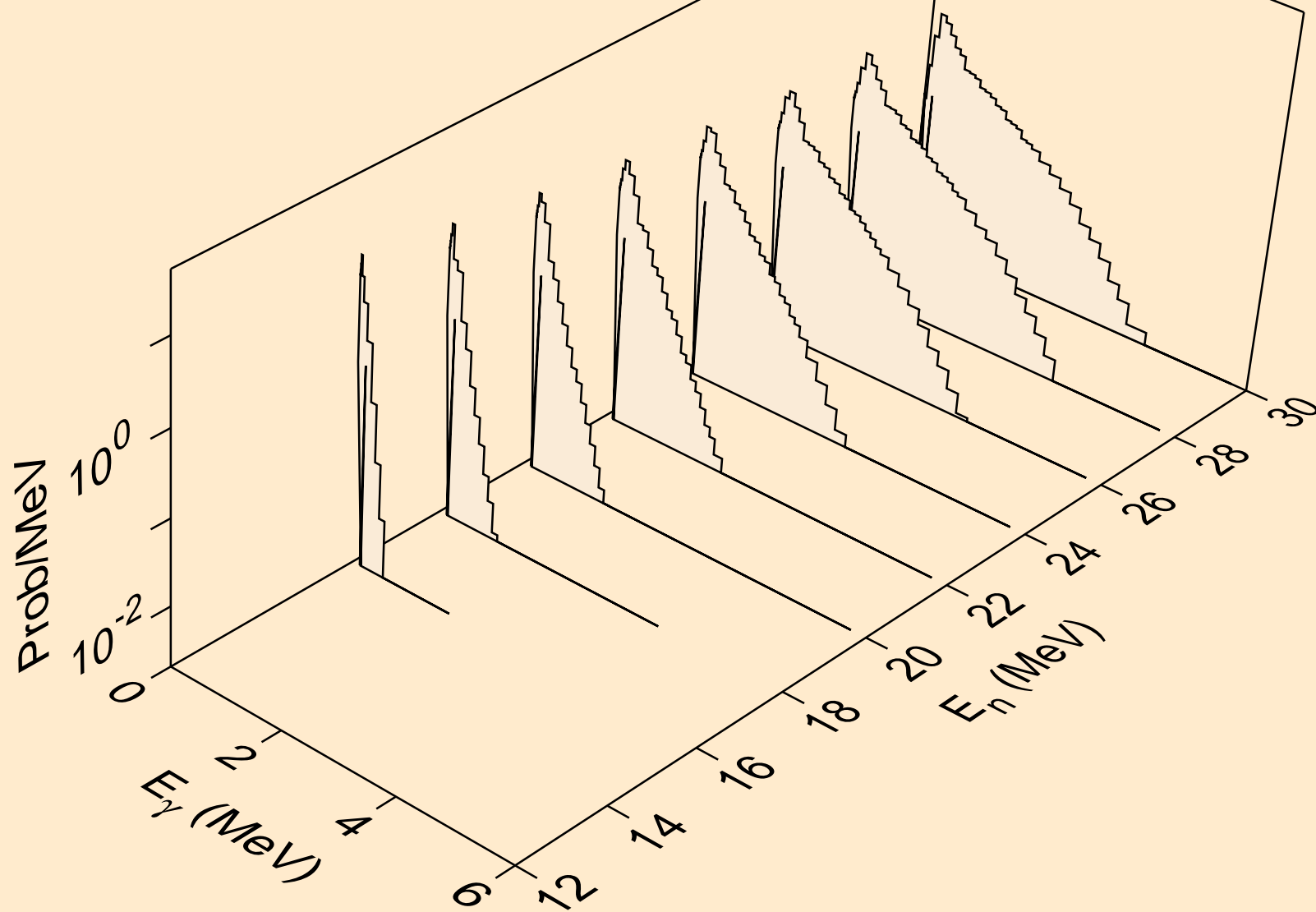

W193 NEUTRON ACER TENDL-2021 LIBRARY; T=293.6K
Photon emission for (n,n*)he3

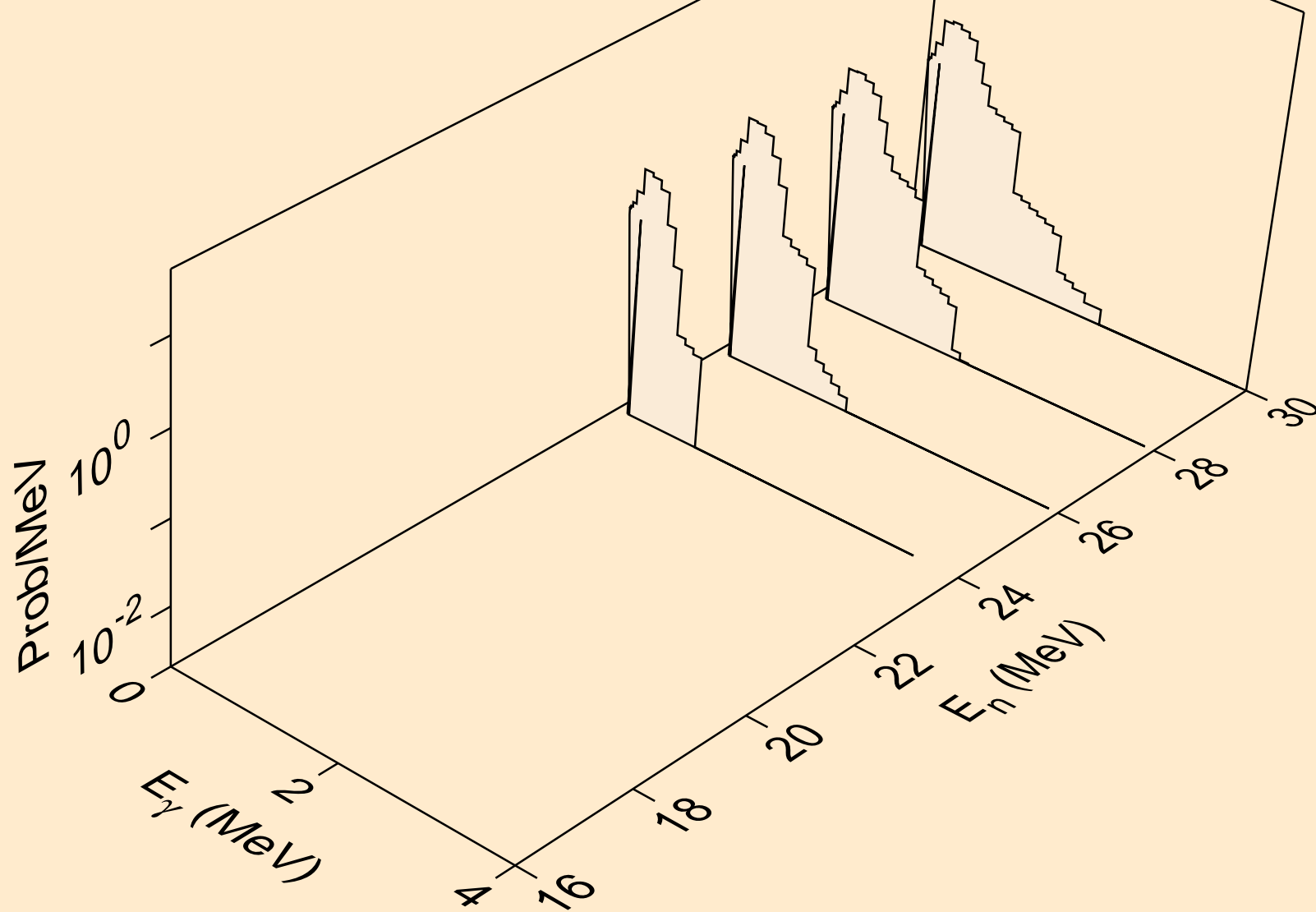

W193 NEUTRON ACER TENDL-2021 LIBRARY; T=293.6K
Photon emission for (n,4n)

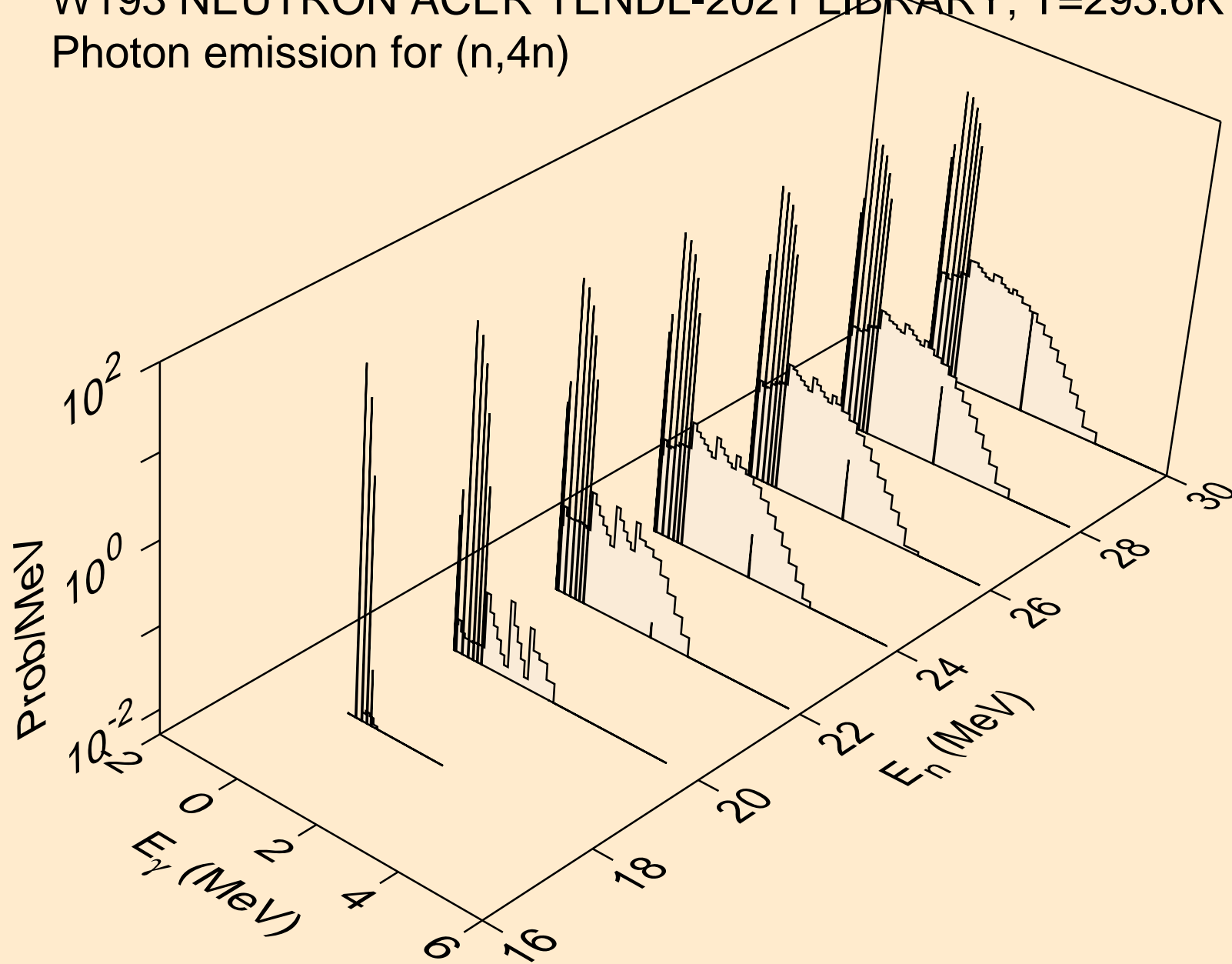

W193 NEUTRON ACER TENDL-2021 LIBRARY; T=293.6K
Photon emission for (n,2np)

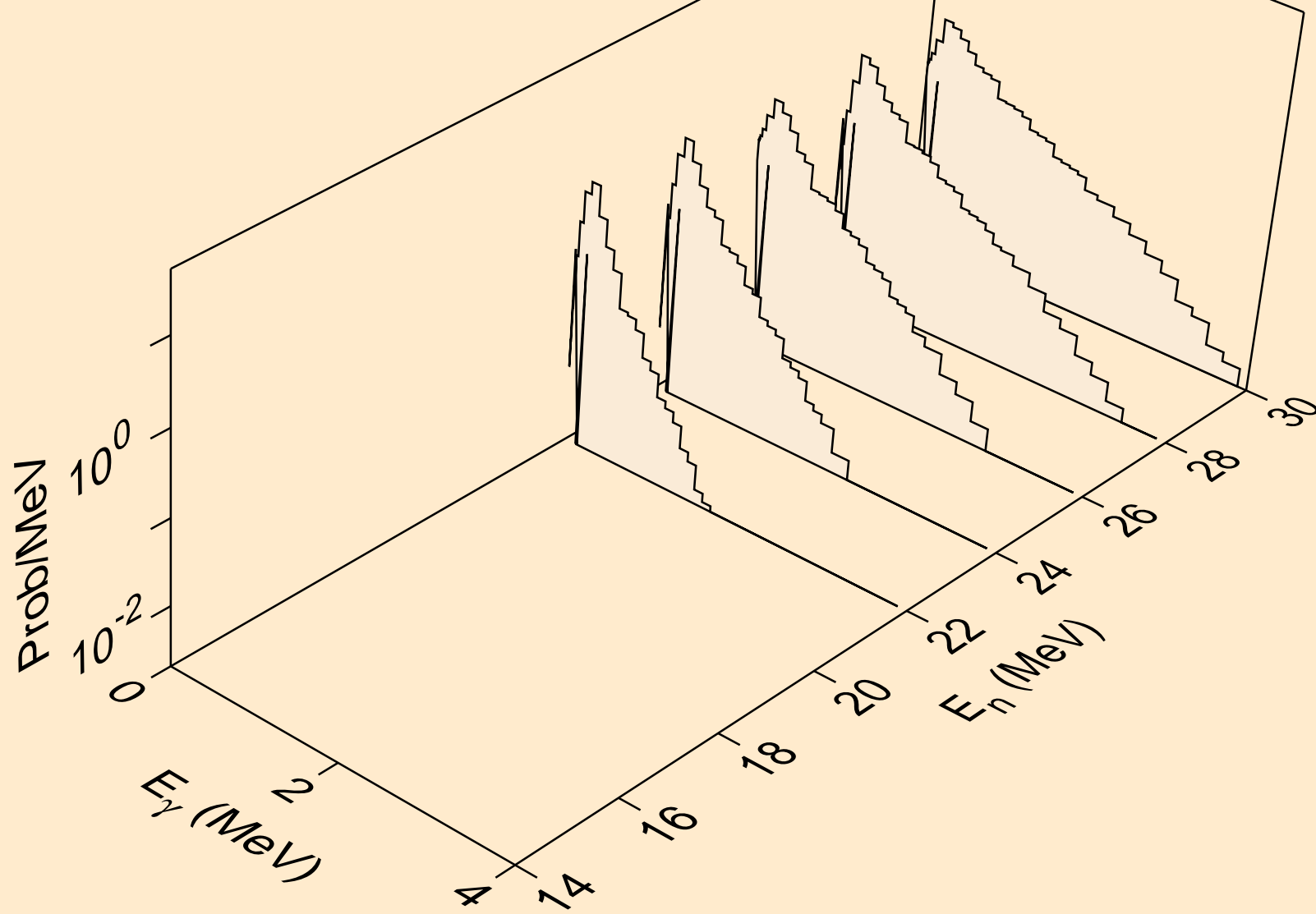

W193 NEUTRON ACER TENDL-2021 LIBRARY; T=293.6K
Photon emission for (n,3np)

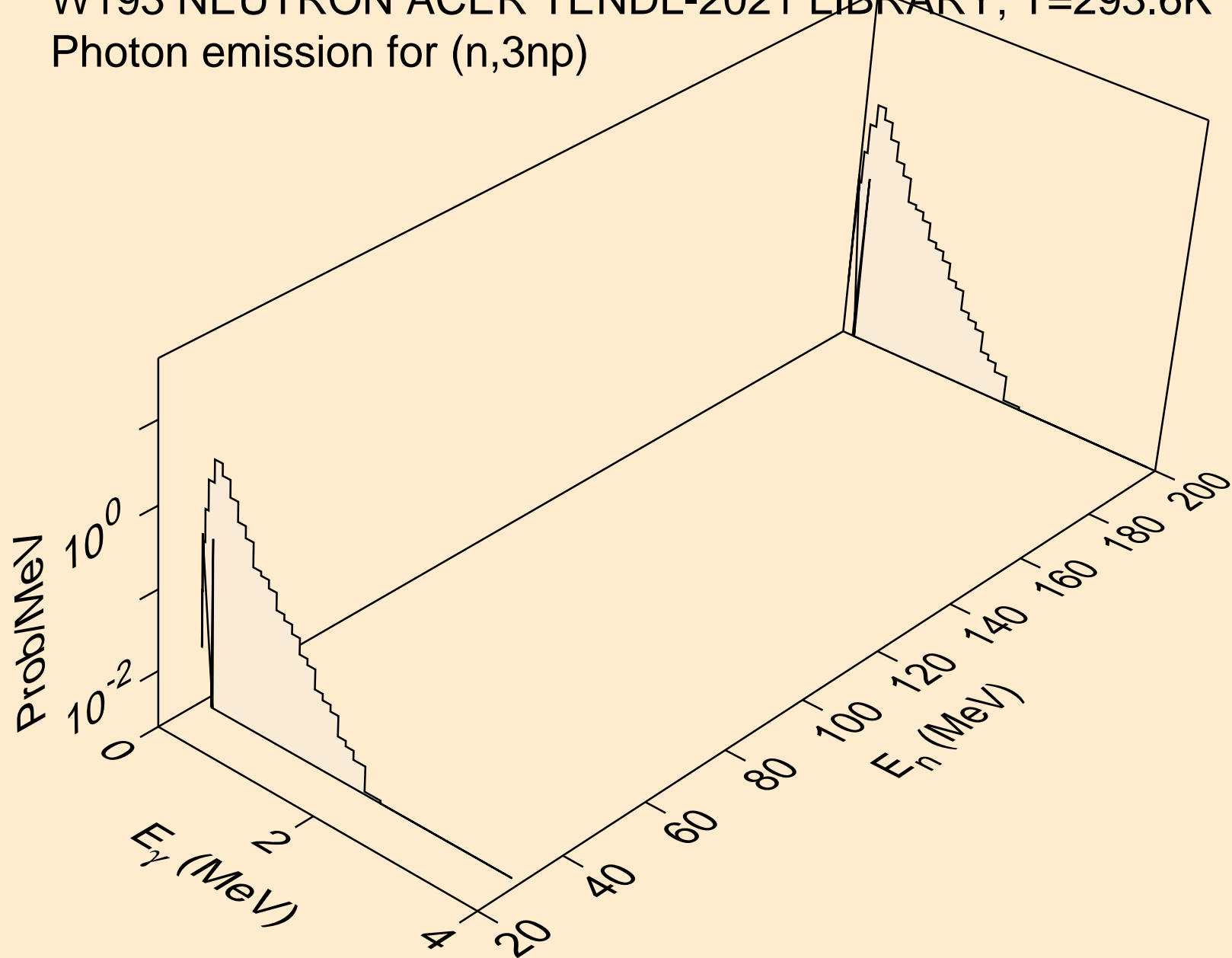

W193 NEUTRON ACER TENDL-2021 LIBRARY; T=293.6K
Photon emission for (n,n*c)

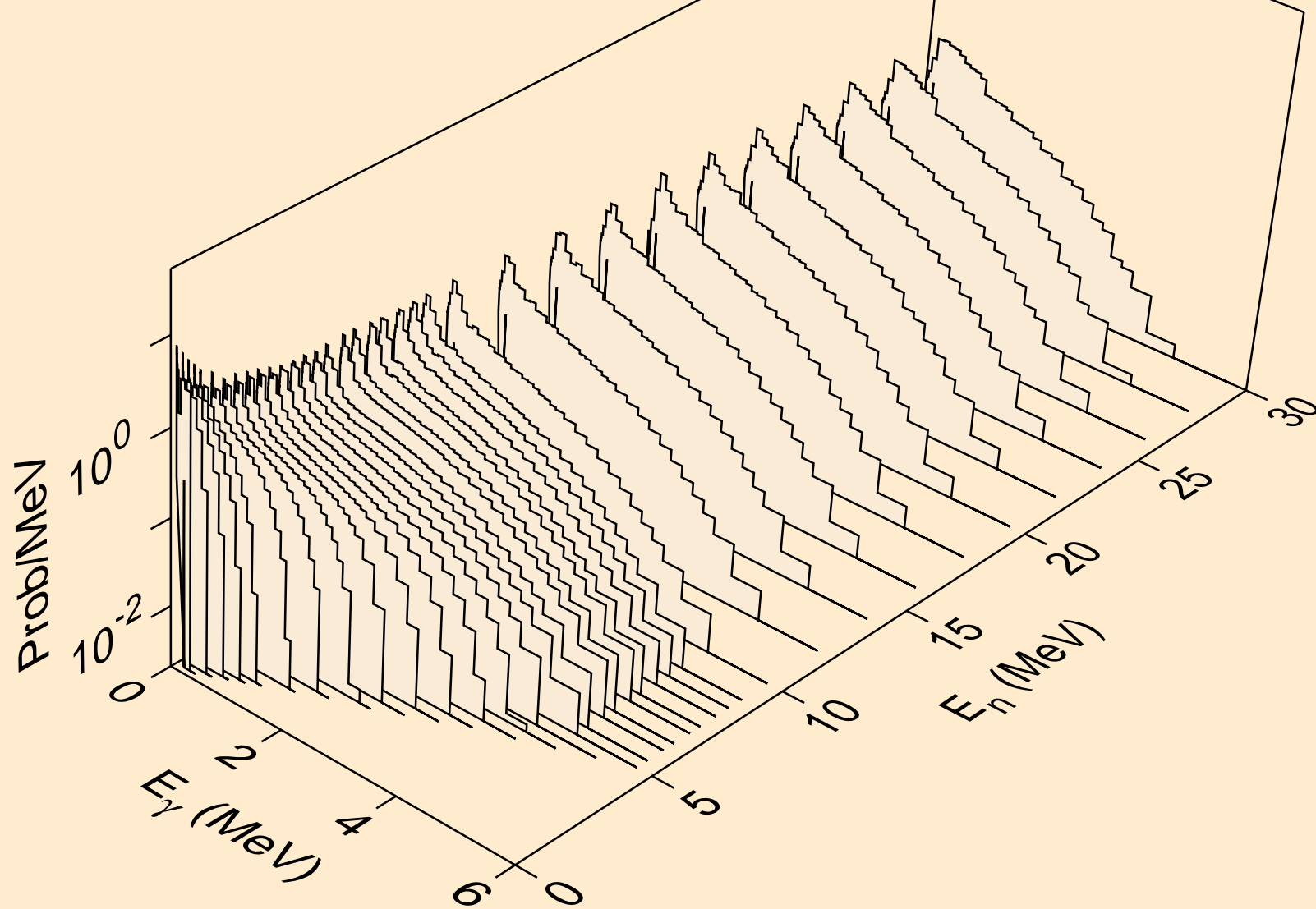

W193 NEUTRON ACER TENDL-2021 LIBRARY; T=293.6K
Photon emission for (n,gma)

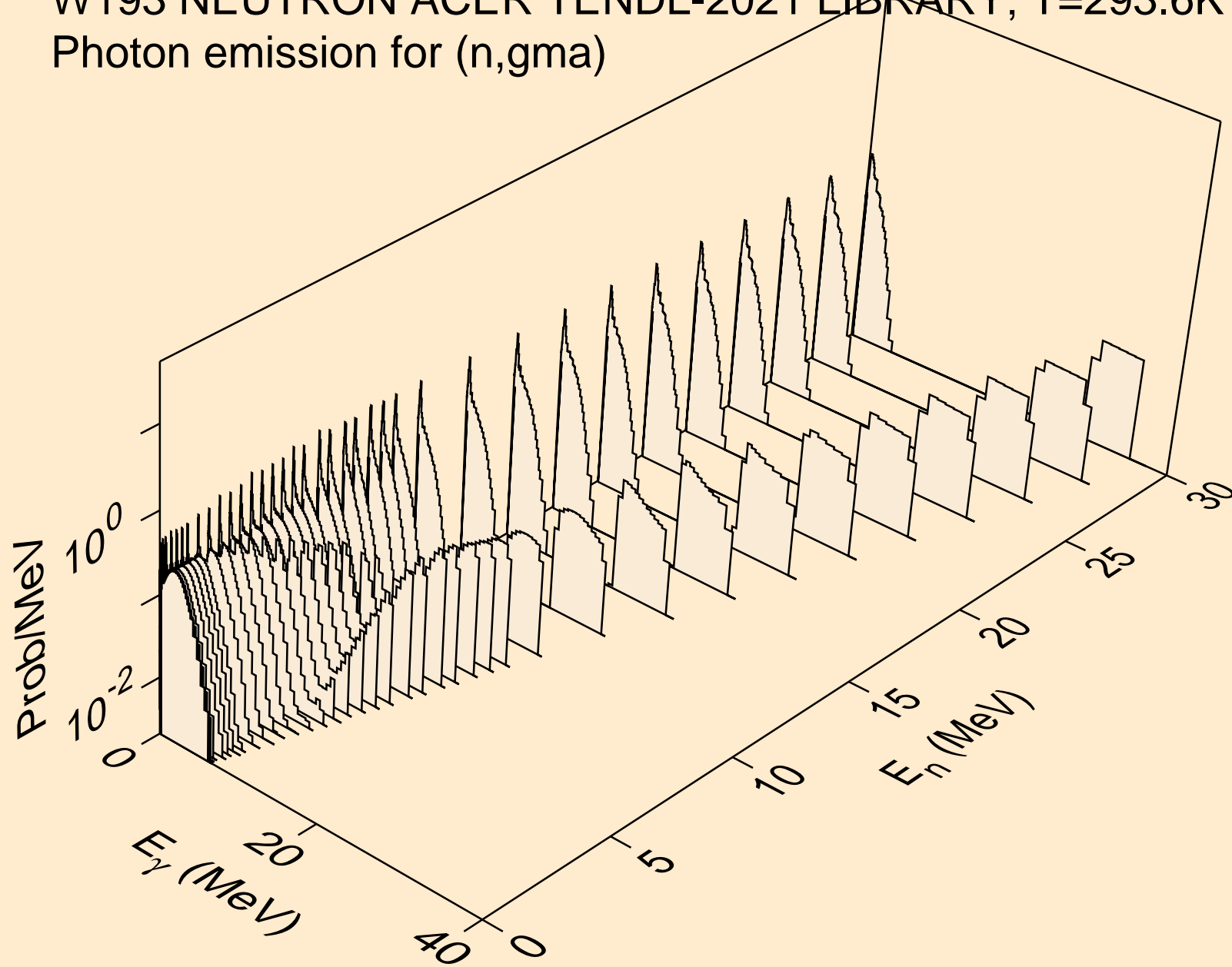

W193 NEUTRON ACER TENDL-2021 LIBRARY; T=293.6K
Photon emission for (n,p)

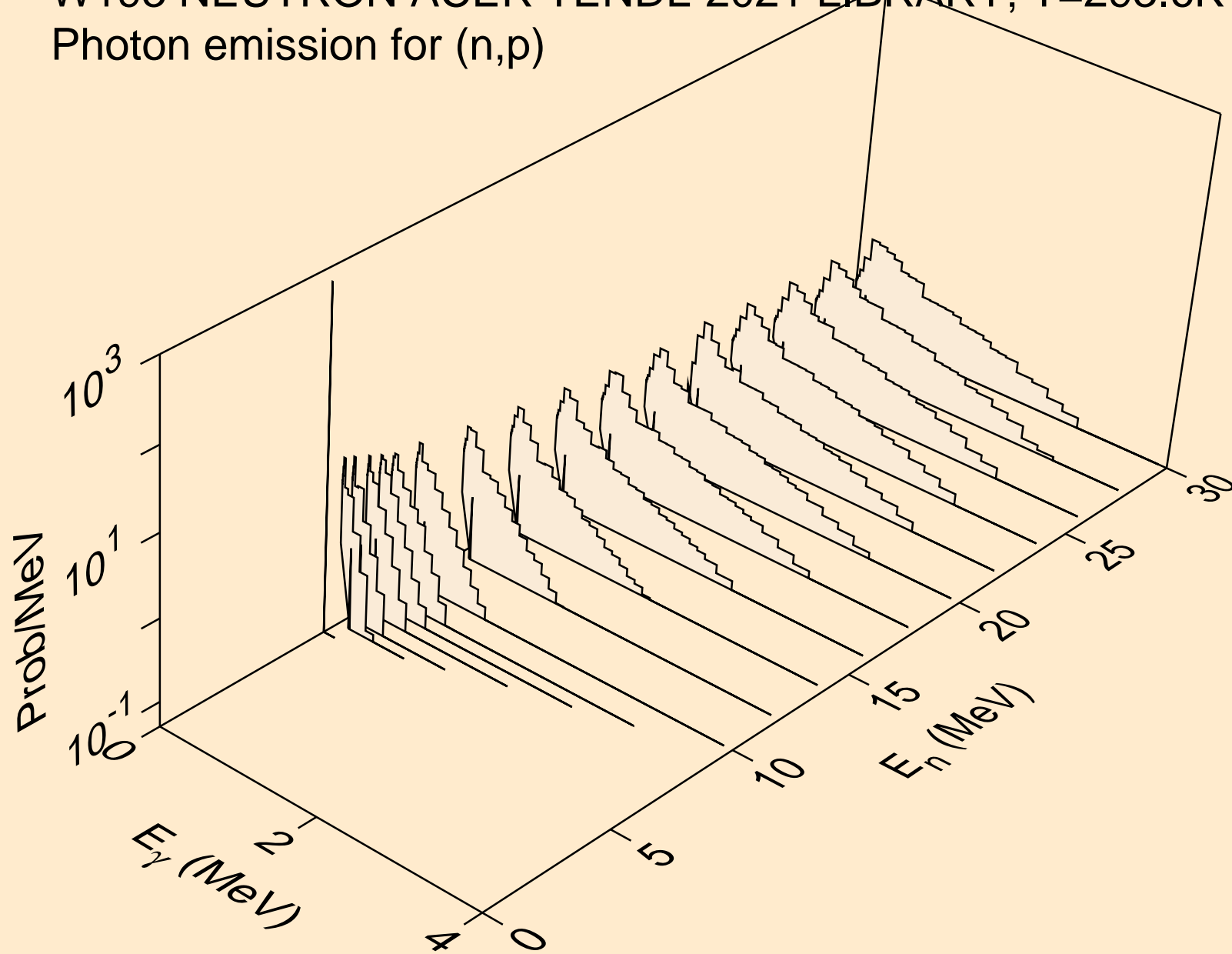

W193 NEUTRON ACER TENDL-2021 LIBRARY; T=293.6K
Photon emission for (n,d)

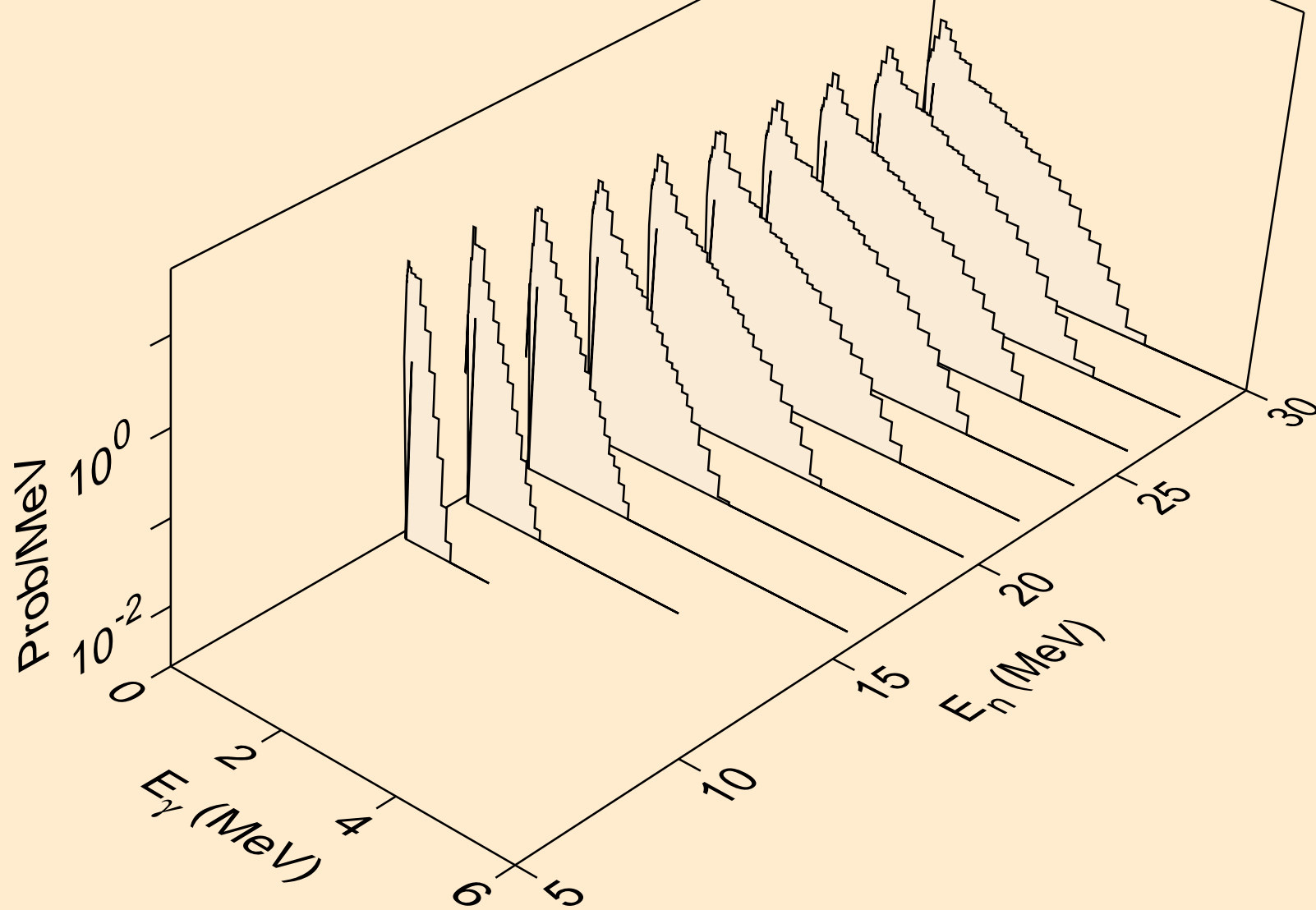

W193 NEUTRON ACER TENDL-2021 LIBRARY; T=293.6K
Photon emission for (n,t)

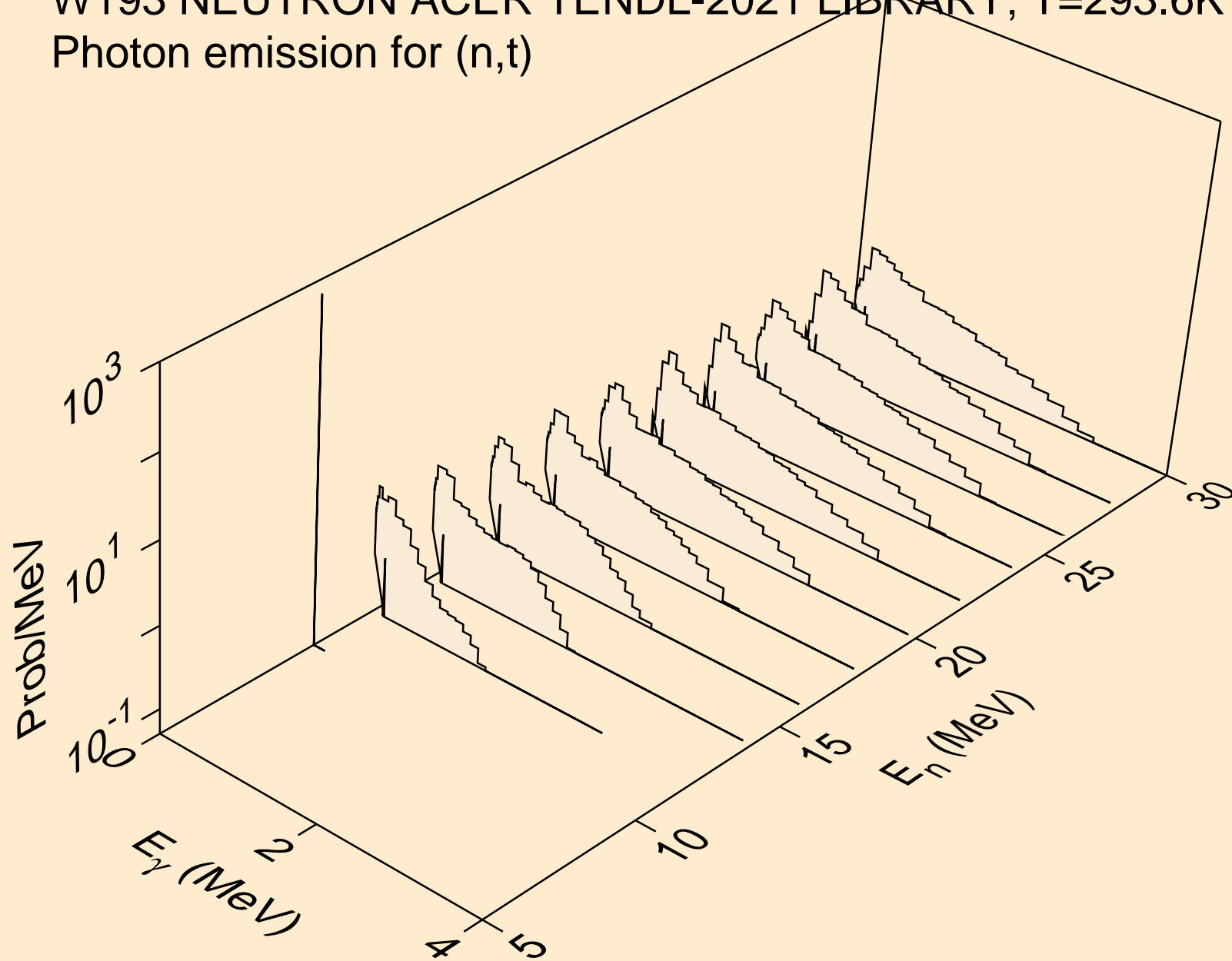

W193 NEUTRON ACER TENDL-2021 LIBRARY; T=293.6K
Photon emission for (n,he3)

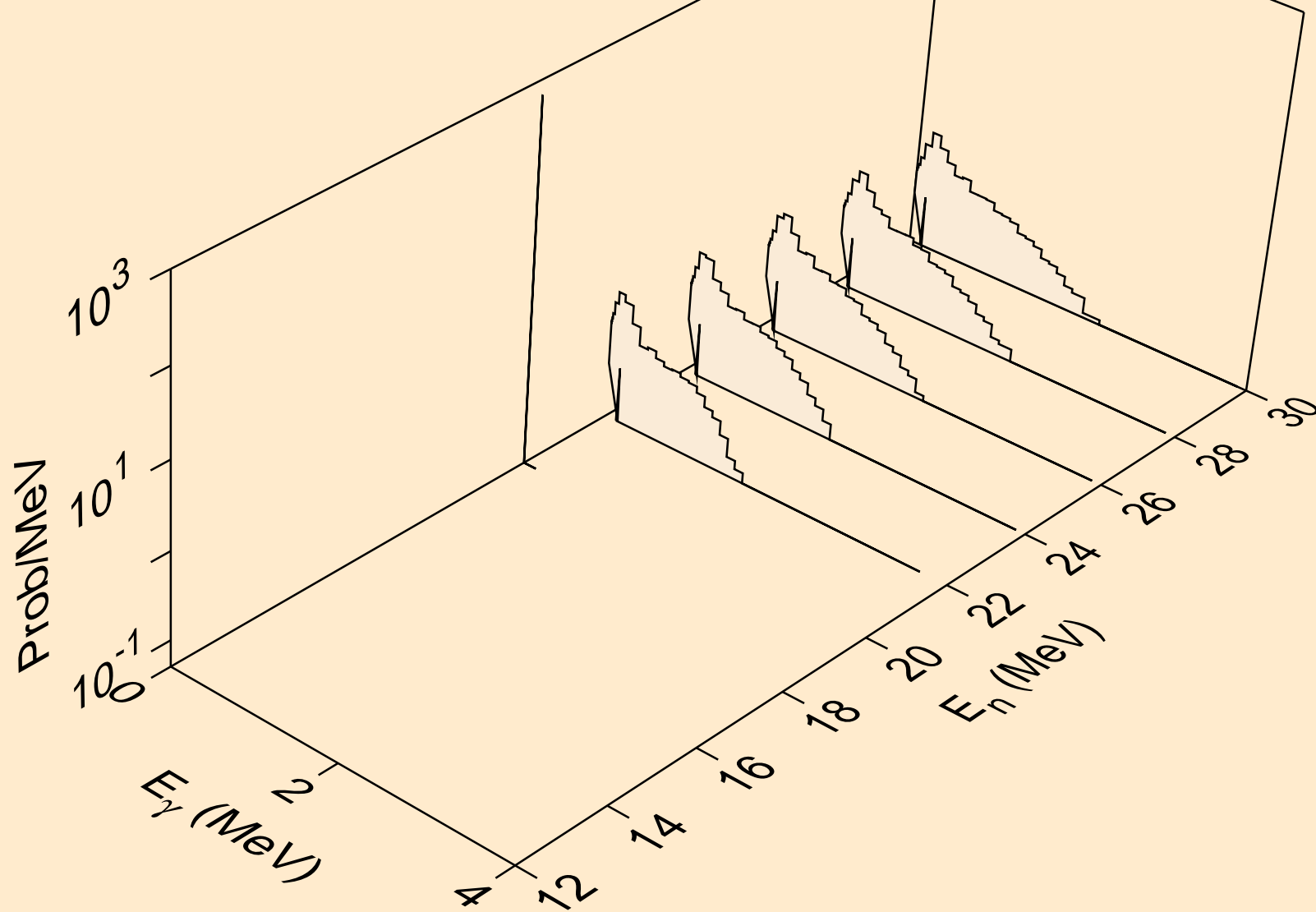

W193 NEUTRON ACER TENDL-2021 LIBRARY; T=293.6K
Photon emission for (n,a)

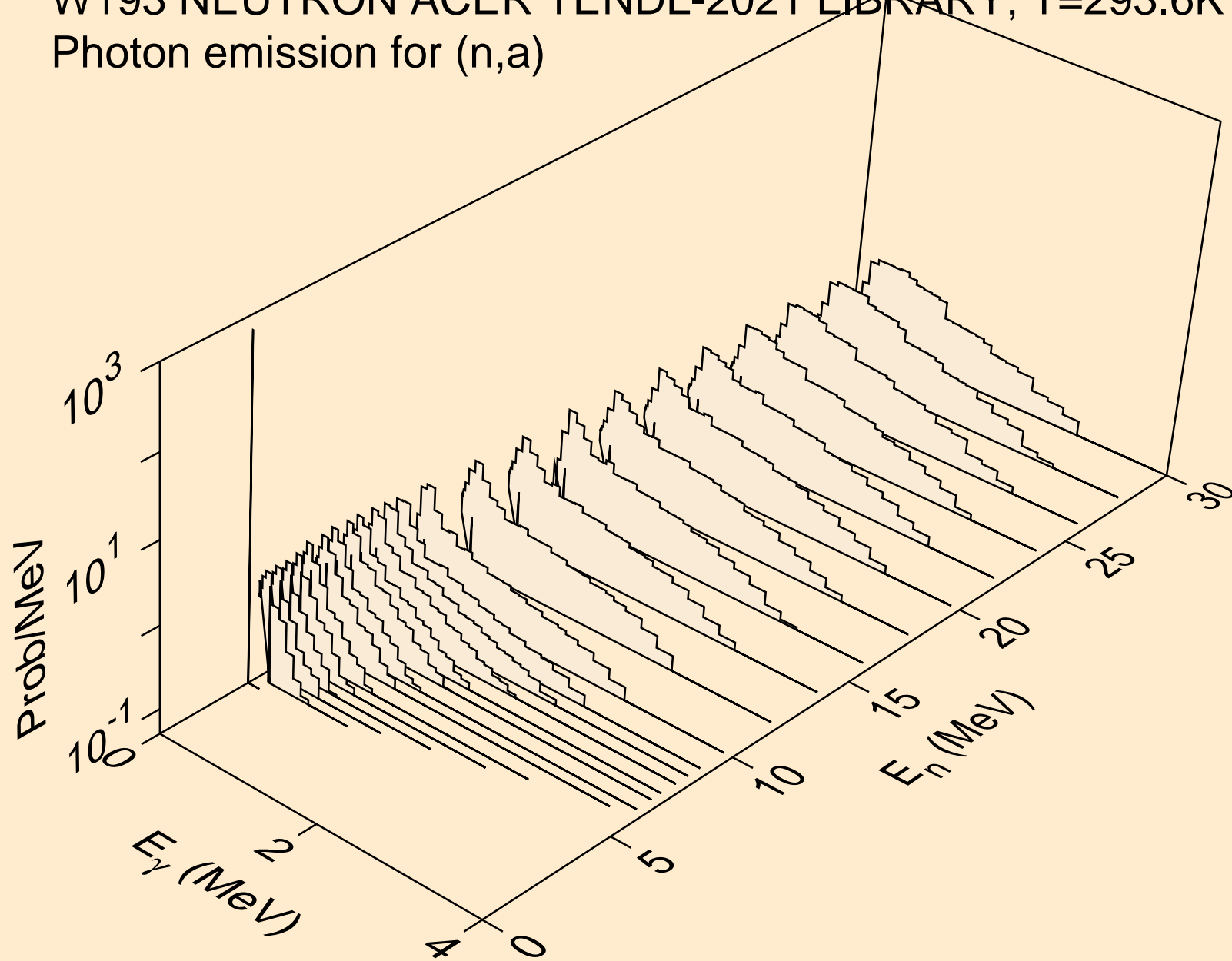

W193 NEUTRON ACER TENDL-2021 LIBRARY; T=293.6K
Photon emission for (n,2p)

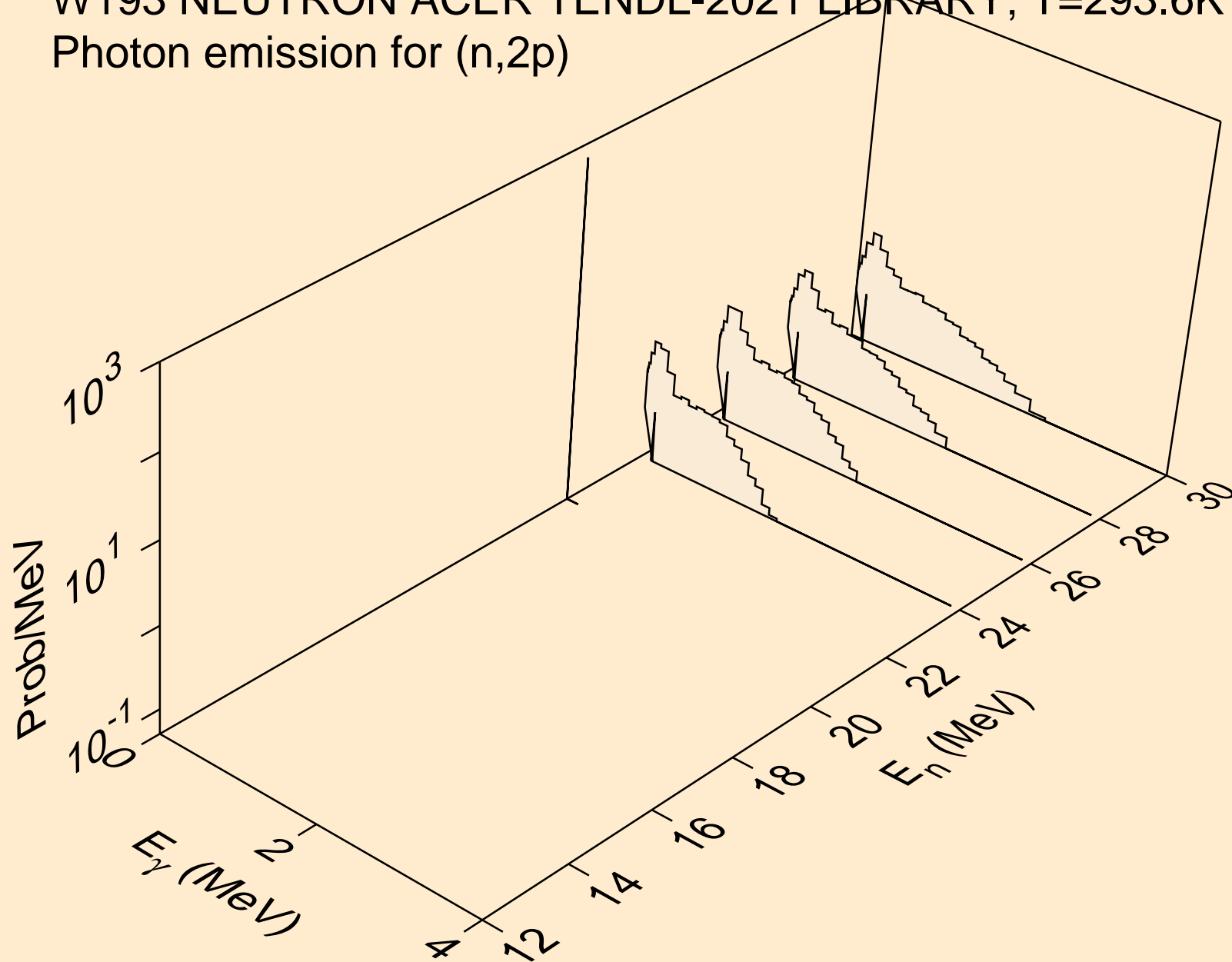

W193 NEUTRON ACER TENDL-2021 LIBRARY; T=293.6K
thermal capture photon spectrum

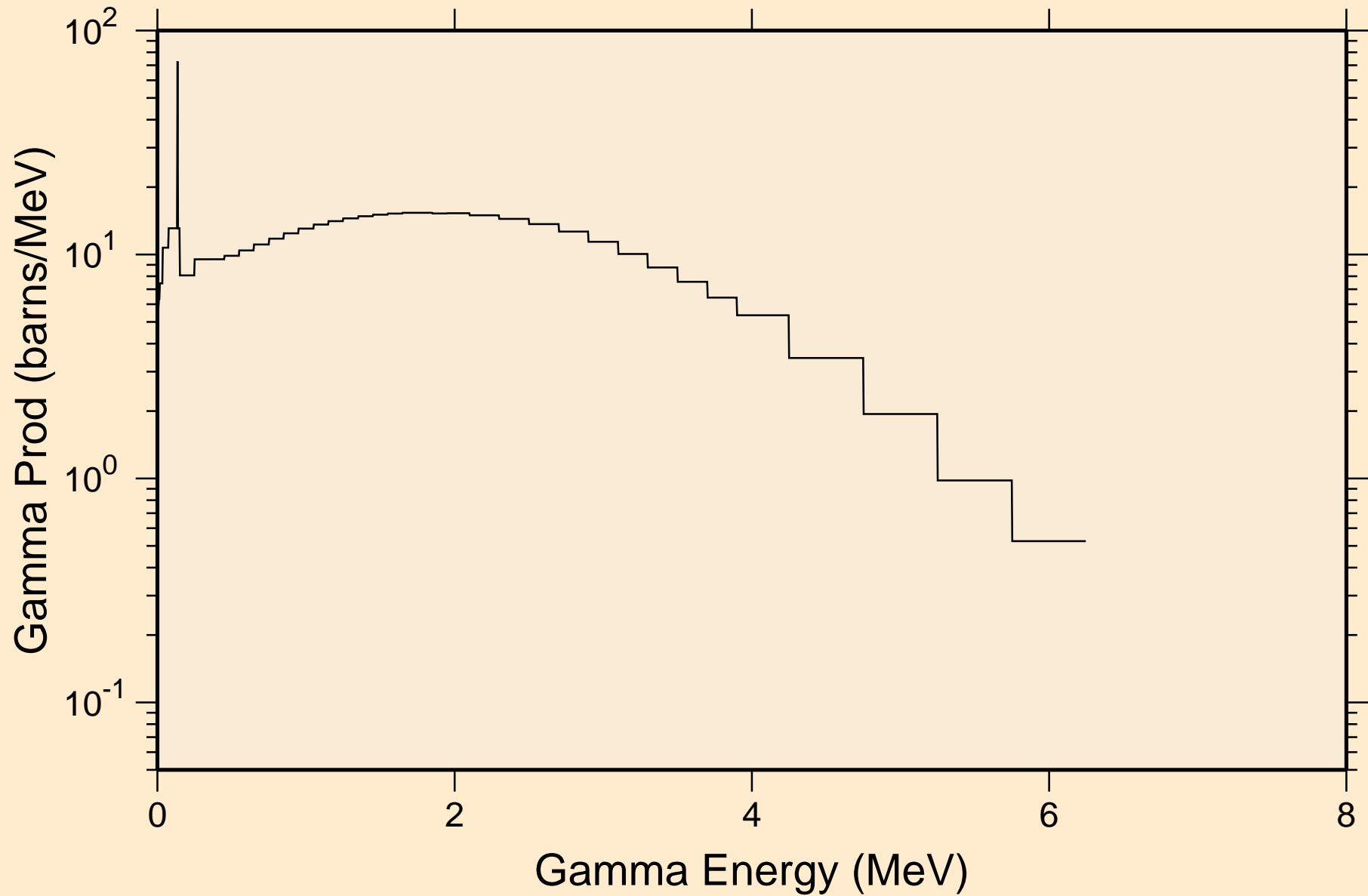

W193 NEUTRON ACER TENDL-2021 LIBRARY; T=293.6K
14 MeV photon spectrum

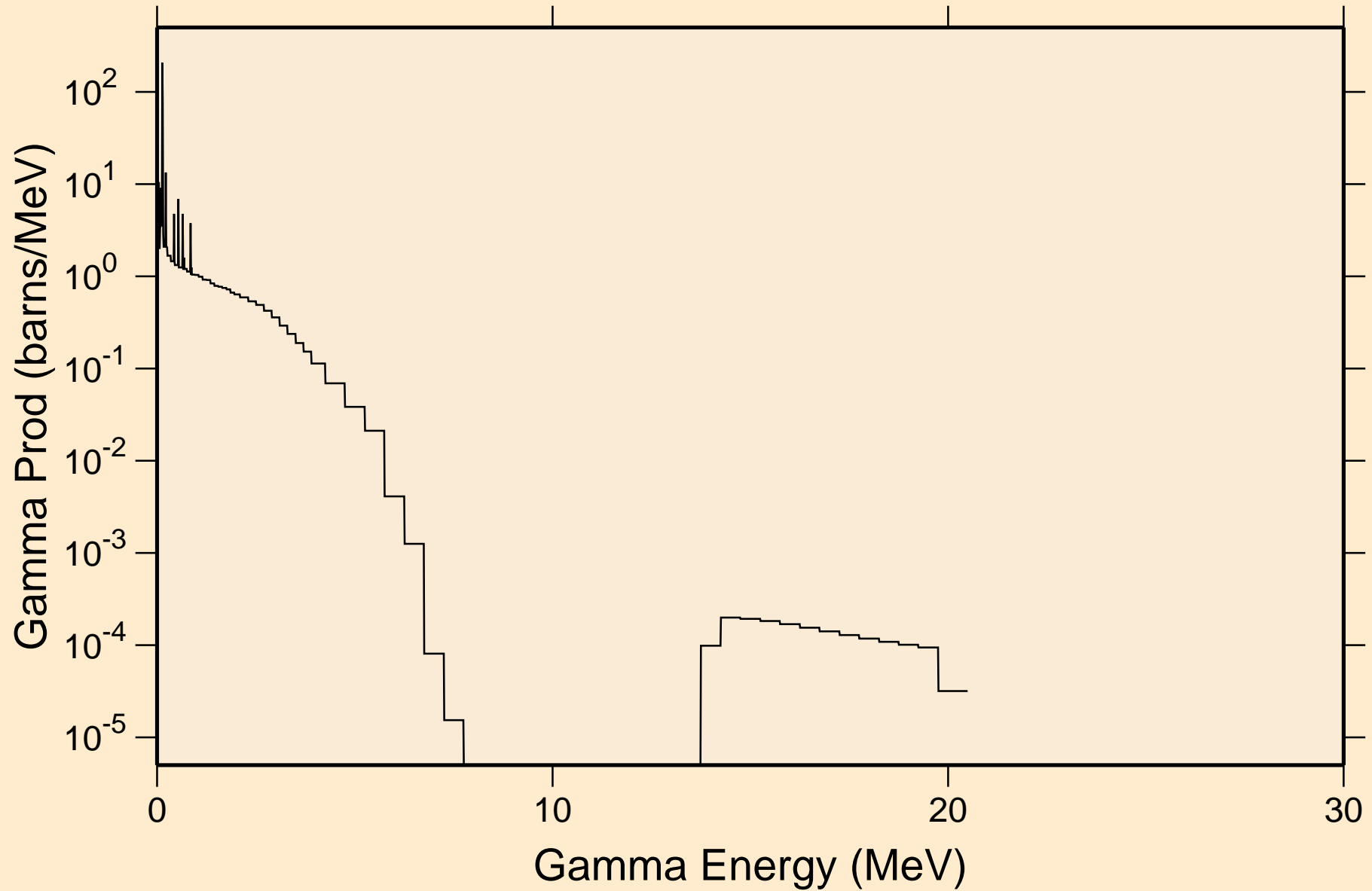

W193 NEUTRON ACER TENDL-2021 LIBRARY; T=293.6K
Particle heating contributions

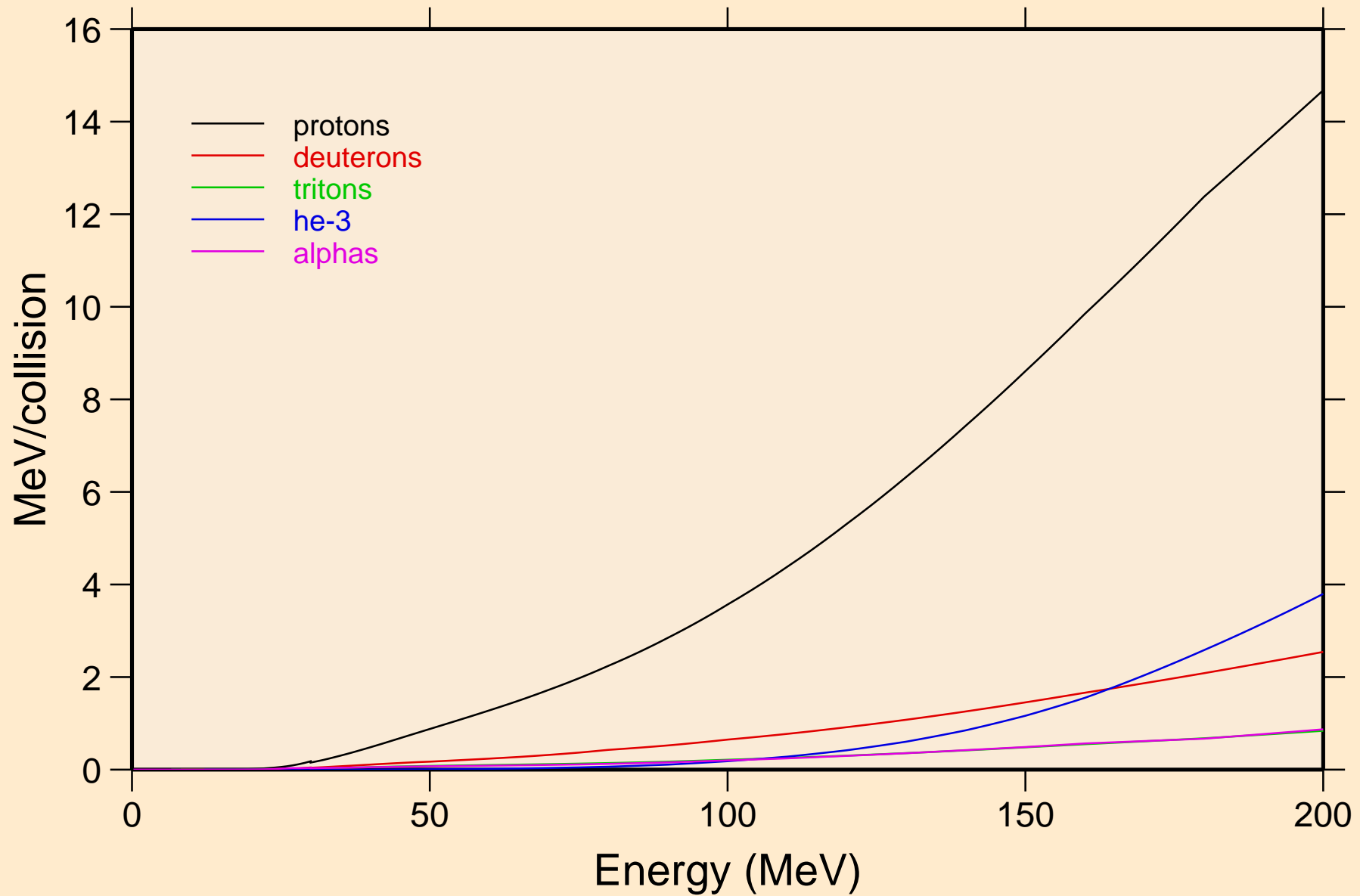

W193 NEUTRON ACER TENDL-2021 LIBRARY; T=293.6K
Recoil Heating

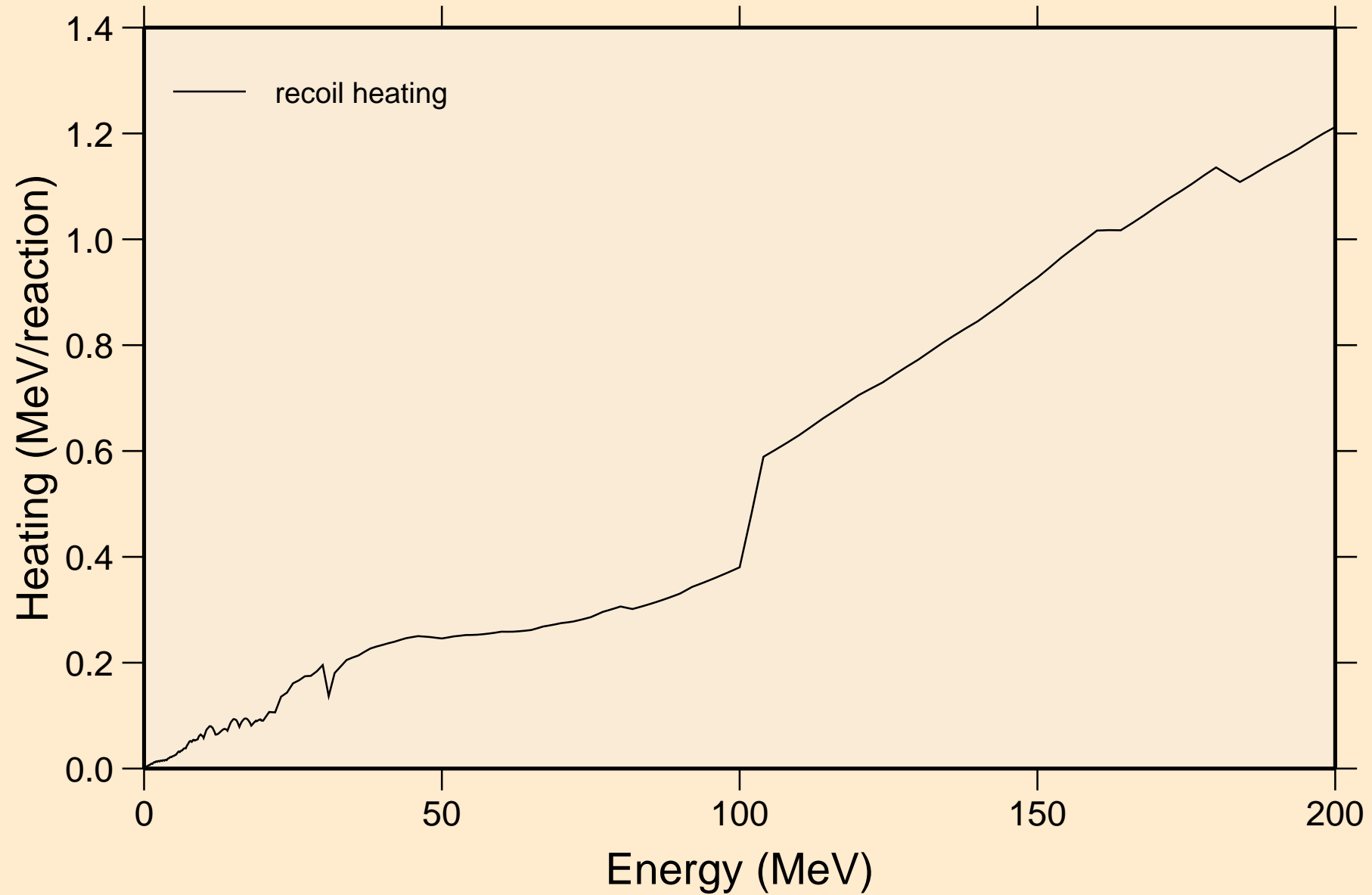

W193 NEUTRON ACER TENDL-2021 LIBRARY; T=293.6K
Particle production cross sections

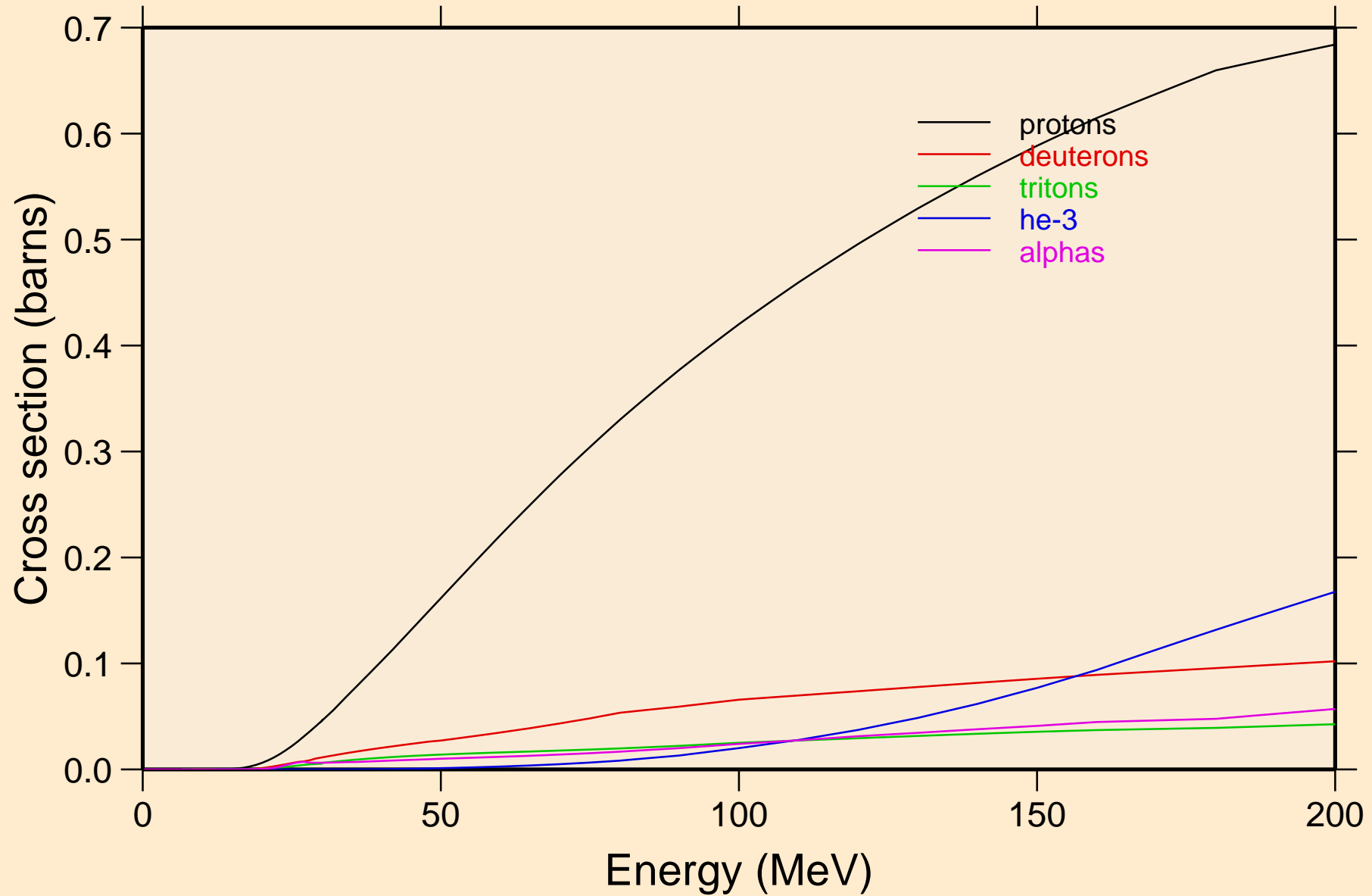

W193 NEUTRON ACER TENDL-2021 LIBRARY; T=293.6K
protons from (n,x)

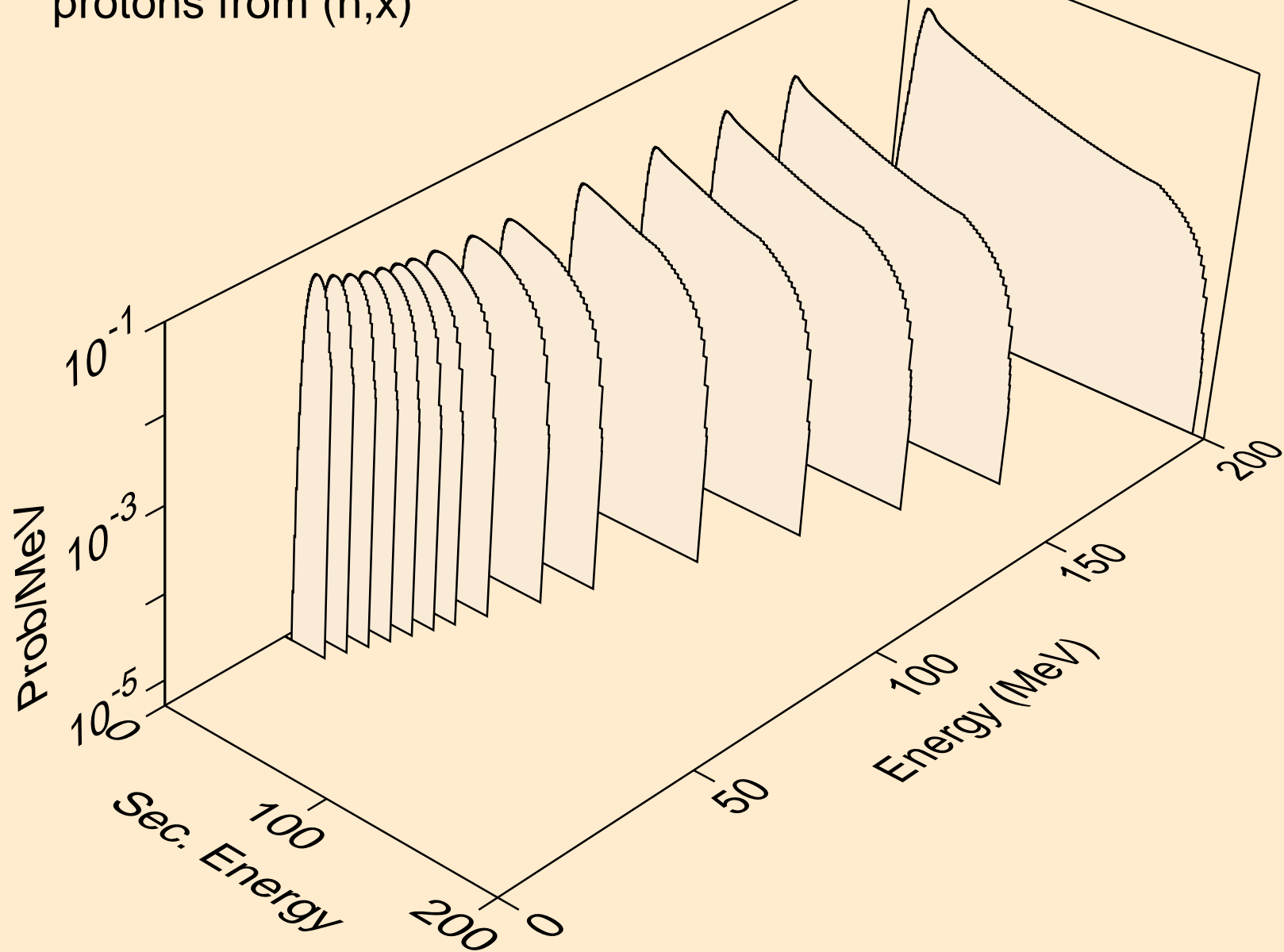

W193 NEUTRON ACER TENDL-2021 LIBRARY; T=293.6K
protons from (n,n*)p

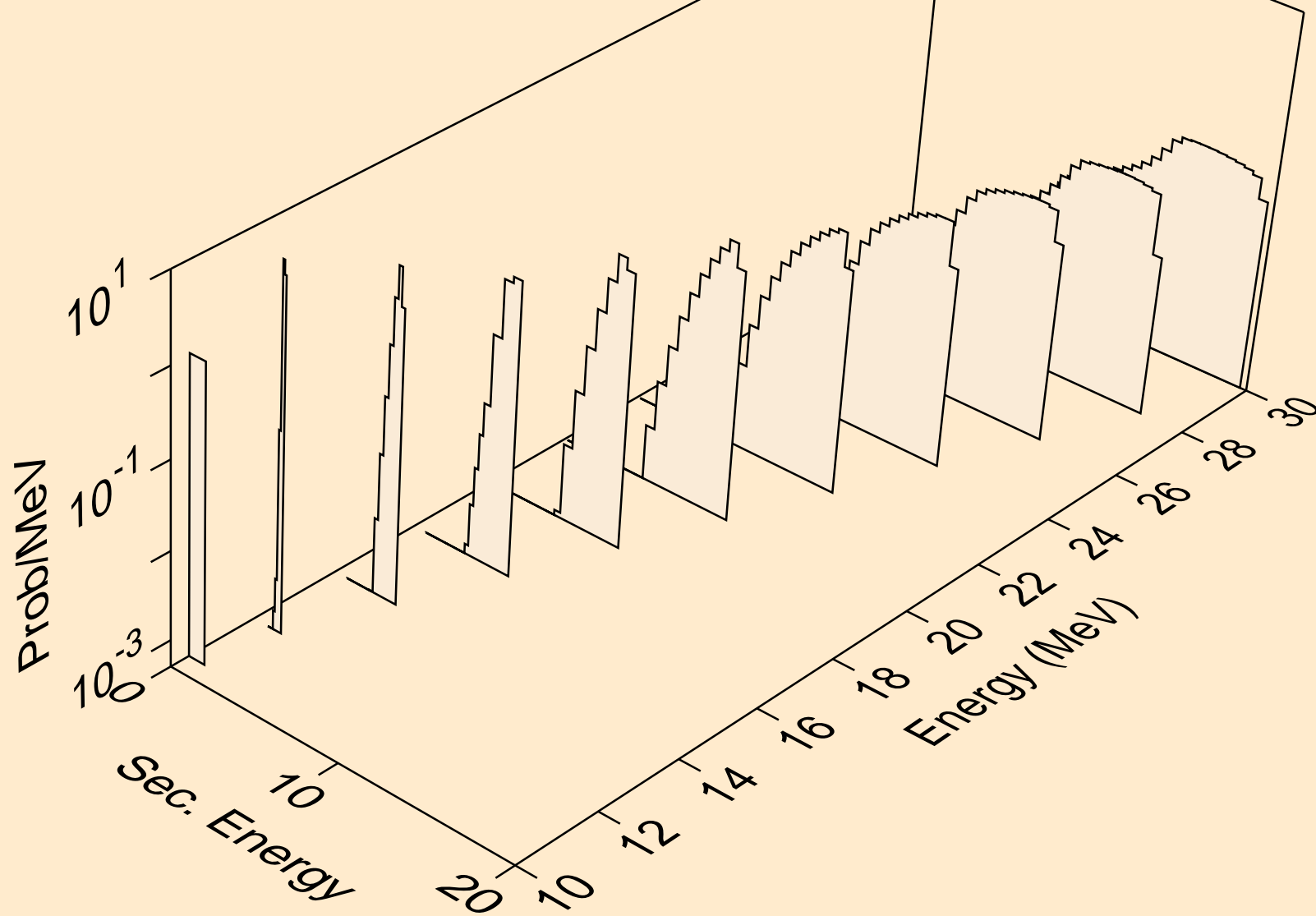

W193 NEUTRON ACER TENDL-2021 LIBRARY; T=293.6K
protons from (n,2np)

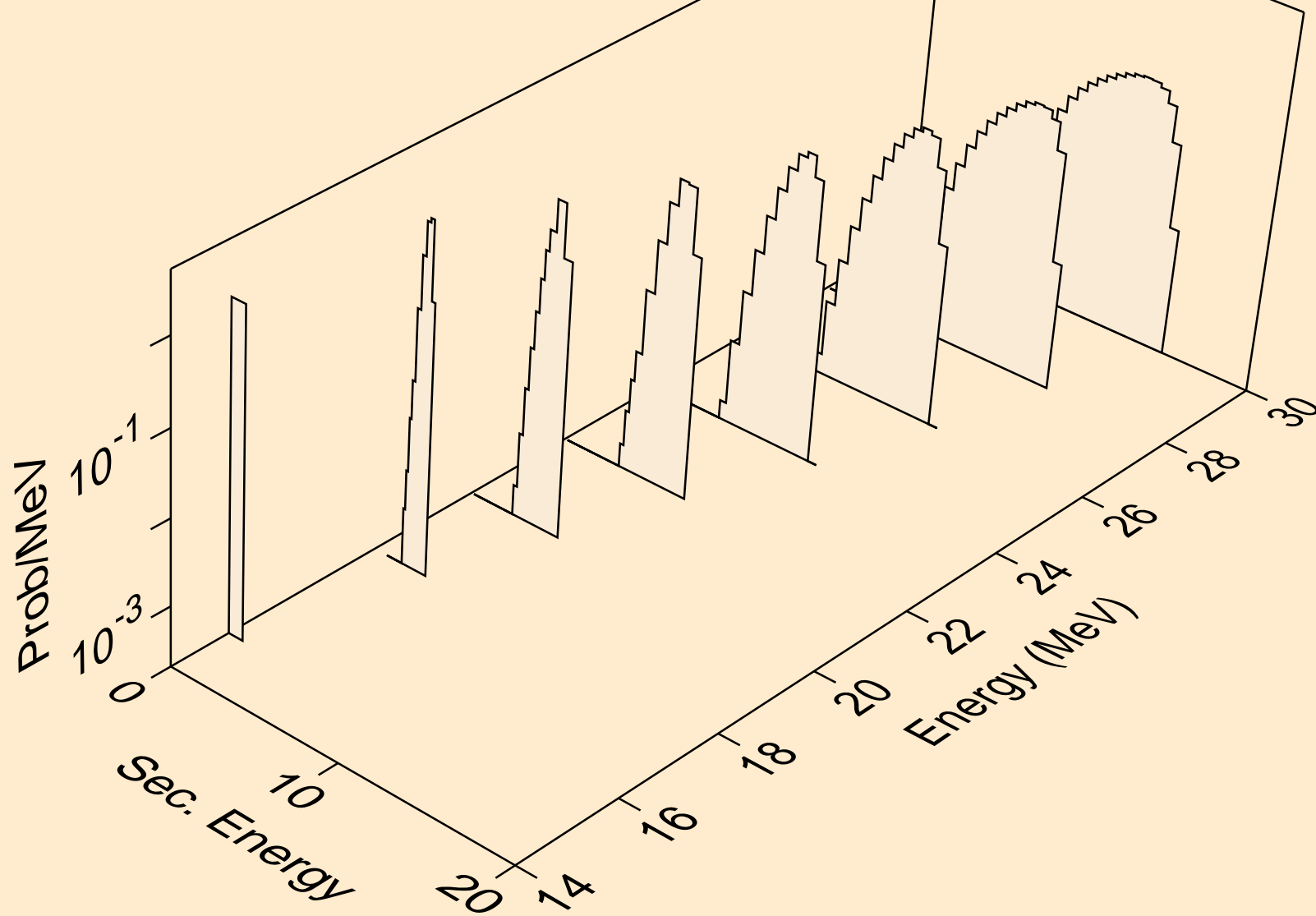

W193 NEUTRON ACER TENDL-2021 LIBRARY; T=293.6K
protons from (n,3np)

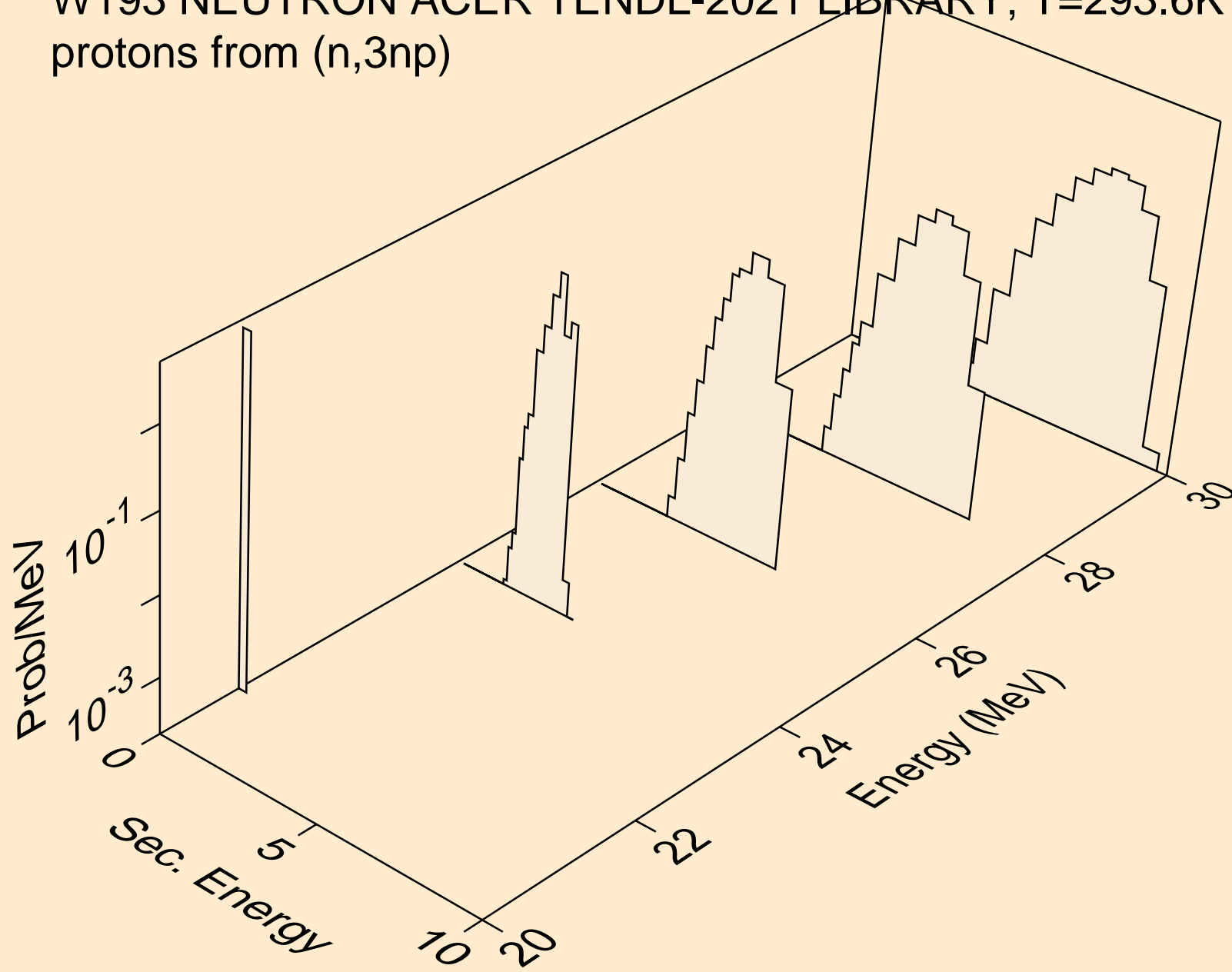

W193 NEUTRON ACER TENDL-2021 LIBRARY; T=293.6K
protons from (n,p)

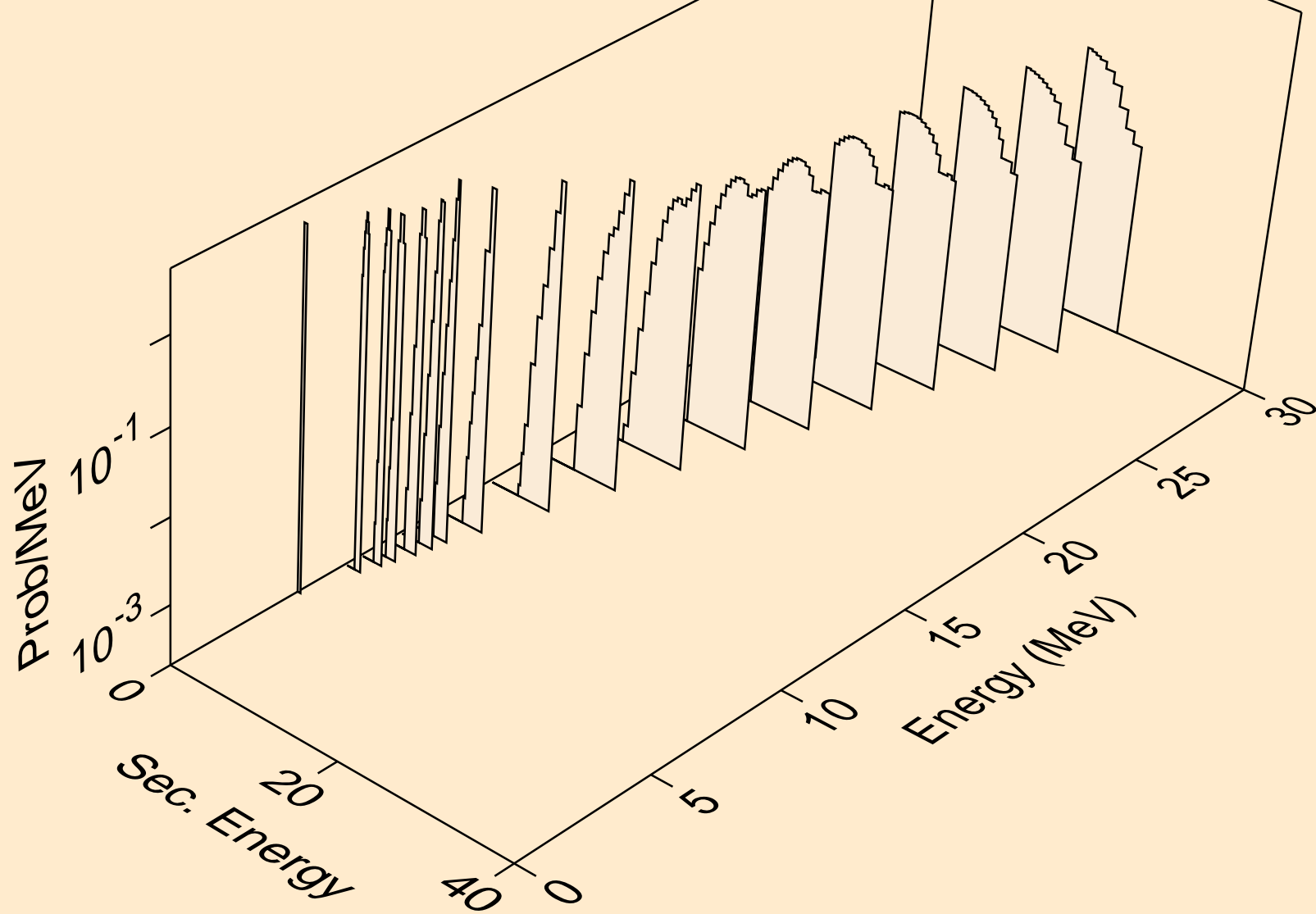

W193 NEUTRON ACER TENDL-2021 LIBRARY; T=293.6K
protons from (n,2p)

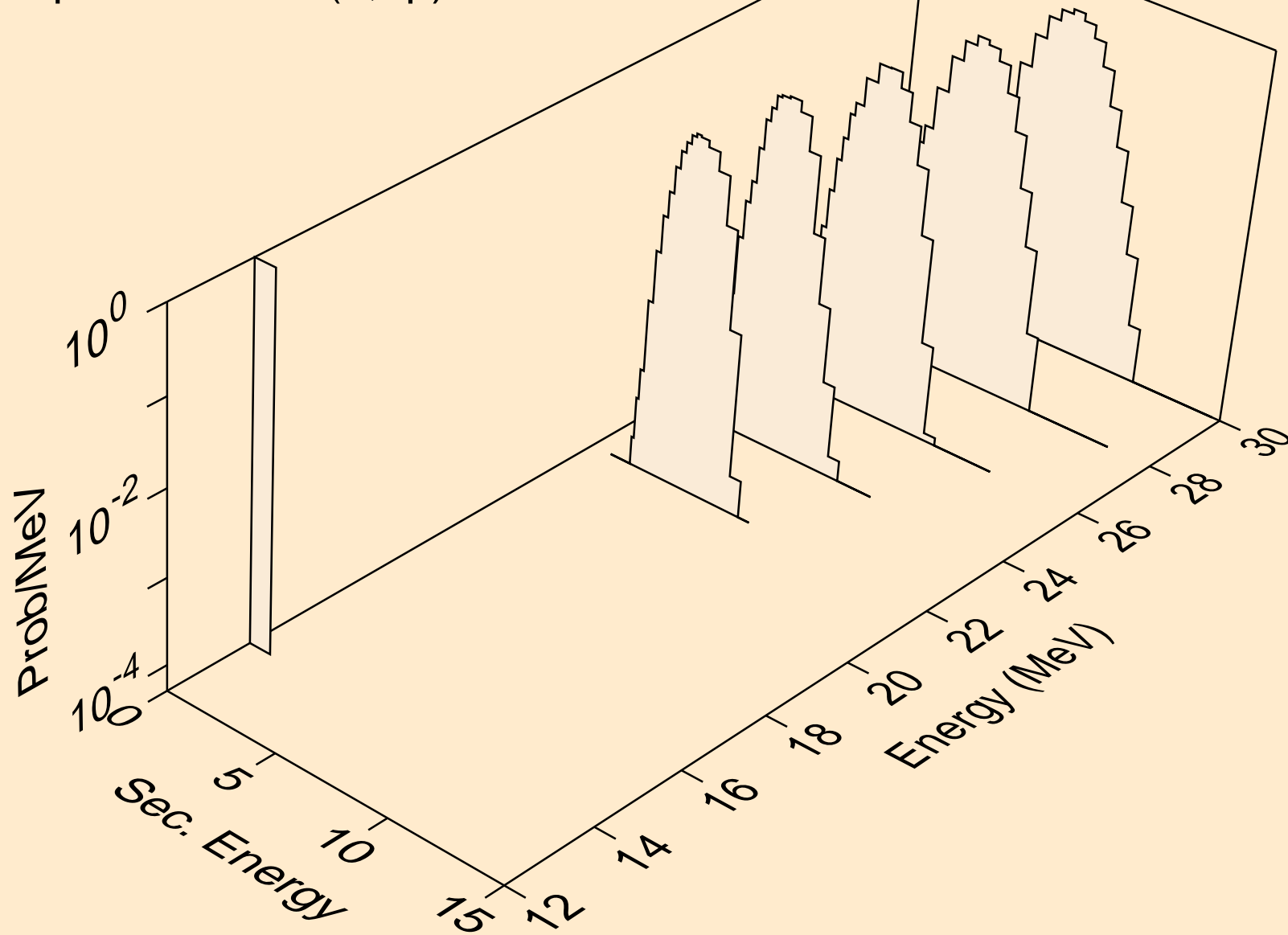

W193 NEUTRON ACER TENDL-2021 LIBRARY; T=293.6K
deuterons from (n,x)

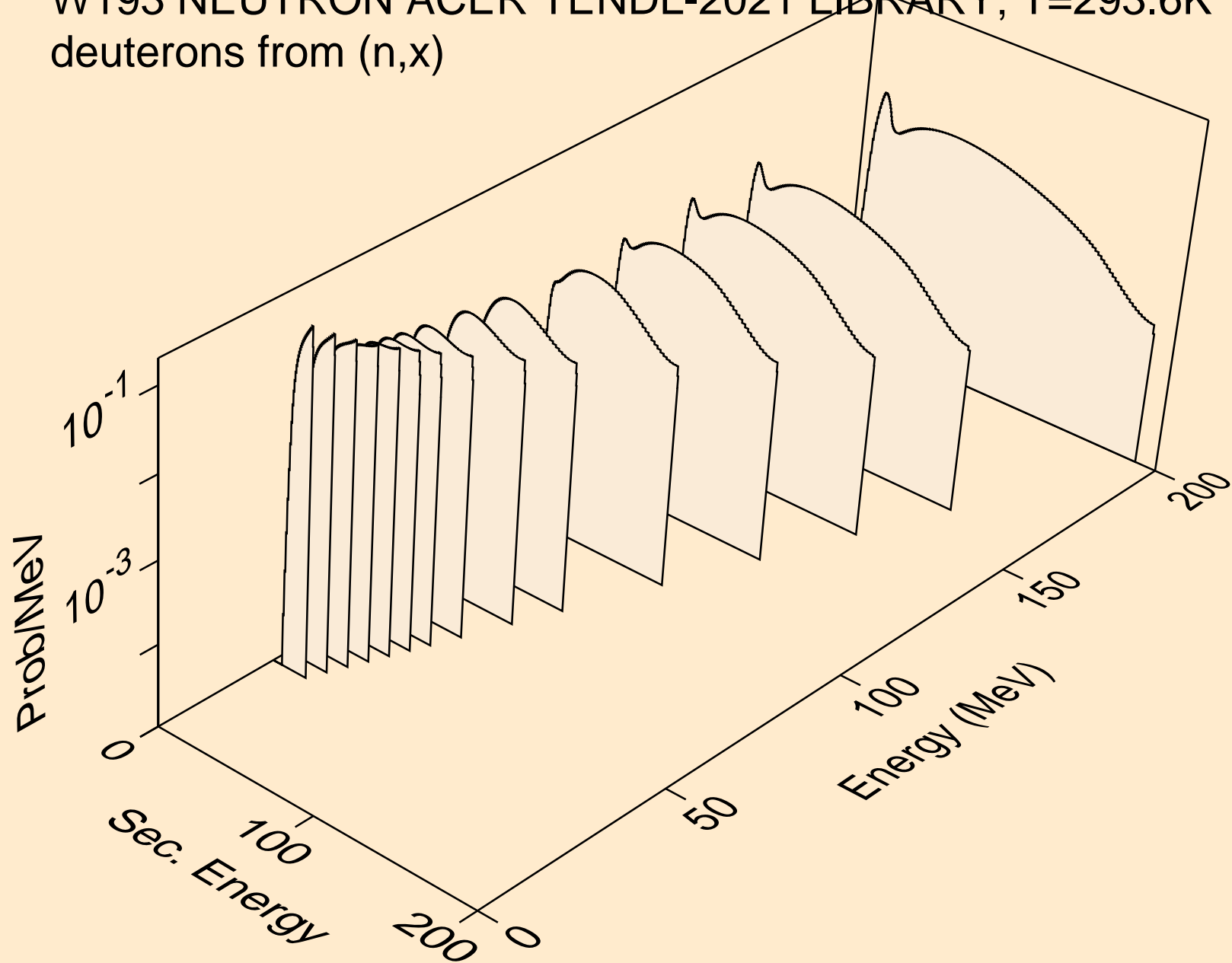

W193 NEUTRON ACER TENDL-2021 LIBRARY; T=293.6K
deuterons from (n,2nd)

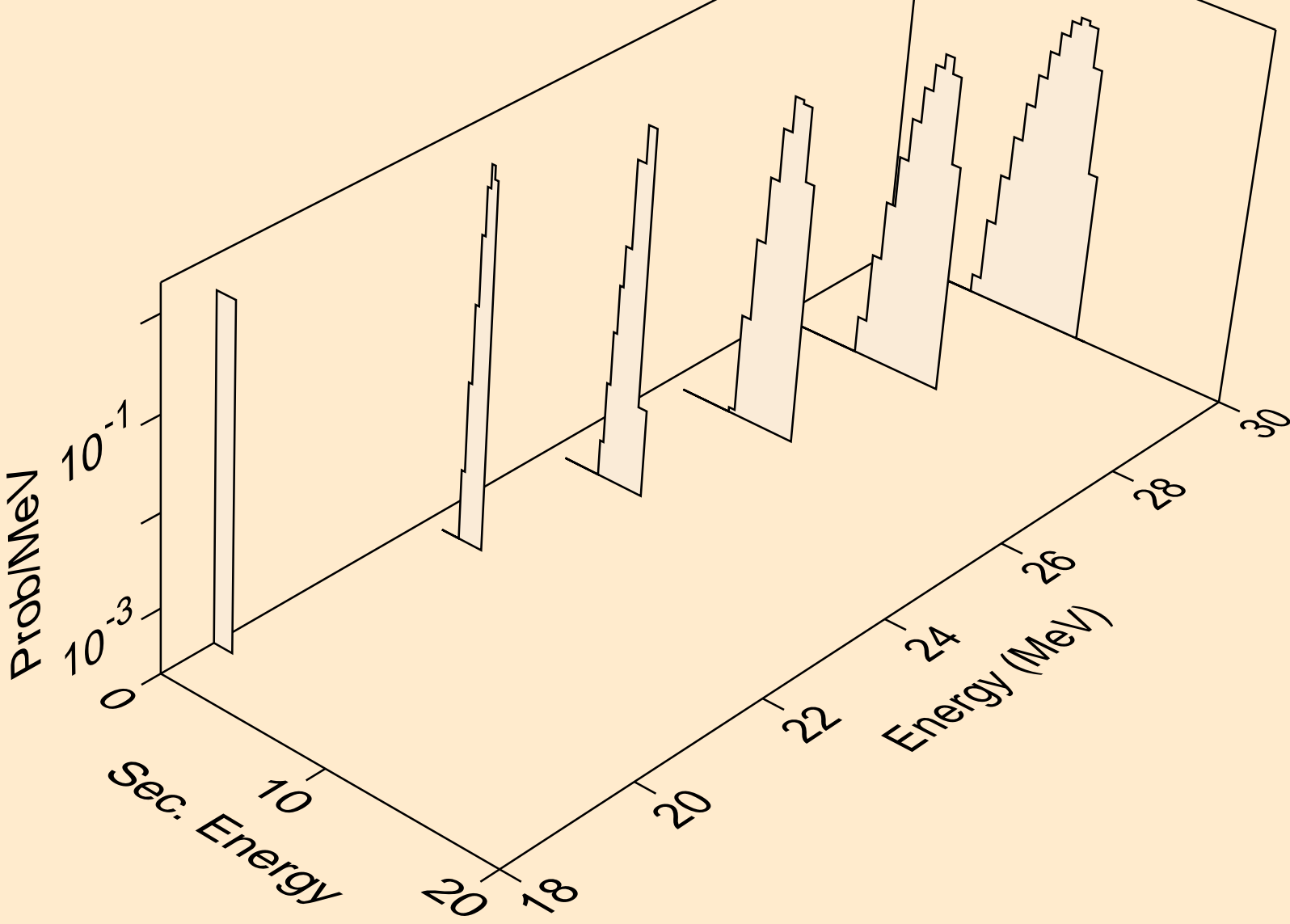

W193 NEUTRON ACER TENDL-2021 LIBRARY; T=293.6K
deuterons from (n,n*)d

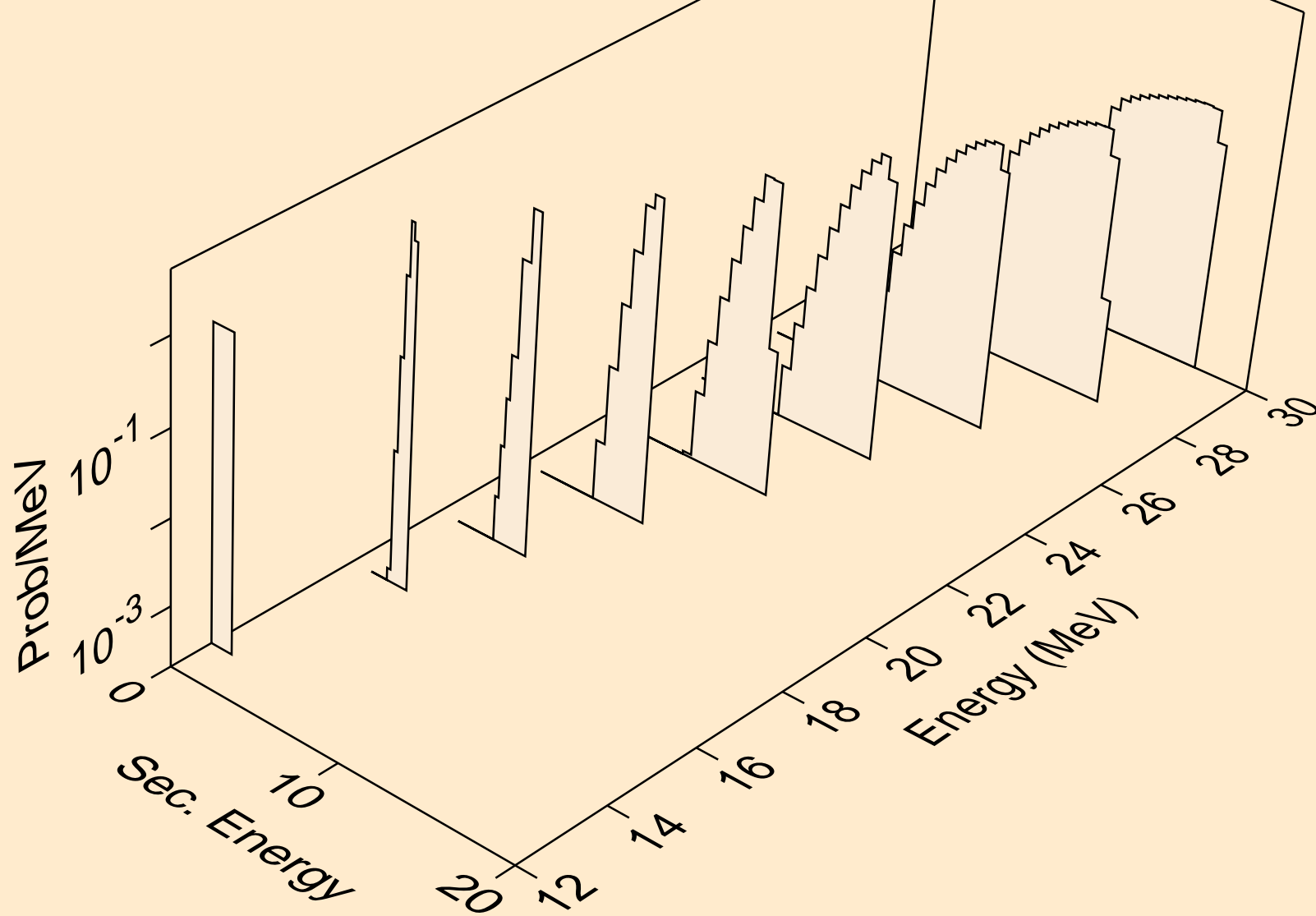

W193 NEUTRON ACER TENDL-2021 LIBRARY; T=293.6K
deuterons from (n,d)

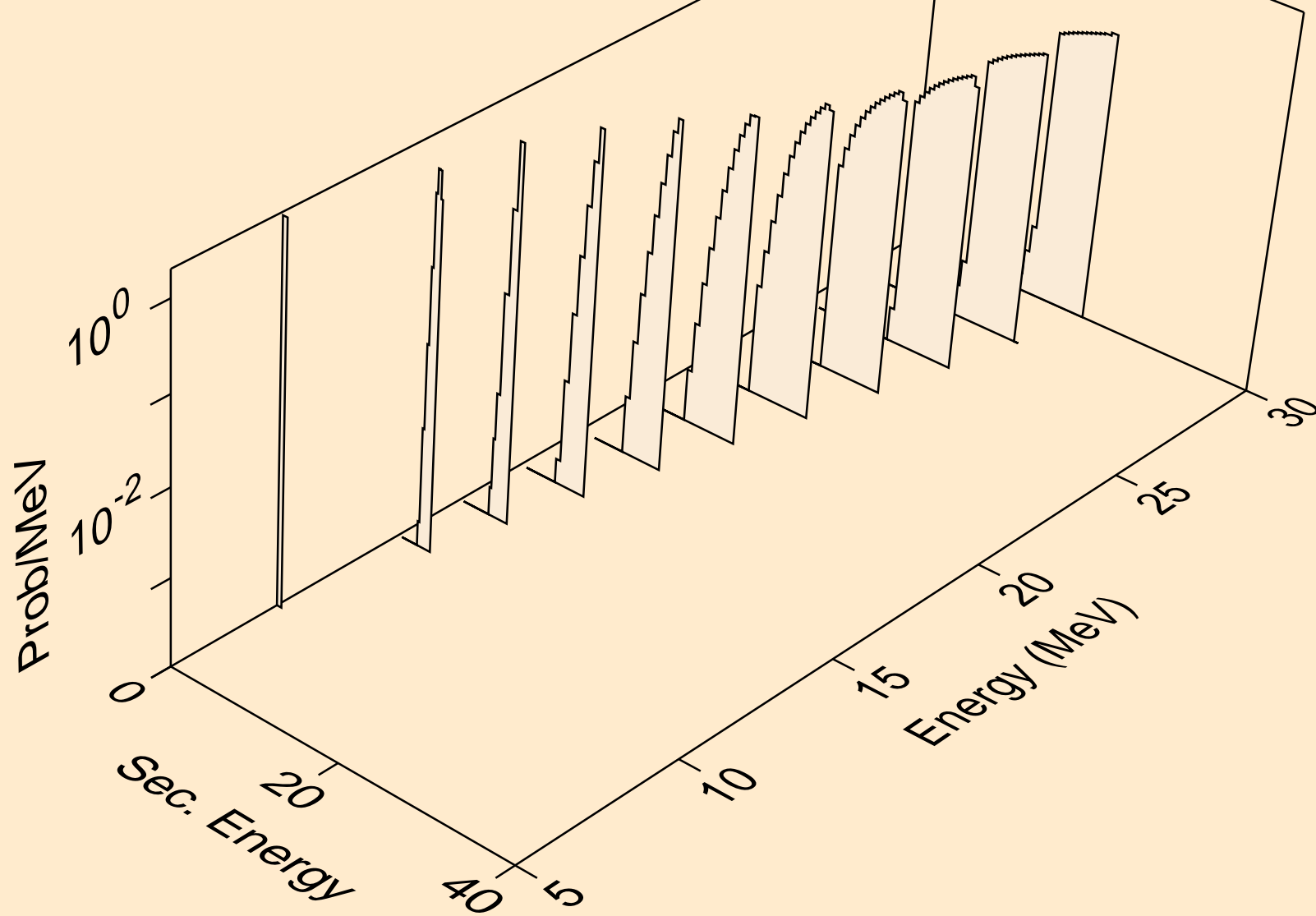

W193 NEUTRON ACER TENDL-2021 LIBRARY; T=293.6K
tritons from (n,x)

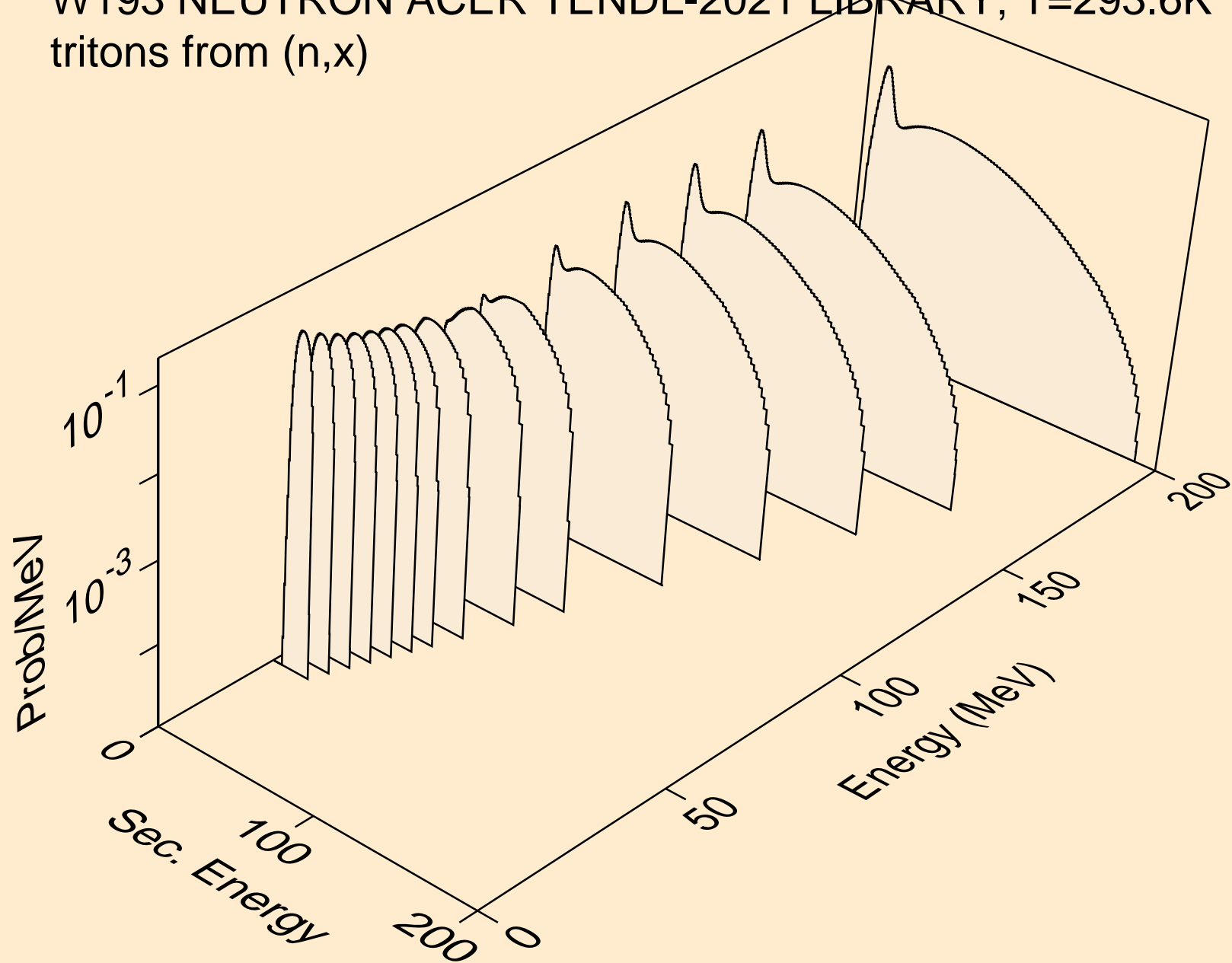

W193 NEUTRON ACER TENDL-2021 LIBRARY; T=293.6K
tritons from (n,n*)t

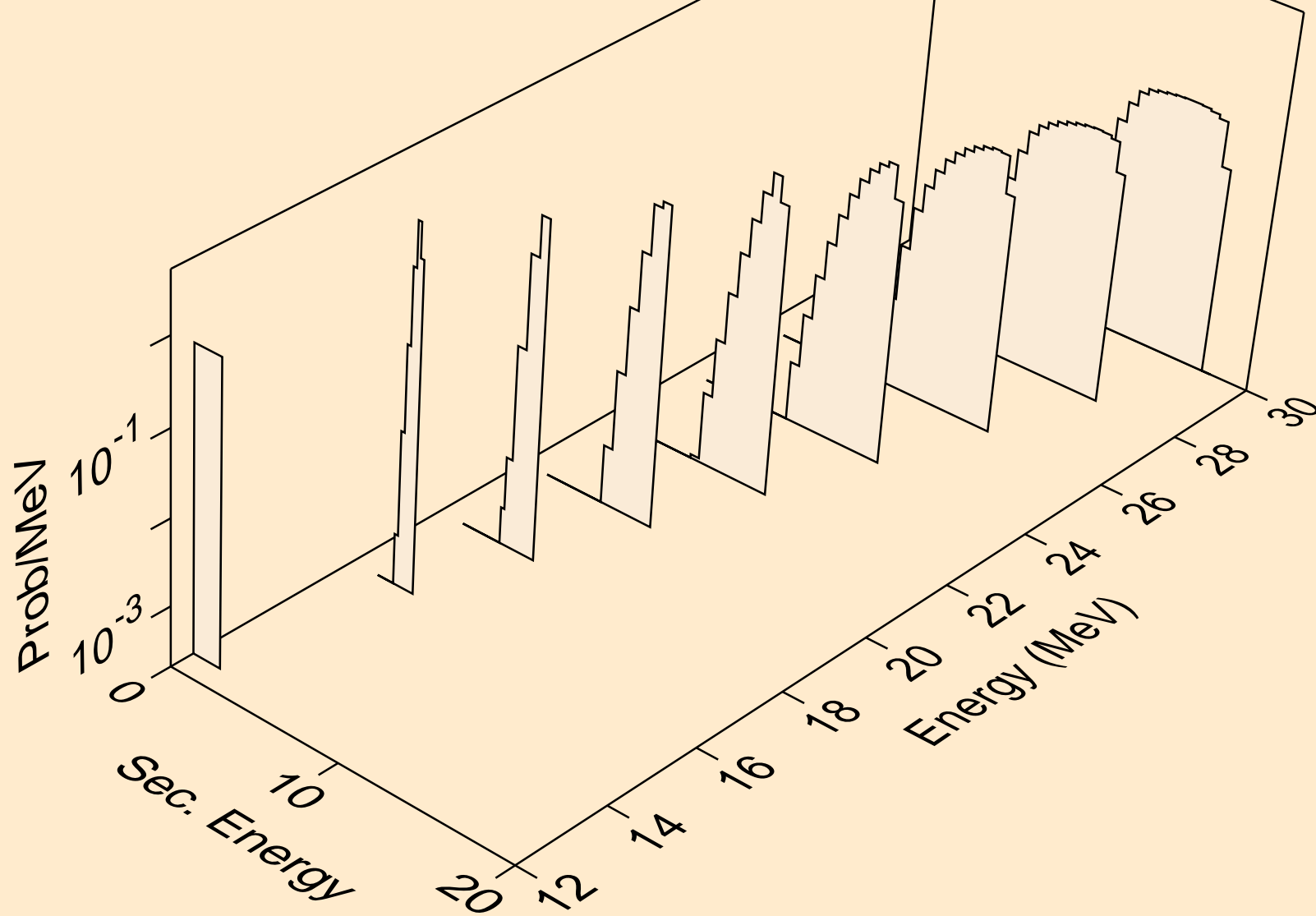

W193 NEUTRON ACER TENDL-2021 LIBRARY; T=293.6K
tritons from (n,t)

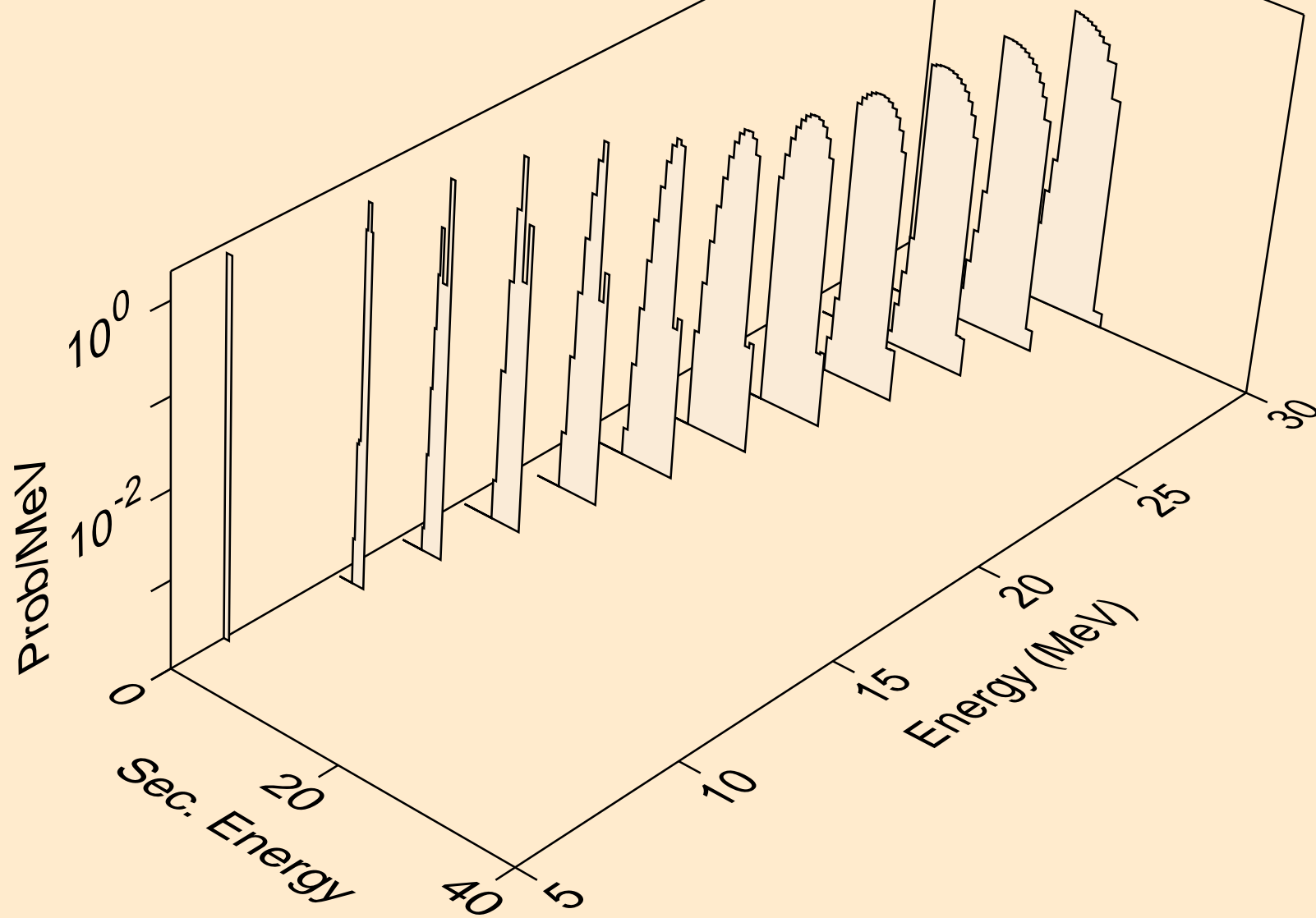

W193 NEUTRON ACER TENDL-2021 LIBRARY; T=293.6K
he3s from (n,x)

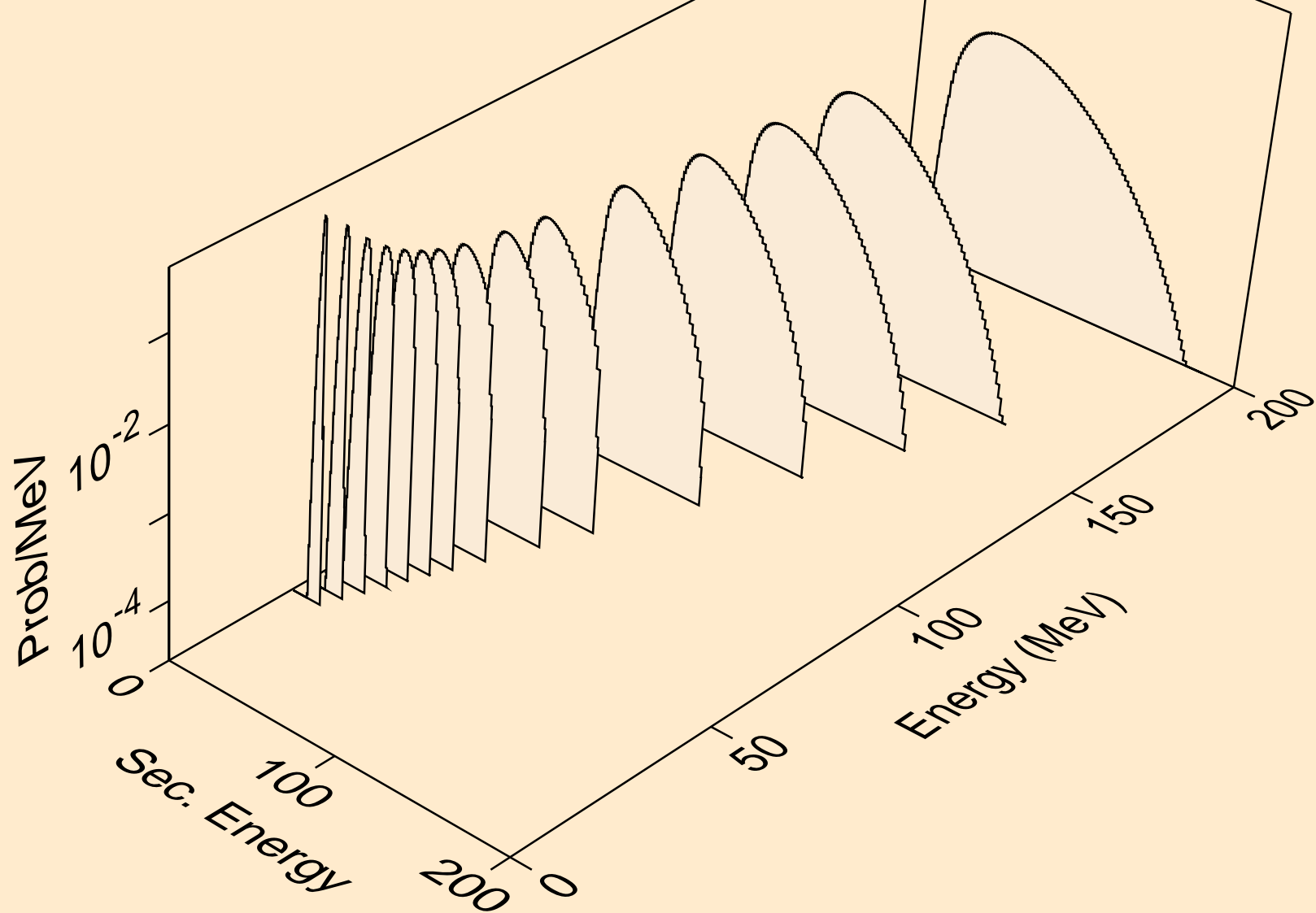

W193 NEUTRON ACER TENDL-2021 LIBRARY; T=293.6K
he3s from (n,n*)he3

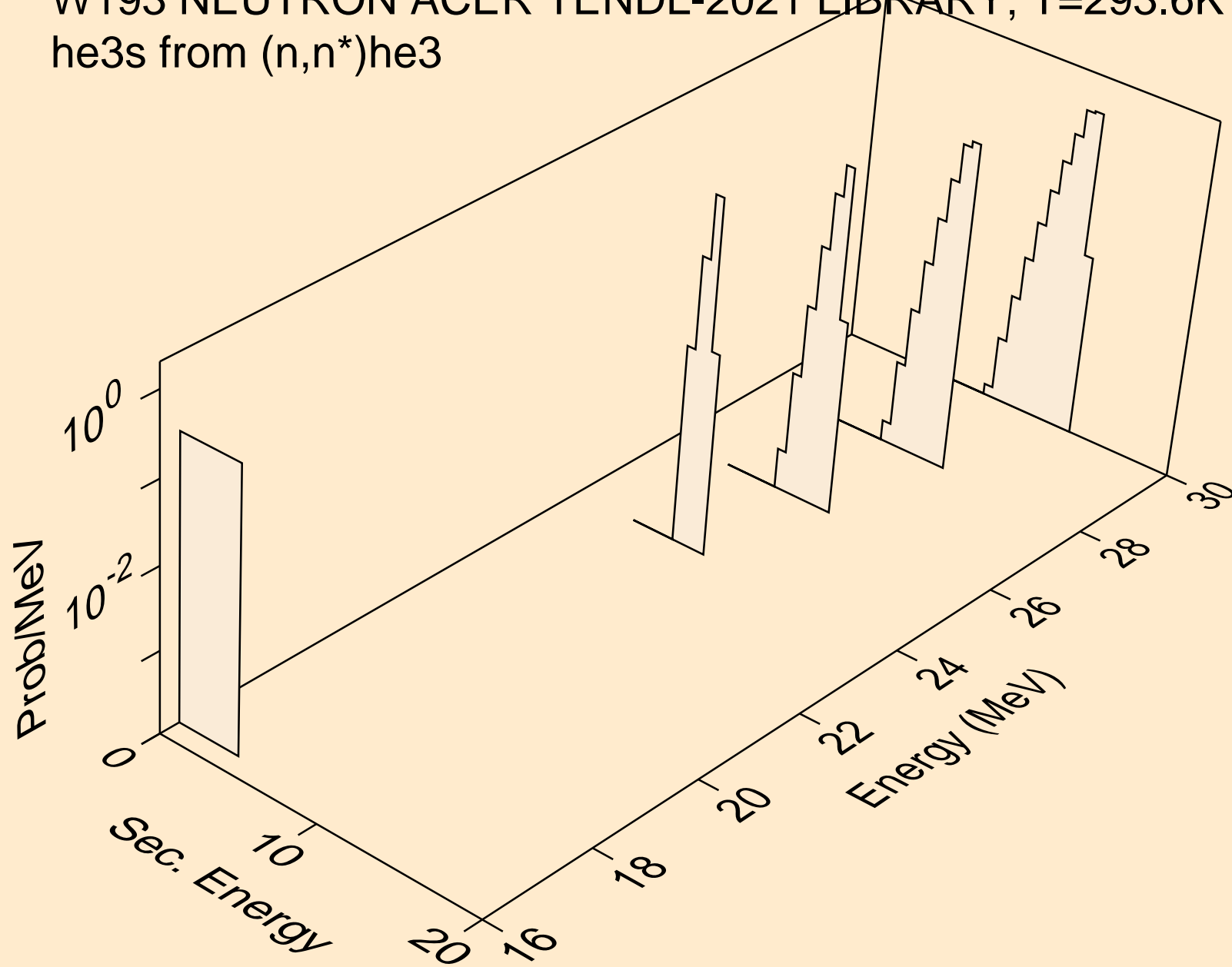

W193 NEUTRON ACER TENDL-2021 LIBRARY; T=293.6K
he3s from (n,he3)

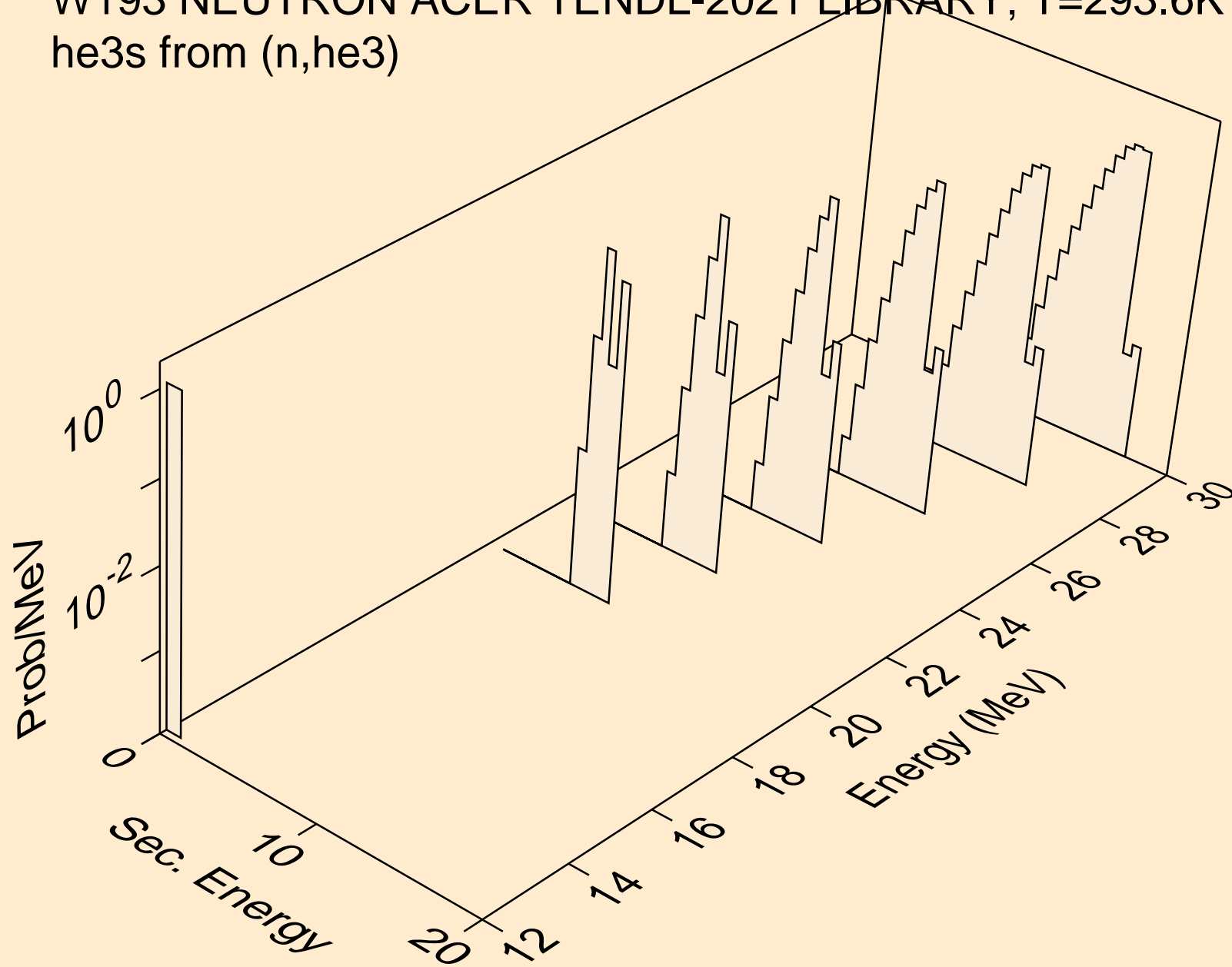

W193 NEUTRON ACER TENDL-2021 LIBRARY; T=293.6K
alphas from (n,x)

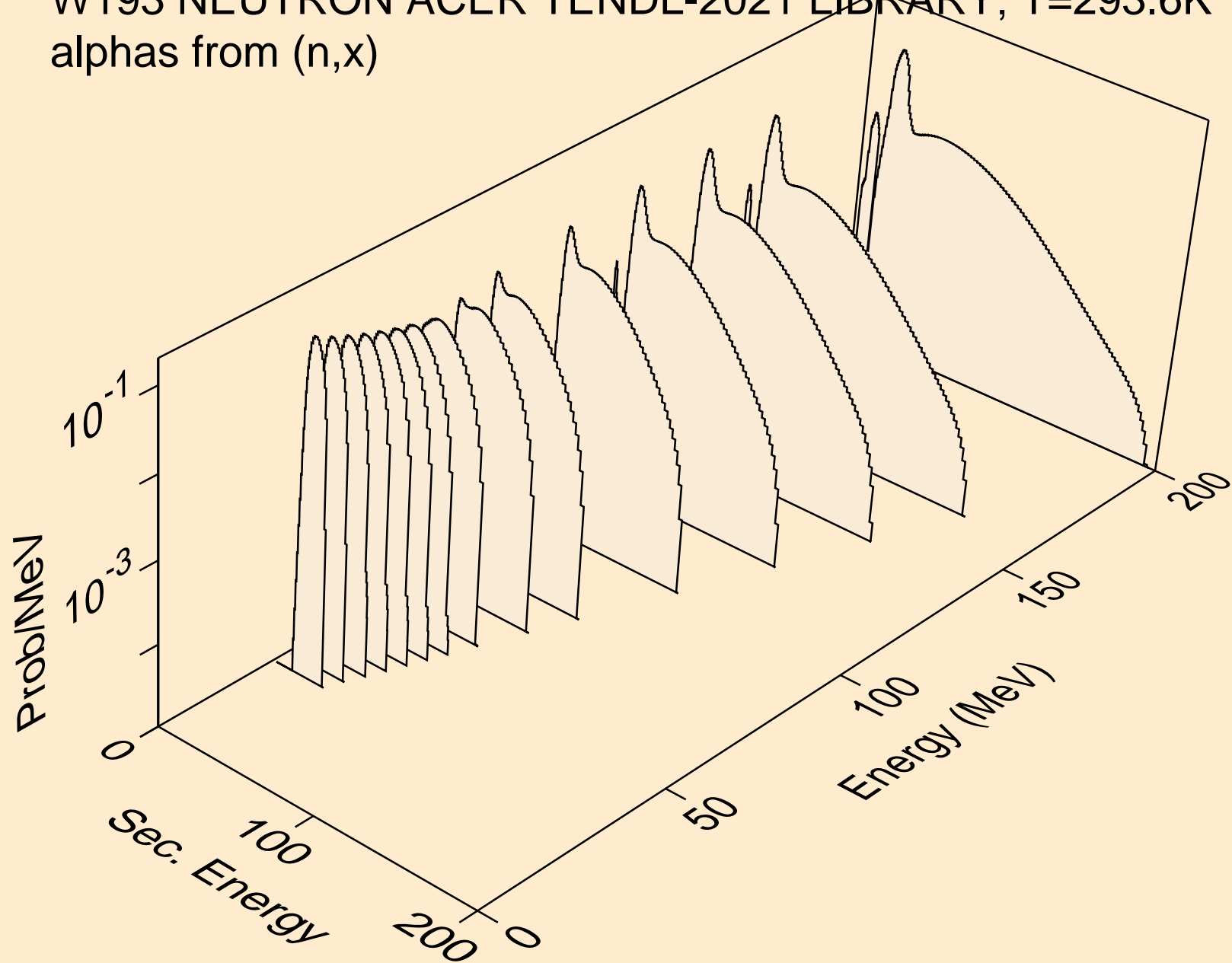

W193 NEUTRON ACER TENDL-2021 LIBRARY; T=293.6K
alphas from (n,n*)a

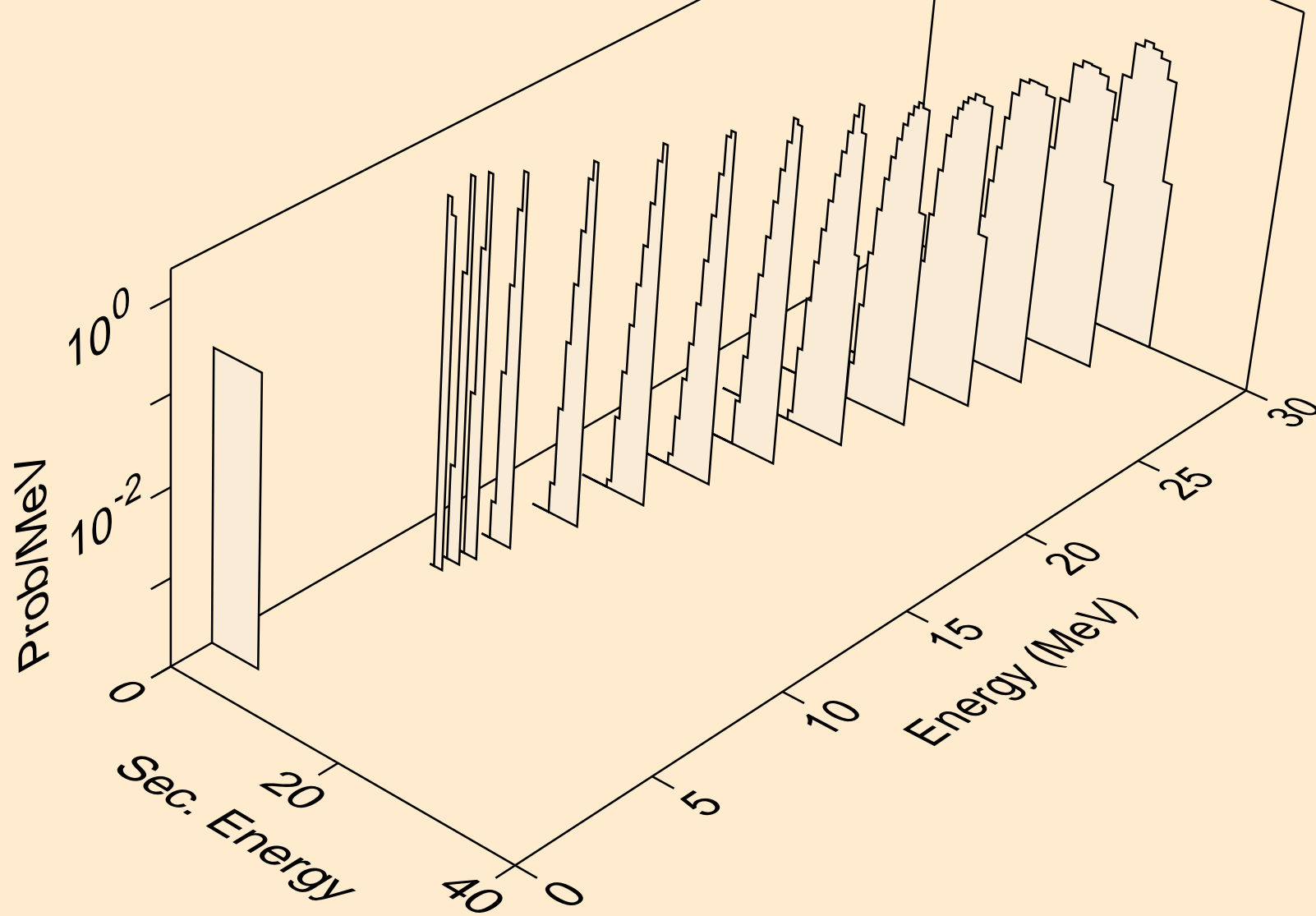

W193 NEUTRON ACER TENDL-2021 LIBRARY; T=293.6K
alphas from (n,2n)a

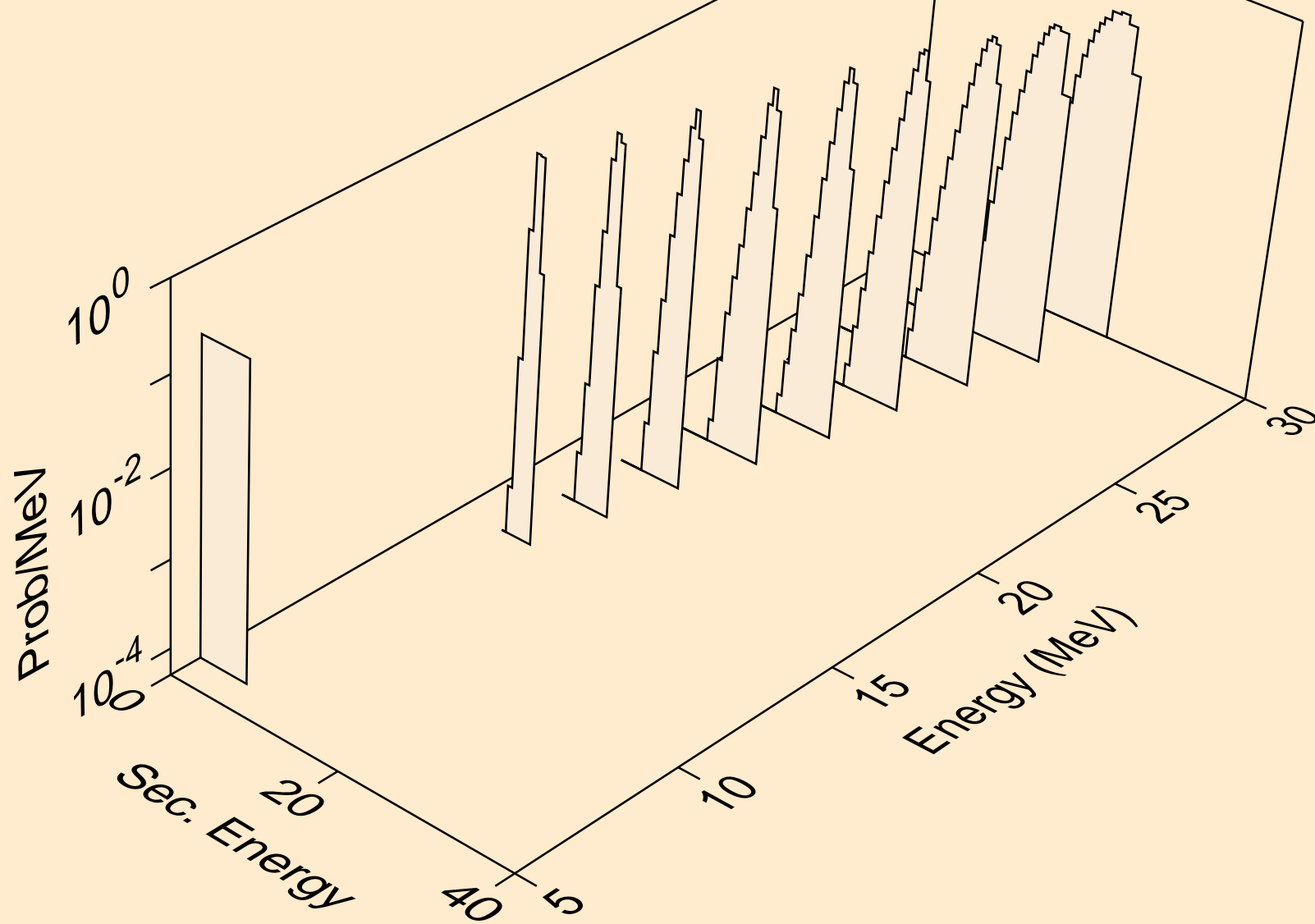

W193 NEUTRON ACER TENDL-2021 LIBRARY; T=293.6K
alphas from (n,3n)a

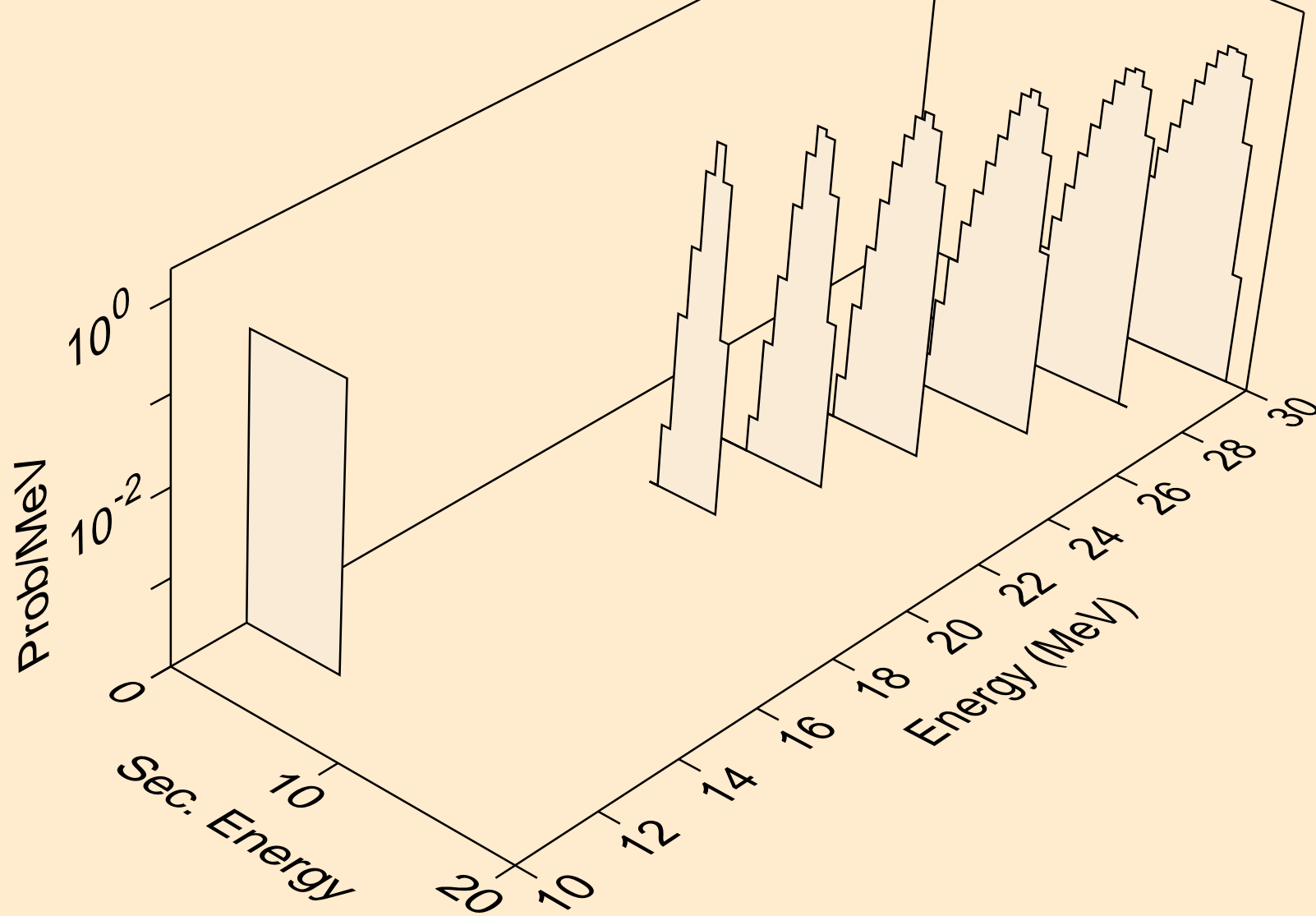

W193 NEUTRON ACER TENDL-2021 LIBRARY; T=293.6K
alphas from (n,a)

