

XE114 NEUTRON ACER TENDL-2021 LIBRARY; T=293.6K

Principal cross sections

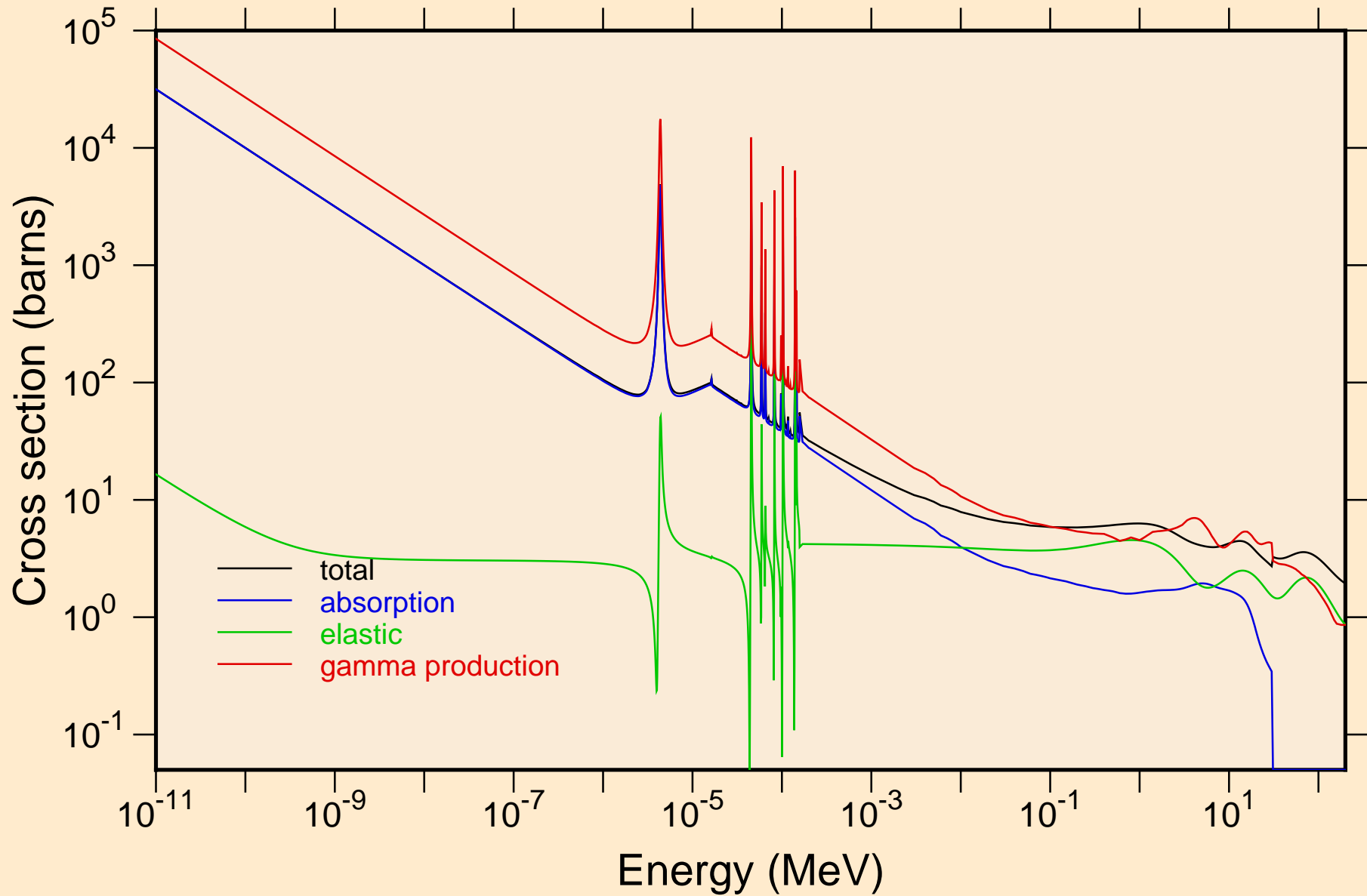

XE114 NEUTRON ACER TENDL-2021 LIBRARY; T=293.6K
resonance total cross section

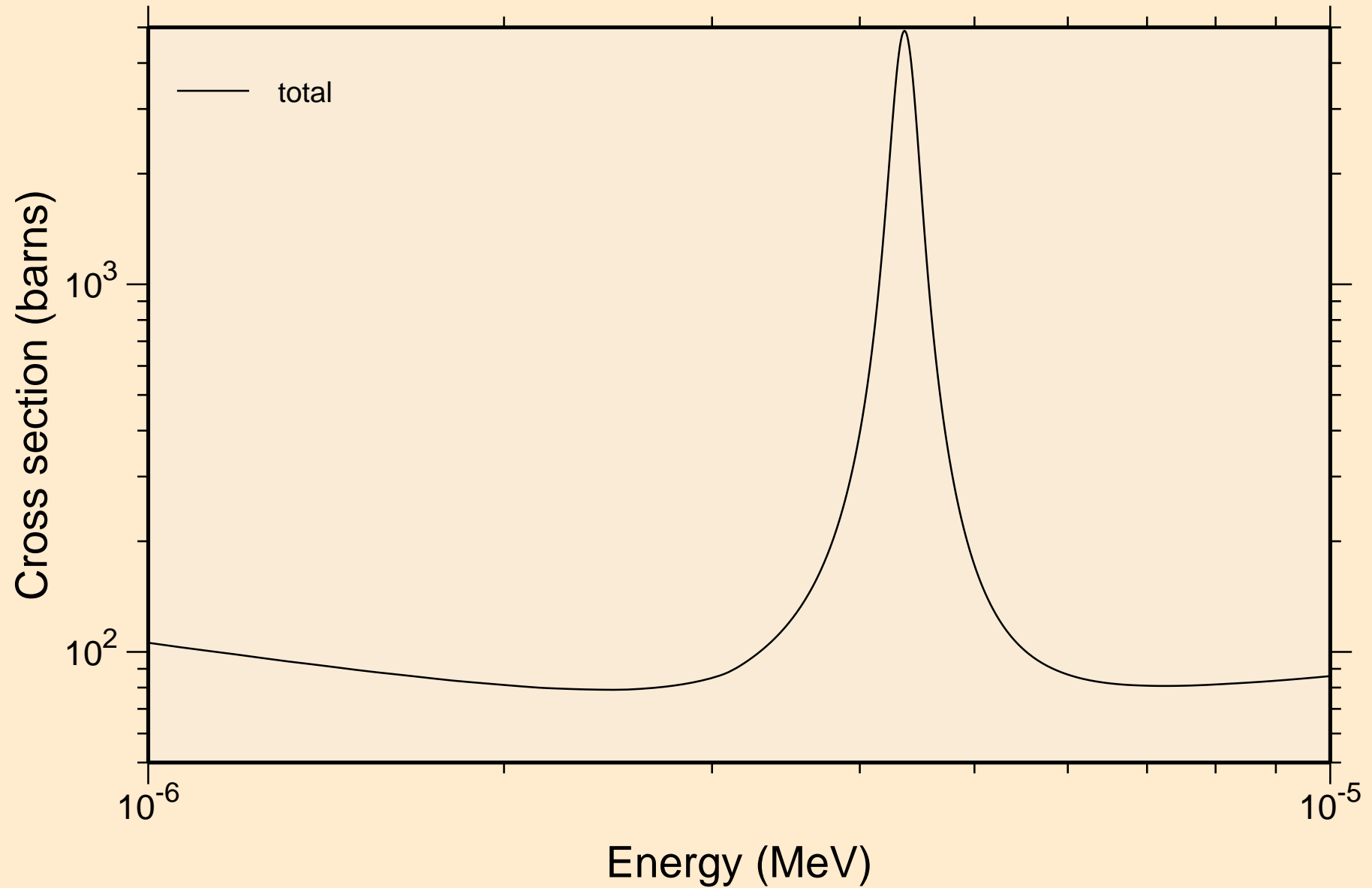

XE114 NEUTRON ACER TENDL-2021 LIBRARY; T=293.6K
resonance total cross section

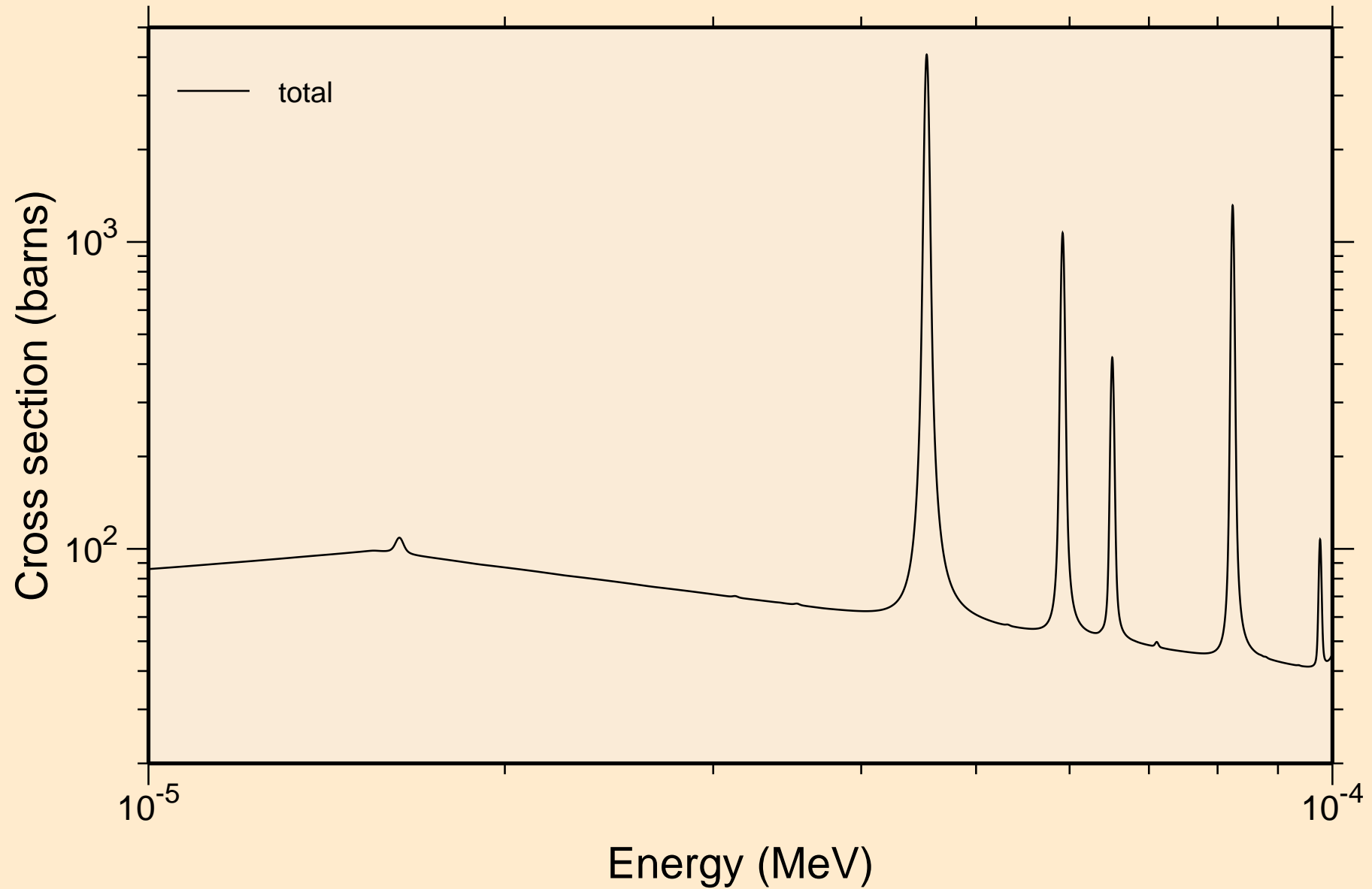

XE114 NEUTRON ACER TENDL-2021 LIBRARY; T=293.6K
resonance total cross section

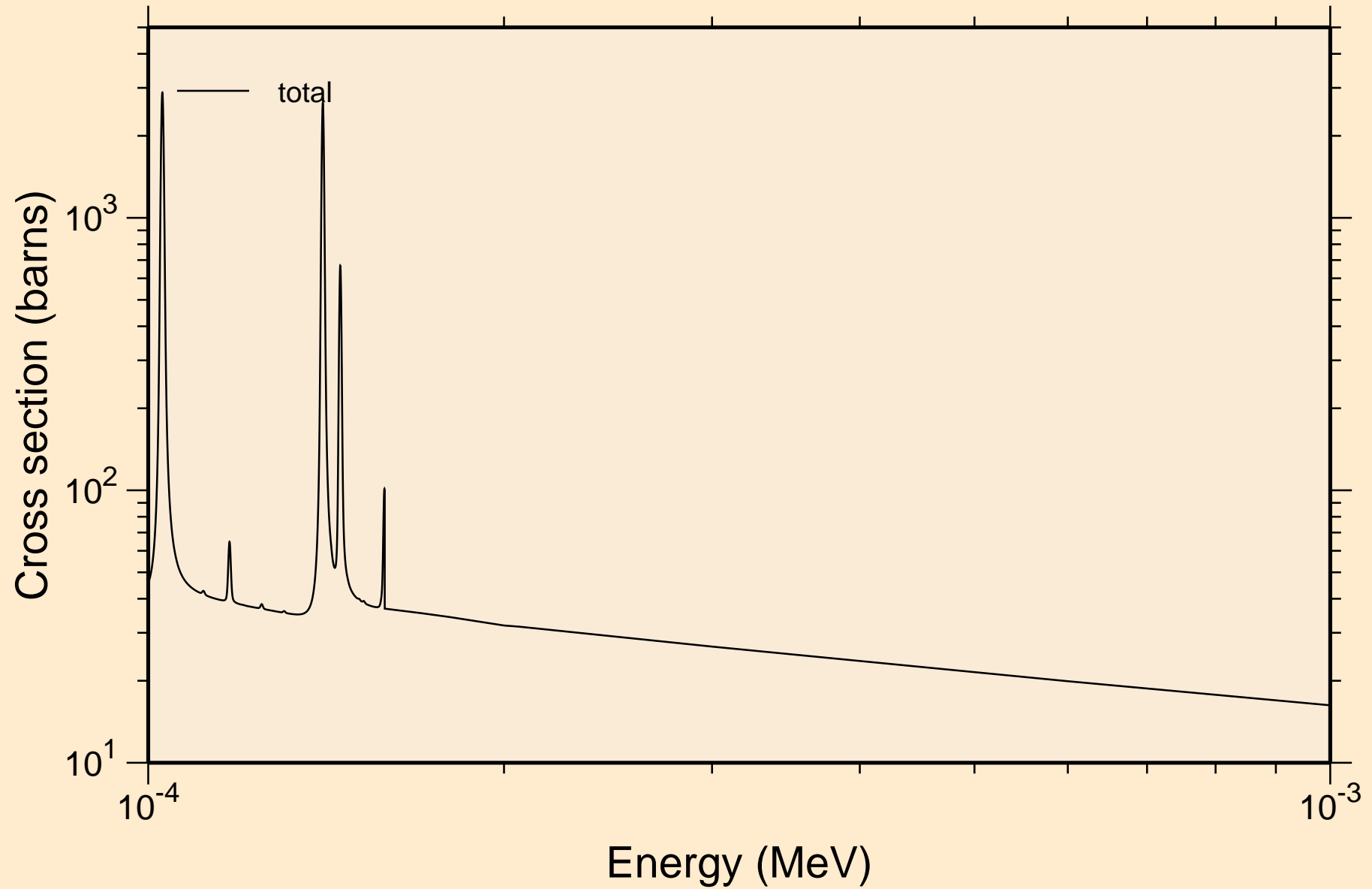

XE114 NEUTRON ACER TENDL-2021 LIBRARY; T=293.6K
resonance total cross section

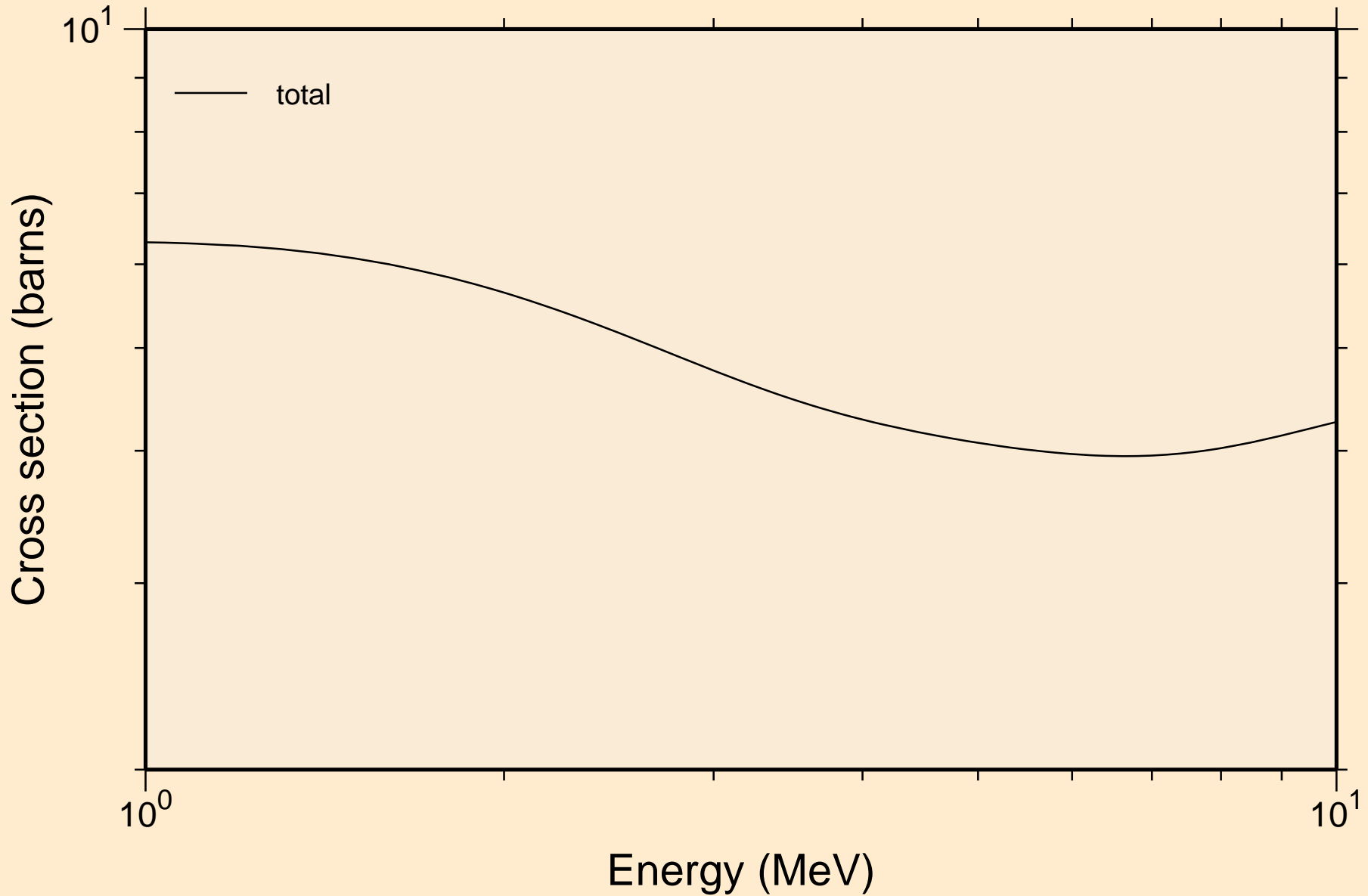

XE114 NEUTRON ACER TENDL-2021 LIBRARY; T=293.6K
resonance absorption cross sections

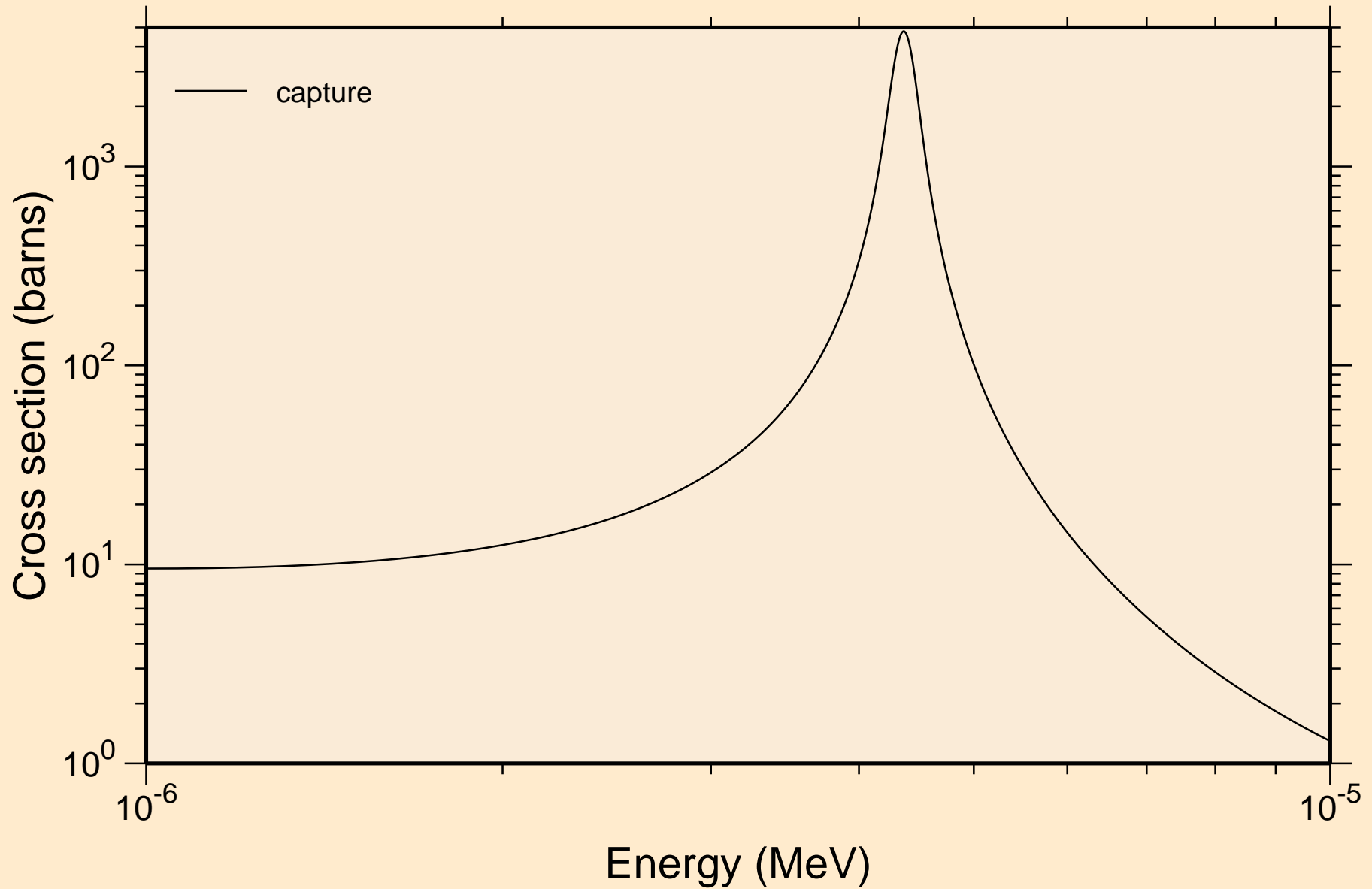

XE114 NEUTRON ACER TENDL-2021 LIBRARY; T=293.6K
resonance absorption cross sections

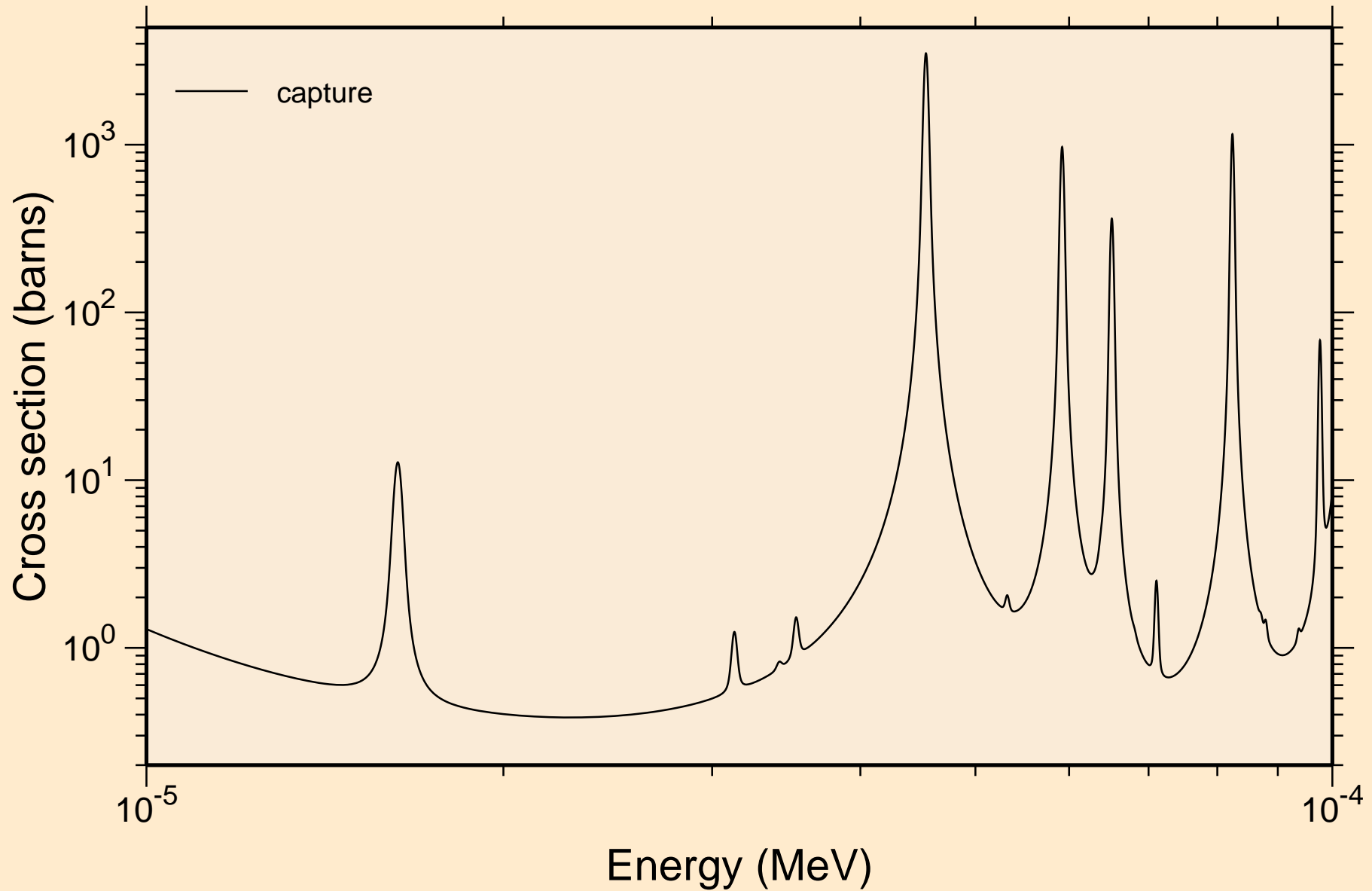

XE114 NEUTRON ACER TENDL-2021 LIBRARY; T=293.6K
resonance absorption cross sections

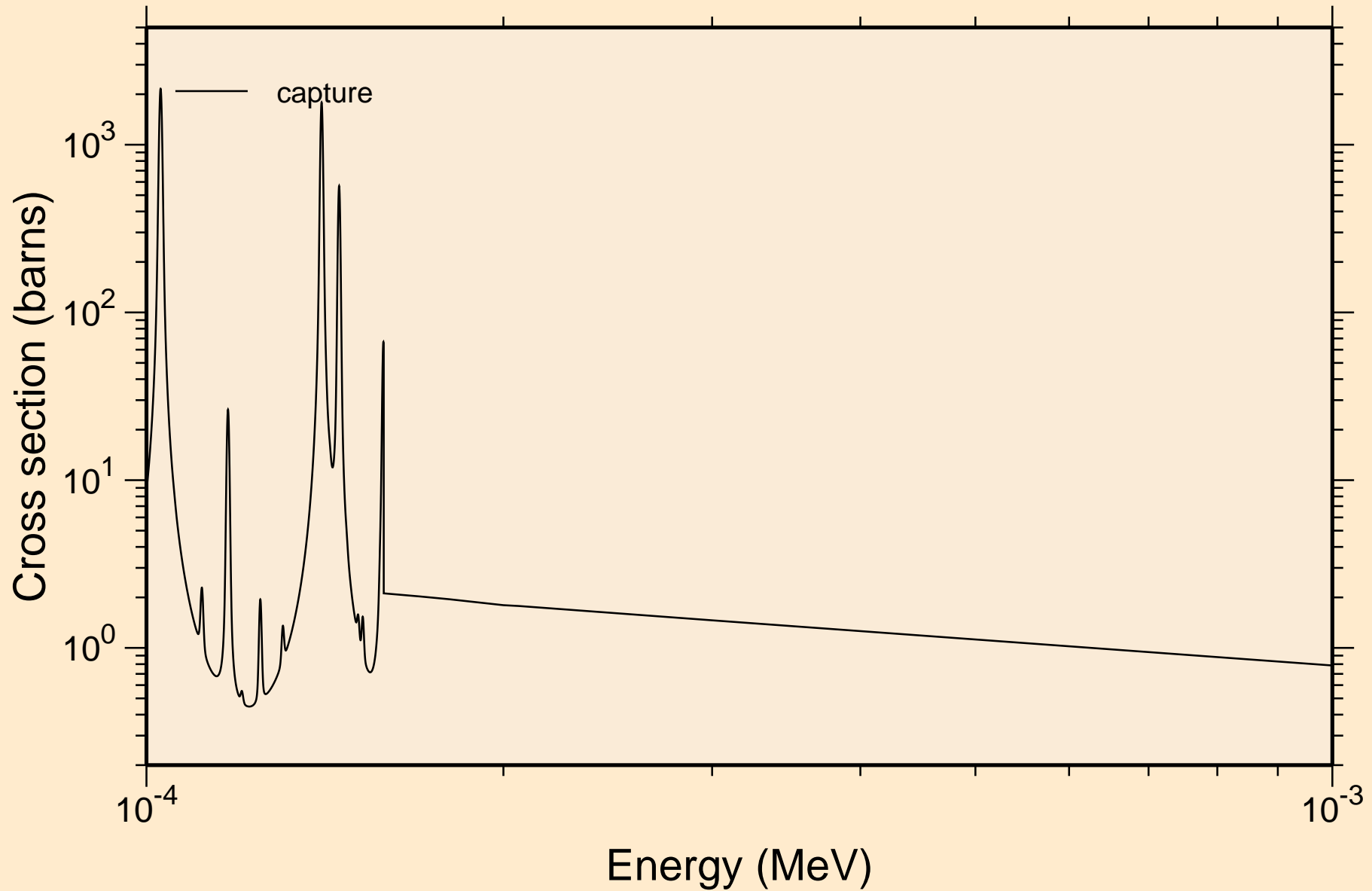

XE114 NEUTRON ACER TENDL-2021 LIBRARY; T=293.6K
resonance absorption cross sections

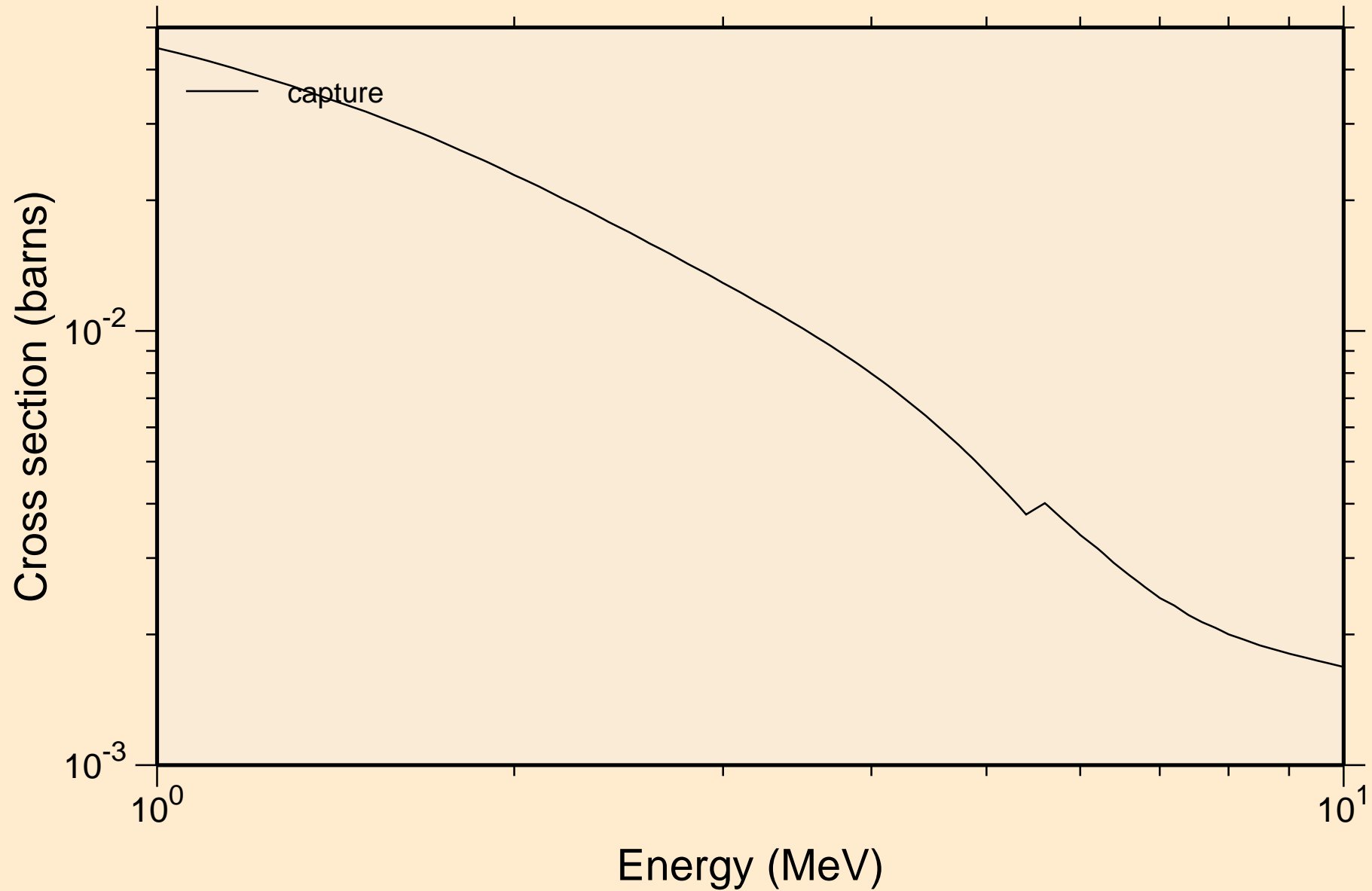

XE114 NEUTRON ACER TENDL-2021 LIBRARY; T=293.6K
Heating

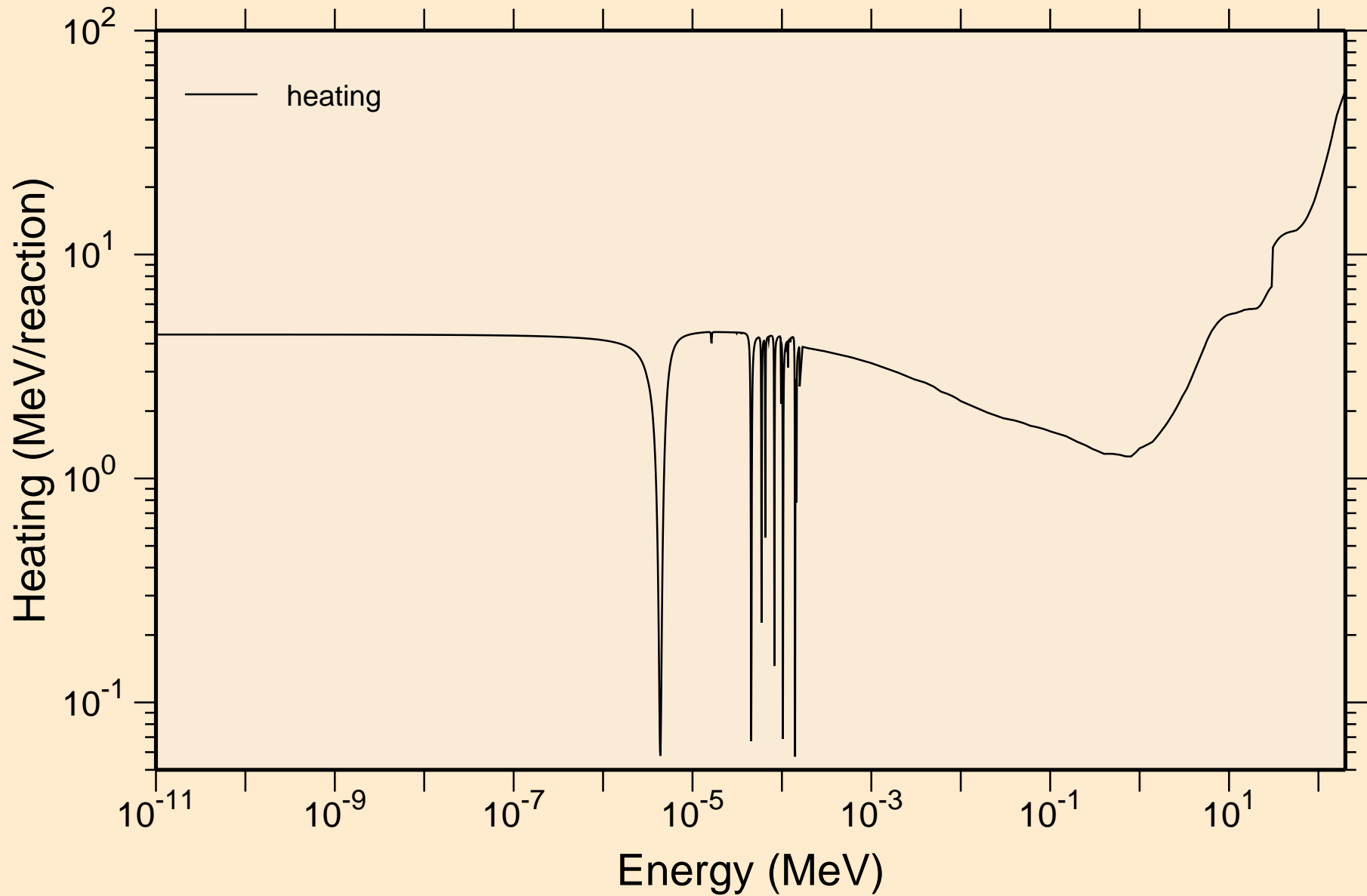

XE114 NEUTRON ACER TENDL-2021 LIBRARY; T=293.6K
Damage

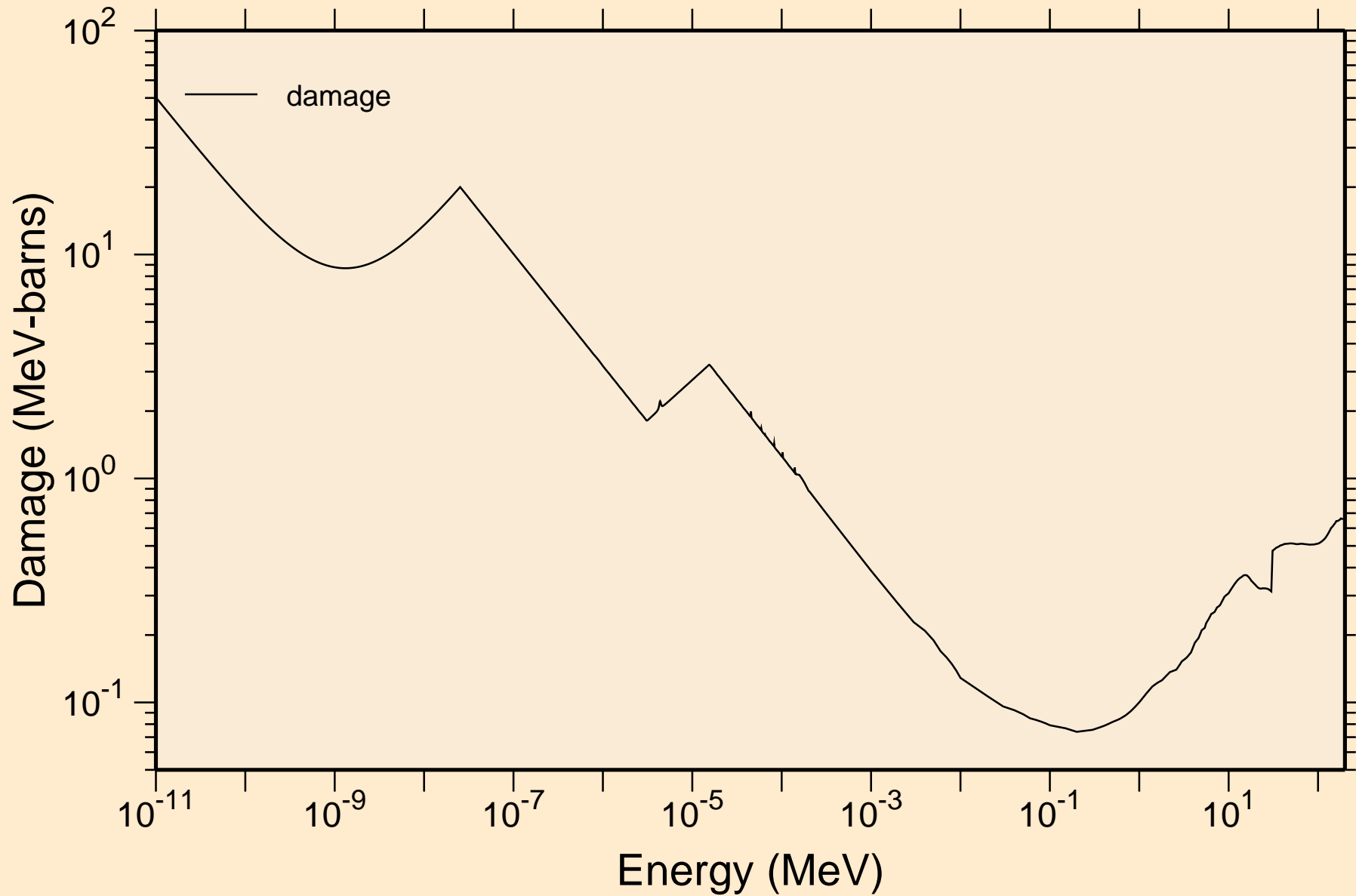

XE114 NEUTRON ACER TENDL-2021 LIBRARY; T=293.6K
Non-threshold reactions

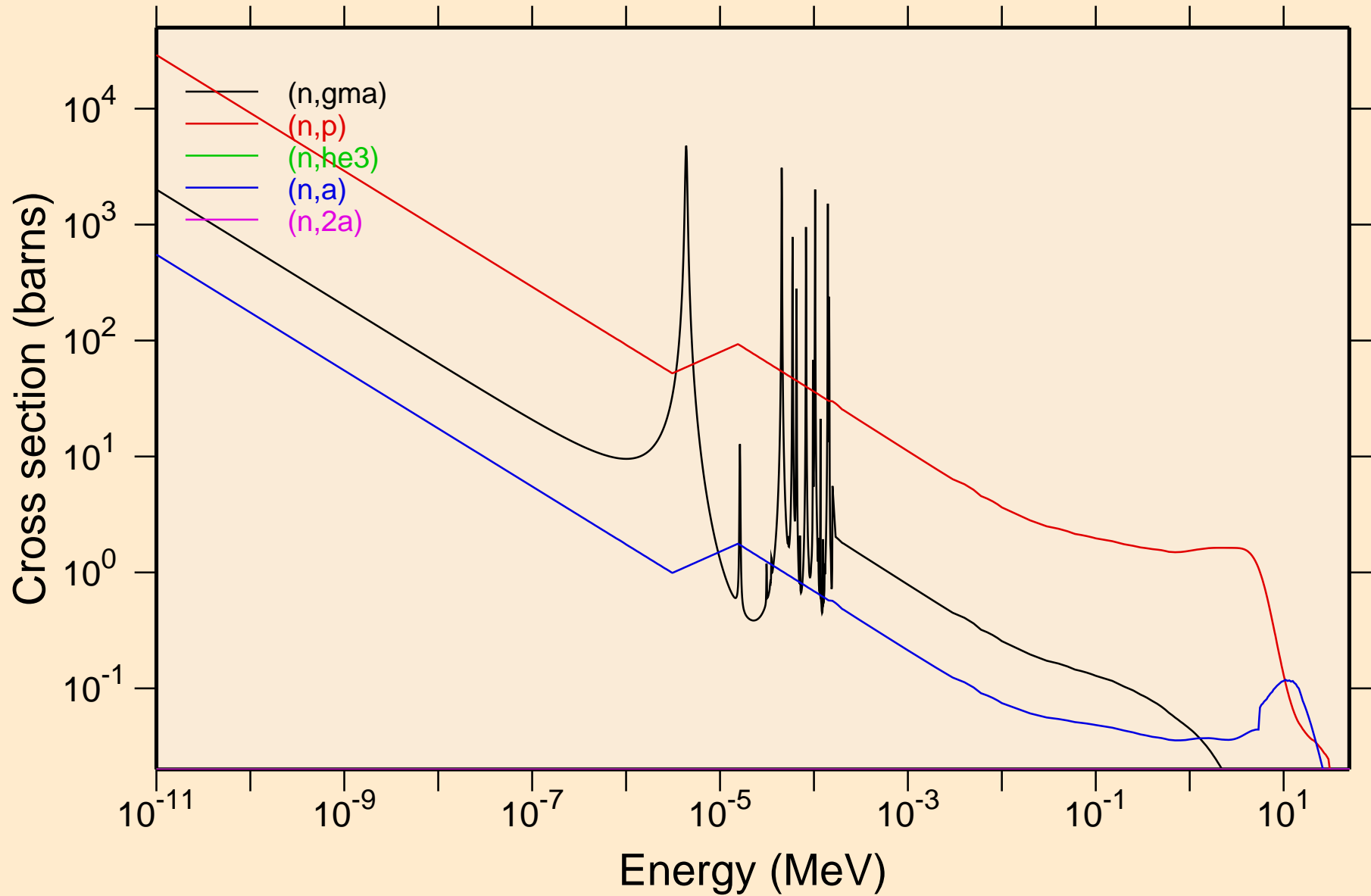

XE114 NEUTRON ACER TENDL-2021 LIBRARY; T=293.6K

Non-threshold reactions

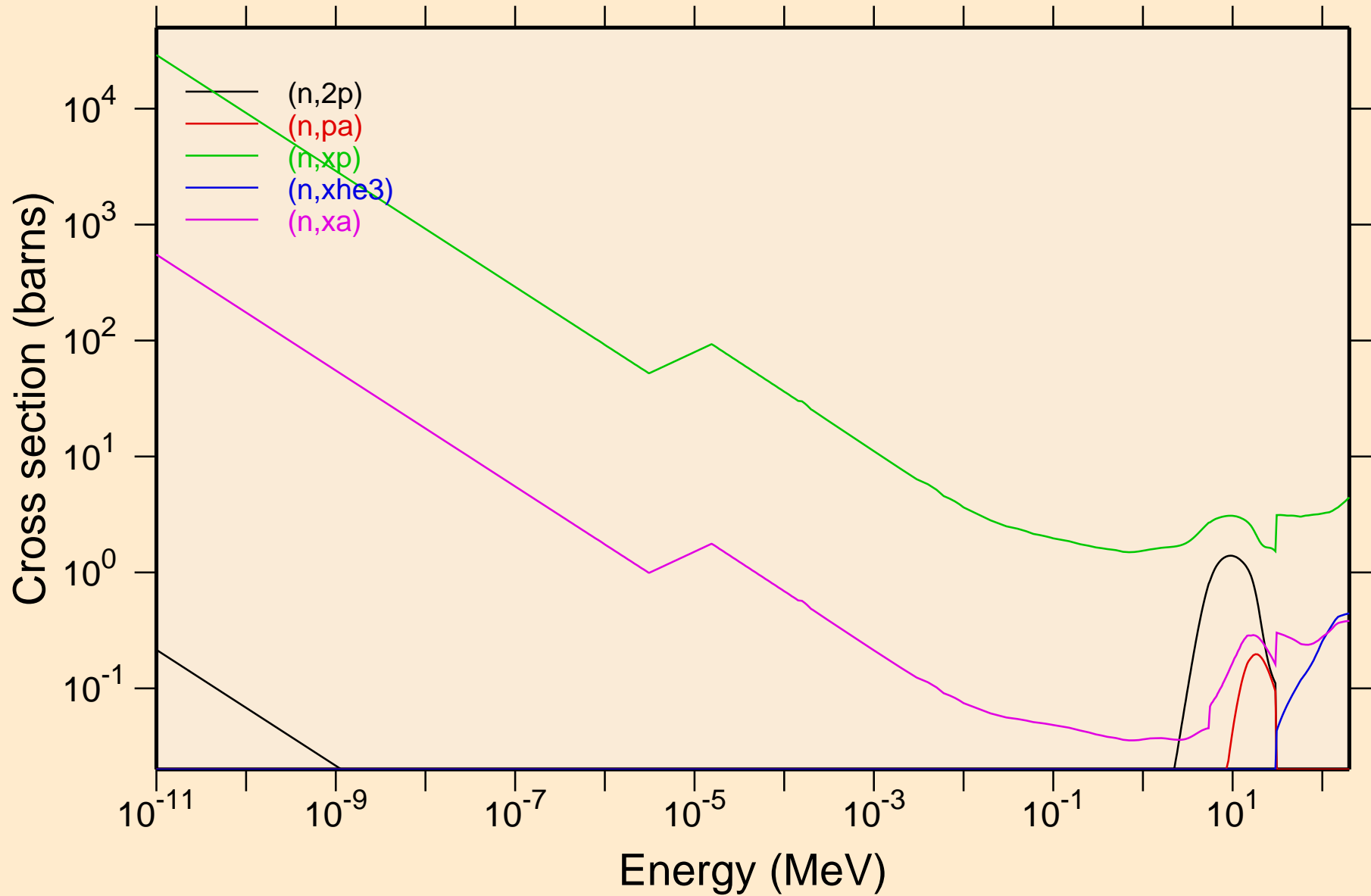

XE114 NEUTRON ACER TENDL-2021 LIBRARY; T=293.6K

Principal cross sections

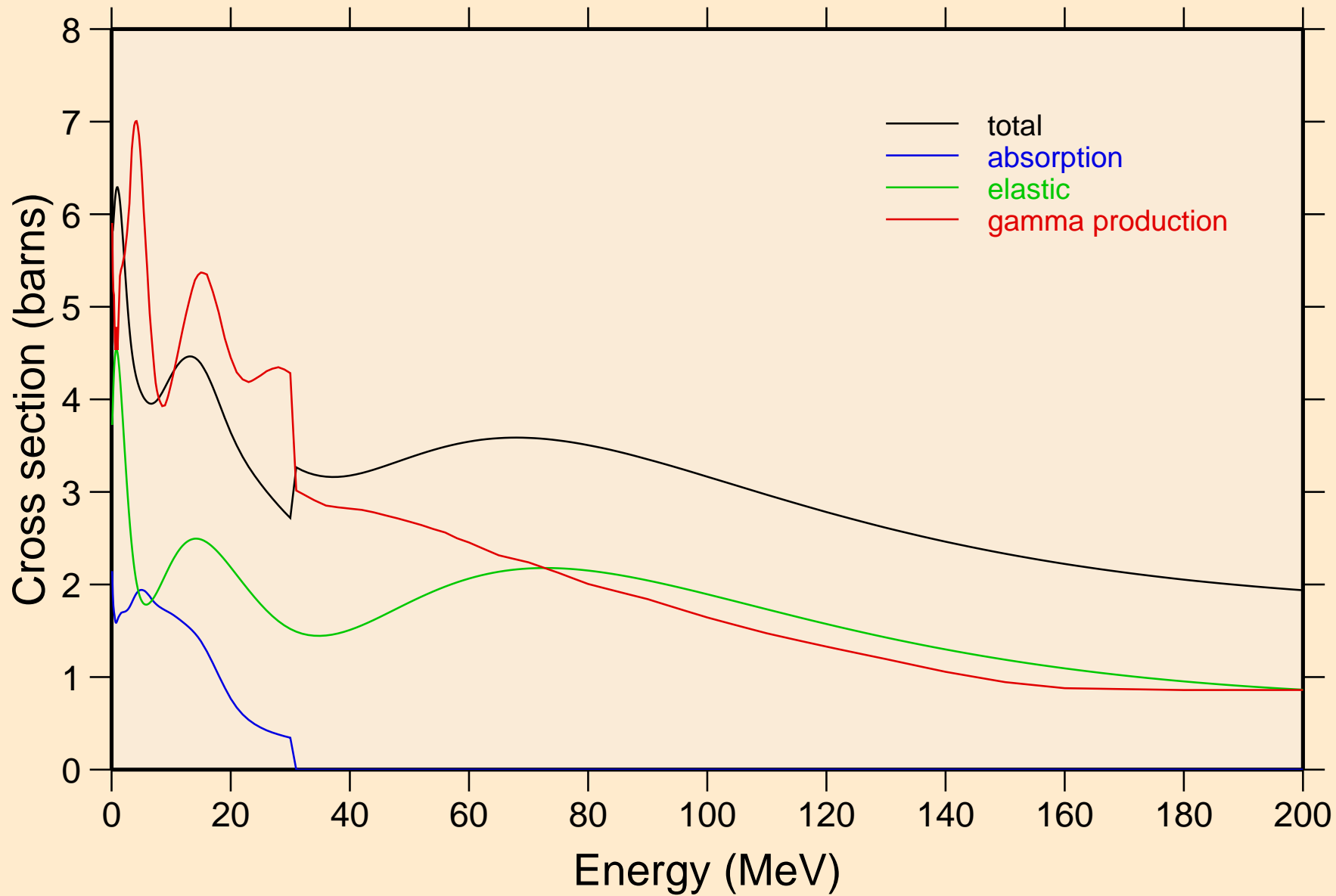

XE114 NEUTRON ACER TENDL-2021 LIBRARY; T=293.6K
Heating

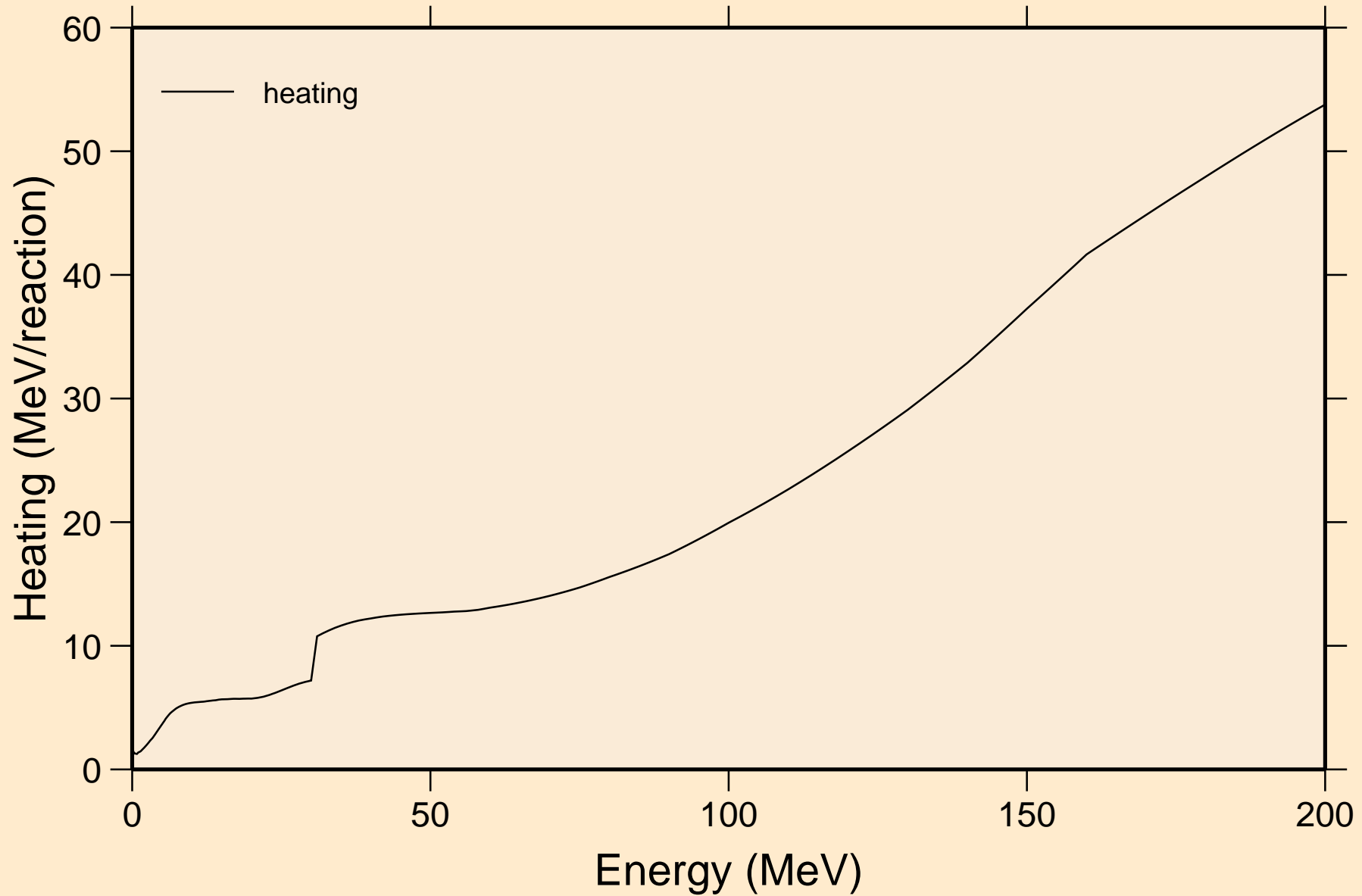

XE114 NEUTRON ACER TENDL-2021 LIBRARY; T=293.6K
Damage

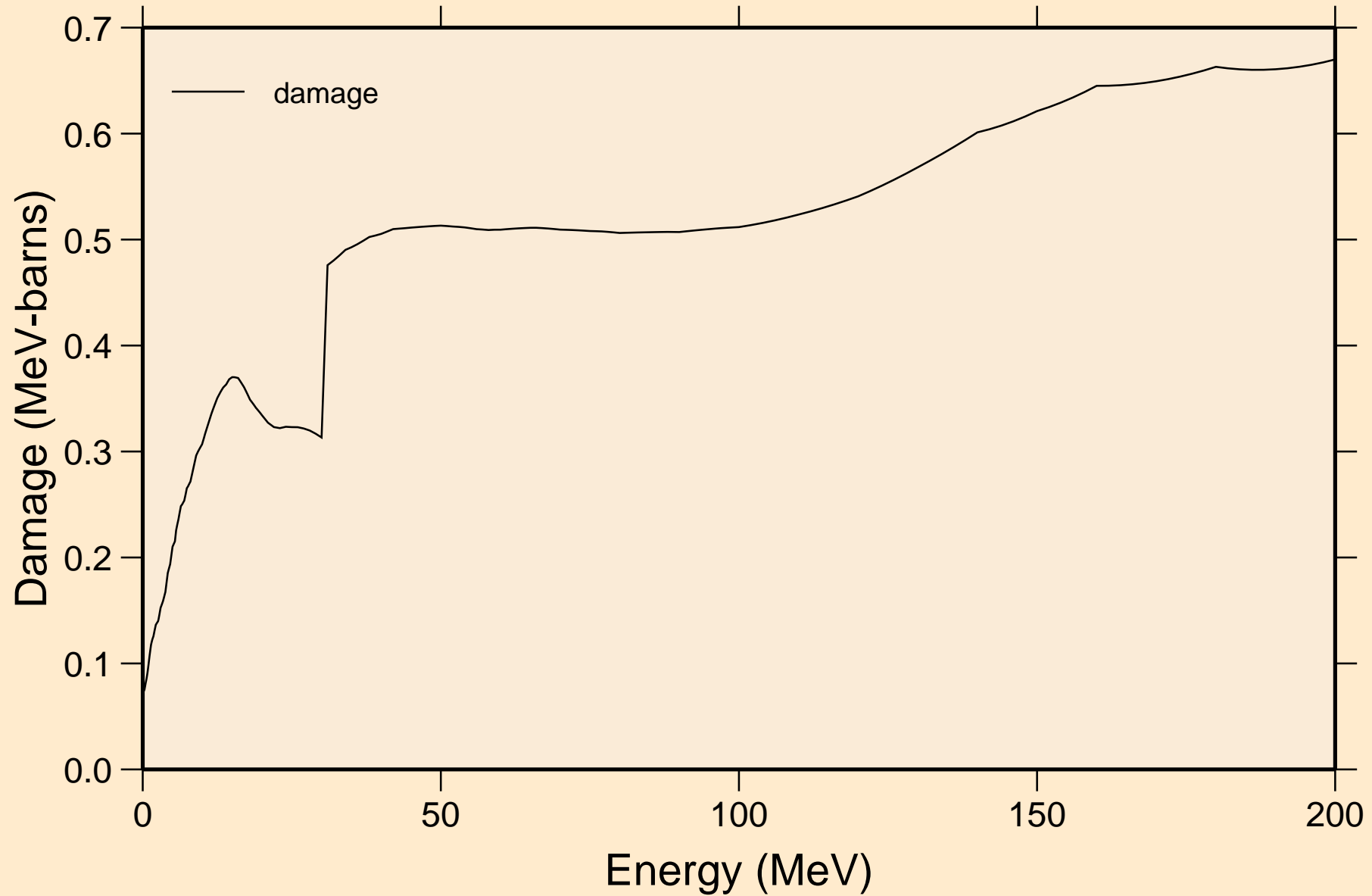

XE114 NEUTRON ACER TENDL-2021 LIBRARY; T=293.6K
Non-threshold reactions

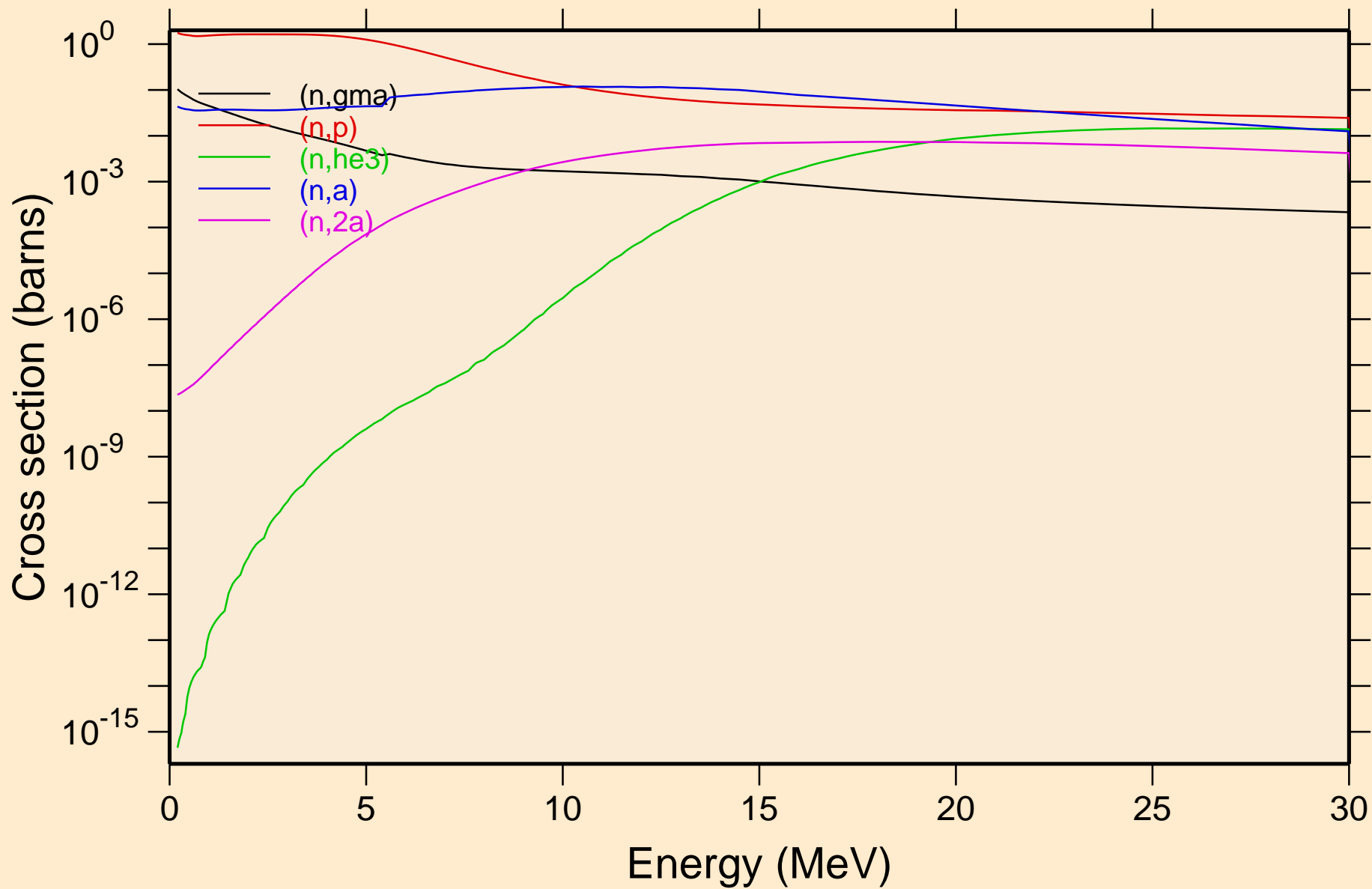

XE114 NEUTRON ACER TENDL-2021 LIBRARY; T=293.6K
Non-threshold reactions

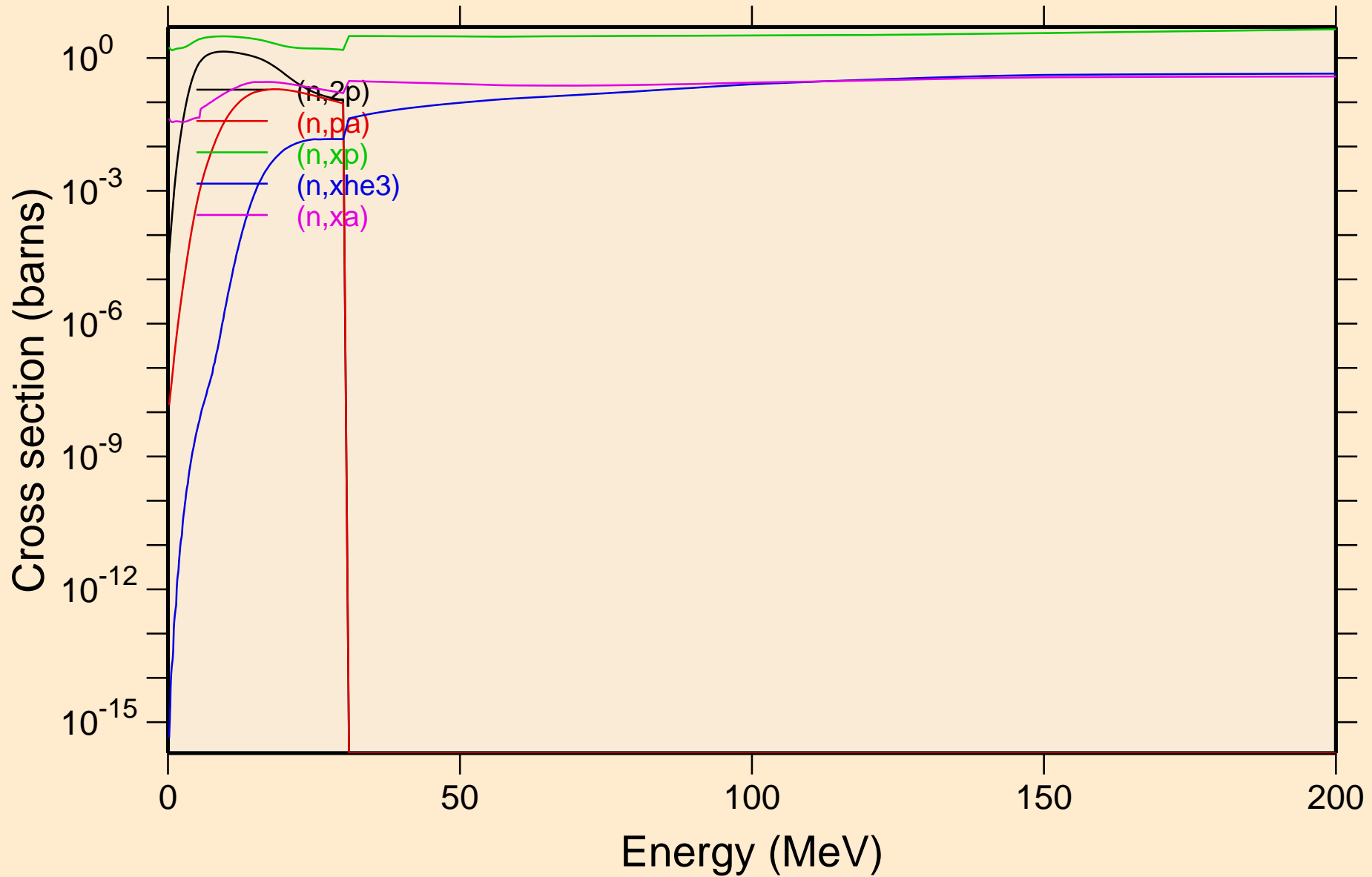

XE114 NEUTRON ACER TENDL-2021 LIBRARY; T=293.6K
Inelastic levels

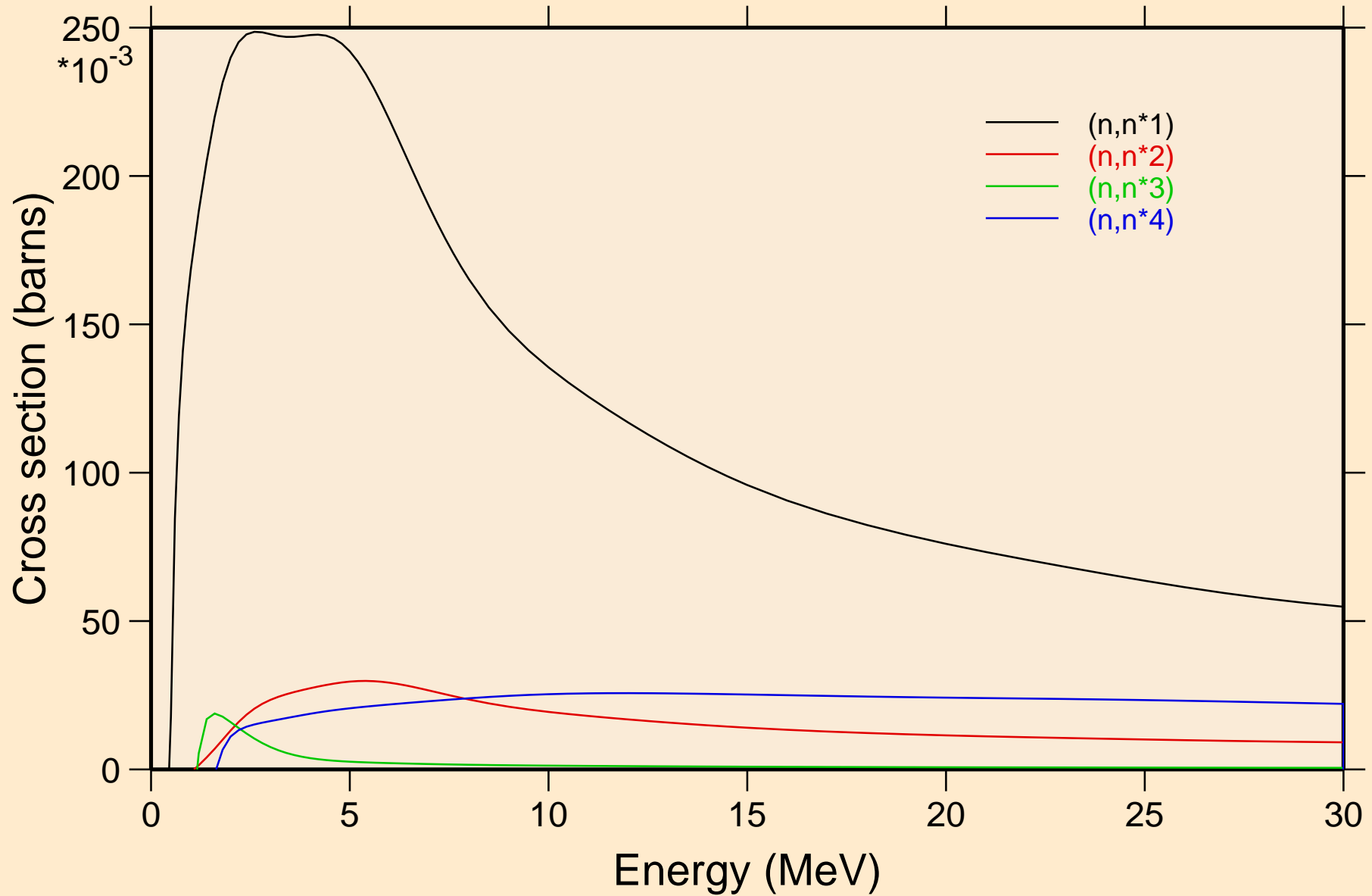

XE114 NEUTRON ACER TENDL-2021 LIBRARY; T=293.6K

Threshold reactions

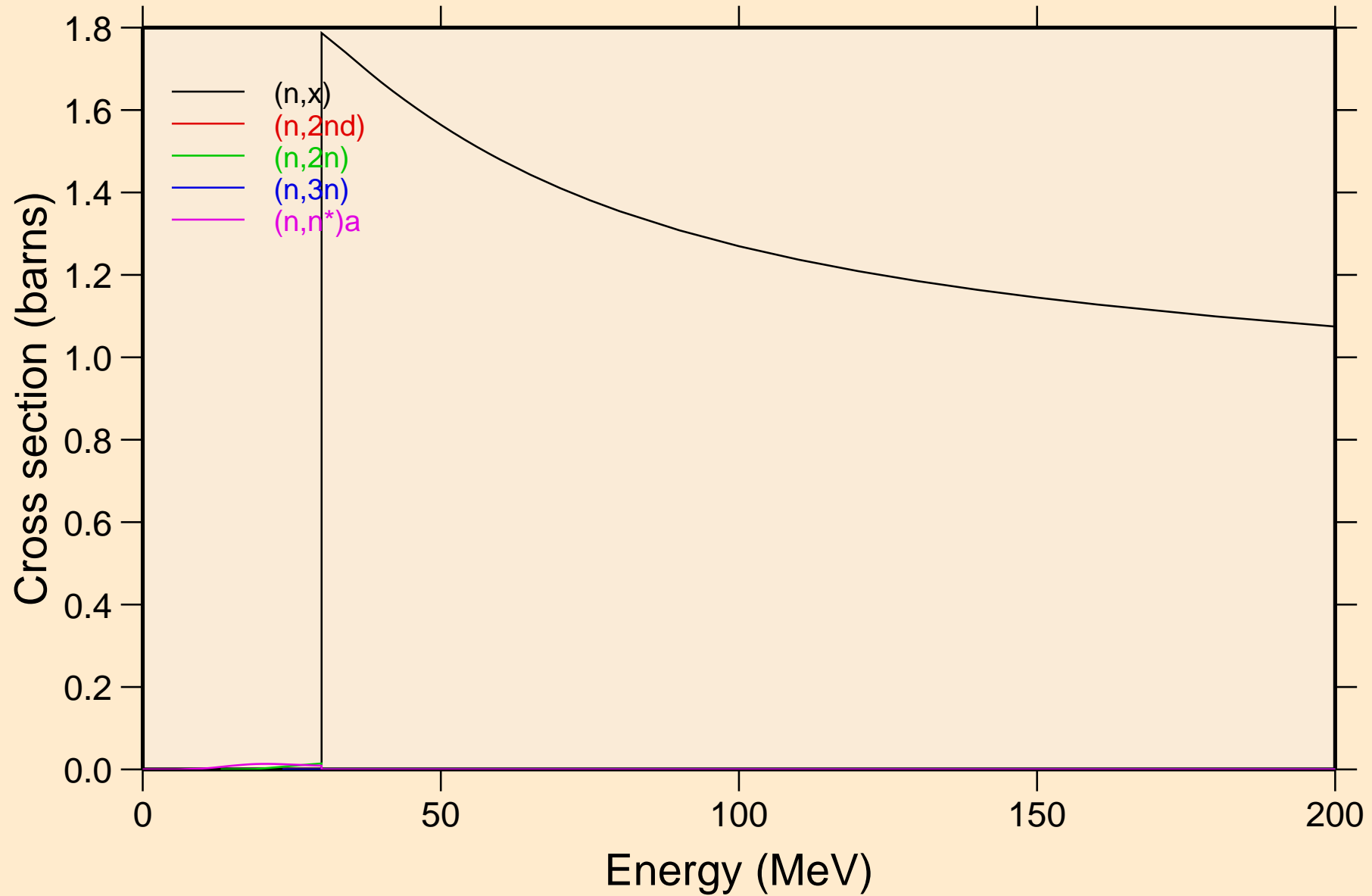

XE114 NEUTRON ACER TENDL-2021 LIBRARY; T=293.6K
Threshold reactions

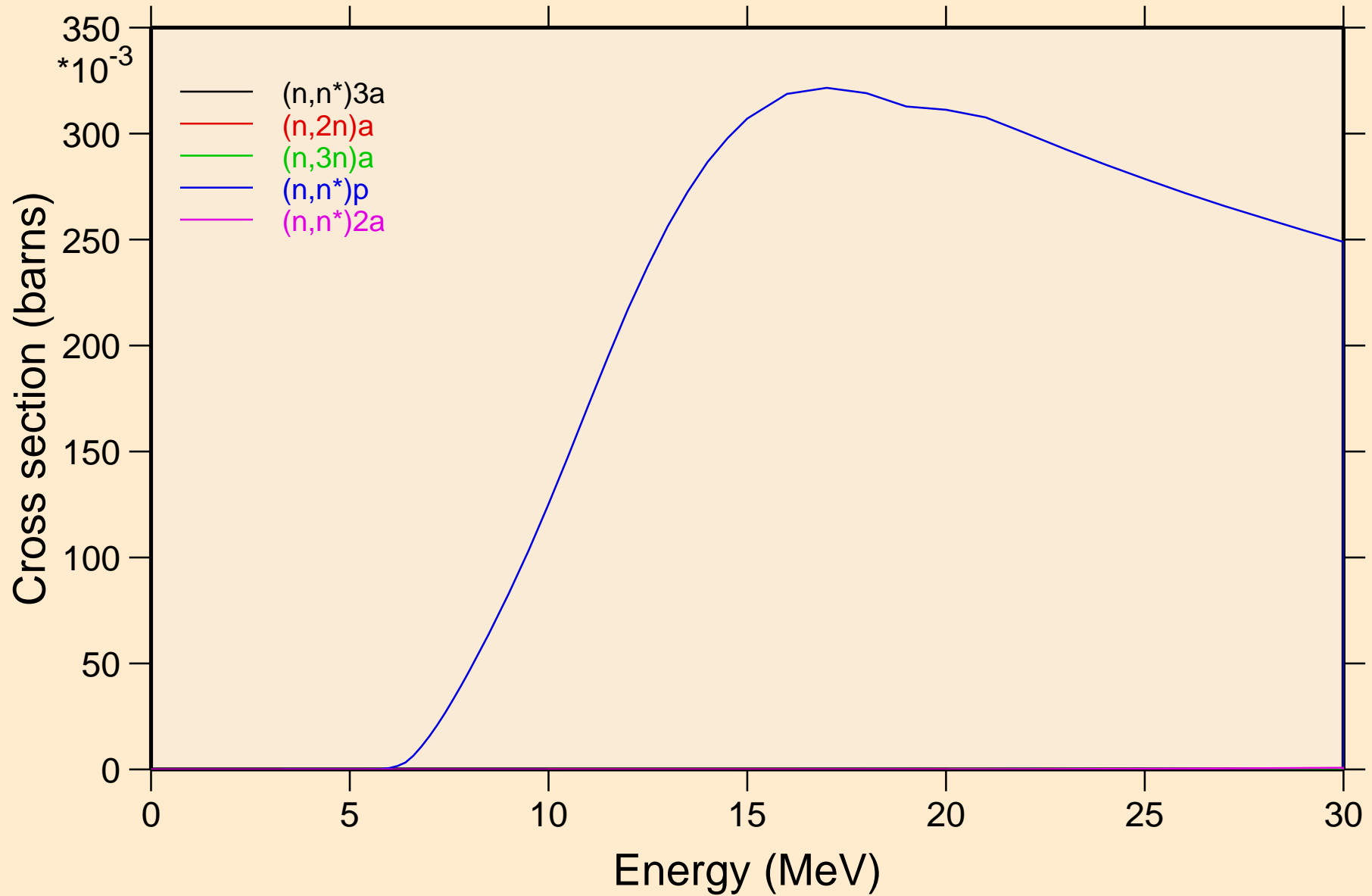

XE114 NEUTRON ACER TENDL-2021 LIBRARY; T=293.6K
Threshold reactions

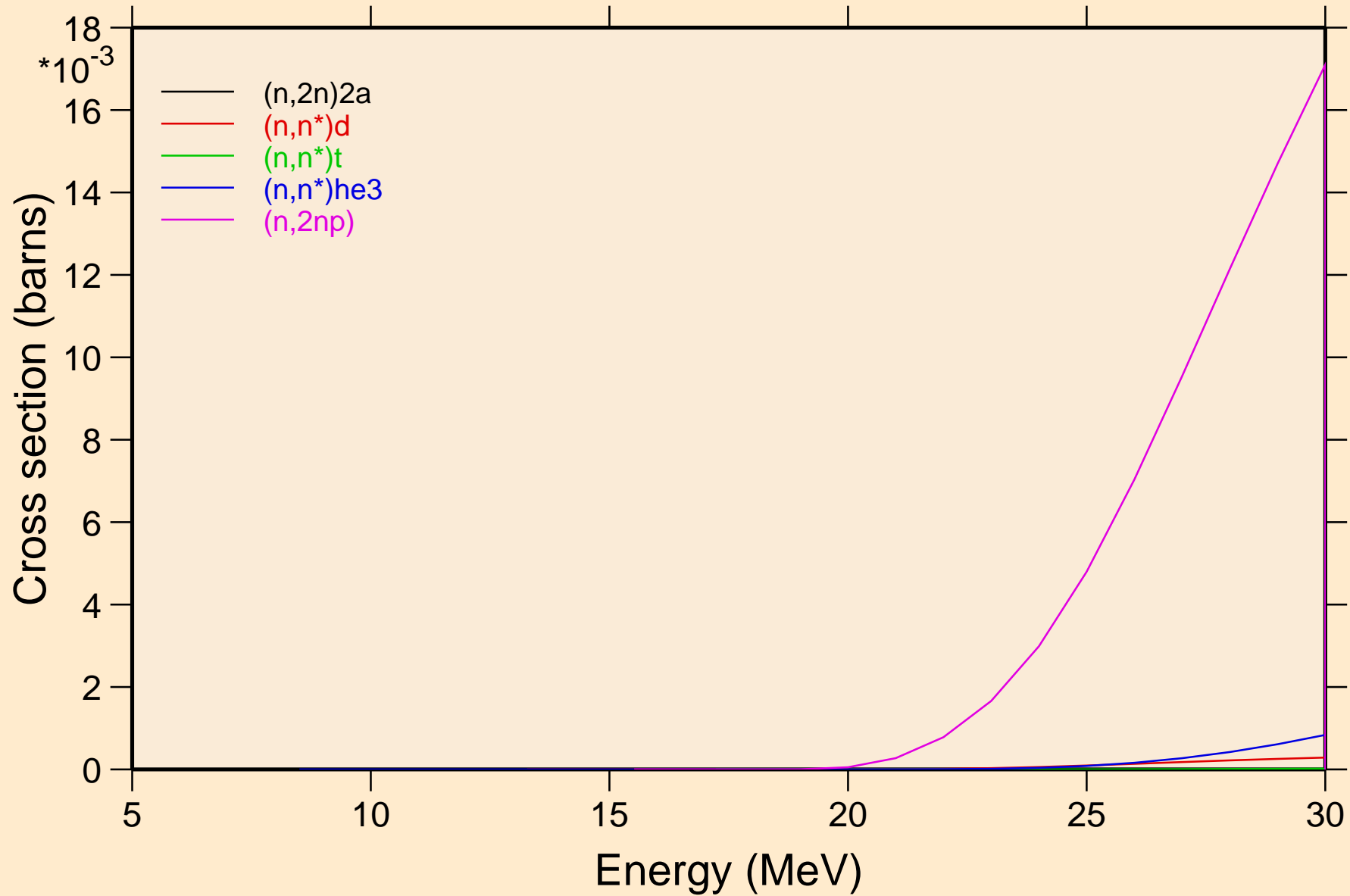

XE114 NEUTRON ACER TENDL-2021 LIBRARY; T=293.6K
Threshold reactions

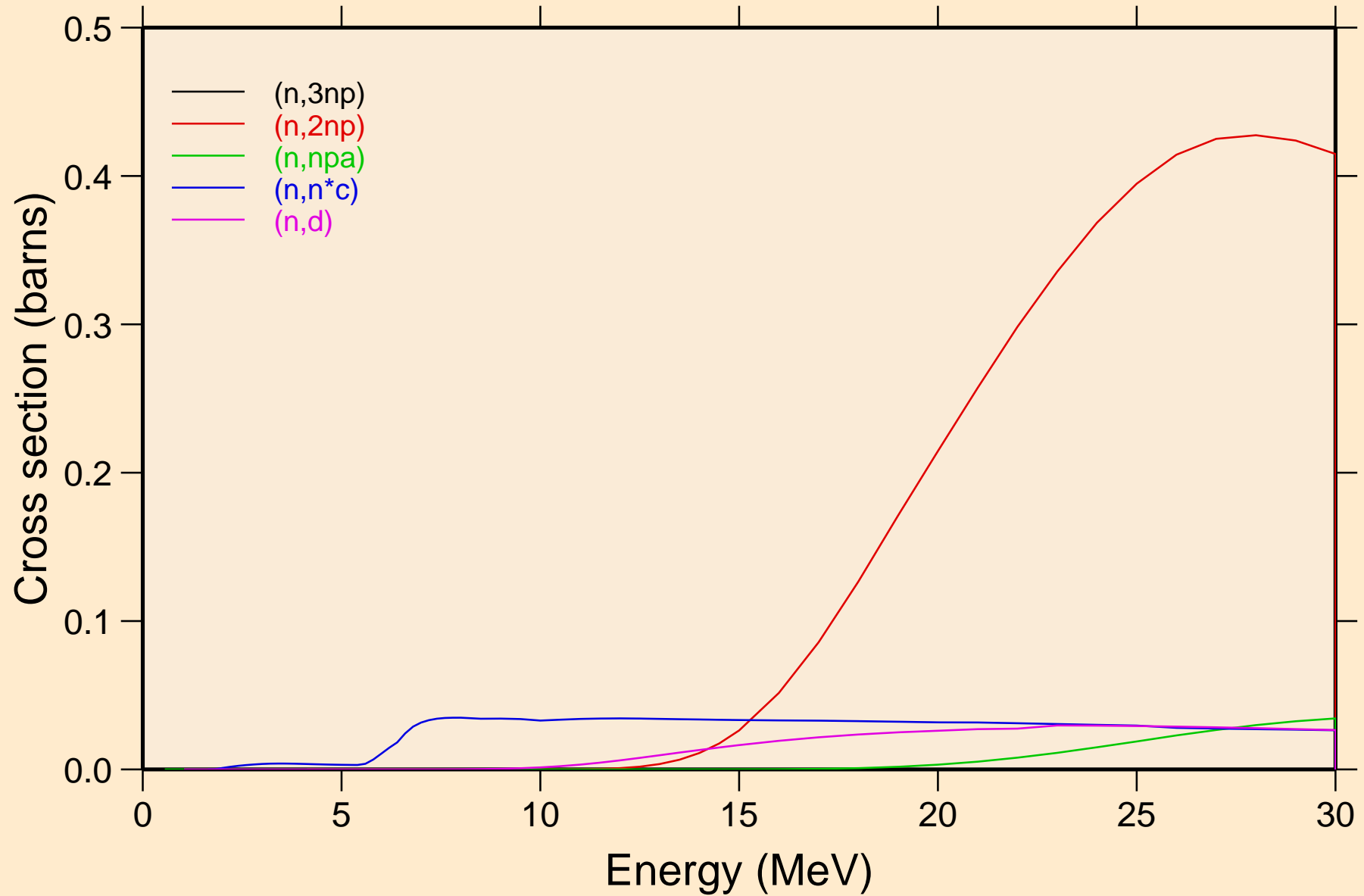

XE114 NEUTRON ACER TENDL-2021 LIBRARY; T=293.6K

Threshold reactions

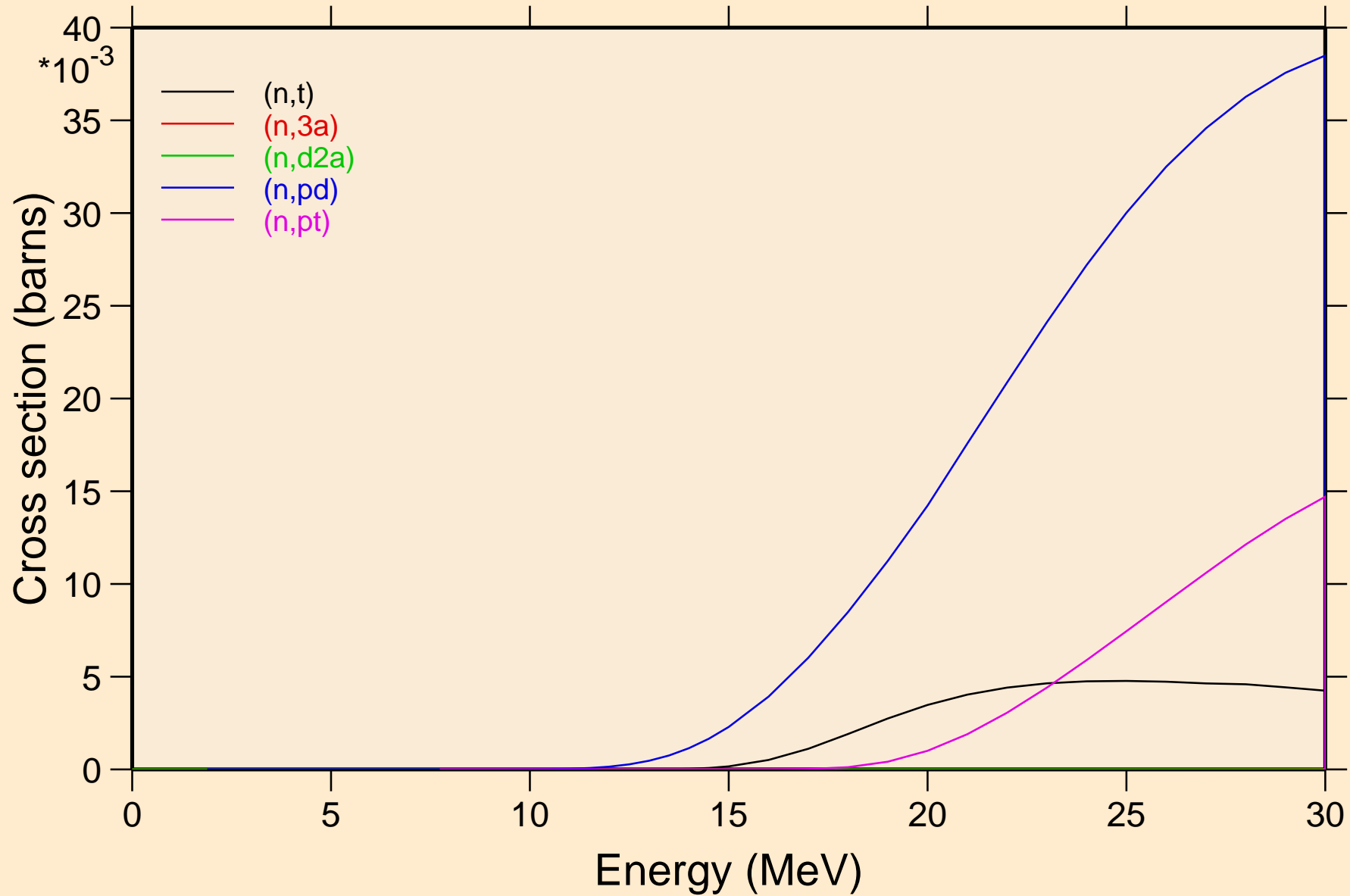

XE114 NEUTRON ACER TENDL-2021 LIBRARY; T=293.6K
Threshold reactions

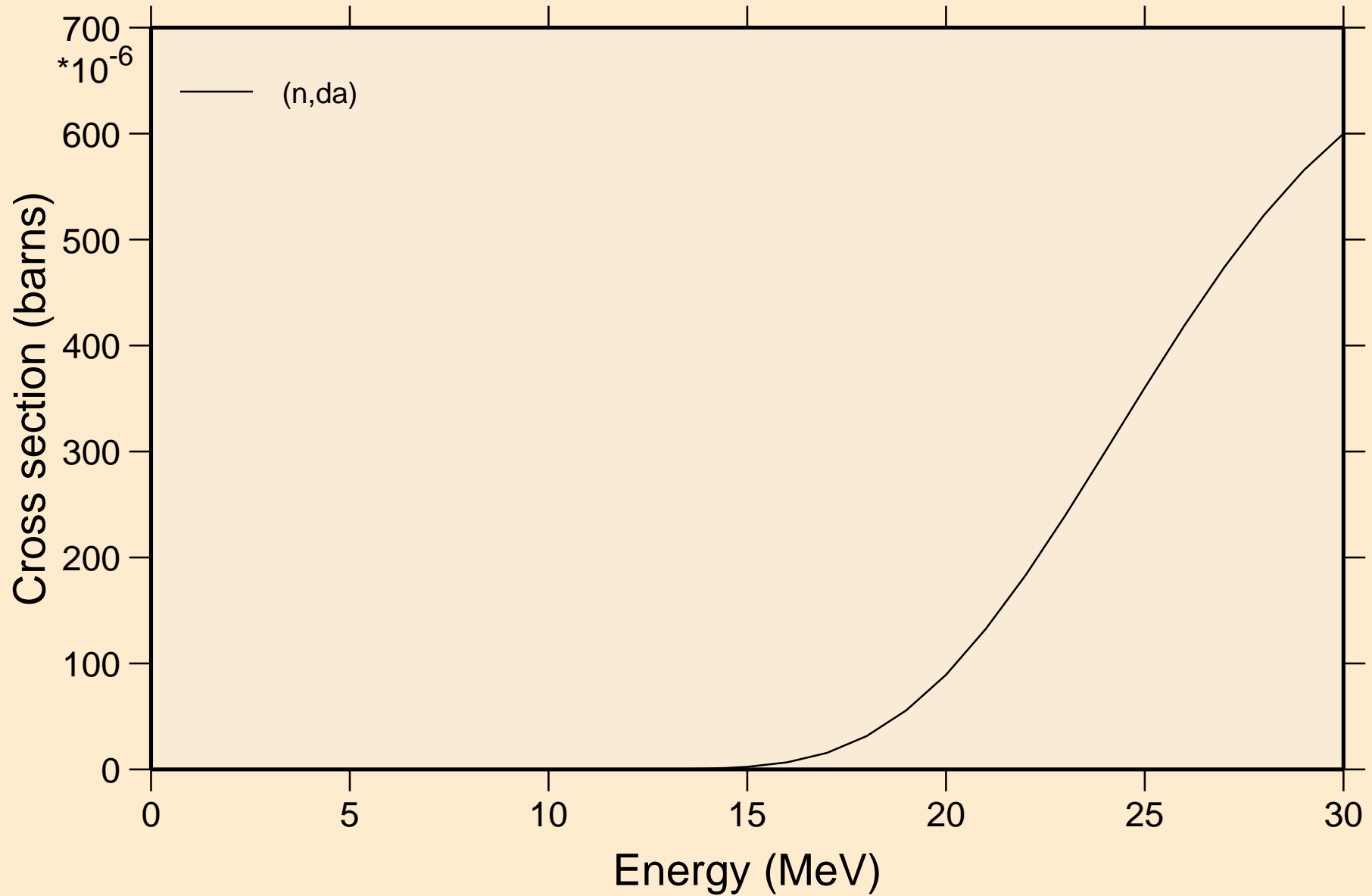

XE114 NEUTRON ACER TENDL-2021 LIBRARY; T=293.6K

Threshold reactions

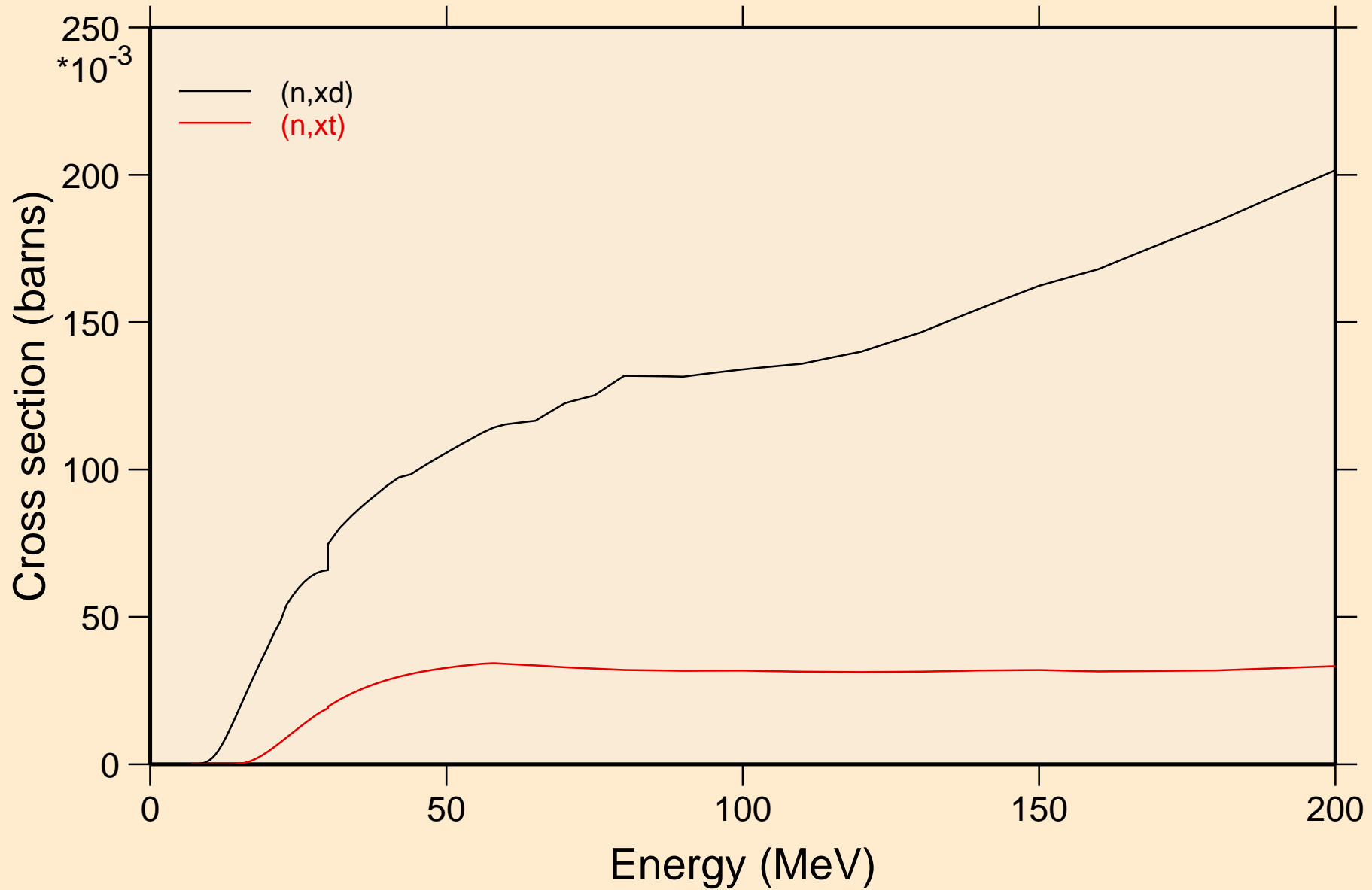

XE114 NEUTRON ACER TENDL-2021 LIBRARY; T=293.6K
angular distribution for elastic

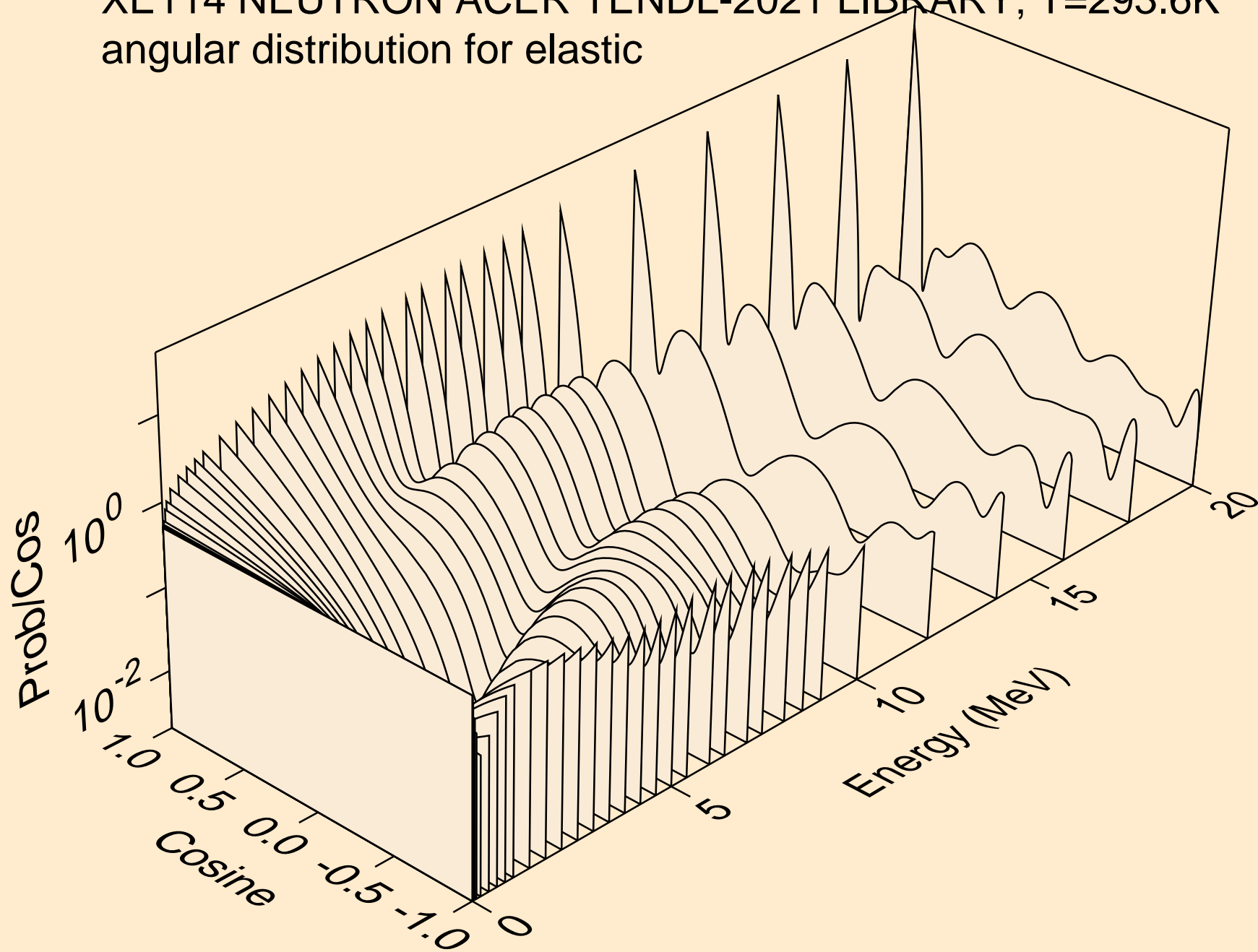

XE114 NEUTRON ACER TENDL-2021 LIBRARY; T=293.6K
angular distribution for elastic

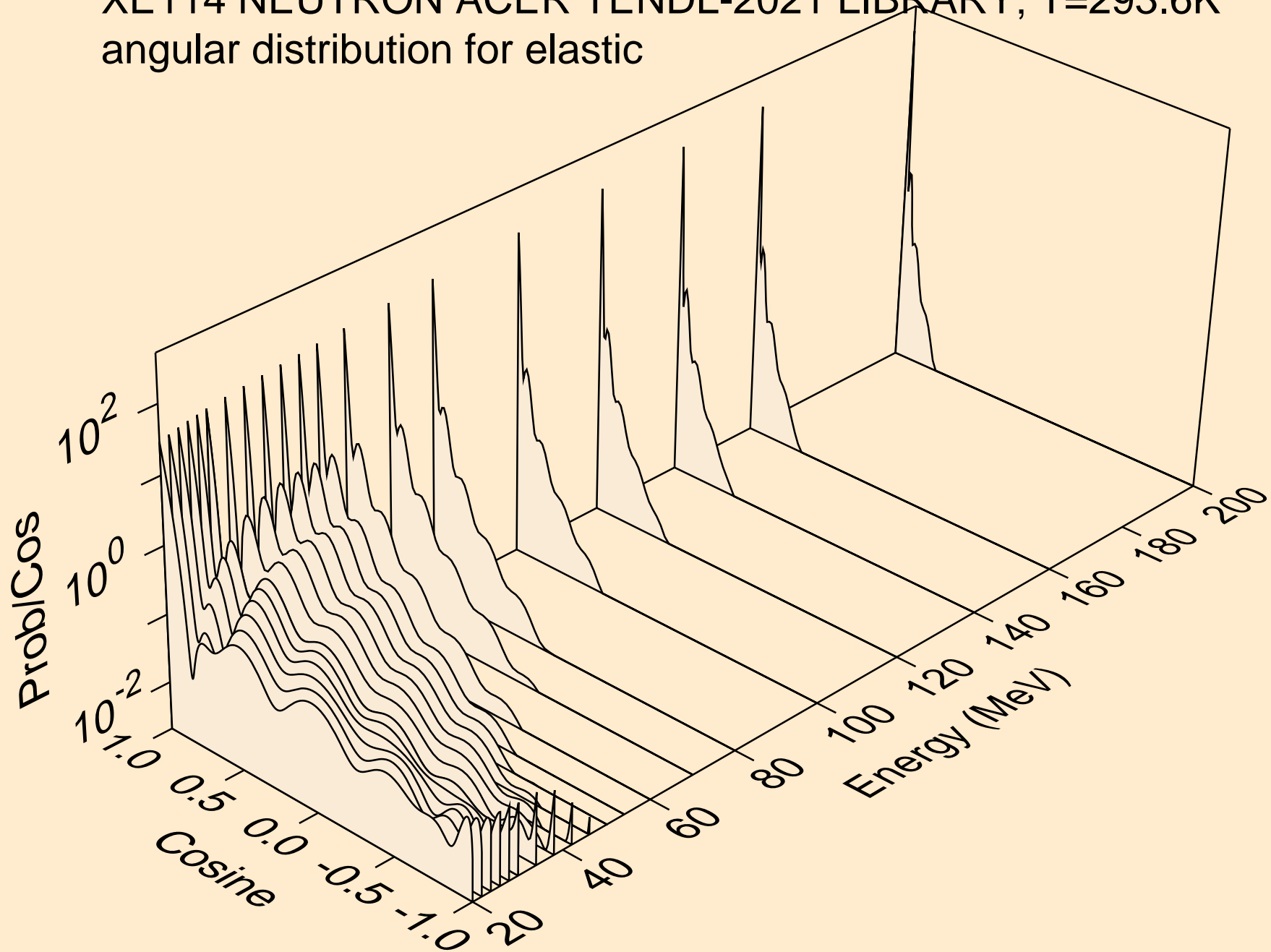

XE114 NEUTRON ACER TENDL-2021 LIBRARY; T=293.6K
angular distribution for (n,n*1)

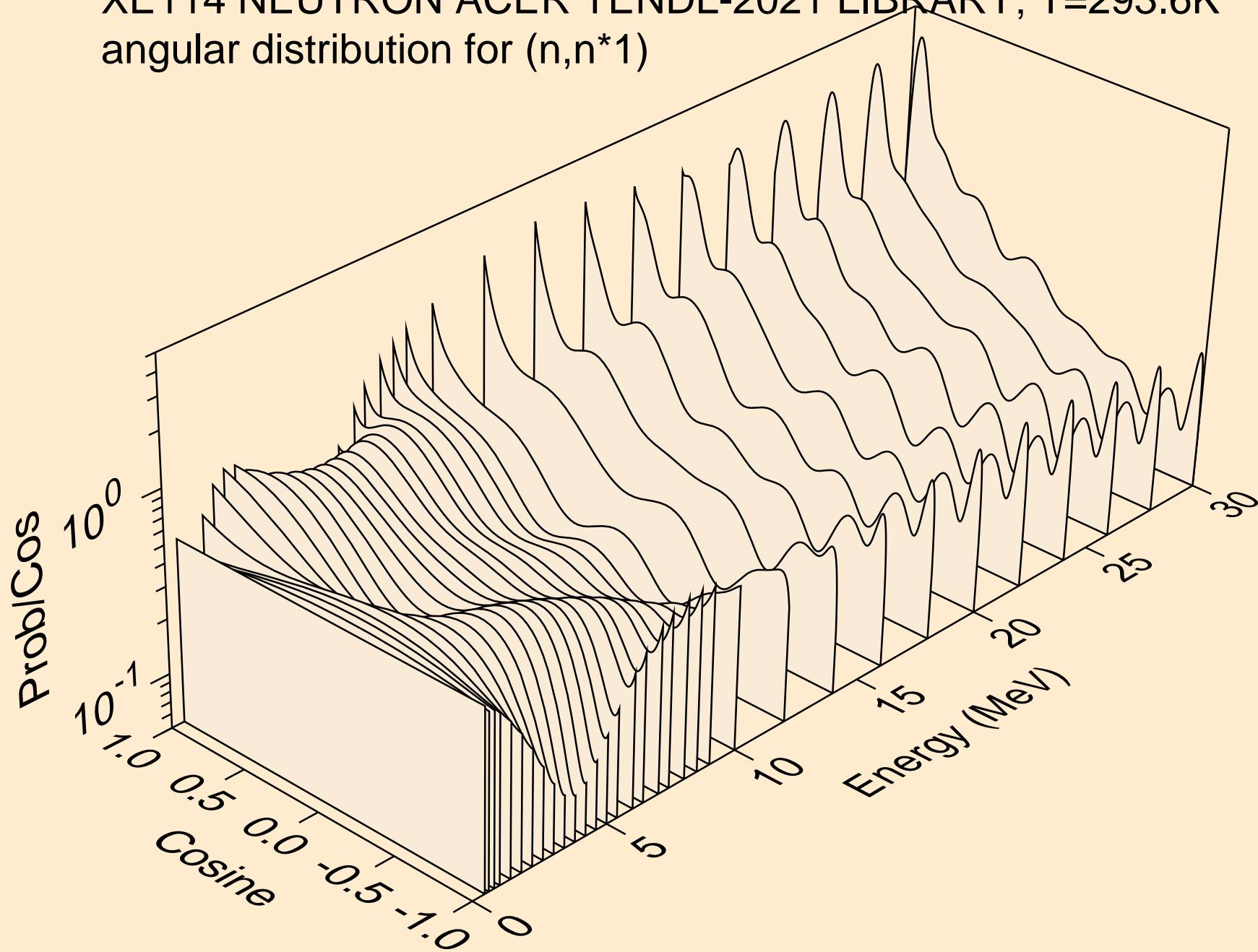

XE114 NEUTRON ACER TENDL-2021 LIBRARY; T=293.6K
angular distribution for (n,n*2)

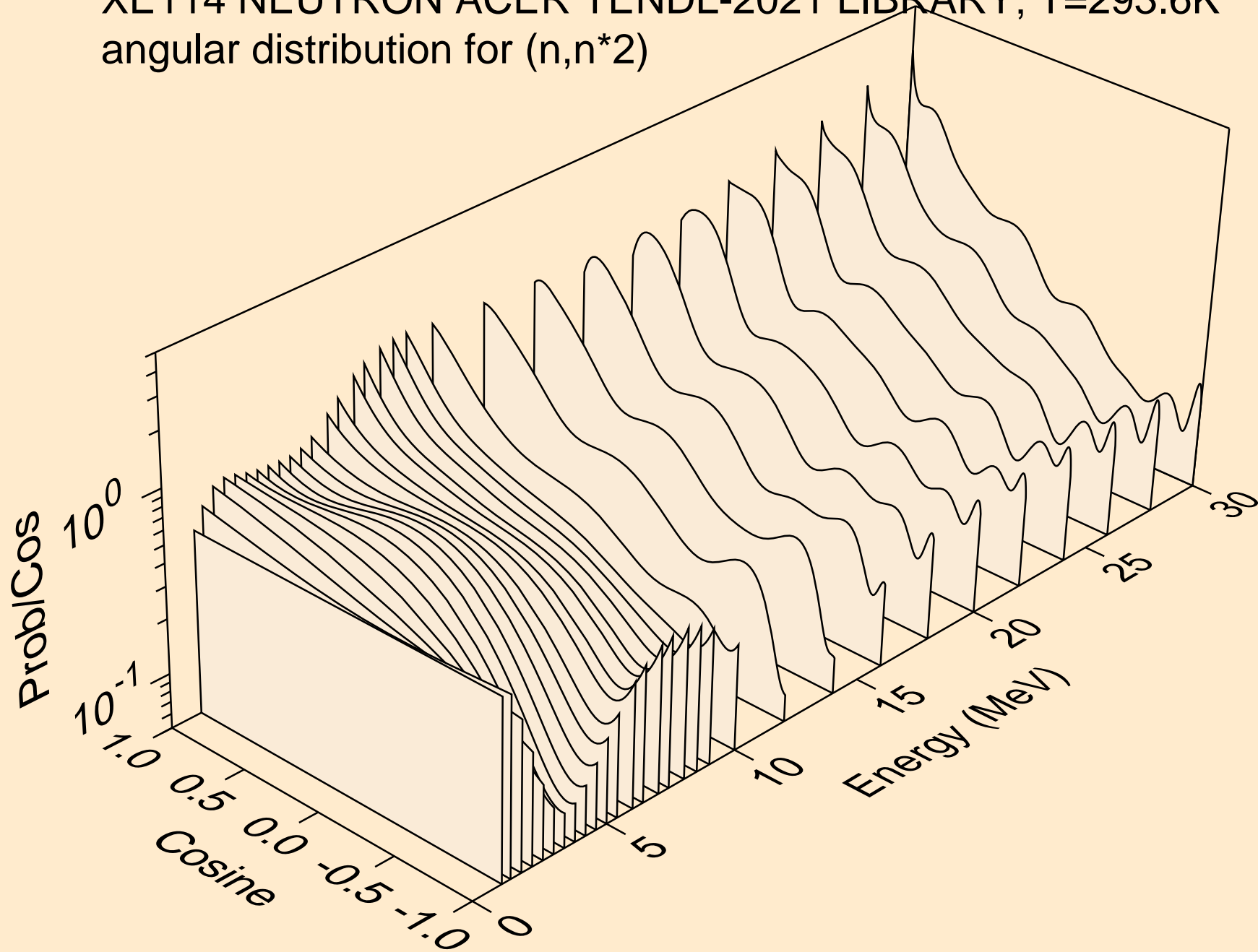

XE114 NEUTRON ACER TENDL-2021 LIBRARY; T=293.6K
angular distribution for (n,n*3)

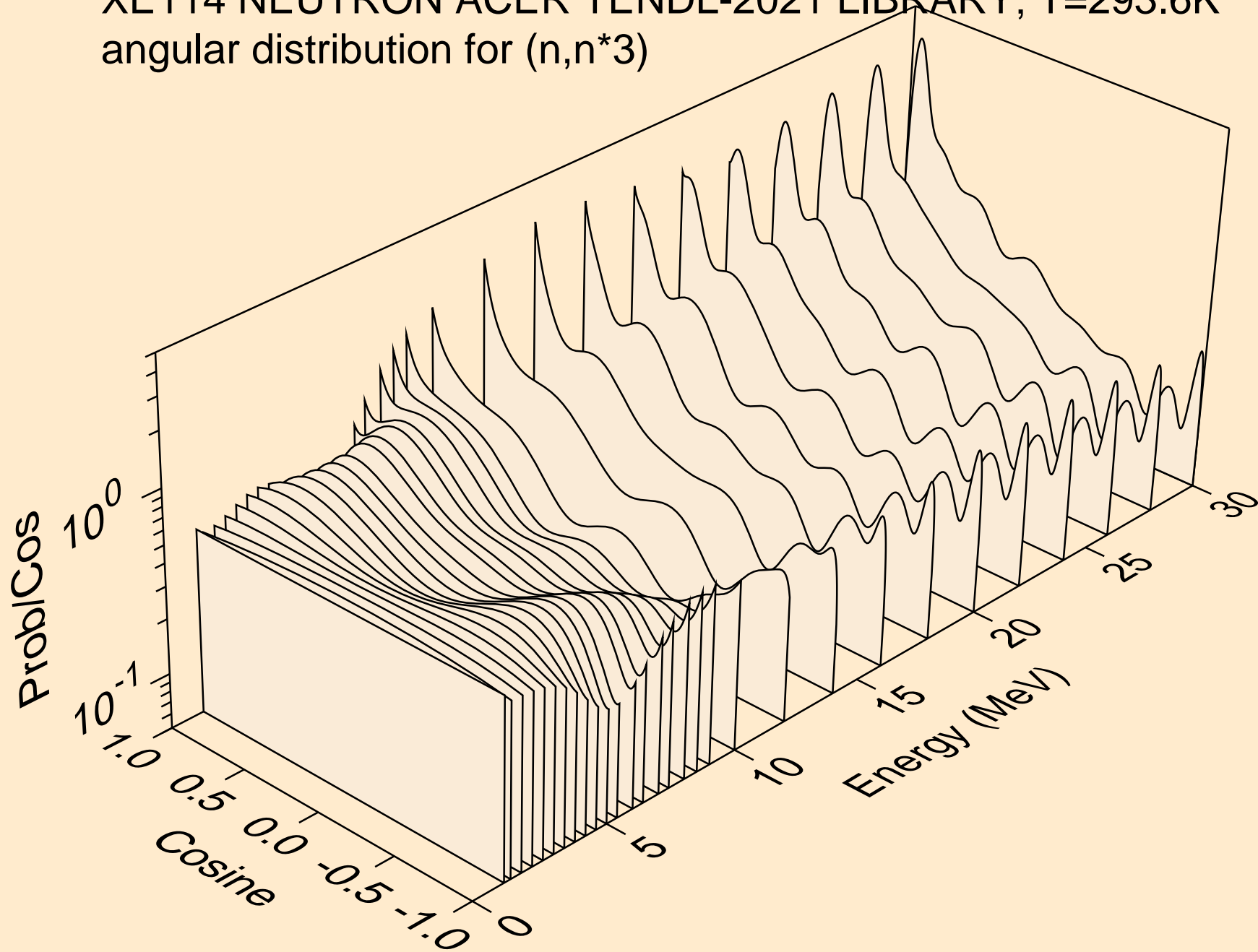

XE114 NEUTRON ACER TENDL-2021 LIBRARY; T=293.6K
angular distribution for (n,n*4)

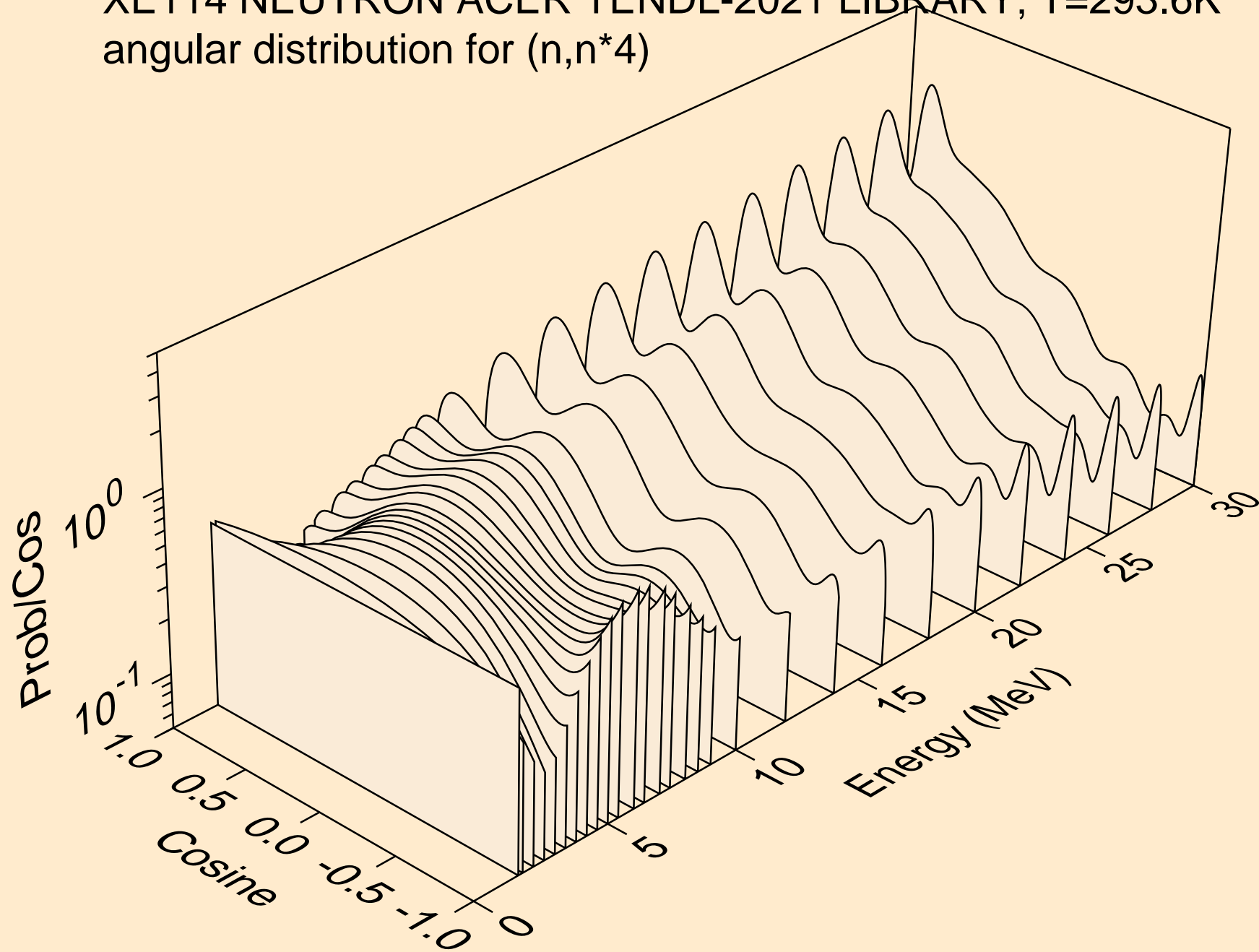

XE114 NEUTRON ACER TENDL-2021 LIBRARY; T=293.6K
Neutron emission for (n,x)

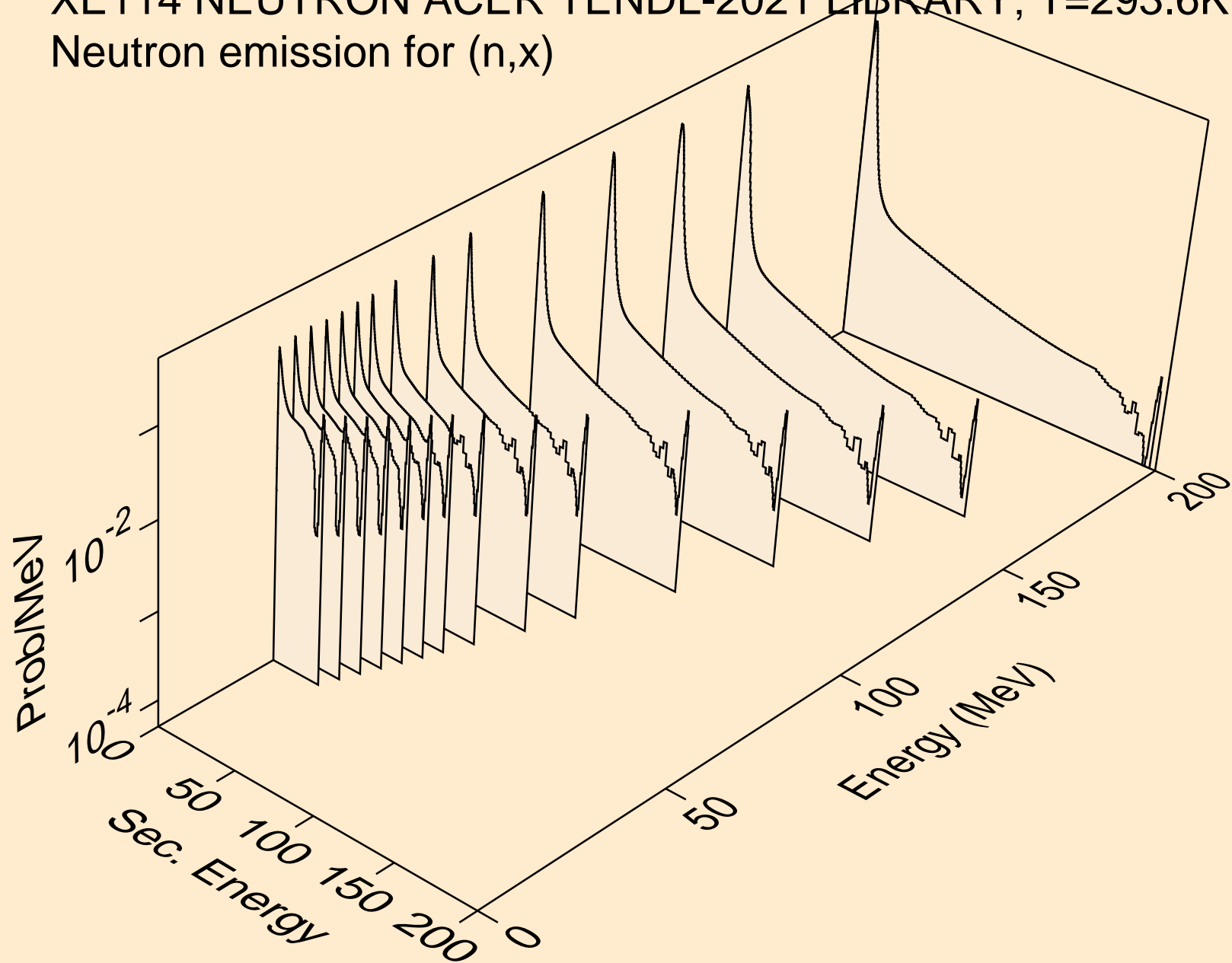

XE114 NEUTRON ACER TENDL-2021 LIBRARY; T=293.6K
Neutron emission for (n,2nd)

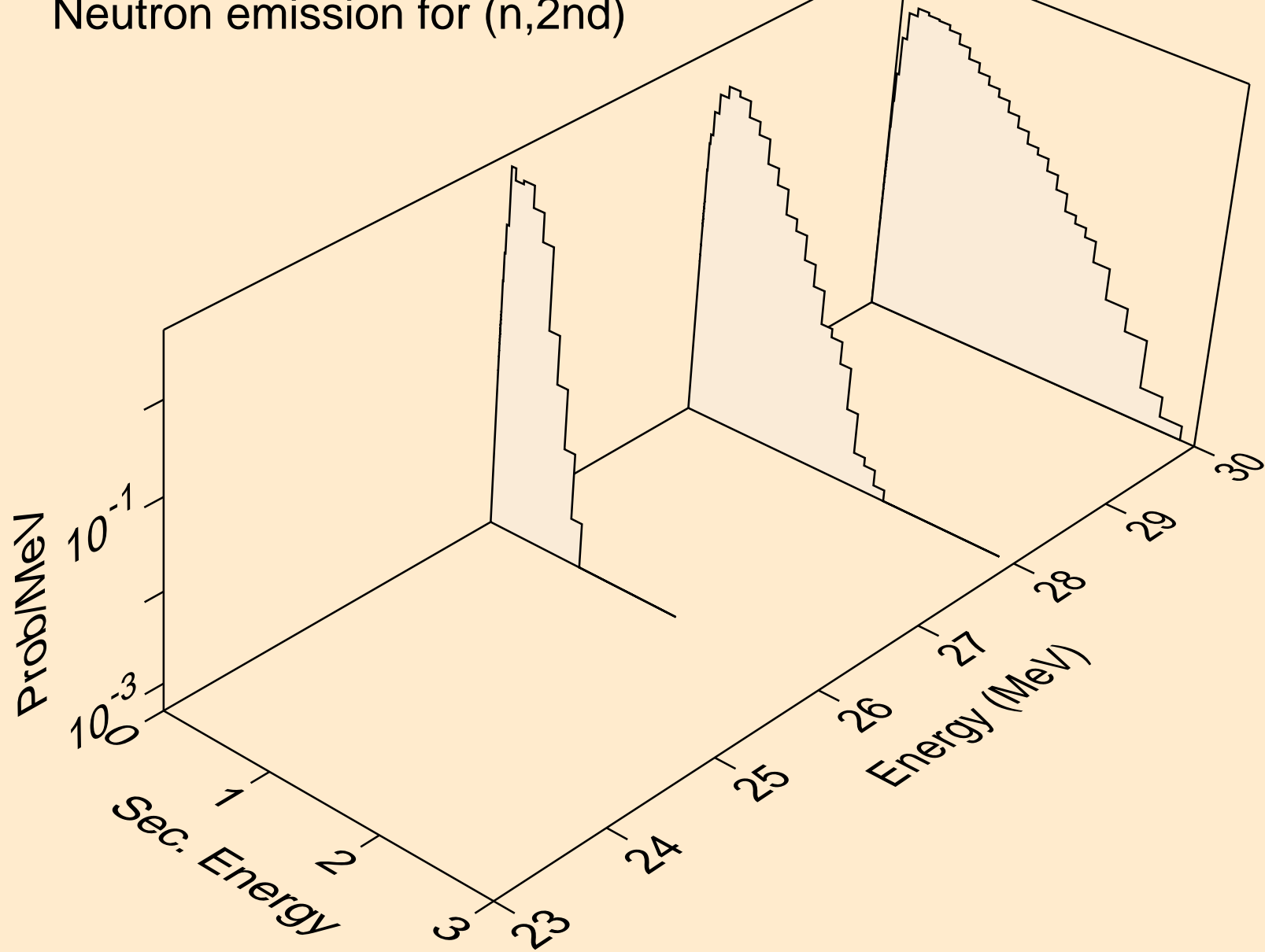

XE114 NEUTRON ACER TENDL-2021 LIBRARY; T=293.6K
Neutron emission for (n,2n)

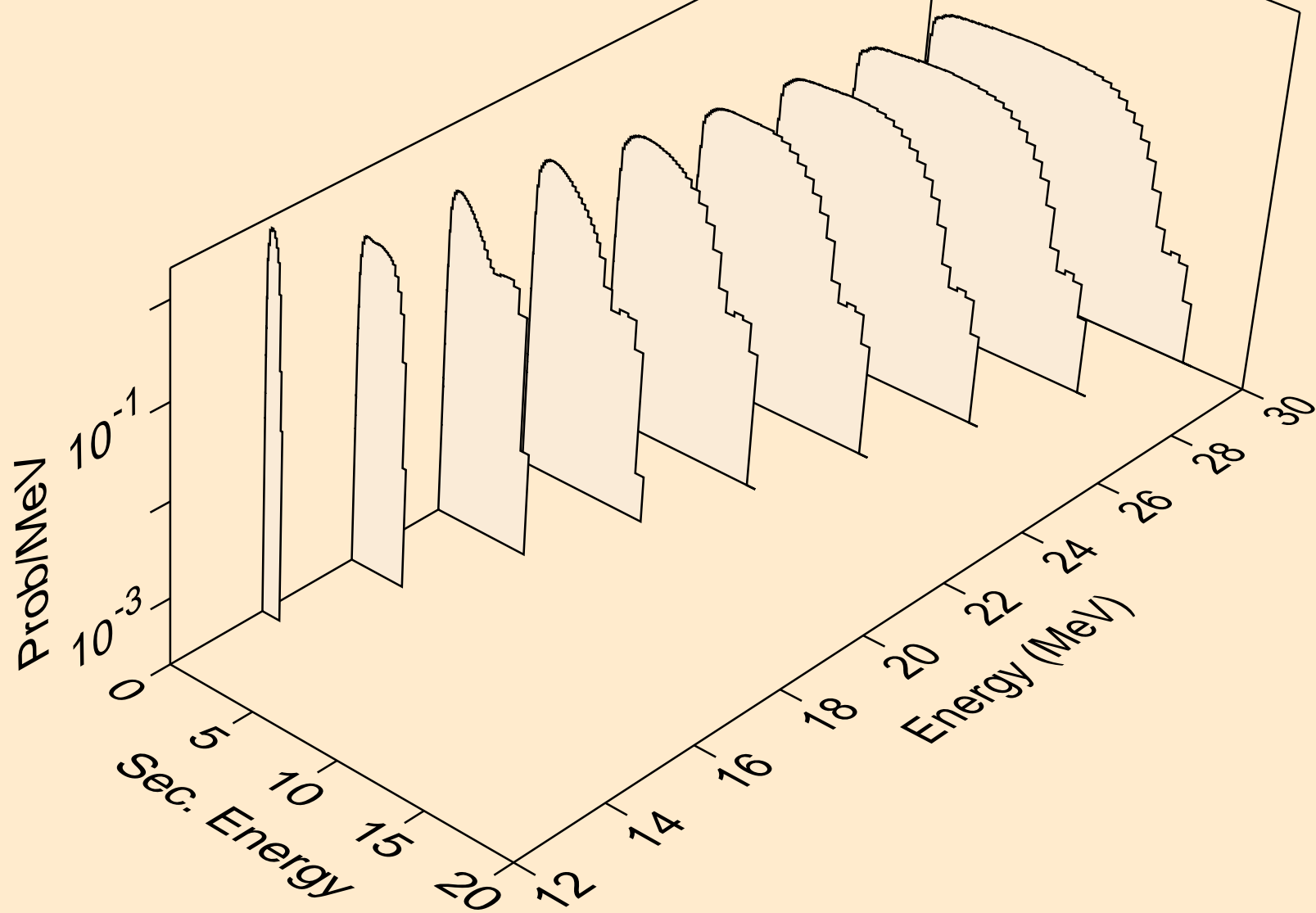

XE114 NEUTRON ACER TENDL-2021 LIBRARY; T=293.6K
Neutron emission for (n,3n)

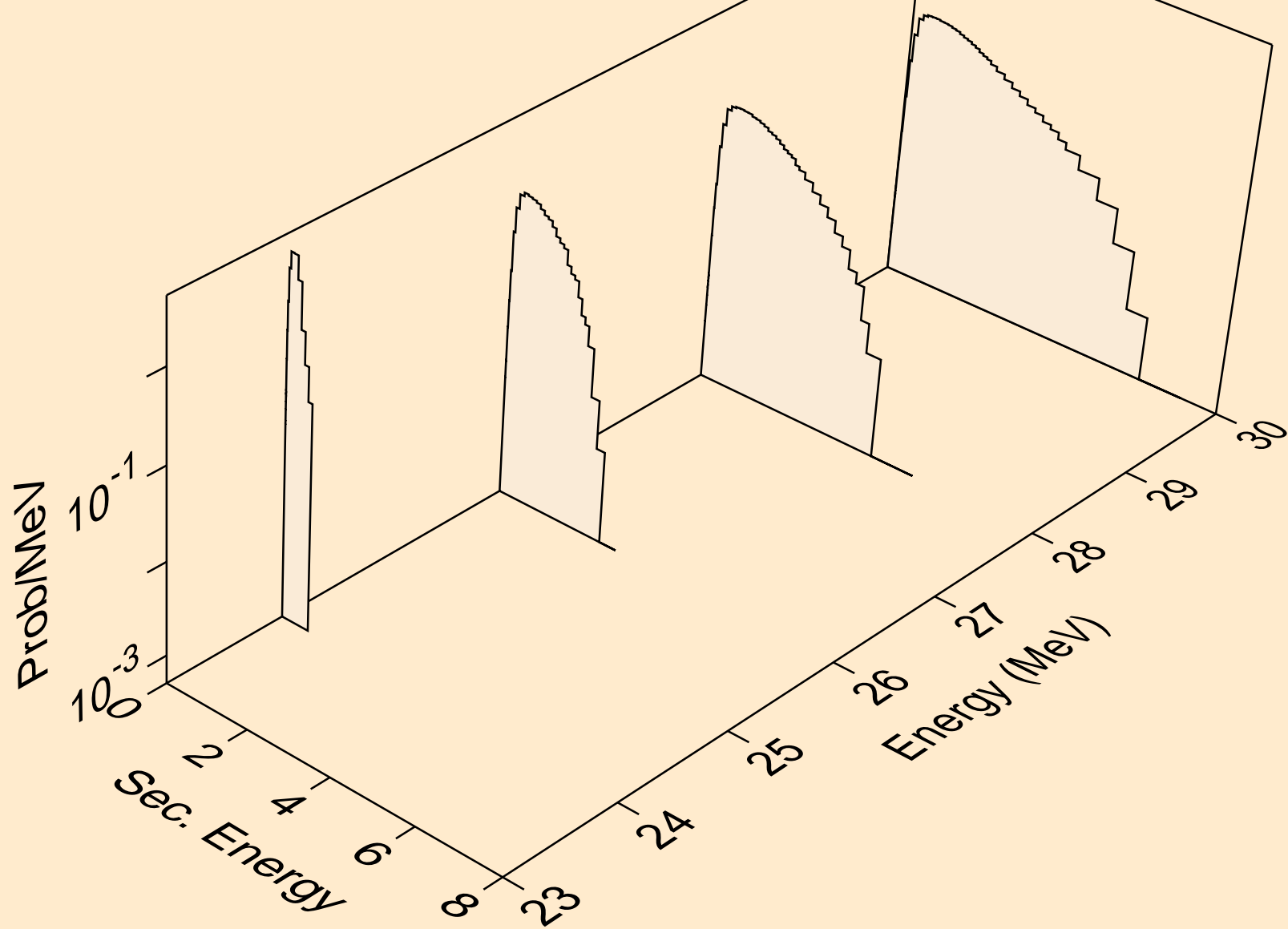

XE114 NEUTRON ACER TENDL-2021 LIBRARY; T=293.6K
Neutron emission for (n,n*)a

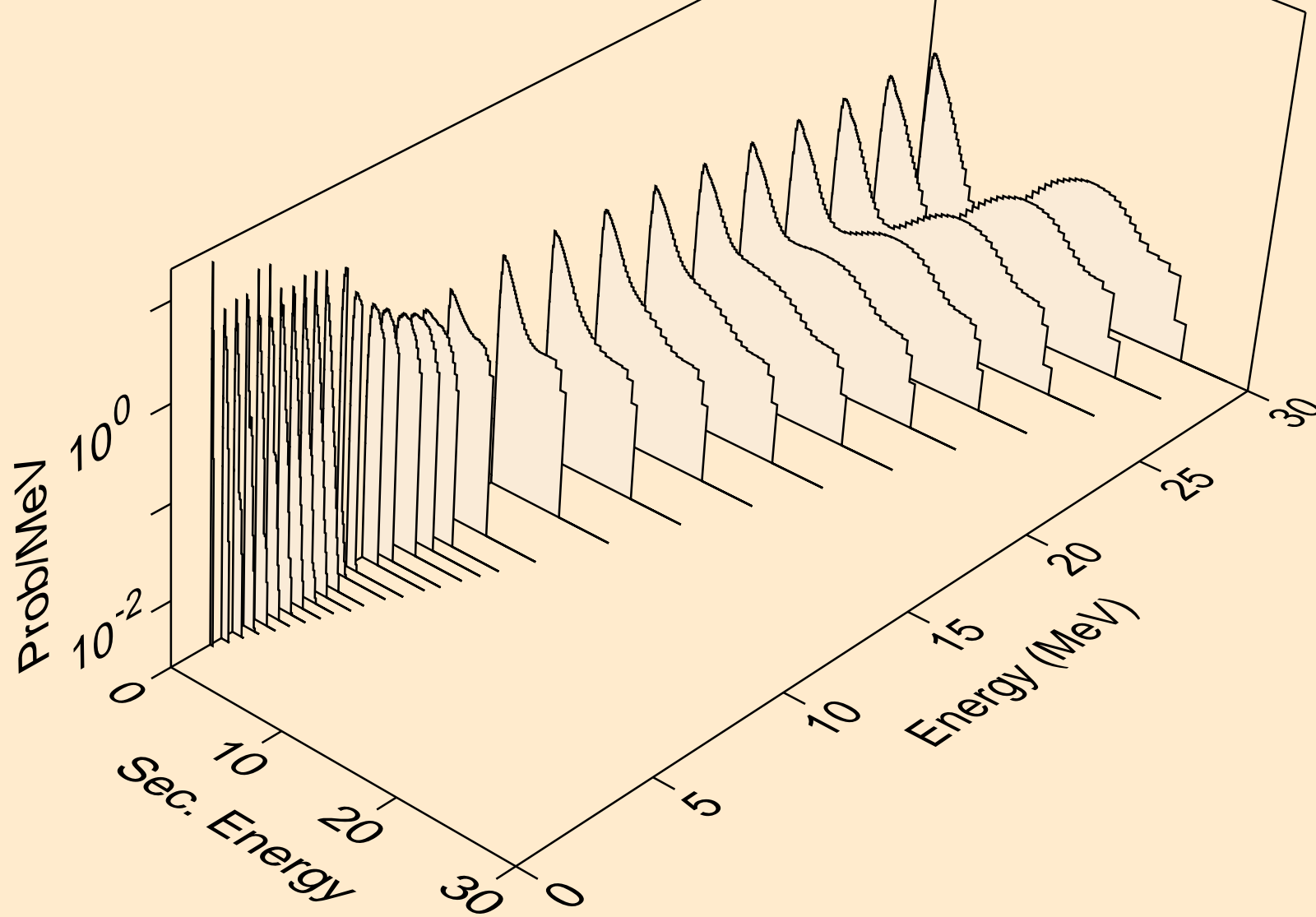

XE114 NEUTRON ACER TENDL-2021 LIBRARY; T=293.6K
Neutron emission for (n,n*)3a

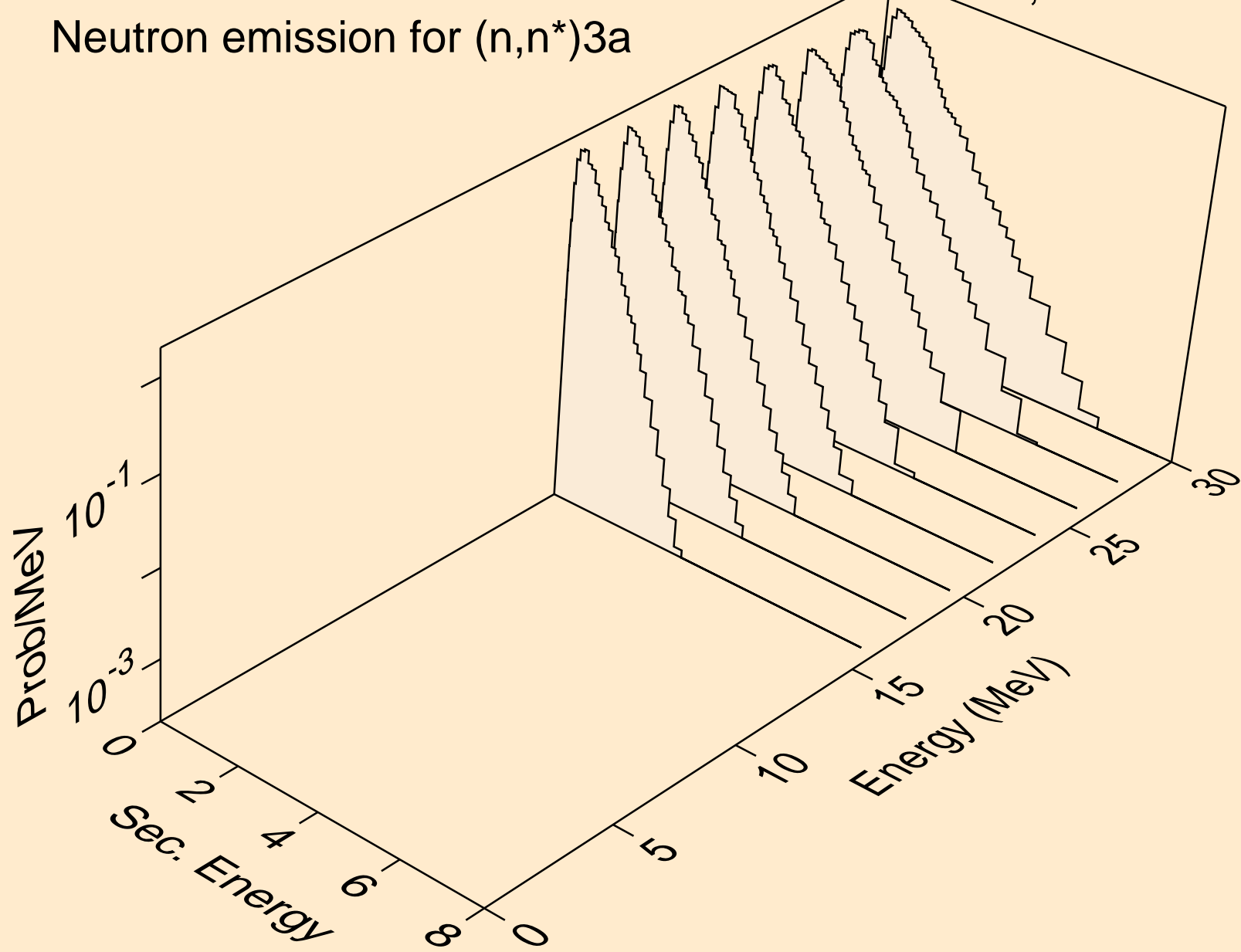

XE114 NEUTRON ACER TENDL-2021 LIBRARY; T=293.6K
Neutron emission for (n,2n)_a

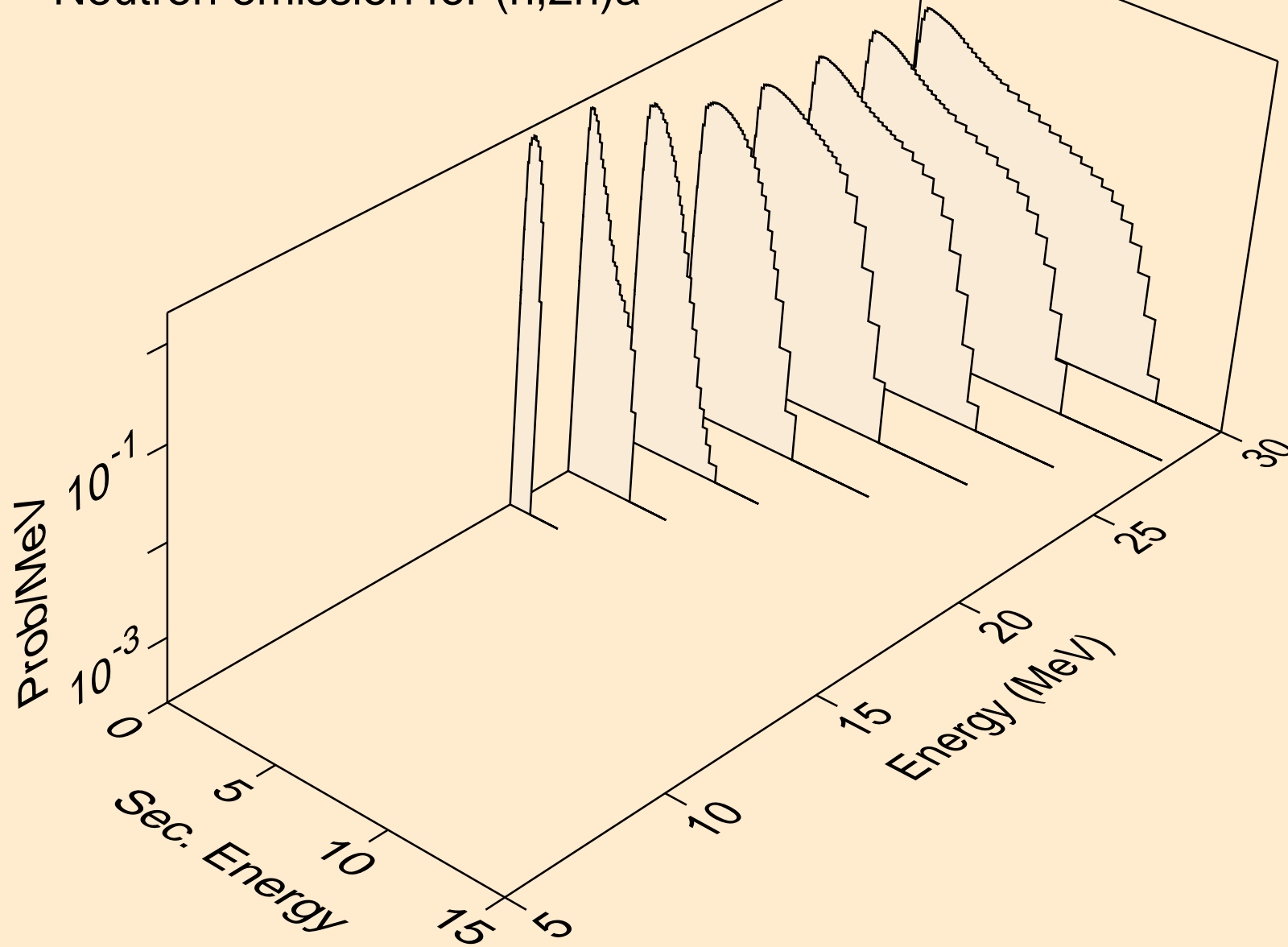

XE114 NEUTRON ACER TENDL-2021 LIBRARY; T=293.6K
Neutron emission for (n,3n)a

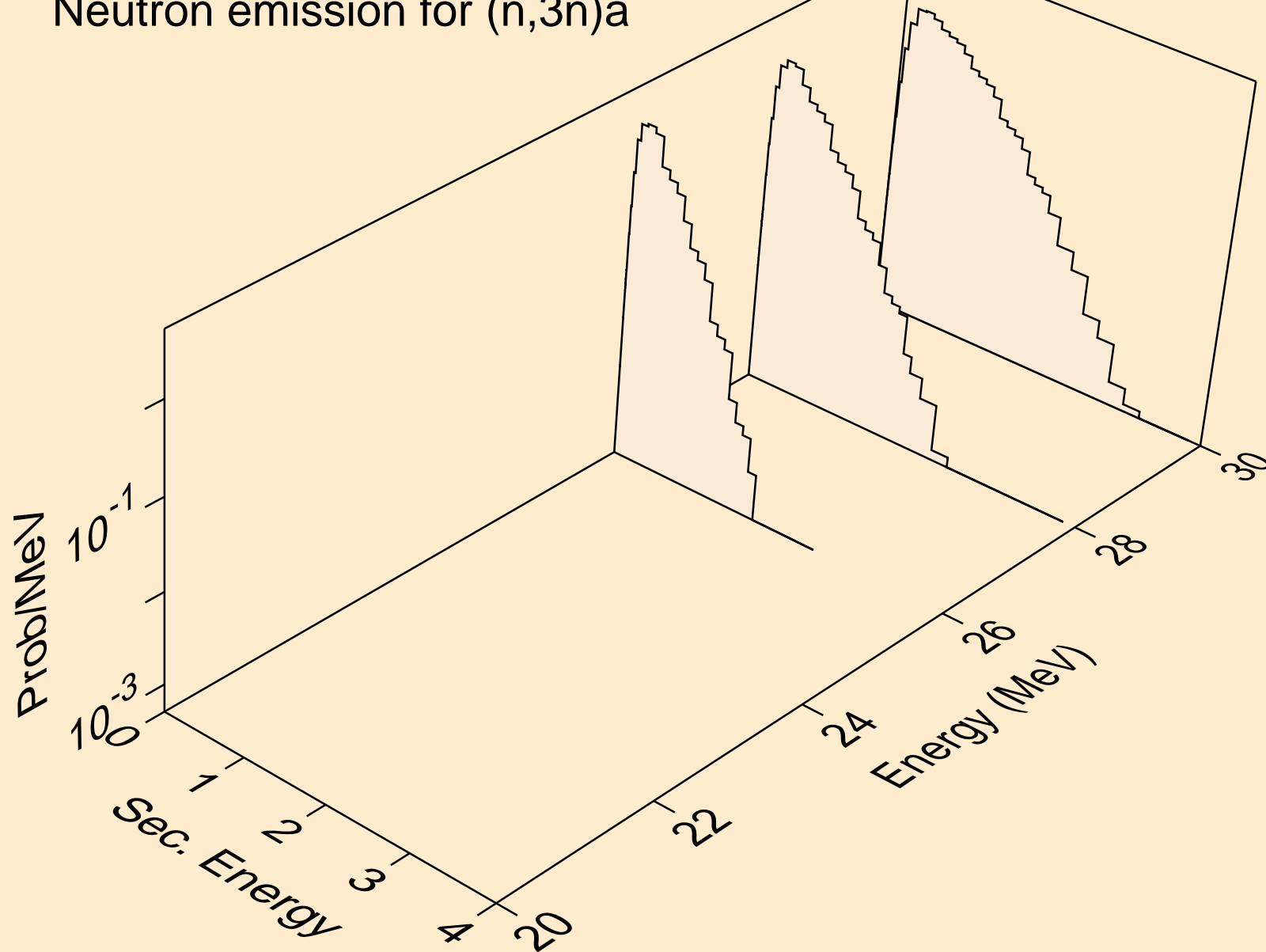

XE114 NEUTRON ACER TENDL-2021 LIBRARY; T=293.6K
Neutron emission for (n,n*)p

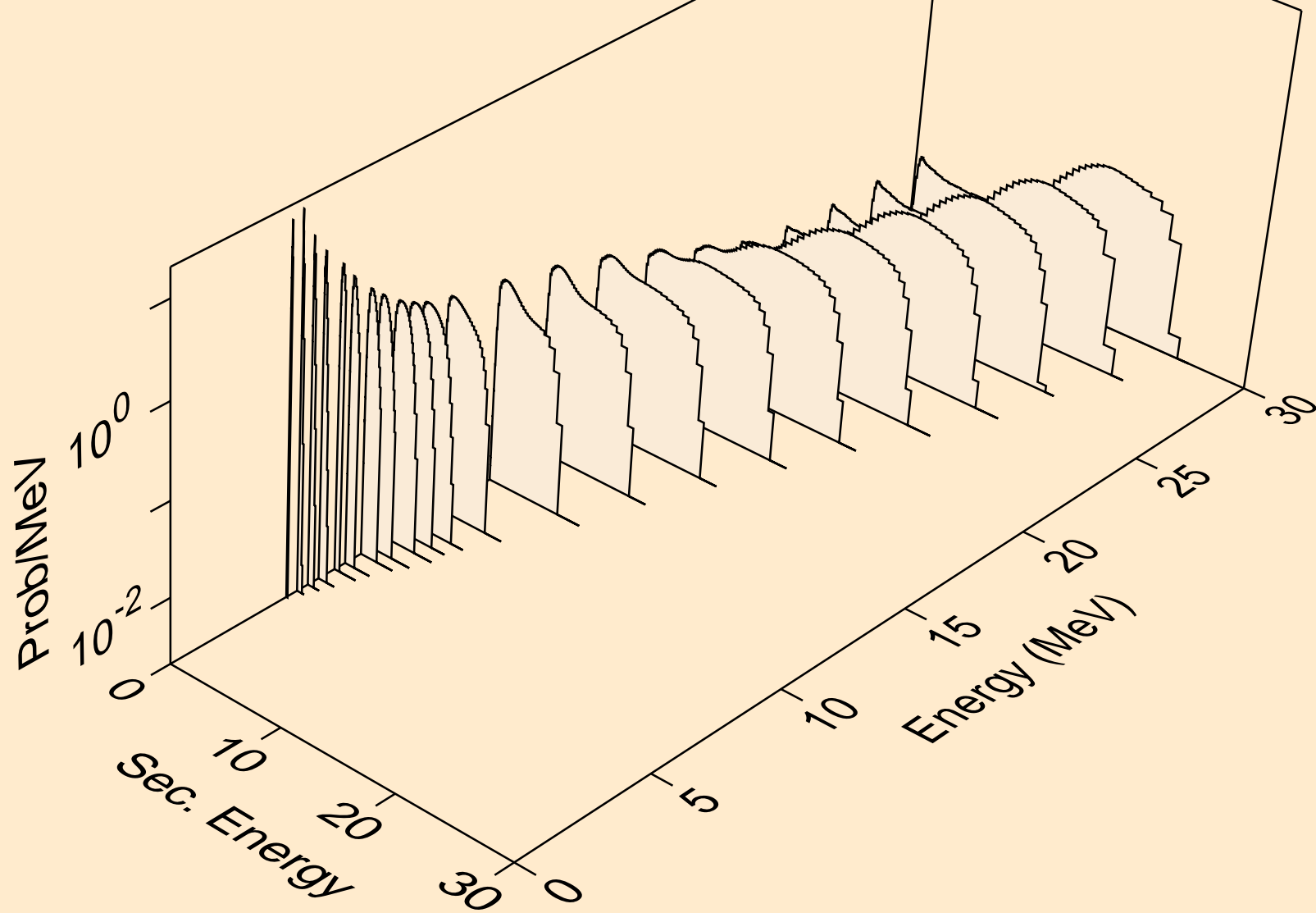

XE114 NEUTRON ACER TENDL-2021 LIBRARY; T=293.6K
Neutron emission for (n,n*)2a

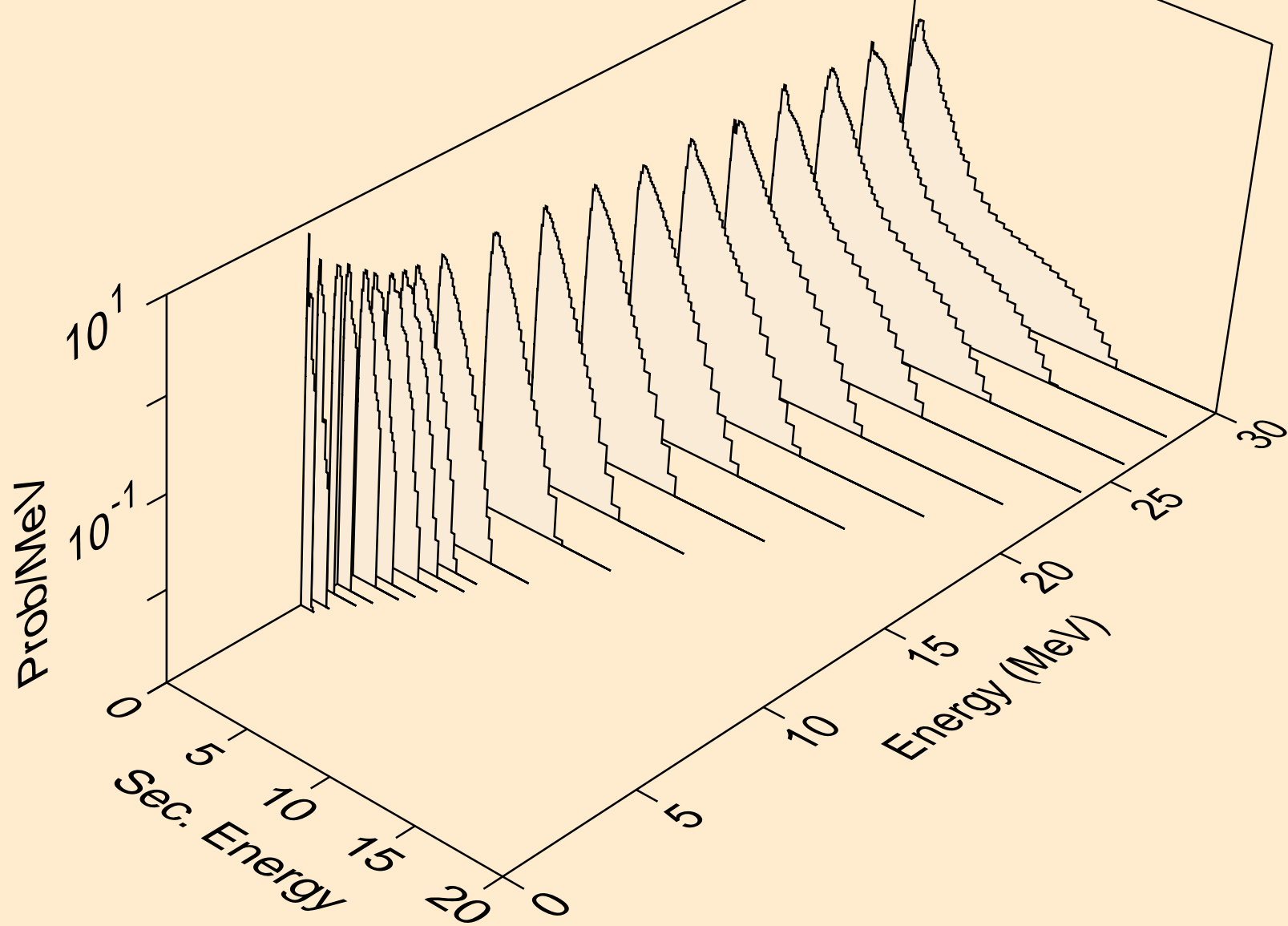

XE114 NEUTRON ACER TENDL-2021 LIBRARY; T=293.6K
Neutron emission for (n,2n)2a

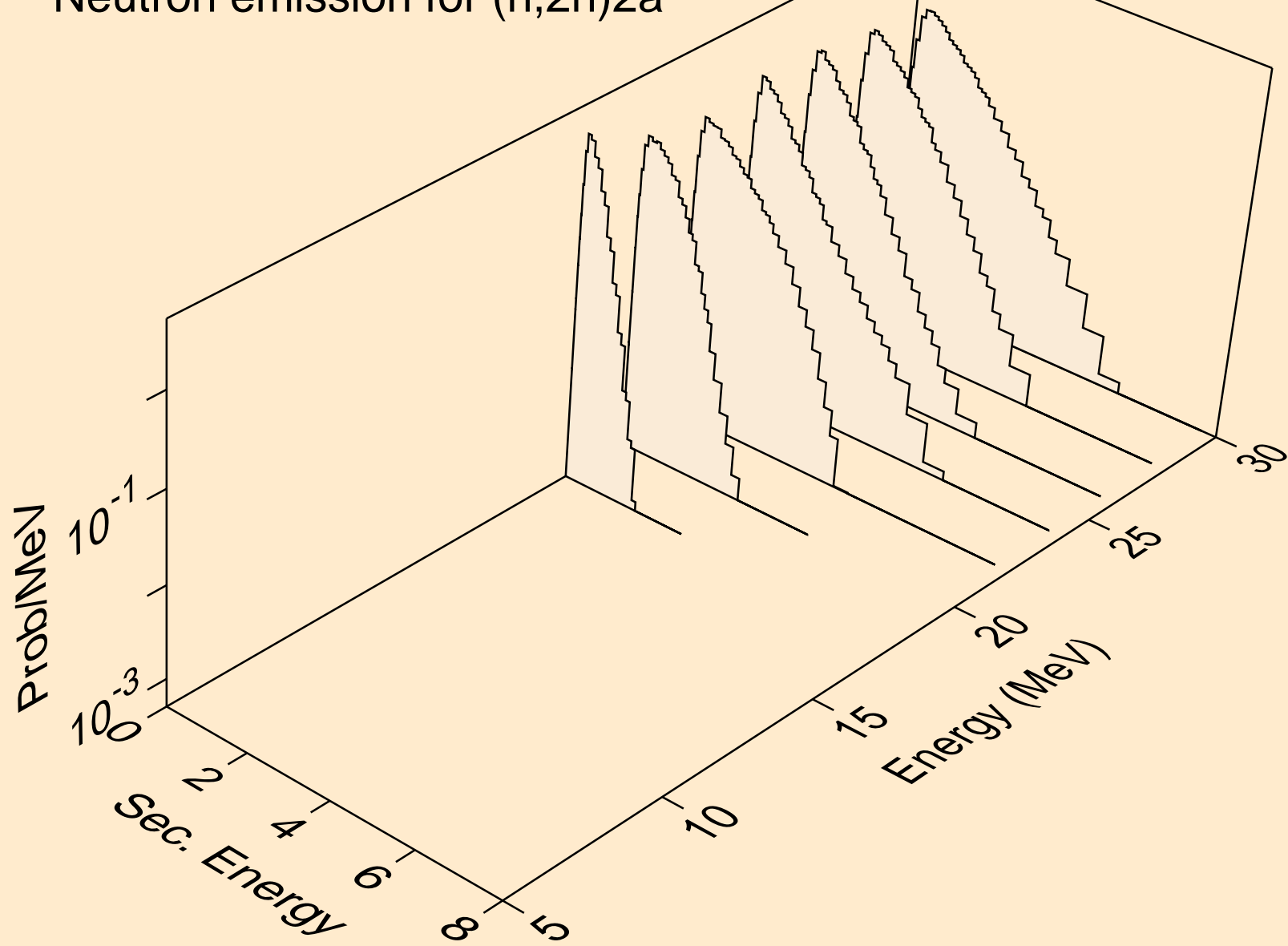

XE114 NEUTRON ACER TENDL-2021 LIBRARY; T=293.6K
Neutron emission for (n,n*)d

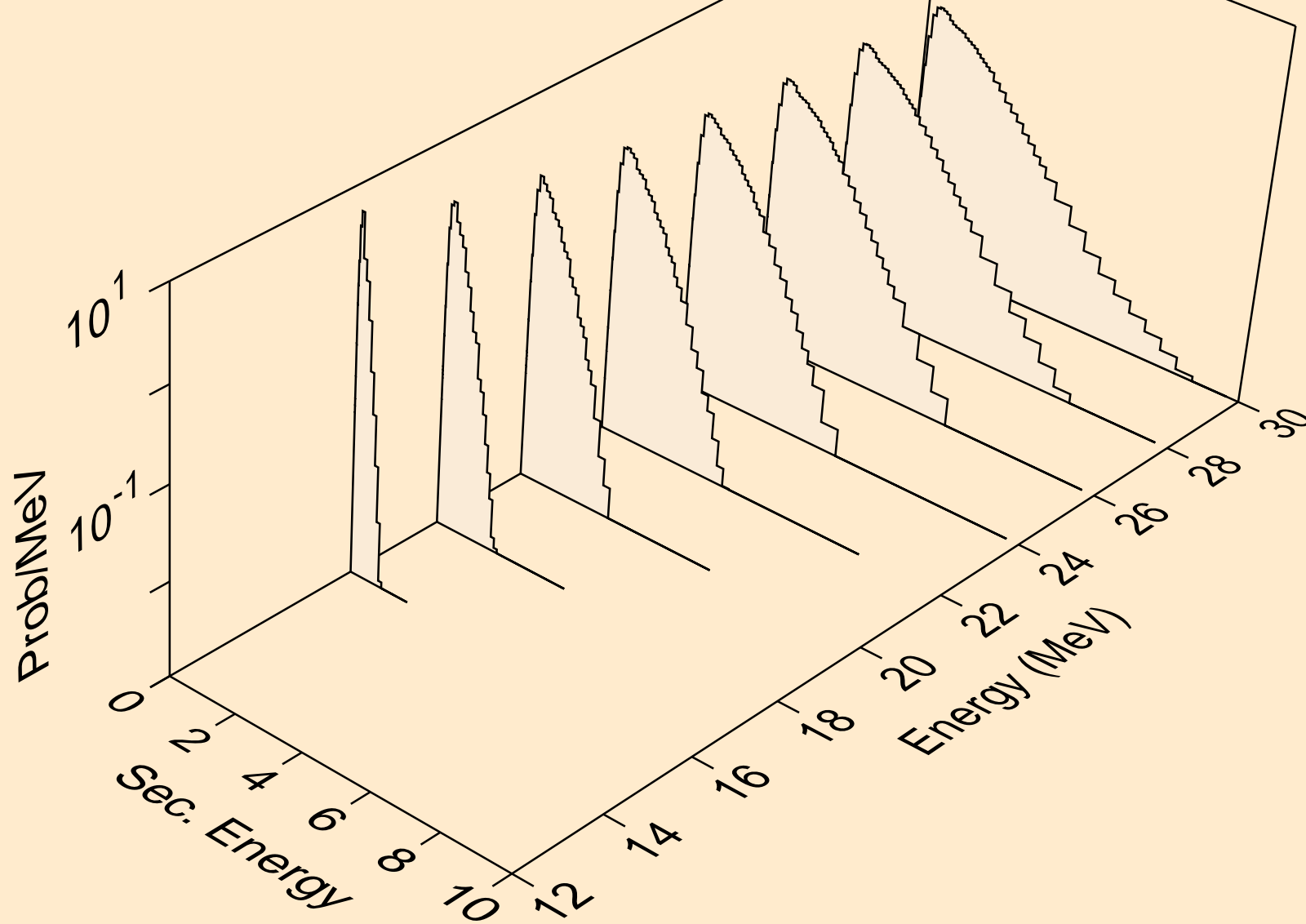

XE114 NEUTRON ACER TENDL-2021 LIBRARY; T=293.6K
Neutron emission for (n,n*)t

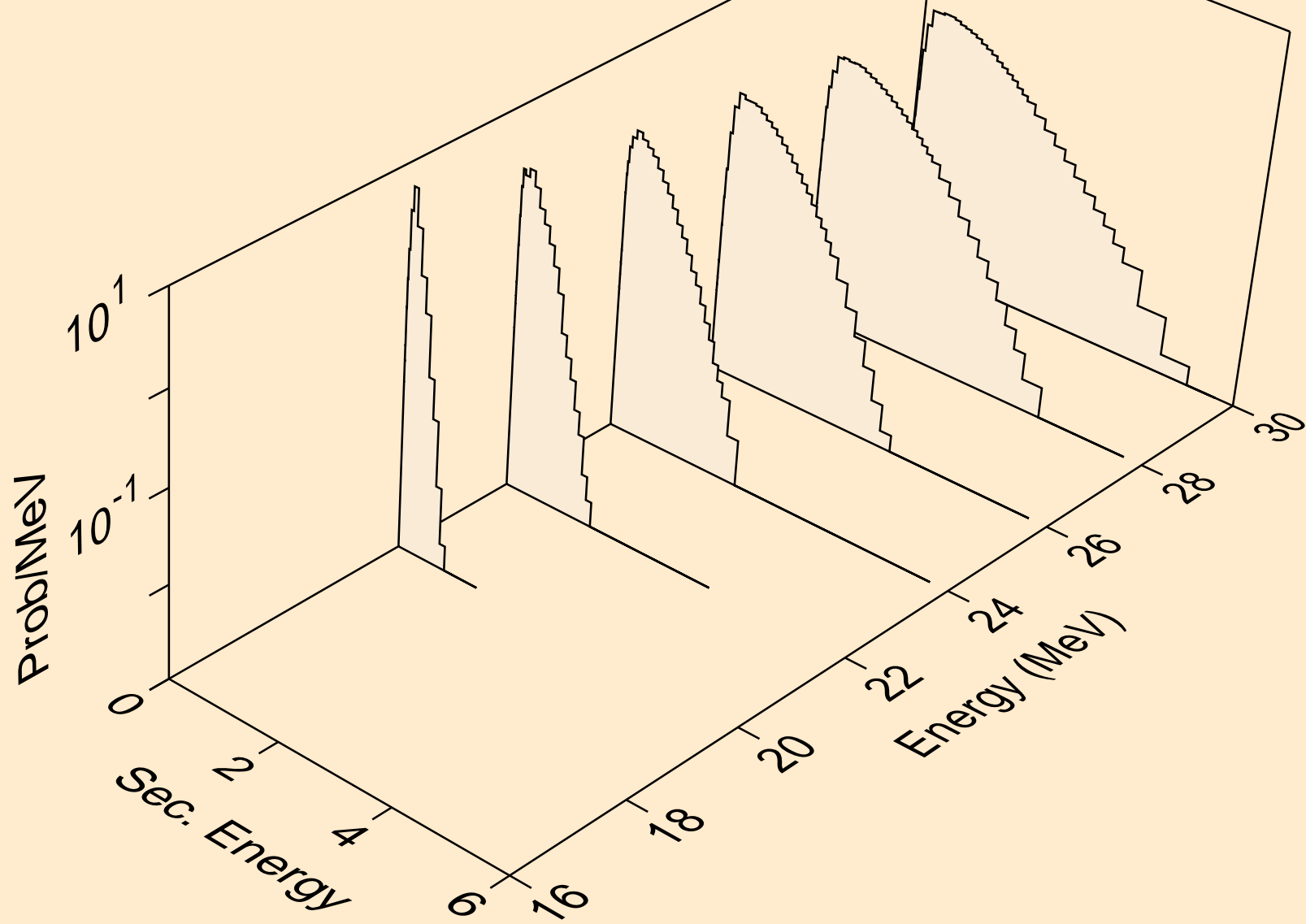

XE114 NEUTRON ACER TENDL-2021 LIBRARY; T=293.6K
Neutron emission for (n,n*)he3

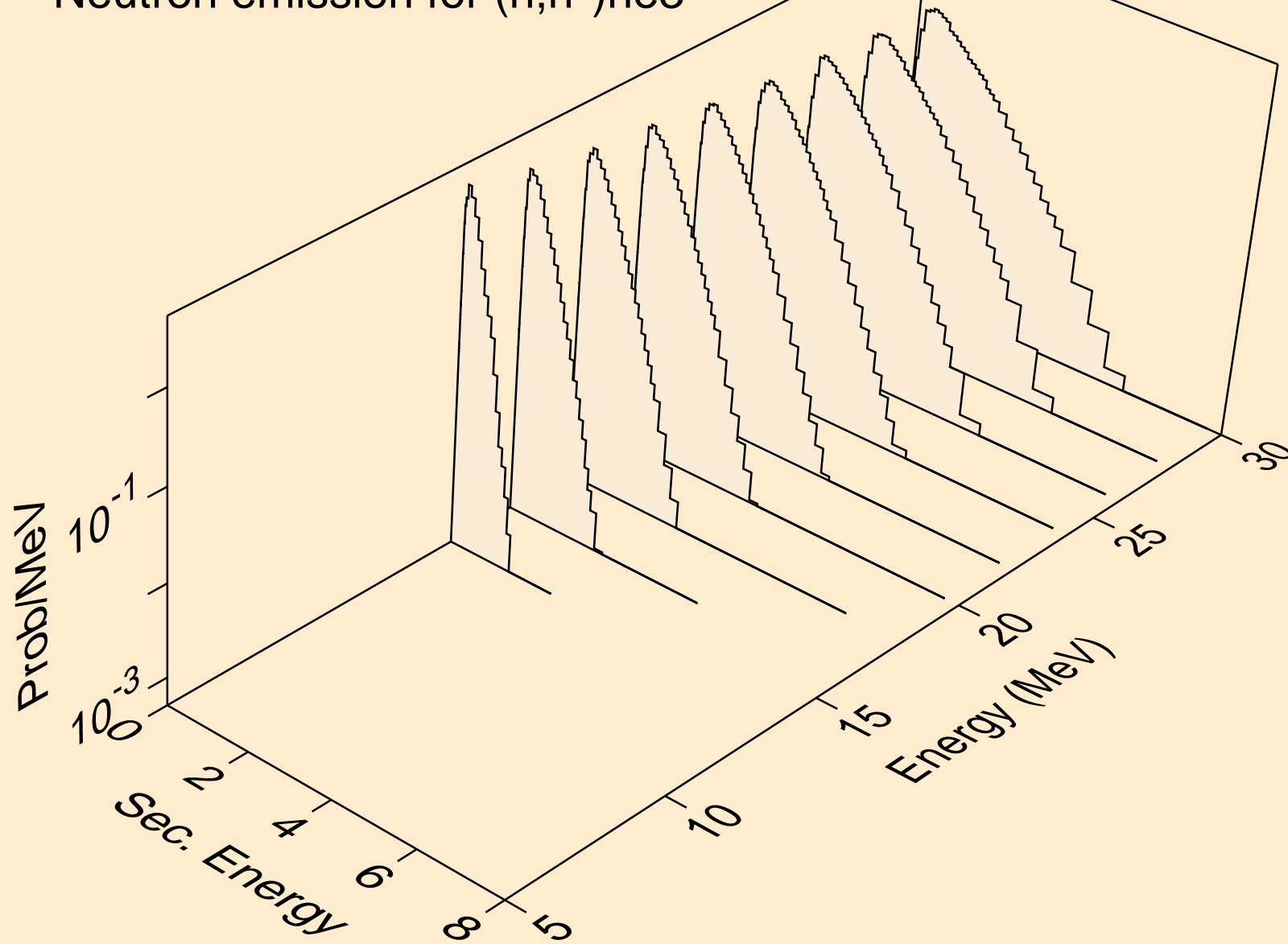

XE114 NEUTRON ACER TENDL-2021 LIBRARY; T=293.6K
Neutron emission for (n,2np)

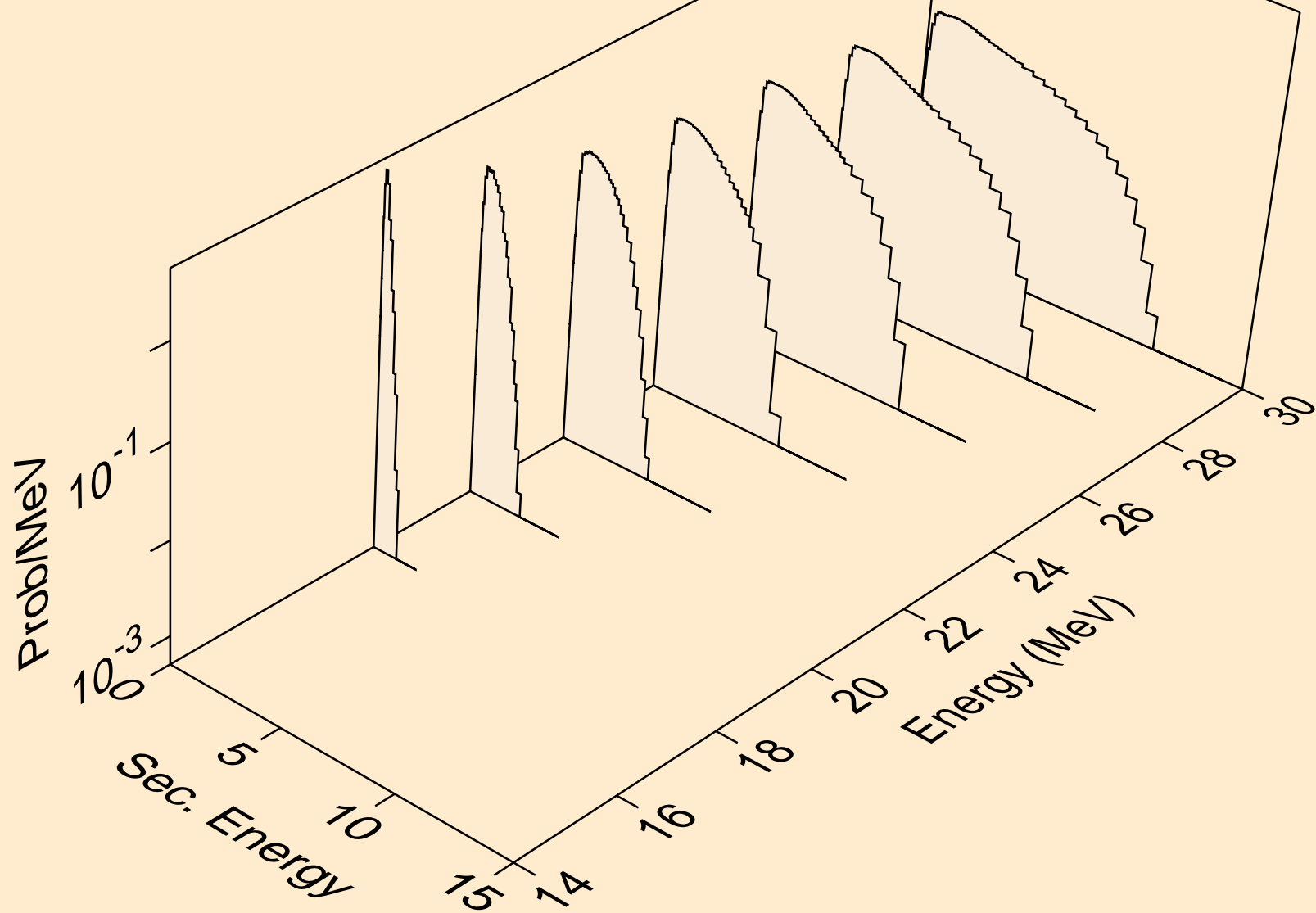

XE114 NEUTRON ACER TENDL-2021 LIBRARY; T=293.6K
Neutron emission for (n,3np)

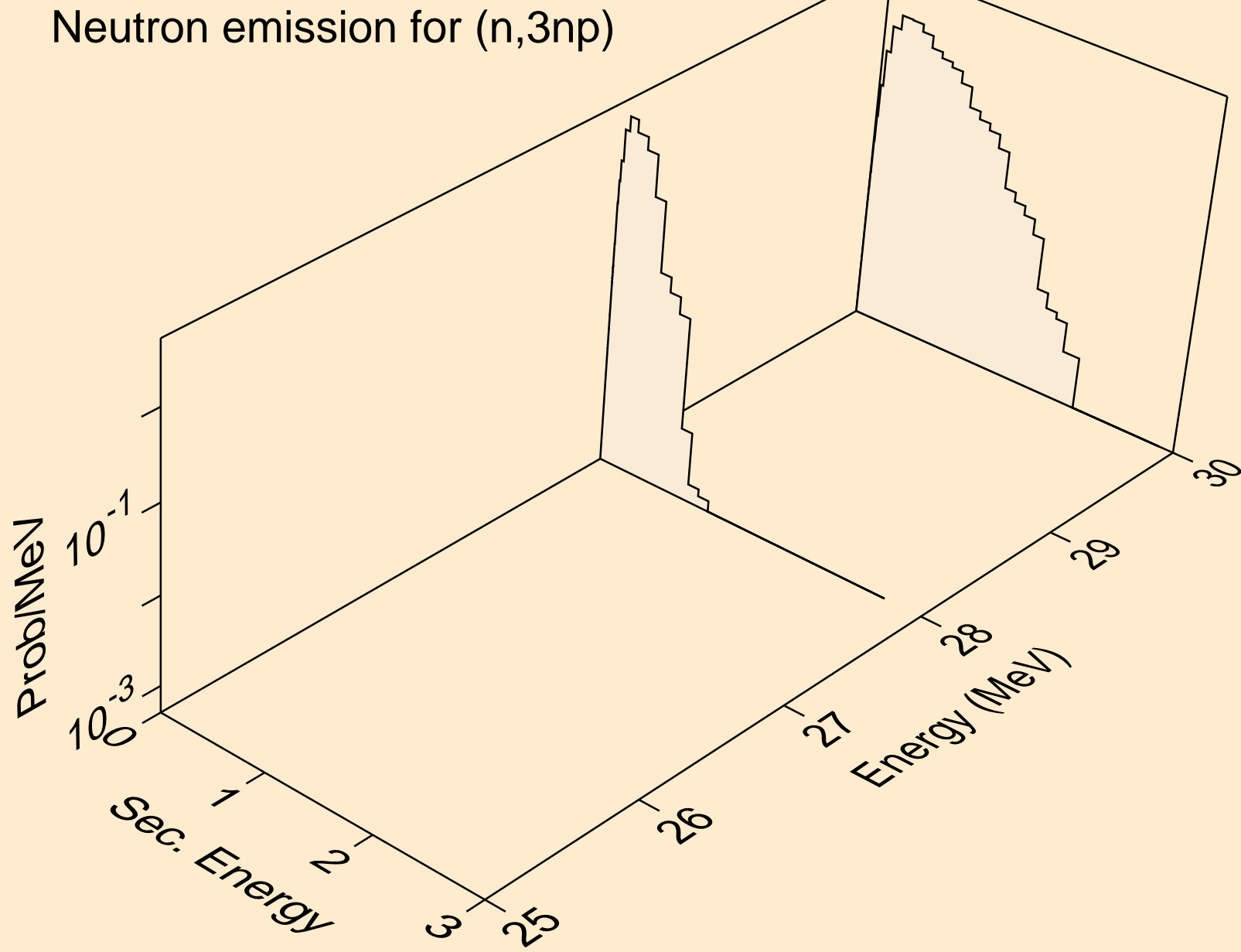

XE114 NEUTRON ACER TENDL-2021 LIBRARY; T=293.6K
Neutron emission for (n,2np)

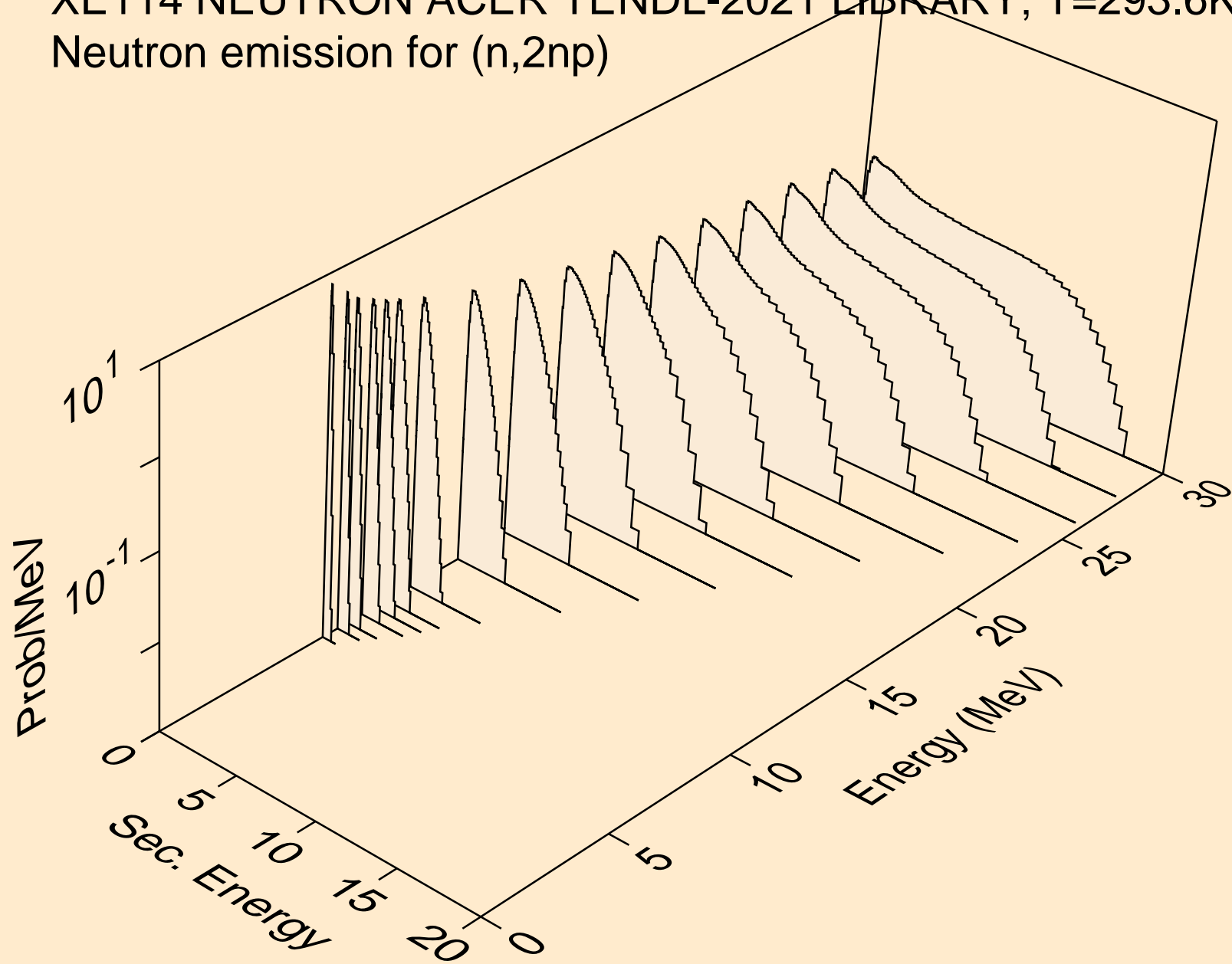

XE114 NEUTRON ACER TENDL-2021 LIBRARY; T=293.6K
Neutron emission for (n,npa)

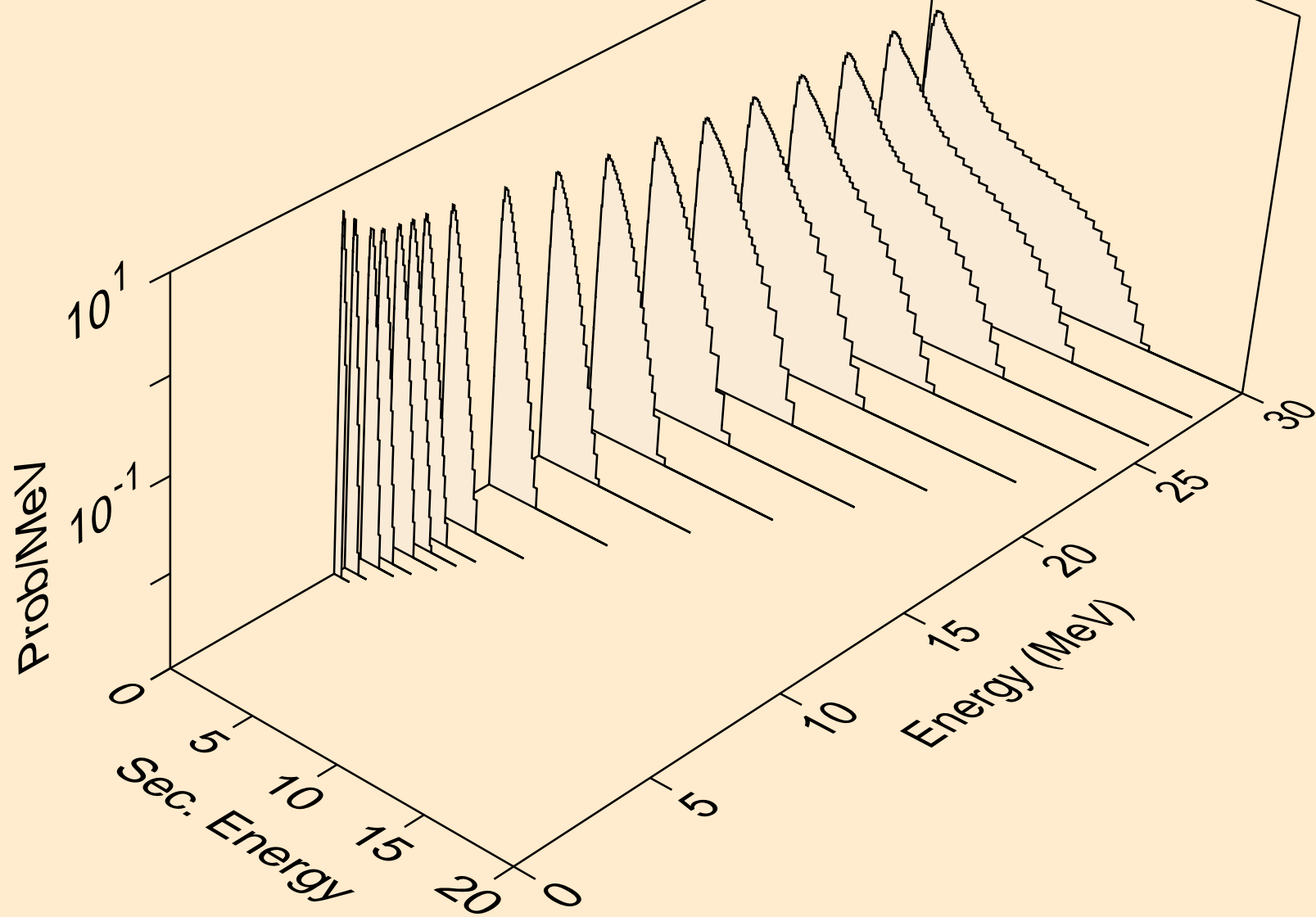

XE114 NEUTRON ACER TENDL-2021 LIBRARY; T=293.6K
Neutron emission for (n,n*c)

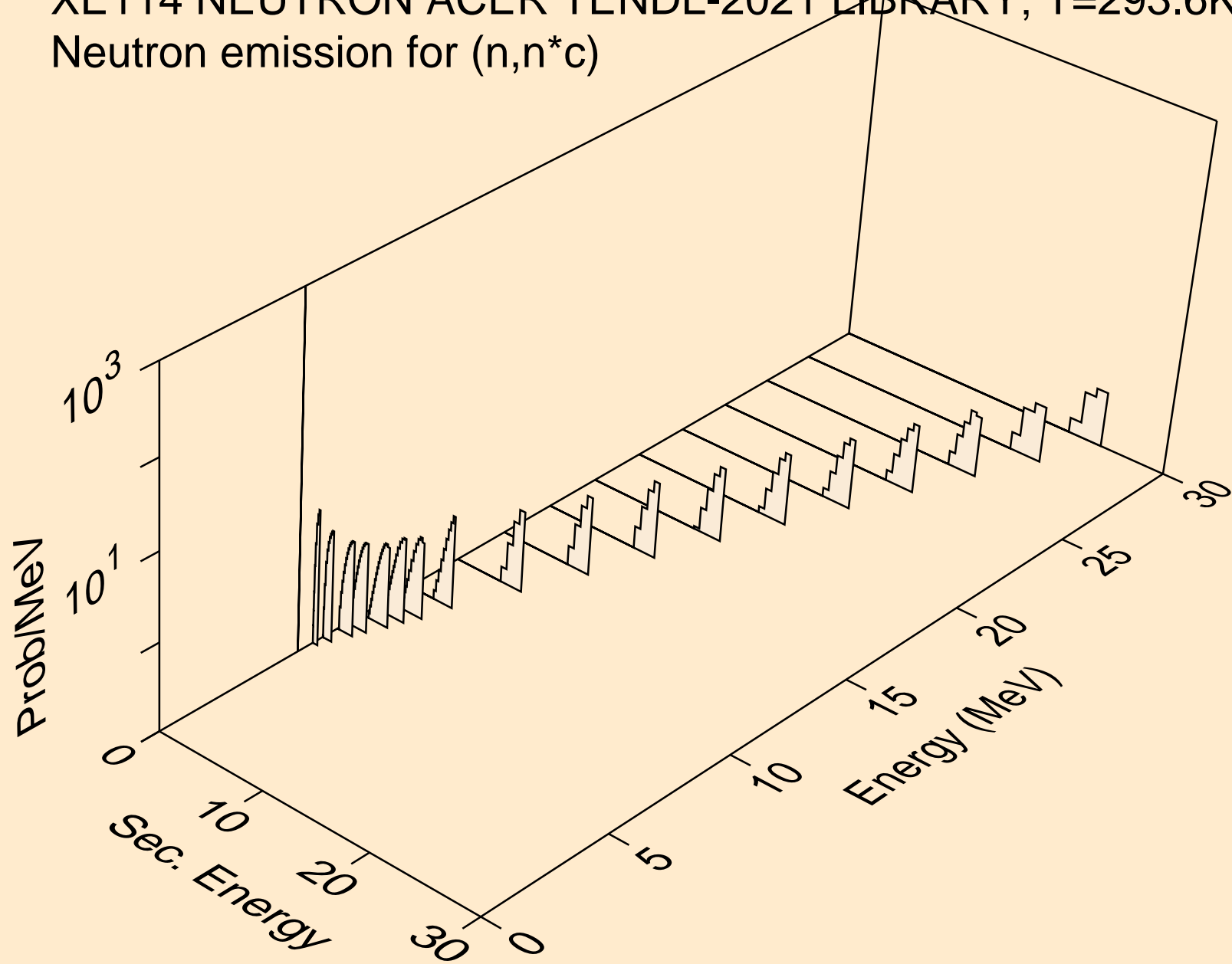

XE114 NEUTRON ACER TENDL-2021 LIBRARY; T=293.6K
Photon emission for (n,x)

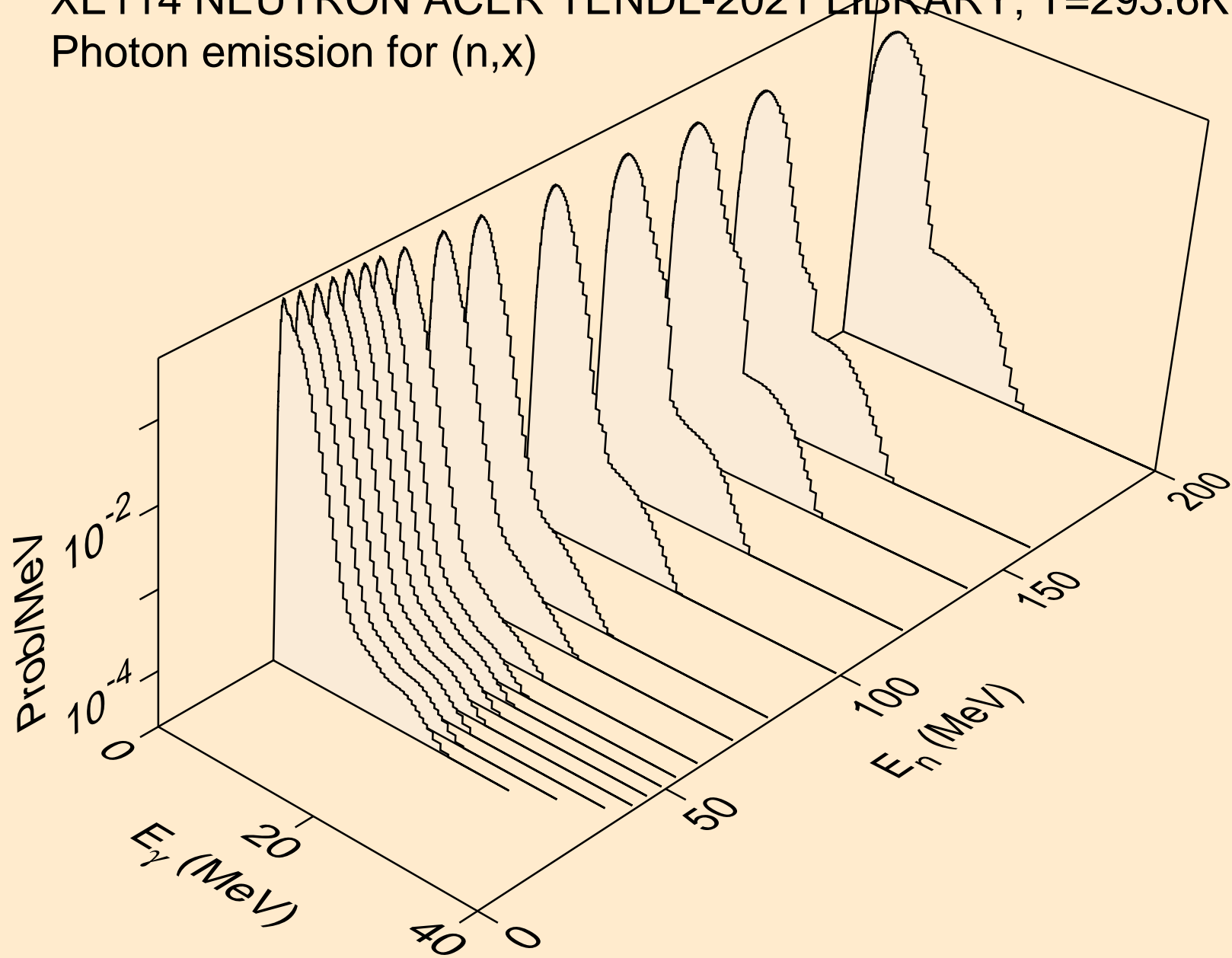

XE114 NEUTRON ACER TENDL-2021 LIBRARY; T=293.6K
Photon emission for (n,2nd)

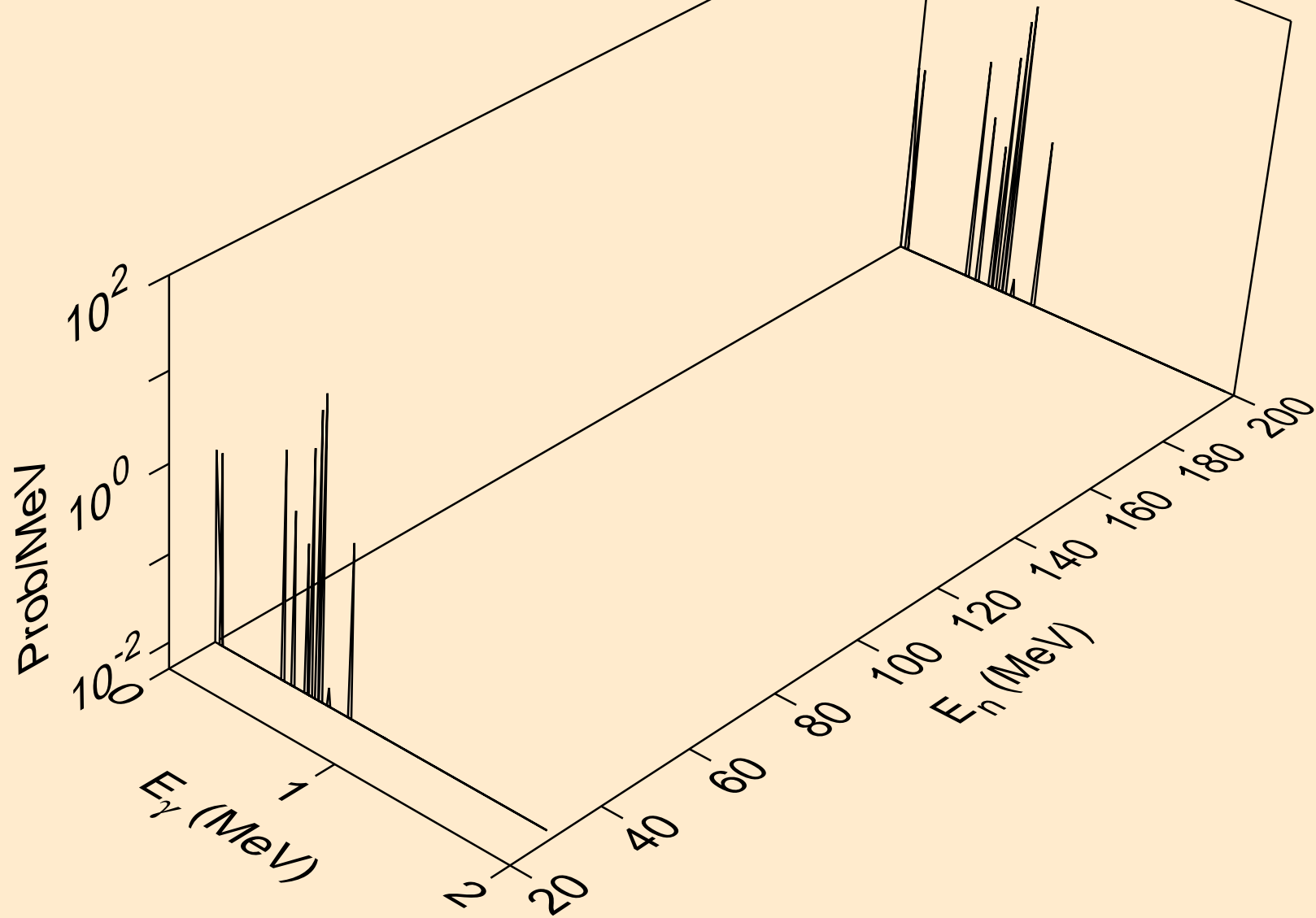

XE114 NEUTRON ACER TENDL-2021 LIBRARY; T=293.6K
Photon emission for (n,2n)

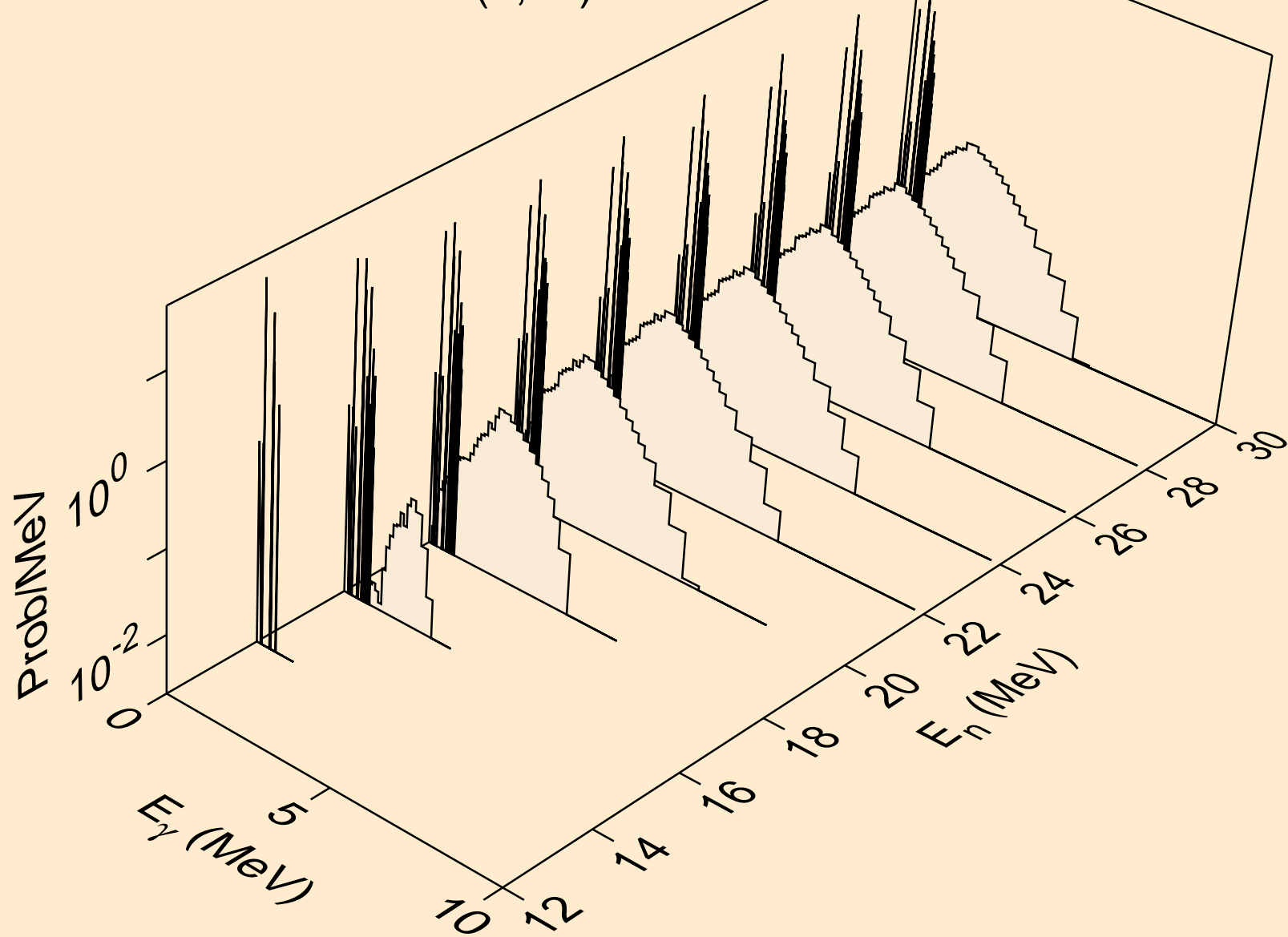

XE114 NEUTRON ACER TENDL-2021 LIBRARY; T=293.6K
Photon emission for (n,3n)

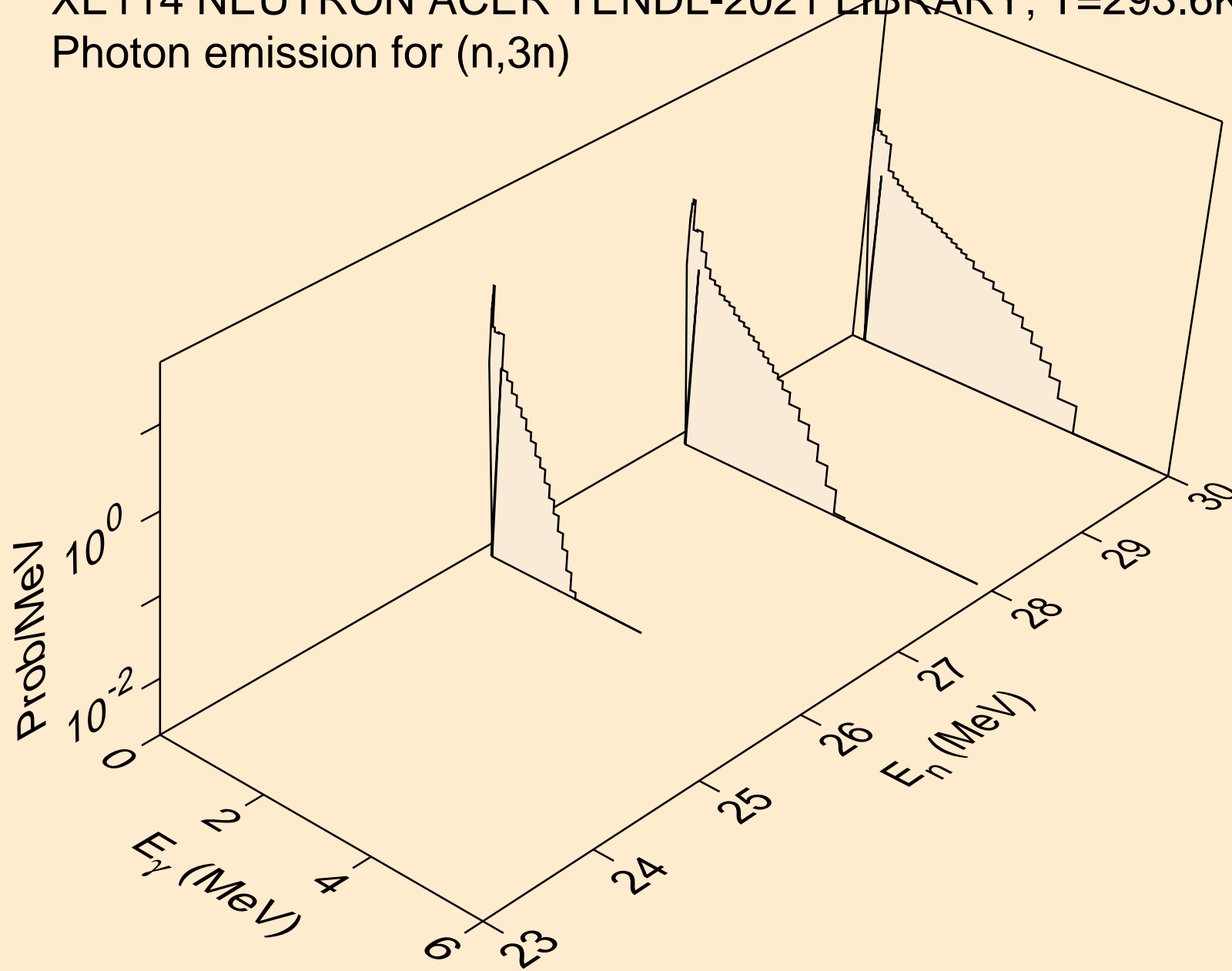

XE114 NEUTRON ACER TENDL-2021 LIBRARY; T=293.6K
Photon emission for (n,n*)a

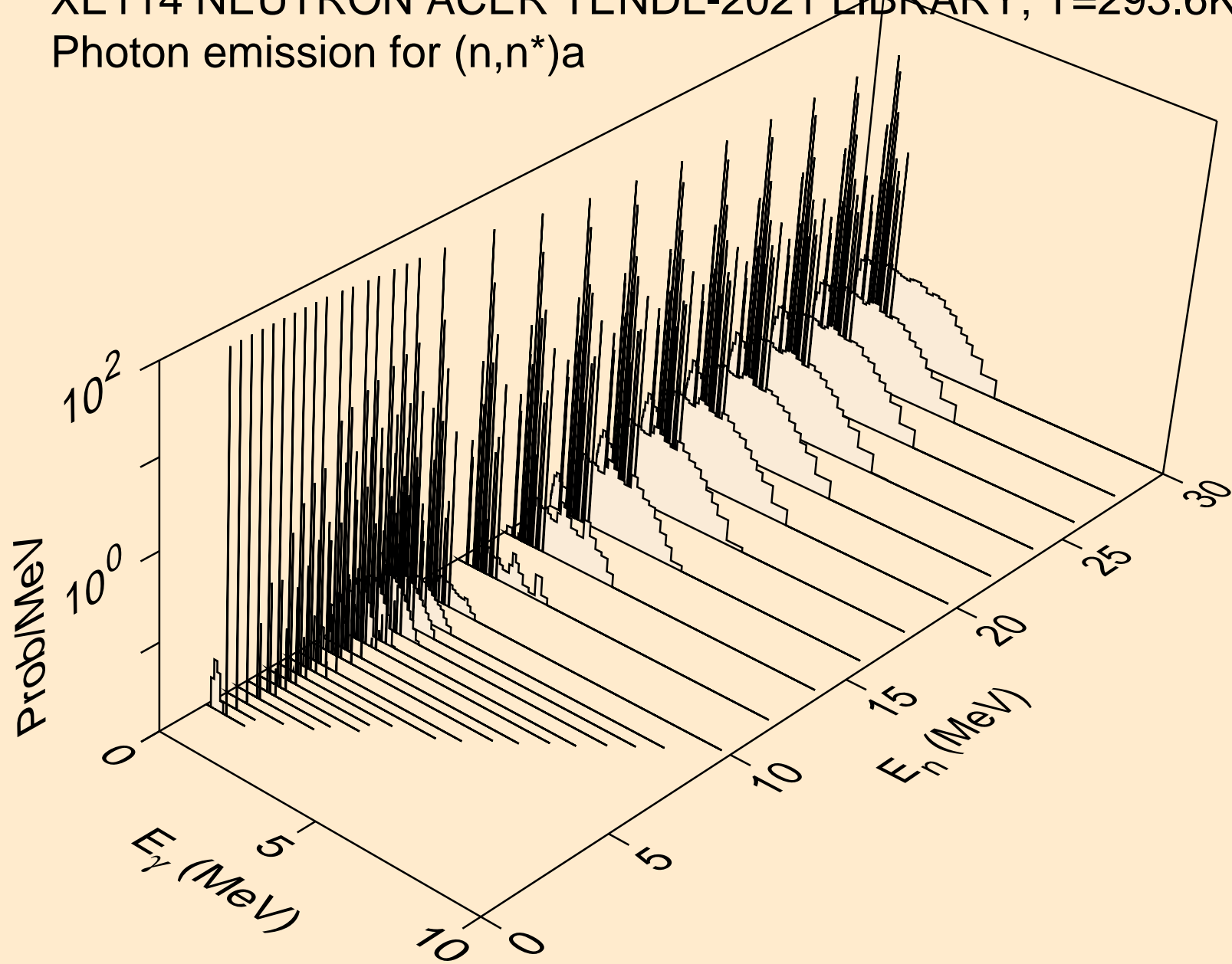

XE114 NEUTRON ACER TENDL-2021 LIBRARY; T=293.6K
Photon emission for (n,n*)3a

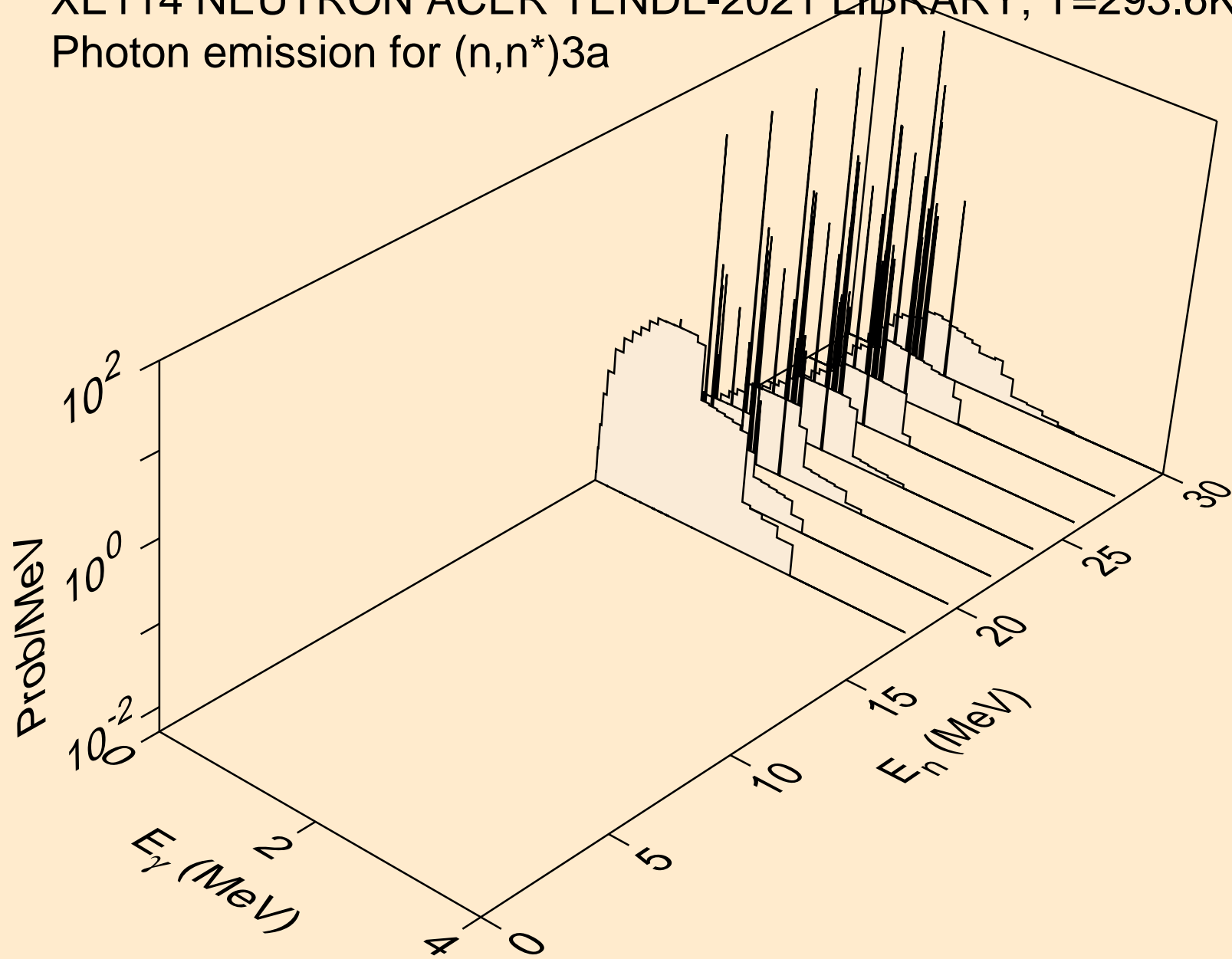

XE114 NEUTRON ACER TENDL-2021 LIBRARY; T=293.6K
Photon emission for (n,2n)a

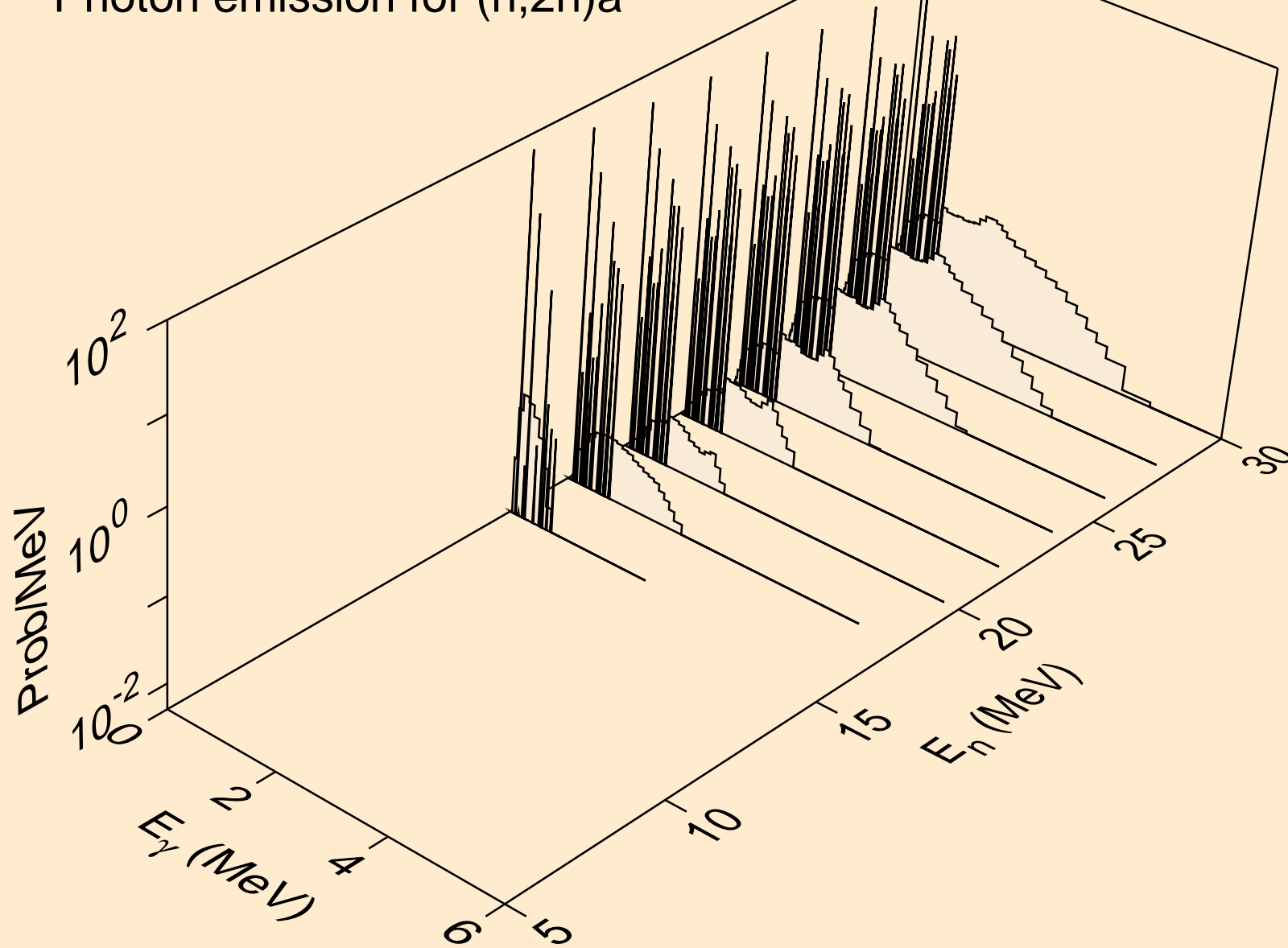

XE114 NEUTRON ACER TENDL-2021 LIBRARY; T=293.6K
Photon emission for (n,3n)a

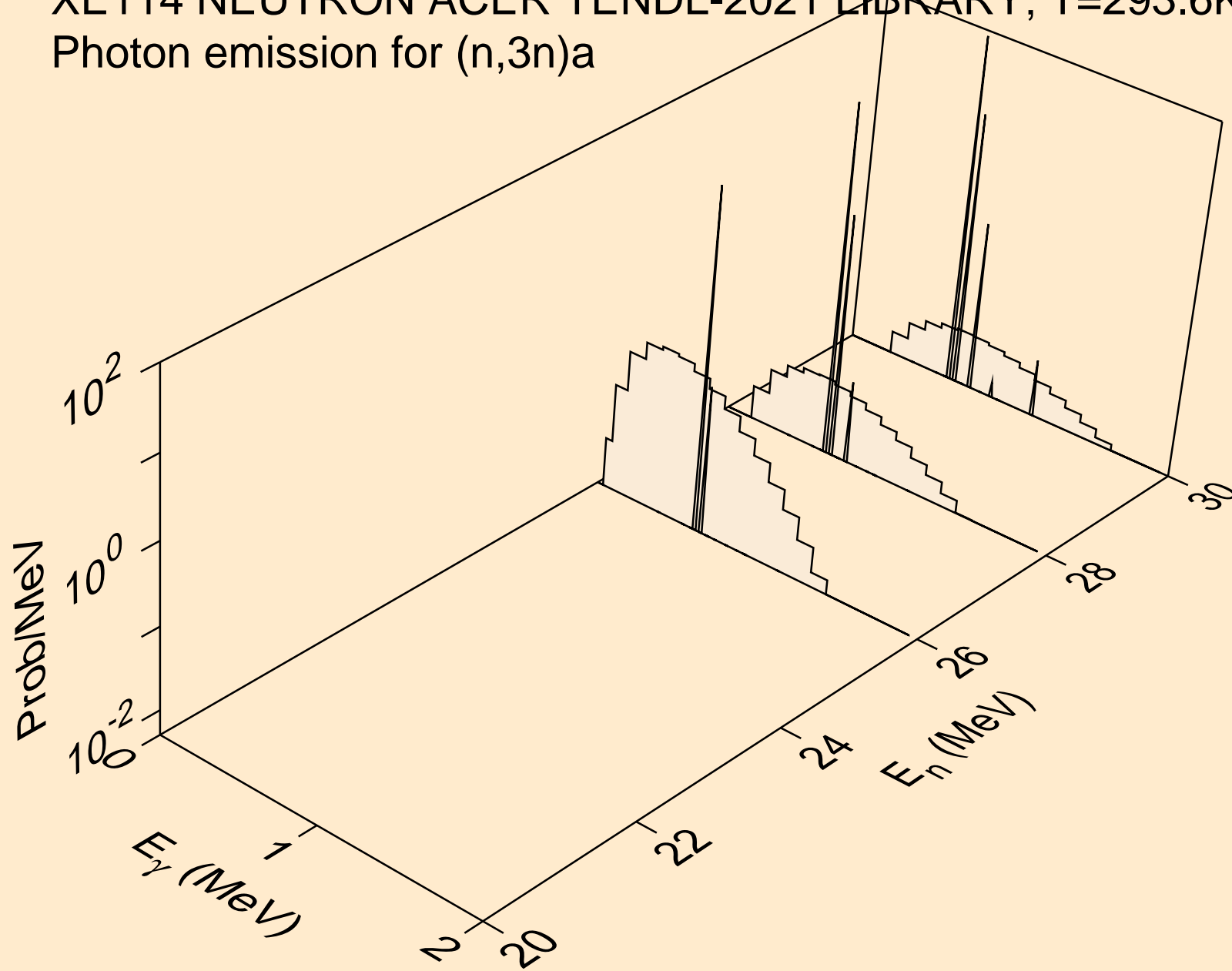

XE114 NEUTRON ACER TENDL-2021 LIBRARY; T=293.6K
Photon emission for (n,n*)p

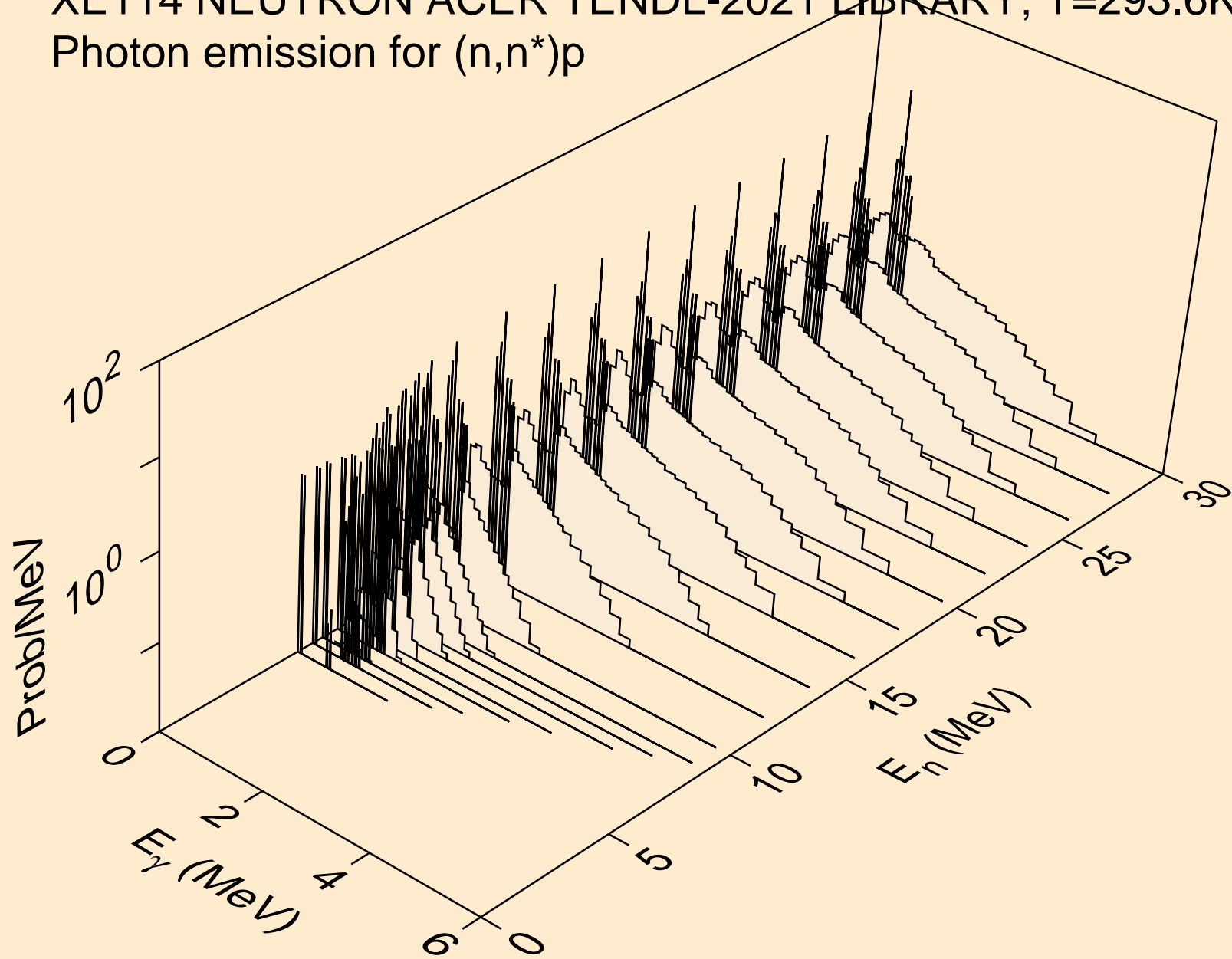

XE114 NEUTRON ACER TENDL-2021 LIBRARY; T=293.6K
Photon emission for (n,n*)2a

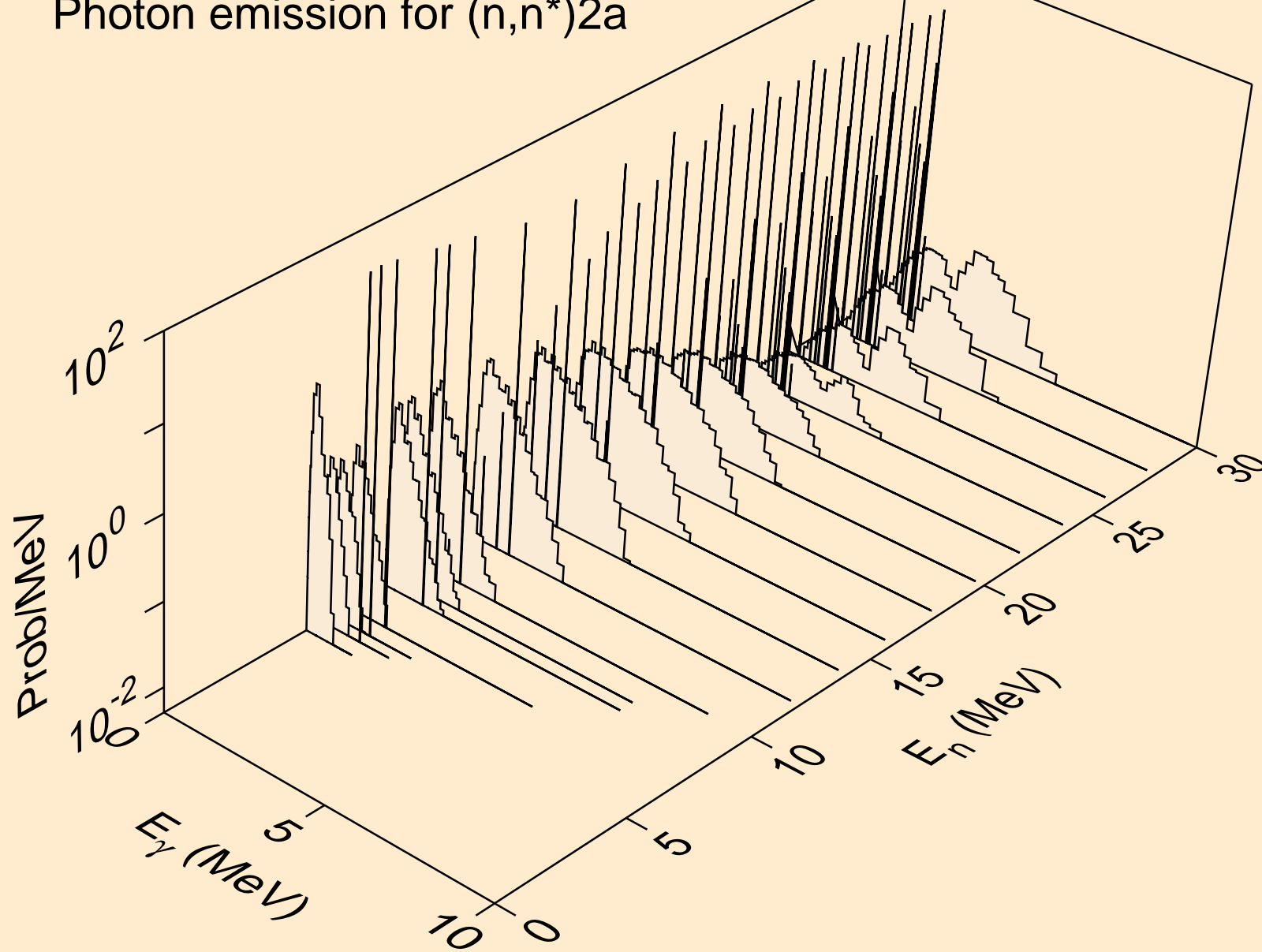

XE114 NEUTRON ACER TENDL-2021 LIBRARY; T=293.6K
Photon emission for (n,2n)2a

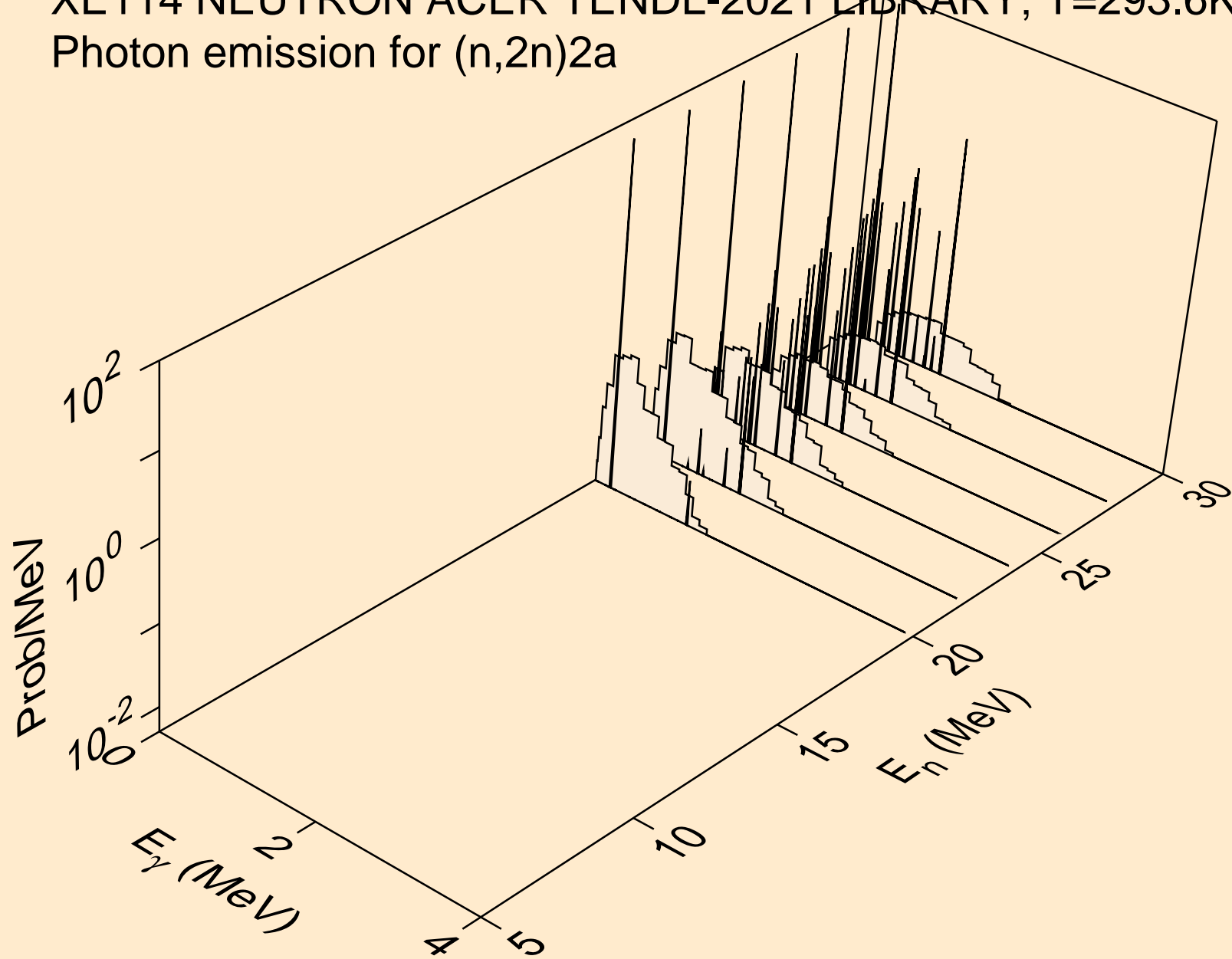

XE114 NEUTRON ACER TENDL-2021 LIBRARY; T=293.6K
Photon emission for (n,n*)d

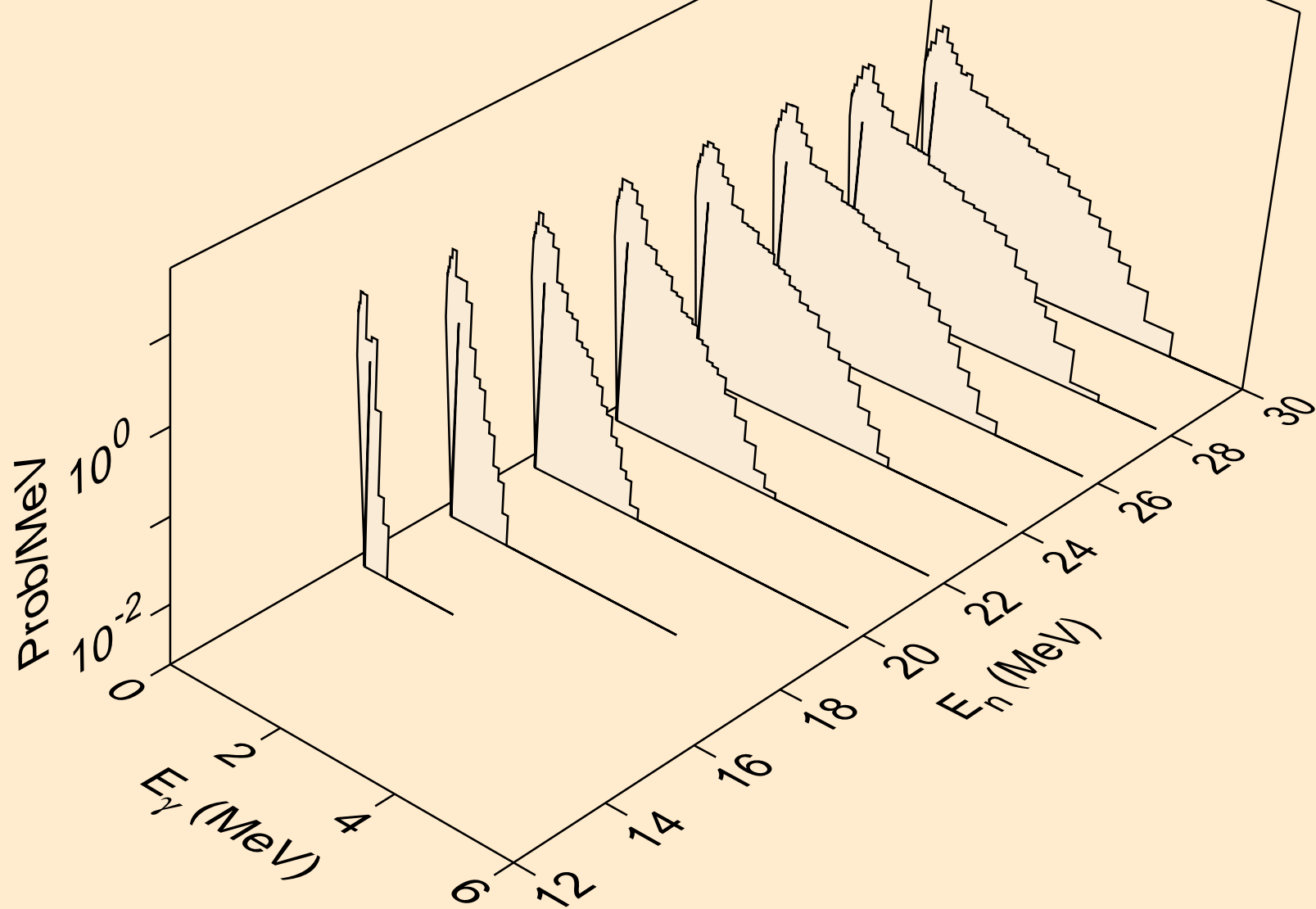

XE114 NEUTRON ACER TENDL-2021 LIBRARY; T=293.6K
Photon emission for (n,n*)t

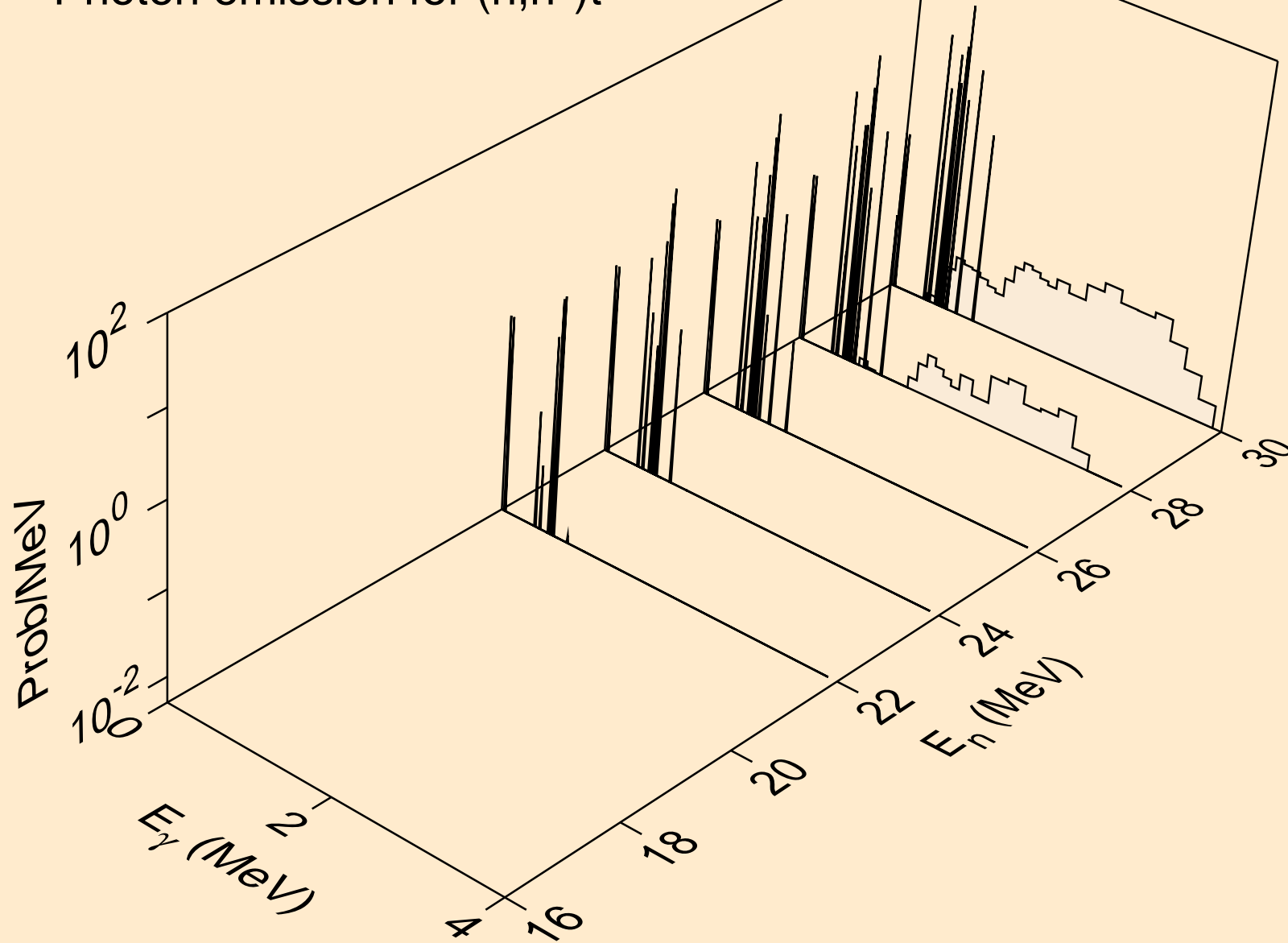

XE114 NEUTRON ACER TENDL-2021 LIBRARY; T=293.6K
Photon emission for (n,n*)he3

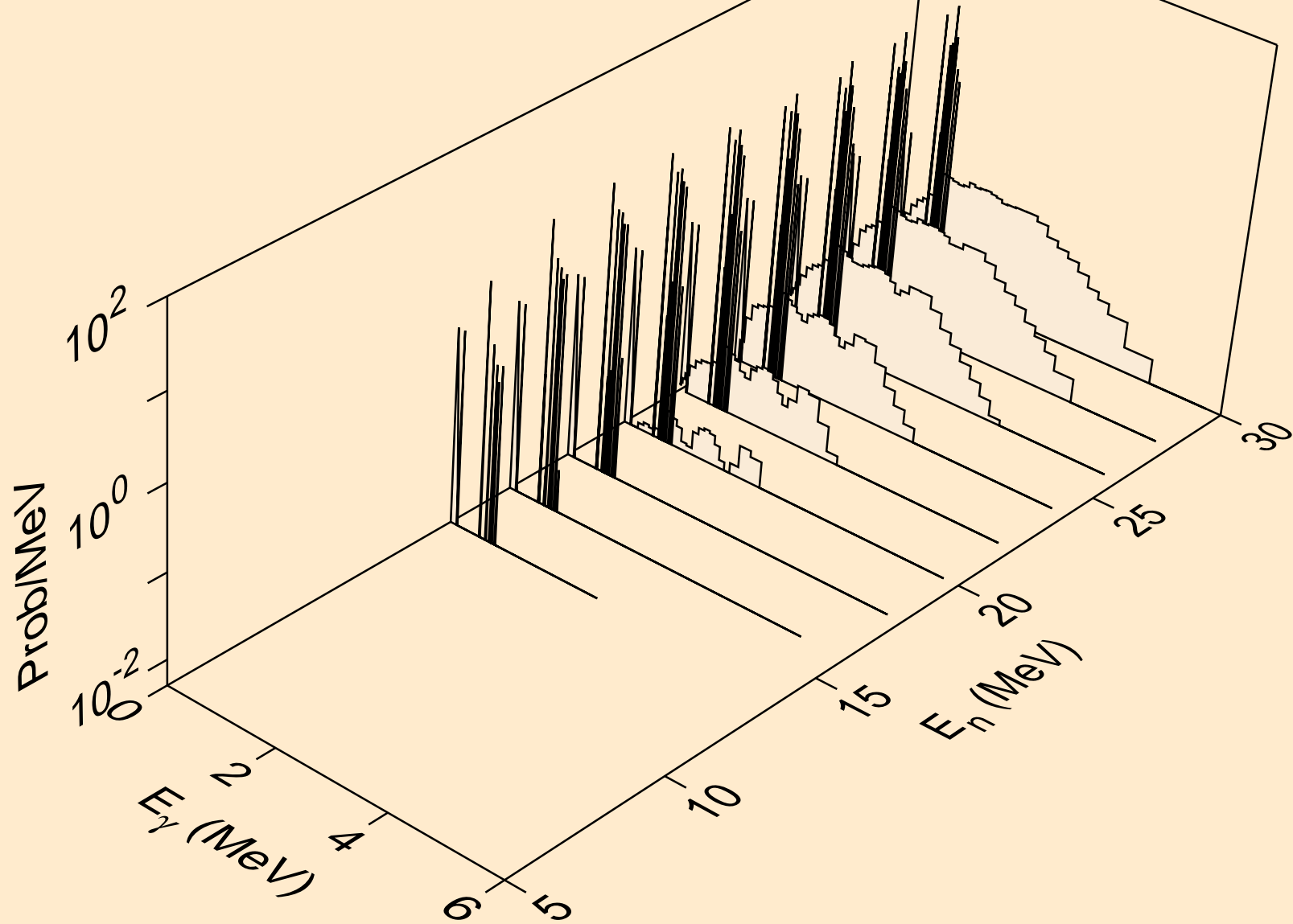

XE114 NEUTRON ACER TENDL-2021 LIBRARY; T=293.6K
Photon emission for (n,2np)

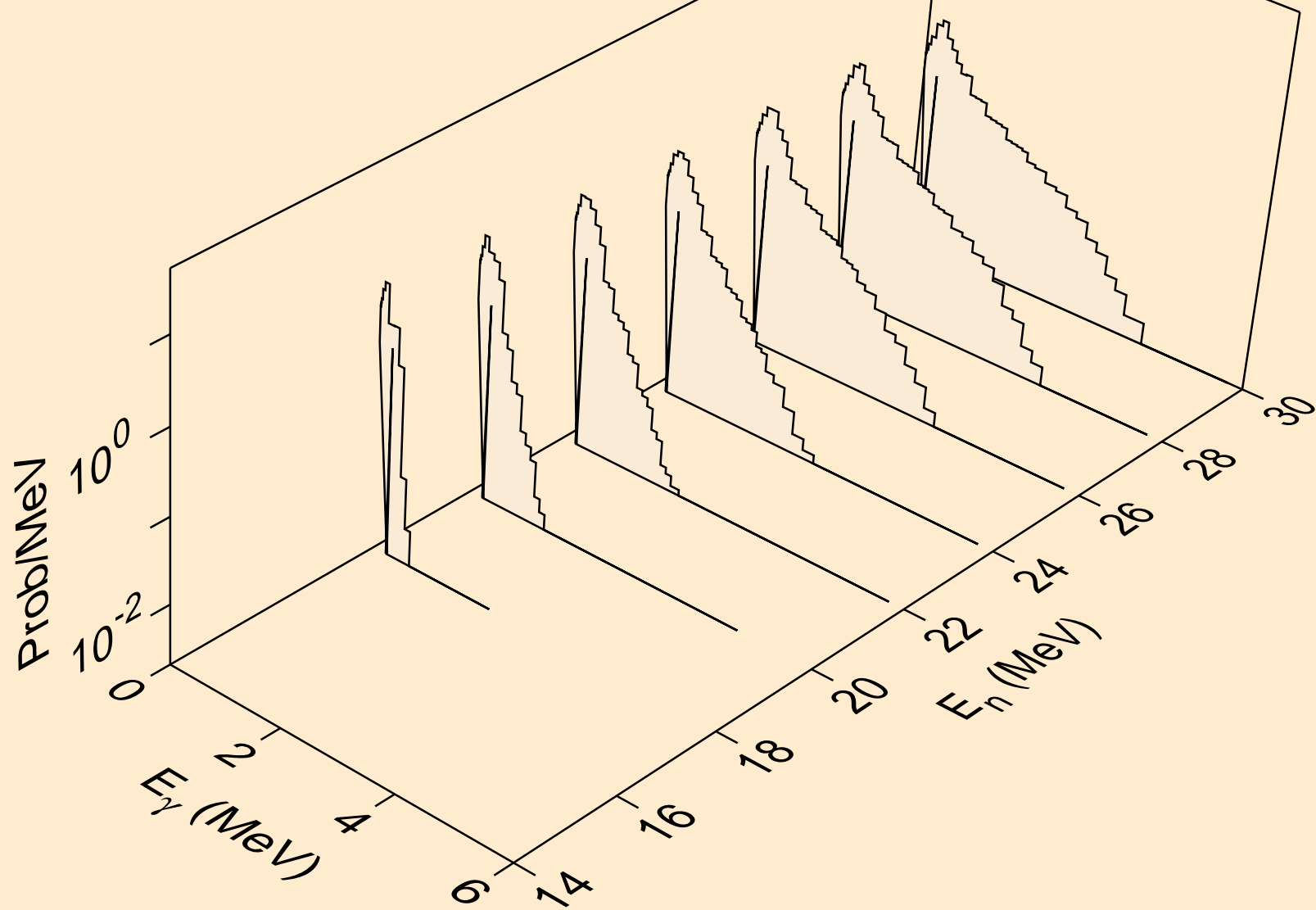

XE114 NEUTRON ACER TENDL-2021 LIBRARY; T=293.6K
Photon emission for (n,3np)

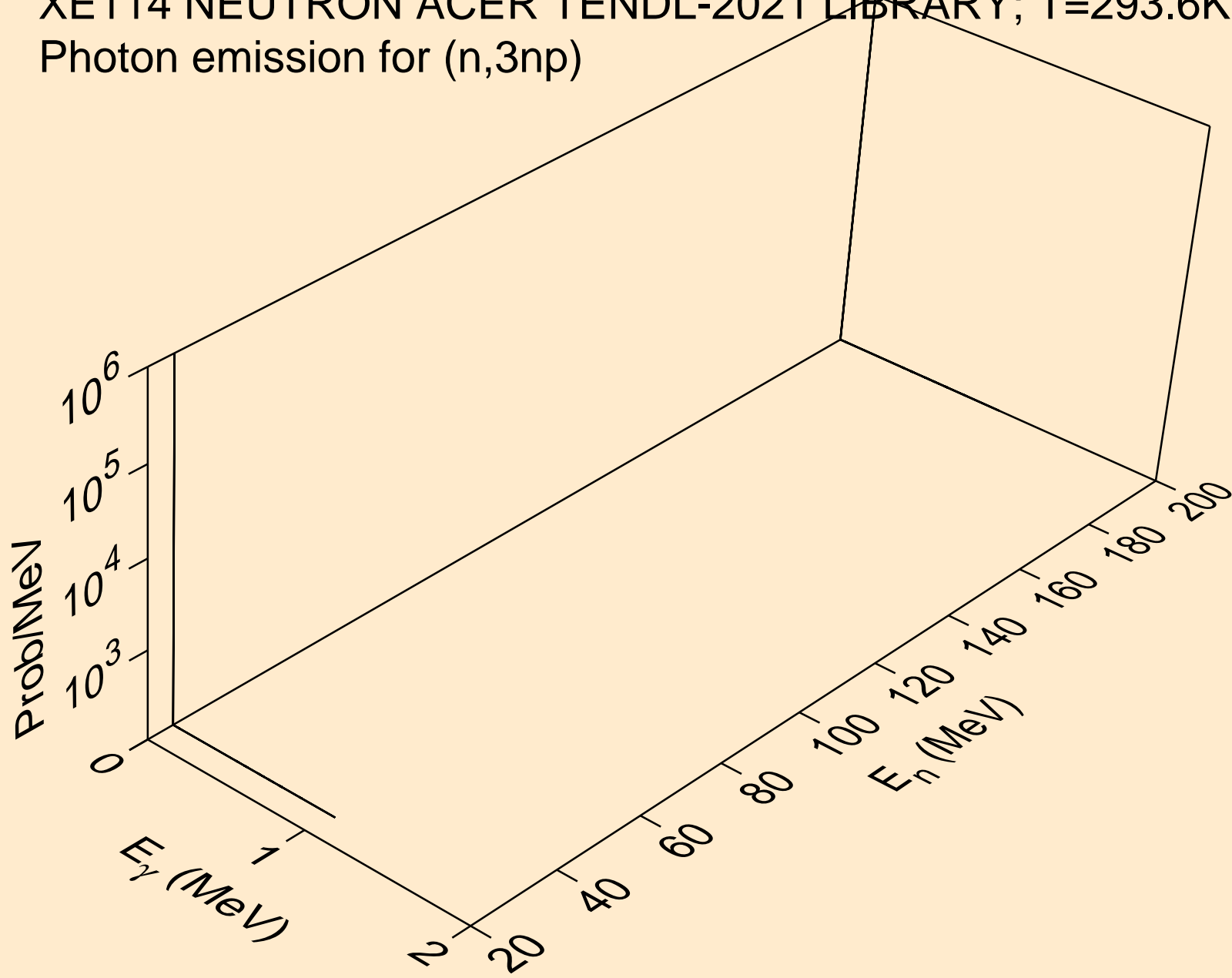

XE114 NEUTRON ACER TENDL-2021 LIBRARY; T=293.6K
Photon emission for (n,2np)

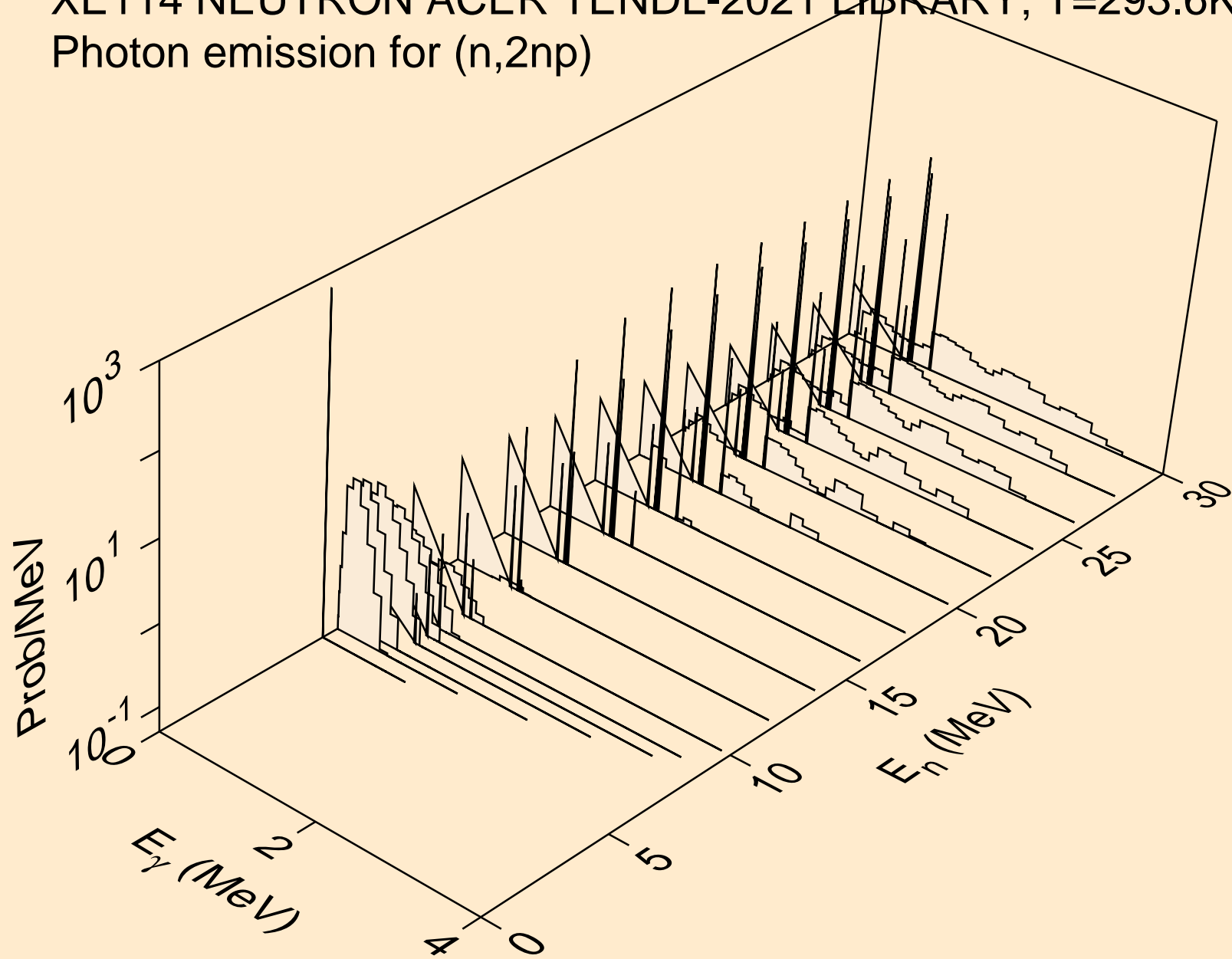

XE114 NEUTRON ACER TENDL-2021 LIBRARY; T=293.6K
Photon emission for (n,npa)

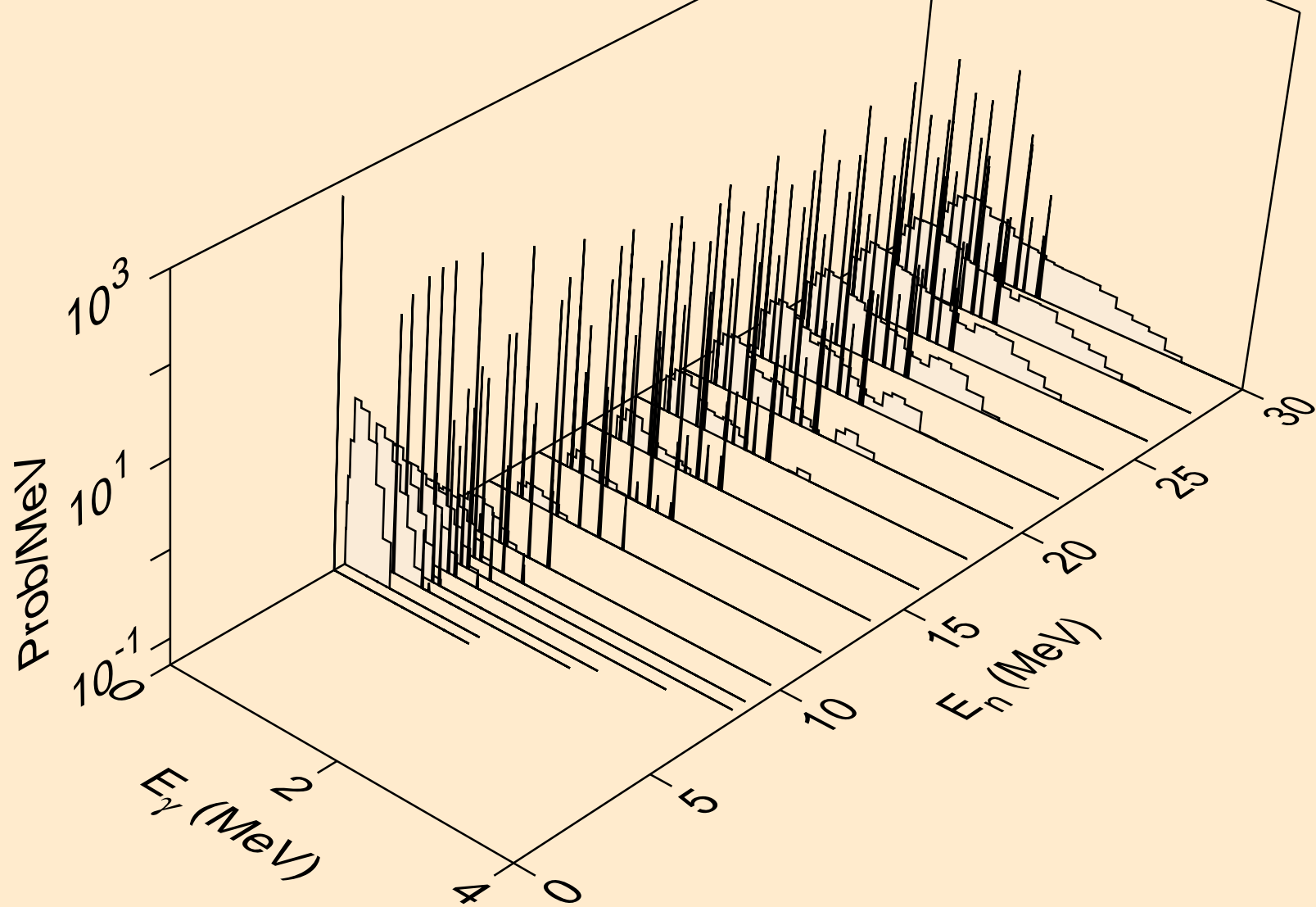

XE114 NEUTRON ACER TENDL-2021 LIBRARY; T=293.6K
Photon emission for (n,n*c)

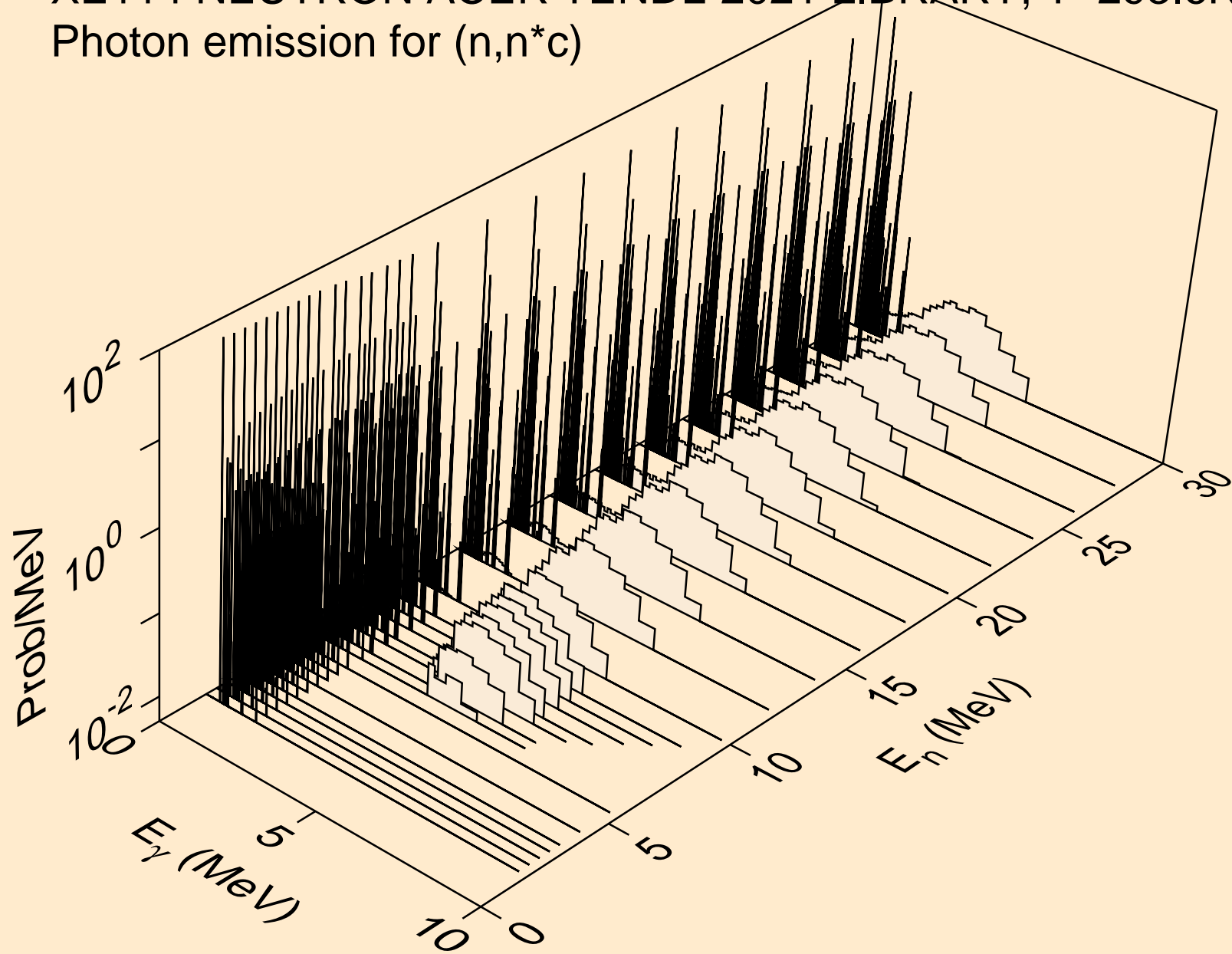

XE114 NEUTRON ACER TENDL-2021 LIBRARY; T=293.6K
Photon emission for (n,gma)

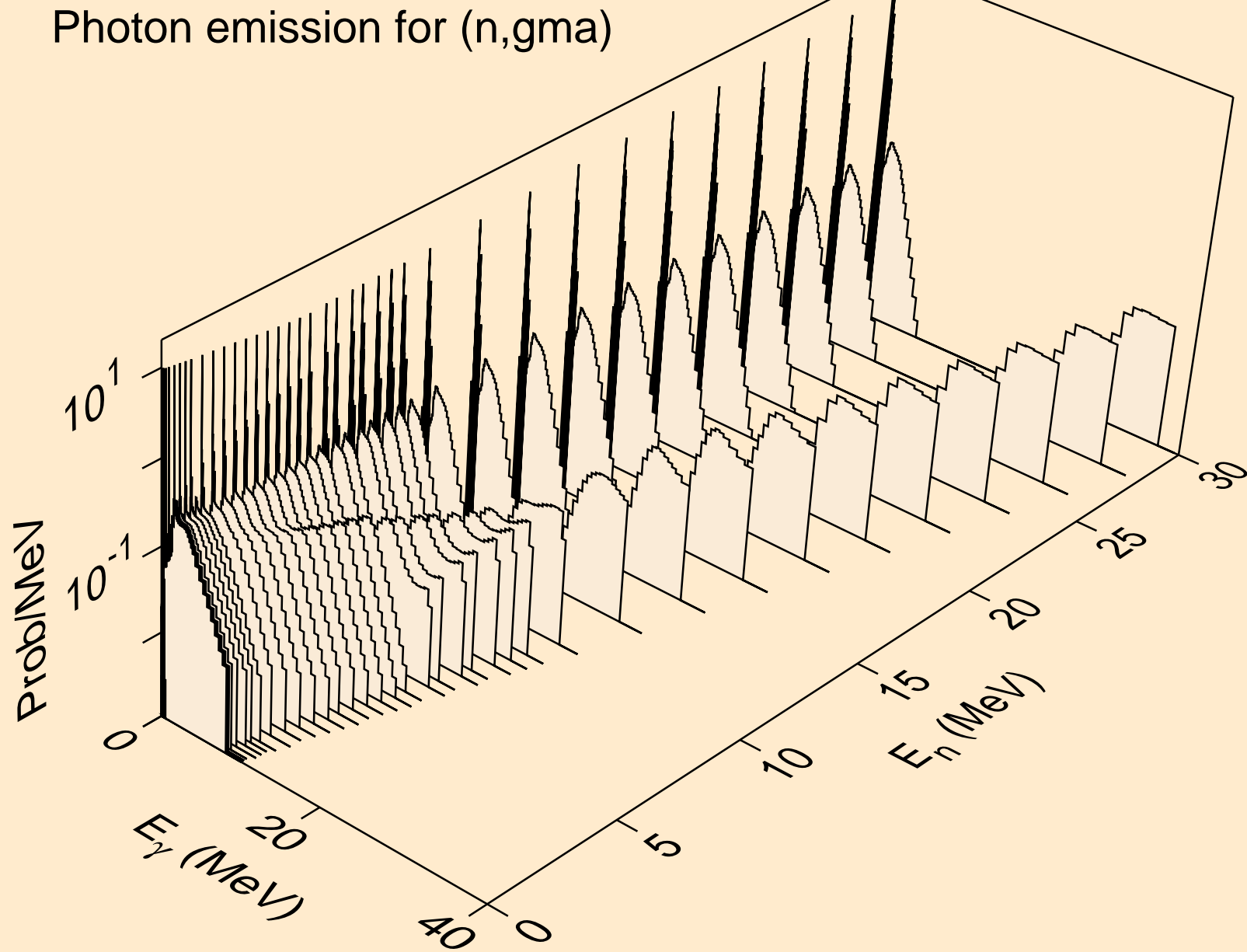

XE114 NEUTRON ACER TENDL-2021 LIBRARY; T=293.6K
Photon emission for (n,p)

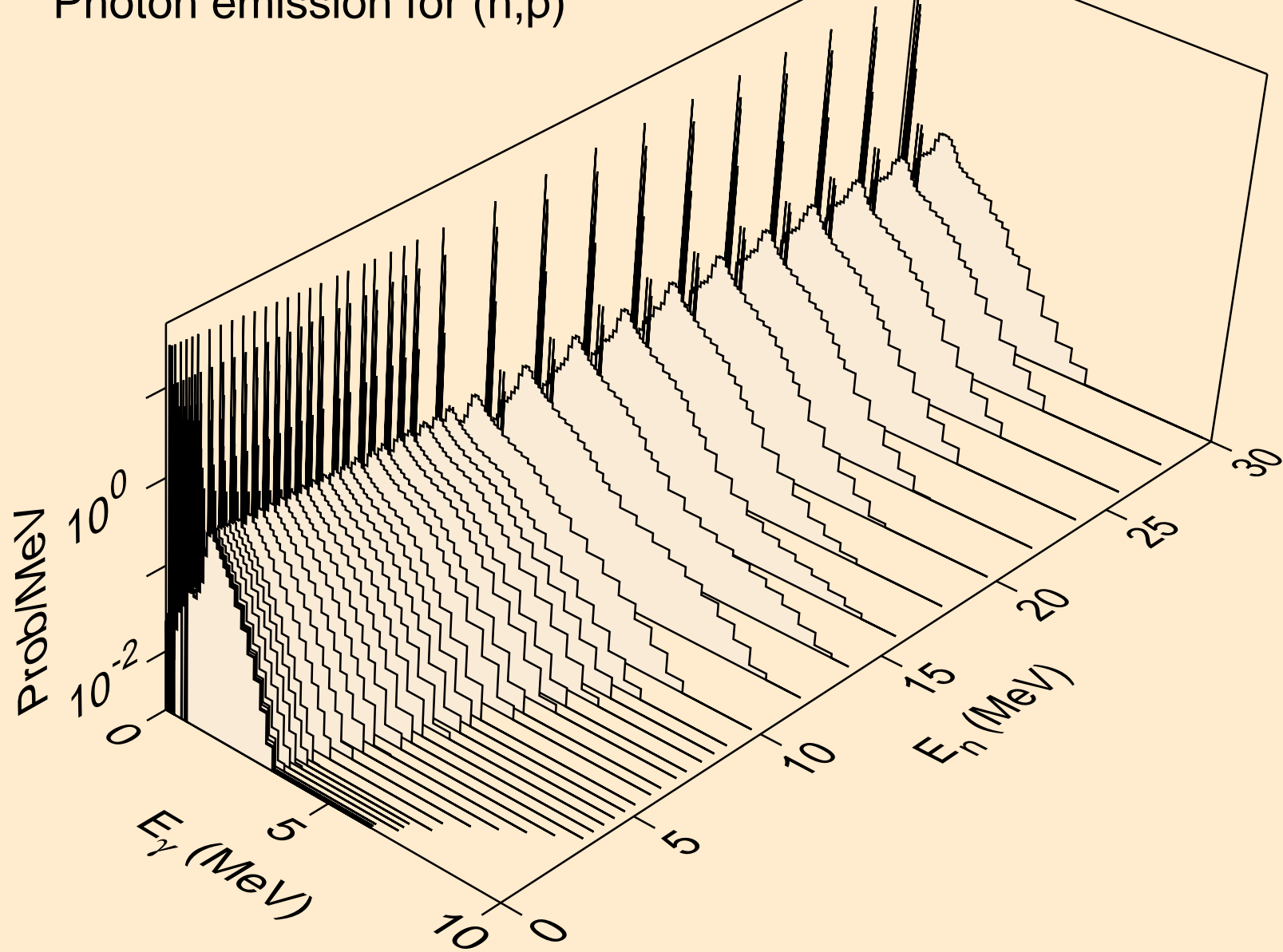

XE114 NEUTRON ACER TENDL-2021 LIBRARY; T=293.6K
Photon emission for (n,d)

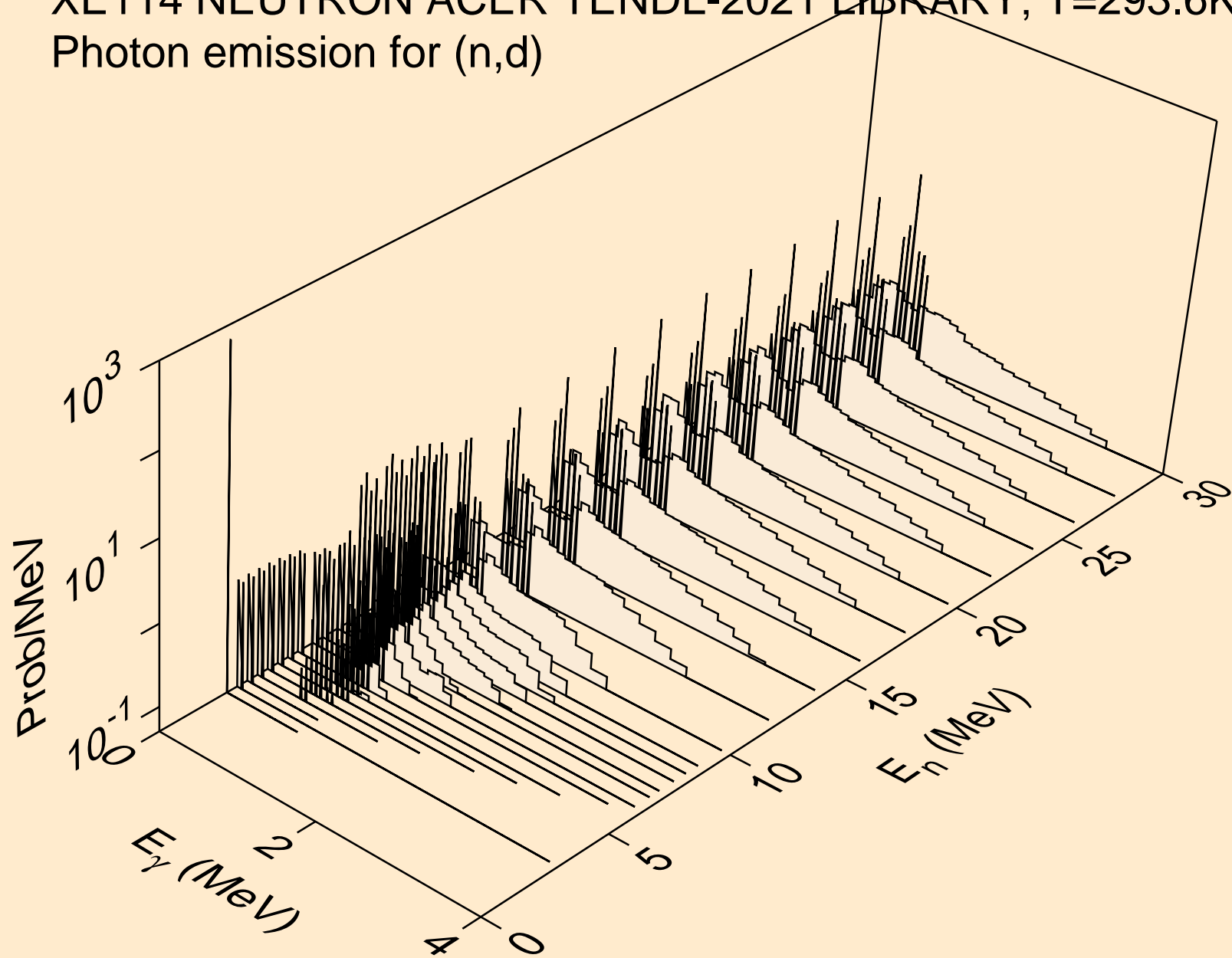

XE114 NEUTRON ACER TENDL-2021 LIBRARY; T=293.6K
Photon emission for (n,t)

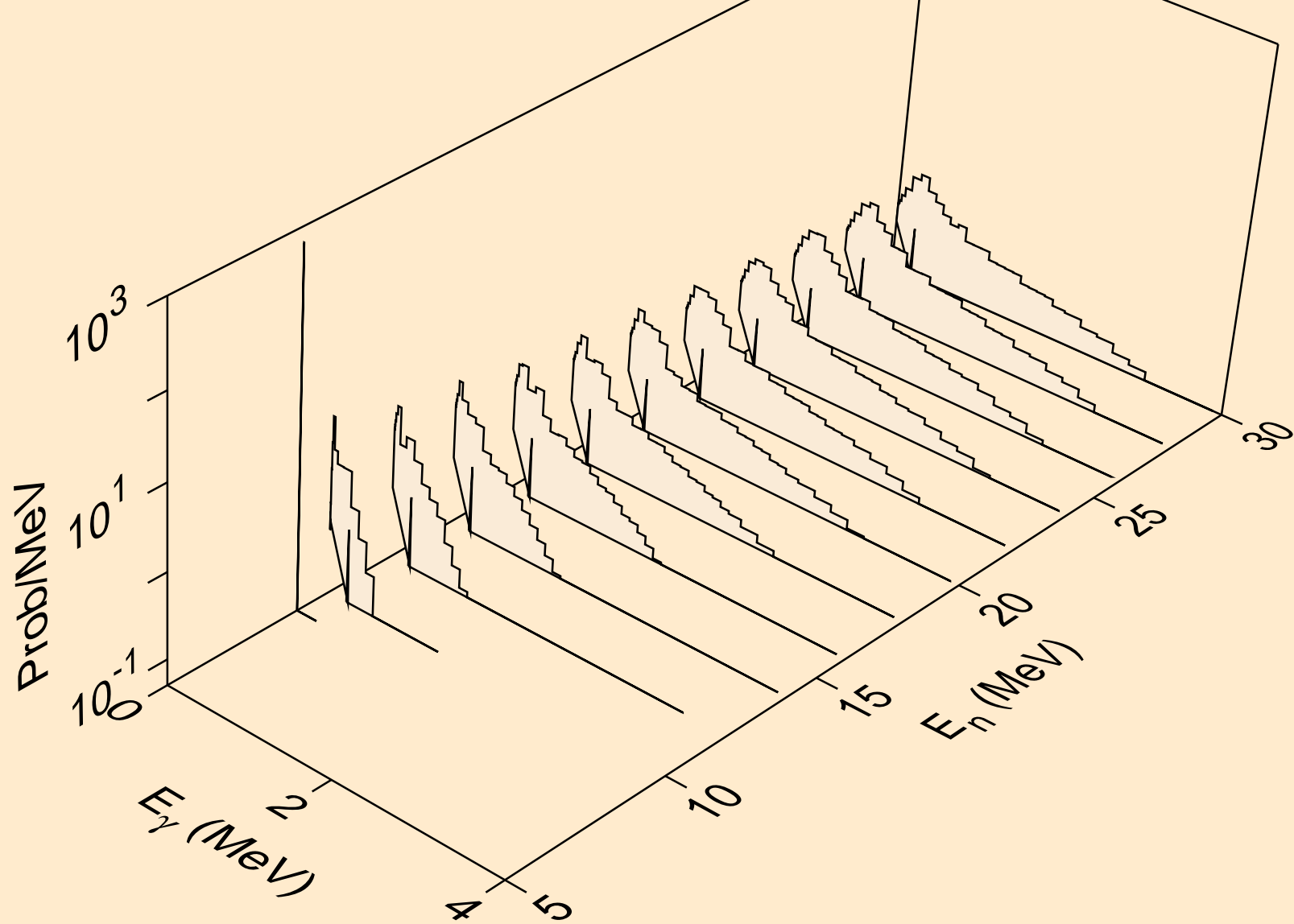

XE114 NEUTRON ACER TENDL-2021 LIBRARY; T=293.6K
Photon emission for (n,he3)

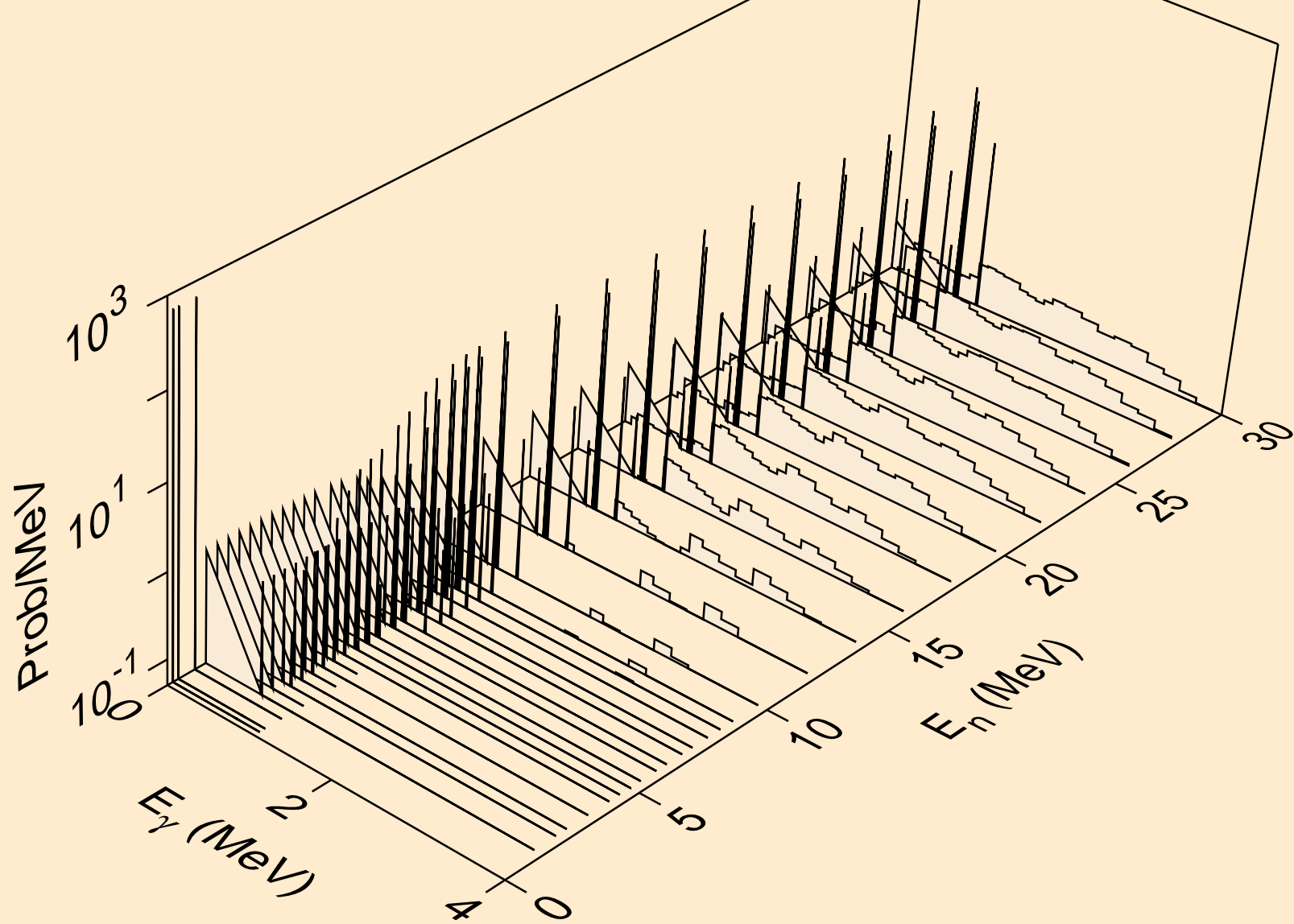

XE114 NEUTRON ACER TENDL-2021 LIBRARY; T=293.6K
Photon emission for (n,a)

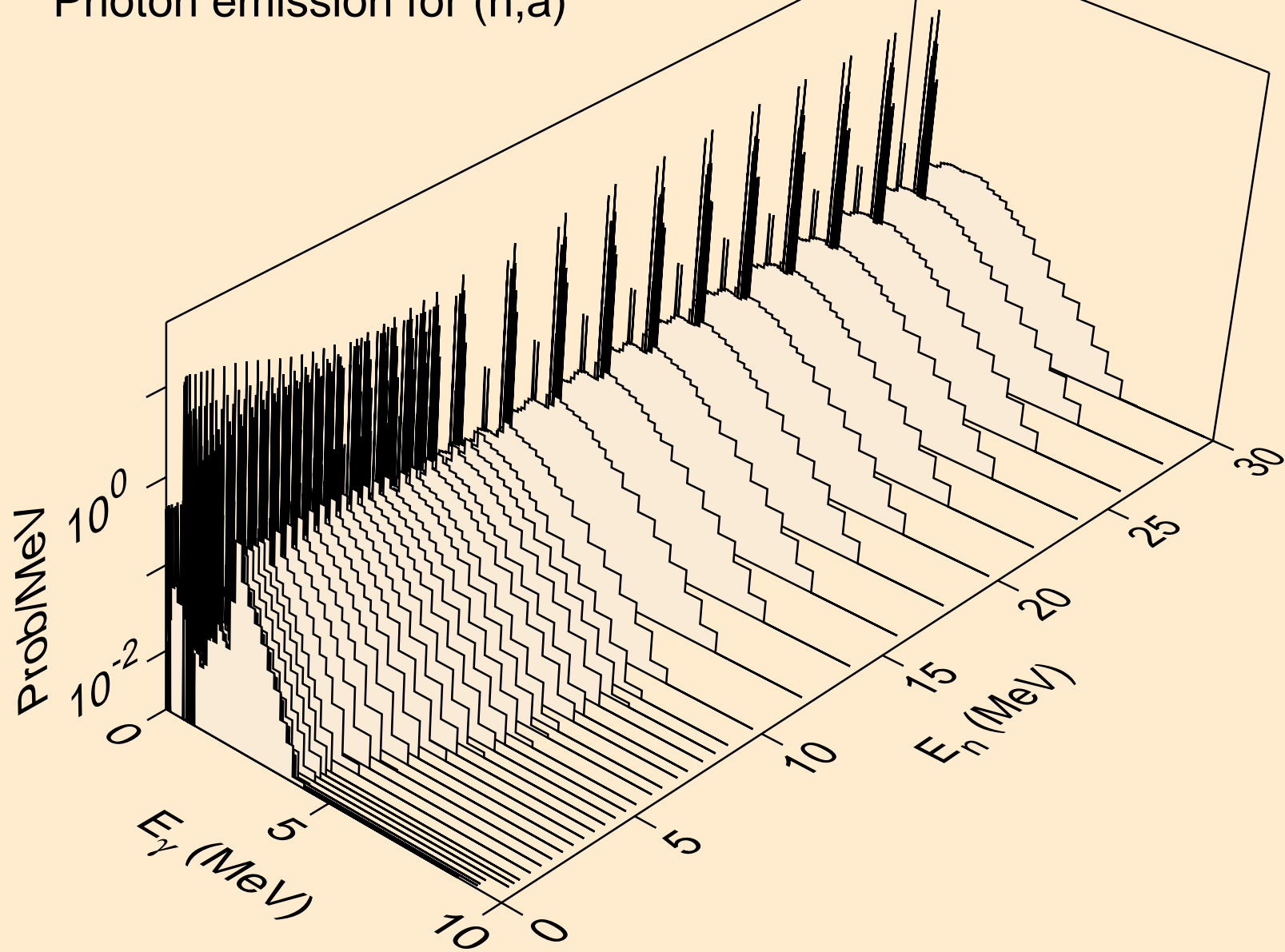

XE114 NEUTRON ACER TENDL-2021 LIBRARY; T=293.6K
Photon emission for (n,2a)

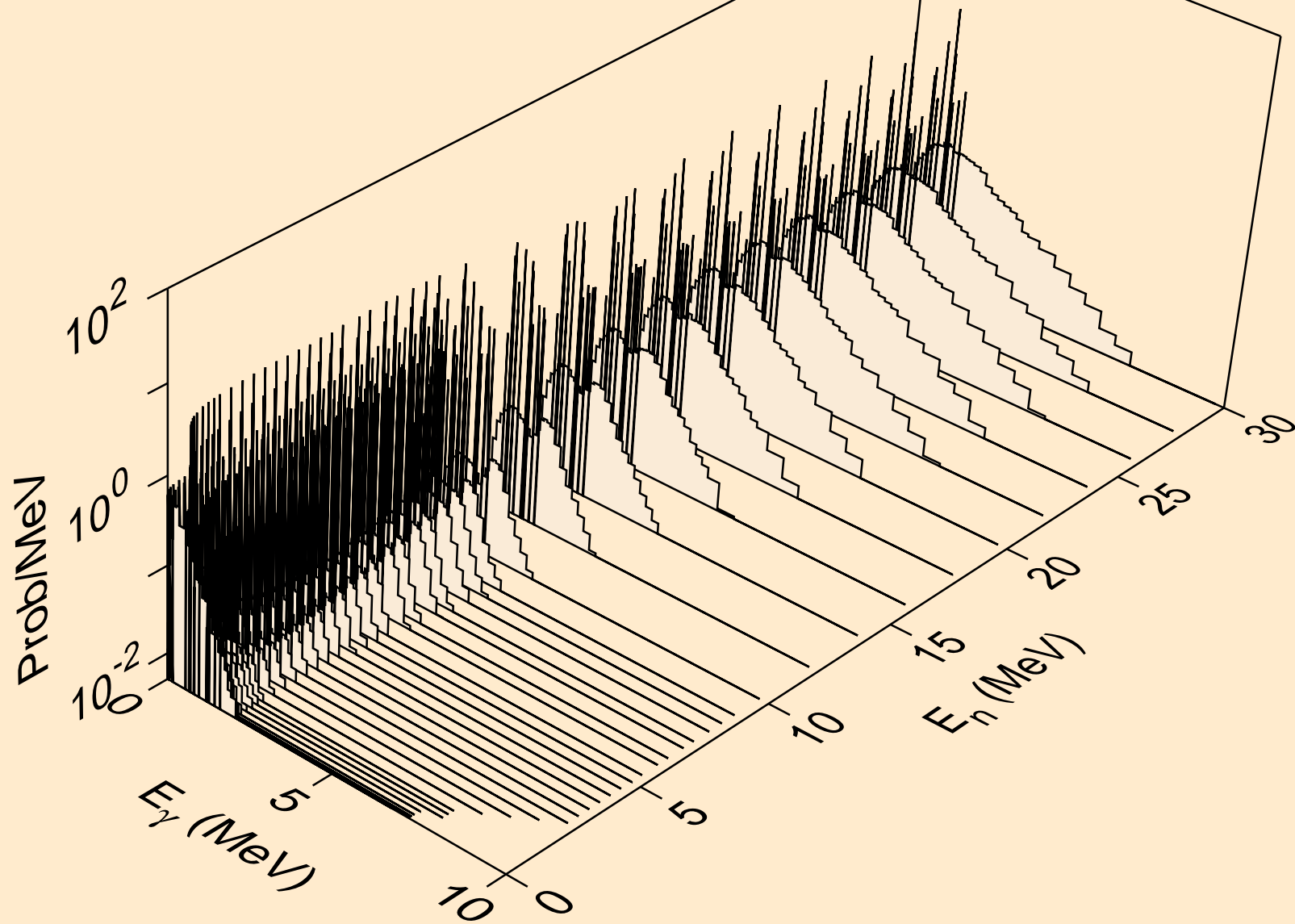

XE114 NEUTRON ACER TENDL-2021 LIBRARY; T=293.6K
Photon emission for (n,3a)

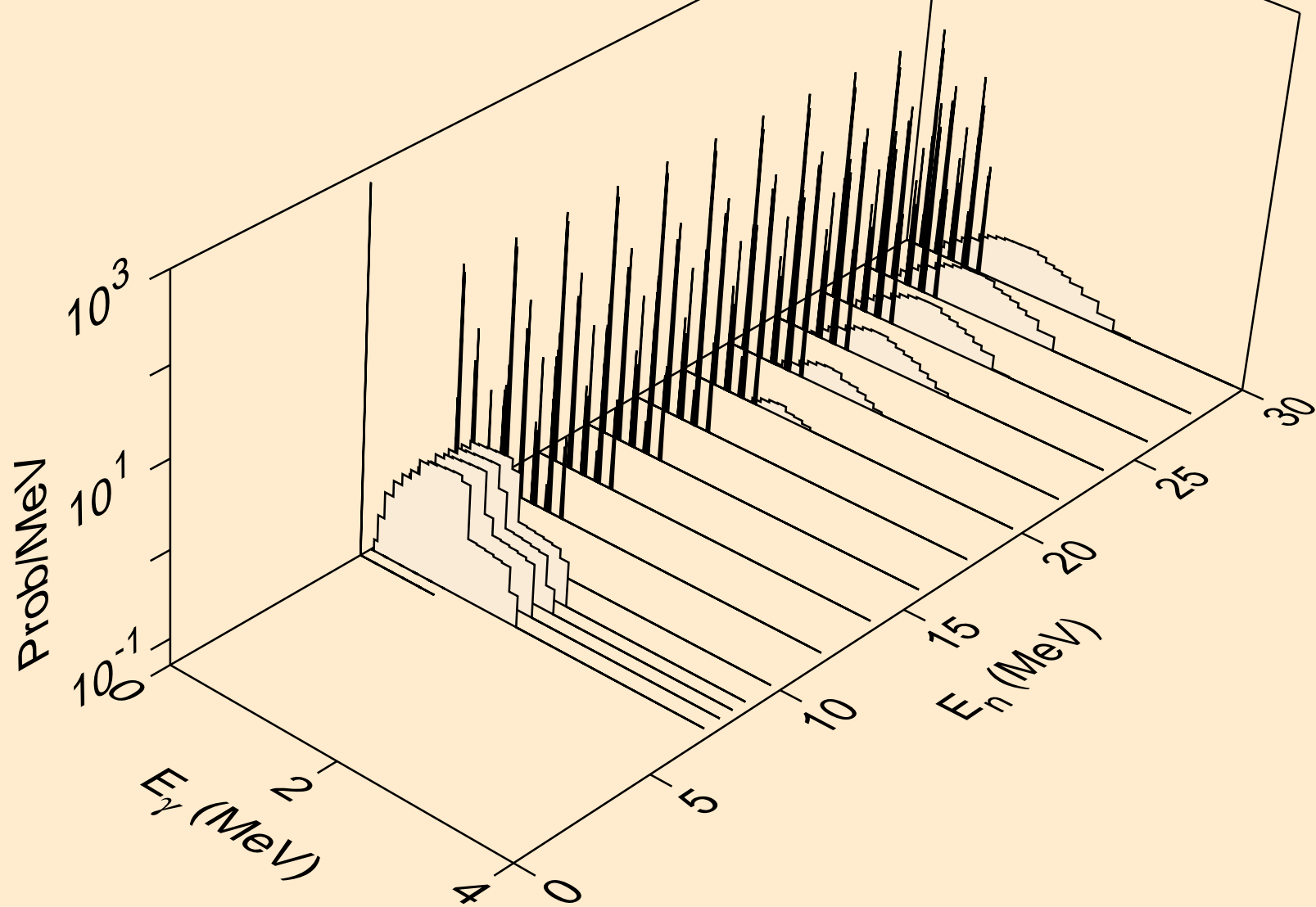

XE114 NEUTRON ACER TENDL-2021 LIBRARY; T=293.6K
Photon emission for (n,2p)

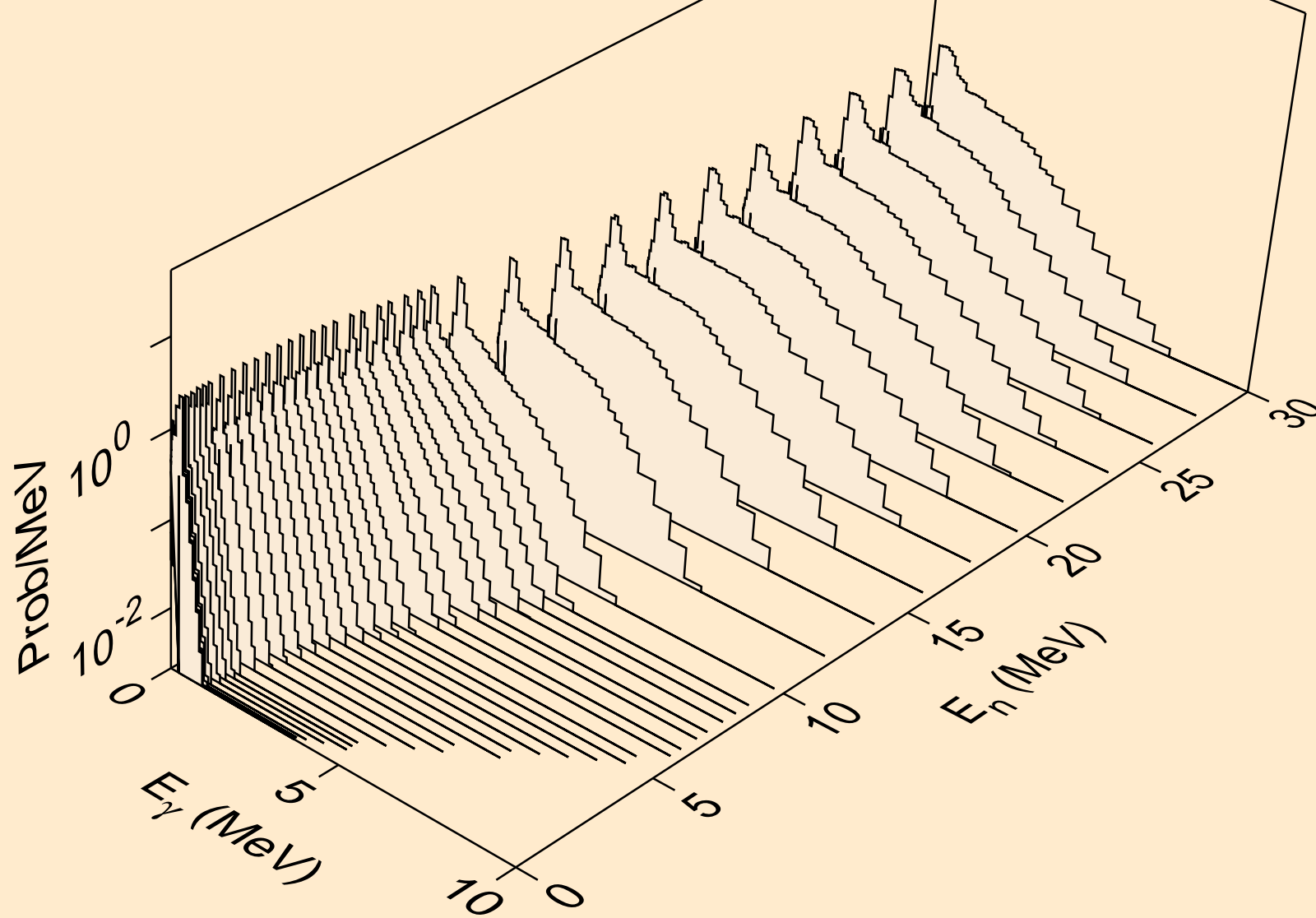

XE114 NEUTRON ACER TENDL-2021 LIBRARY; T=293.6K
Photon emission for (n,p α)

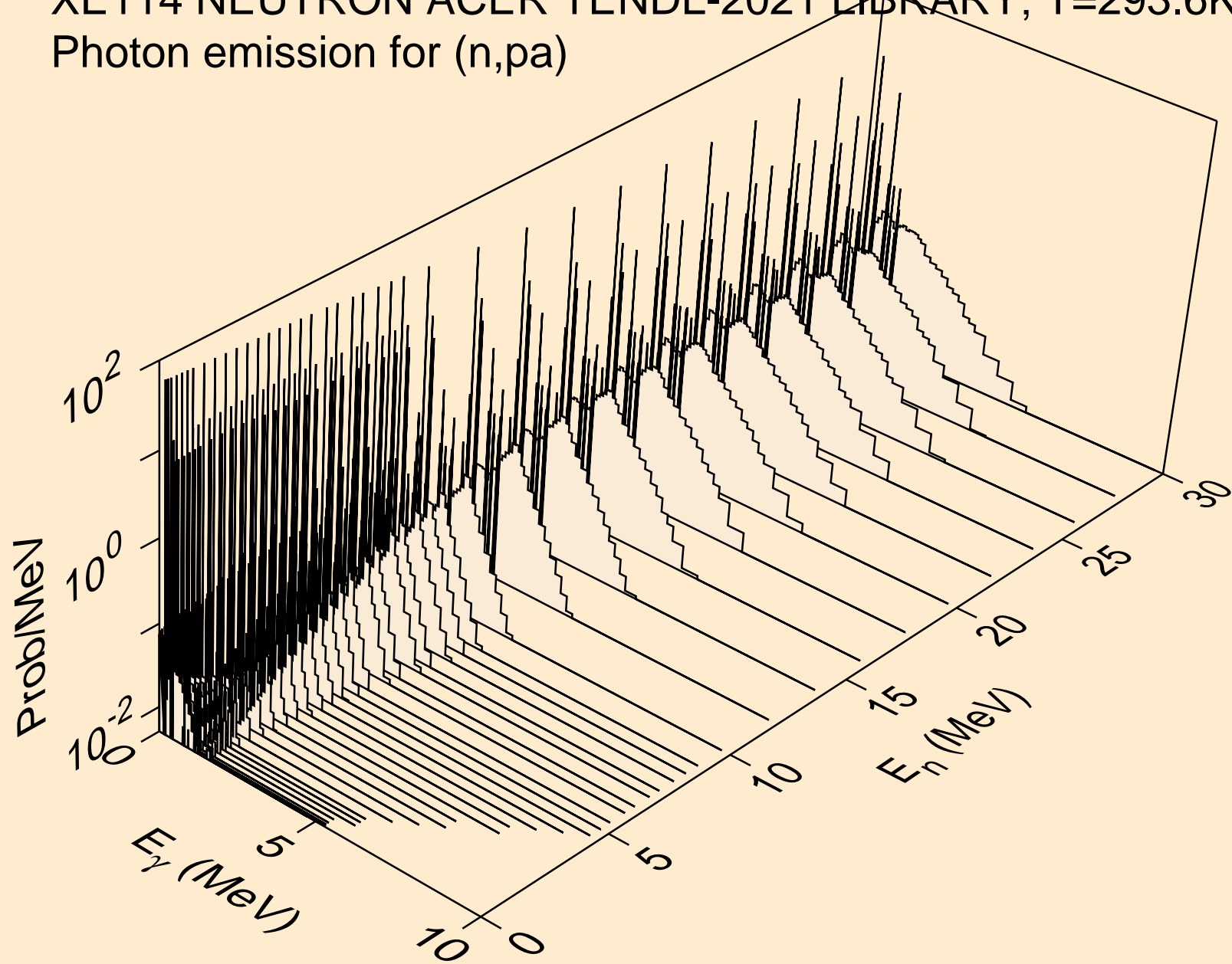

XE114 NEUTRON ACER TENDL-2021 LIBRARY; T=293.6K
Photon emission for (n,d2a)

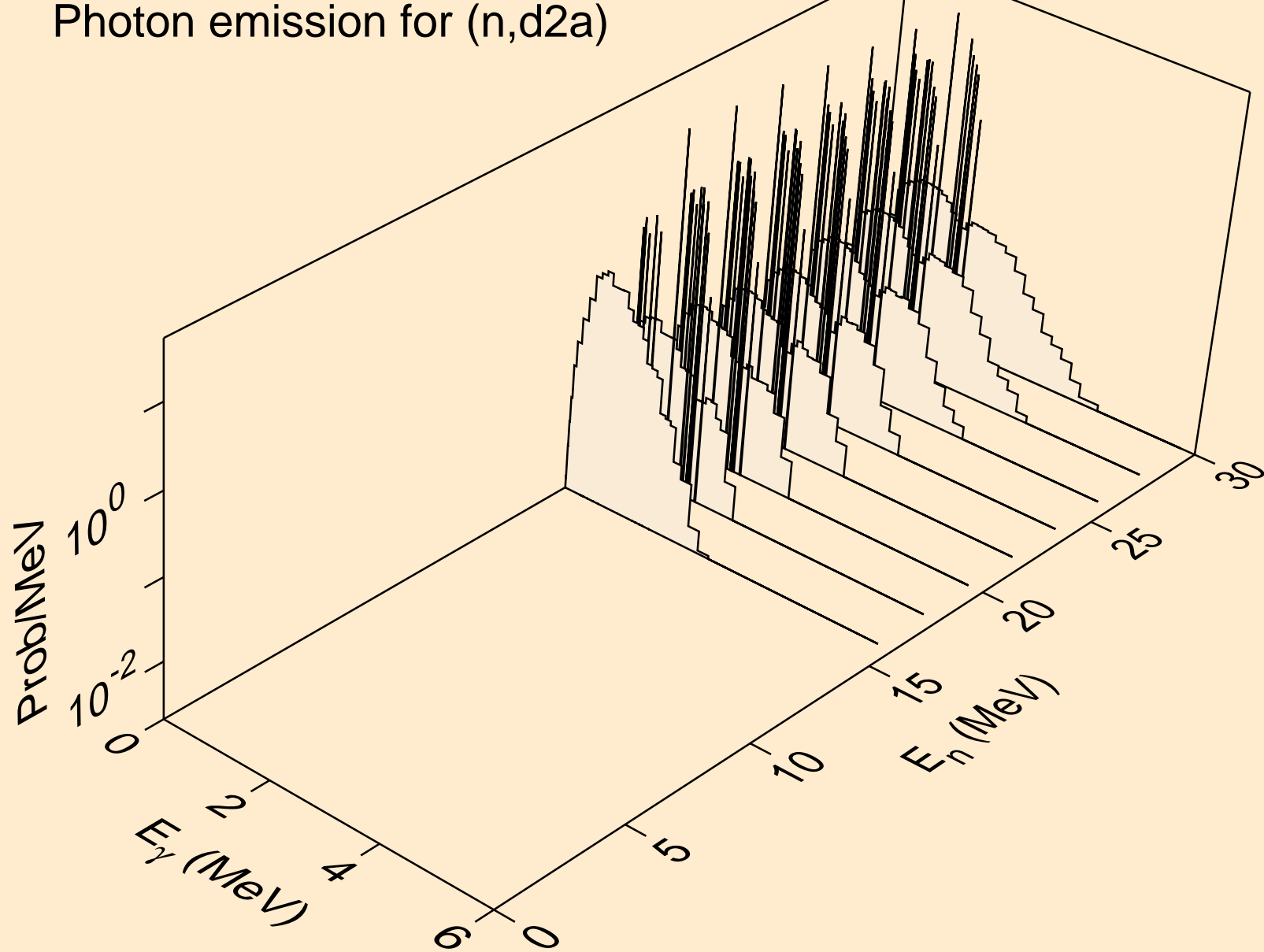

XE114 NEUTRON ACER TENDL-2021 LIBRARY; T=293.6K
Photon emission for (n,pd)

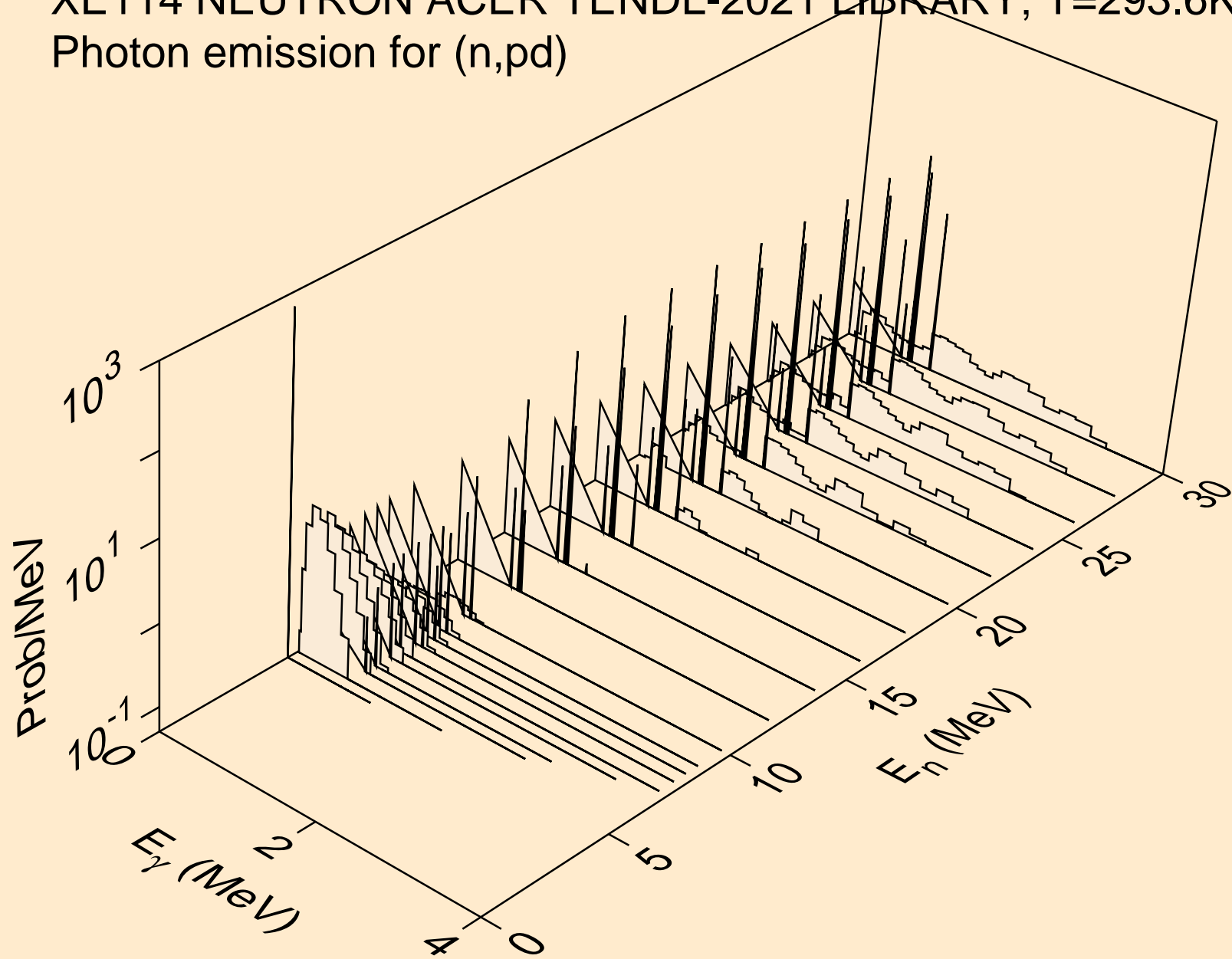

XE114 NEUTRON ACER TENDL-2021 LIBRARY; T=293.6K
Photon emission for (n,pt)

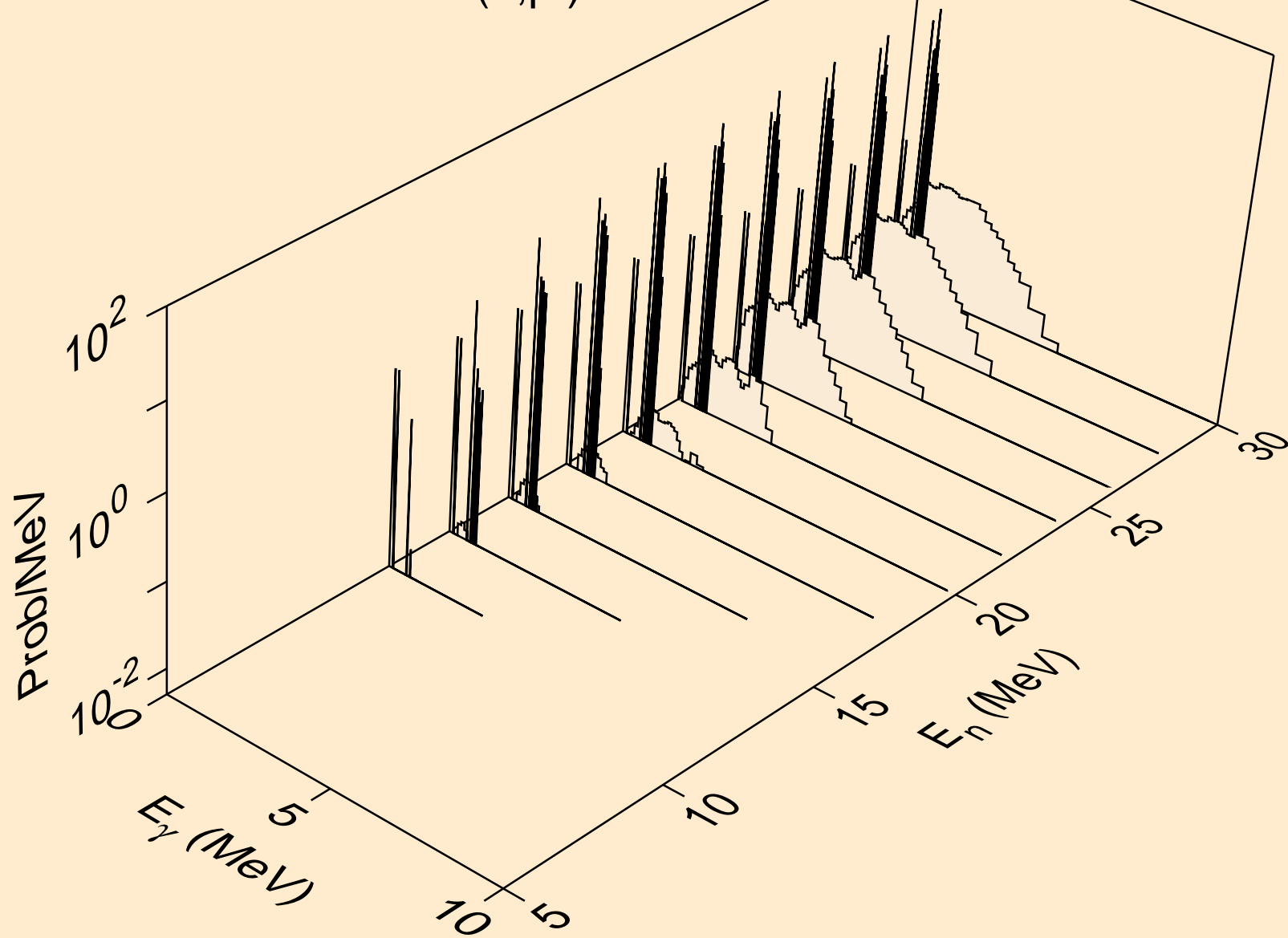

XE114 NEUTRON ACER TENDL-2021 LIBRARY; T=293.6K
Photon emission for (n,da)

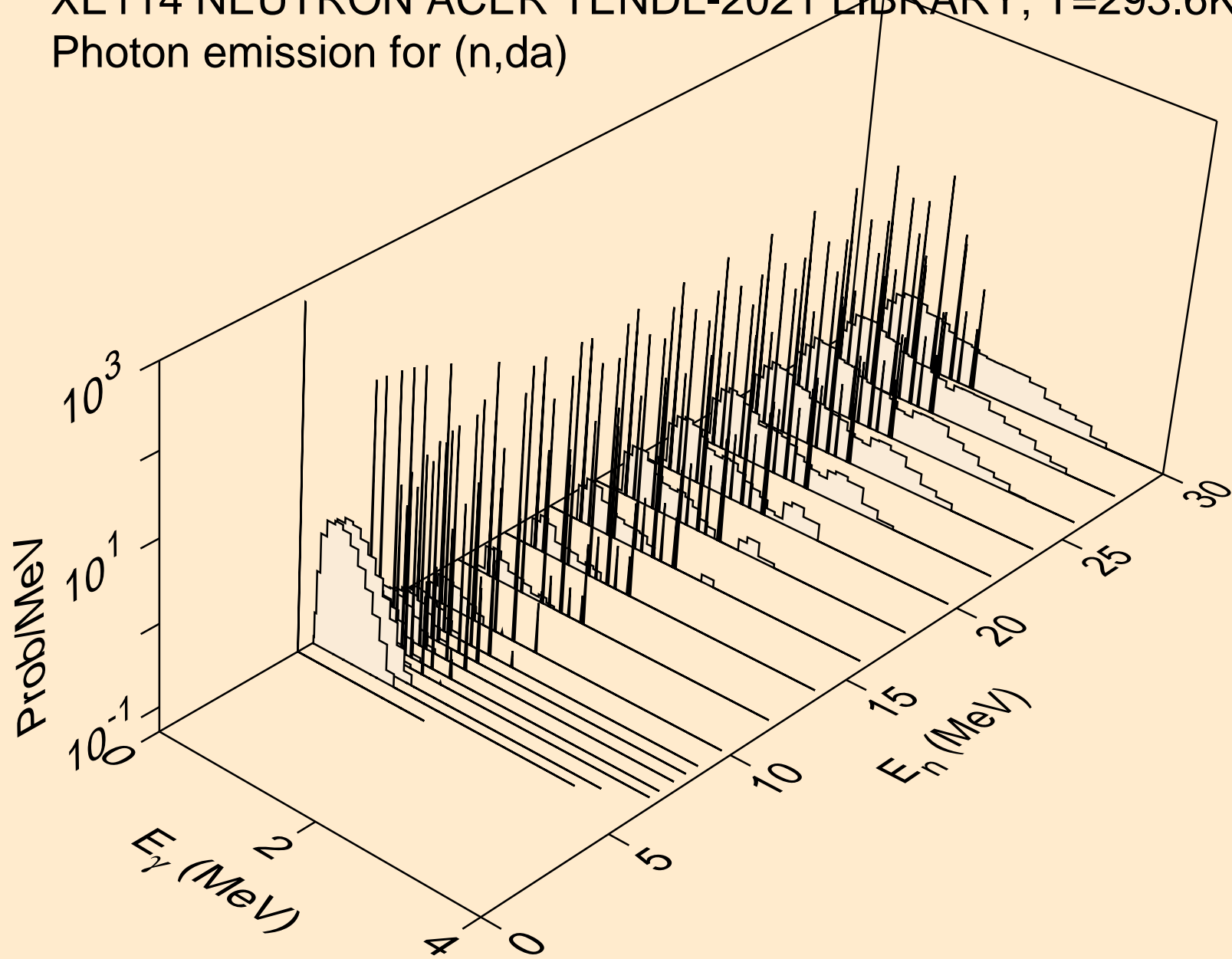

XE114 NEUTRON ACER TENDL-2021 LIBRARY; T=293.6K
thermal capture photon spectrum

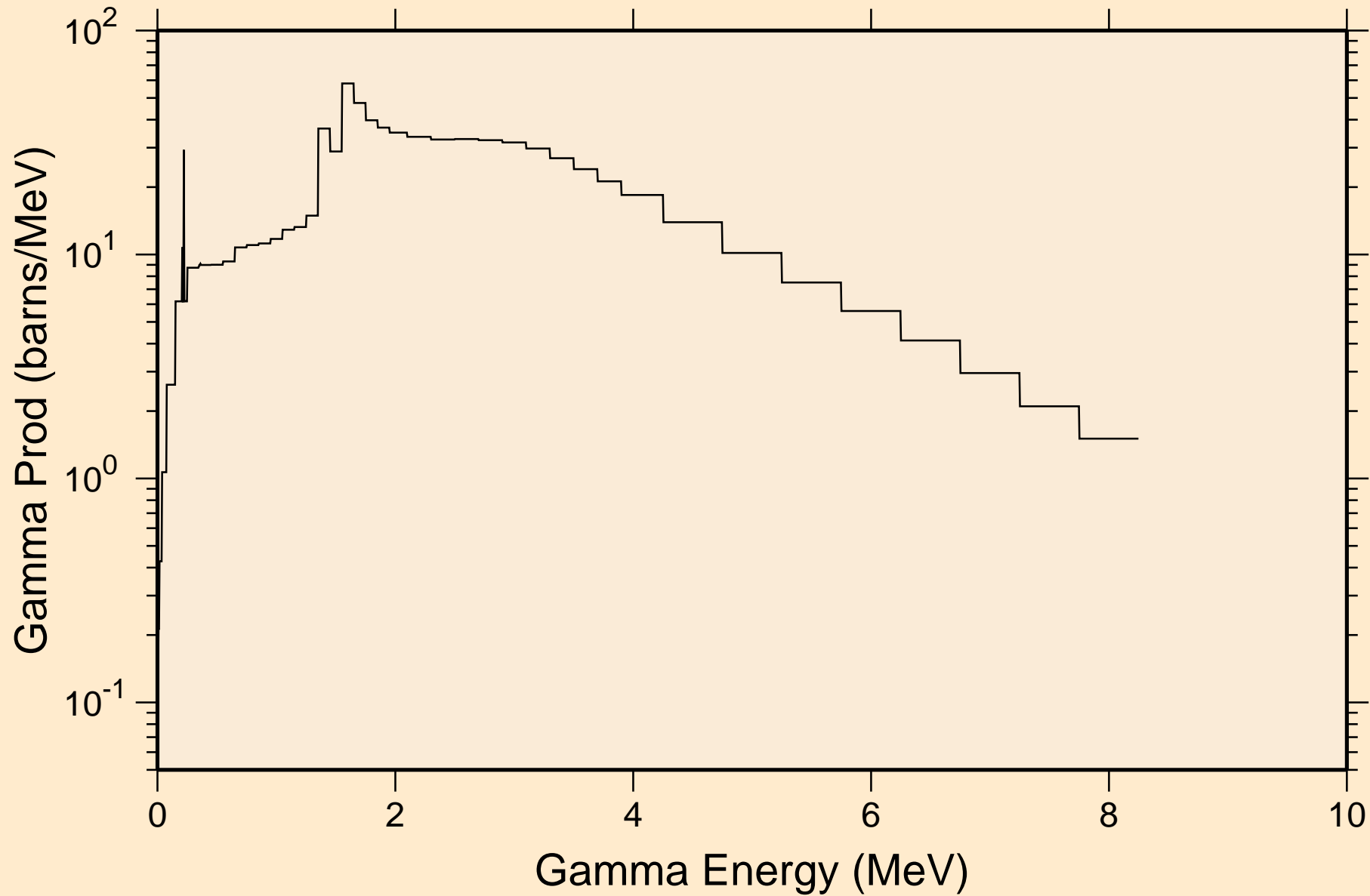

XE114 NEUTRON ACER TENDL-2021 LIBRARY; T=293.6K
14 MeV photon spectrum

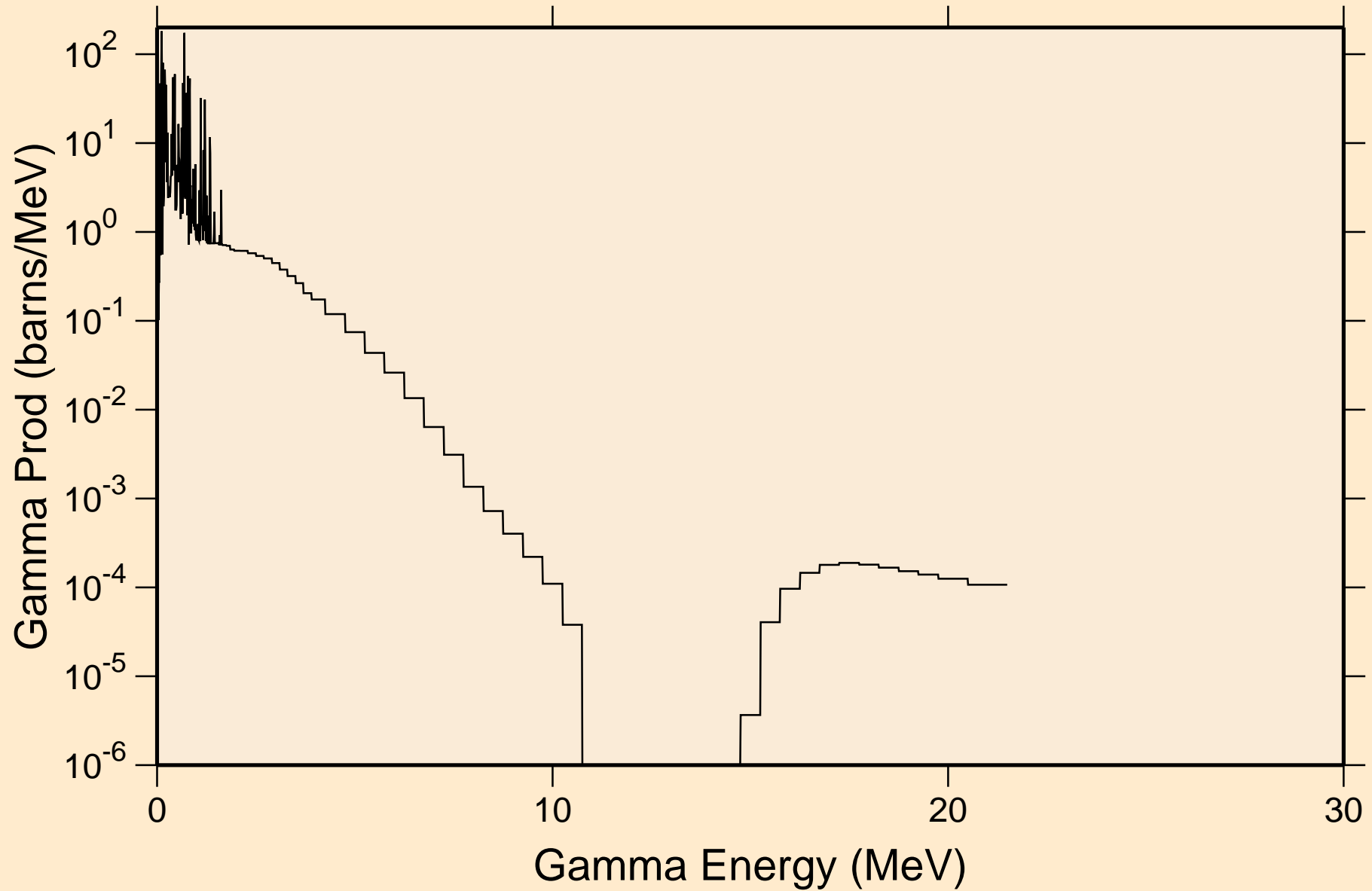

XE114 NEUTRON ACER TENDL-2021 LIBRARY; T=293.6K

Particle heating contributions

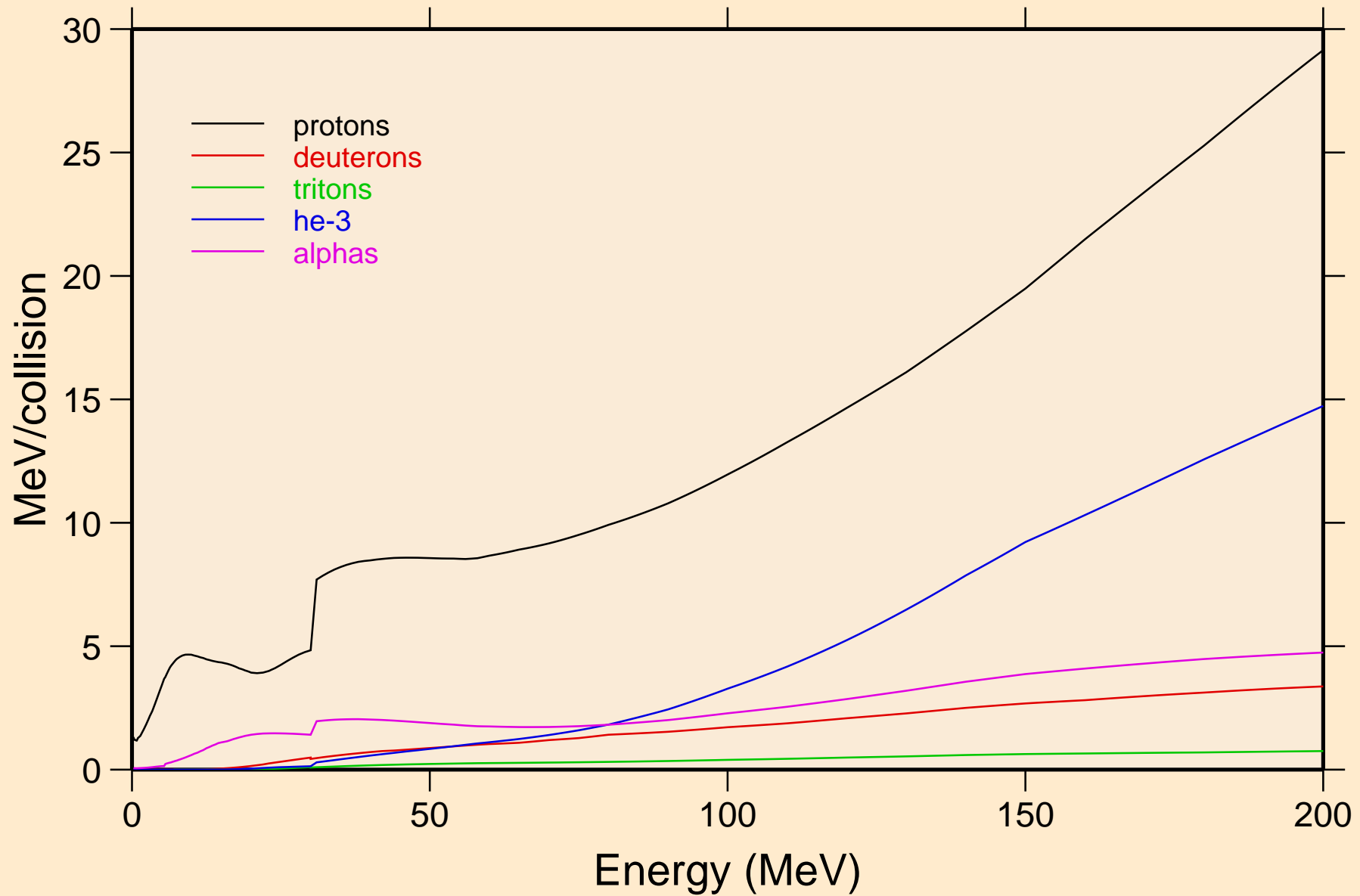

XE114 NEUTRON ACER TENDL-2021 LIBRARY; T=293.6K
Recoil Heating

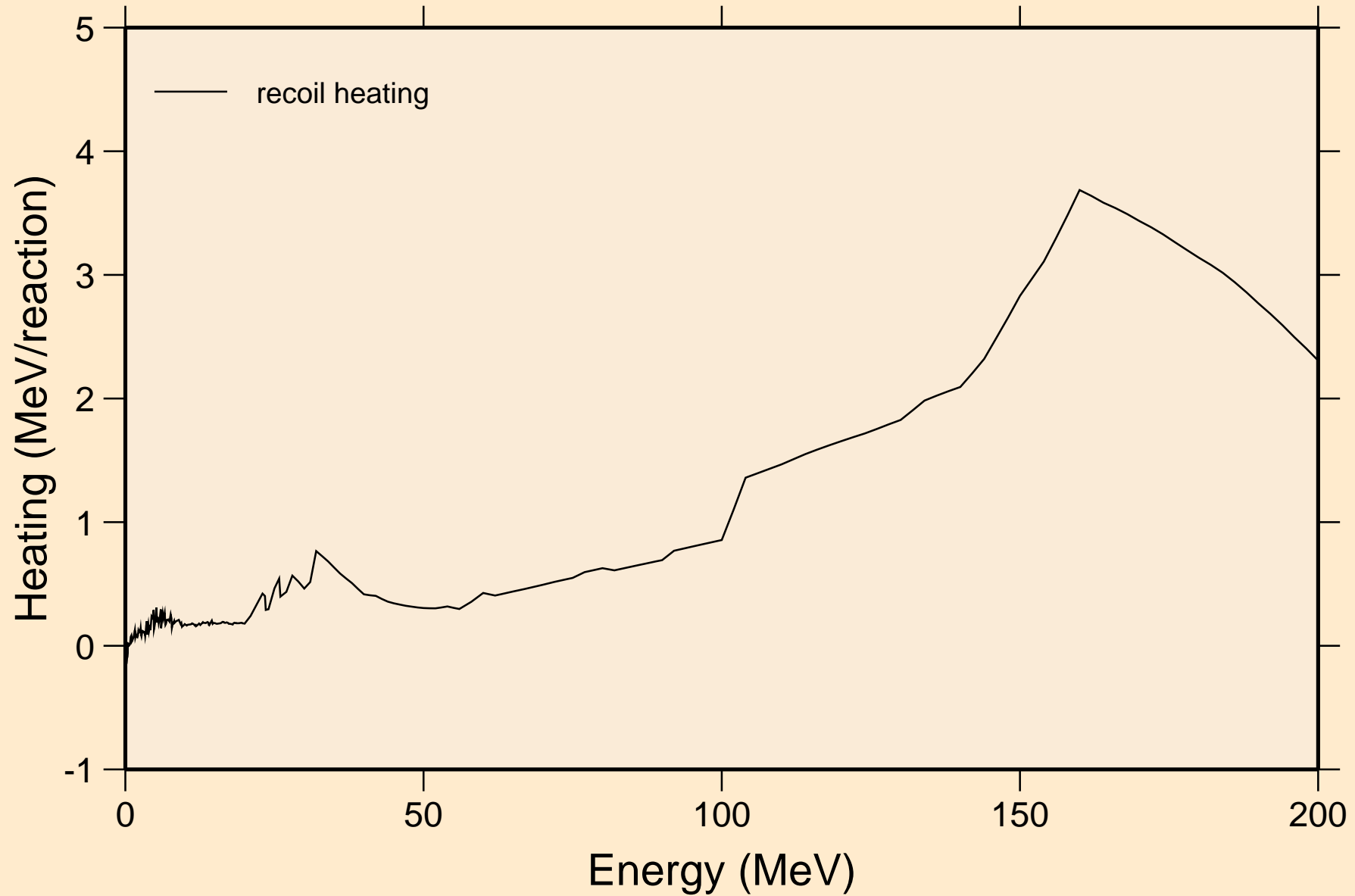

XE114 NEUTRON ACER TENDL-2021 LIBRARY; T=293.6K
Particle production cross sections

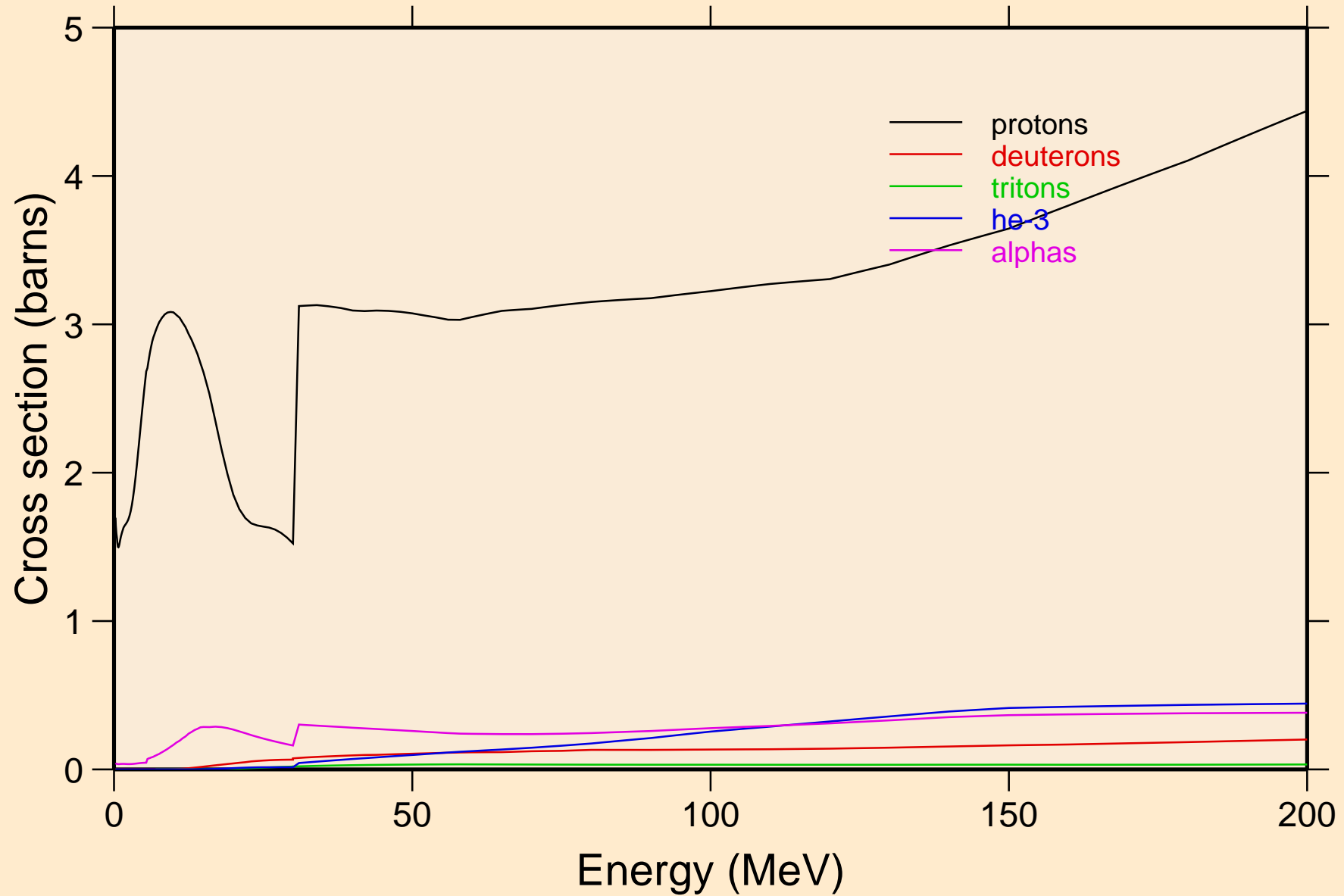

XE114 NEUTRON ACER TENDL-2021 LIBRARY; T=293.6K
protons from (n,x)

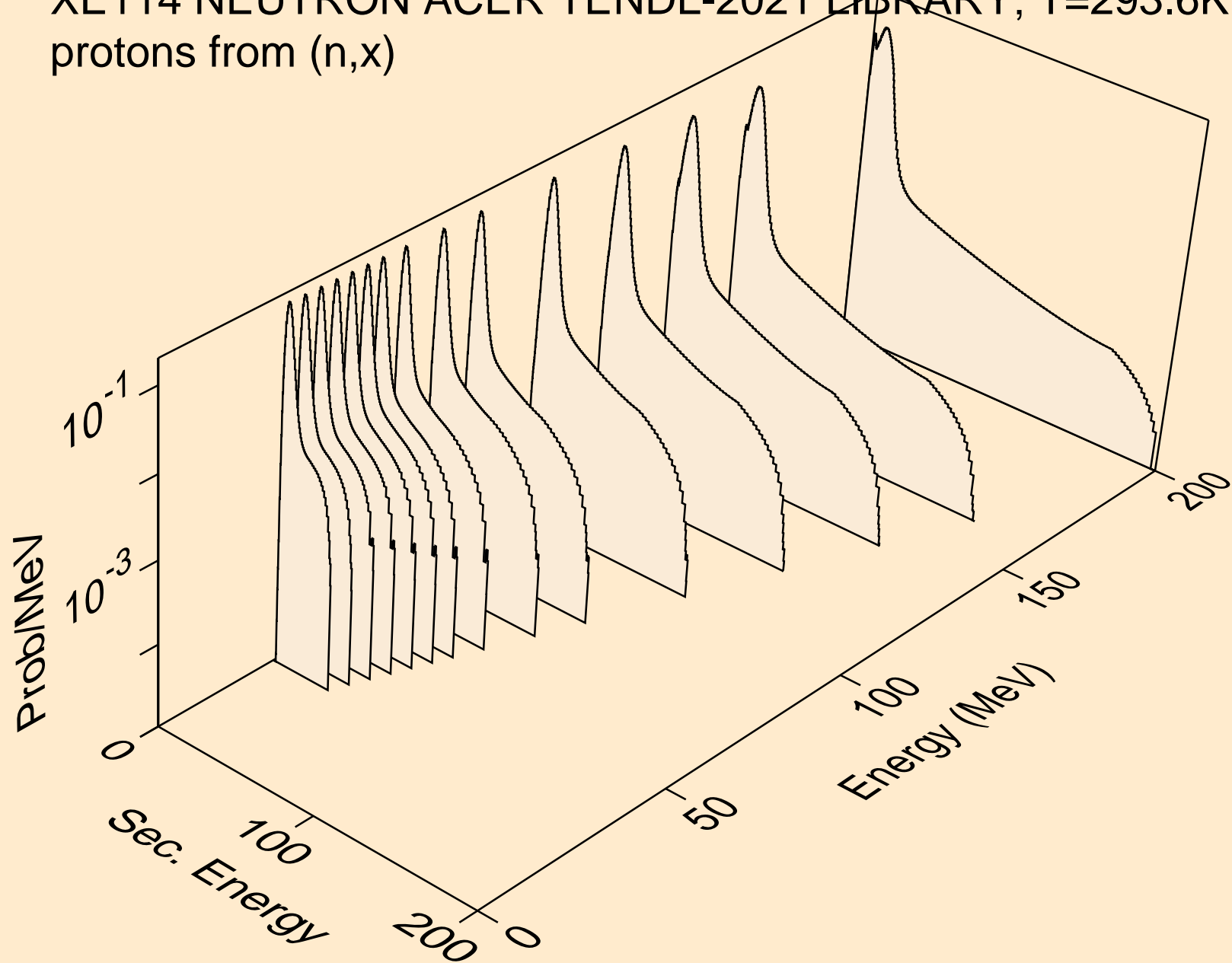

XE114 NEUTRON ACER TENDL-2021 LIBRARY; T=293.6K
protons from (n,n*)p

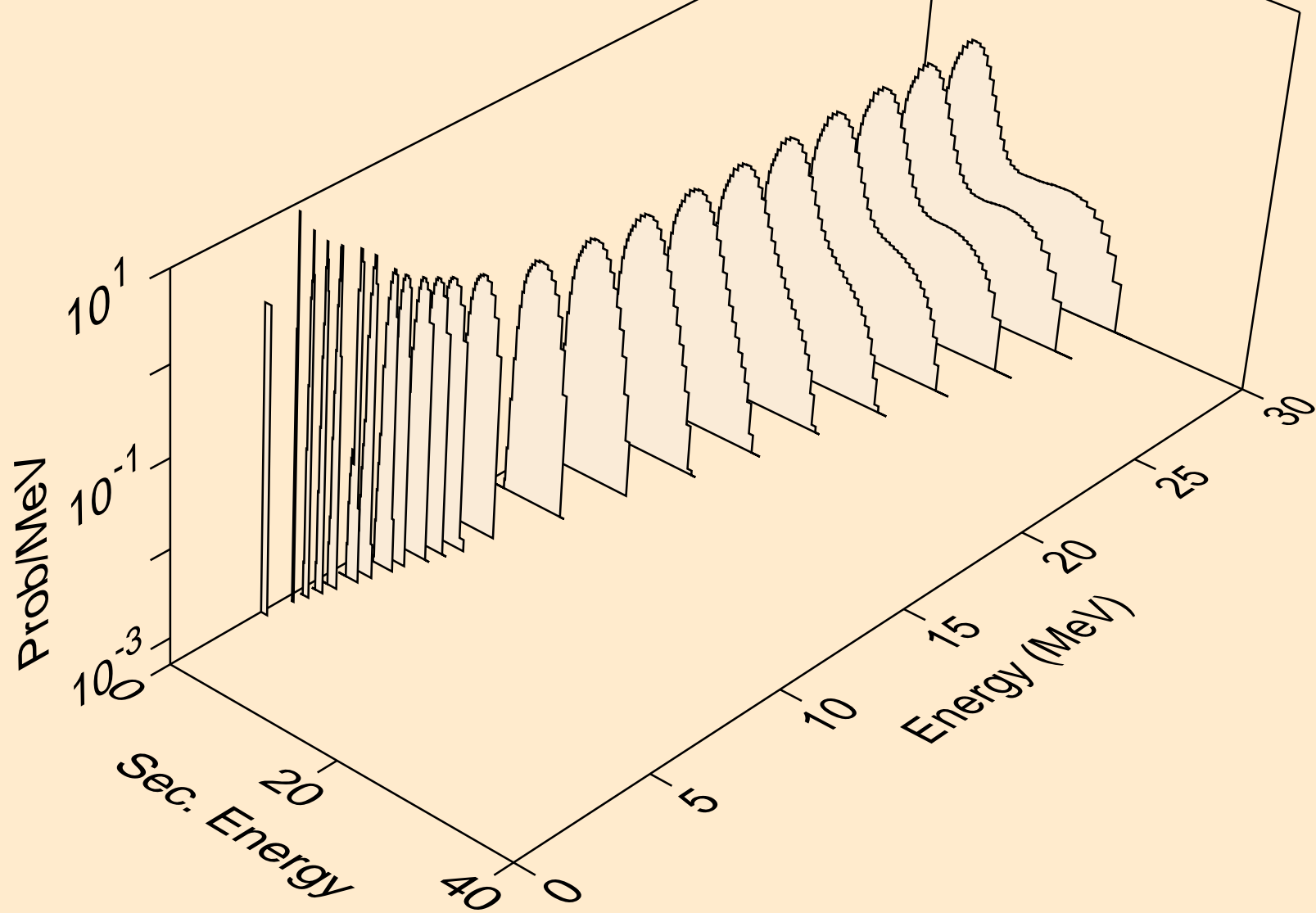

XE114 NEUTRON ACER TENDL-2021 LIBRARY; T=293.6K
protons from (n,2np)

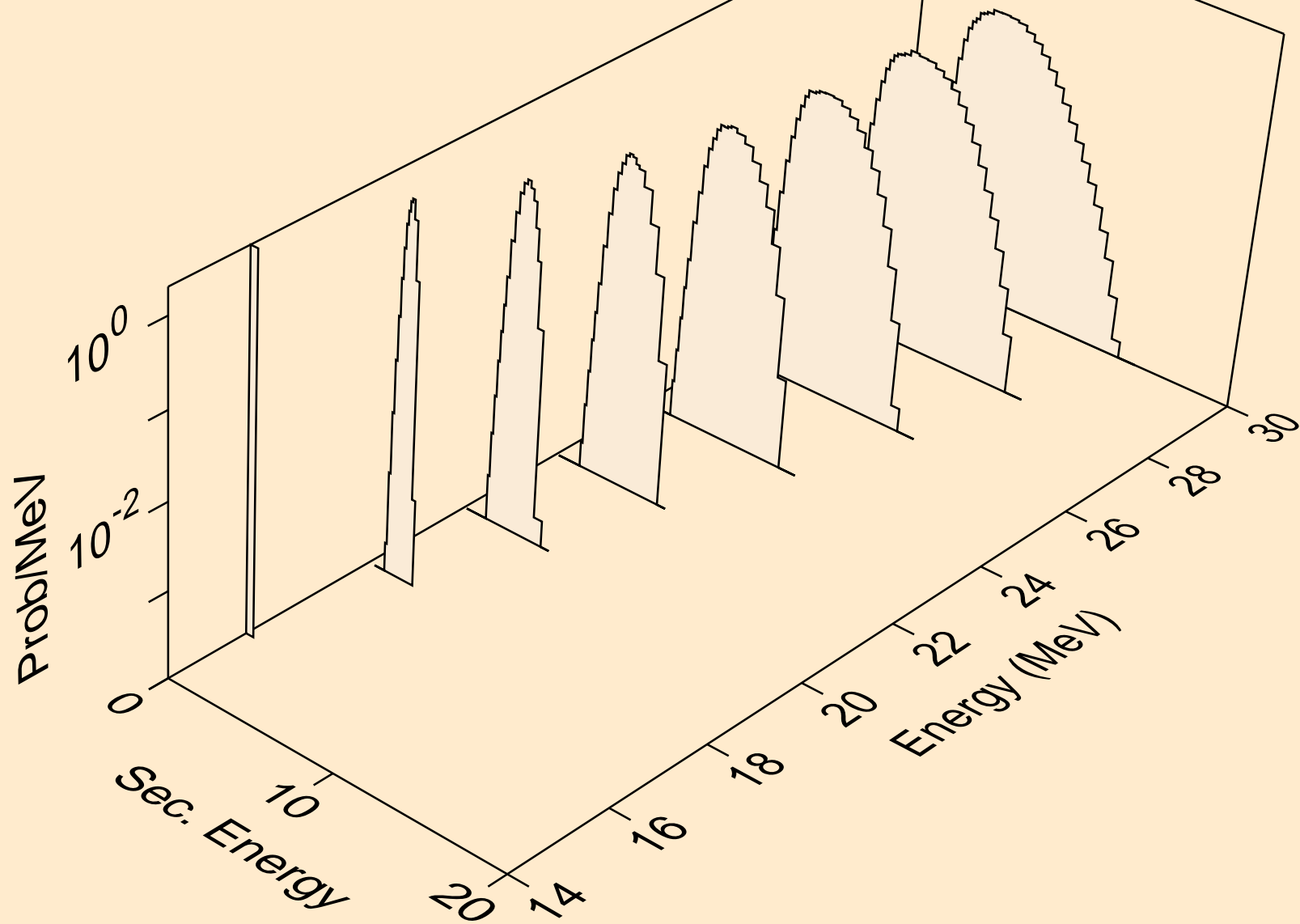

XE114 NEUTRON ACER TENDL-2021 LIBRARY; T=293.6K
protons from (n,3np)

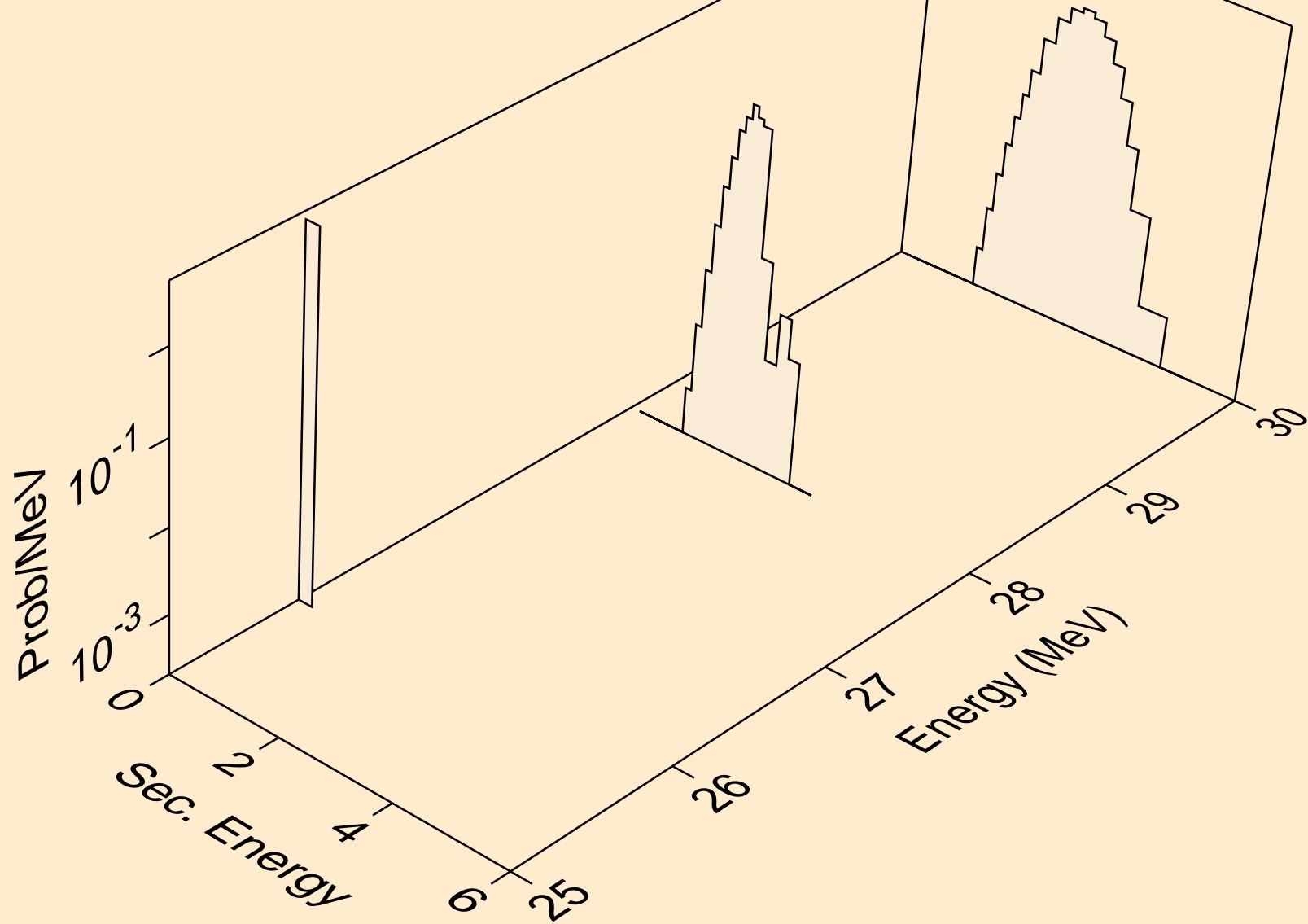

XE114 NEUTRON ACER TENDL-2021 LIBRARY; T=293.6K
protons from (n,2np)

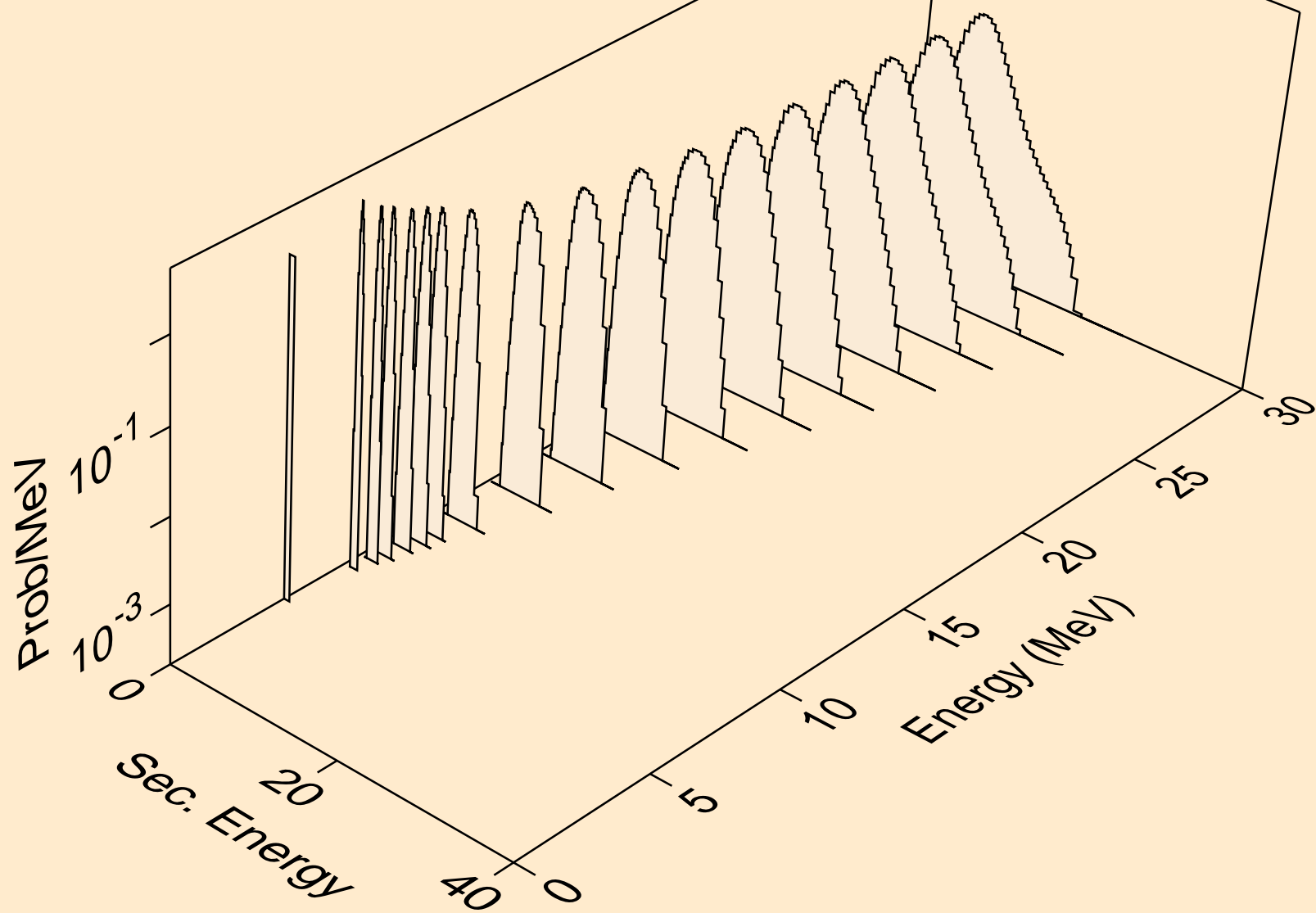

XE114 NEUTRON ACER TENDL-2021 LIBRARY; T=293.6K
protons from (n,npa)

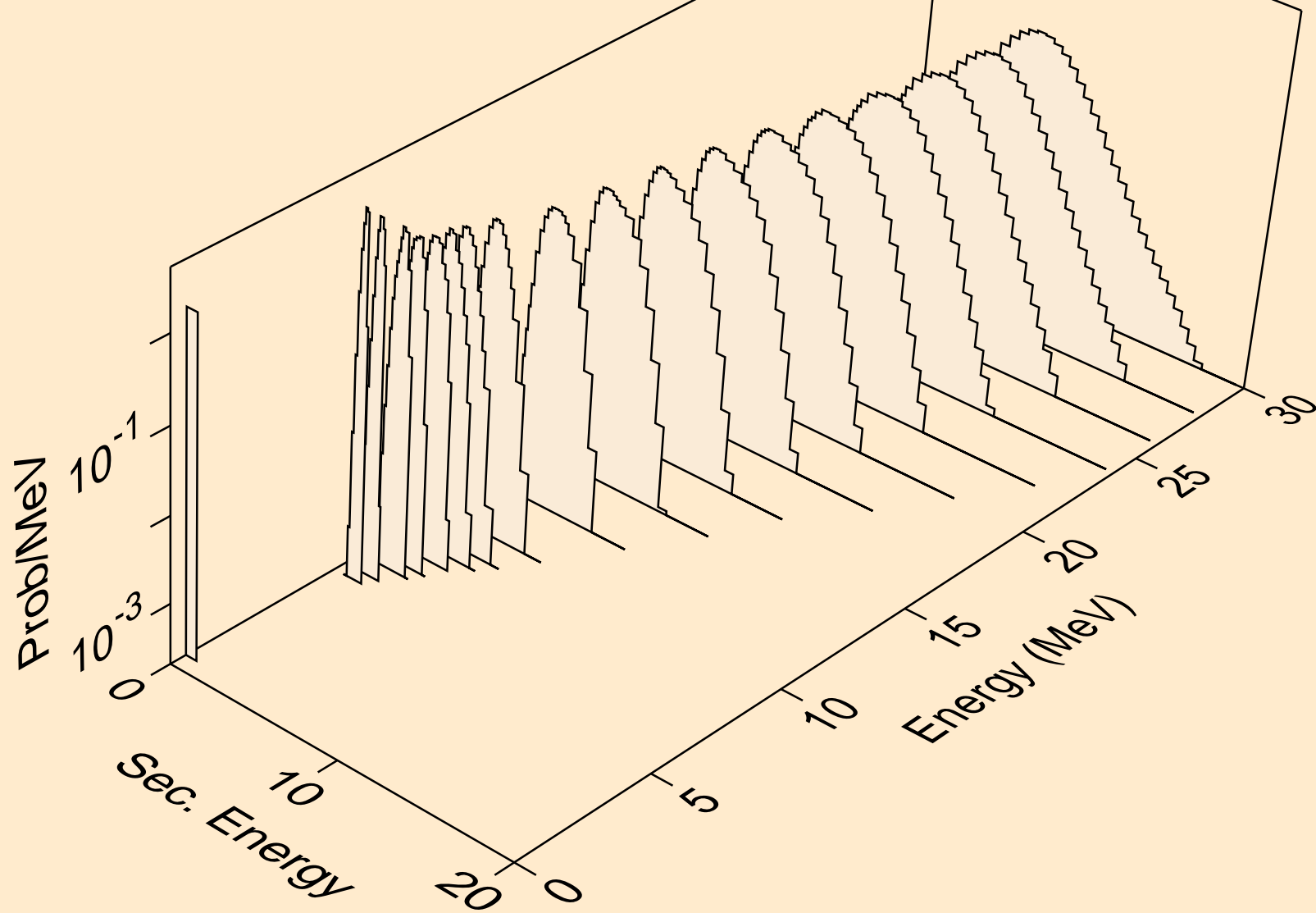

XE114 NEUTRON ACER TENDL-2021 LIBRARY; T=293.6K
protons from (n,p)

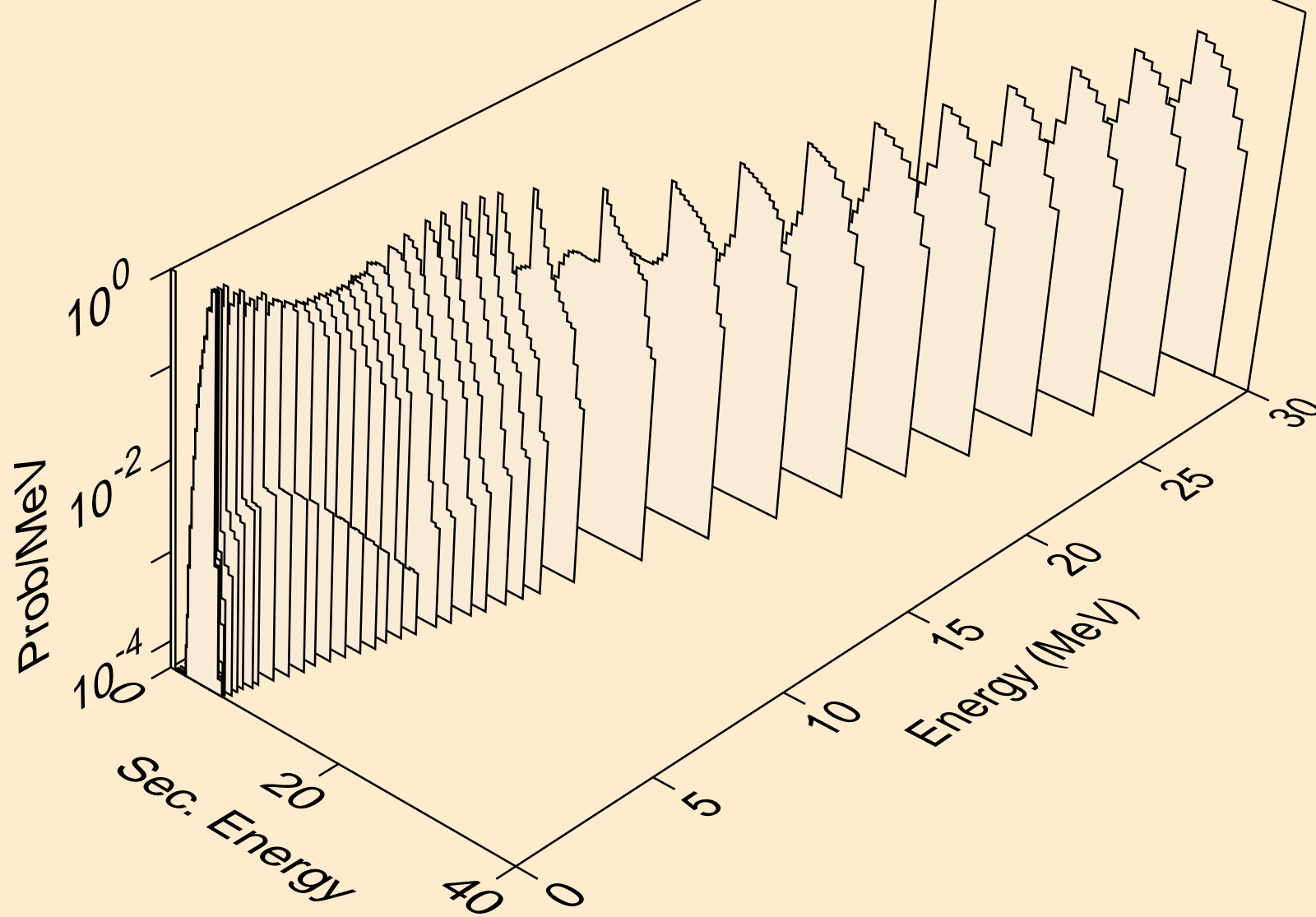

XE114 NEUTRON ACER TENDL-2021 LIBRARY; T=293.6K
protons from (n,2p)

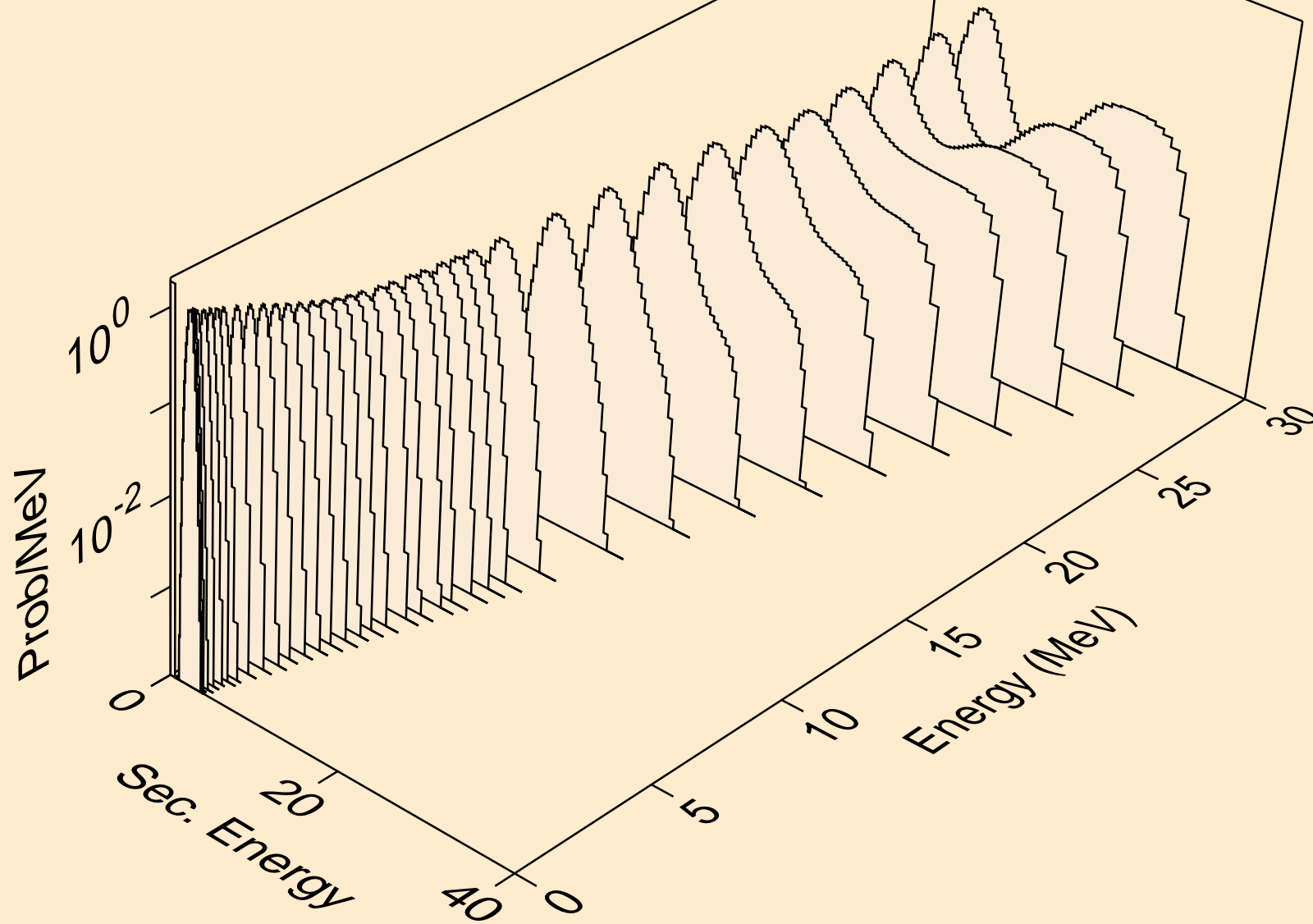

XE114 NEUTRON ACER TENDL-2021 LIBRARY; T=293.6K
protons from (n,p)

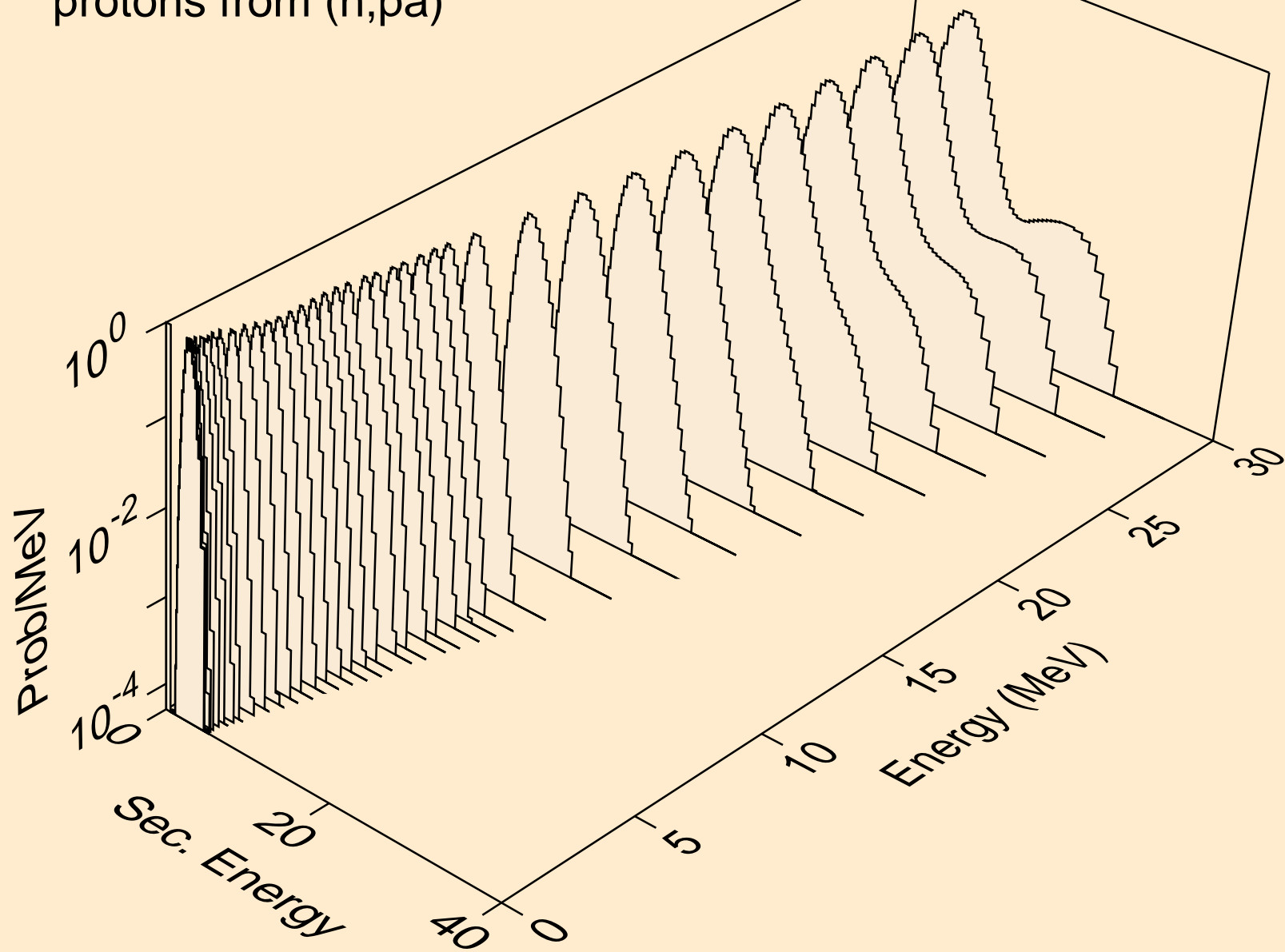

XE114 NEUTRON ACER TENDL-2021 LIBRARY; T=293.6K
protons from (n,pd)

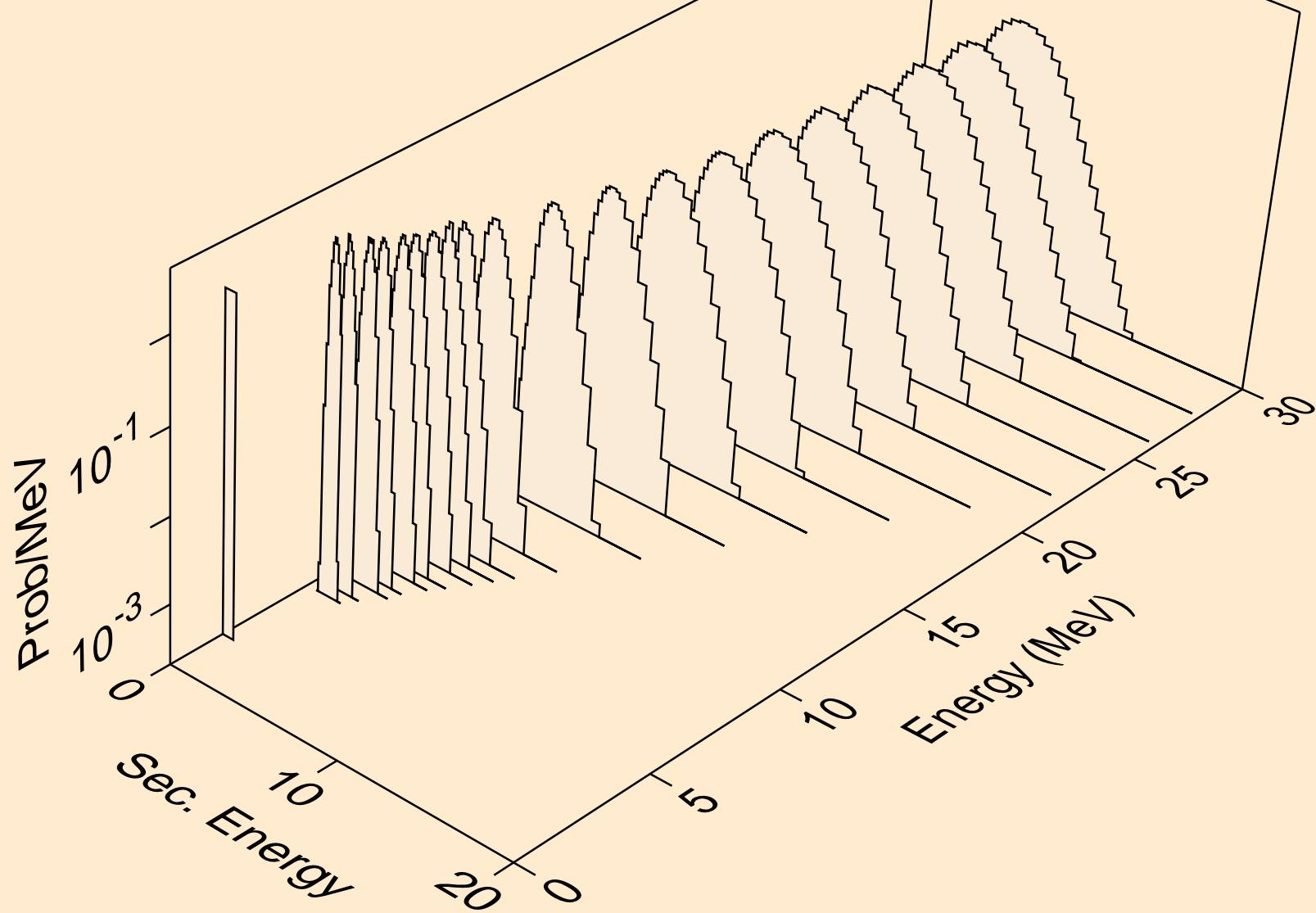

XE114 NEUTRON ACER TENDL-2021 LIBRARY; T=293.6K
protons from (n,pt)

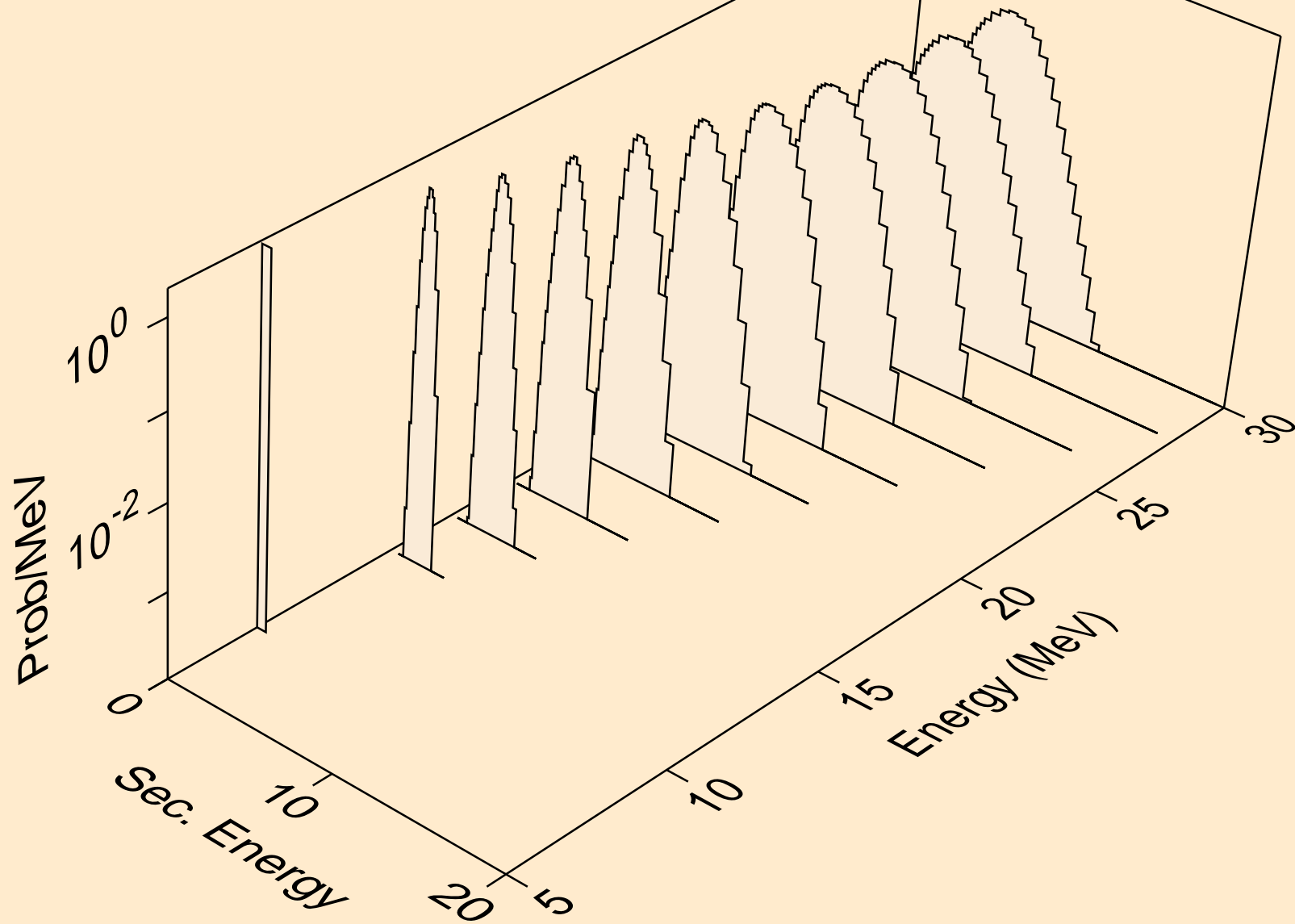

XE114 NEUTRON ACER TENDL-2021 LIBRARY; T=293.6K
deuterons from (n,x)

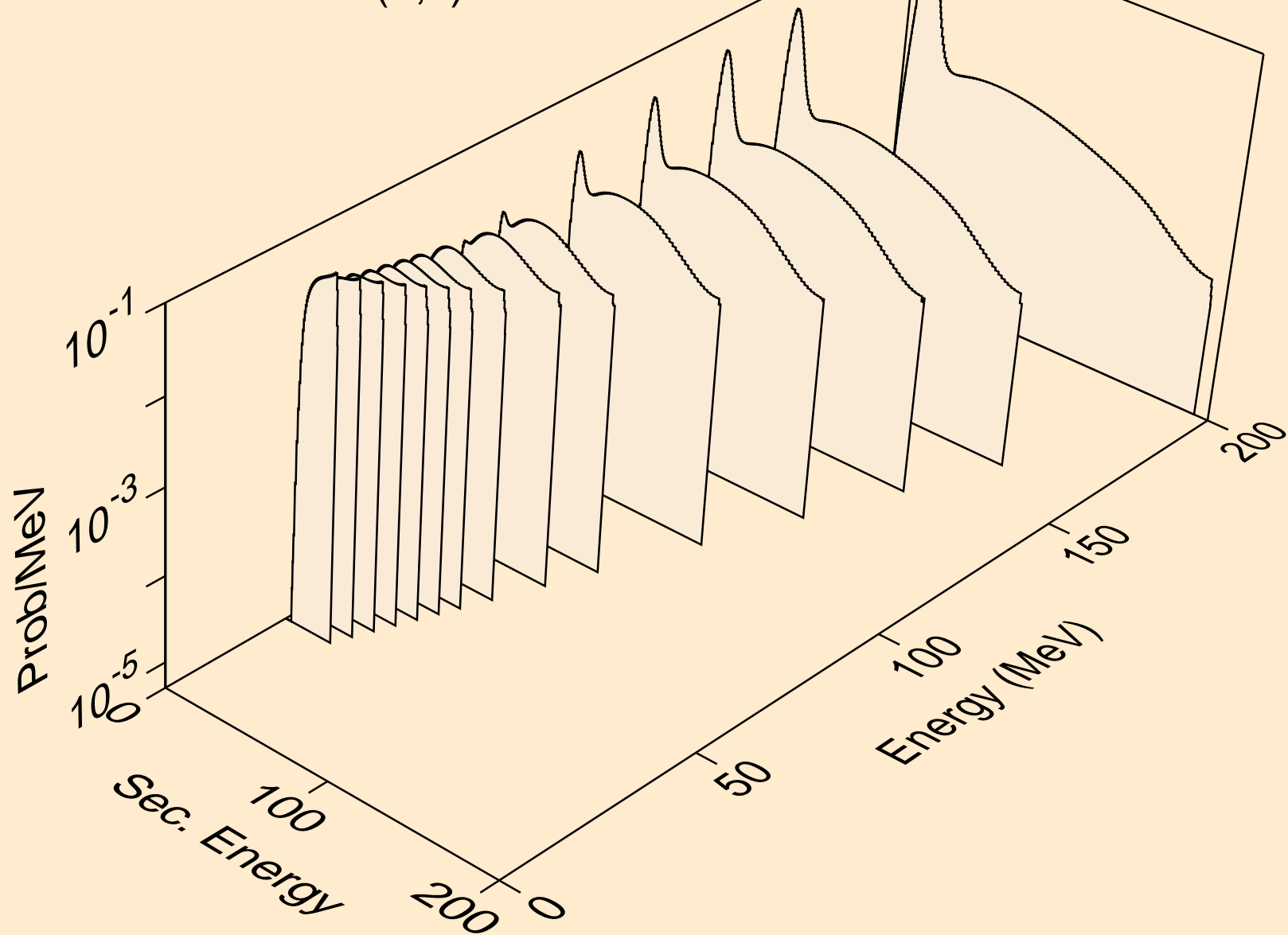

XE114 NEUTRON ACER TENDL-2021 LIBRARY; T=293.6K
deuterons from (n,2nd)

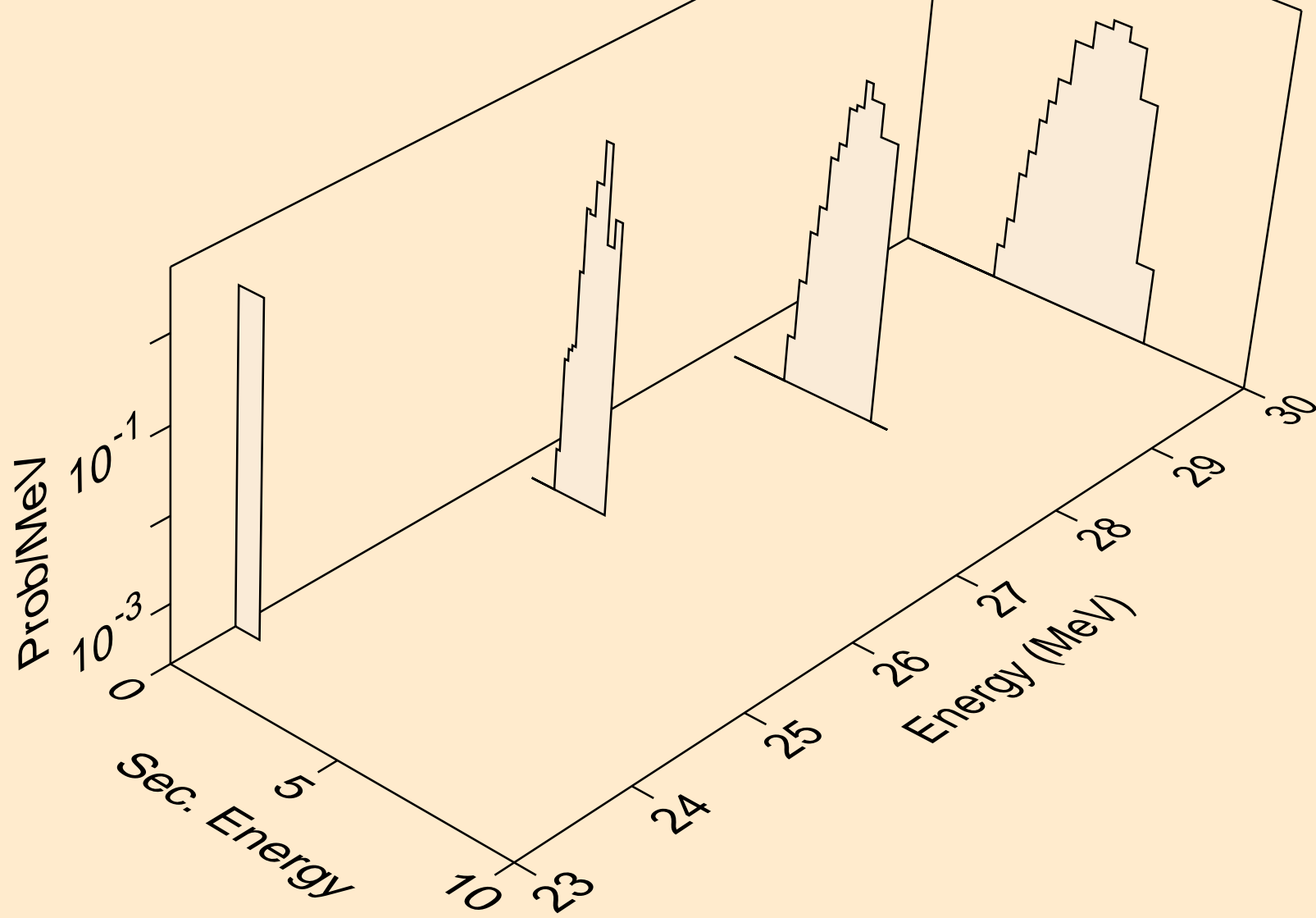

XE114 NEUTRON ACER TENDL-2021 LIBRARY; T=293.6K
deuterons from (n,n*)d

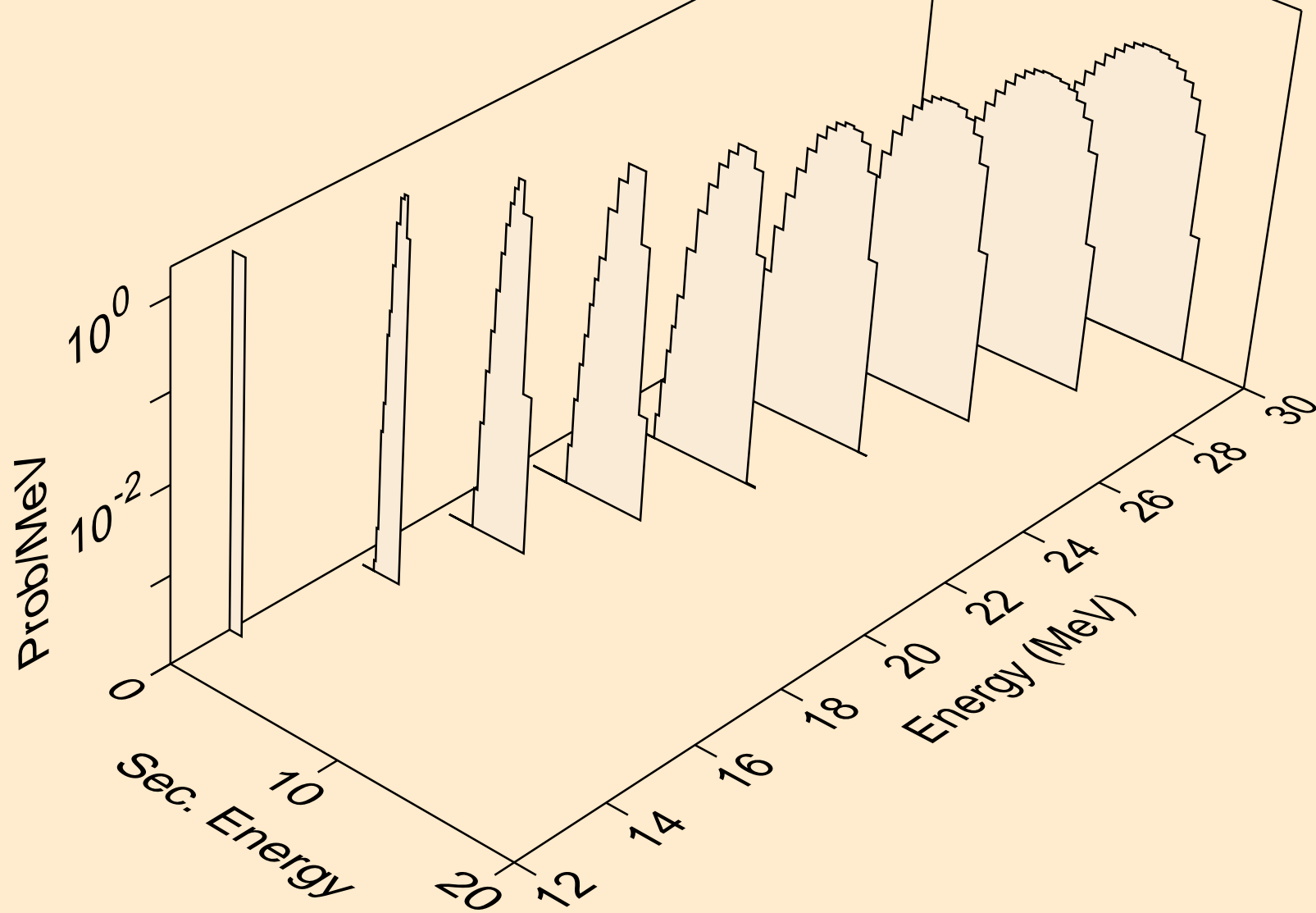

XE114 NEUTRON ACER TENDL-2021 LIBRARY; T=293.6K
deuterons from (n,d)

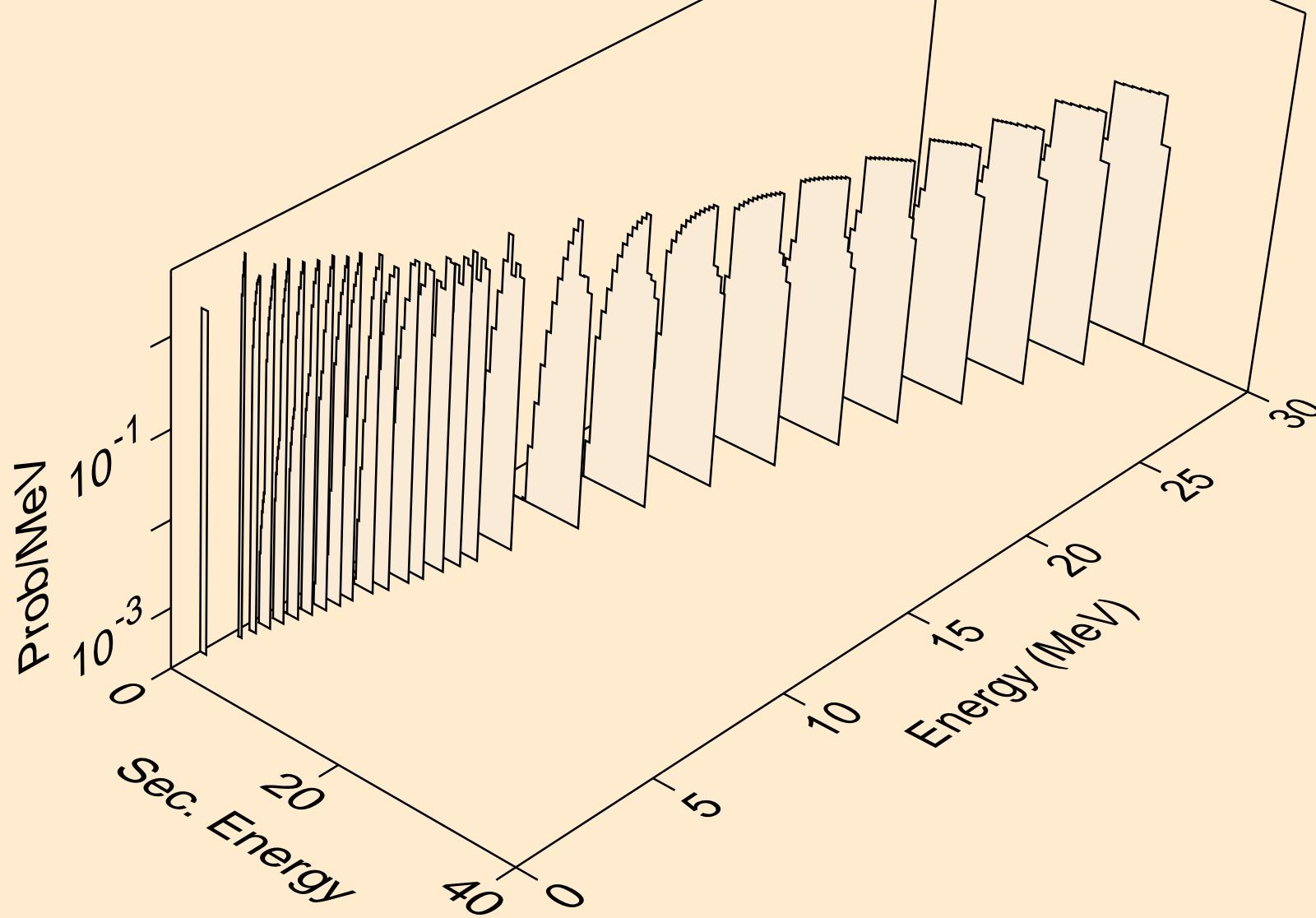

XE114 NEUTRON ACER TENDL-2021 LIBRARY; T=293.6K
deuterons from (n,d2a)

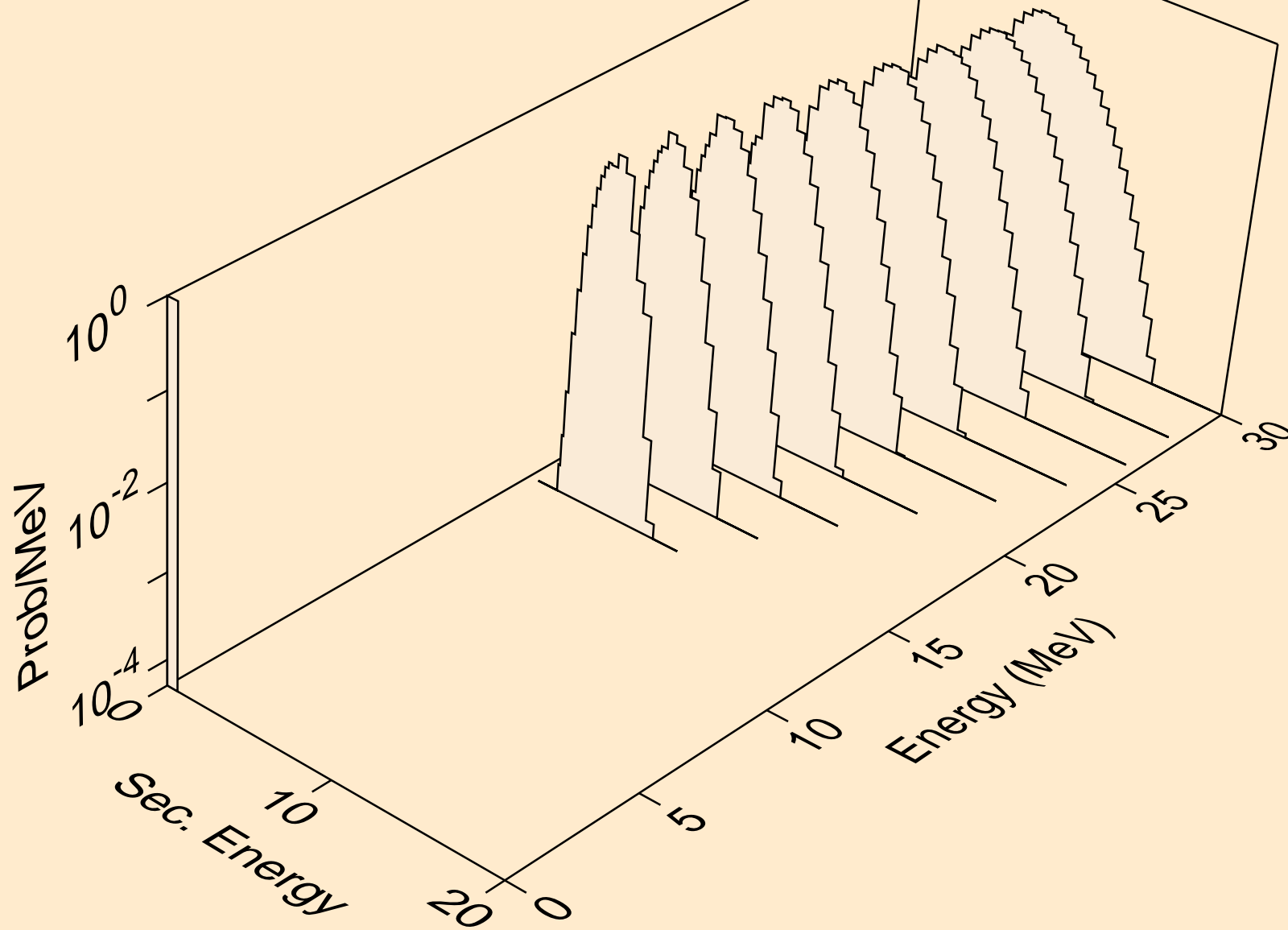

XE114 NEUTRON ACER TENDL-2021 LIBRARY; T=293.6K
deuterons from (n,pd)

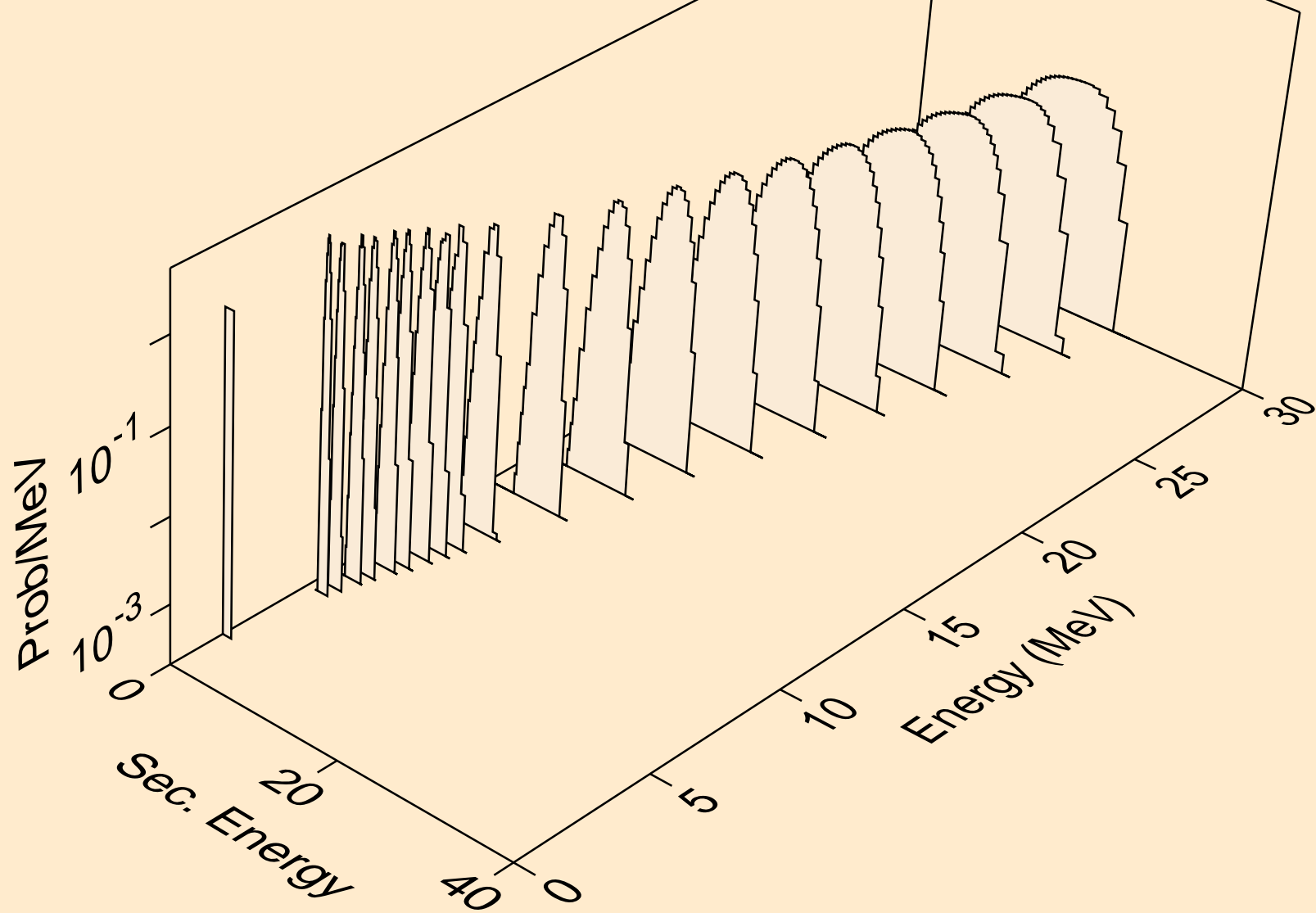

XE114 NEUTRON ACER TENDL-2021 LIBRARY; T=293.6K
deuterons from (n,da)

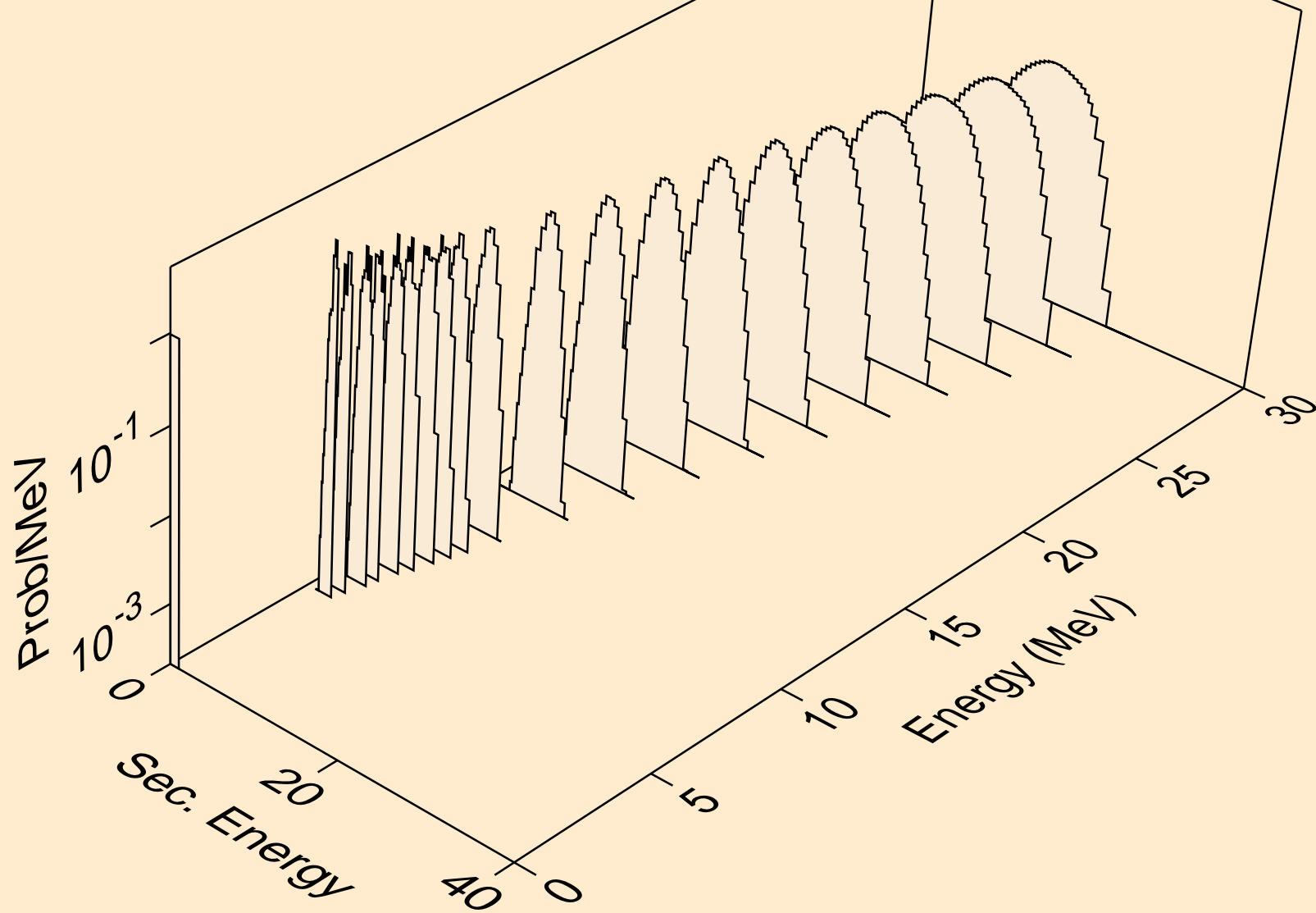

XE114 NEUTRON ACER TENDL-2021 LIBRARY; T=293.6K
tritons from (n,x)

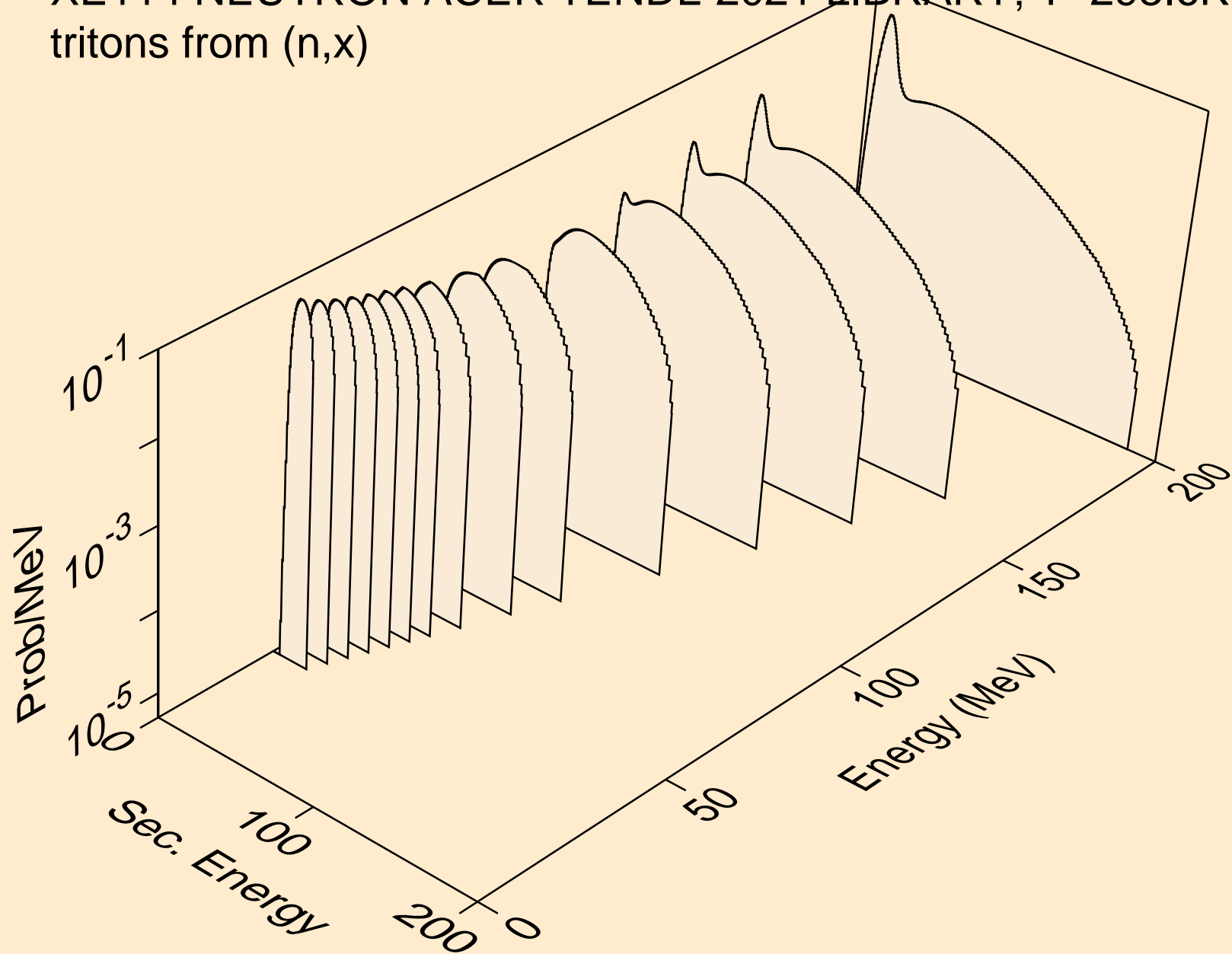

XE114 NEUTRON ACER TENDL-2021 LIBRARY; T=293.6K
tritons from (n,n*)t

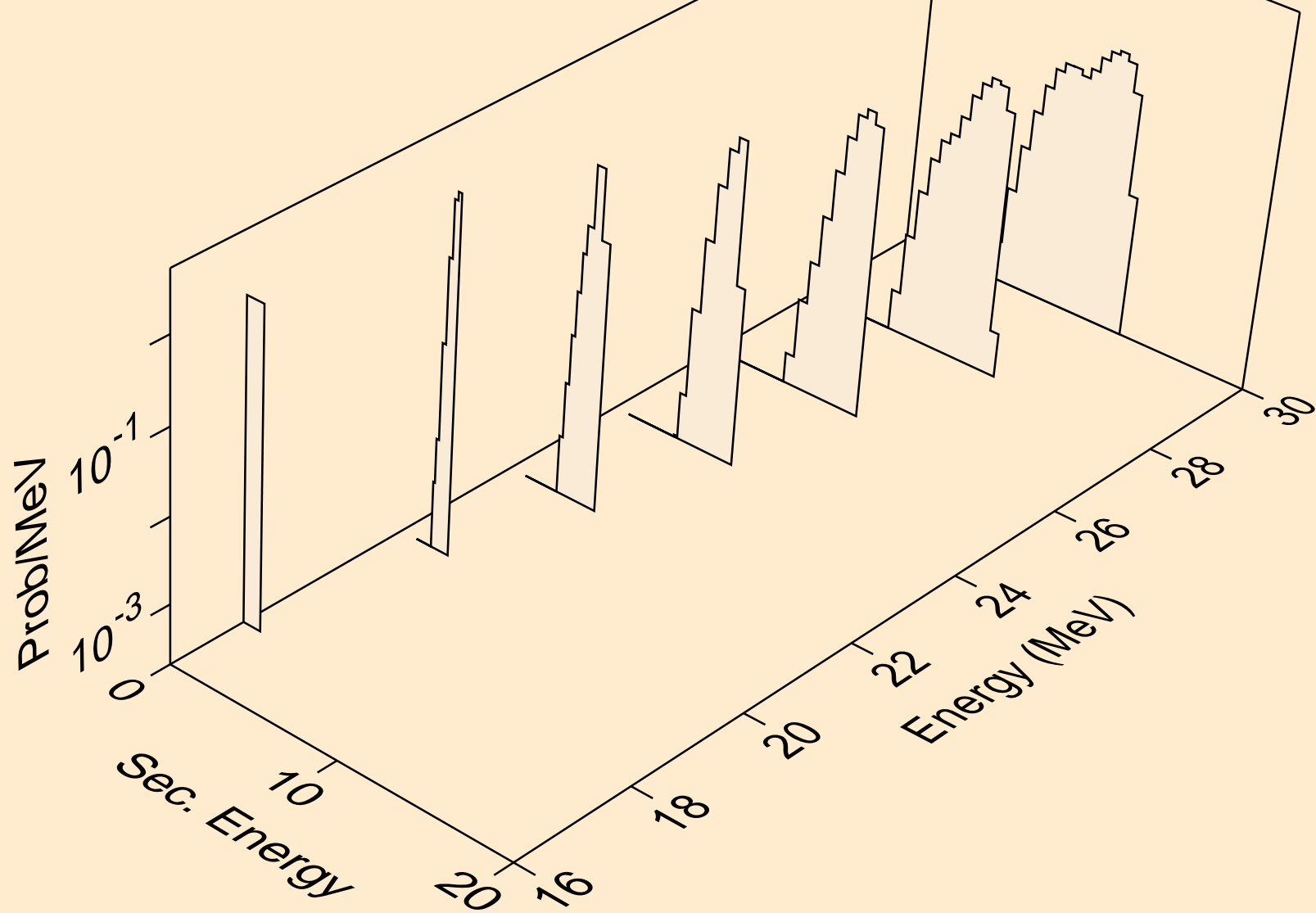

XE114 NEUTRON ACER TENDL-2021 LIBRARY; T=293.6K
tritons from (n,t)

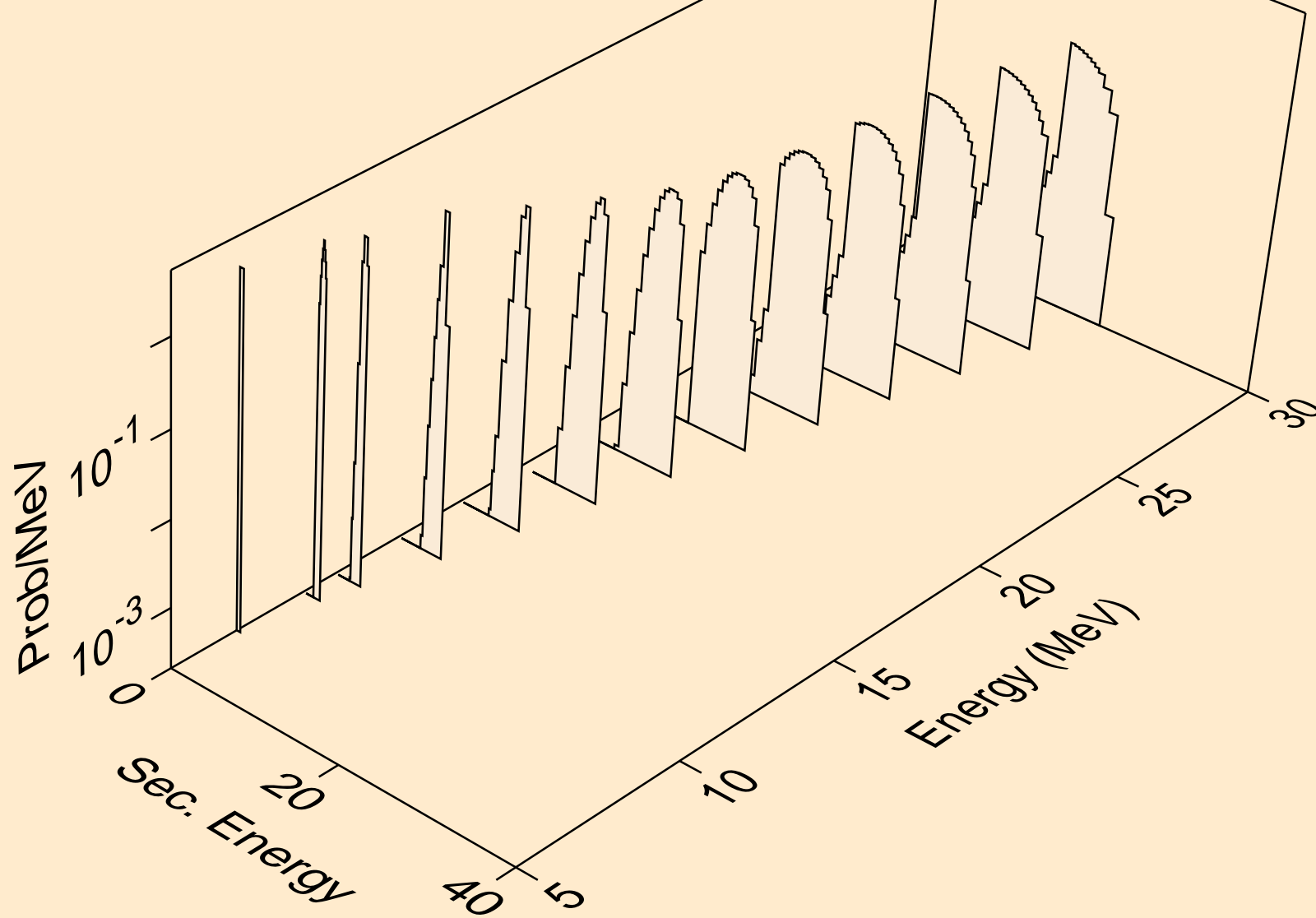

XE114 NEUTRON ACER TENDL-2021 LIBRARY; T=293.6K
tritons from (n,pt)

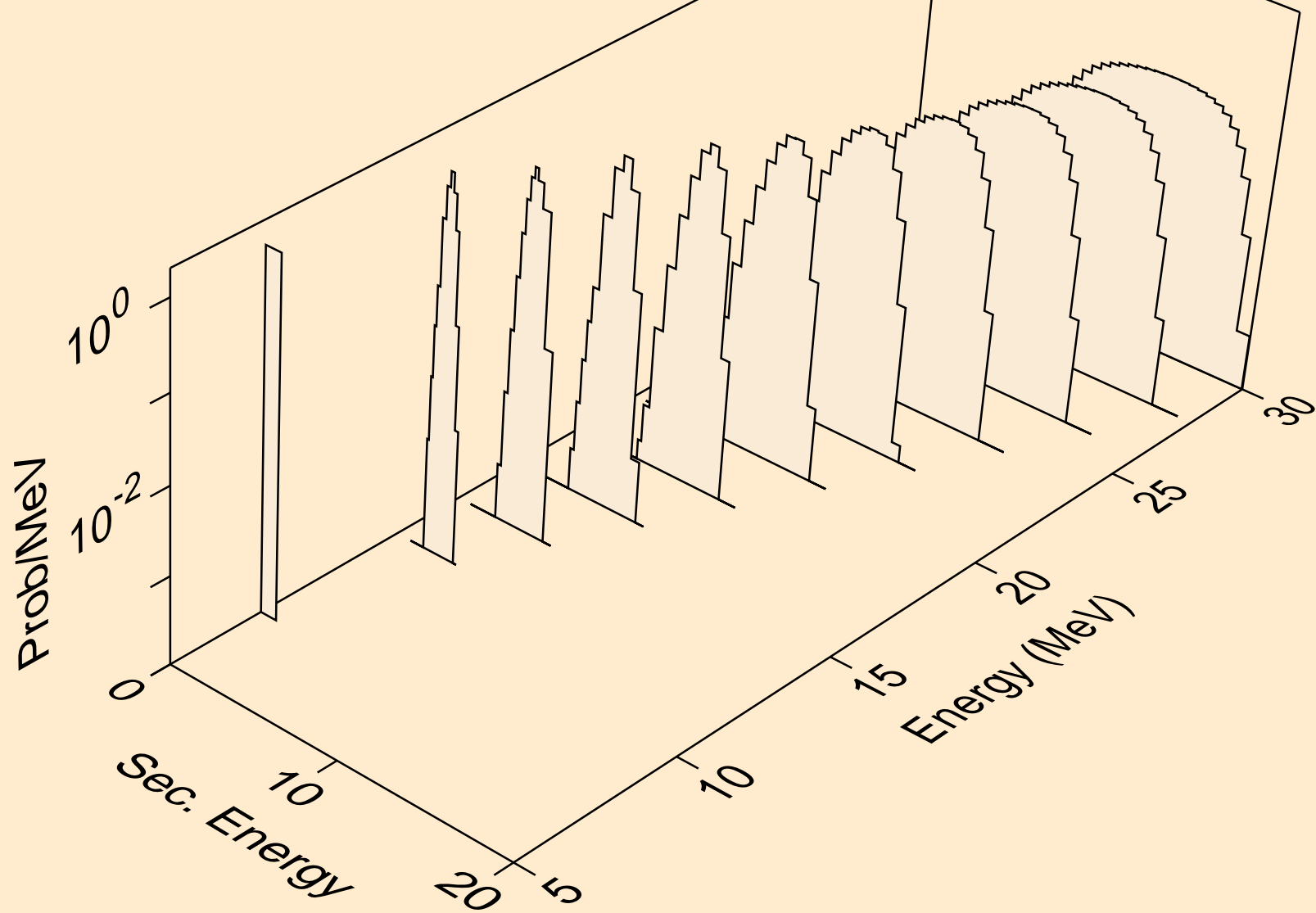

XE114 NEUTRON ACER TENDL-2021 LIBRARY; T=293.6K
he3s from (n,x)

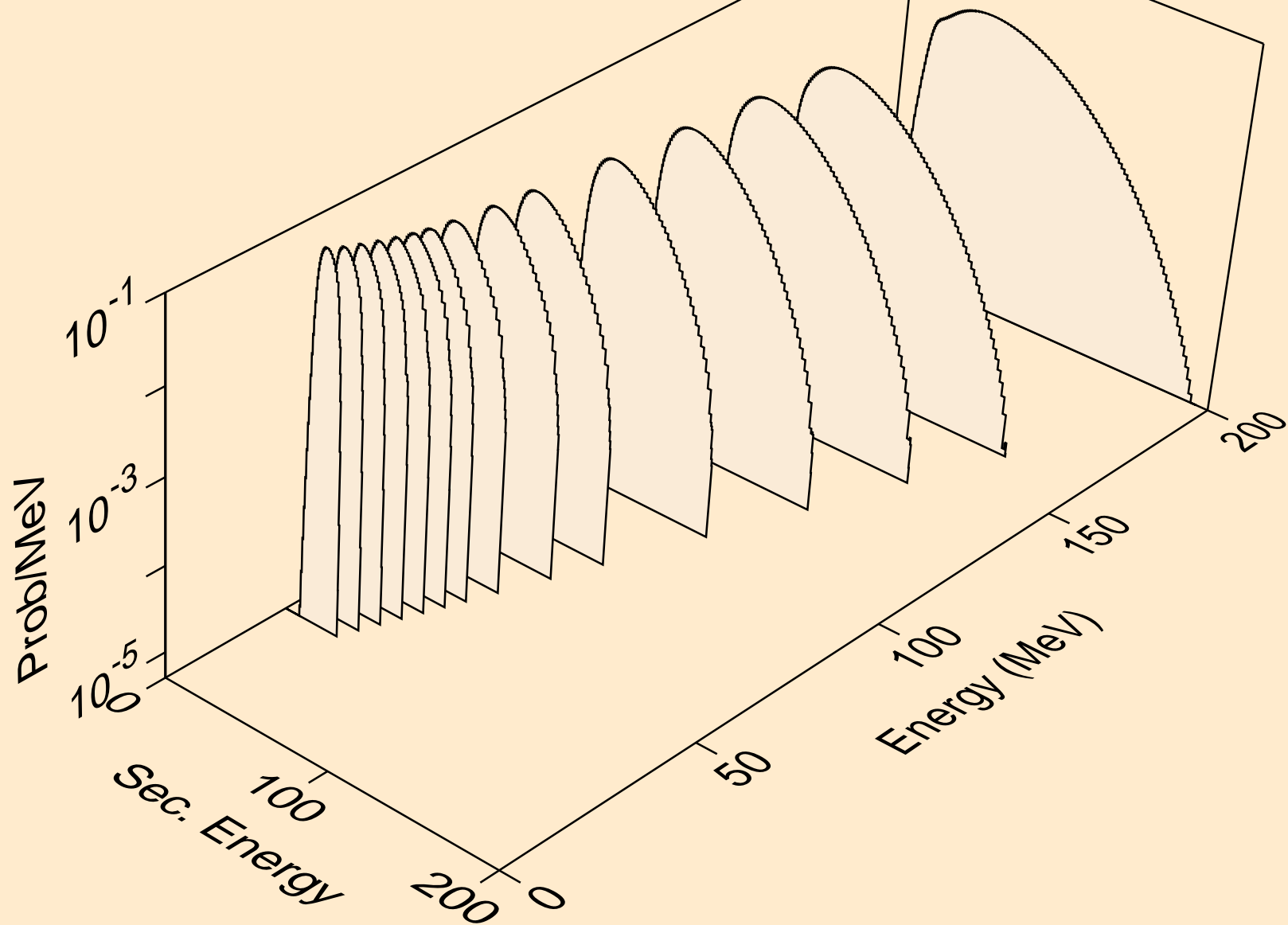

XE114 NEUTRON ACER TENDL-2021 LIBRARY; T=293.6K
he3s from (n,n*)he3

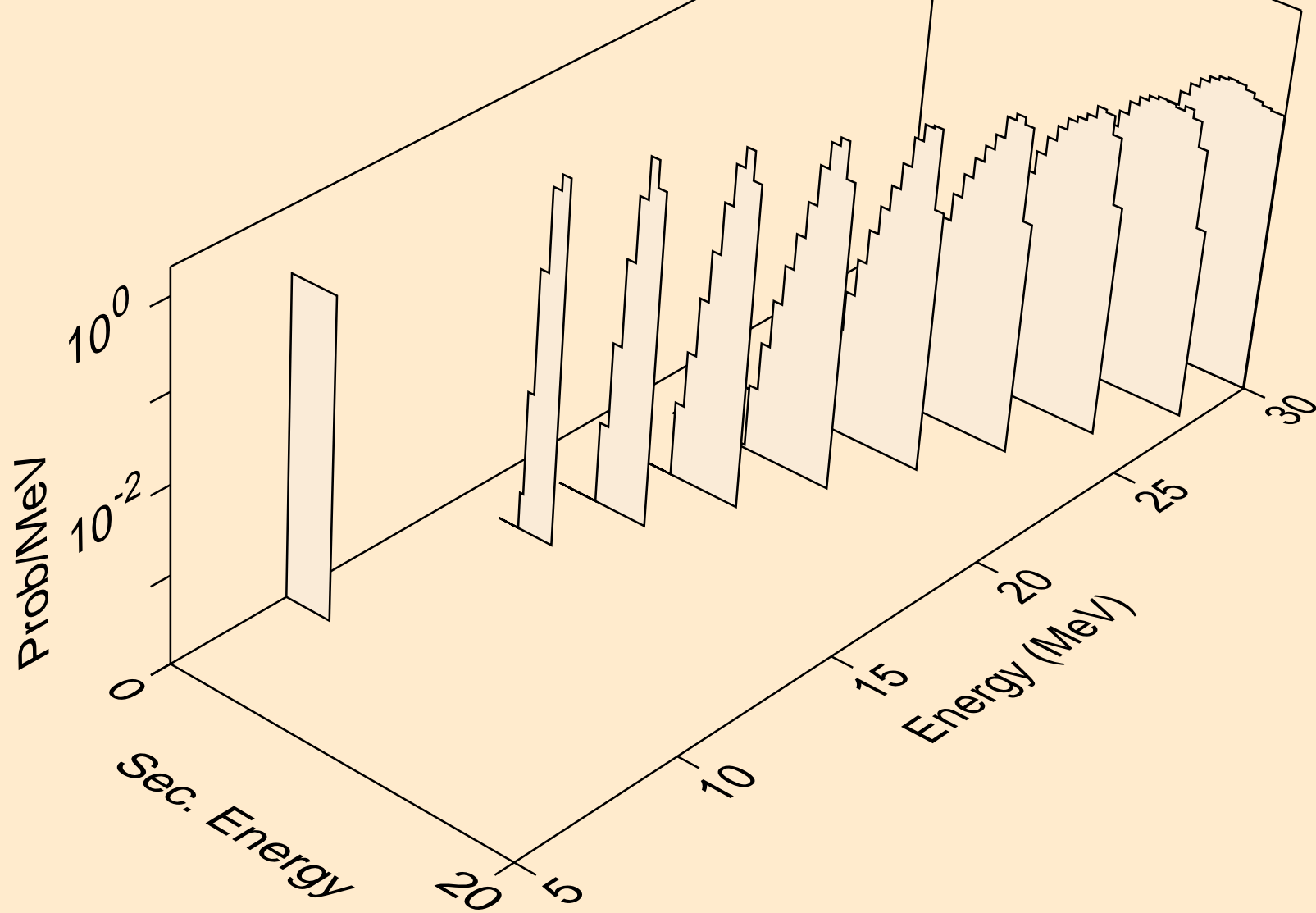

XE114 NEUTRON ACER TENDL-2021 LIBRARY; T=293.6K
he3s from (n,he3)

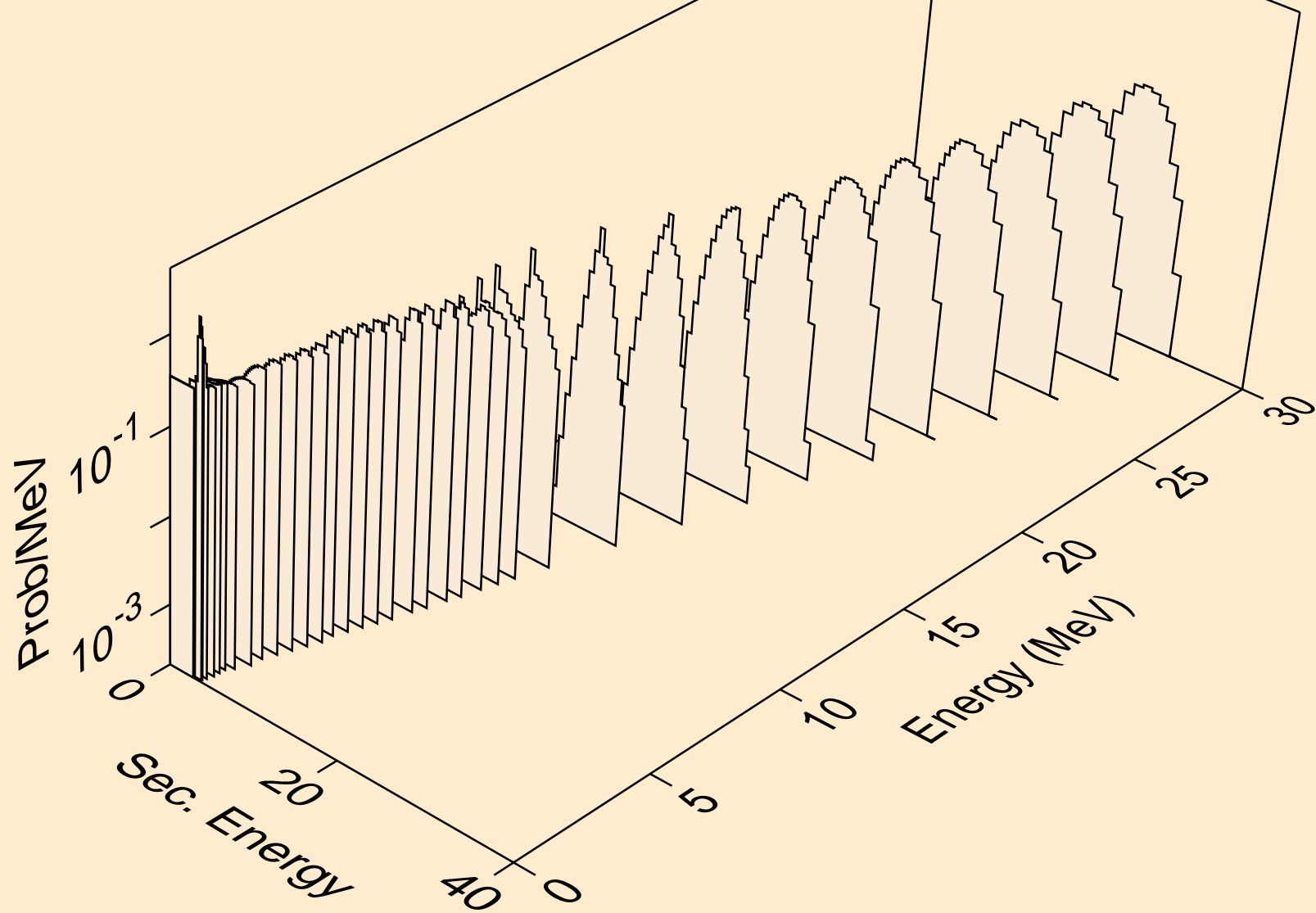

XE114 NEUTRON ACER TENDL-2021 LIBRARY; T=293.6K
alphas from (n,x)

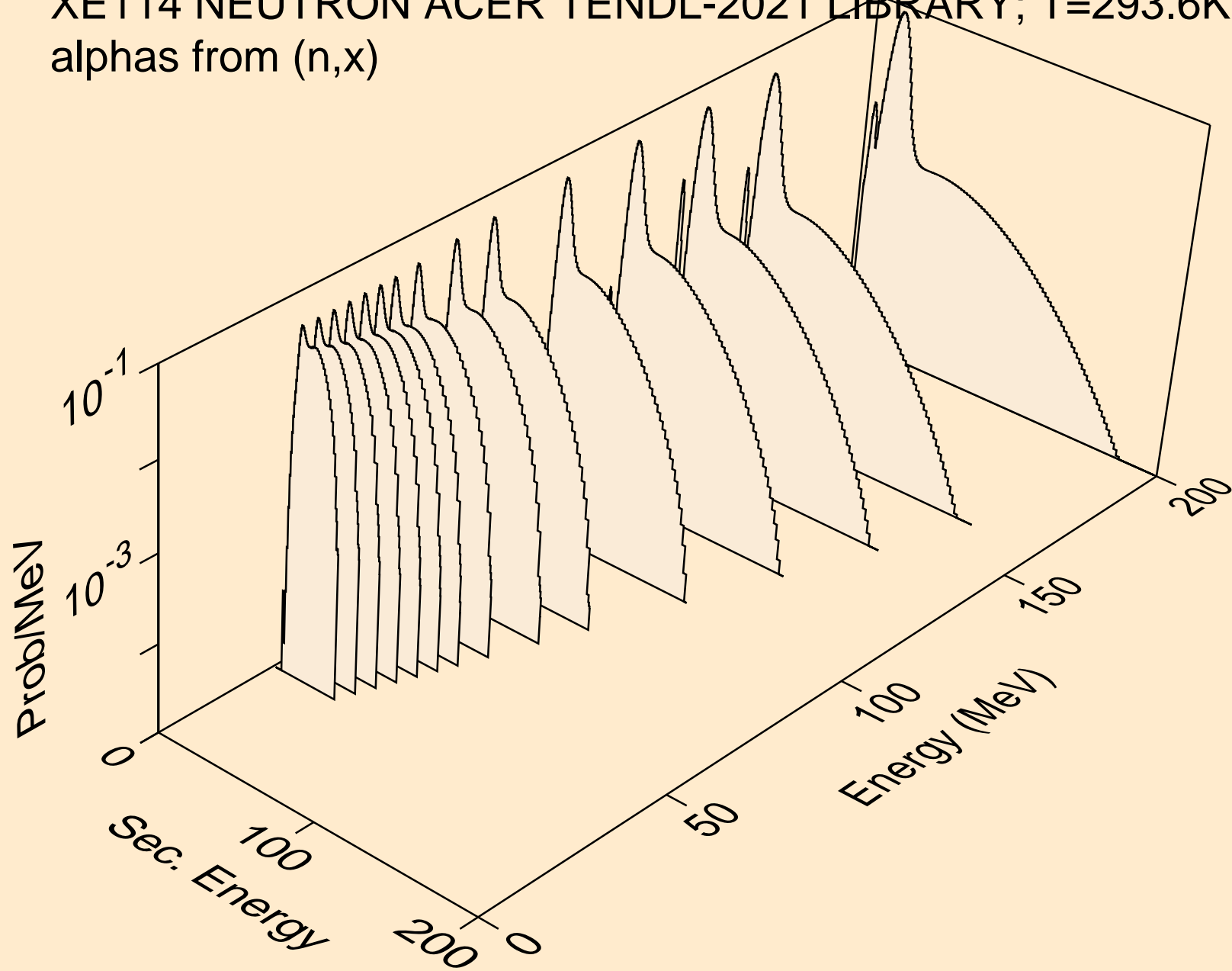

XE114 NEUTRON ACER TENDL-2021 LIBRARY; T=293.6K
alphas from (n,n*)a

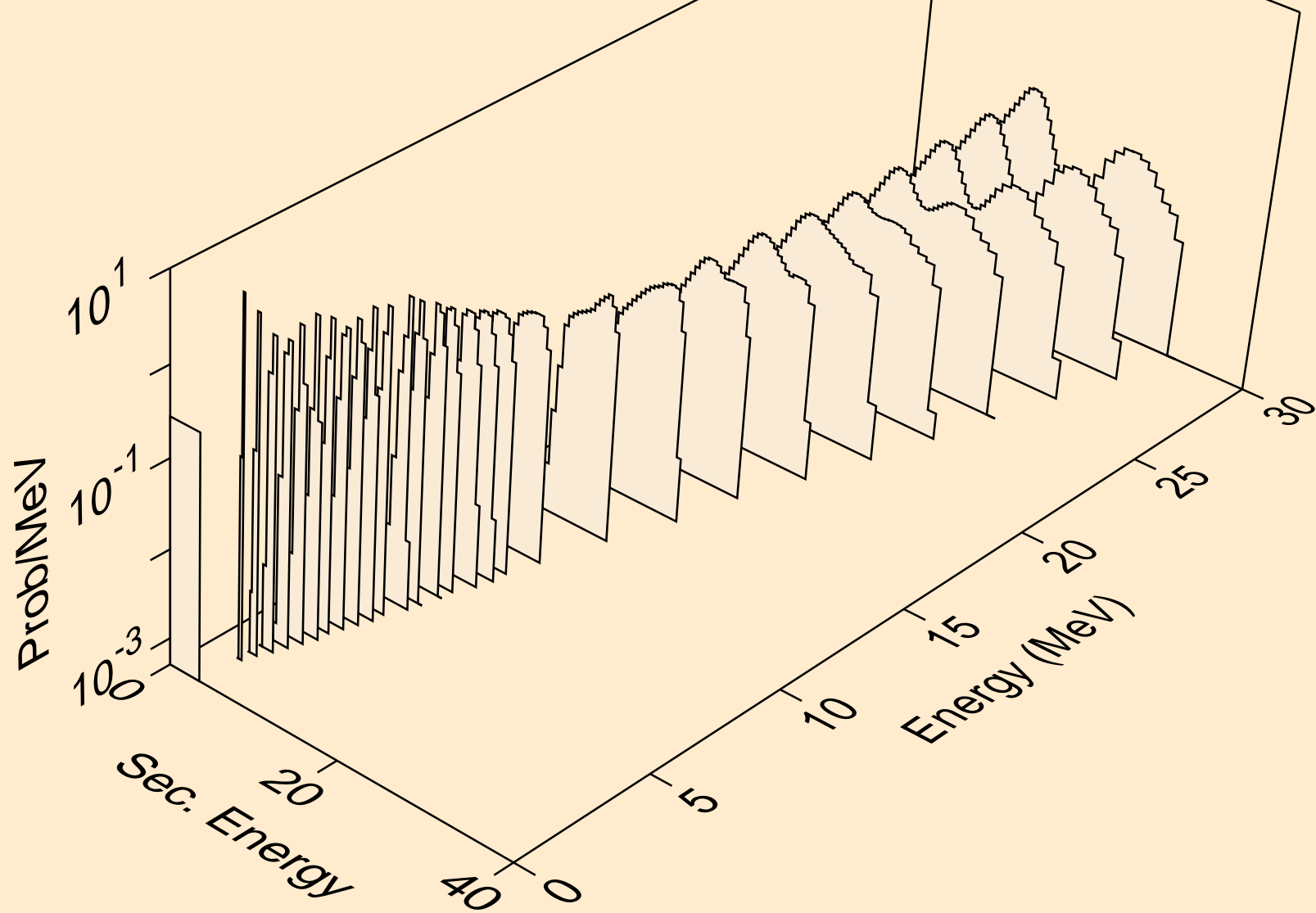

XE114 NEUTRON ACER TENDL-2021 LIBRARY; T=293.6K
alphas from (n,n*)3a

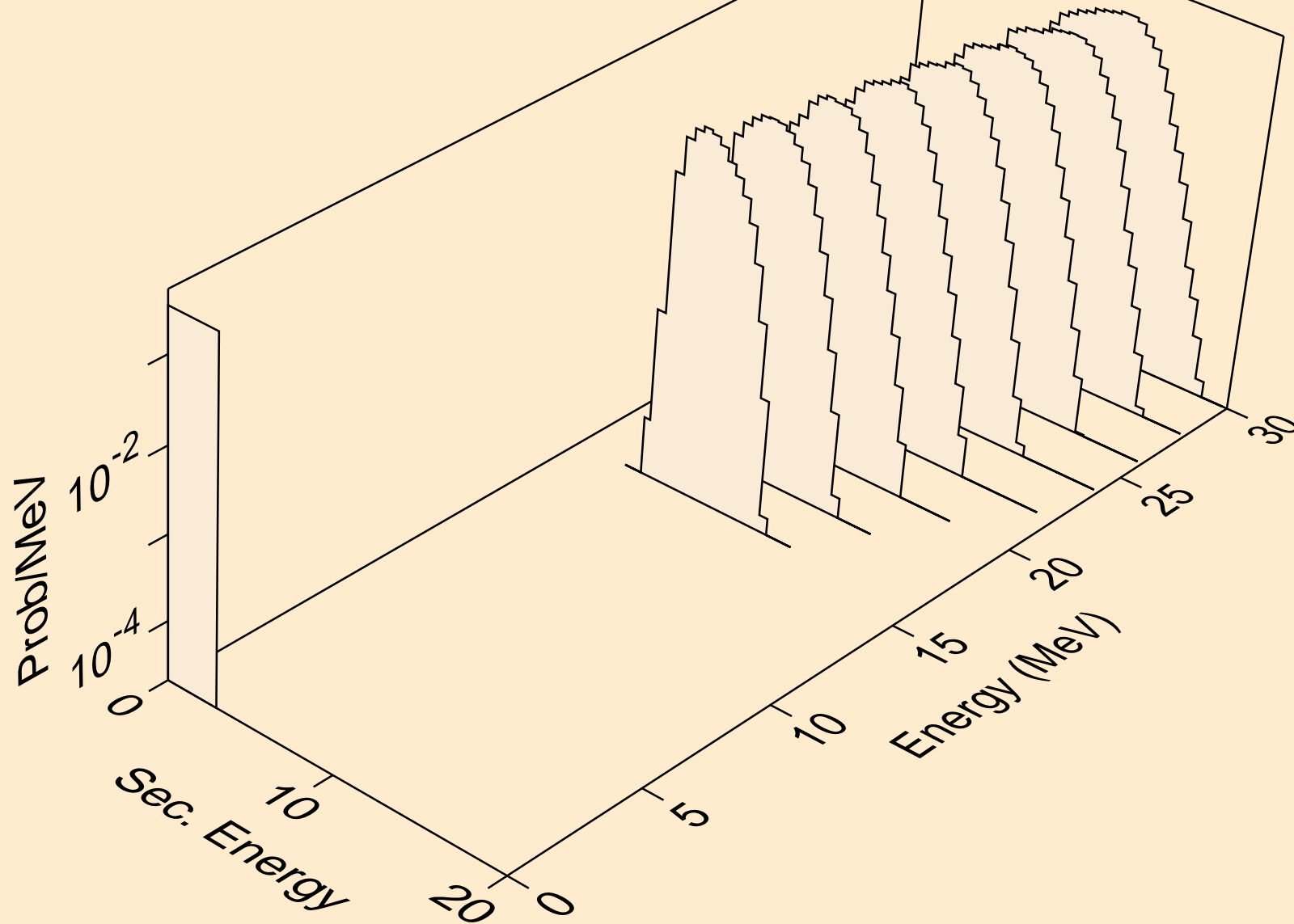

XE114 NEUTRON ACER TENDL-2021 LIBRARY; T=293.6K
alphas from (n,2n)a

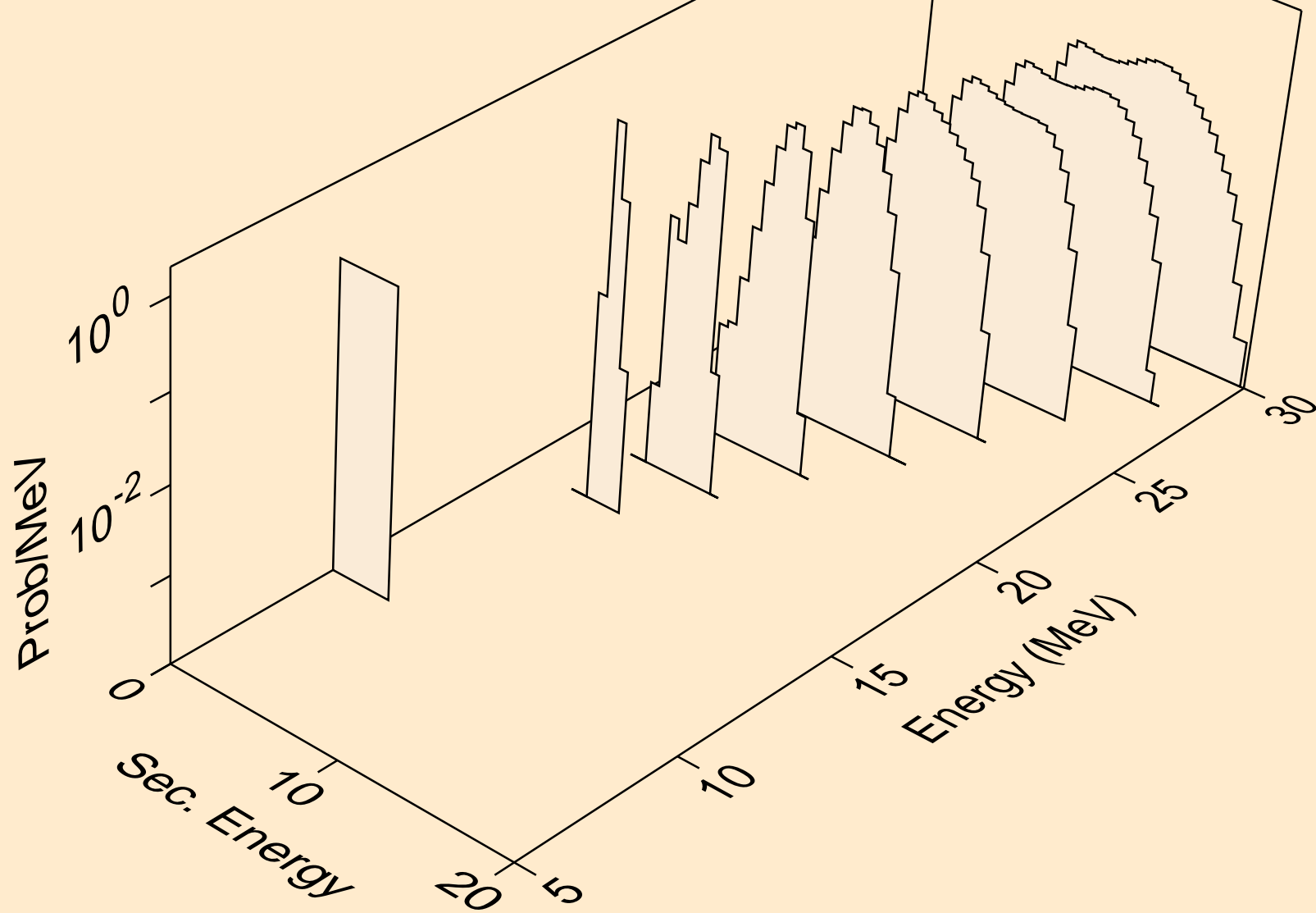

XE114 NEUTRON ACER TENDL-2021 LIBRARY; T=293.6K
alphas from (n,3n)a

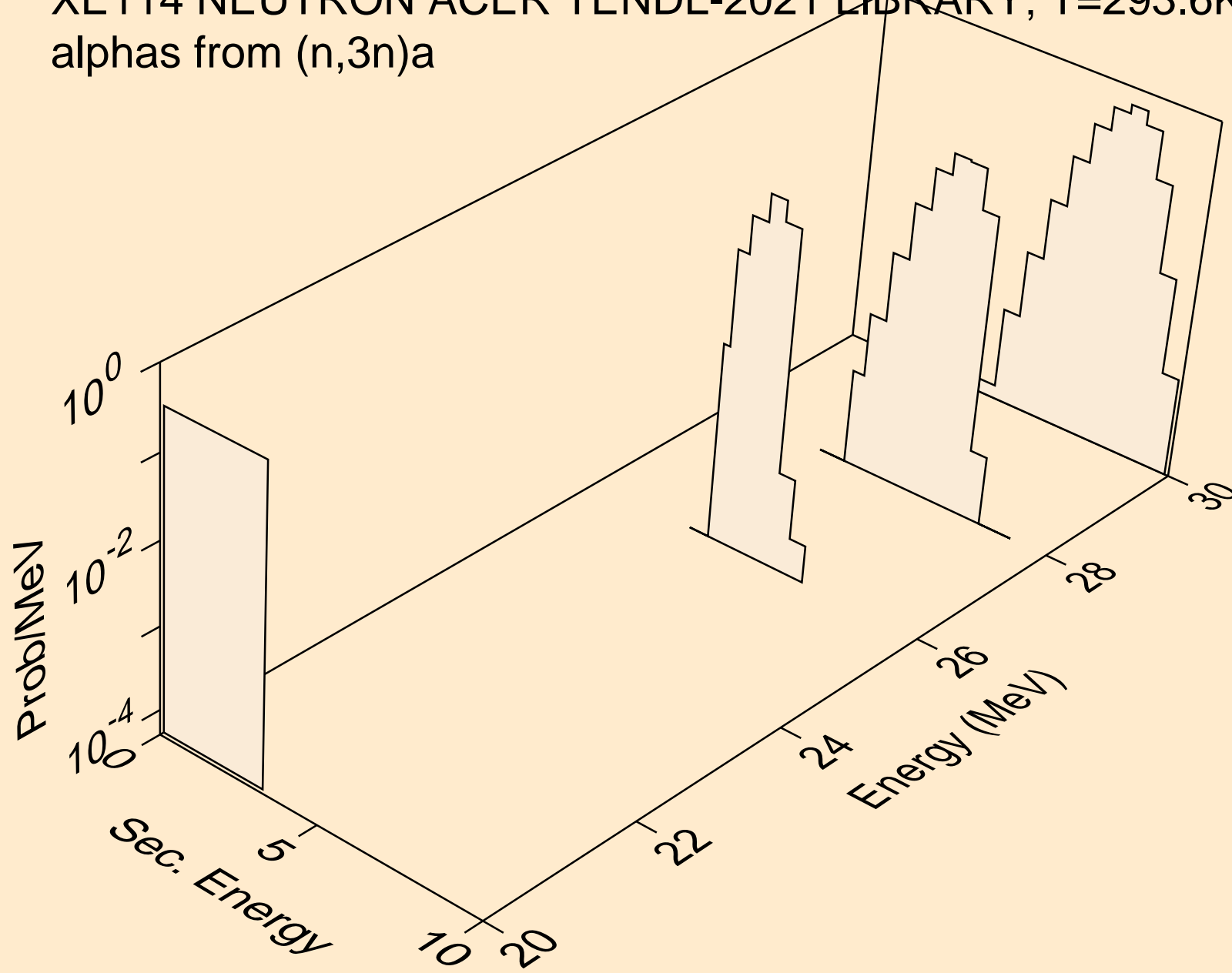

XE114 NEUTRON ACER TENDL-2021 LIBRARY; T=293.6K
alphas from (n,n*)2a

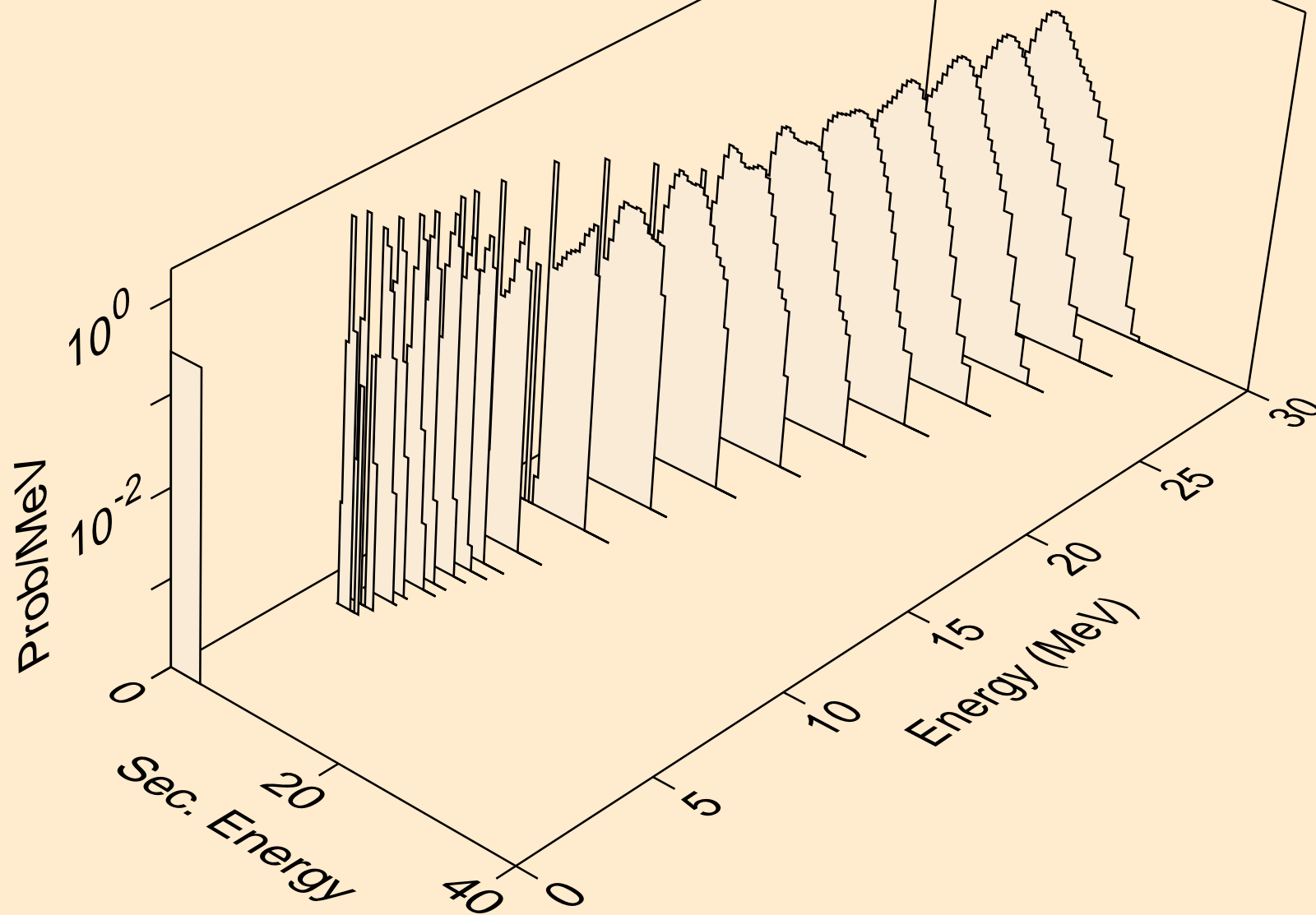

XE114 NEUTRON ACER TENDL-2021 LIBRARY; T=293.6K
alphas from (n,2n)2a

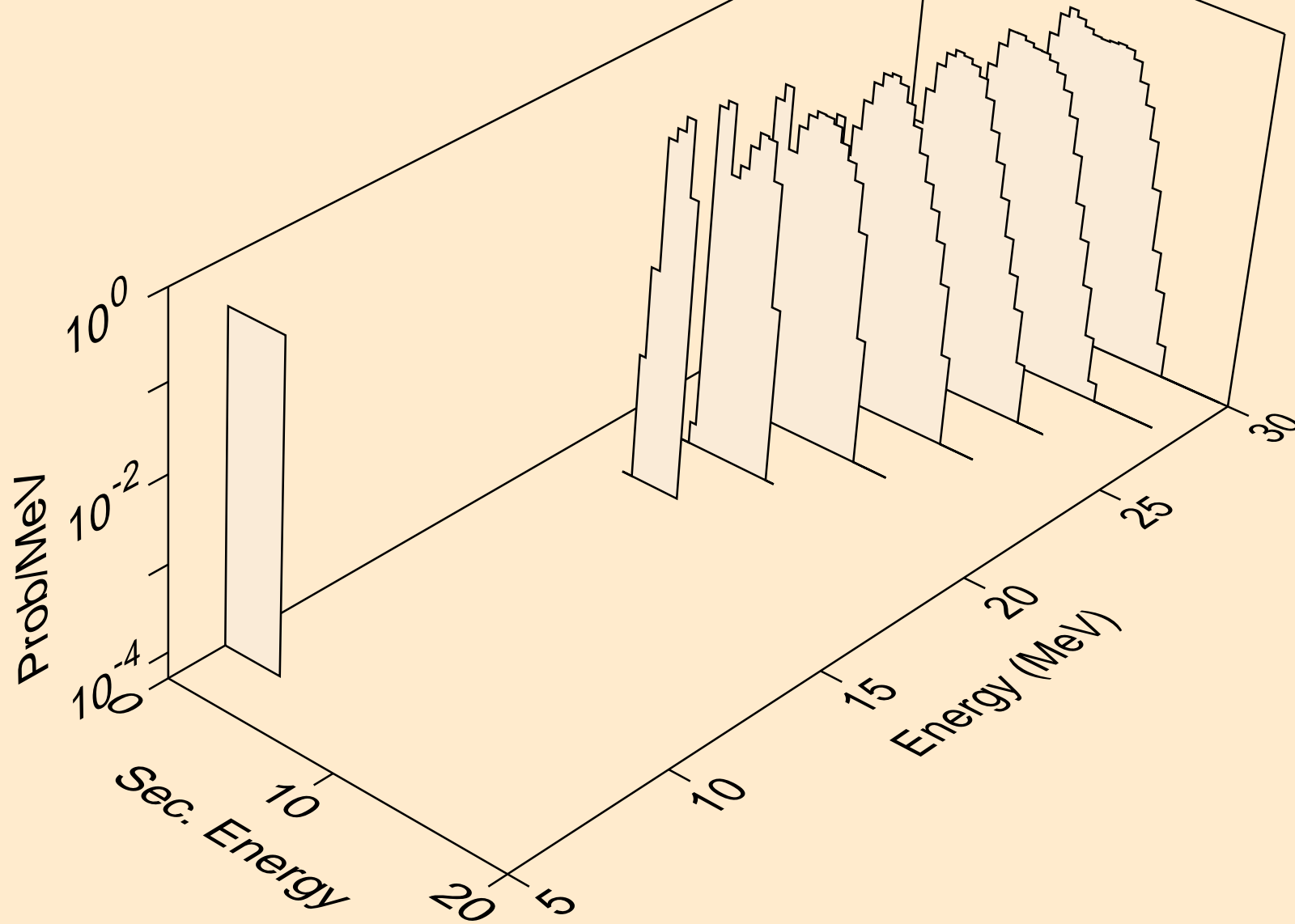

XE114 NEUTRON ACER TENDL-2021 LIBRARY; T=293.6K
alphas from (n,npa)

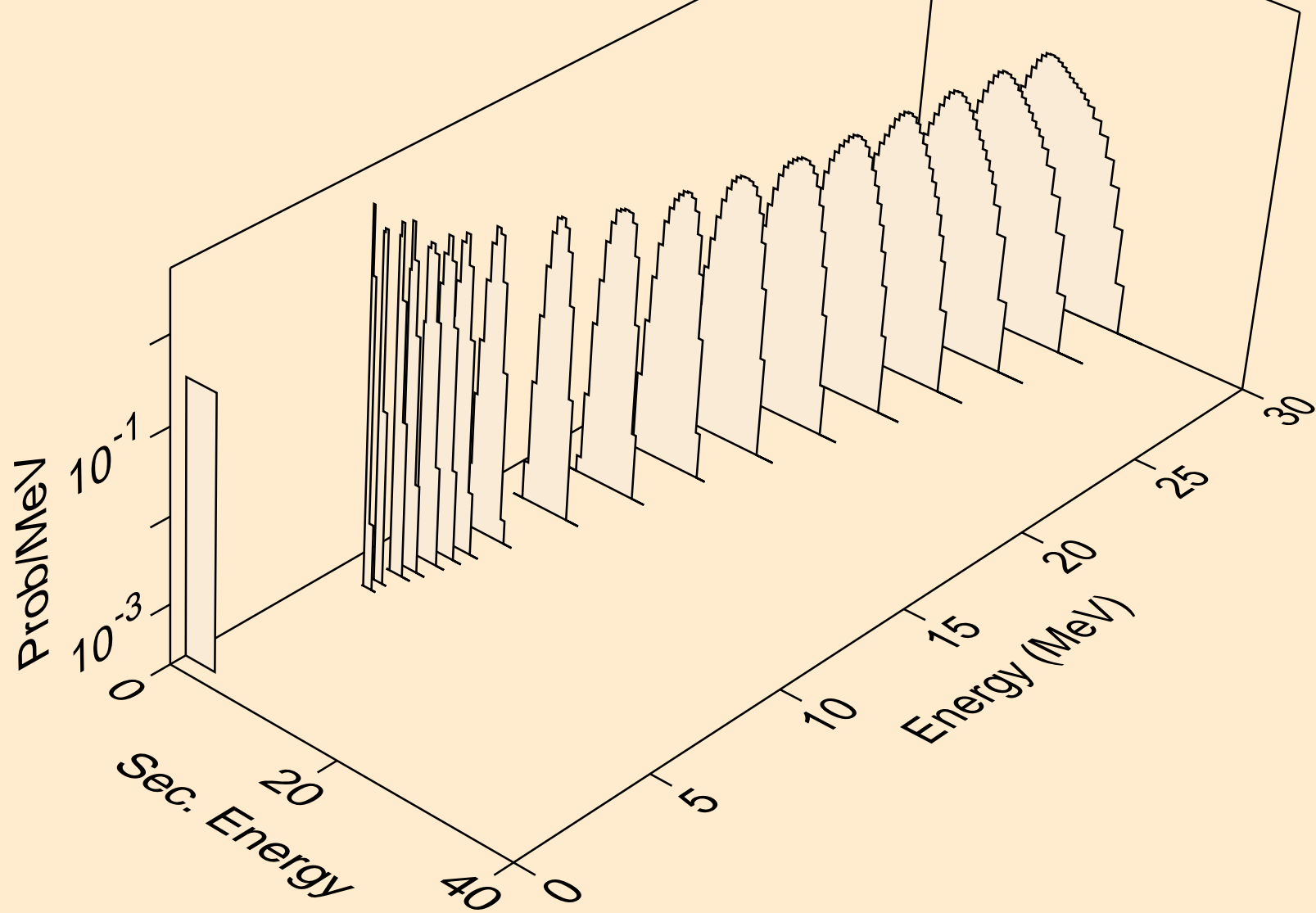

XE114 NEUTRON ACER TENDL-2021 LIBRARY; T=293.6K
alphas from (n,a)

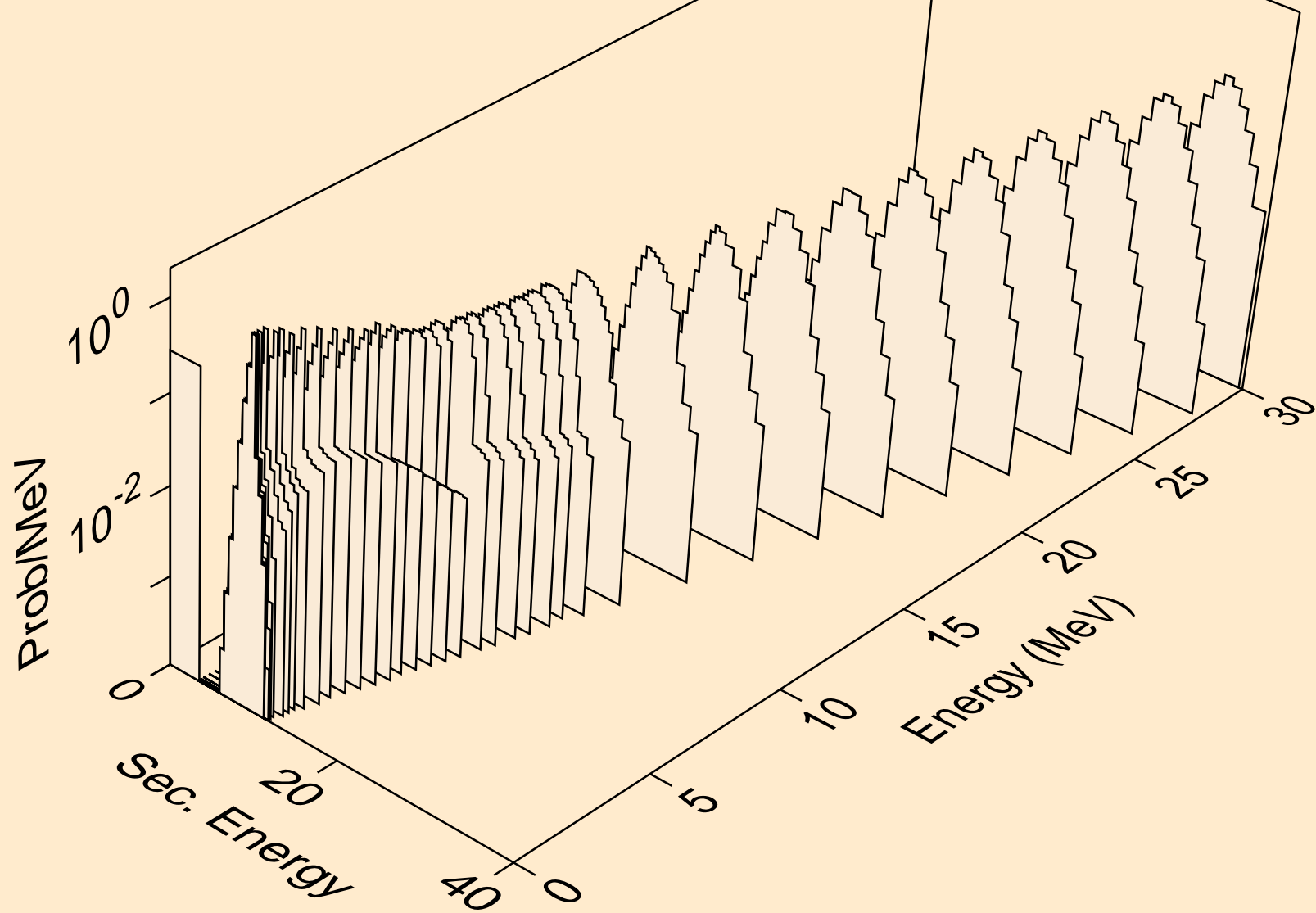

XE114 NEUTRON ACER TENDL-2021 LIBRARY; T=293.6K
alphas from (n,2a)

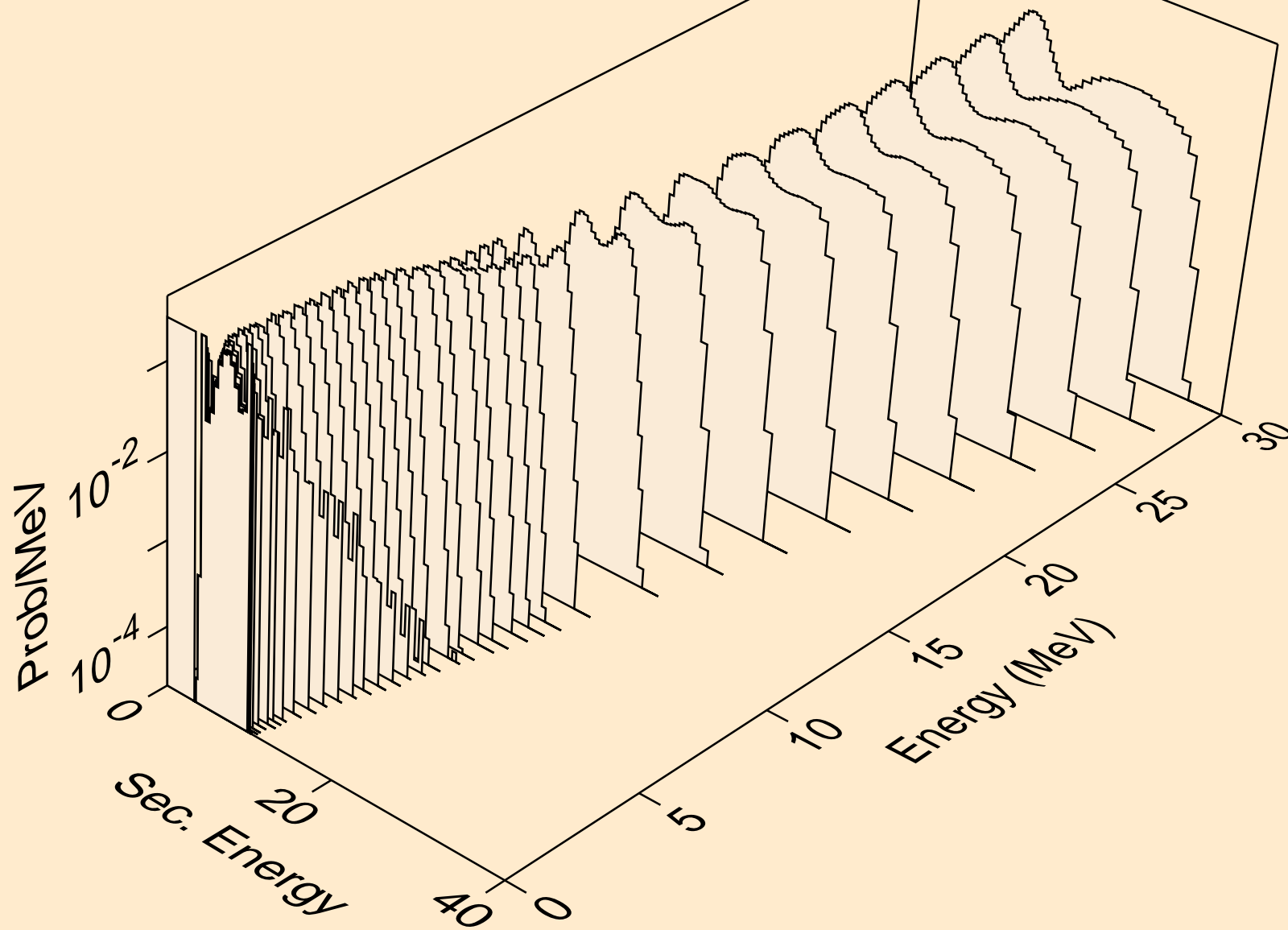

XE114 NEUTRON ACER TENDL-2021 LIBRARY; T=293.6K
alphas from (n,3a)

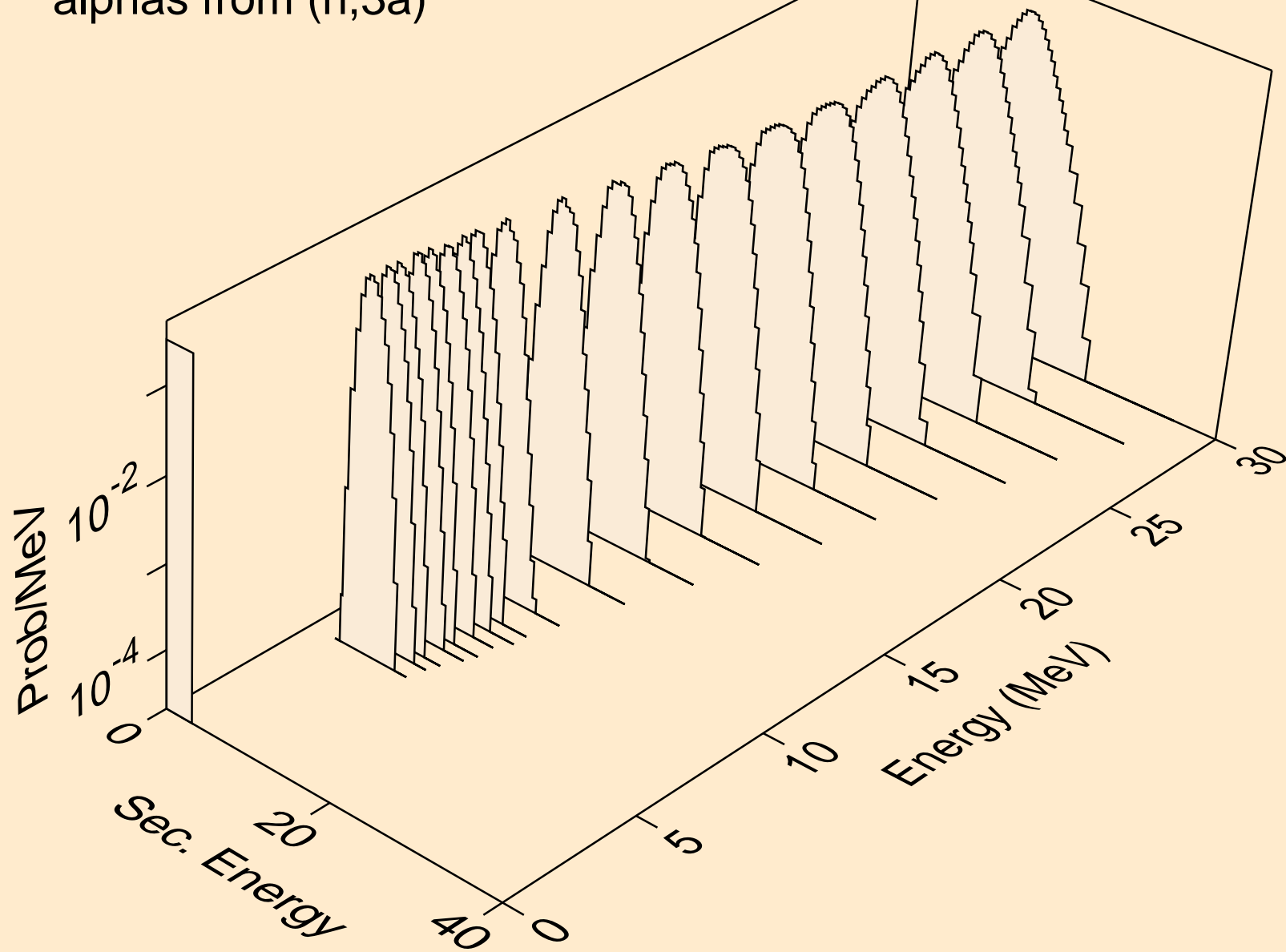

XE114 NEUTRON ACER TENDL-2021 LIBRARY; T=293.6K
alphas from (n,pa)

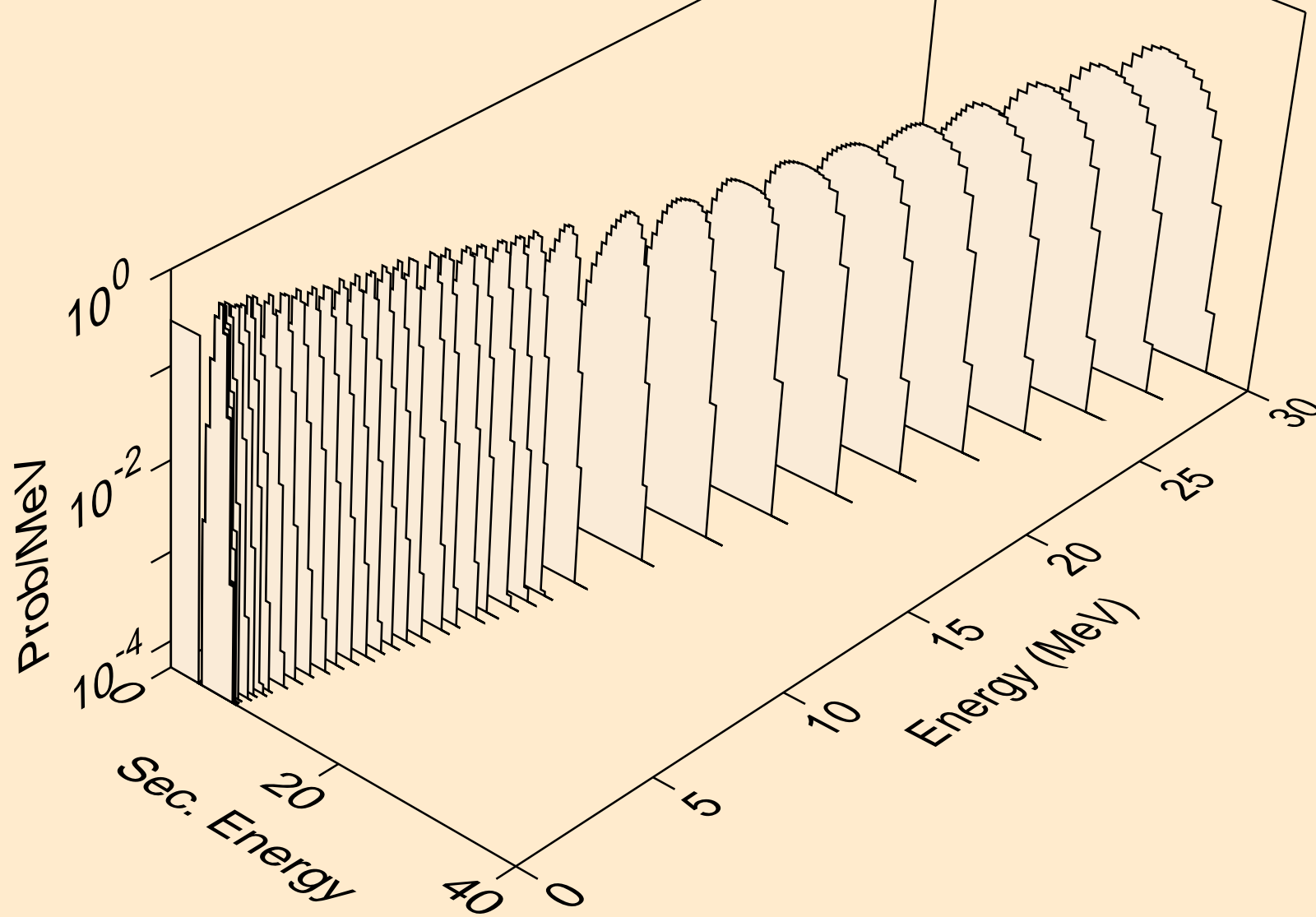

XE114 NEUTRON ACER TENDL-2021 LIBRARY; T=293.6K
alphas from (n,d2a)

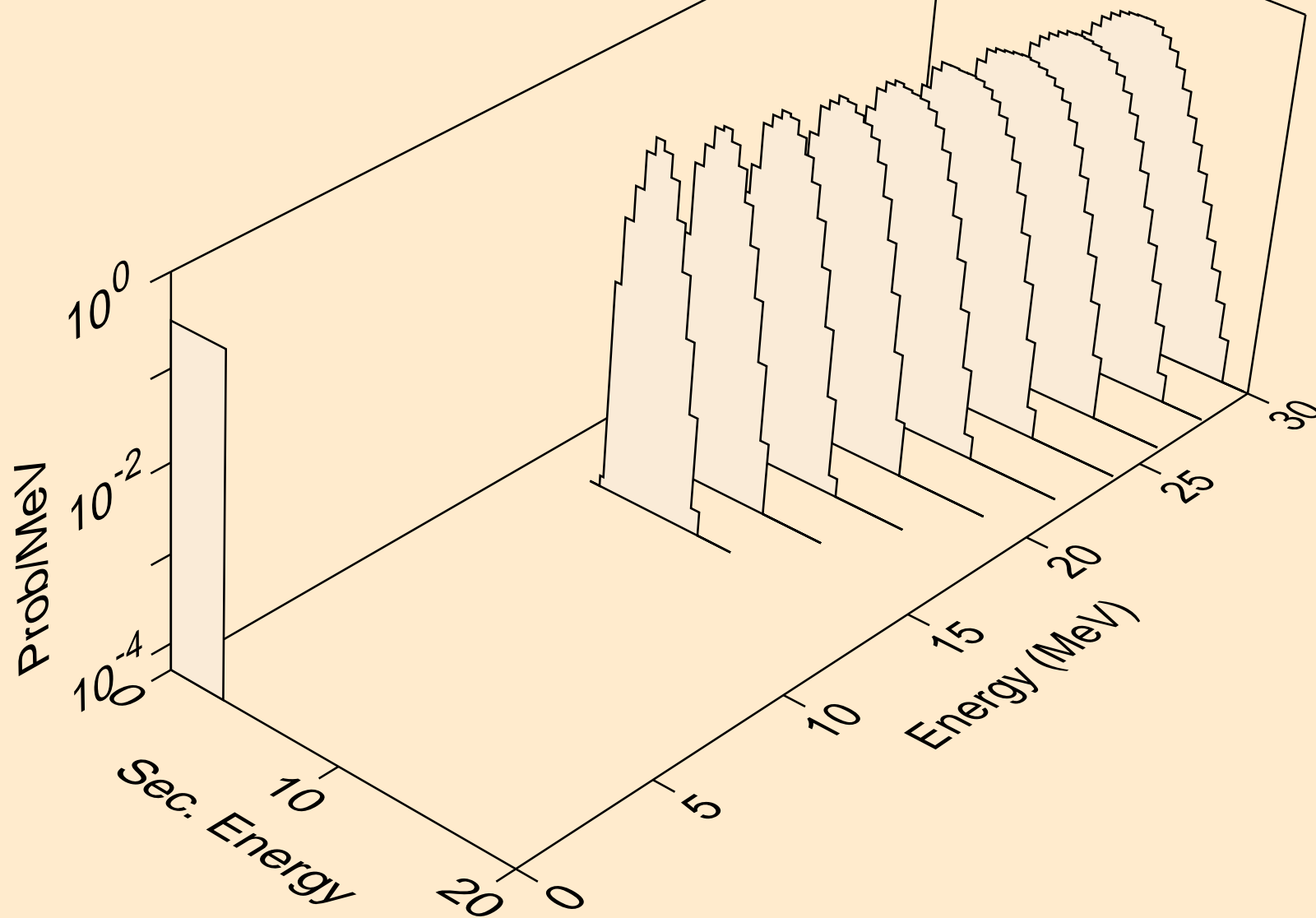

XE114 NEUTRON ACER TENDL-2021 LIBRARY; T=293.6K
alphas from (n,da)

