

# XE136 NEUTRON ACER TENDL-2021 LIBRARY; T=293.6K

## Principal cross sections

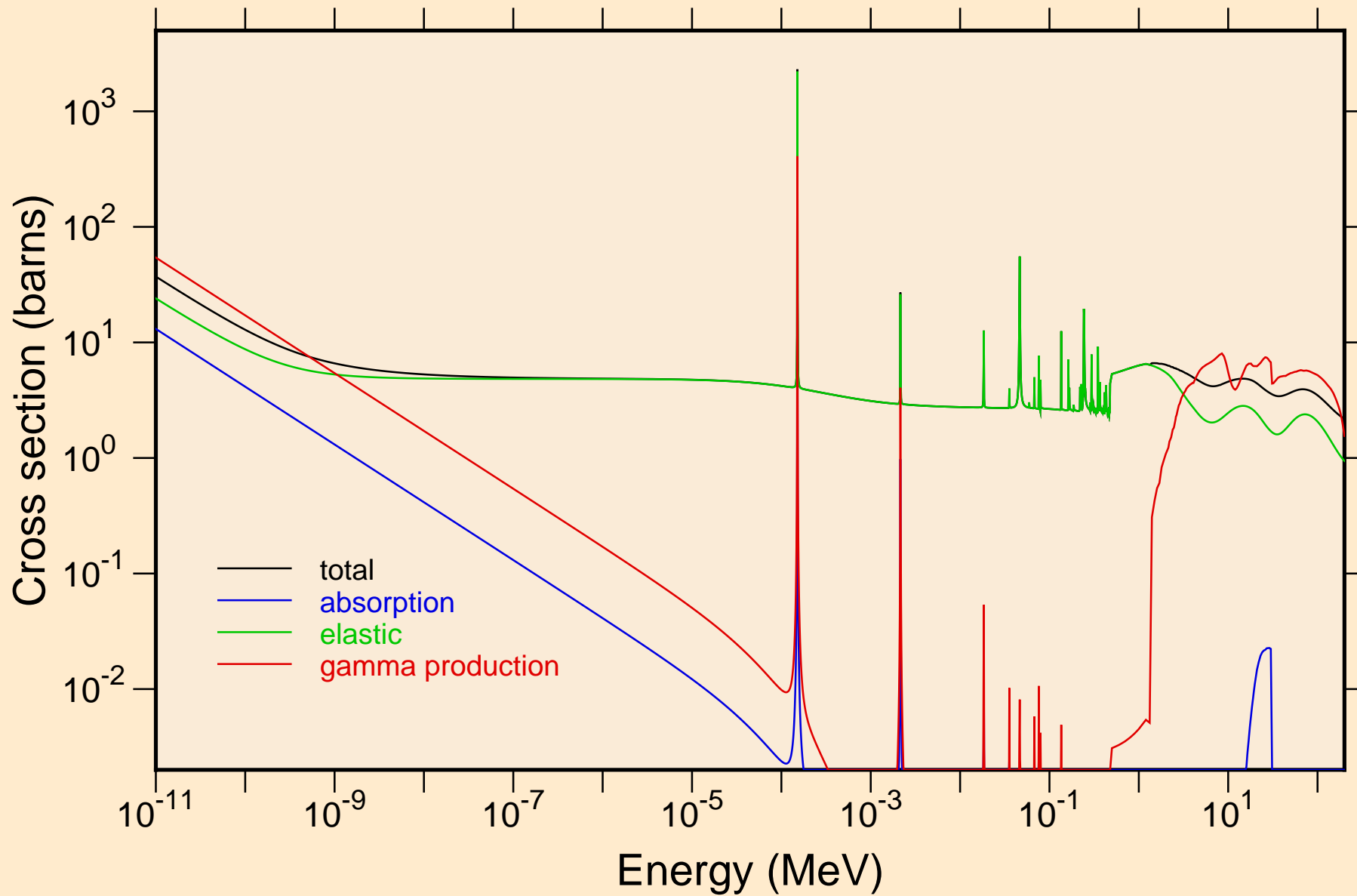

XE136 NEUTRON ACER TENDL-2021 LIBRARY; T=293.6K  
resonance total cross section

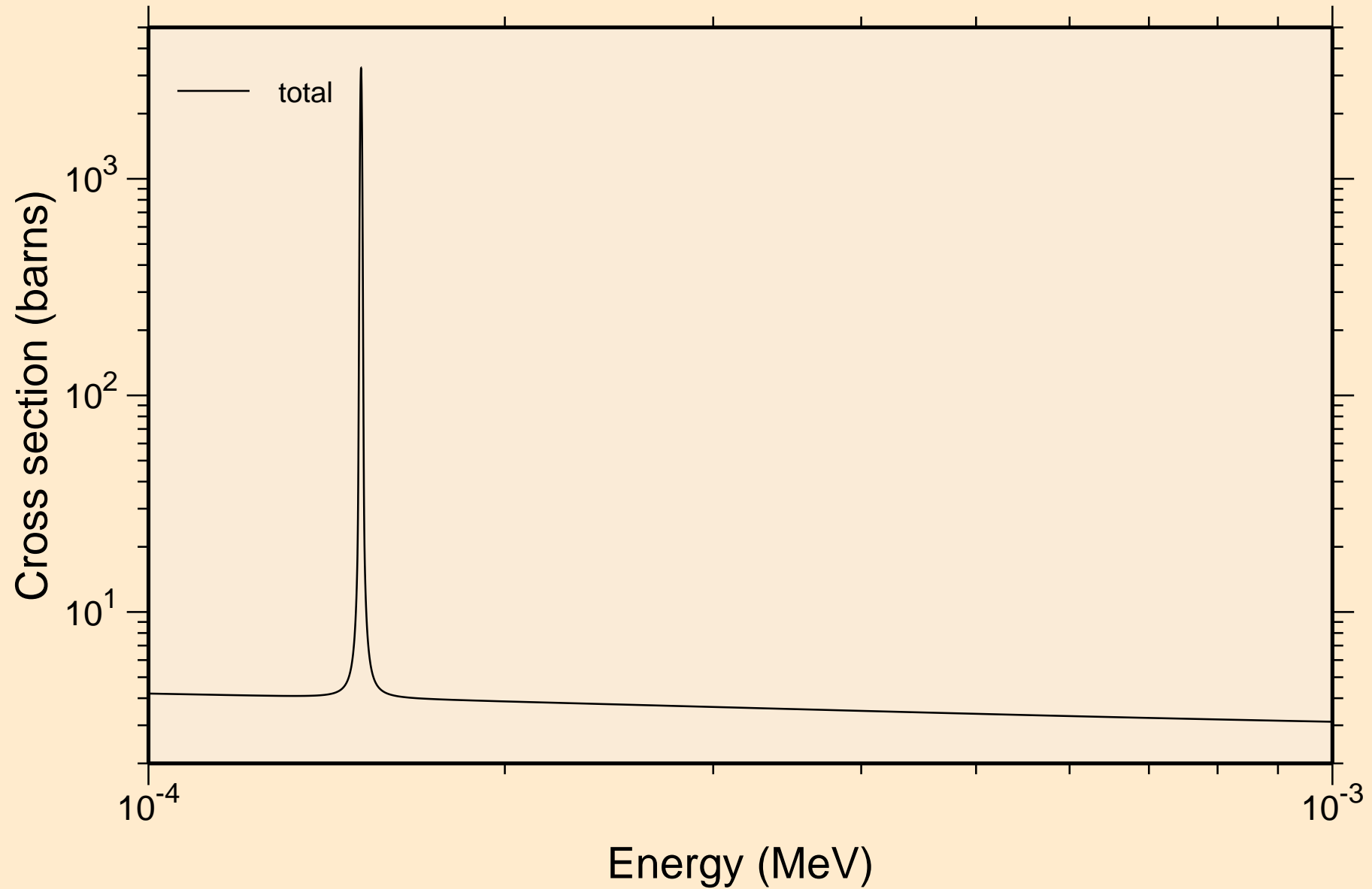

XE136 NEUTRON ACER TENDL-2021 LIBRARY; T=293.6K  
resonance total cross section

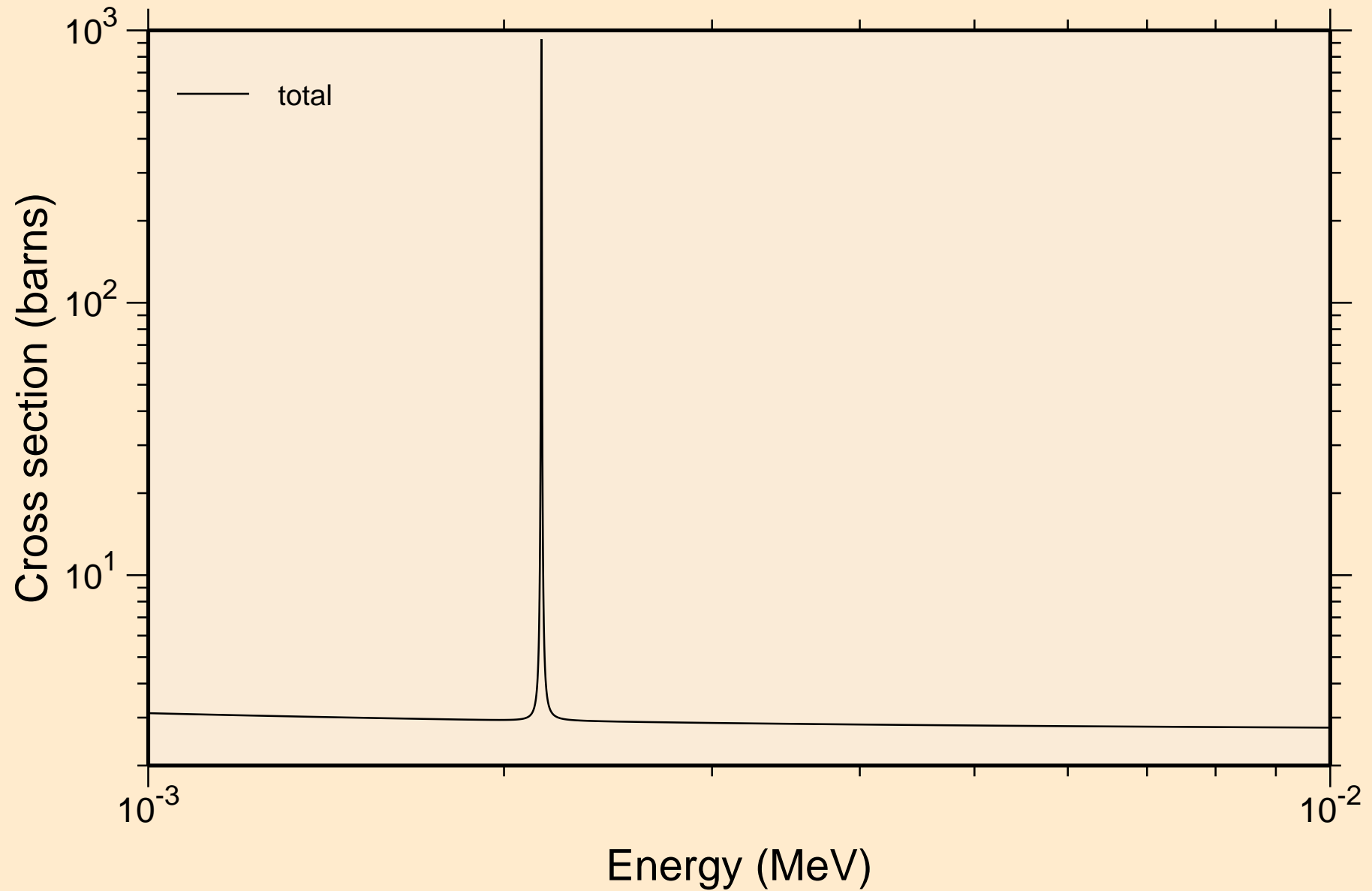

XE136 NEUTRON ACER TENDL-2021 LIBRARY; T=293.6K  
resonance total cross section

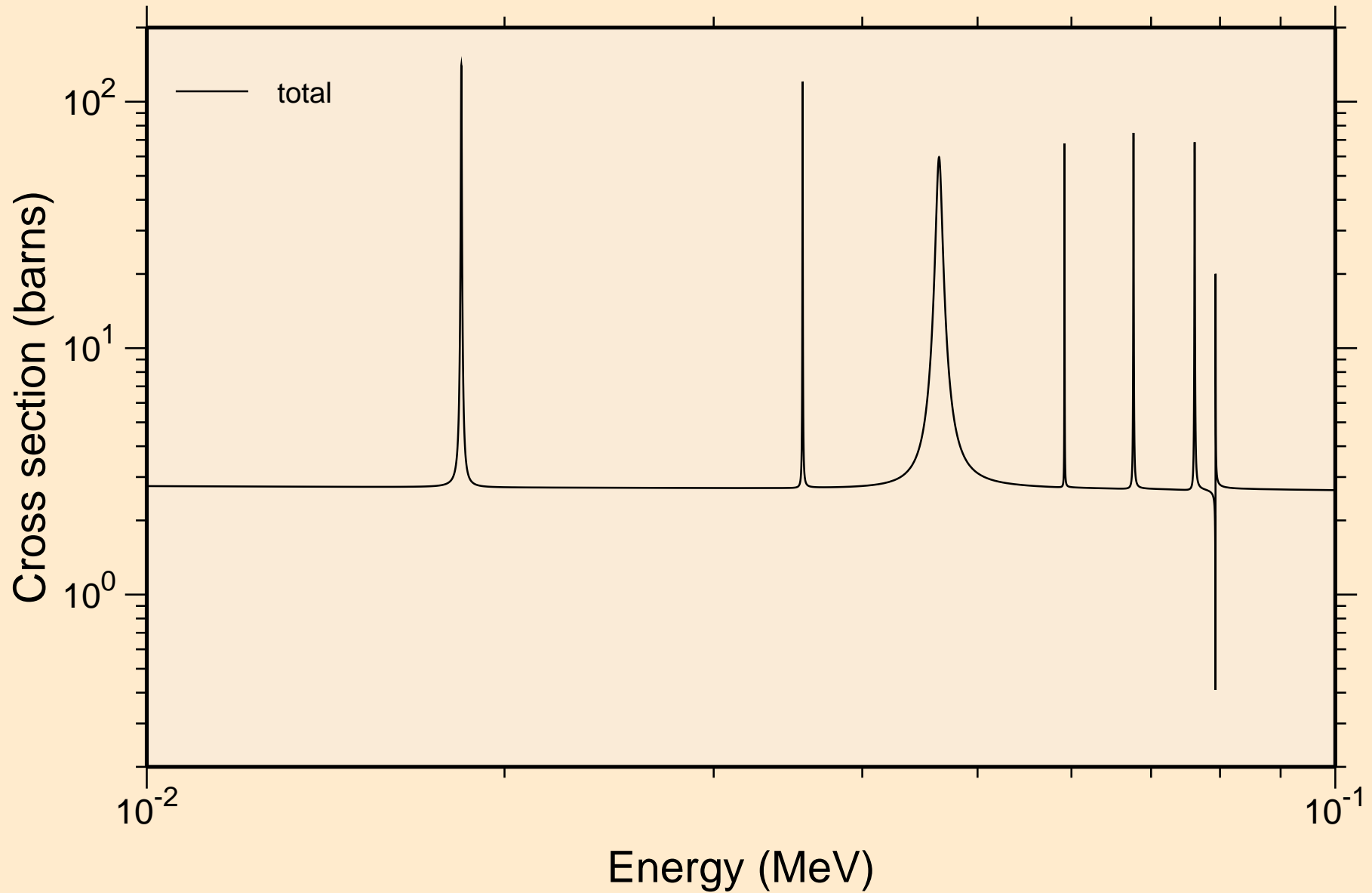

XE136 NEUTRON ACER TENDL-2021 LIBRARY; T=293.6K  
resonance total cross section

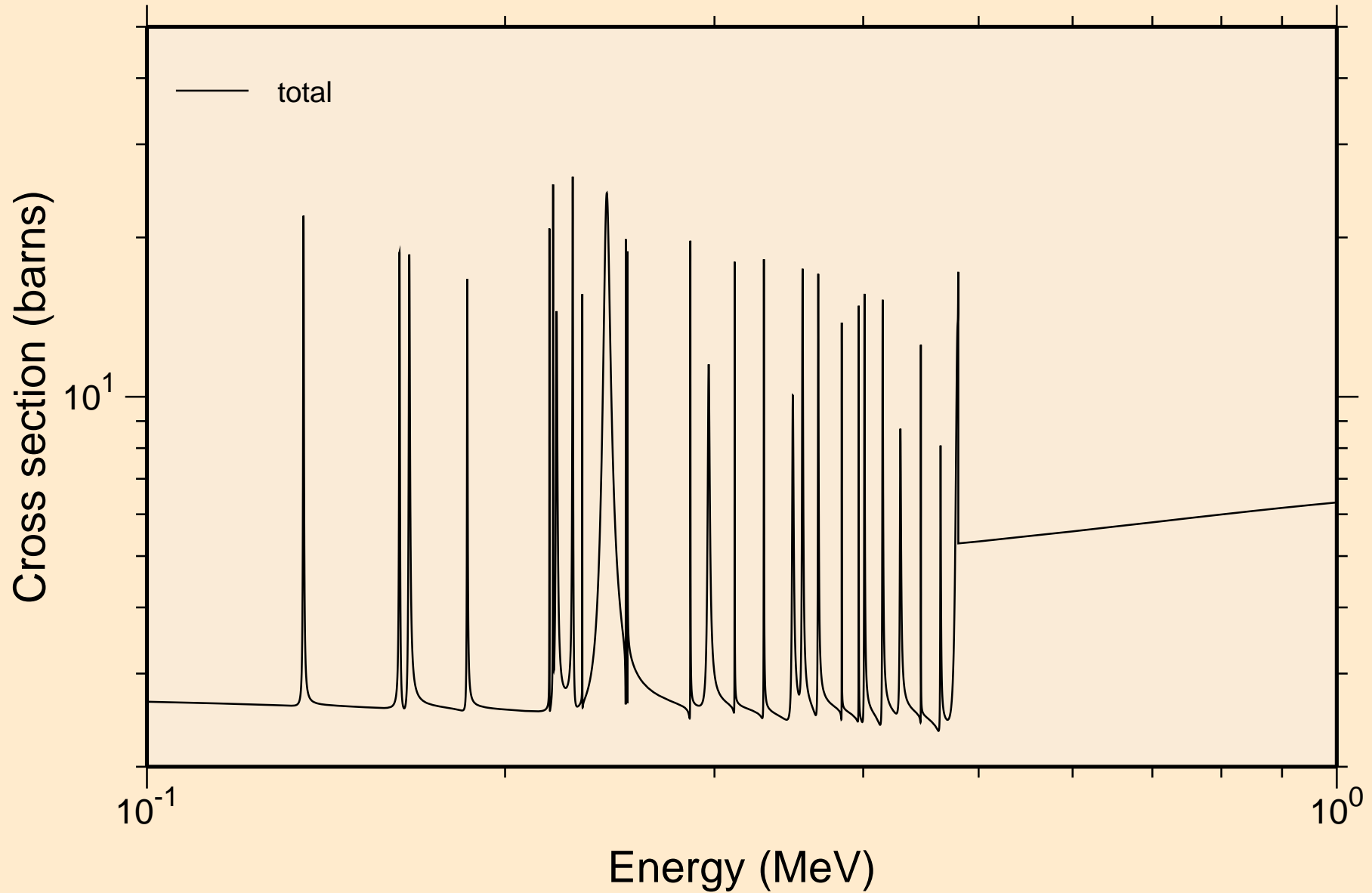

XE136 NEUTRON ACER TENDL-2021 LIBRARY; T=293.6K  
resonance total cross section

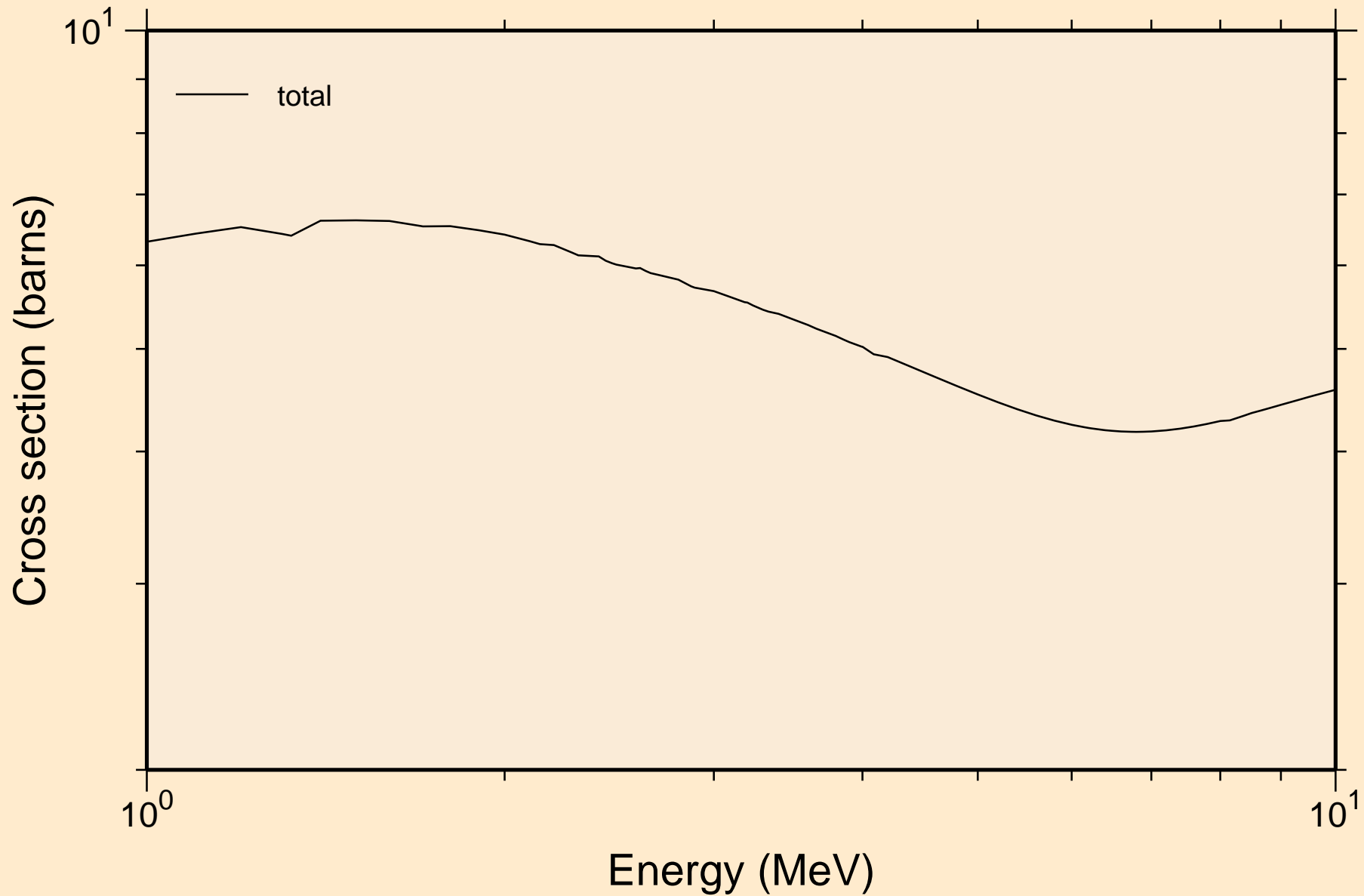

XE136 NEUTRON ACER TENDL-2021 LIBRARY; T=293.6K  
resonance absorption cross sections

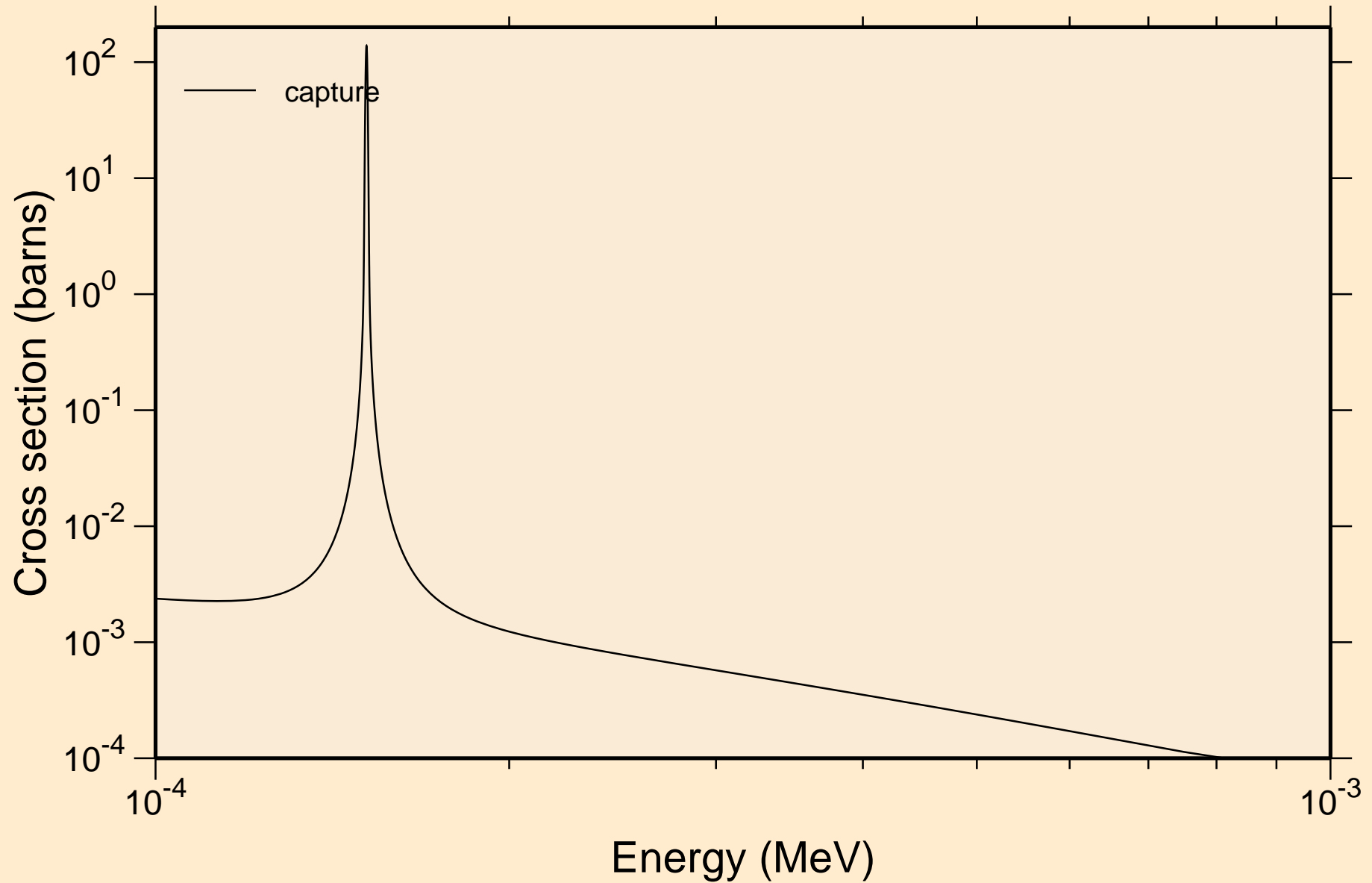

XE136 NEUTRON ACER TENDL-2021 LIBRARY; T=293.6K  
resonance absorption cross sections

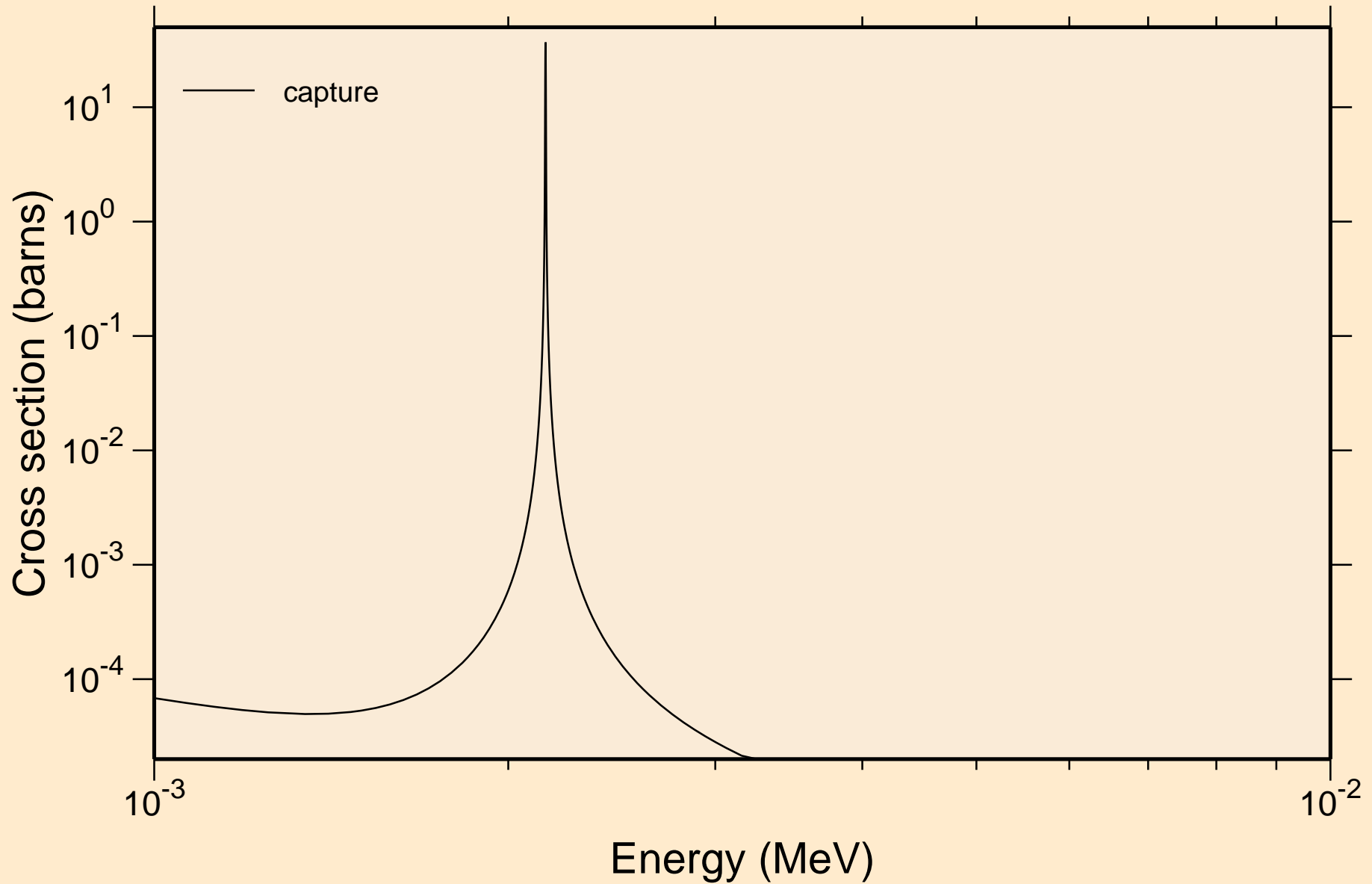



XE136 NEUTRON ACER TENDL-2021 LIBRARY; T=293.6K  
resonance absorption cross sections

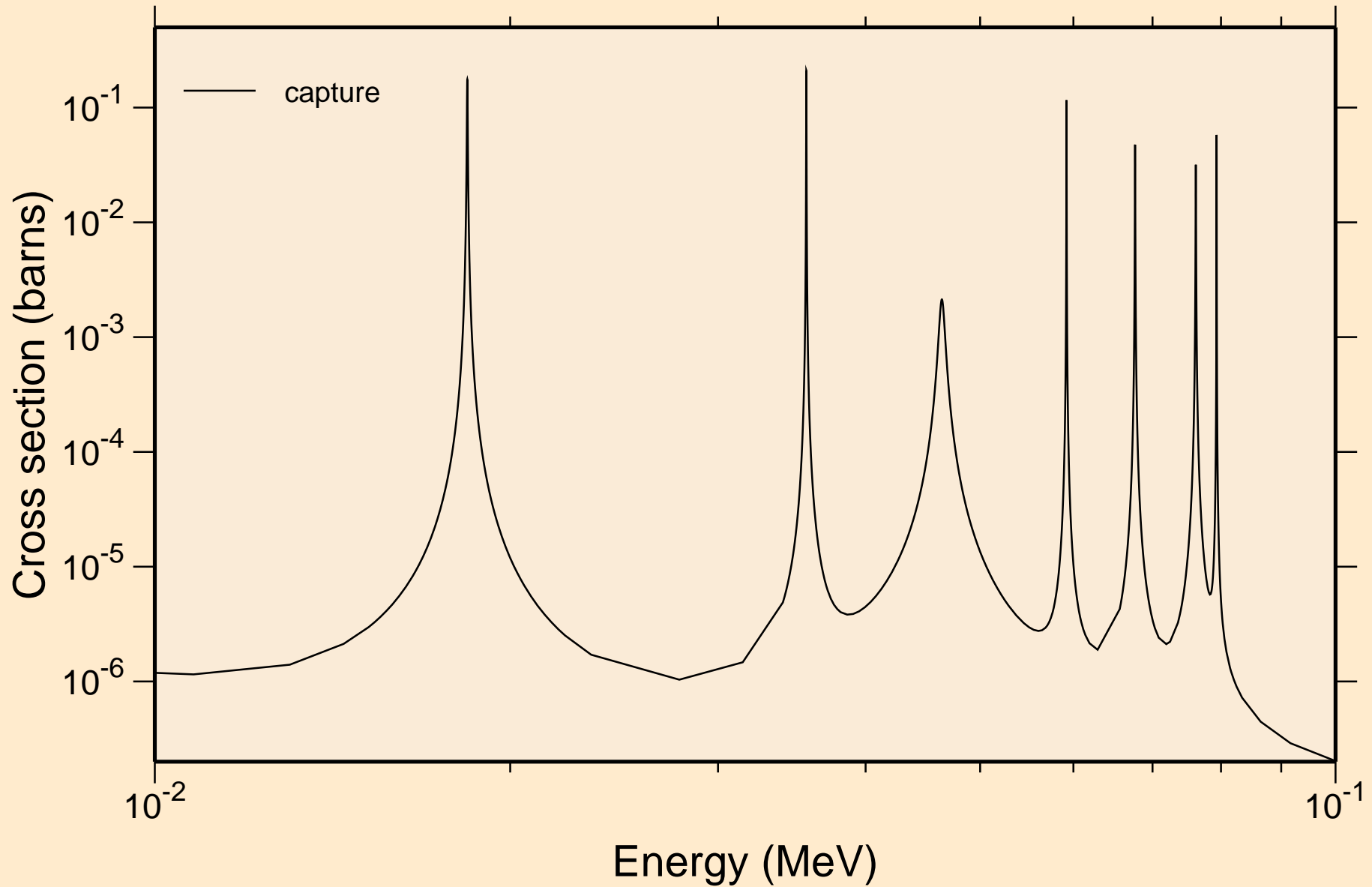

XE136 NEUTRON ACER TENDL-2021 LIBRARY; T=293.6K  
resonance absorption cross sections

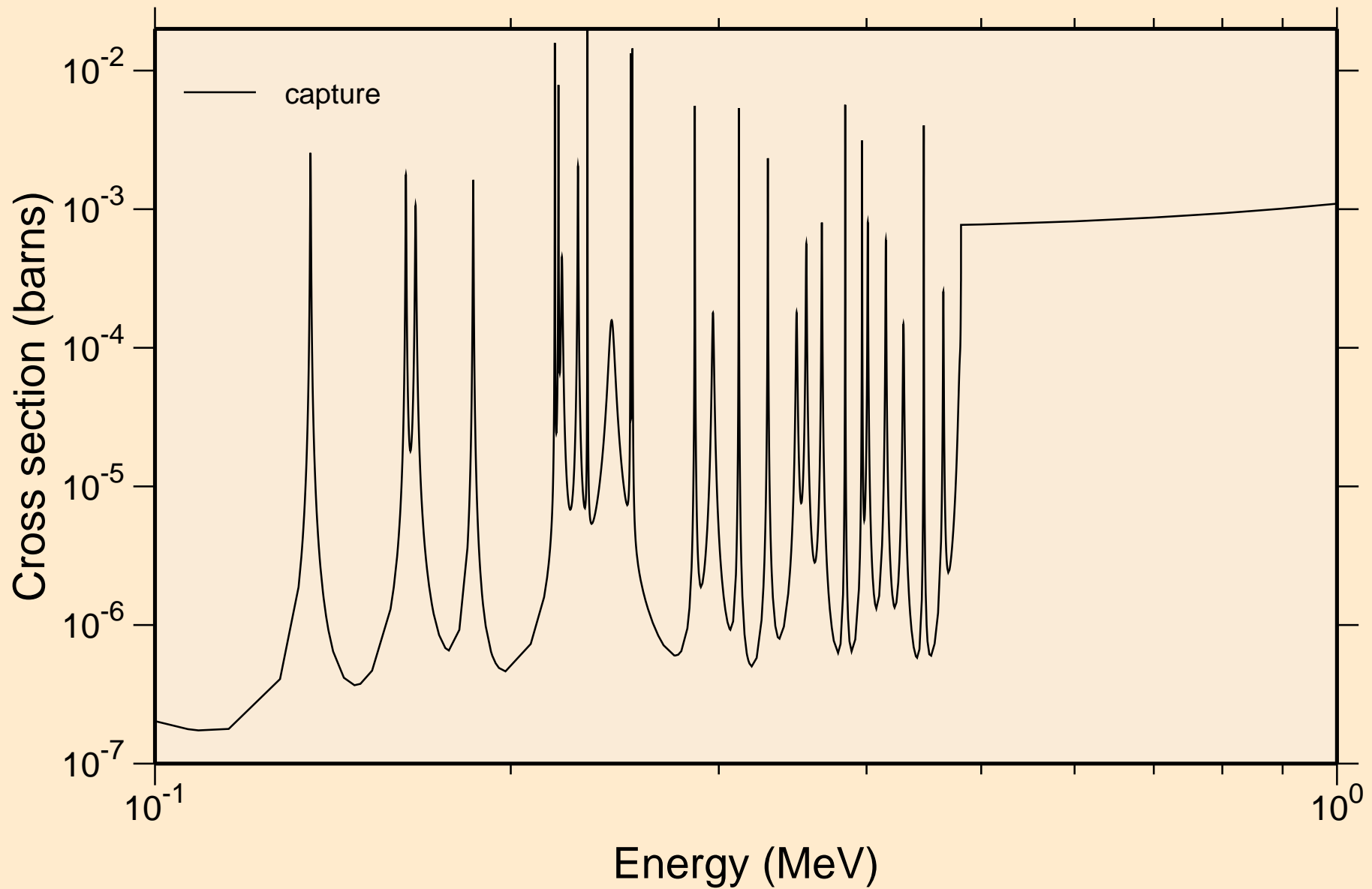

XE136 NEUTRON ACER TENDL-2021 LIBRARY; T=293.6K  
resonance absorption cross sections

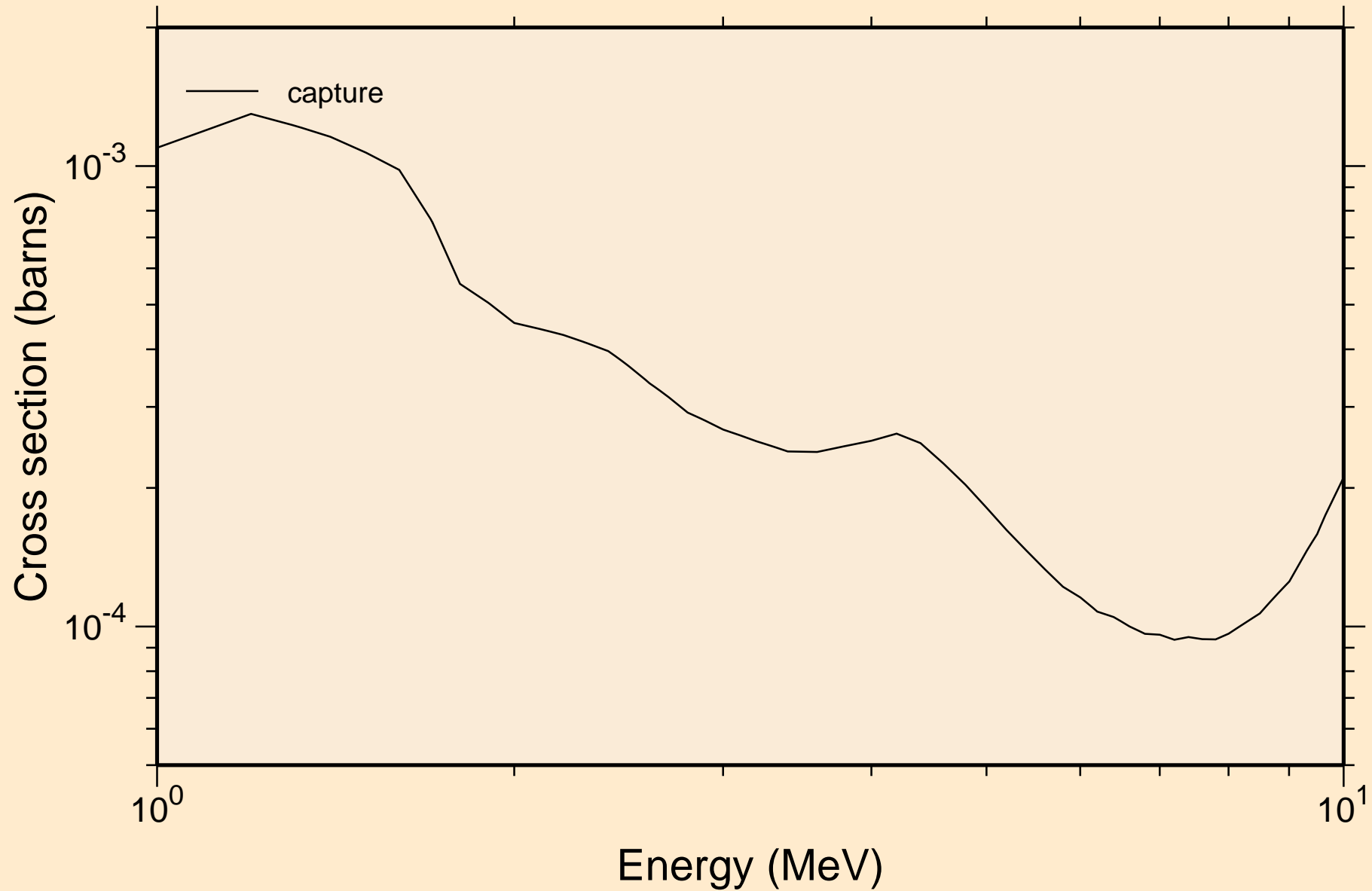

XE136 NEUTRON ACER TENDL-2021 LIBRARY; T=293.6K  
Heating

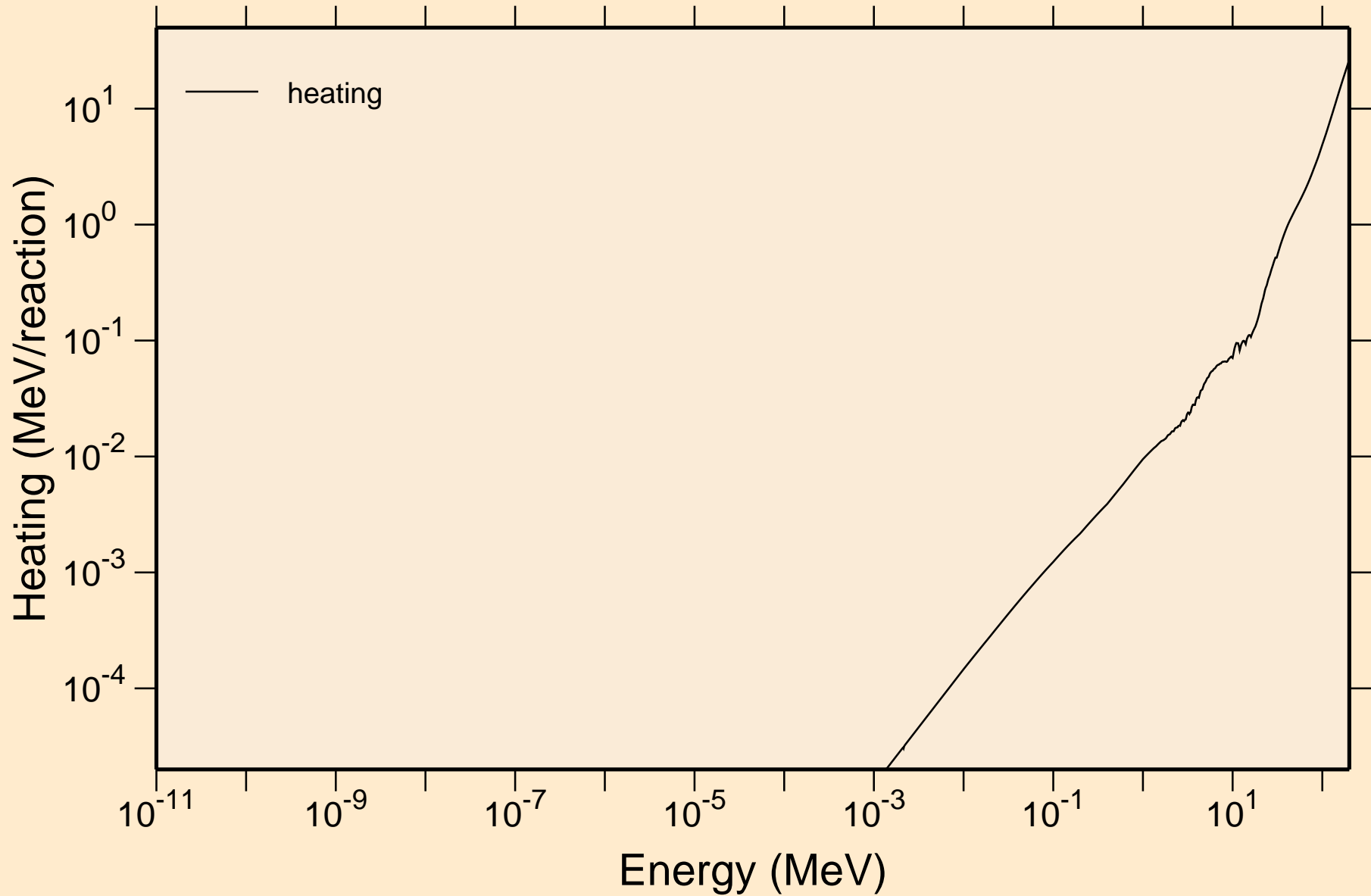

XE136 NEUTRON ACER TENDL-2021 LIBRARY; T=293.6K  
Damage

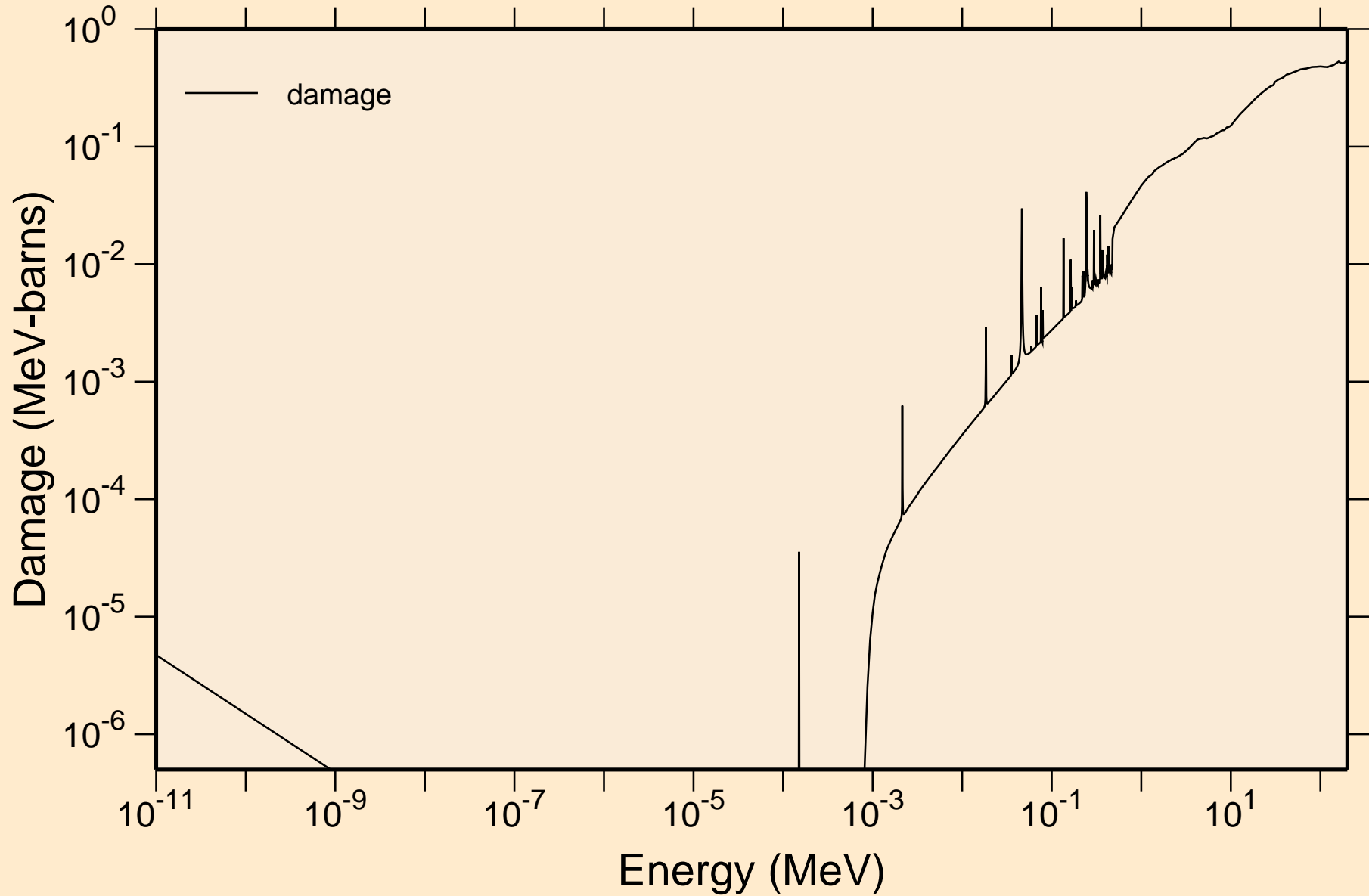

XE136 NEUTRON ACER TENDL-2021 LIBRARY; T=293.6K  
Non-threshold reactions

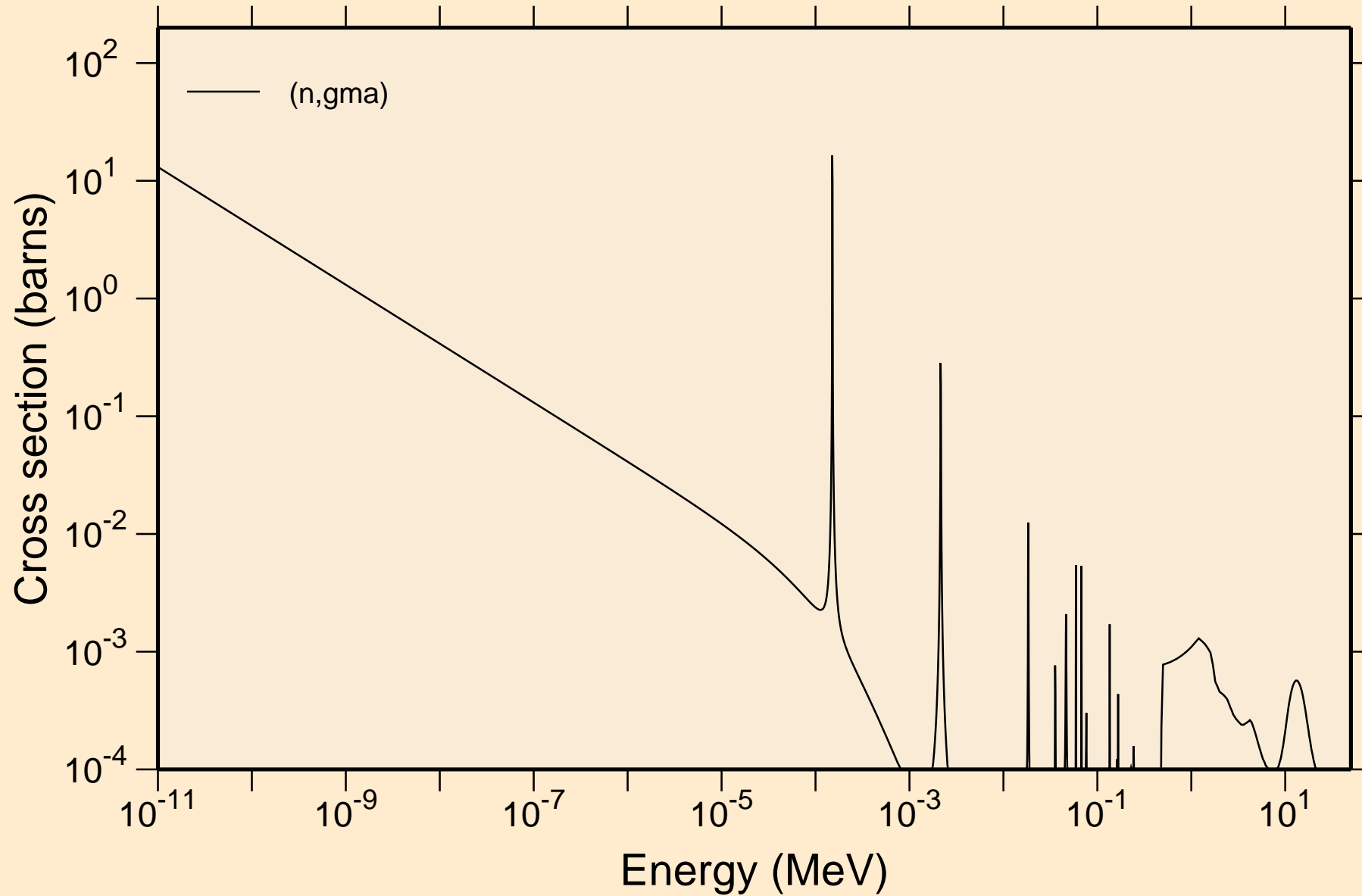

XE136 NEUTRON ACER TENDL-2021 LIBRARY; T=293.6K  
Principal cross sections

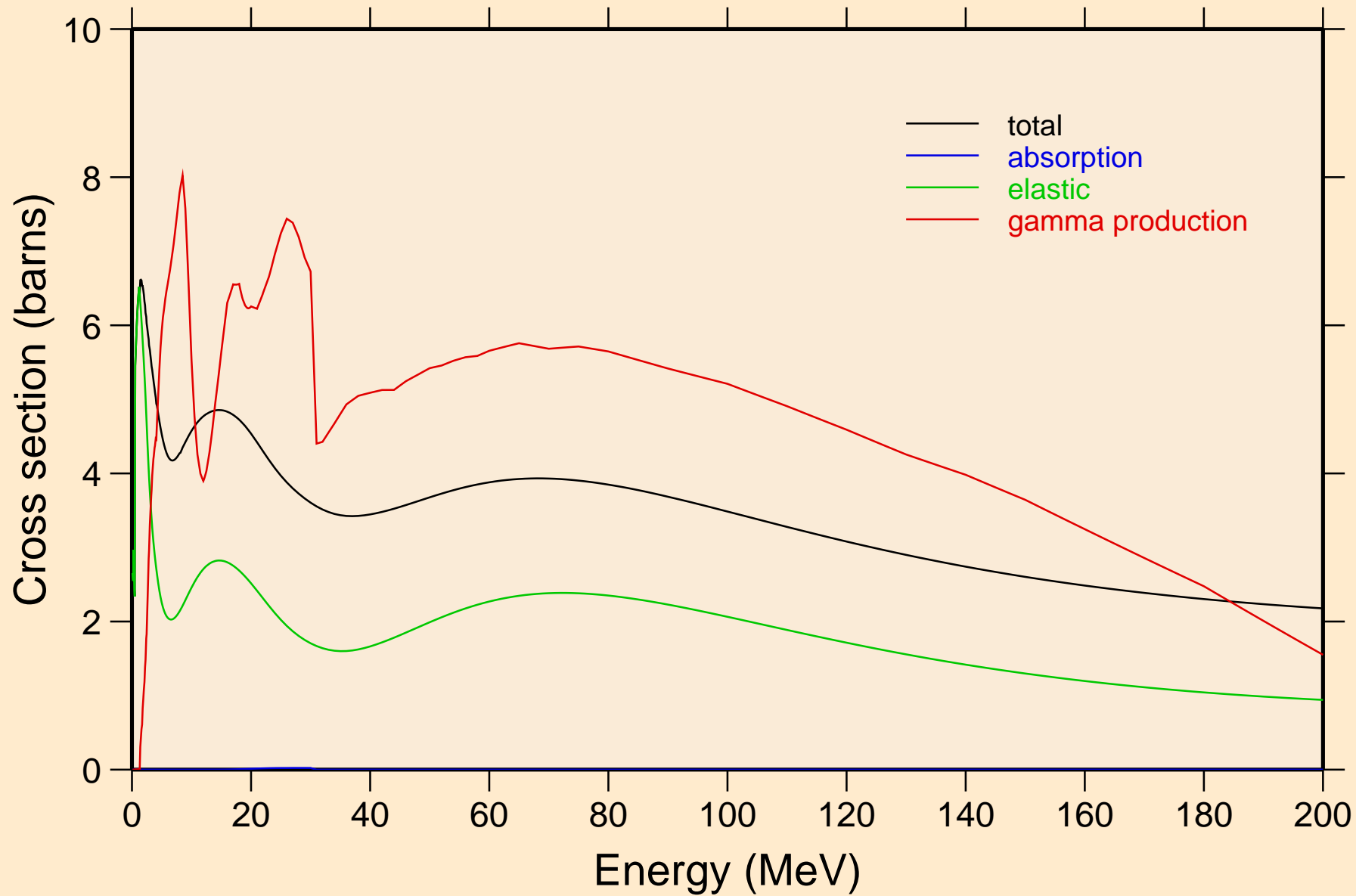

XE136 NEUTRON ACER TENDL-2021 LIBRARY; T=293.6K

Heating

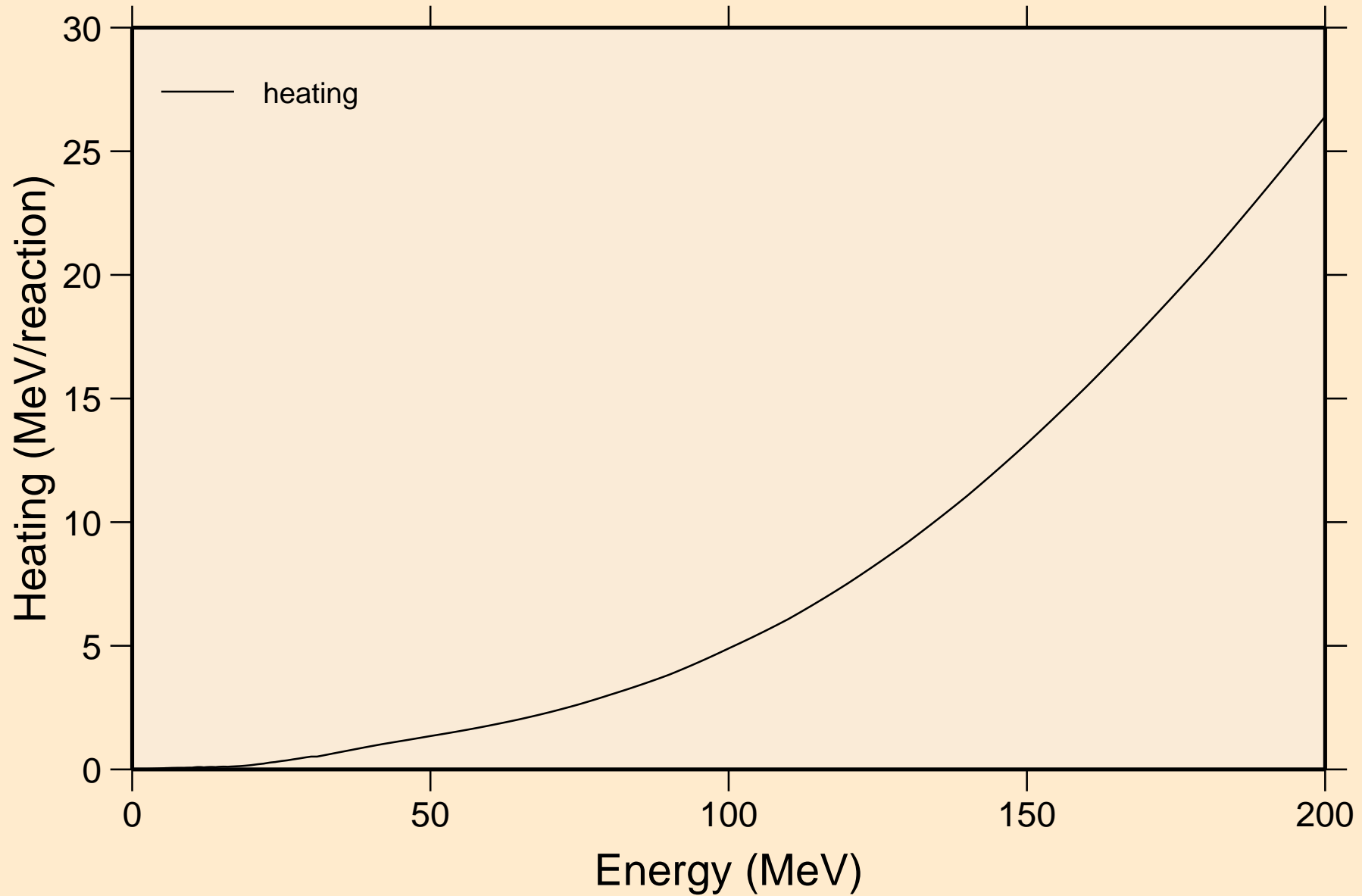



XE136 NEUTRON ACER TENDL-2021 LIBRARY; T=293.6K  
Damage

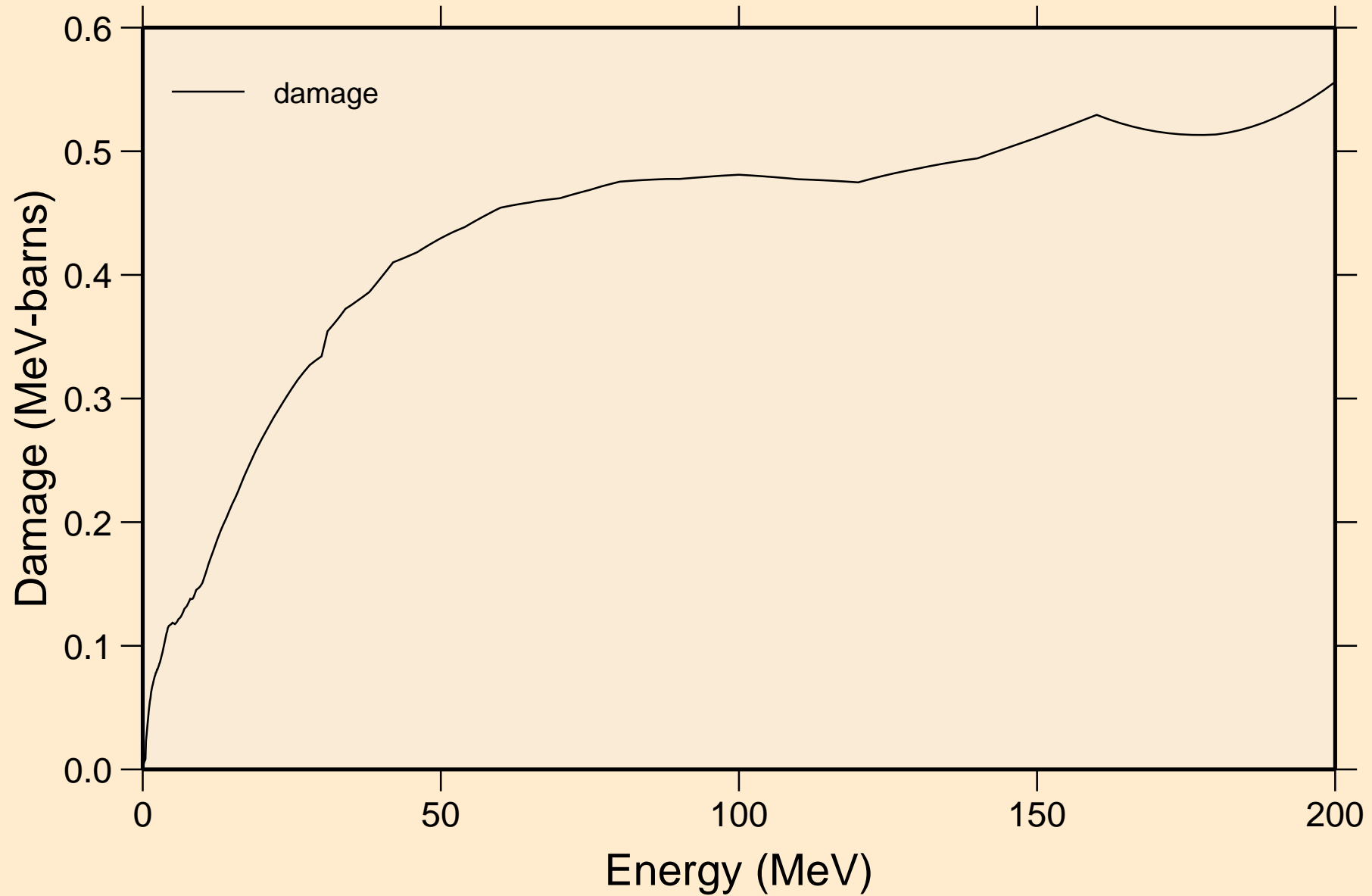

XE136 NEUTRON ACER TENDL-2021 LIBRARY; T=293.6K  
Non-threshold reactions

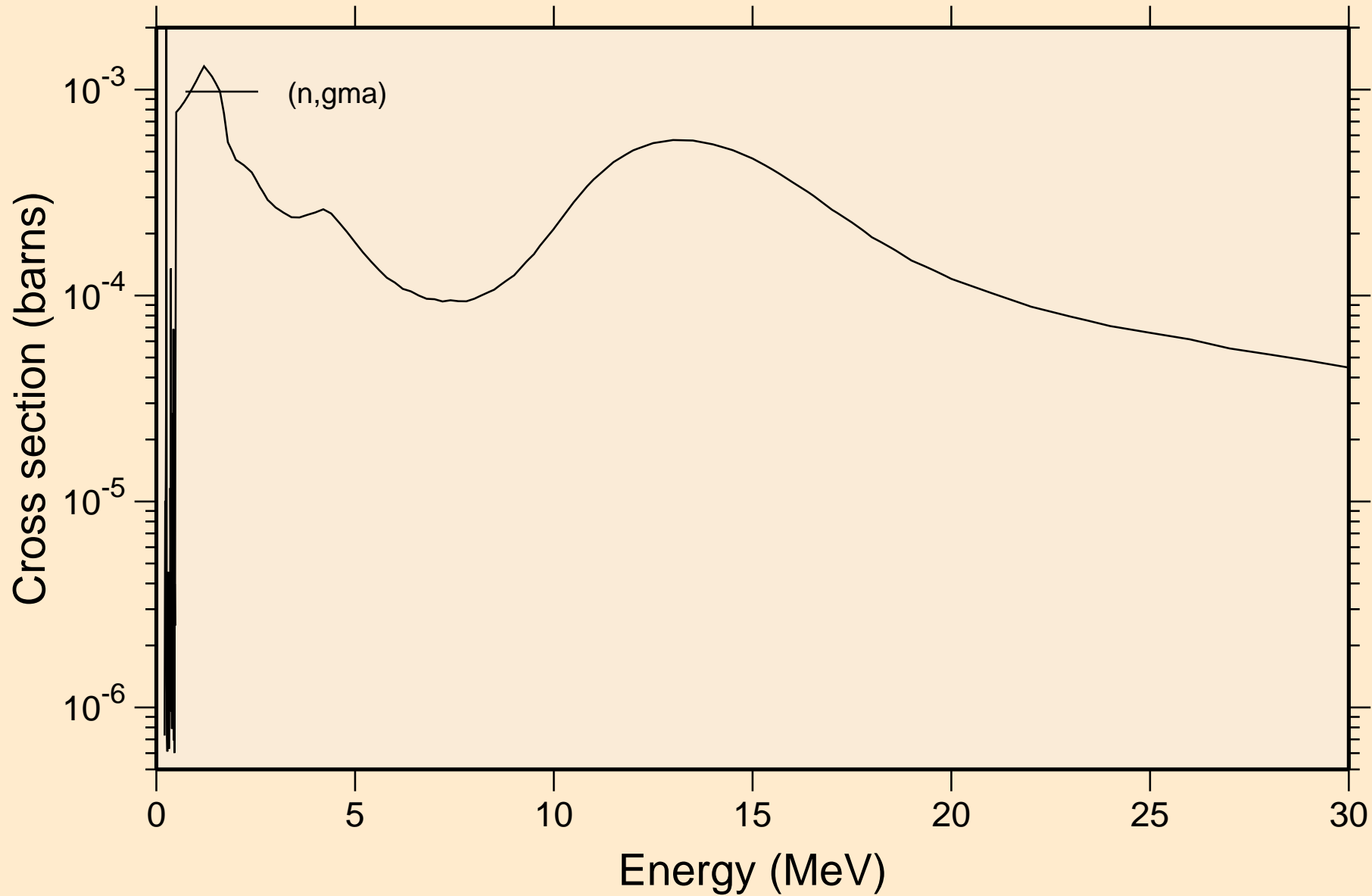

XE136 NEUTRON ACER TENDL-2021 LIBRARY; T=293.6K  
Inelastic levels

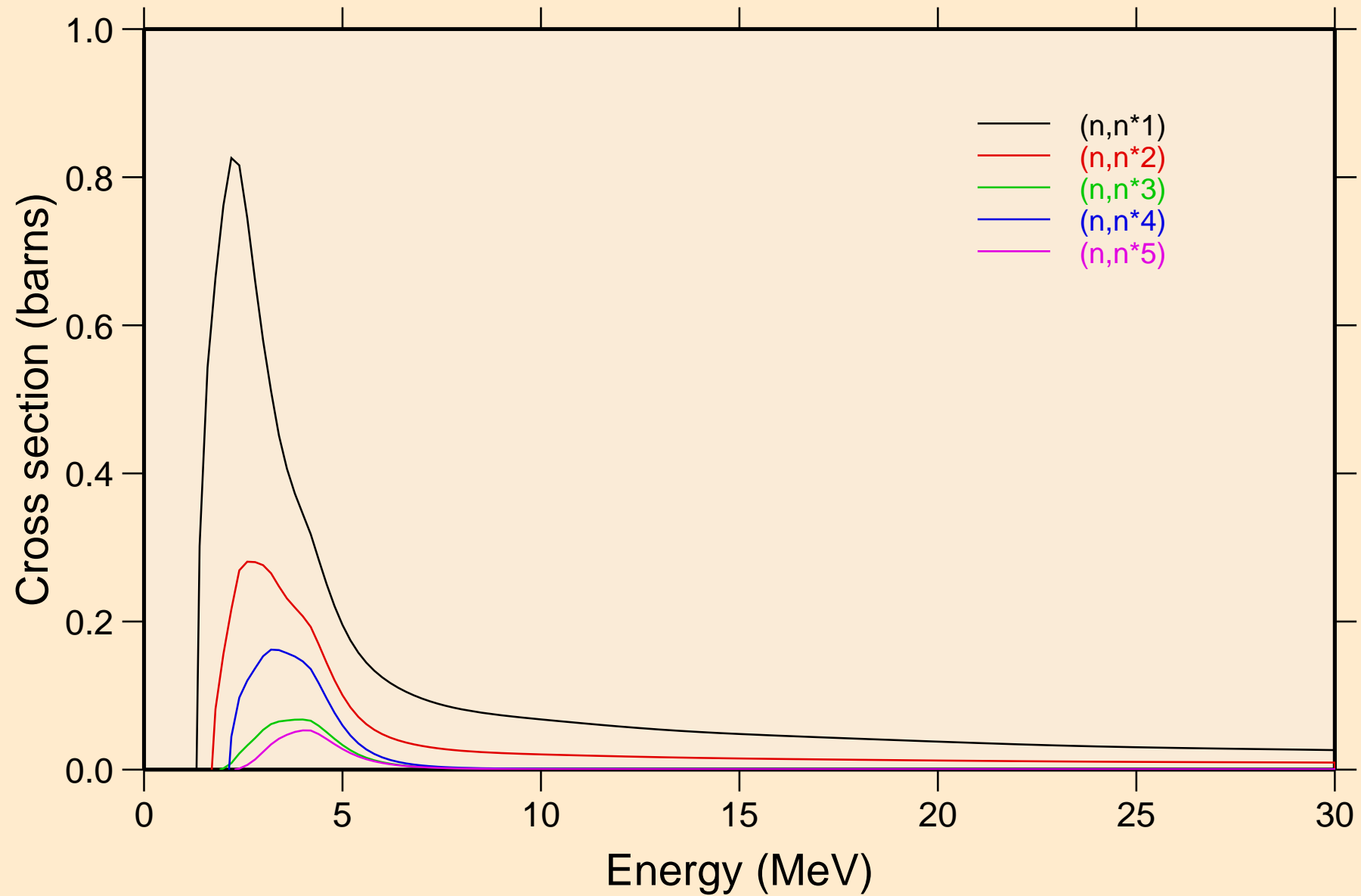

XE136 NEUTRON ACER TENDL-2021 LIBRARY; T=293.6K  
Inelastic levels

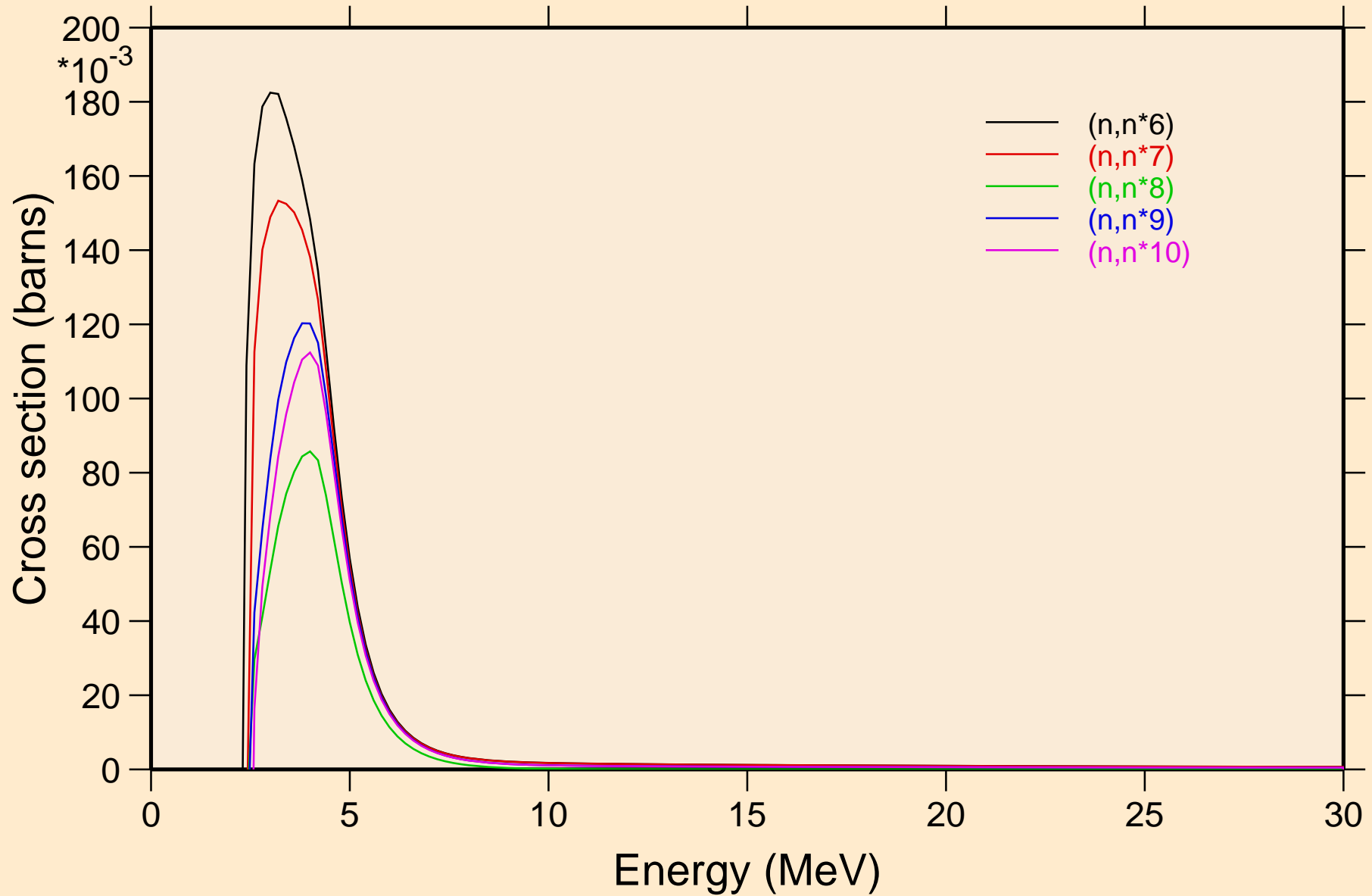

XE136 NEUTRON ACER TENDL-2021 LIBRARY; T=293.6K  
Inelastic levels

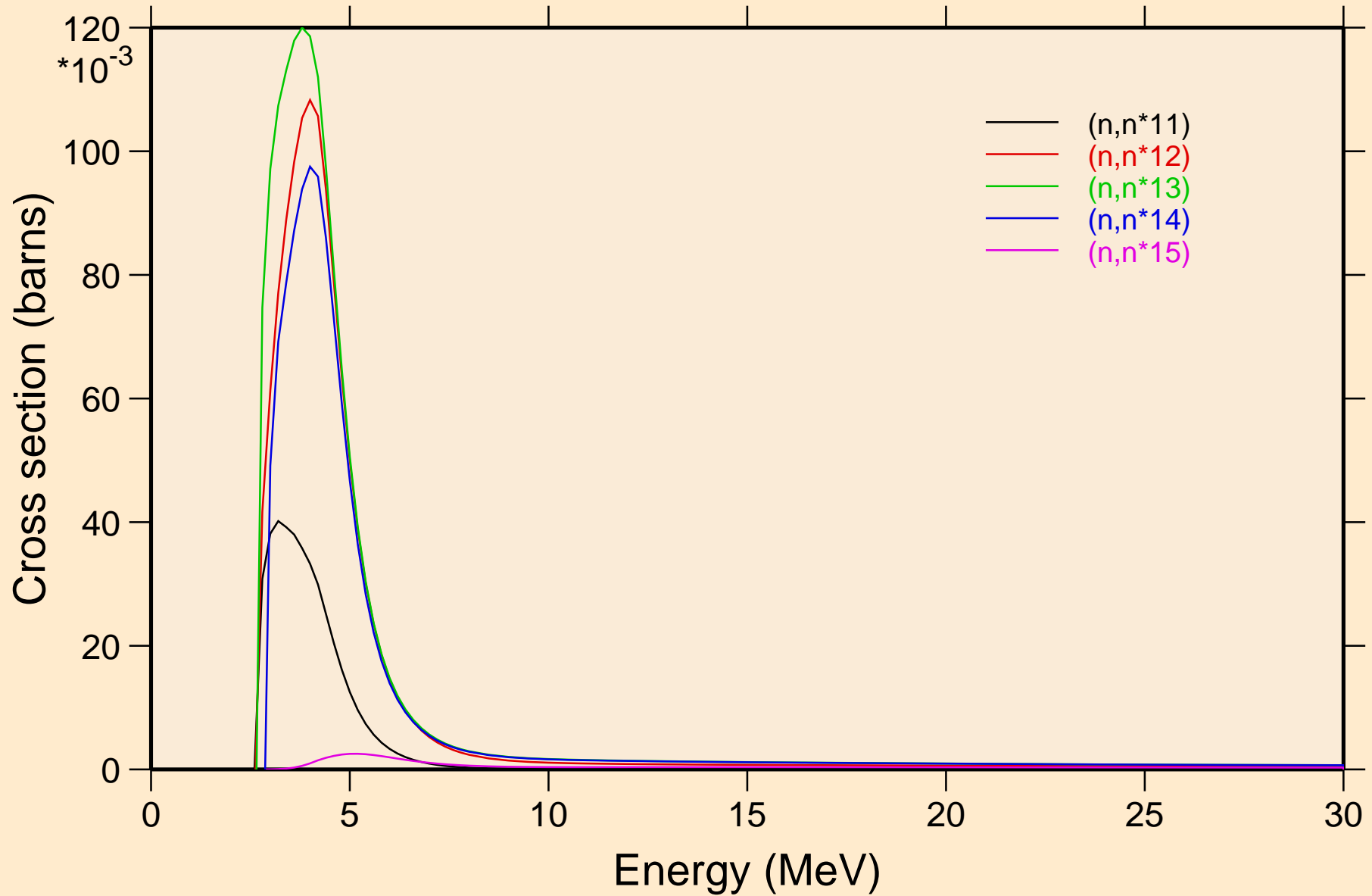

XE136 NEUTRON ACER TENDL-2021 LIBRARY; T=293.6K  
Inelastic levels

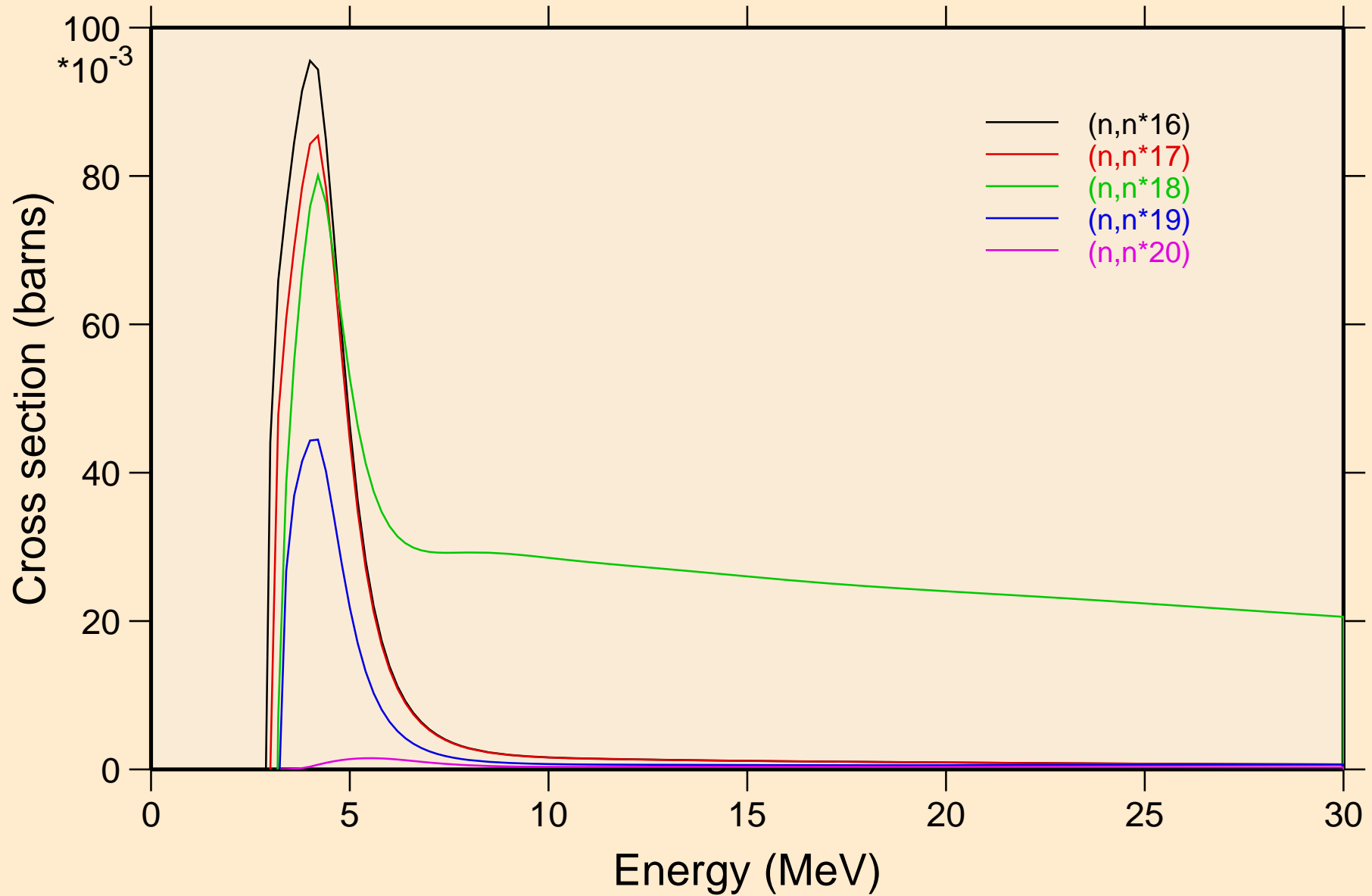

XE136 NEUTRON ACER TENDL-2021 LIBRARY; T=293.6K  
Inelastic levels

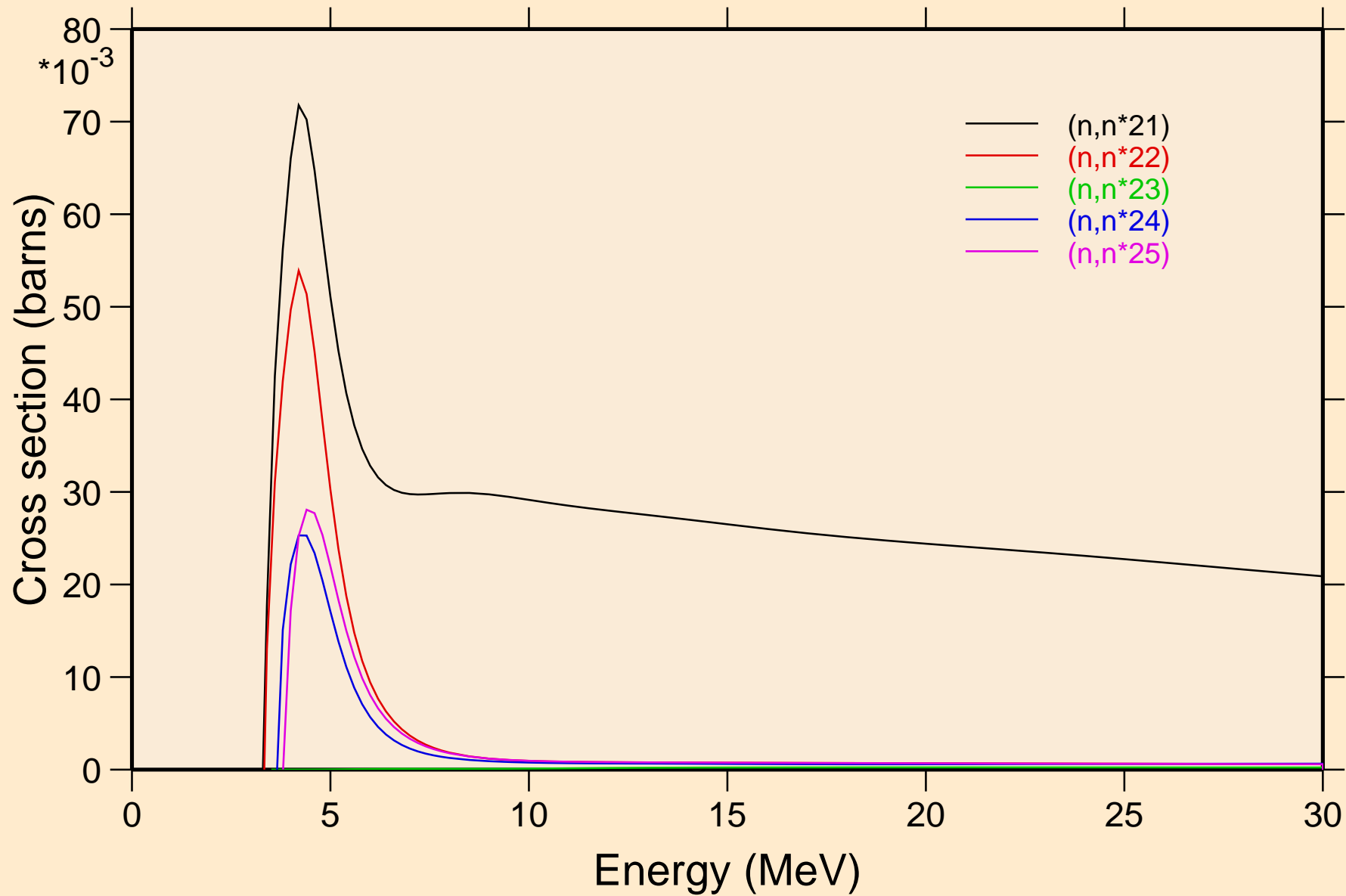

XE136 NEUTRON ACER TENDL-2021 LIBRARY; T=293.6K  
Inelastic levels

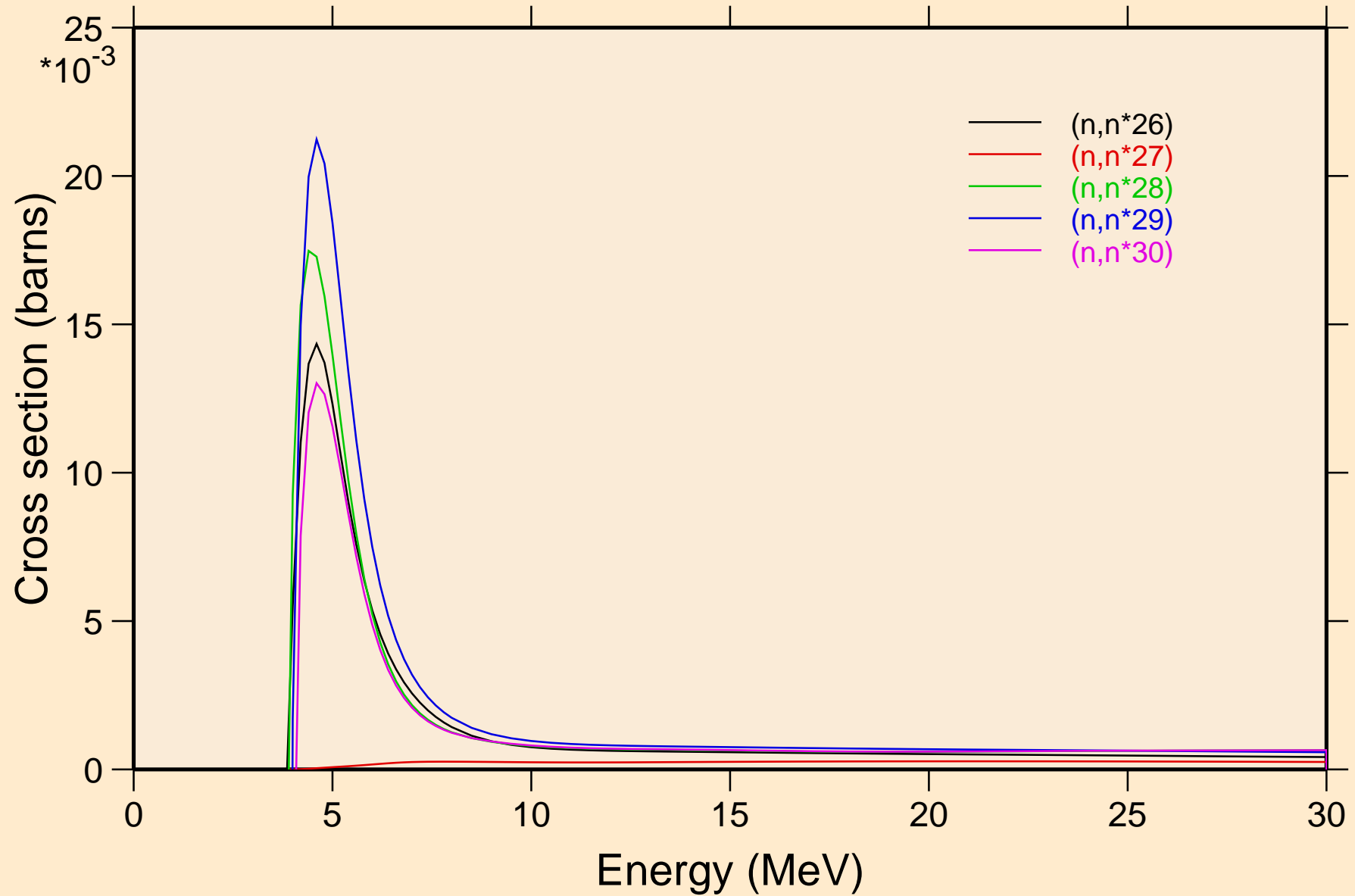



XE136 NEUTRON ACER TENDL-2021 LIBRARY; T=293.6K  
Threshold reactions

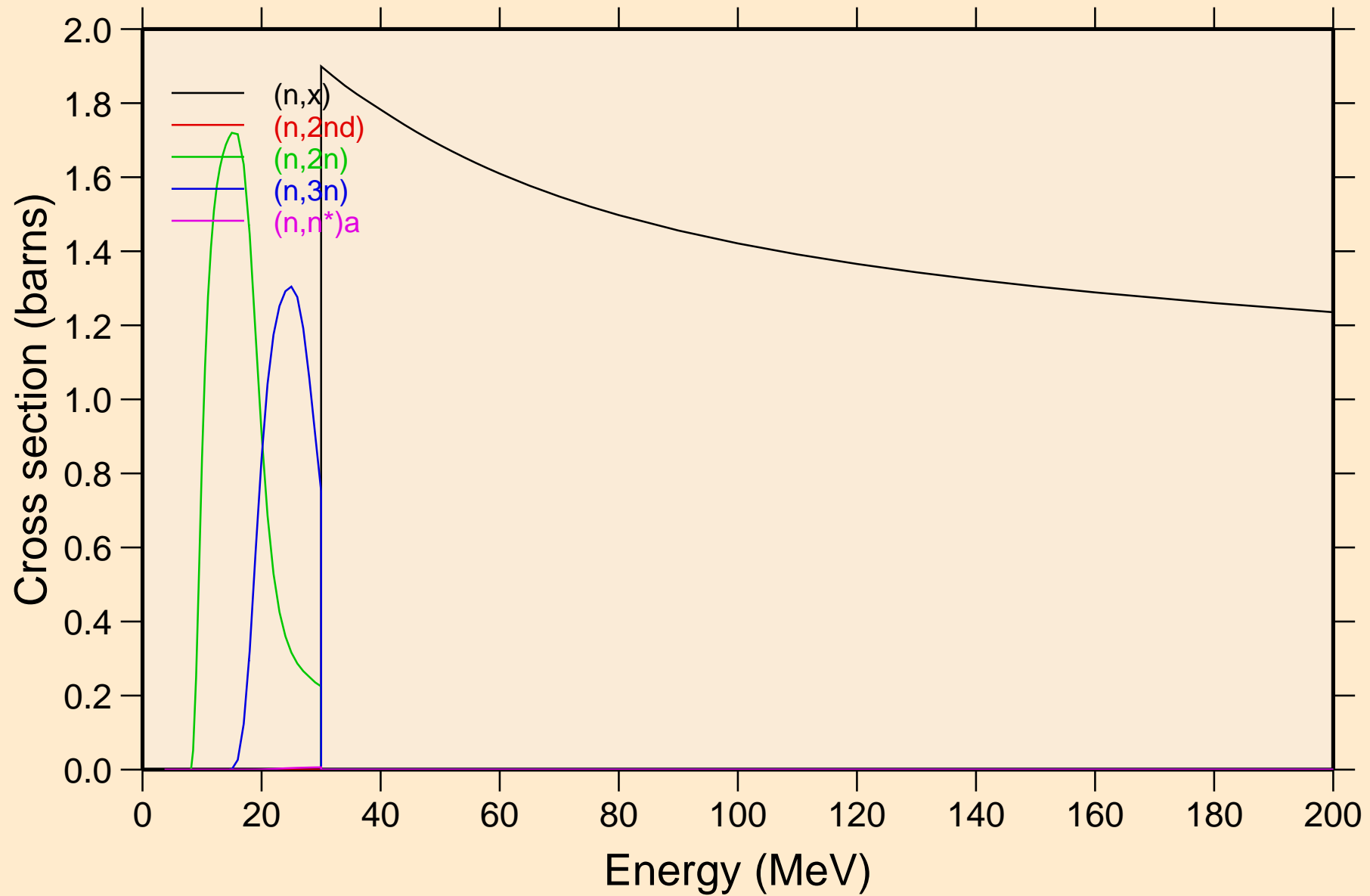

# XE136 NEUTRON ACER TENDL-2021 LIBRARY; T=293.6K

## Threshold reactions

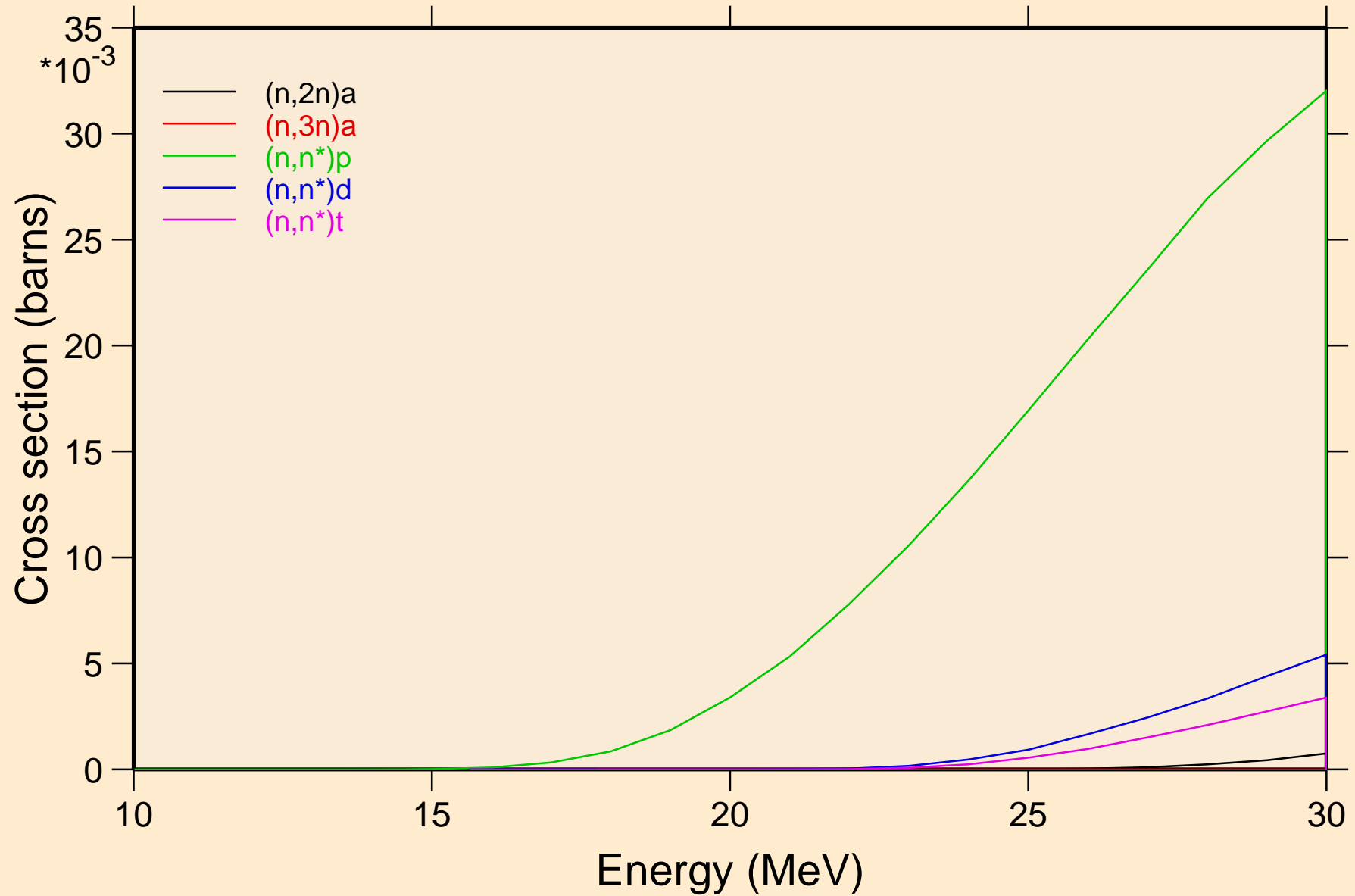

XE136 NEUTRON ACER TENDL-2021 LIBRARY; T=293.6K  
Threshold reactions

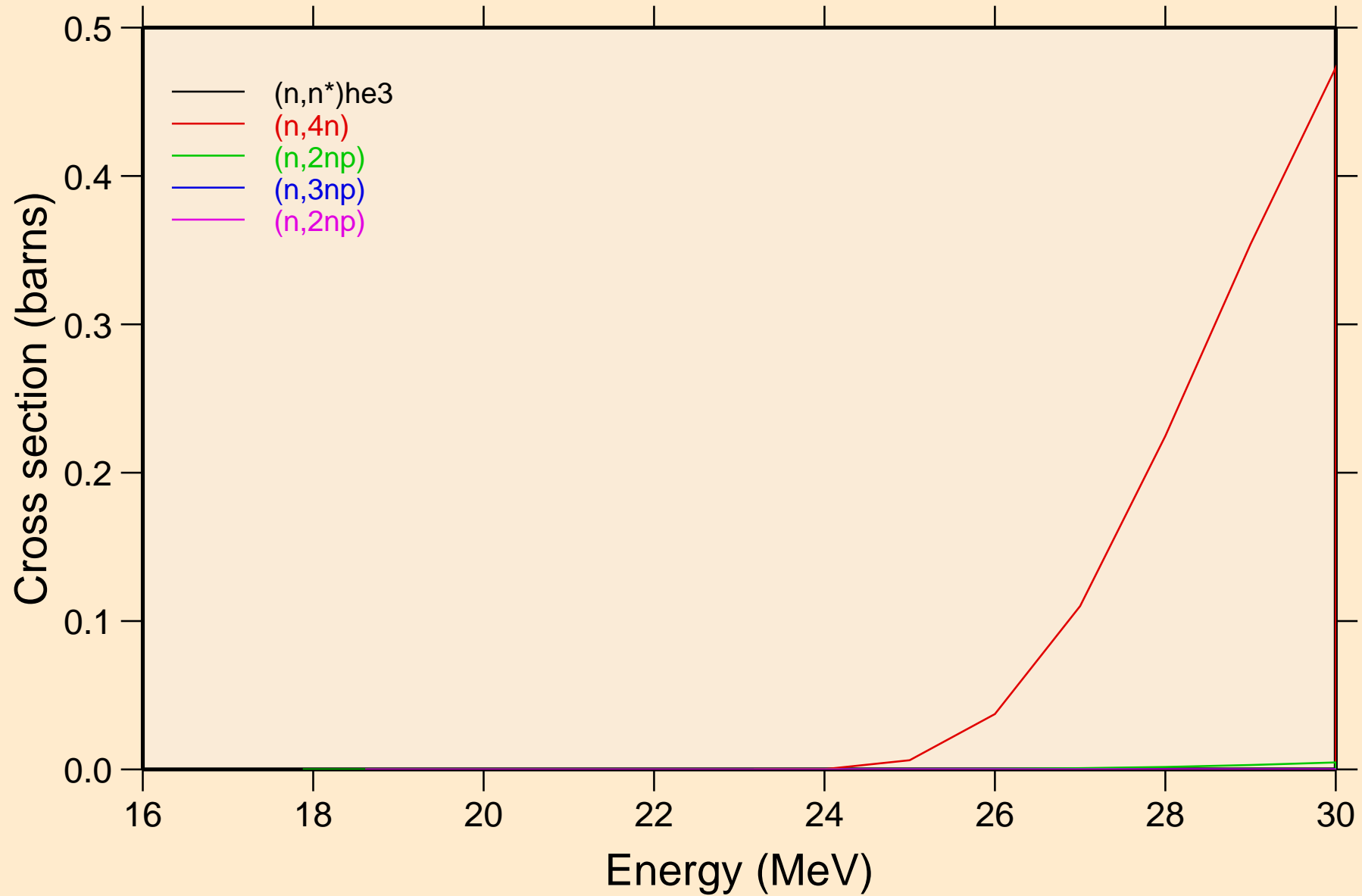

XE136 NEUTRON ACER TENDL-2021 LIBRARY; T=293.6K  
Threshold reactions

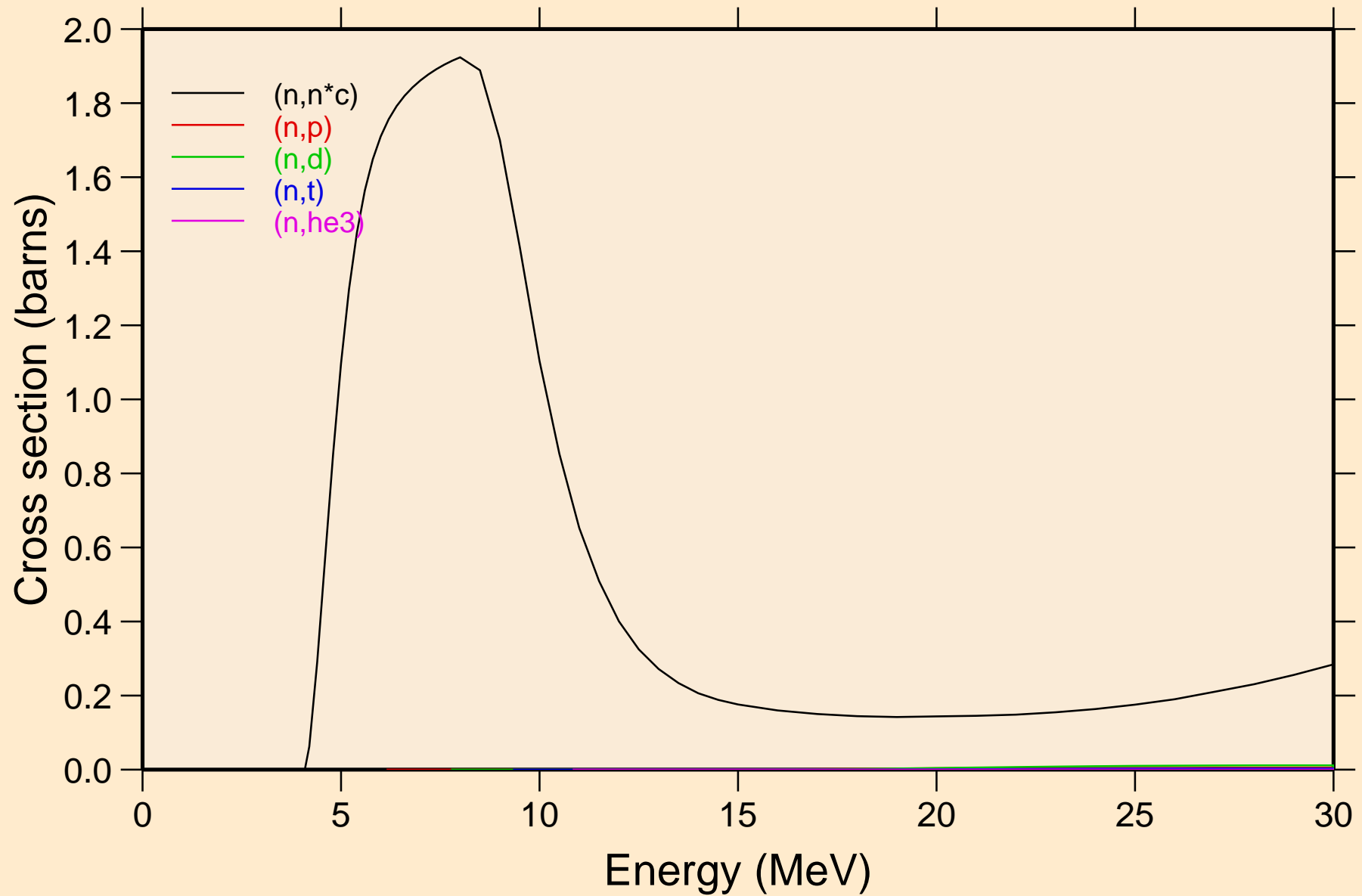

XE136 NEUTRON ACER TENDL-2021 LIBRARY; T=293.6K  
Threshold reactions

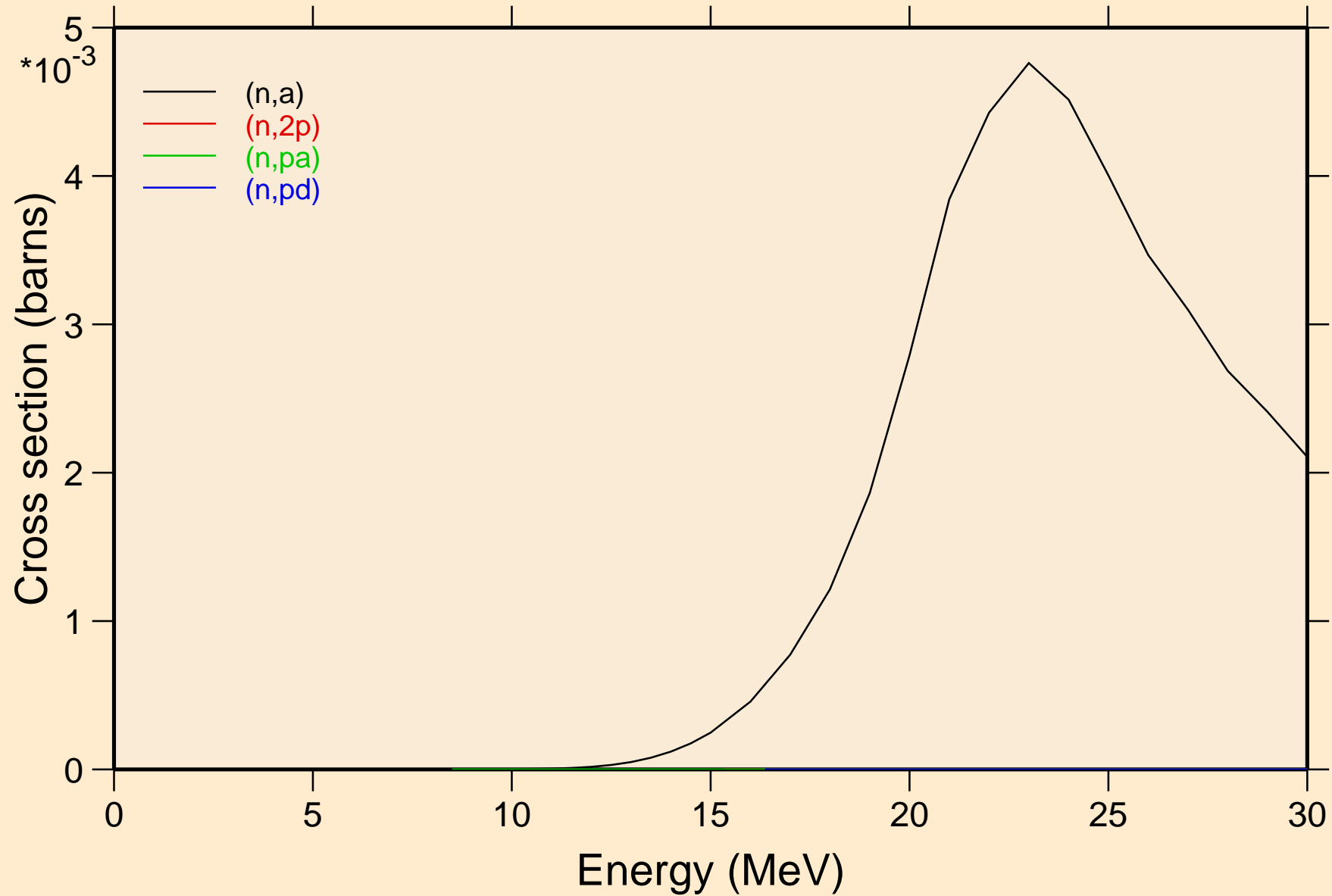

XE136 NEUTRON ACER TENDL-2021 LIBRARY; T=293.6K  
Threshold reactions

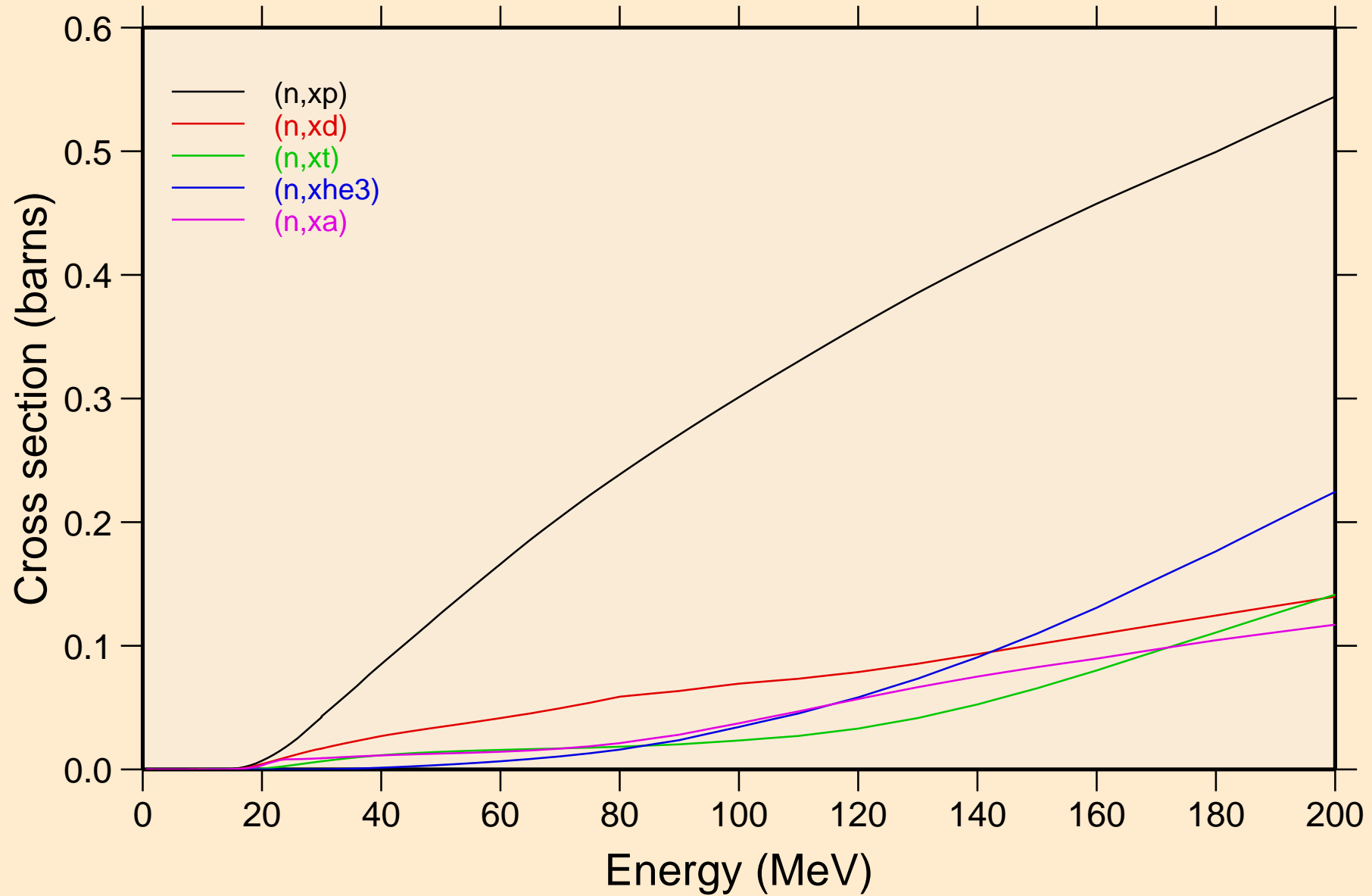

XE136 NEUTRON ACER TENDL-2021 LIBRARY; T=293.6K  
angular distribution for elastic

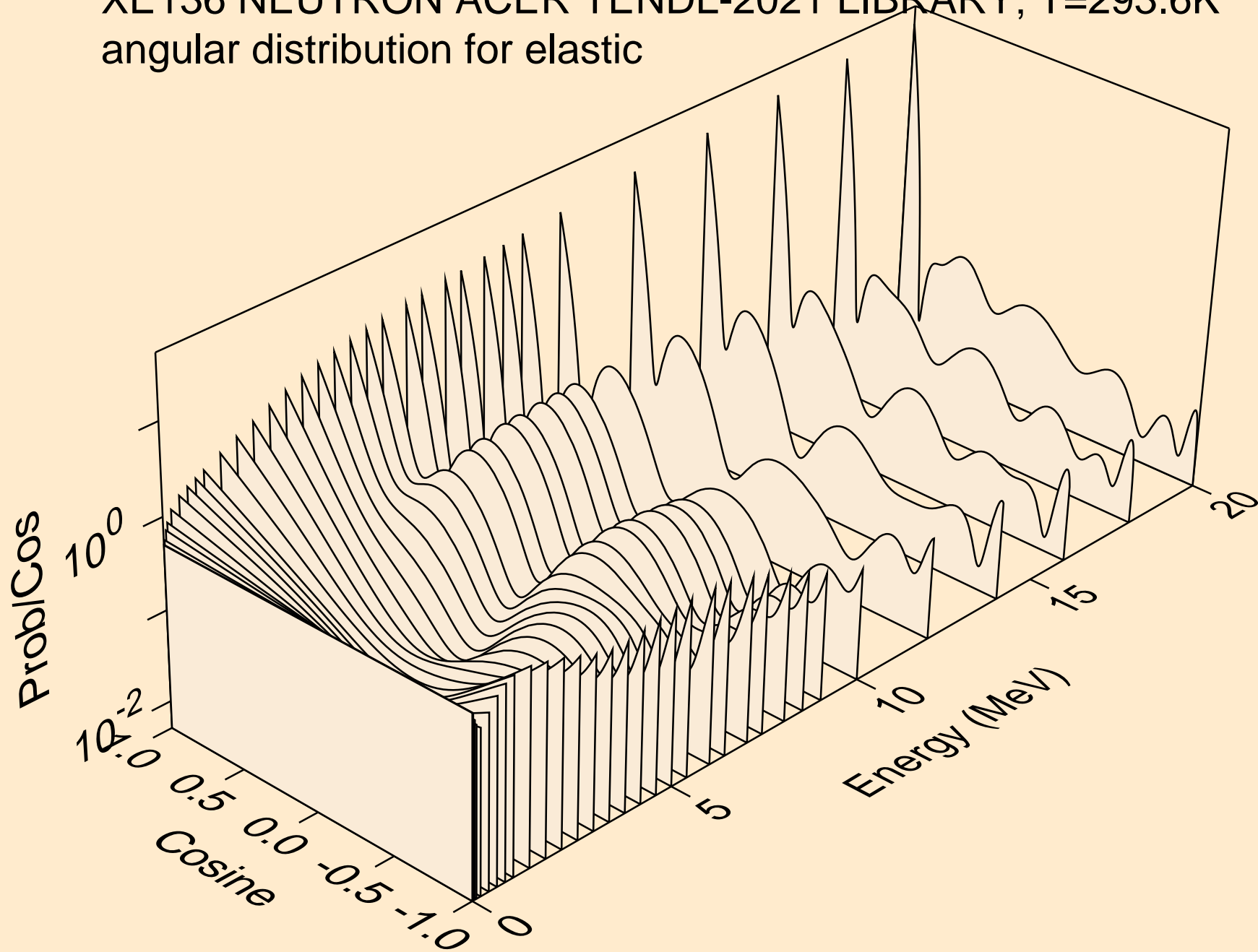

XE136 NEUTRON ACER TENDL-2021 LIBRARY; T=293.6K  
angular distribution for elastic

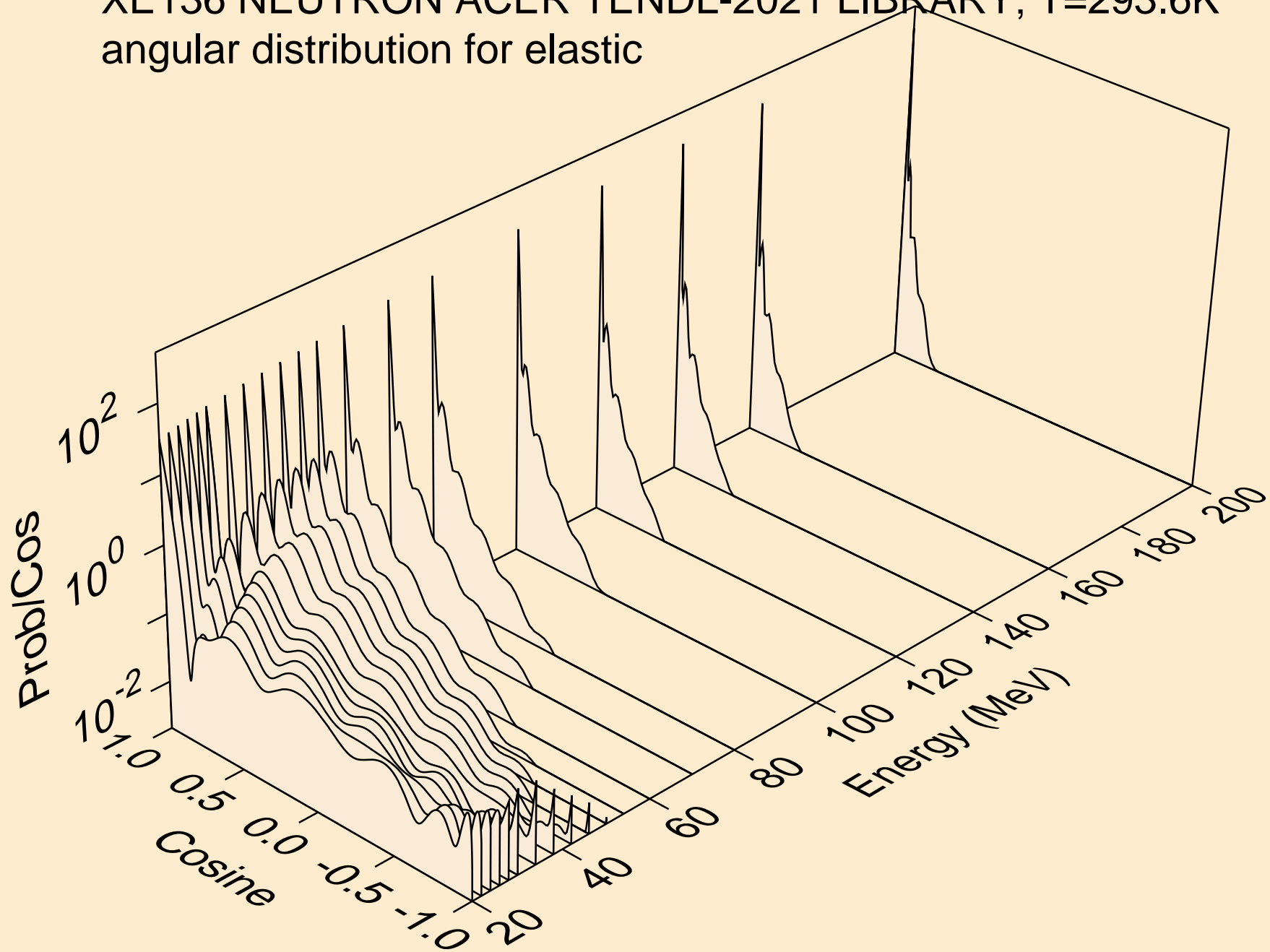



XE136 NEUTRON ACER TENDL-2021 LIBRARY; T=293.6K  
angular distribution for (n,n\*1)

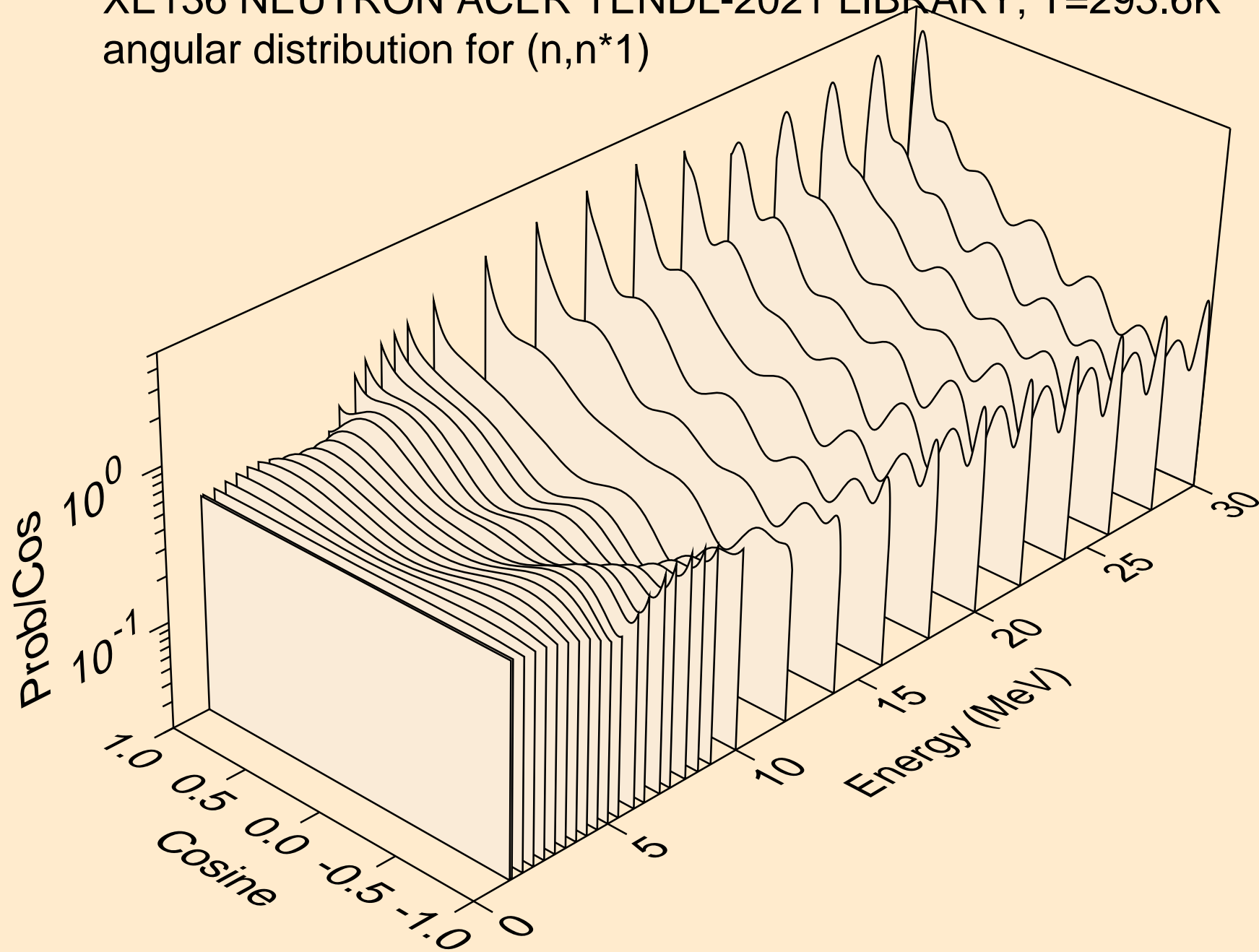

XE136 NEUTRON ACER TENDL-2021 LIBRARY; T=293.6K  
angular distribution for (n,n\*2)

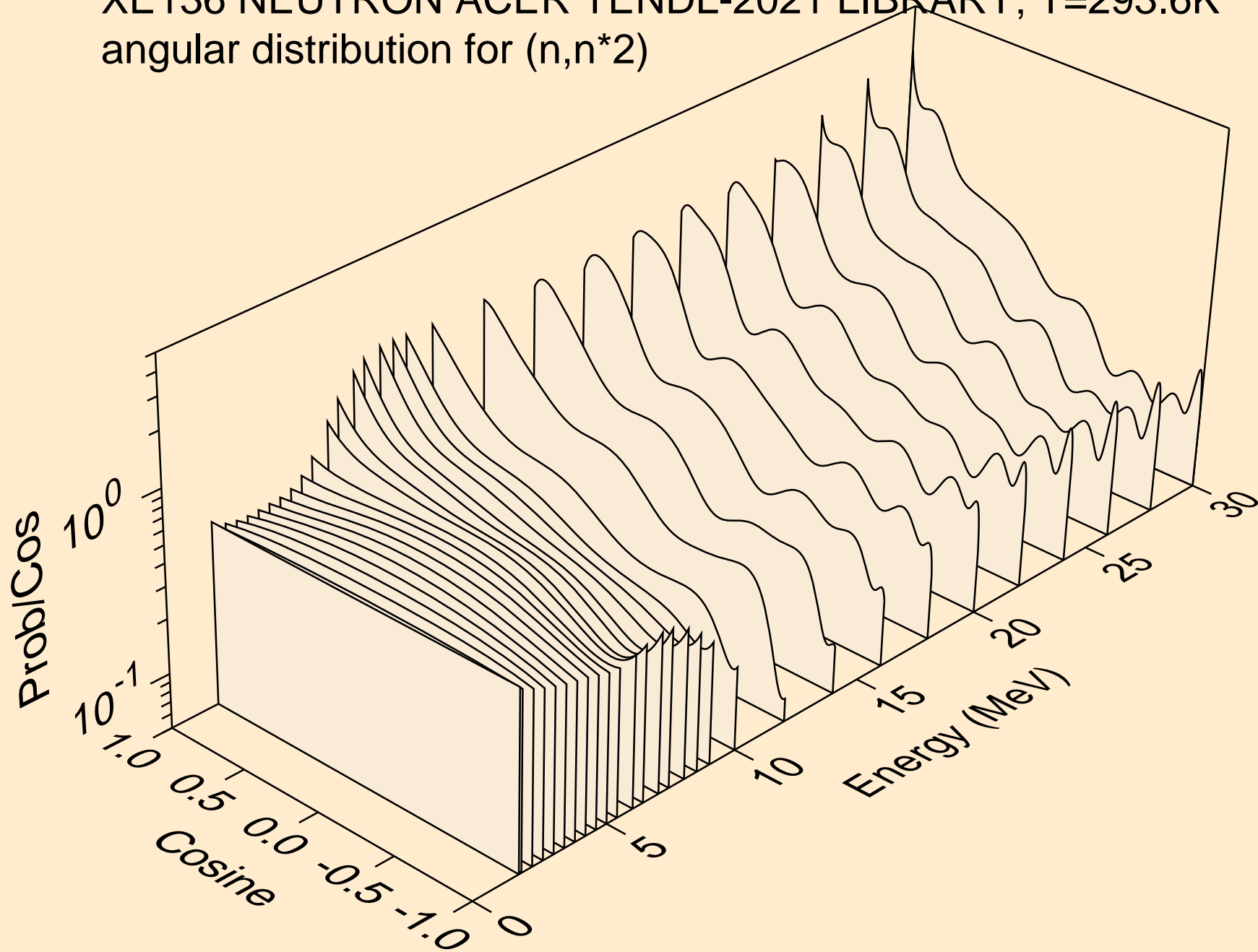

XE136 NEUTRON ACER TENDL-2021 LIBRARY; T=293.6K  
angular distribution for (n,n\*3)

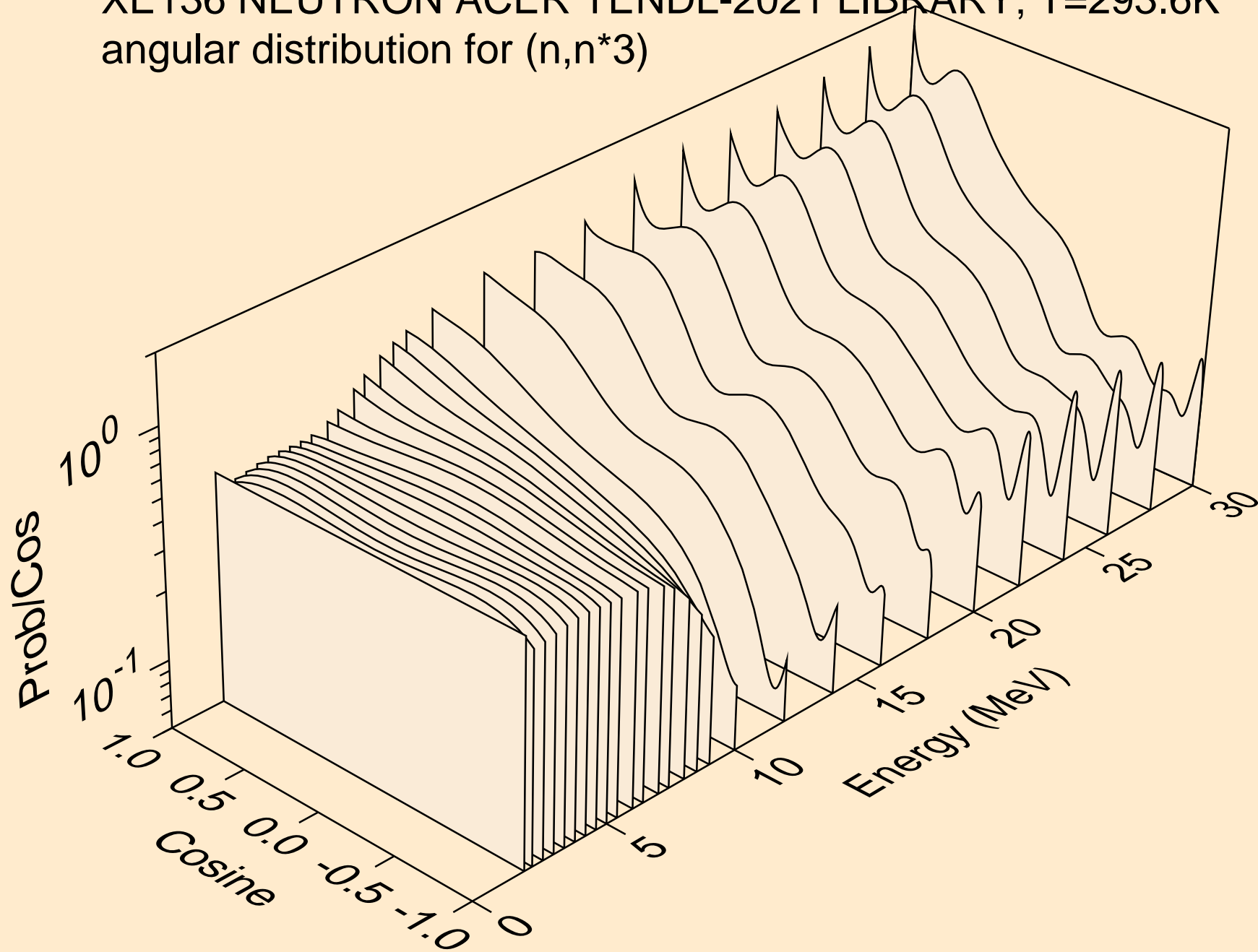

XE136 NEUTRON ACER TENDL-2021 LIBRARY; T=293.6K  
angular distribution for (n,n\*4)

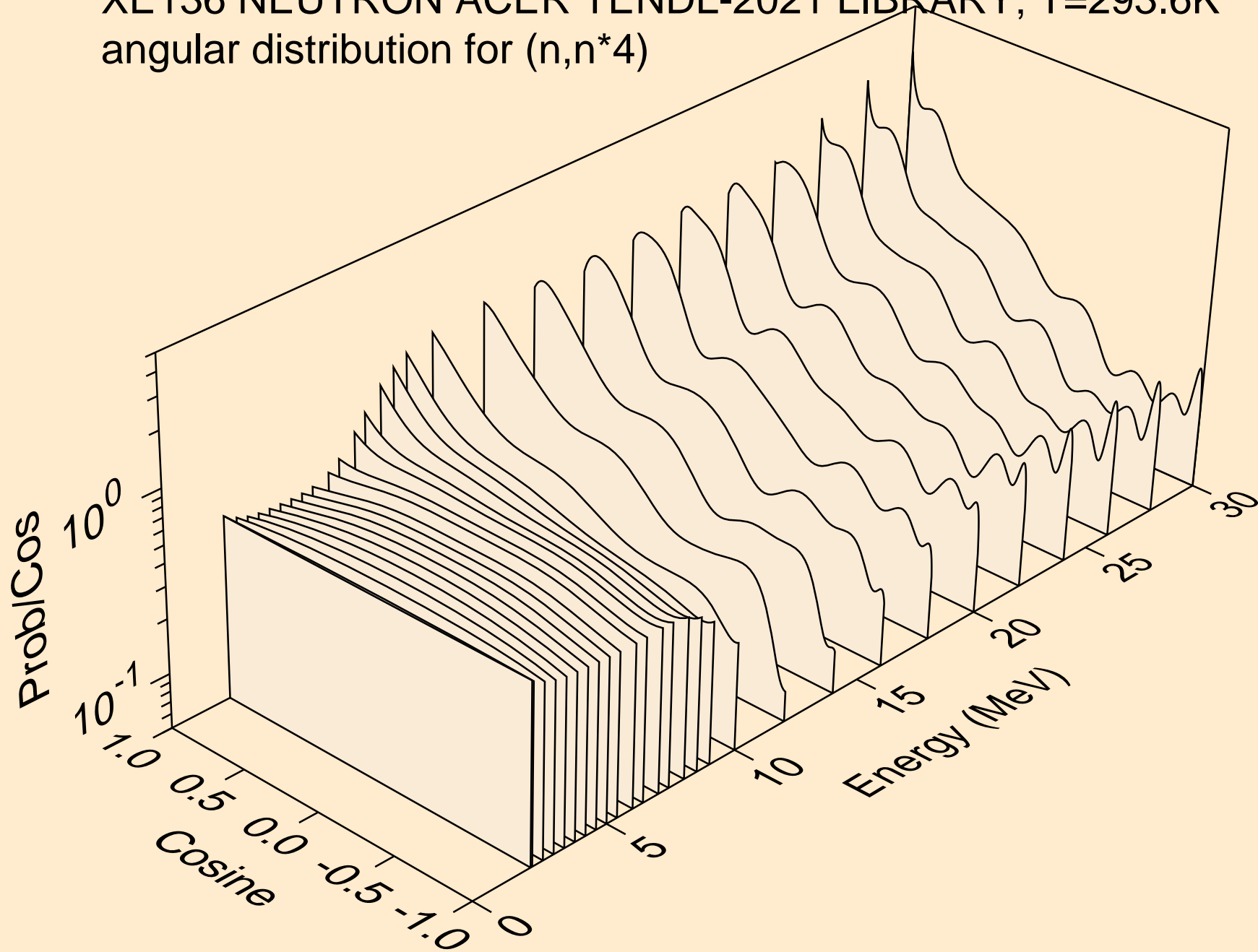

XE136 NEUTRON ACER TENDL-2021 LIBRARY; T=293.6K  
angular distribution for (n,n\*5)

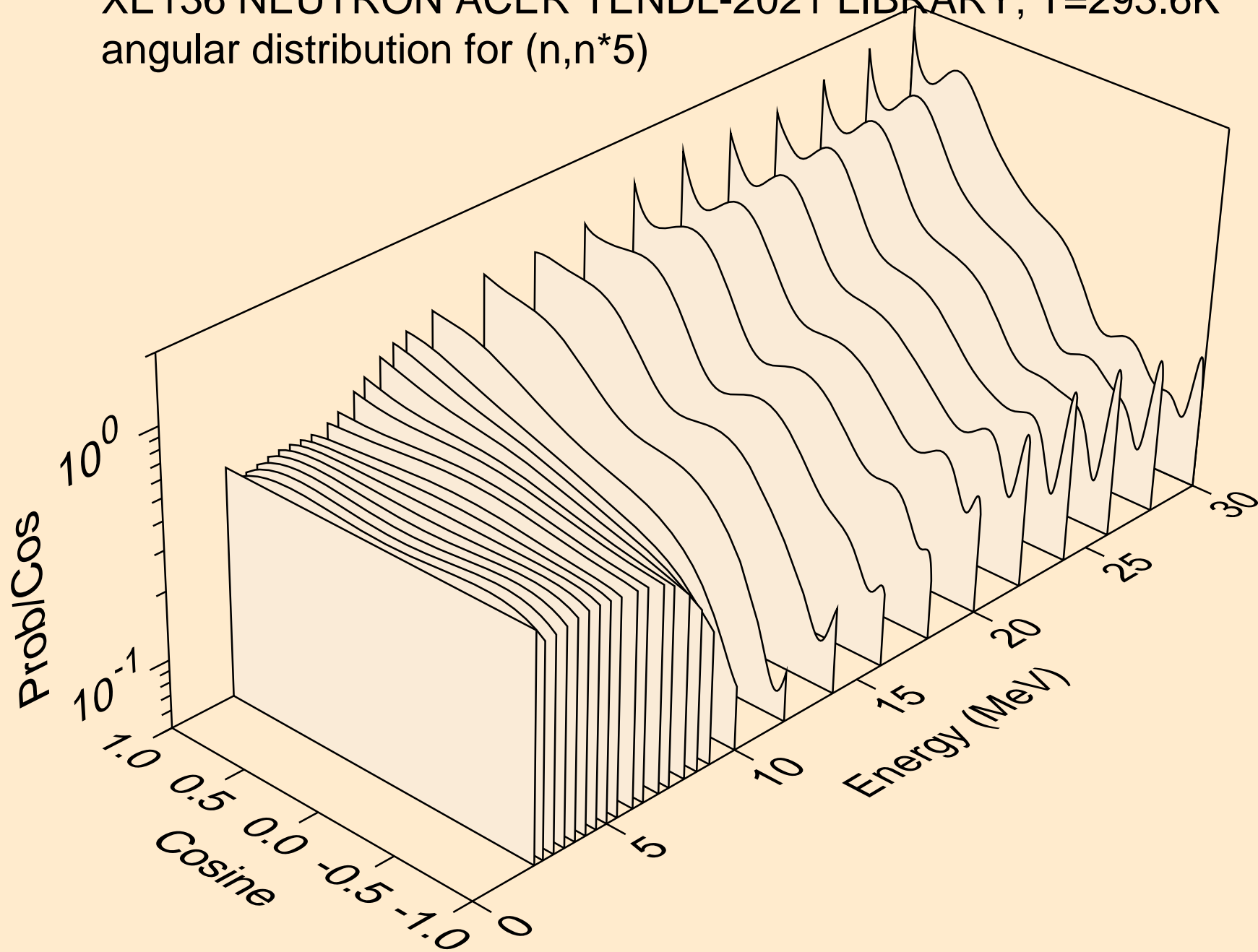

XE136 NEUTRON ACER TENDL-2021 LIBRARY; T=293.6K  
angular distribution for (n,n\*6)

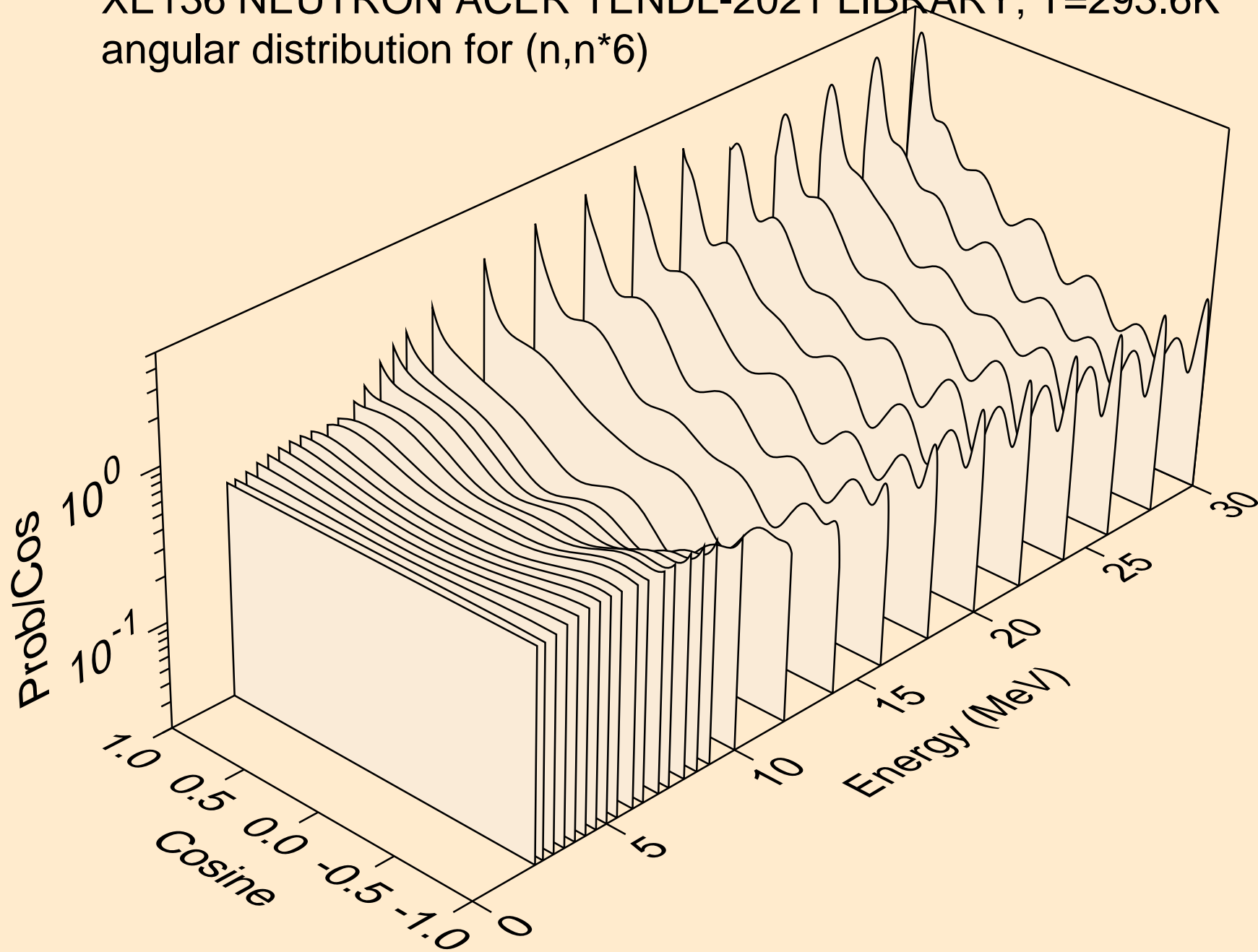

XE136 NEUTRON ACER TENDL-2021 LIBRARY; T=293.6K  
angular distribution for (n,n\*7)

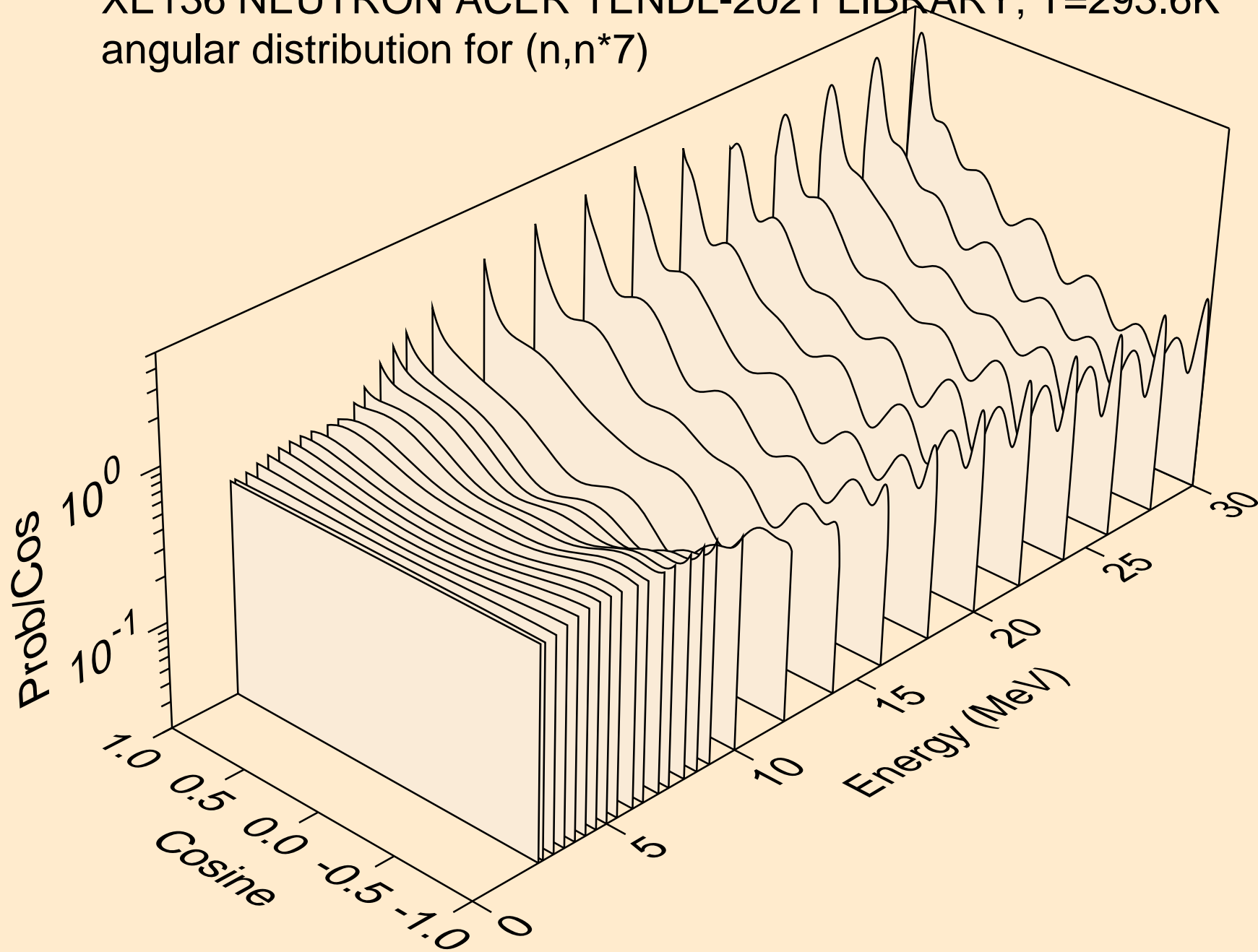

XE136 NEUTRON ACER TENDL-2021 LIBRARY; T=293.6K  
angular distribution for (n,n\*8)

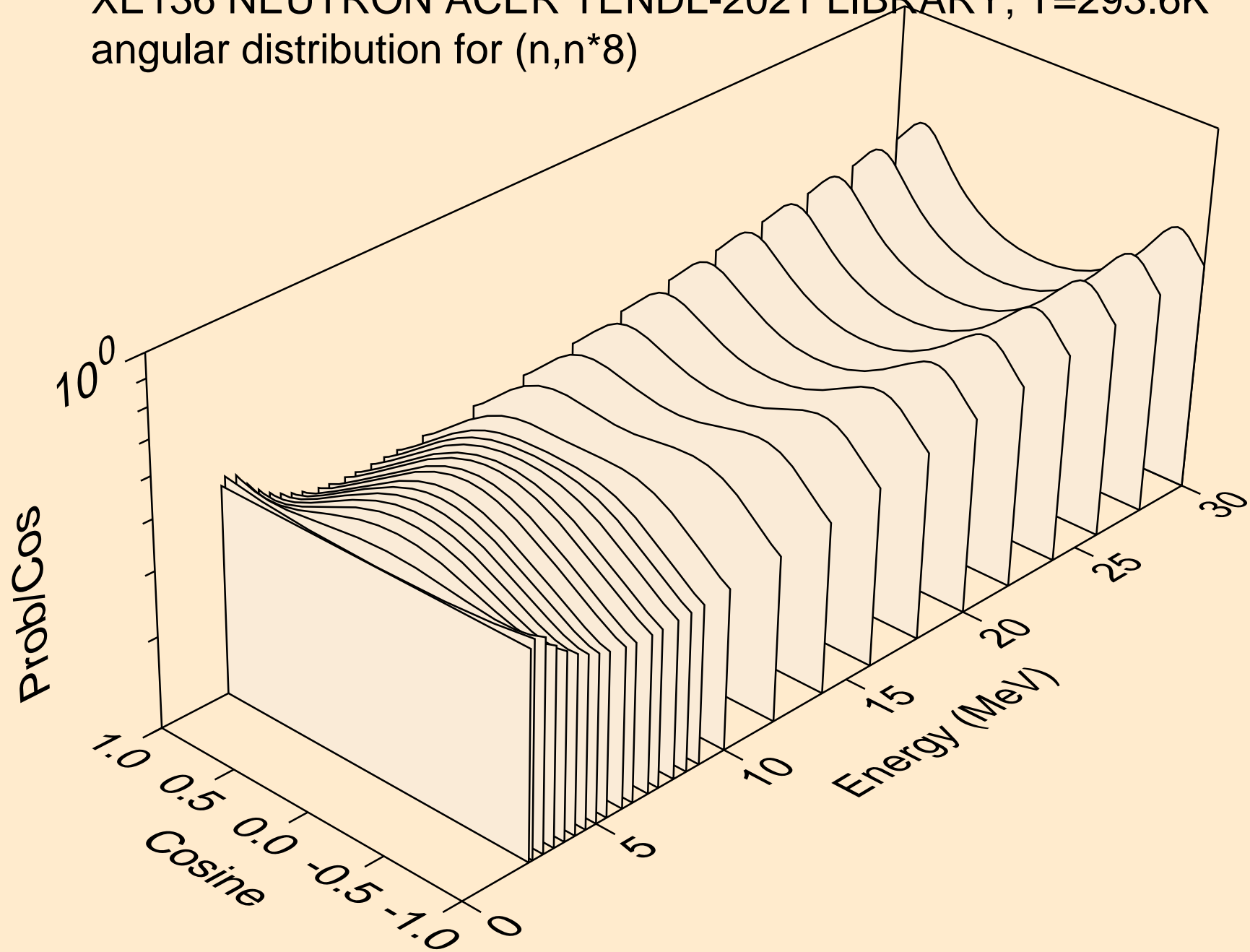



XE136 NEUTRON ACER TENDL-2021 LIBRARY; T=293.6K  
angular distribution for (n,n\*9)

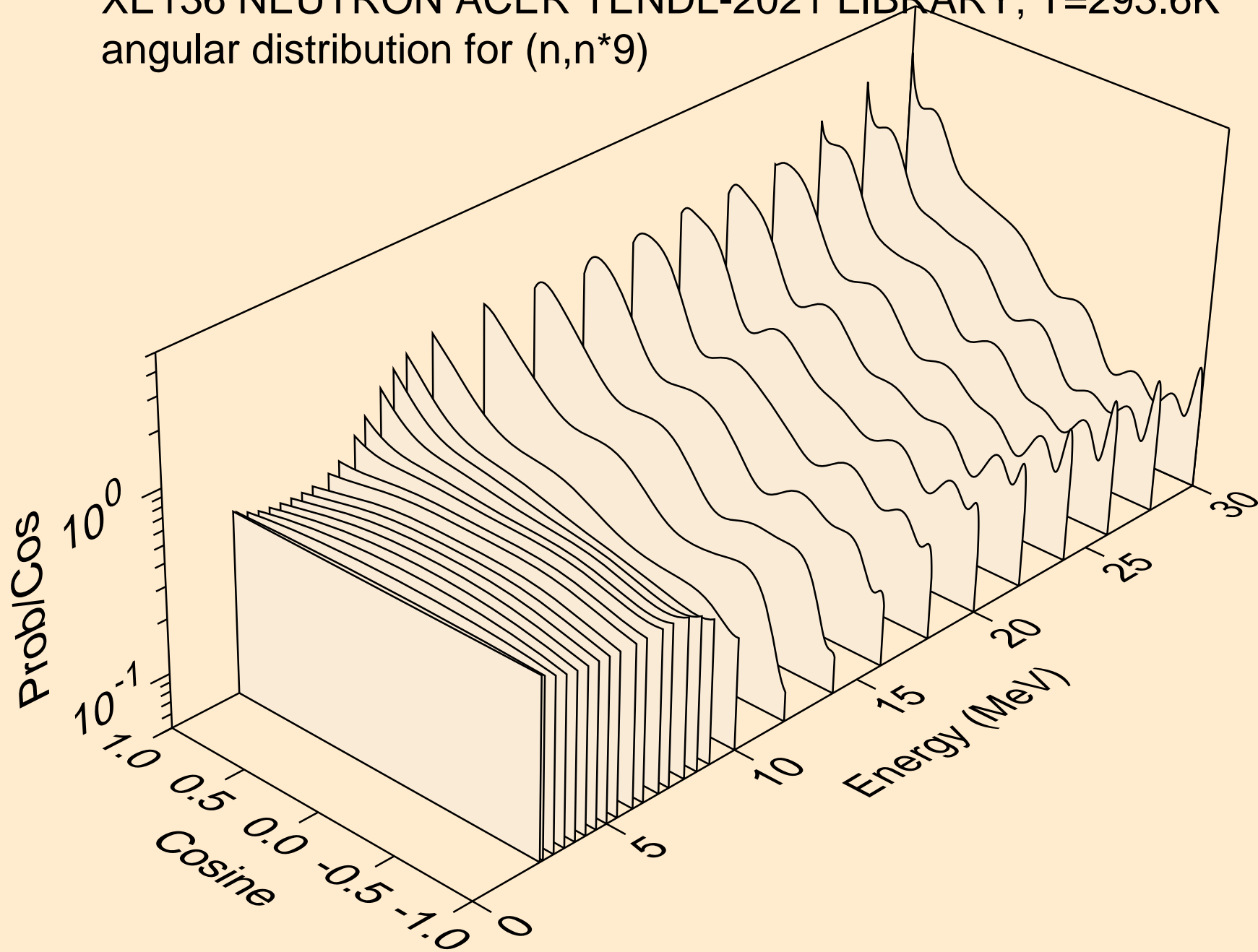

XE136 NEUTRON ACER TENDL-2021 LIBRARY; T=293.6K  
angular distribution for (n,n\*10)

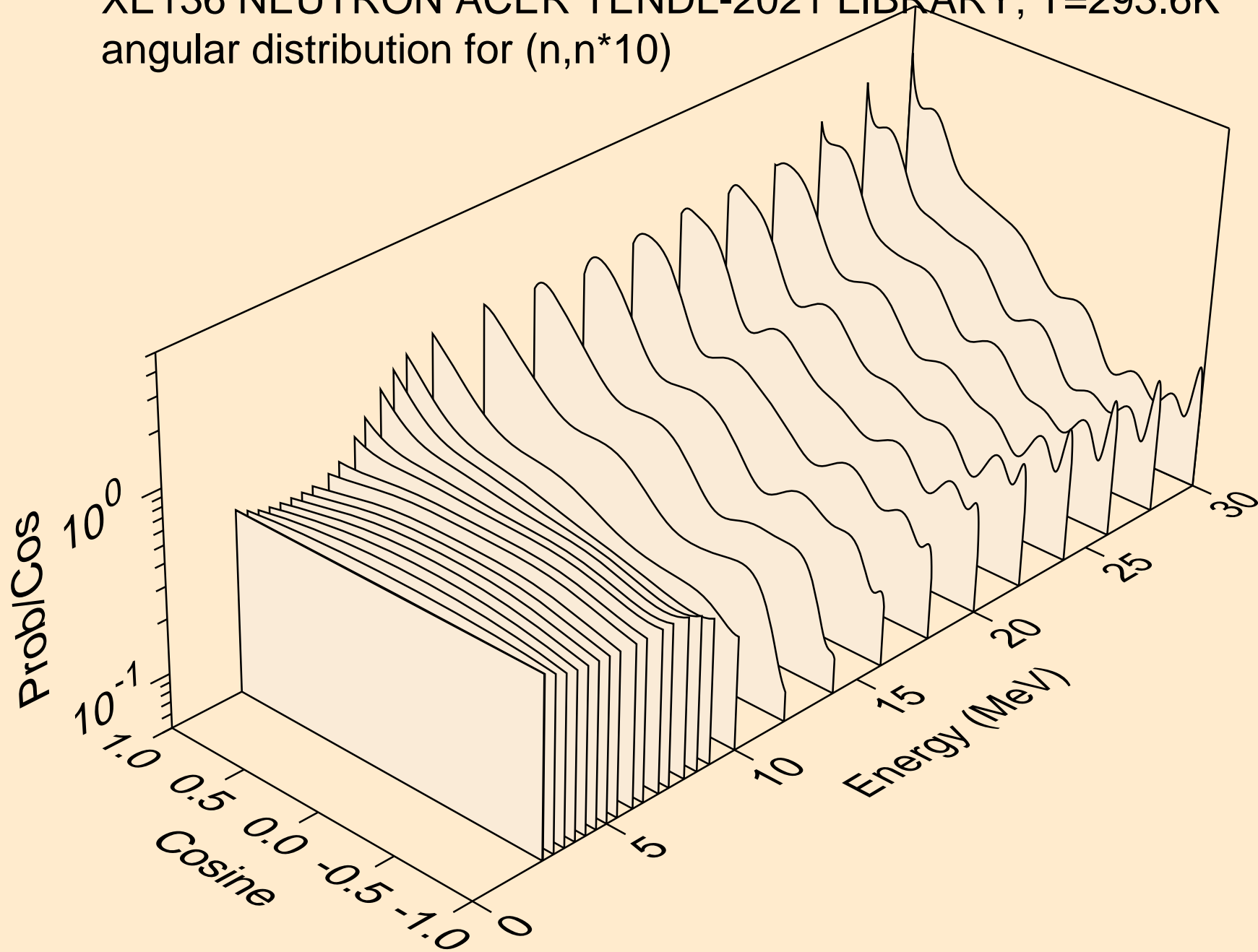

XE136 NEUTRON ACER TENDL-2021 LIBRARY; T=293.6K  
angular distribution for (n,n\*11)

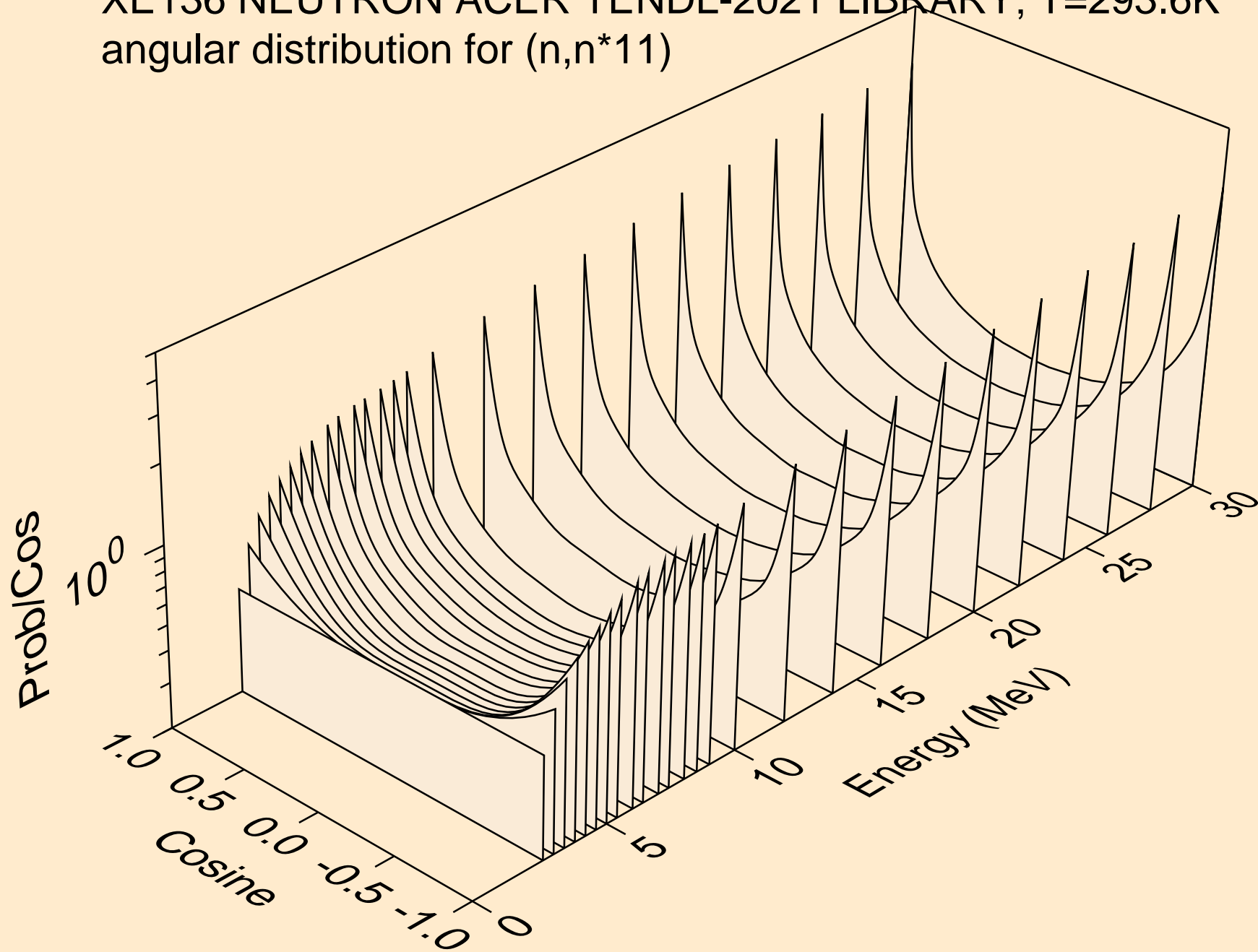

XE136 NEUTRON ACER TENDL-2021 LIBRARY; T=293.6K  
angular distribution for (n,n\*12)

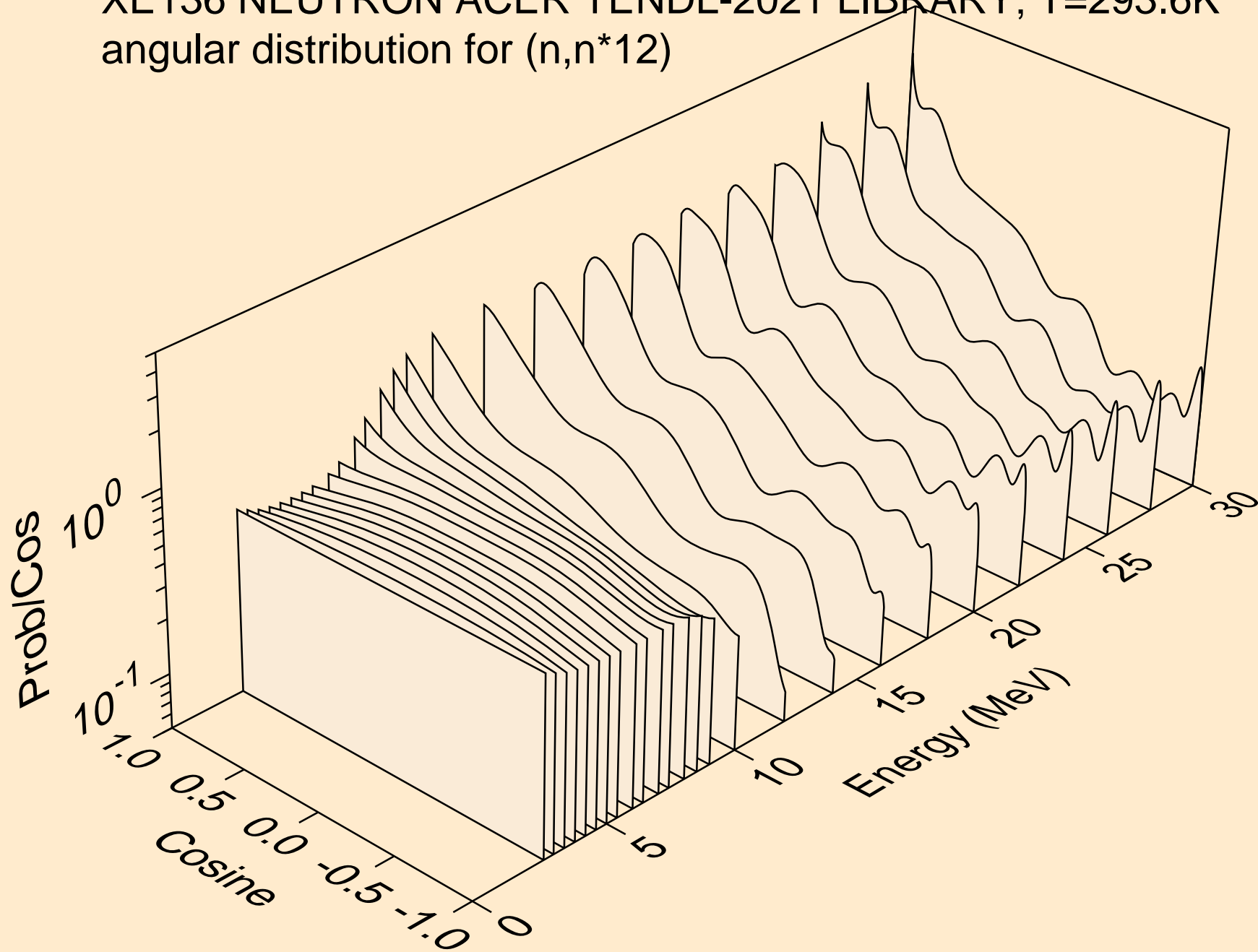

XE136 NEUTRON ACER TENDL-2021 LIBRARY; T=293.6K  
angular distribution for (n,n\*13)

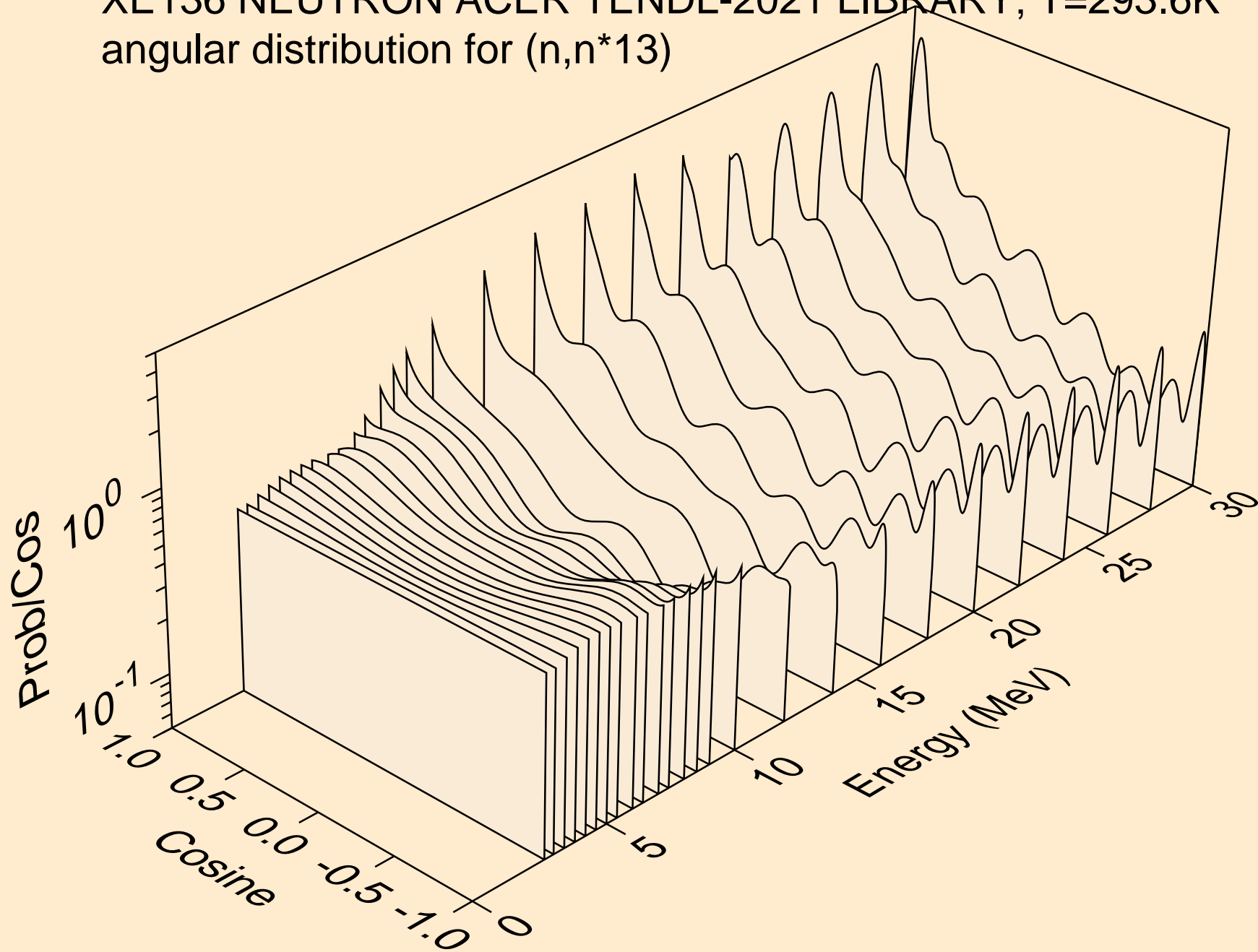

XE136 NEUTRON ACER TENDL-2021 LIBRARY; T=293.6K  
angular distribution for (n,n\*14)

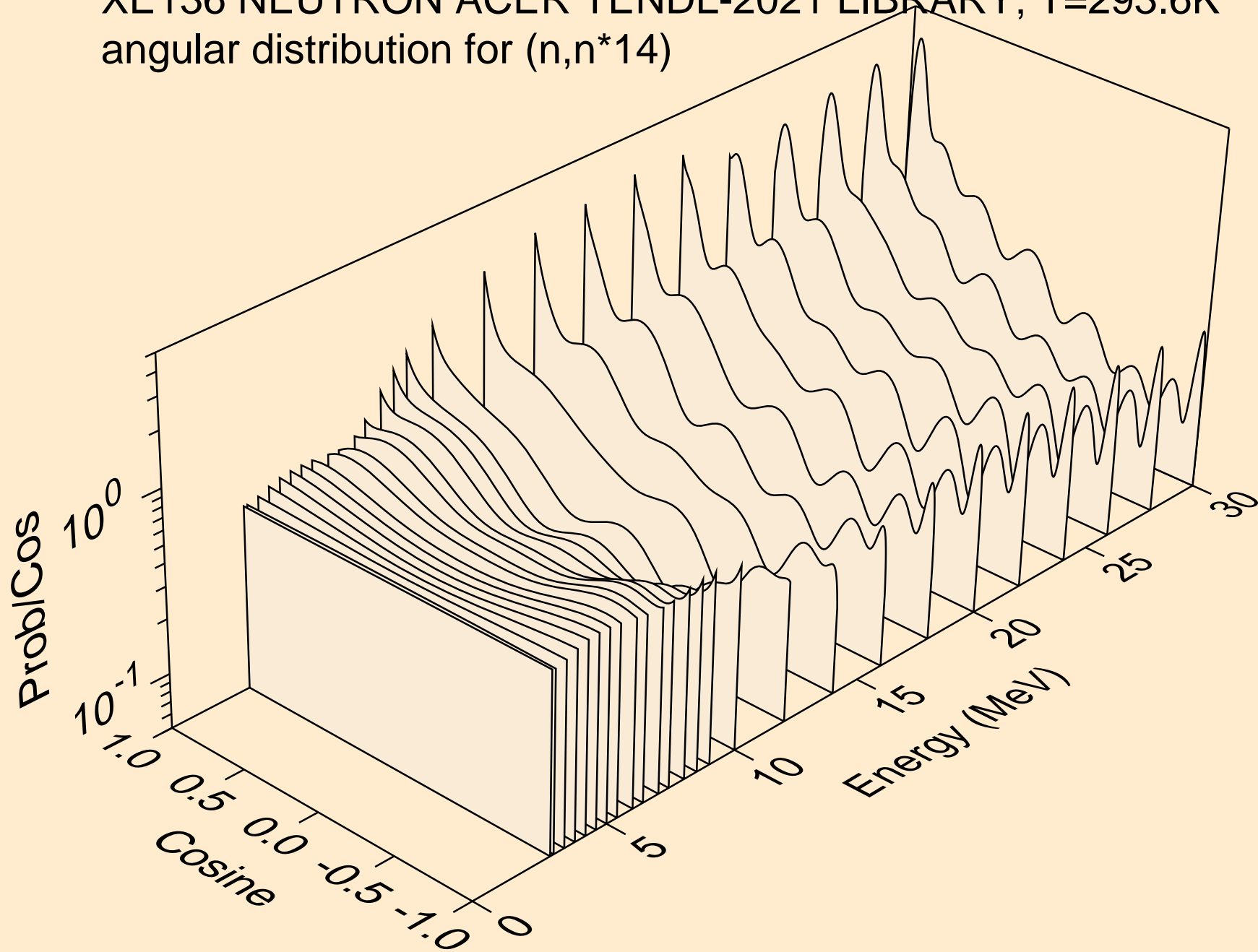

XE136 NEUTRON ACER TENDL-2021 LIBRARY; T=293.6K  
angular distribution for (n,n\*15)

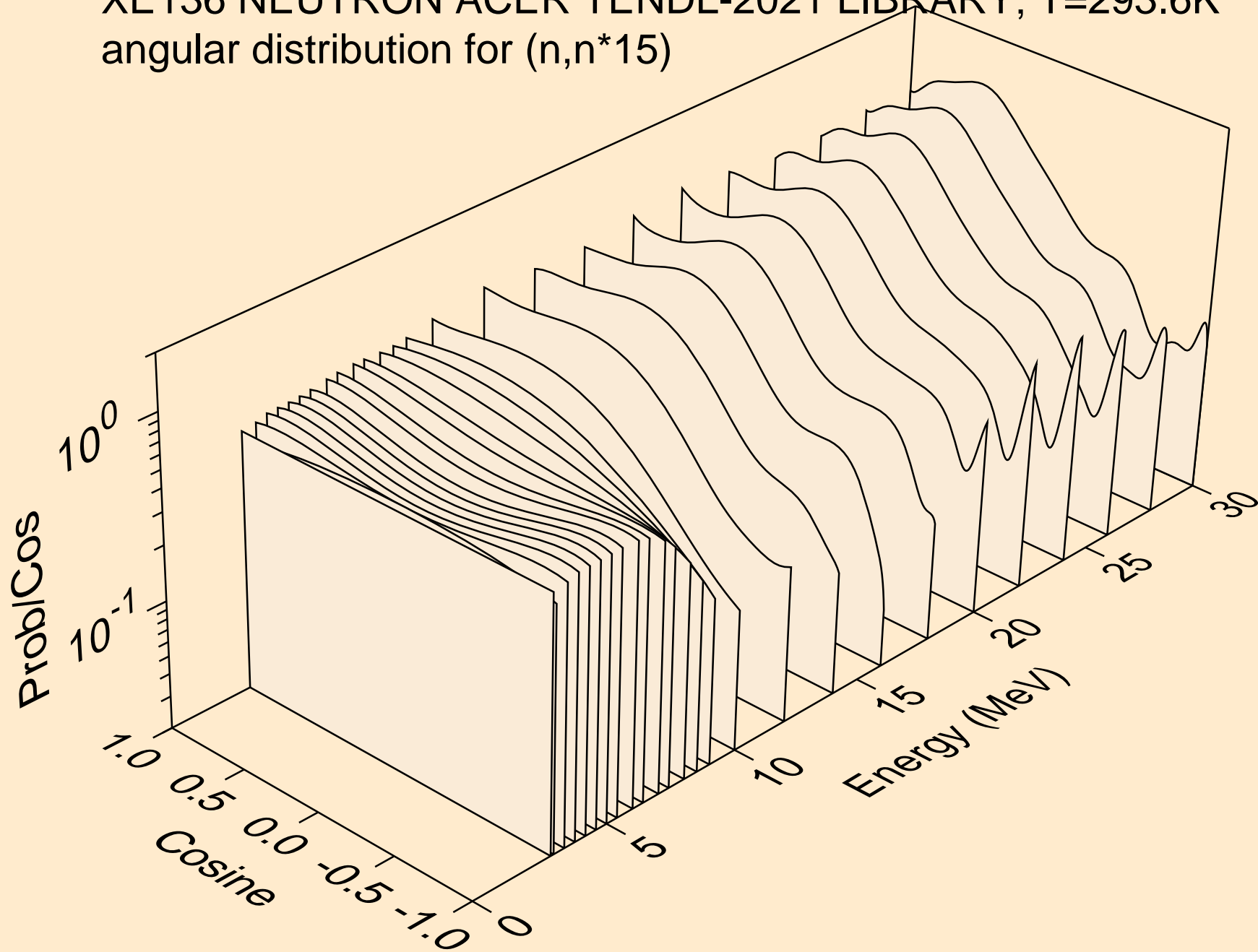

XE136 NEUTRON ACER TENDL-2021 LIBRARY; T=293.6K  
angular distribution for (n,n\*16)

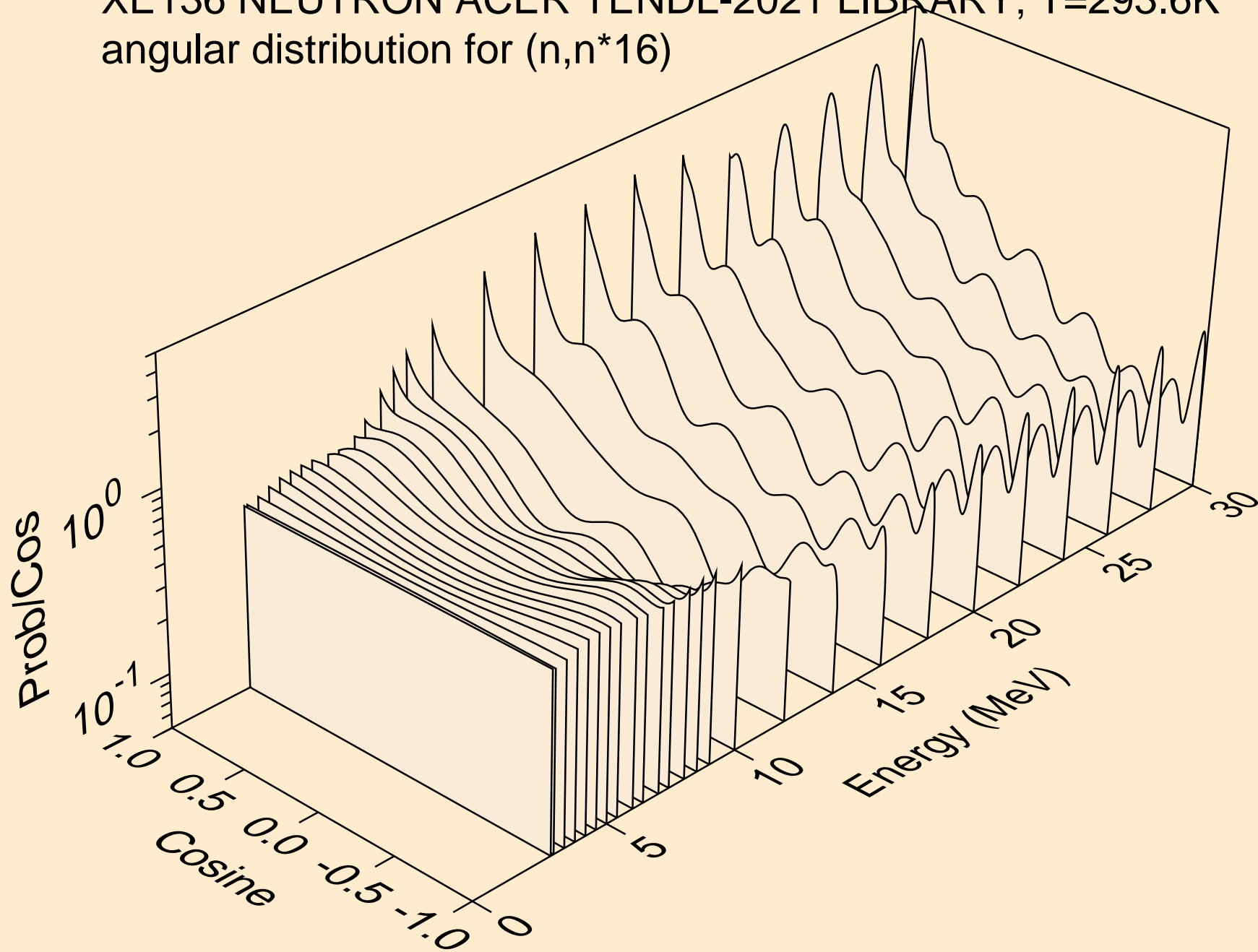



XE136 NEUTRON ACER TENDL-2021 LIBRARY; T=293.6K  
angular distribution for (n,n\*17)

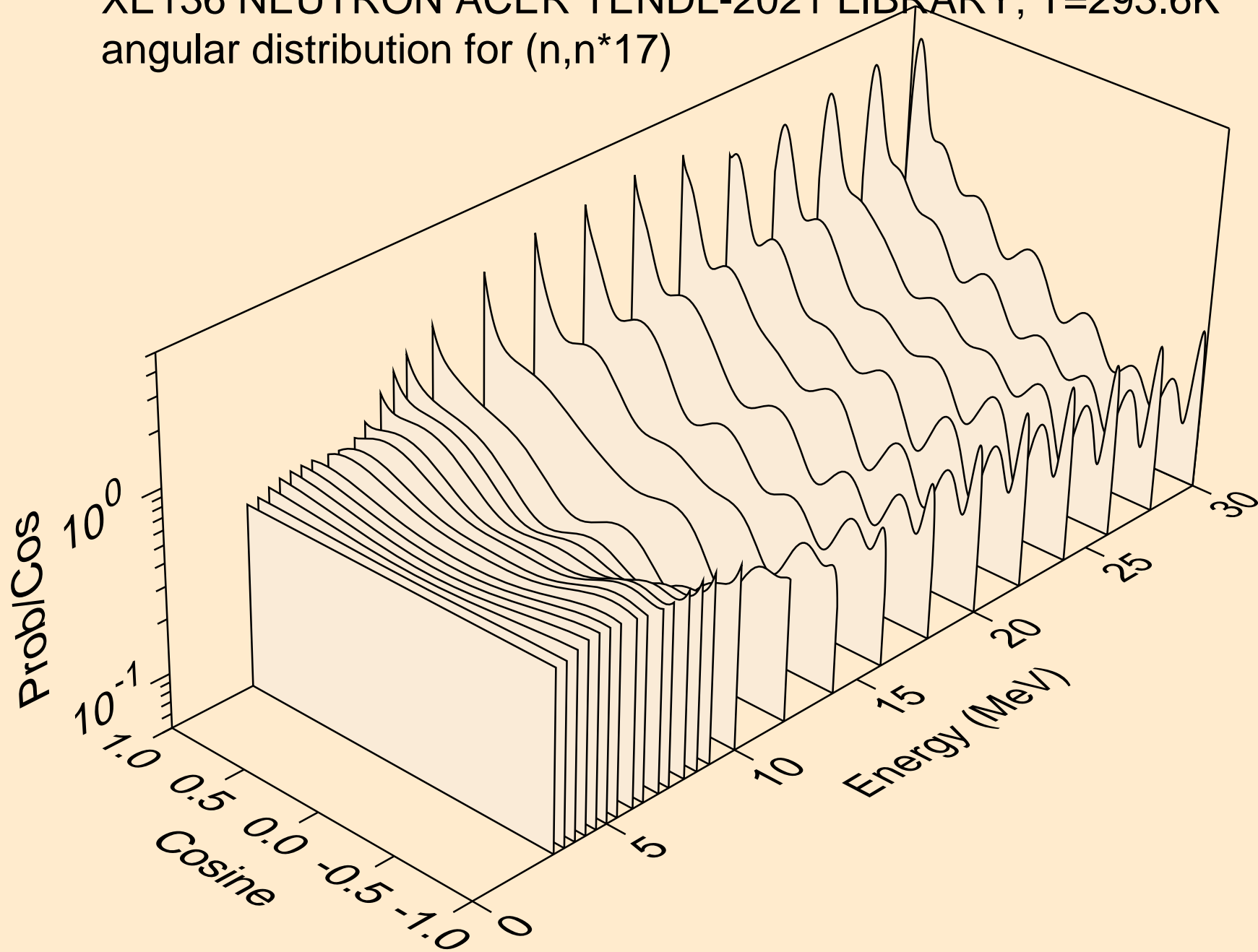

XE136 NEUTRON ACER TENDL-2021 LIBRARY; T=293.6K  
angular distribution for (n,n\*18)

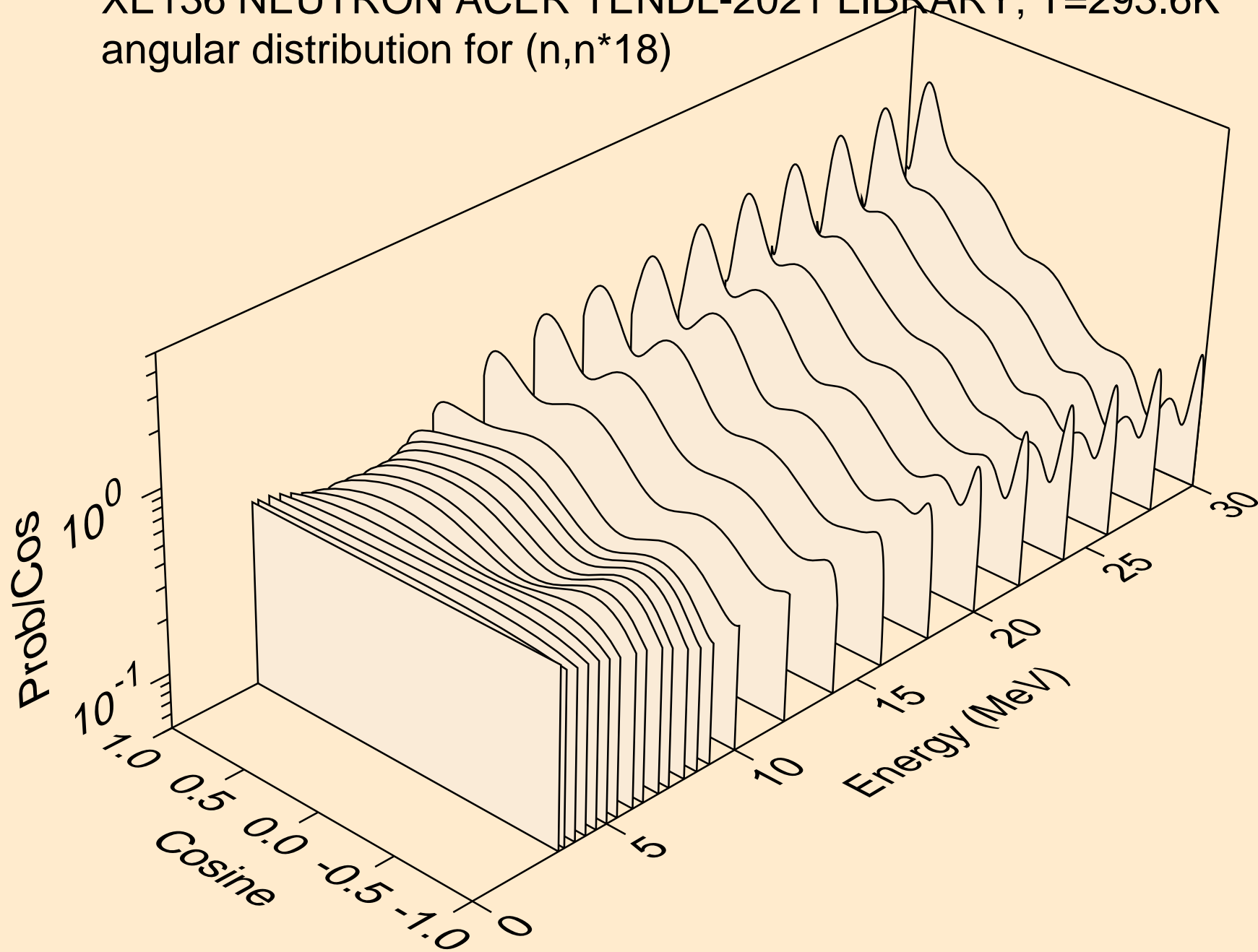

XE136 NEUTRON ACER TENDL-2021 LIBRARY; T=293.6K  
angular distribution for (n,n\*19)

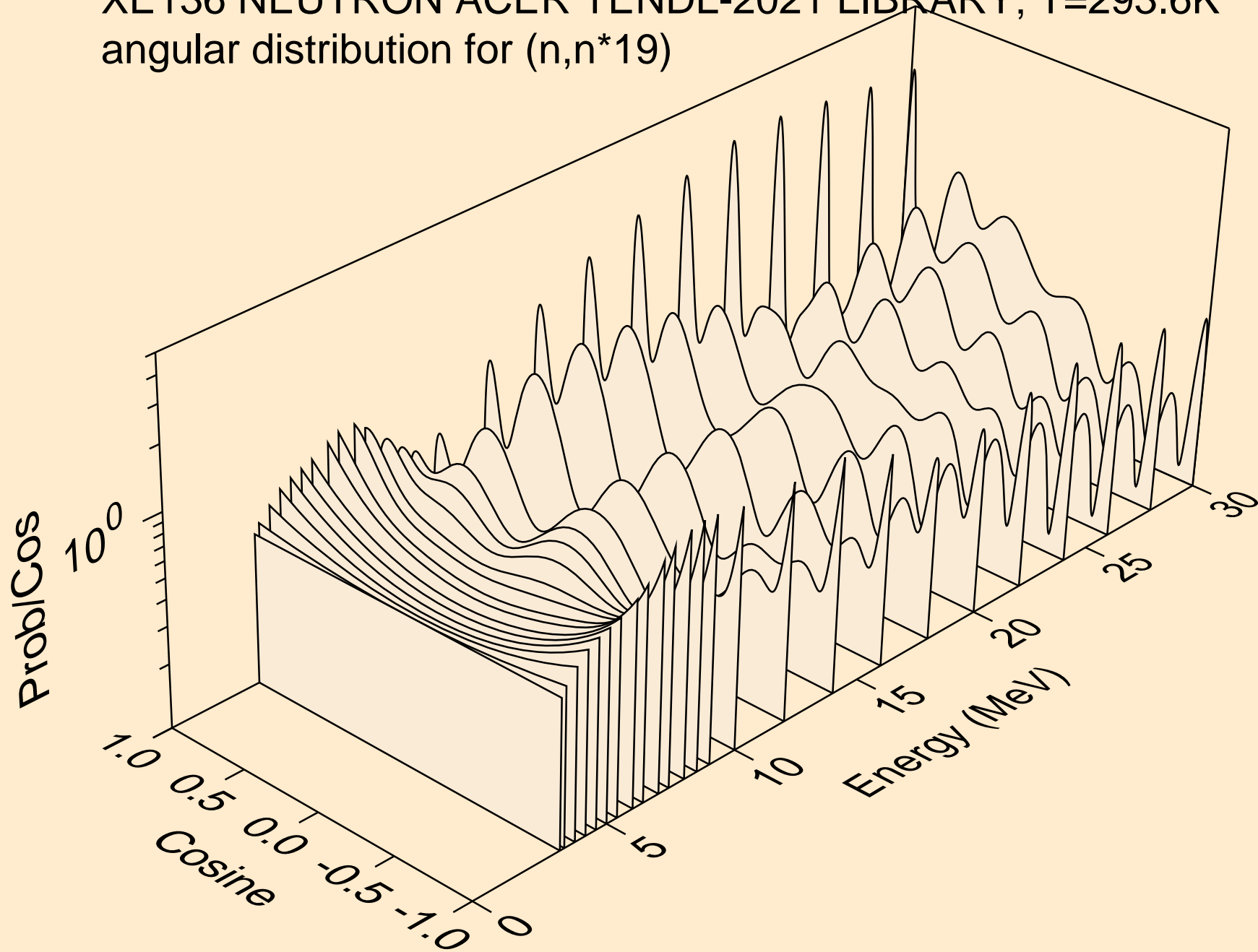

XE136 NEUTRON ACER TENDL-2021 LIBRARY; T=293.6K  
angular distribution for (n,n\*20)

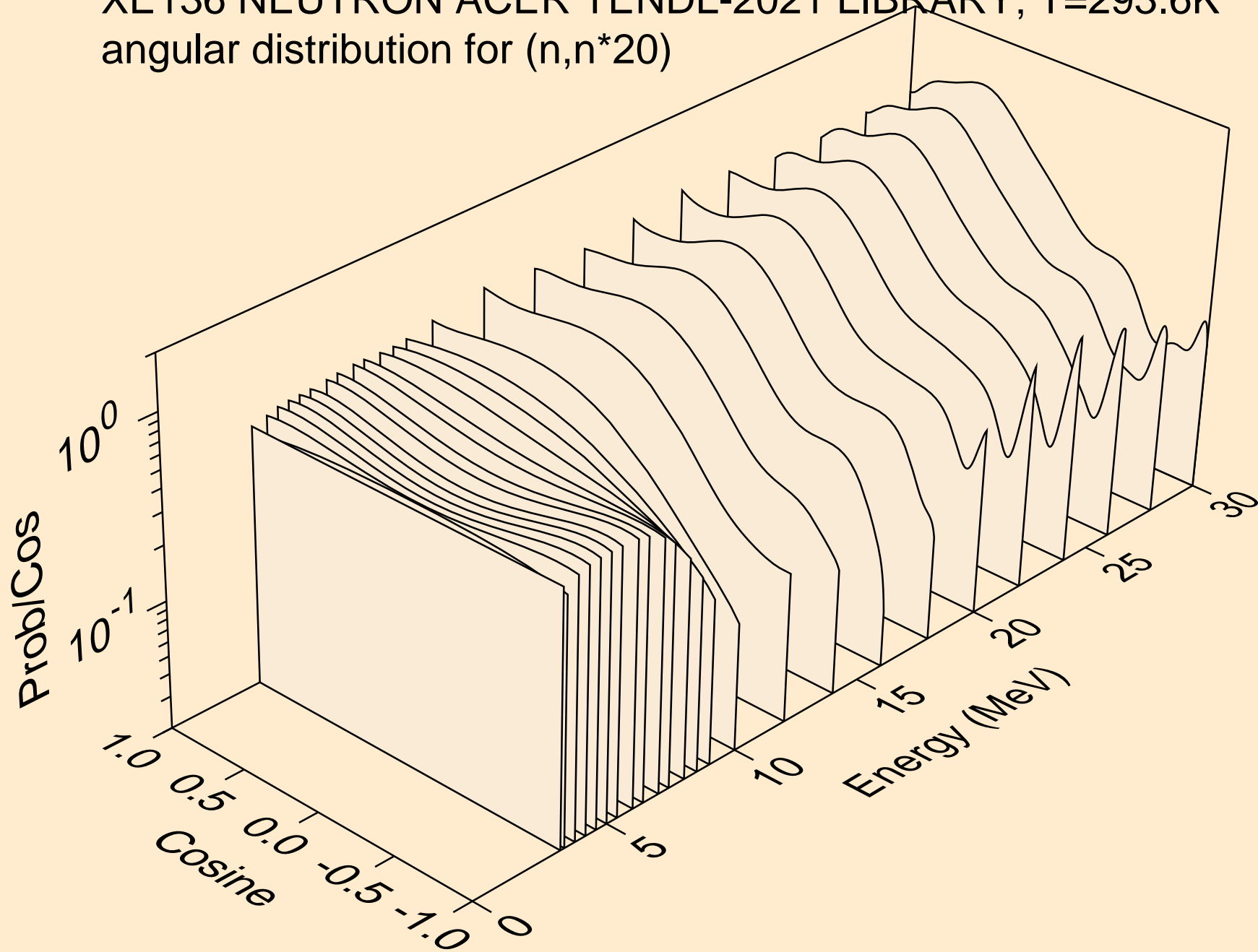

XE136 NEUTRON ACER TENDL-2021 LIBRARY; T=293.6K  
angular distribution for (n,n\*21)

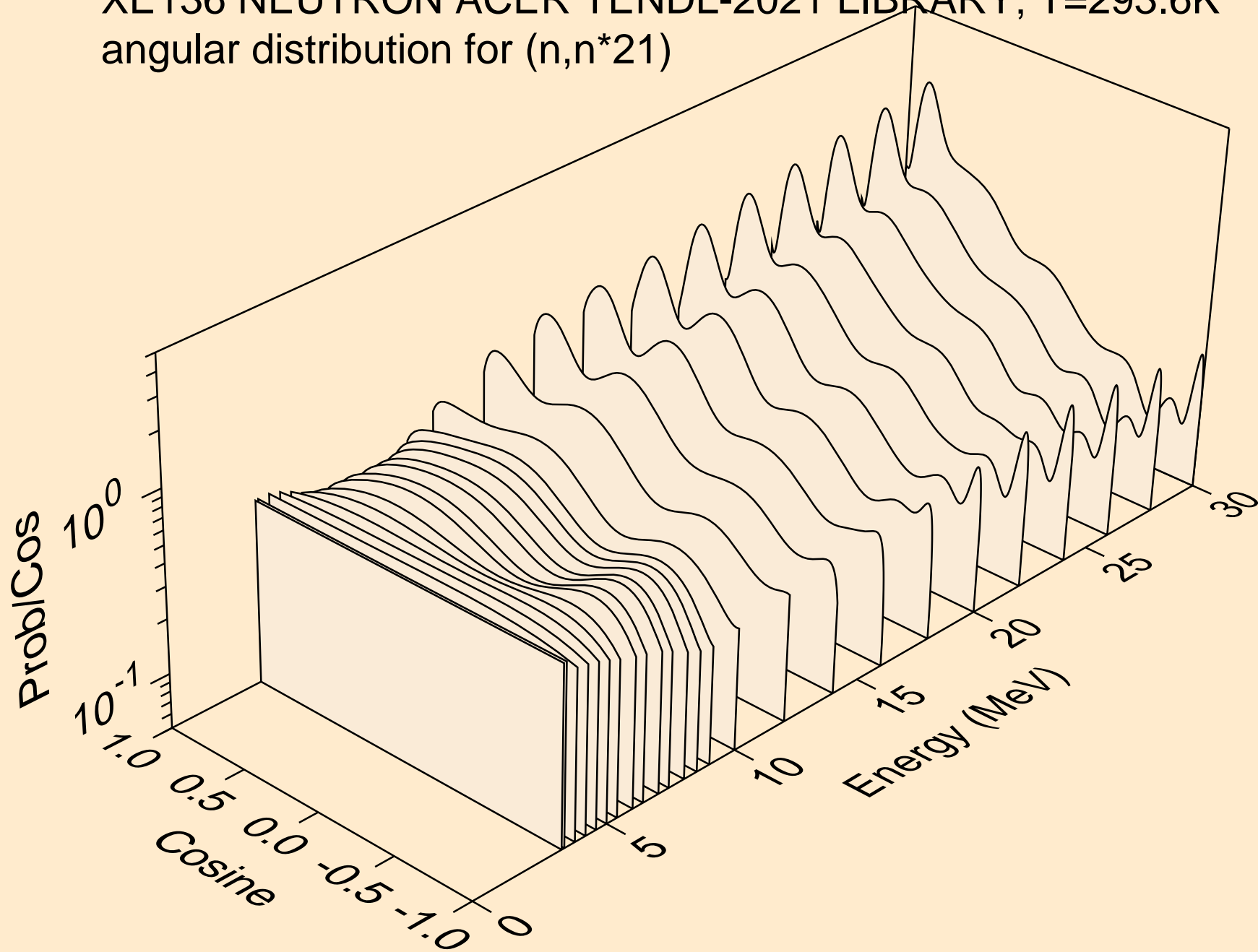

XE136 NEUTRON ACER TENDL-2021 LIBRARY; T=293.6K  
angular distribution for (n,n\*22)

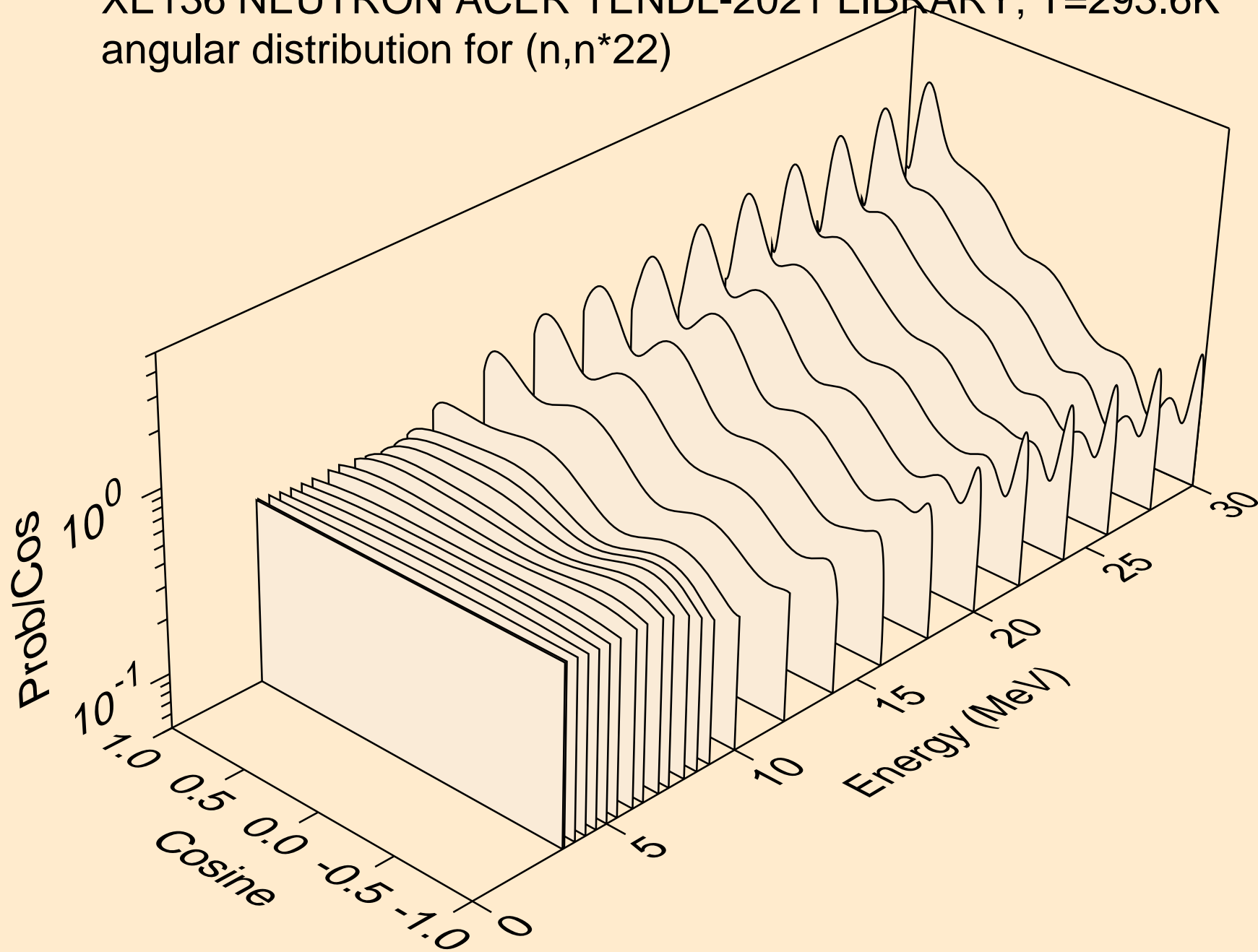

XE136 NEUTRON ACER TENDL-2021 LIBRARY; T=293.6K  
angular distribution for (n,n\*23)

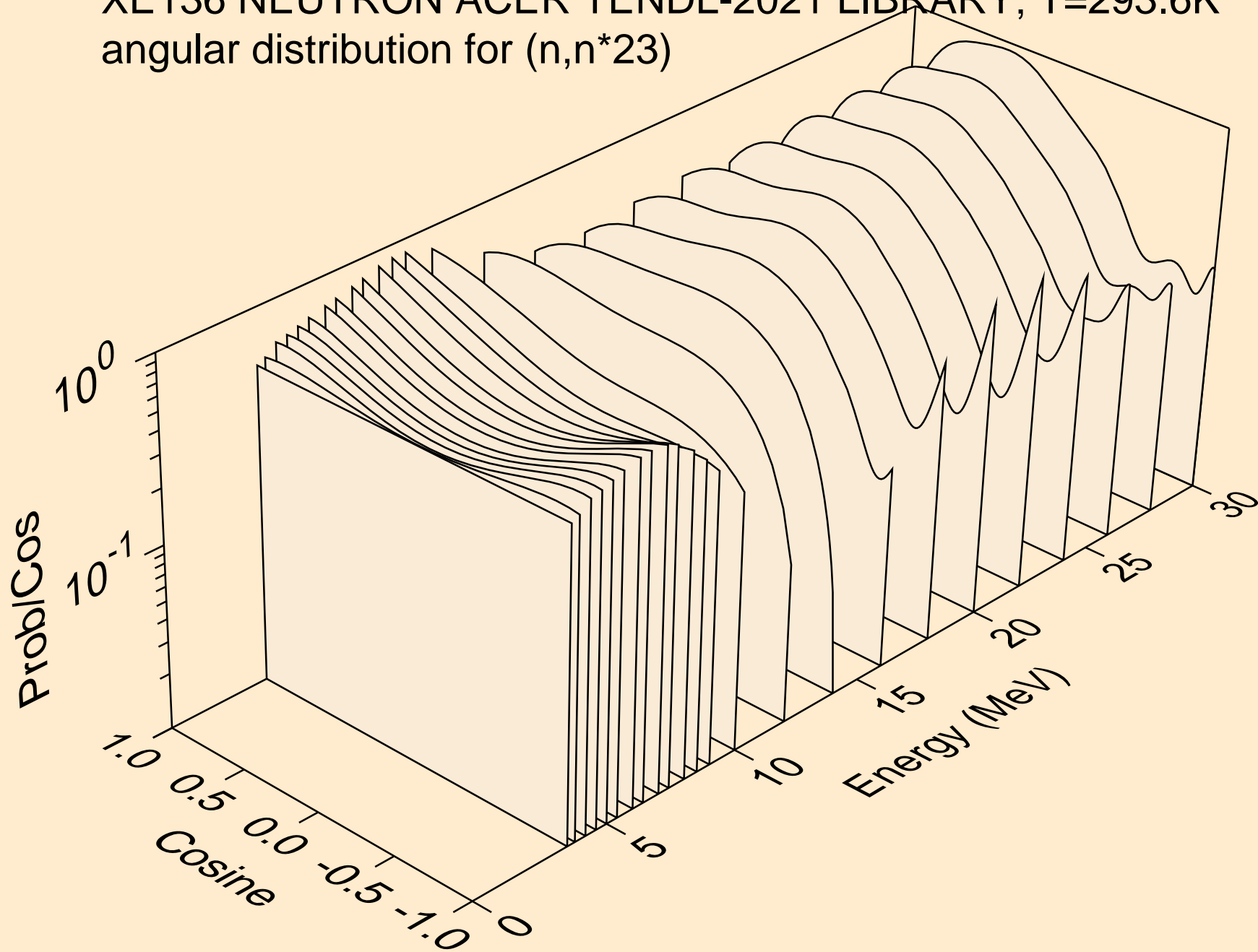

XE136 NEUTRON ACER TENDL-2021 LIBRARY; T=293.6K  
angular distribution for (n,n\*24)

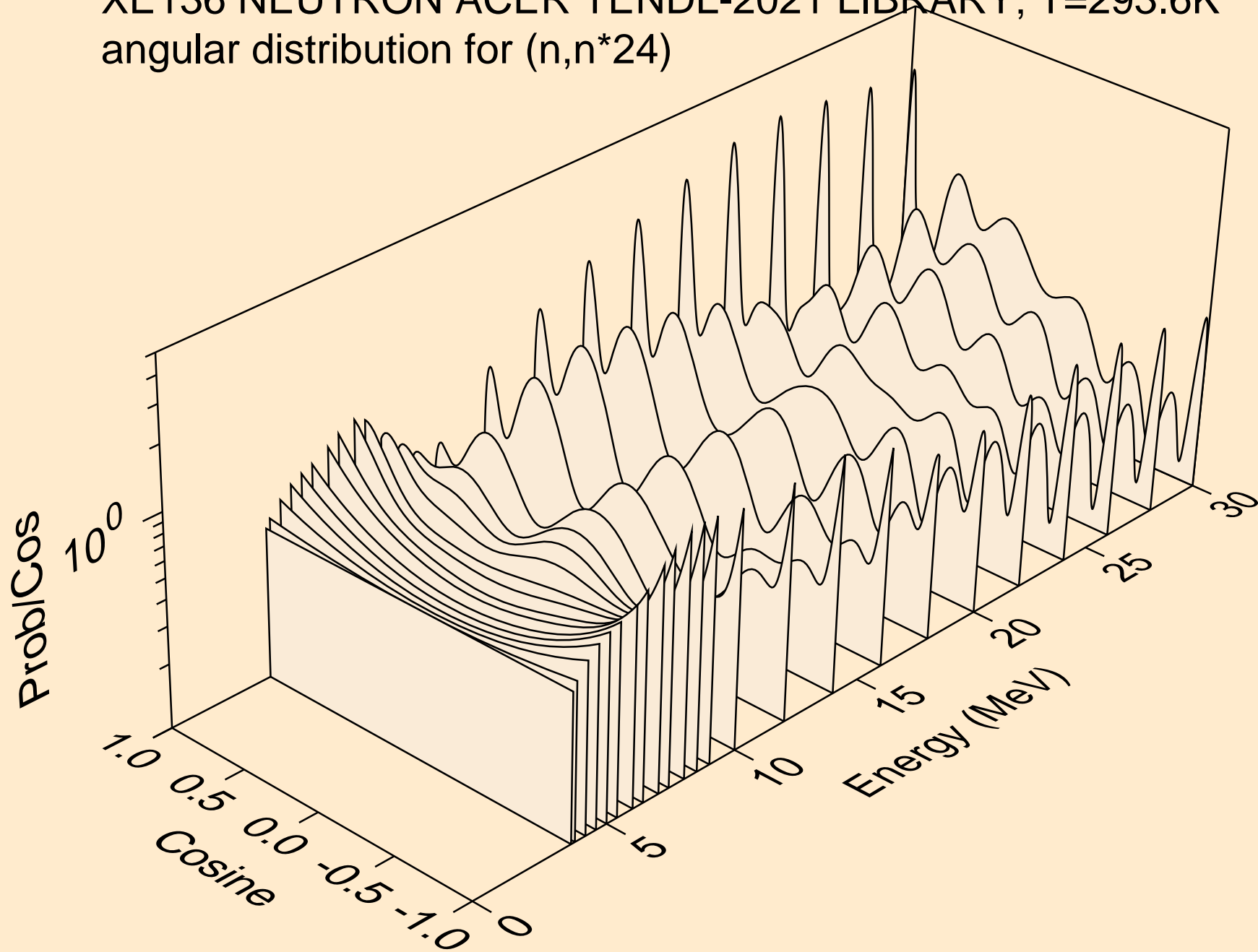



XE136 NEUTRON ACER TENDL-2021 LIBRARY; T=293.6K  
angular distribution for (n,n\*25)

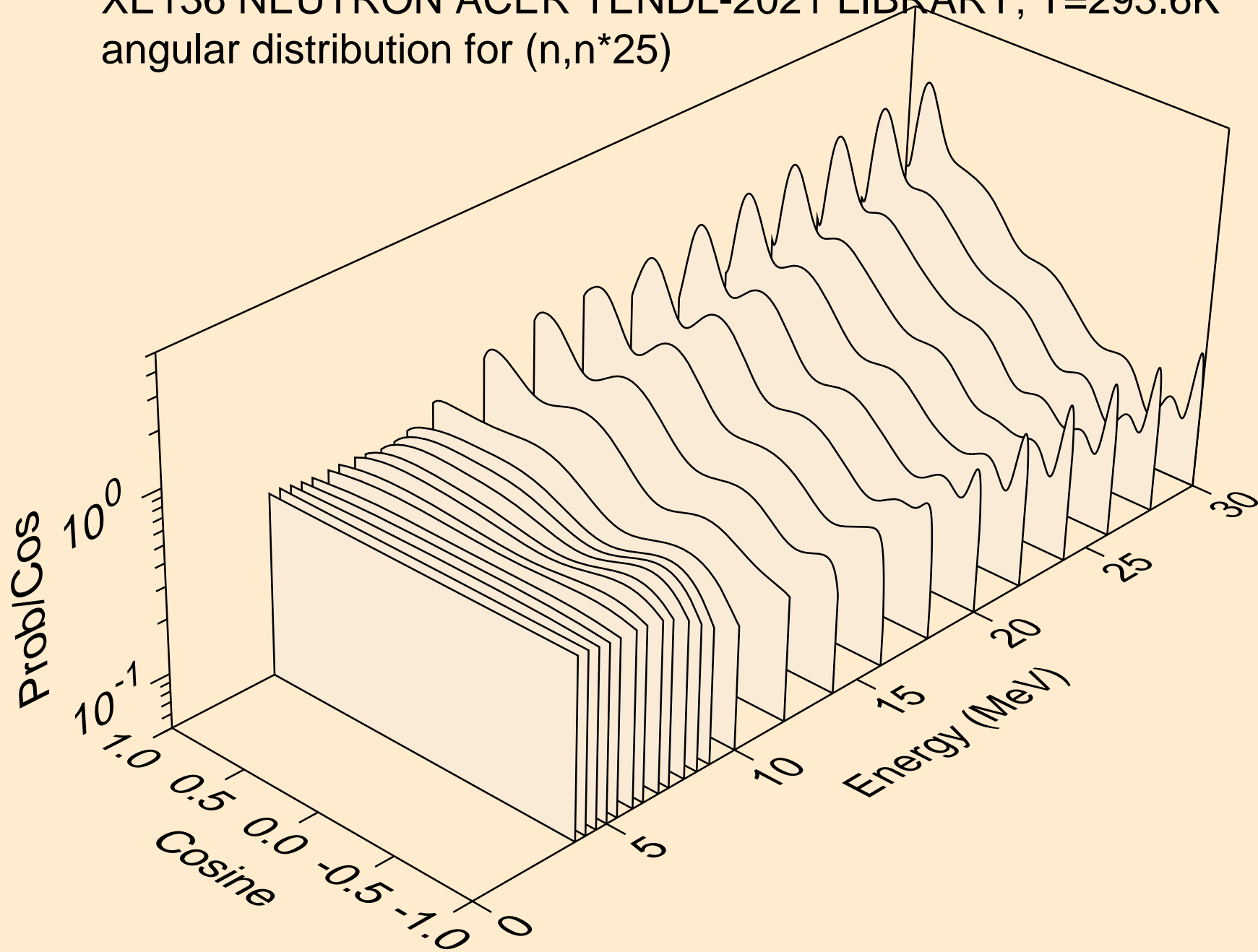

XE136 NEUTRON ACER TENDL-2021 LIBRARY; T=293.6K  
angular distribution for (n,n\*26)

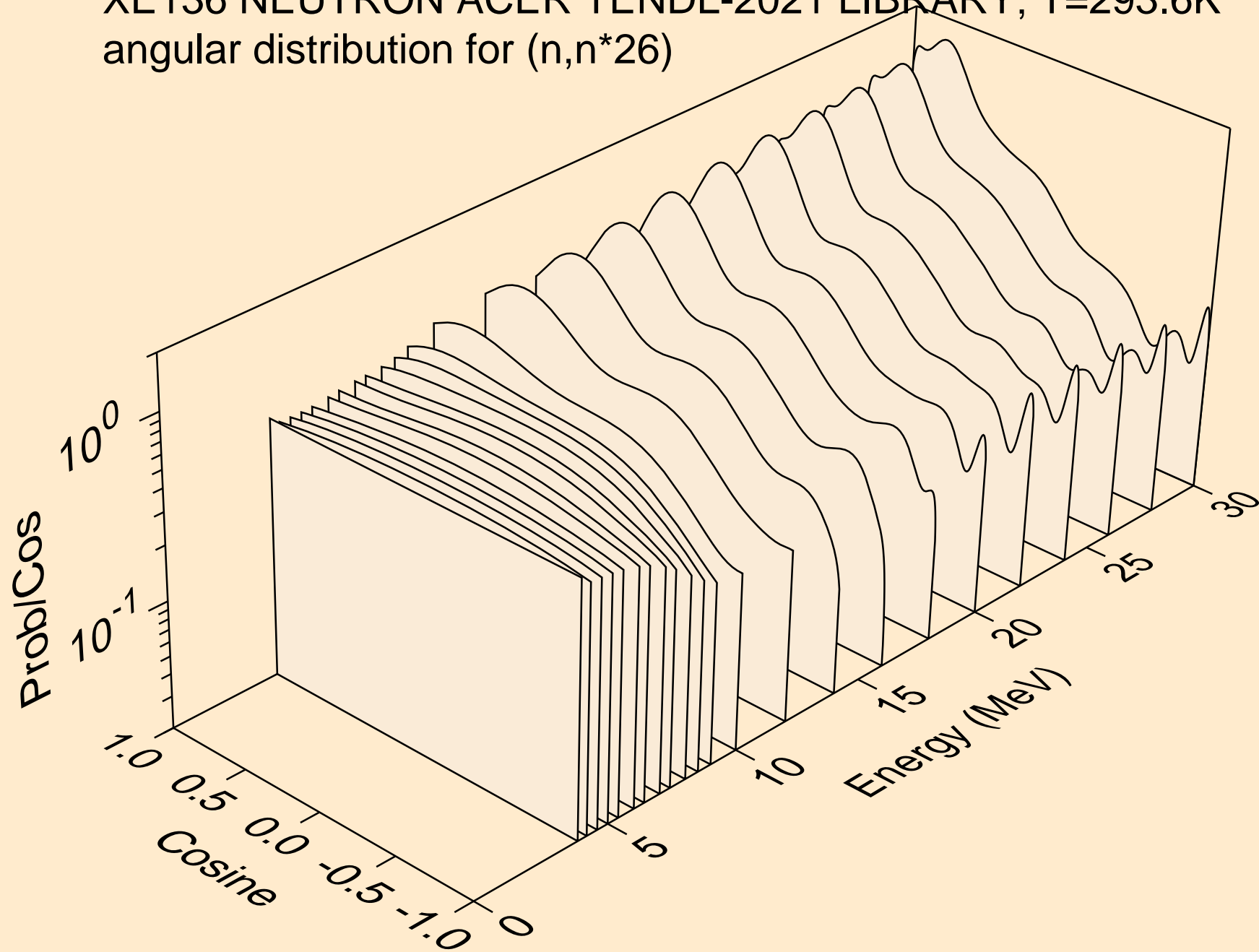

XE136 NEUTRON ACER TENDL-2021 LIBRARY; T=293.6K  
angular distribution for (n,n\*27)

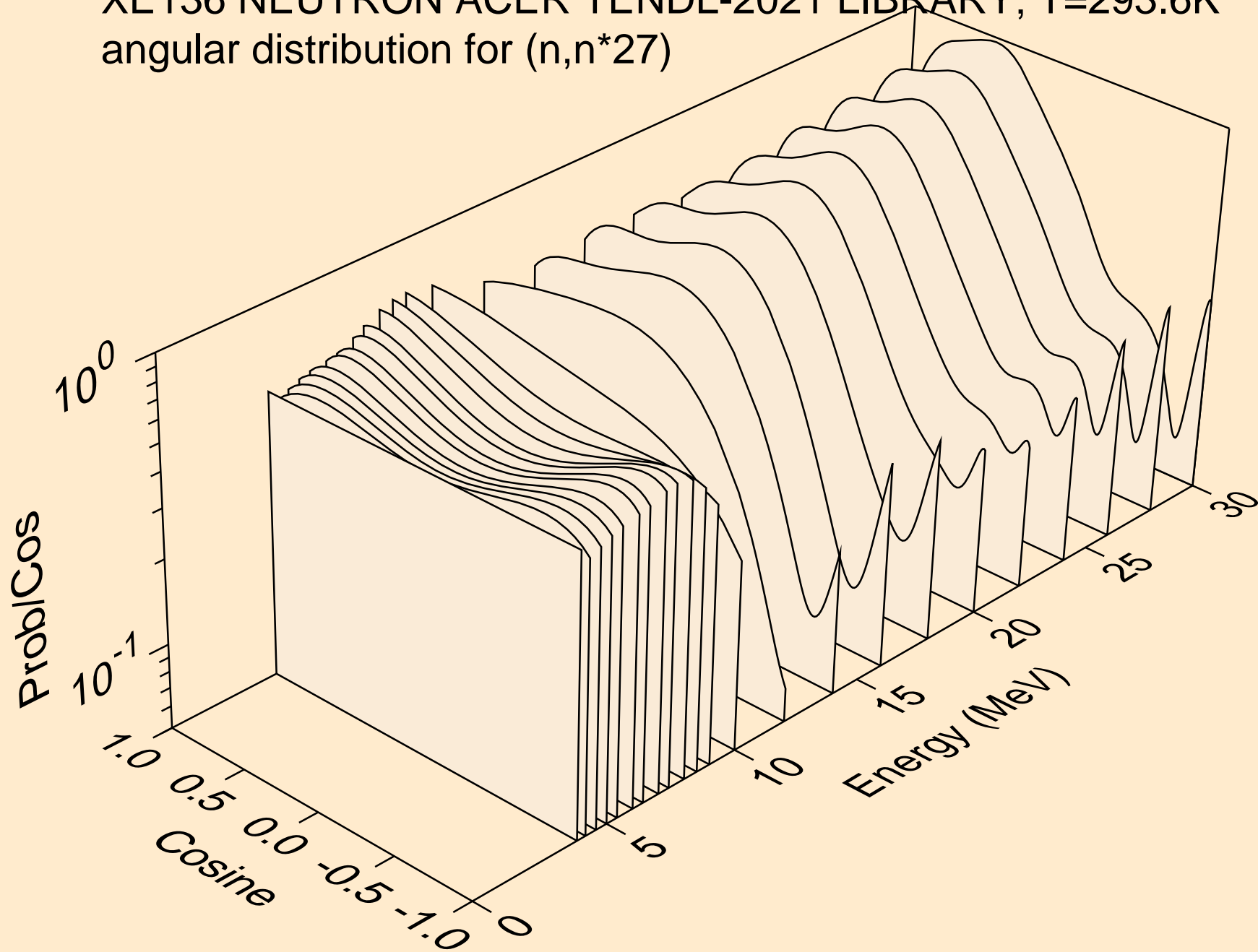

XE136 NEUTRON ACER TENDL-2021 LIBRARY; T=293.6K  
angular distribution for (n,n\*28)

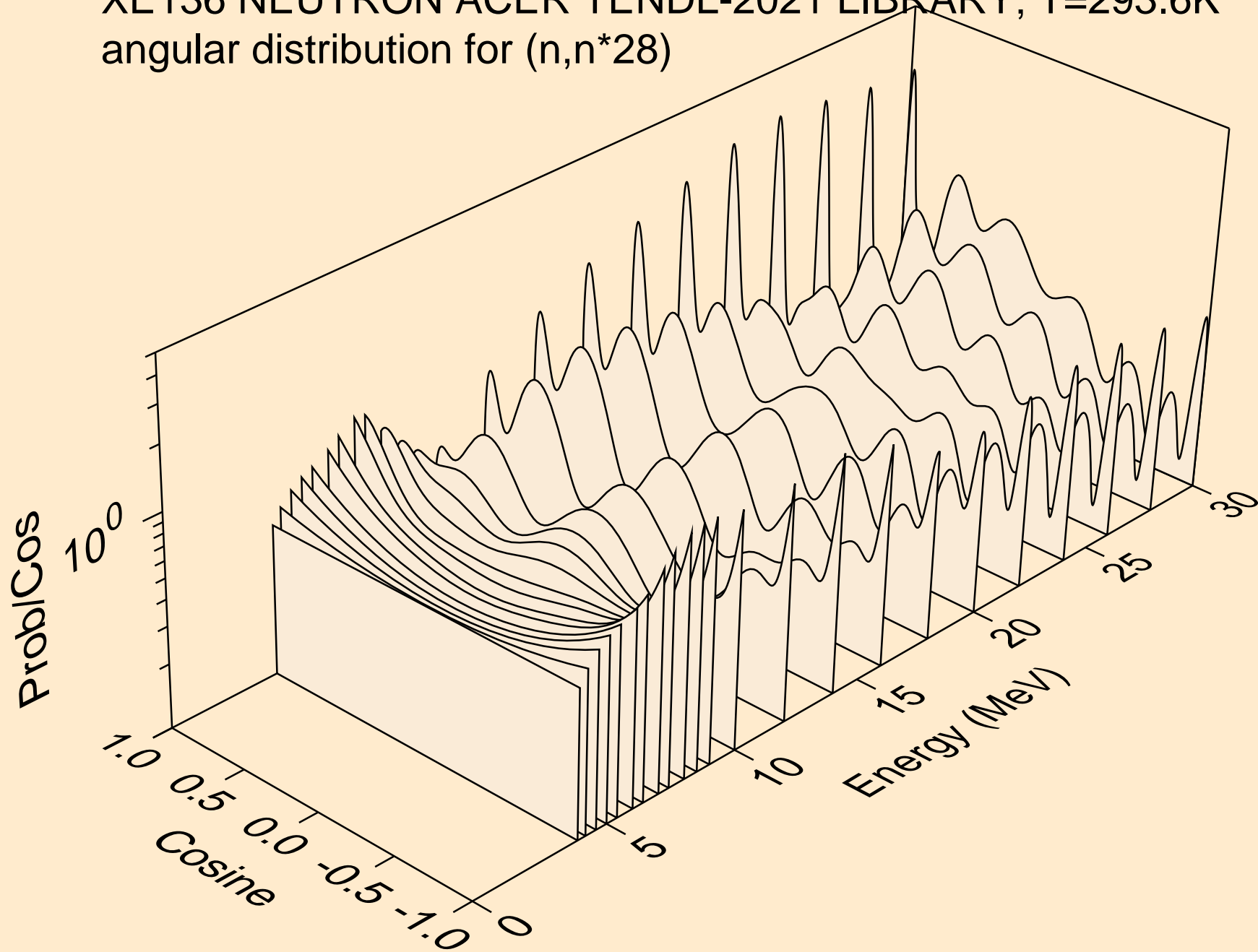

XE136 NEUTRON ACER TENDL-2021 LIBRARY; T=293.6K  
angular distribution for (n,n\*29)

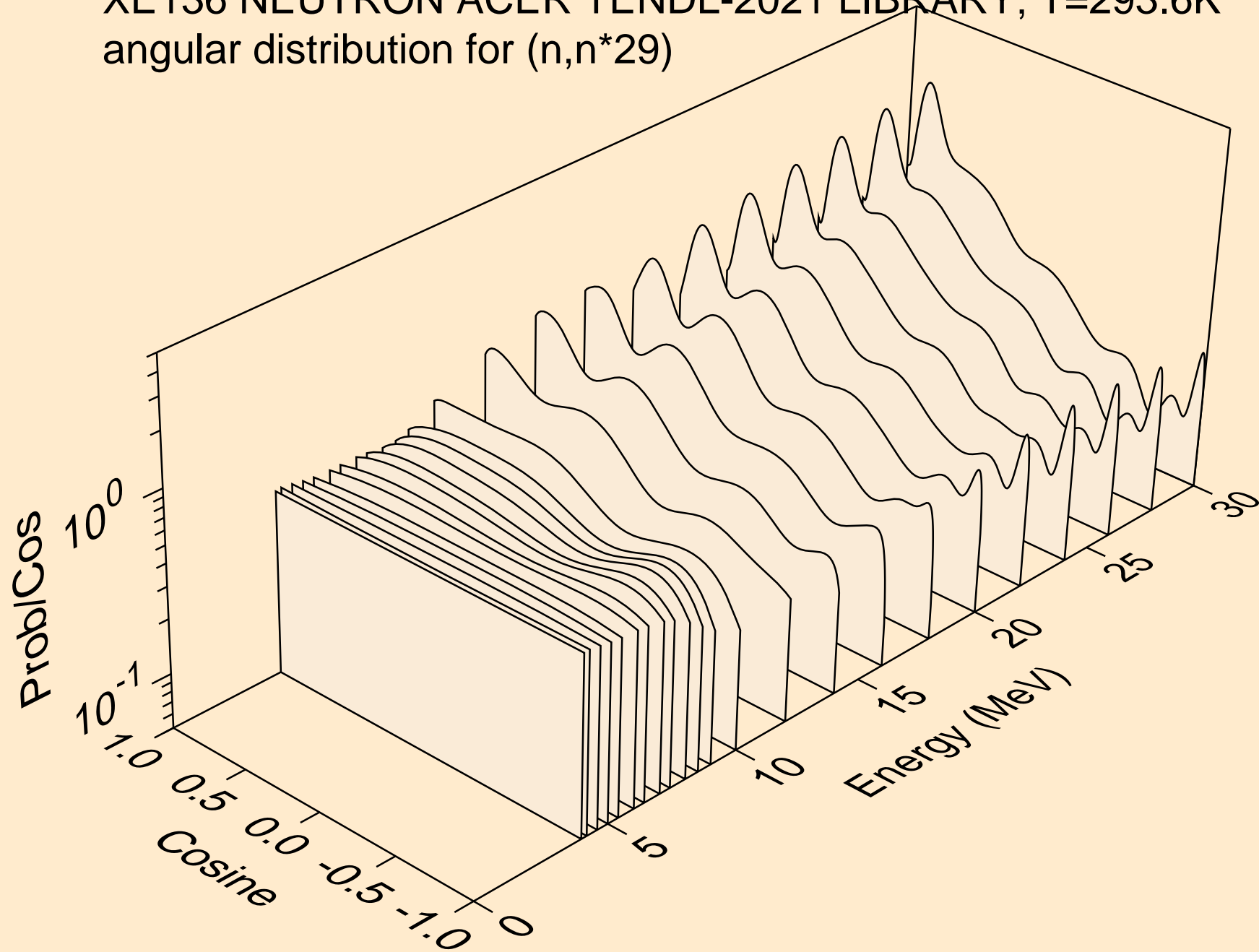

XE136 NEUTRON ACER TENDL-2021 LIBRARY; T=293.6K  
angular distribution for (n,n\*30)

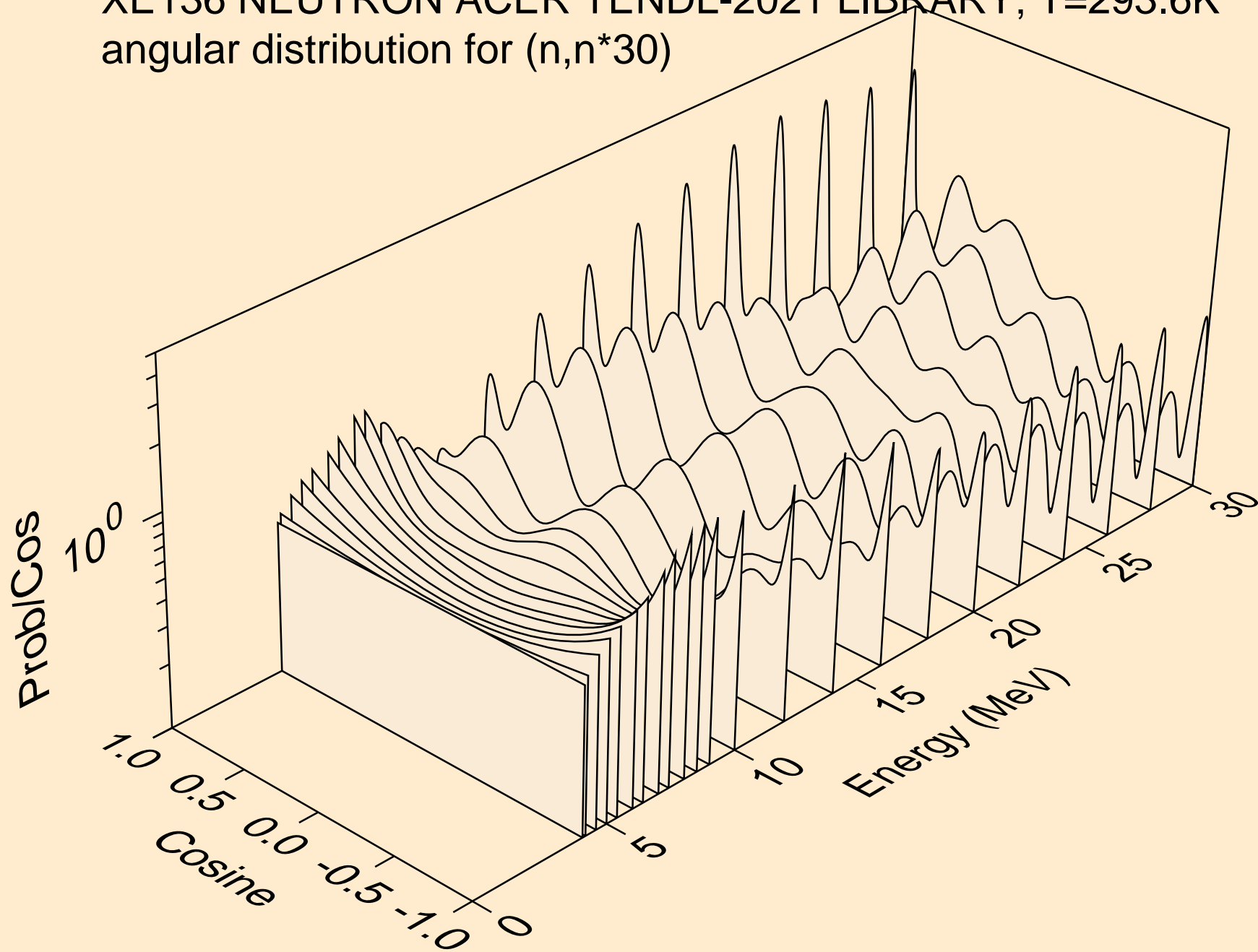

XE136 NEUTRON ACER TENDL-2021 LIBRARY; T=293.6K  
Neutron emission for (n,x)

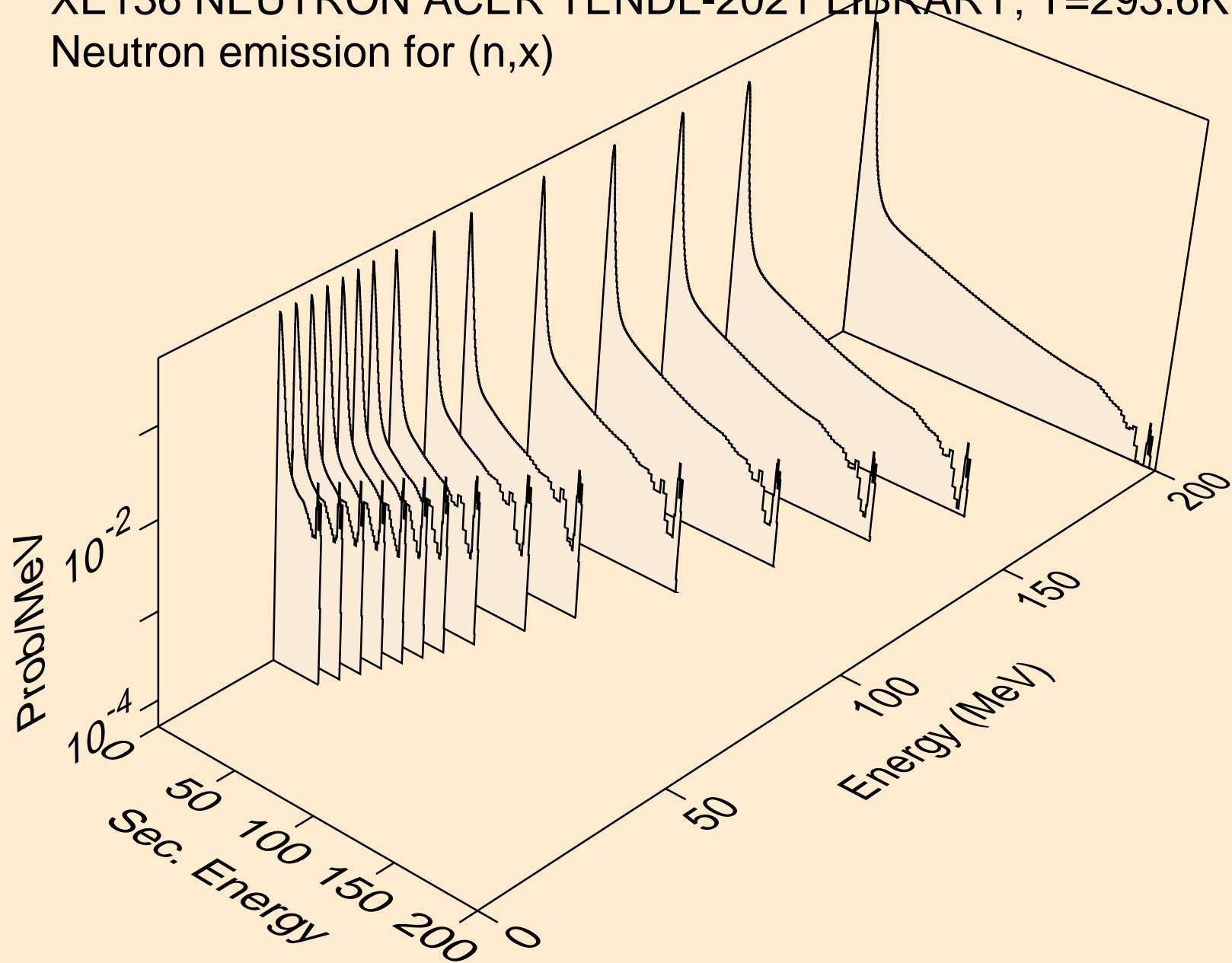

XE136 NEUTRON ACER TENDL-2021 LIBRARY; T=293.6K  
Neutron emission for (n,2nd)

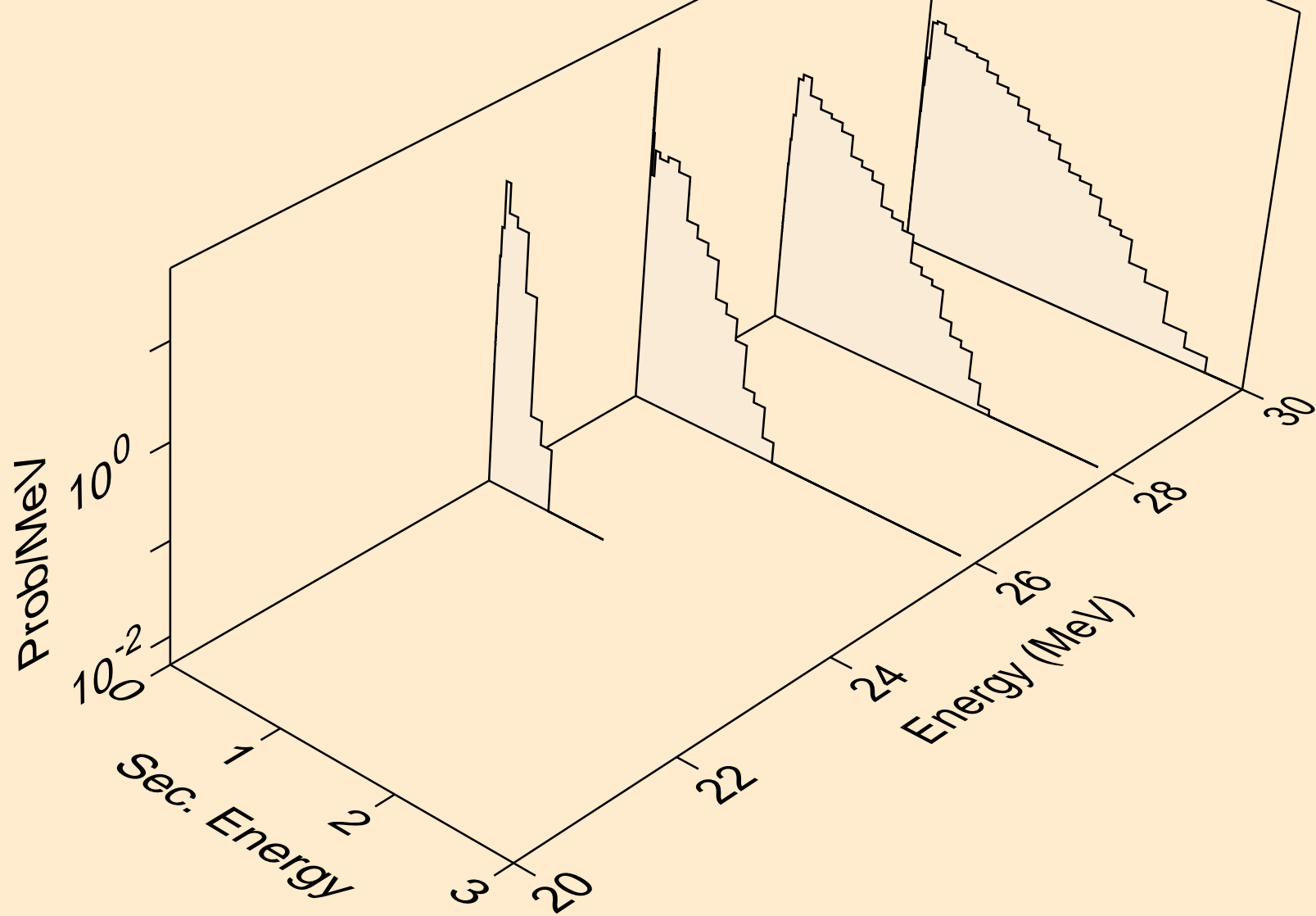



XE136 NEUTRON ACER TENDL-2021 LIBRARY; T=293.6K  
Neutron emission for (n,2n)

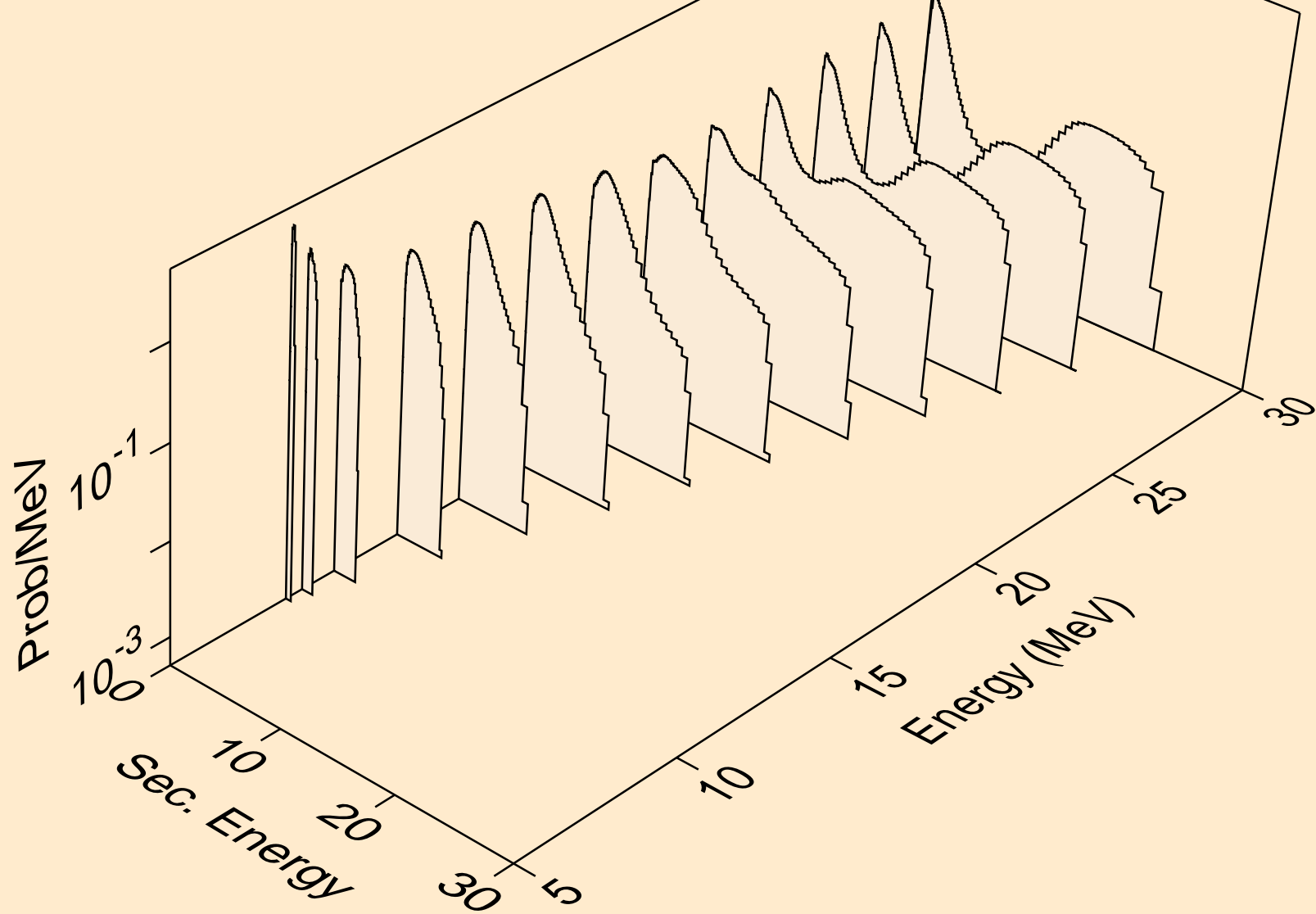

XE136 NEUTRON ACER TENDL-2021 LIBRARY; T=293.6K  
Neutron emission for (n,3n)

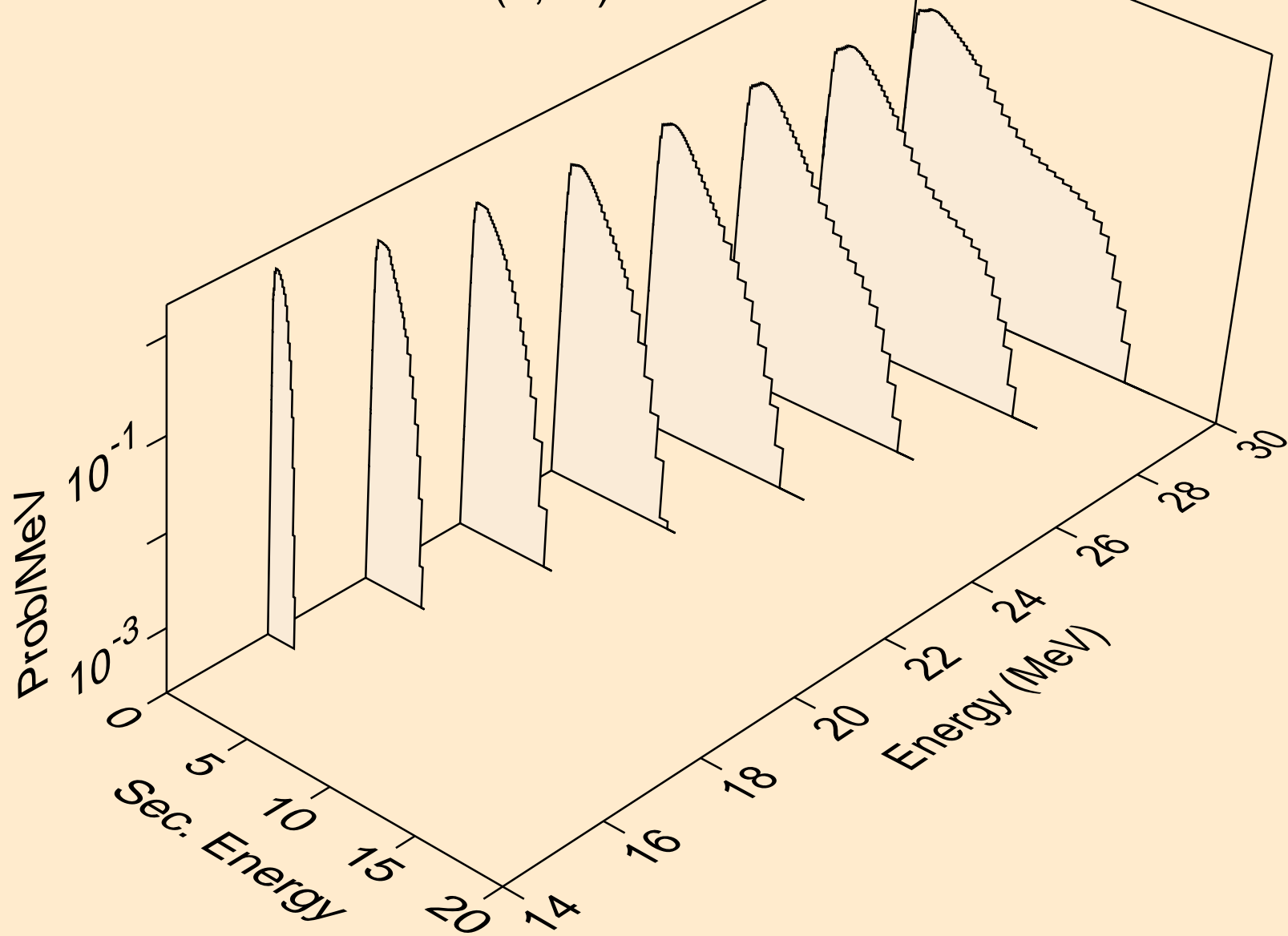

XE136 NEUTRON ACER TENDL-2021 LIBRARY; T=293.6K  
Neutron emission for (n,n\*)a

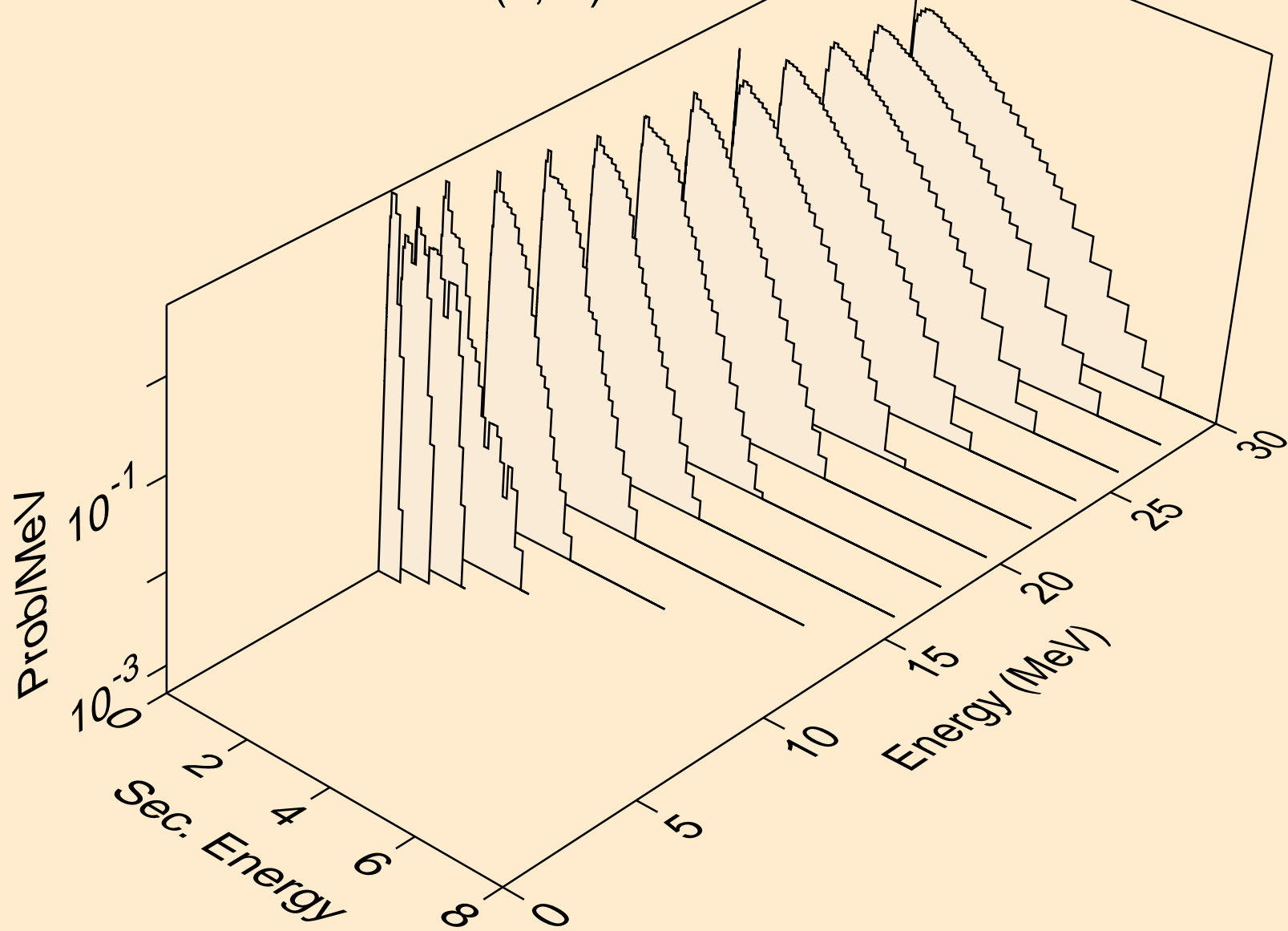

XE136 NEUTRON ACER TENDL-2021 LIBRARY; T=293.6K  
Neutron emission for (n,2n)<sub>a</sub>

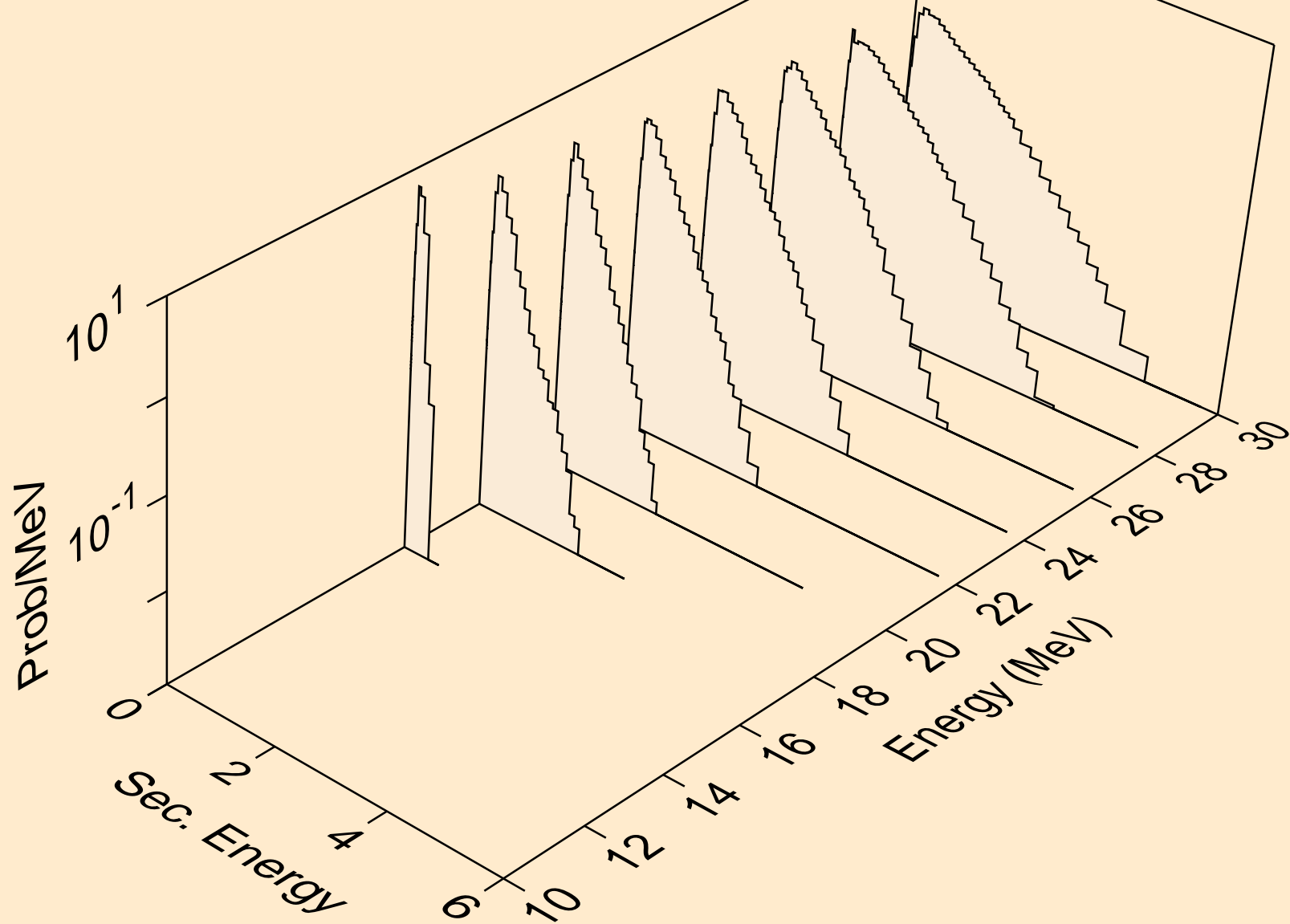

XE136 NEUTRON ACER TENDL-2021 LIBRARY; T=293.6K  
Neutron emission for (n,3n)<sub>a</sub>

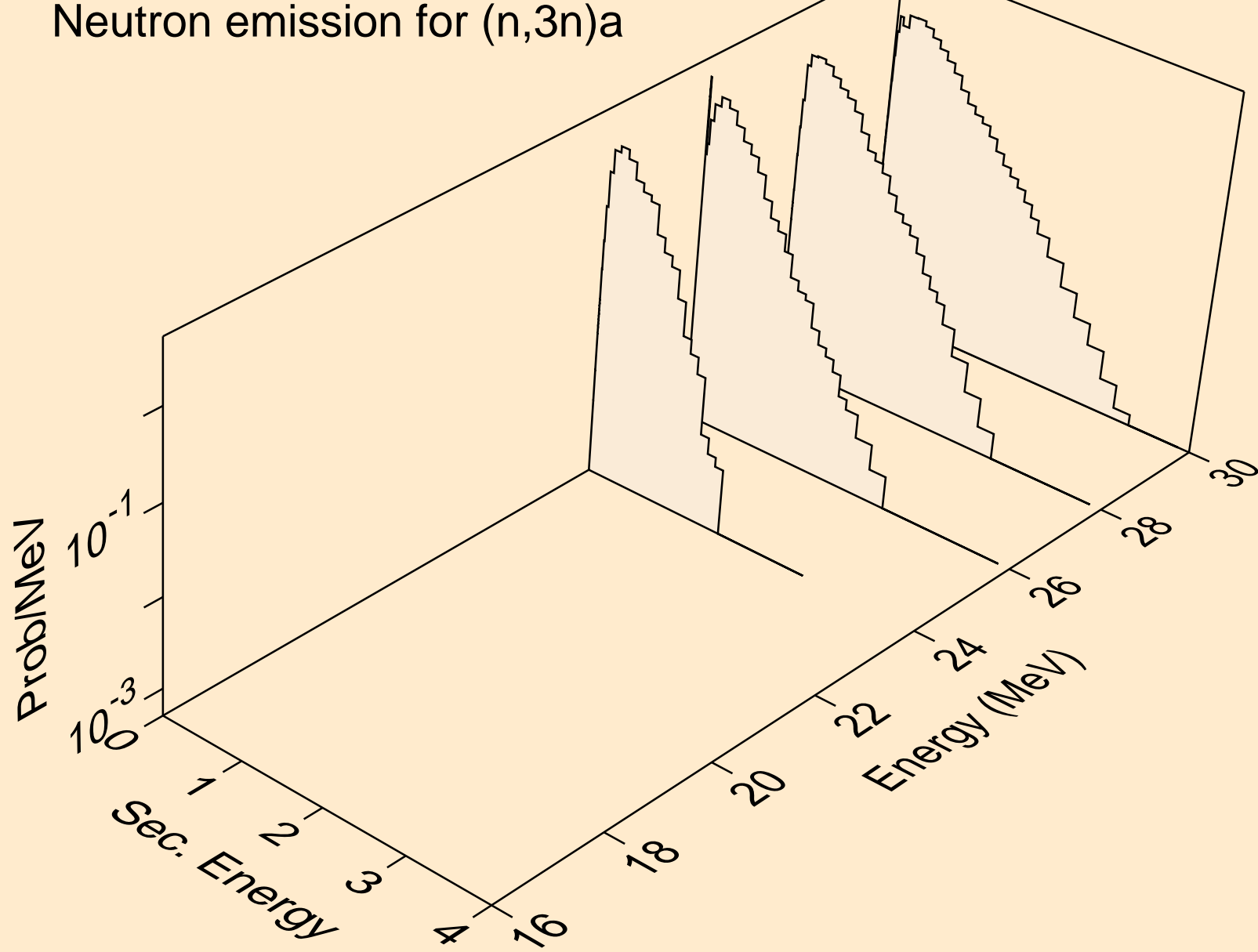

XE136 NEUTRON ACER TENDL-2021 LIBRARY; T=293.6K  
Neutron emission for (n,n\*)p

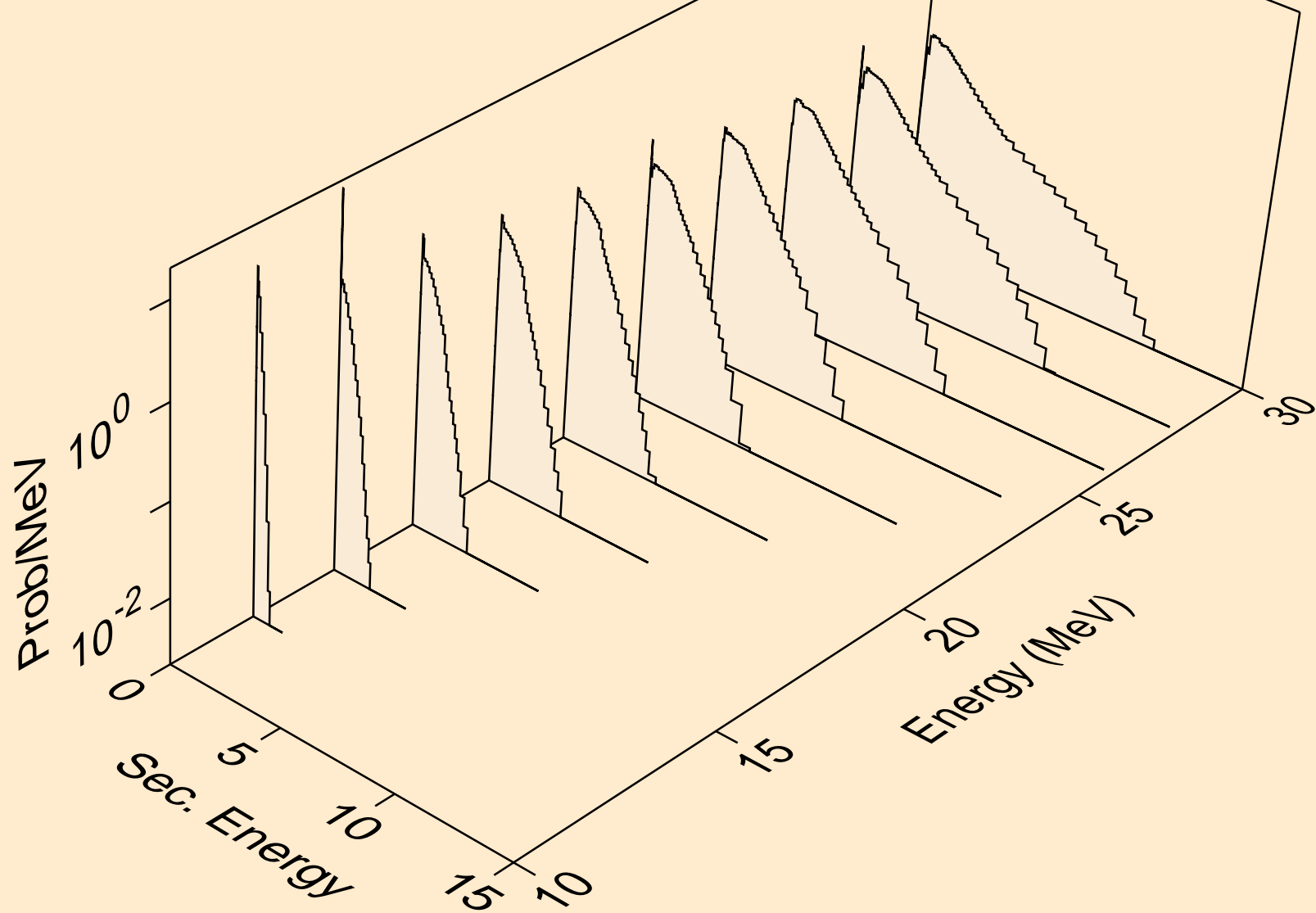

XE136 NEUTRON ACER TENDL-2021 LIBRARY; T=293.6K  
Neutron emission for (n,n\*)d

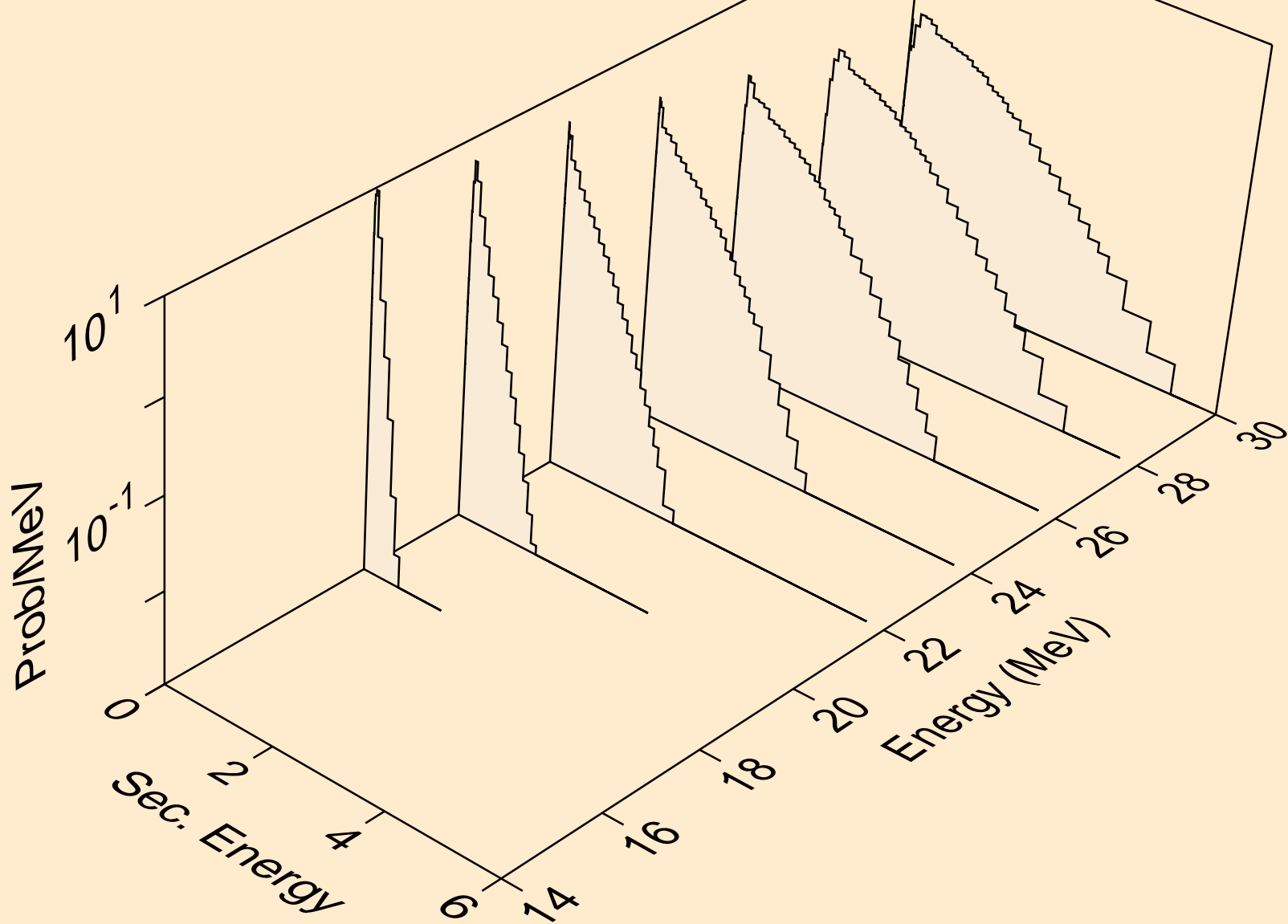

XE136 NEUTRON ACER TENDL-2021 LIBRARY; T=293.6K  
Neutron emission for (n,n\*)t

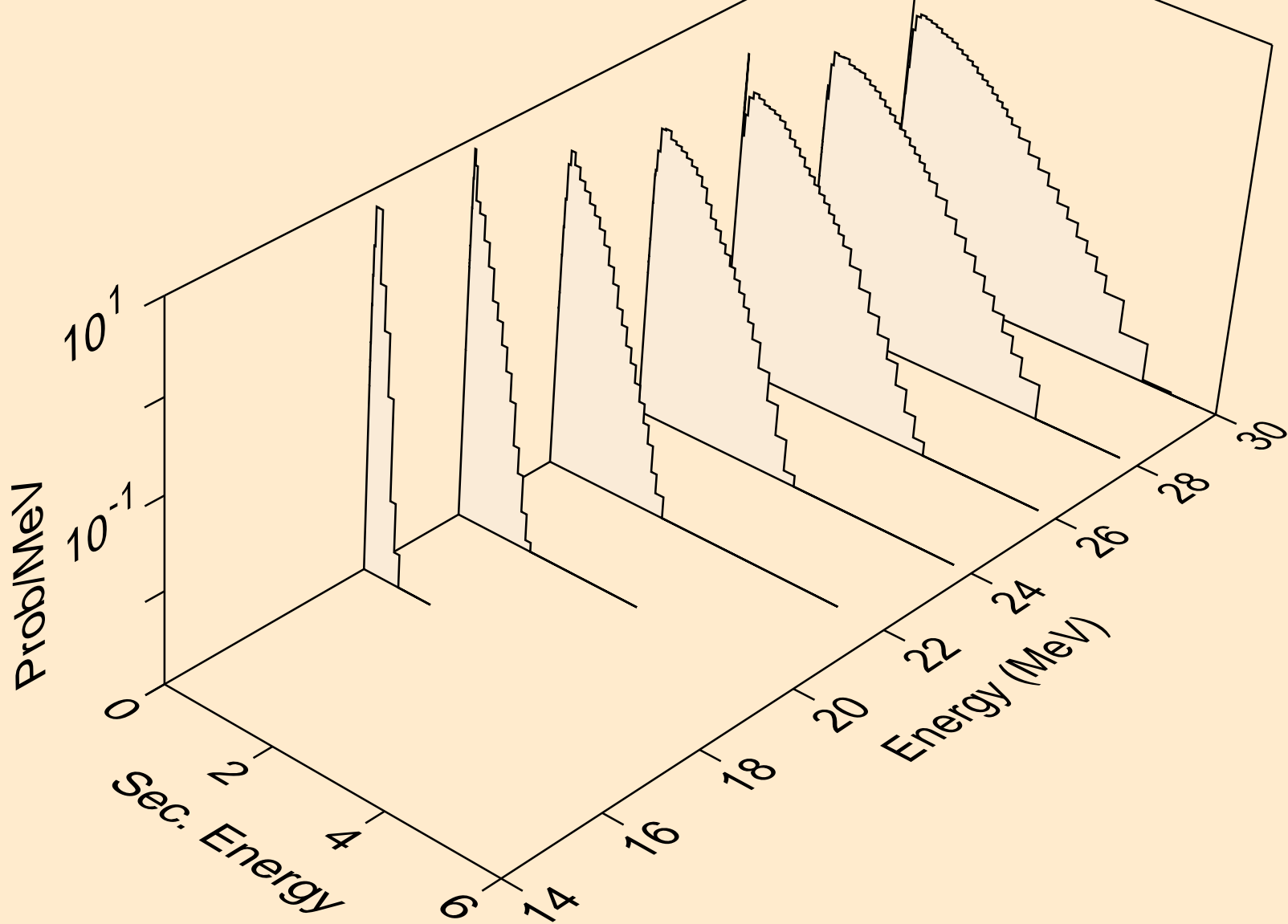



XE136 NEUTRON ACER TENDL-2021 LIBRARY; T=293.6K  
Neutron emission for (n,n\*)he3

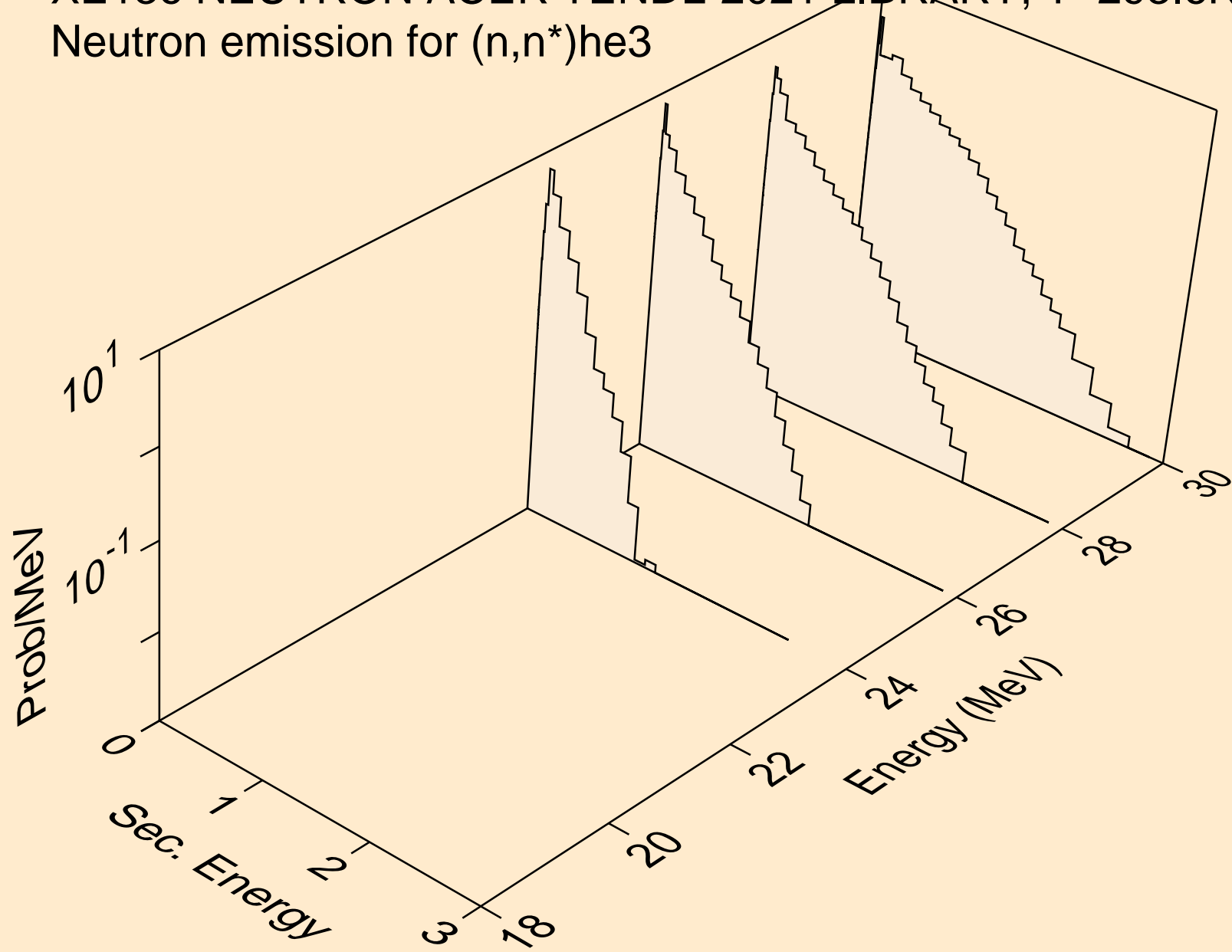

XE136 NEUTRON ACER TENDL-2021 LIBRARY; T=293.6K  
Neutron emission for (n,4n)

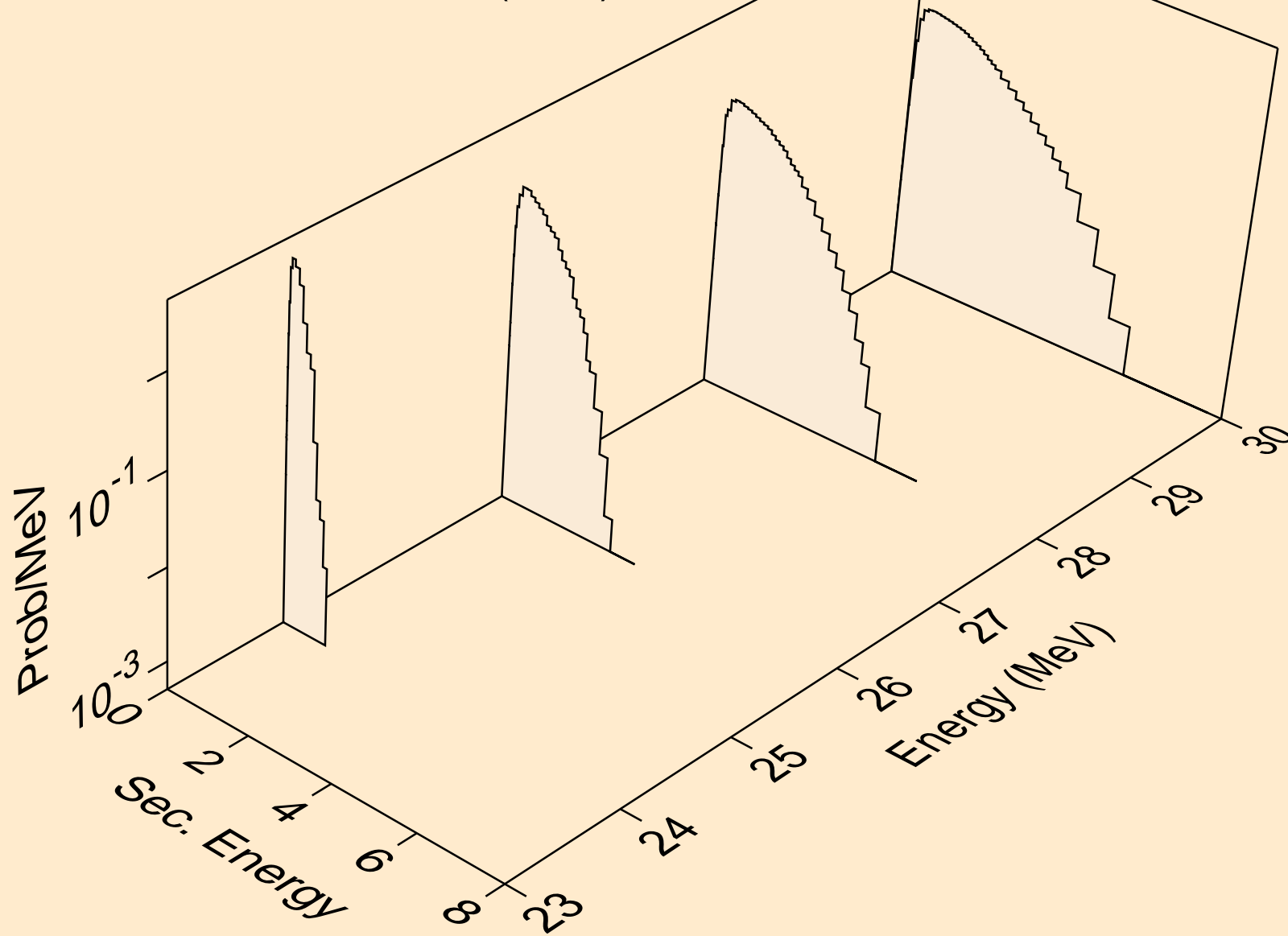

XE136 NEUTRON ACER TENDL-2021 LIBRARY; T=293.6K  
Neutron emission for (n,2np)

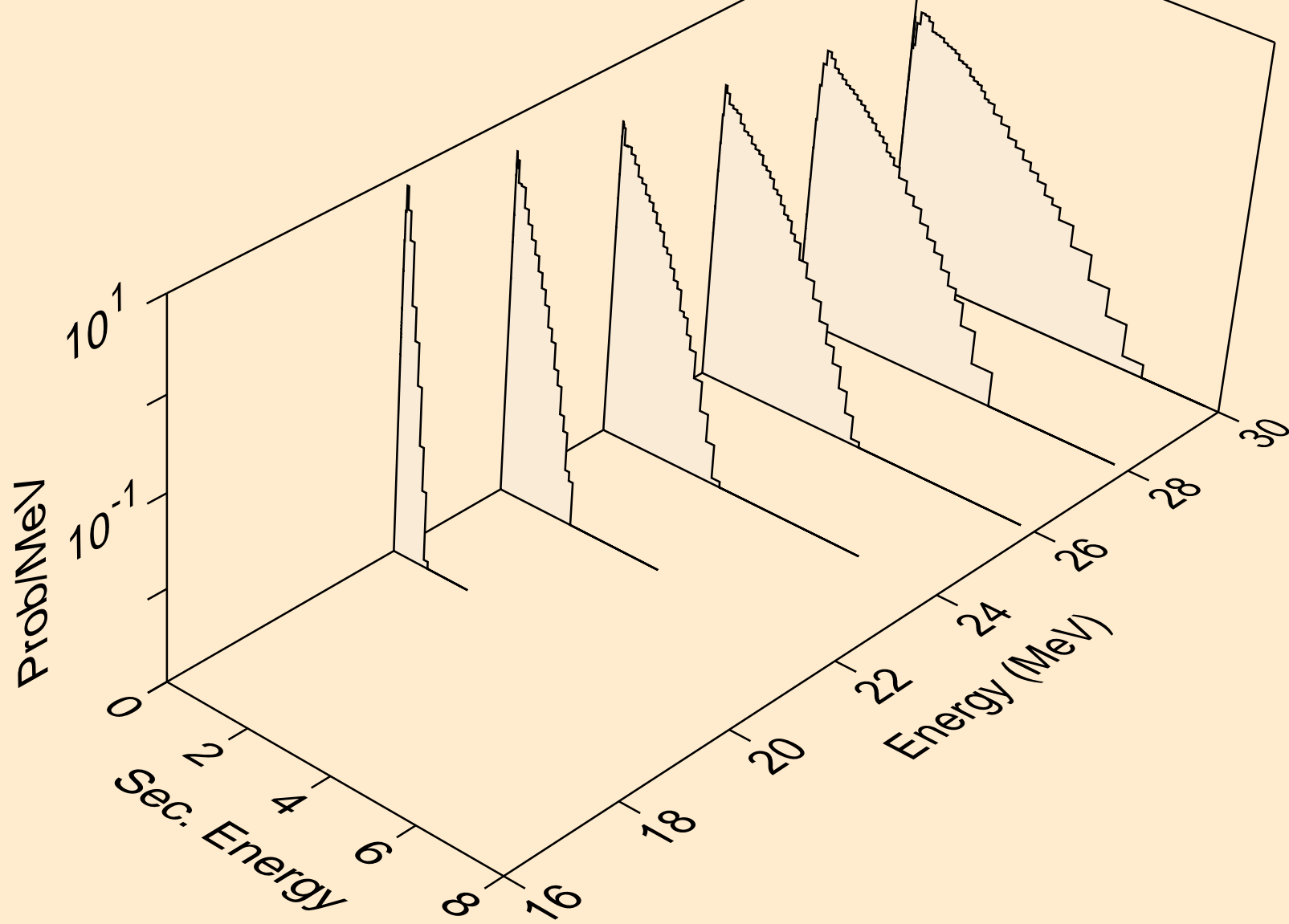

XE136 NEUTRON ACER TENDL-2021 LIBRARY; T=293.6K  
Neutron emission for (n,3np)

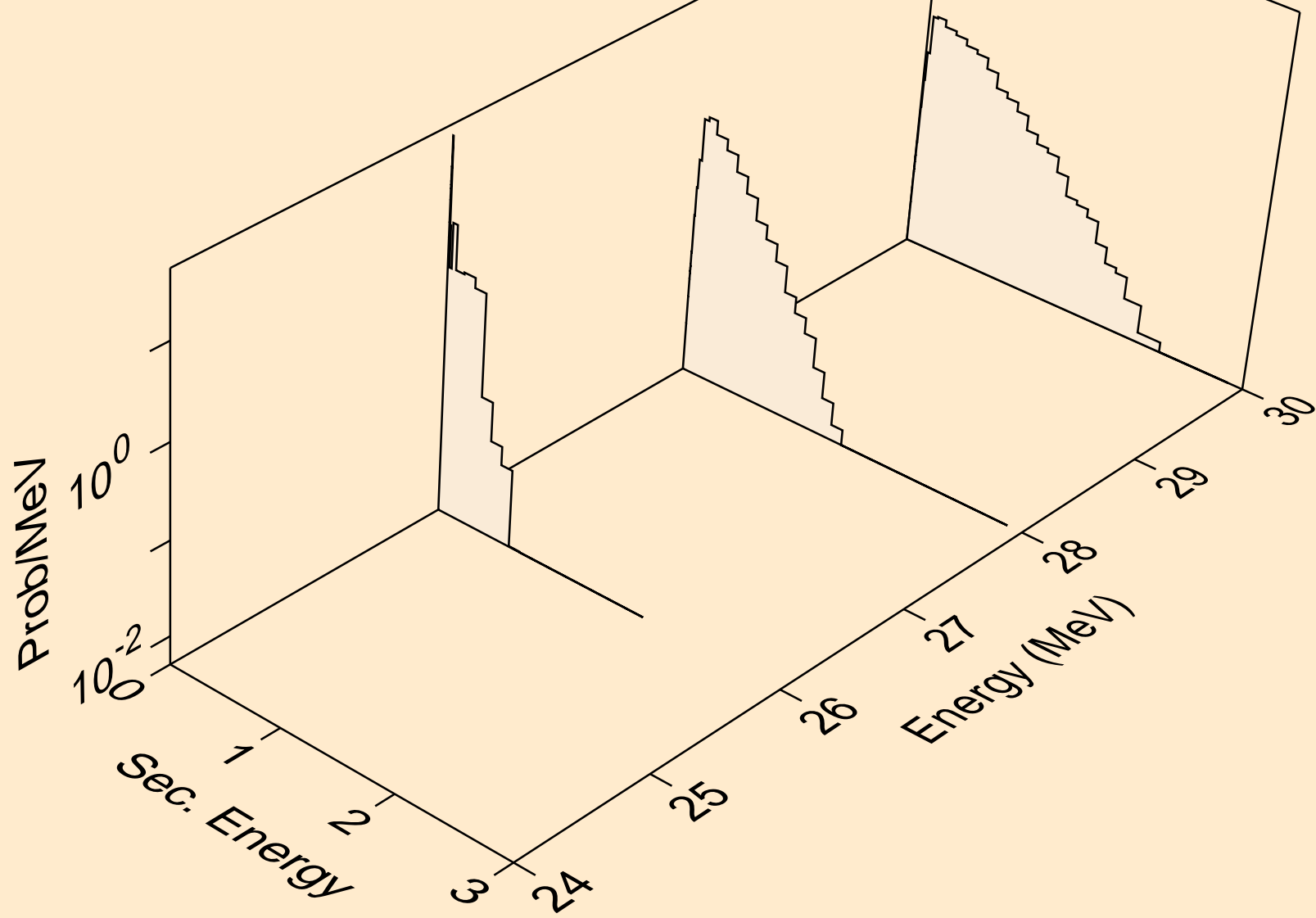

XE136 NEUTRON ACER TENDL-2021 LIBRARY; T=293.6K  
Neutron emission for (n,2np)

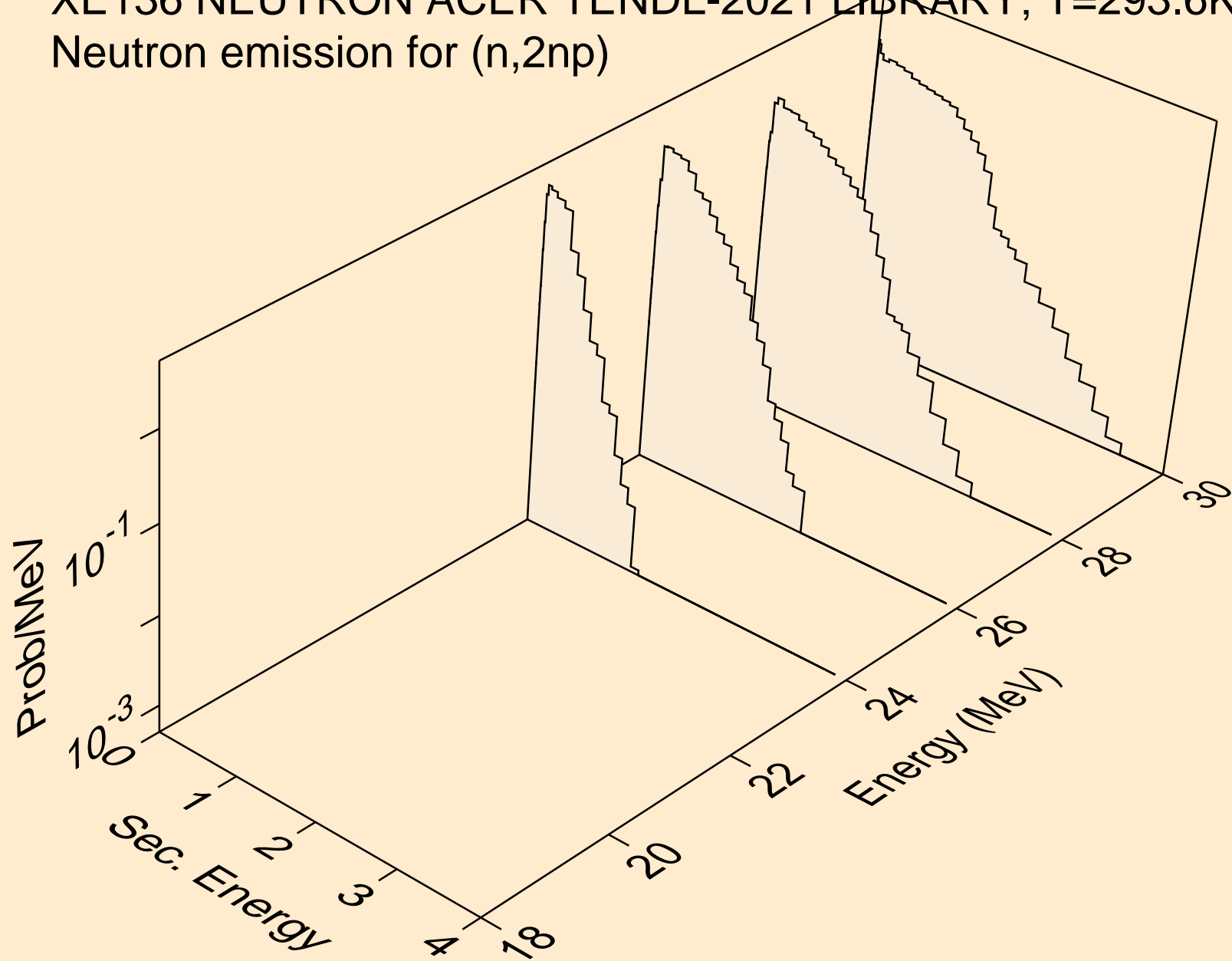

XE136 NEUTRON ACER TENDL-2021 LIBRARY; T=293.6K  
Neutron emission for (n,n\*c)

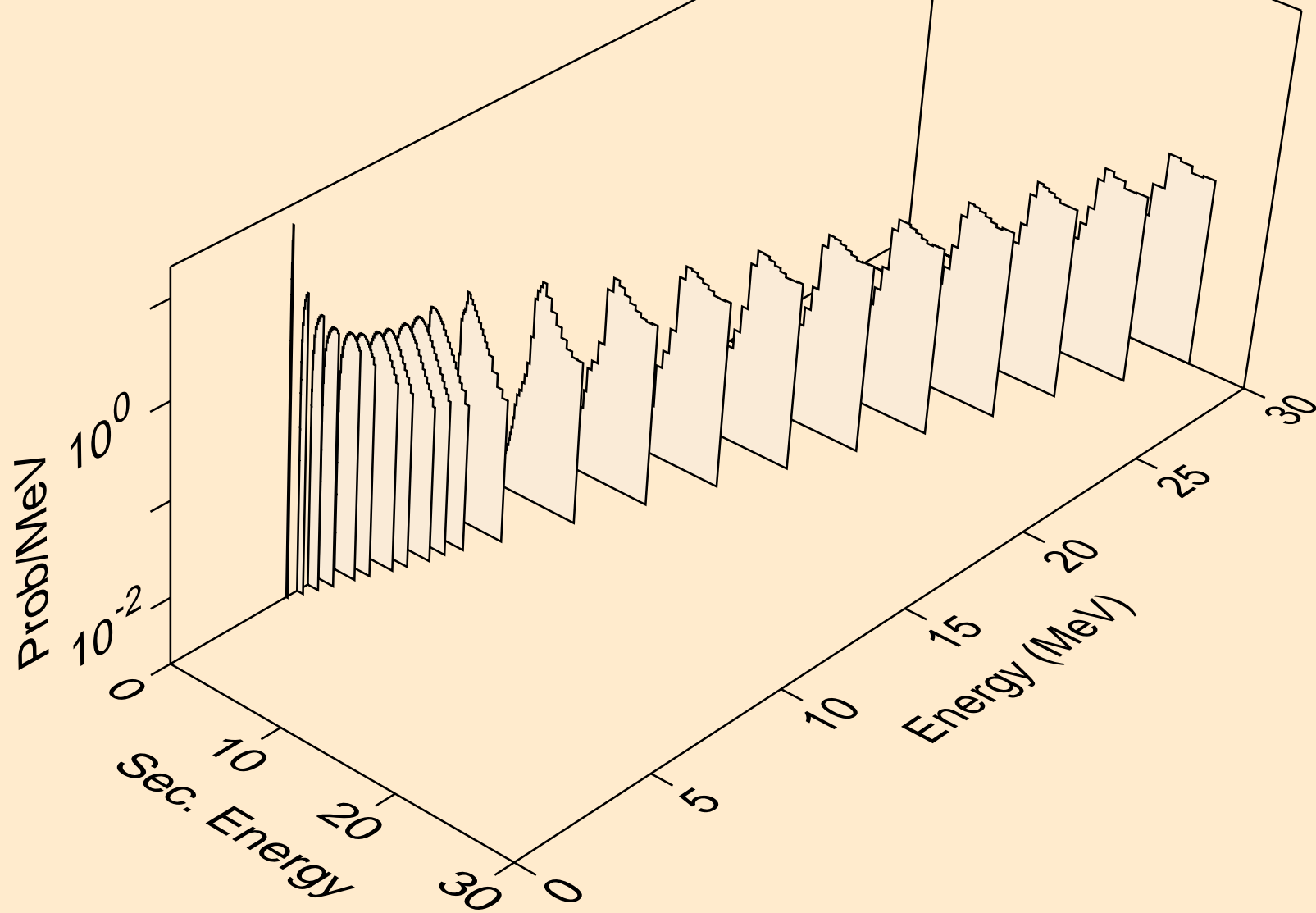

XE136 NEUTRON ACER TENDL-2021 LIBRARY; T=293.6K  
Photon emission for (n,x)

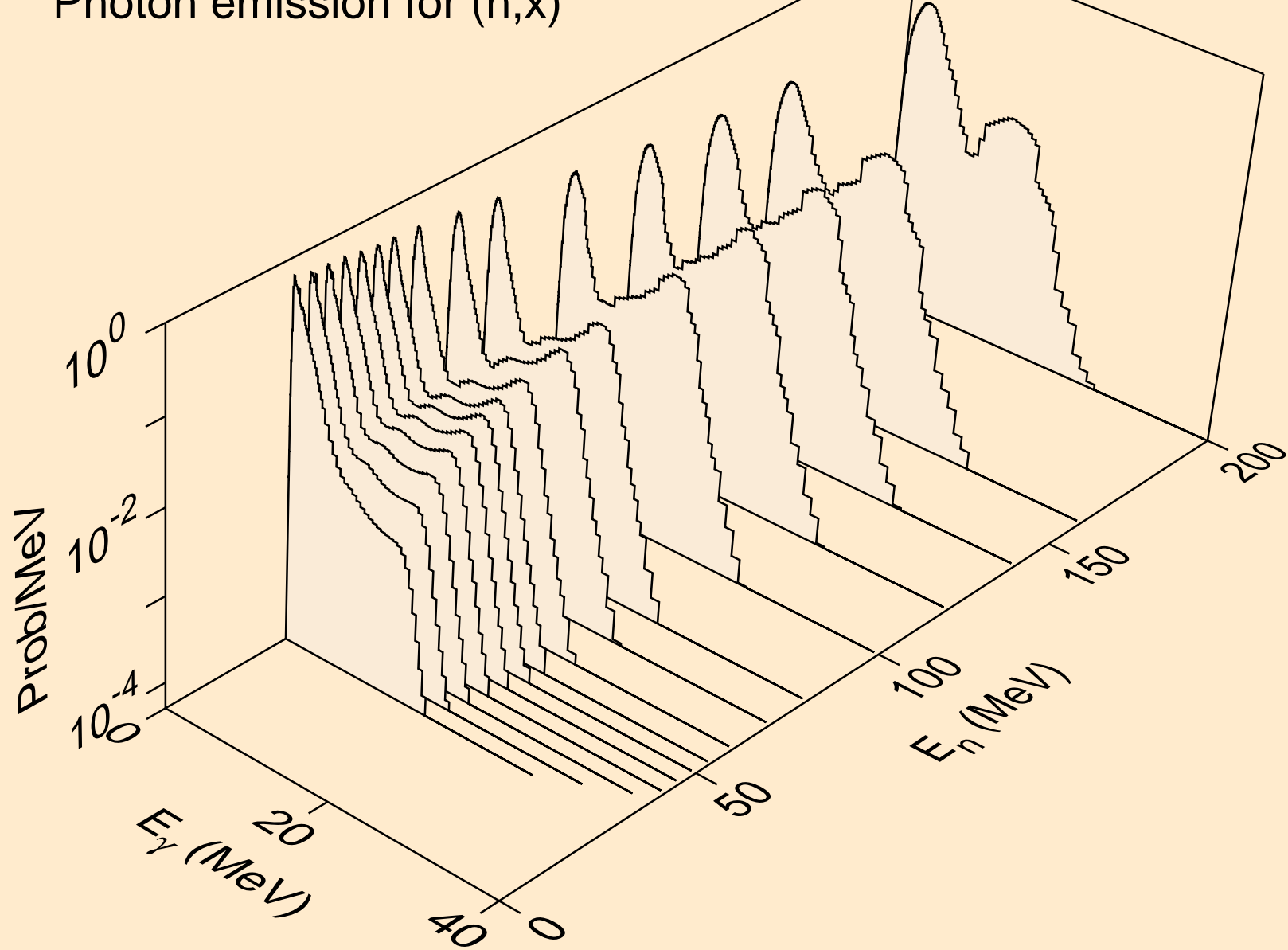

XE136 NEUTRON ACER TENDL-2021 LIBRARY; T=293.6K  
Photon emission for (n,2nd)

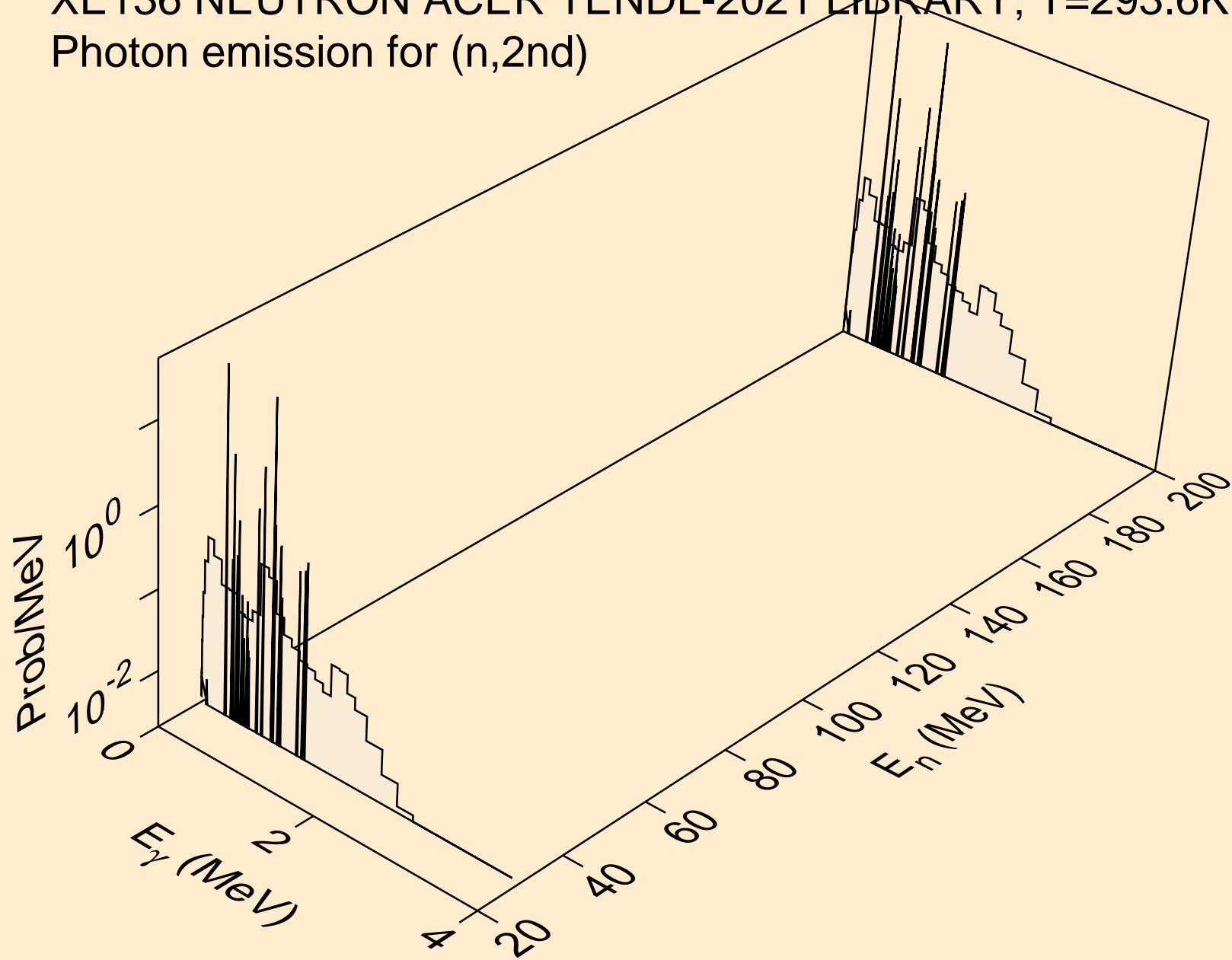



XE136 NEUTRON ACER TENDL-2021 LIBRARY; T=293.6K  
Photon emission for (n,2n)

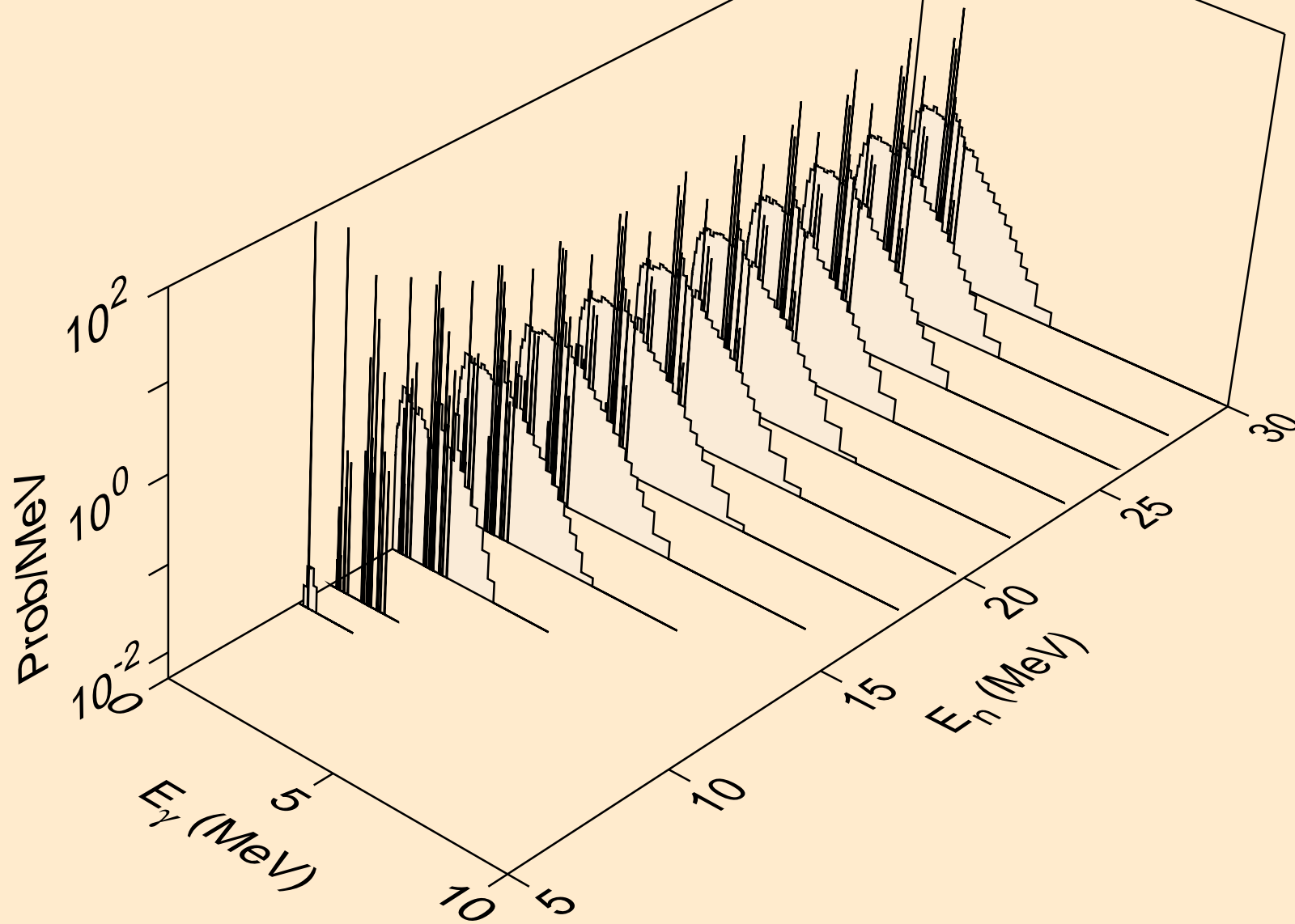

XE136 NEUTRON ACER TENDL-2021 LIBRARY; T=293.6K  
Photon emission for (n,3n)

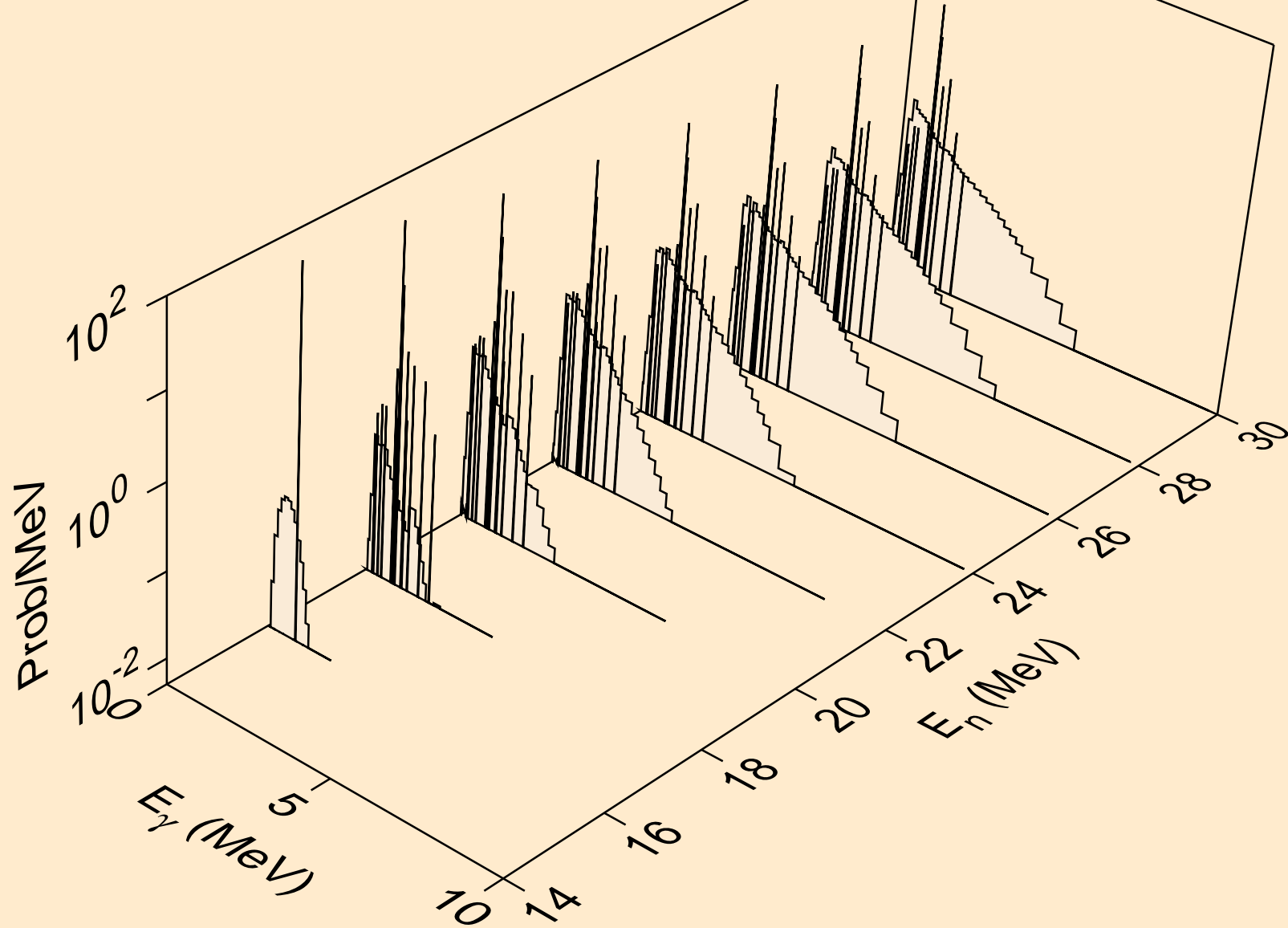

XE136 NEUTRON ACER TENDL-2021 LIBRARY; T=293.6K  
Photon emission for (n,n\*)a

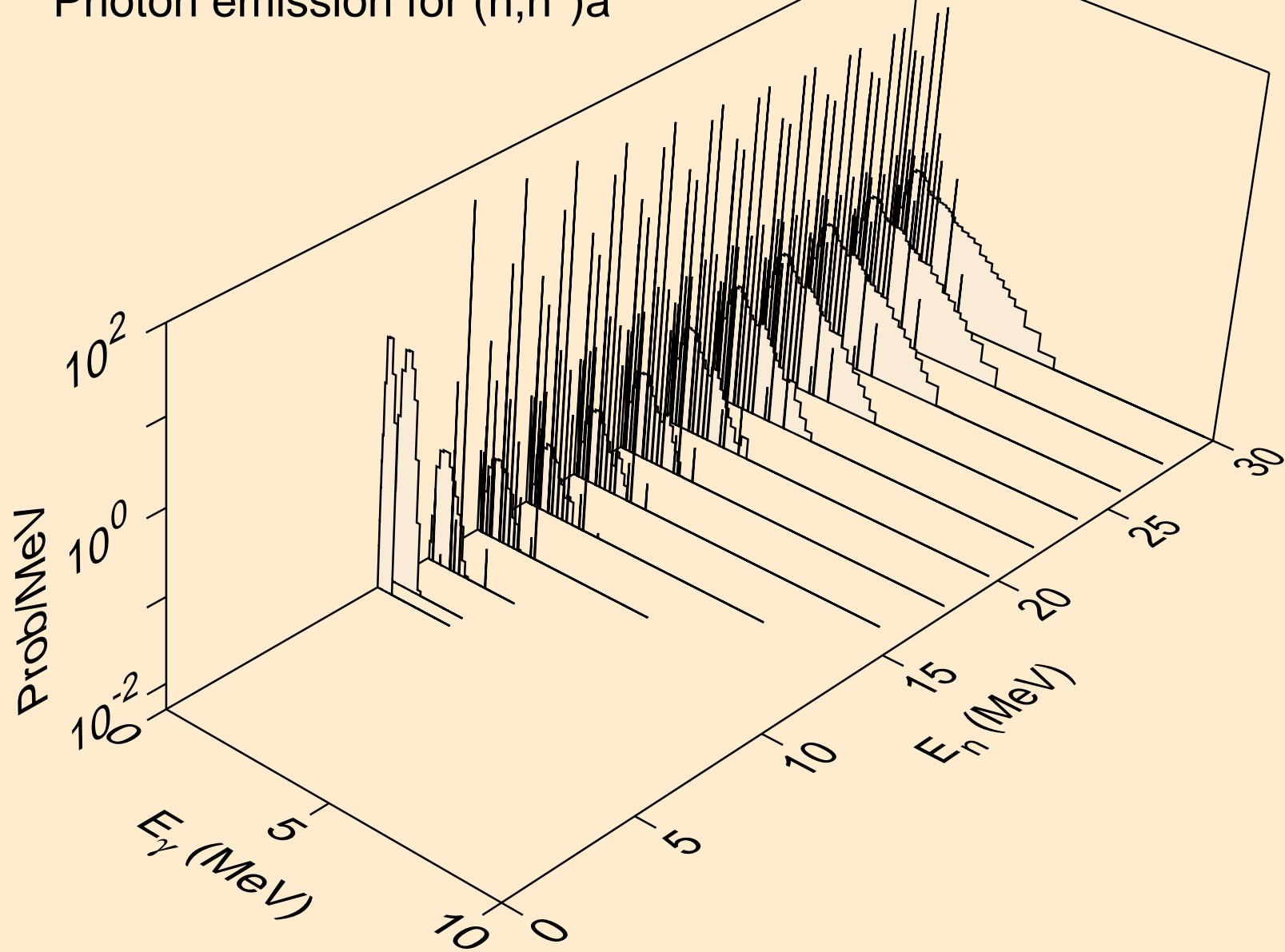

XE136 NEUTRON ACER TENDL-2021 LIBRARY; T=293.6K  
Photon emission for (n,2n)a

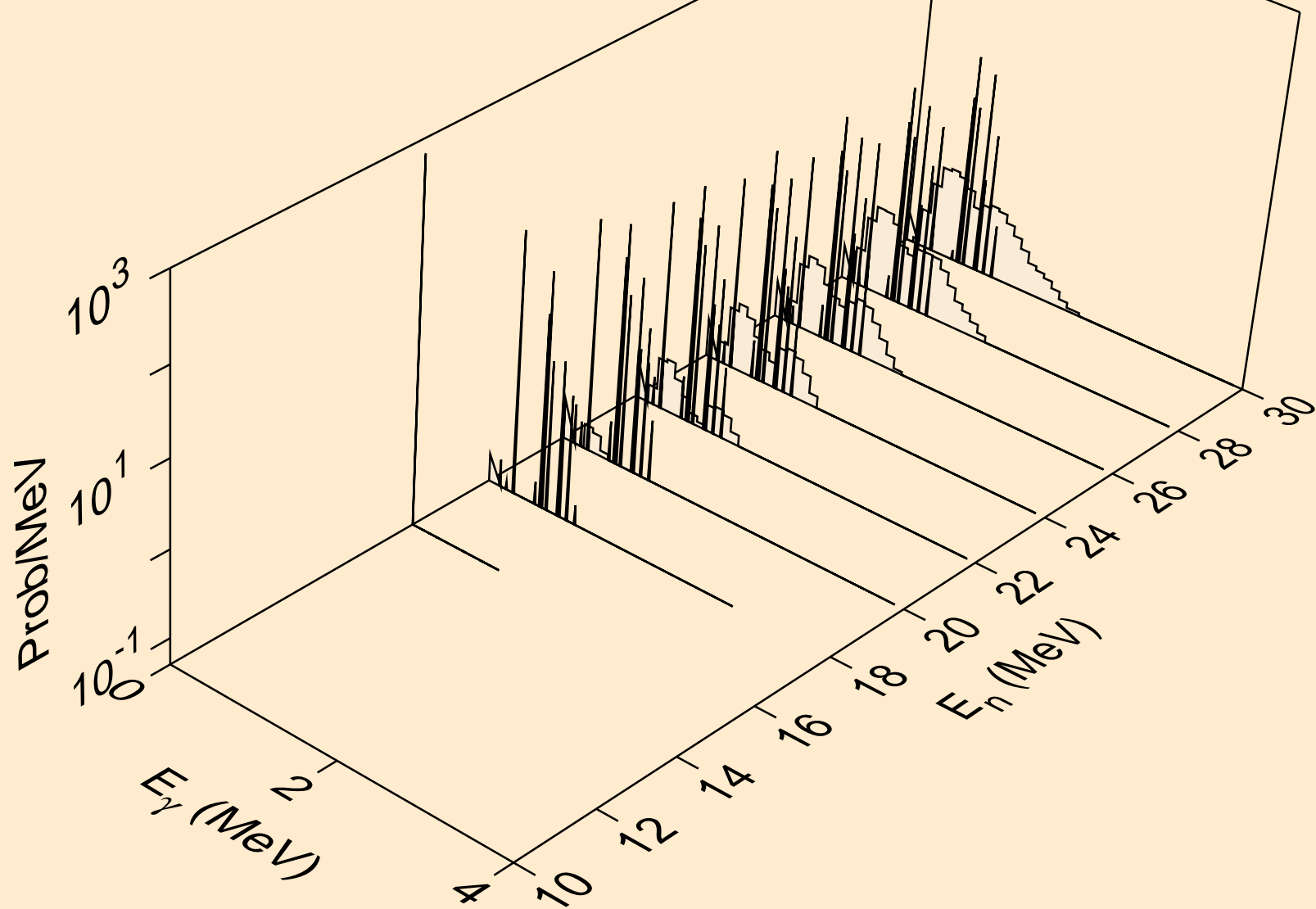

XE136 NEUTRON ACER TENDL-2021 LIBRARY; T=293.6K  
Photon emission for (n,3n)a

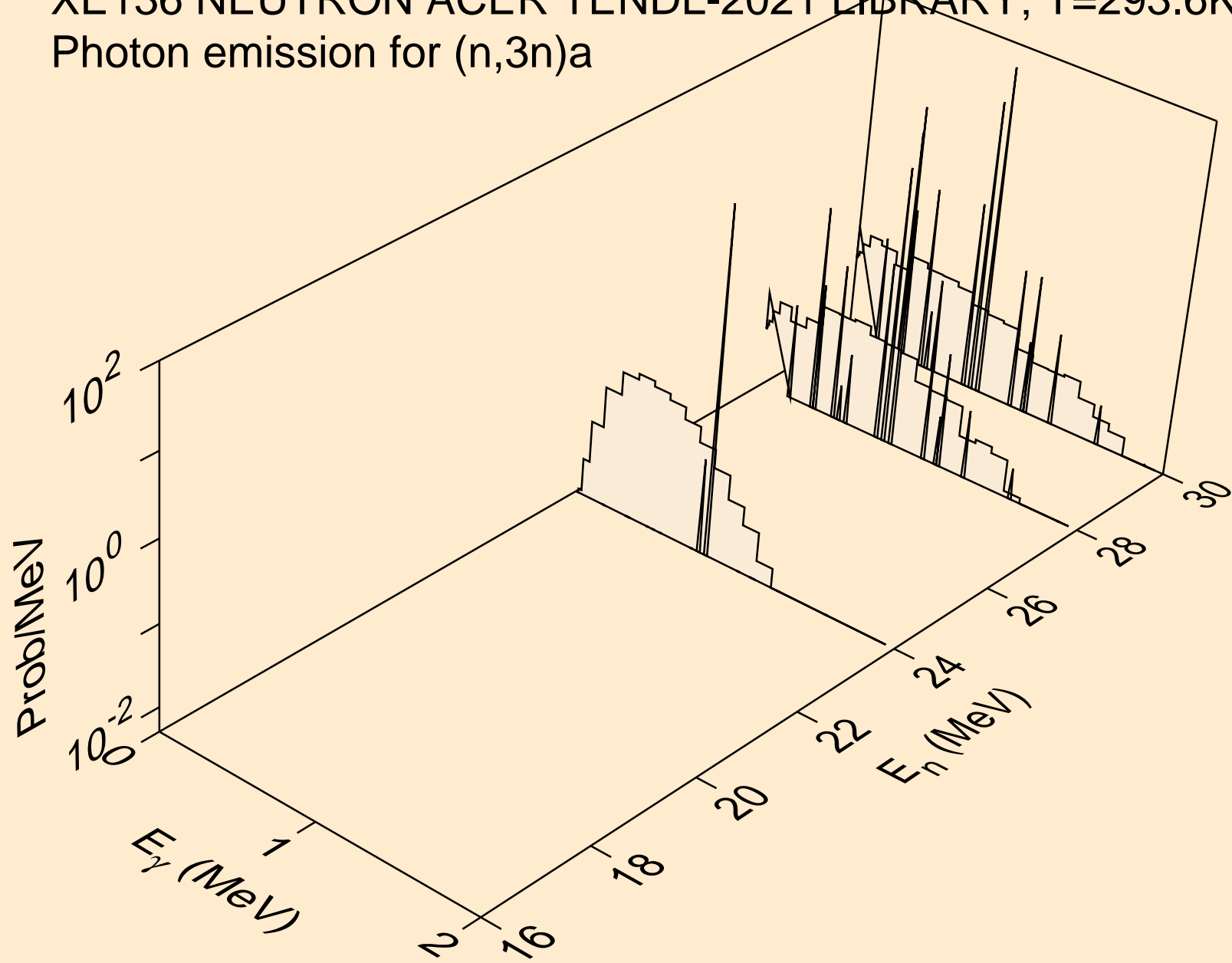

XE136 NEUTRON ACER TENDL-2021 LIBRARY; T=293.6K  
Photon emission for (n,n\*)p

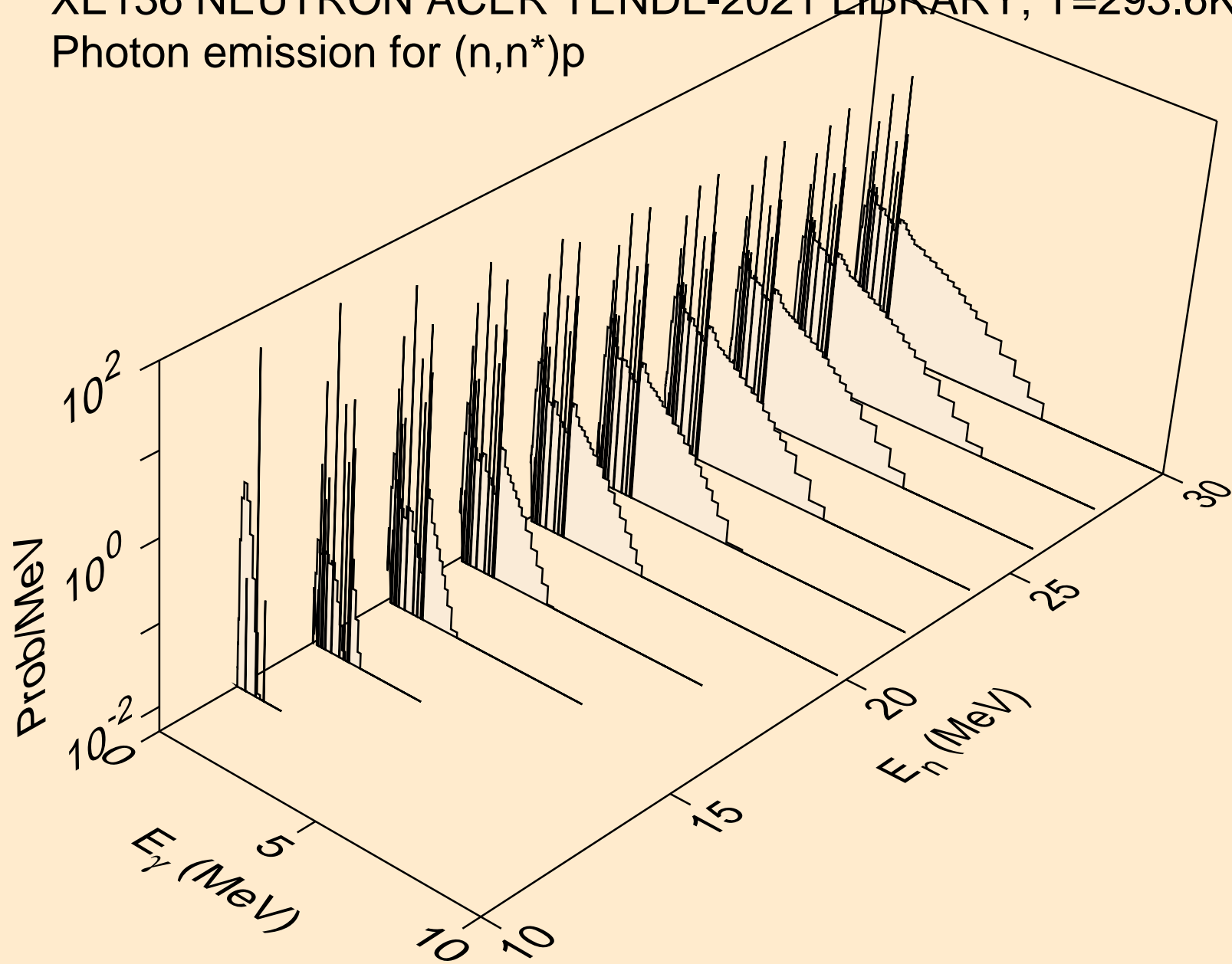

XE136 NEUTRON ACER TENDL-2021 LIBRARY; T=293.6K  
Photon emission for (n,n\*)d

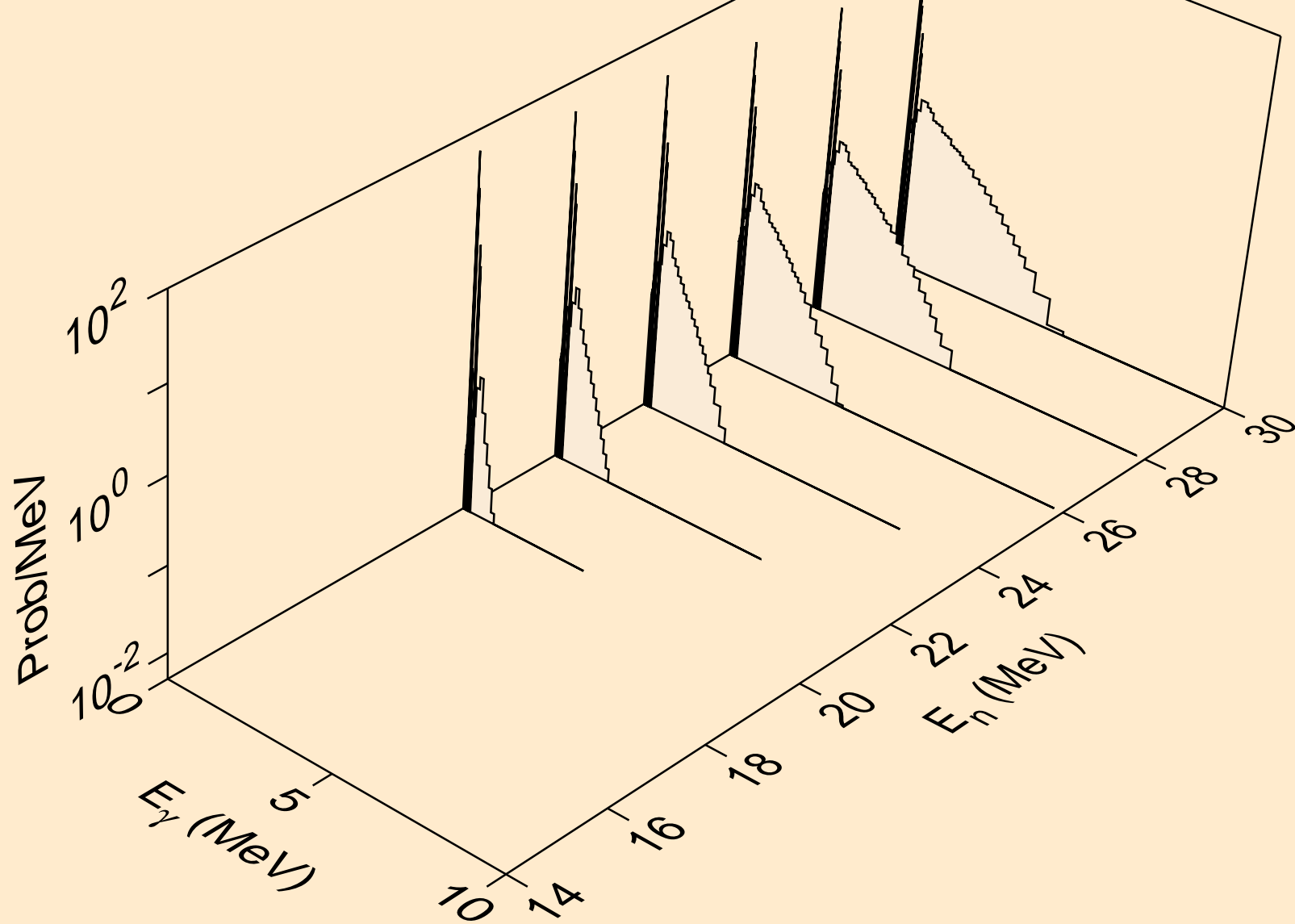

XE136 NEUTRON ACER TENDL-2021 LIBRARY; T=293.6K  
Photon emission for (n,n\*)t

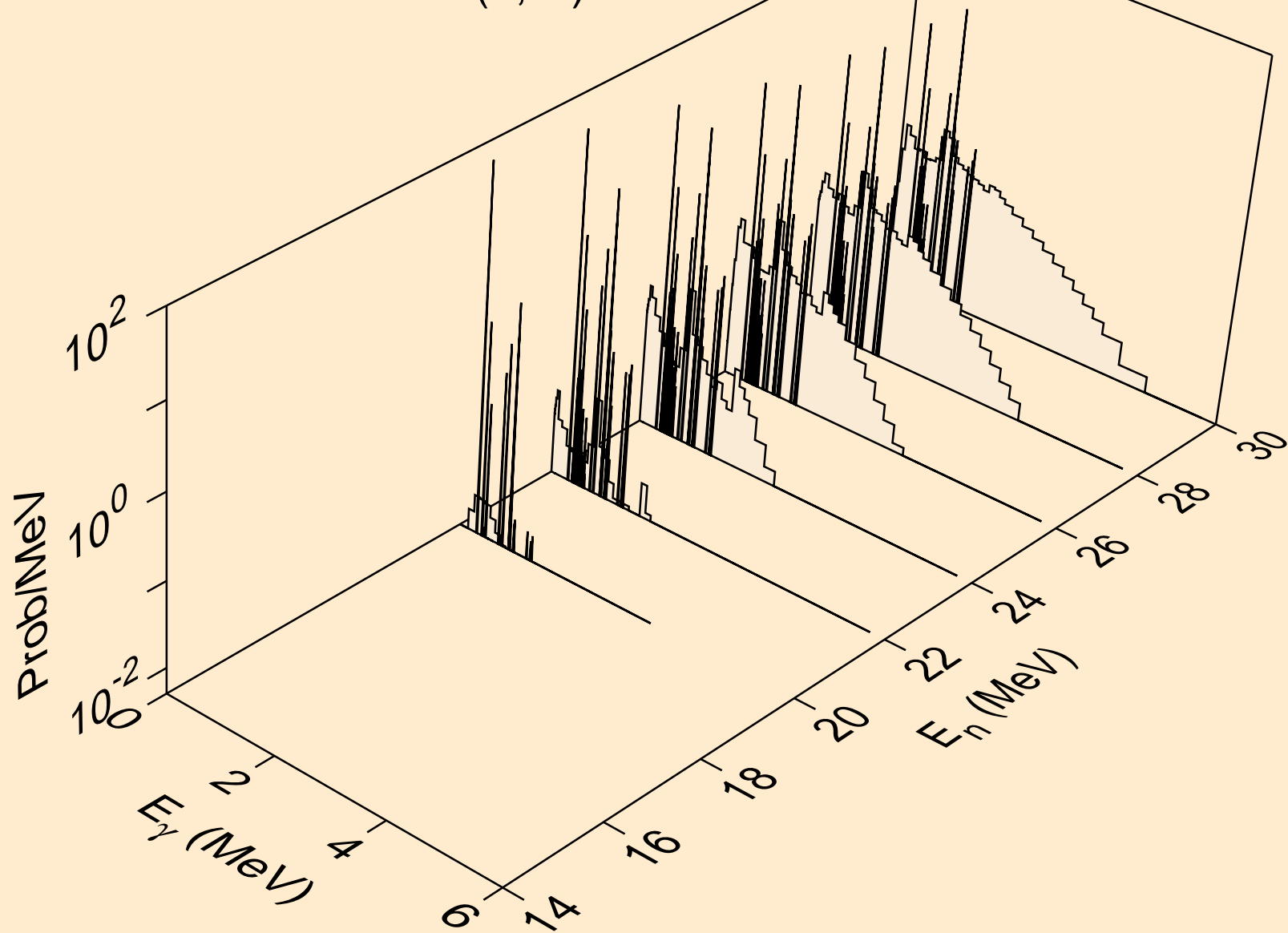



XE136 NEUTRON ACER TENDL-2021 LIBRARY; T=293.6K  
Photon emission for (n,n\*)he3

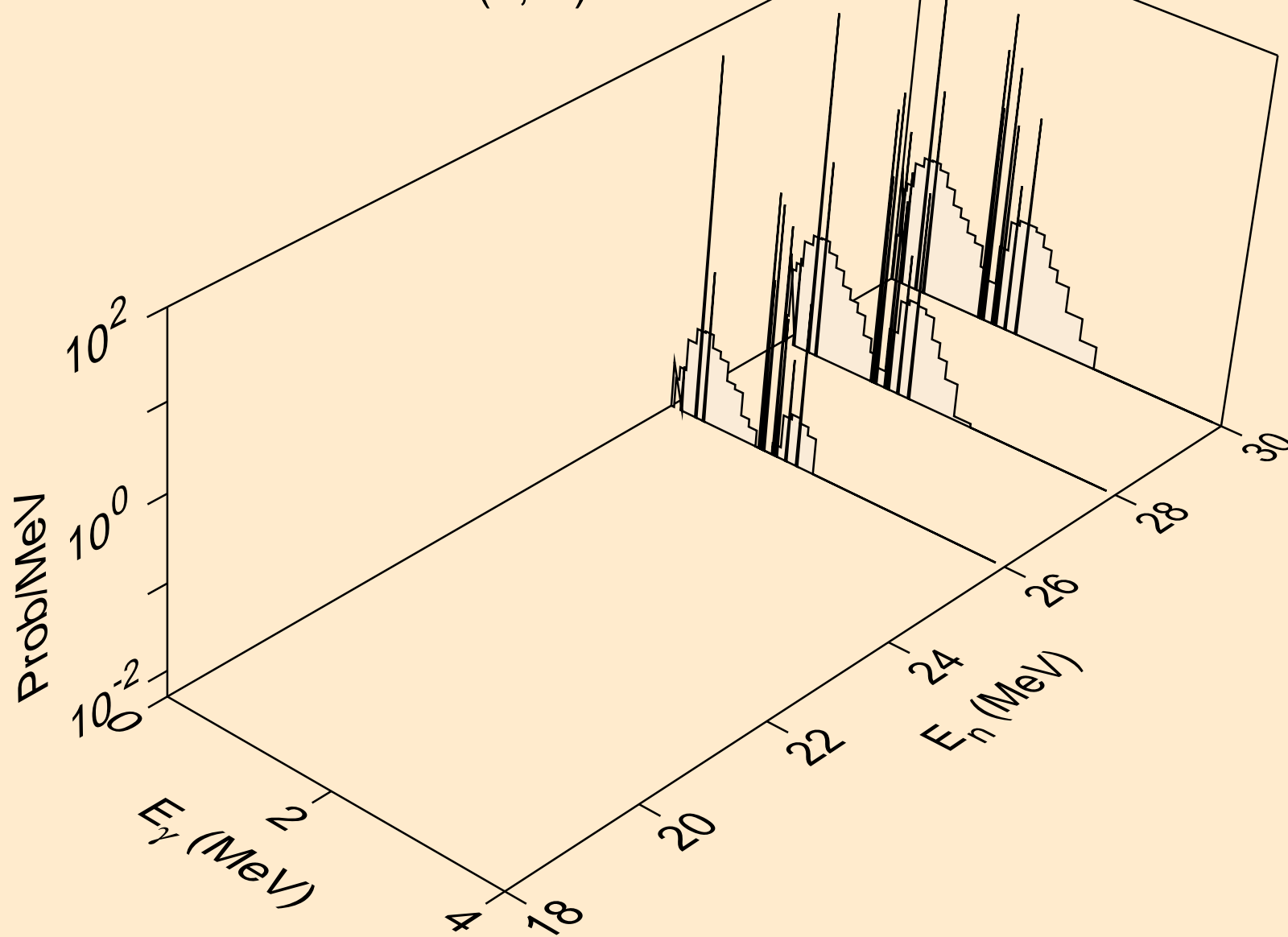

XE136 NEUTRON ACER TENDL-2021 LIBRARY; T=293.6K  
Photon emission for (n,4n)

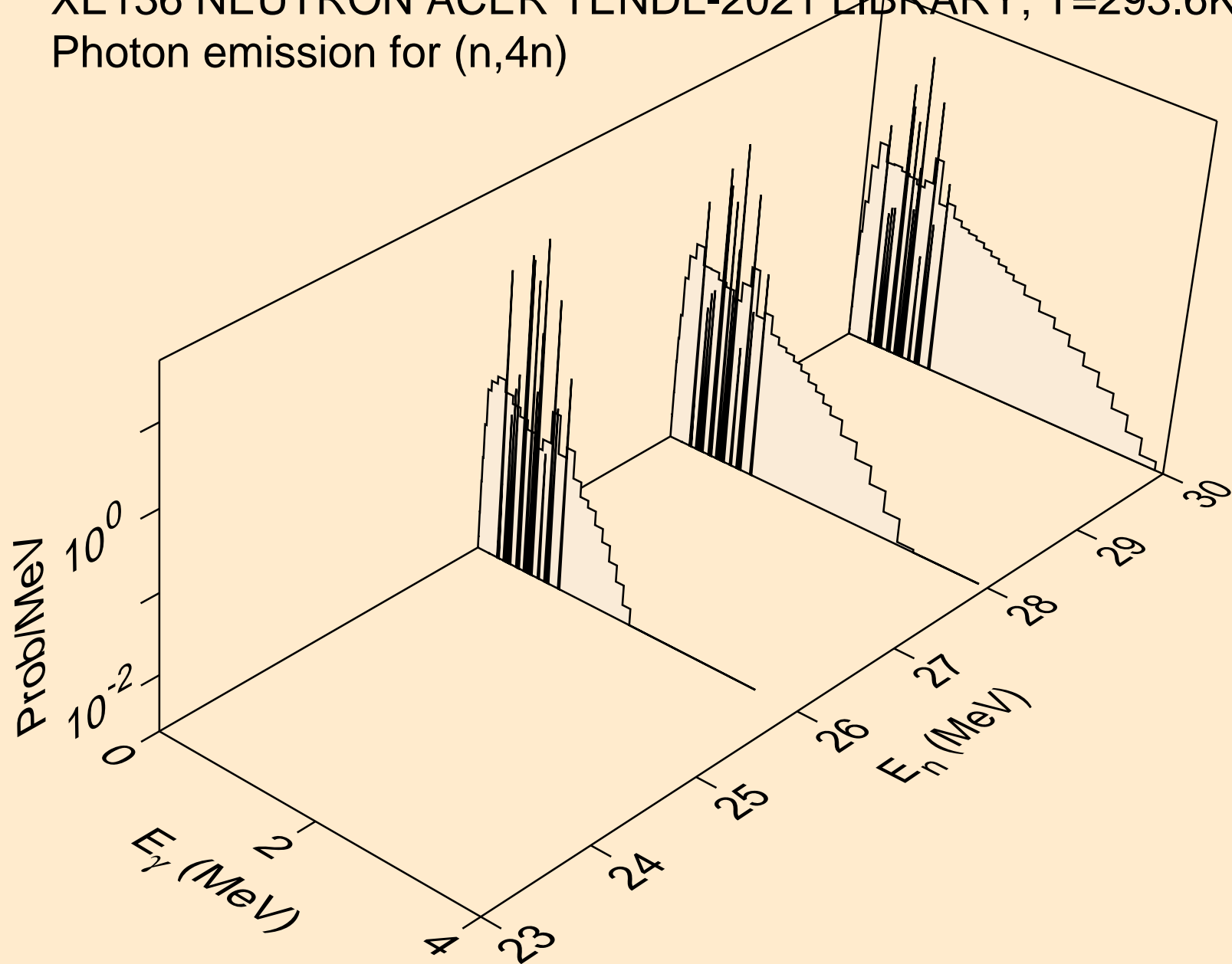

XE136 NEUTRON ACER TENDL-2021 LIBRARY; T=293.6K  
Photon emission for (n,2np)

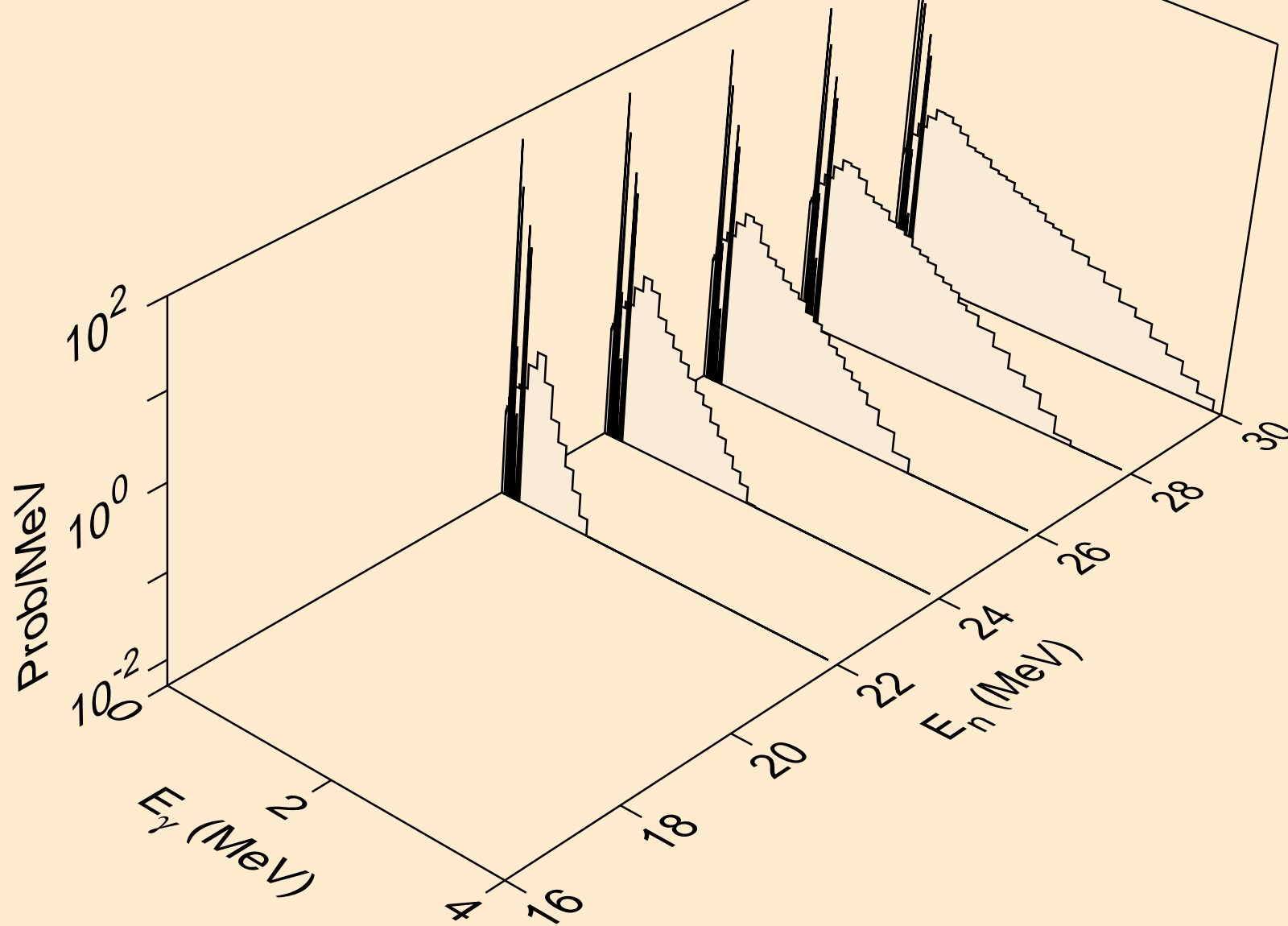

XE136 NEUTRON ACER TENDL-2021 LIBRARY; T=293.6K  
Photon emission for (n,3np)

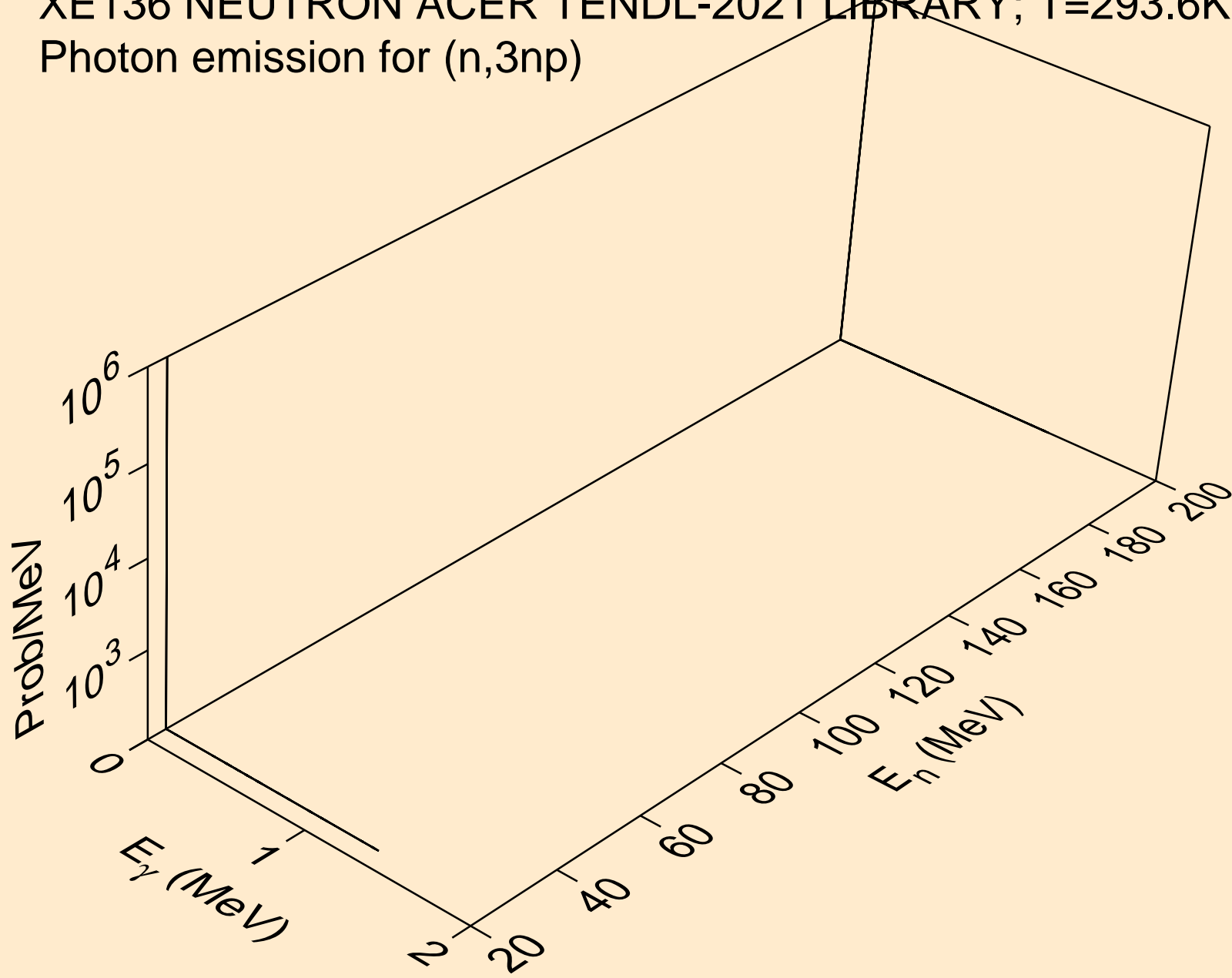

XE136 NEUTRON ACER TENDL-2021 LIBRARY; T=293.6K  
Photon emission for (n,2np)

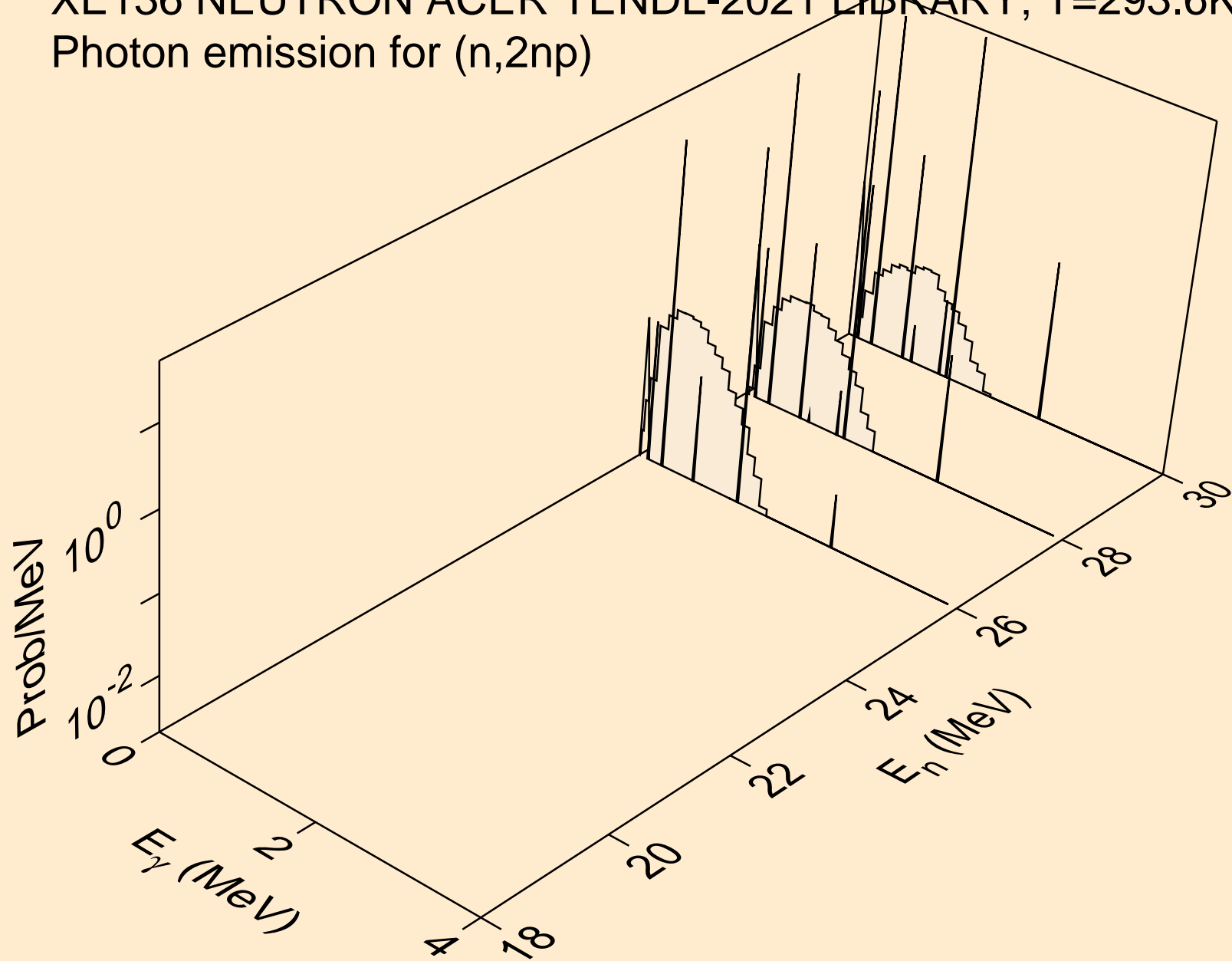

XE136 NEUTRON ACER TENDL-2021 LIBRARY; T=293.6K  
Photon emission for (n,n\*c)

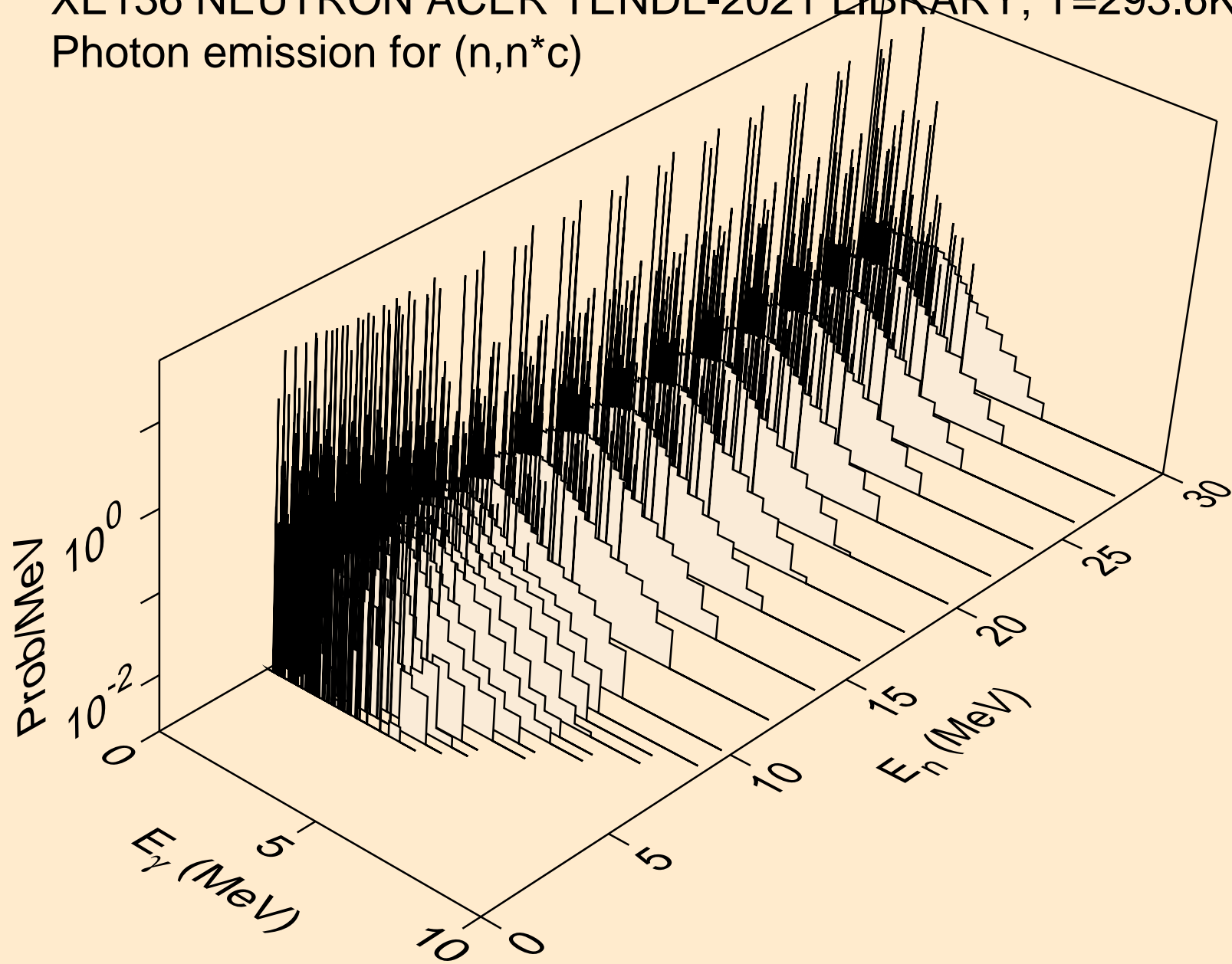

XE136 NEUTRON ACER TENDL-2021 LIBRARY; T=293.6K  
Photon emission for (n,gma)

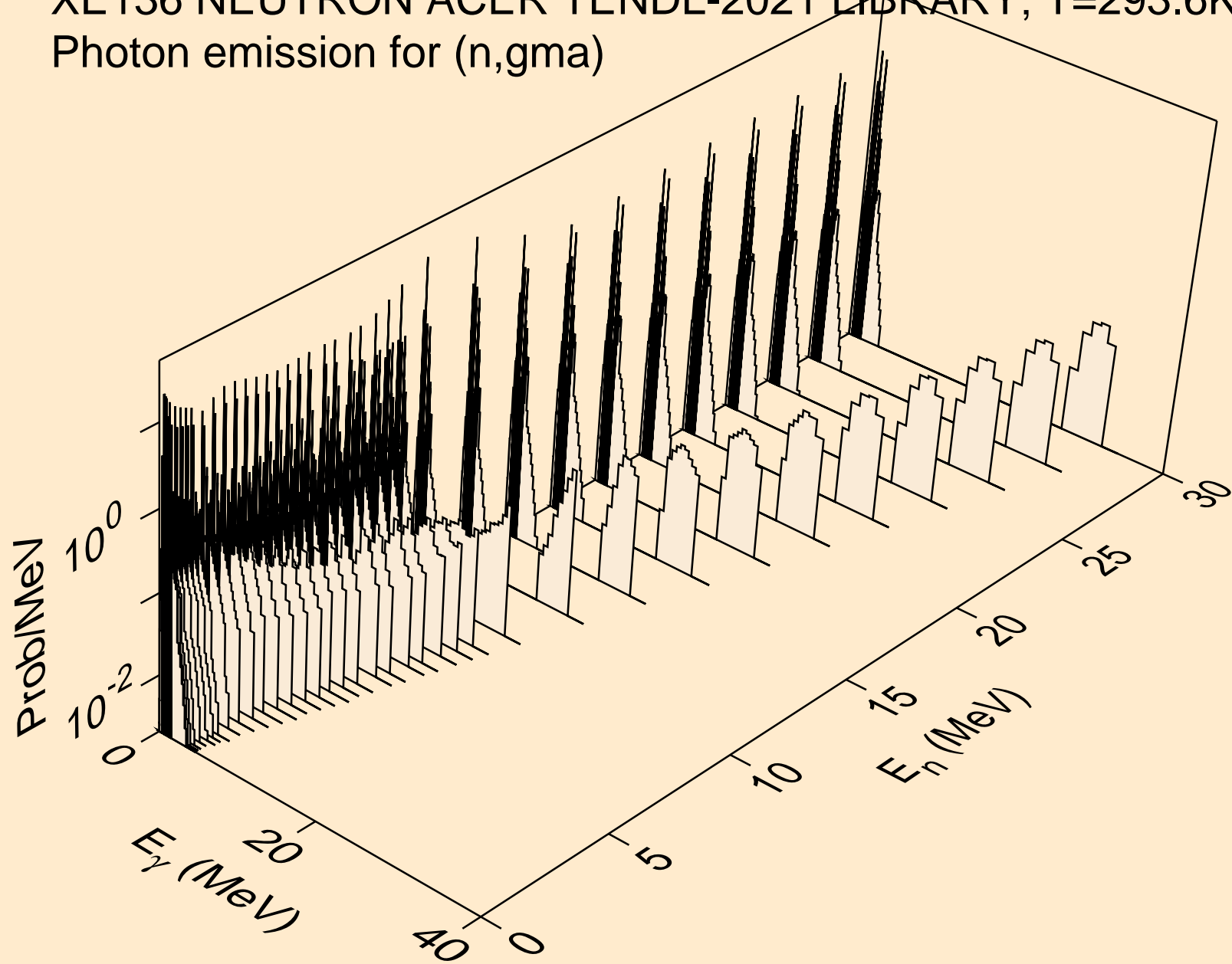

XE136 NEUTRON ACER TENDL-2021 LIBRARY; T=293.6K  
Photon emission for (n,p)

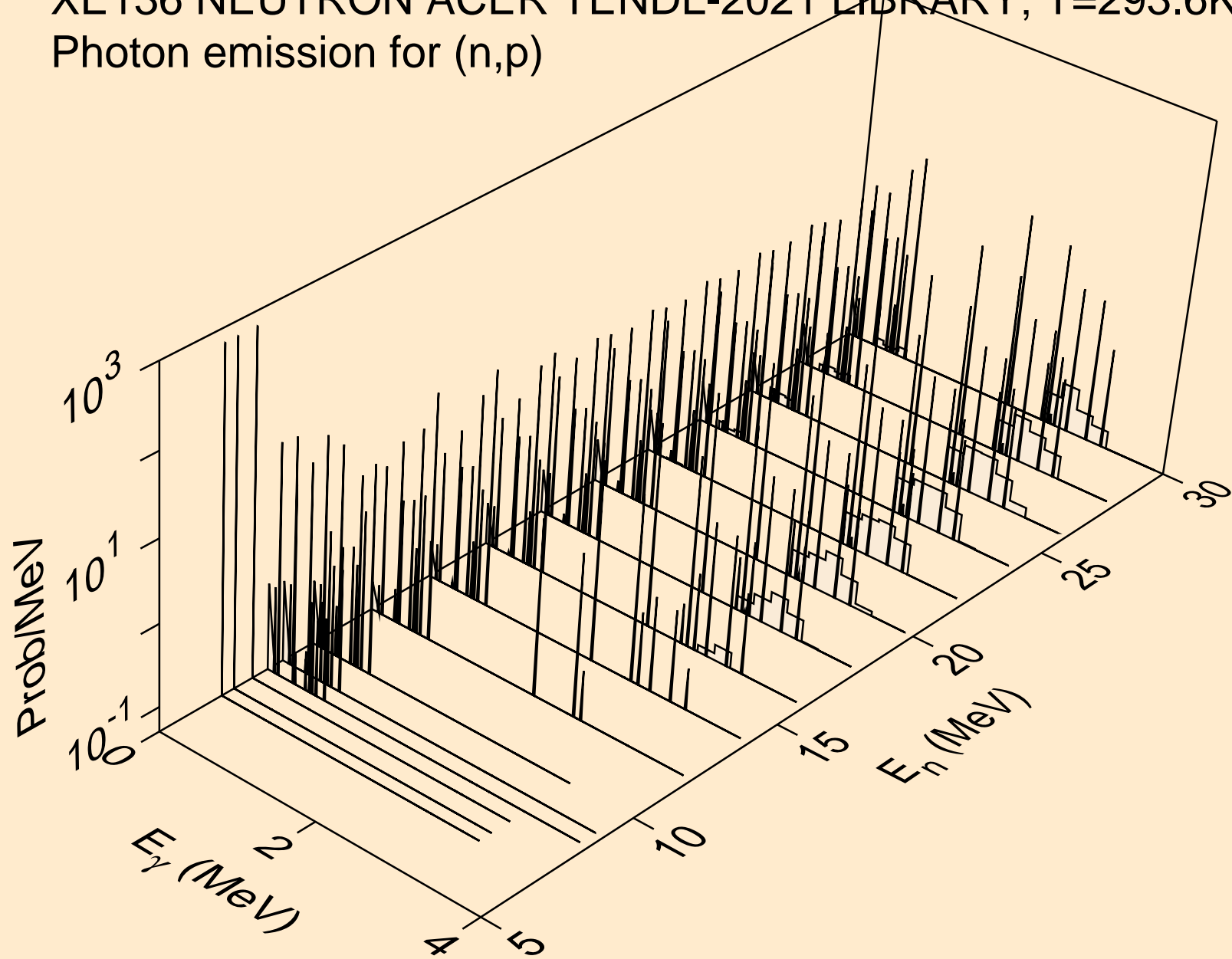



XE136 NEUTRON ACER TENDL-2021 LIBRARY; T=293.6K  
Photon emission for (n,d)

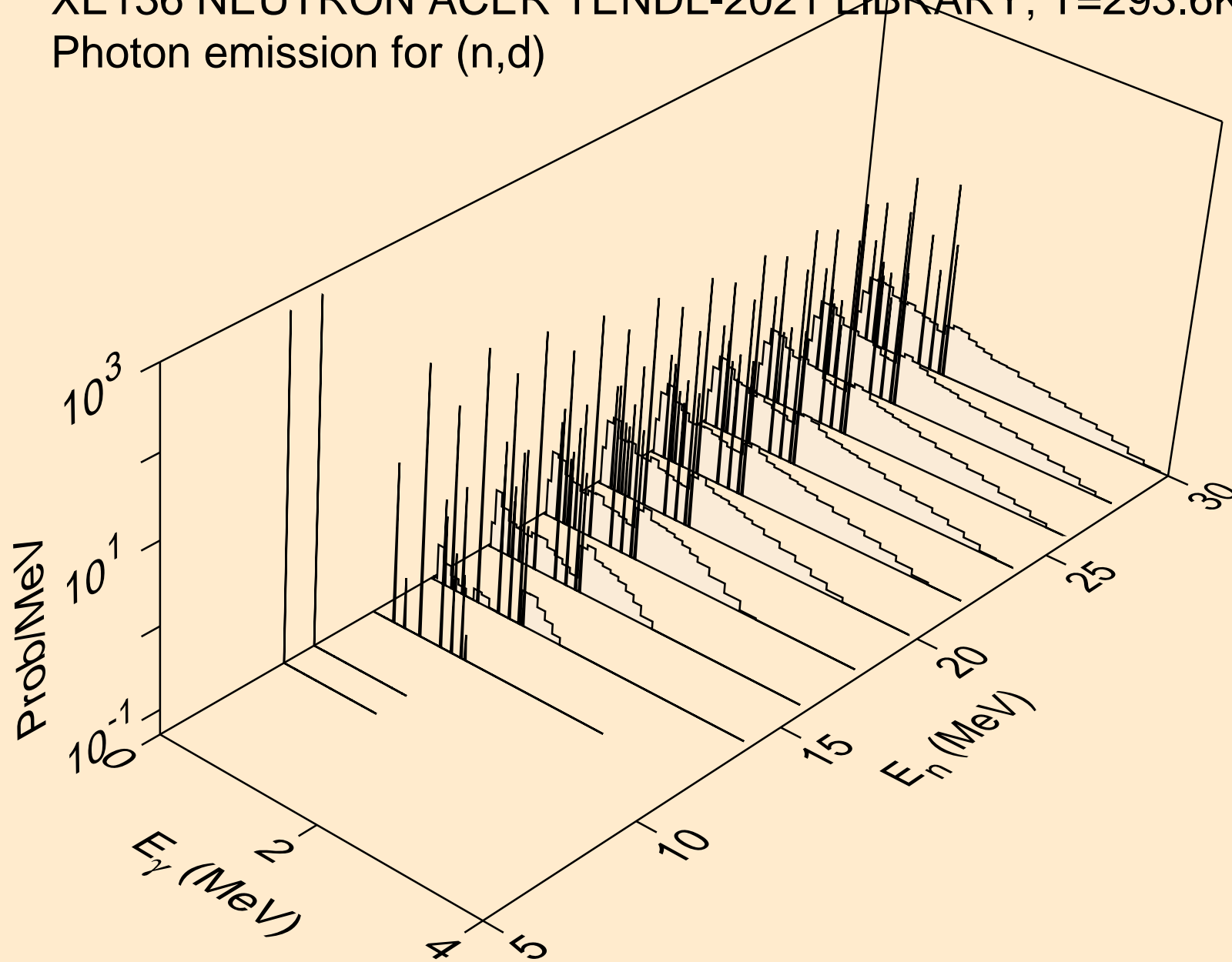

XE136 NEUTRON ACER TENDL-2021 LIBRARY; T=293.6K  
Photon emission for (n,t)

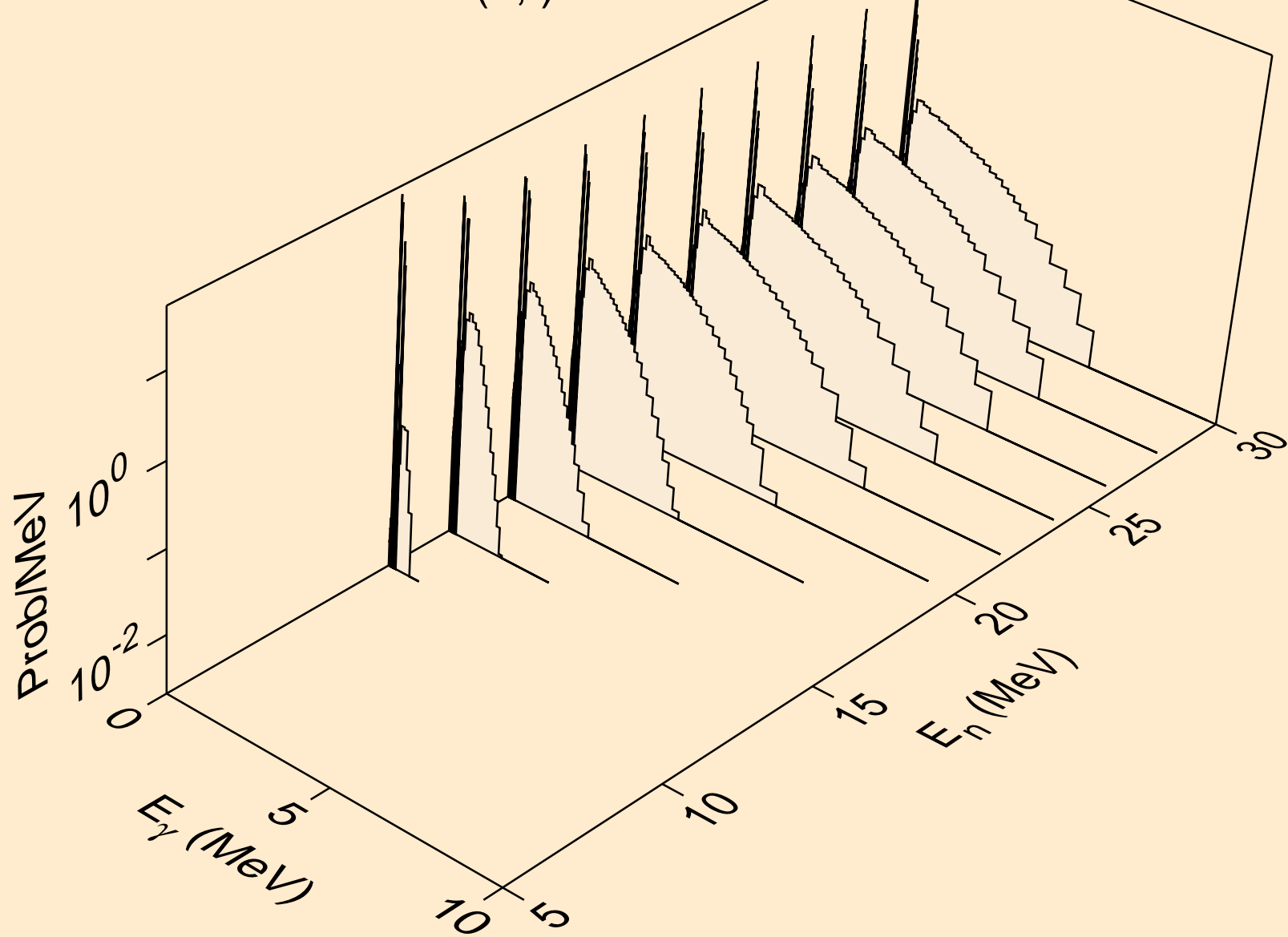

XE136 NEUTRON ACER TENDL-2021 LIBRARY; T=293.6K  
Photon emission for (n,he3)

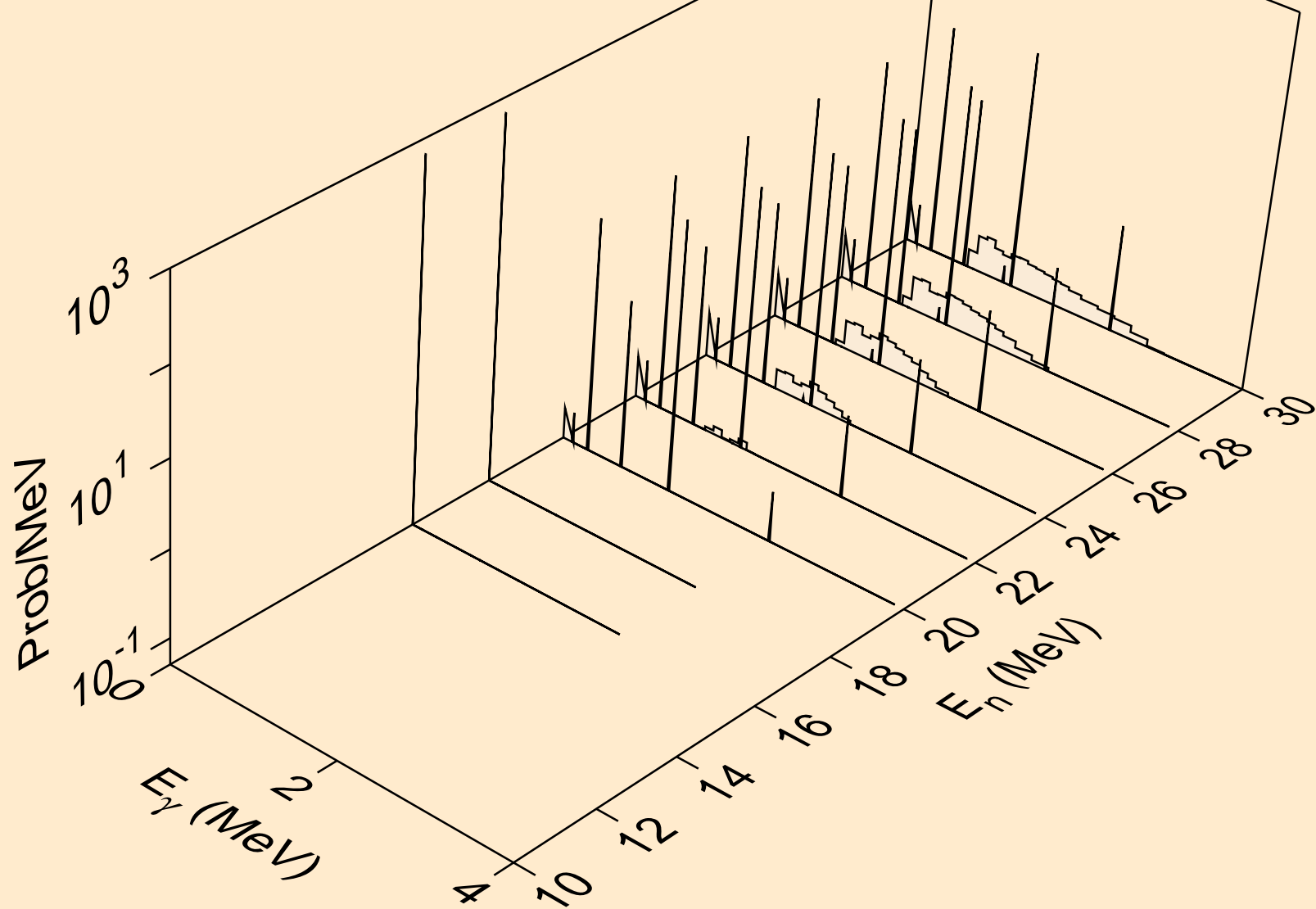

XE136 NEUTRON ACER TENDL-2021 LIBRARY; T=293.6K  
Photon emission for (n,a)

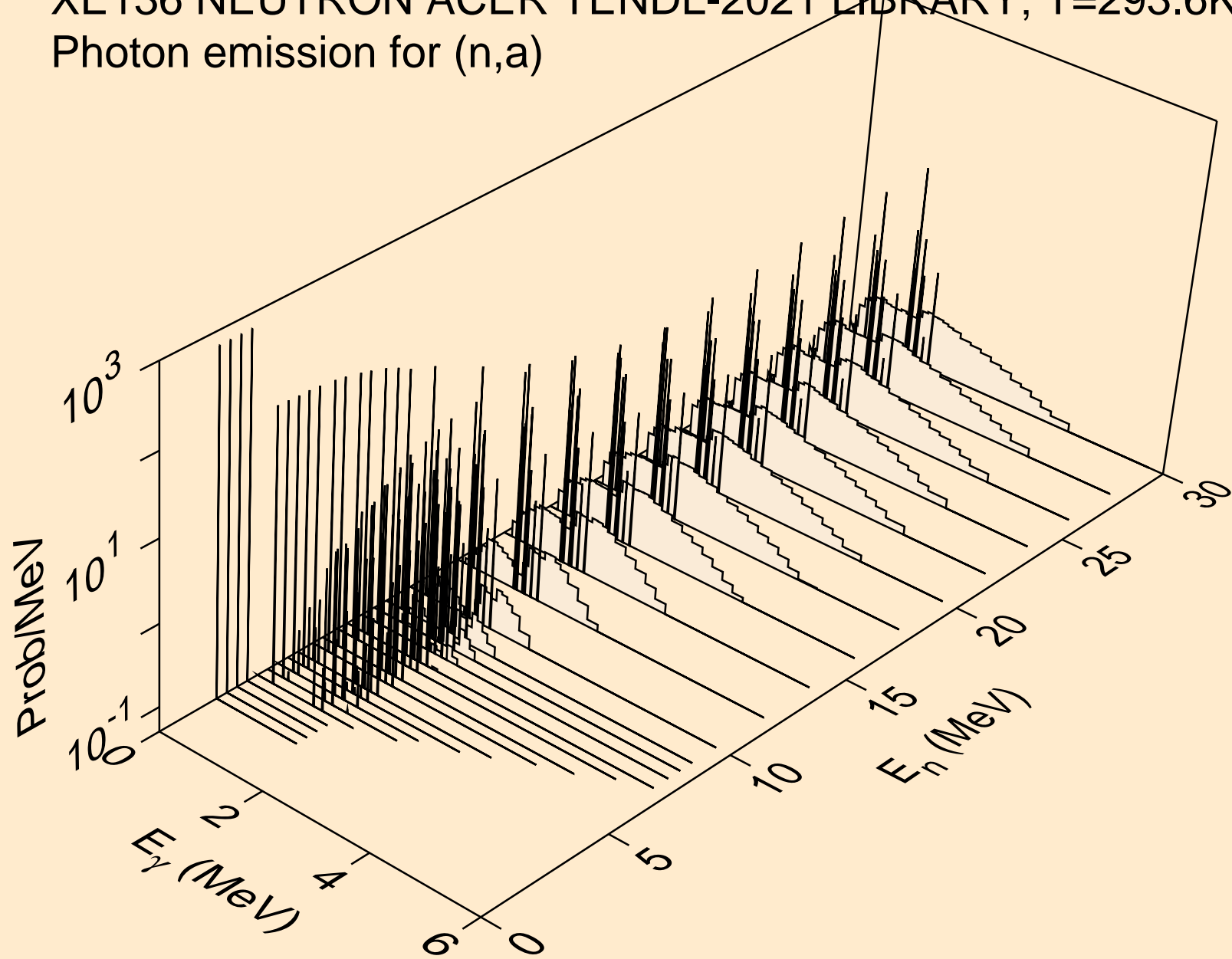

XE136 NEUTRON ACER TENDL-2021 LIBRARY; T=293.6K  
Photon emission for (n,2p)

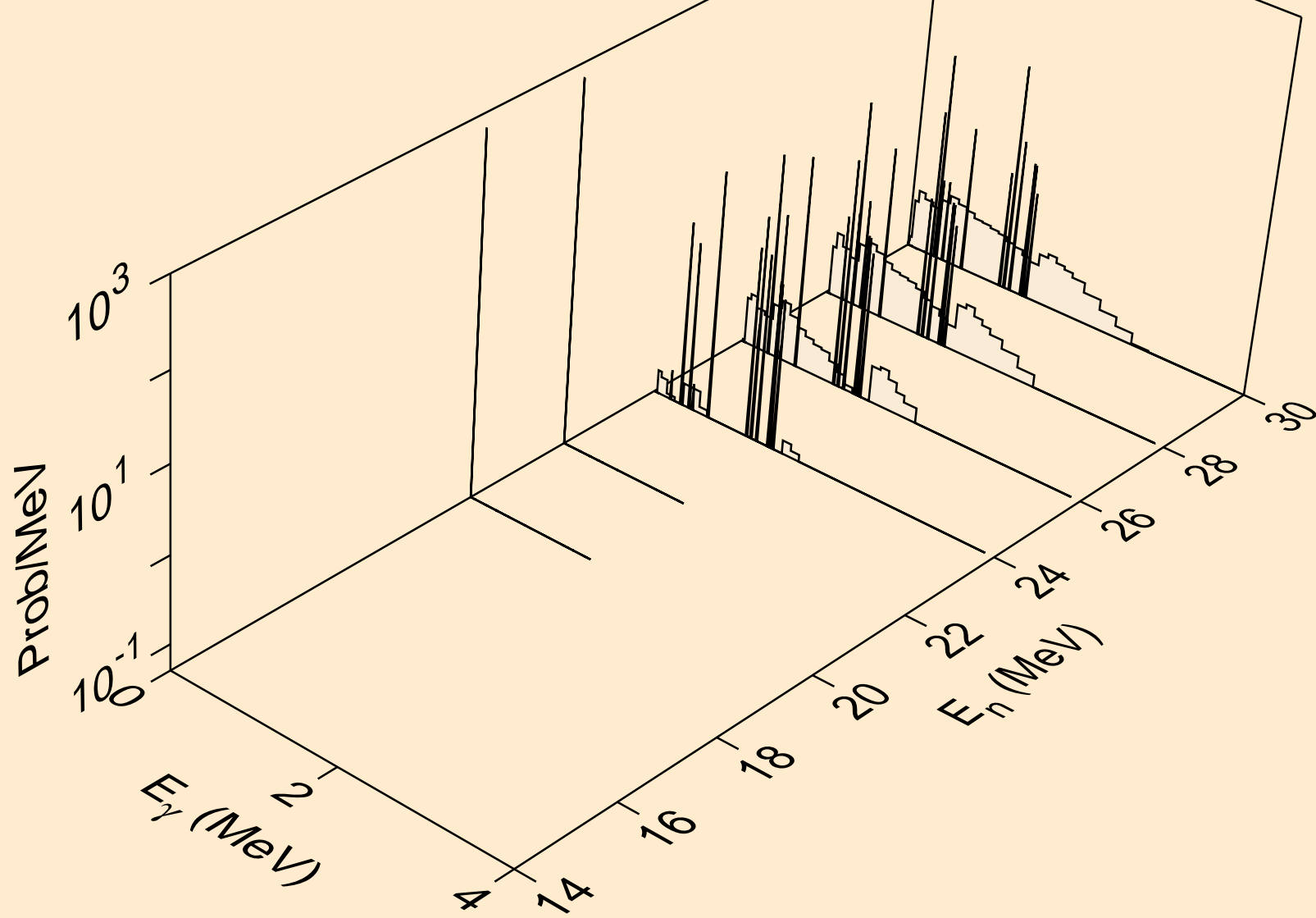

XE136 NEUTRON ACER TENDL-2021 LIBRARY; T=293.6K  
Photon emission for (n,p)

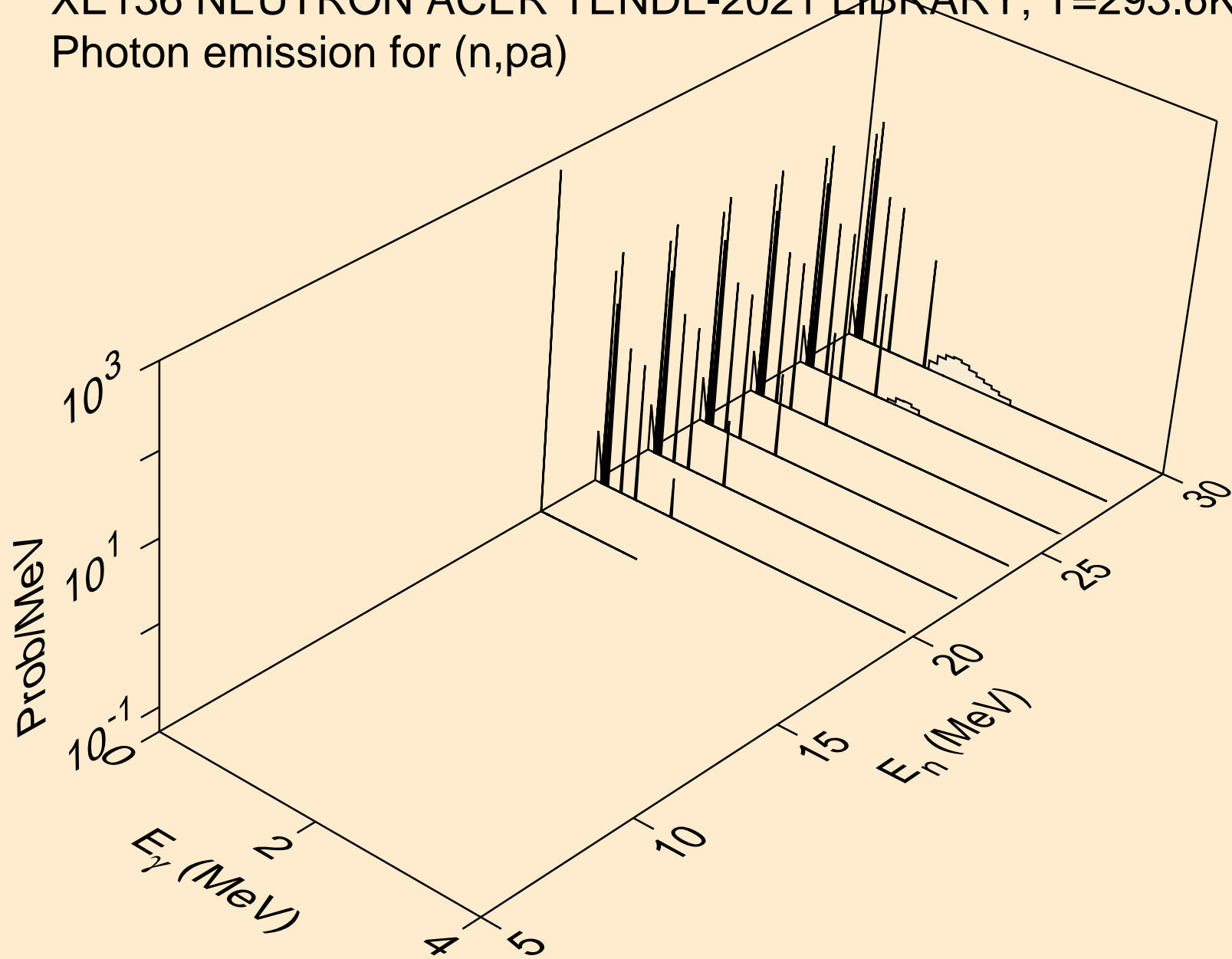

XE136 NEUTRON ACER TENDL-2021 LIBRARY; T=293.6K  
Photon emission for (n,pd)

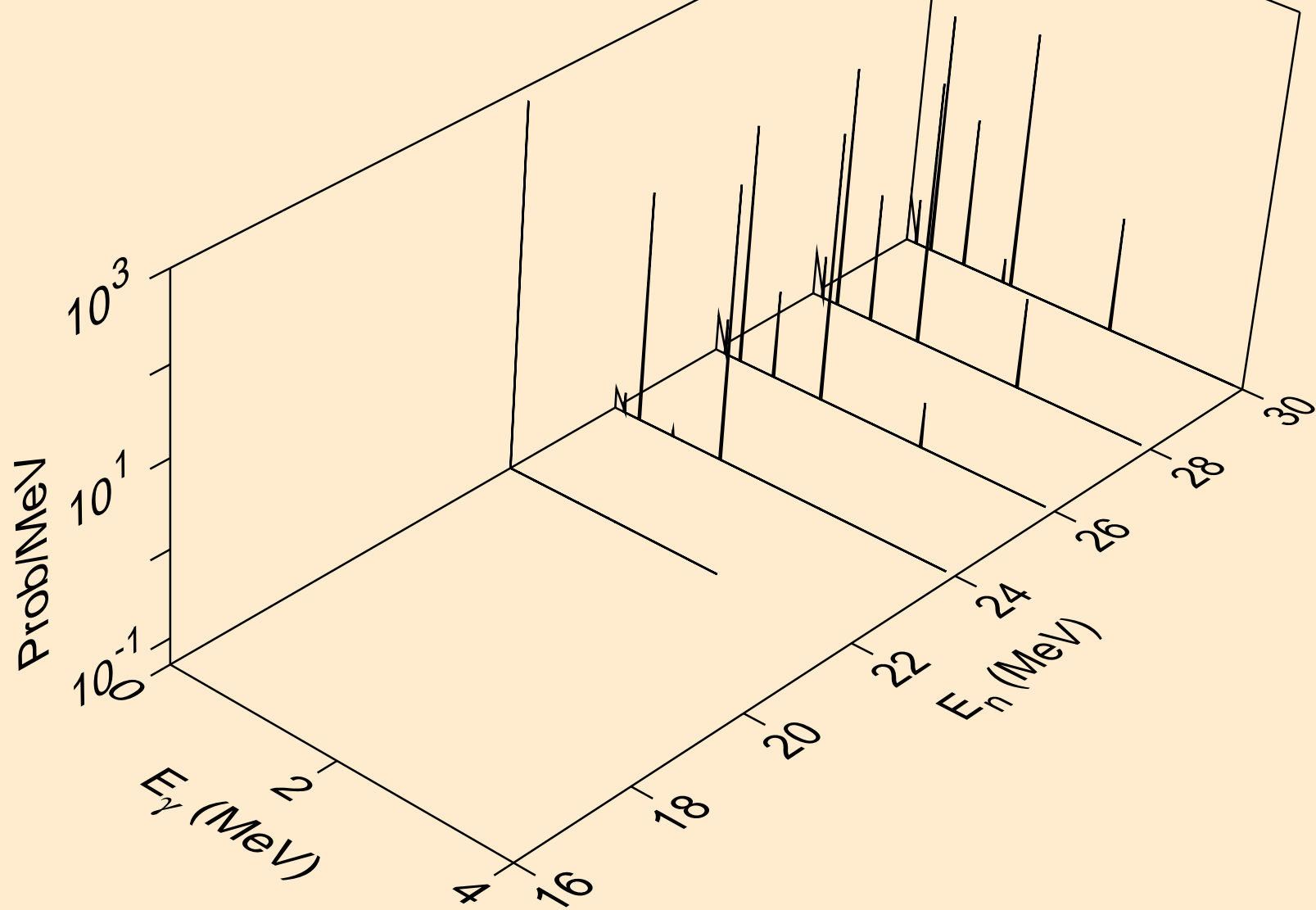

XE136 NEUTRON ACER TENDL-2021 LIBRARY; T=293.6K  
thermal capture photon spectrum

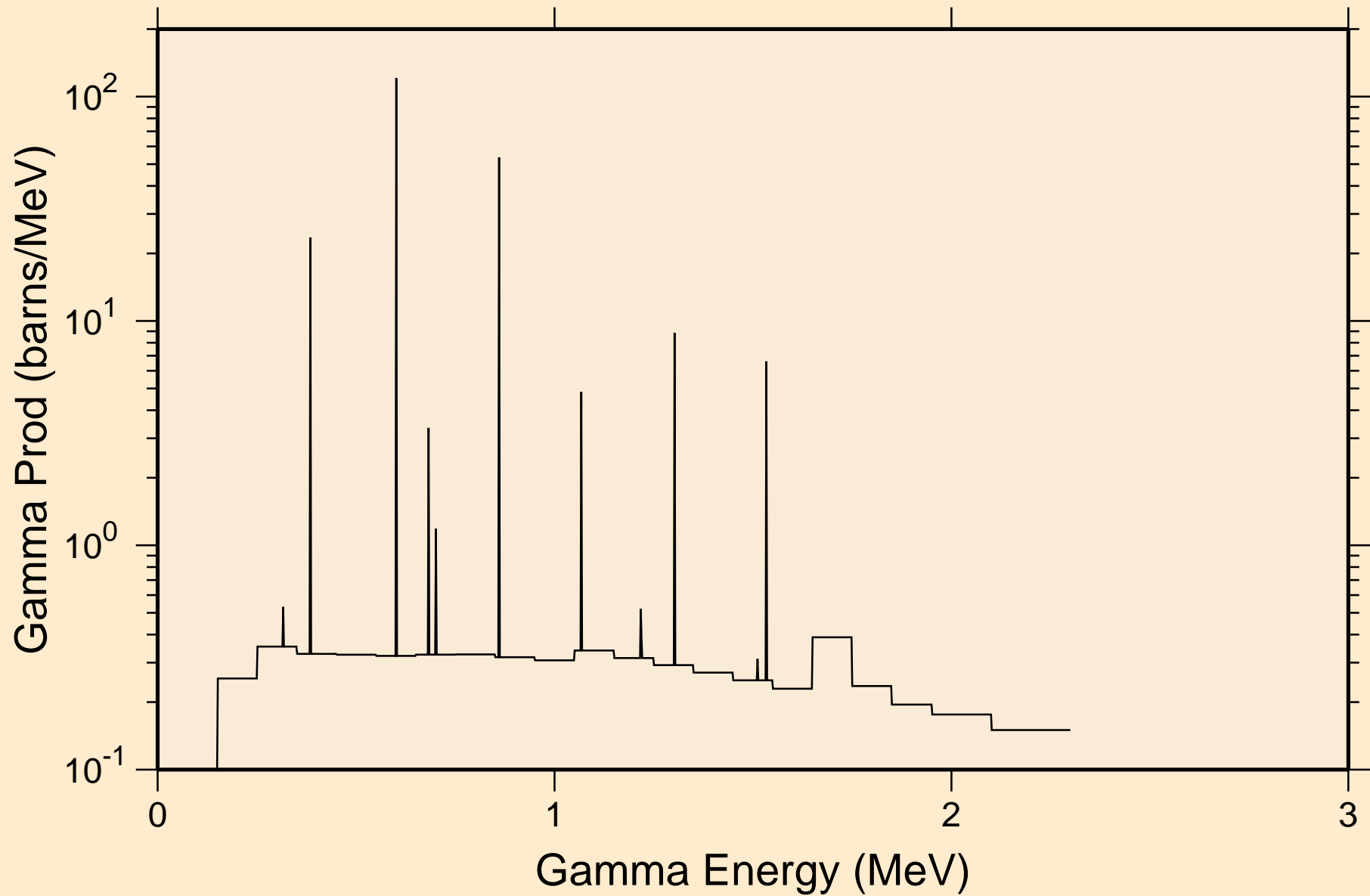



XE136 NEUTRON ACER TENDL-2021 LIBRARY; T=293.6K  
14 MeV photon spectrum

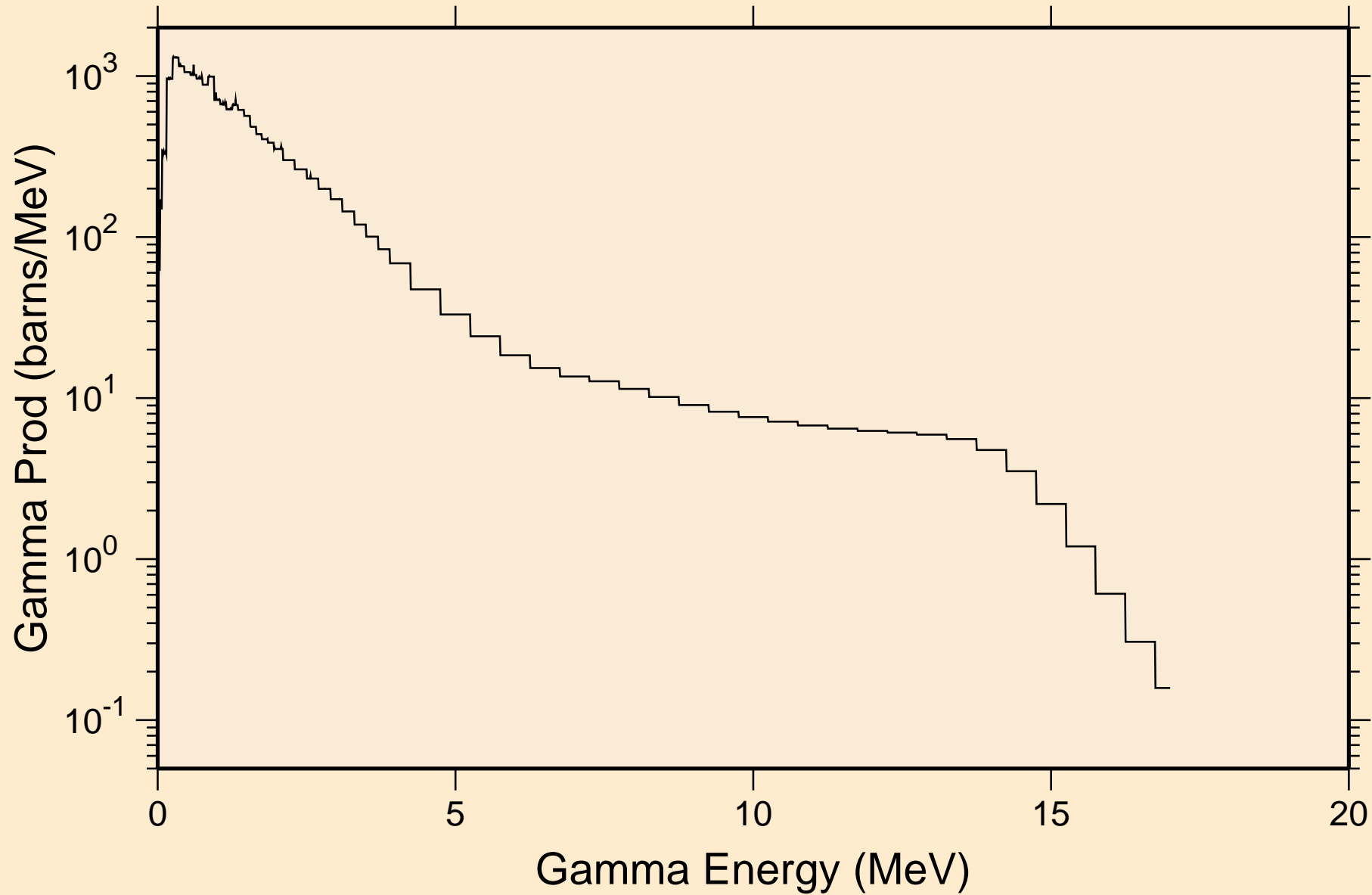

XE136 NEUTRON ACER TENDL-2021 LIBRARY; T=293.6K  
Particle heating contributions

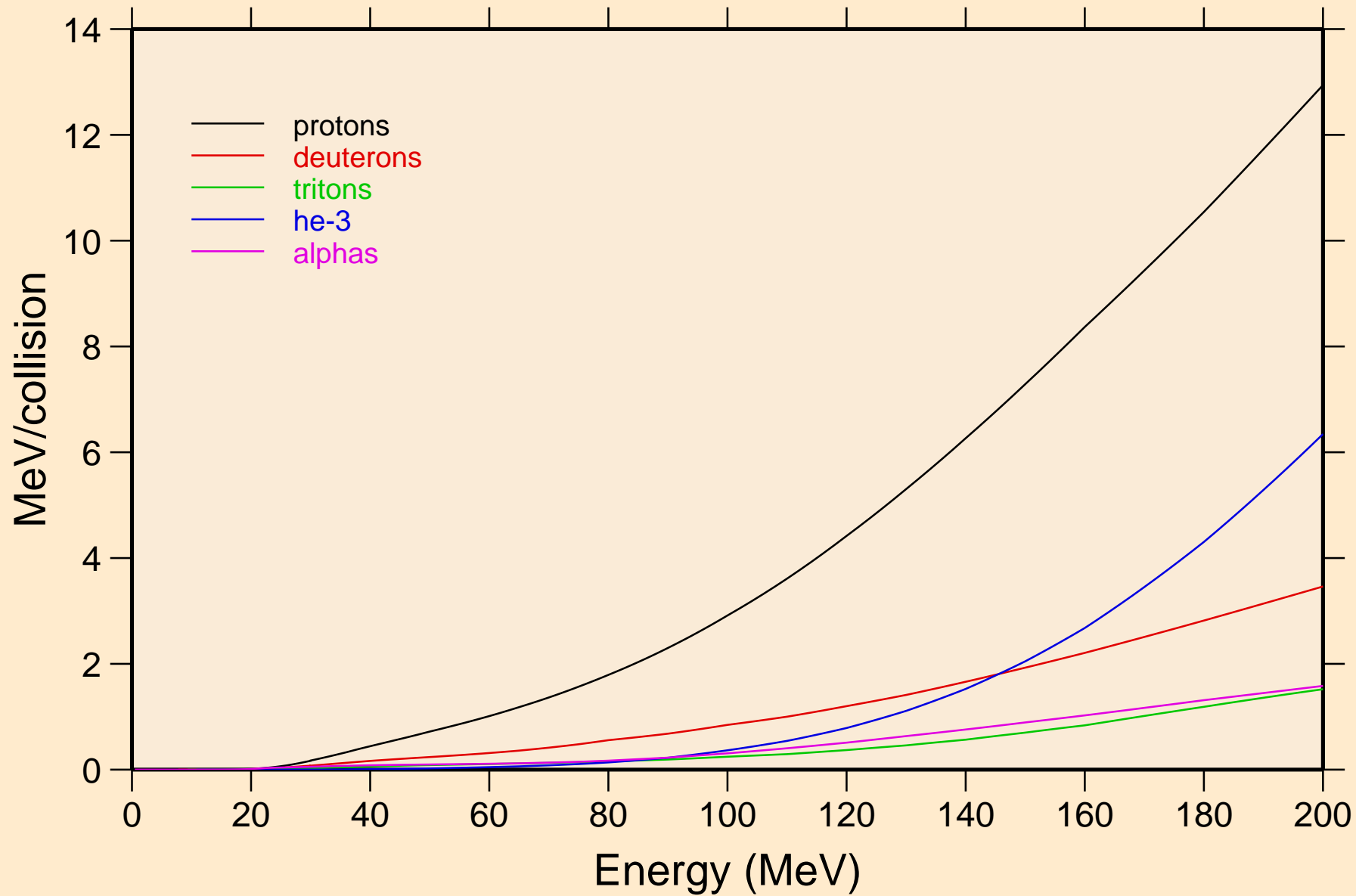

XE136 NEUTRON ACER TENDL-2021 LIBRARY; T=293.6K  
Recoil Heating

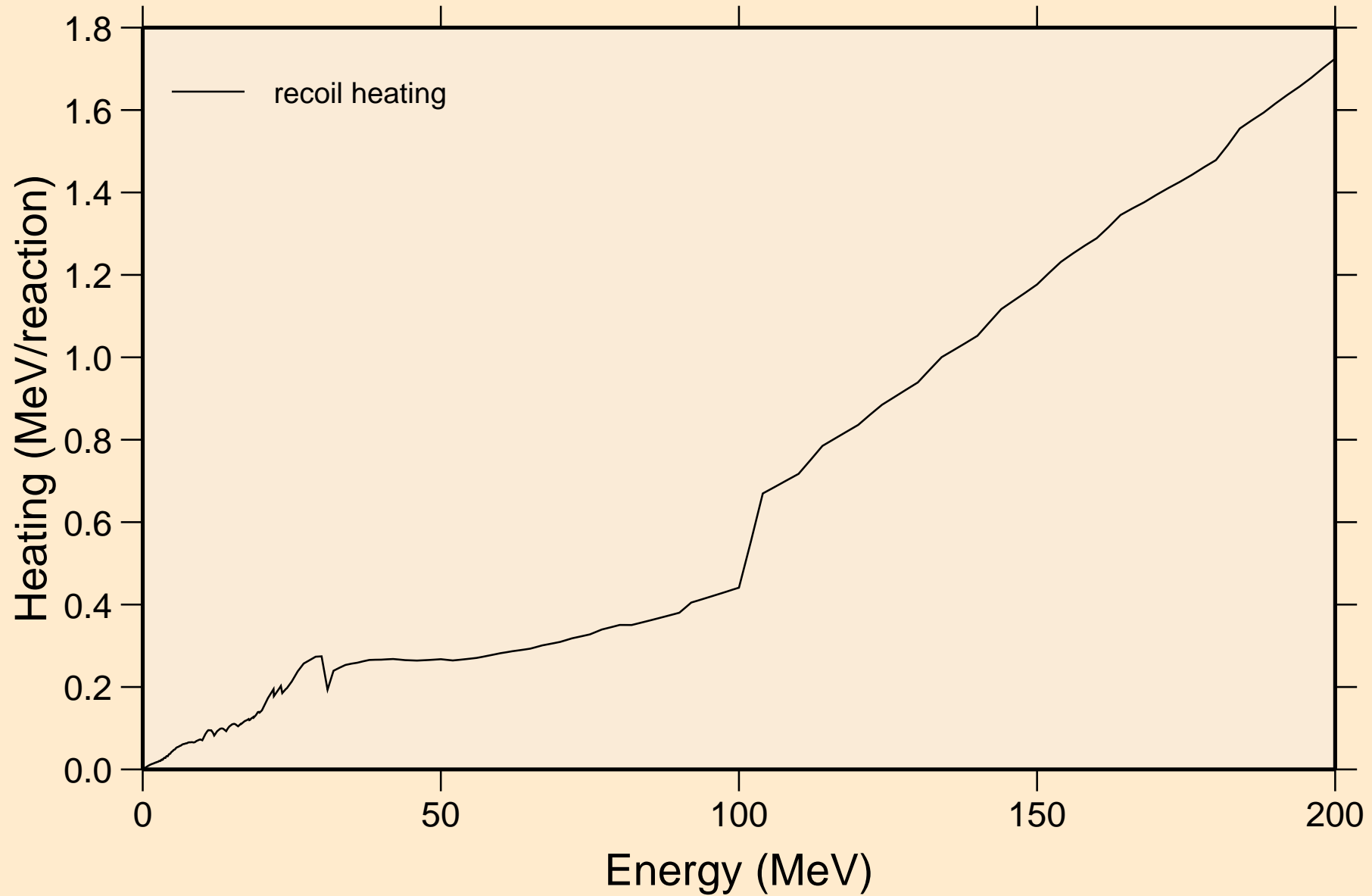

XE136 NEUTRON ACER TENDL-2021 LIBRARY; T=293.6K  
Particle production cross sections

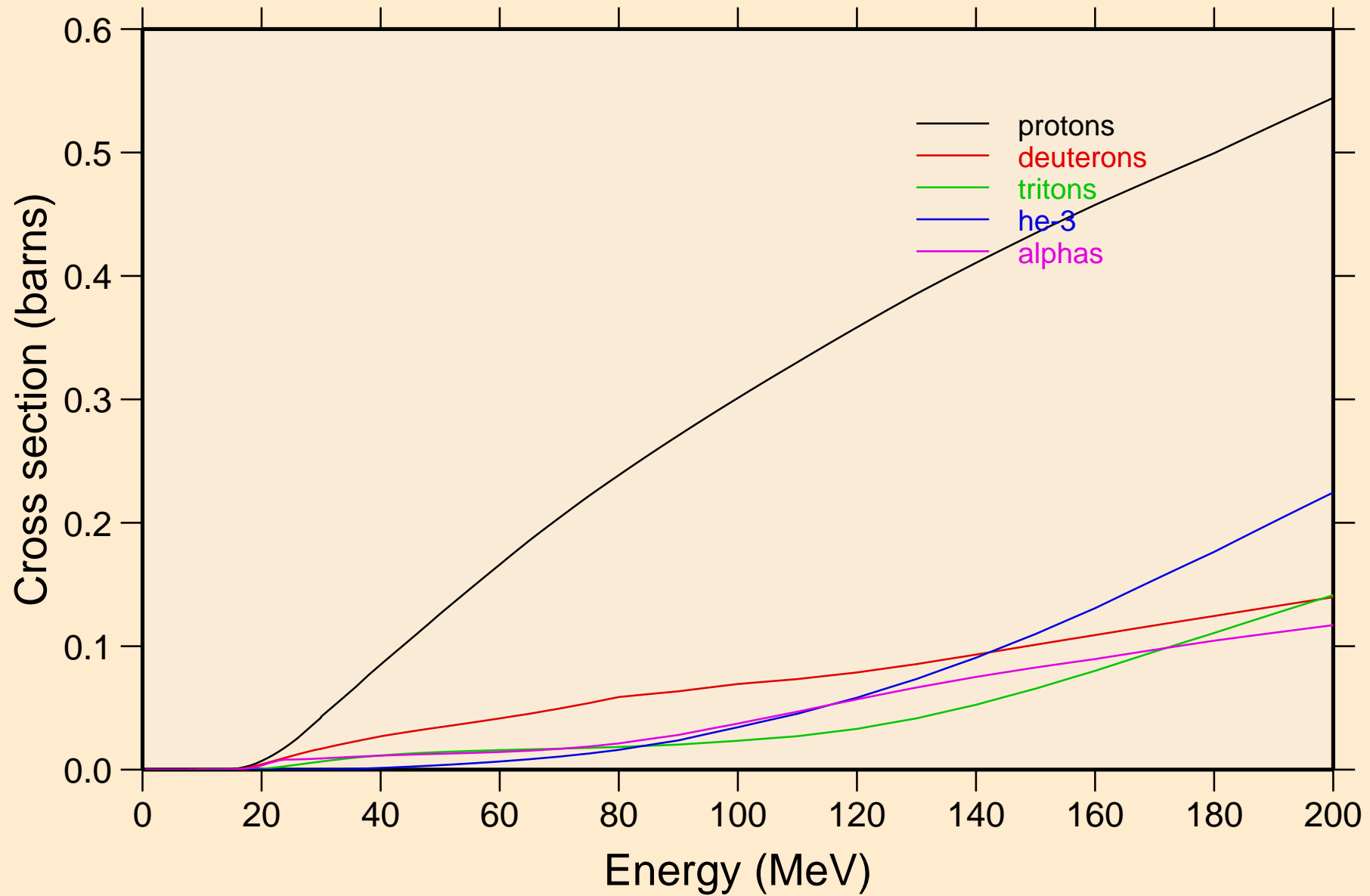

XE136 NEUTRON ACER TENDL-2021 LIBRARY; T=293.6K  
protons from (n,x)

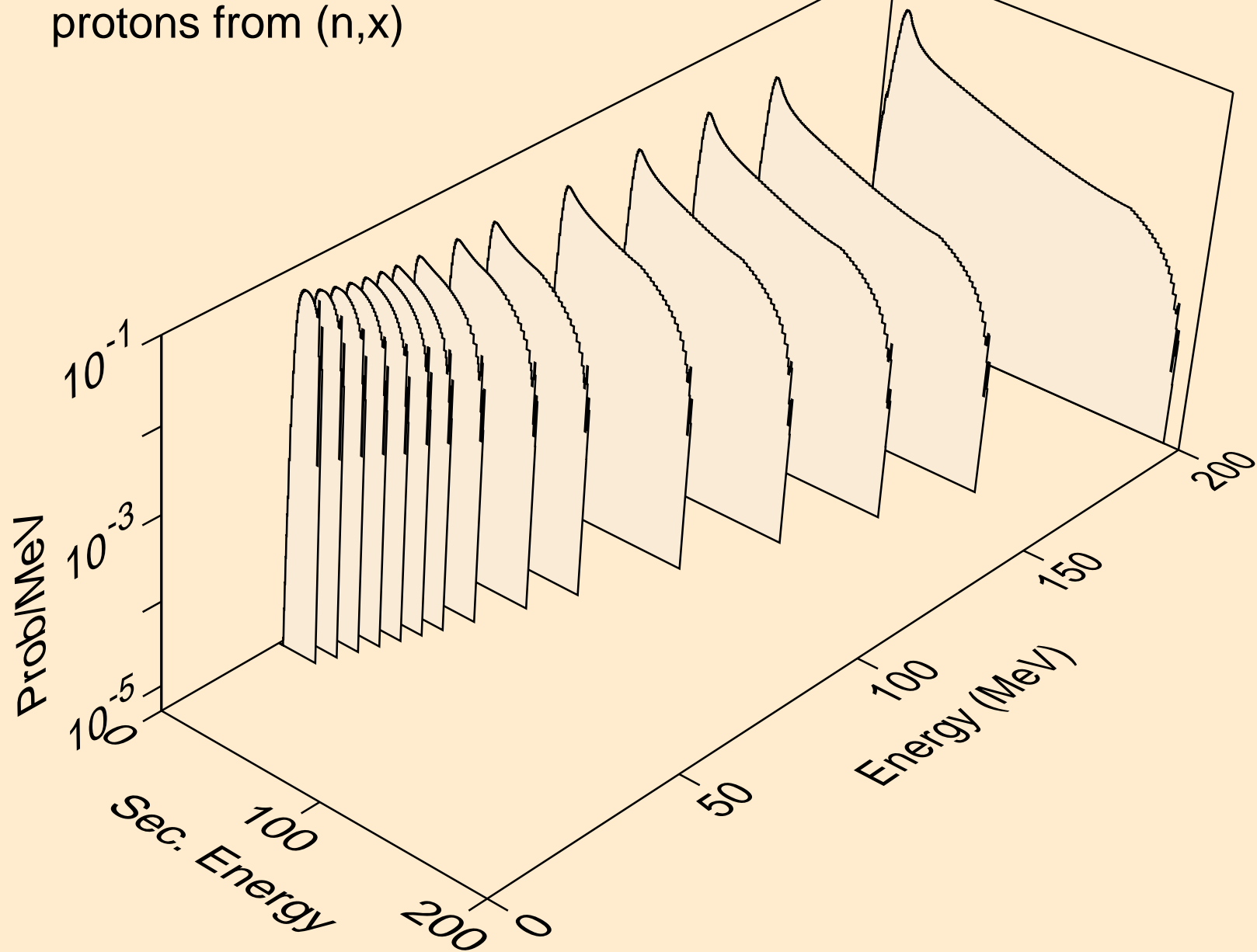

XE136 NEUTRON ACER TENDL-2021 LIBRARY; T=293.6K  
protons from (n,n\*)p

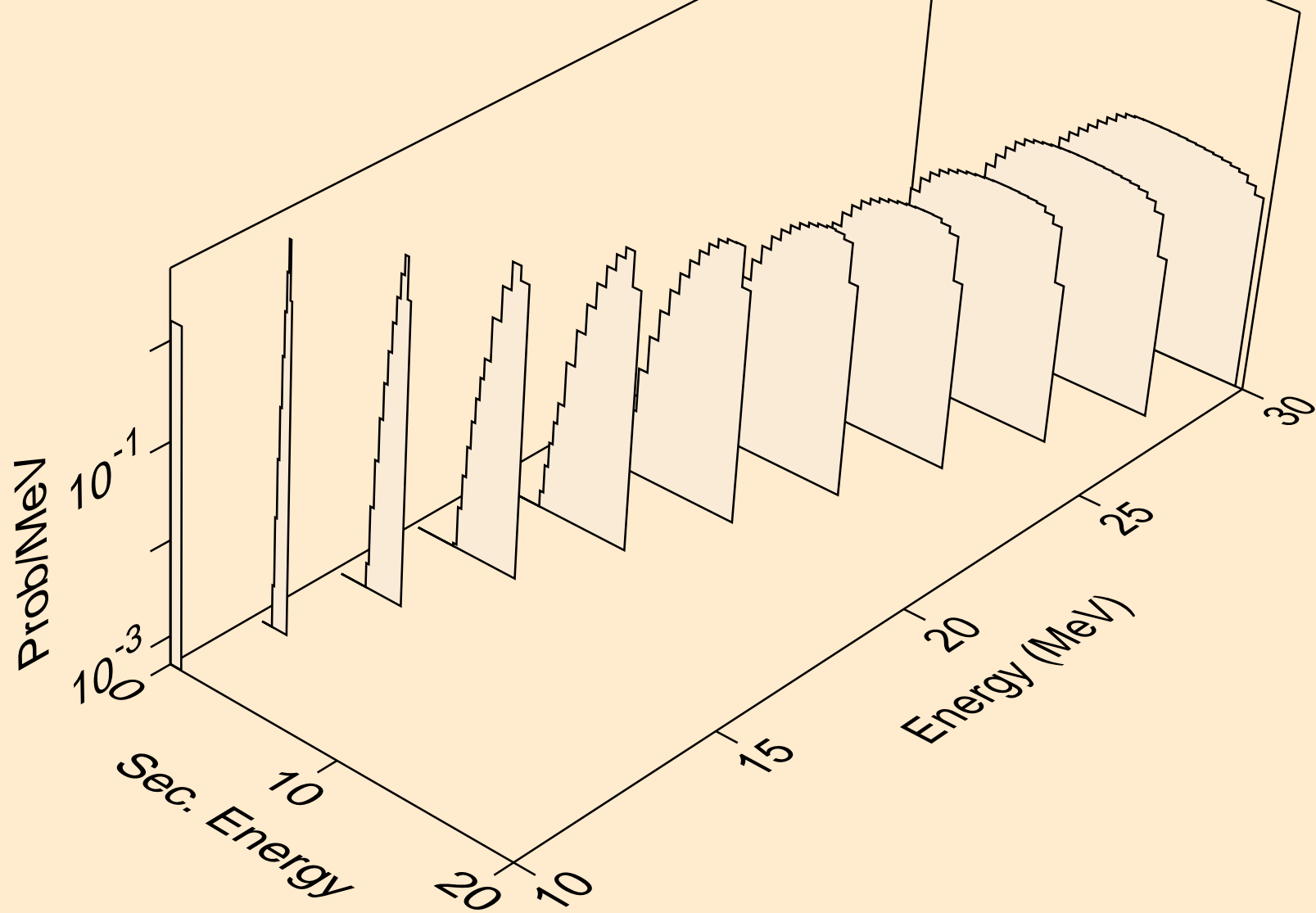

XE136 NEUTRON ACER TENDL-2021 LIBRARY; T=293.6K  
protons from (n,2np)

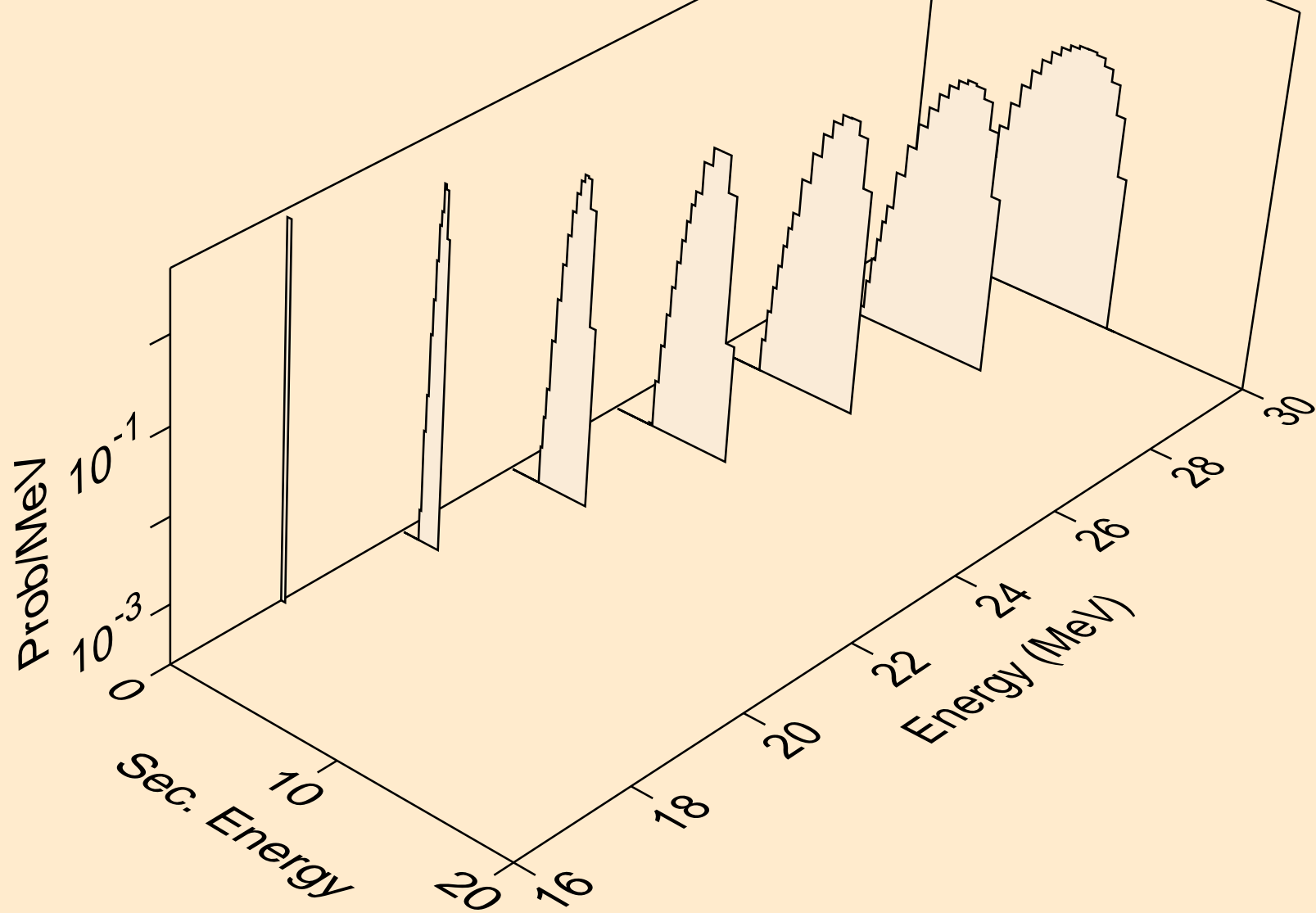

XE136 NEUTRON ACER TENDL-2021 LIBRARY; T=293.6K  
protons from (n,3np)

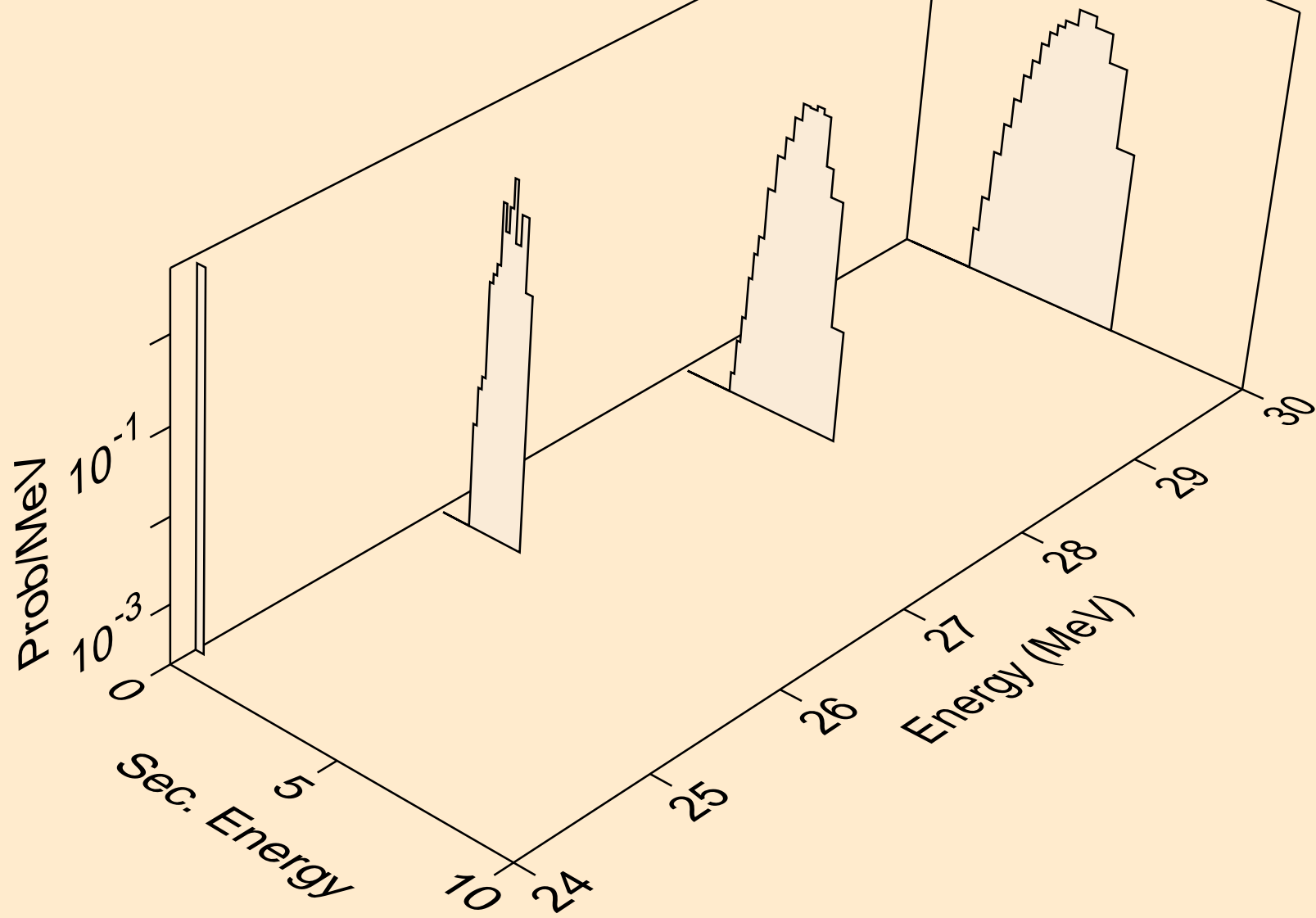



XE136 NEUTRON ACER TENDL-2021 LIBRARY; T=293.6K  
protons from (n,2np)

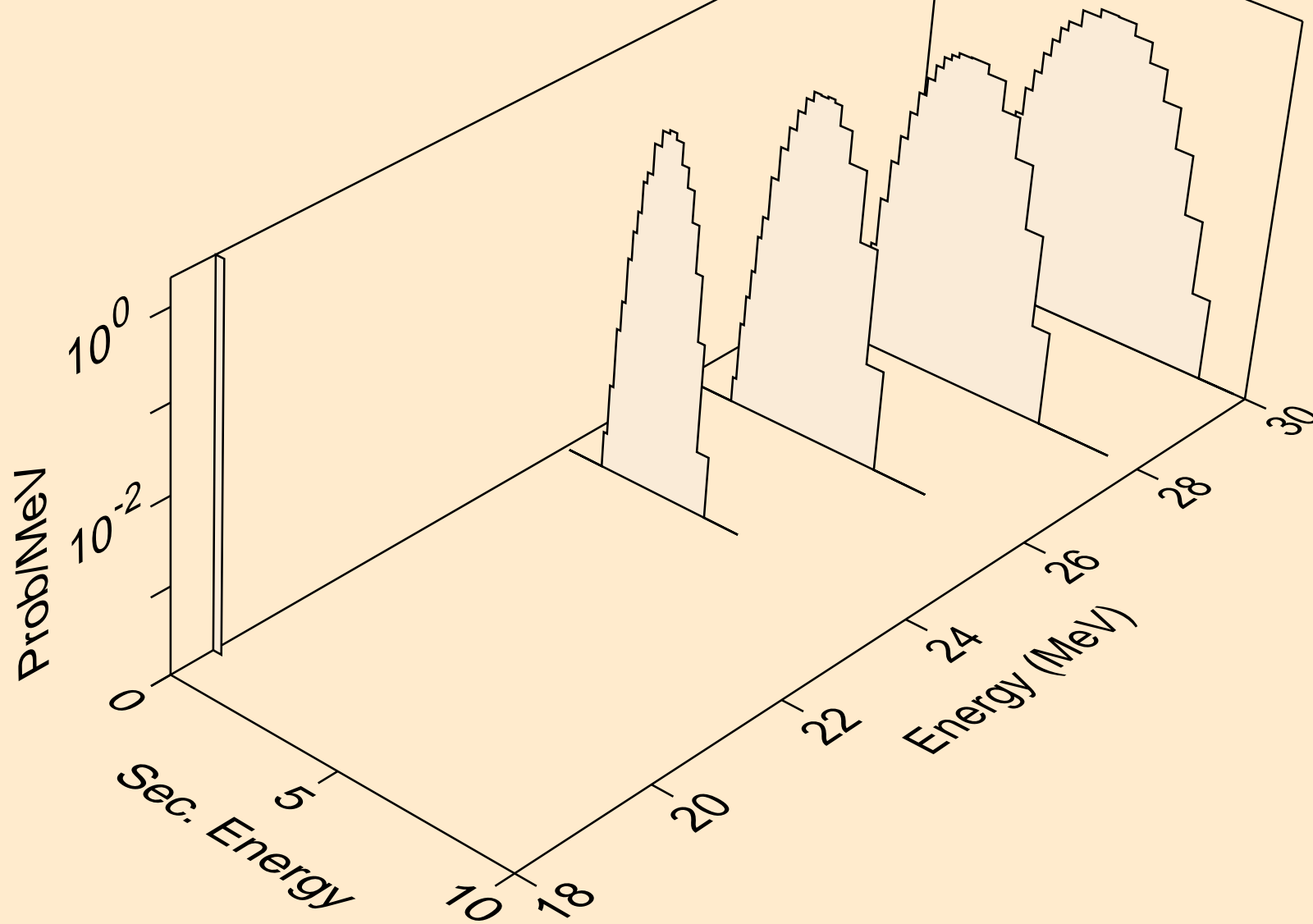

XE136 NEUTRON ACER TENDL-2021 LIBRARY; T=293.6K  
protons from (n,p)

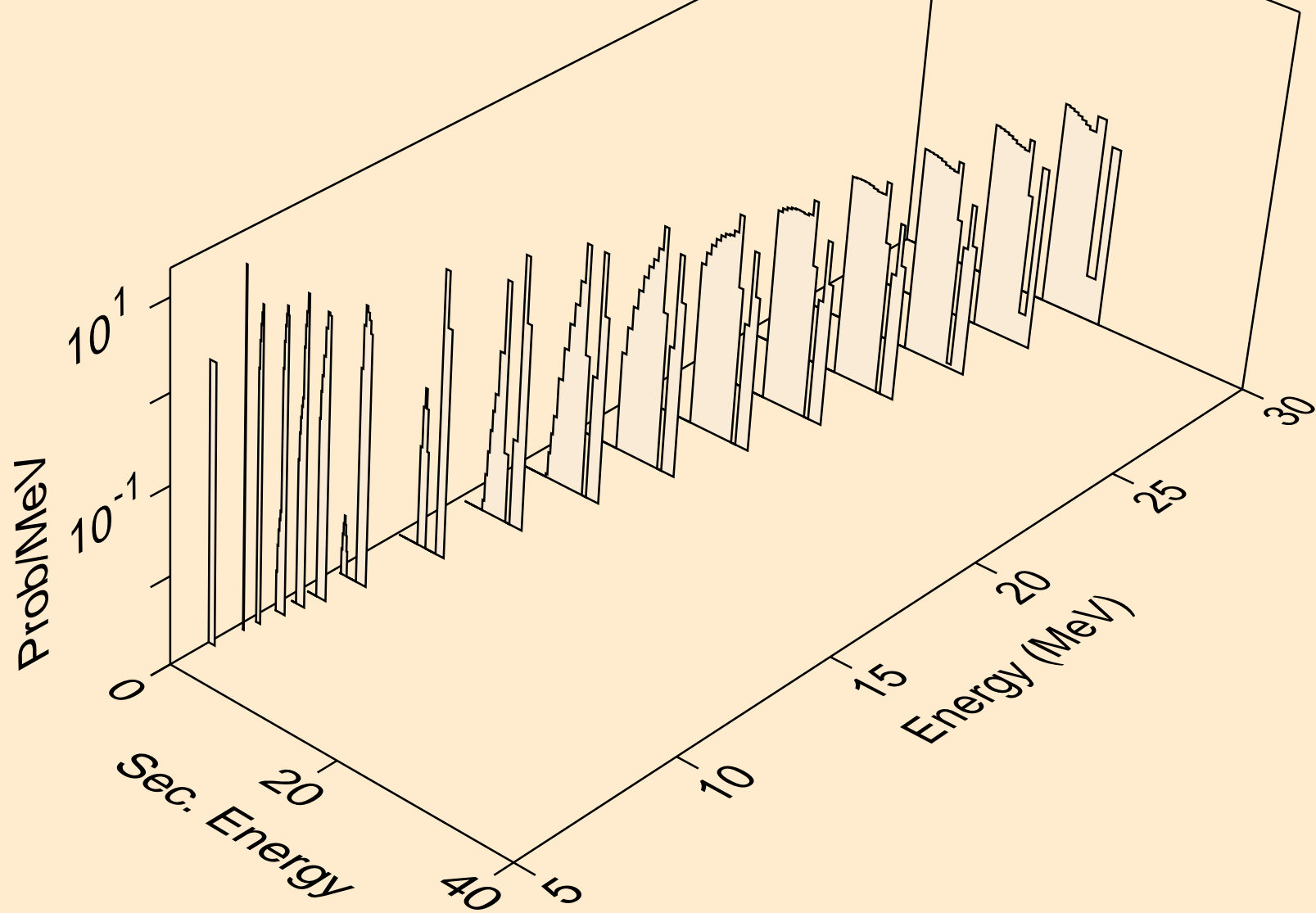

XE136 NEUTRON ACER TENDL-2021 LIBRARY; T=293.6K  
protons from (n,2p)

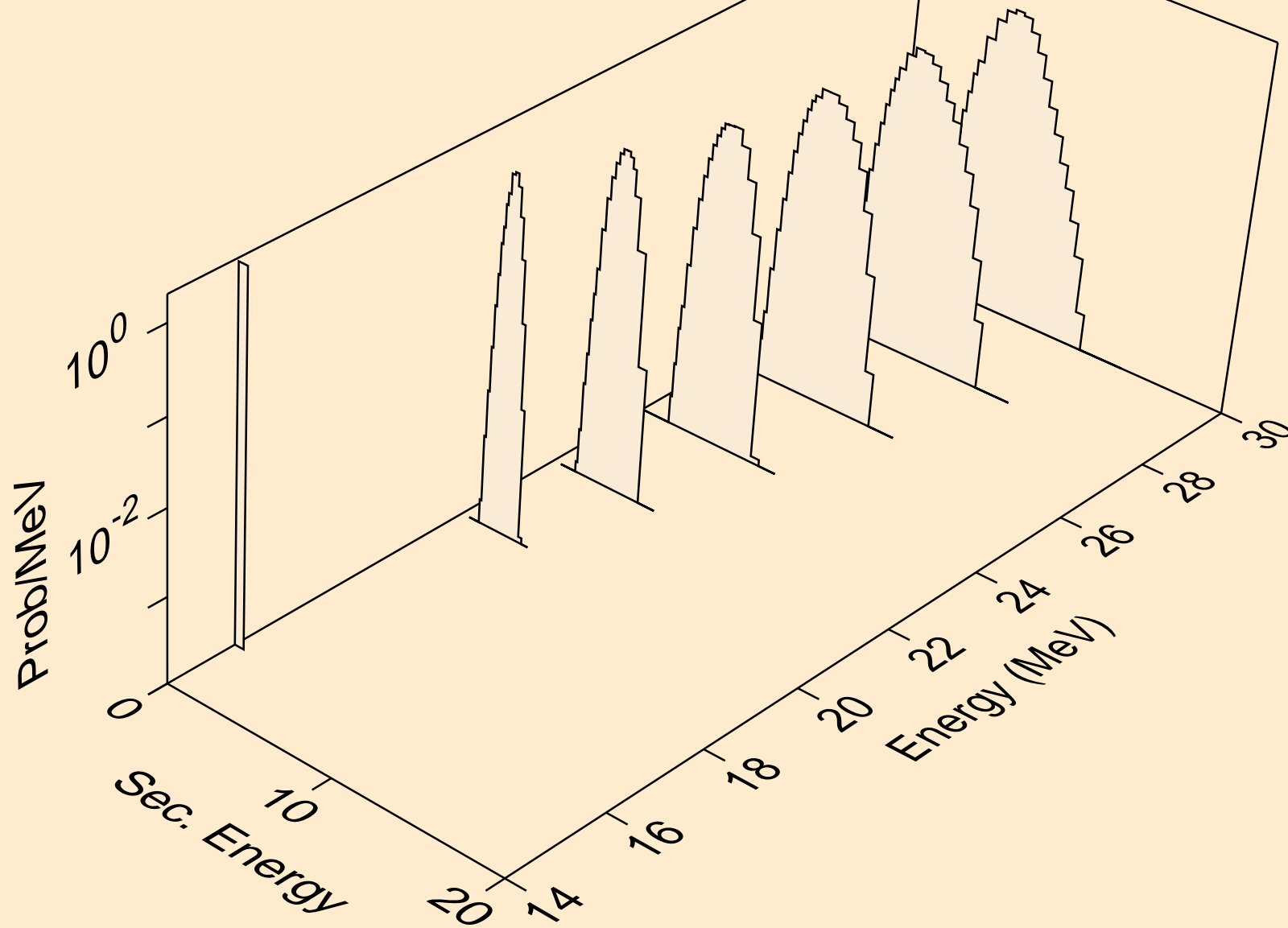

XE136 NEUTRON ACER TENDL-2021 LIBRARY; T=293.6K  
protons from (n,p)

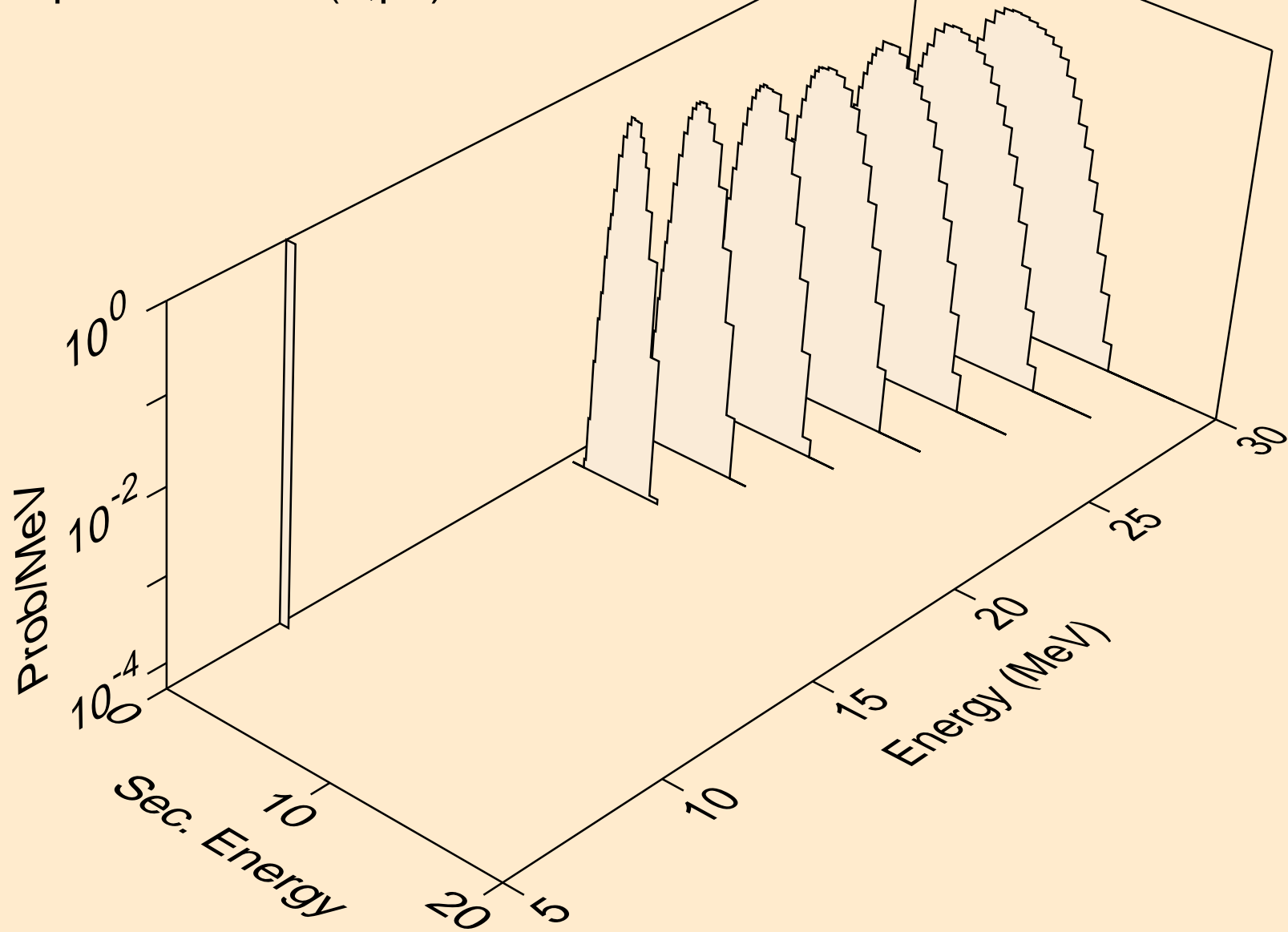

XE136 NEUTRON ACER TENDL-2021 LIBRARY; T=293.6K  
protons from (n,pd)

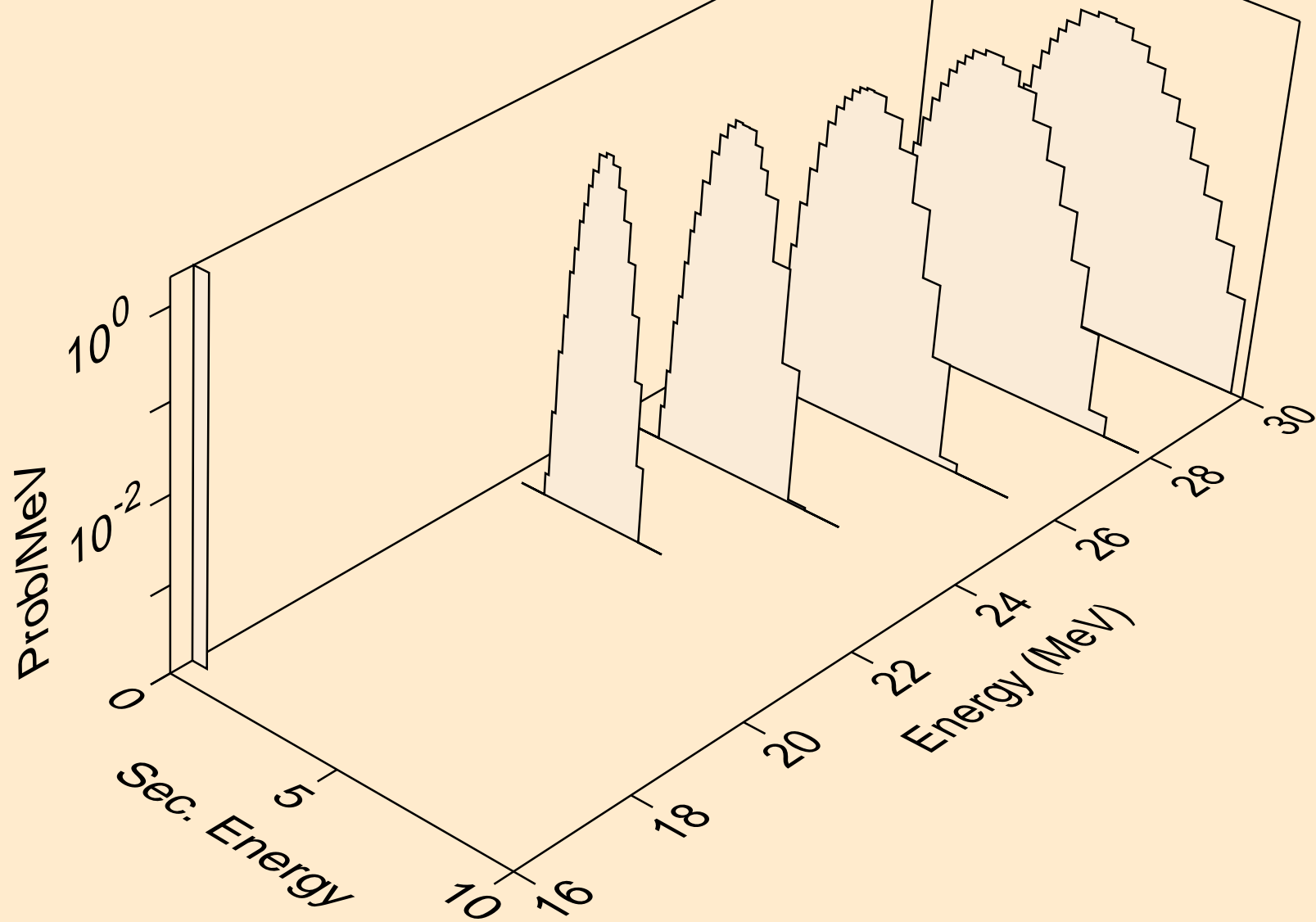

XE136 NEUTRON ACER TENDL-2021 LIBRARY; T=293.6K  
deuterons from (n,x)

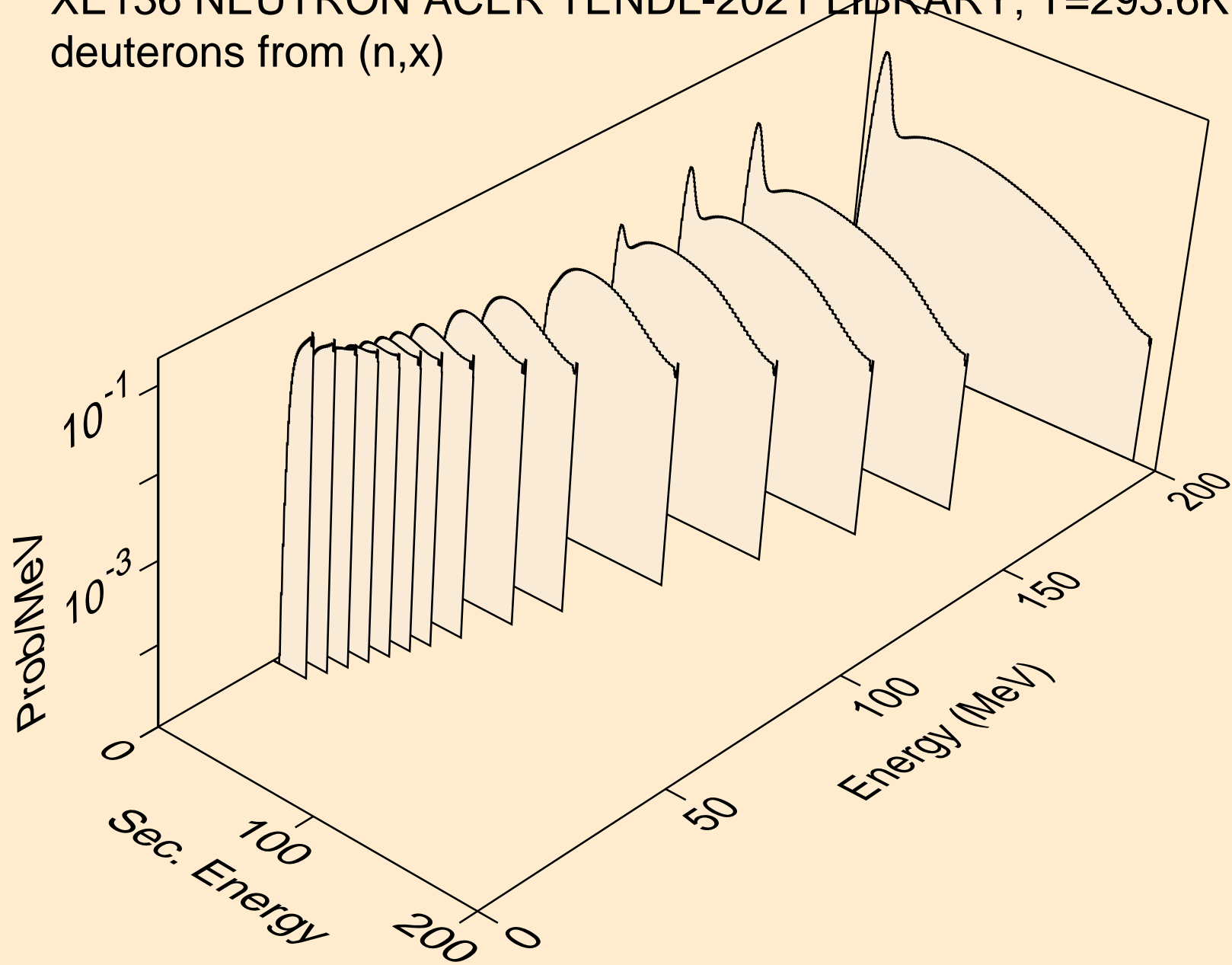

XE136 NEUTRON ACER TENDL-2021 LIBRARY; T=293.6K  
deuterons from (n,2nd)

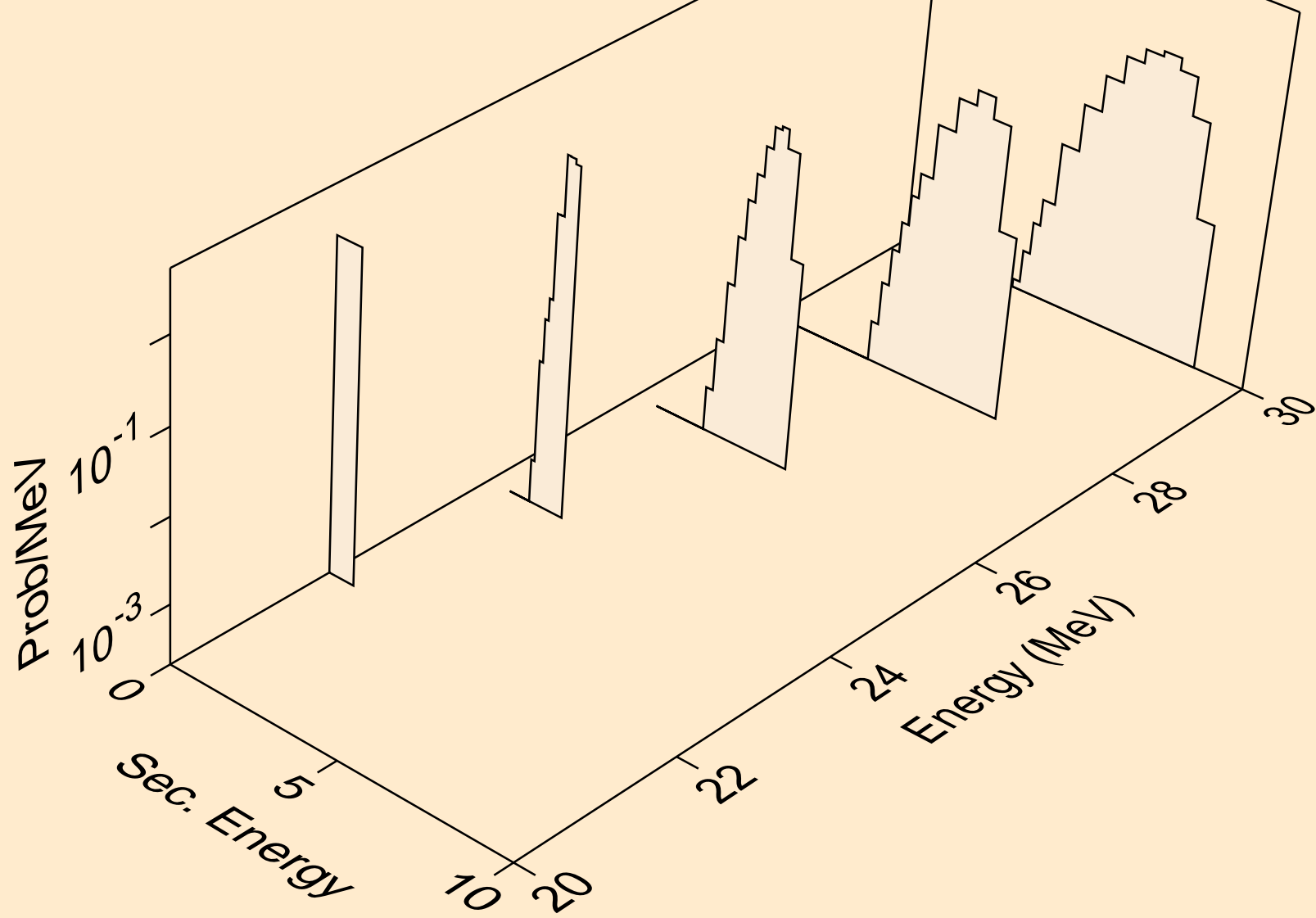

XE136 NEUTRON ACER TENDL-2021 LIBRARY; T=293.6K  
deuterons from (n,n\*)d

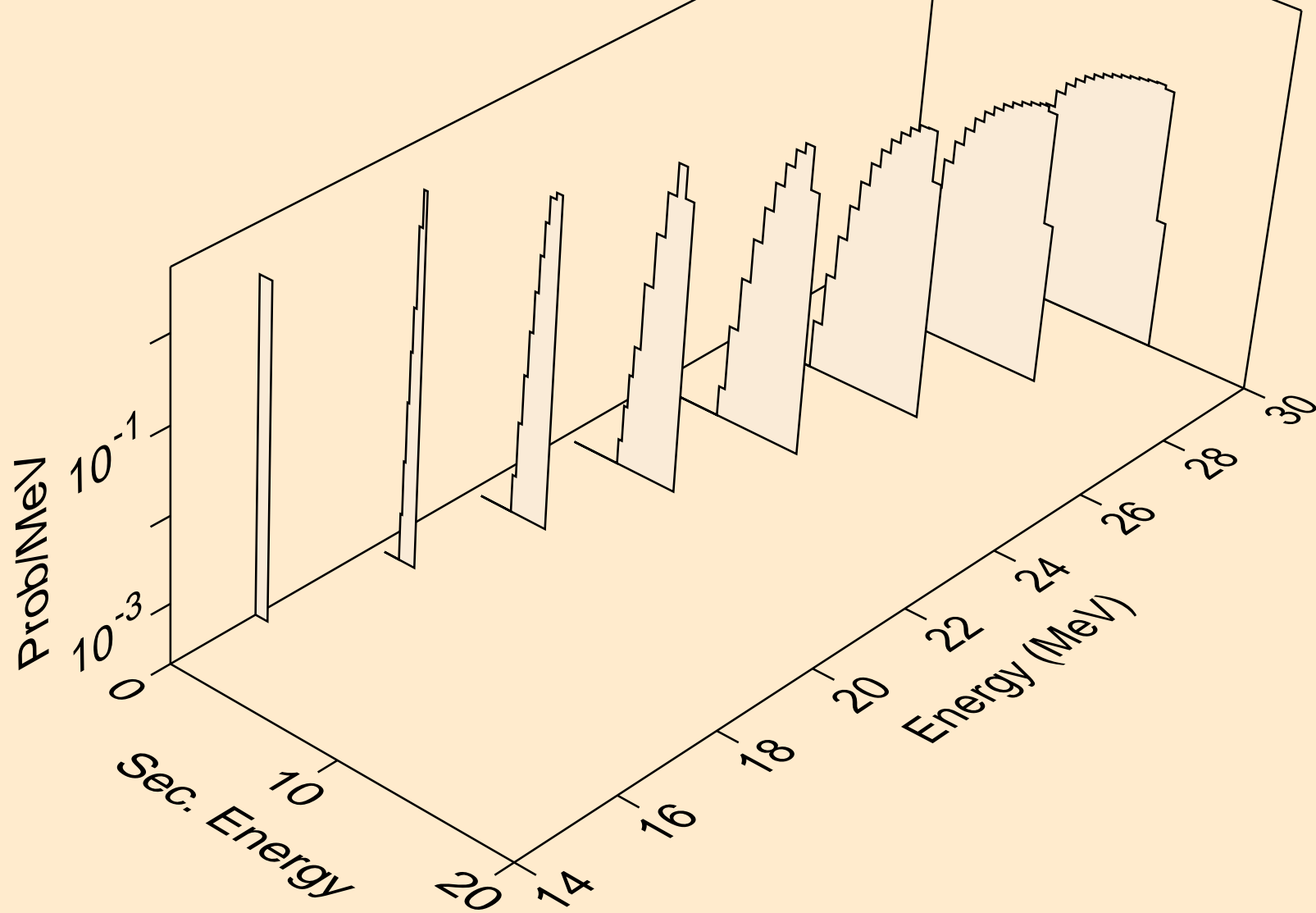



XE136 NEUTRON ACER TENDL-2021 LIBRARY; T=293.6K  
deuterons from (n,d)

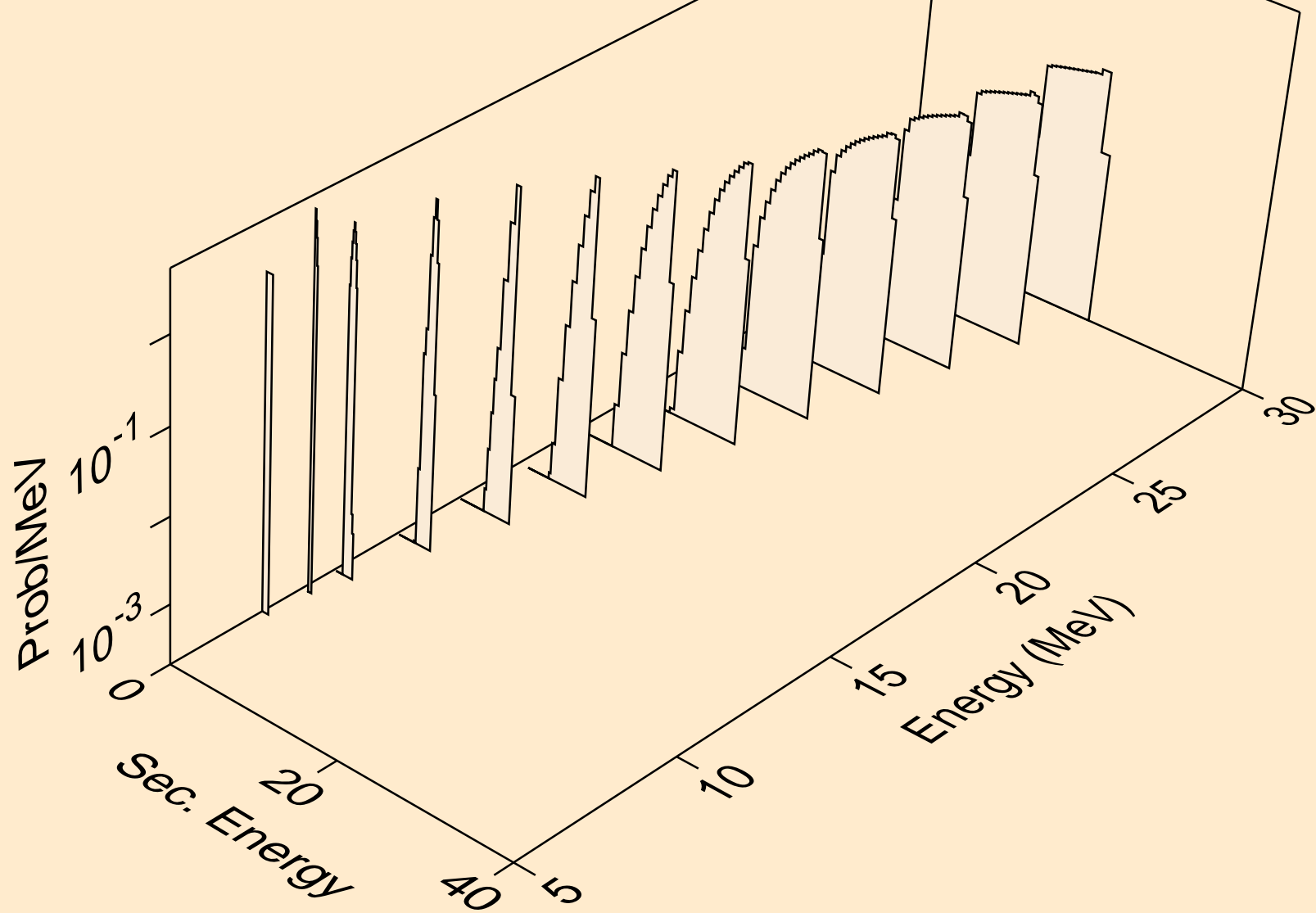

XE136 NEUTRON ACER TENDL-2021 LIBRARY; T=293.6K  
deuterons from (n,pd)

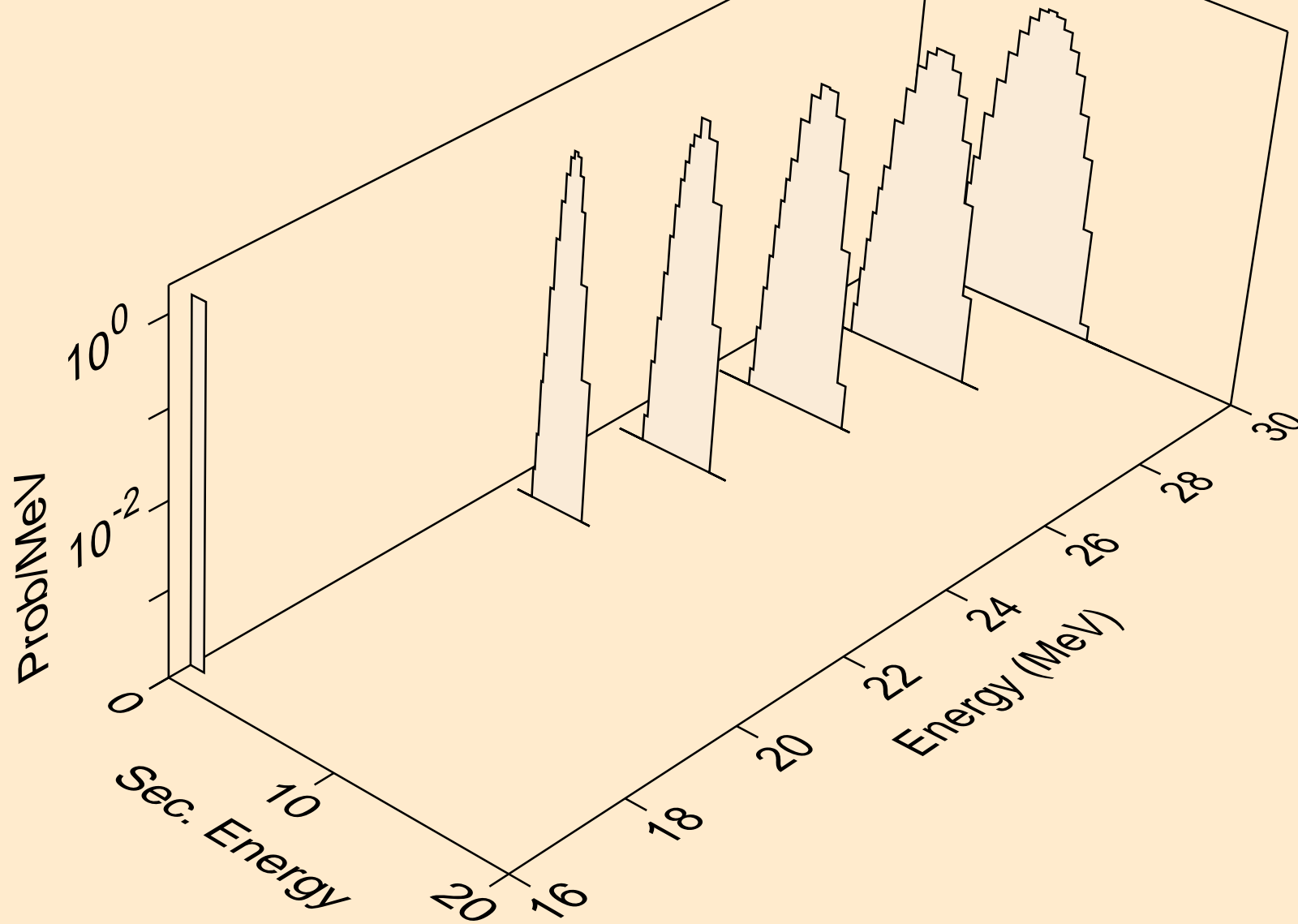

XE136 NEUTRON ACER TENDL-2021 LIBRARY; T=293.6K  
tritons from (n,x)

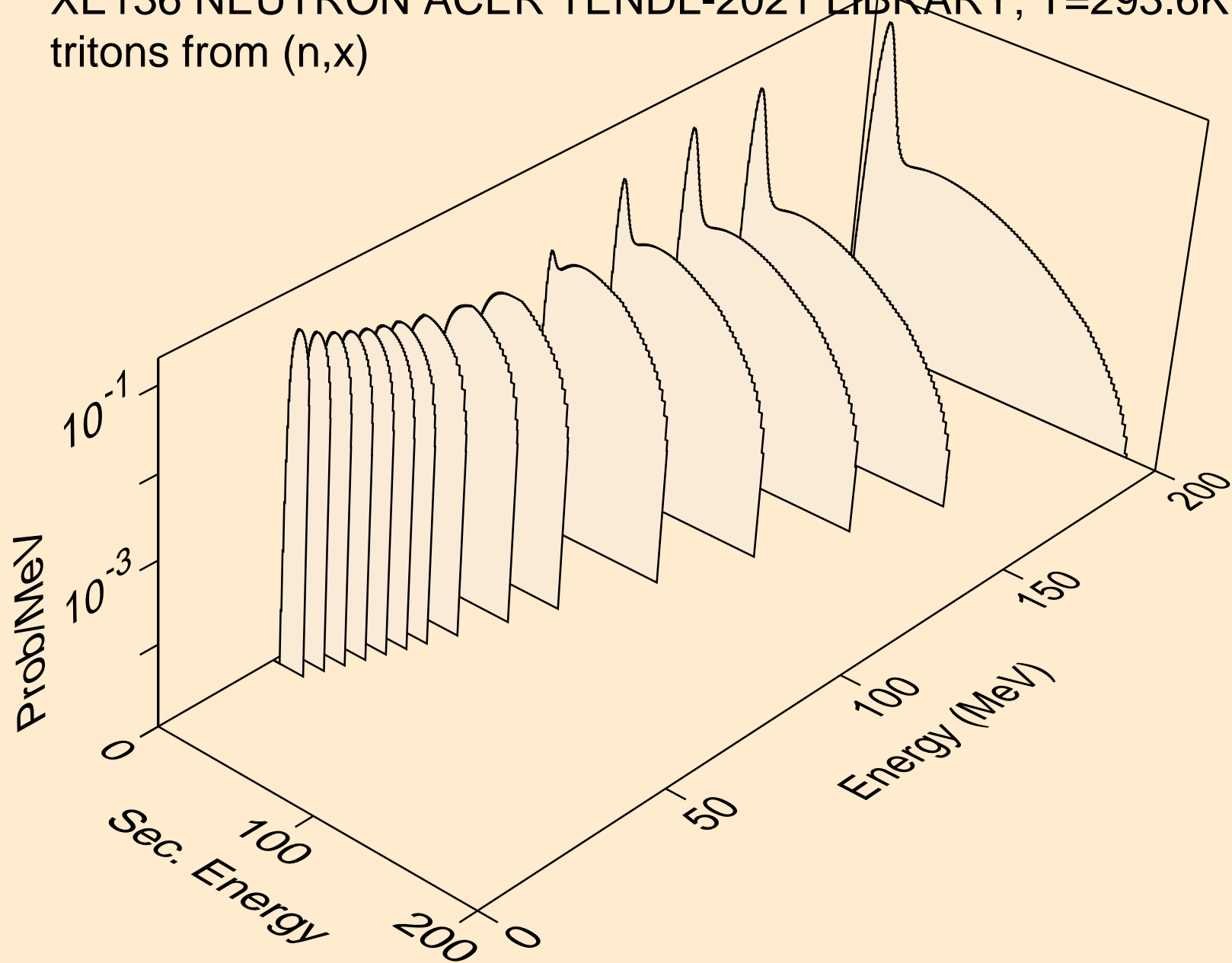

XE136 NEUTRON ACER TENDL-2021 LIBRARY; T=293.6K  
tritons from (n,n\*)t

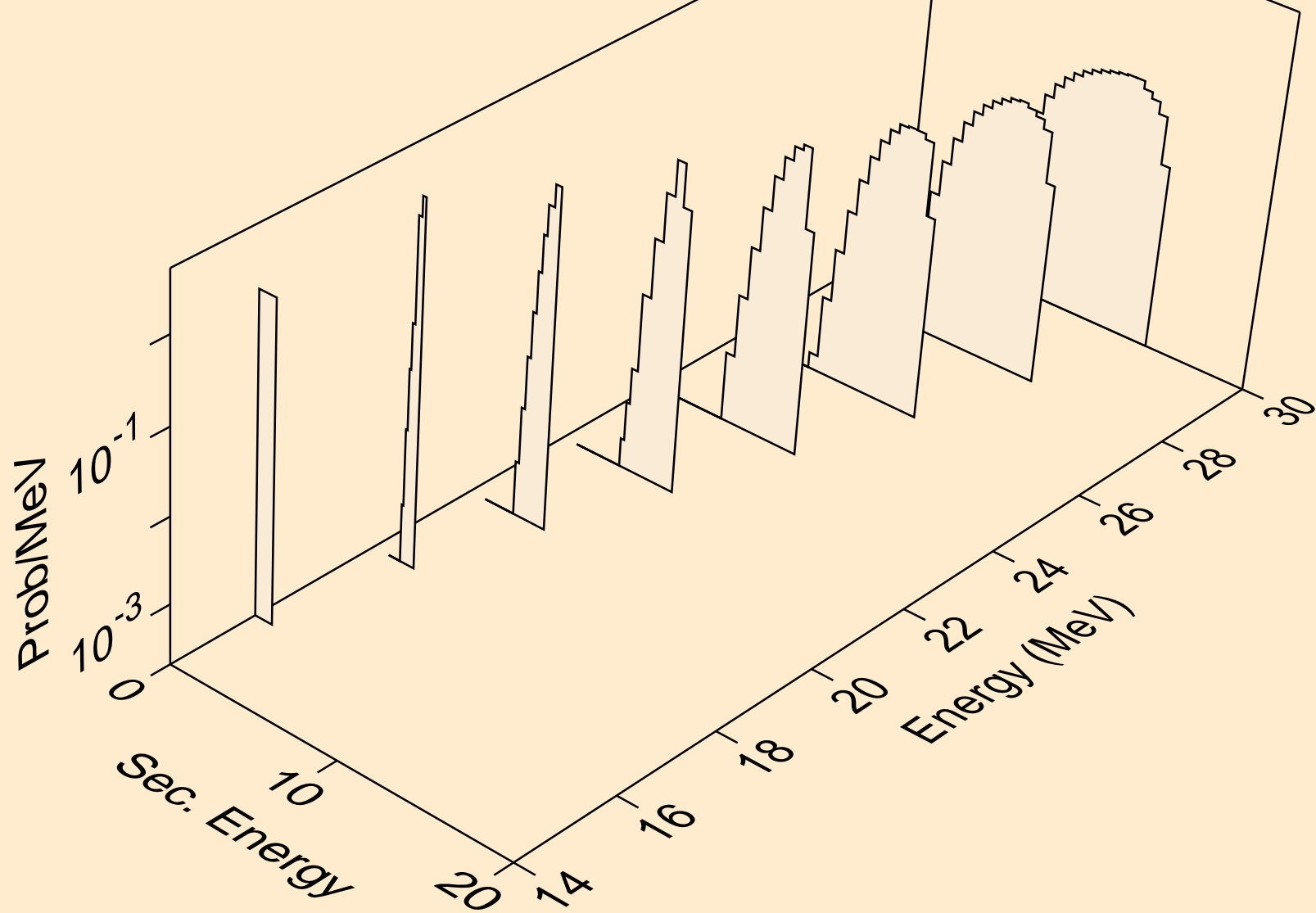

XE136 NEUTRON ACER TENDL-2021 LIBRARY; T=293.6K  
tritons from (n,t)

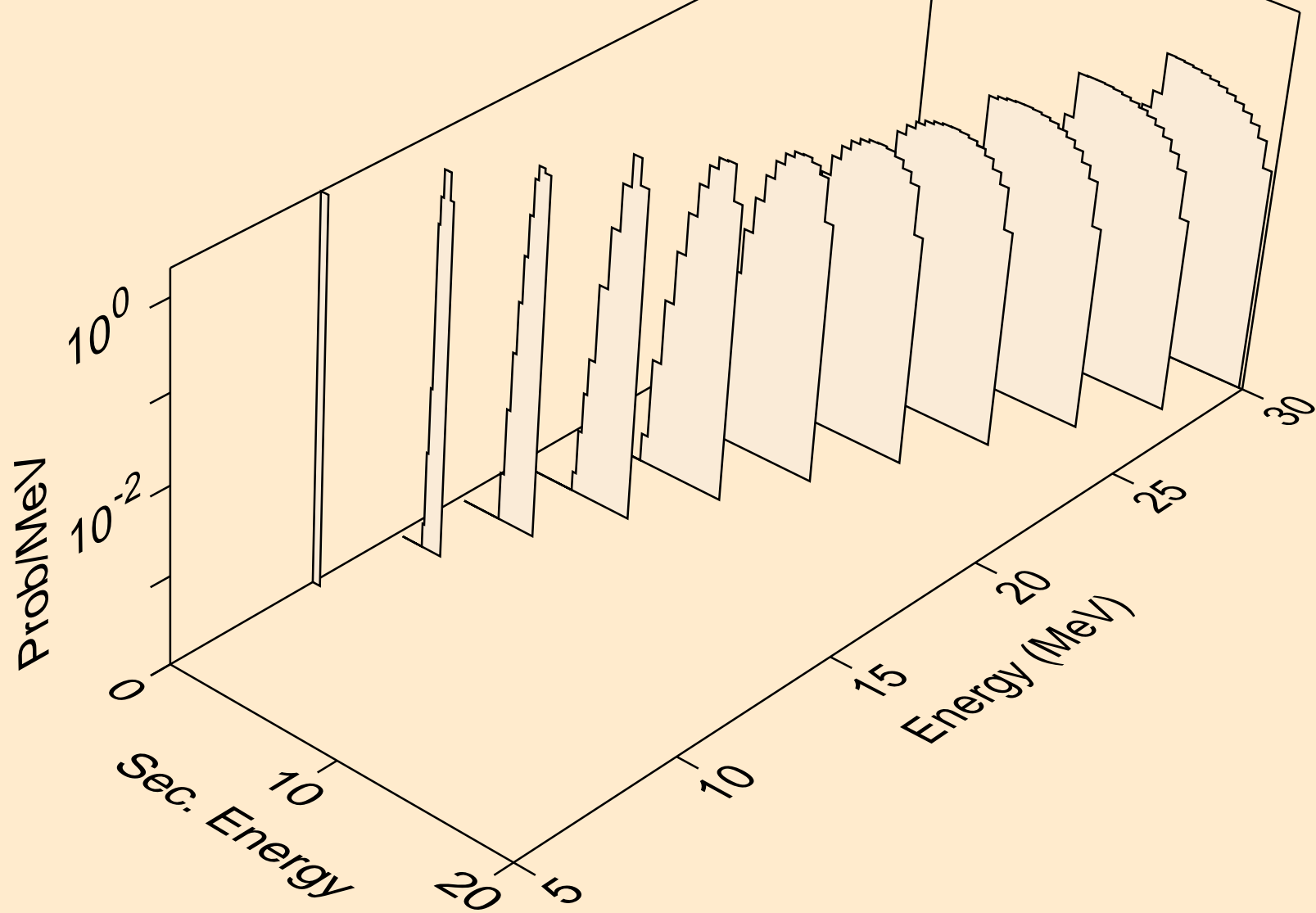

XE136 NEUTRON ACER TENDL-2021 LIBRARY; T=293.6K  
he3s from (n,x)

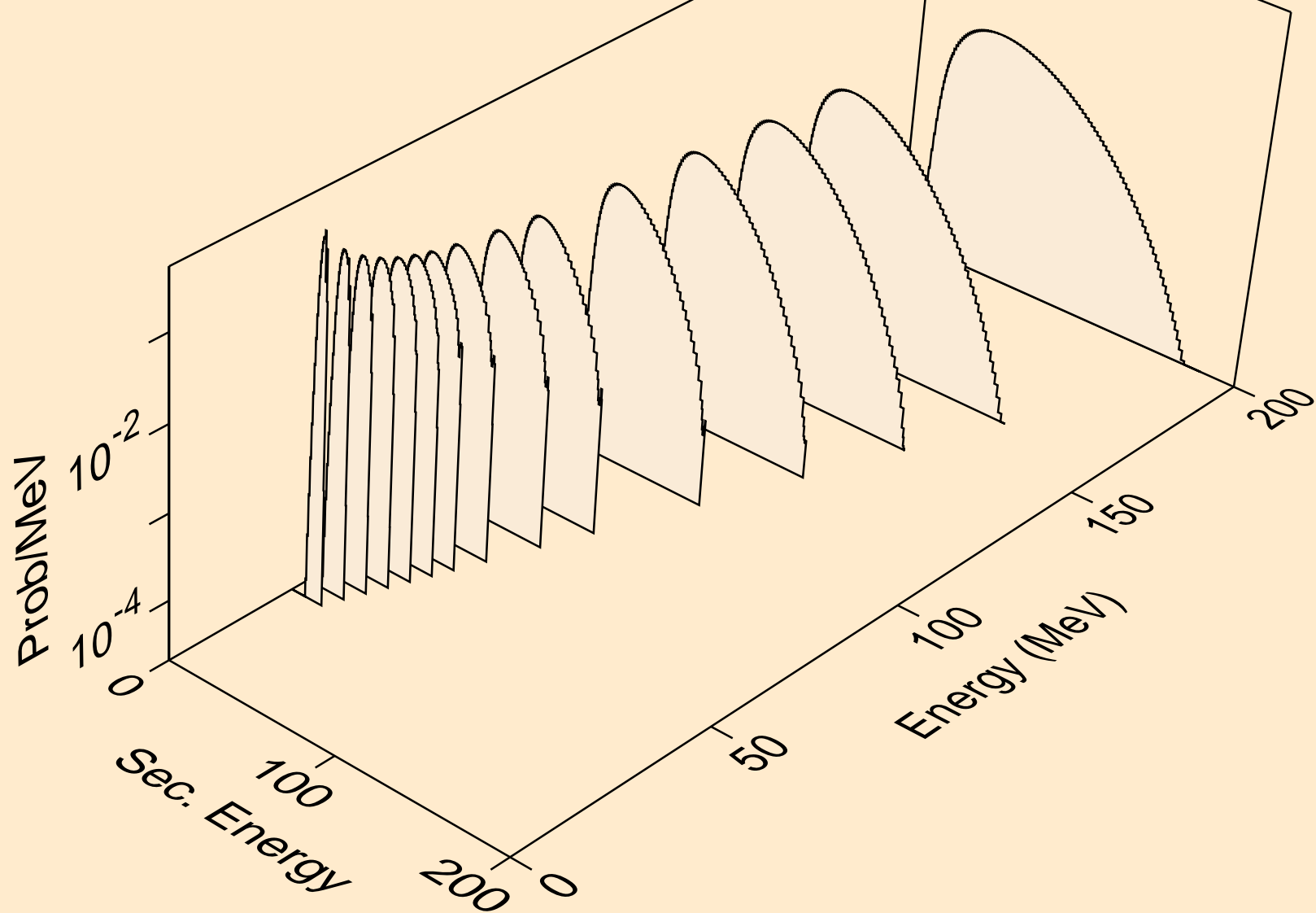

XE136 NEUTRON ACER TENDL-2021 LIBRARY; T=293.6K  
he3s from (n,n\*)he3

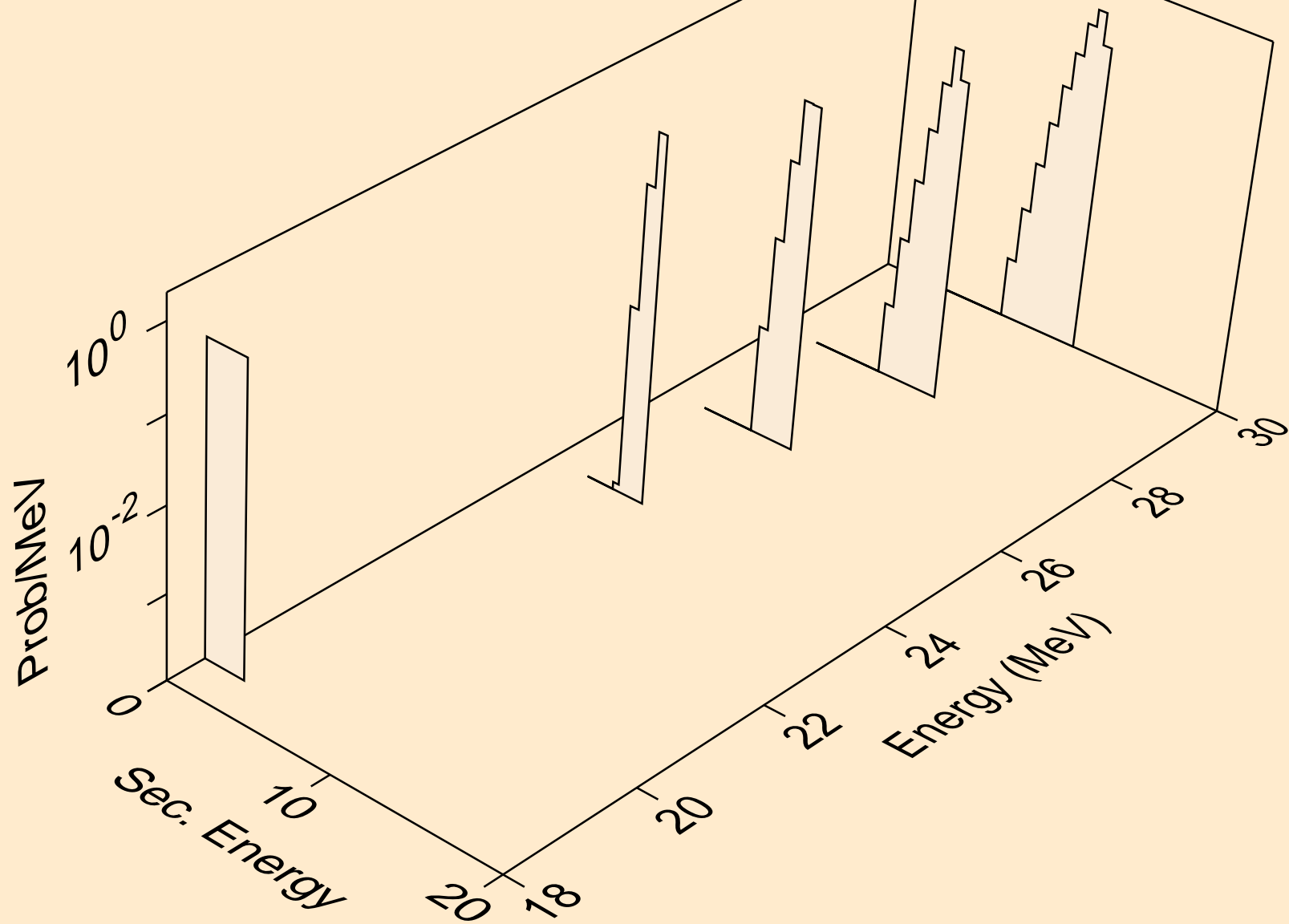

XE136 NEUTRON ACER TENDL-2021 LIBRARY; T=293.6K  
he3s from (n,he3)

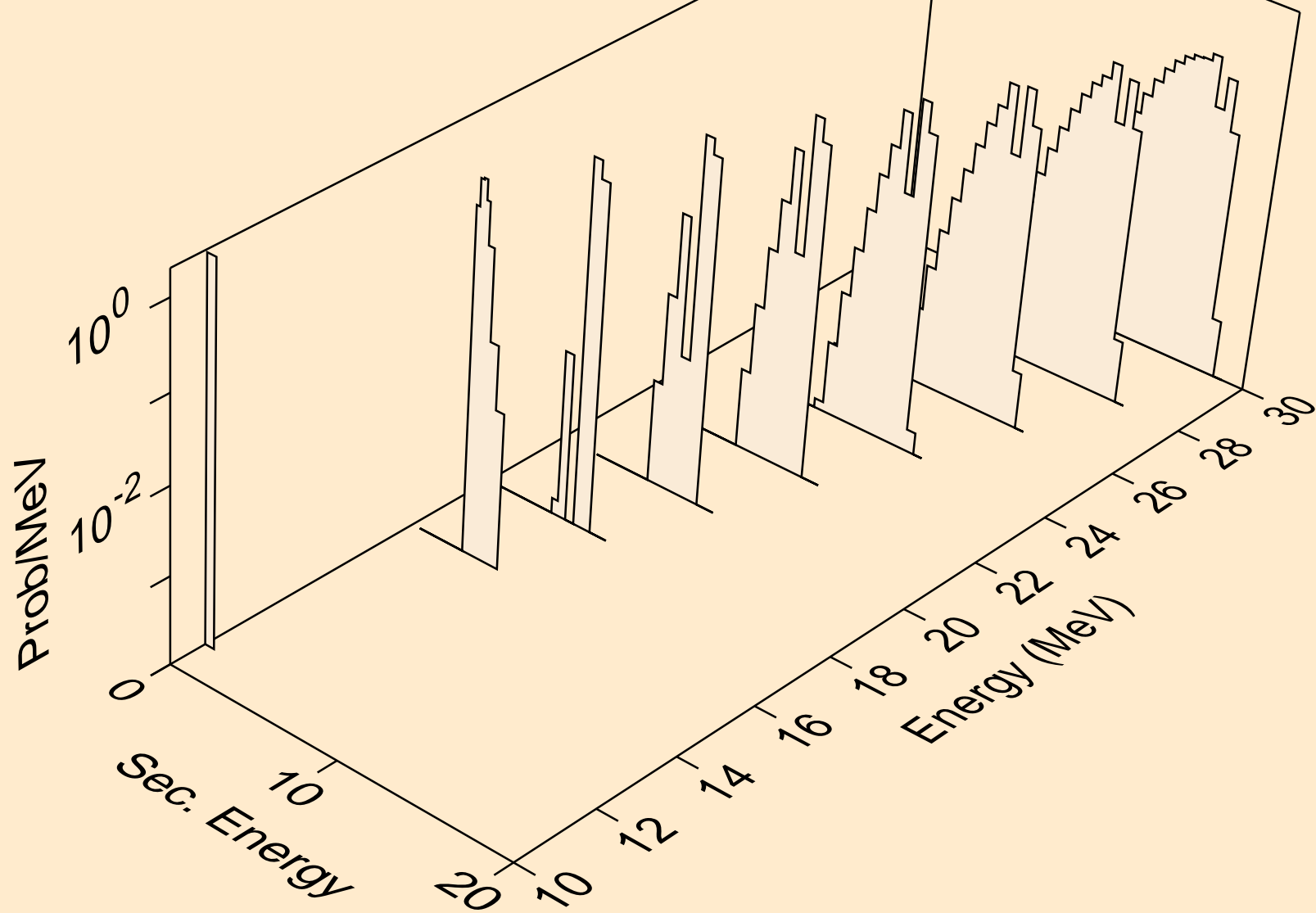



XE136 NEUTRON ACER TENDL-2021 LIBRARY; T=293.6K  
alphas from (n,x)

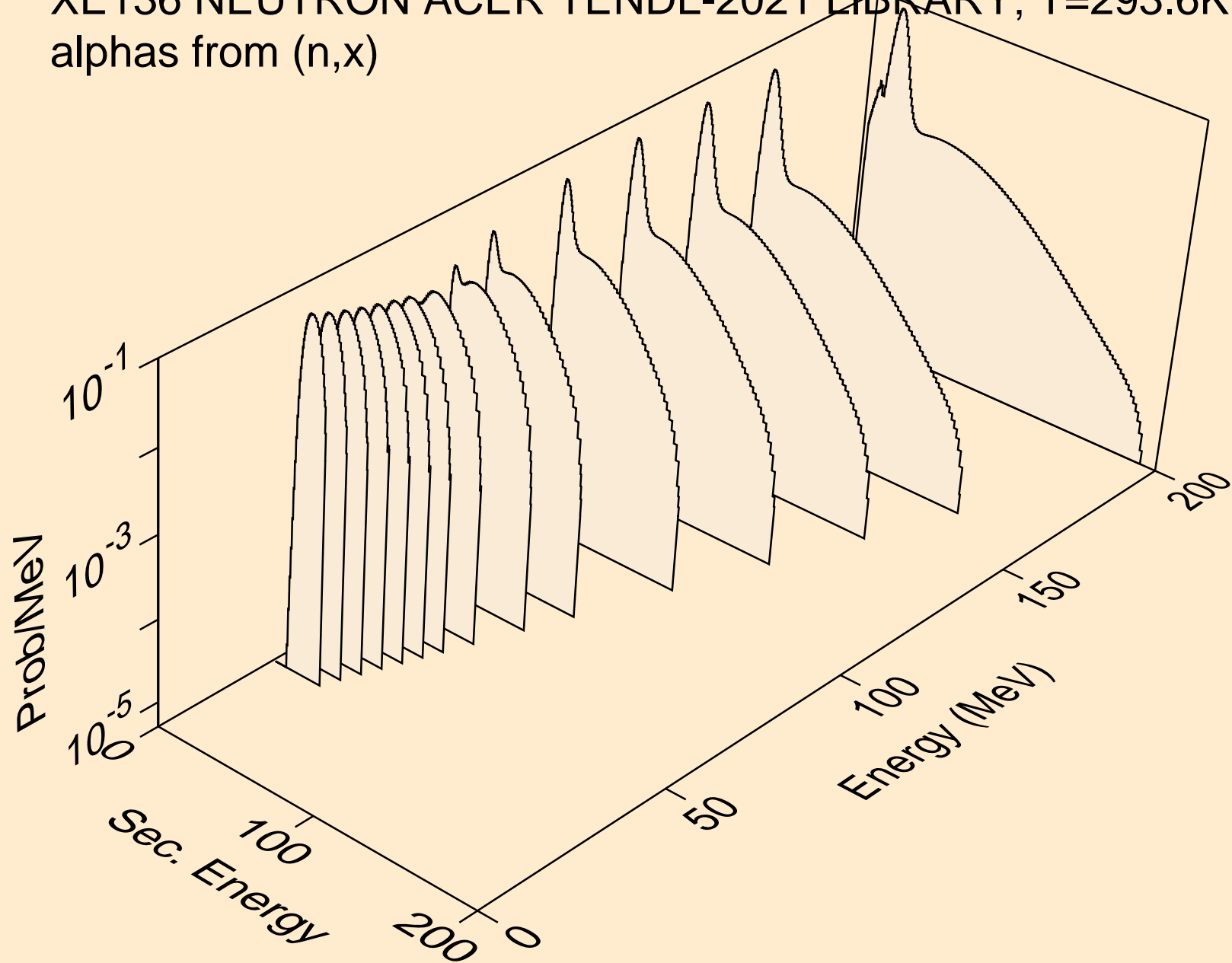

XE136 NEUTRON ACER TENDL-2021 LIBRARY; T=293.6K  
alphas from (n,n\*)a

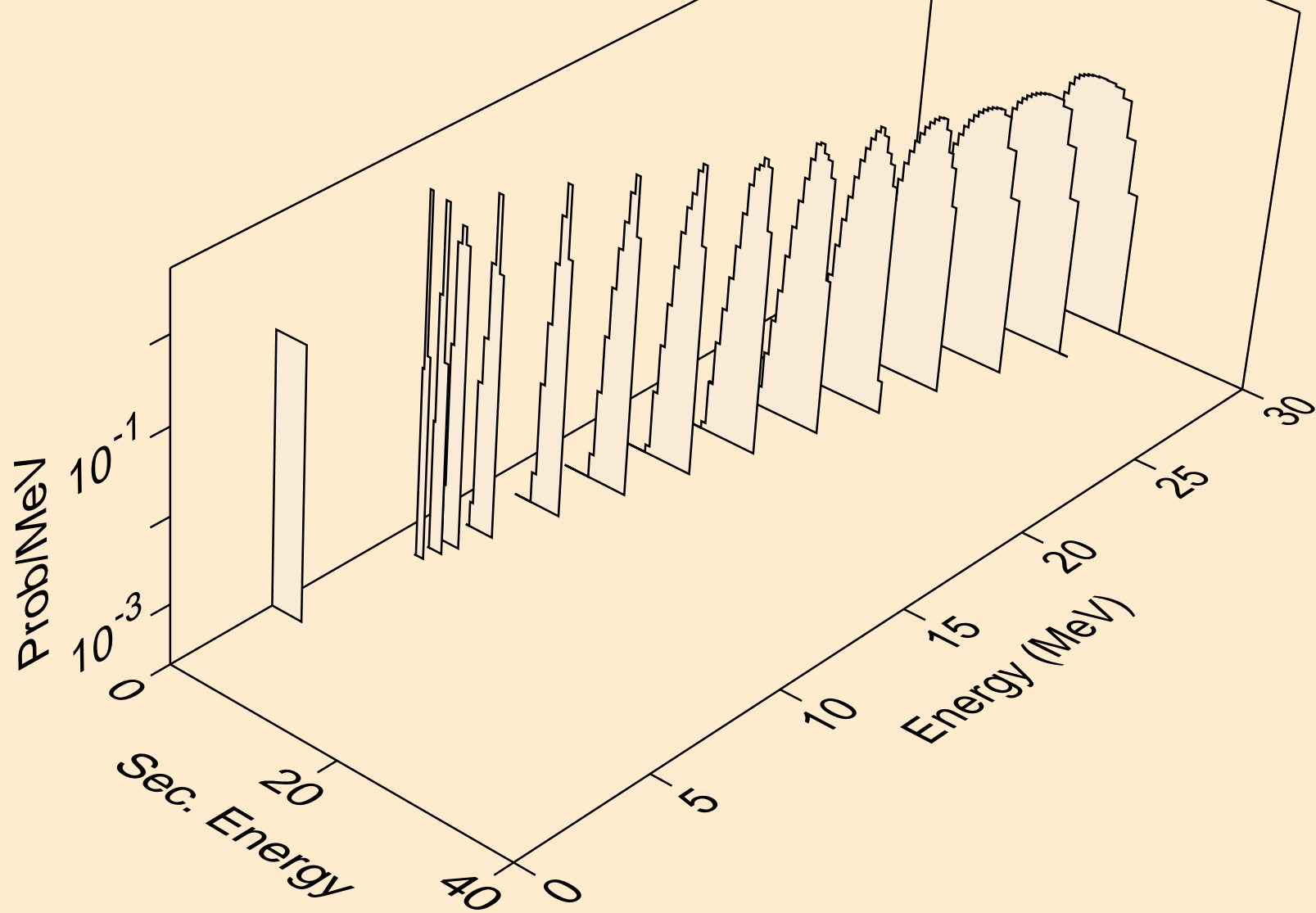

XE136 NEUTRON ACER TENDL-2021 LIBRARY; T=293.6K  
alphas from (n,2n)a

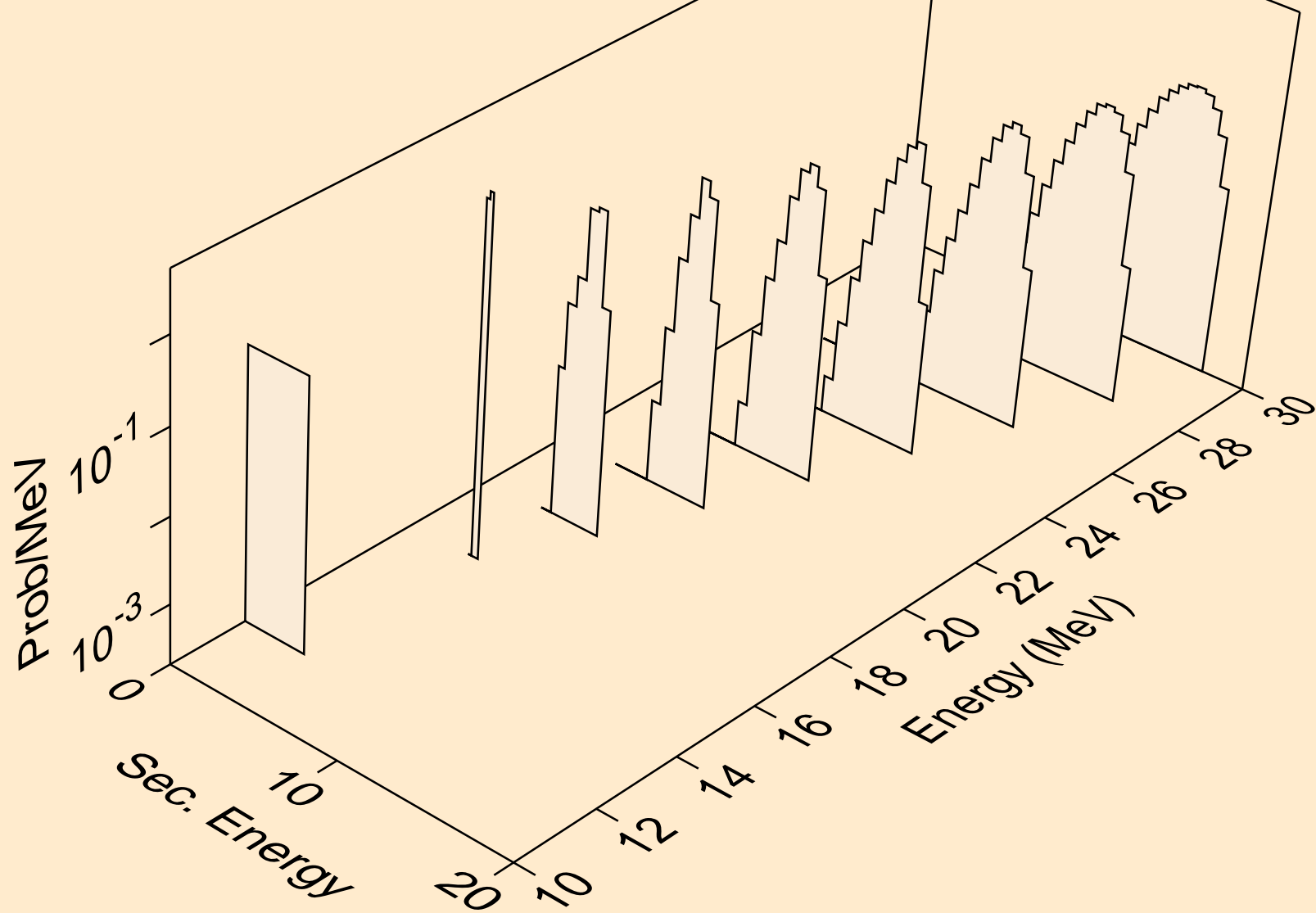

XE136 NEUTRON ACER TENDL-2021 LIBRARY; T=293.6K  
alphas from (n,3n)a

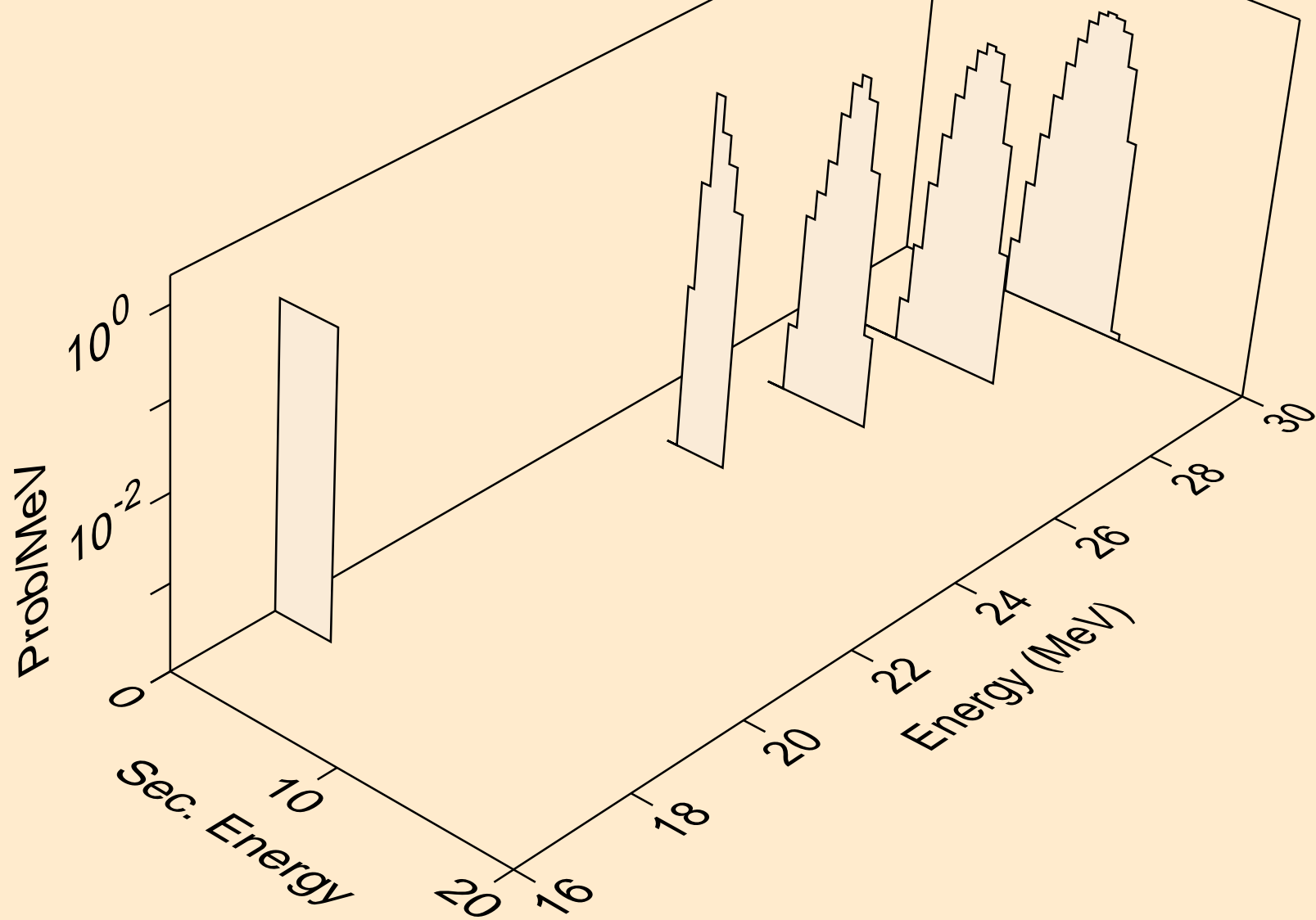

XE136 NEUTRON ACER TENDL-2021 LIBRARY; T=293.6K  
alphas from (n,a)

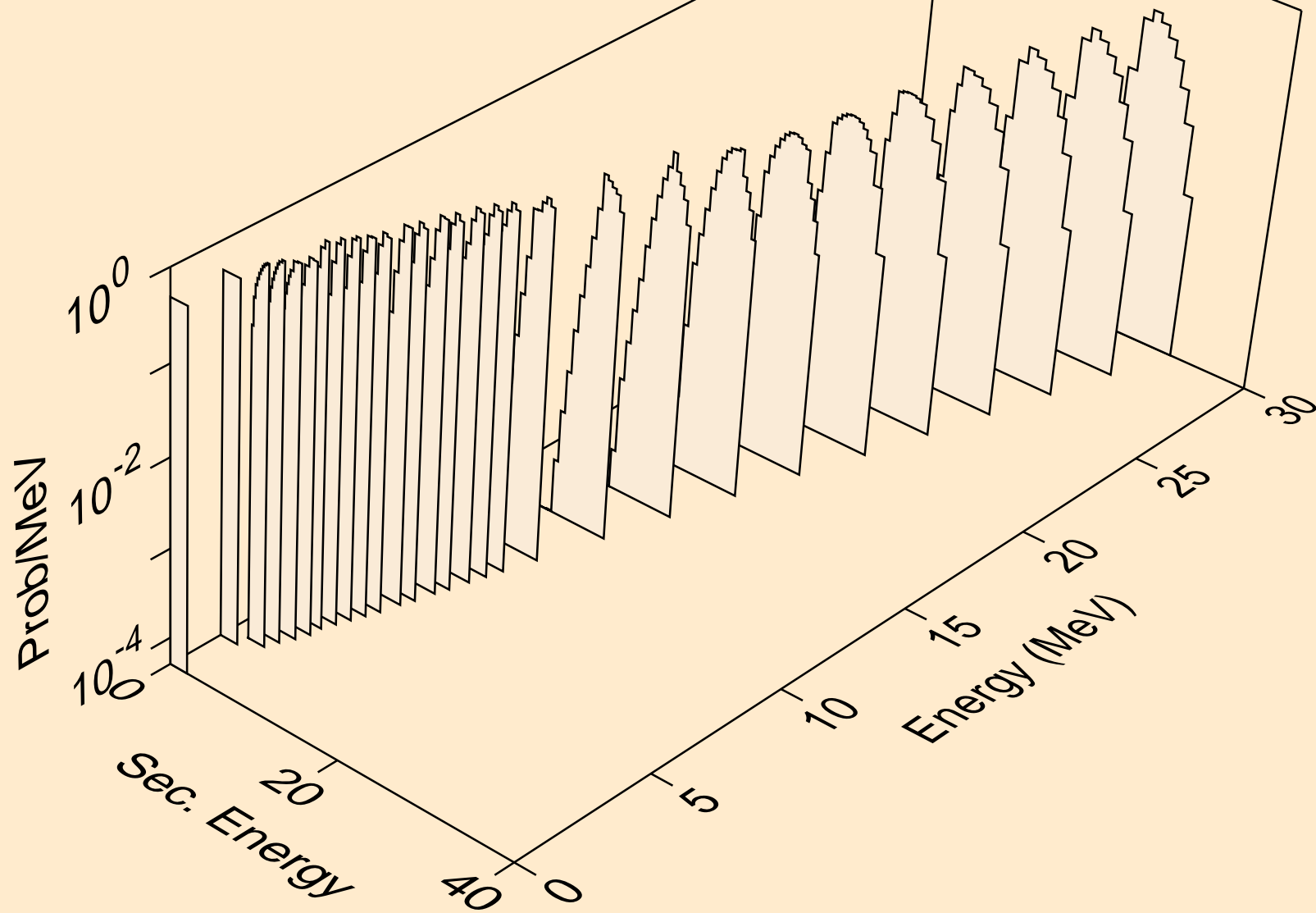

XE136 NEUTRON ACER TENDL-2021 LIBRARY; T=293.6K  
alphas from (n,pa)

