

Y086 NEUTRON ACER TENDL-2021 LIBRARY; T=293.6K  
Principal cross sections

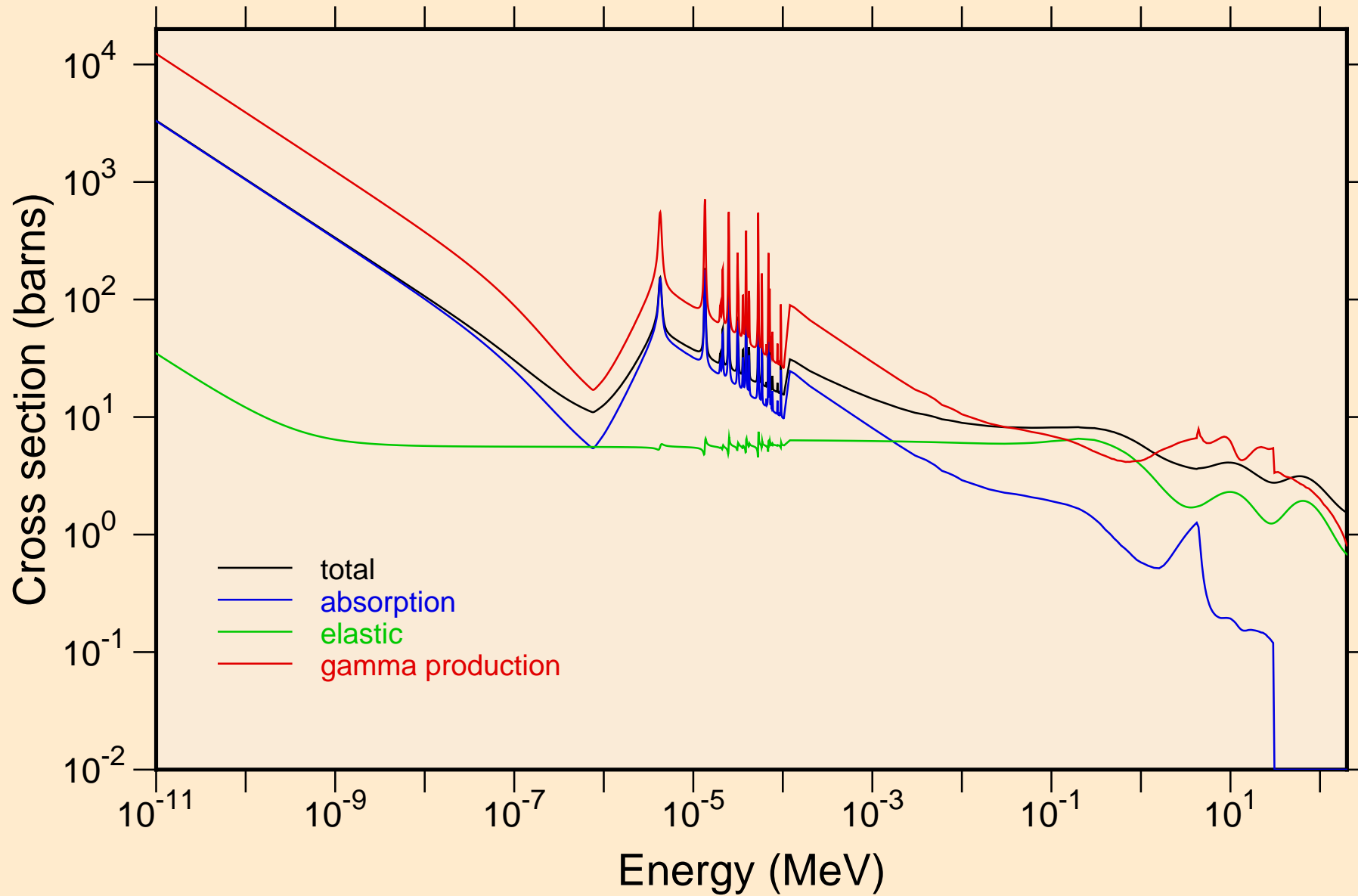

Y086 NEUTRON ACER TENDL-2021 LIBRARY; T=293.6K  
resonance total cross section

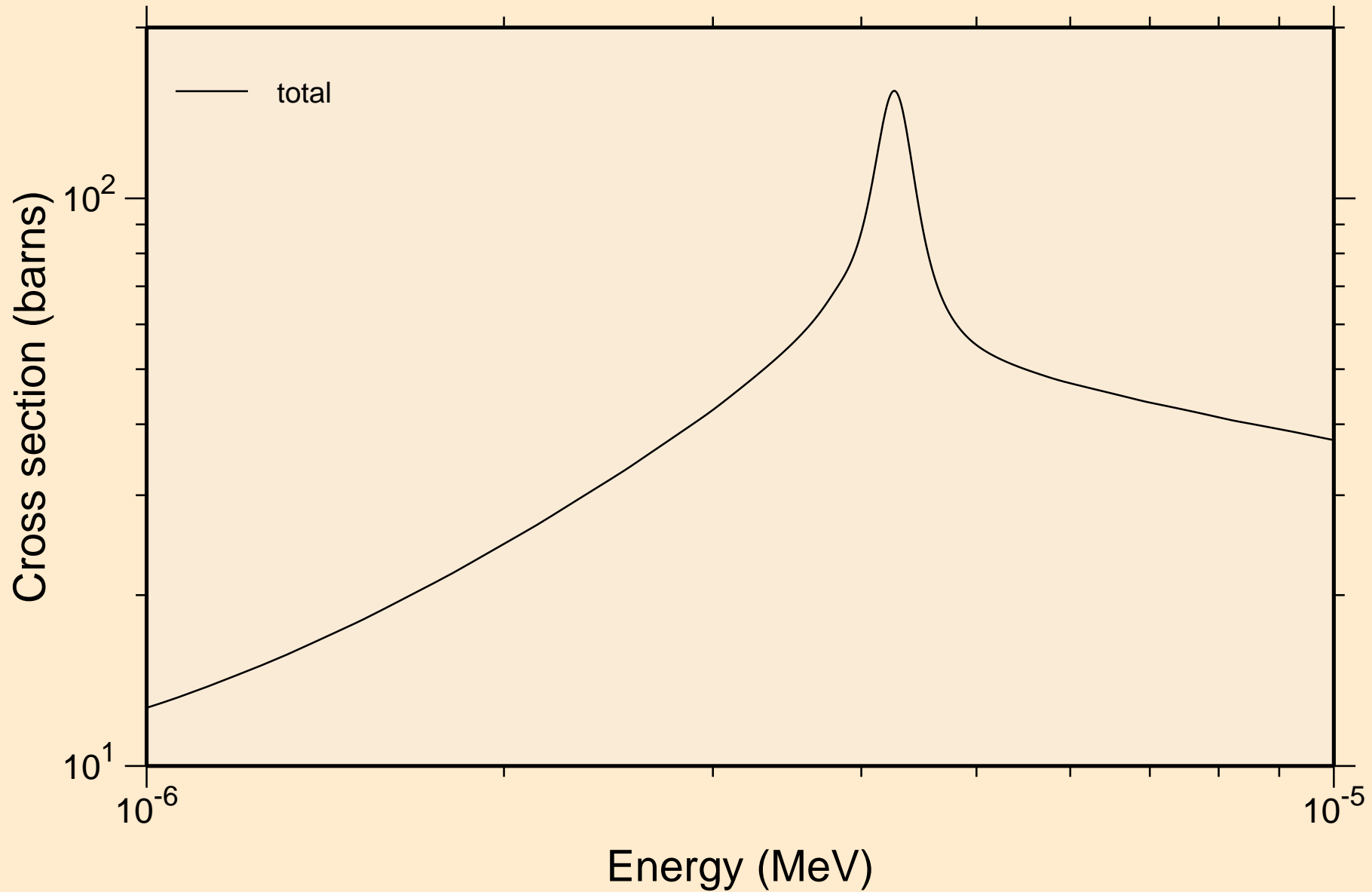

Y086 NEUTRON ACER TENDL-2021 LIBRARY; T=293.6K  
resonance total cross section

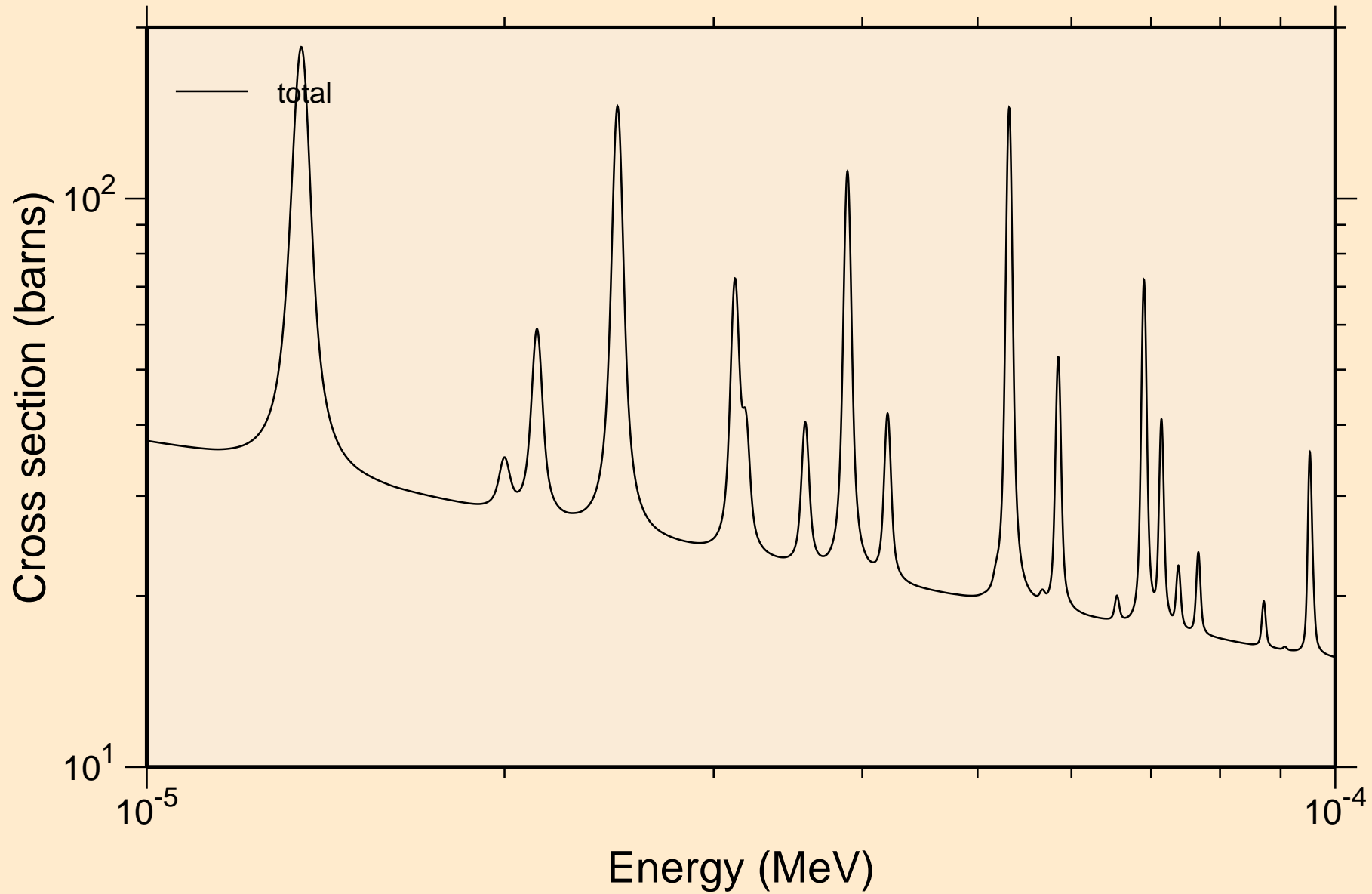

Y086 NEUTRON ACER TENDL-2021 LIBRARY; T=293.6K  
resonance total cross section

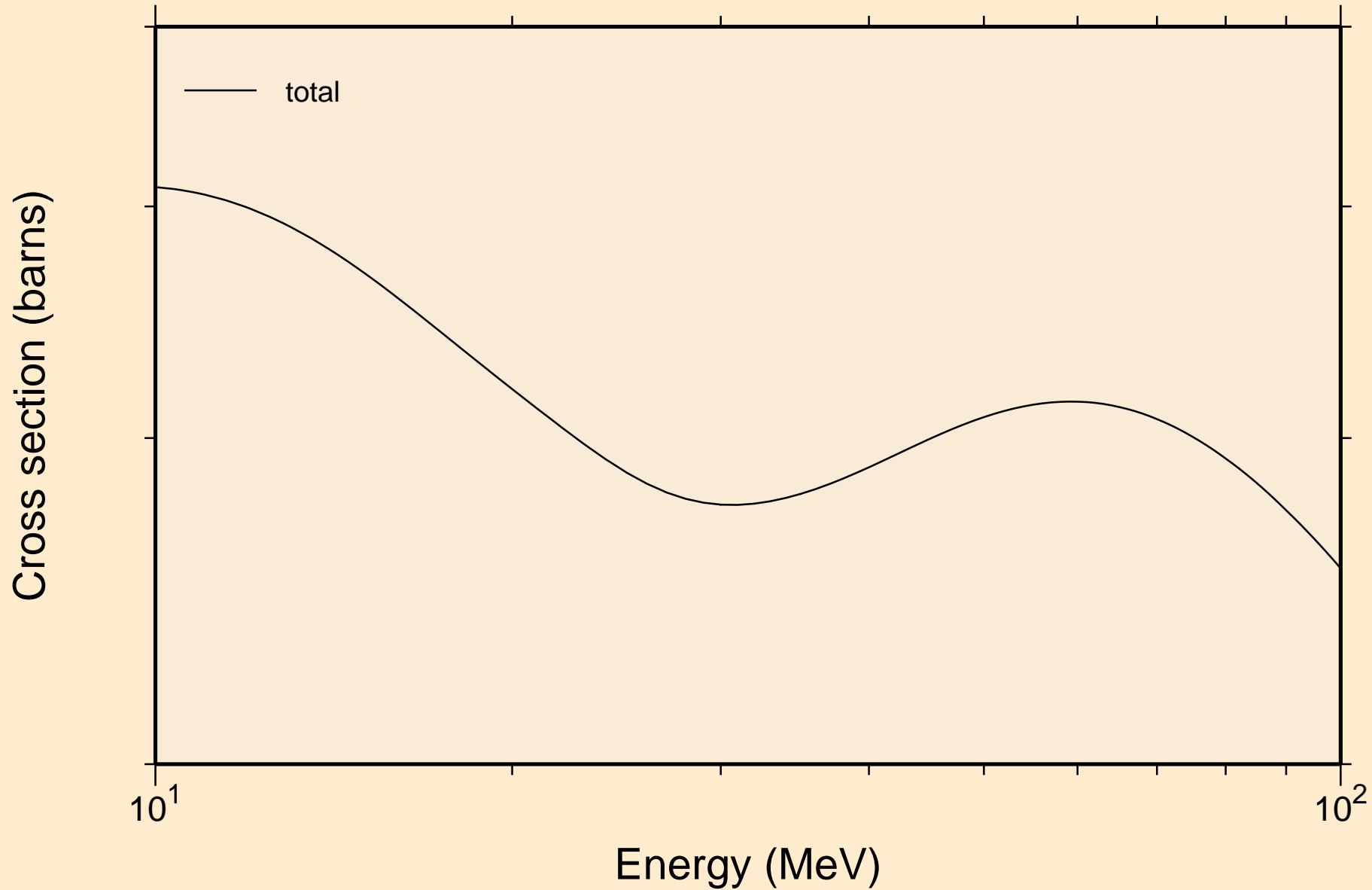

Y086 NEUTRON ACER TENDL-2021 LIBRARY; T=293.6K  
resonance absorption cross sections

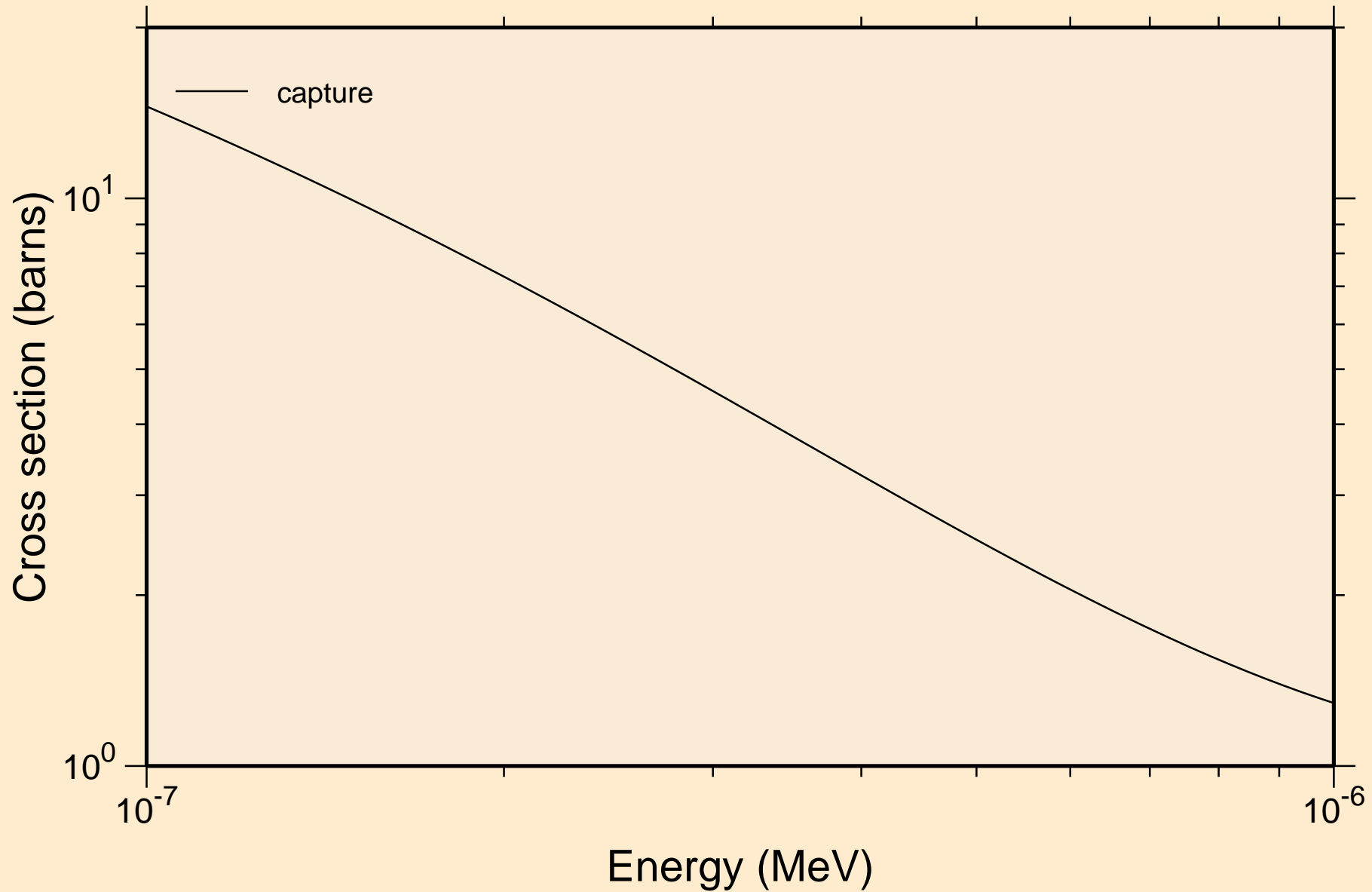

Y086 NEUTRON ACER TENDL-2021 LIBRARY; T=293.6K  
resonance absorption cross sections

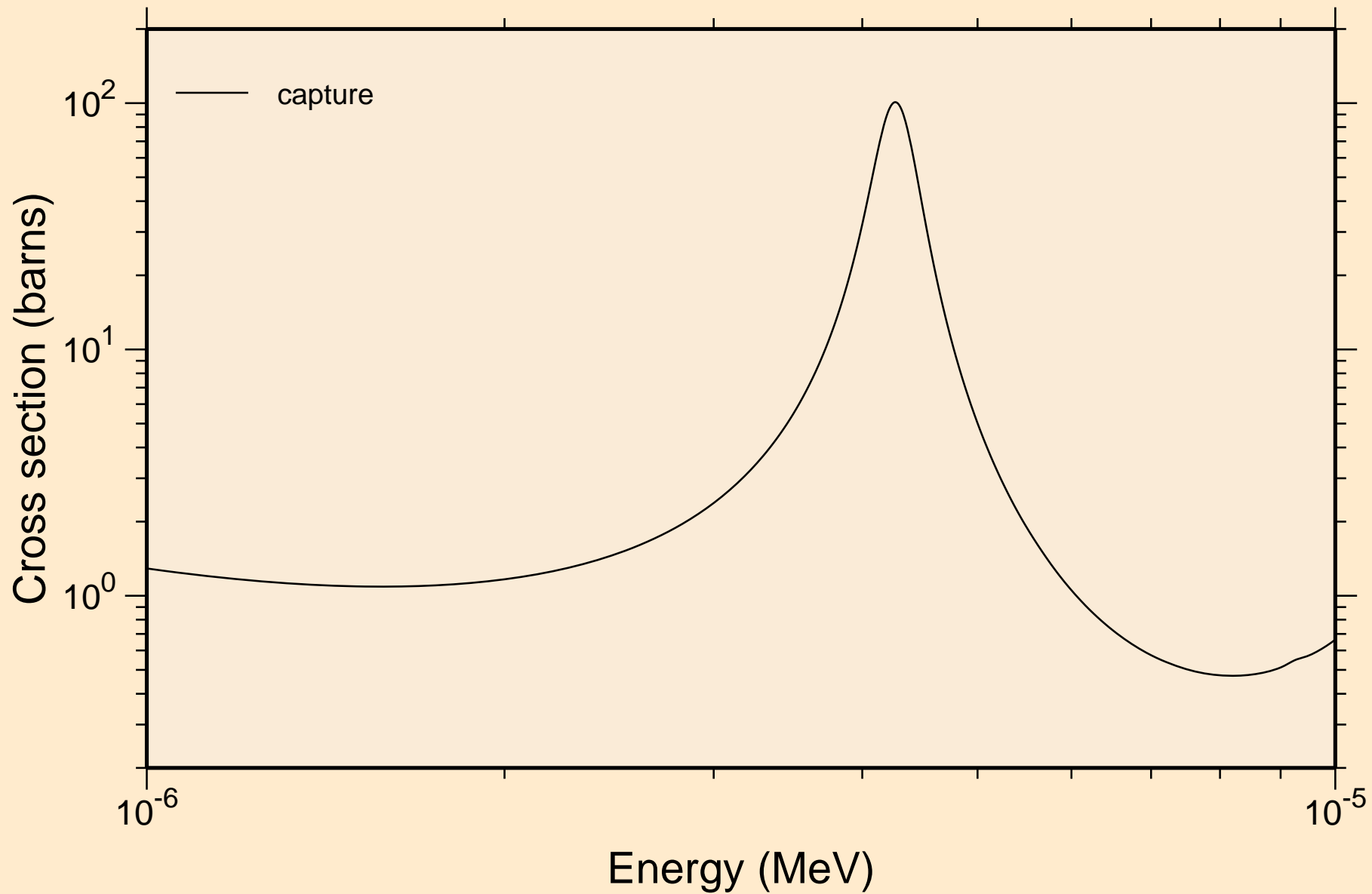

Y086 NEUTRON ACER TENDL-2021 LIBRARY; T=293.6K  
resonance absorption cross sections

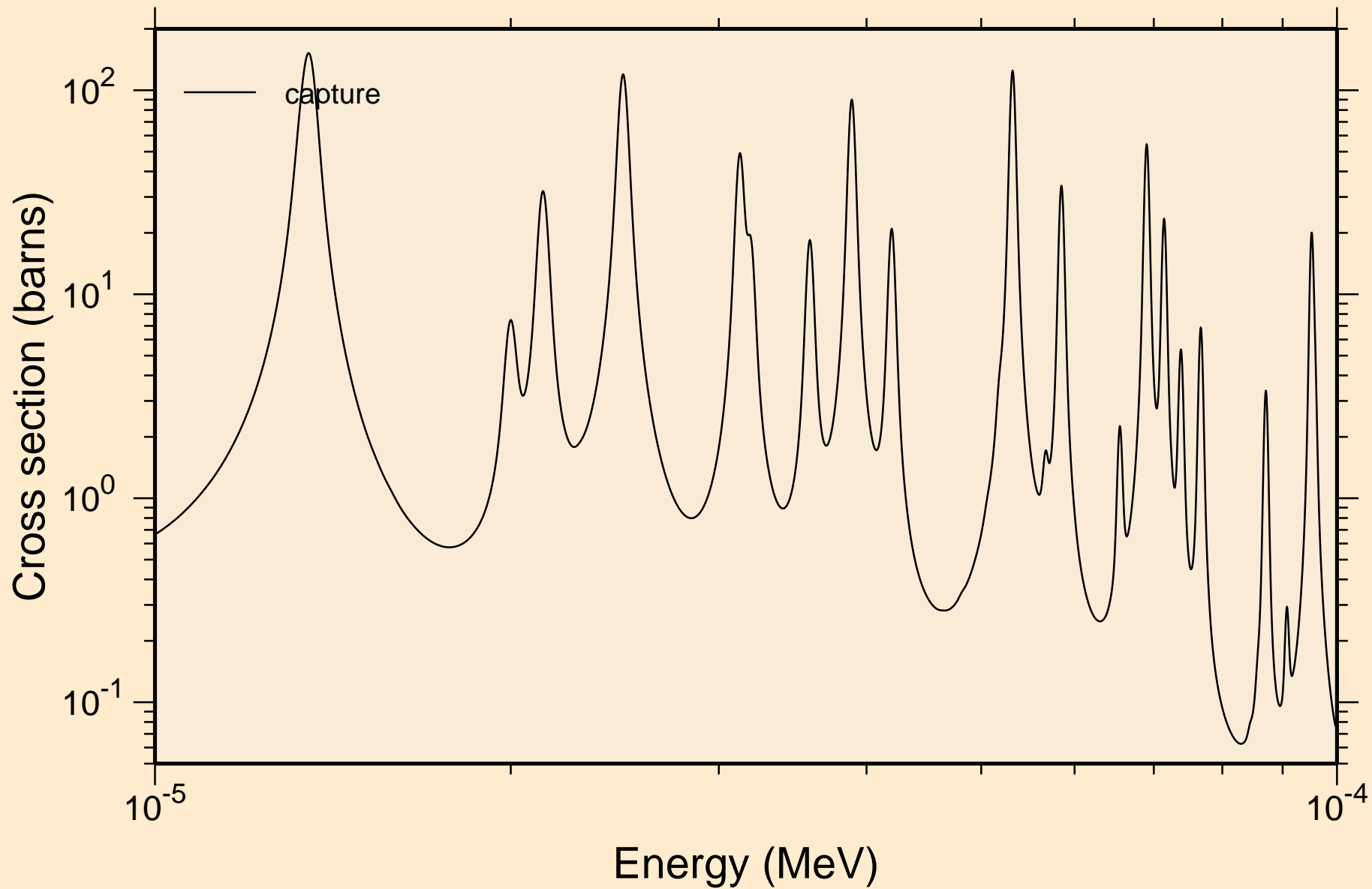

Y086 NEUTRON ACER TENDL-2021 LIBRARY; T=293.6K  
resonance absorption cross sections

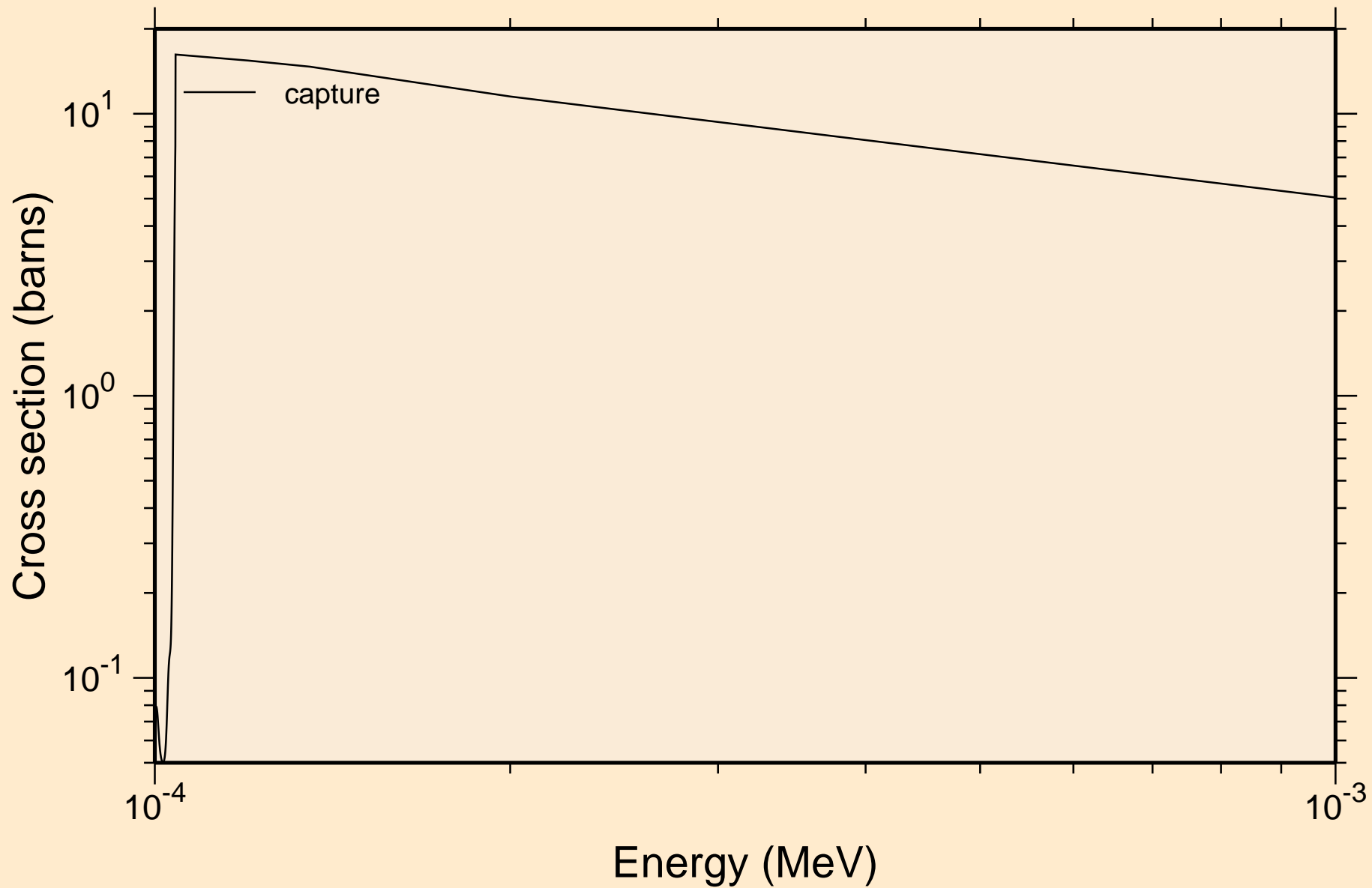



Y086 NEUTRON ACER TENDL-2021 LIBRARY; T=293.6K  
resonance absorption cross sections

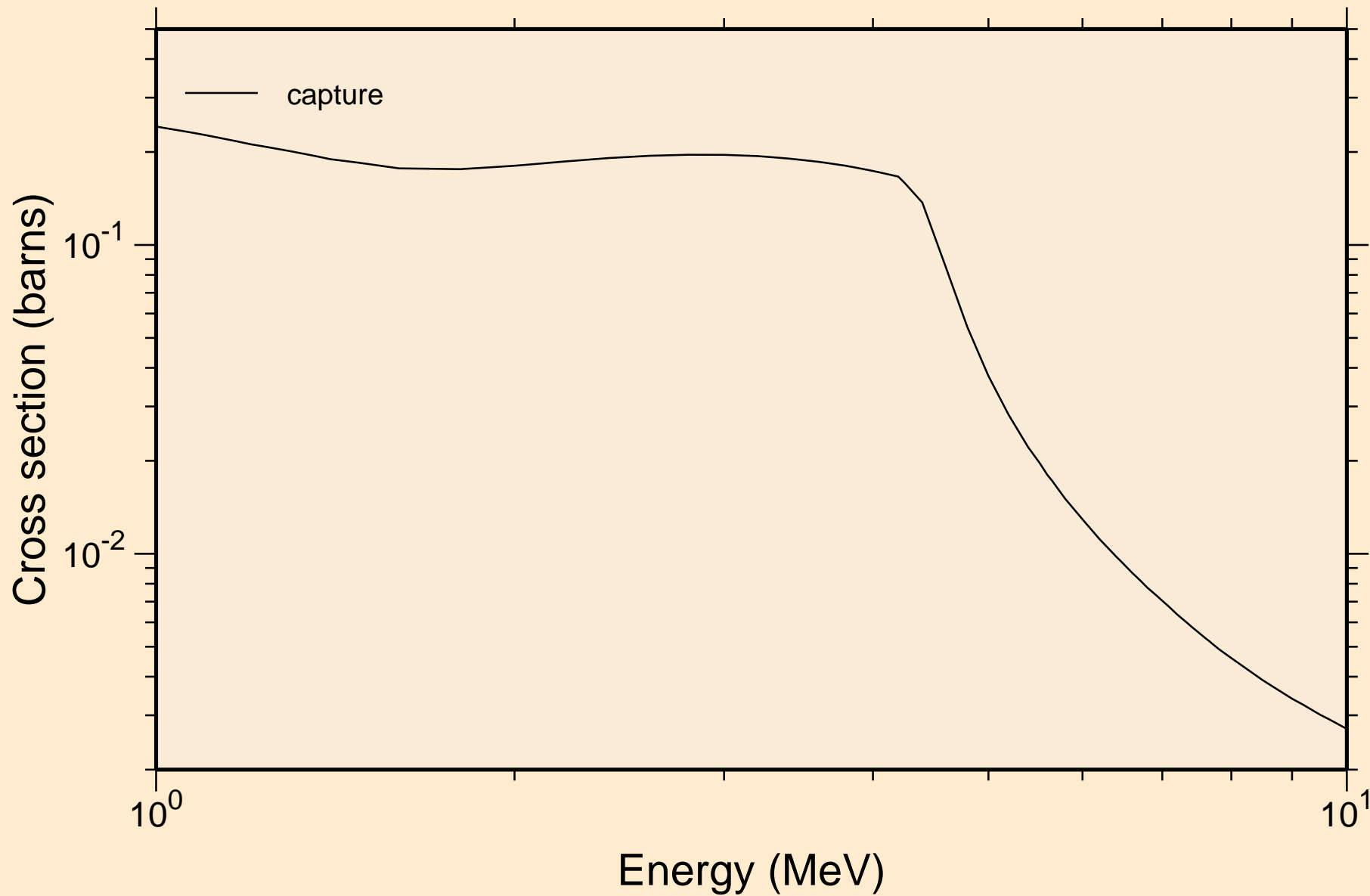

Y086 NEUTRON ACER TENDL-2021 LIBRARY; T=293.6K

Heating

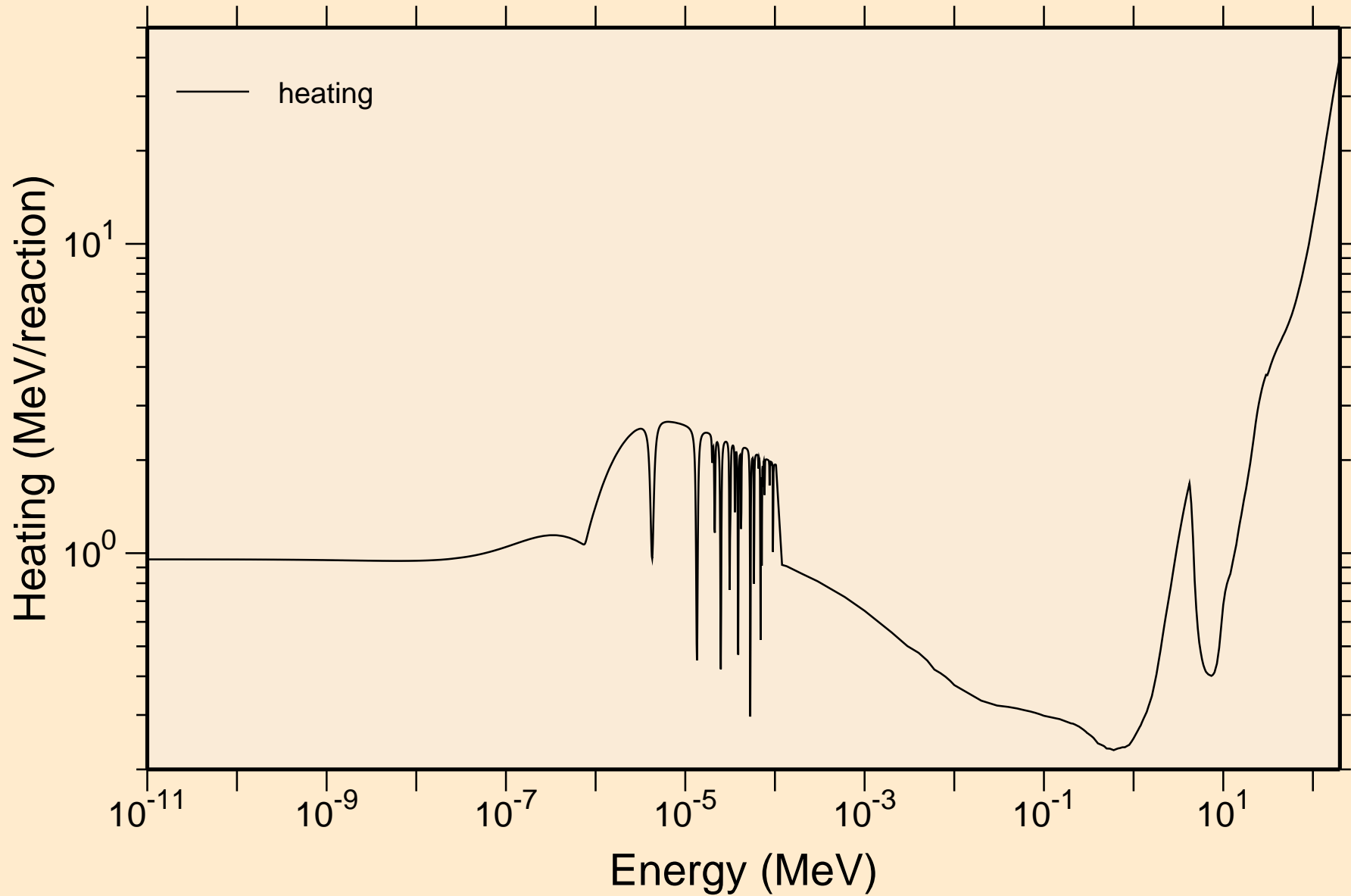

Y086 NEUTRON ACER TENDL-2021 LIBRARY; T=293.6K  
Damage

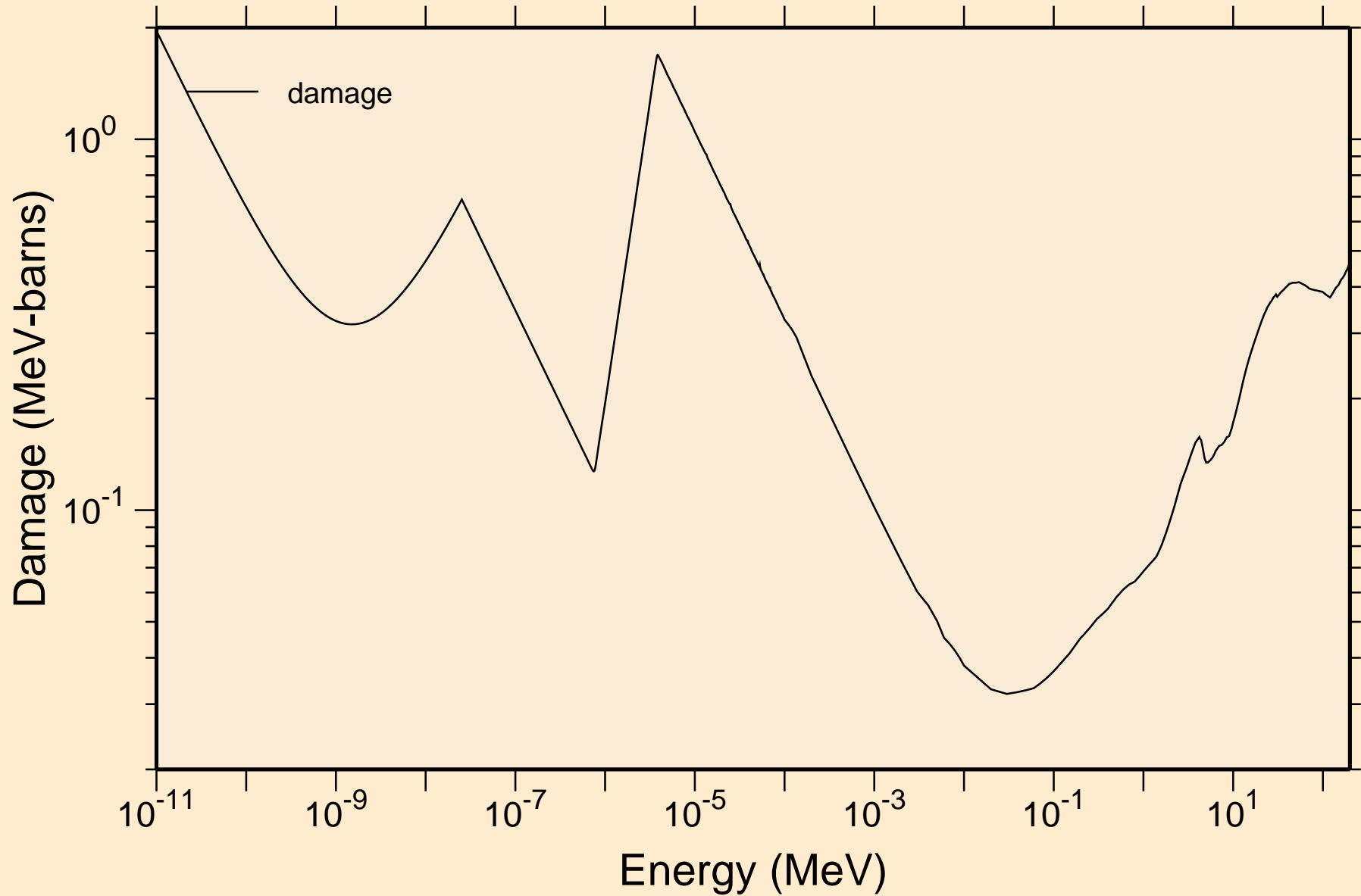

Y086 NEUTRON ACER TENDL-2021 LIBRARY; T=293.6K  
Non-threshold reactions

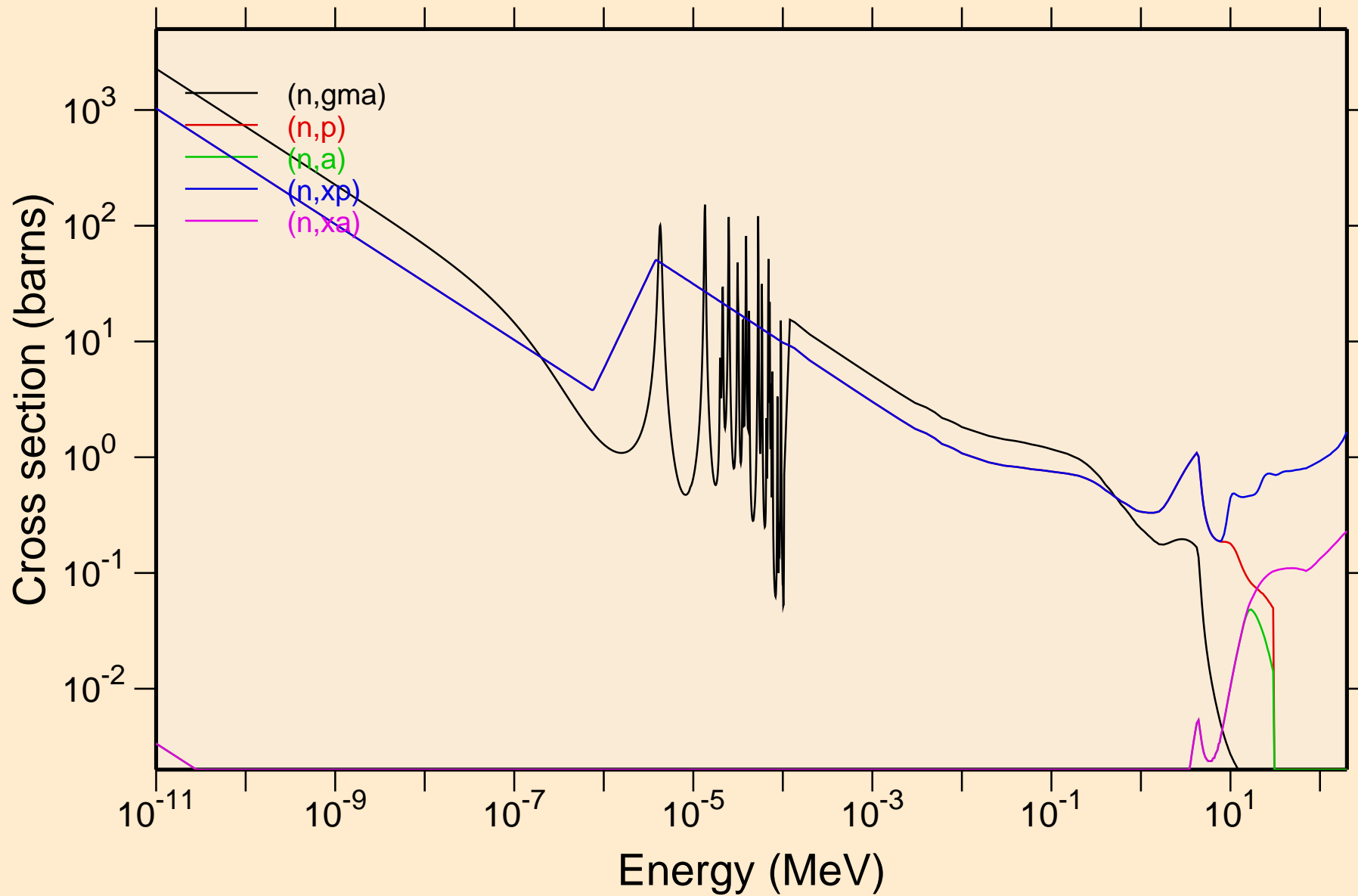

Y086 NEUTRON ACER TENDL-2021 LIBRARY; T=293.6K  
Principal cross sections

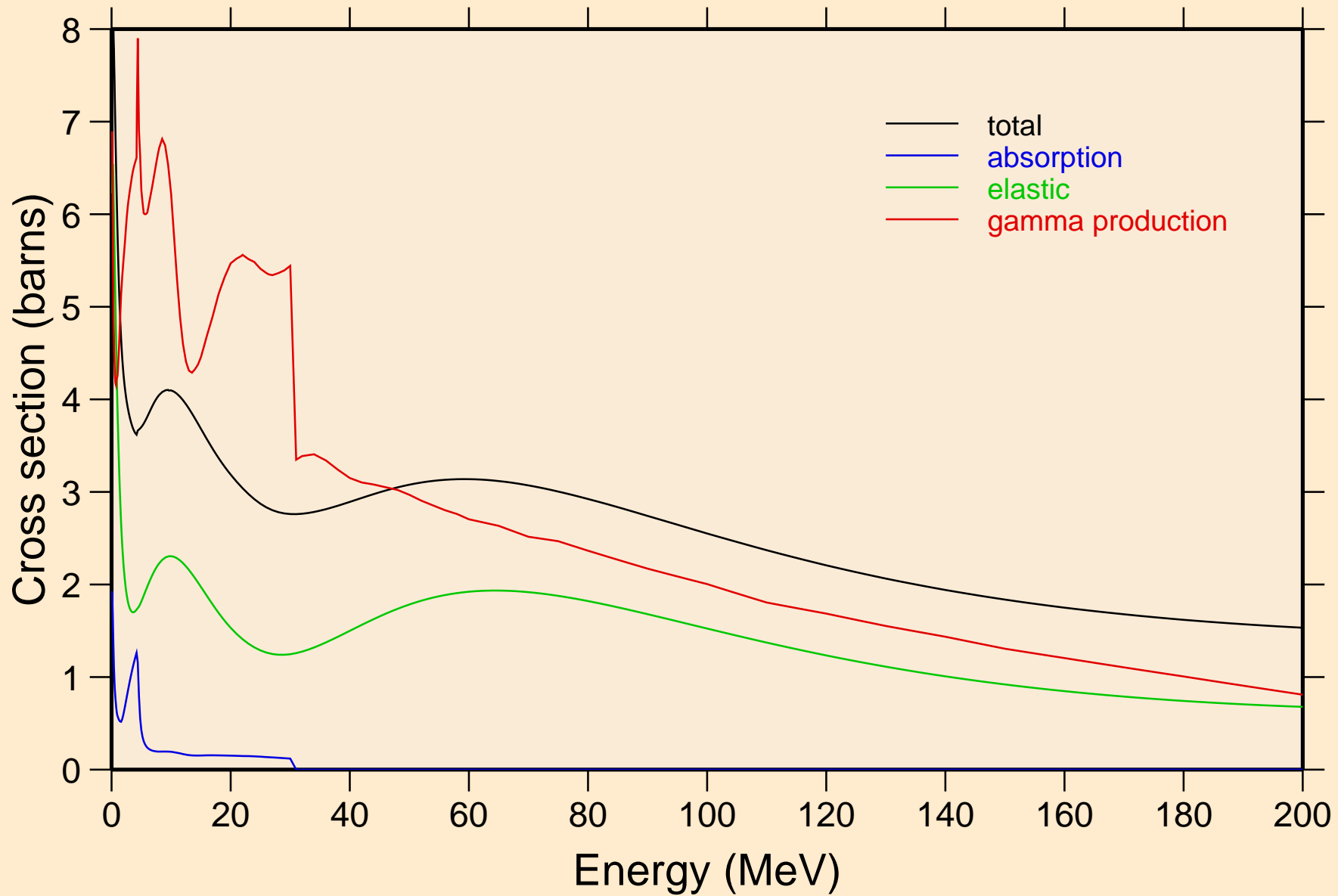

Y086 NEUTRON ACER TENDL-2021 LIBRARY; T=293.6K

Heating

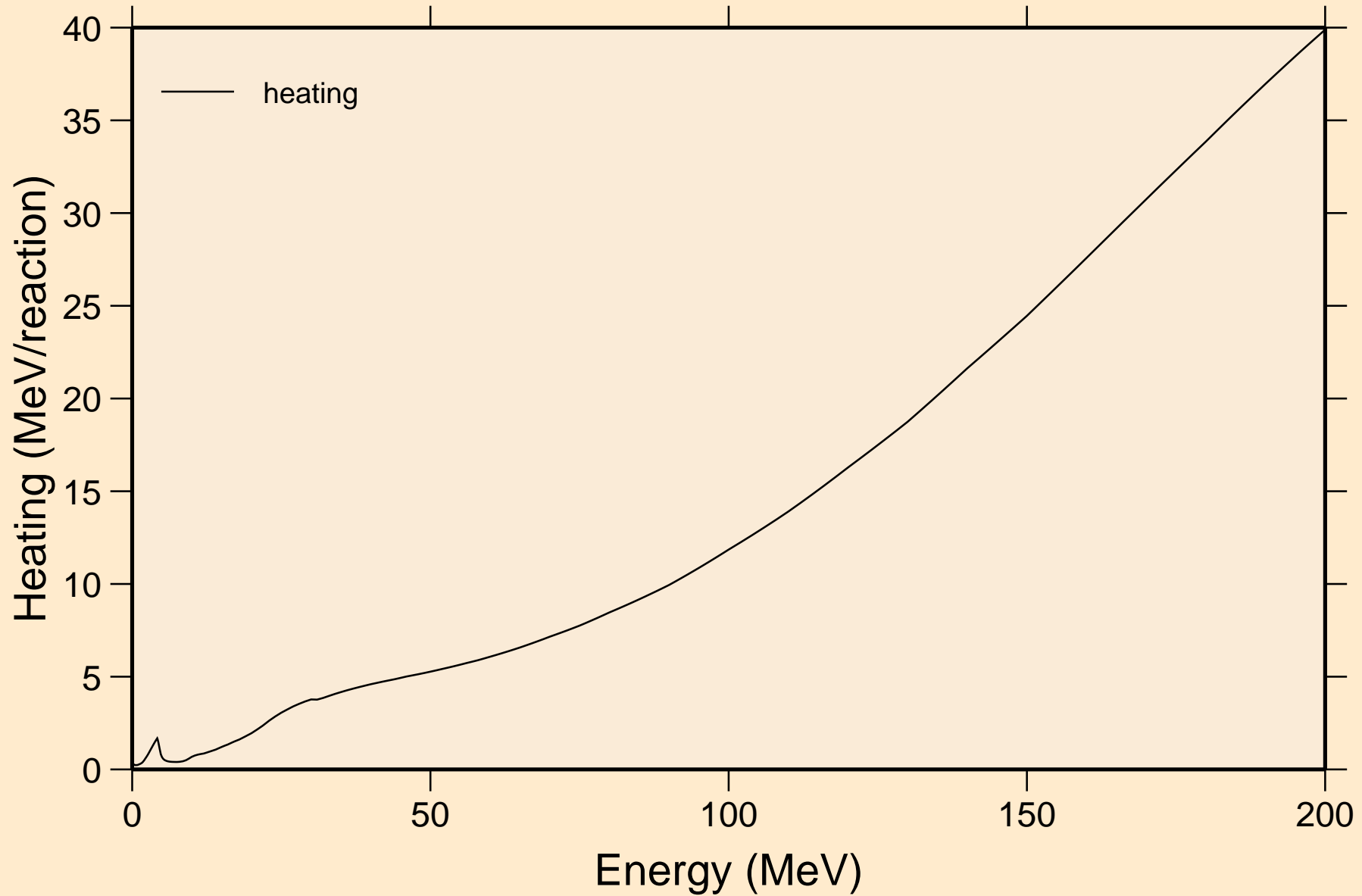

Y086 NEUTRON ACER TENDL-2021 LIBRARY; T=293.6K  
Damage

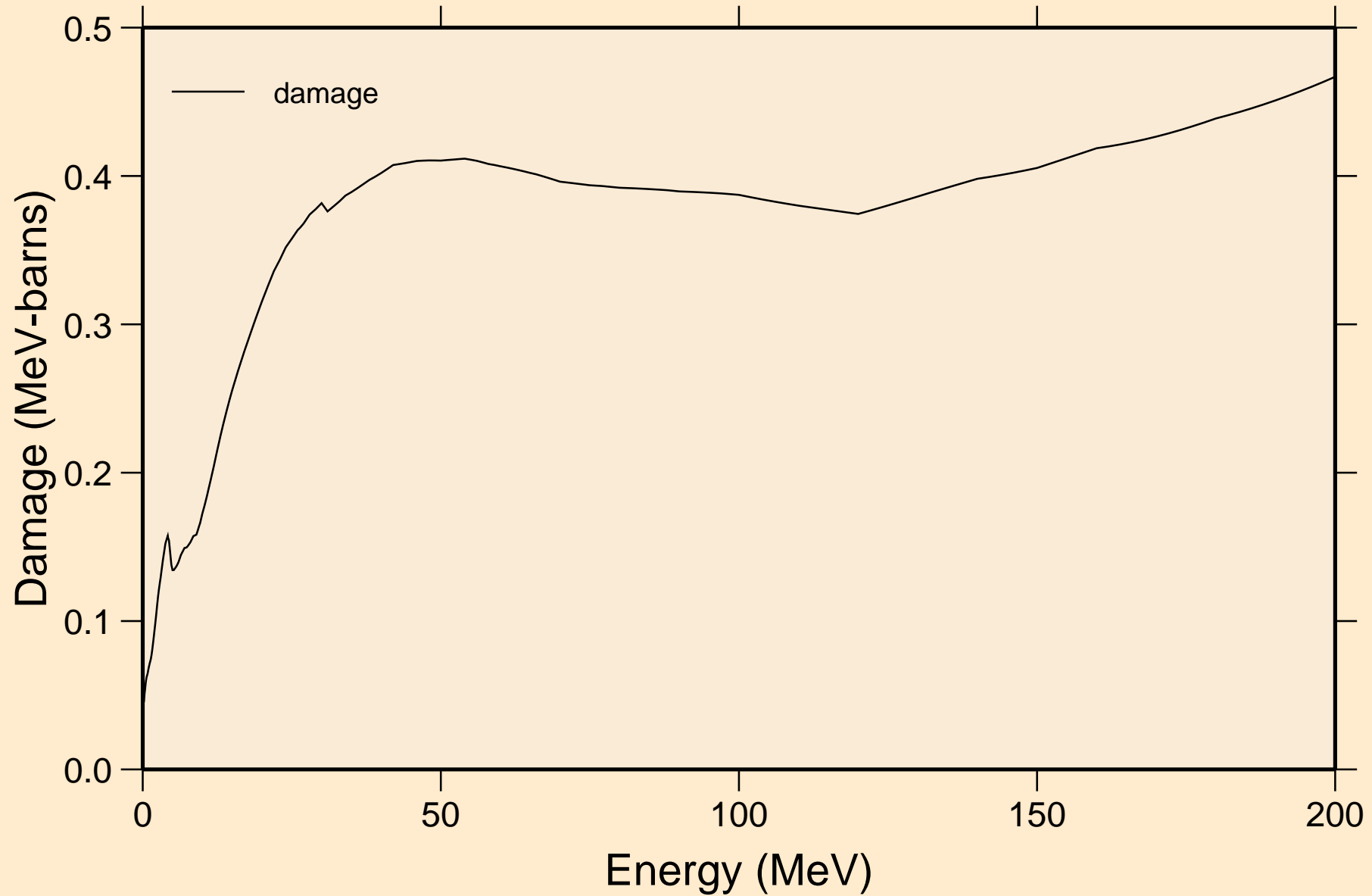

Y086 NEUTRON ACER TENDL-2021 LIBRARY; T=293.6K  
Non-threshold reactions

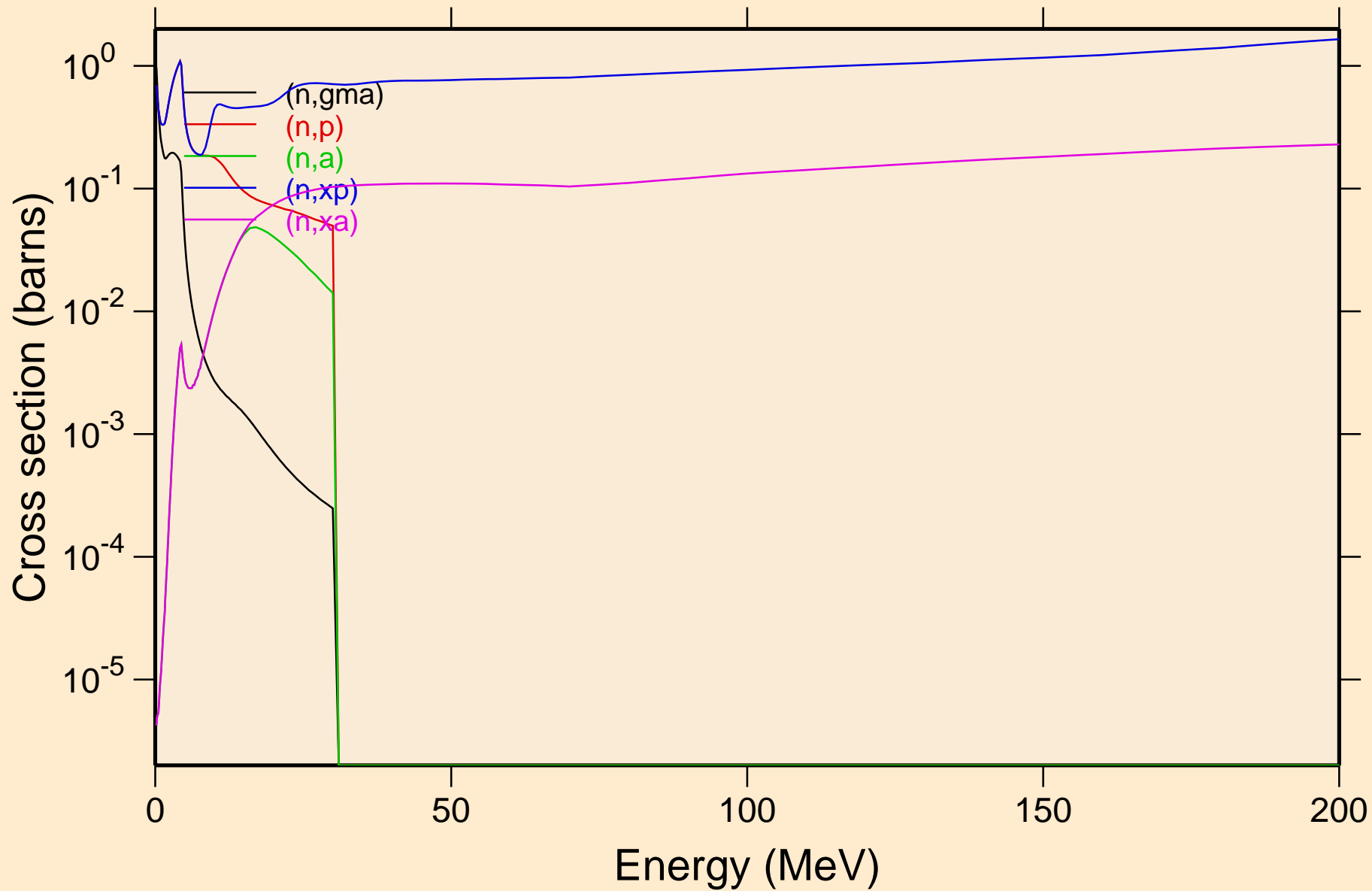



Y086 NEUTRON ACER TENDL-2021 LIBRARY; T=293.6K  
Inelastic levels

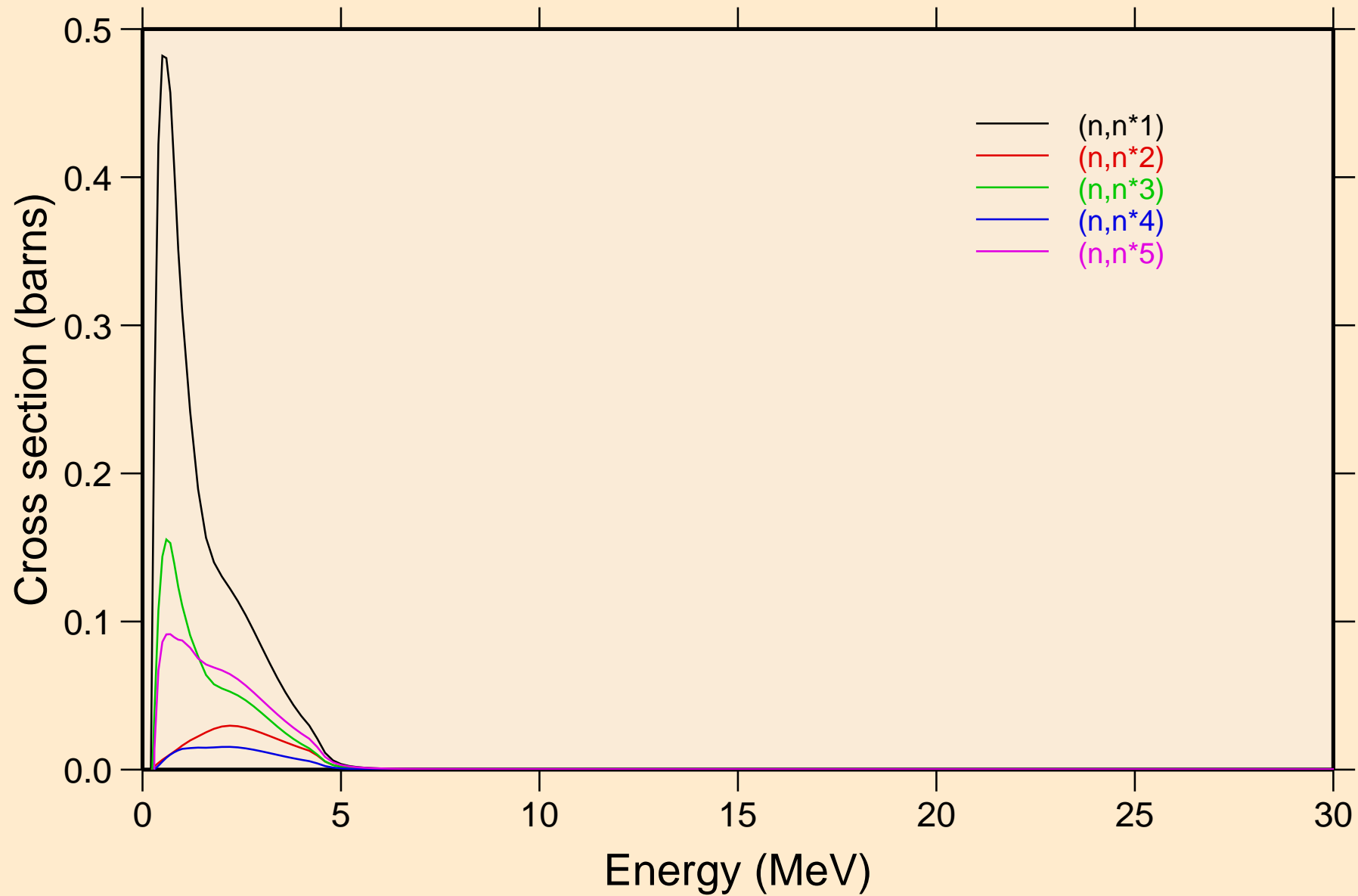

Y086 NEUTRON ACER TENDL-2021 LIBRARY; T=293.6K  
Inelastic levels

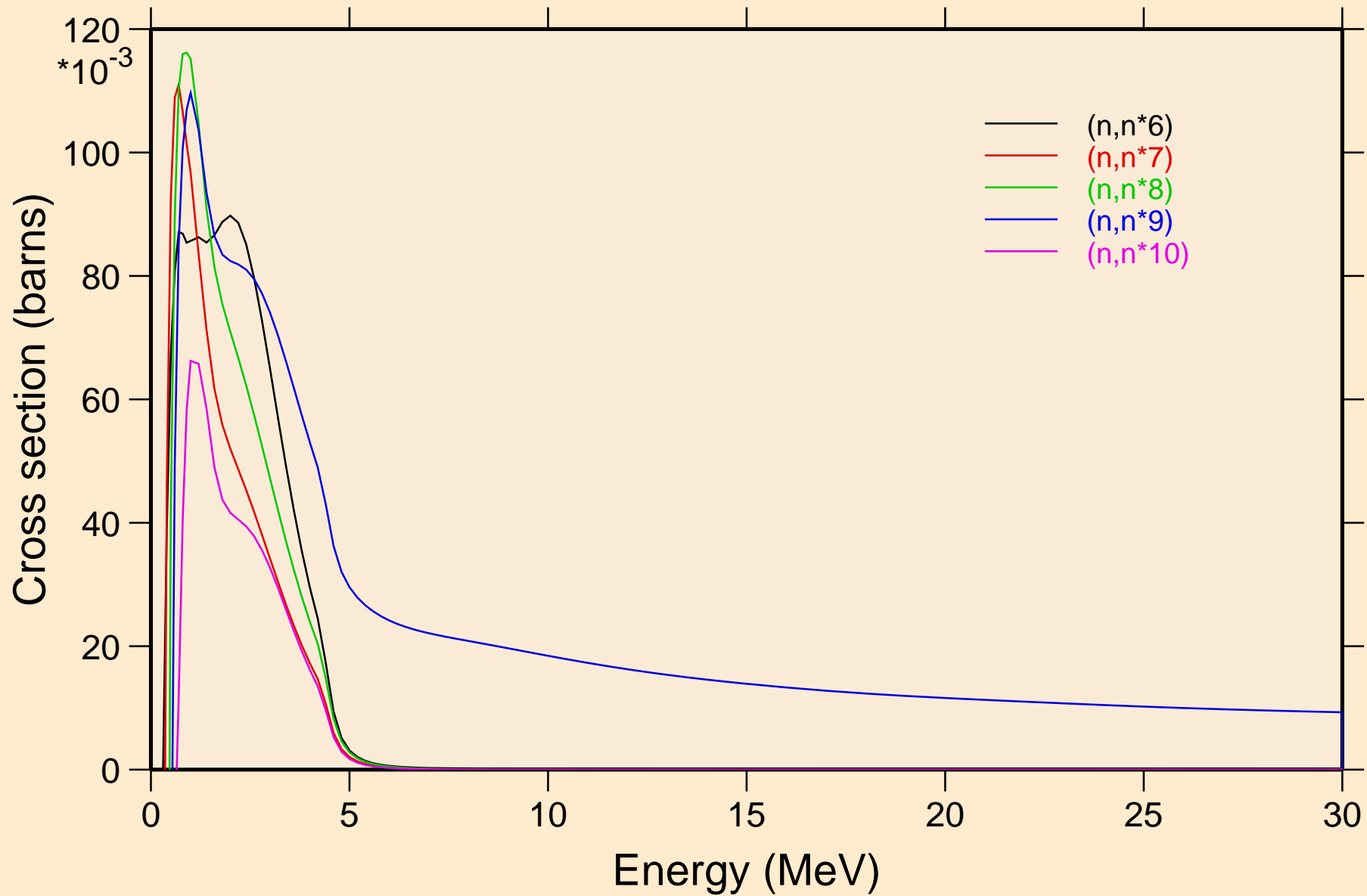

Y086 NEUTRON ACER TENDL-2021 LIBRARY; T=293.6K  
Inelastic levels

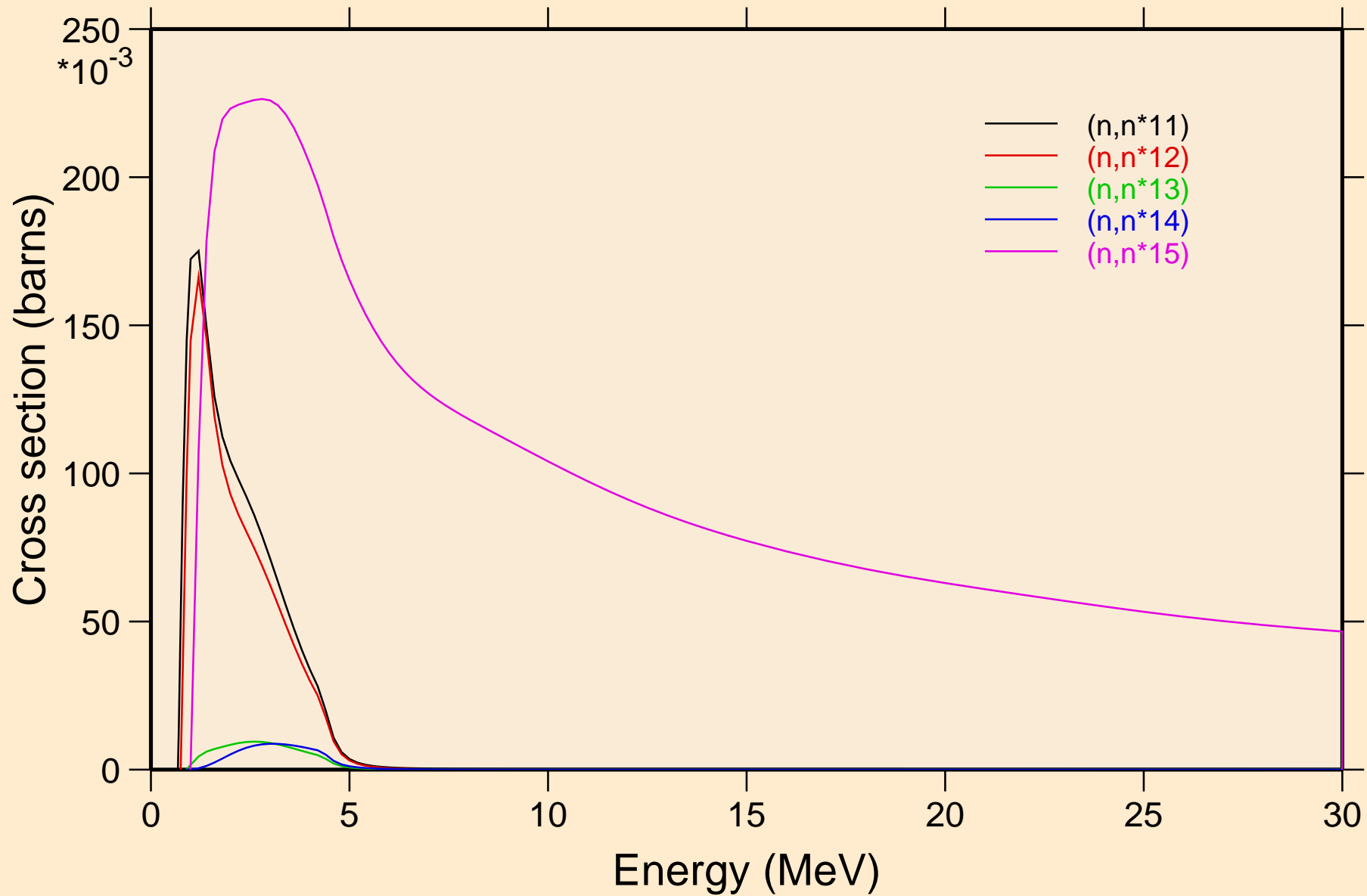

Y086 NEUTRON ACER TENDL-2021 LIBRARY; T=293.6K  
Inelastic levels

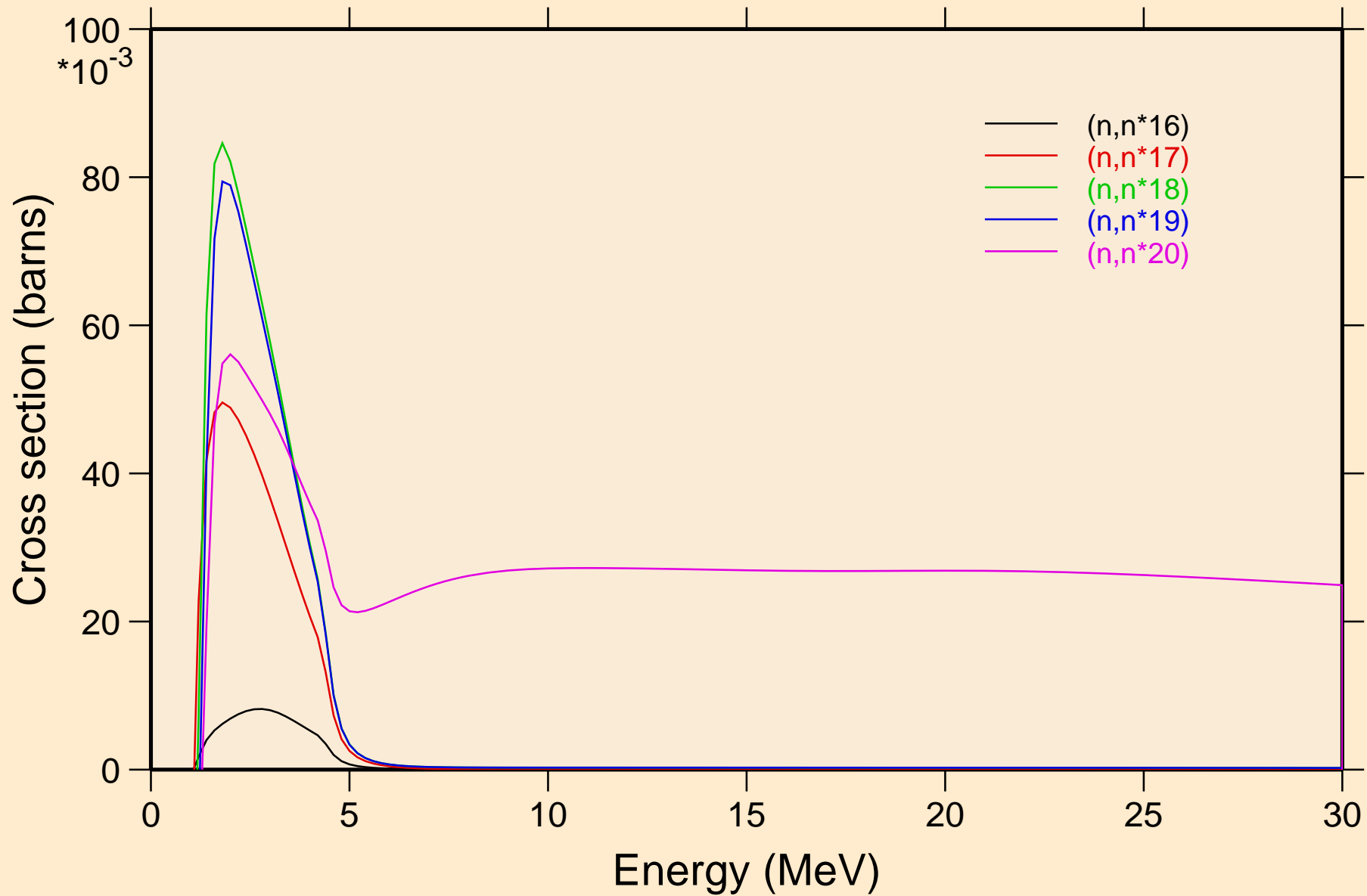

Y086 NEUTRON ACER TENDL-2021 LIBRARY; T=293.6K  
Inelastic levels

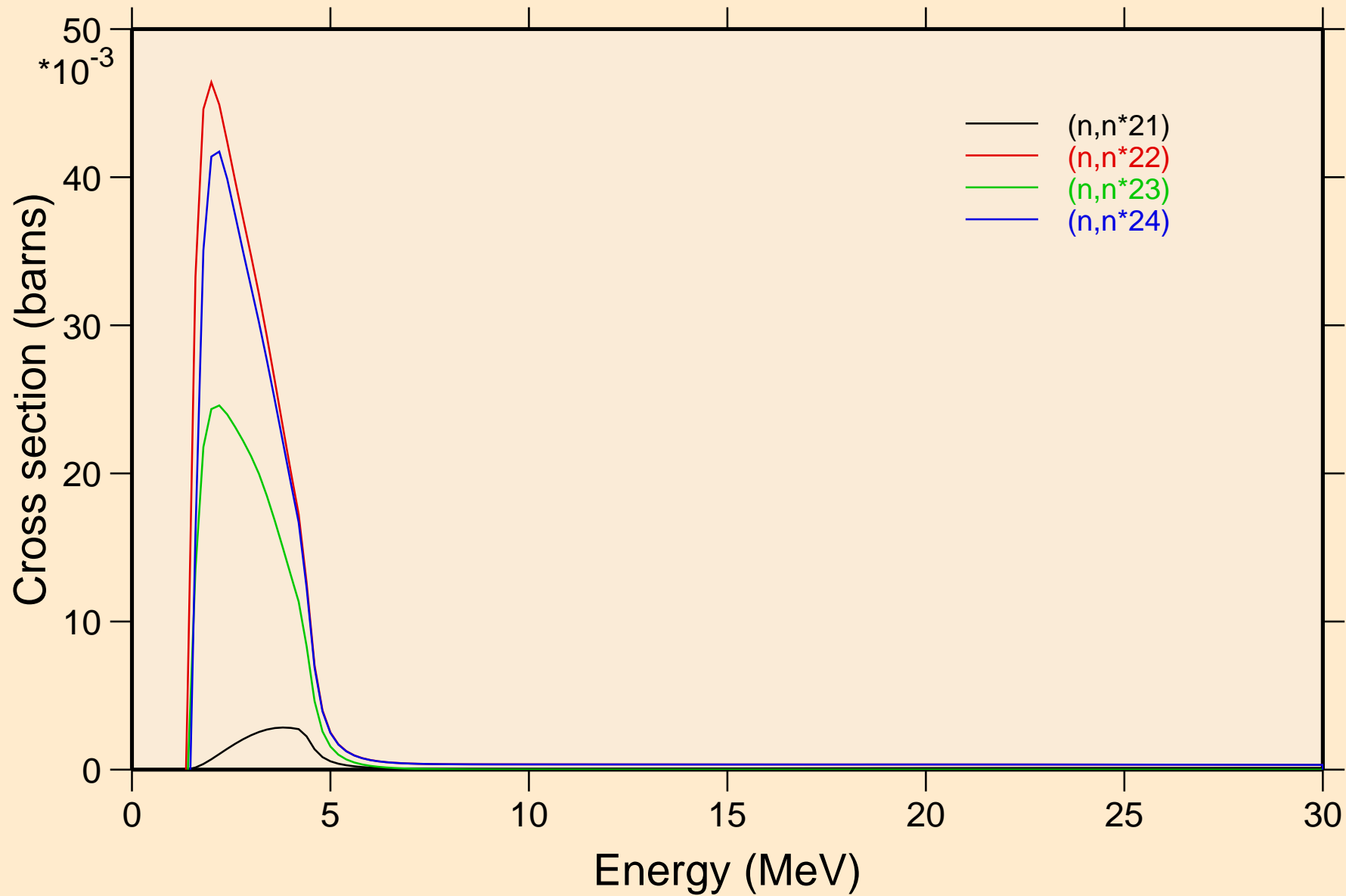

Y086 NEUTRON ACER TENDL-2021 LIBRARY; T=293.6K  
Threshold reactions

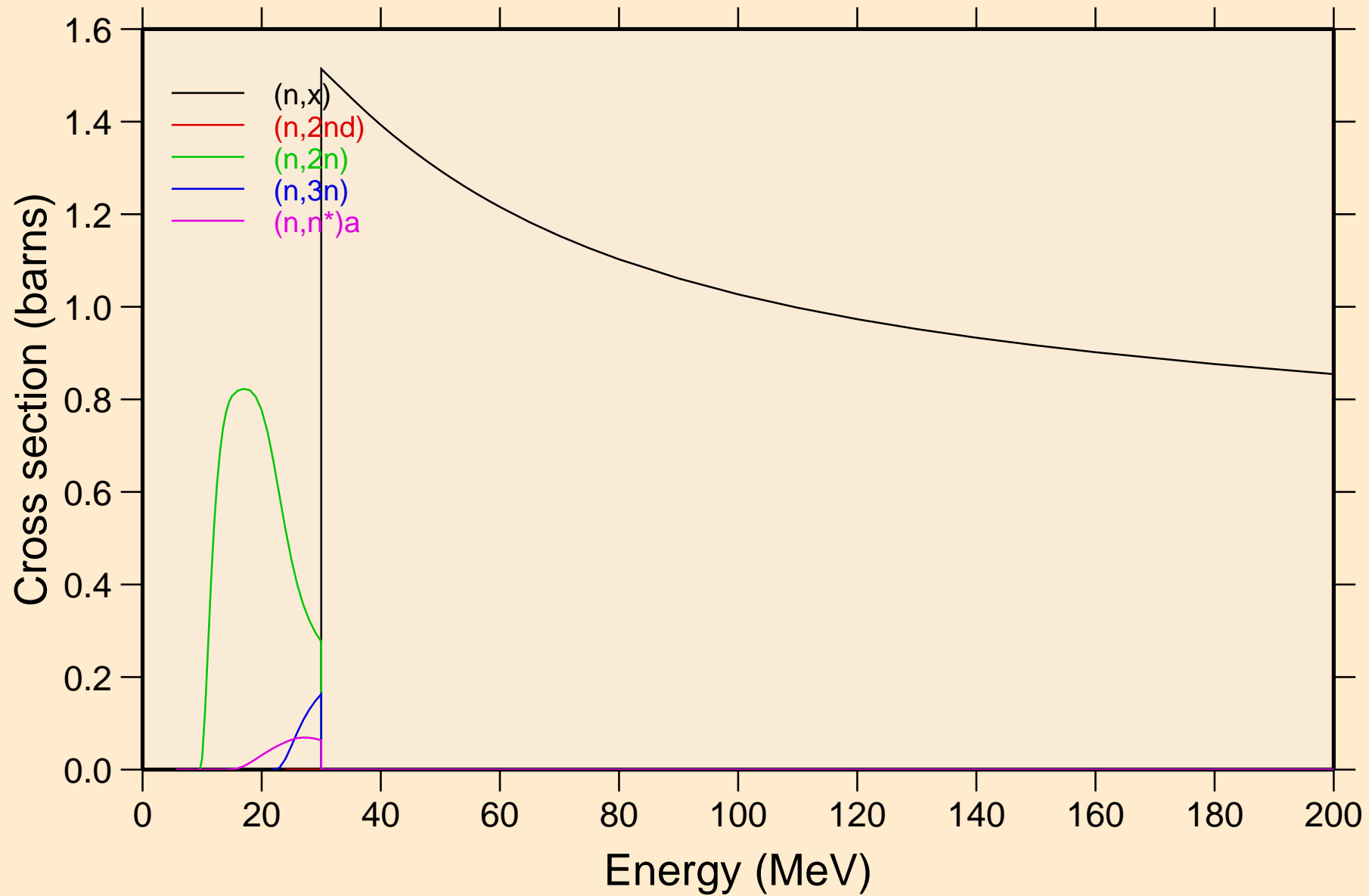

Y086 NEUTRON ACER TENDL-2021 LIBRARY; T=293.6K  
Threshold reactions

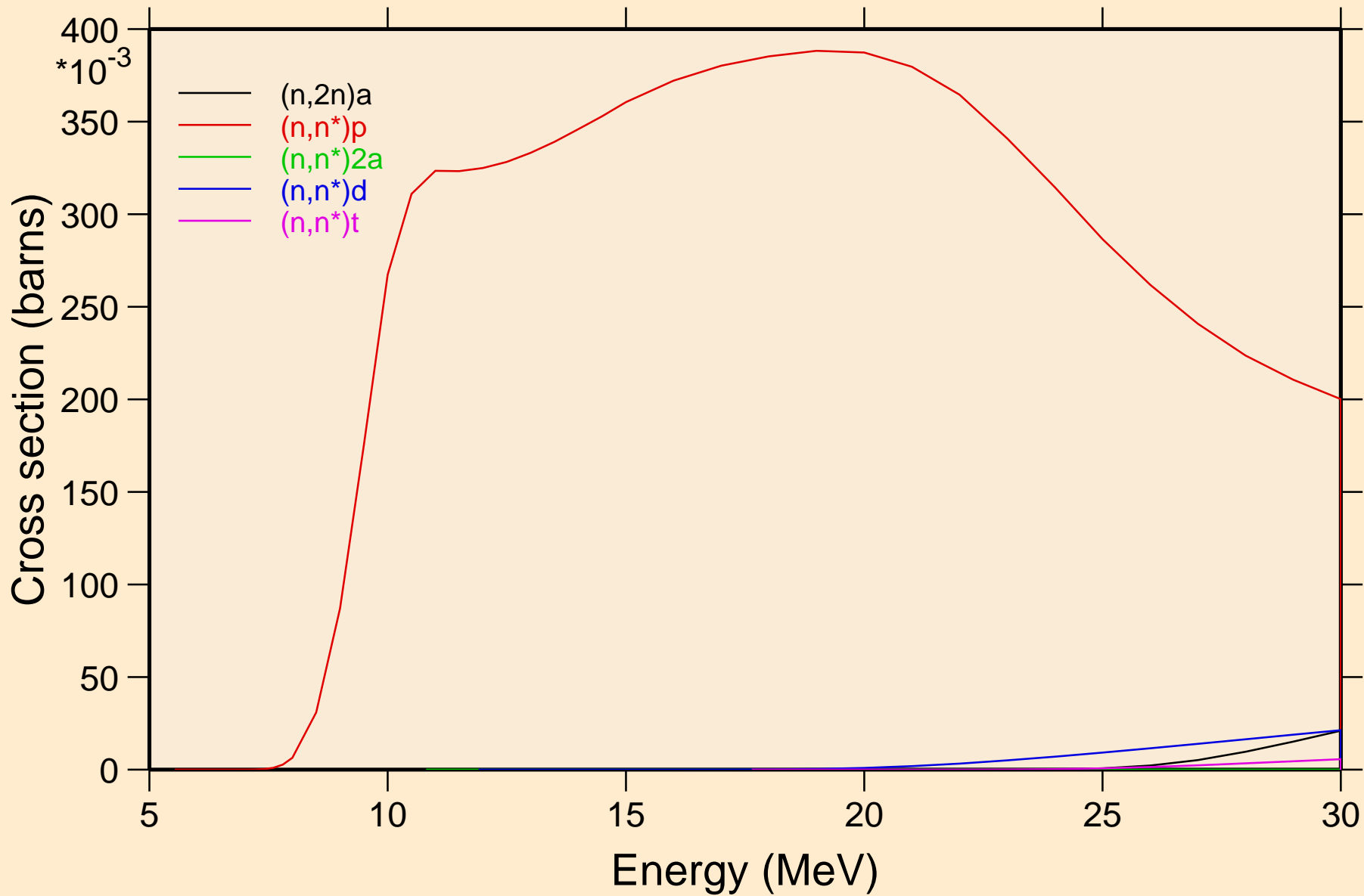

Y086 NEUTRON ACER TENDL-2021 LIBRARY; T=293.6K  
Threshold reactions

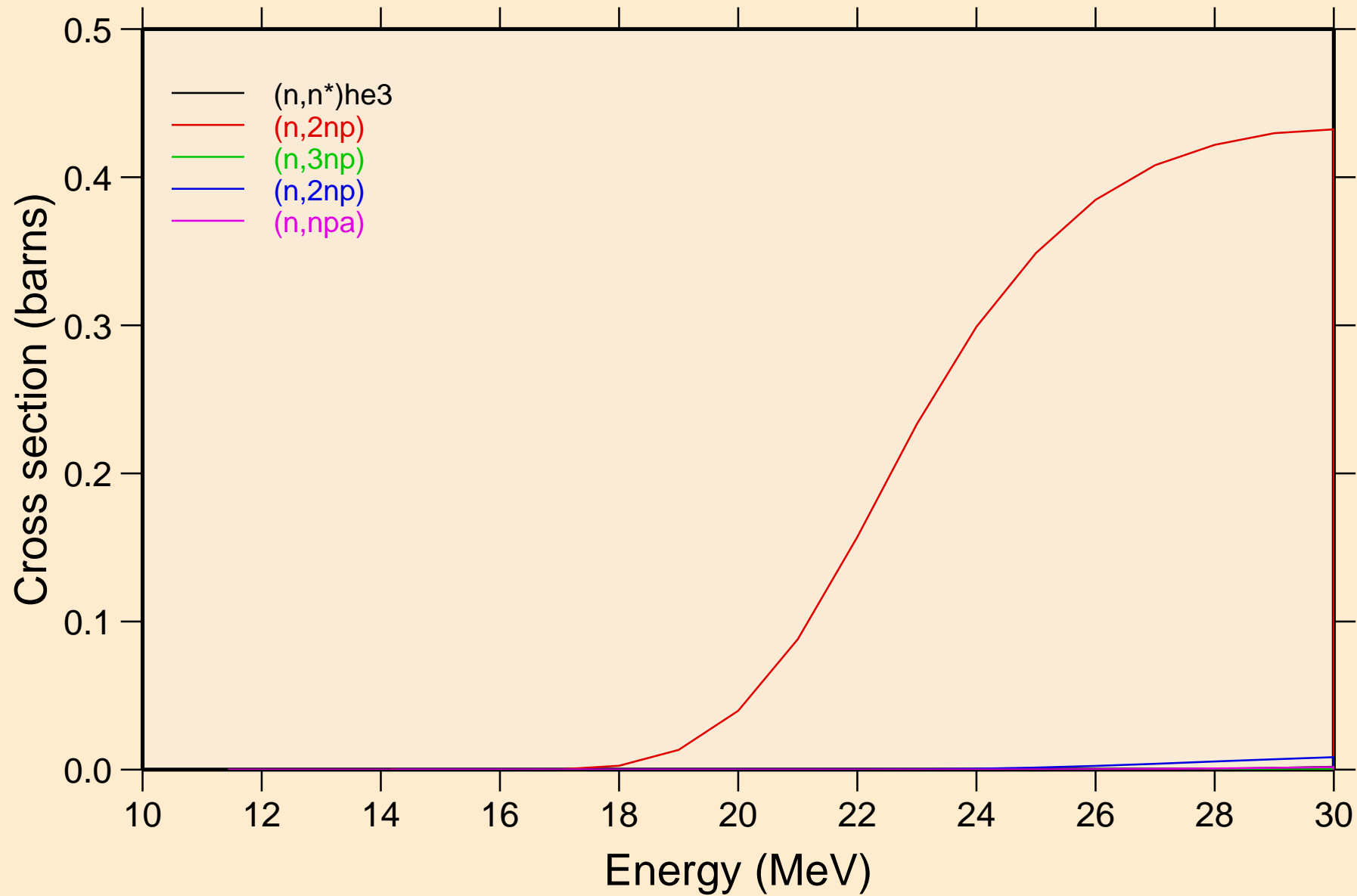



Y086 NEUTRON ACER TENDL-2021 LIBRARY; T=293.6K  
Threshold reactions

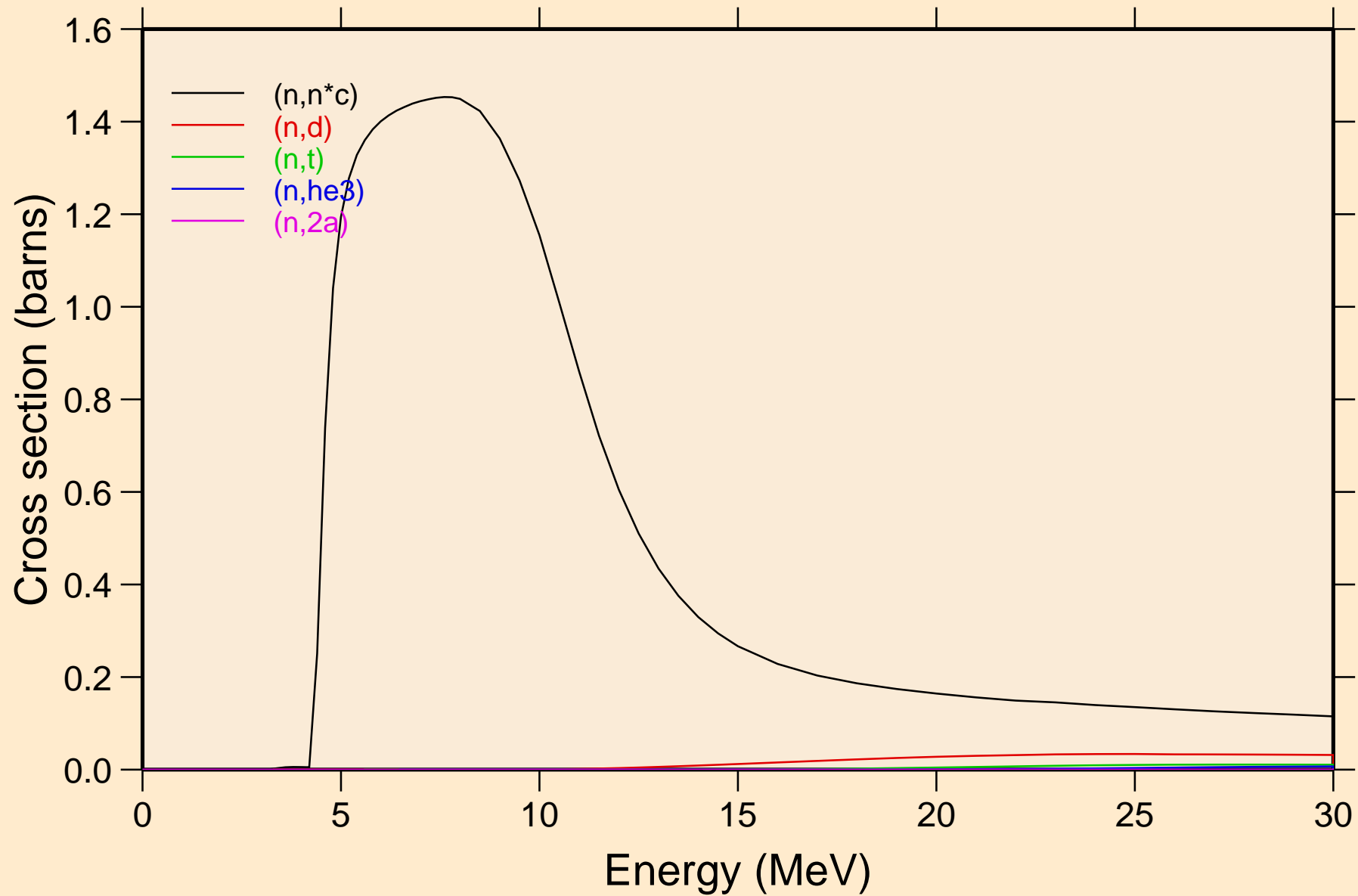

Y086 NEUTRON ACER TENDL-2021 LIBRARY; T=293.6K  
Threshold reactions

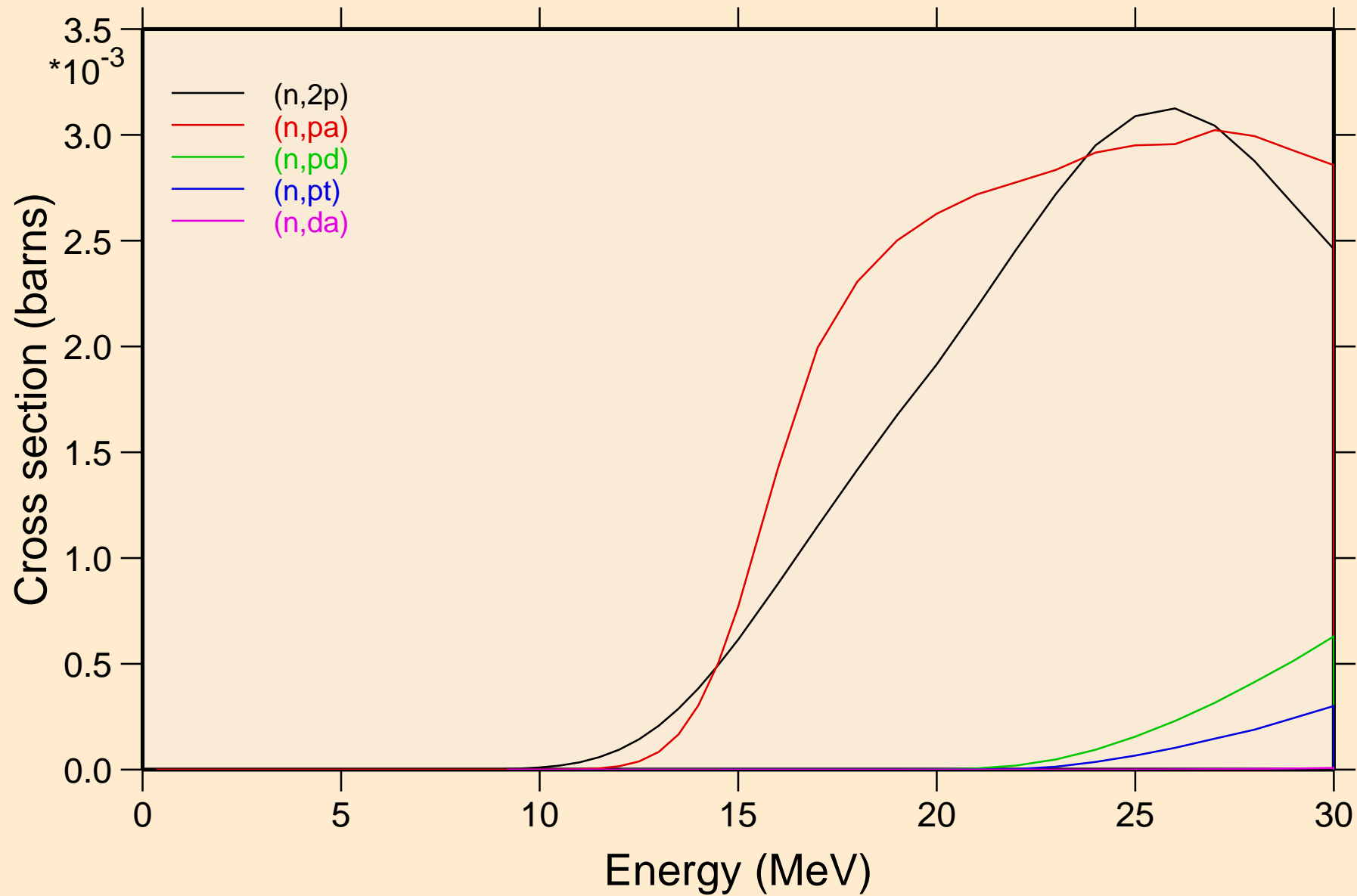

Y086 NEUTRON ACER TENDL-2021 LIBRARY; T=293.6K  
Threshold reactions

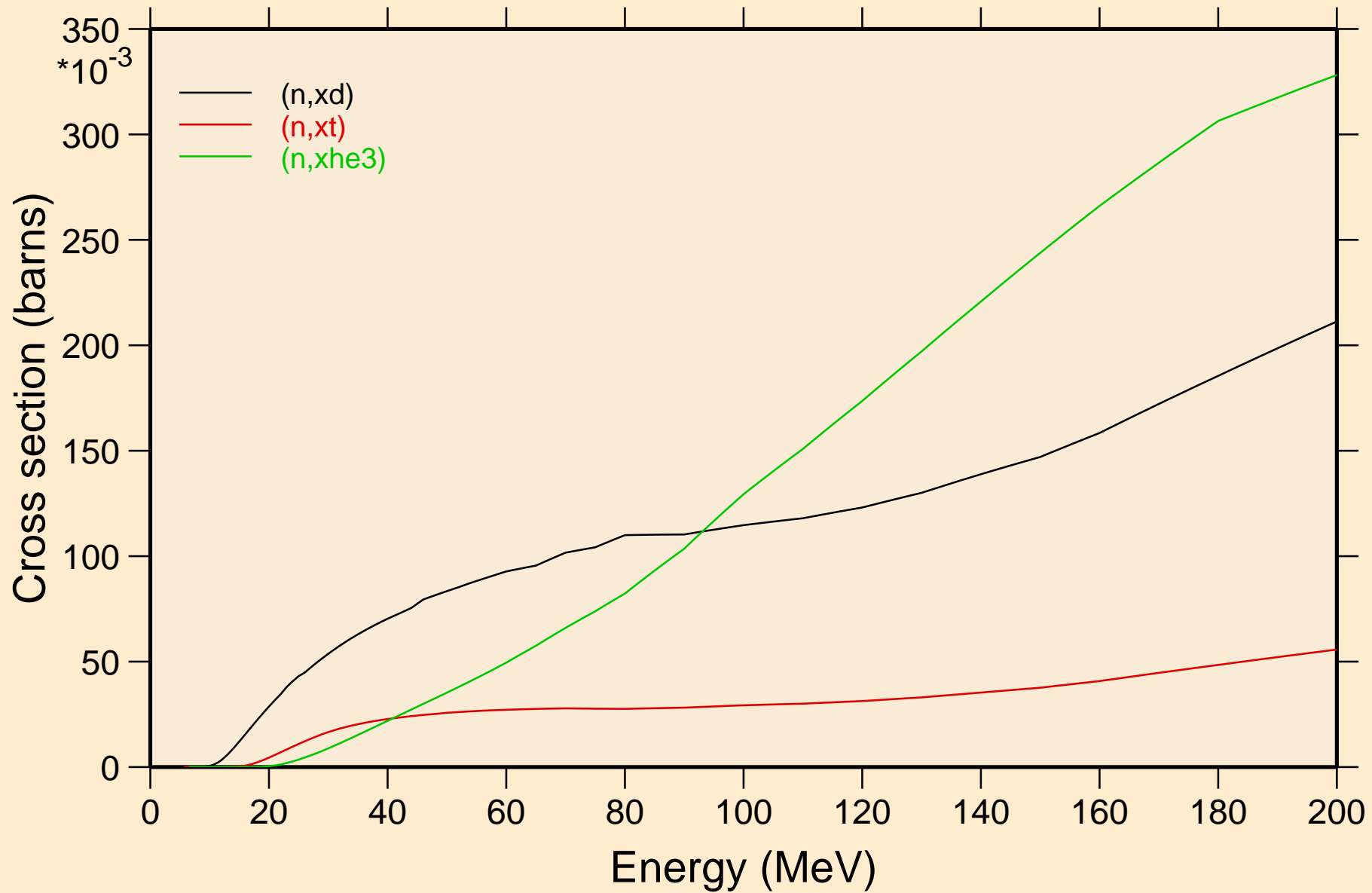

Y086 NEUTRON ACER TENDL-2021 LIBRARY; T=293.6K  
angular distribution for elastic

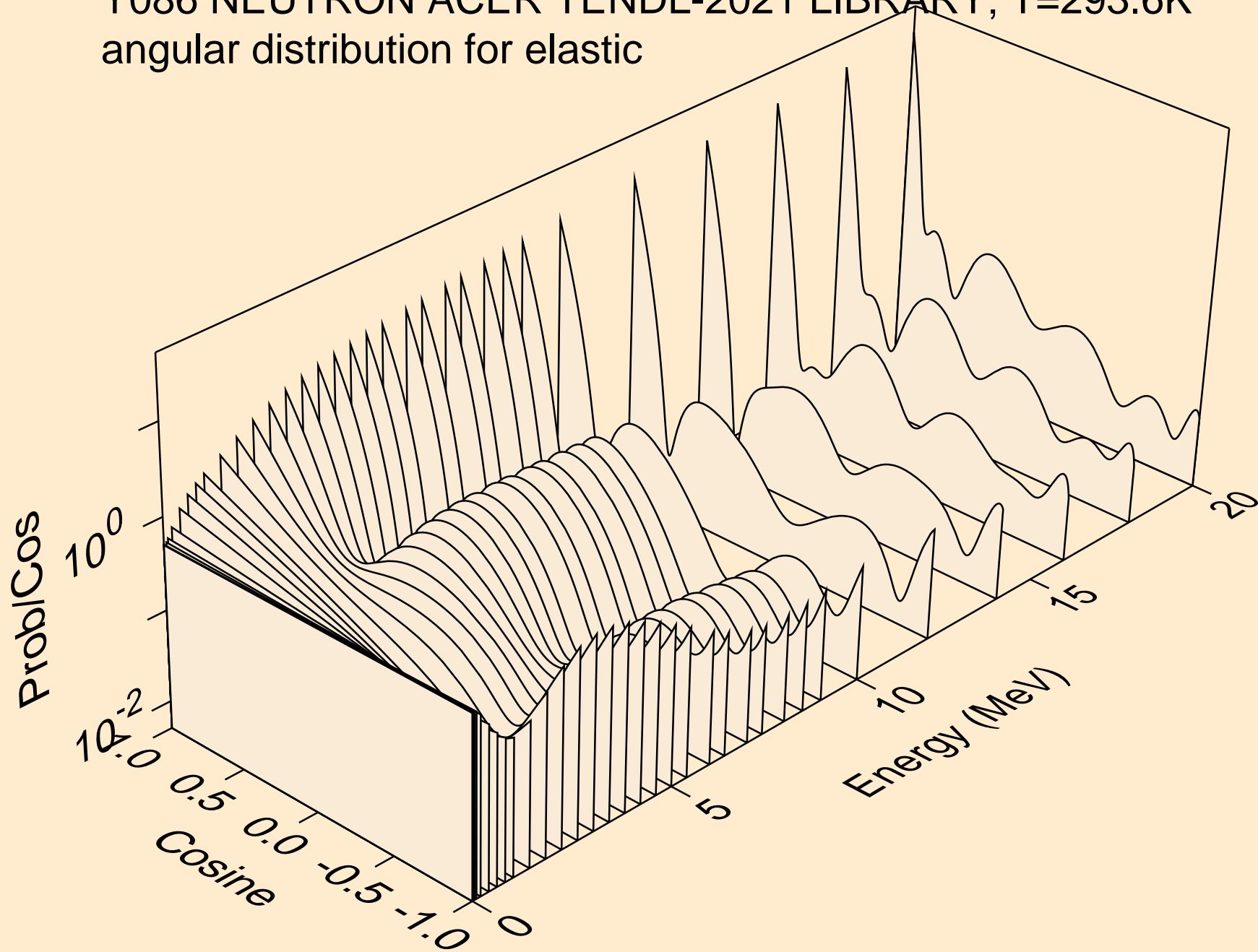

Y086 NEUTRON ACER TENDL-2021 LIBRARY; T=293.6K  
angular distribution for elastic

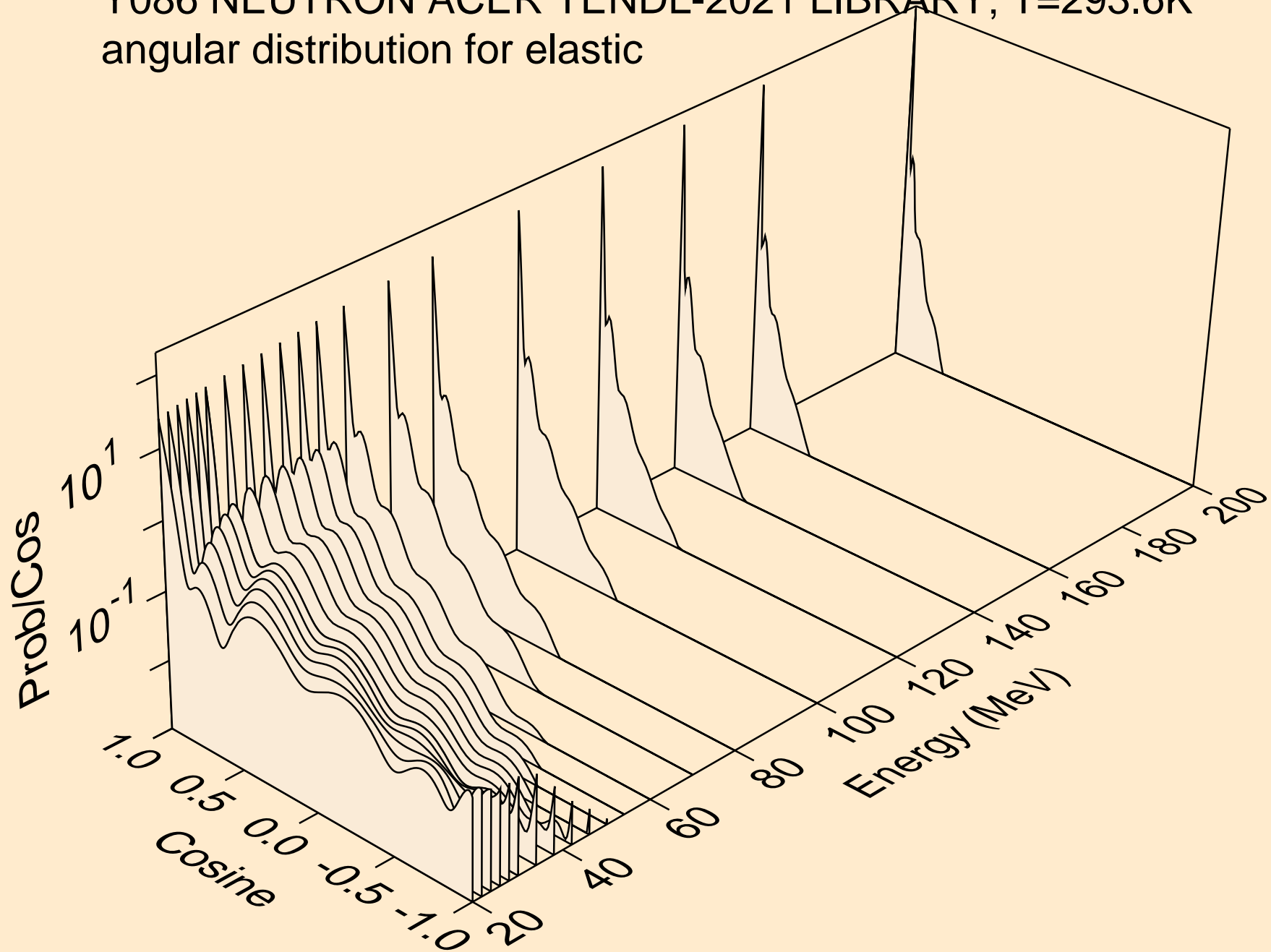

Y086 NEUTRON ACER TENDL-2021 LIBRARY; T=293.6K  
angular distribution for (n,n\*1)

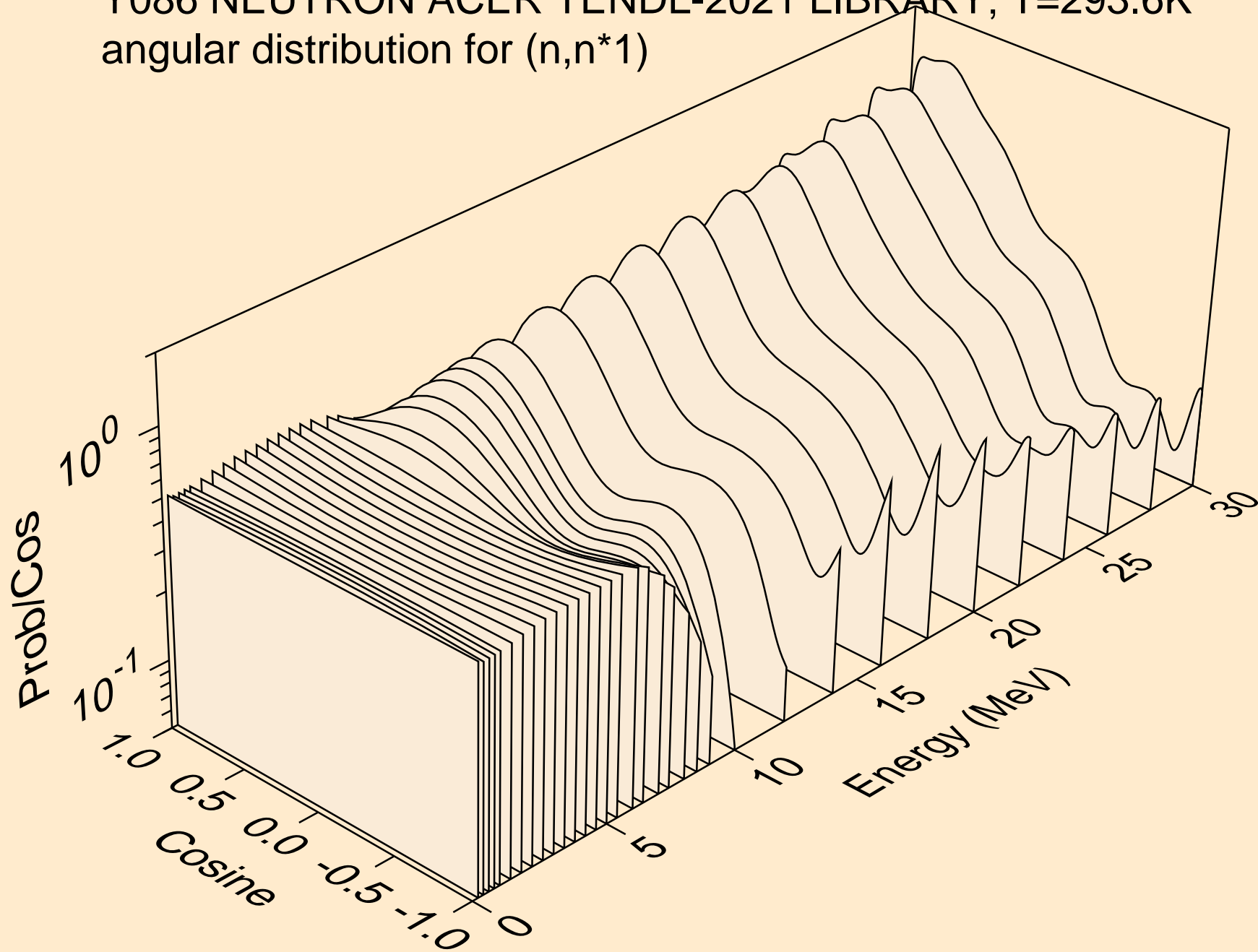

Y086 NEUTRON ACER TENDL-2021 LIBRARY; T=293.6K  
angular distribution for (n,n\*2)

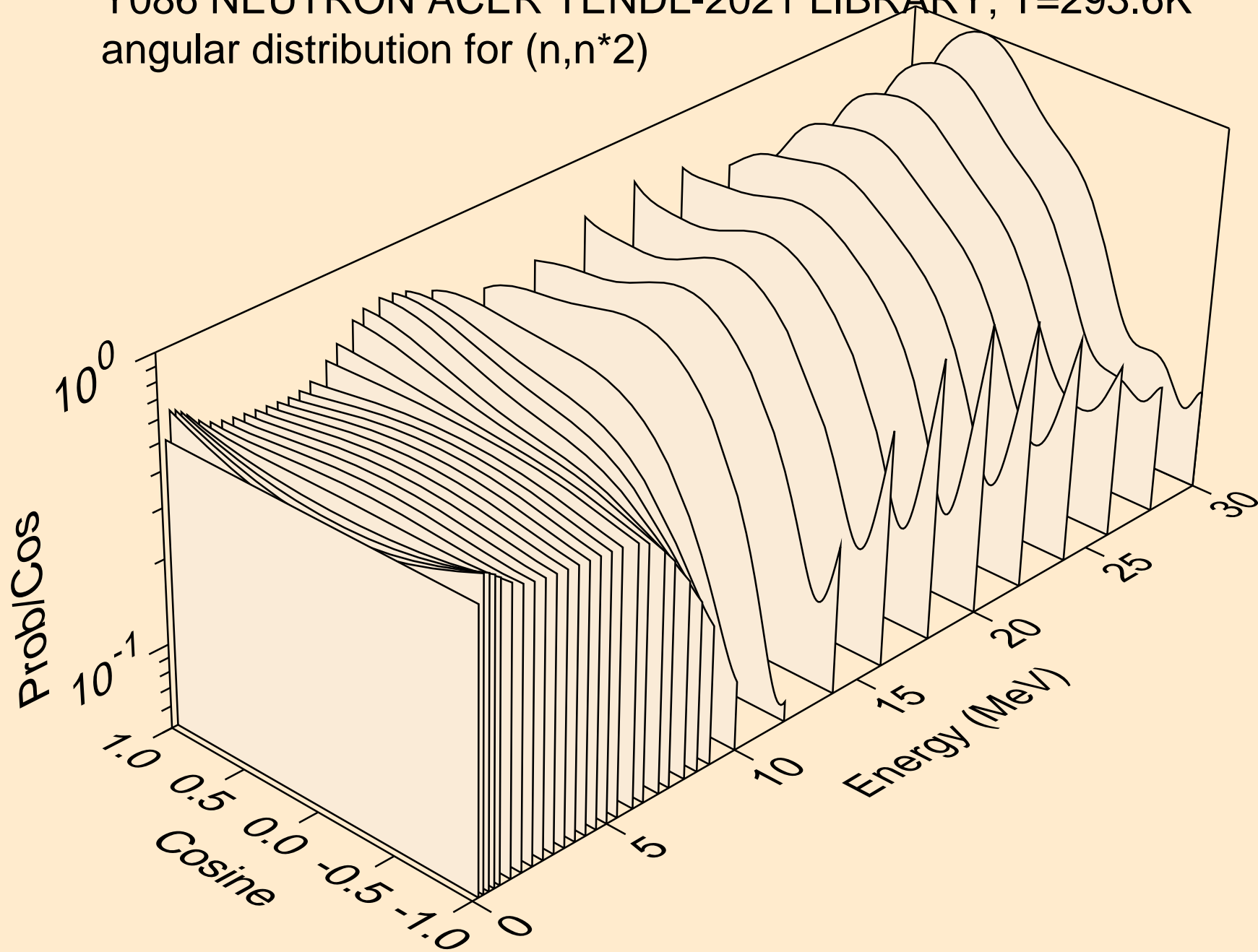

Y086 NEUTRON ACER TENDL-2021 LIBRARY; T=293.6K  
angular distribution for (n,n\*3)

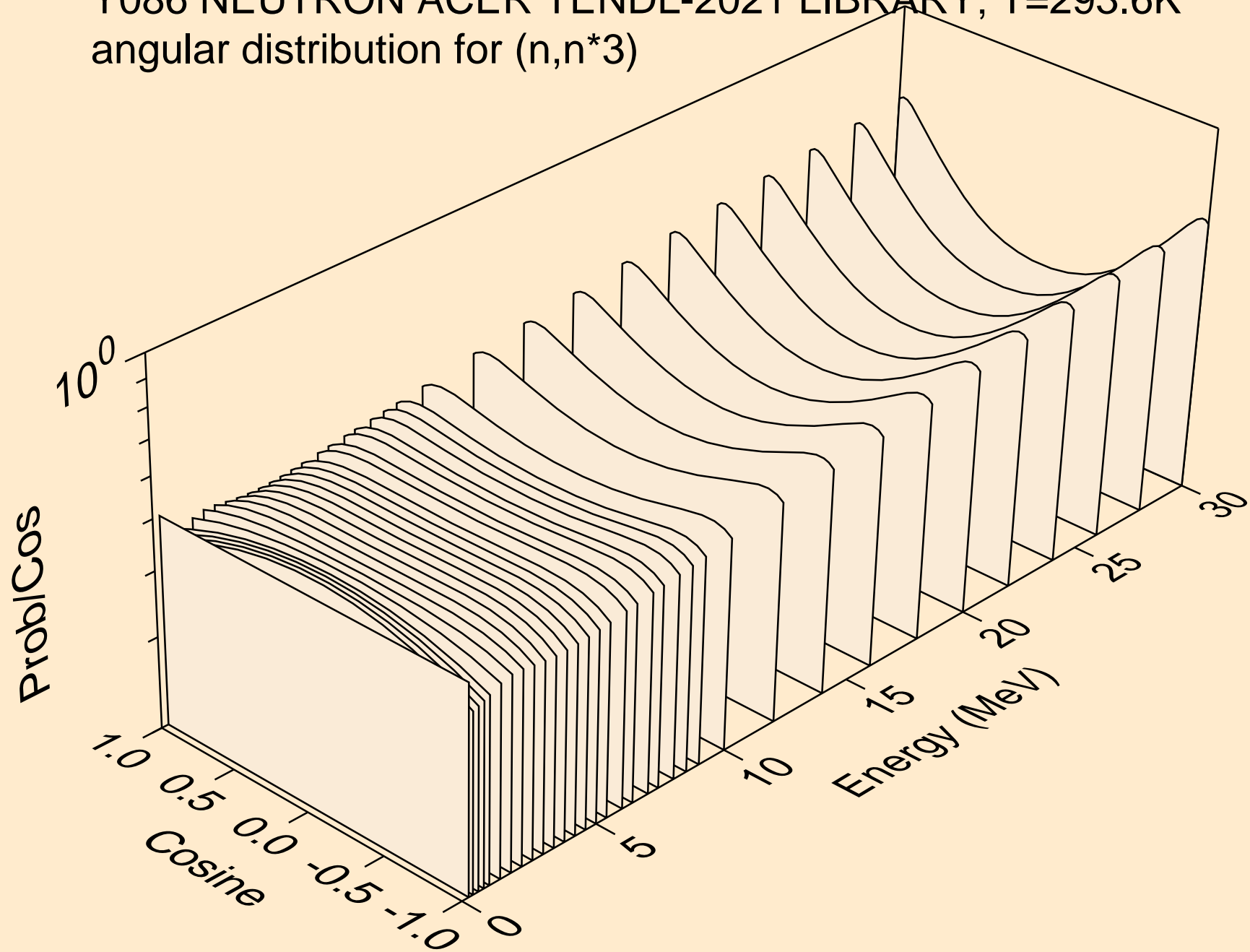



Y086 NEUTRON ACER TENDL-2021 LIBRARY; T=293.6K  
angular distribution for (n,n\*4)

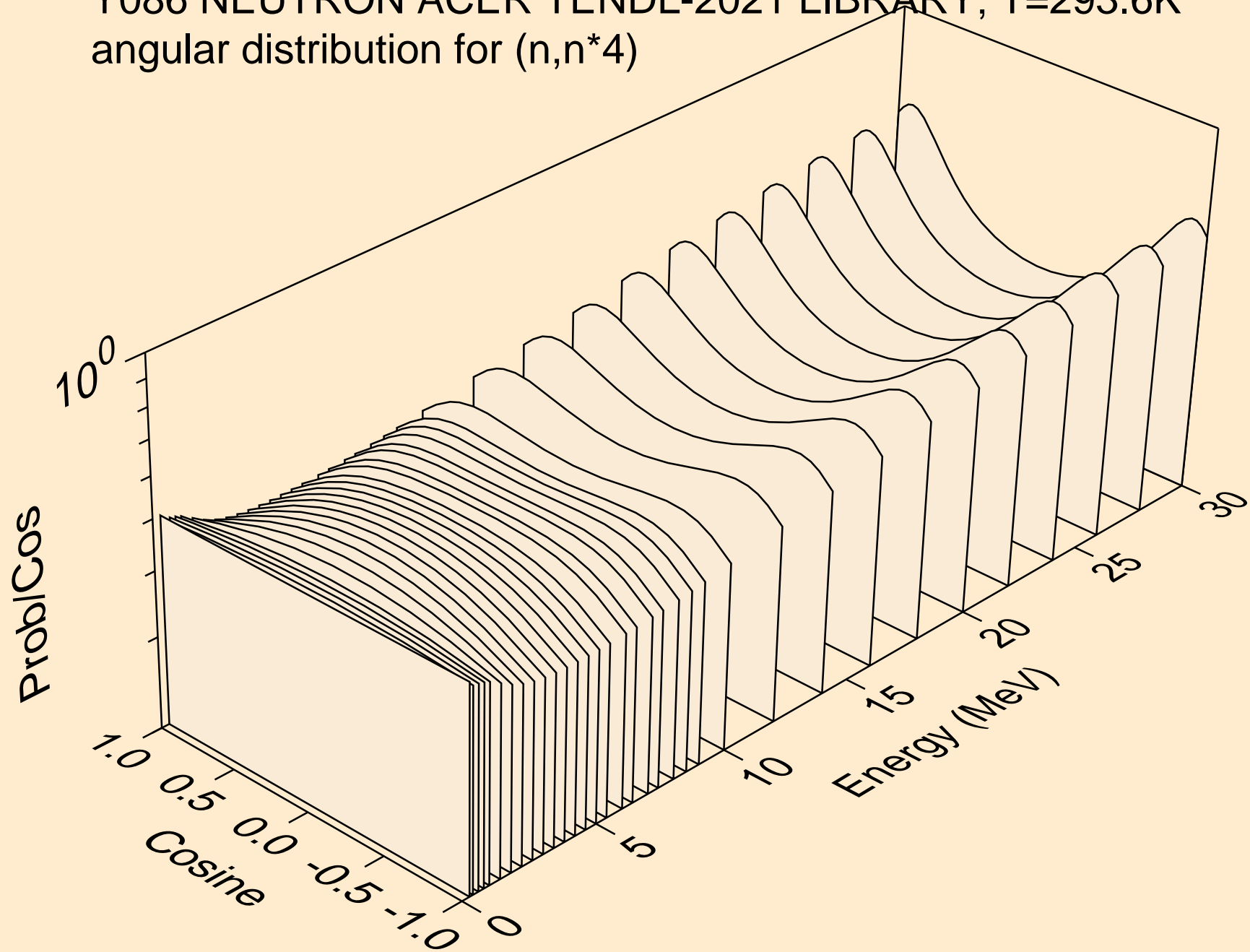

Y086 NEUTRON ACER TENDL-2021 LIBRARY; T=293.6K  
angular distribution for (n,n\*5)

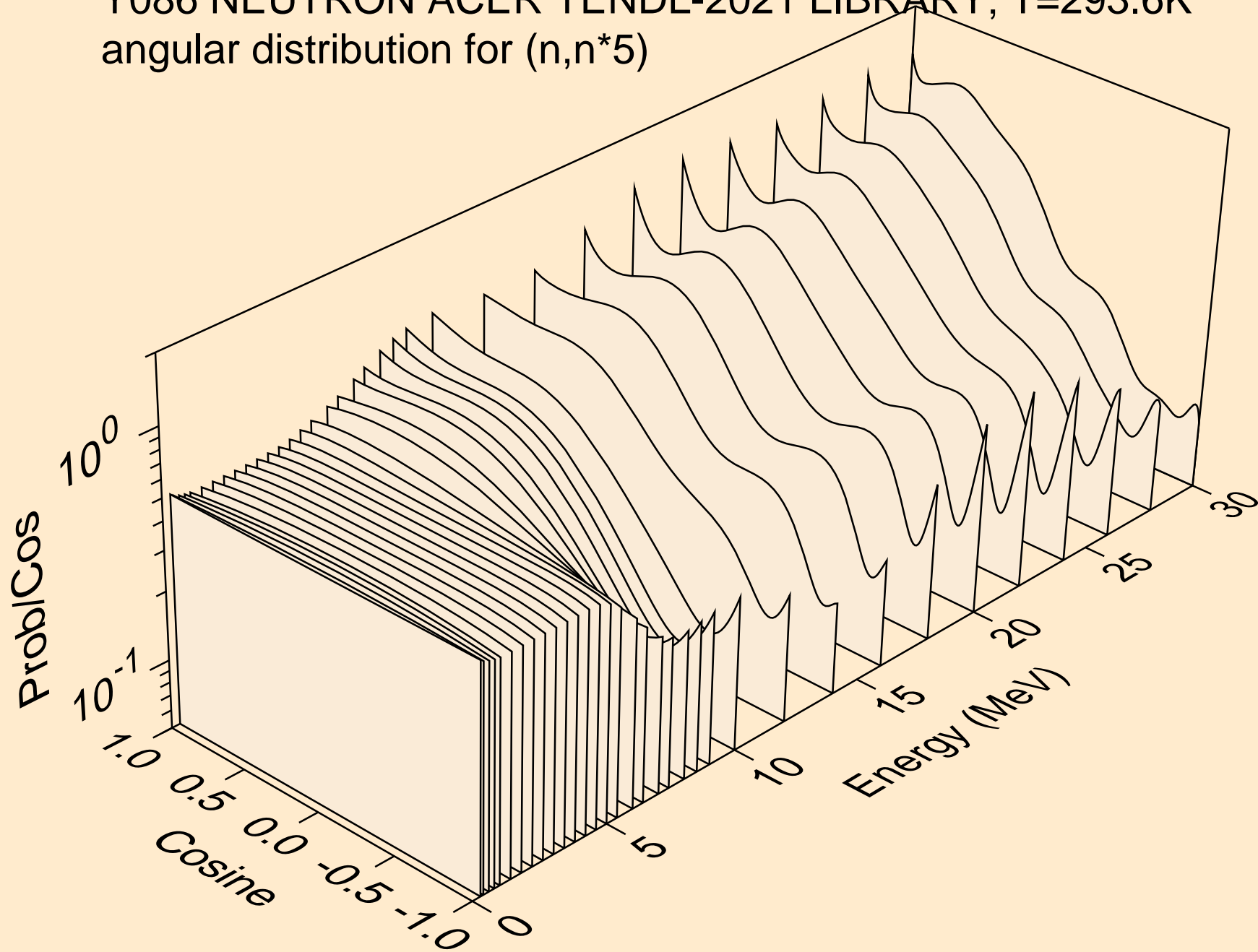

Y086 NEUTRON ACER TENDL-2021 LIBRARY; T=293.6K  
angular distribution for (n,n\*6)

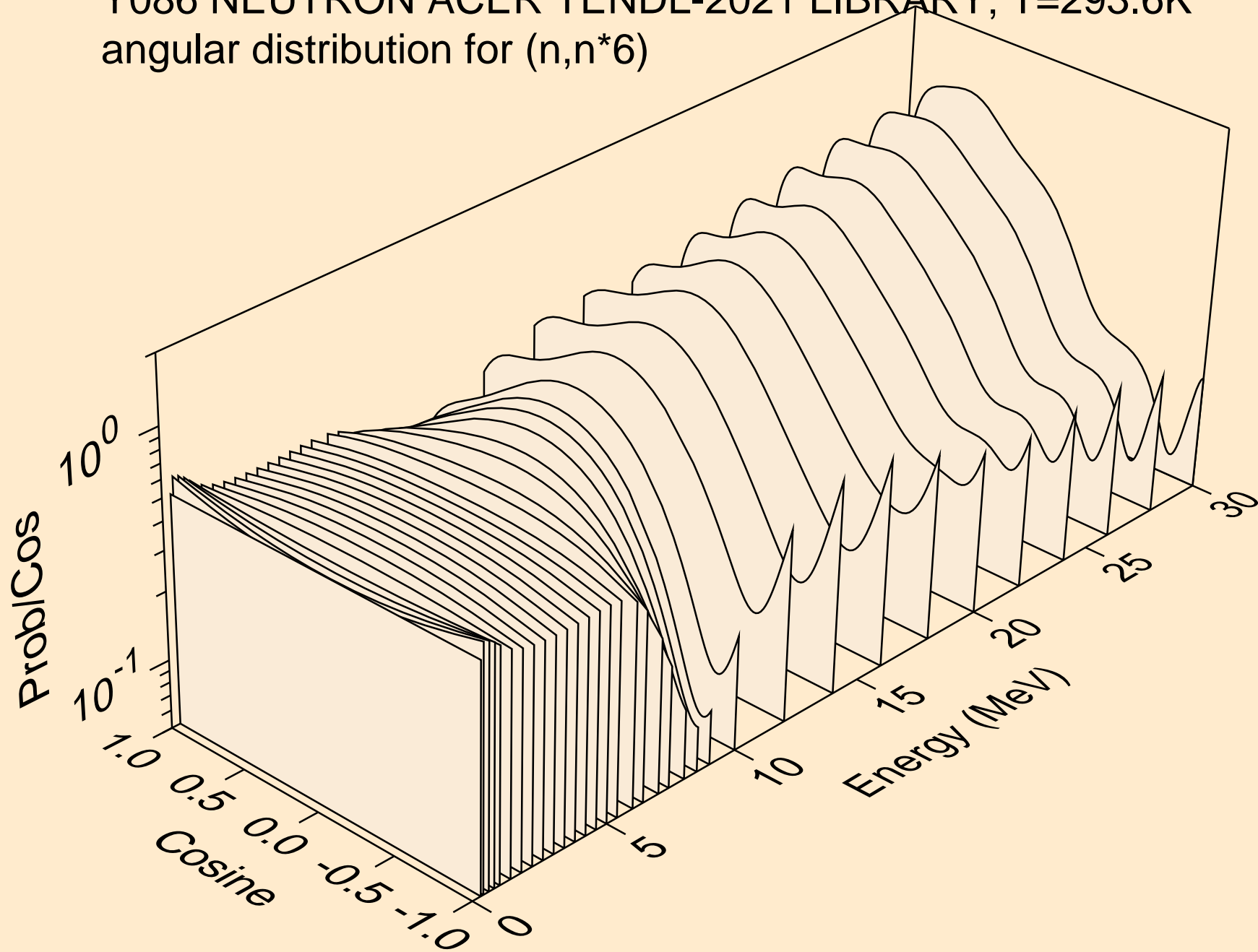

Y086 NEUTRON ACER TENDL-2021 LIBRARY; T=293.6K  
angular distribution for (n,n\*7)

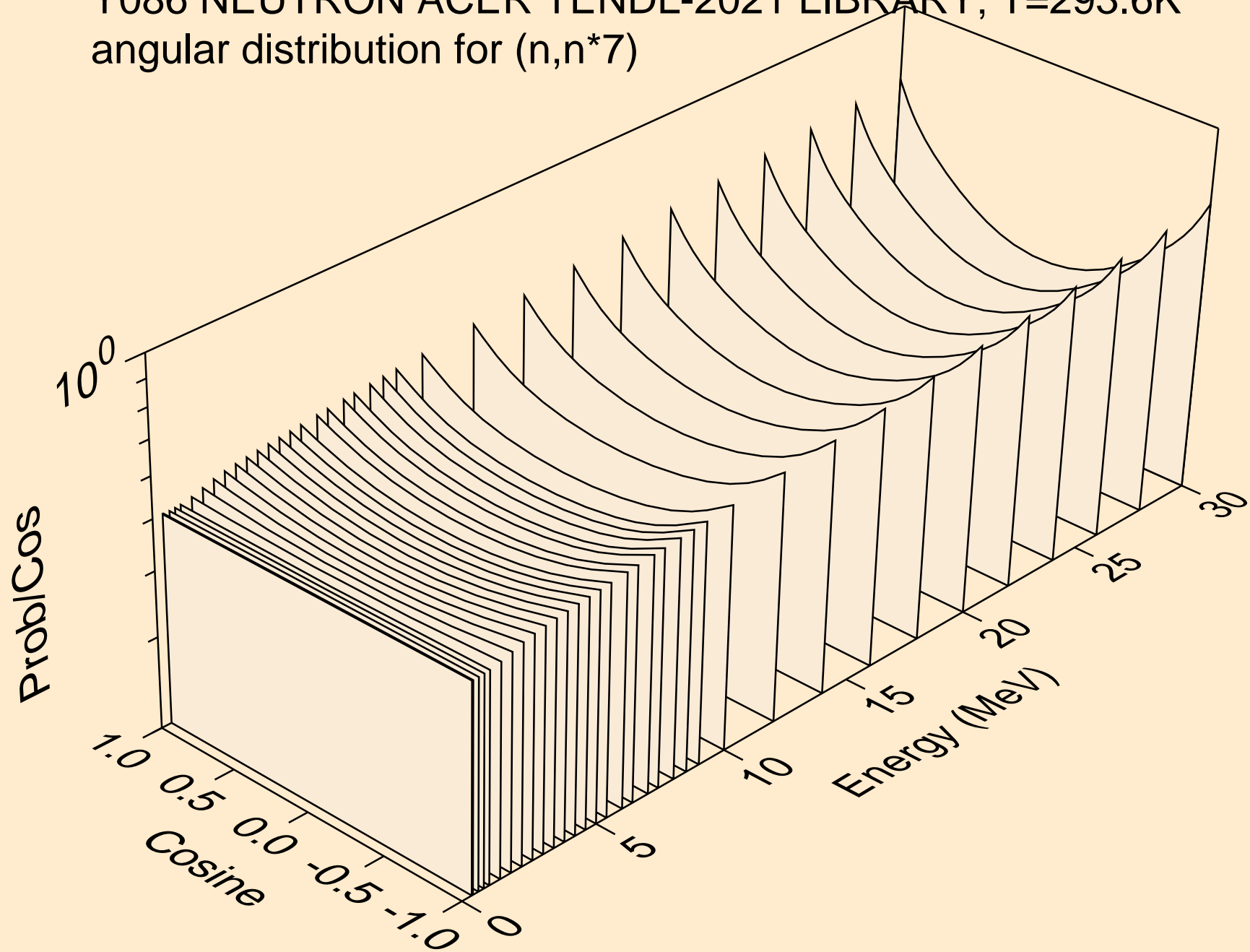

Y086 NEUTRON ACER TENDL-2021 LIBRARY; T=293.6K  
angular distribution for (n,n\*8)

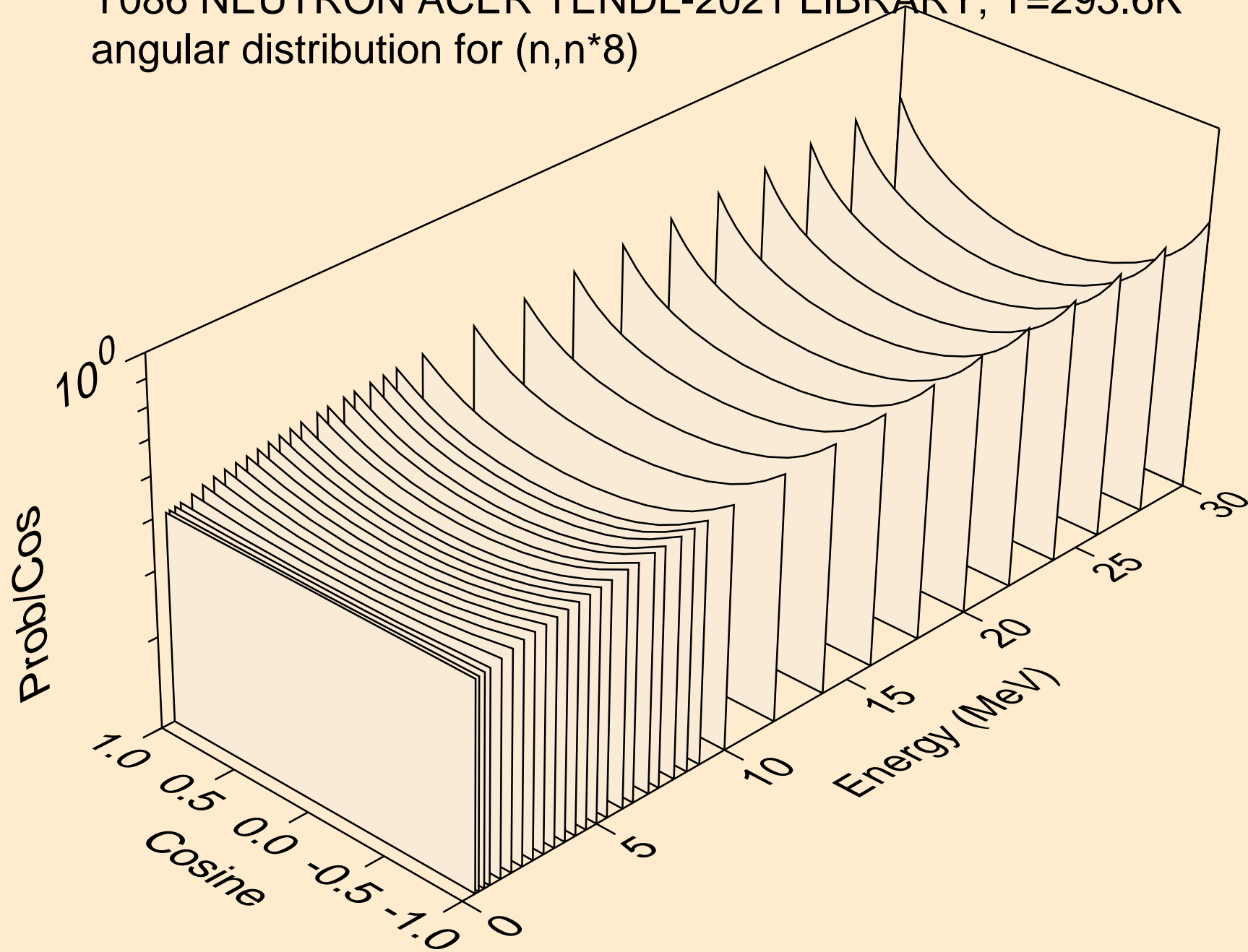

Y086 NEUTRON ACER TENDL-2021 LIBRARY; T=293.6K  
angular distribution for (n,n\*9)

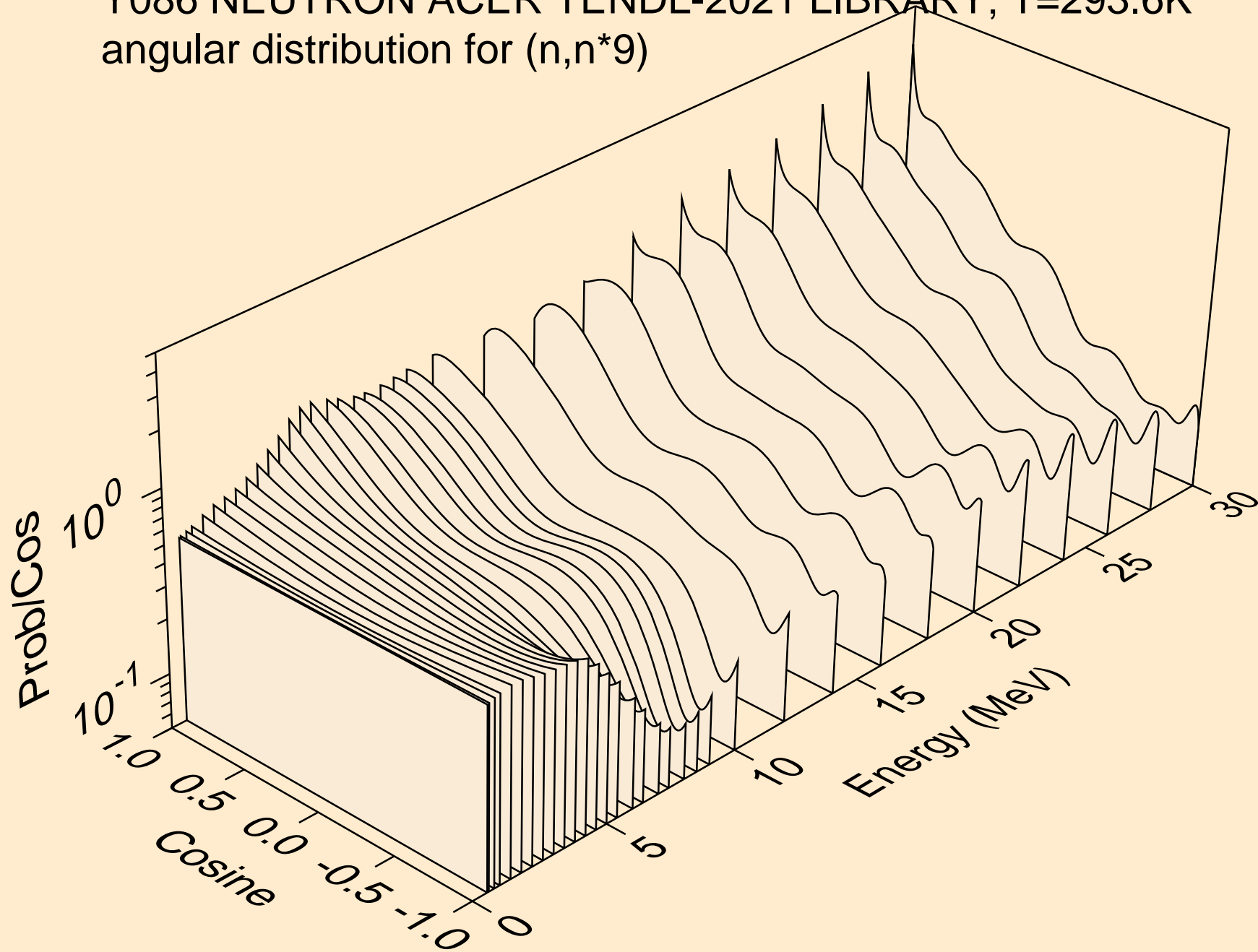

Y086 NEUTRON ACER TENDL-2021 LIBRARY; T=293.6K  
angular distribution for (n,n\*10)

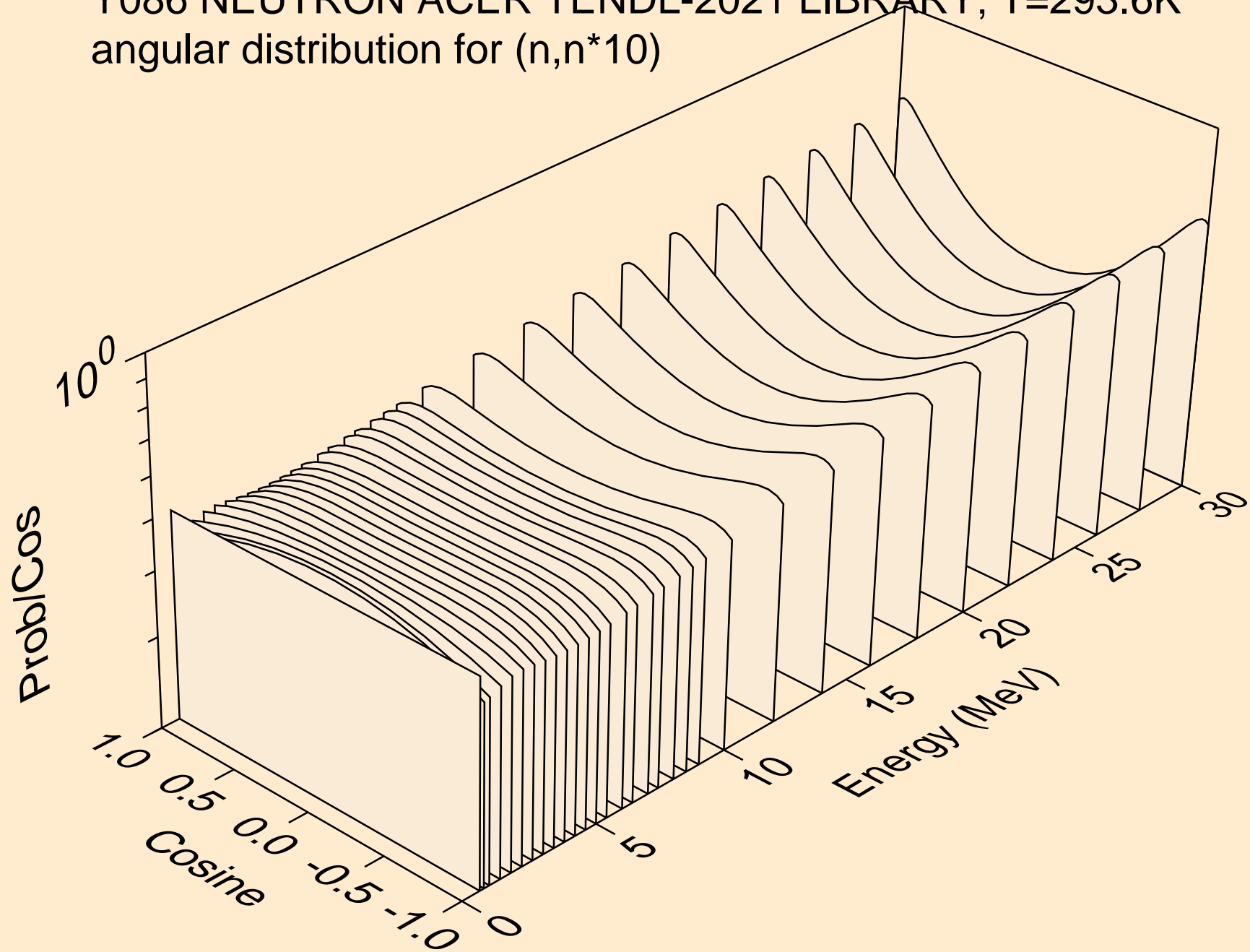

Y086 NEUTRON ACER TENDL-2021 LIBRARY; T=293.6K  
angular distribution for (n,n\*11)

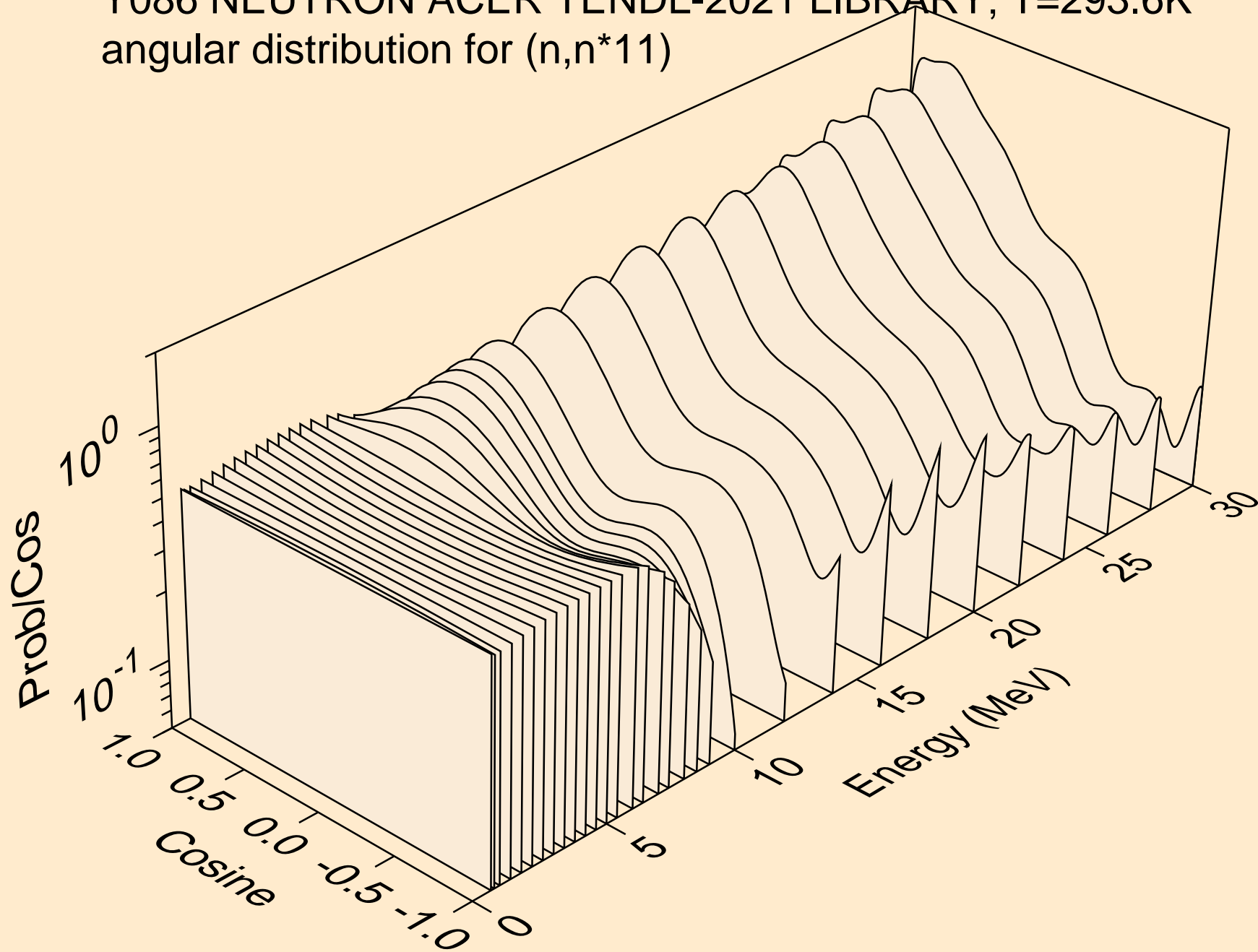



Y086 NEUTRON ACER TENDL-2021 LIBRARY; T=293.6K  
angular distribution for (n,n\*12)

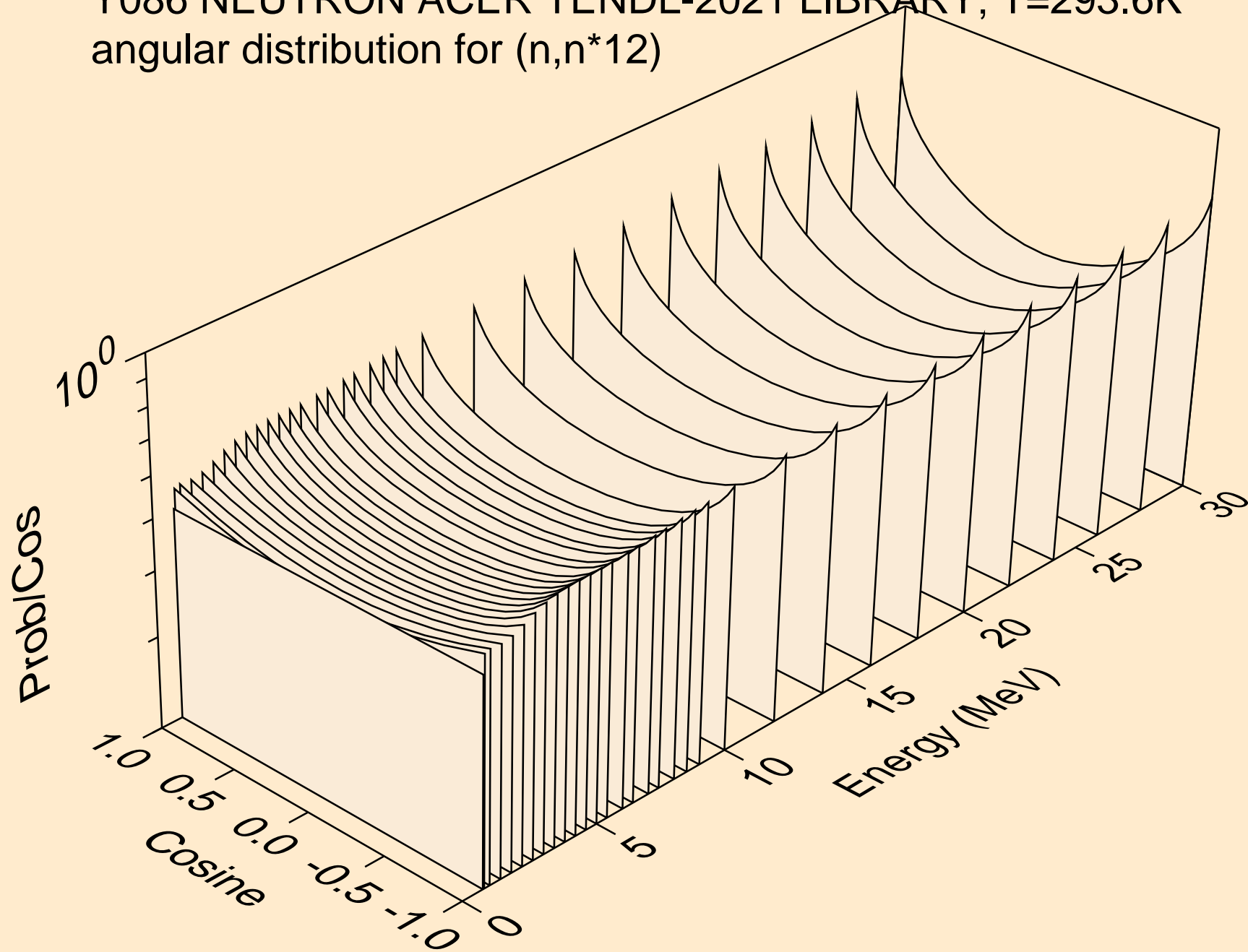

Y086 NEUTRON ACER TENDL-2021 LIBRARY; T=293.6K  
angular distribution for (n,n\*13)

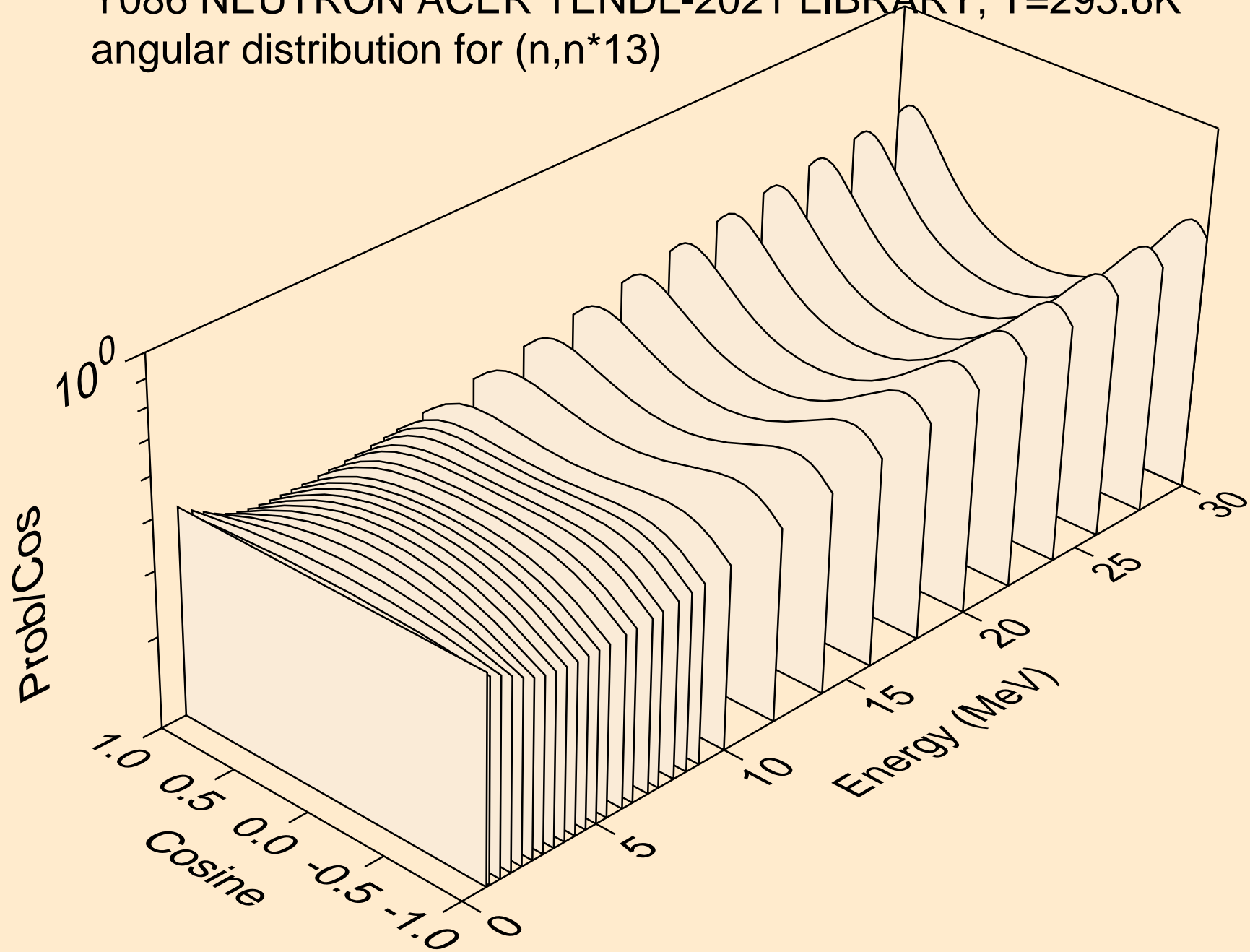

Y086 NEUTRON ACER TENDL-2021 LIBRARY; T=293.6K  
angular distribution for (n,n\*14)

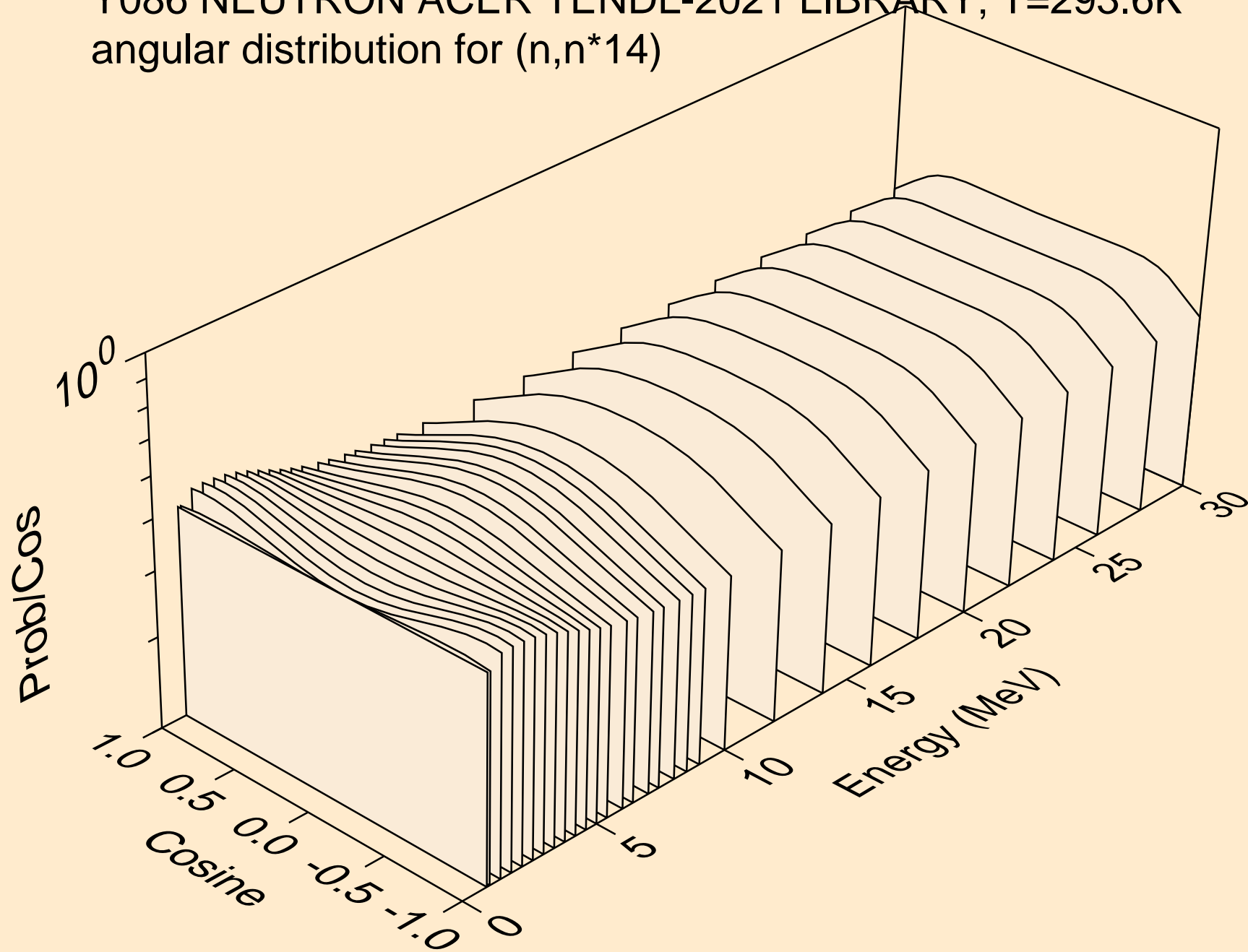

Y086 NEUTRON ACER TENDL-2021 LIBRARY; T=293.6K  
angular distribution for (n,n\*15)

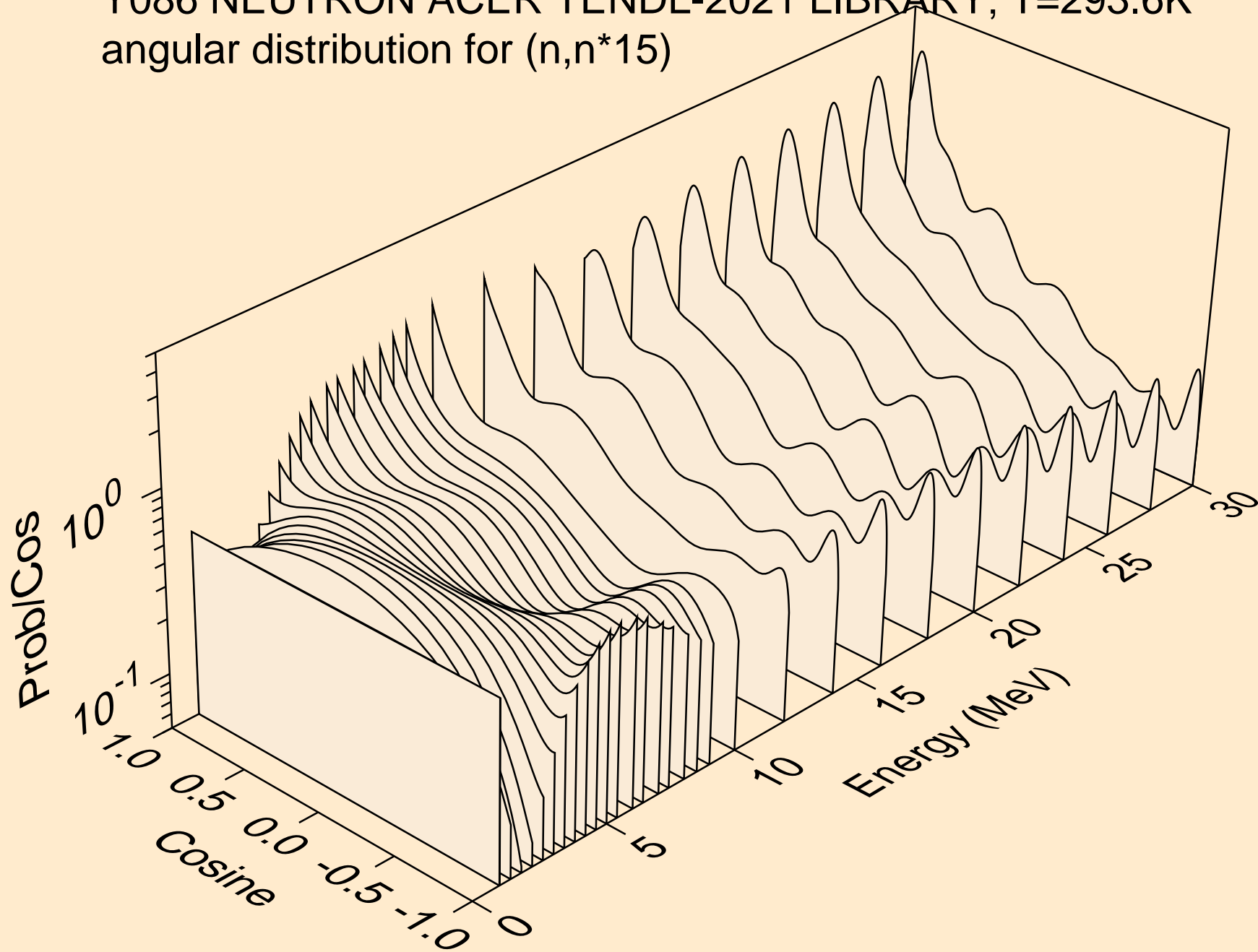

Y086 NEUTRON ACER TENDL-2021 LIBRARY; T=293.6K  
angular distribution for (n,n\*16)

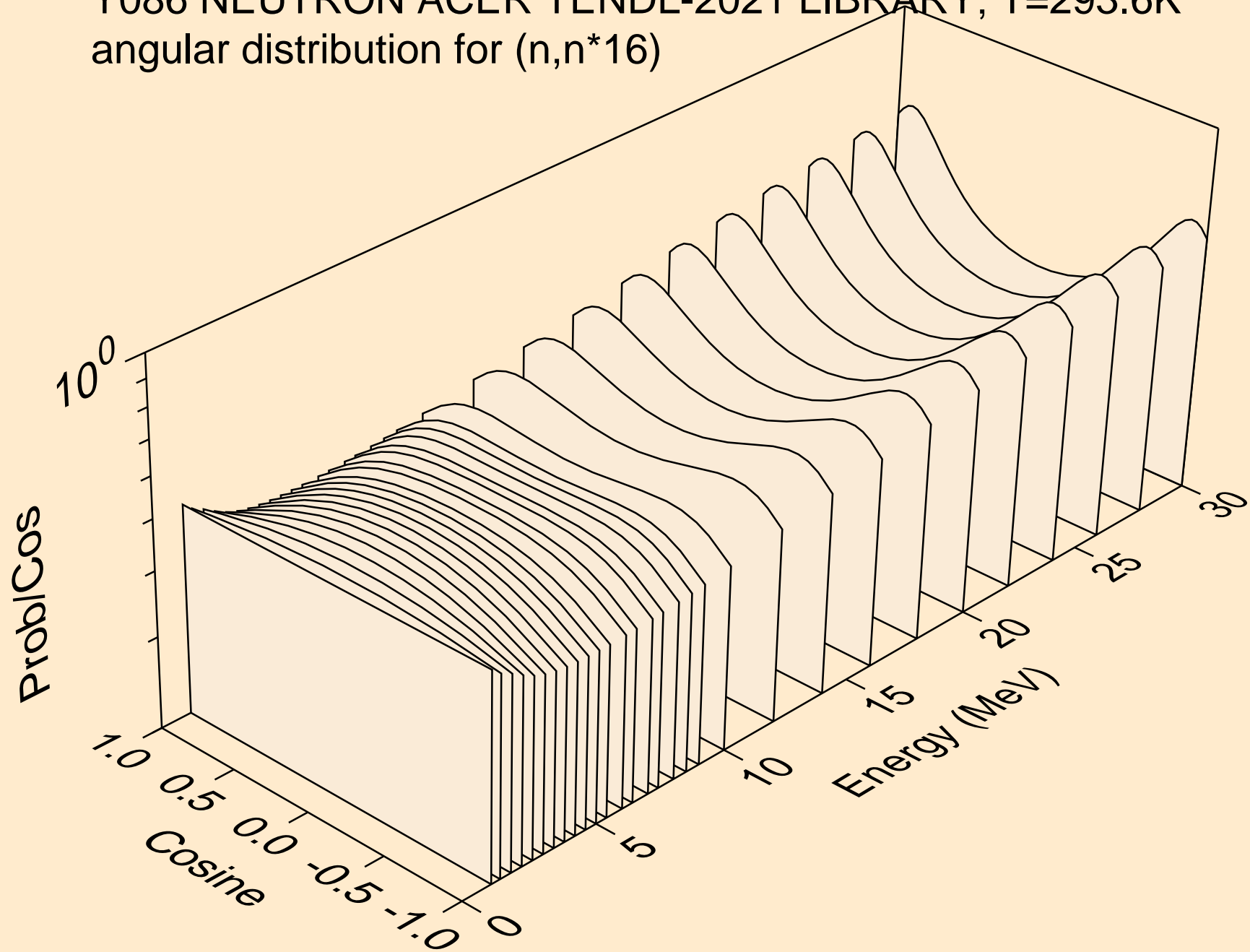

Y086 NEUTRON ACER TENDL-2021 LIBRARY; T=293.6K  
angular distribution for (n,n\*17)

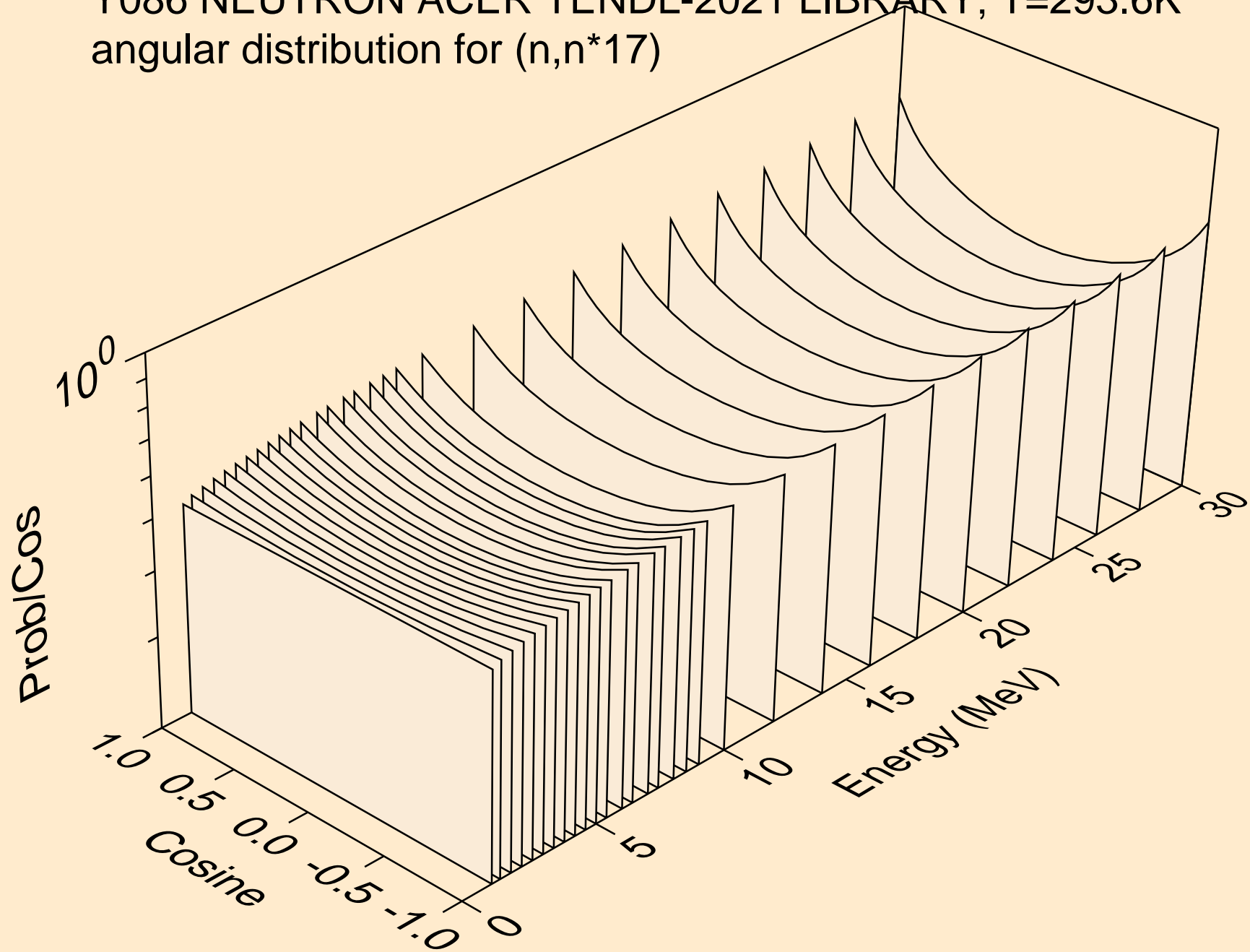

Y086 NEUTRON ACER TENDL-2021 LIBRARY; T=293.6K  
angular distribution for (n,n\*18)

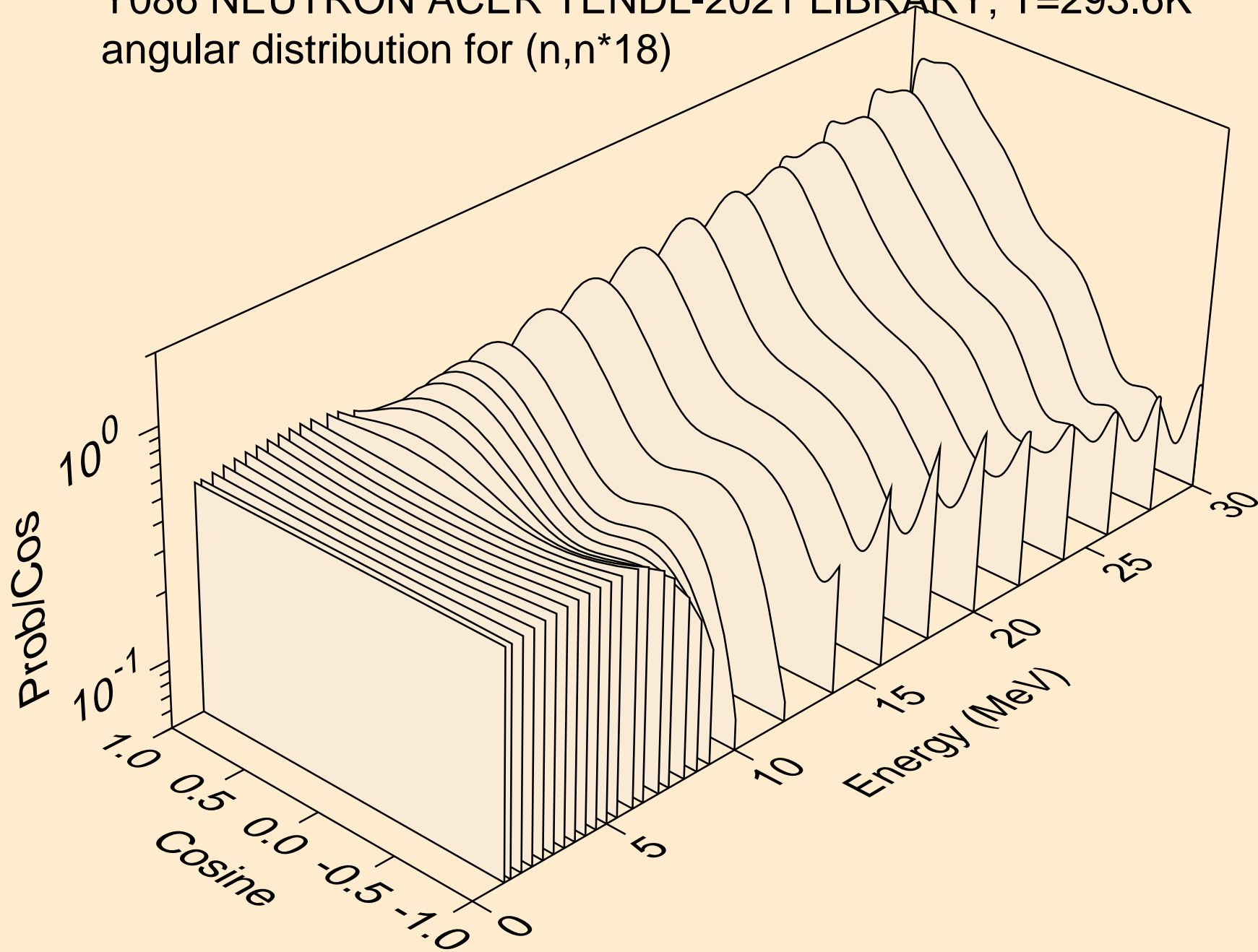

Y086 NEUTRON ACER TENDL-2021 LIBRARY; T=293.6K  
angular distribution for (n,n\*19)

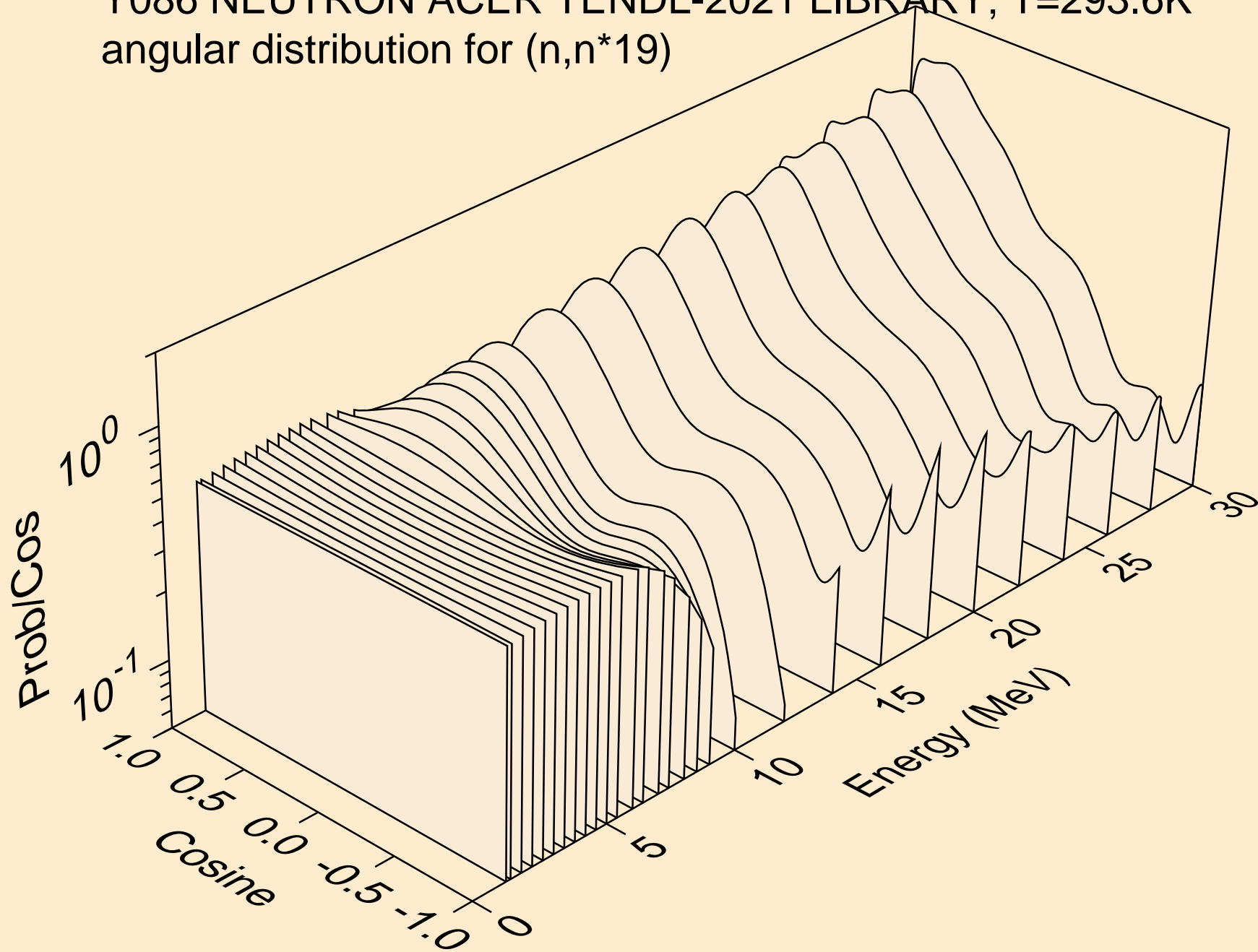



Y086 NEUTRON ACER TENDL-2021 LIBRARY; T=293.6K  
angular distribution for (n,n\*20)

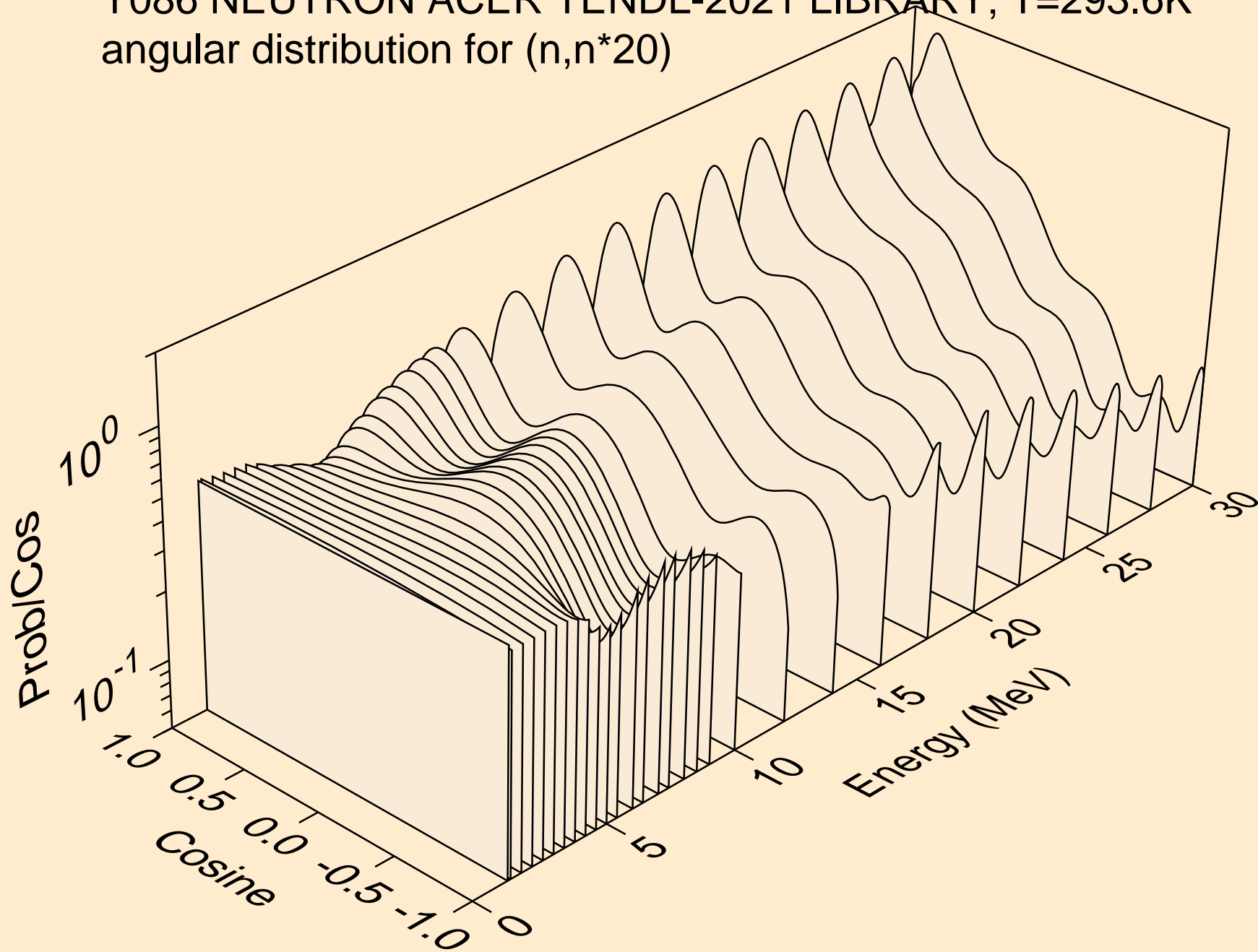

Y086 NEUTRON ACER TENDL-2021 LIBRARY; T=293.6K  
angular distribution for (n,n\*21)

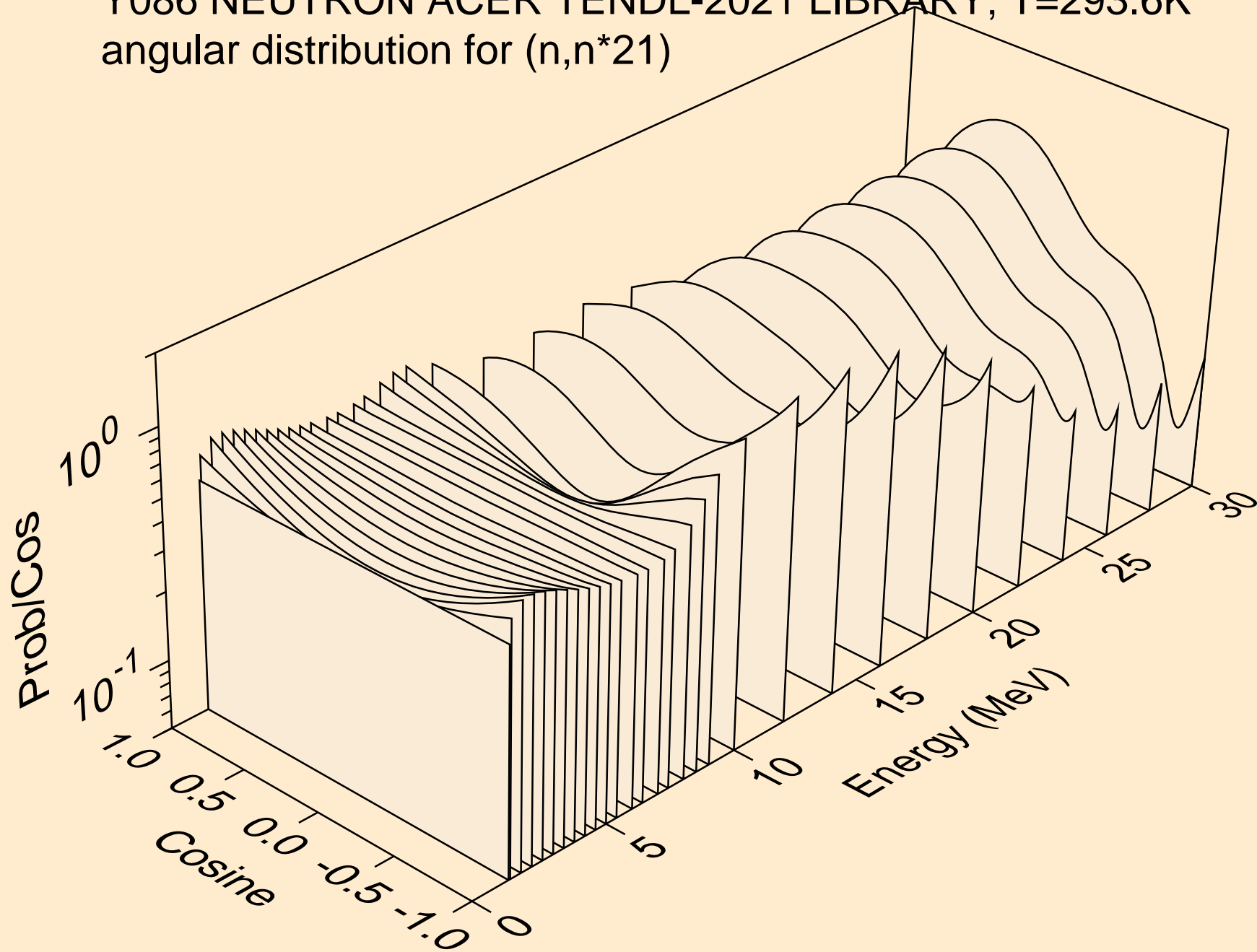

Y086 NEUTRON ACER TENDL-2021 LIBRARY; T=293.6K  
angular distribution for (n,n\*22)

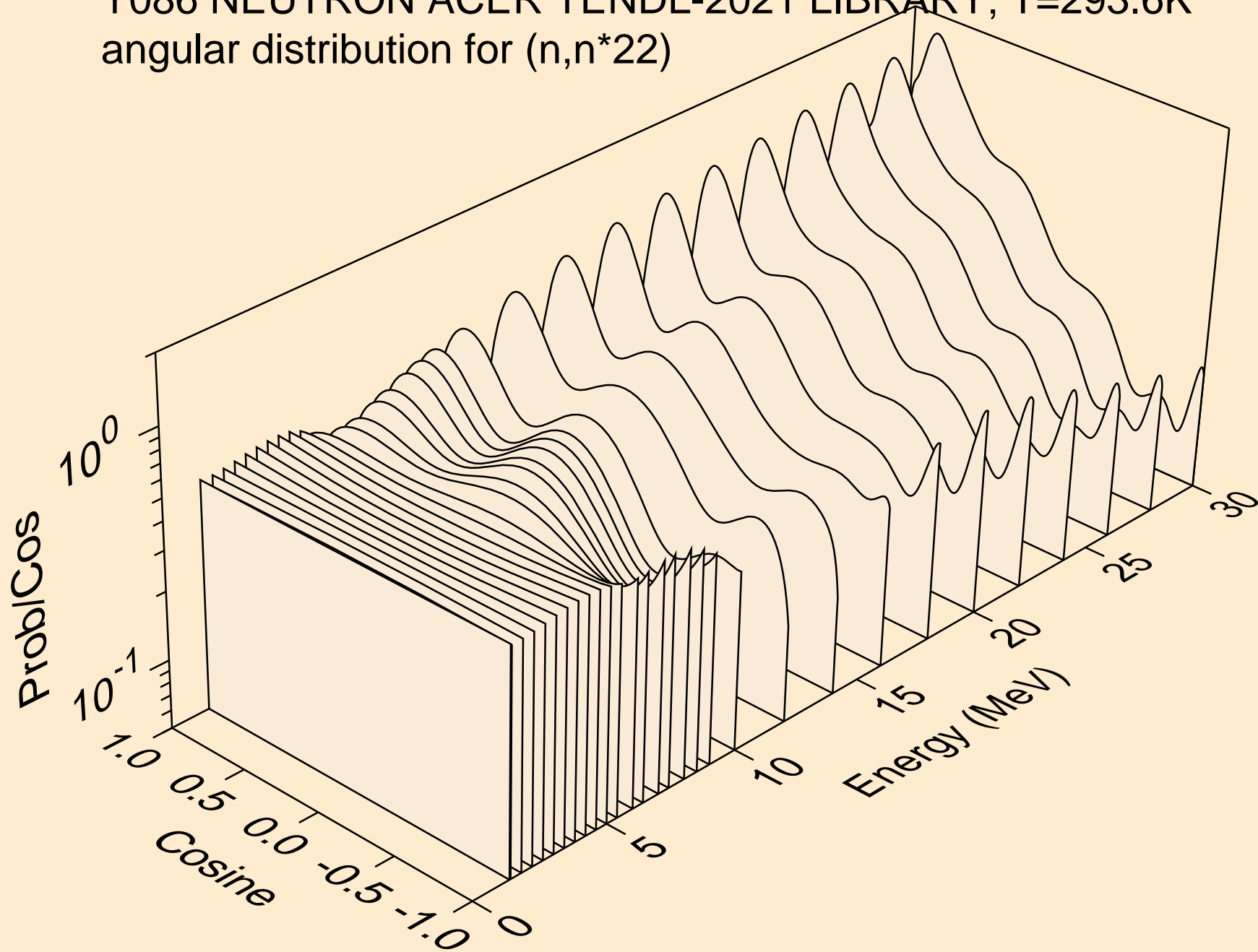

Y086 NEUTRON ACER TENDL-2021 LIBRARY; T=293.6K  
angular distribution for (n,n\*23)

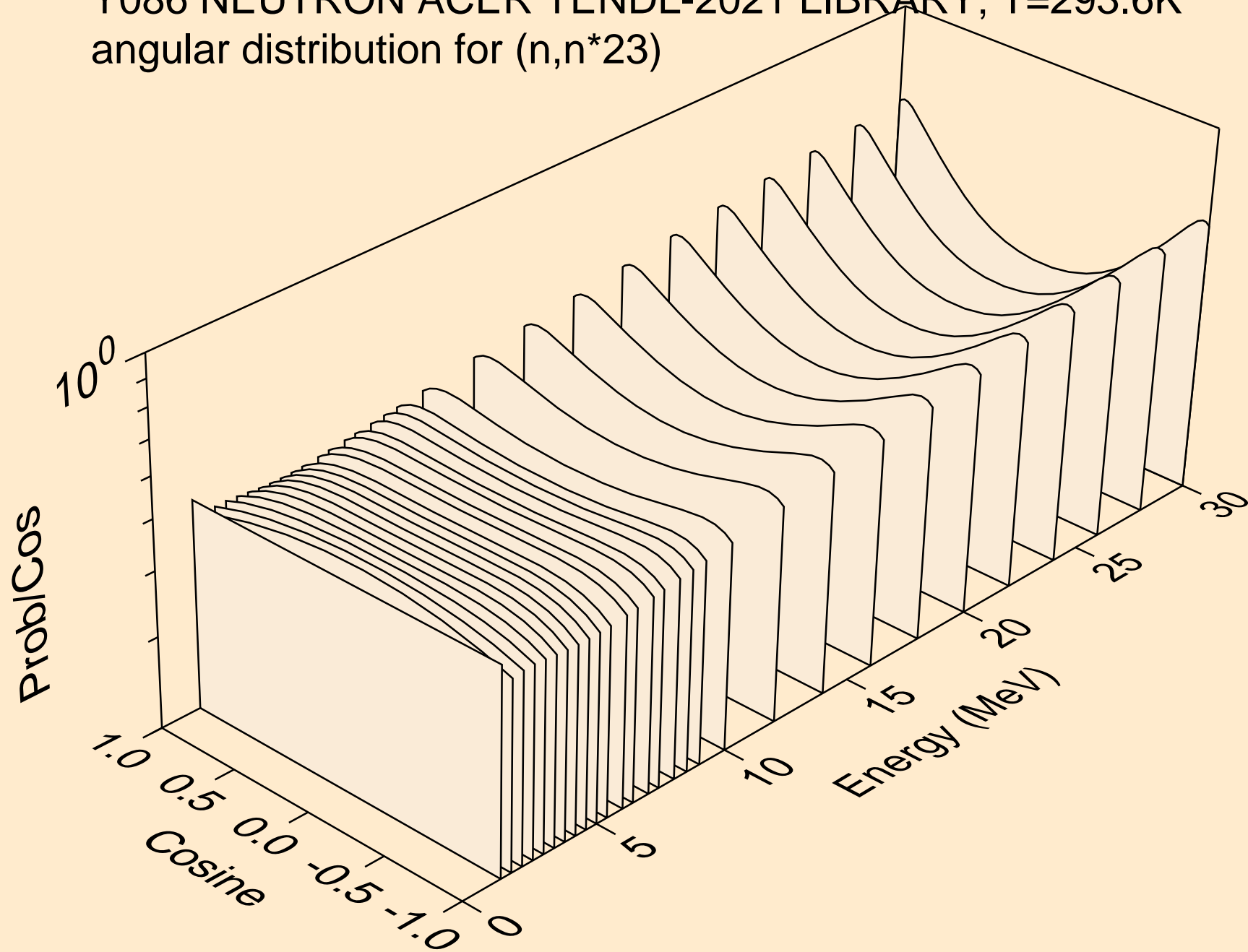

Y086 NEUTRON ACER TENDL-2021 LIBRARY; T=293.6K  
angular distribution for (n,n\*24)

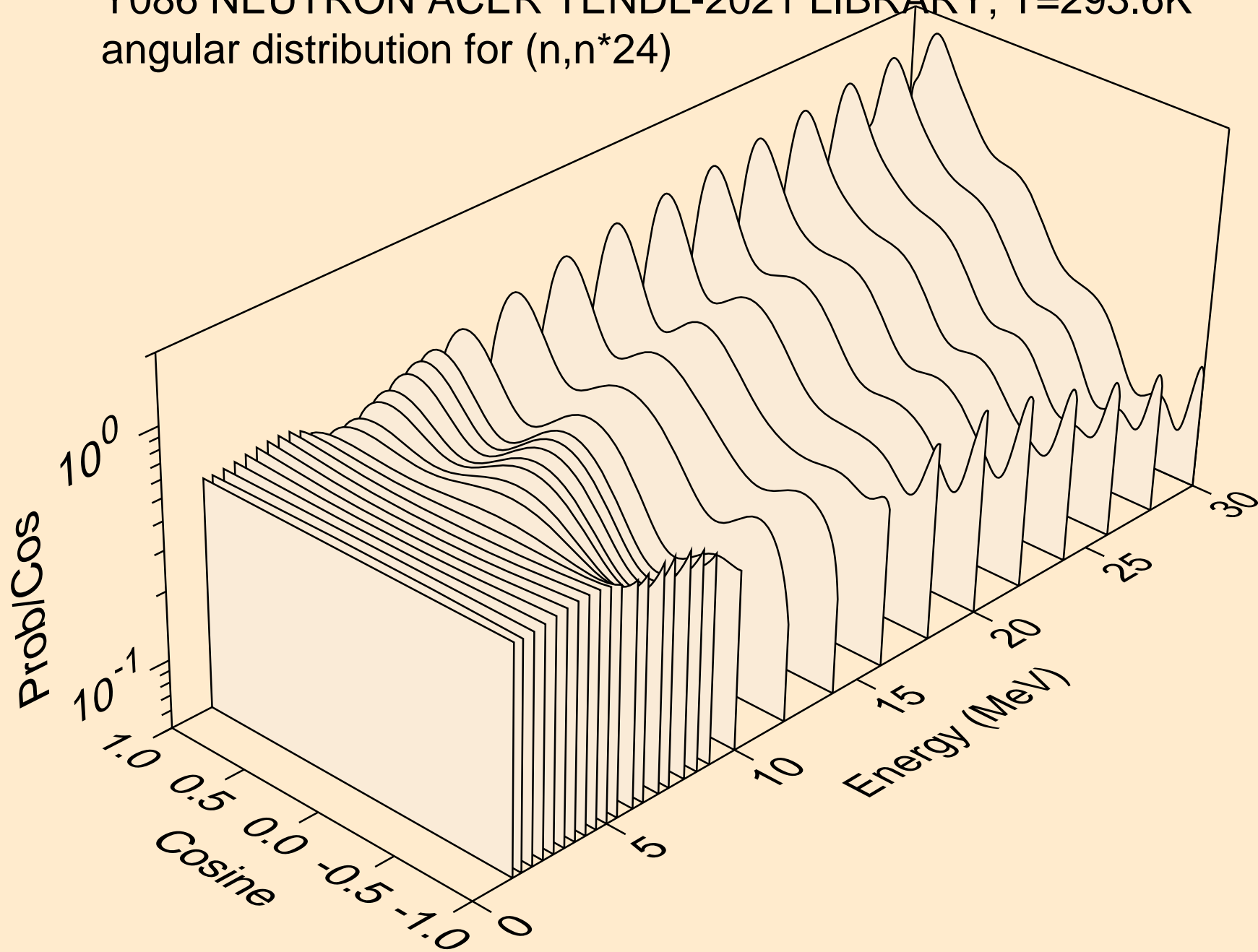

Y086 NEUTRON ACER TENDL-2021 LIBRARY; T=293.6K  
Neutron emission for (n,x)

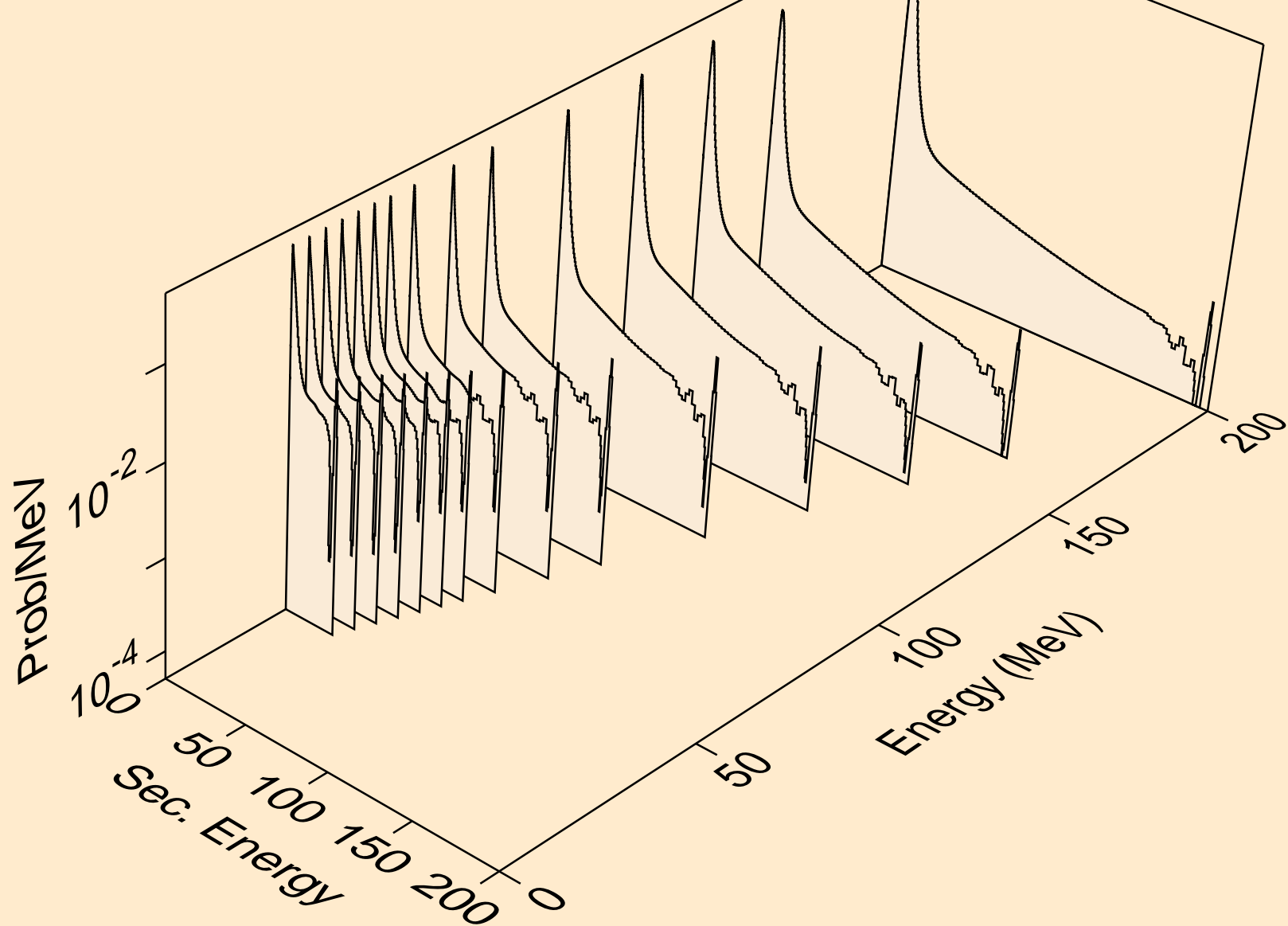

Y086 NEUTRON ACER TENDL-2021 LIBRARY; T=293.6K  
Neutron emission for (n,2nd)

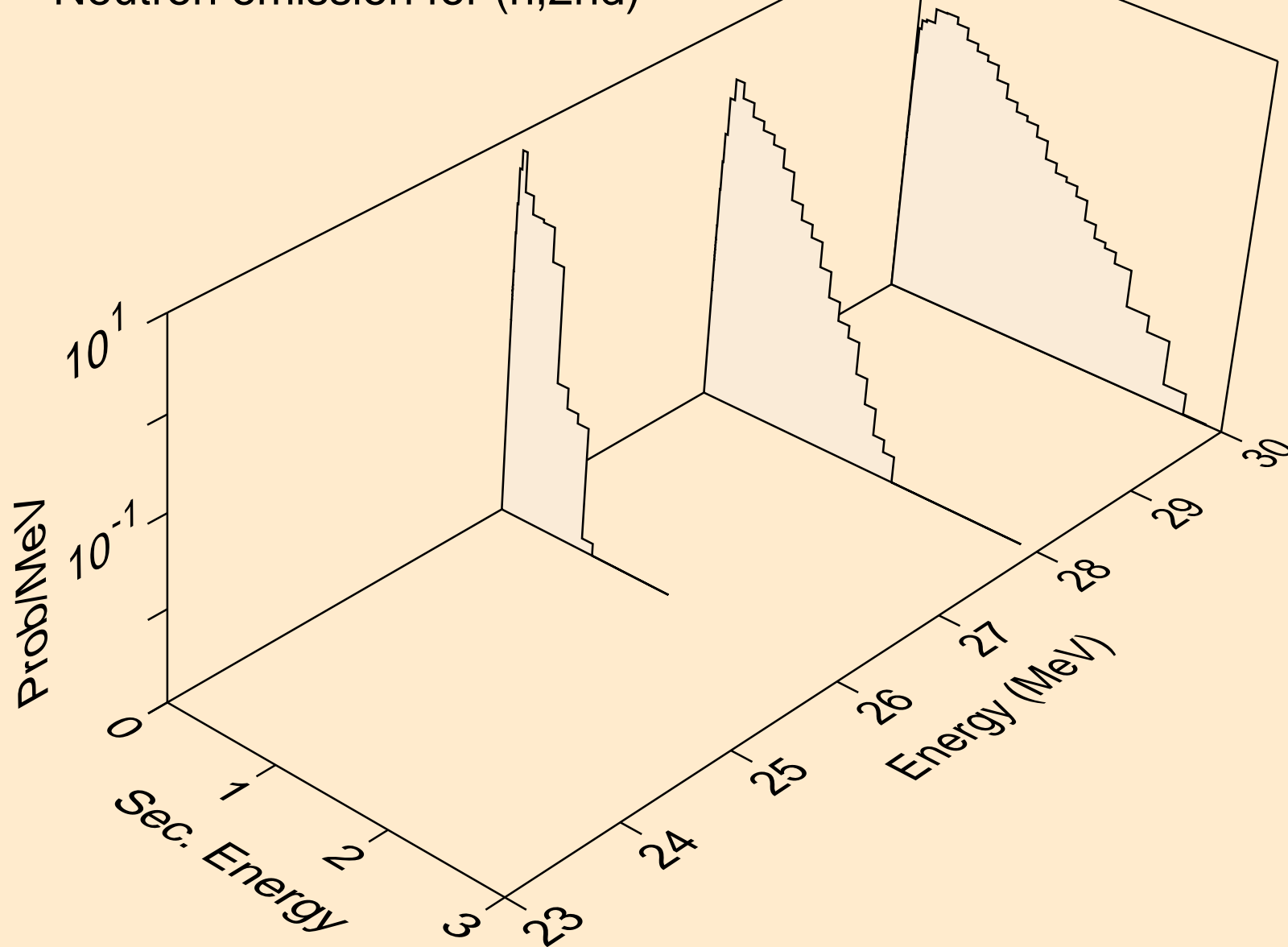

Y086 NEUTRON ACER TENDL-2021 LIBRARY; T=293.6K  
Neutron emission for (n,2n)

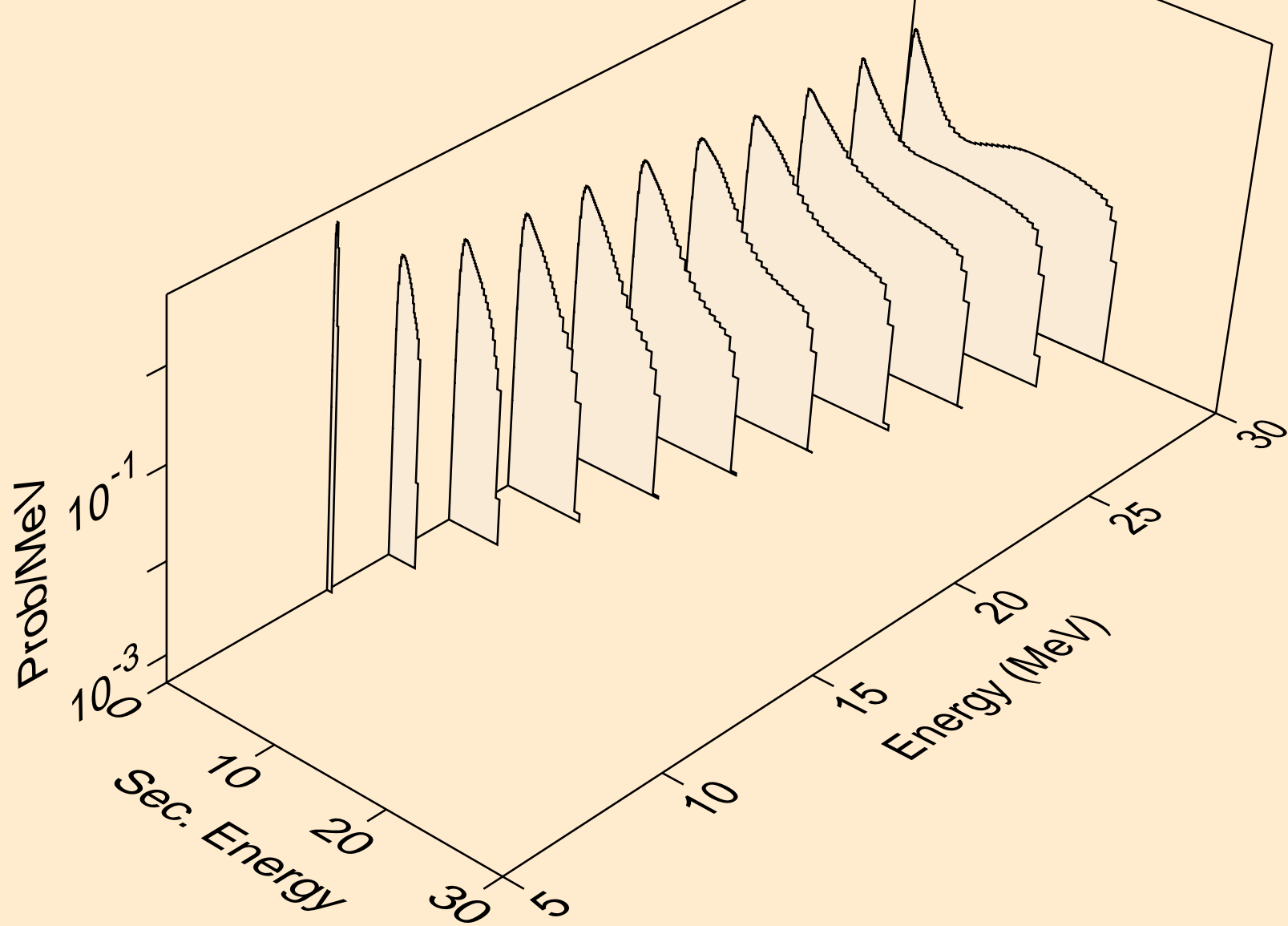



Y086 NEUTRON ACER TENDL-2021 LIBRARY; T=293.6K  
Neutron emission for (n,3n)

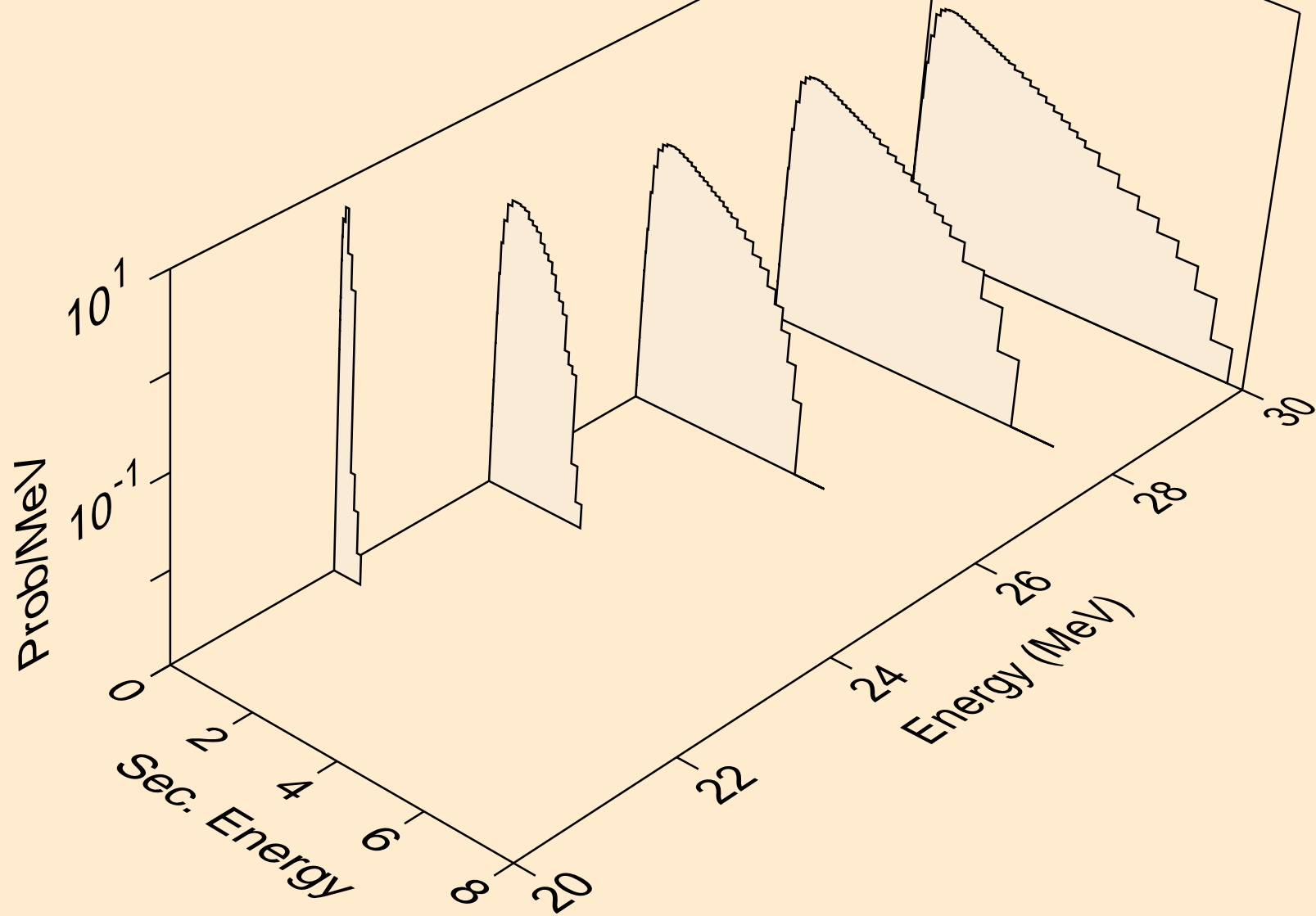

Y086 NEUTRON ACER TENDL-2021 LIBRARY; T=293.6K  
Neutron emission for (n,n\*)a

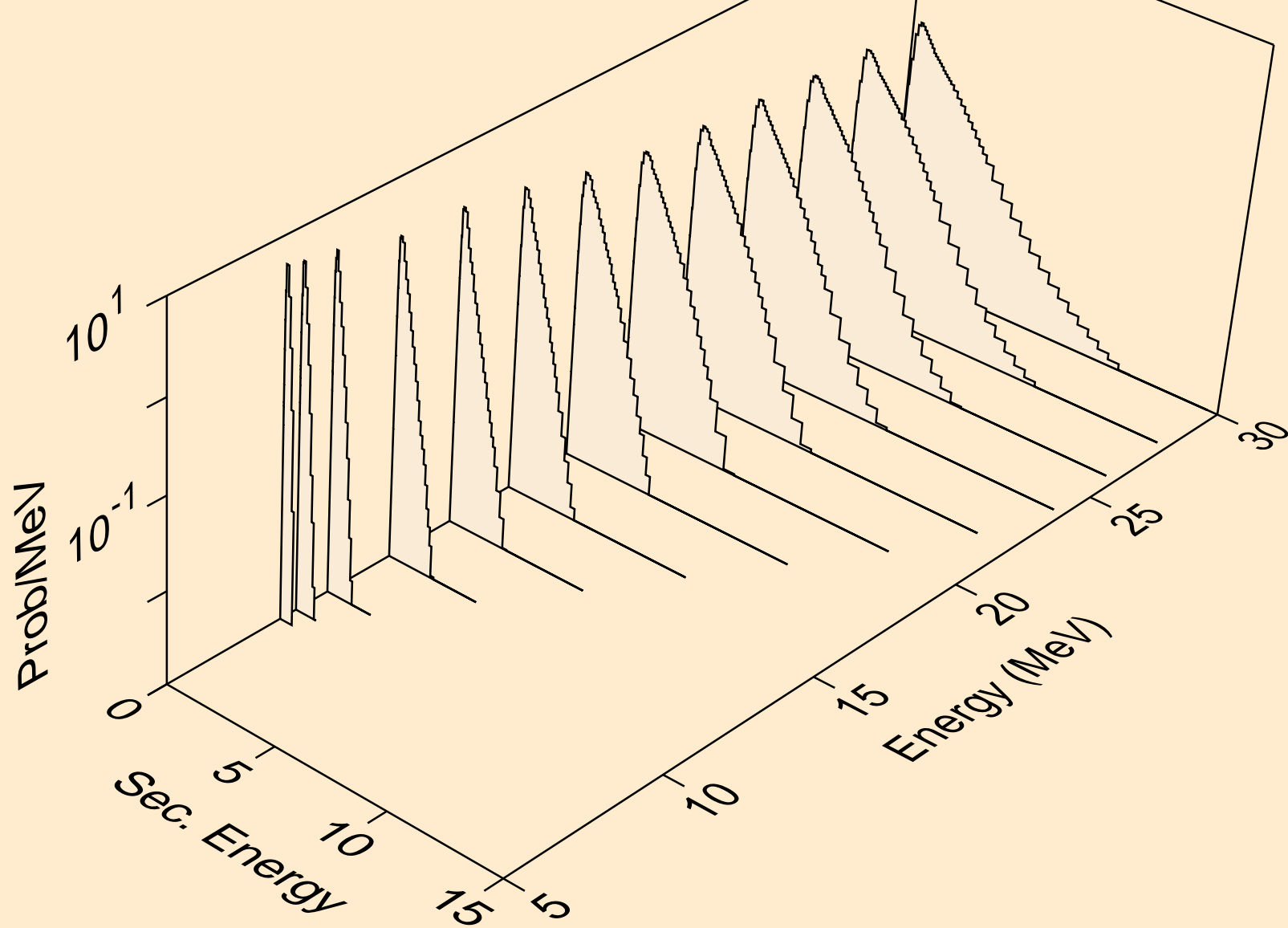

Y086 NEUTRON ACER TENDL-2021 LIBRARY; T=293.6K  
Neutron emission for (n,2n)a

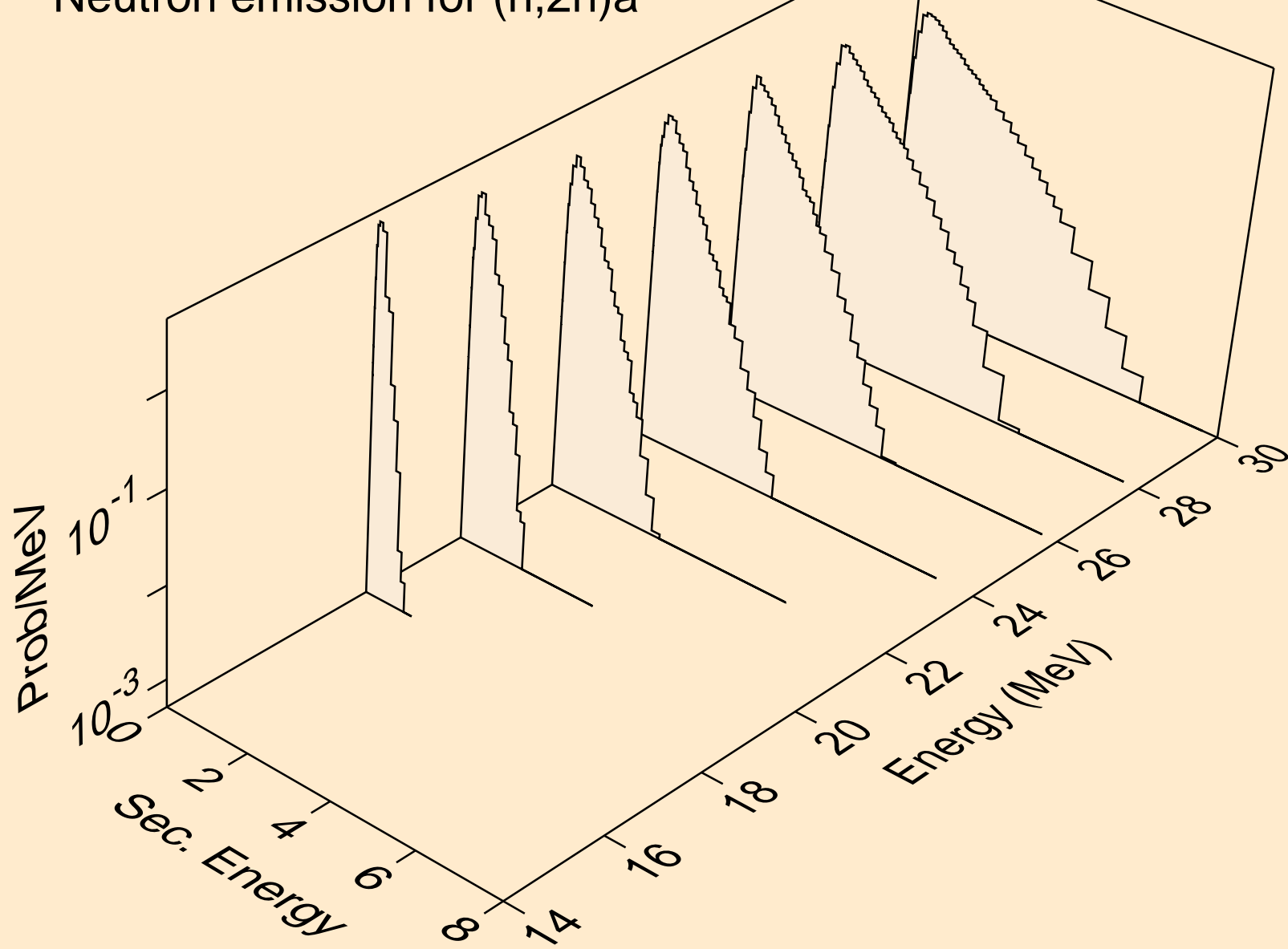

Y086 NEUTRON ACER TENDL-2021 LIBRARY; T=293.6K  
Neutron emission for (n,n\*)p

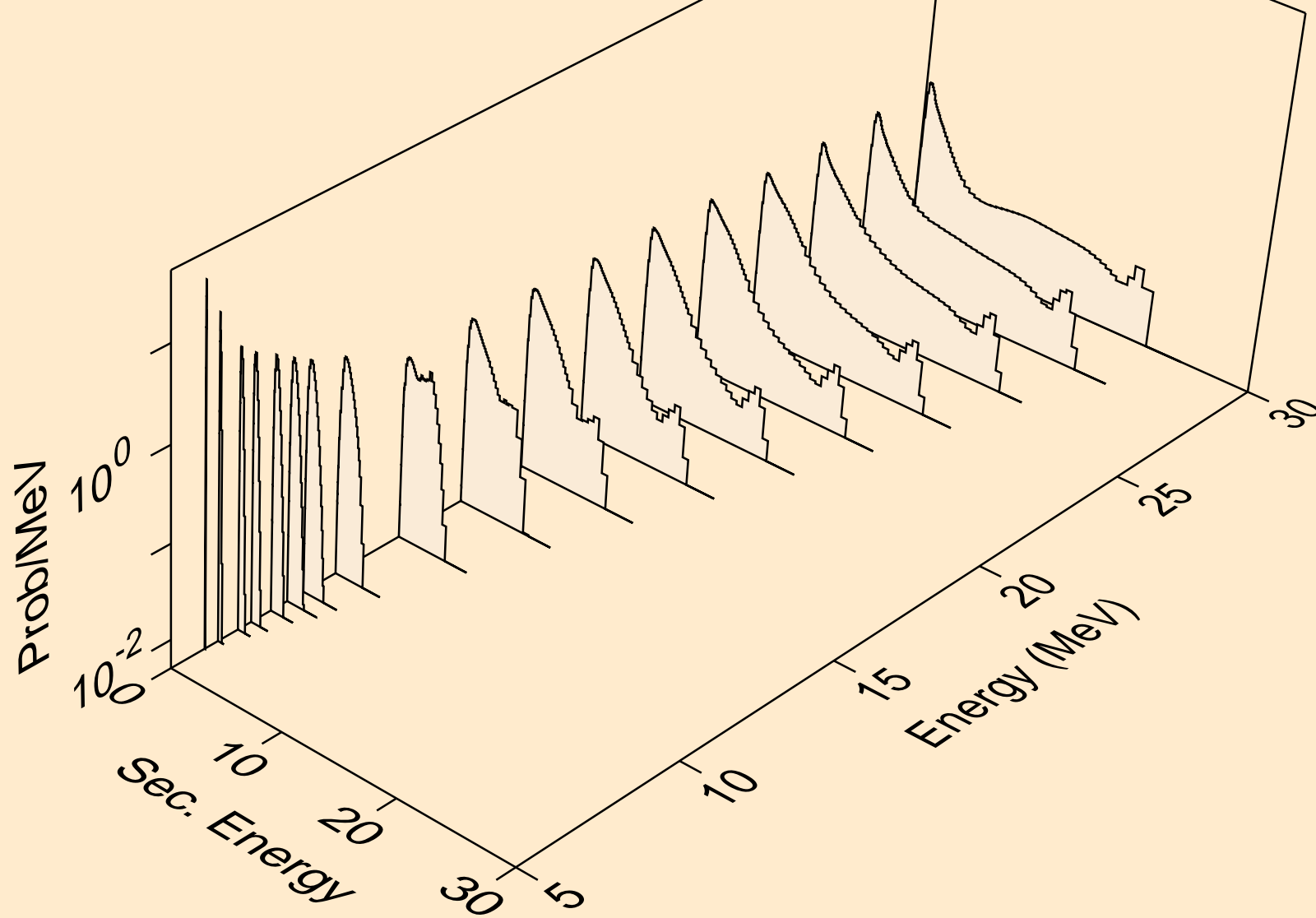

Y086 NEUTRON ACER TENDL-2021 LIBRARY; T=293.6K  
Neutron emission for (n,n\*)2a

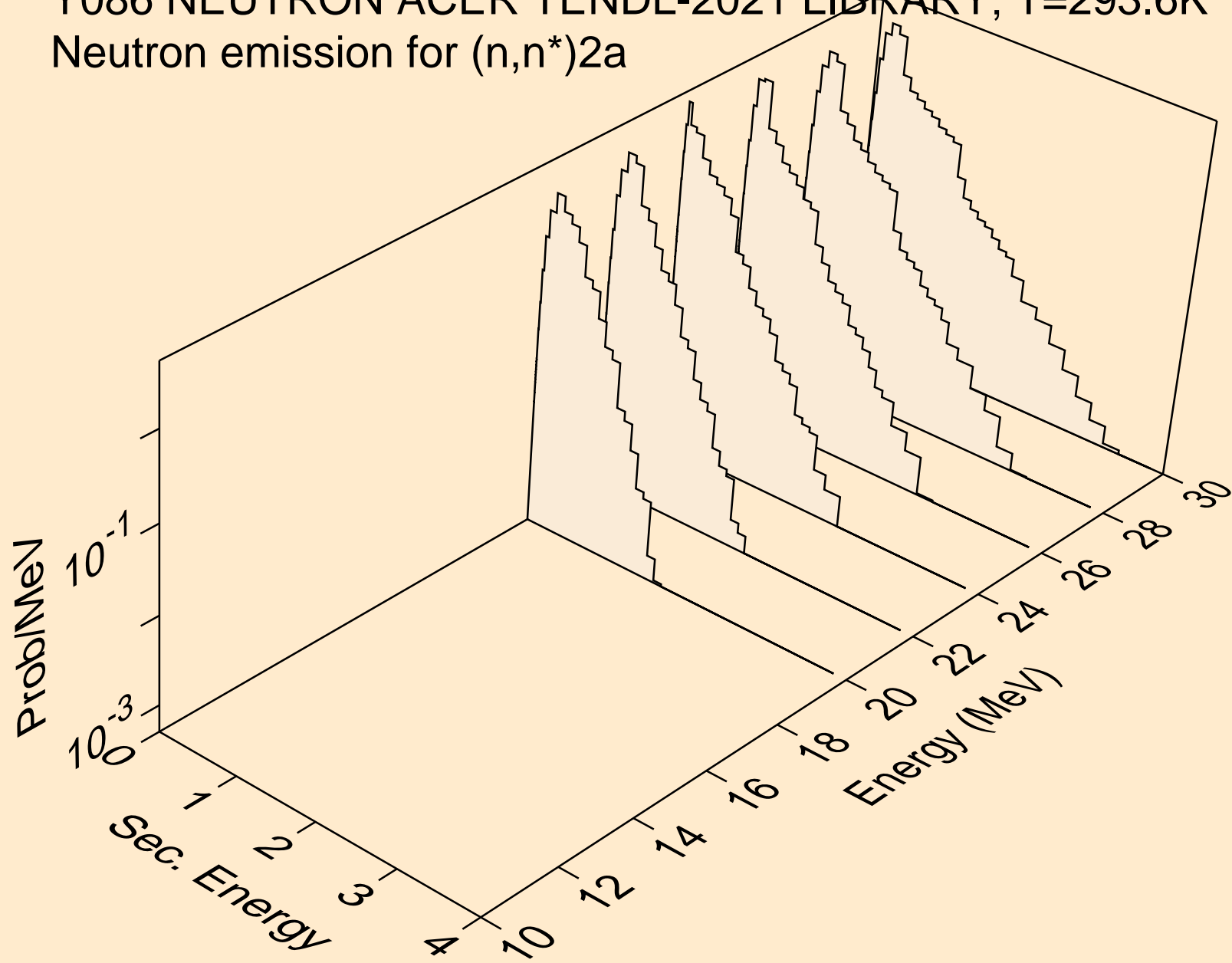

Y086 NEUTRON ACER TENDL-2021 LIBRARY; T=293.6K  
Neutron emission for (n,n\*)d

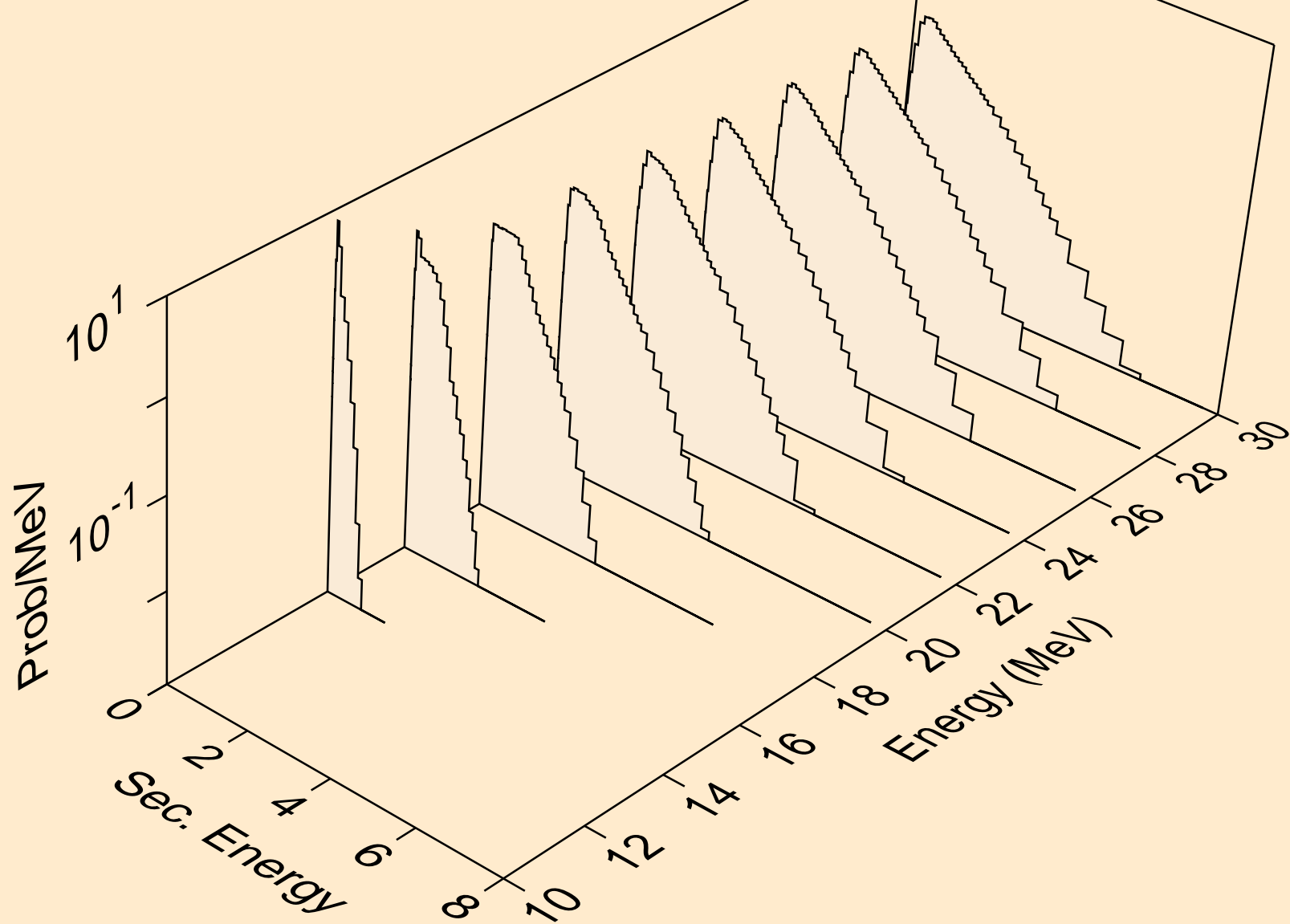

Y086 NEUTRON ACER TENDL-2021 LIBRARY; T=293.6K  
Neutron emission for (n,n\*)t

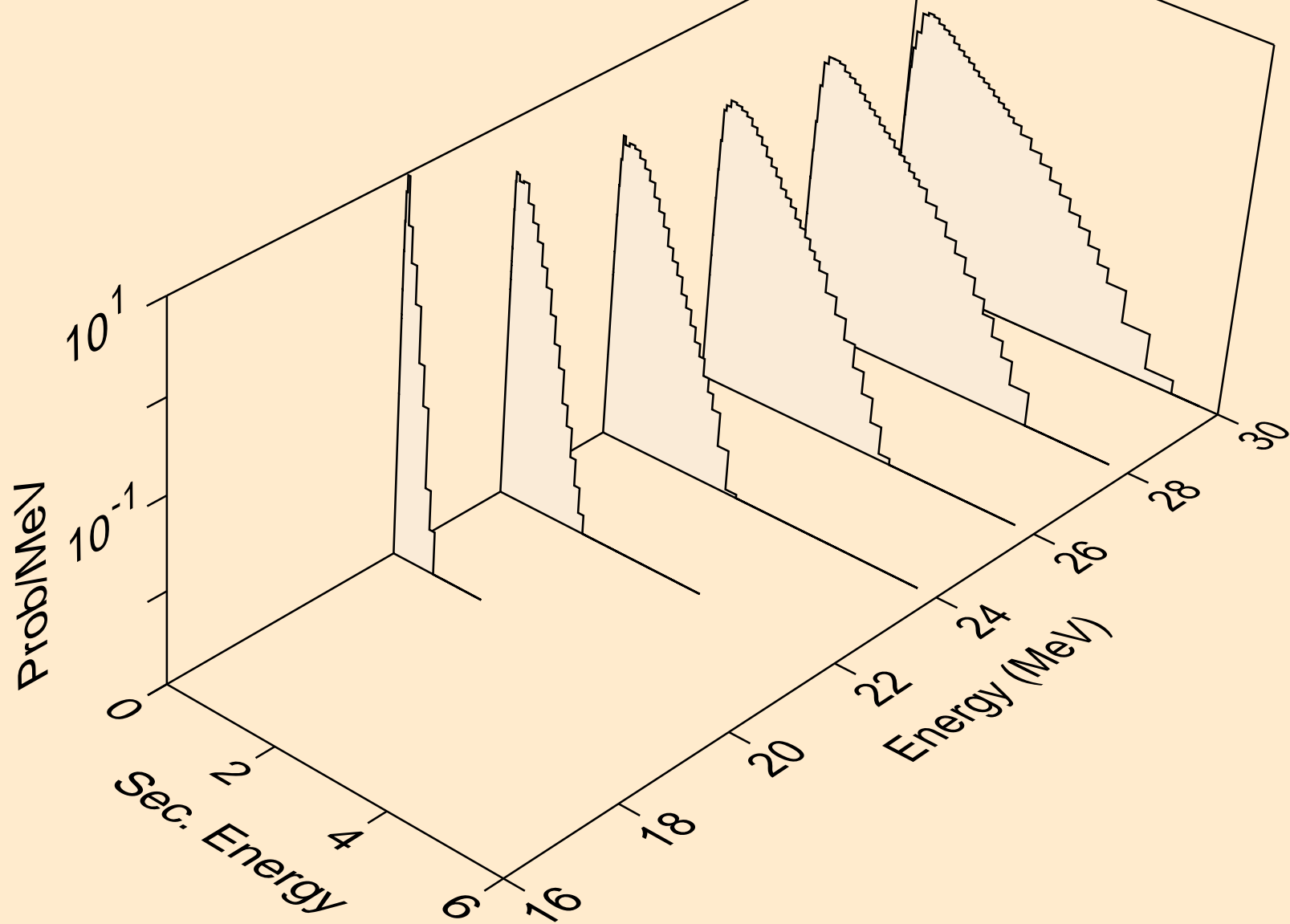

Y086 NEUTRON ACER TENDL-2021 LIBRARY; T=293.6K  
Neutron emission for (n,n\*)he3

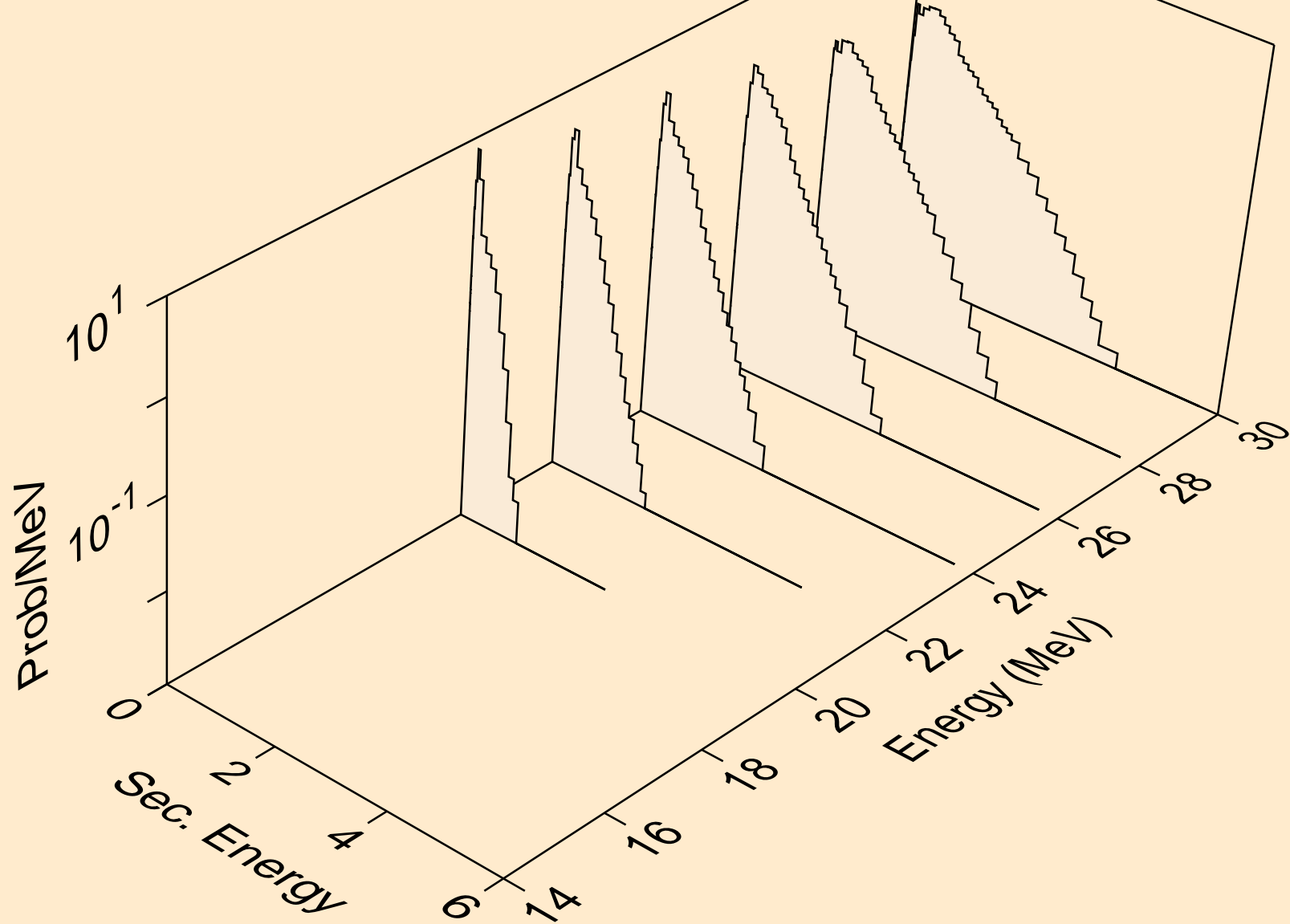



Y086 NEUTRON ACER TENDL-2021 LIBRARY; T=293.6K  
Neutron emission for (n,2np)

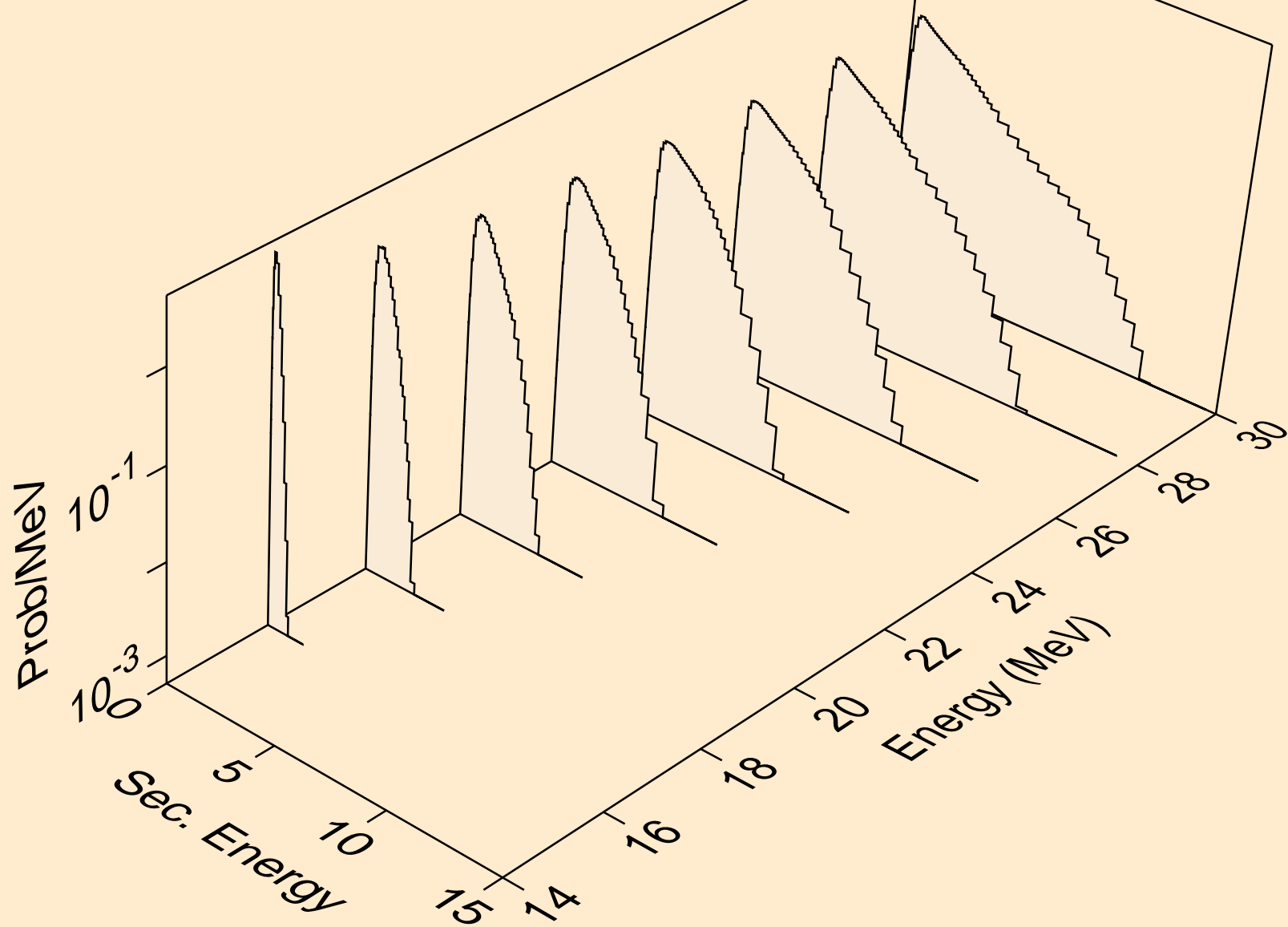

Y086 NEUTRON ACER TENDL-2021 LIBRARY; T=293.6K  
Neutron emission for (n,3np)

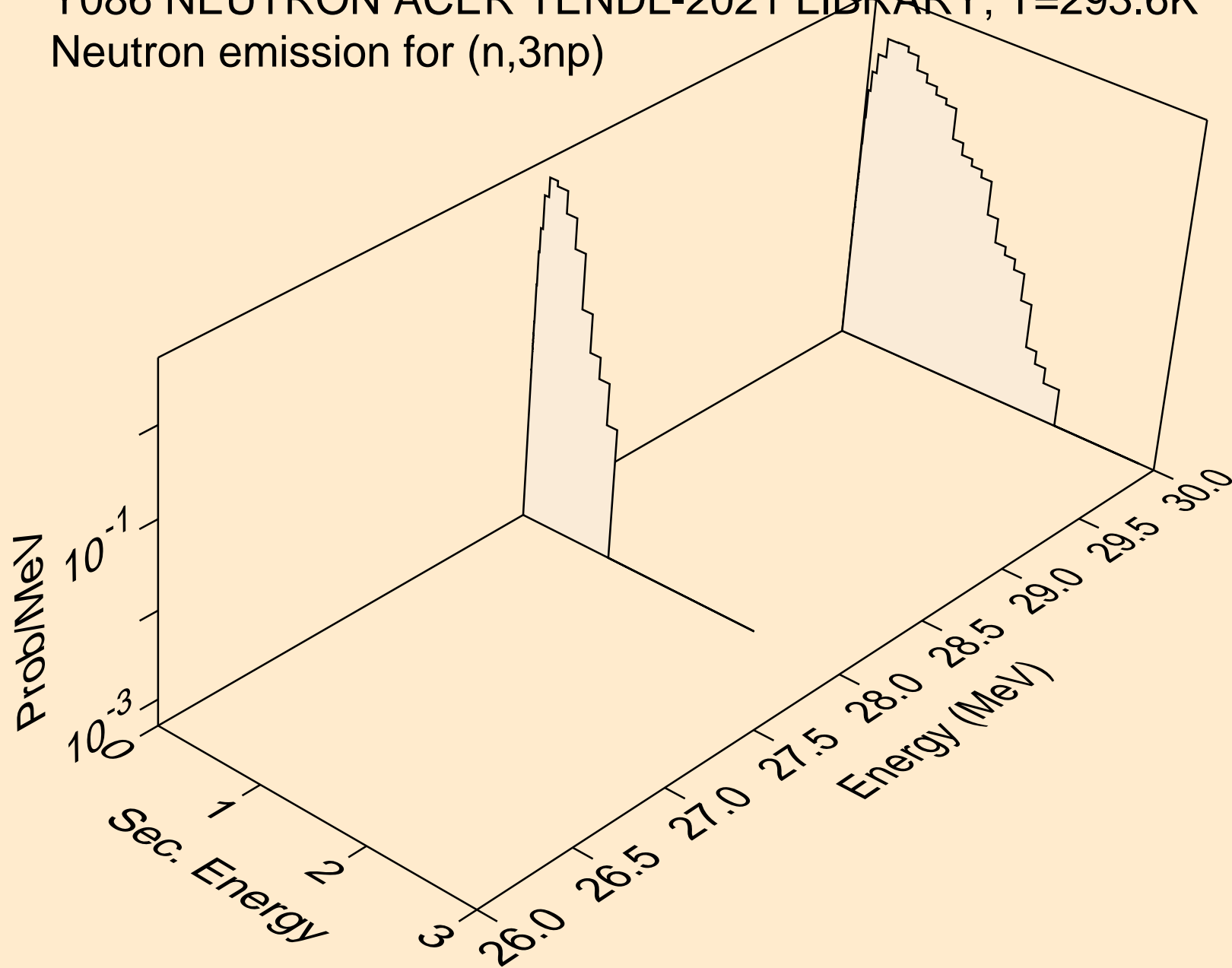

Y086 NEUTRON ACER TENDL-2021 LIBRARY; T=293.6K  
Neutron emission for (n,2np)

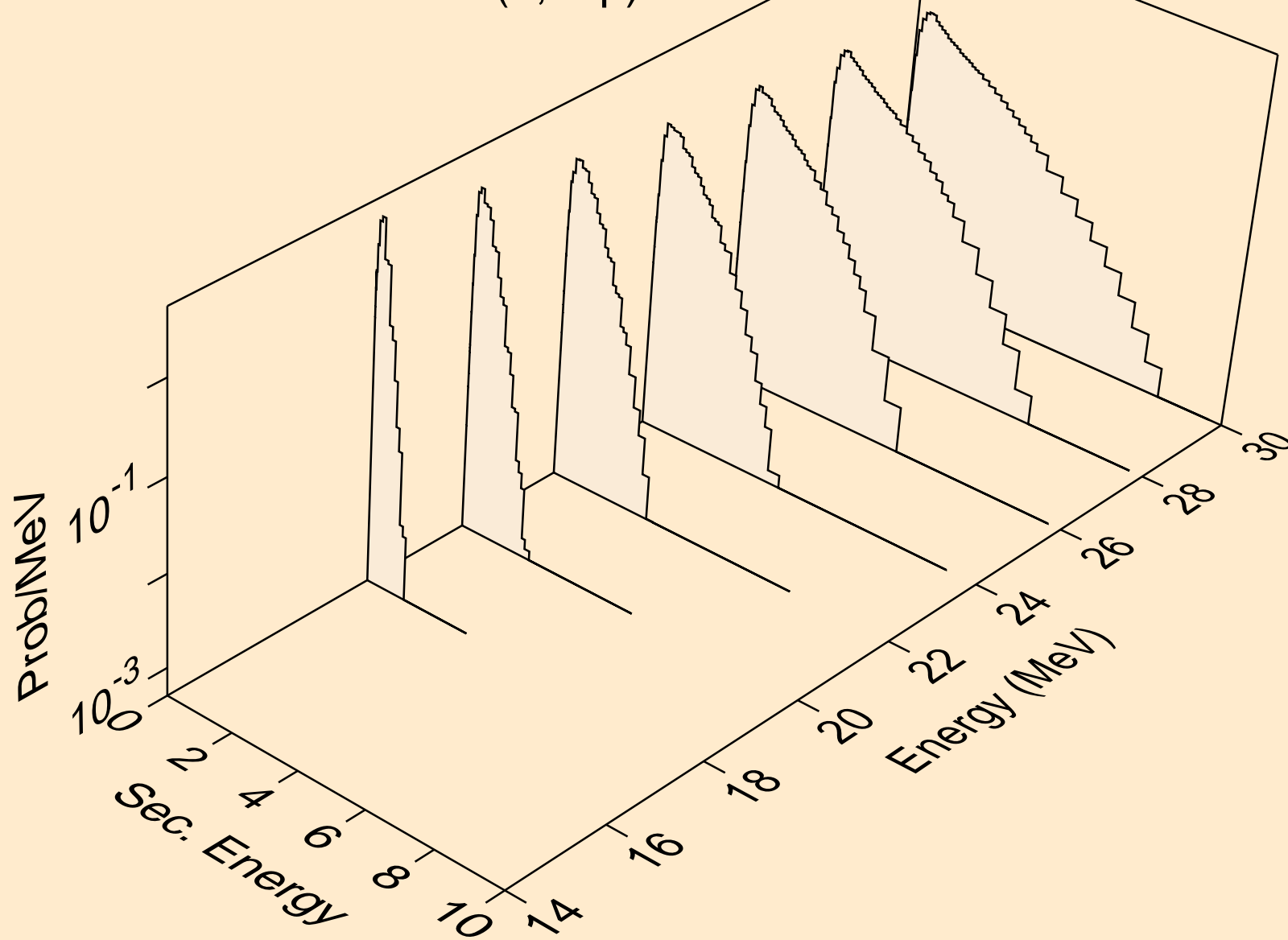

Y086 NEUTRON ACER TENDL-2021 LIBRARY; T=293.6K  
Neutron emission for (n,npa)

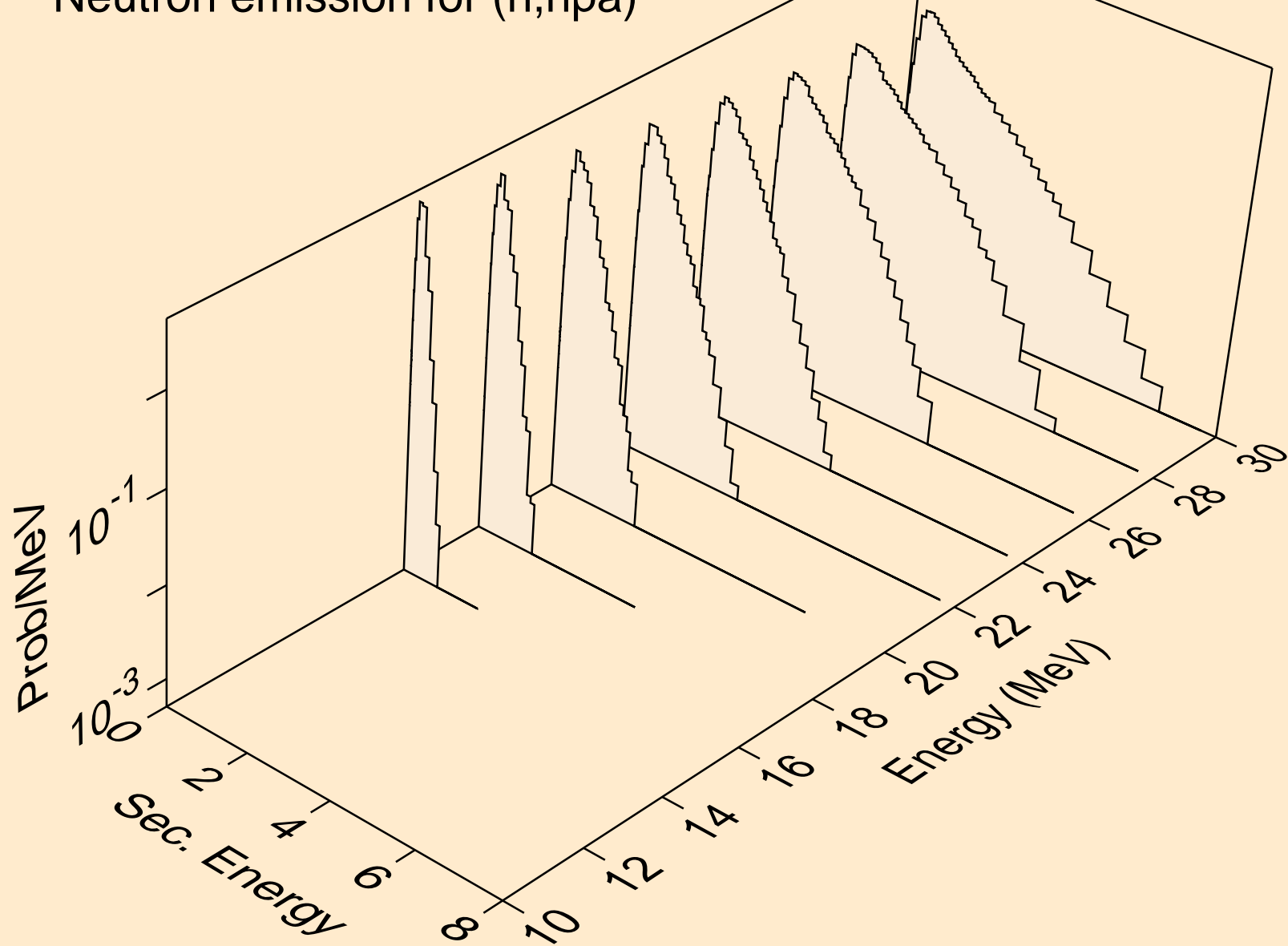

Y086 NEUTRON ACER TENDL-2021 LIBRARY; T=293.6K  
Neutron emission for (n,n\*c)

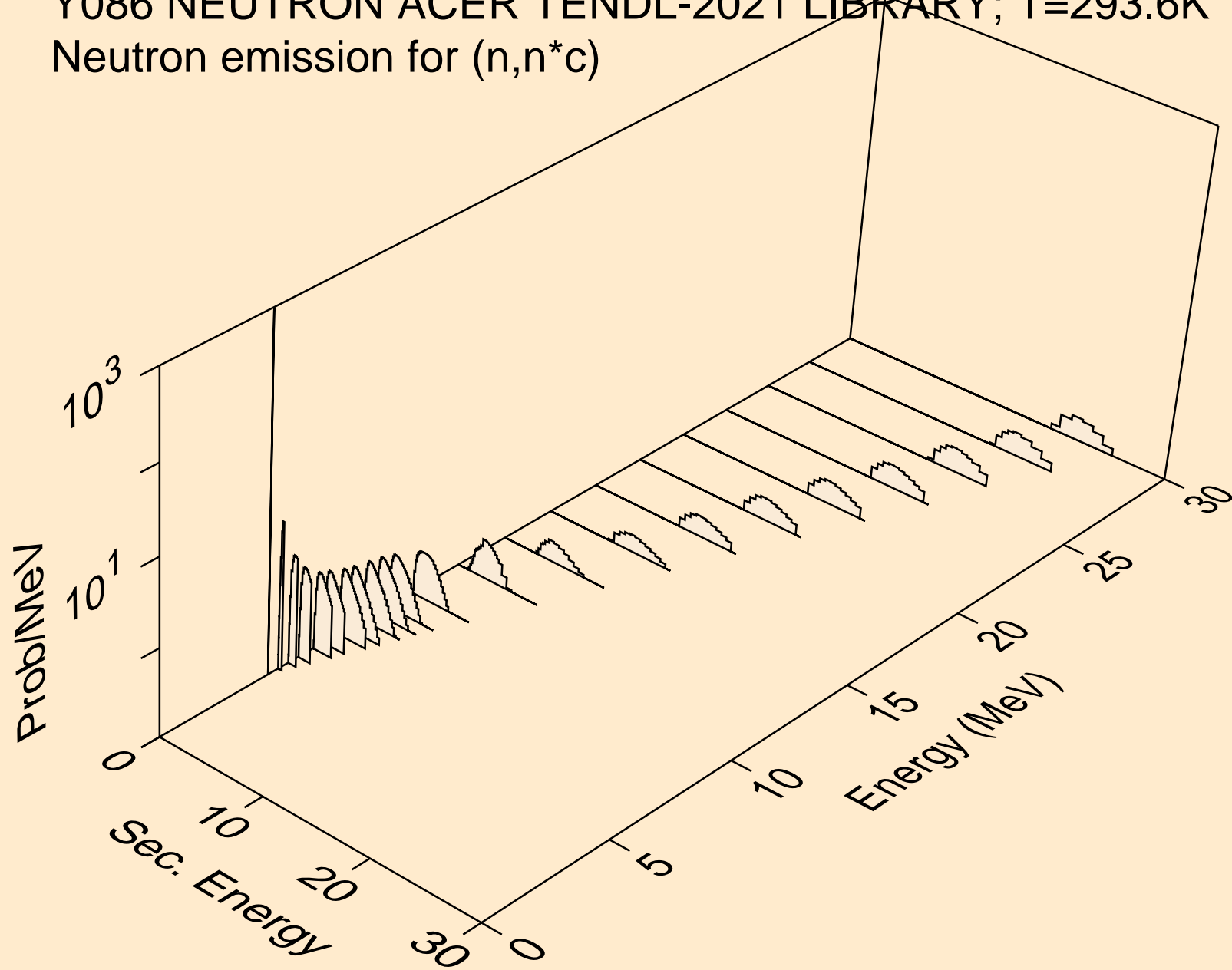

Y086 NEUTRON ACER TENDL-2021 LIBRARY; T=293.6K  
Photon emission for (n,x)

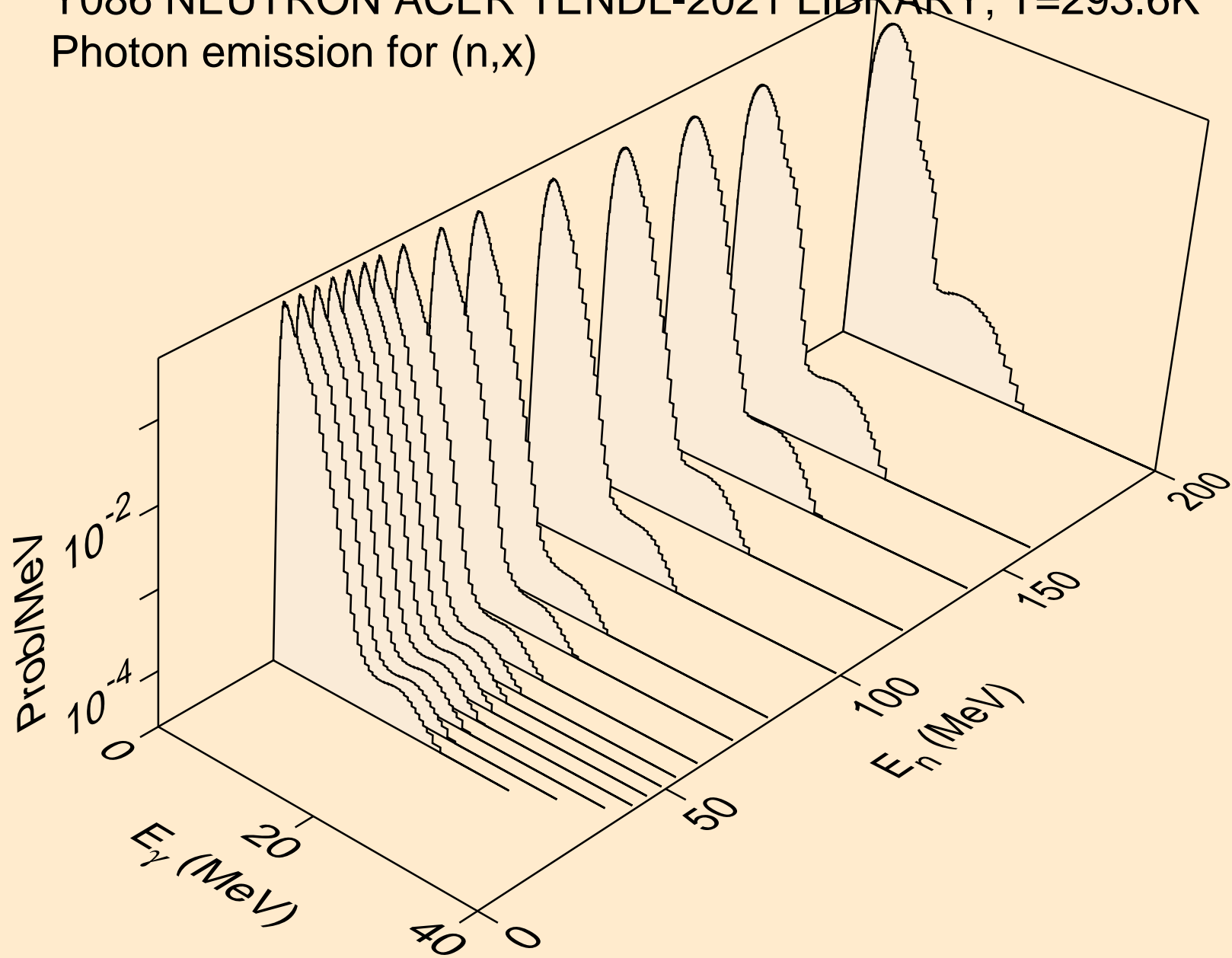

Y086 NEUTRON ACER TENDL-2021 LIBRARY; T=293.6K  
Photon emission for (n,2nd)

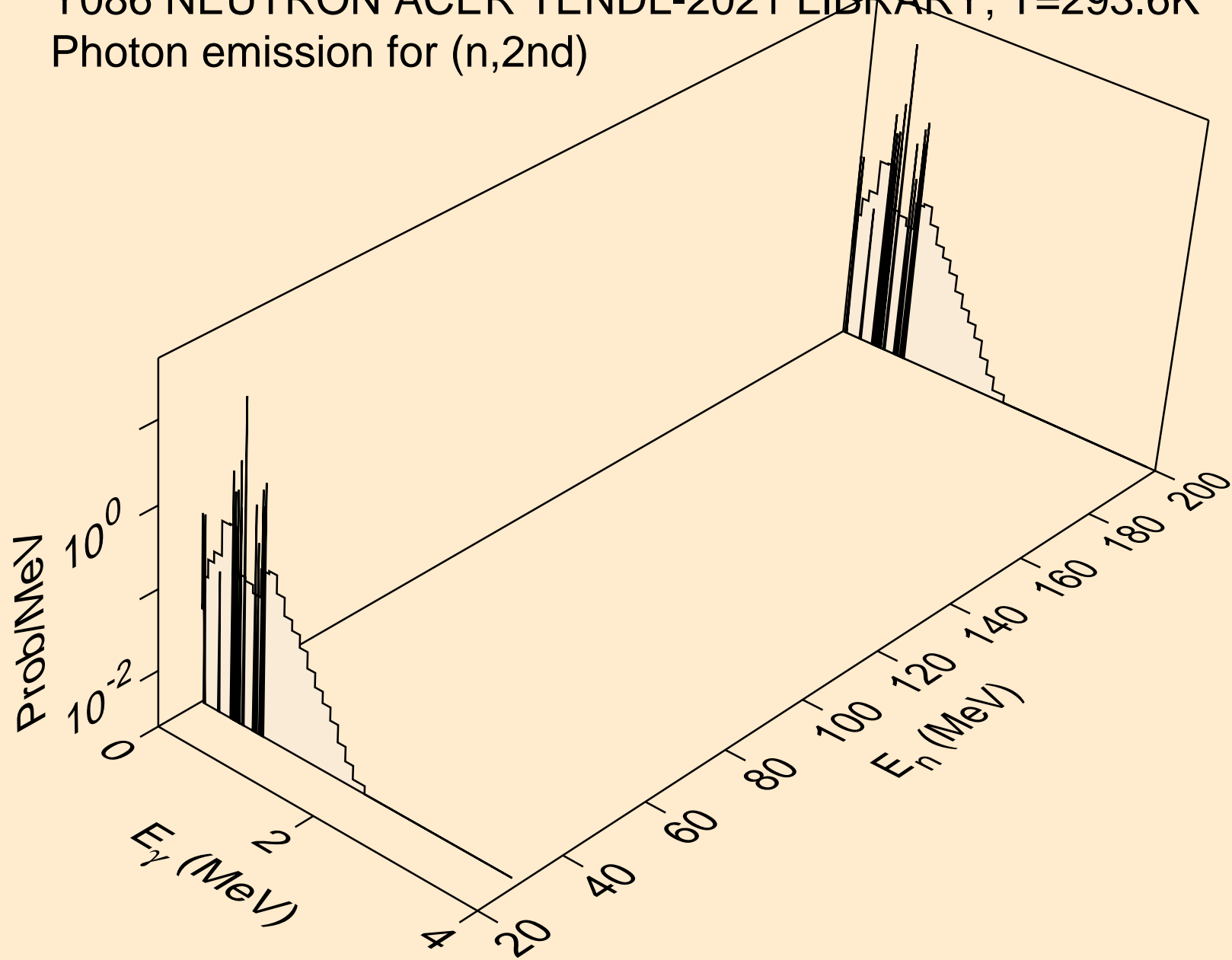

Y086 NEUTRON ACER TENDL-2021 LIBRARY; T=293.6K  
Photon emission for (n,2n)

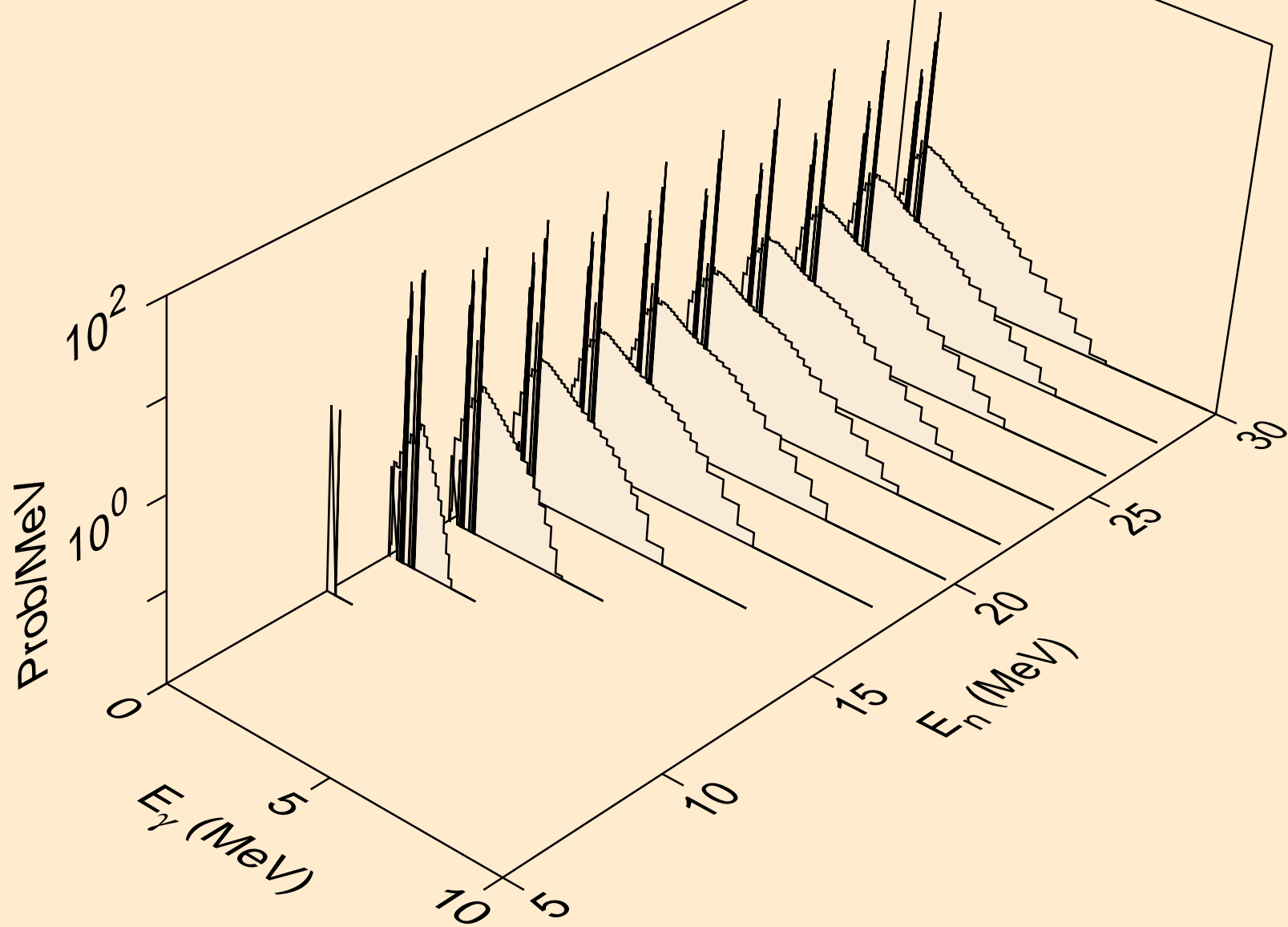



Y086 NEUTRON ACER TENDL-2021 LIBRARY; T=293.6K  
Photon emission for (n,3n)

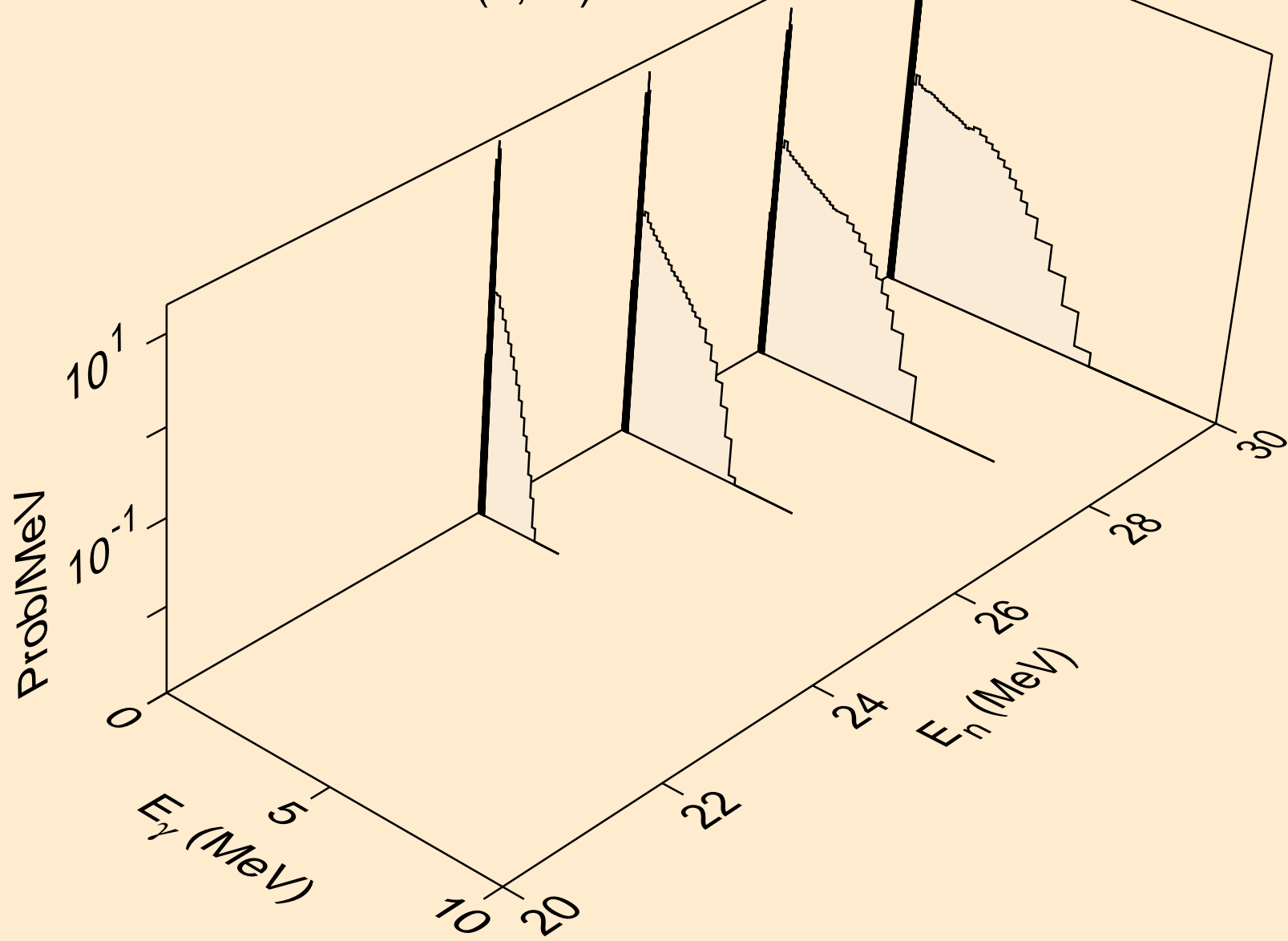

Y086 NEUTRON ACER TENDL-2021 LIBRARY; T=293.6K  
Photon emission for (n,n\*)a

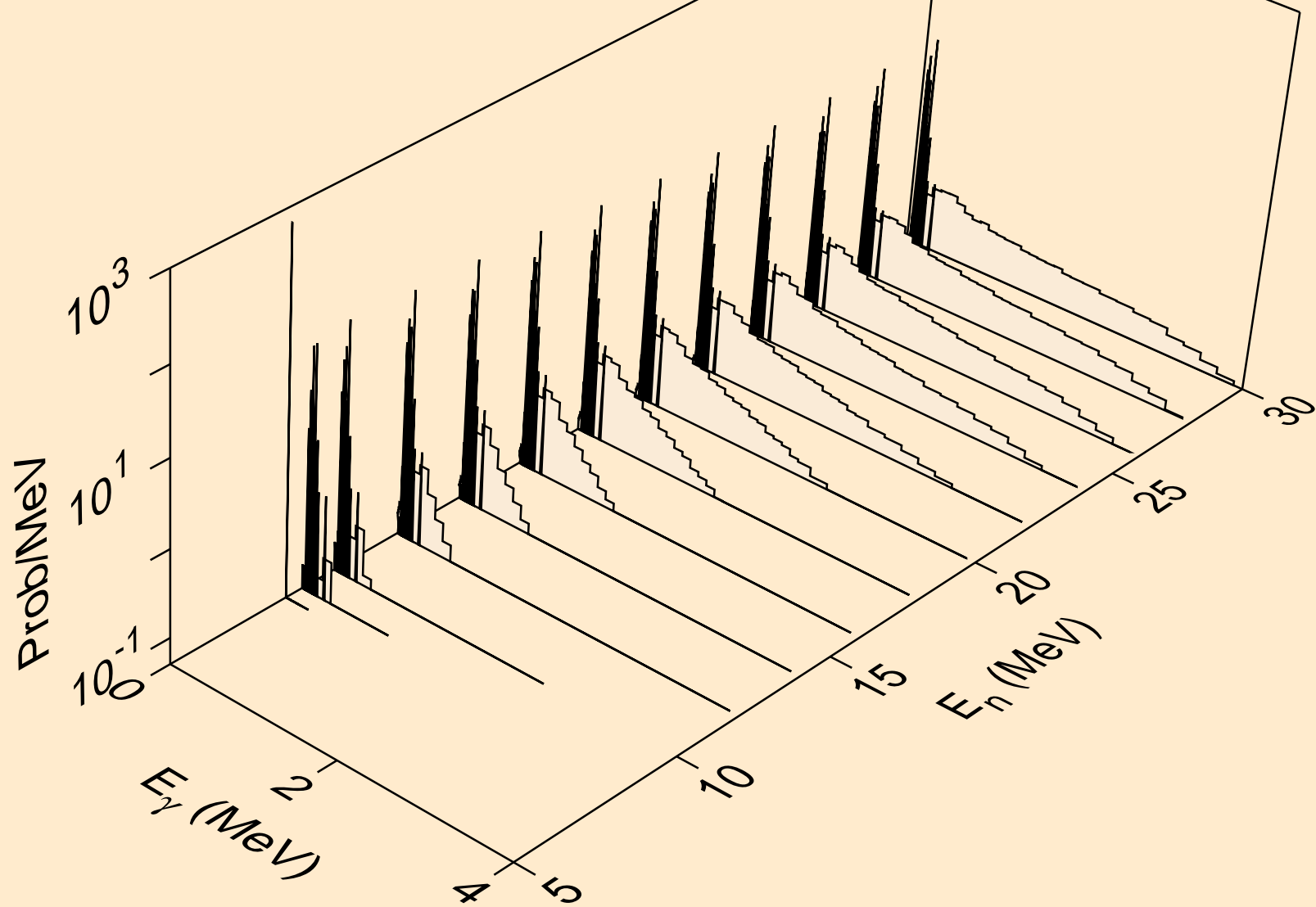

Y086 NEUTRON ACER TENDL-2021 LIBRARY; T=293.6K  
Photon emission for (n,2n)a

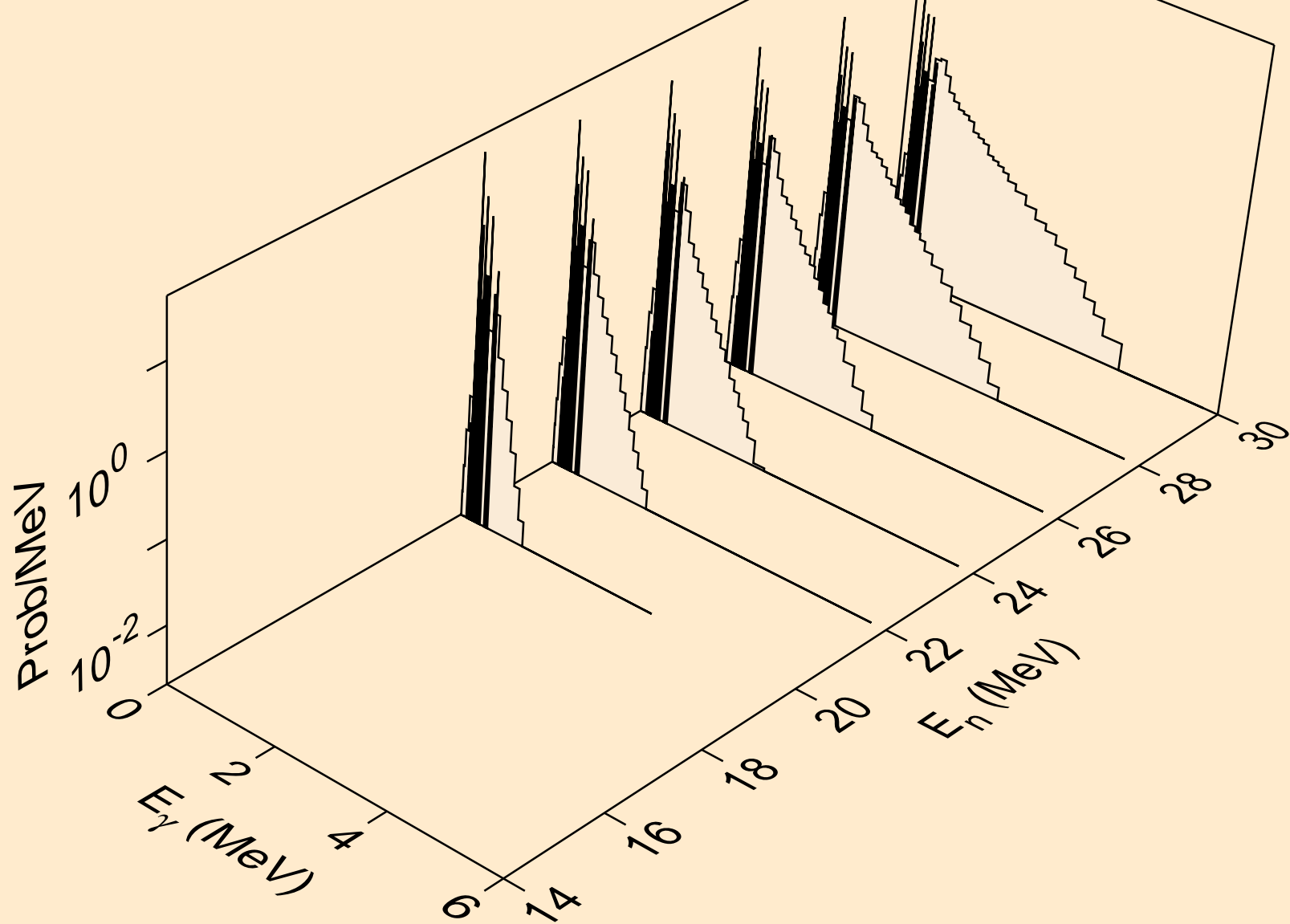

Y086 NEUTRON ACER TENDL-2021 LIBRARY; T=293.6K  
Photon emission for (n,n\*)p

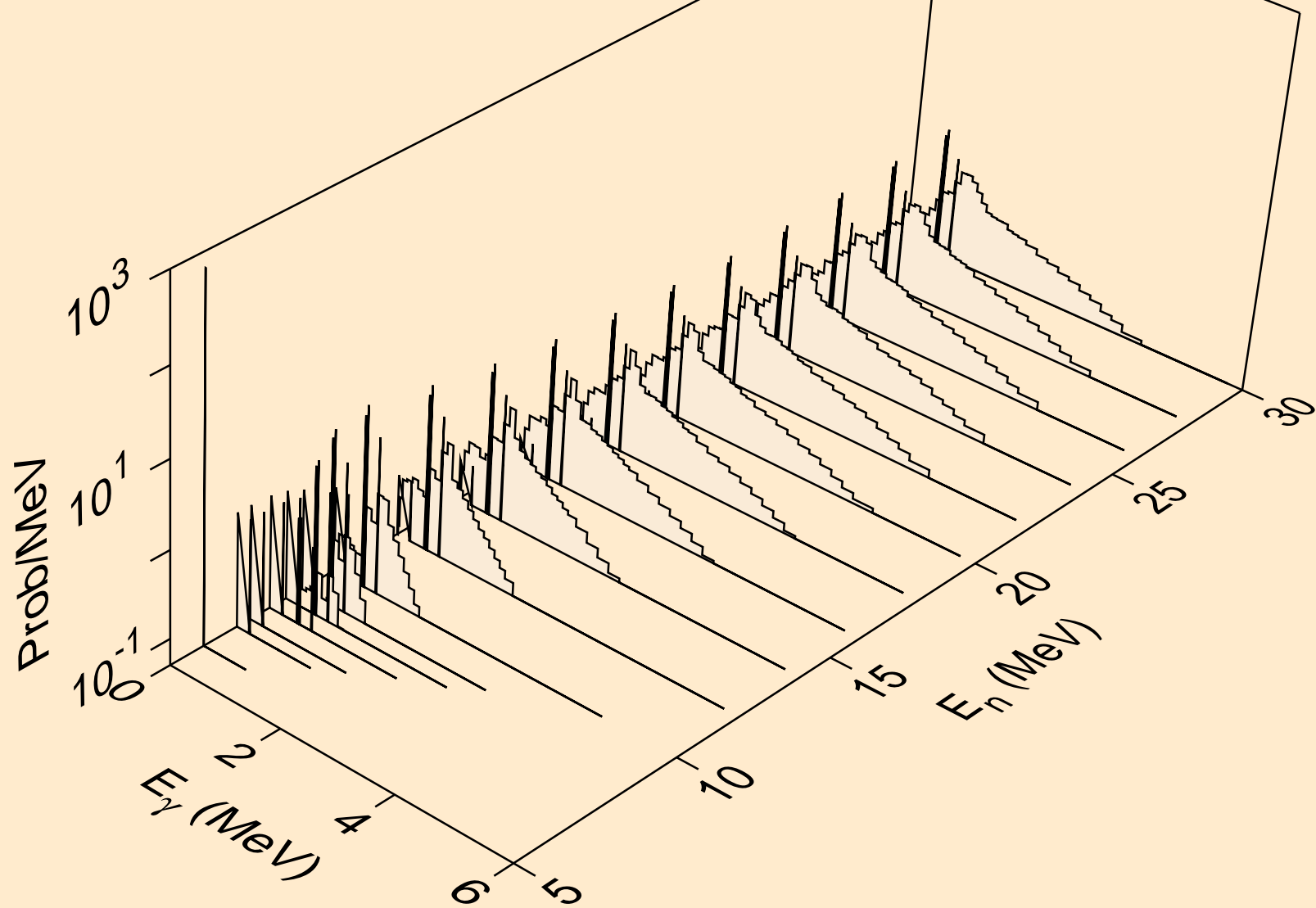

Y086 NEUTRON ACER TENDL-2021 LIBRARY; T=293.6K  
Photon emission for (n,n\*)2a

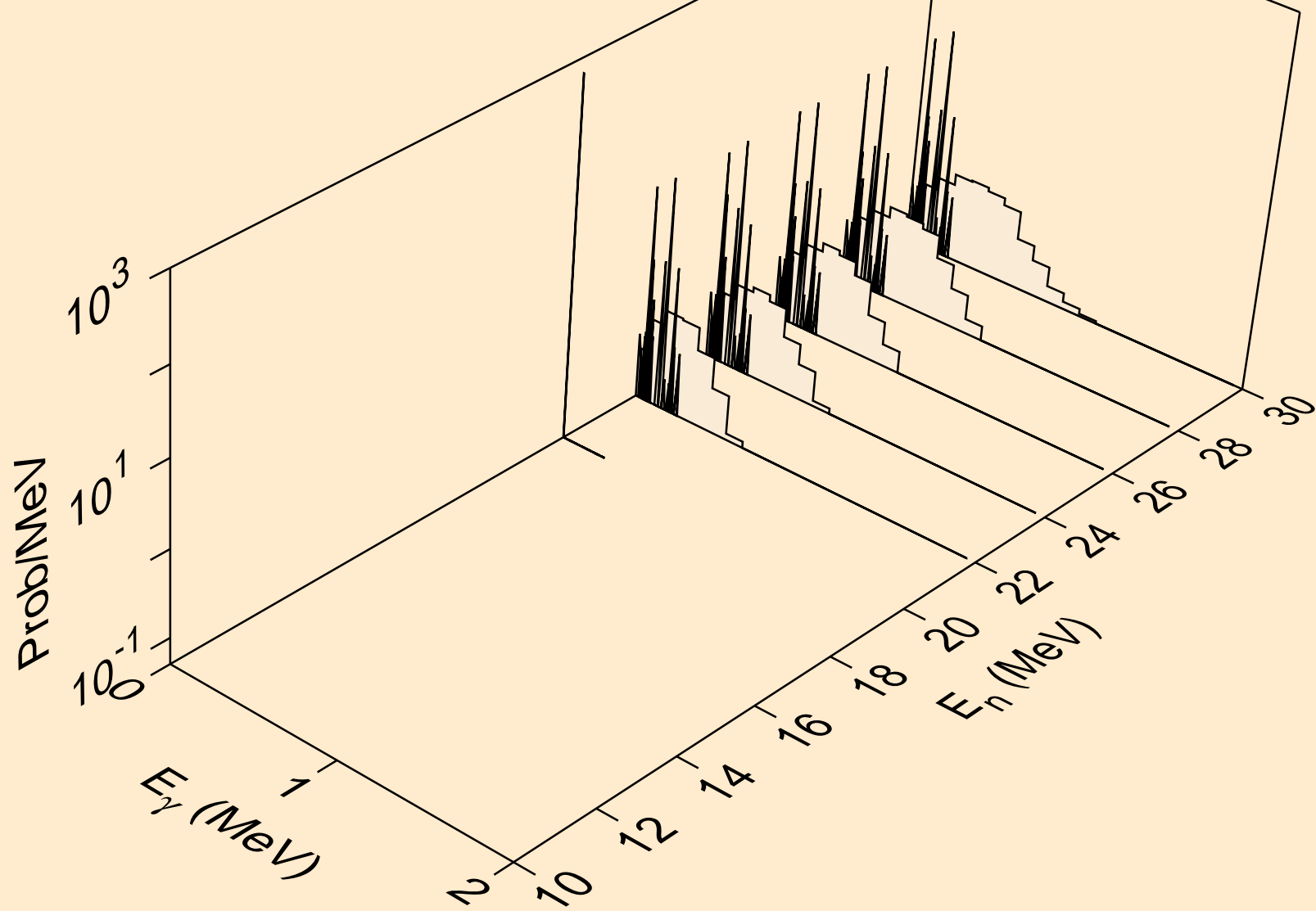

Y086 NEUTRON ACER TENDL-2021 LIBRARY; T=293.6K  
Photon emission for (n,n\*)d

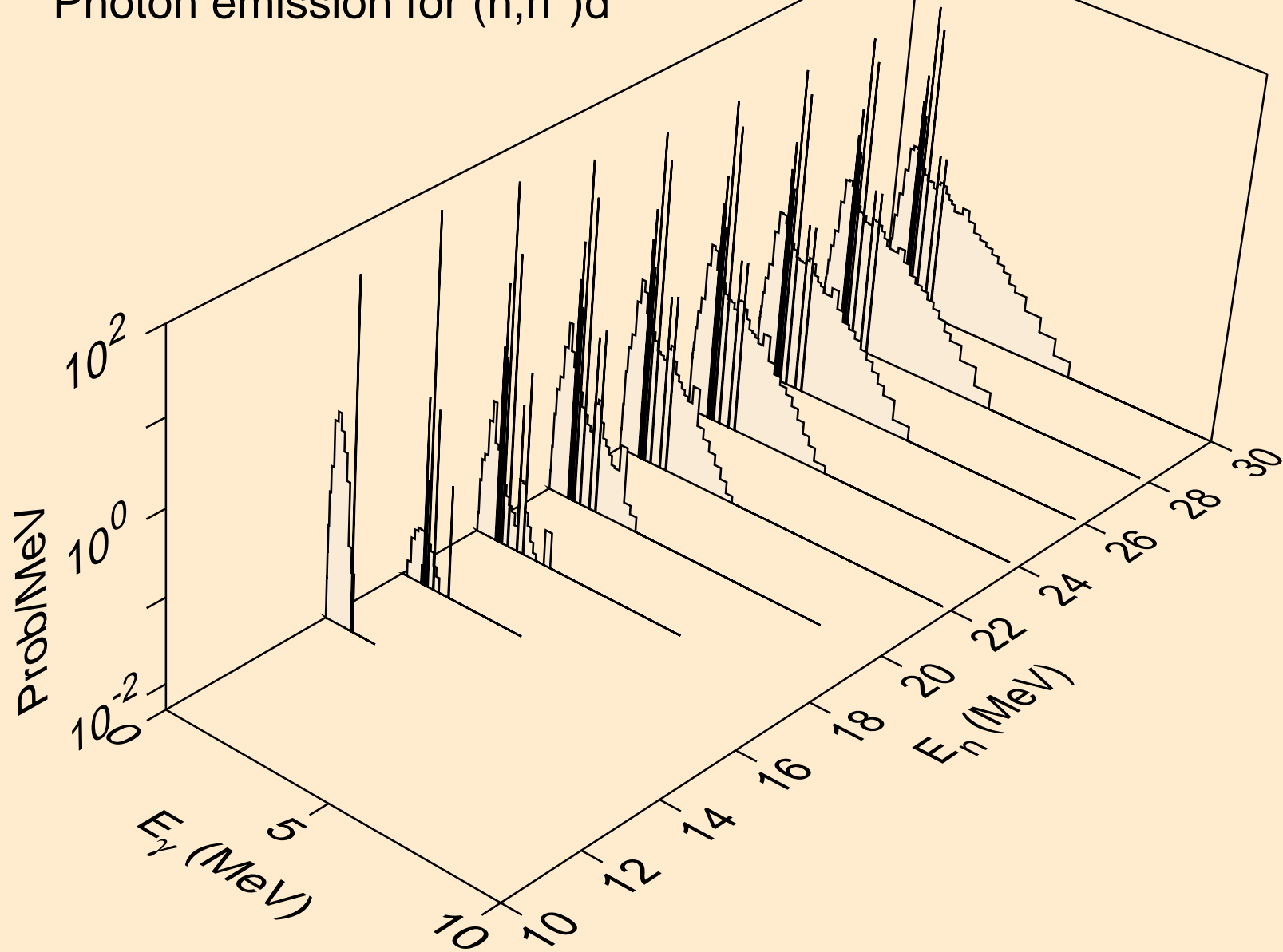

Y086 NEUTRON ACER TENDL-2021 LIBRARY; T=293.6K  
Photon emission for (n,n\*)t

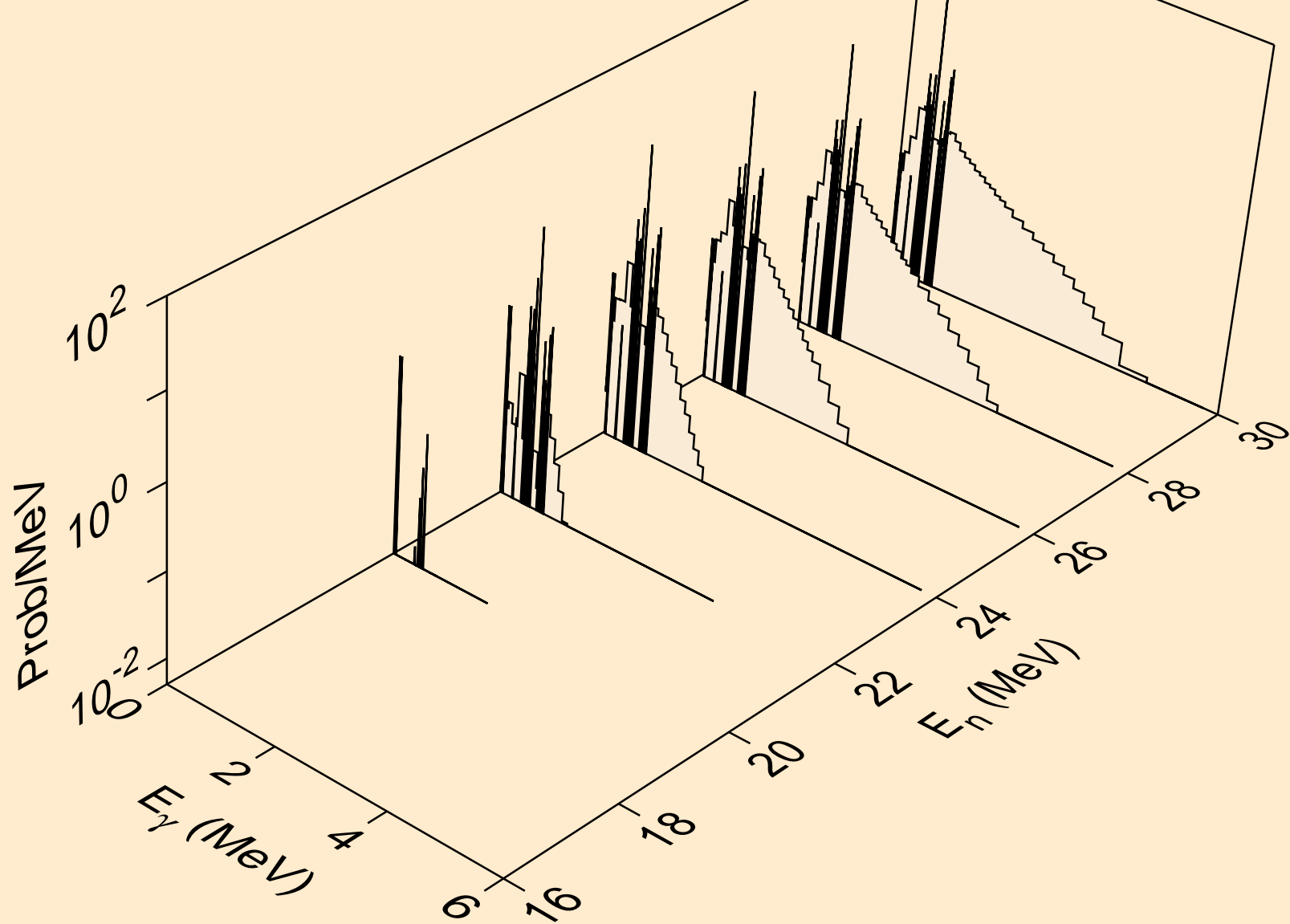

Y086 NEUTRON ACER TENDL-2021 LIBRARY; T=293.6K  
Photon emission for (n,n\*)he3

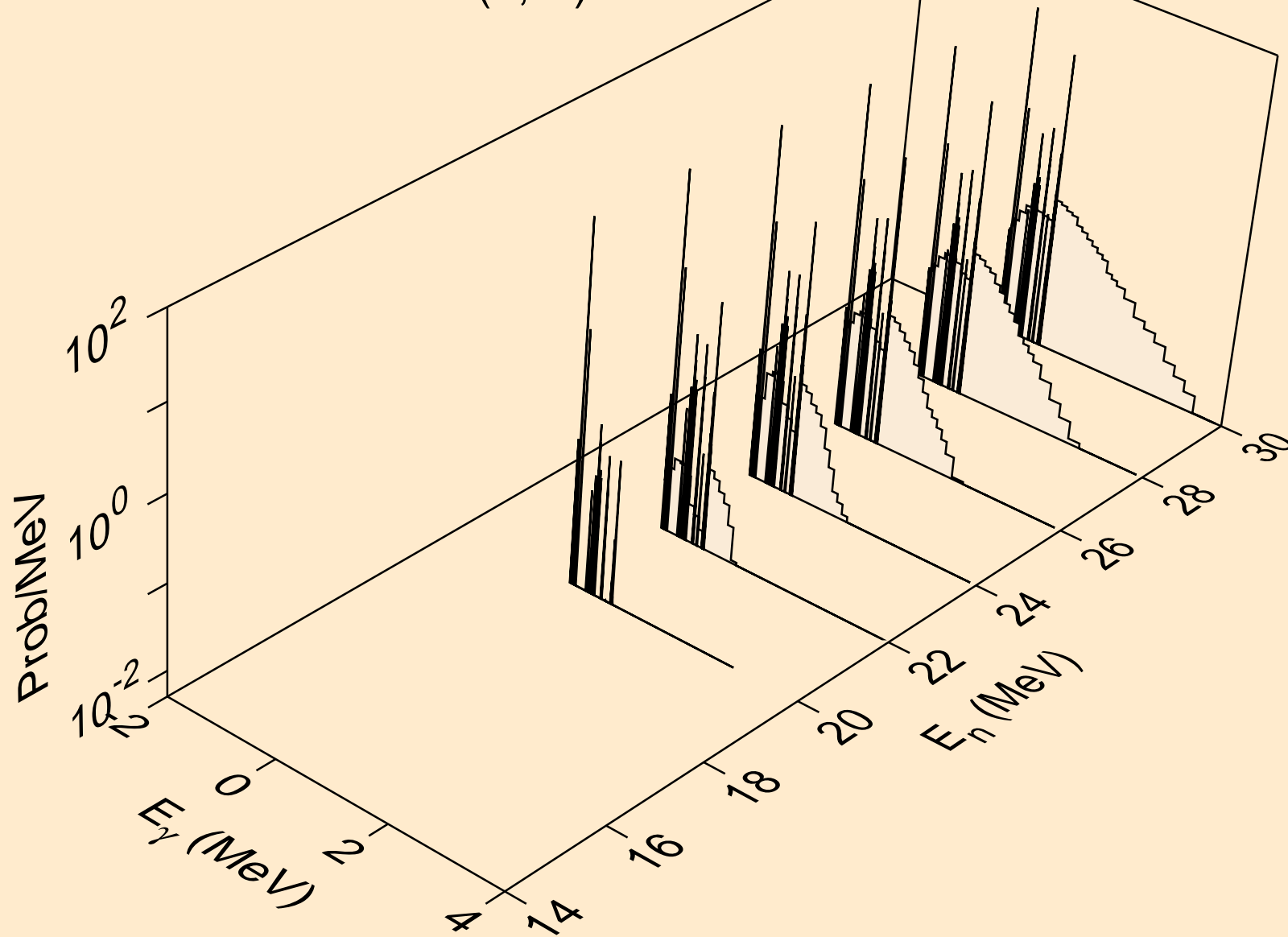



Y086 NEUTRON ACER TENDL-2021 LIBRARY; T=293.6K  
Photon emission for (n,2np)

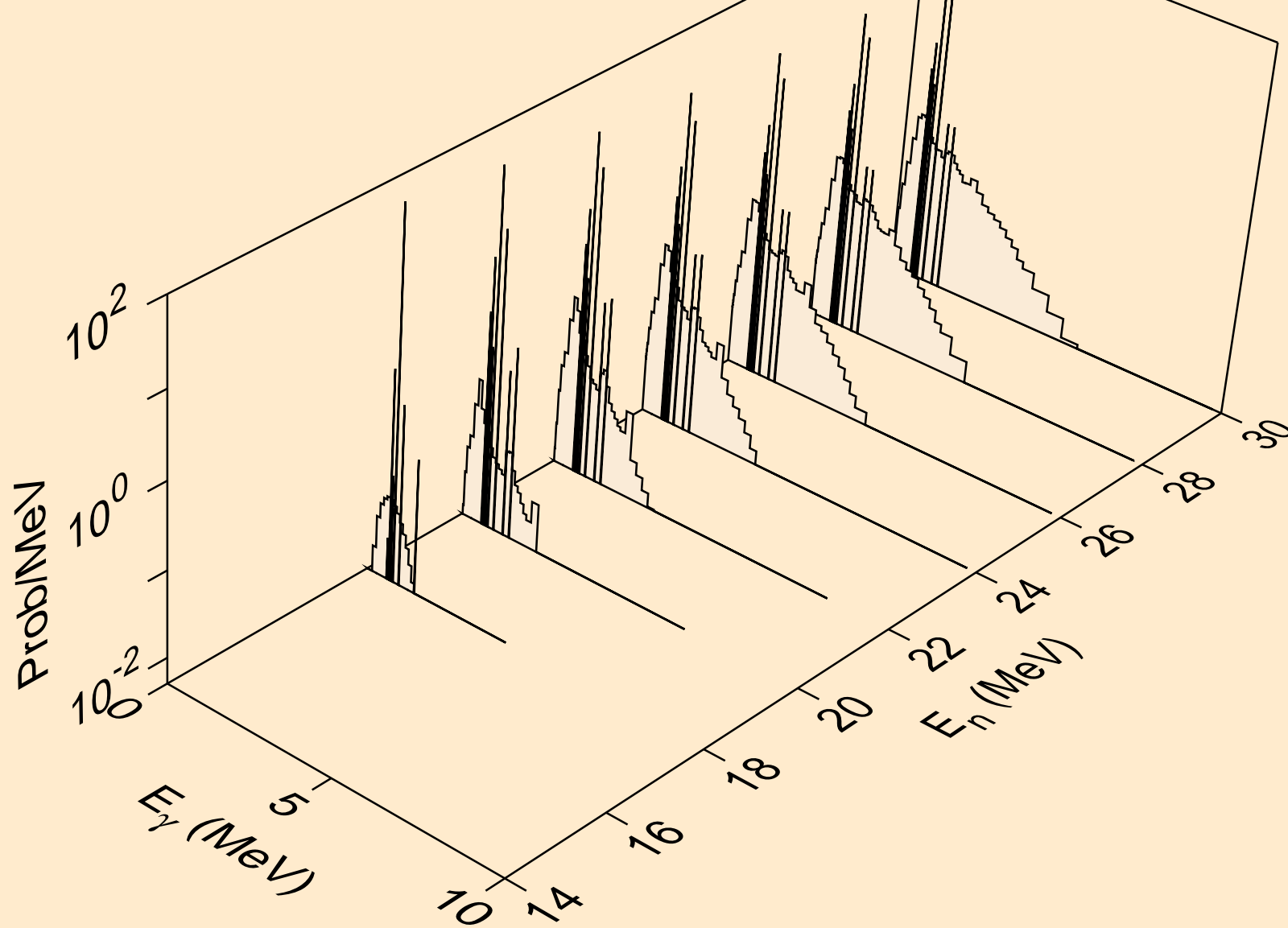

Y086 NEUTRON ACER TENDL-2021 LIBRARY; T=293.6K  
Photon emission for (n,3np)

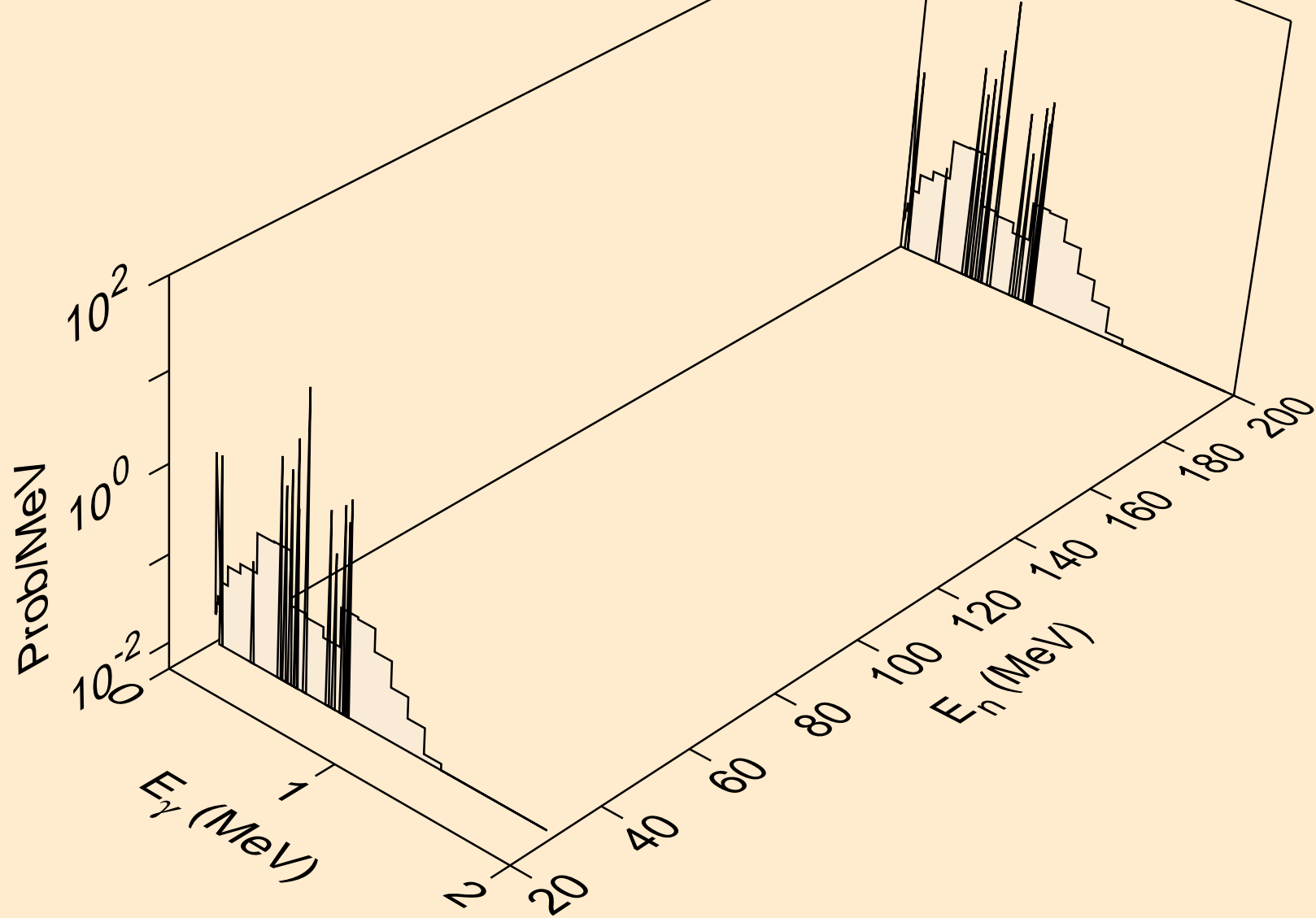

Y086 NEUTRON ACER TENDL-2021 LIBRARY; T=293.6K  
Photon emission for (n,2np)

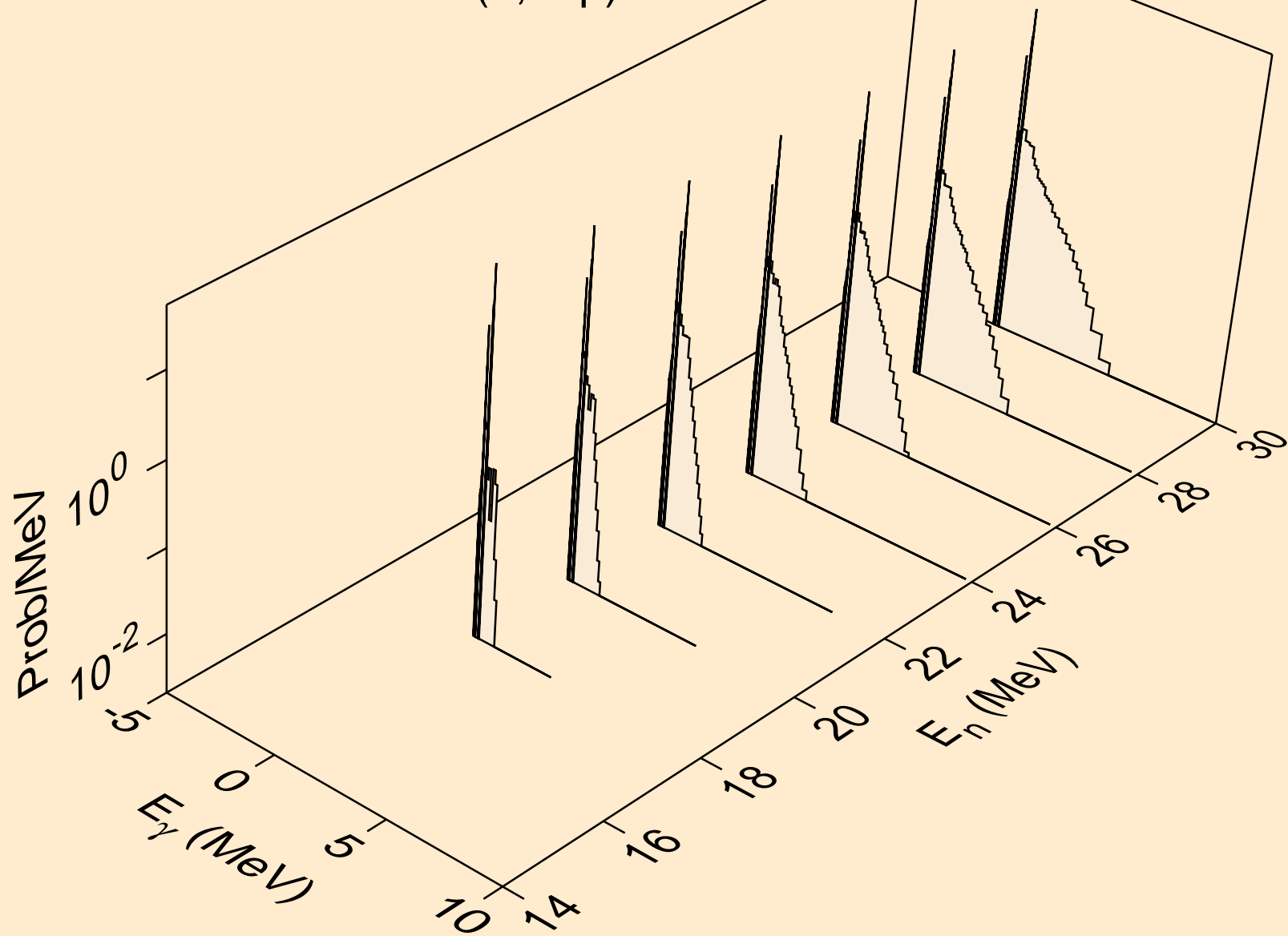

Y086 NEUTRON ACER TENDL-2021 LIBRARY; T=293.6K  
Photon emission for (n,npa)

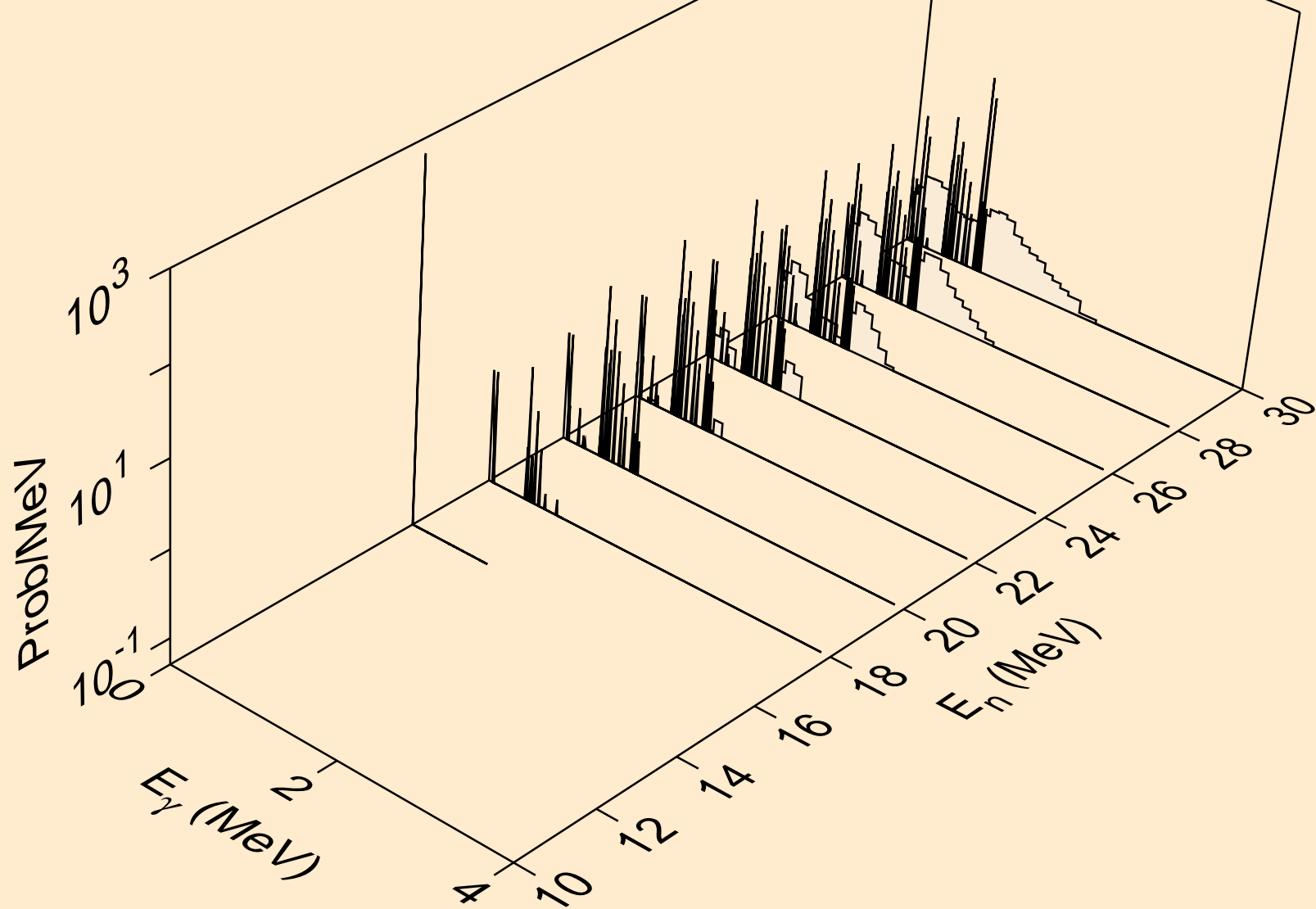

Y086 NEUTRON ACER TENDL-2021 LIBRARY; T=293.6K  
Photon emission for (n,n\*c)

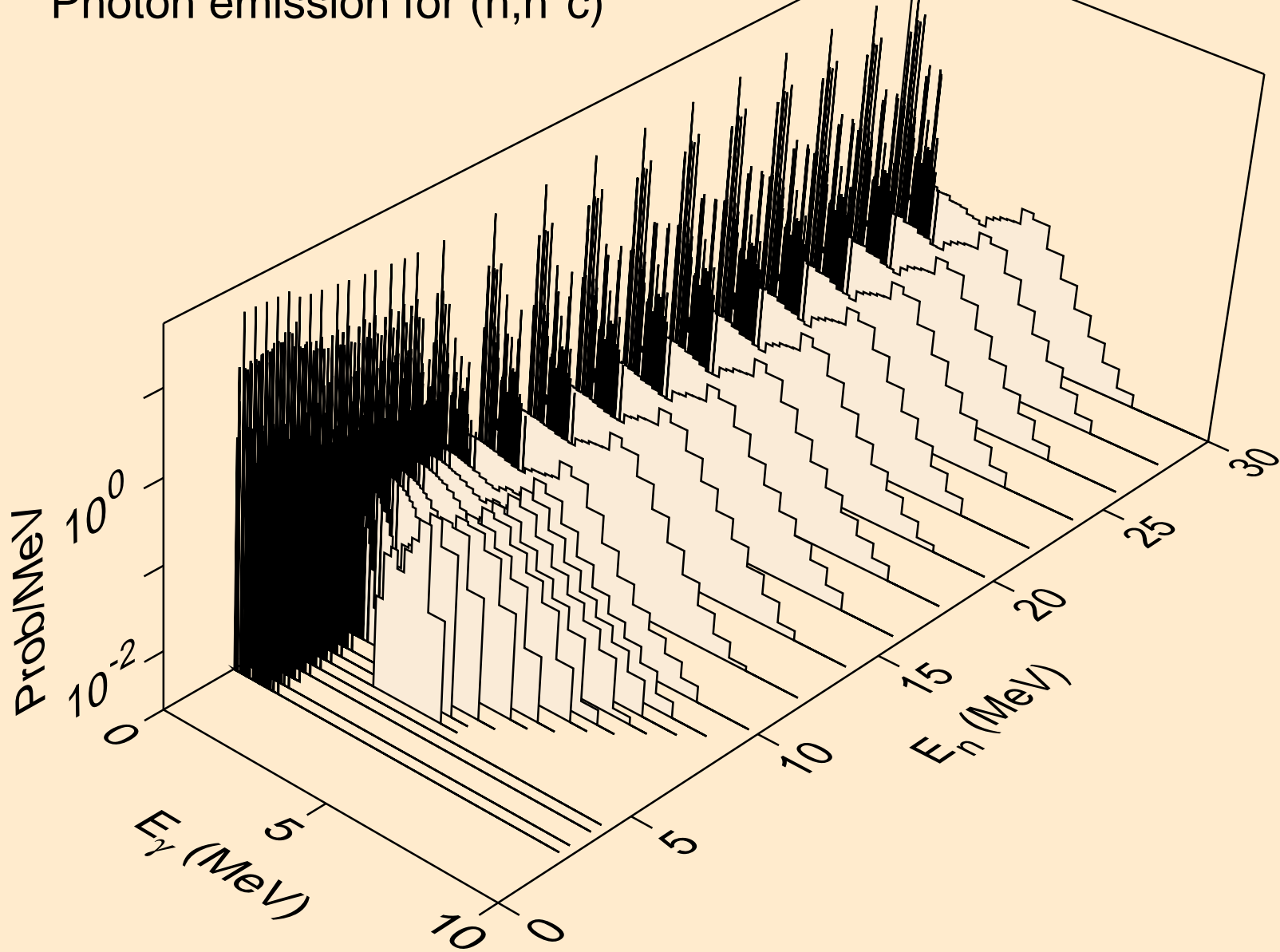

Y086 NEUTRON ACER TENDL-2021 LIBRARY; T=293.6K  
Photon emission for (n,gma)

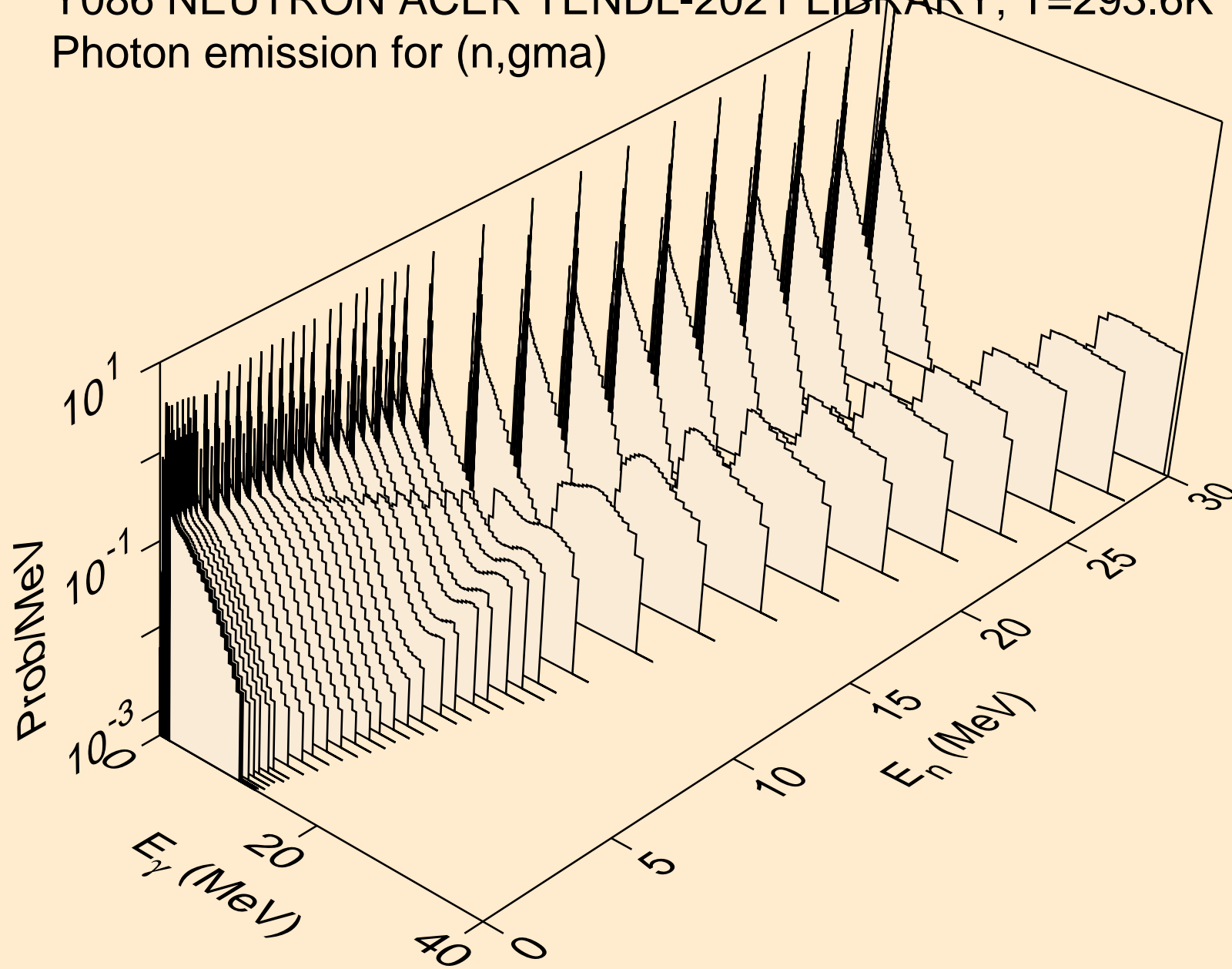

Y086 NEUTRON ACER TENDL-2021 LIBRARY; T=293.6K  
Photon emission for (n,p)

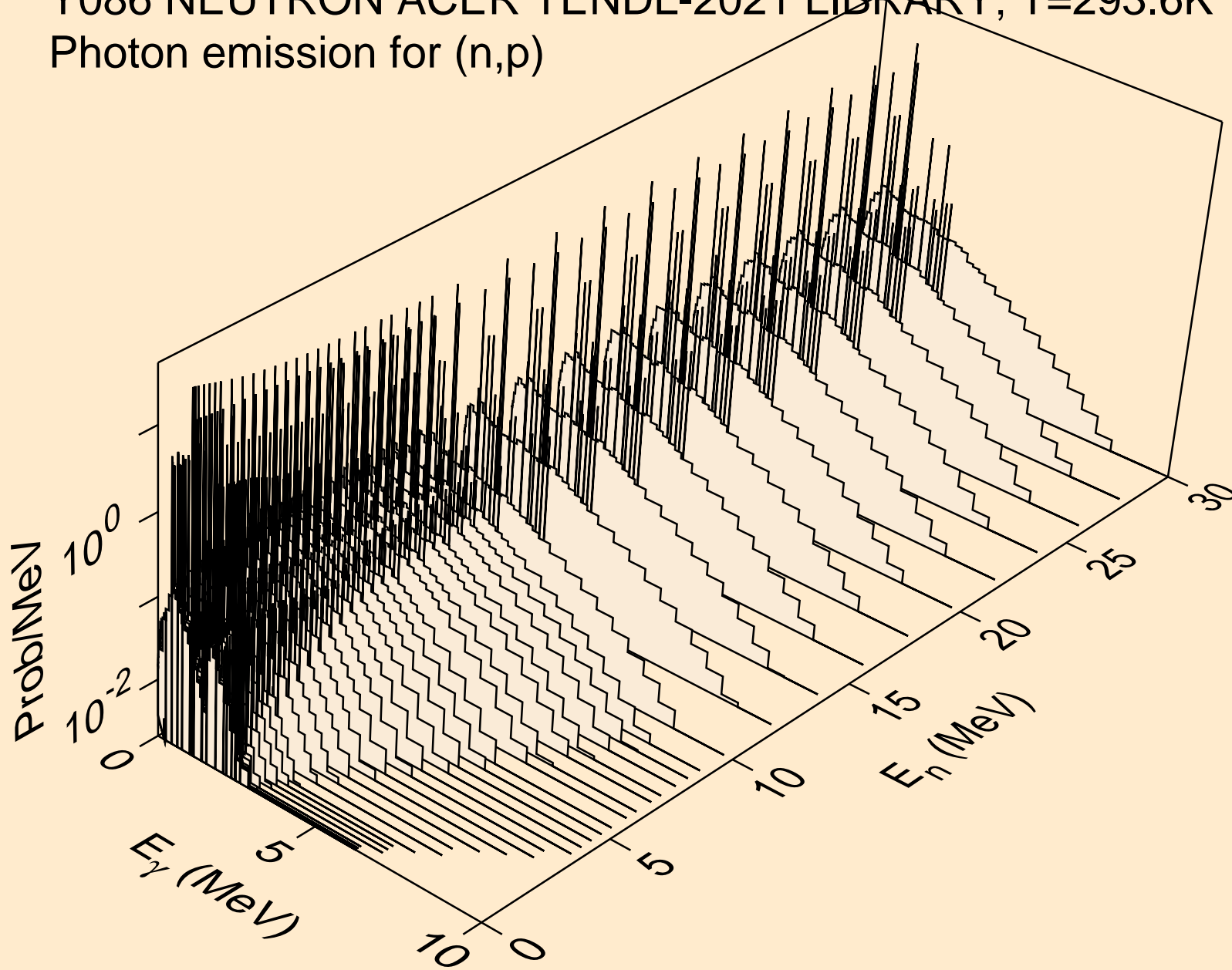

Y086 NEUTRON ACER TENDL-2021 LIBRARY; T=293.6K  
Photon emission for (n,d)

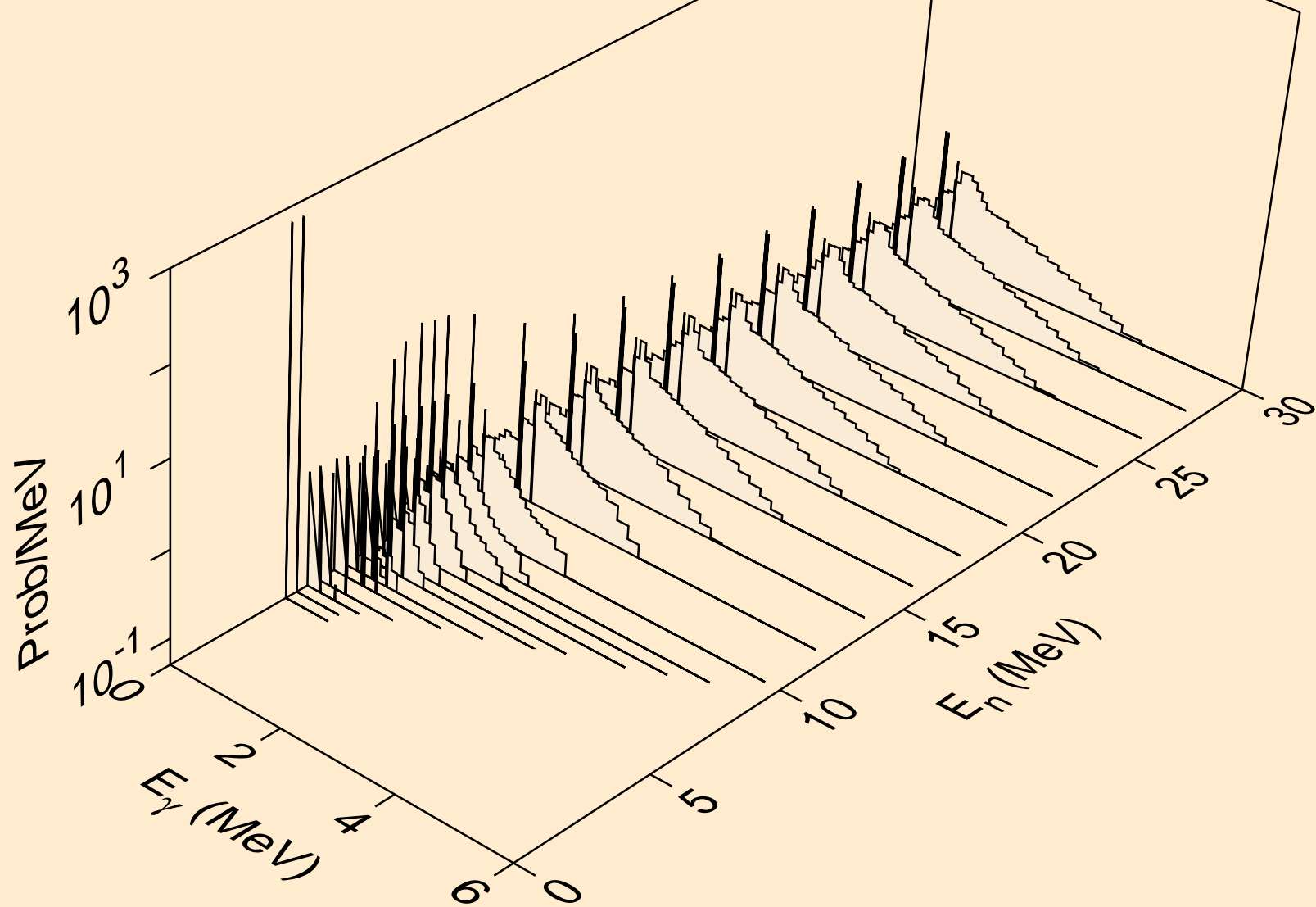



Y086 NEUTRON ACER TENDL-2021 LIBRARY; T=293.6K  
Photon emission for (n,t)

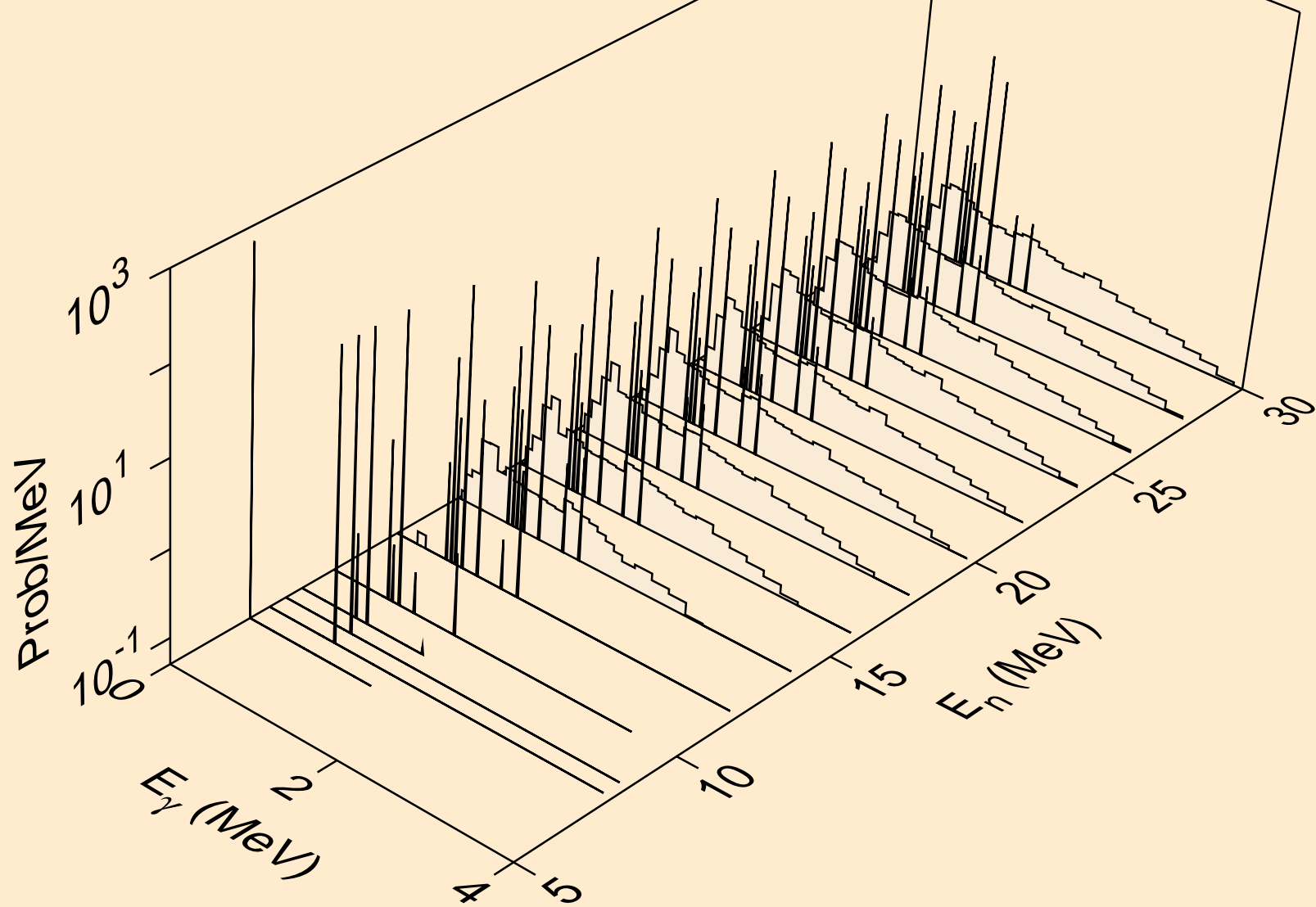

Y086 NEUTRON ACER TENDL-2021 LIBRARY; T=293.6K  
Photon emission for (n,he3)

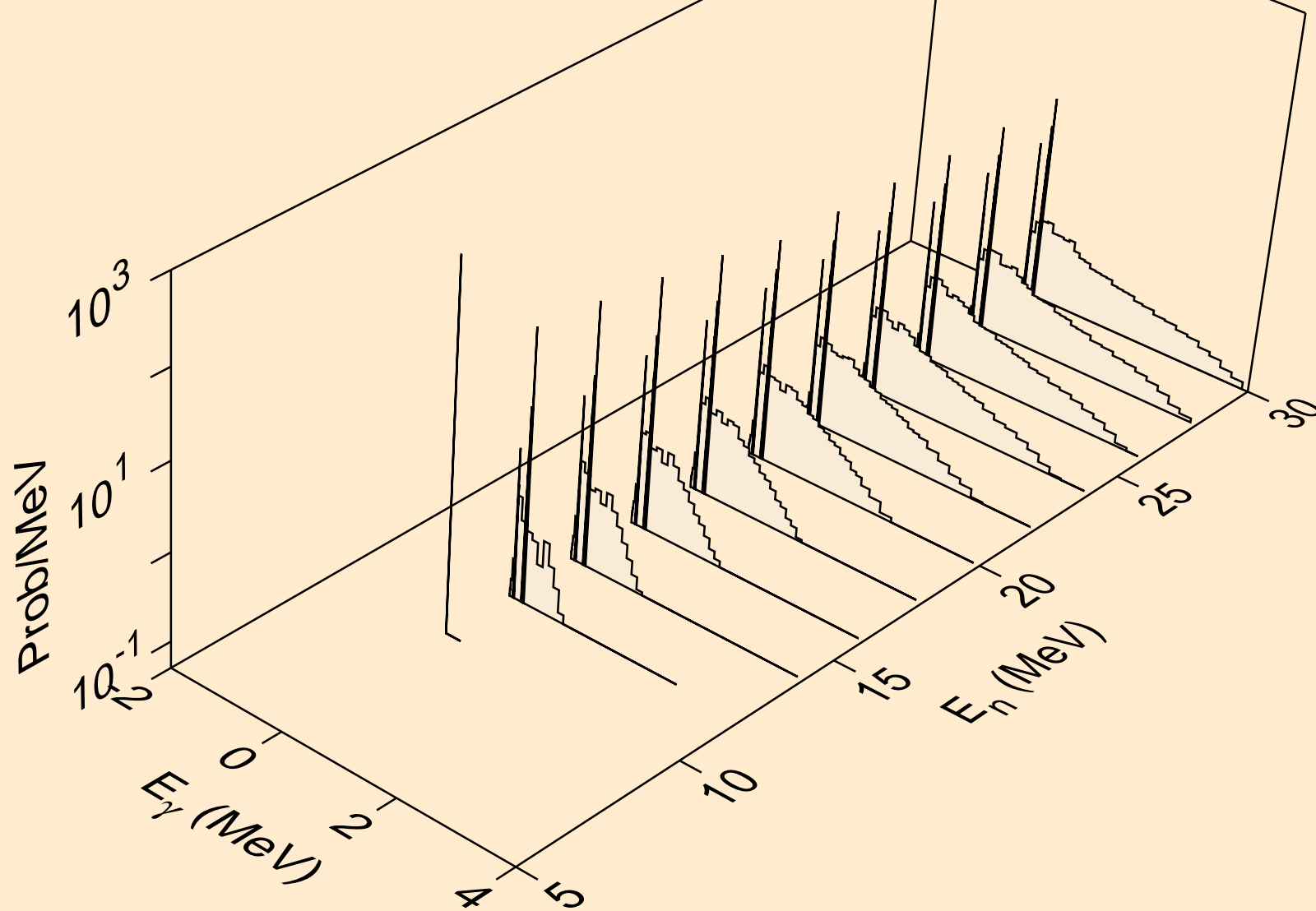

Y086 NEUTRON ACER TENDL-2021 LIBRARY; T=293.6K  
Photon emission for (n,a)

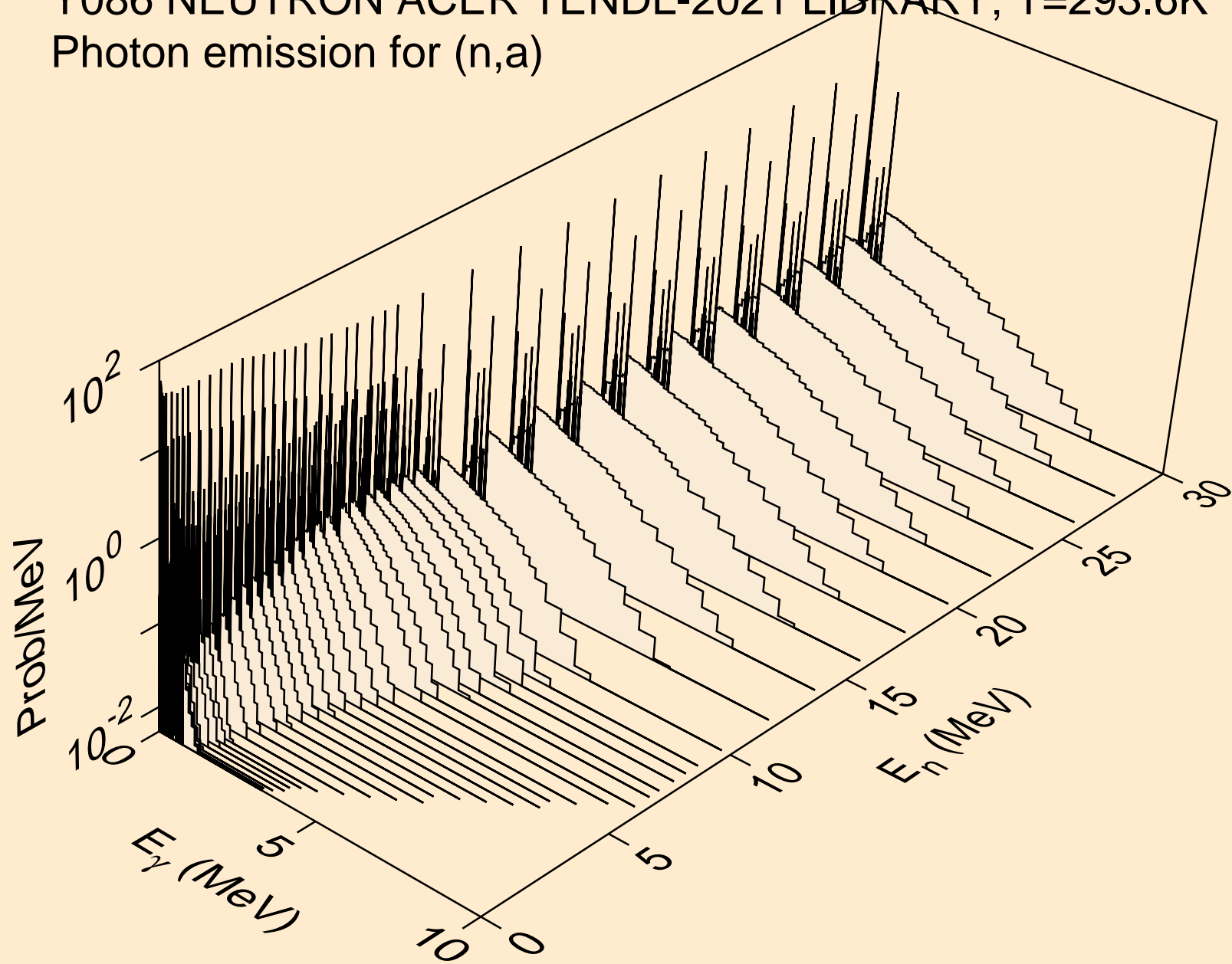

Y086 NEUTRON ACER TENDL-2021 LIBRARY; T=293.6K  
Photon emission for (n,2a)

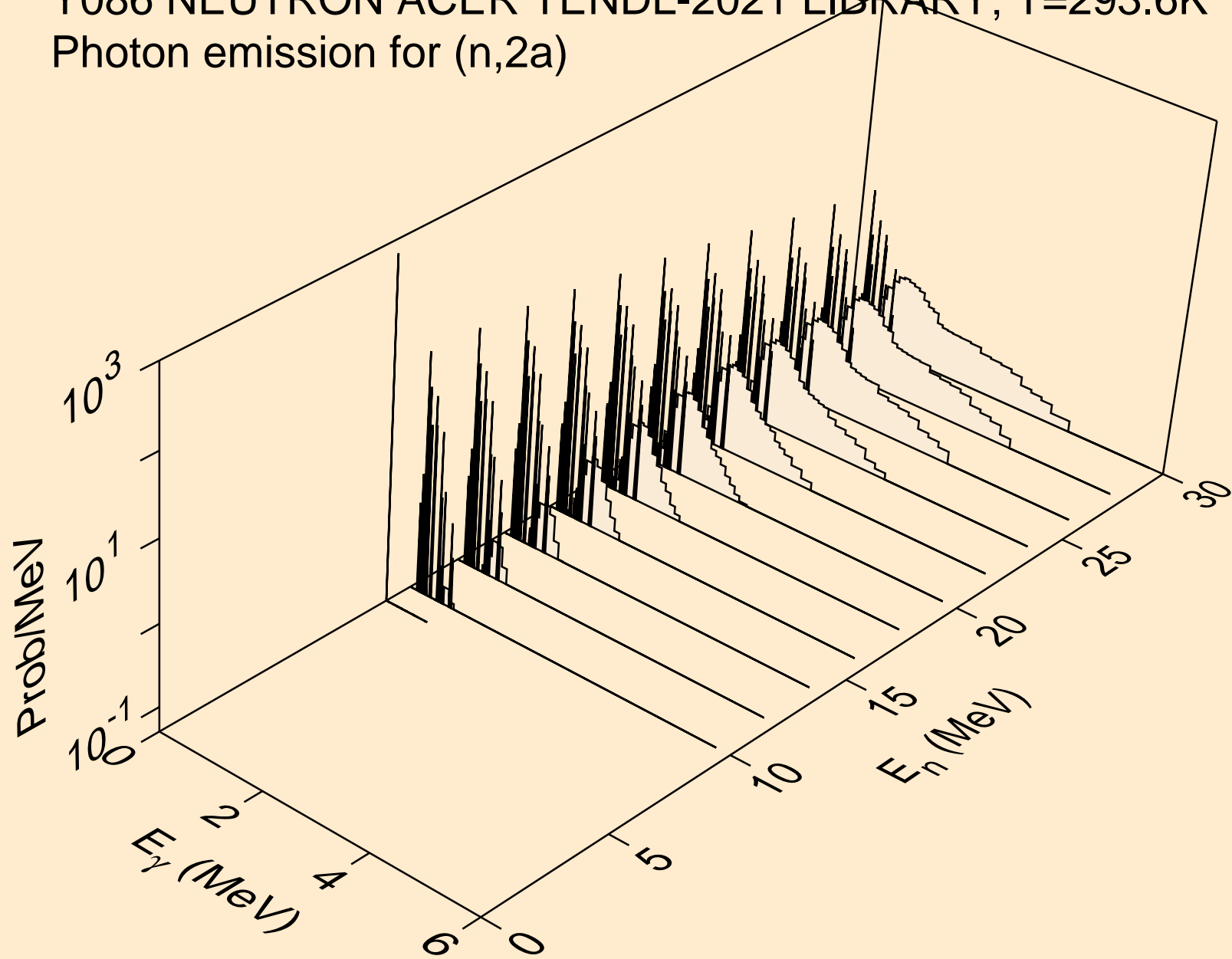

Y086 NEUTRON ACER TENDL-2021 LIBRARY; T=293.6K  
Photon emission for (n,2p)

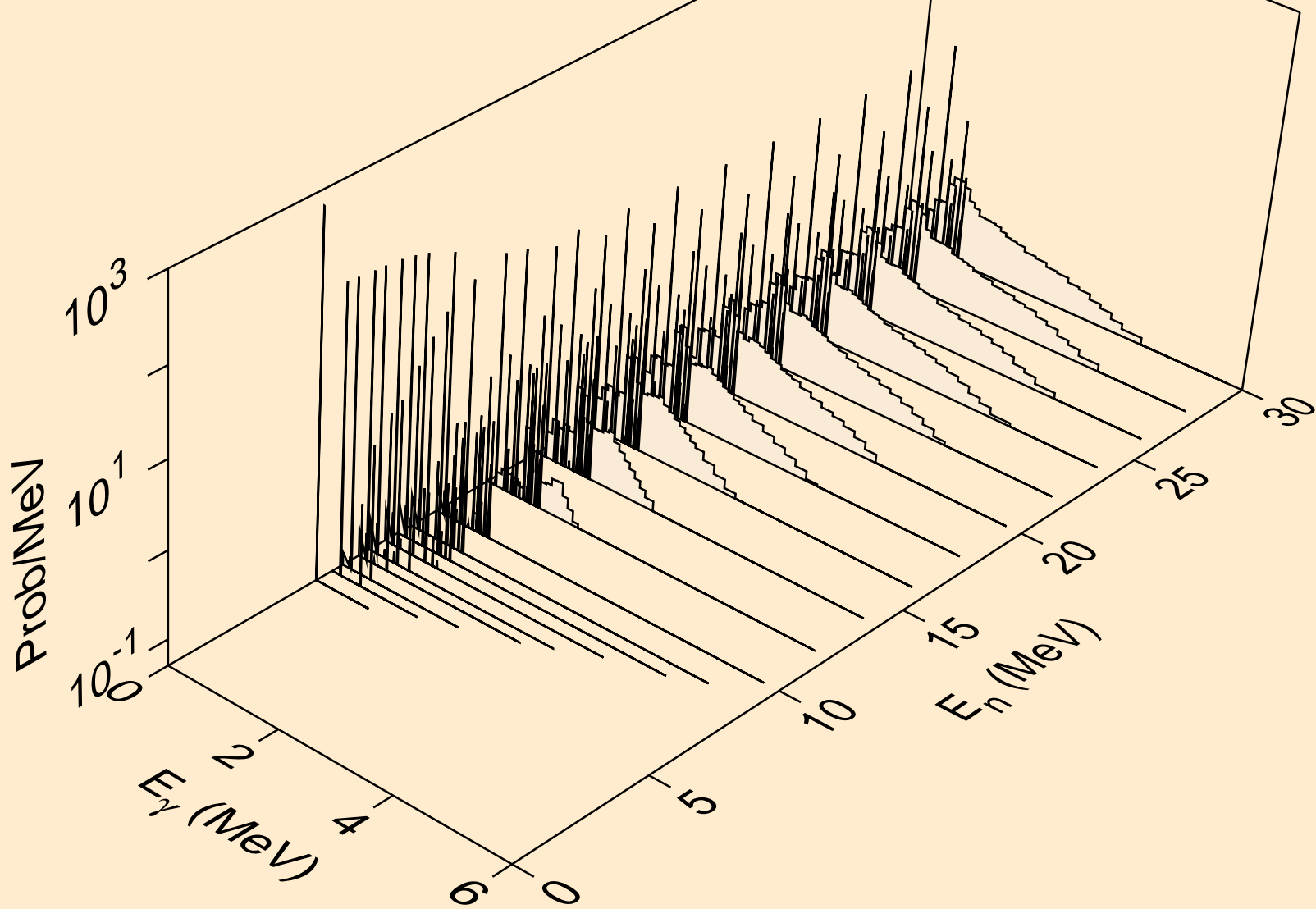

Y086 NEUTRON ACER TENDL-2021 LIBRARY; T=293.6K  
Photon emission for (n,p $\alpha$ )

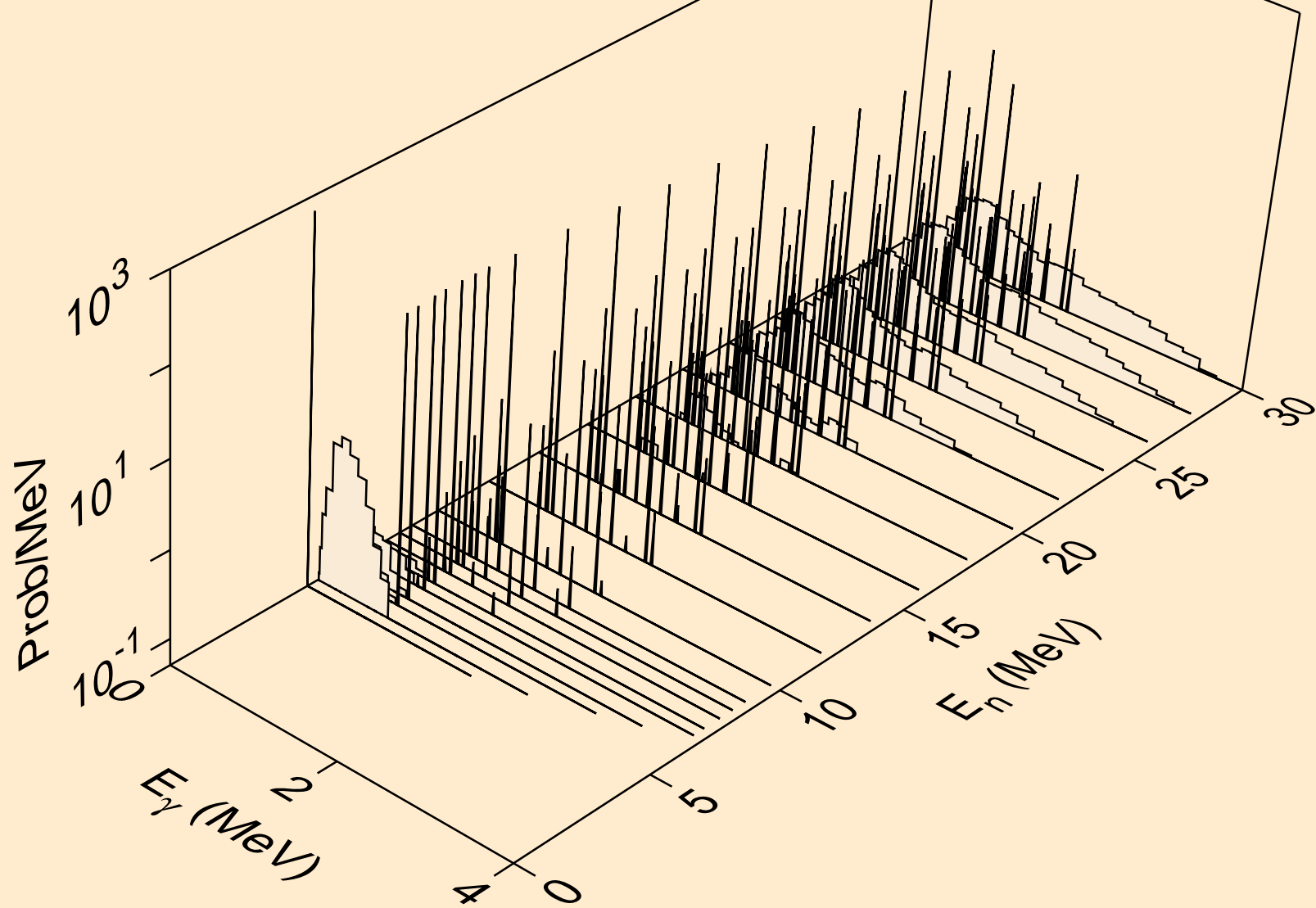

Y086 NEUTRON ACER TENDL-2021 LIBRARY; T=293.6K  
Photon emission for (n,pd)

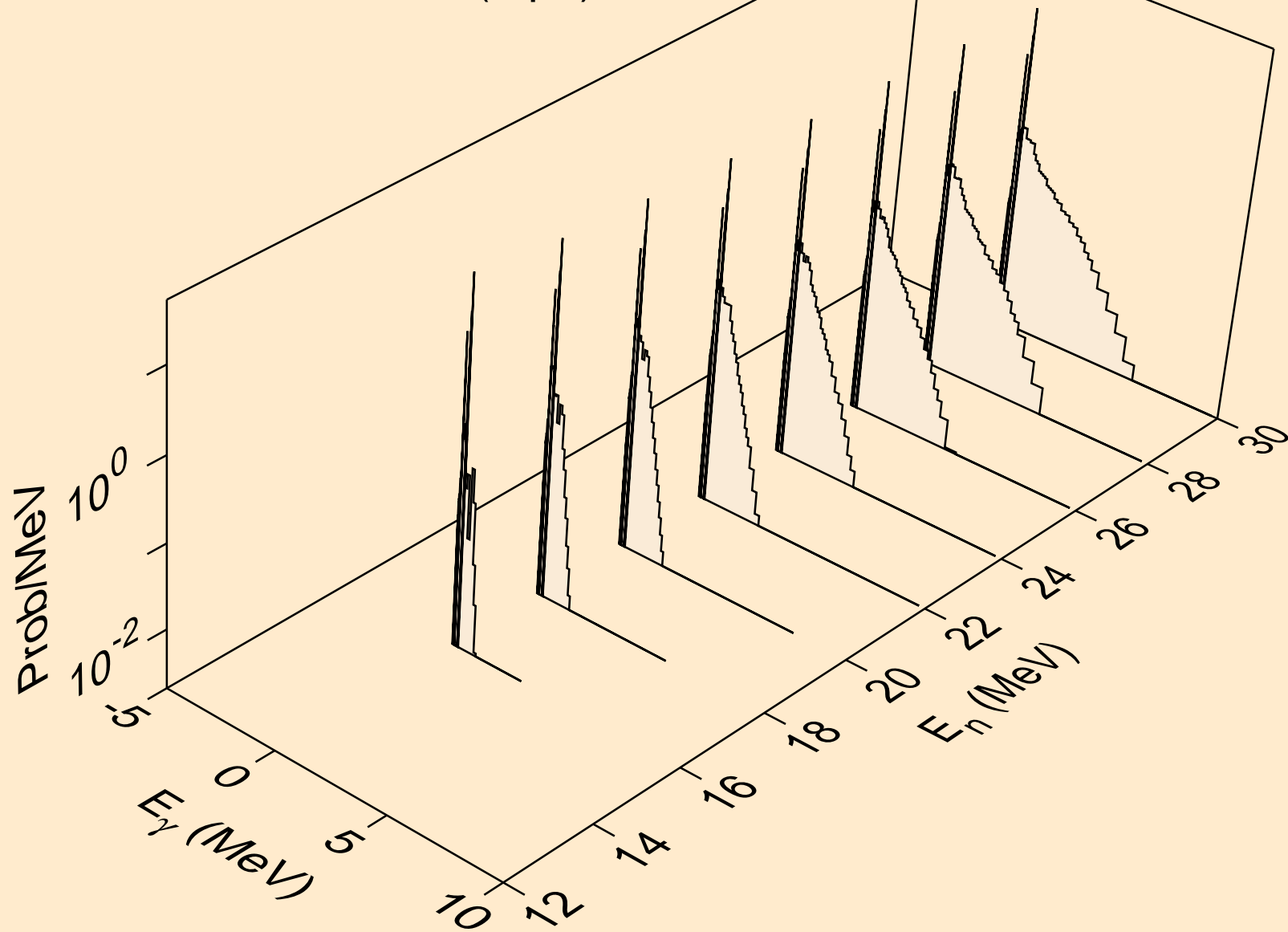

Y086 NEUTRON ACER TENDL-2021 LIBRARY; T=293.6K  
Photon emission for (n,pt)

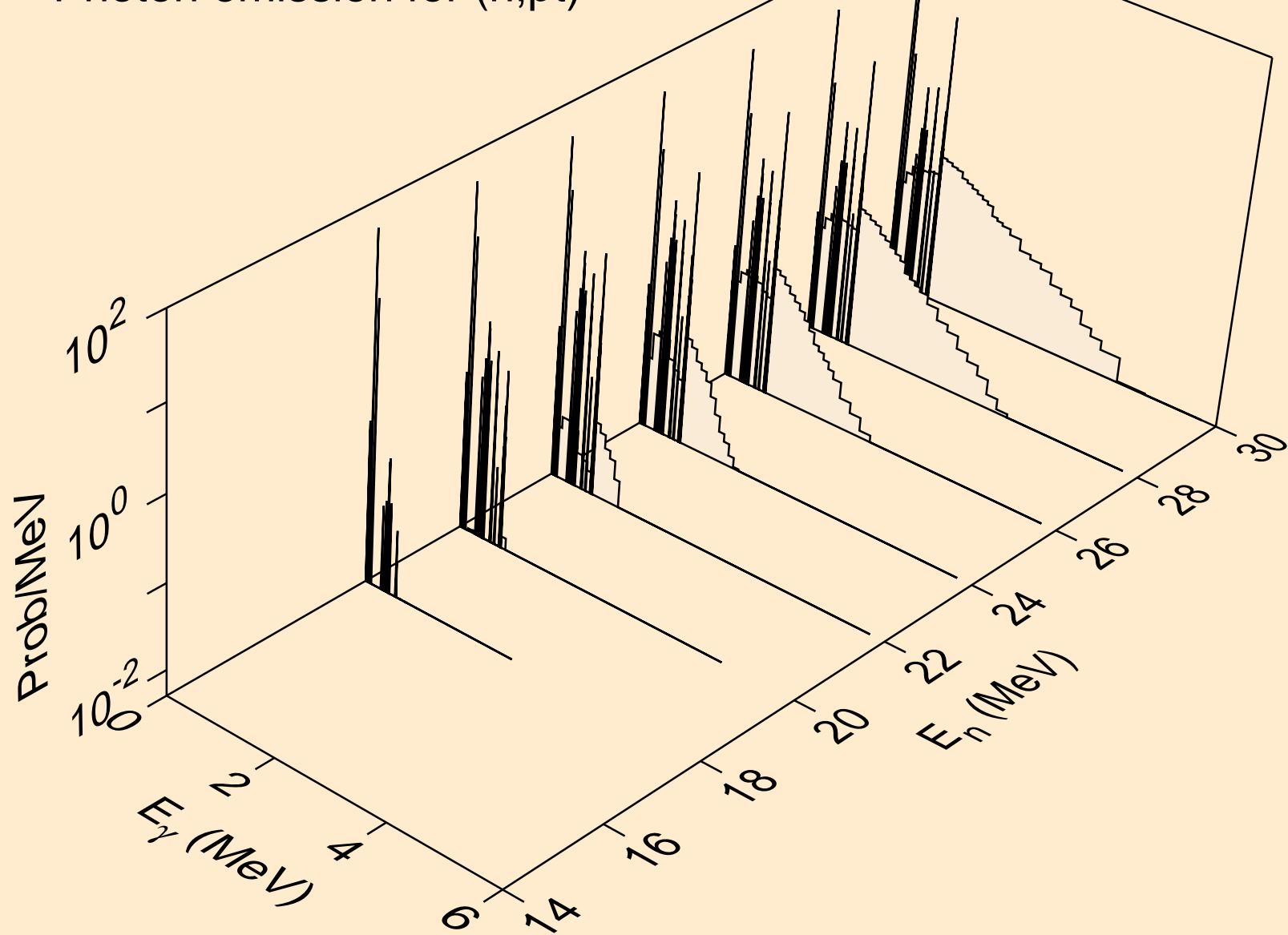



Y086 NEUTRON ACER TENDL-2021 LIBRARY; T=293.6K  
Photon emission for (n,da)

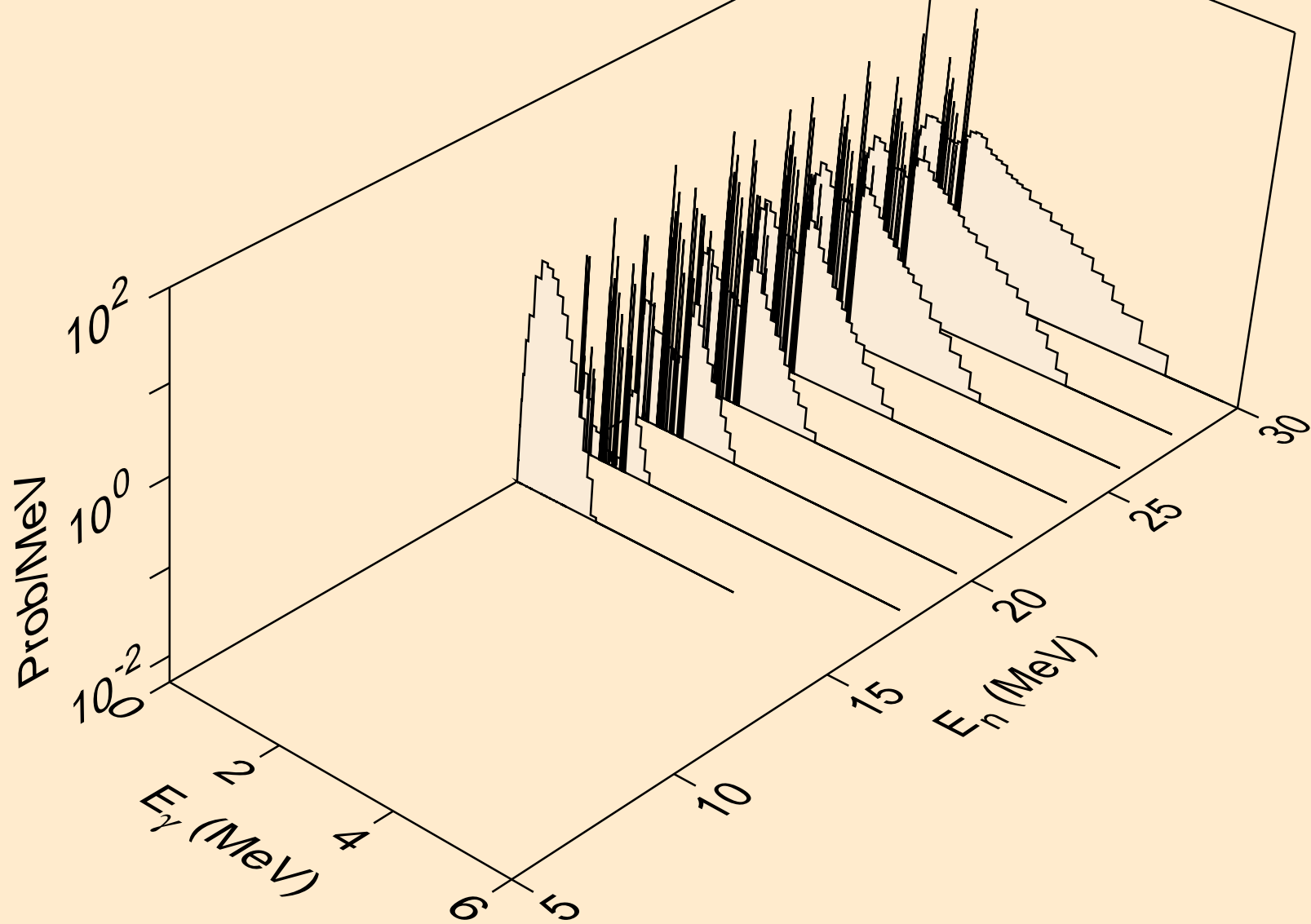

Y086 NEUTRON ACER TENDL-2021 LIBRARY; T=293.6K  
thermal capture photon spectrum

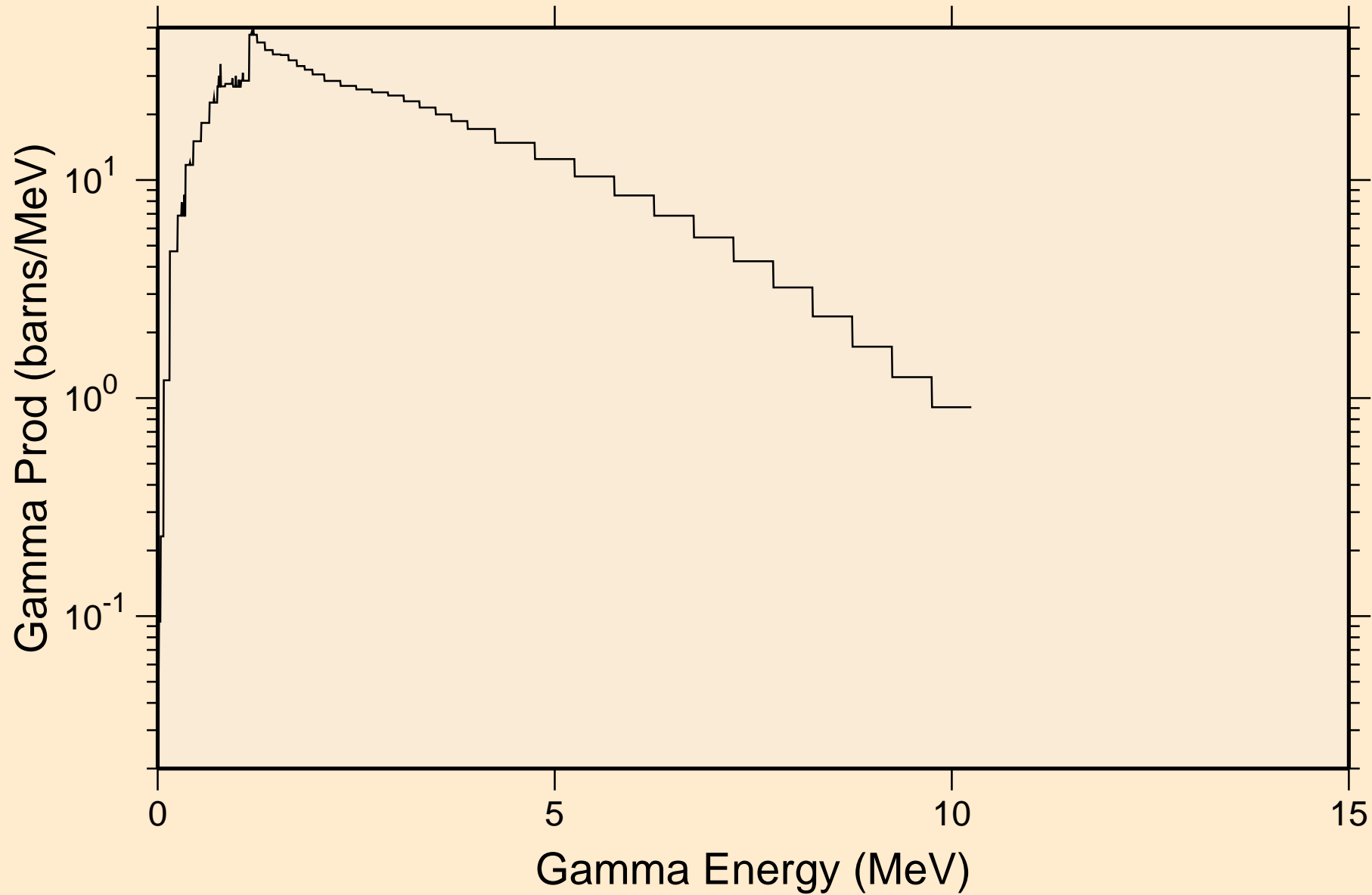

Y086 NEUTRON ACER TENDL-2021 LIBRARY; T=293.6K  
14 MeV photon spectrum

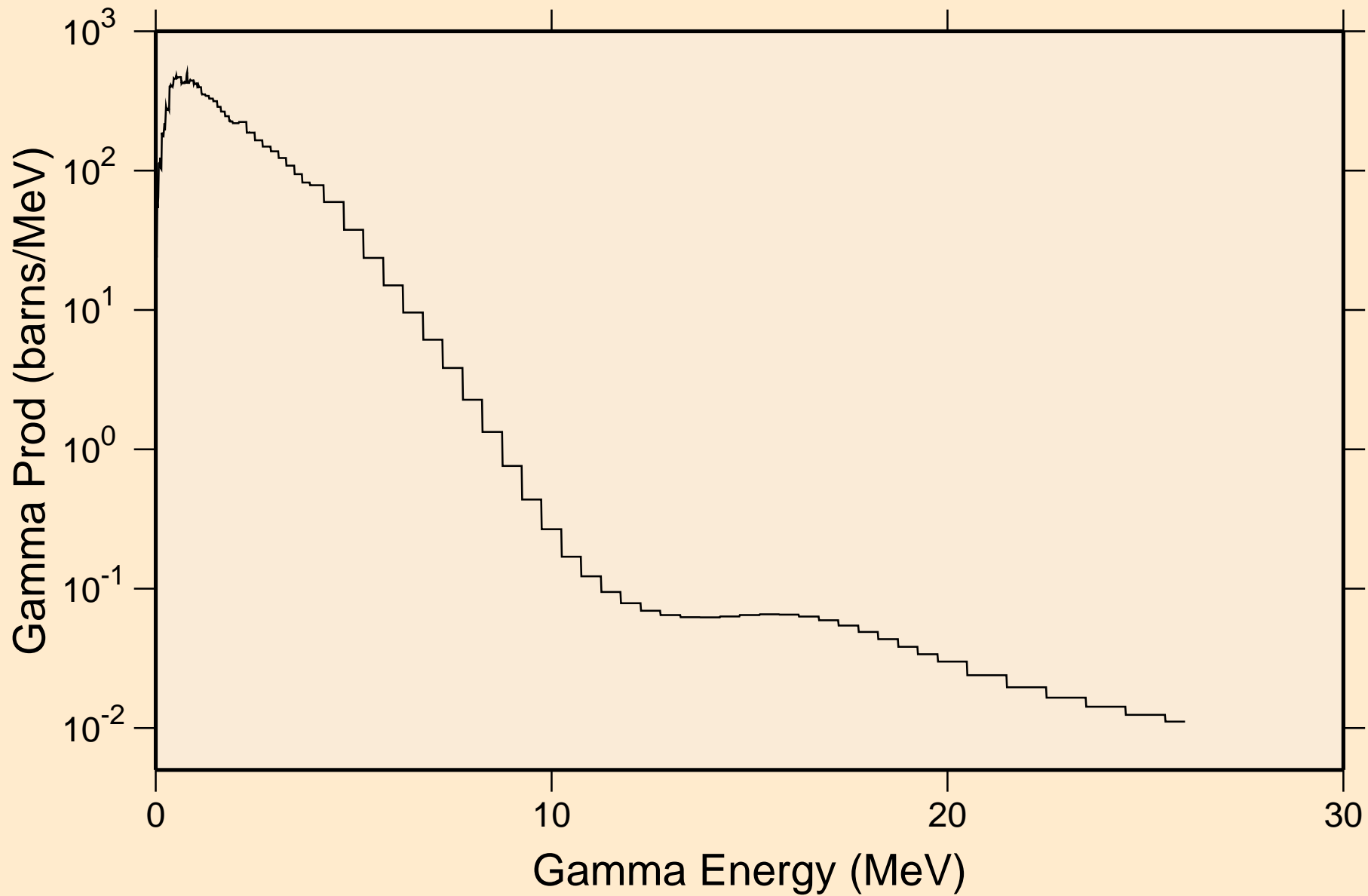

Y086 NEUTRON ACER TENDL-2021 LIBRARY; T=293.6K  
Particle heating contributions

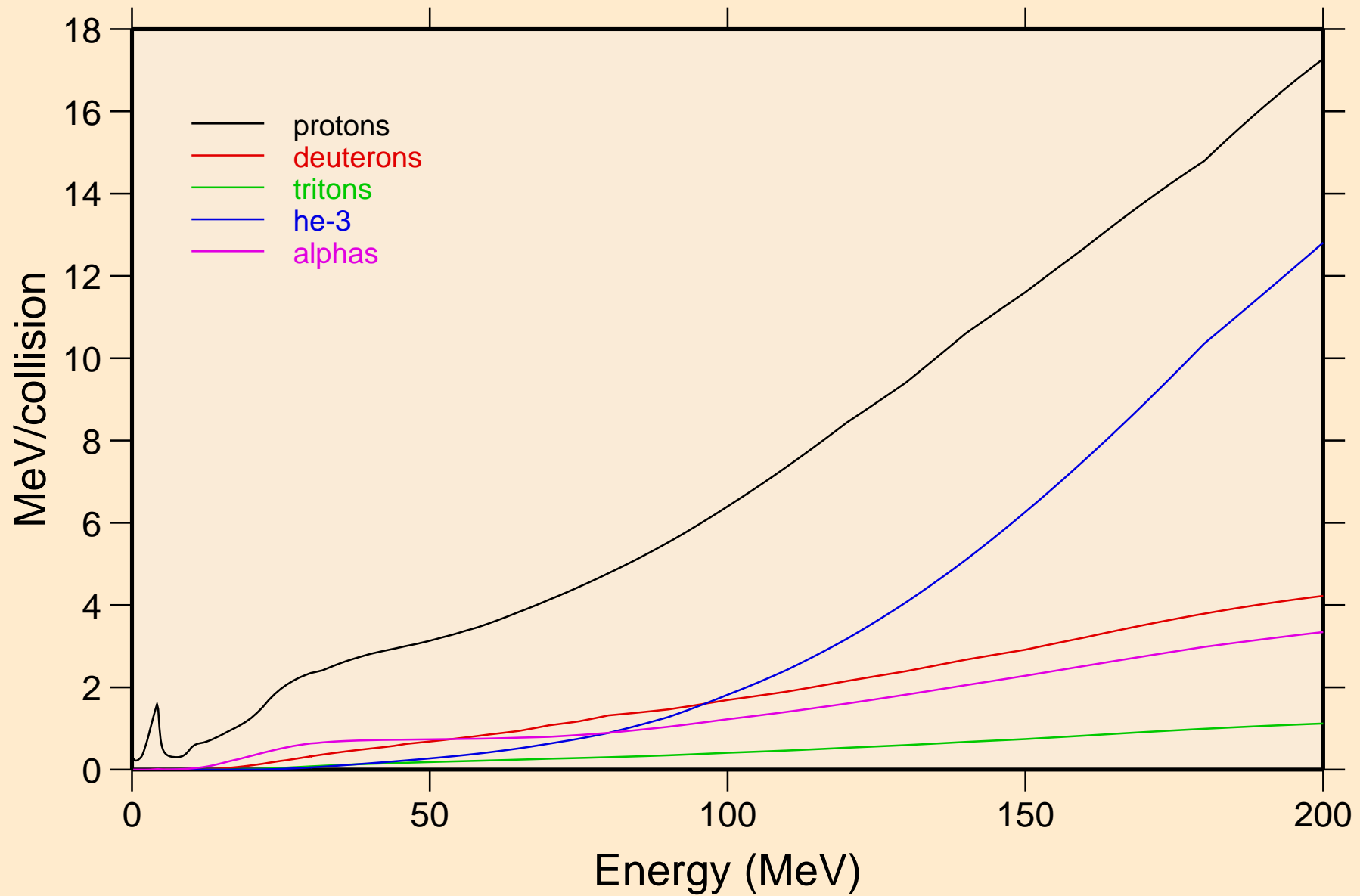

Y086 NEUTRON ACER TENDL-2021 LIBRARY; T=293.6K  
Recoil Heating

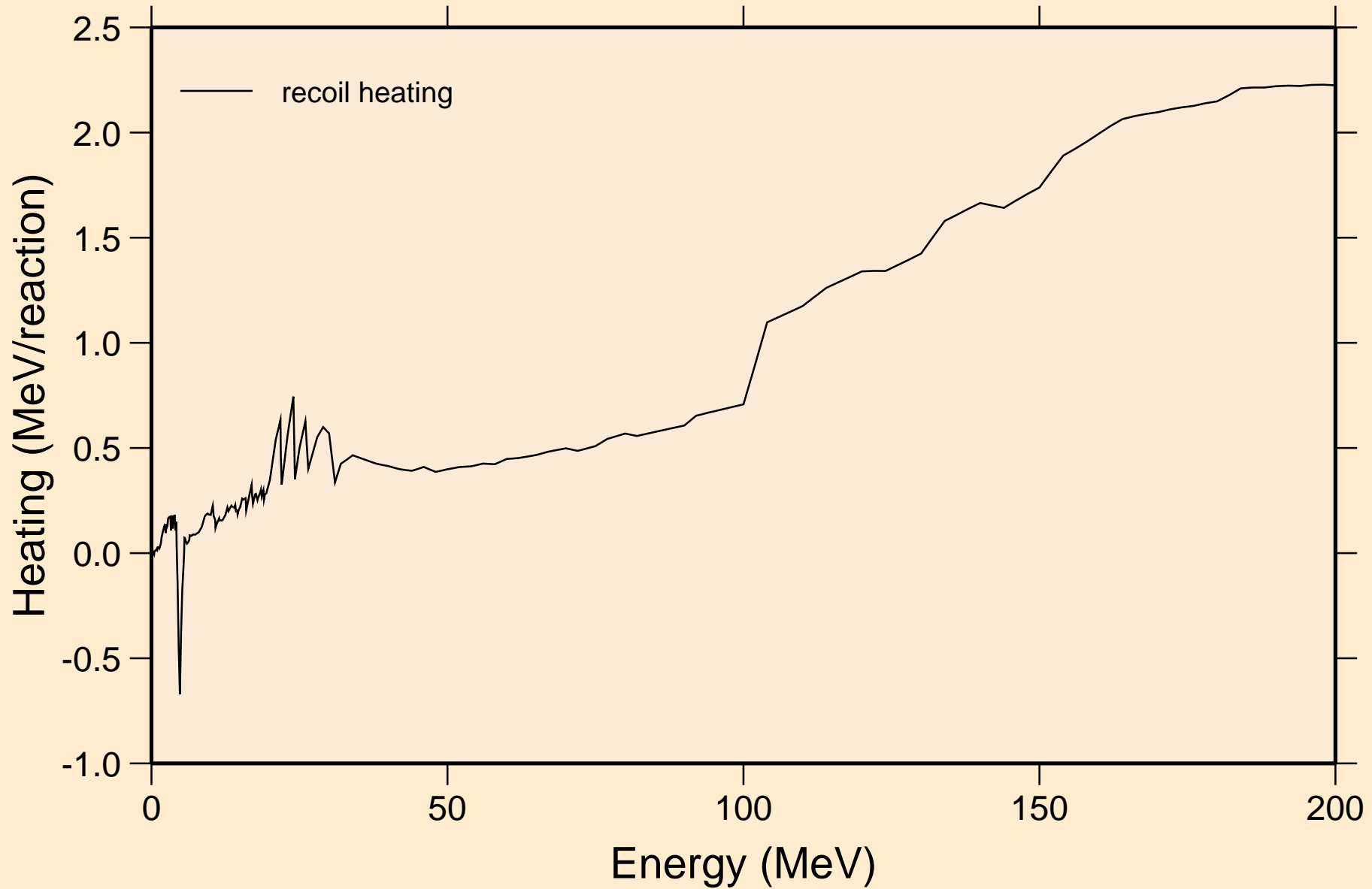

Y086 NEUTRON ACER TENDL-2021 LIBRARY; T=293.6K  
Particle production cross sections

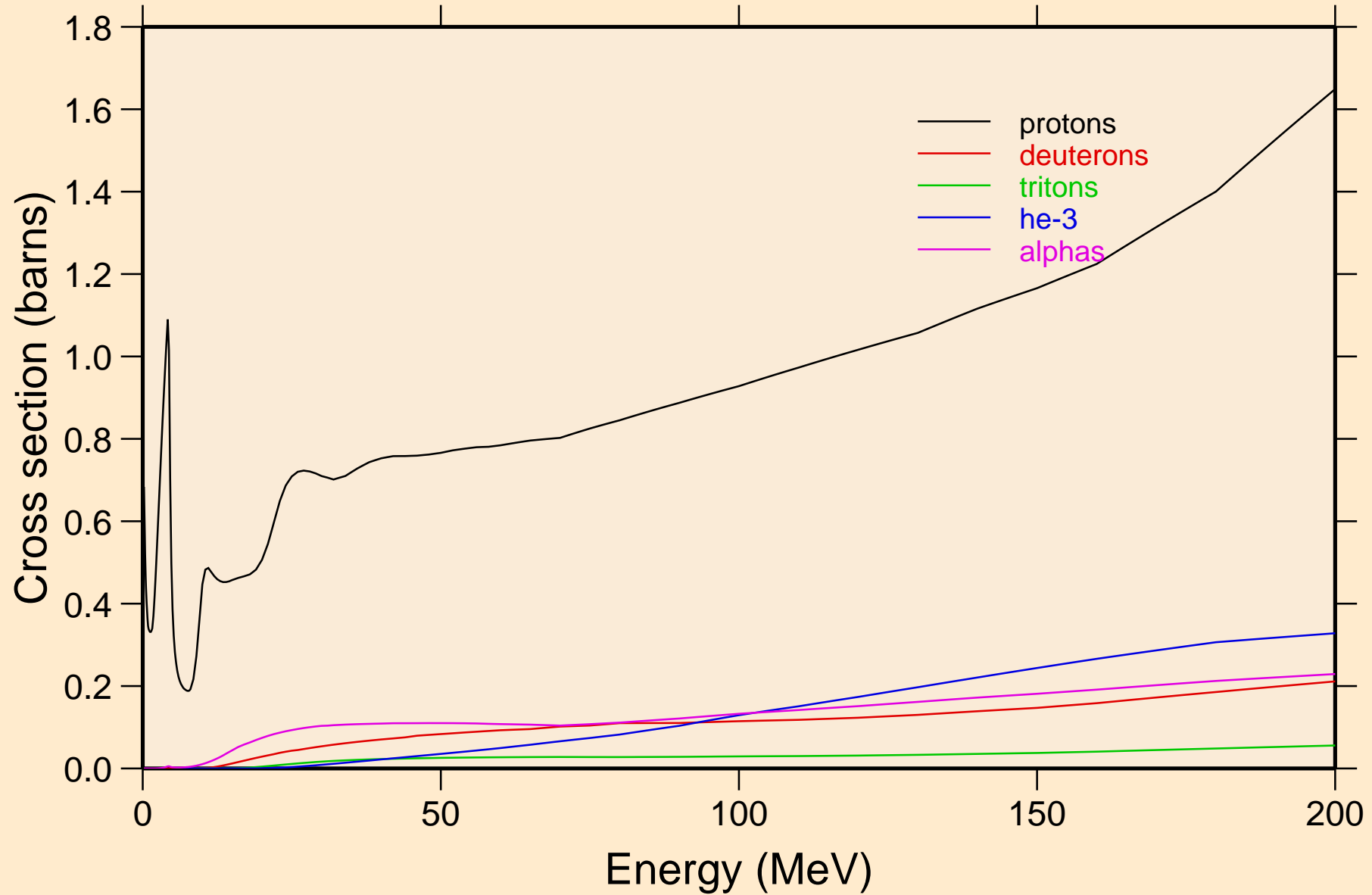

Y086 NEUTRON ACER TENDL-2021 LIBRARY; T=293.6K  
protons from (n,x)

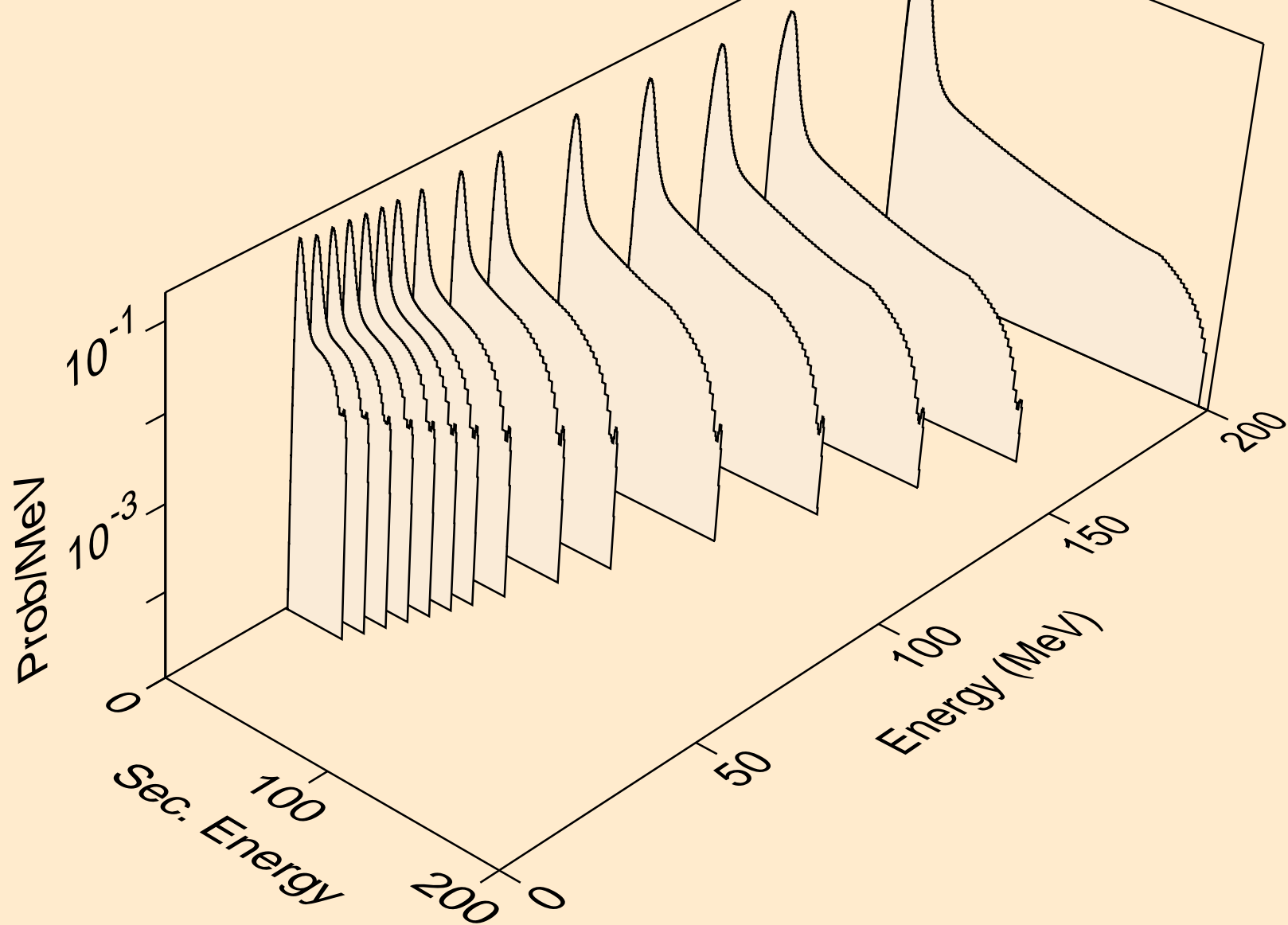

Y086 NEUTRON ACER TENDL-2021 LIBRARY; T=293.6K  
protons from (n,n\*)p

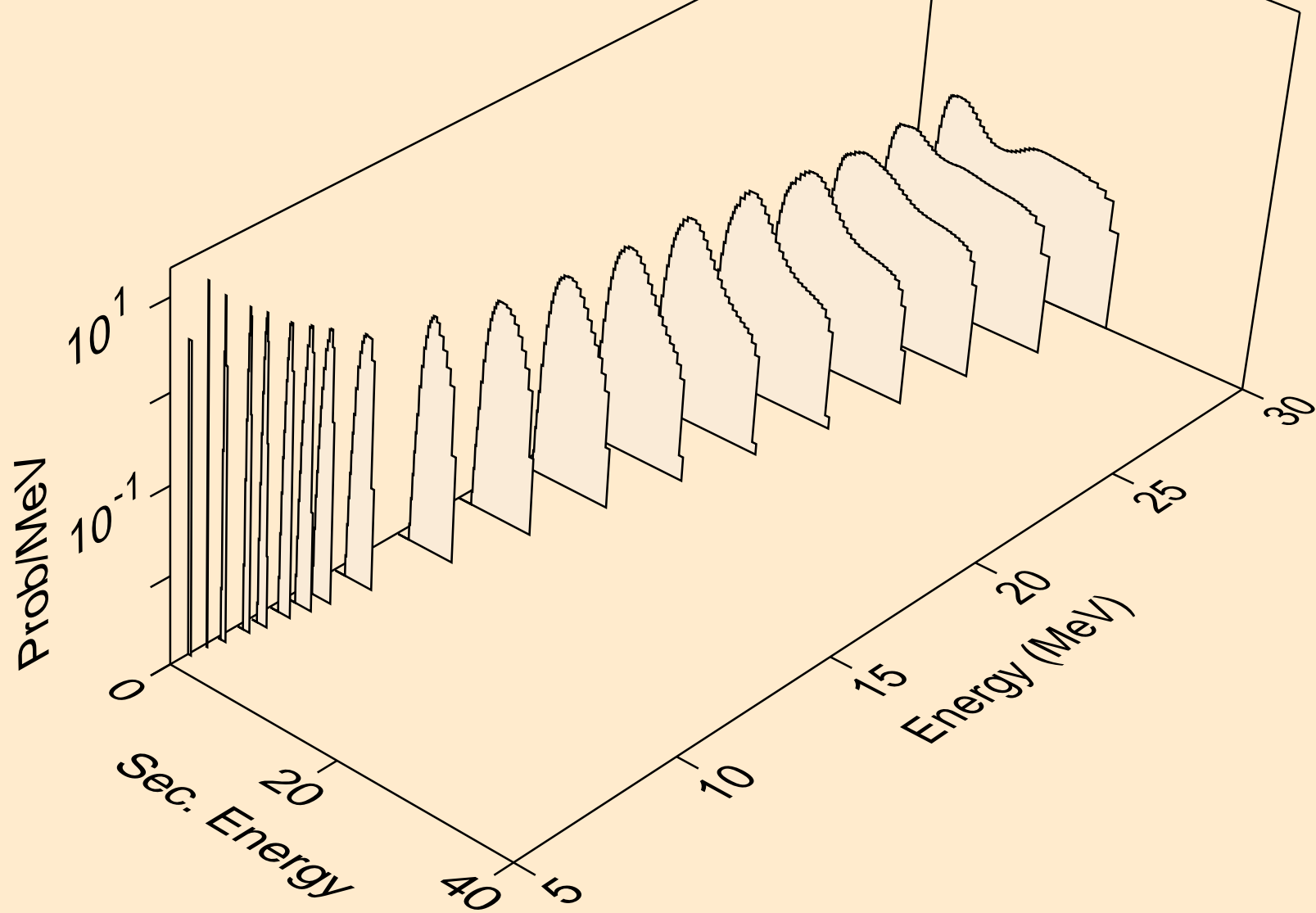



Y086 NEUTRON ACER TENDL-2021 LIBRARY; T=293.6K  
protons from (n,2np)

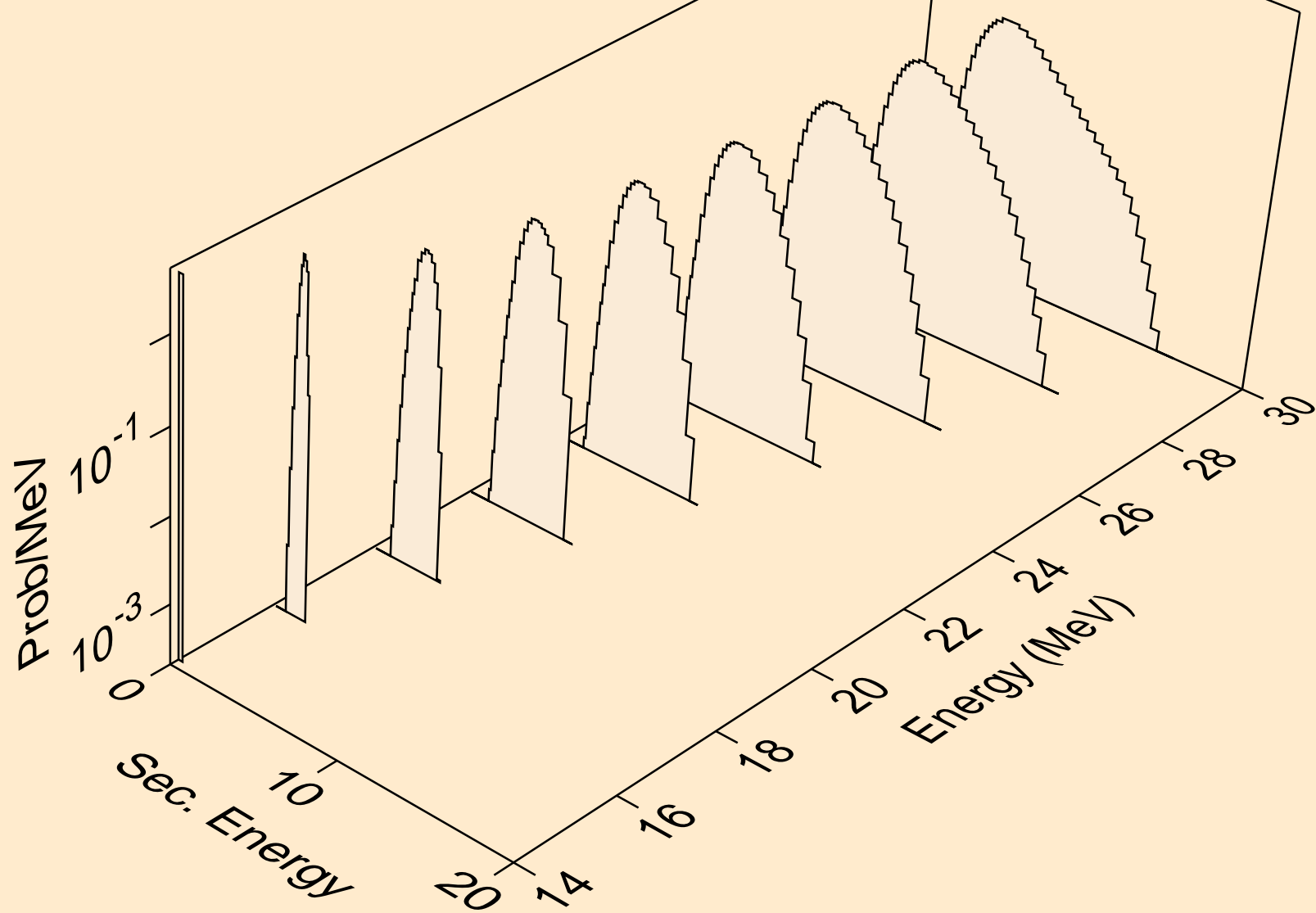

Y086 NEUTRON ACER TENDL-2021 LIBRARY; T=293.6K  
protons from (n,3np)

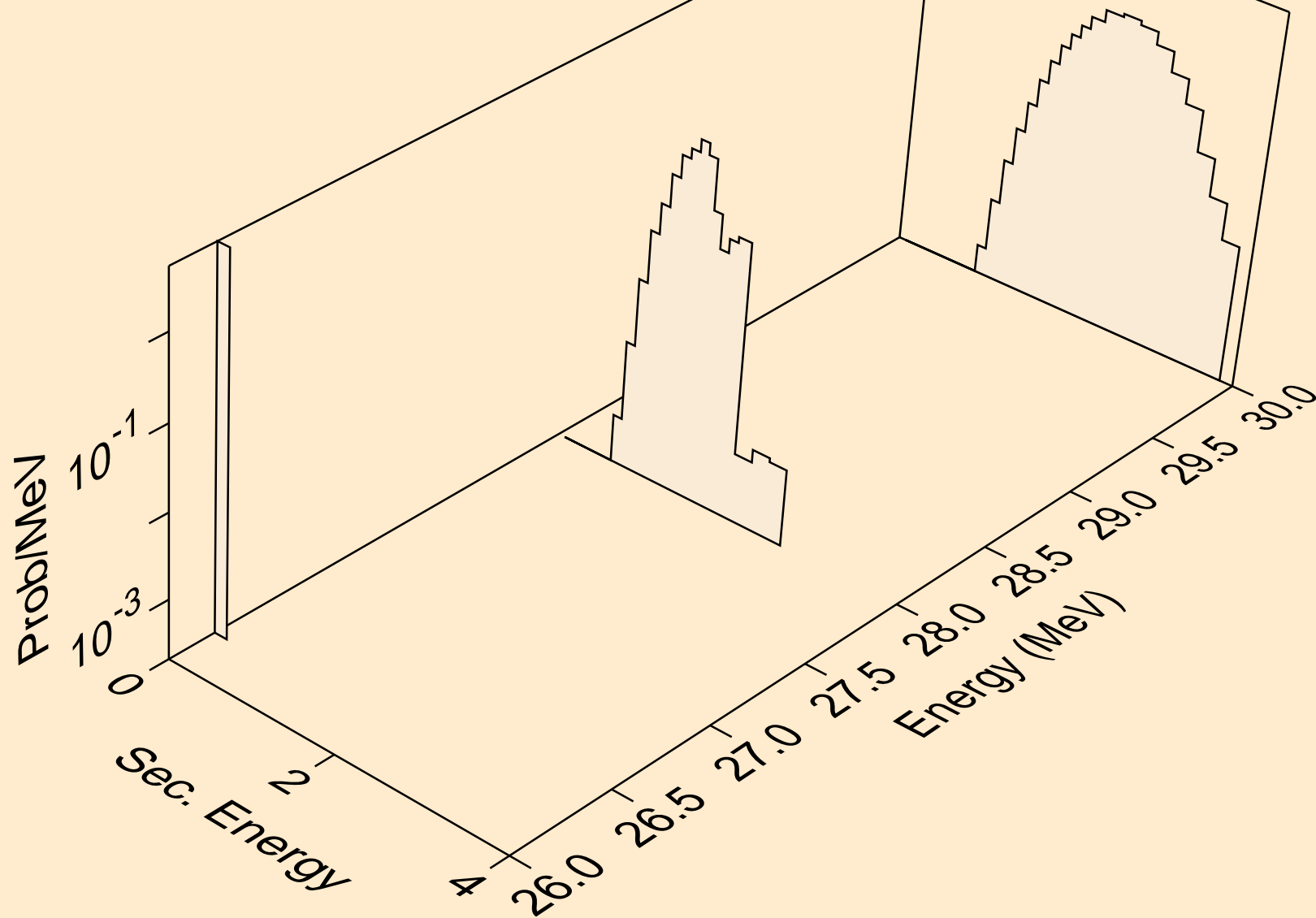

Y086 NEUTRON ACER TENDL-2021 LIBRARY; T=293.6K  
protons from (n,2np)

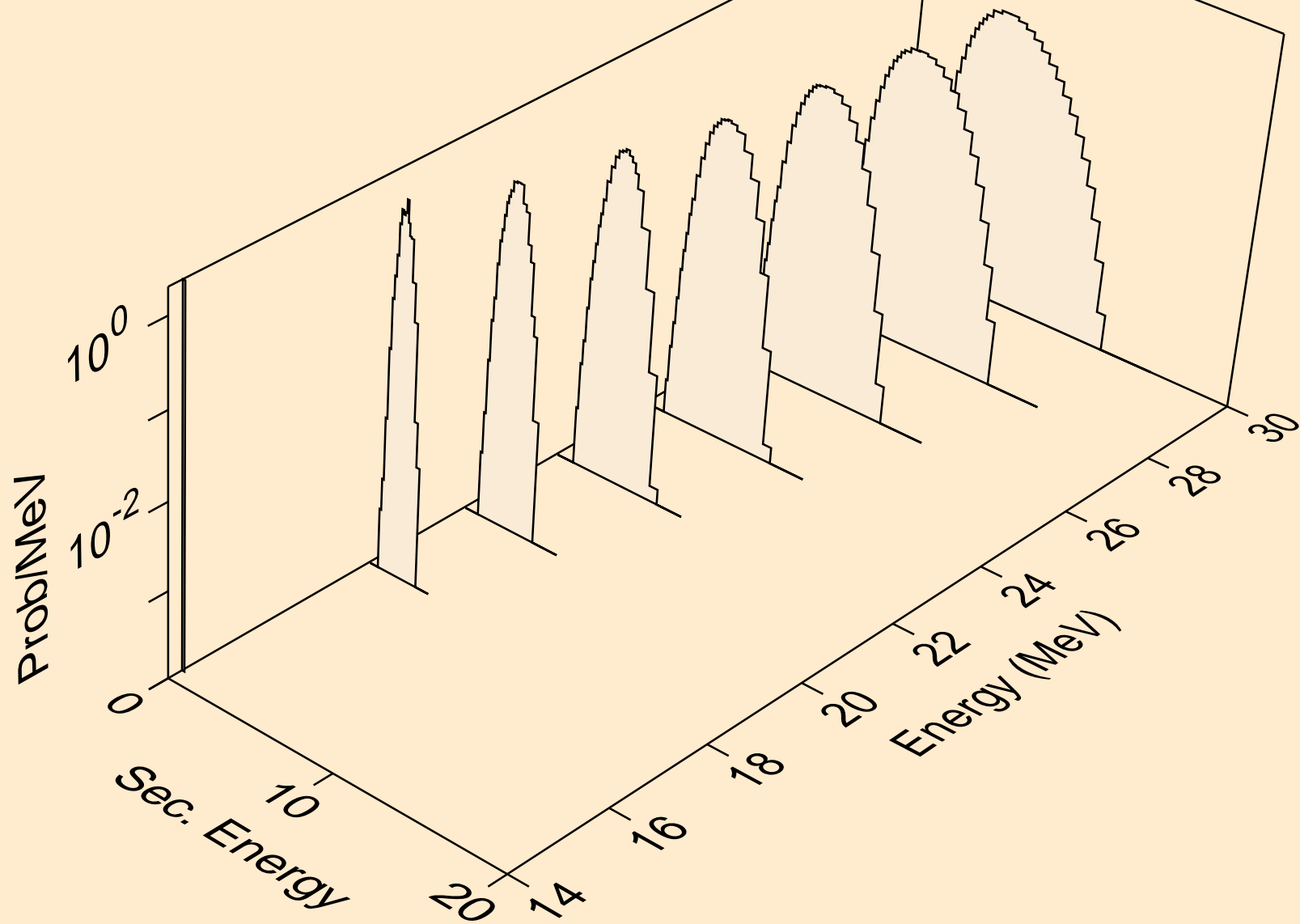

Y086 NEUTRON ACER TENDL-2021 LIBRARY; T=293.6K  
protons from (n,npa)

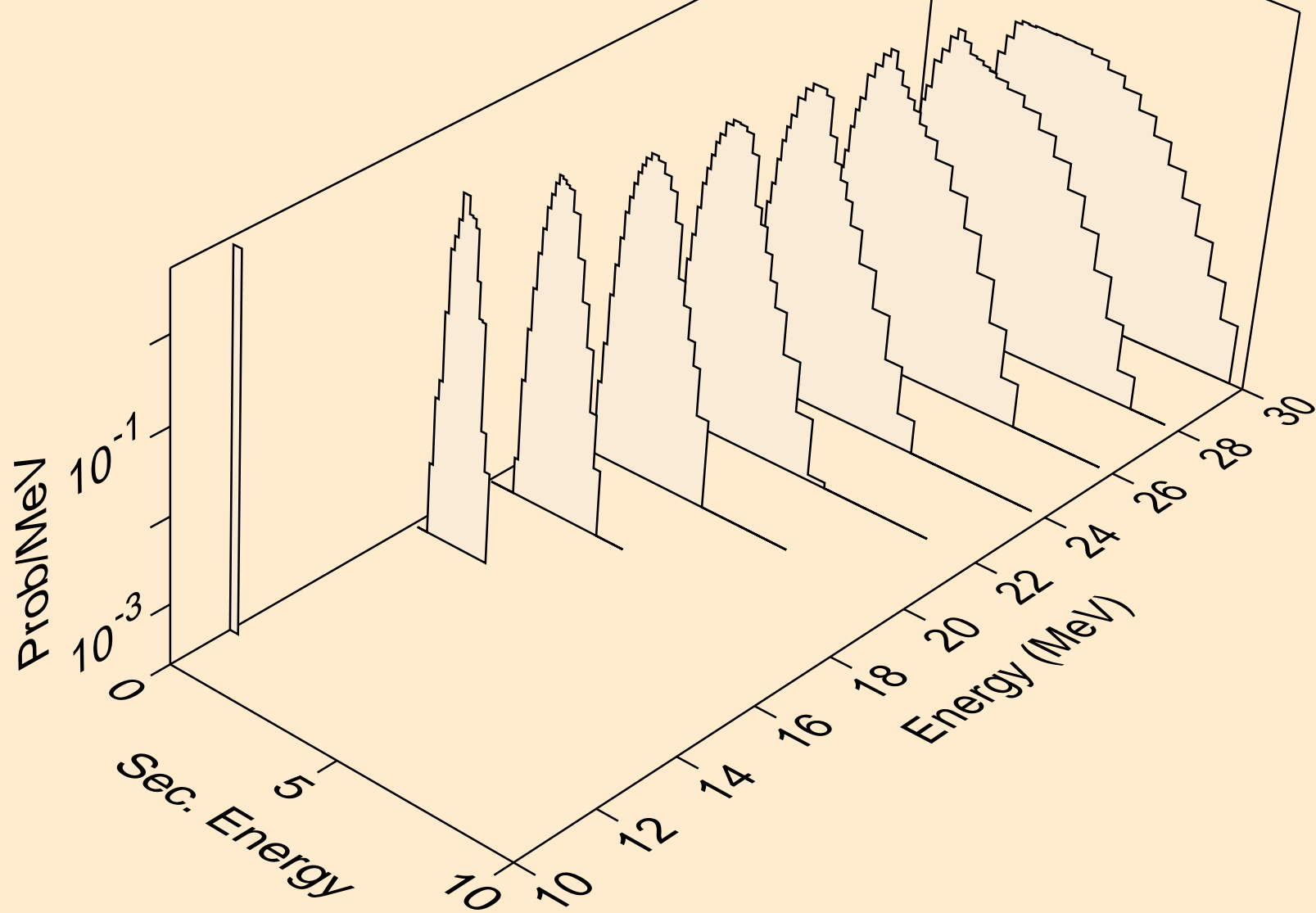

Y086 NEUTRON ACER TENDL-2021 LIBRARY; T=293.6K  
protons from (n,p)

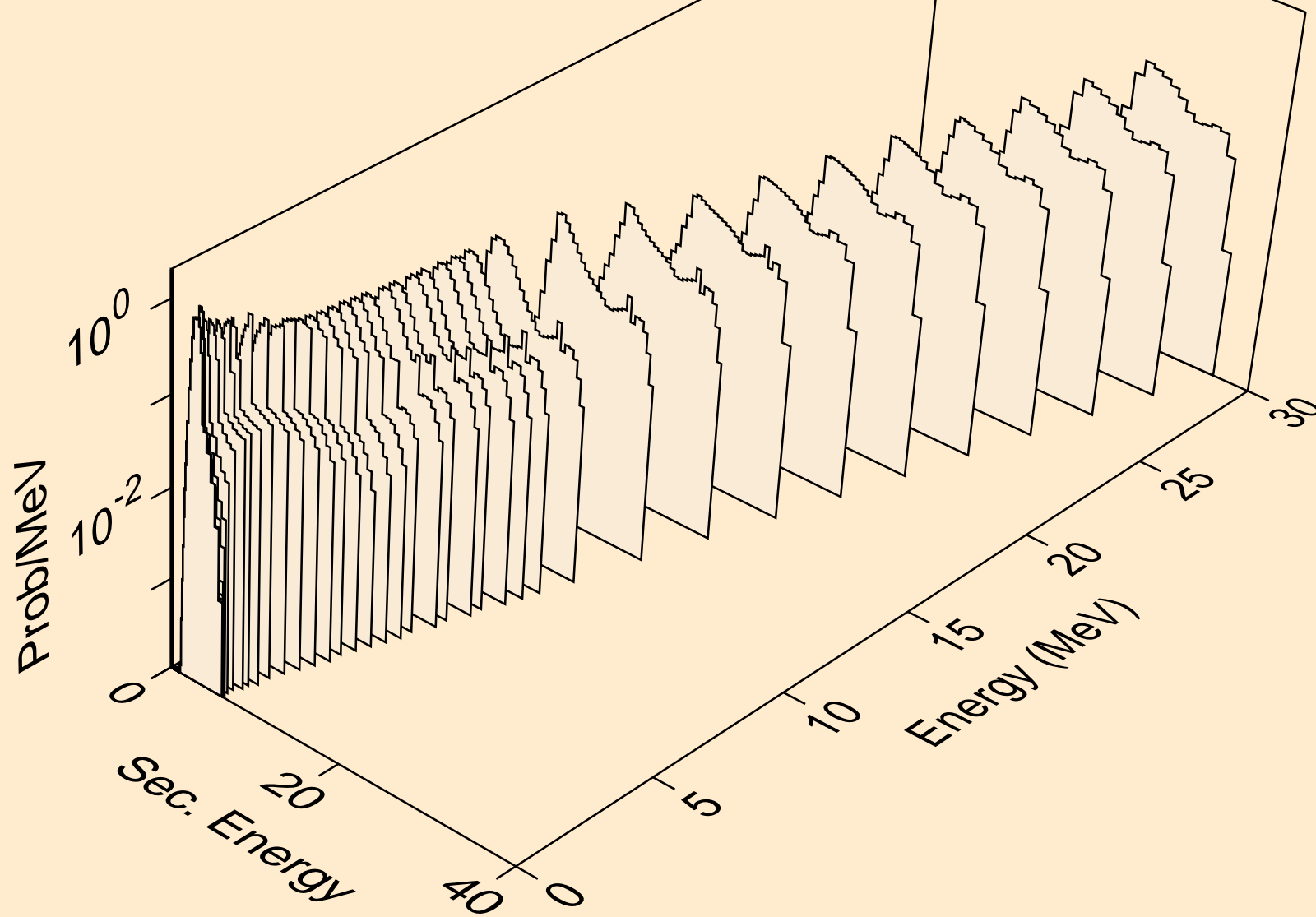

Y086 NEUTRON ACER TENDL-2021 LIBRARY; T=293.6K  
protons from (n,2p)

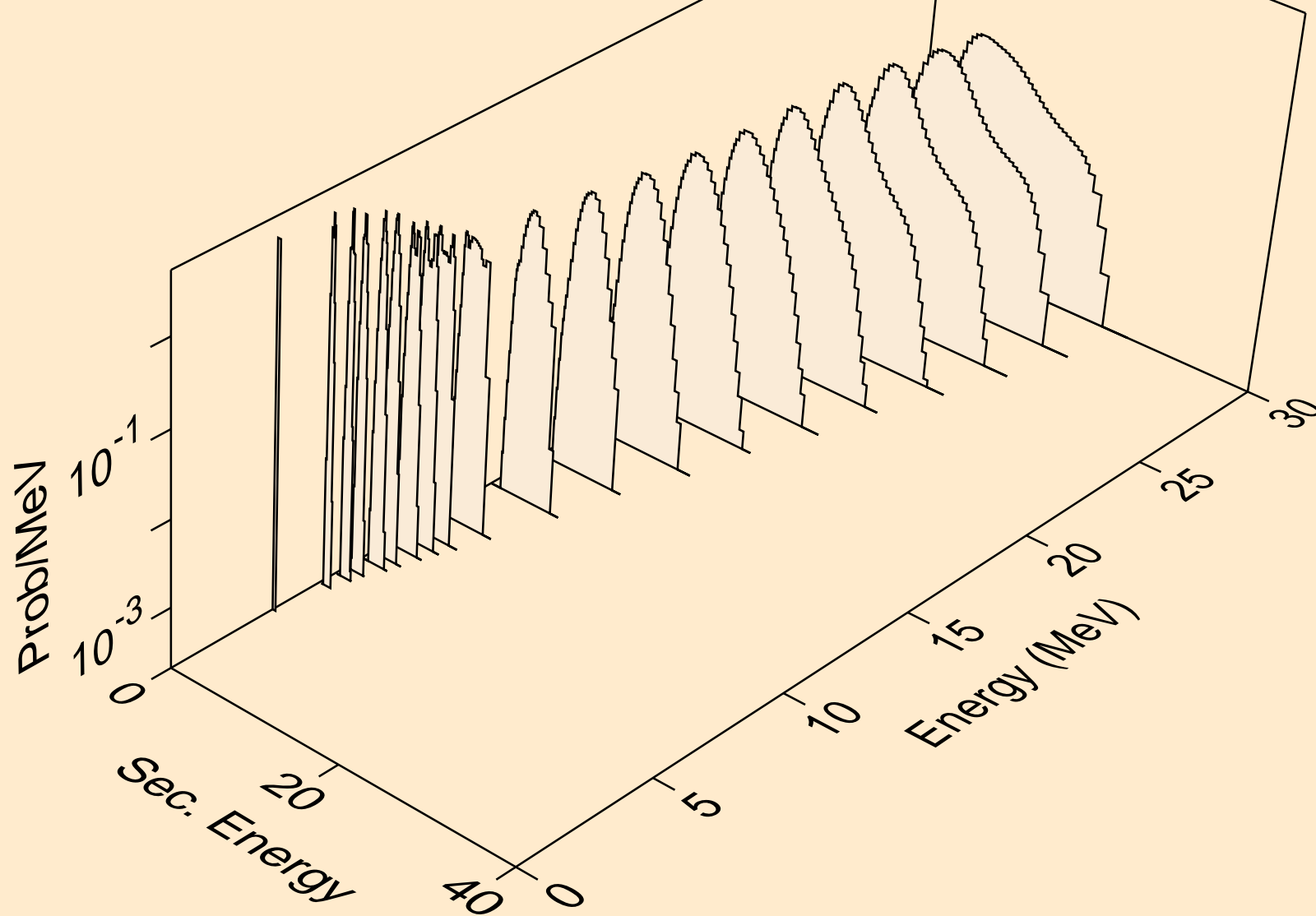

Y086 NEUTRON ACER TENDL-2021 LIBRARY; T=293.6K  
protons from (n,p)

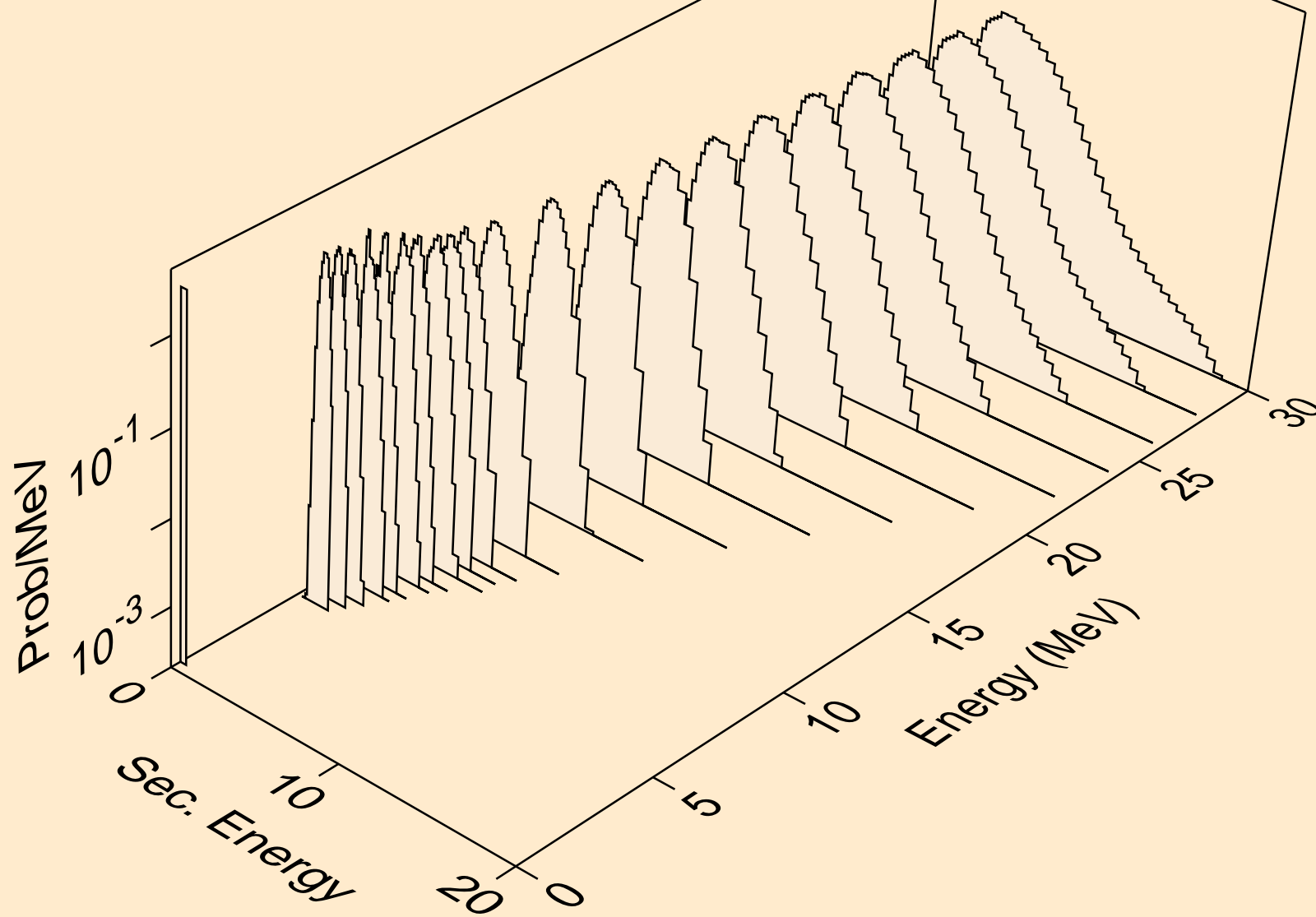

Y086 NEUTRON ACER TENDL-2021 LIBRARY; T=293.6K  
protons from (n,pd)

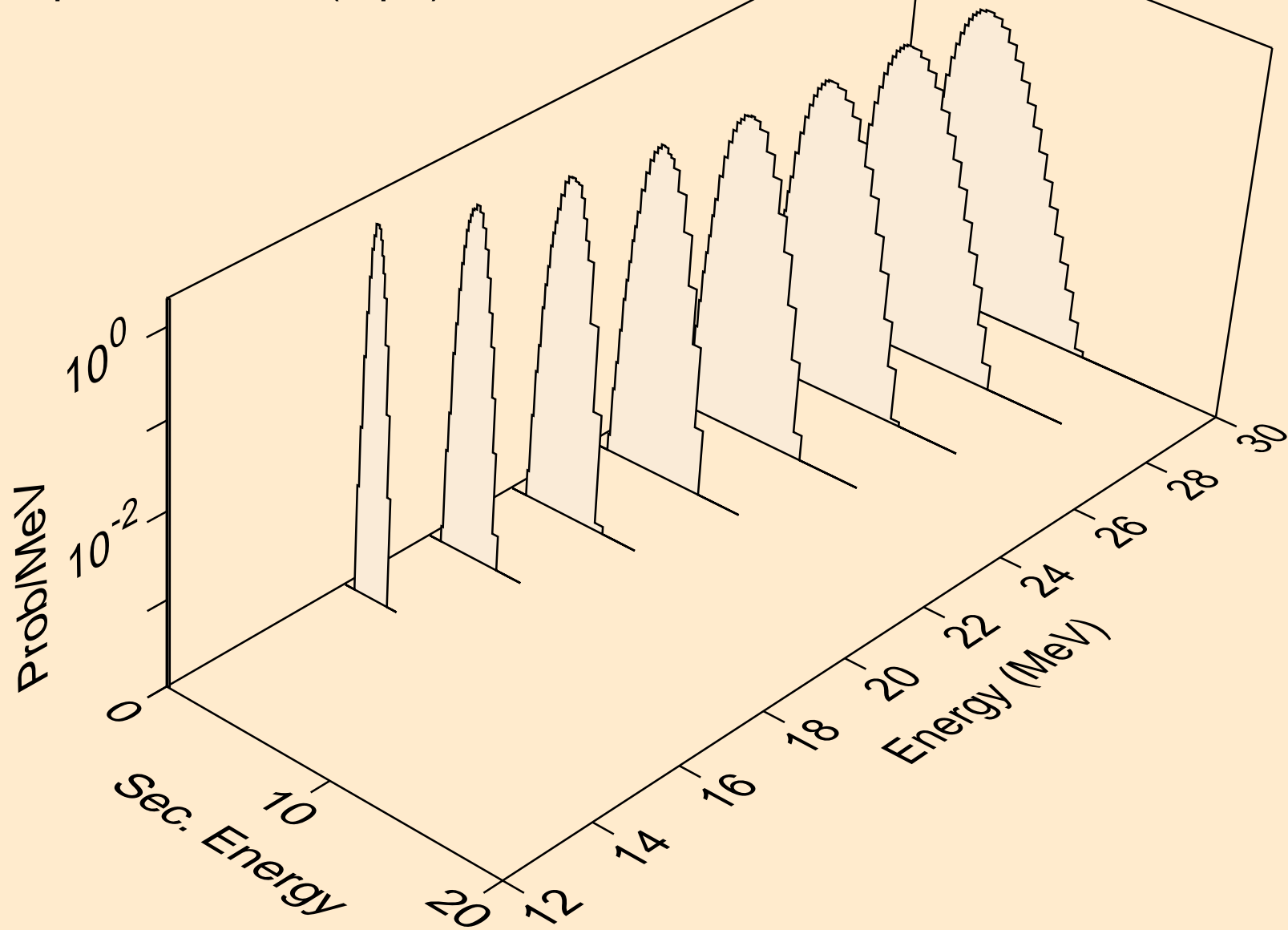



Y086 NEUTRON ACER TENDL-2021 LIBRARY; T=293.6K  
protons from (n,pt)

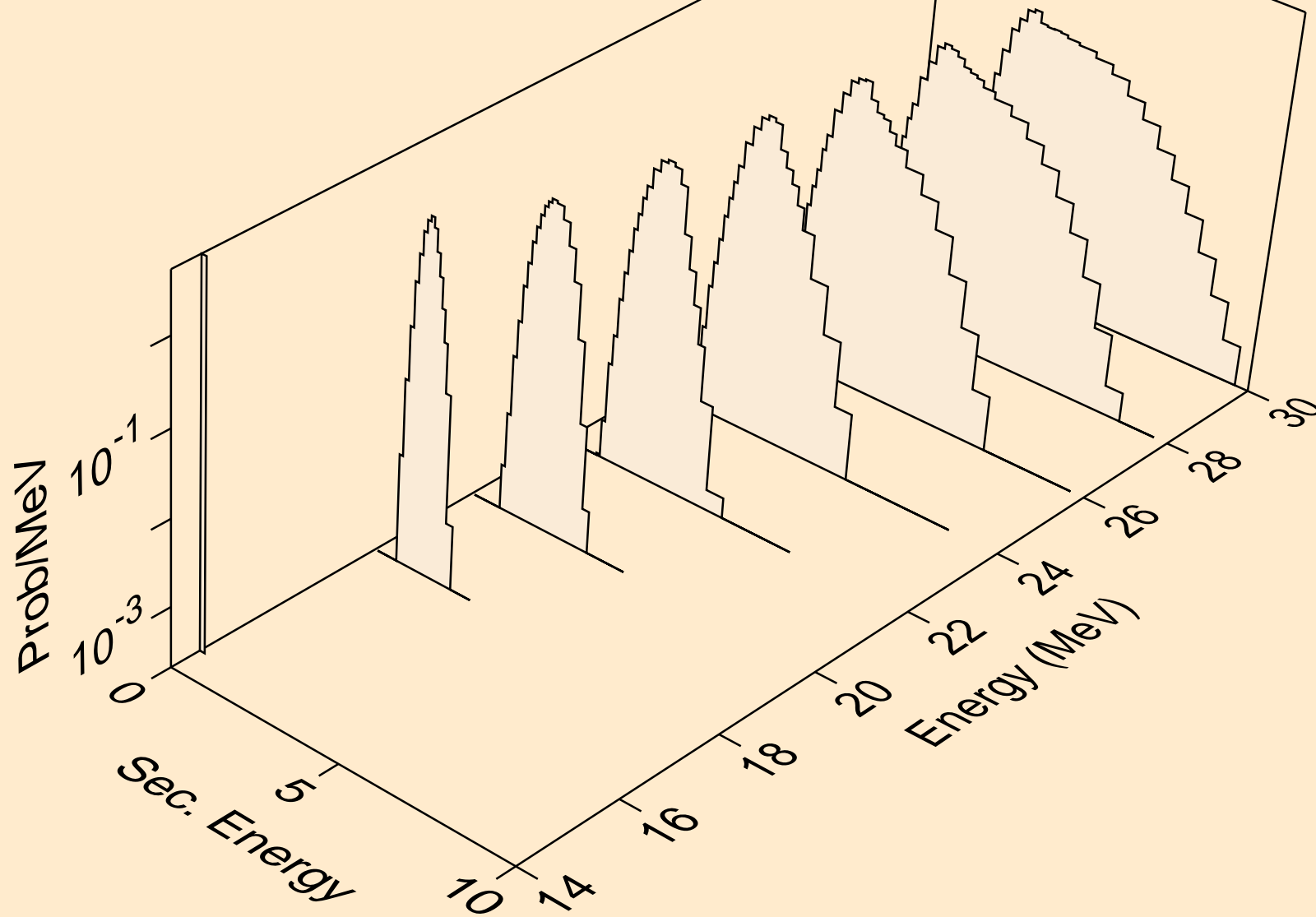

Y086 NEUTRON ACER TENDL-2021 LIBRARY; T=293.6K  
deuterons from (n,x)

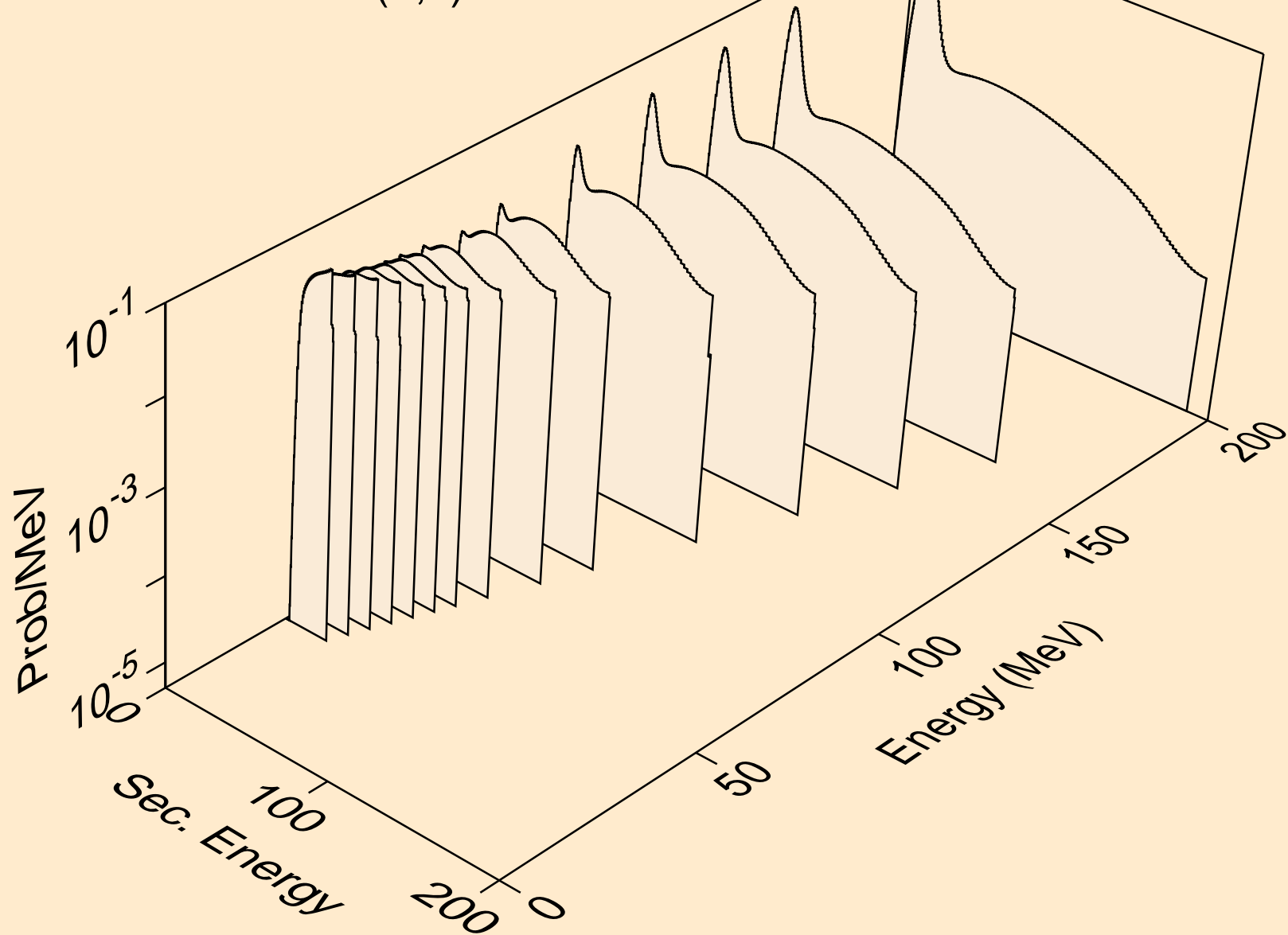

Y086 NEUTRON ACER TENDL-2021 LIBRARY; T=293.6K  
deuterons from (n,2nd)

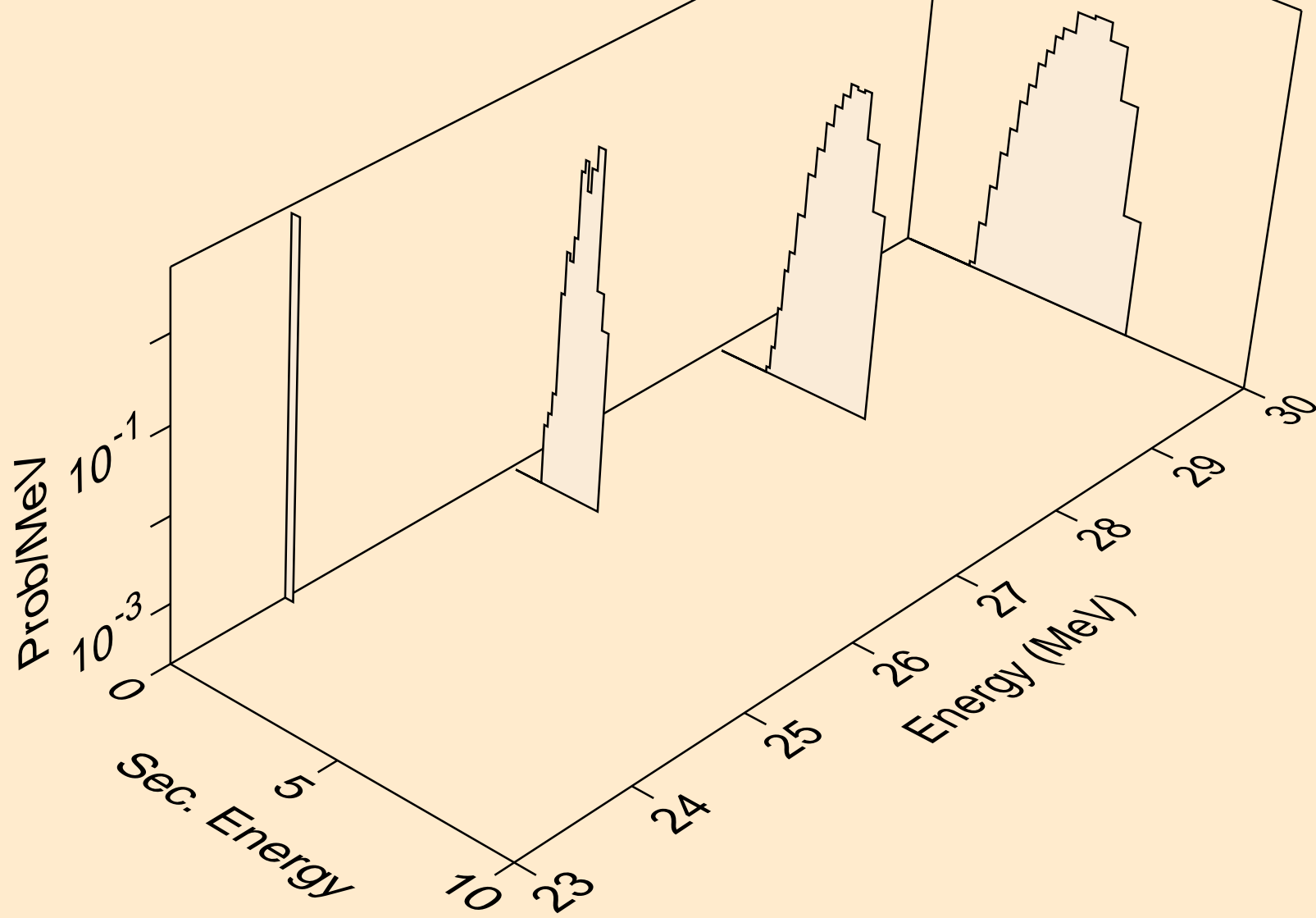

Y086 NEUTRON ACER TENDL-2021 LIBRARY; T=293.6K  
deuterons from (n,n\*)d

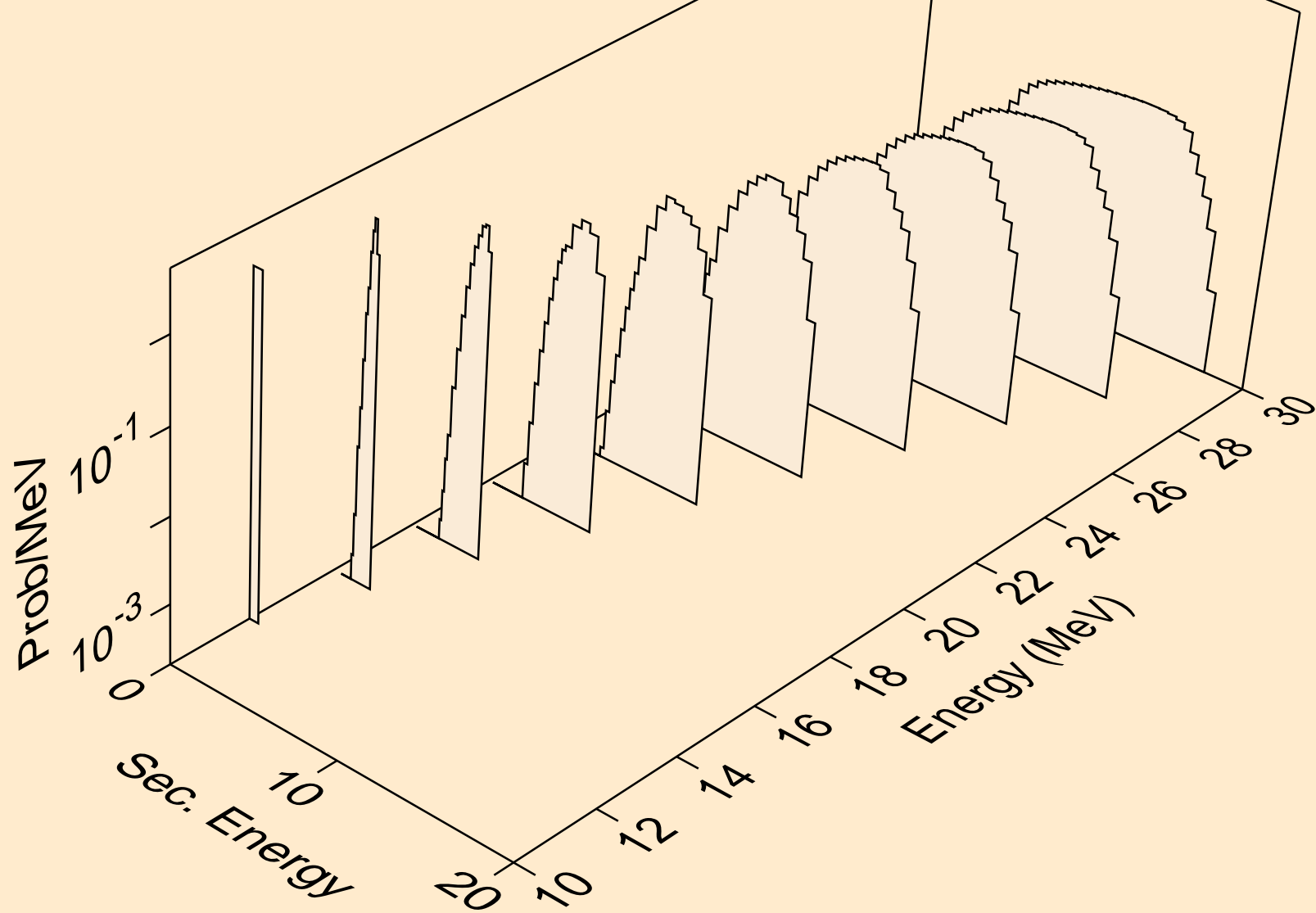

Y086 NEUTRON ACER TENDL-2021 LIBRARY; T=293.6K  
deuterons from (n,d)

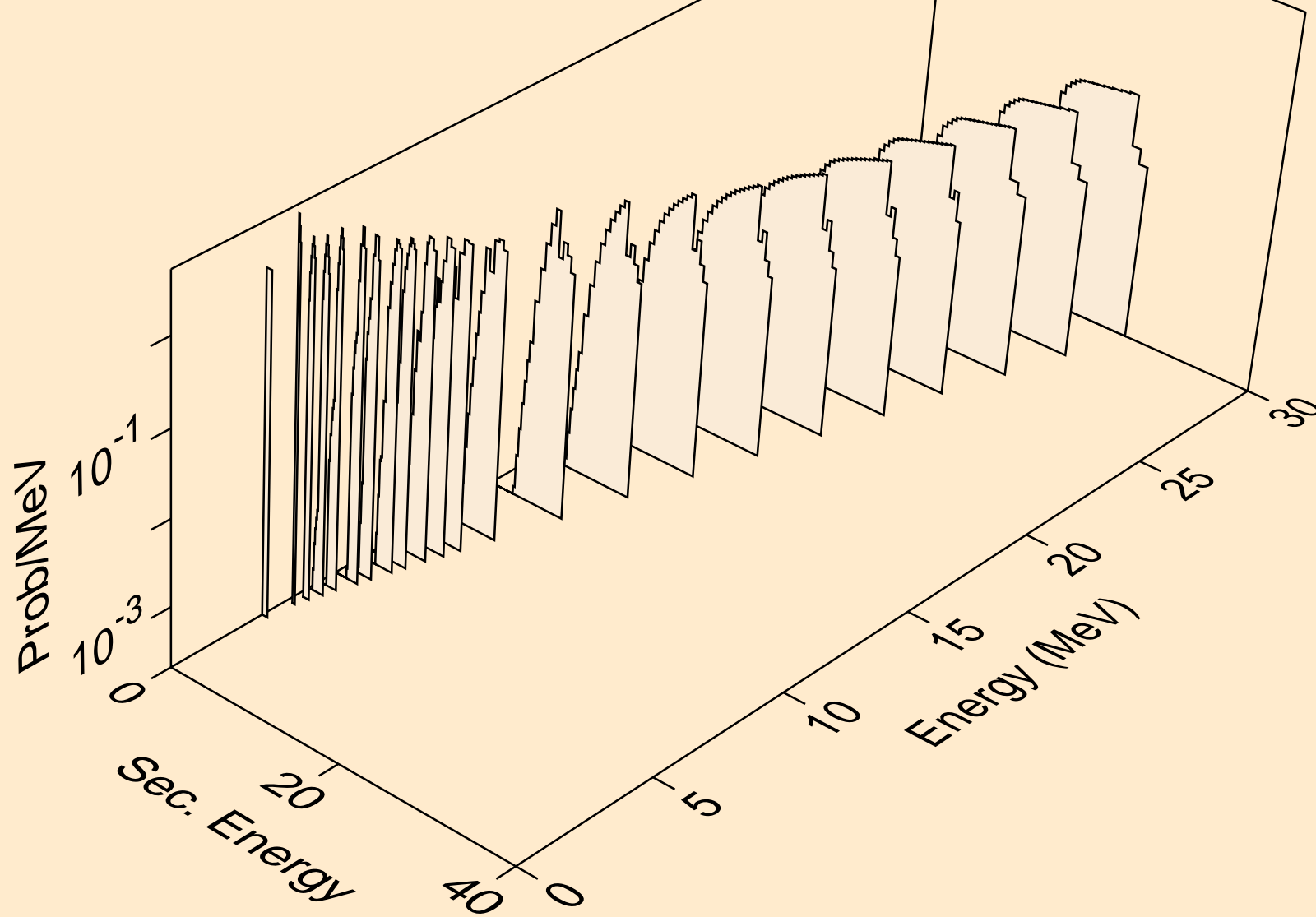

Y086 NEUTRON ACER TENDL-2021 LIBRARY; T=293.6K  
deuterons from (n,pd)

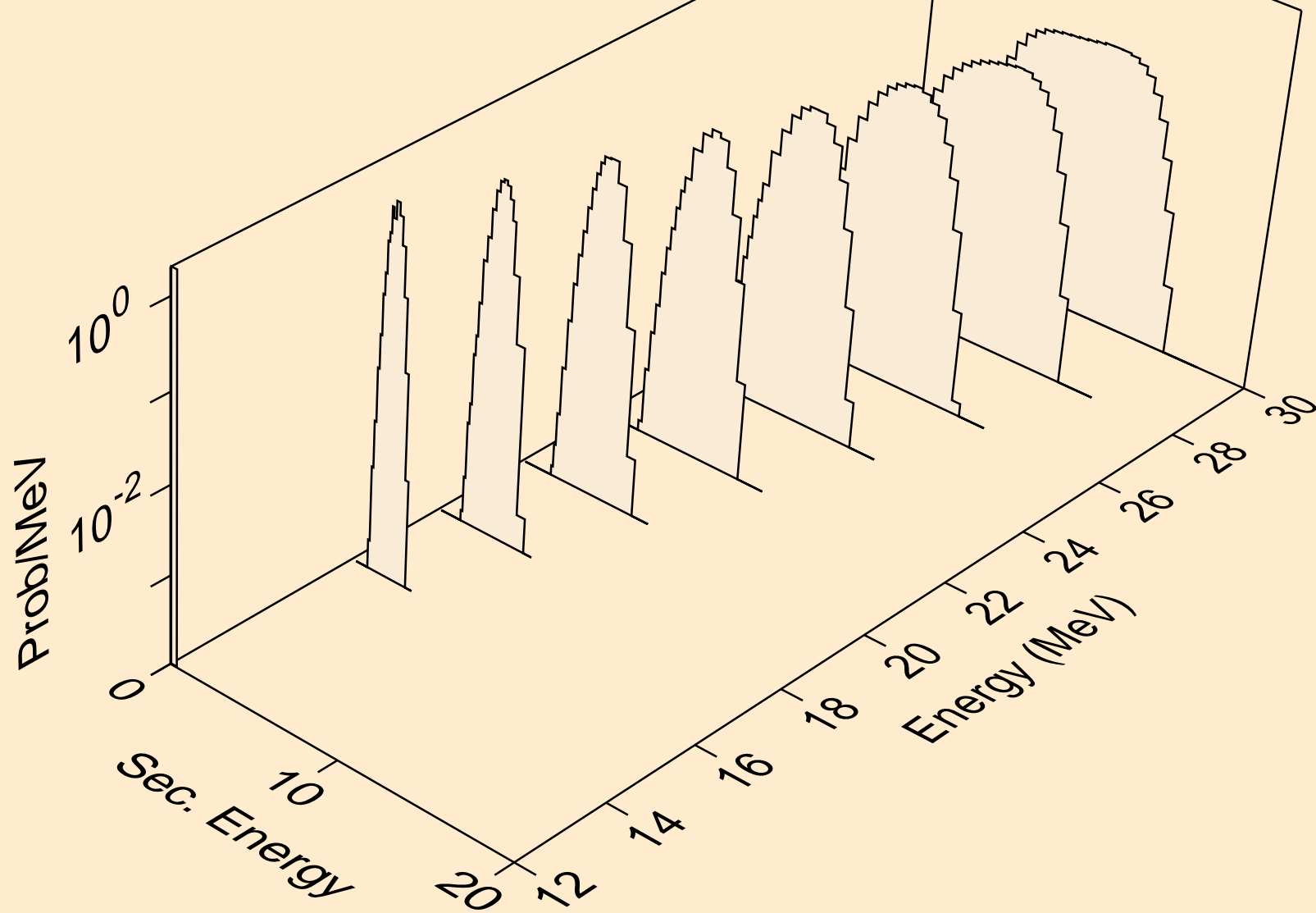

Y086 NEUTRON ACER TENDL-2021 LIBRARY; T=293.6K  
deuterons from (n,da)

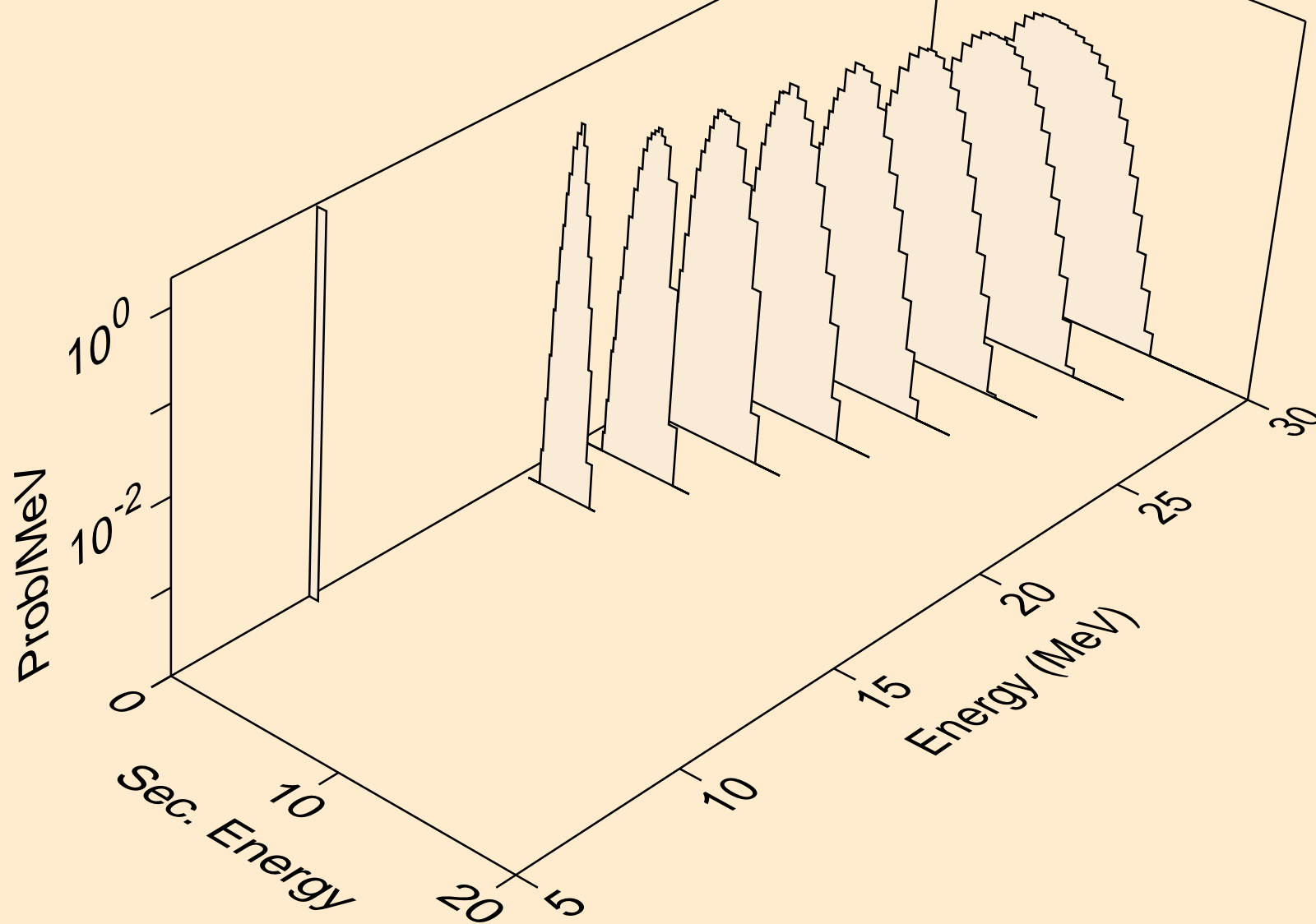

Y086 NEUTRON ACER TENDL-2021 LIBRARY; T=293.6K  
tritons from (n,x)

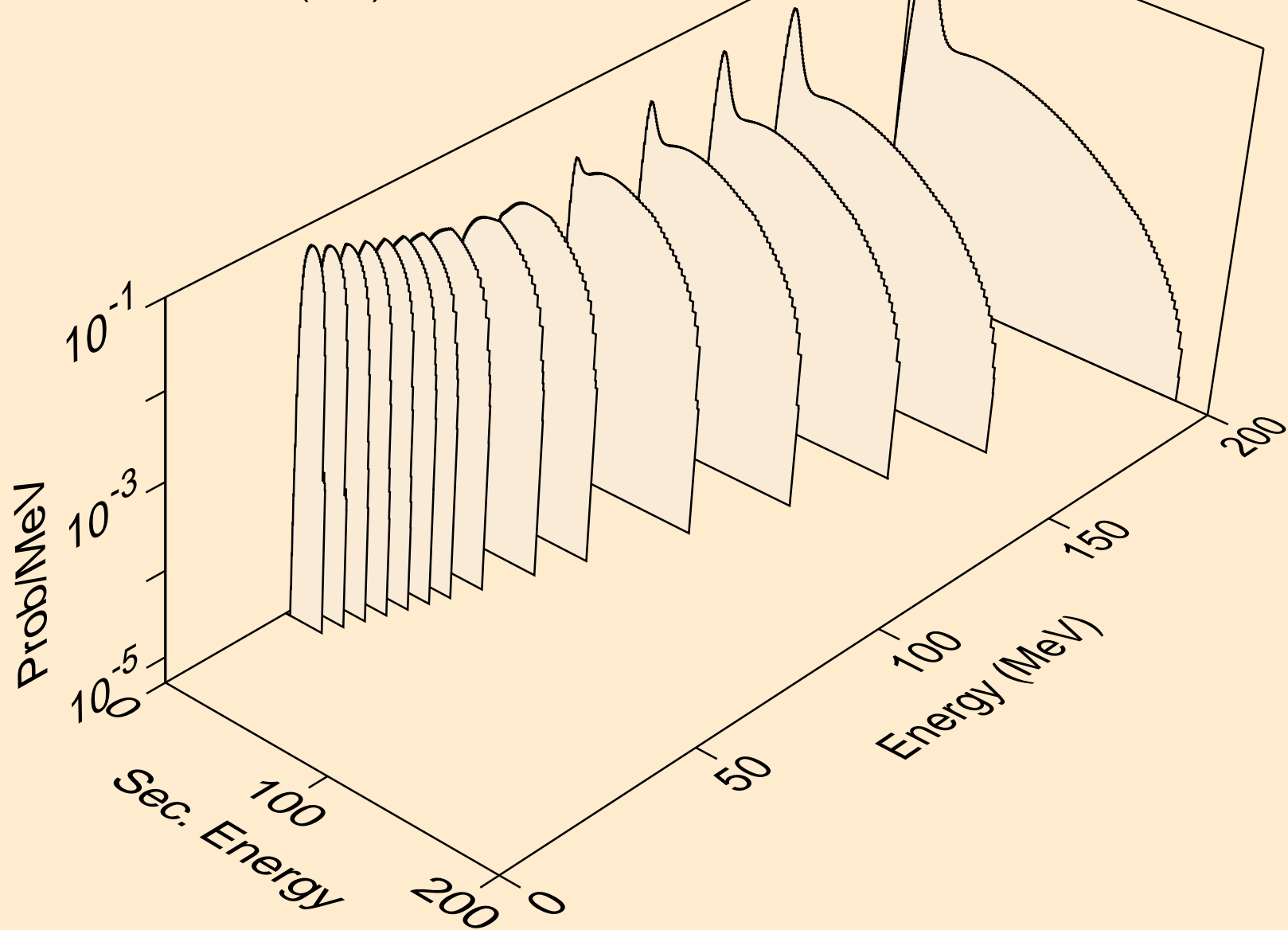



Y086 NEUTRON ACER TENDL-2021 LIBRARY; T=293.6K  
tritons from (n,n\*)t

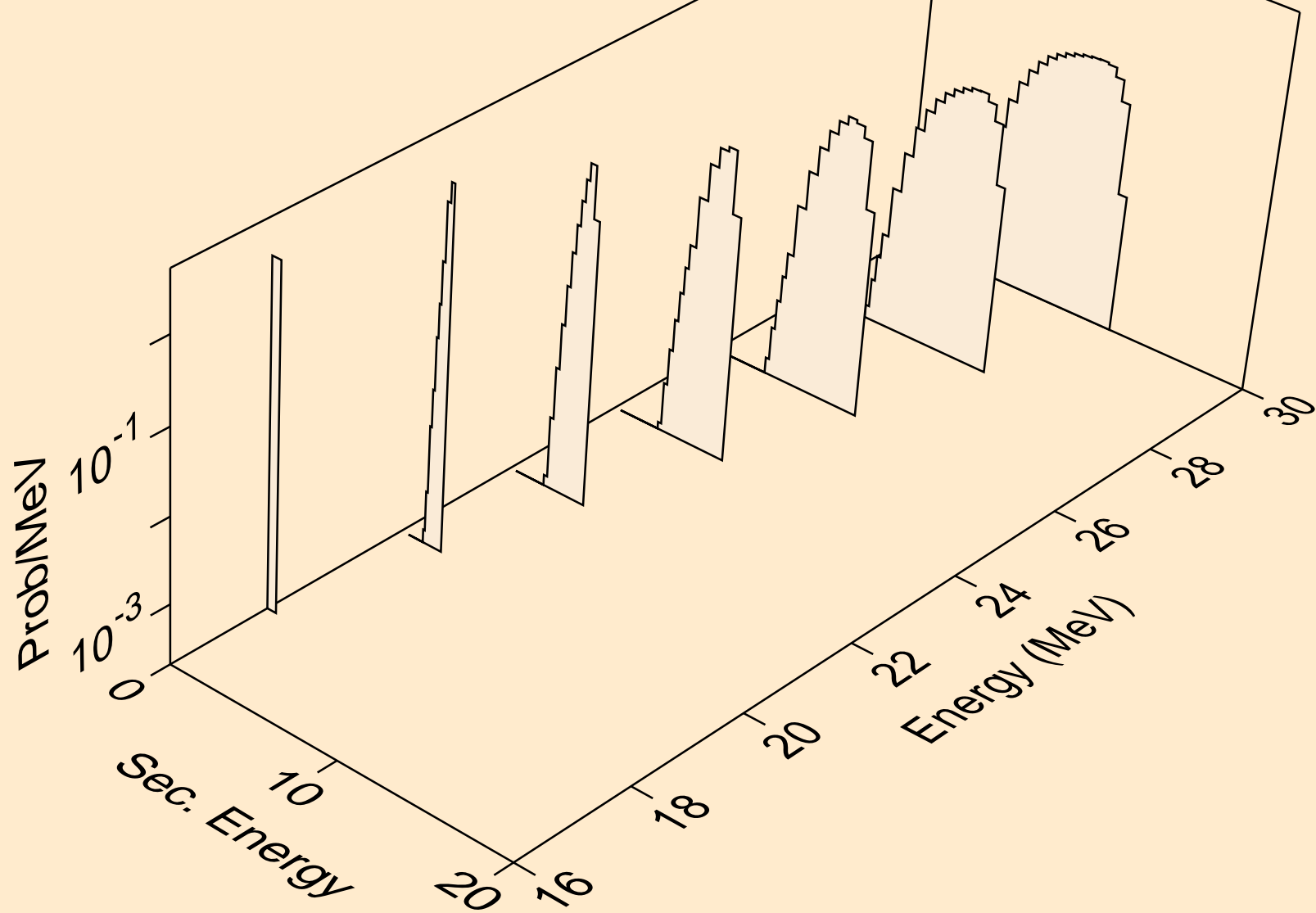

Y086 NEUTRON ACER TENDL-2021 LIBRARY; T=293.6K  
tritons from (n,t)

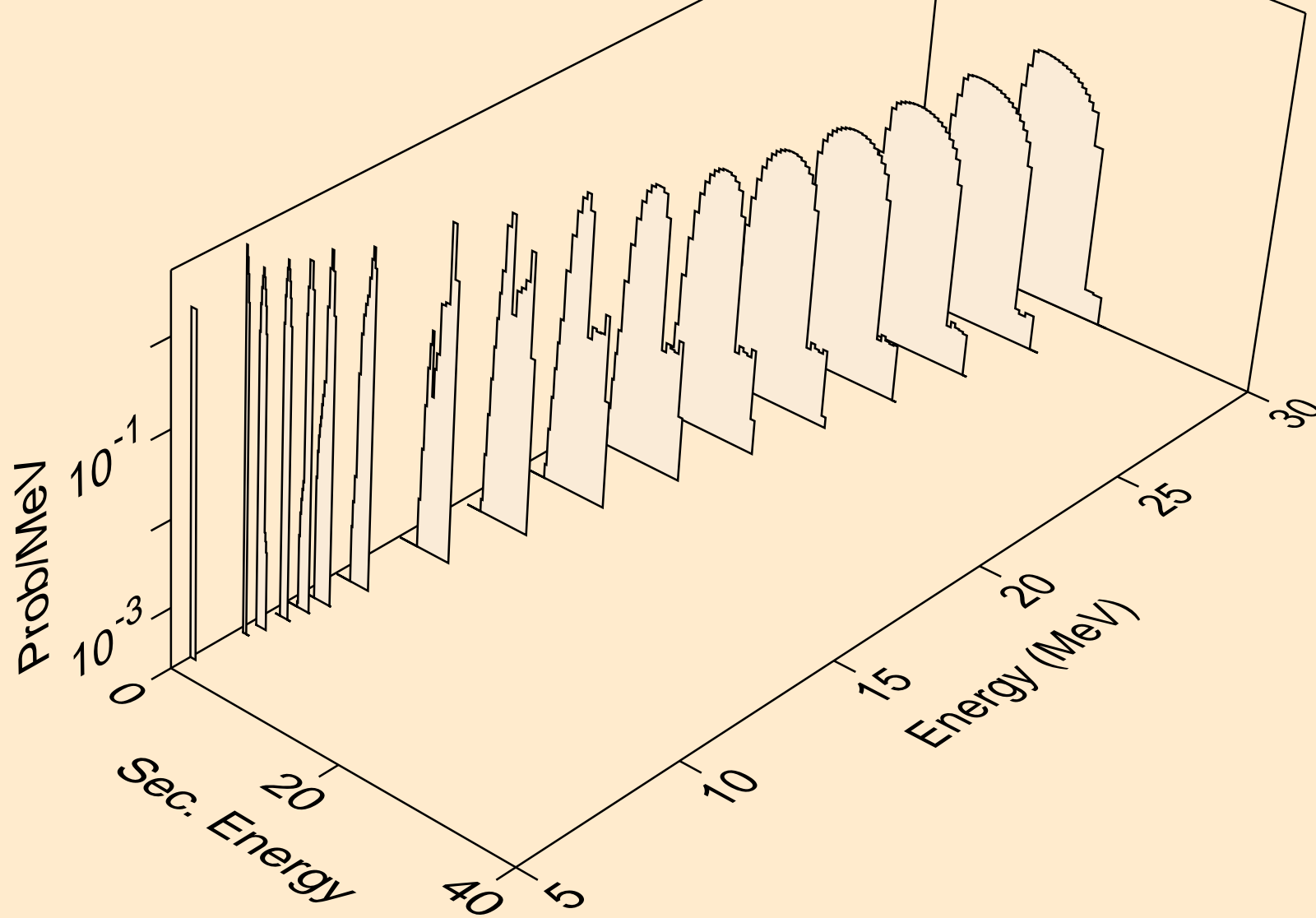

Y086 NEUTRON ACER TENDL-2021 LIBRARY; T=293.6K  
tritons from (n,pt)

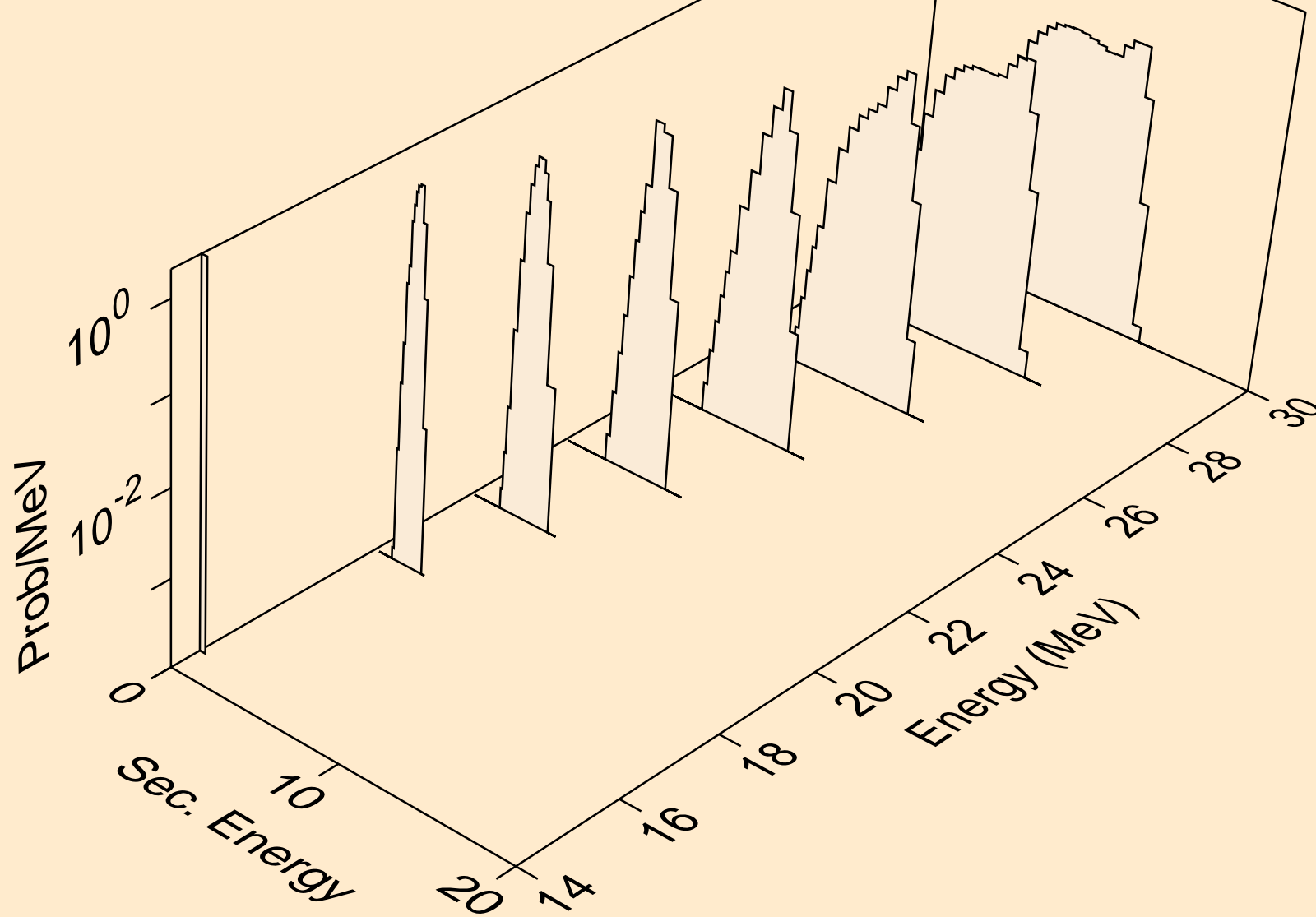

Y086 NEUTRON ACER TENDL-2021 LIBRARY; T=293.6K  
he3s from (n,x)

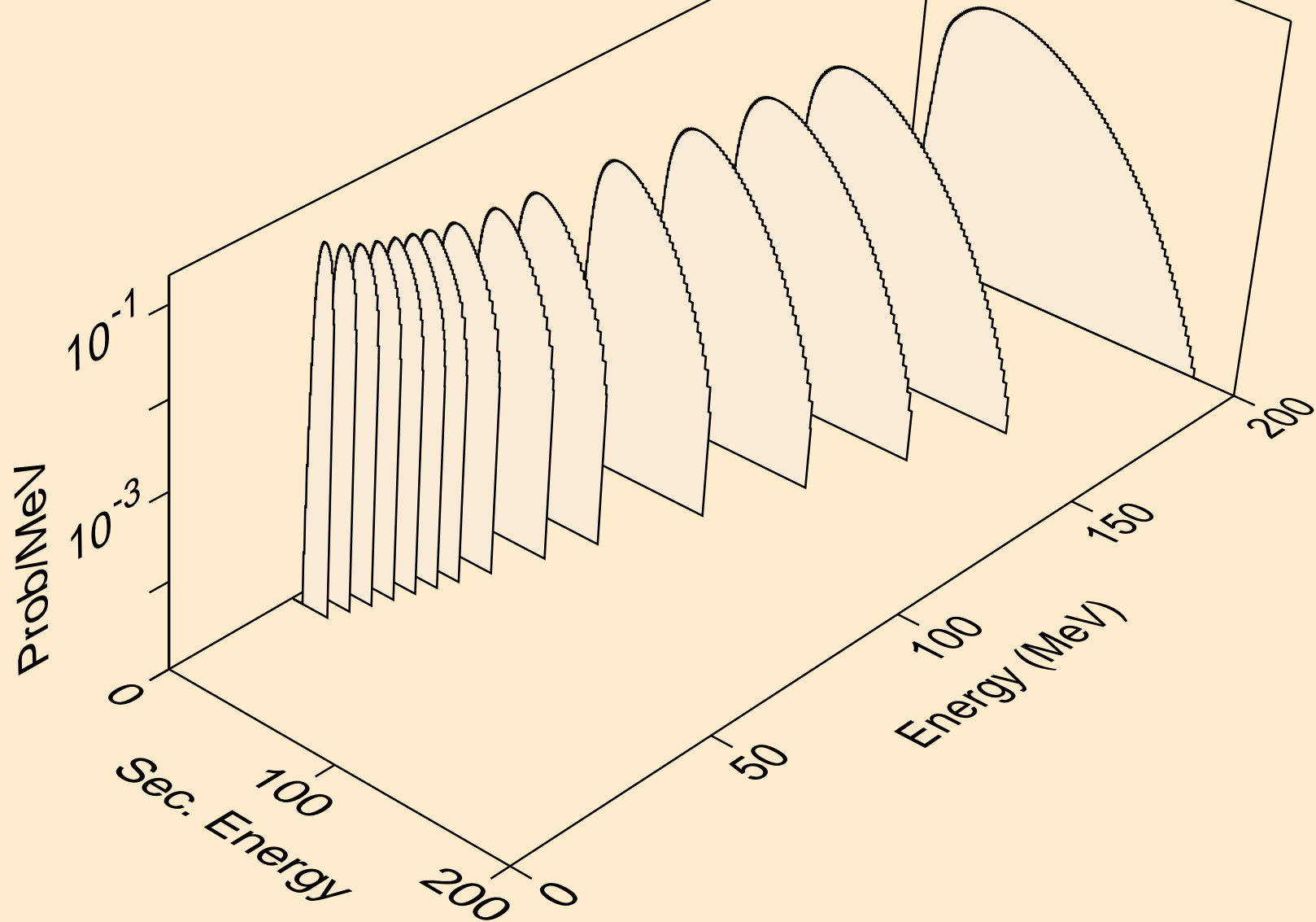

Y086 NEUTRON ACER TENDL-2021 LIBRARY; T=293.6K  
he3s from (n,n\*)he3

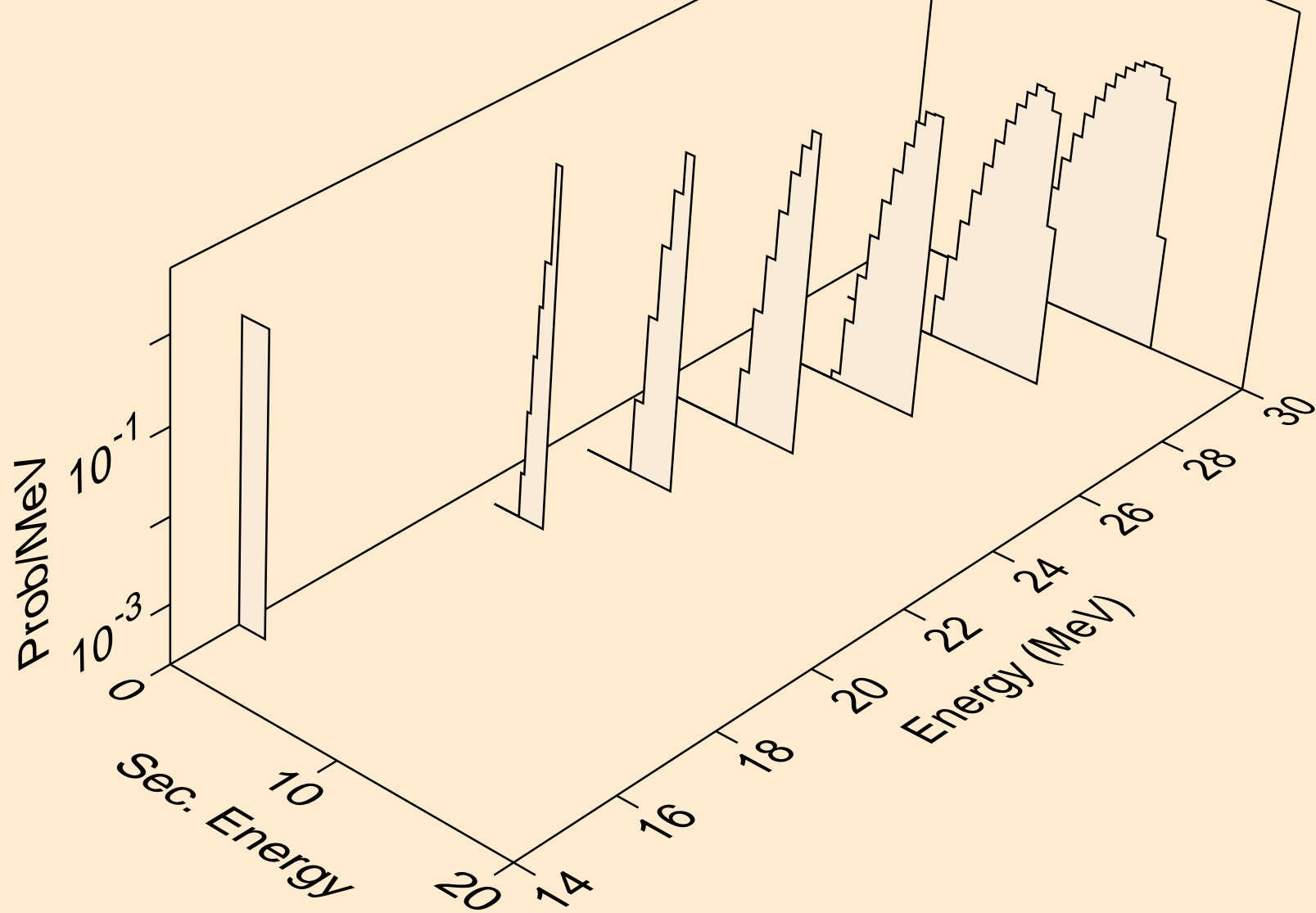

Y086 NEUTRON ACER TENDL-2021 LIBRARY; T=293.6K  
he3s from (n,he3)

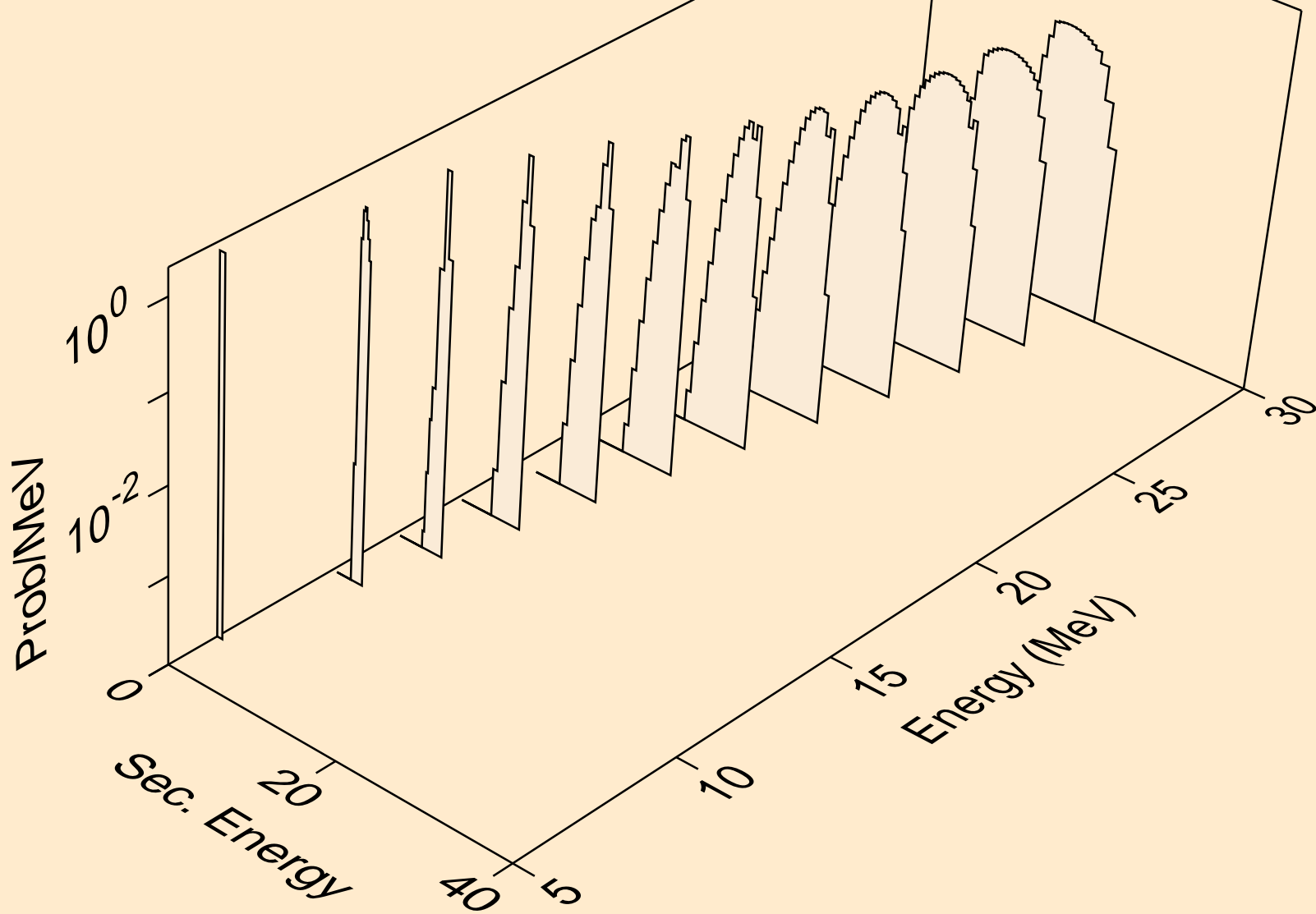

Y086 NEUTRON ACER TENDL-2021 LIBRARY; T=293.6K  
alphas from (n,x)

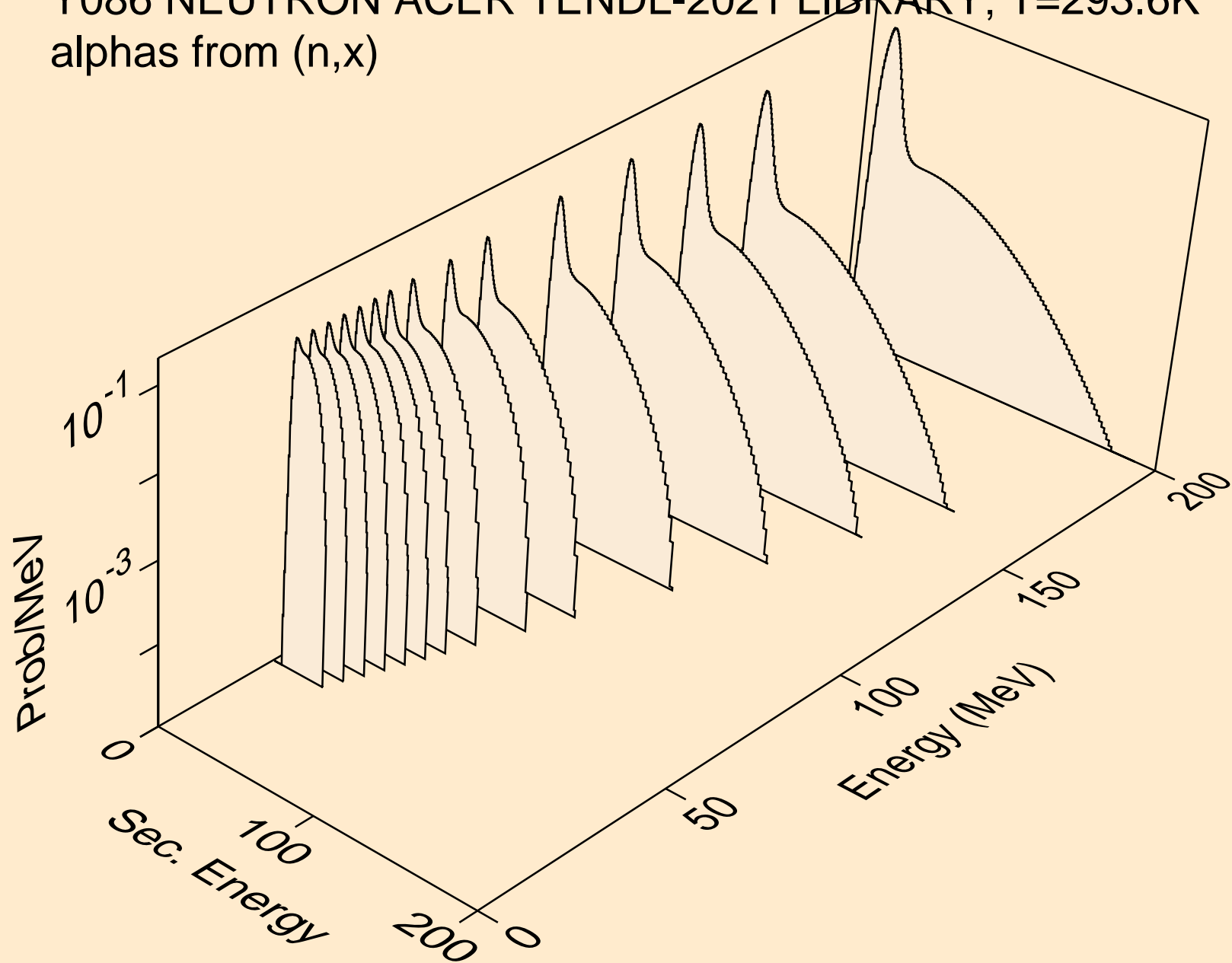

Y086 NEUTRON ACER TENDL-2021 LIBRARY; T=293.6K  
alphas from (n,n\*)a

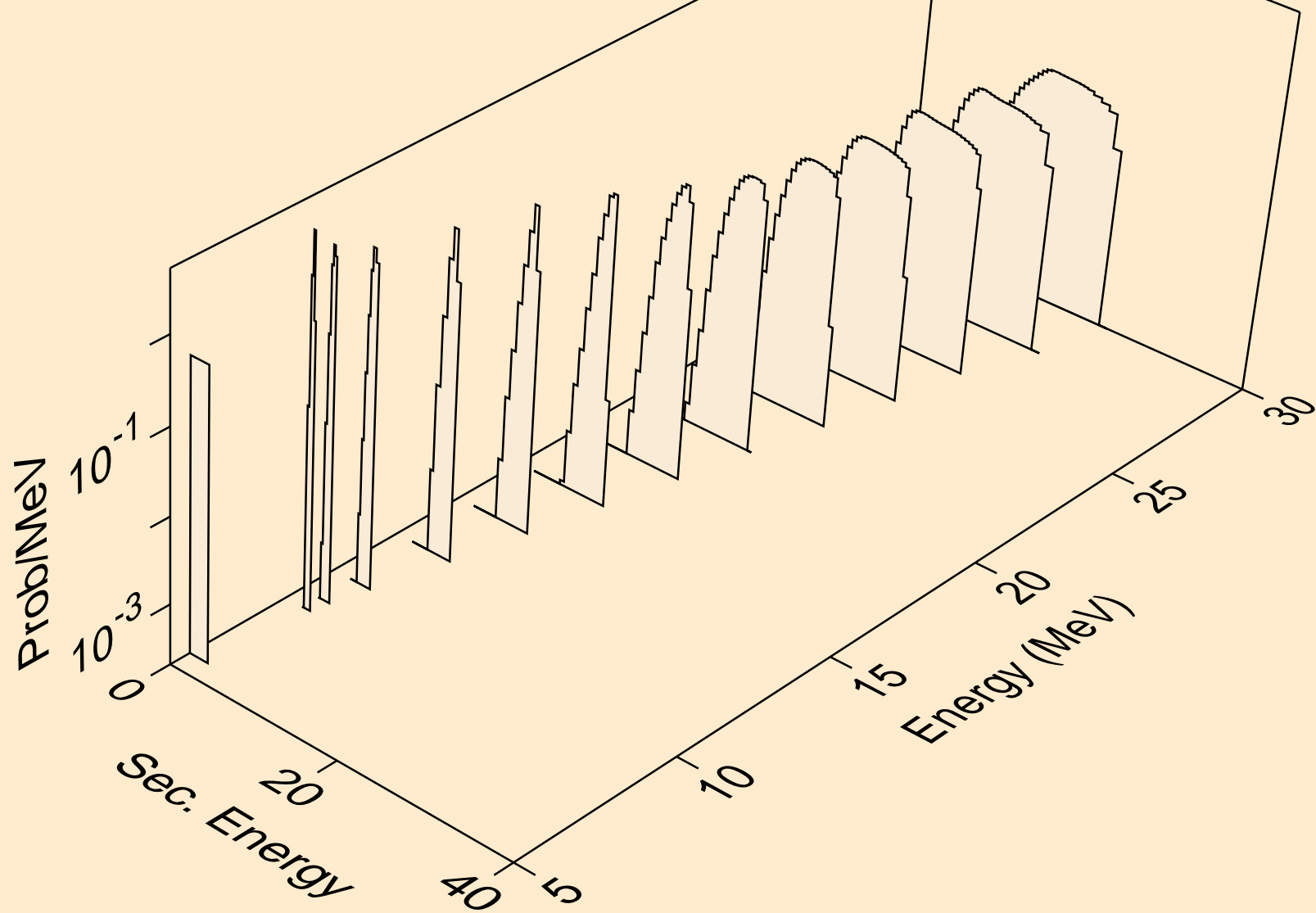



Y086 NEUTRON ACER TENDL-2021 LIBRARY; T=293.6K  
alphas from (n,2n)a

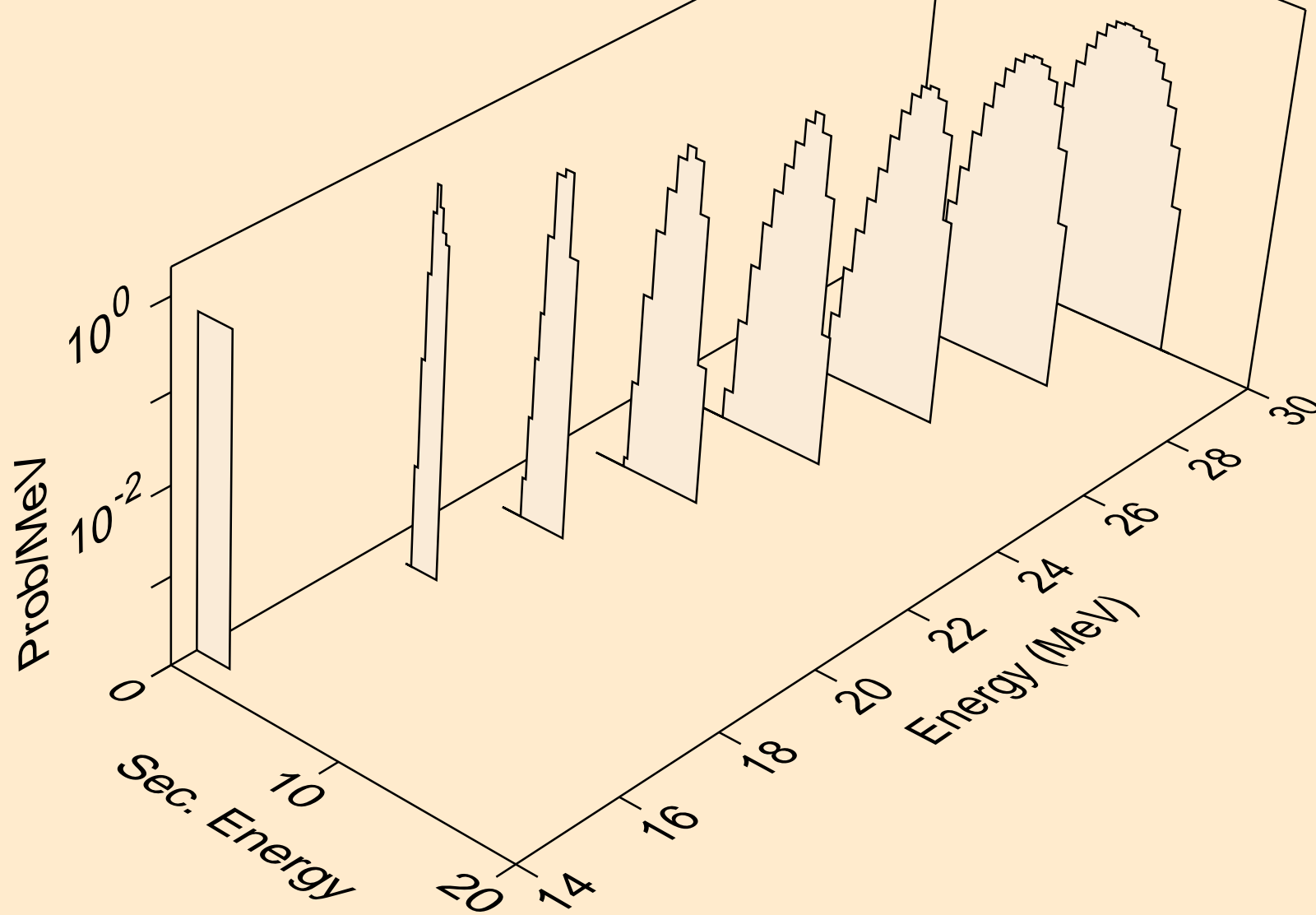

Y086 NEUTRON ACER TENDL-2021 LIBRARY; T=293.6K  
alphas from (n,n\*)2a

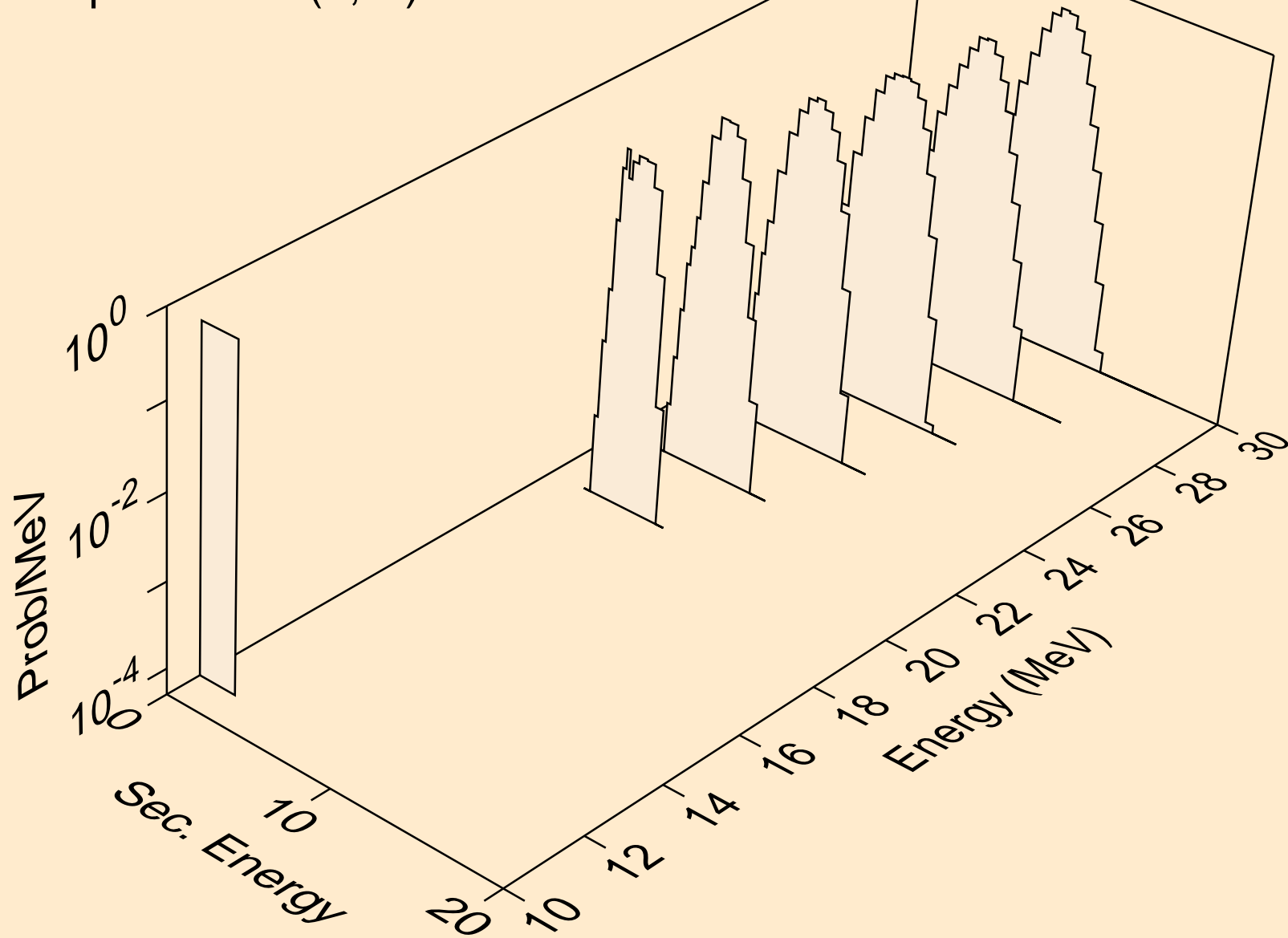

Y086 NEUTRON ACER TENDL-2021 LIBRARY; T=293.6K  
alphas from (n,npa)

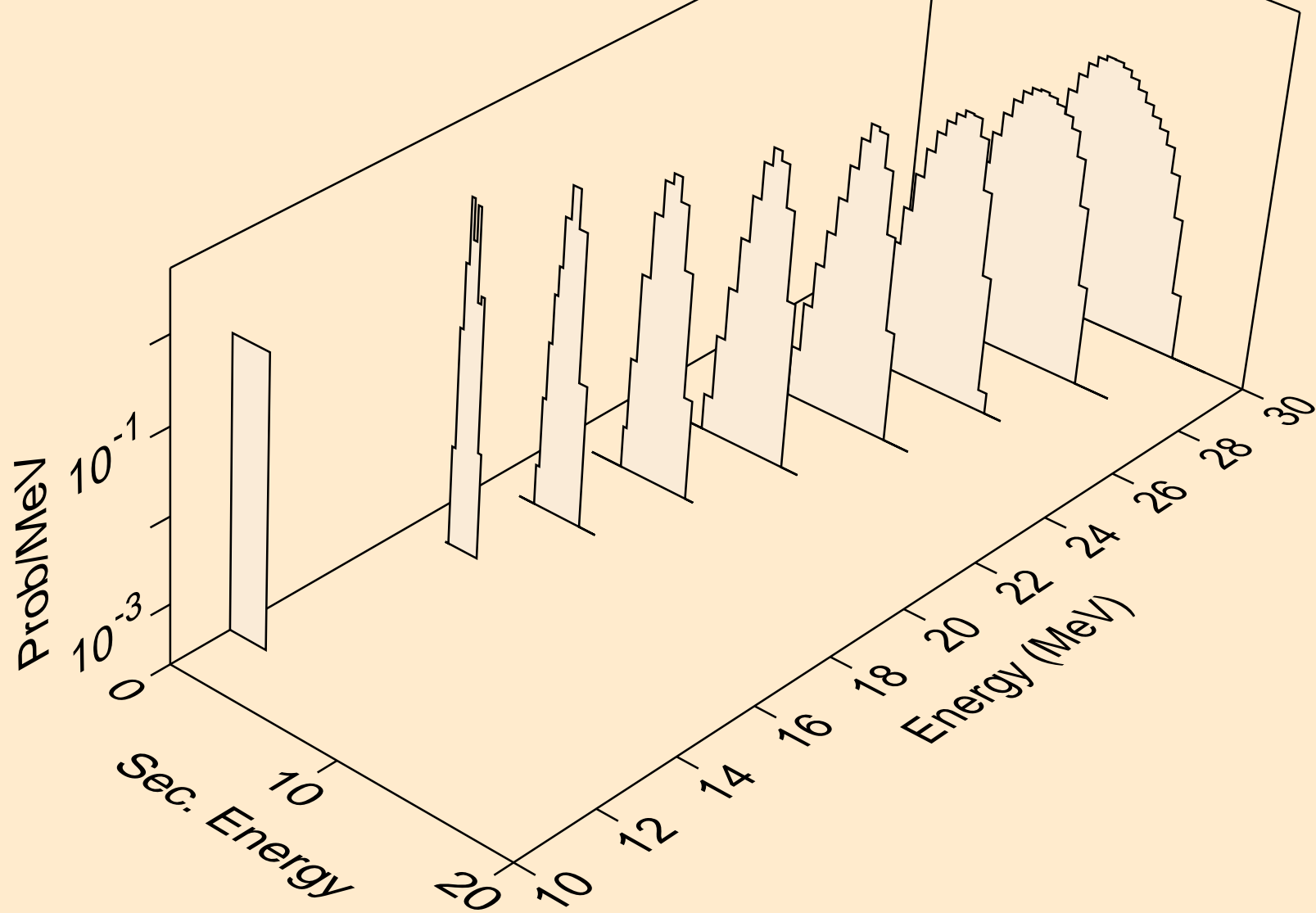

Y086 NEUTRON ACER TENDL-2021 LIBRARY; T=293.6K  
alphas from (n,a)

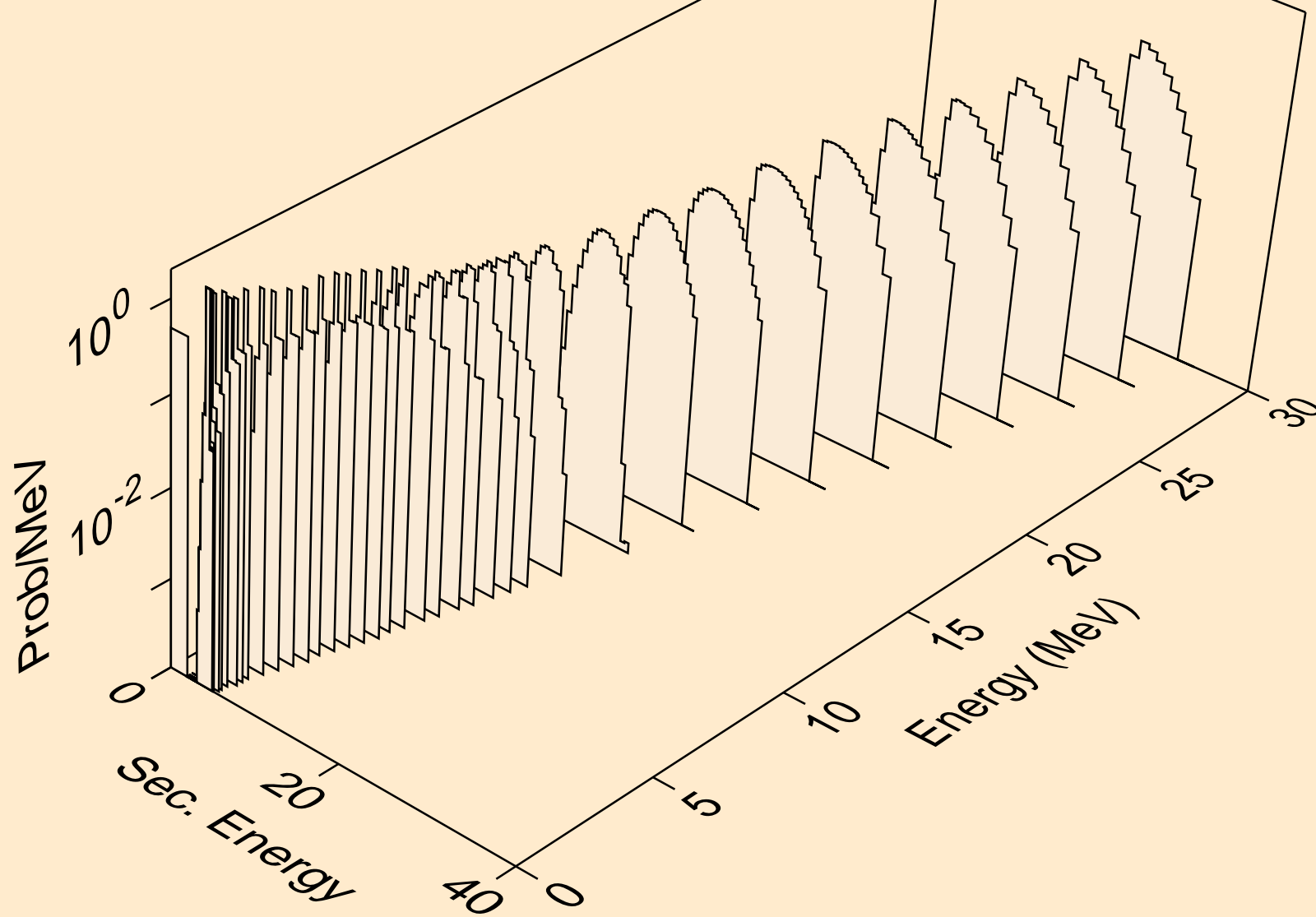

Y086 NEUTRON ACER TENDL-2021 LIBRARY; T=293.6K  
alphas from (n,2a)

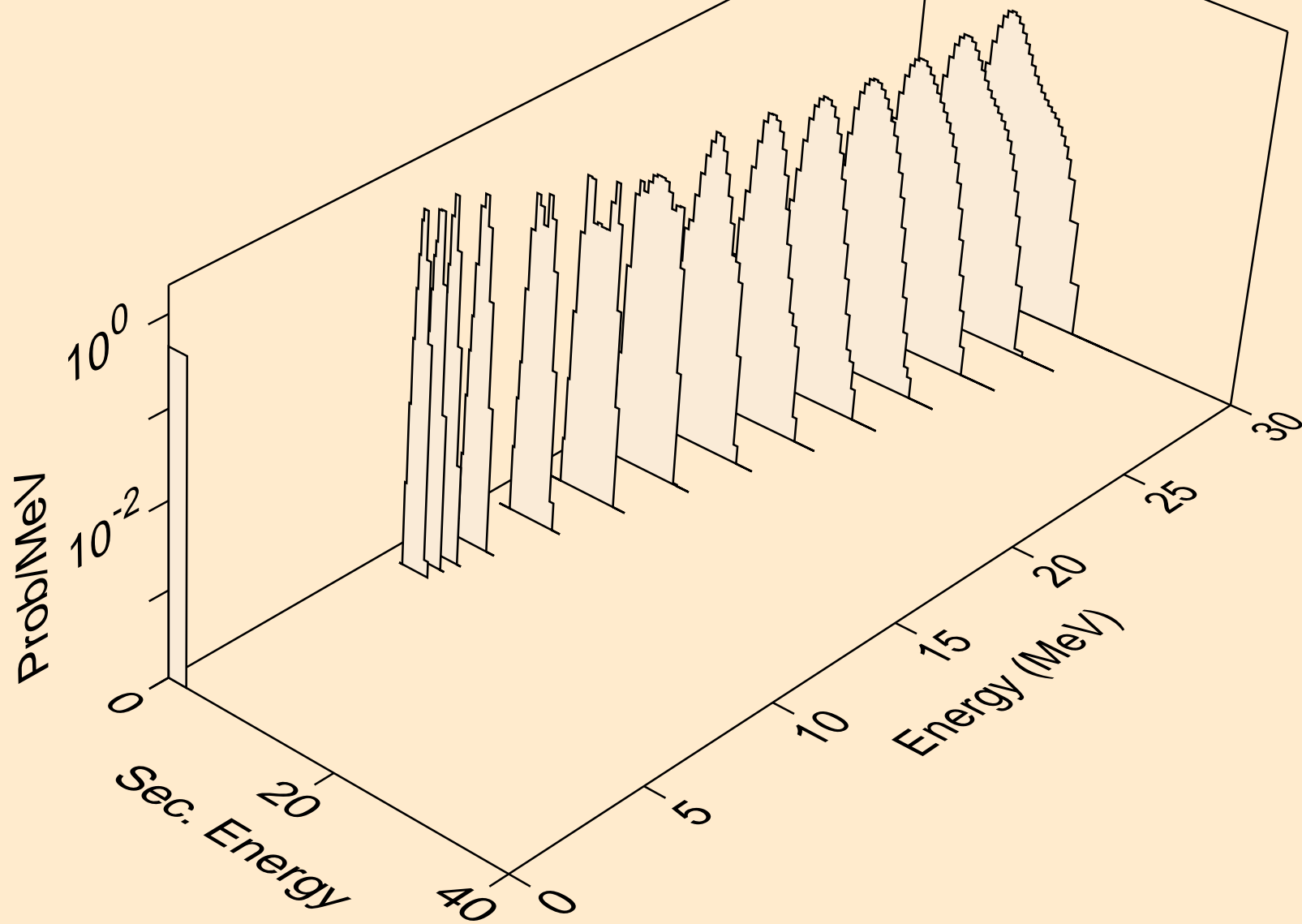

Y086 NEUTRON ACER TENDL-2021 LIBRARY; T=293.6K  
alphas from (n,pa)

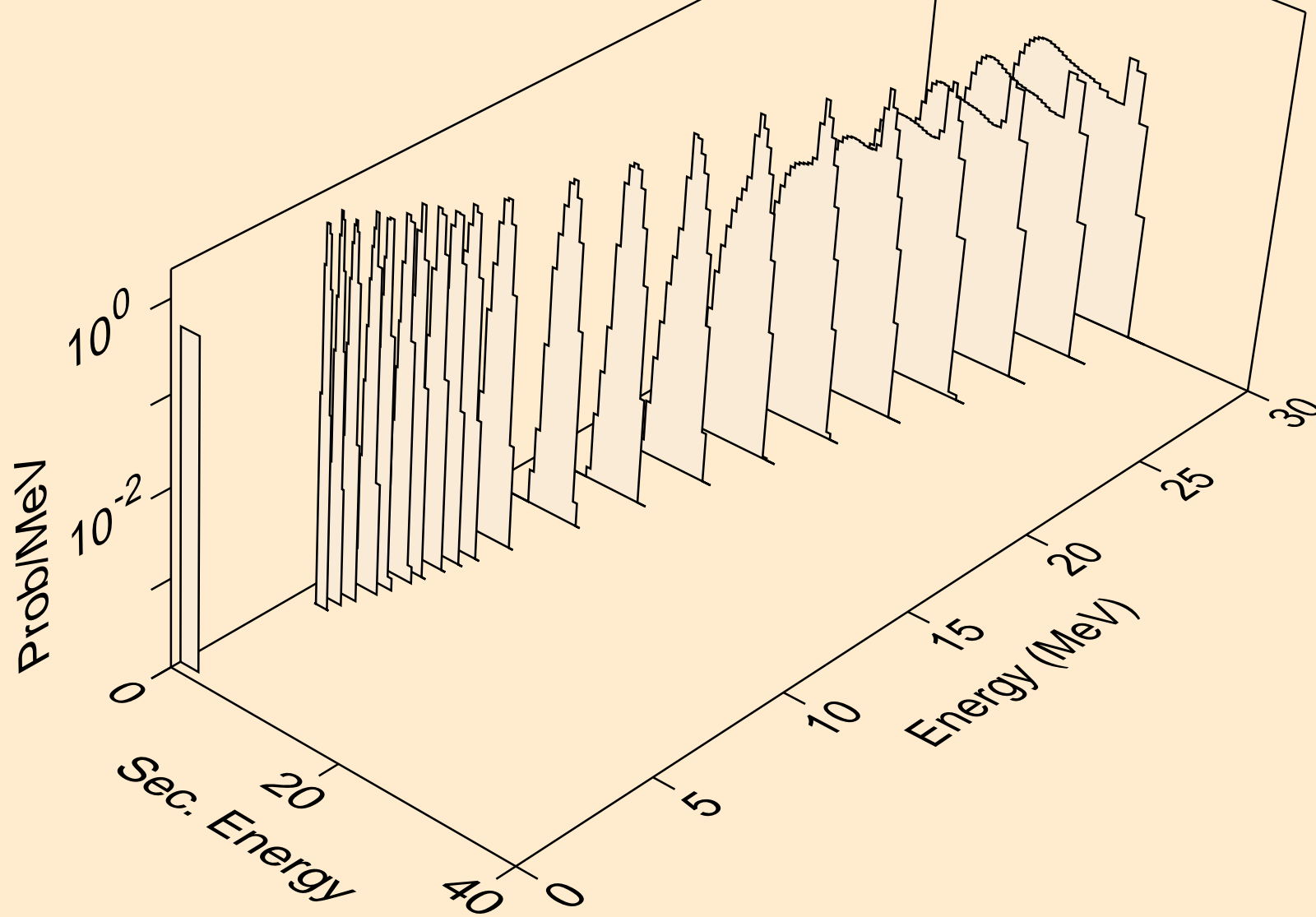

Y086 NEUTRON ACER TENDL-2021 LIBRARY; T=293.6K  
alphas from (n,da)

