

YB162 NEUTRON ACER TENDL-2021 LIBRARY; T=293.6K  
Principal cross sections

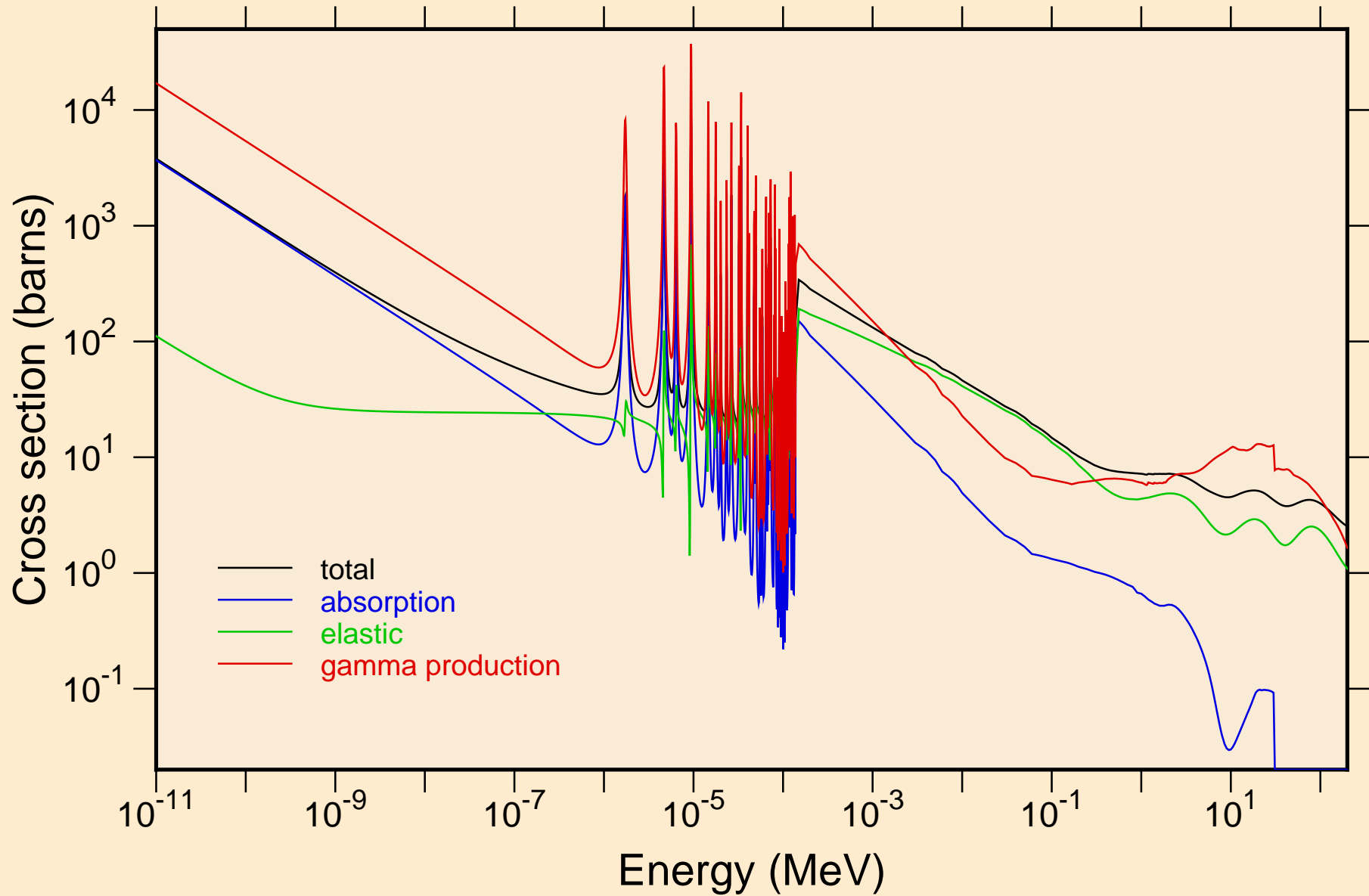

YB162 NEUTRON ACER TENDL-2021 LIBRARY; T=293.6K  
resonance total cross section

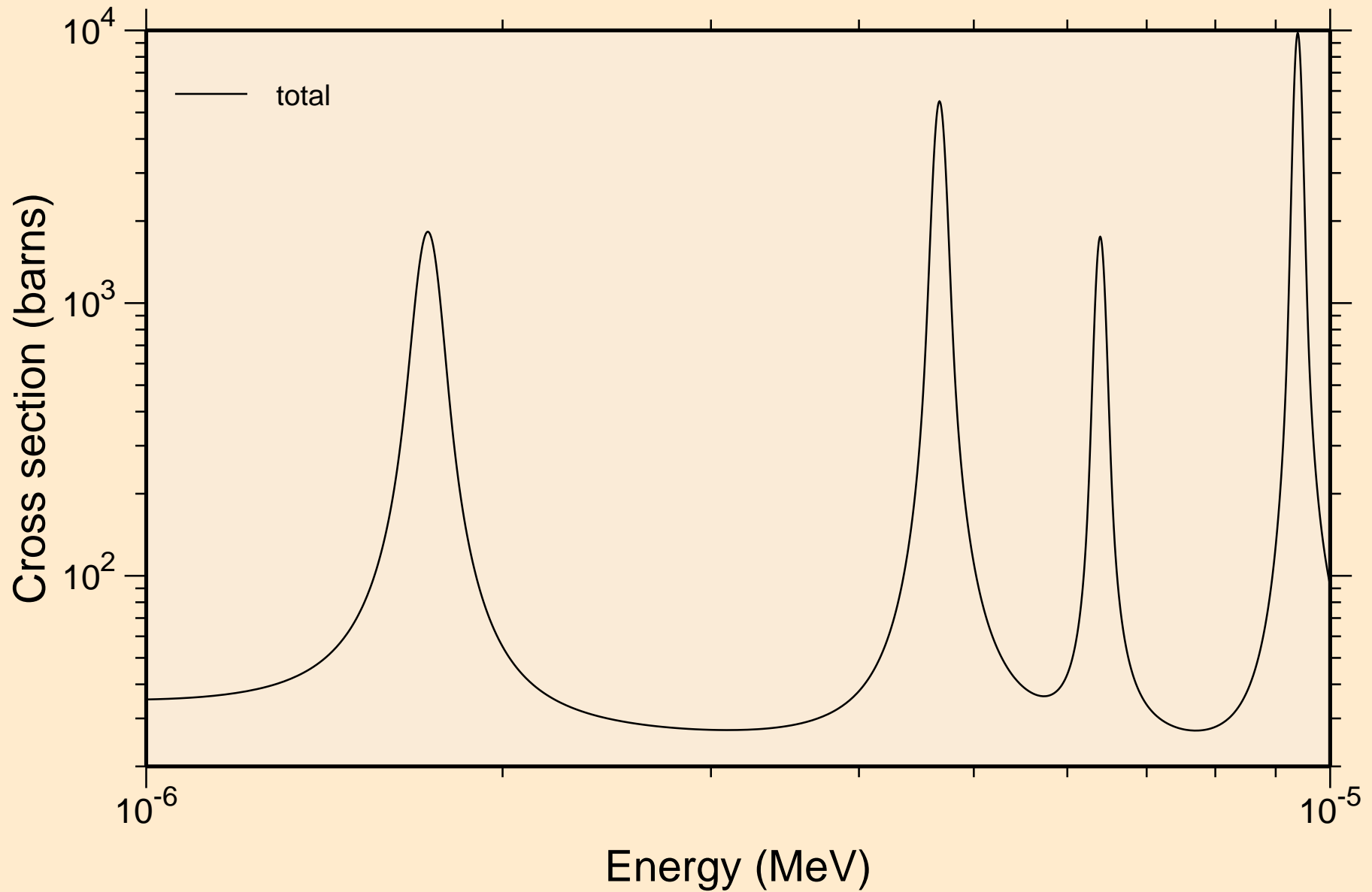

YB162 NEUTRON ACER TENDL-2021 LIBRARY; T=293.6K  
resonance total cross section

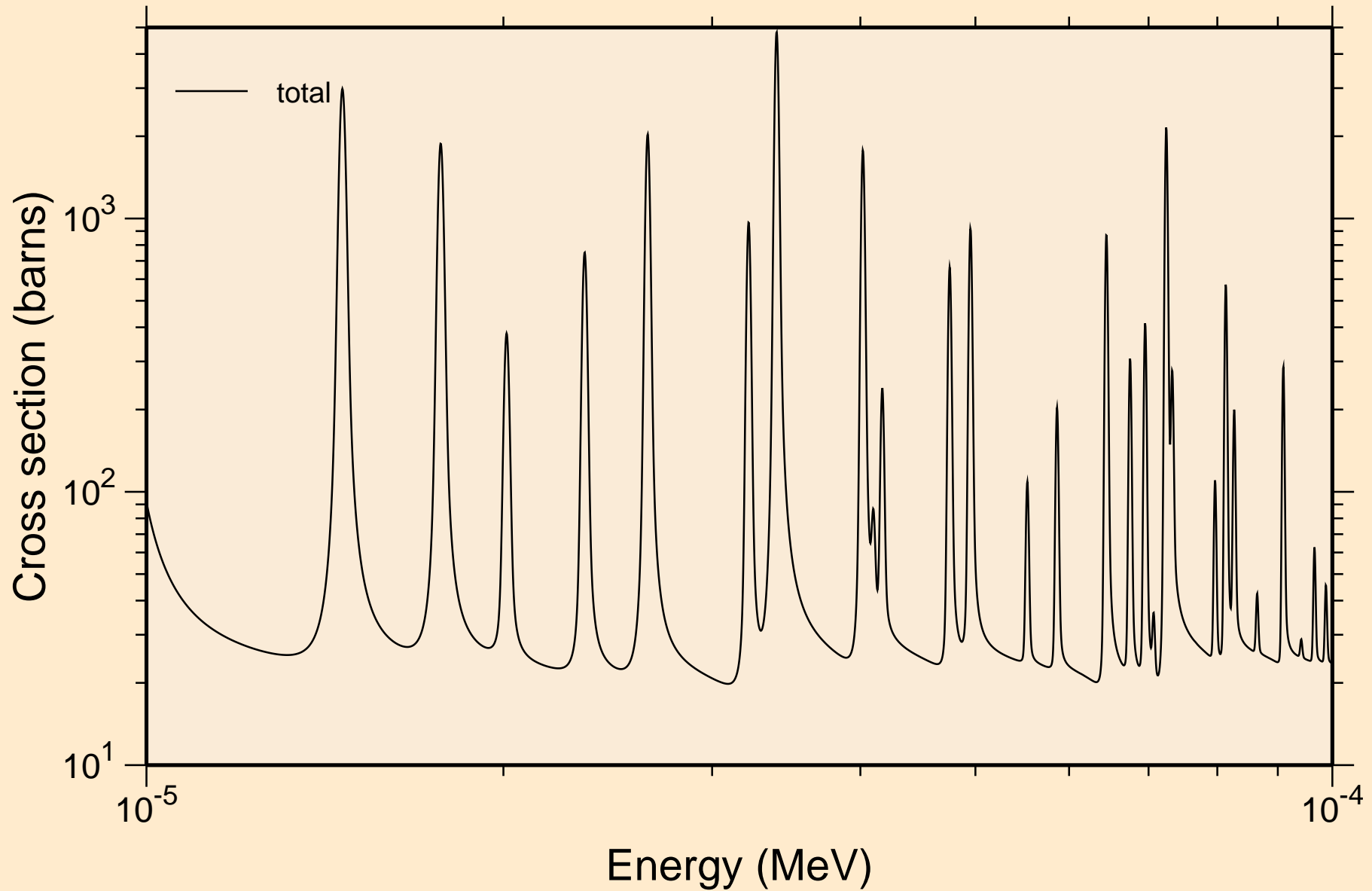

YB162 NEUTRON ACER TENDL-2021 LIBRARY; T=293.6K  
resonance total cross section

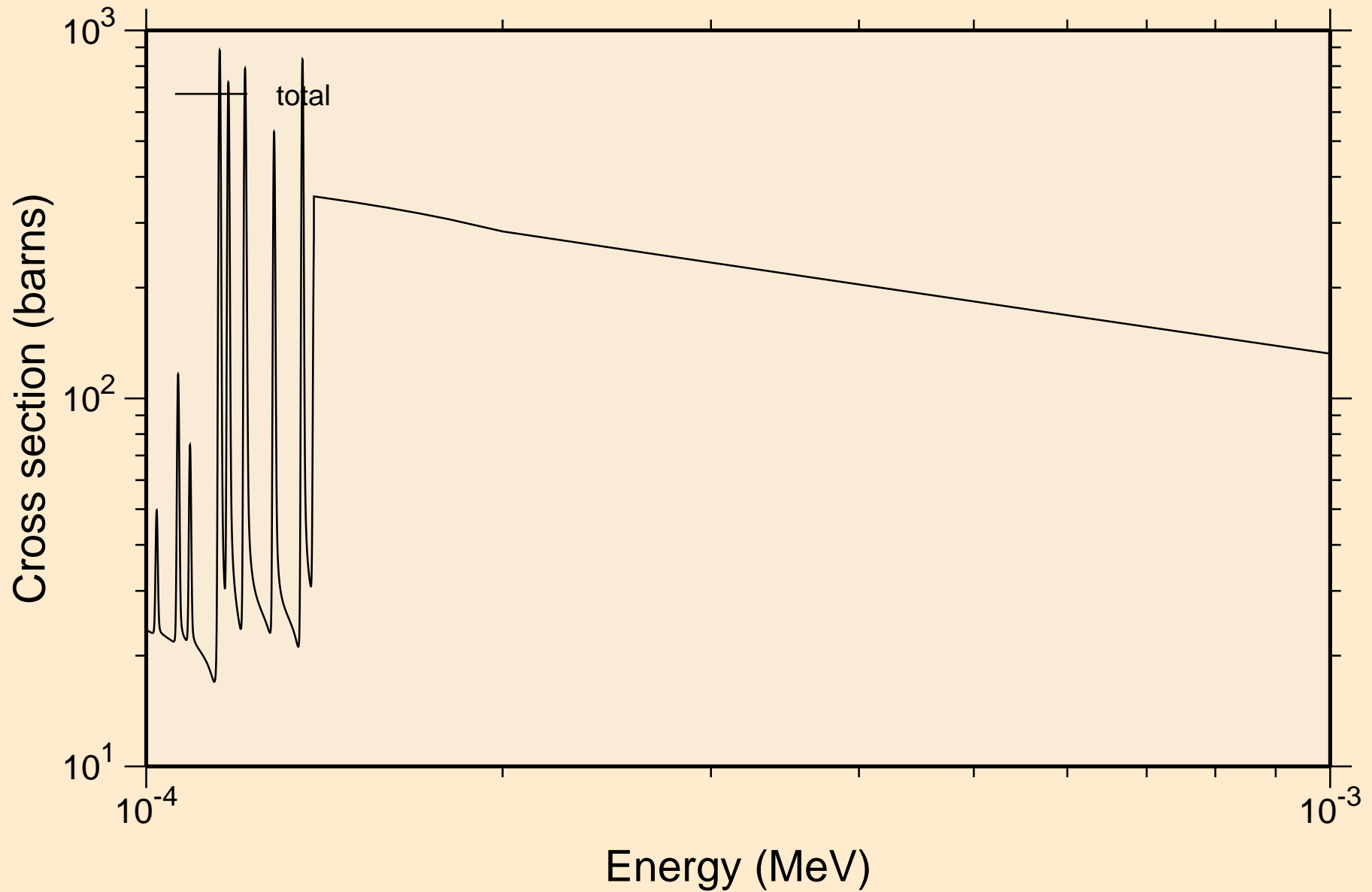

YB162 NEUTRON ACER TENDL-2021 LIBRARY; T=293.6K  
resonance total cross section

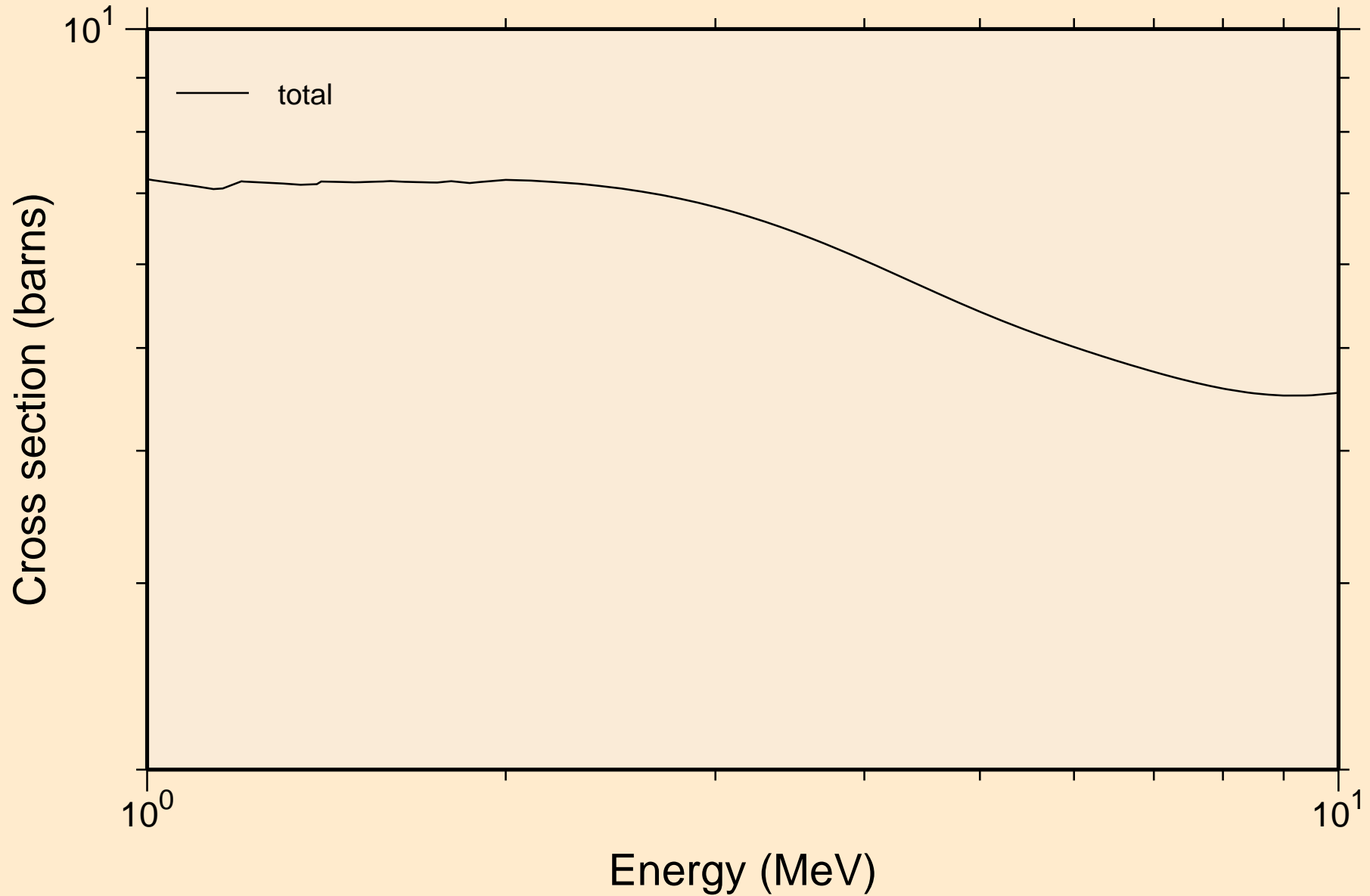

YB162 NEUTRON ACER TENDL-2021 LIBRARY; T=293.6K  
resonance absorption cross sections

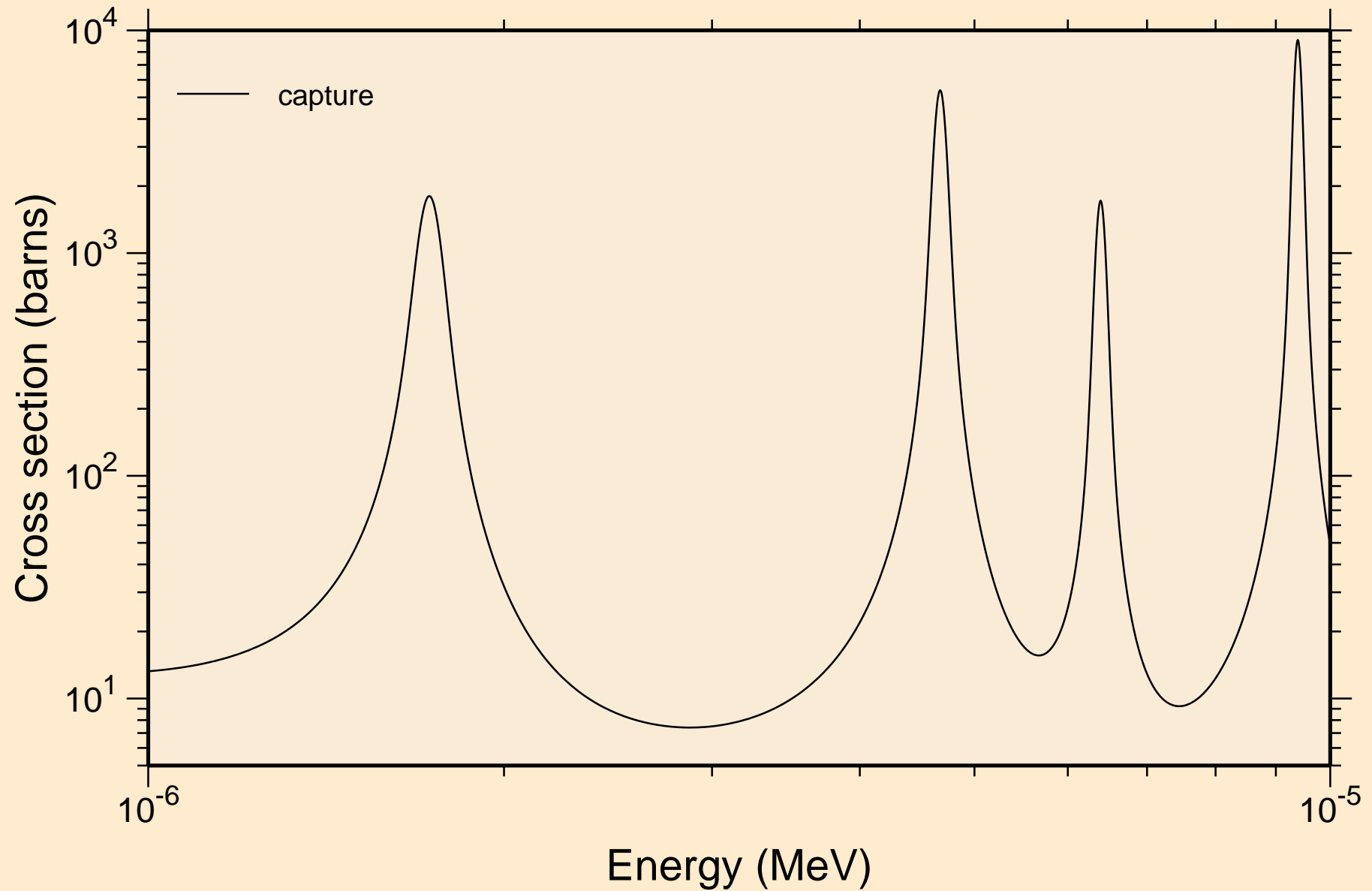

YB162 NEUTRON ACER TENDL-2021 LIBRARY; T=293.6K  
resonance absorption cross sections

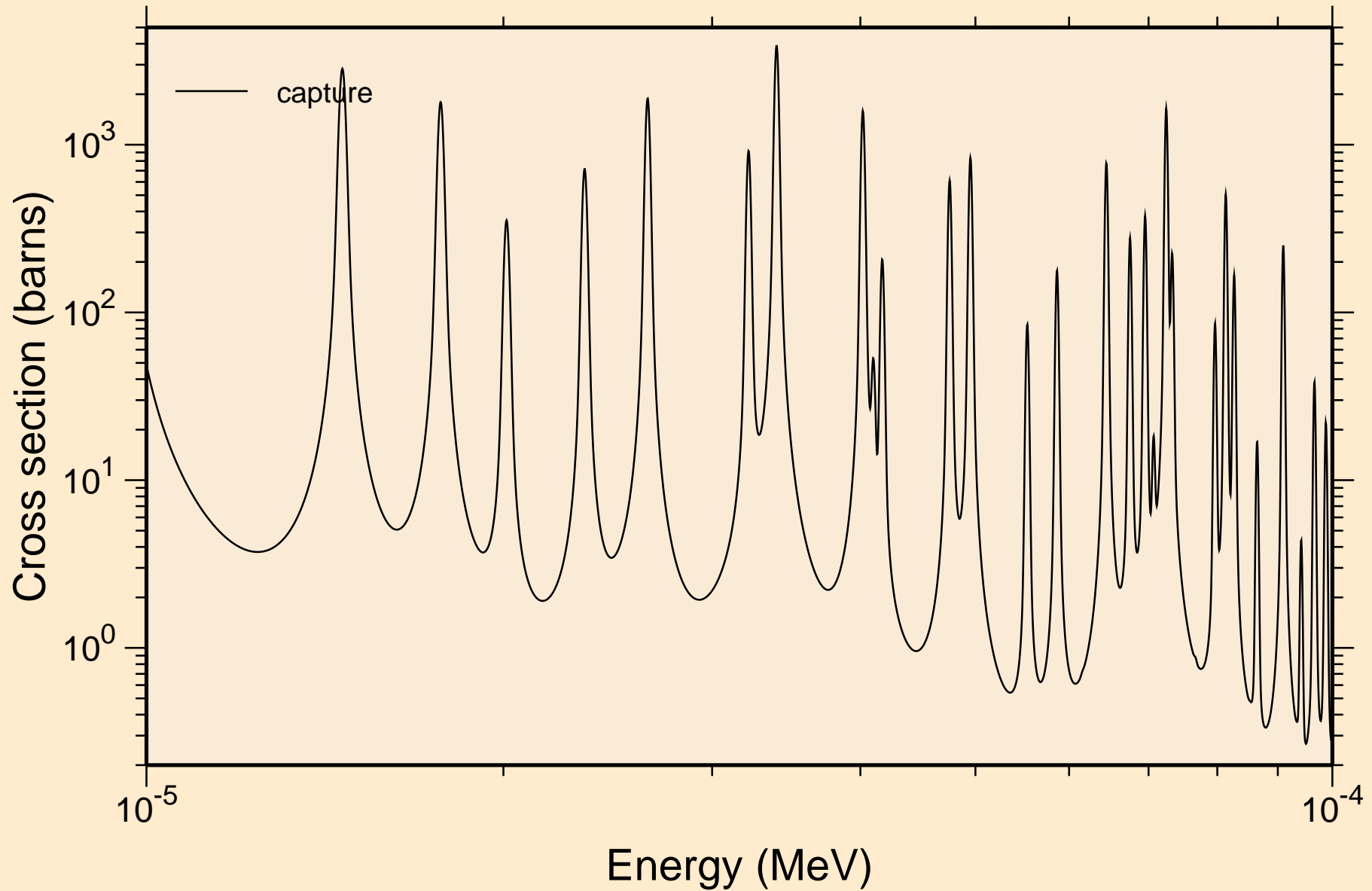

YB162 NEUTRON ACER TENDL-2021 LIBRARY; T=293.6K  
resonance absorption cross sections

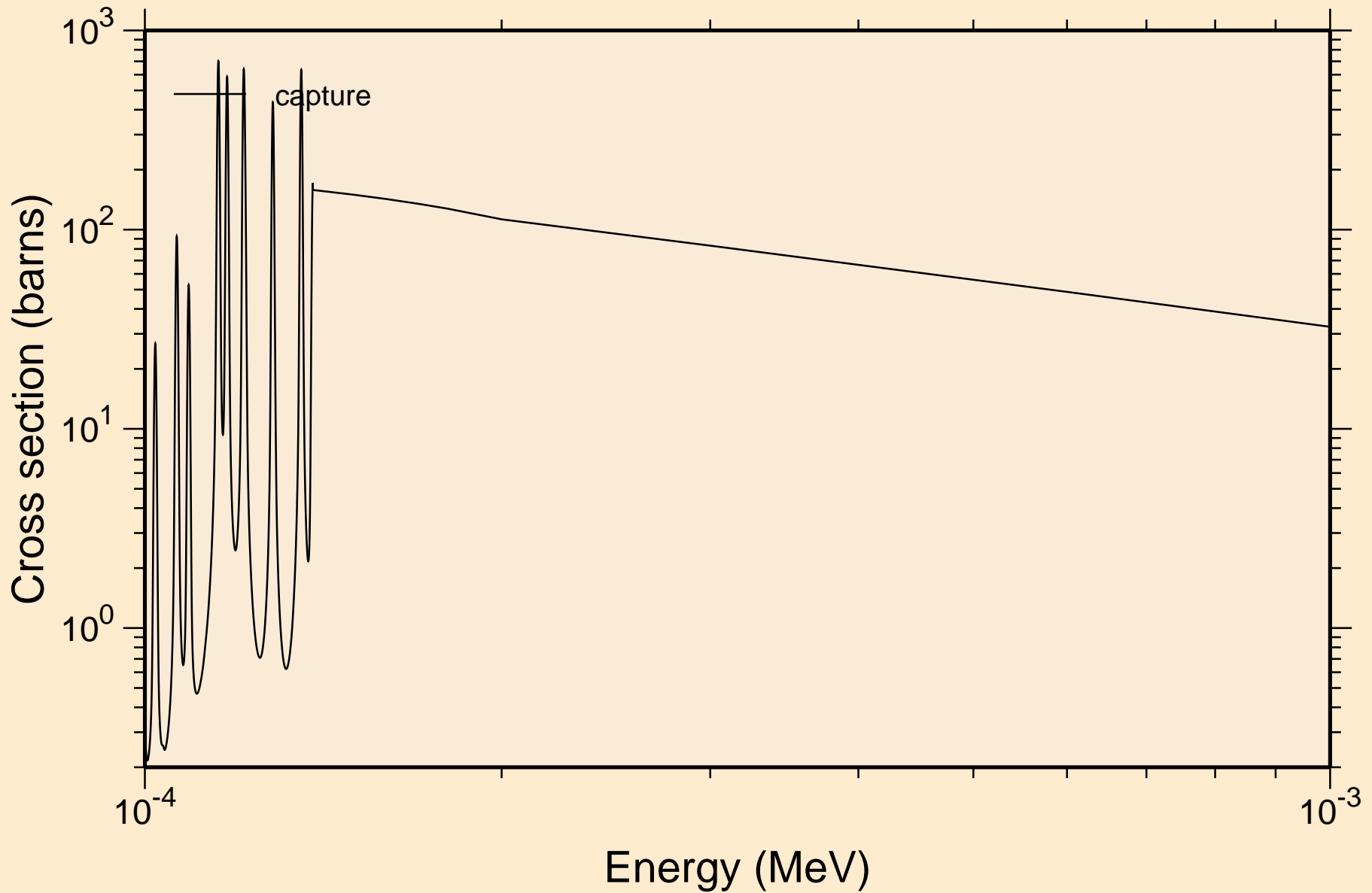



YB162 NEUTRON ACER TENDL-2021 LIBRARY; T=293.6K  
resonance absorption cross sections

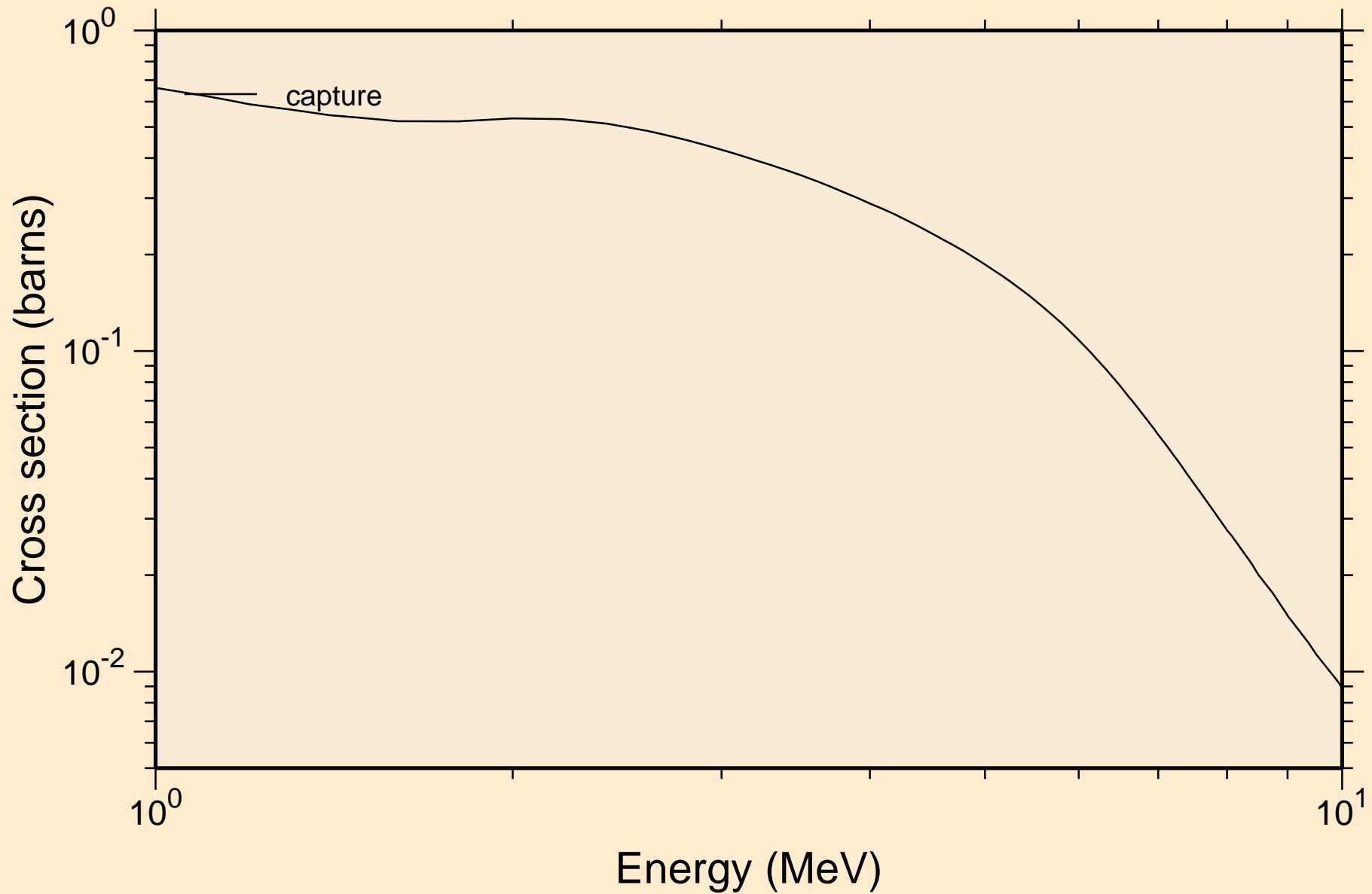

YB162 NEUTRON ACER TENDL-2021 LIBRARY; T=293.6K  
Heating

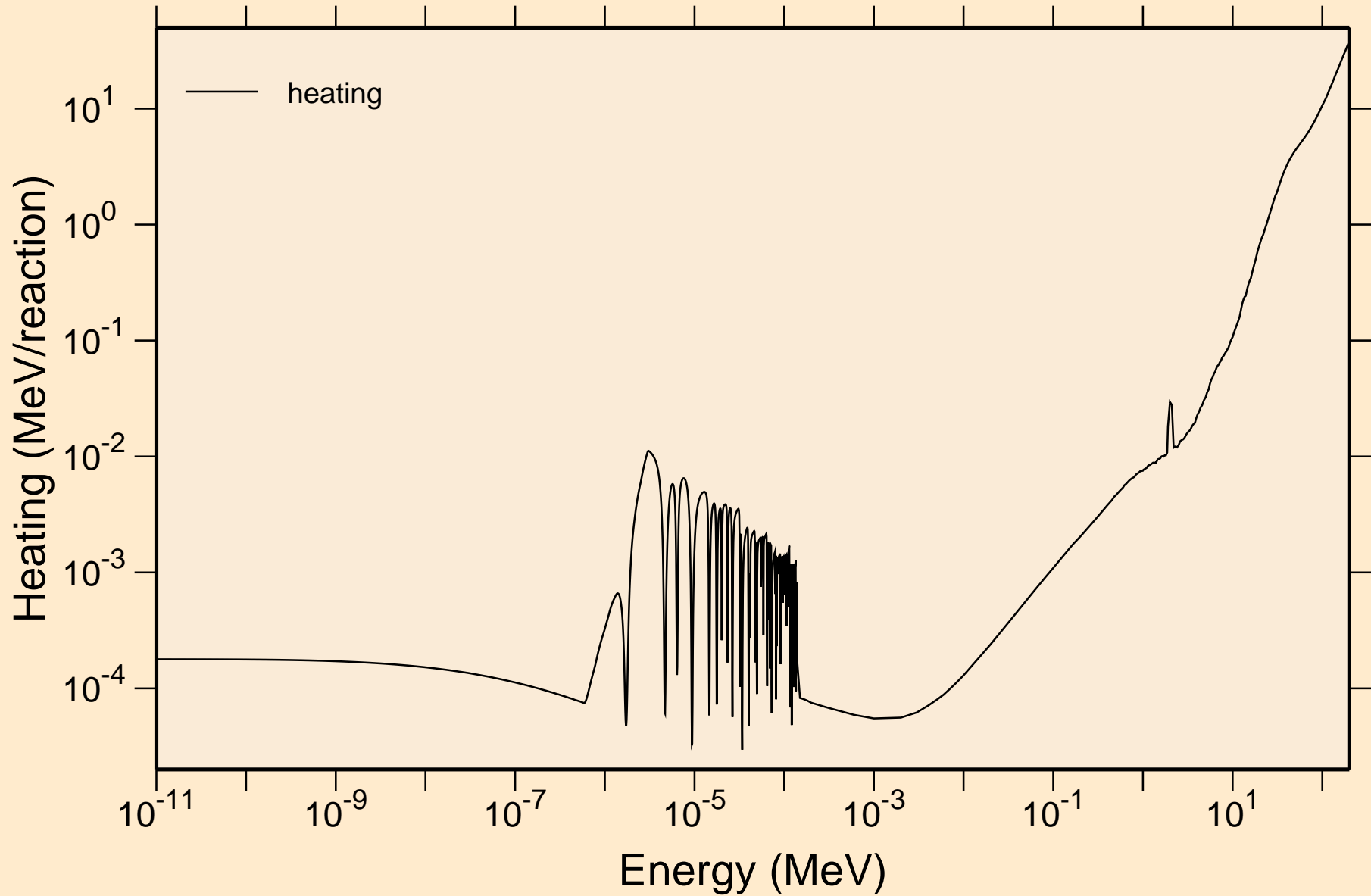

YB162 NEUTRON ACER TENDL-2021 LIBRARY; T=293.6K  
Damage

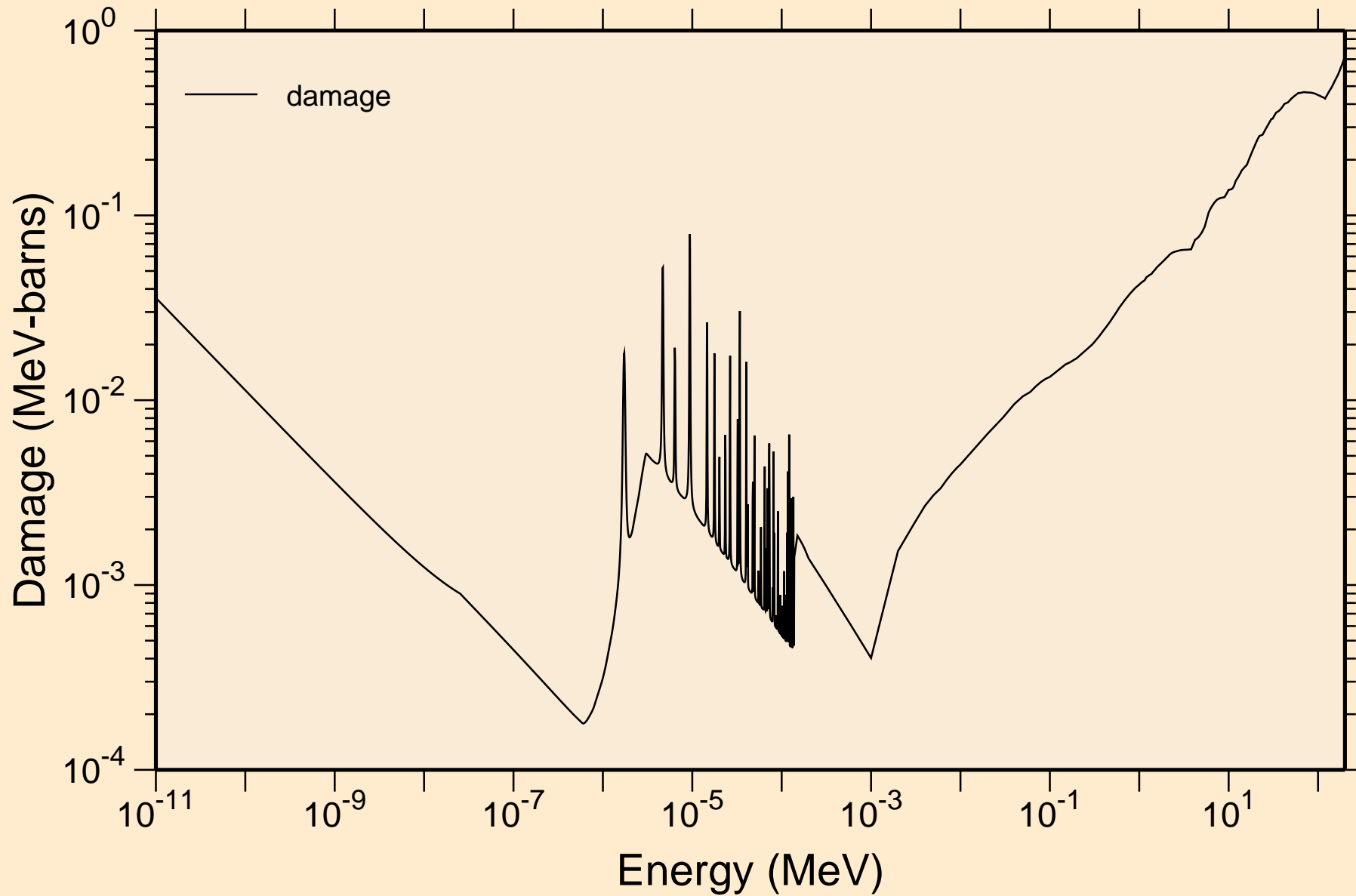

YB162 NEUTRON ACER TENDL-2021 LIBRARY; T=293.6K  
Non-threshold reactions

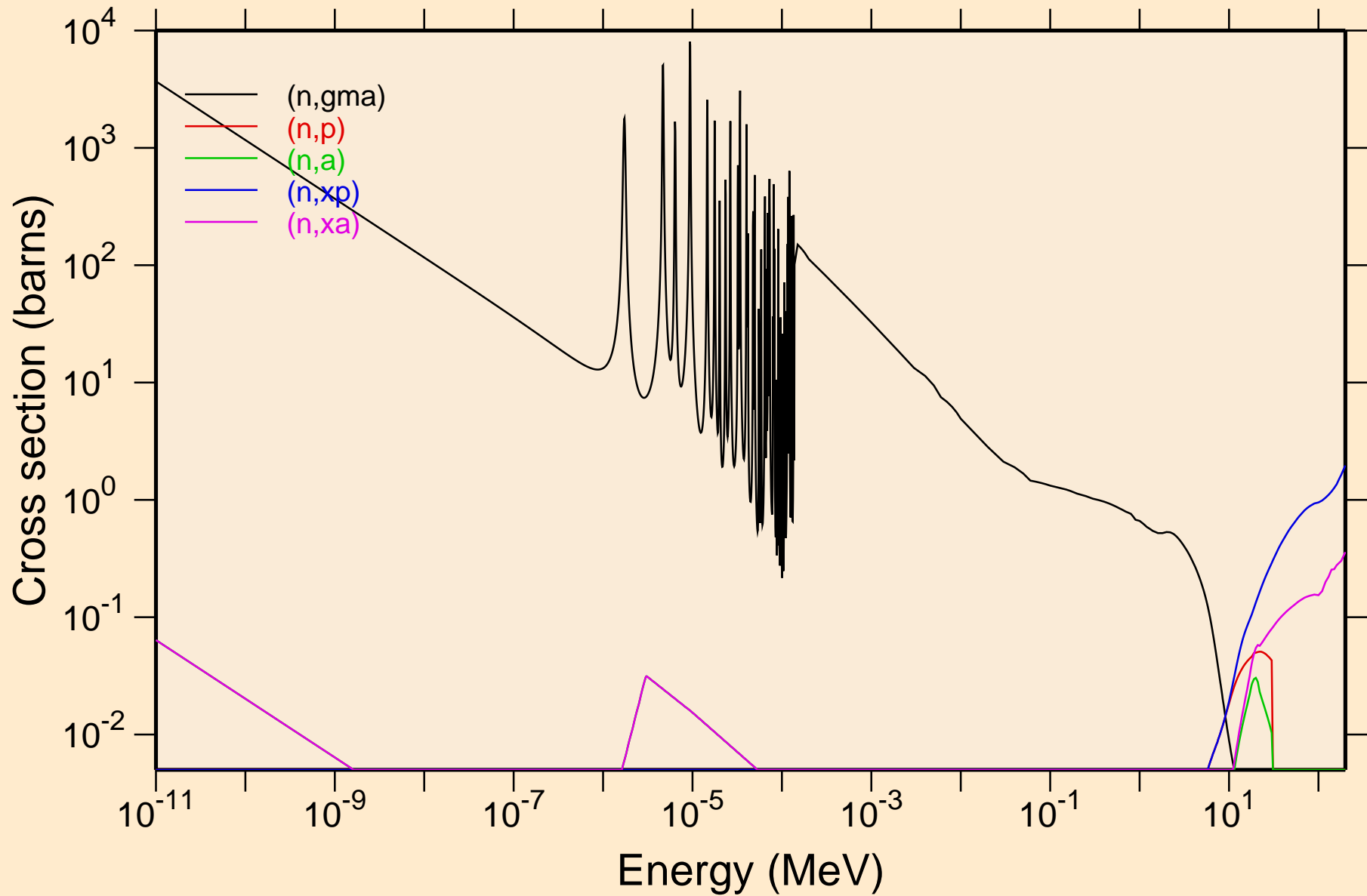

YB162 NEUTRON ACER TENDL-2021 LIBRARY; T=293.6K  
Principal cross sections

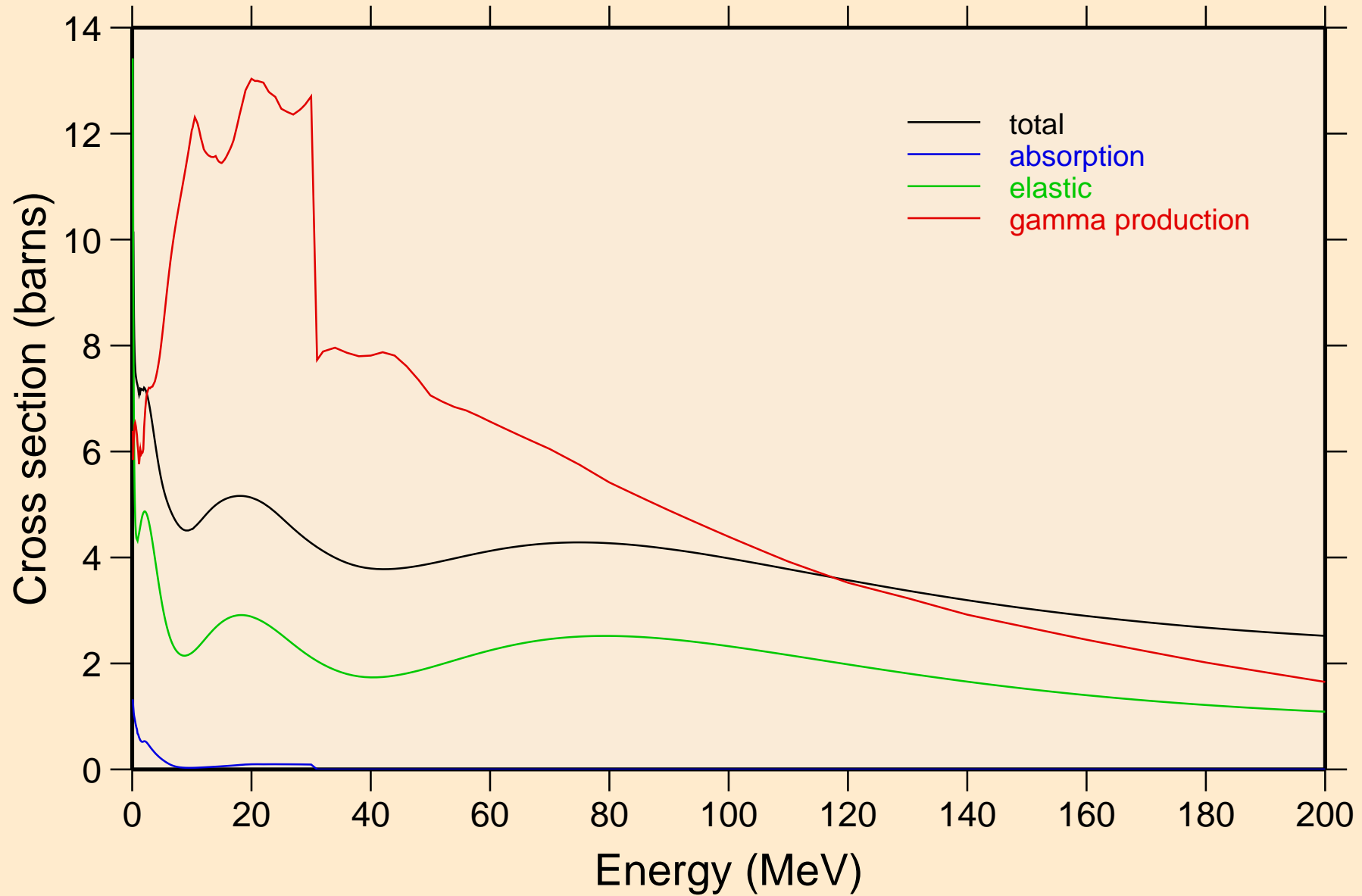

# YB162 NEUTRON ACER TENDL-2021 LIBRARY; T=293.6K

## Heating

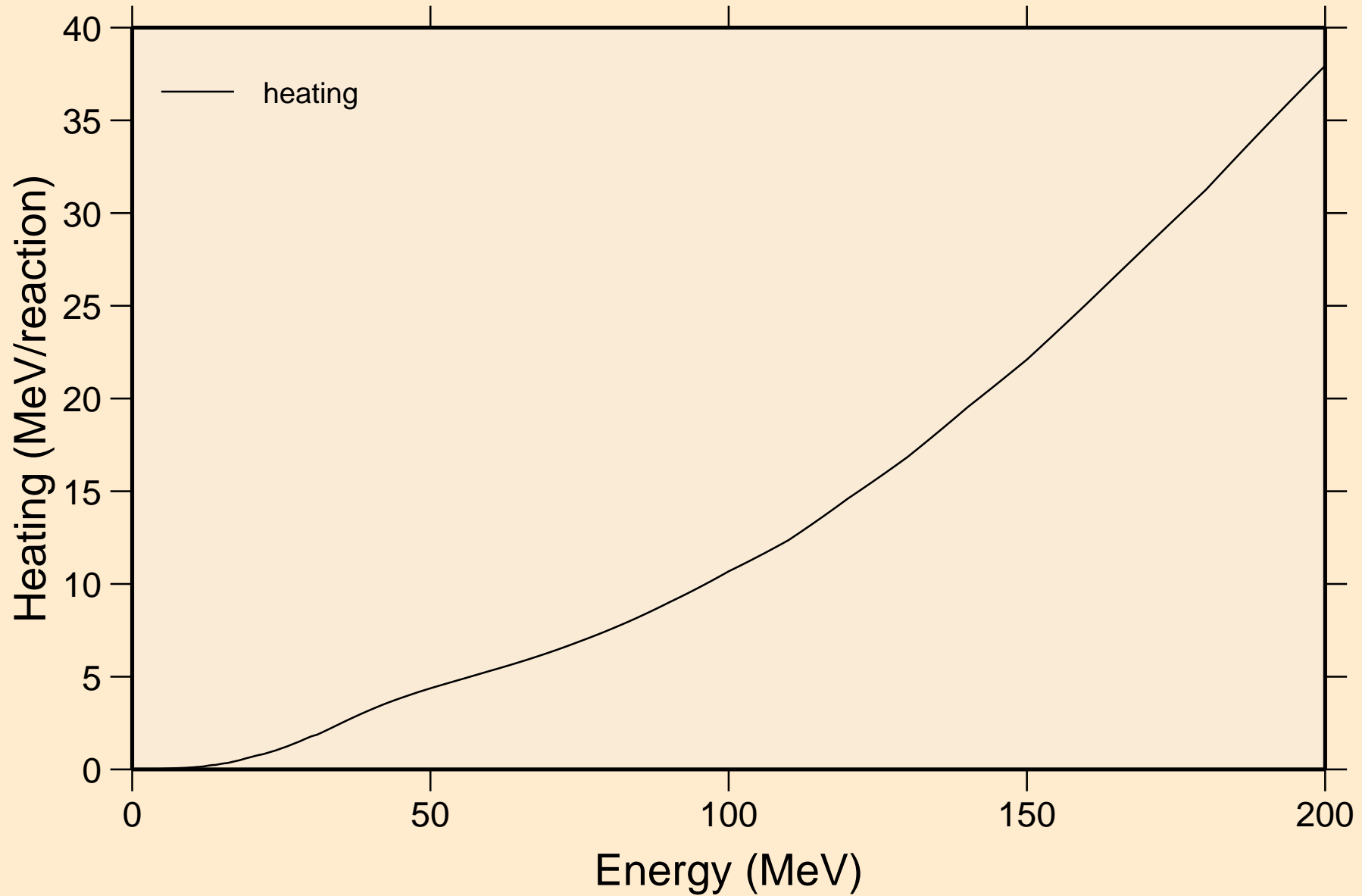

YB162 NEUTRON ACER TENDL-2021 LIBRARY; T=293.6K  
Damage

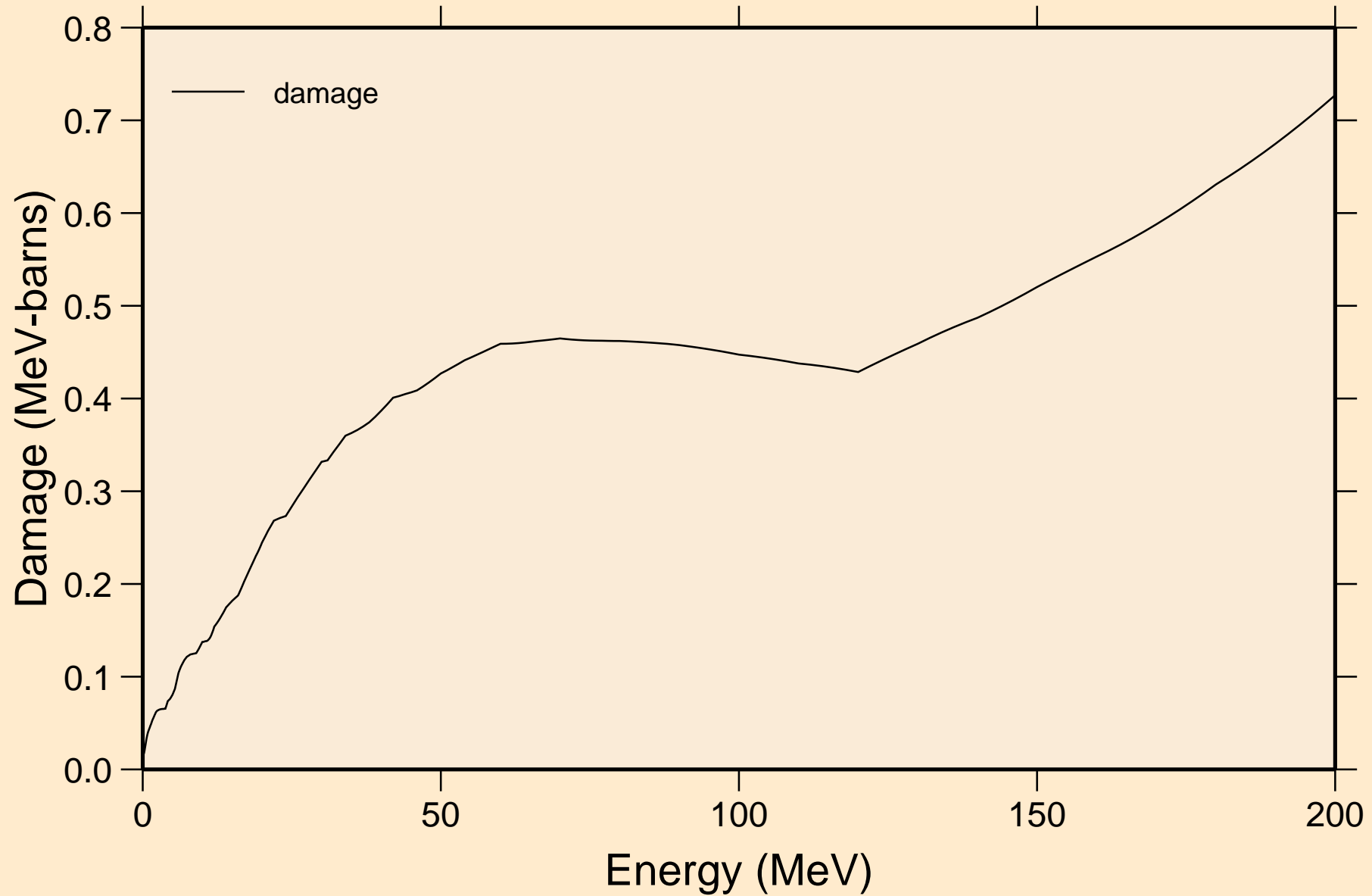

YB162 NEUTRON ACER TENDL-2021 LIBRARY; T=293.6K  
Non-threshold reactions

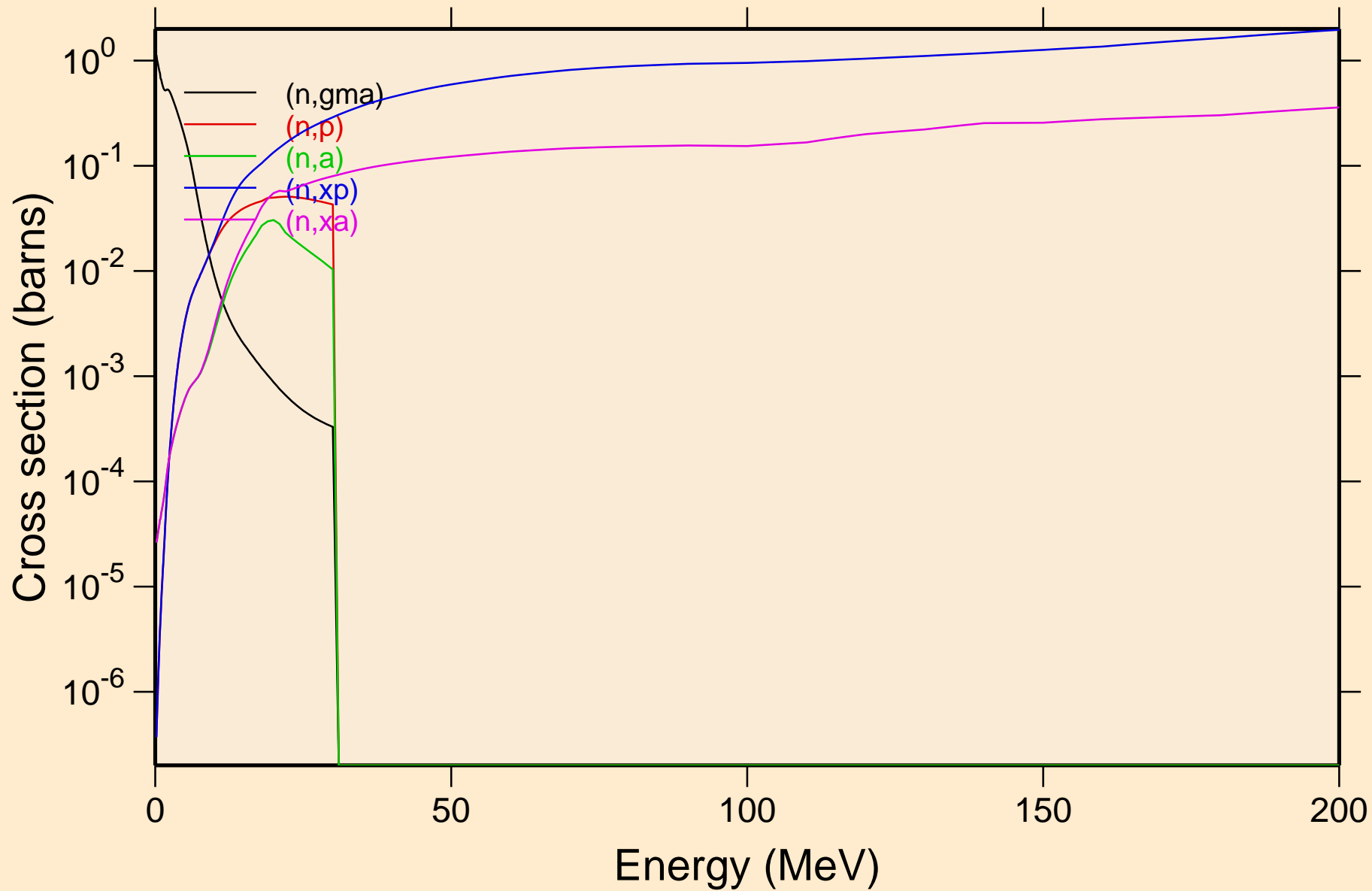



YB162 NEUTRON ACER TENDL-2021 LIBRARY; T=293.6K  
Inelastic levels

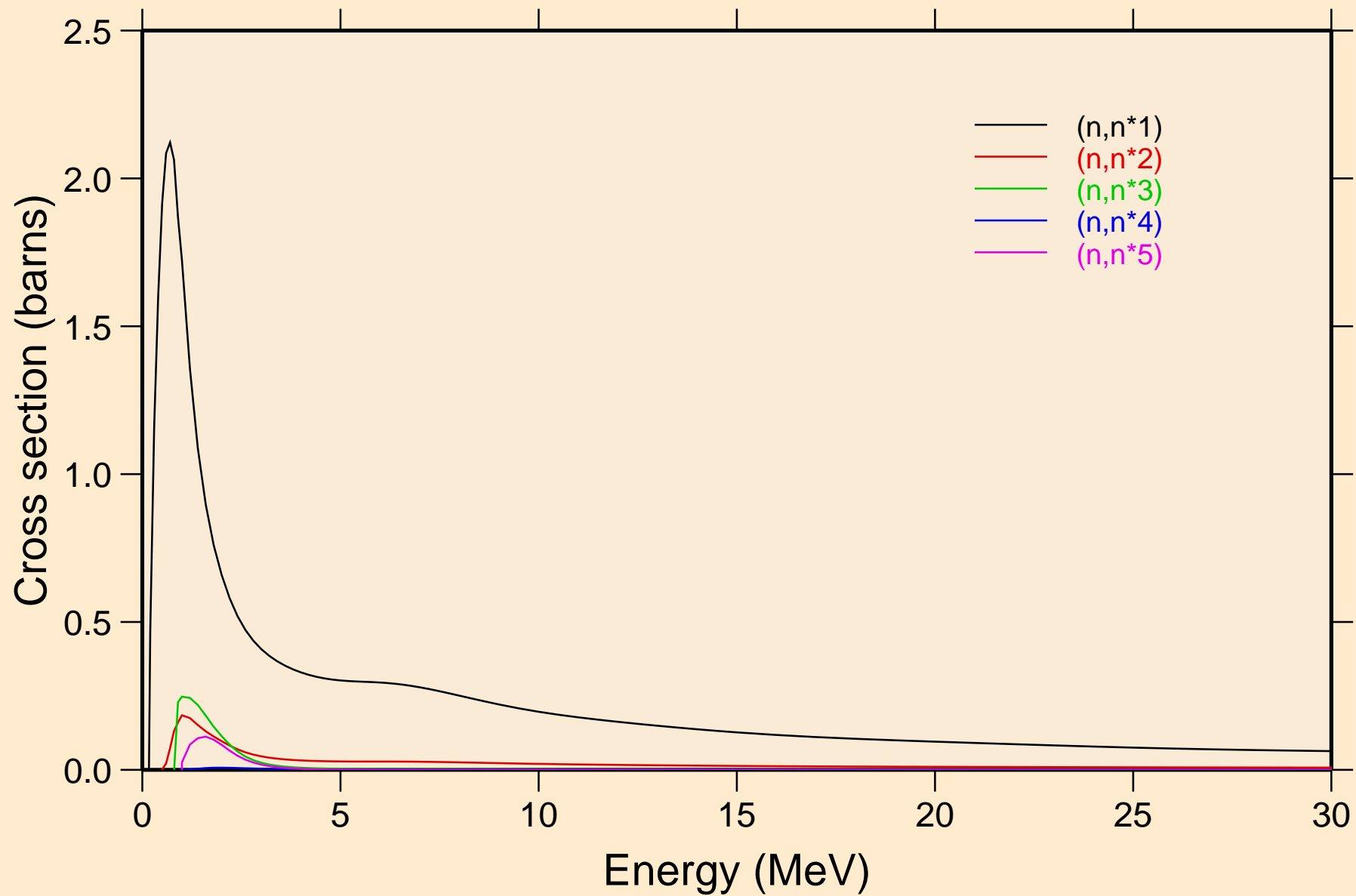

YB162 NEUTRON ACER TENDL-2021 LIBRARY; T=293.6K  
Inelastic levels

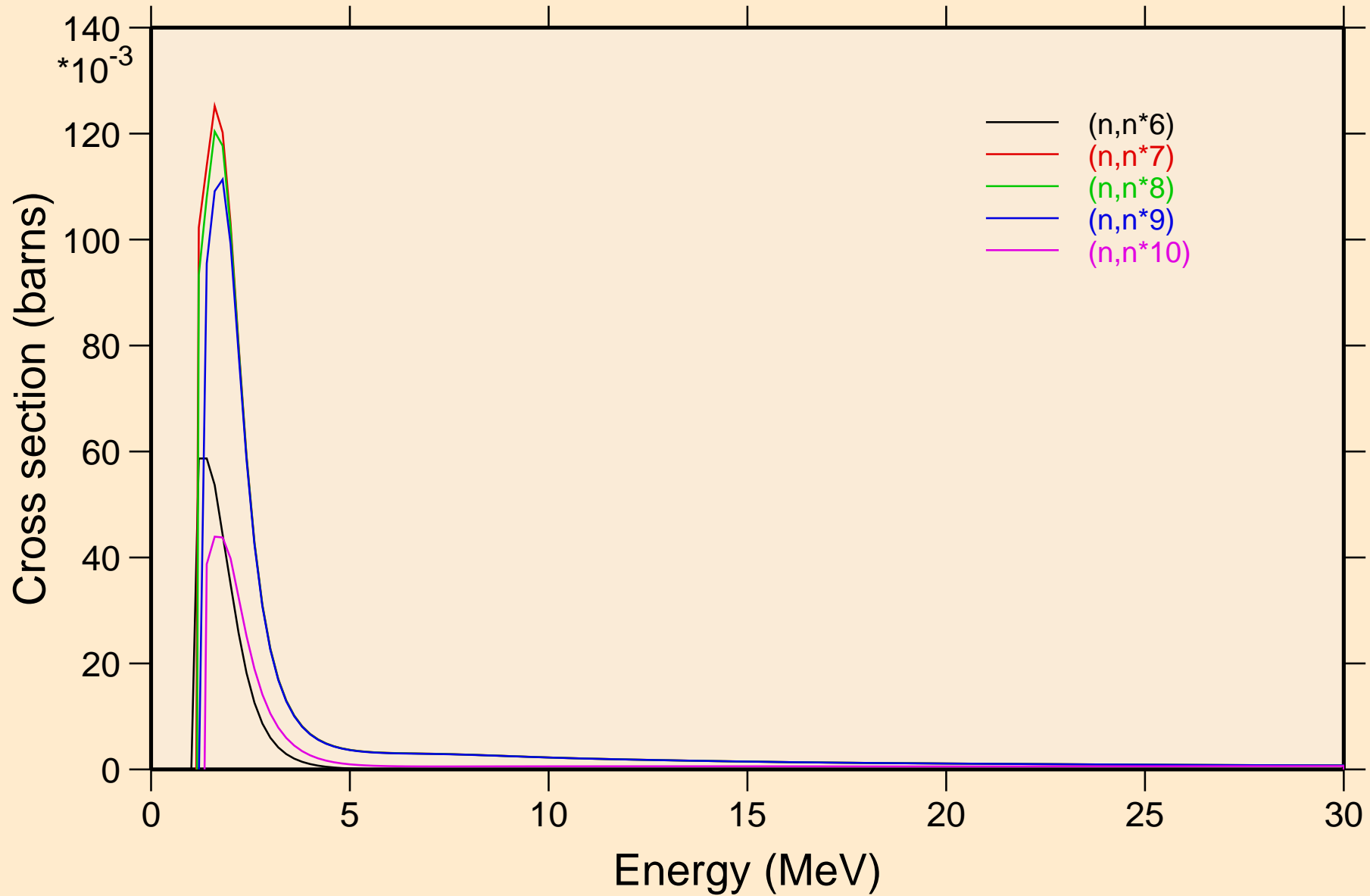

YB162 NEUTRON ACER TENDL-2021 LIBRARY; T=293.6K  
Inelastic levels

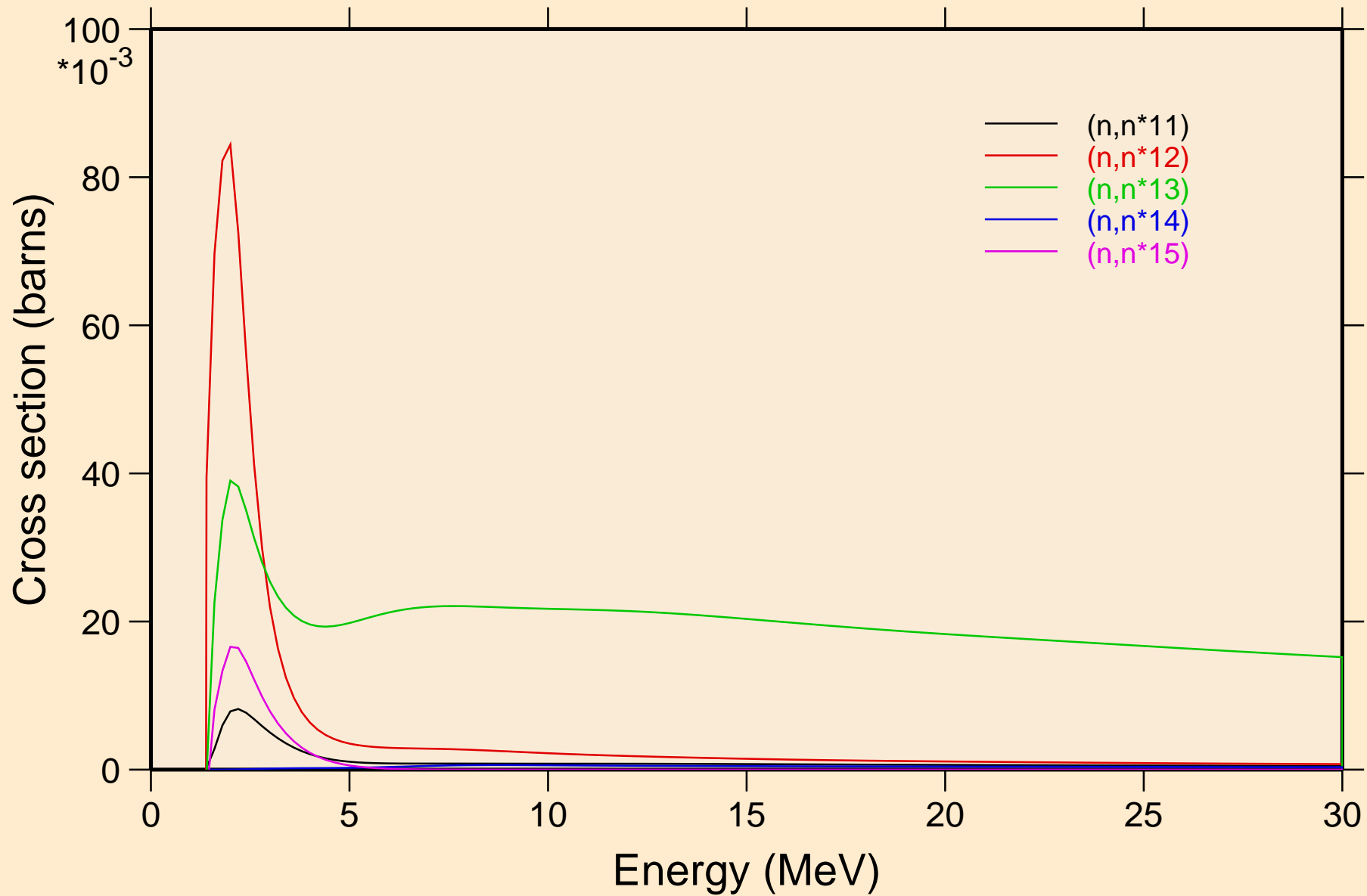

YB162 NEUTRON ACER TENDL-2021 LIBRARY; T=293.6K  
Inelastic levels

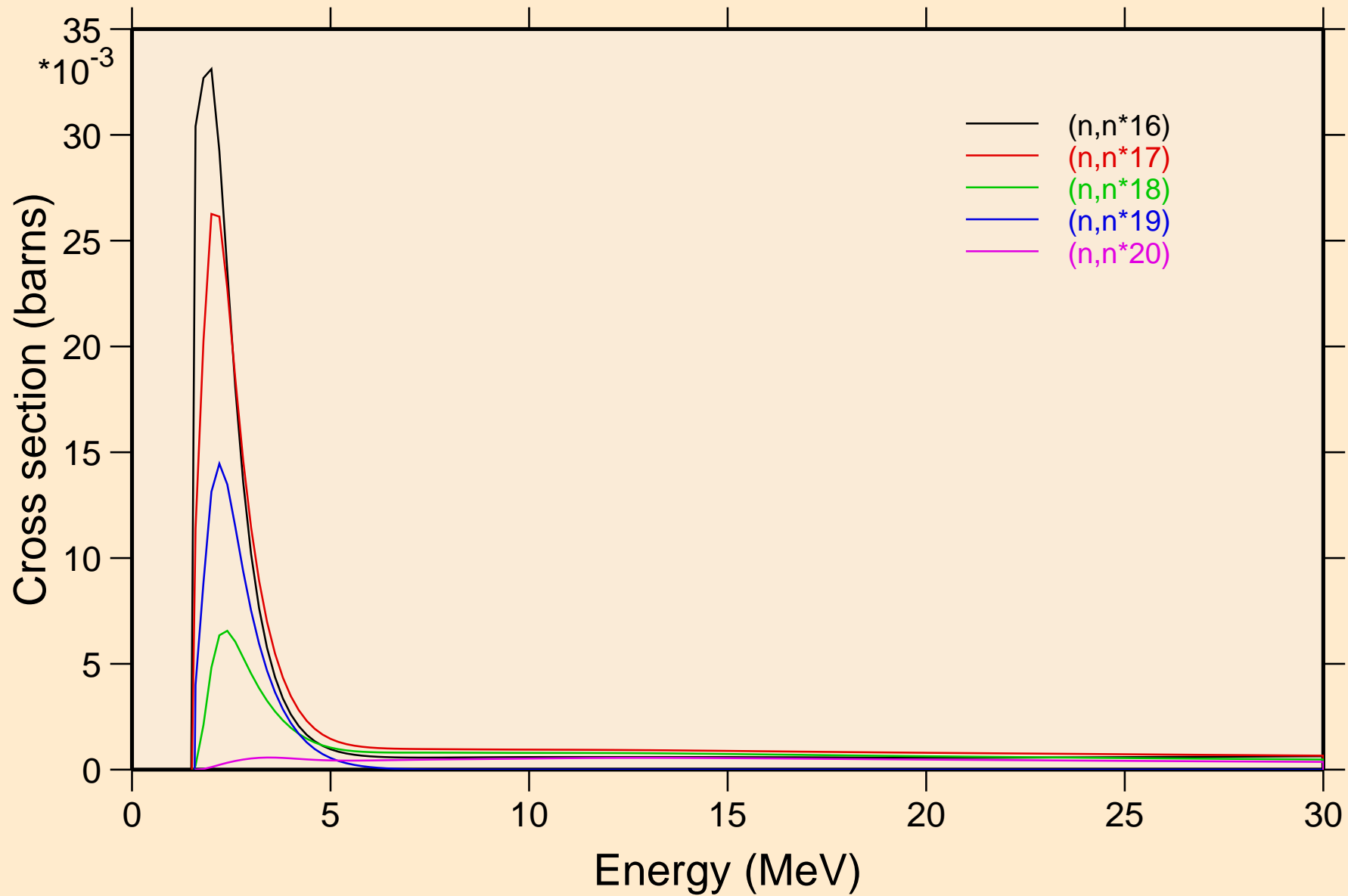

YB162 NEUTRON ACER TENDL-2021 LIBRARY; T=293.6K  
Inelastic levels

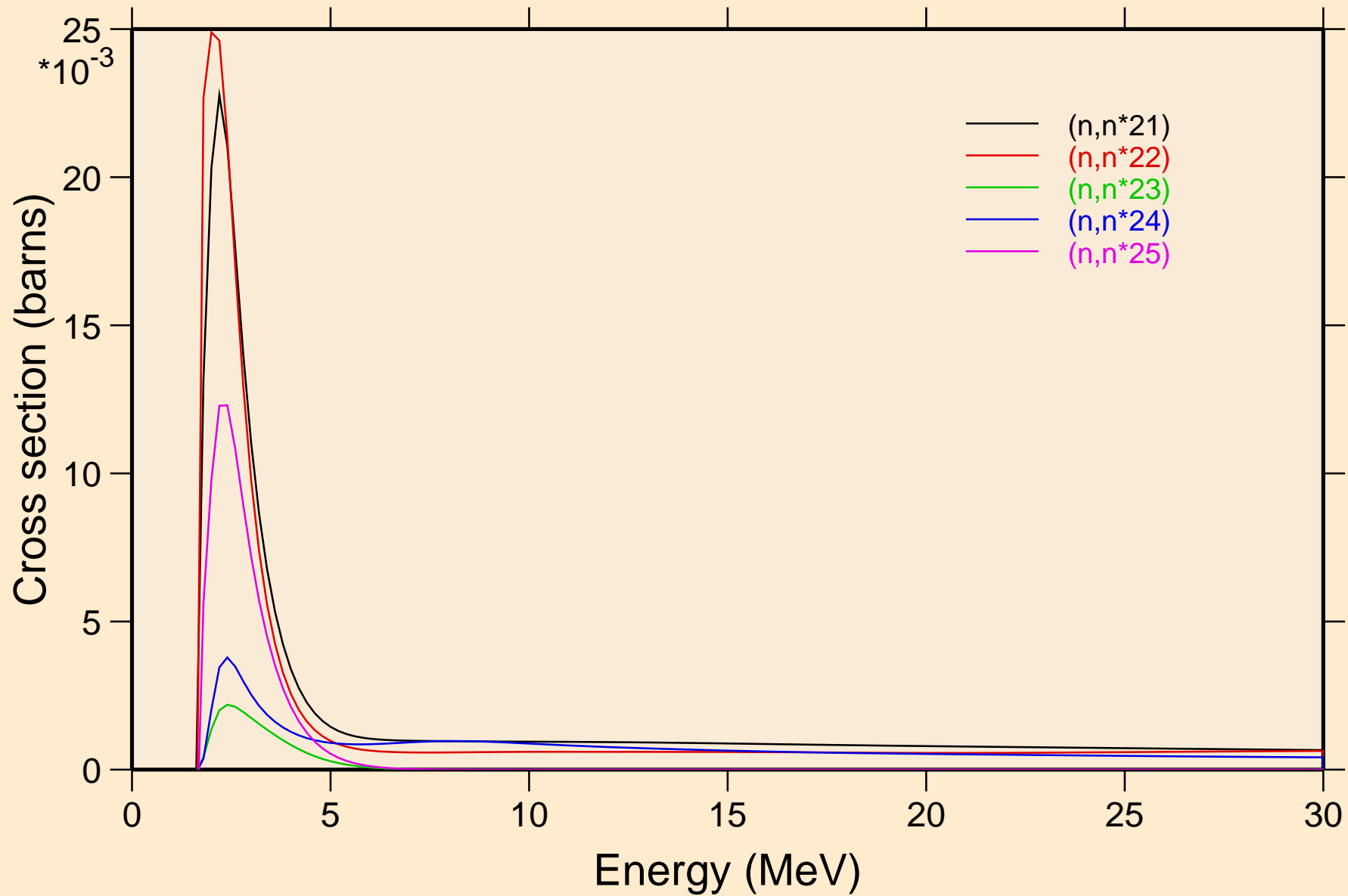

YB162 NEUTRON ACER TENDL-2021 LIBRARY; T=293.6K  
Inelastic levels

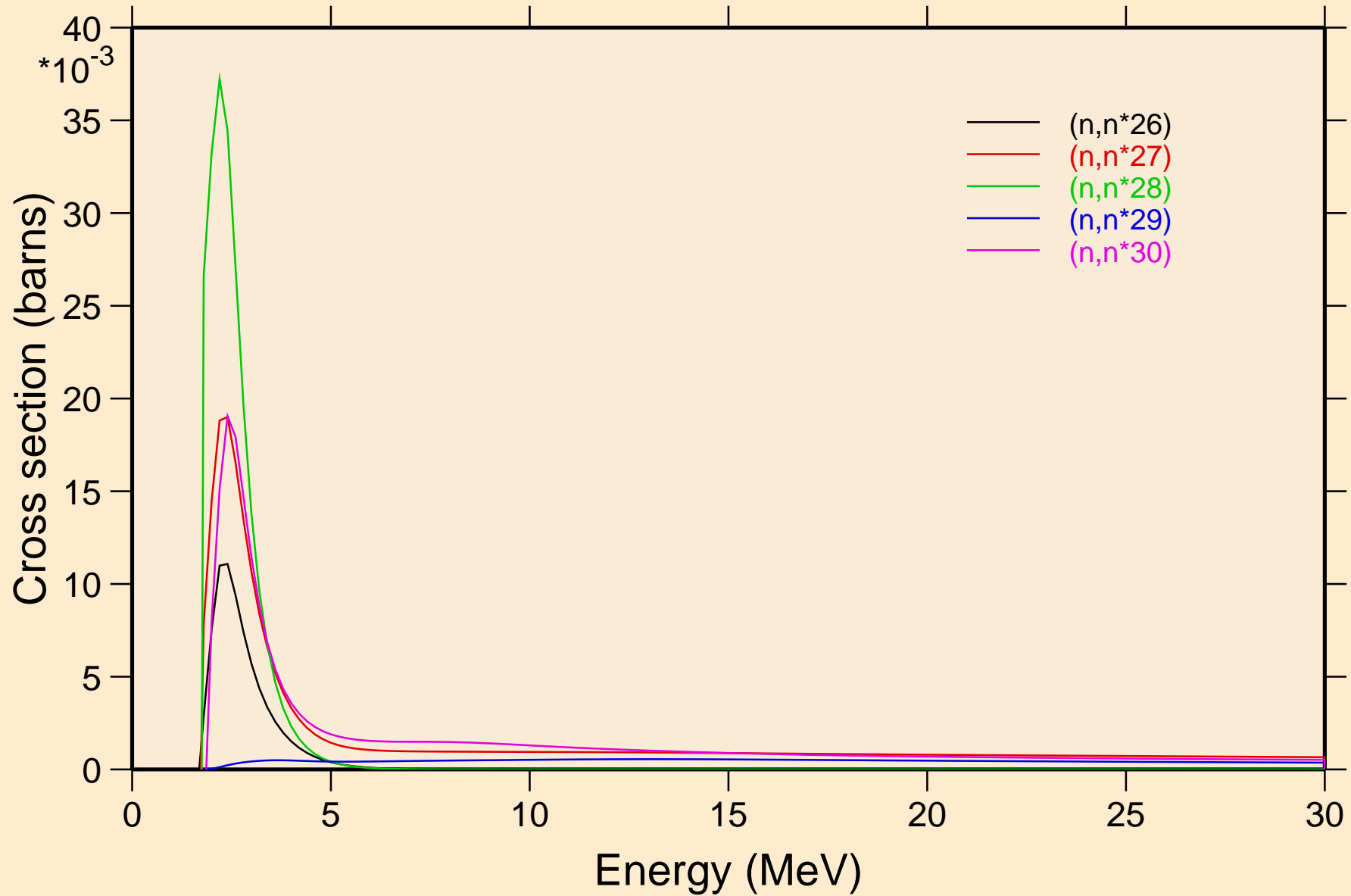

YB162 NEUTRON ACER TENDL-2021 LIBRARY; T=293.6K  
Threshold reactions

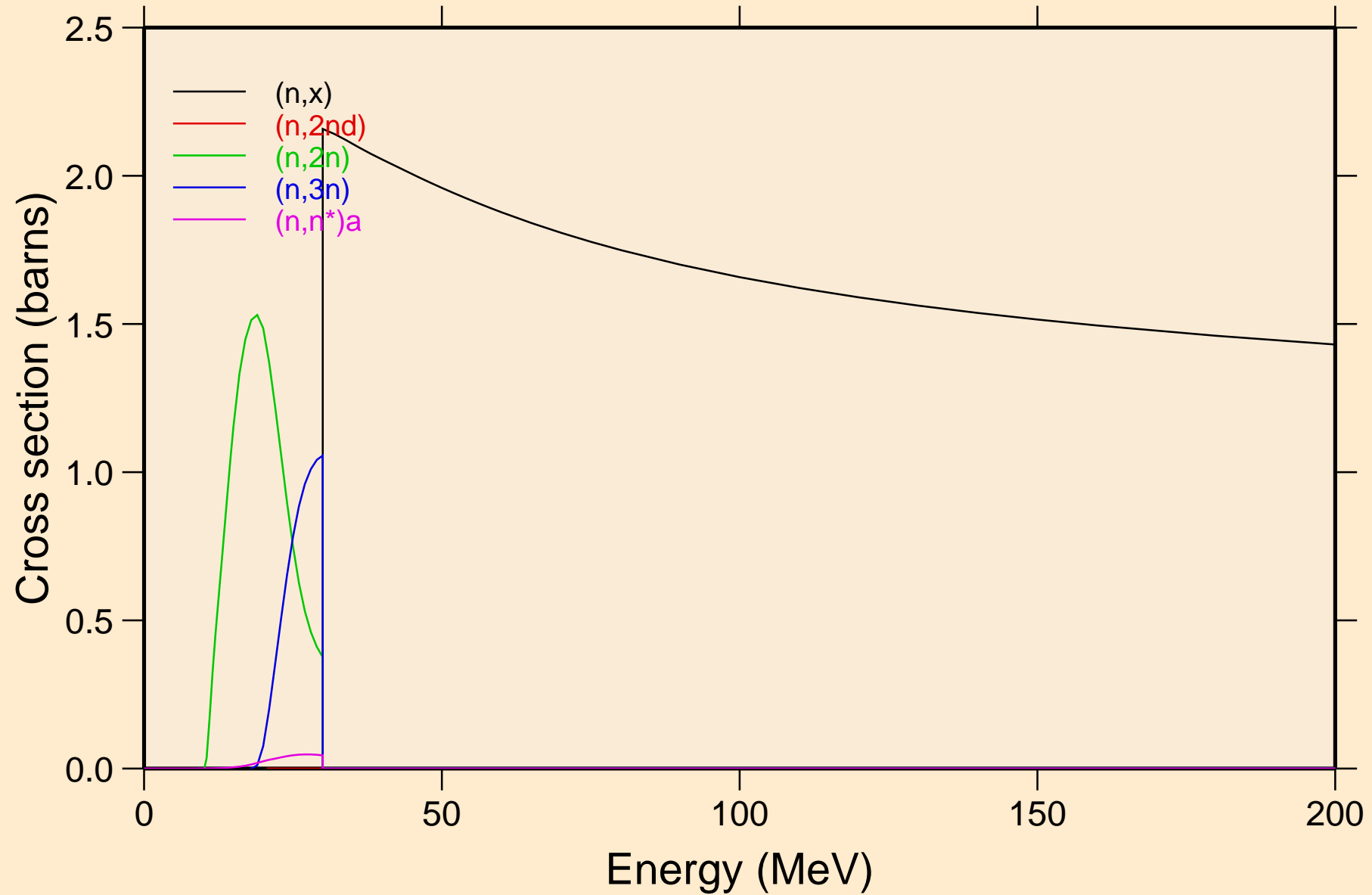

YB162 NEUTRON ACER TENDL-2021 LIBRARY; T=293.6K  
Threshold reactions

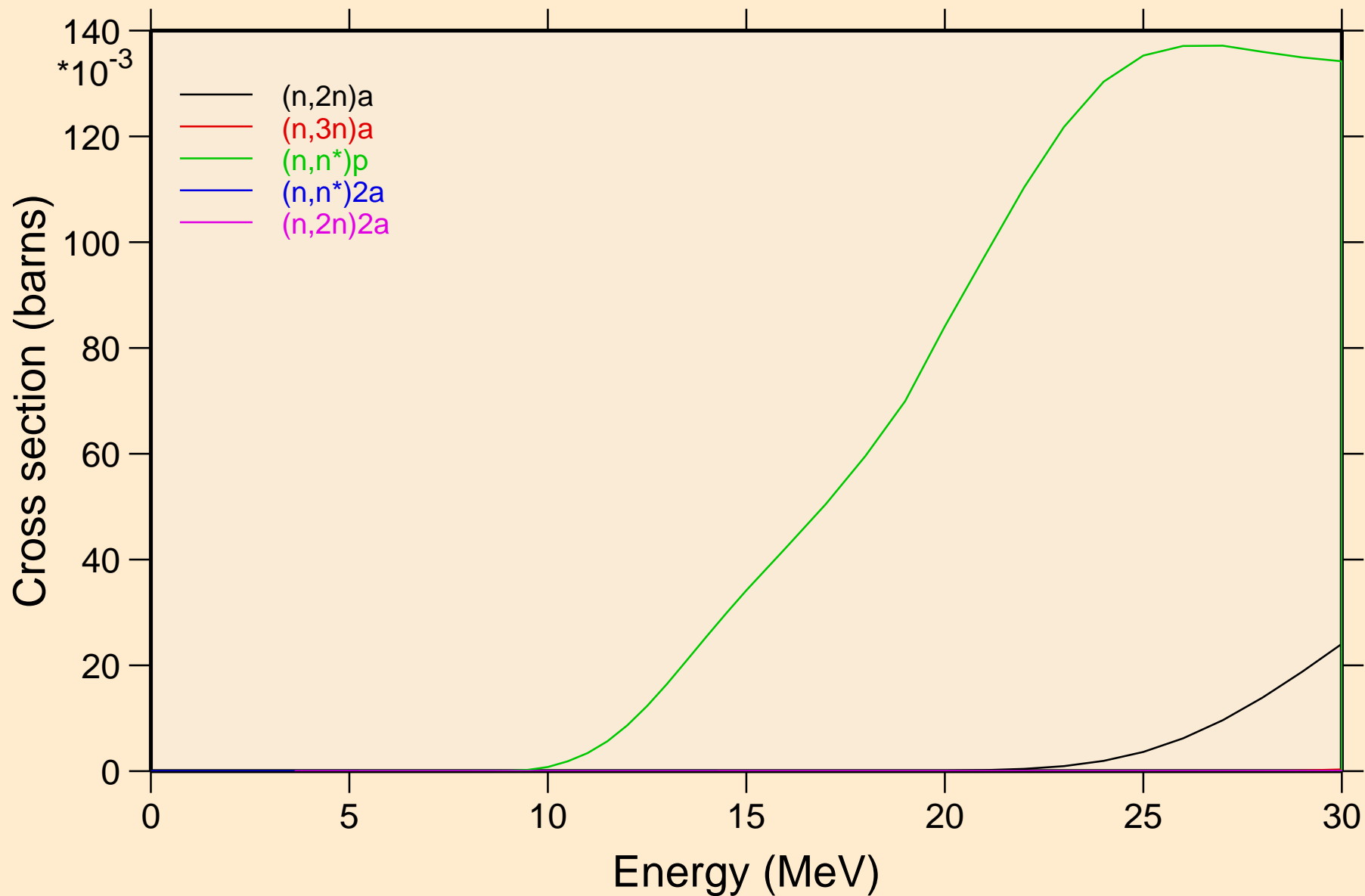



YB162 NEUTRON ACER TENDL-2021 LIBRARY; T=293.6K  
Threshold reactions

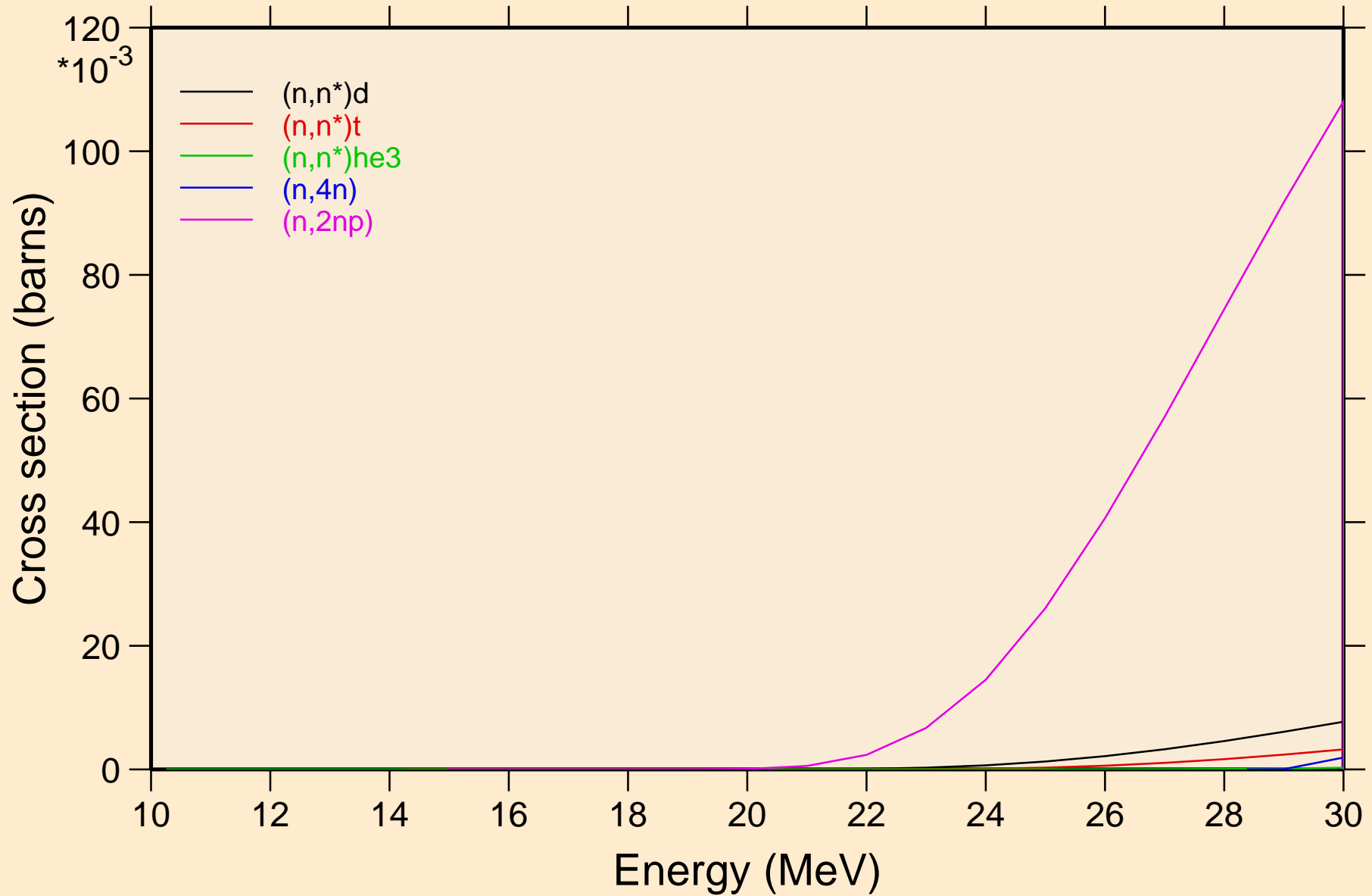

YB162 NEUTRON ACER TENDL-2021 LIBRARY; T=293.6K  
Threshold reactions

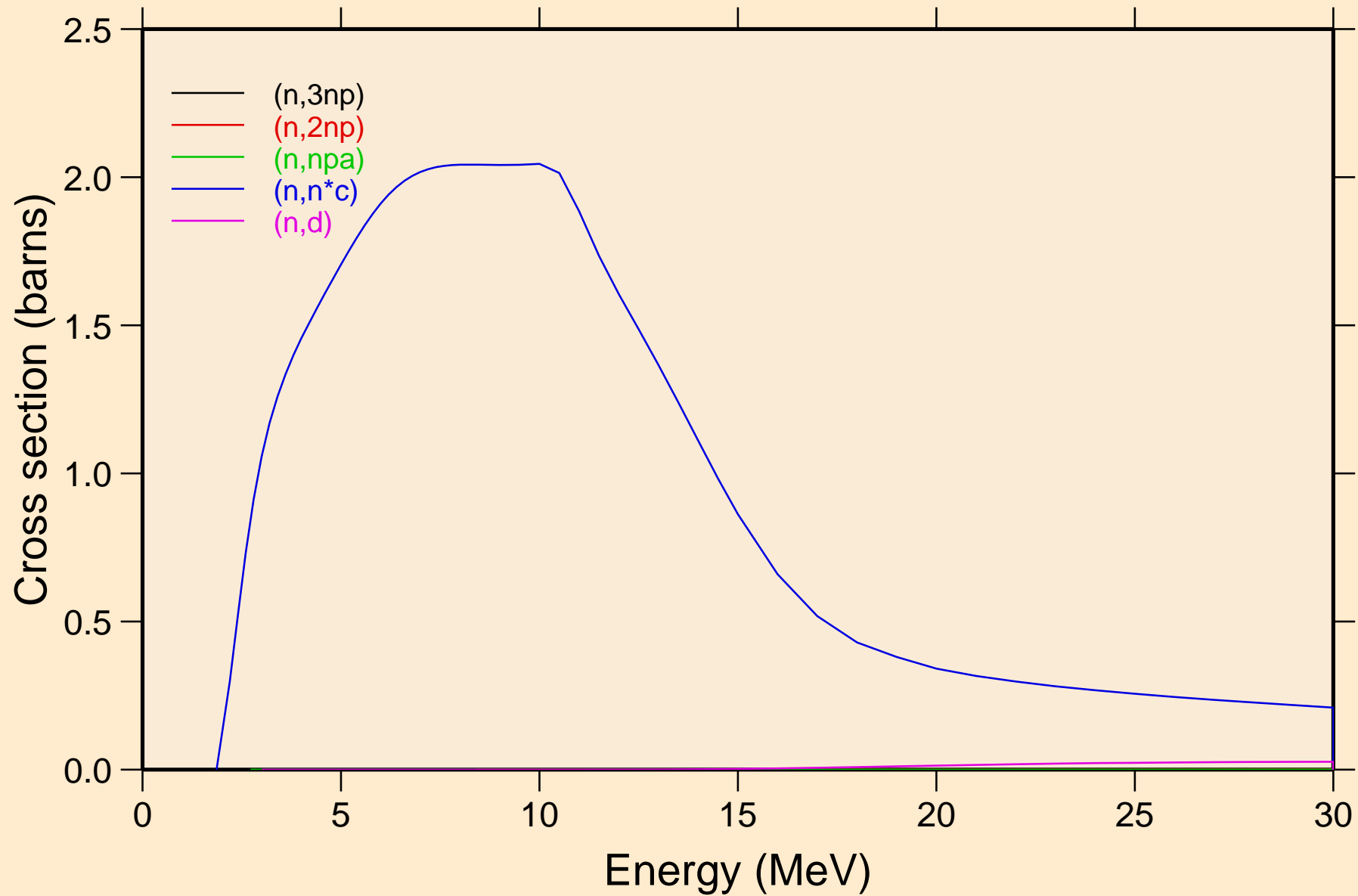

YB162 NEUTRON ACER TENDL-2021 LIBRARY; T=293.6K  
Threshold reactions

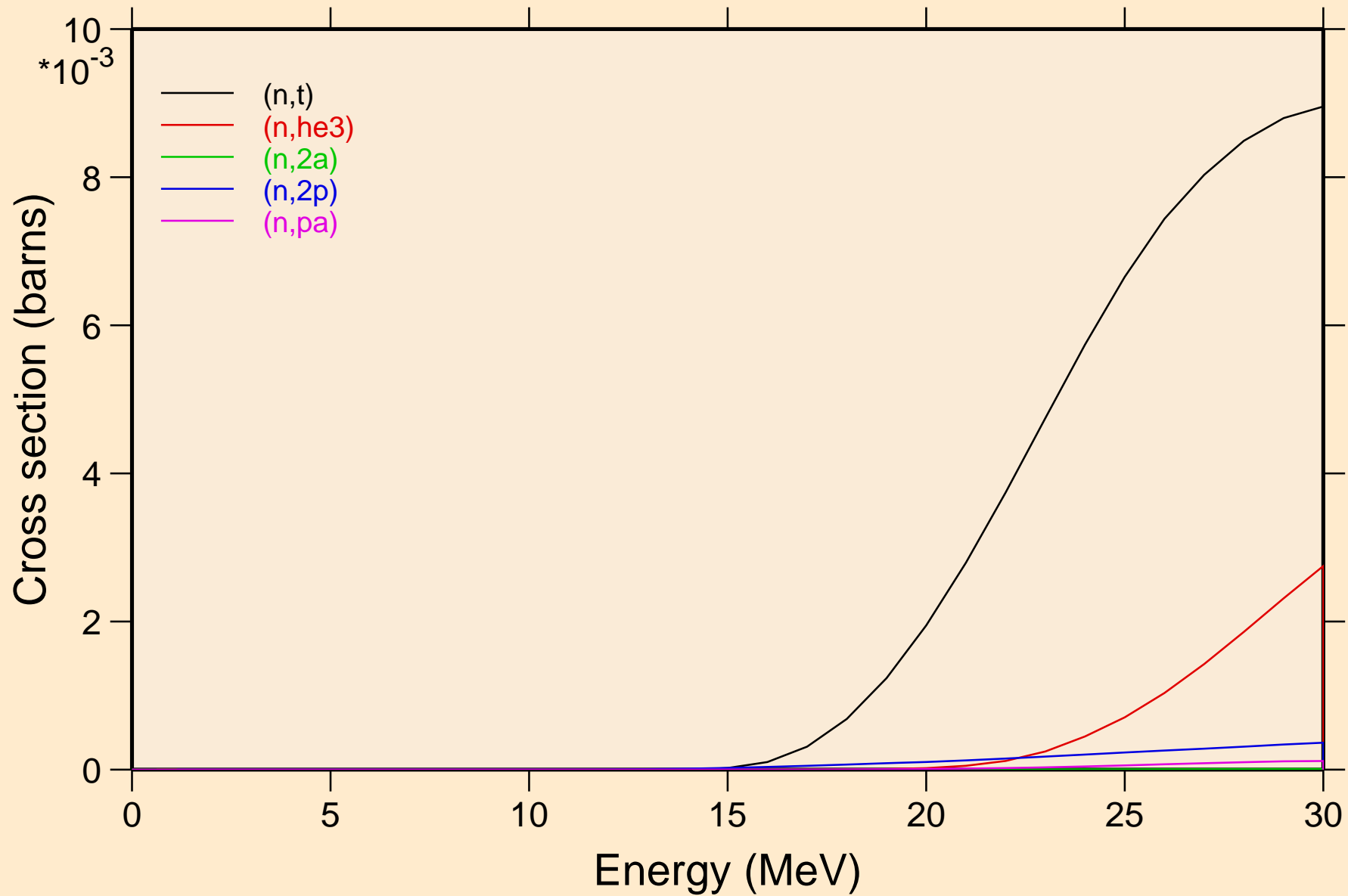

YB162 NEUTRON ACER TENDL-2021 LIBRARY; T=293.6K  
Threshold reactions

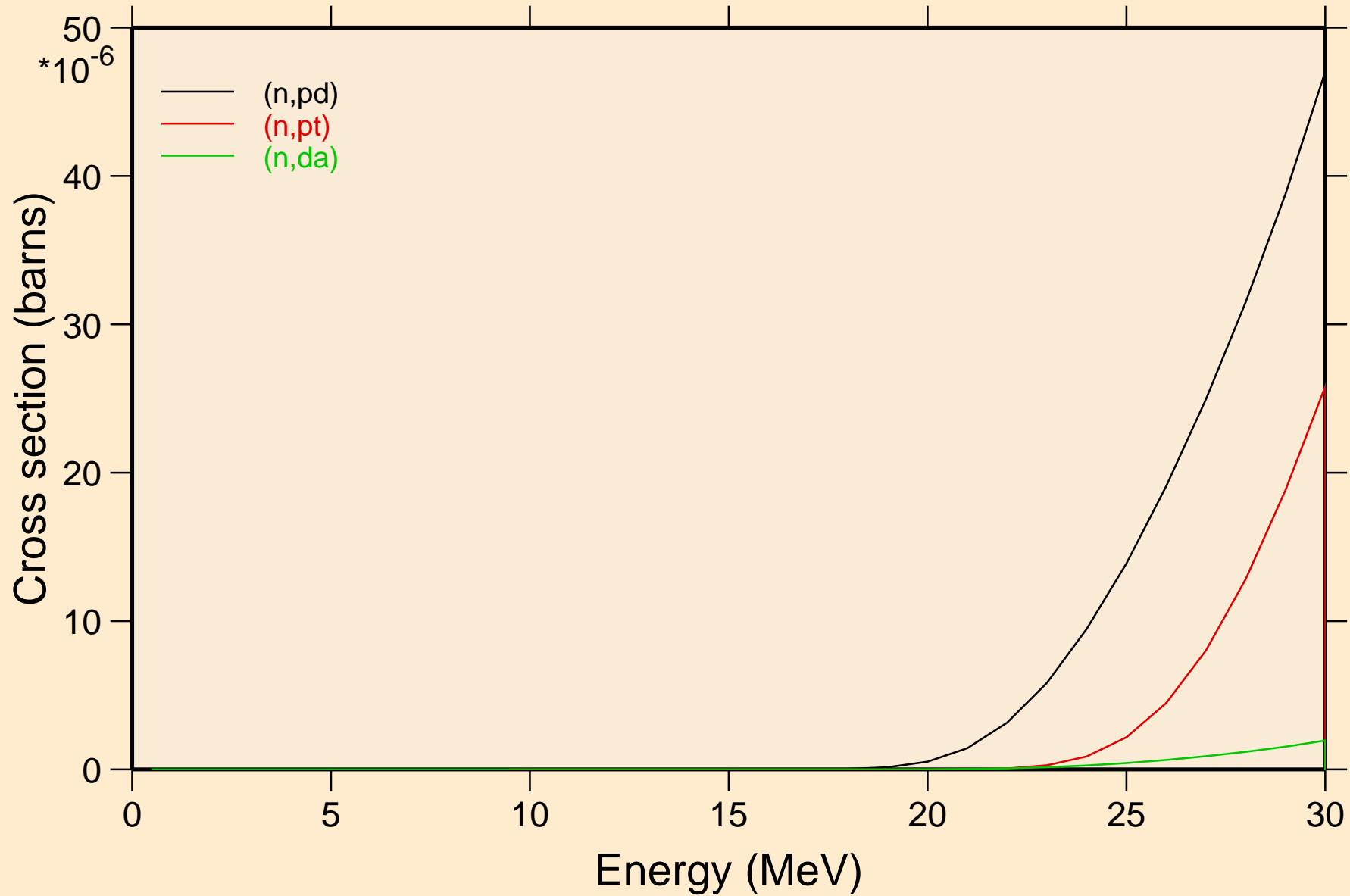

YB162 NEUTRON ACER TENDL-2021 LIBRARY; T=293.6K  
Threshold reactions

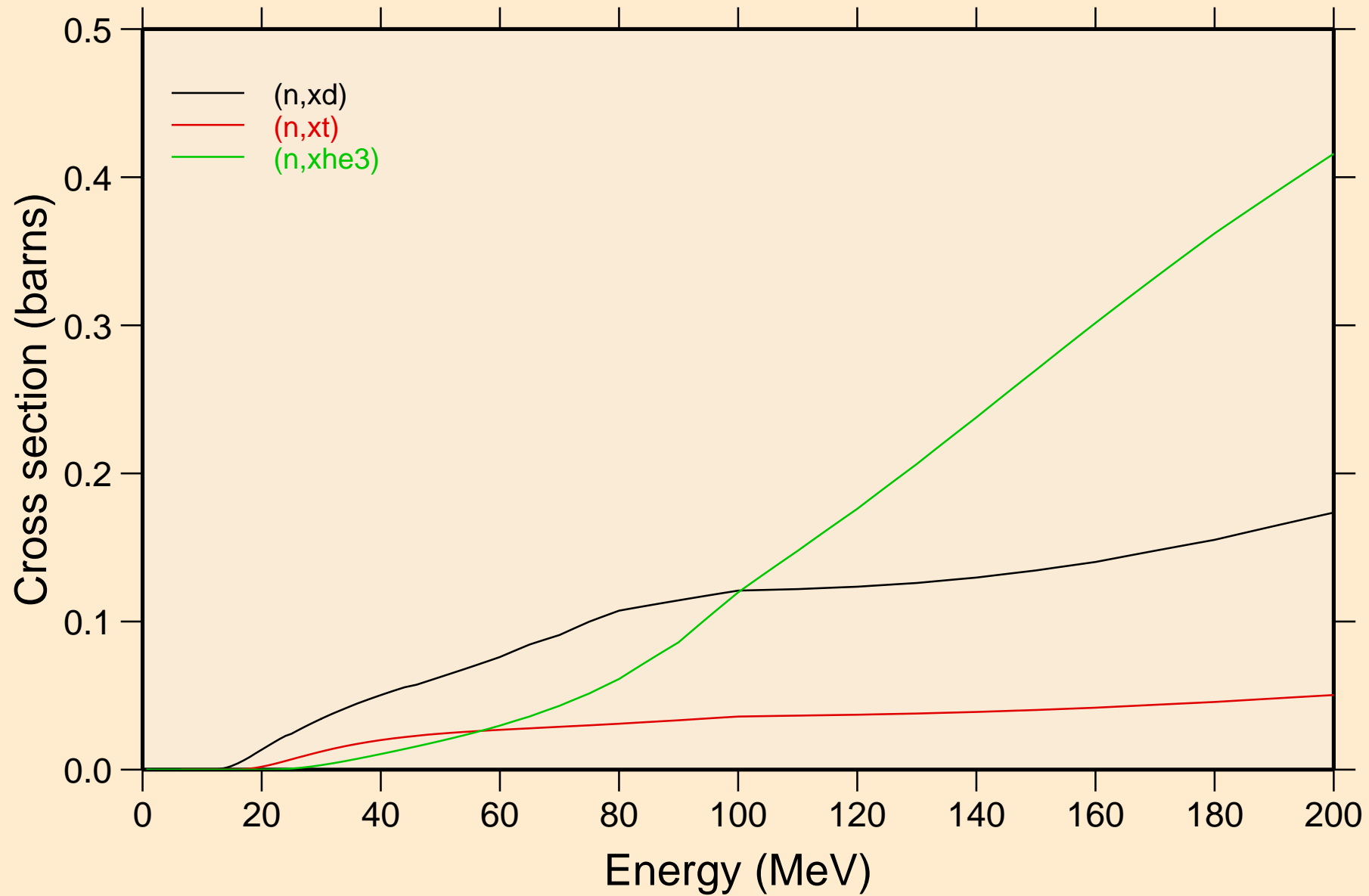

YB162 NEUTRON ACER TENDL-2021 LIBRARY; T=293.6K  
angular distribution for elastic

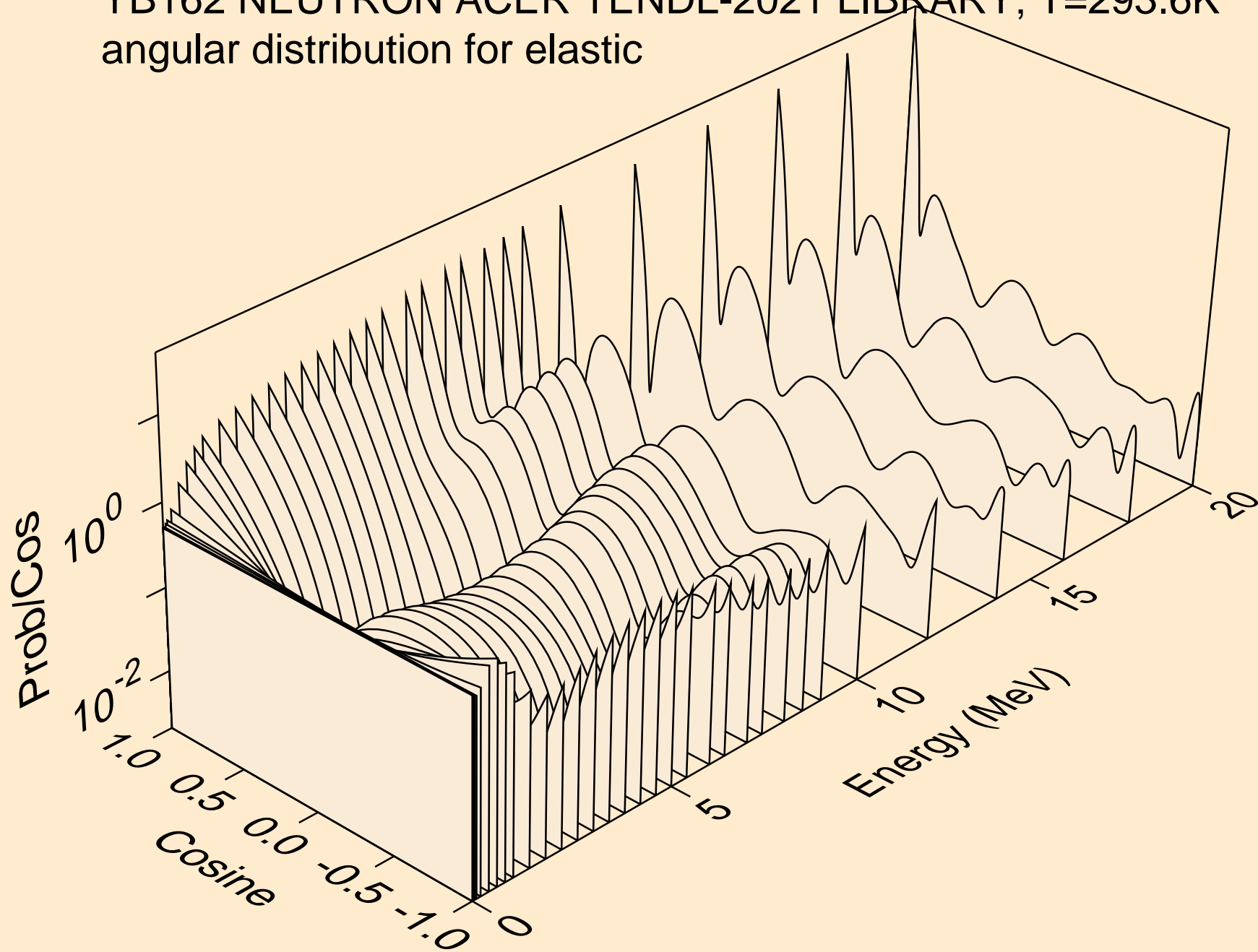

YB162 NEUTRON ACER TENDL-2021 LIBRARY; T=293.6K  
angular distribution for elastic

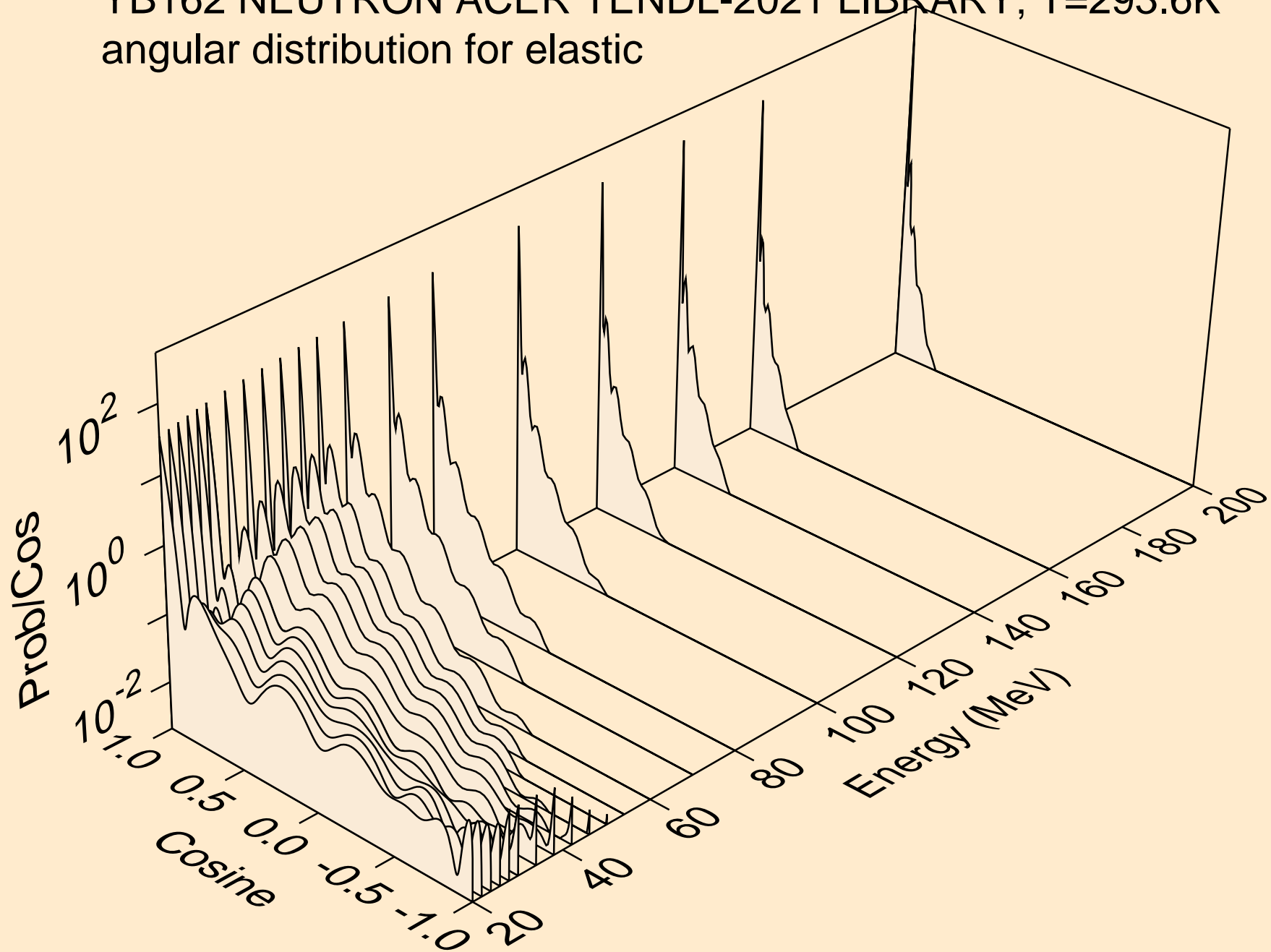

YB162 NEUTRON ACER TENDL-2021 LIBRARY; T=293.6K  
angular distribution for (n,n\*1)

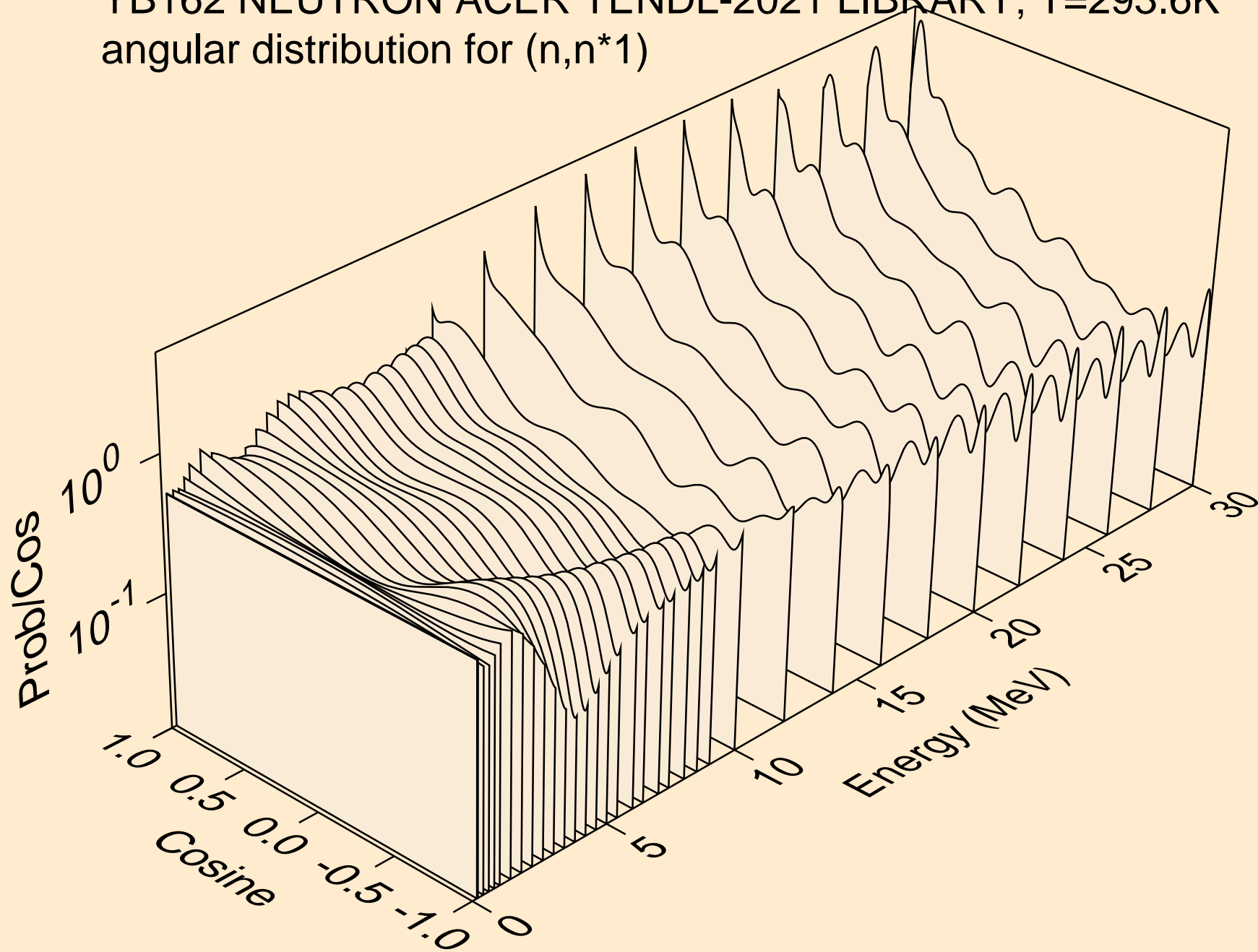



YB162 NEUTRON ACER TENDL-2021 LIBRARY; T=293.6K  
angular distribution for (n,n\*2)

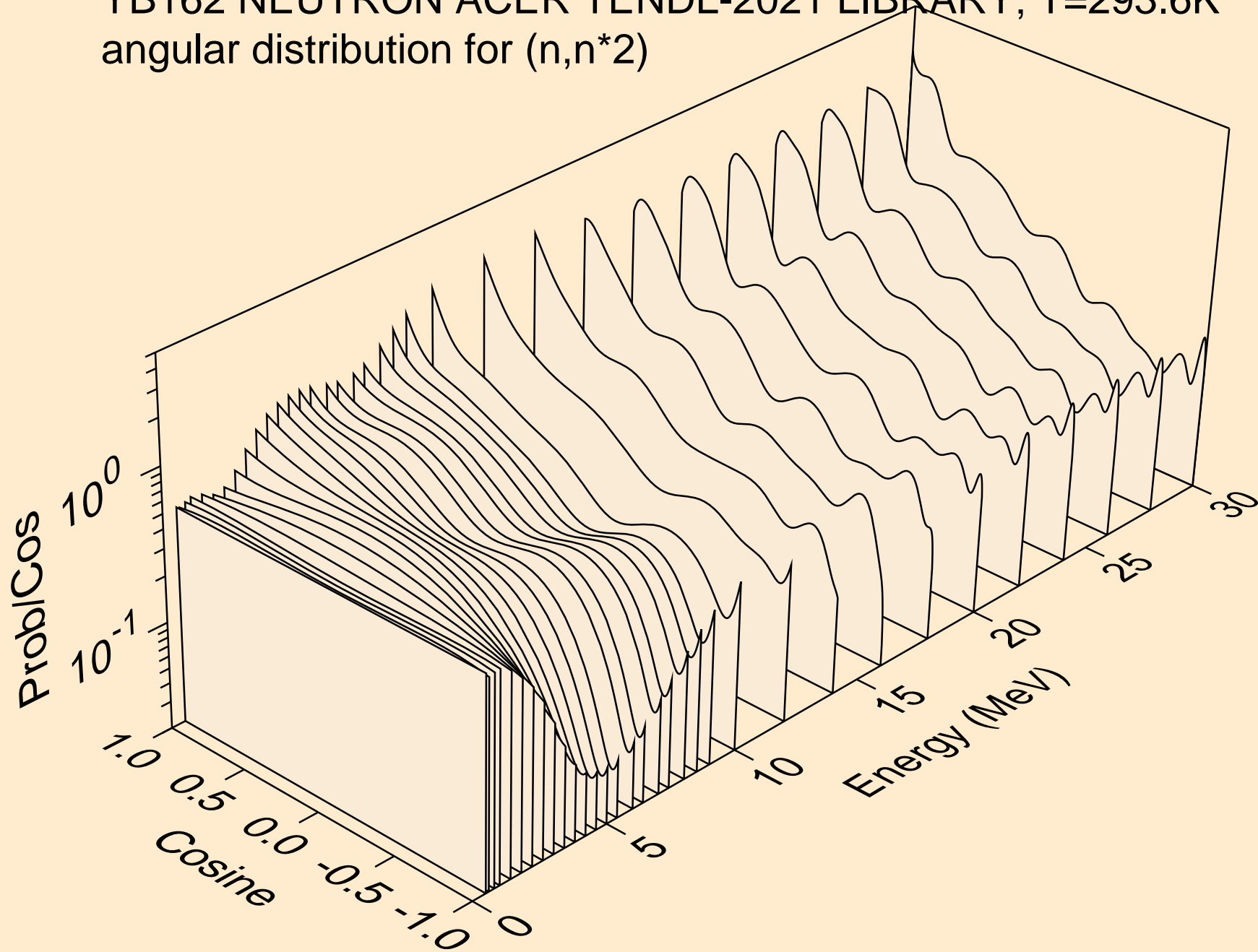

YB162 NEUTRON ACER TENDL-2021 LIBRARY; T=293.6K  
angular distribution for (n,n\*3)

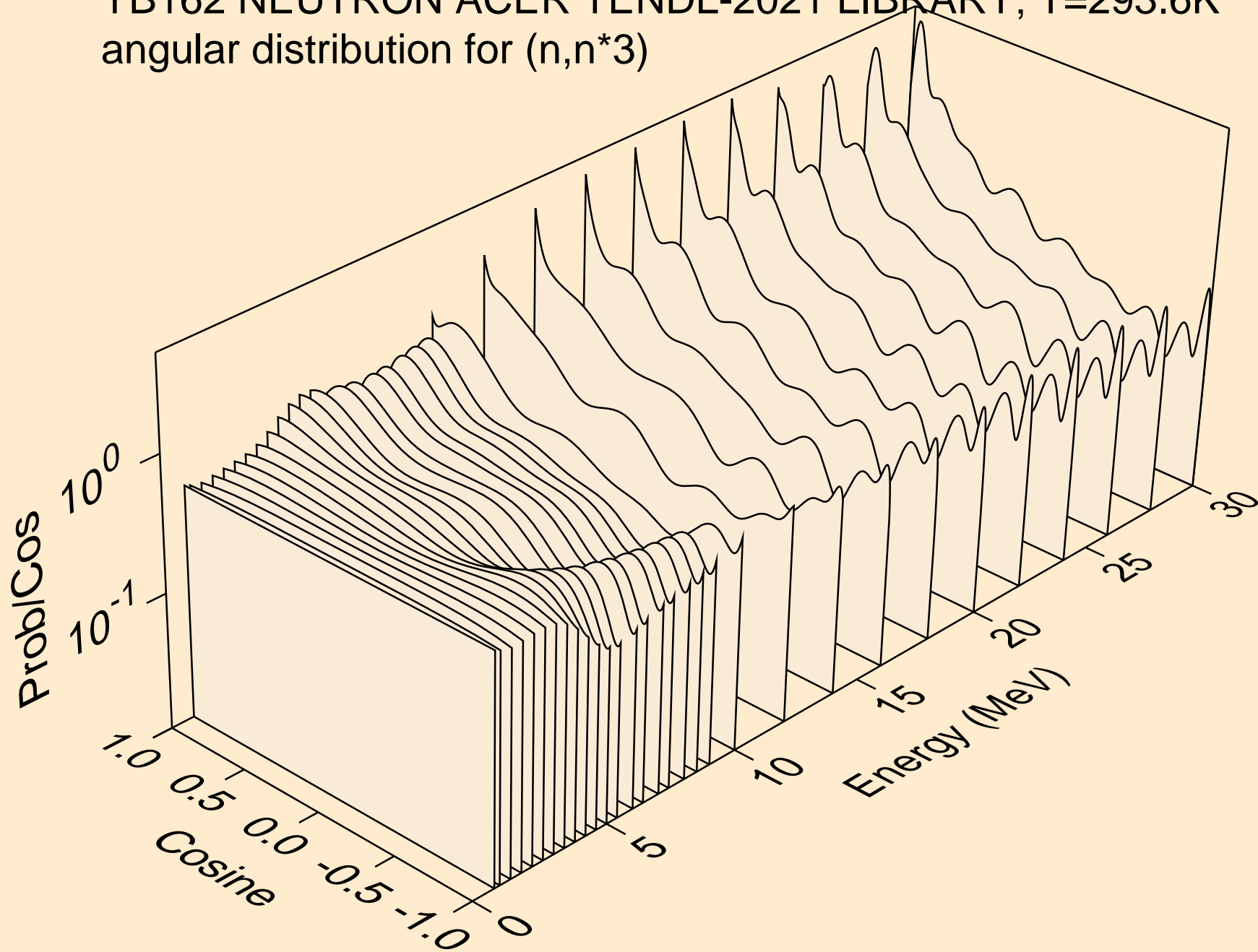

YB162 NEUTRON ACER TENDL-2021 LIBRARY; T=293.6K  
angular distribution for (n,n\*4)

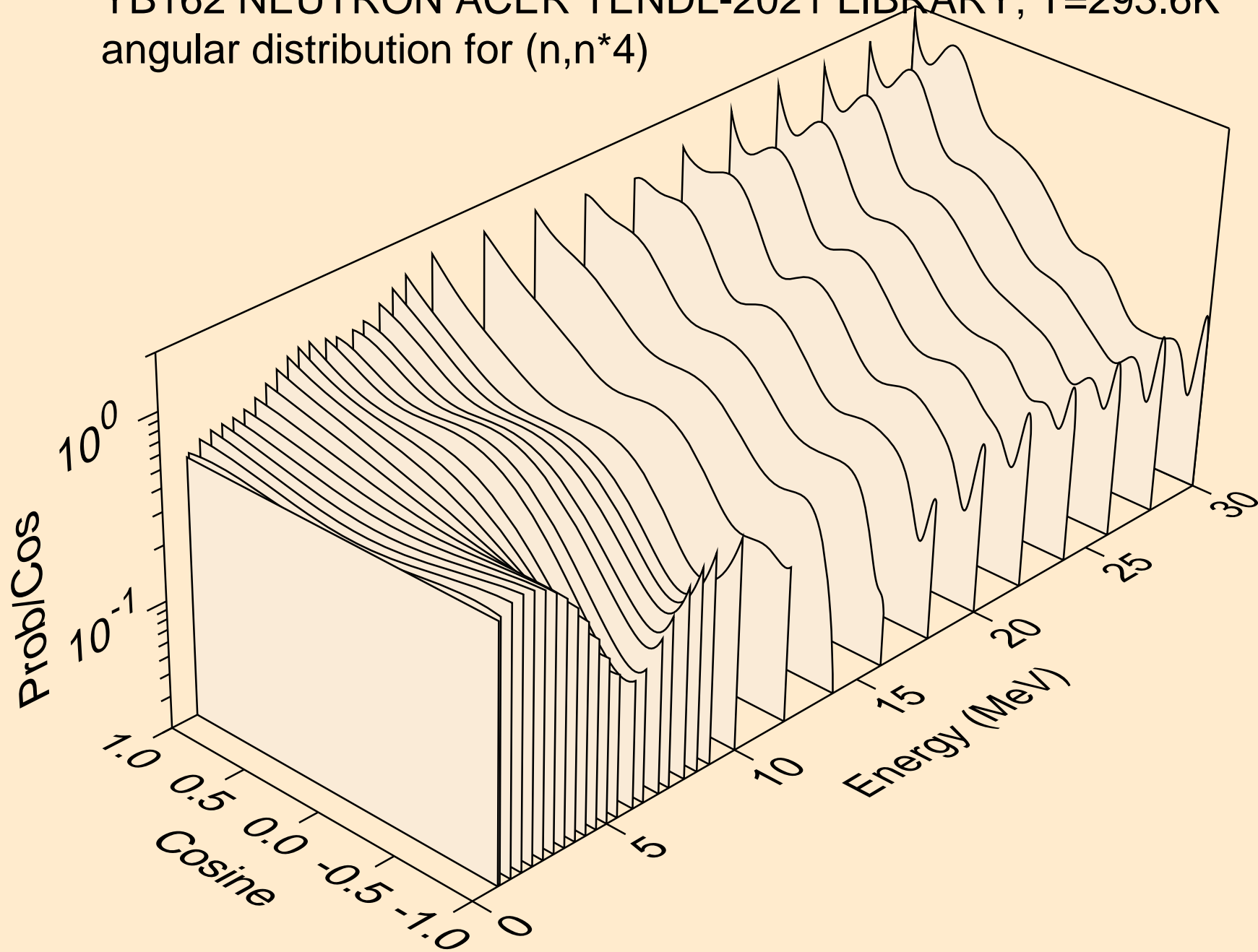

YB162 NEUTRON ACER TENDL-2021 LIBRARY; T=293.6K  
angular distribution for (n,n\*5)

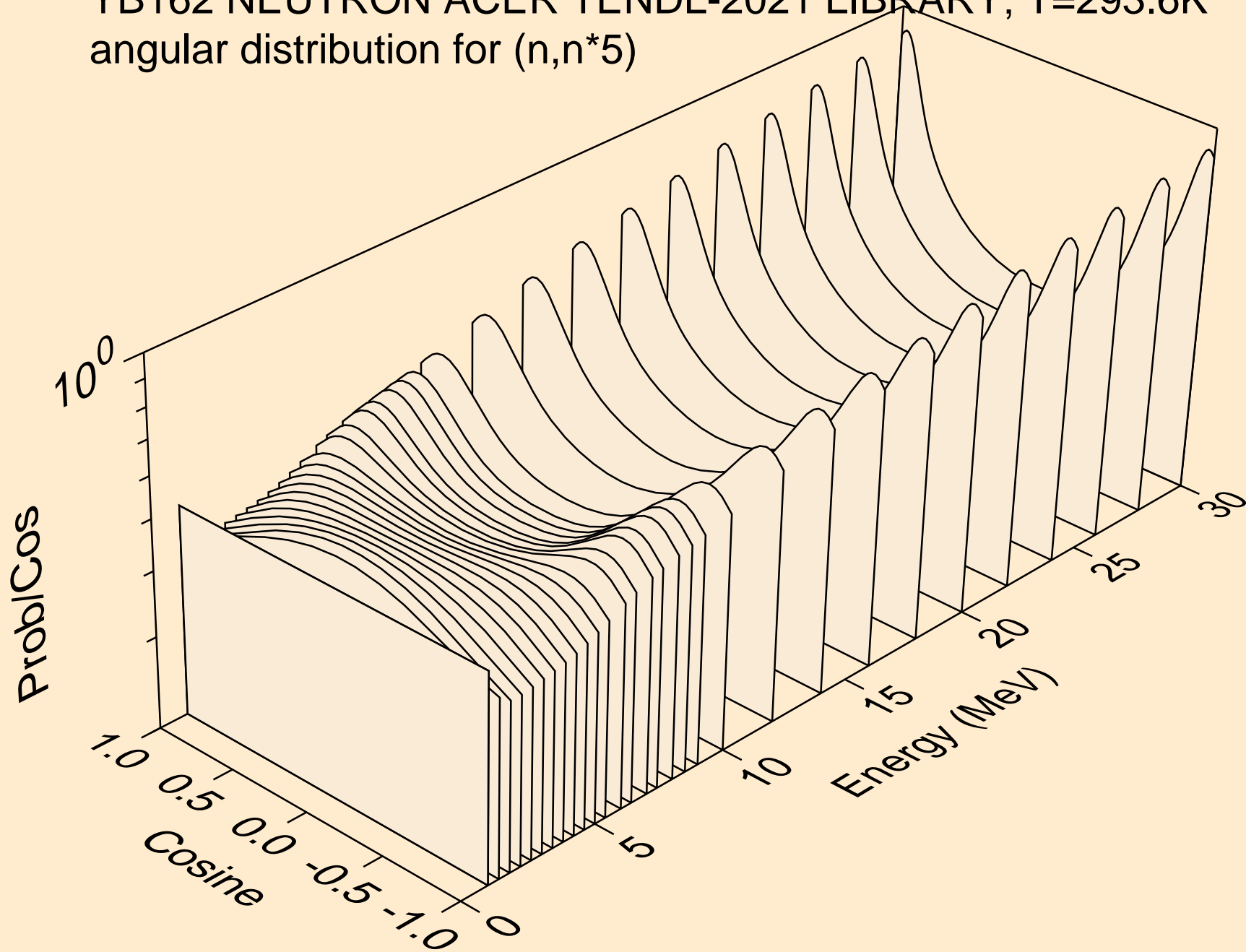

YB162 NEUTRON ACER TENDL-2021 LIBRARY; T=293.6K  
angular distribution for (n,n\*6)

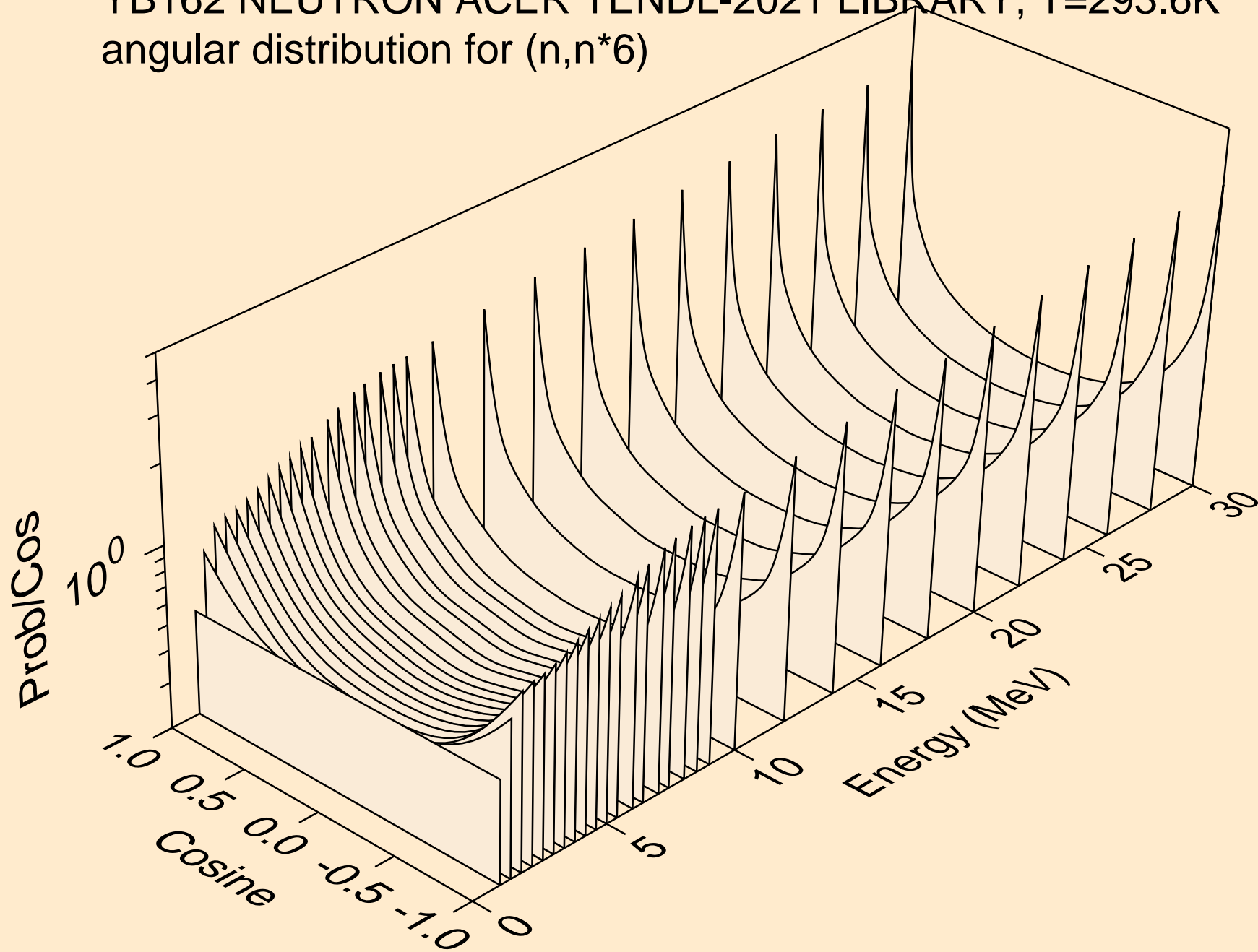

YB162 NEUTRON ACER TENDL-2021 LIBRARY; T=293.6K  
angular distribution for (n,n\*7)

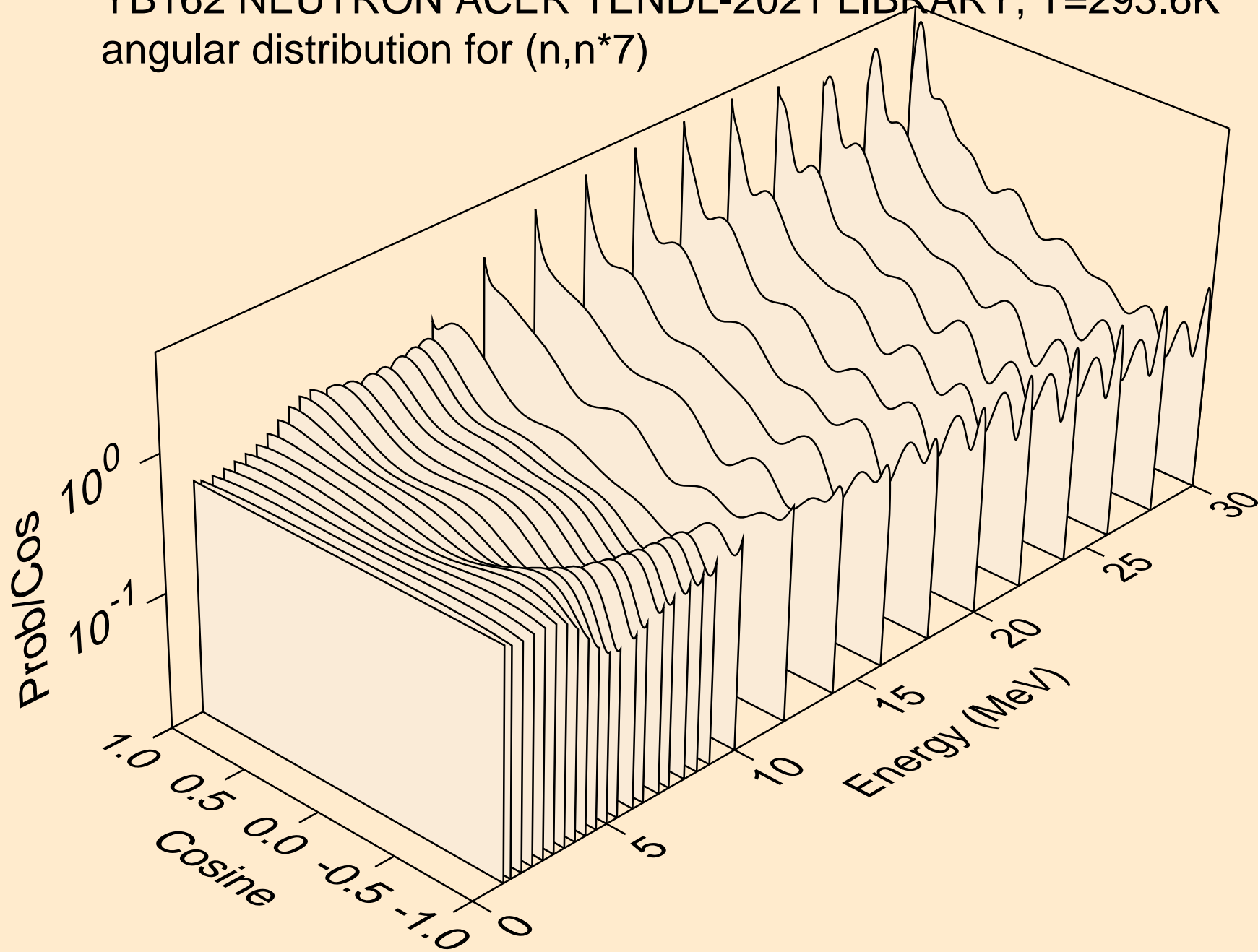

YB162 NEUTRON ACER TENDL-2021 LIBRARY; T=293.6K  
angular distribution for (n,n\*8)

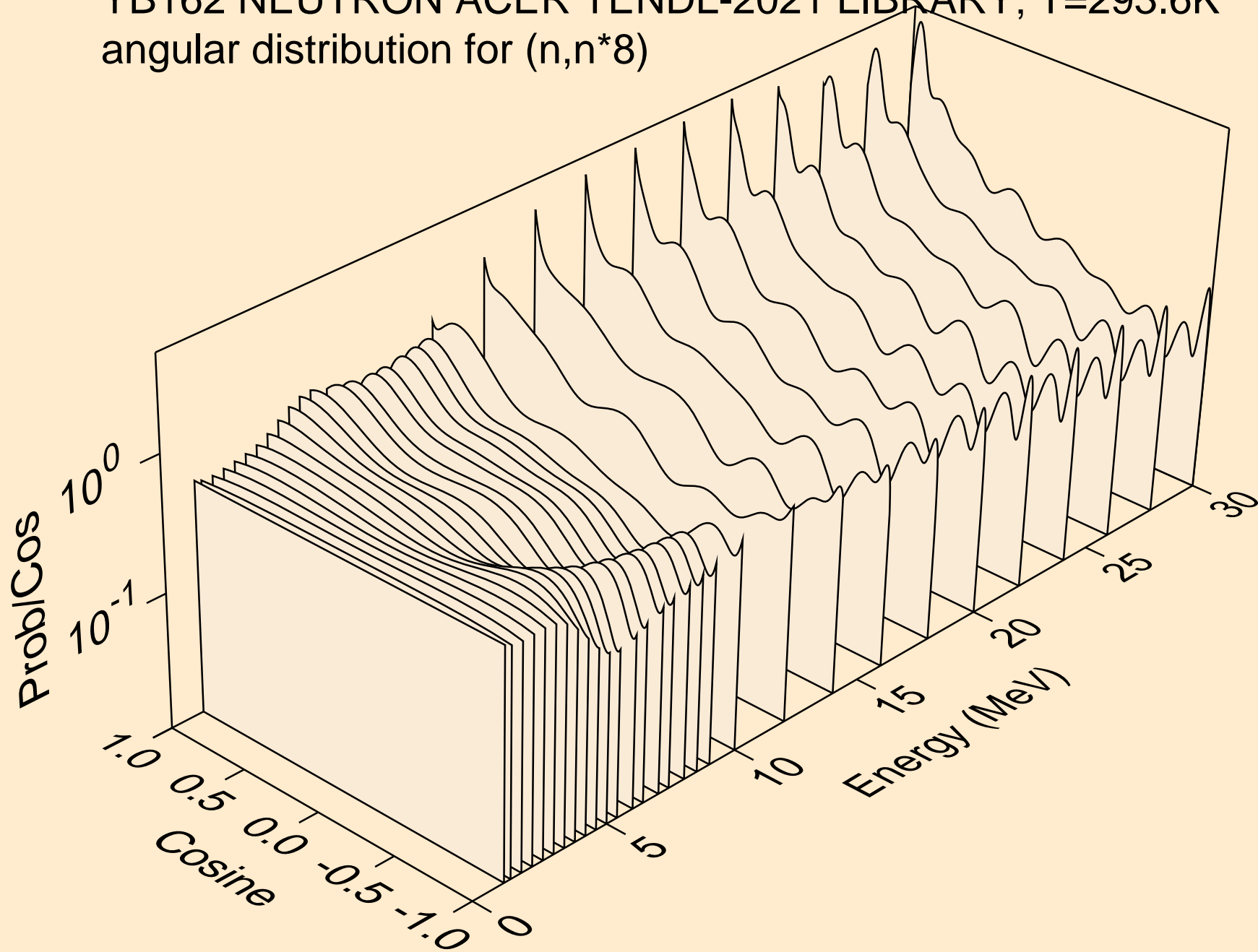

YB162 NEUTRON ACER TENDL-2021 LIBRARY; T=293.6K  
angular distribution for (n,n\*9)

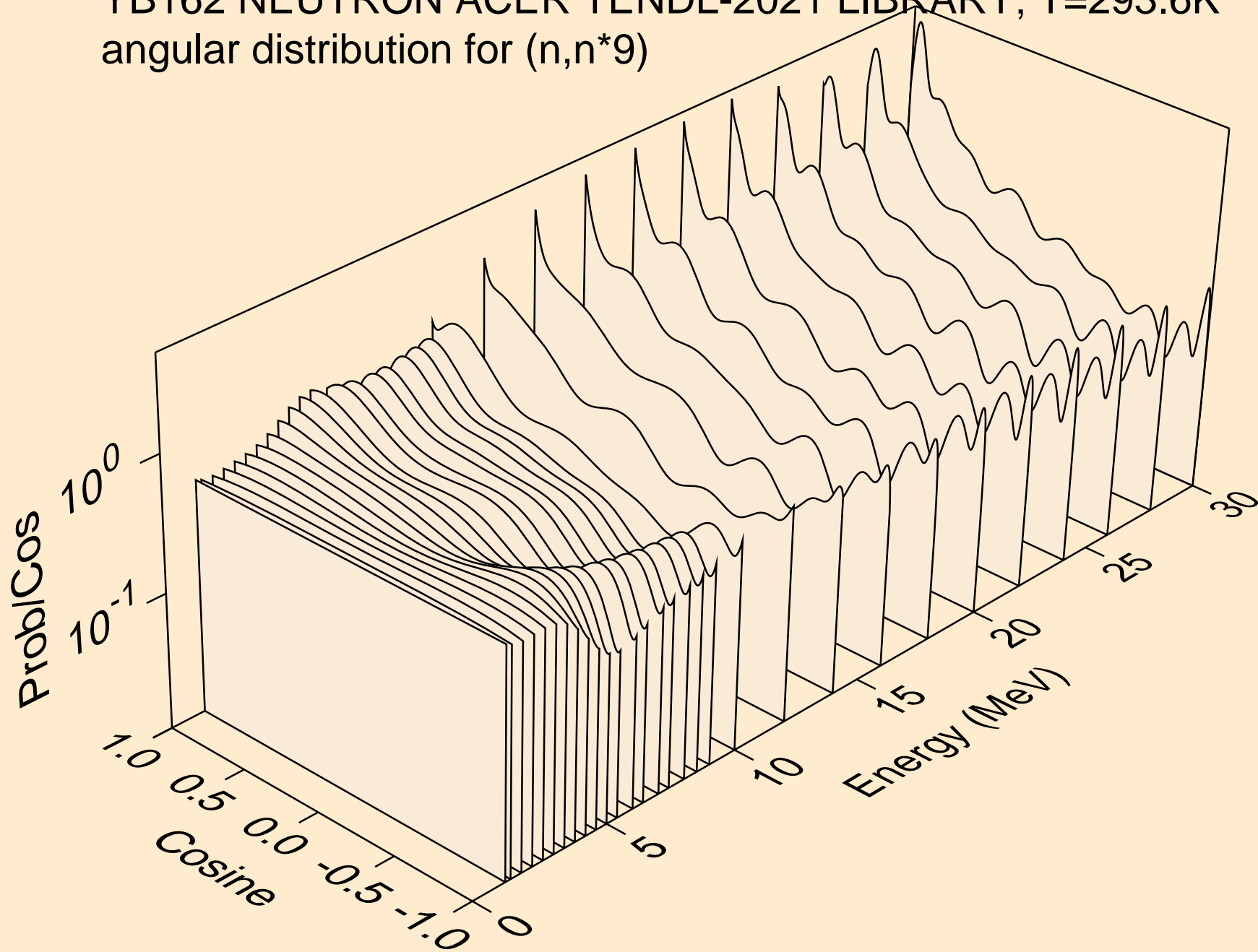



YB162 NEUTRON ACER TENDL-2021 LIBRARY; T=293.6K  
angular distribution for (n,n\*10)

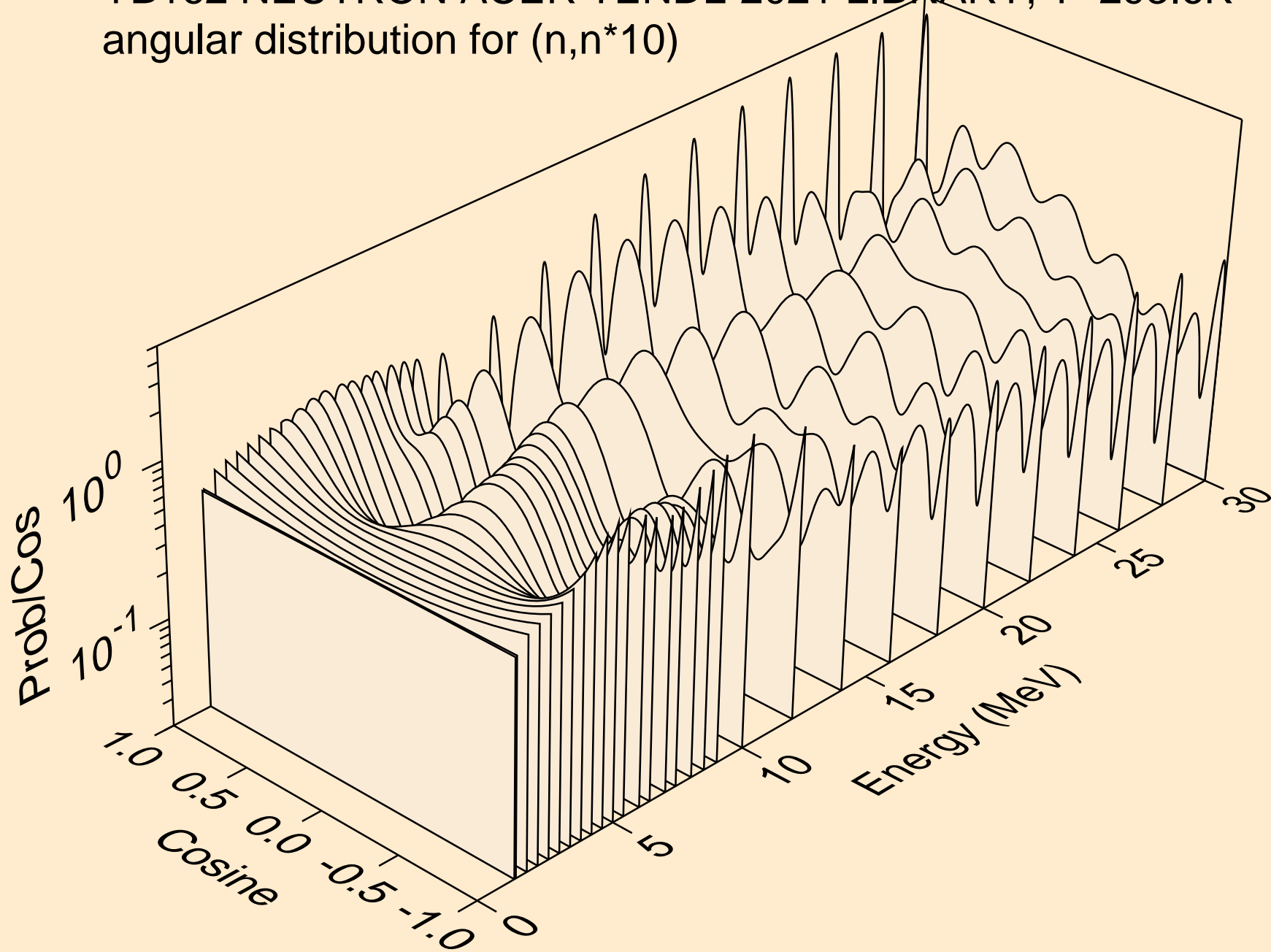

YB162 NEUTRON ACER TENDL-2021 LIBRARY; T=293.6K  
angular distribution for (n,n\*11)

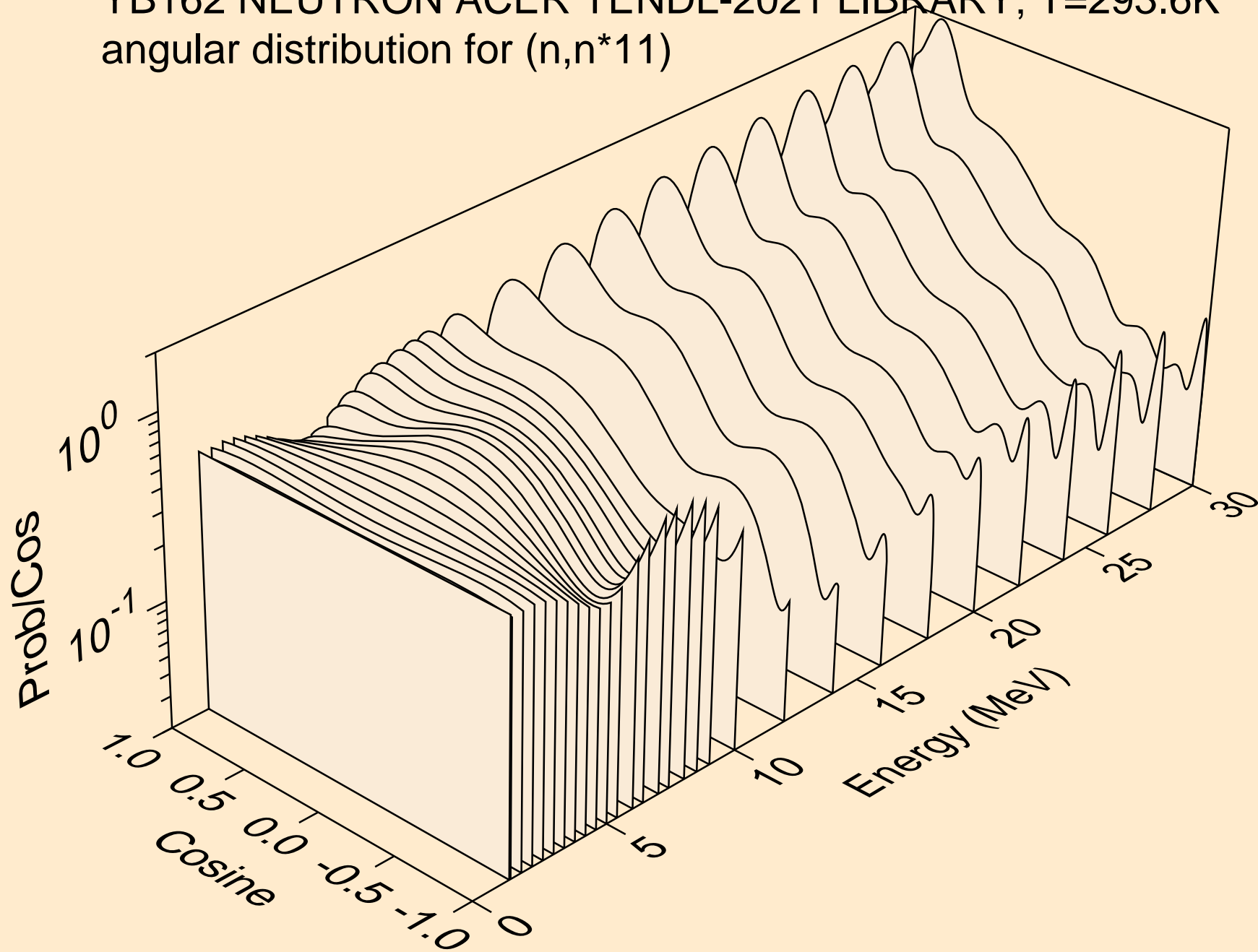

YB162 NEUTRON ACER TENDL-2021 LIBRARY; T=293.6K  
angular distribution for (n,n\*12)

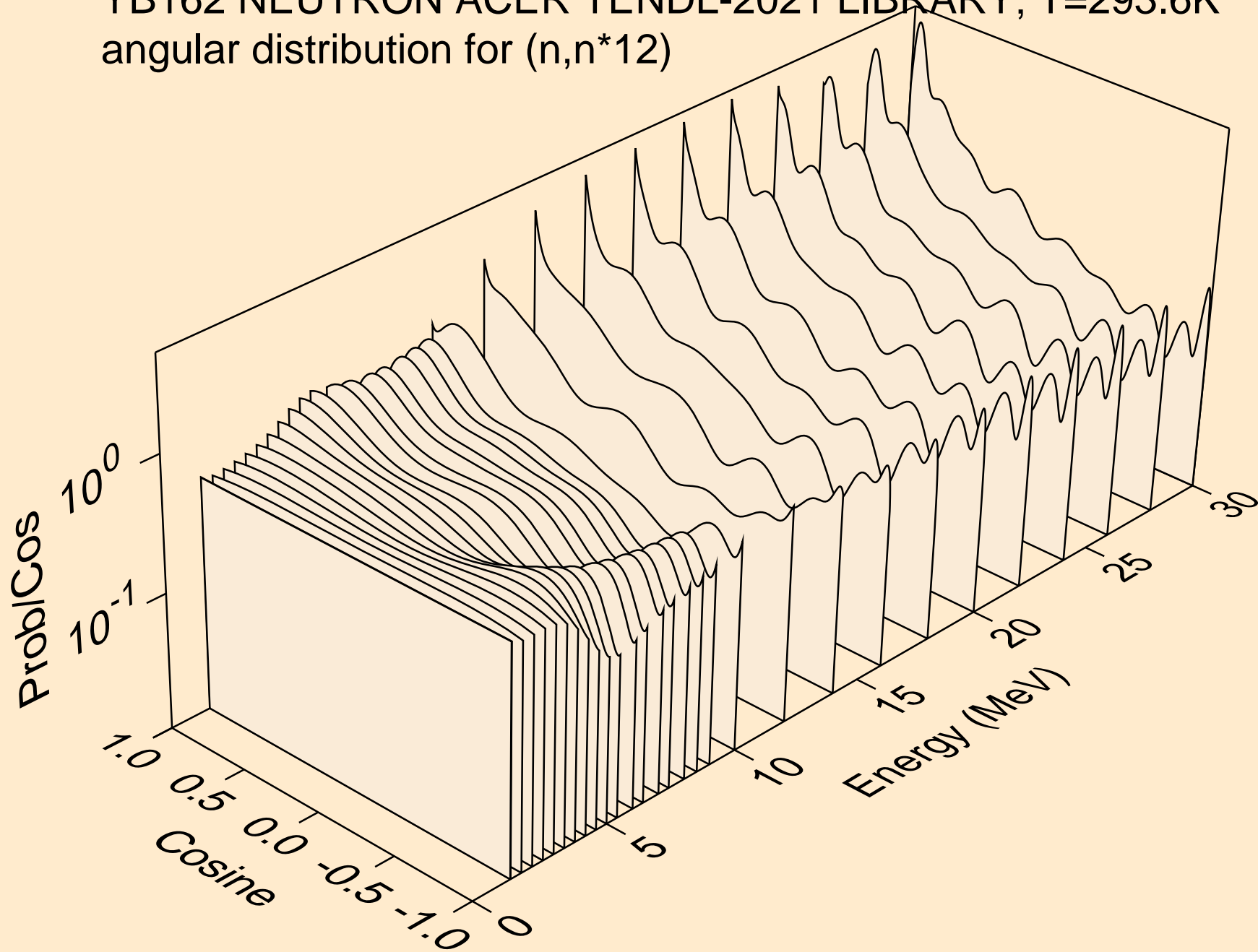

YB162 NEUTRON ACER TENDL-2021 LIBRARY; T=293.6K  
angular distribution for (n,n\*13)

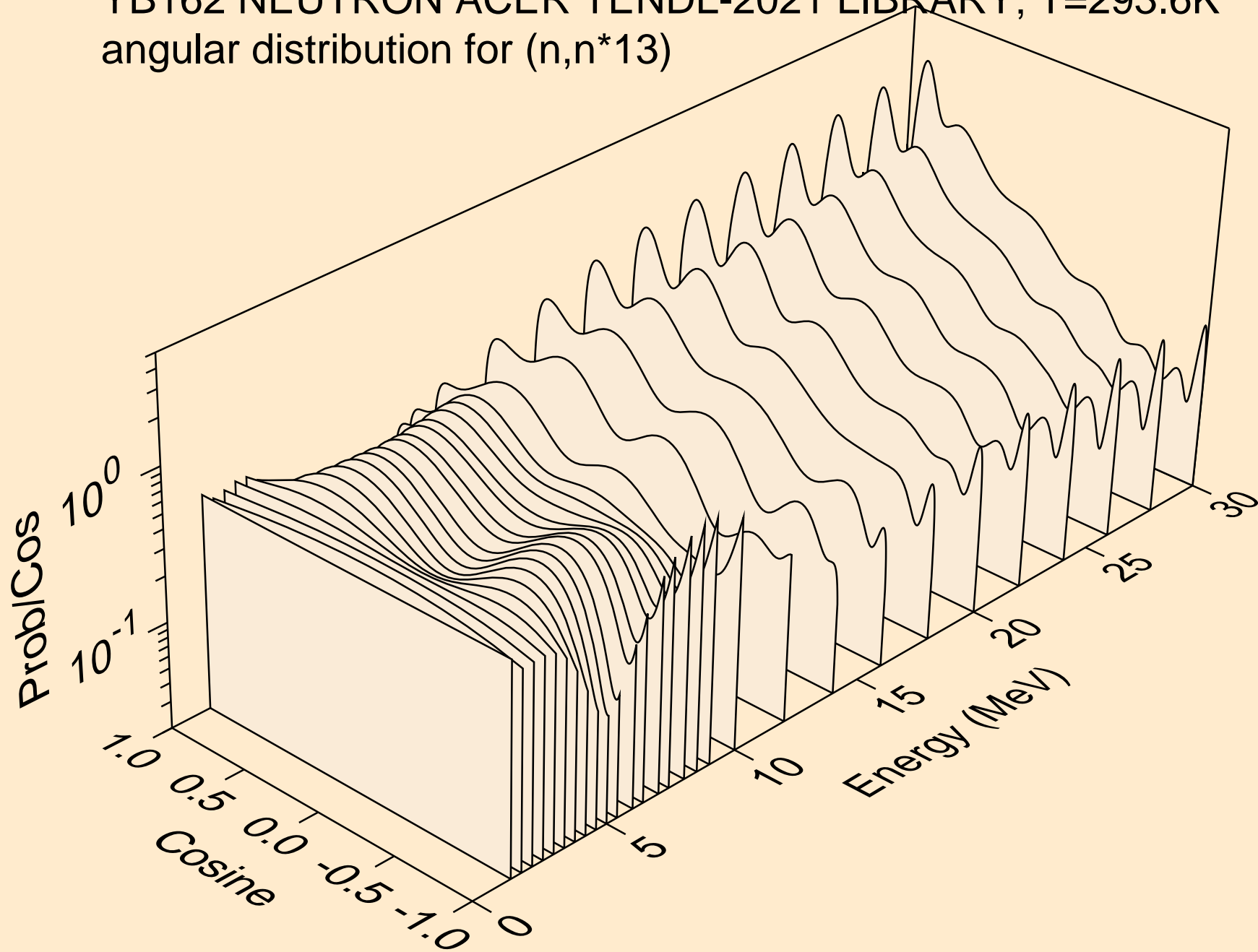

YB162 NEUTRON ACER TENDL-2021 LIBRARY; T=293.6K  
angular distribution for (n,n\*14)

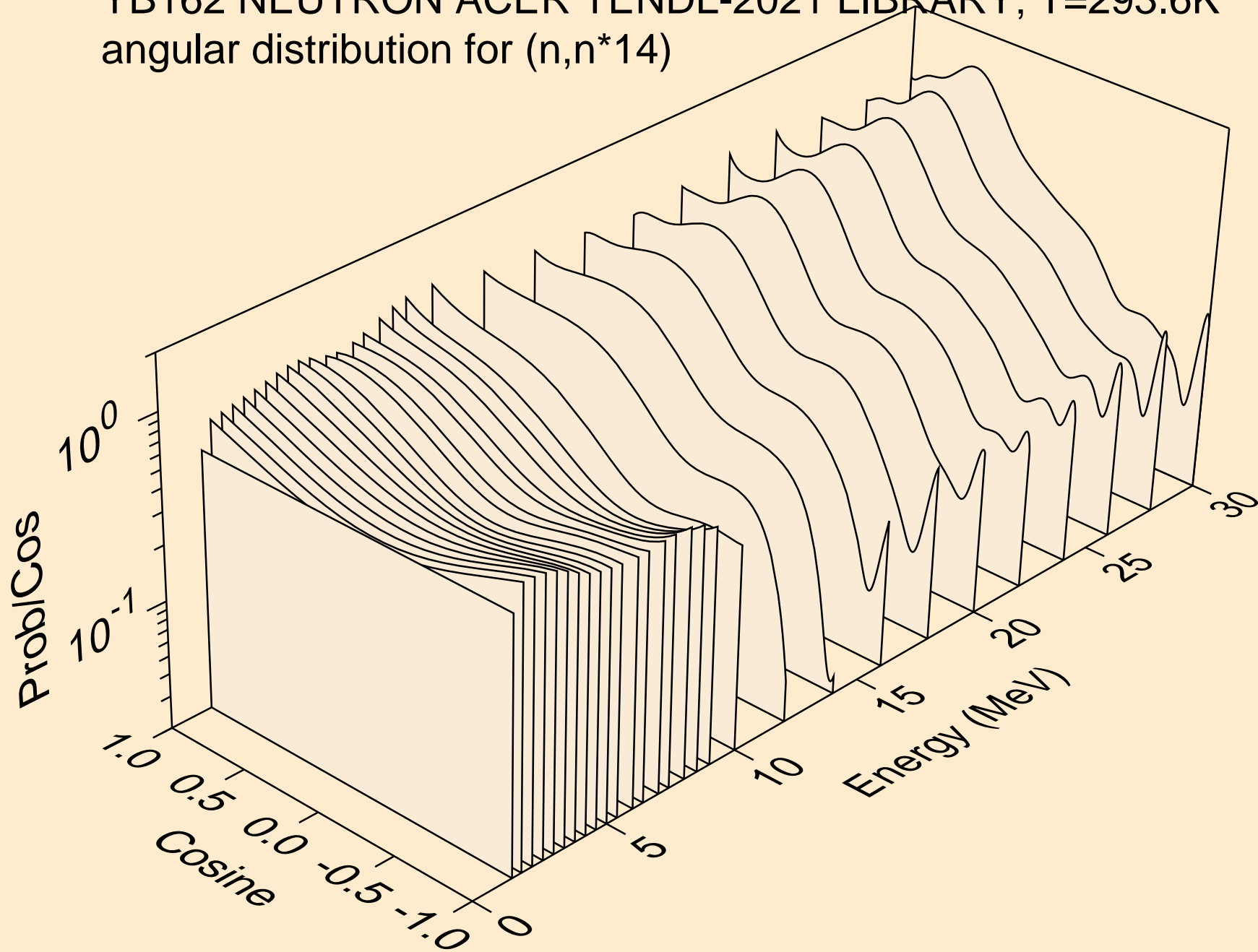

YB162 NEUTRON ACER TENDL-2021 LIBRARY; T=293.6K  
angular distribution for (n,n\*15)

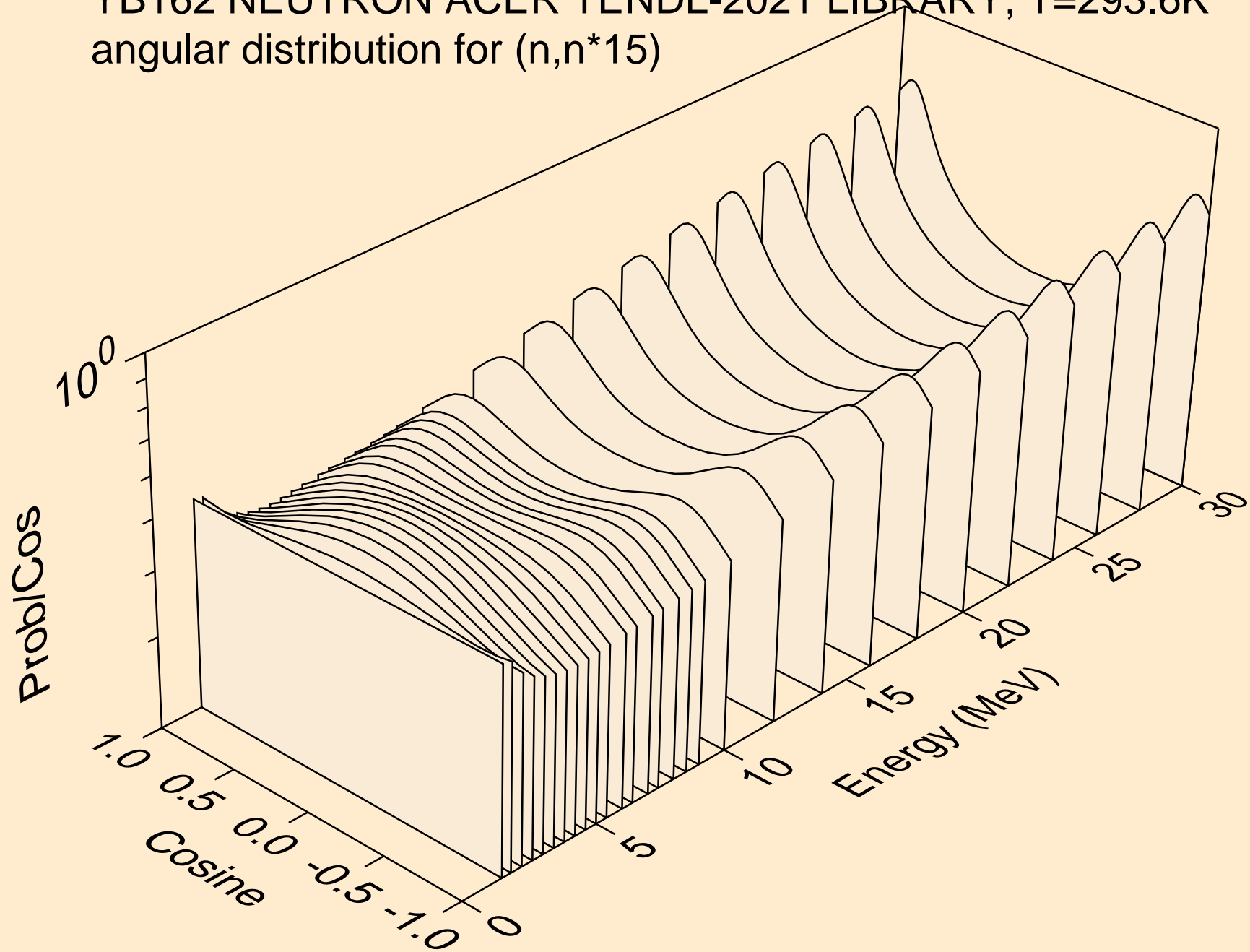

YB162 NEUTRON ACER TENDL-2021 LIBRARY; T=293.6K  
angular distribution for (n,n\*16)

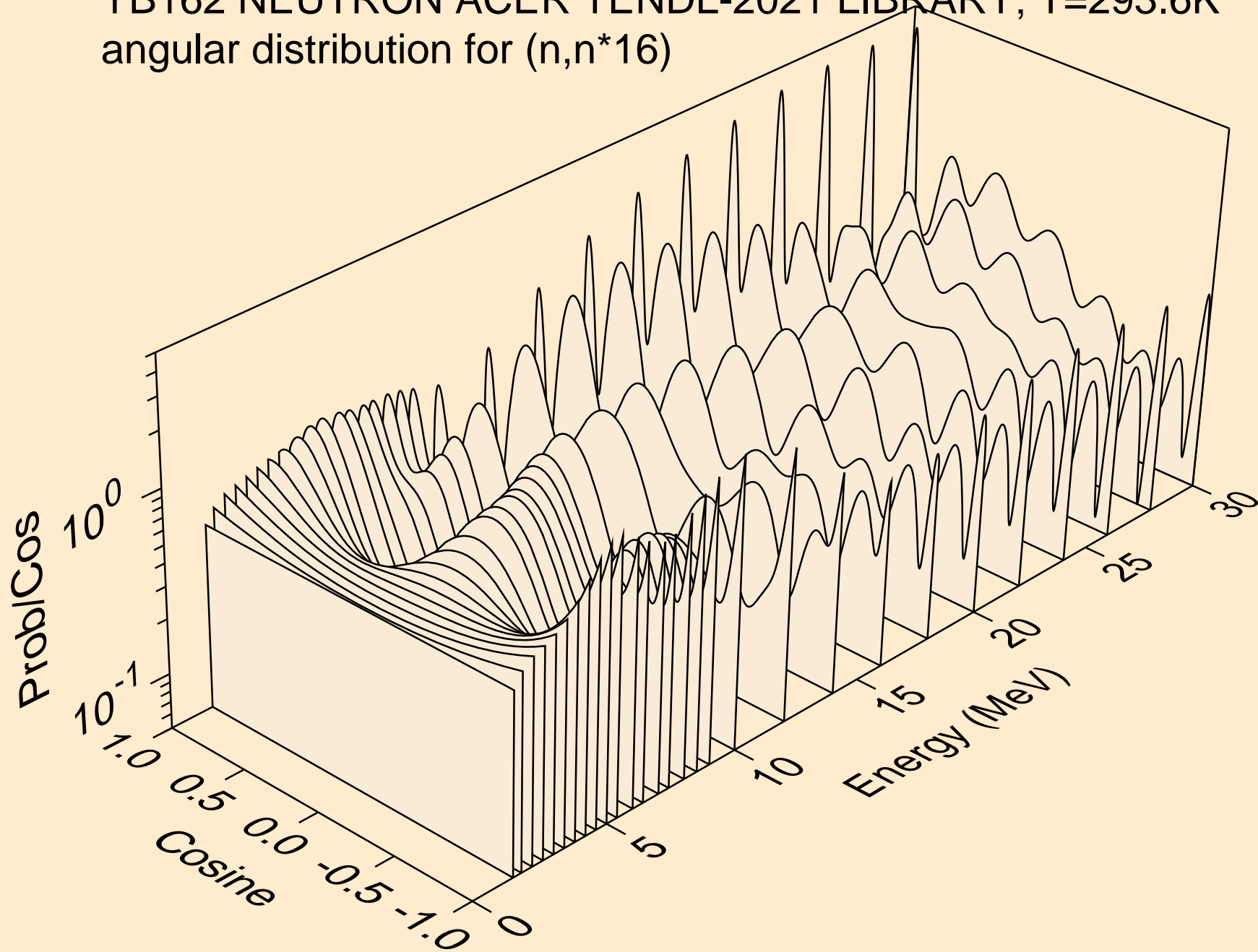

YB162 NEUTRON ACER TENDL-2021 LIBRARY; T=293.6K  
angular distribution for (n,n\*17)

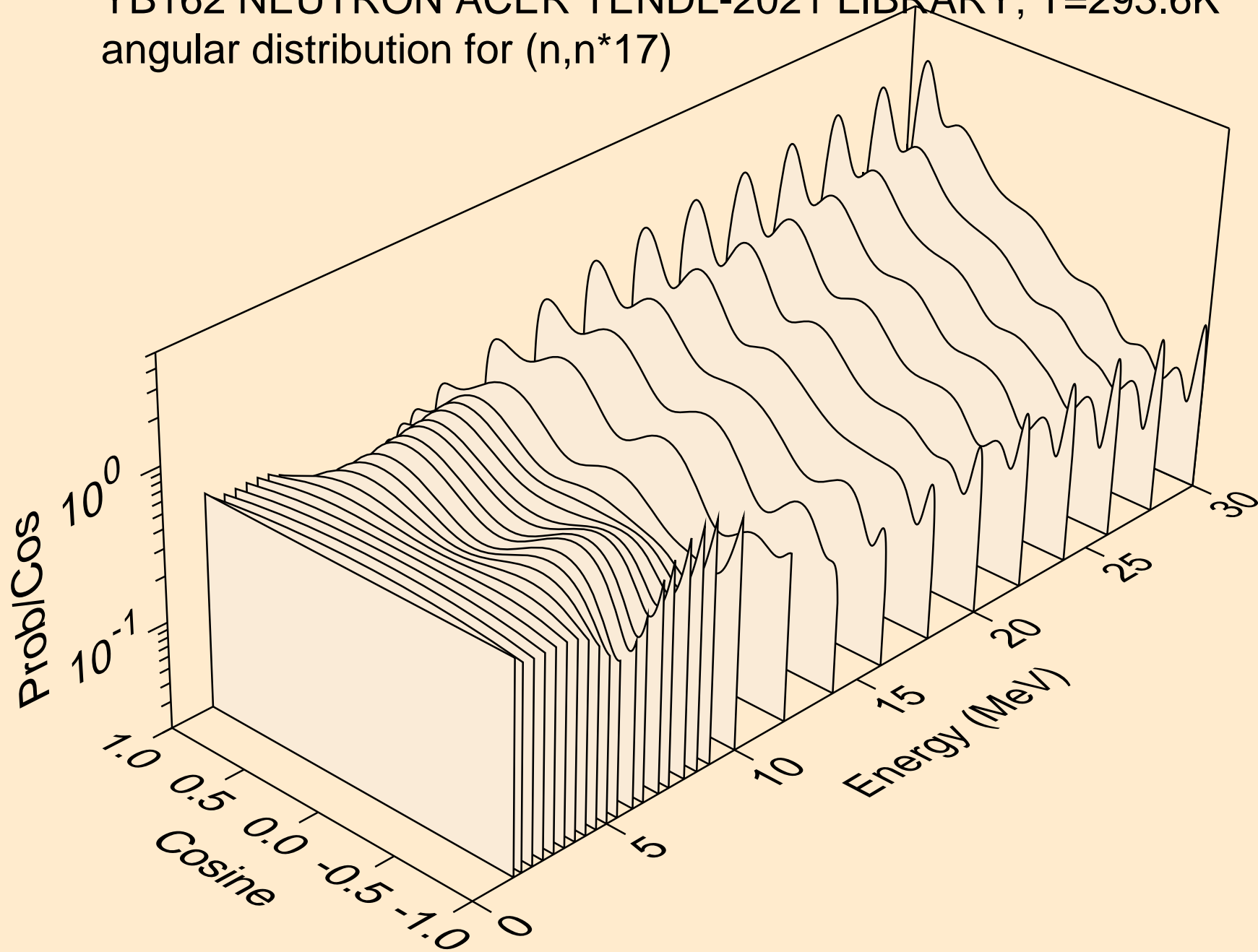



YB162 NEUTRON ACER TENDL-2021 LIBRARY; T=293.6K  
angular distribution for (n,n\*18)

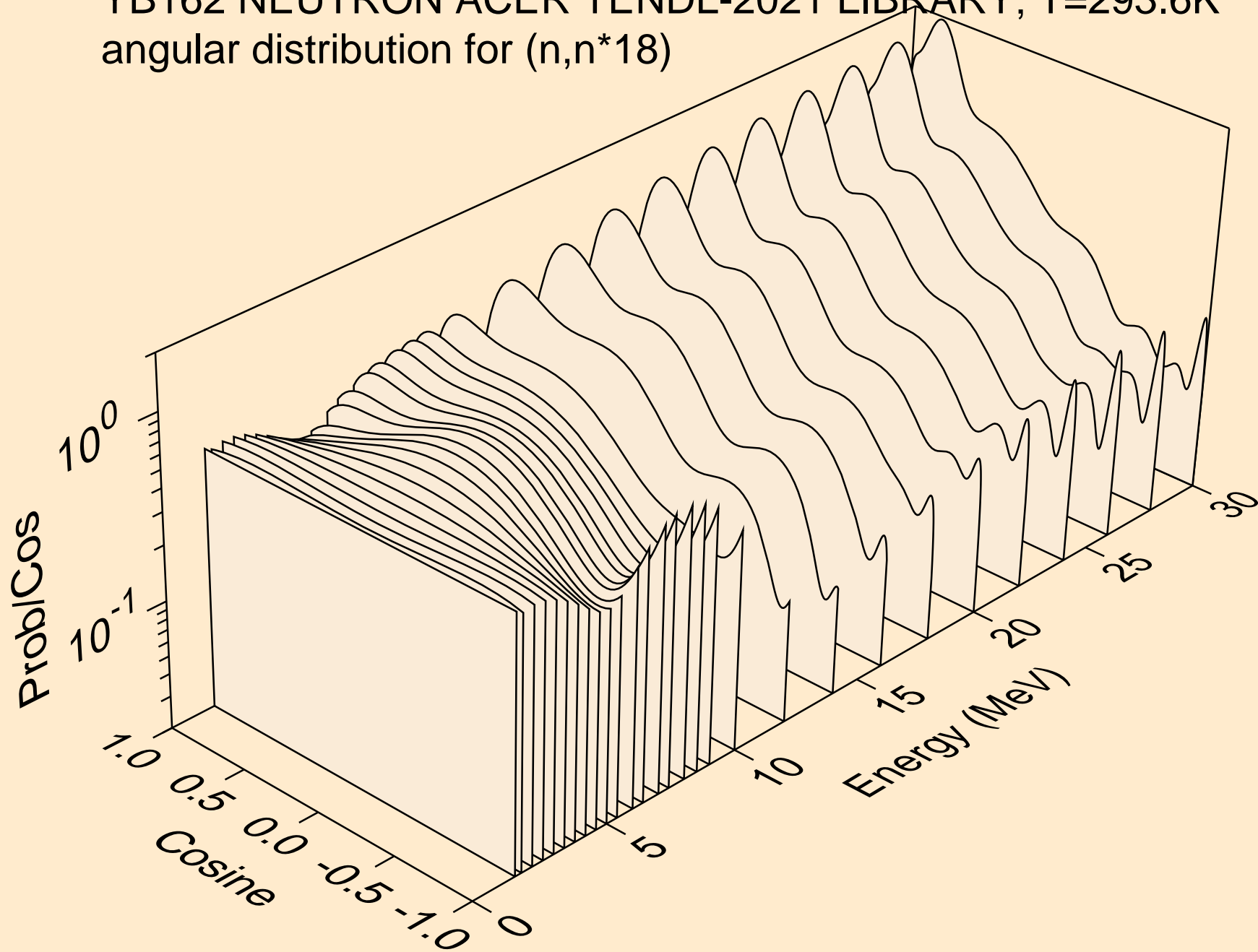

YB162 NEUTRON ACER TENDL-2021 LIBRARY; T=293.6K  
angular distribution for (n,n\*19)

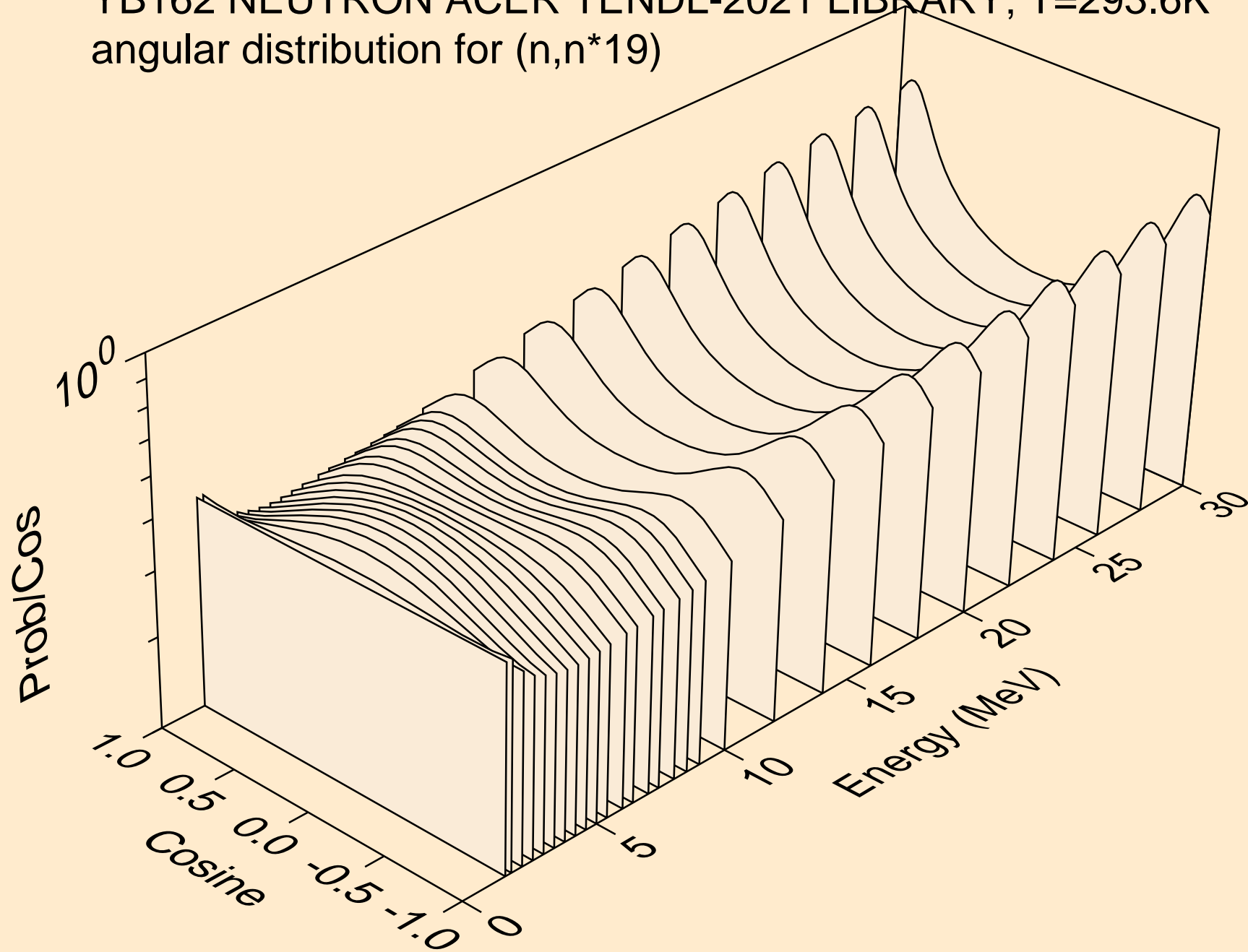

YB162 NEUTRON ACER TENDL-2021 LIBRARY; T=293.6K  
angular distribution for (n,n\*20)

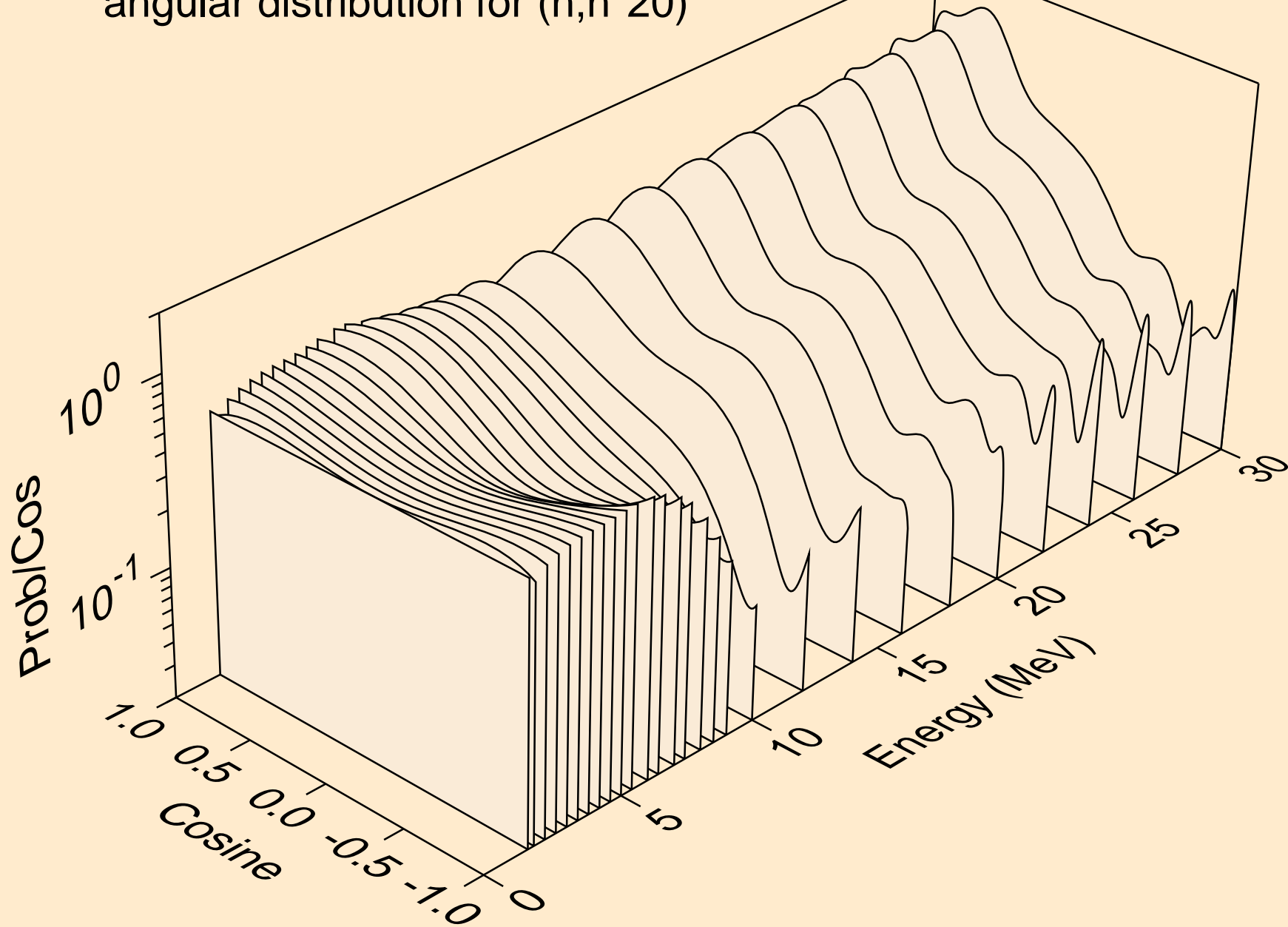

YB162 NEUTRON ACER TENDL-2021 LIBRARY; T=293.6K  
angular distribution for (n,n\*21)

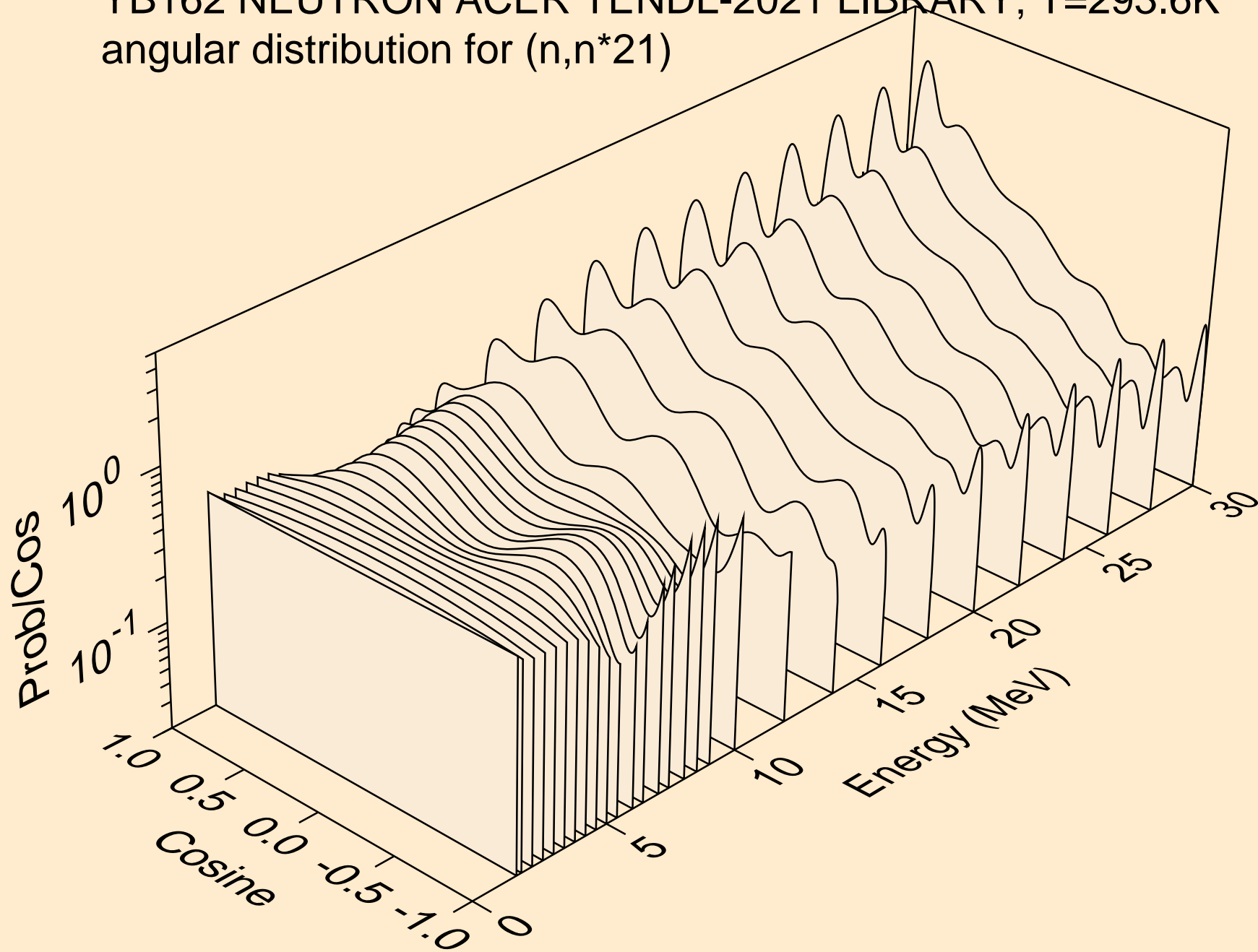

YB162 NEUTRON ACER TENDL-2021 LIBRARY; T=293.6K  
angular distribution for (n,n\*22)

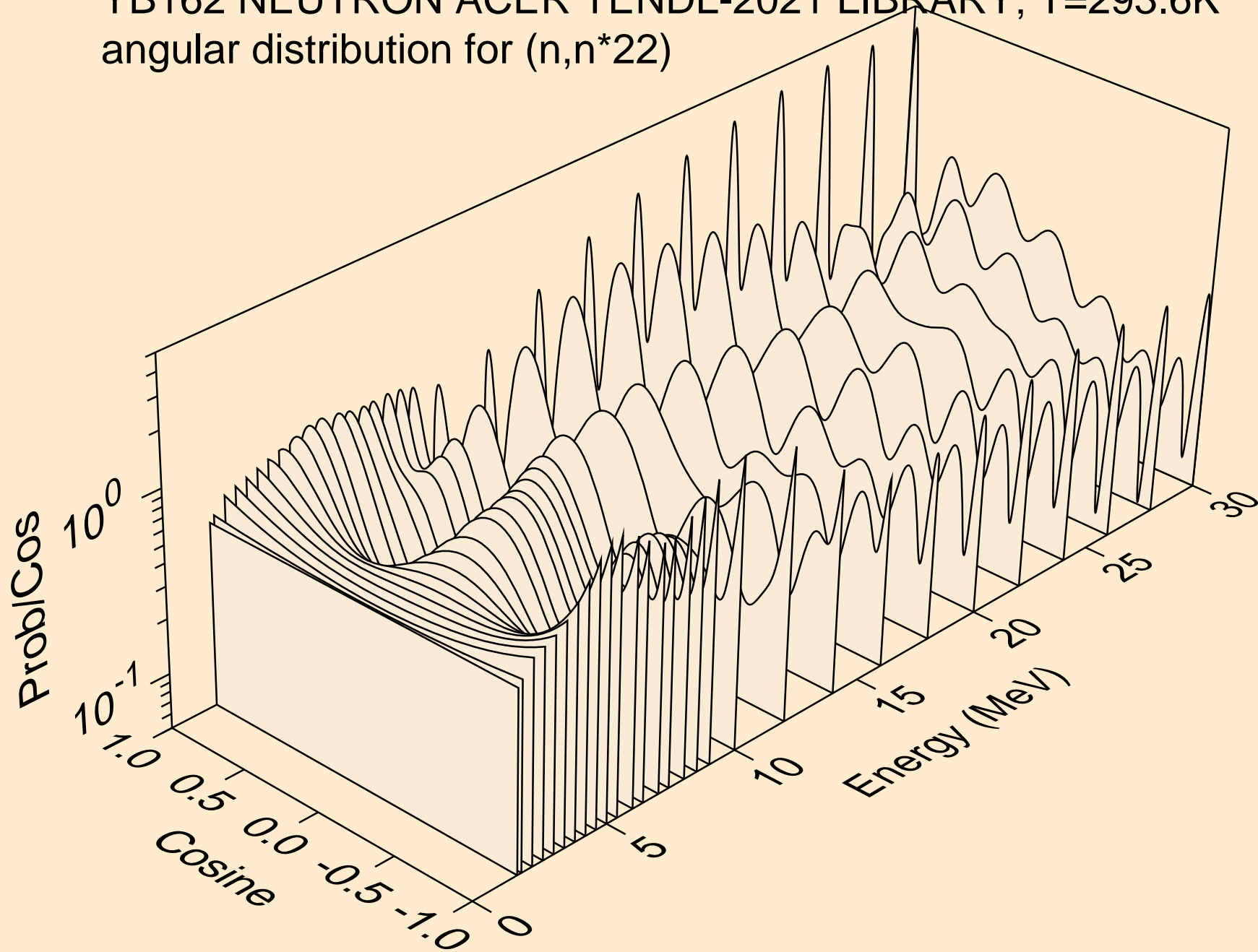

YB162 NEUTRON ACER TENDL-2021 LIBRARY; T=293.6K  
angular distribution for (n,n\*23)

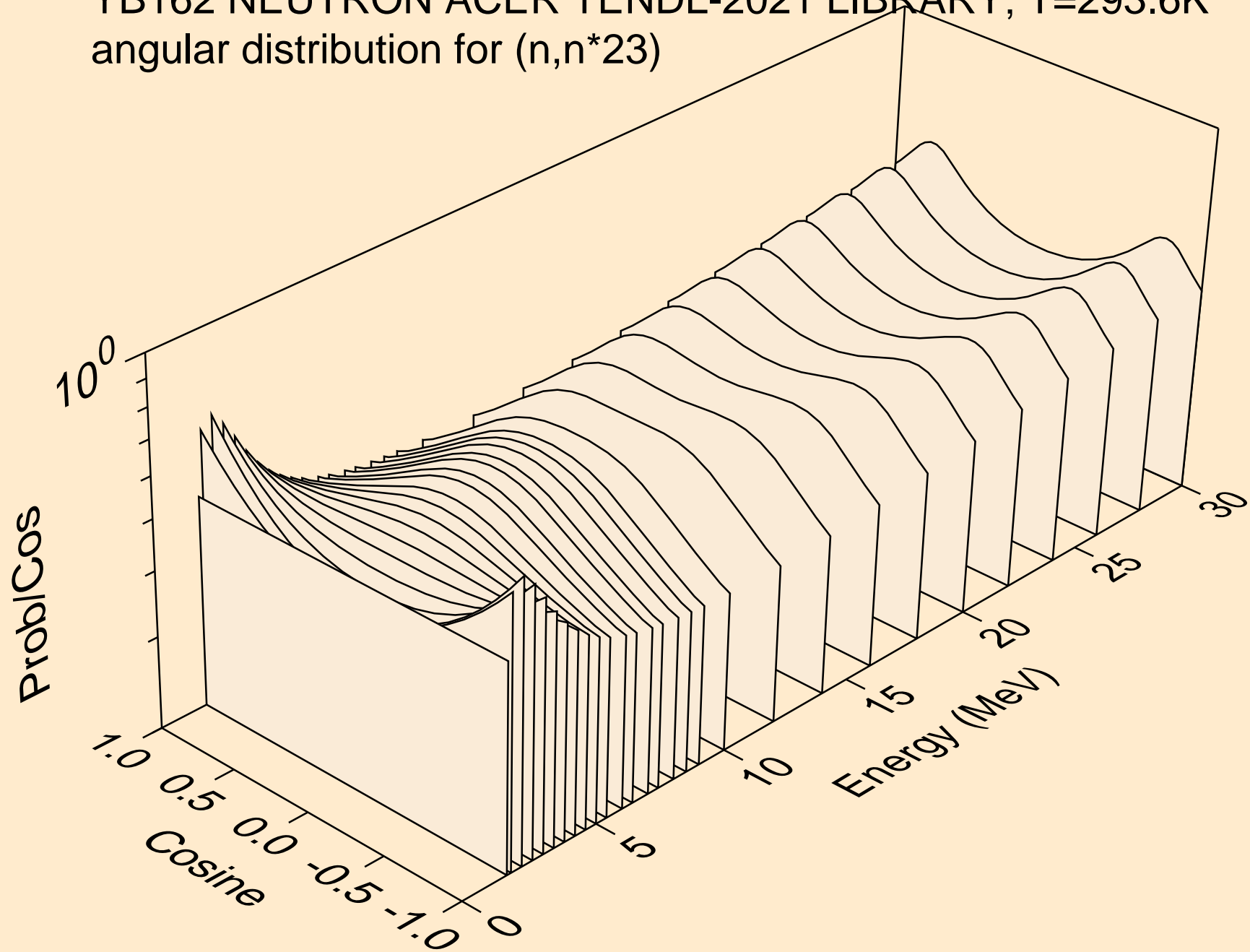

YB162 NEUTRON ACER TENDL-2021 LIBRARY; T=293.6K  
angular distribution for (n,n\*24)

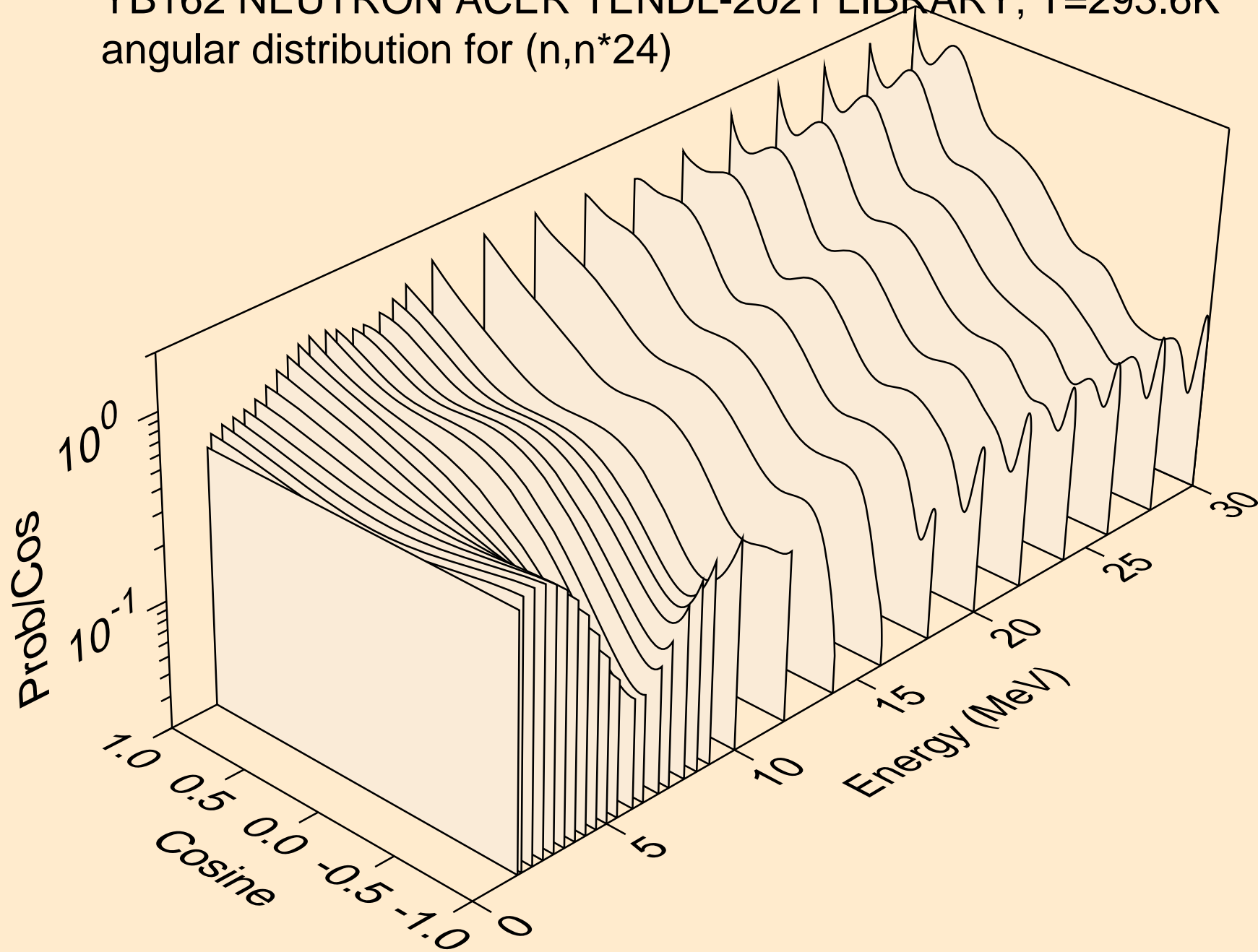

YB162 NEUTRON ACER TENDL-2021 LIBRARY; T=293.6K  
angular distribution for (n,n\*25)

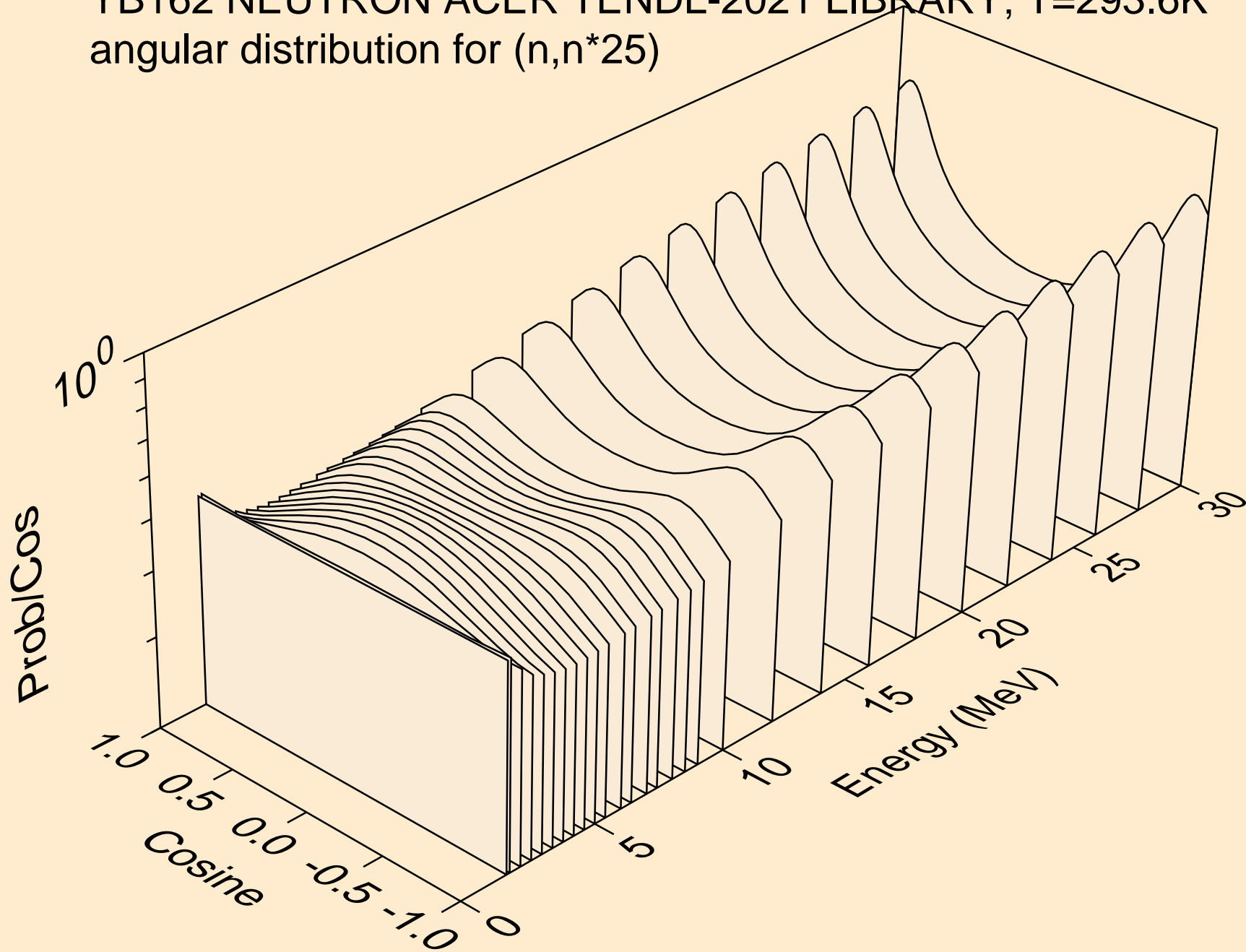



YB162 NEUTRON ACER TENDL-2021 LIBRARY; T=293.6K  
angular distribution for (n,n\*26)

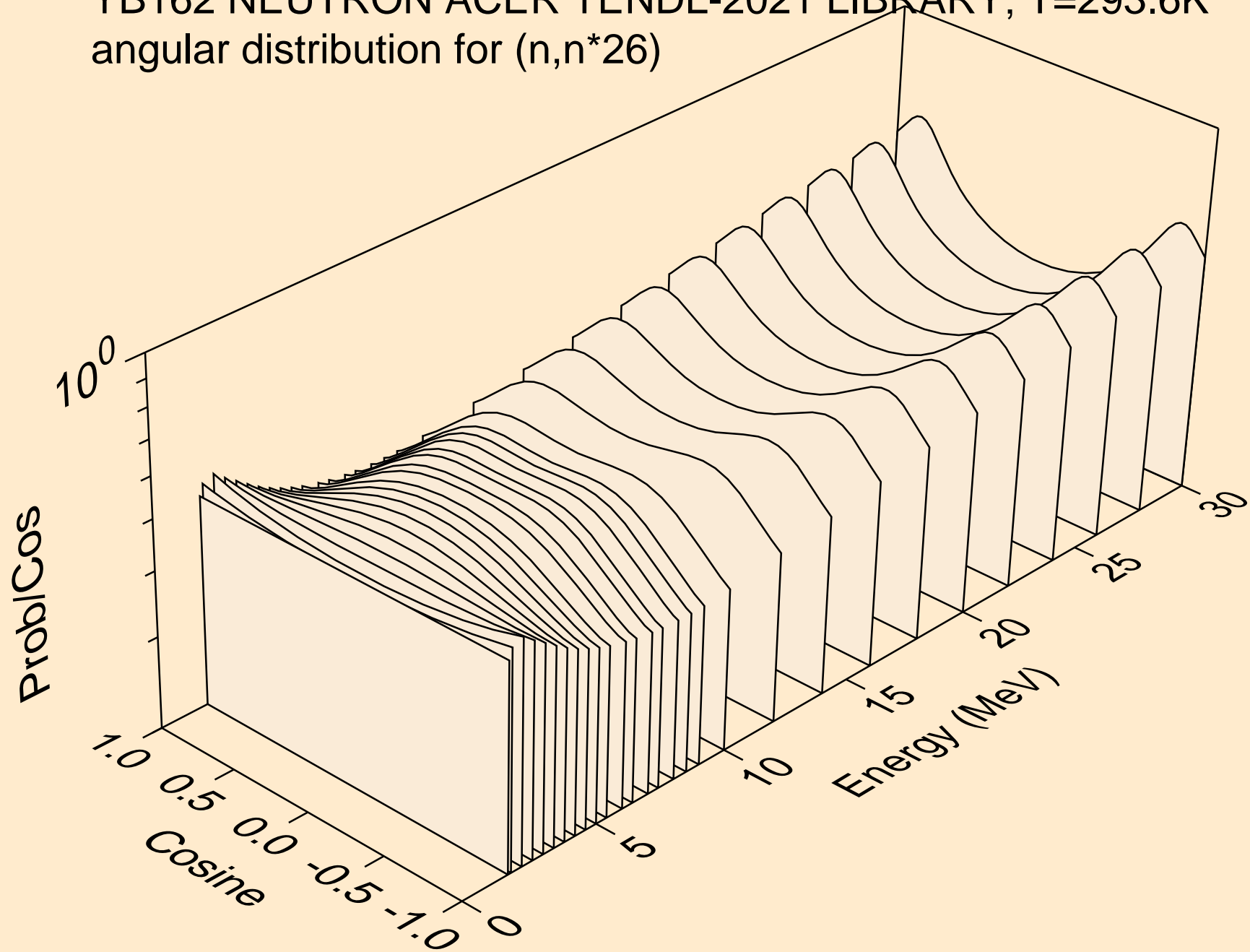

YB162 NEUTRON ACER TENDL-2021 LIBRARY; T=293.6K  
angular distribution for (n,n\*27)

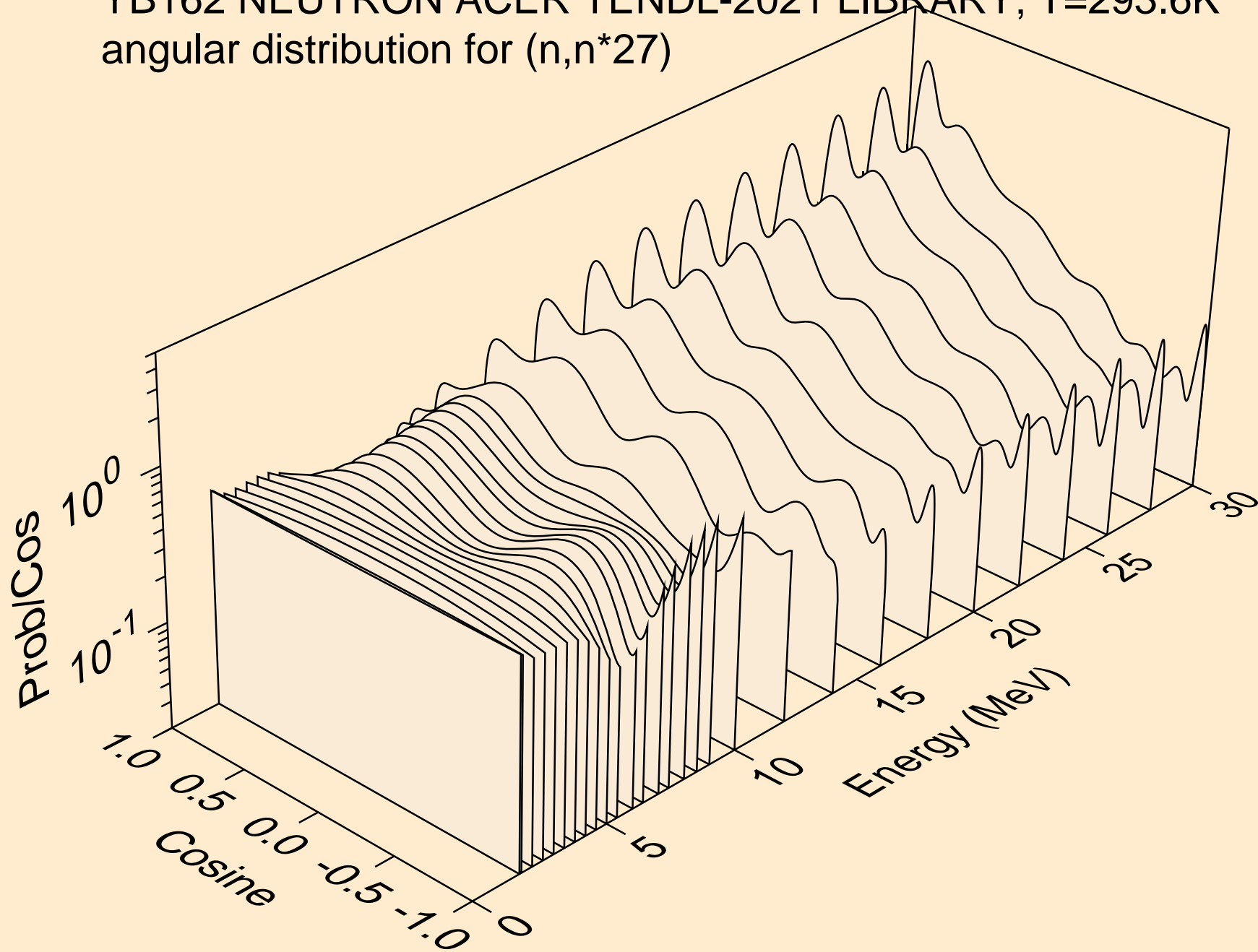

YB162 NEUTRON ACER TENDL-2021 LIBRARY; T=293.6K  
angular distribution for (n,n\*28)

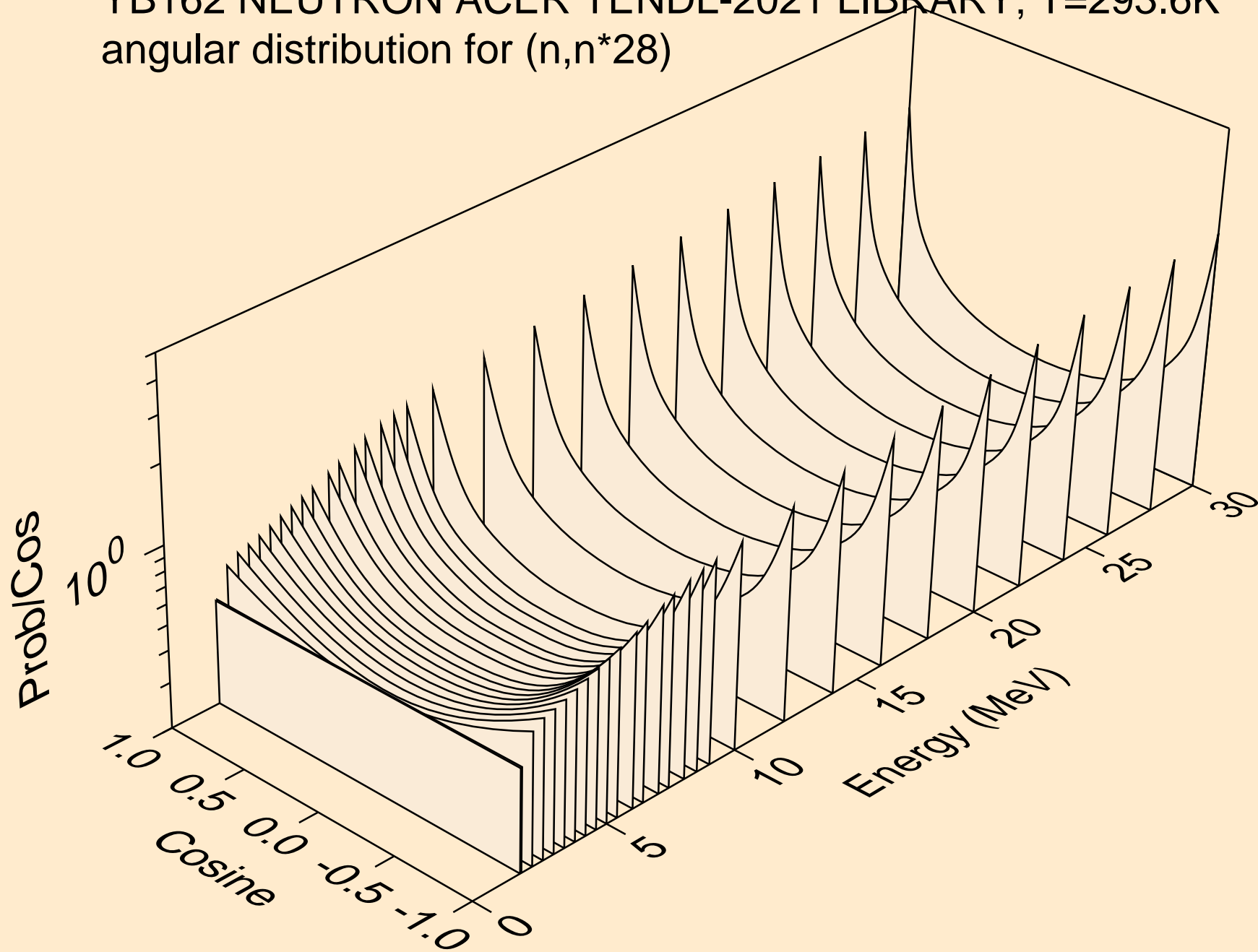

YB162 NEUTRON ACER TENDL-2021 LIBRARY; T=293.6K  
angular distribution for (n,n\*29)

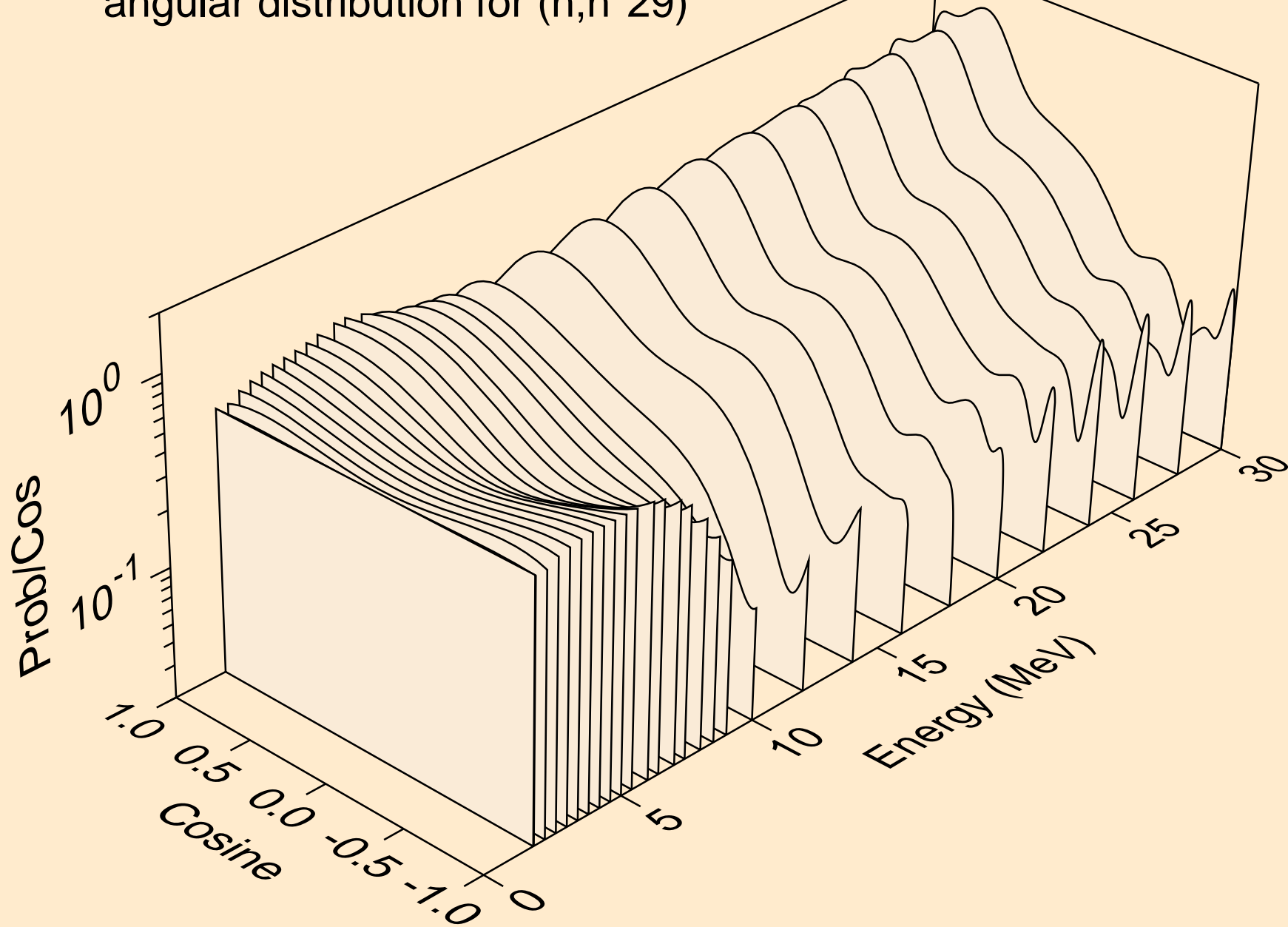

YB162 NEUTRON ACER TENDL-2021 LIBRARY; T=293.6K  
angular distribution for (n,n\*30)

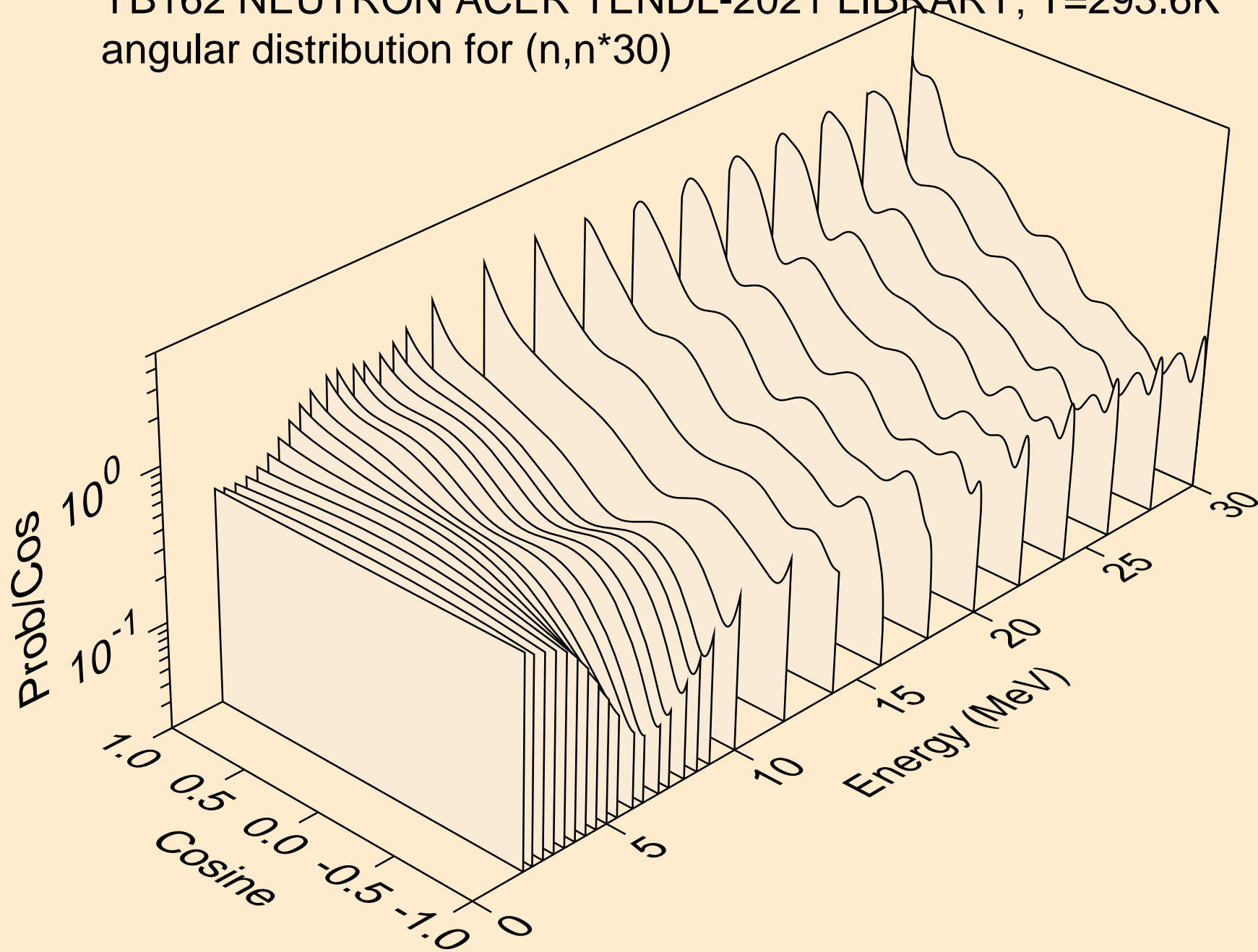

YB162 NEUTRON ACER TENDL-2021 LIBRARY; T=293.6K  
Neutron emission for (n,x)

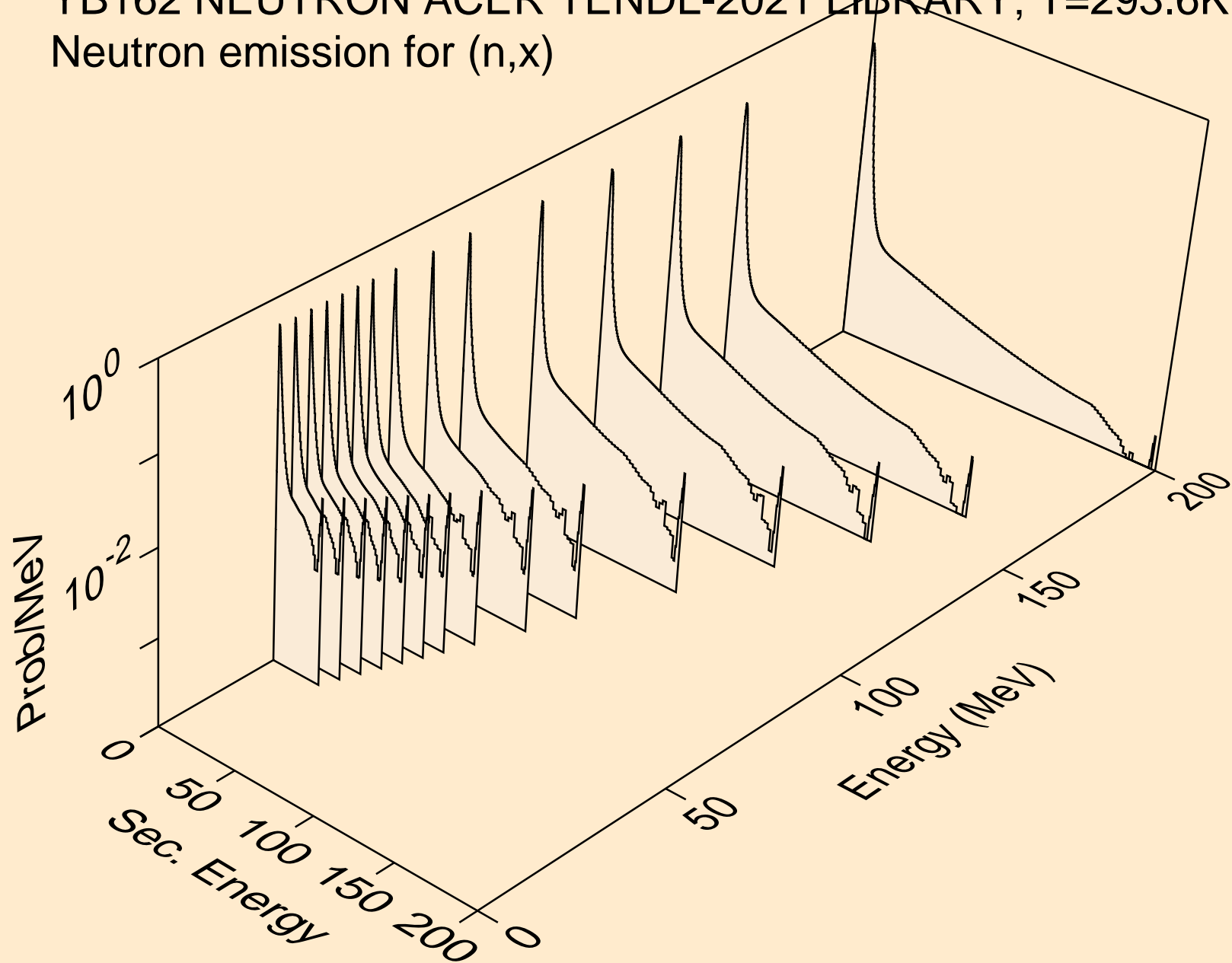

YB162 NEUTRON ACER TENDL-2021 LIBRARY; T=293.6K  
Neutron emission for (n,2nd)

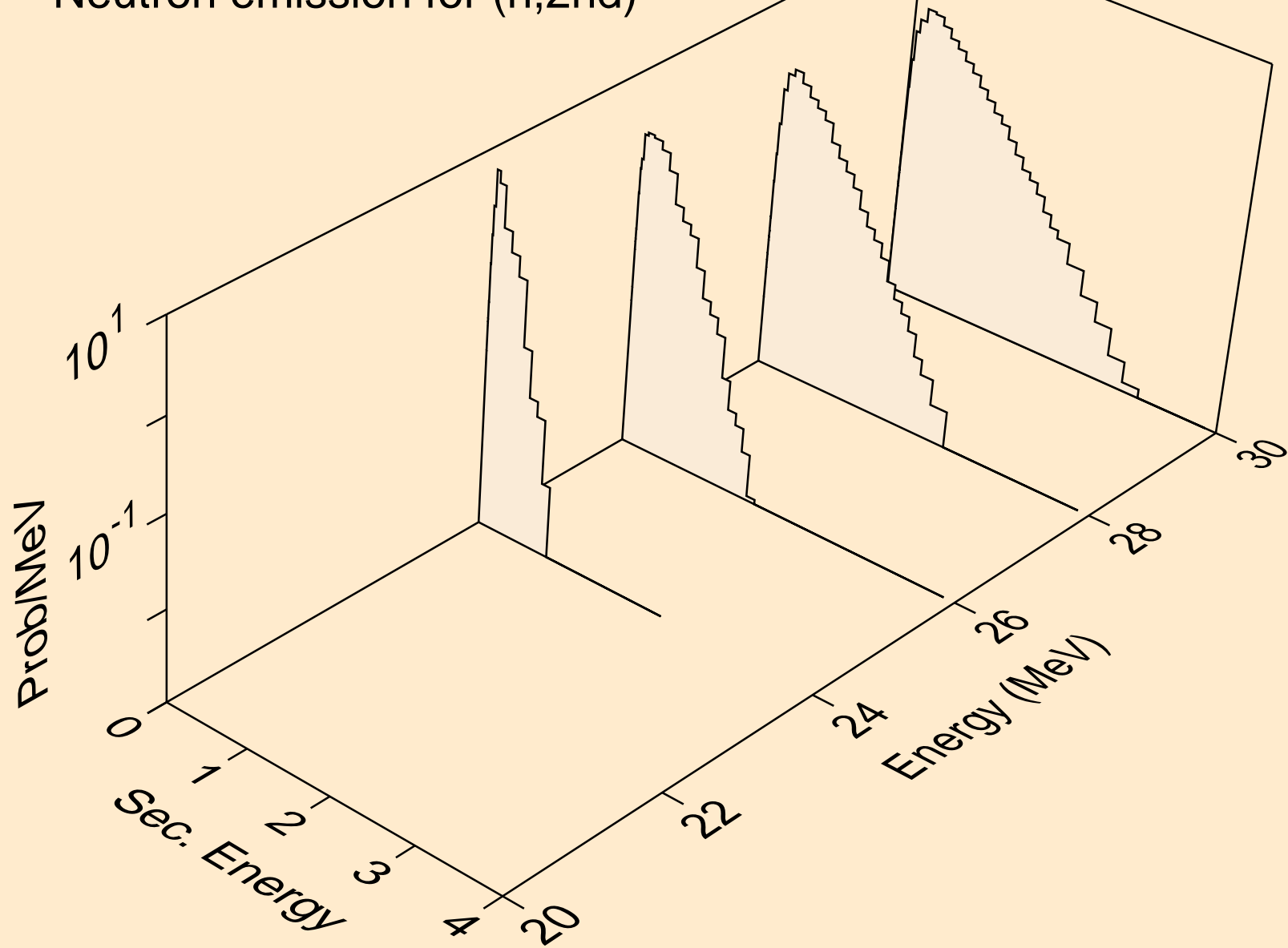

YB162 NEUTRON ACER TENDL-2021 LIBRARY; T=293.6K  
Neutron emission for (n,2n)

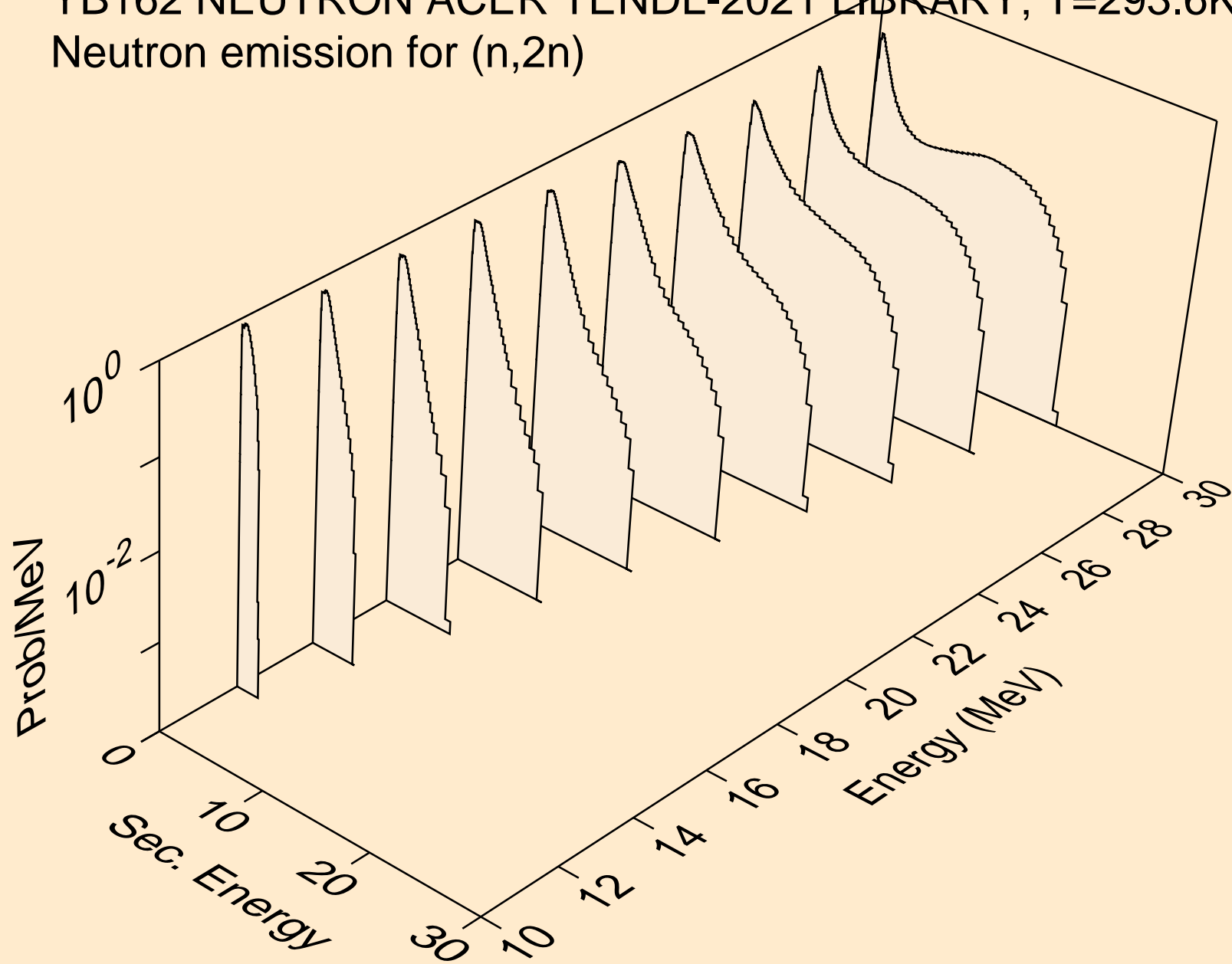



YB162 NEUTRON ACER TENDL-2021 LIBRARY; T=293.6K  
Neutron emission for (n,3n)

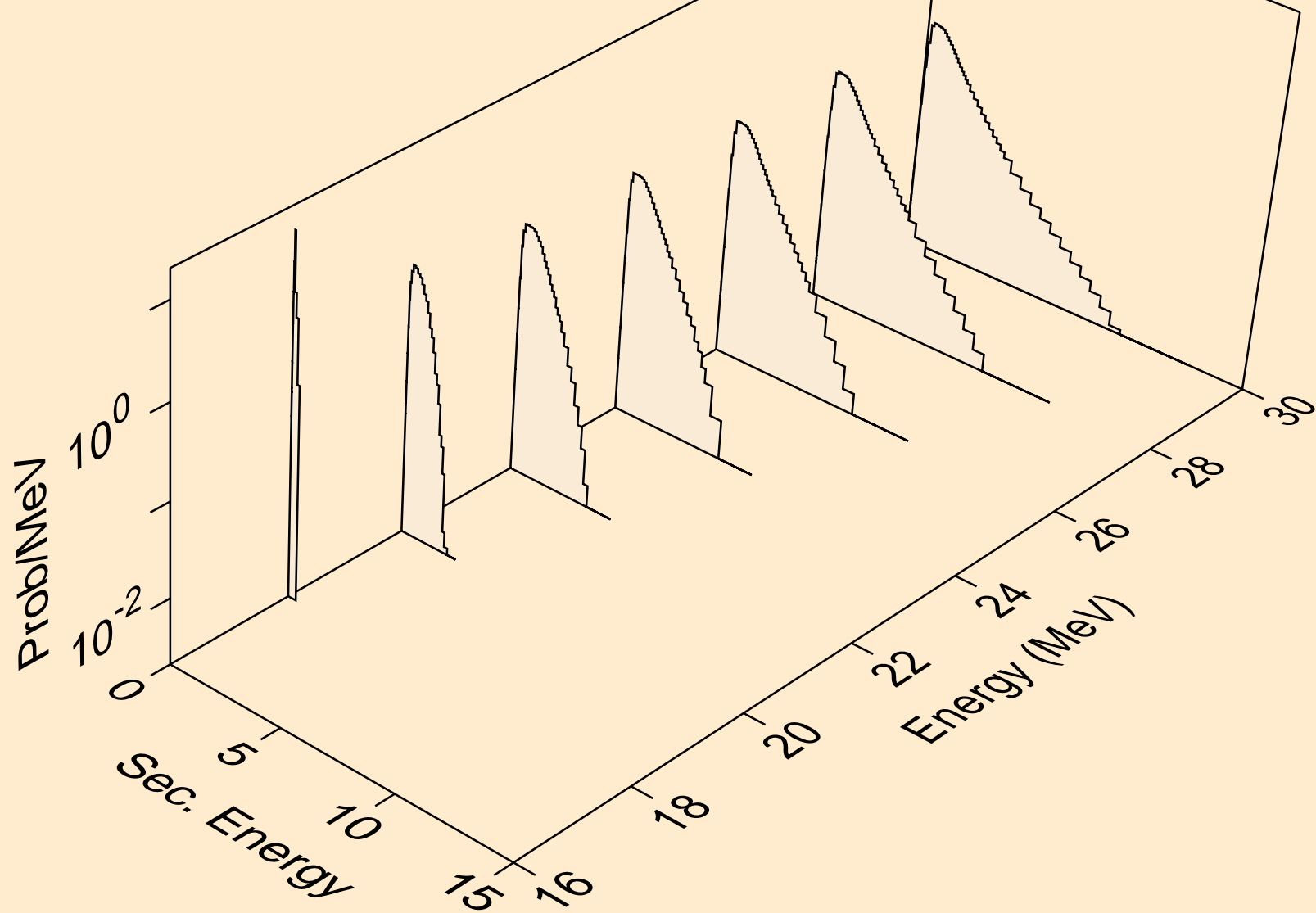

YB162 NEUTRON ACER TENDL-2021 LIBRARY; T=293.6K  
Neutron emission for (n,n\*)a

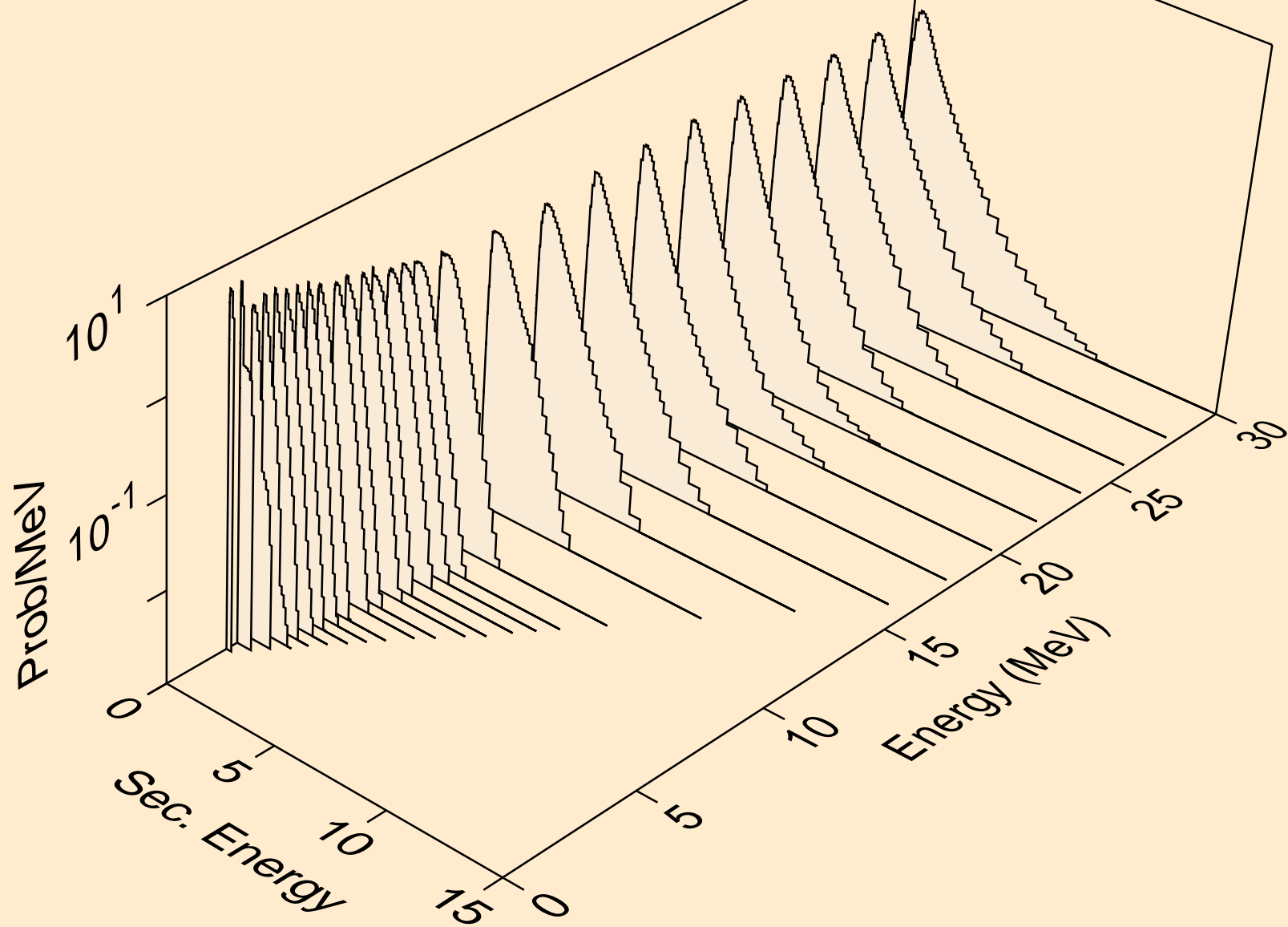

YB162 NEUTRON ACER TENDL-2021 LIBRARY; T=293.6K  
Neutron emission for (n,2n)<sub>a</sub>

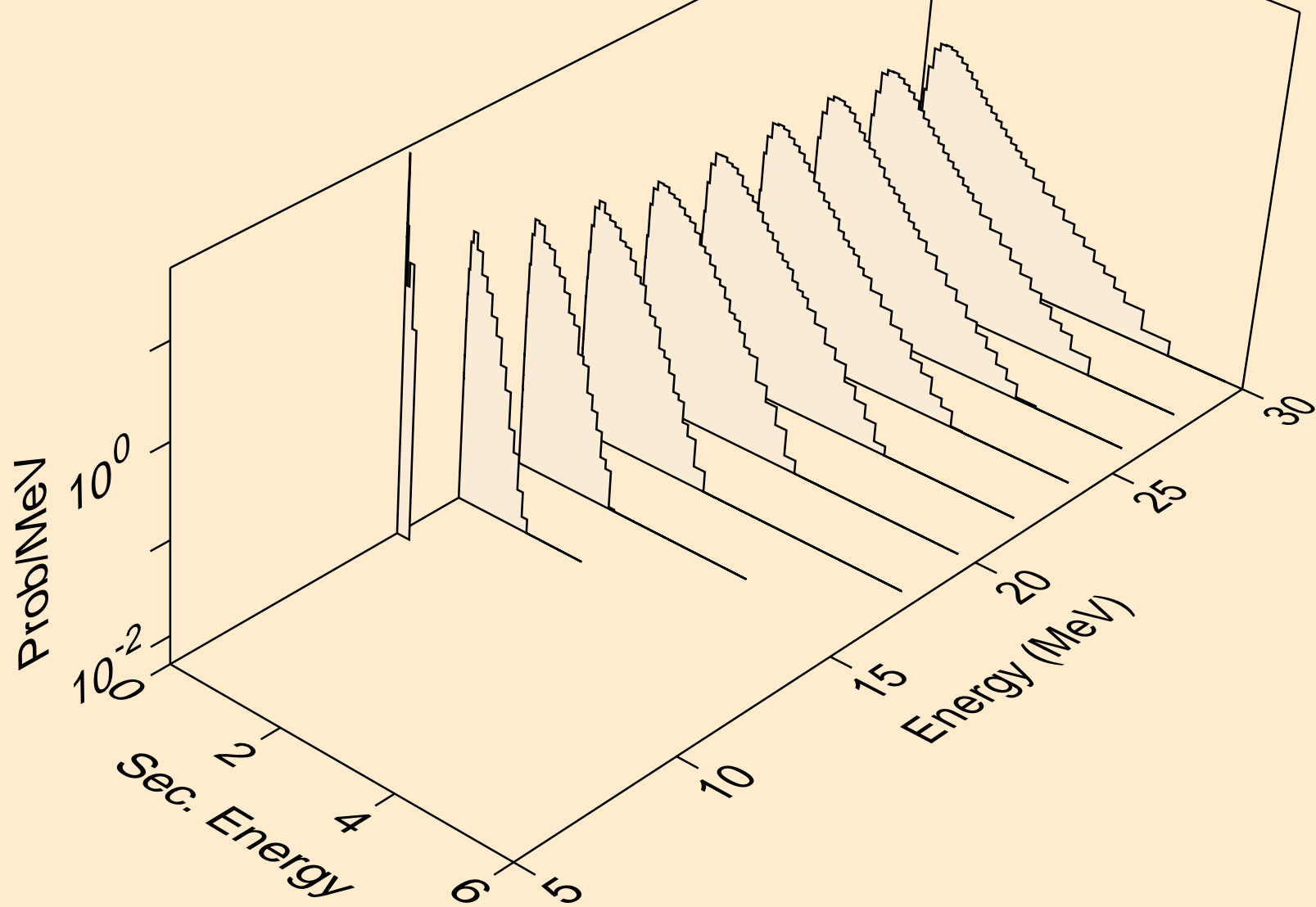

YB162 NEUTRON ACER TENDL-2021 LIBRARY; T=293.6K  
Neutron emission for (n,3n)a

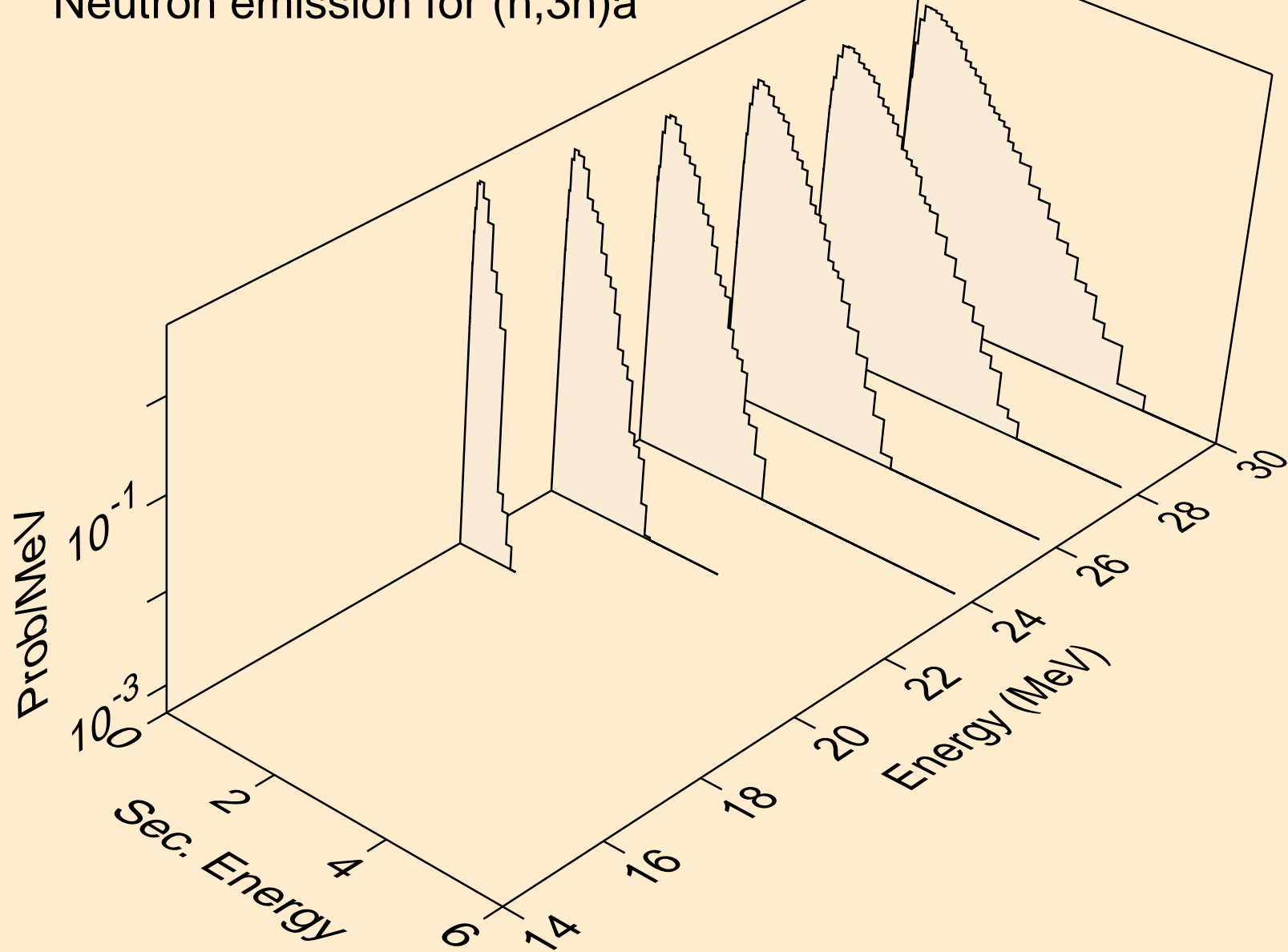

YB162 NEUTRON ACER TENDL-2021 LIBRARY; T=293.6K  
Neutron emission for (n,n\*)p

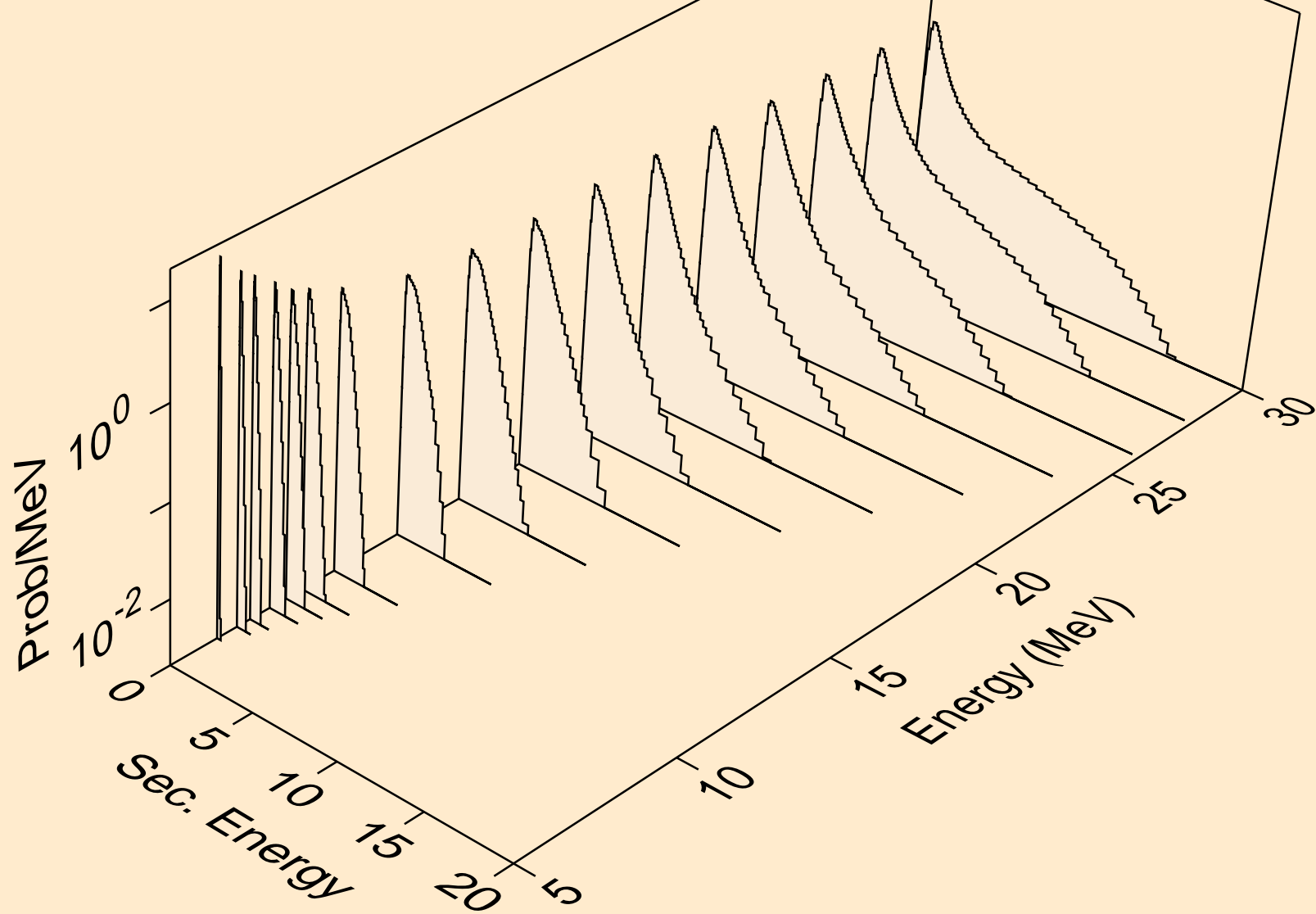

YB162 NEUTRON ACER TENDL-2021 LIBRARY; T=293.6K  
Neutron emission for (n,n\*)2a

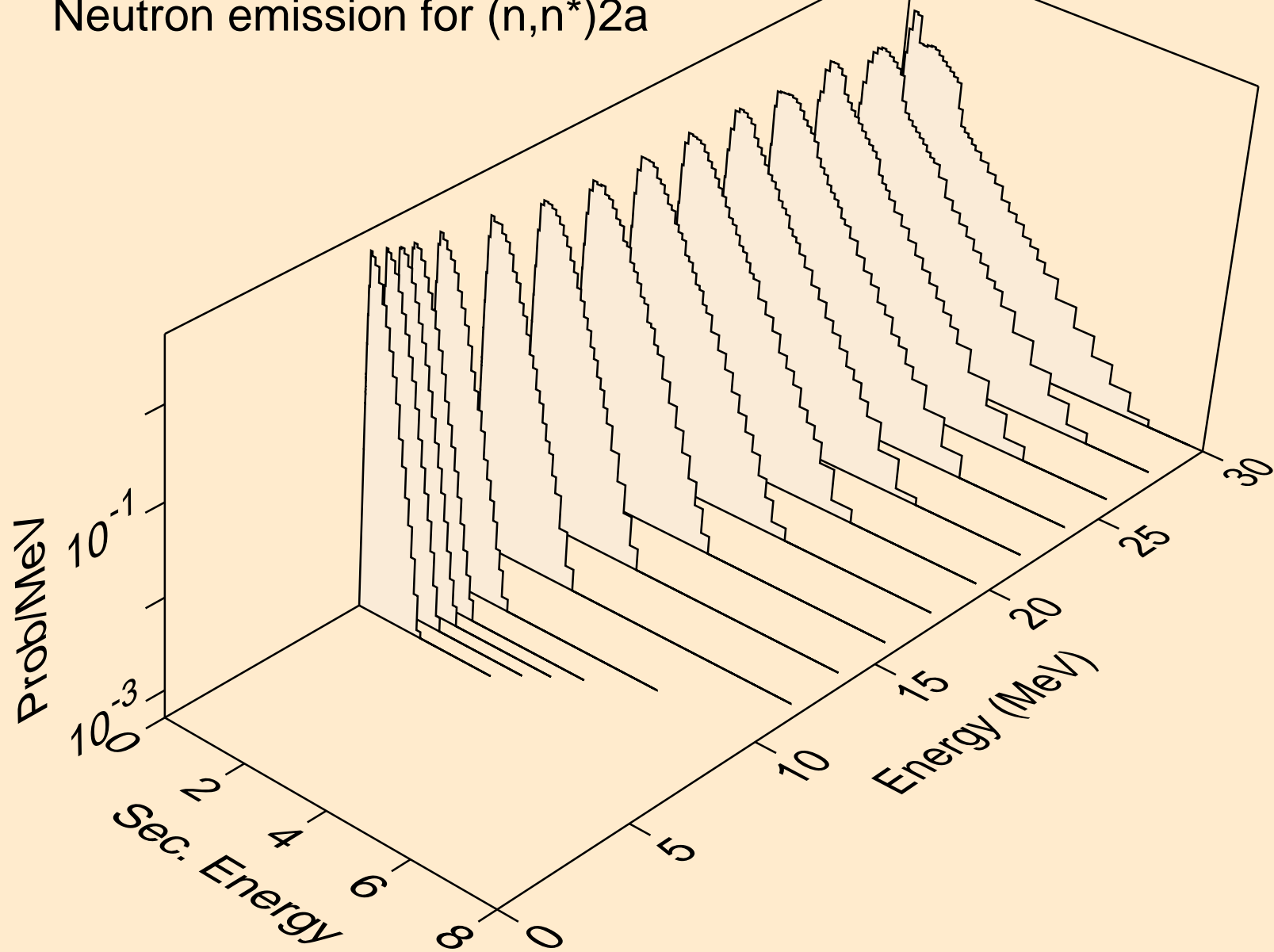

YB162 NEUTRON ACER TENDL-2021 LIBRARY; T=293.6K  
Neutron emission for (n,2n)2a

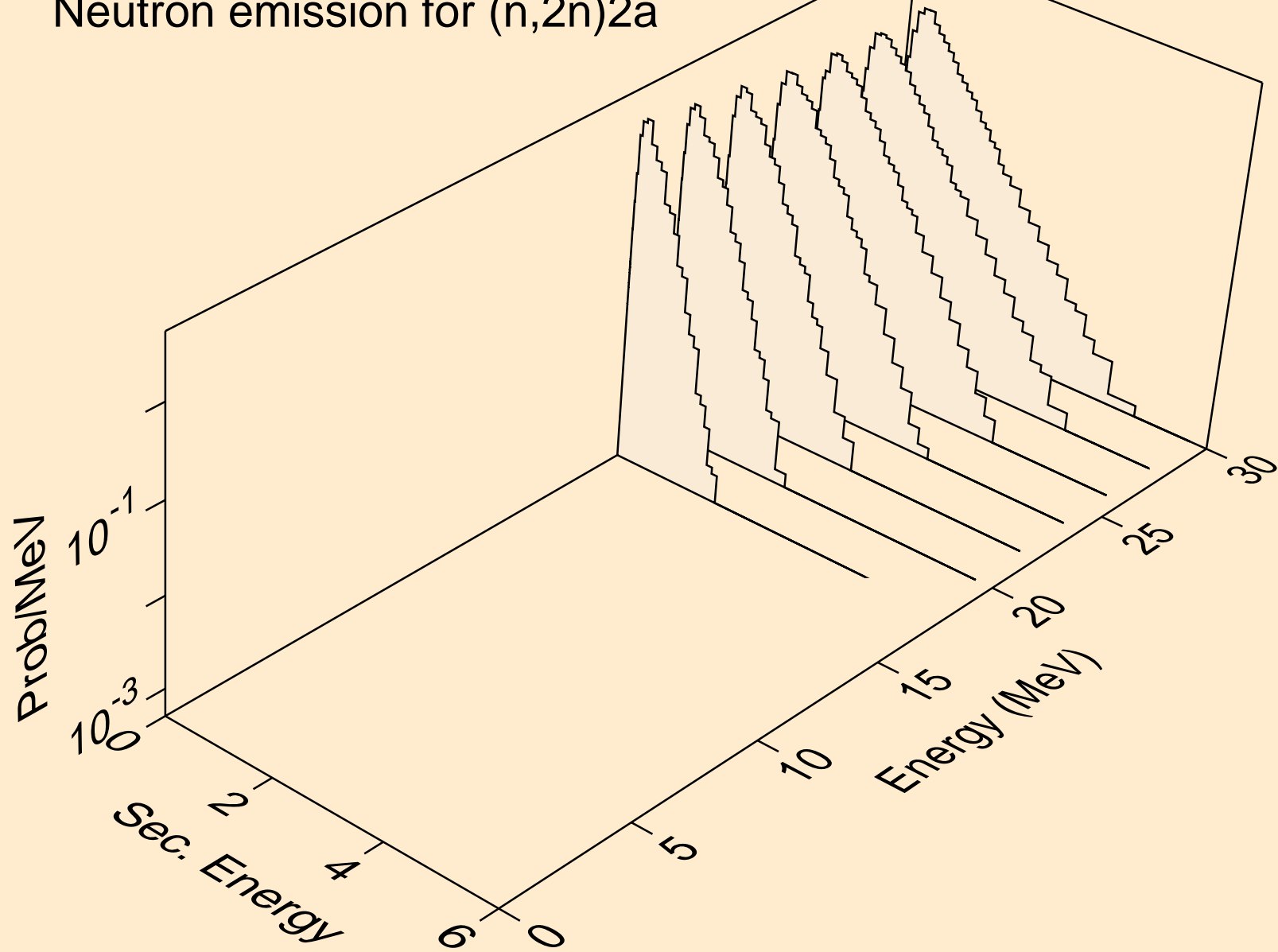

YB162 NEUTRON ACER TENDL-2021 LIBRARY; T=293.6K  
Neutron emission for (n,n\*)d

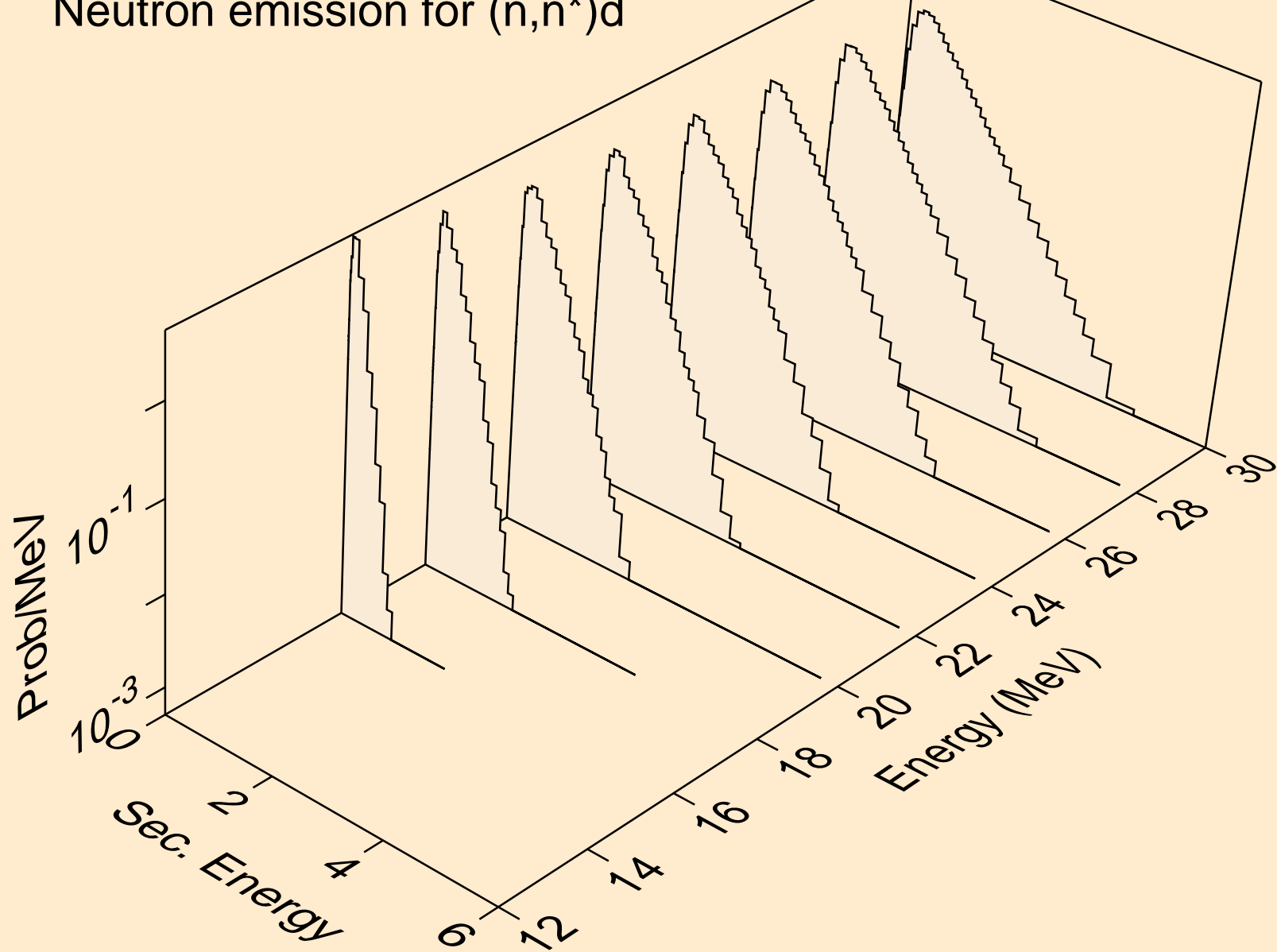



YB162 NEUTRON ACER TENDL-2021 LIBRARY; T=293.6K  
Neutron emission for (n,n\*)t

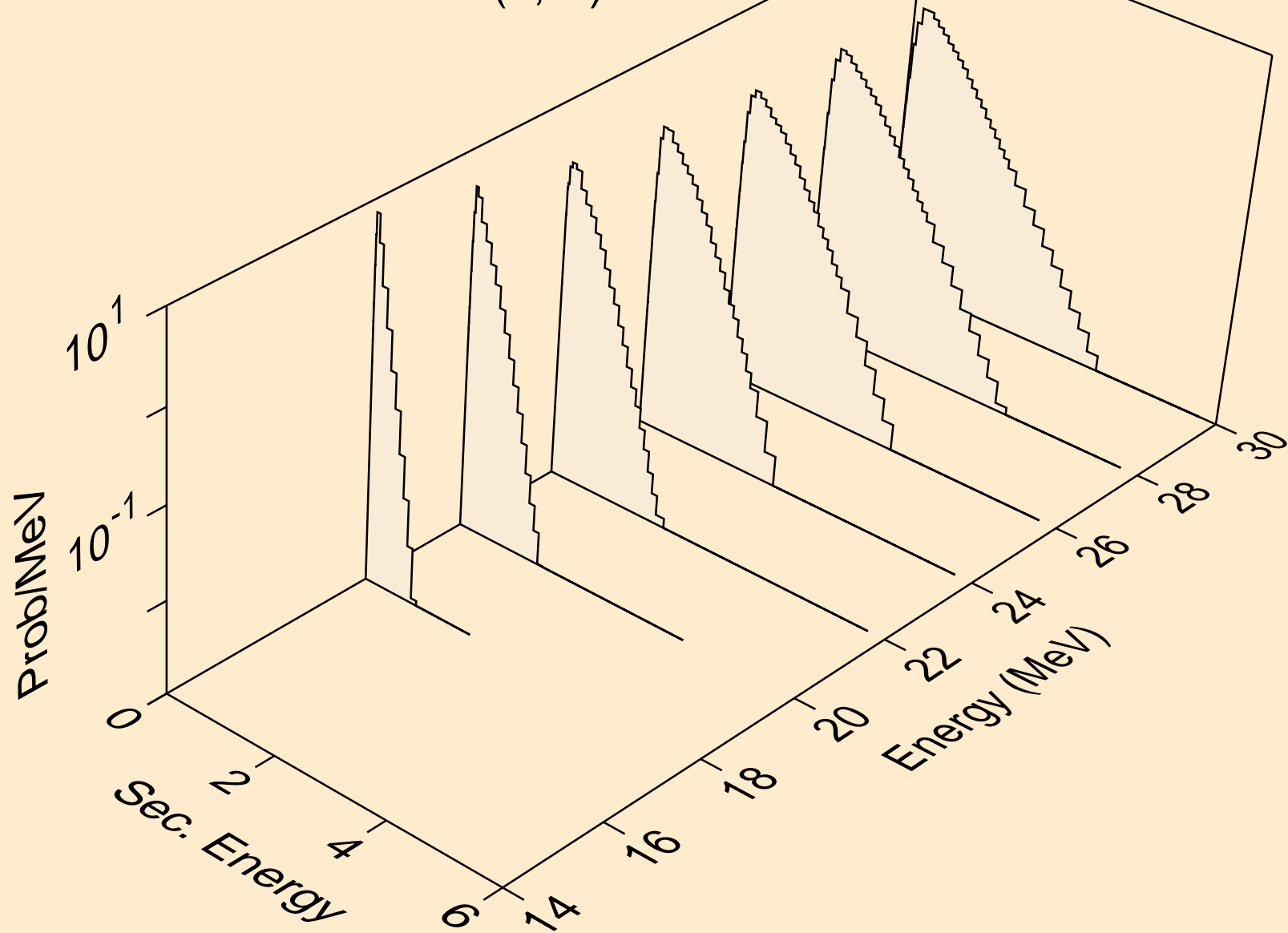

YB162 NEUTRON ACER TENDL-2021 LIBRARY; T=293.6K  
Neutron emission for (n,n\*)he3

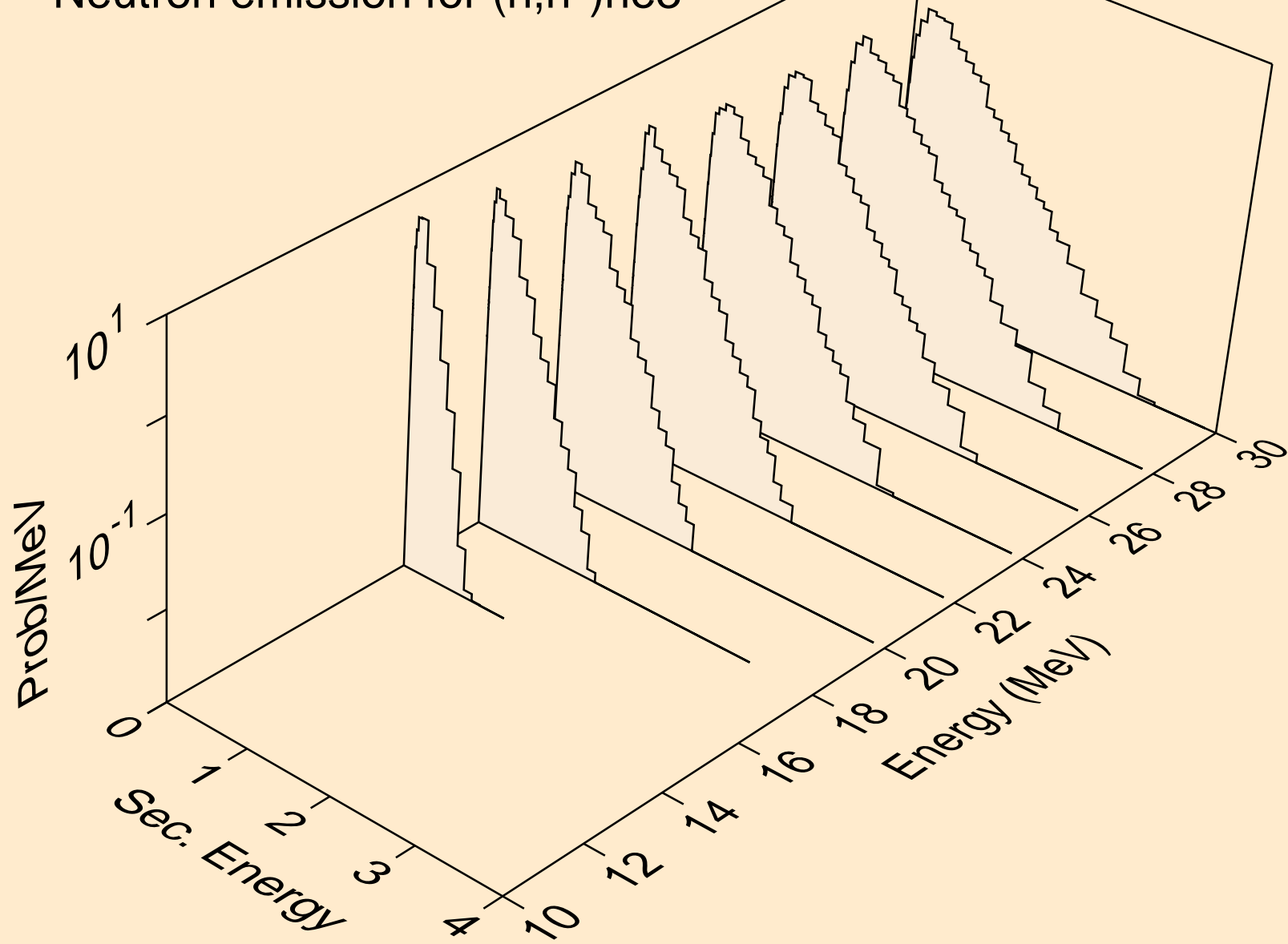

YB162 NEUTRON ACER TENDL-2021 LIBRARY; T=293.6K  
Neutron emission for (n,4n)

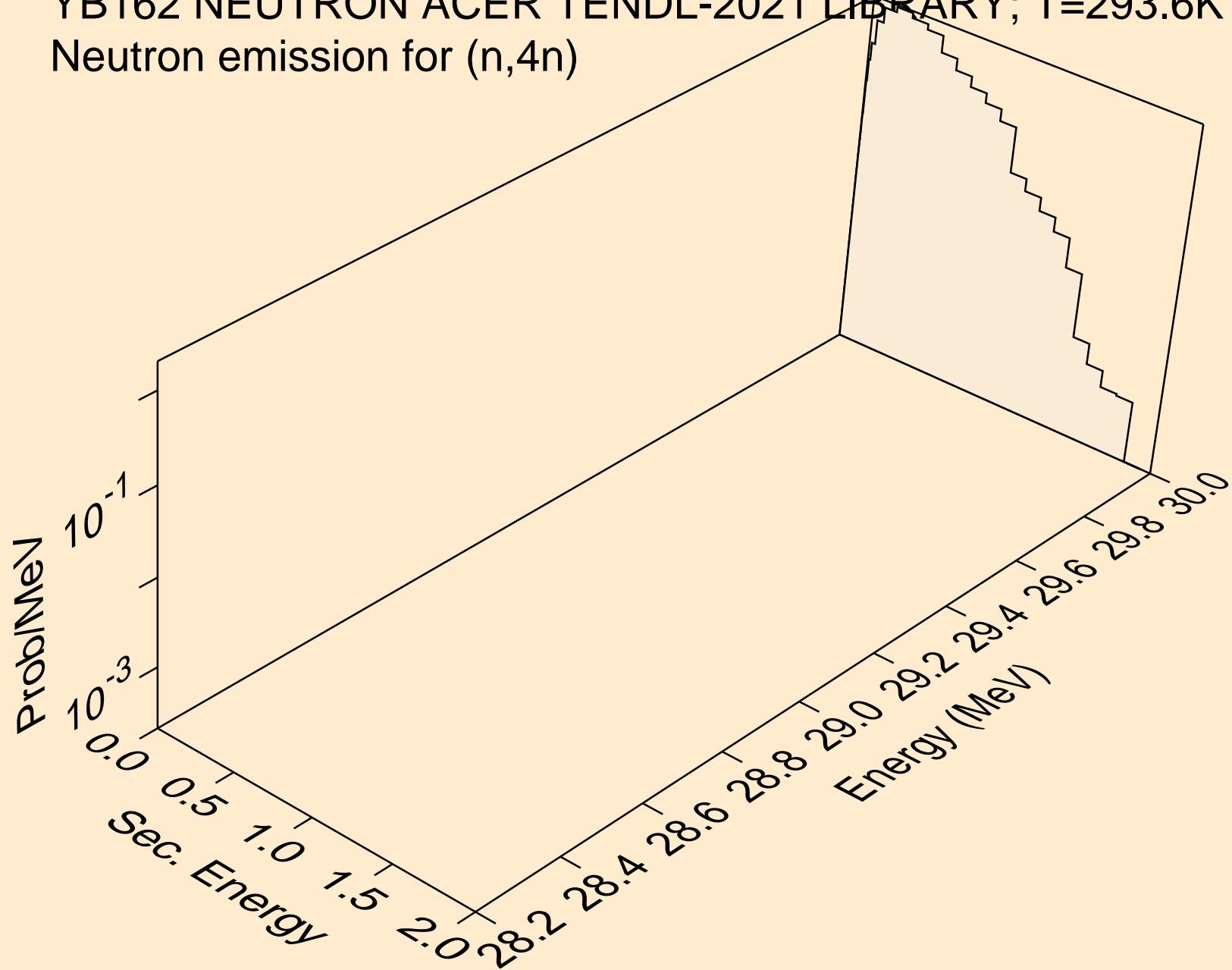

YB162 NEUTRON ACER TENDL-2021 LIBRARY; T=293.6K  
Neutron emission for (n,2np)

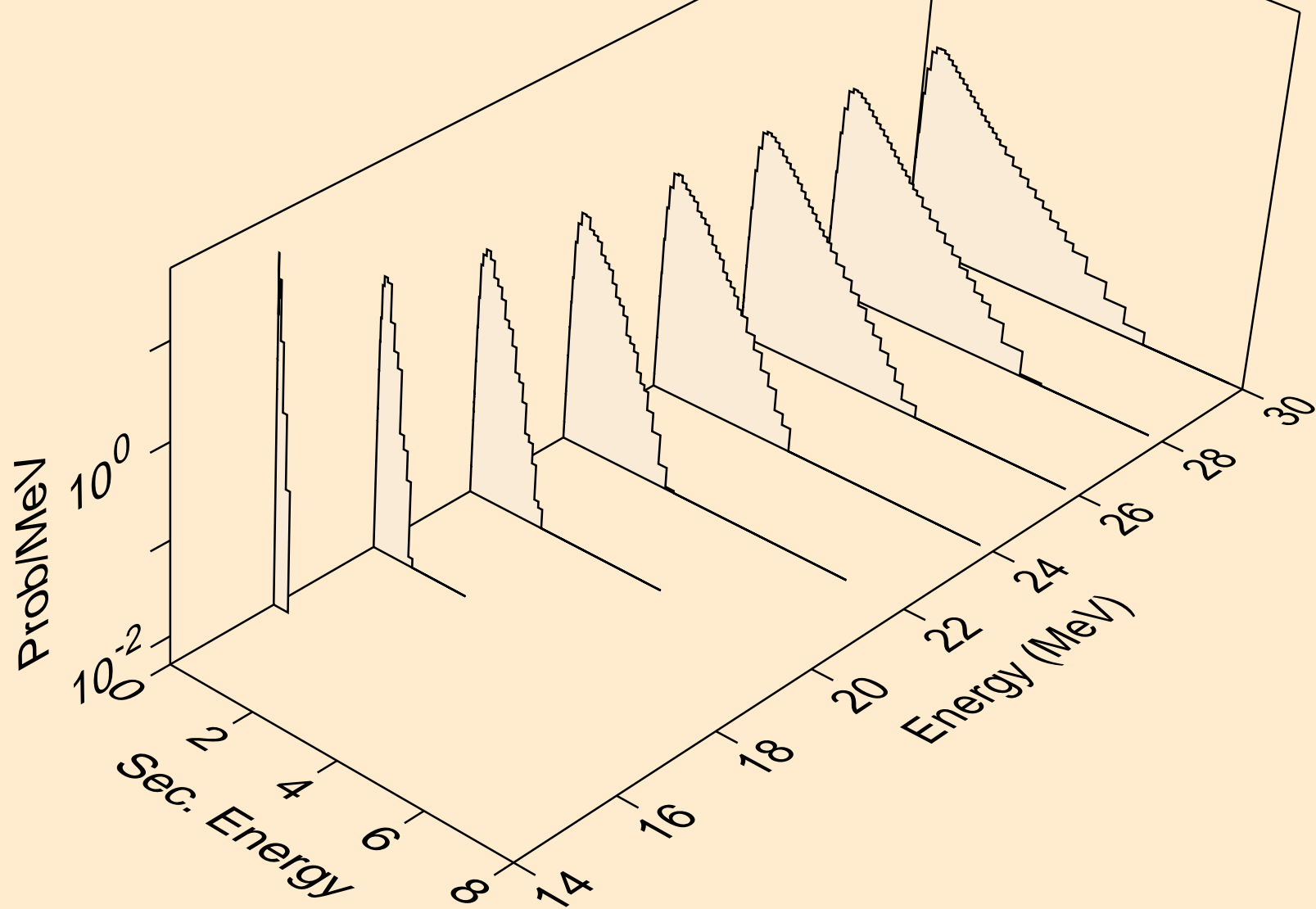

YB162 NEUTRON ACER TENDL-2021 LIBRARY; T=293.6K  
Neutron emission for (n,3np)

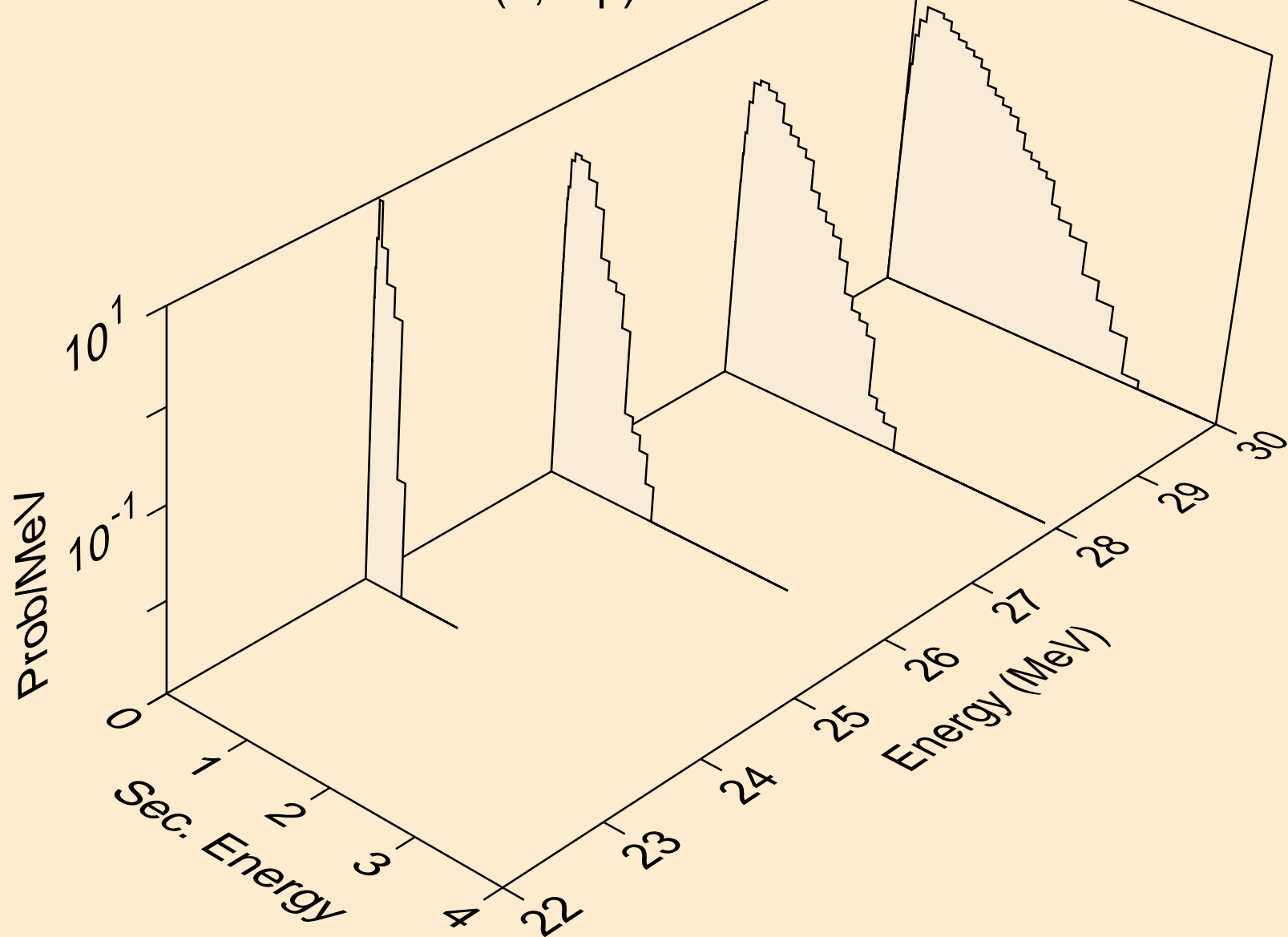

YB162 NEUTRON ACER TENDL-2021 LIBRARY; T=293.6K  
Neutron emission for (n,2np)

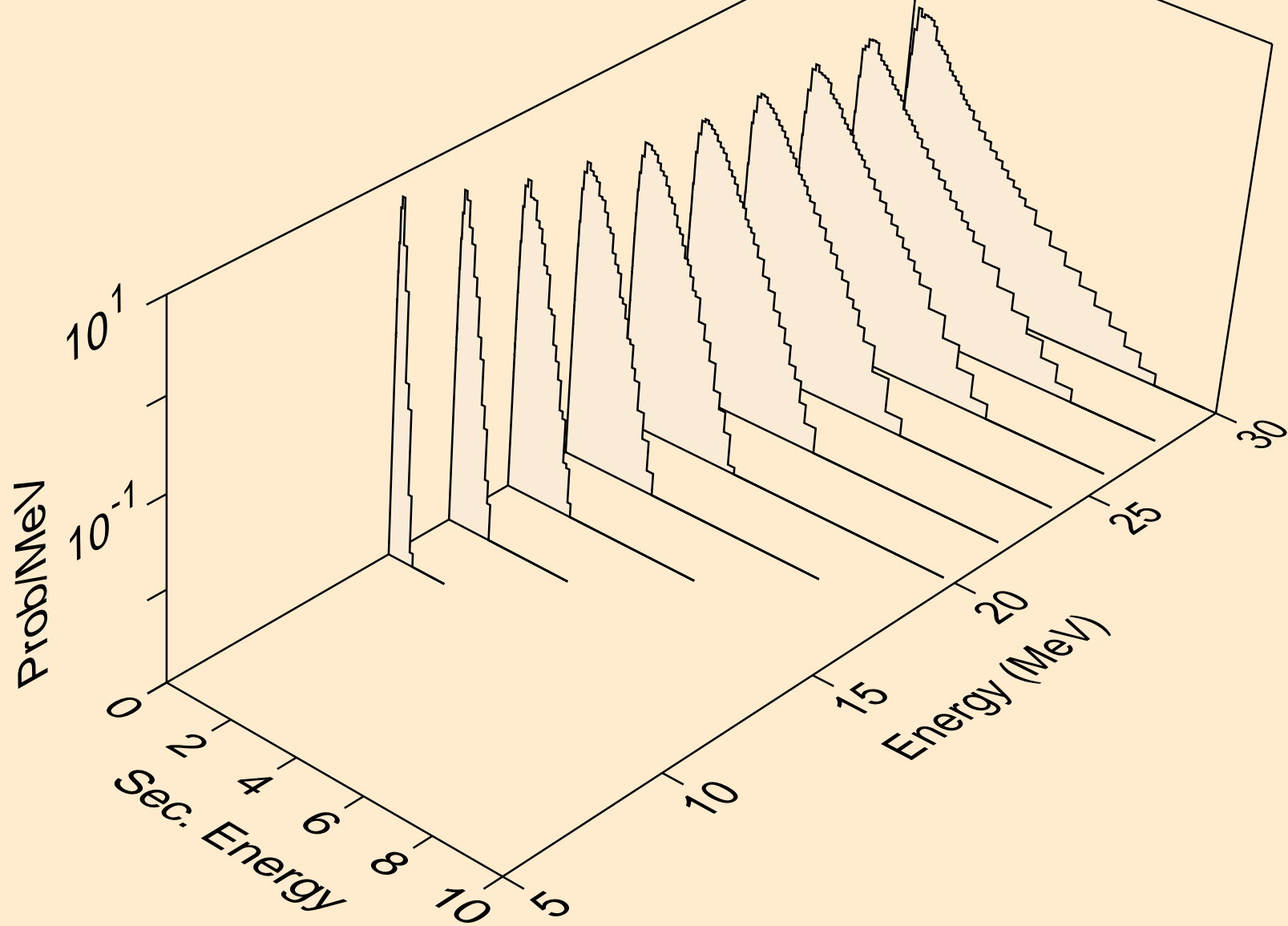

YB162 NEUTRON ACER TENDL-2021 LIBRARY; T=293.6K  
Neutron emission for (n,npa)

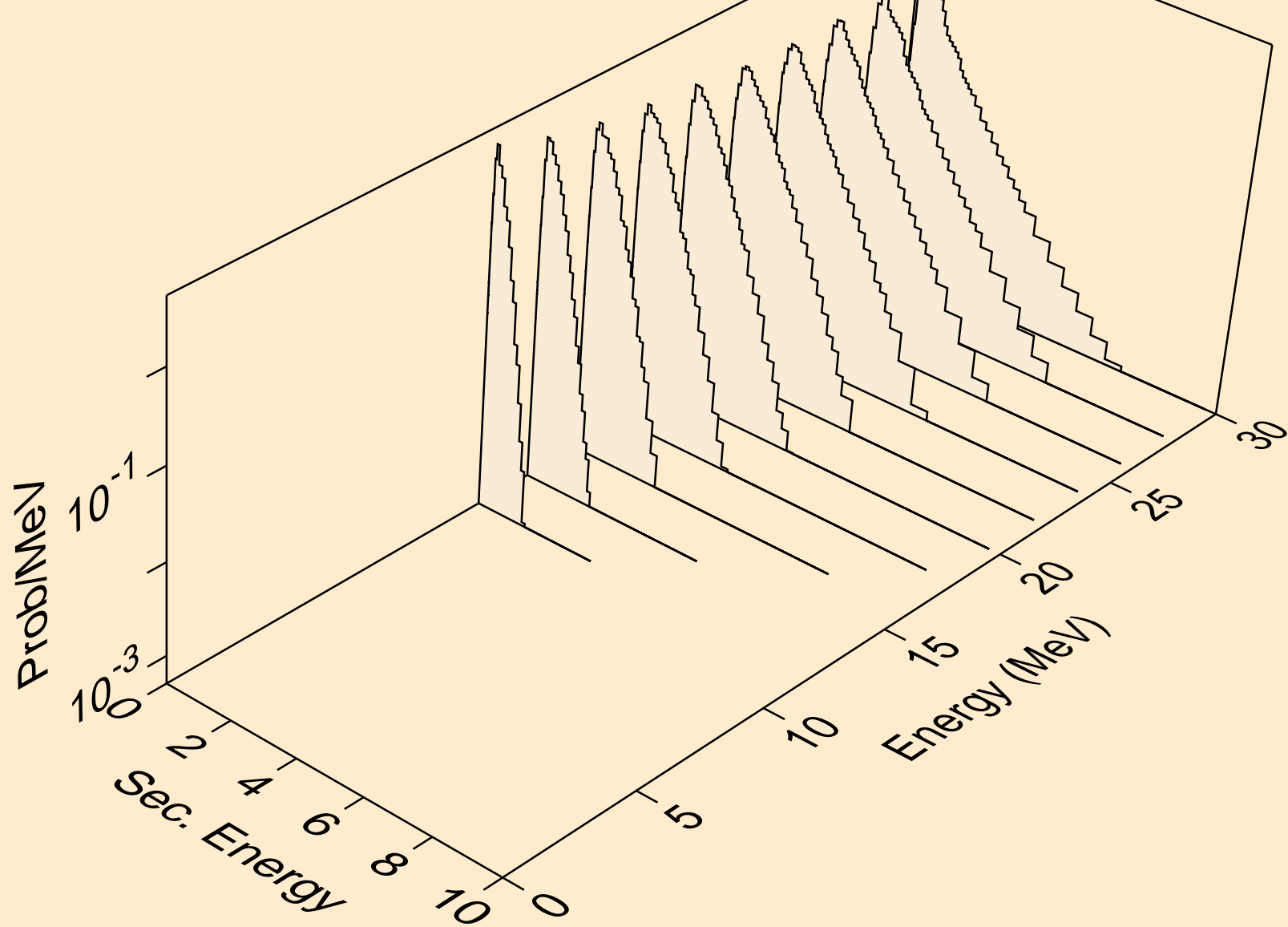

YB162 NEUTRON ACER TENDL-2021 LIBRARY; T=293.6K  
Neutron emission for (n,n\*c)

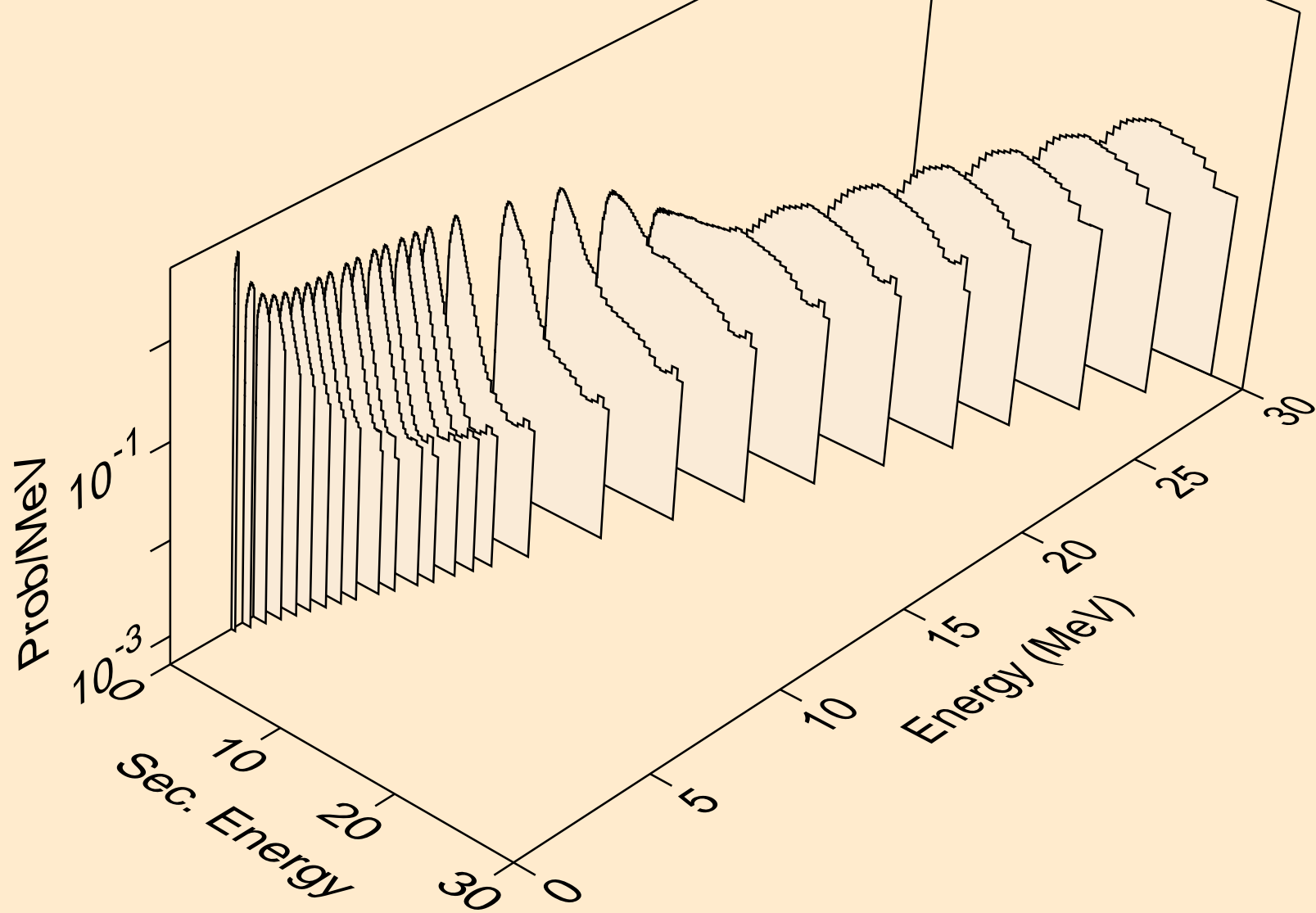



YB162 NEUTRON ACER TENDL-2021 LIBRARY; T=293.6K  
Photon emission for (n,x)

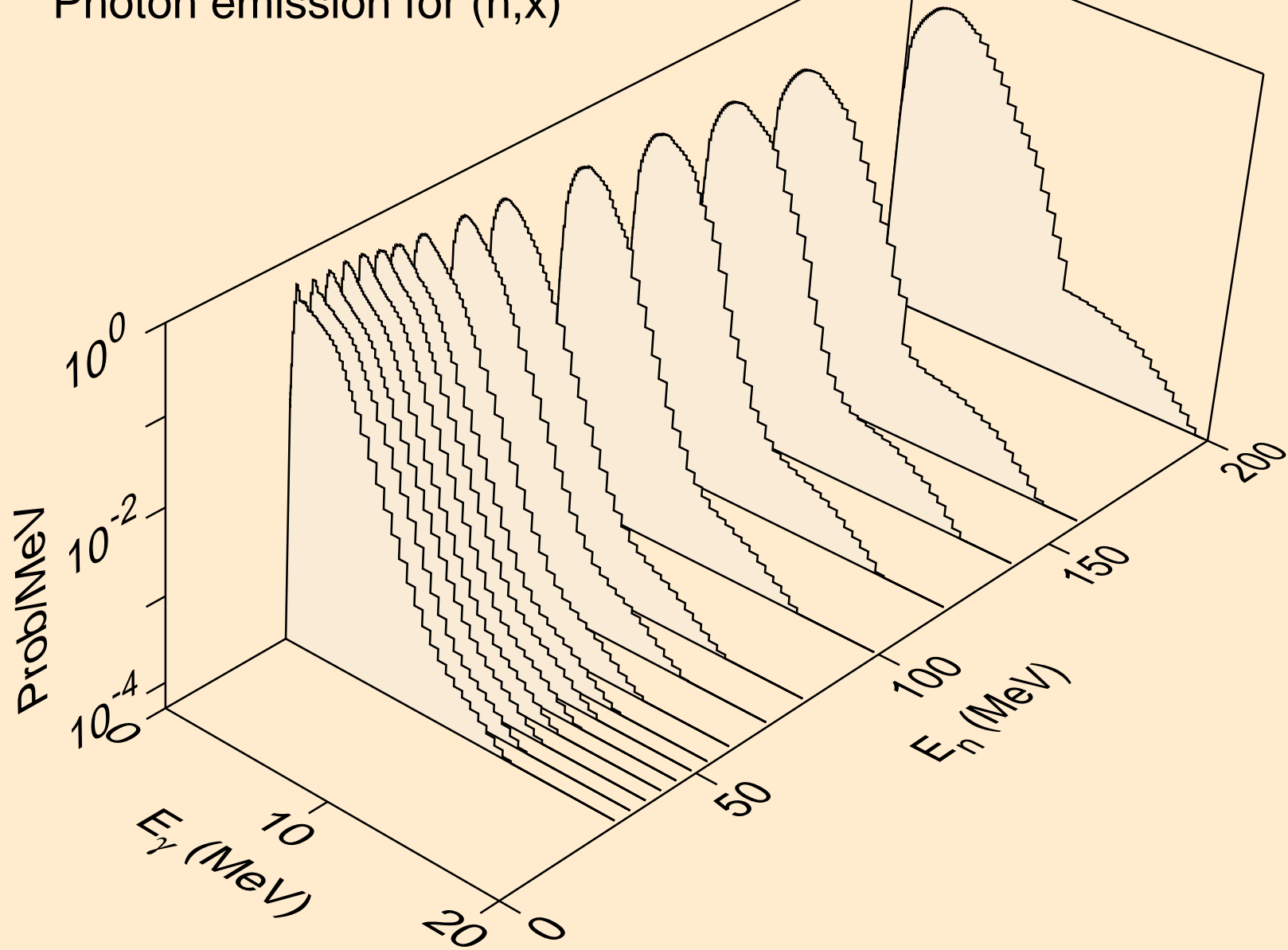

YB162 NEUTRON ACER TENDL-2021 LIBRARY; T=293.6K  
Photon emission for (n,2nd)

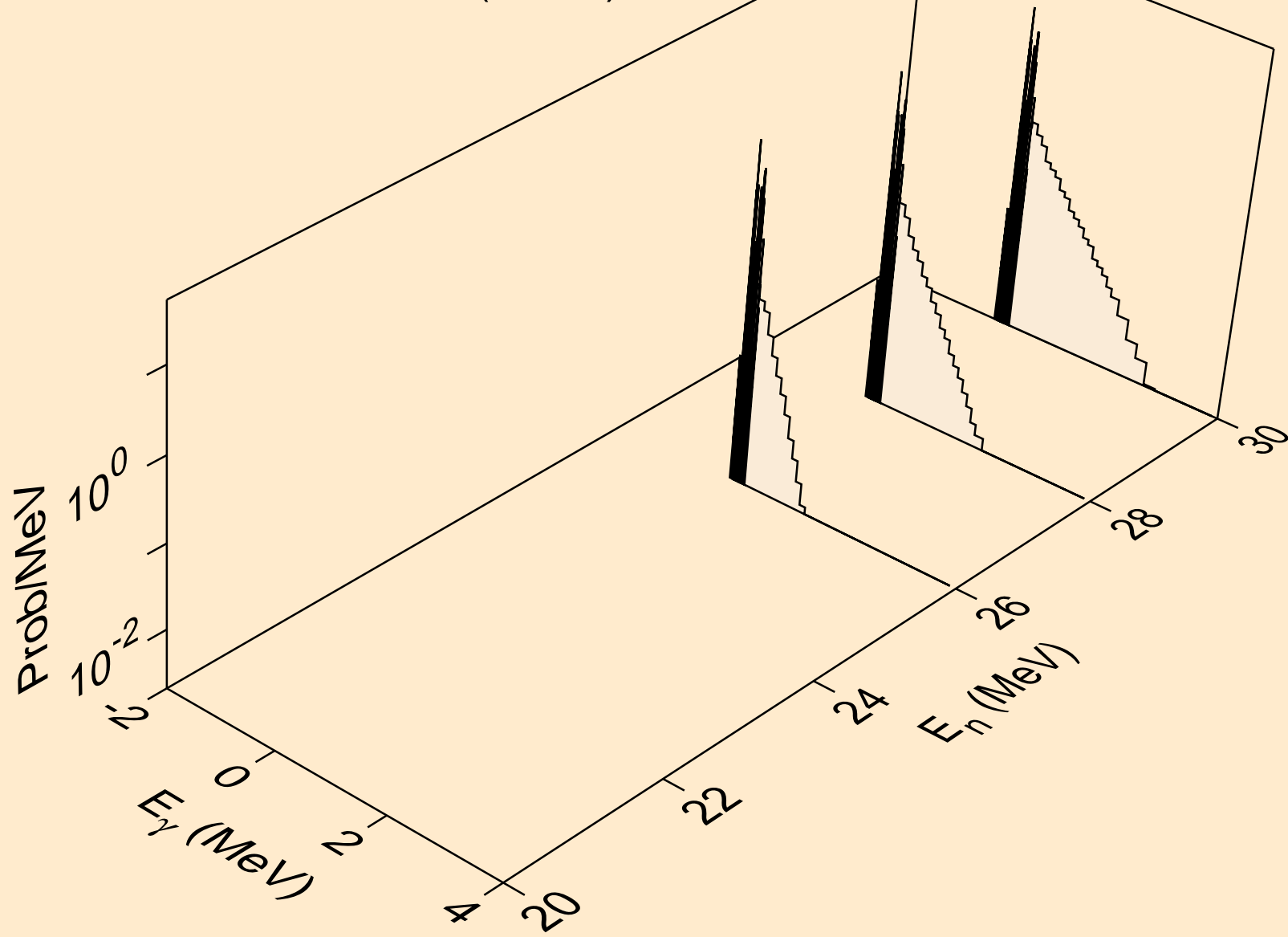

YB162 NEUTRON ACER TENDL-2021 LIBRARY; T=293.6K  
Photon emission for (n,2n)

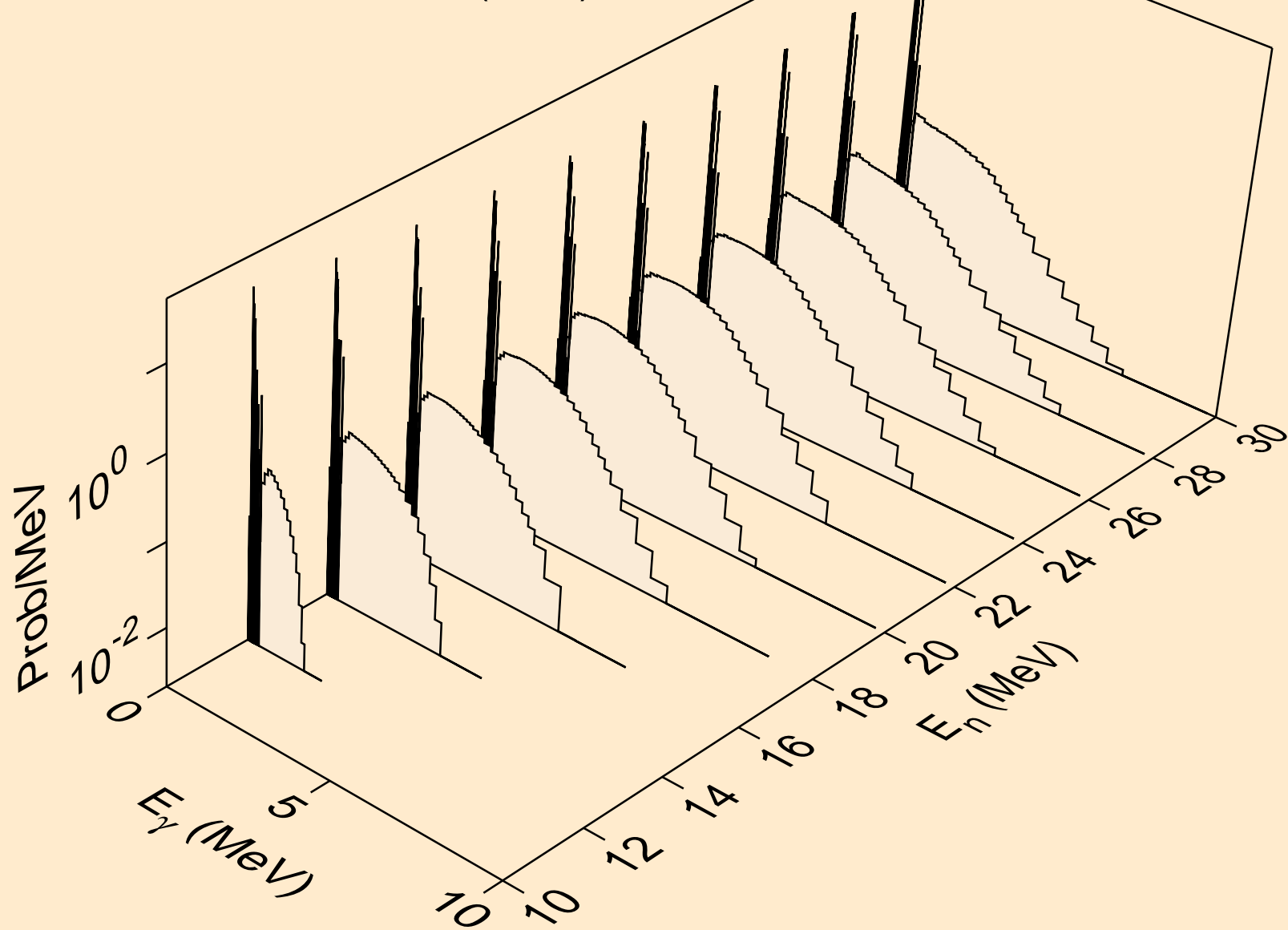

YB162 NEUTRON ACER TENDL-2021 LIBRARY; T=293.6K  
Photon emission for (n,3n)

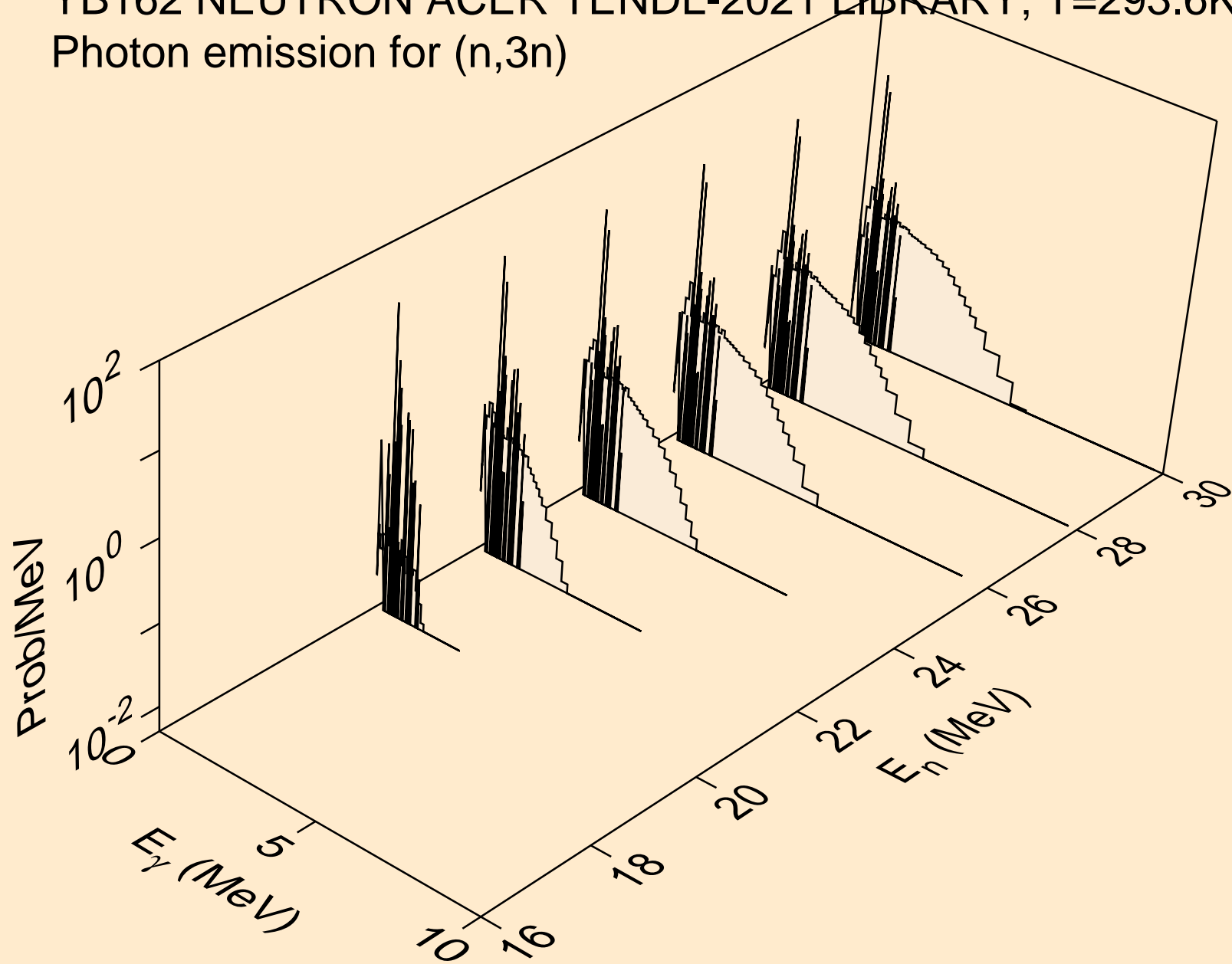

YB162 NEUTRON ACER TENDL-2021 LIBRARY; T=293.6K  
Photon emission for (n,n\*)a

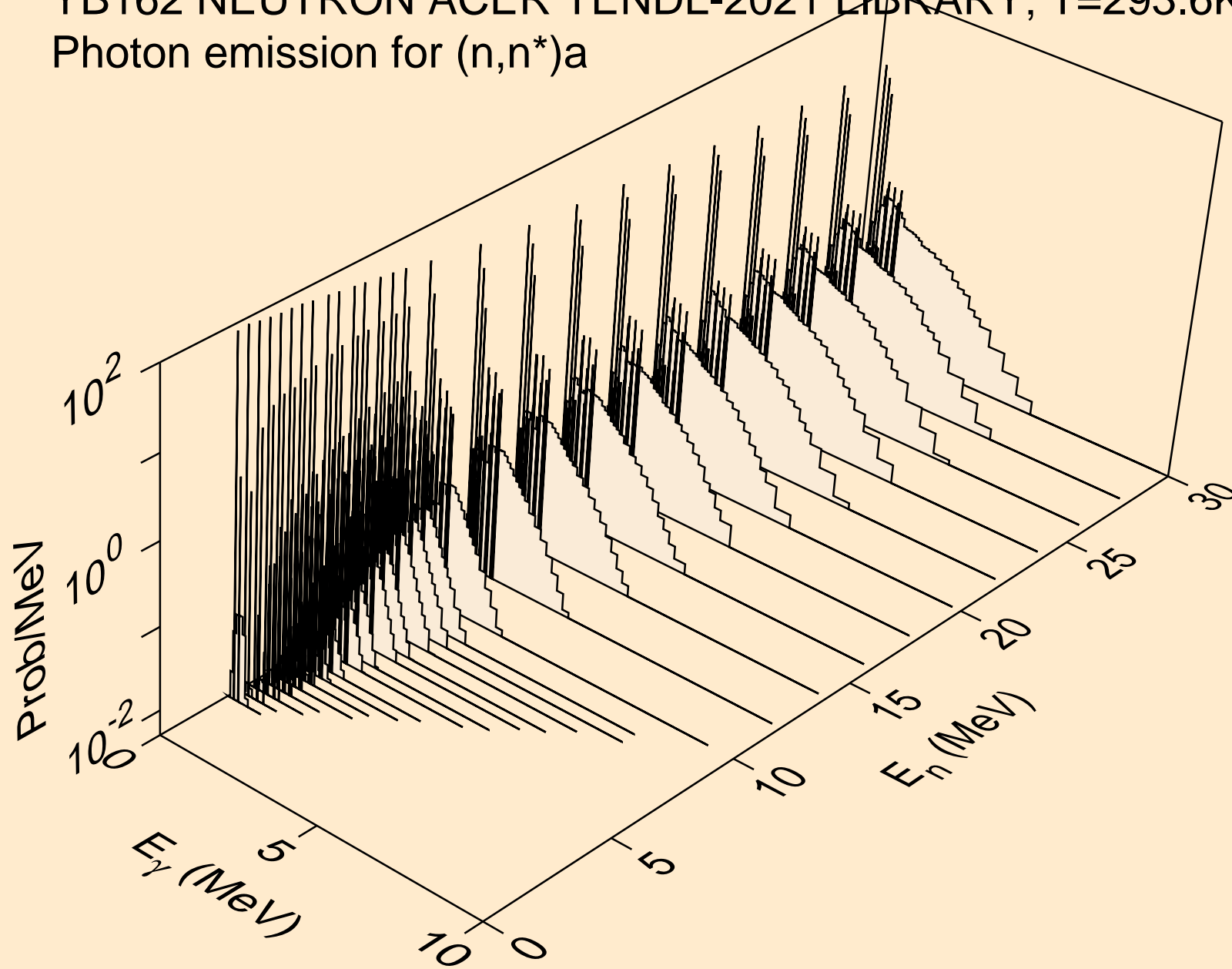

YB162 NEUTRON ACER TENDL-2021 LIBRARY; T=293.6K  
Photon emission for (n,2n) $\alpha$

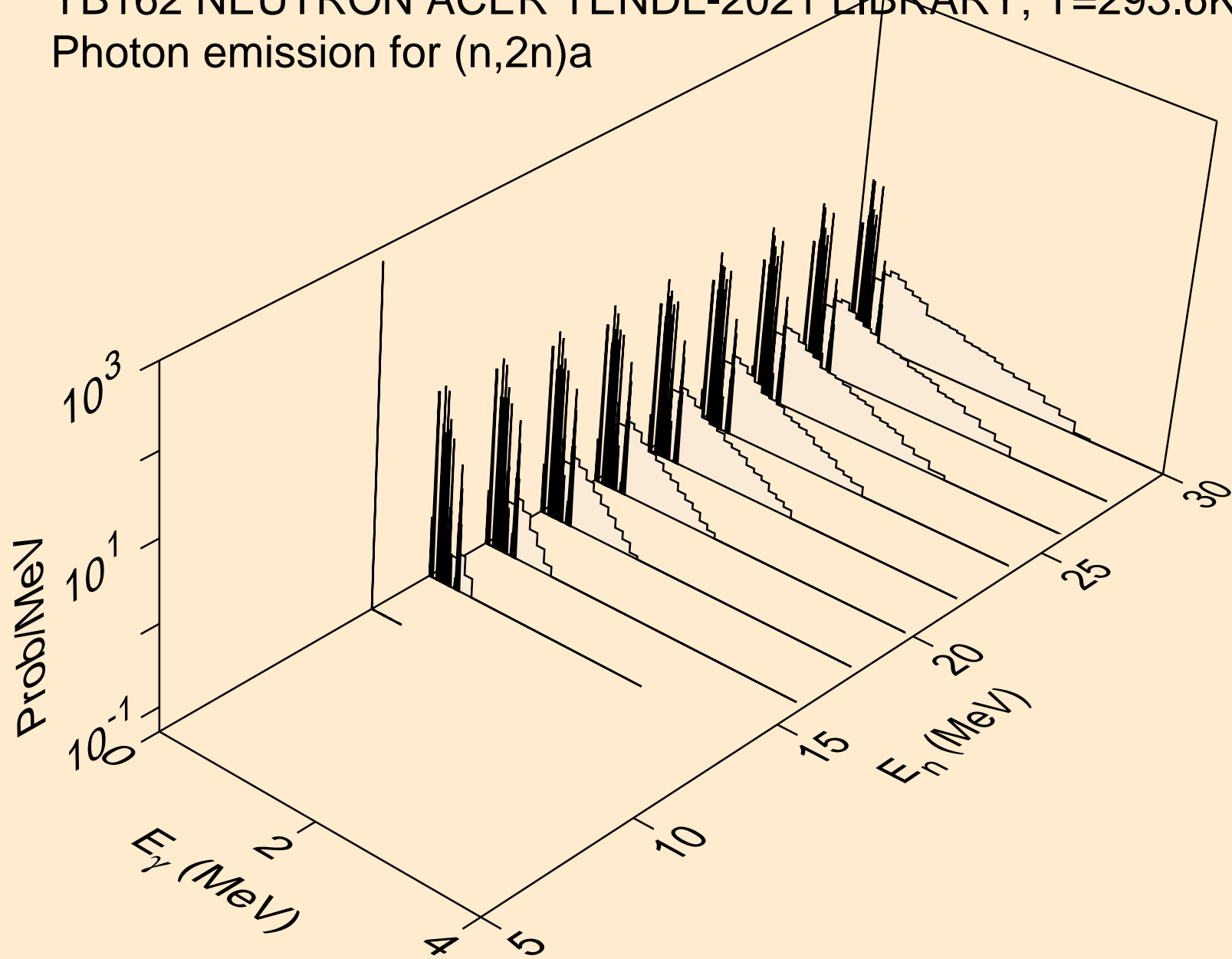

YB162 NEUTRON ACER TENDL-2021 LIBRARY; T=293.6K  
Photon emission for (n,3n)a

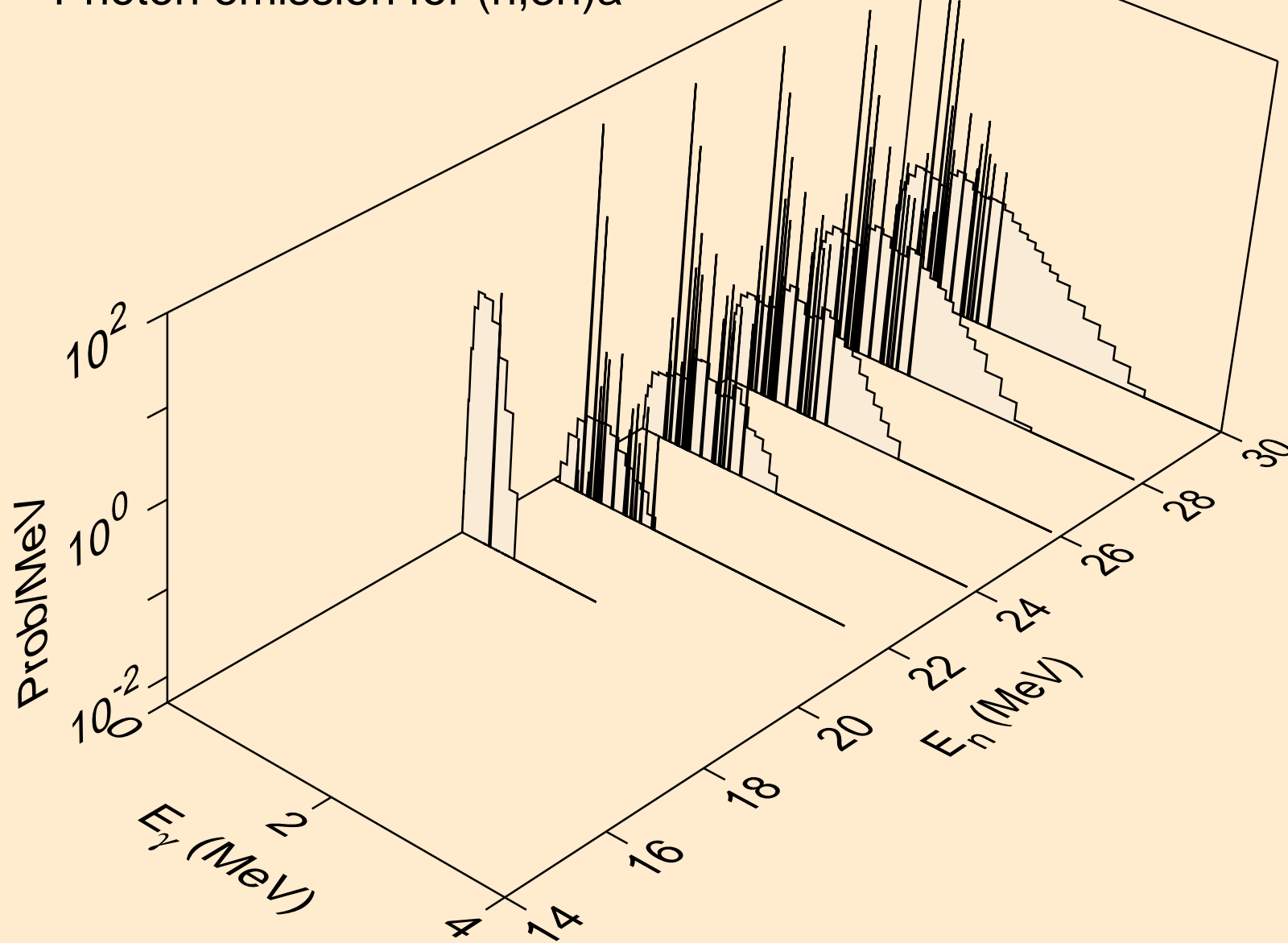

YB162 NEUTRON ACER TENDL-2021 LIBRARY; T=293.6K  
Photon emission for (n,n\*)p

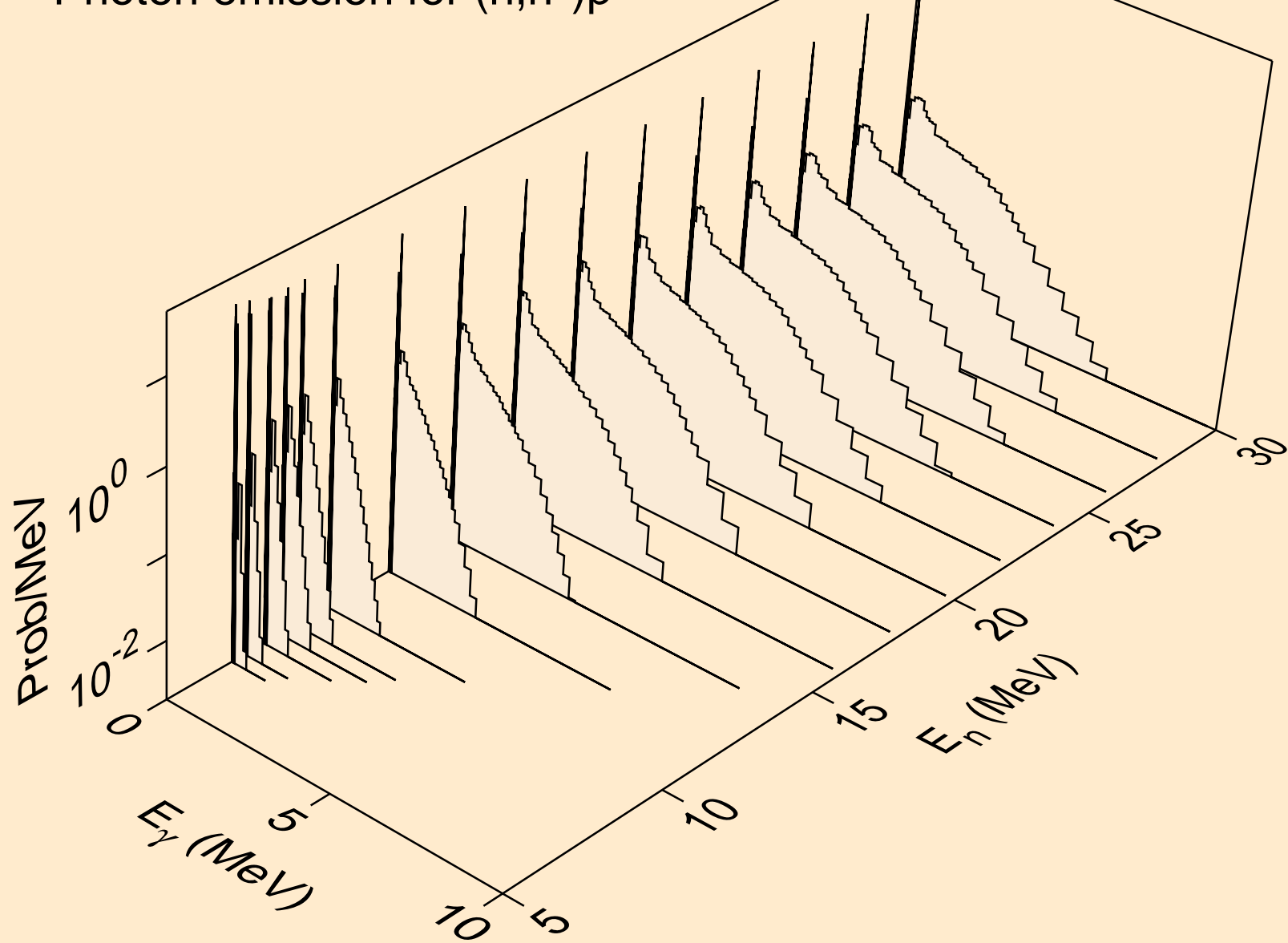



YB162 NEUTRON ACER TENDL-2021 LIBRARY; T=293.6K  
Photon emission for (n,n\*)2a

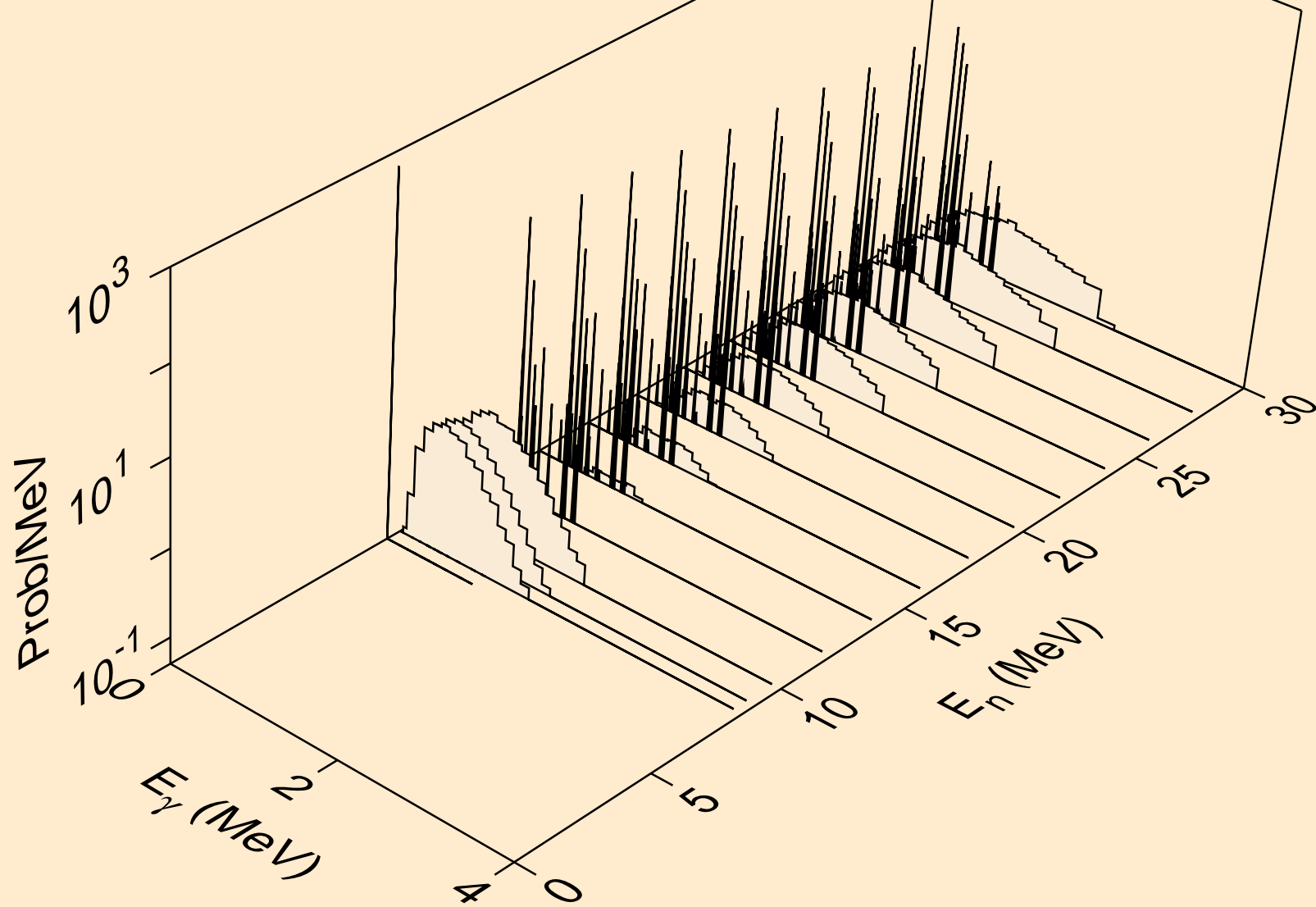

YB162 NEUTRON ACER TENDL-2021 LIBRARY; T=293.6K  
Photon emission for (n,2n)2a

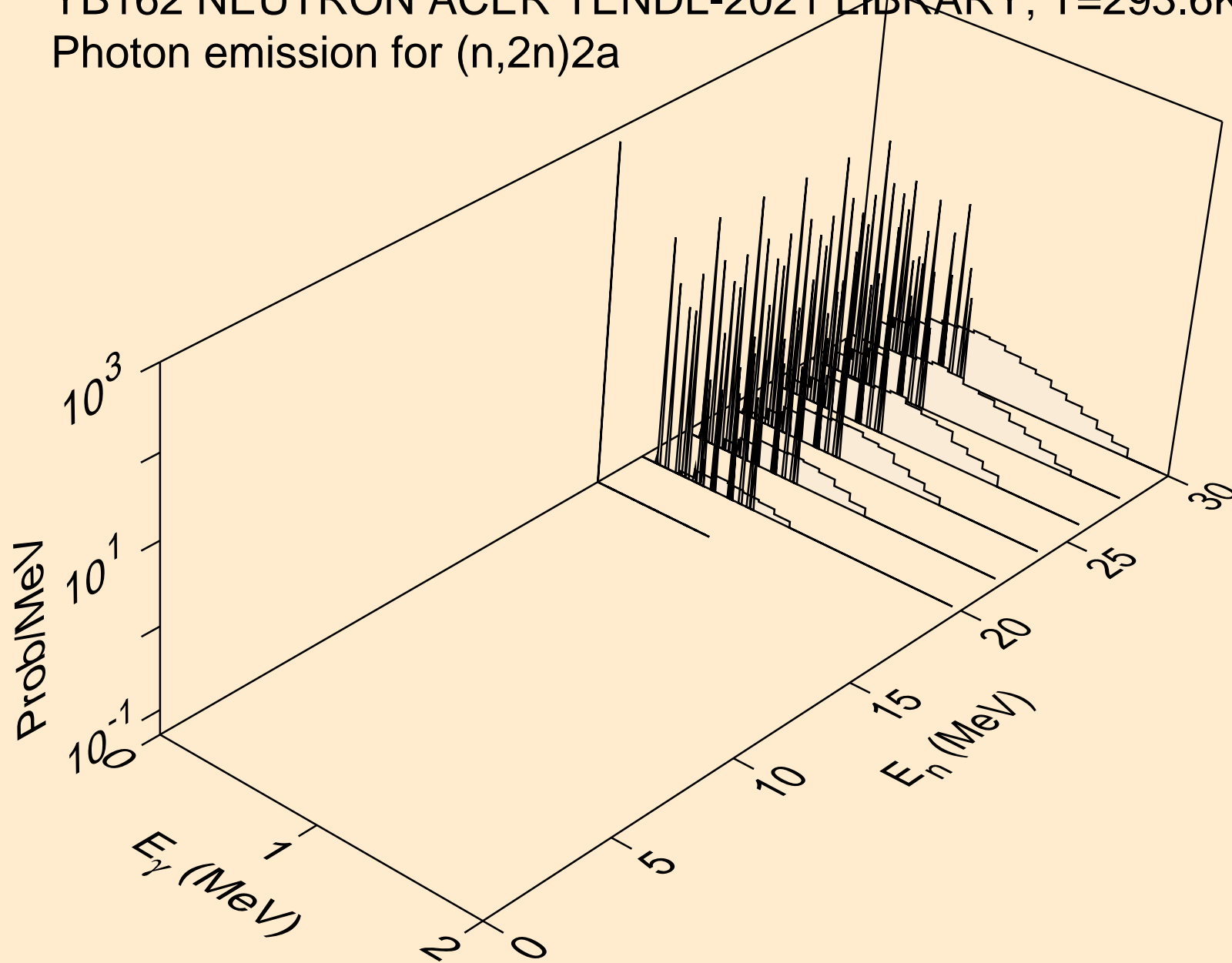

YB162 NEUTRON ACER TENDL-2021 LIBRARY; T=293.6K  
Photon emission for (n,n\*)d

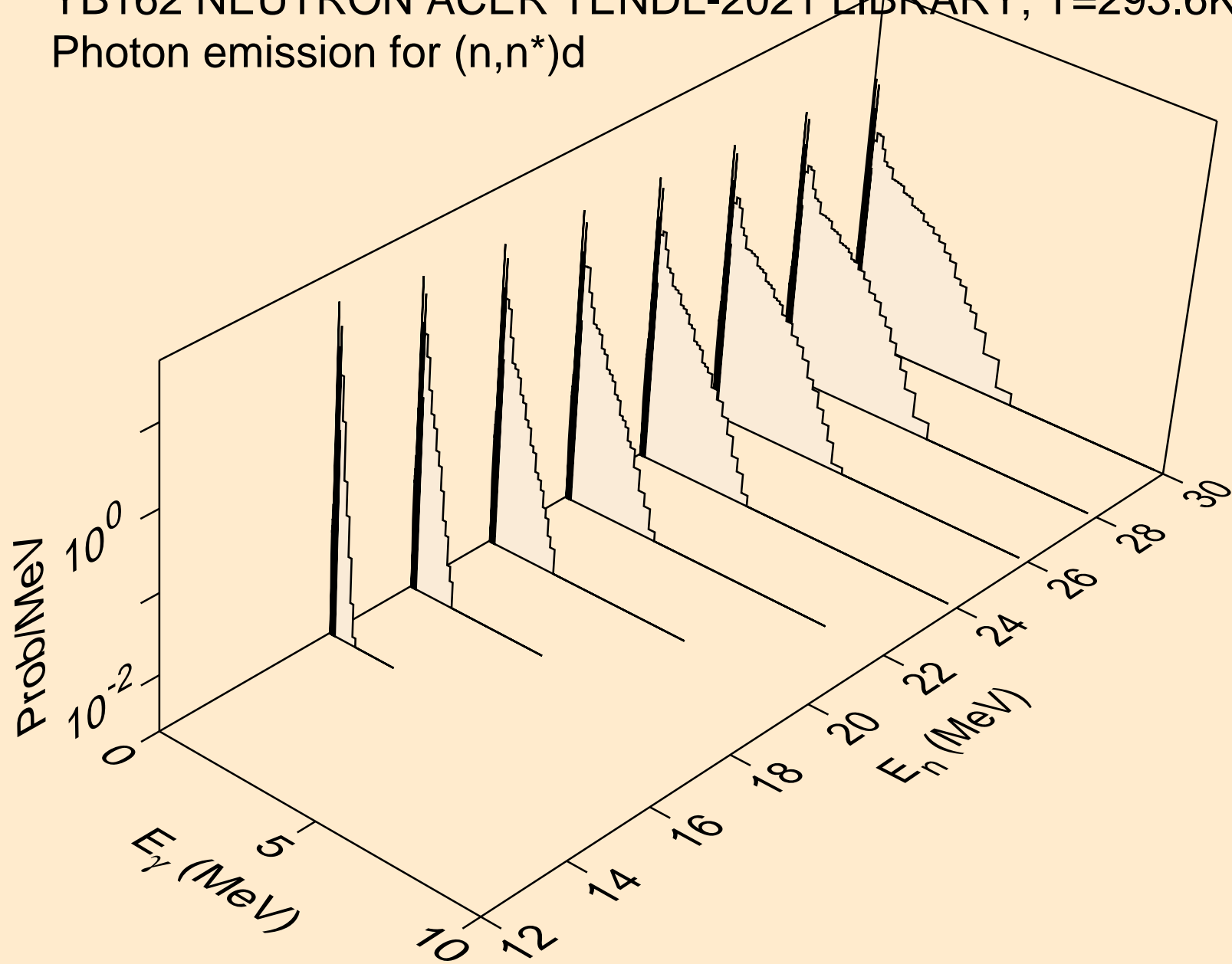

YB162 NEUTRON ACER TENDL-2021 LIBRARY; T=293.6K  
Photon emission for (n,n\*)t

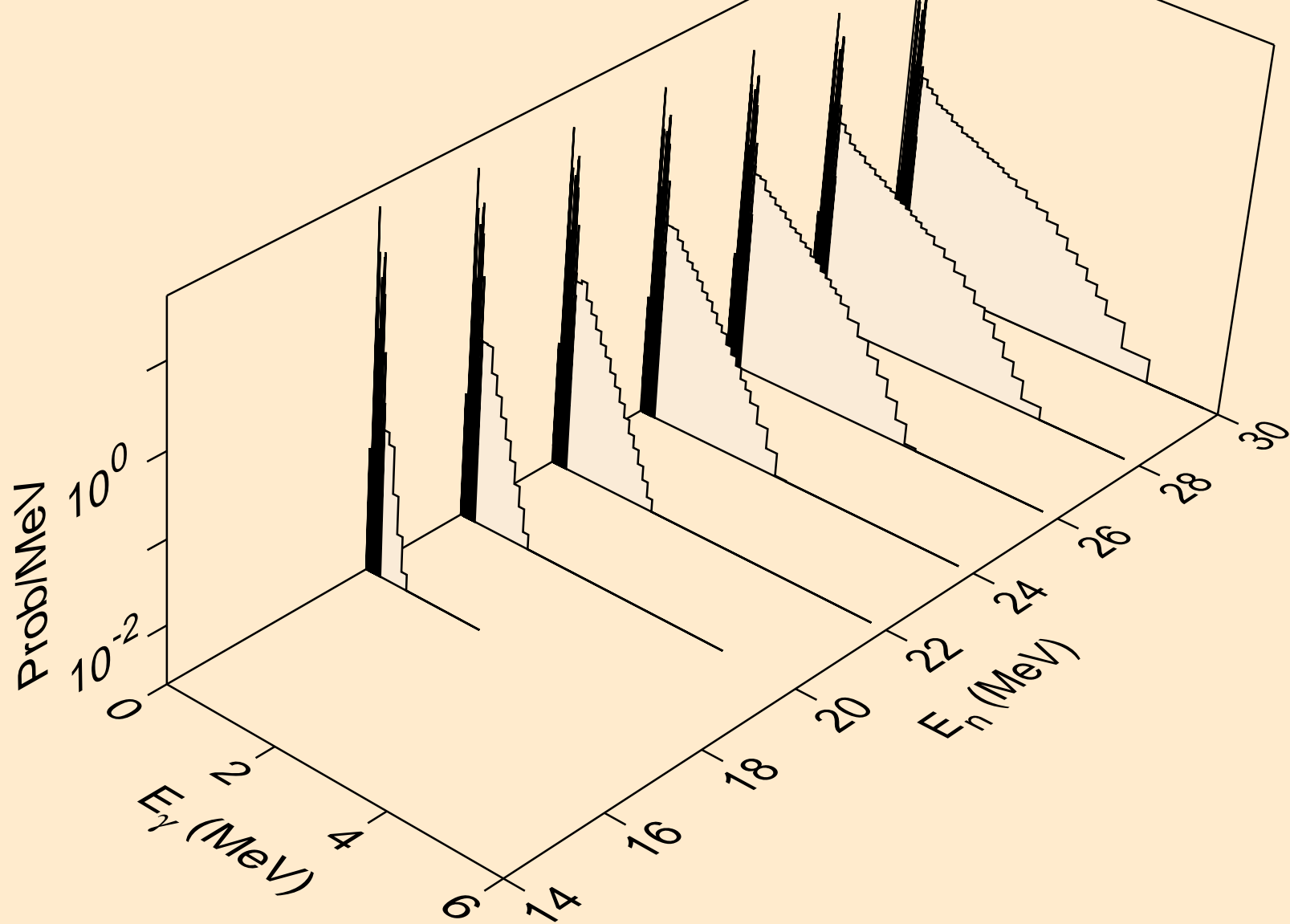

YB162 NEUTRON ACER TENDL-2021 LIBRARY; T=293.6K  
Photon emission for (n,n\*)he3

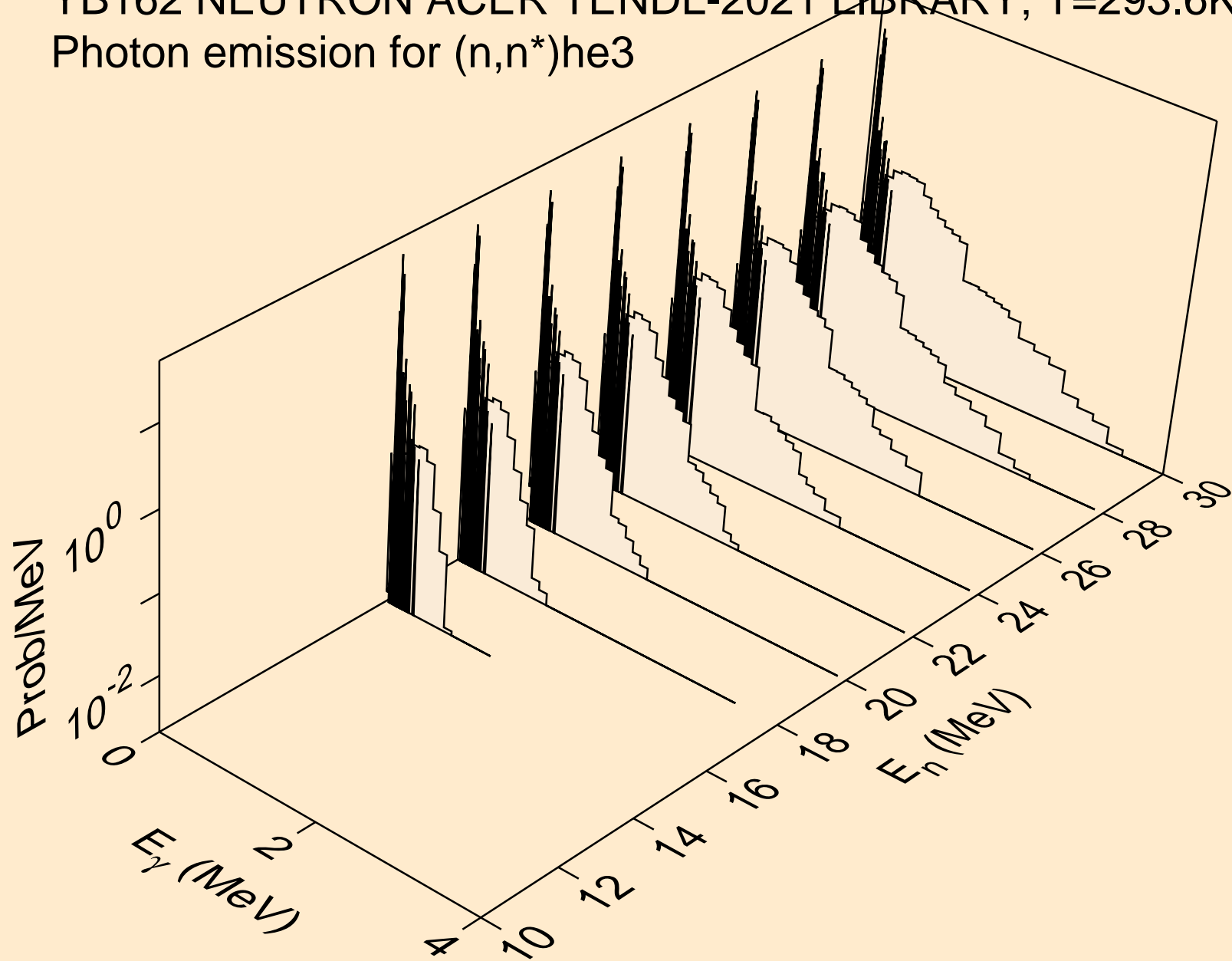

YB162 NEUTRON ACER TENDL-2021 LIBRARY; T=293.6K  
Photon emission for (n,4n)

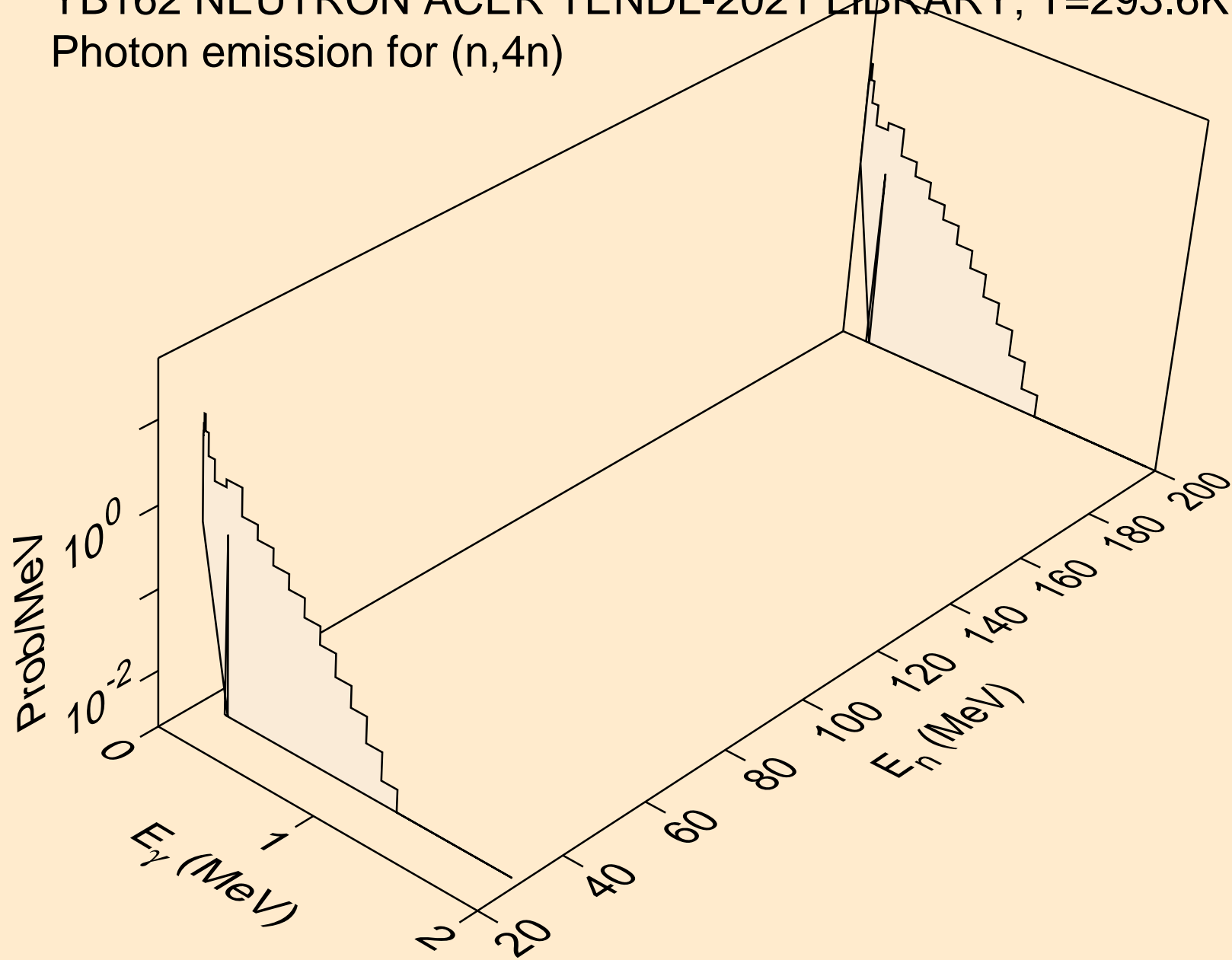

YB162 NEUTRON ACER TENDL-2021 LIBRARY; T=293.6K  
Photon emission for (n,2np)

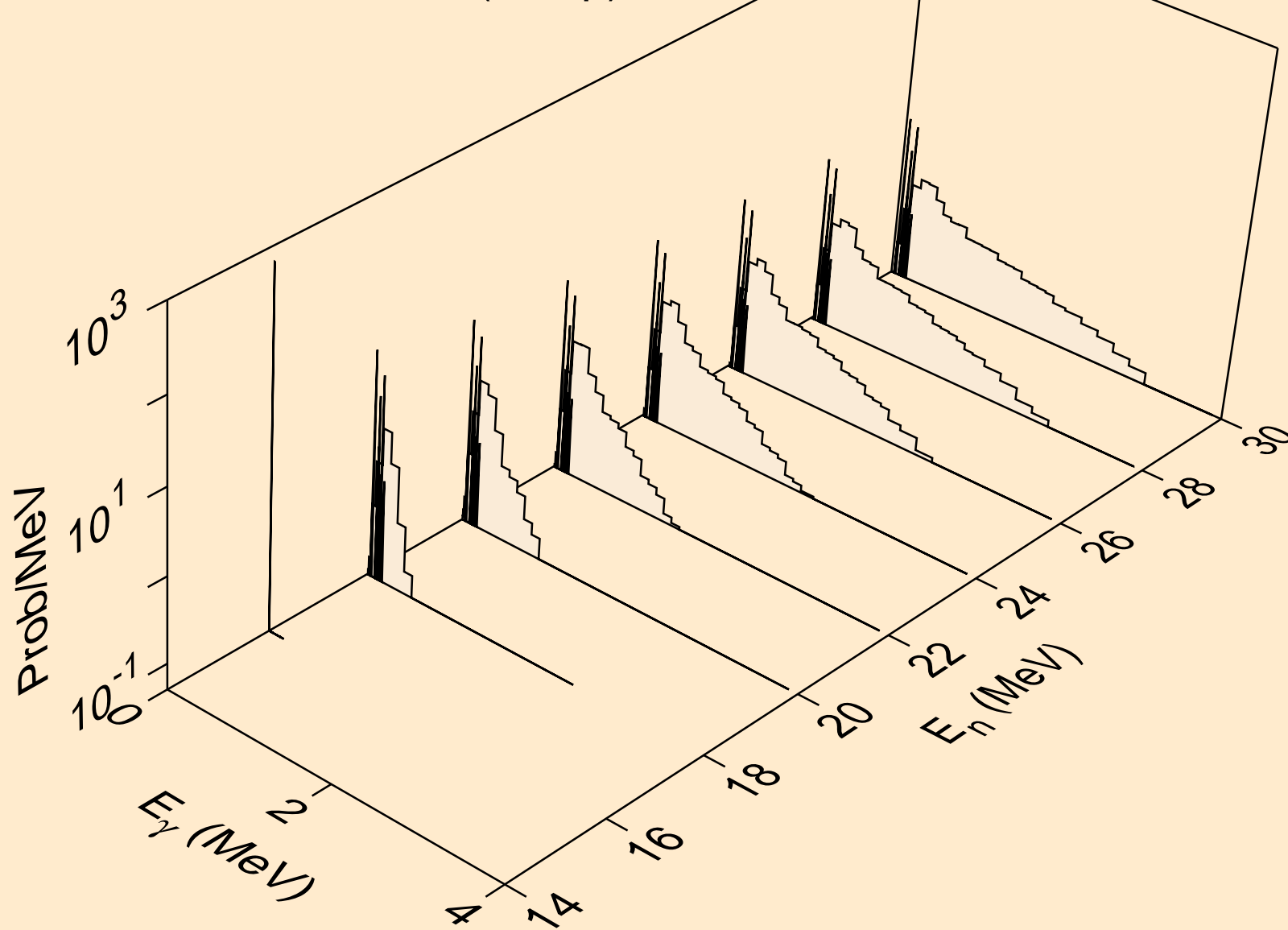

YB162 NEUTRON ACER TENDL-2021 LIBRARY; T=293.6K  
Photon emission for (n,3np)

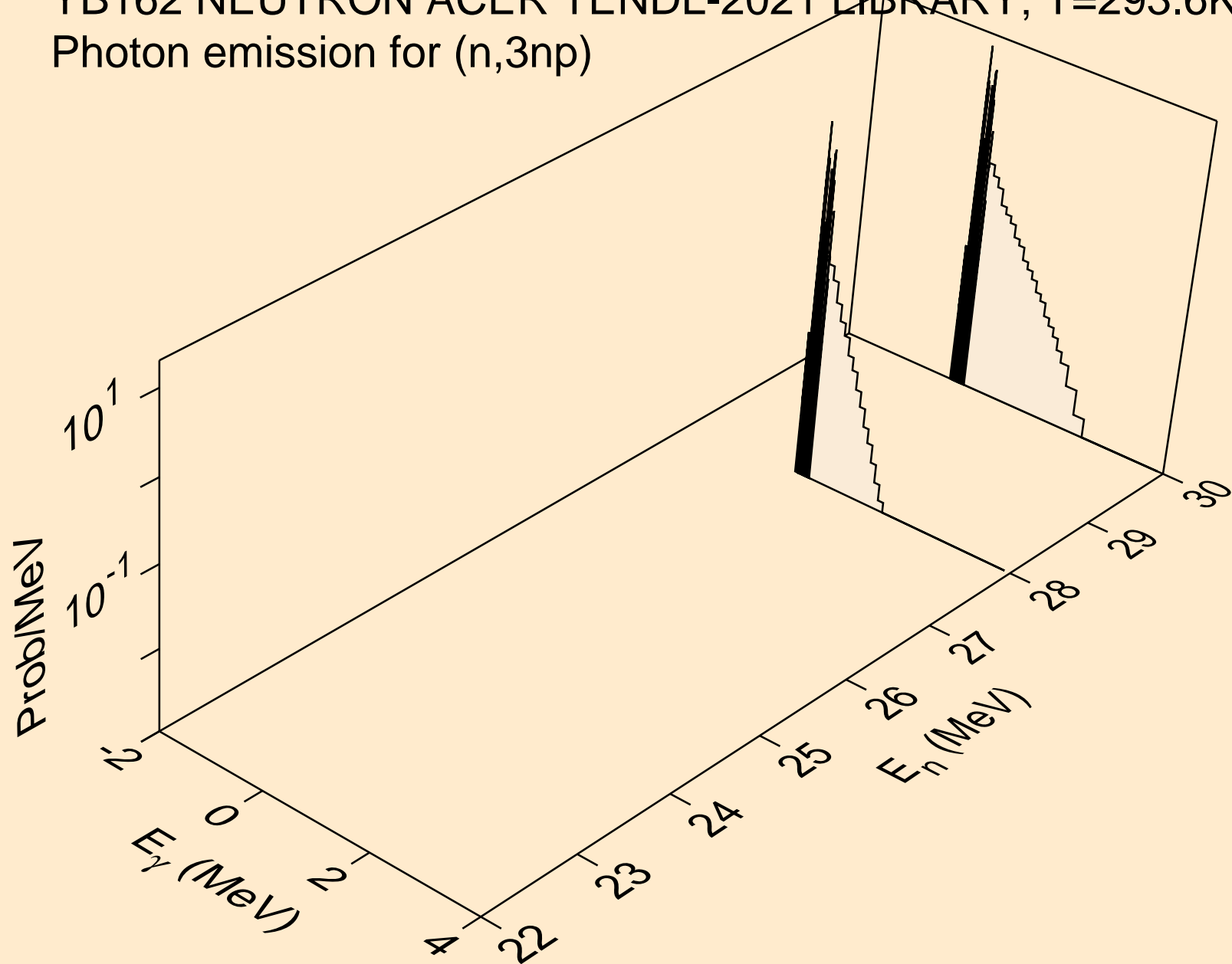



YB162 NEUTRON ACER TENDL-2021 LIBRARY; T=293.6K  
Photon emission for (n,2np)

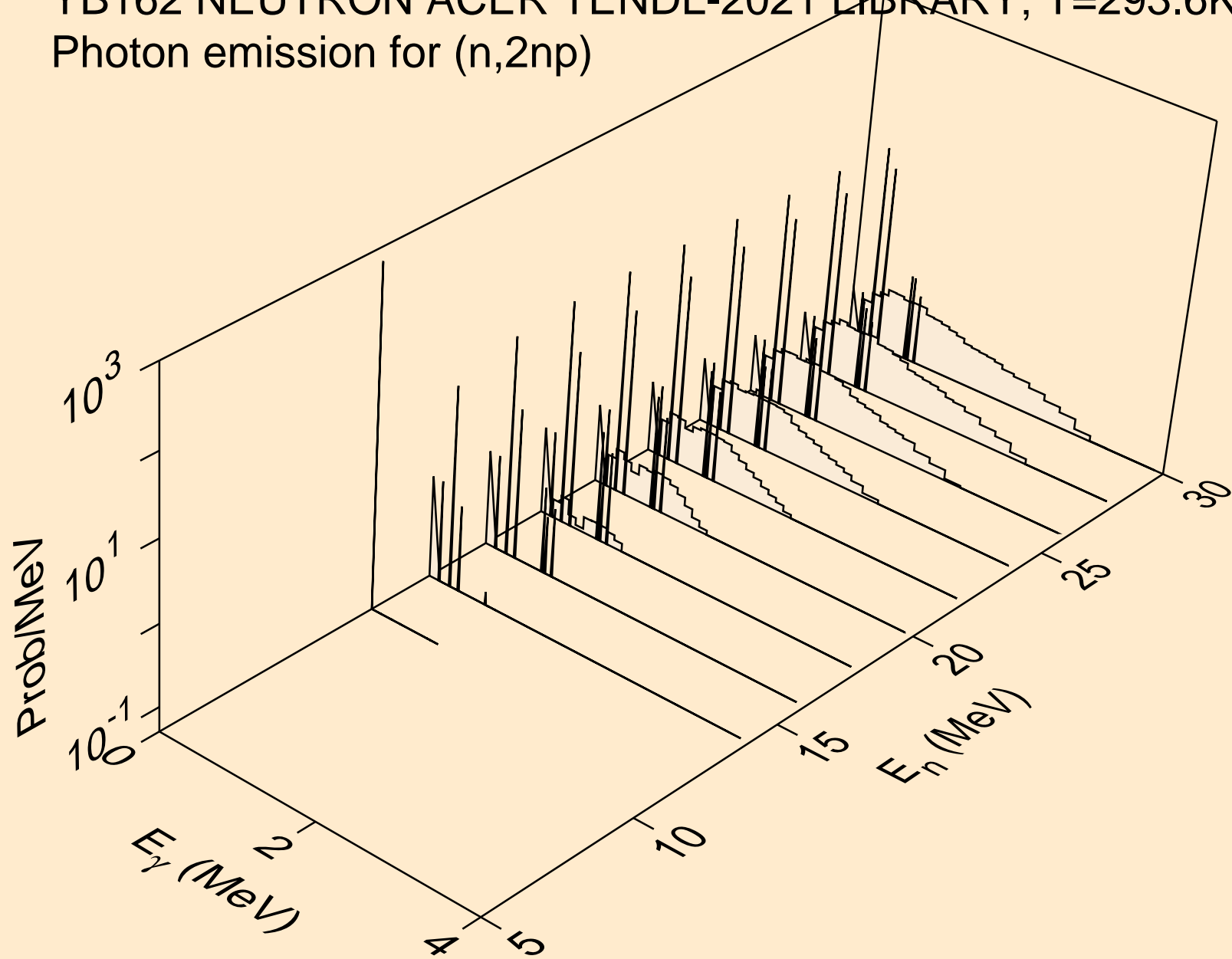

YB162 NEUTRON ACER TENDL-2021 LIBRARY; T=293.6K  
Photon emission for (n,npa)

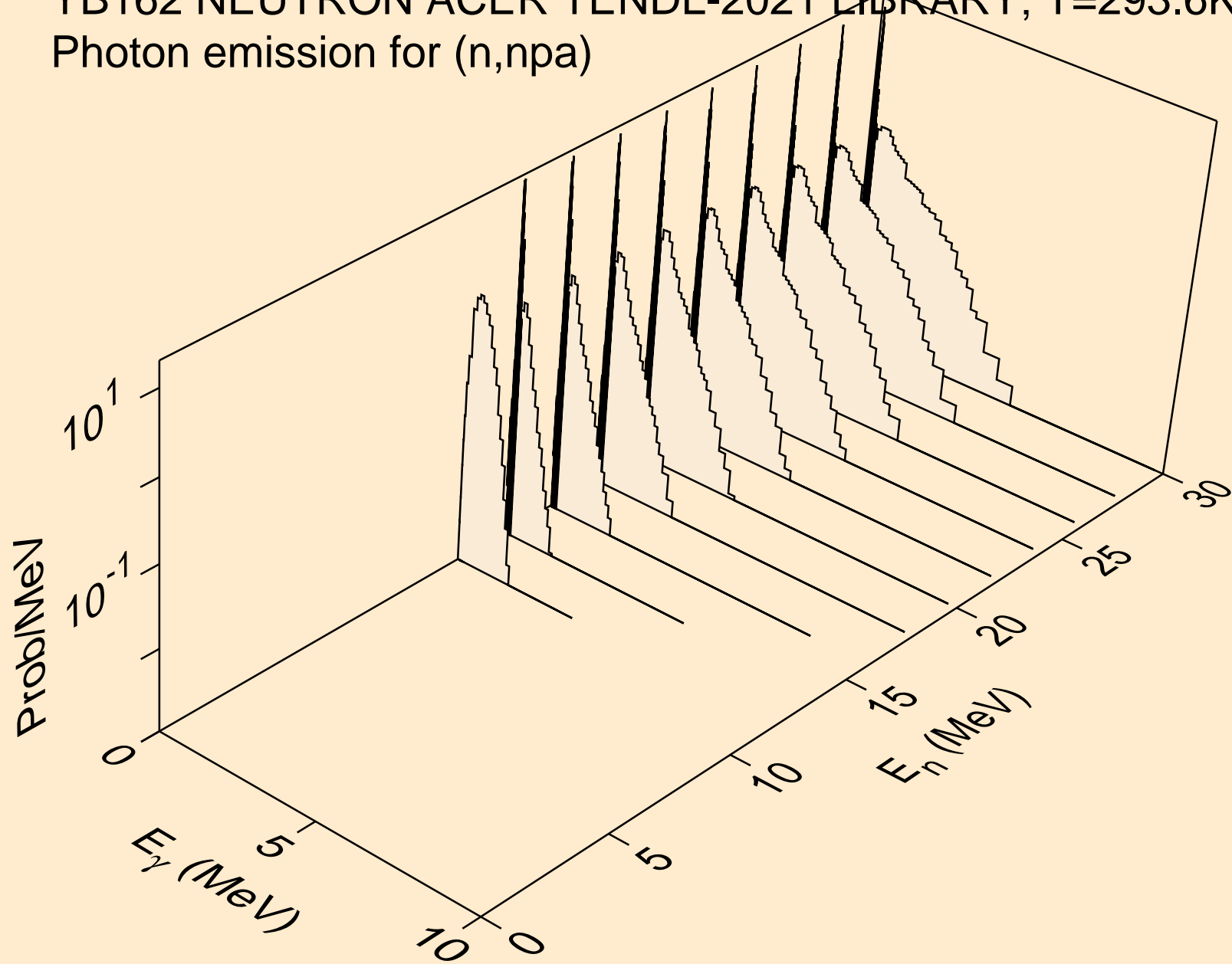

YB162 NEUTRON ACER TENDL-2021 LIBRARY; T=293.6K  
Photon emission for (n,n\*c)

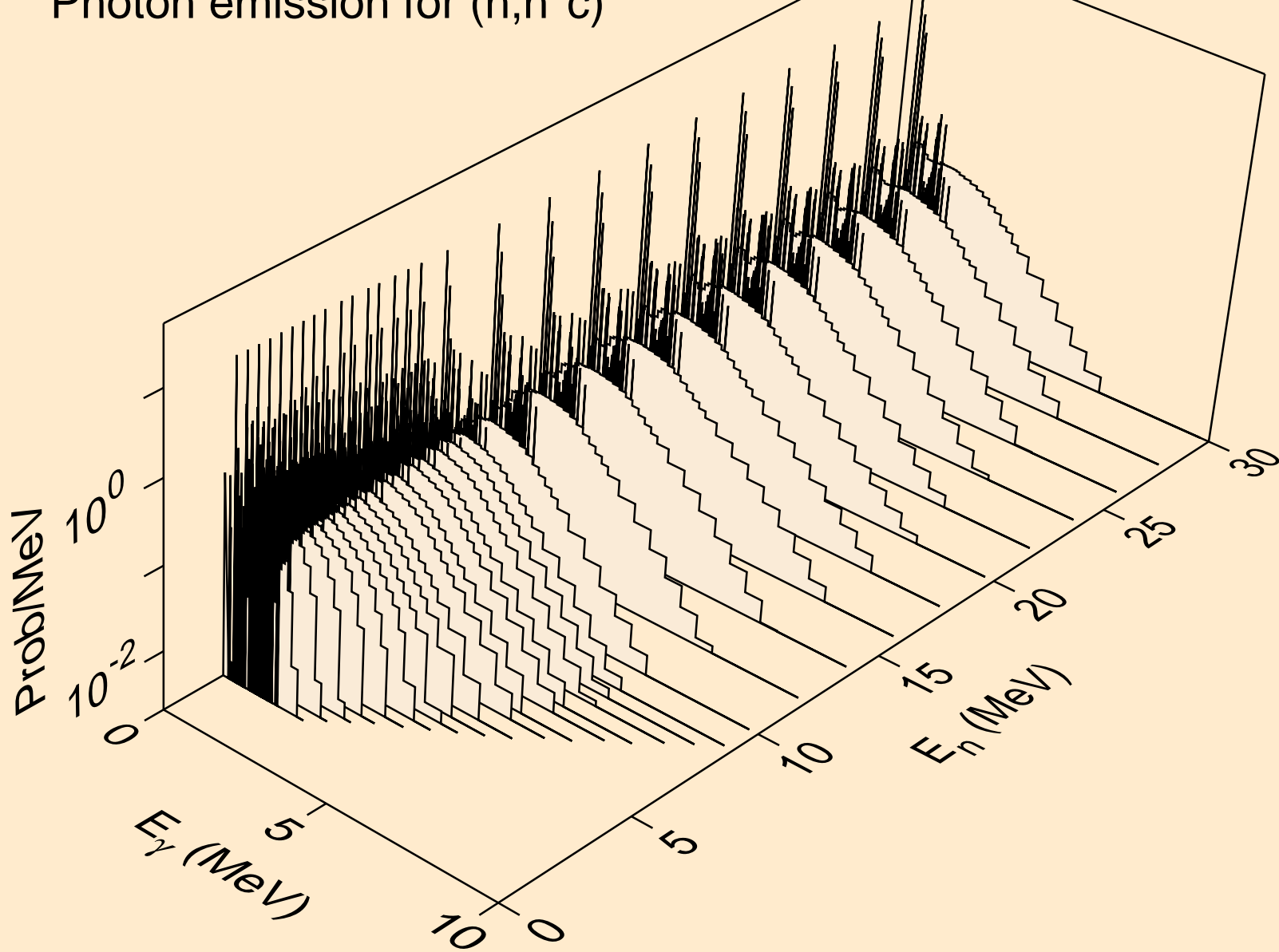

YB162 NEUTRON ACER TENDL-2021 LIBRARY; T=293.6K  
Photon emission for (n,gma)

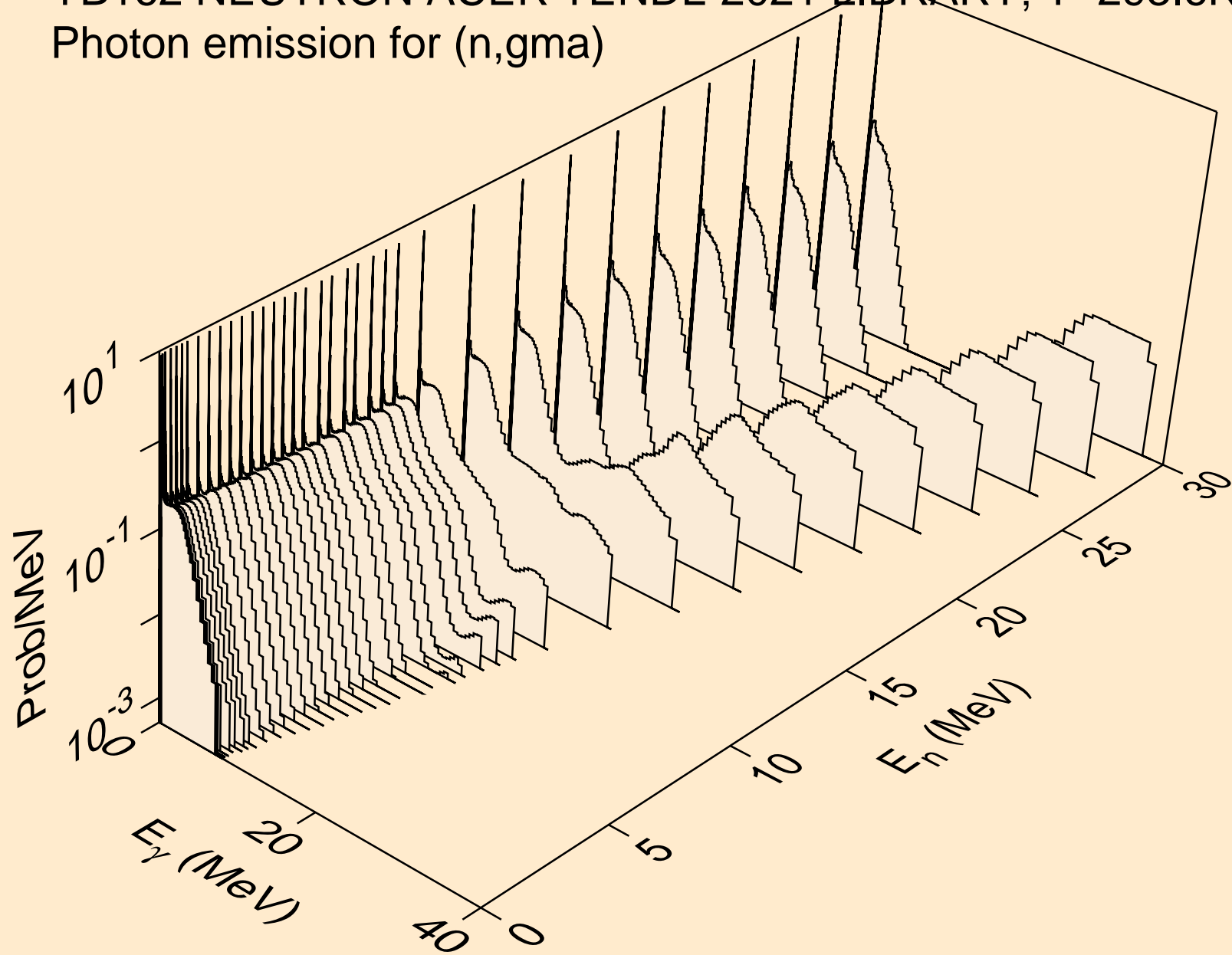

YB162 NEUTRON ACER TENDL-2021 LIBRARY; T=293.6K  
Photon emission for (n,p)

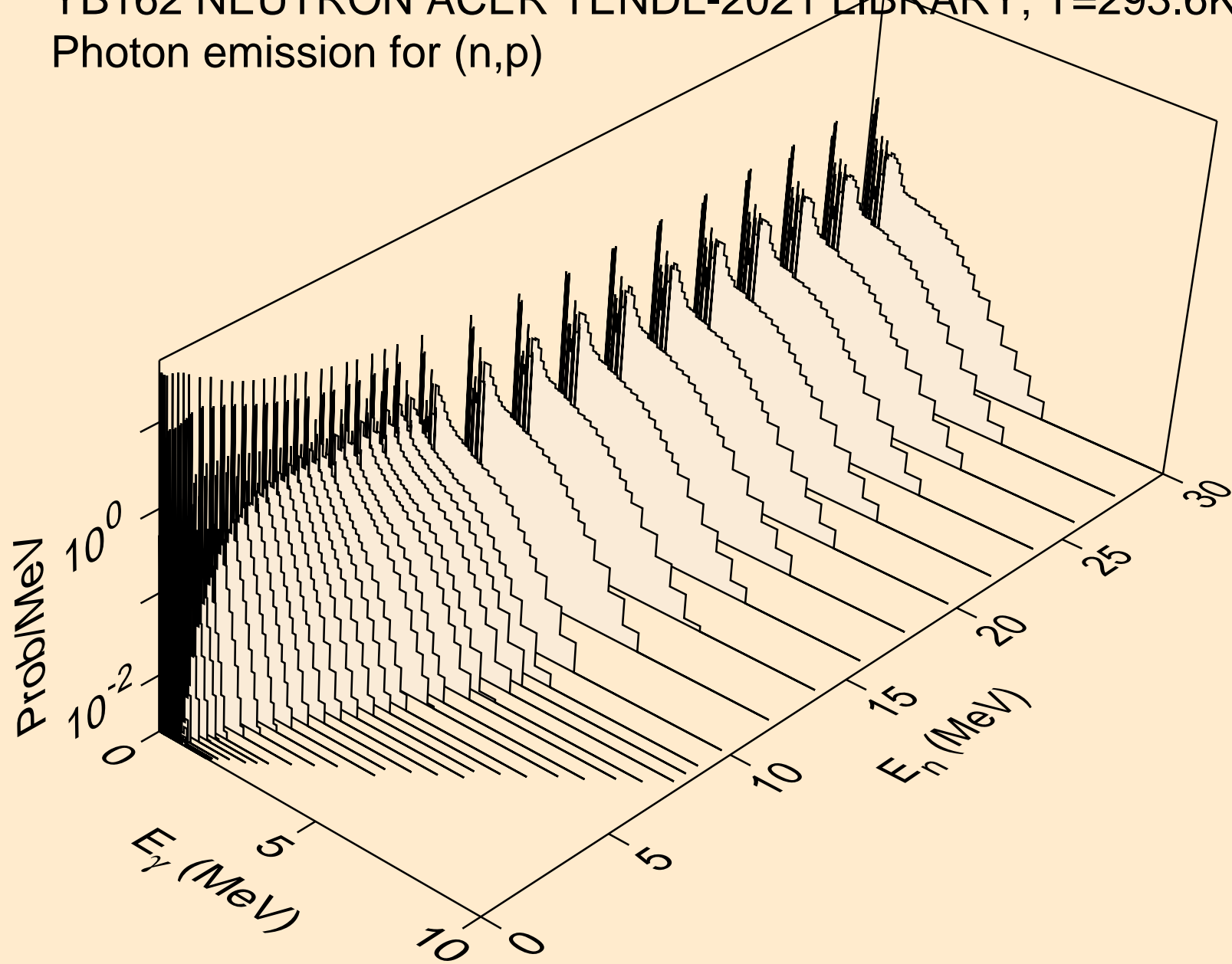

YB162 NEUTRON ACER TENDL-2021 LIBRARY; T=293.6K  
Photon emission for (n,d)

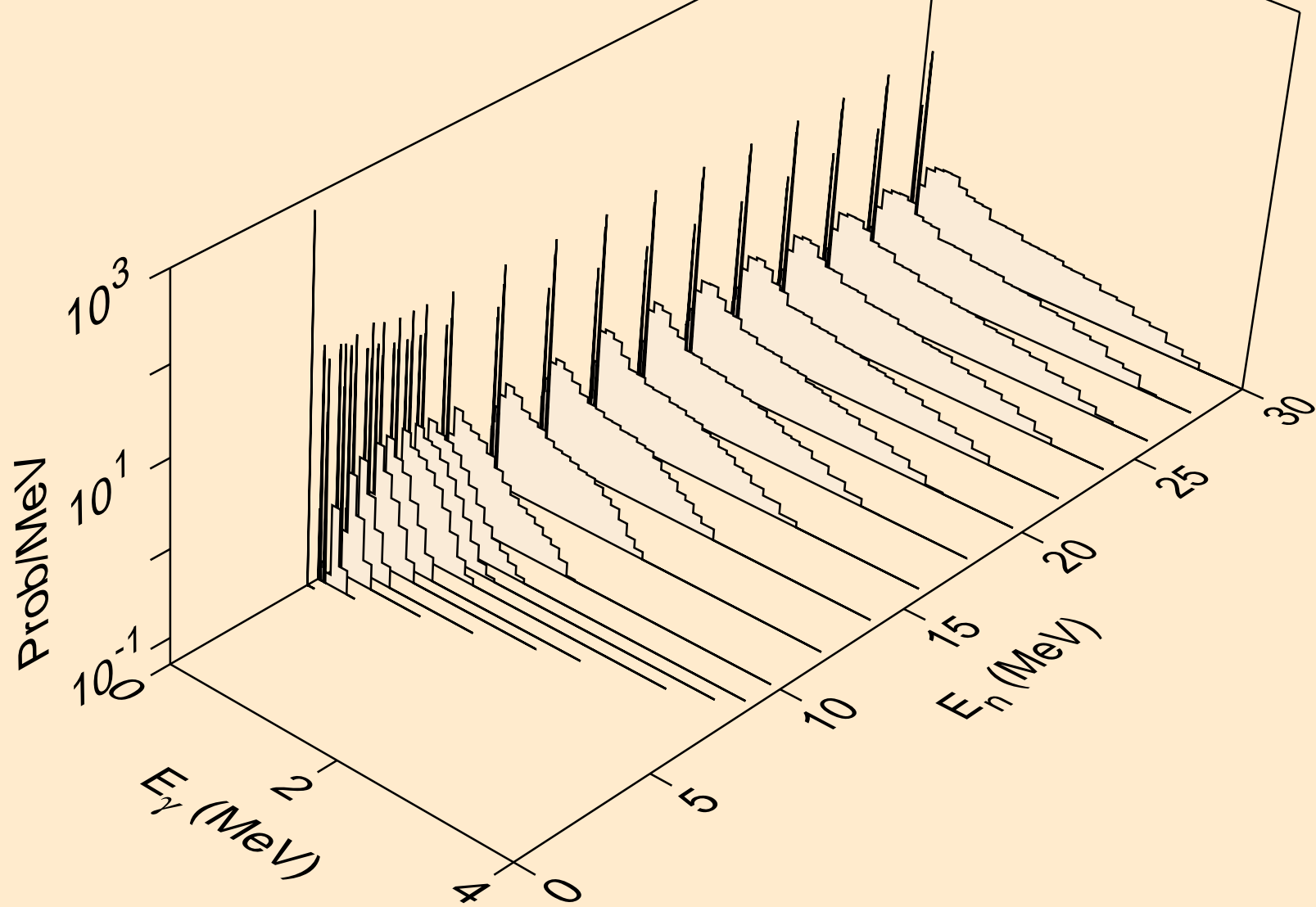

YB162 NEUTRON ACER TENDL-2021 LIBRARY; T=293.6K  
Photon emission for (n,t)

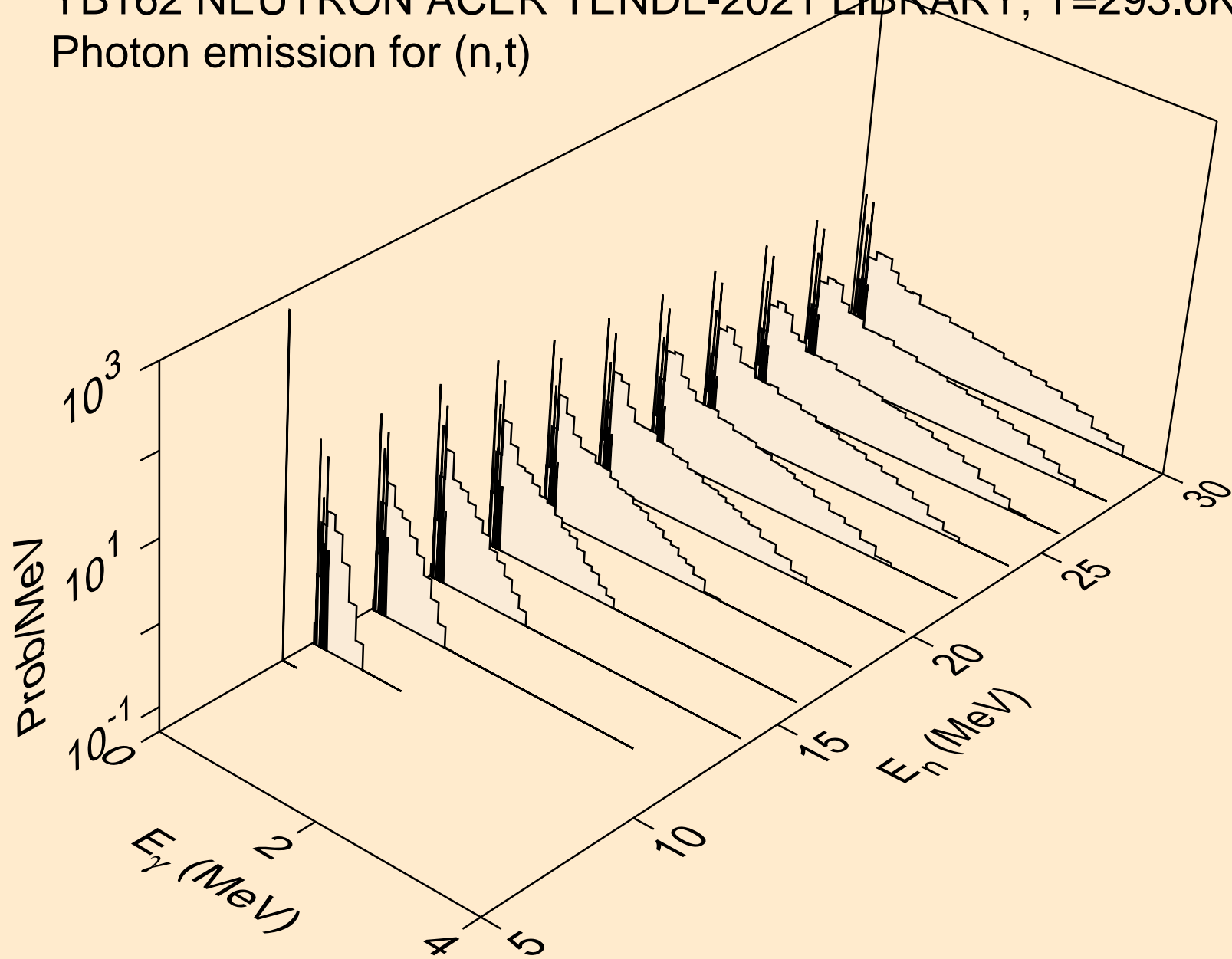

YB162 NEUTRON ACER TENDL-2021 LIBRARY; T=293.6K  
Photon emission for (n,he3)

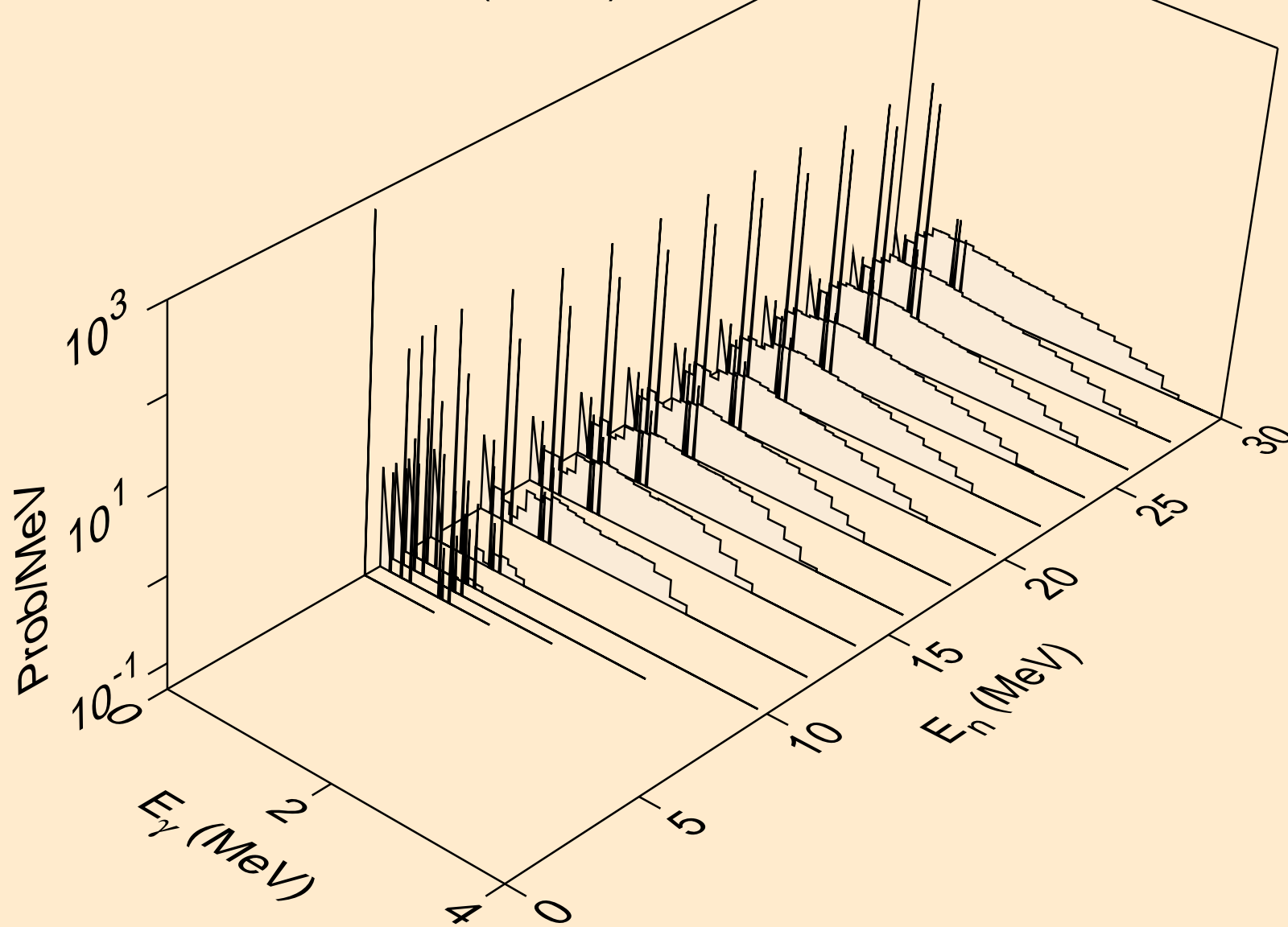



YB162 NEUTRON ACER TENDL-2021 LIBRARY; T=293.6K  
Photon emission for (n,a)

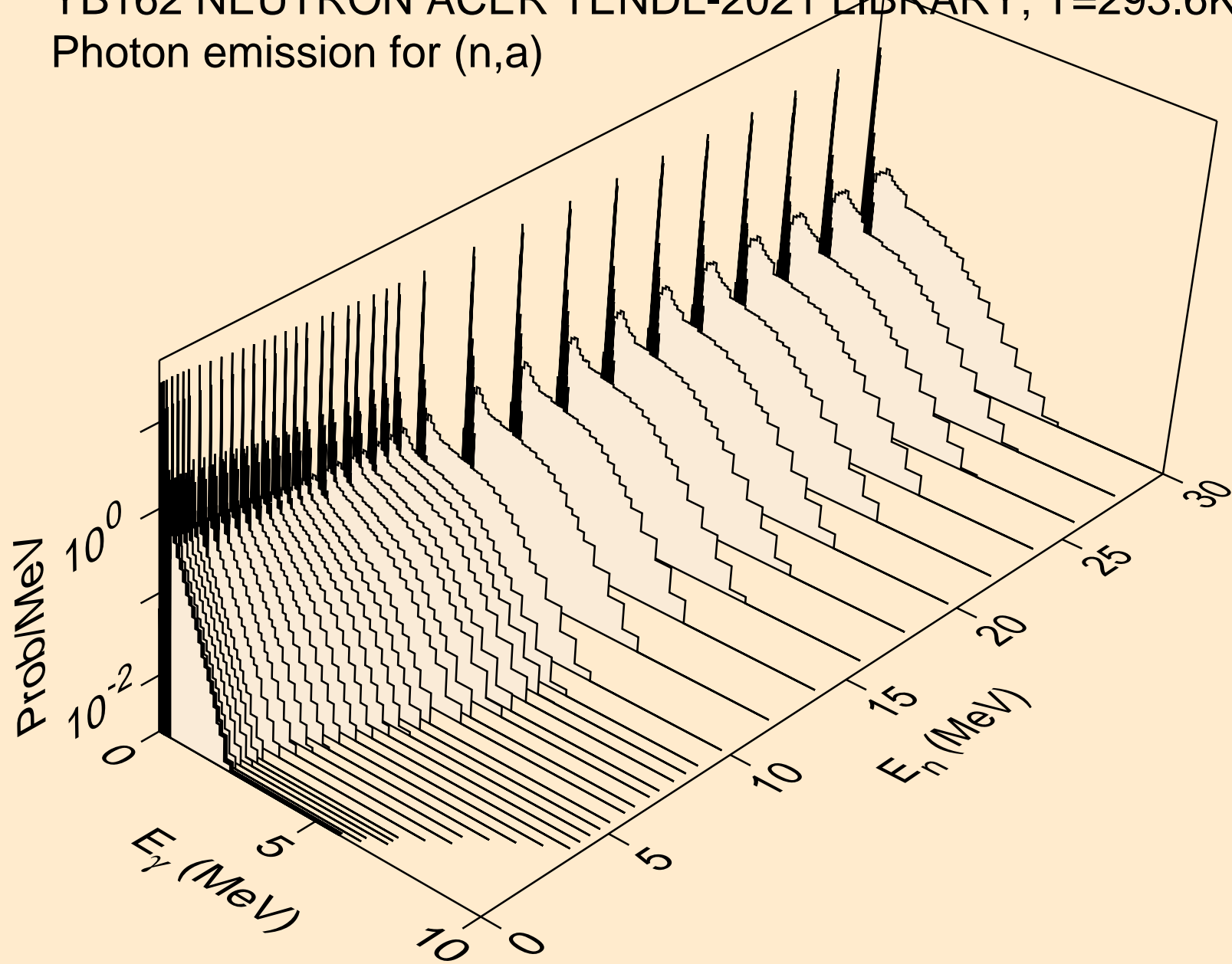

YB162 NEUTRON ACER TENDL-2021 LIBRARY; T=293.6K  
Photon emission for (n,2a)

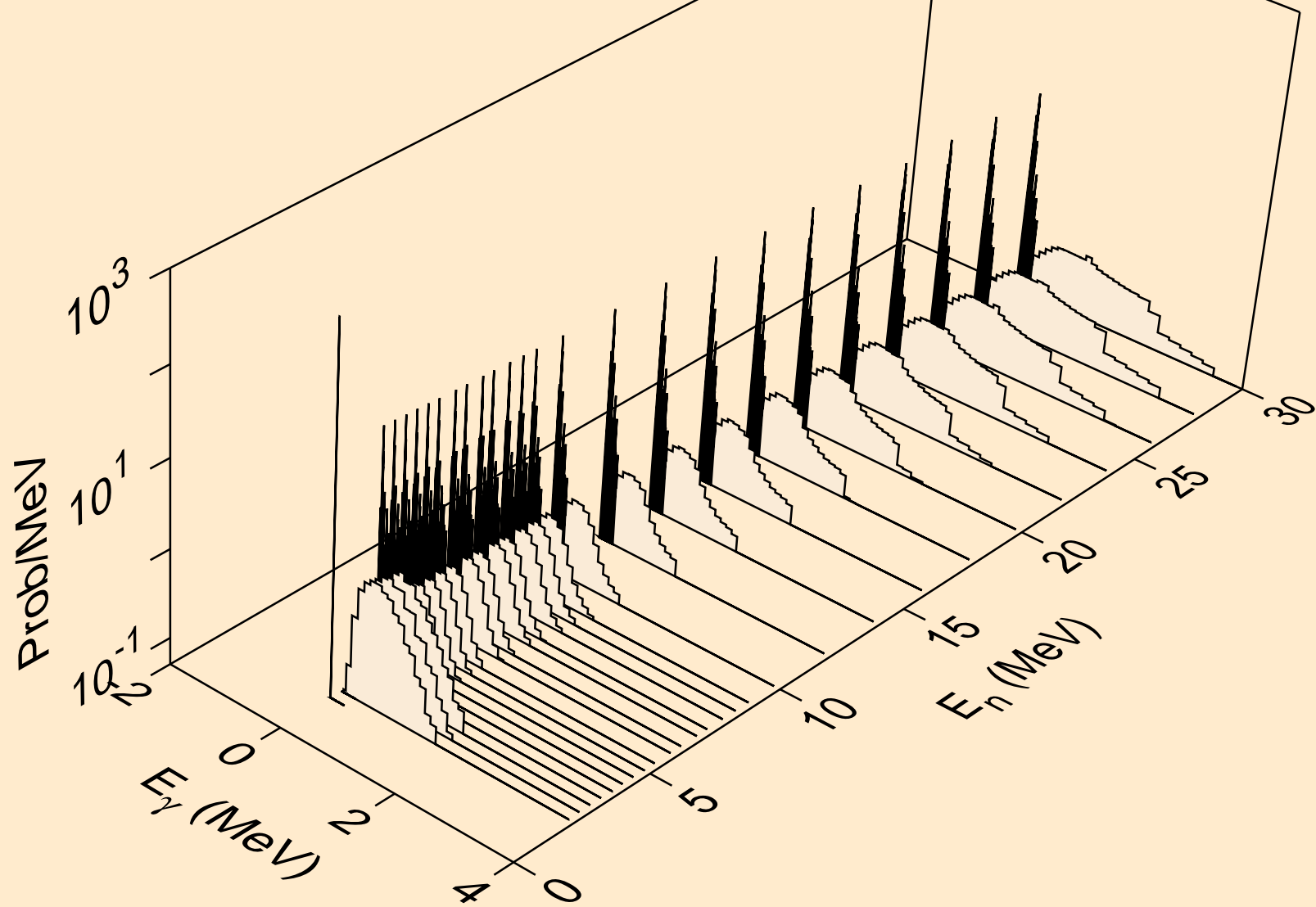

YB162 NEUTRON ACER TENDL-2021 LIBRARY; T=293.6K  
Photon emission for (n,2p)

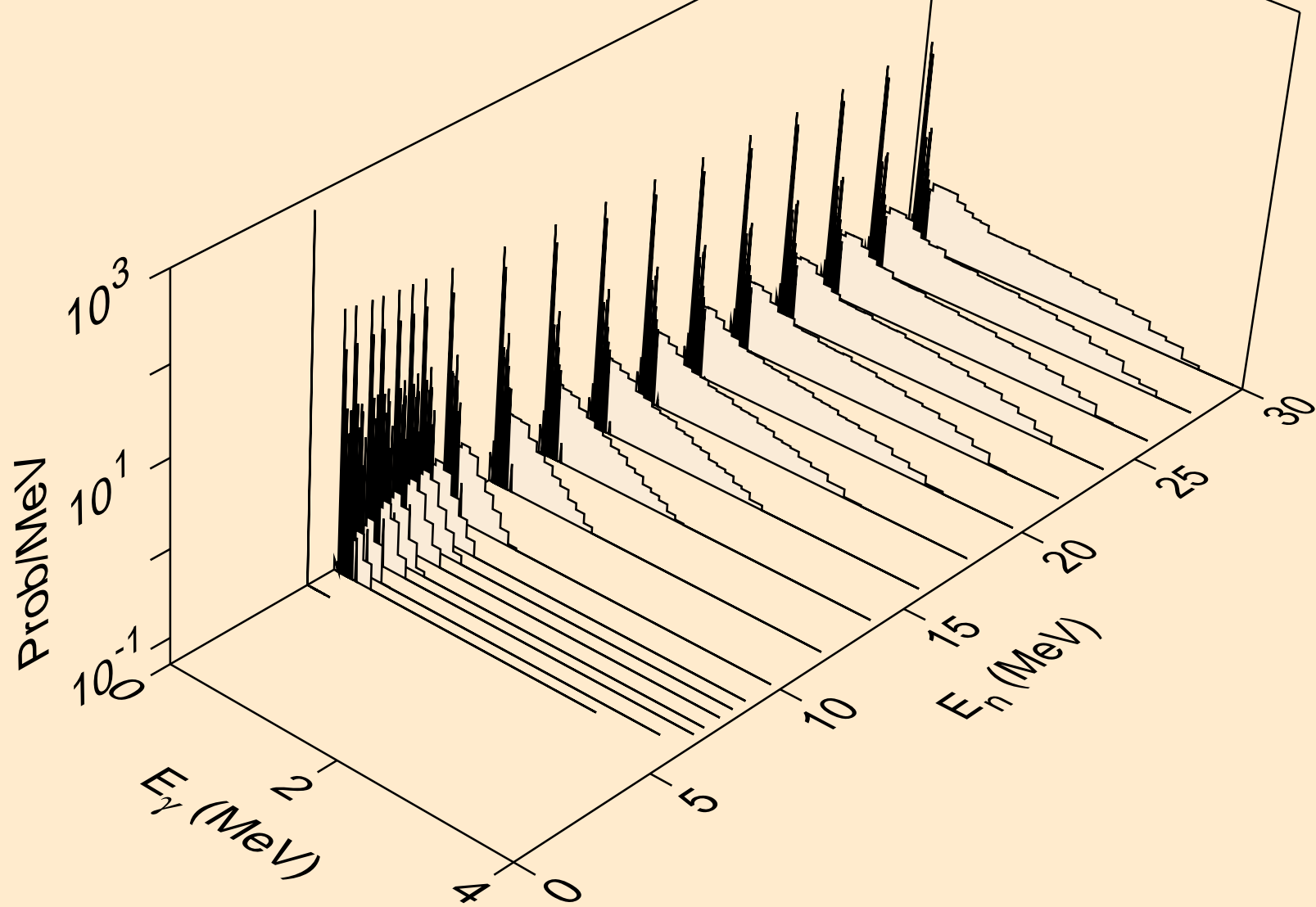

YB162 NEUTRON ACER TENDL-2021 LIBRARY; T=293.6K  
Photon emission for (n,p $\alpha$ )

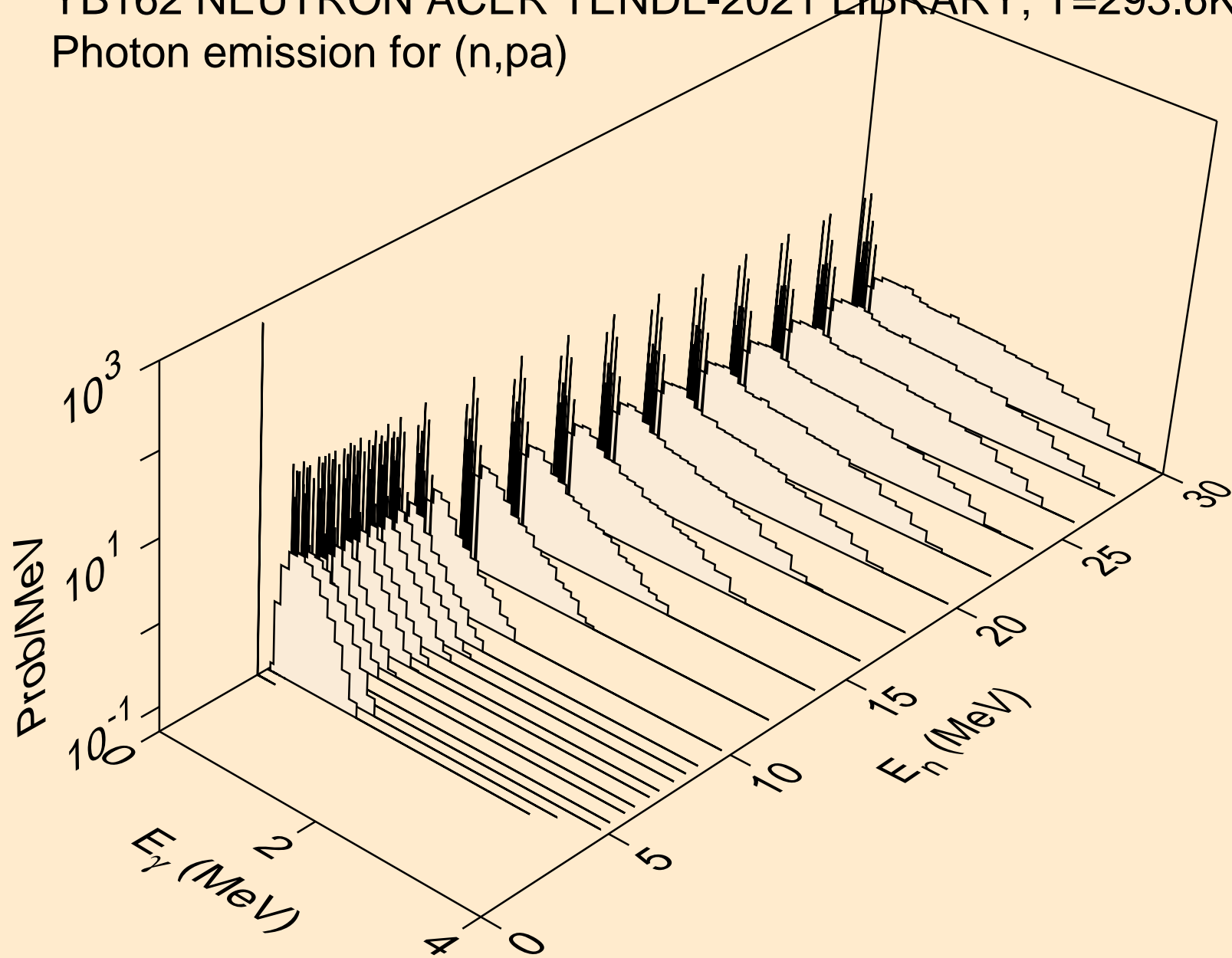

YB162 NEUTRON ACER TENDL-2021 LIBRARY; T=293.6K  
Photon emission for (n,pd)

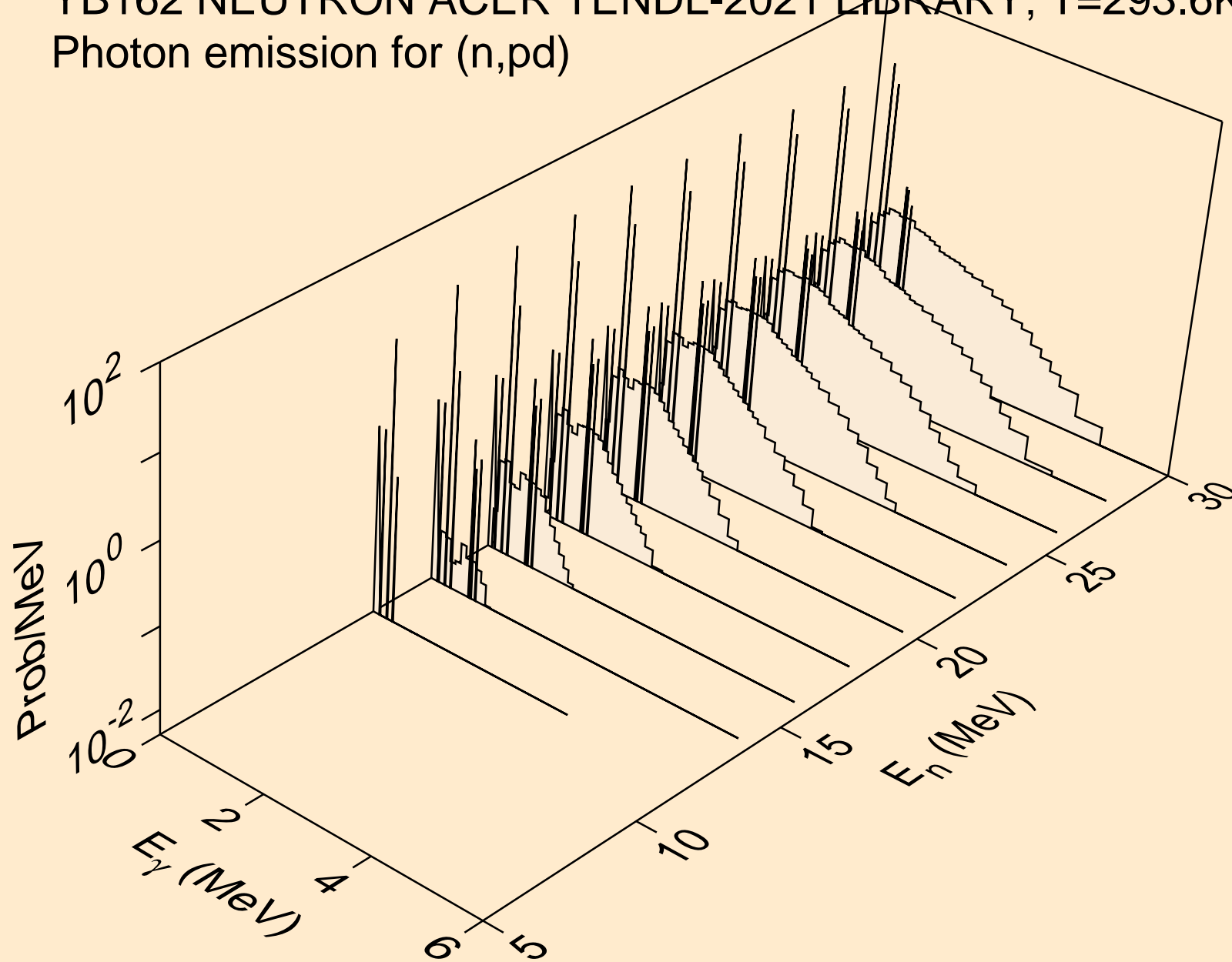

YB162 NEUTRON ACER TENDL-2021 LIBRARY; T=293.6K  
Photon emission for (n,pt)

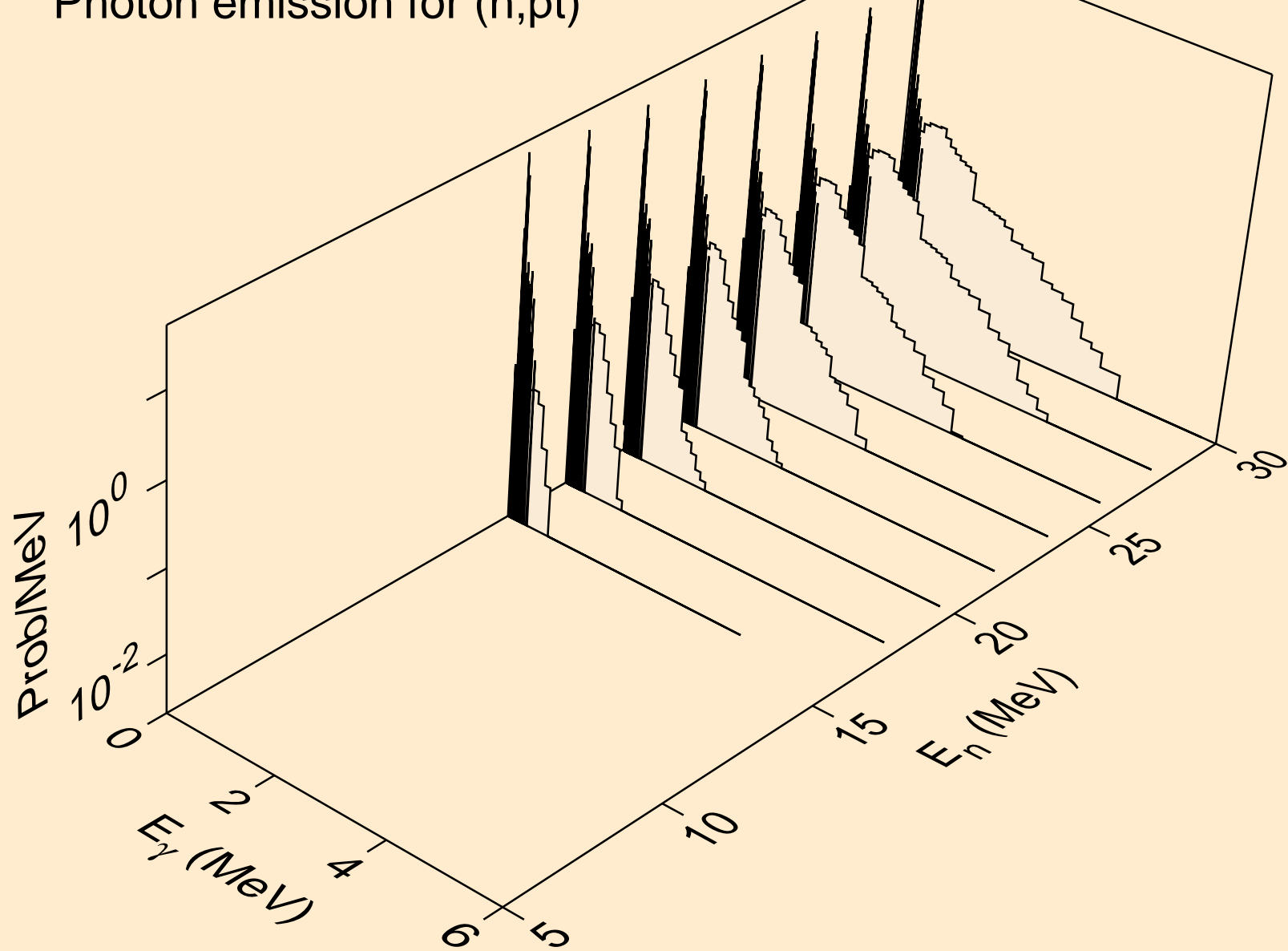

YB162 NEUTRON ACER TENDL-2021 LIBRARY; T=293.6K  
Photon emission for (n,da)

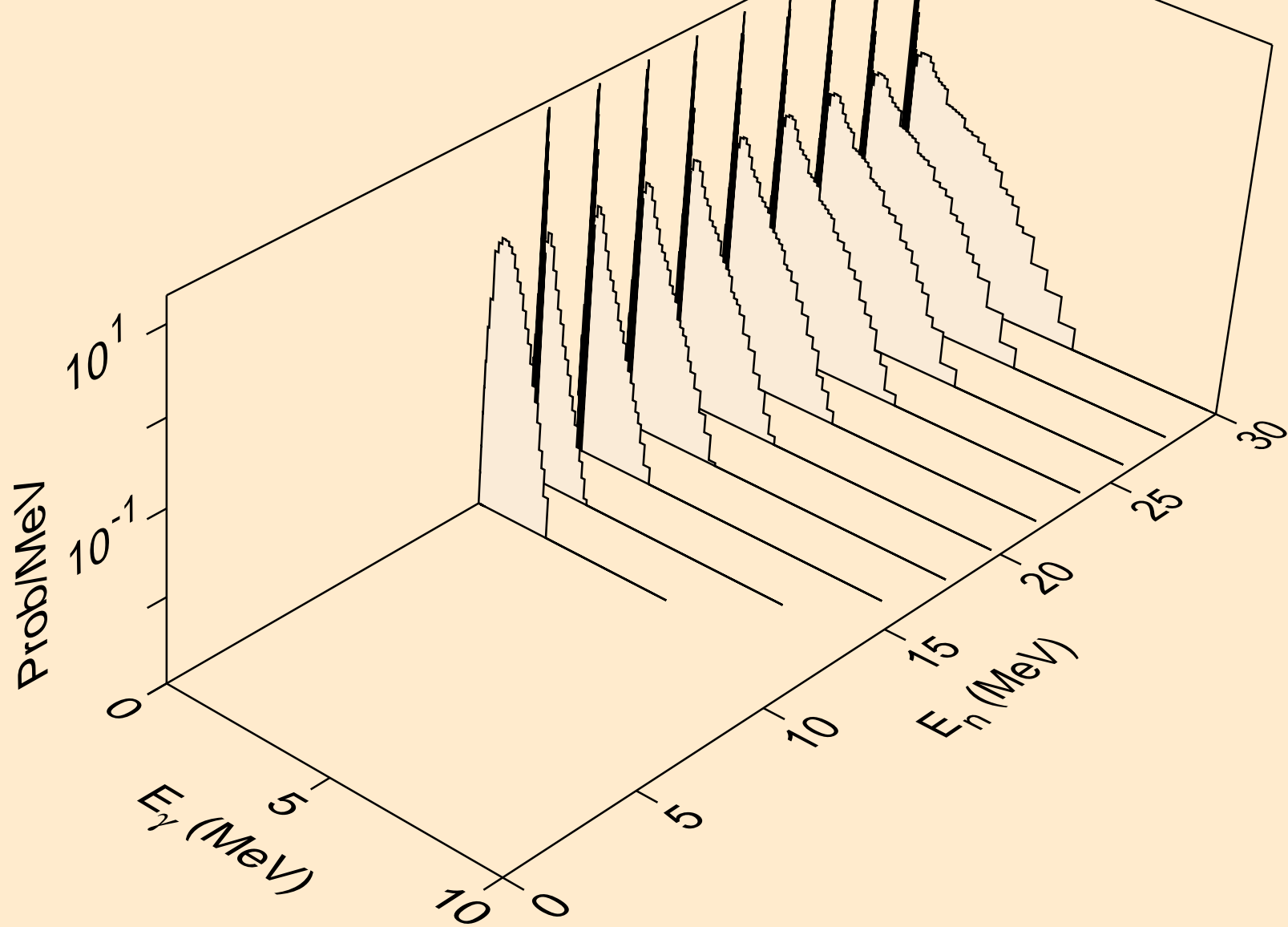

YB162 NEUTRON ACER TENDL-2021 LIBRARY; T=293.6K  
thermal capture photon spectrum

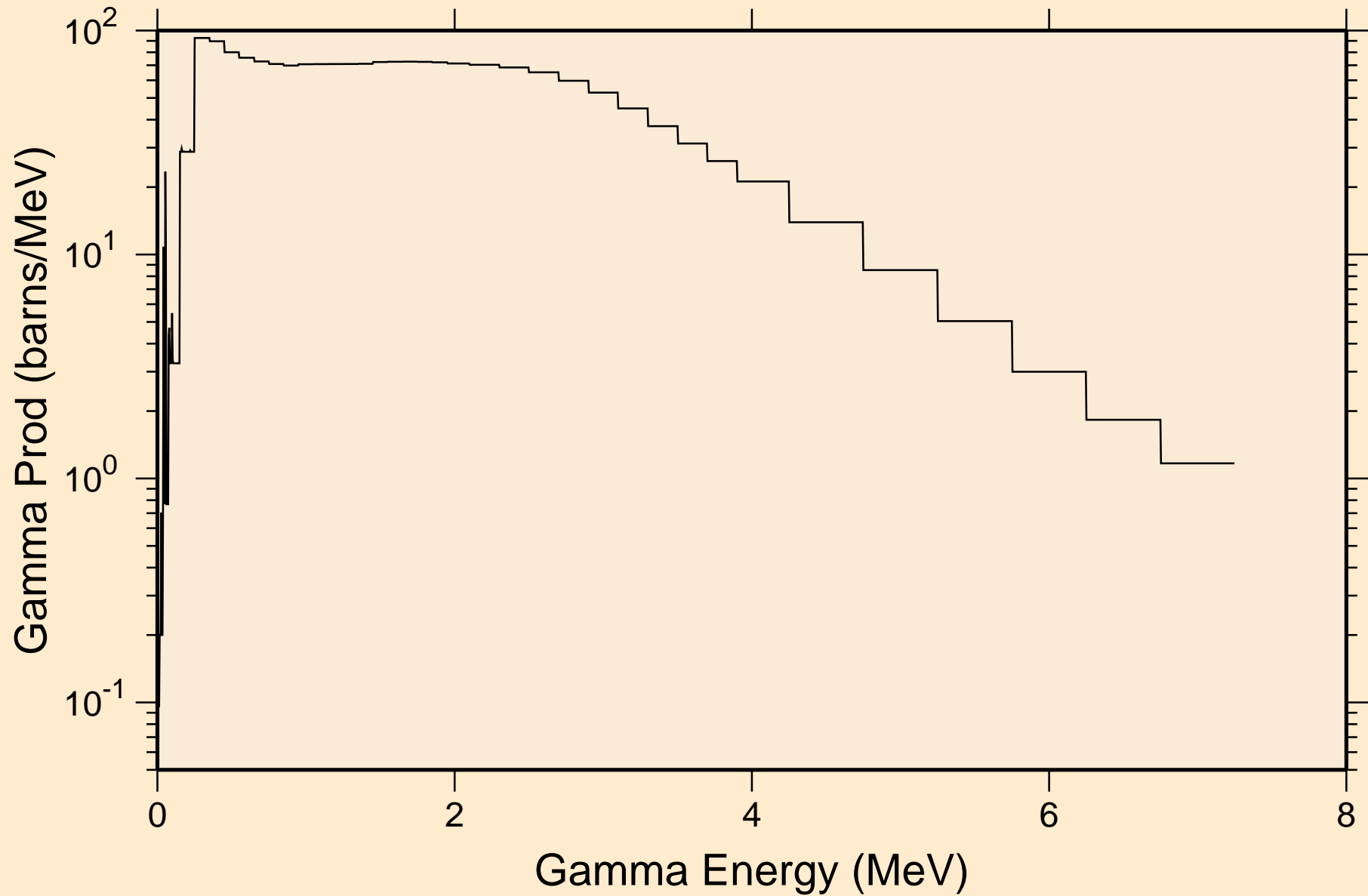



YB162 NEUTRON ACER TENDL-2021 LIBRARY; T=293.6K  
14 MeV photon spectrum

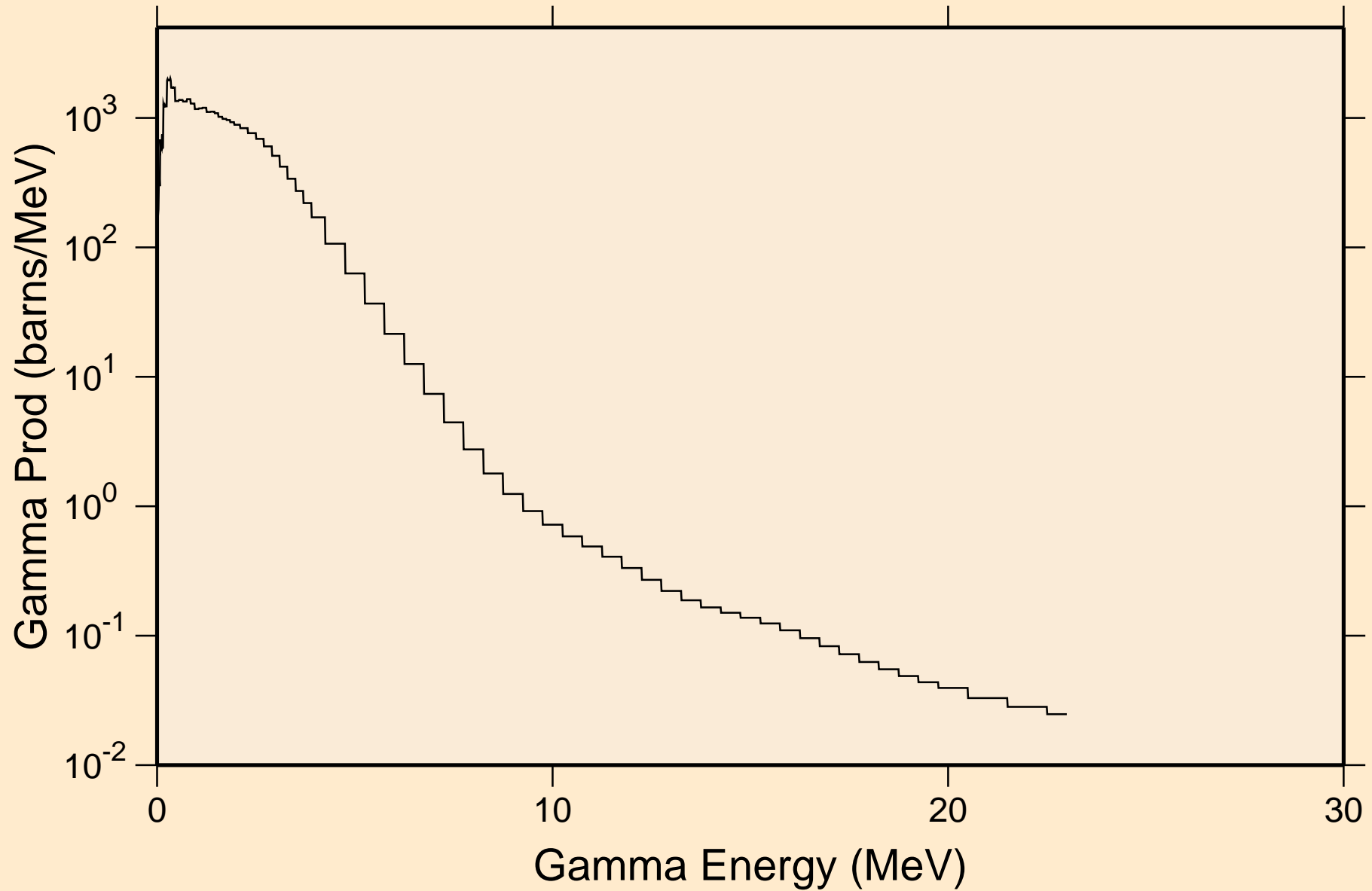

# YB162 NEUTRON ACER TENDL-2021 LIBRARY; T=293.6K

## Particle heating contributions

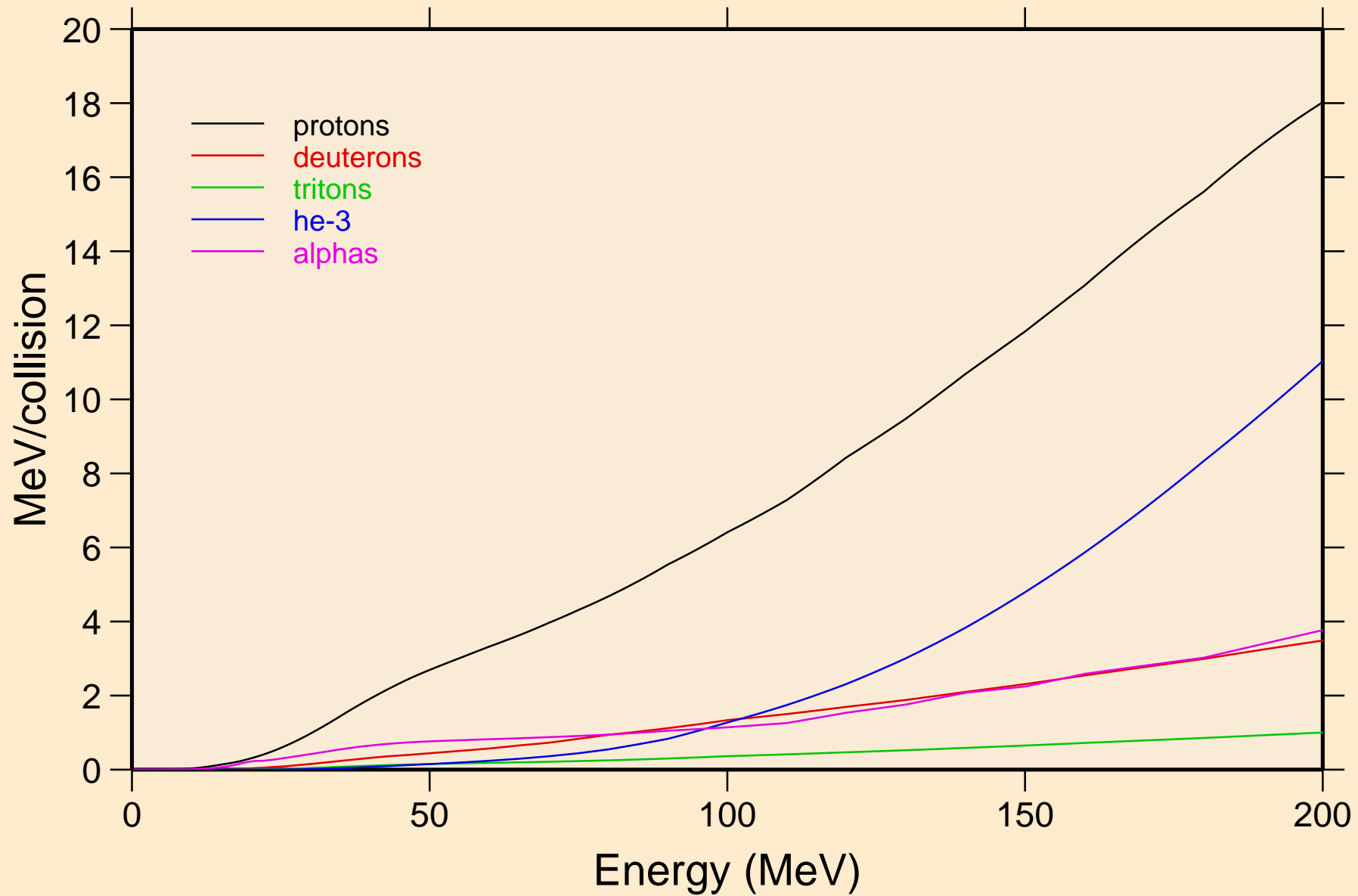

YB162 NEUTRON ACER TENDL-2021 LIBRARY; T=293.6K  
Recoil Heating

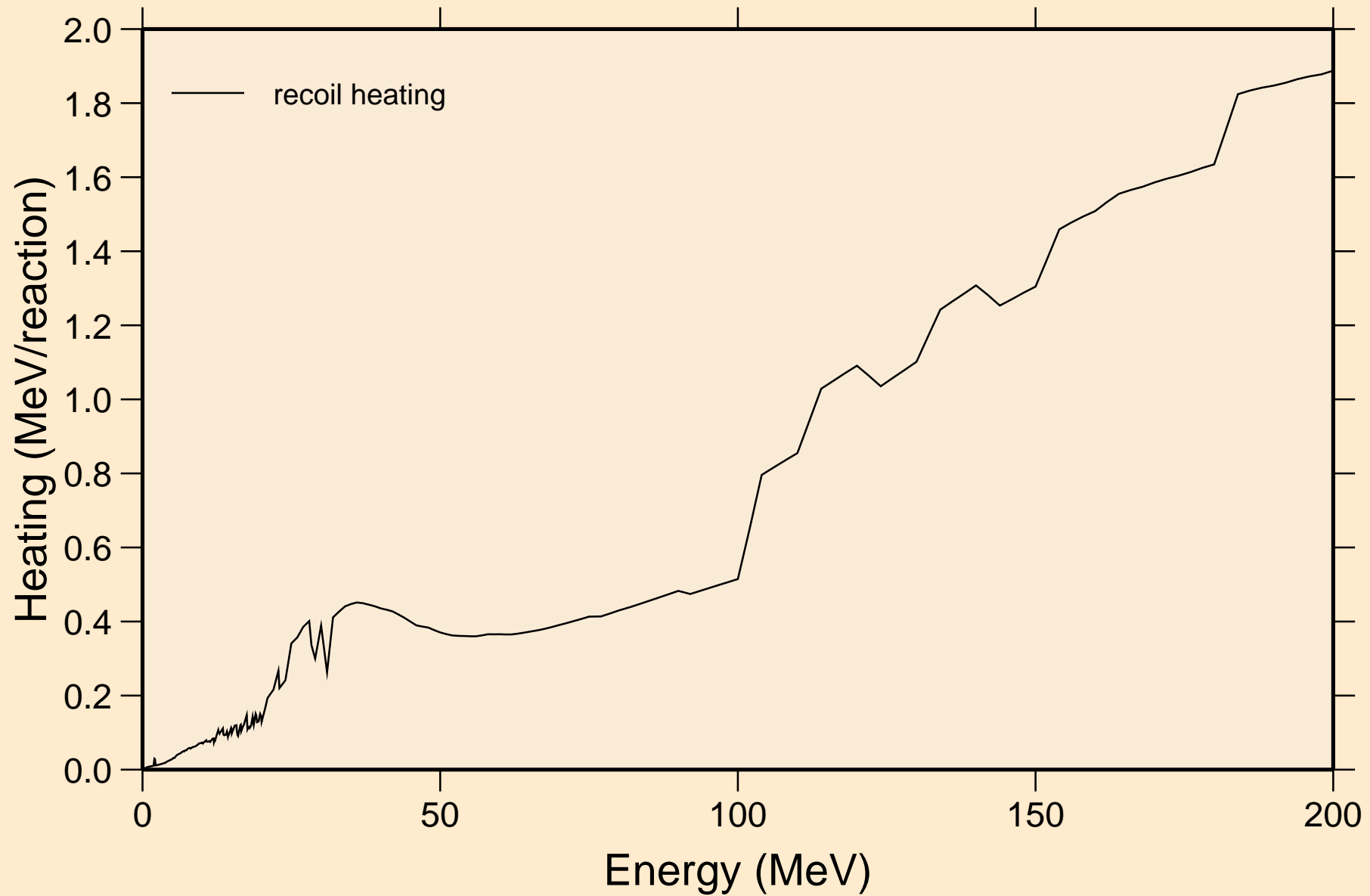

YB162 NEUTRON ACER TENDL-2021 LIBRARY; T=293.6K  
Particle production cross sections

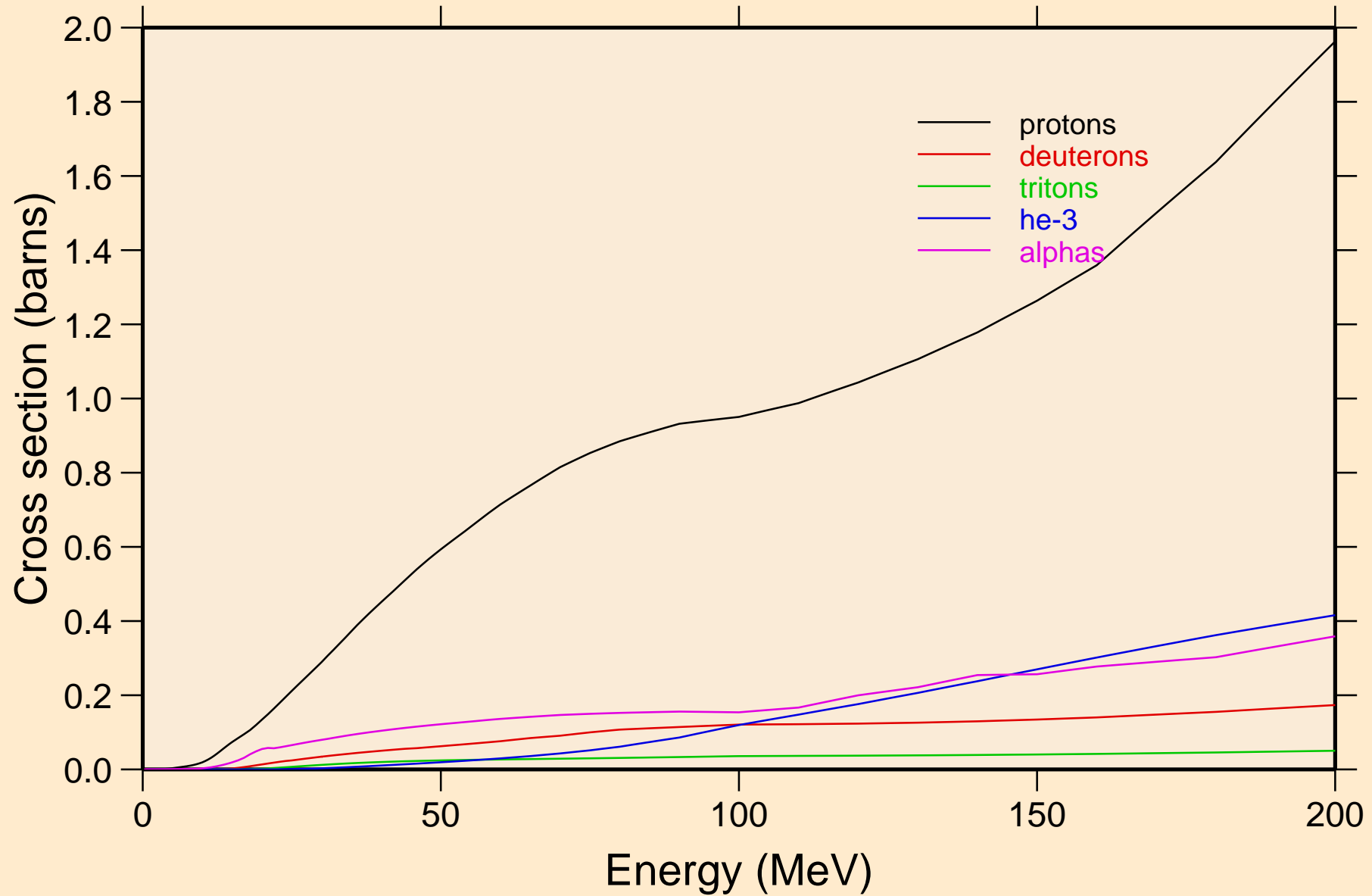

YB162 NEUTRON ACER TENDL-2021 LIBRARY; T=293.6K  
protons from (n,x)

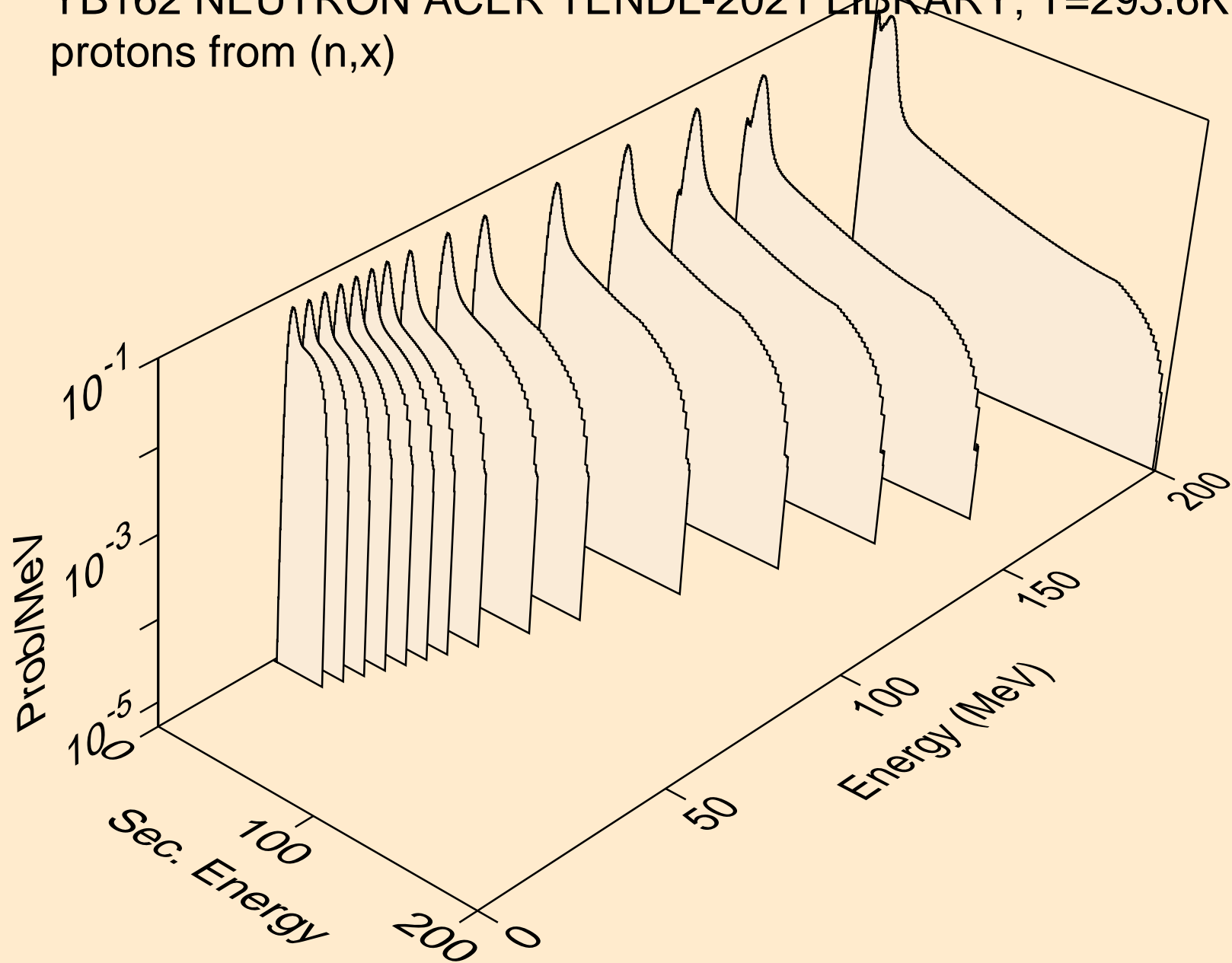

YB162 NEUTRON ACER TENDL-2021 LIBRARY; T=293.6K  
protons from (n,n\*)p

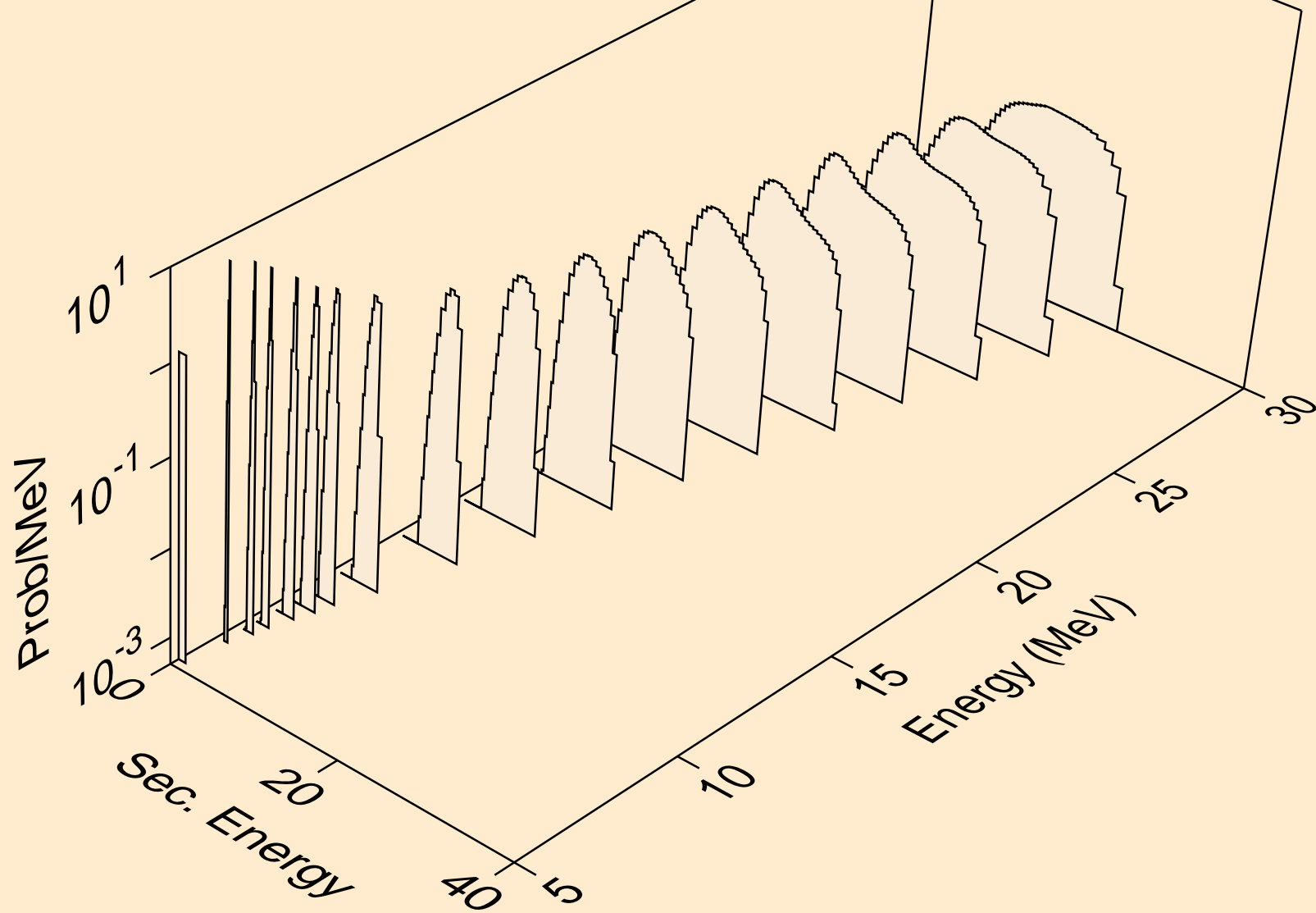

YB162 NEUTRON ACER TENDL-2021 LIBRARY; T=293.6K  
protons from (n,2np)

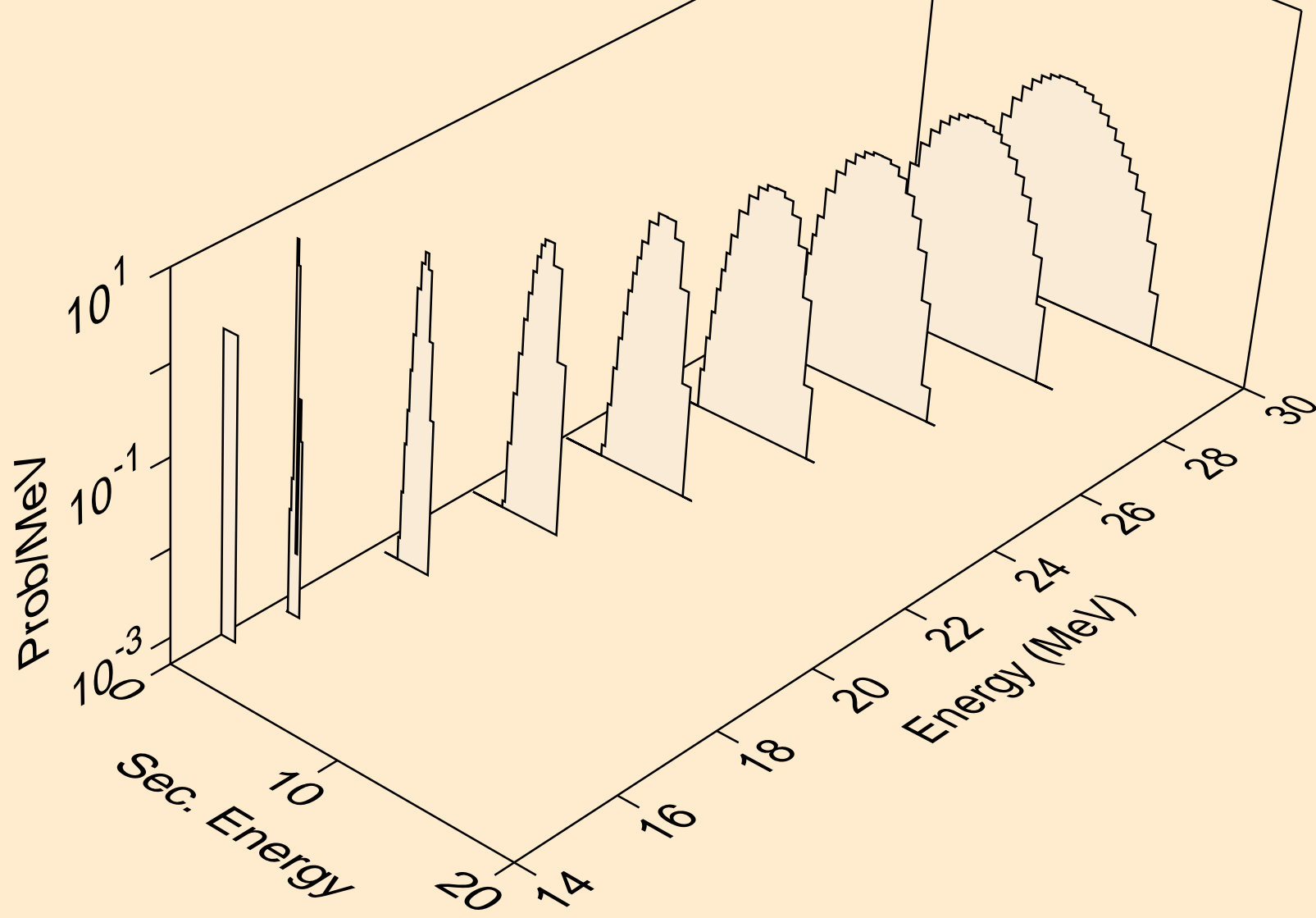

YB162 NEUTRON ACER TENDL-2021 LIBRARY; T=293.6K  
protons from (n,3np)

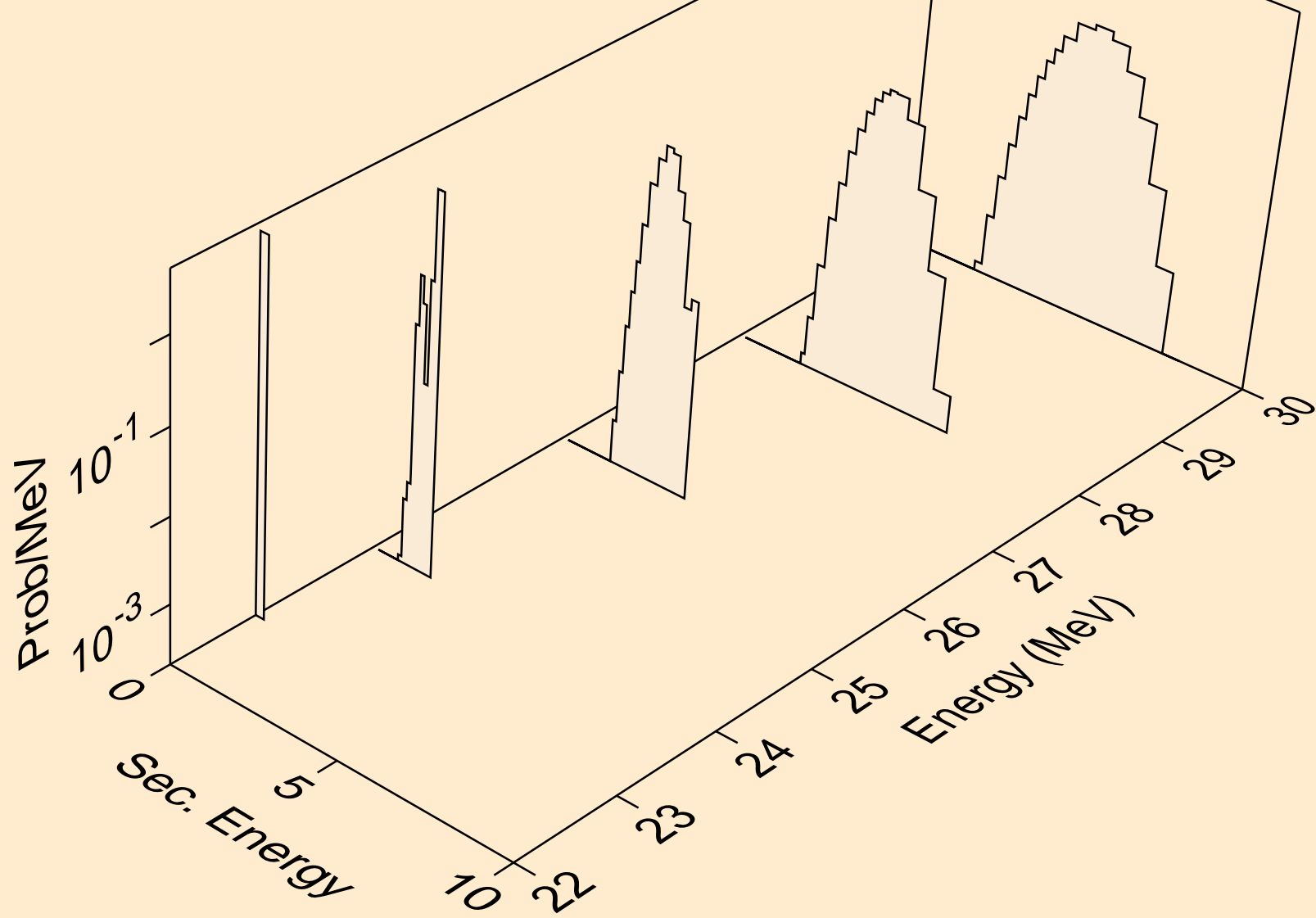



YB162 NEUTRON ACER TENDL-2021 LIBRARY; T=293.6K  
protons from (n,2np)

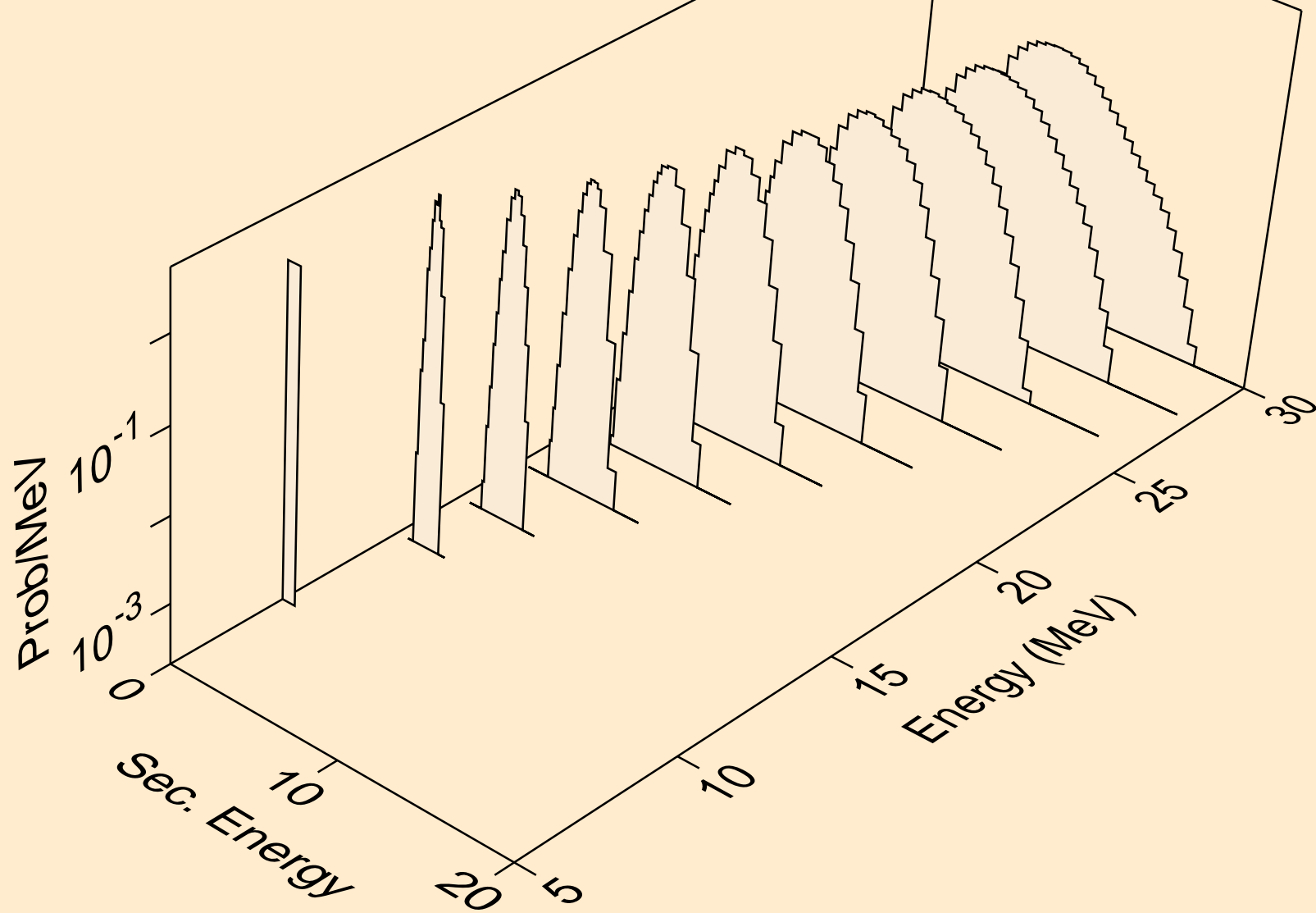

YB162 NEUTRON ACER TENDL-2021 LIBRARY; T=293.6K  
protons from (n,npa)

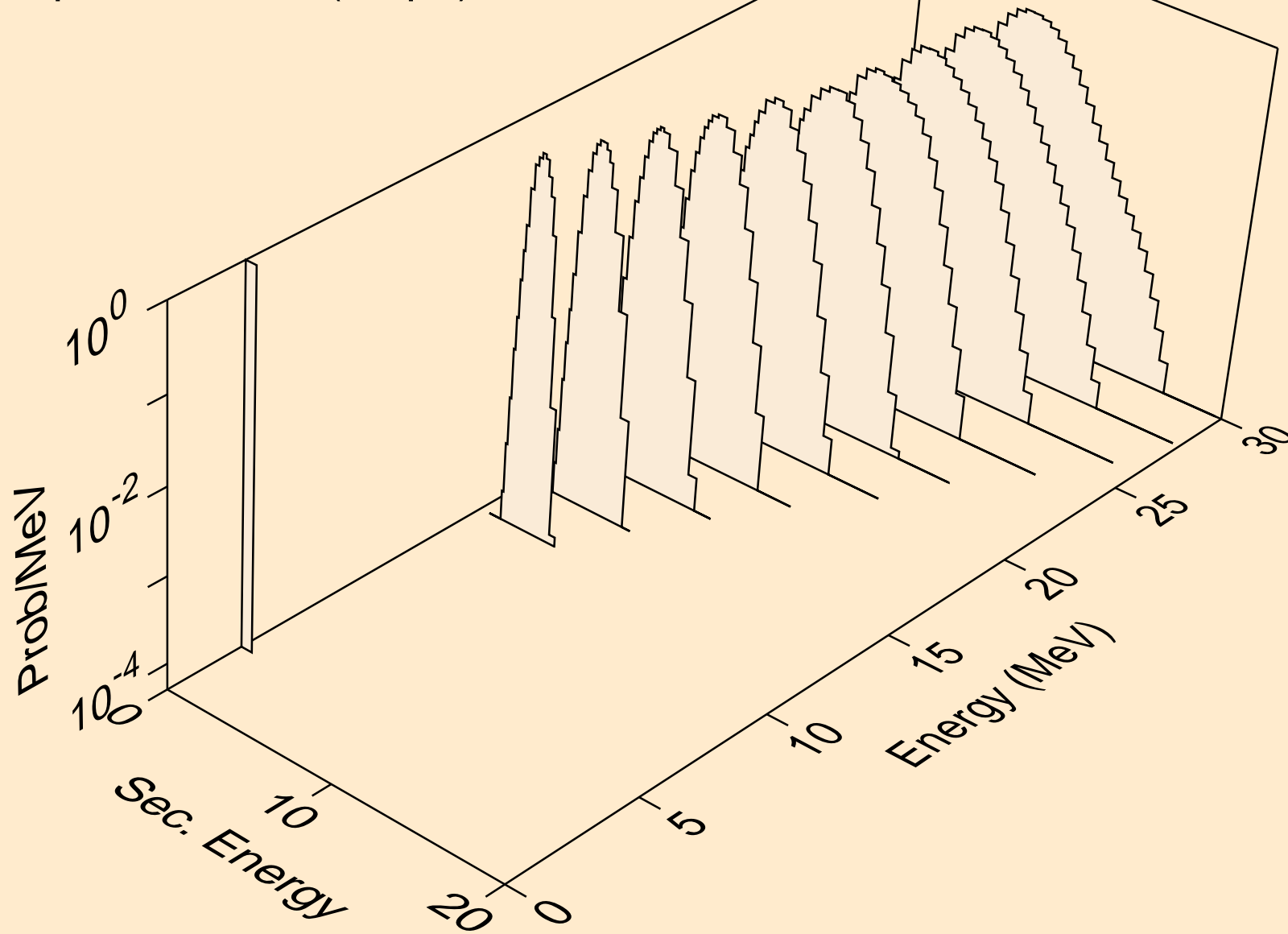

YB162 NEUTRON ACER TENDL-2021 LIBRARY; T=293.6K  
protons from (n,p)

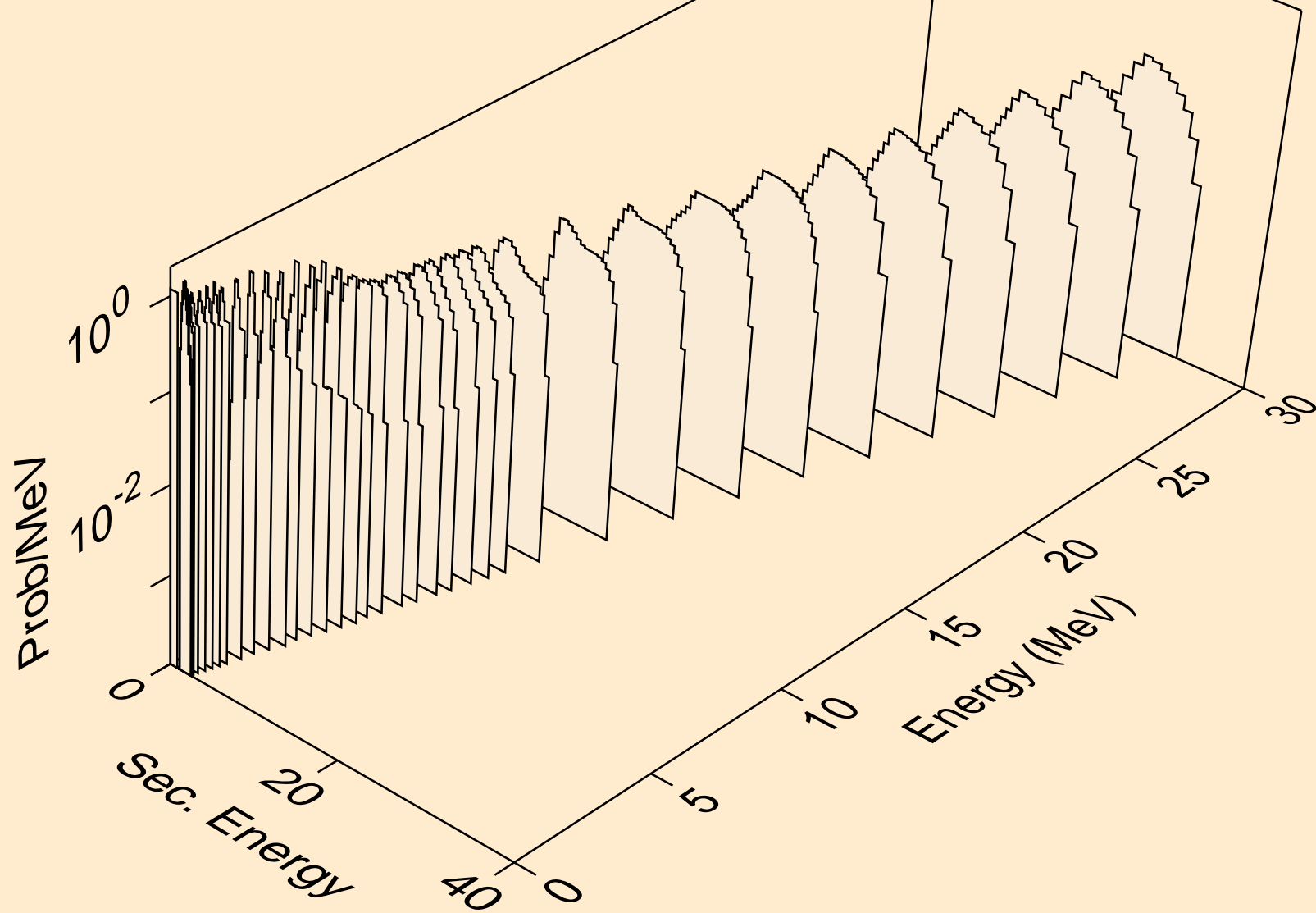

YB162 NEUTRON ACER TENDL-2021 LIBRARY; T=293.6K  
protons from (n,2p)

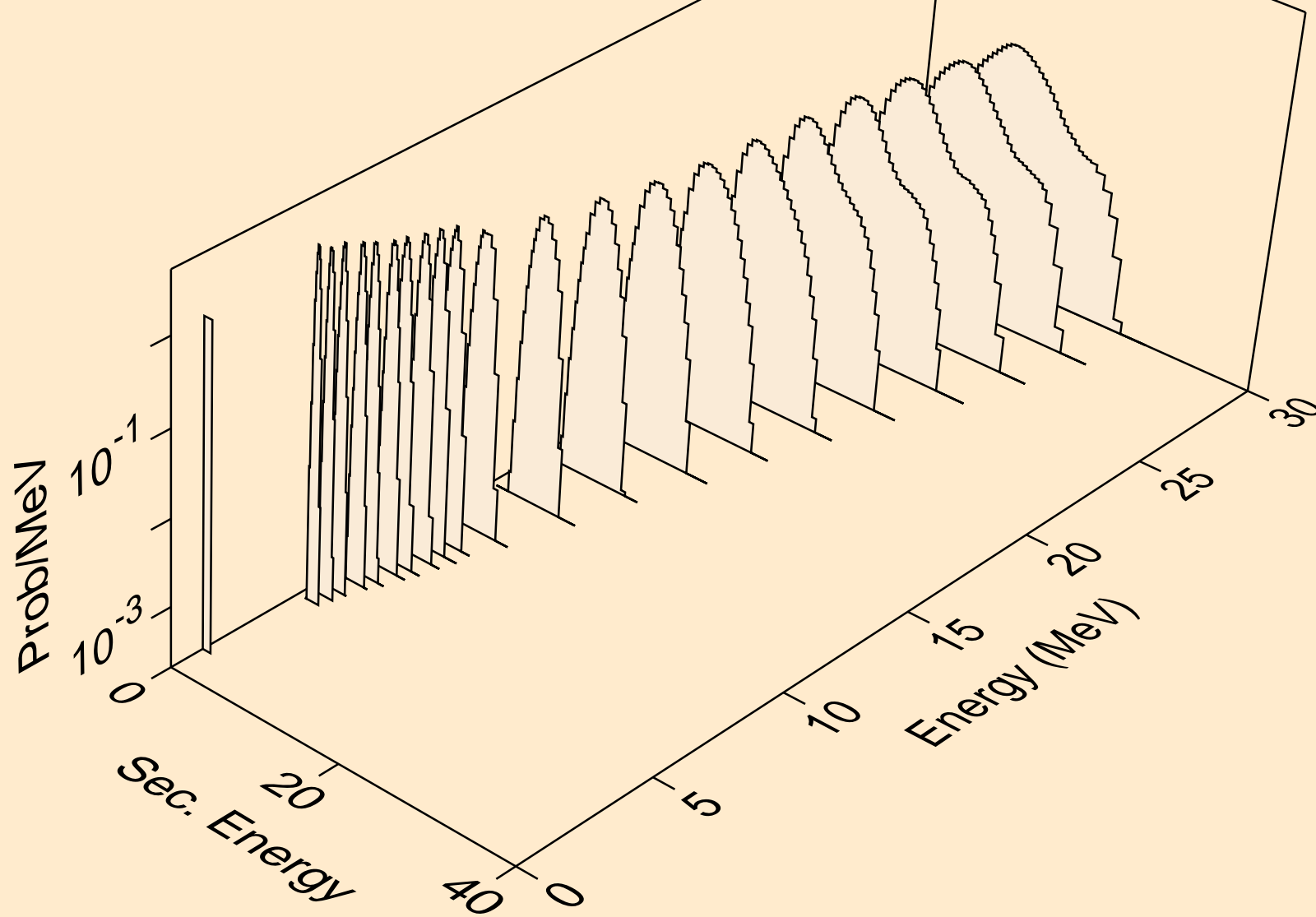

YB162 NEUTRON ACER TENDL-2021 LIBRARY; T=293.6K  
protons from (n,p)

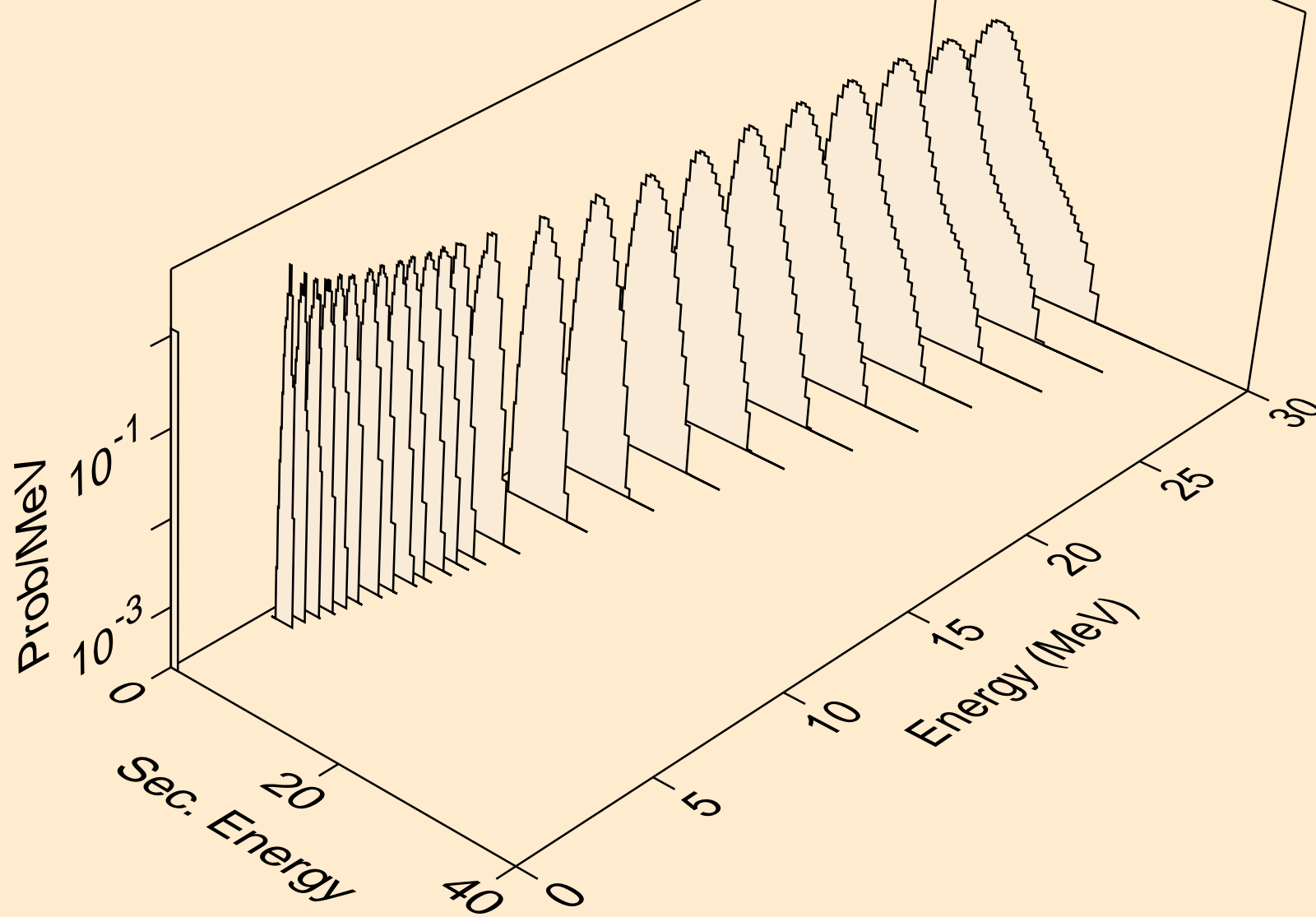

YB162 NEUTRON ACER TENDL-2021 LIBRARY; T=293.6K  
protons from (n,pd)

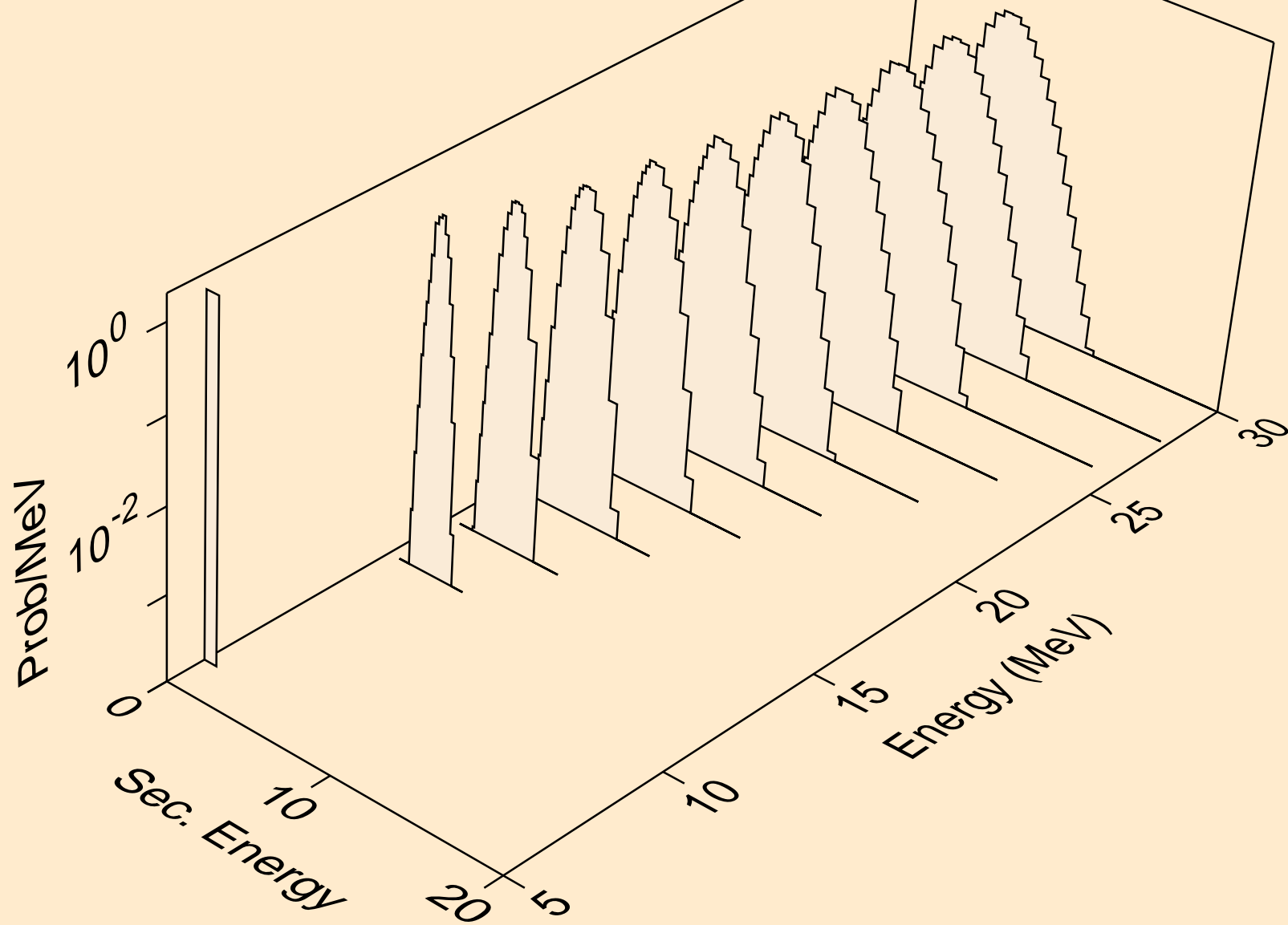

YB162 NEUTRON ACER TENDL-2021 LIBRARY; T=293.6K  
protons from (n,pt)

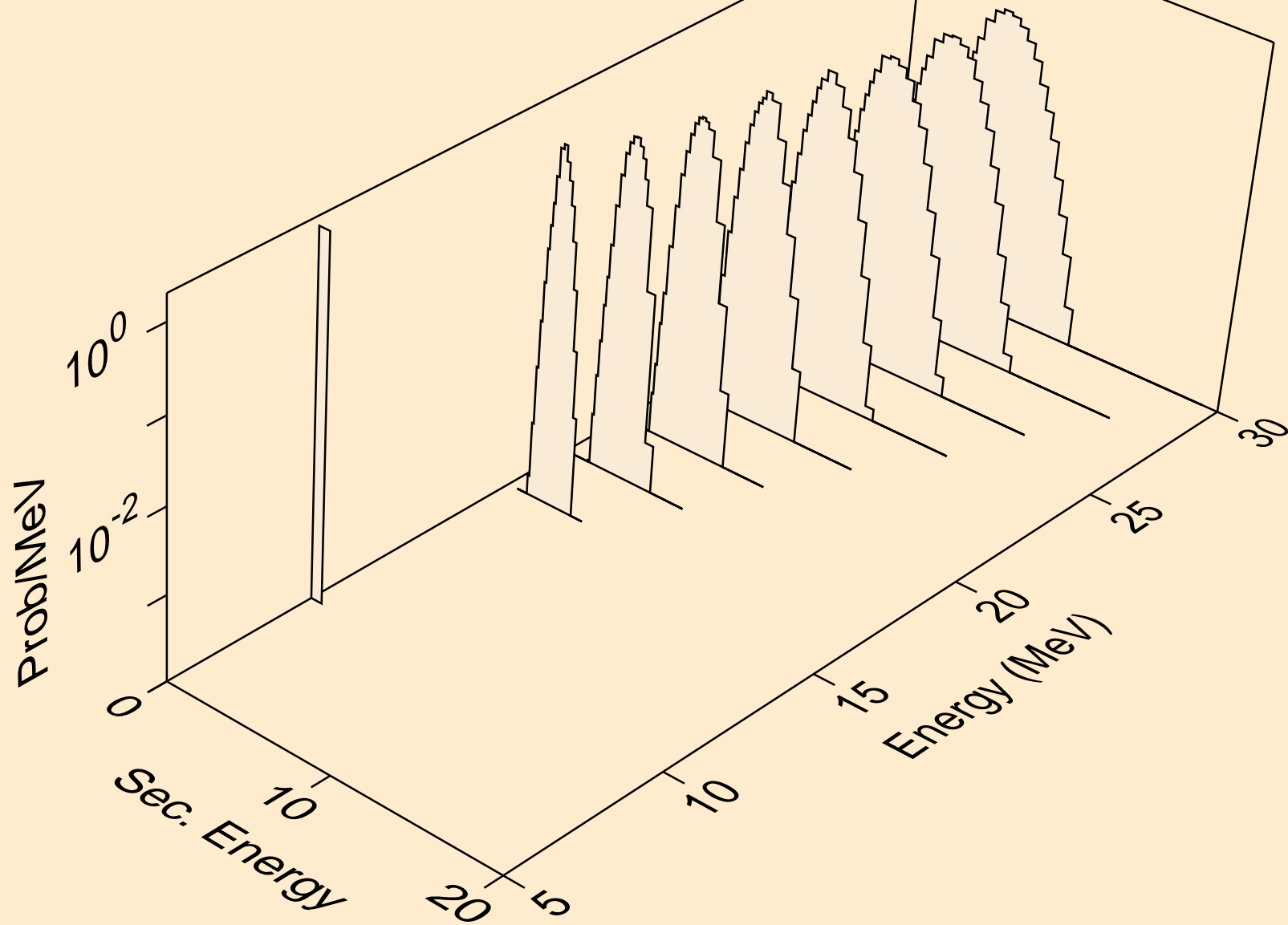

YB162 NEUTRON ACER TENDL-2021 LIBRARY; T=293.6K  
deuterons from (n,x)

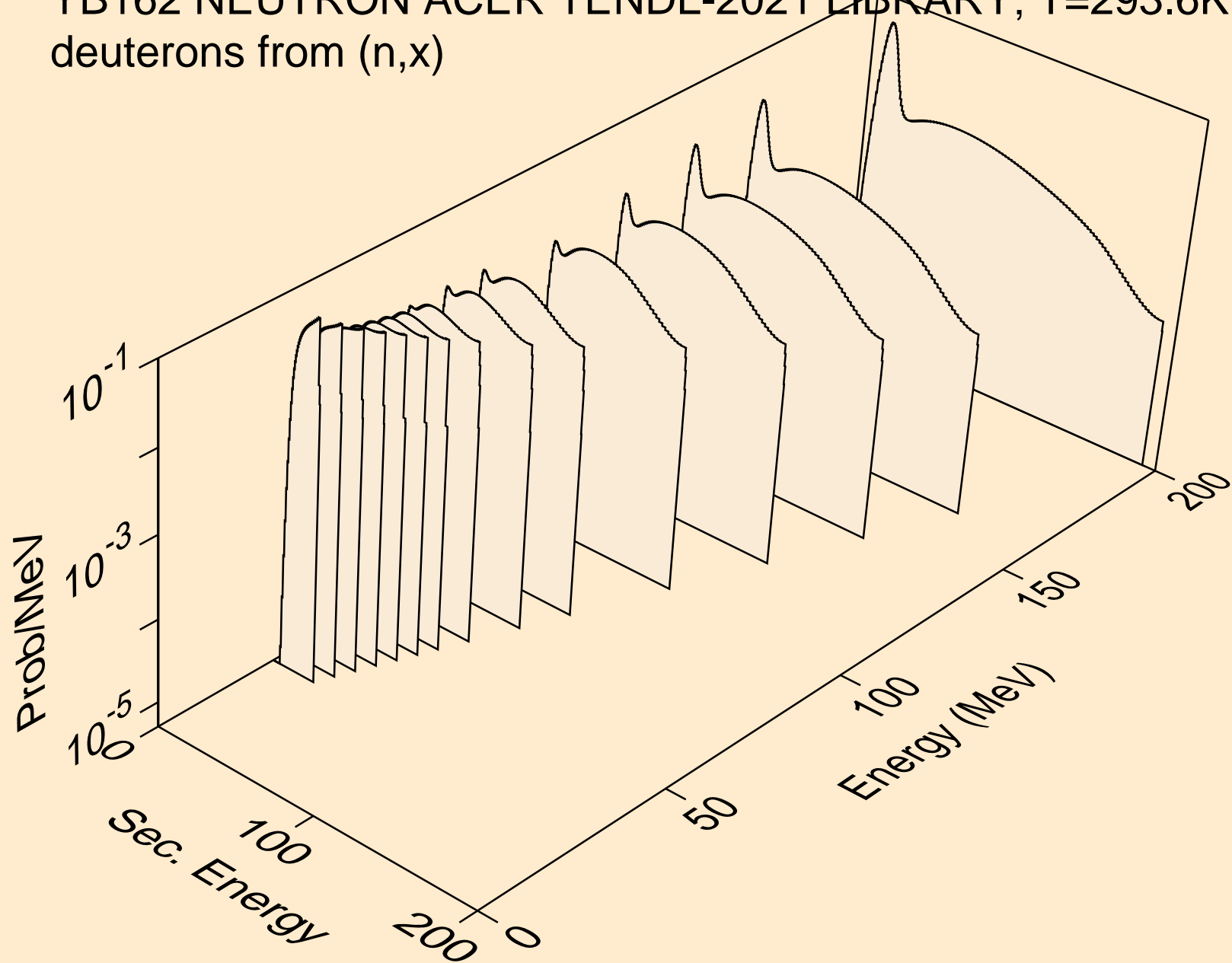



YB162 NEUTRON ACER TENDL-2021 LIBRARY; T=293.6K  
deuterons from (n,2nd)

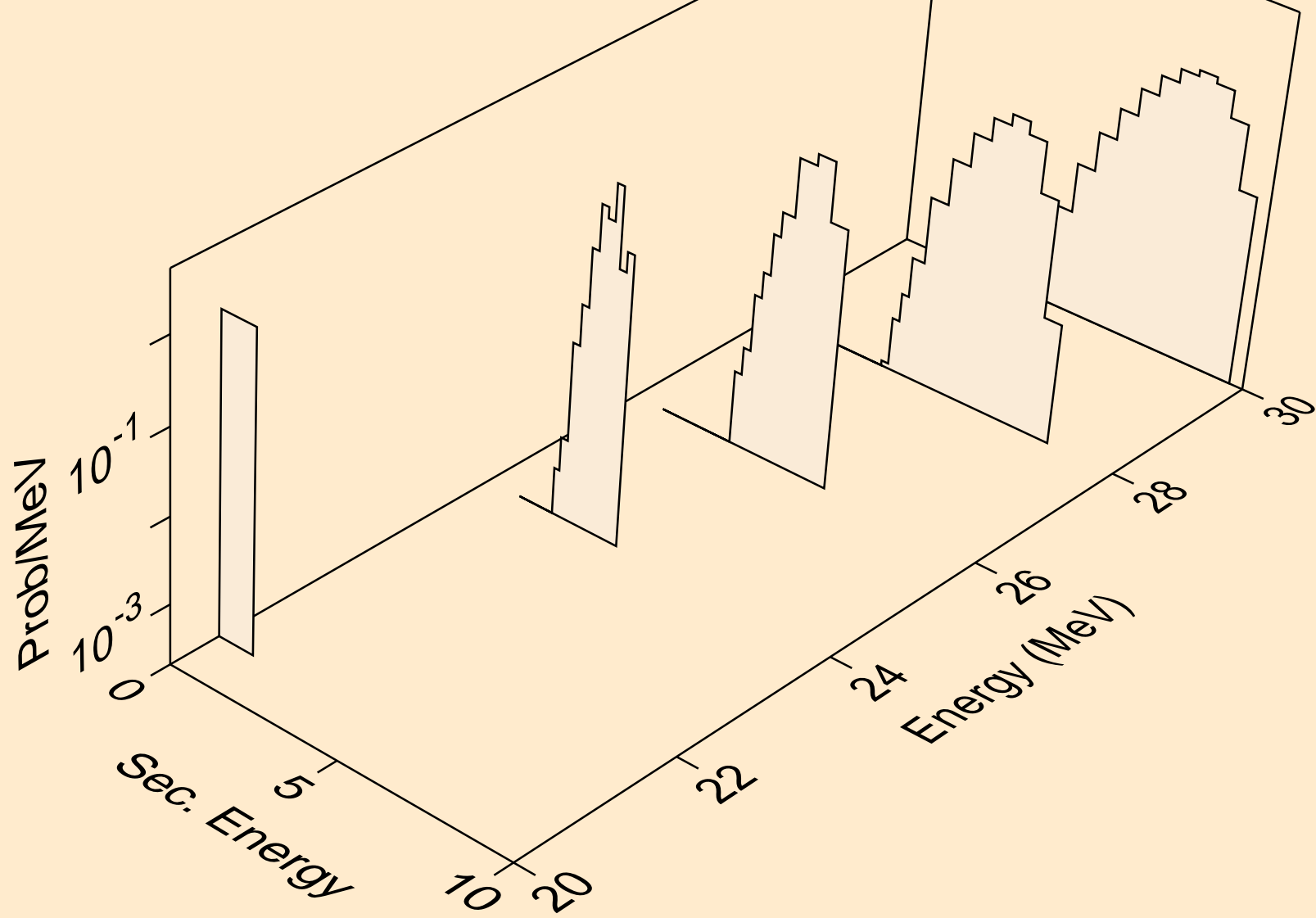

YB162 NEUTRON ACER TENDL-2021 LIBRARY; T=293.6K  
deuterons from (n,n\*)d

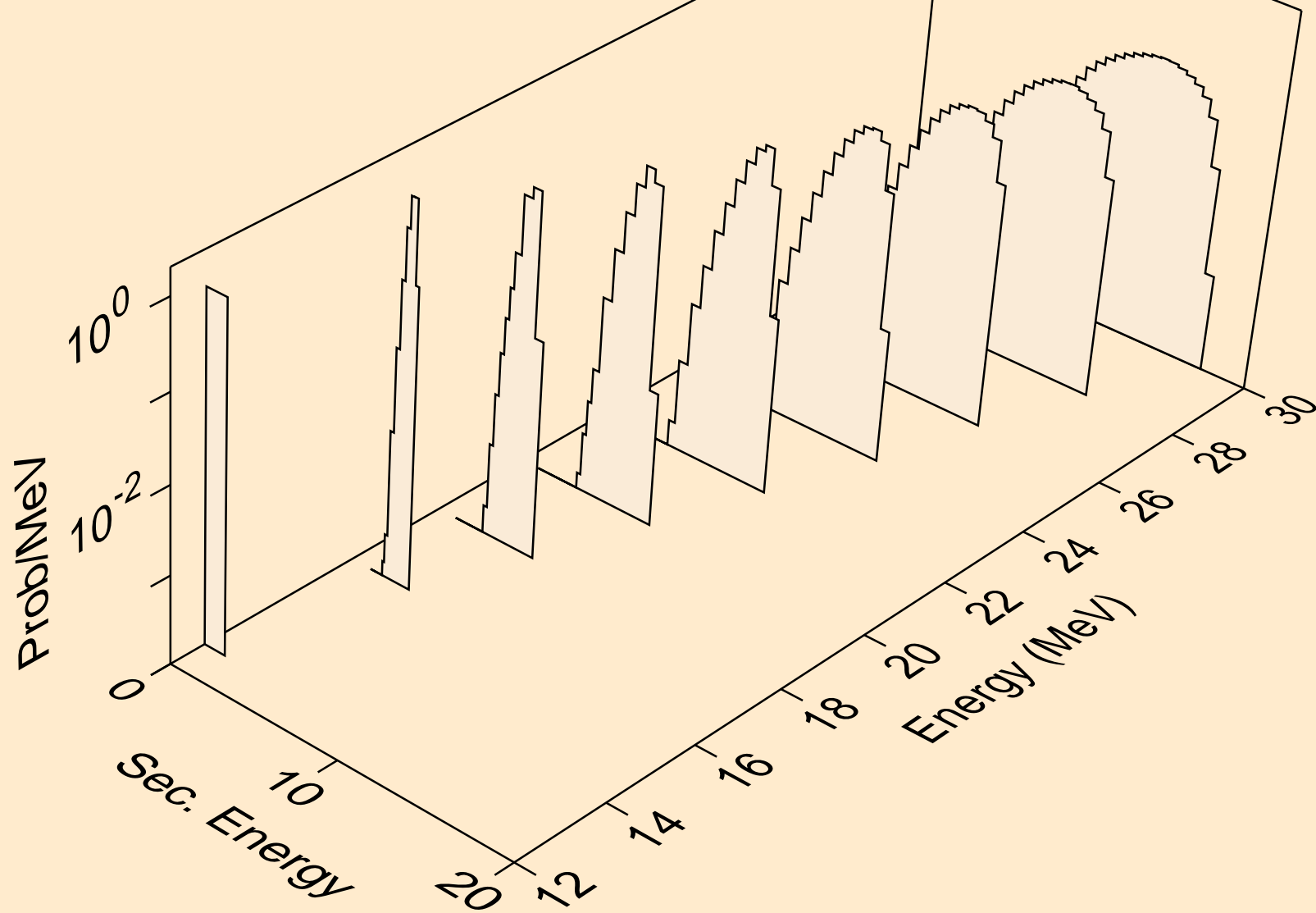

YB162 NEUTRON ACER TENDL-2021 LIBRARY; T=293.6K  
deuterons from (n,d)

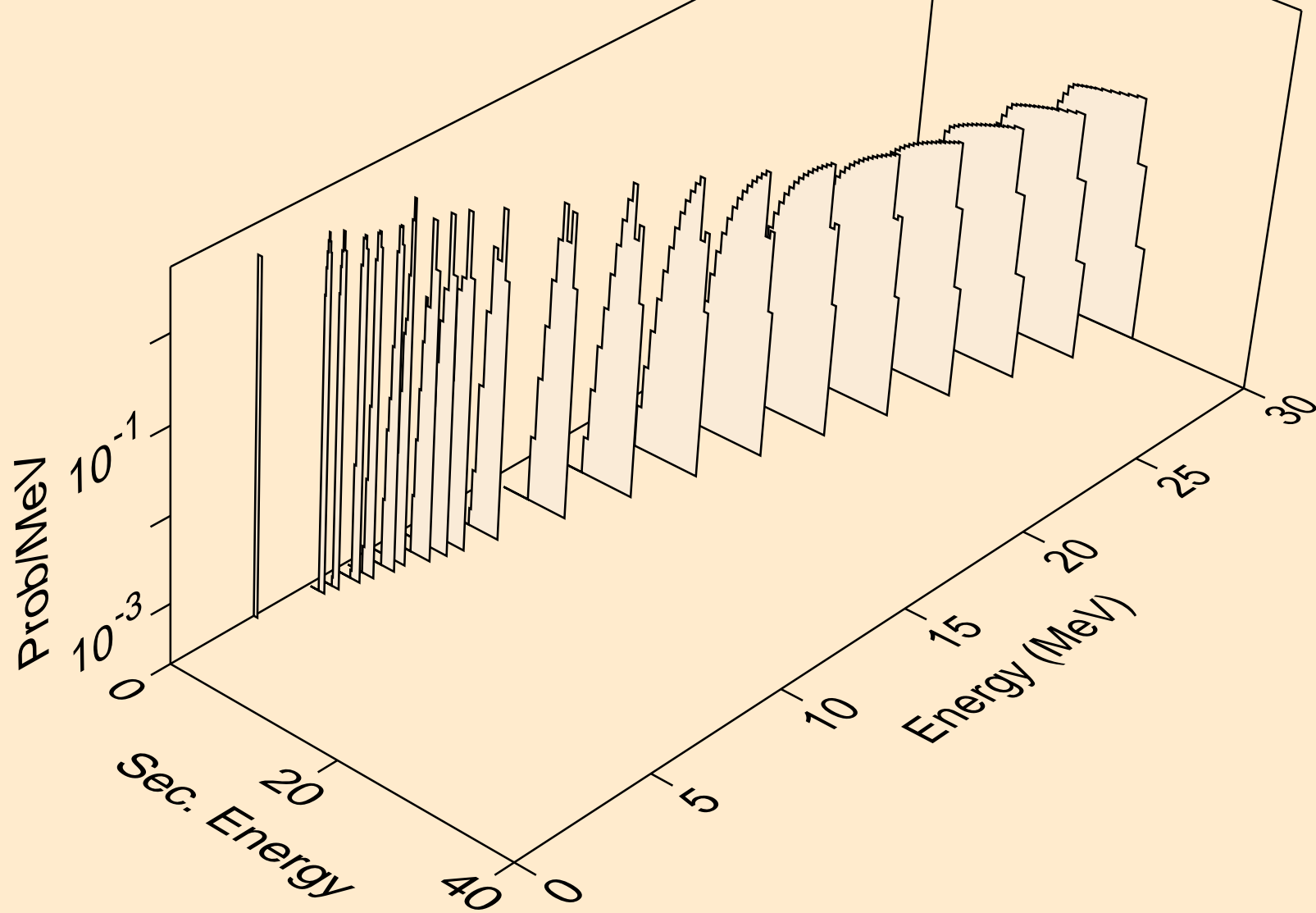

YB162 NEUTRON ACER TENDL-2021 LIBRARY; T=293.6K  
deuterons from (n,pd)

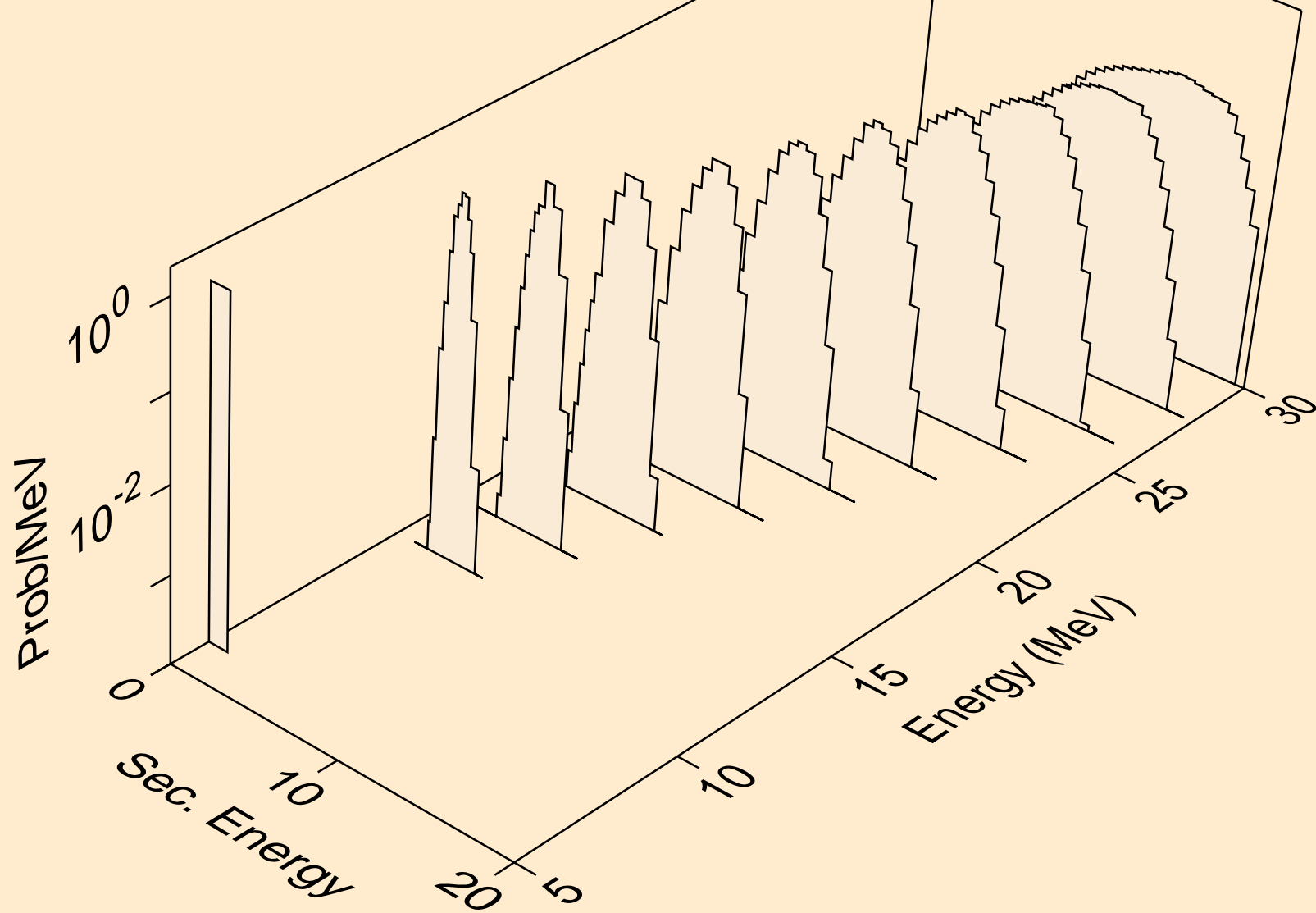

YB162 NEUTRON ACER TENDL-2021 LIBRARY; T=293.6K  
deuterons from (n,da)

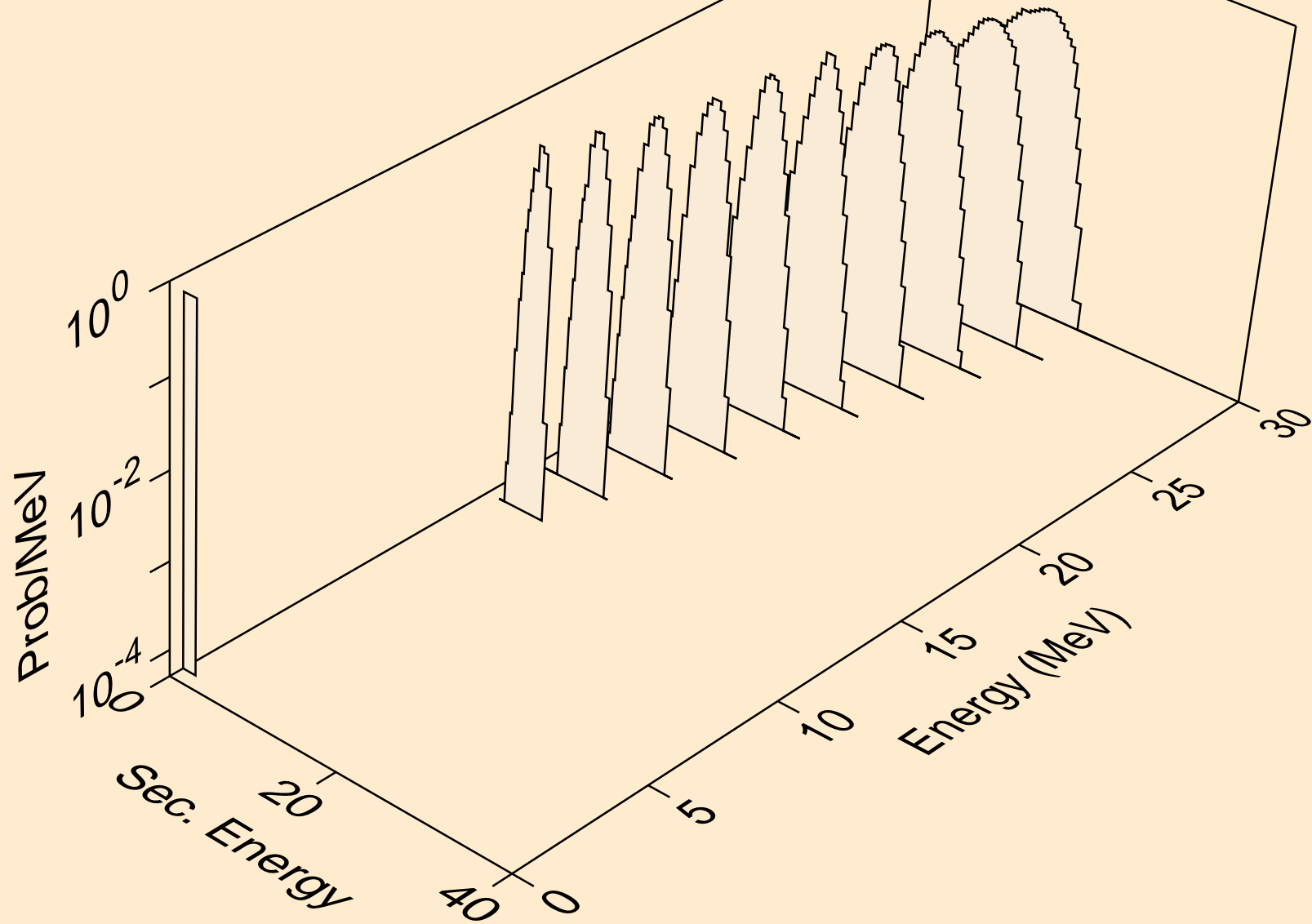

YB162 NEUTRON ACER TENDL-2021 LIBRARY; T=293.6K  
tritons from (n,x)

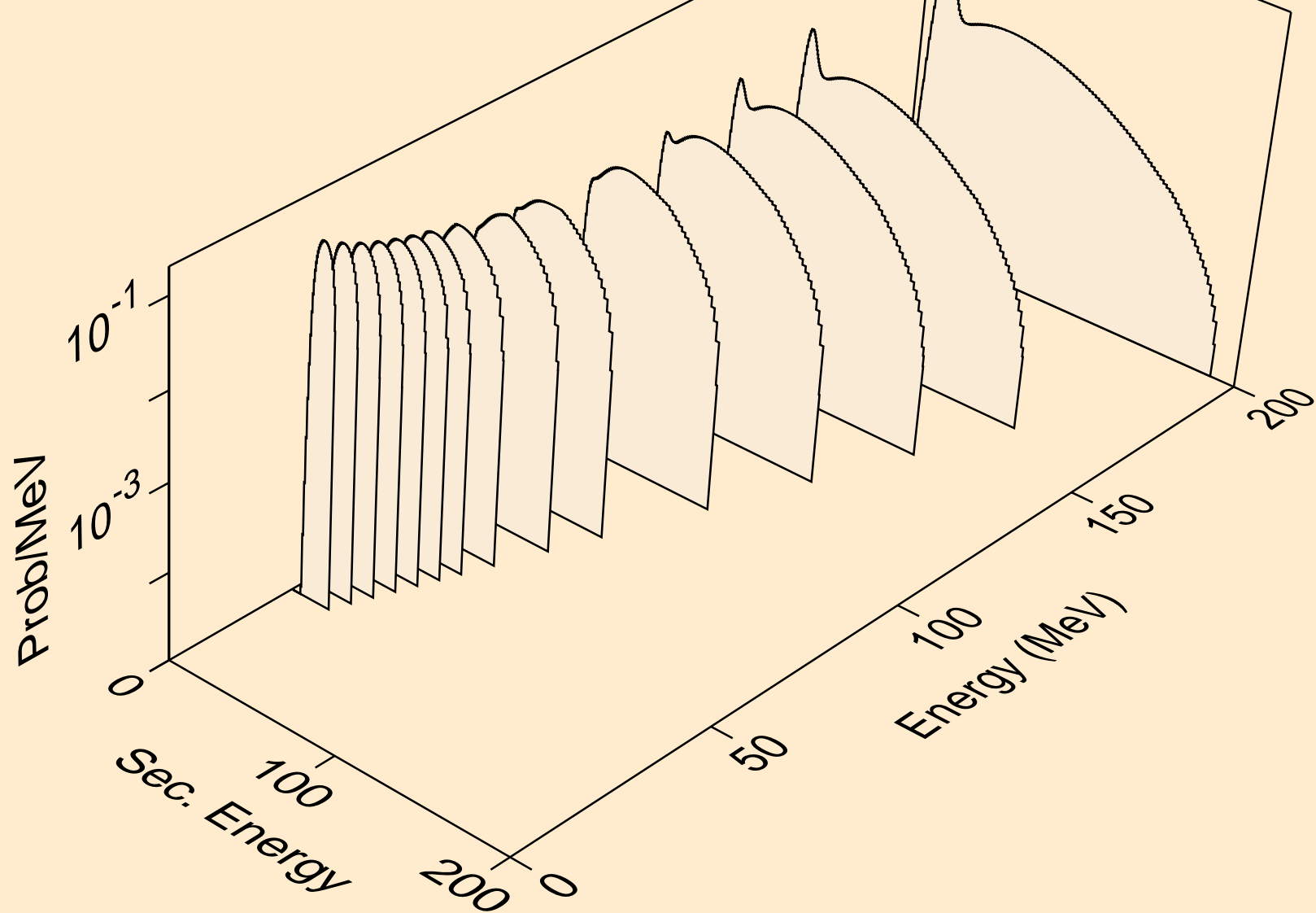

YB162 NEUTRON ACER TENDL-2021 LIBRARY; T=293.6K  
tritons from (n,n\*)t

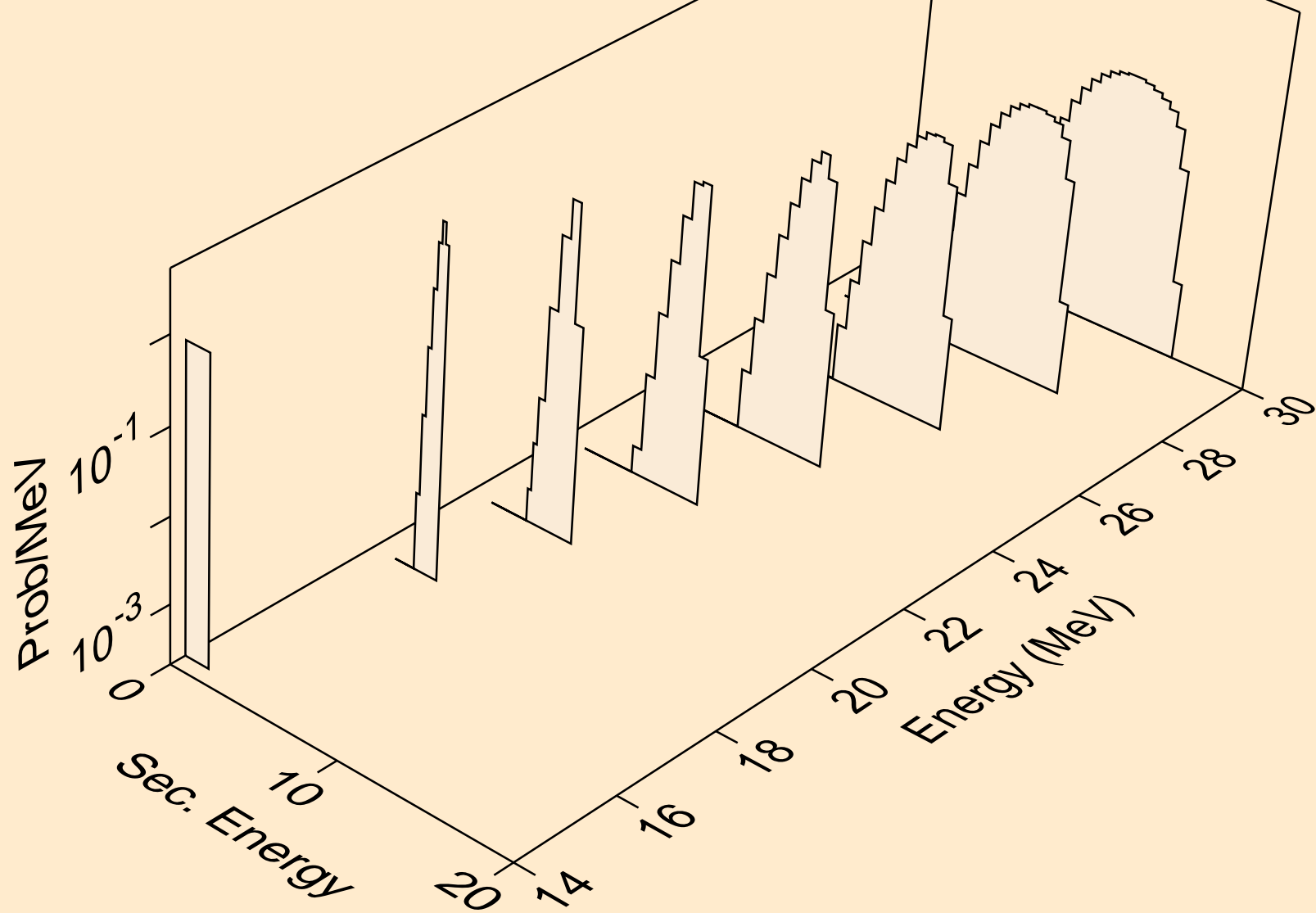

YB162 NEUTRON ACER TENDL-2021 LIBRARY; T=293.6K  
tritons from (n,t)

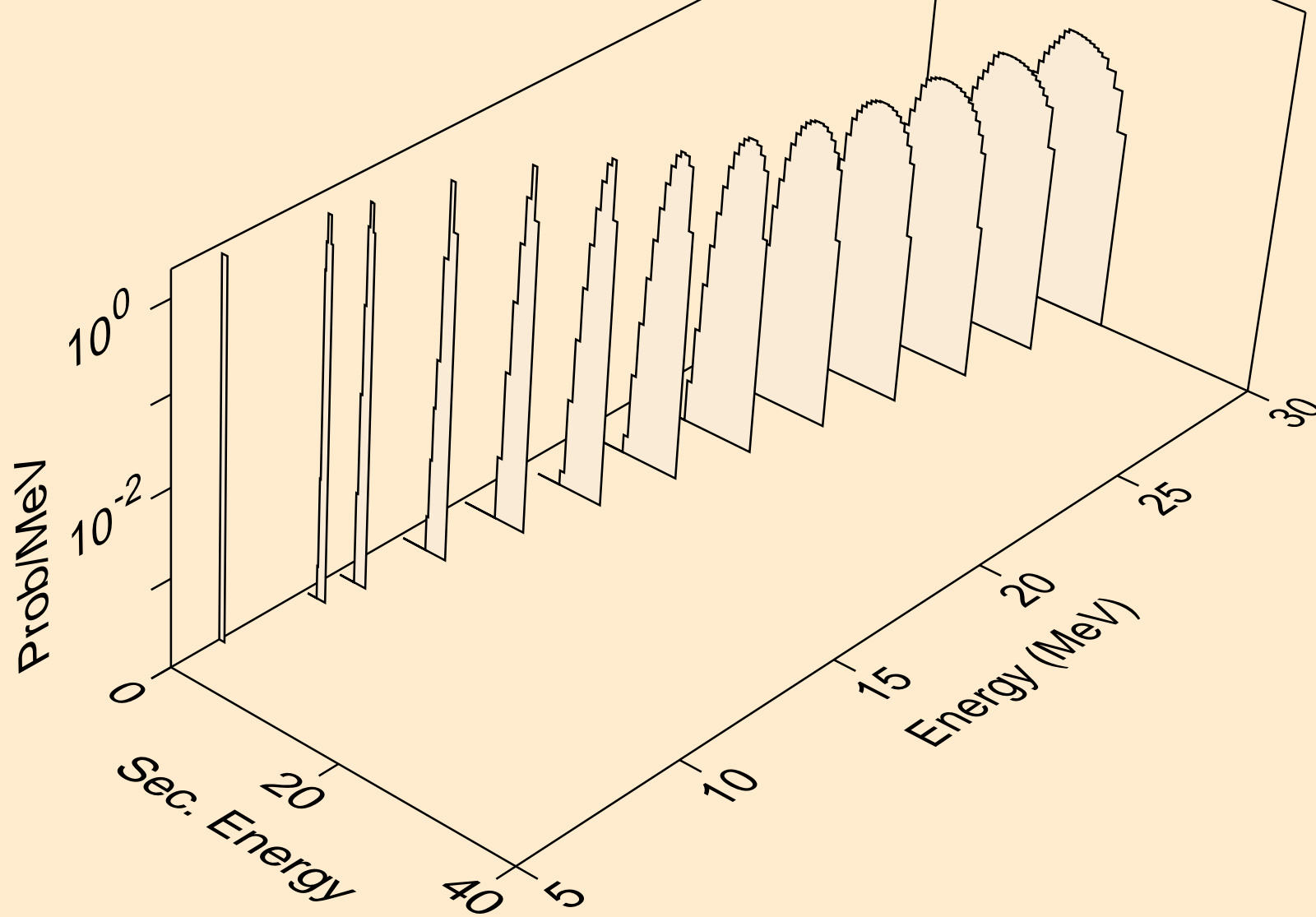



YB162 NEUTRON ACER TENDL-2021 LIBRARY; T=293.6K  
tritons from (n,pt)

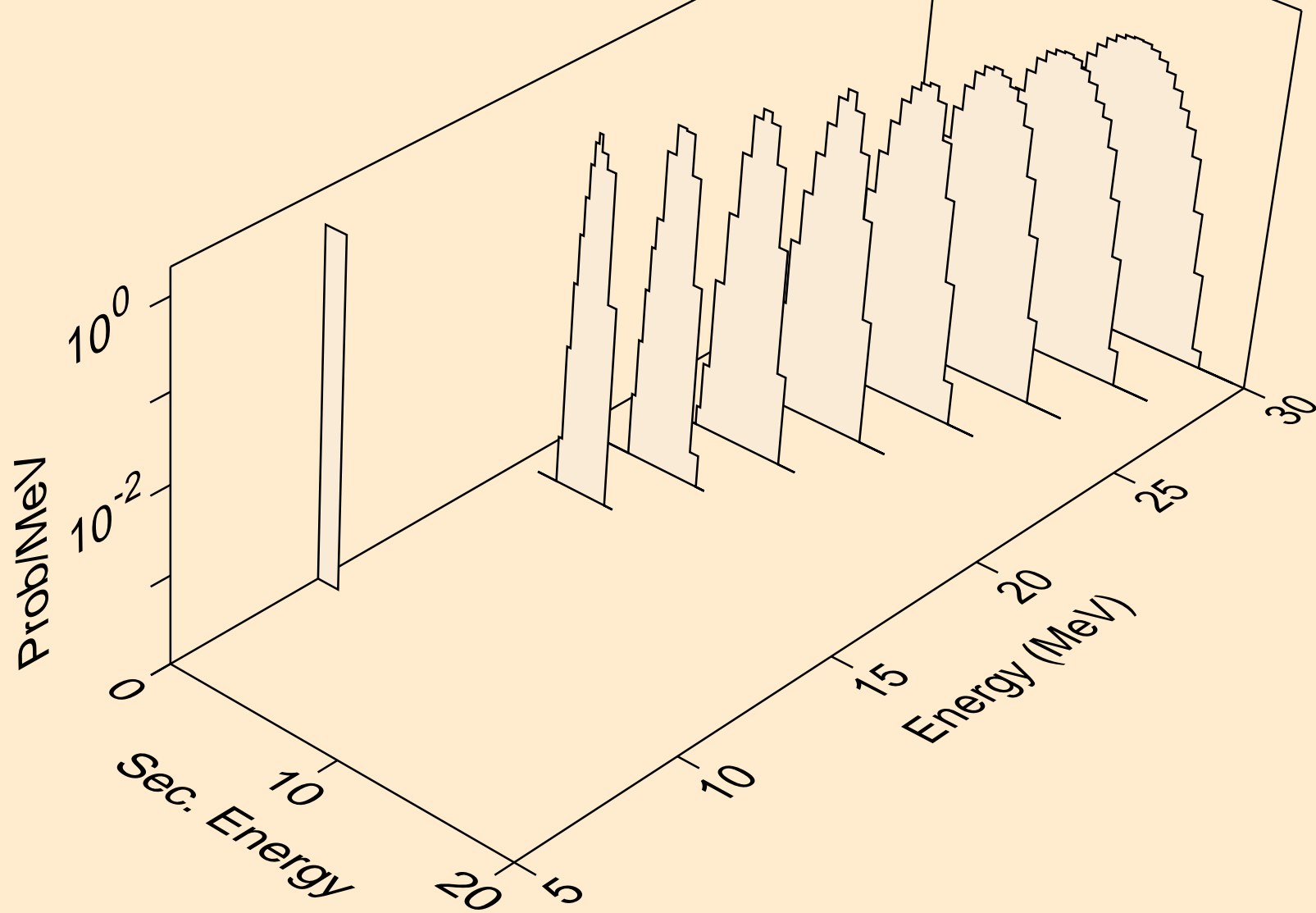

YB162 NEUTRON ACER TENDL-2021 LIBRARY; T=293.6K  
he3s from (n,x)

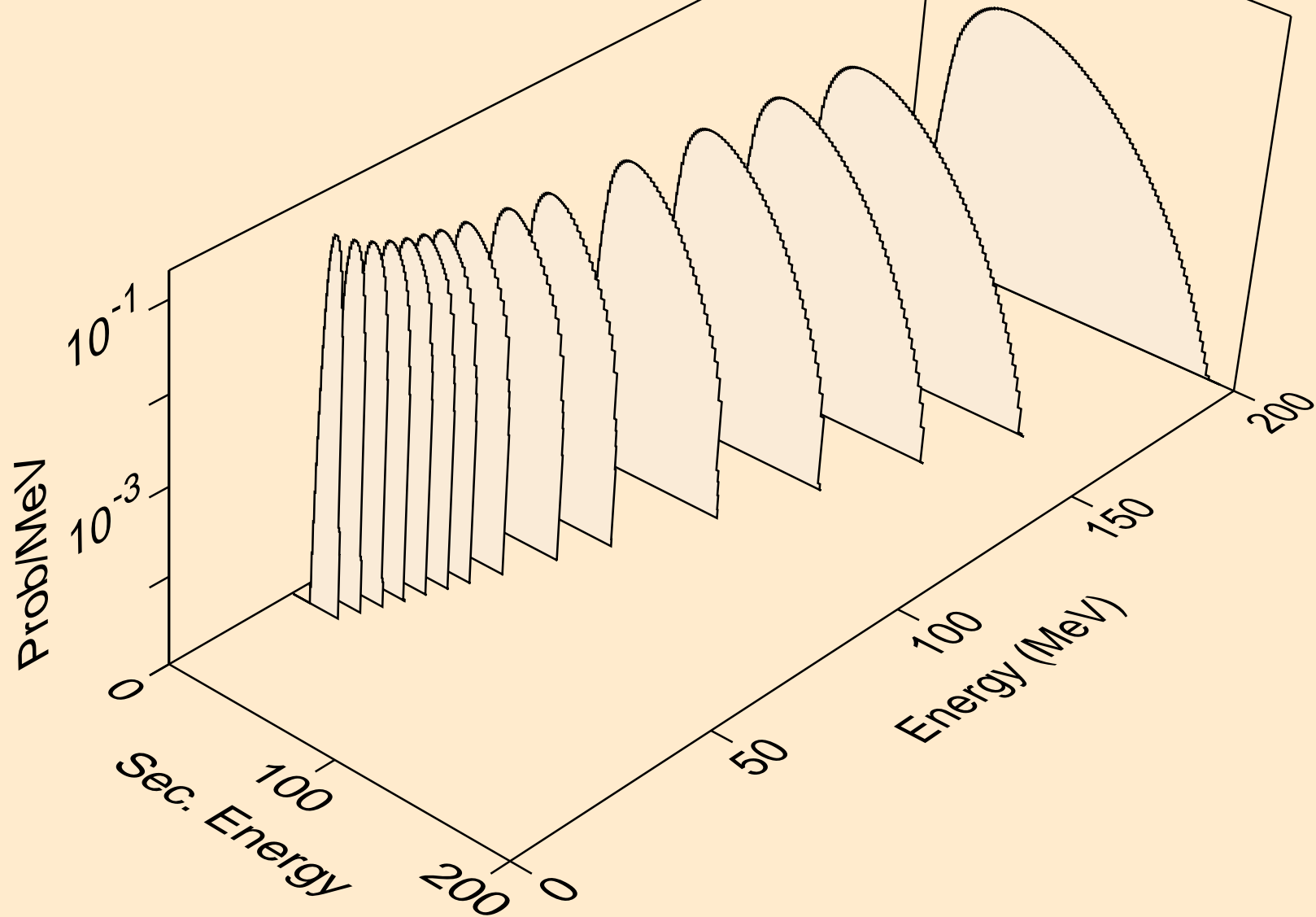

YB162 NEUTRON ACER TENDL-2021 LIBRARY; T=293.6K  
he3s from (n,n\*)he3

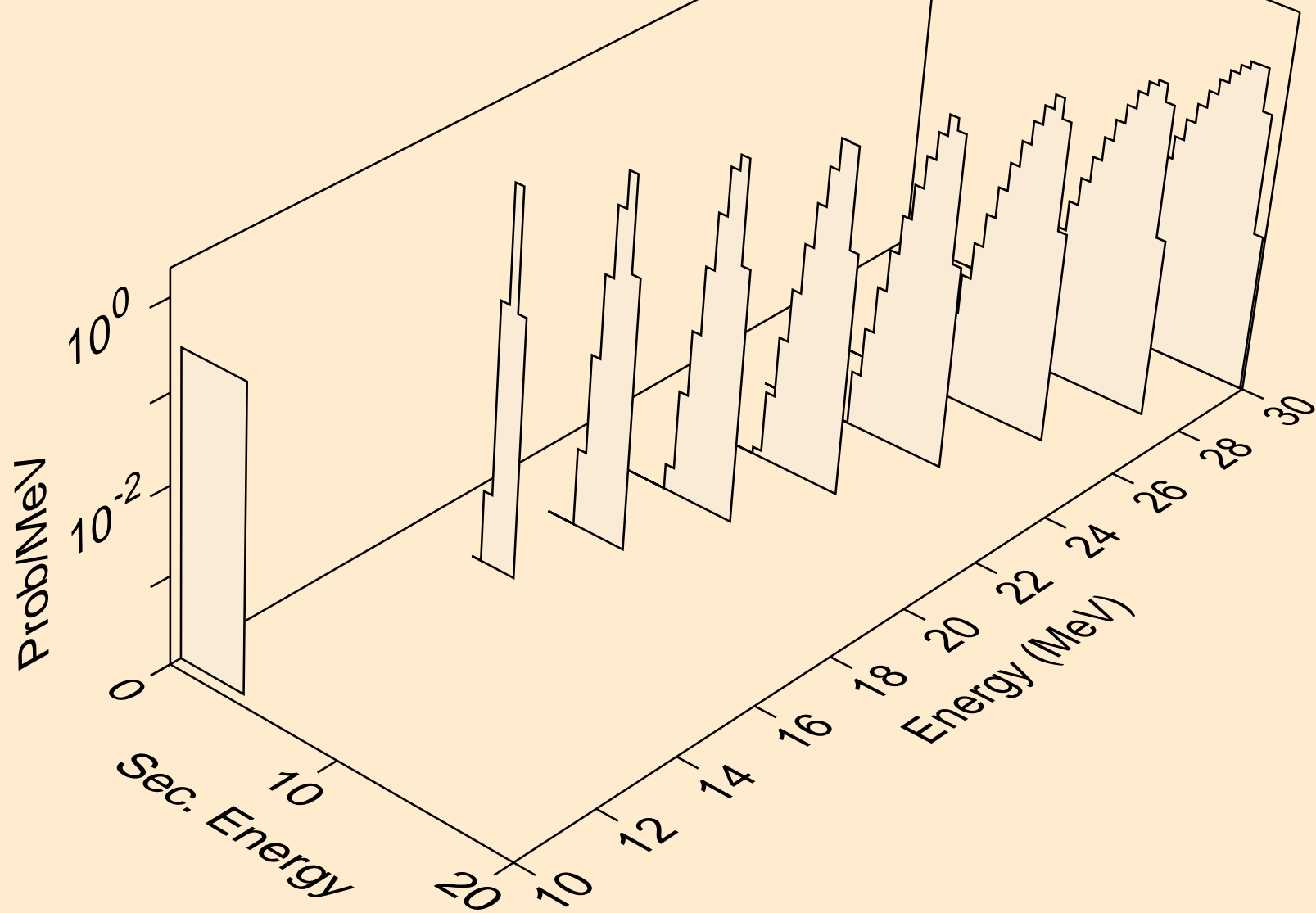

YB162 NEUTRON ACER TENDL-2021 LIBRARY; T=293.6K  
he3s from (n,he3)

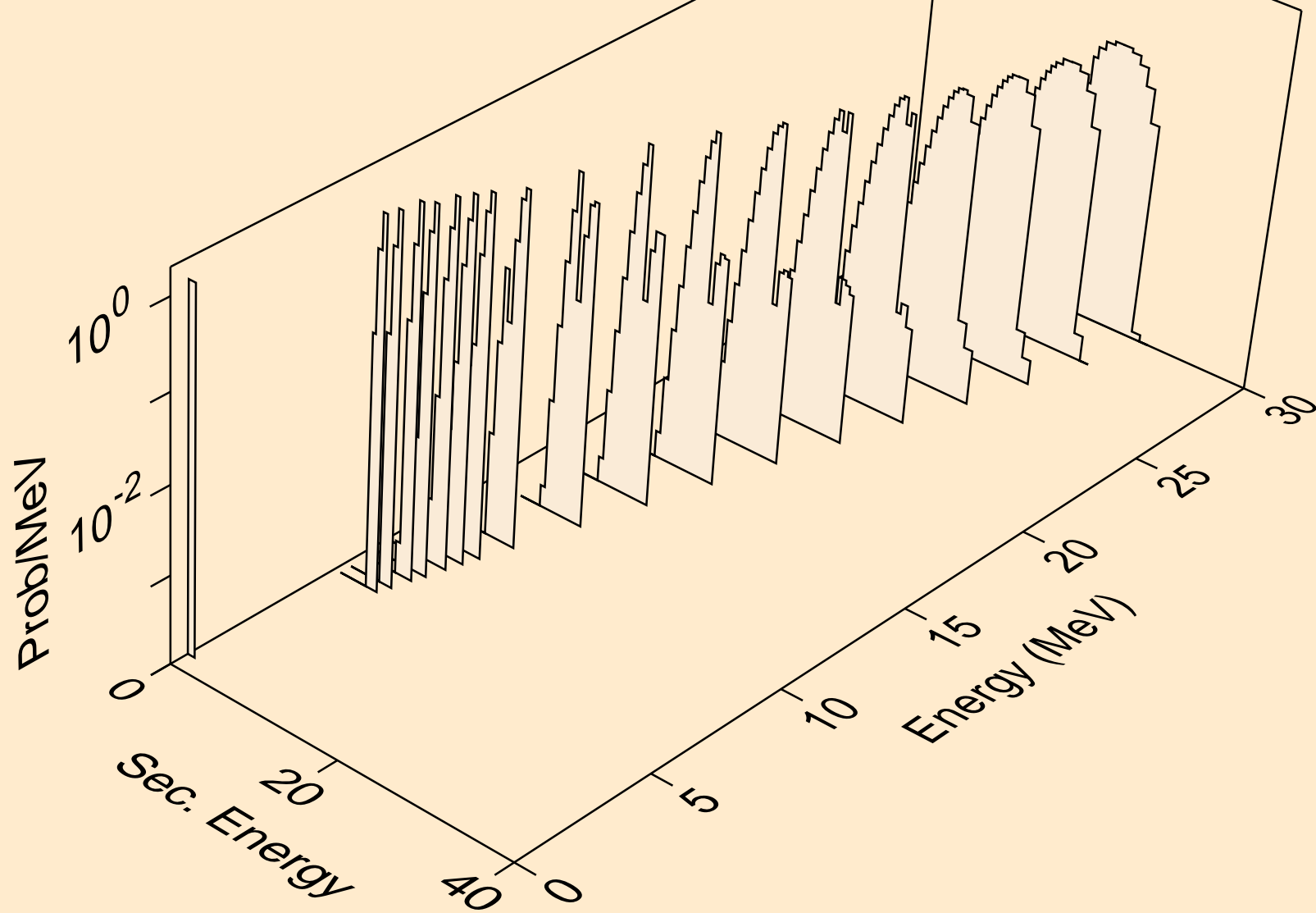

YB162 NEUTRON ACER TENDL-2021 LIBRARY; T=293.6K  
alphas from (n,x)

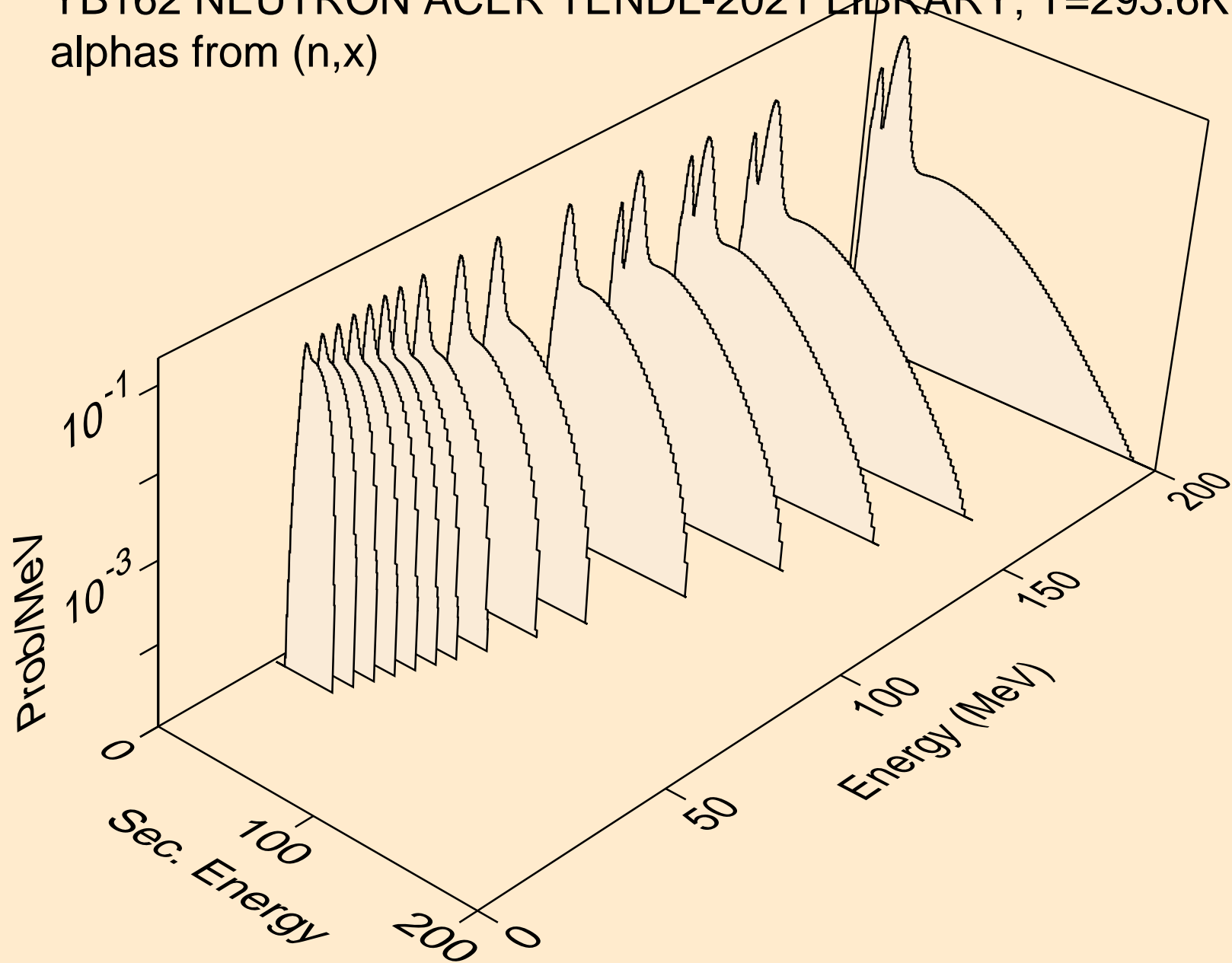

YB162 NEUTRON ACER TENDL-2021 LIBRARY; T=293.6K  
alphas from (n,n\*)a

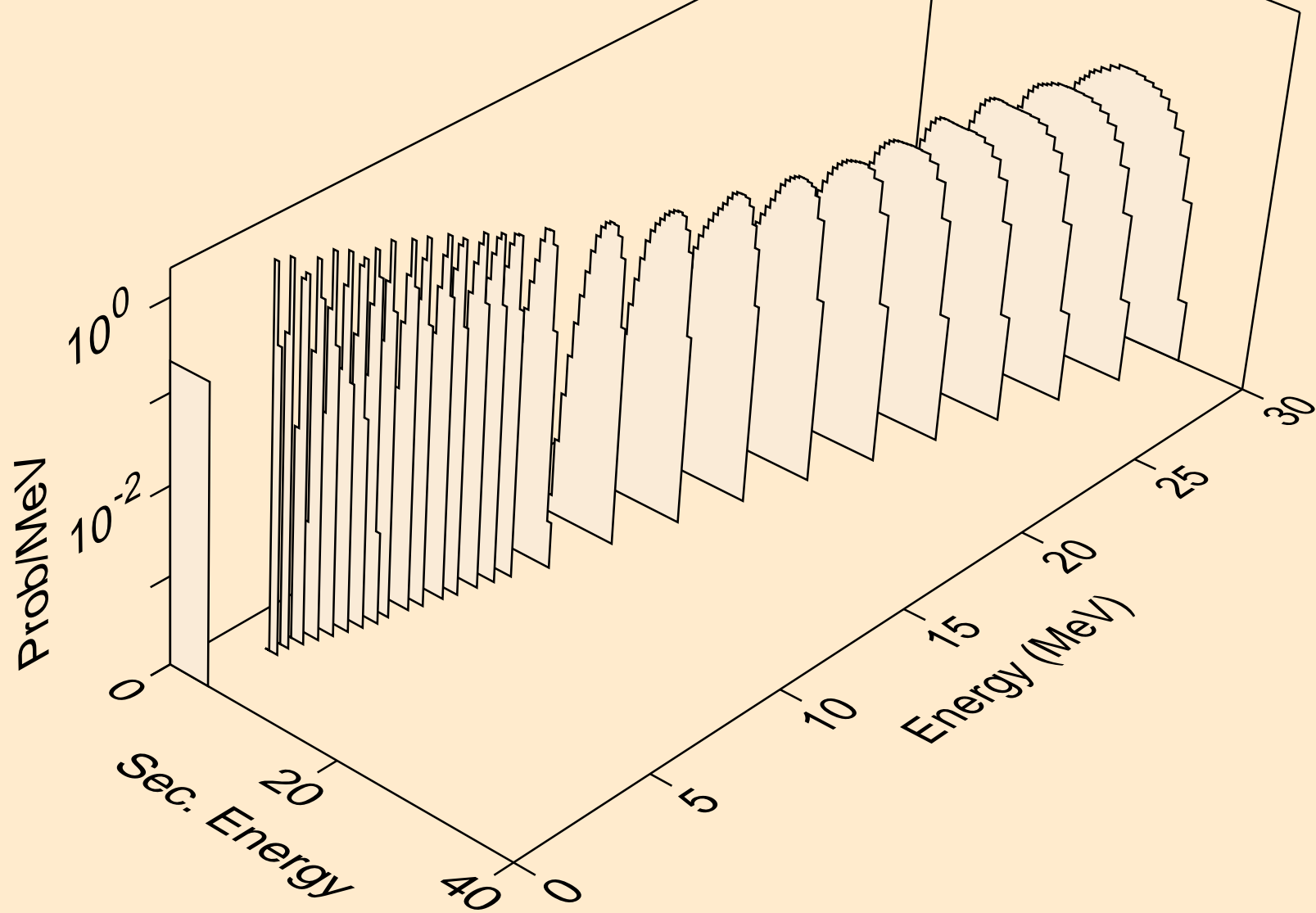

YB162 NEUTRON ACER TENDL-2021 LIBRARY; T=293.6K  
alphas from (n,2n)a

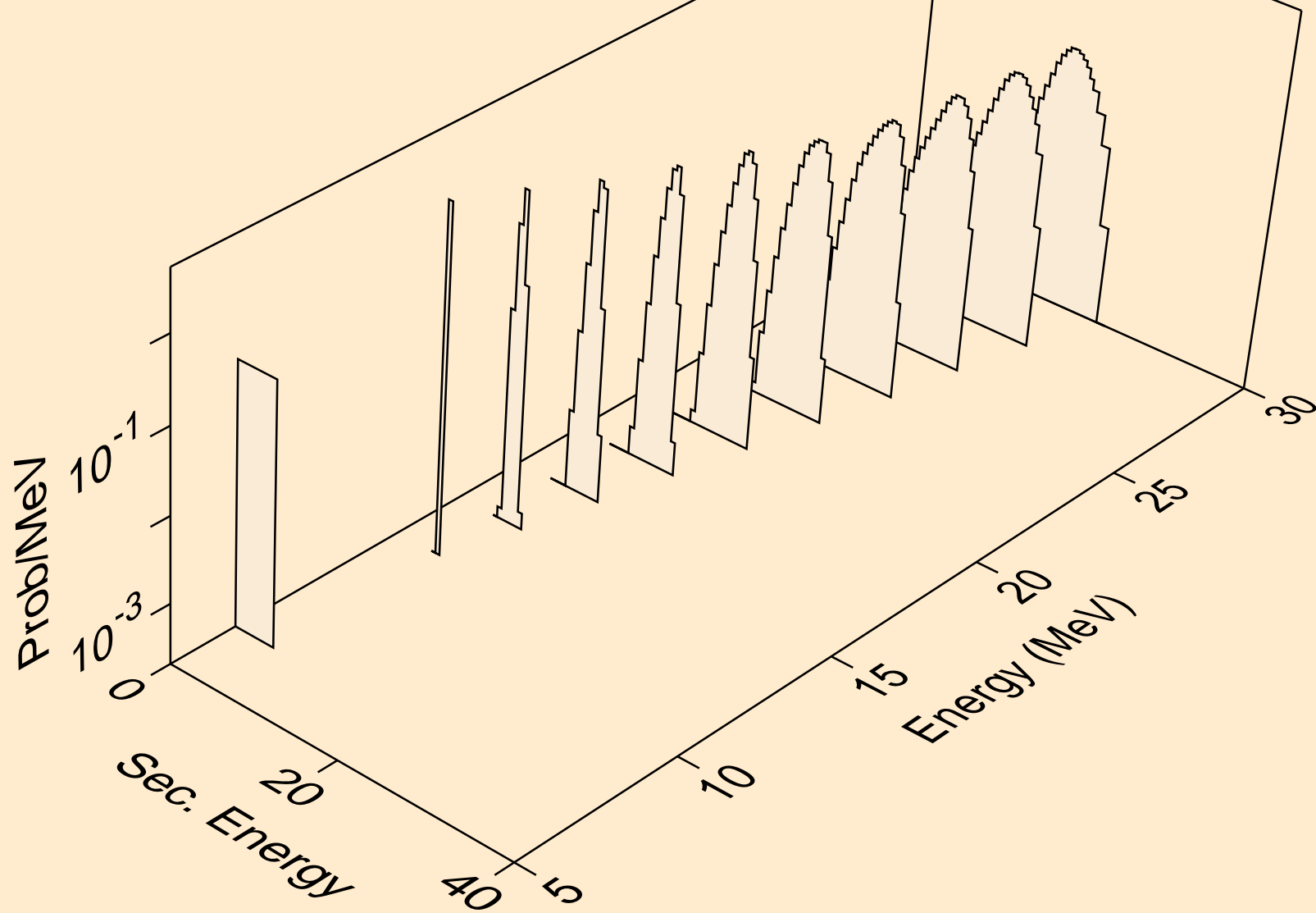

YB162 NEUTRON ACER TENDL-2021 LIBRARY; T=293.6K  
alphas from (n,3n)a

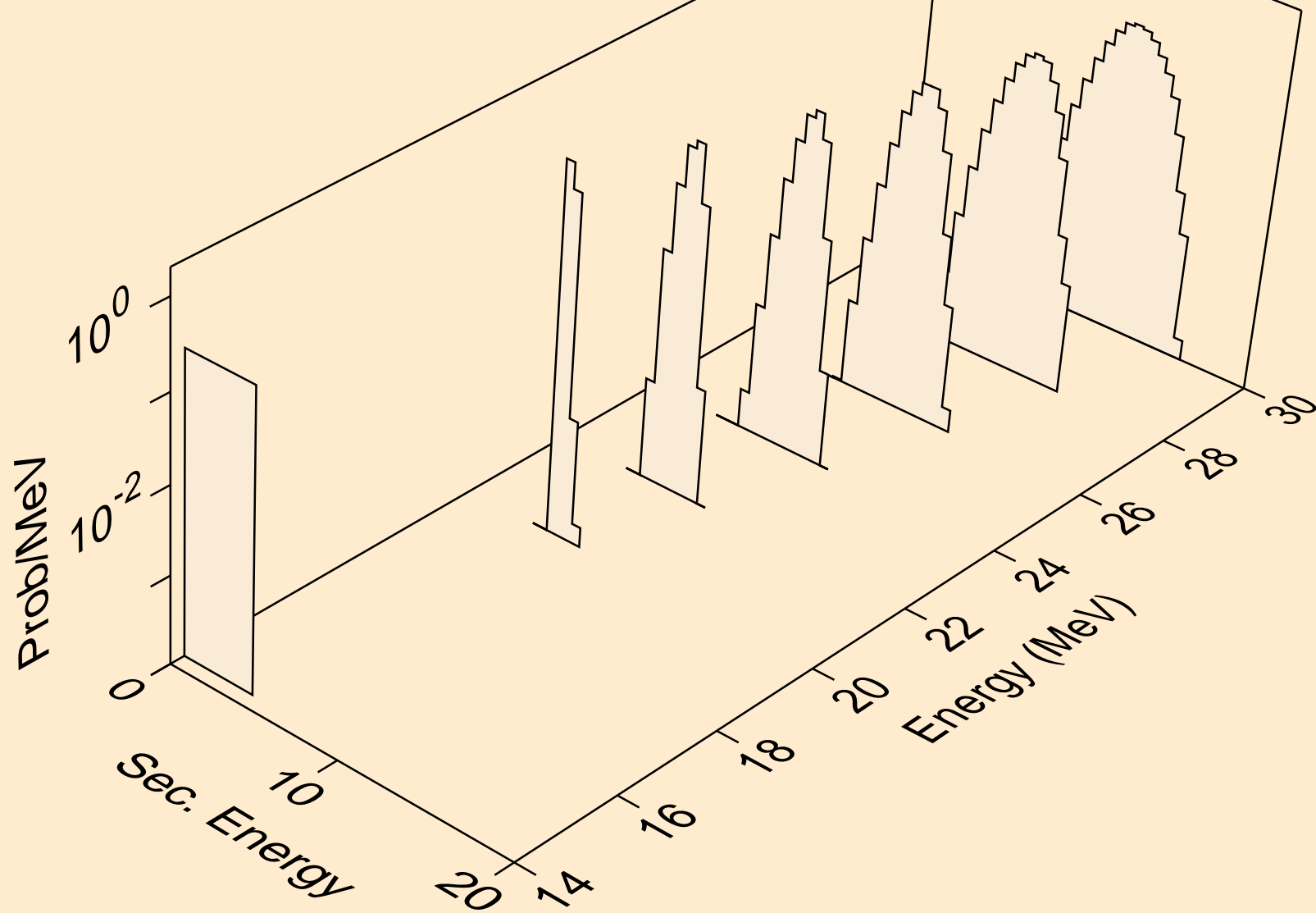



YB162 NEUTRON ACER TENDL-2021 LIBRARY; T=293.6K  
alphas from (n,n\*)2a

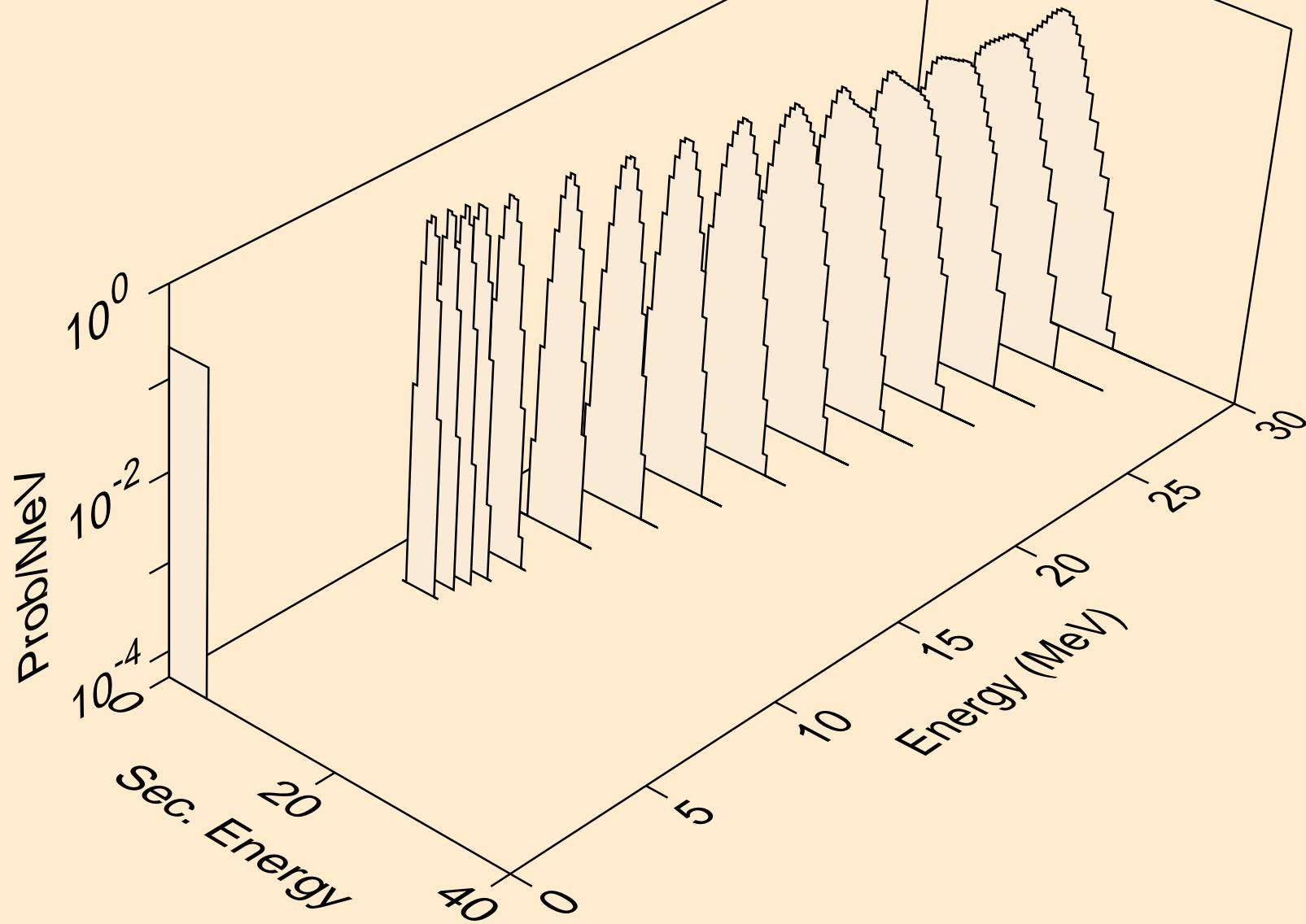

YB162 NEUTRON ACER TENDL-2021 LIBRARY; T=293.6K  
alphas from (n,2n)2a

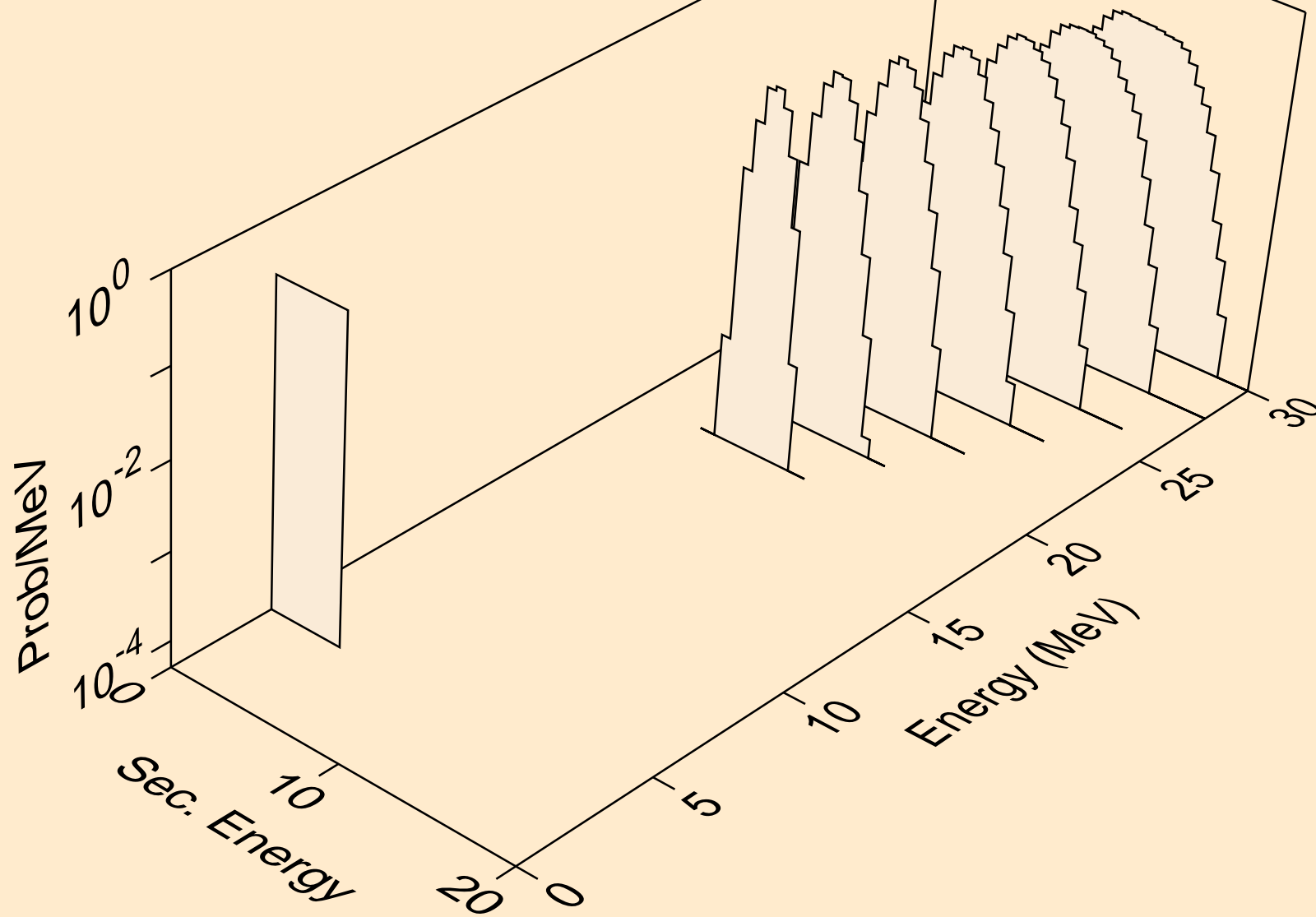

YB162 NEUTRON ACER TENDL-2021 LIBRARY; T=293.6K  
alphas from (n,npa)

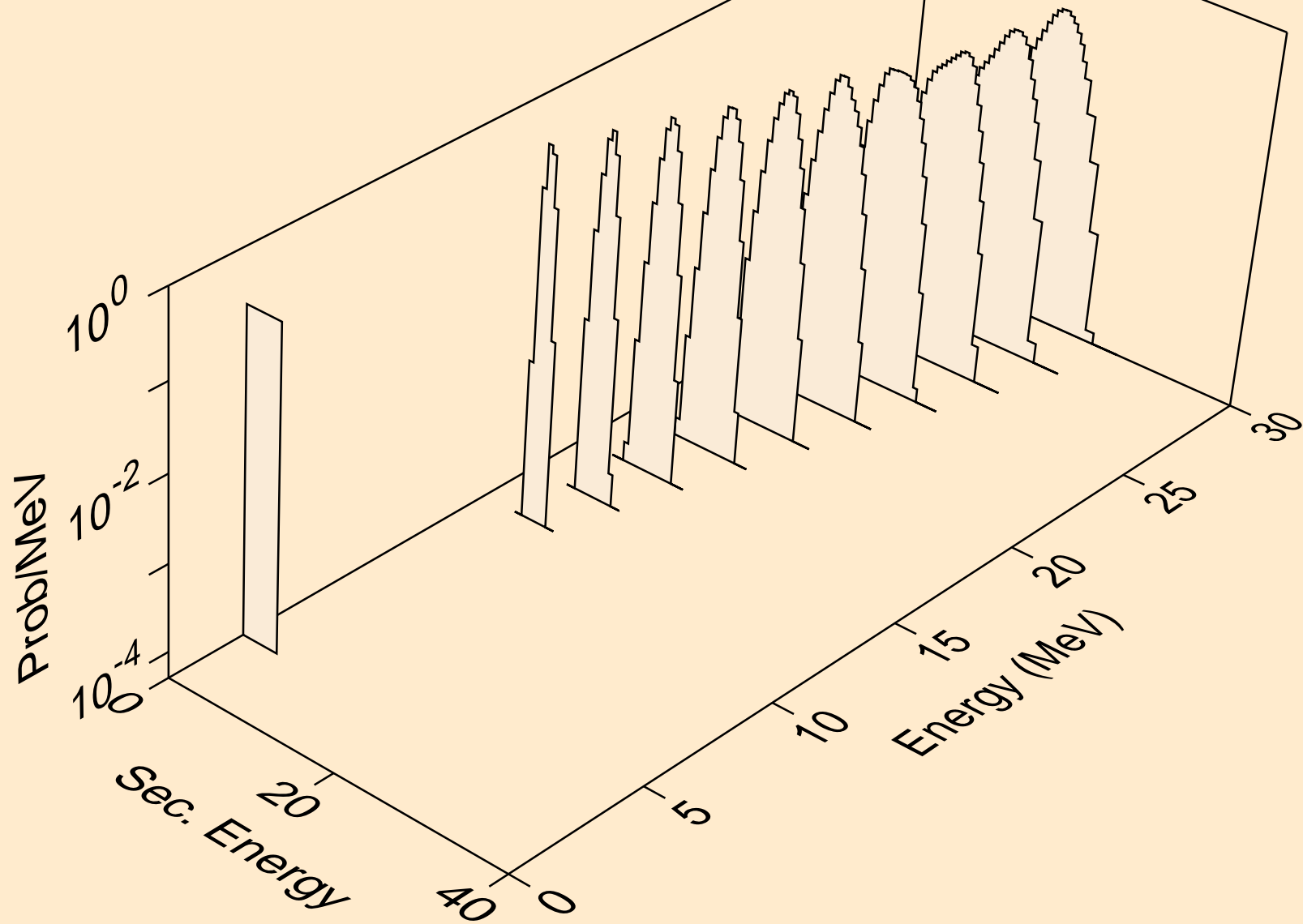

YB162 NEUTRON ACER TENDL-2021 LIBRARY; T=293.6K  
alphas from (n,a)

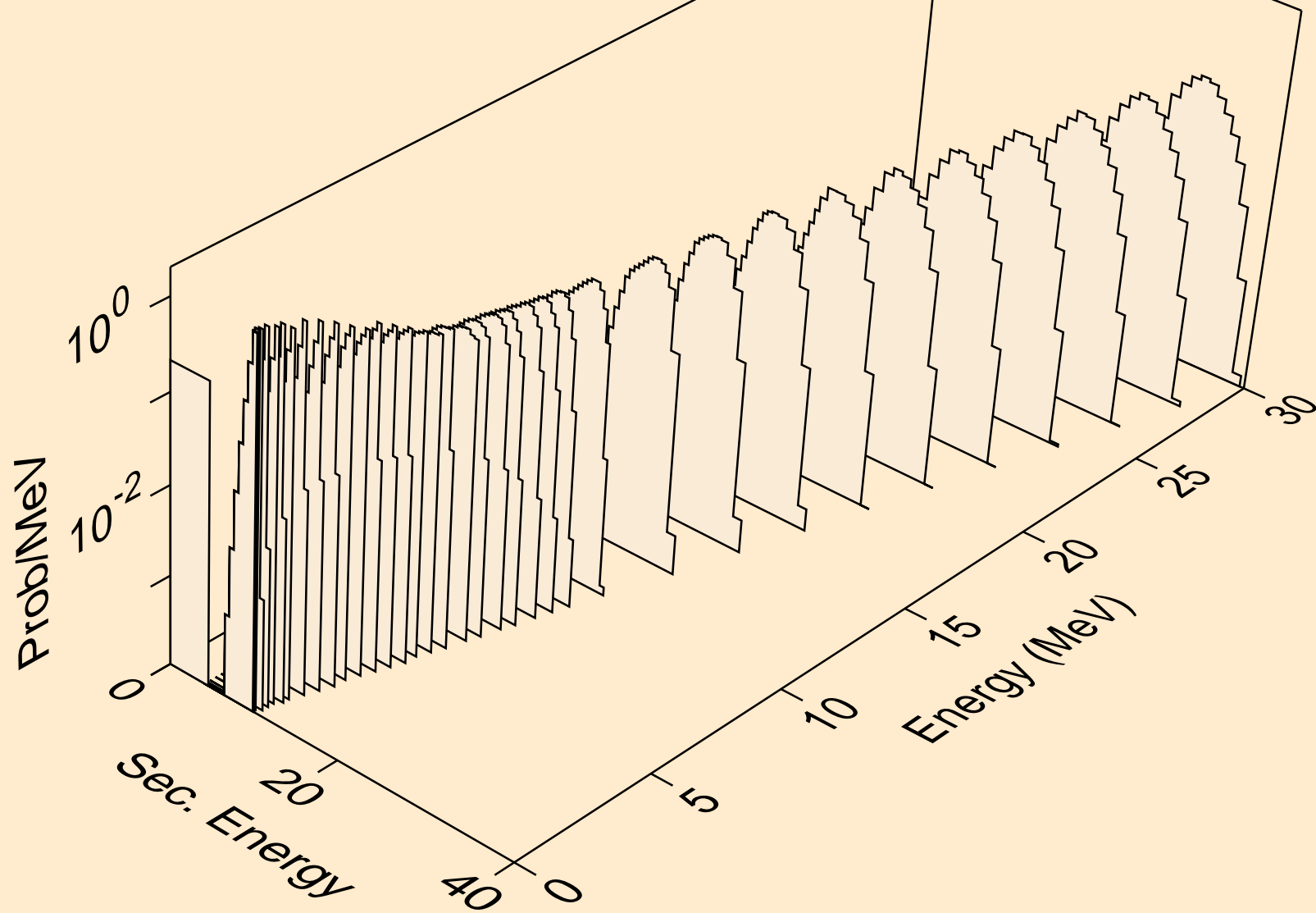

YB162 NEUTRON ACER TENDL-2021 LIBRARY; T=293.6K  
alphas from (n,2a)

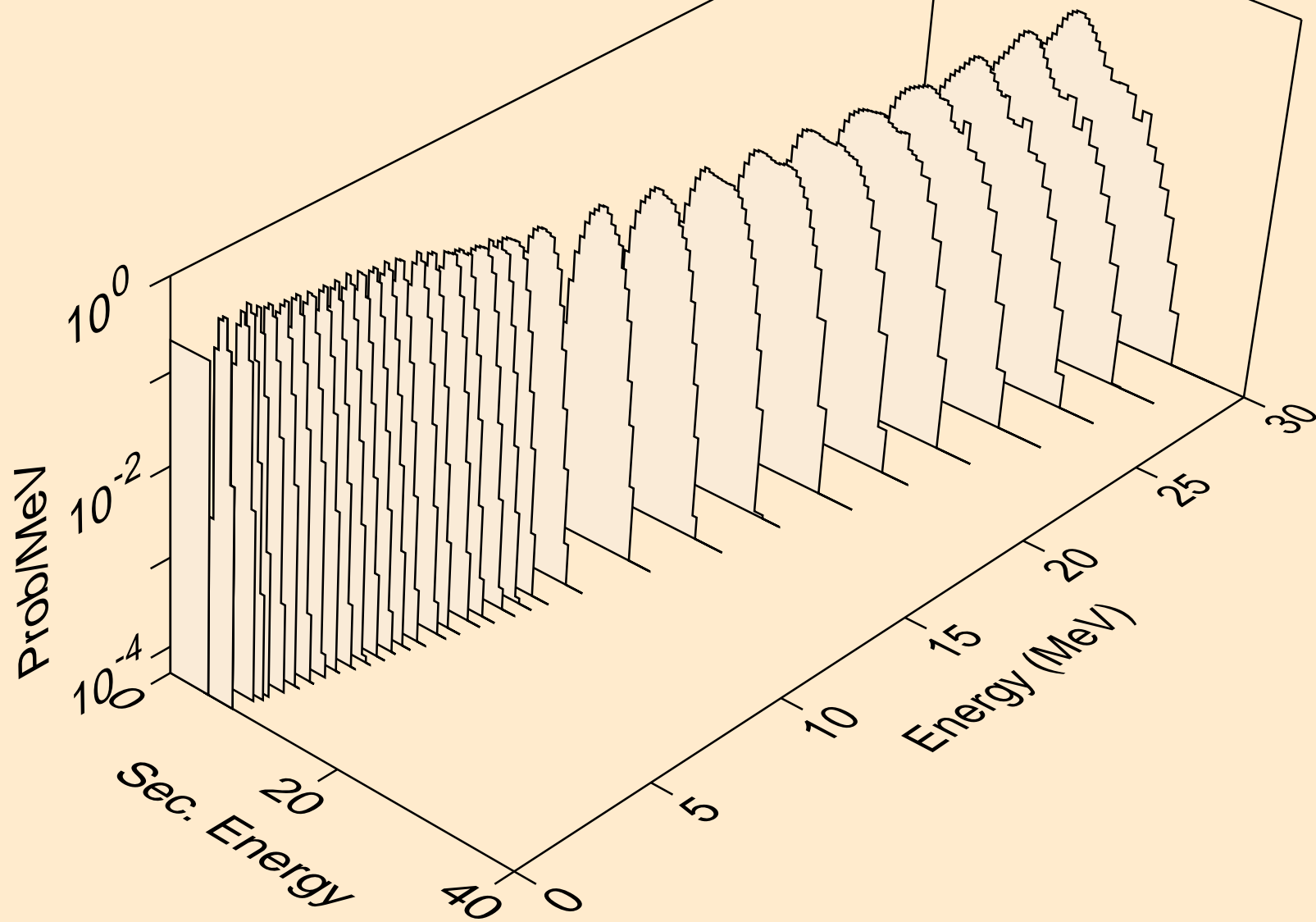

YB162 NEUTRON ACER TENDL-2021 LIBRARY; T=293.6K  
alphas from (n,pa)

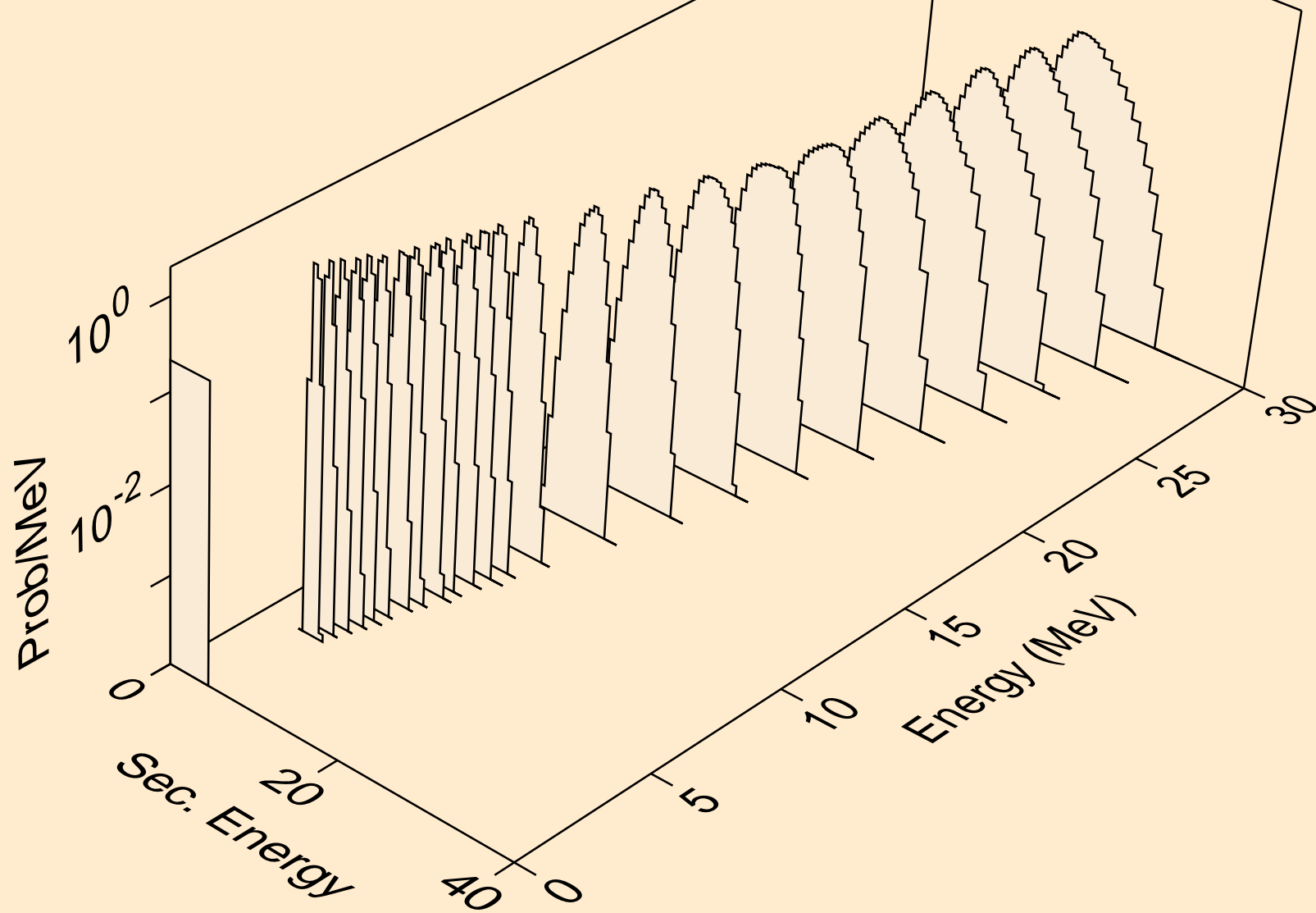

YB162 NEUTRON ACER TENDL-2021 LIBRARY; T=293.6K  
alphas from (n,da)

