

Program EVALPLOT
(Version 2018-1)

by

Dermott E. Cullen
(Present Contact Information)

Dermott E. Cullen
1466 Hudson Way
Livermore, CA 94550
U.S.A.

Tele: 925-443-1911

E.Mail:redcullen1@comcast.net

Web:redcullen1.net/HOMEPAGE.NEW

Press Mouse Button to Start

MAT 7022

Major
293 Kelvin Cross Sections

70-Yb-167

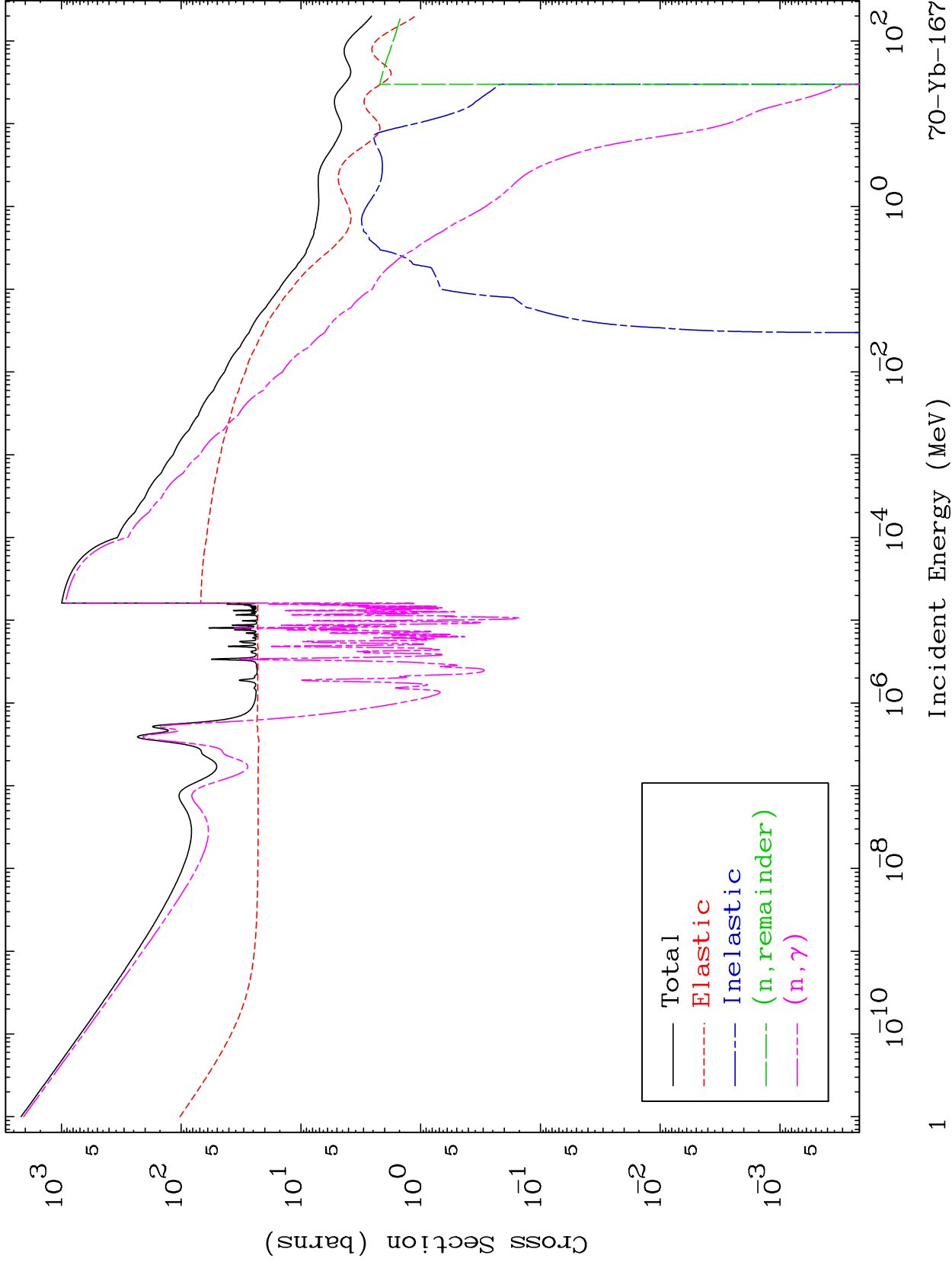

MAT 7022

Neutron Production
293 Kelvin Cross Sections

70-Yb-167

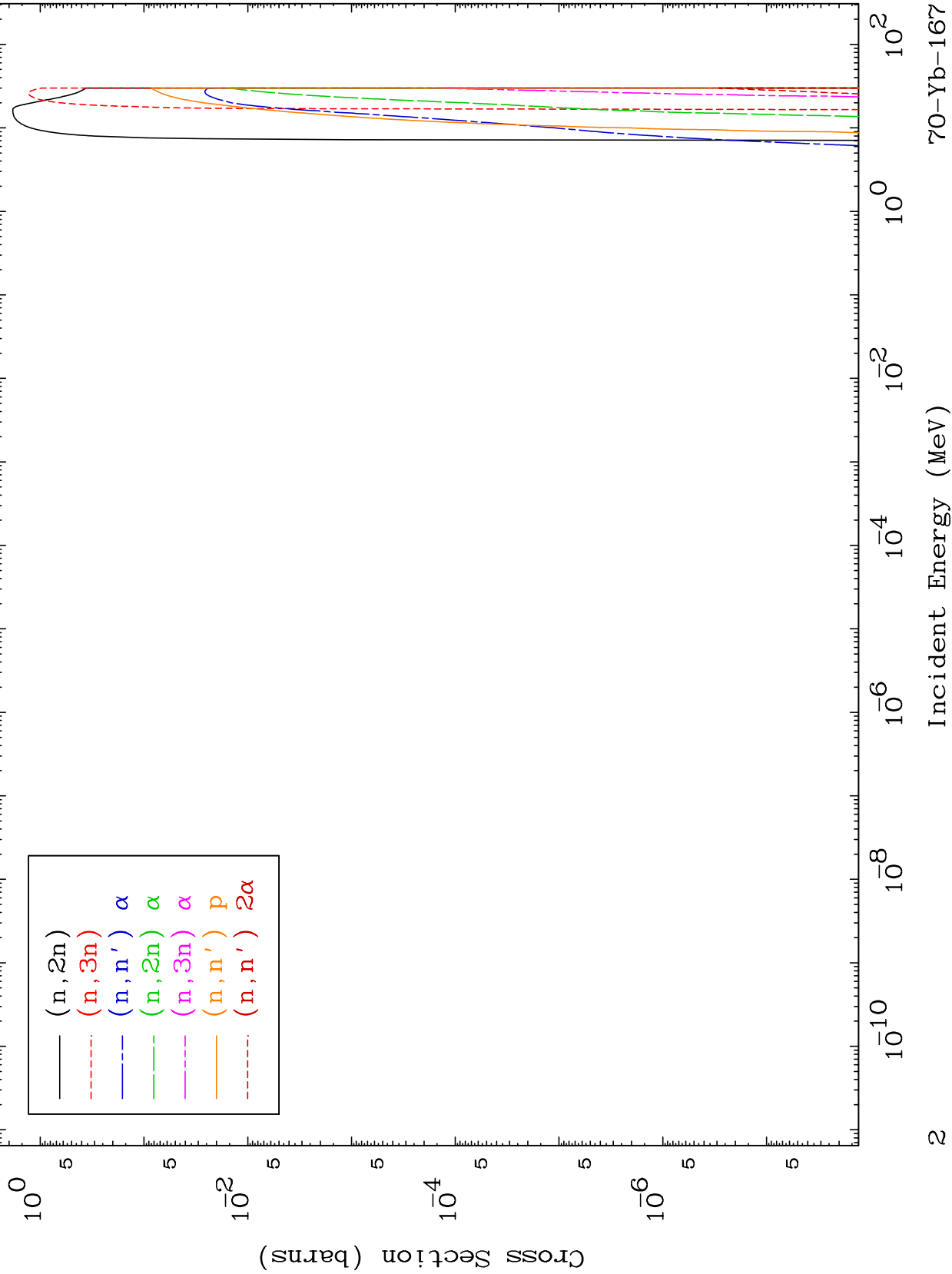

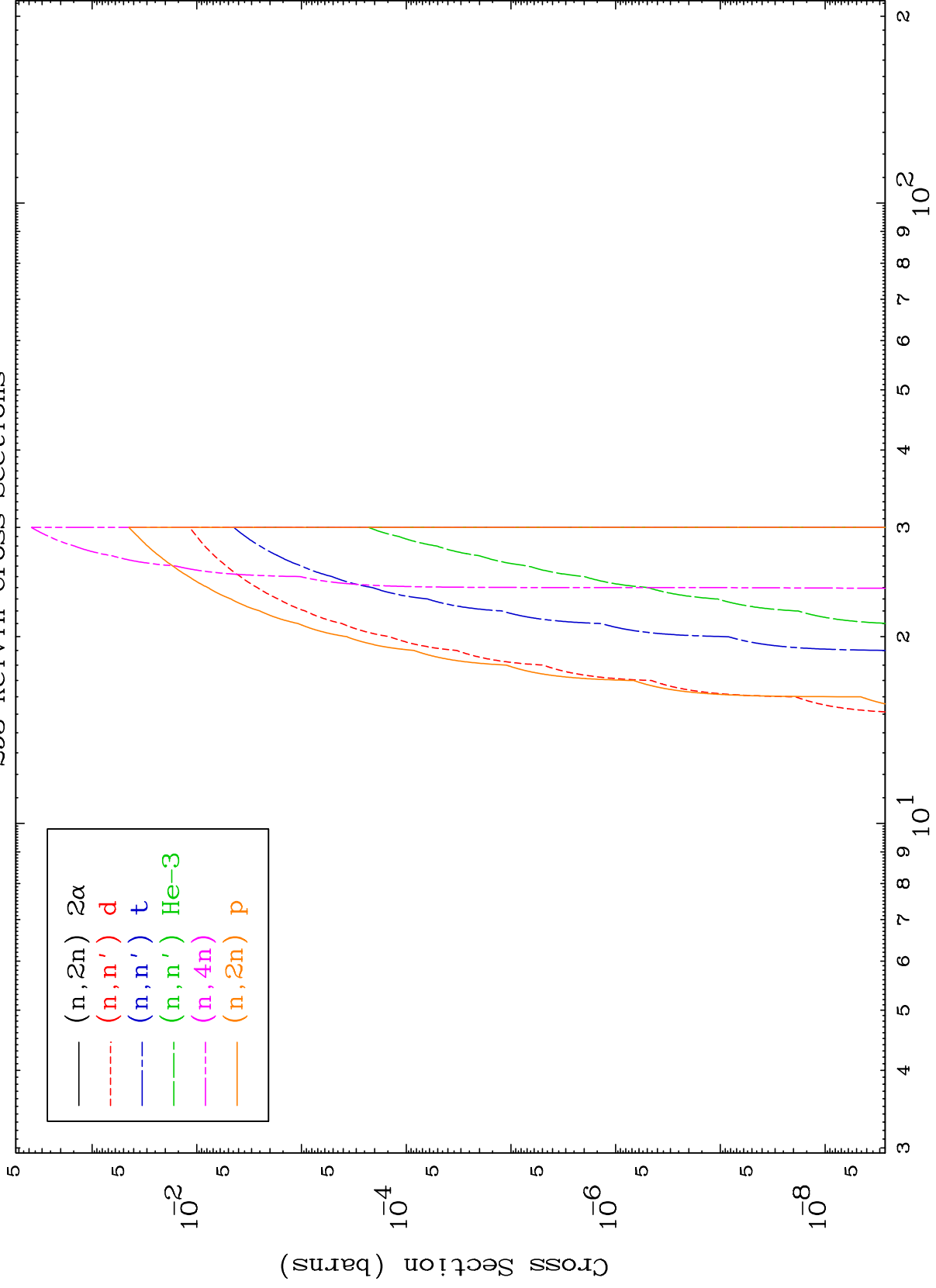

MAT 7022

Charged Particle
293 Kelvin Cross Sections

70-Yb-167

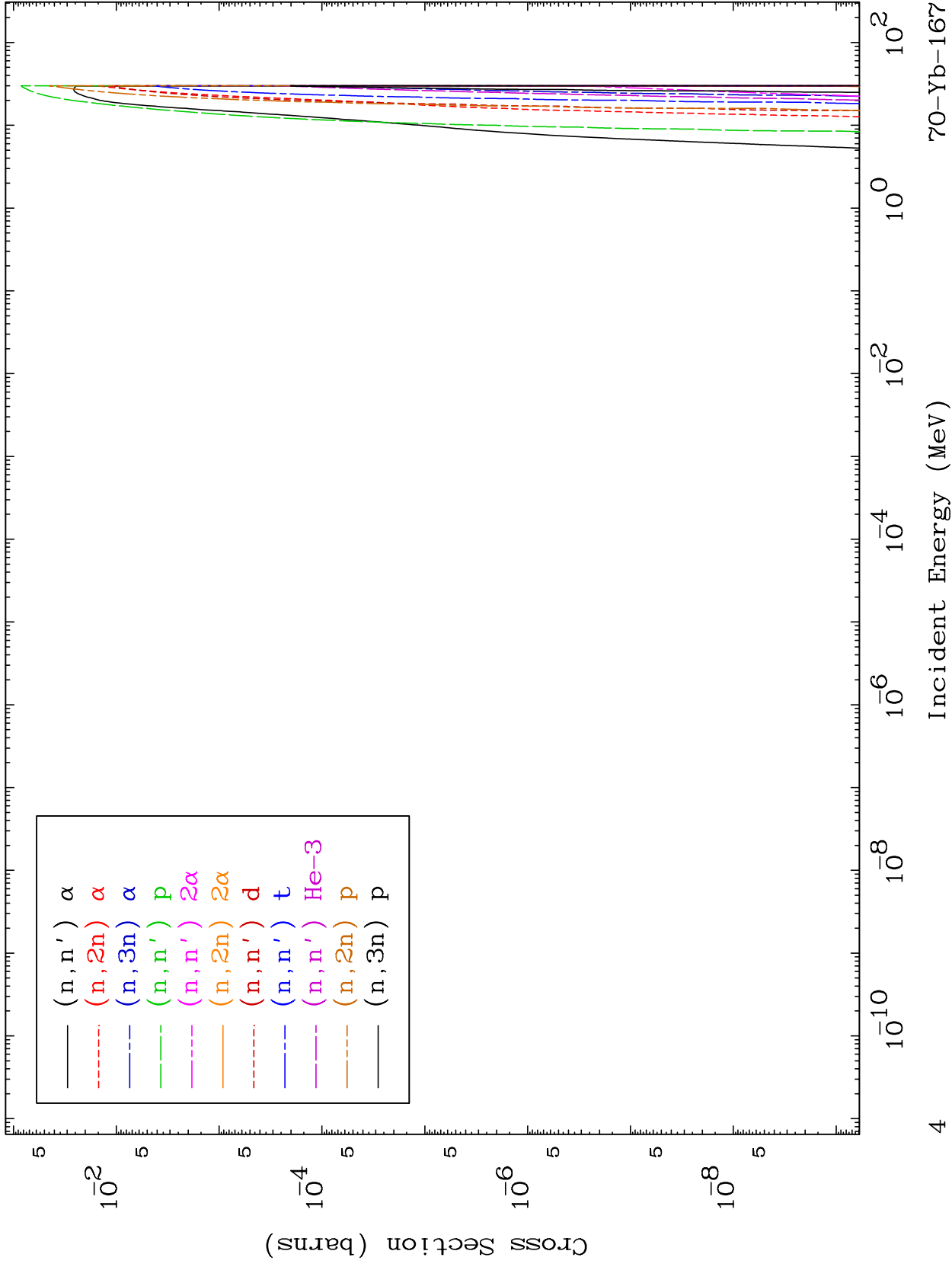

MAT 7022

Charged Particle
293 Kelvin Cross Sections

70-Yb-167

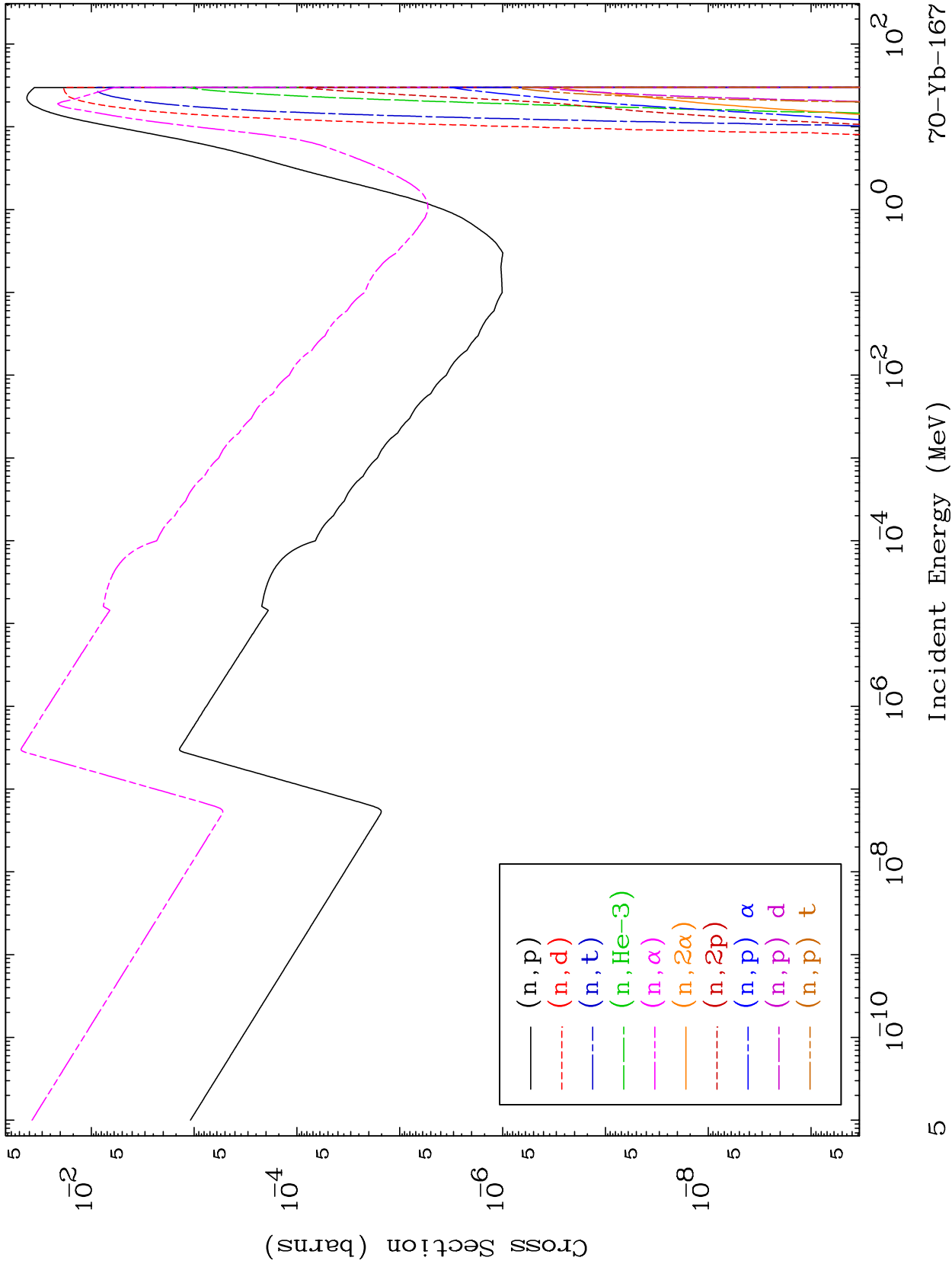

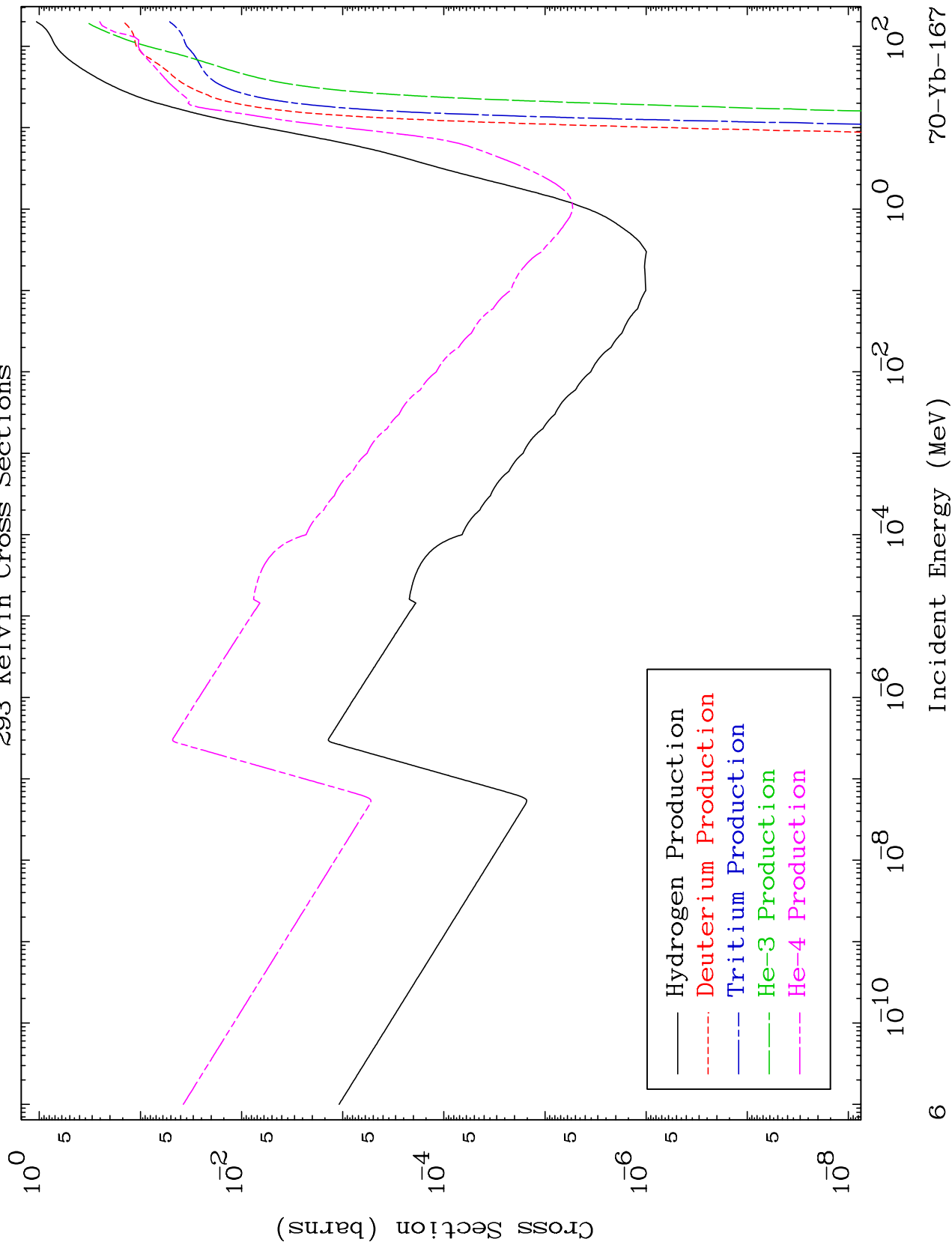

293 Kelvin Cross Sections

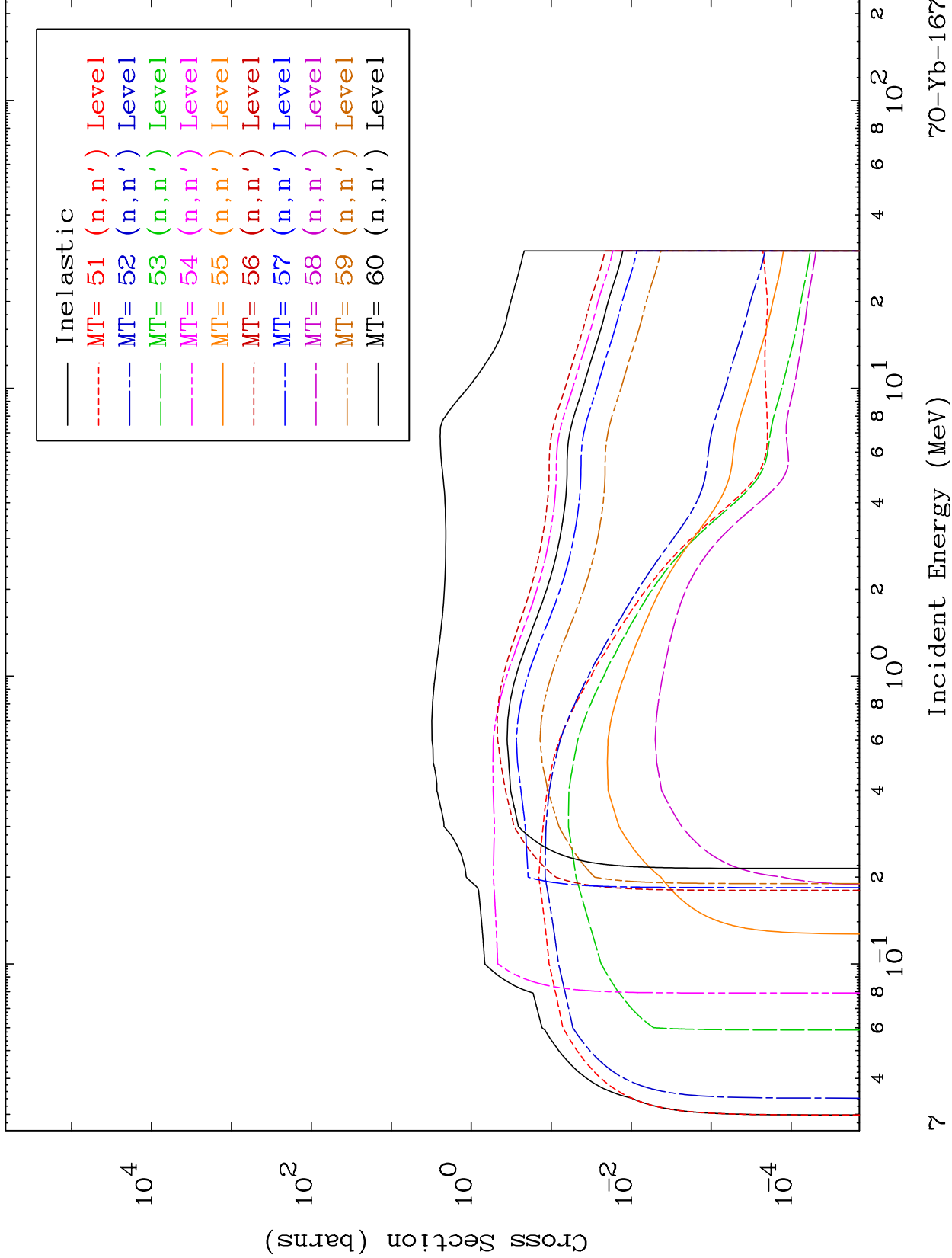

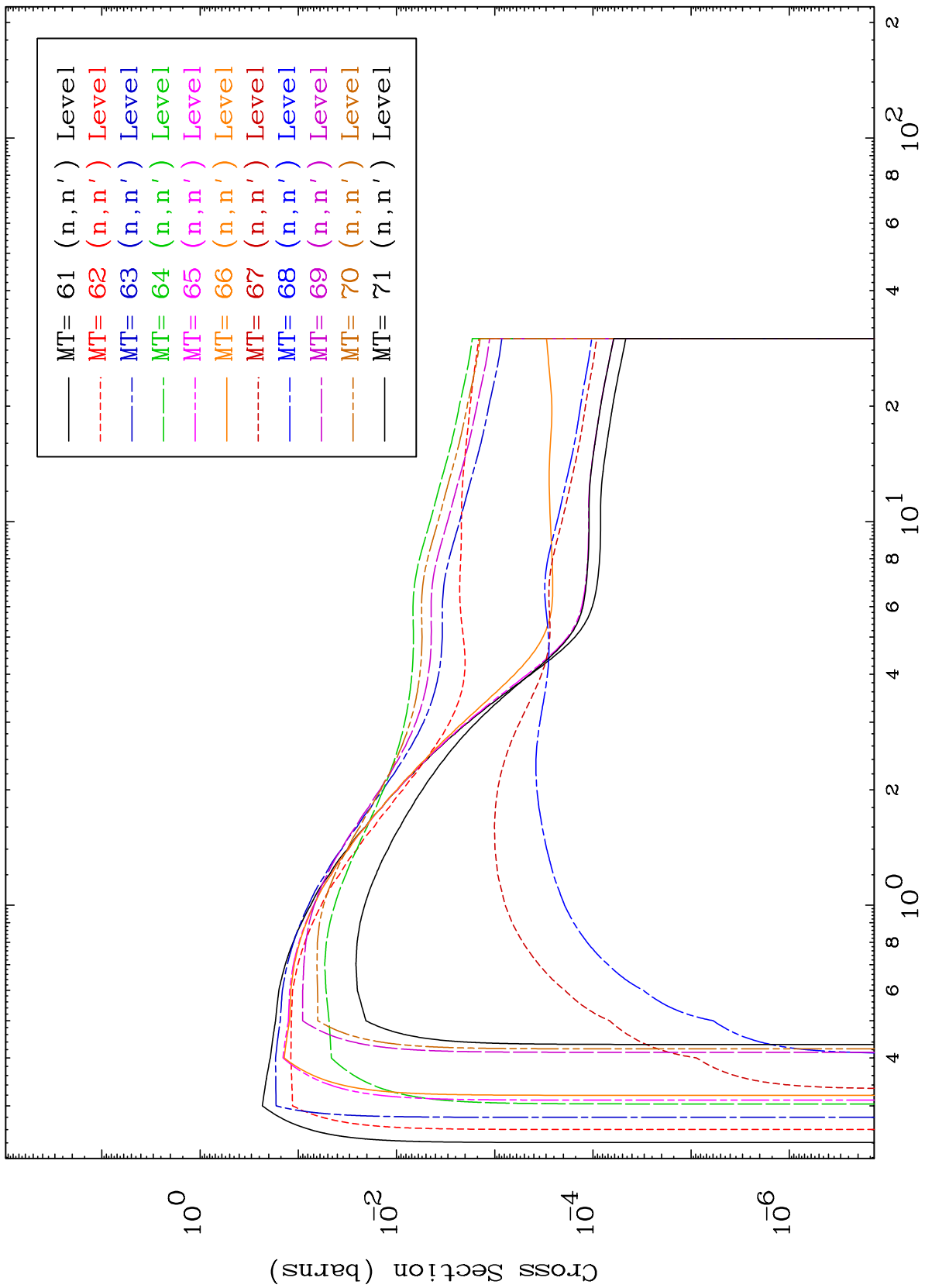

293 Kelvin Cross Sections

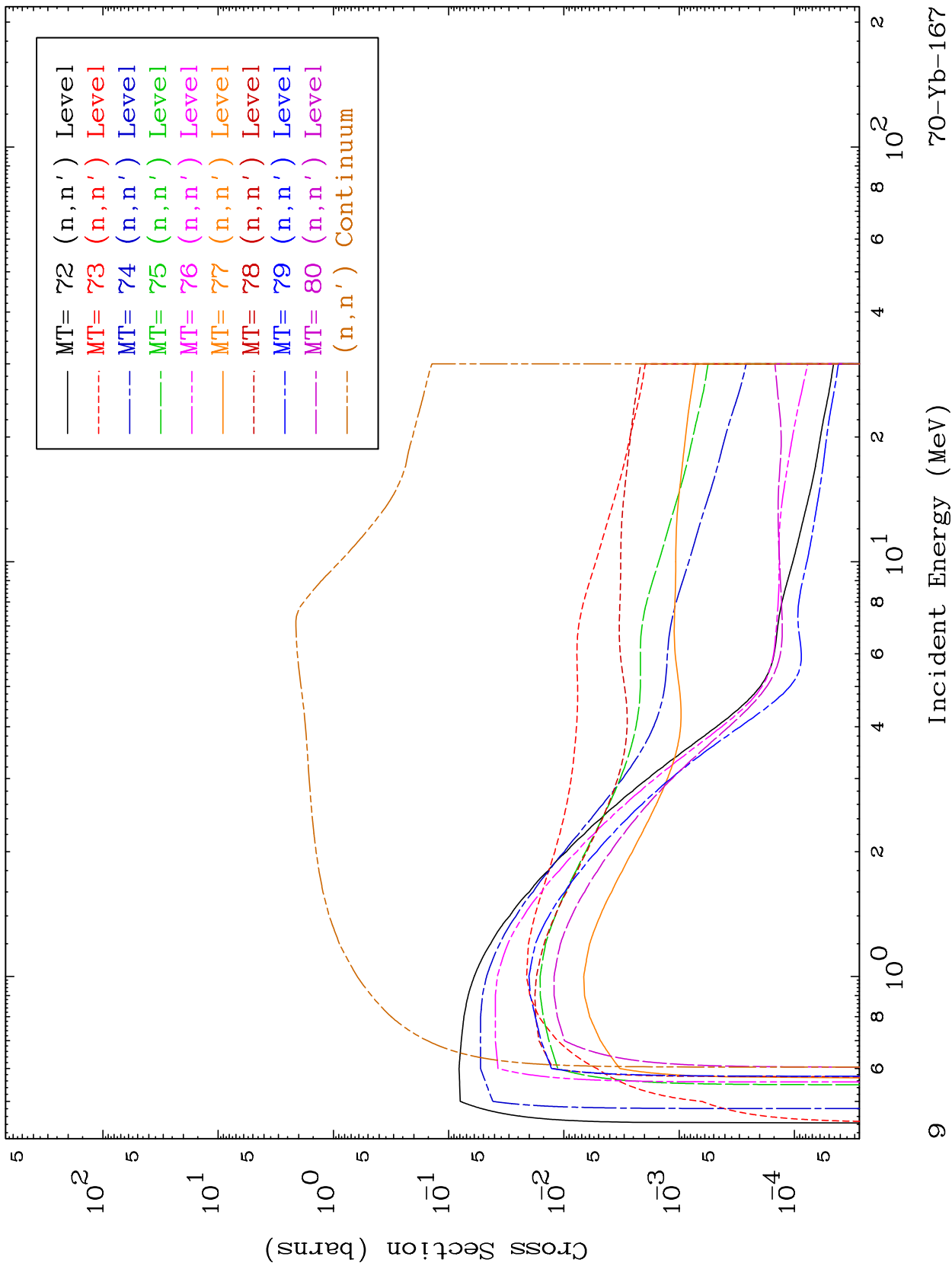

MAT 7022

(n,p) Levels
293 Kelvin Cross Sections

70-Yb-167

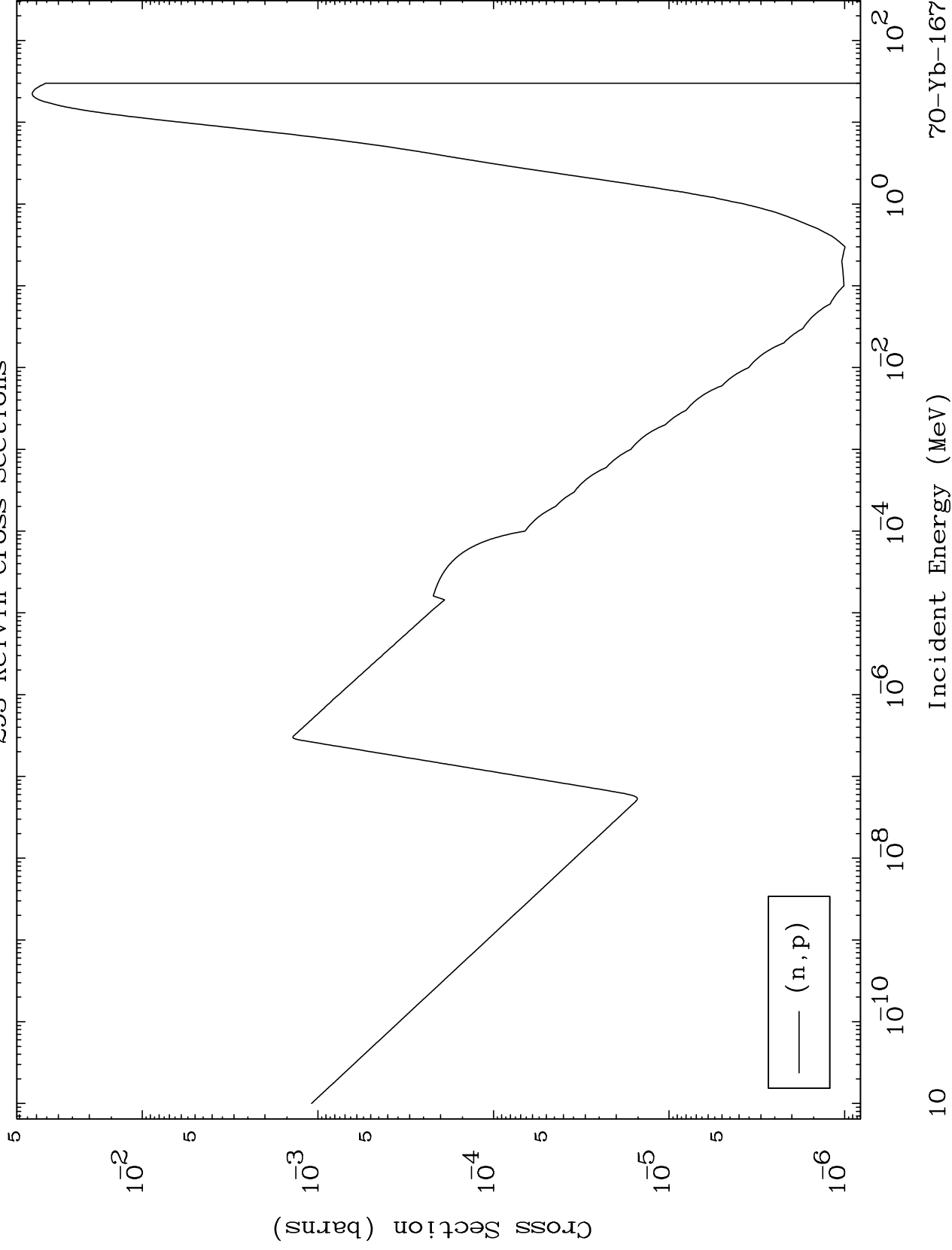

MAT 7022

(n,d) Levels
293 Kelvin Cross Sections

70-Yb-167

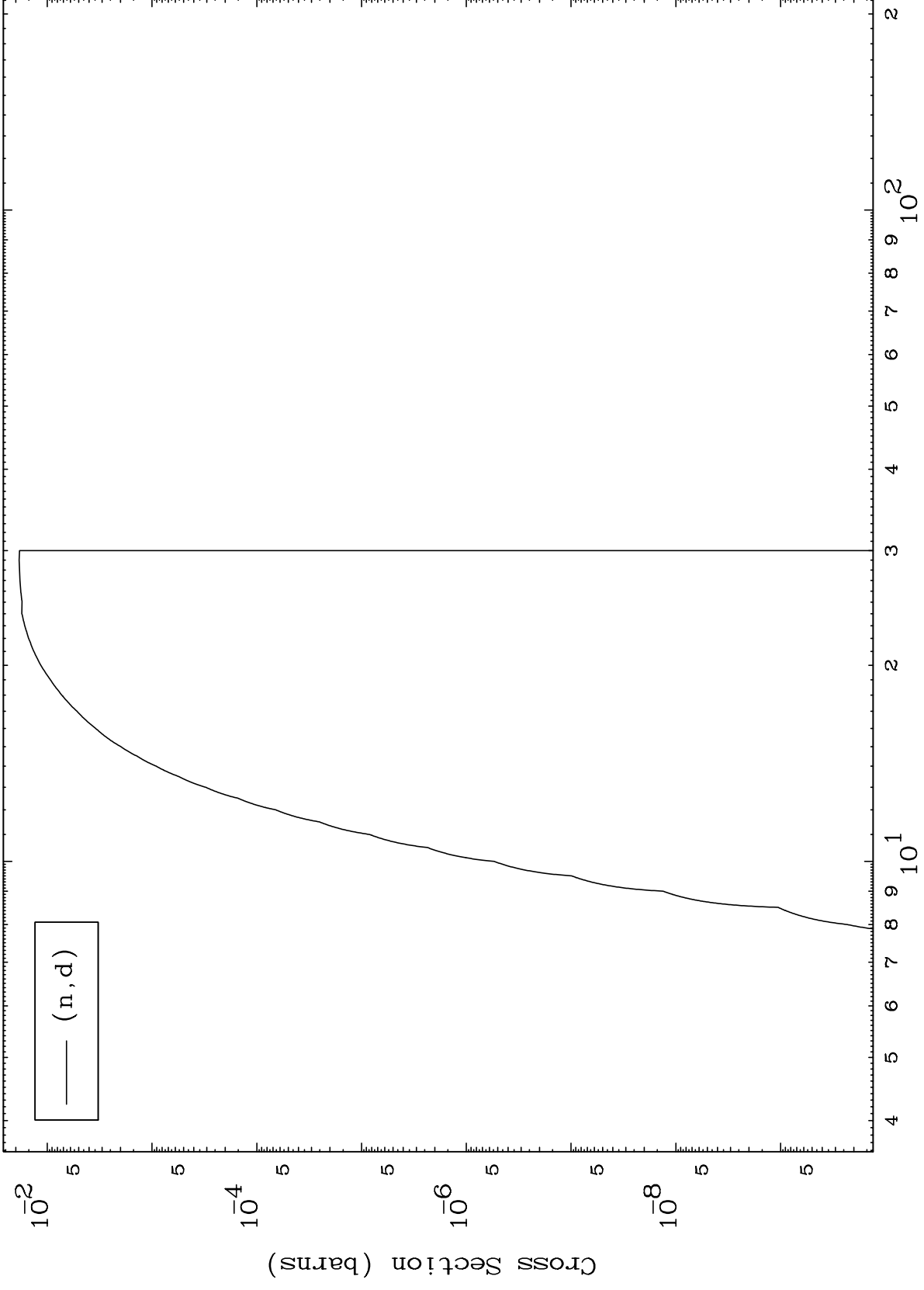

11

Incident Energy (MeV)

70-Yb-167

MAT 7022

(n,t) Levels
293 Kelvin Cross Sections

70-Yb-167

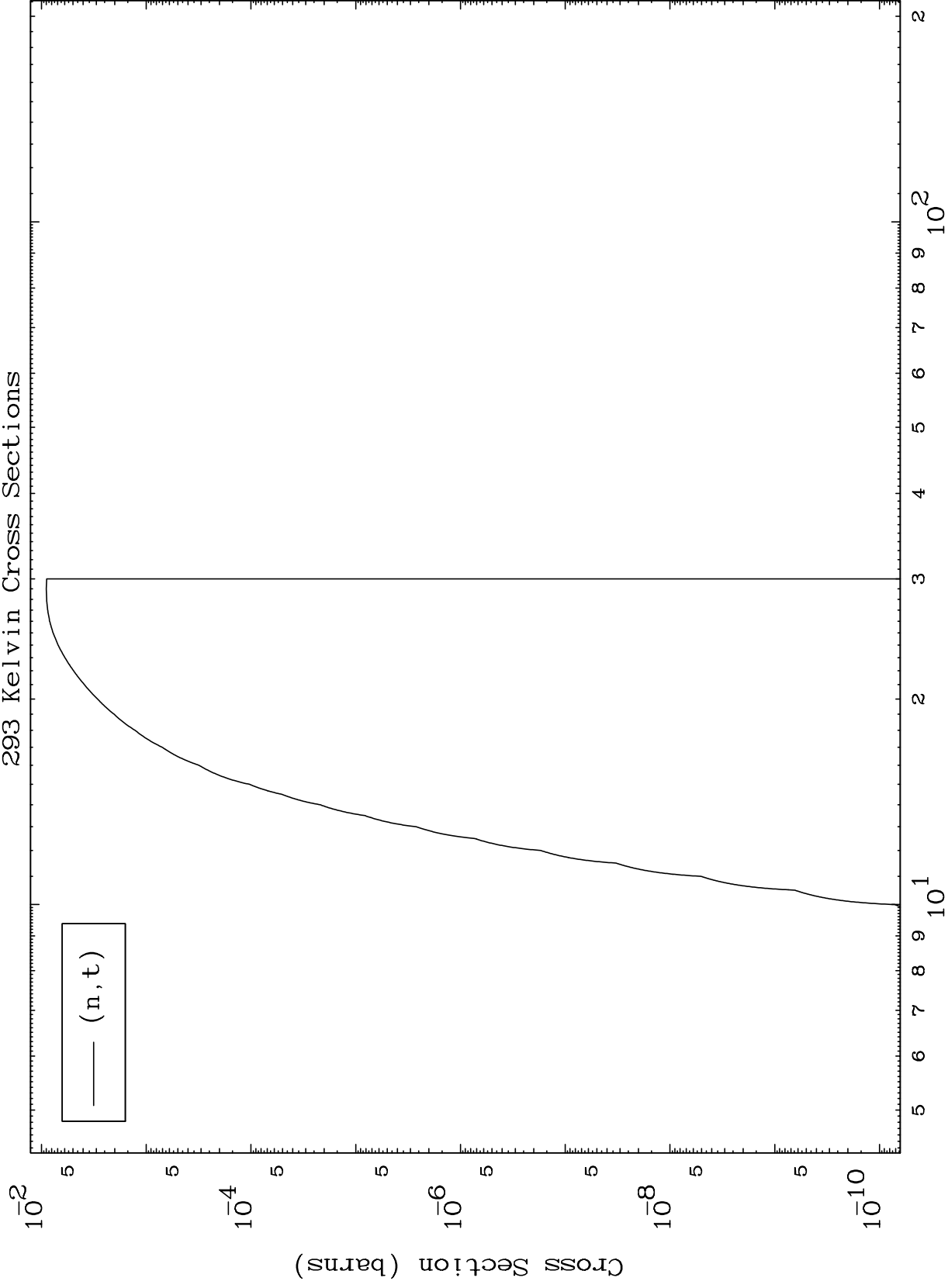

12

Incident Energy (MeV)

70-Yb-167

MAT 7022

(n,He3) Levels
293 Kelvin Cross Sections

70-Yb-167

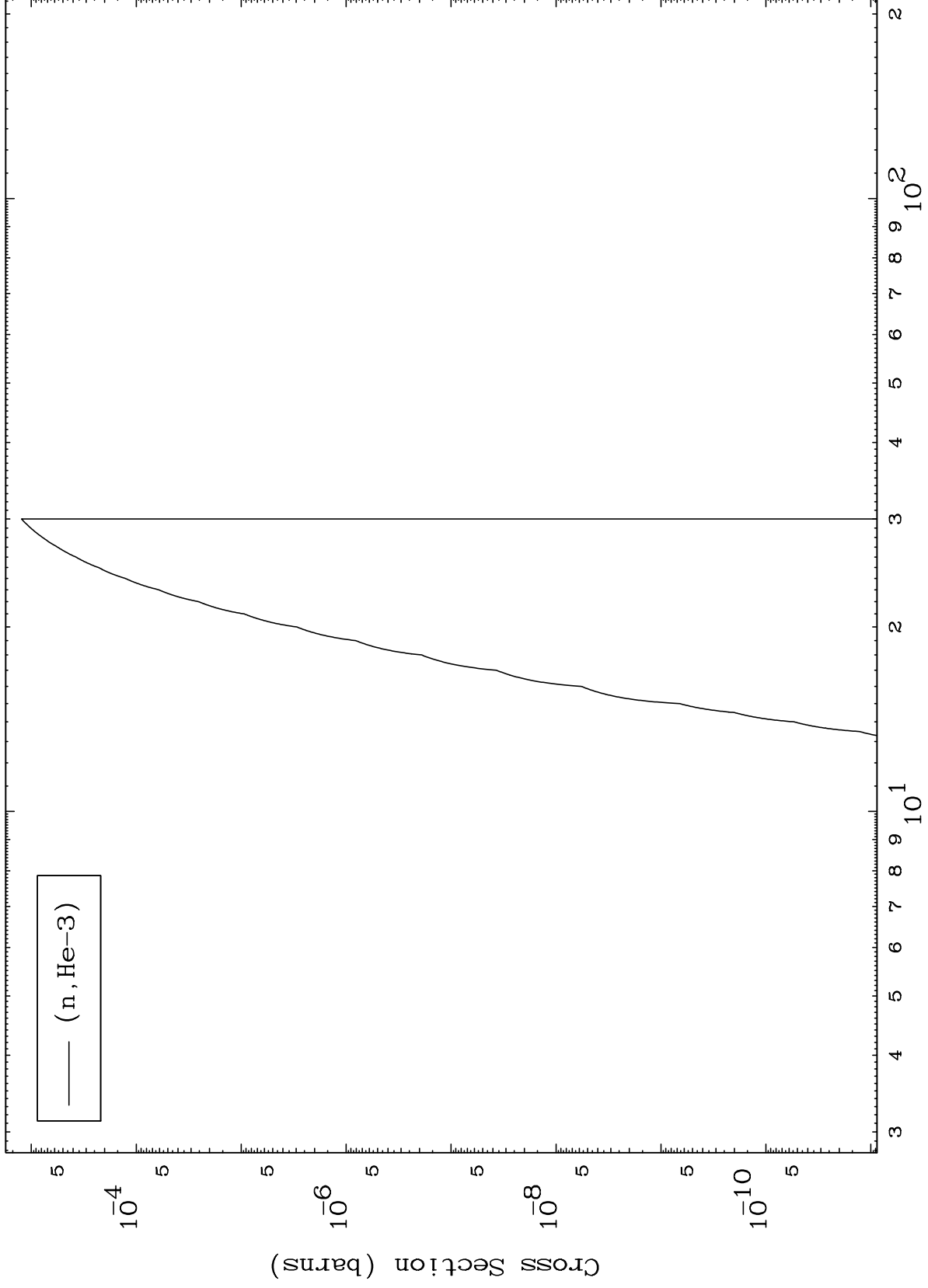

13

Incident Energy (MeV)

70-Yb-167

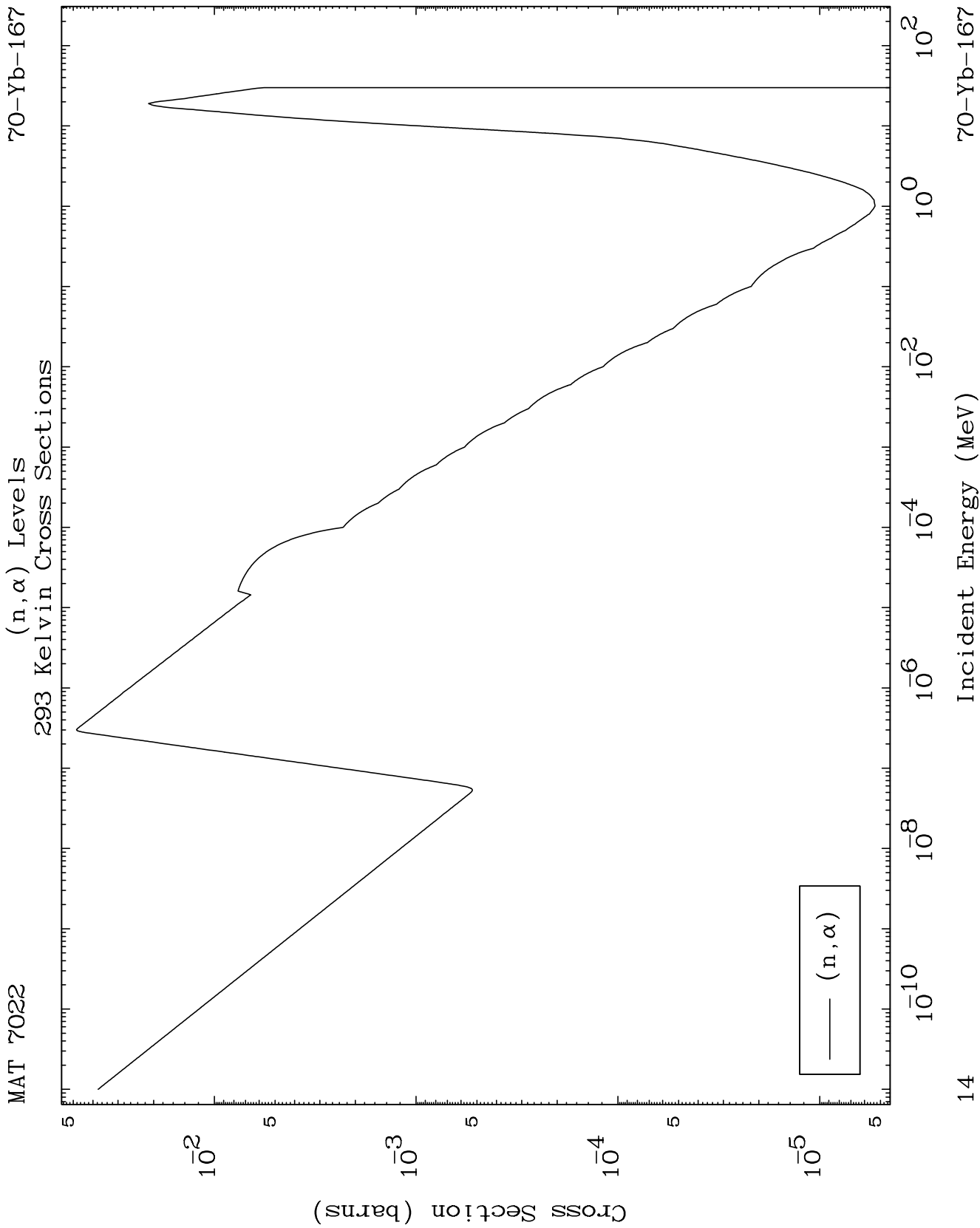

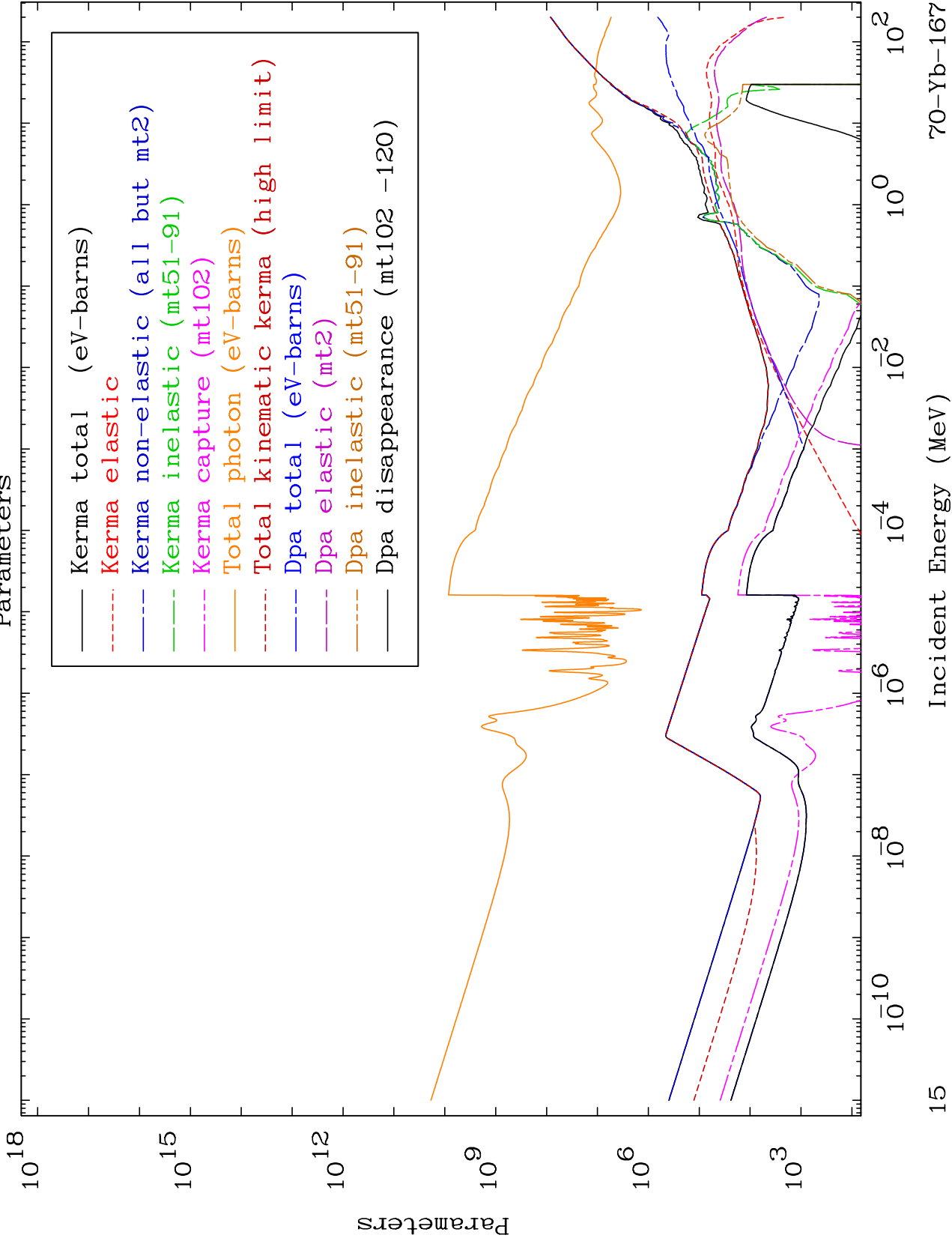

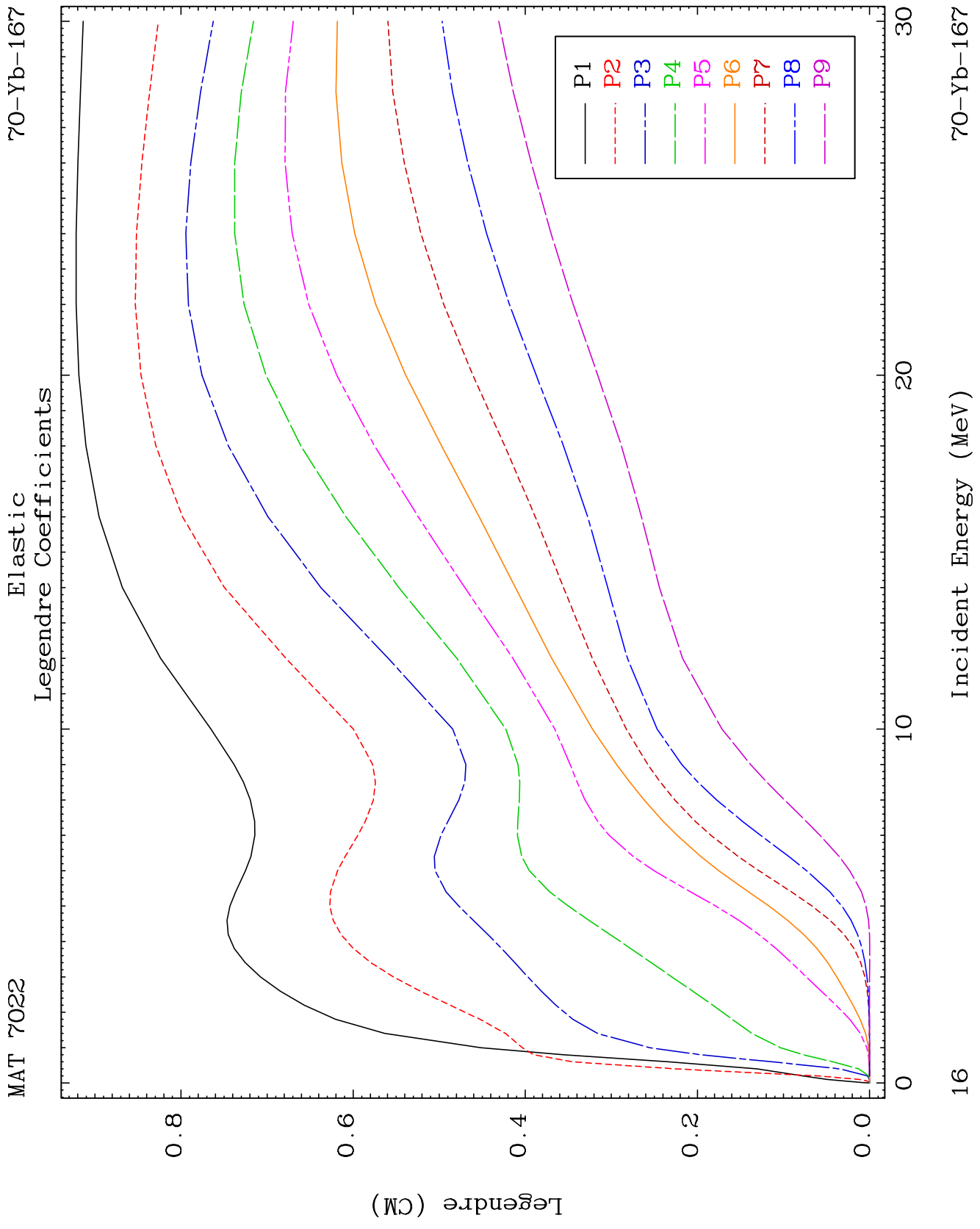

MAT 7022

Elastic Legendre Coefficients

70-Yb-167

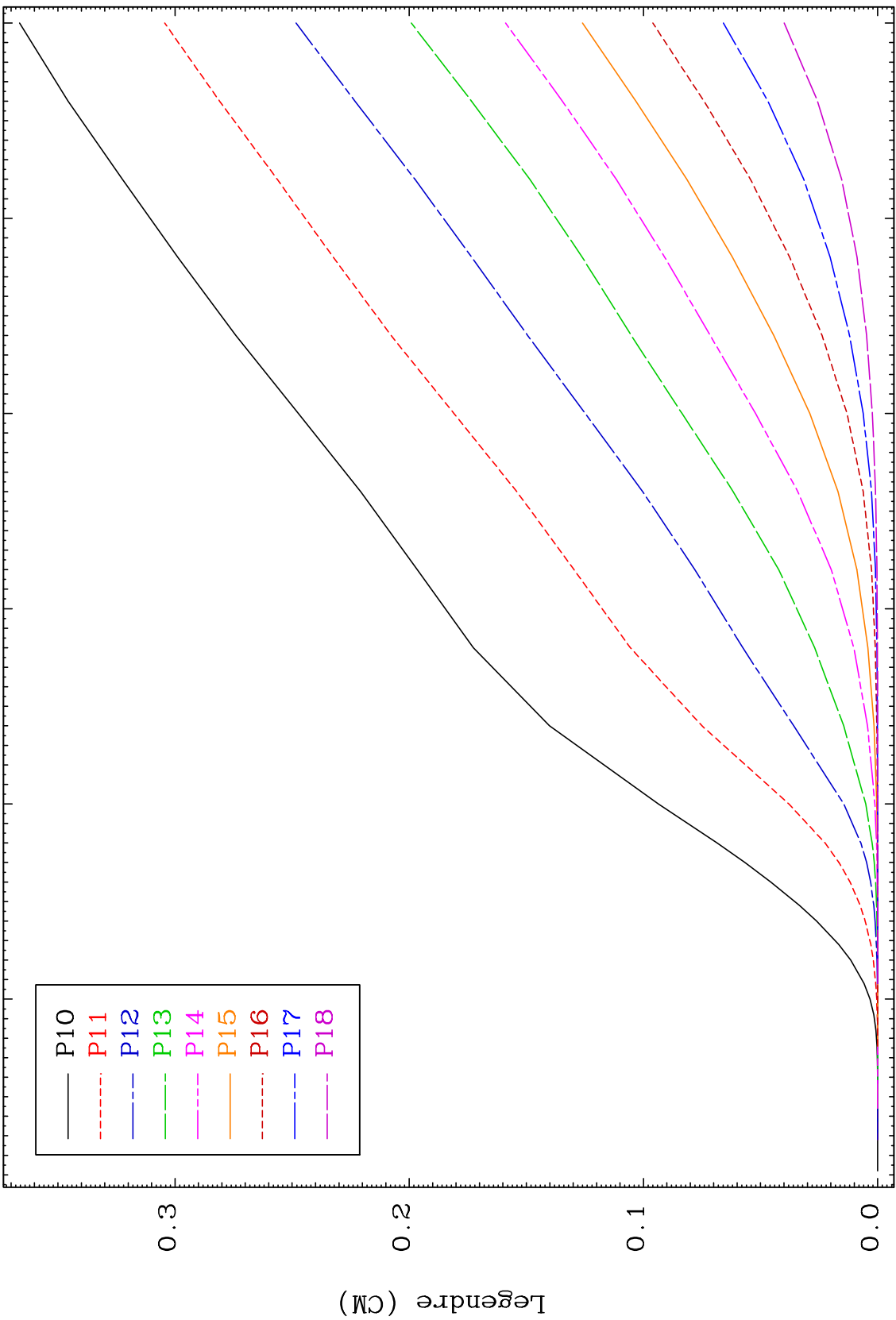

17

70-Yb-167

Incident Energy (MeV)

MAT 7022

Elastic Legendre Coefficients

70-Yb-167

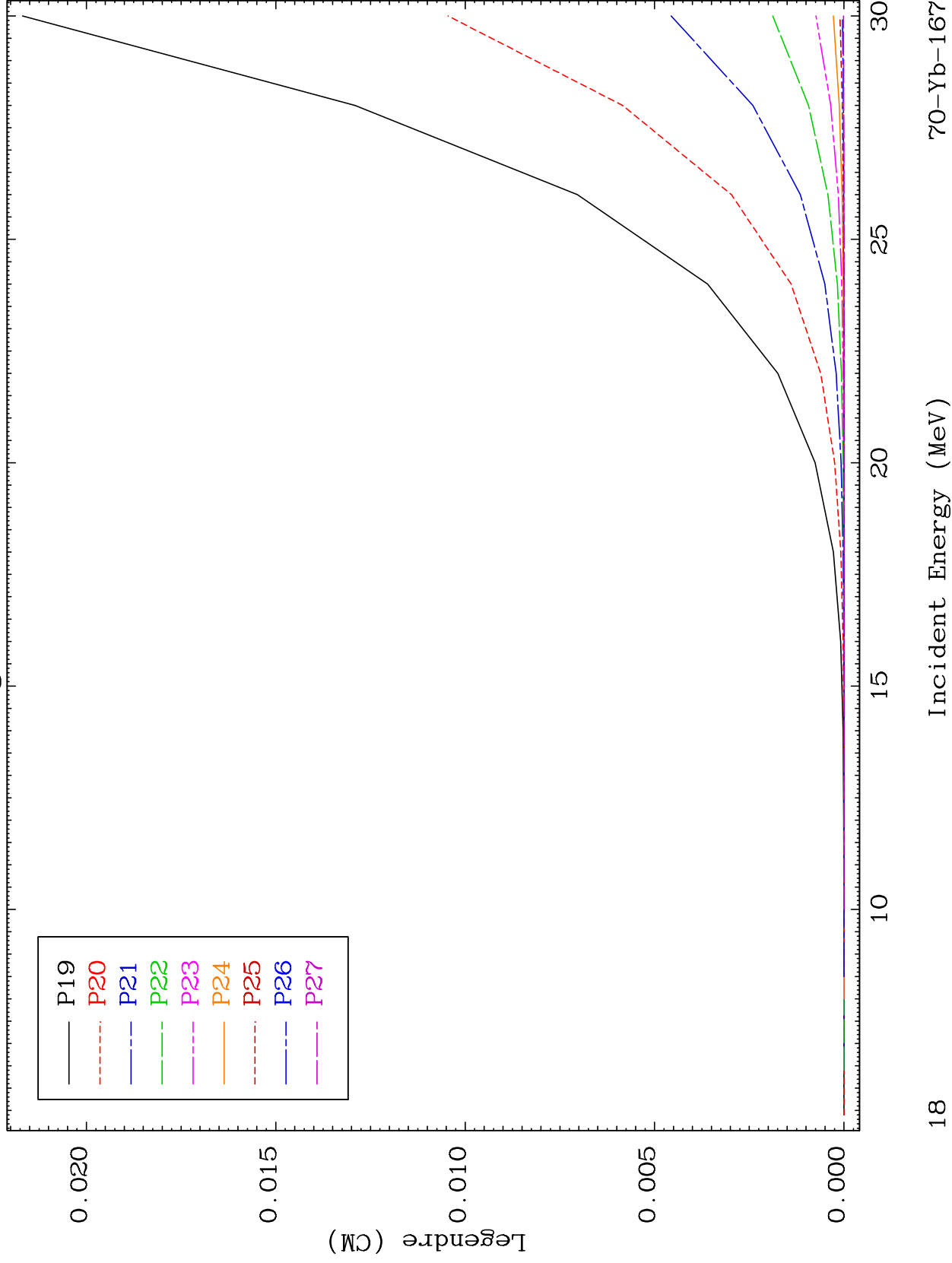

18

Incident Energy (MeV)

70-Yb-167

MAT 7022

Elastic
Legendre Coefficients

70-Yb-167

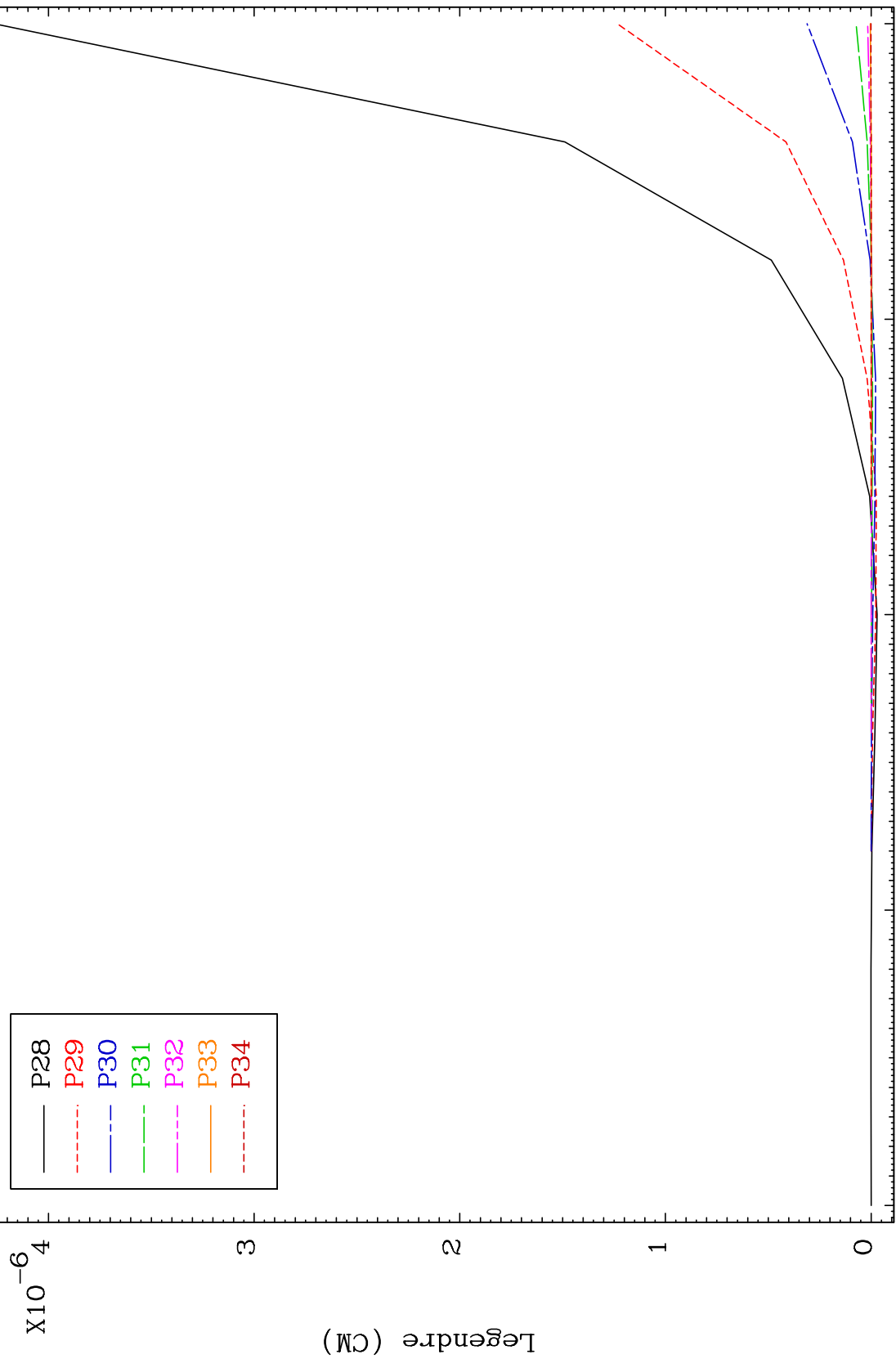
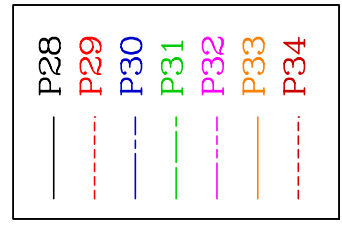

70-Yb-167

Incident Energy (MeV)

19

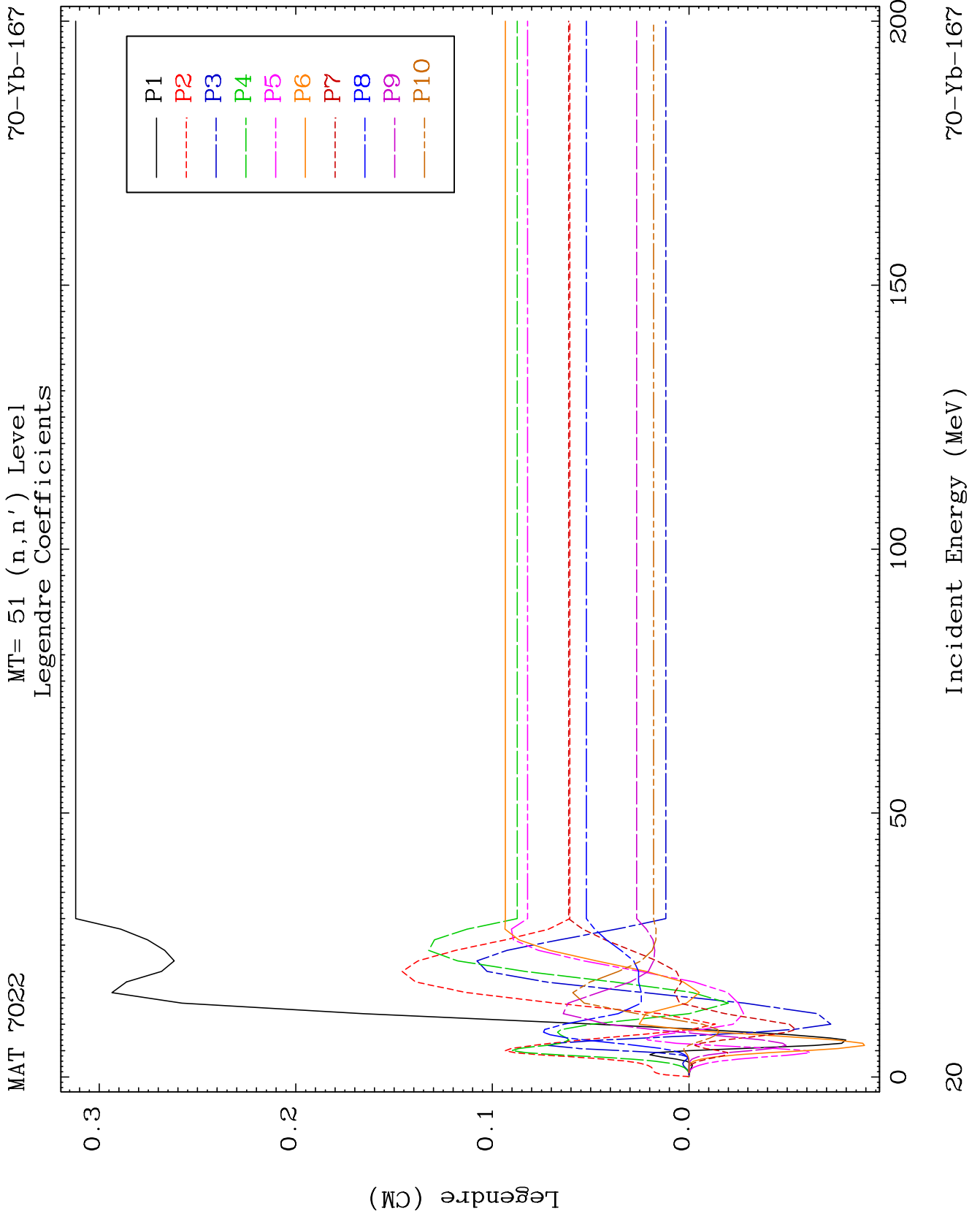

MAT 7022

MT= 51 (n,n') Level
Legendre Coefficients

70-Yb-167

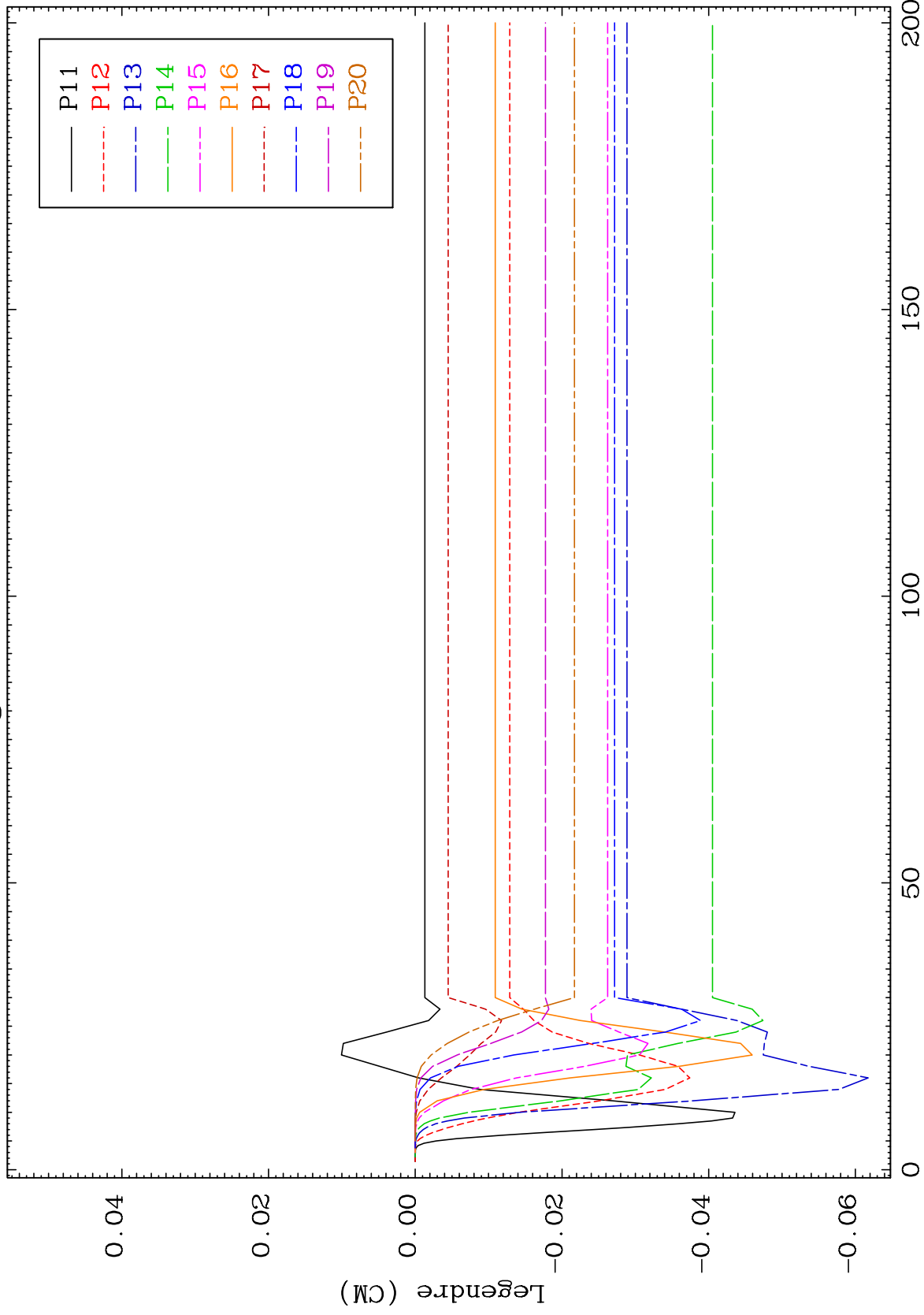

21

Incident Energy (MeV)

70-Yb-167

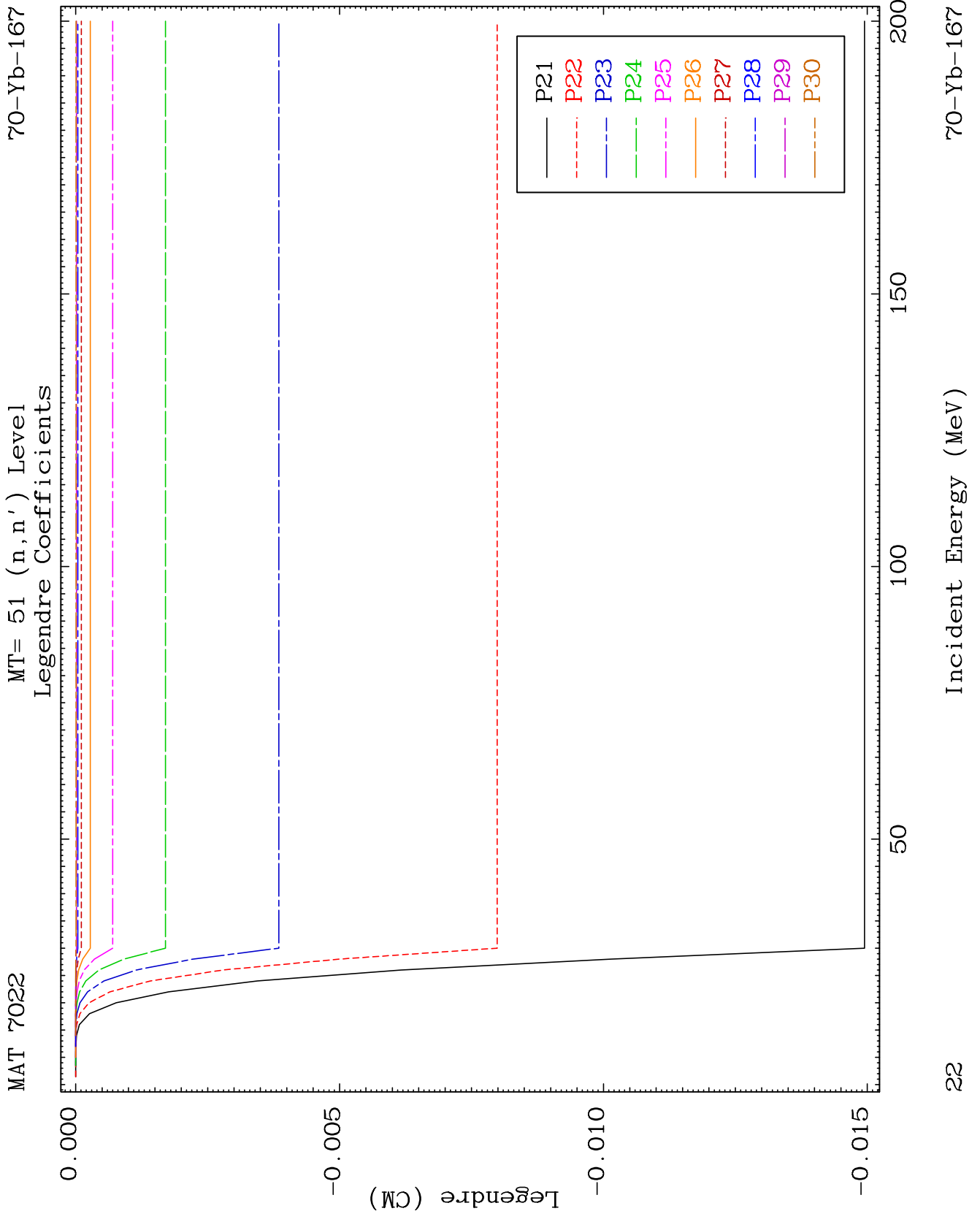

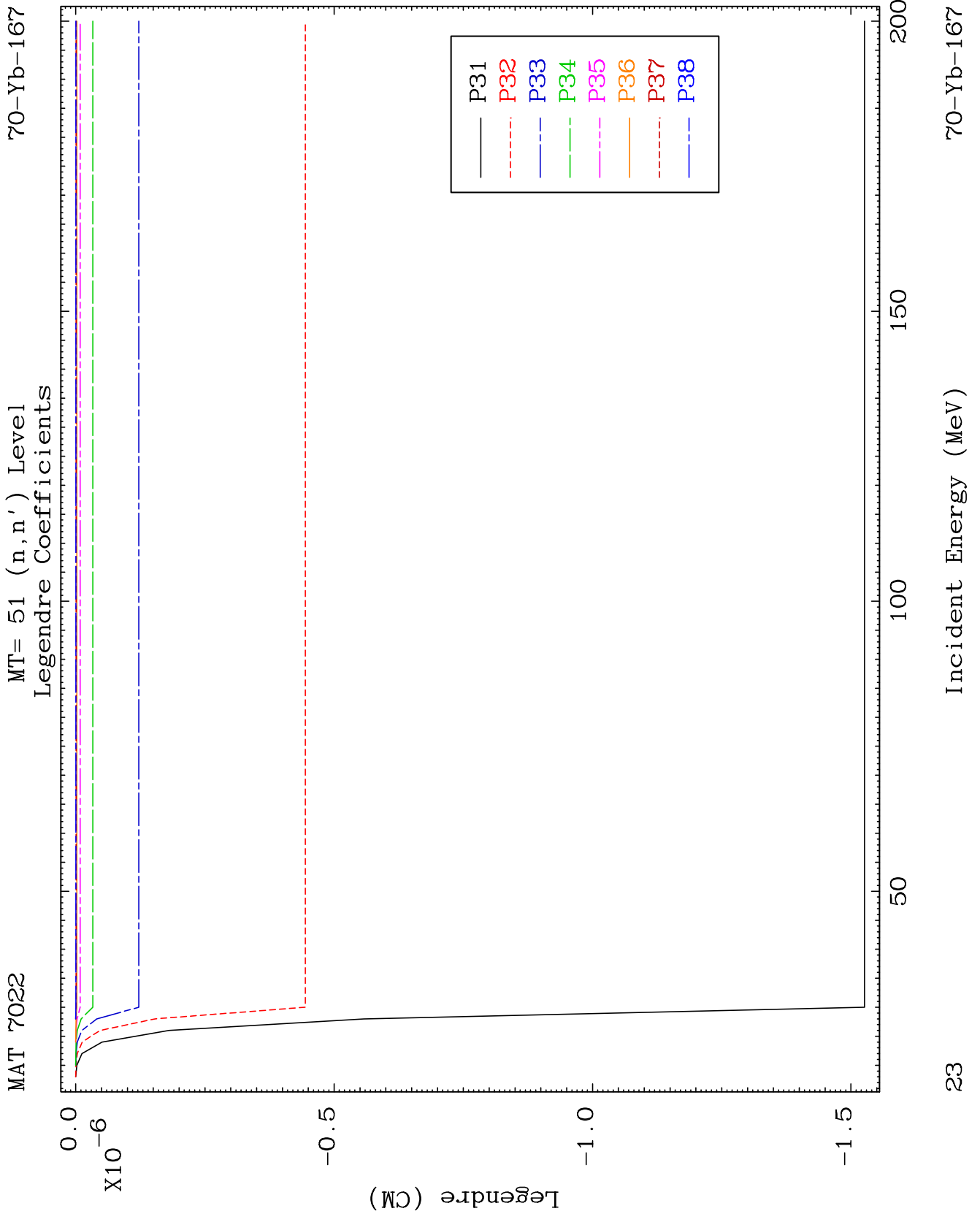

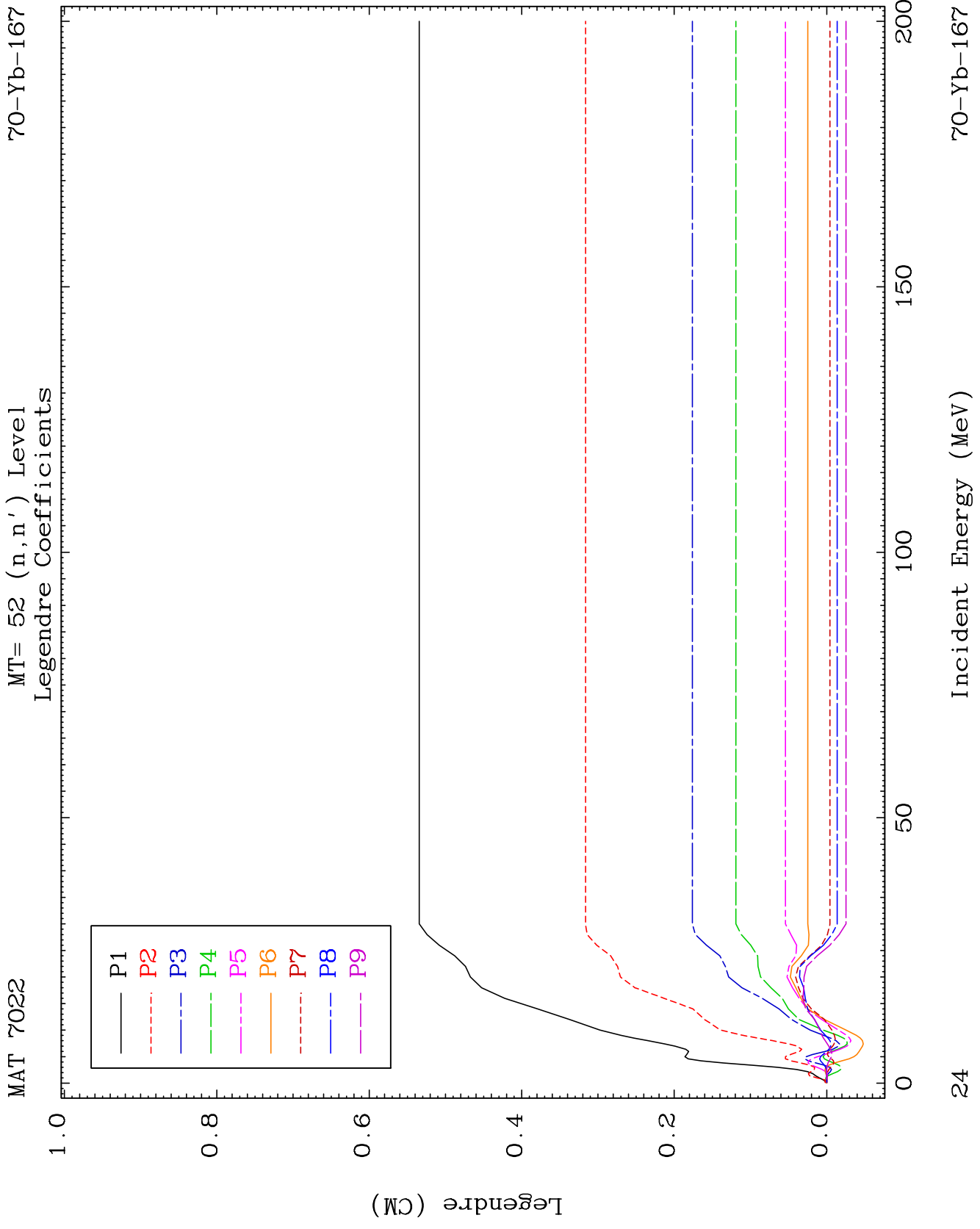

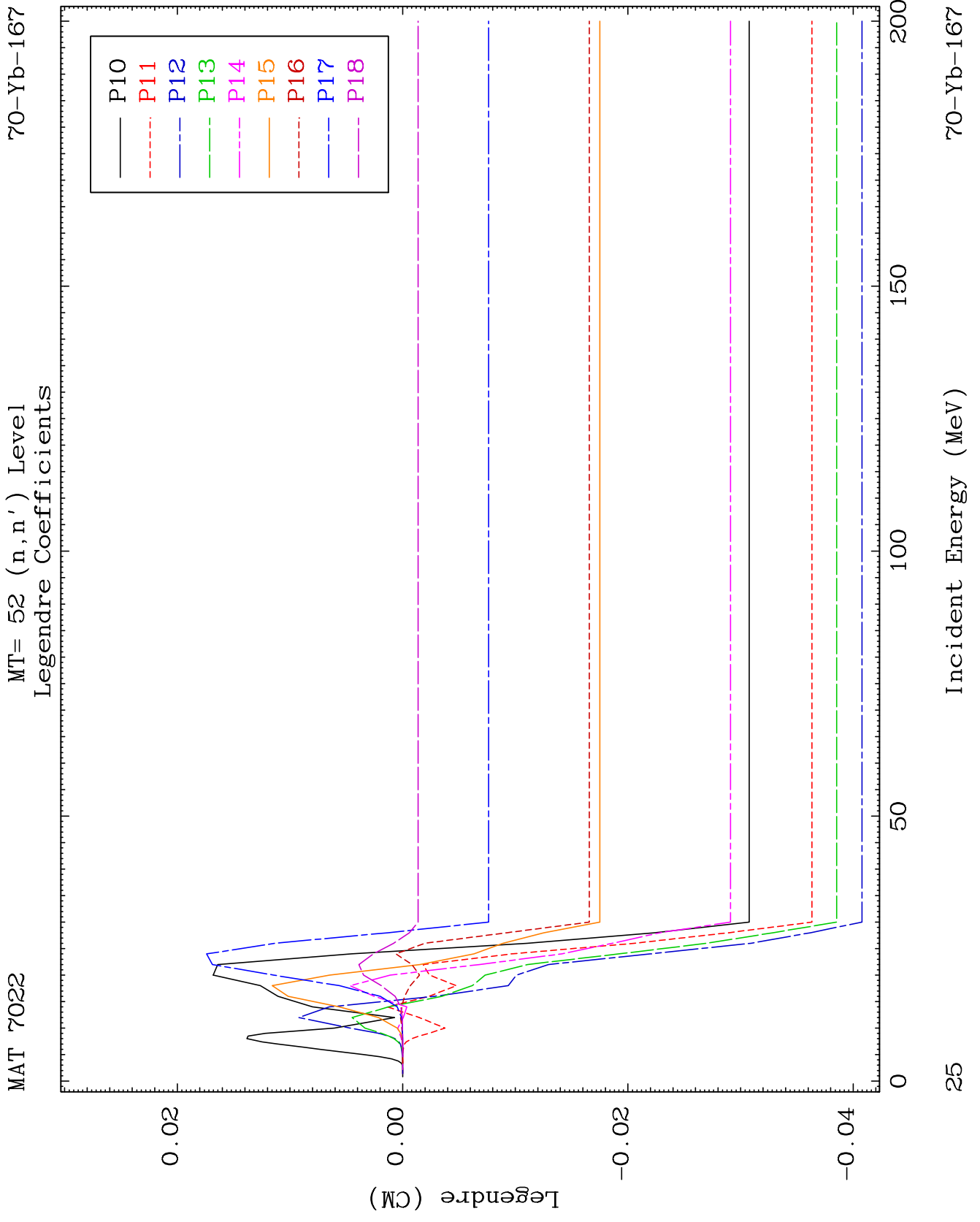

MAT 7022

MT= 52 (n,n') Level
Legendre Coefficients

70-Yb-167

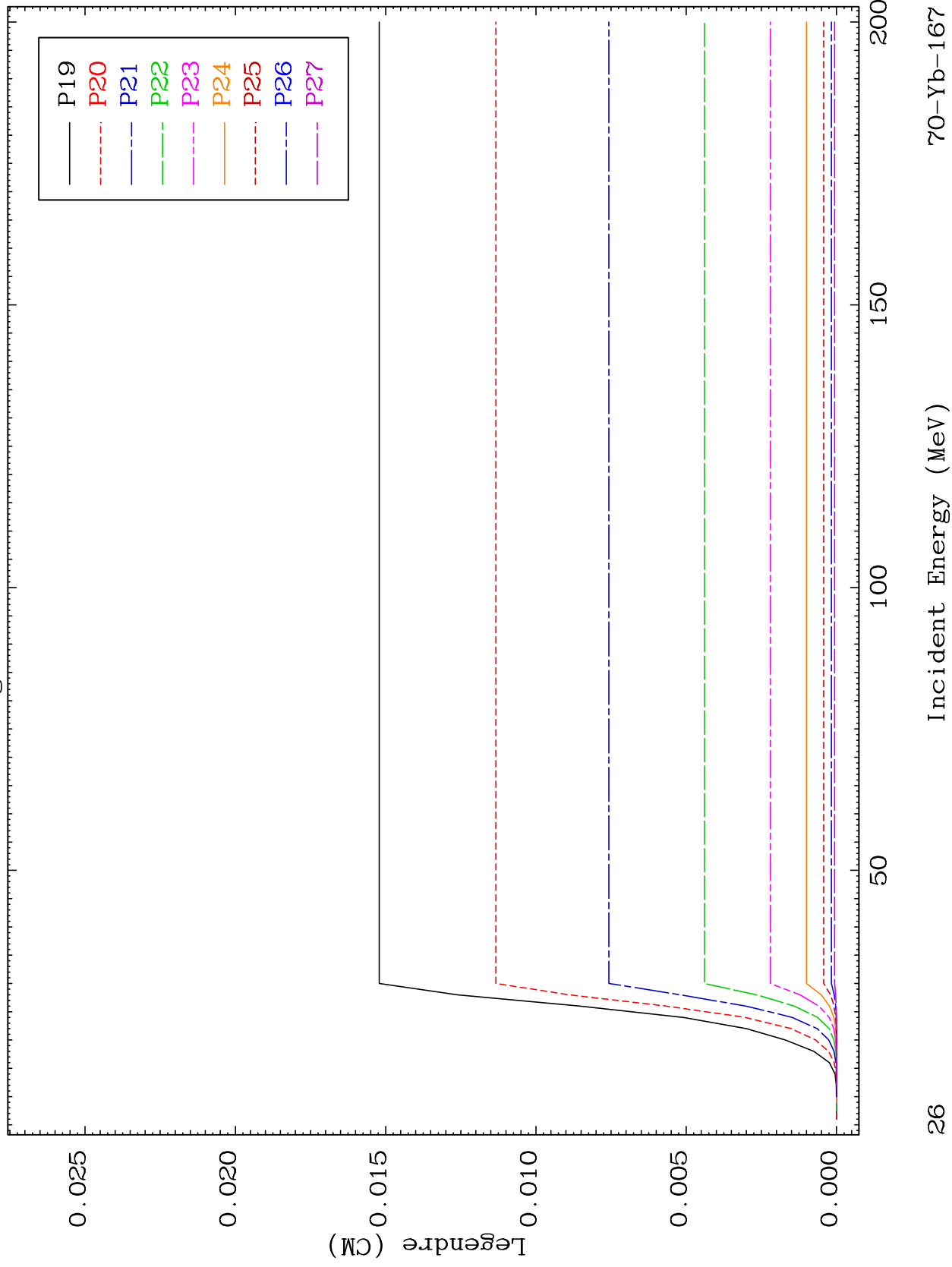

26

Incident Energy (MeV)

70-Yb-167

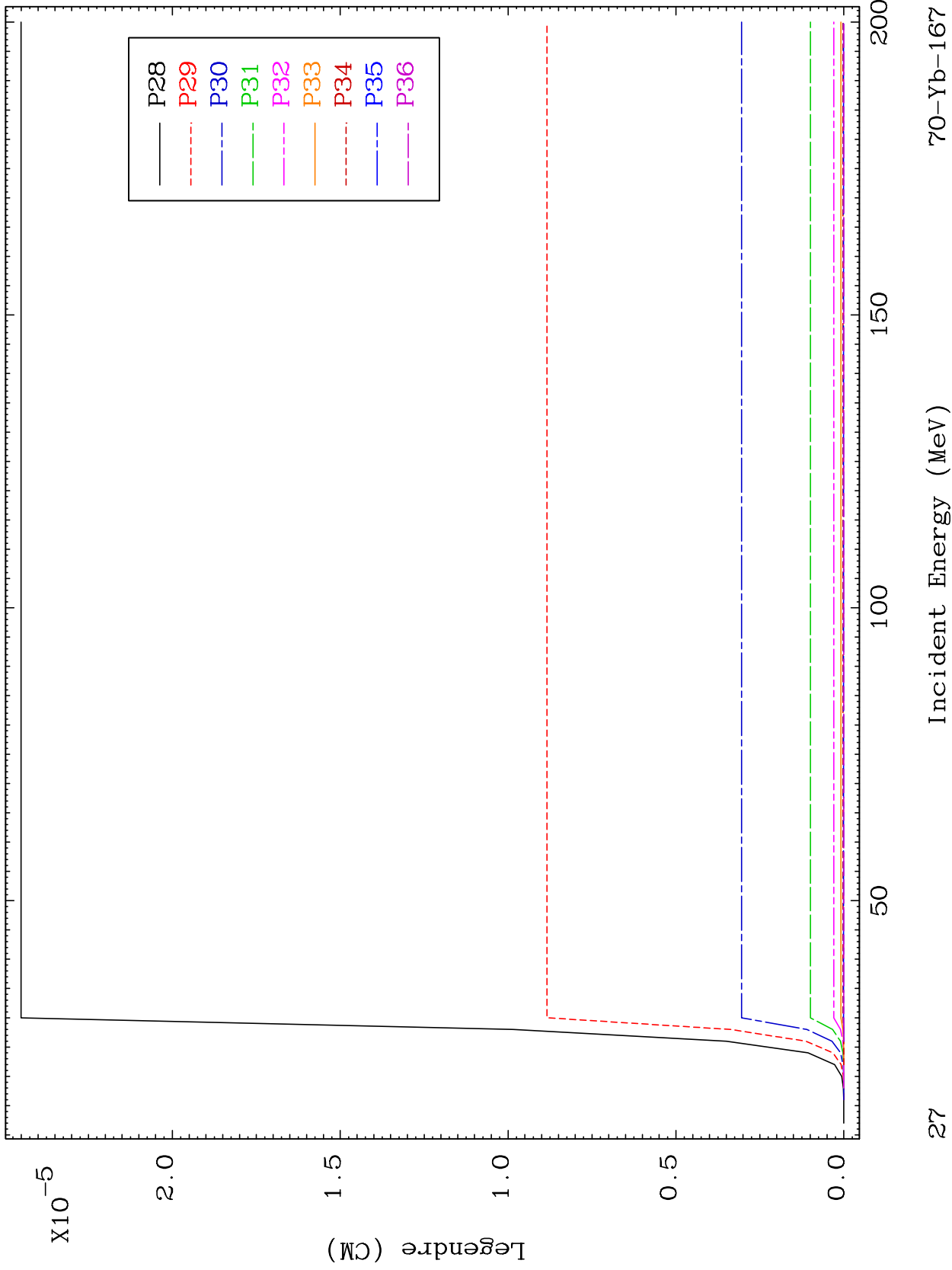

MAT 7022

MT= 53 (n,n') Level
Legendre Coefficients

70-Yb-167

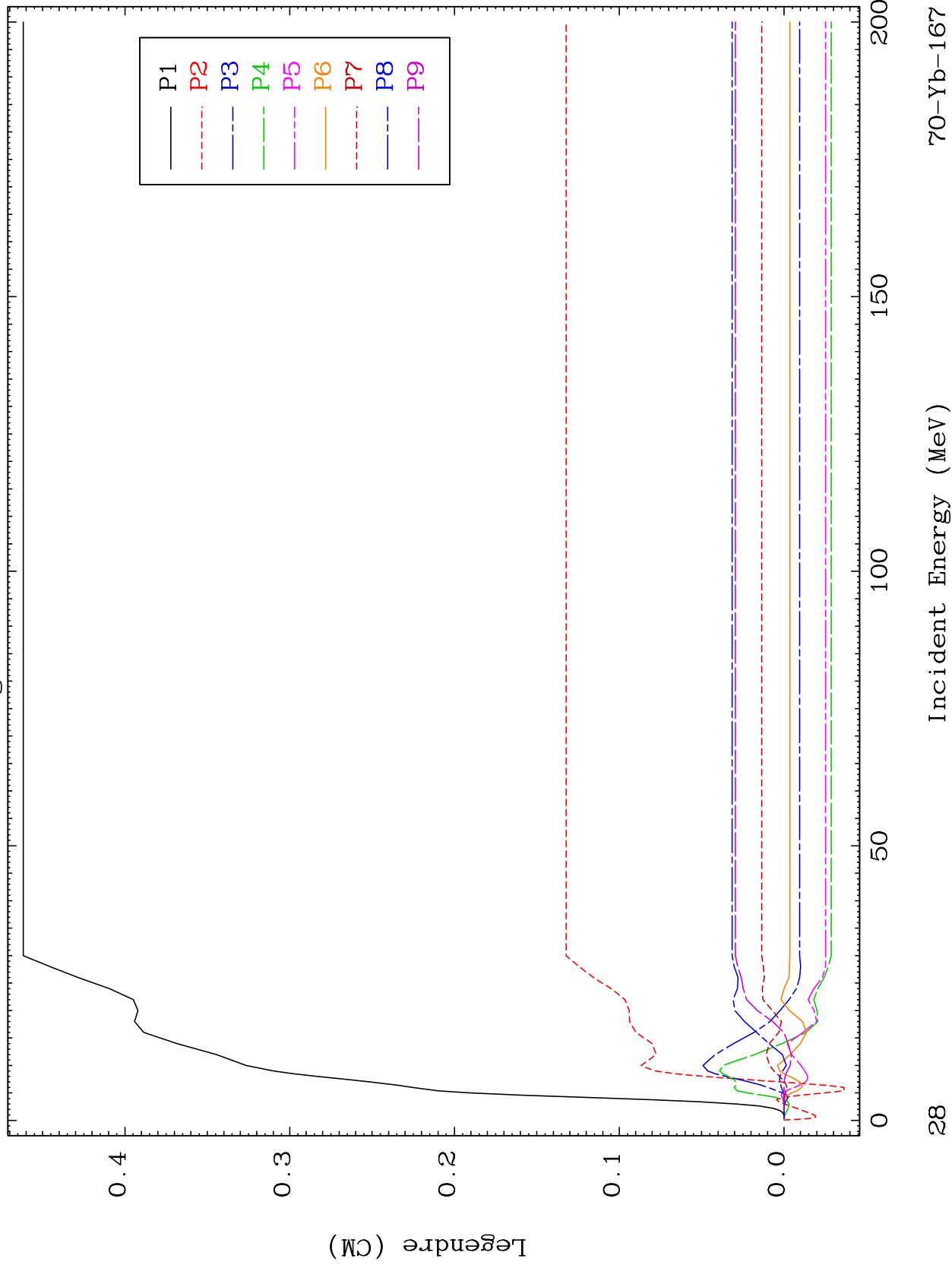

70-Yb-167

Incident Energy (MeV)

28

MAT 7022

MT= 53 (n,n') Level
Legendre Coefficients

70-Yb-167

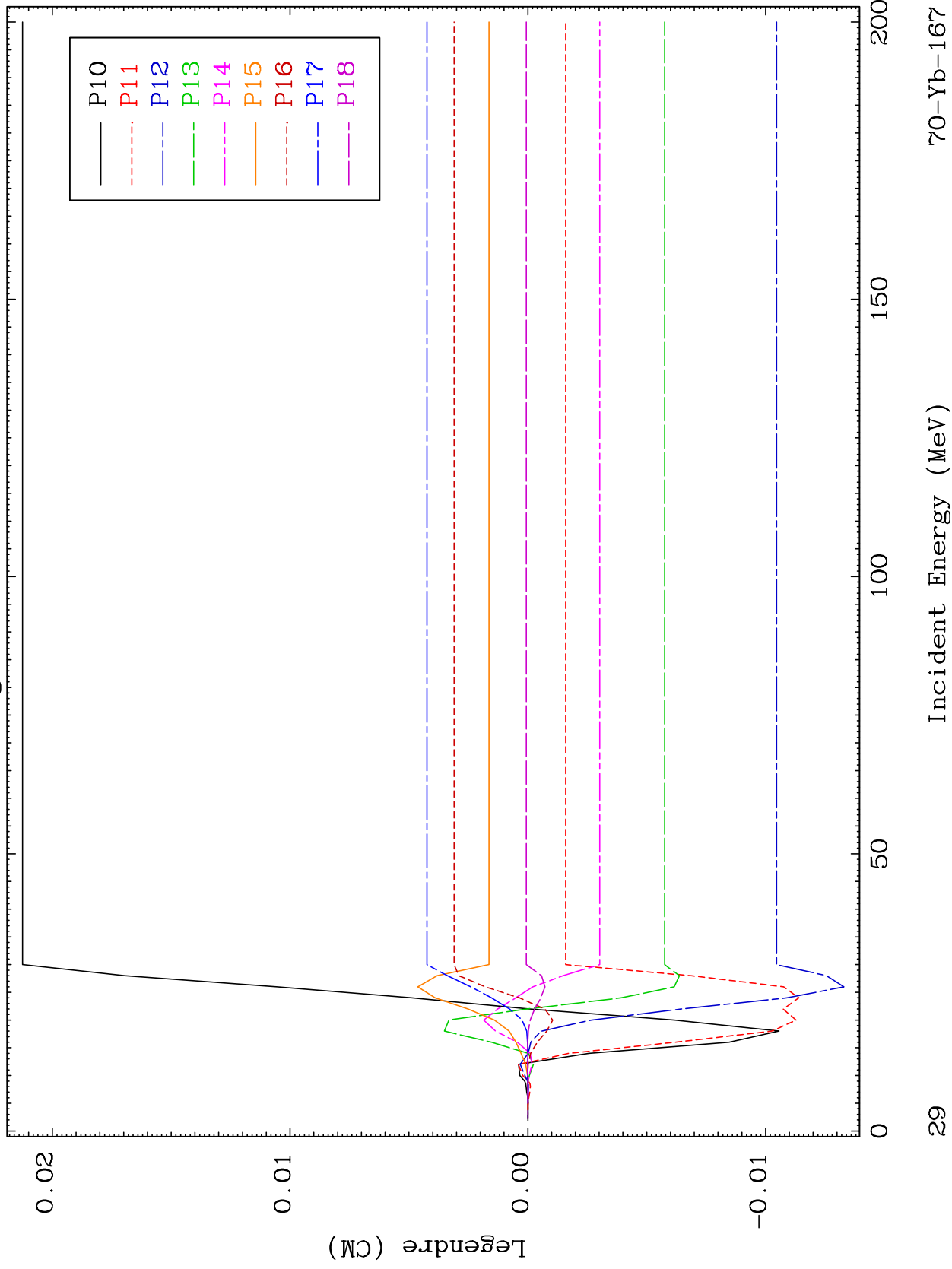

29

Incident Energy (MeV)

70-Yb-167

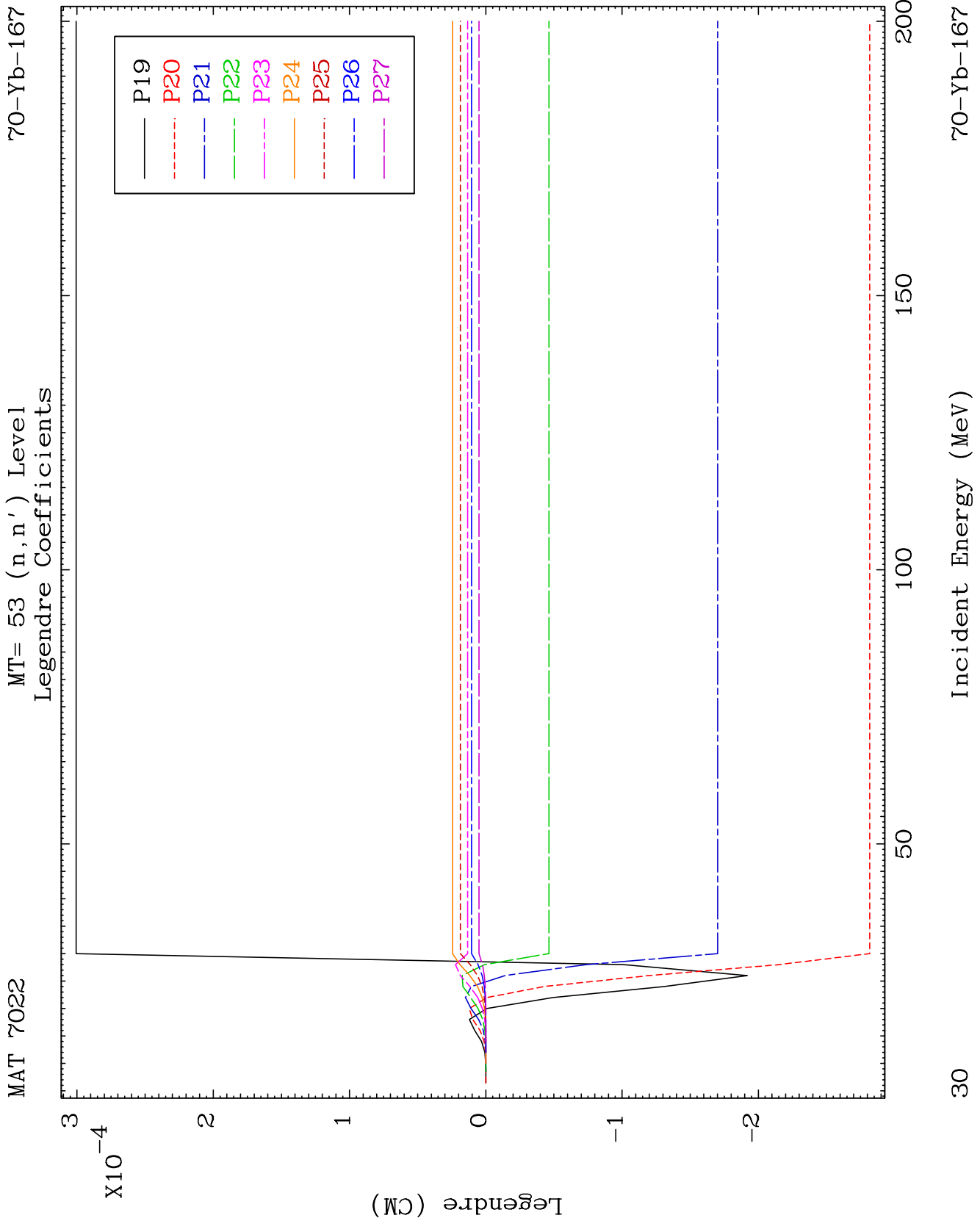

MAT 7022

MT= 53 (n,n') Level
Legendre Coefficients

70-Yb-167

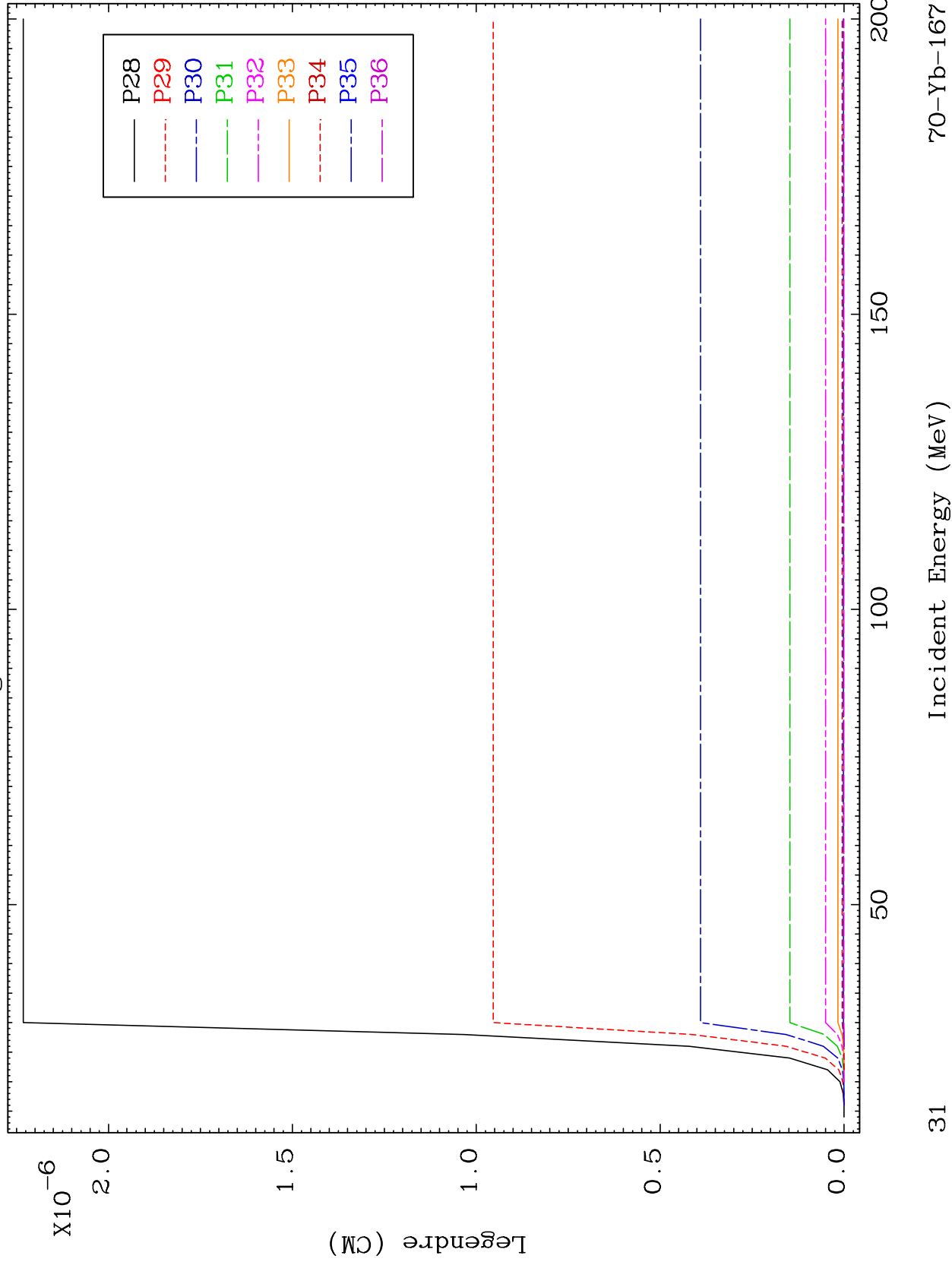

31

MAT 7022

MT= 54 (n,n') Level
Legendre Coefficients

70-Yb-167

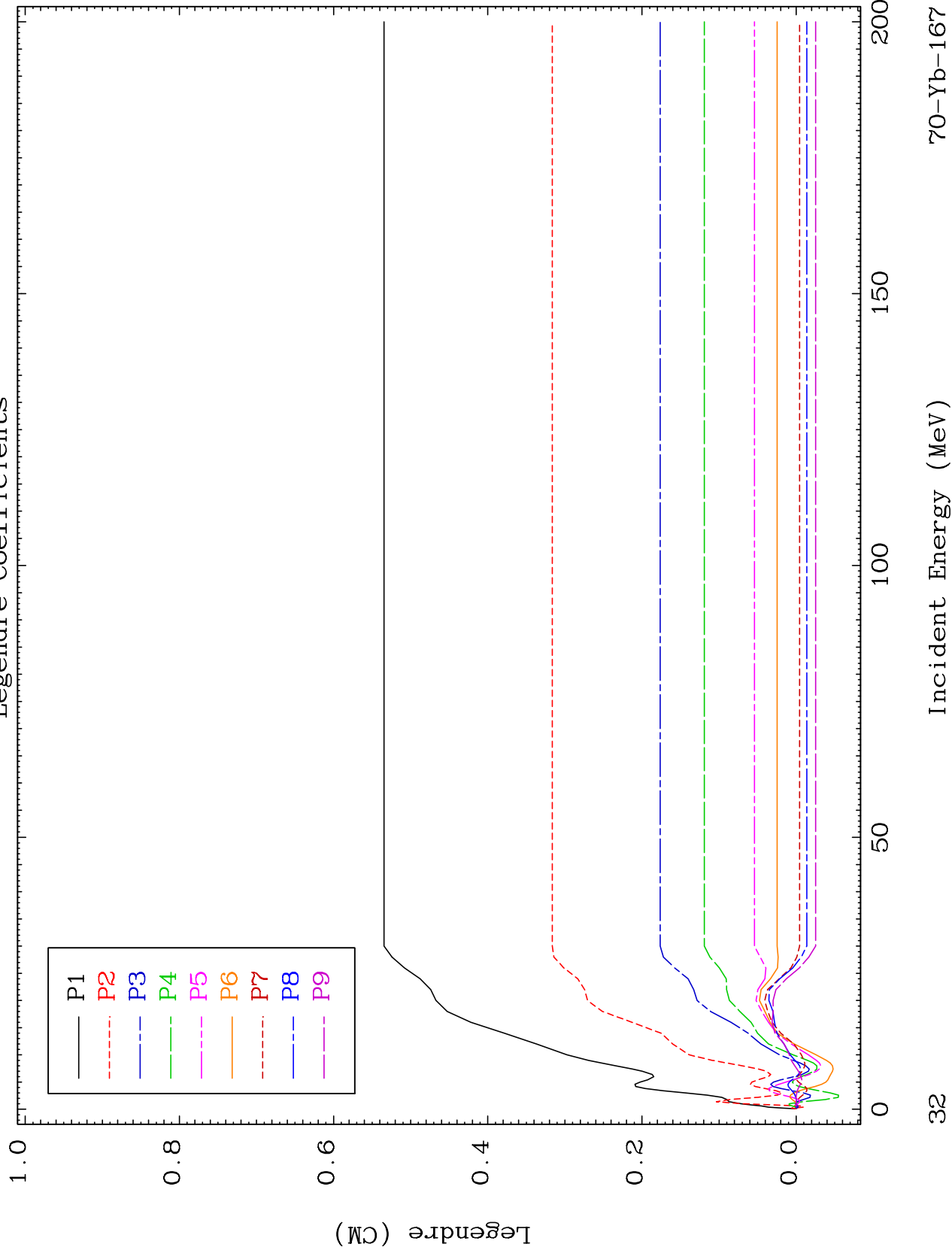

32

Incident Energy (MeV)

70-Yb-167

MAT 7022

MT= 54 (n,n') Level
Legendre Coefficients

70-Yb-167

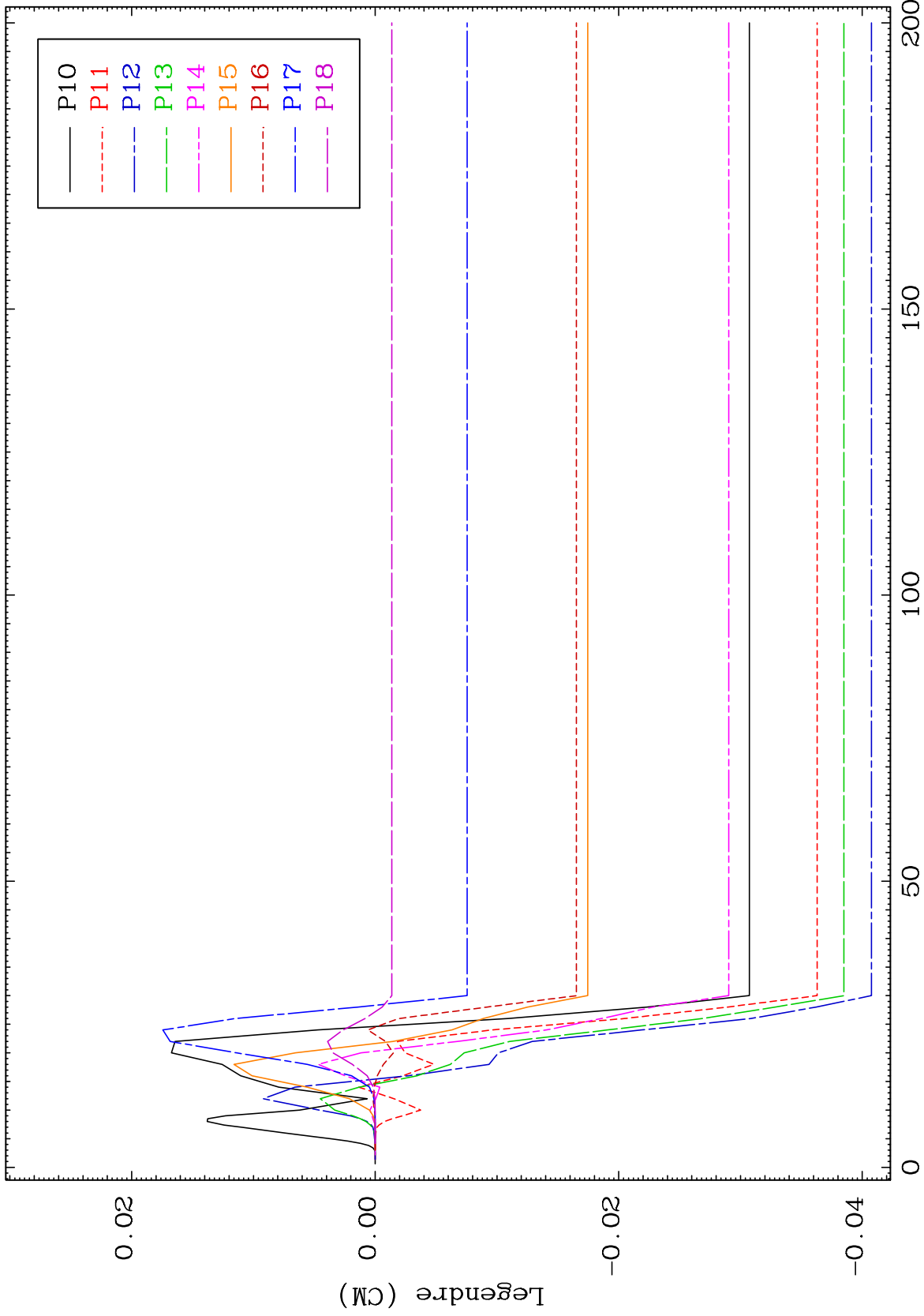

33

Incident Energy (MeV)

70-Yb-167

MAT 7022

MT= 54 (n,n') Level
Legendre Coefficients

70-Yb-167

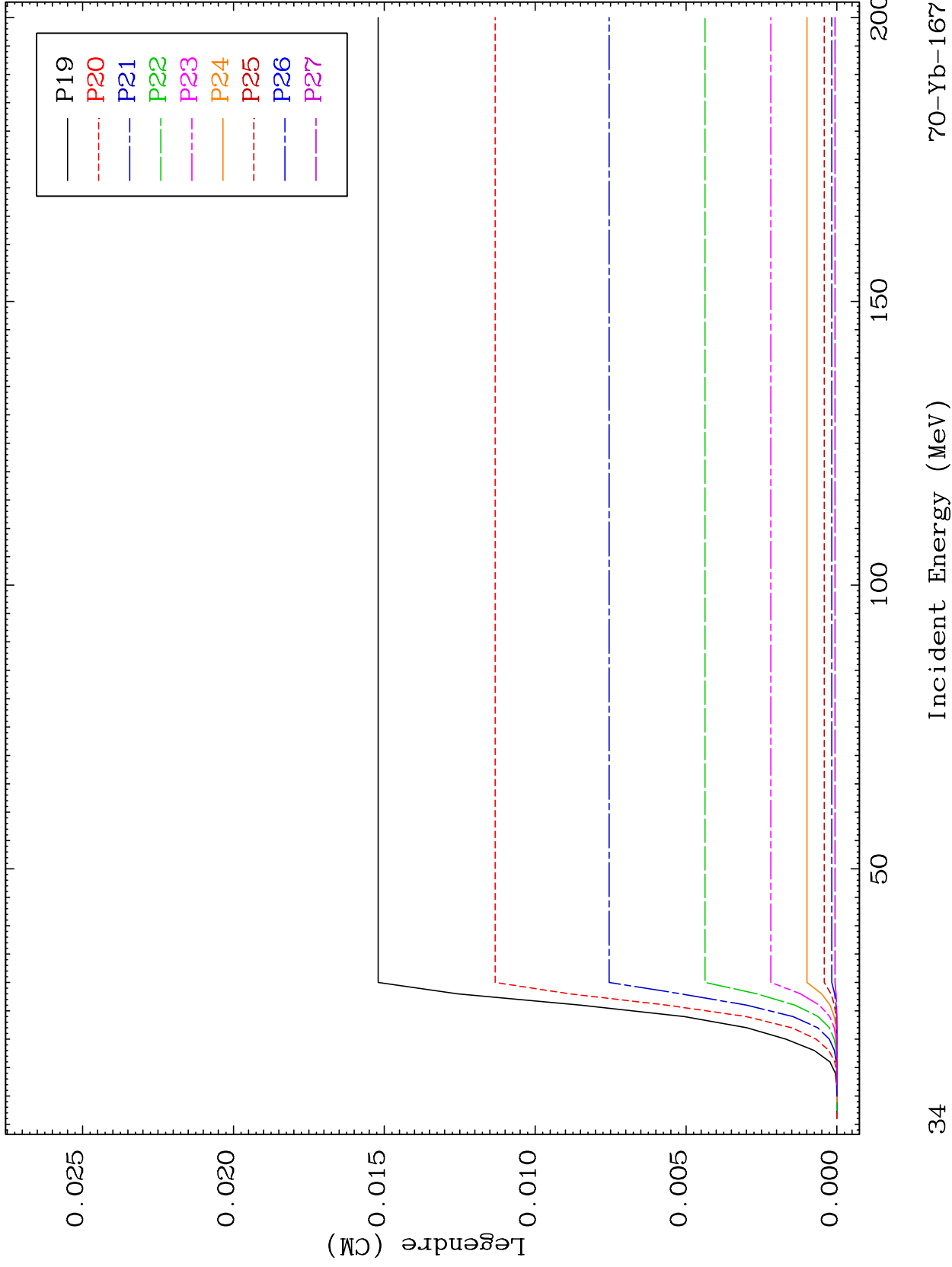

34

70-Yb-167

MAT 7022

MT= 54 (n,n') Level
Legendre Coefficients

70-Yb-167

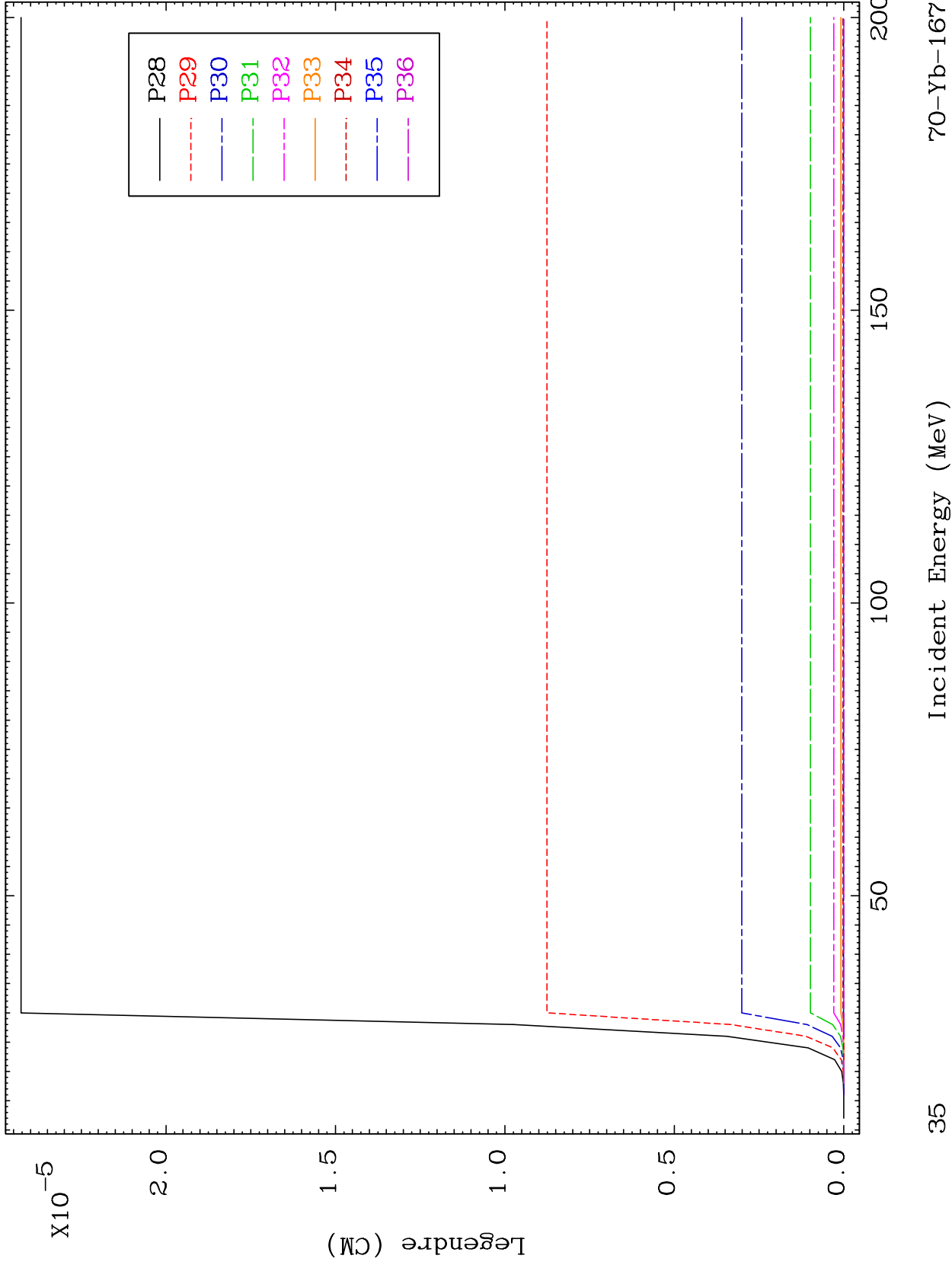

35

Incident Energy (MeV)

70-Yb-167

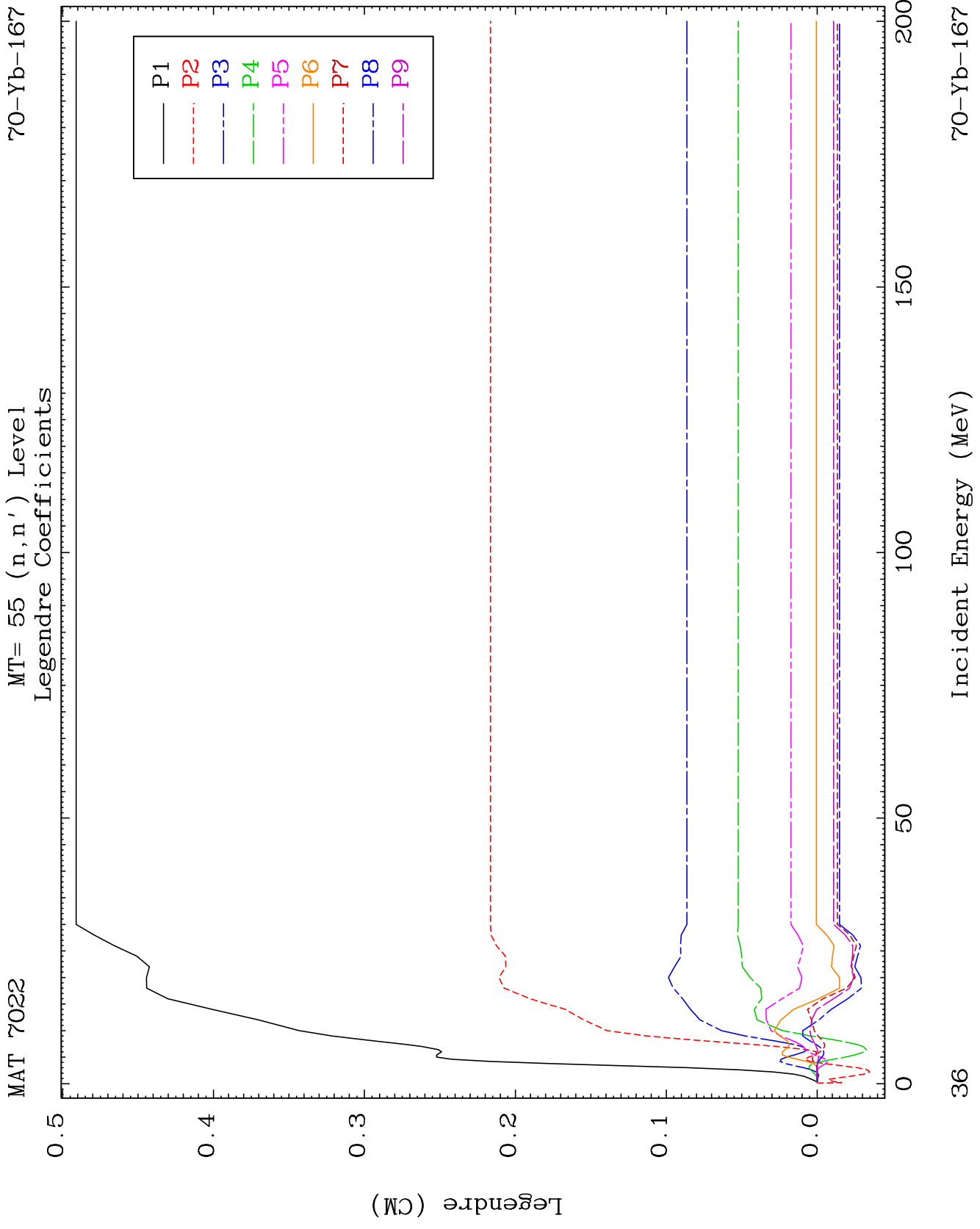

MAT 7022

MT= 55 (n,n') Level
Legendre Coefficients

70-Yb-167

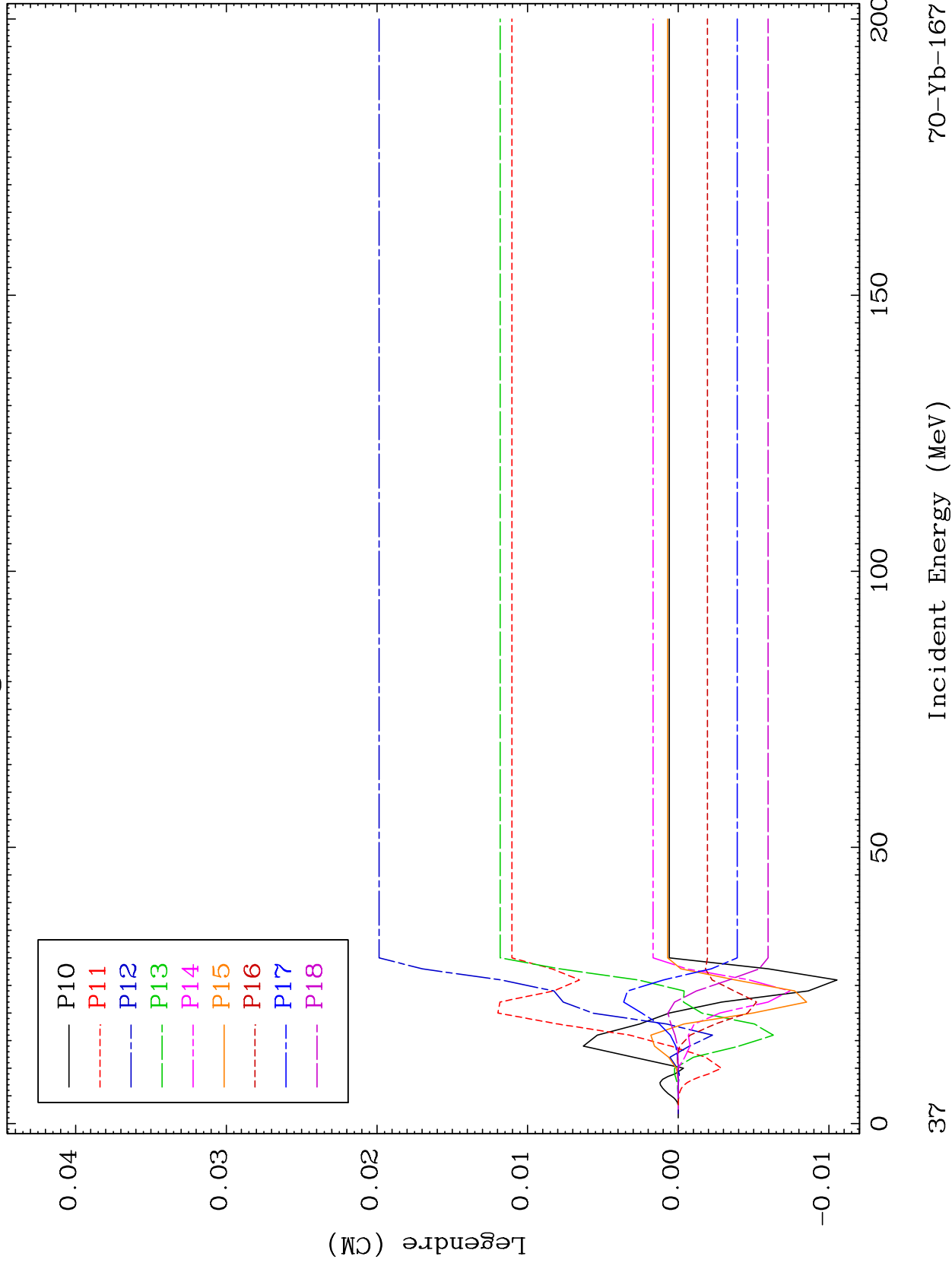

MAT 7022

MT= 55 (n,n') Level
Legendre Coefficients

70-Yb-167

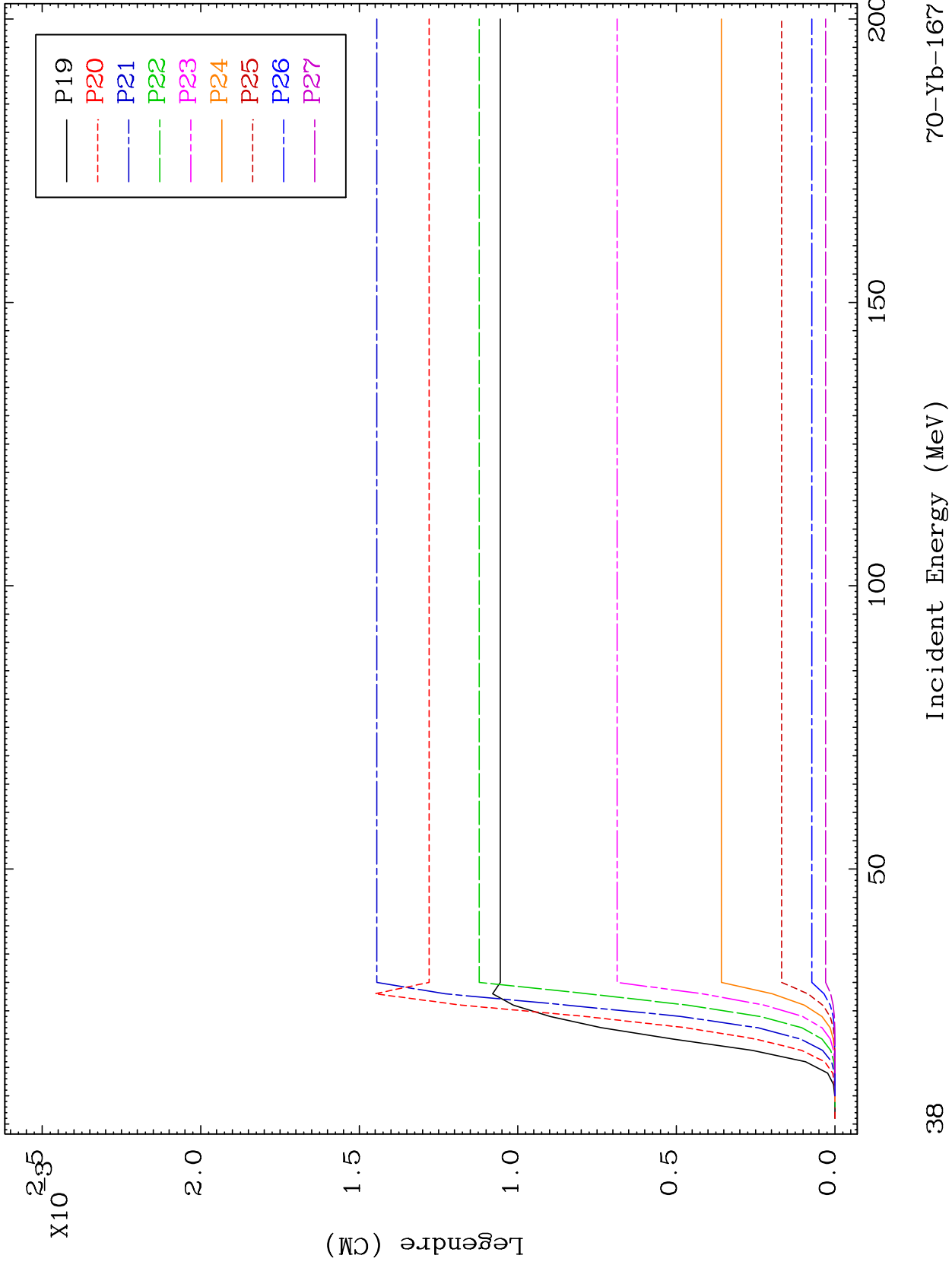

38

70-Yb-167

MAT 7022

MT= 55 (n,n') Level
Legendre Coefficients

70-Yb-167

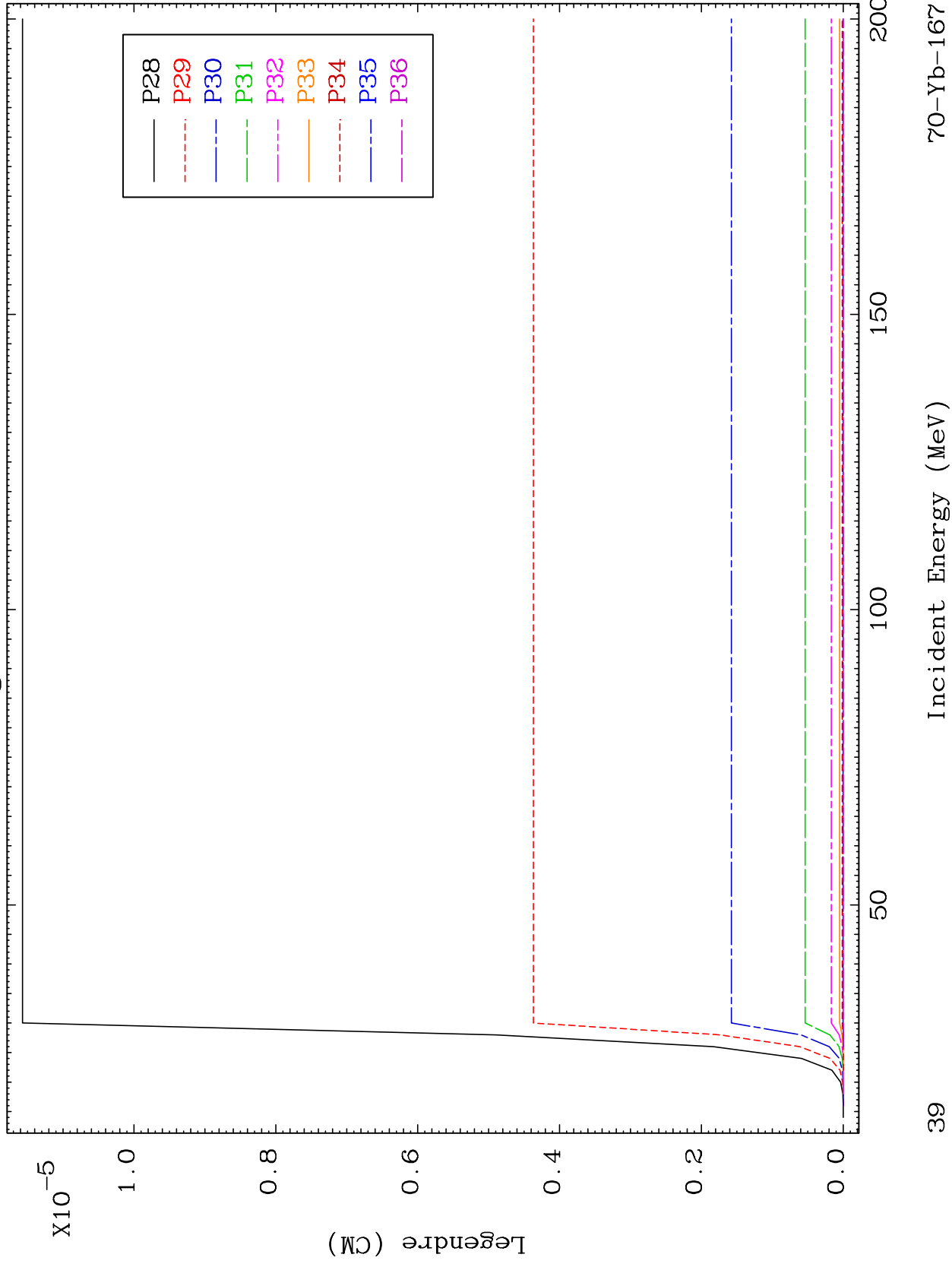

39

70-Yb-167

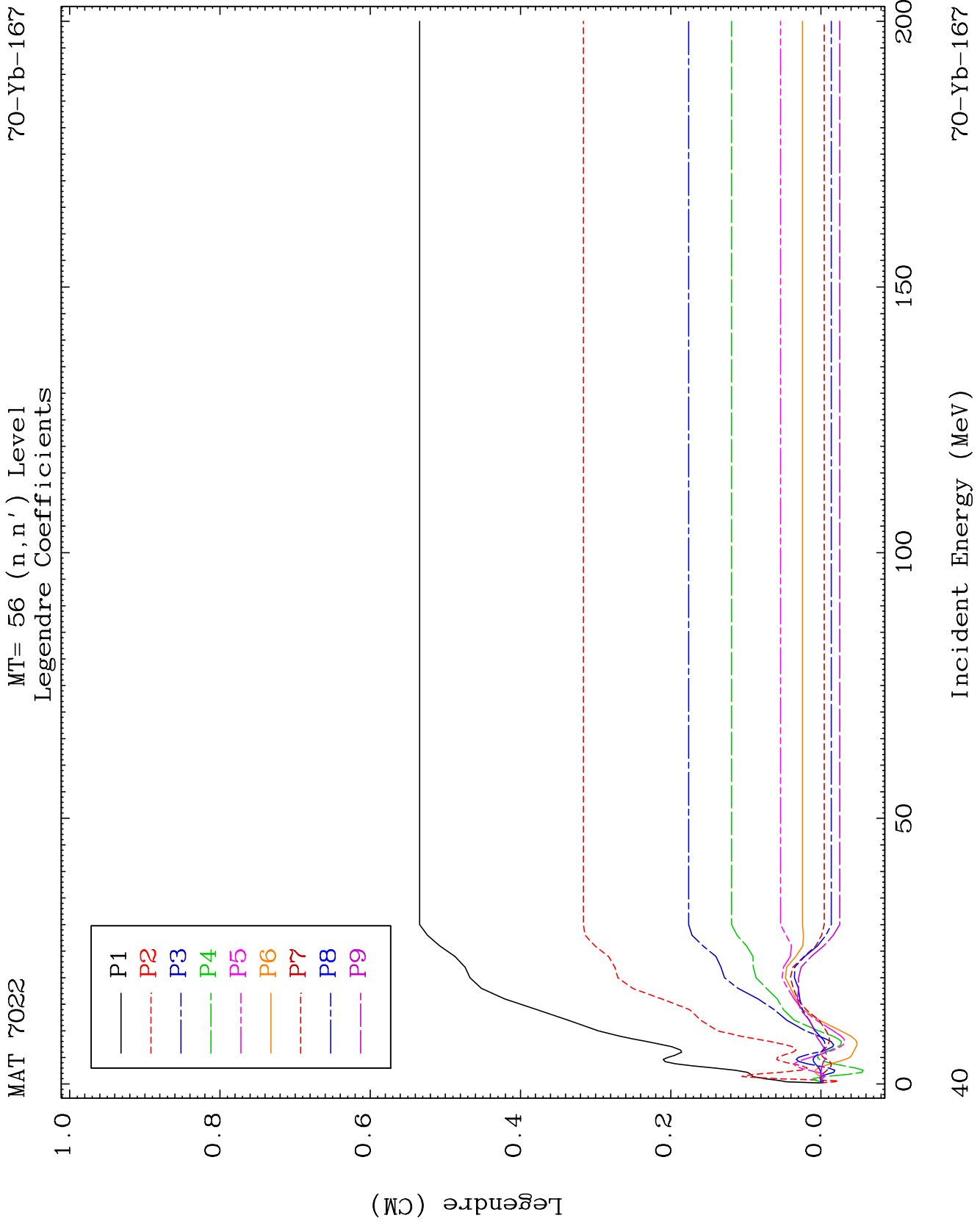

MAT 70222

MT= 56 (n,n') Level
Legendre Coefficients

70-Yb-167

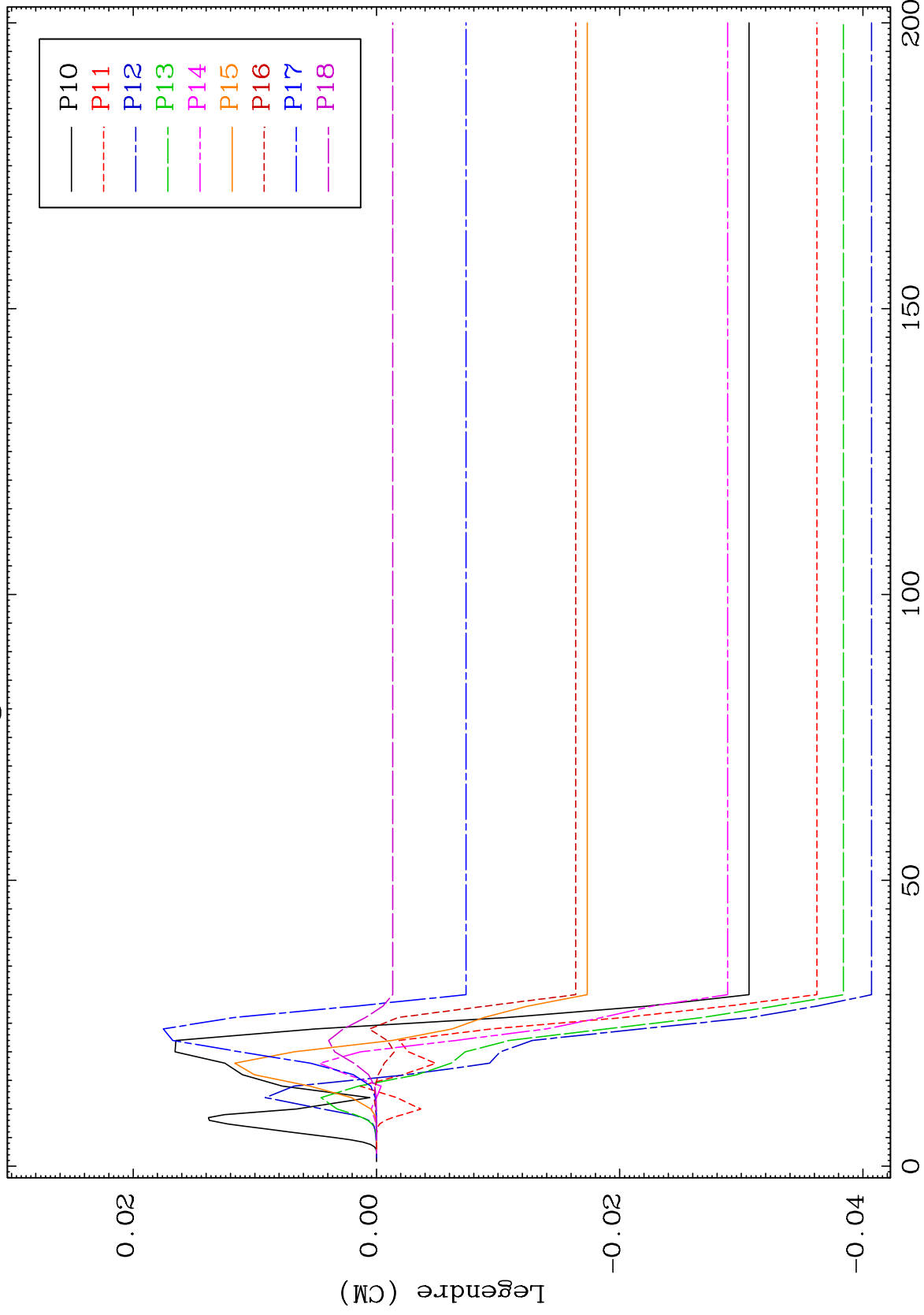

41

Incident Energy (MeV)

70-Yb-167

MAT 7022

MT= 56 (n,n') Level
Legendre Coefficients

70-Yb-167

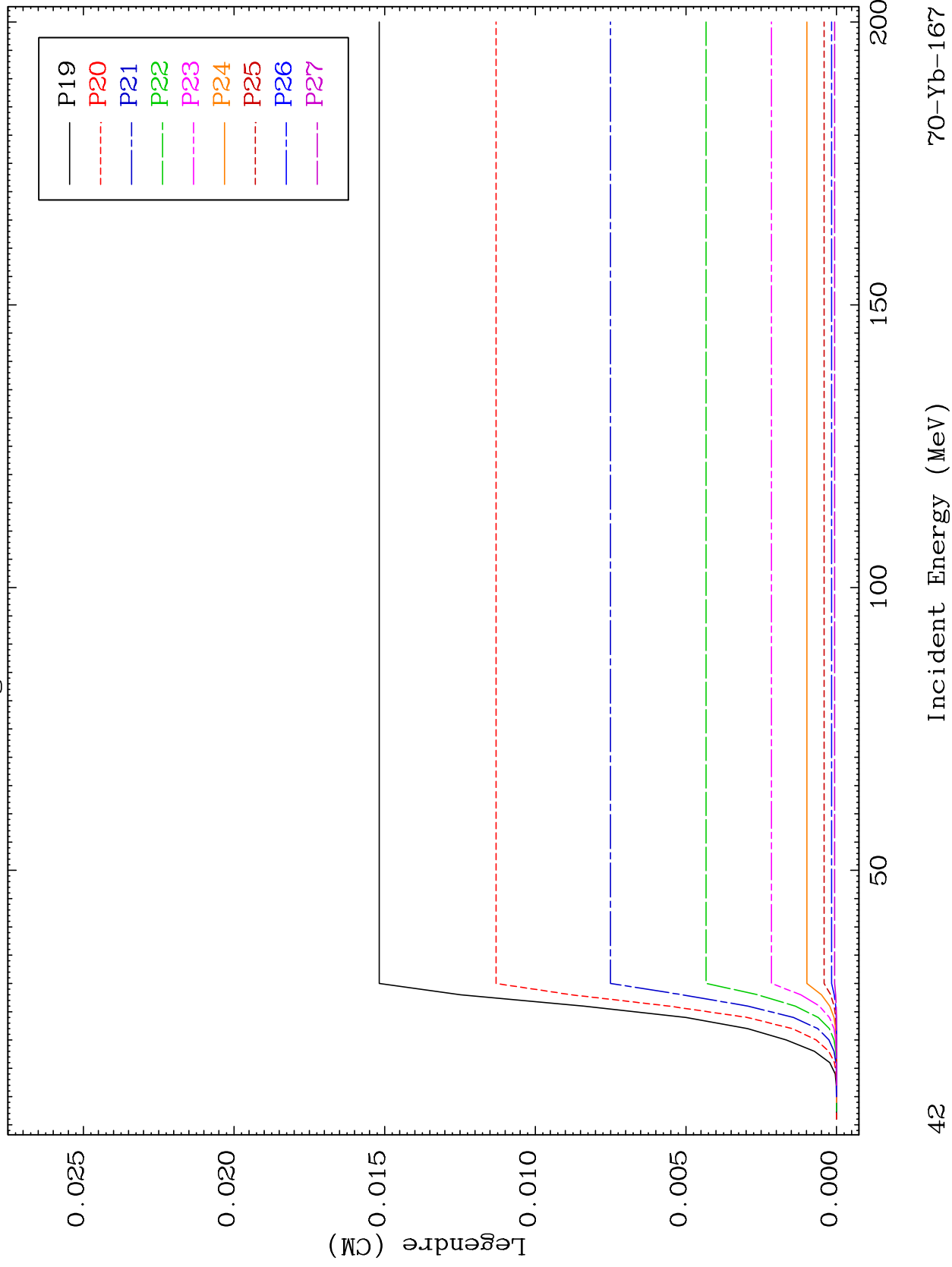

42

Incident Energy (MeV)

70-Yb-167

MAT 7022

MT= 56 (n,n') Level
Legendre Coefficients

70-Yb-167

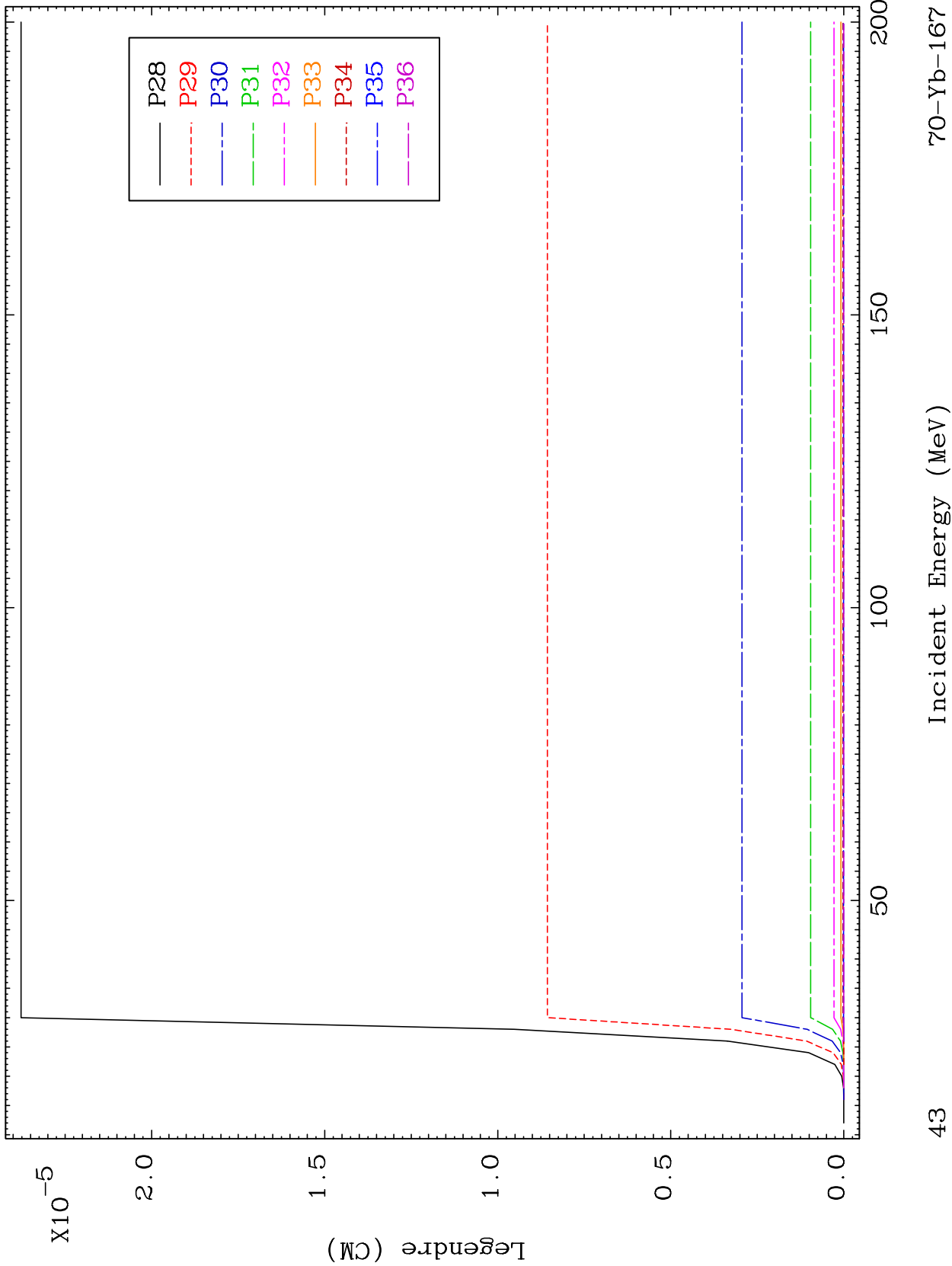

43

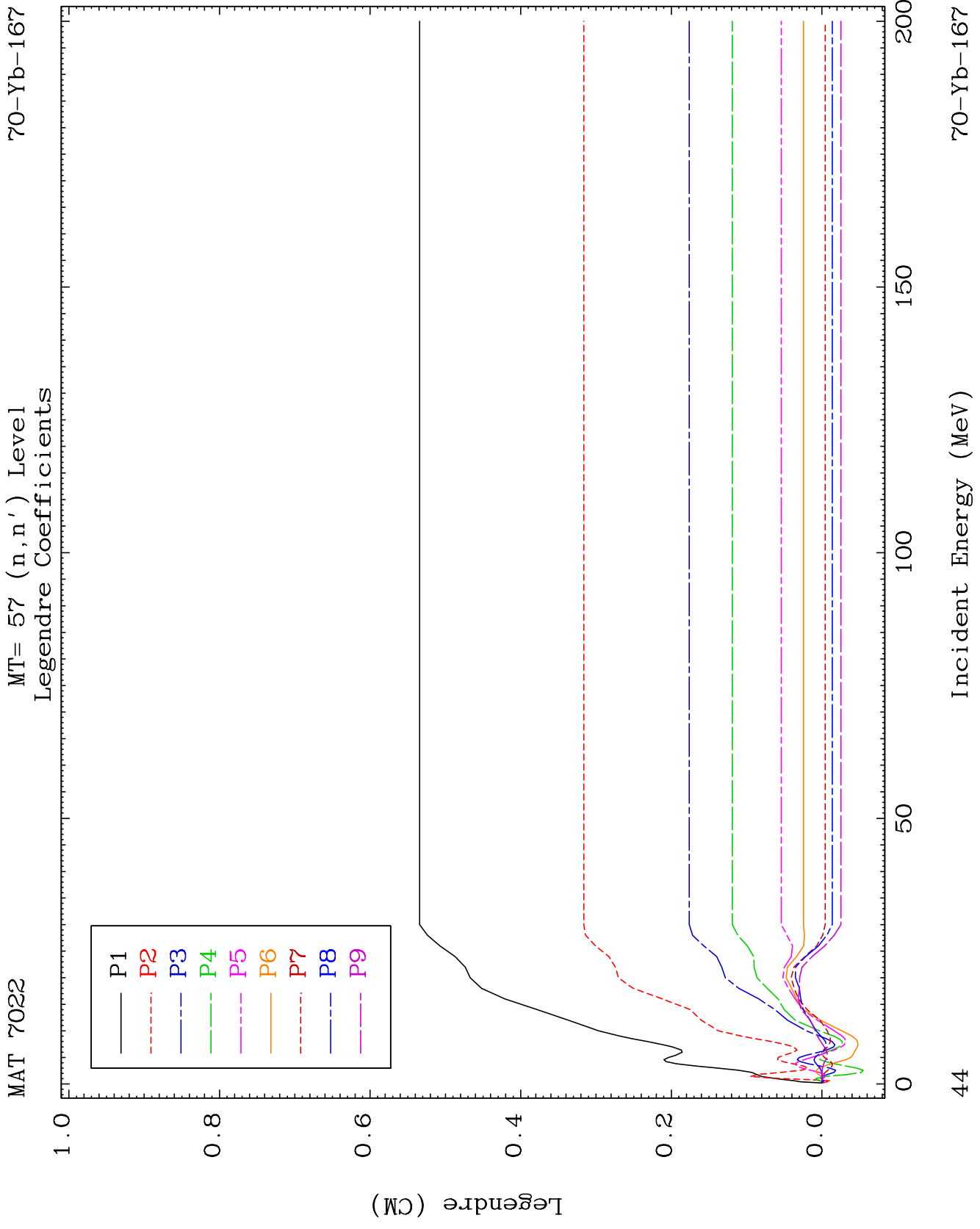

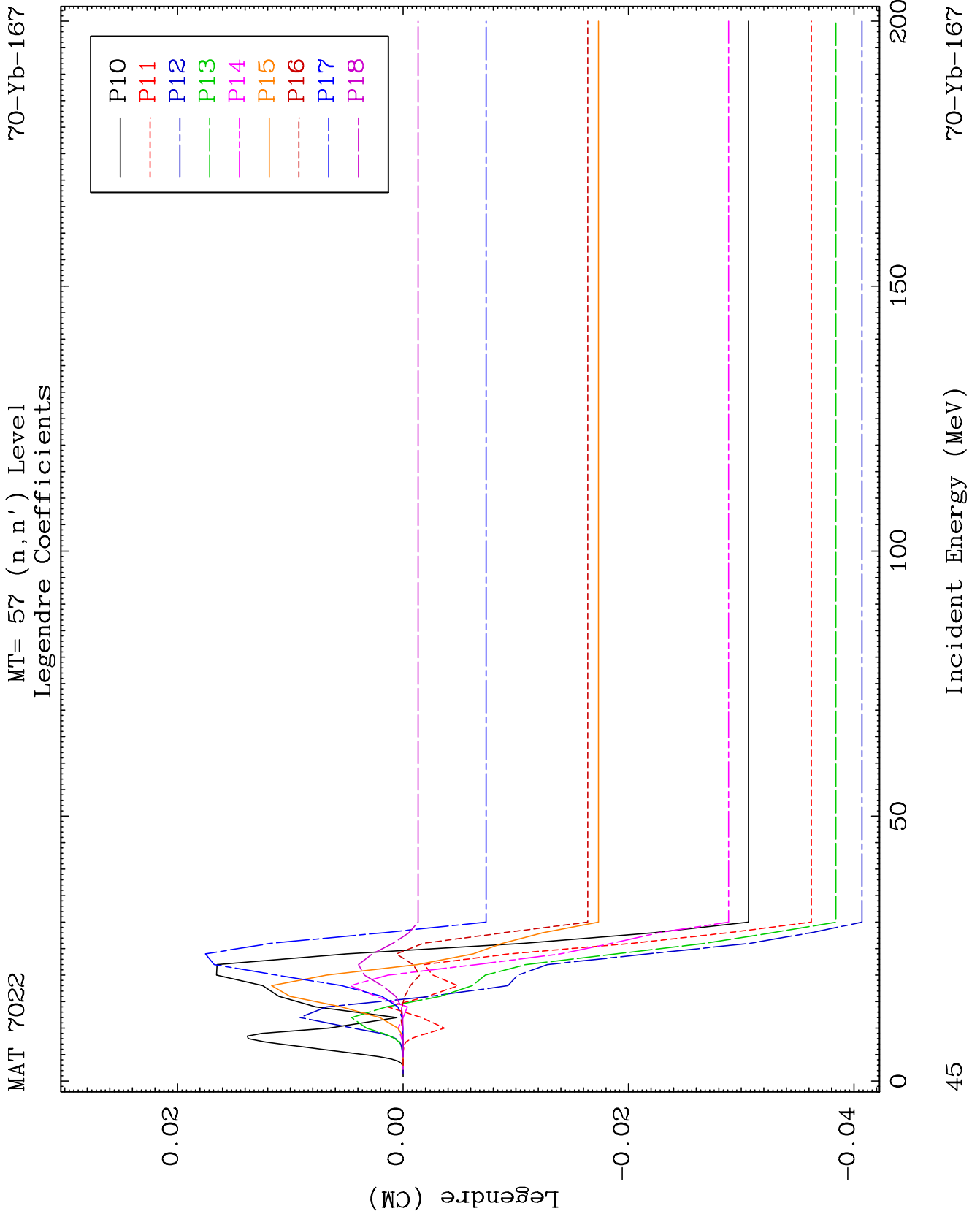

MAT 7022

MT= 57 (n,n') Level
Legendre Coefficients

70-Yb-167

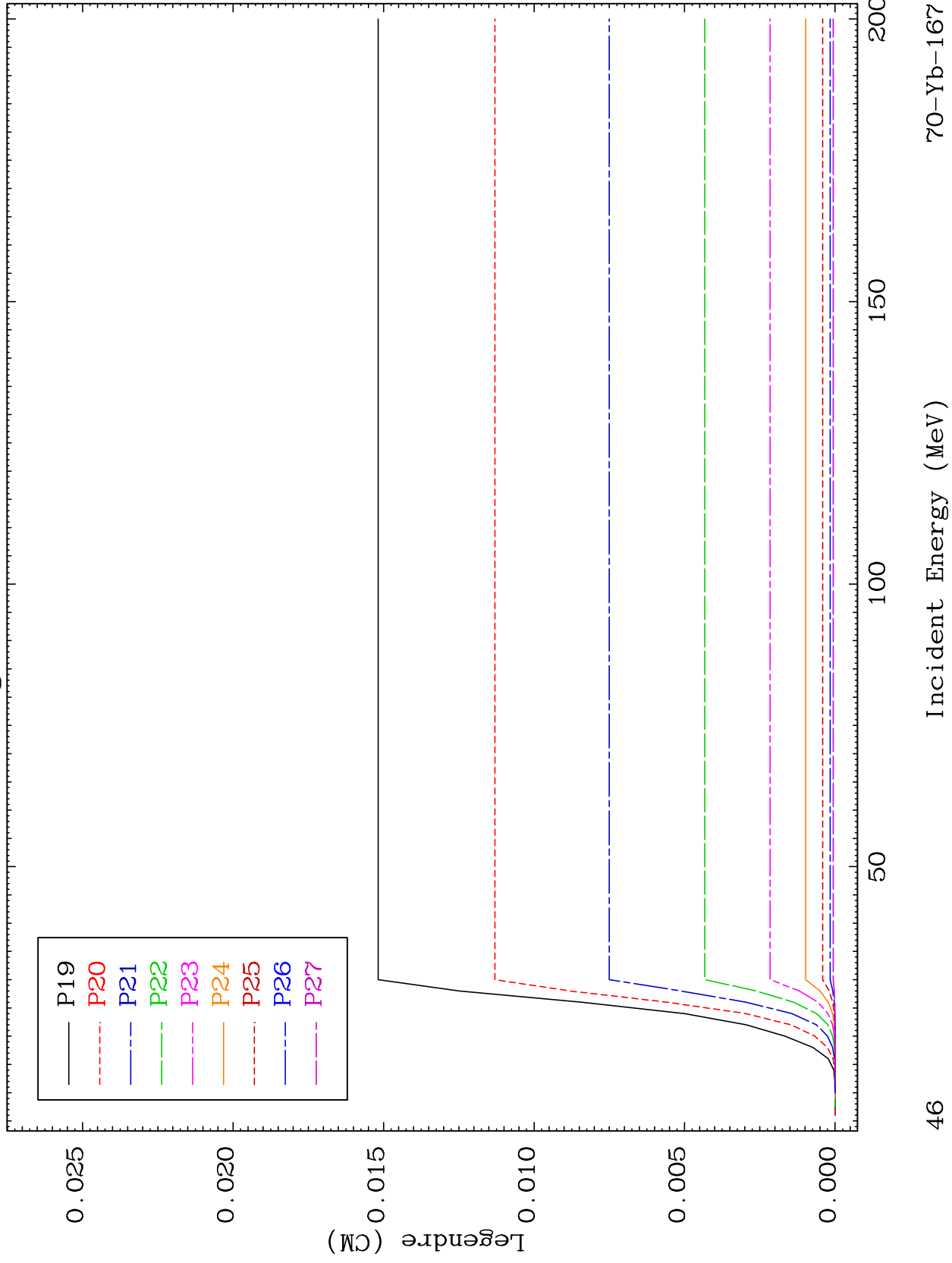

46

Incident Energy (MeV)

70-Yb-167

MAT 7022

MT= 57 (n,n') Level
Legendre Coefficients

70-Yb-167

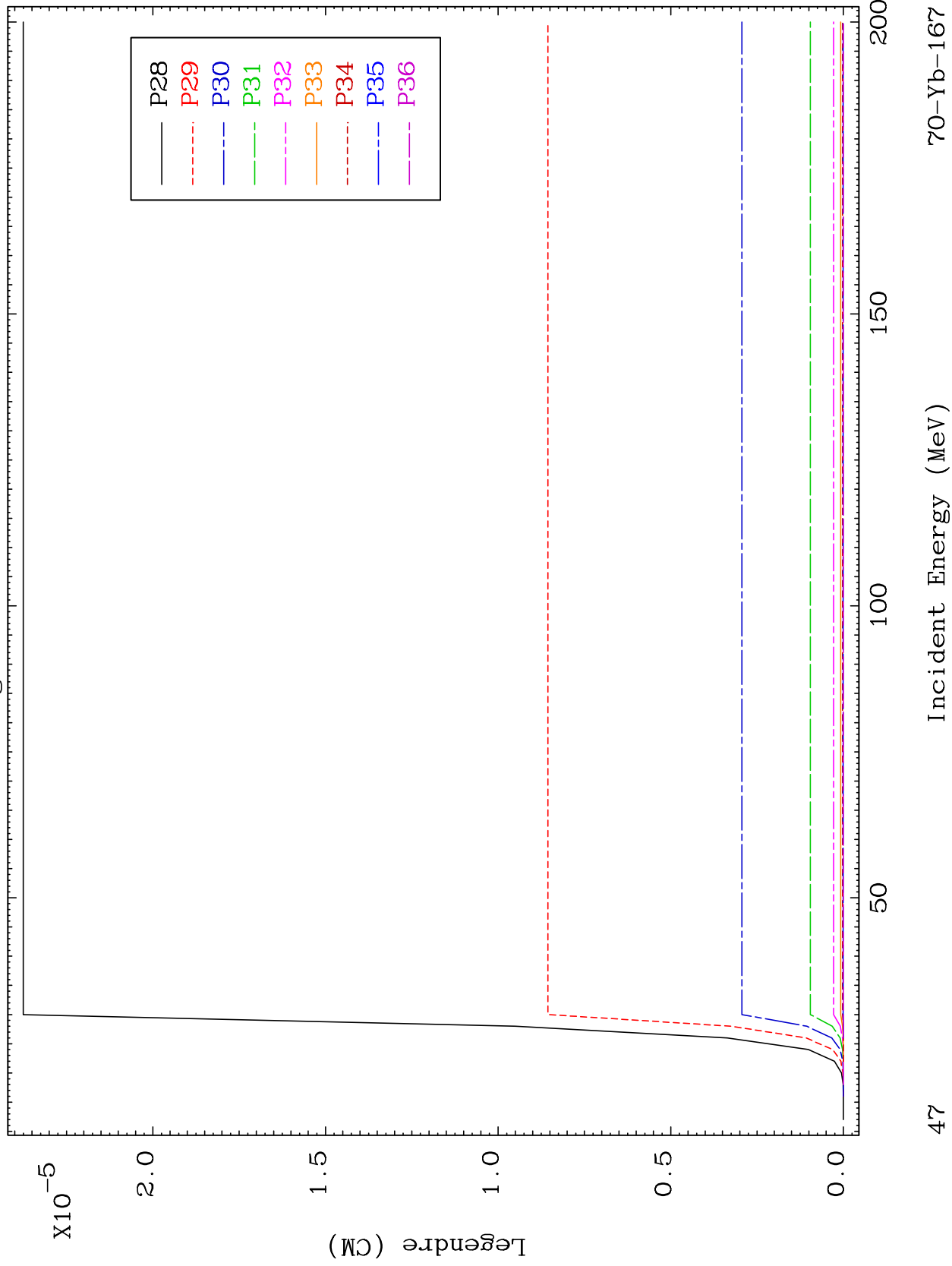

47

Incident Energy (MeV)

70-Yb-167

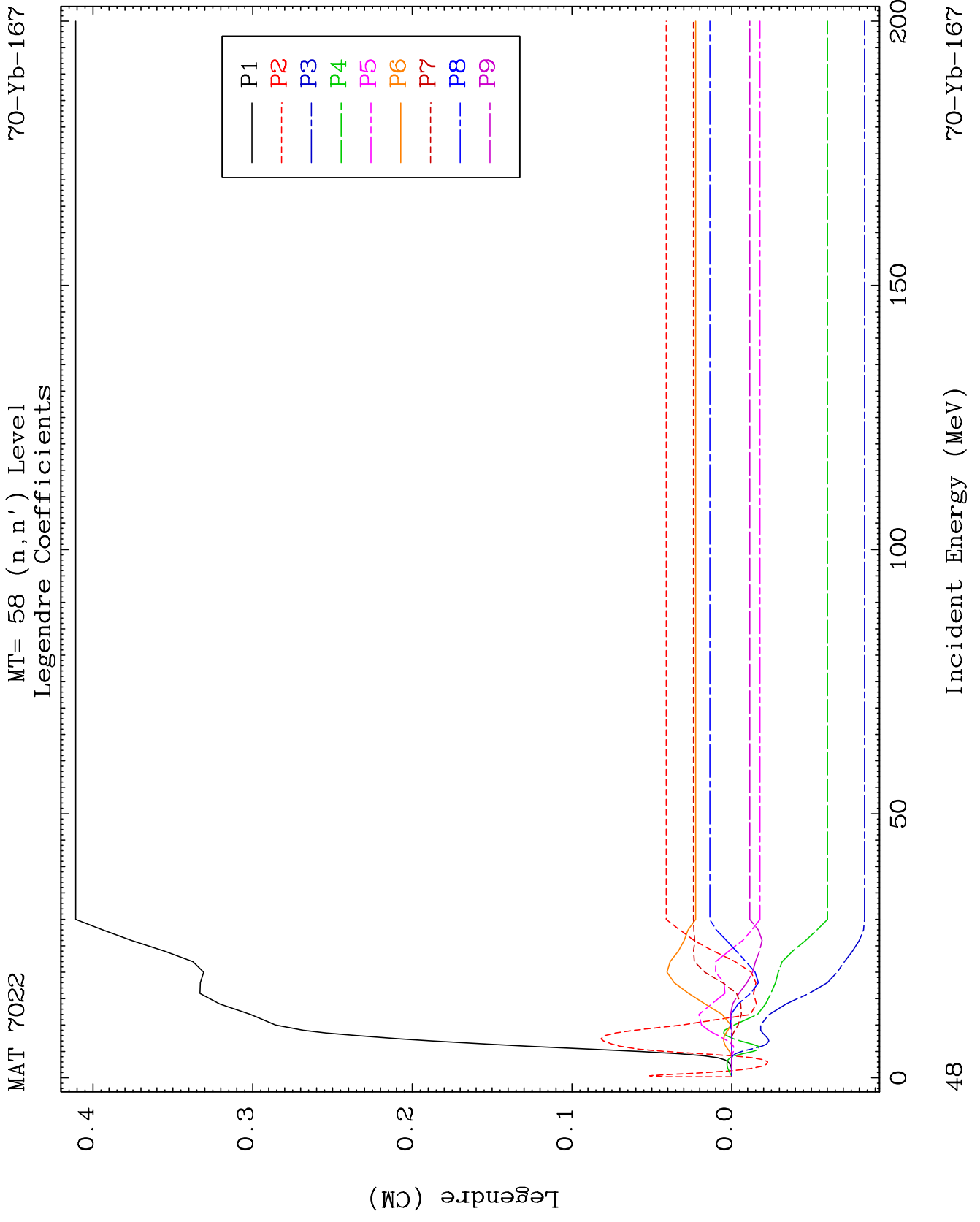

MAT 7022

MT= 58 (n,n') Level
Legendre Coefficients

70-Yb-167

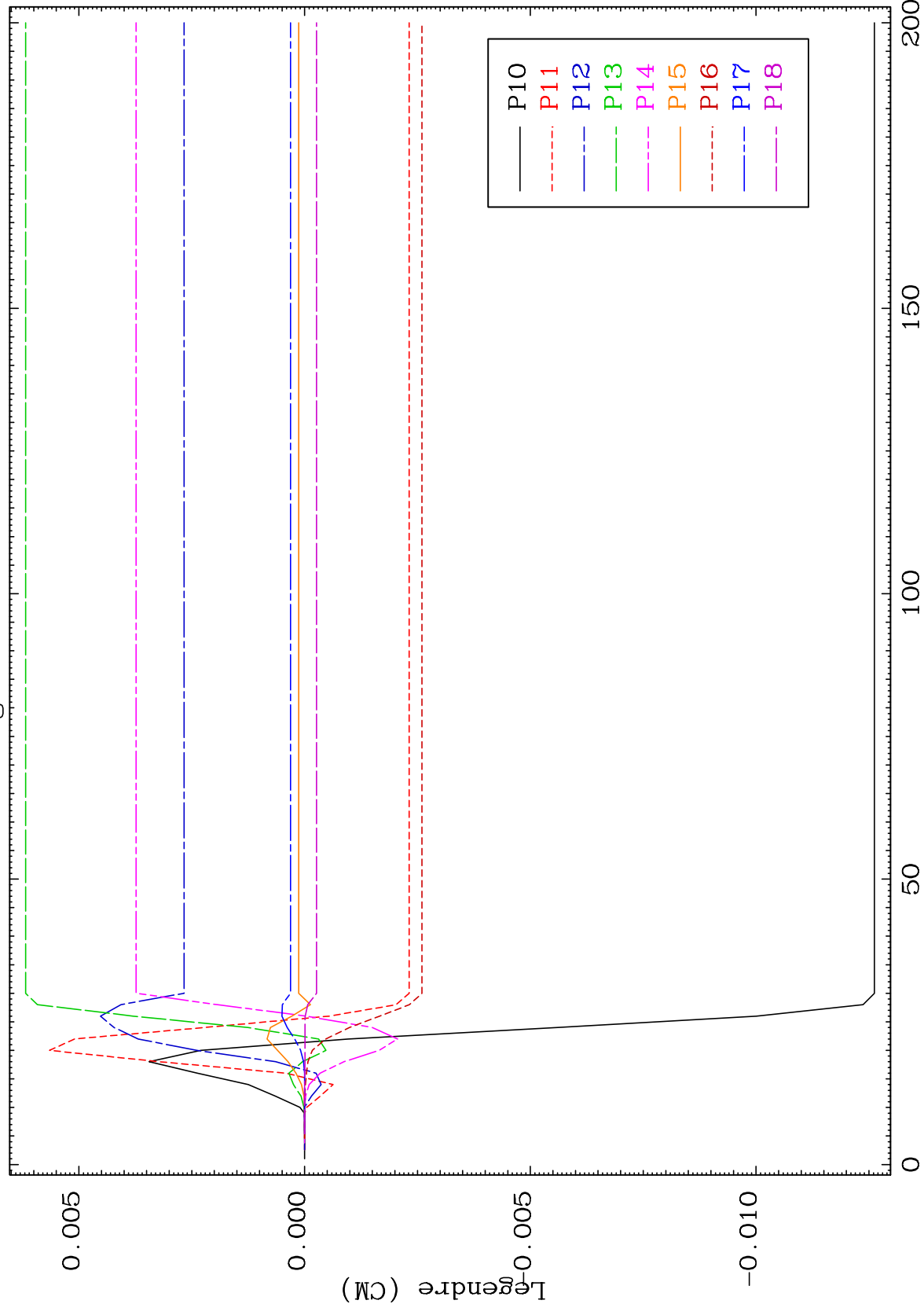

49

Incident Energy (MeV)

70-Yb-167

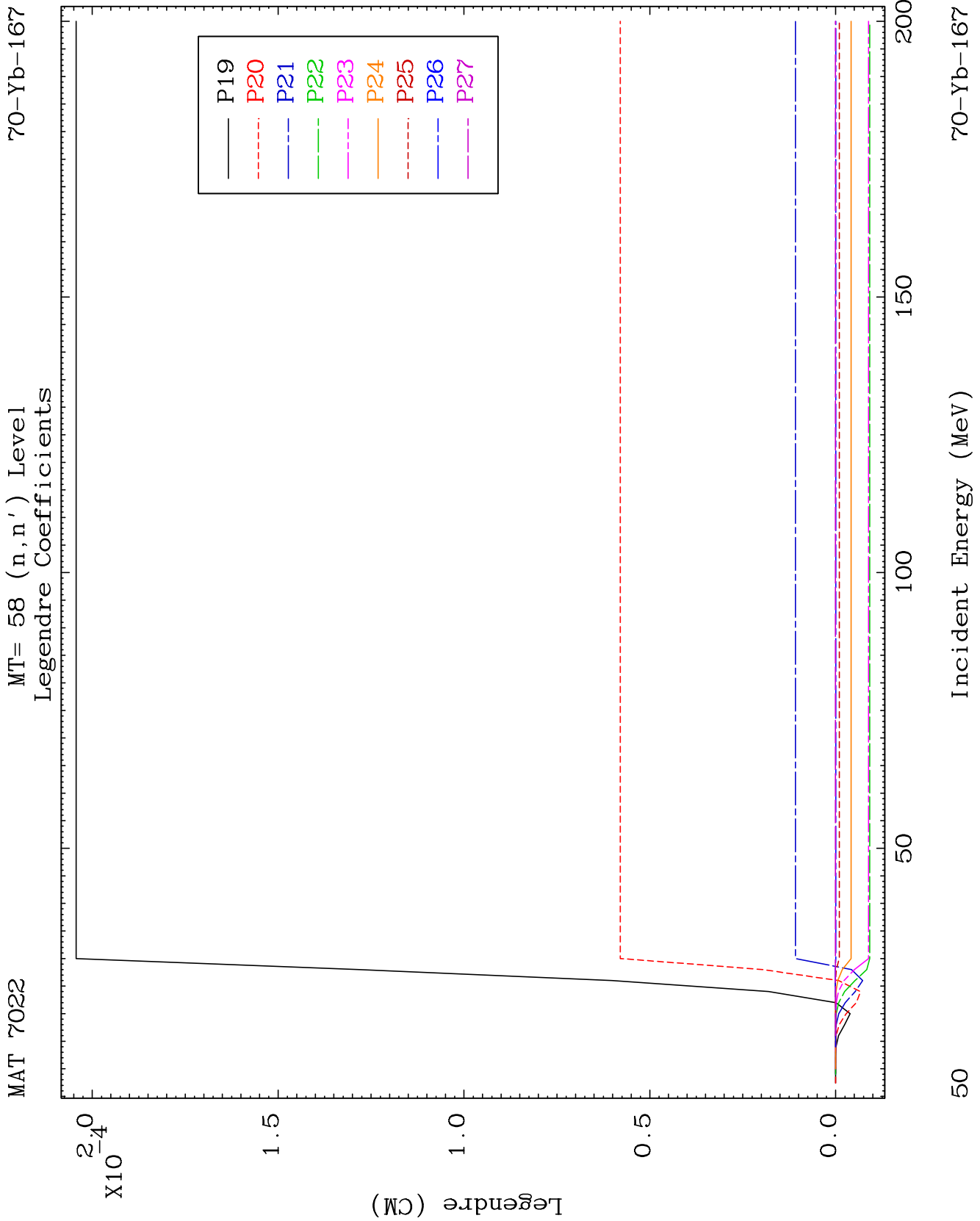

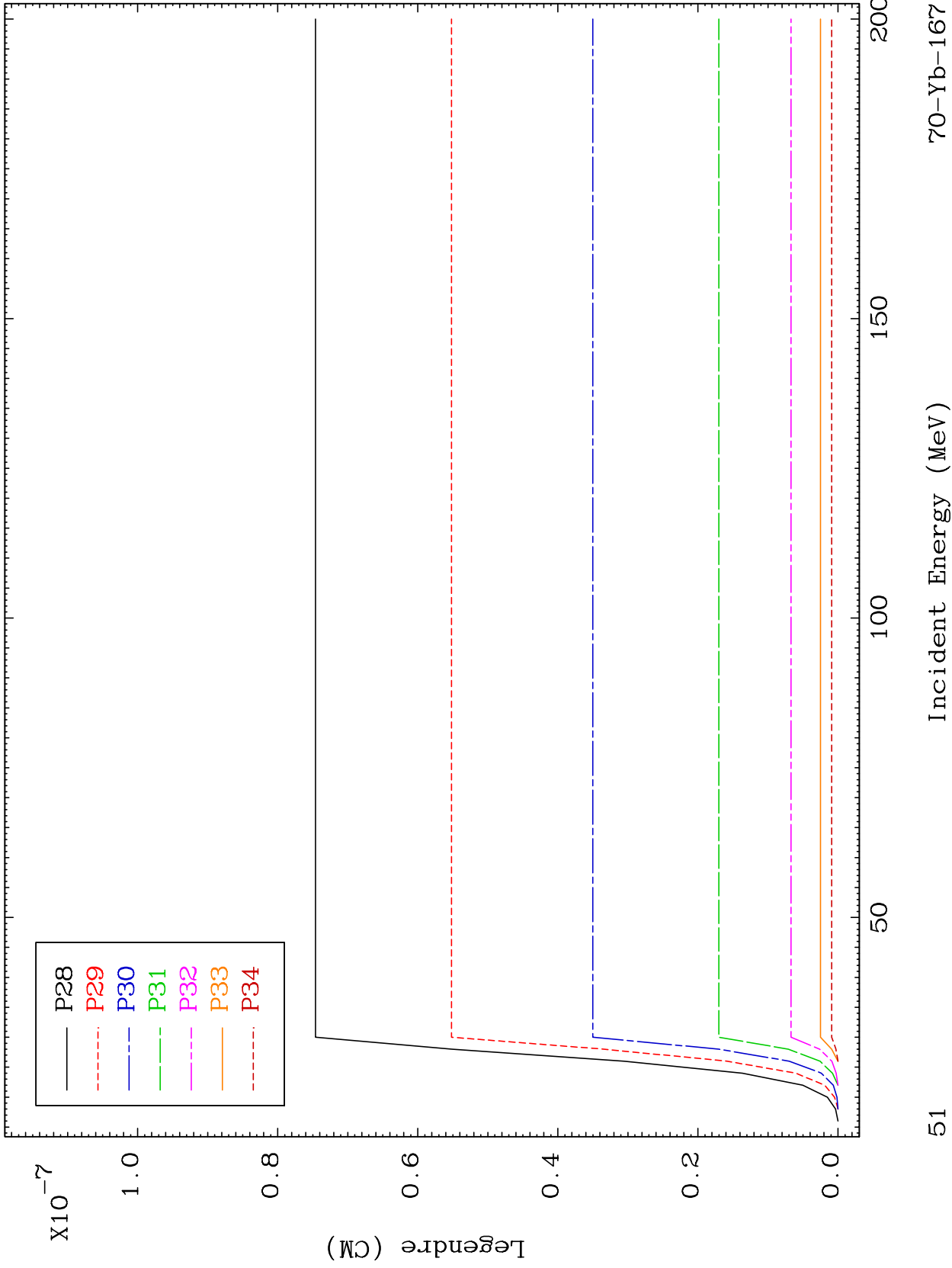

MAT 7022

MT= 59 (n,n') Level
Legendre Coefficients

70-Yb-167

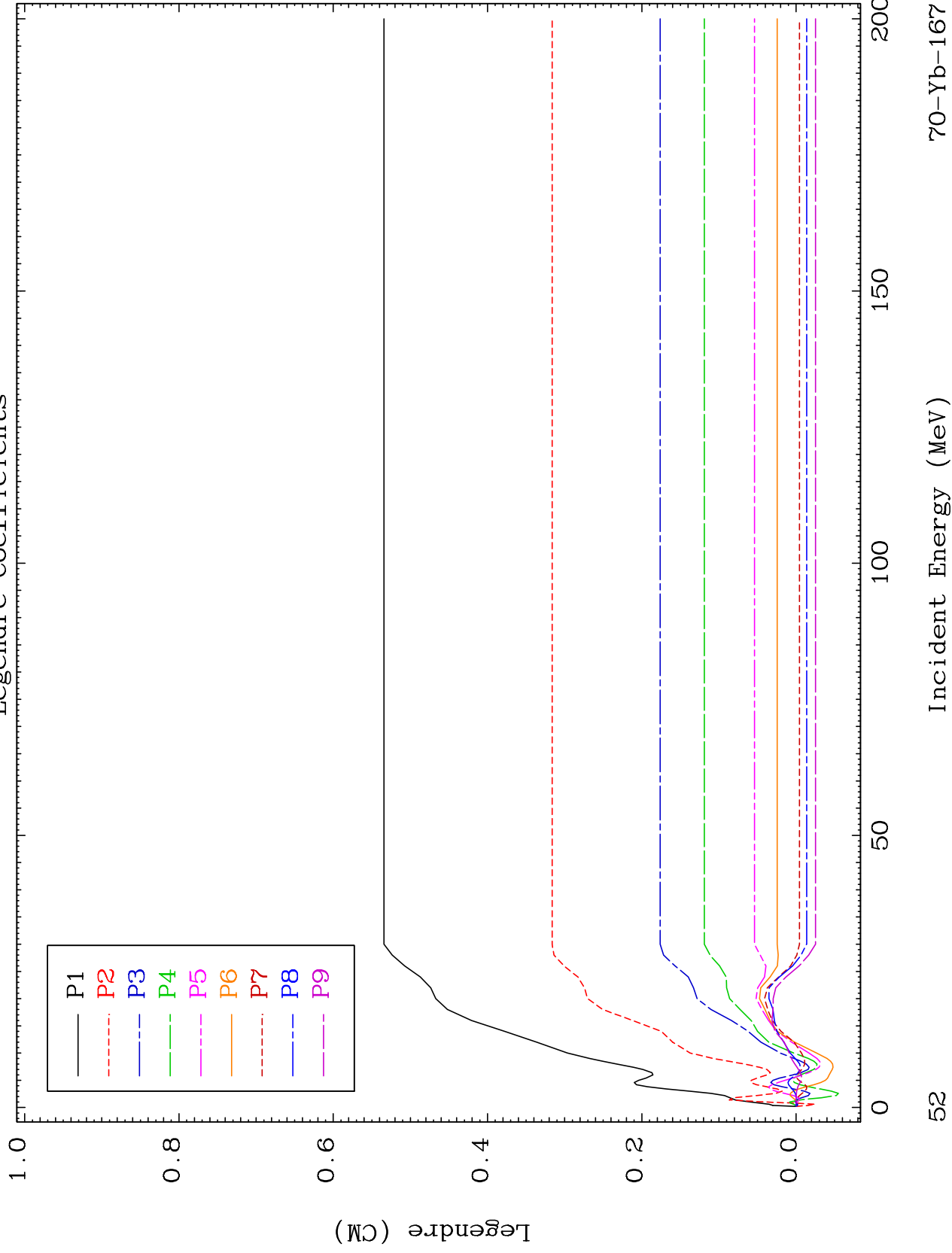

52

Incident Energy (MeV)

70-Yb-167

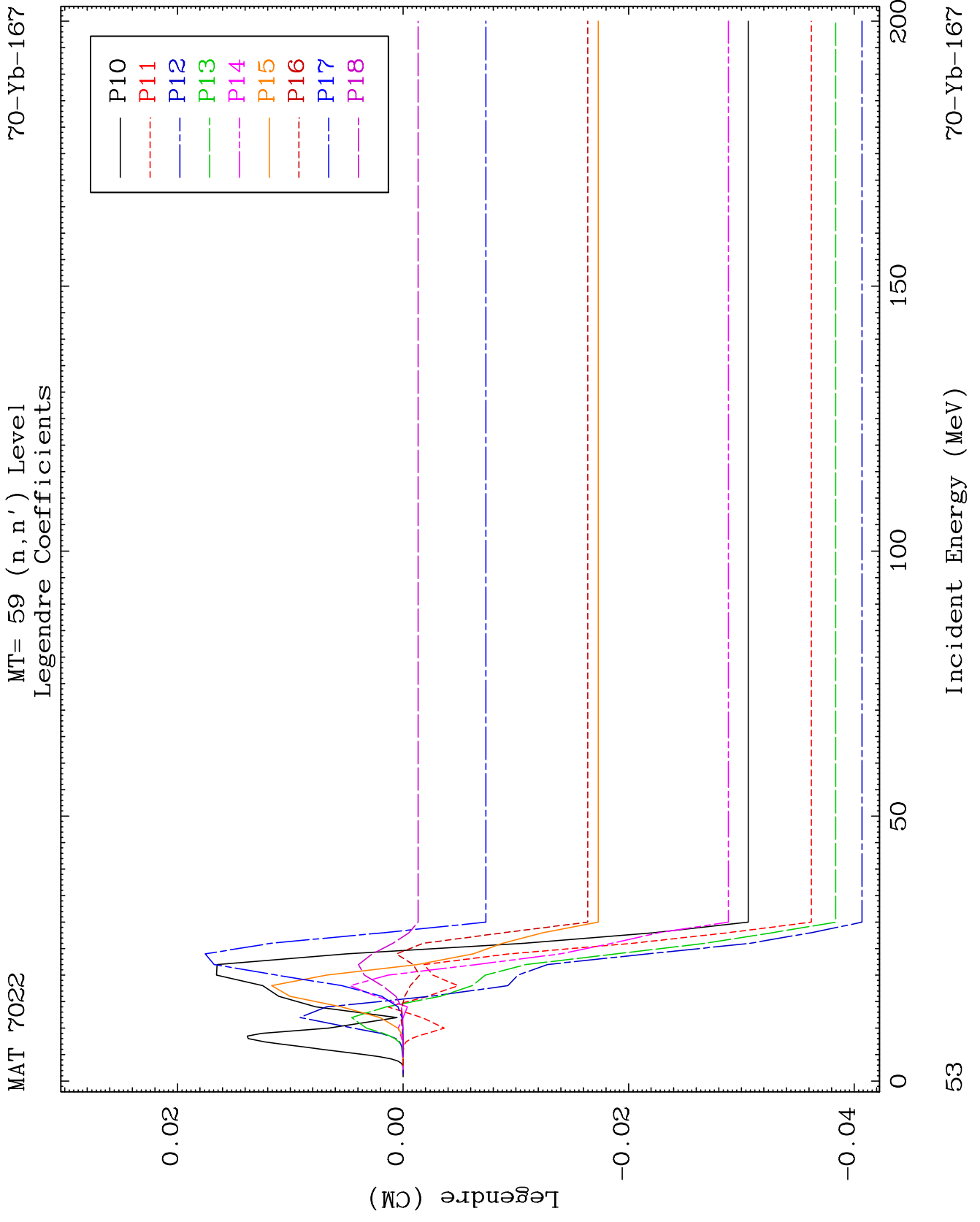

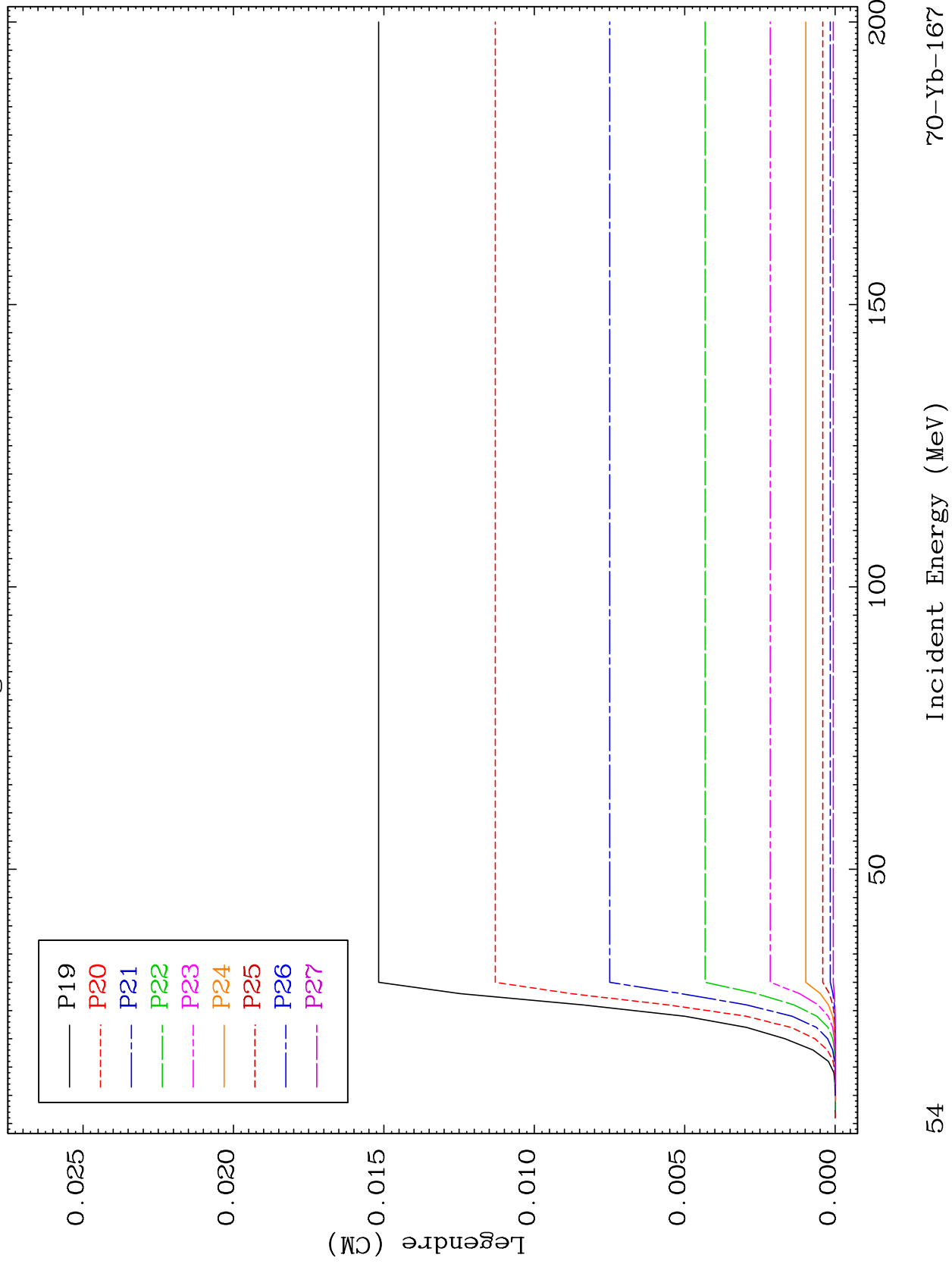

MAT 7022

MT= 59 (n,n') Level
Legendre Coefficients

70-Yb-167

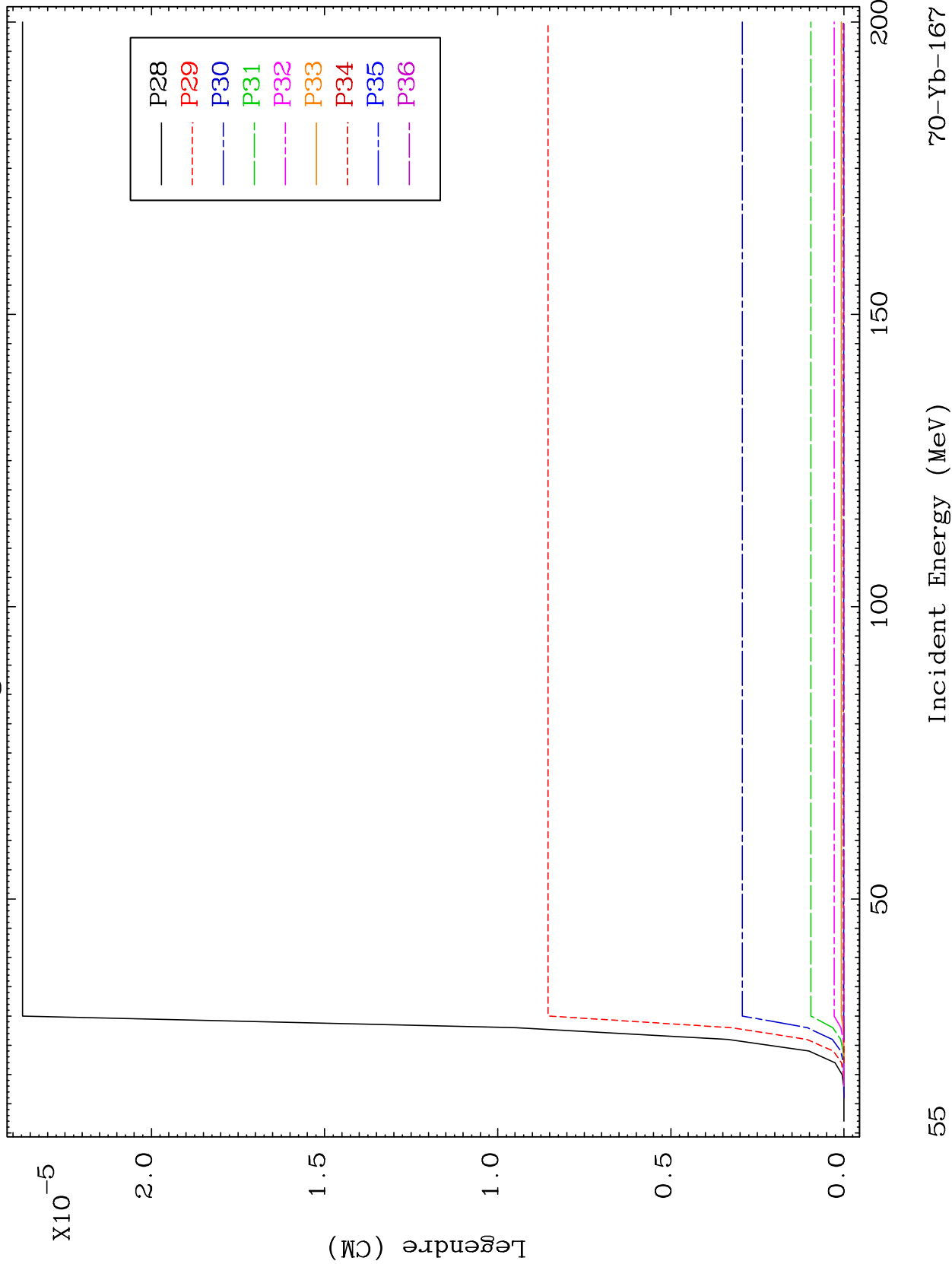

55

Incident Energy (MeV)

70-Yb-167

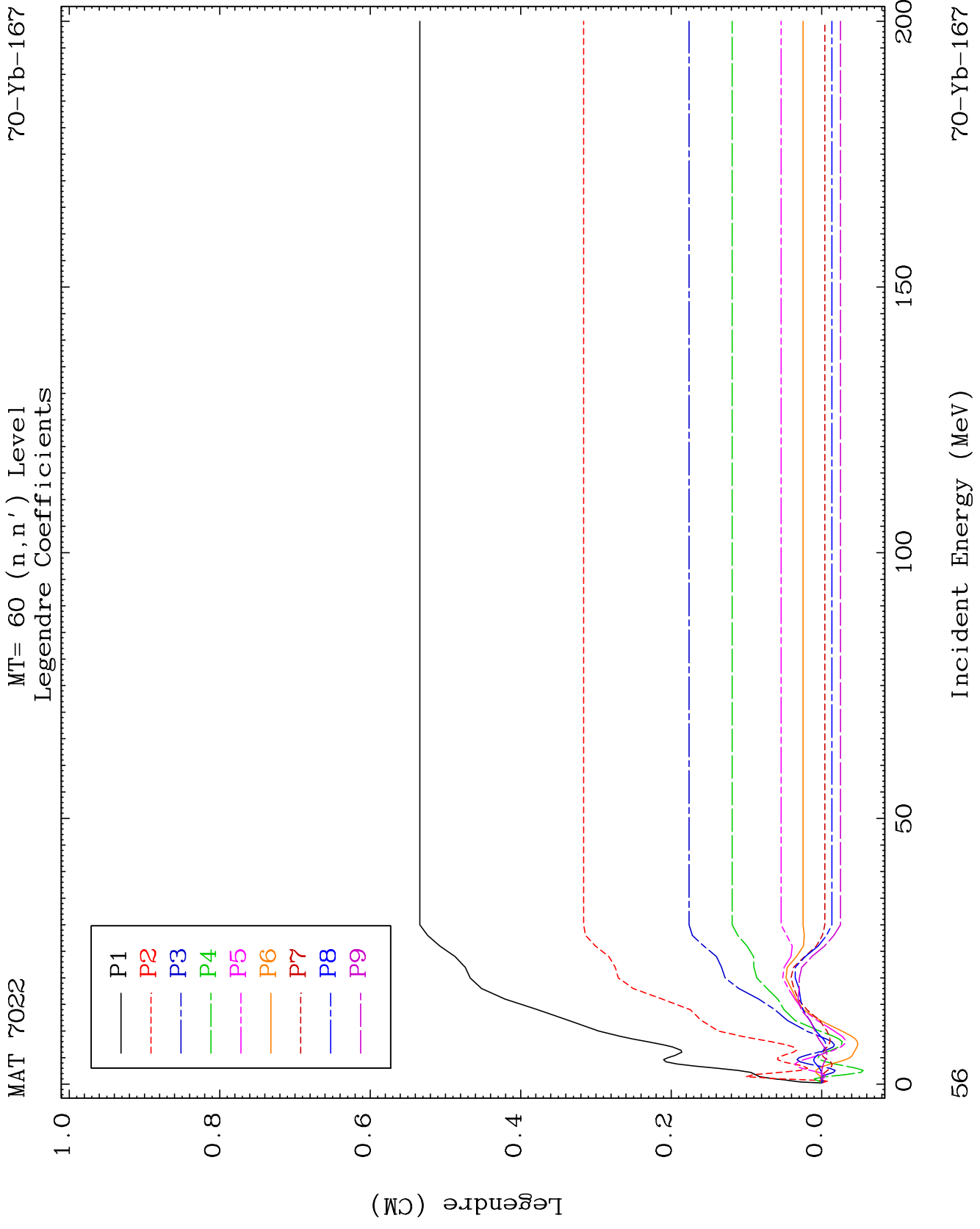

MAT 7022

MT= 60 (n,n') Level
Legendre Coefficients

70-Yb-167

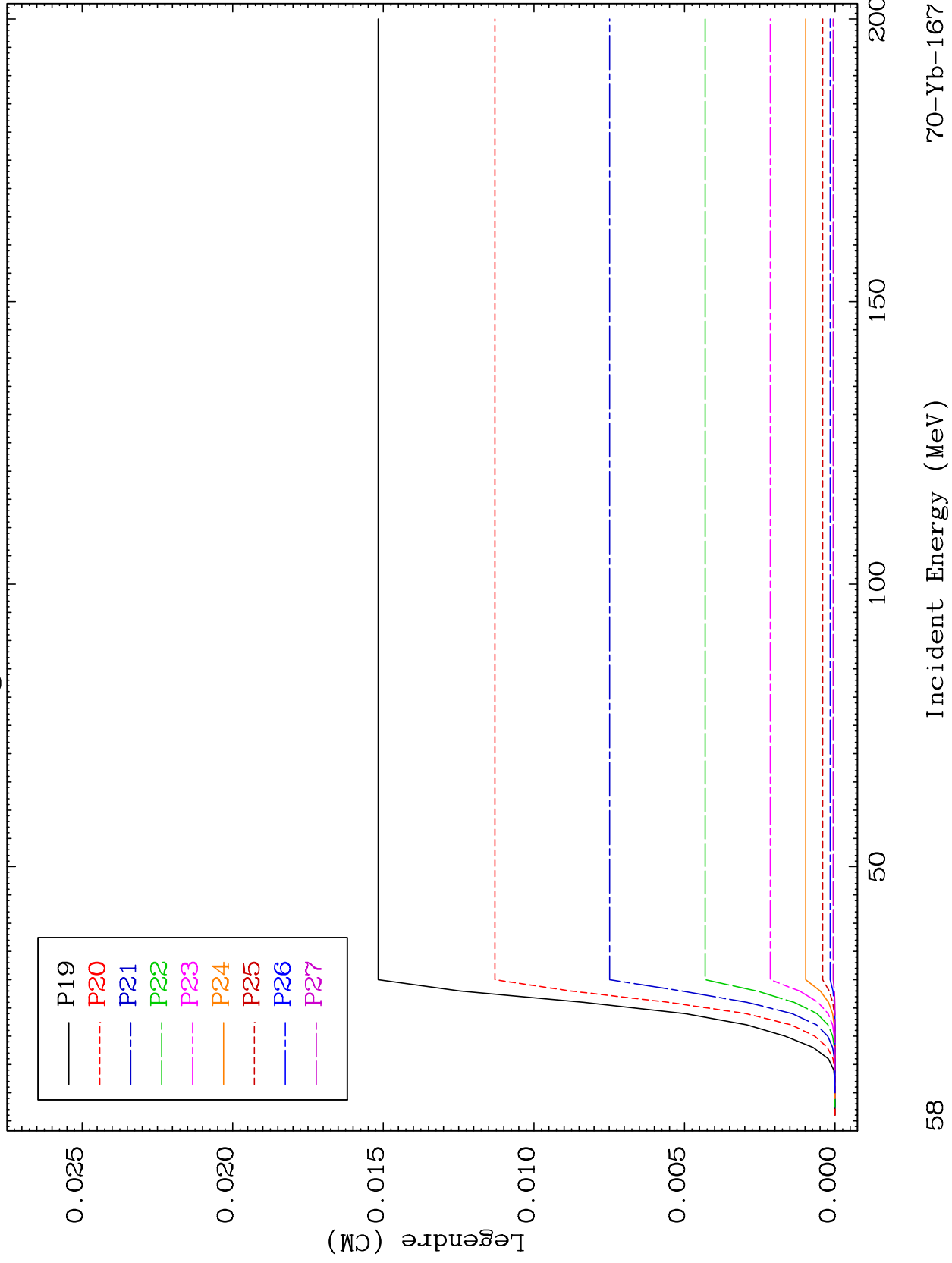

58

70-Yb-167

Incident Energy (MeV)

MAT 7022

MT= 60 (n,n') Level
Legendre Coefficients

70-Yb-167

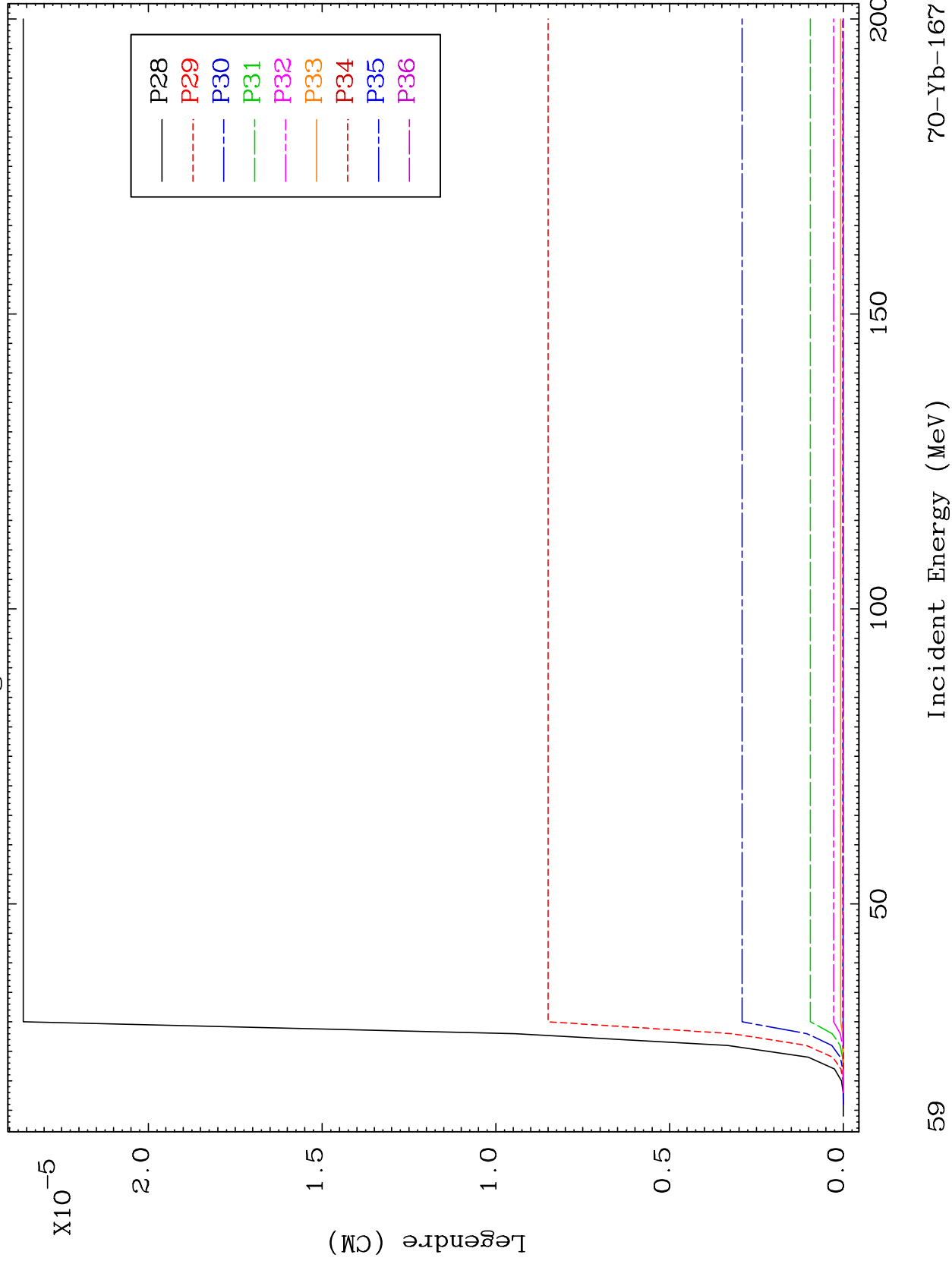

59

70-Yb-167

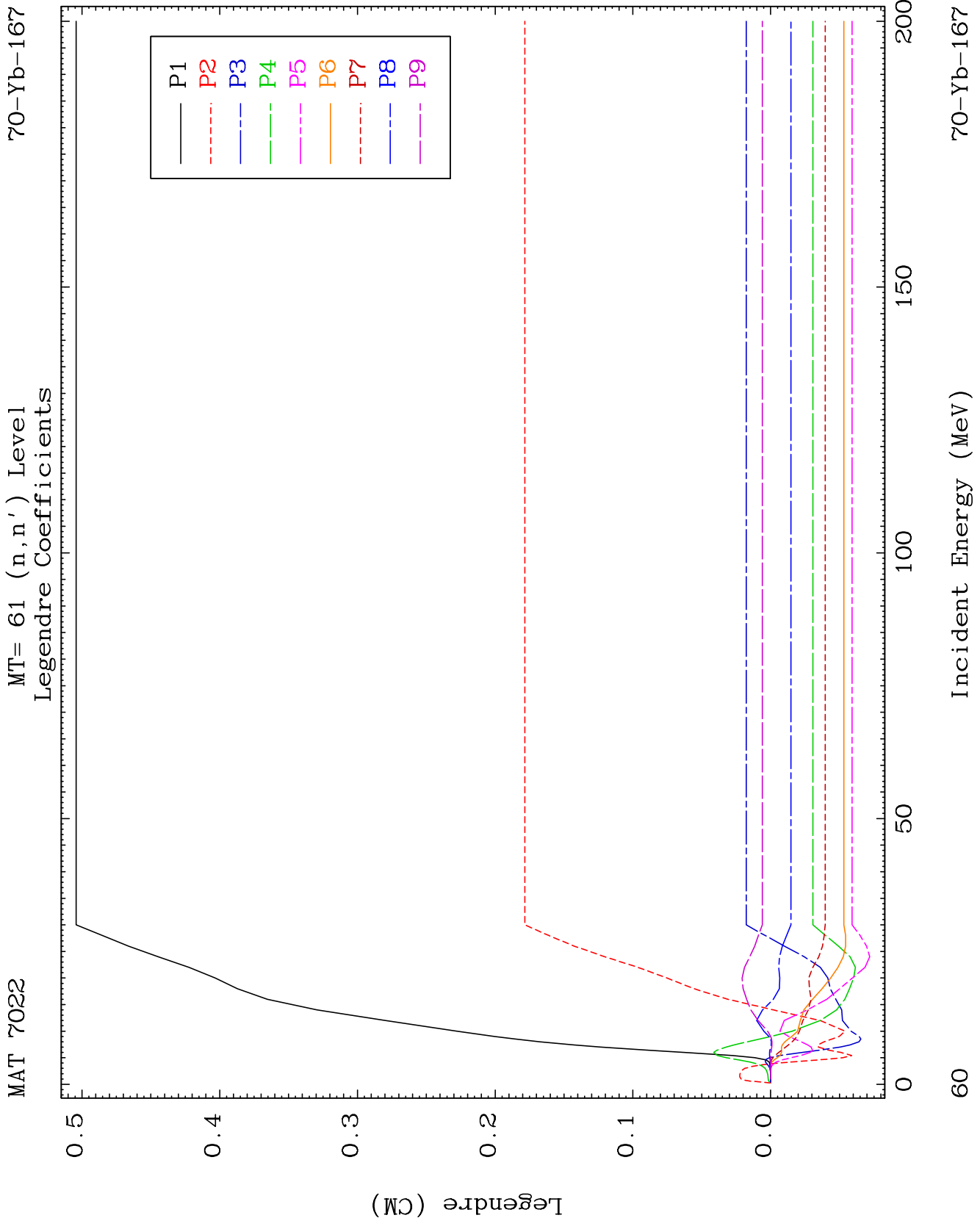

MAT 7022

MT= 61 (n,n') Level
Legendre Coefficients

70-Yb-167

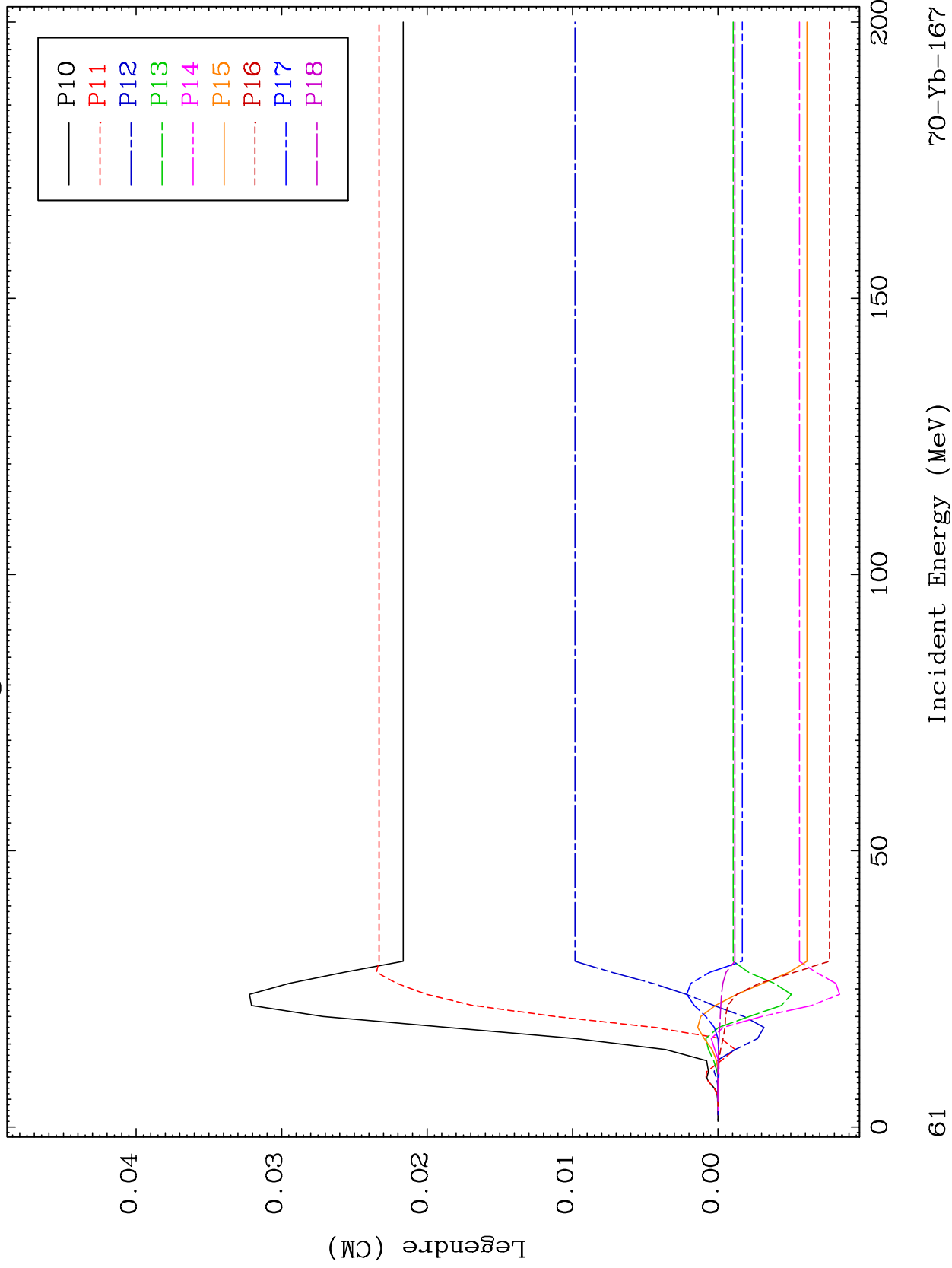

61

Incident Energy (MeV)

70-Yb-167

MAT 7022

MT= 61 (n,n') Level
Legendre Coefficients

70-Yb-167

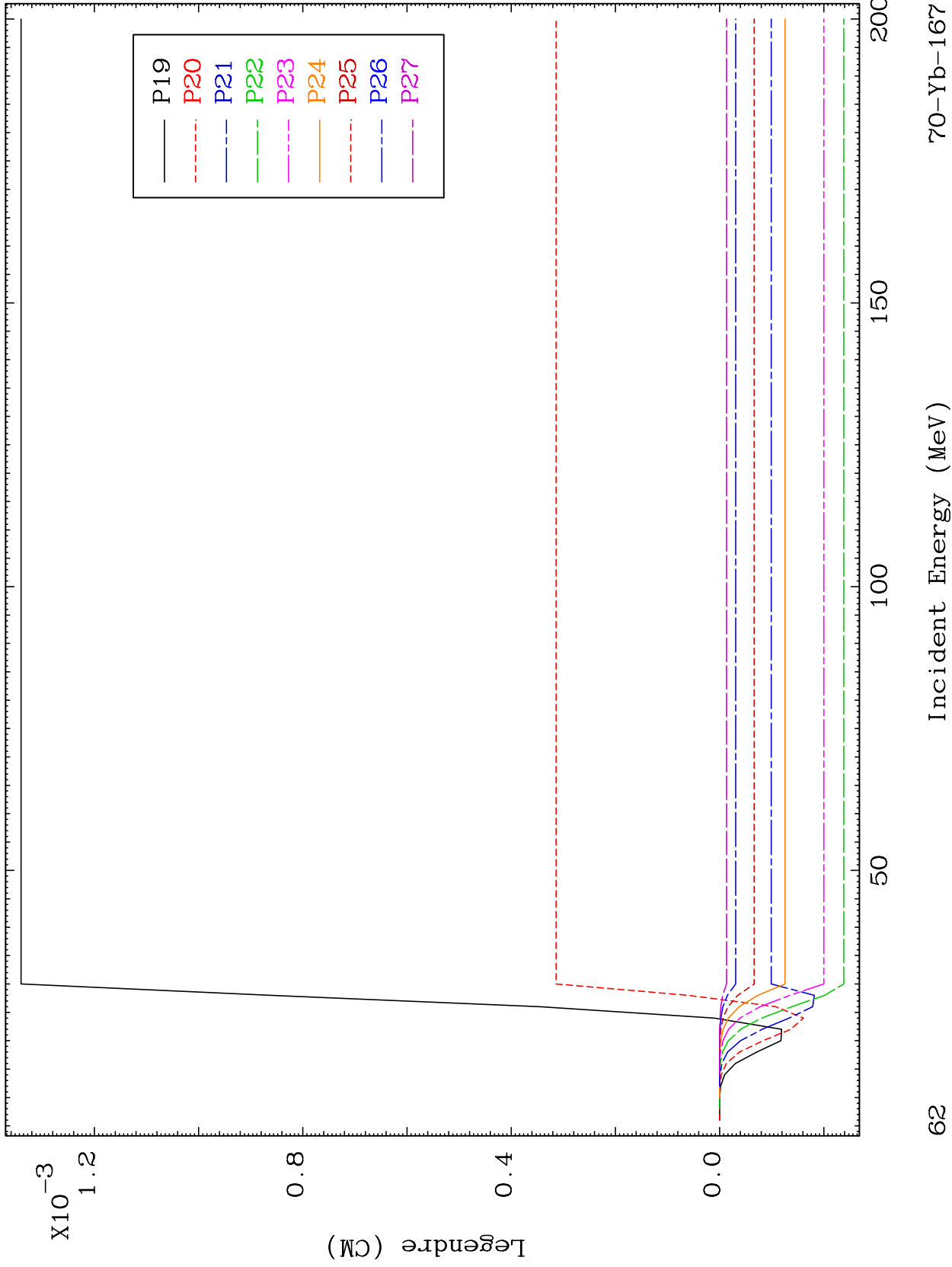

62

Incident Energy (MeV)

70-Yb-167

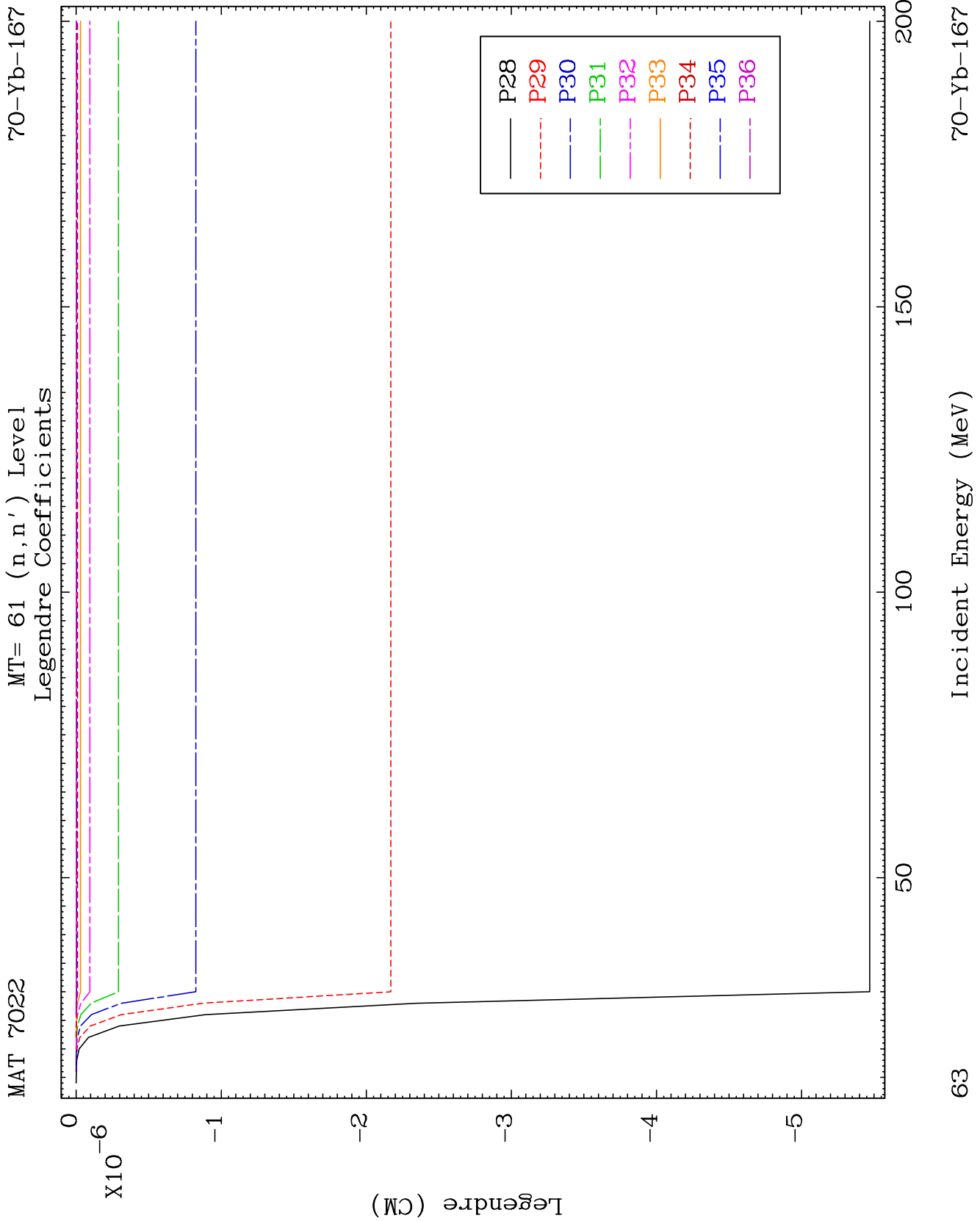

MAT 7022

MT= 62 (n,n') Level
Legendre Coefficients

70-Yb-167

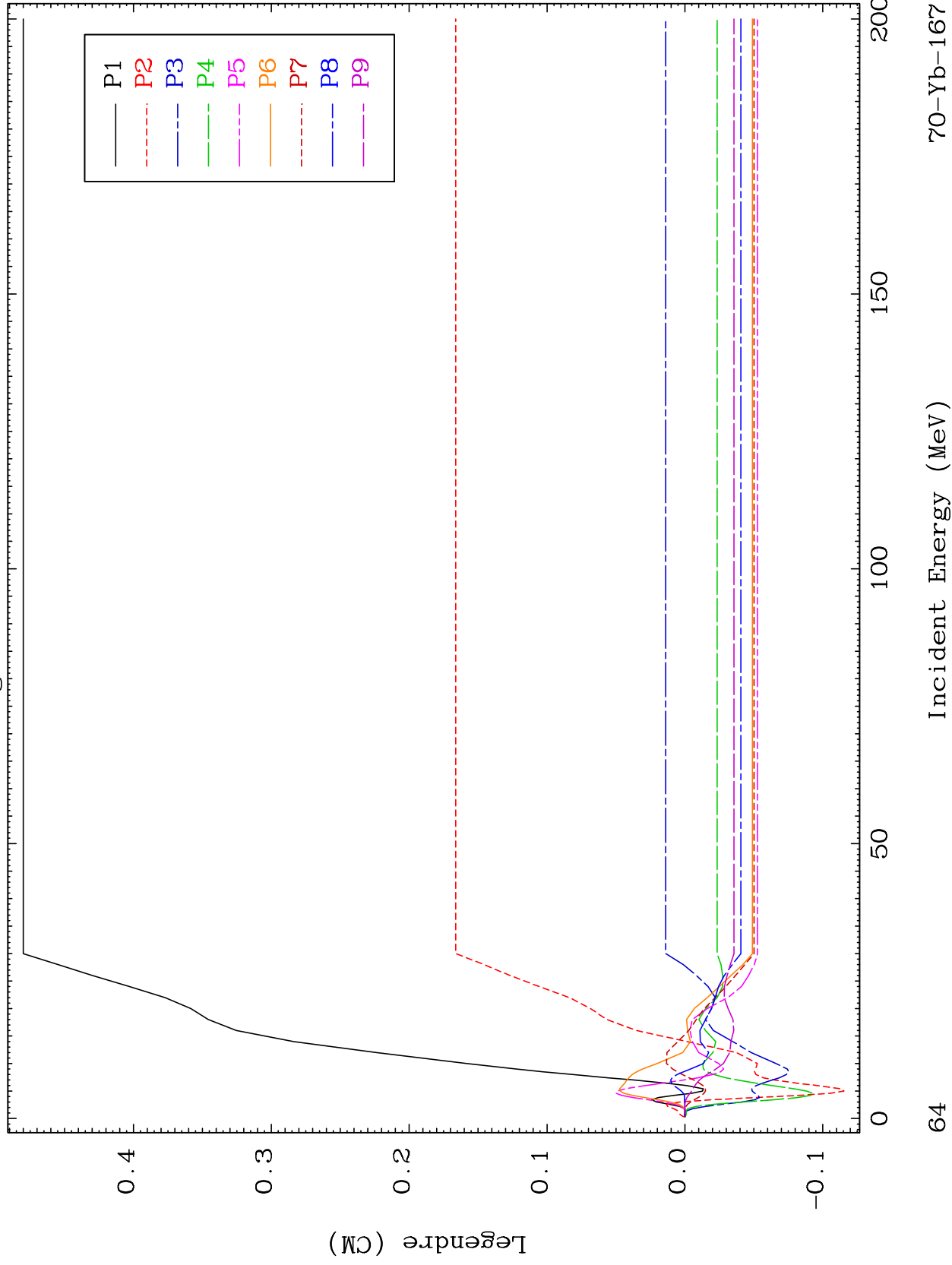

70-Yb-167

Incident Energy (MeV)

64

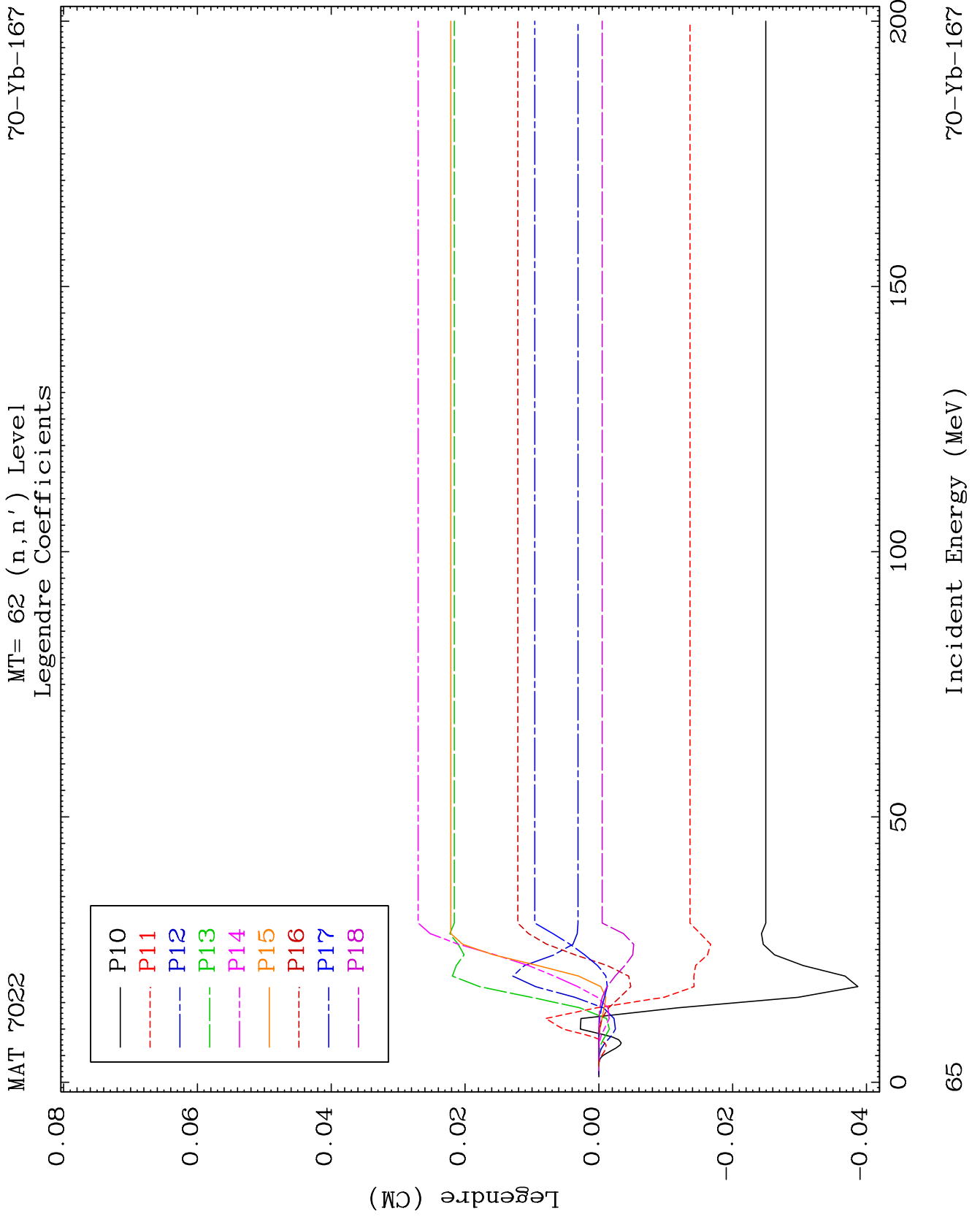

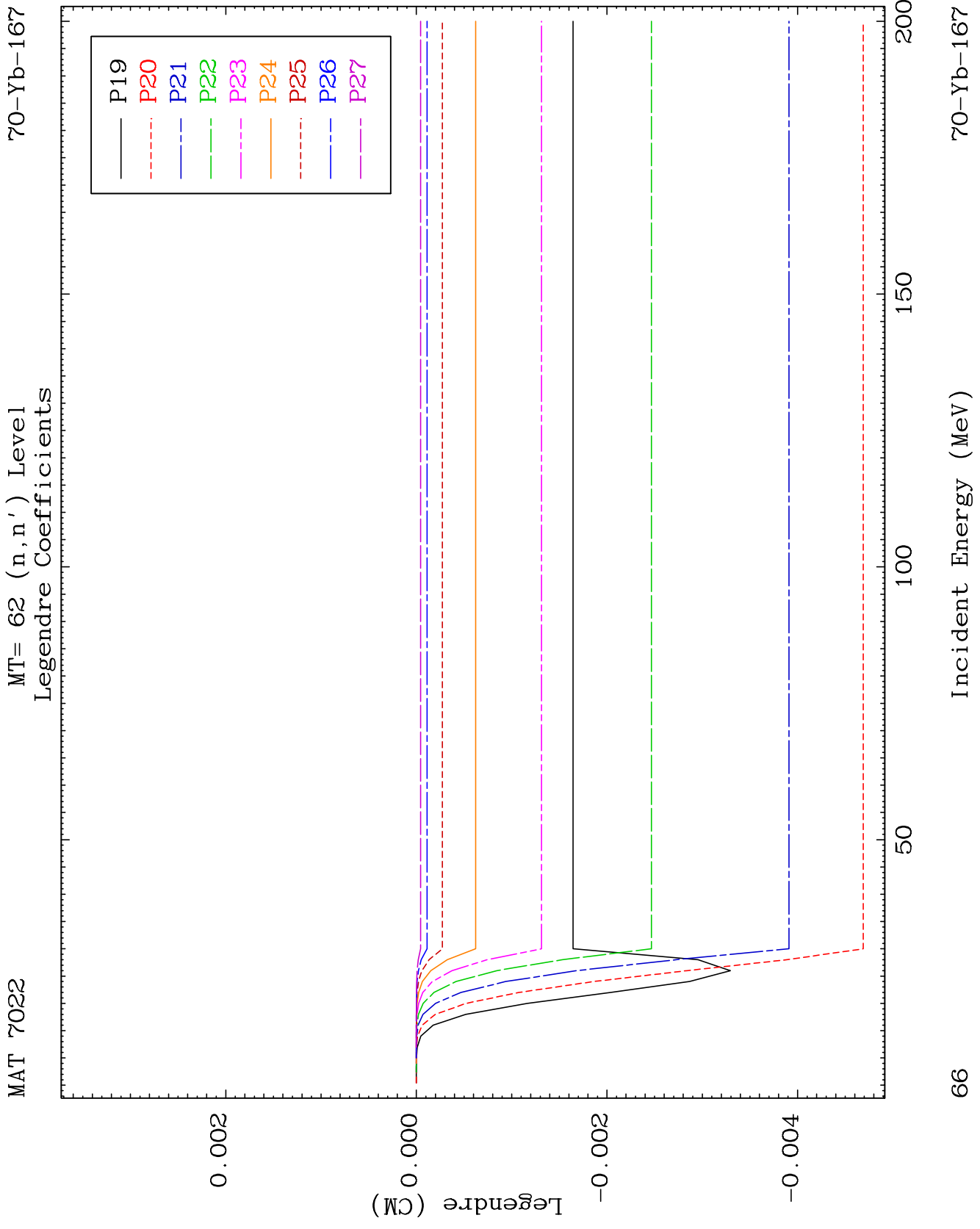

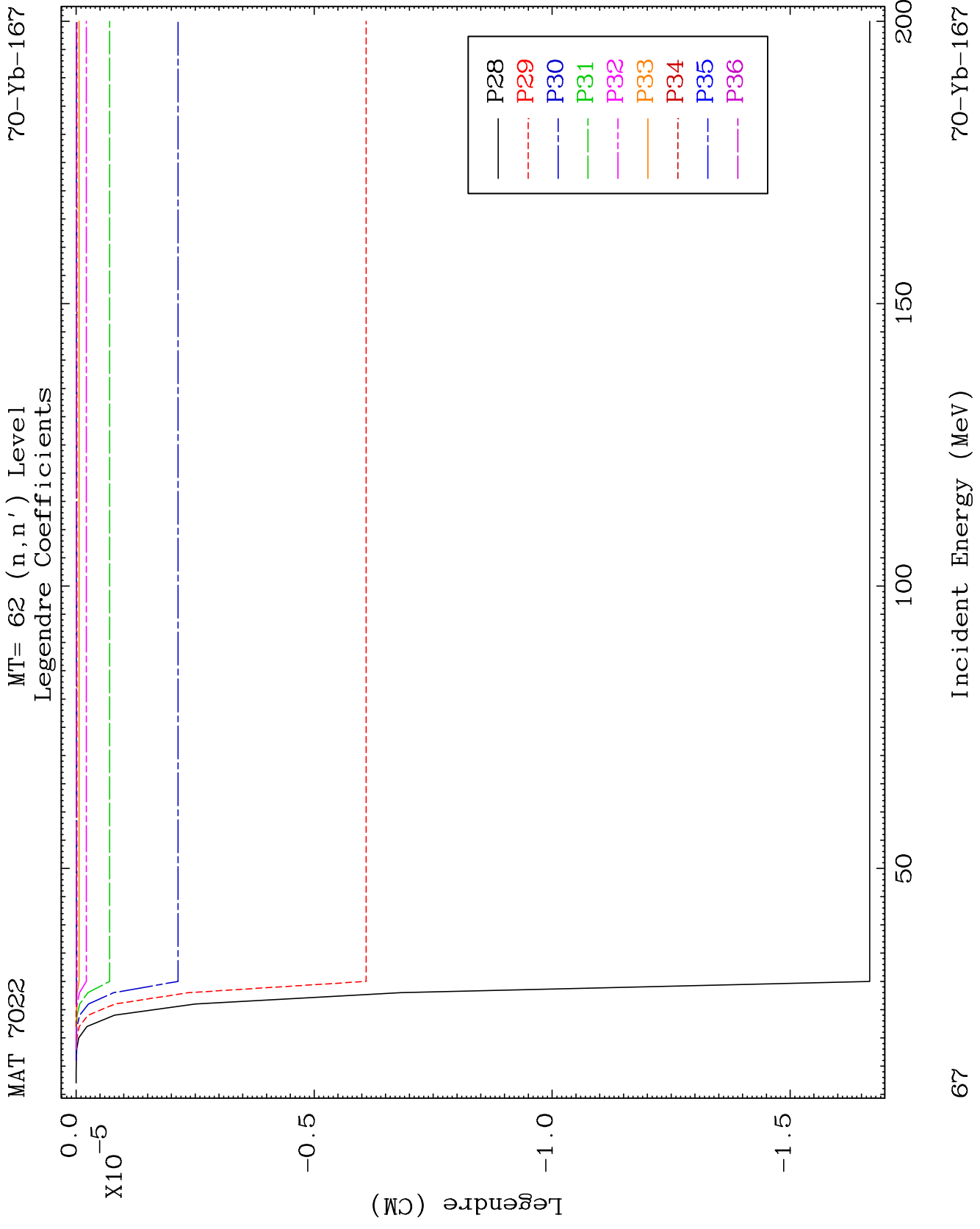

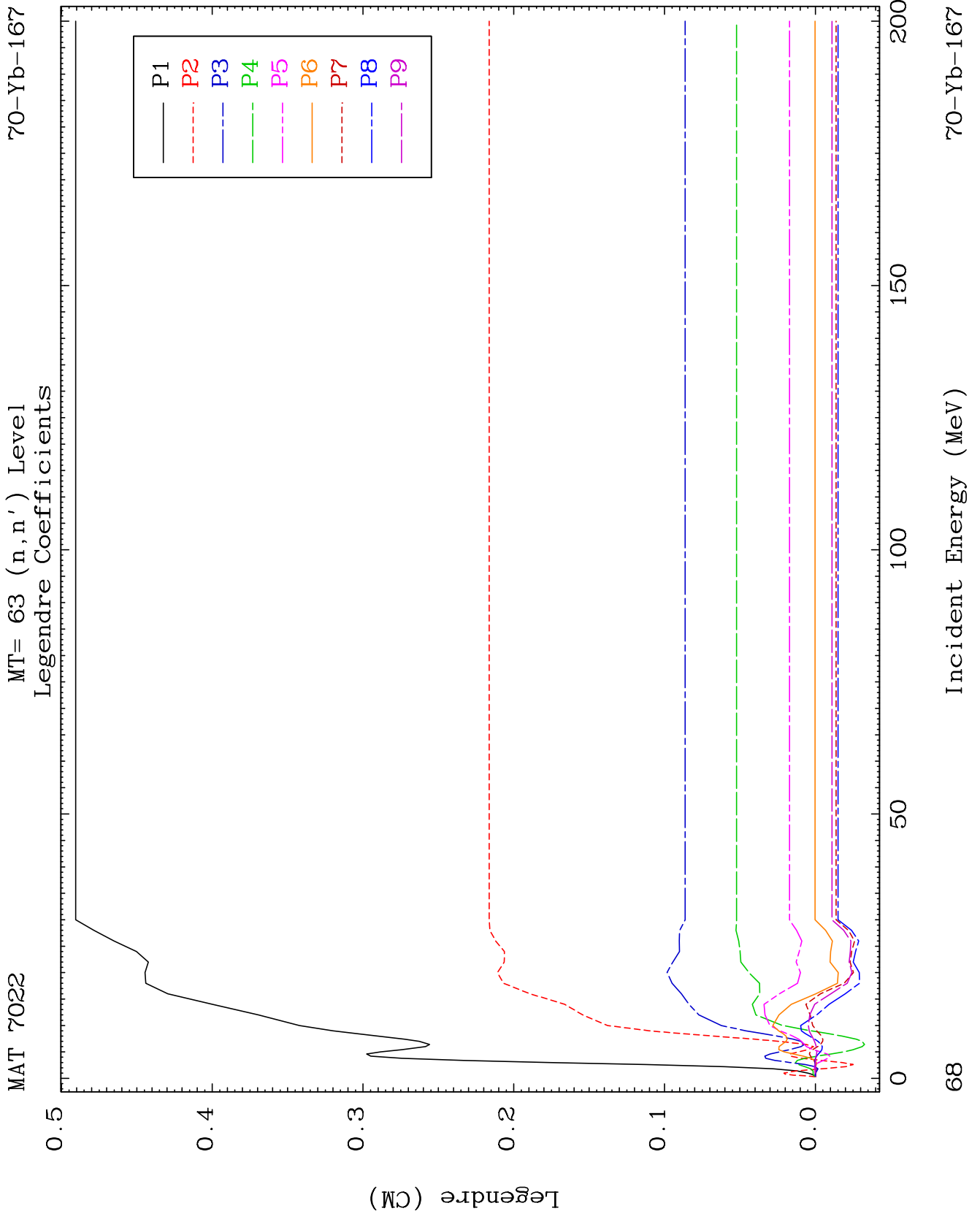

MAT 7022

MT= 63 (n,n') Level
Legendre Coefficients

70-Yb-167

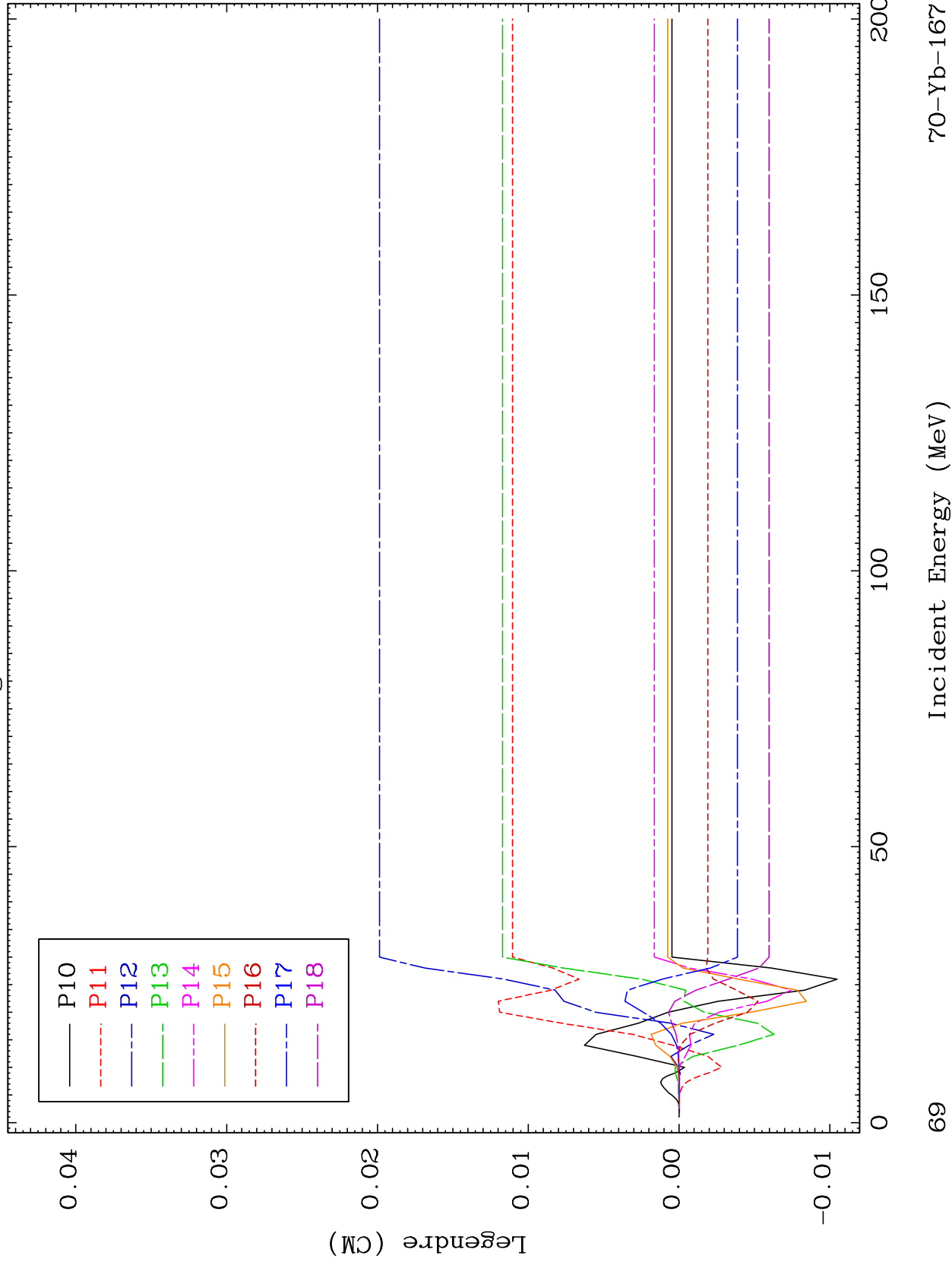

MAT 7022

MT= 63 (n,n') Level
Legendre Coefficients

70-Yb-167

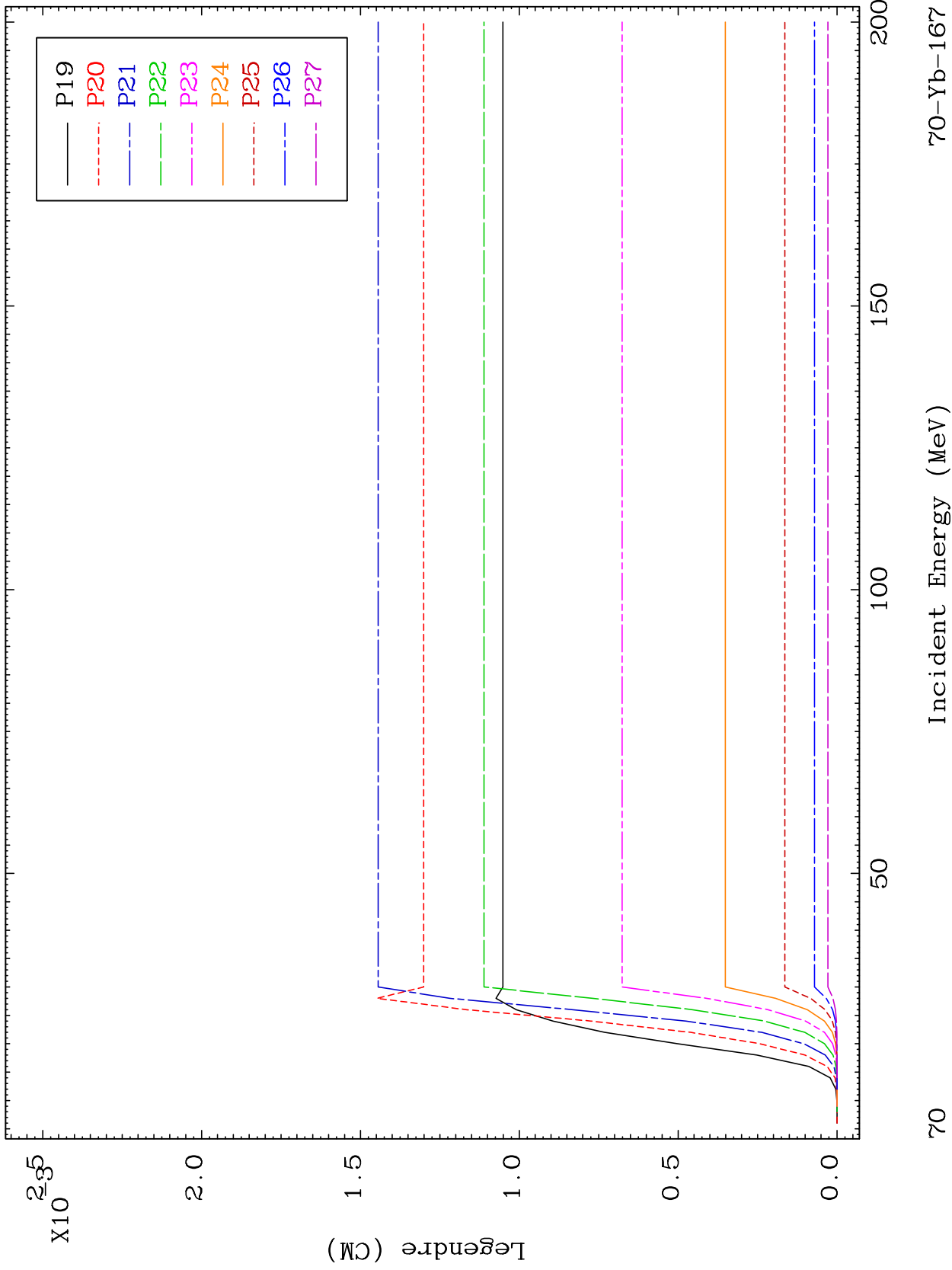

70

70-Yb-167

MAT 7022

MT= 63 (n,n') Level
Legendre Coefficients

70-Yb-167

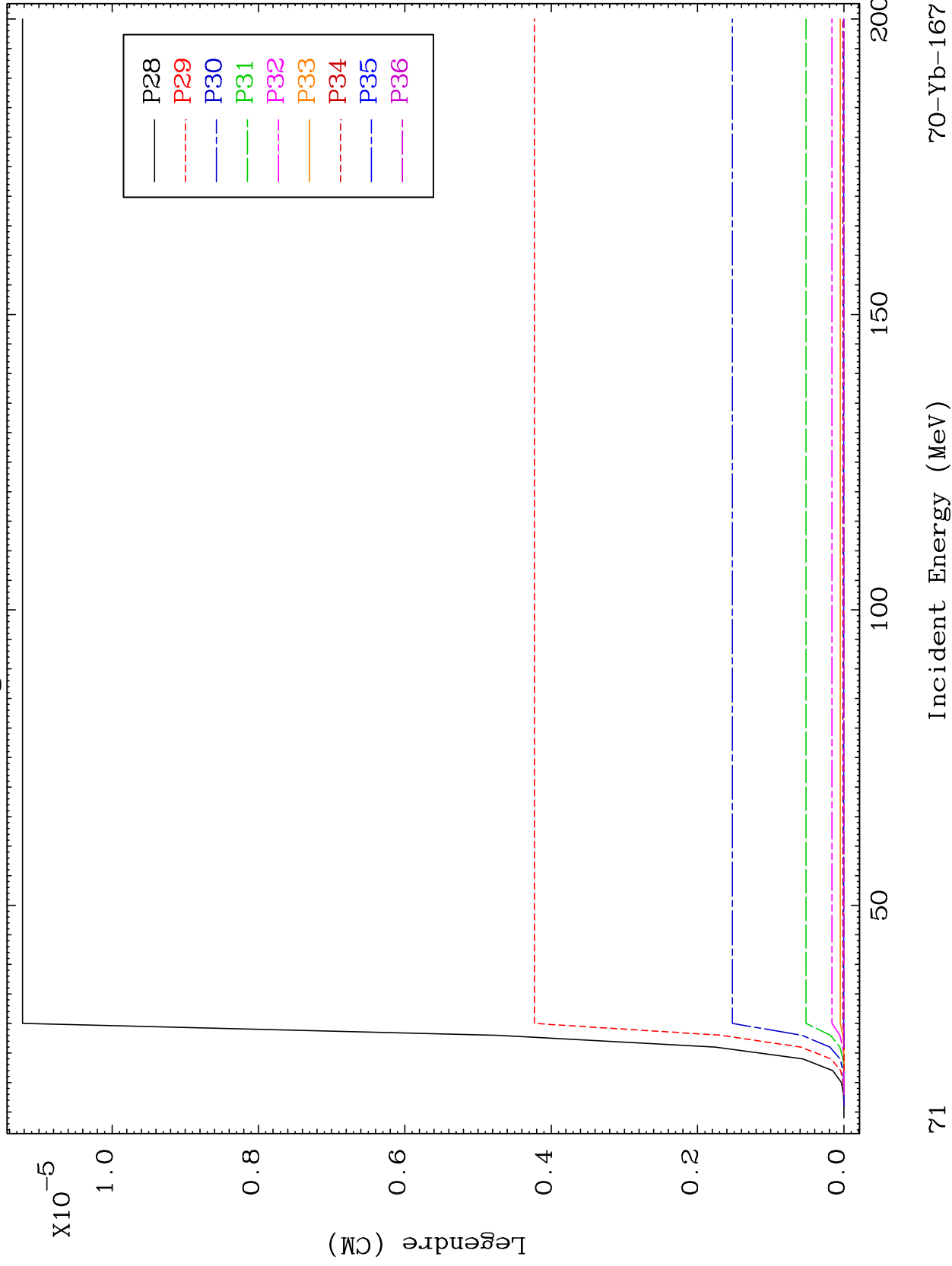

71

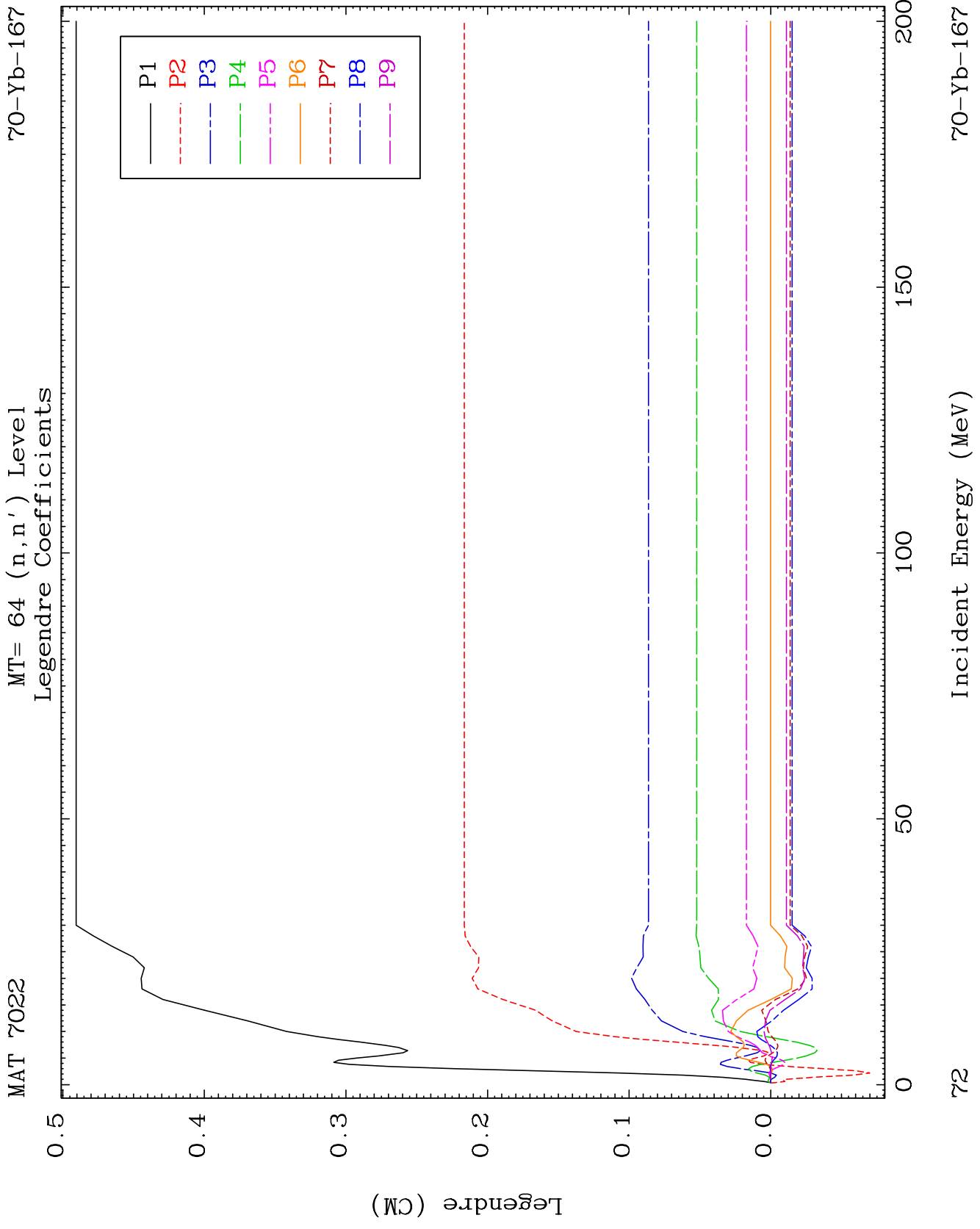

MAT 7022

MT= 64 (n,n') Level
Legendre Coefficients

70-Yb-167

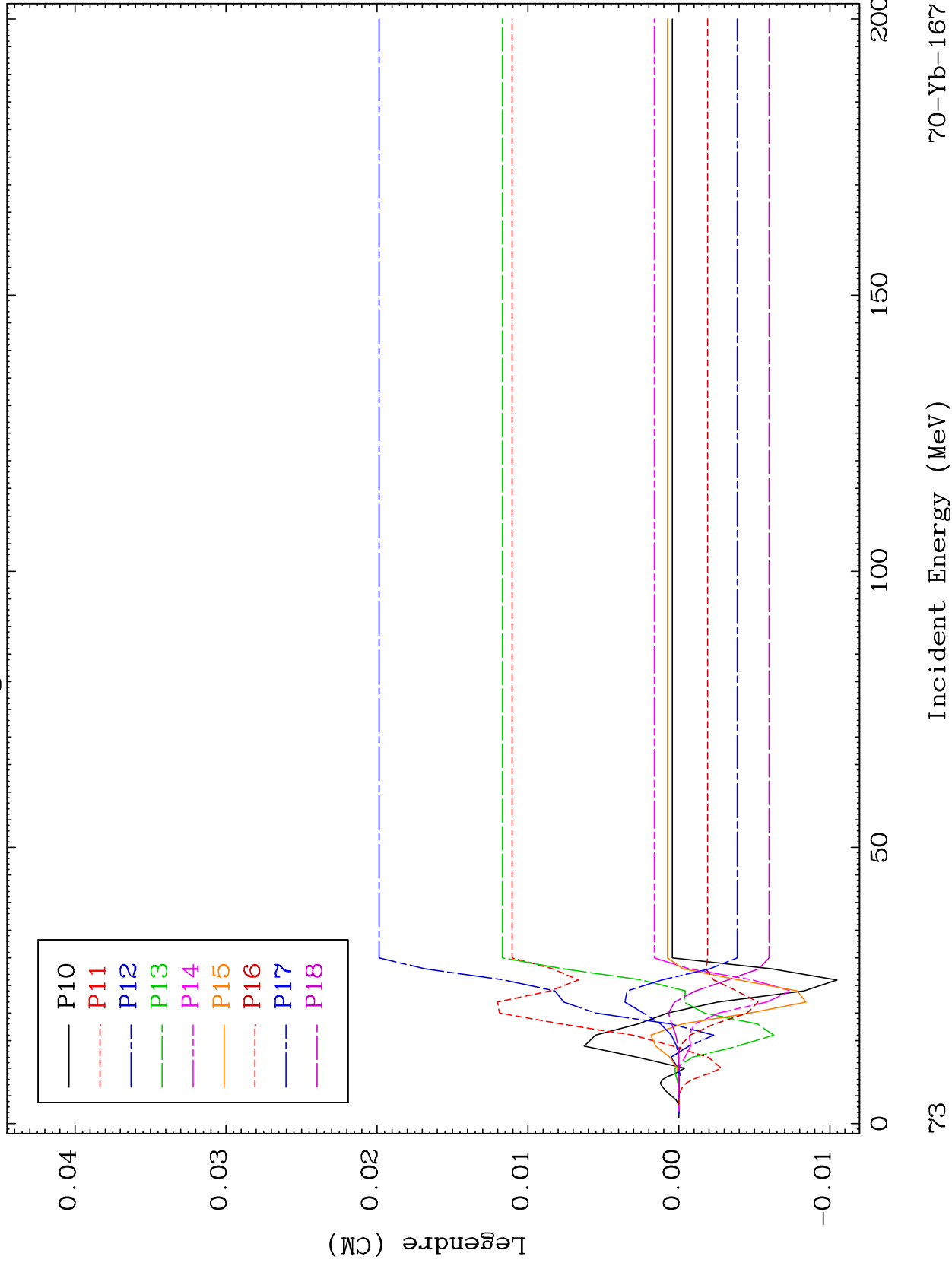

73

Incident Energy (MeV)

70-Yb-167

MAT 7022

MT= 64 (n,n') Level
Legendre Coefficients

70-Yb-167

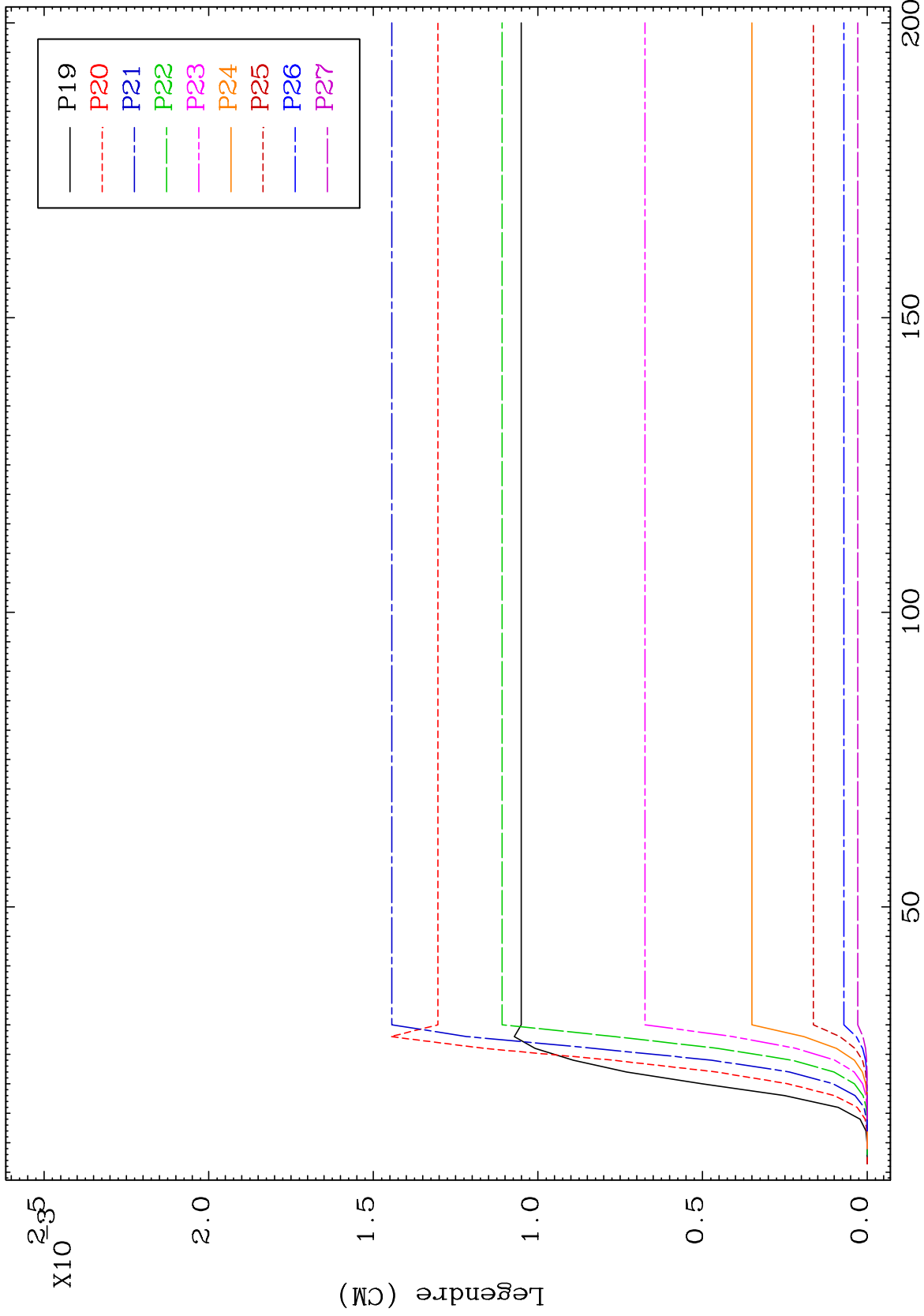

74

Incident Energy (MeV)

70-Yb-167

MAT 7022

MT= 64 (n,n') Level
Legendre Coefficients

70-Yb-167

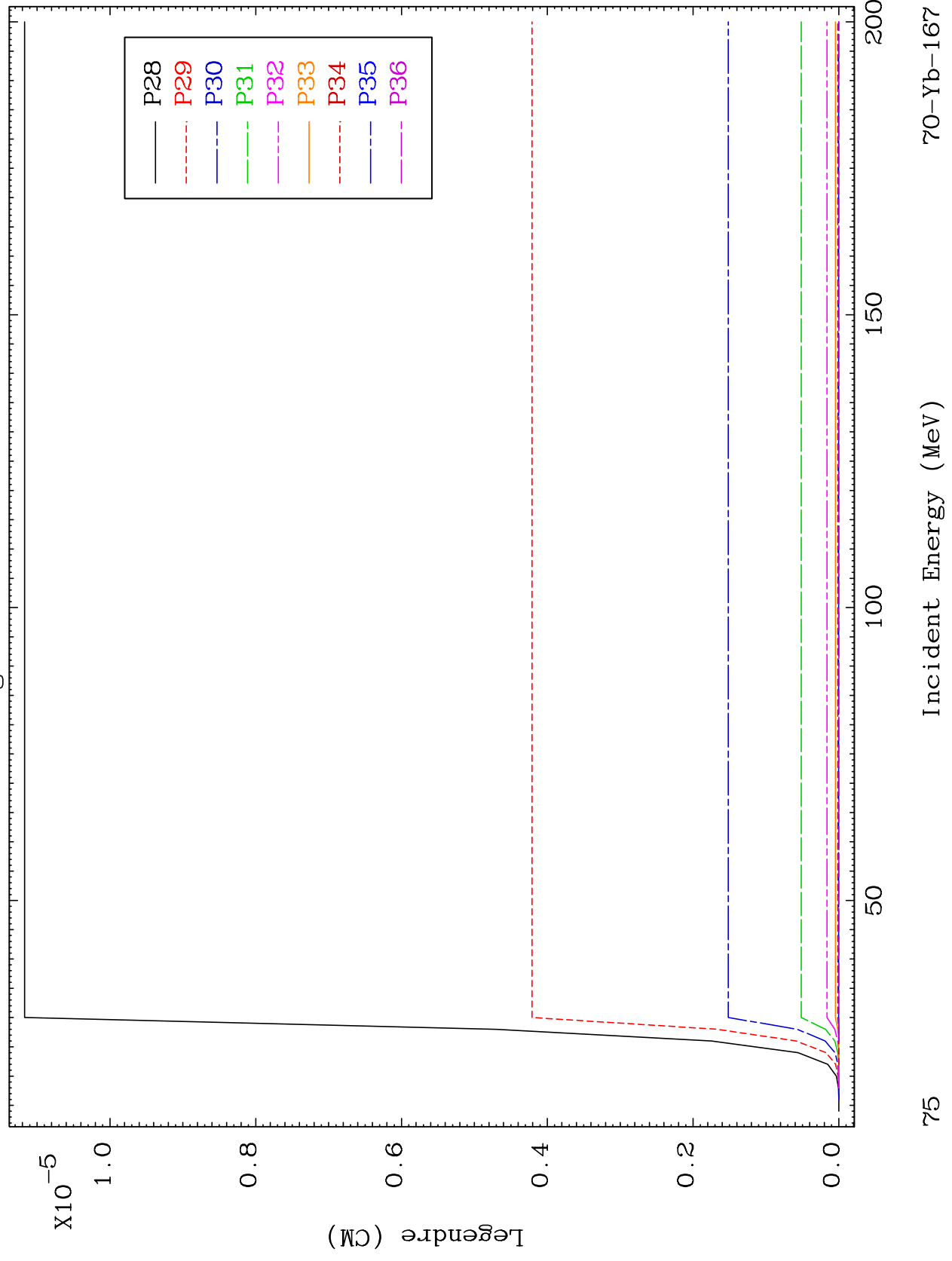

70-Yb-167

Incident Energy (MeV)

75

MAT 7022

MT= 65 (n,n') Level
Legendre Coefficients

70-Yb-167

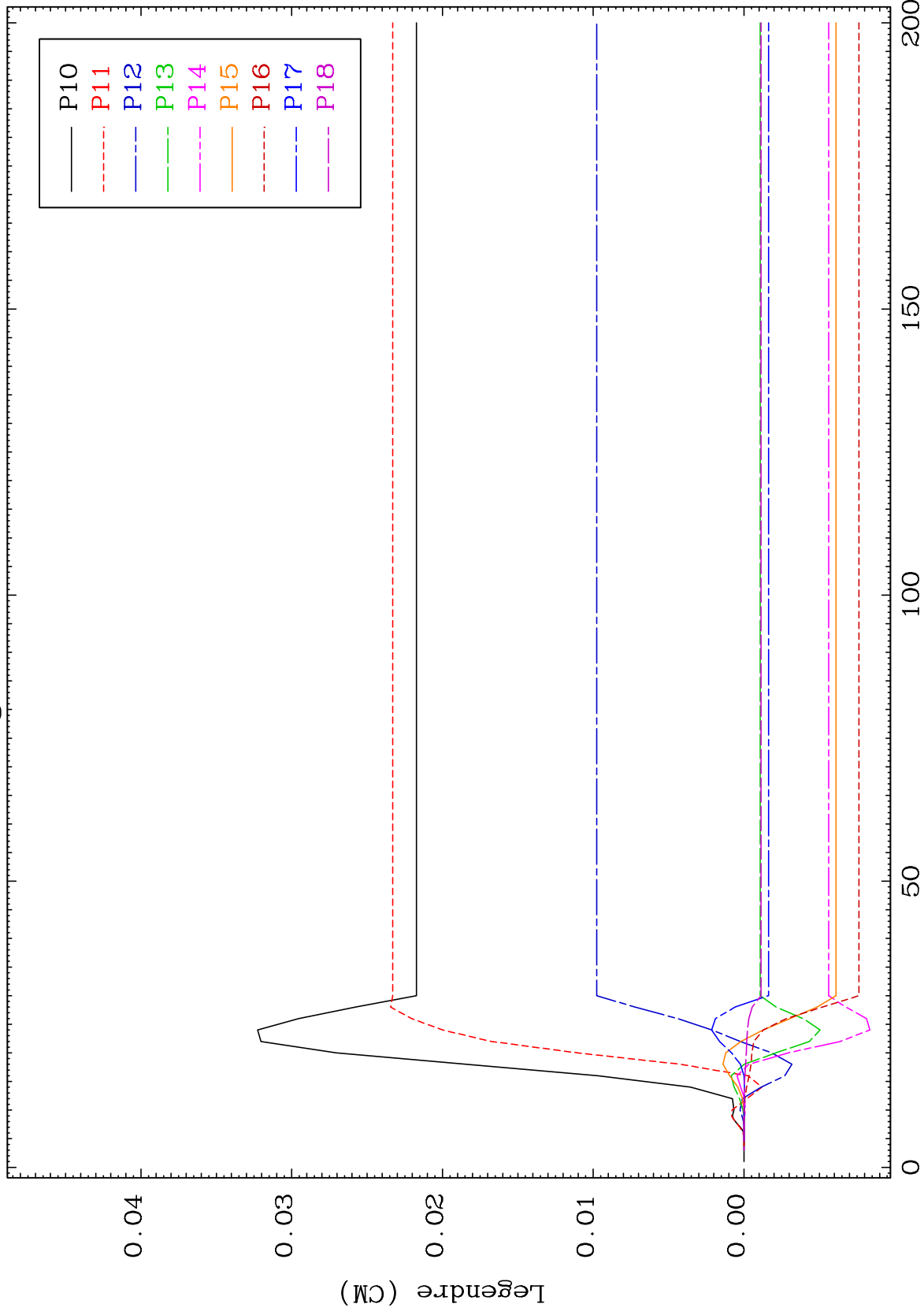

77

Incident Energy (MeV)

70-Yb-167

MAT 7022

MT= 65 (n,n') Level
Legendre Coefficients

70-Yb-167

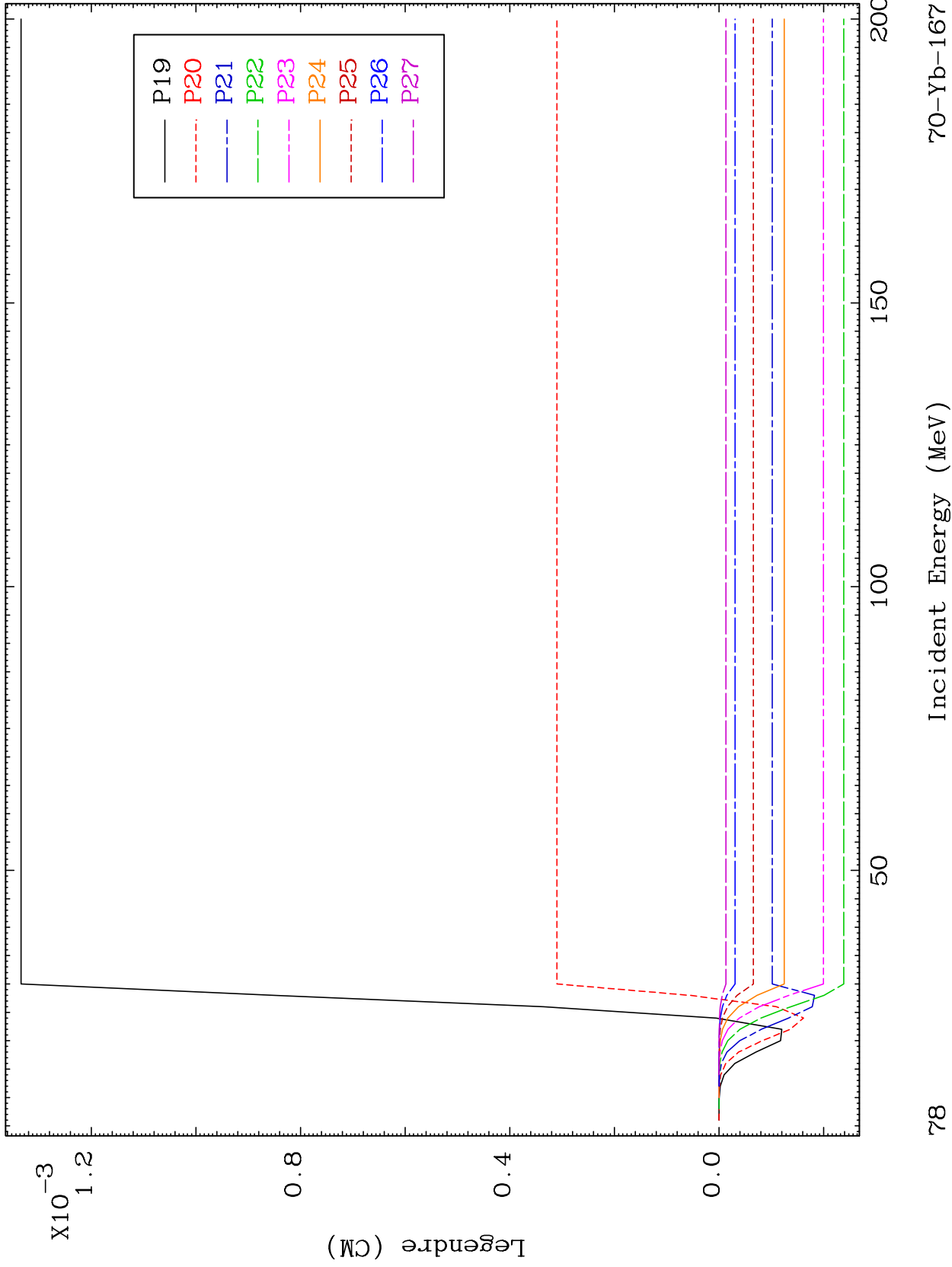

78

70-Yb-167

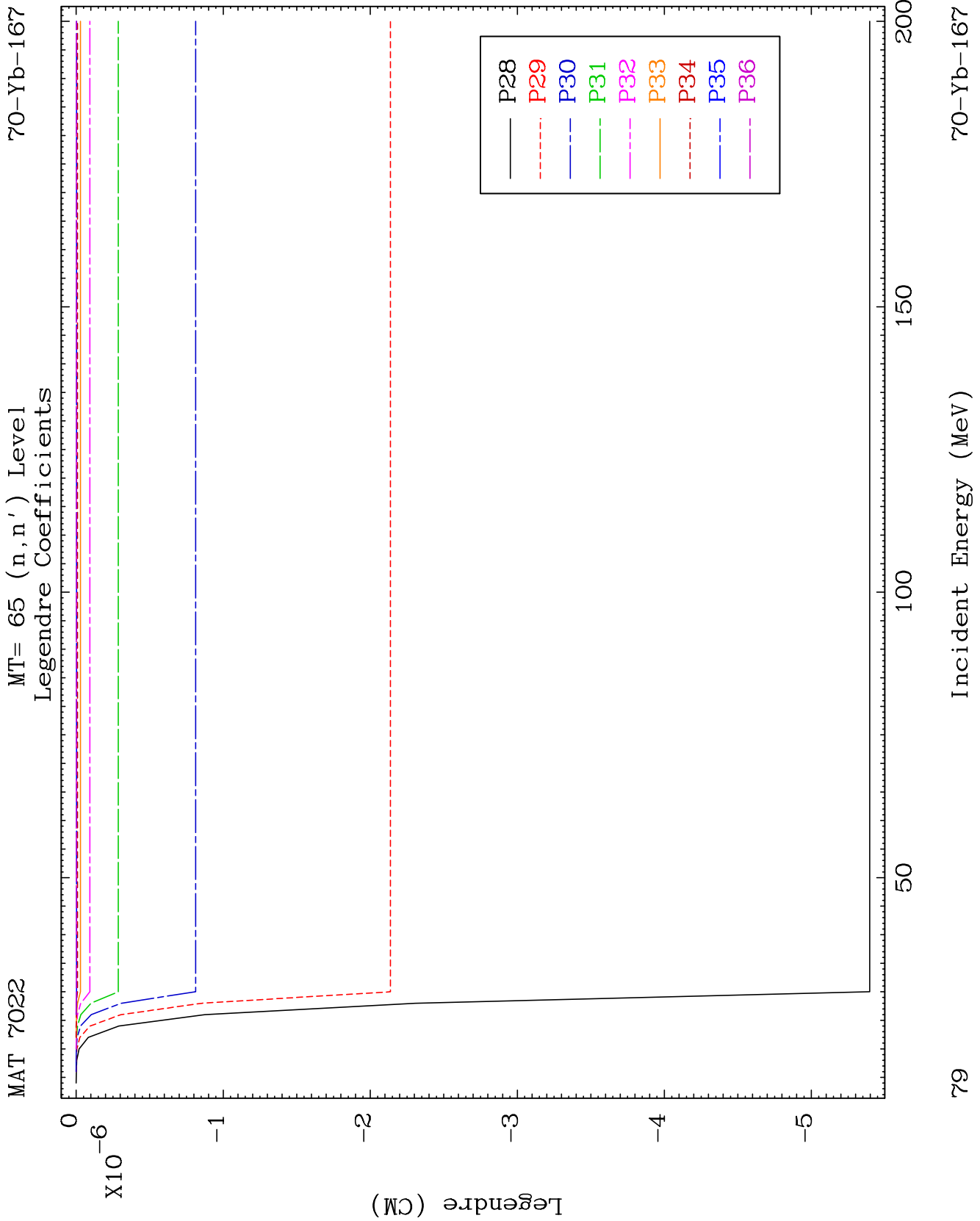

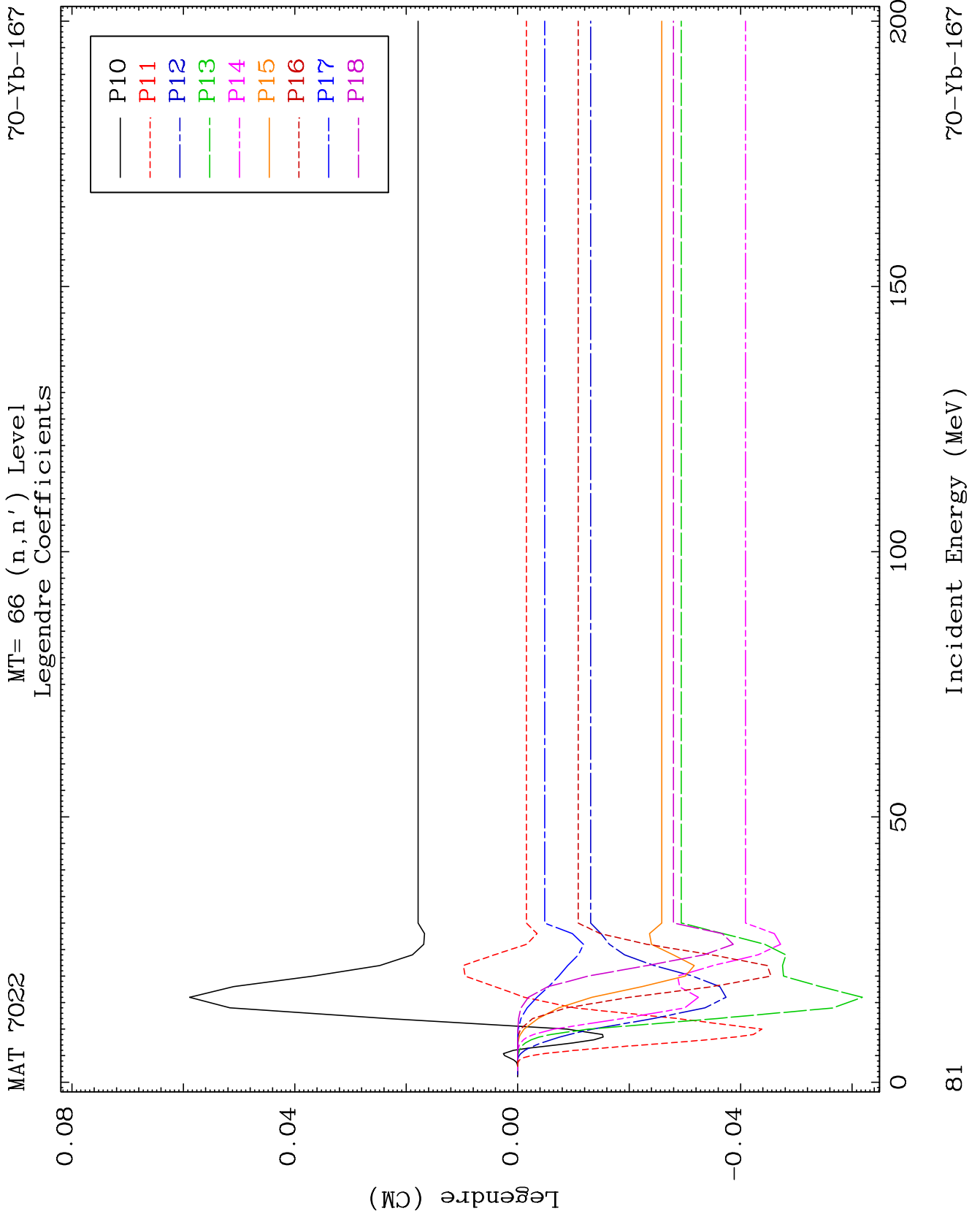

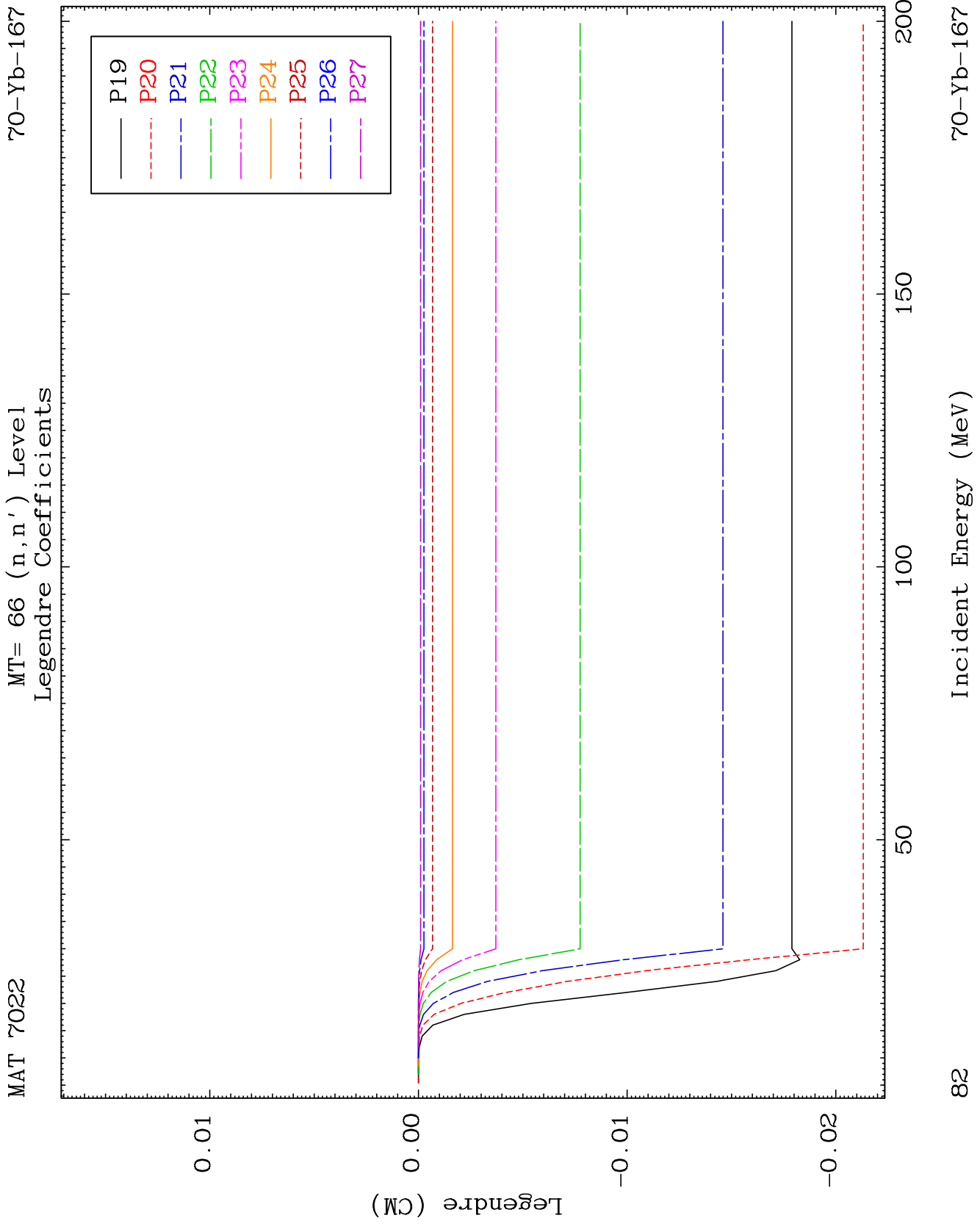

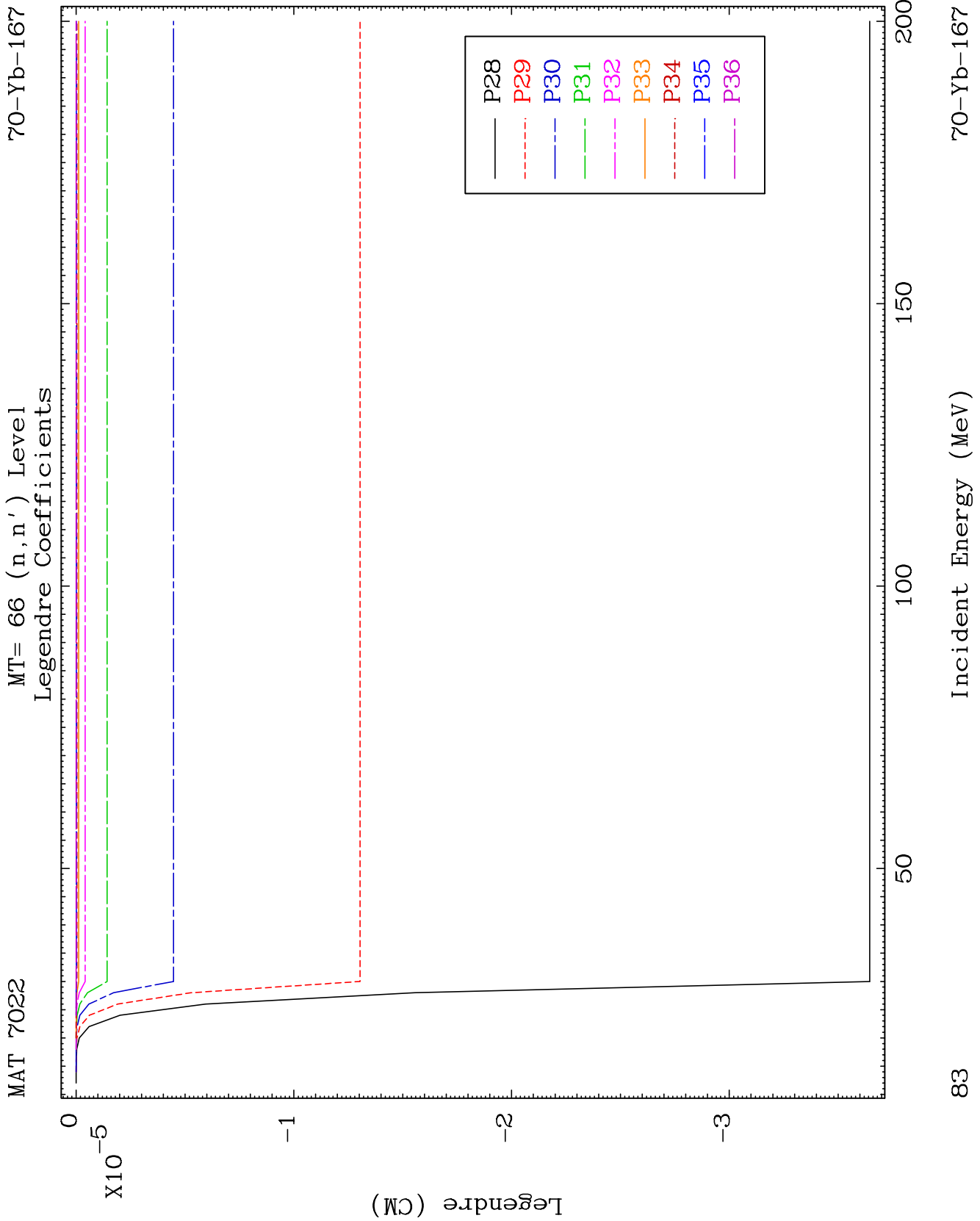

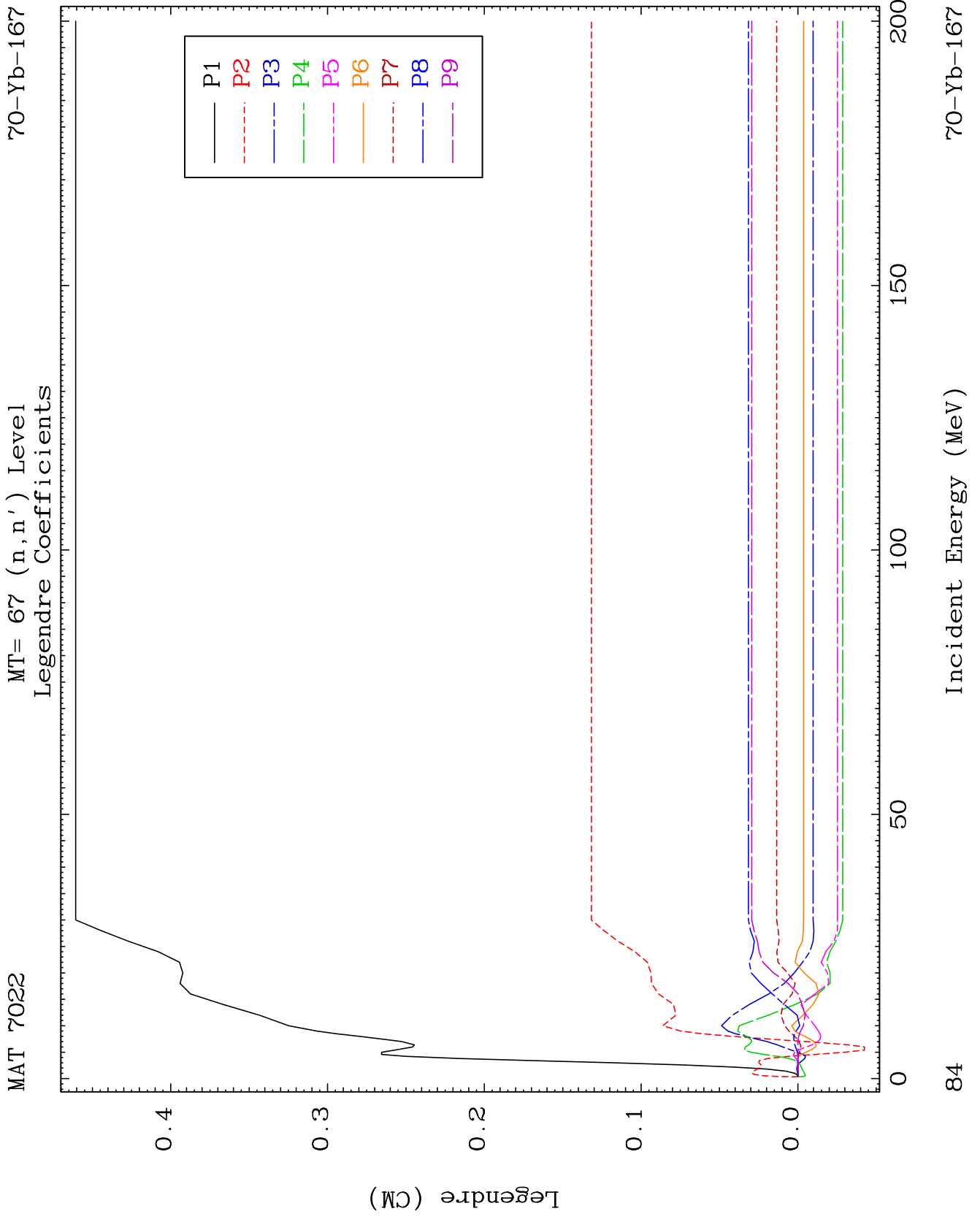

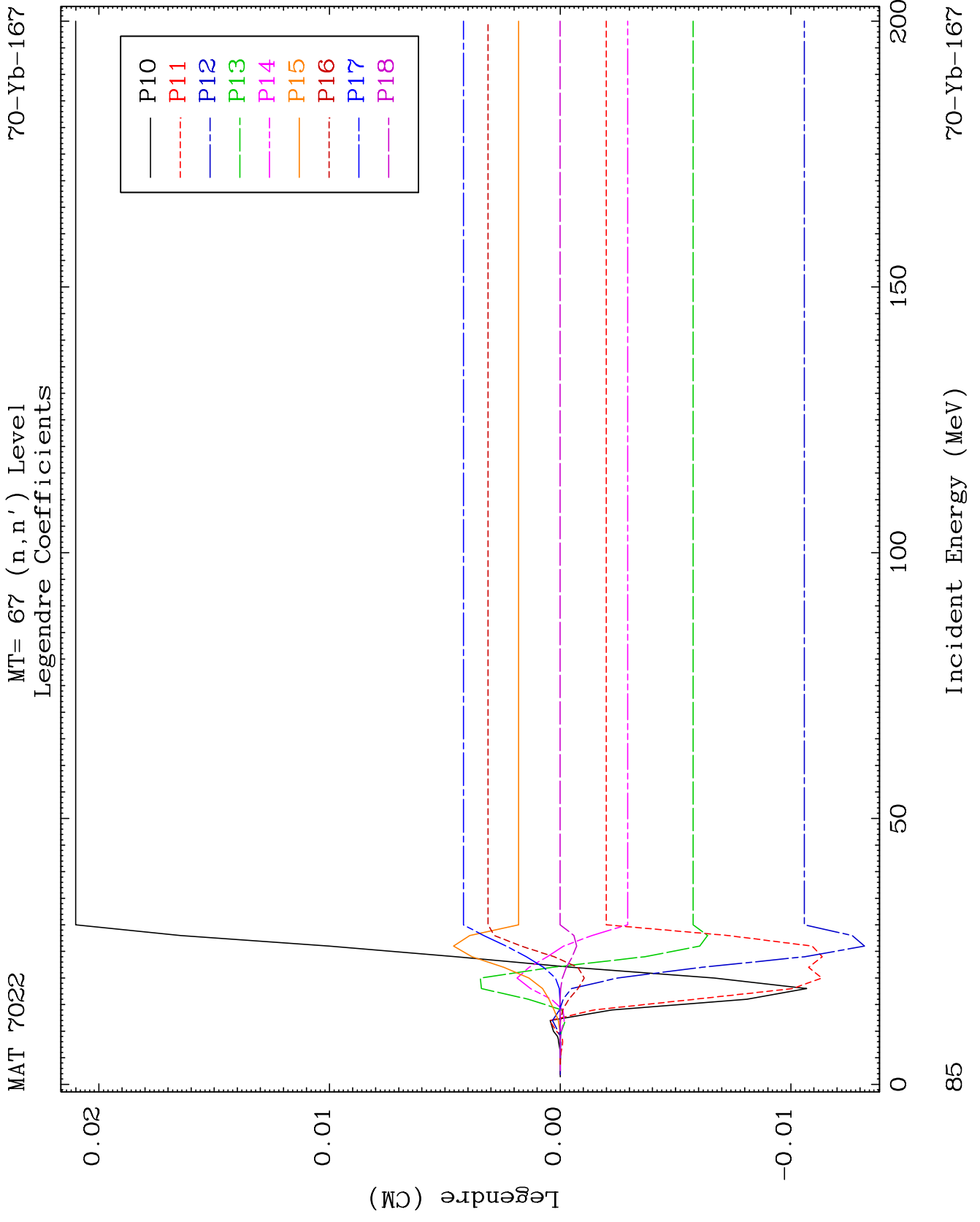

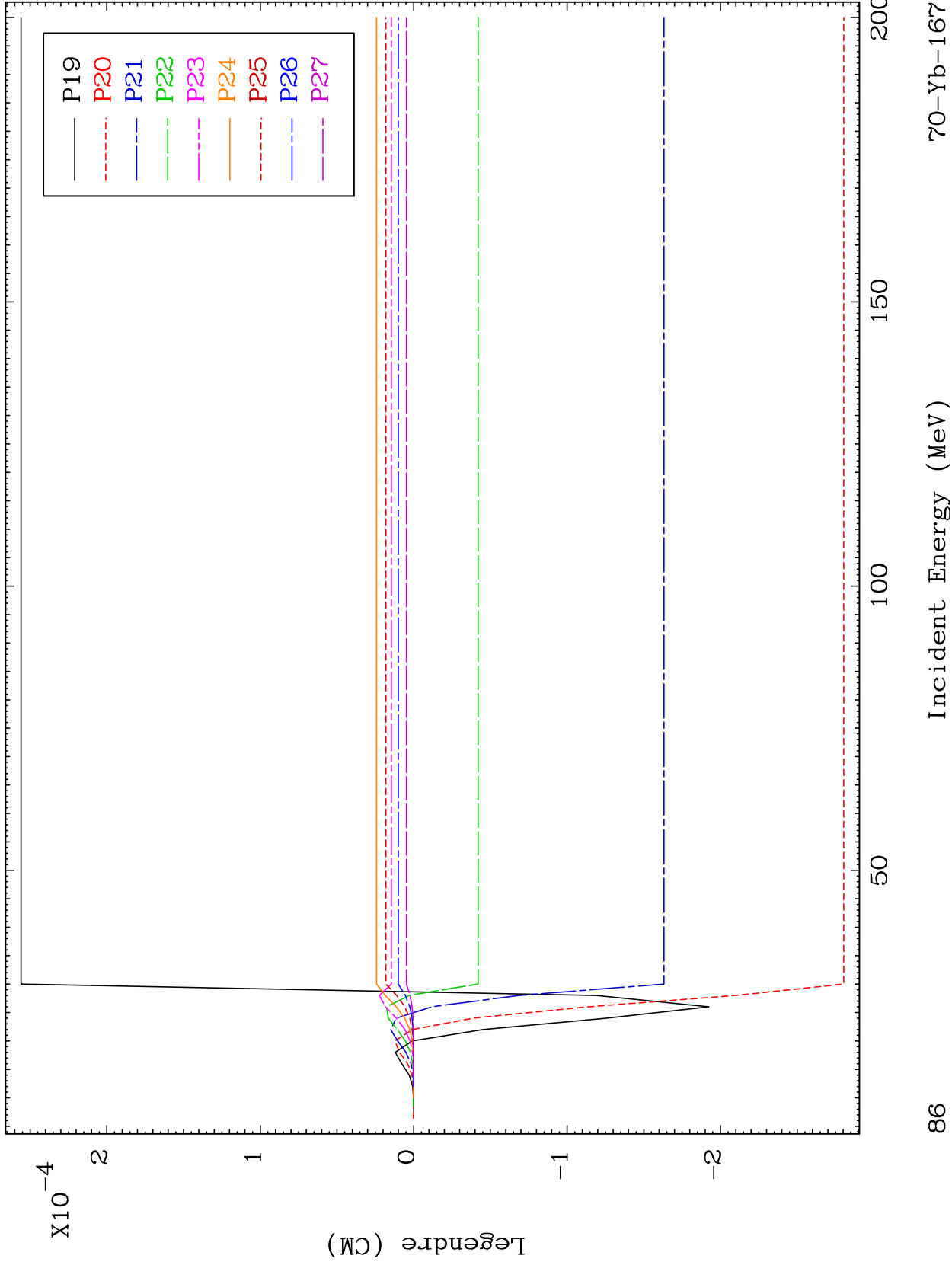

MAT 7022

MT= 67 (n,n') Level
Legendre Coefficients

70-Yb-167

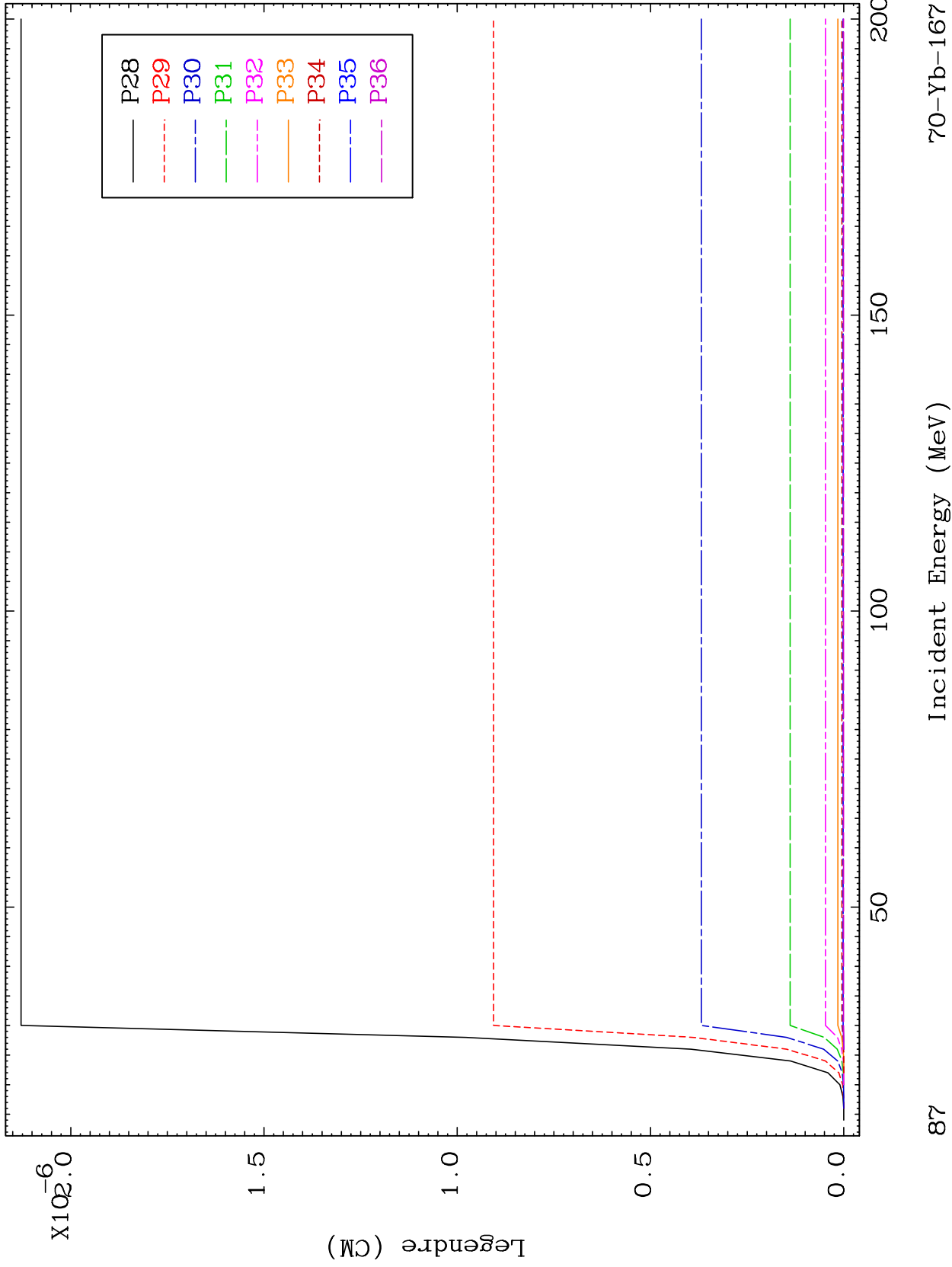

87

Incident Energy (MeV)

70-Yb-167

MAT 7022

MT= 68 (n,n') Level
Legendre Coefficients

70-Yb-167

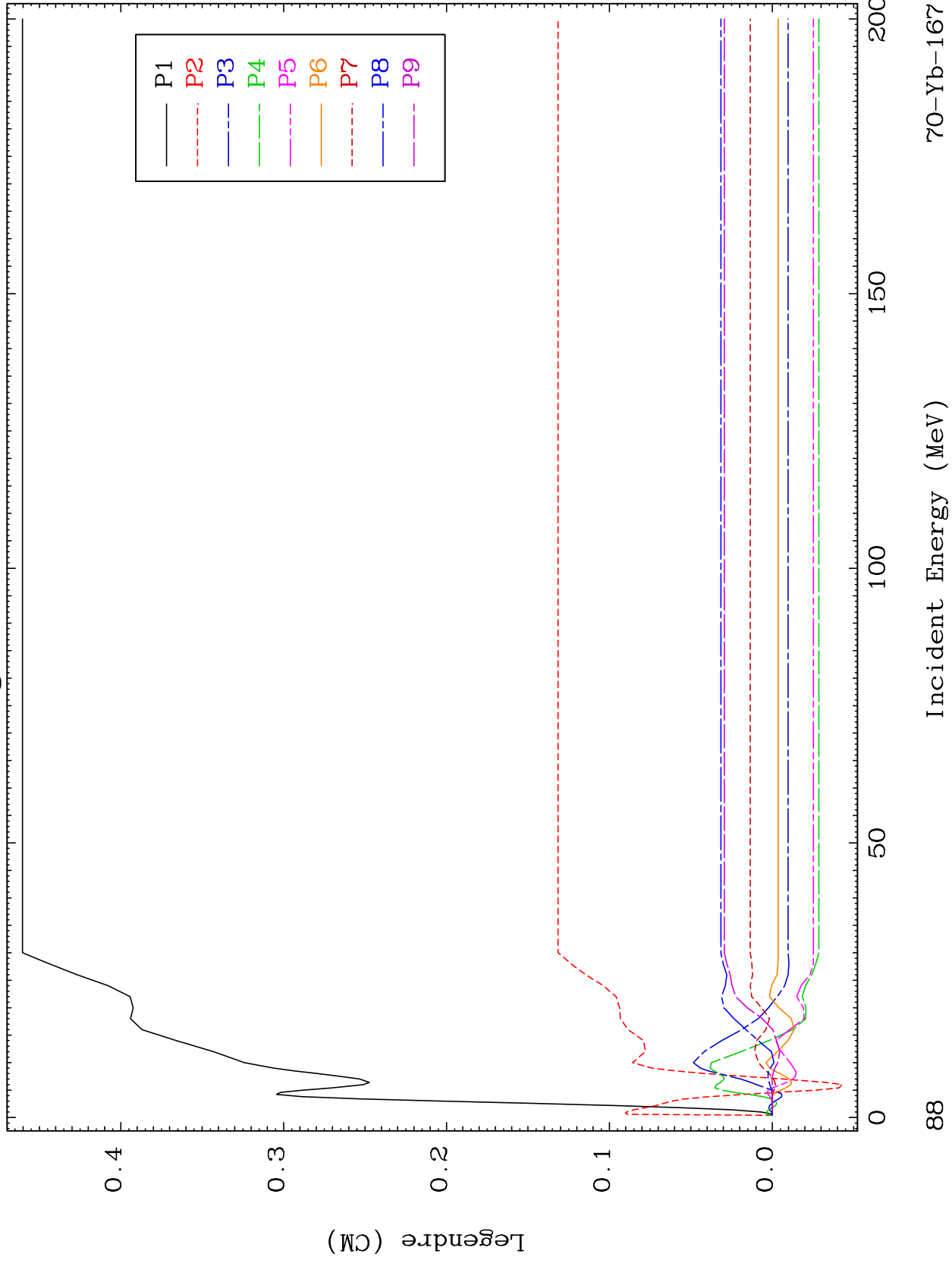

88

Incident Energy (MeV)

70-Yb-167

MAT 7022

MT= 68 (n,n') Level
Legendre Coefficients

70-Yb-167

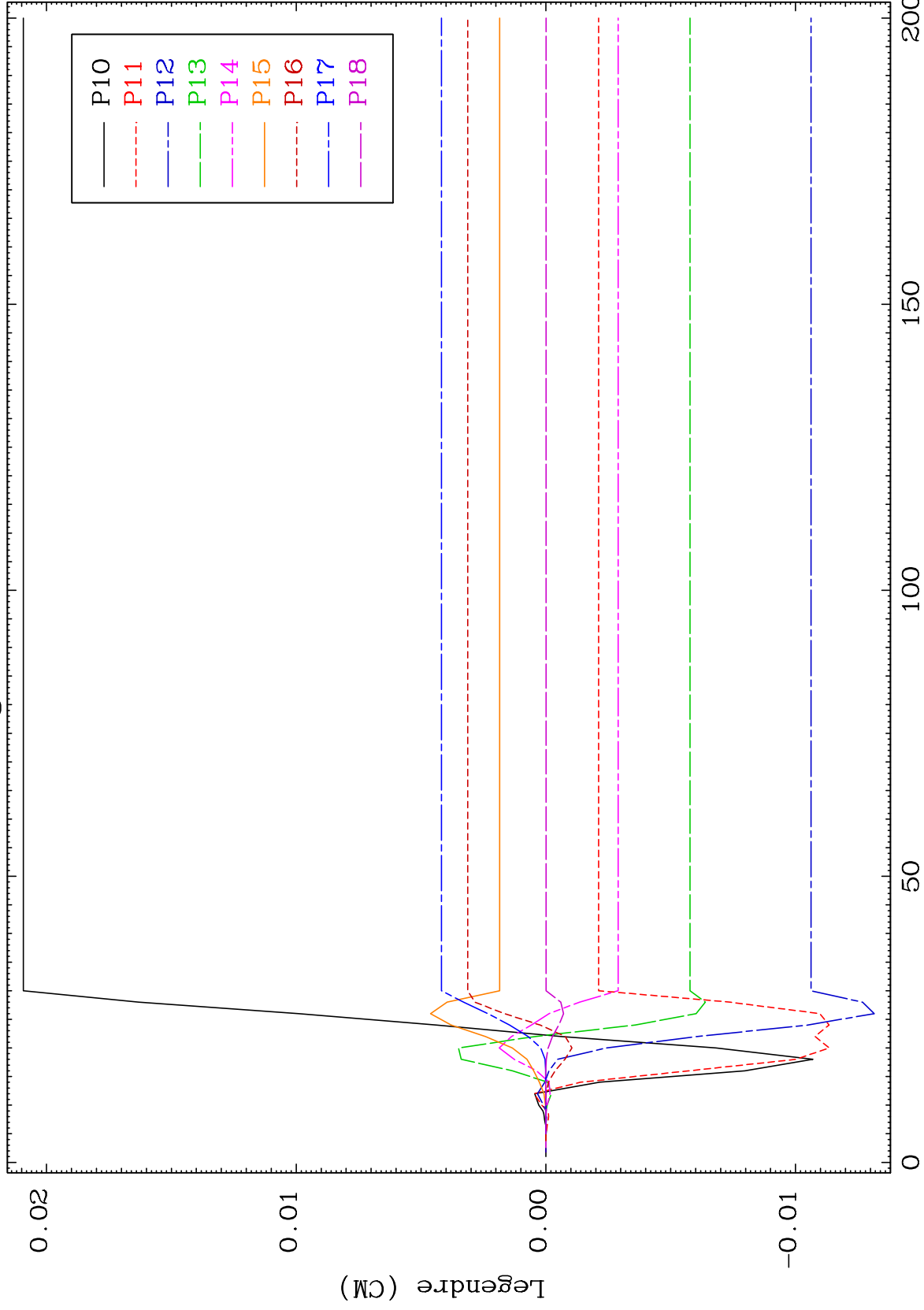

89

Incident Energy (MeV)

70-Yb-167

MAT 7022

MT= 68 (n,n') Level
Legendre Coefficients

70-Yb-167

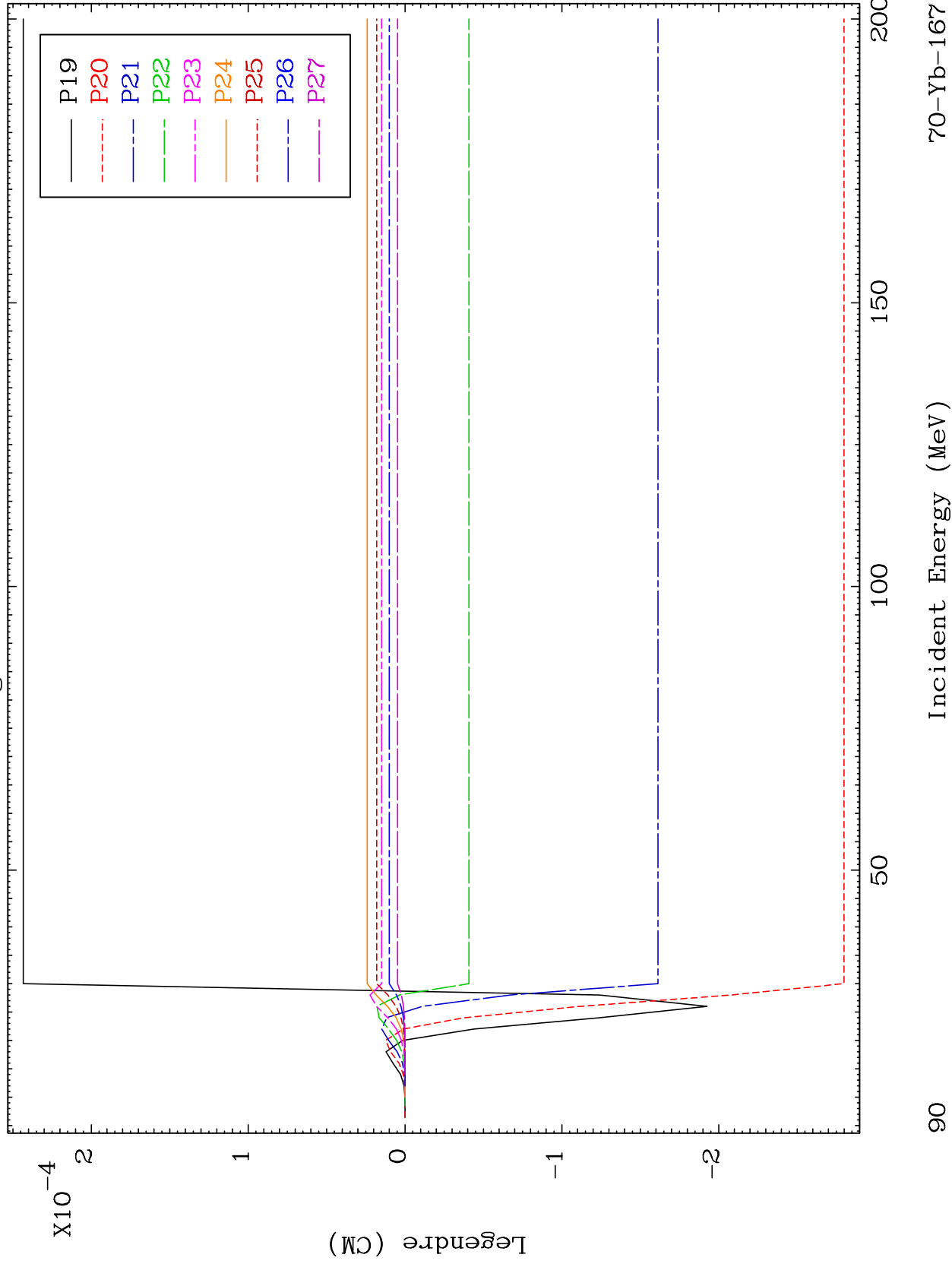

MAT 7022

MT= 68 (n,n') Level
Legendre Coefficients

70-Yb-167

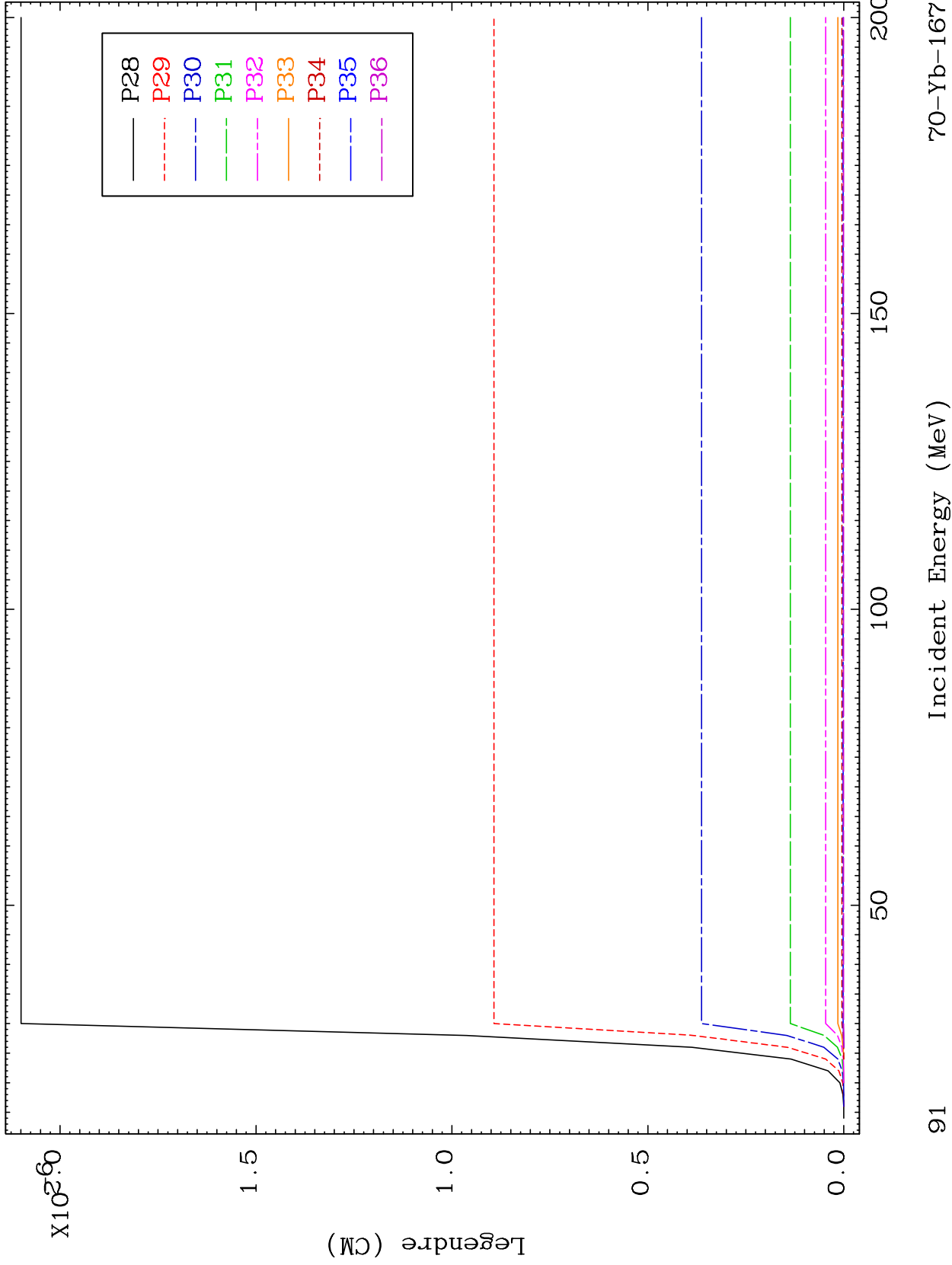

91

70-Yb-167

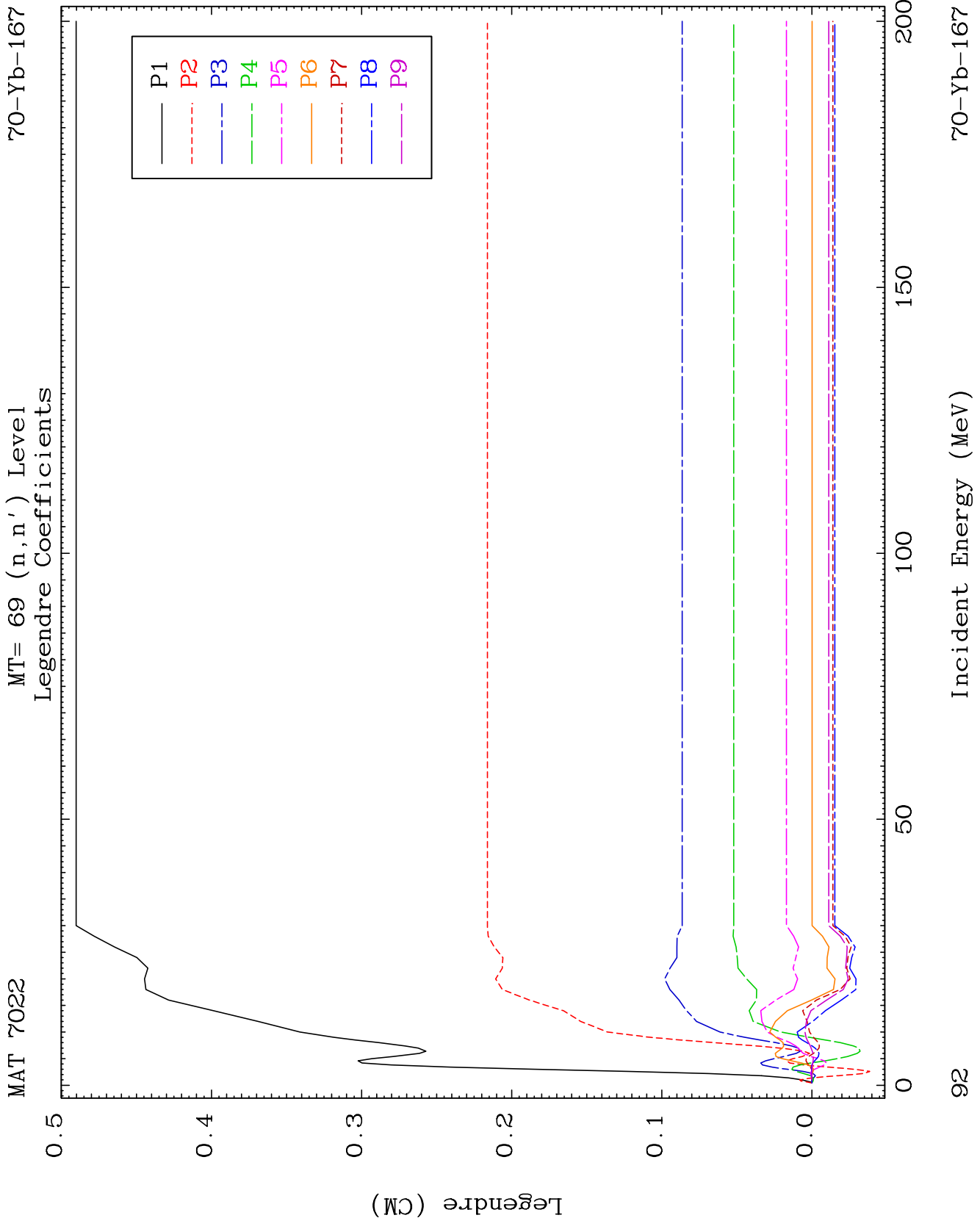

MAT 7022

MT= 69 (n,n') Level
Legendre Coefficients

70-Yb-167

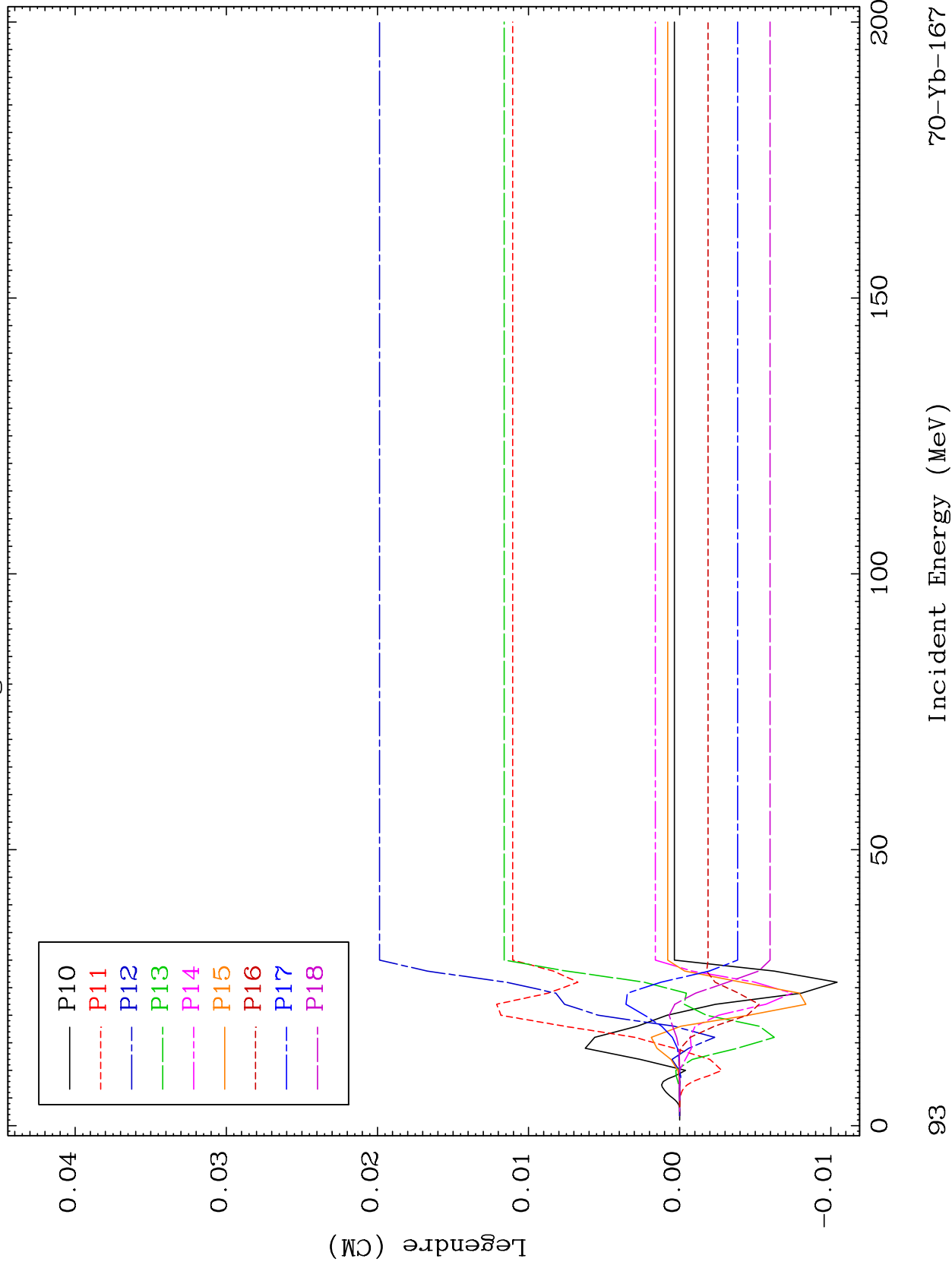

93

Incident Energy (MeV)

70-Yb-167

MAT 7022

MT= 69 (n,n') Level
Legendre Coefficients

70-Yb-167

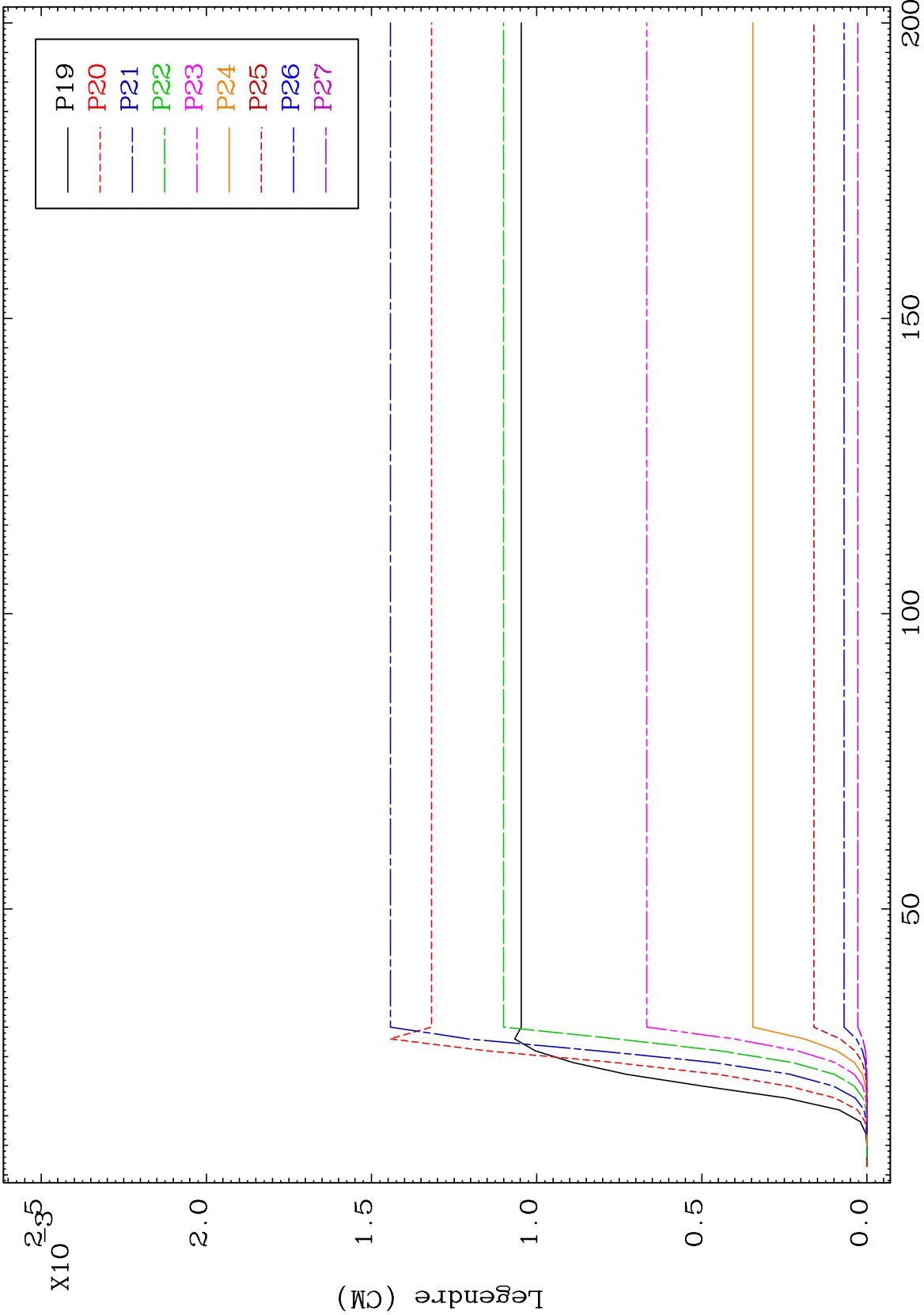

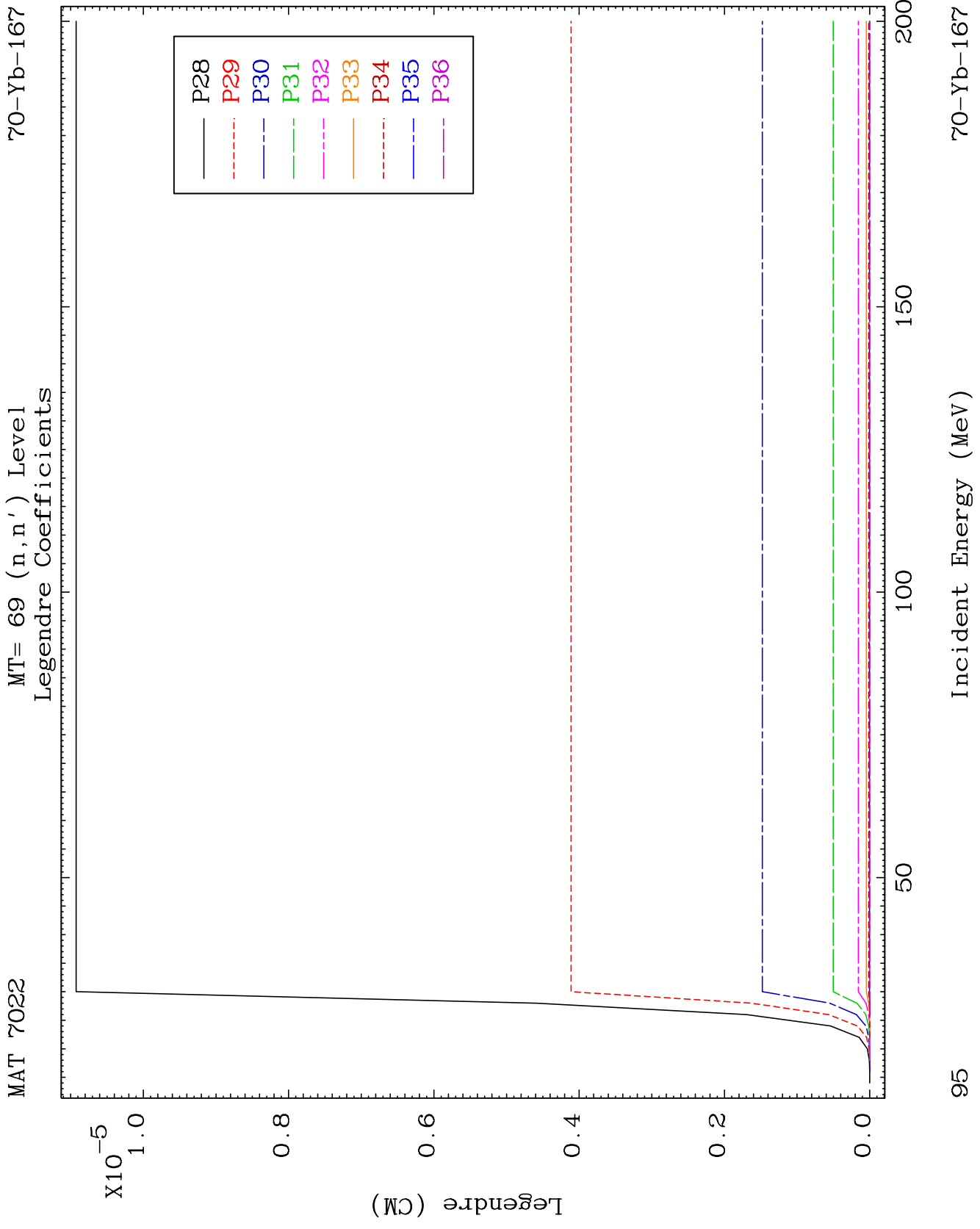

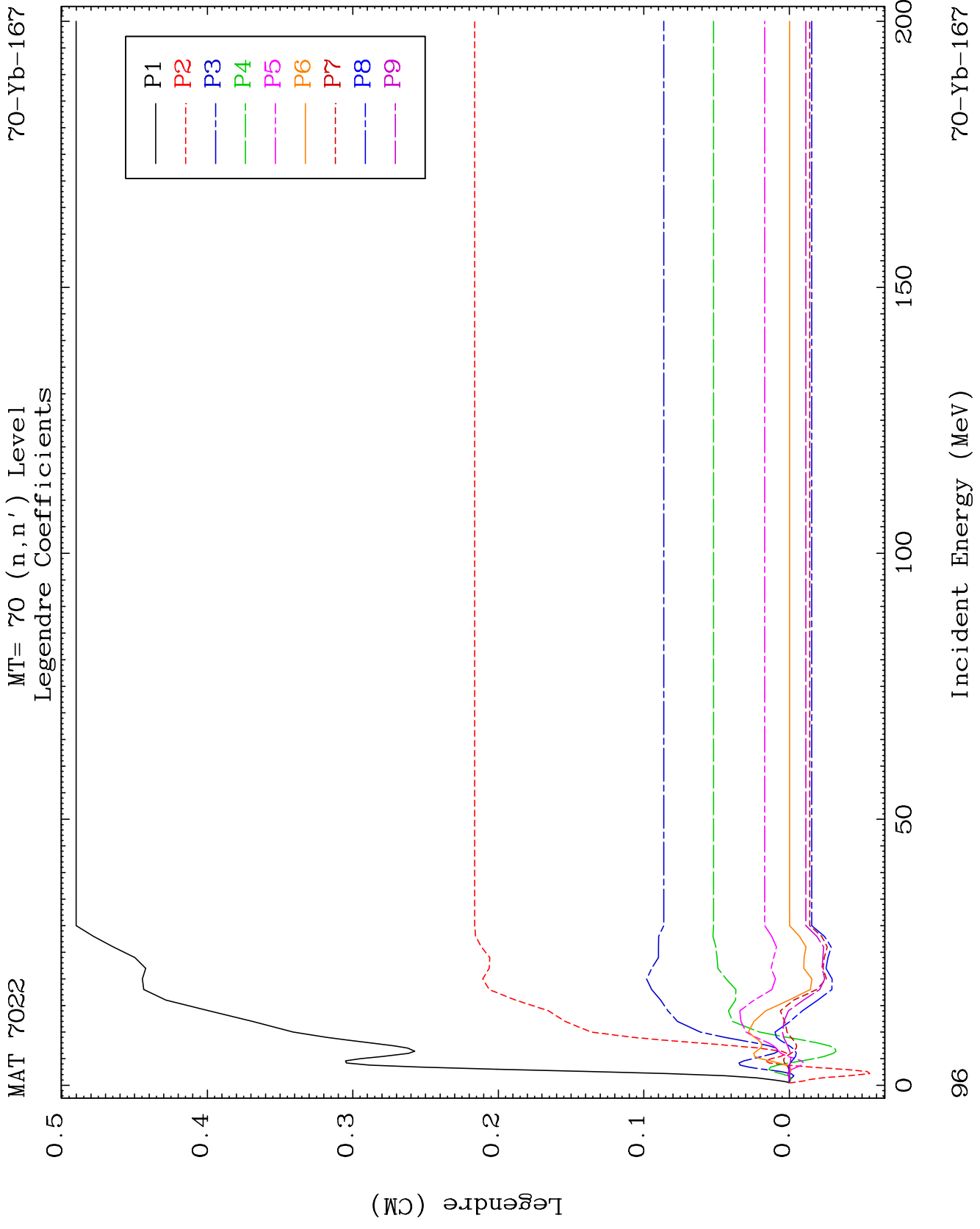

MAT 7022

MT= 70 (n,n') Level
Legendre Coefficients

70-Yb-167

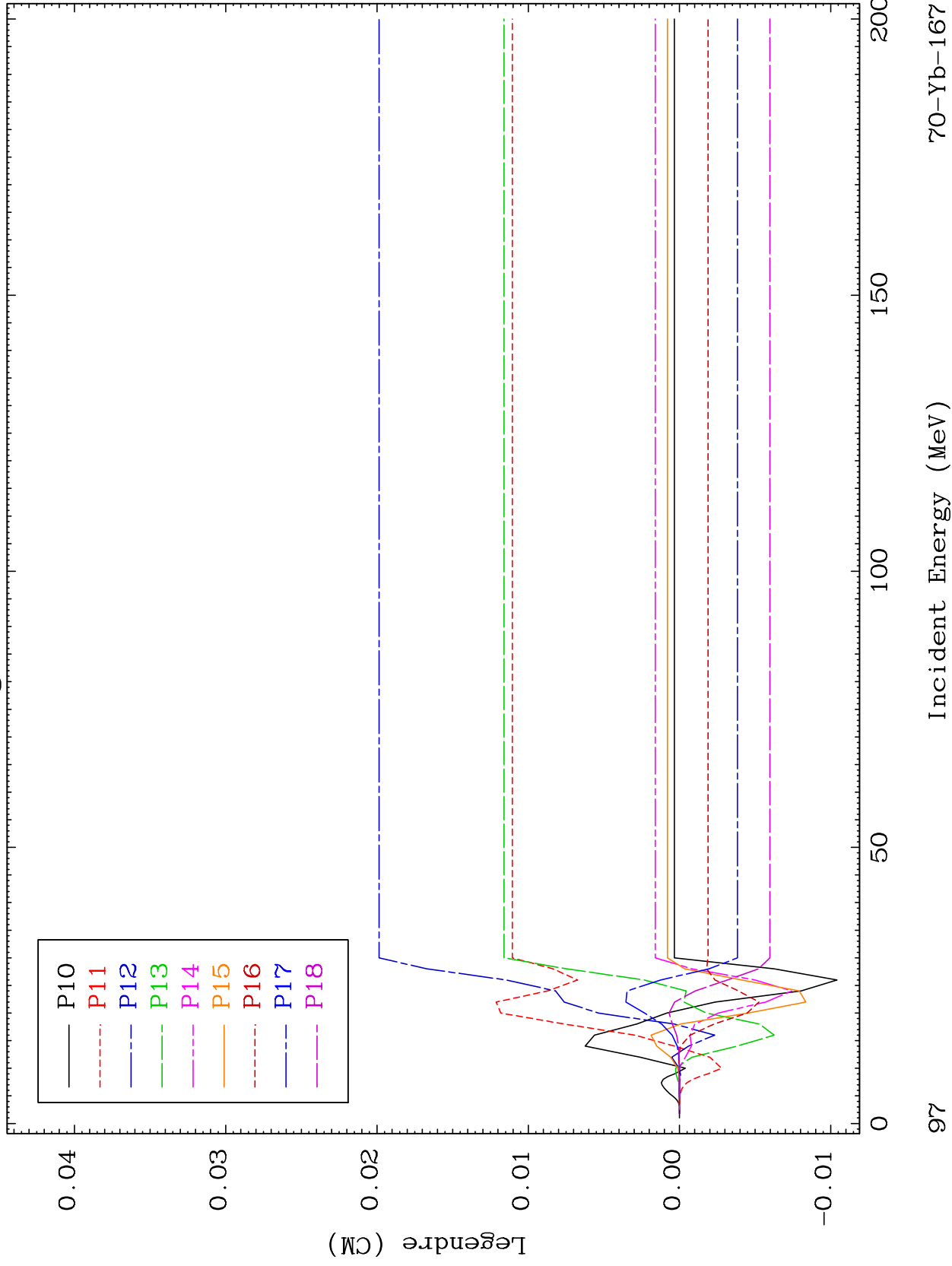

97

Incident Energy (MeV)

70-Yb-167

MAT 7022

MT= 70 (n,n') Level
Legendre Coefficients

70-Yb-167

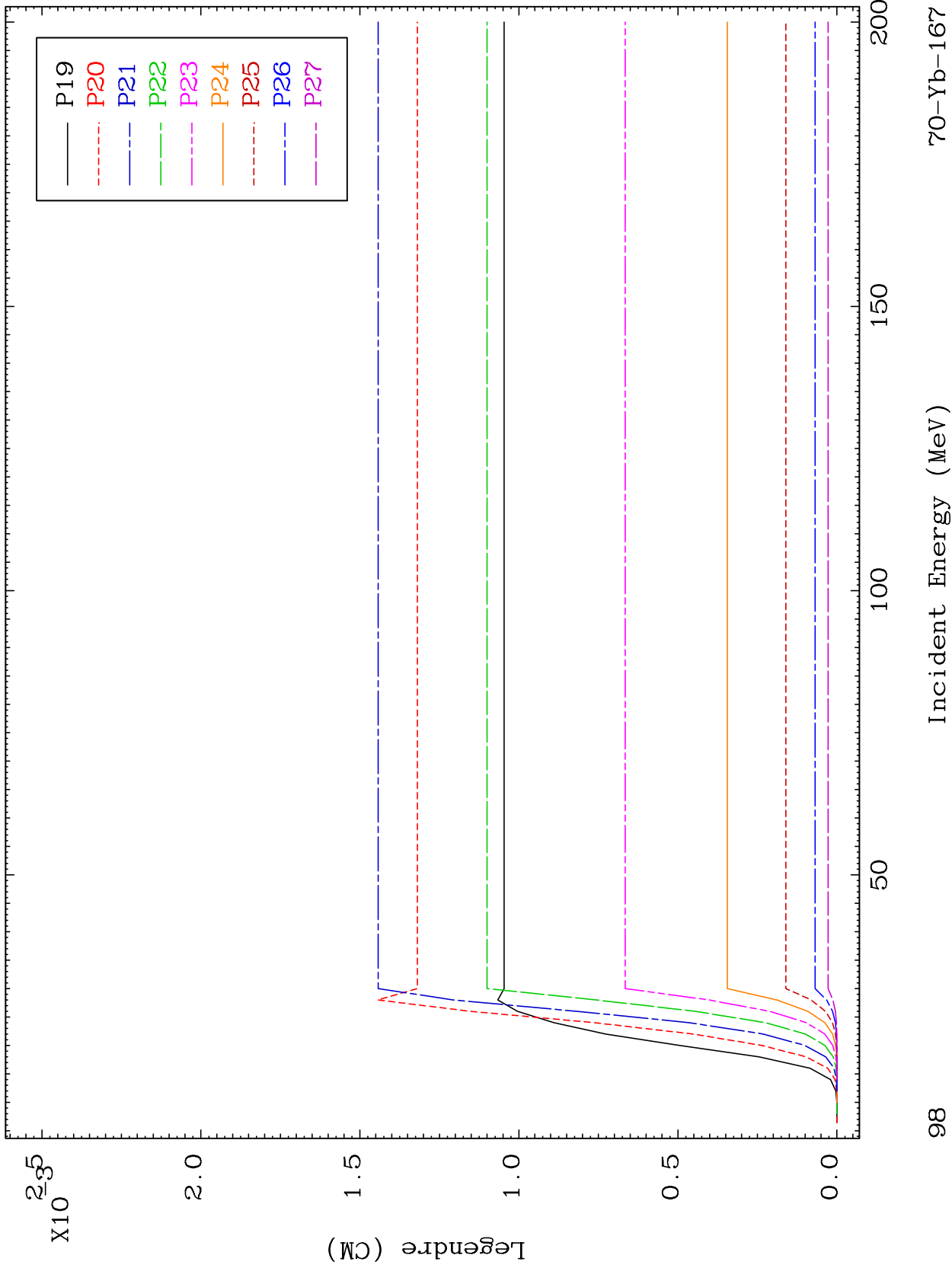

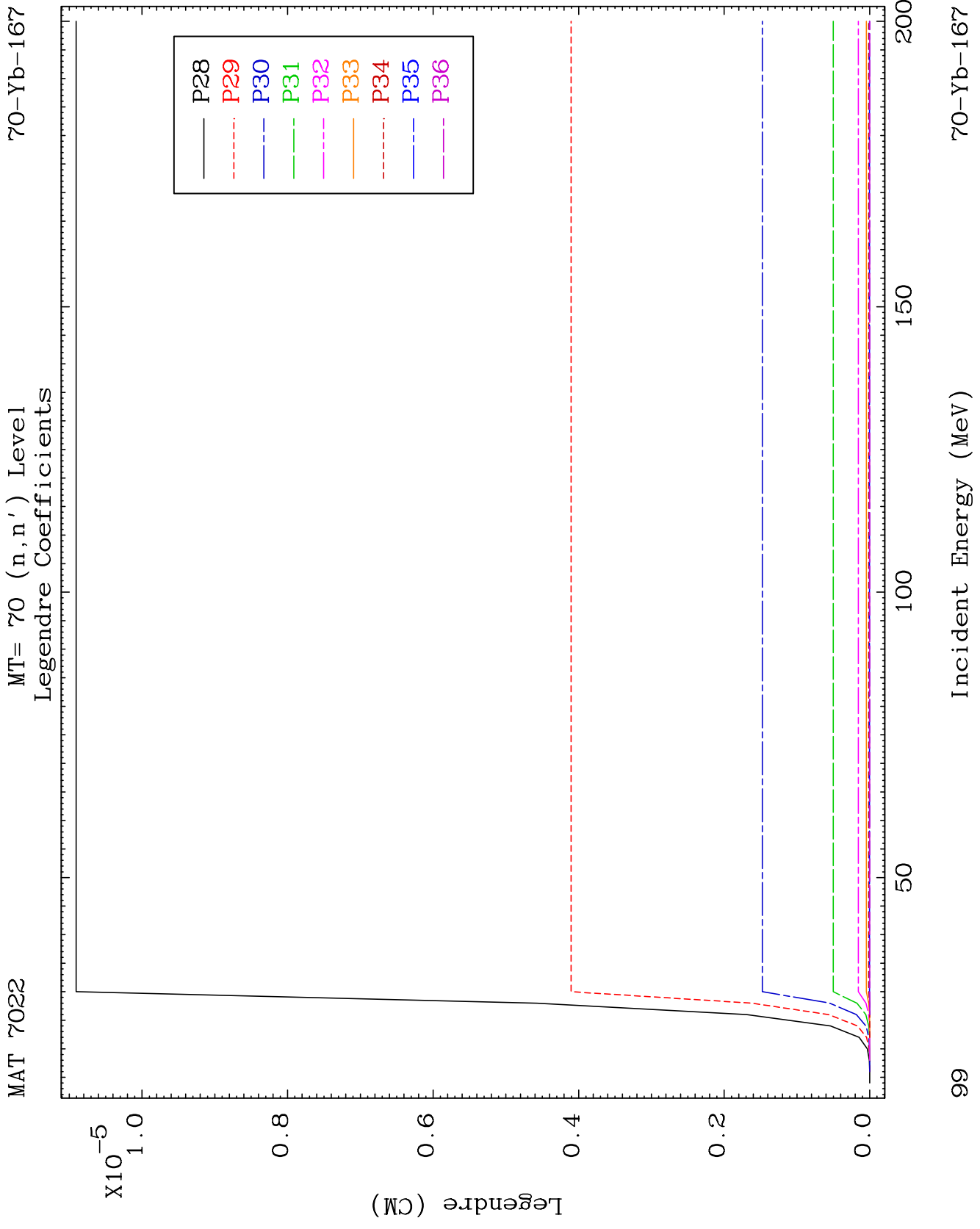

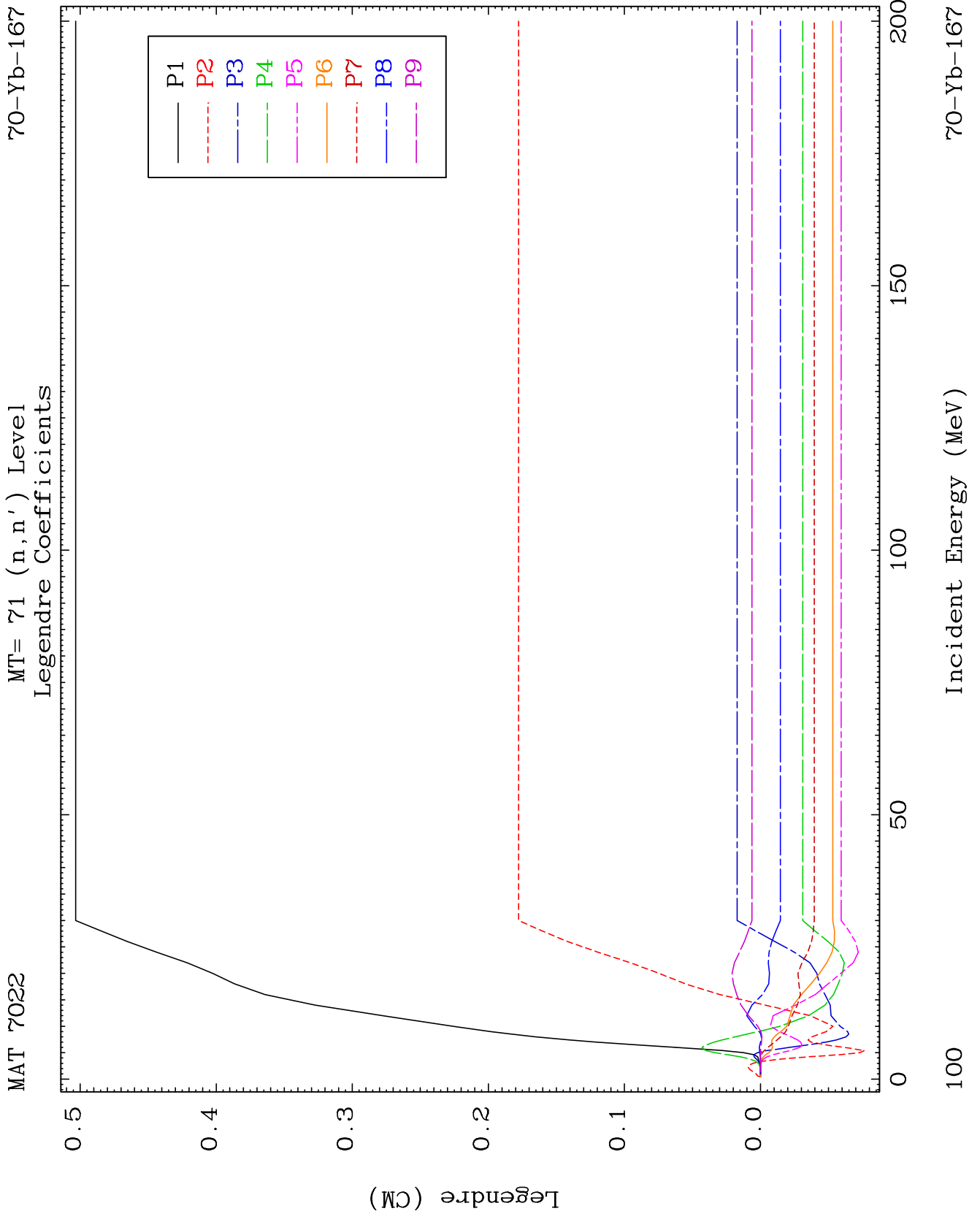

MAT 7022

MT= 71 (n,n') Level
Legendre Coefficients

70-Yb-167

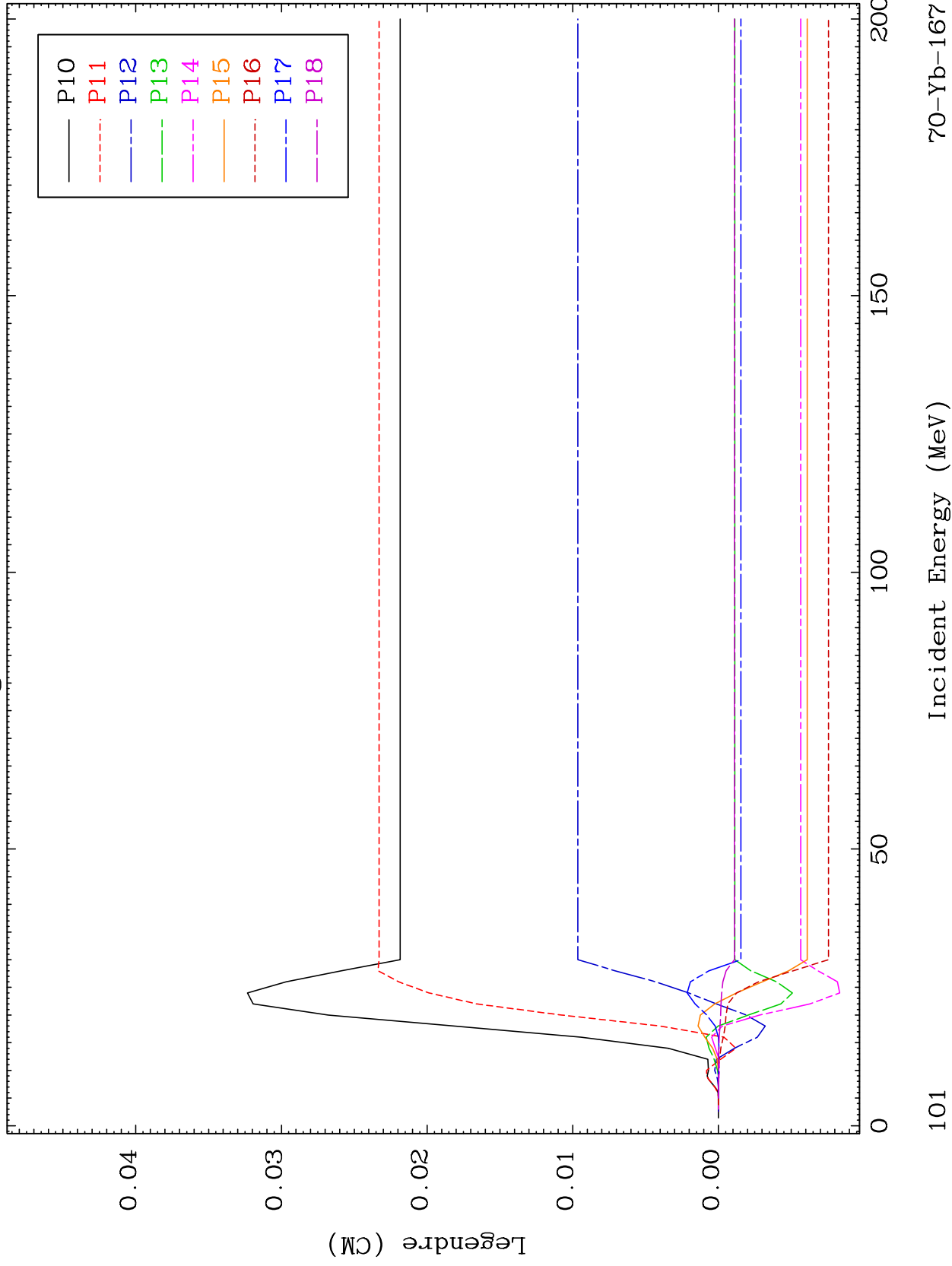

70-Yb-167

Incident Energy (MeV)

101

MAT 7022

MT= 71 (n,n') Level
Legendre Coefficients

70-Yb-167

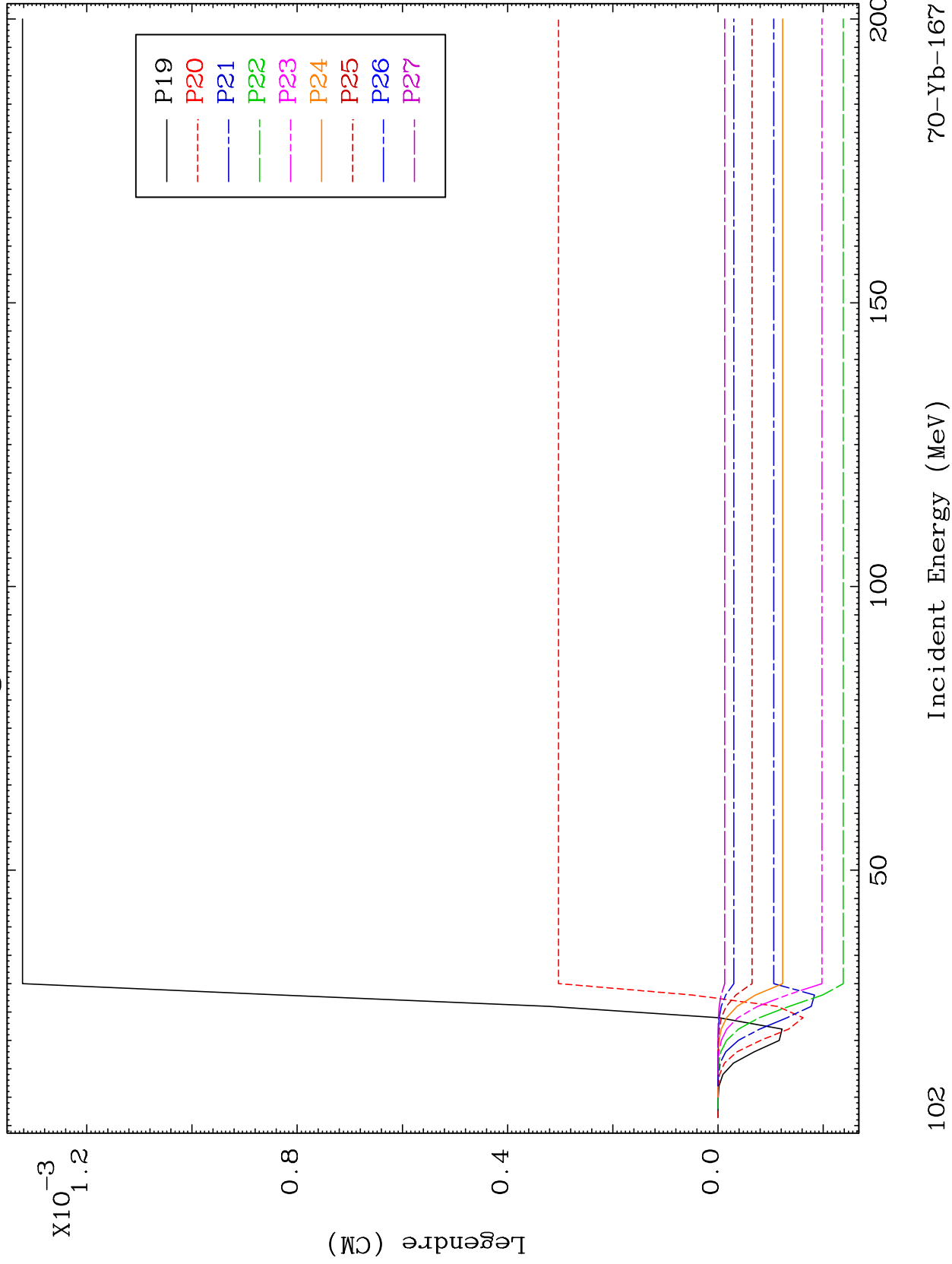

102

Incident Energy (MeV)

70-Yb-167

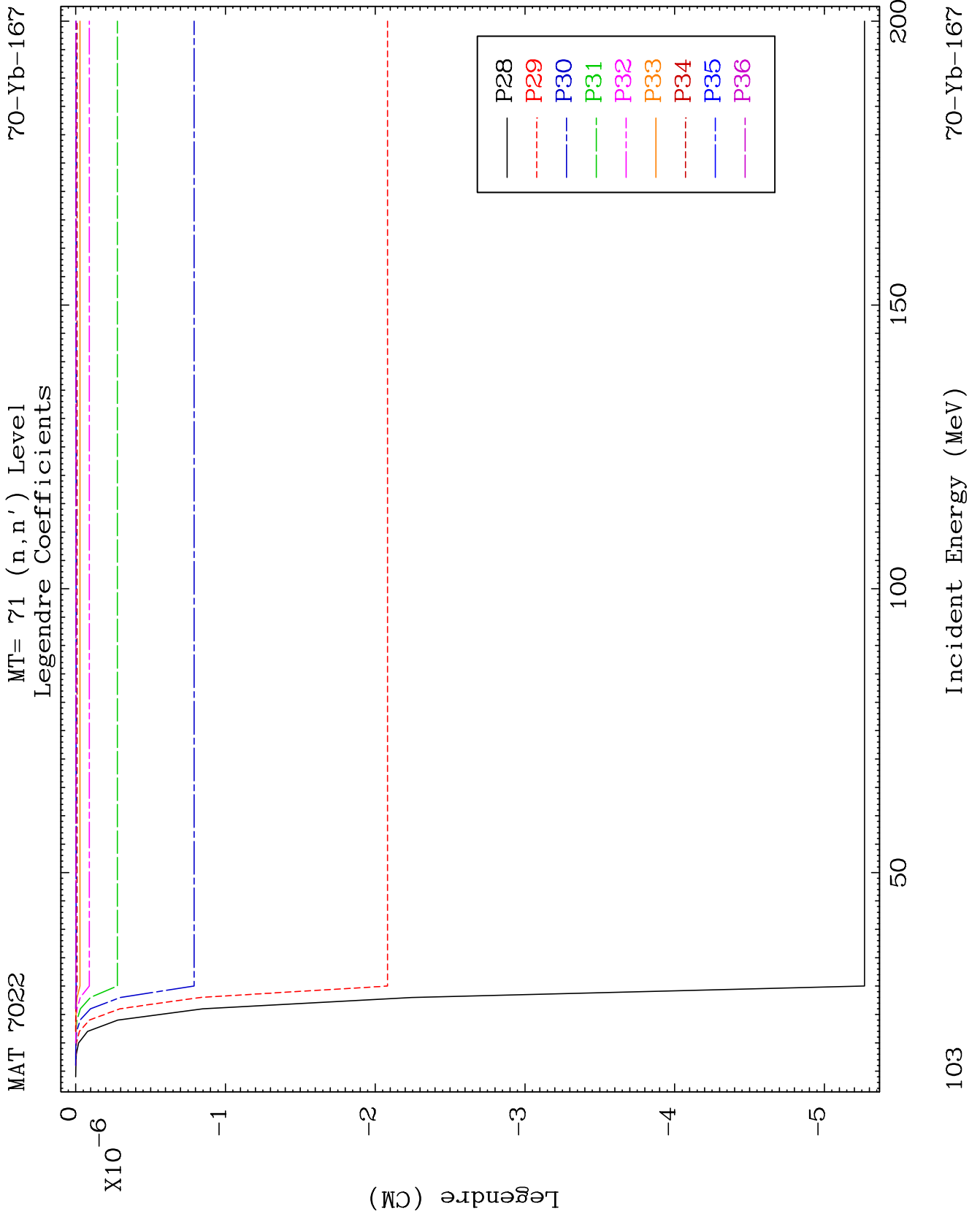

MAT 7022

MT= 72 (n,n') Level
Legendre Coefficients

70-Yb-167

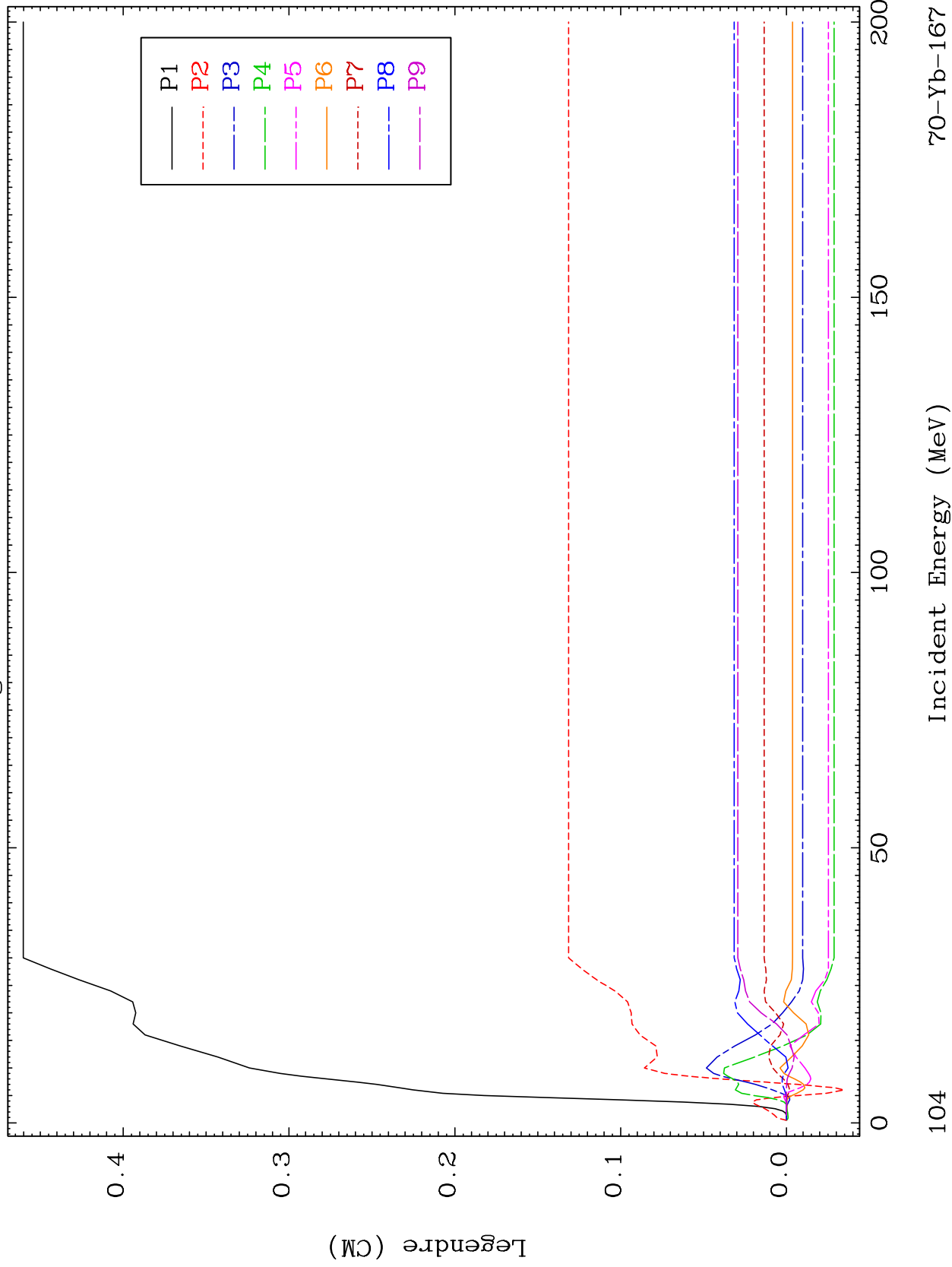

104

Incident Energy (MeV)

70-Yb-167

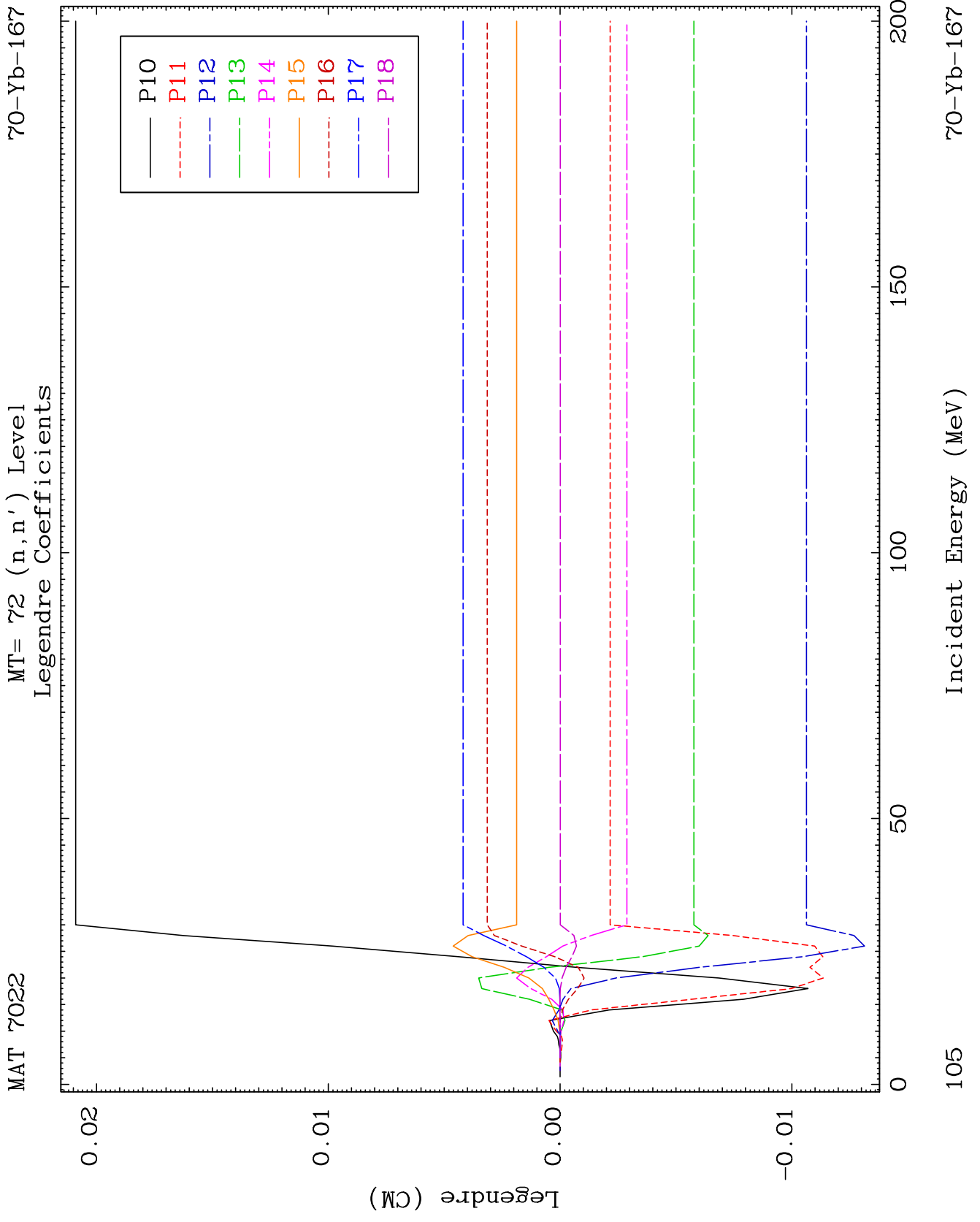

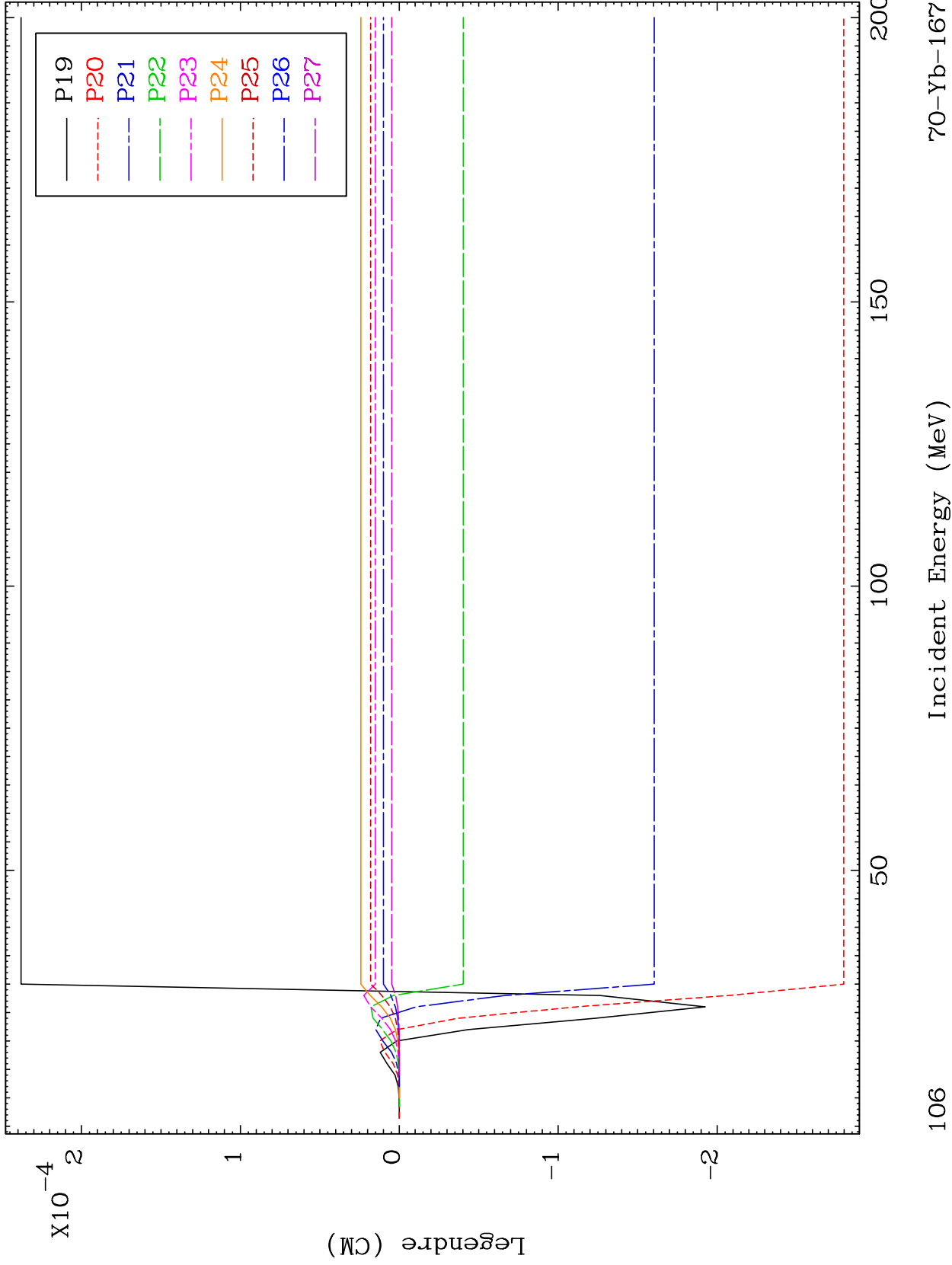

MAT 7022

MT= 72 (n,n') Level
Legendre Coefficients

70-Yb-167

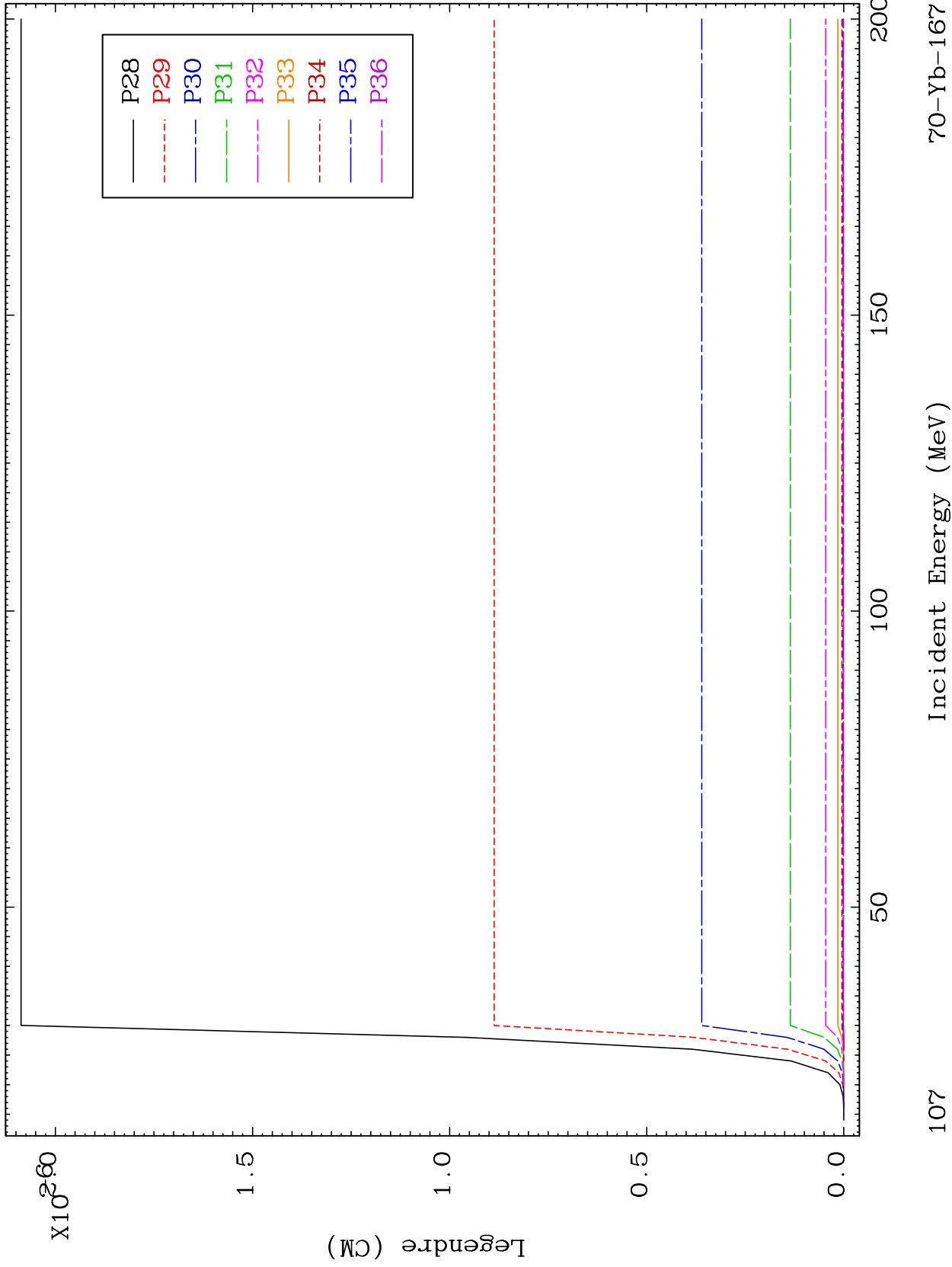

107

Incident Energy (MeV)

70-Yb-167

MAT 7022

MT= 73 (n,n') Level
Legendre Coefficients

70-Yb-167

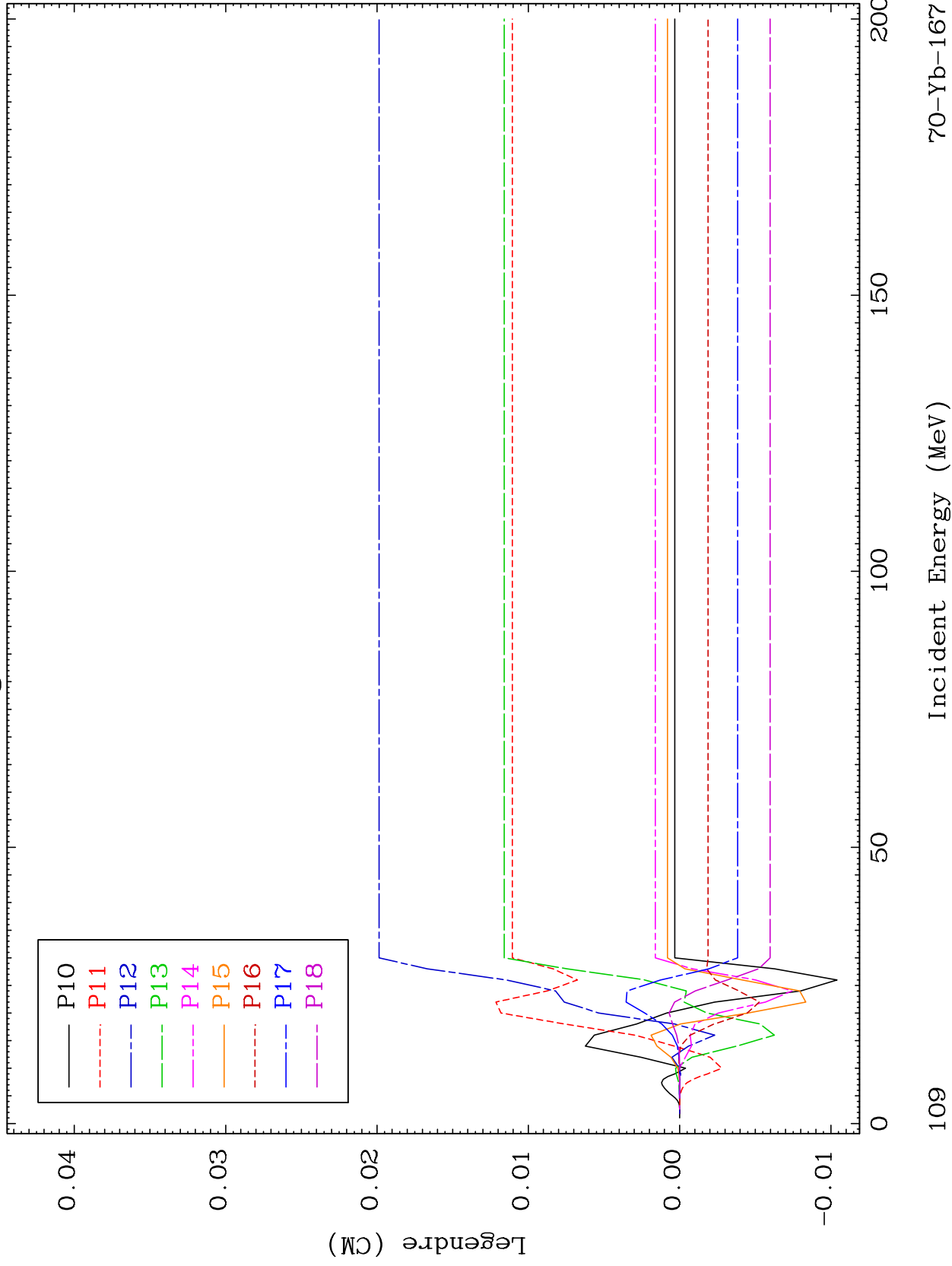

70-Yb-167

Incident Energy (MeV)

109

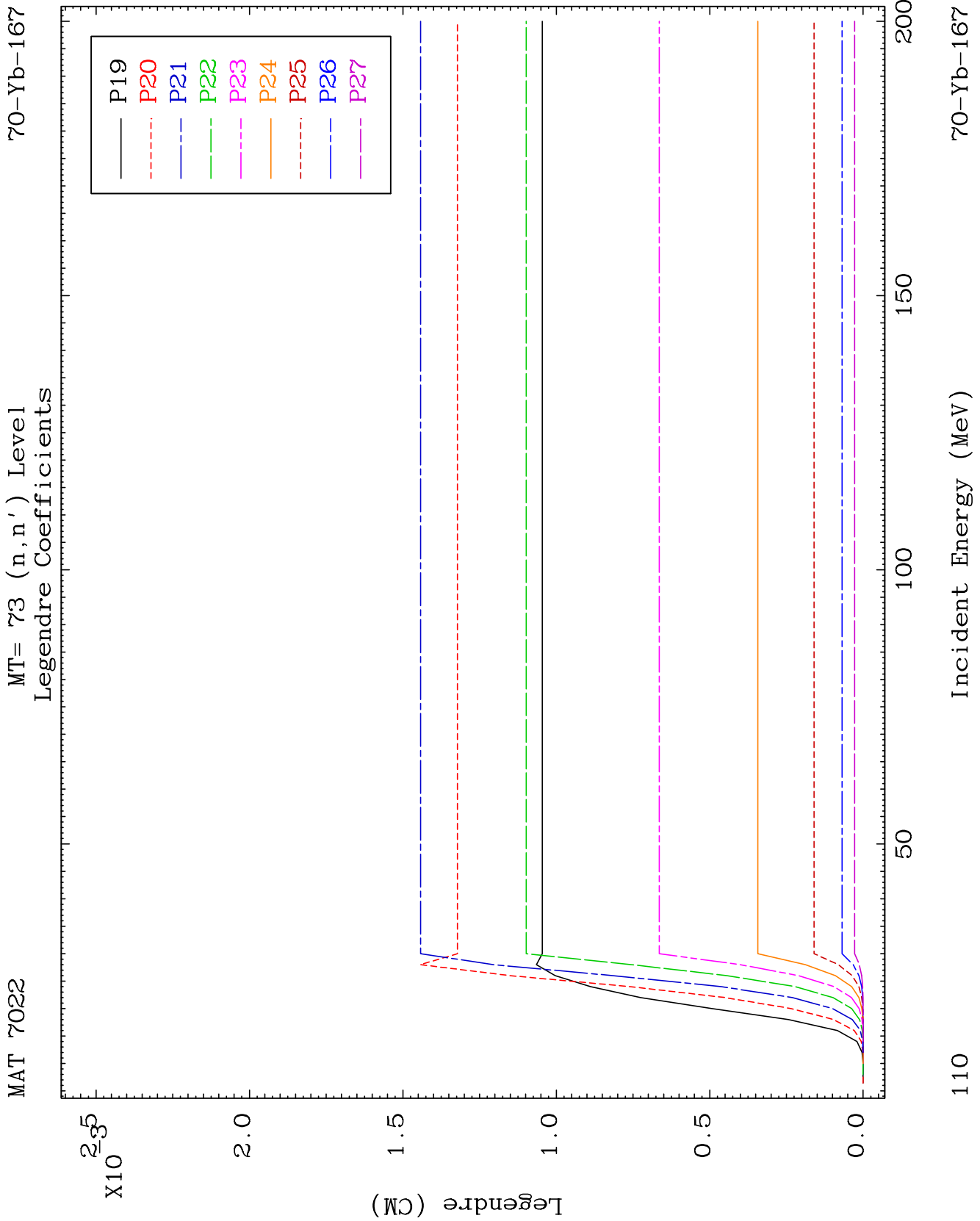

MAT 7022

MT= 73 (n,n') Level
Legendre Coefficients

70-Yb-167

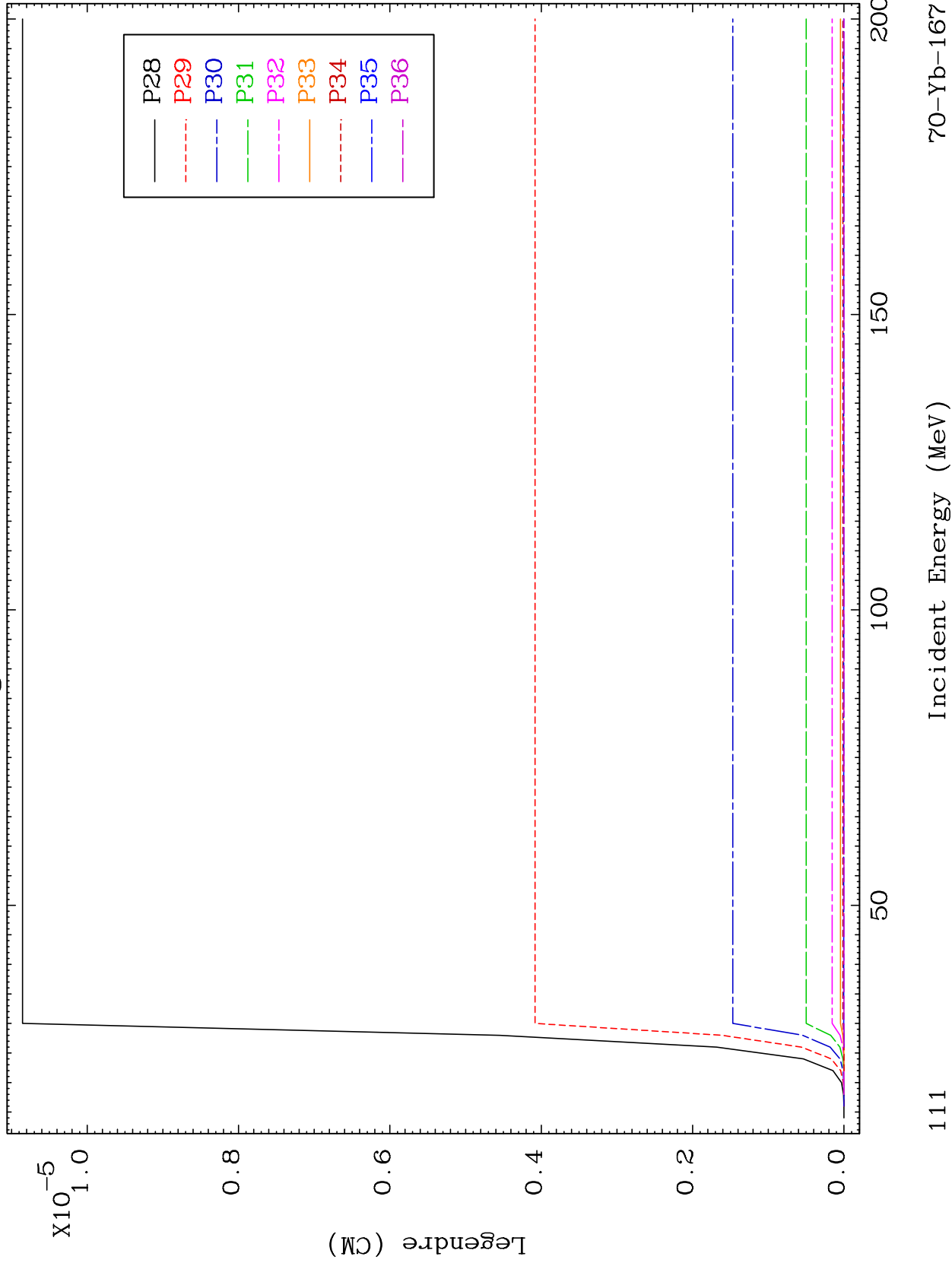

111

Incident Energy (MeV)

70-Yb-167

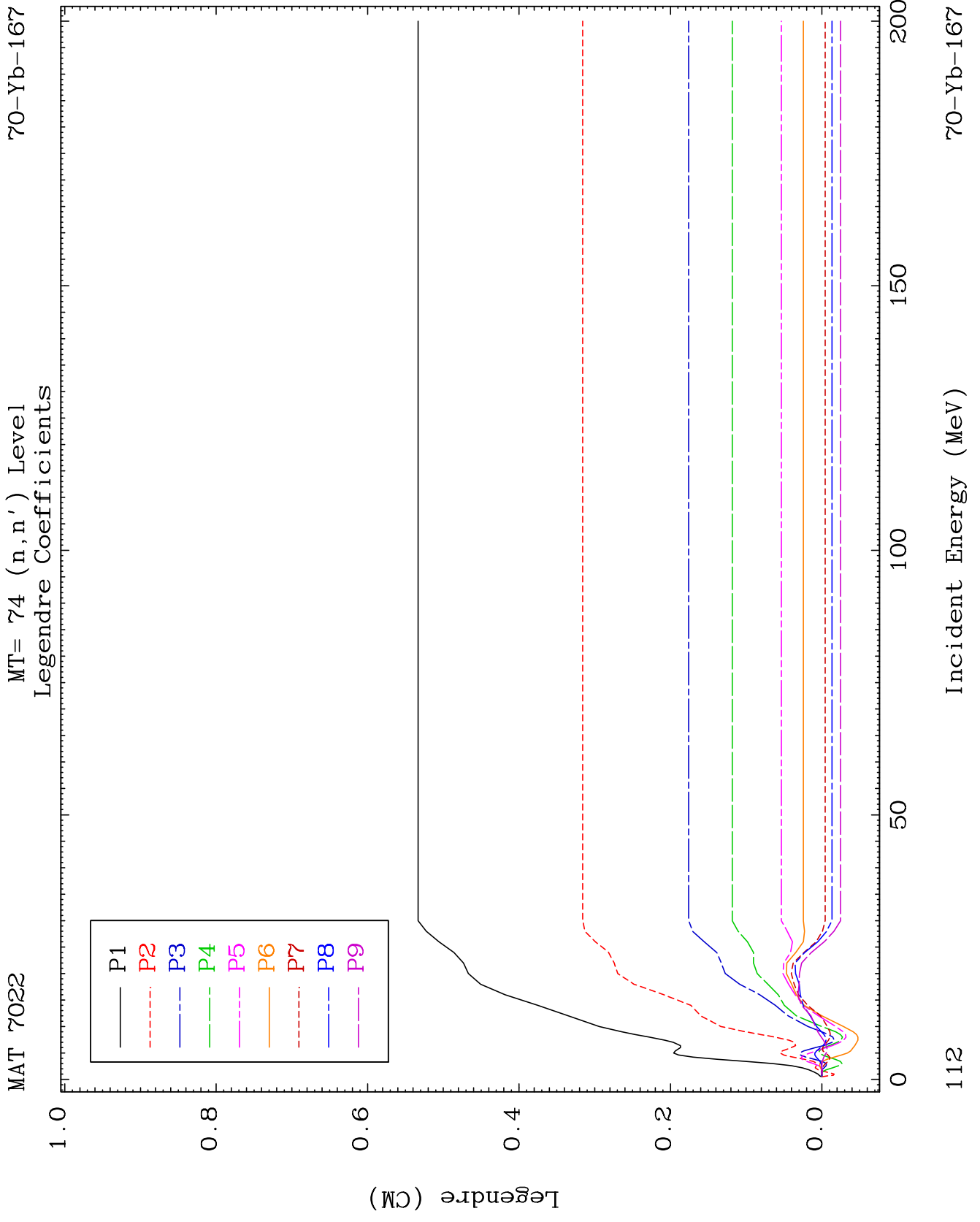

MAT 7022

MT= 74 (n,n') Level
Legendre Coefficients

70-Yb-167

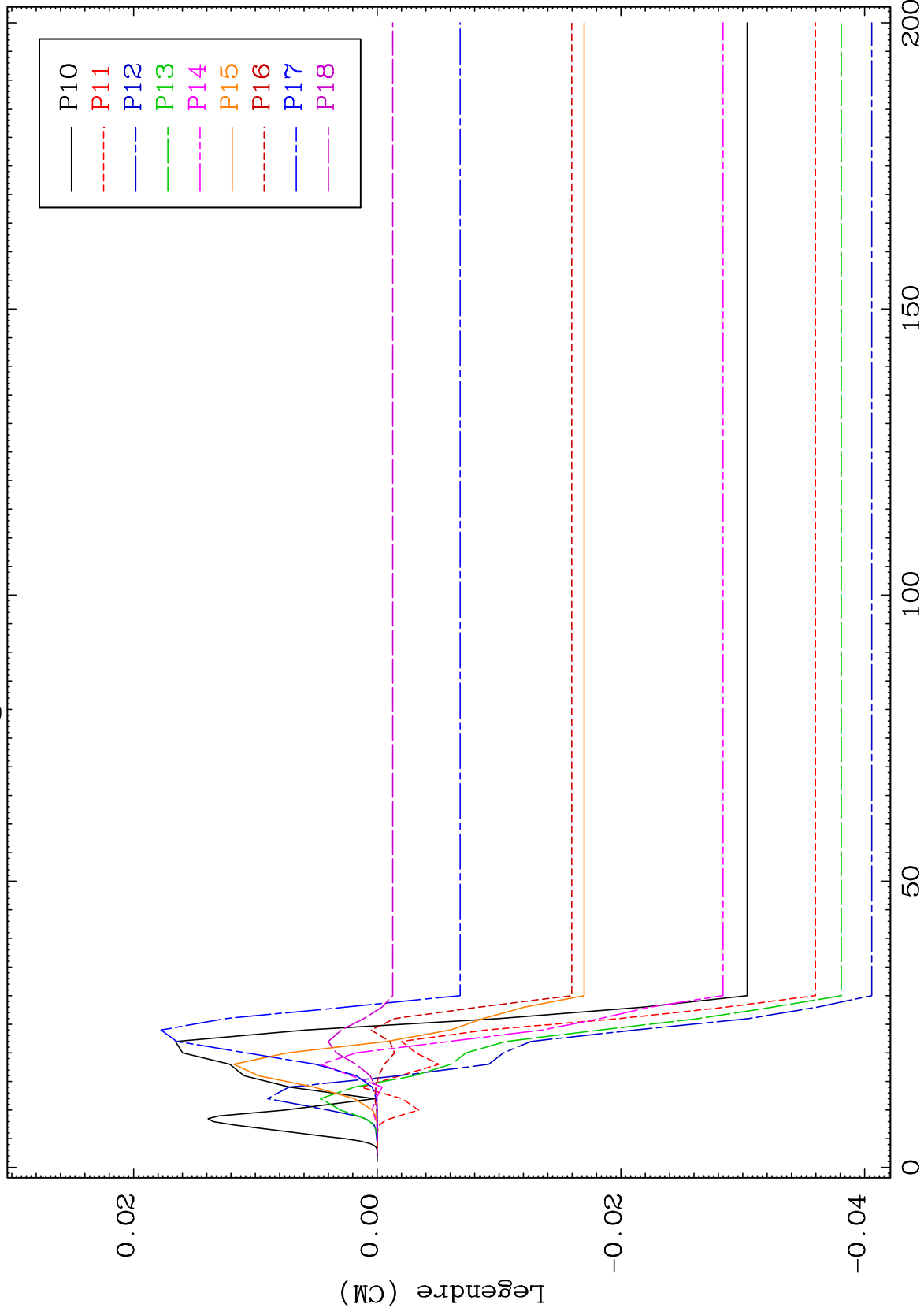

113

Incident Energy (MeV)

70-Yb-167

MAT 7022

MT= 74 (n,n') Level
Legendre Coefficients

70-Yb-167

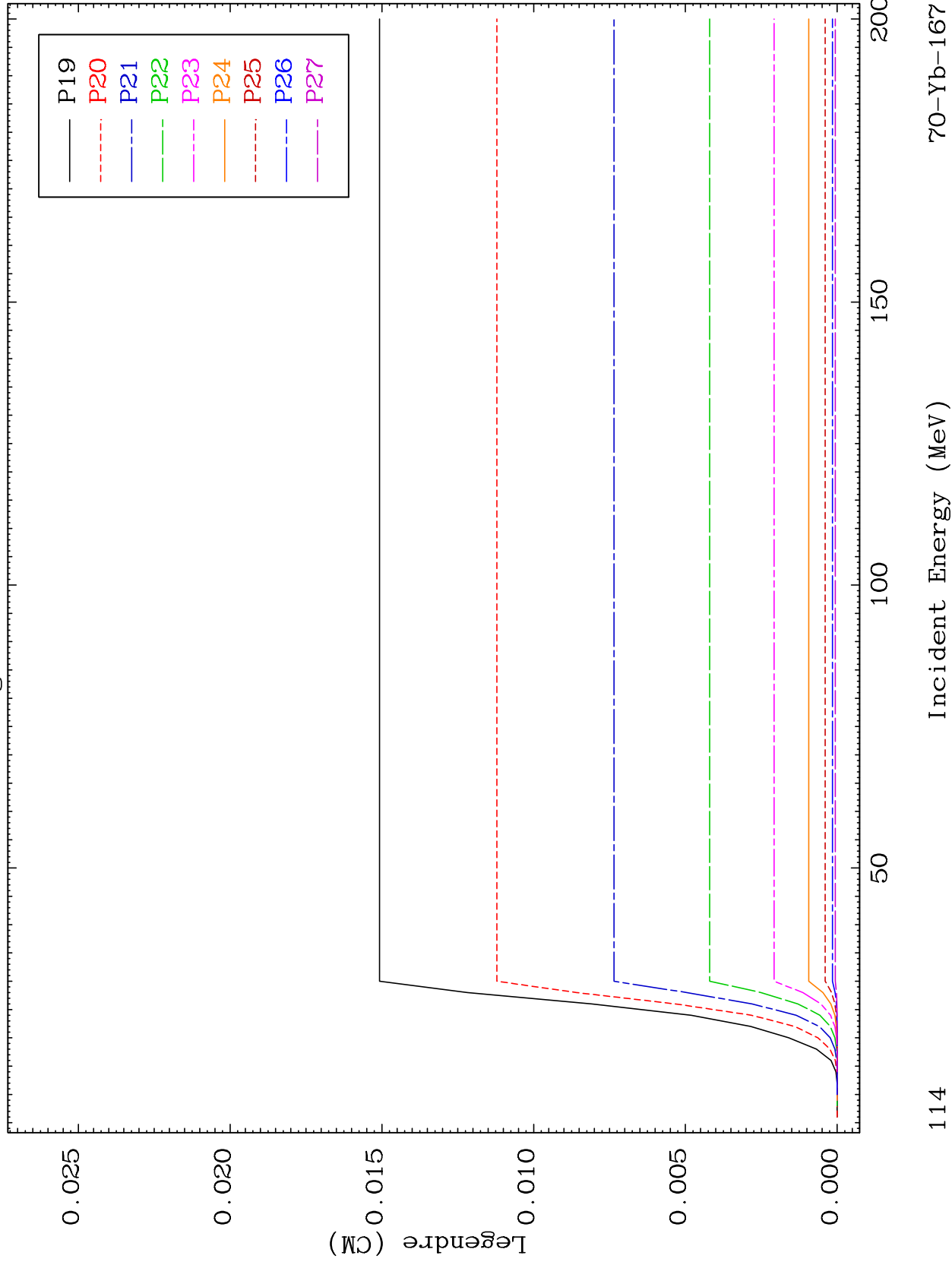

114

Incident Energy (MeV)

70-Yb-167

MAT 7022

MT= 74 (n,n') Level
Legendre Coefficients

70-Yb-167

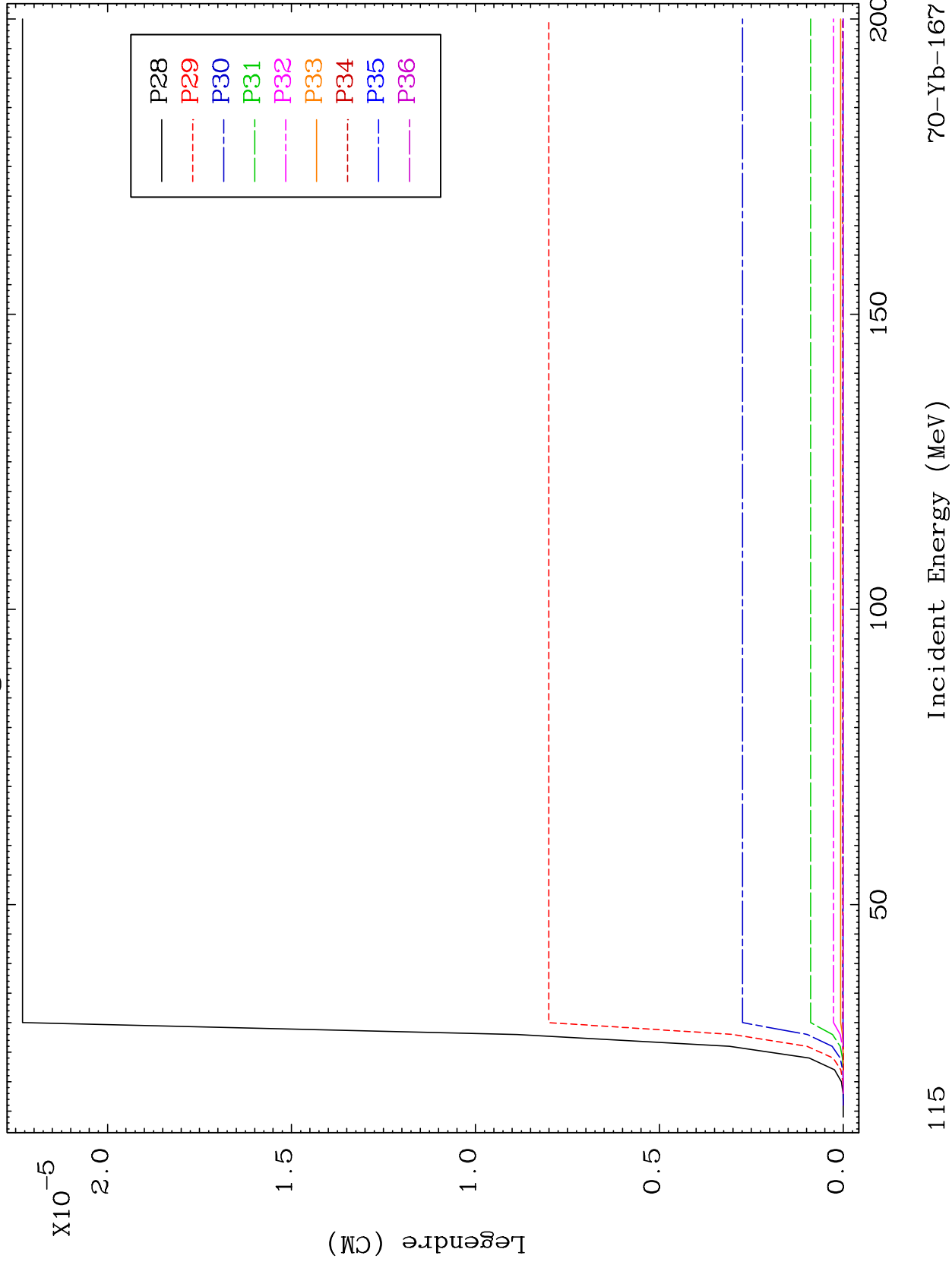

MAT 7022

MT= 75 (n,n') Level
Legendre Coefficients

70-Yb-167

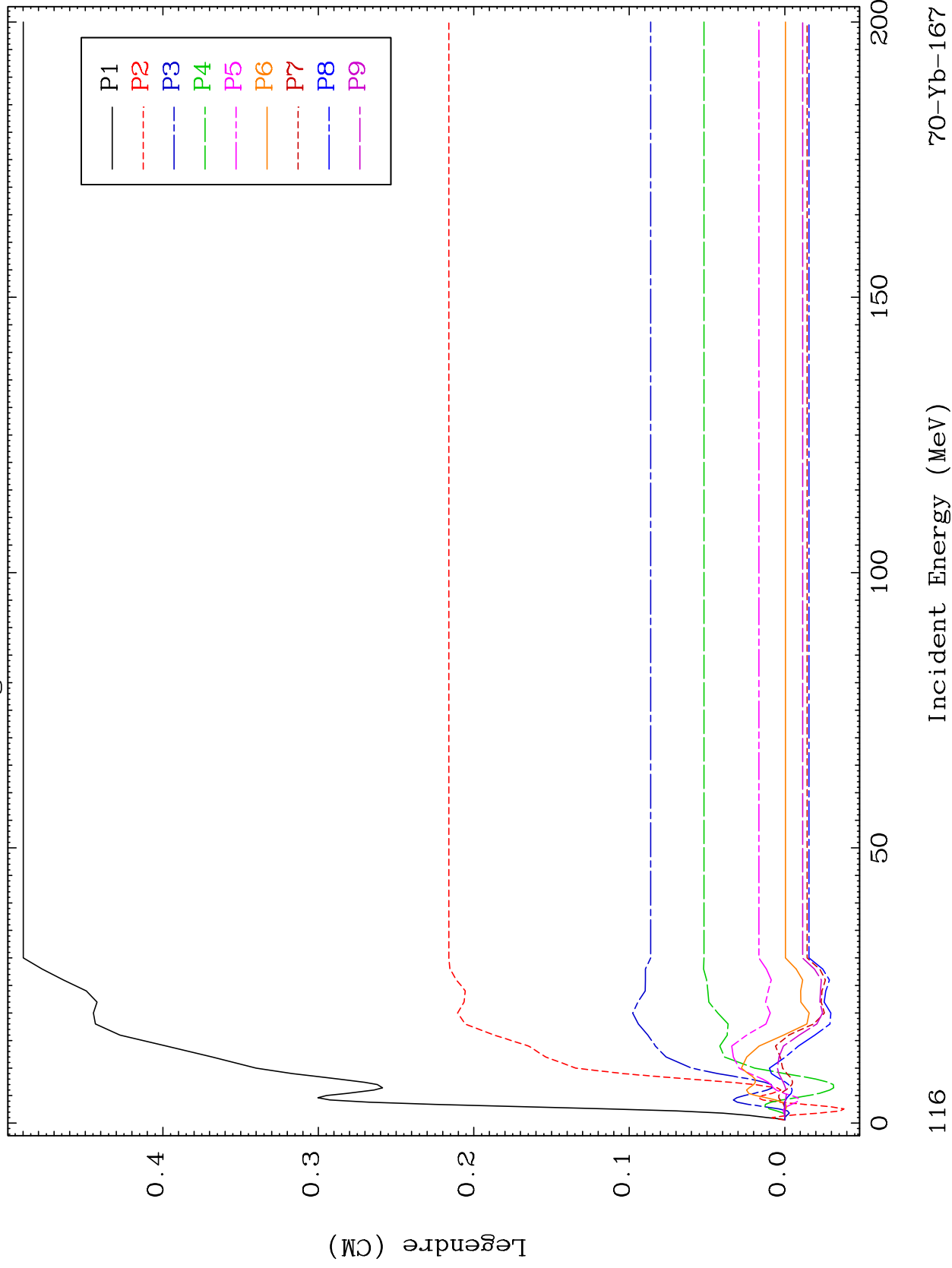

70-Yb-167

Incident Energy (MeV)

116

MAT 70222

MT= 75 (n,n') Level
Legendre Coefficients

70-Yb-167

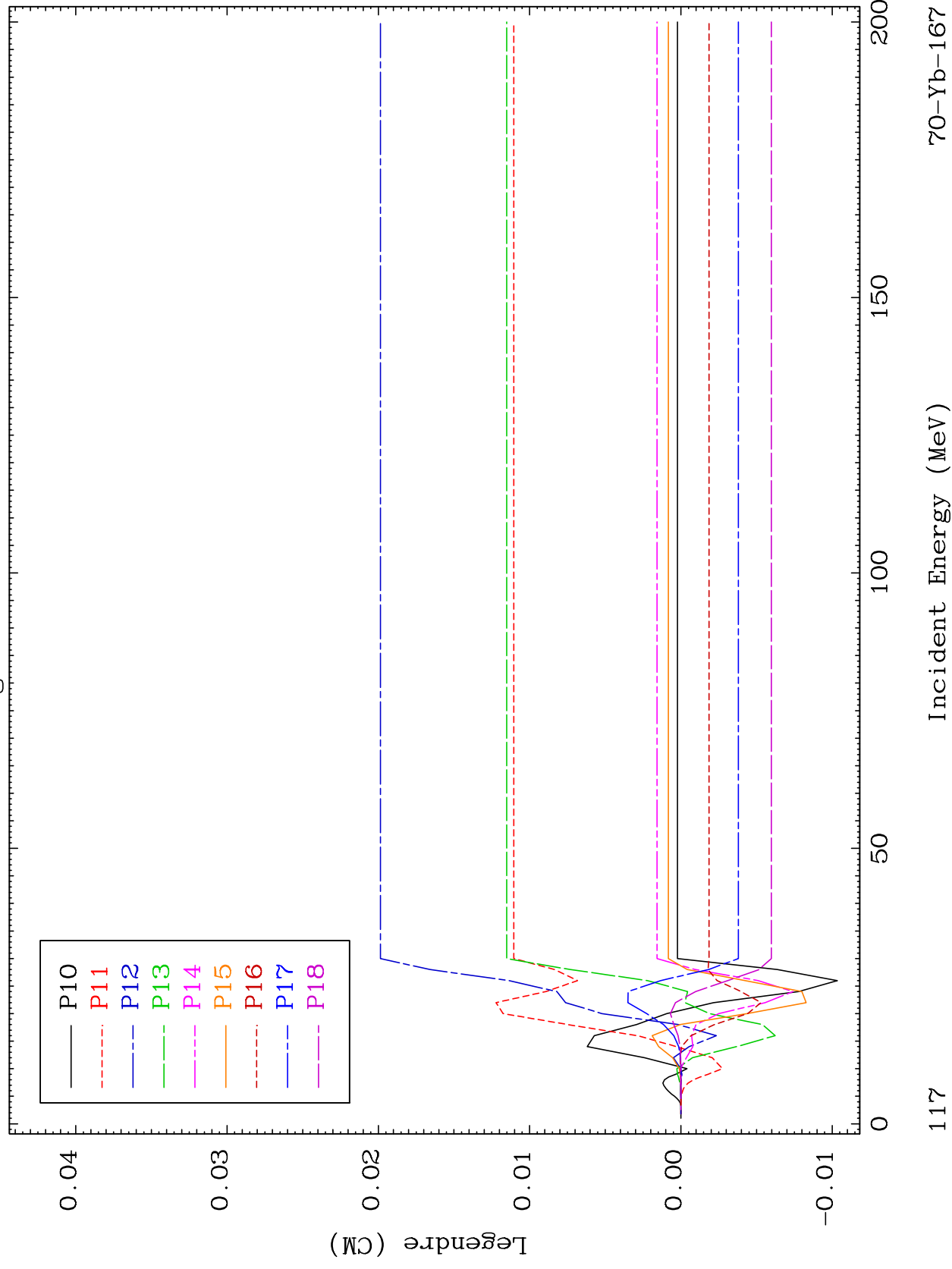

117

Incident Energy (MeV)

70-Yb-167

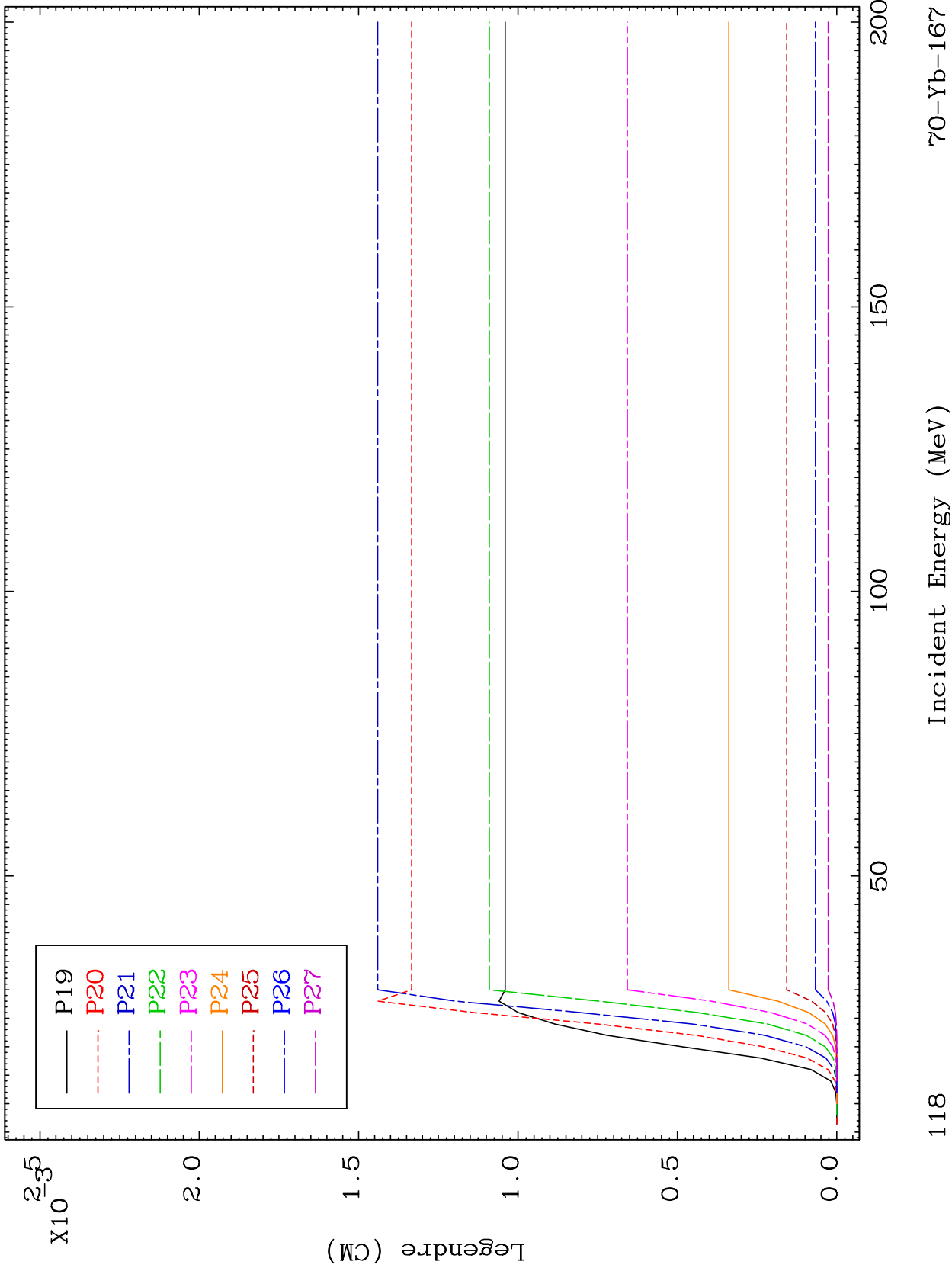

MAT 7022

MT= 75 (n,n') Level
Legendre Coefficients

70-Yb-167

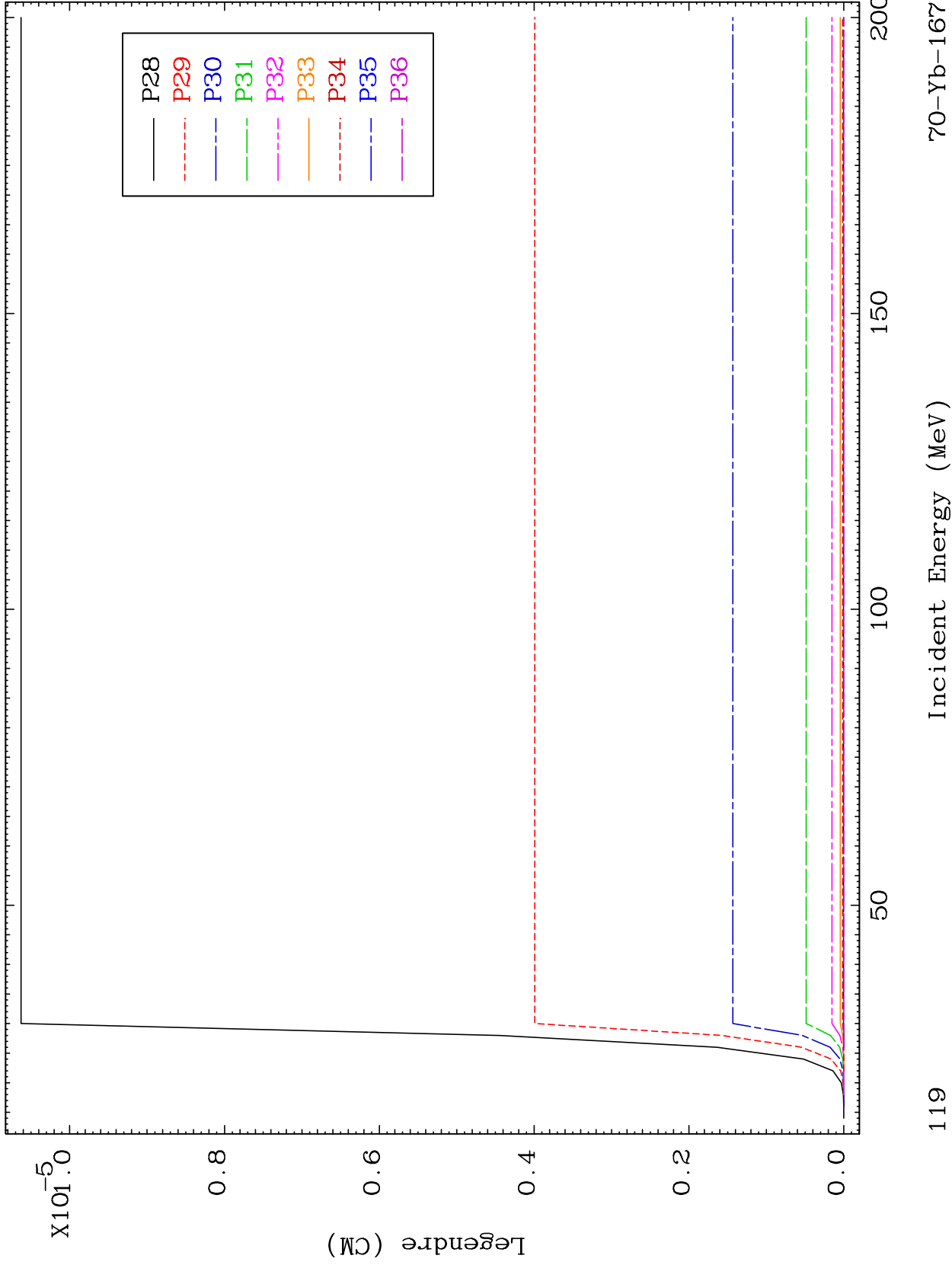

119

Incident Energy (MeV)

70-Yb-167

MAT 7022

MT= 76 (n,n') Level
Legendre Coefficients

70-Yb-167

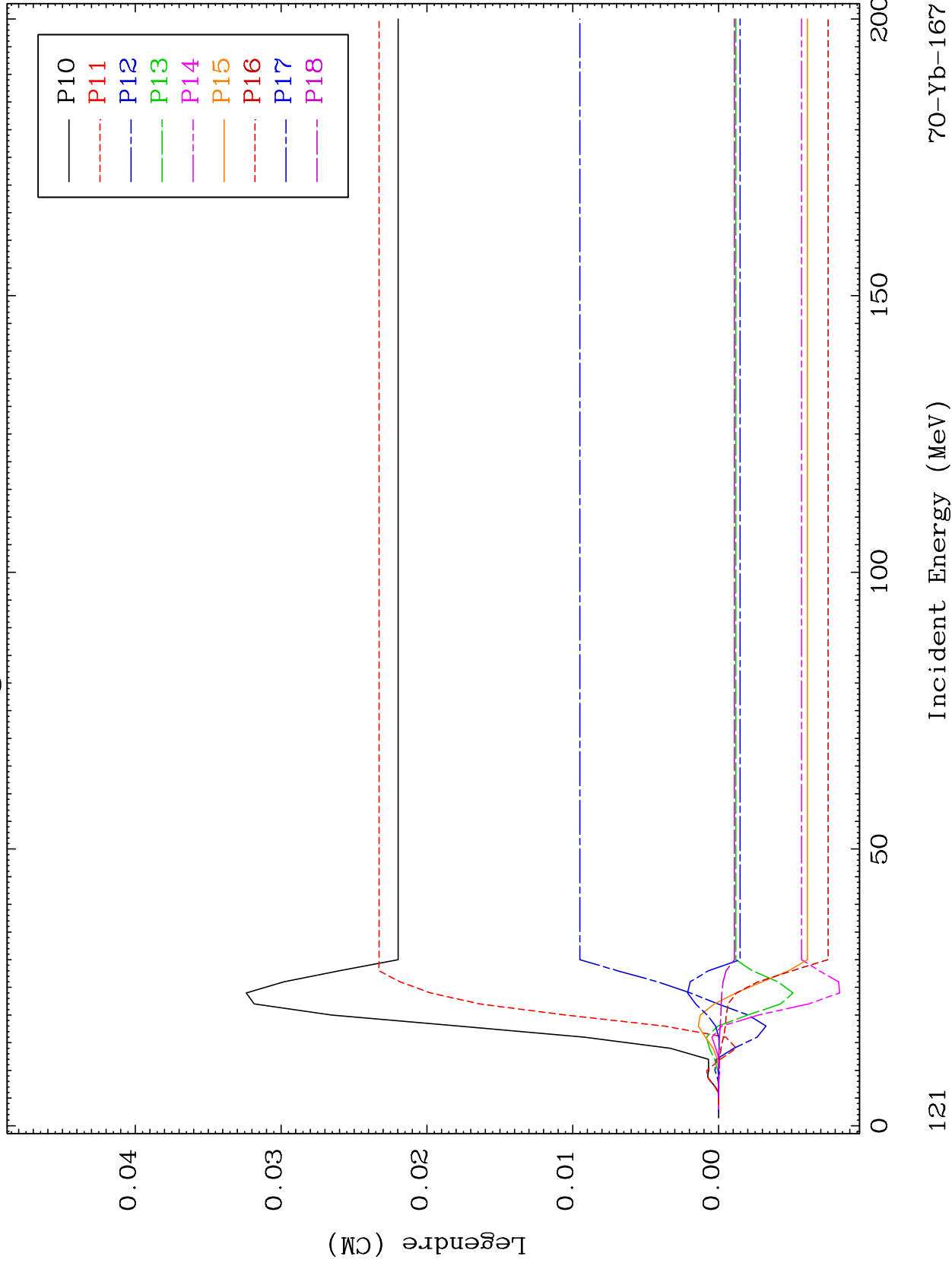

70-Yb-167

Incident Energy (MeV)

121

MAT 7022

MT= 76 (n,n') Level
Legendre Coefficients

70-Yb-167

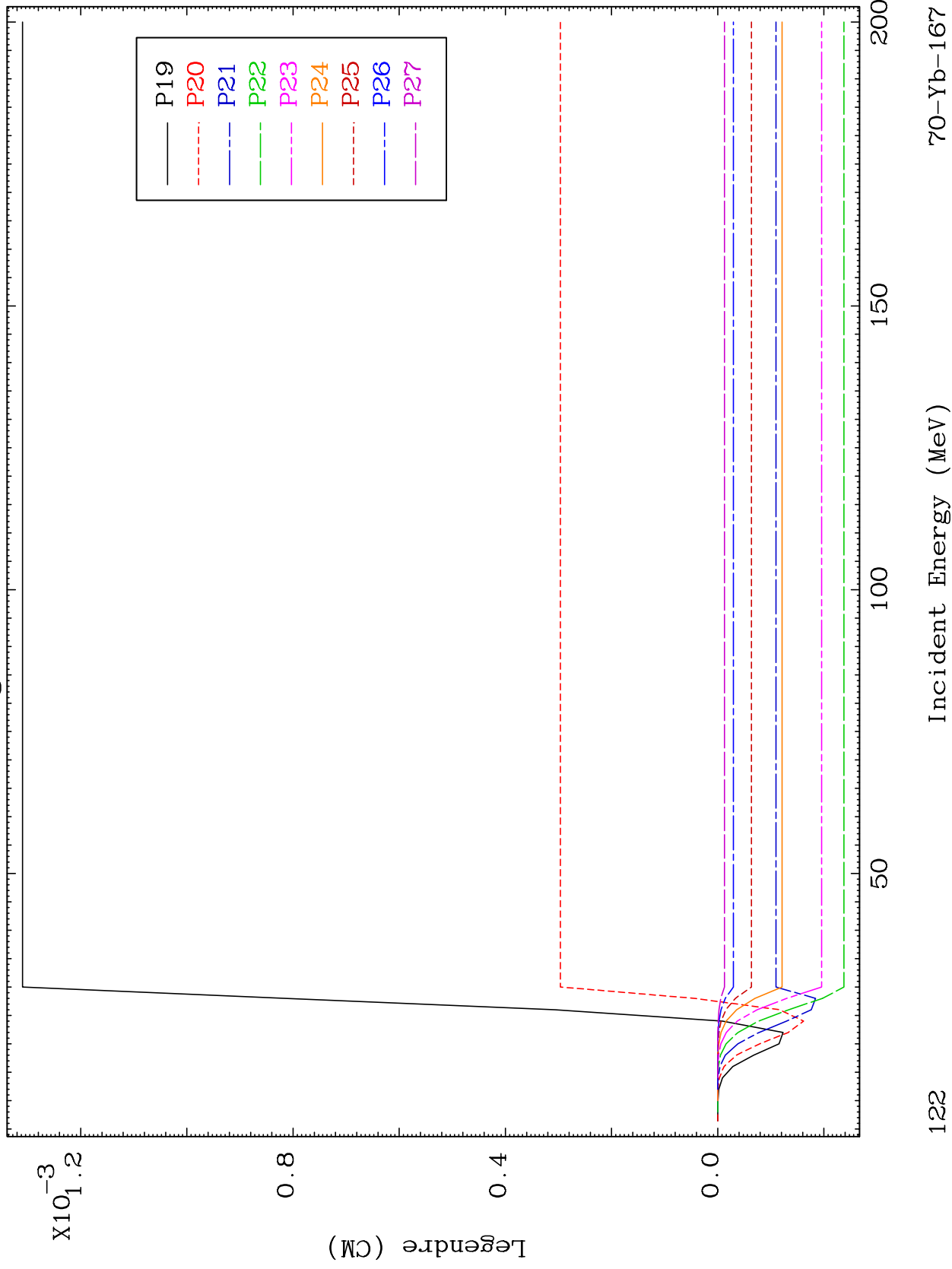

122

Incident Energy (MeV)

70-Yb-167

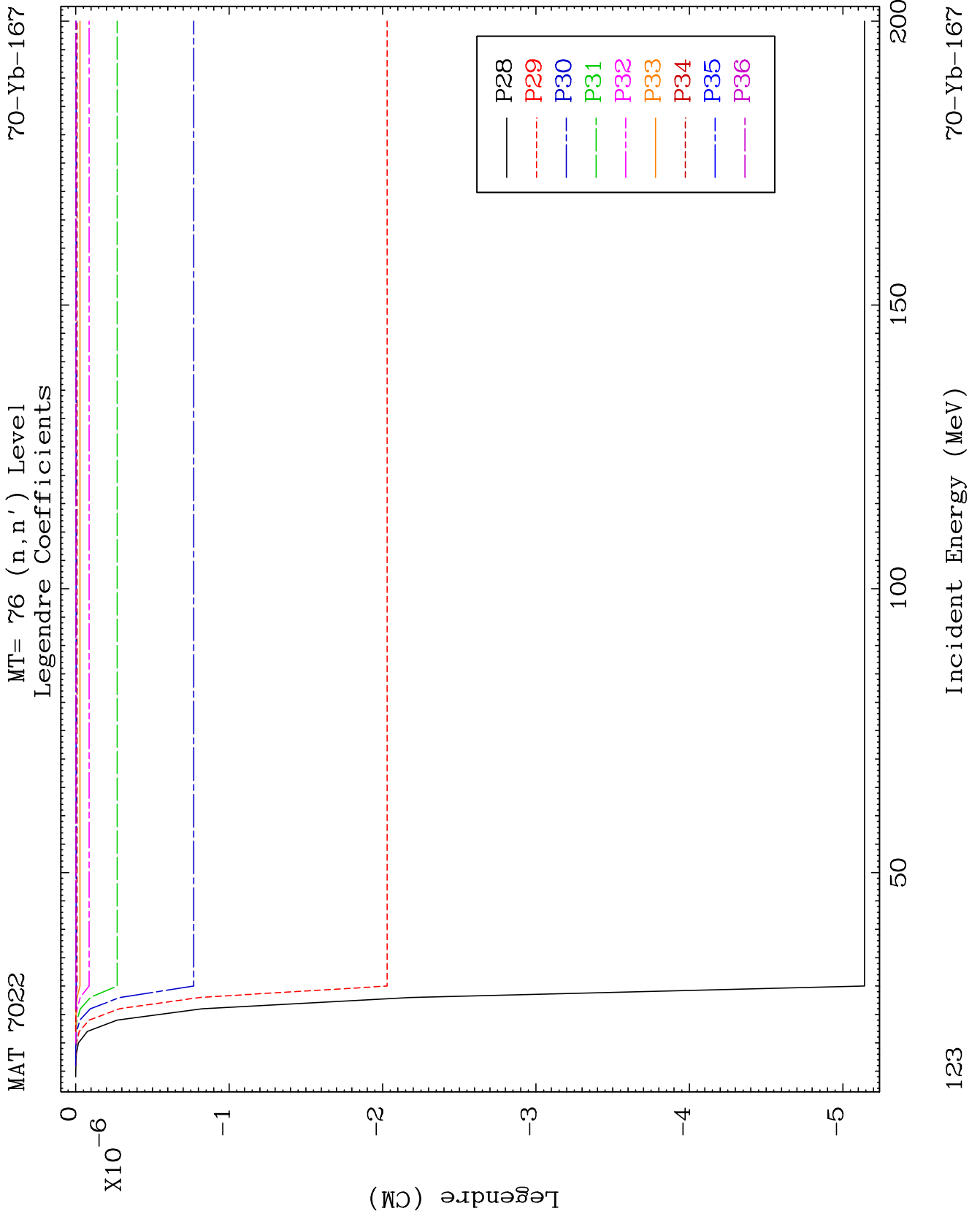

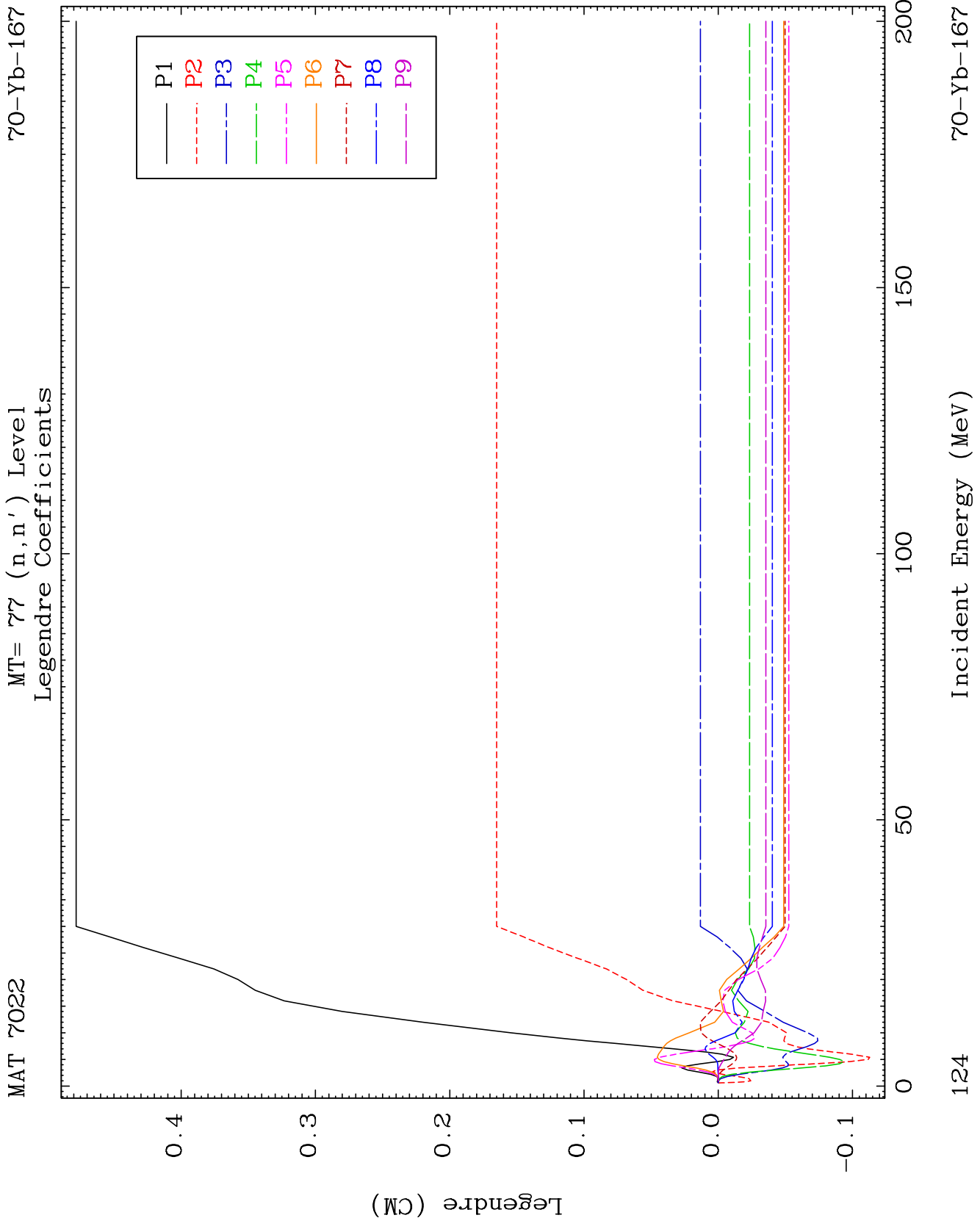

MAT 7022

MT= 77 (n,n') Level
Legendre Coefficients

70-Yb-167

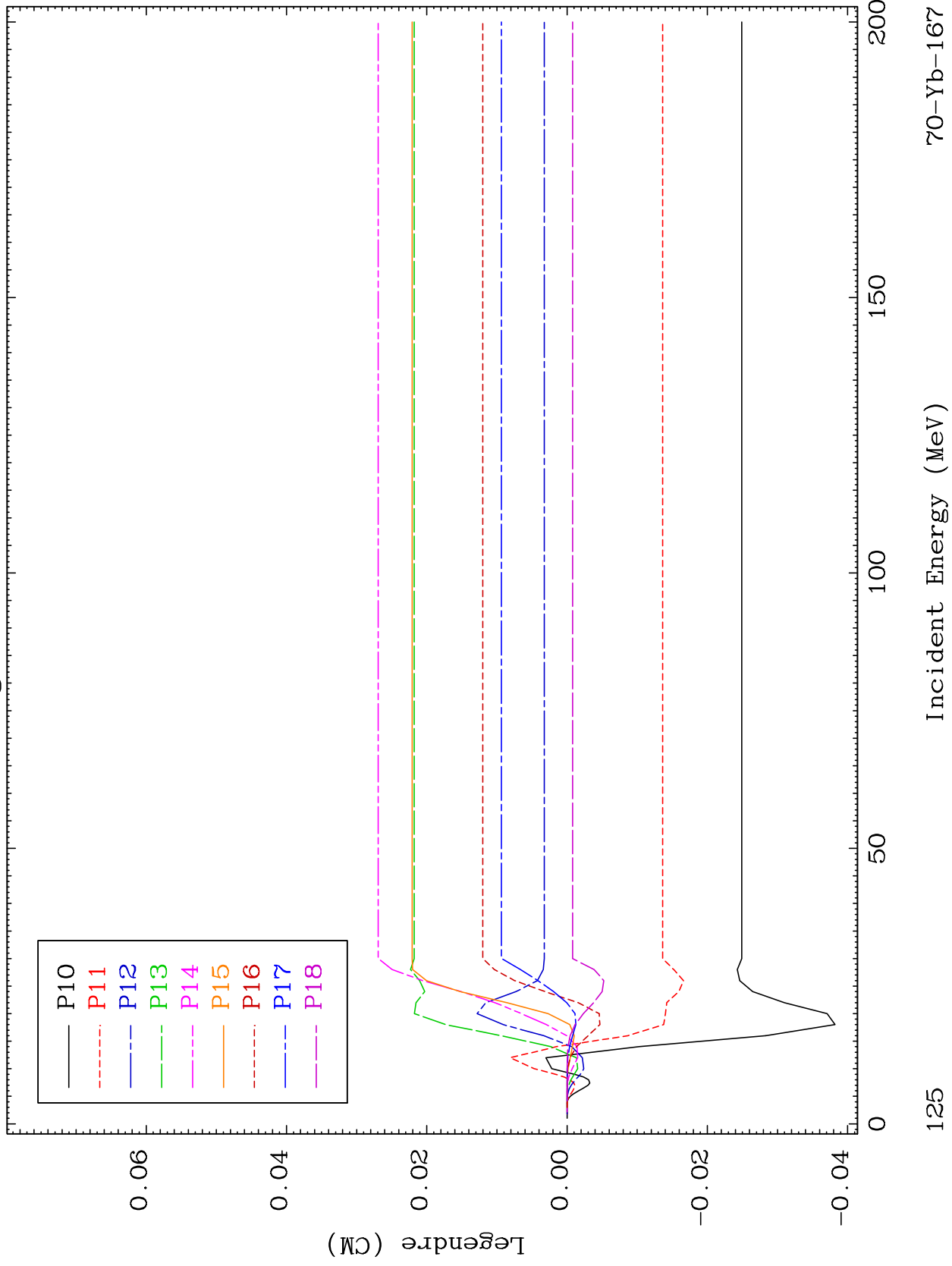

70-Yb-167

Incident Energy (MeV)

125

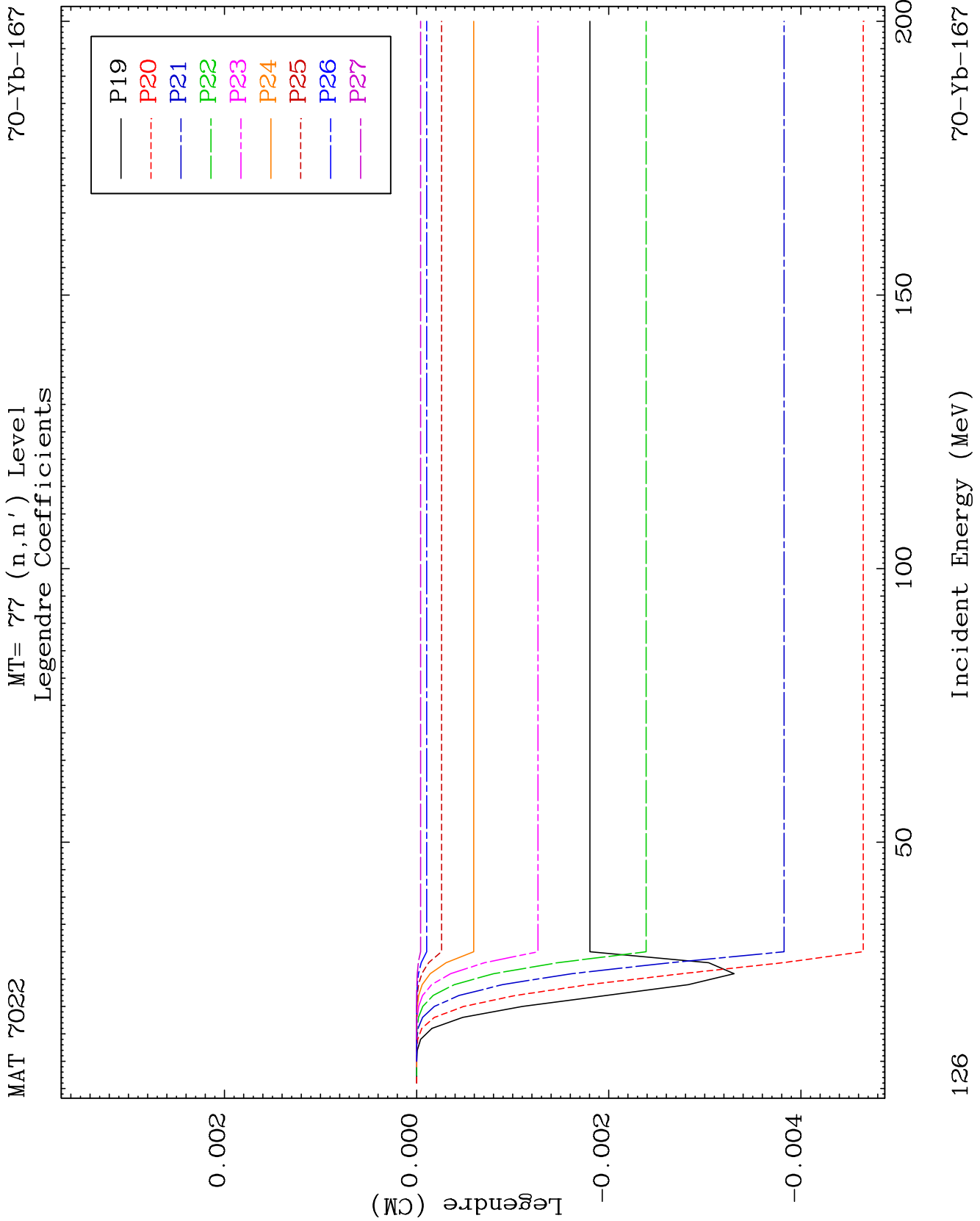

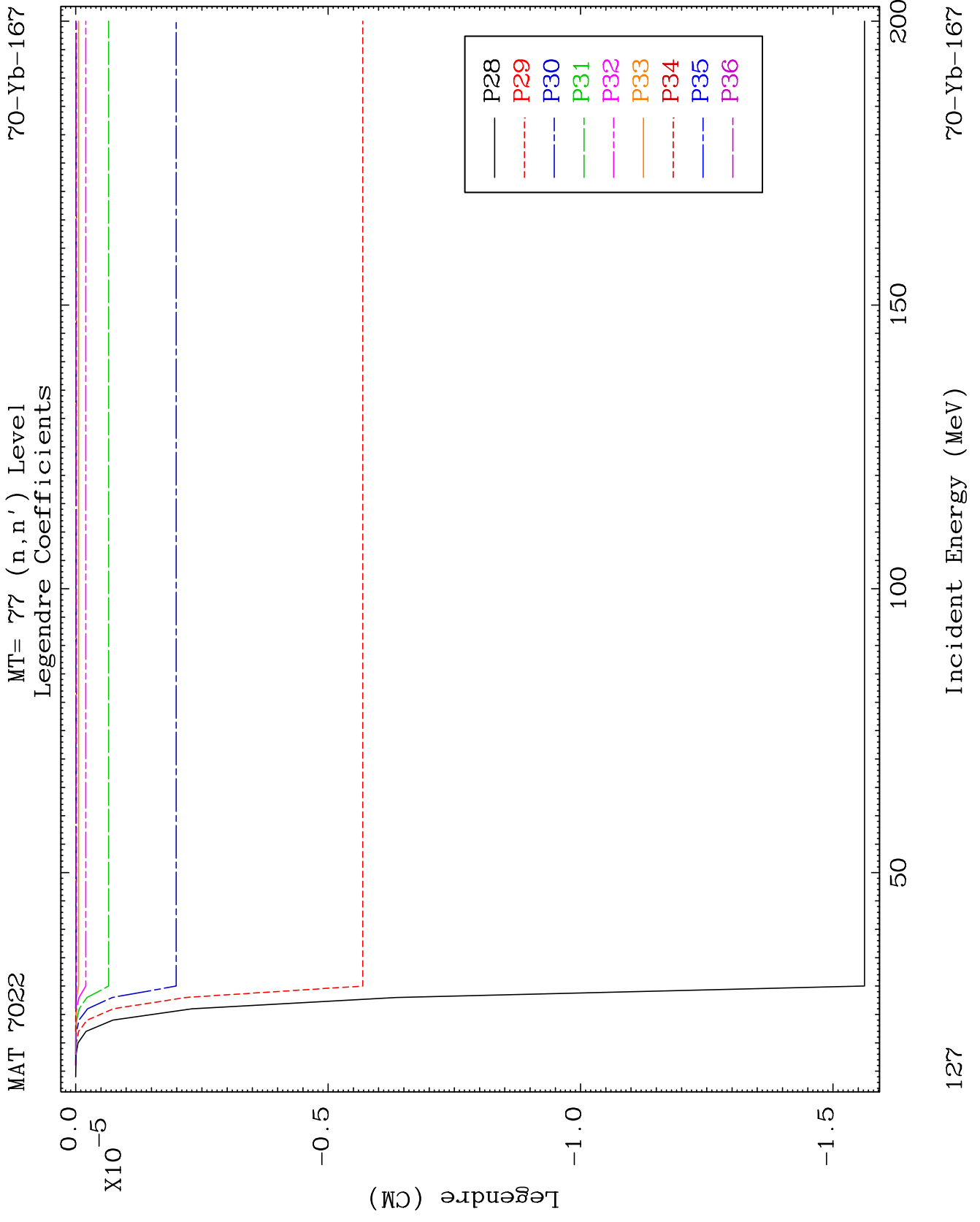

MAT 7022

MT= 78 (n,n') Level
Legendre Coefficients

70-Yb-167

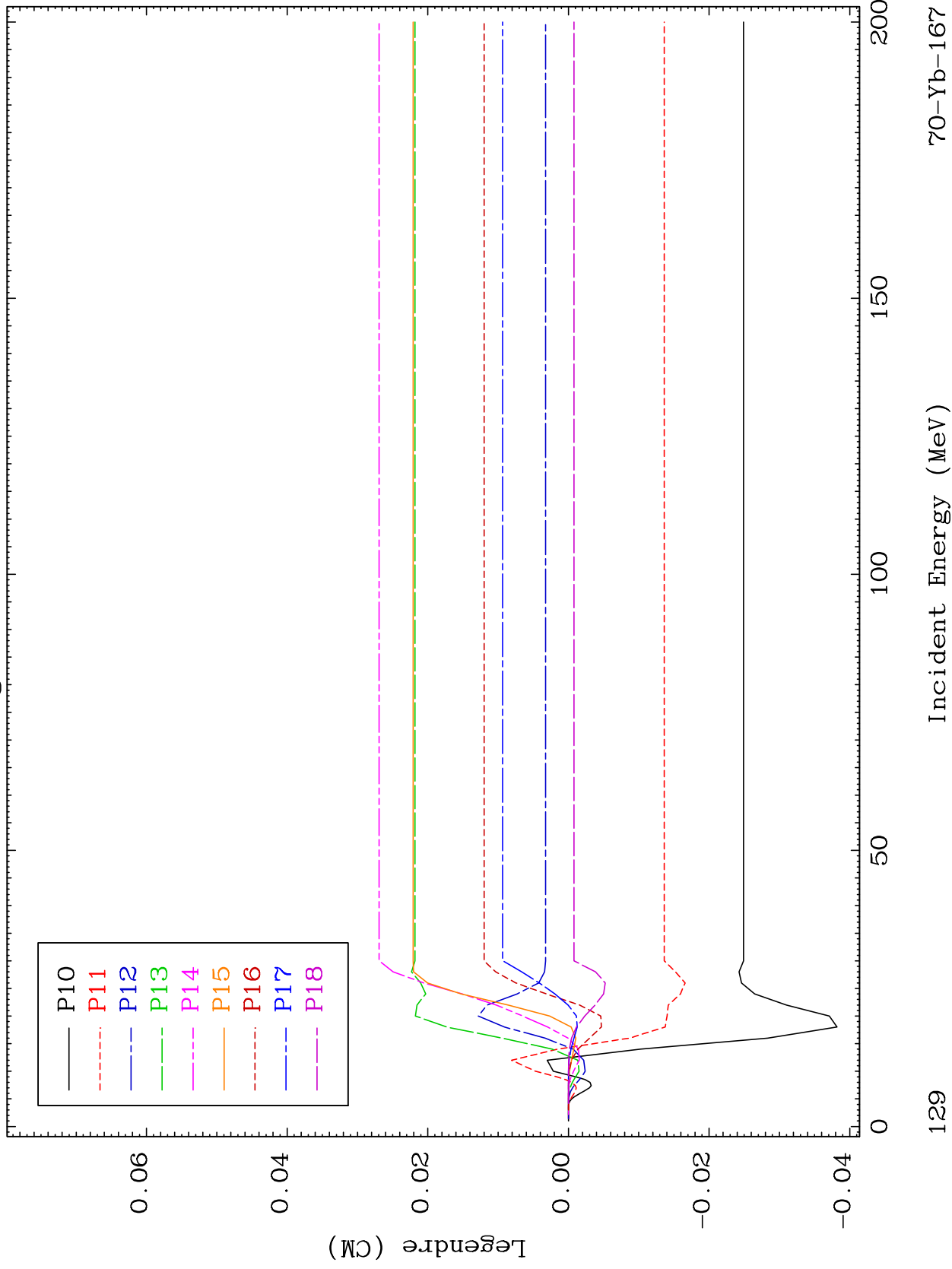

70-Yb-167

Incident Energy (MeV)

129

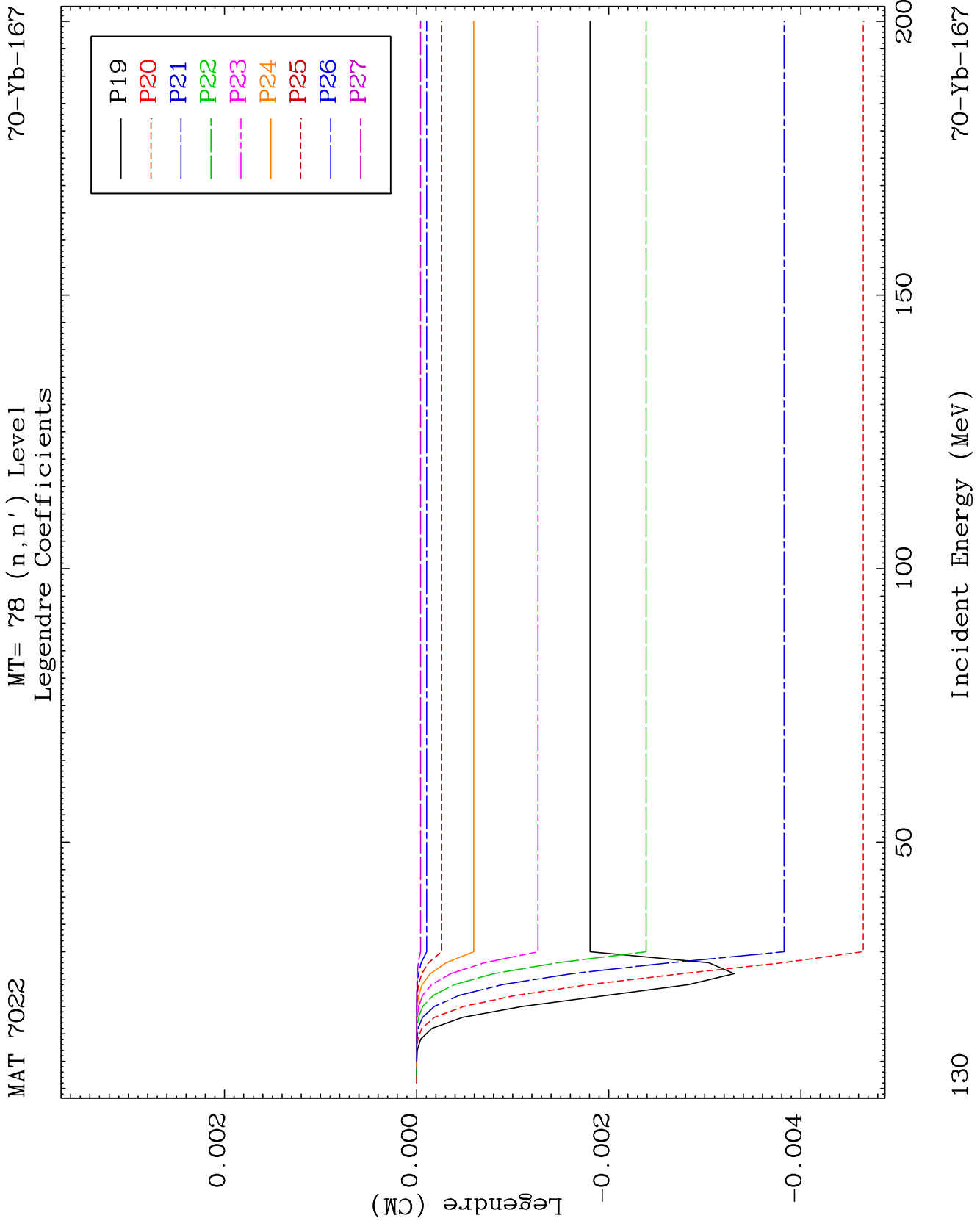

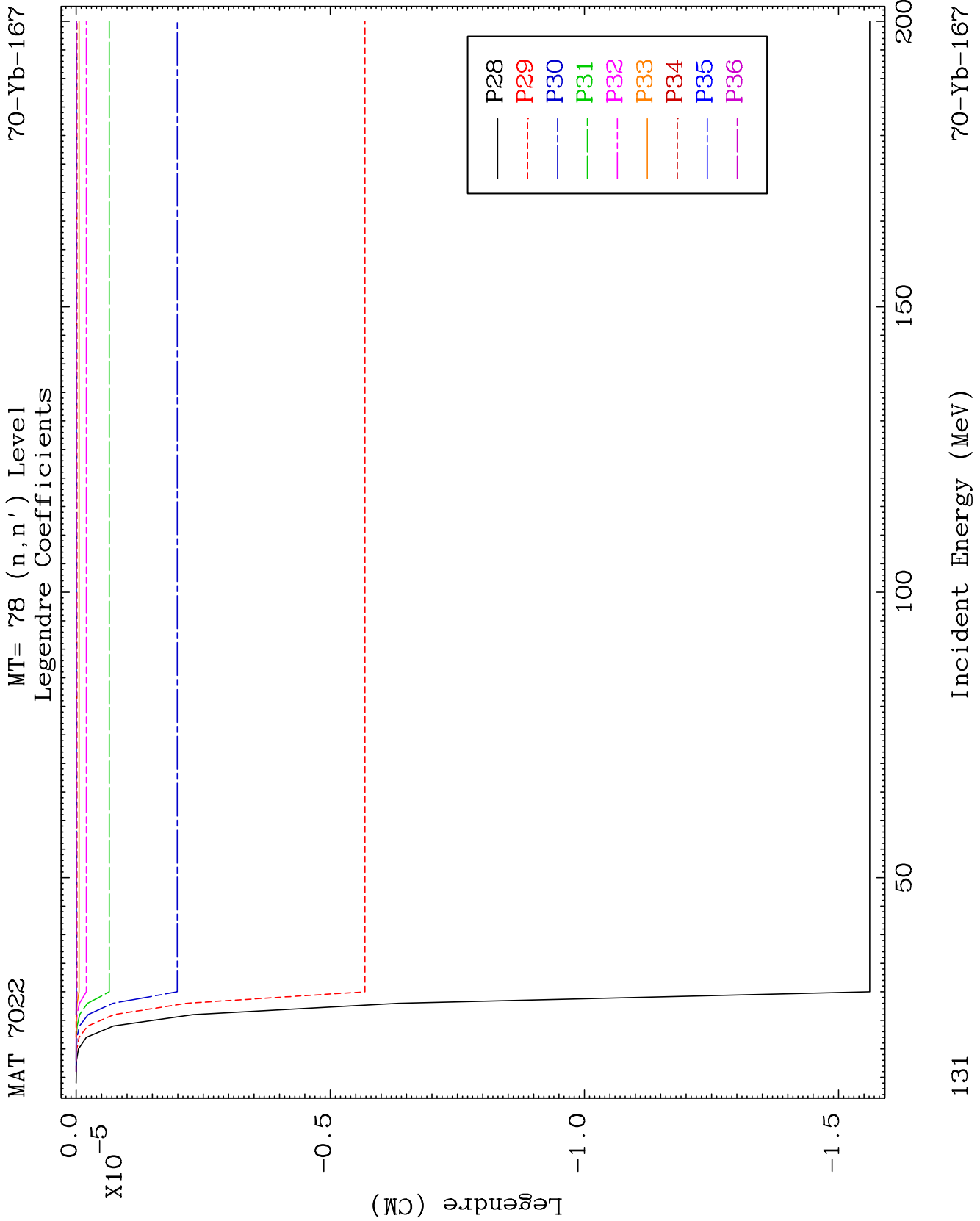

MAT 7022

MT= 79 (n,n') Level
Legendre Coefficients

70-Yb-167

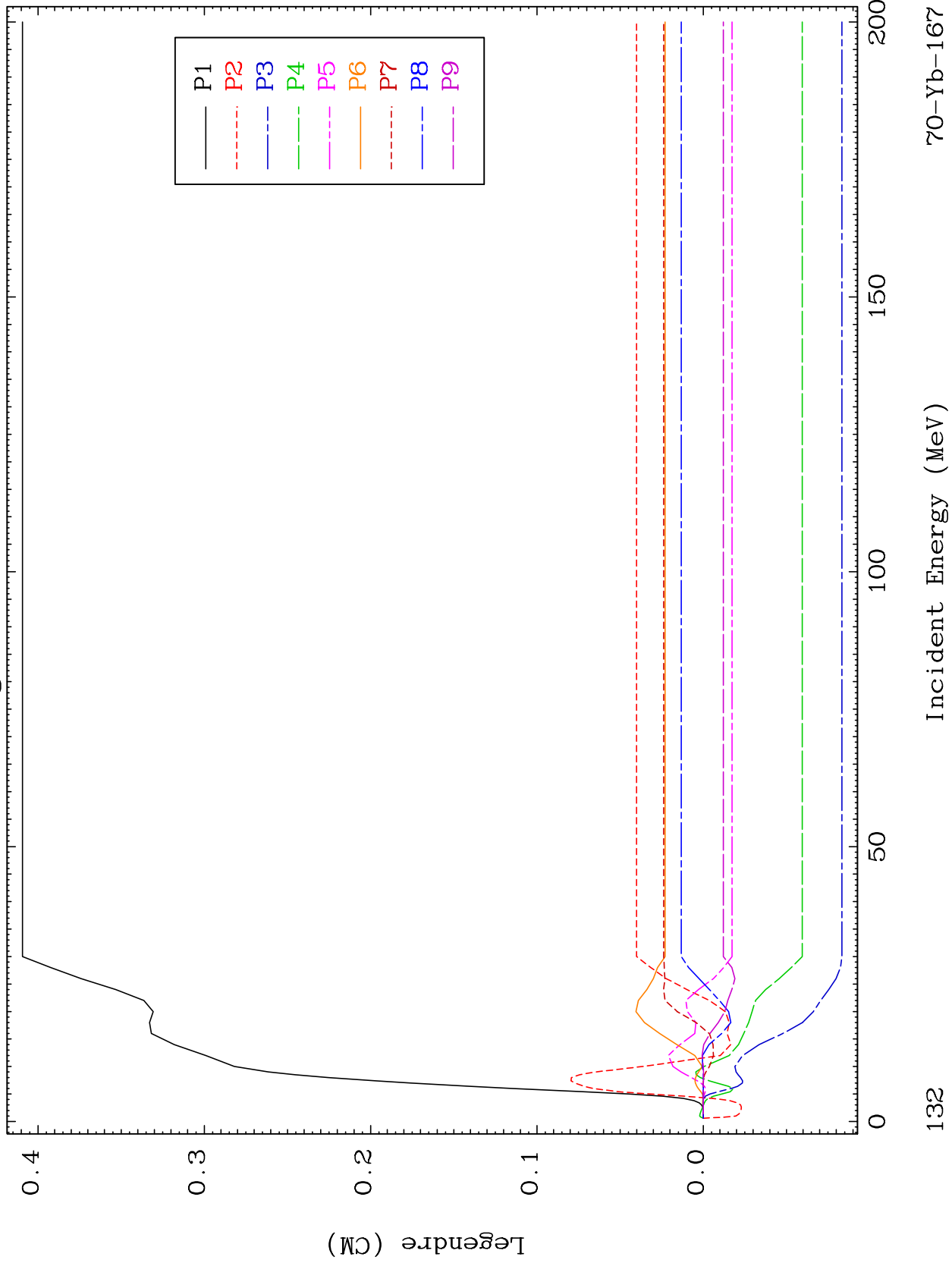

MAT 7022

MT= 79 (n,n') Level
Legendre Coefficients

70-Yb-167

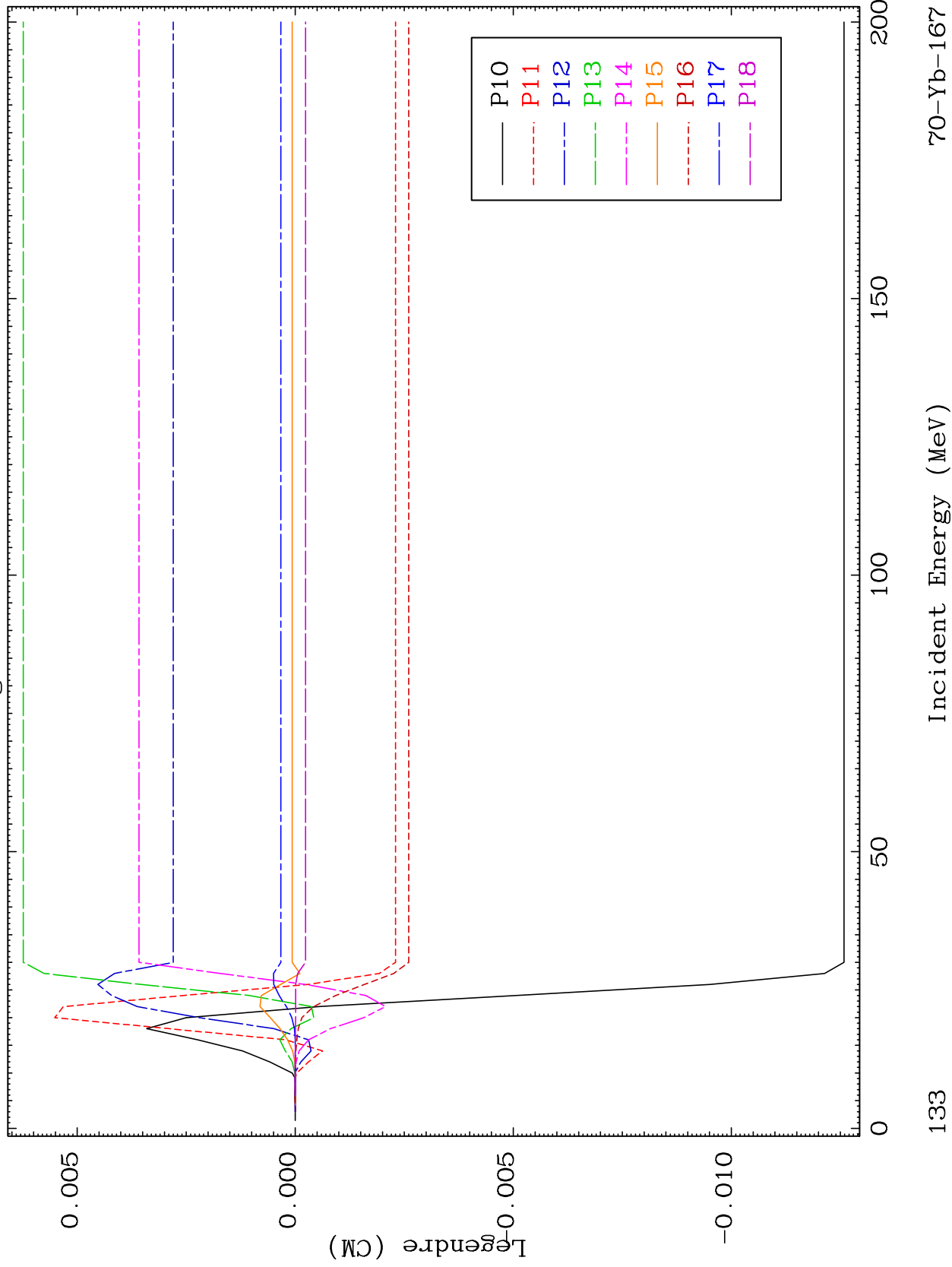

133

Incident Energy (MeV)

70-Yb-167

MAT 7022

MT= 79 (n,n') Level
Legendre Coefficients

70-Yb-167

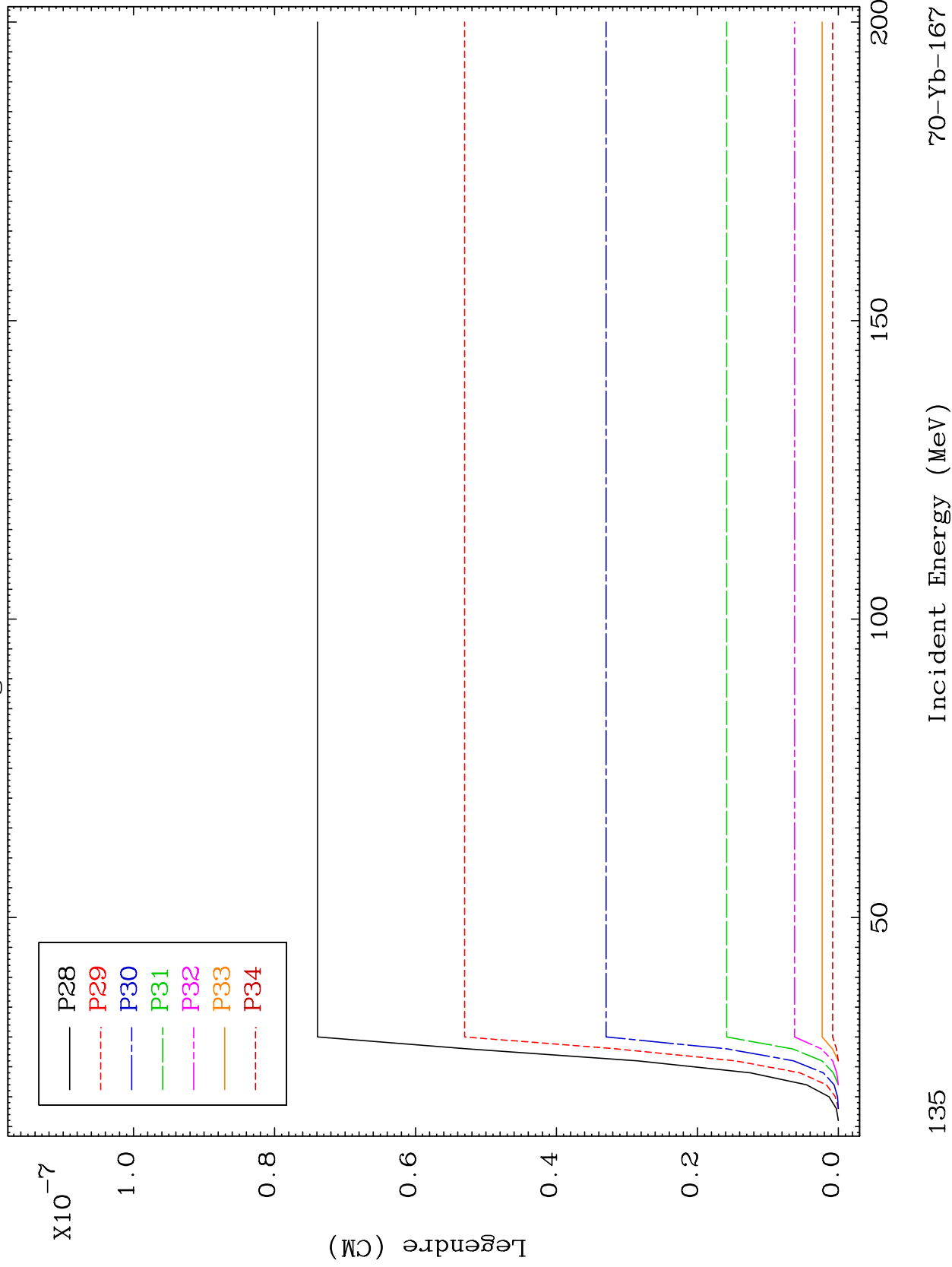

135

Incident Energy (MeV)

70-Yb-167

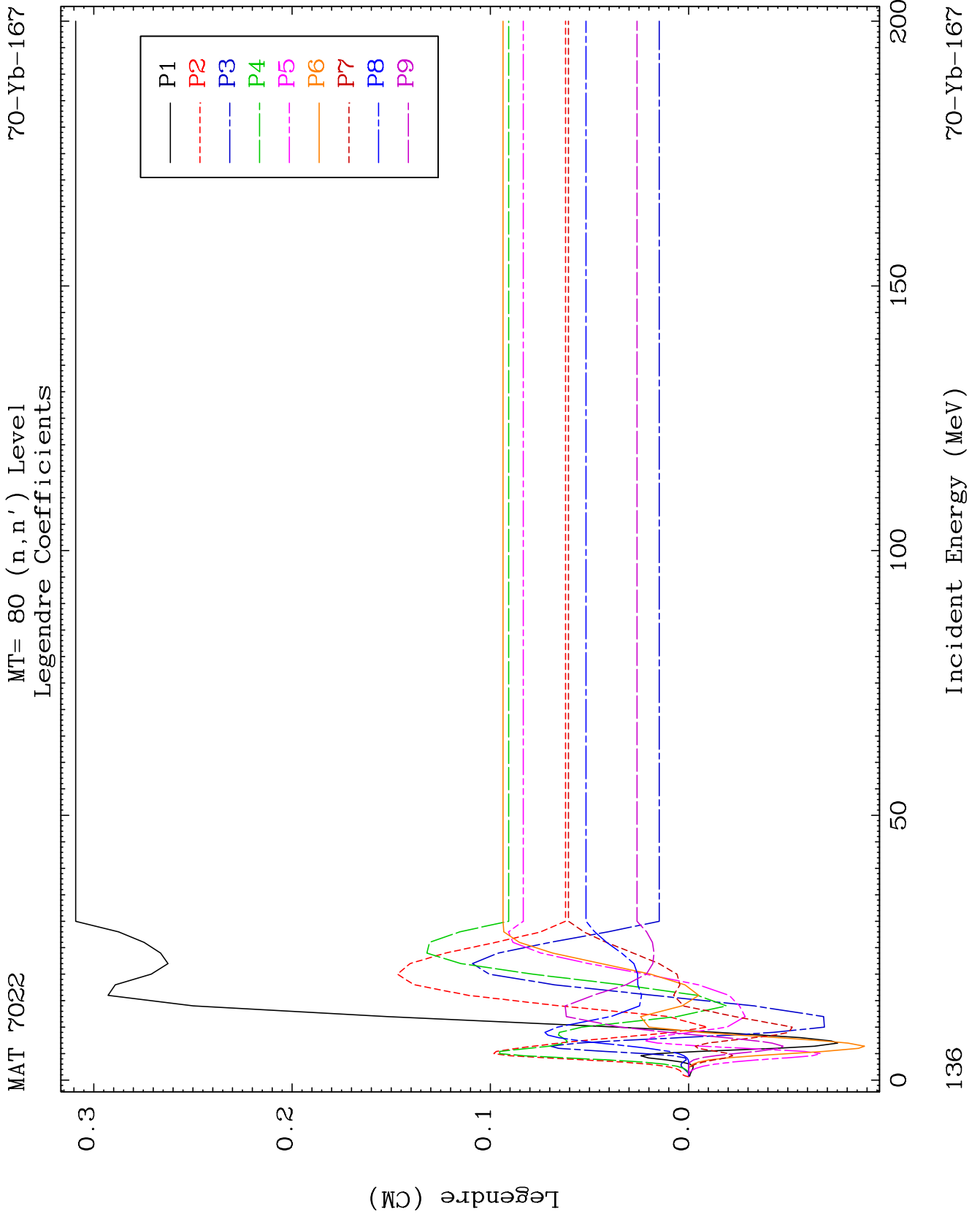

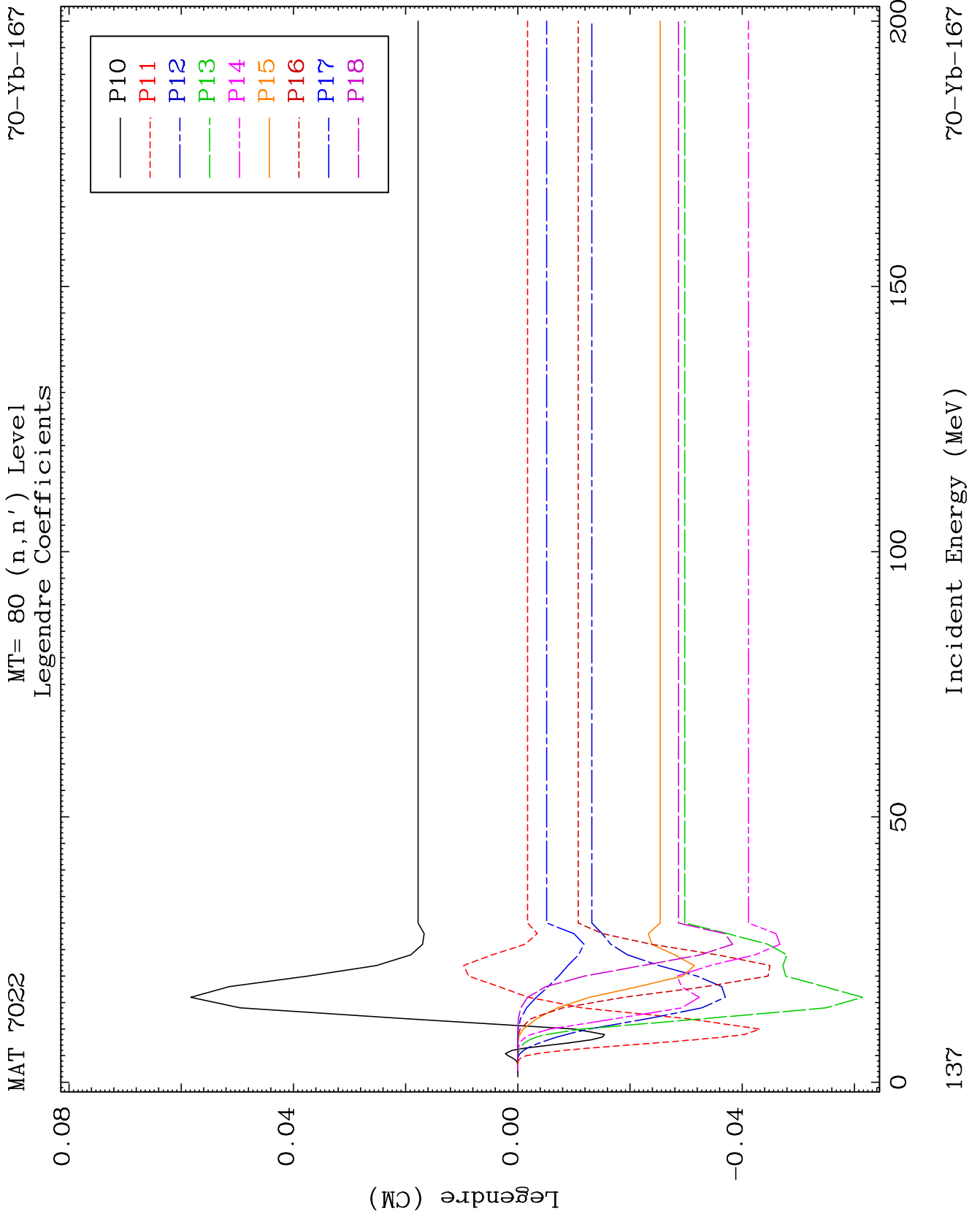

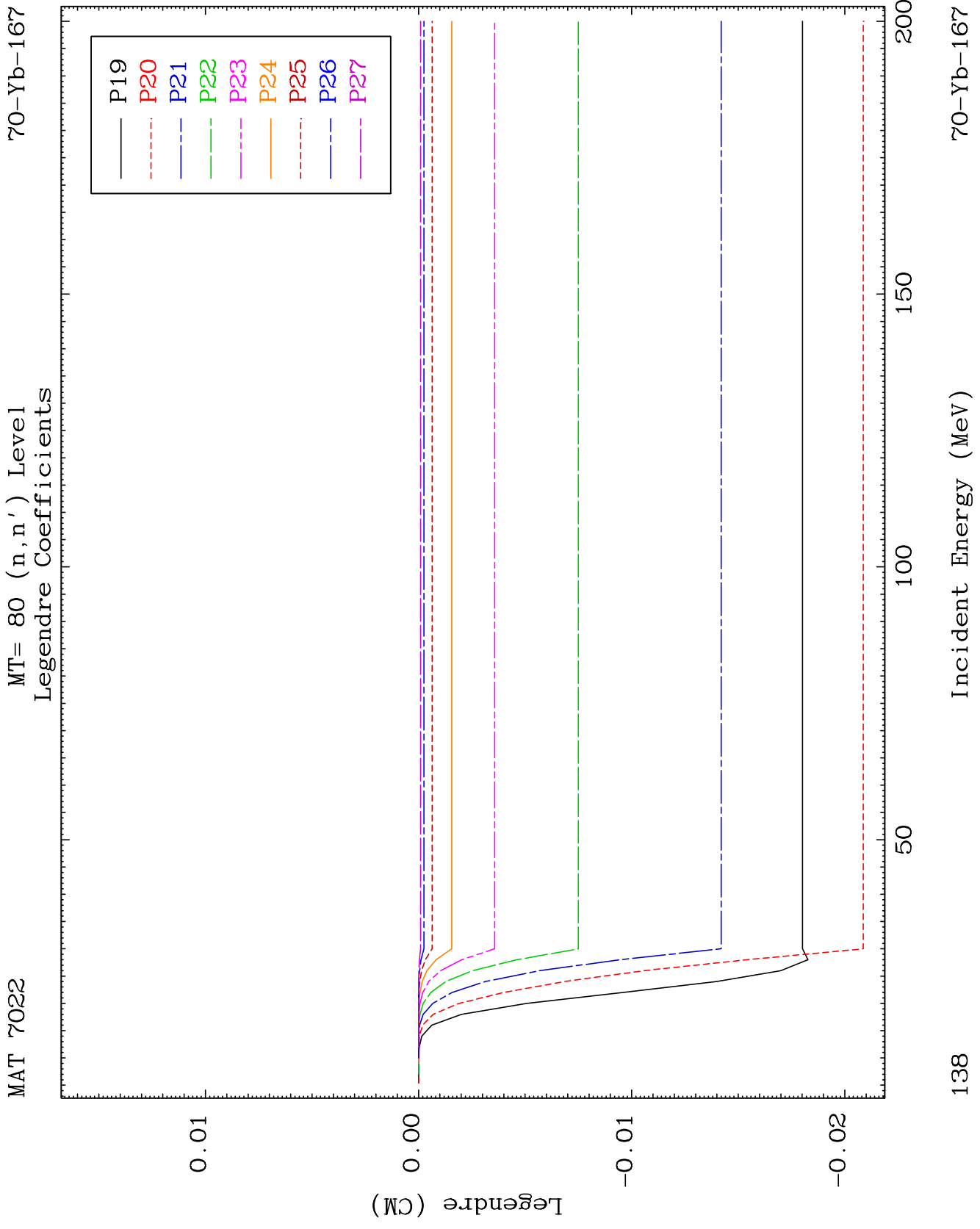

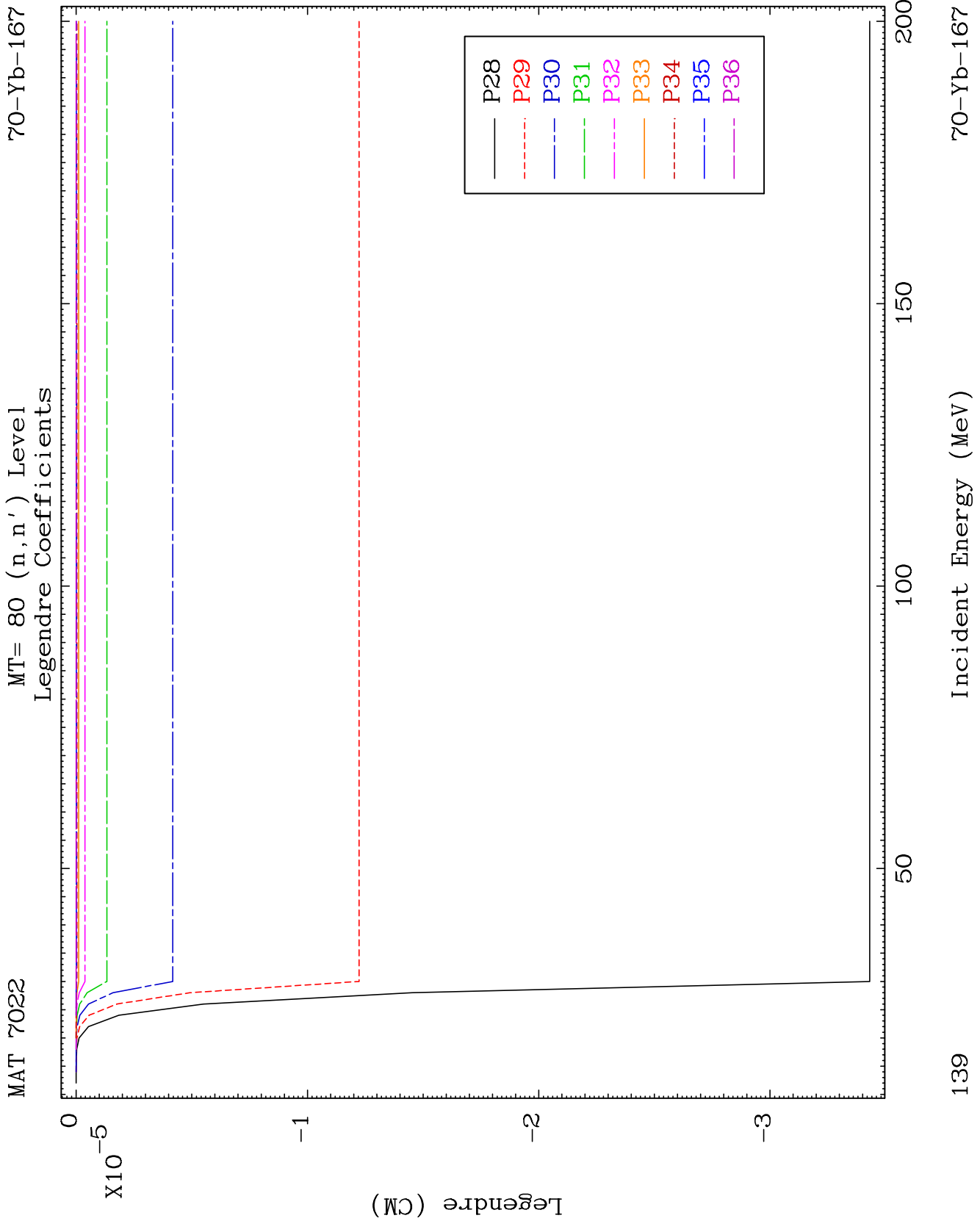

MAT 7022

(n,2n) d

70-Yb-167

Radionuclide Production Cross Section

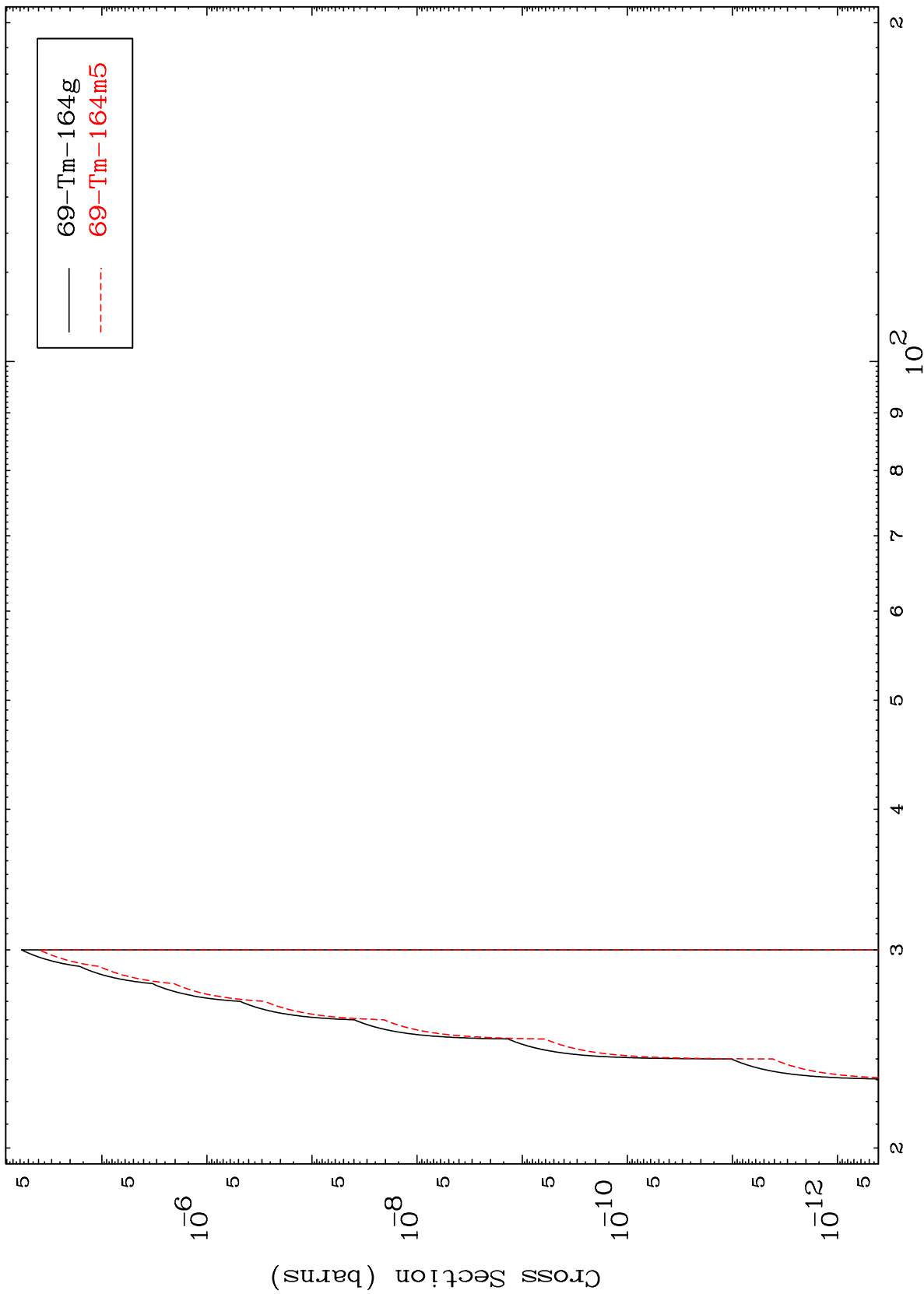

140

Incident Energy (MeV)

70-Yb-167

Radionuclide Production Cross Section

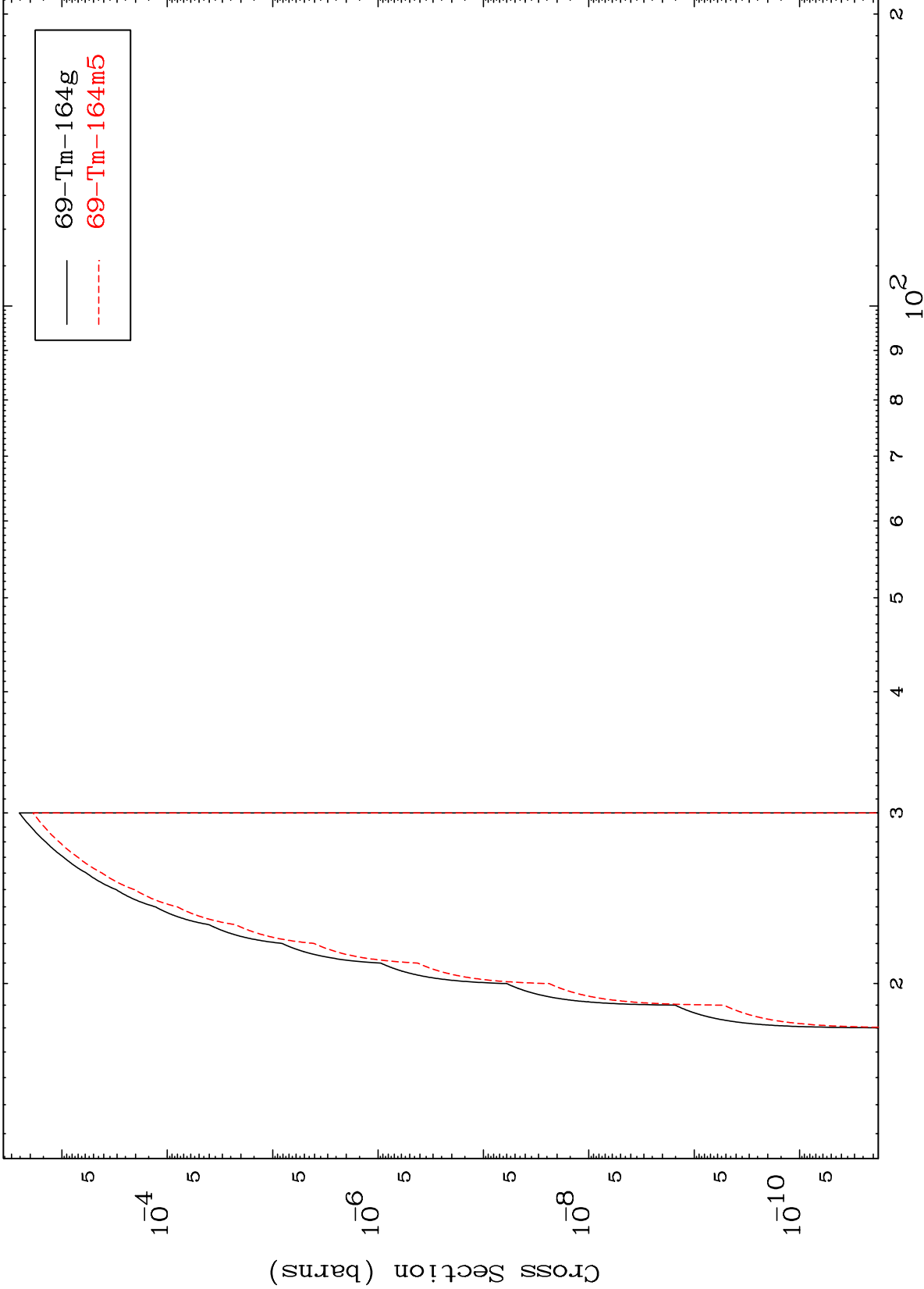

69-Tm-164g
69-Tm-164m5

Radionuclide Production Cross Section

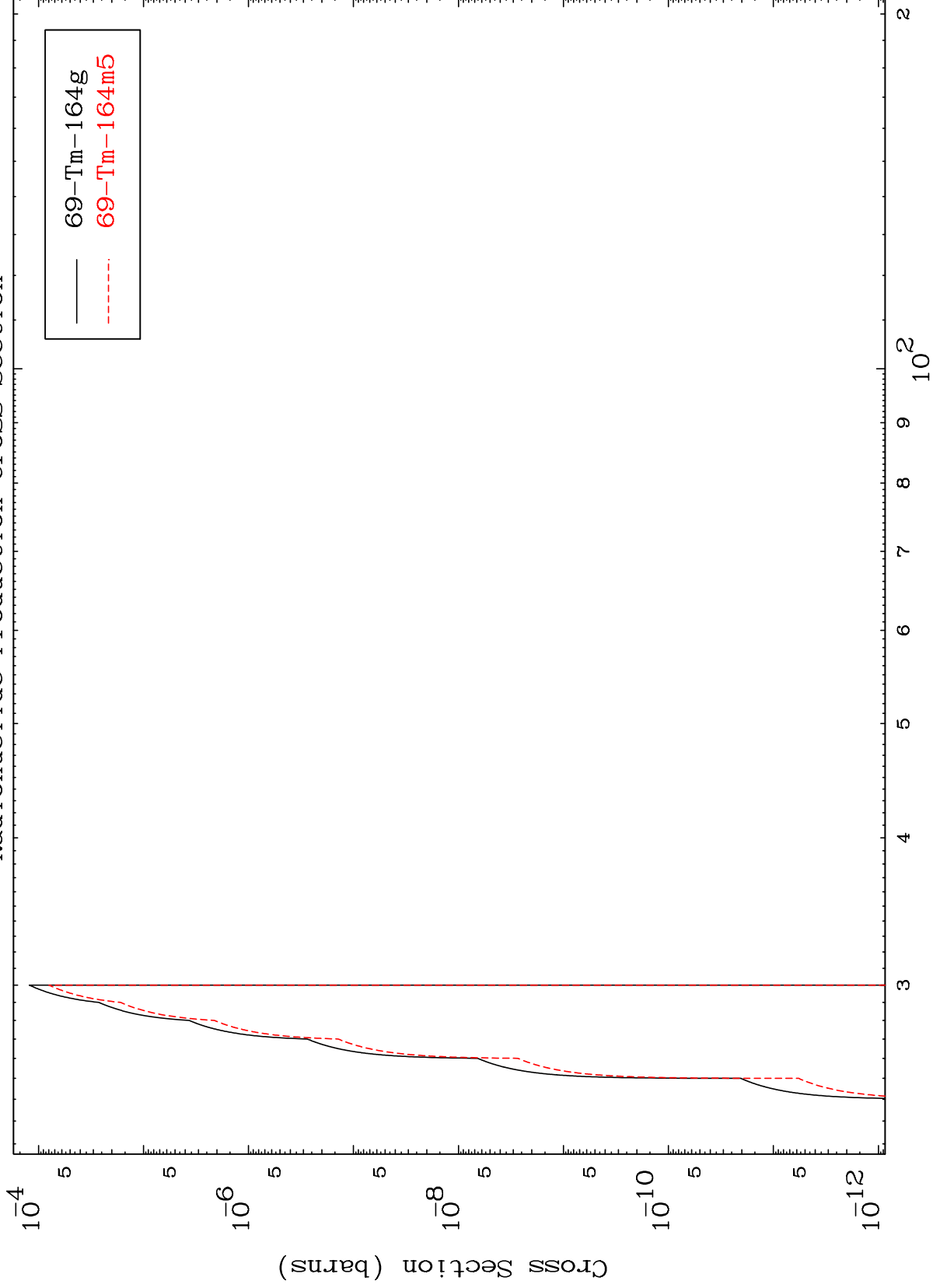

MAT 7022

(n,n') p α

70-Yb-167

Radionuclide Production Cross Section

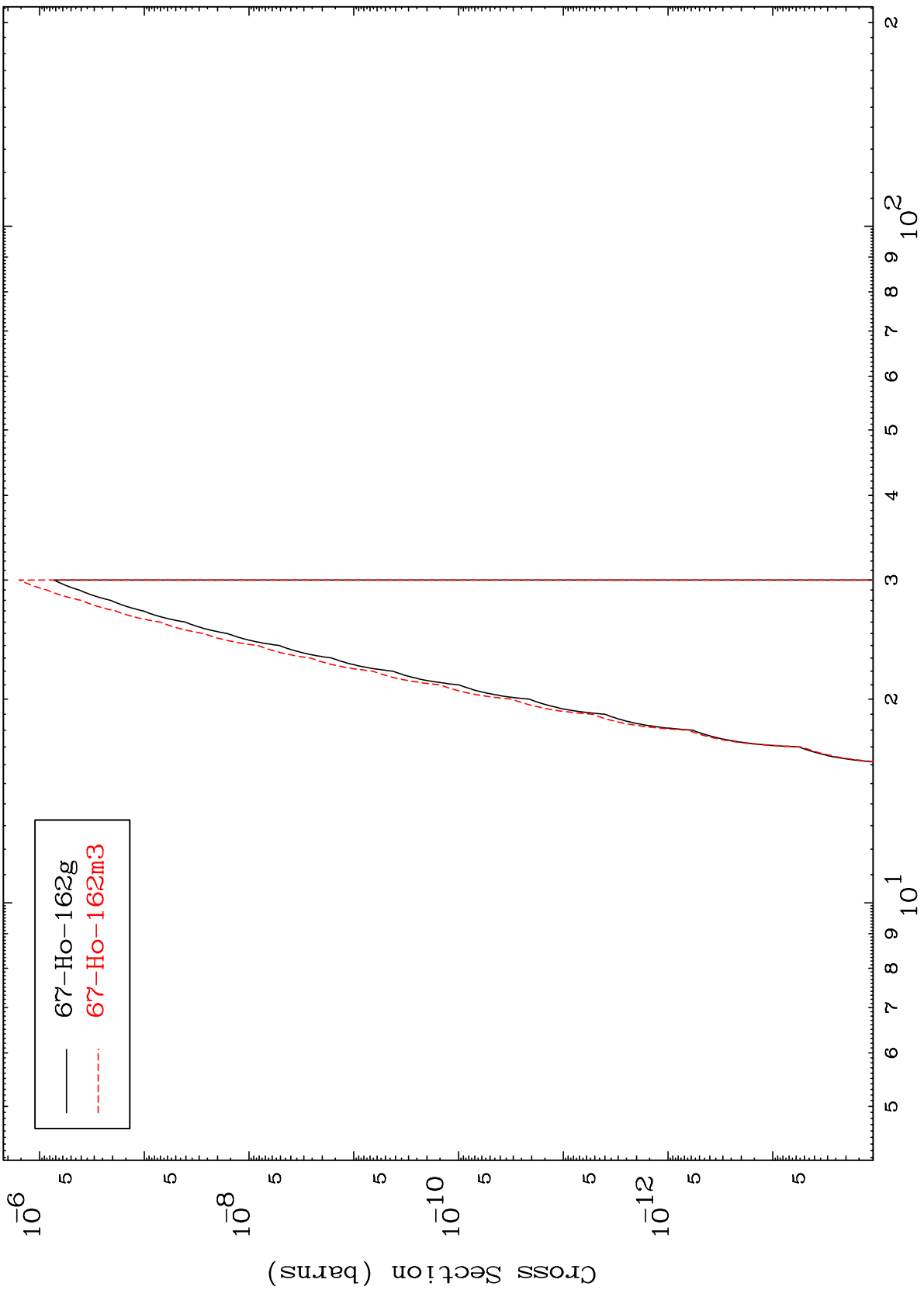

143

Incident Energy (MeV)

70-Yb-167

MAT 7022

(n,p) α

$^{70}\text{Yb-167}$

Radionuclide Production Cross Section

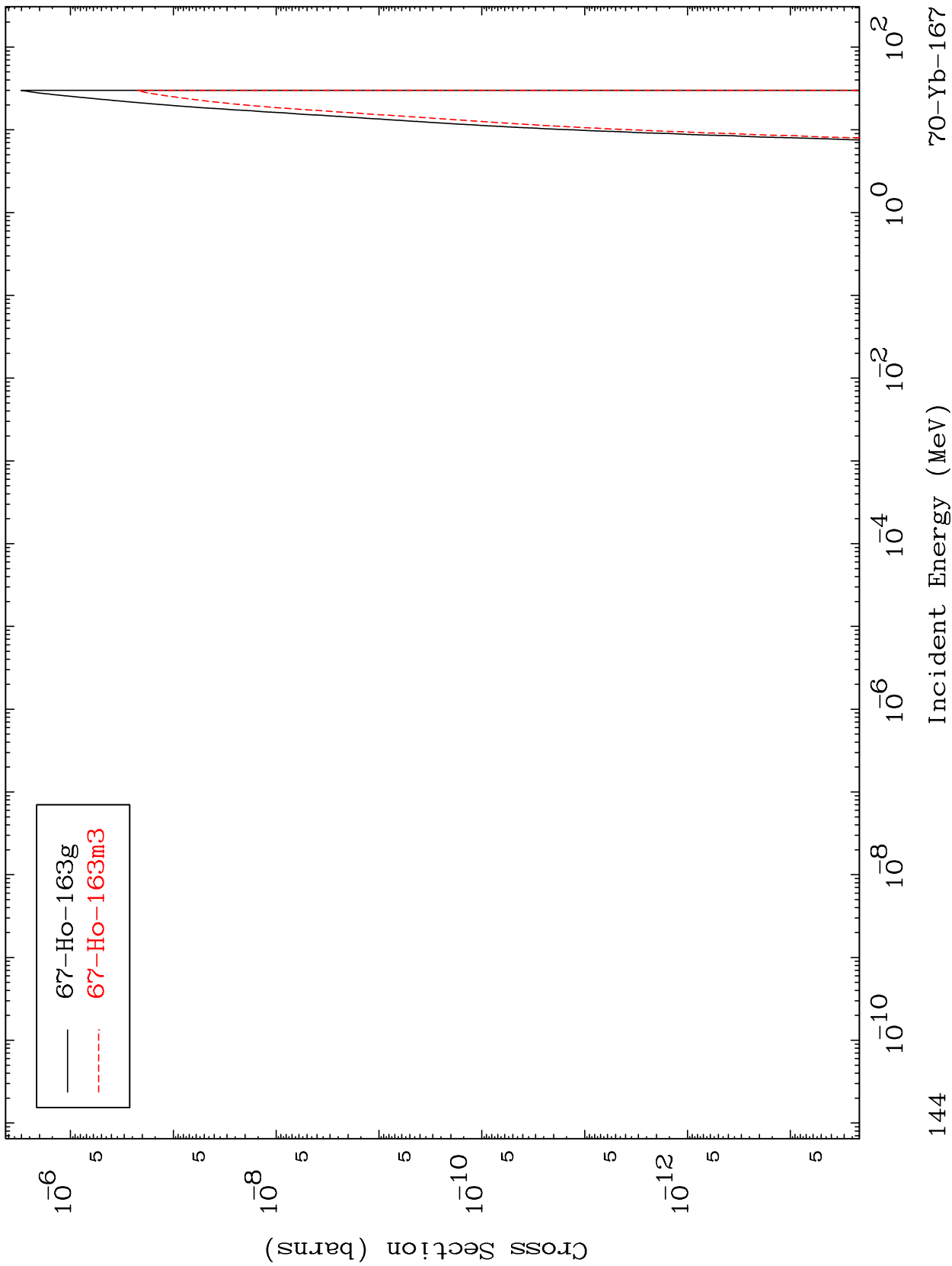

Radionuclide Production Cross Section

