

YB179 NEUTRON ACER TENDL-2021 LIBRARY; T=293.6K

Principal cross sections

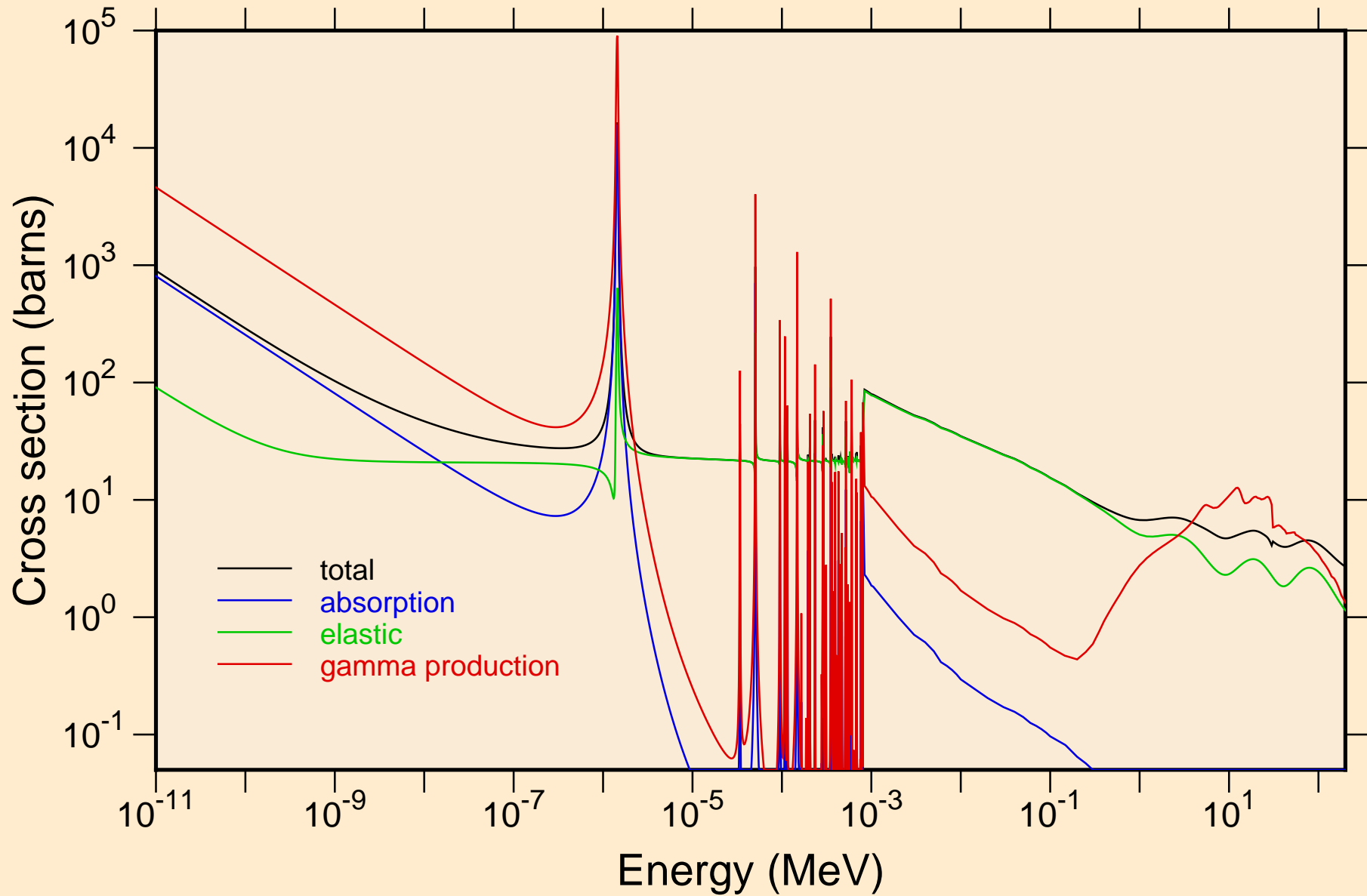

YB179 NEUTRON ACER TENDL-2021 LIBRARY; T=293.6K
resonance total cross section

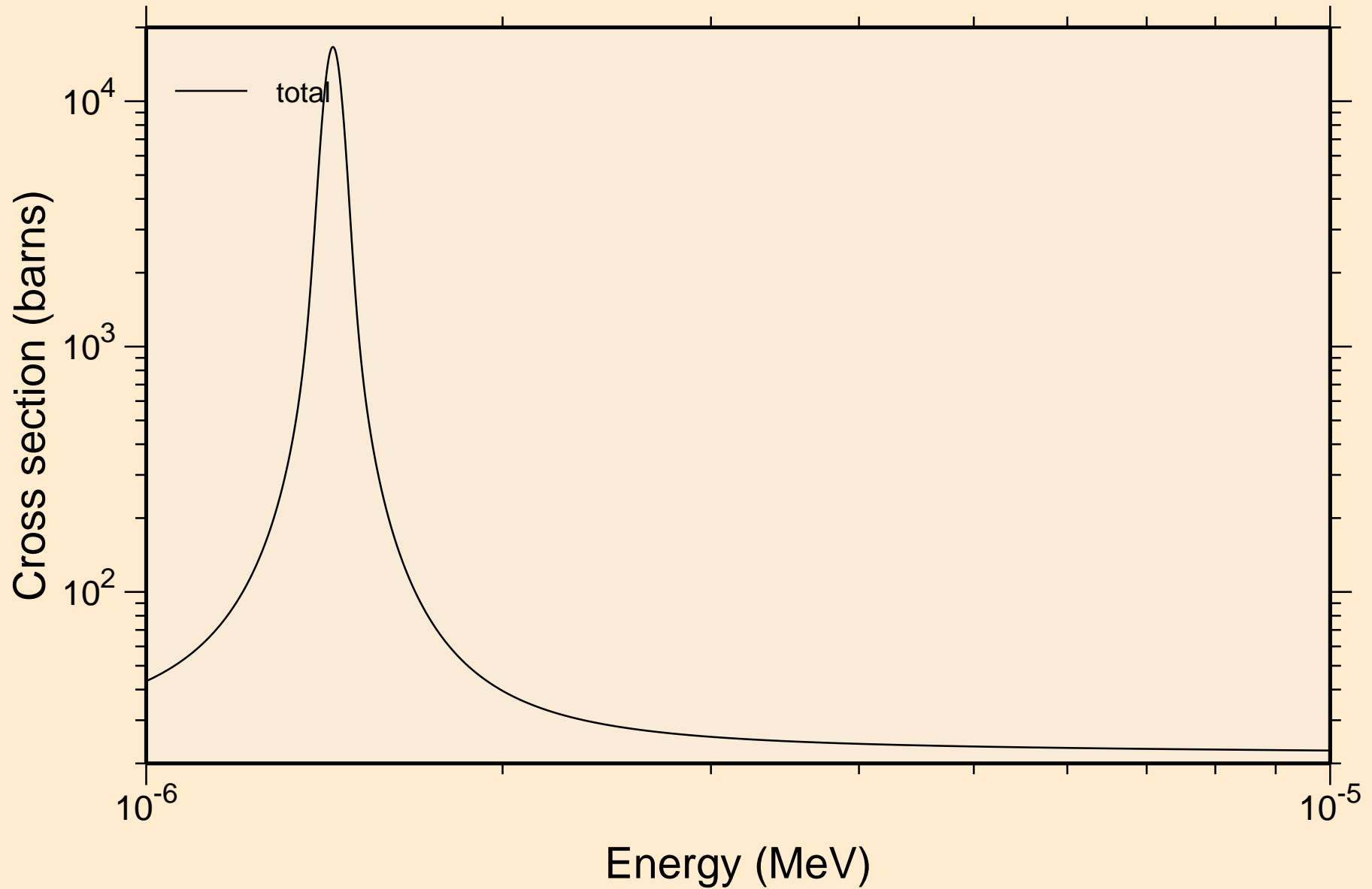

YB179 NEUTRON ACER TENDL-2021 LIBRARY; T=293.6K
resonance total cross section

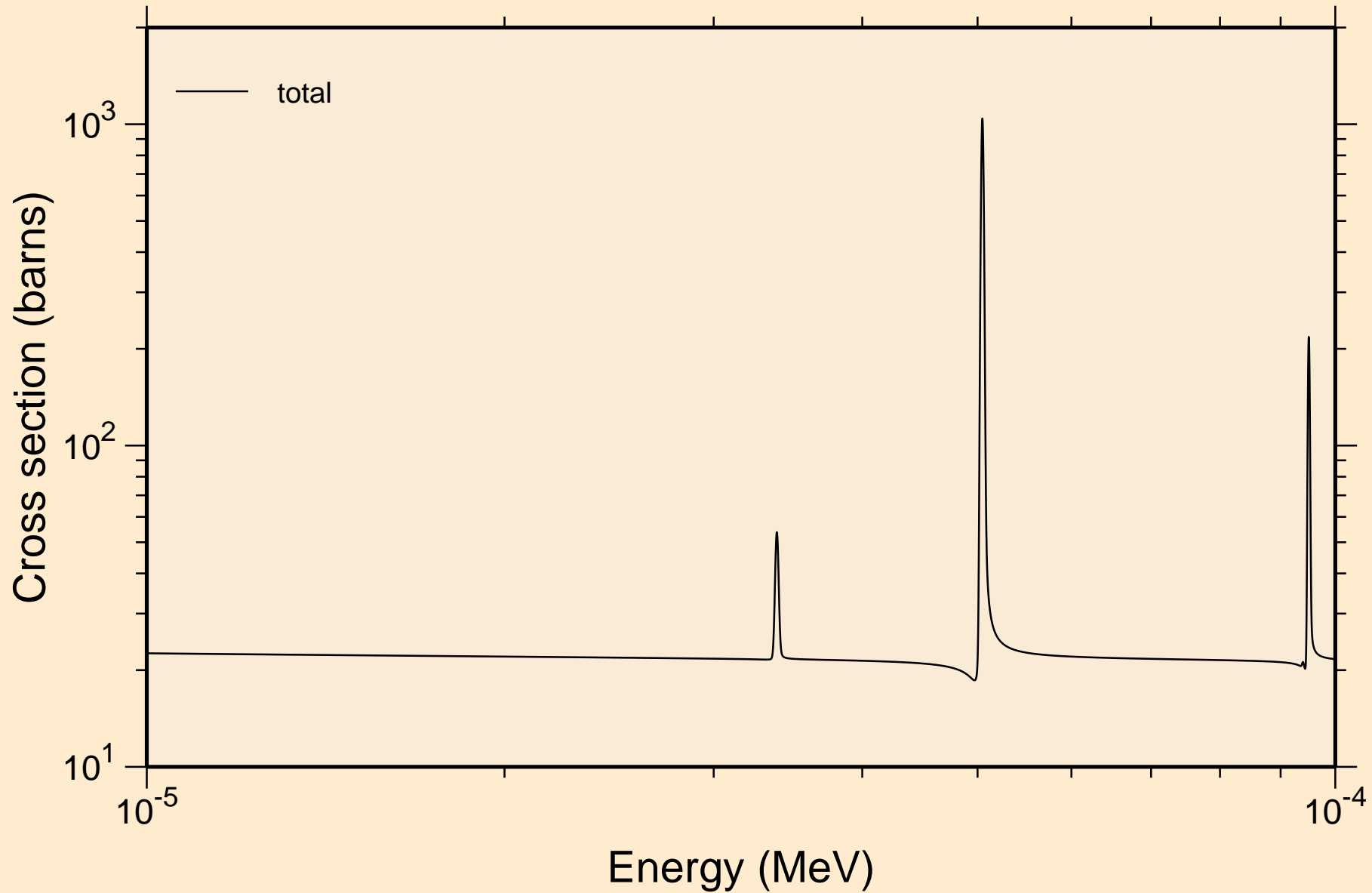

YB179 NEUTRON ACER TENDL-2021 LIBRARY; T=293.6K
resonance total cross section

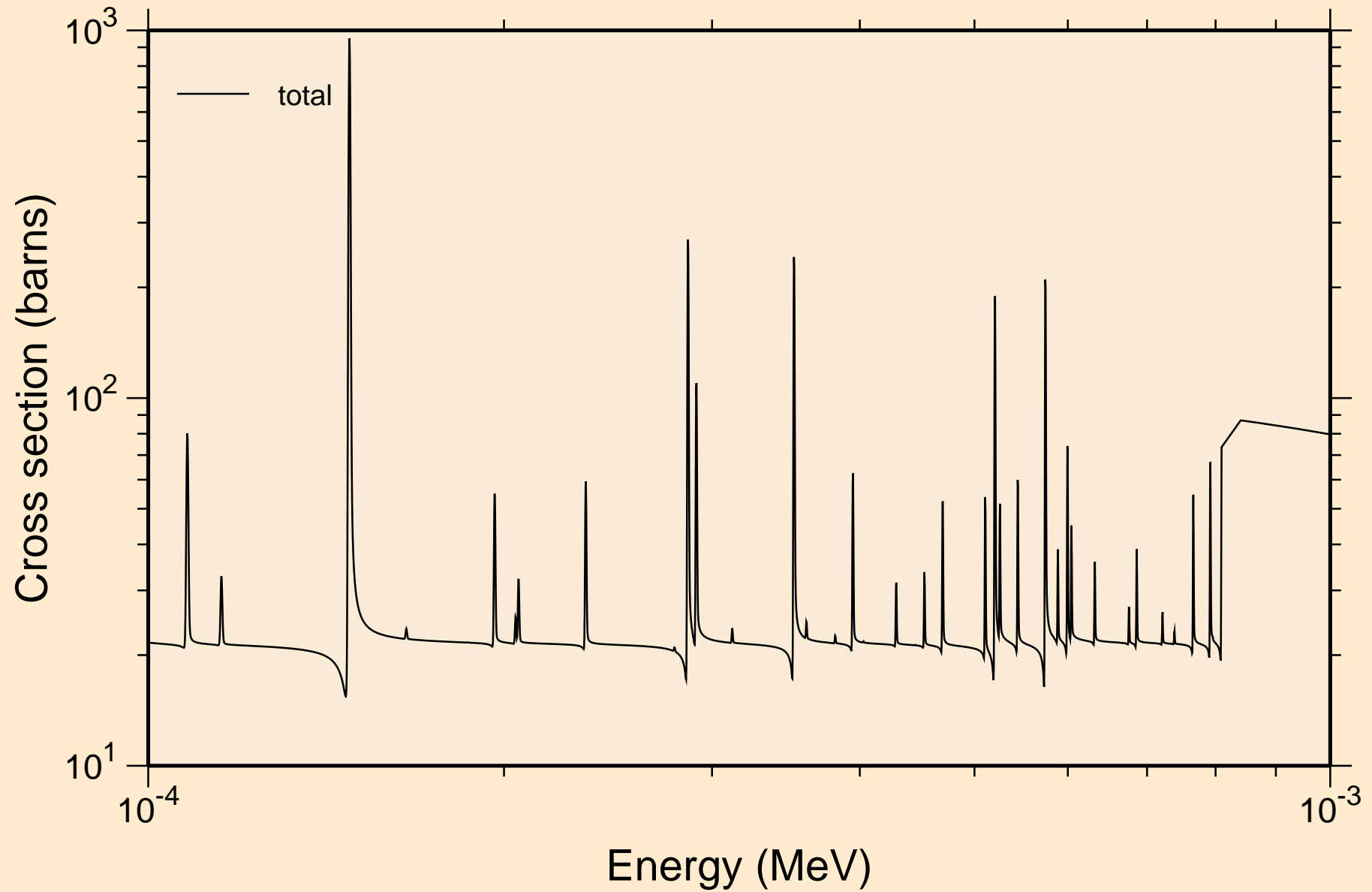

YB179 NEUTRON ACER TENDL-2021 LIBRARY; T=293.6K
resonance total cross section

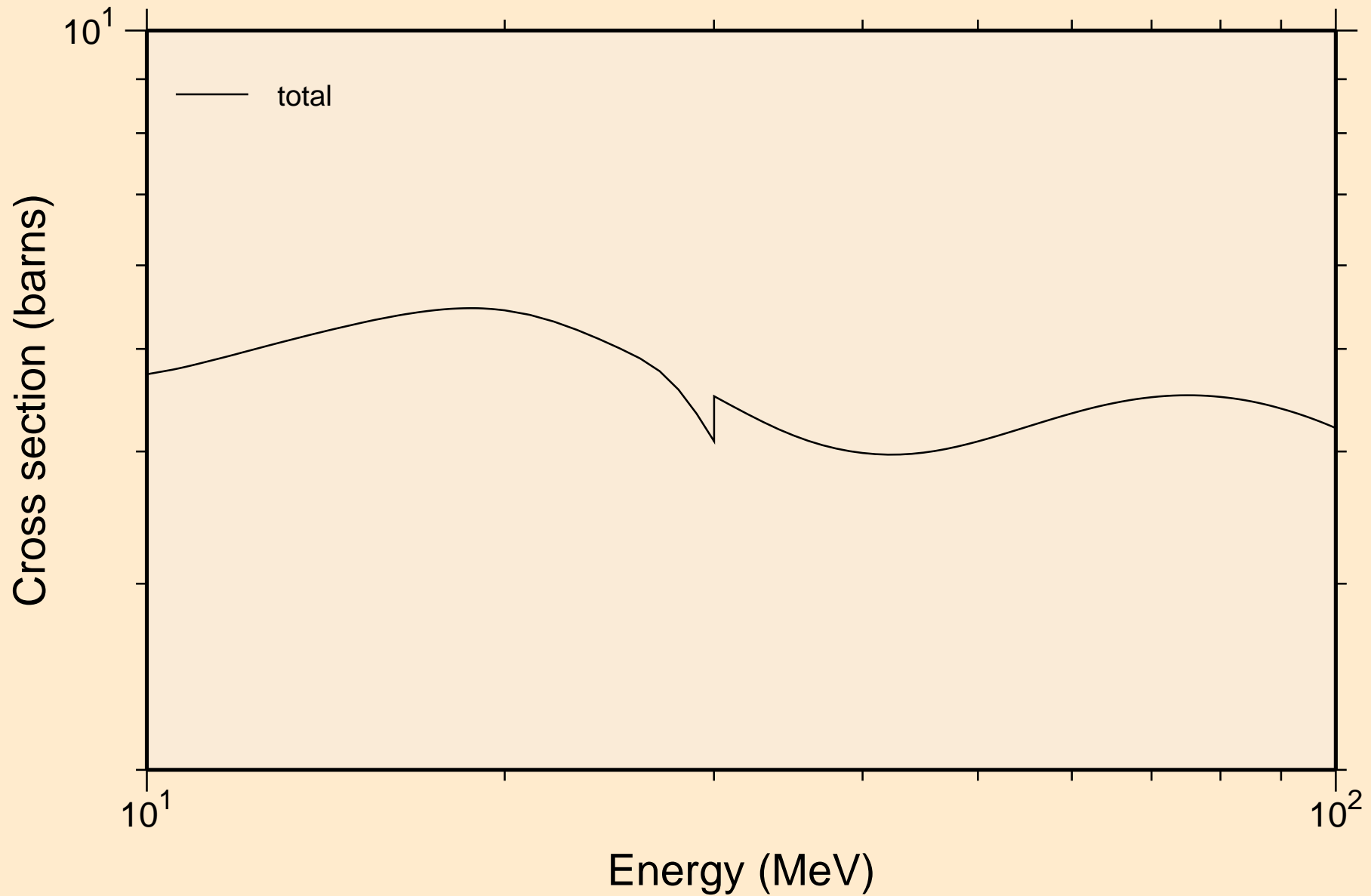

YB179 NEUTRON ACER TENDL-2021 LIBRARY; T=293.6K
resonance absorption cross sections

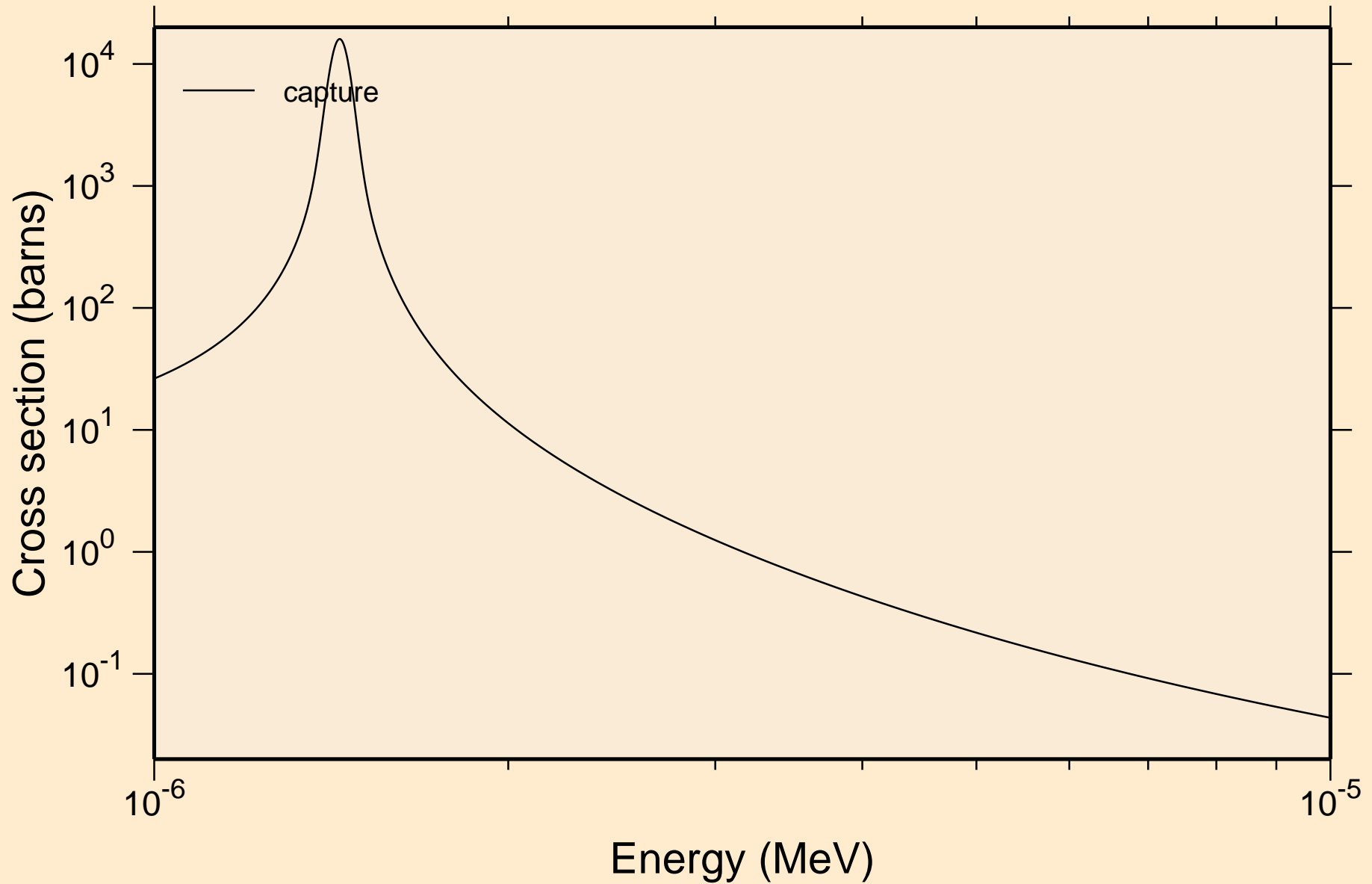

YB179 NEUTRON ACER TENDL-2021 LIBRARY; T=293.6K
resonance absorption cross sections

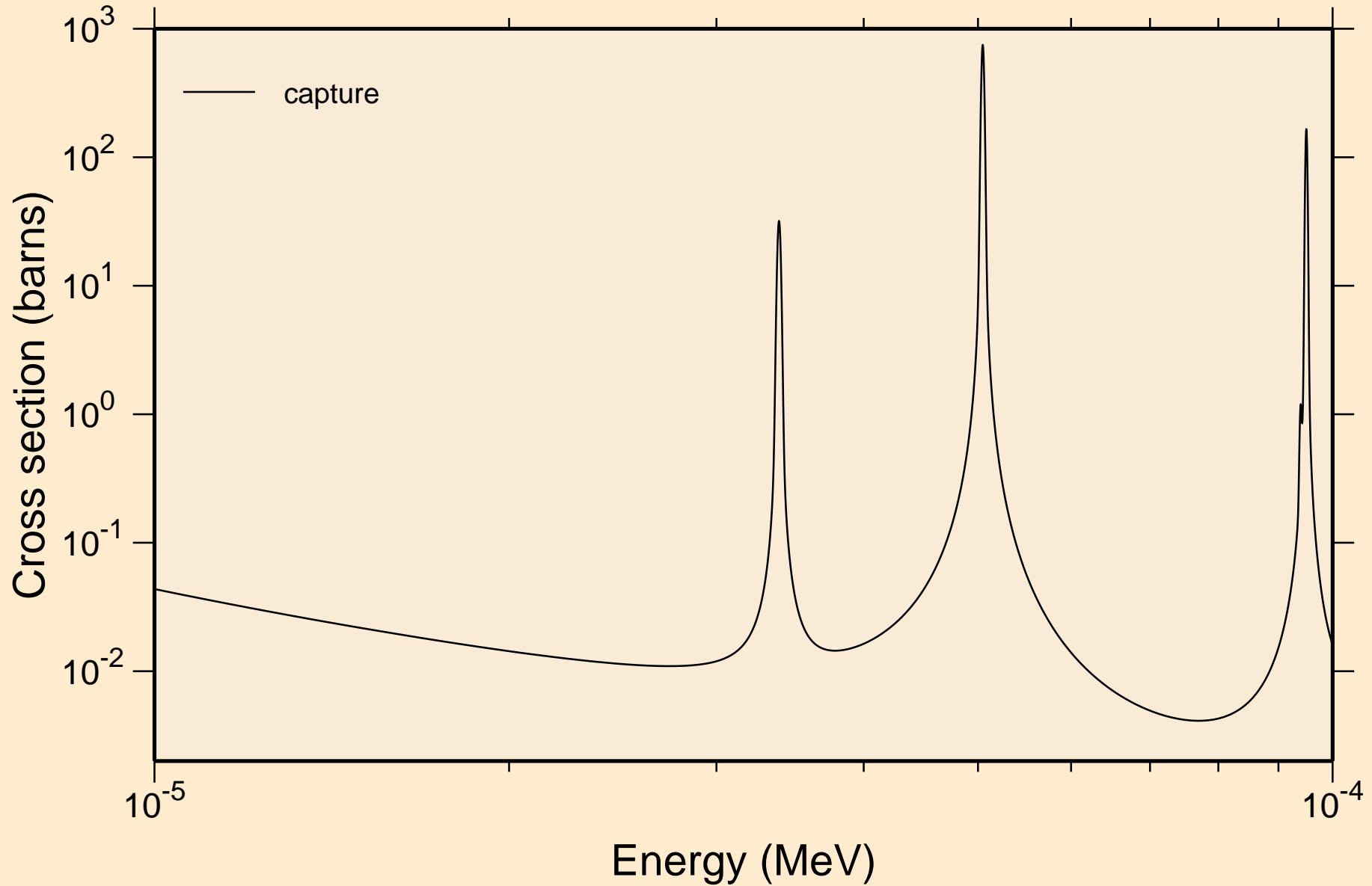

YB179 NEUTRON ACER TENDL-2021 LIBRARY; T=293.6K
resonance absorption cross sections

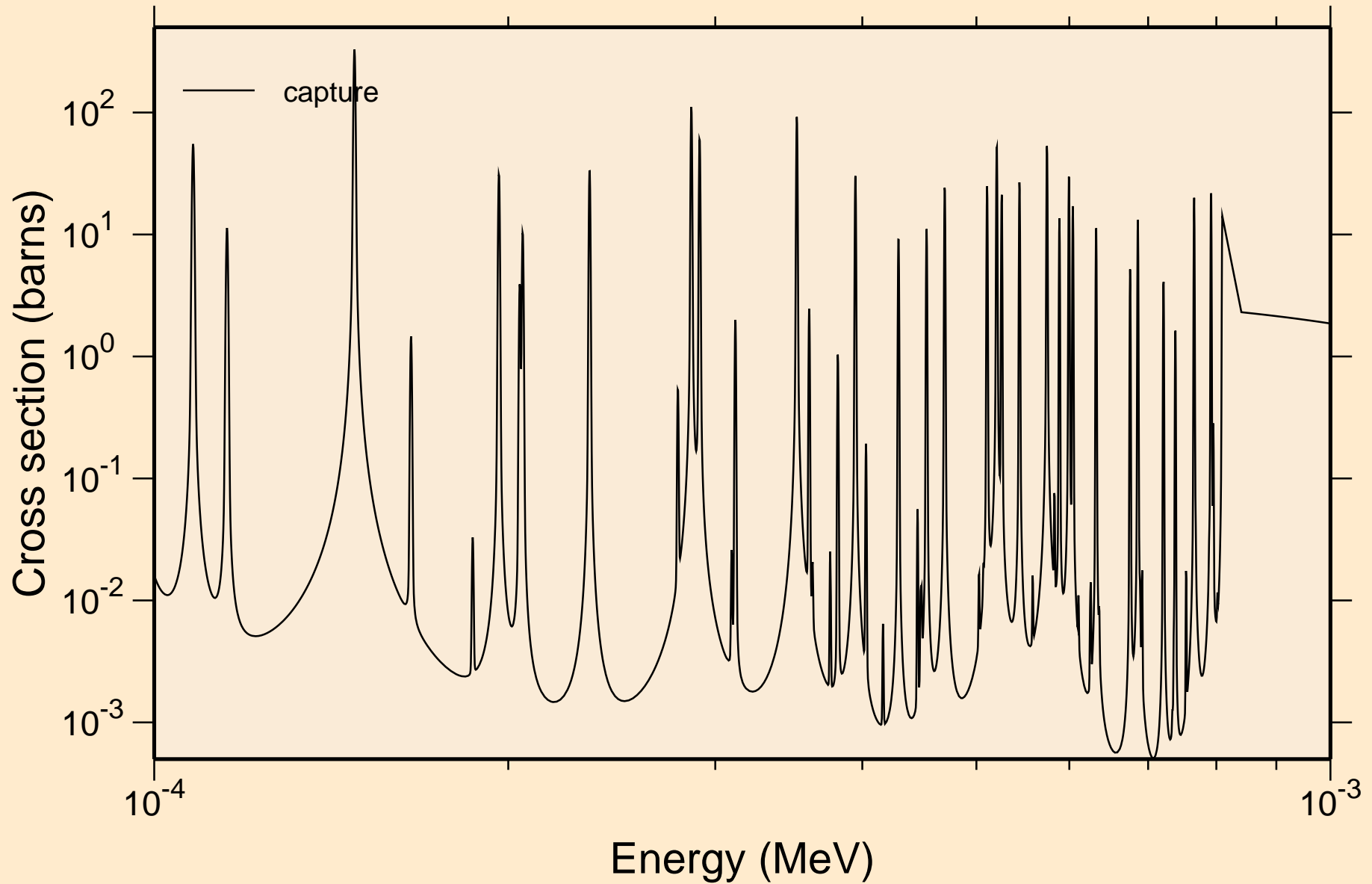

YB179 NEUTRON ACER TENDL-2021 LIBRARY; T=293.6K
resonance absorption cross sections

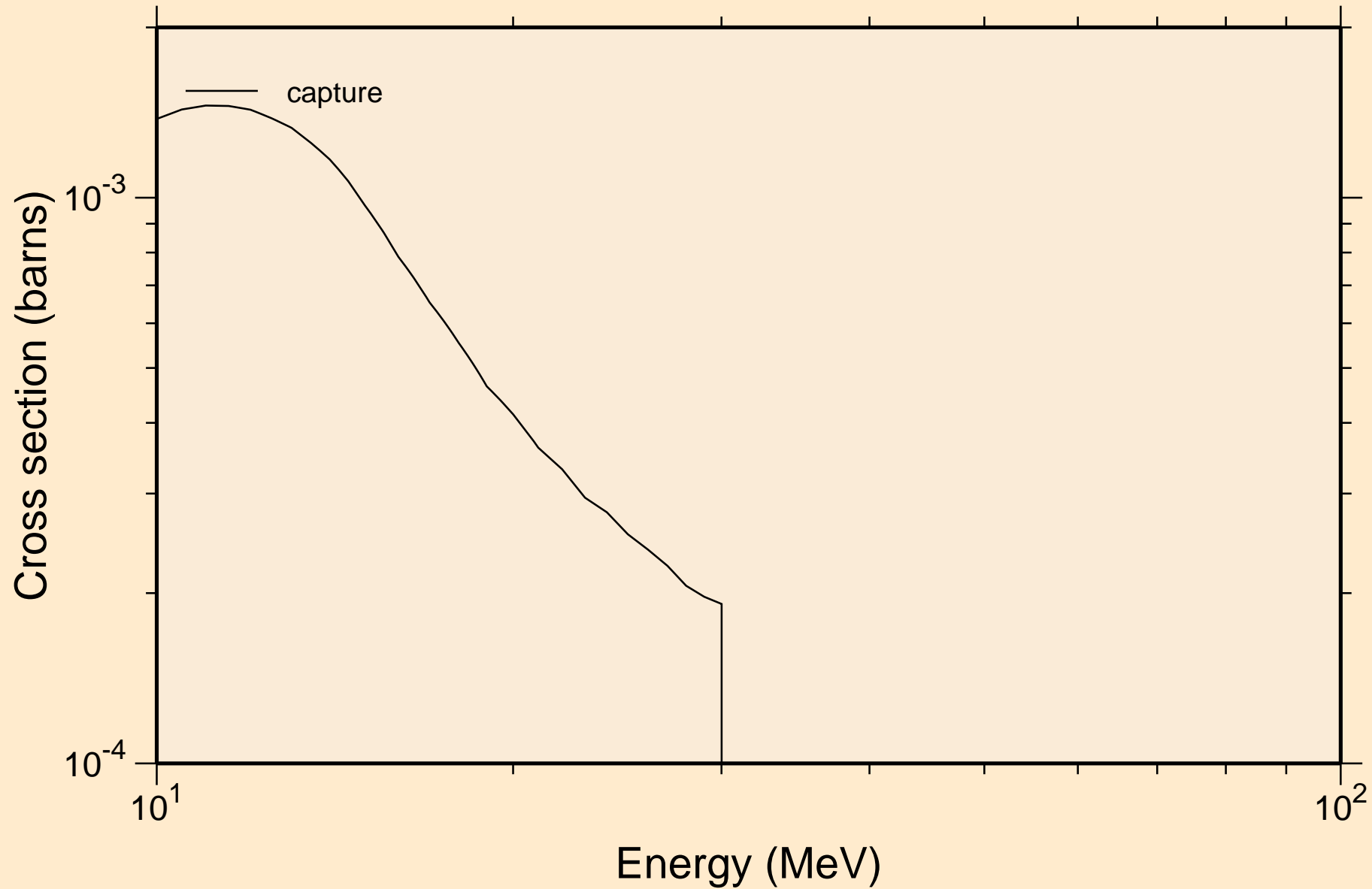

YB179 NEUTRON ACER TENDL-2021 LIBRARY; T=293.6K
Heating

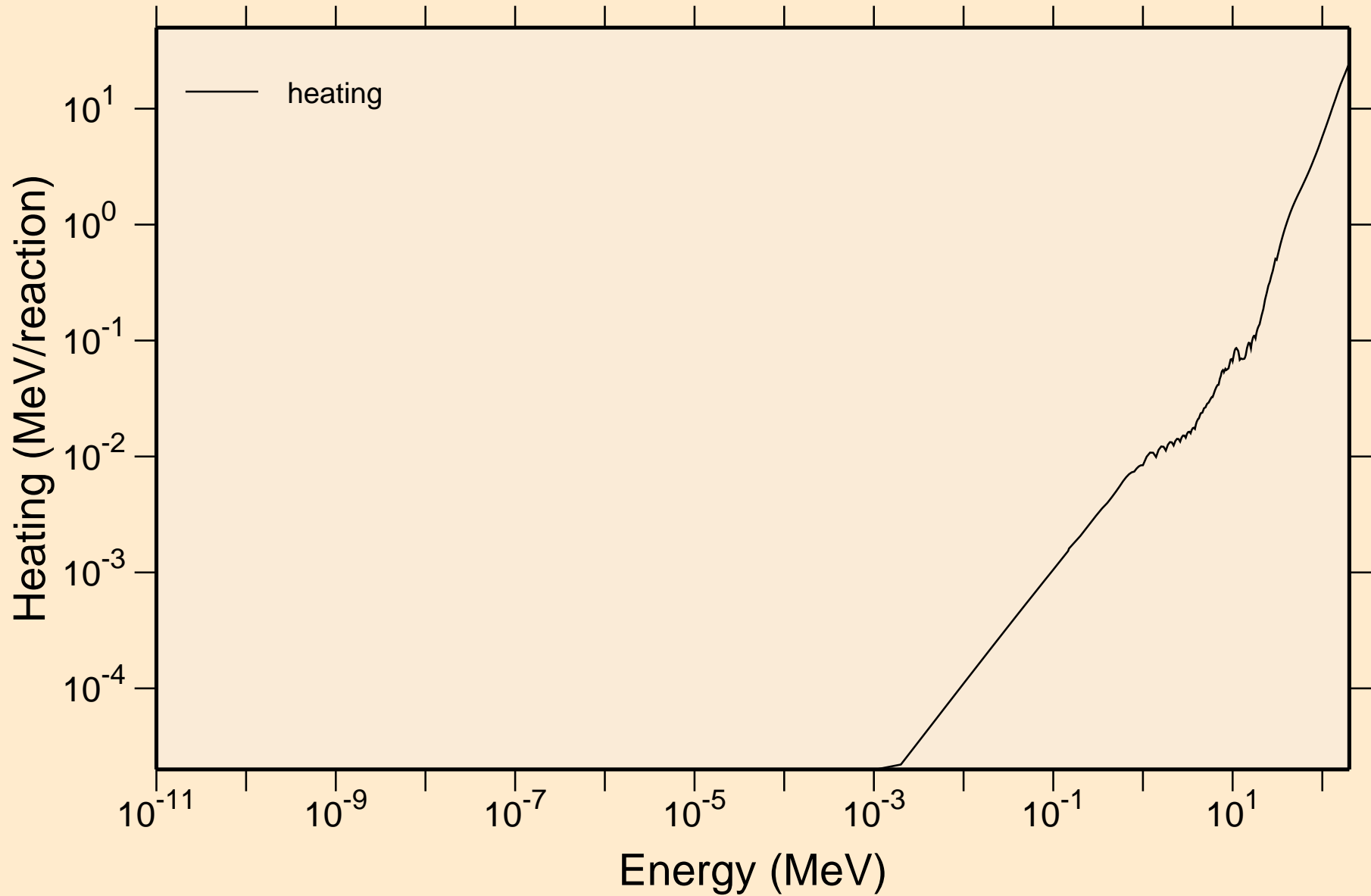

YB179 NEUTRON ACER TENDL-2021 LIBRARY; T=293.6K

Damage

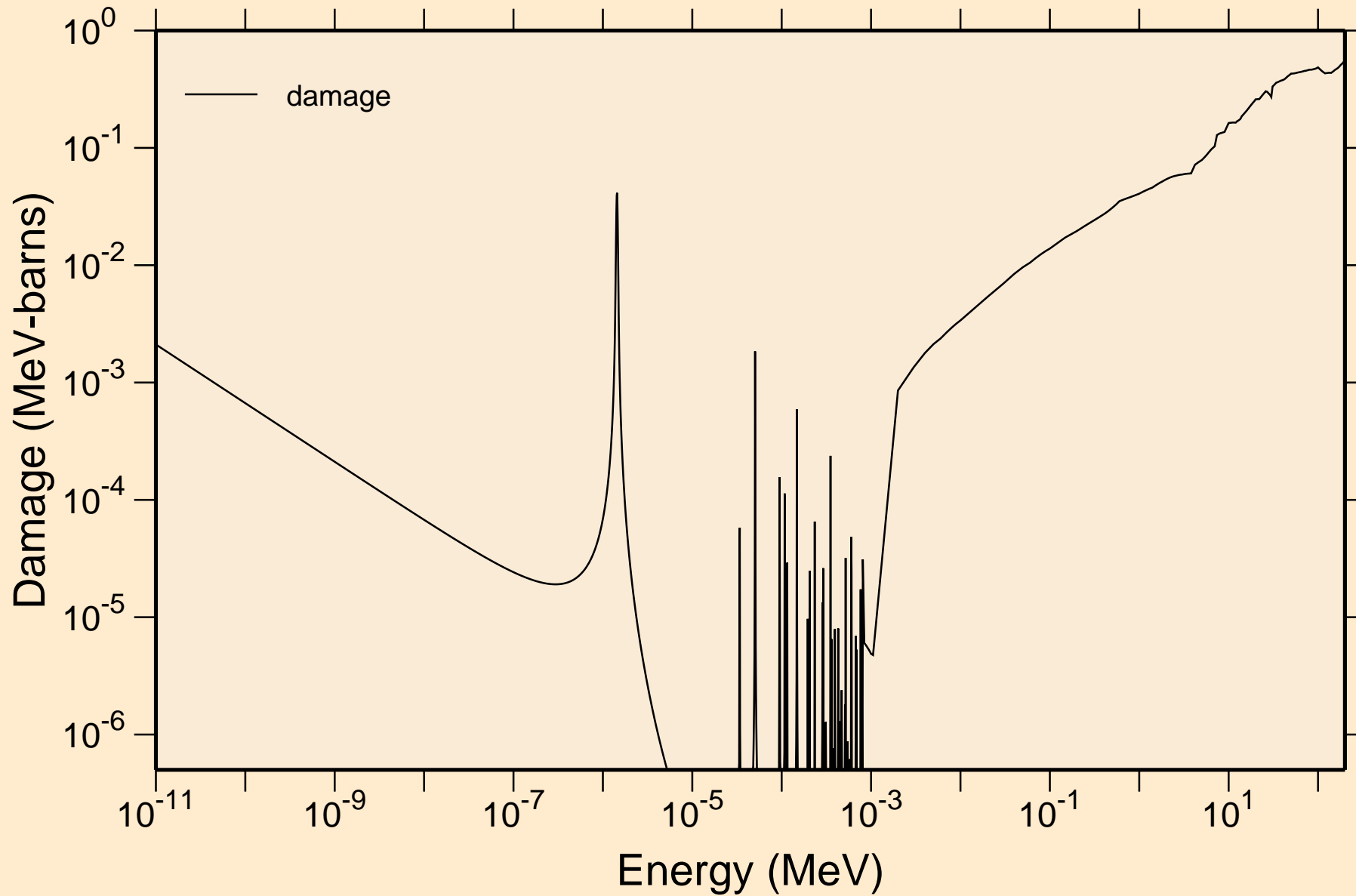

YB179 NEUTRON ACER TENDL-2021 LIBRARY; T=293.6K
Non-threshold reactions

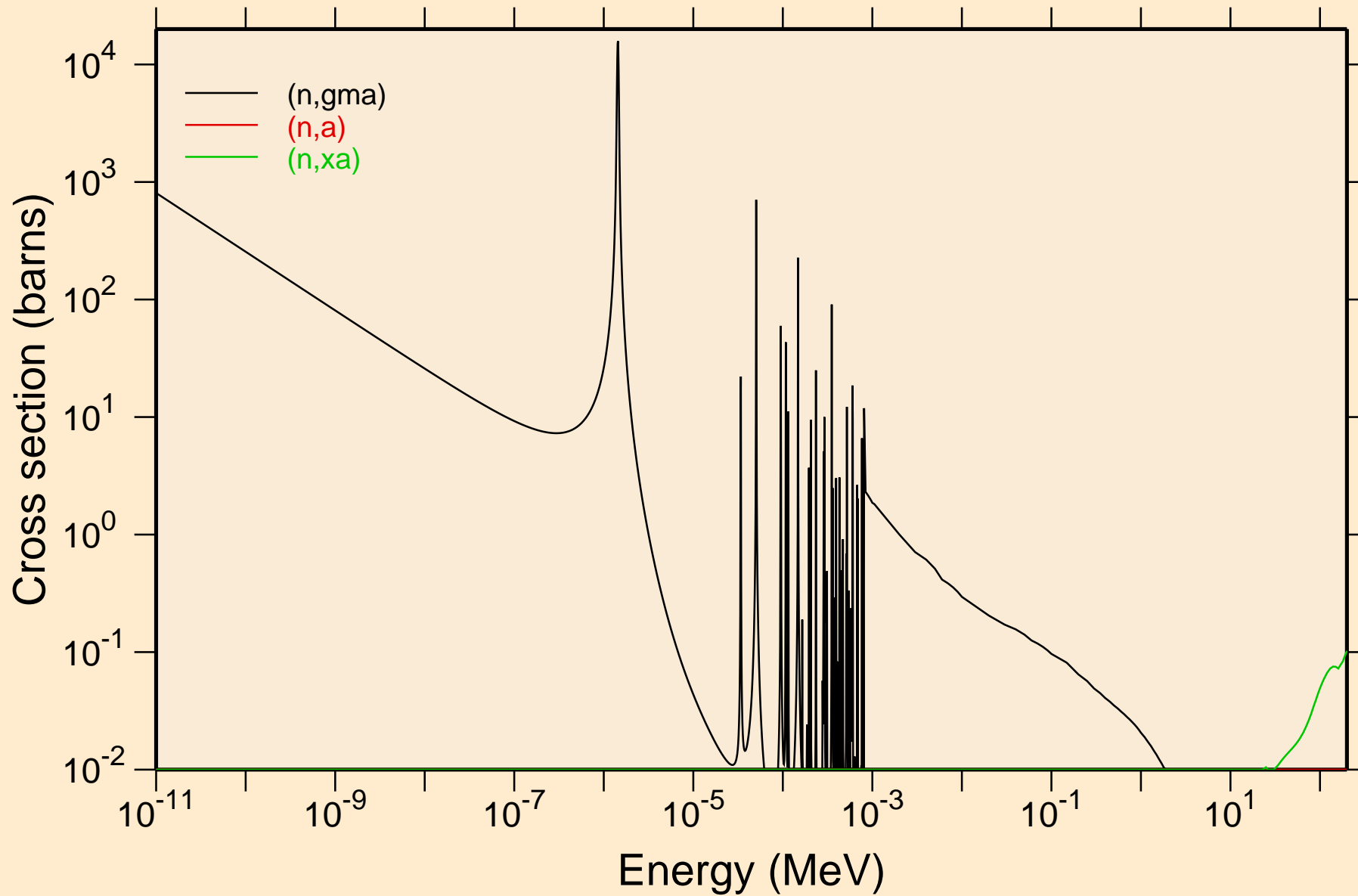

YB179 NEUTRON ACER TENDL-2021 LIBRARY; T=293.6K
Principal cross sections

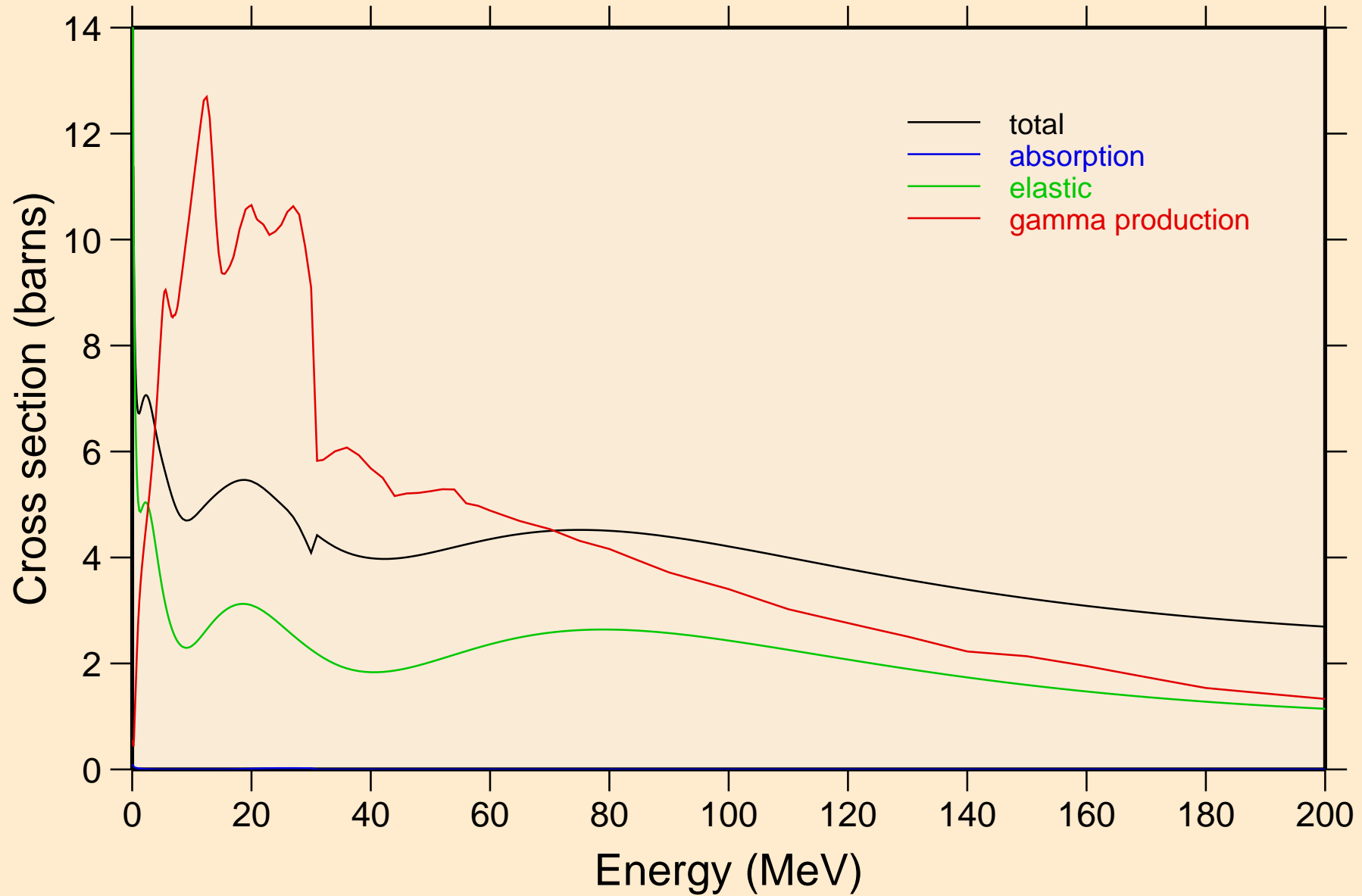

YB179 NEUTRON ACER TENDL-2021 LIBRARY; T=293.6K
Heating

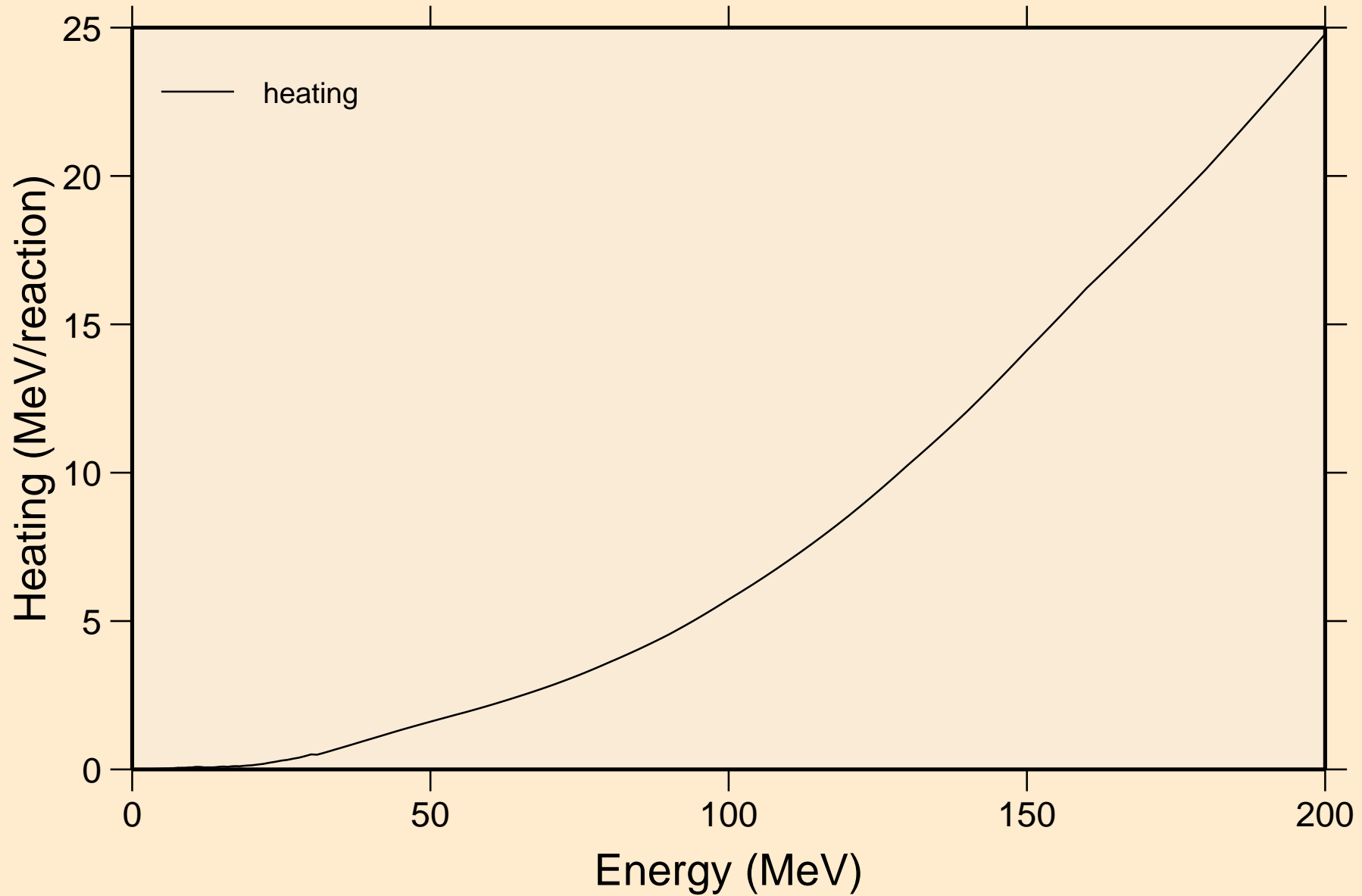

YB179 NEUTRON ACER TENDL-2021 LIBRARY; T=293.6K
Damage

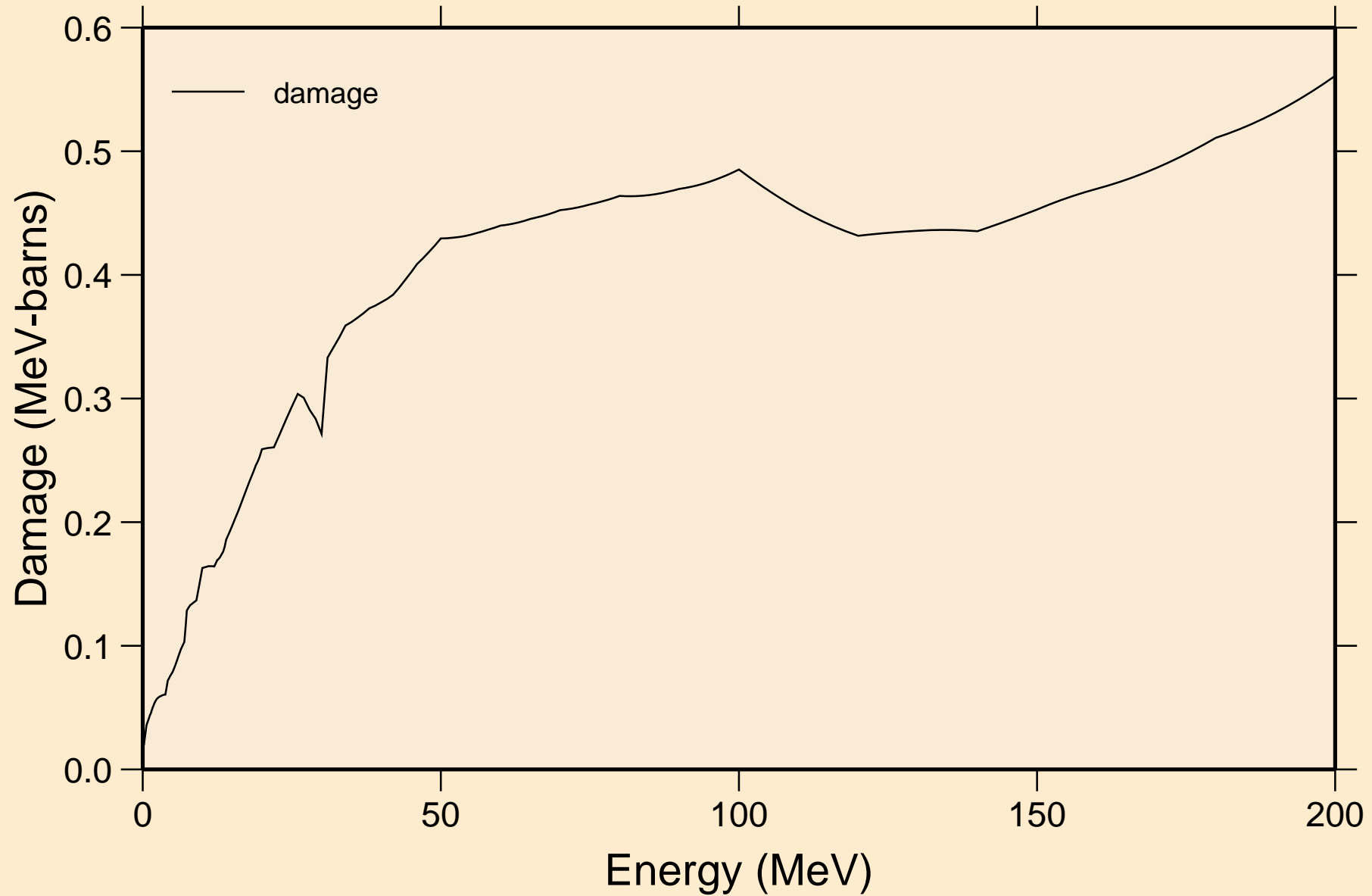

YB179 NEUTRON ACER TENDL-2021 LIBRARY; T=293.6K
Non-threshold reactions

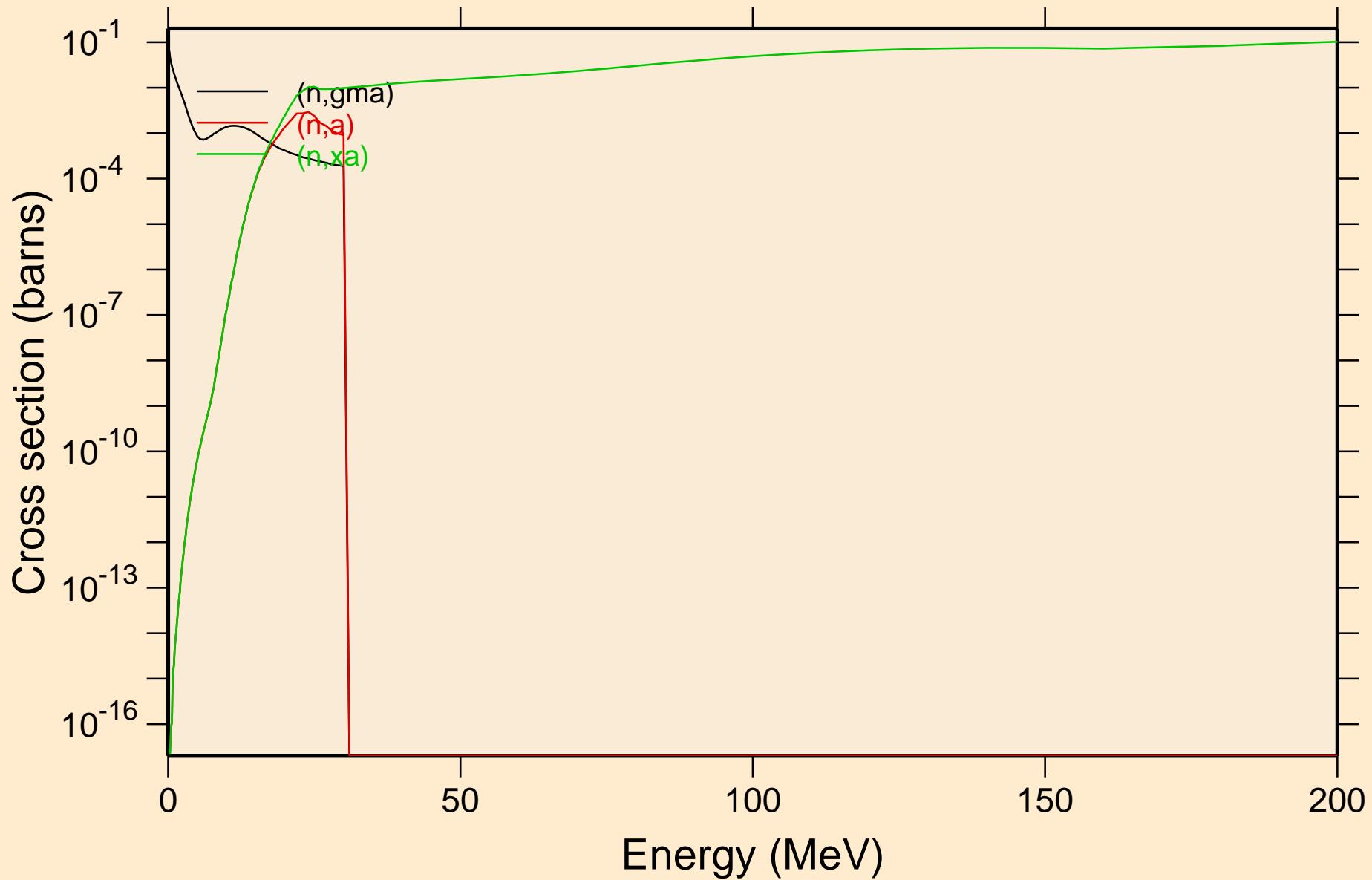

YB179 NEUTRON ACER TENDL-2021 LIBRARY; T=293.6K
Inelastic levels

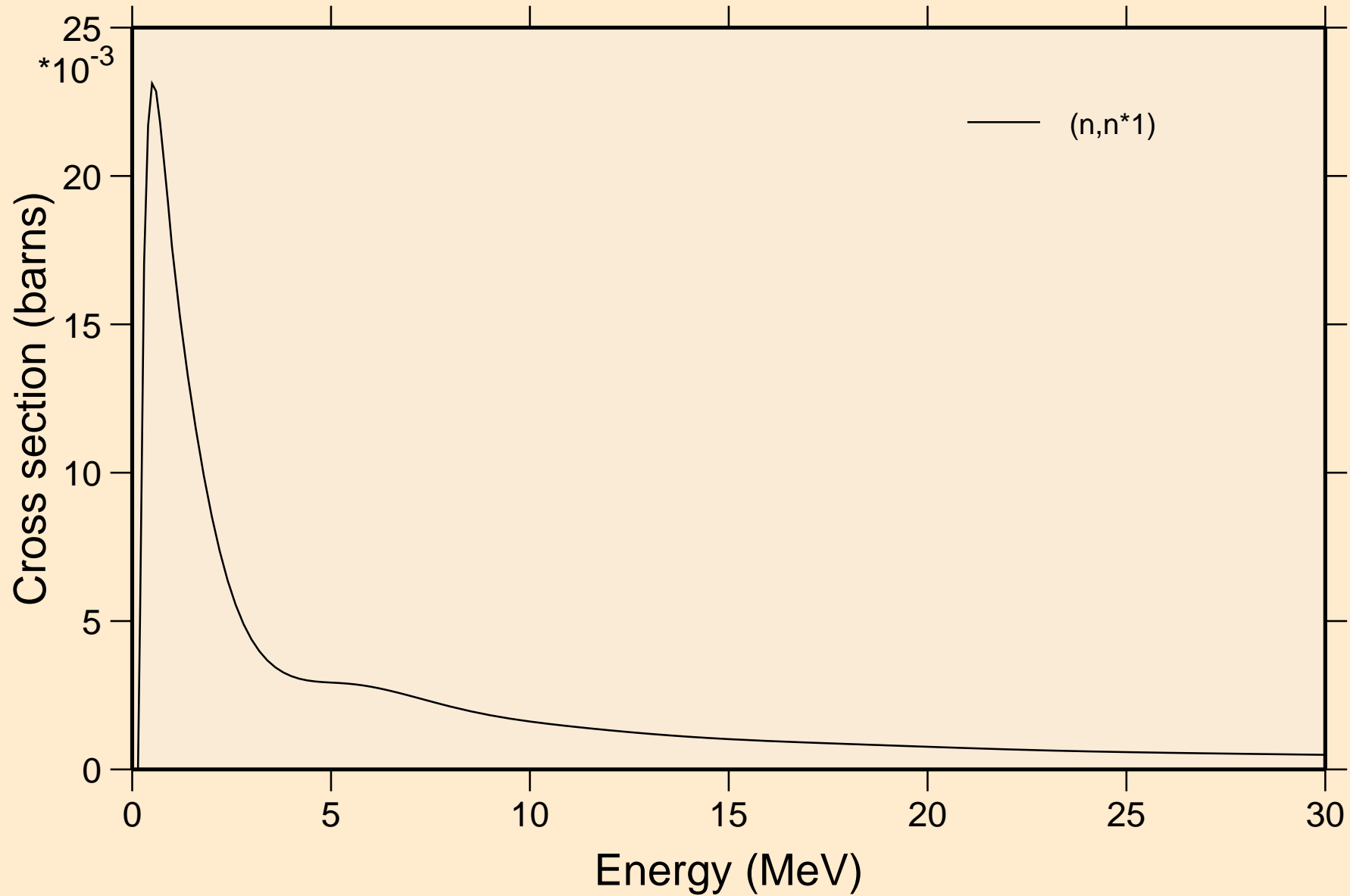

YB179 NEUTRON ACER TENDL-2021 LIBRARY; T=293.6K
Threshold reactions

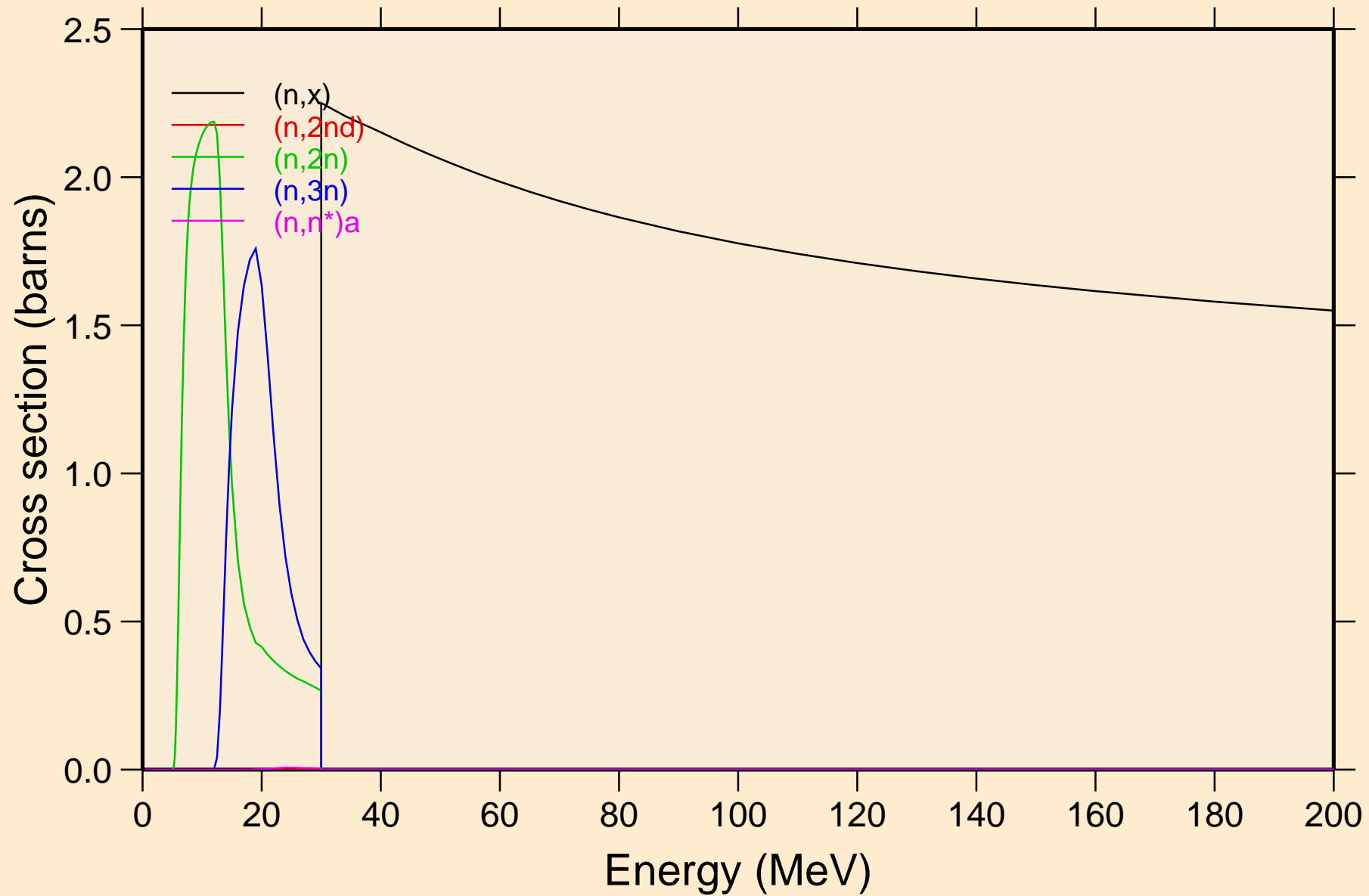

YB179 NEUTRON ACER TENDL-2021 LIBRARY; T=293.6K
Threshold reactions

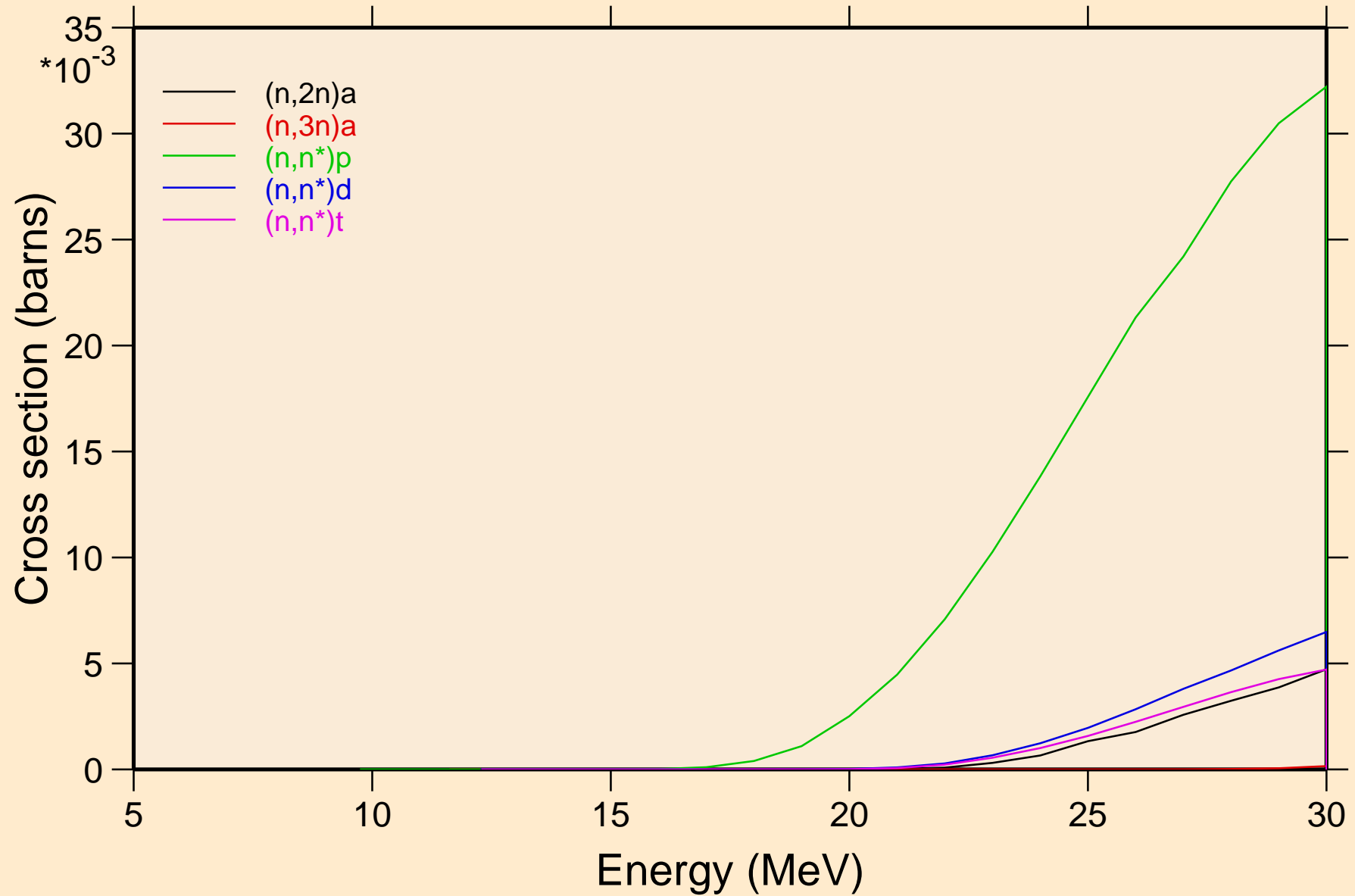

YB179 NEUTRON ACER TENDL-2021 LIBRARY; T=293.6K
Threshold reactions

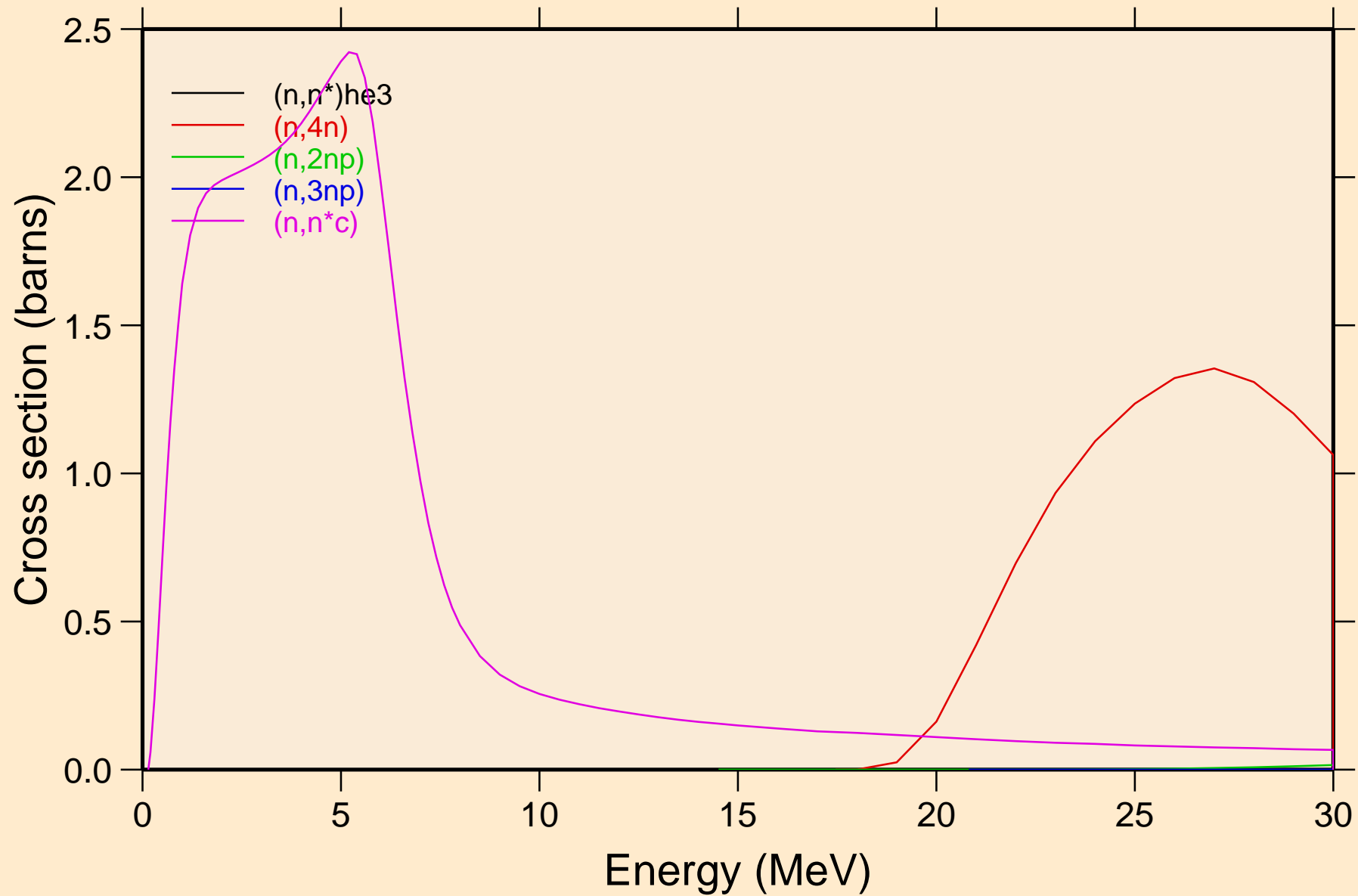

YB179 NEUTRON ACER TENDL-2021 LIBRARY; T=293.6K
Threshold reactions

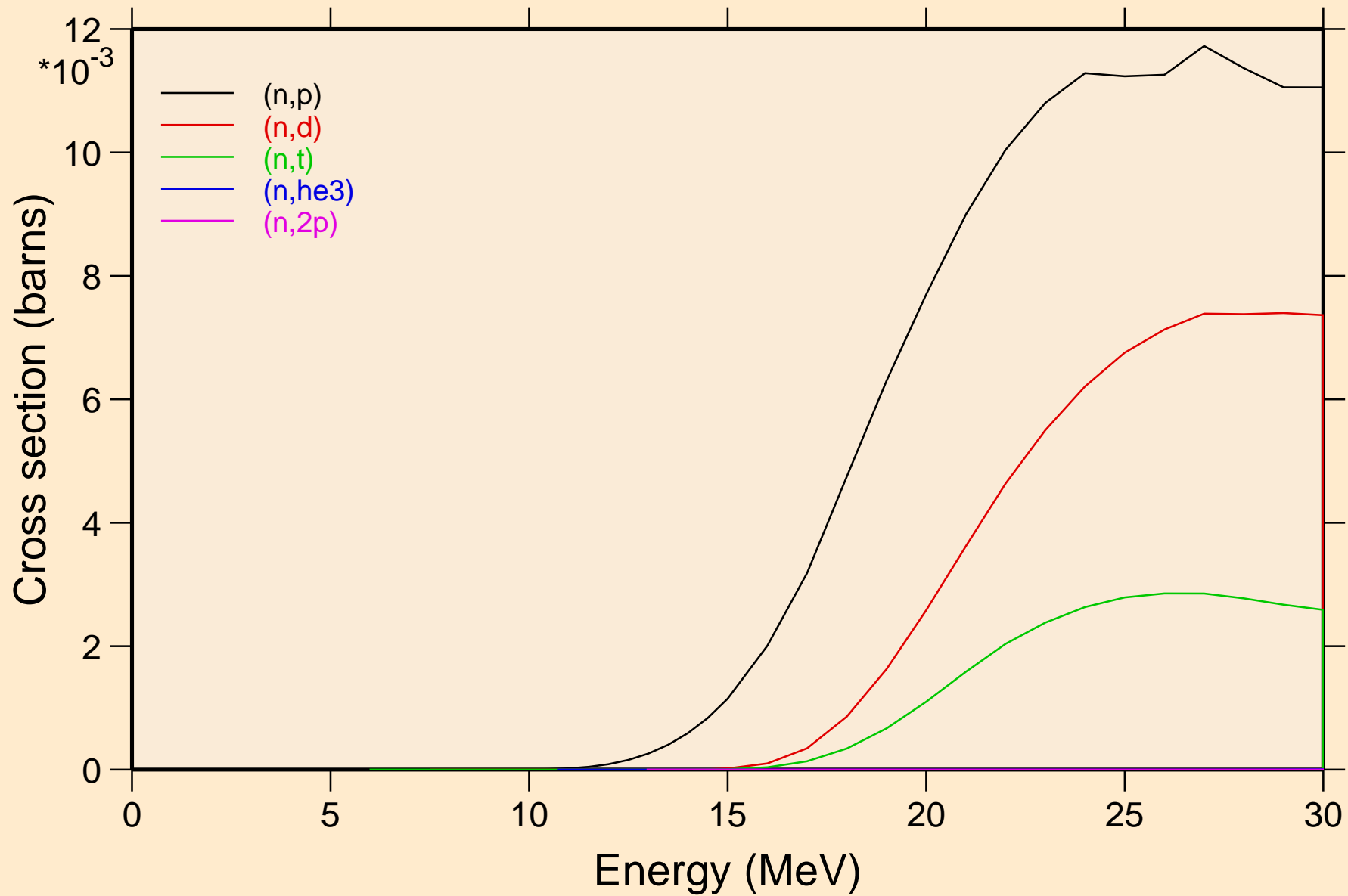

YB179 NEUTRON ACER TENDL-2021 LIBRARY; T=293.6K
Threshold reactions

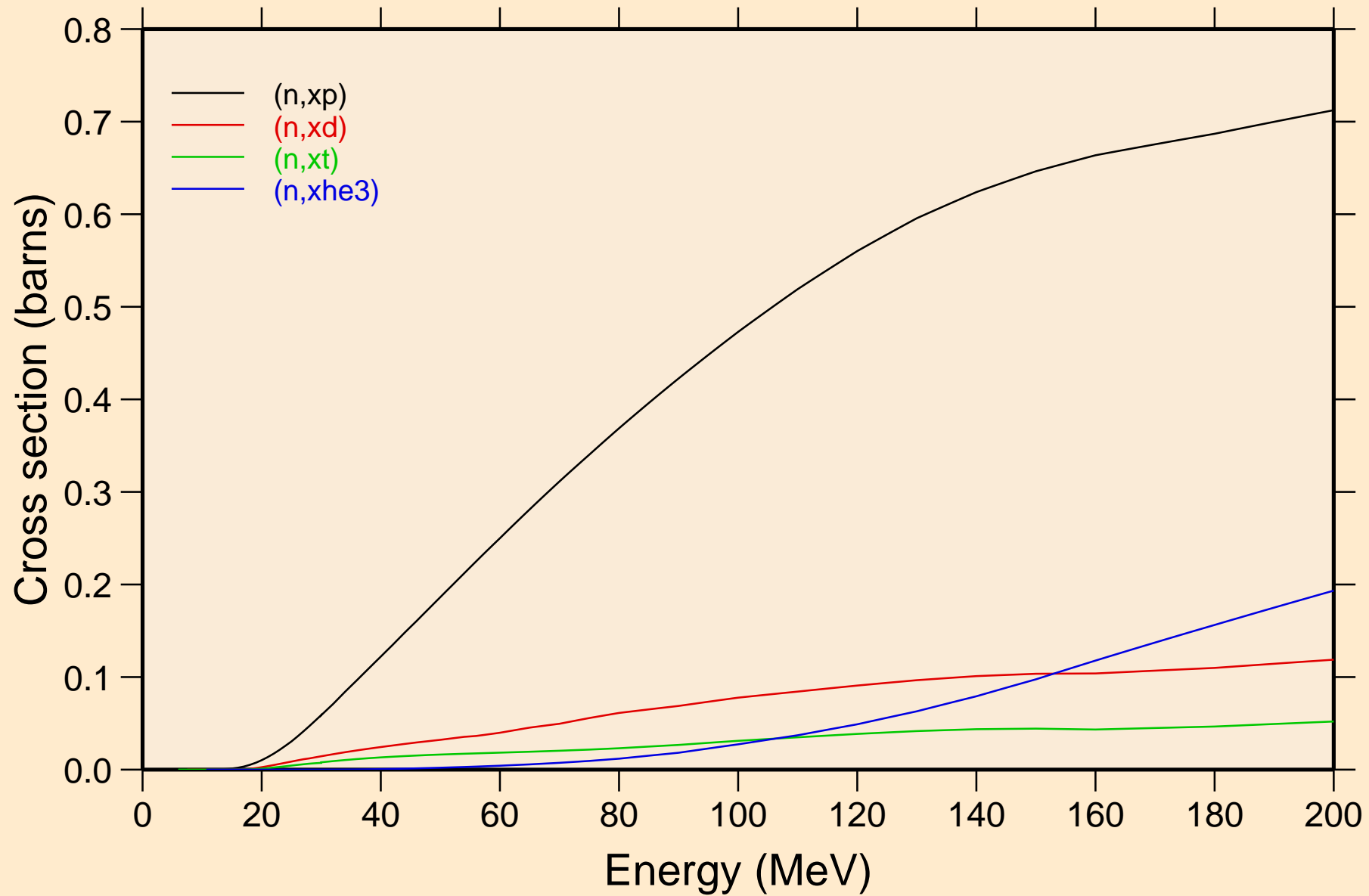

YB179 NEUTRON ACER TENDL-2021 LIBRARY; T=293.6K
angular distribution for elastic

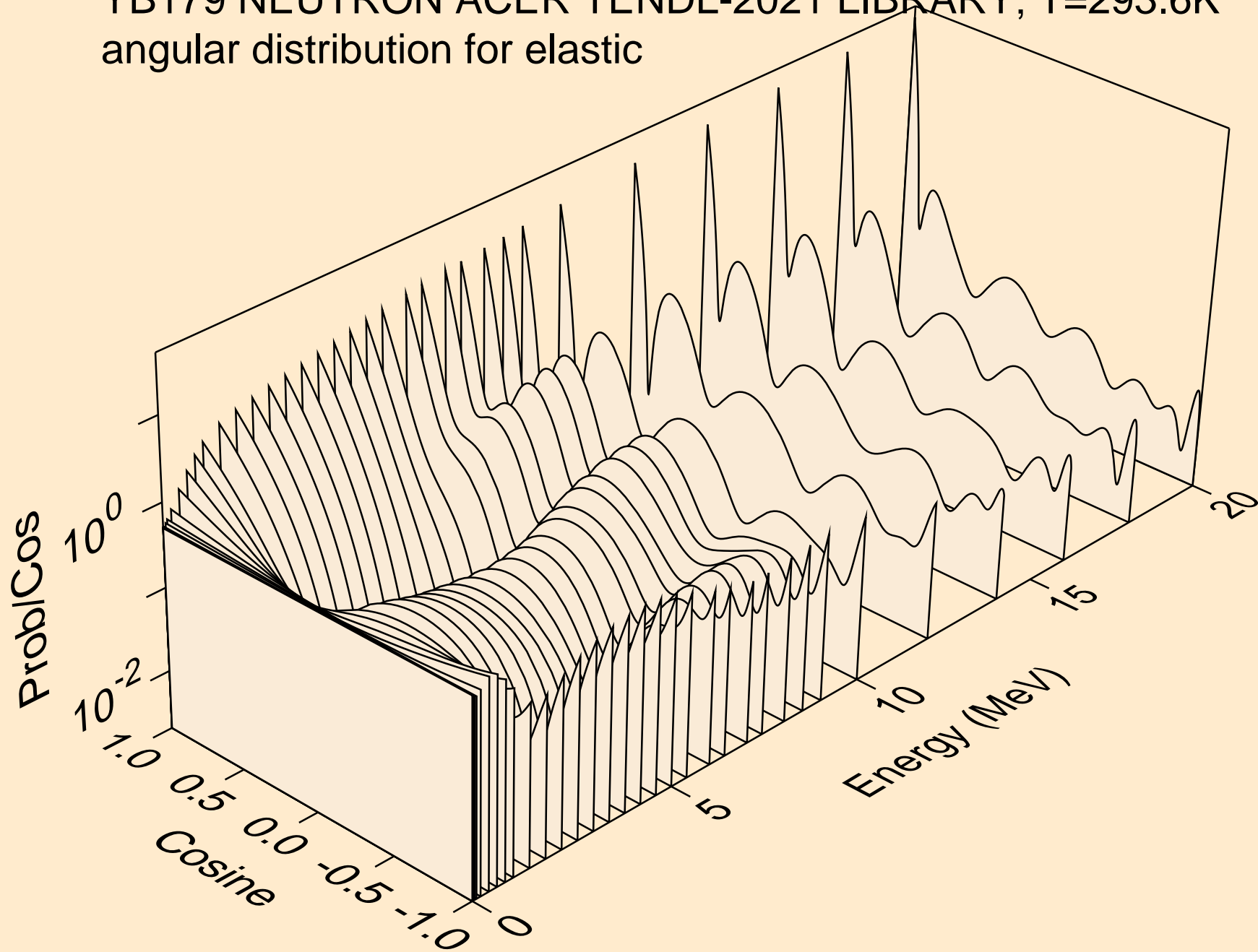

YB179 NEUTRON ACER TENDL-2021 LIBRARY; T=293.6K
angular distribution for elastic

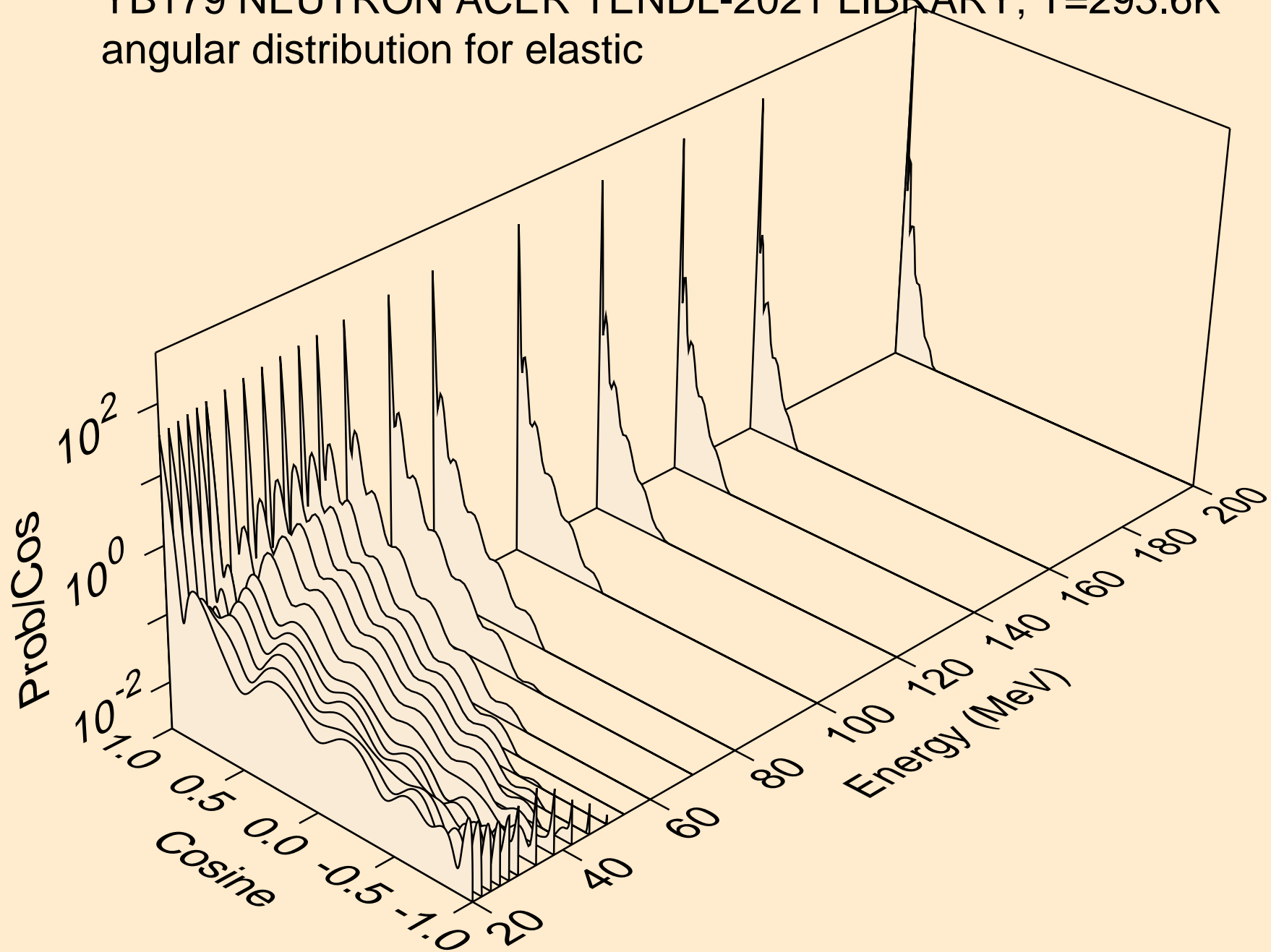

YB179 NEUTRON ACER TENDL-2021 LIBRARY; T=293.6K
angular distribution for (n,n*1)

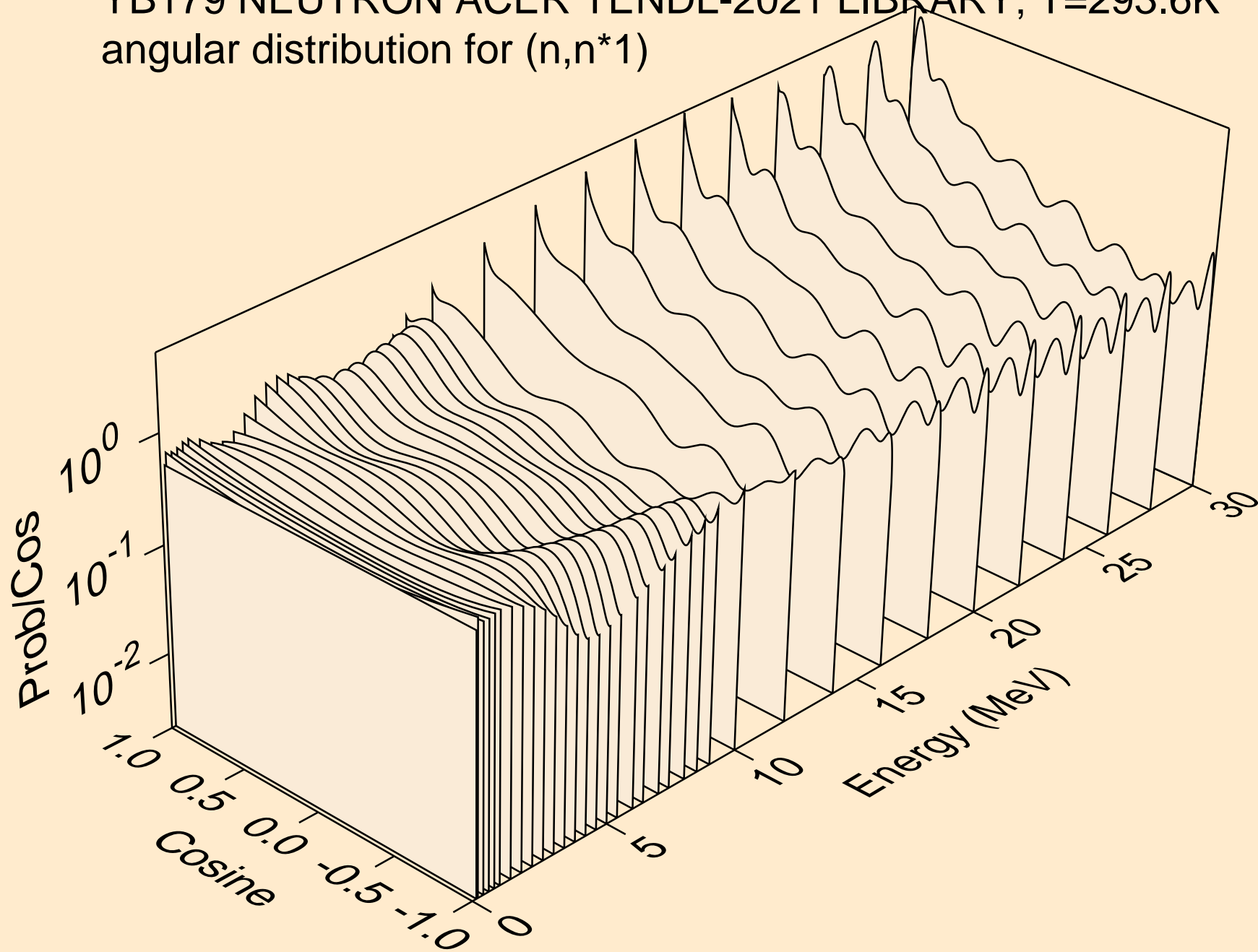

YB179 NEUTRON ACER TENDL-2021 LIBRARY; T=293.6K
Neutron emission for (n,x)

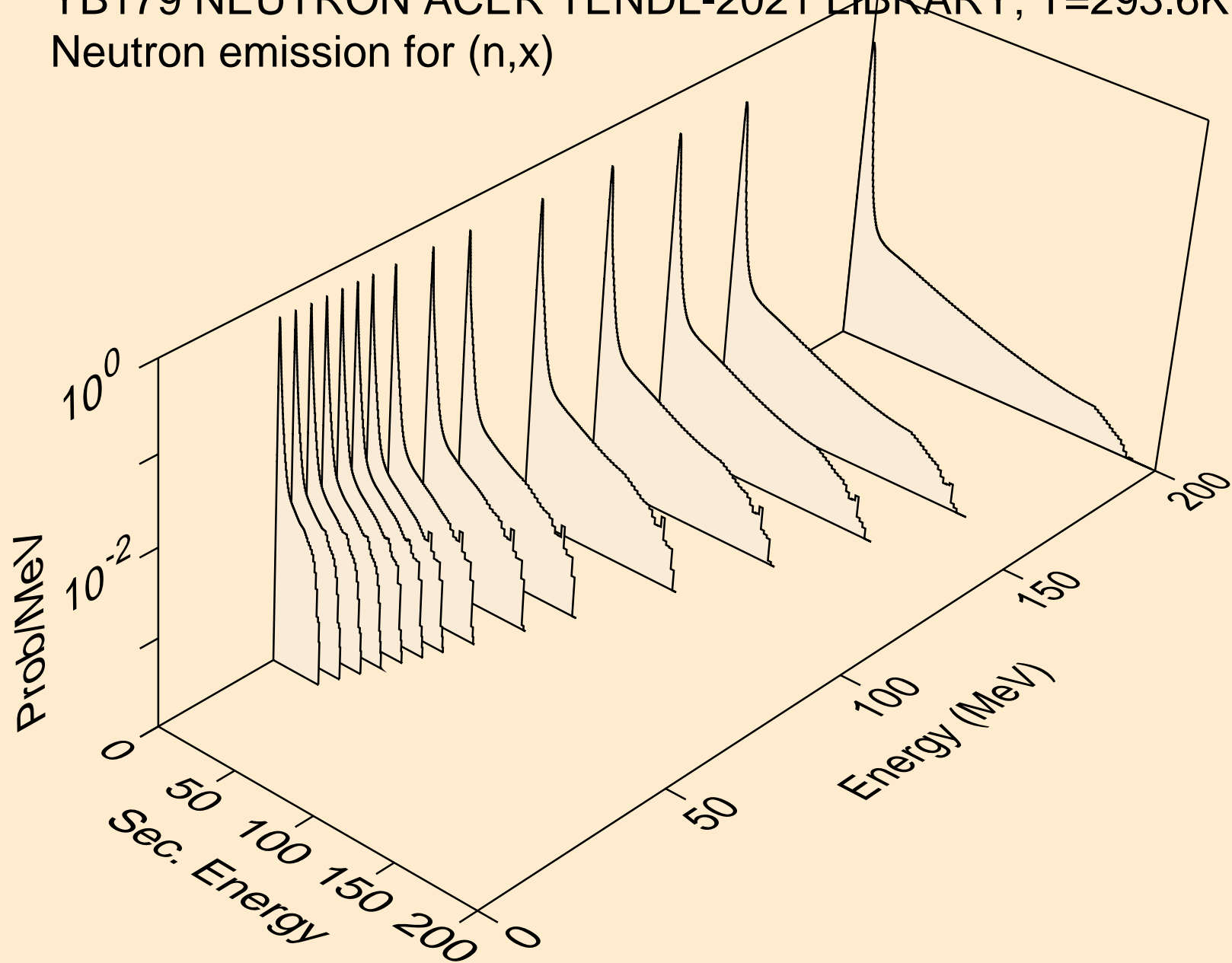

YB179 NEUTRON ACER TENDL-2021 LIBRARY; T=293.6K
Neutron emission for (n,2nd)

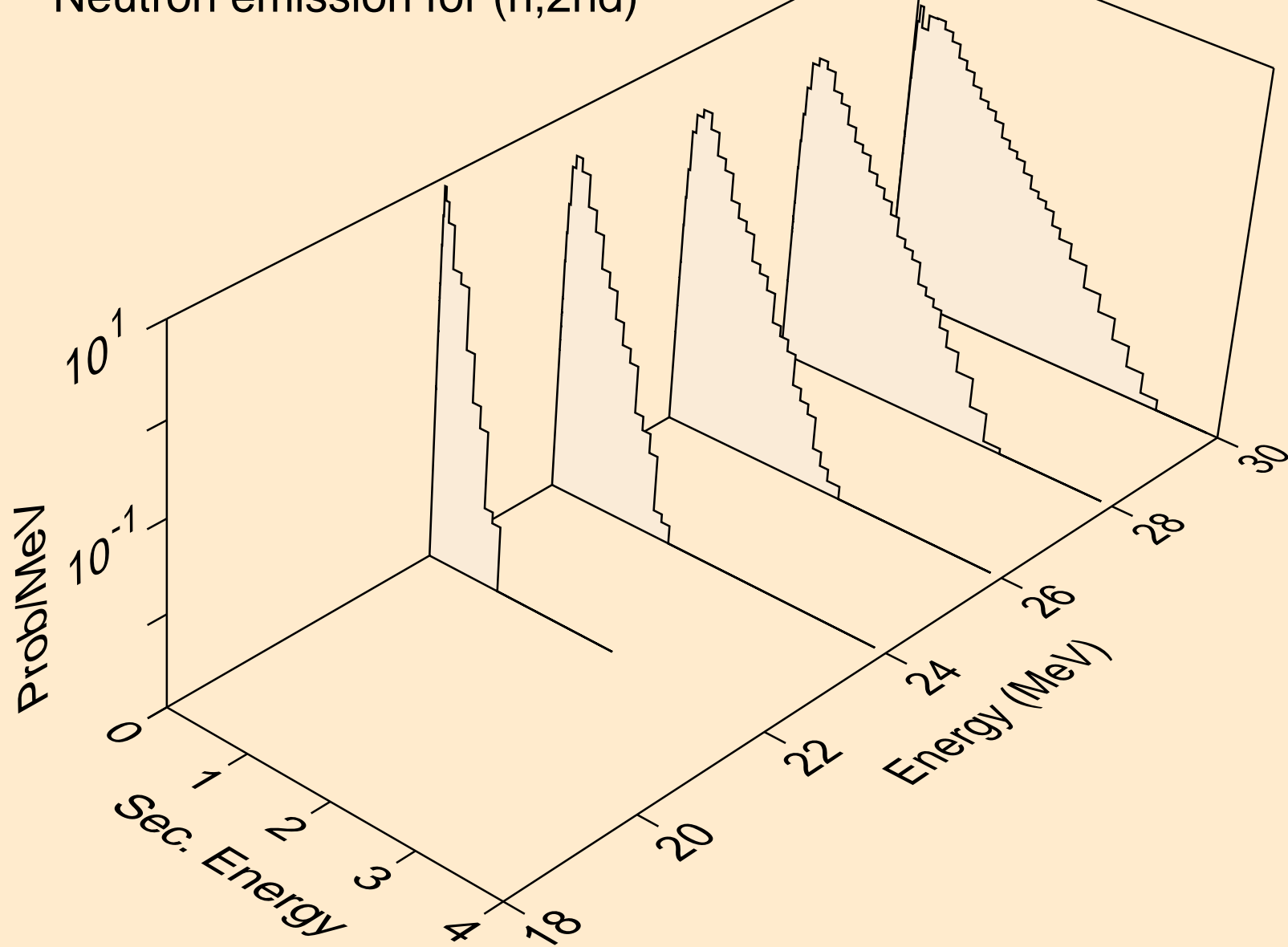

YB179 NEUTRON ACER TENDL-2021 LIBRARY; T=293.6K
Neutron emission for (n,2n)

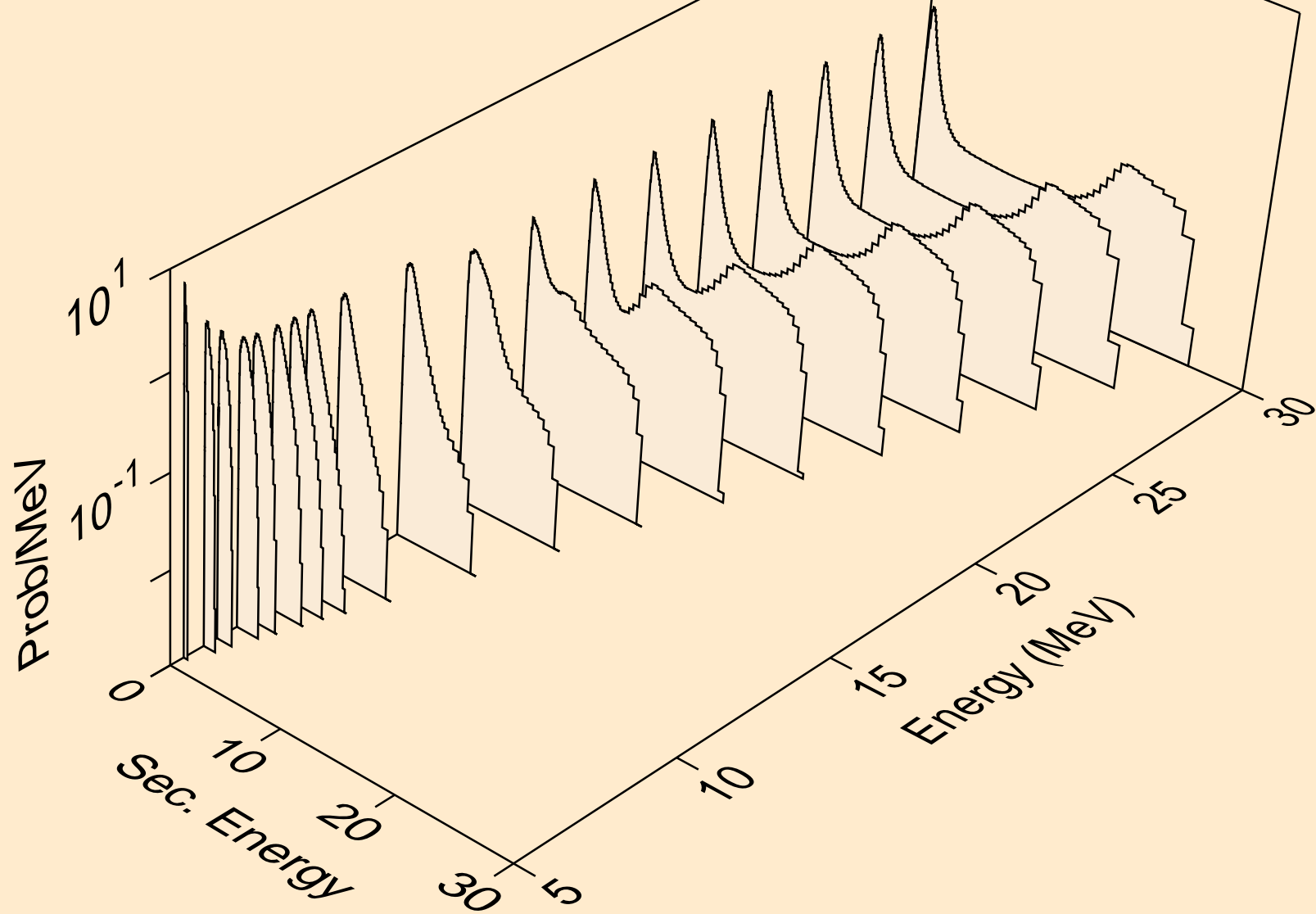

YB179 NEUTRON ACER TENDL-2021 LIBRARY; T=293.6K
Neutron emission for (n,3n)

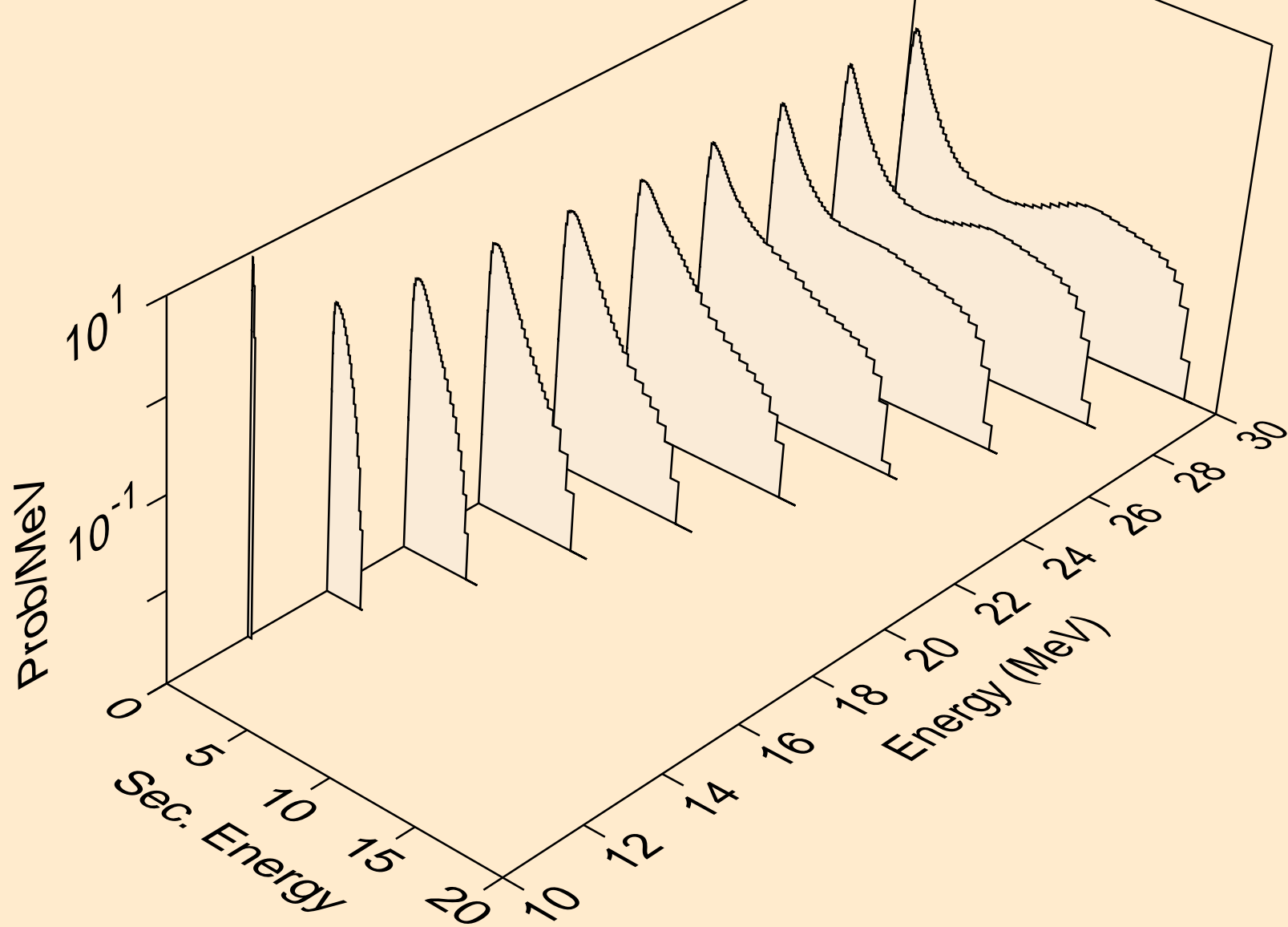

YB179 NEUTRON ACER TENDL-2021 LIBRARY; T=293.6K
Neutron emission for (n,n*)a

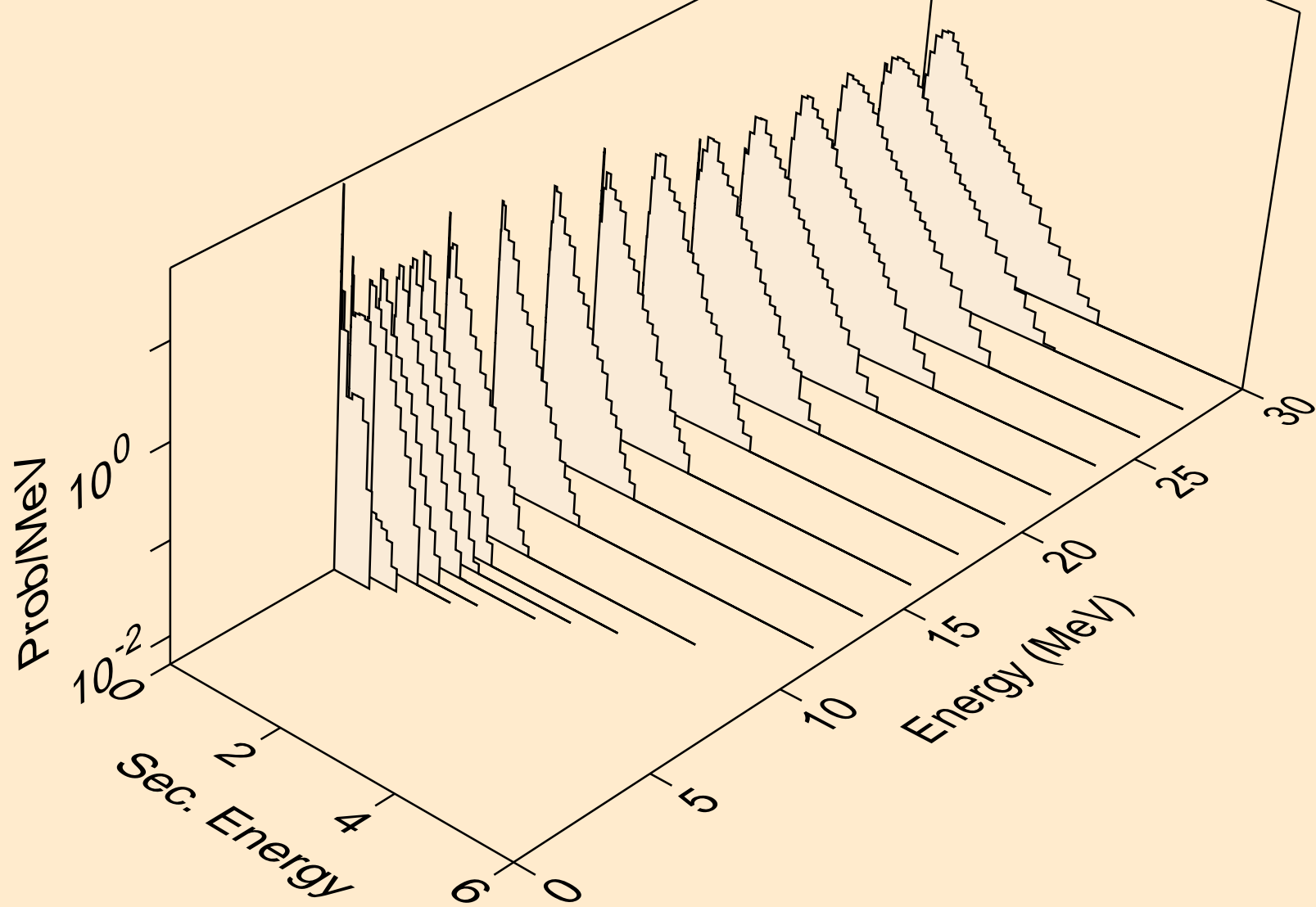

YB179 NEUTRON ACER TENDL-2021 LIBRARY; T=293.6K
Neutron emission for (n,2n)_a

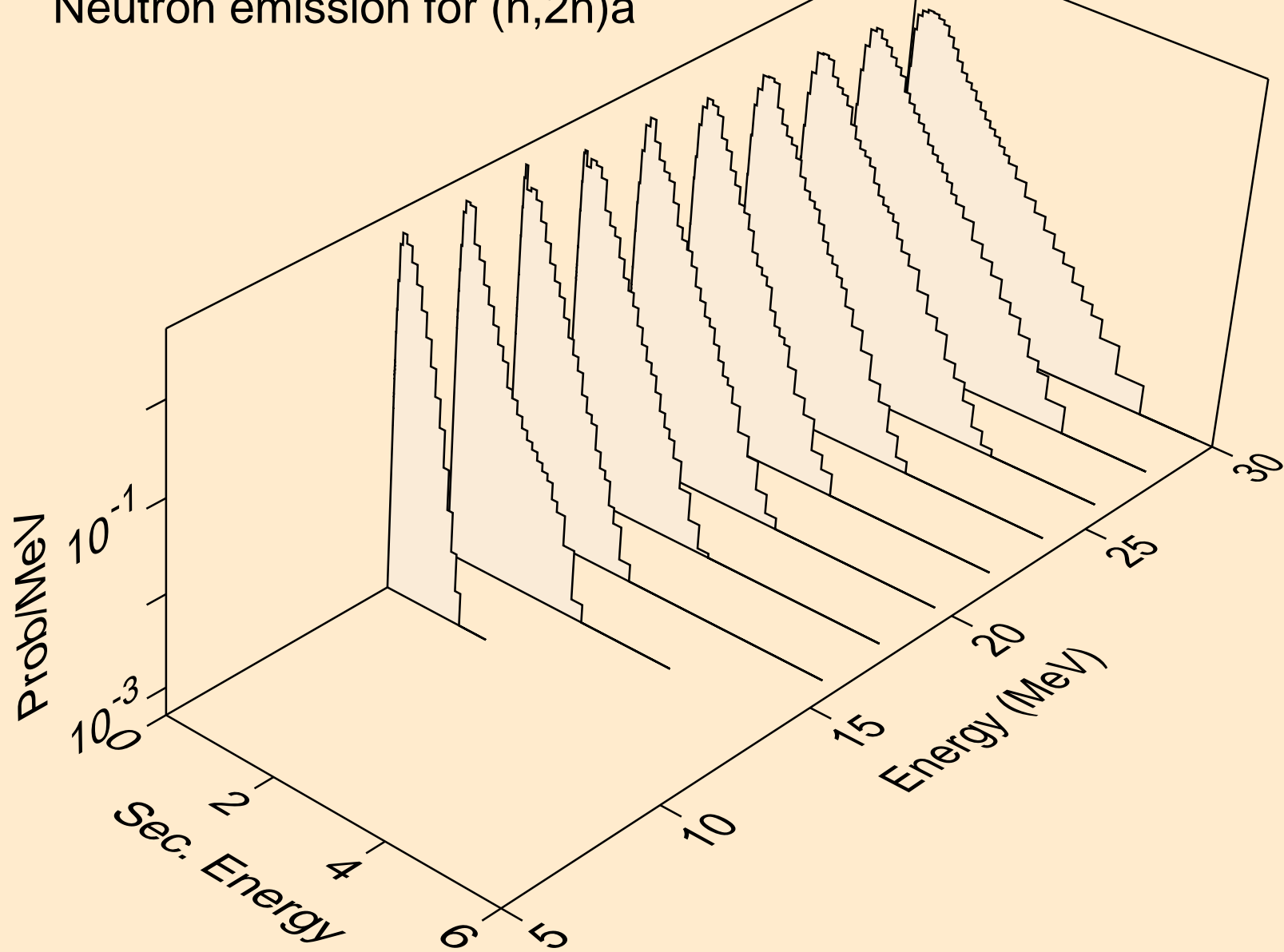

YB179 NEUTRON ACER TENDL-2021 LIBRARY; T=293.6K
Neutron emission for (n,3n)_a

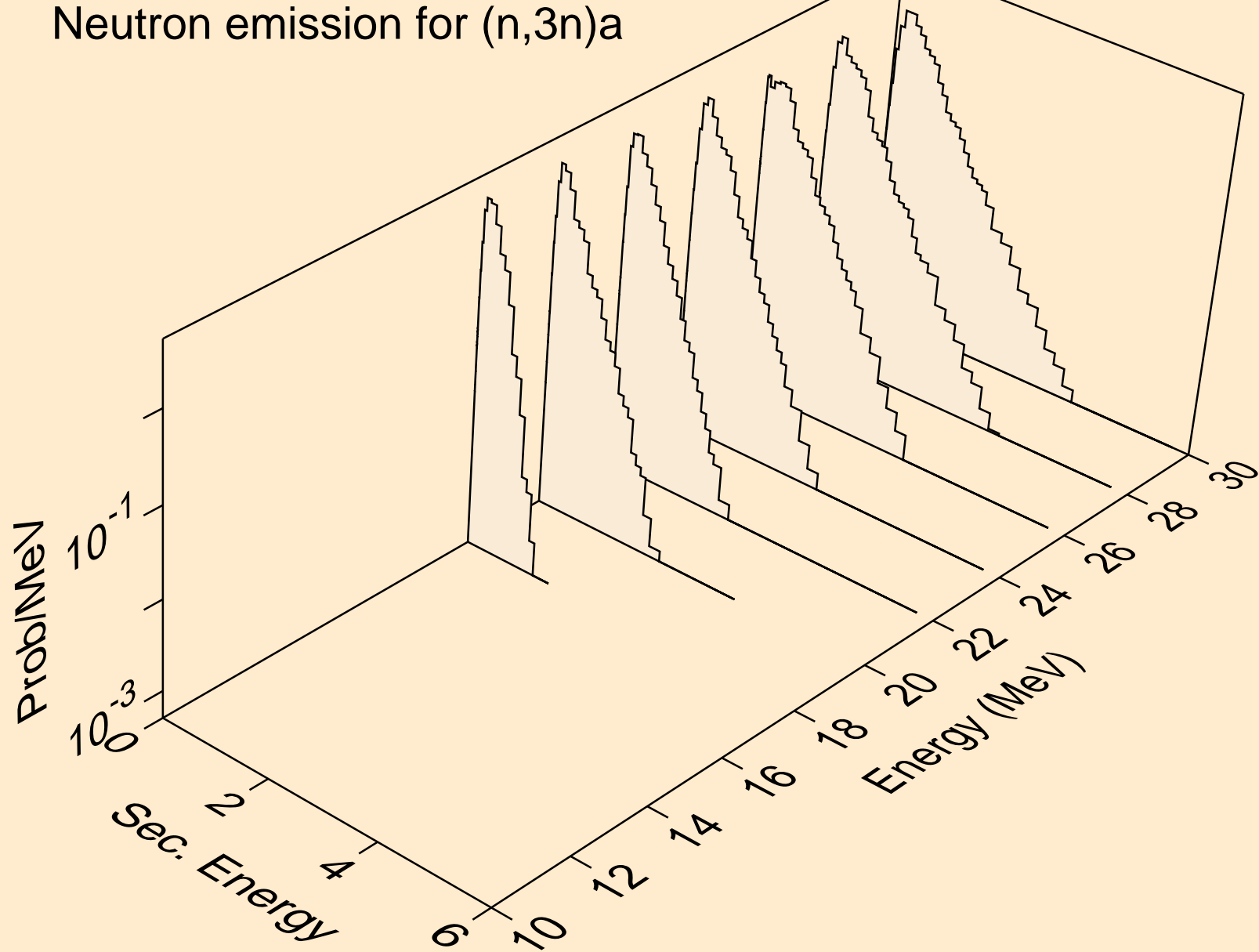

YB179 NEUTRON ACER TENDL-2021 LIBRARY; T=293.6K
Neutron emission for (n,n*)p

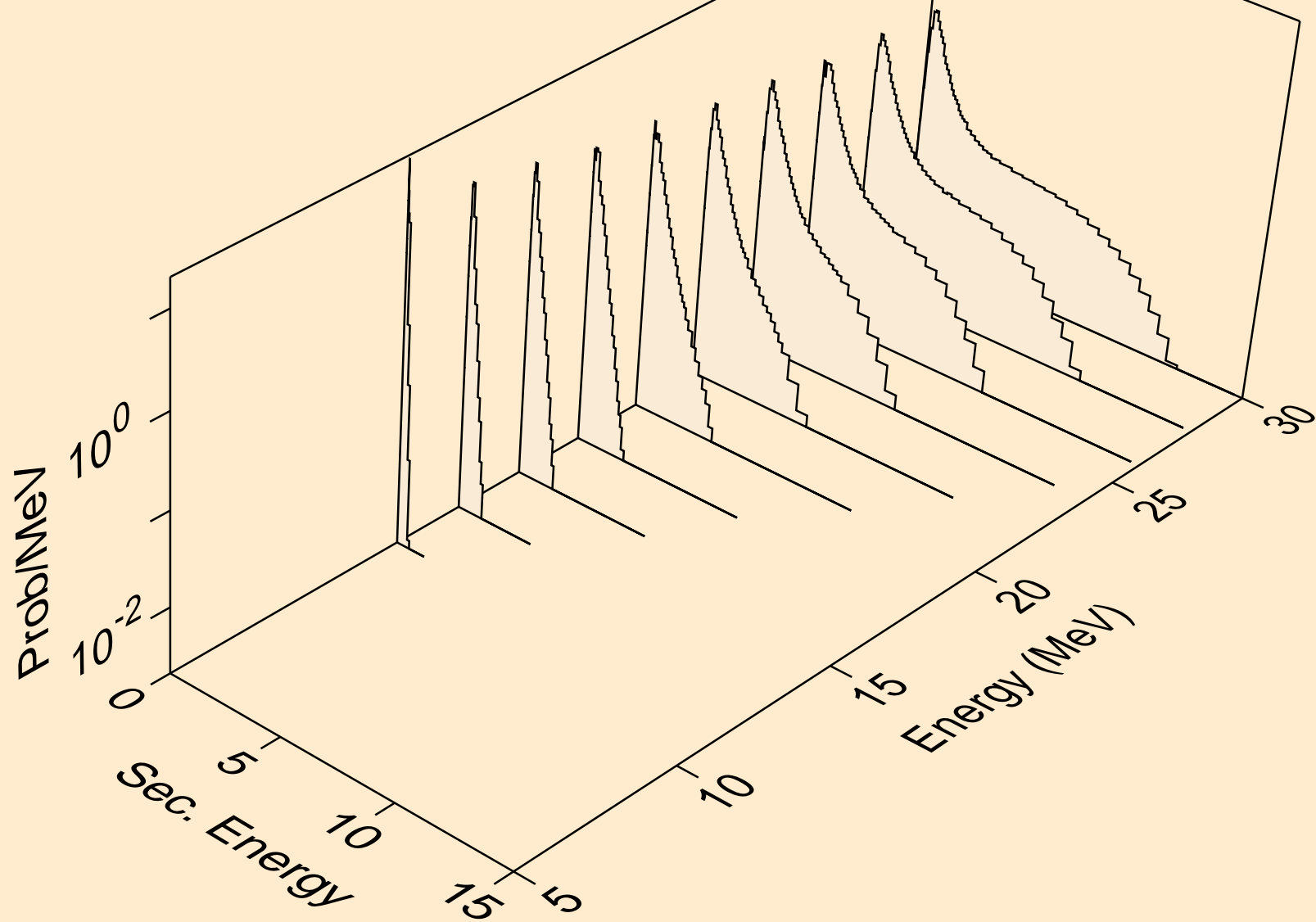

YB179 NEUTRON ACER TENDL-2021 LIBRARY; T=293.6K
Neutron emission for (n,n*)d

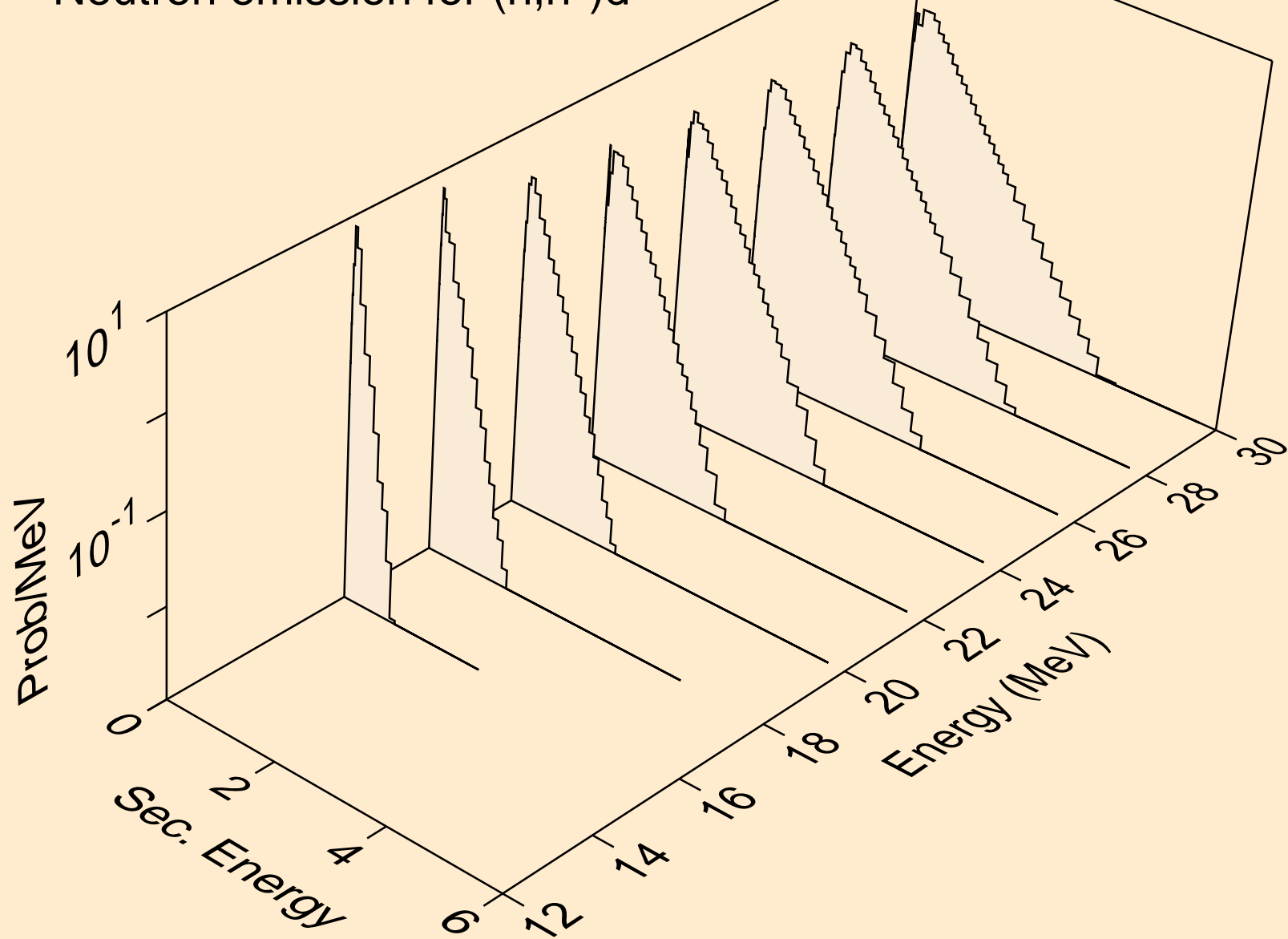

YB179 NEUTRON ACER TENDL-2021 LIBRARY; T=293.6K
Neutron emission for (n,n*)t

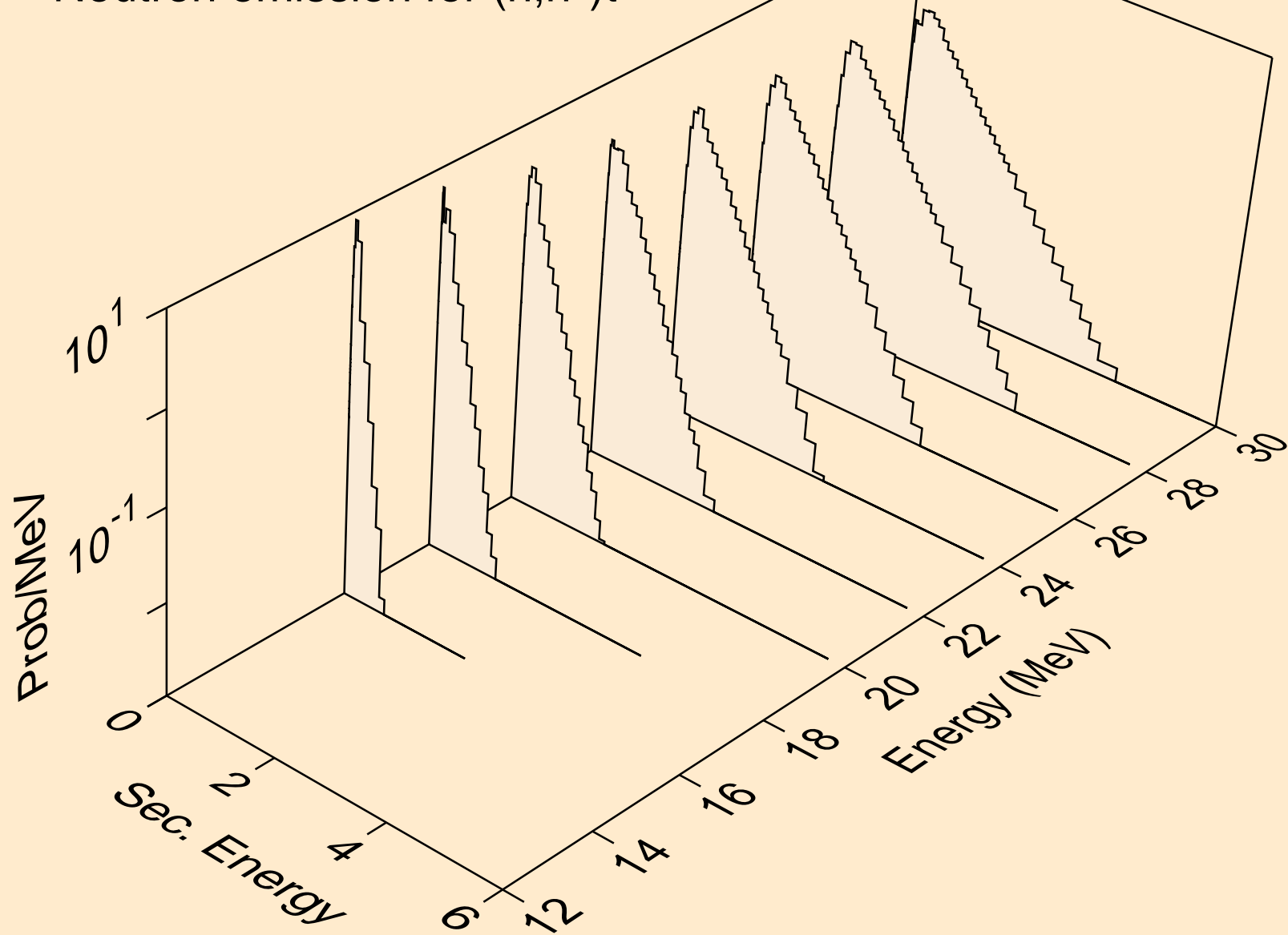

YB179 NEUTRON ACER TENDL-2021 LIBRARY; T=293.6K
Neutron emission for (n,n*)he3

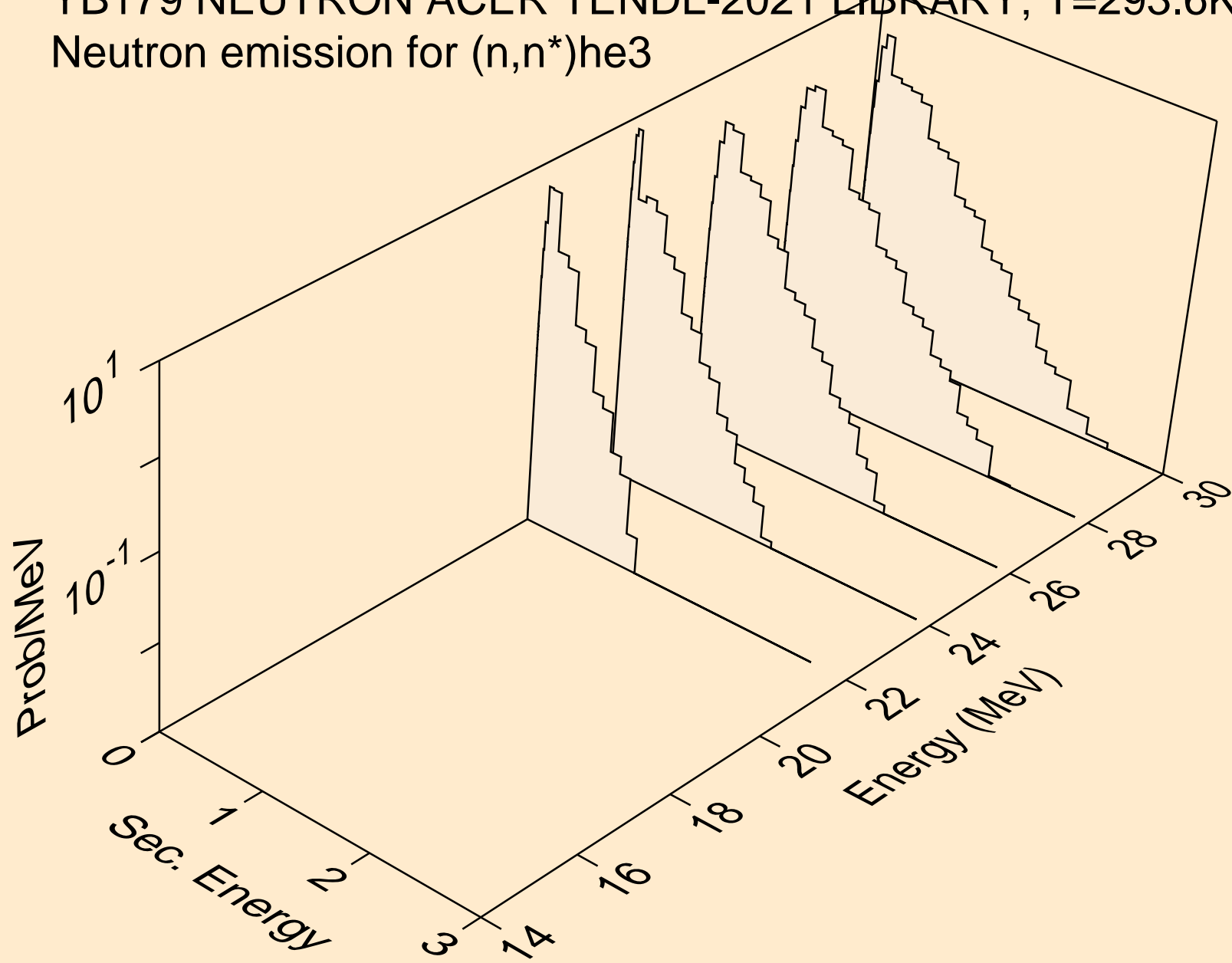

YB179 NEUTRON ACER TENDL-2021 LIBRARY; T=293.6K
Neutron emission for (n,4n)

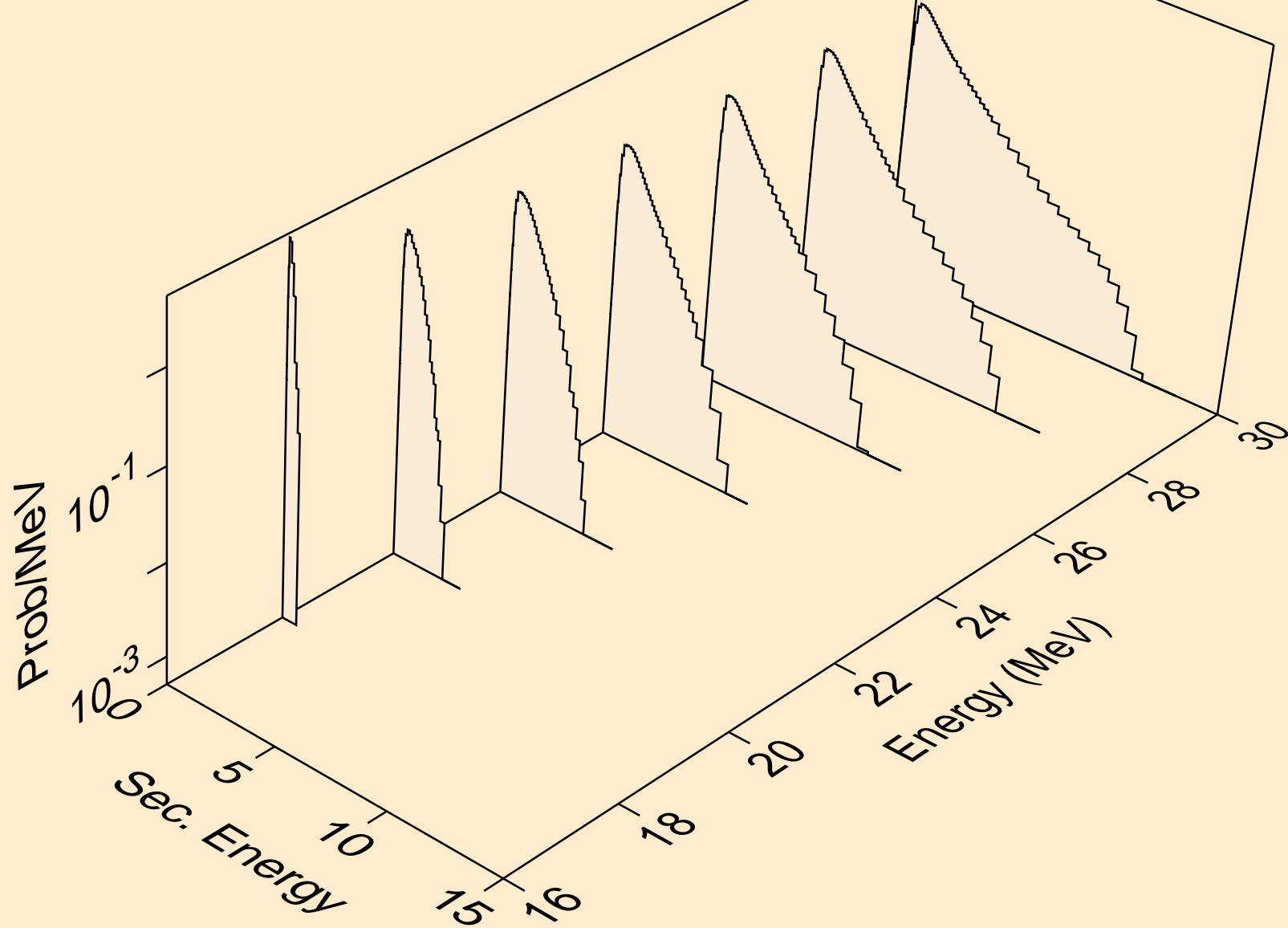

YB179 NEUTRON ACER TENDL-2021 LIBRARY; T=293.6K
Neutron emission for (n,2np)

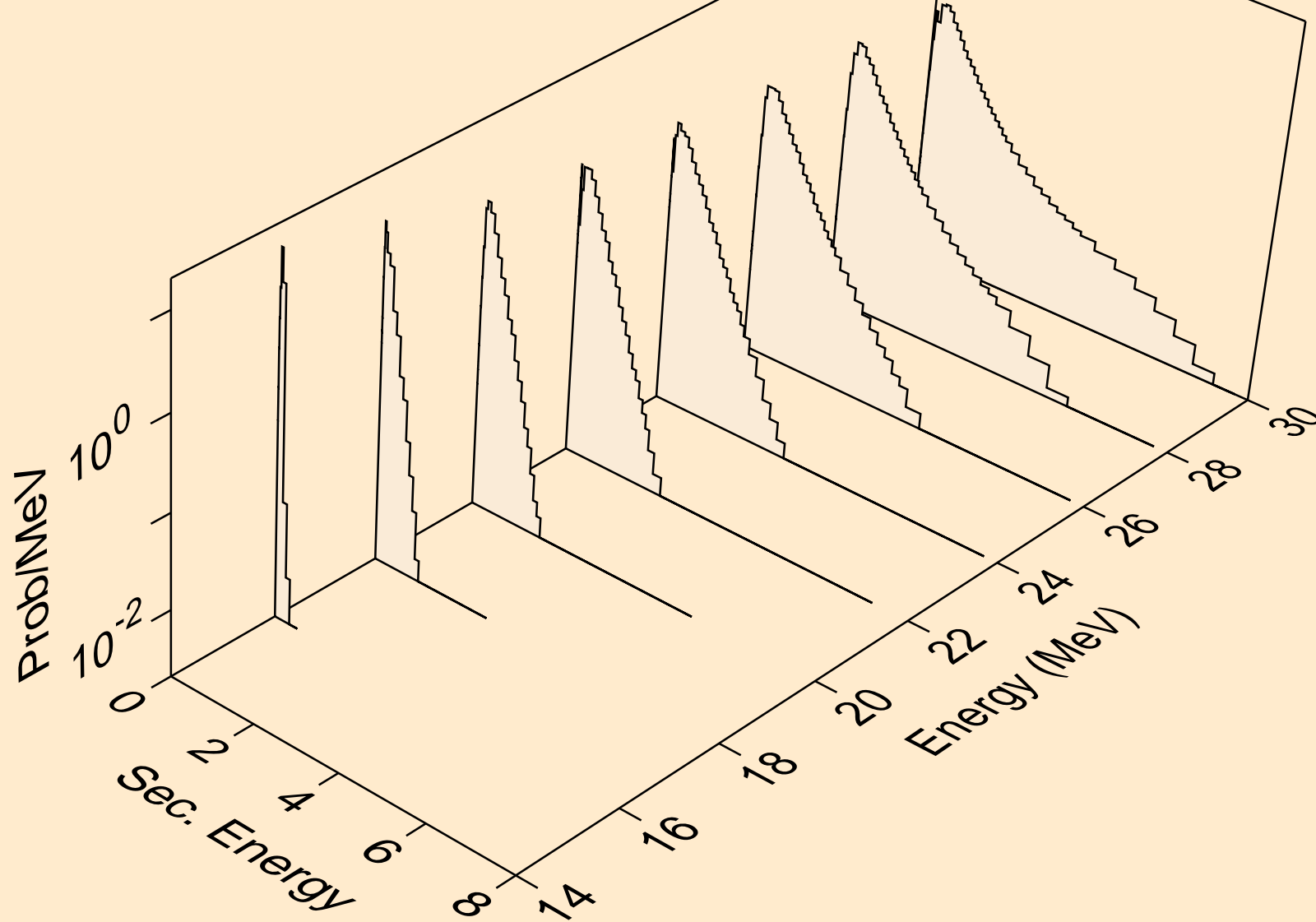

YB179 NEUTRON ACER TENDL-2021 LIBRARY; T=293.6K
Neutron emission for (n,3np)

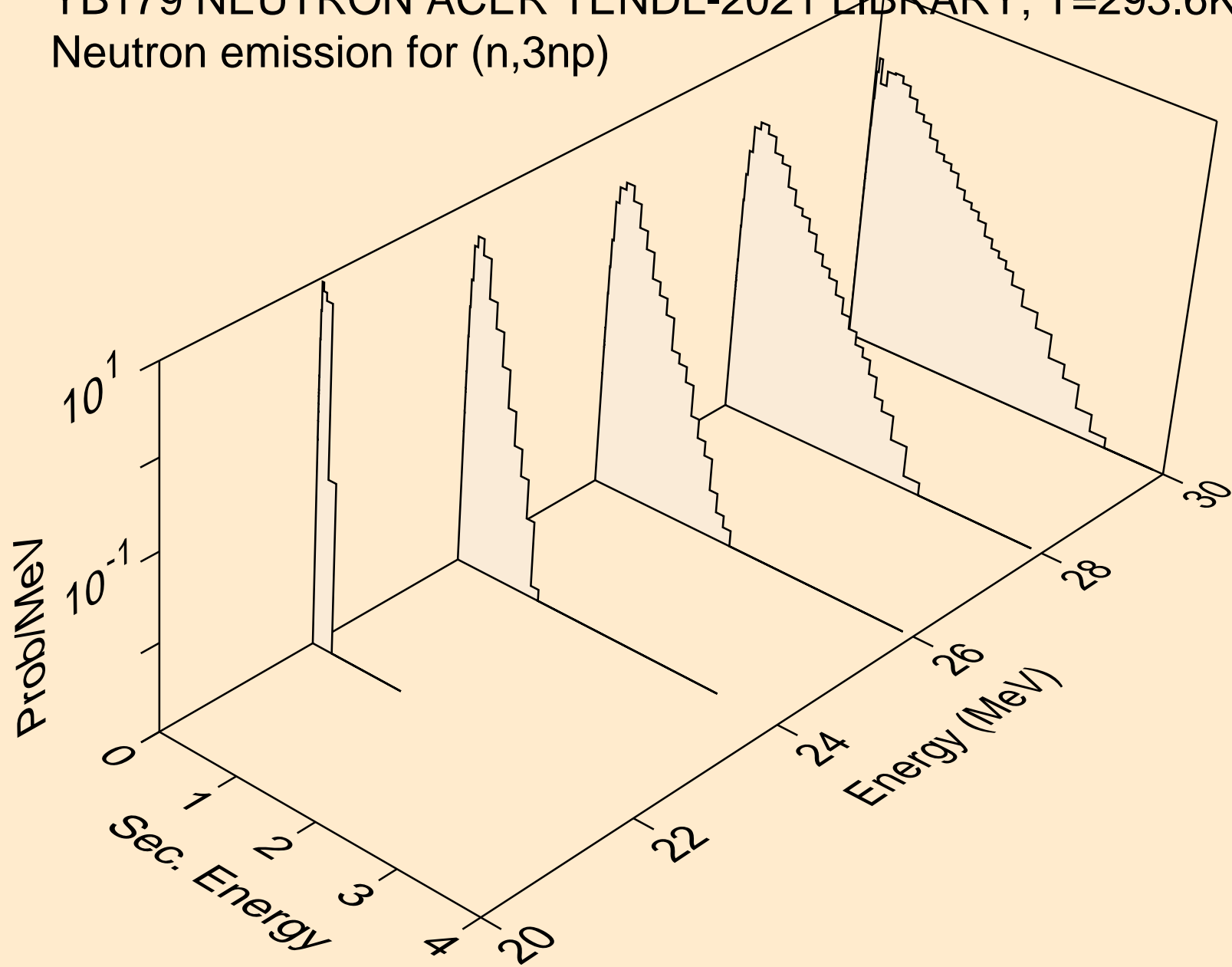

YB179 NEUTRON ACER TENDL-2021 LIBRARY; T=293.6K
Neutron emission for (n,n*c)

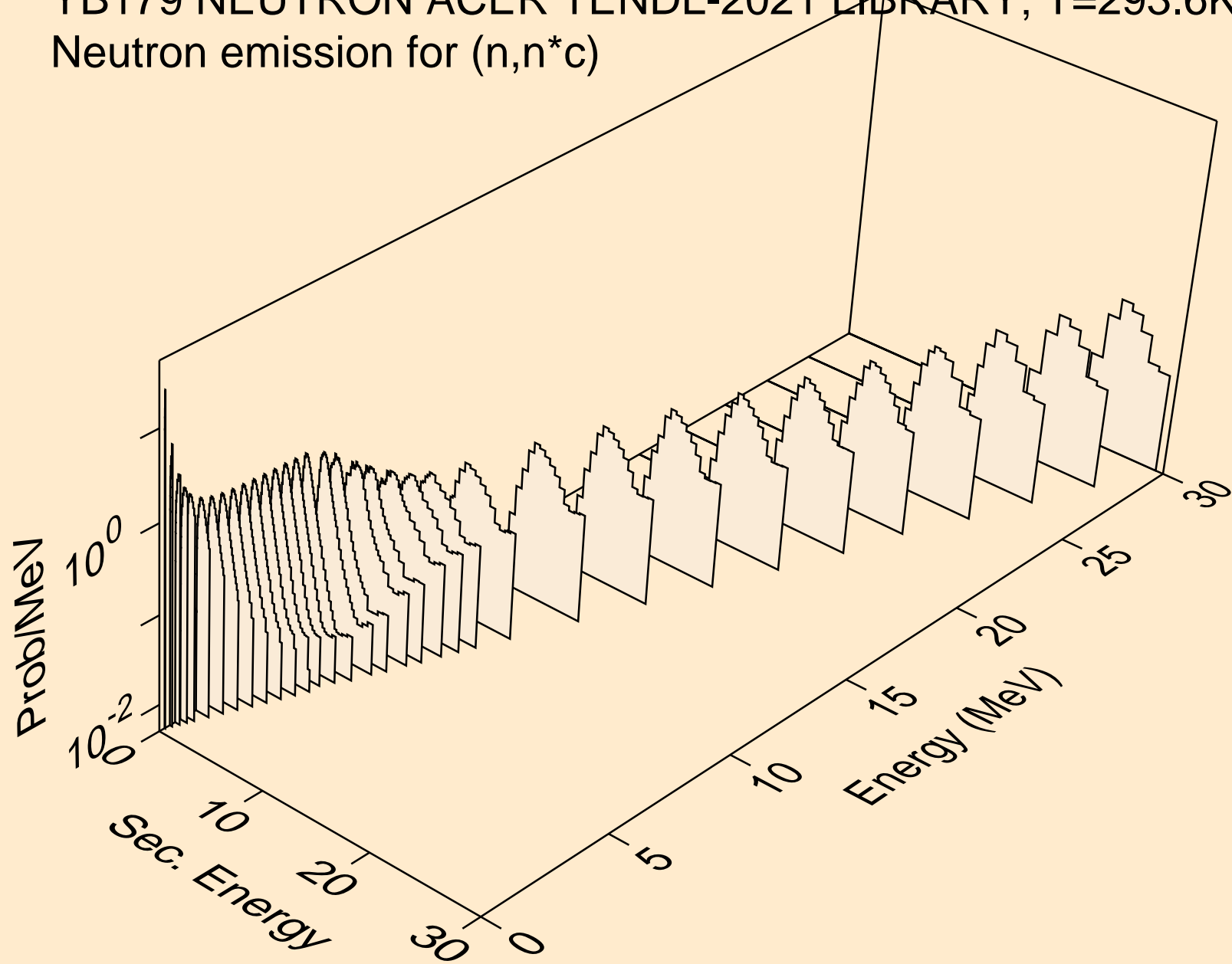

YB179 NEUTRON ACER TENDL-2021 LIBRARY; T=293.6K
Photon emission for (n,x)

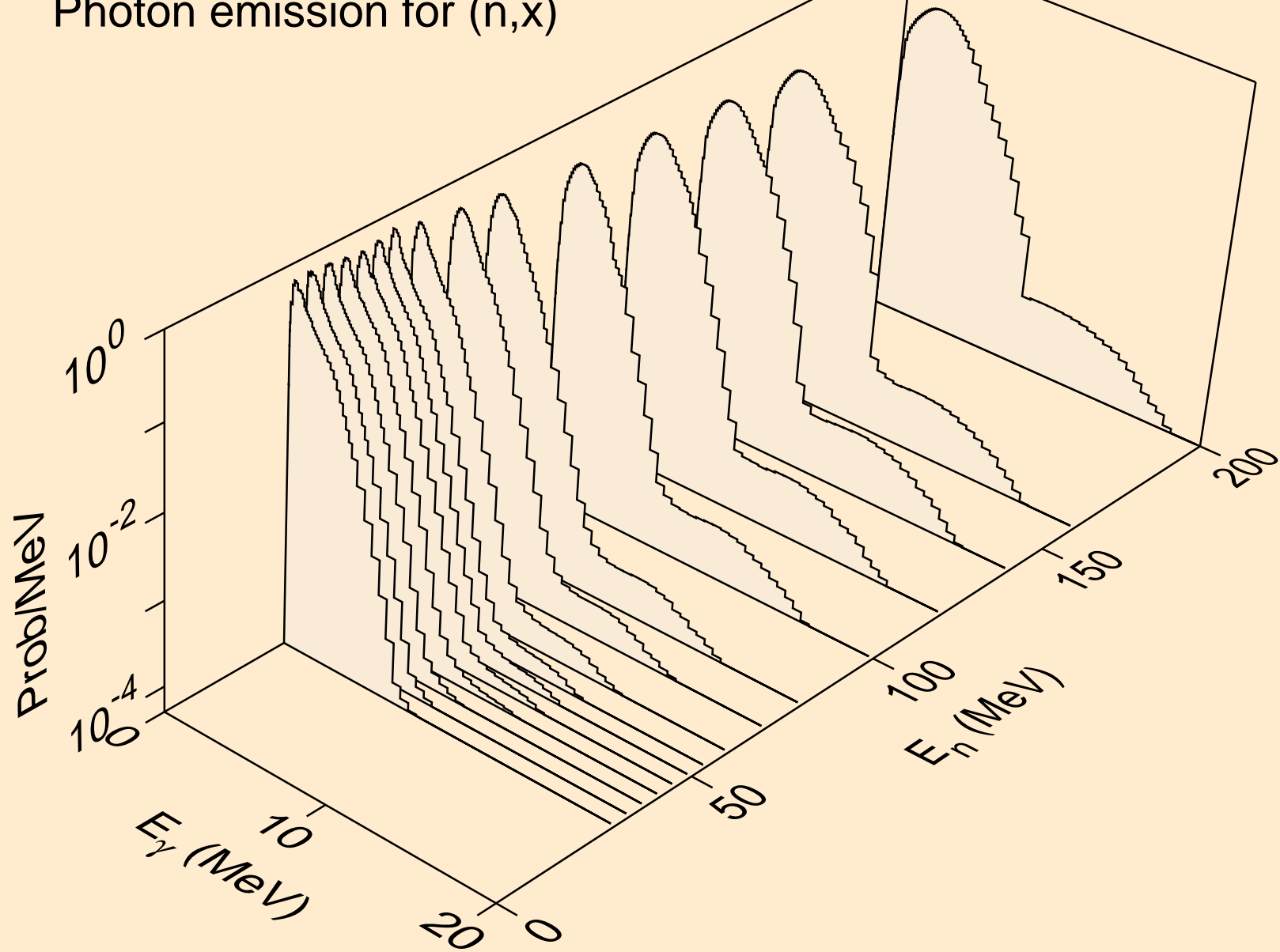

YB179 NEUTRON ACER TENDL-2021 LIBRARY; T=293.6K
Photon emission for (n,2nd)

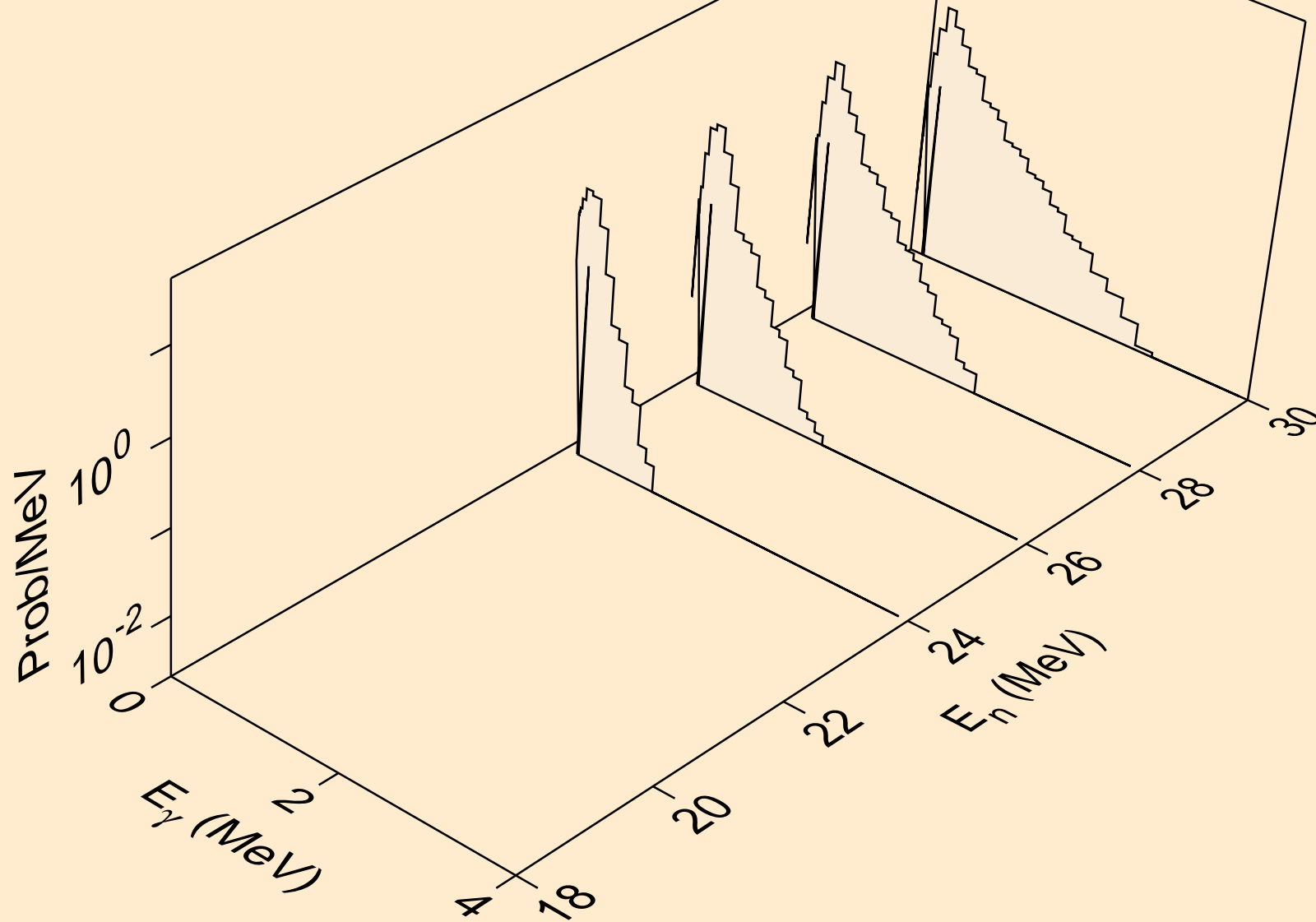

YB179 NEUTRON ACER TENDL-2021 LIBRARY; T=293.6K
Photon emission for (n,2n)

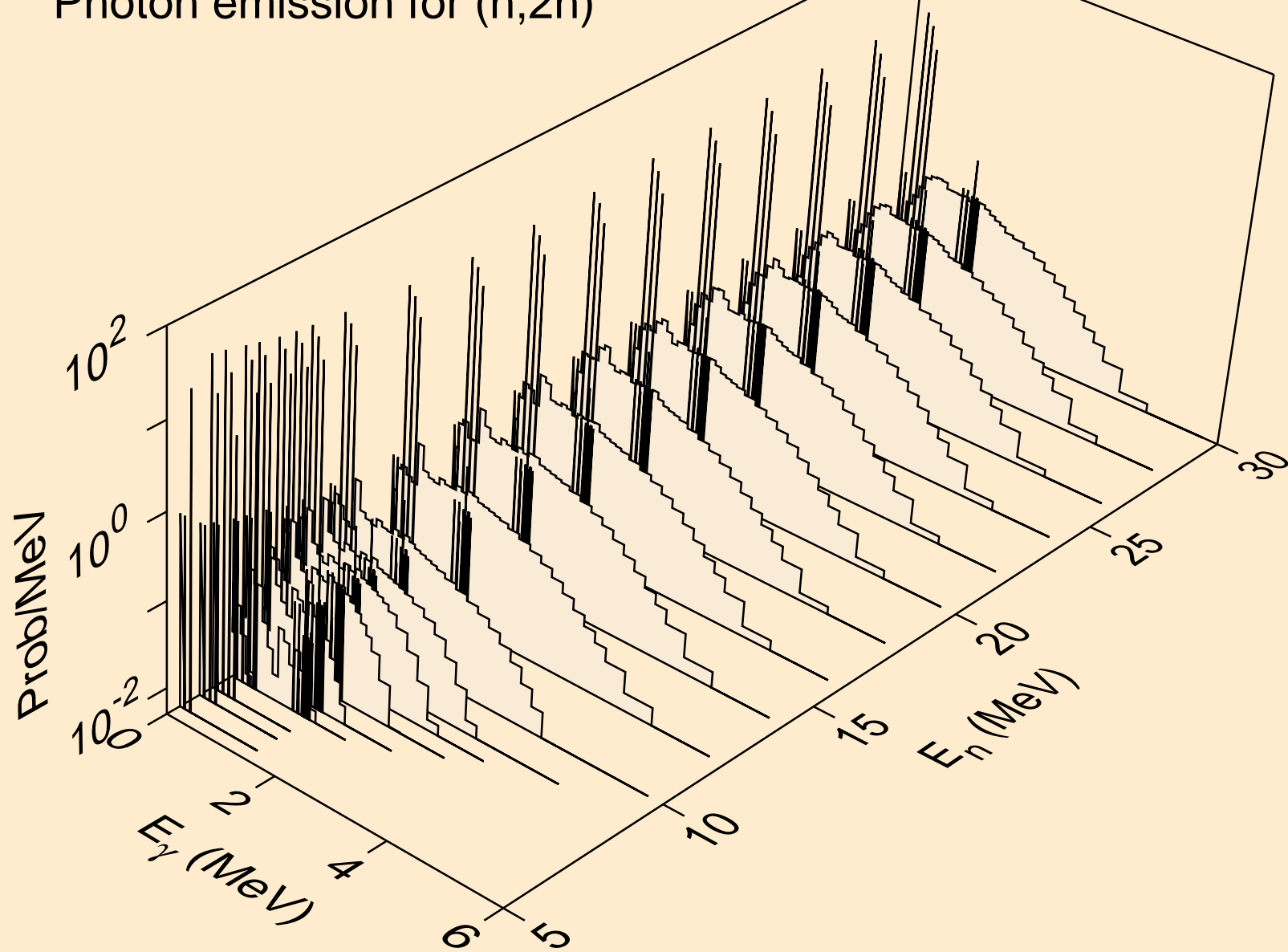

YB179 NEUTRON ACER TENDL-2021 LIBRARY; T=293.6K
Photon emission for (n,3n)

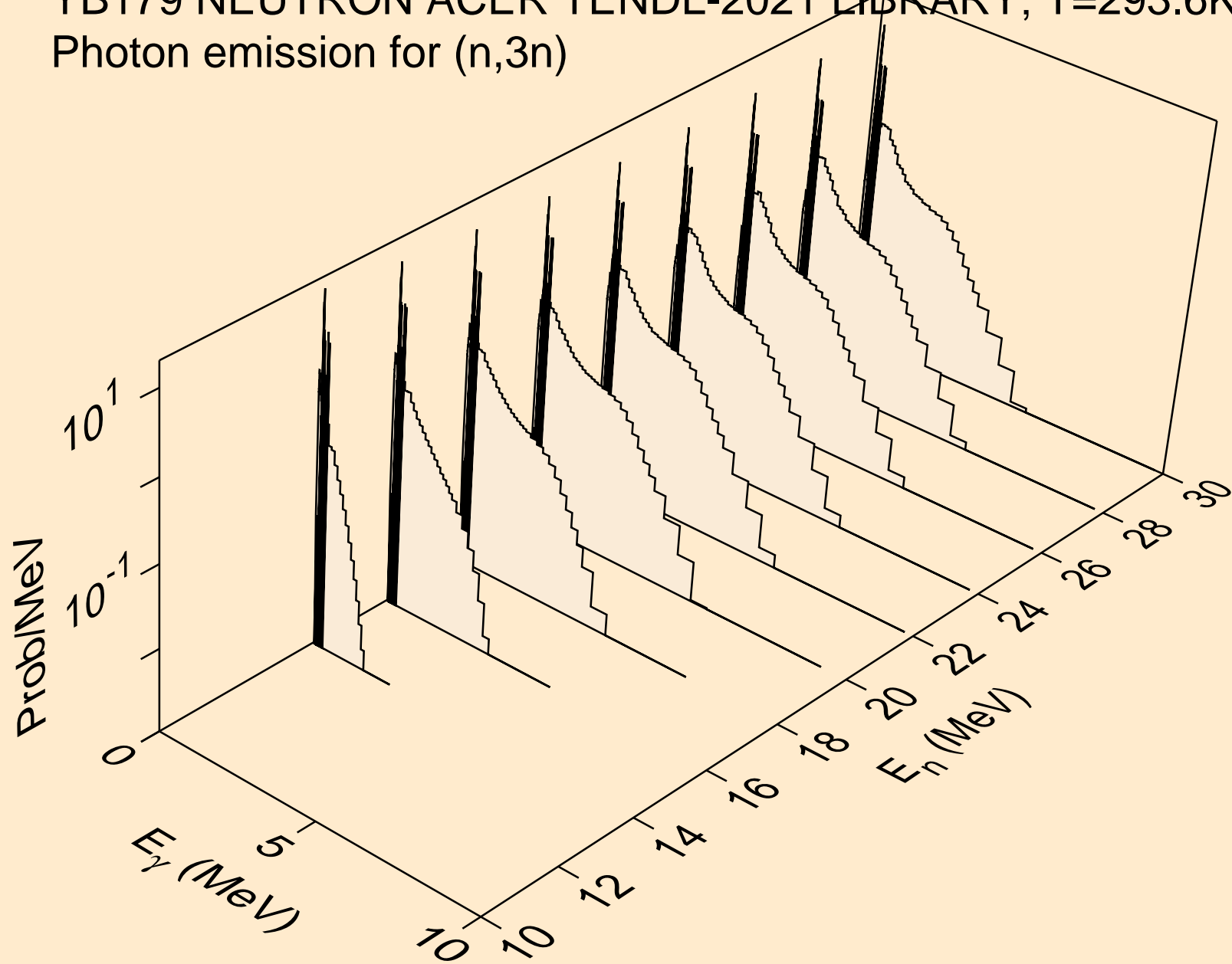

YB179 NEUTRON ACER TENDL-2021 LIBRARY; T=293.6K
Photon emission for (n,n*)a

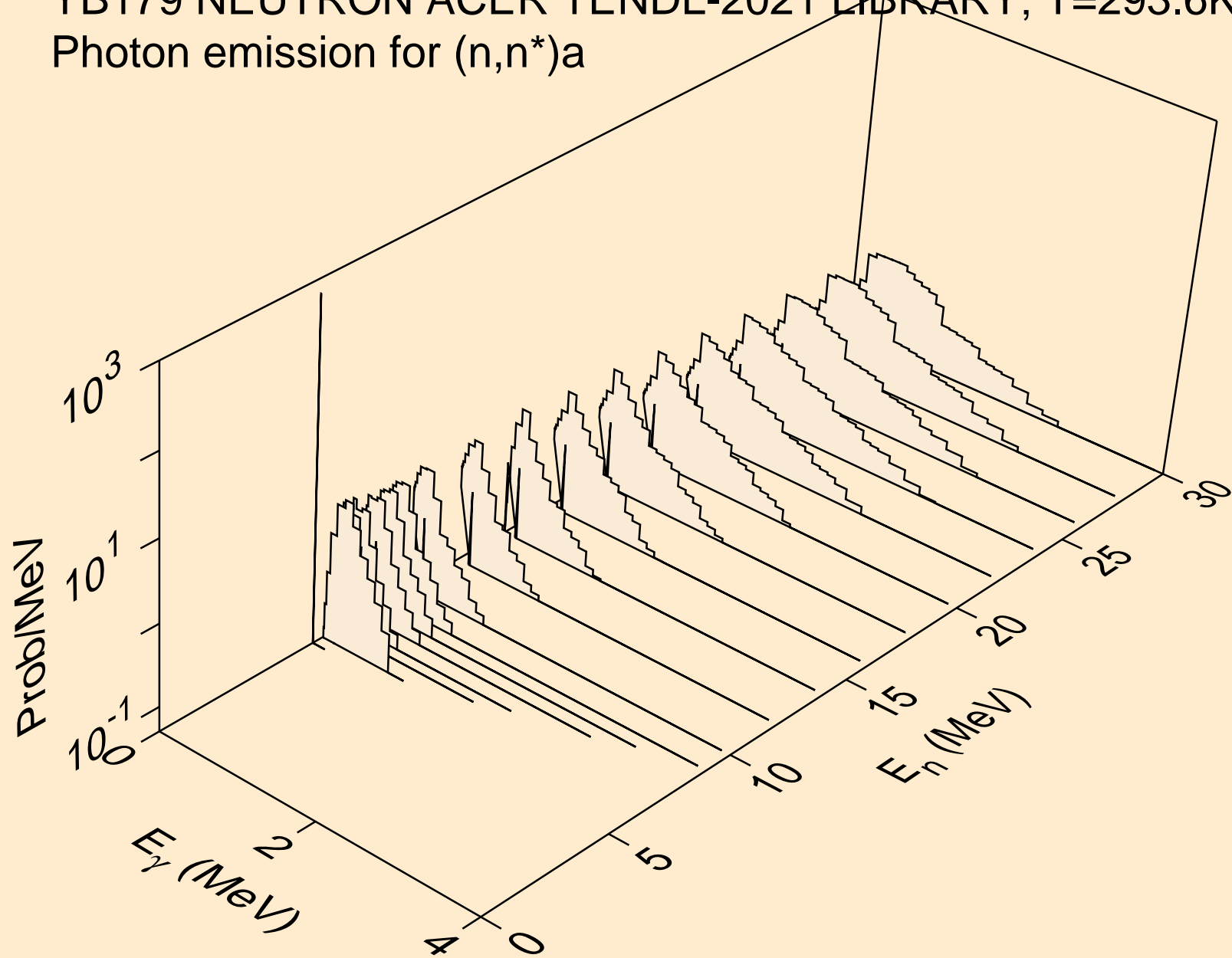

YB179 NEUTRON ACER TENDL-2021 LIBRARY; T=293.6K
Photon emission for (n,2n)a

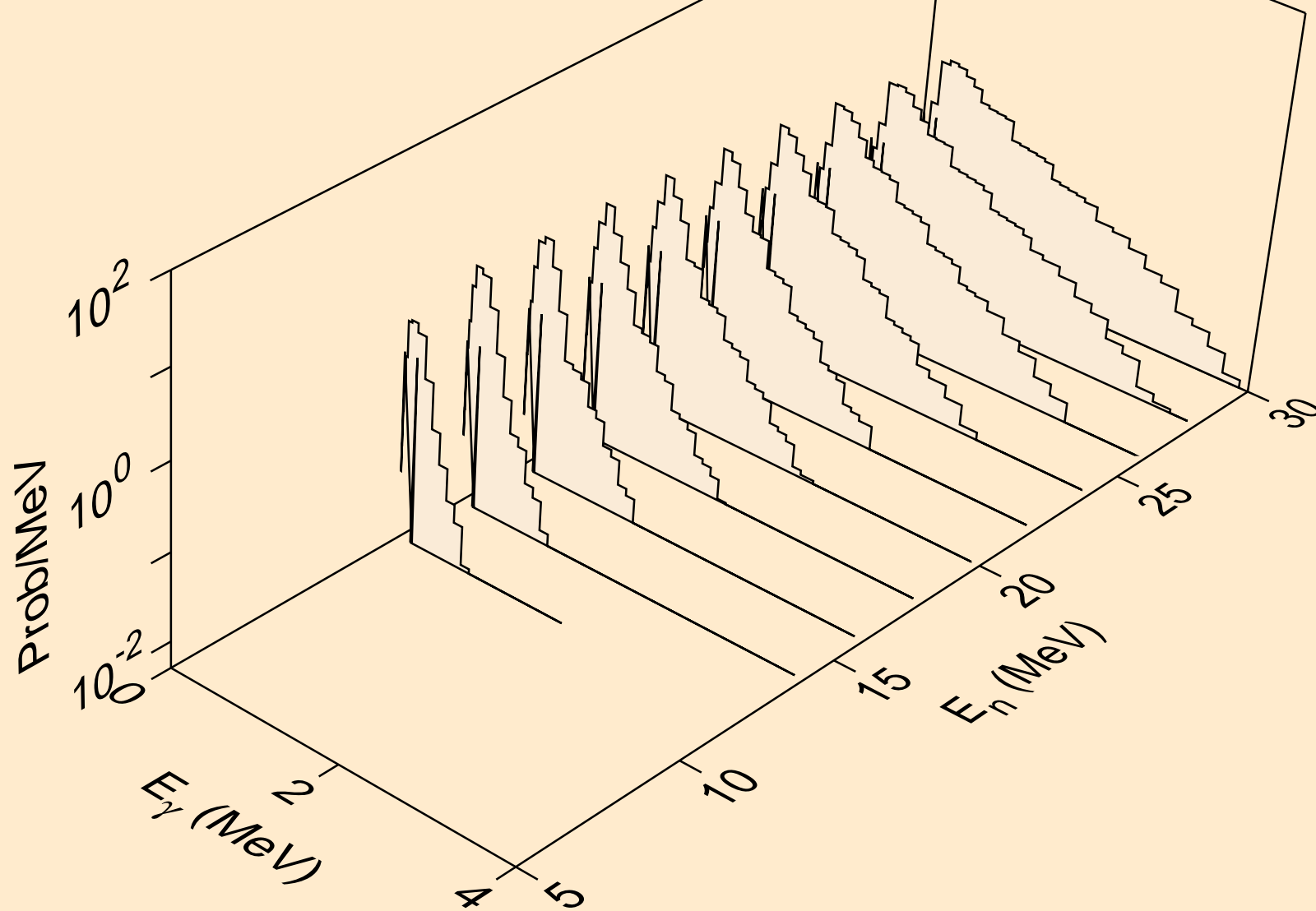

YB179 NEUTRON ACER TENDL-2021 LIBRARY; T=293.6K
Photon emission for (n,3n)a

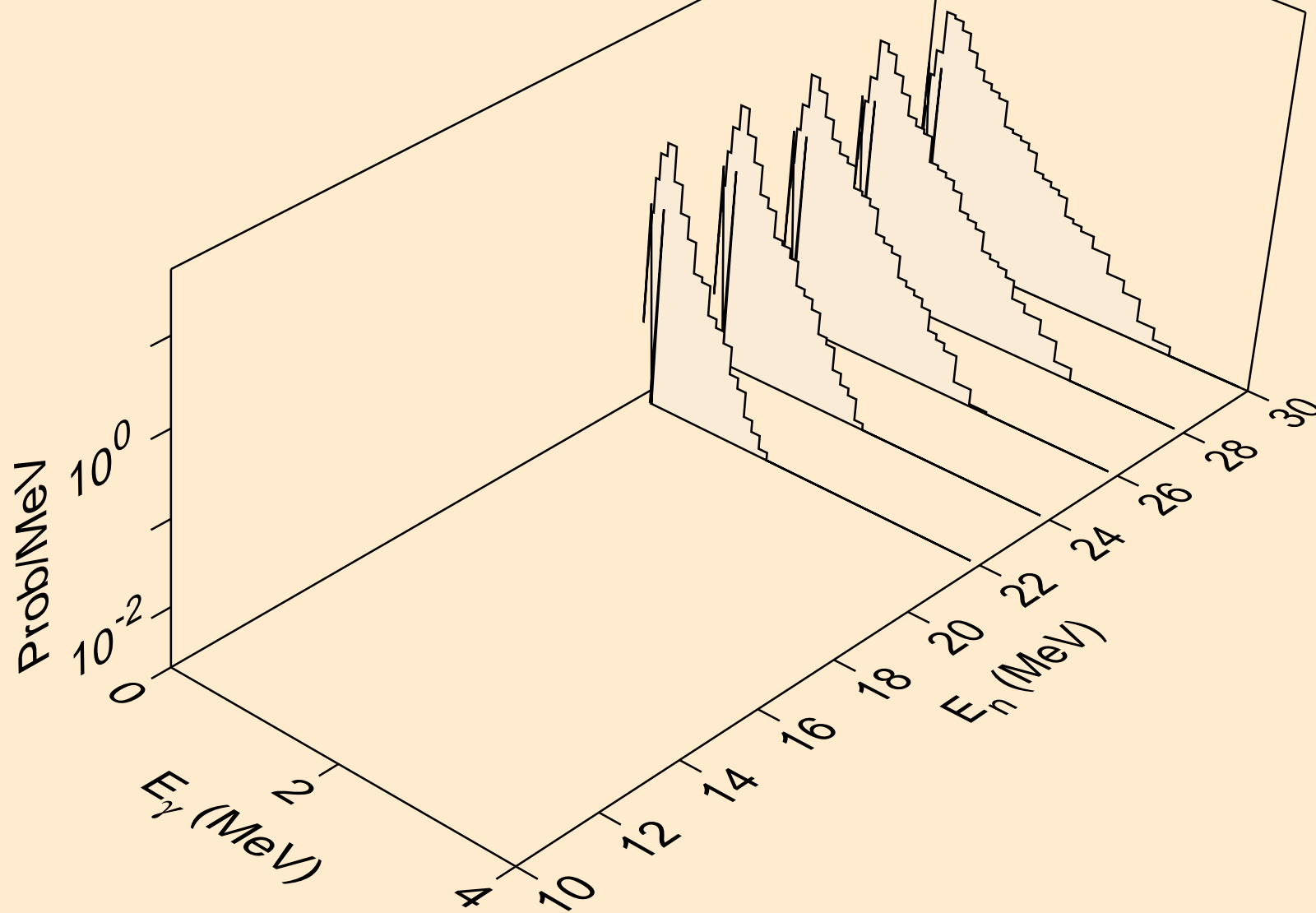

YB179 NEUTRON ACER TENDL-2021 LIBRARY; T=293.6K
Photon emission for (n,n*)p

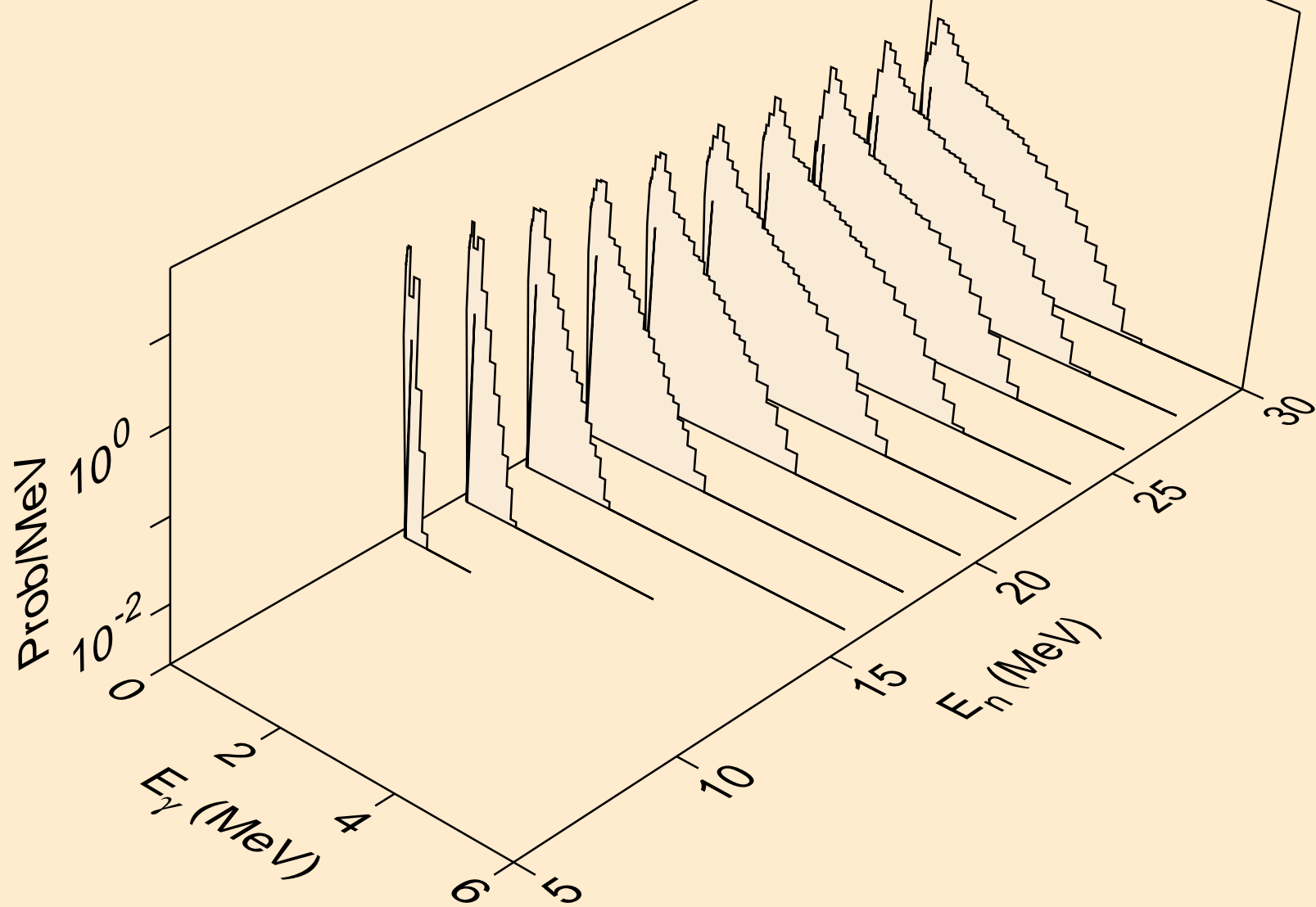

YB179 NEUTRON ACER TENDL-2021 LIBRARY; T=293.6K
Photon emission for (n,n*)d

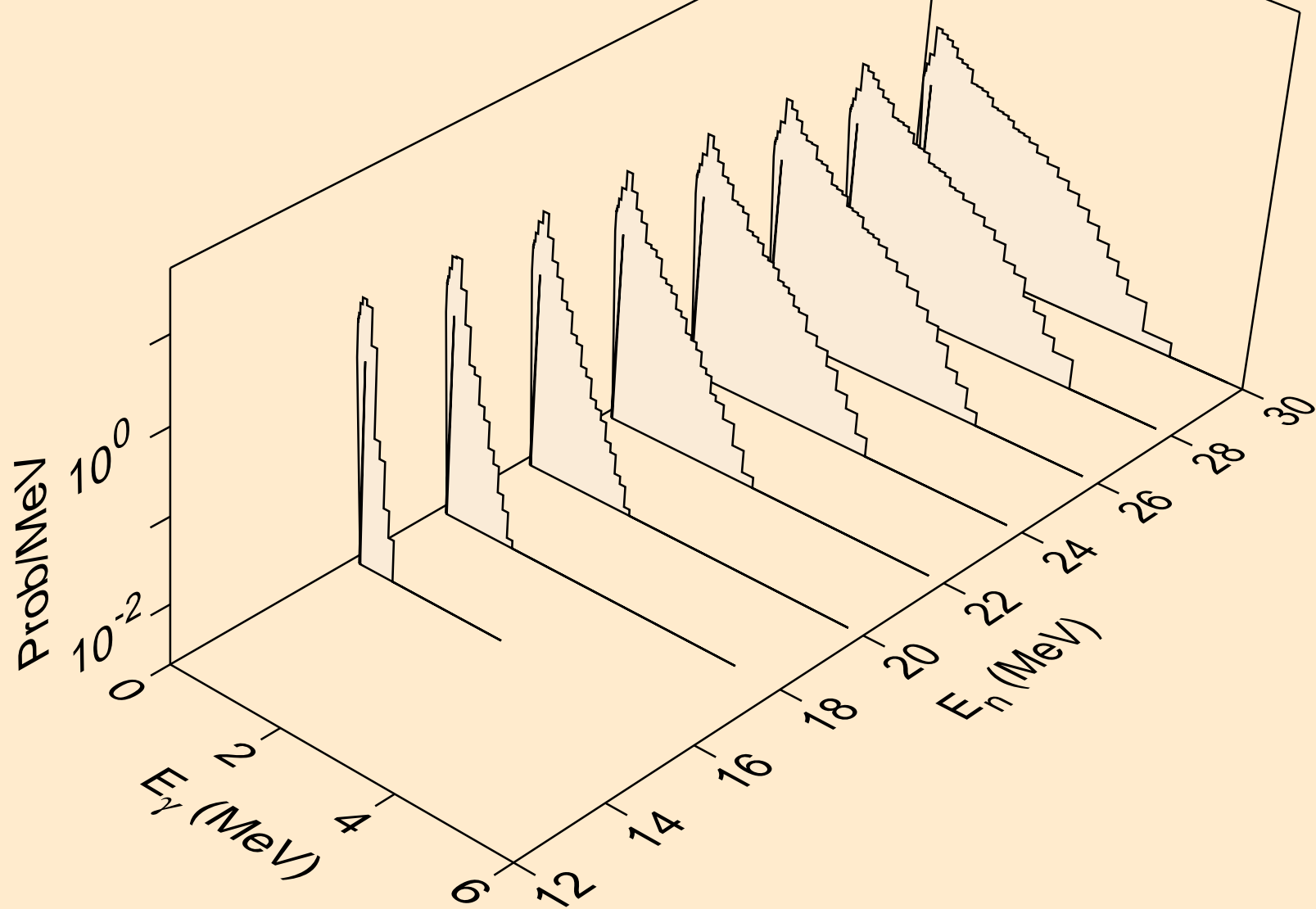

YB179 NEUTRON ACER TENDL-2021 LIBRARY; T=293.6K
Photon emission for (n,n*)t

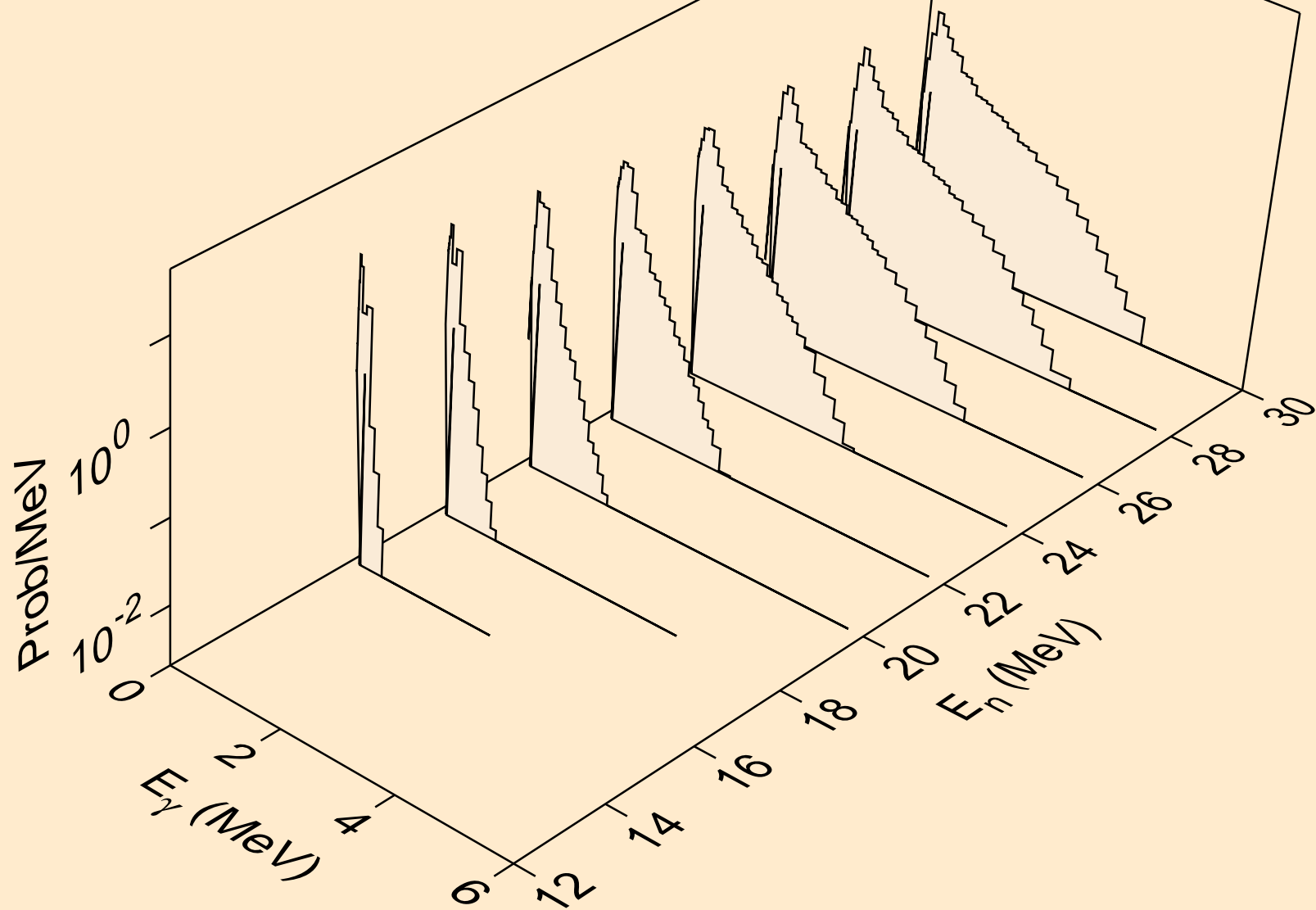

YB179 NEUTRON ACER TENDL-2021 LIBRARY; T=293.6K
Photon emission for (n,n*)he3

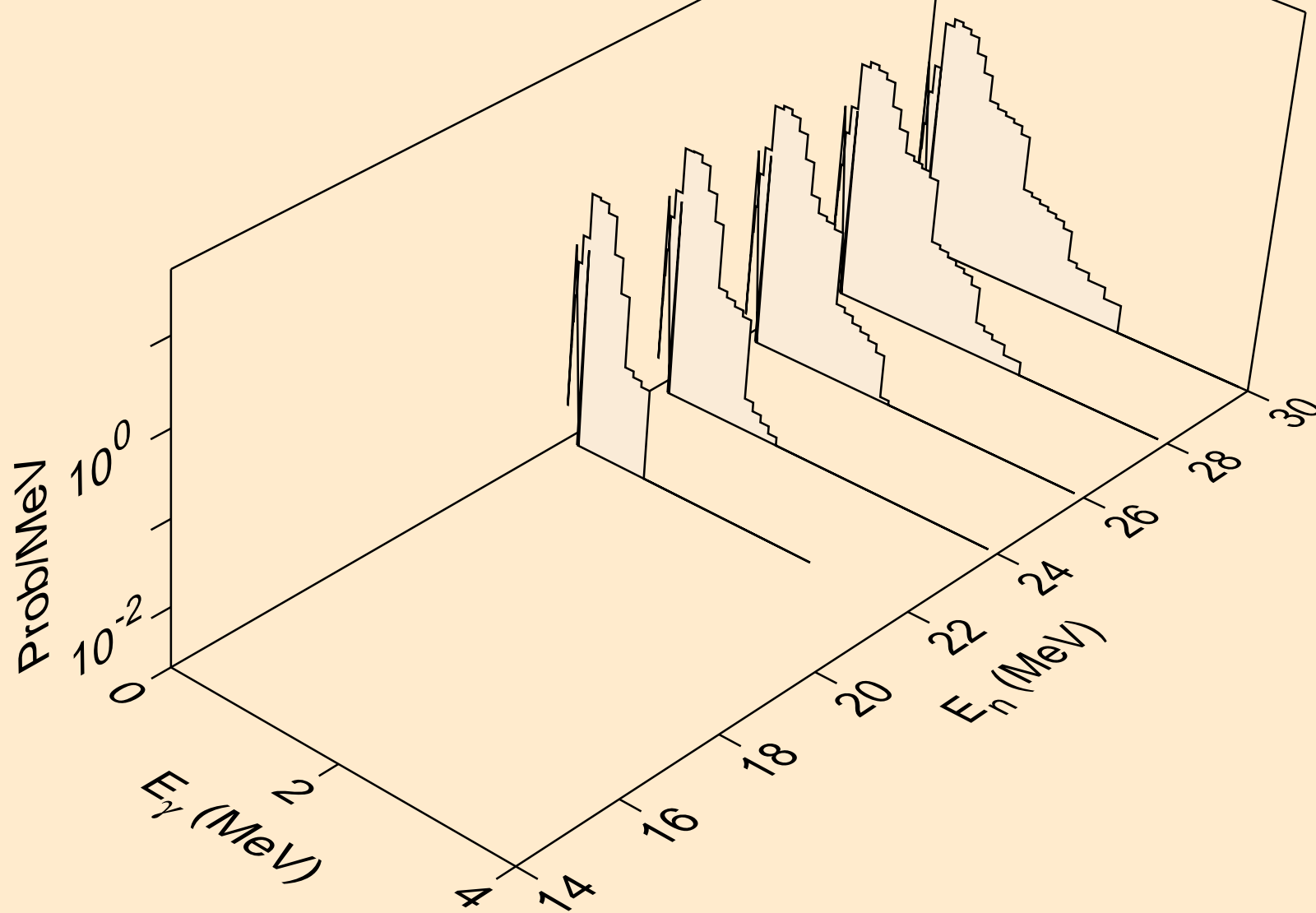

YB179 NEUTRON ACER TENDL-2021 LIBRARY; T=293.6K
Photon emission for (n,4n)

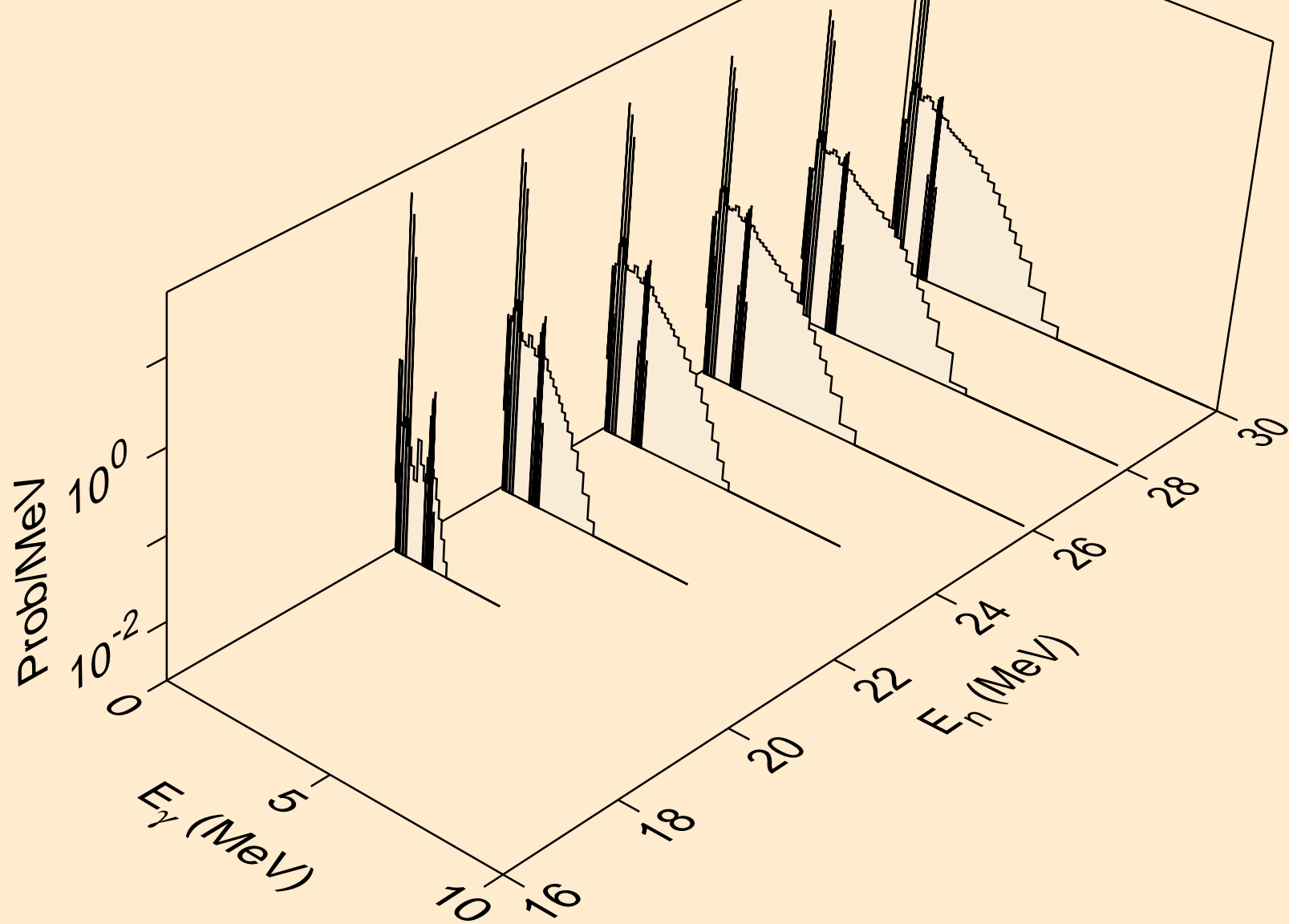

YB179 NEUTRON ACER TENDL-2021 LIBRARY; T=293.6K
Photon emission for (n,2np)

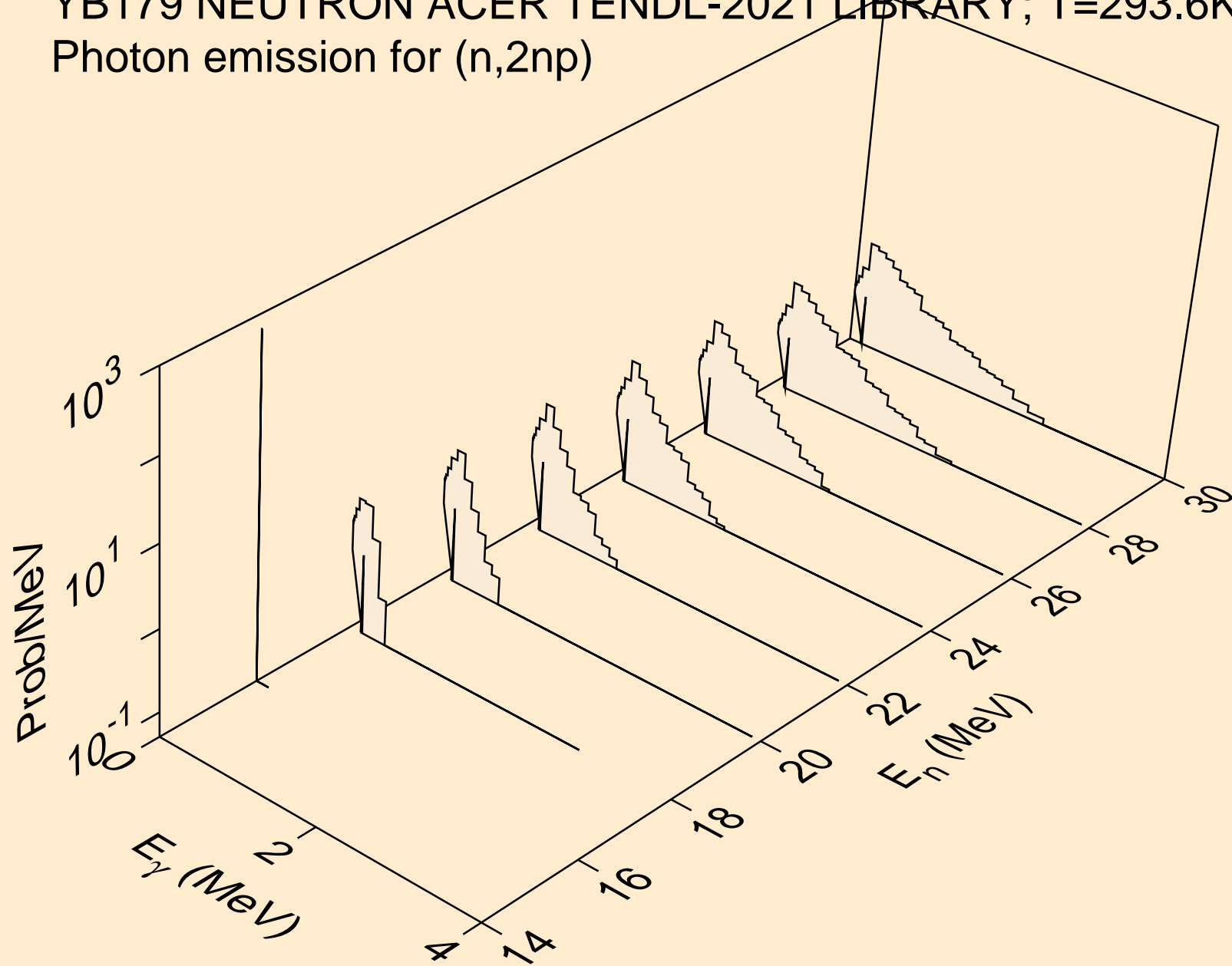

YB179 NEUTRON ACER TENDL-2021 LIBRARY; T=293.6K
Photon emission for (n,3np)

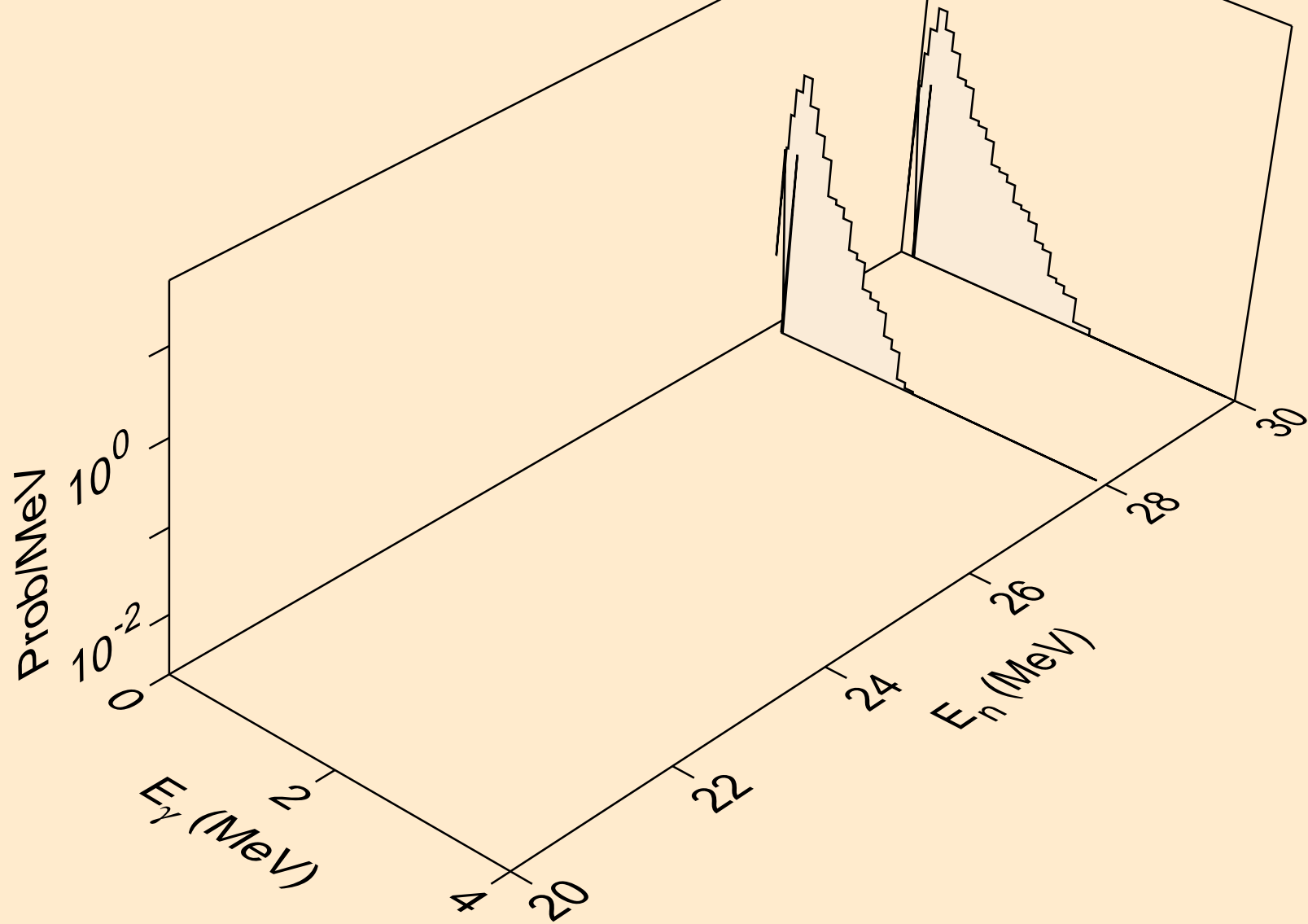

YB179 NEUTRON ACER TENDL-2021 LIBRARY; T=293.6K
Photon emission for (n,n*c)

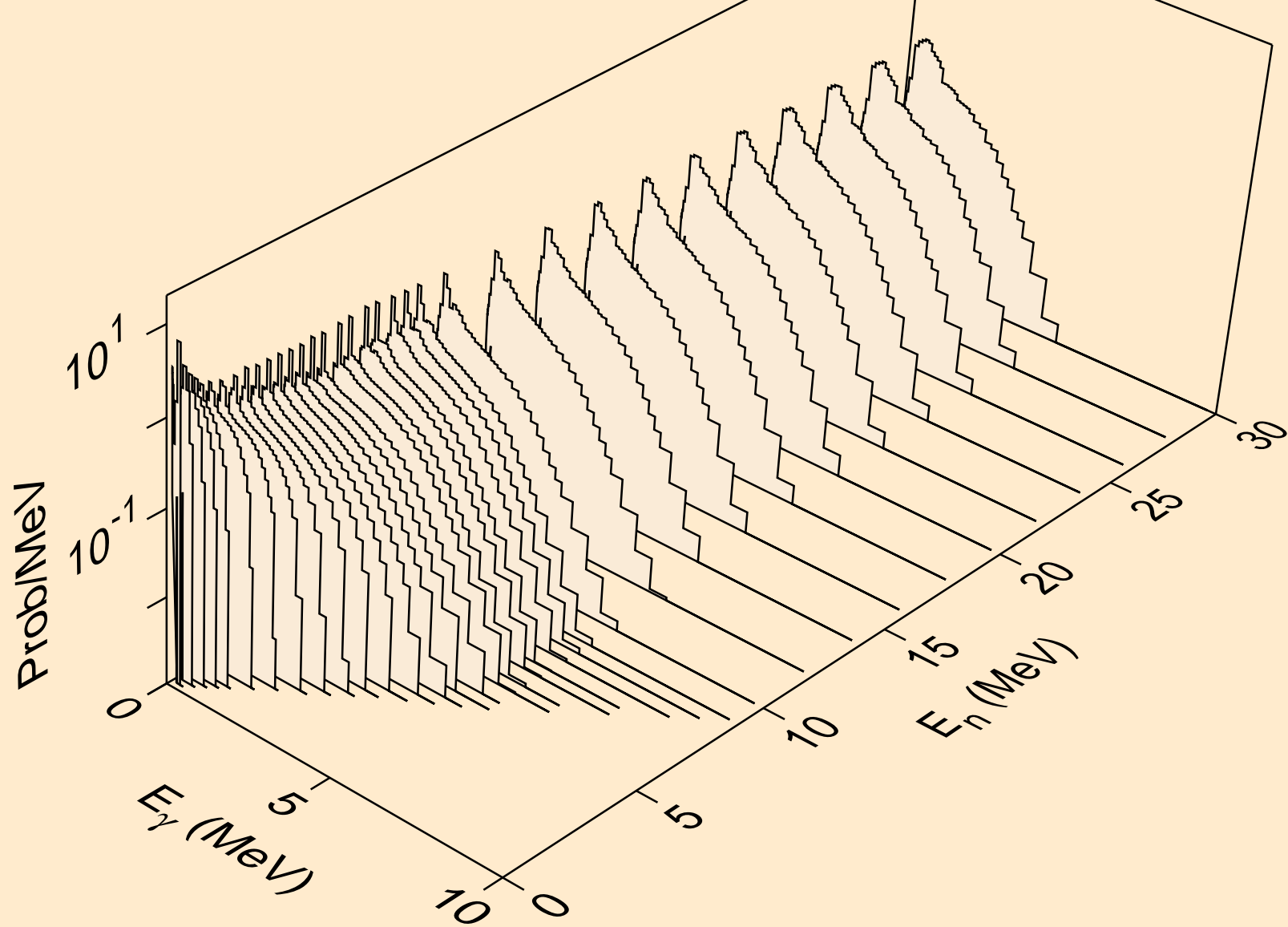

YB179 NEUTRON ACER TENDL-2021 LIBRARY; T=293.6K
Photon emission for (n,gma)

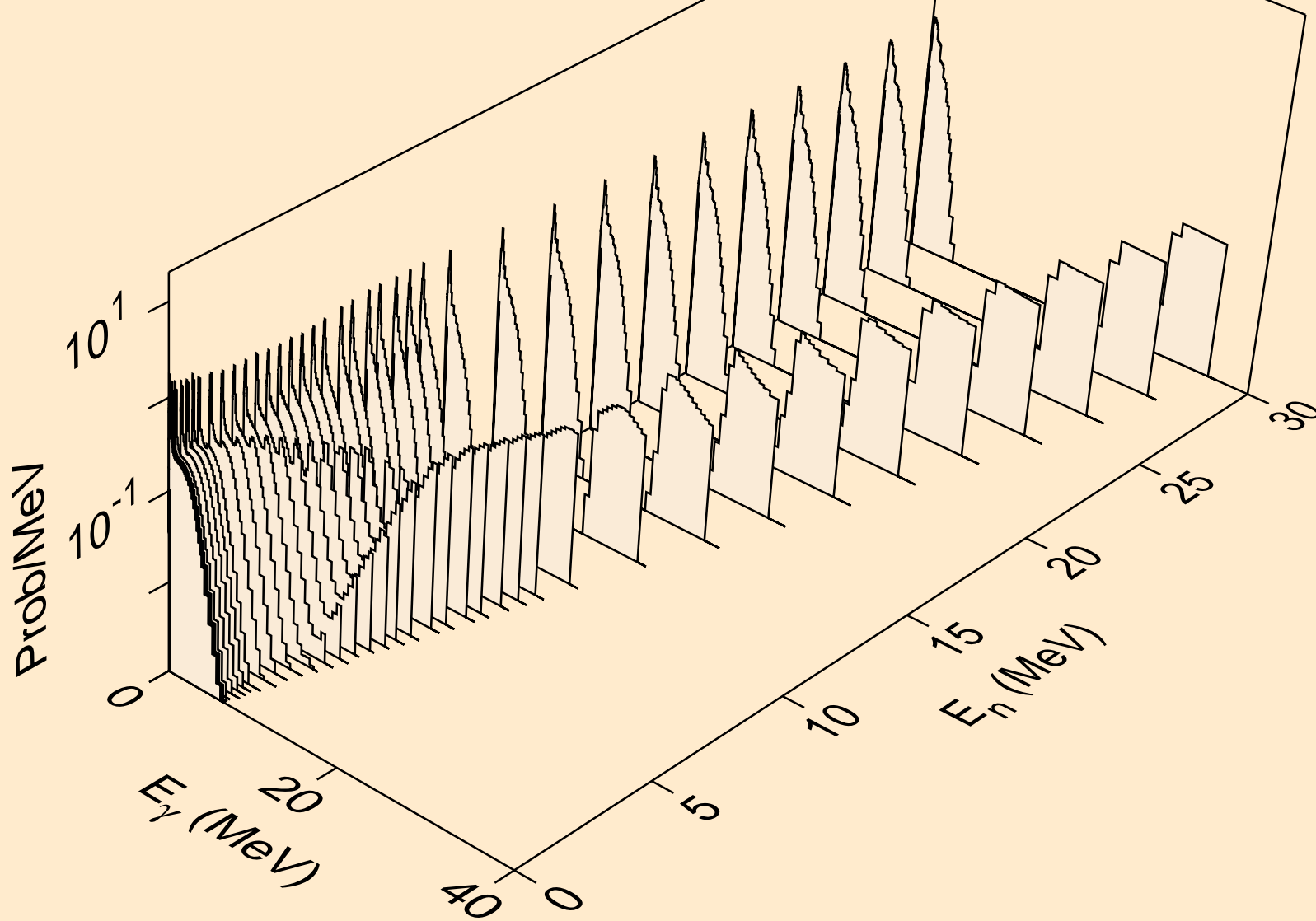

YB179 NEUTRON ACER TENDL-2021 LIBRARY; T=293.6K
Photon emission for (n,p)

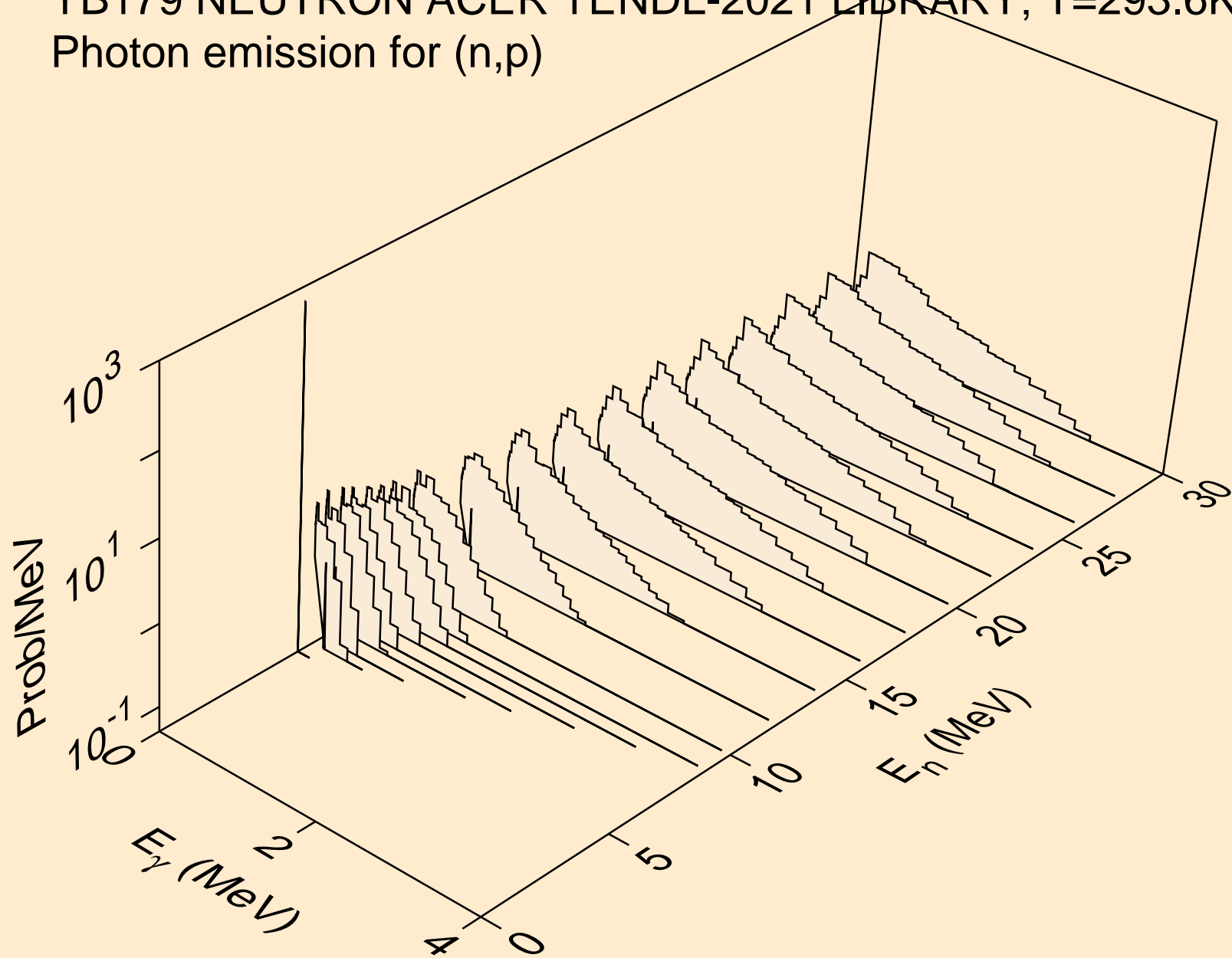

YB179 NEUTRON ACER TENDL-2021 LIBRARY; T=293.6K
Photon emission for (n,d)

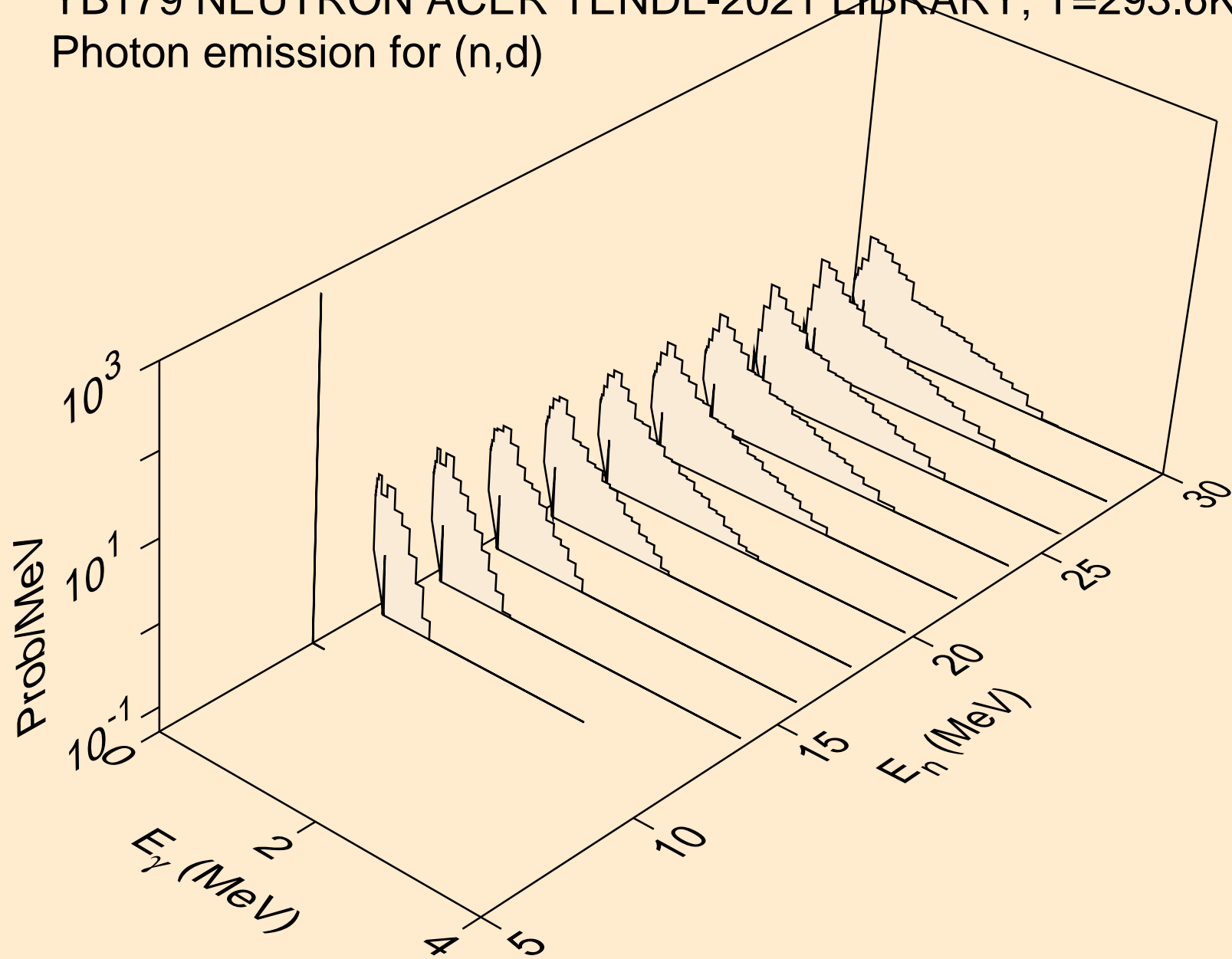

YB179 NEUTRON ACER TENDL-2021 LIBRARY; T=293.6K
Photon emission for (n,t)

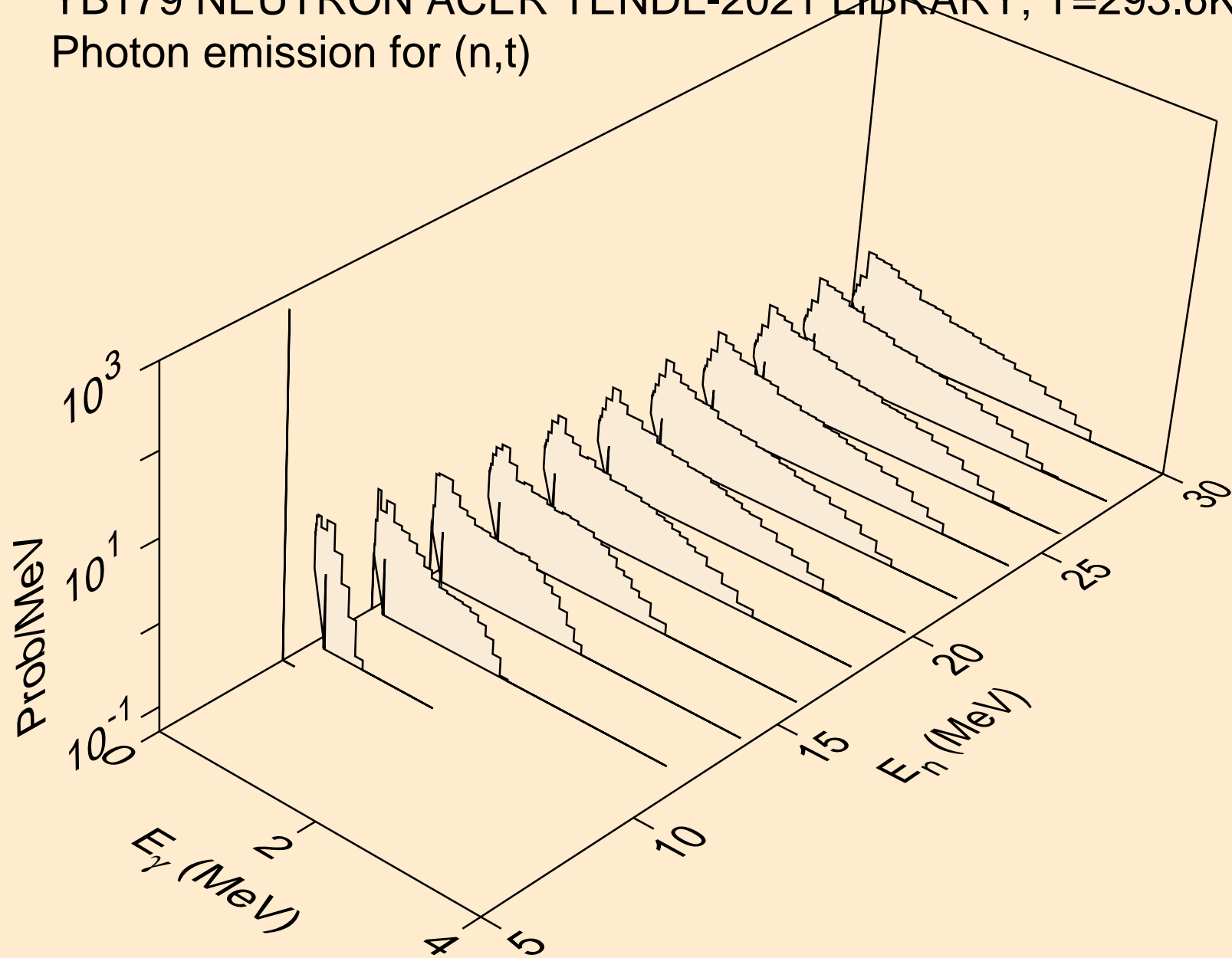

YB179 NEUTRON ACER TENDL-2021 LIBRARY; T=293.6K
Photon emission for (n,he3)

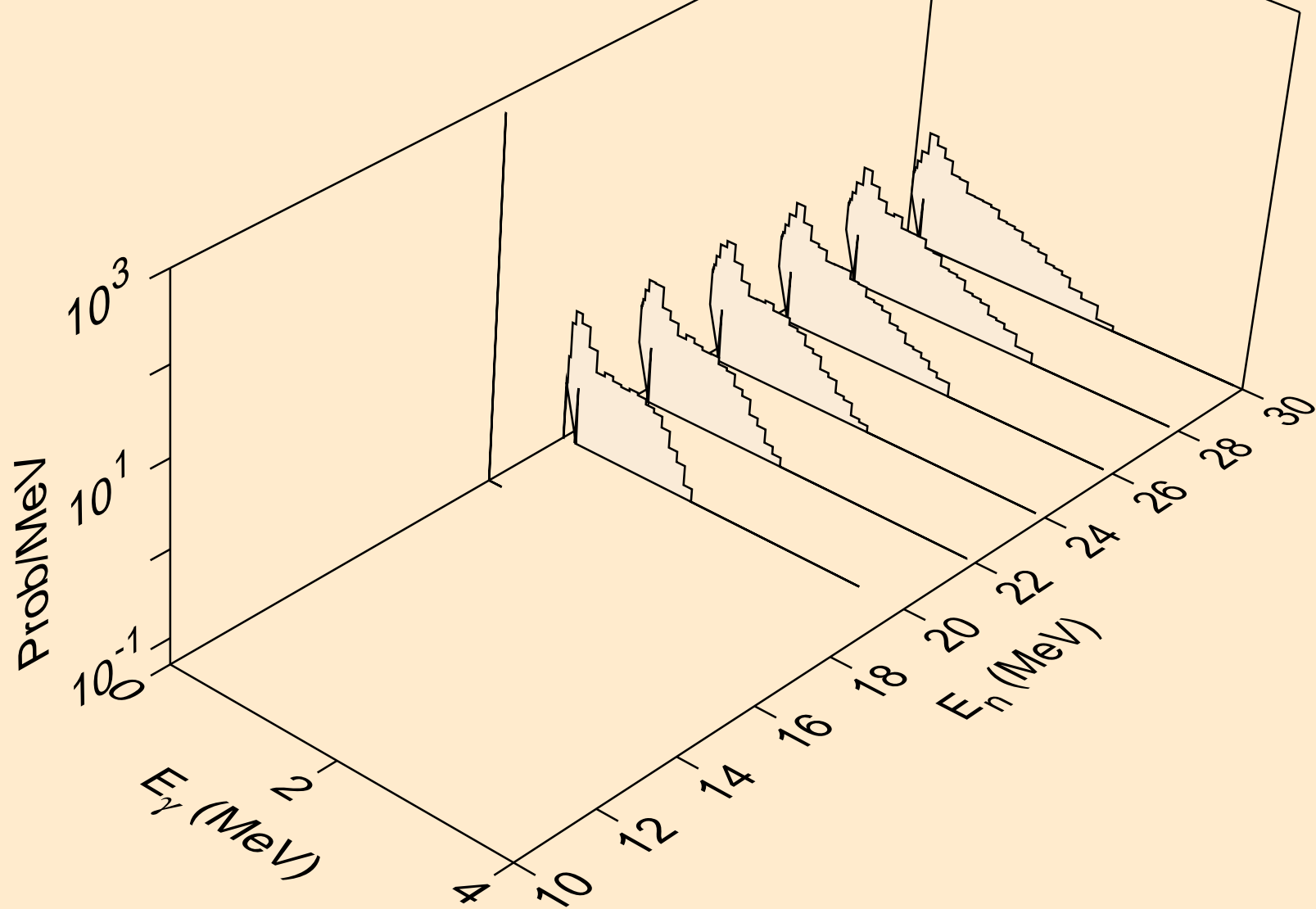

YB179 NEUTRON ACER TENDL-2021 LIBRARY; T=293.6K
Photon emission for (n,a)

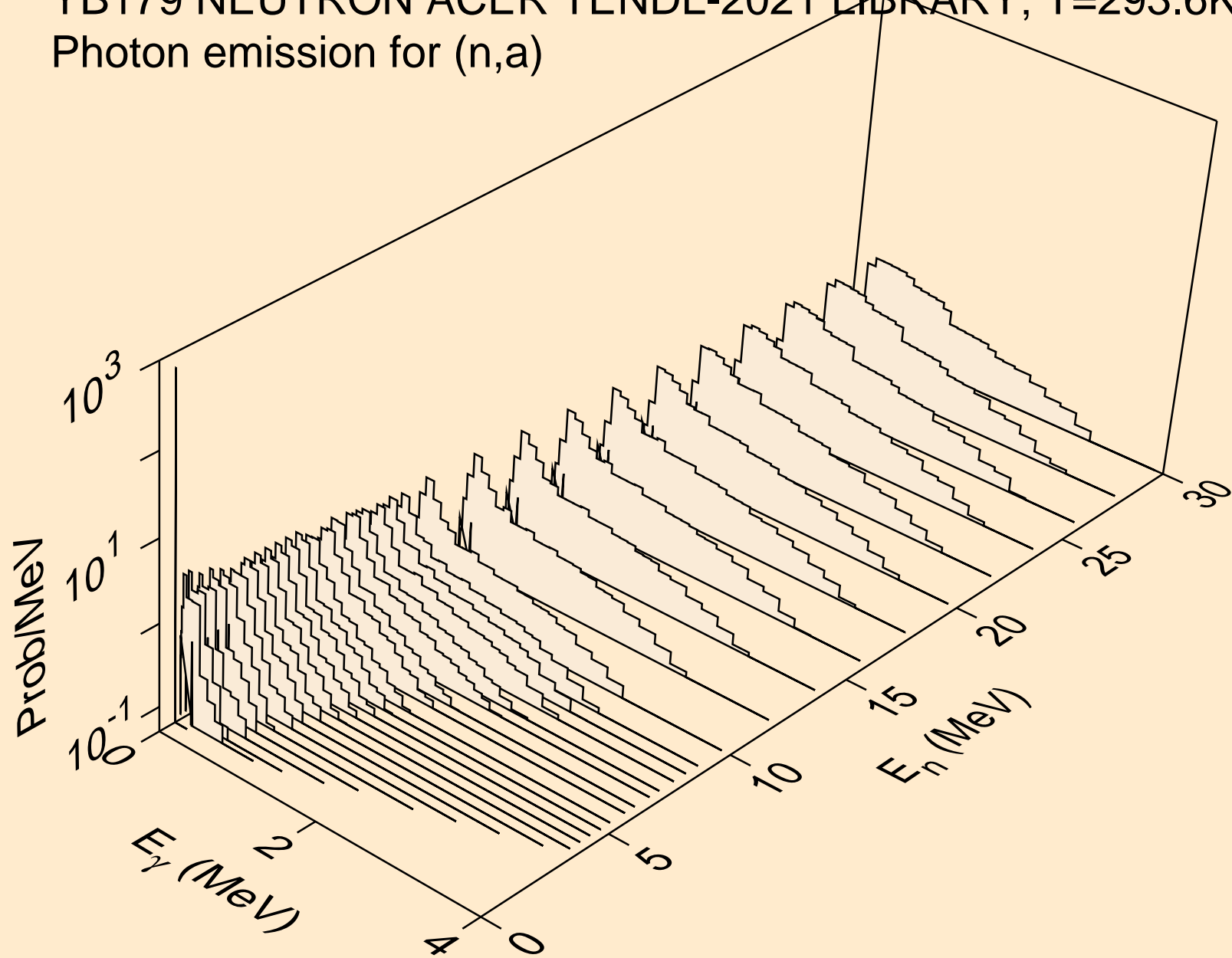

YB179 NEUTRON ACER TENDL-2021 LIBRARY; T=293.6K
Photon emission for (n,2p)

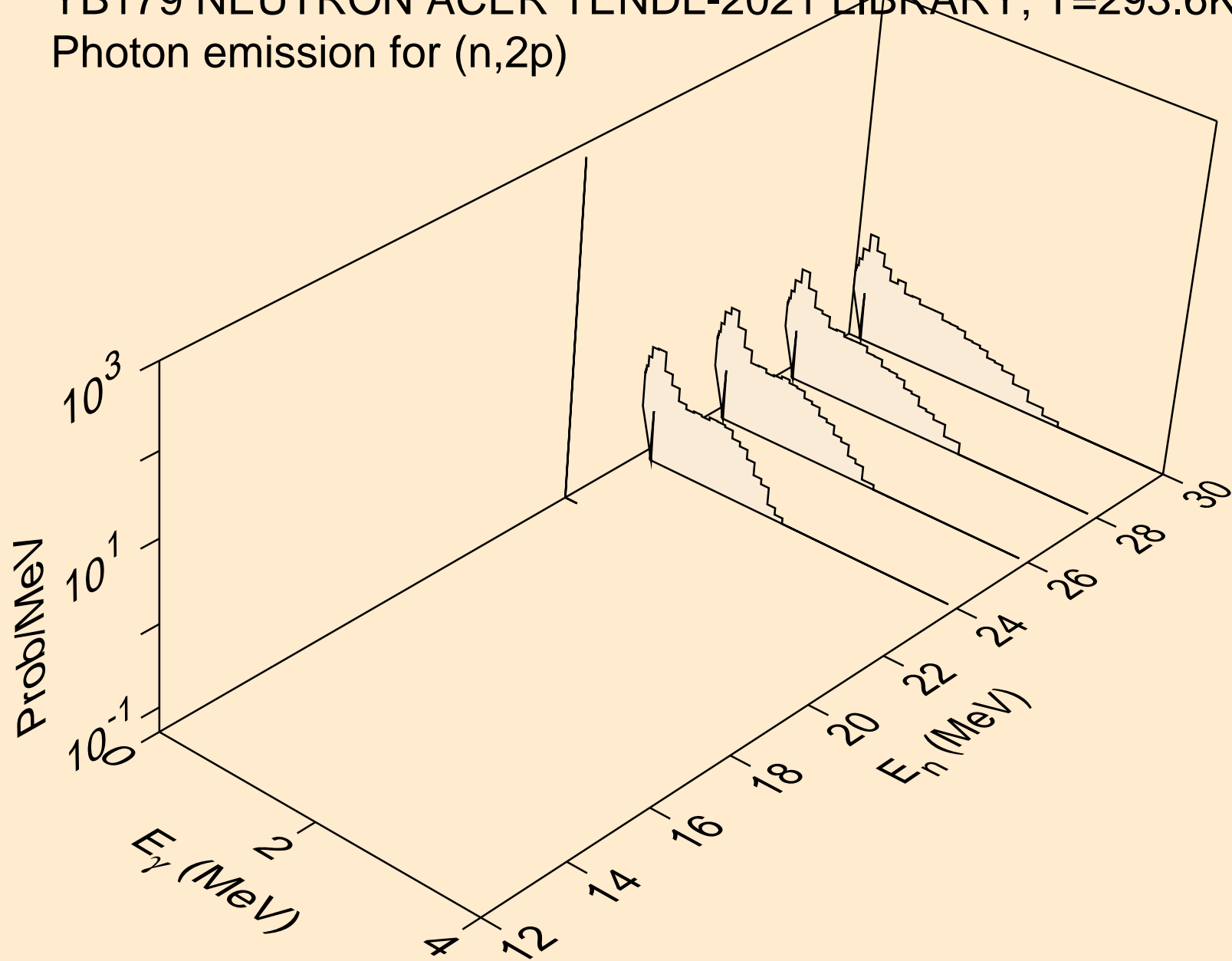

YB179 NEUTRON ACER TENDL-2021 LIBRARY; T=293.6K
thermal capture photon spectrum

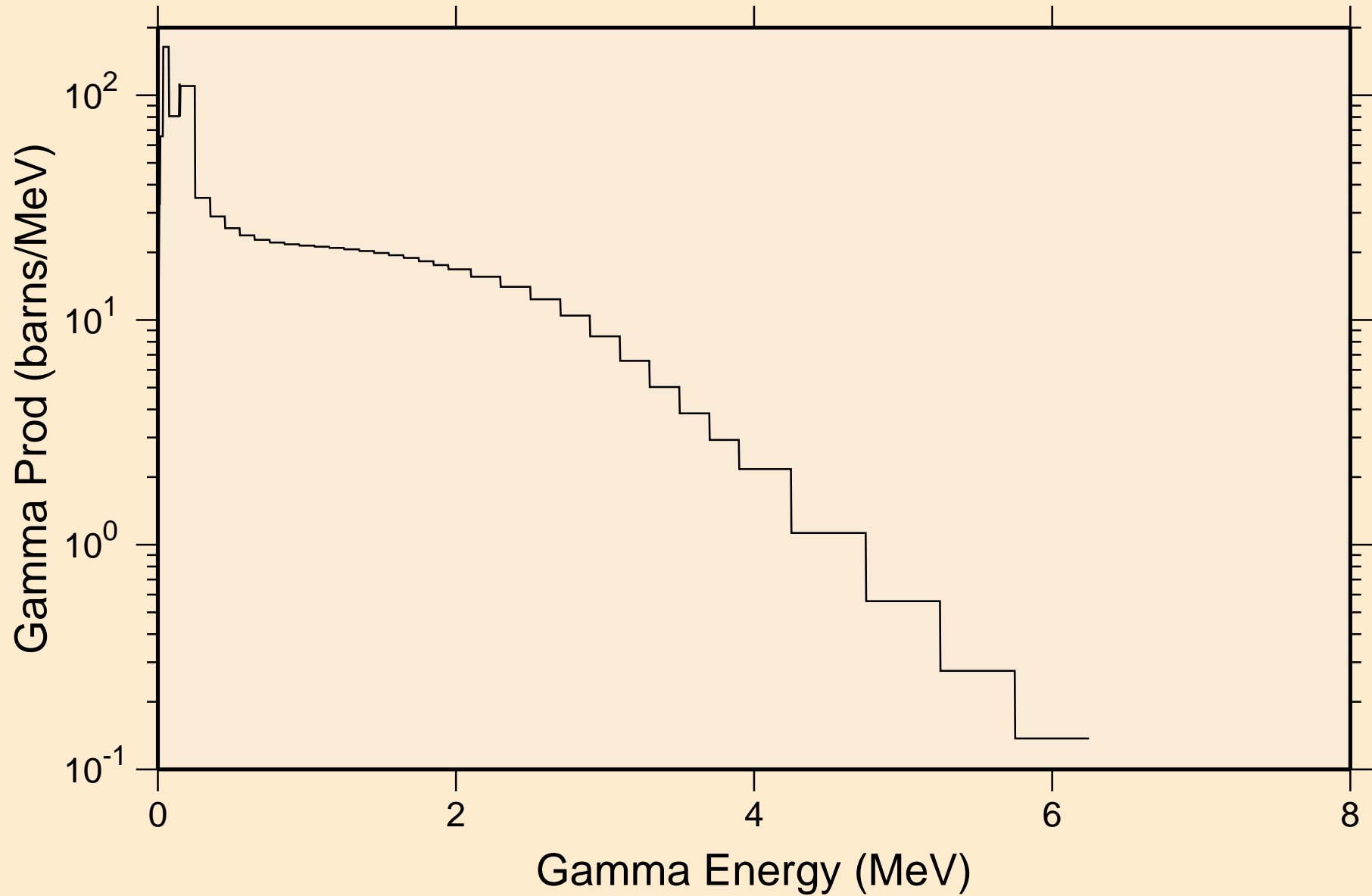

YB179 NEUTRON ACER TENDL-2021 LIBRARY; T=293.6K
14 MeV photon spectrum

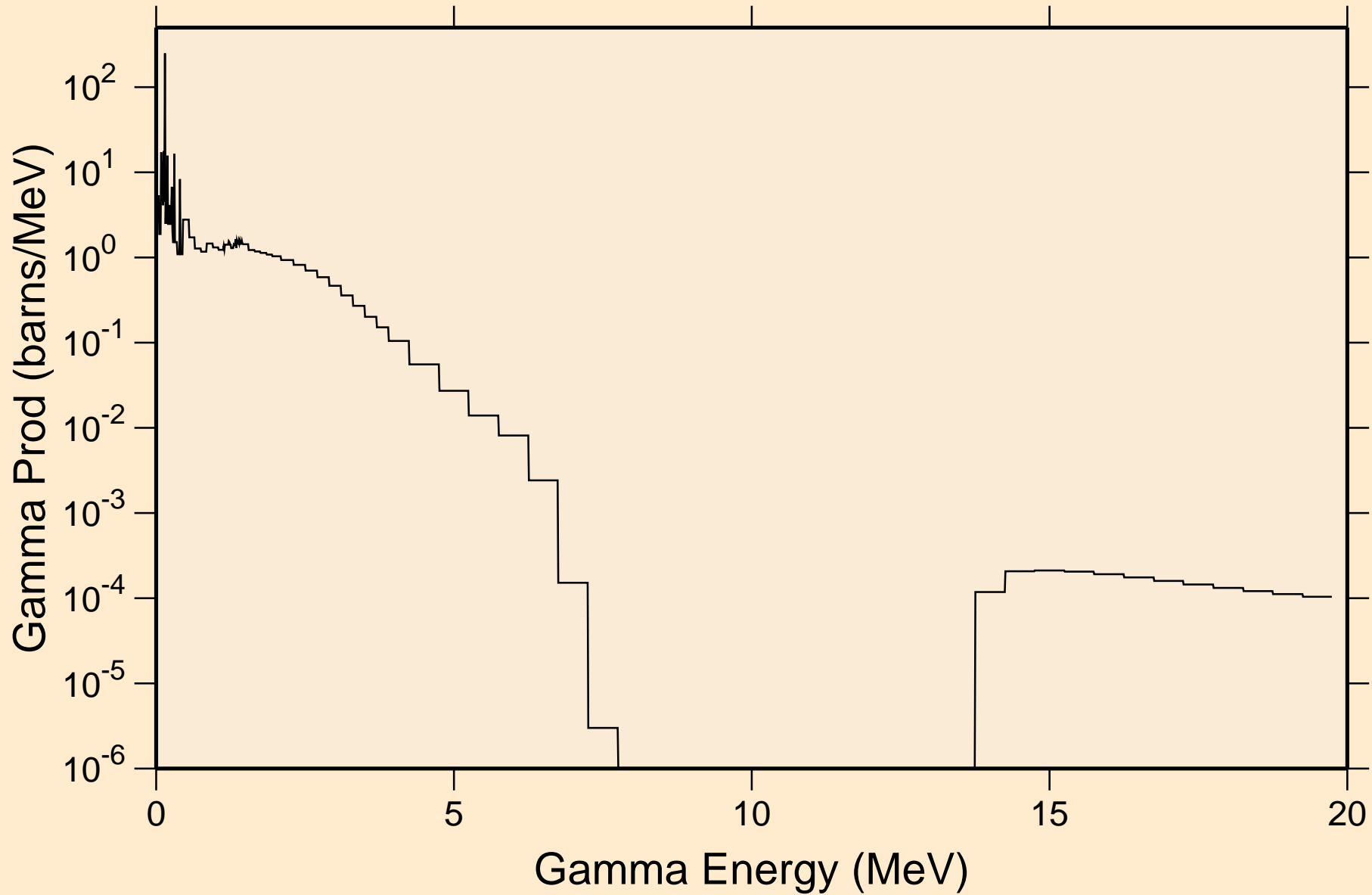

YB179 NEUTRON ACER TENDL-2021 LIBRARY; T=293.6K
Particle heating contributions

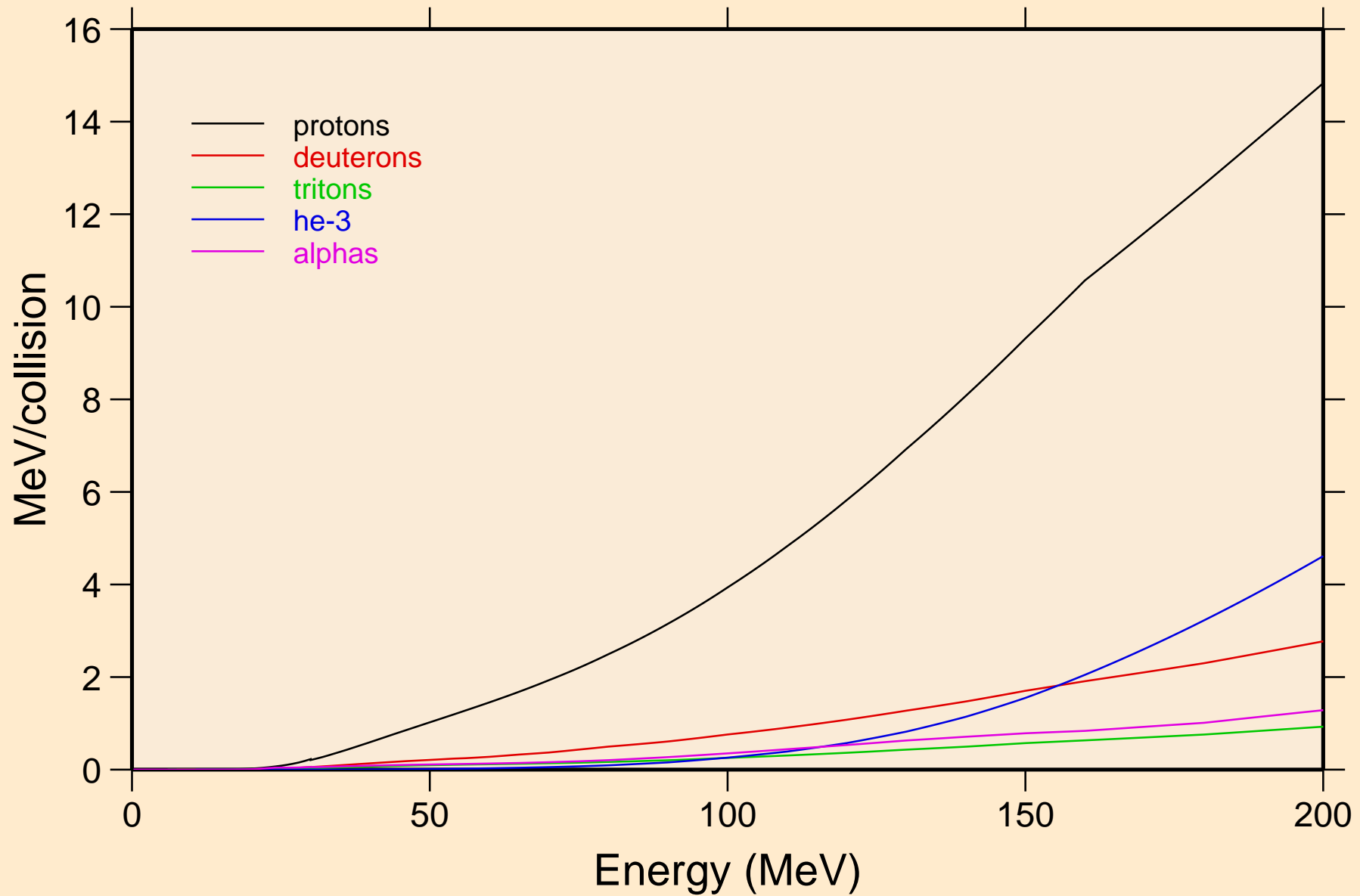

YB179 NEUTRON ACER TENDL-2021 LIBRARY; T=293.6K
Recoil Heating

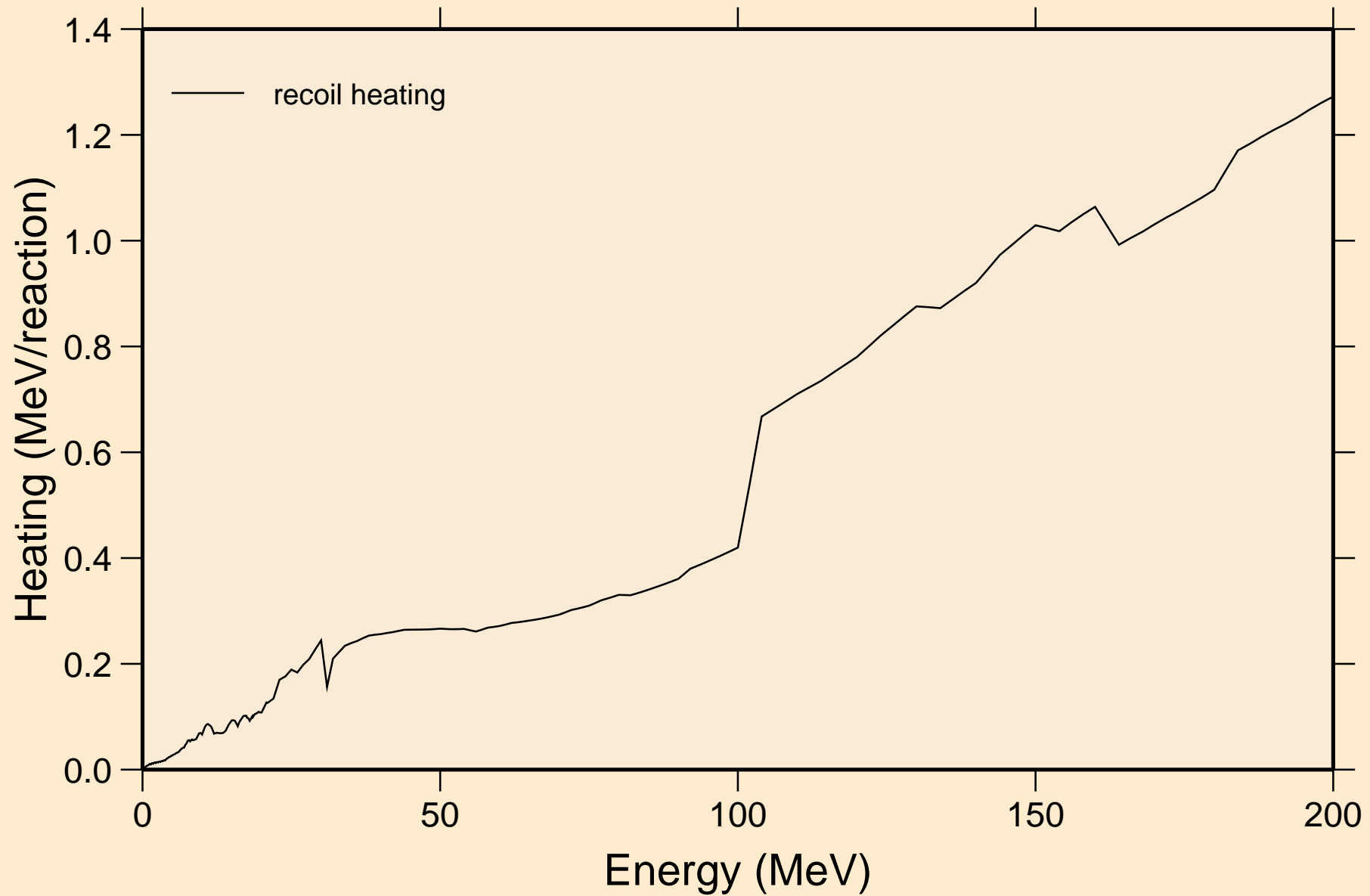

YB179 NEUTRON ACER TENDL-2021 LIBRARY; T=293.6K
Particle production cross sections

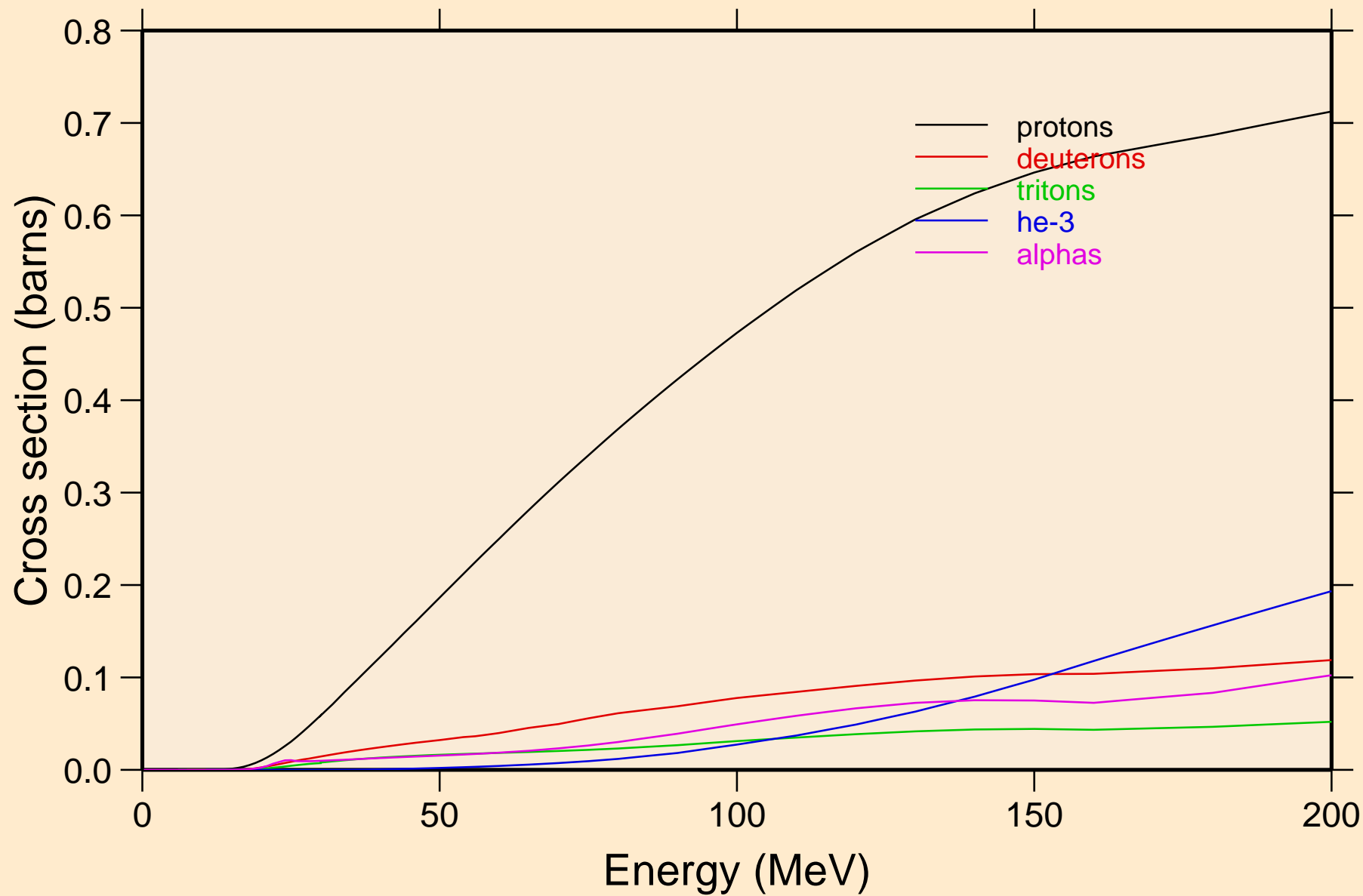

YB179 NEUTRON ACER TENDL-2021 LIBRARY; T=293.6K
protons from (n,x)

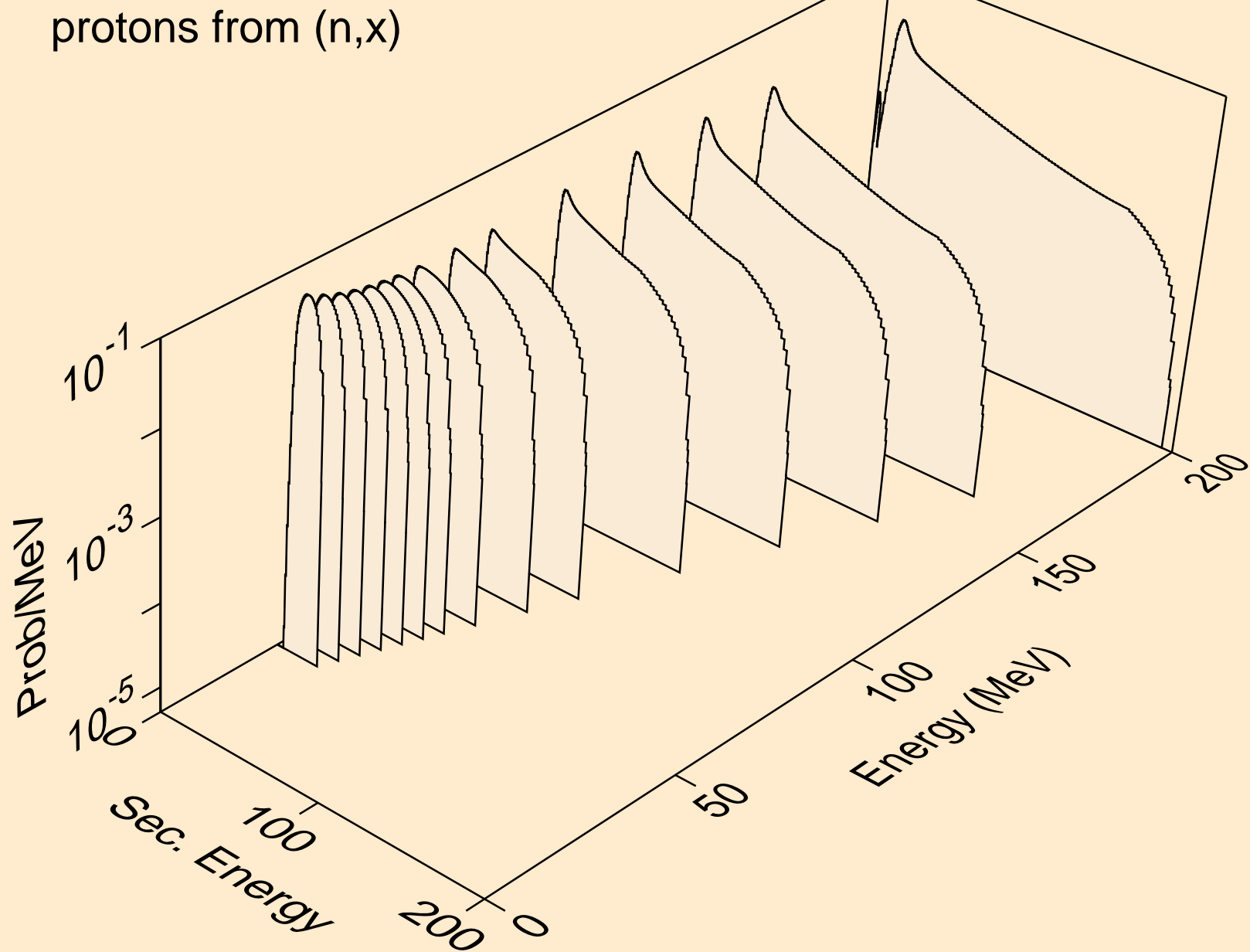

YB179 NEUTRON ACER TENDL-2021 LIBRARY; T=293.6K
protons from (n,n*)p

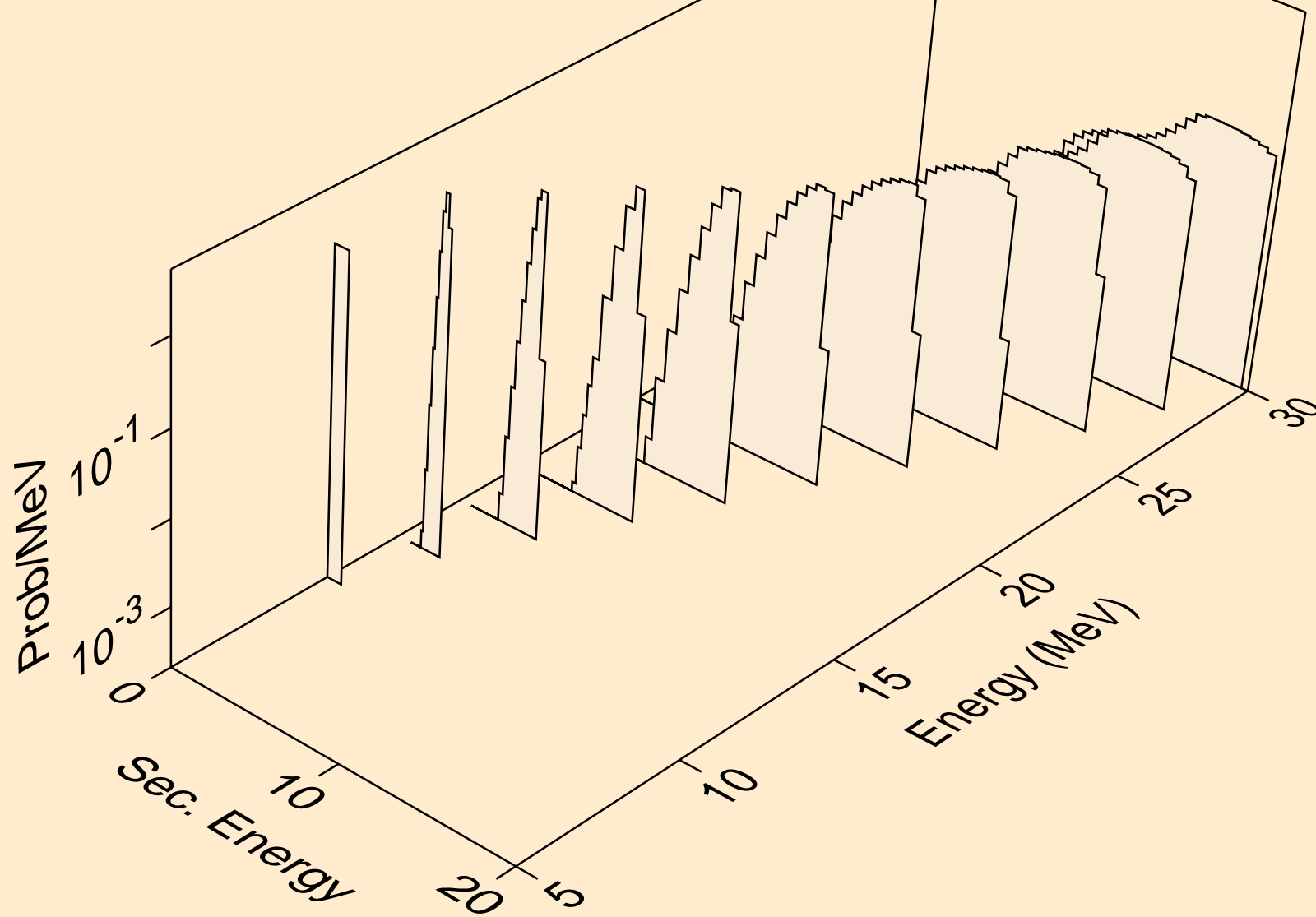

YB179 NEUTRON ACER TENDL-2021 LIBRARY; T=293.6K
protons from (n,2np)

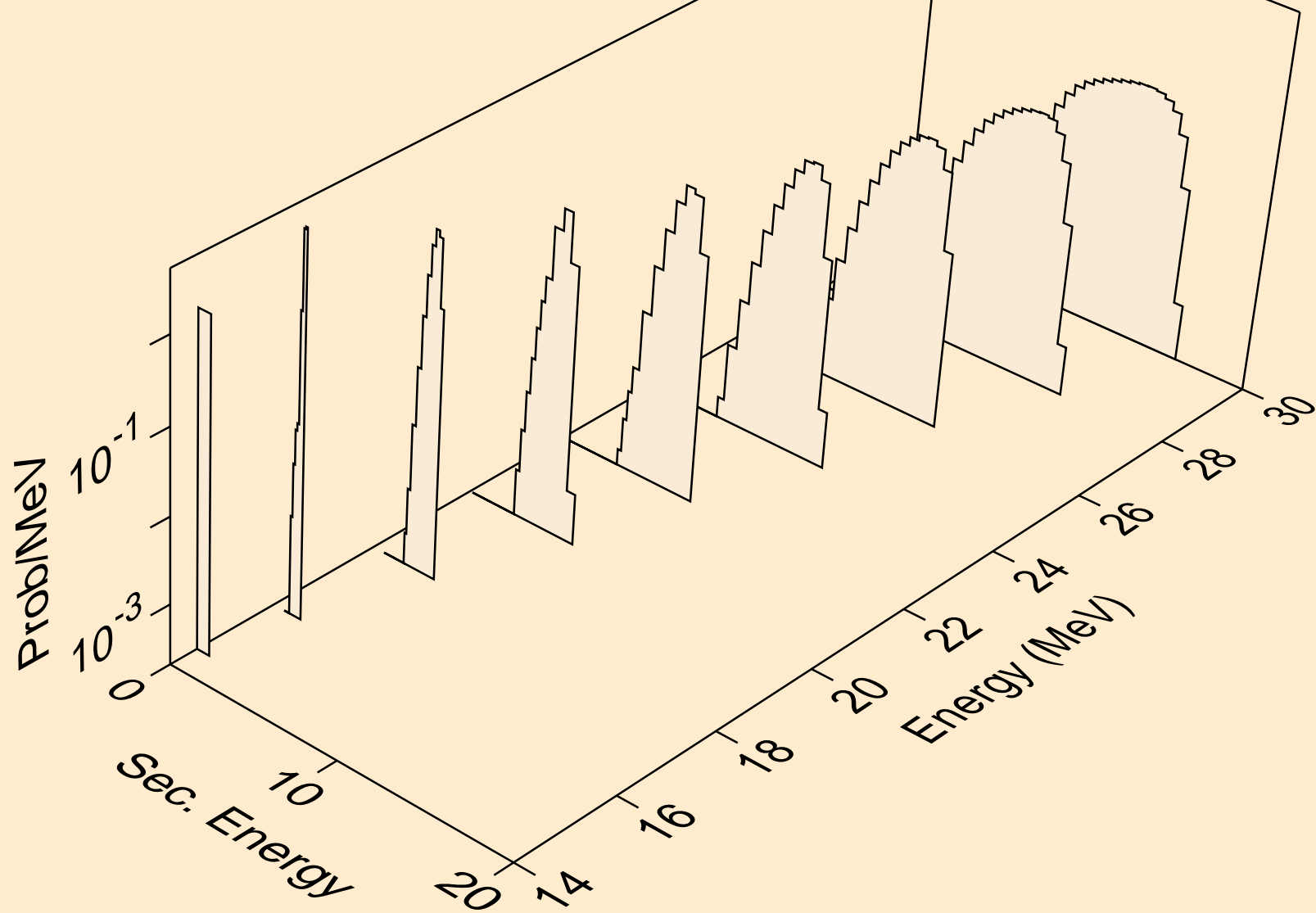

YB179 NEUTRON ACER TENDL-2021 LIBRARY; T=293.6K
protons from (n,3np)

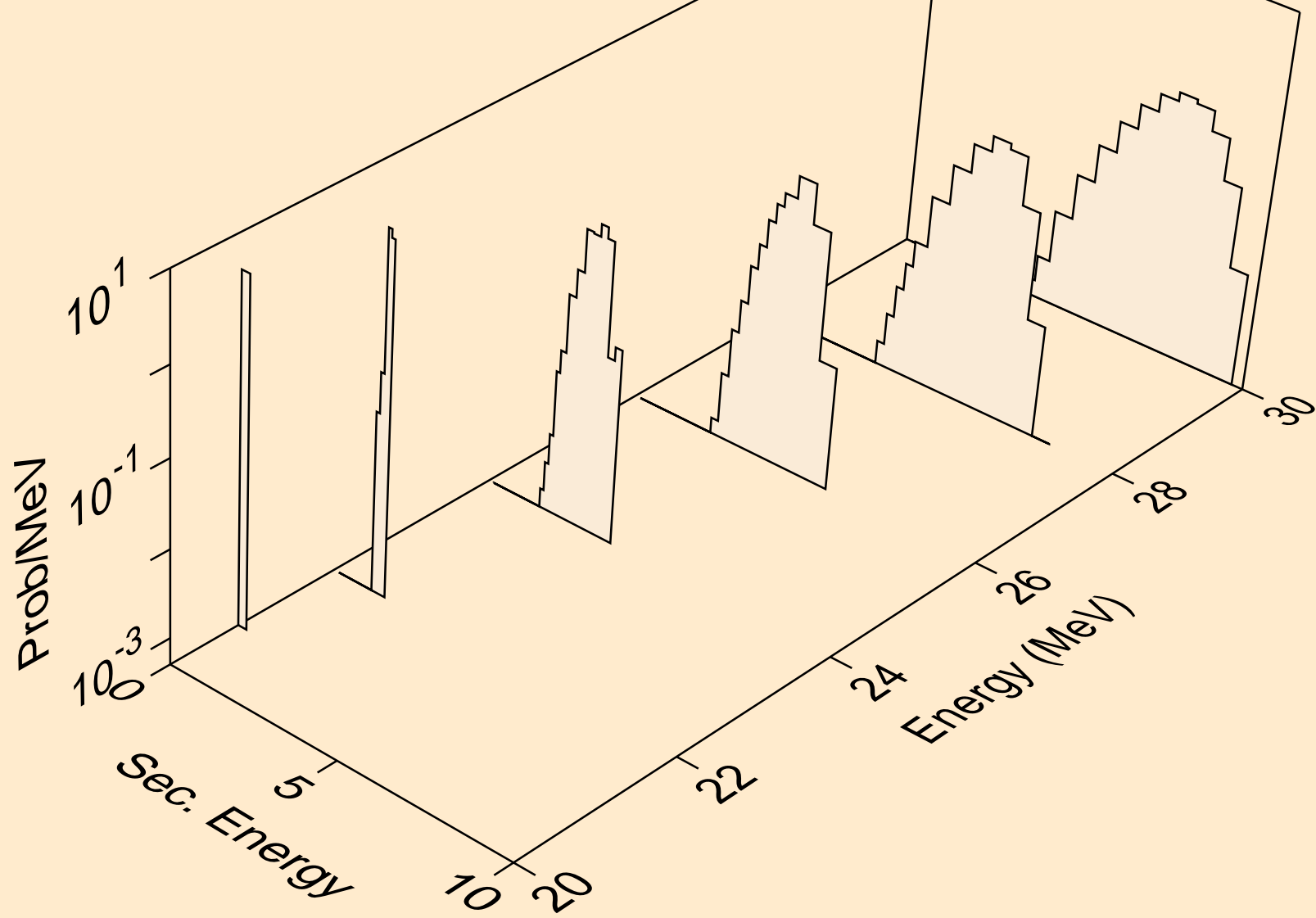

YB179 NEUTRON ACER TENDL-2021 LIBRARY; T=293.6K
protons from (n,p)

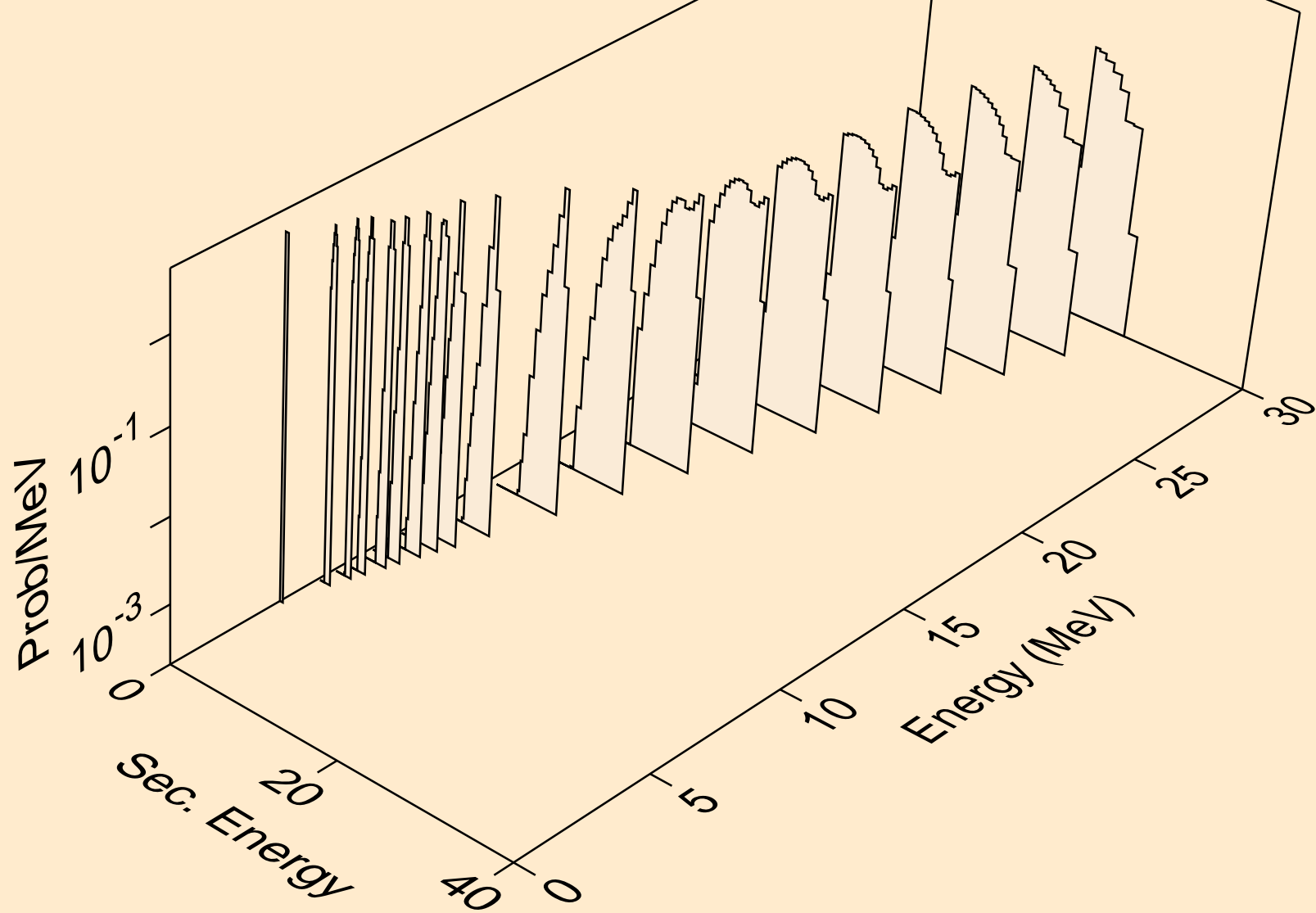

YB179 NEUTRON ACER TENDL-2021 LIBRARY; T=293.6K
protons from (n,2p)

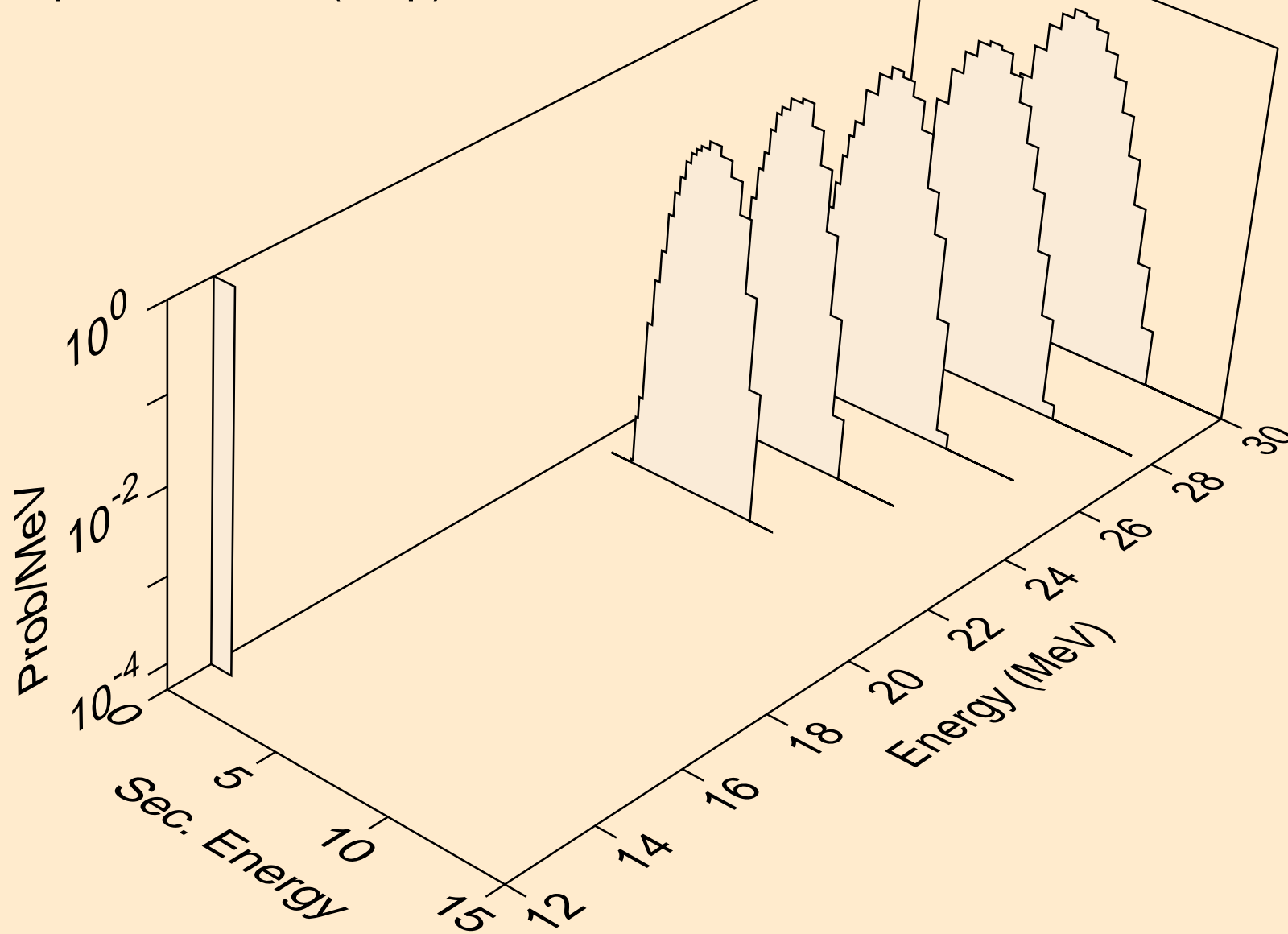

YB179 NEUTRON ACER TENDL-2021 LIBRARY; T=293.6K
deuterons from (n,x)

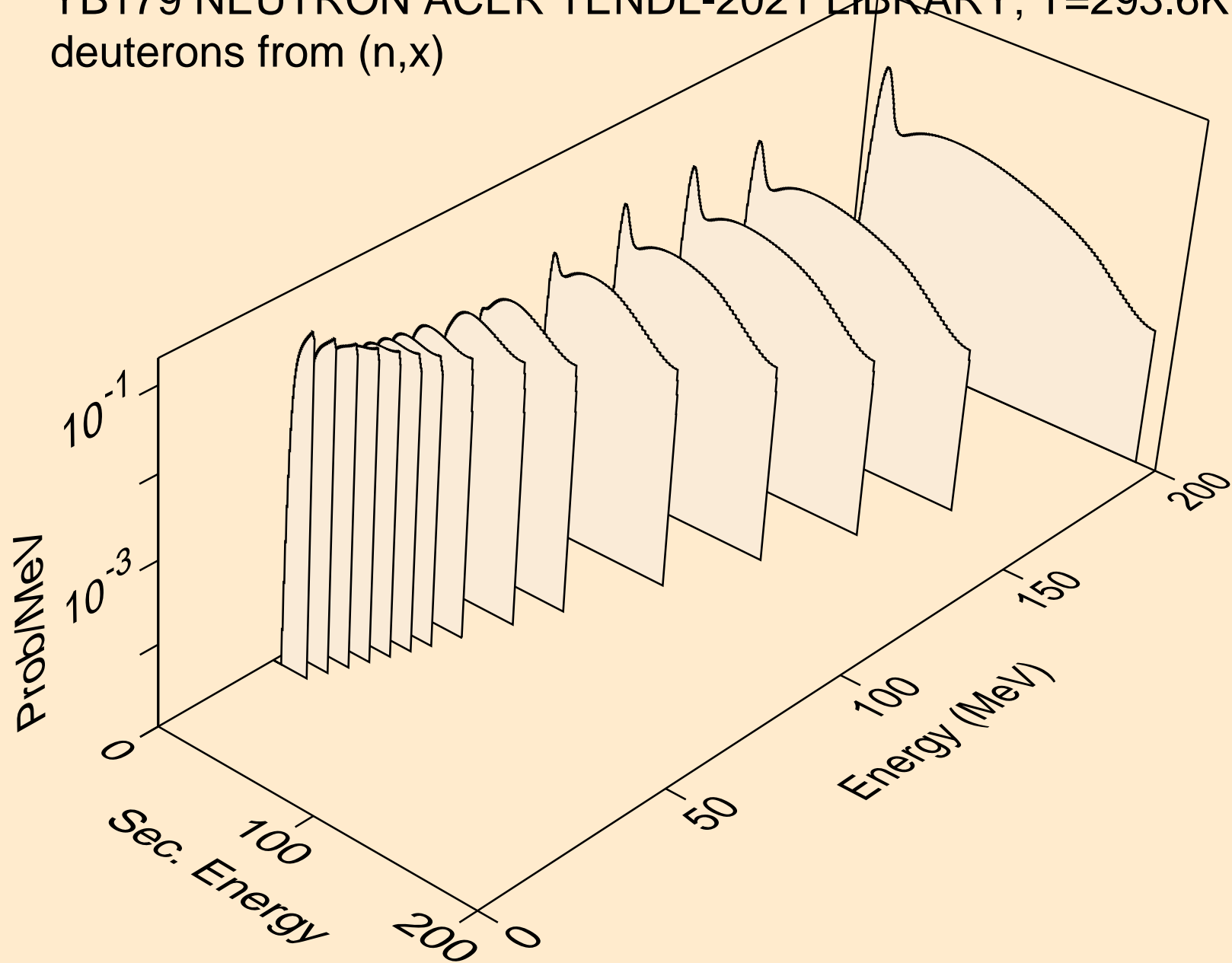

YB179 NEUTRON ACER TENDL-2021 LIBRARY; T=293.6K
deuterons from (n,2nd)

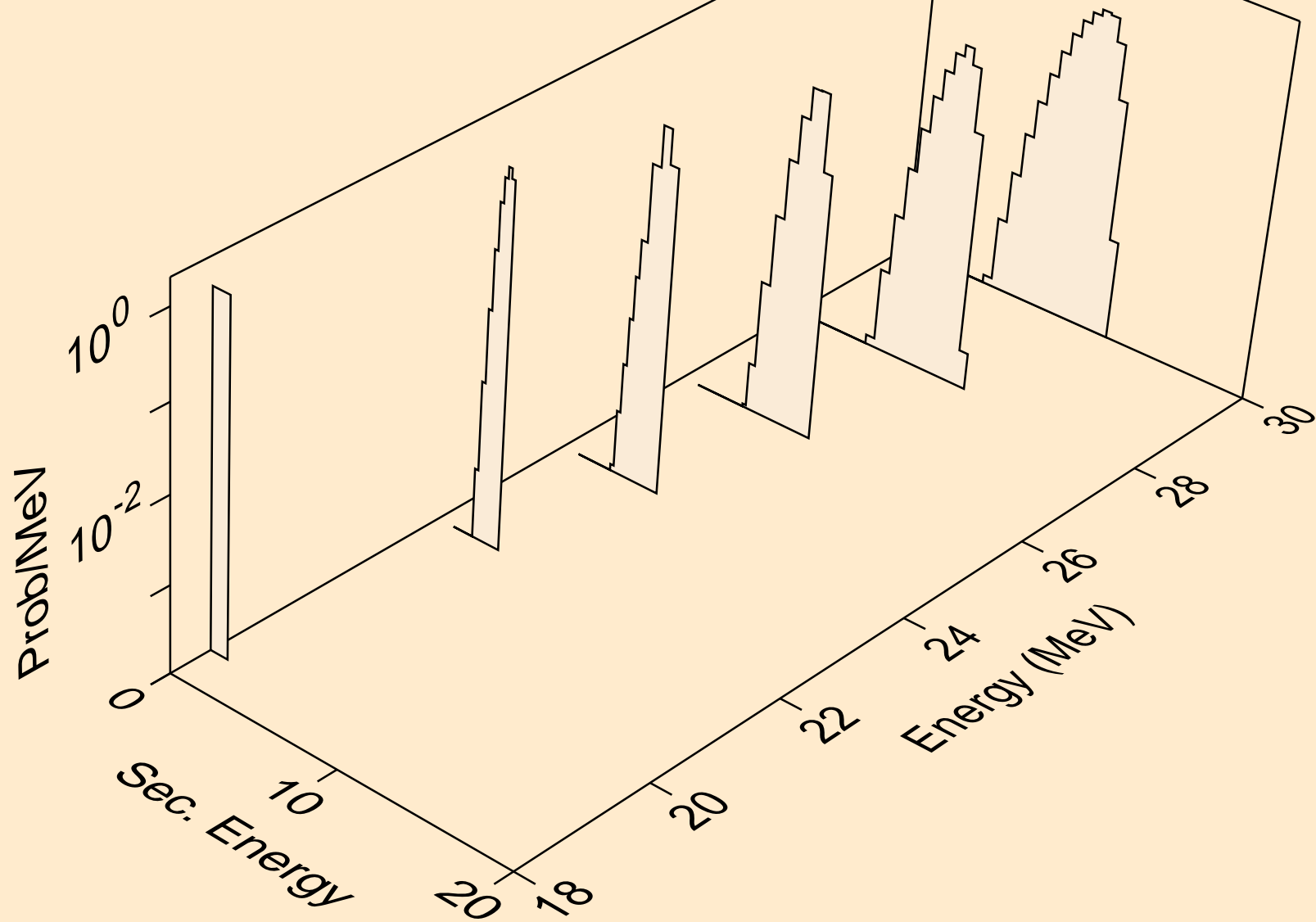

YB179 NEUTRON ACER TENDL-2021 LIBRARY; T=293.6K
deuterons from (n,n*)d

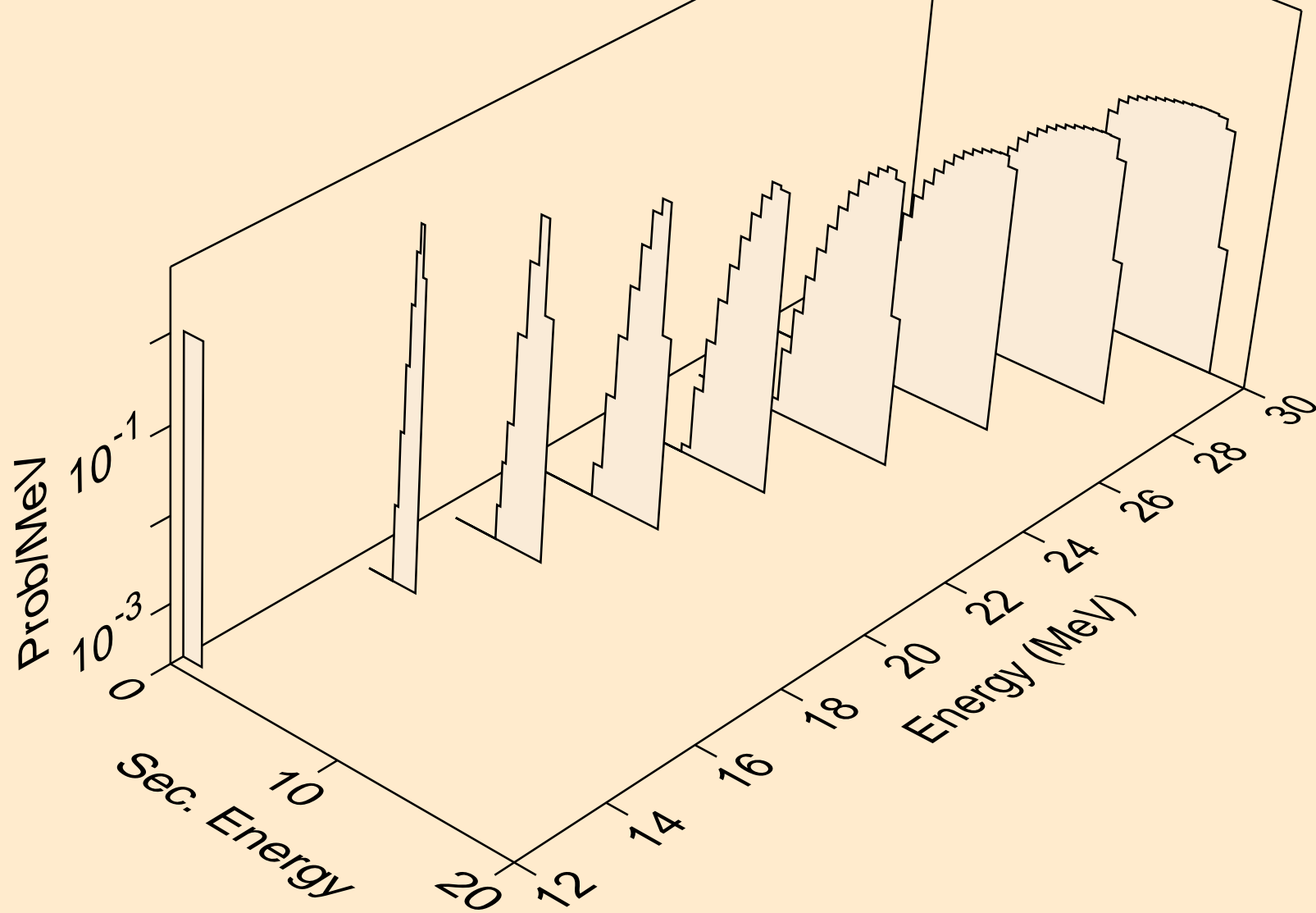

YB179 NEUTRON ACER TENDL-2021 LIBRARY; T=293.6K
deuterons from (n,d)

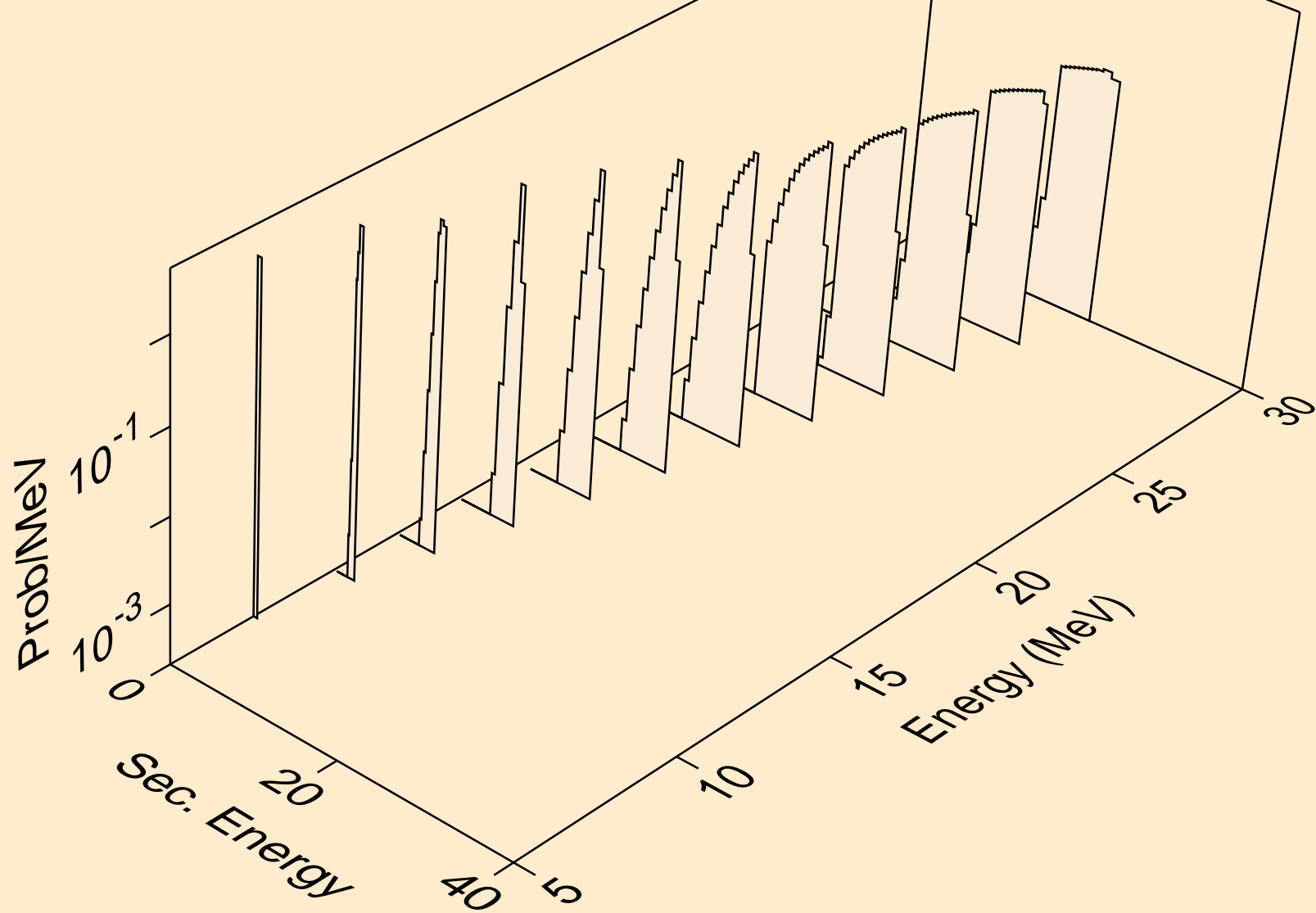

YB179 NEUTRON ACER TENDL-2021 LIBRARY; T=293.6K
tritons from (n,x)

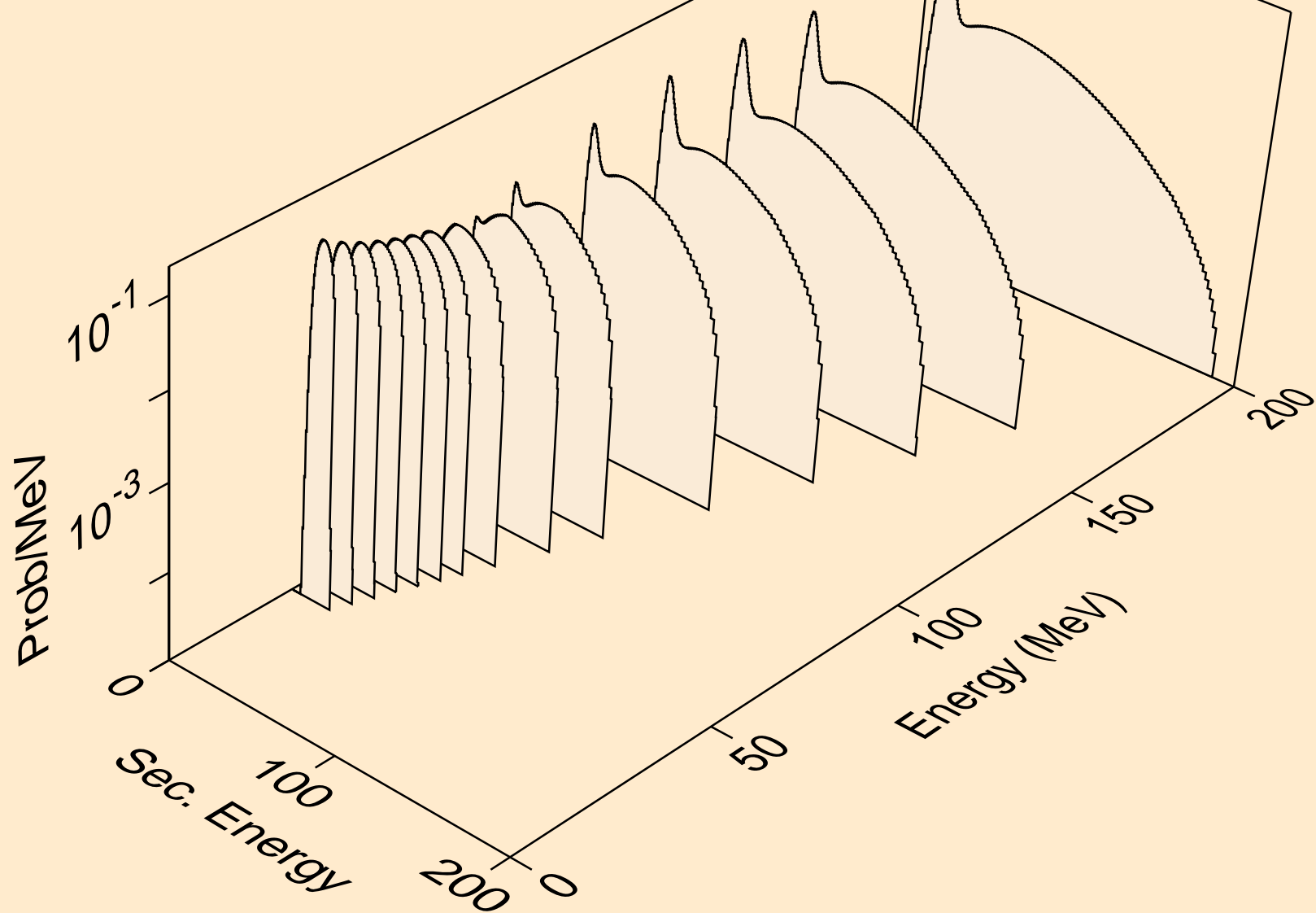

YB179 NEUTRON ACER TENDL-2021 LIBRARY; T=293.6K
tritons from (n,n*)t

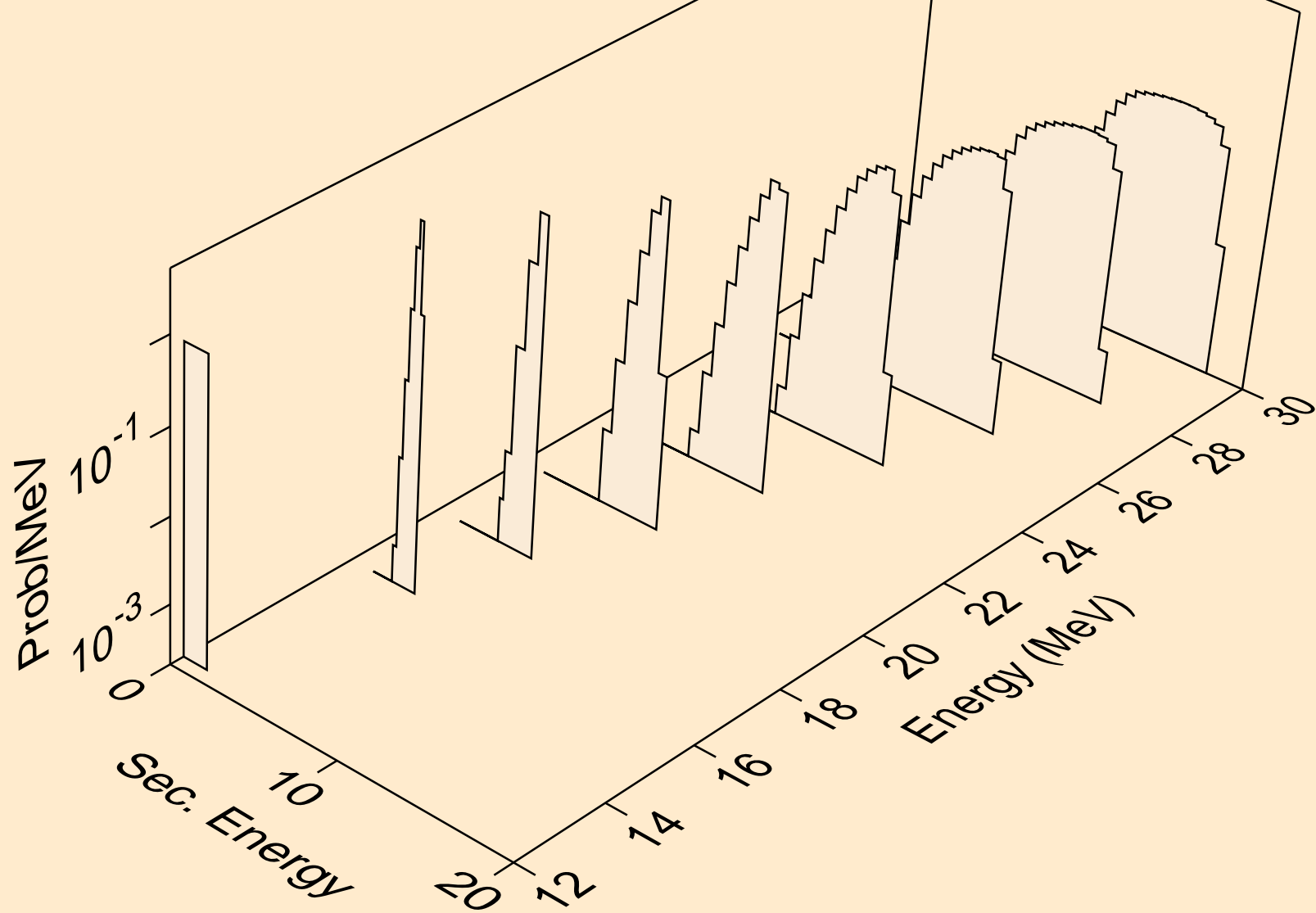

YB179 NEUTRON ACER TENDL-2021 LIBRARY; T=293.6K
tritons from (n,t)

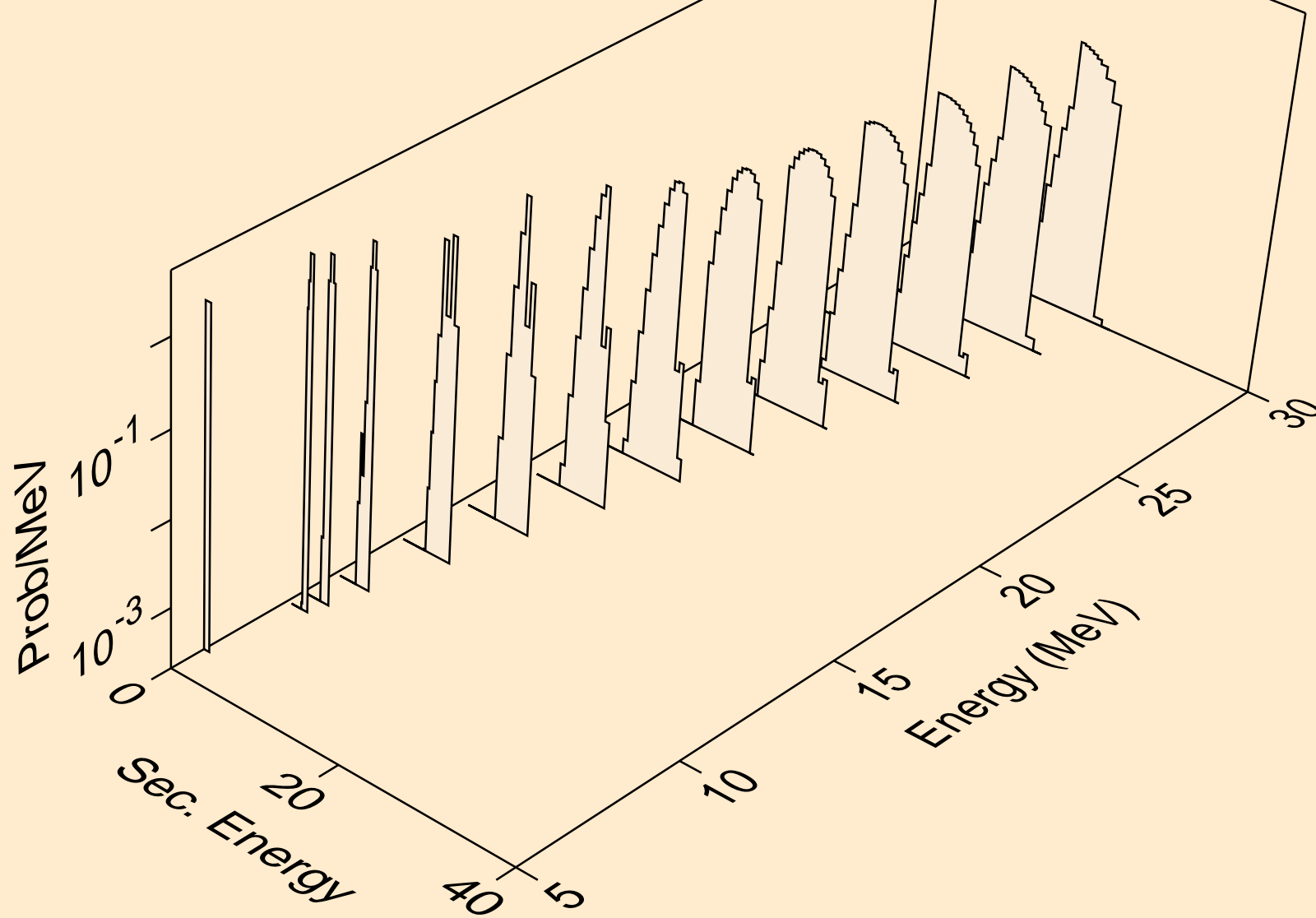

YB179 NEUTRON ACER TENDL-2021 LIBRARY; T=293.6K
he3s from (n,x)

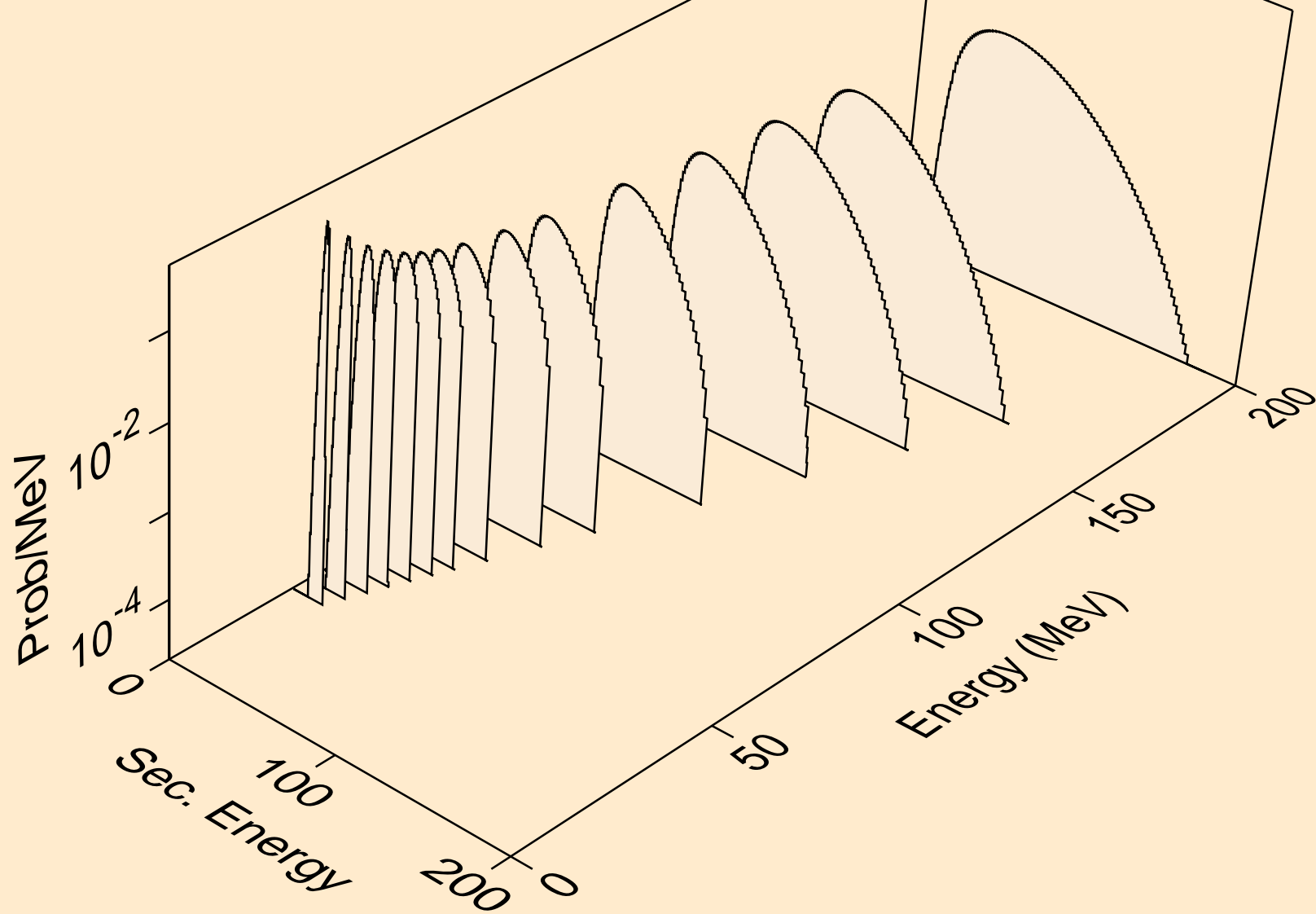

YB179 NEUTRON ACER TENDL-2021 LIBRARY; T=293.6K
he3s from (n,n*)he3

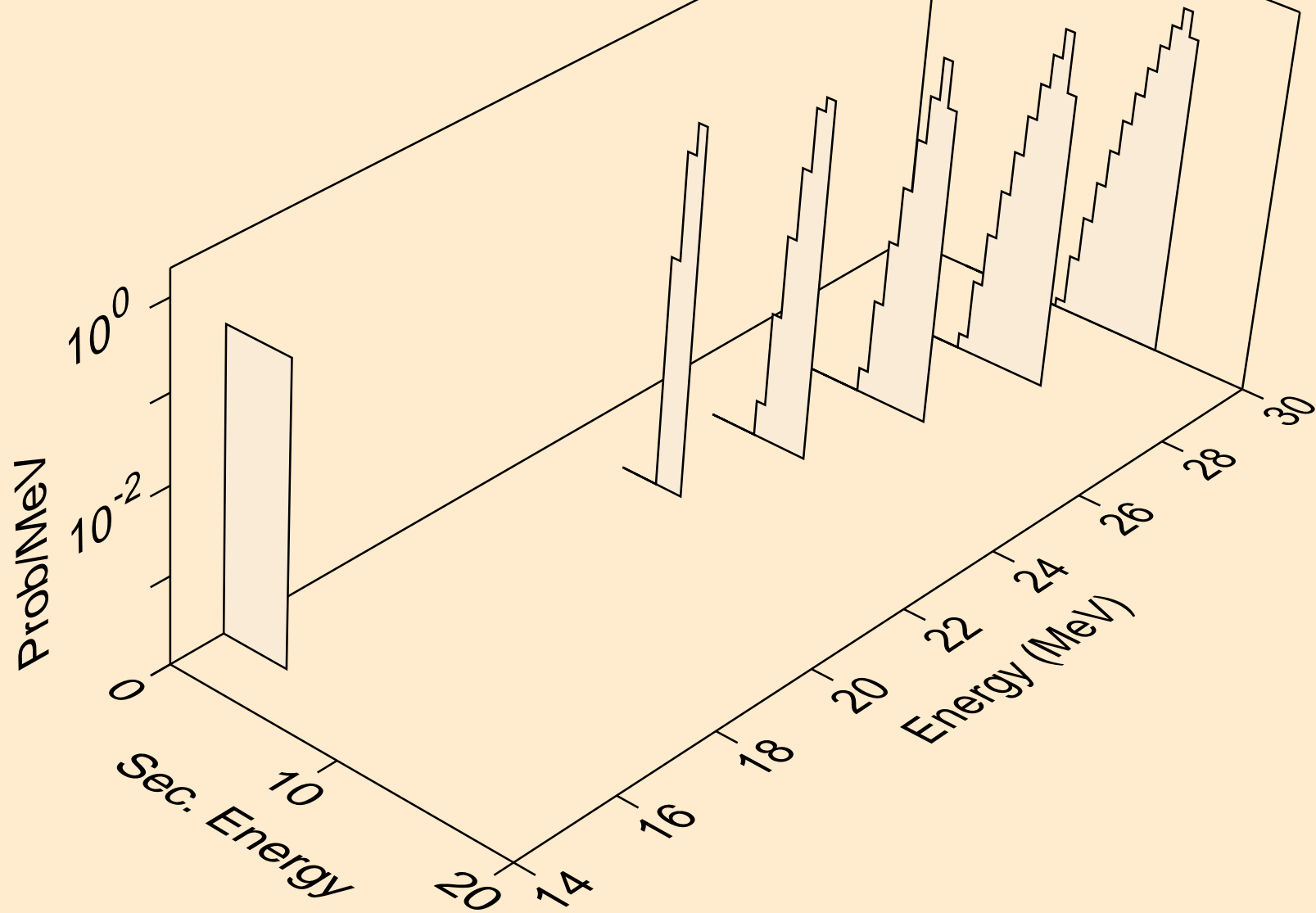

YB179 NEUTRON ACER TENDL-2021 LIBRARY; T=293.6K
he3s from (n,he3)

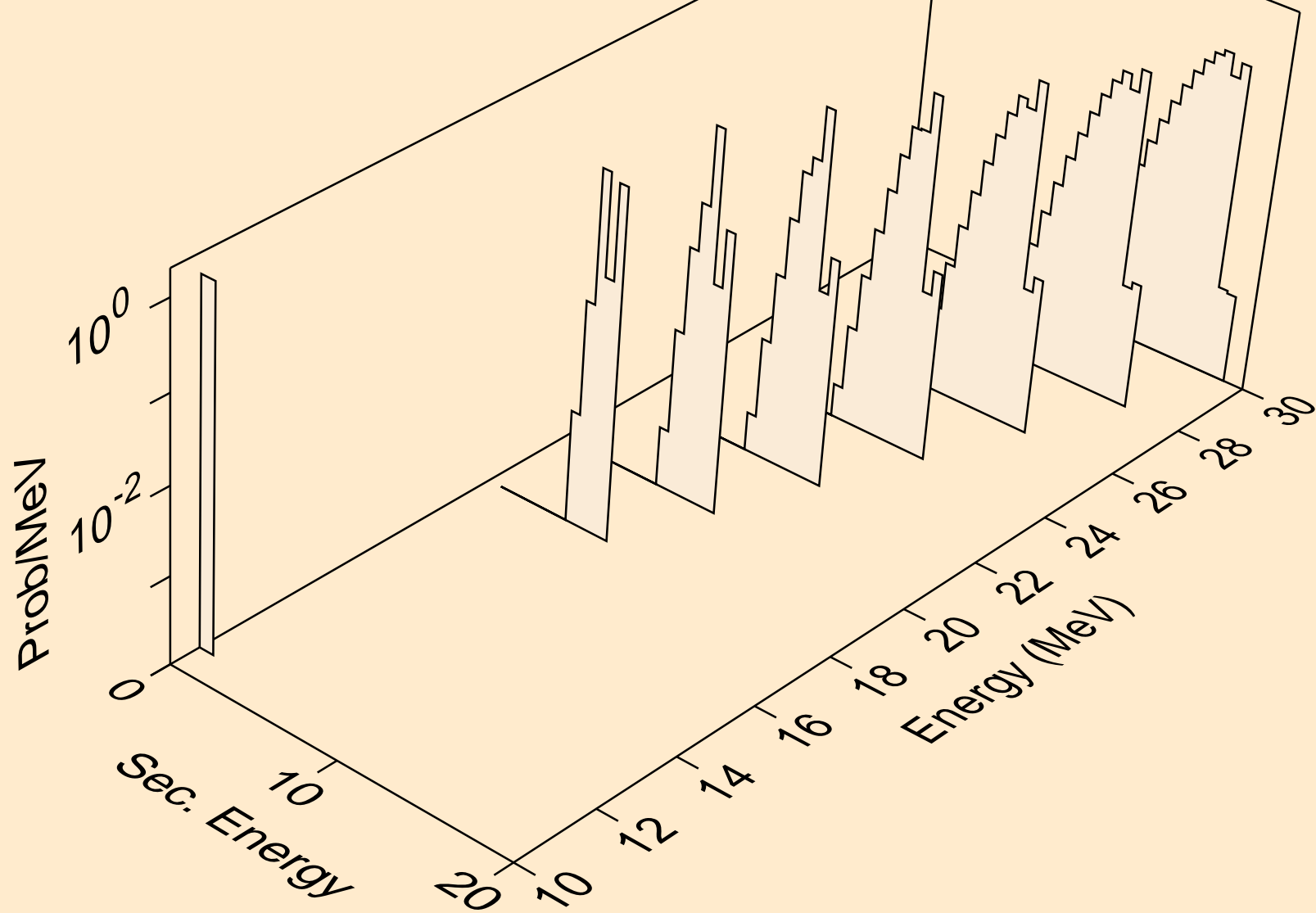

YB179 NEUTRON ACER TENDL-2021 LIBRARY; T=293.6K
alphas from (n,x)

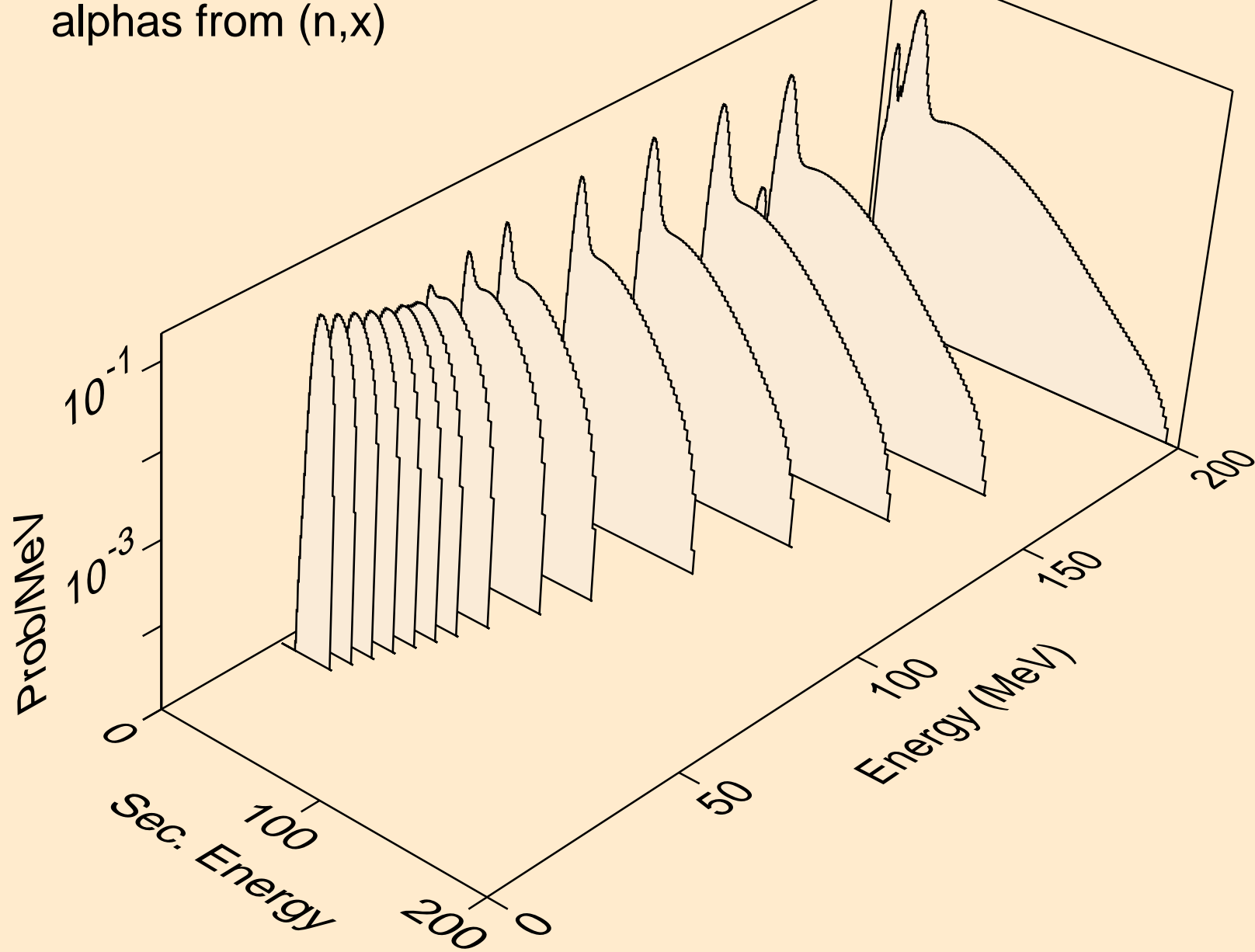

YB179 NEUTRON ACER TENDL-2021 LIBRARY; T=293.6K
alphas from (n,n*)a

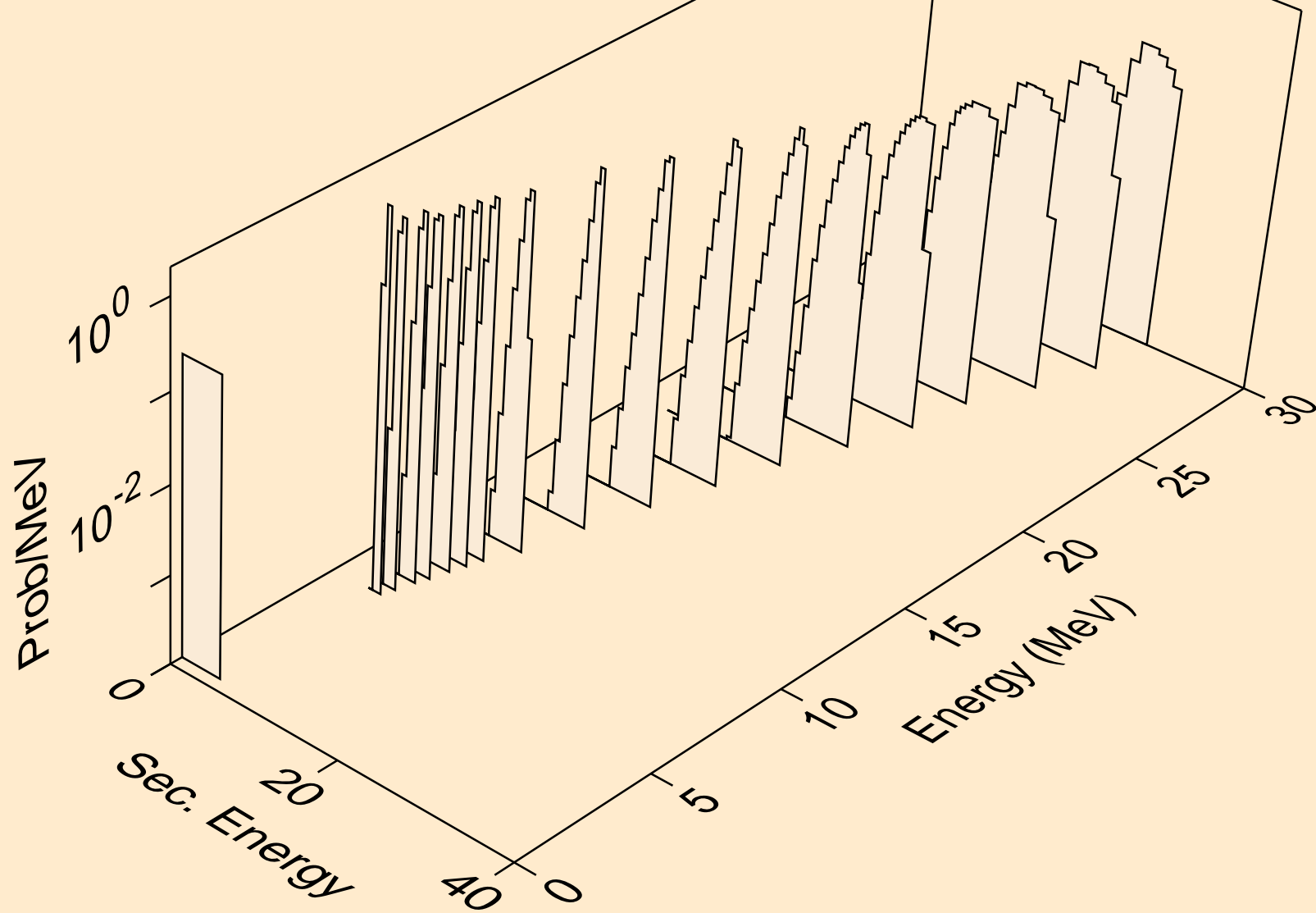

YB179 NEUTRON ACER TENDL-2021 LIBRARY; T=293.6K
alphas from (n,2n)a

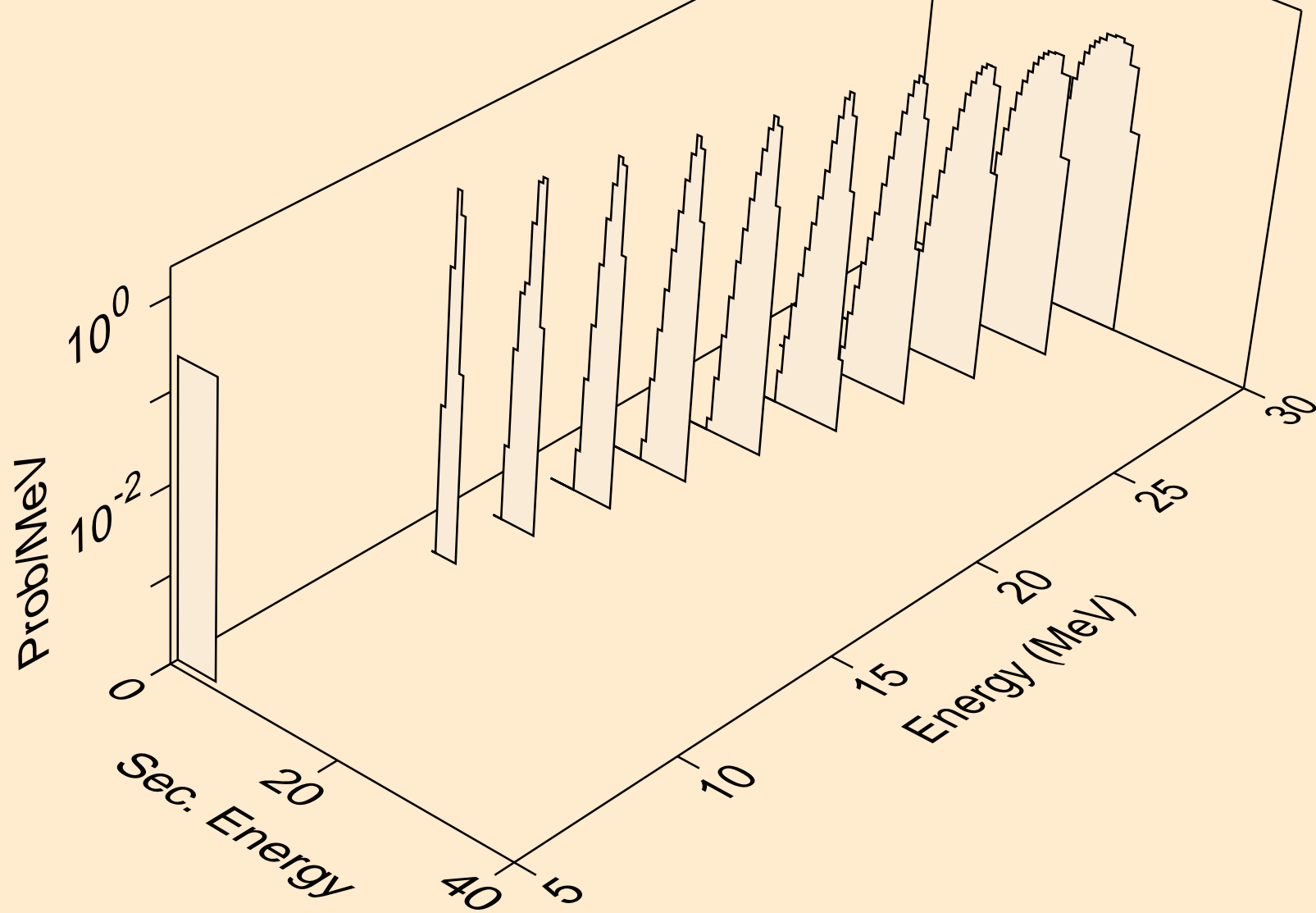

YB179 NEUTRON ACER TENDL-2021 LIBRARY; T=293.6K
alphas from (n,3n)a

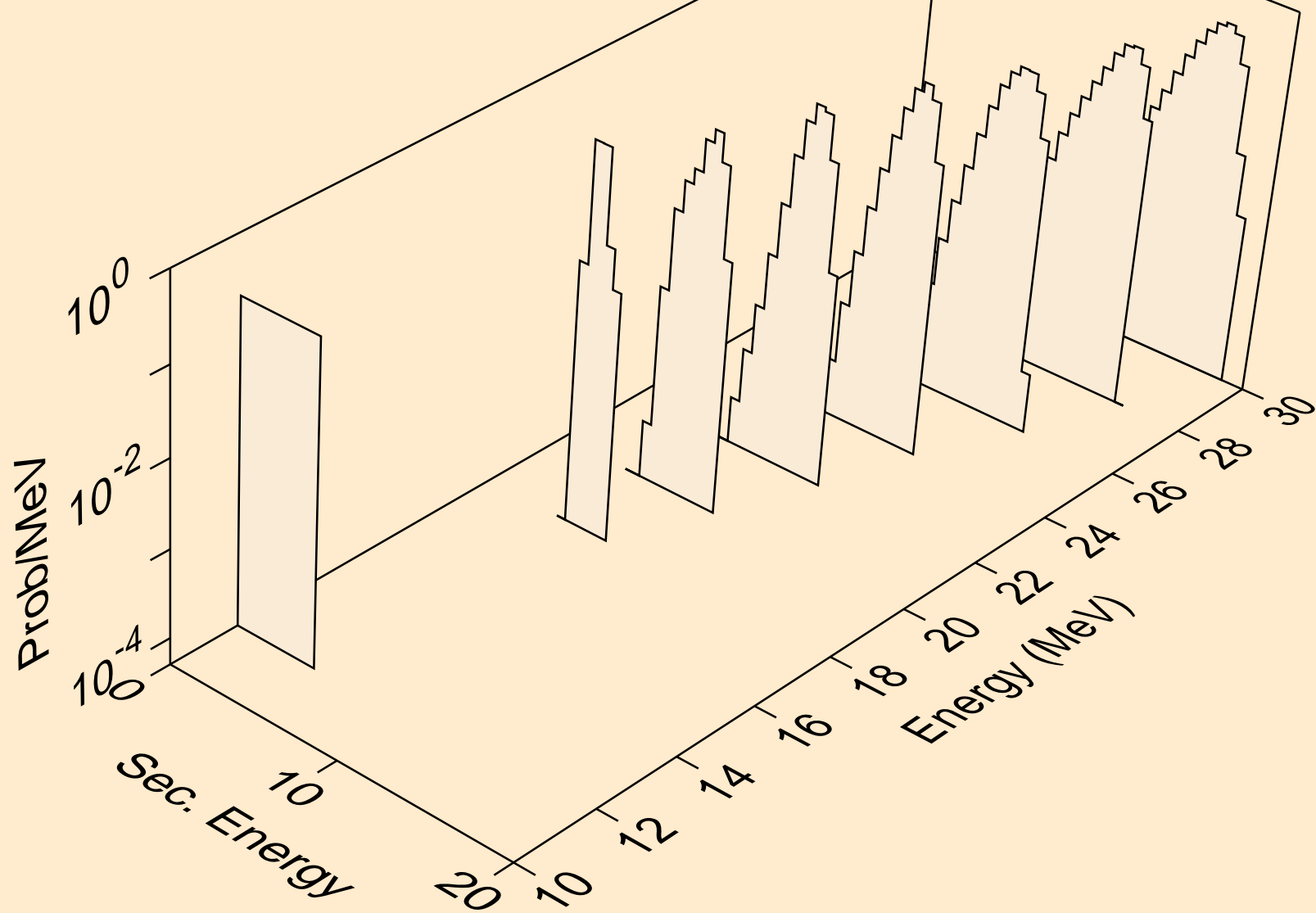

YB179 NEUTRON ACER TENDL-2021 LIBRARY; T=293.6K
alphas from (n,a)

