

ZR085M NEUTRON ACER TENDL-2021 LIBRARY; T=293.6K
Principal cross sections

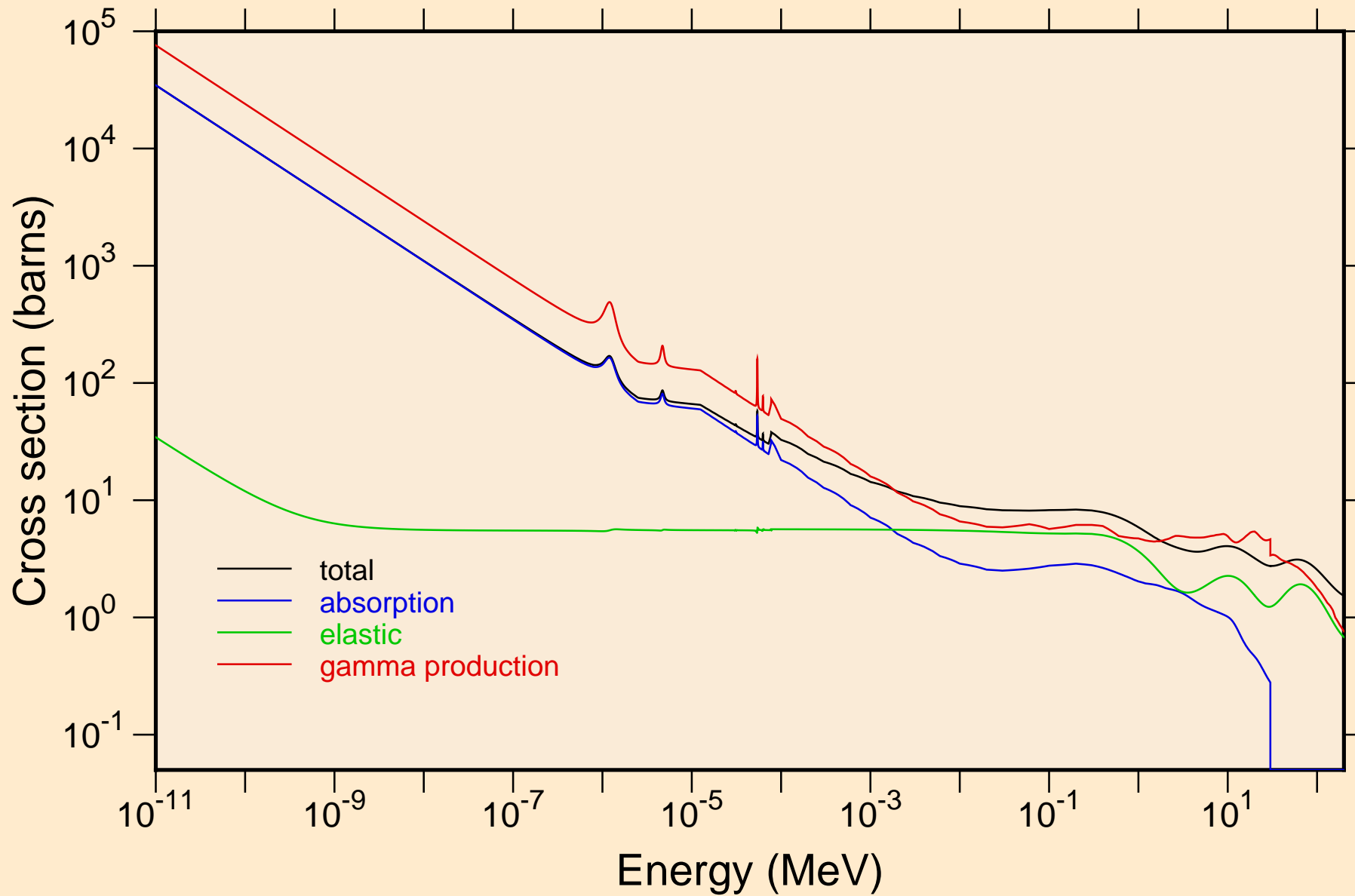

ZR085M NEUTRON ACER TENDL-2021 LIBRARY; T=293.6K
resonance total cross section

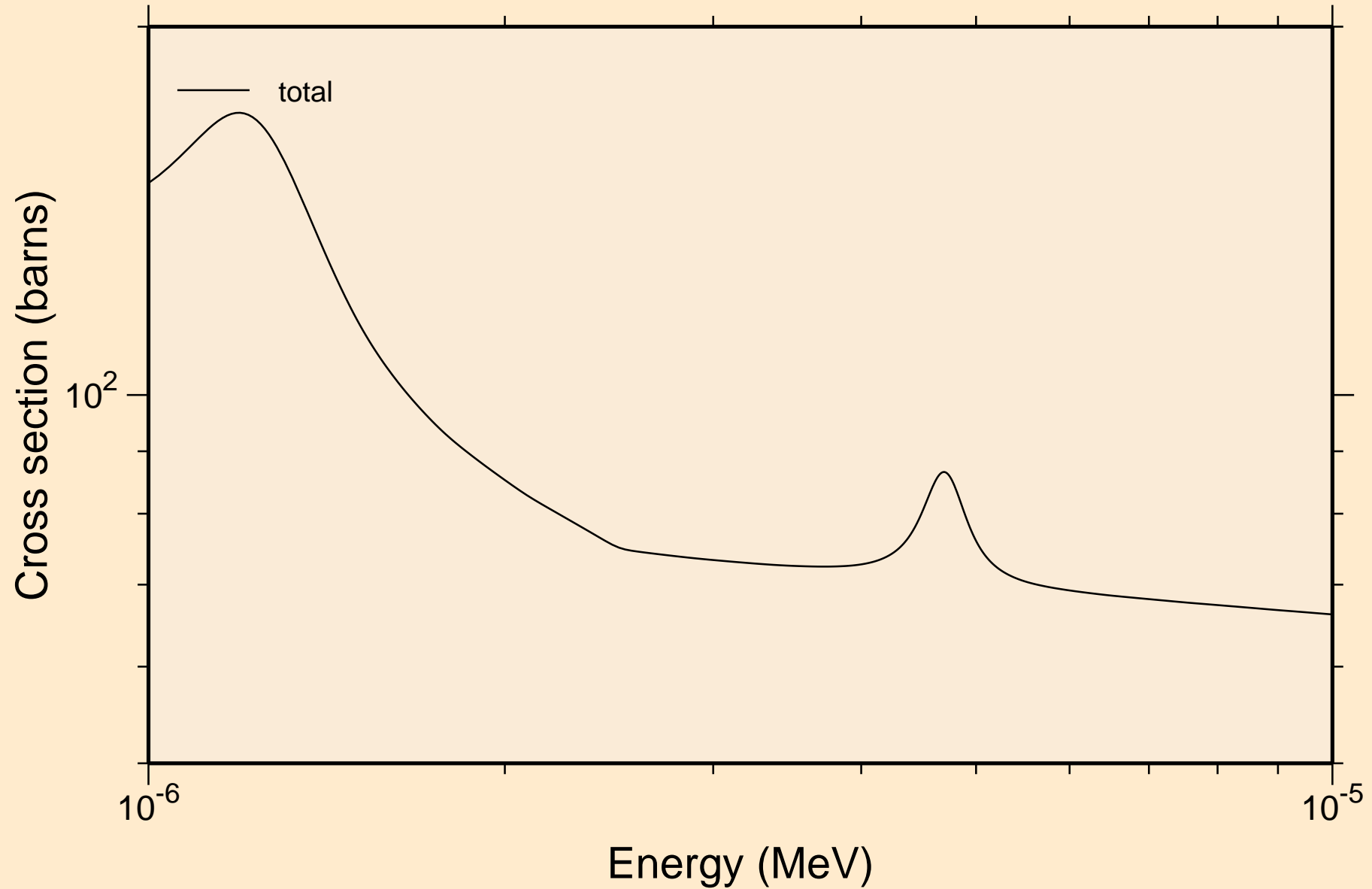

ZR085M NEUTRON ACER TENDL-2021 LIBRARY; T=293.6K
resonance total cross section

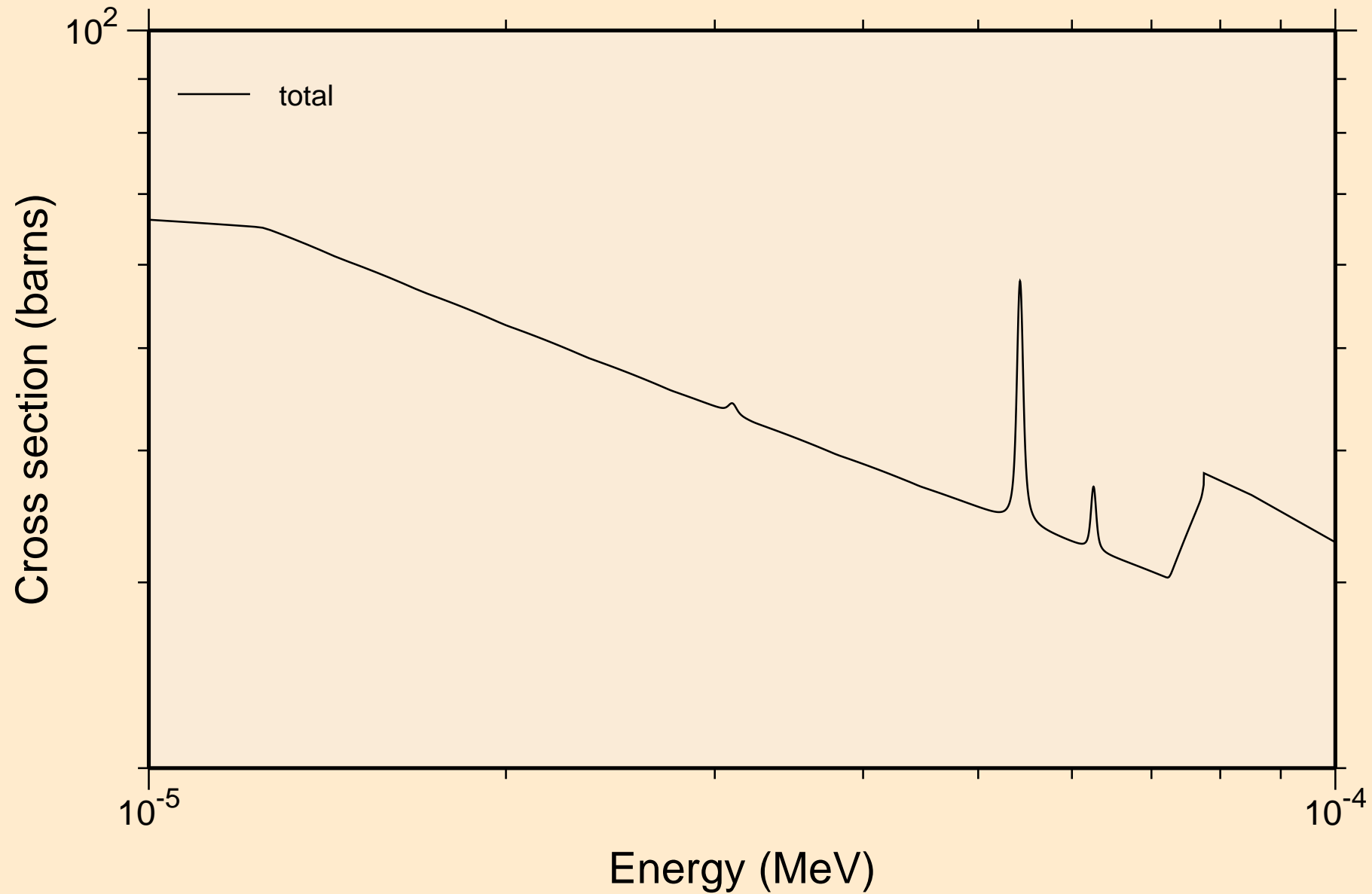

ZR085M NEUTRON ACER TENDL-2021 LIBRARY; T=293.6K
resonance total cross section

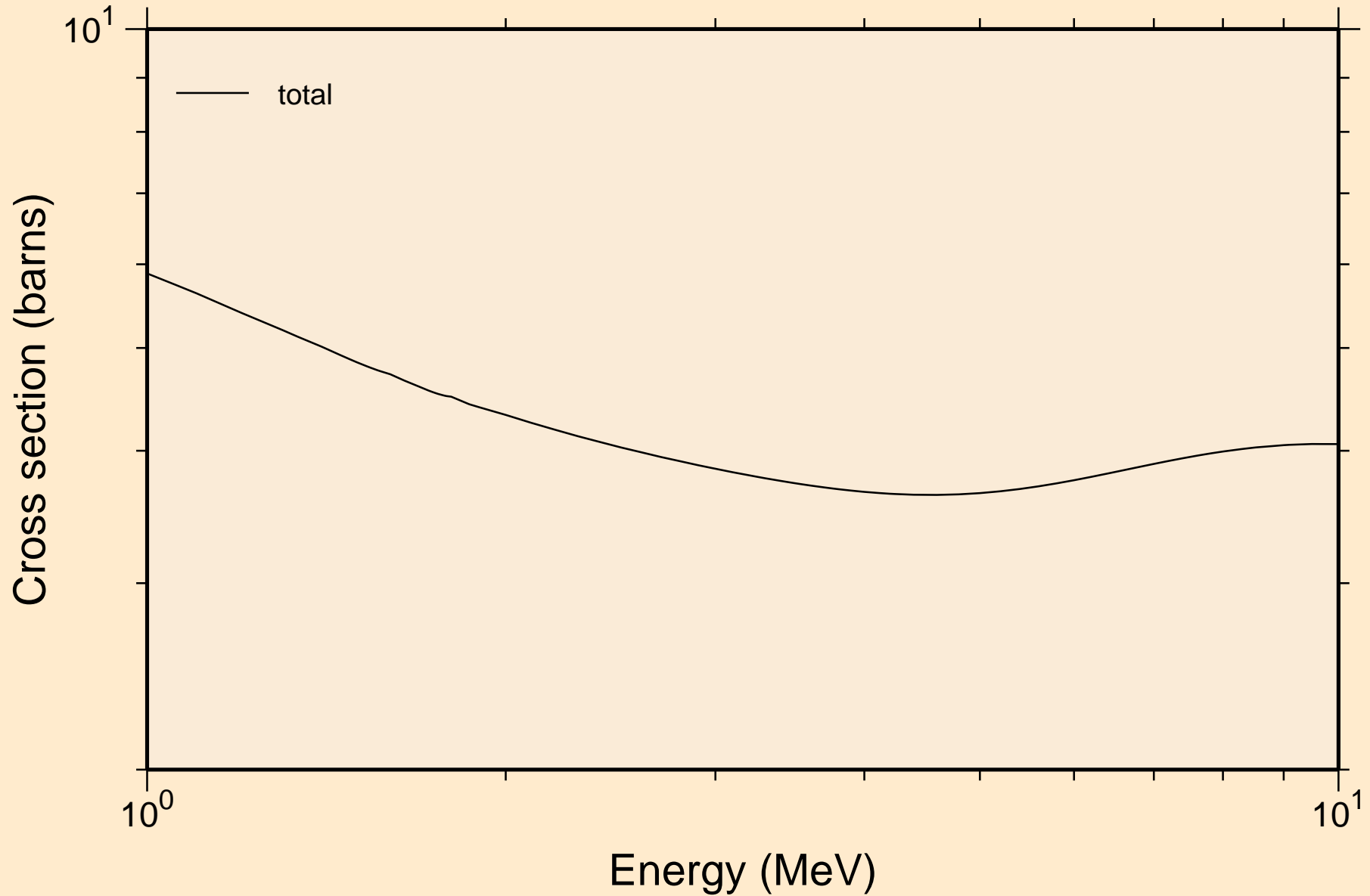

ZR085M NEUTRON ACER TENDL-2021 LIBRARY; T=293.6K
resonance absorption cross sections

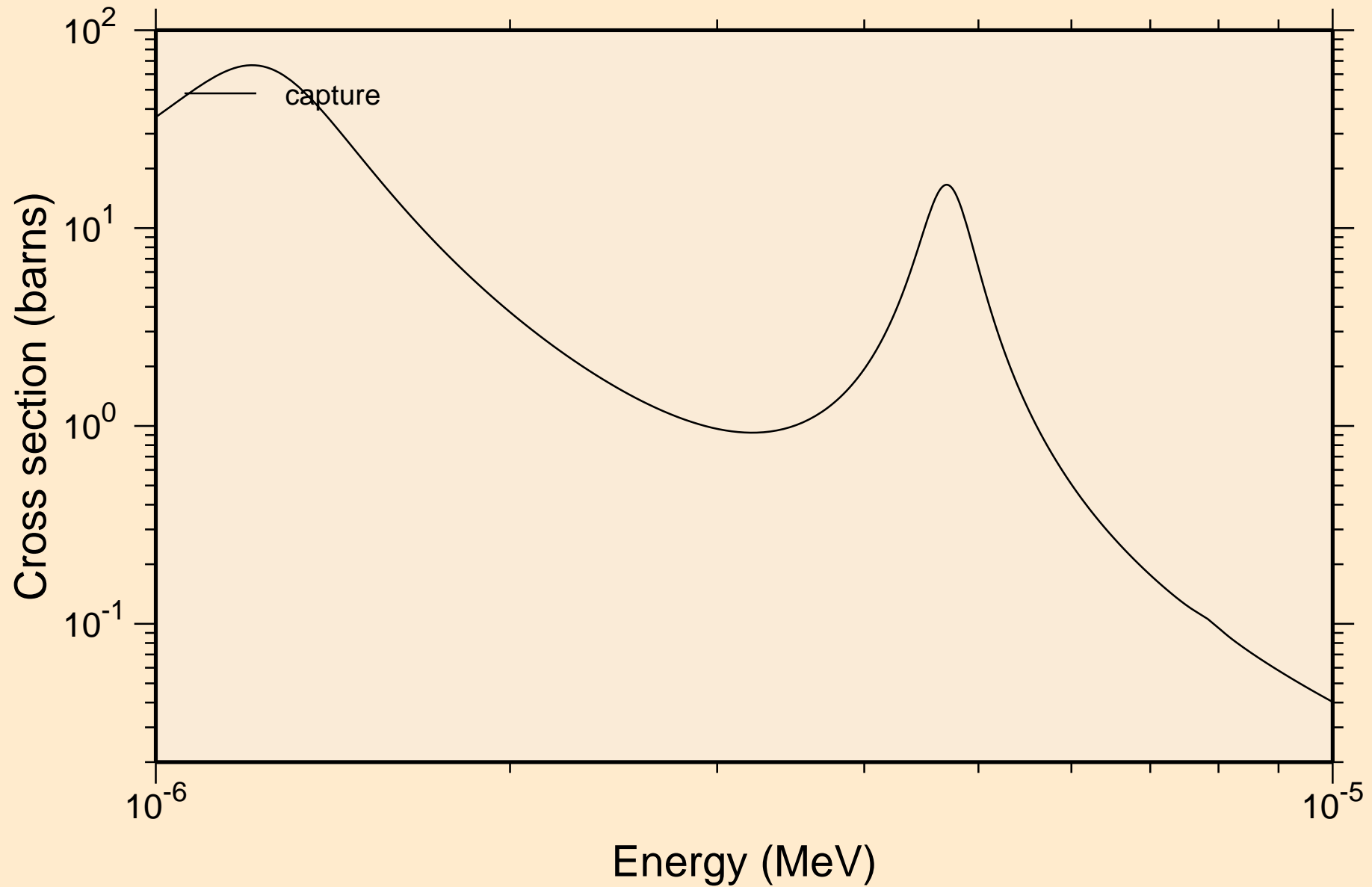

ZR085M NEUTRON ACER TENDL-2021 LIBRARY; T=293.6K
resonance absorption cross sections

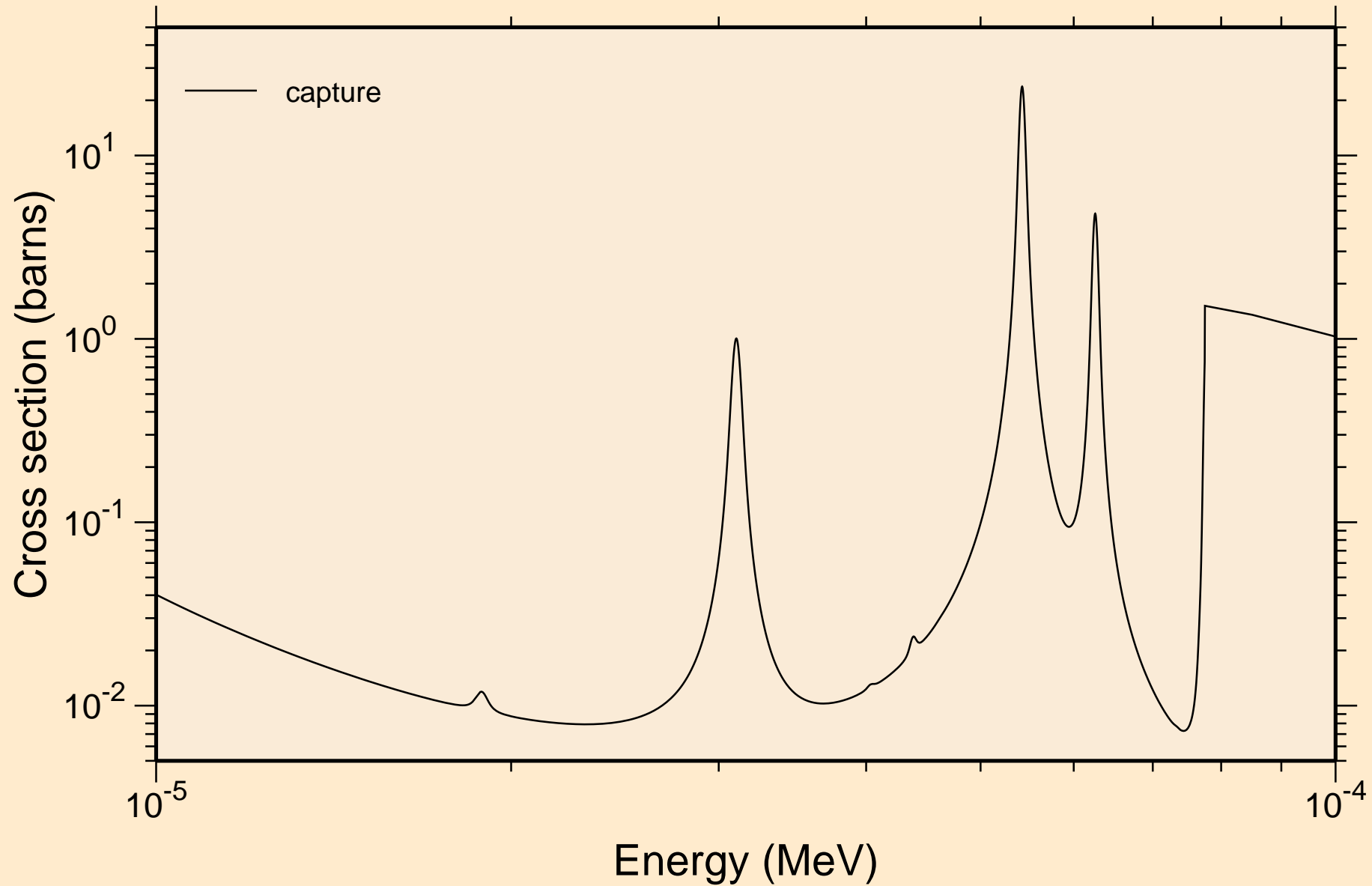

ZR085M NEUTRON ACER TENDL-2021 LIBRARY; T=293.6K
resonance absorption cross sections

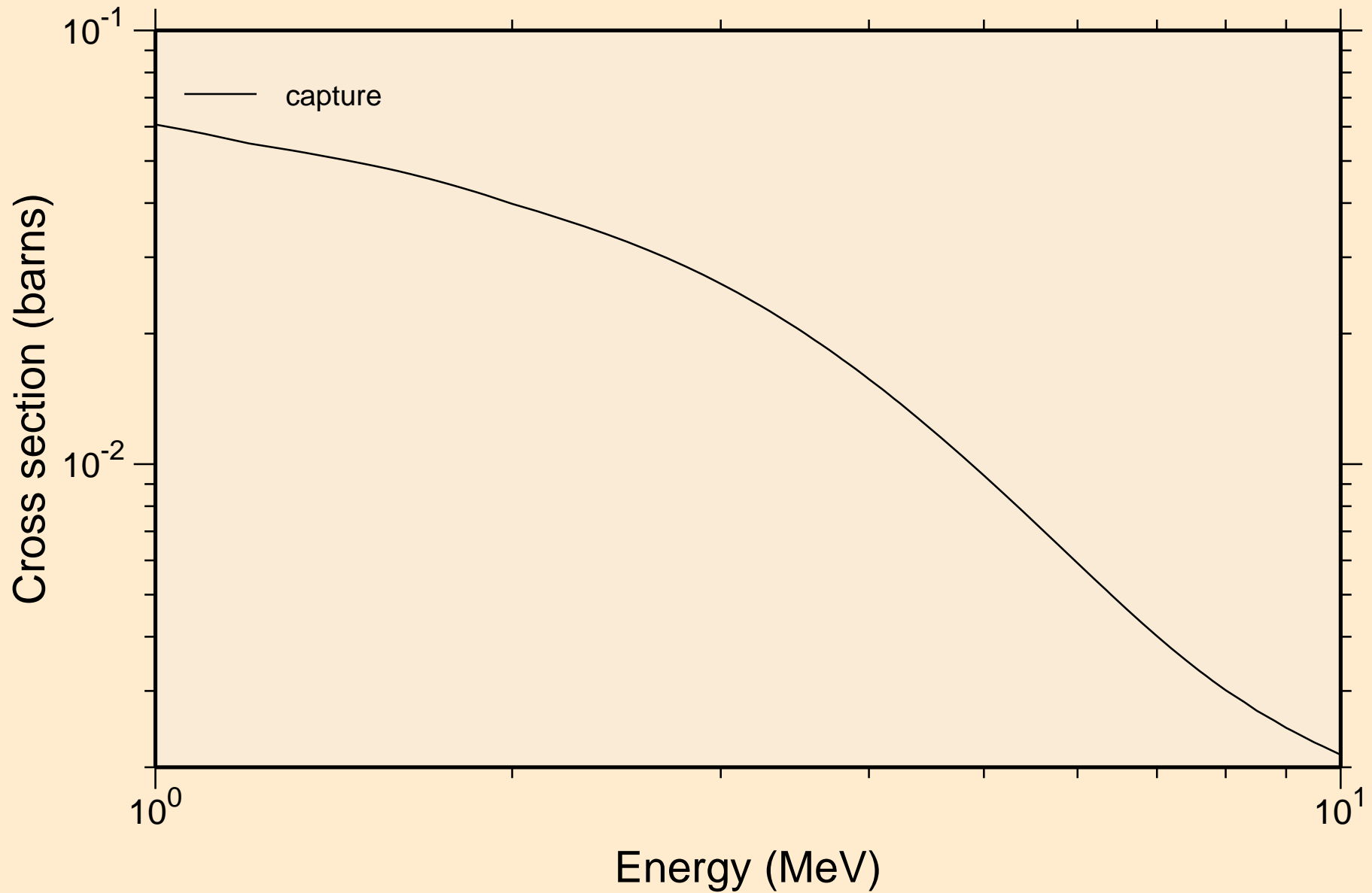

ZR085M NEUTRON ACER TENDL-2021 LIBRARY; T=293.6K
Heating

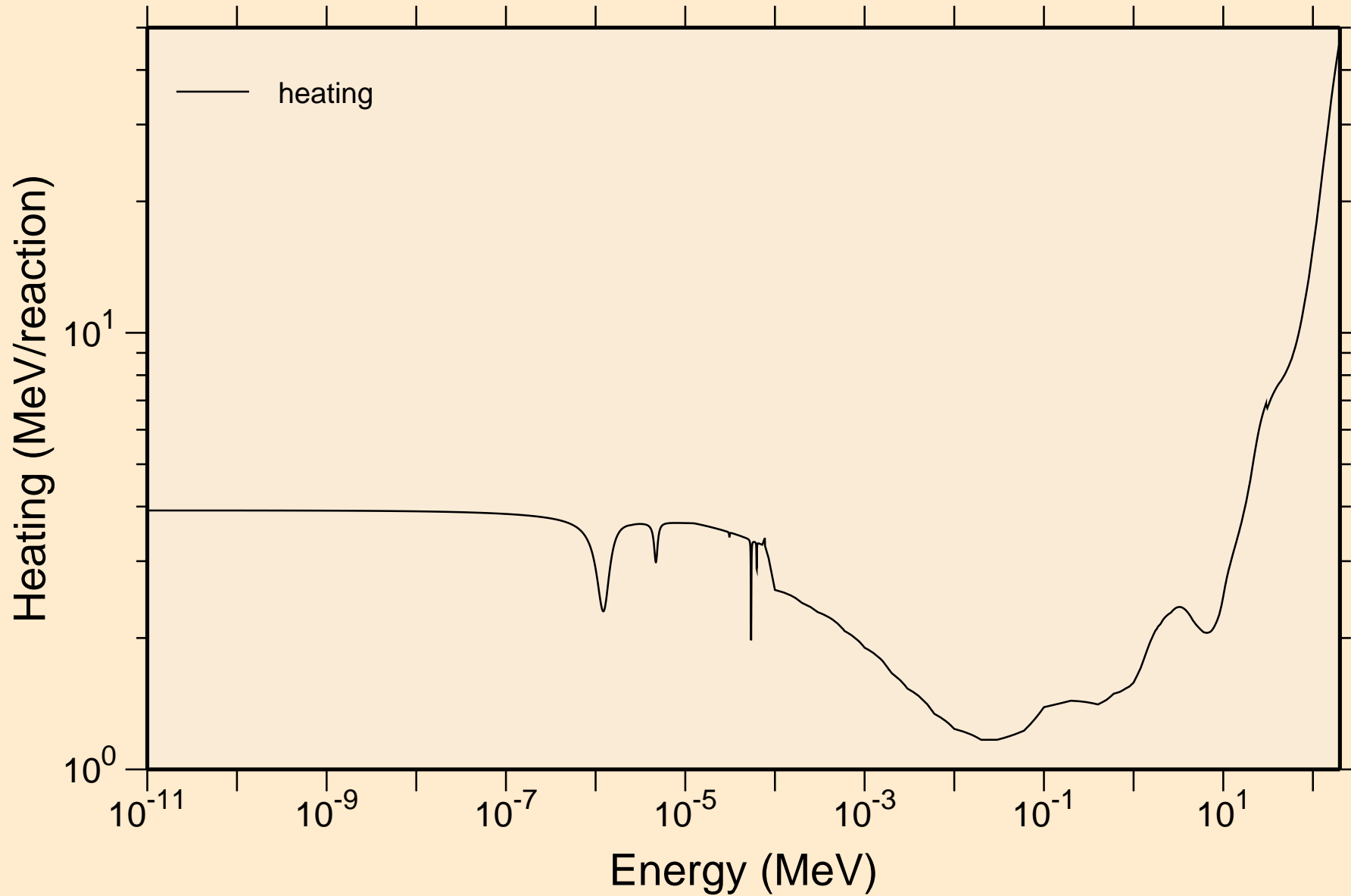

ZR085M NEUTRON ACER TENDL-2021 LIBRARY; T=293.6K
Damage

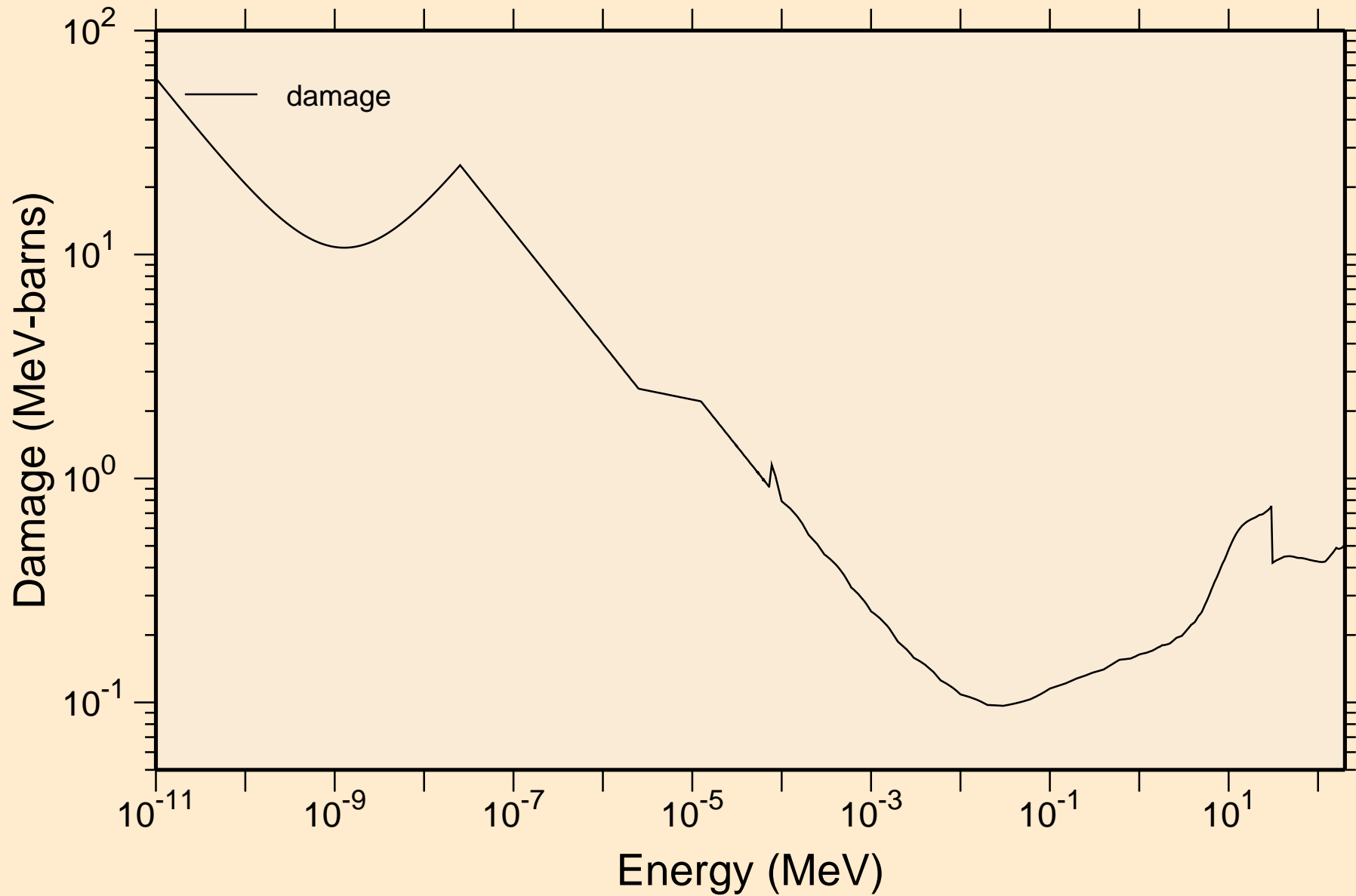

ZR085M NEUTRON ACER TENDL-2021 LIBRARY; T=293.6K
Non-threshold reactions

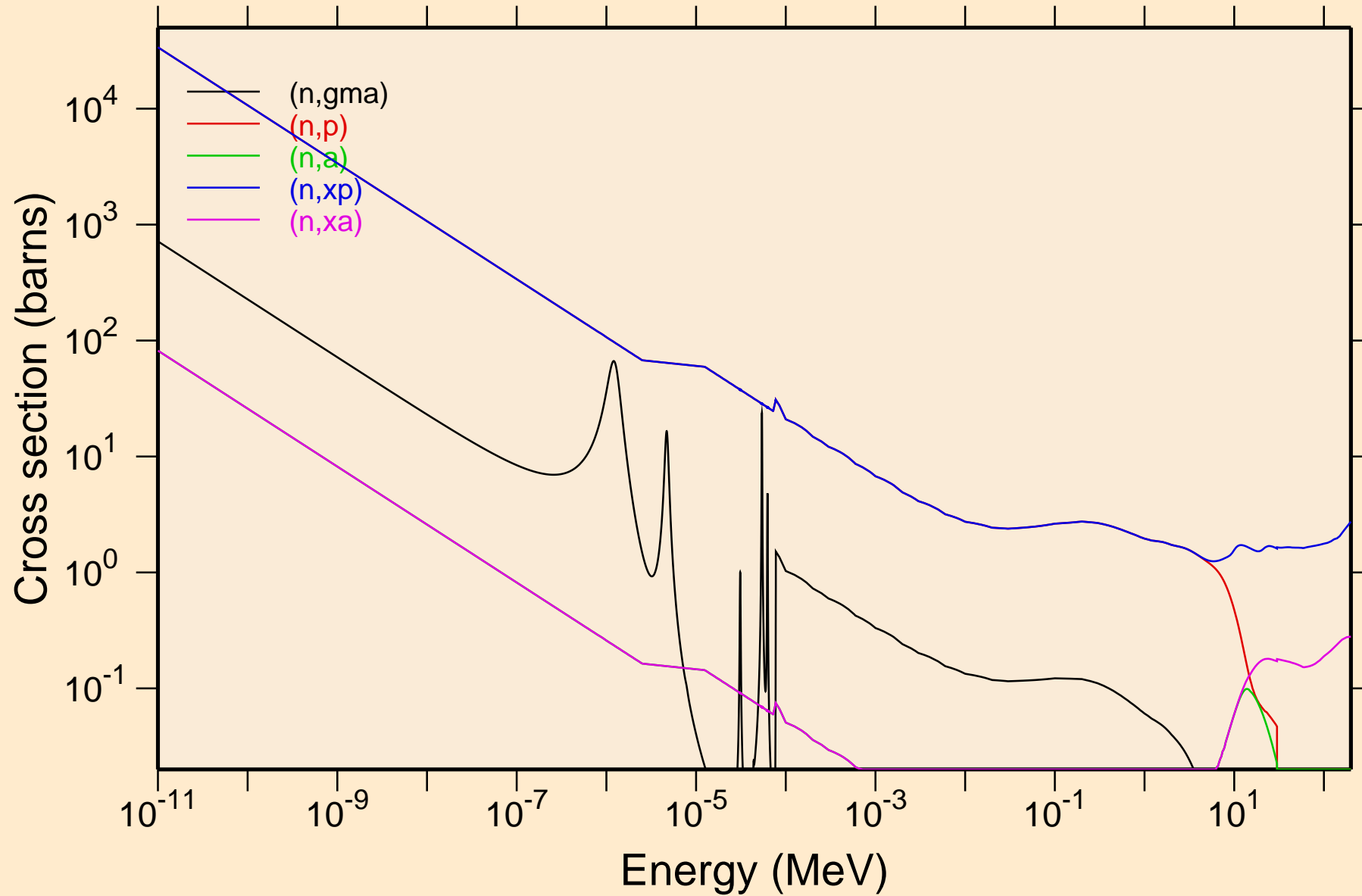

ZR085M NEUTRON ACER TENDL-2021 LIBRARY; T=293.6K
Principal cross sections

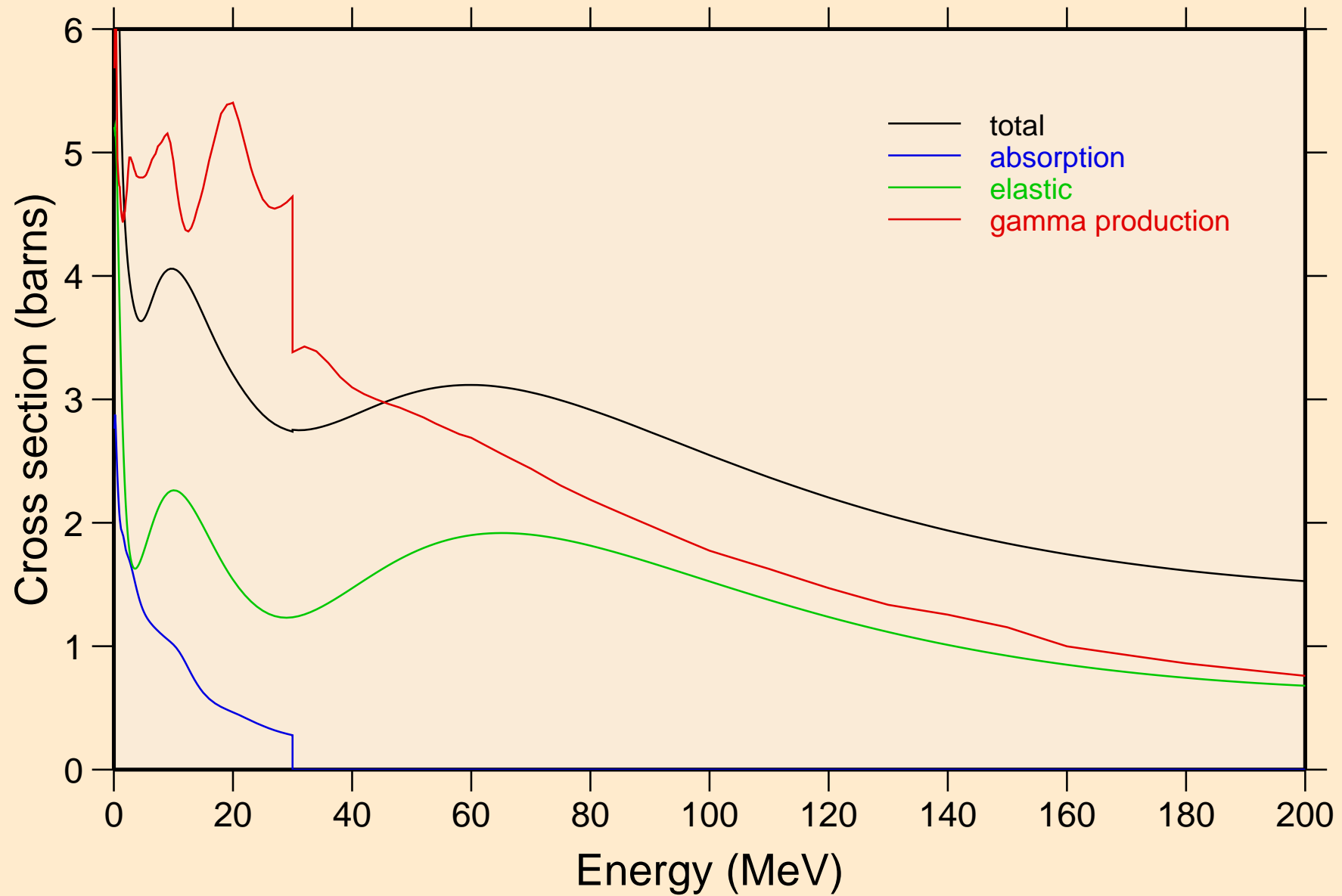

ZR085M NEUTRON ACER TENDL-2021 LIBRARY; T=293.6K
Heating

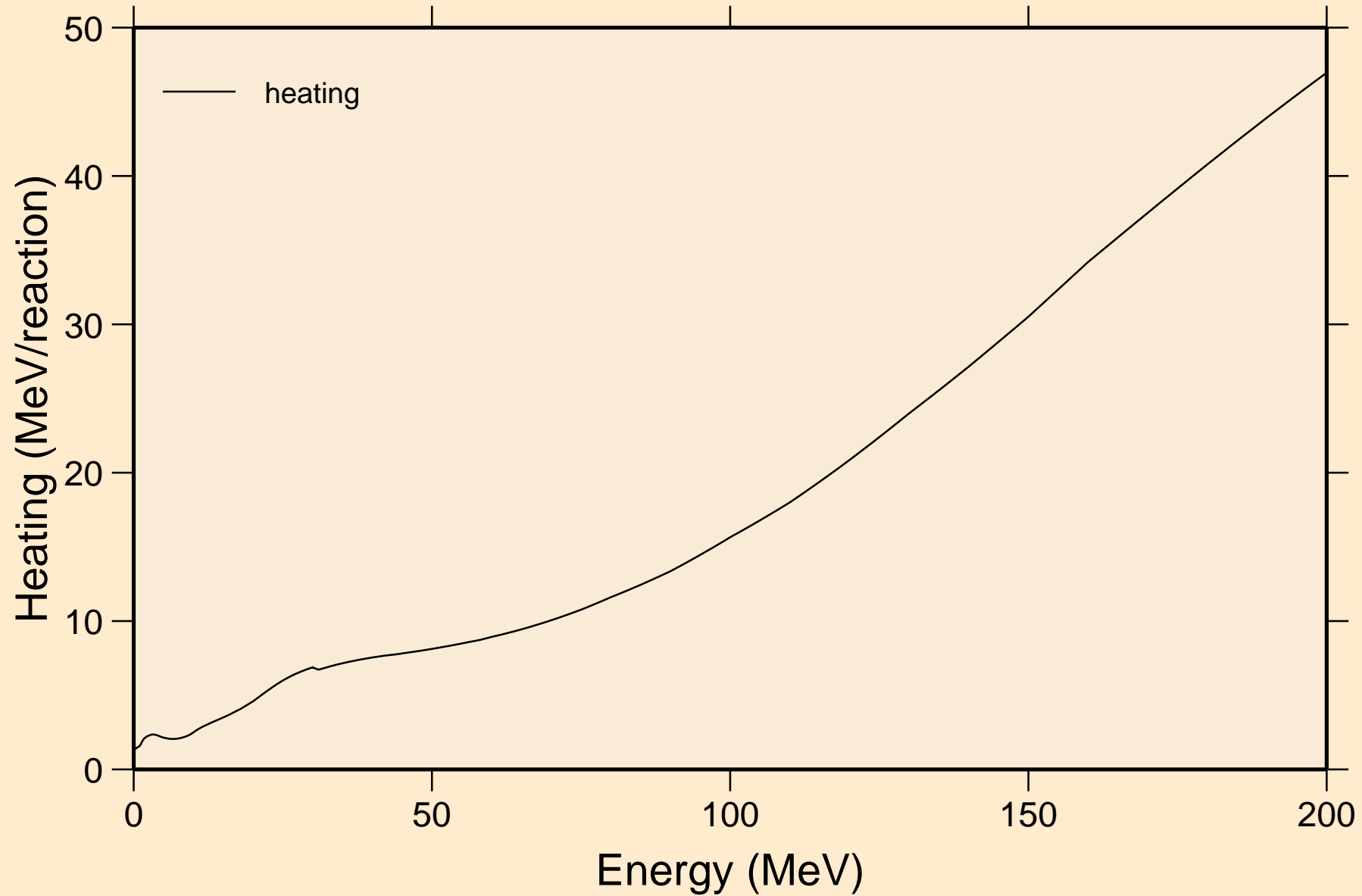

ZR085M NEUTRON ACER TENDL-2021 LIBRARY; T=293.6K
Damage

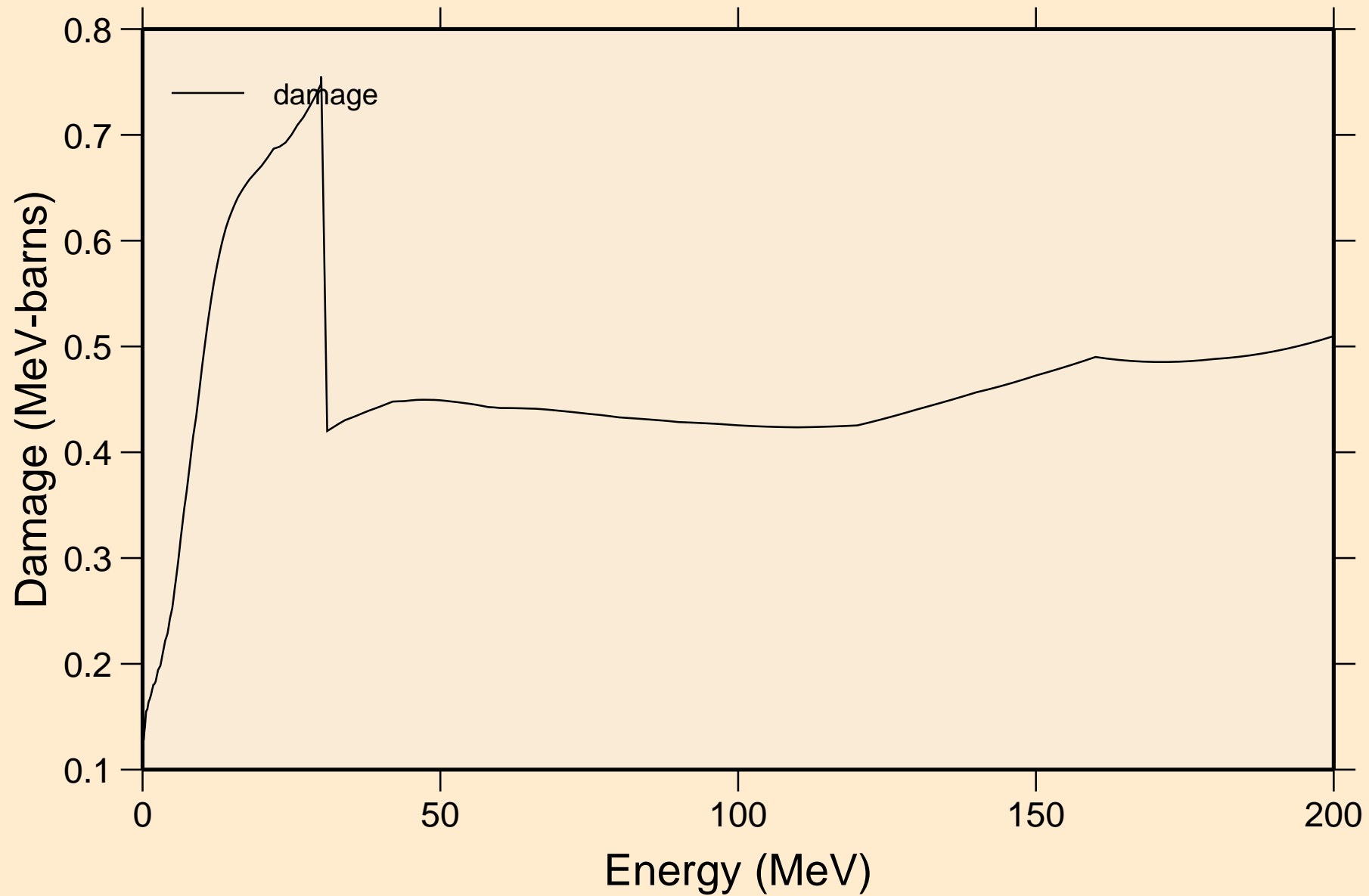

ZR085M NEUTRON ACER TENDL-2021 LIBRARY; T=293.6K
Non-threshold reactions

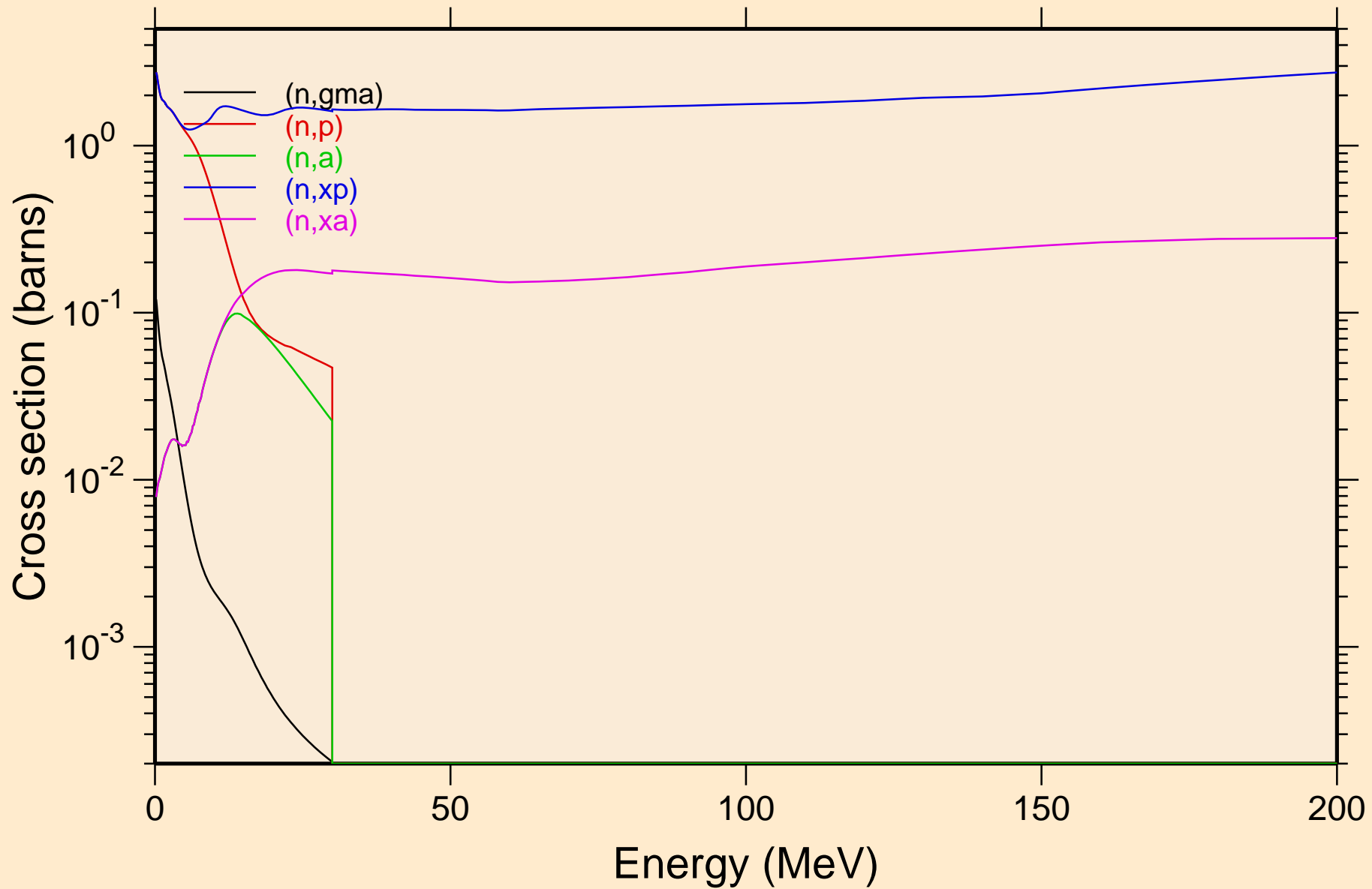

ZR085M NEUTRON ACER TENDL-2021 LIBRARY; T=293.6K
Inelastic levels

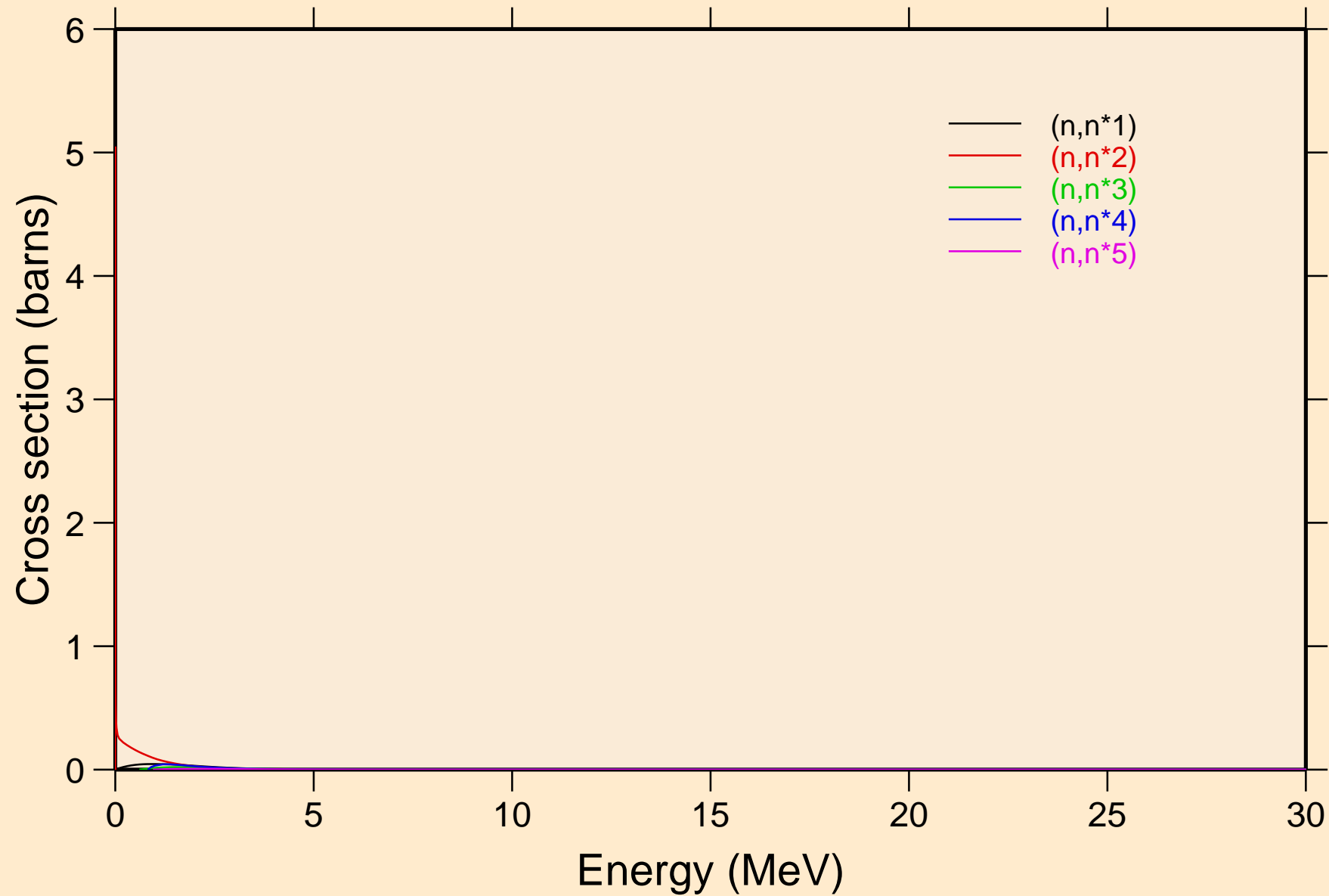

ZR085M NEUTRON ACER TENDL-2021 LIBRARY; T=293.6K
Inelastic levels

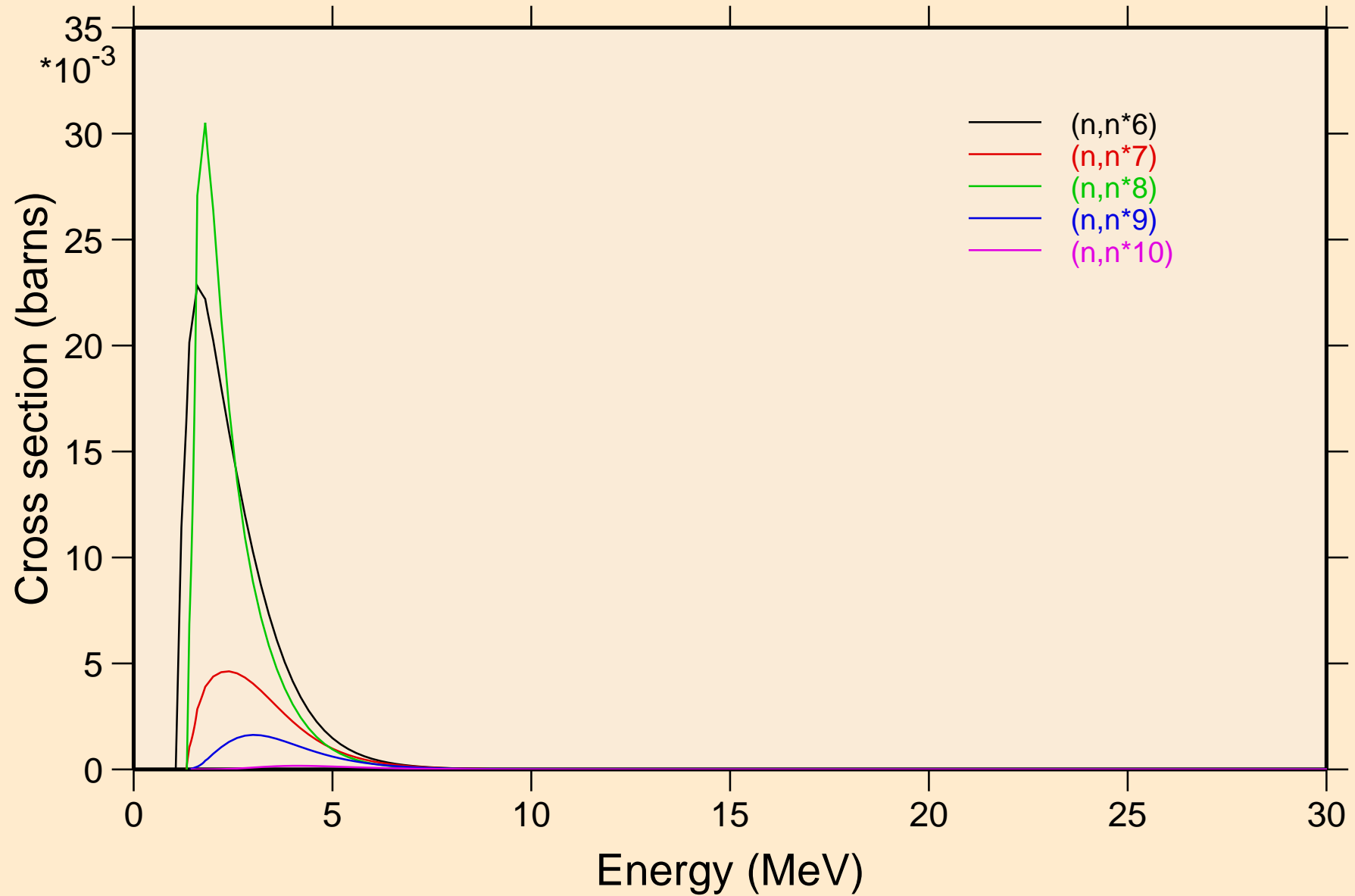

ZR085M NEUTRON ACER TENDL-2021 LIBRARY; T=293.6K
Inelastic levels

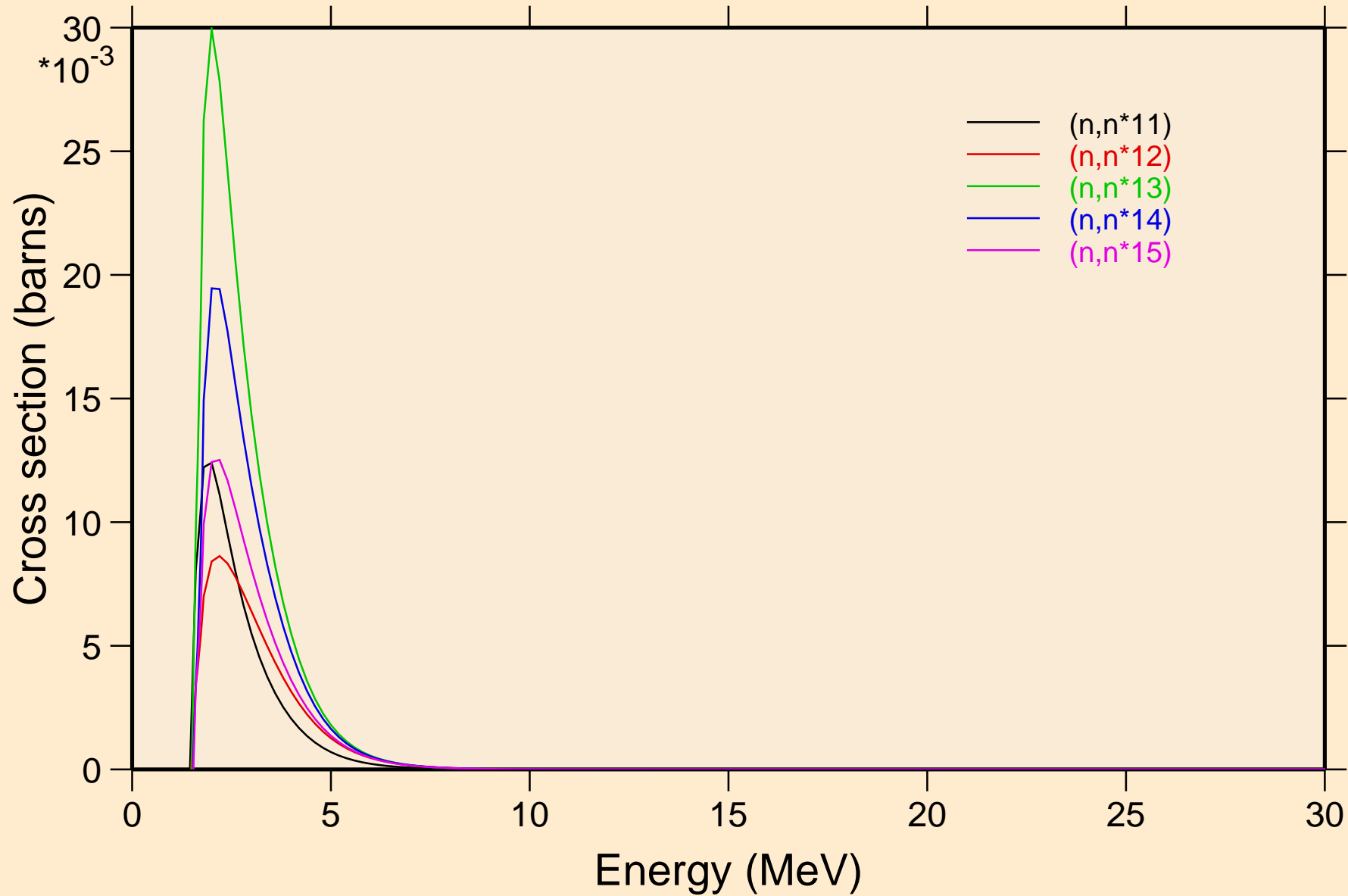

ZR085M NEUTRON ACER TENDL-2021 LIBRARY; T=293.6K
Inelastic levels

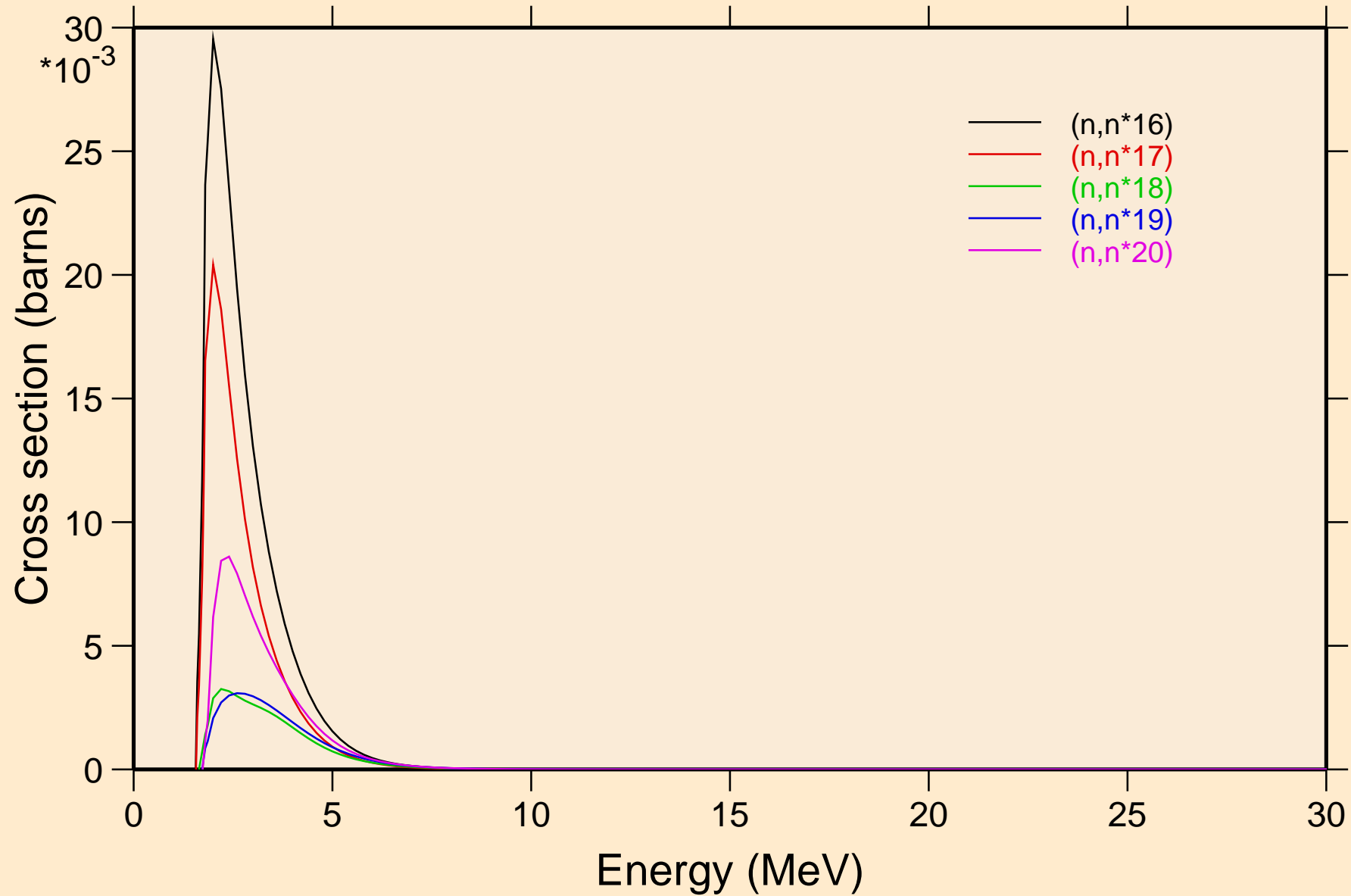

ZR085M NEUTRON ACER TENDL-2021 LIBRARY; T=293.6K
Inelastic levels

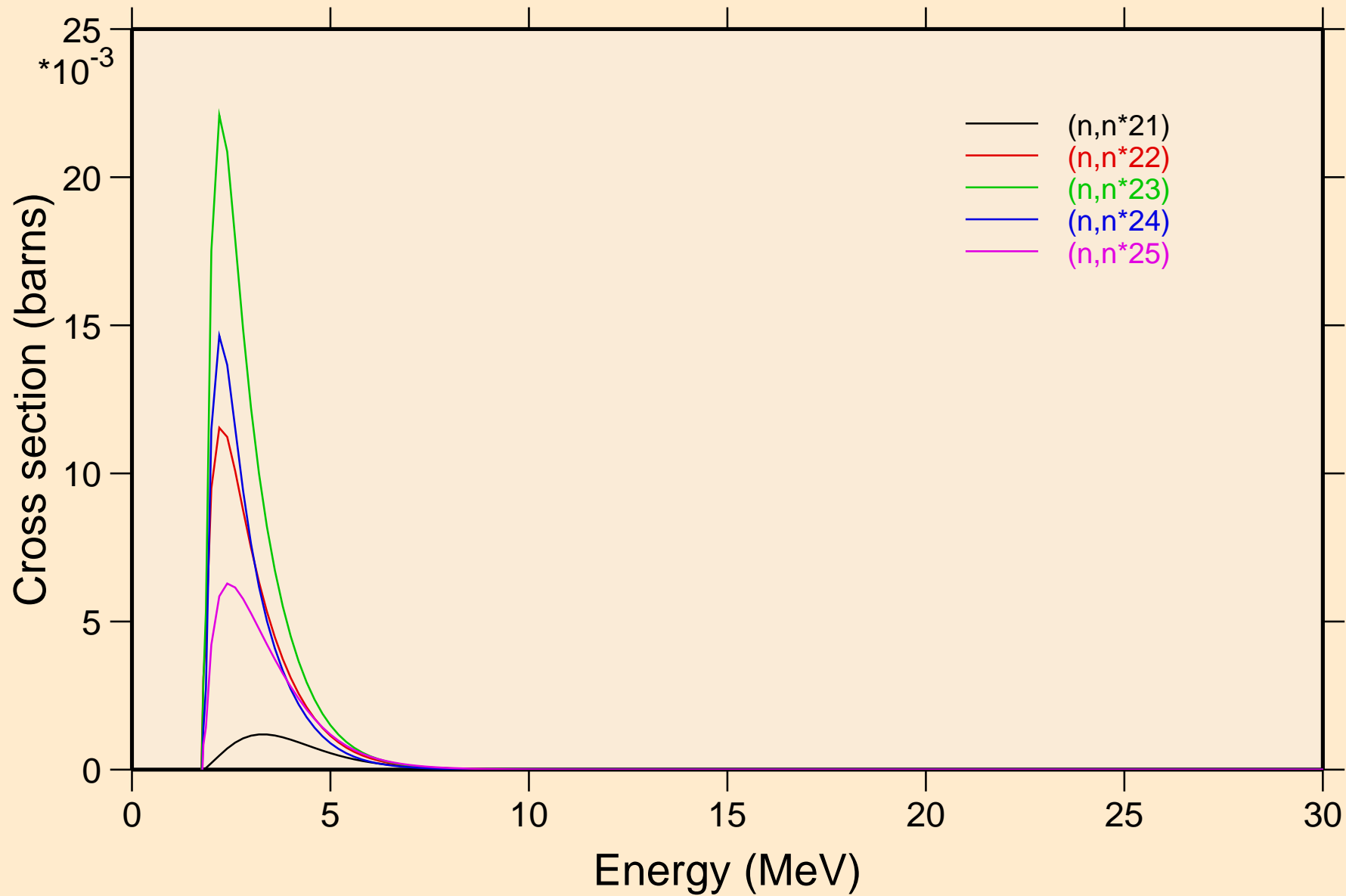

ZR085M NEUTRON ACER TENDL-2021 LIBRARY; T=293.6K
Inelastic levels

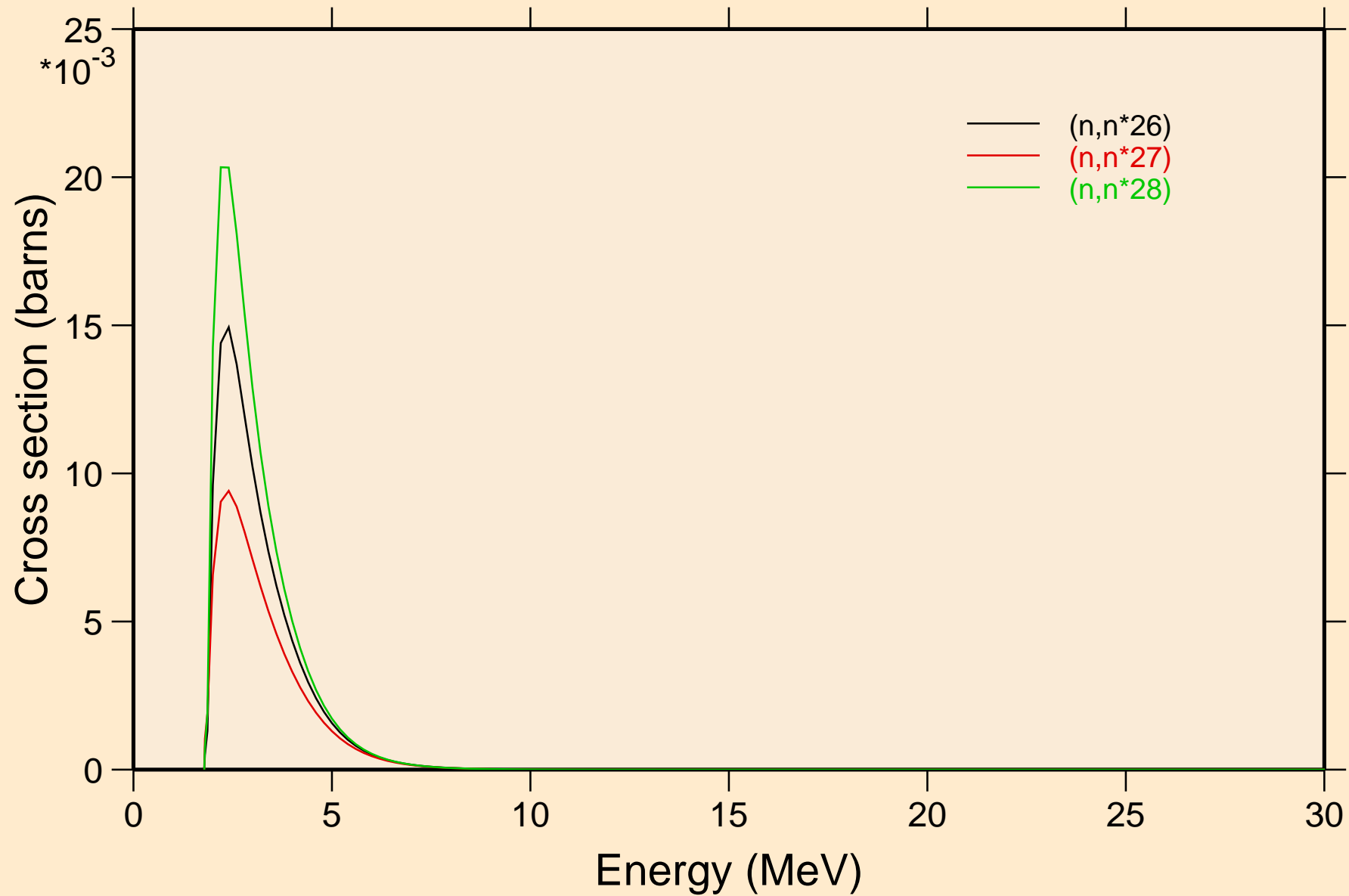

ZR085M NEUTRON ACER TENDL-2021 LIBRARY; T=293.6K
Threshold reactions

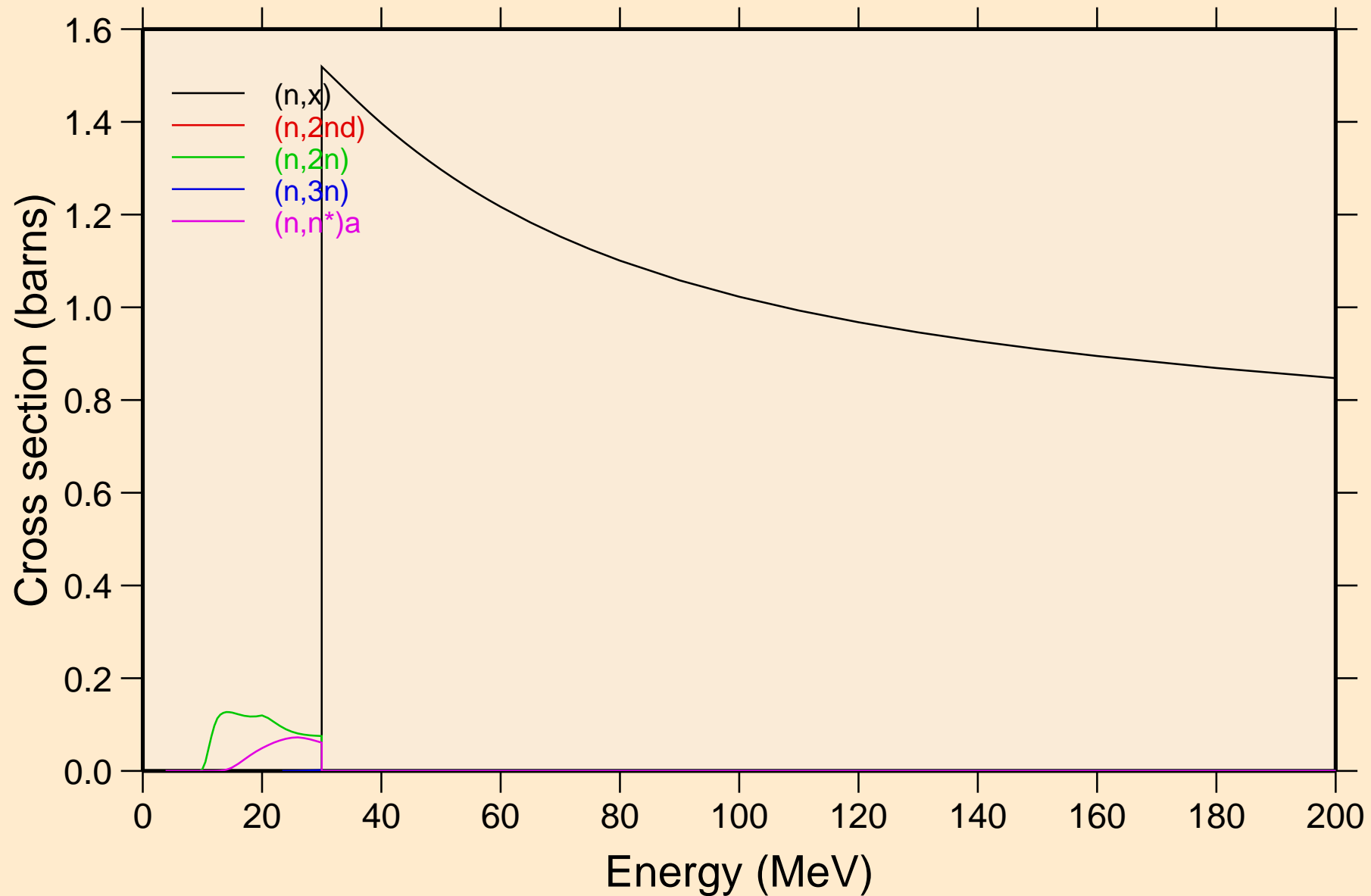

ZR085M NEUTRON ACER TENDL-2021 LIBRARY; T=293.6K
Threshold reactions

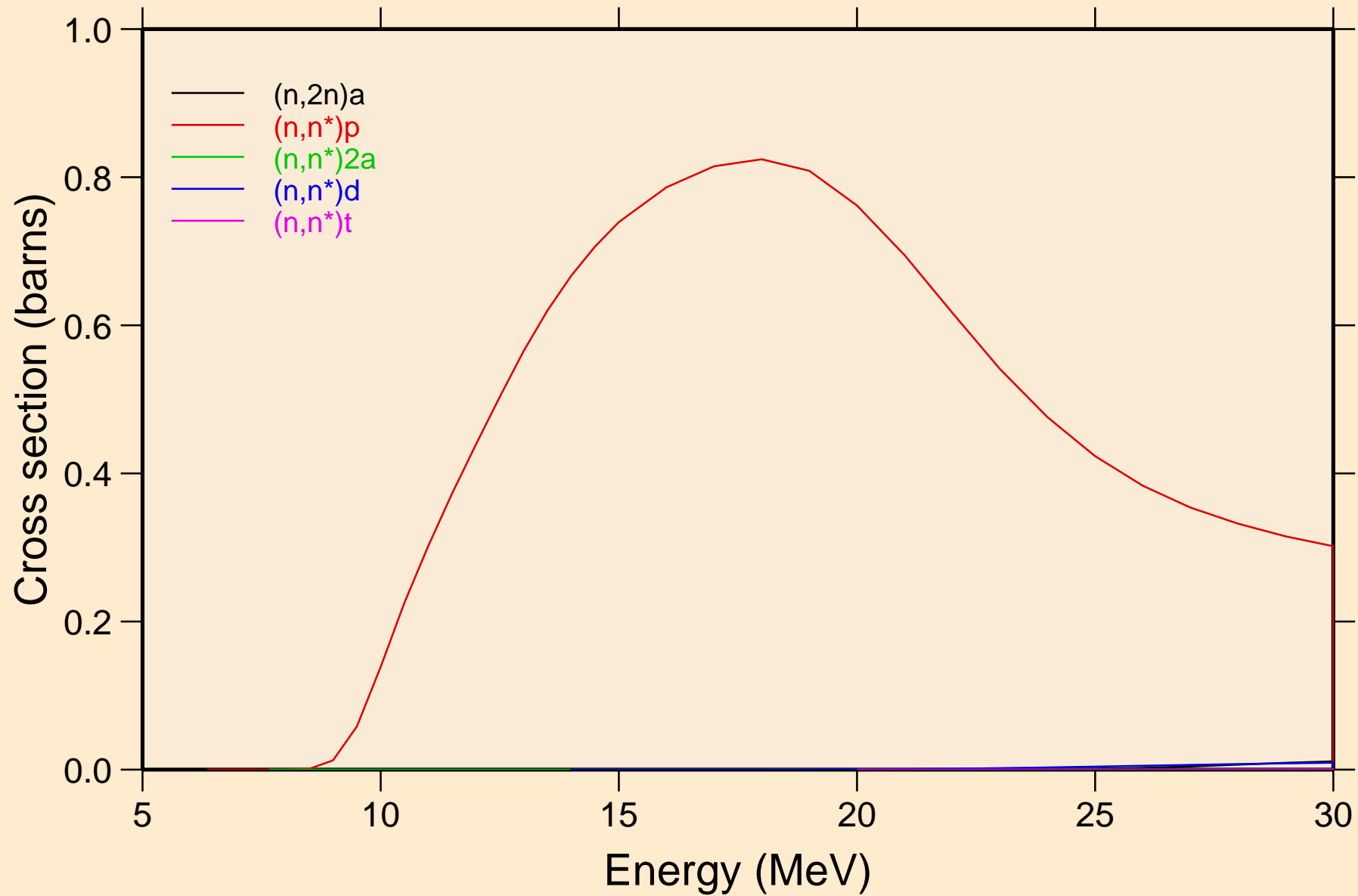

ZR085M NEUTRON ACER TENDL-2021 LIBRARY; T=293.6K
Threshold reactions

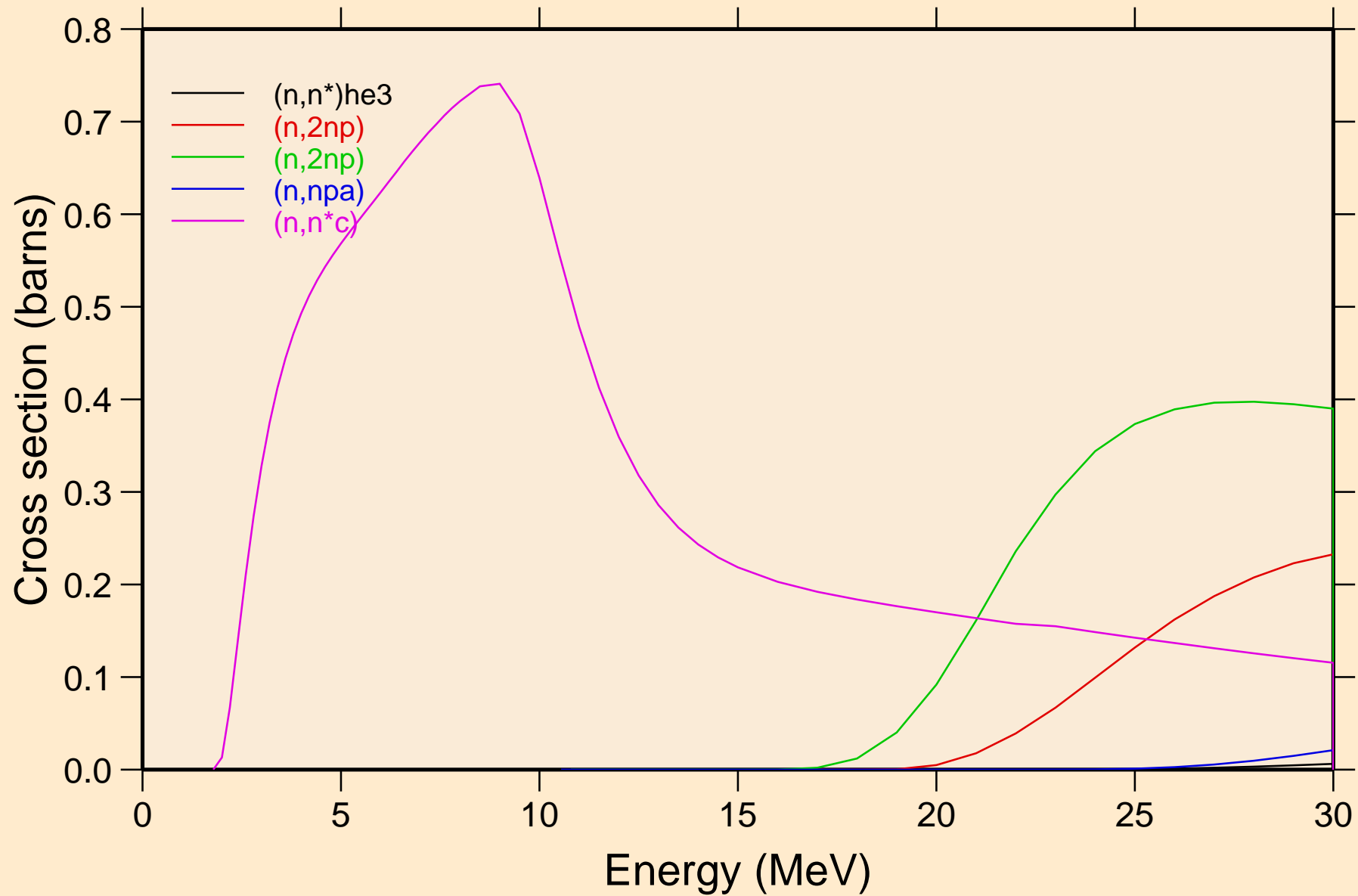

ZR085M NEUTRON ACER TENDL-2021 LIBRARY; T=293.6K
Threshold reactions

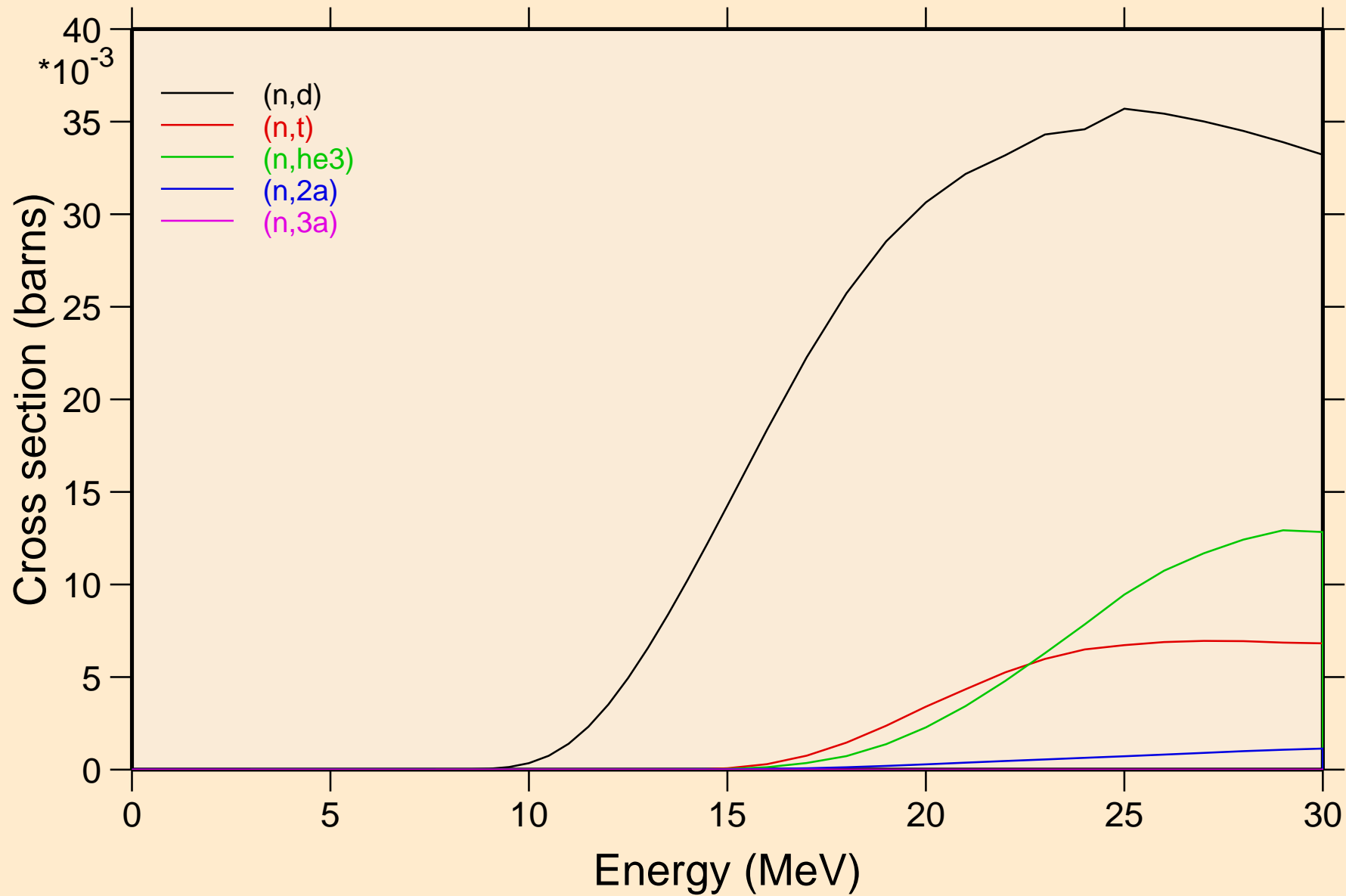

ZR085M NEUTRON ACER TENDL-2021 LIBRARY; T=293.6K
Threshold reactions

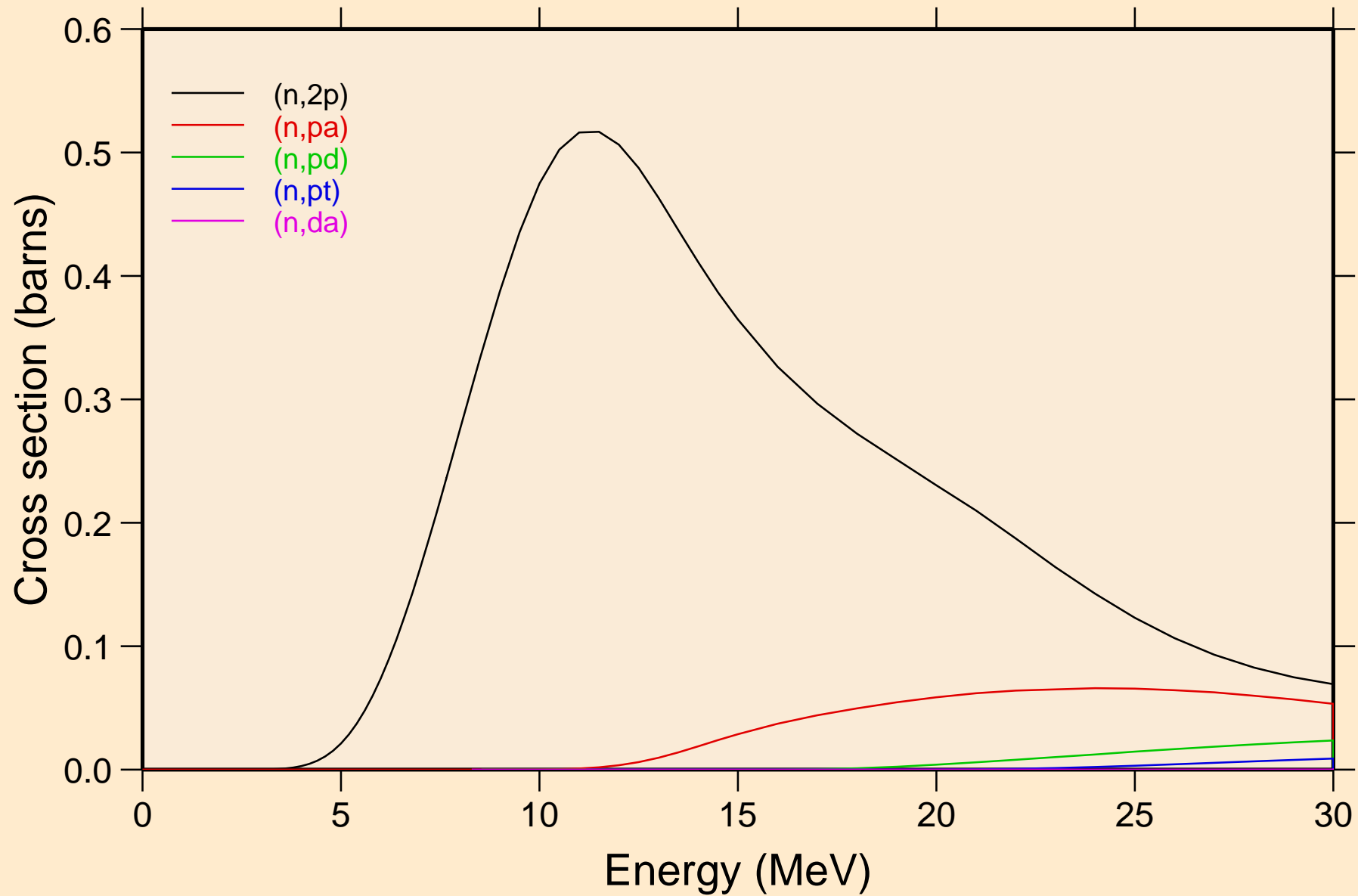

ZR085M NEUTRON ACER TENDL-2021 LIBRARY; T=293.6K
Threshold reactions

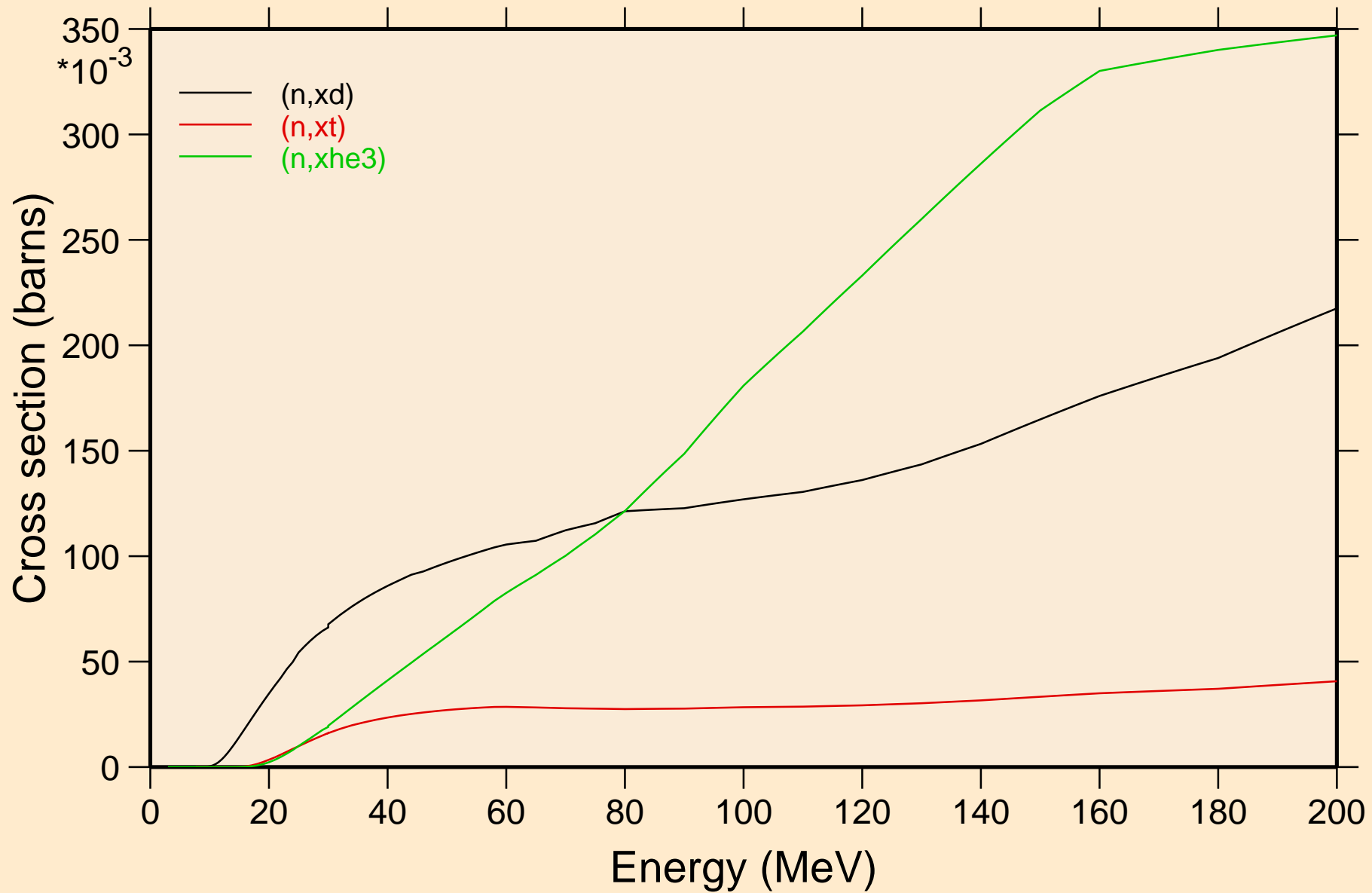

ZR085M NEUTRON ACER TENDL-2021 LIBRARY; T=293.6K
angular distribution for elastic

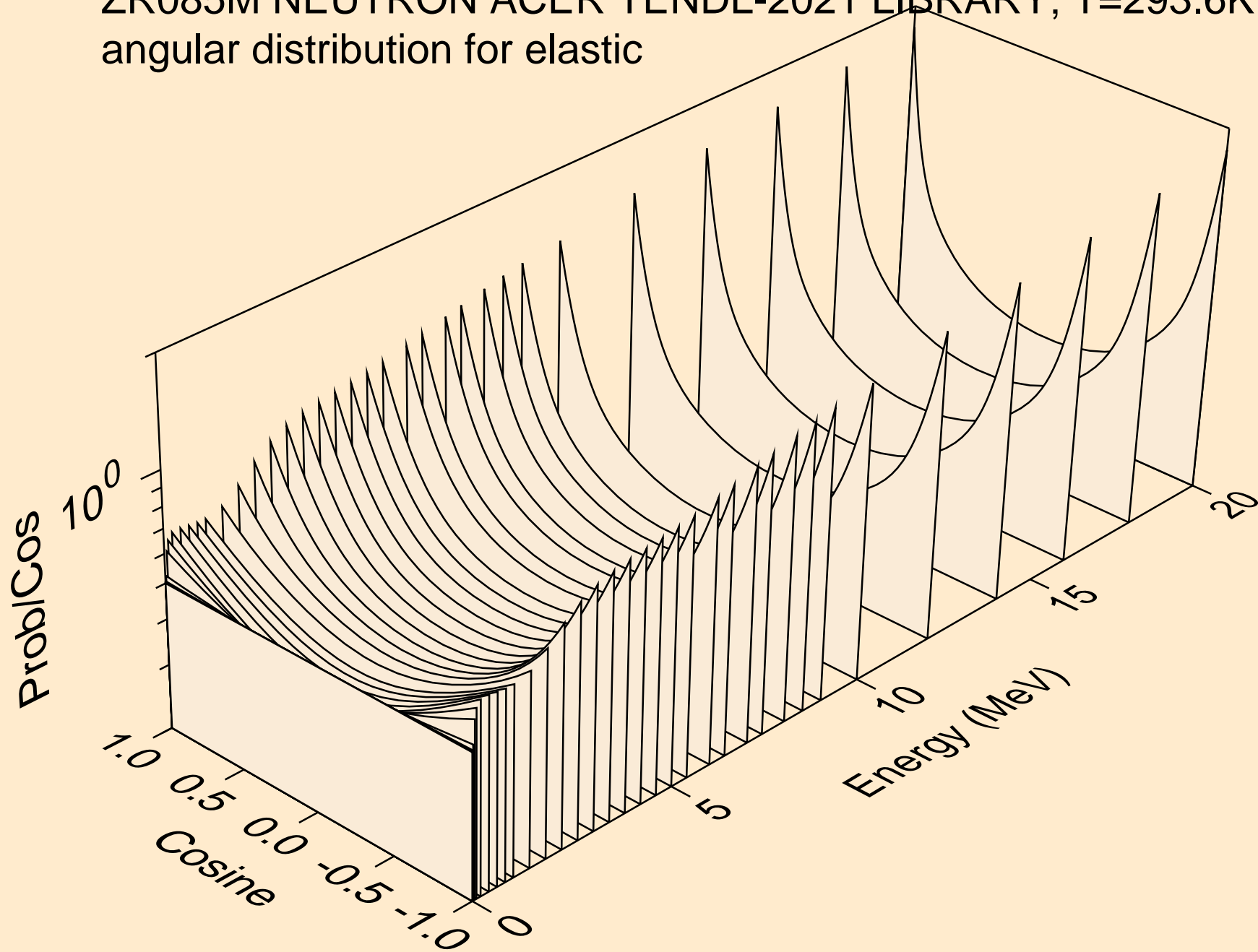

ZR085M NEUTRON ACER TENDL-2021 LIBRARY; T=293.6K
angular distribution for elastic

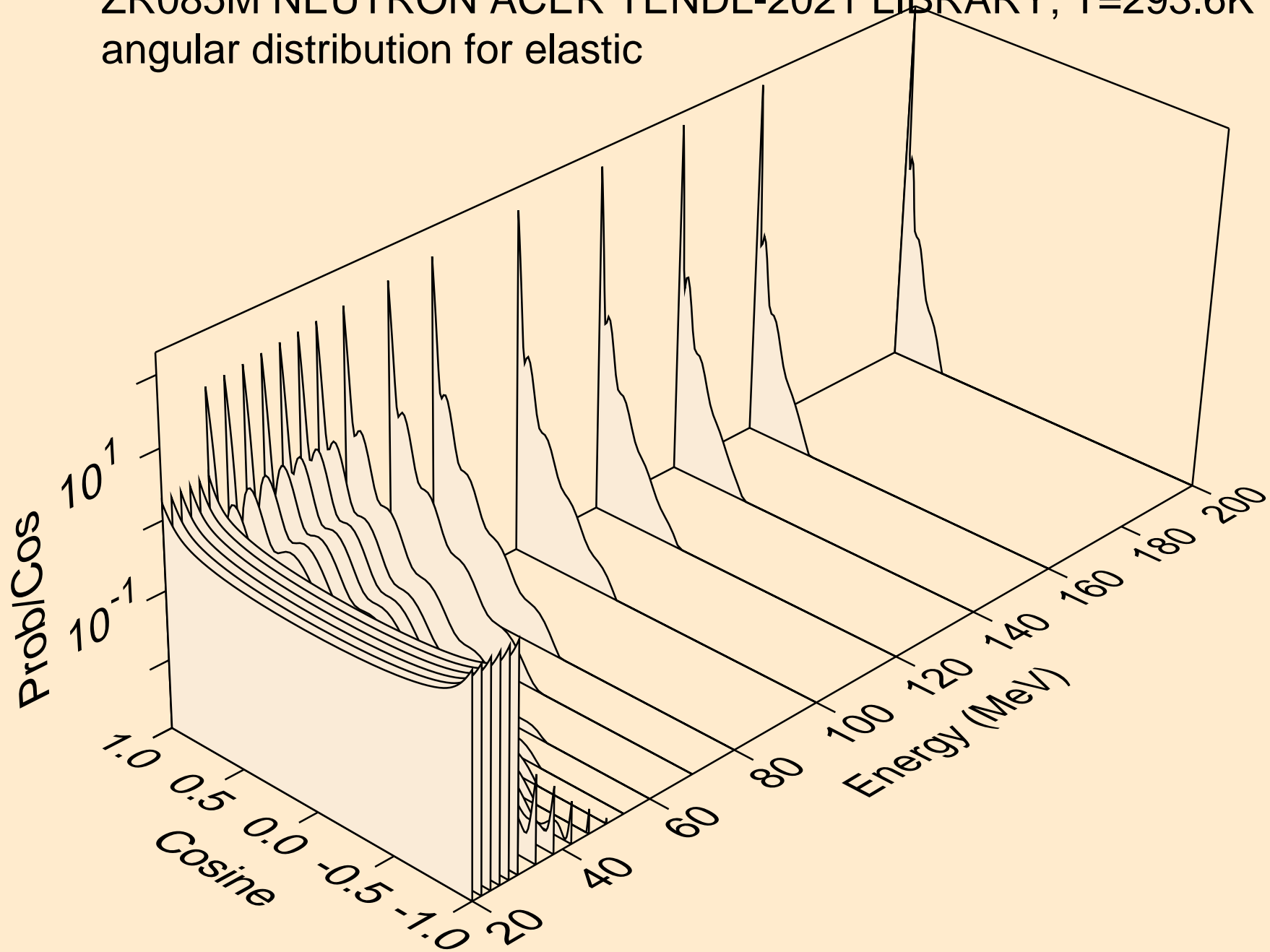

ZR085M NEUTRON ACER TENDL-2021 LIBRARY; T=293.6K
angular distribution for (n,n*1)

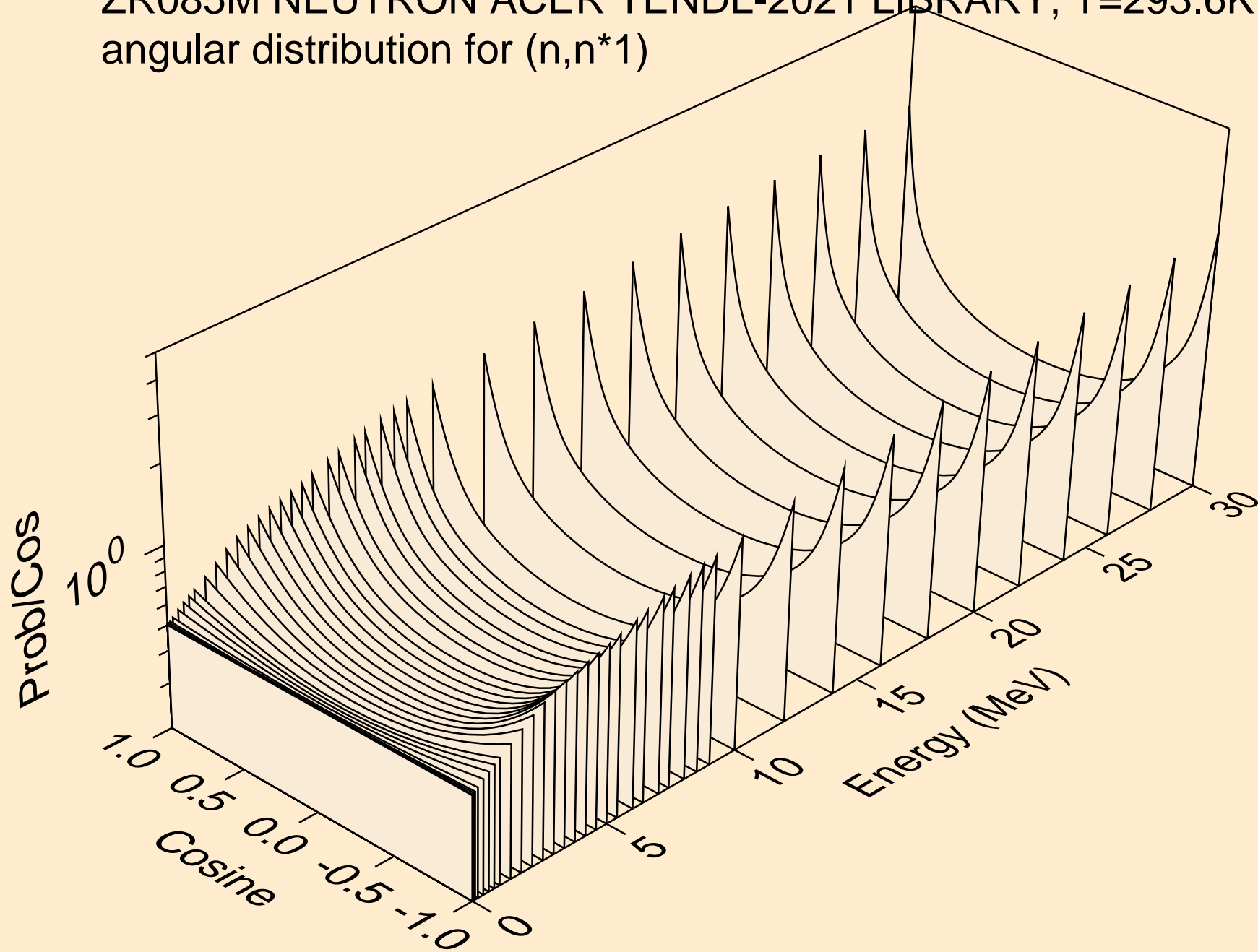

ZR085M NEUTRON ACER TENDL-2021 LIBRARY; T=293.6K
angular distribution for (n,n*2)

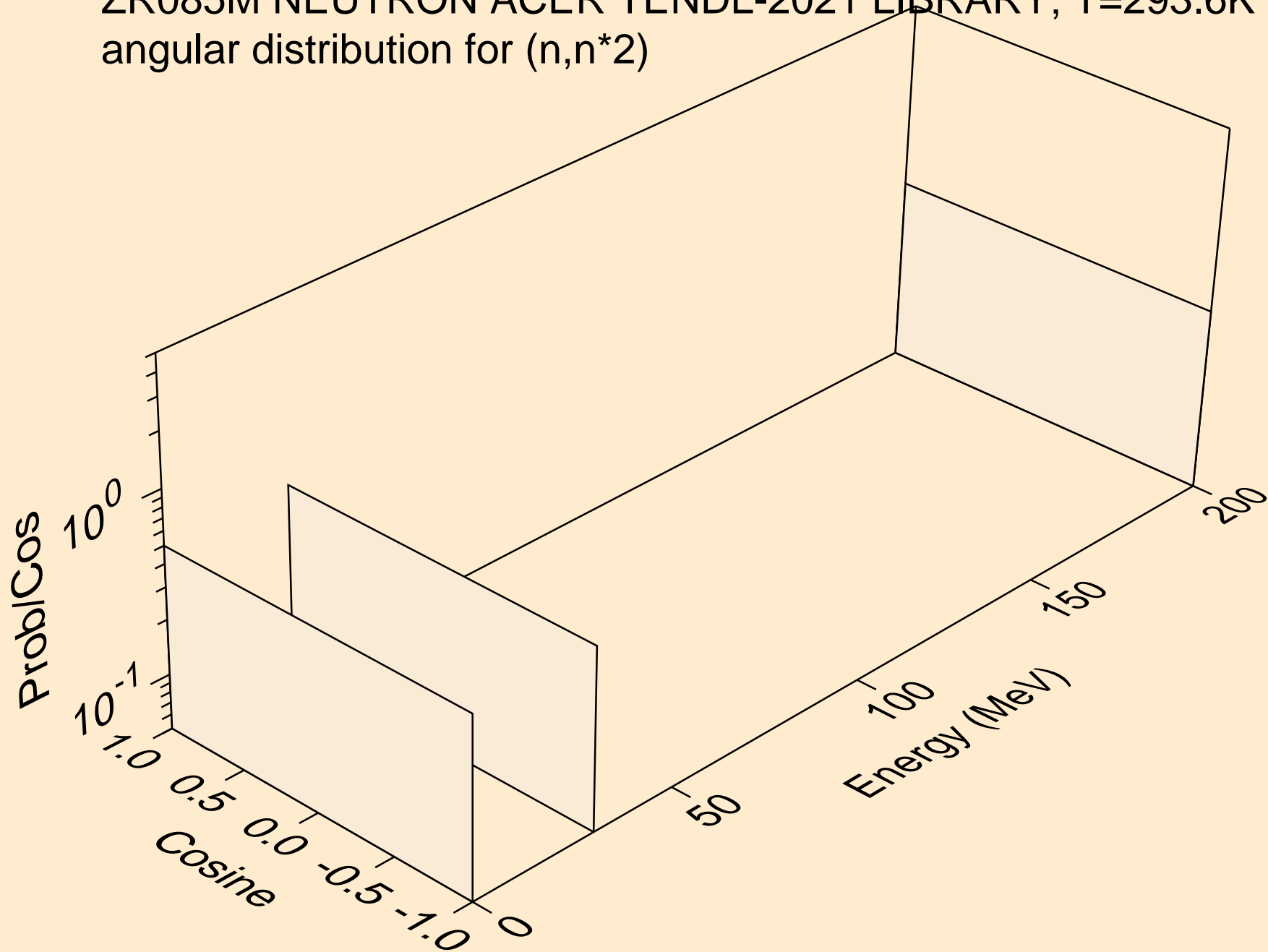

ZR085M NEUTRON ACER TENDL-2021 LIBRARY; T=293.6K
angular distribution for (n,n*3)

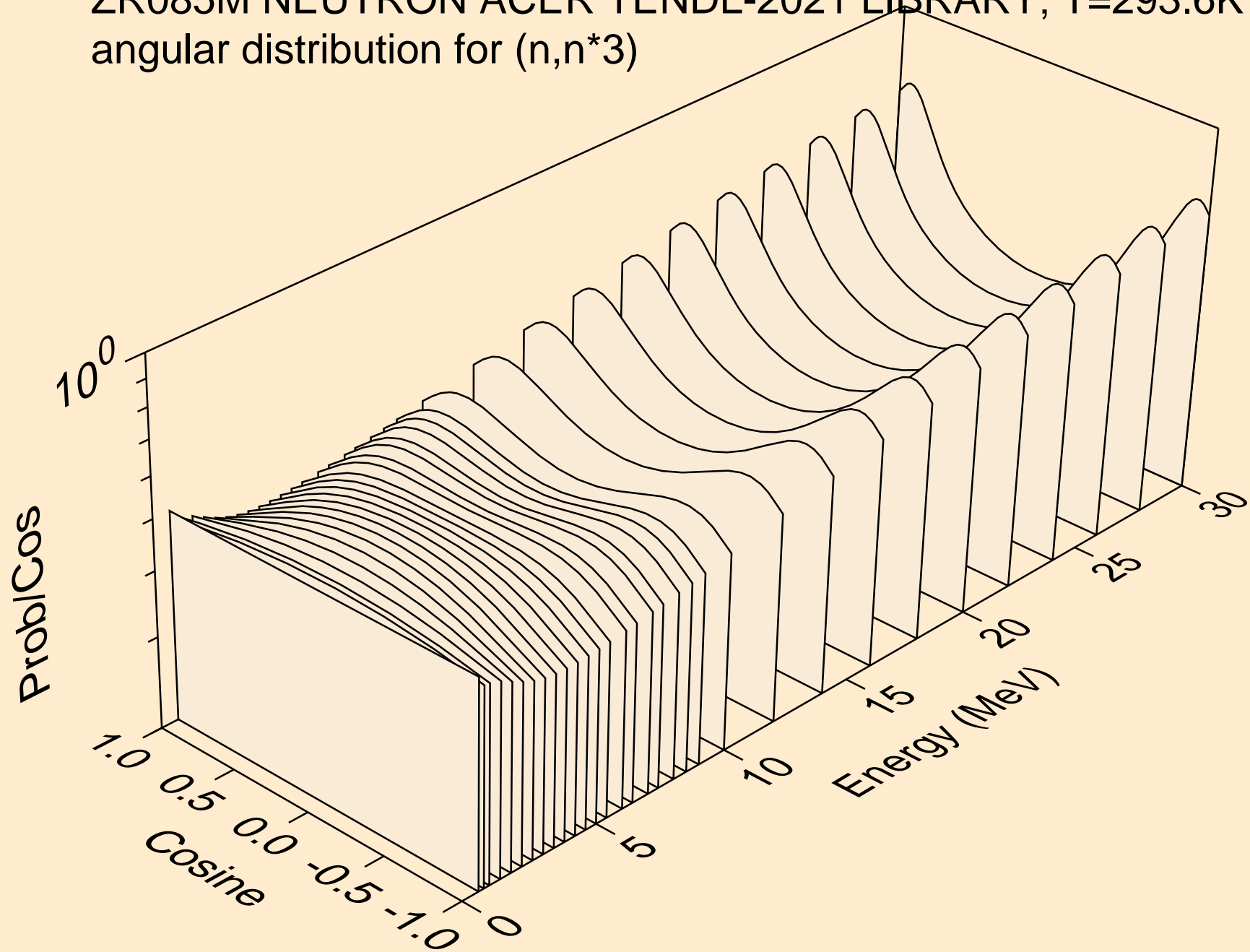

ZR085M NEUTRON ACER TENDL-2021 LIBRARY; T=293.6K
angular distribution for (n,n*4)

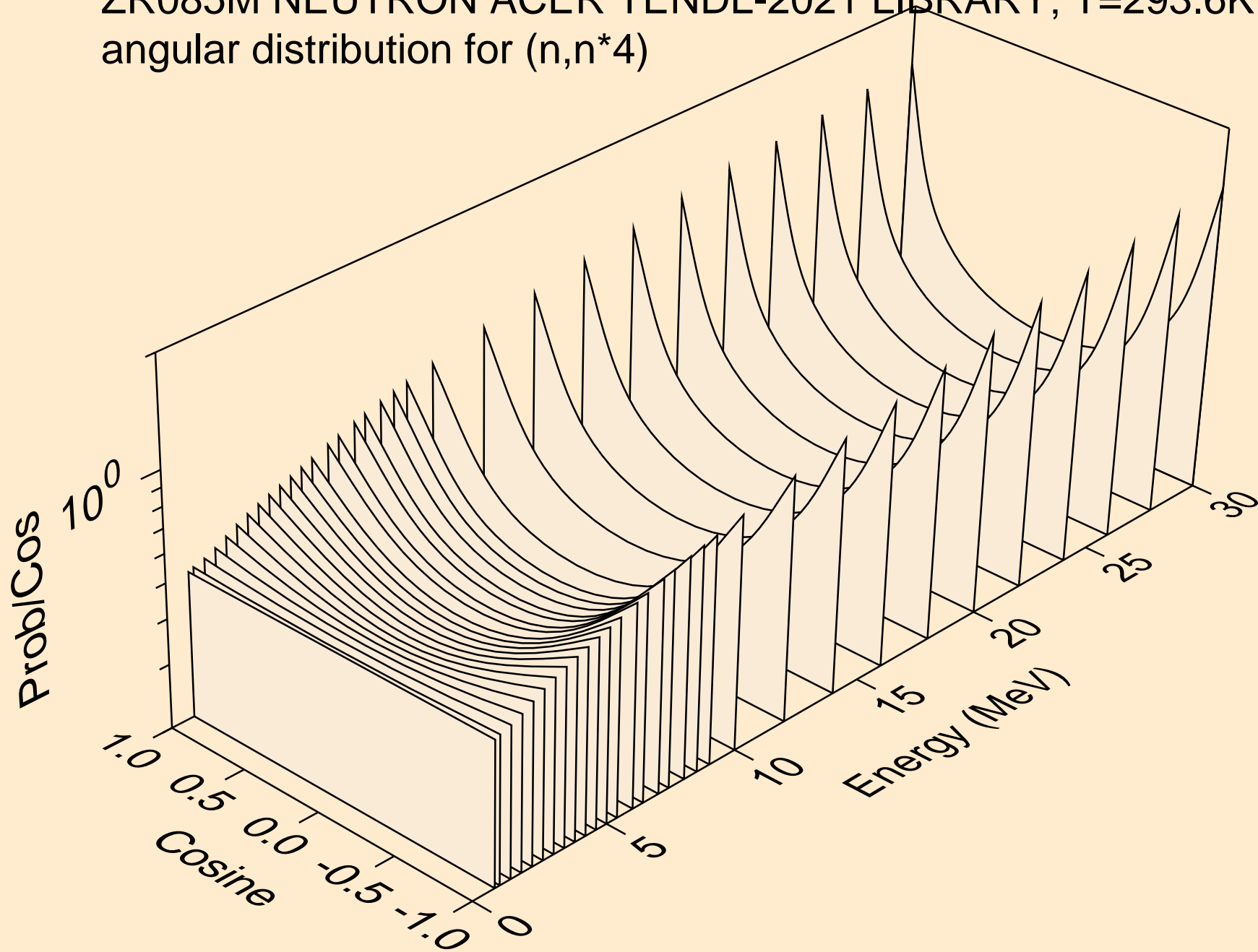

ZR085M NEUTRON ACER TENDL-2021 LIBRARY; T=293.6K
angular distribution for (n,n*5)

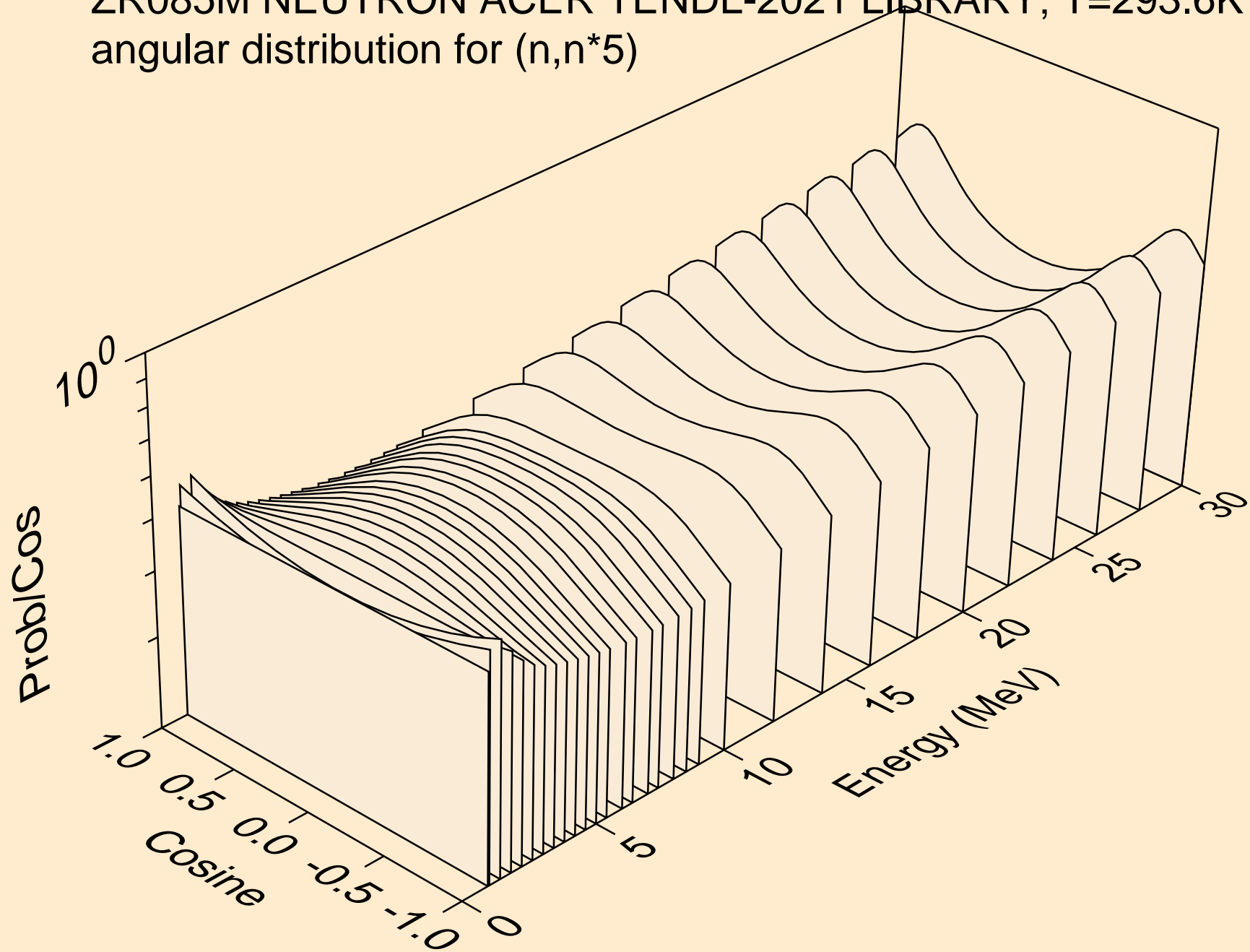

ZR085M NEUTRON ACER TENDL-2021 LIBRARY; T=293.6K
angular distribution for (n,n*6)

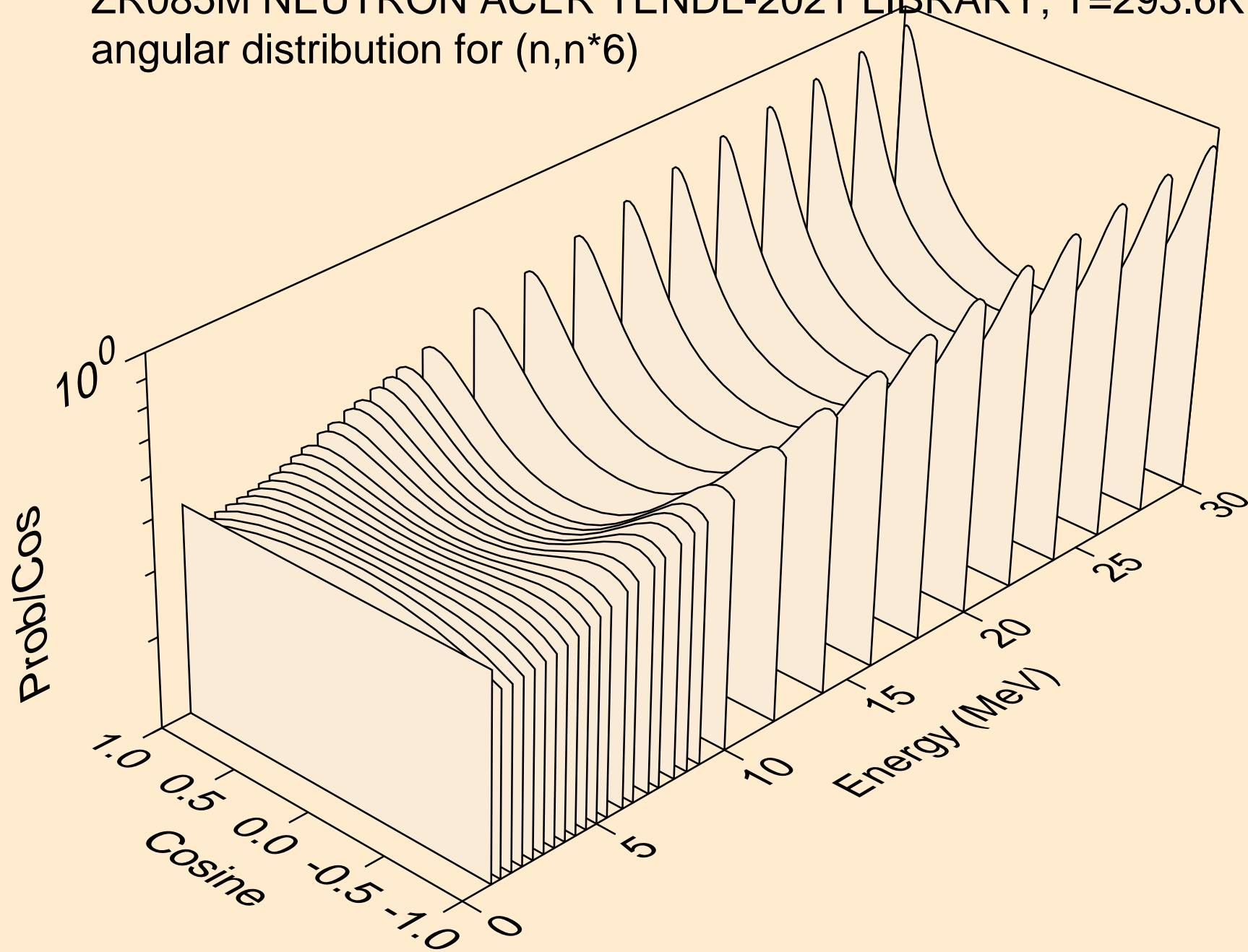

ZR085M NEUTRON ACER TENDL-2021 LIBRARY; T=293.6K
angular distribution for (n,n*7)

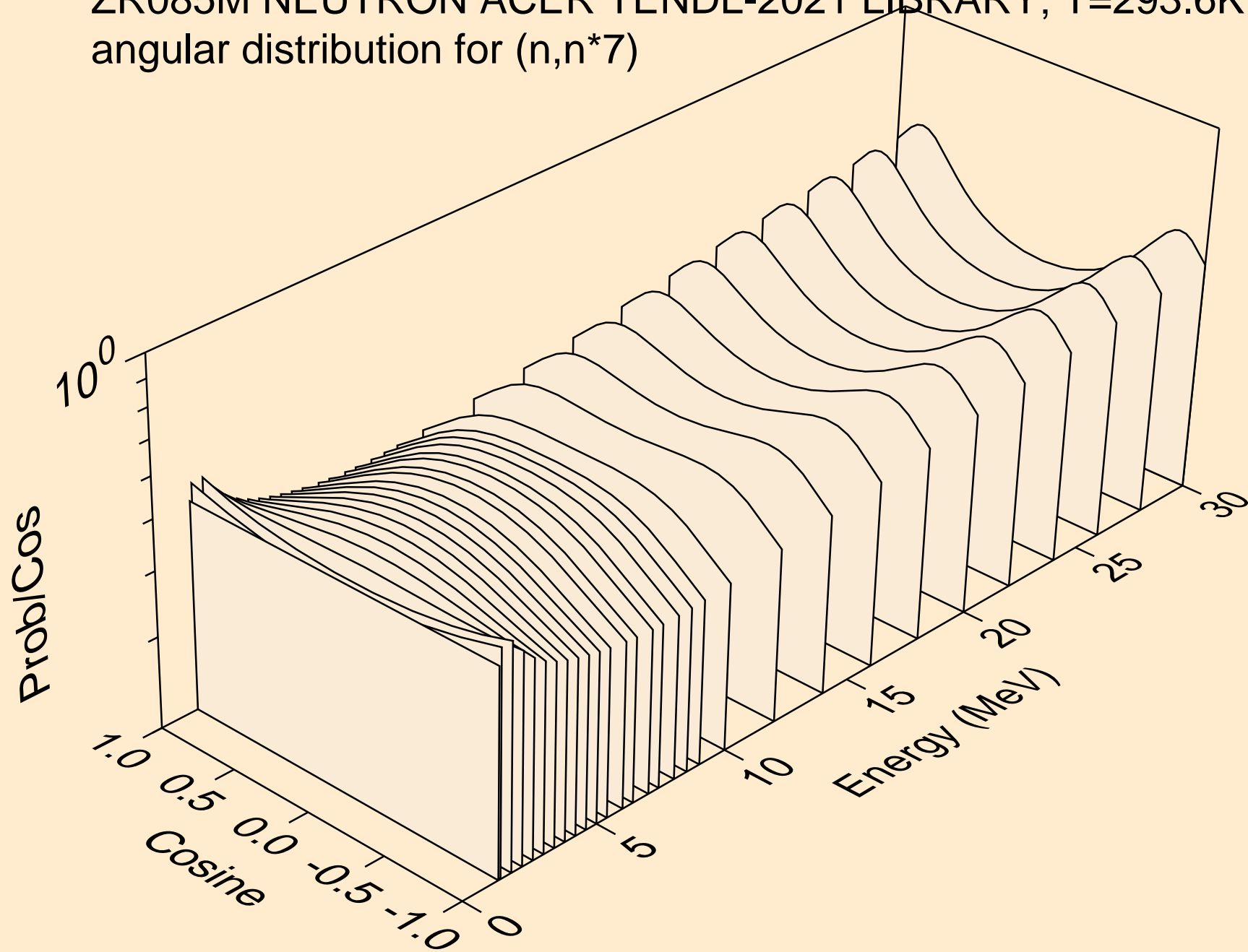

ZR085M NEUTRON ACER TENDL-2021 LIBRARY; T=293.6K
angular distribution for (n,n*8)

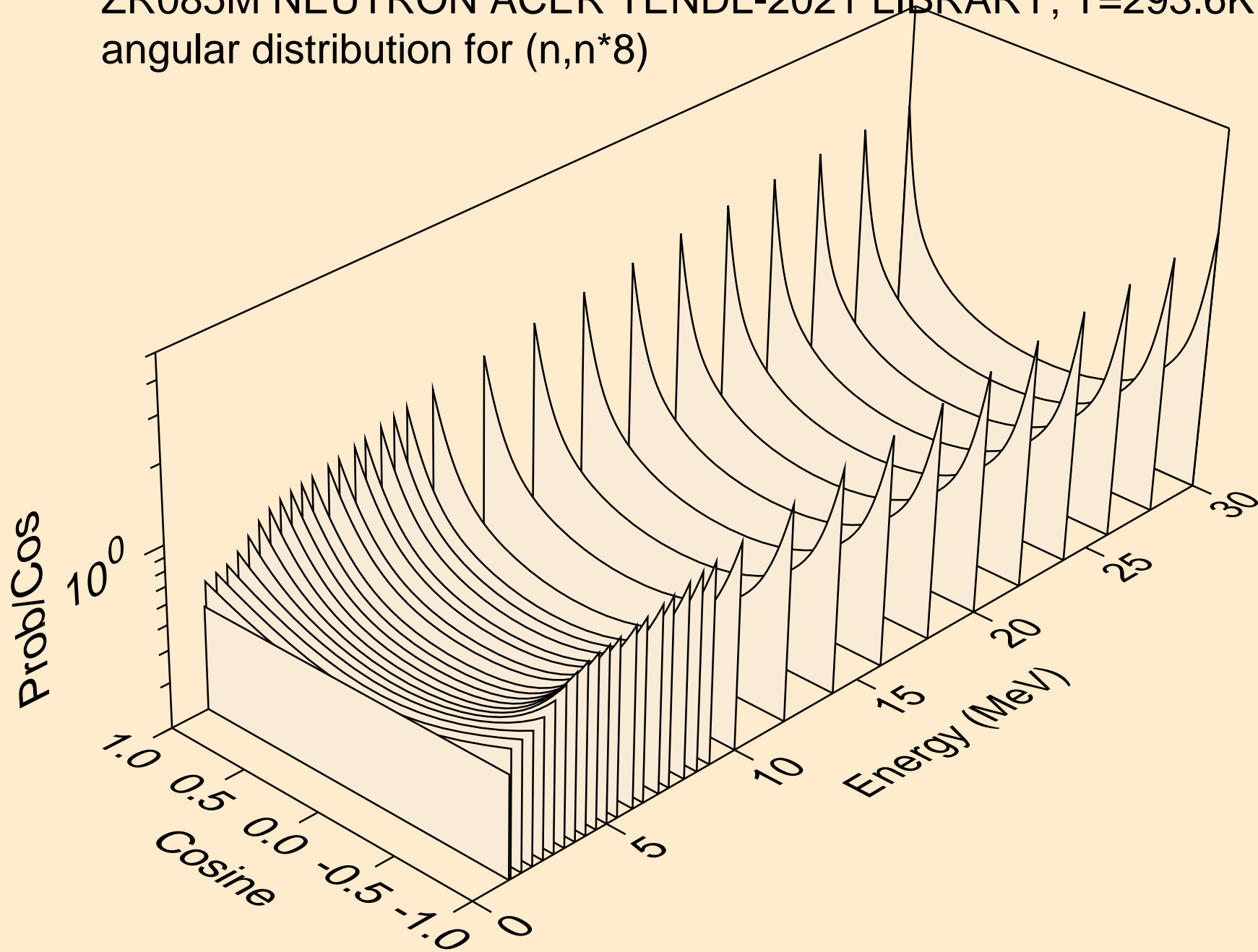

ZR085M NEUTRON ACER TENDL-2021 LIBRARY; T=293.6K
angular distribution for (n,n*9)

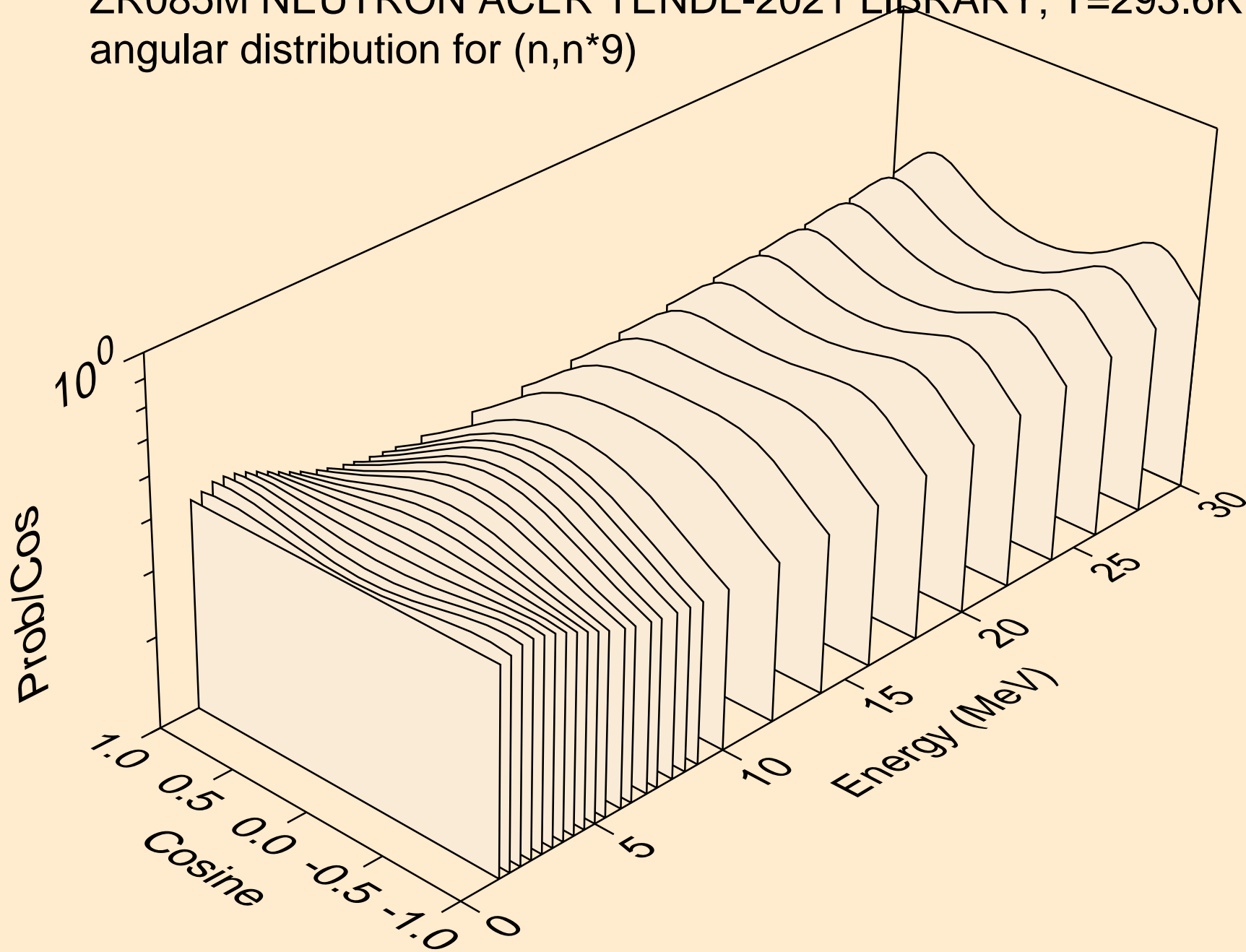

ZR085M NEUTRON ACER TENDL-2021 LIBRARY; T=293.6K
angular distribution for (n,n*10)

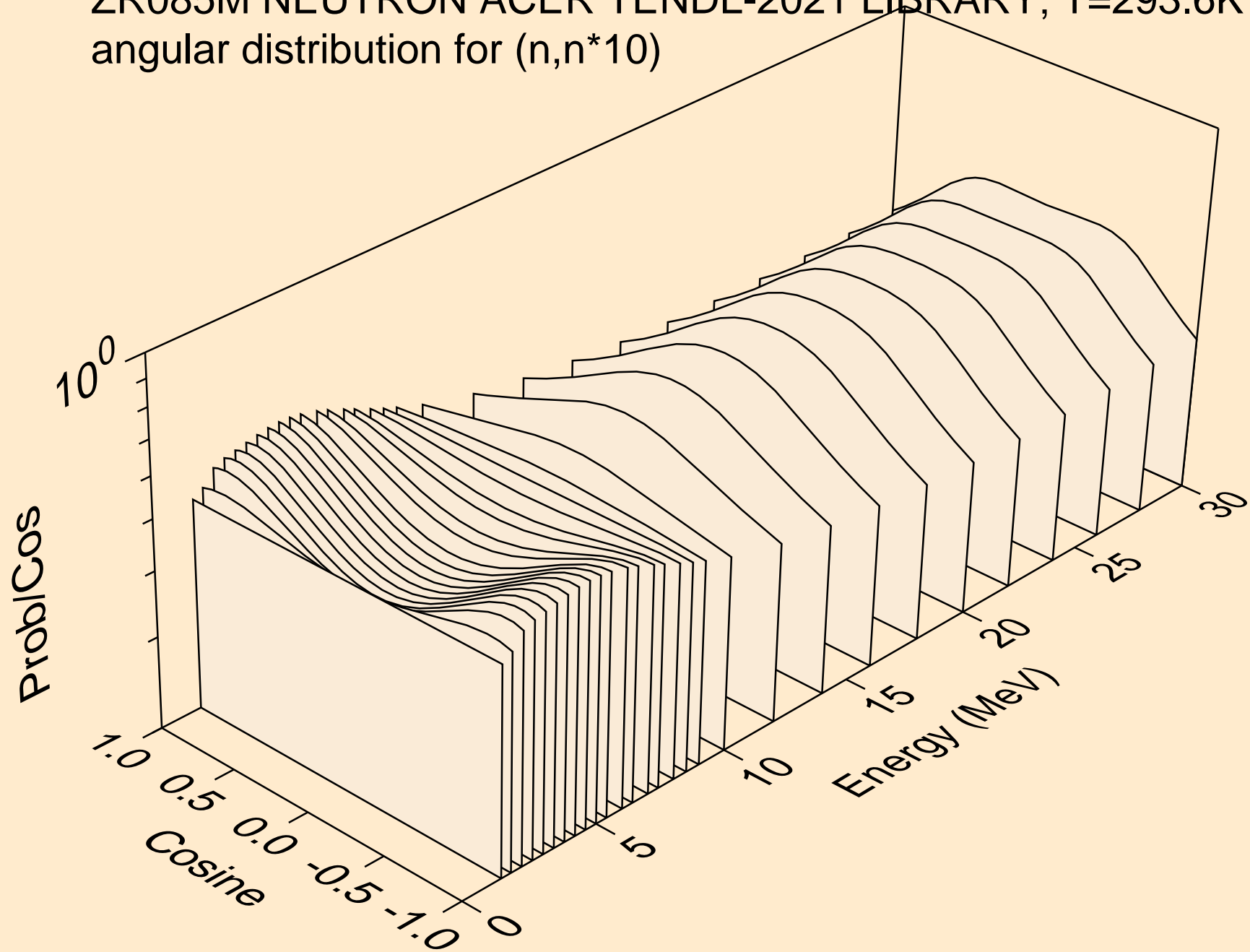

ZR085M NEUTRON ACER TENDL-2021 LIBRARY; T=293.6K
angular distribution for (n,n*11)

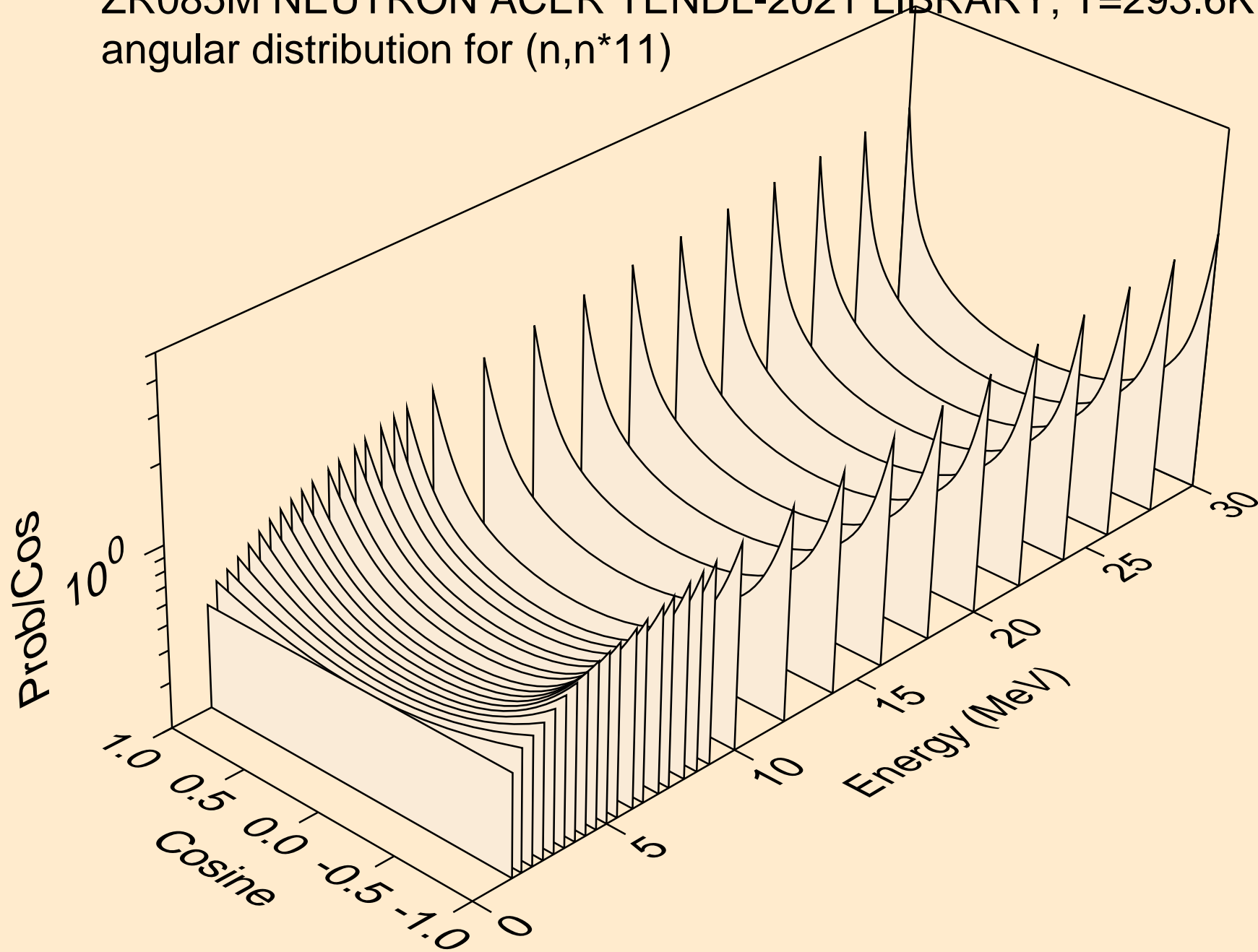

ZR085M NEUTRON ACER TENDL-2021 LIBRARY; T=293.6K
angular distribution for (n,n*12)

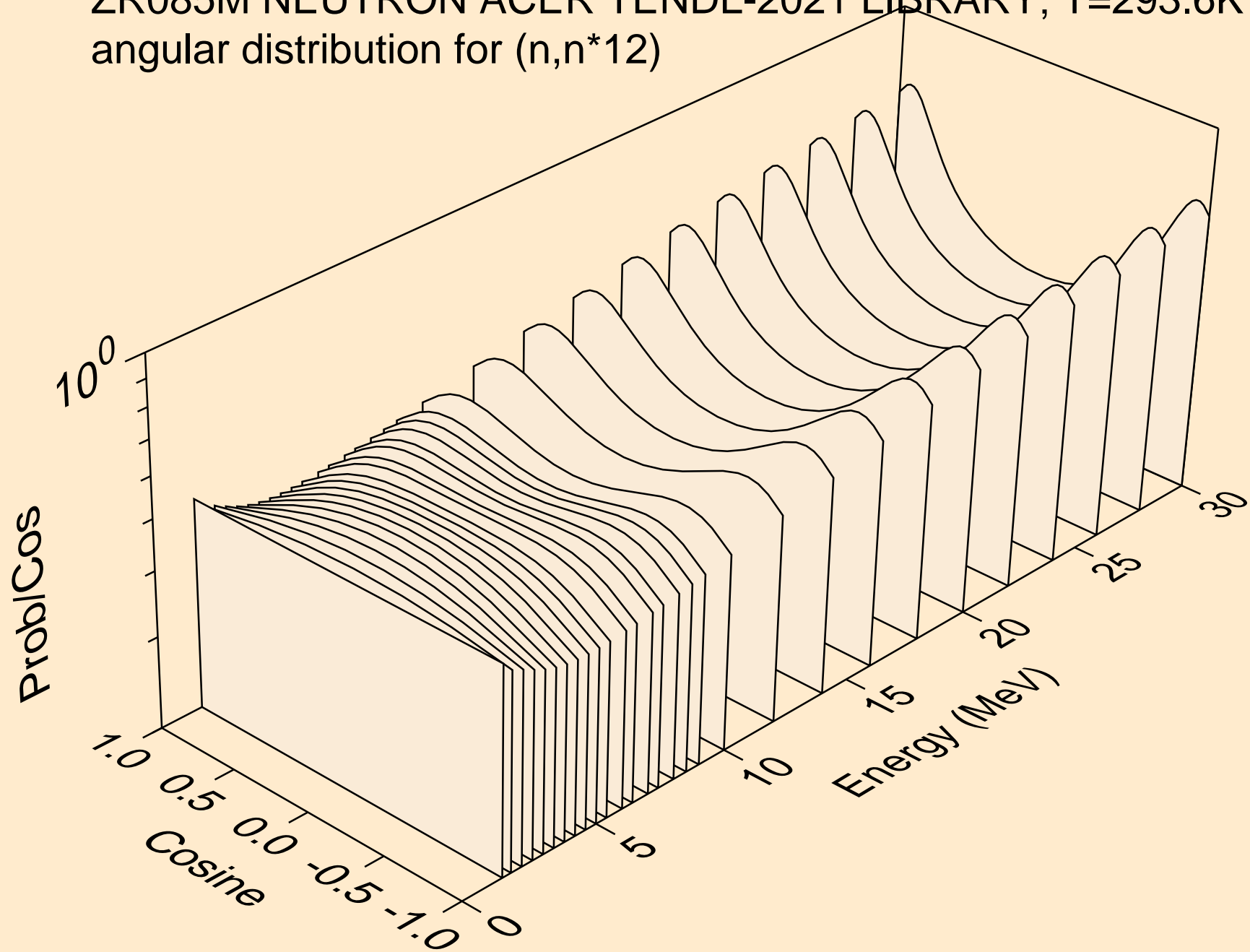

ZR085M NEUTRON ACER TENDL-2021 LIBRARY; T=293.6K
angular distribution for (n,n*13)

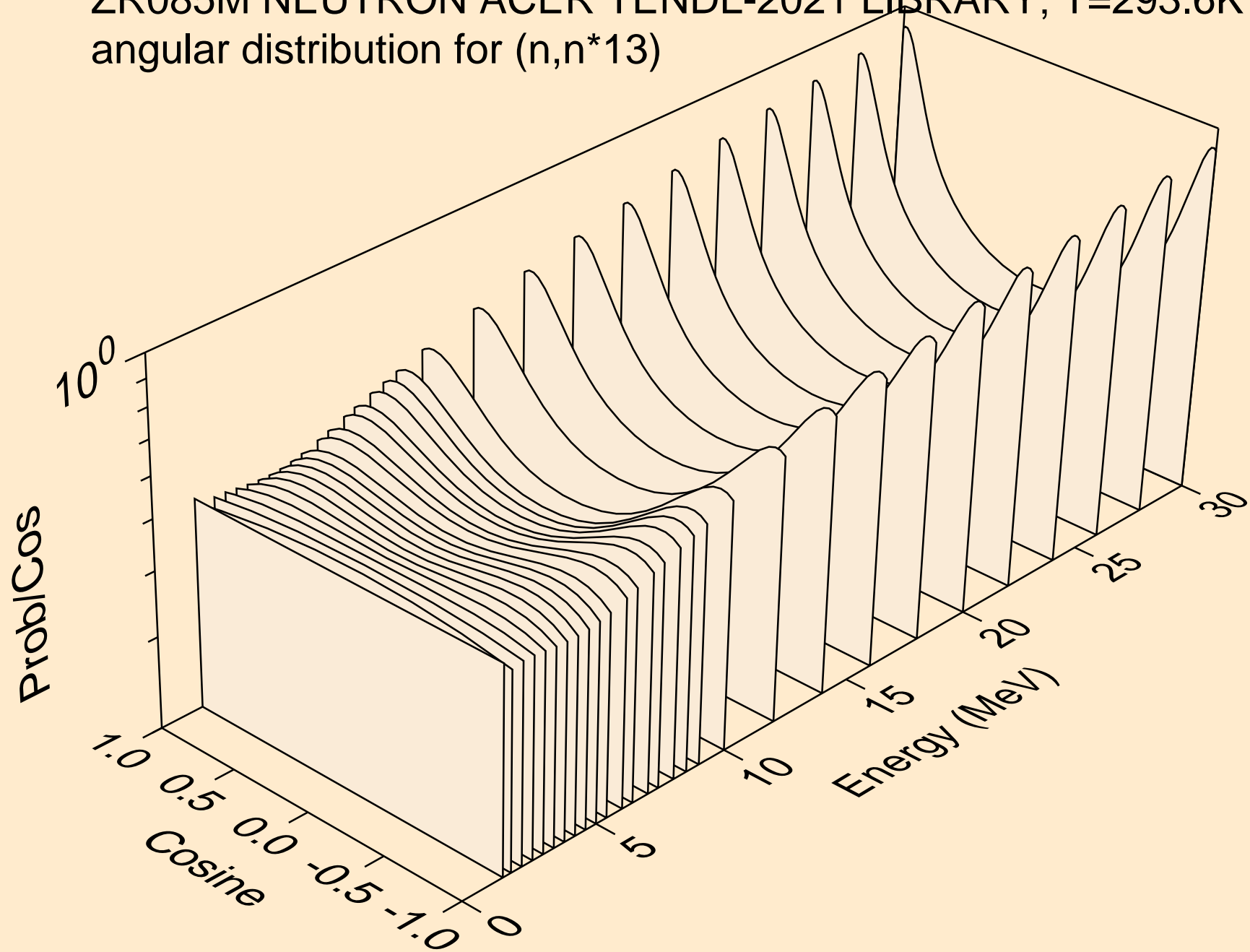

ZR085M NEUTRON ACER TENDL-2021 LIBRARY; T=293.6K
angular distribution for (n,n*14)

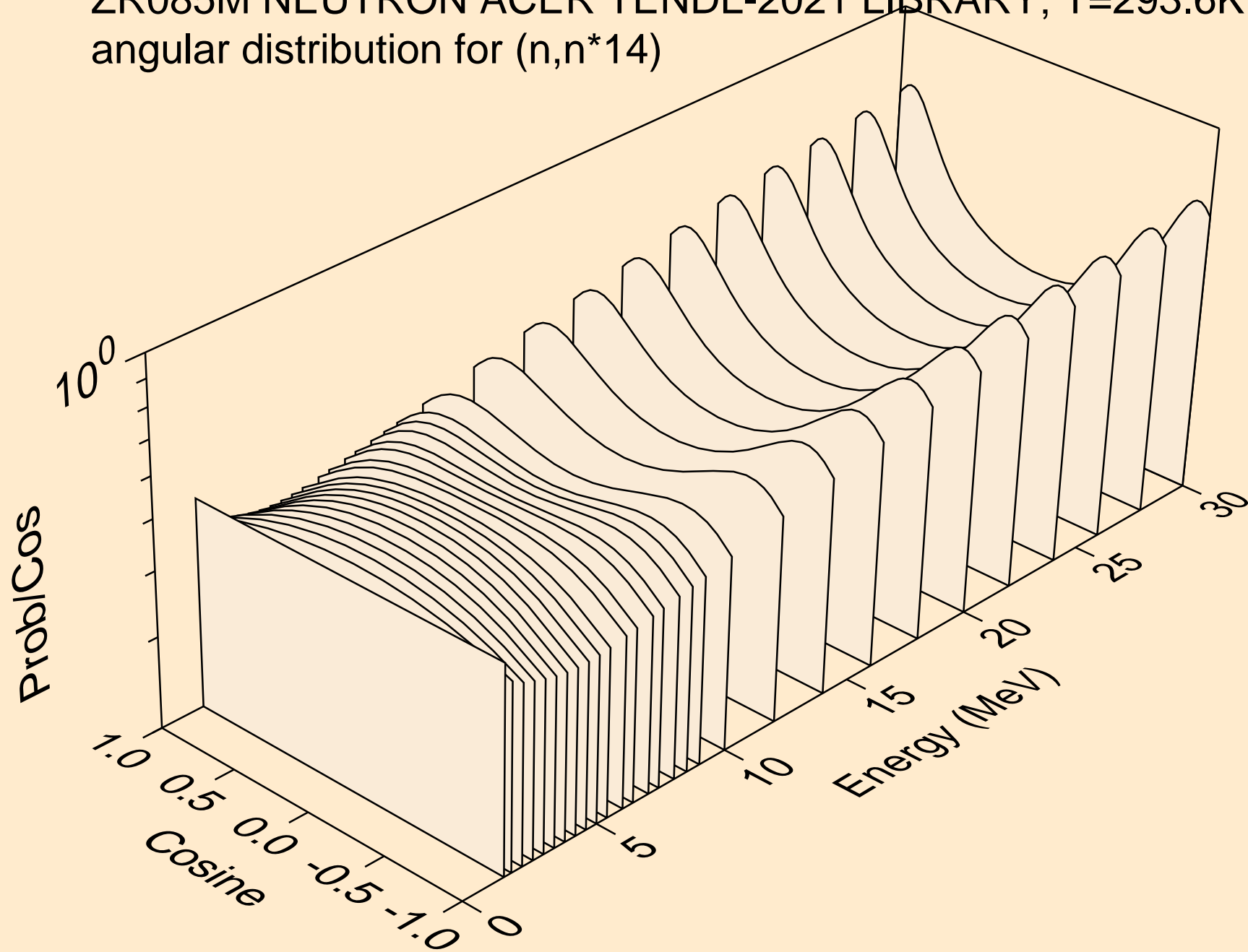

ZR085M NEUTRON ACER TENDL-2021 LIBRARY; T=293.6K
angular distribution for (n,n*15)

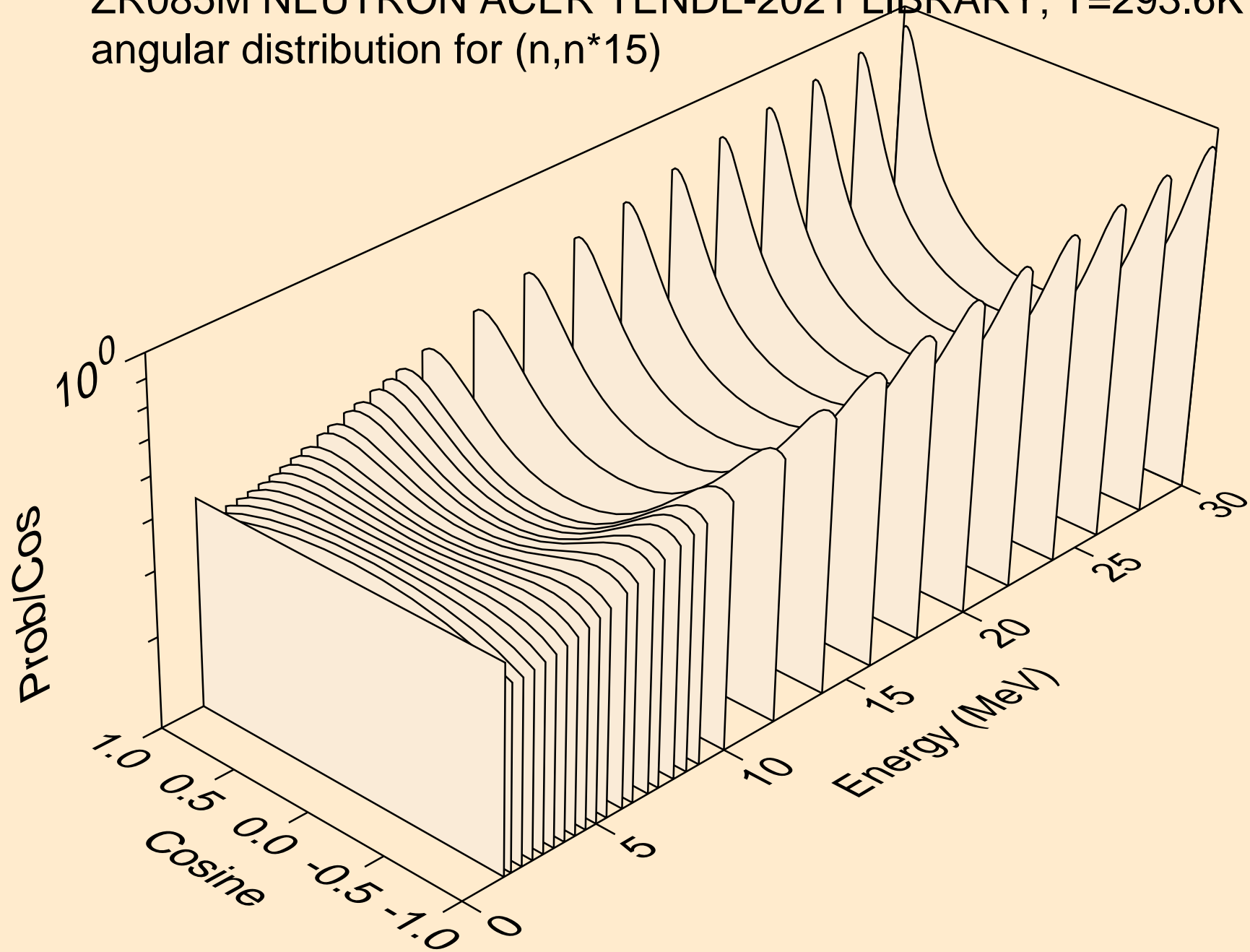

ZR085M NEUTRON ACER TENDL-2021 LIBRARY; T=293.6K
angular distribution for (n,n*16)

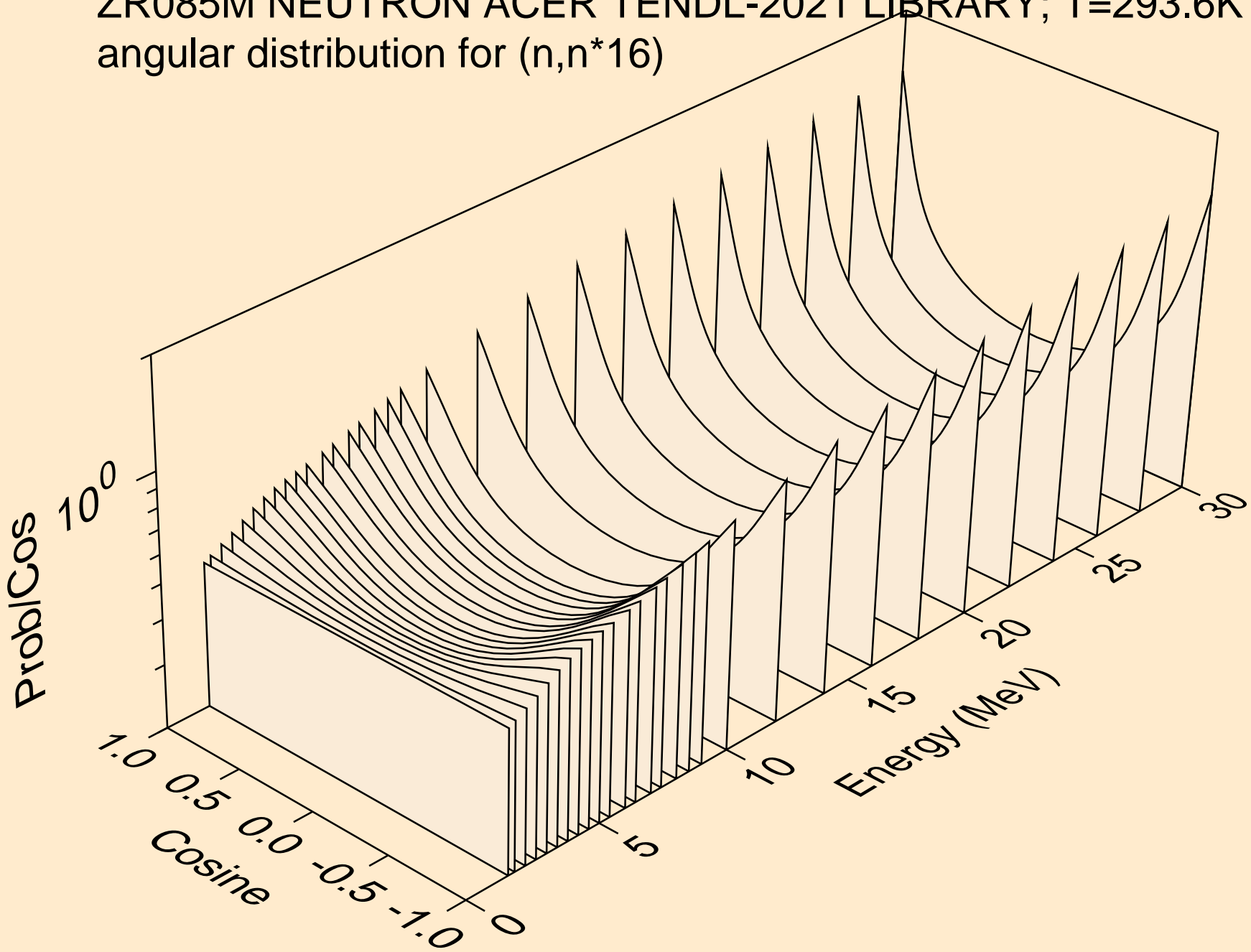

ZR085M NEUTRON ACER TENDL-2021 LIBRARY; T=293.6K
angular distribution for (n,n*17)

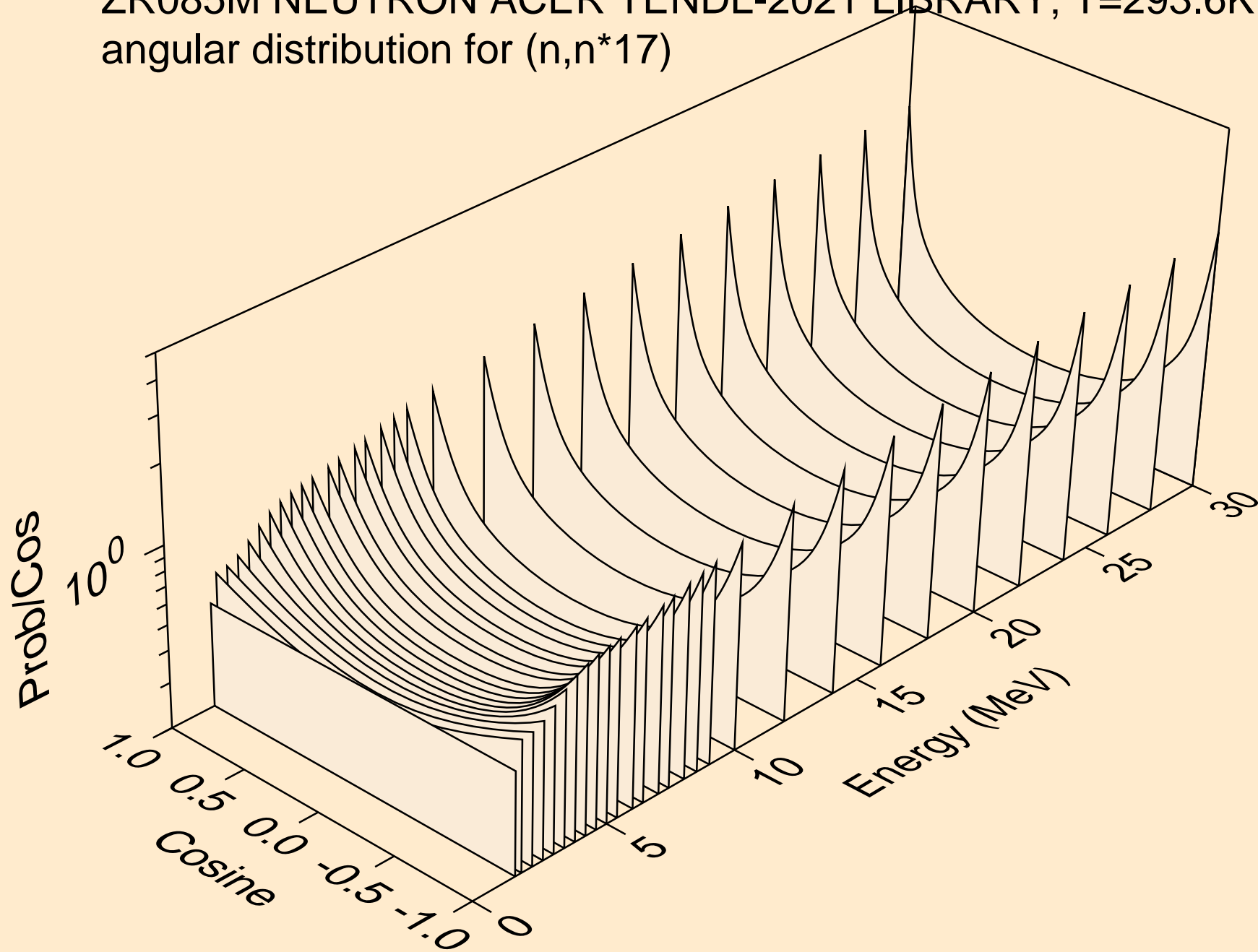

ZR085M NEUTRON ACER TENDL-2021 LIBRARY; T=293.6K
angular distribution for (n,n*18)

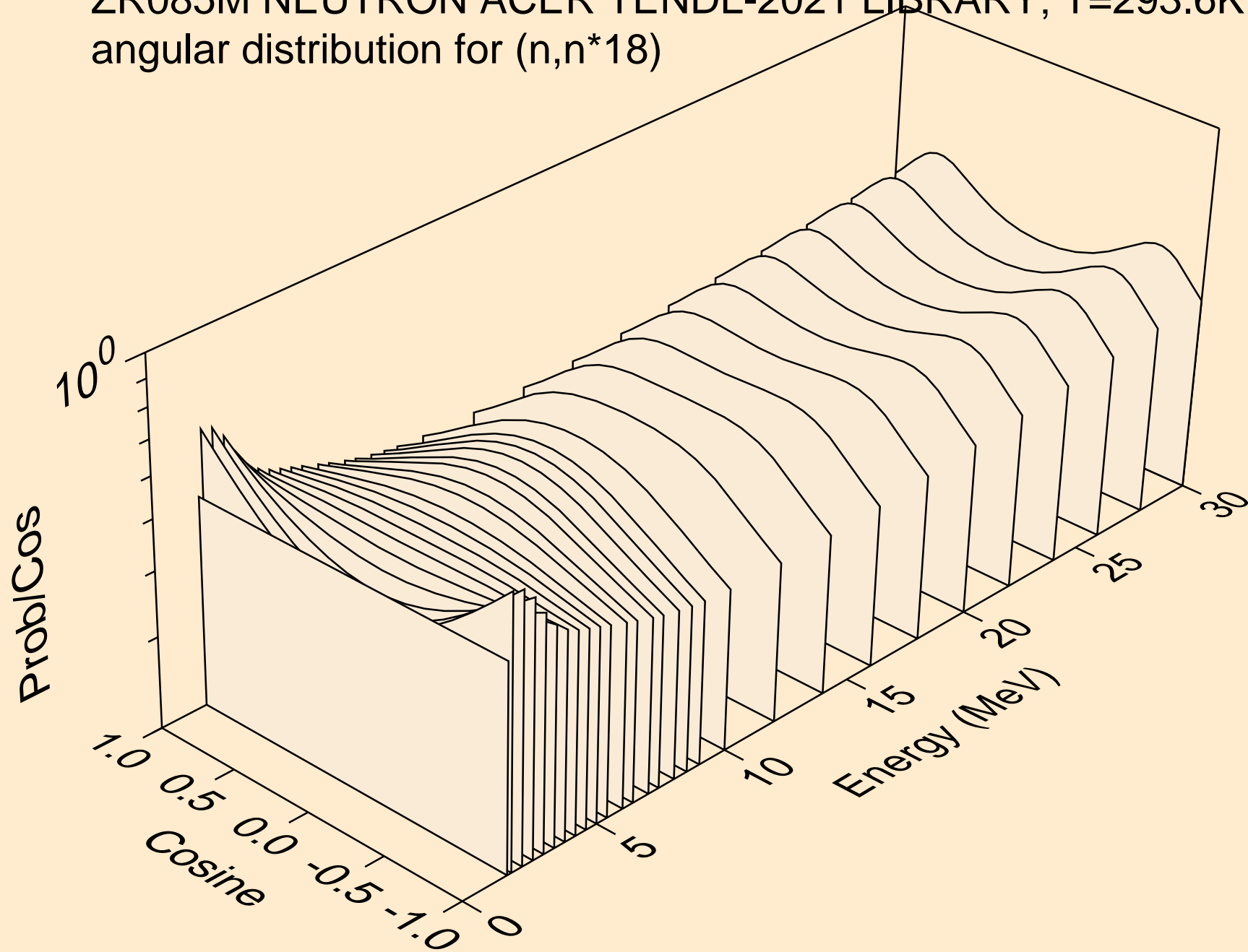

ZR085M NEUTRON ACER TENDL-2021 LIBRARY; T=293.6K
angular distribution for (n,n*19)

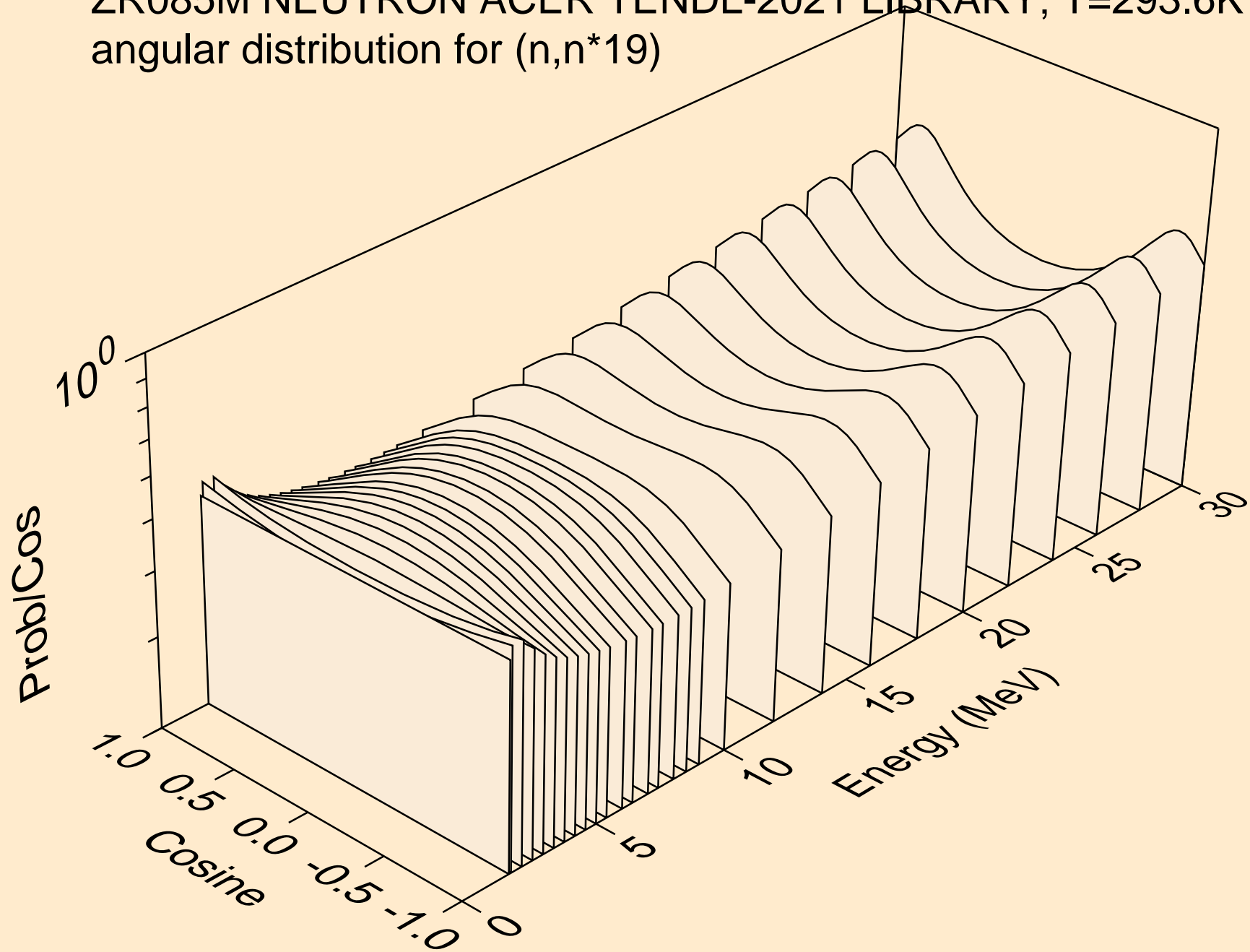

ZR085M NEUTRON ACER TENDL-2021 LIBRARY; T=293.6K
angular distribution for (n,n*20)

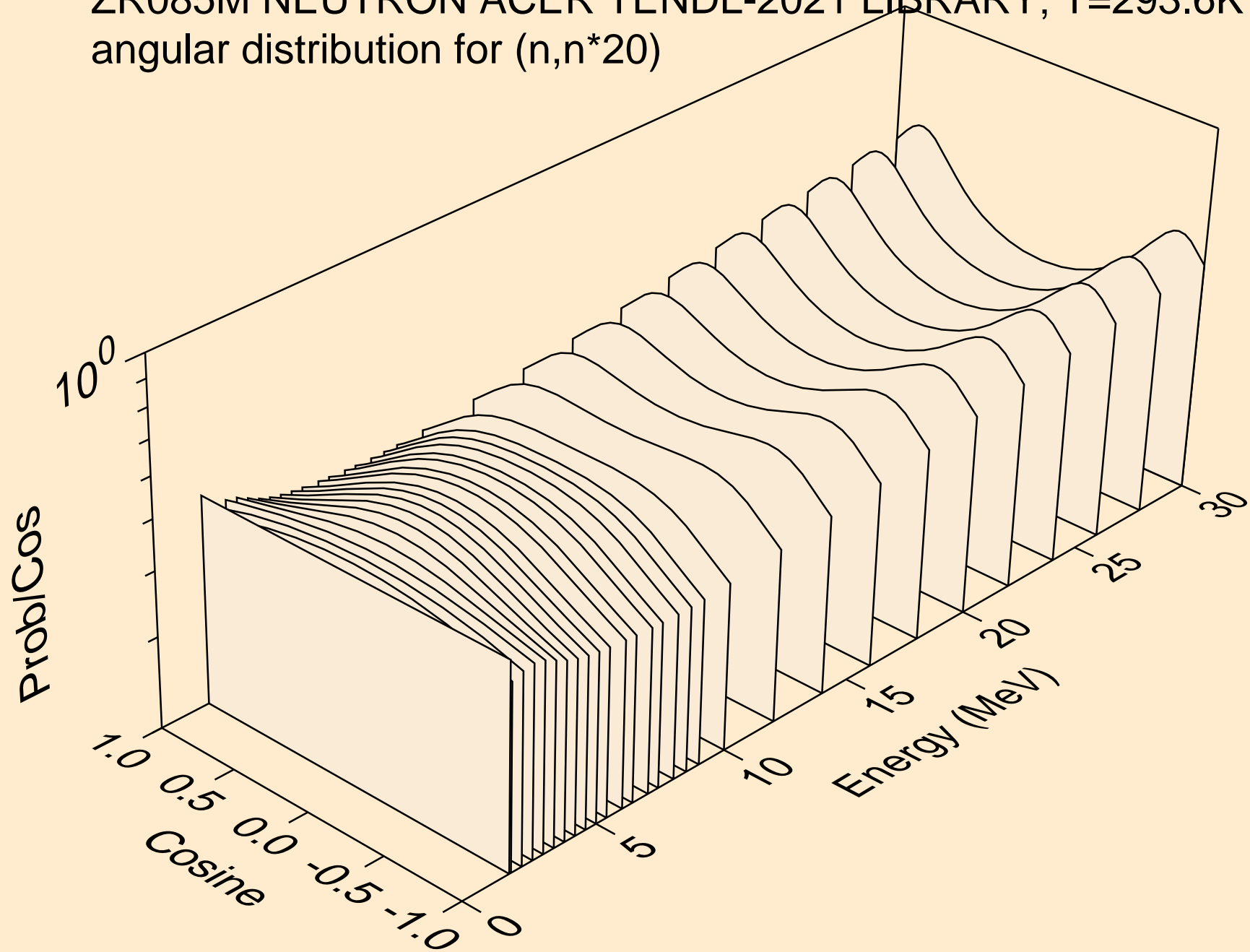

ZR085M NEUTRON ACER TENDL-2021 LIBRARY; T=293.6K
angular distribution for (n,n*21)

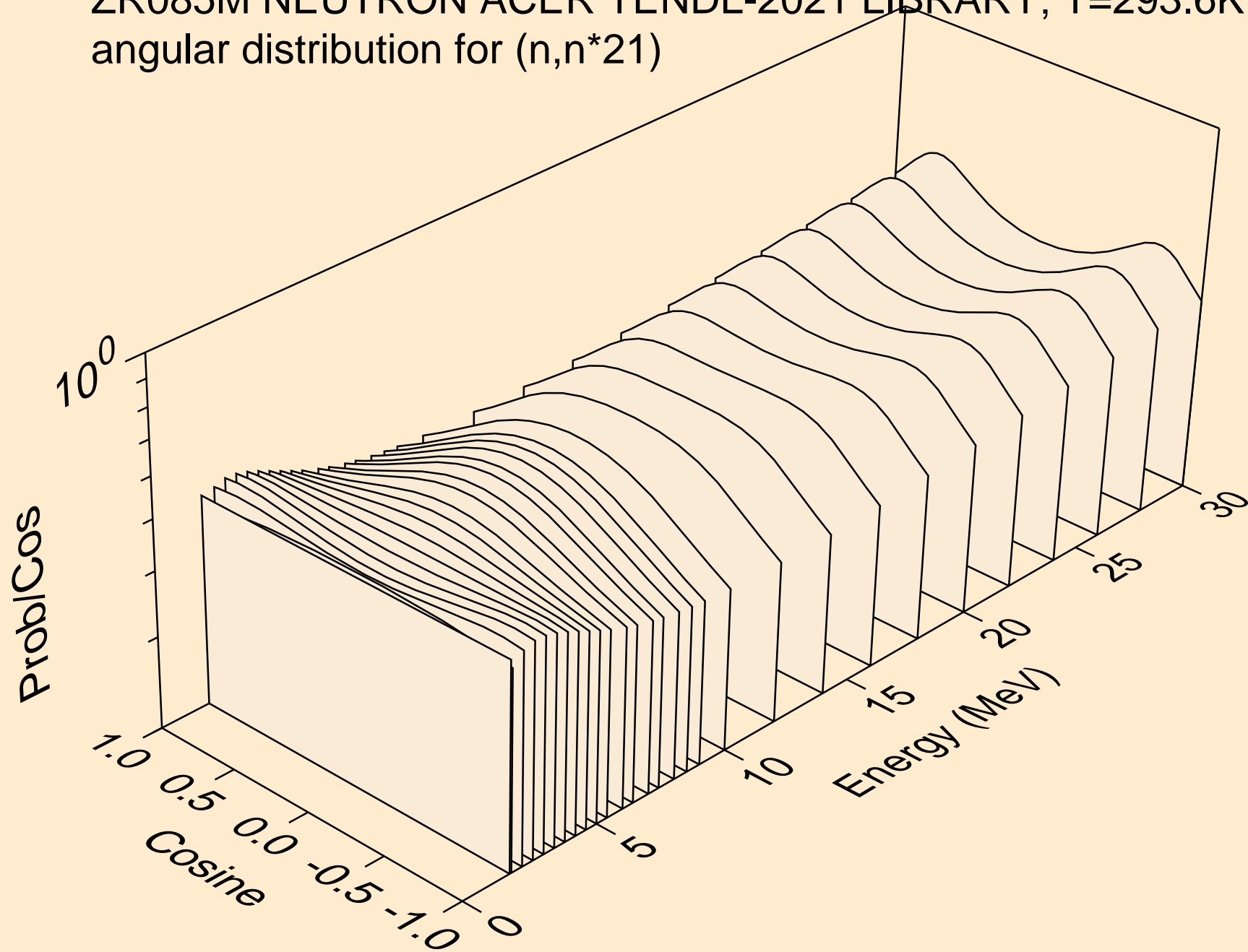

ZR085M NEUTRON ACER TENDL-2021 LIBRARY; T=293.6K
angular distribution for (n,n*22)

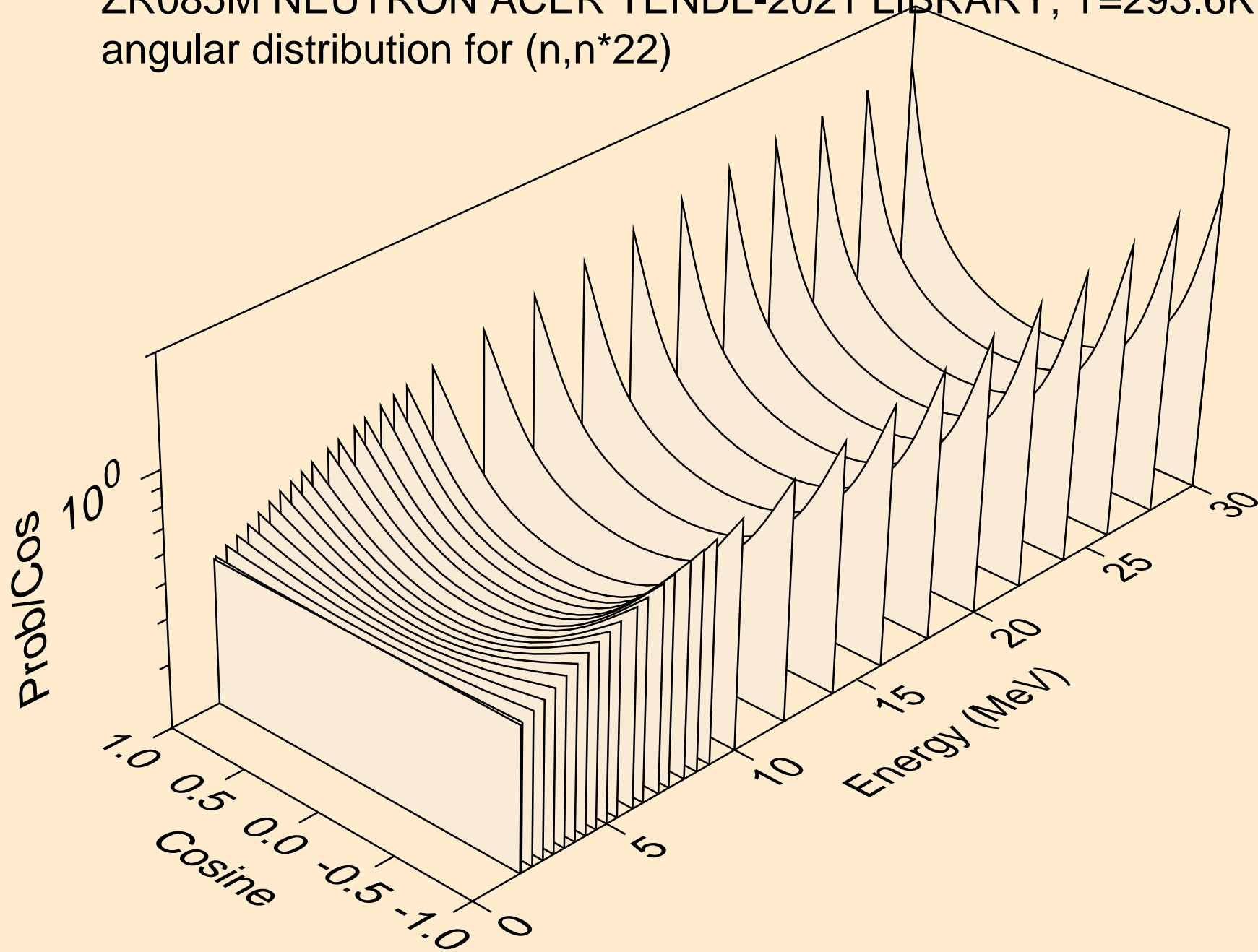

ZR085M NEUTRON ACER TENDL-2021 LIBRARY; T=293.6K
angular distribution for (n,n*23)

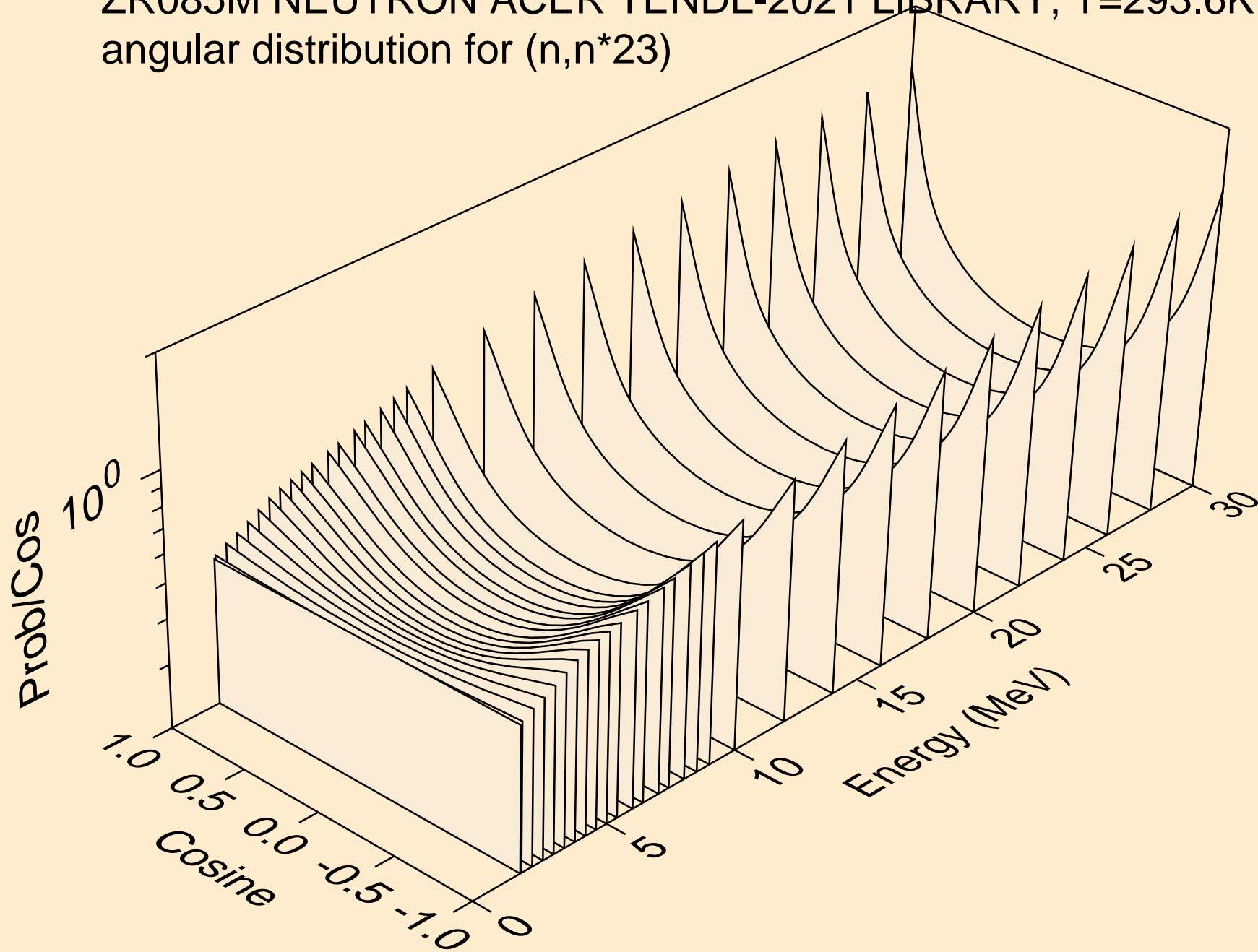

ZR085M NEUTRON ACER TENDL-2021 LIBRARY; T=293.6K
angular distribution for (n,n*24)

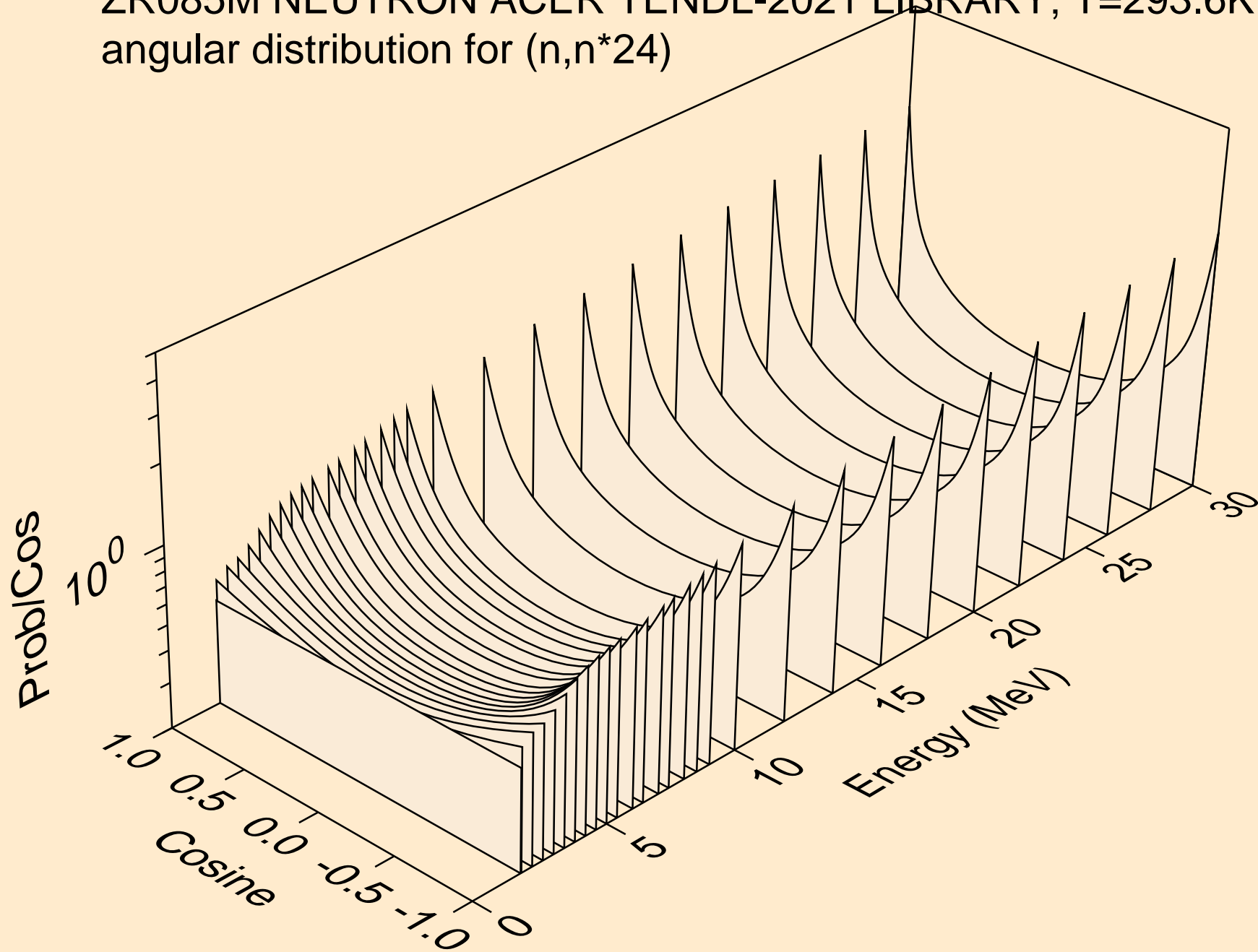

ZR085M NEUTRON ACER TENDL-2021 LIBRARY; T=293.6K
angular distribution for (n,n*25)

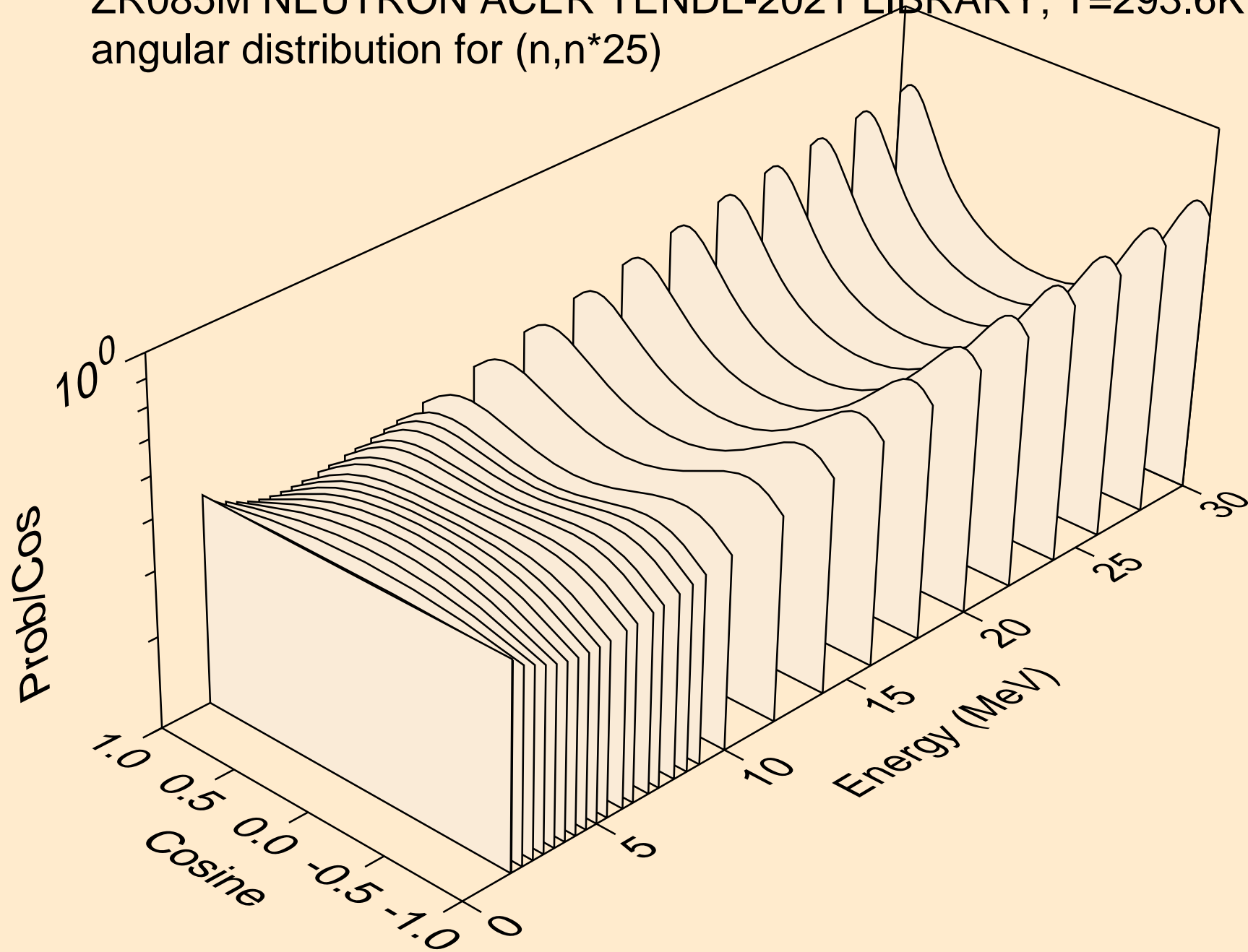

ZR085M NEUTRON ACER TENDL-2021 LIBRARY; T=293.6K
angular distribution for (n,n*26)

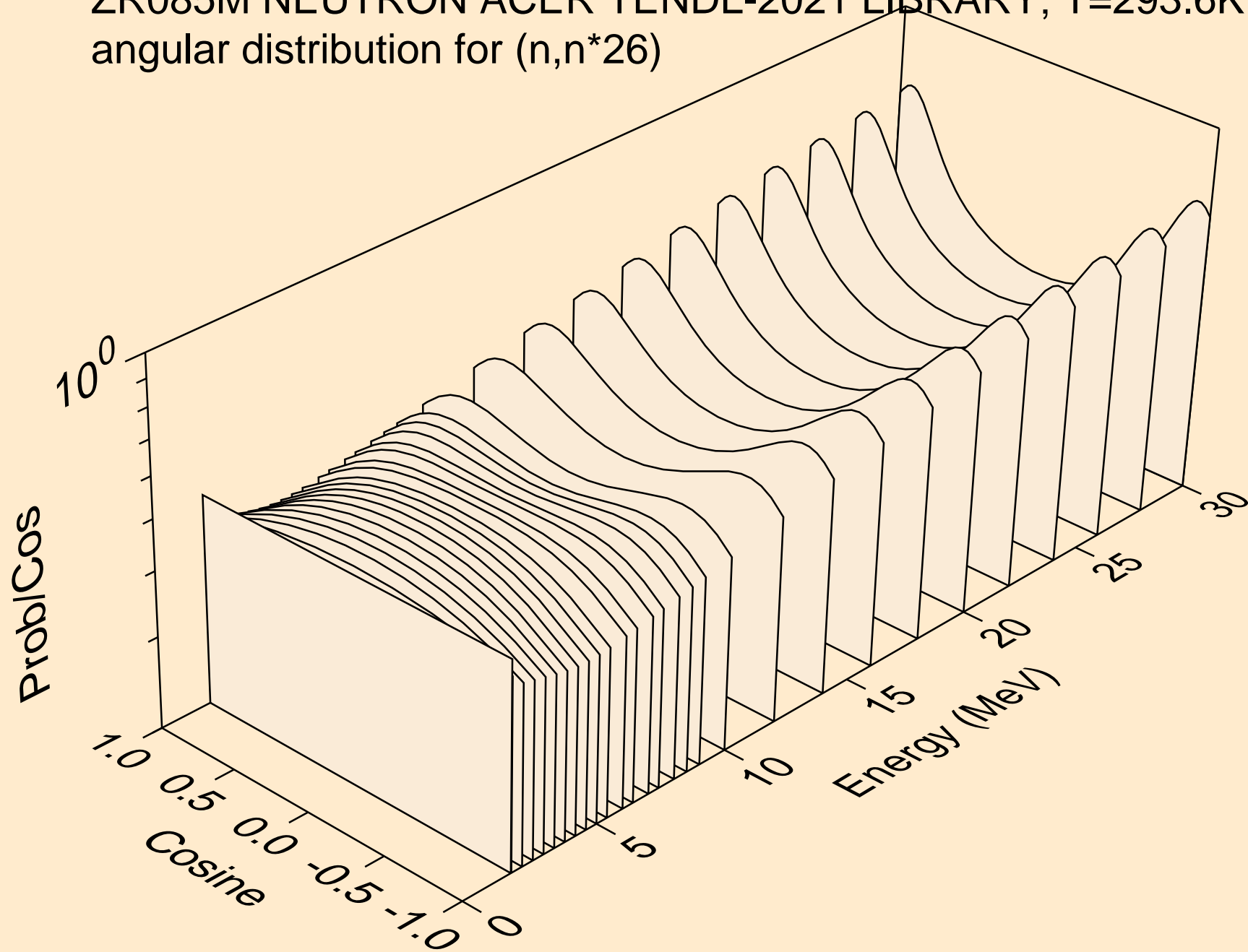

ZR085M NEUTRON ACER TENDL-2021 LIBRARY; T=293.6K
angular distribution for (n,n*27)

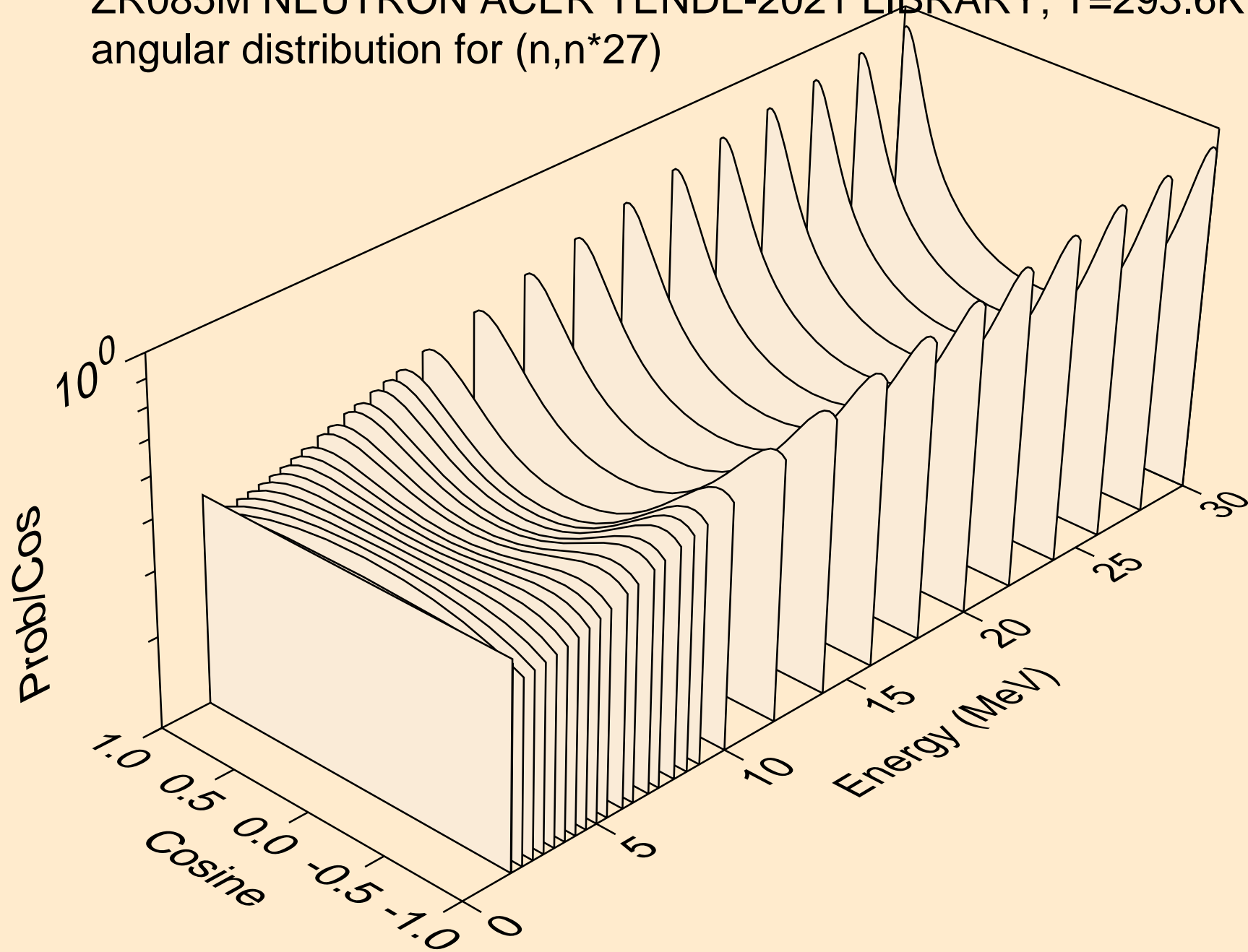

ZR085M NEUTRON ACER TENDL-2021 LIBRARY; T=293.6K
angular distribution for (n,n*28)

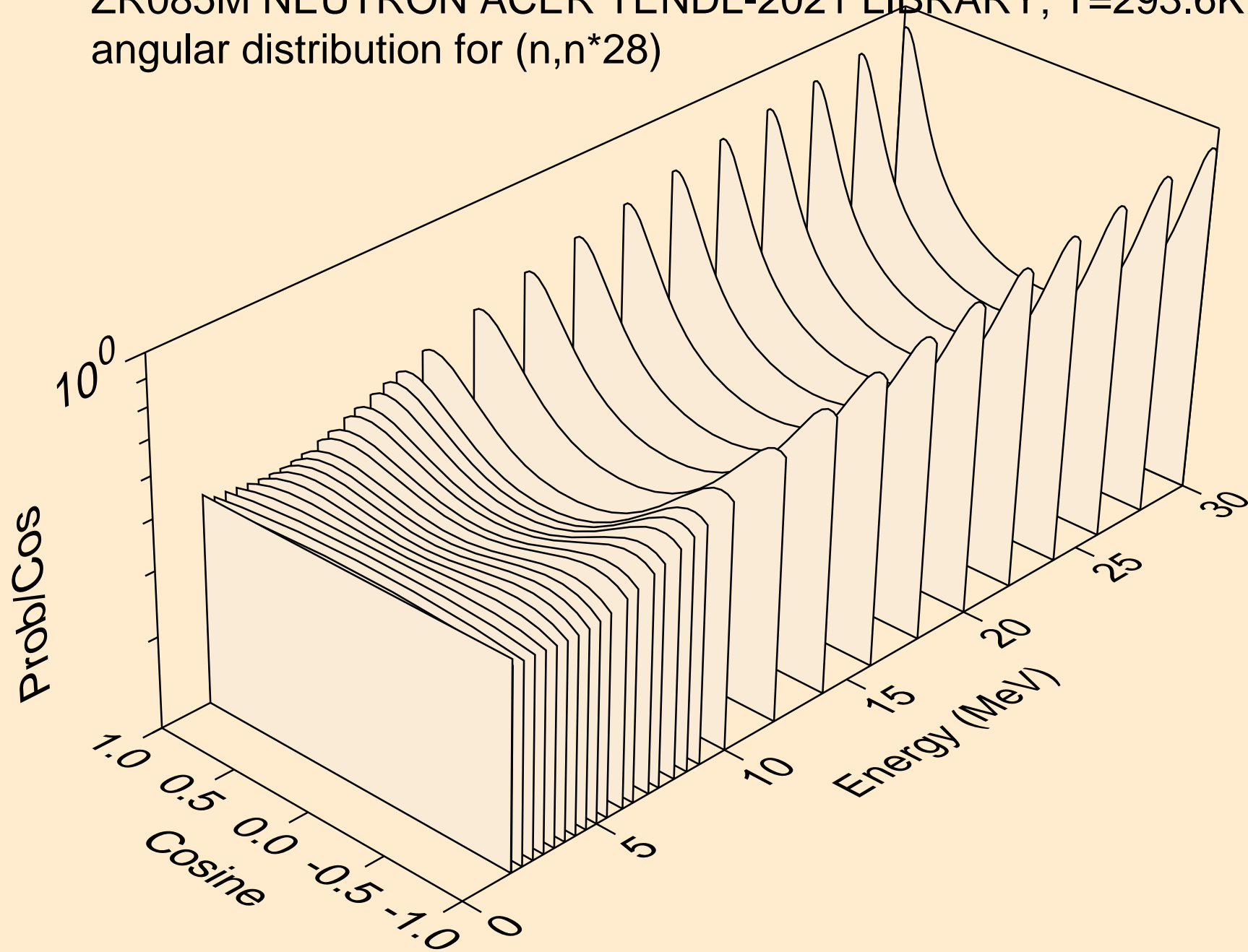

ZR085M NEUTRON ACER TENDL-2021 LIBRARY; T=293.6K
Neutron emission for (n,x)

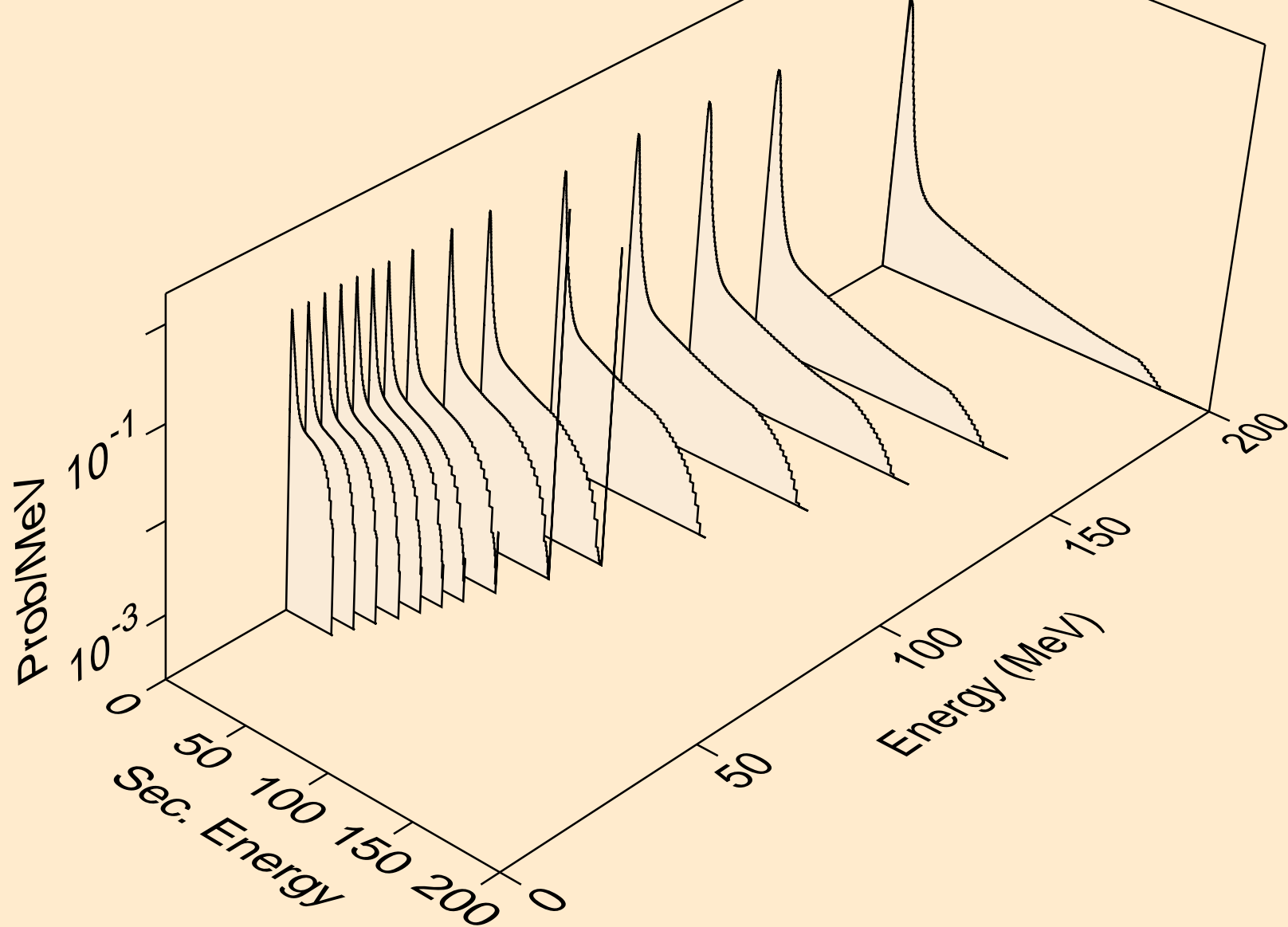

ZR085M NEUTRON ACER TENDL-2021 LIBRARY; T=293.6K
Neutron emission for (n,2nd)

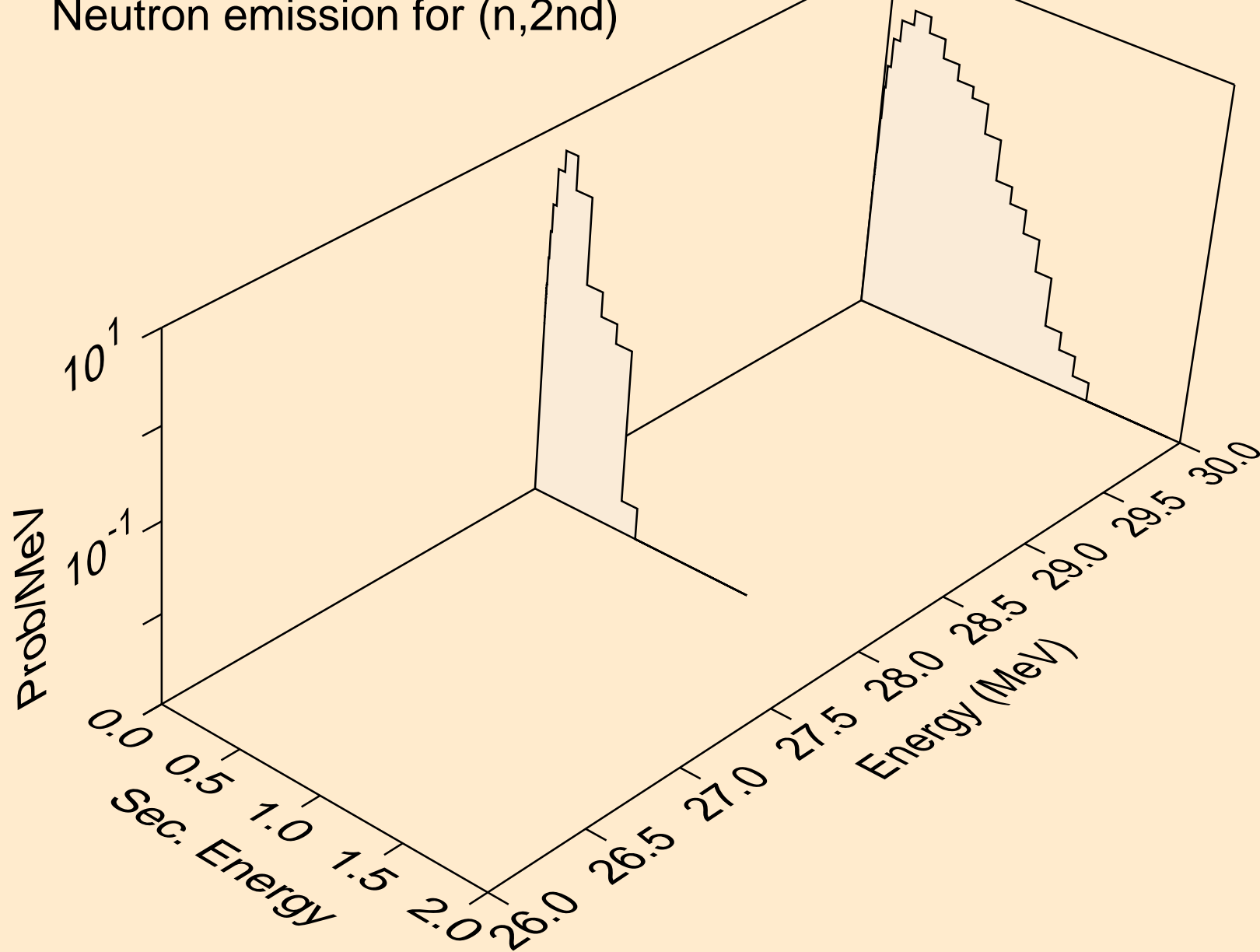

ZR085M NEUTRON ACER TENDL-2021 LIBRARY; T=293.6K
Neutron emission for (n,2n)

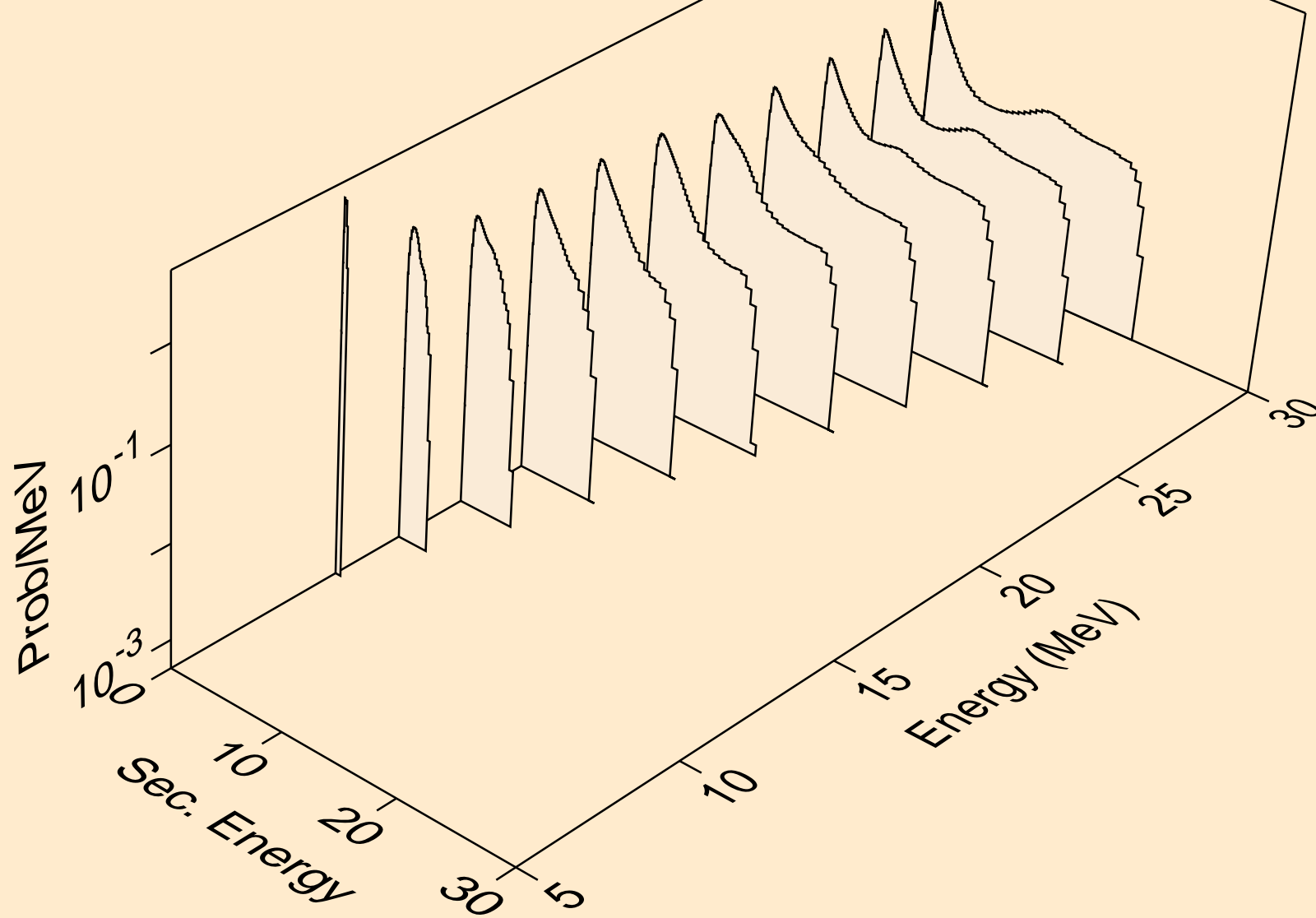

ZR085M NEUTRON ACER TENDL-2021 LIBRARY; T=293.6K
Neutron emission for (n,3n)

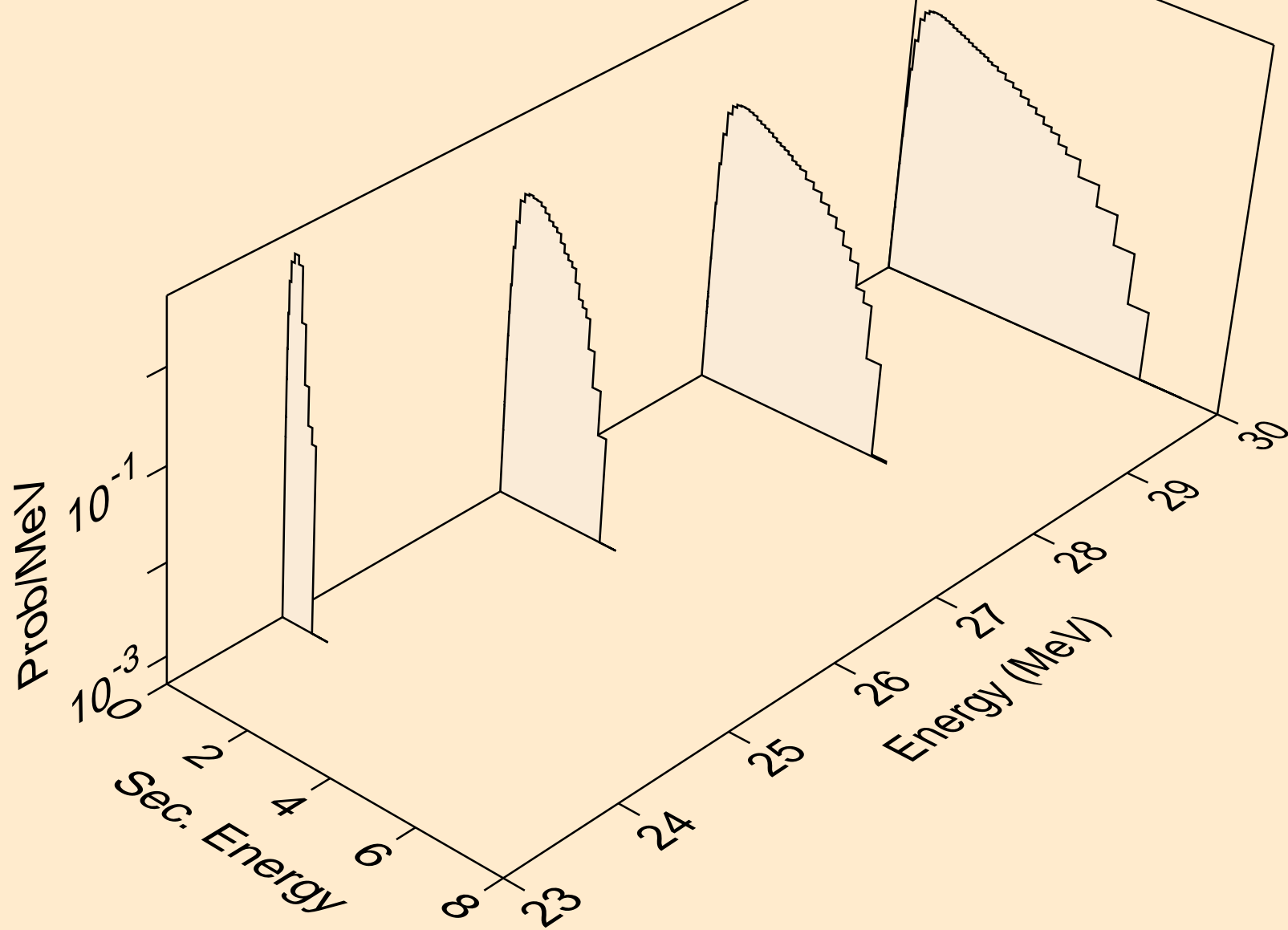

ZR085M NEUTRON ACER TENDL-2021 LIBRARY; T=293.6K
Neutron emission for (n,n*)a

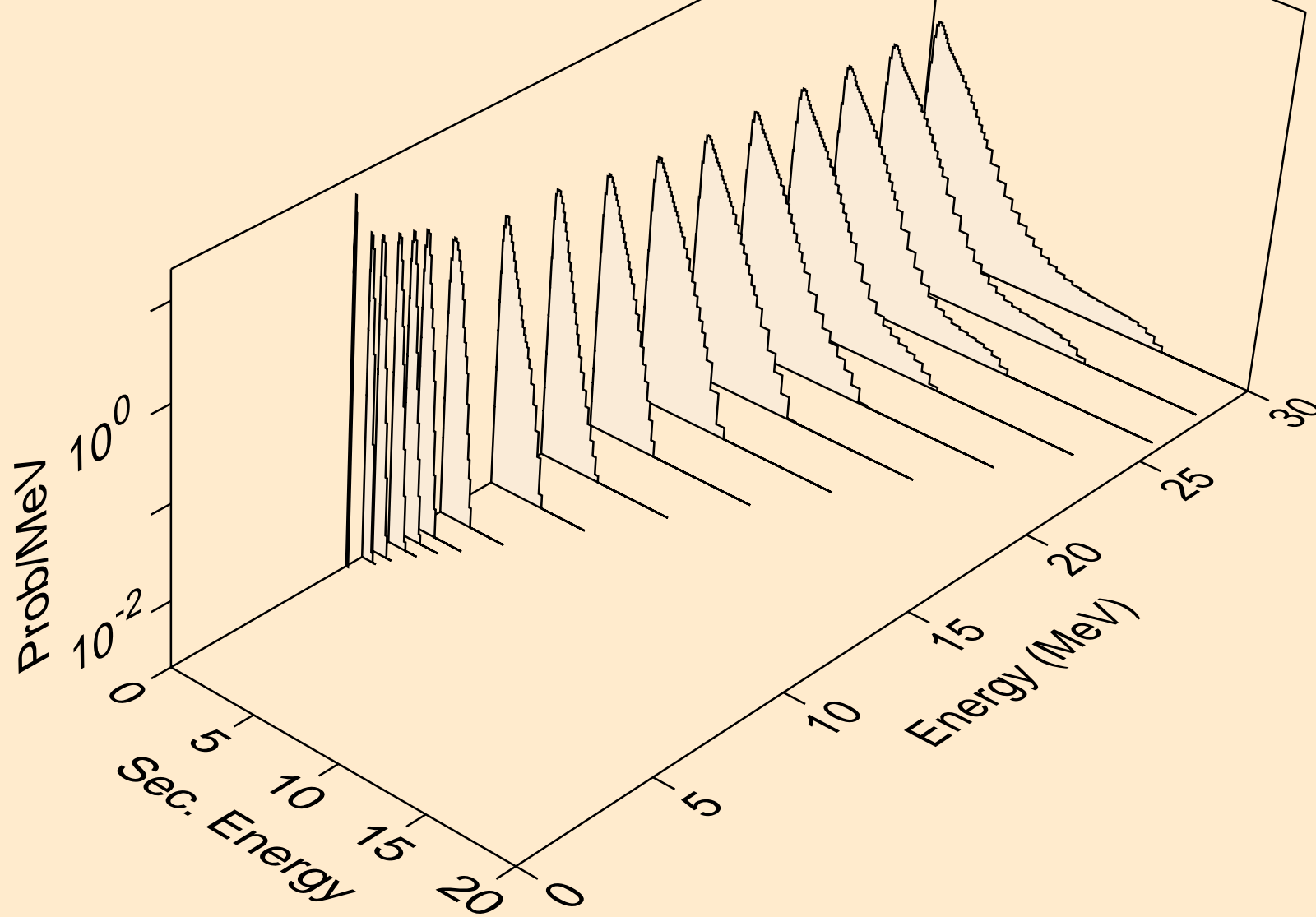

ZR085M NEUTRON ACER TENDL-2021 LIBRARY; T=293.6K
Neutron emission for (n,2n)a

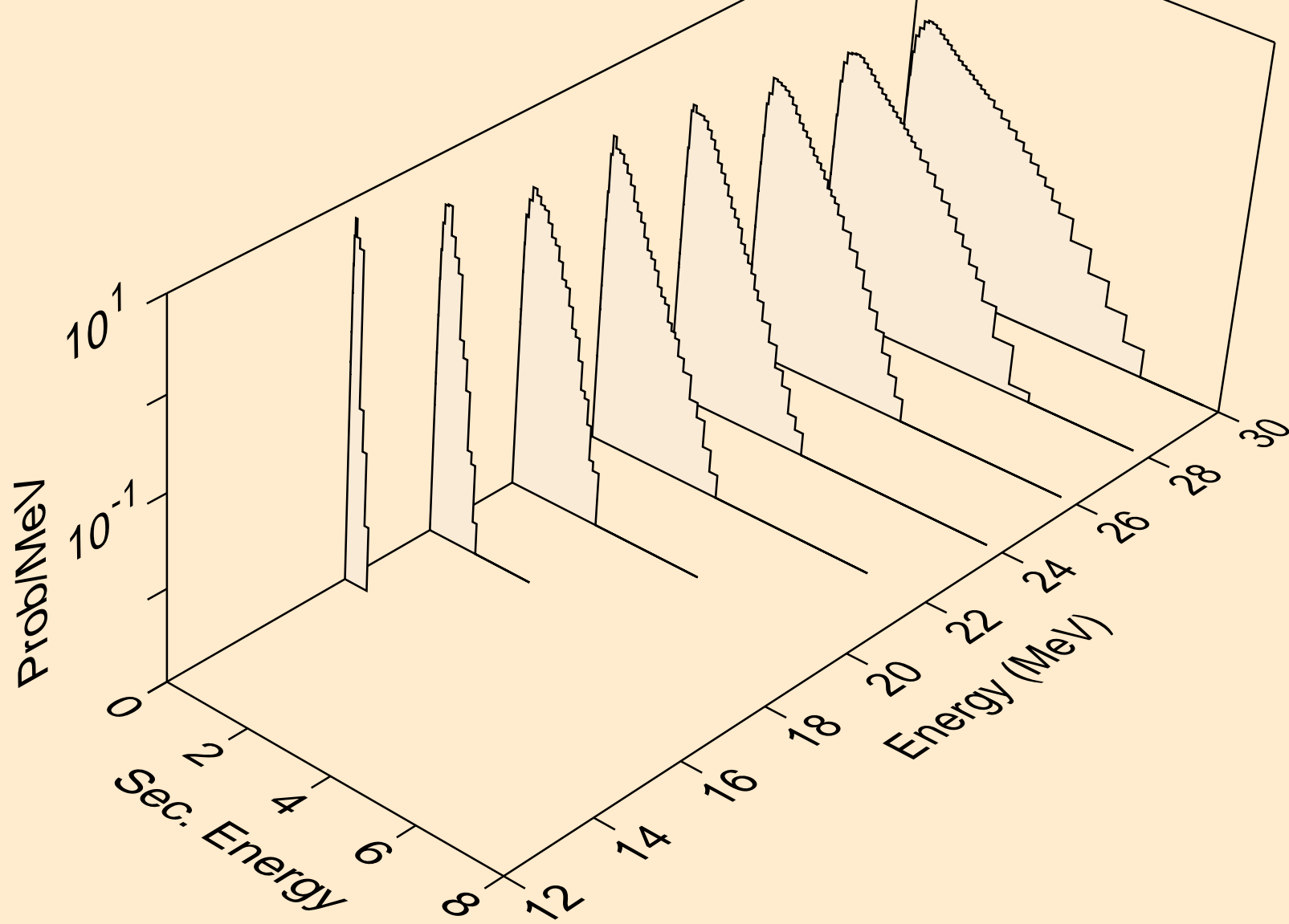

ZR085M NEUTRON ACER TENDL-2021 LIBRARY; T=293.6K
Neutron emission for (n,n*)p

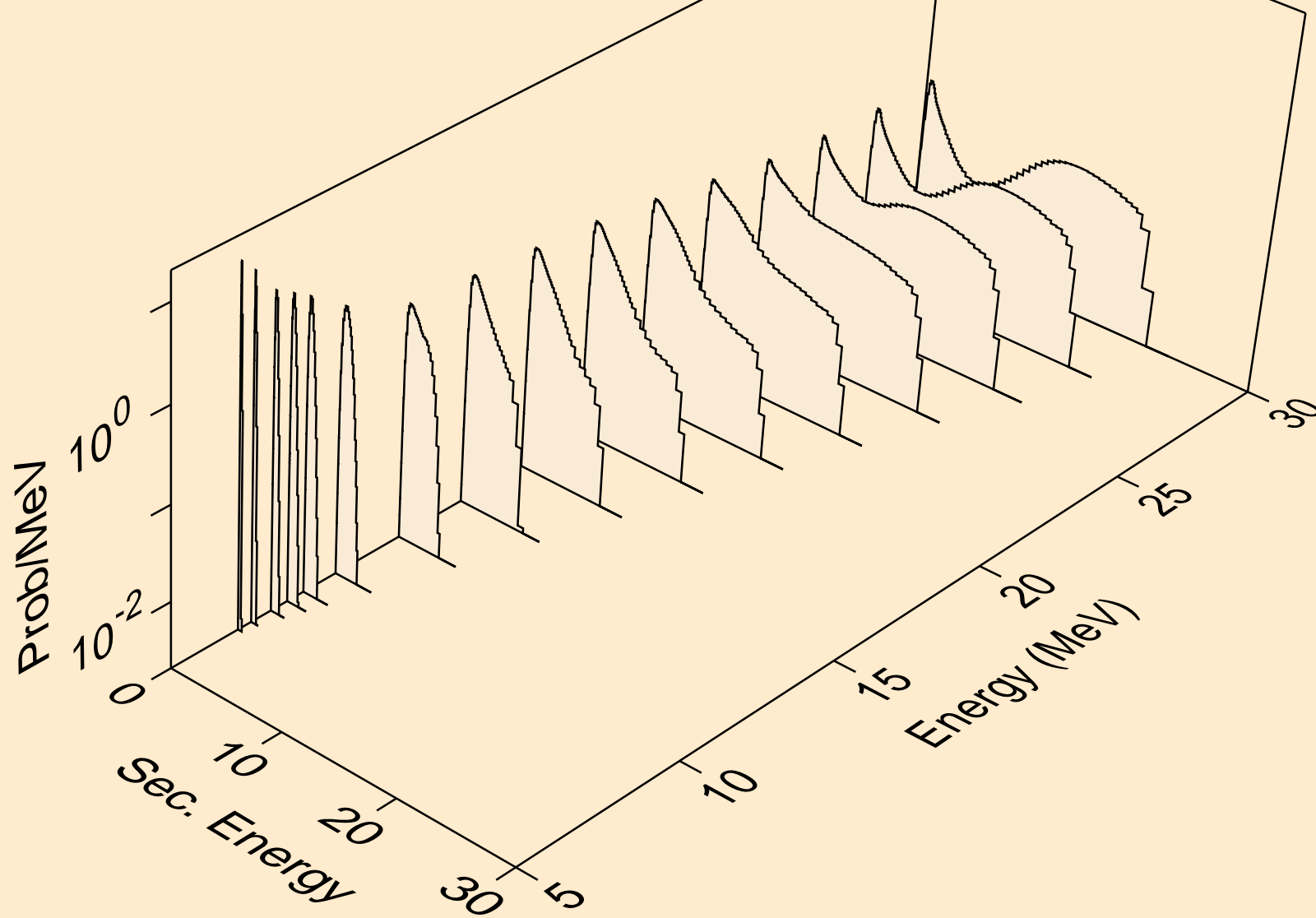

ZR085M NEUTRON ACER TENDL-2021 LIBRARY; T=293.6K
Neutron emission for (n,n*)2a

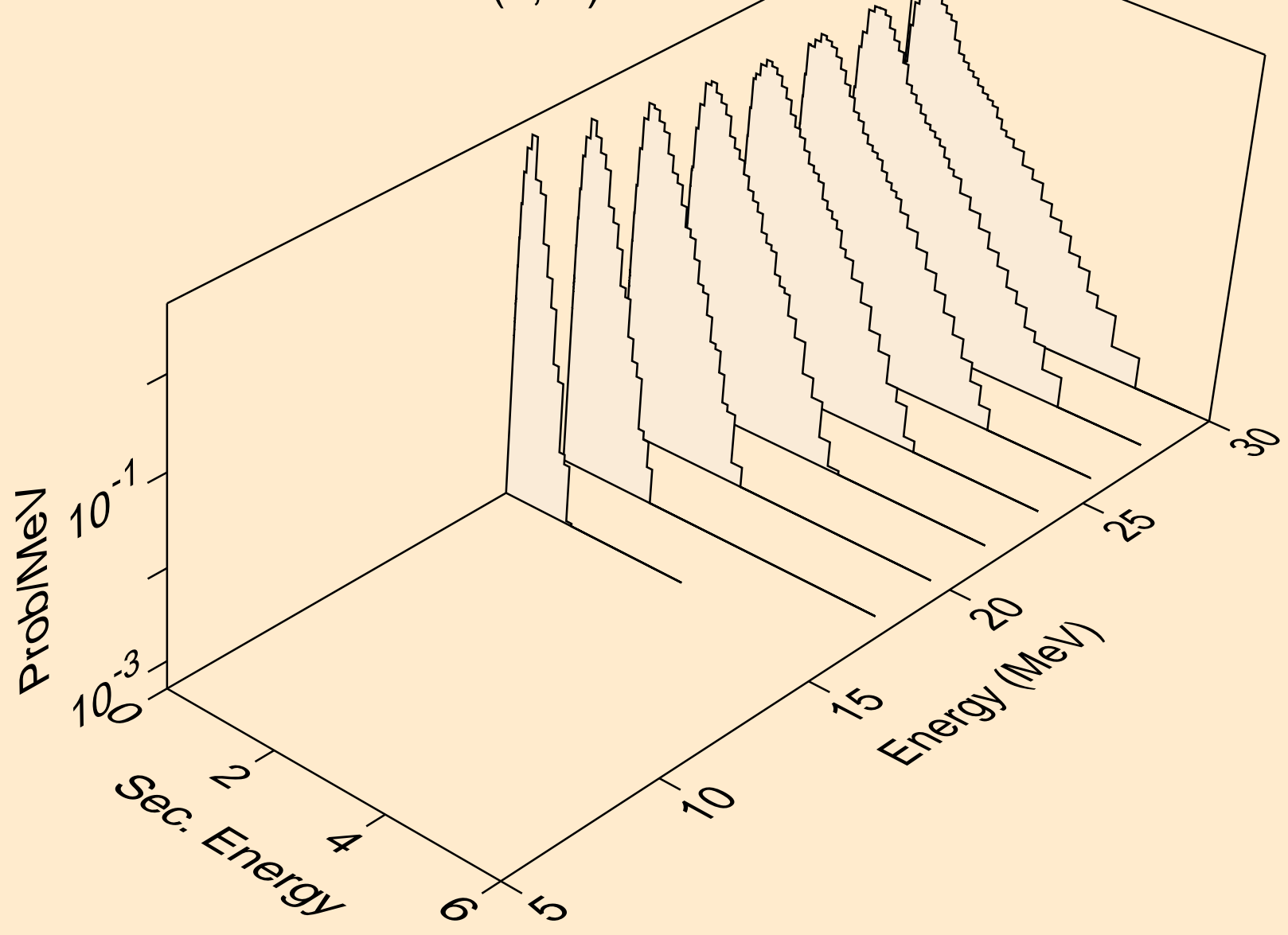

ZR085M NEUTRON ACER TENDL-2021 LIBRARY; T=293.6K
Neutron emission for (n,n*)d

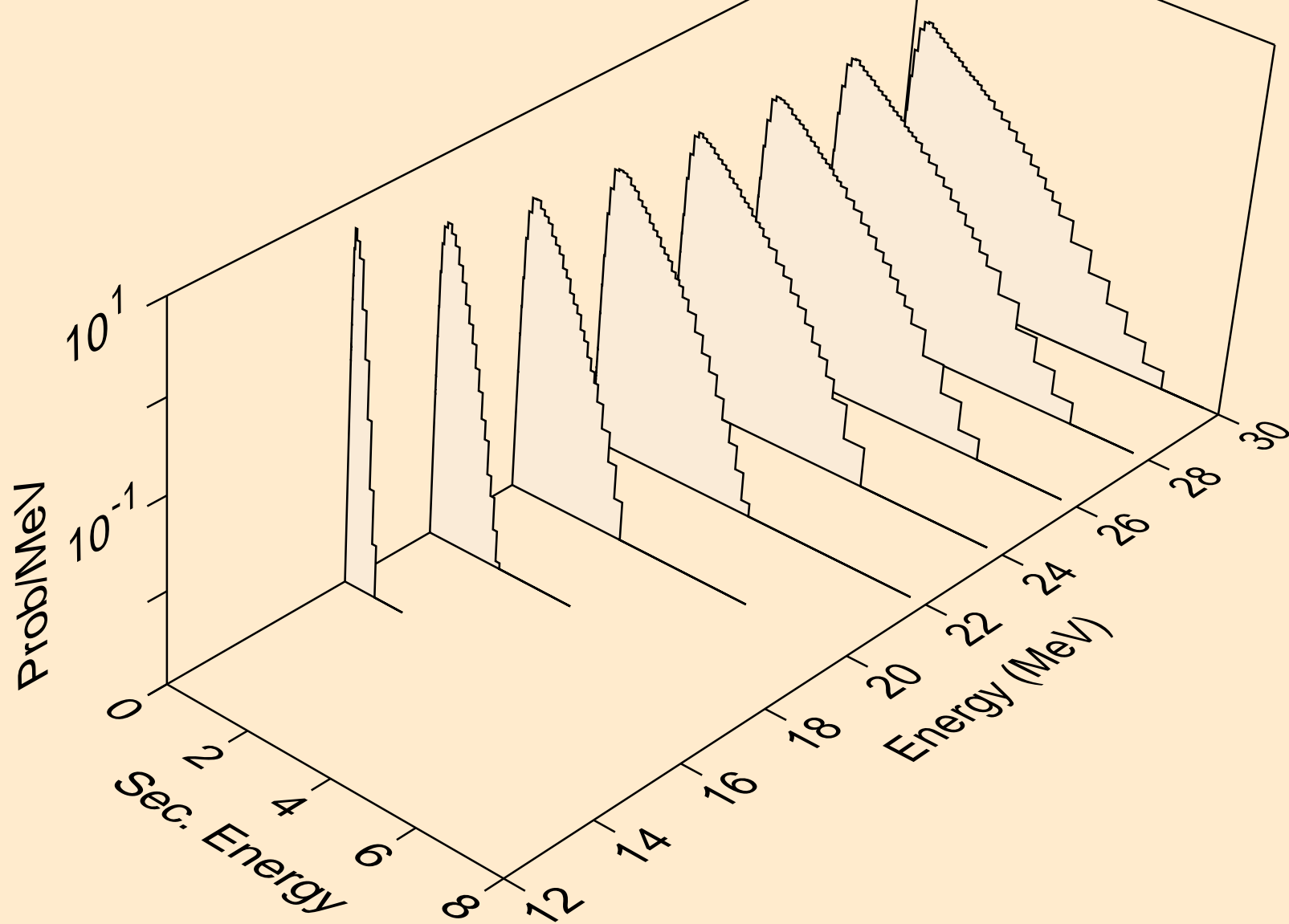

ZR085M NEUTRON ACER TENDL-2021 LIBRARY; T=293.6K
Neutron emission for (n,n*)t

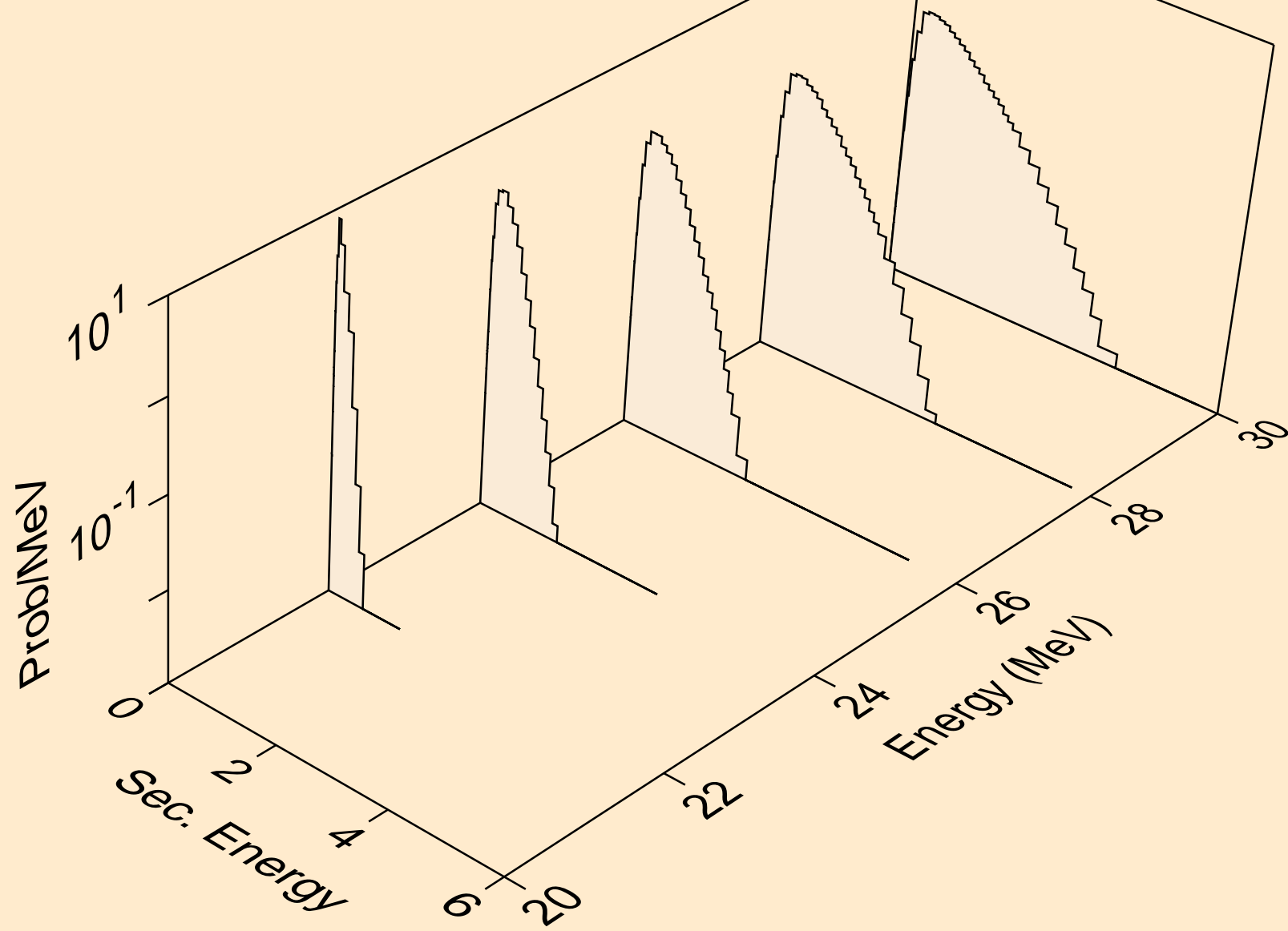

ZR085M NEUTRON ACER TENDL-2021 LIBRARY; T=293.6K
Neutron emission for (n,n*)he3

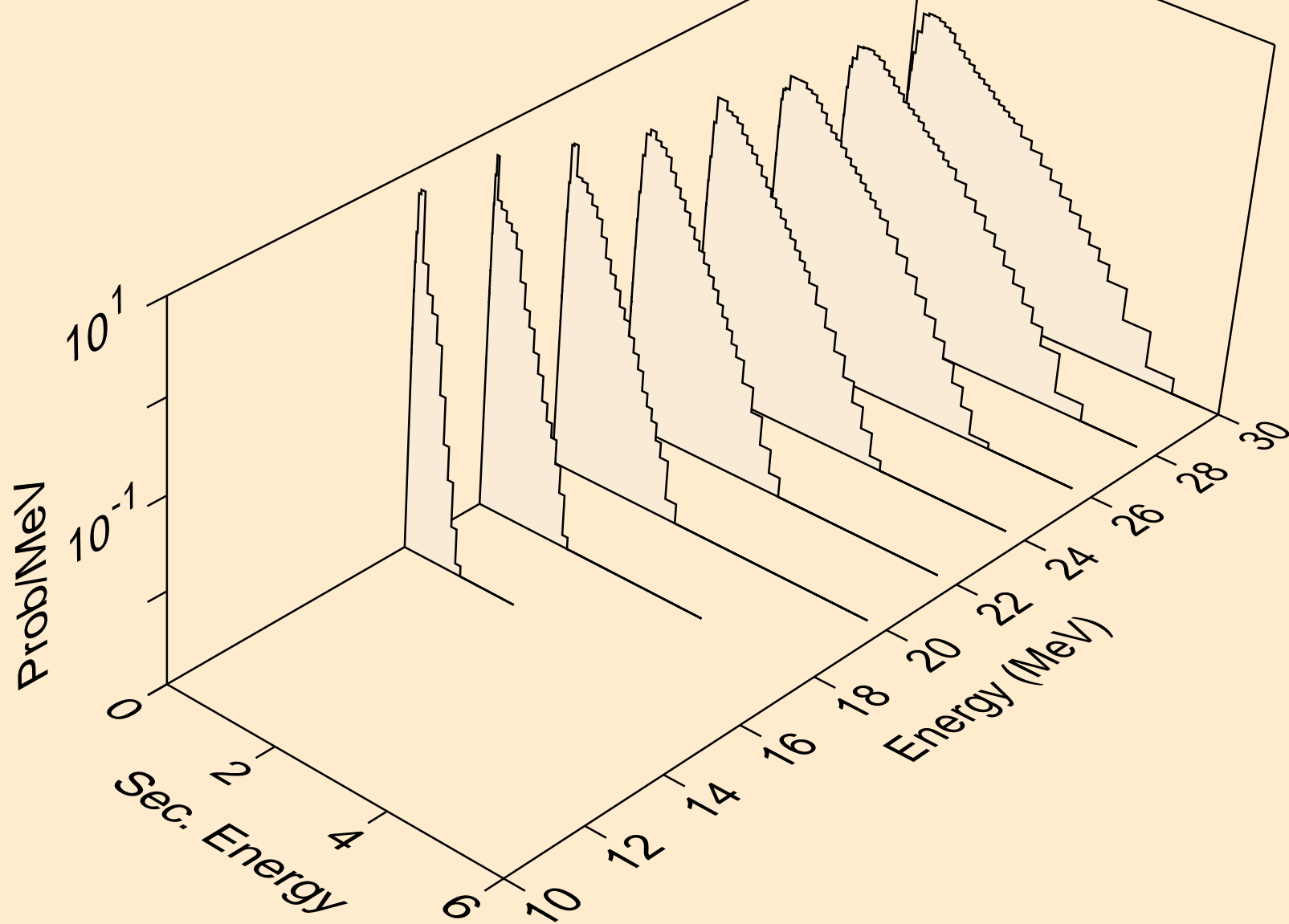

ZR085M NEUTRON ACER TENDL-2021 LIBRARY; T=293.6K
Neutron emission for (n,2np)

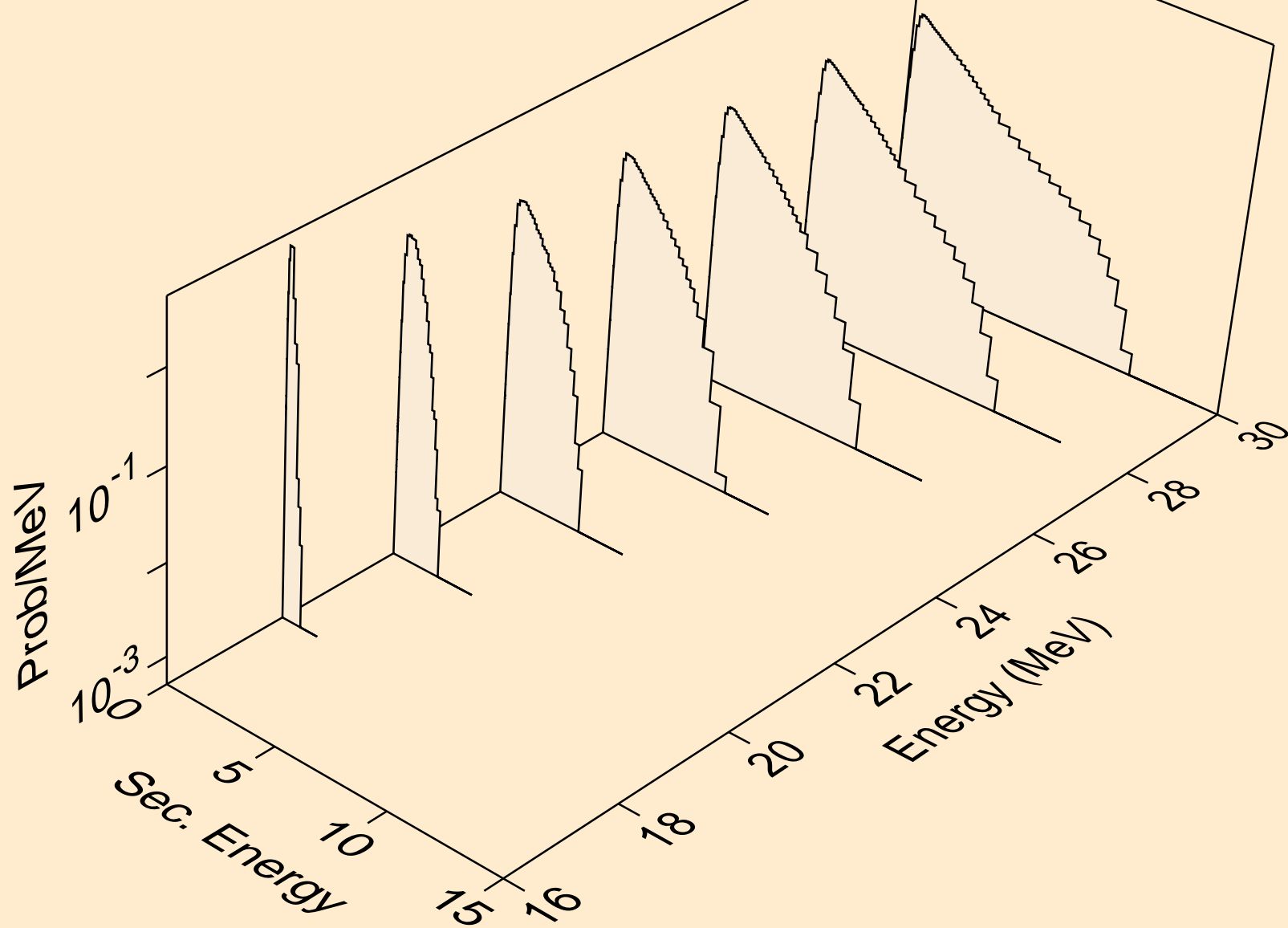

ZR085M NEUTRON ACER TENDL-2021 LIBRARY; T=293.6K
Neutron emission for (n,2np)

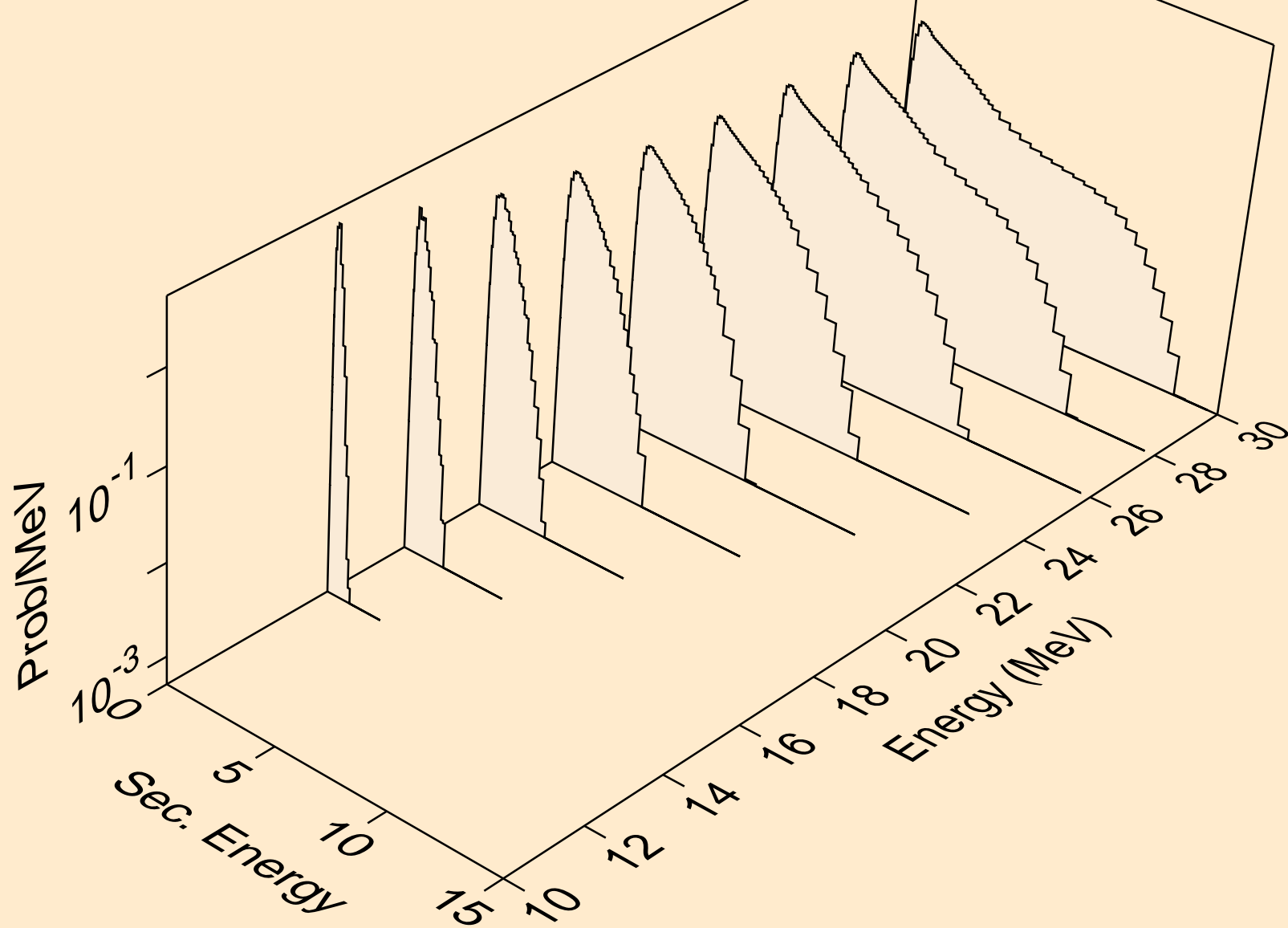

ZR085M NEUTRON ACER TENDL-2021 LIBRARY; T=293.6K
Neutron emission for (n,npa)

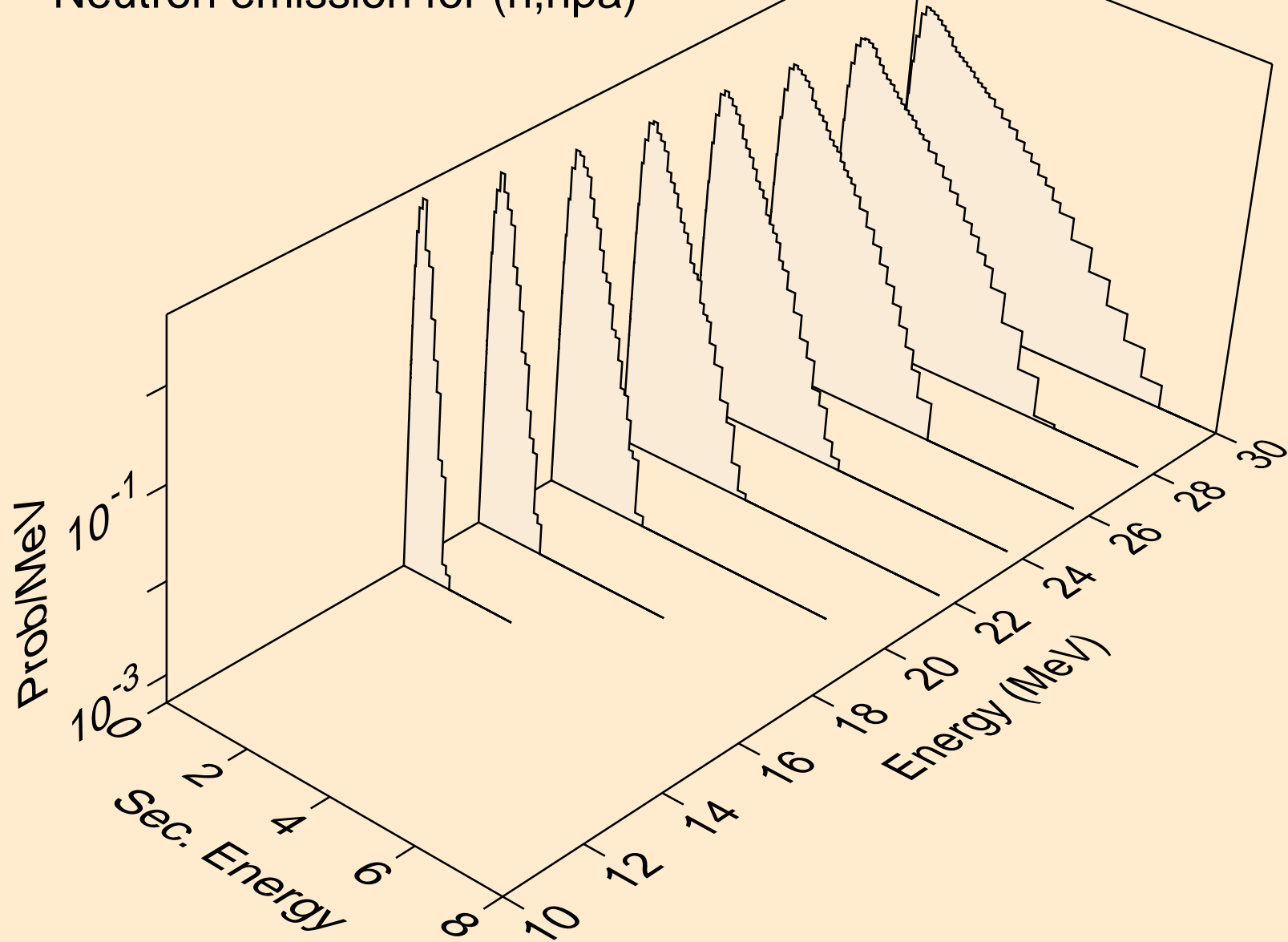

ZR085M NEUTRON ACER TENDL-2021 LIBRARY; T=293.6K
Neutron emission for (n,n*c)

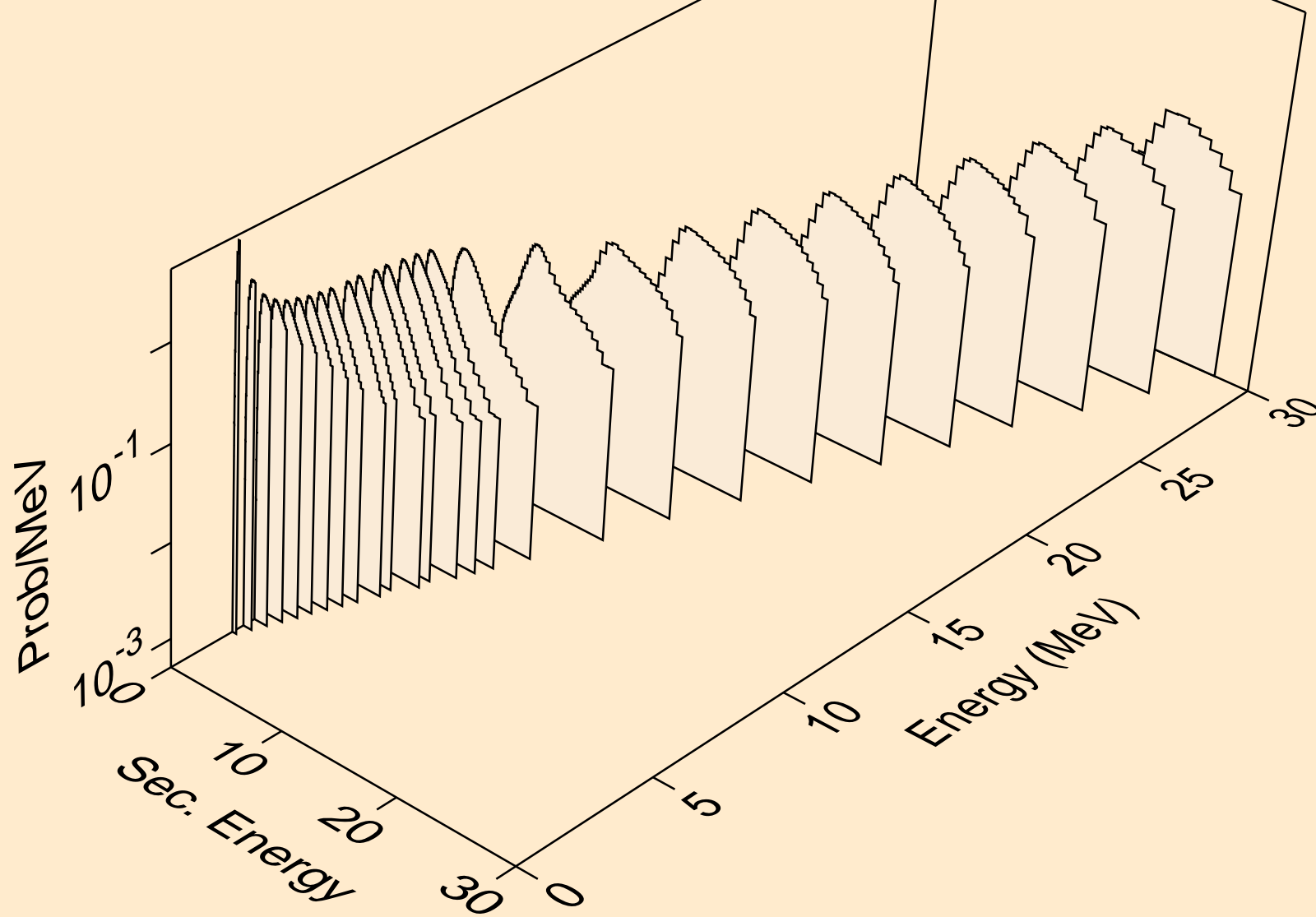

ZR085M NEUTRON ACER TENDL-2021 LIBRARY; T=293.6K
Photon emission for (n,x)

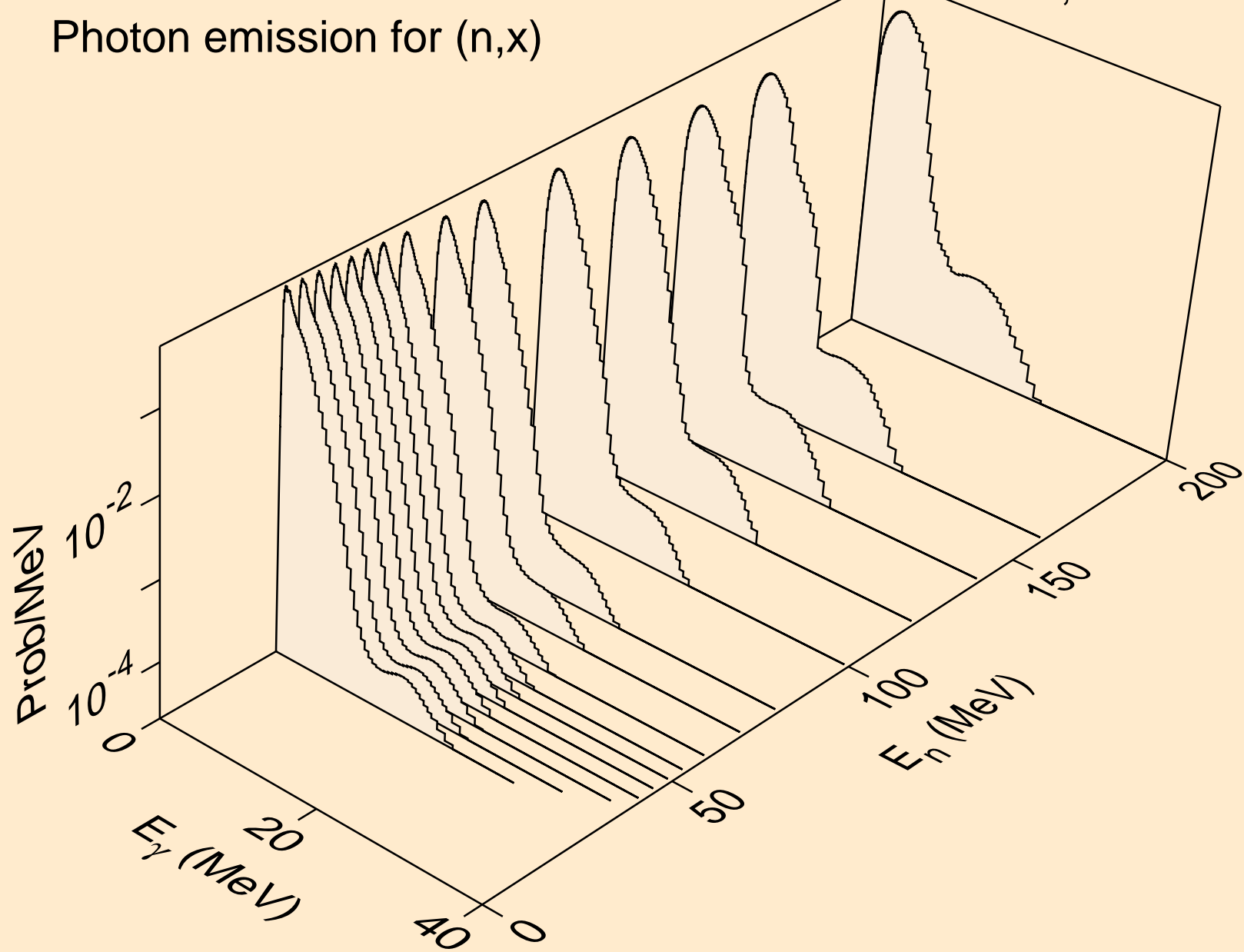

ZR085M NEUTRON ACER TENDL-2021 LIBRARY; T=293.6K
Photon emission for (n,2nd)

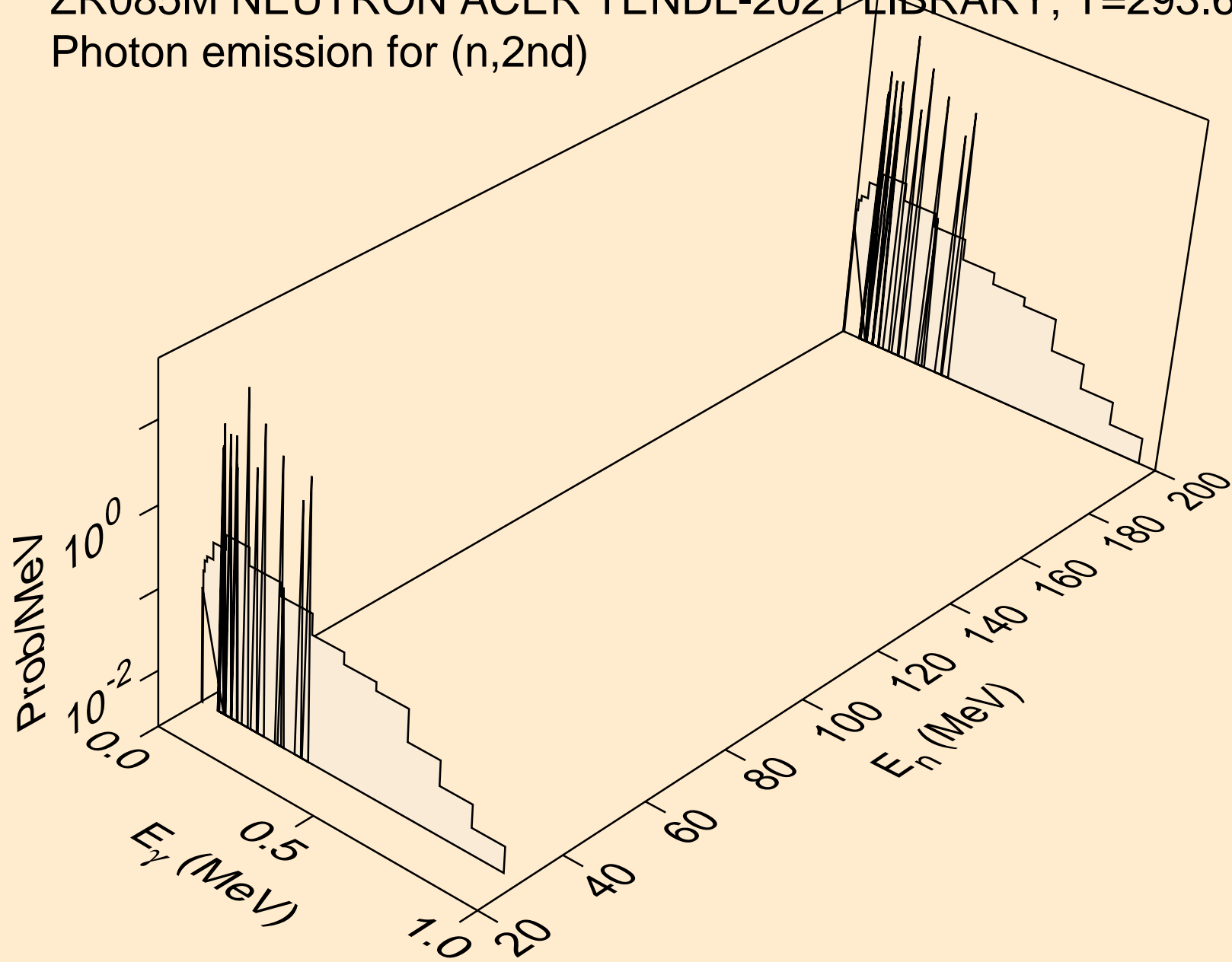

ZR085M NEUTRON ACER TENDL-2021 LIBRARY; T=293.6K
Photon emission for (n,2n)

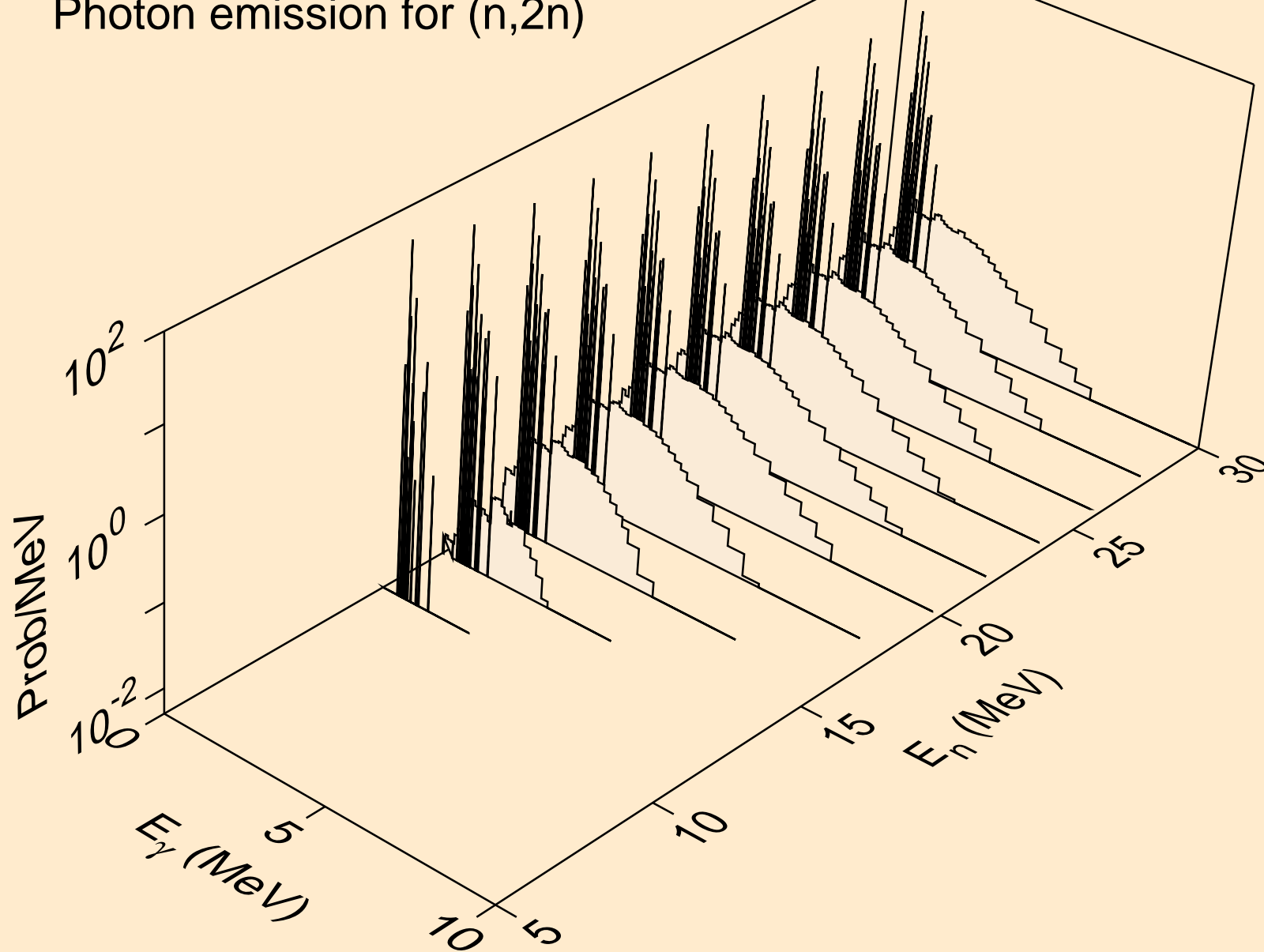

ZR085M NEUTRON ACER TENDL-2021 LIBRARY; T=293.6K
Photon emission for (n,3n)

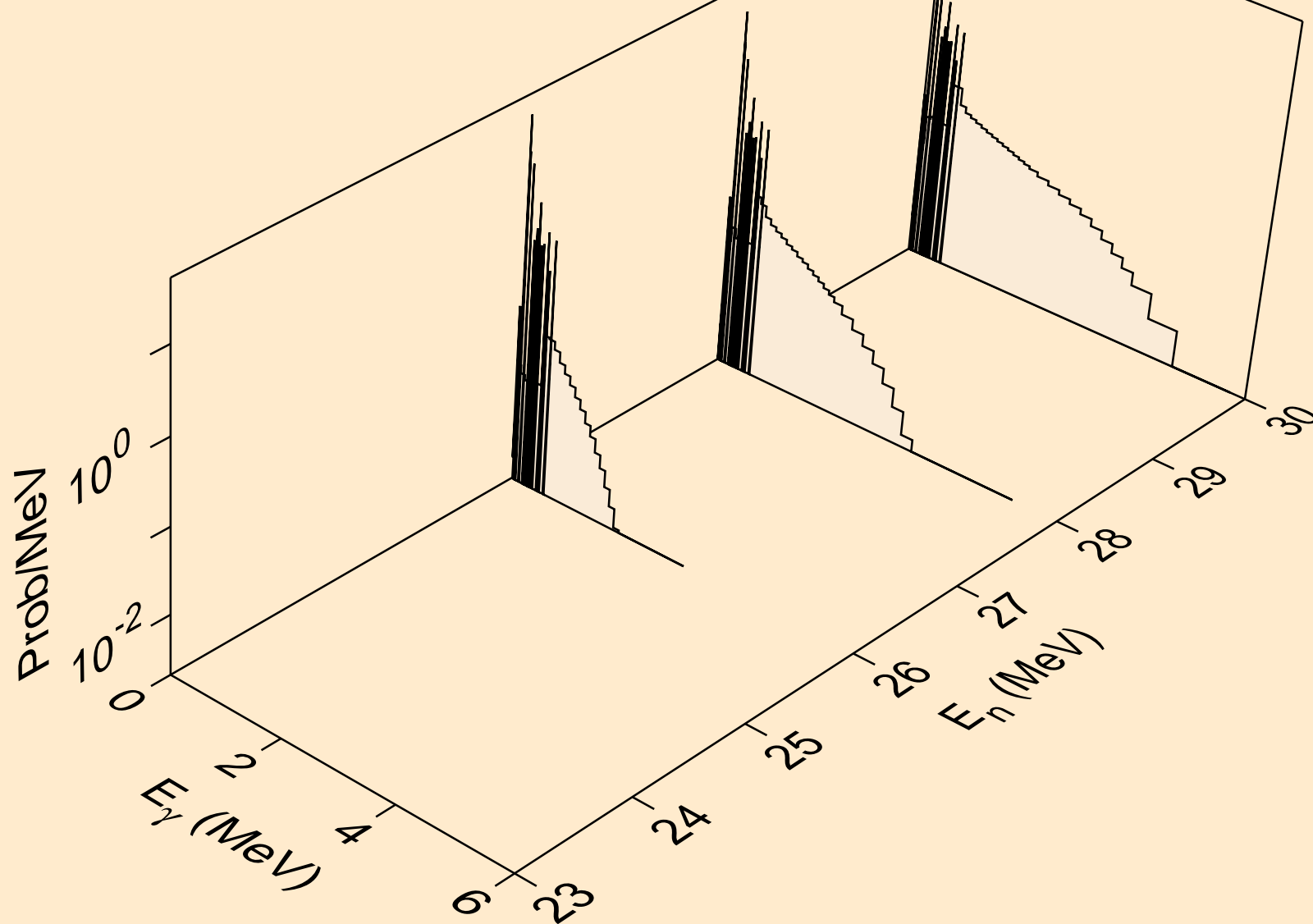

ZR085M NEUTRON ACER TENDL-2021 LIBRARY; T=293.6K
Photon emission for (n,n*)a

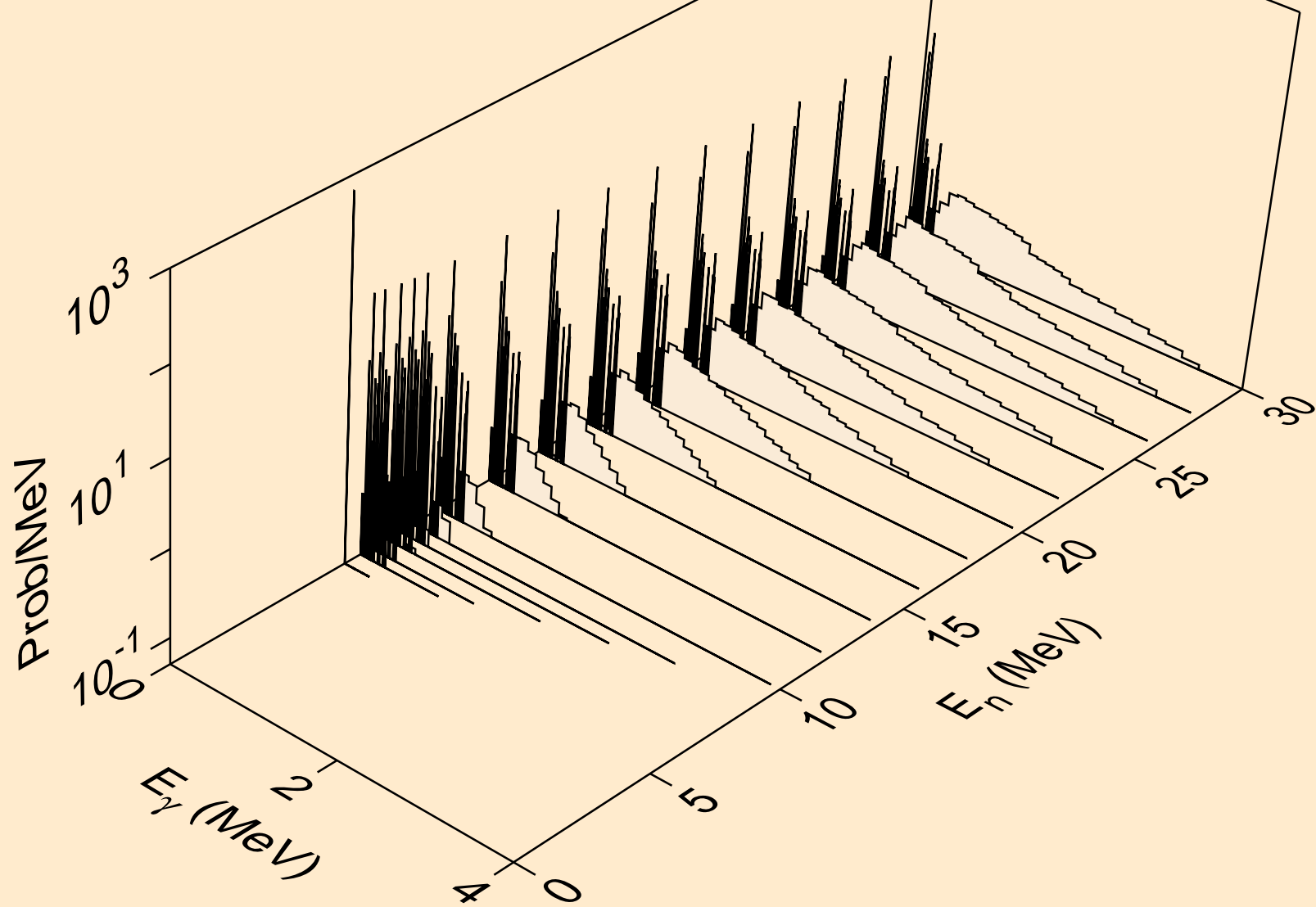

ZR085M NEUTRON ACER TENDL-2021 LIBRARY; T=293.6K
Photon emission for (n,2n)a

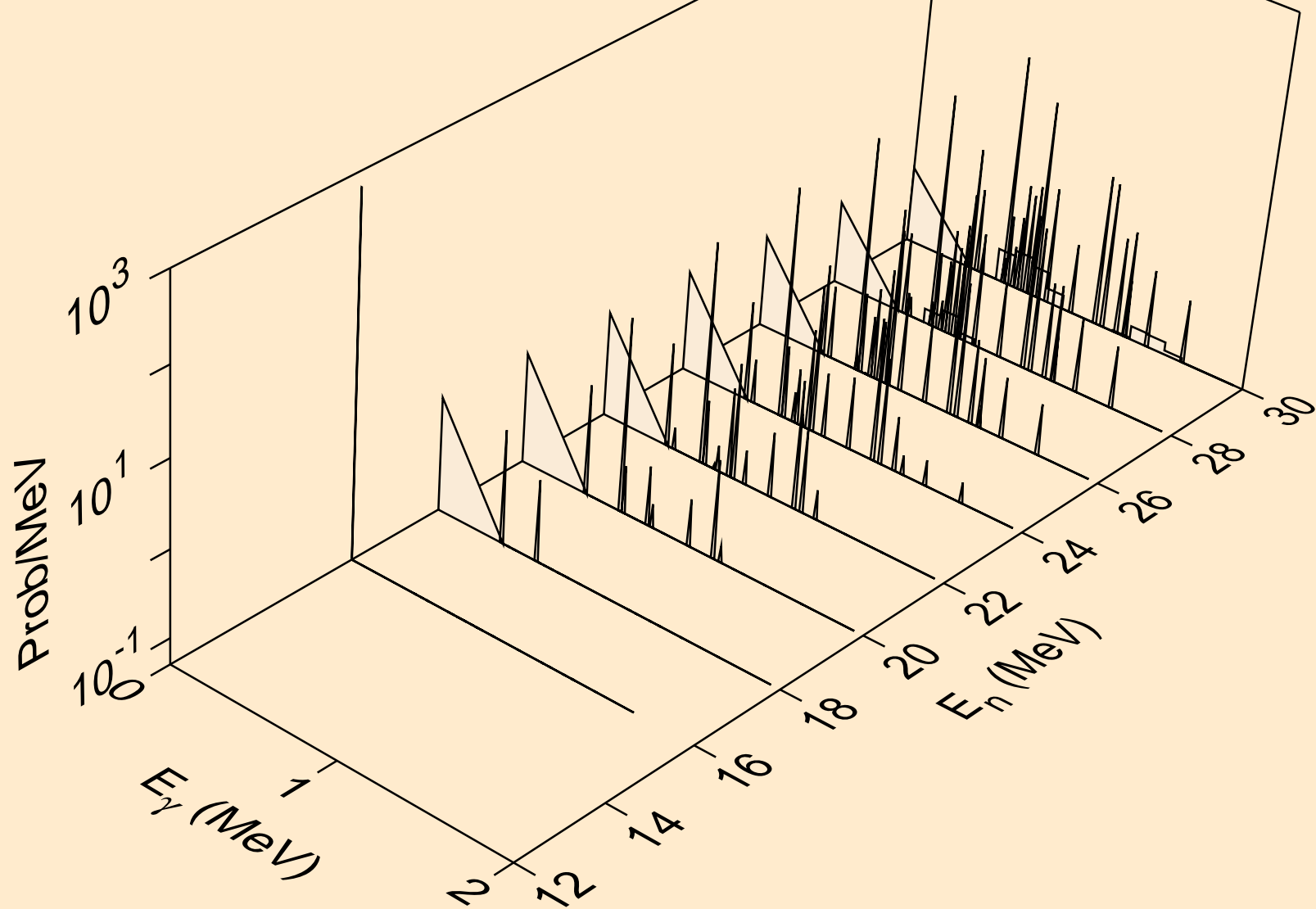

ZR085M NEUTRON ACER TENDL-2021 LIBRARY; T=293.6K
Photon emission for (n,n*)p

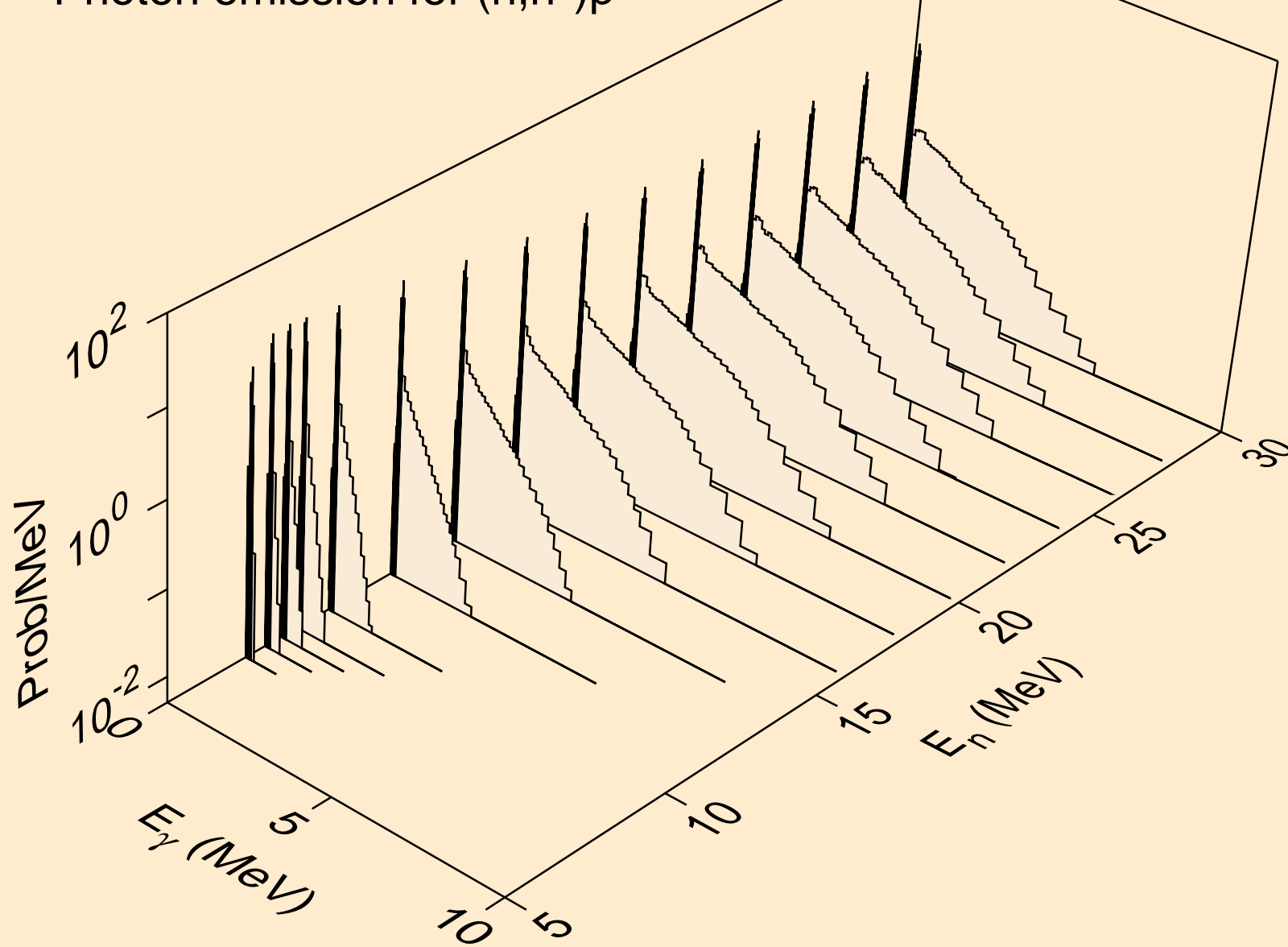

ZR085M NEUTRON ACER TENDL-2021 LIBRARY; T=293.6K
Photon emission for (n,n*)2a

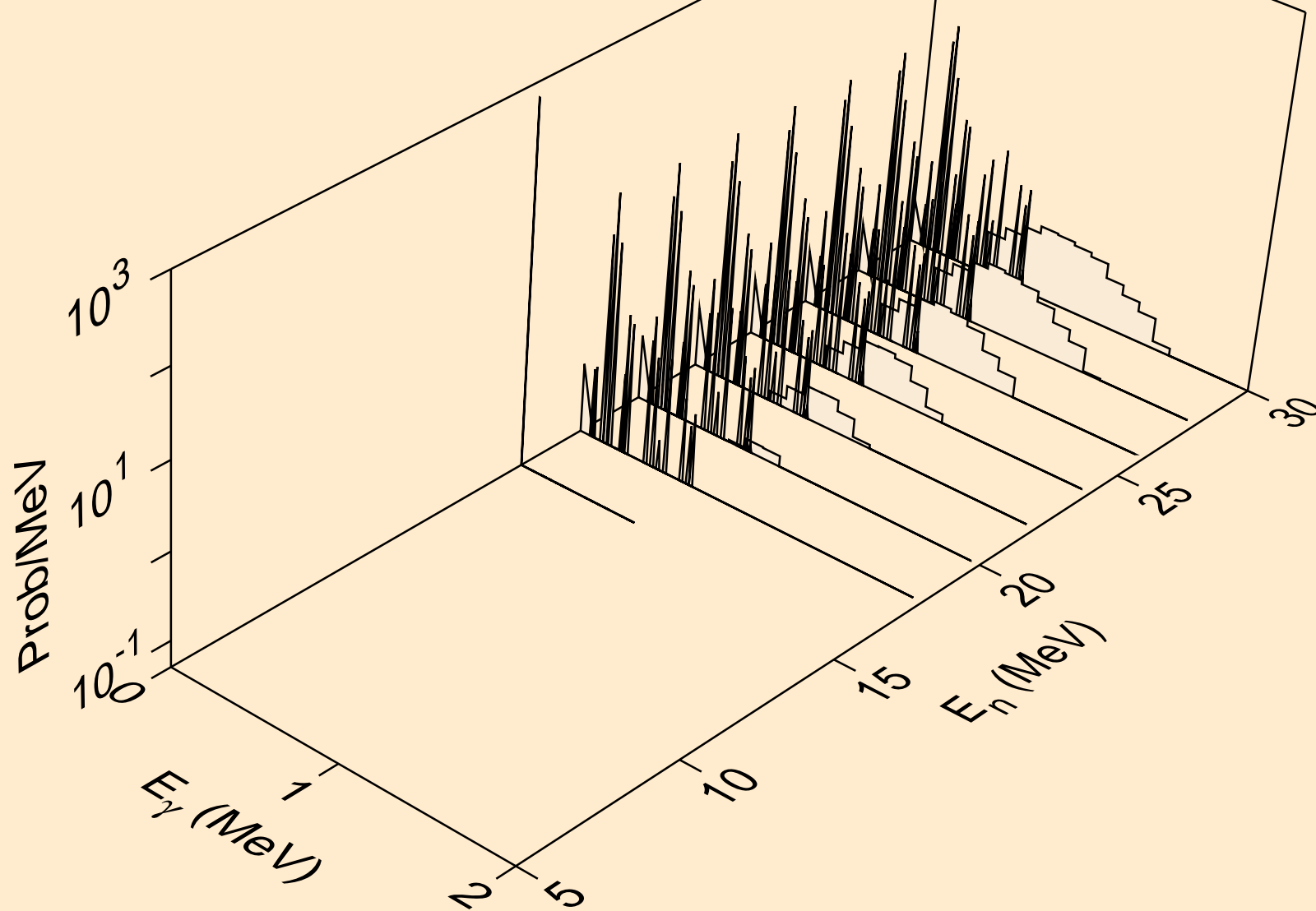

ZR085M NEUTRON ACER TENDL-2021 LIBRARY; T=293.6K
Photon emission for (n,n*)d

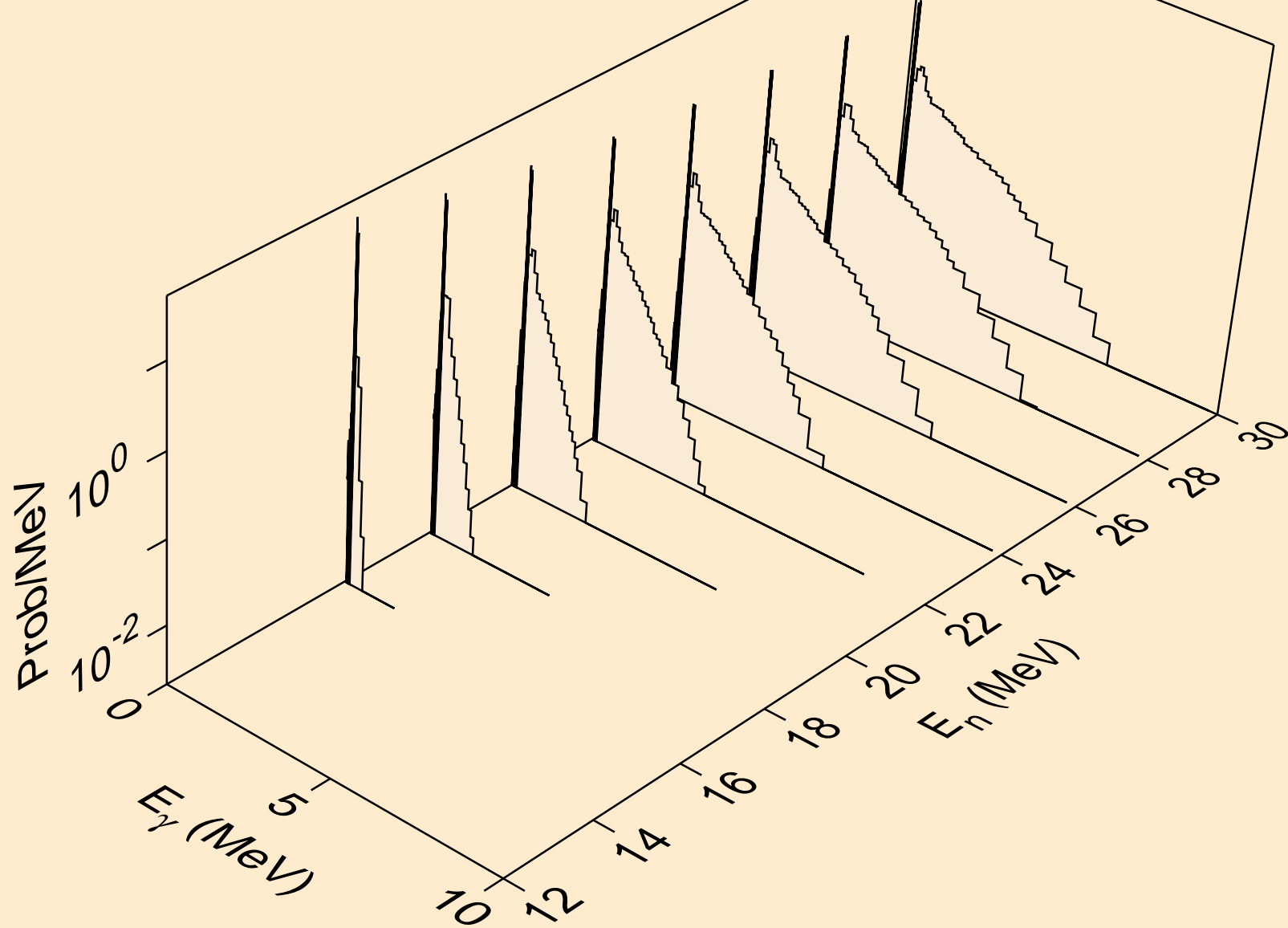

ZR085M NEUTRON ACER TENDL-2021 LIBRARY; T=293.6K
Photon emission for (n,n*)t

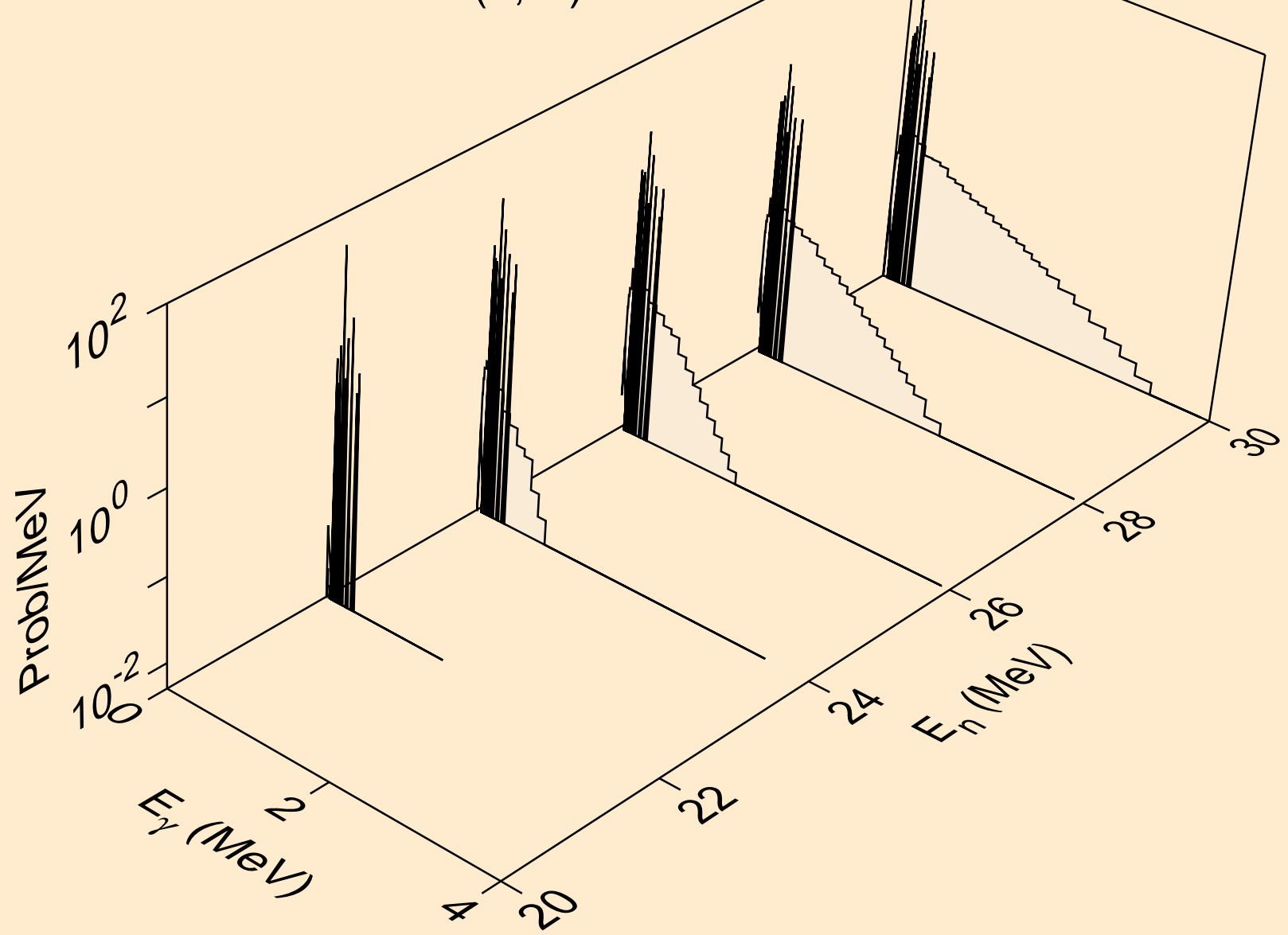

ZR085M NEUTRON ACER TENDL-2021 LIBRARY; T=293.6K
Photon emission for (n,n*)he3

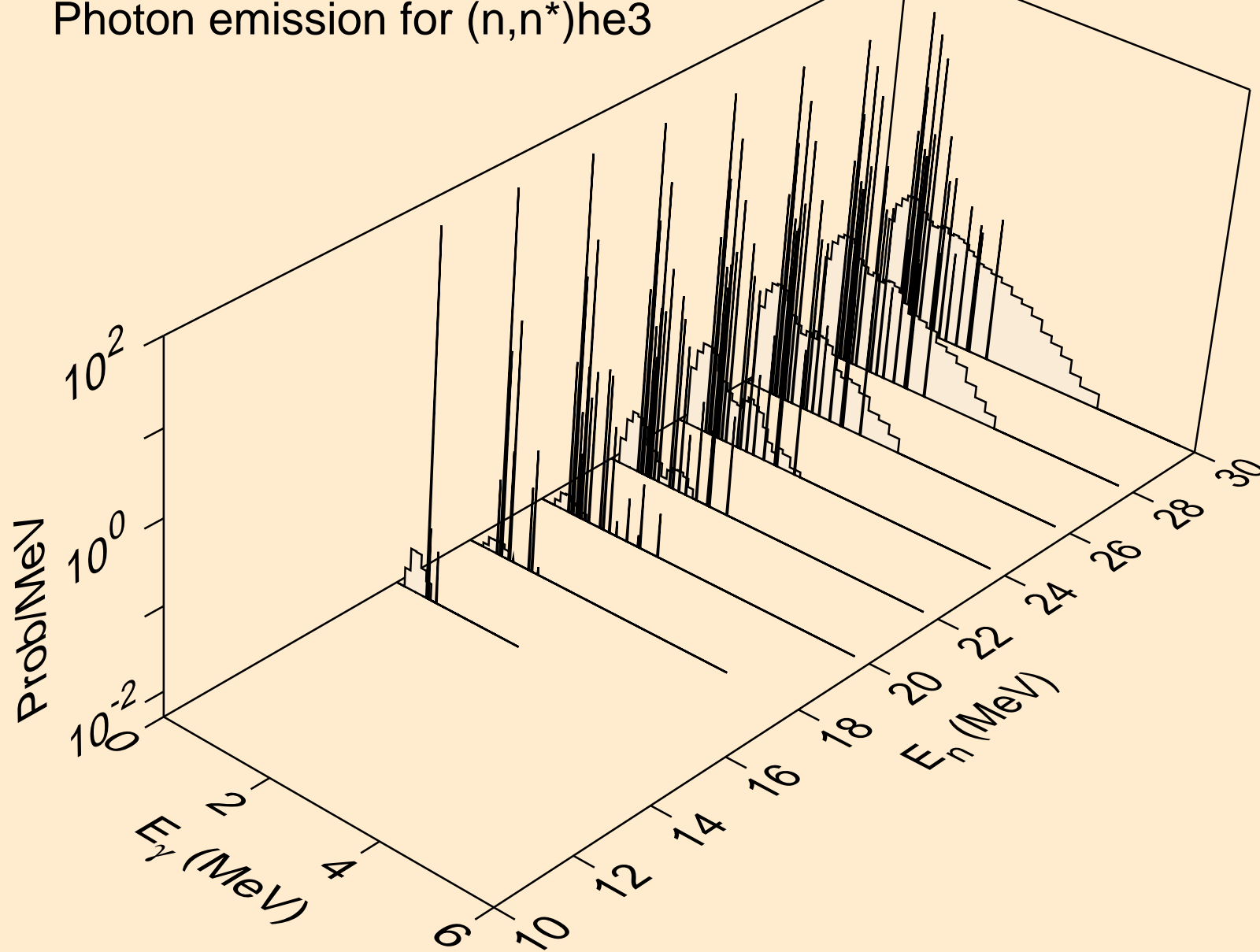

ZR085M NEUTRON ACER TENDL-2021 LIBRARY; T=293.6K
Photon emission for (n,2np)

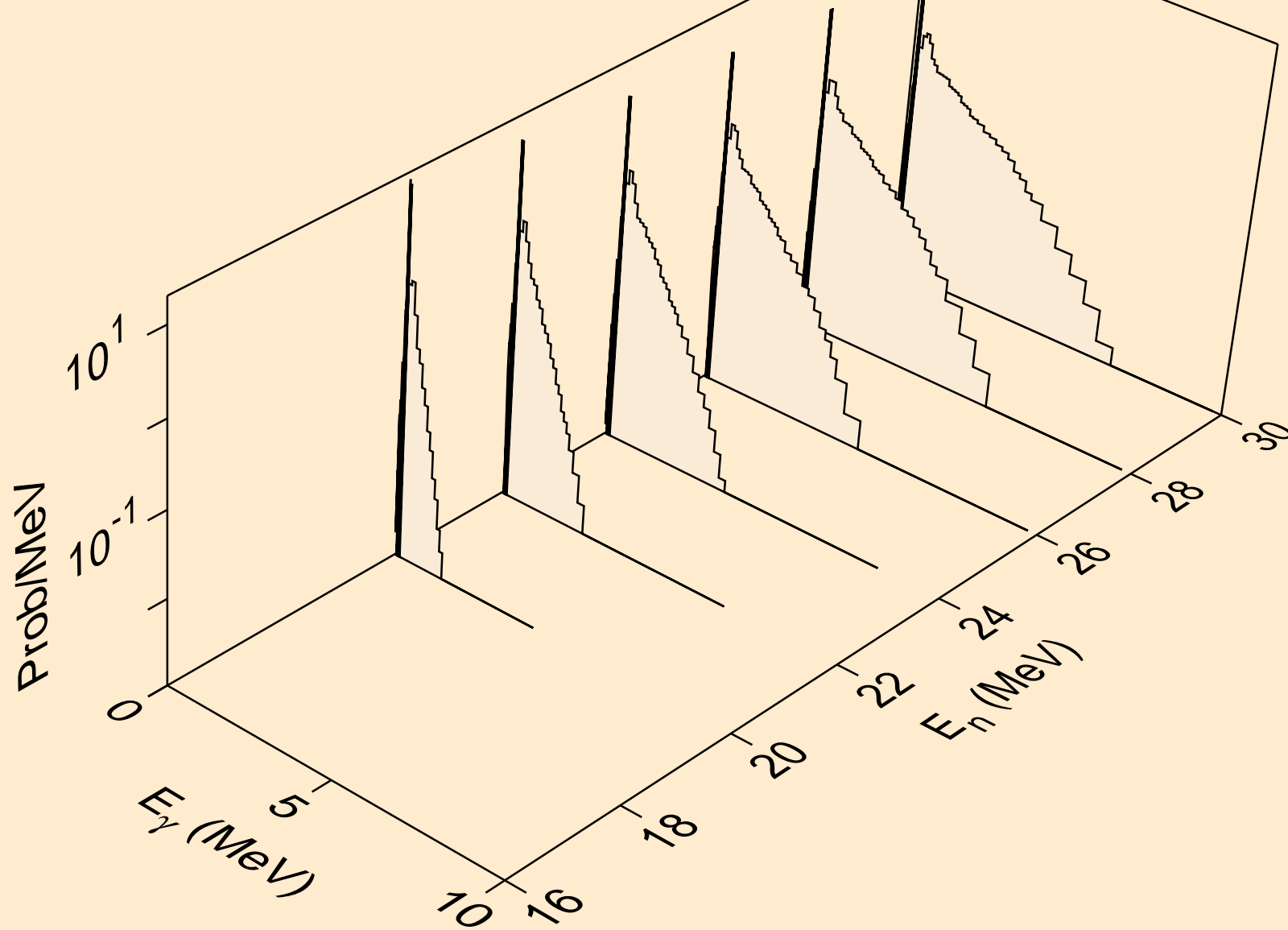

ZR085M NEUTRON ACER TENDL-2021 LIBRARY; T=293.6K
Photon emission for (n,2np)

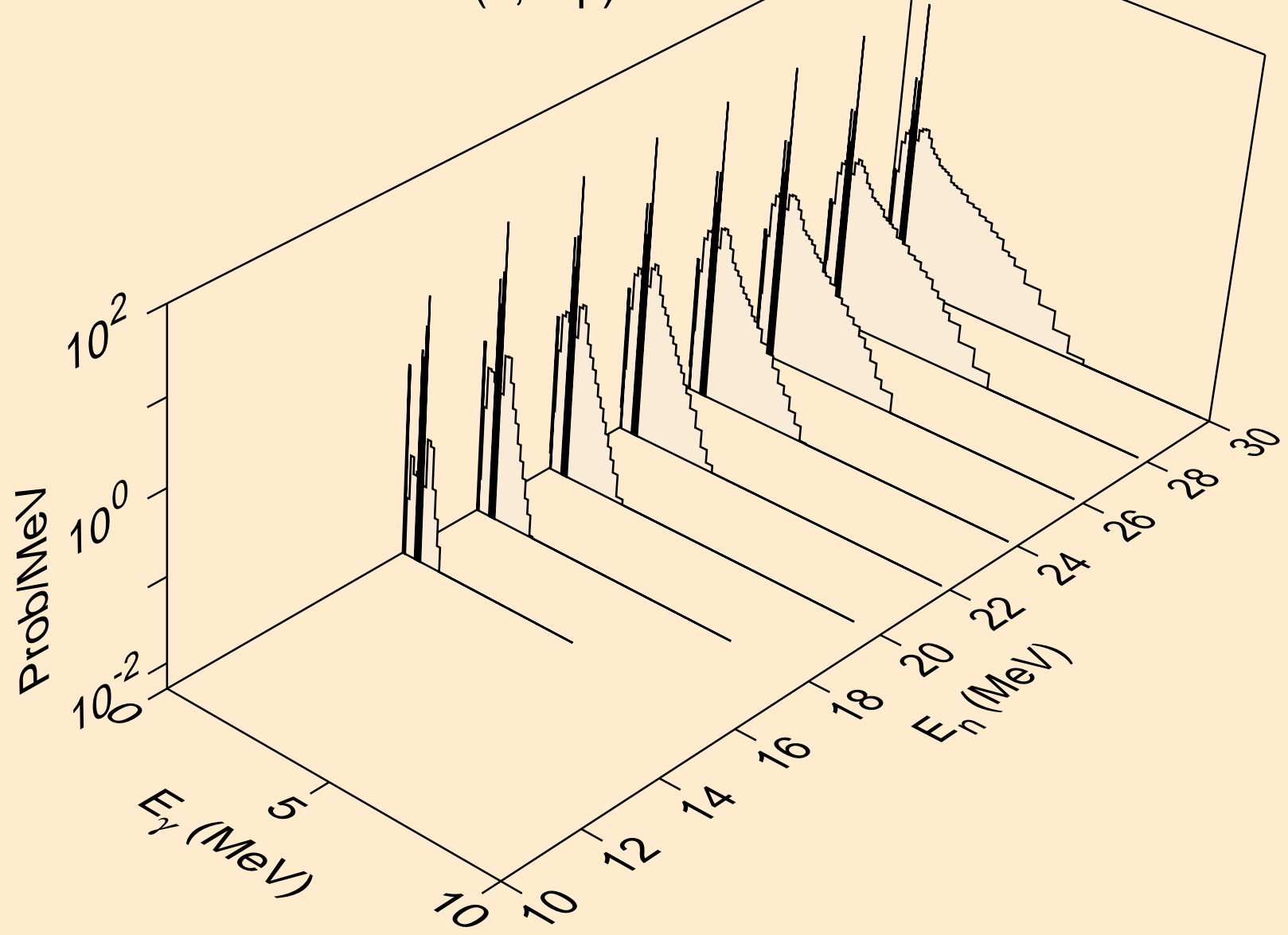

ZR085M NEUTRON ACER TENDL-2021 LIBRARY; T=293.6K
Photon emission for (n,npa)

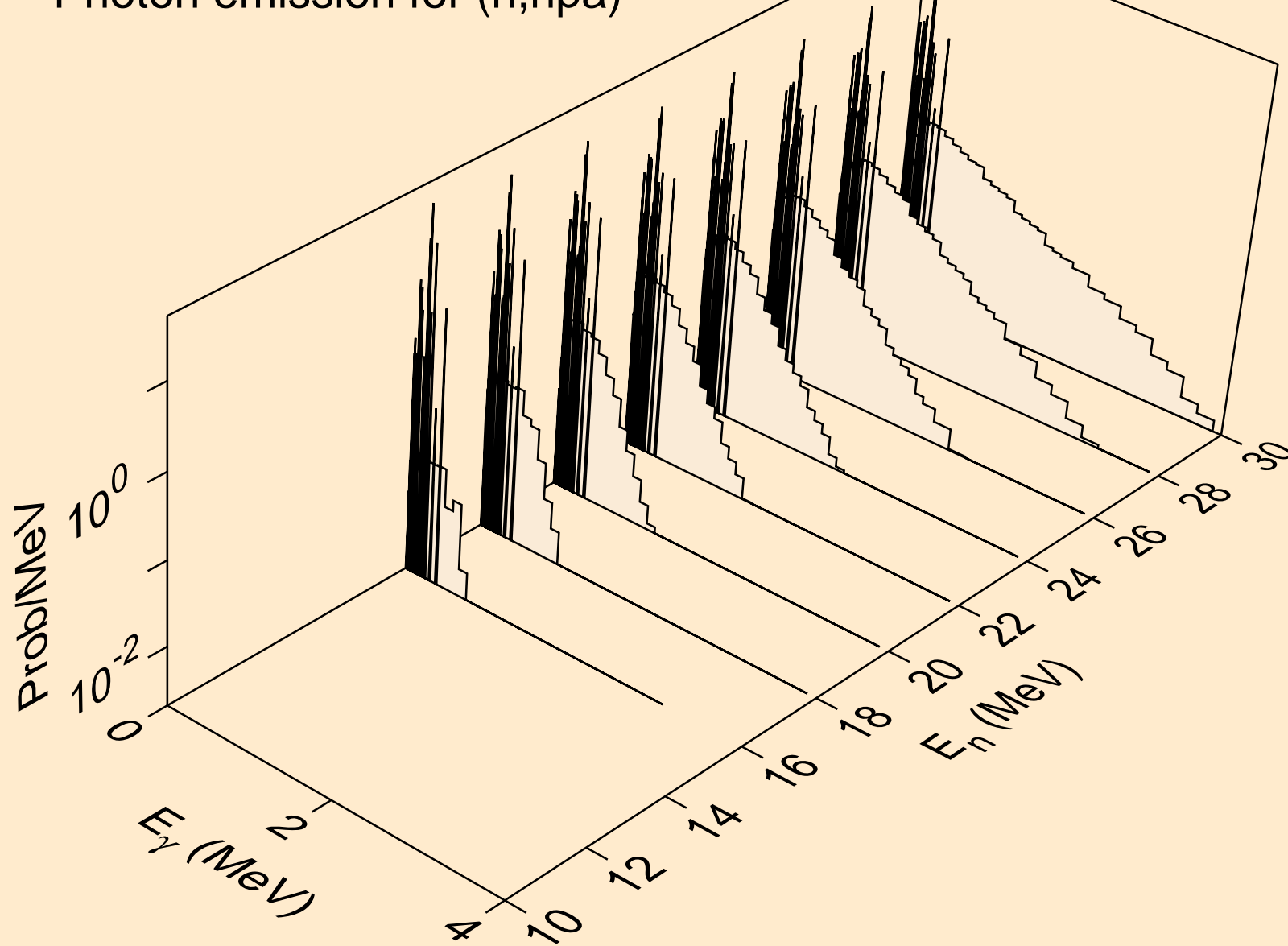

ZR085M NEUTRON ACER TENDL-2021 LIBRARY; T=293.6K
Photon emission for (n,n*1)

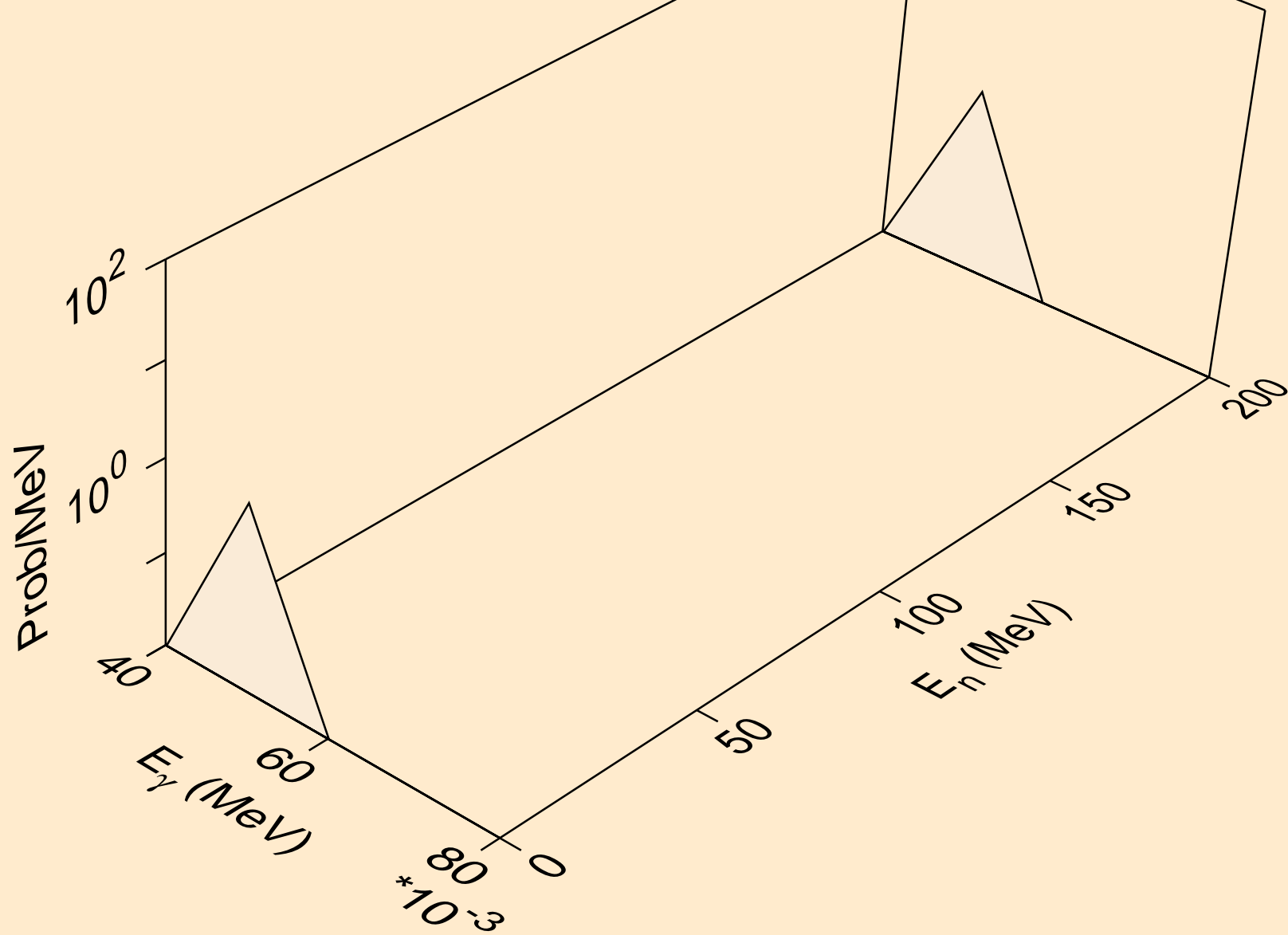

ZR085M NEUTRON ACER TENDL-2021 LIBRARY; T=293.6K
Photon emission for (n,n*3)

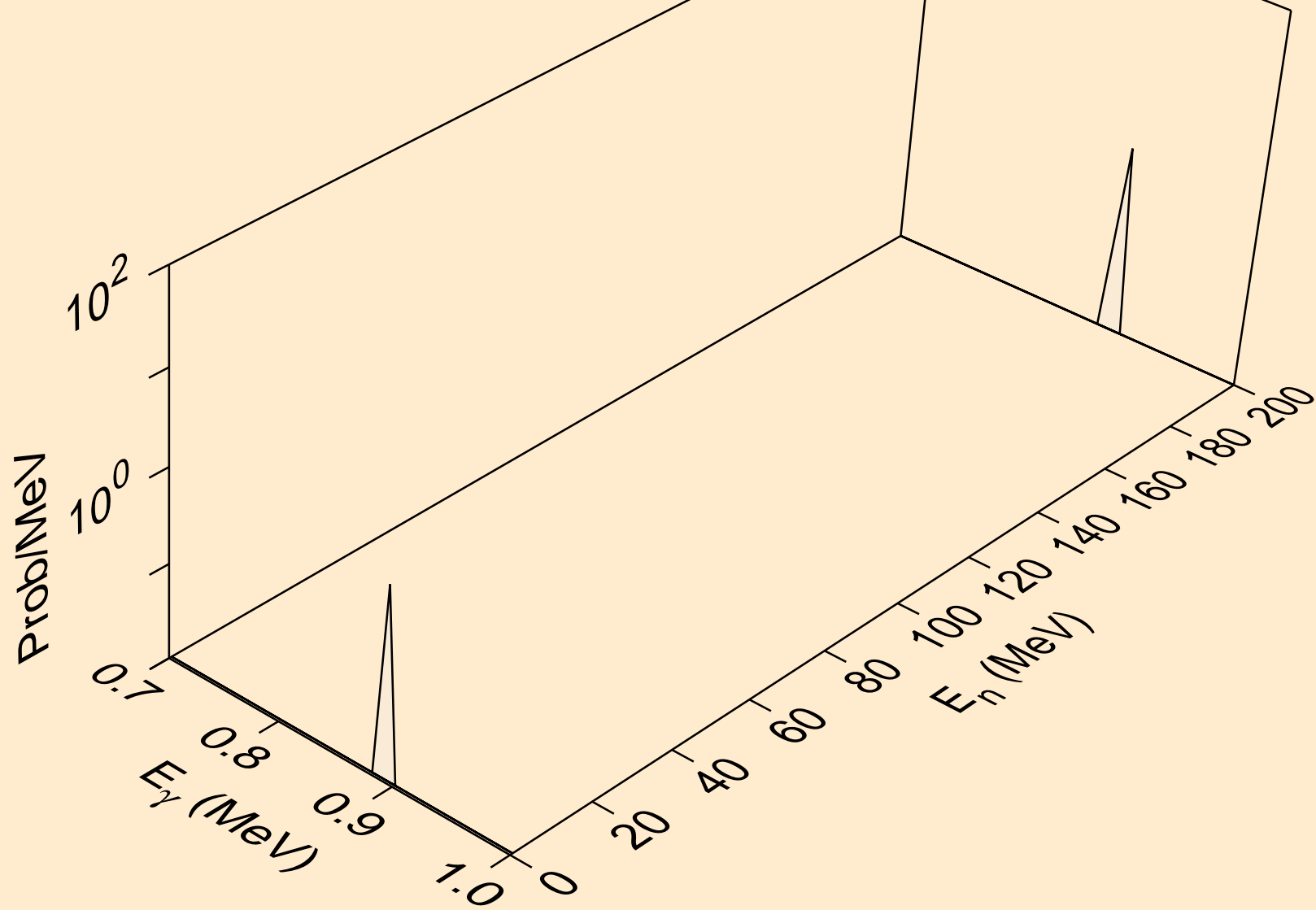

ZR085M NEUTRON ACER TENDL-2021 LIBRARY; T=293.6K
Photon emission for (n,n*4)

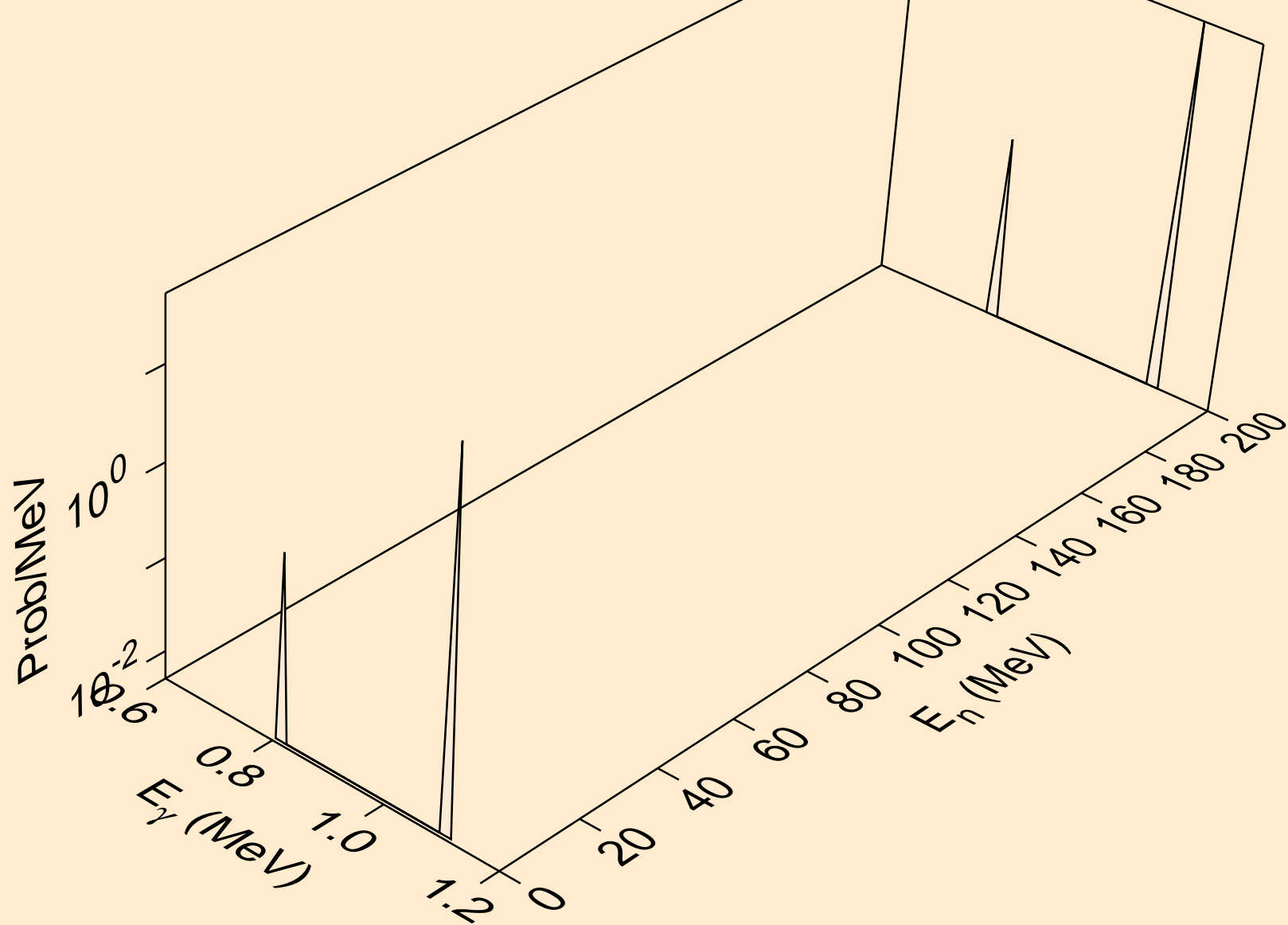

ZR085M NEUTRON ACER TENDL-2021 LIBRARY; T=293.6K
Photon emission for (n,n*5)

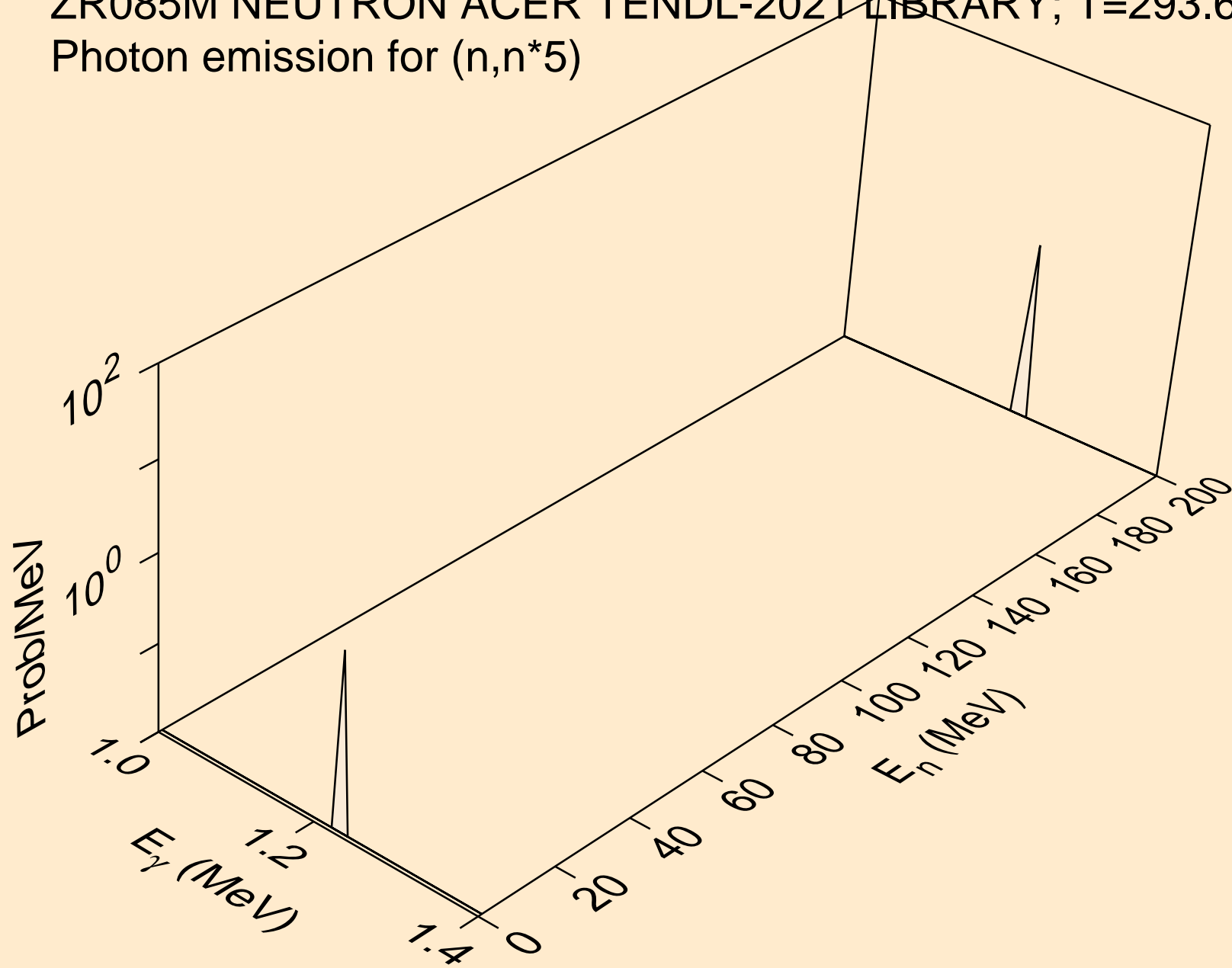

ZR085M NEUTRON ACER TENDL-2021 LIBRARY; T=293.6K
Photon emission for (n,n*6)

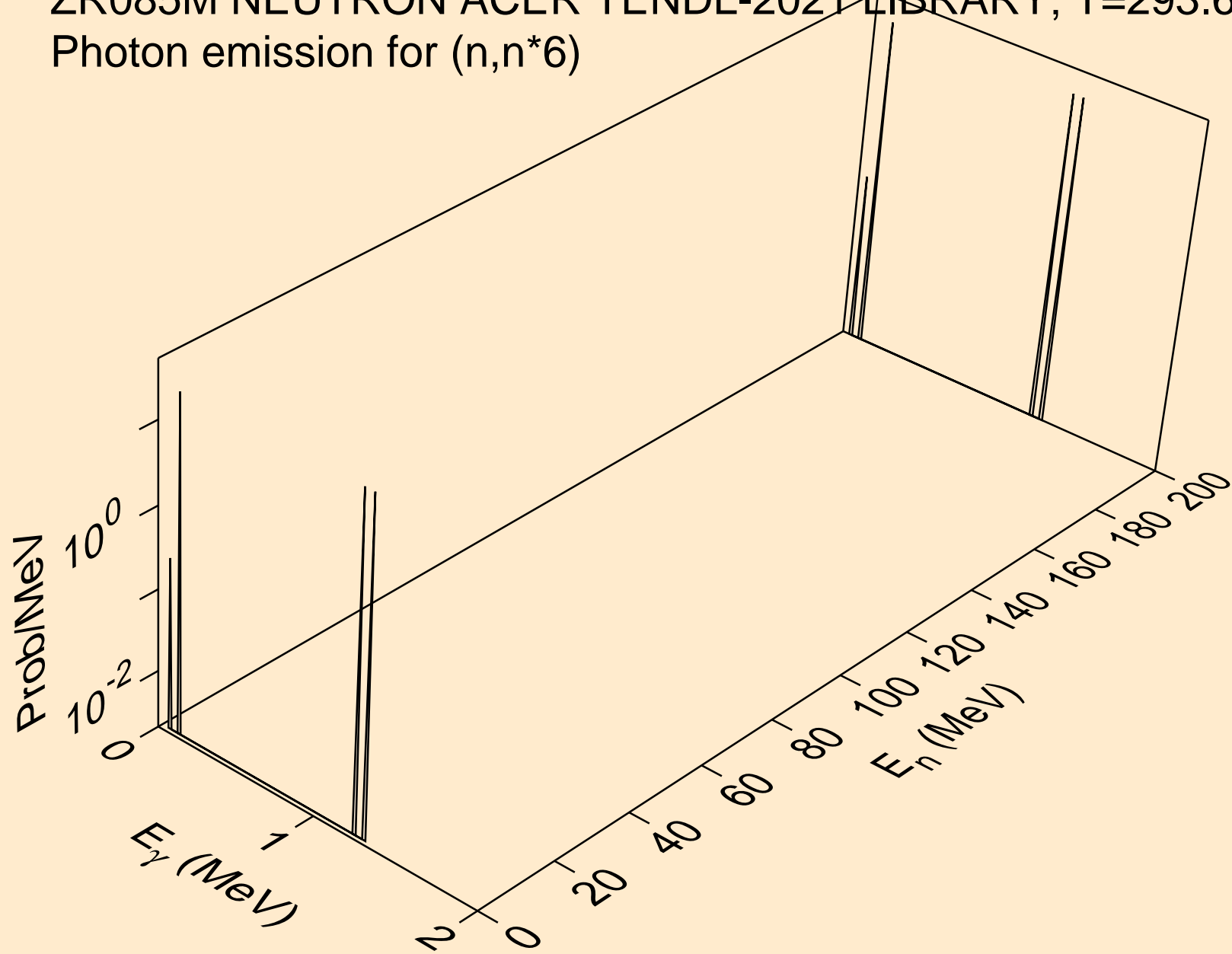

ZR085M NEUTRON ACER TENDL-2021 LIBRARY; T=293.6K
Photon emission for (n,n*7)

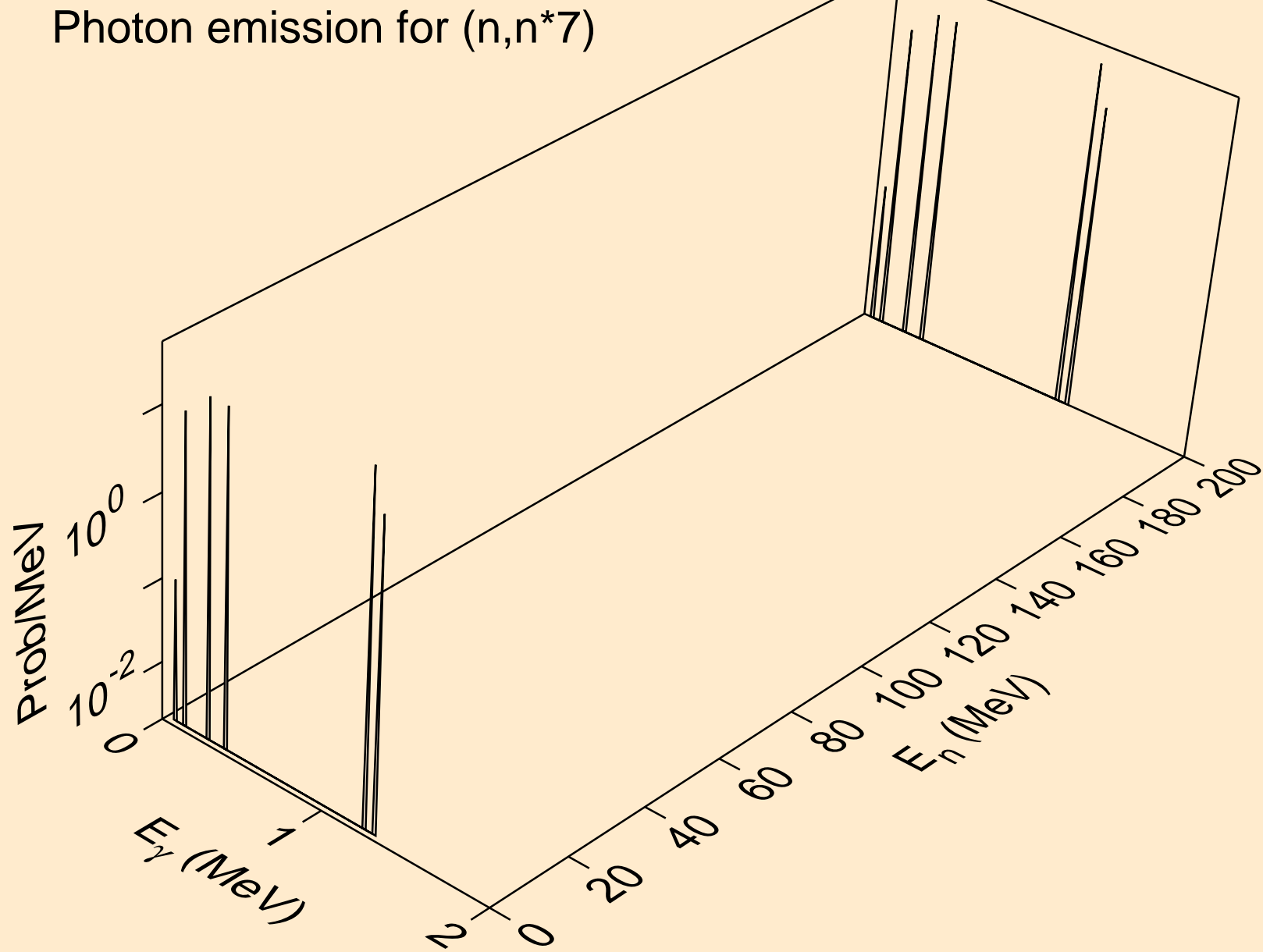

ZR085M NEUTRON ACER TENDL-2021 LIBRARY; T=293.6K
Photon emission for (n,n*8)

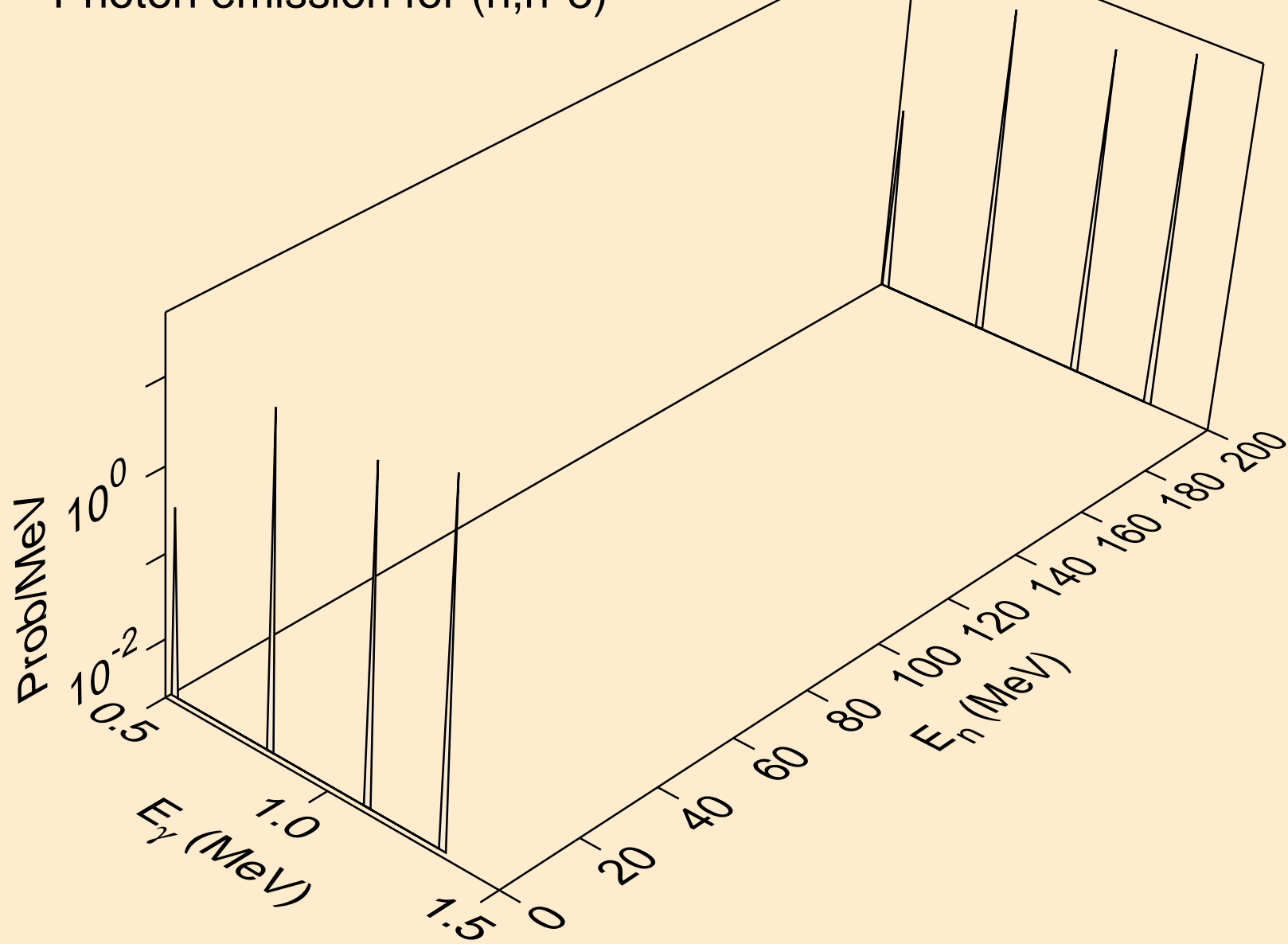

ZR085M NEUTRON ACER TENDL-2021 LIBRARY; T=293.6K
Photon emission for (n,n*9)

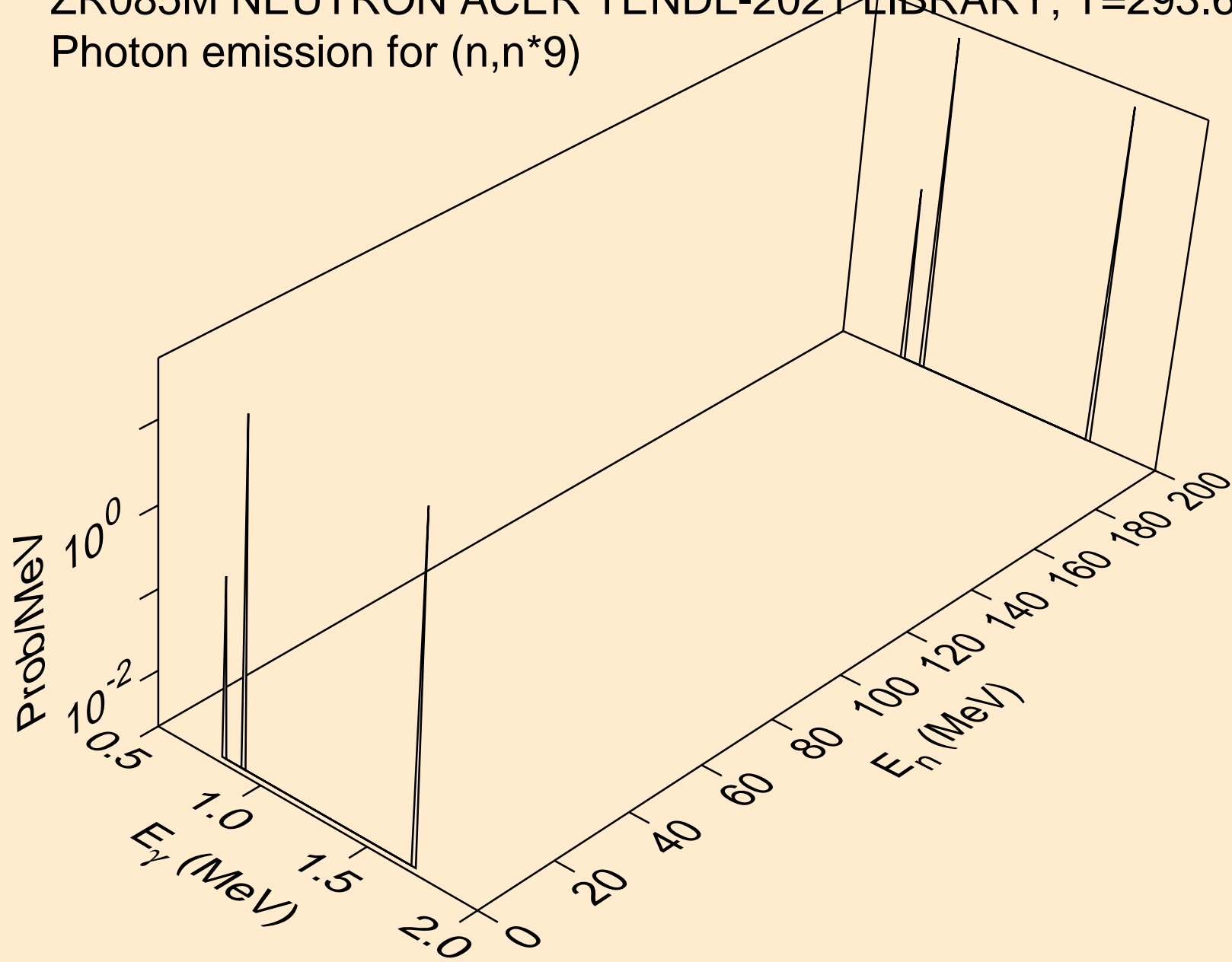

ZR085M NEUTRON ACER TENDL-2021 LIBRARY; T=293.6K
Photon emission for (n,n*10)

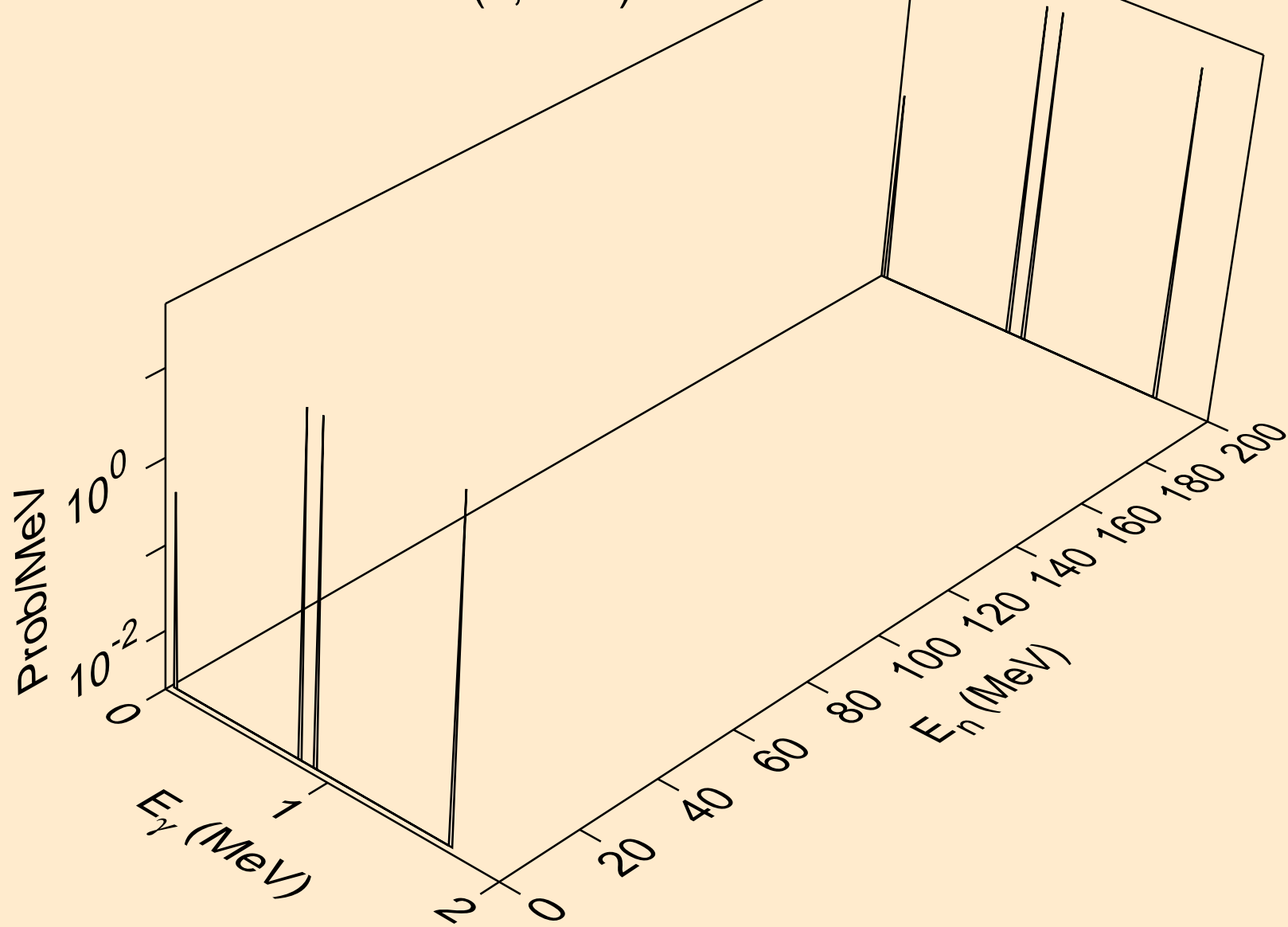

ZR085M NEUTRON ACER TENDL-2021 LIBRARY; T=293.6K
Photon emission for (n,n*11)

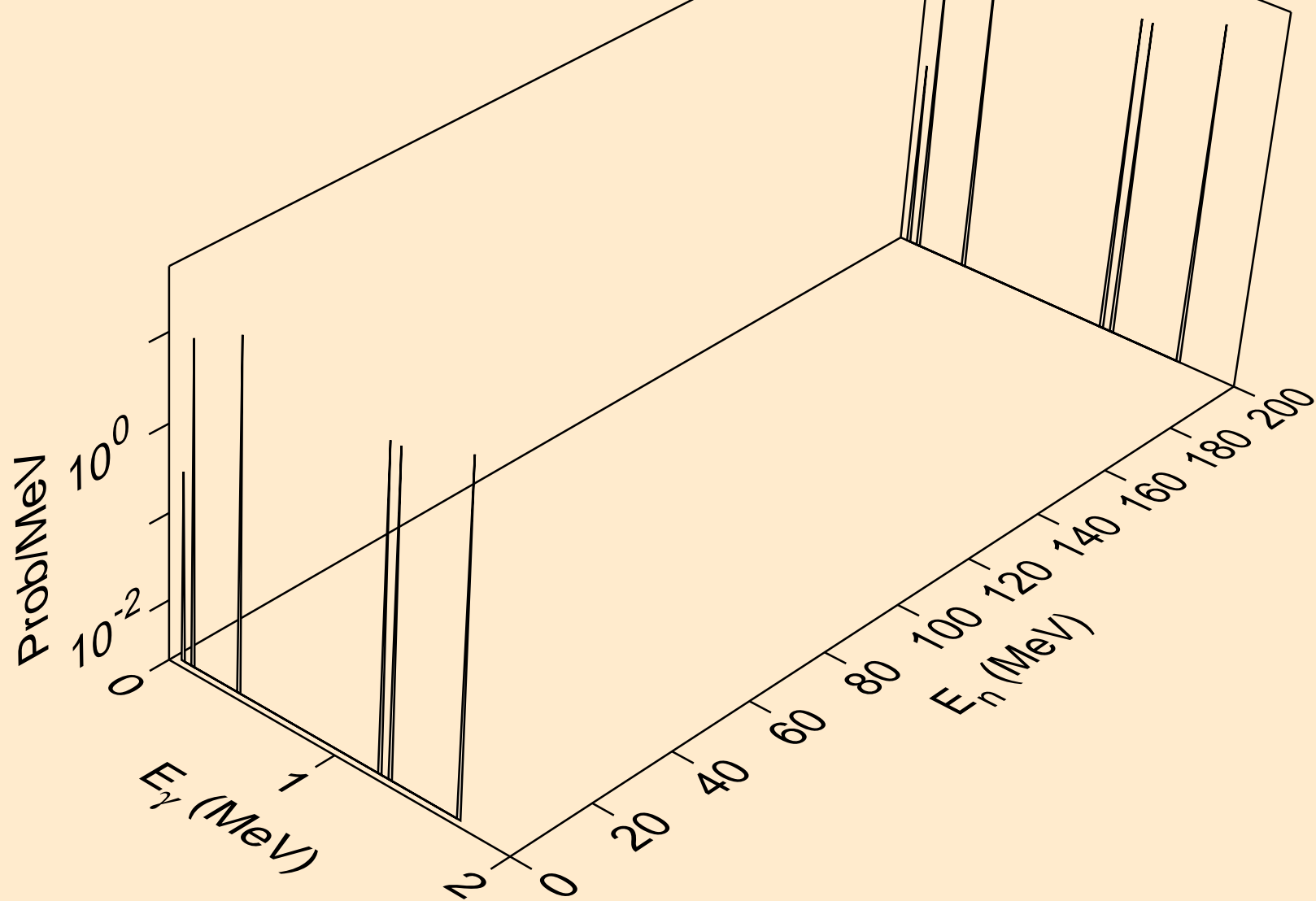

ZR085M NEUTRON ACER TENDL-2021 LIBRARY; T=293.6K
Photon emission for (n,n*12)

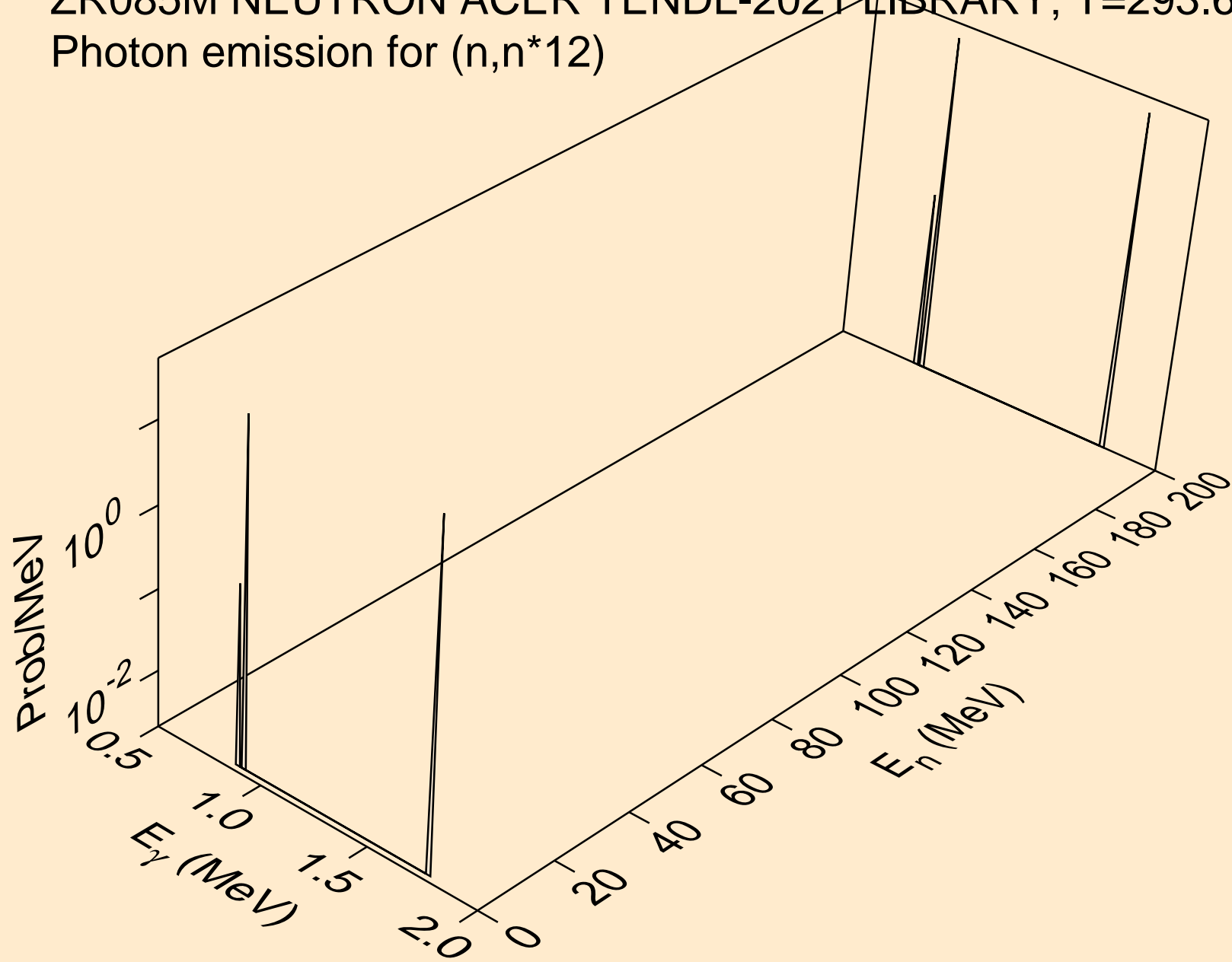

ZR085M NEUTRON ACER TENDL-2021 LIBRARY; T=293.6K
Photon emission for (n,n*13)

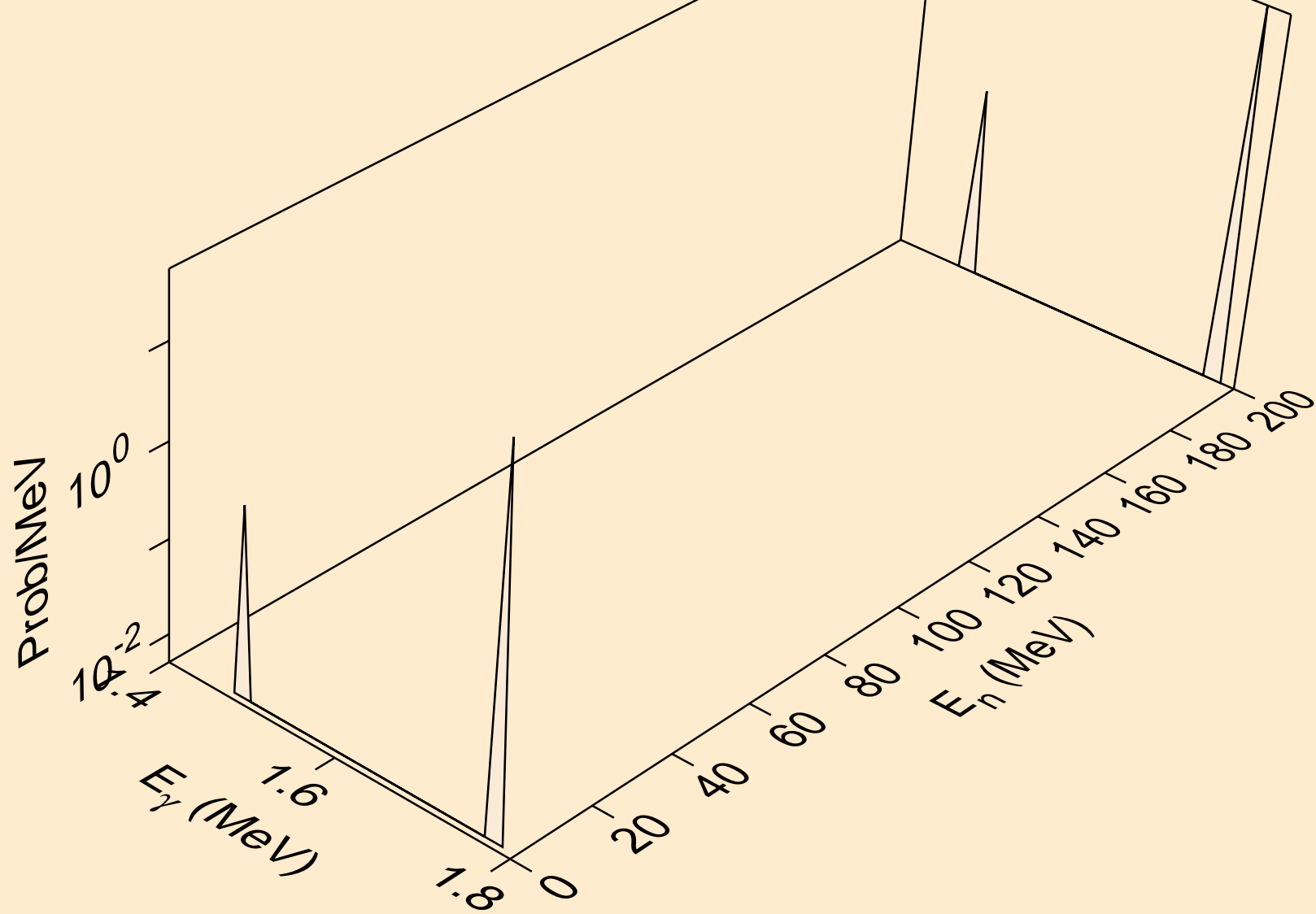

ZR085M NEUTRON ACER TENDL-2021 LIBRARY; T=293.6K
Photon emission for (n,n*14)

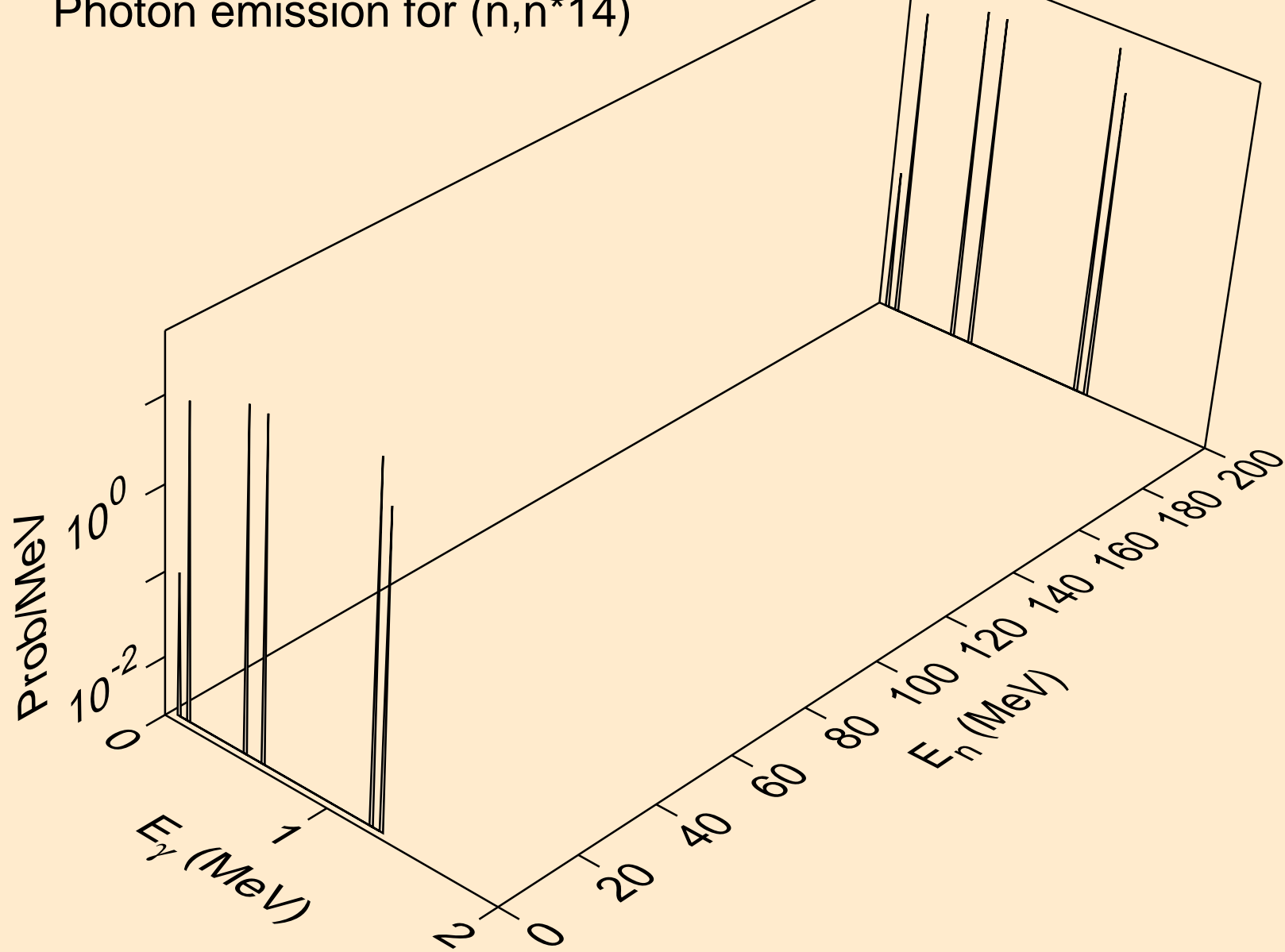

ZR085M NEUTRON ACER TENDL-2021 LIBRARY; T=293.6K
Photon emission for (n,n*15)

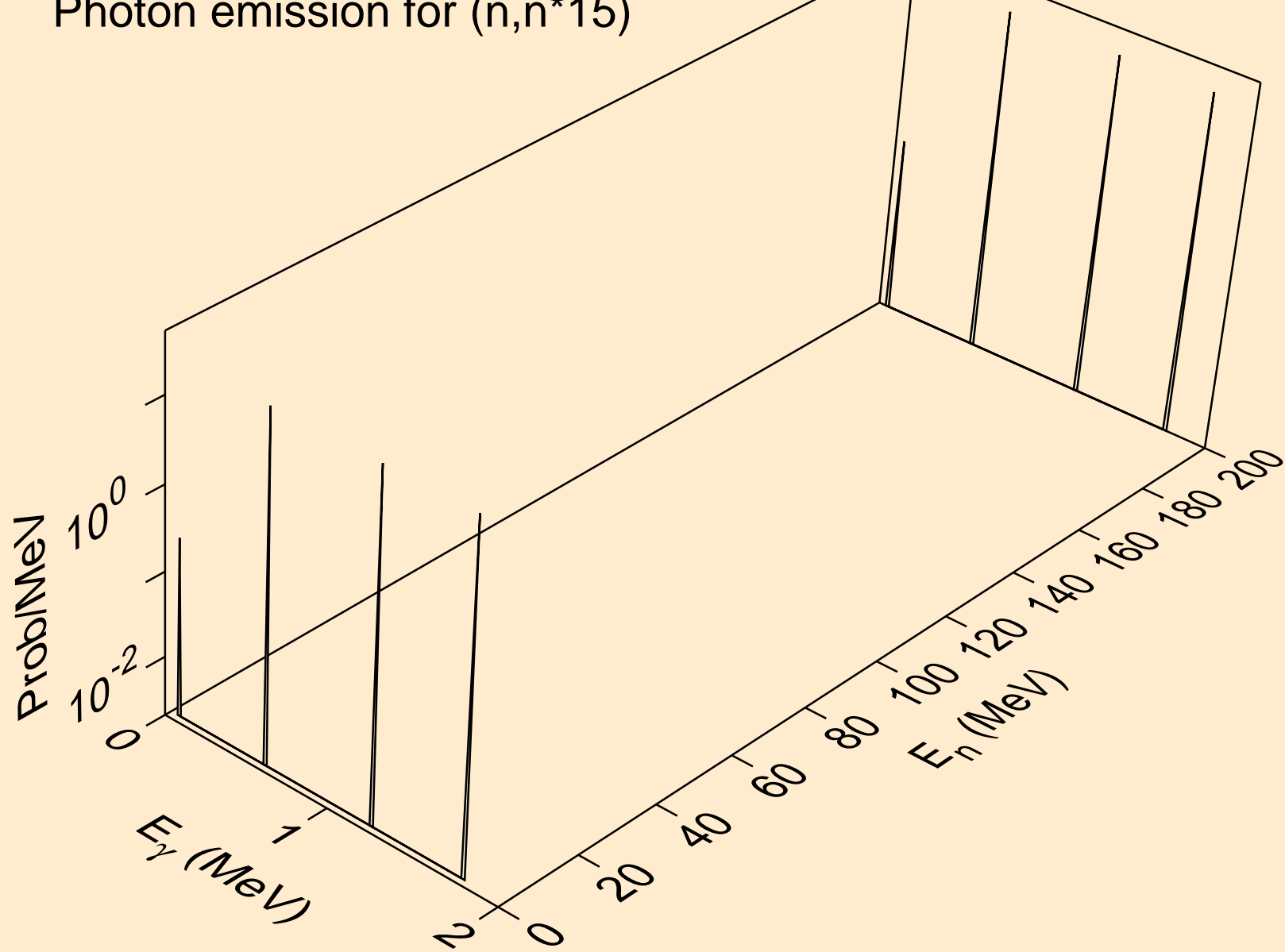

ZR085M NEUTRON ACER TENDL-2021 LIBRARY; T=293.6K
Photon emission for (n,n*16)

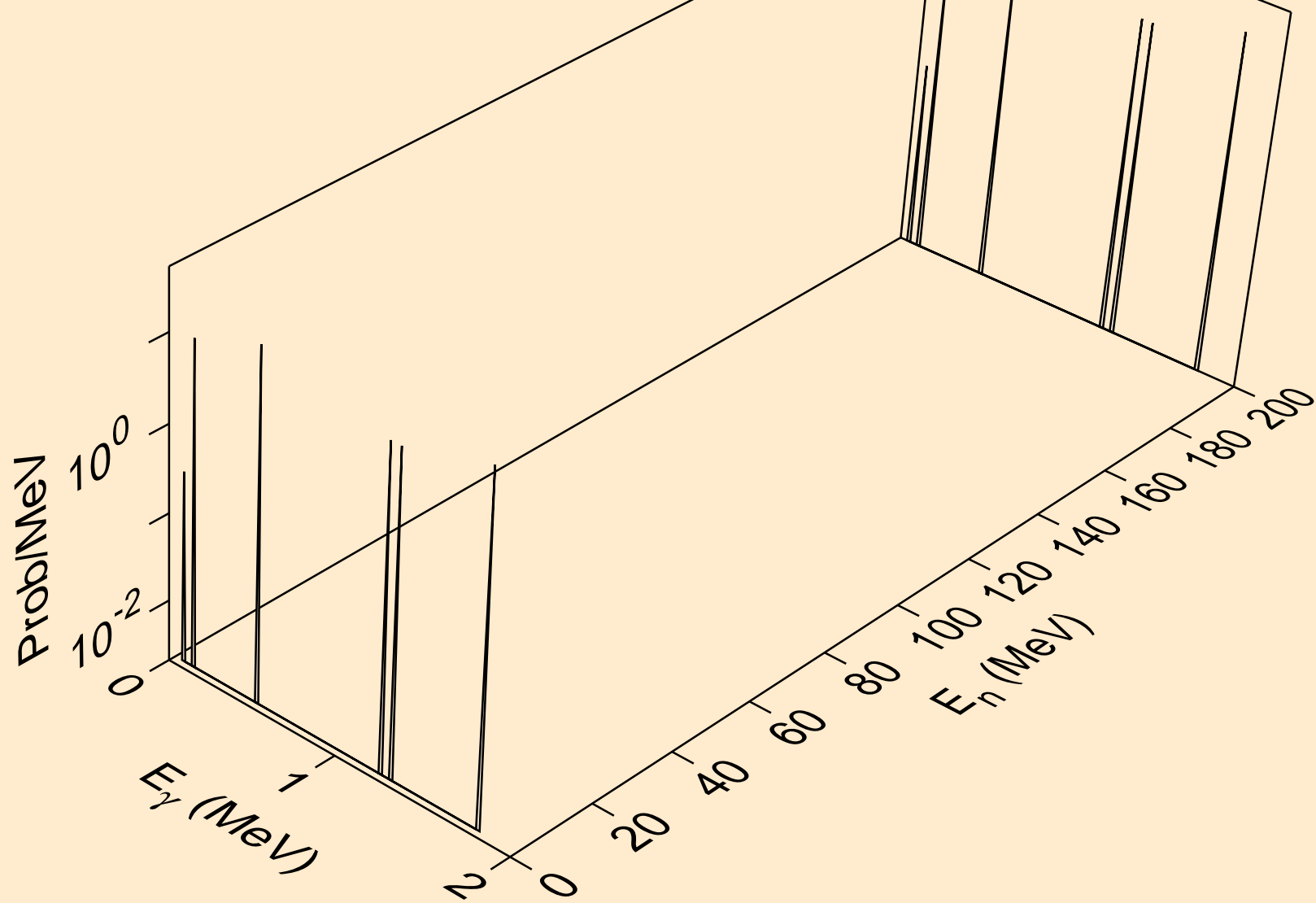

ZR085M NEUTRON ACER TENDL-2021 LIBRARY; T=293.6K
Photon emission for (n,n*17)

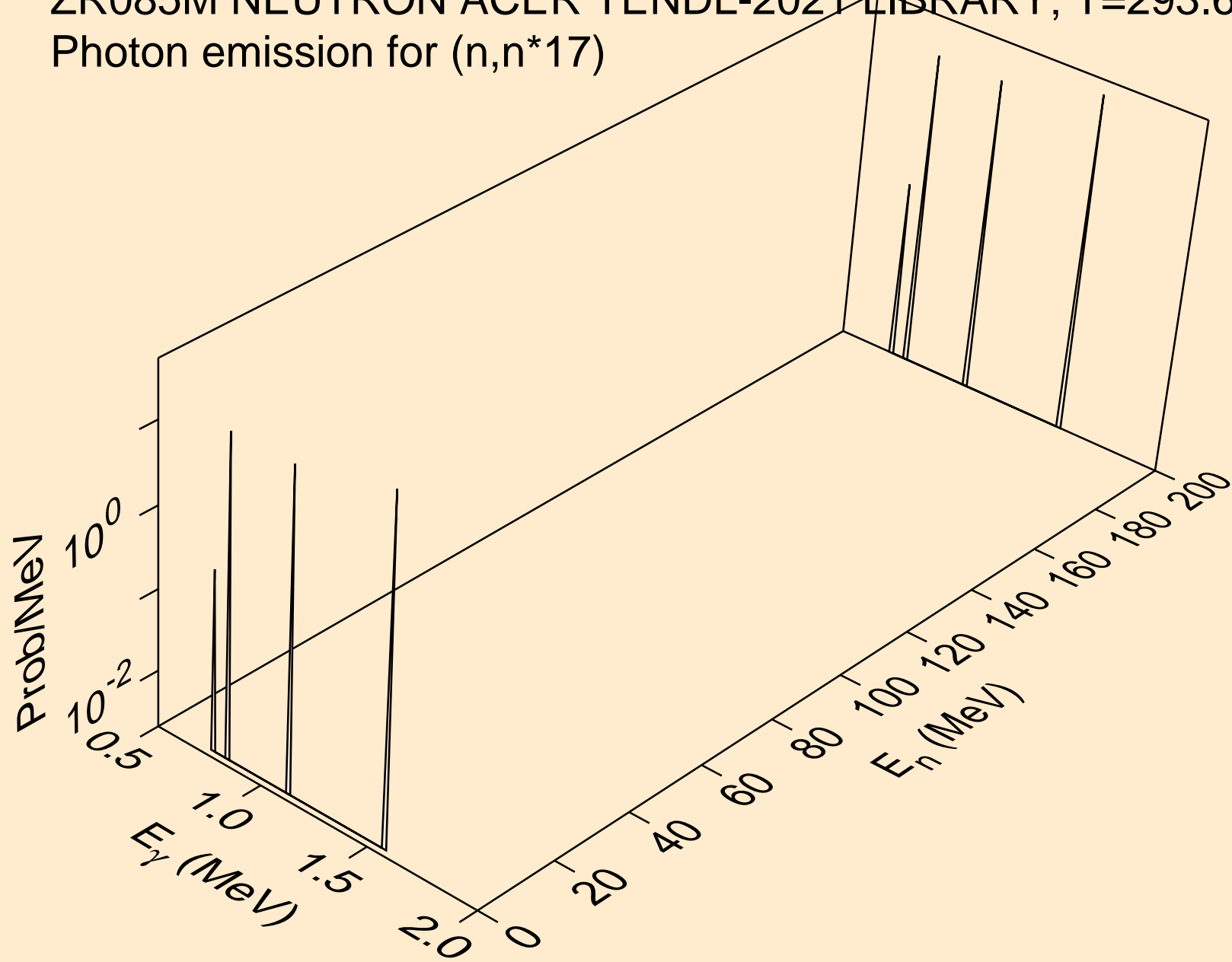

ZR085M NEUTRON ACER TENDL-2021 LIBRARY; T=293.6K
Photon emission for (n,n*18)

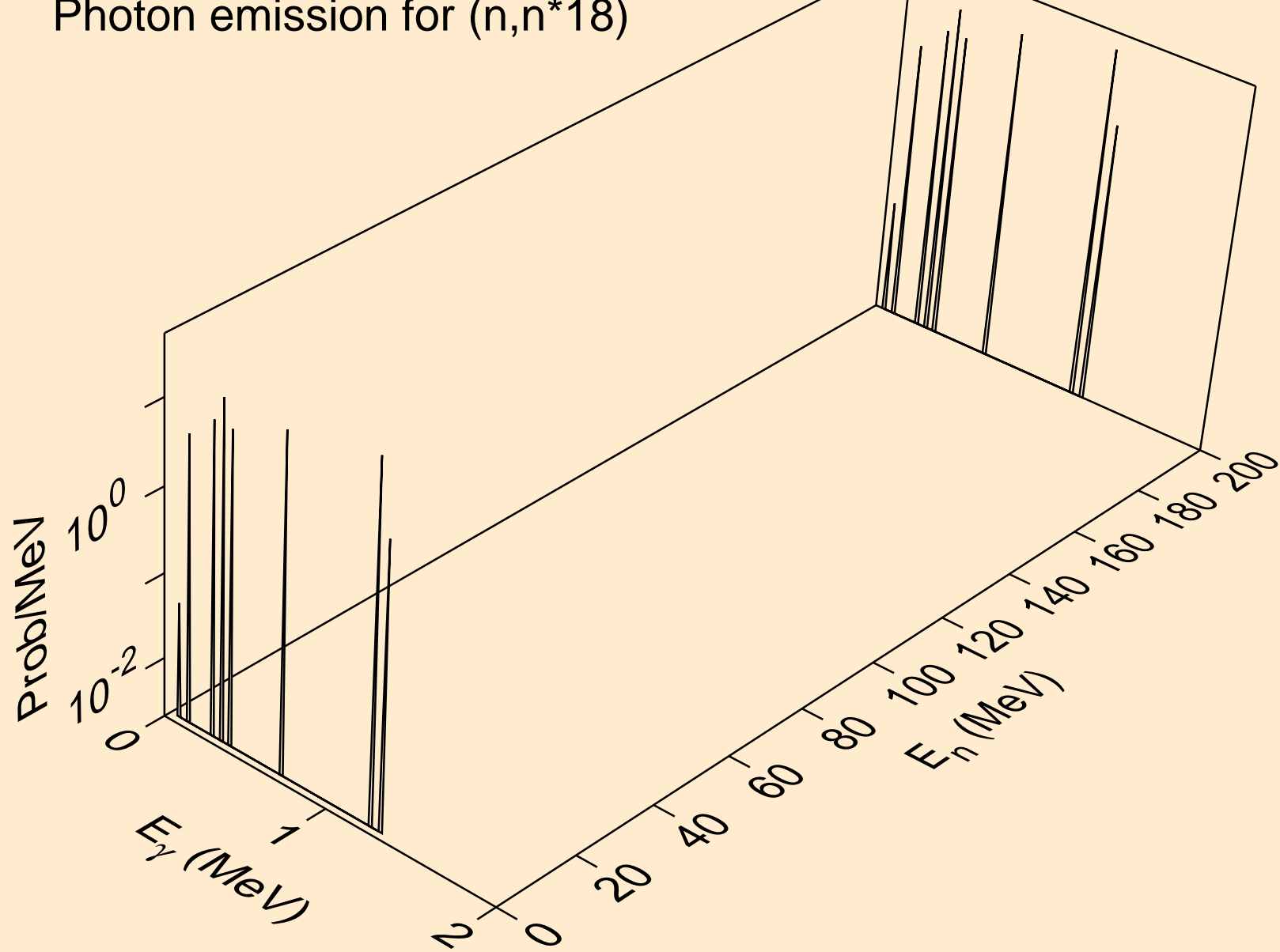

ZR085M NEUTRON ACER TENDL-2021 LIBRARY; T=293.6K
Photon emission for (n,n*19)

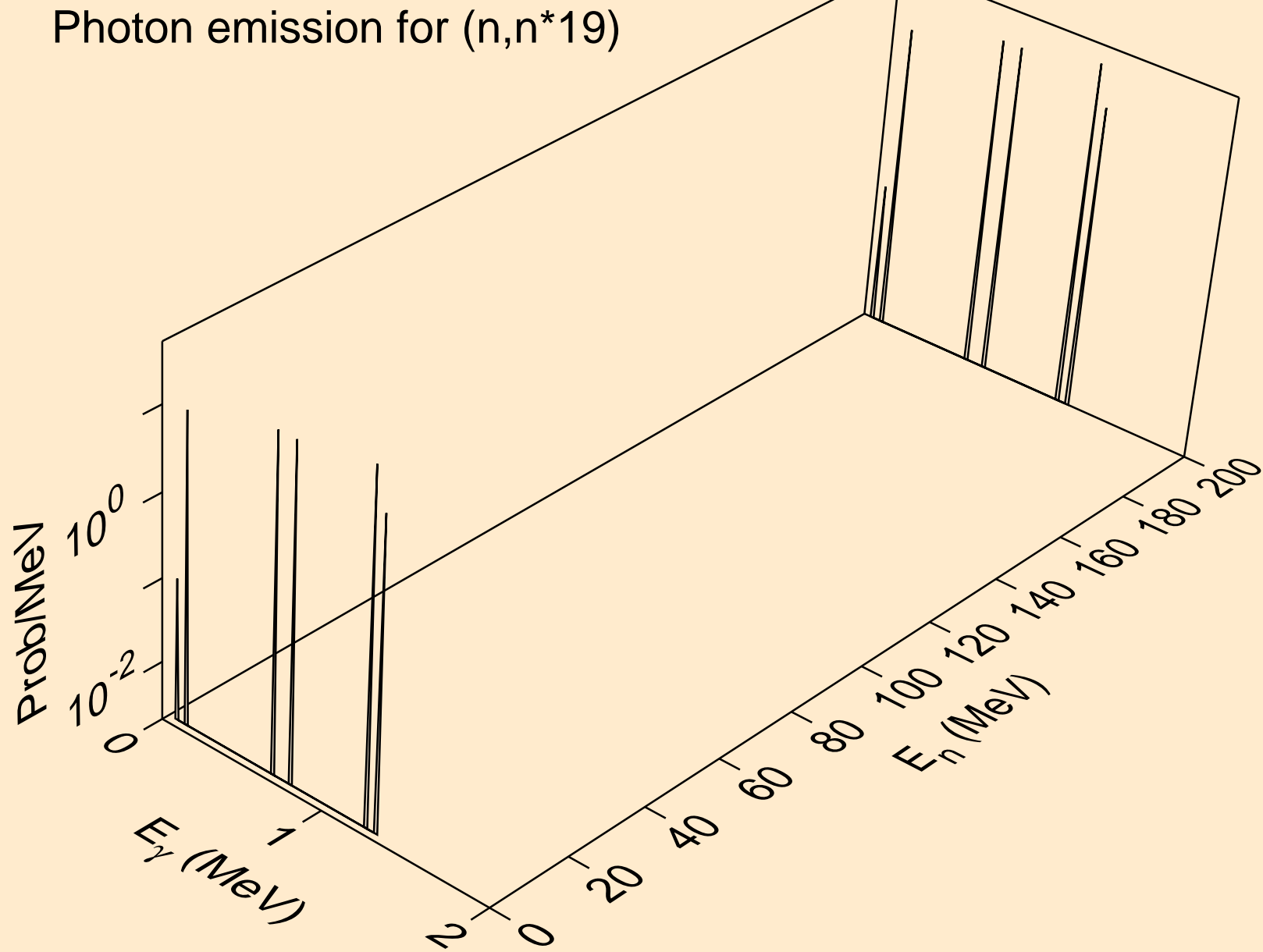

ZR085M NEUTRON ACER TENDL-2021 LIBRARY; T=293.6K
Photon emission for (n,n*20)

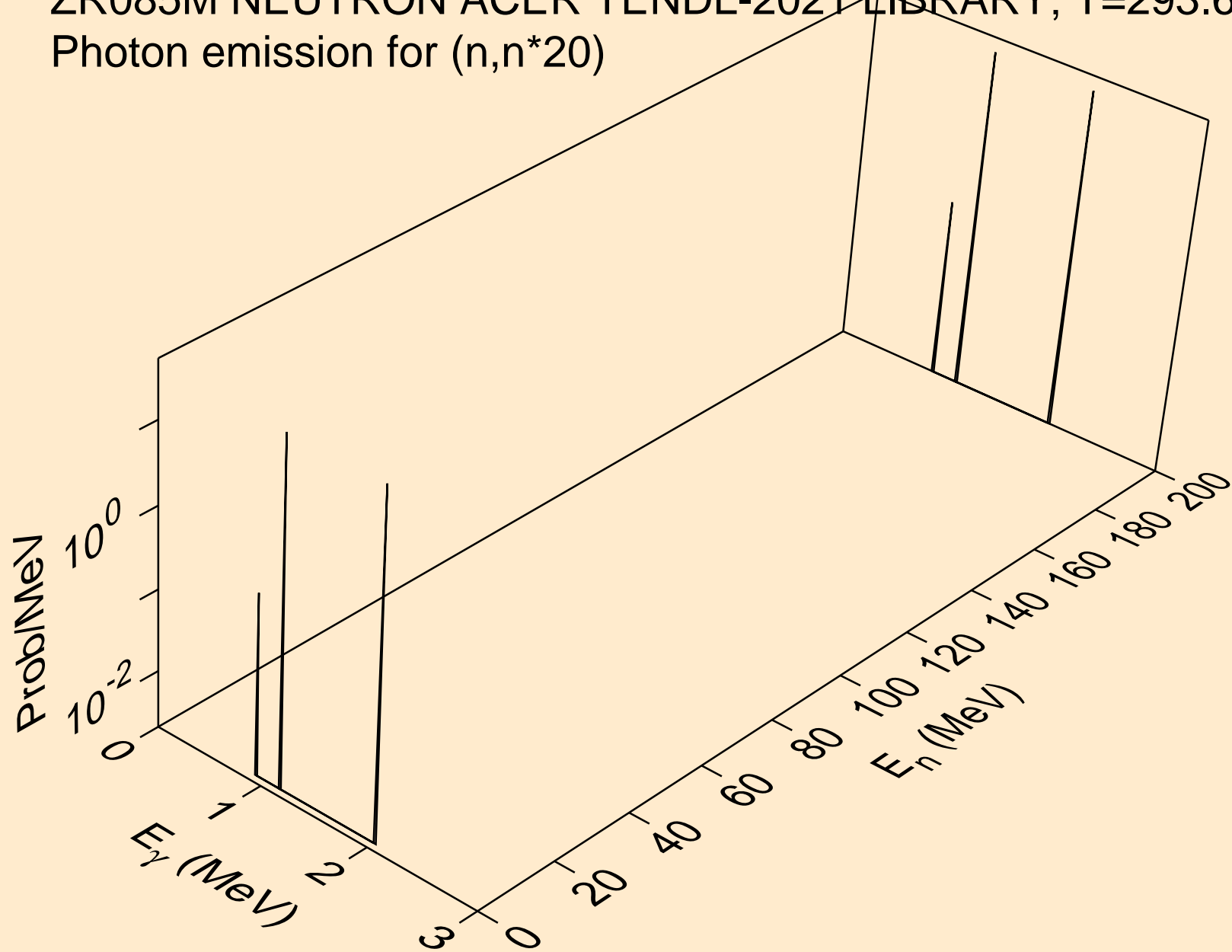

ZR085M NEUTRON ACER TENDL-2021 LIBRARY; T=293.6K
Photon emission for (n,n*21)

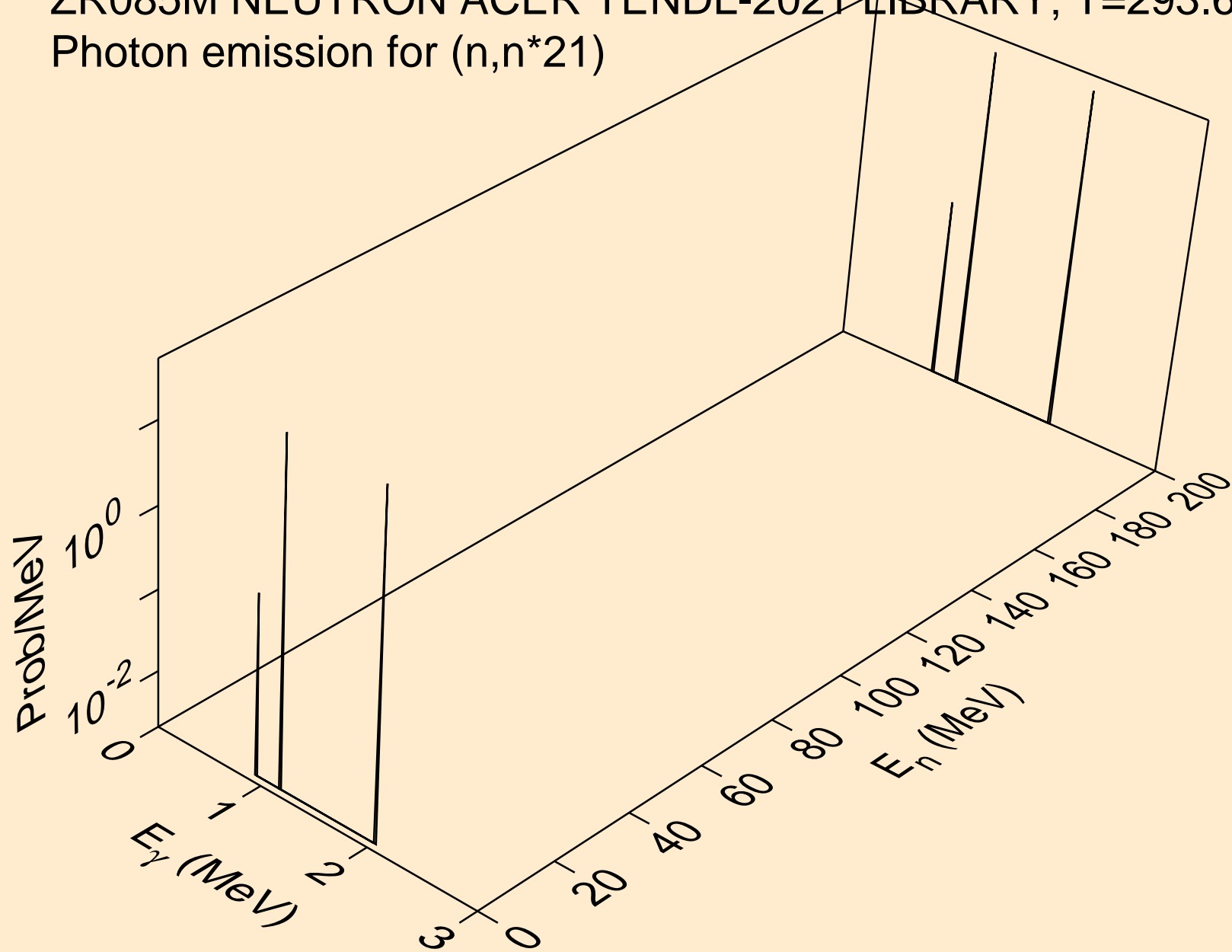

ZR085M NEUTRON ACER TENDL-2021 LIBRARY; T=293.6K
Photon emission for (n,n*22)

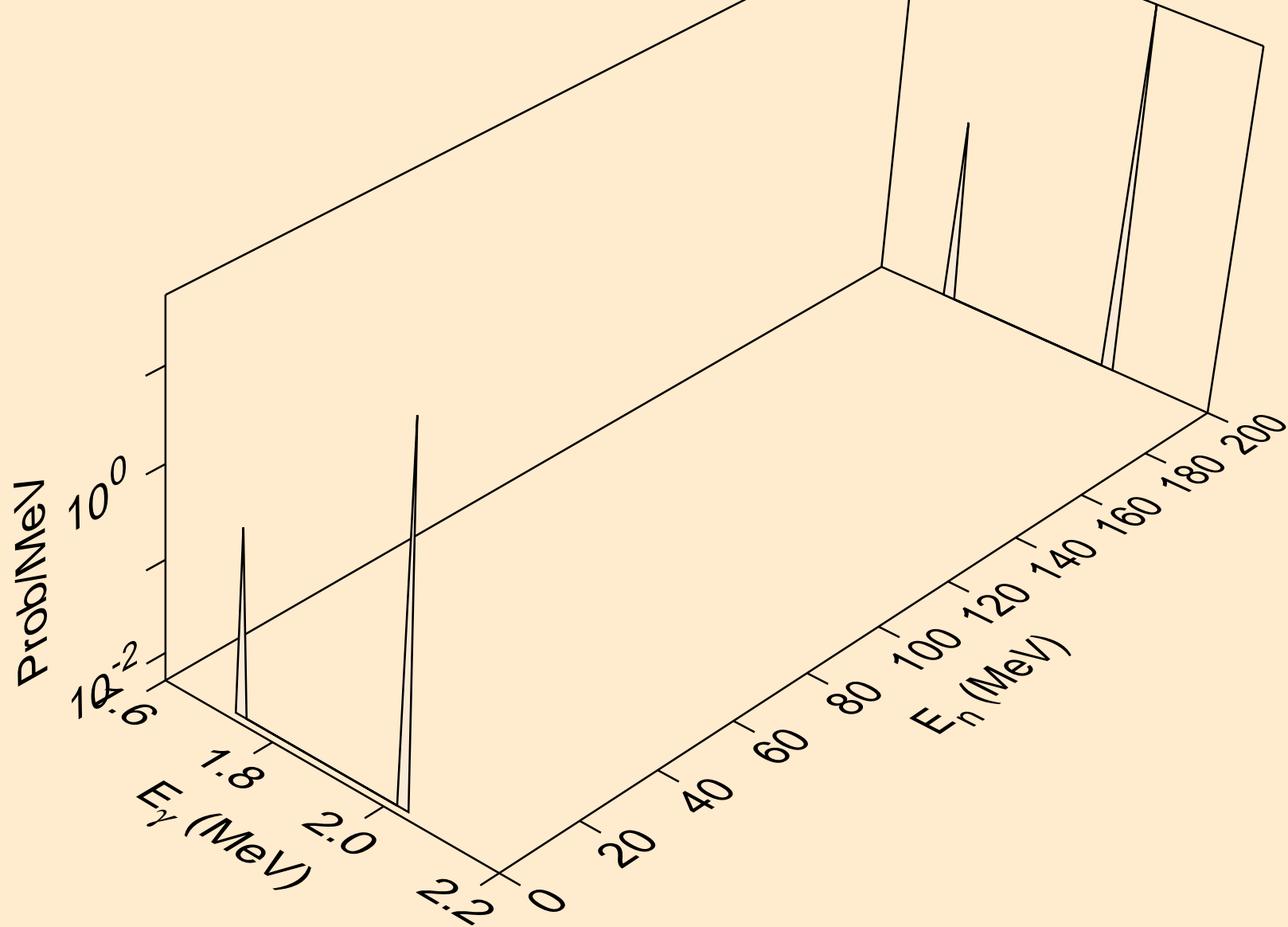

ZR085M NEUTRON ACER TENDL-2021 LIBRARY; T=293.6K
Photon emission for (n,n*23)

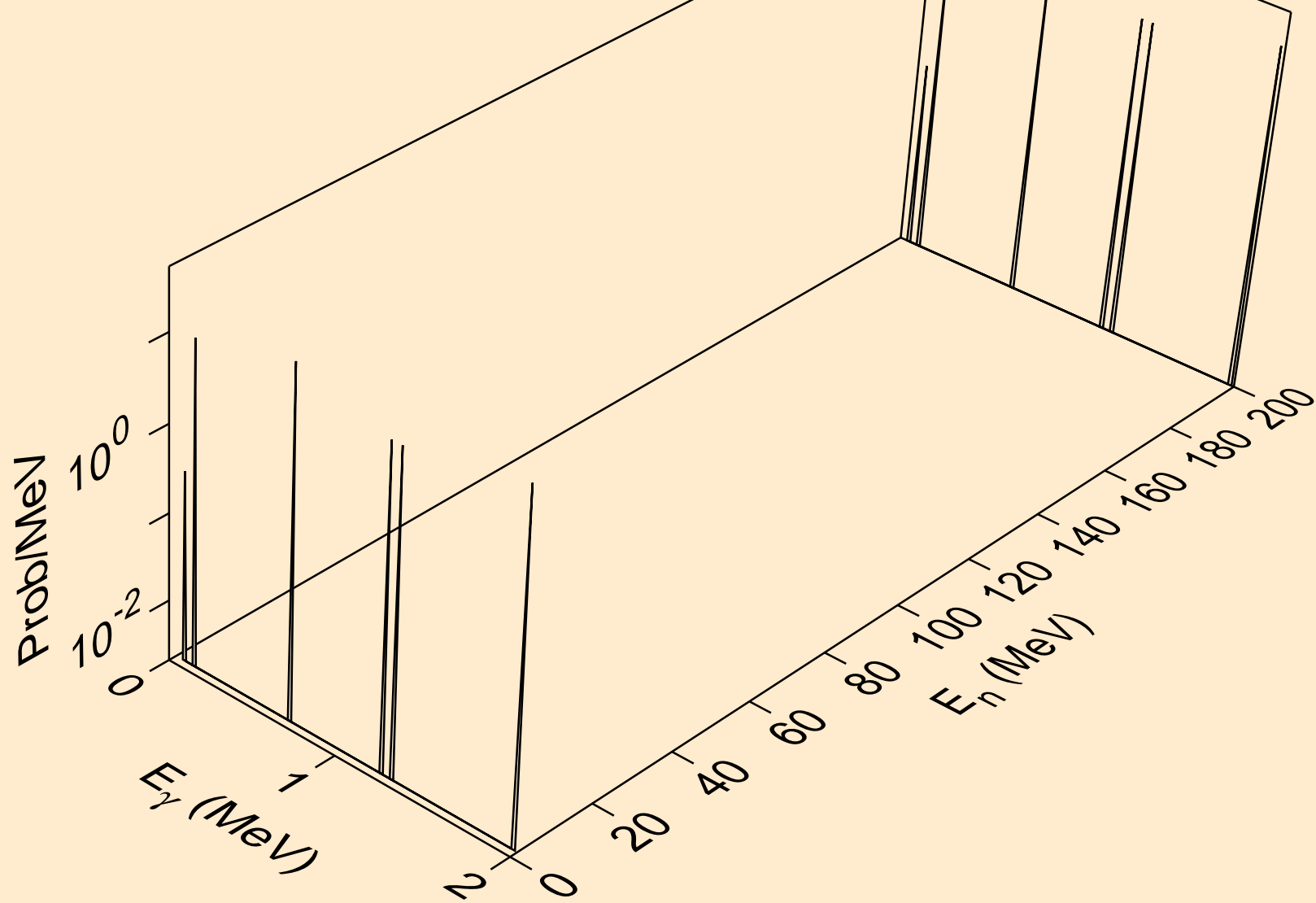

ZR085M NEUTRON ACER TENDL-2021 LIBRARY; T=293.6K
Photon emission for (n,n*24)

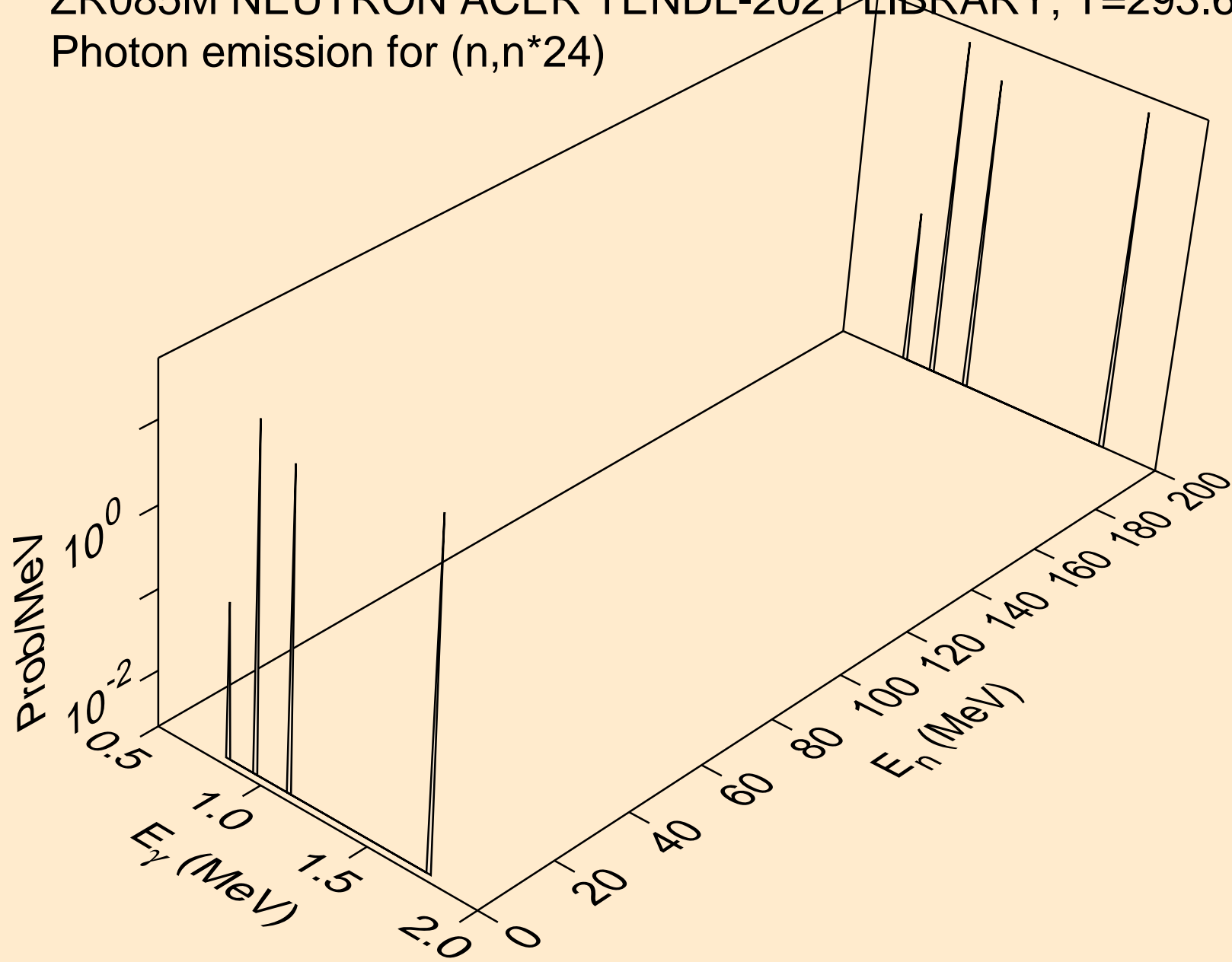

ZR085M NEUTRON ACER TENDL-2021 LIBRARY; T=293.6K
Photon emission for (n,n*25)

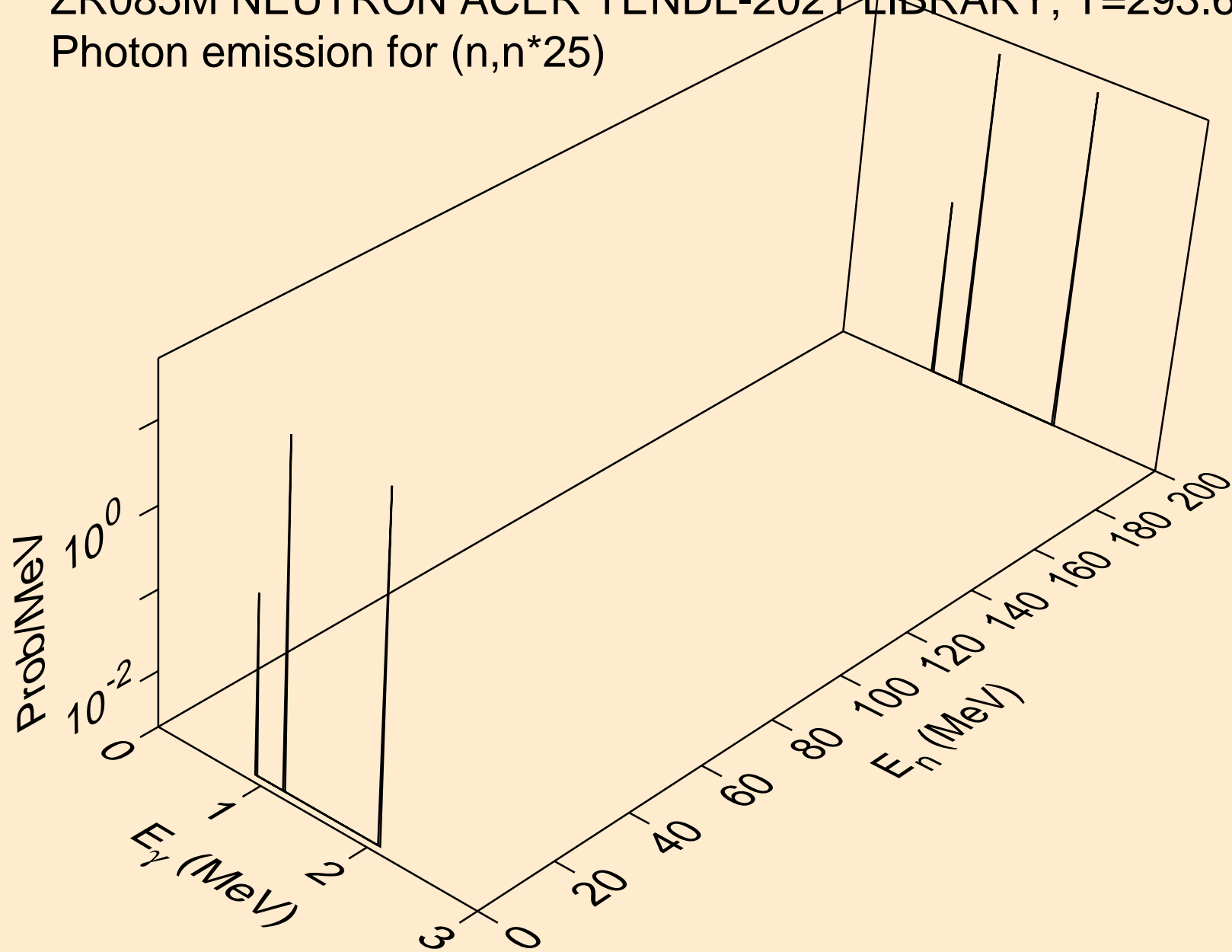

ZR085M NEUTRON ACER TENDL-2021 LIBRARY; T=293.6K
Photon emission for (n,n*26)

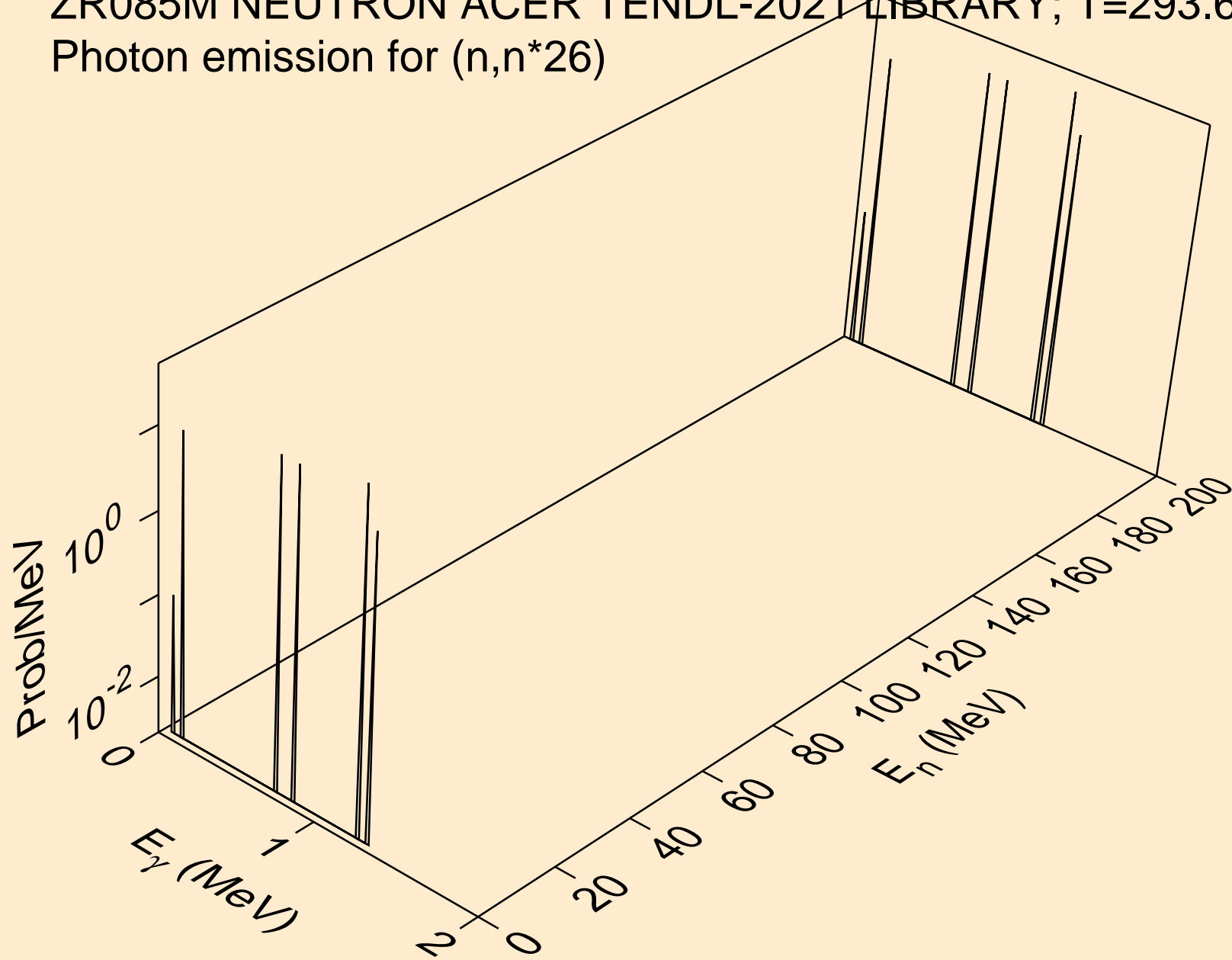

ZR085M NEUTRON ACER TENDL-2021 LIBRARY; T=293.6K
Photon emission for (n,n*27)

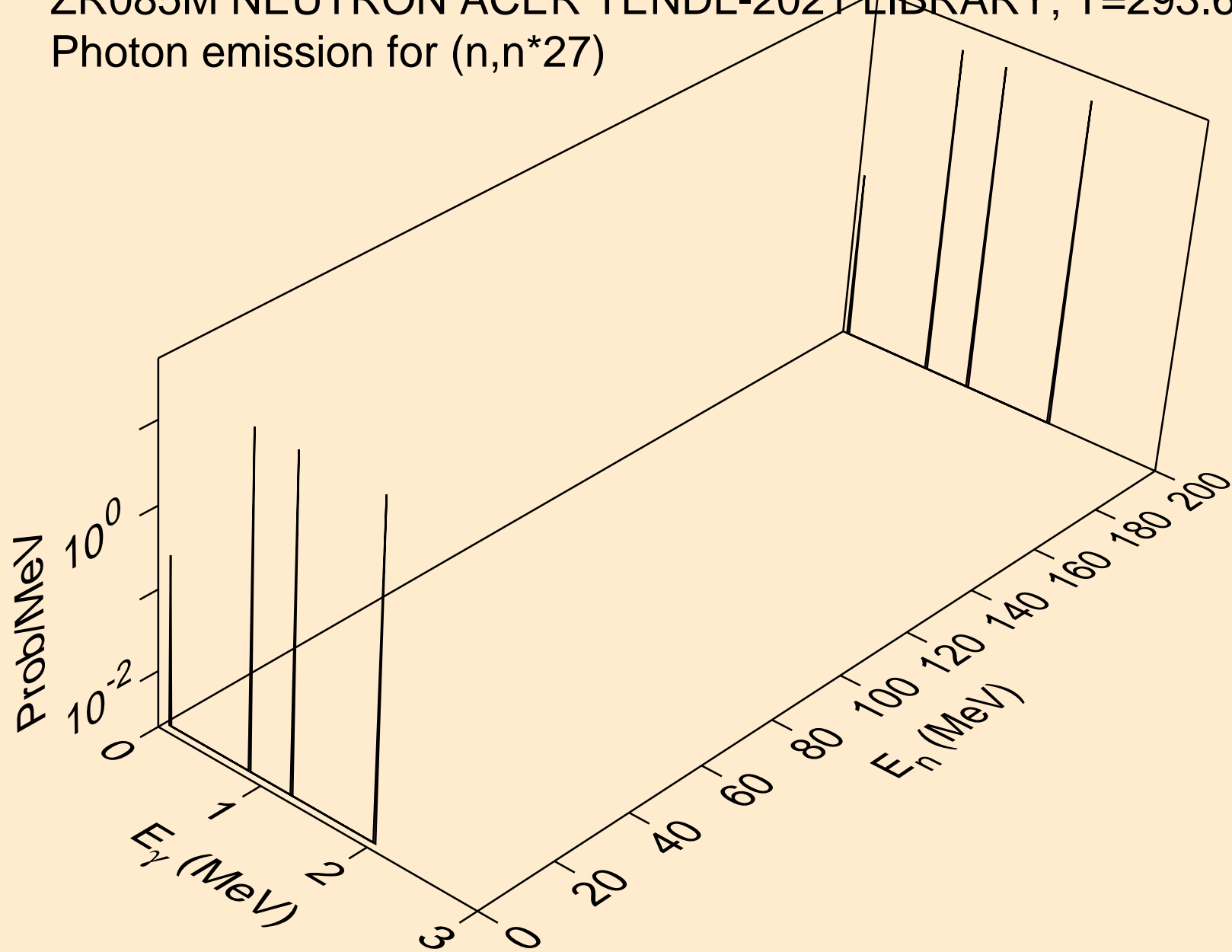

ZR085M NEUTRON ACER TENDL-2021 LIBRARY; T=293.6K
Photon emission for (n,n*28)

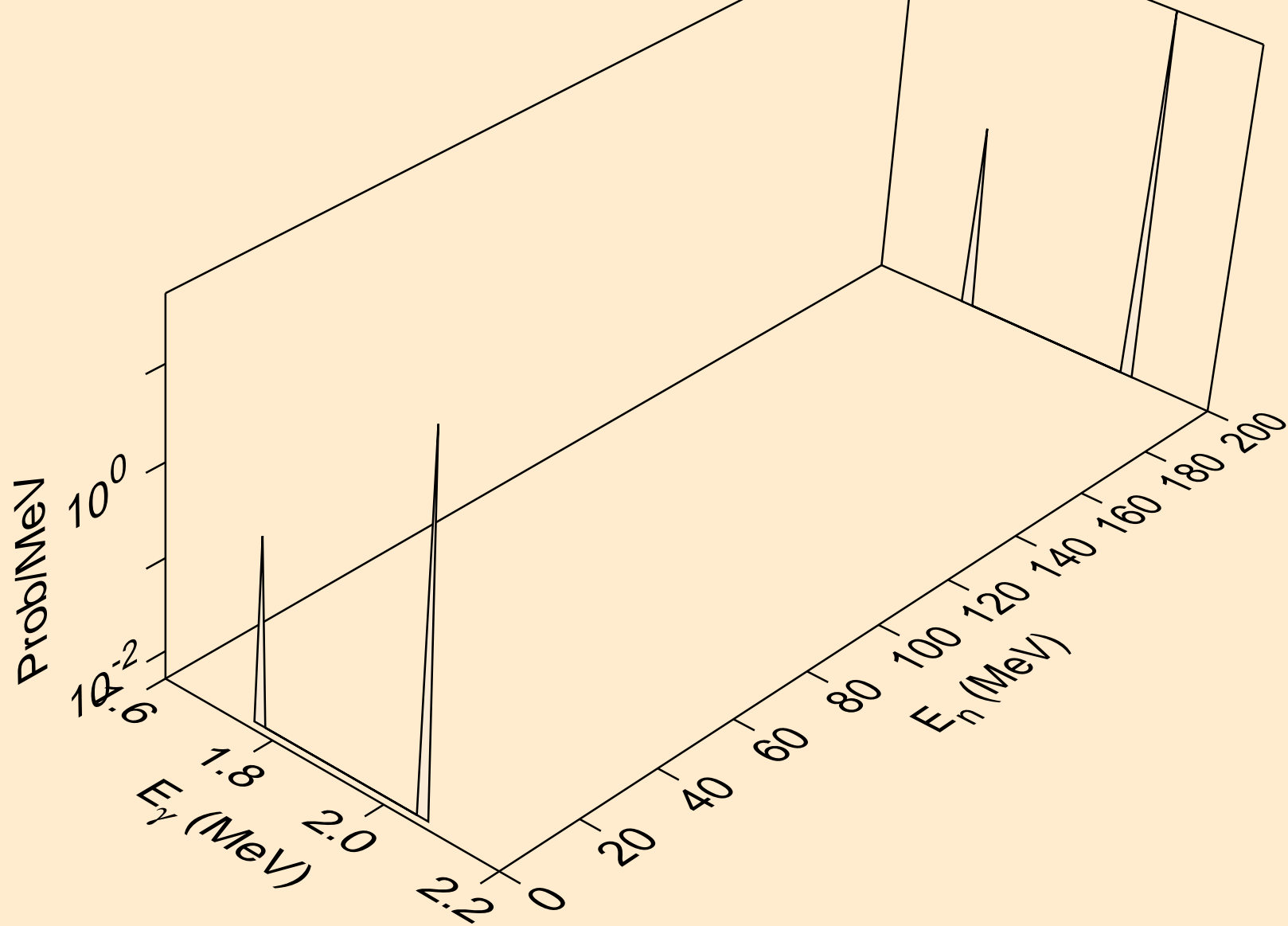

ZR085M NEUTRON ACER TENDL-2021 LIBRARY; T=293.6K
Photon emission for (n,n*c)

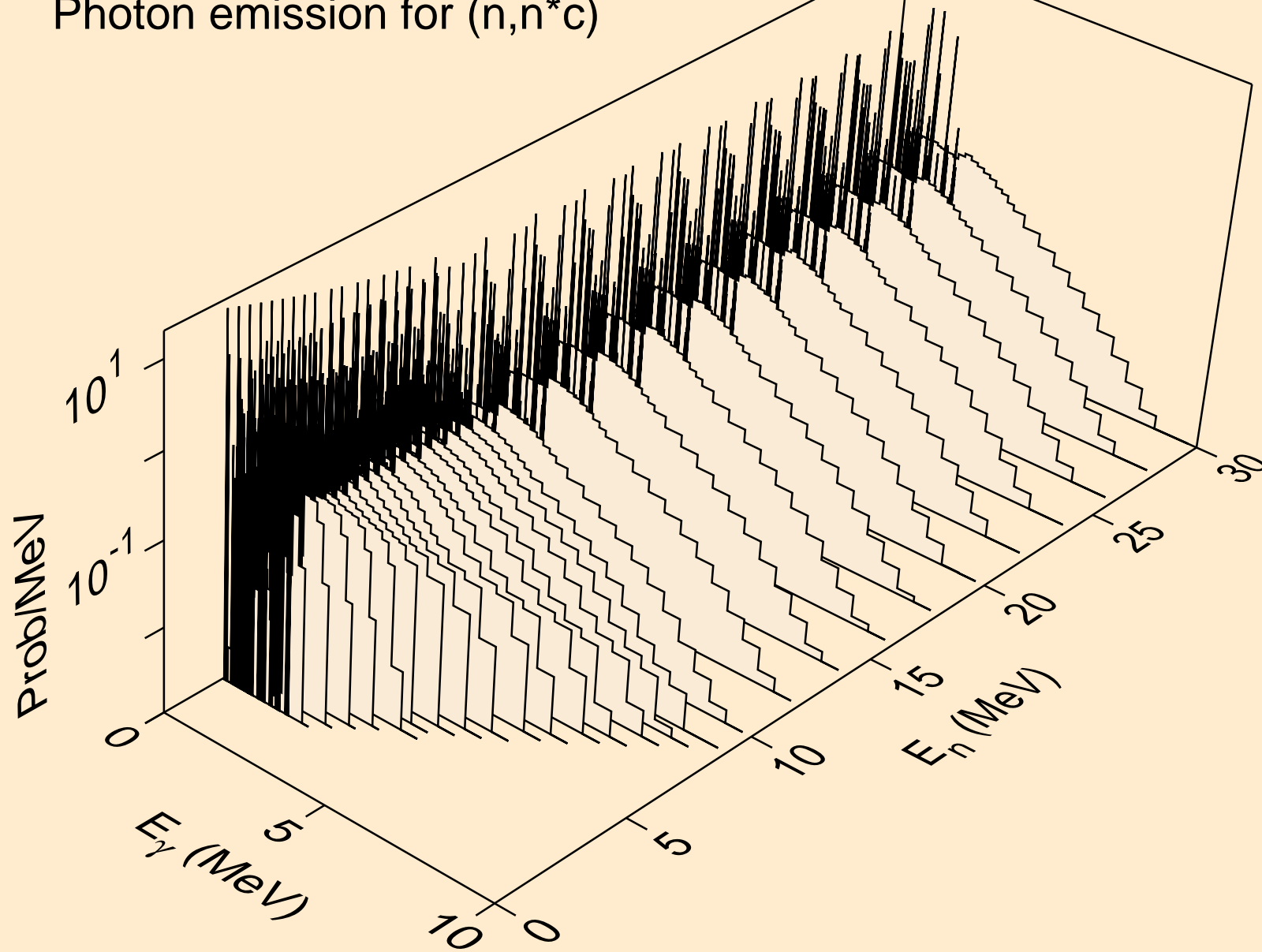

ZR085M NEUTRON ACER TENDL-2021 LIBRARY; T=293.6K
Photon emission for (n,gma)

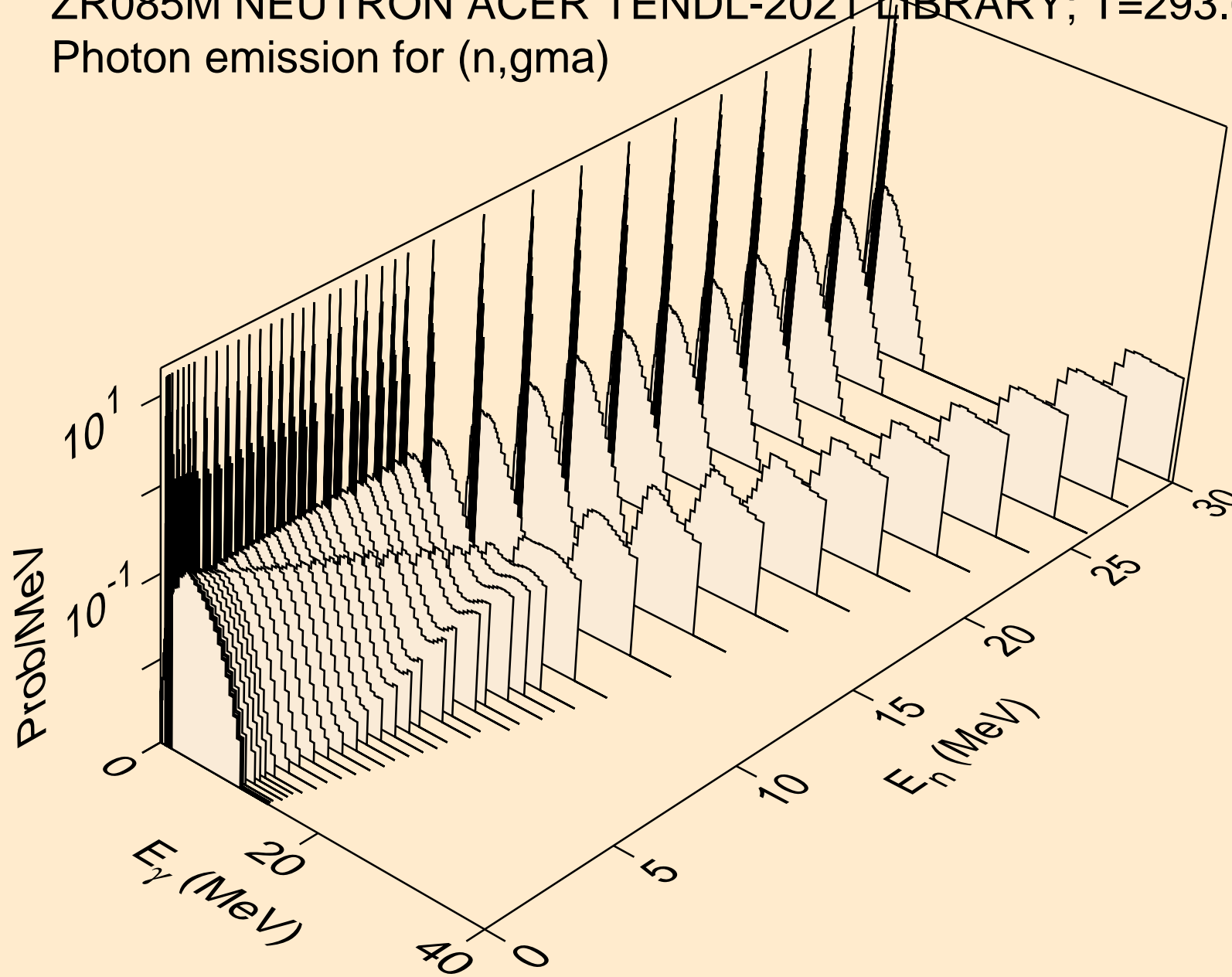

ZR085M NEUTRON ACER TENDL-2021 LIBRARY; T=293.6K
Photon emission for (n,p)

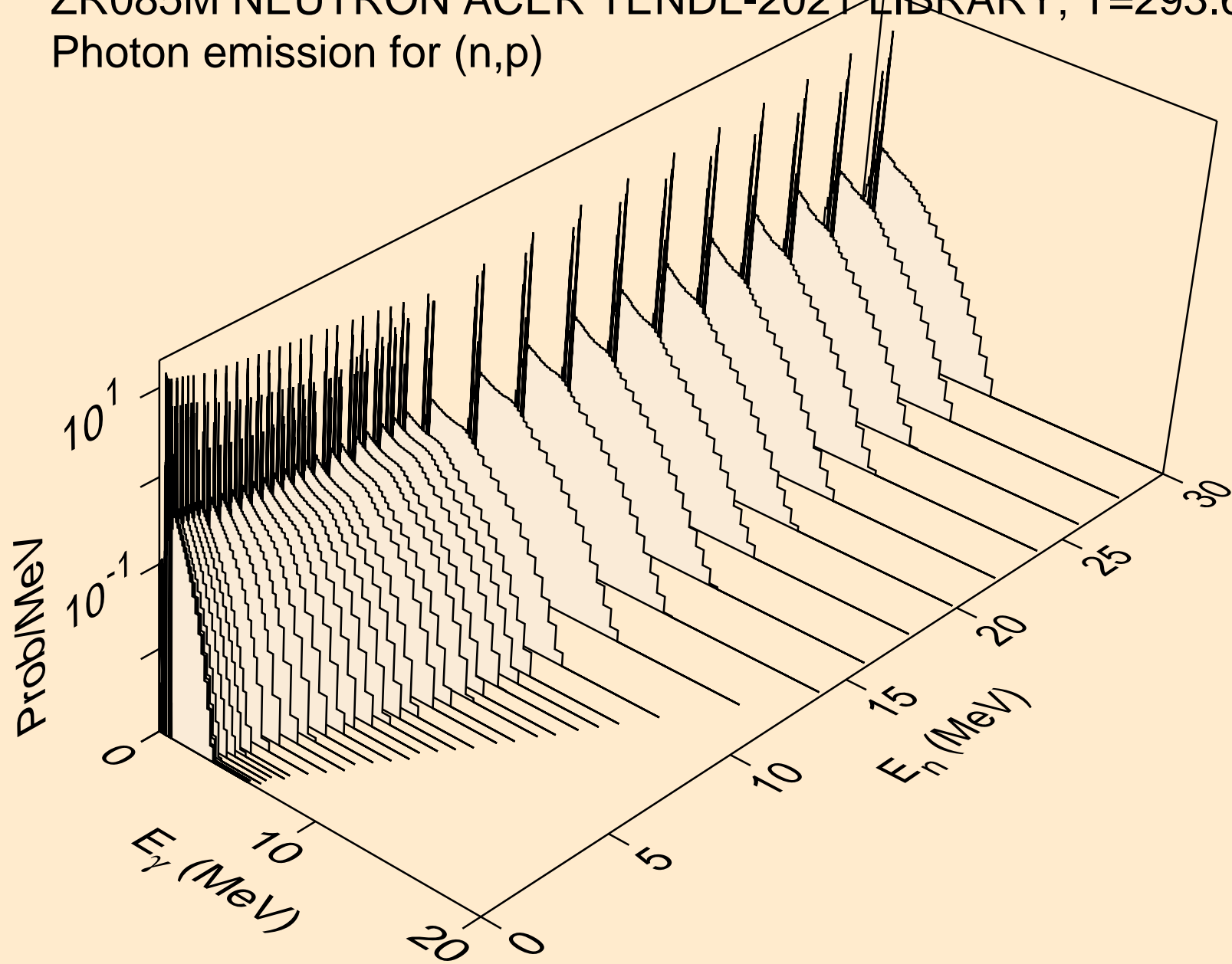

ZR085M NEUTRON ACER TENDL-2021 LIBRARY; T=293.6K
Photon emission for (n,d)

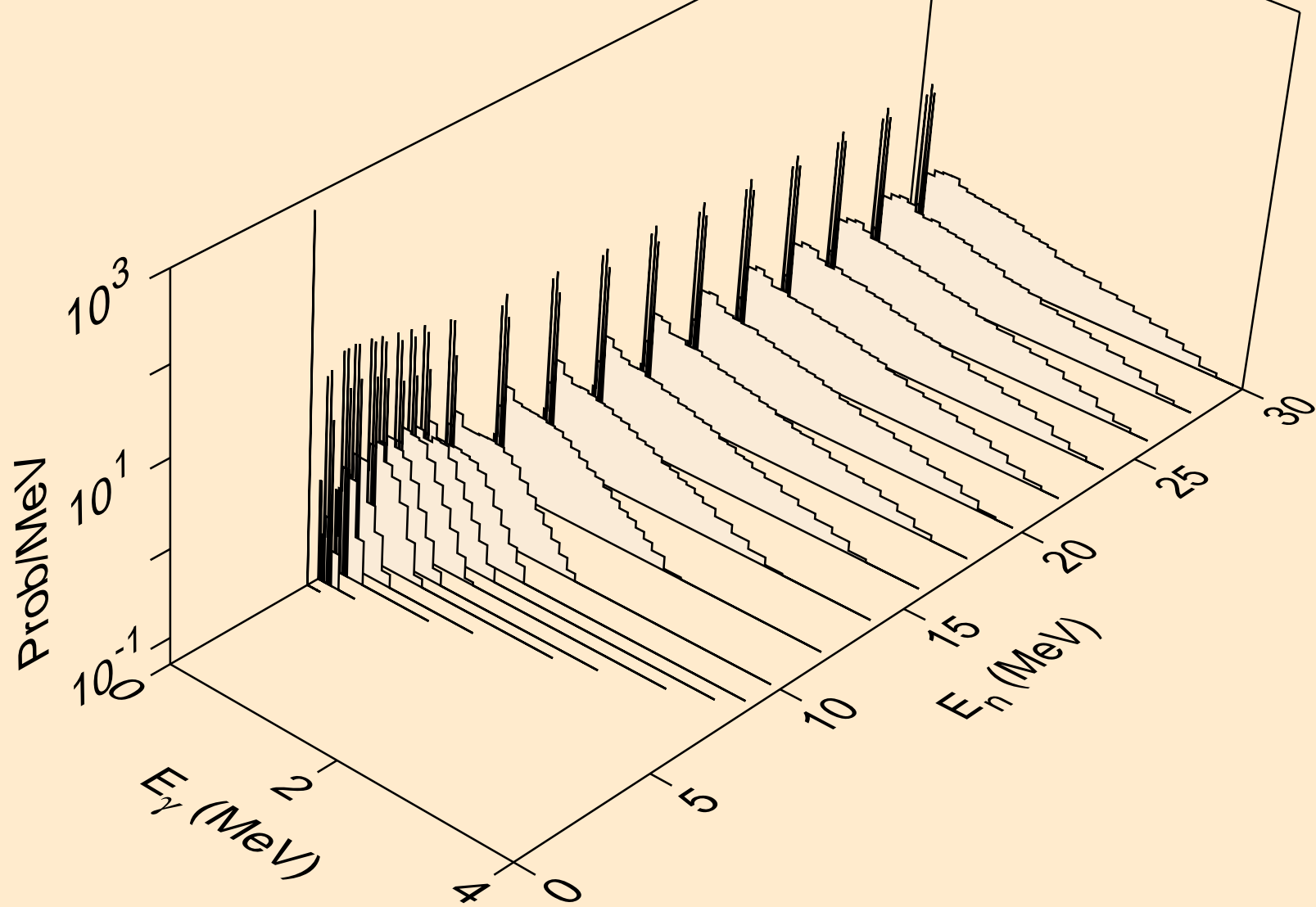

ZR085M NEUTRON ACER TENDL-2021 LIBRARY; T=293.6K
Photon emission for (n,t)

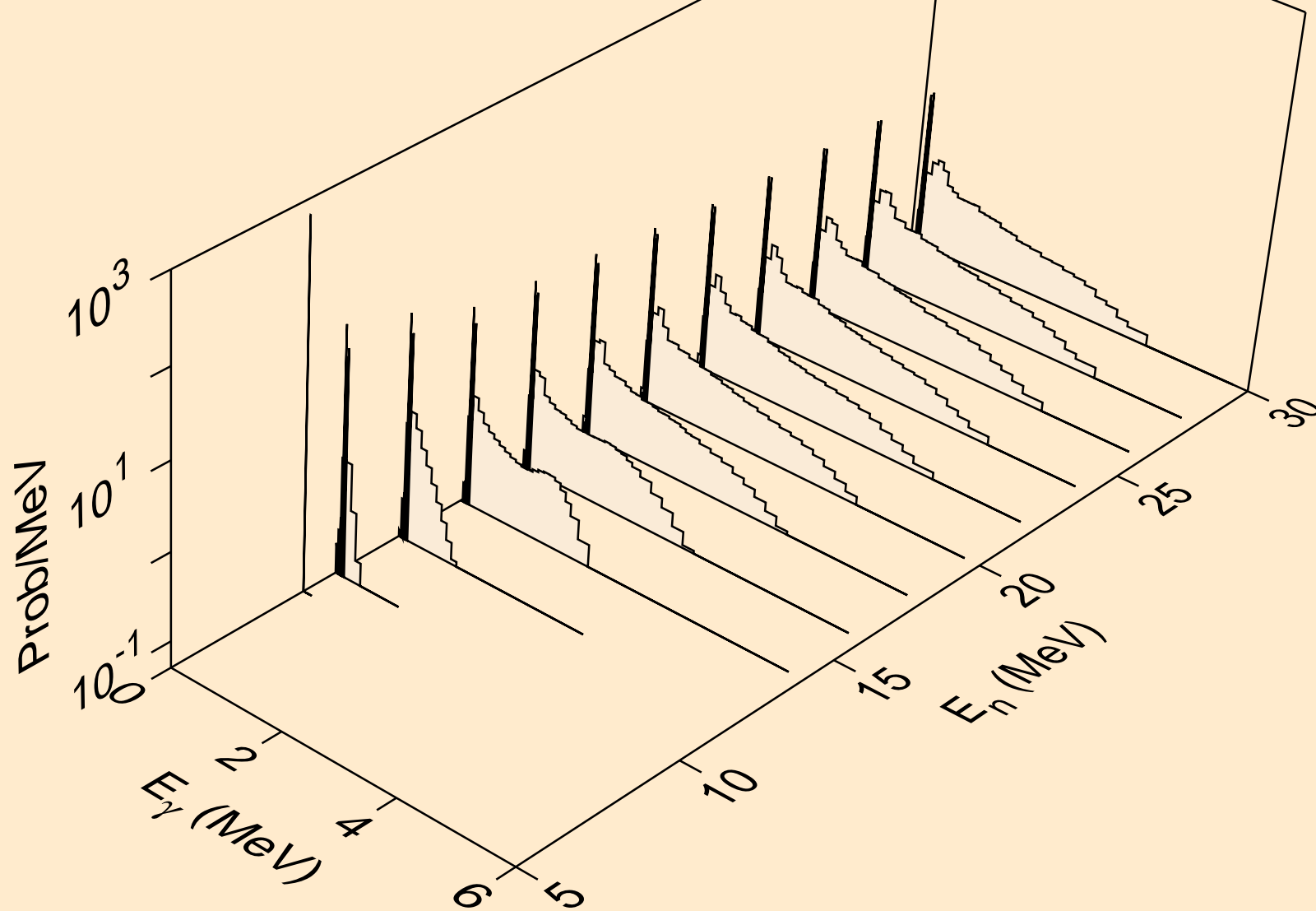

ZR085M NEUTRON ACER TENDL-2021 LIBRARY; T=293.6K
Photon emission for (n,he3)

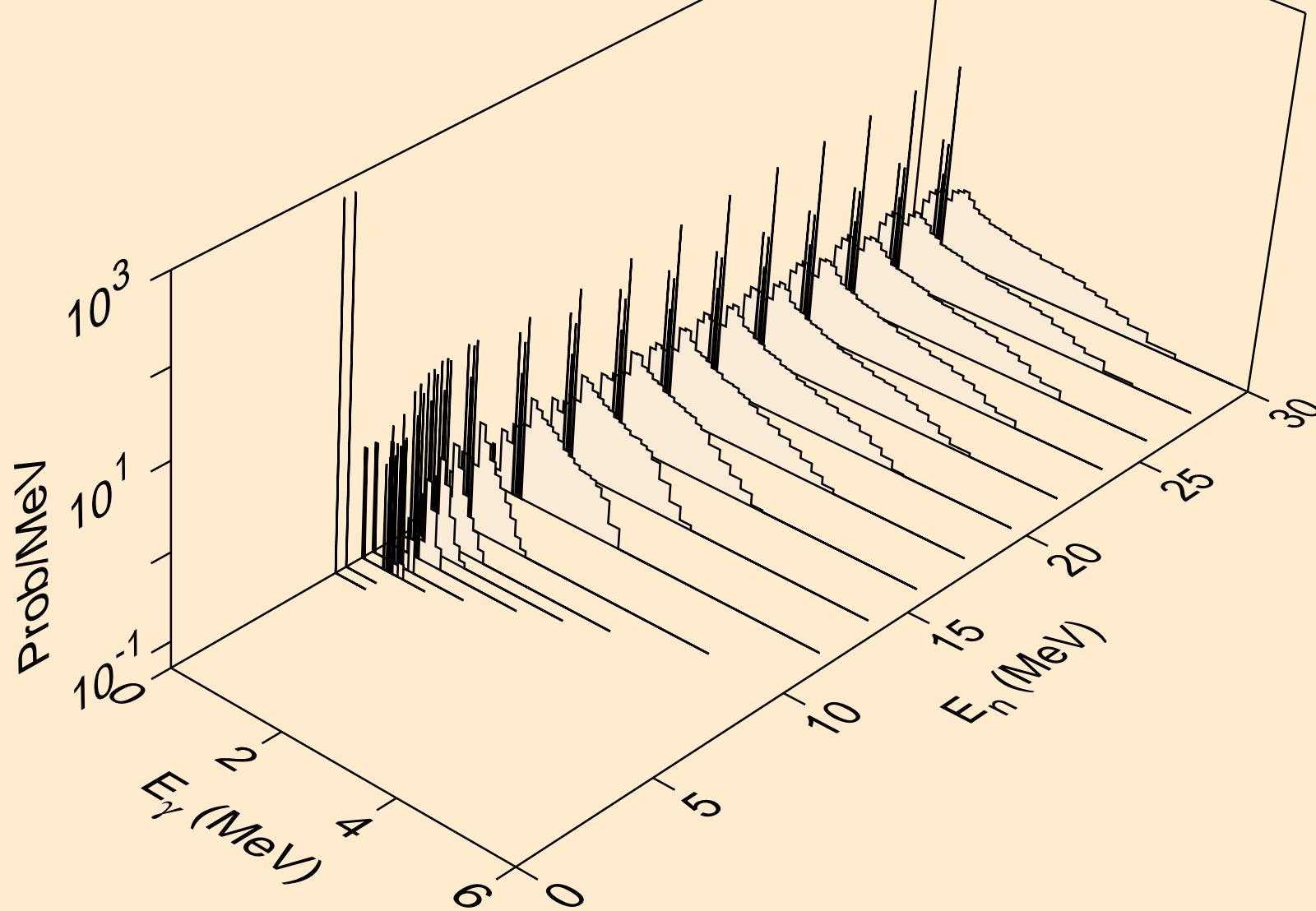

ZR085M NEUTRON ACER TENDL-2021 LIBRARY; T=293.6K
Photon emission for (n,a)

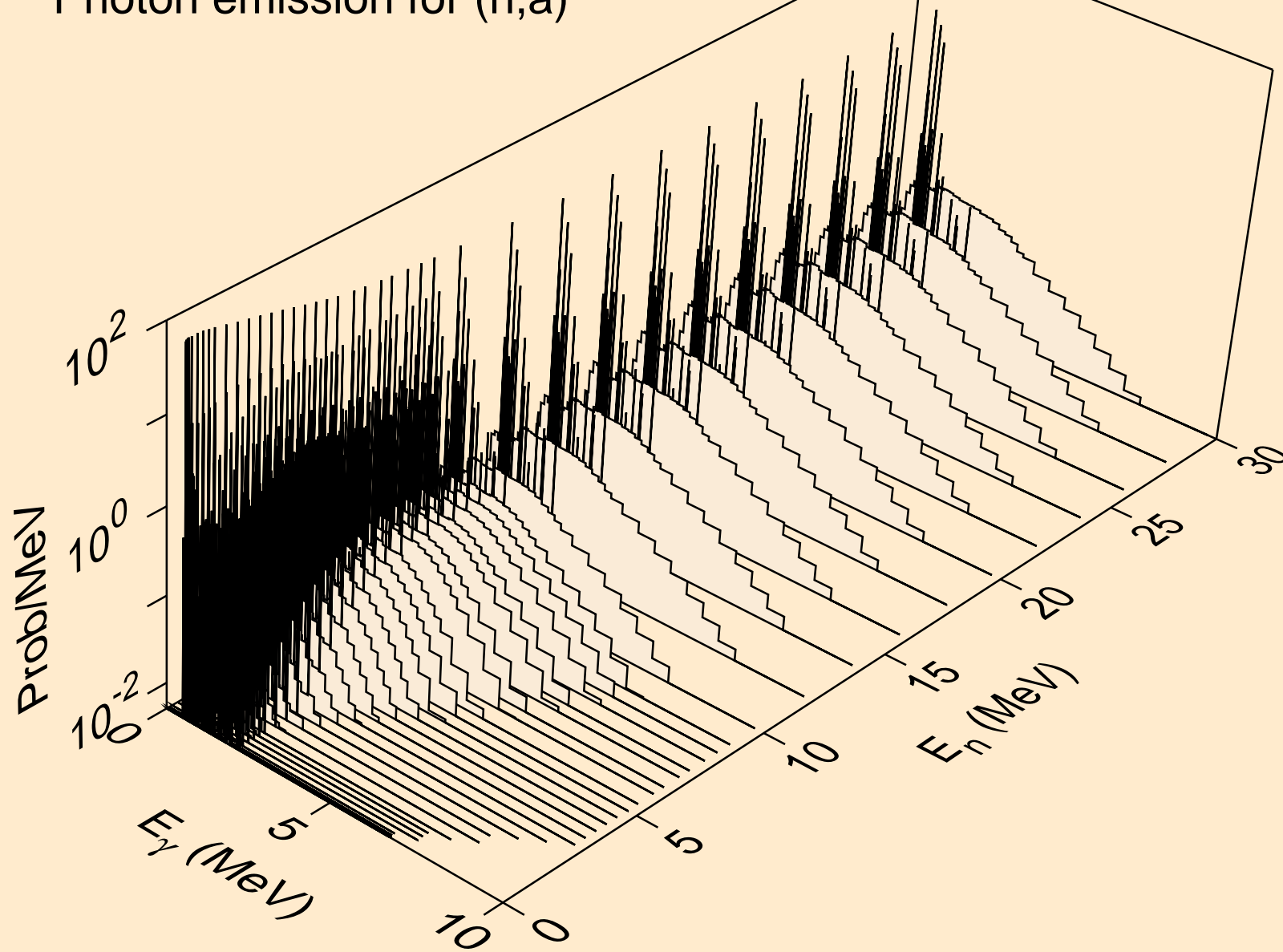

ZR085M NEUTRON ACER TENDL-2021 LIBRARY; T=293.6K
Photon emission for (n,2a)

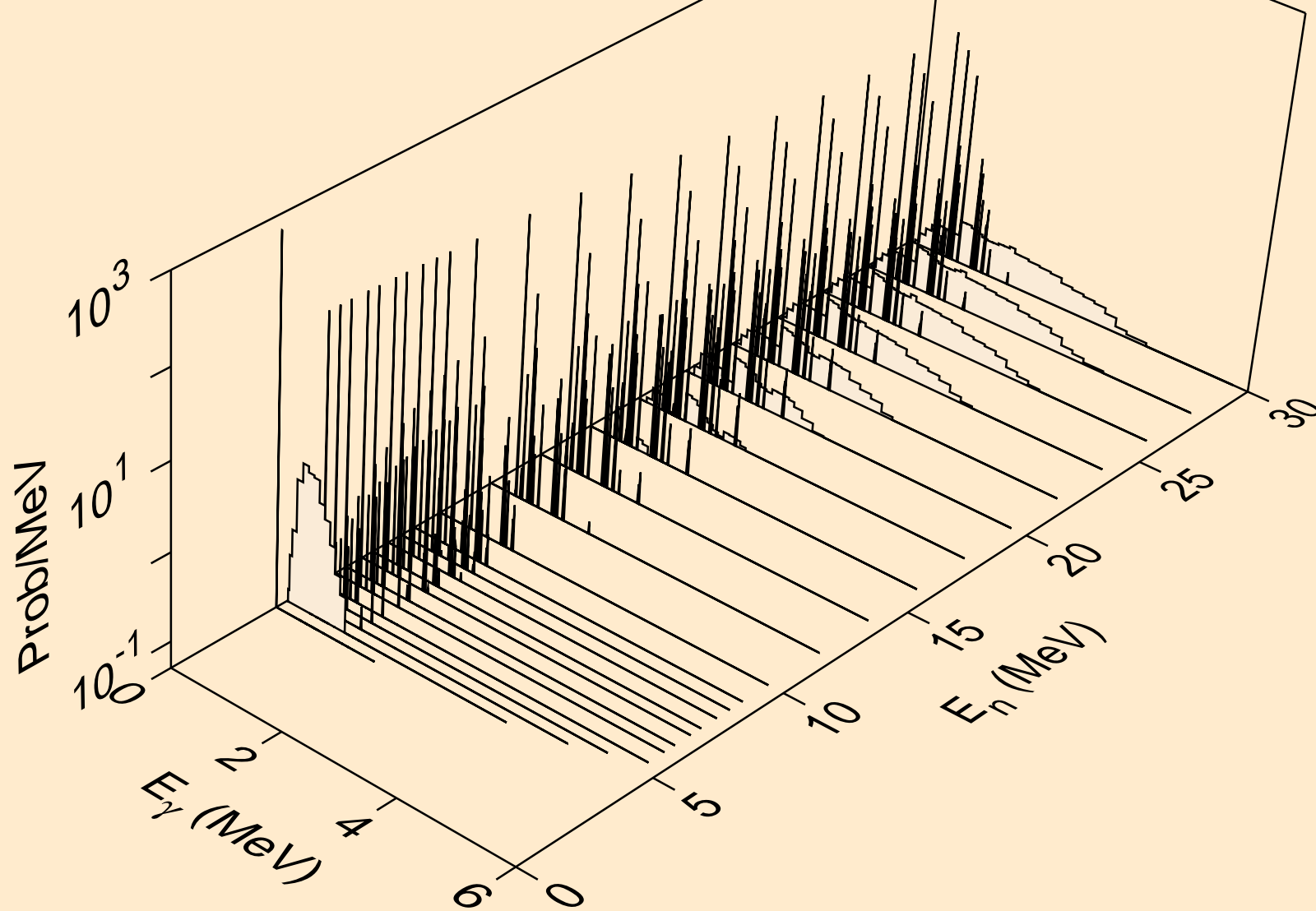

ZR085M NEUTRON ACER TENDL-2021 LIBRARY; T=293.6K
Photon emission for (n,3a)

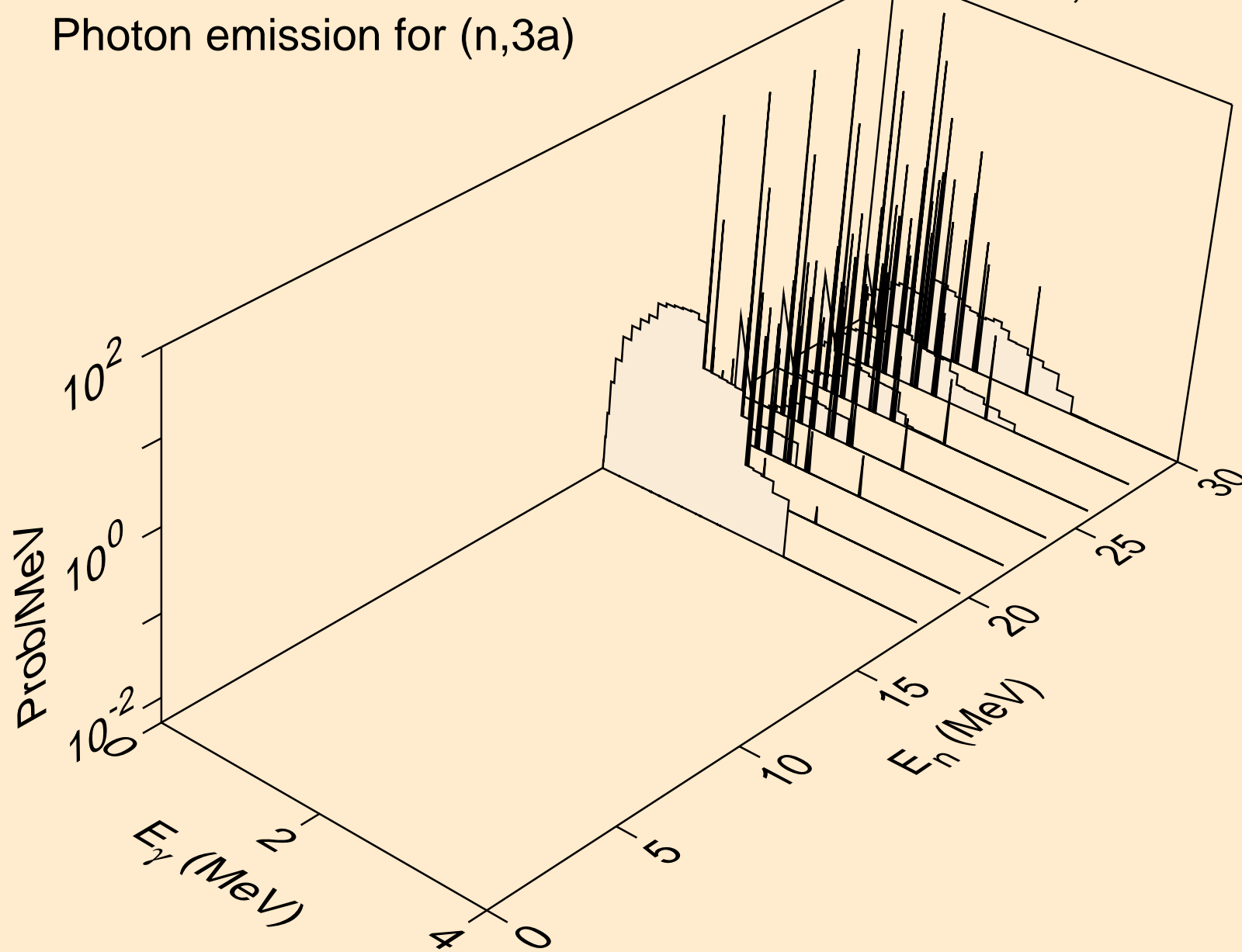

ZR085M NEUTRON ACER TENDL-2021 LIBRARY; T=293.6K
Photon emission for (n,2p)

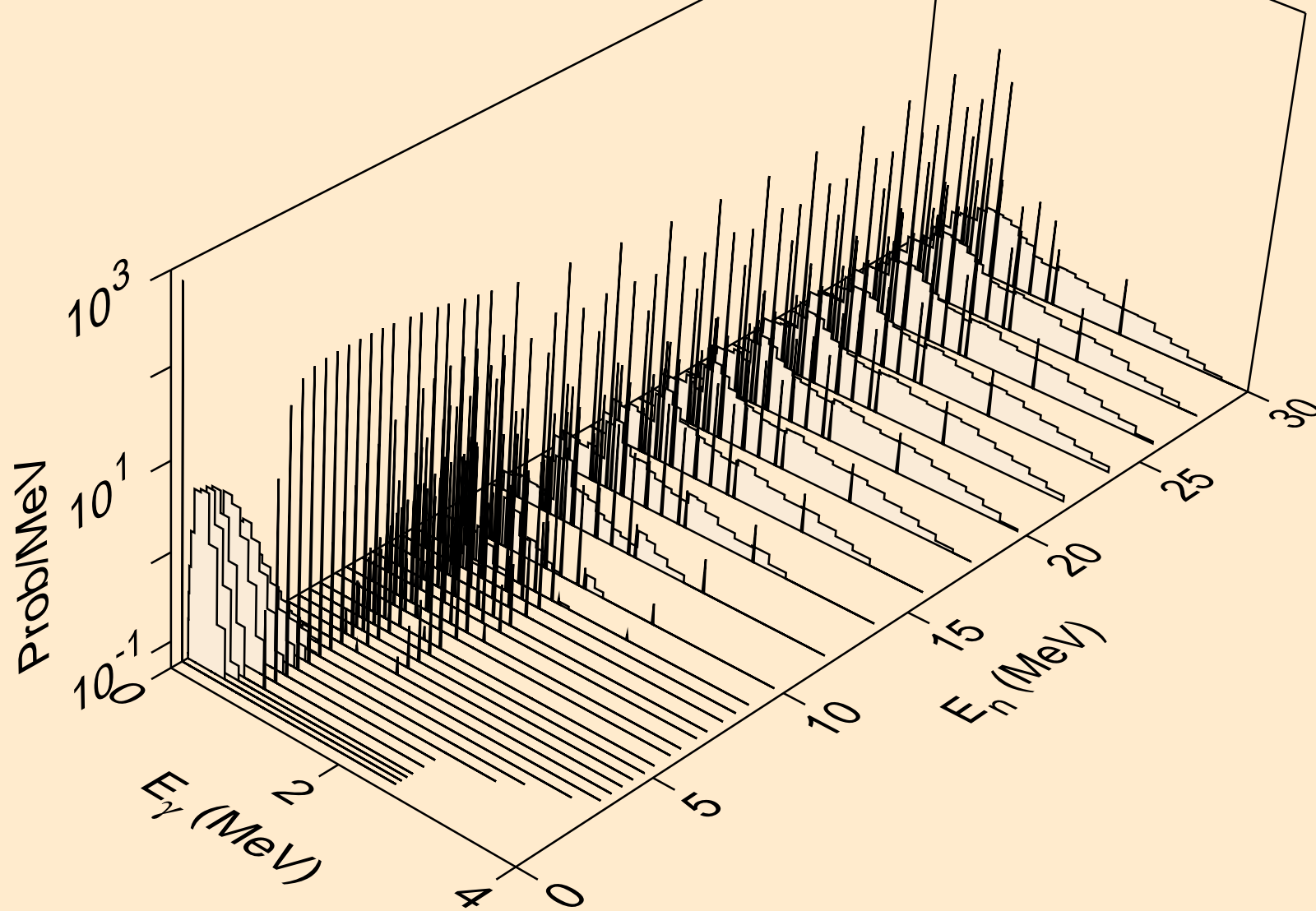

ZR085M NEUTRON ACER TENDL-2021 LIBRARY; T=293.6K
Photon emission for (n,p)

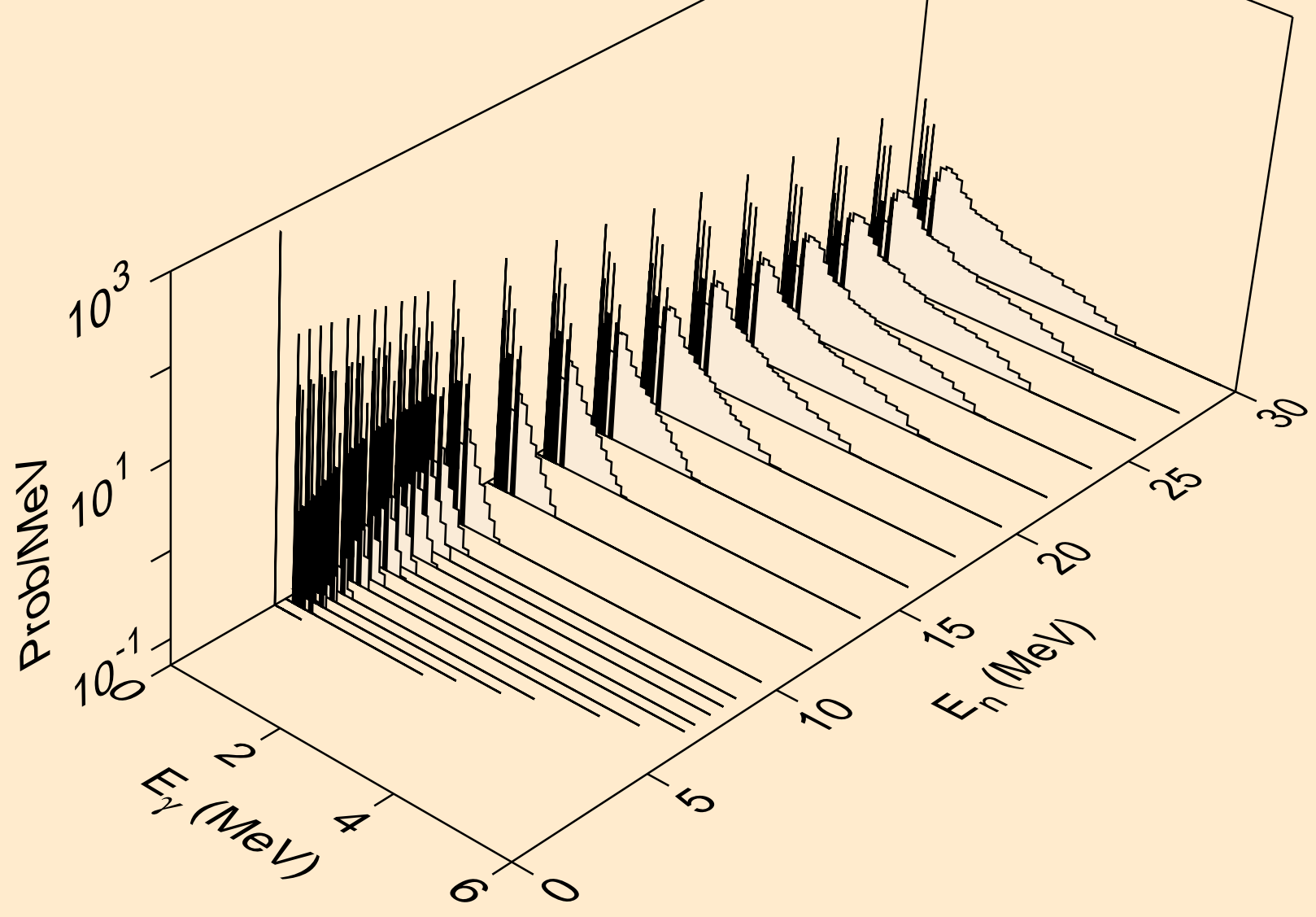

ZR085M NEUTRON ACER TENDL-2021 LIBRARY; T=293.6K
Photon emission for (n,pd)

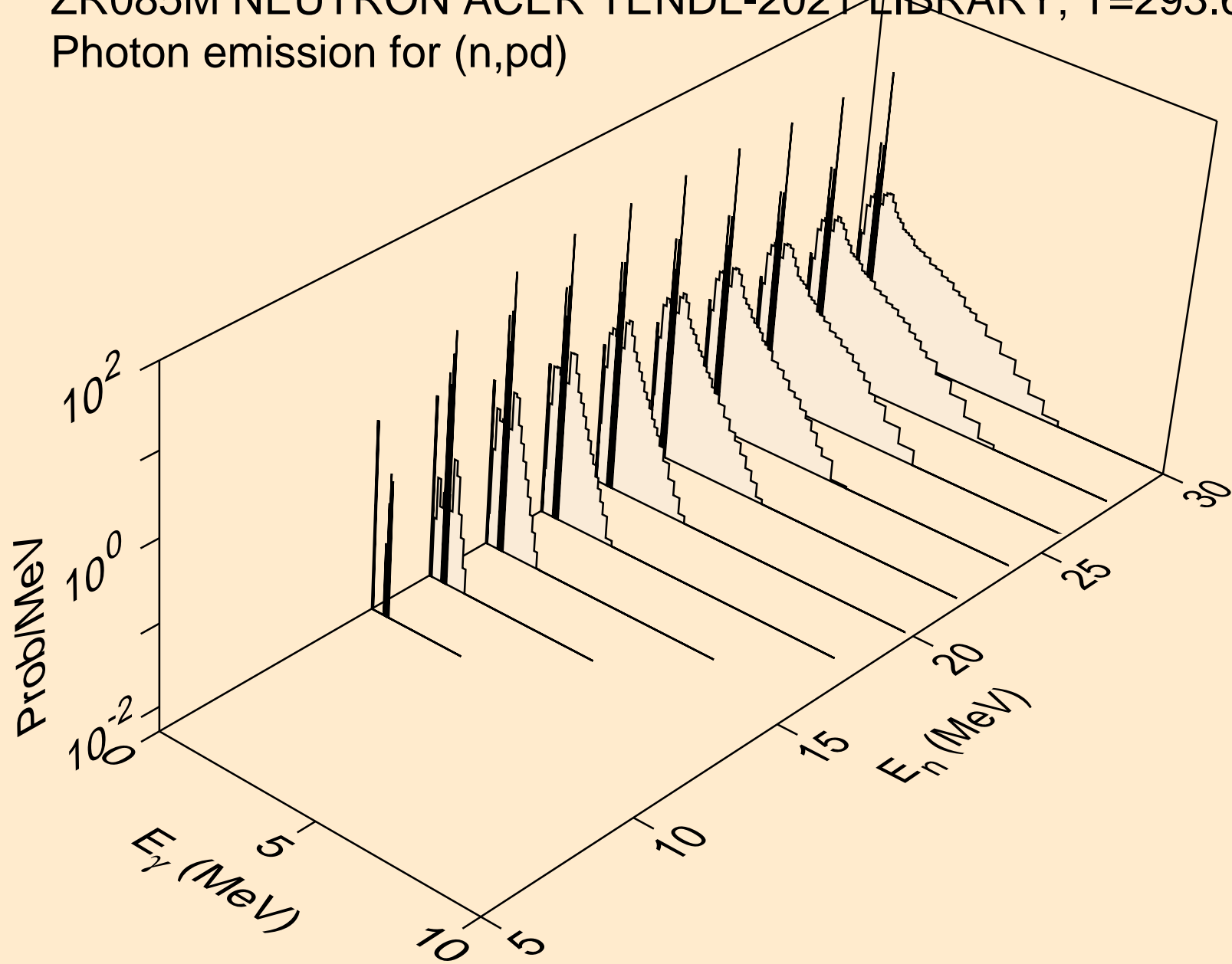

ZR085M NEUTRON ACER TENDL-2021 LIBRARY; T=293.6K
Photon emission for (n,pt)

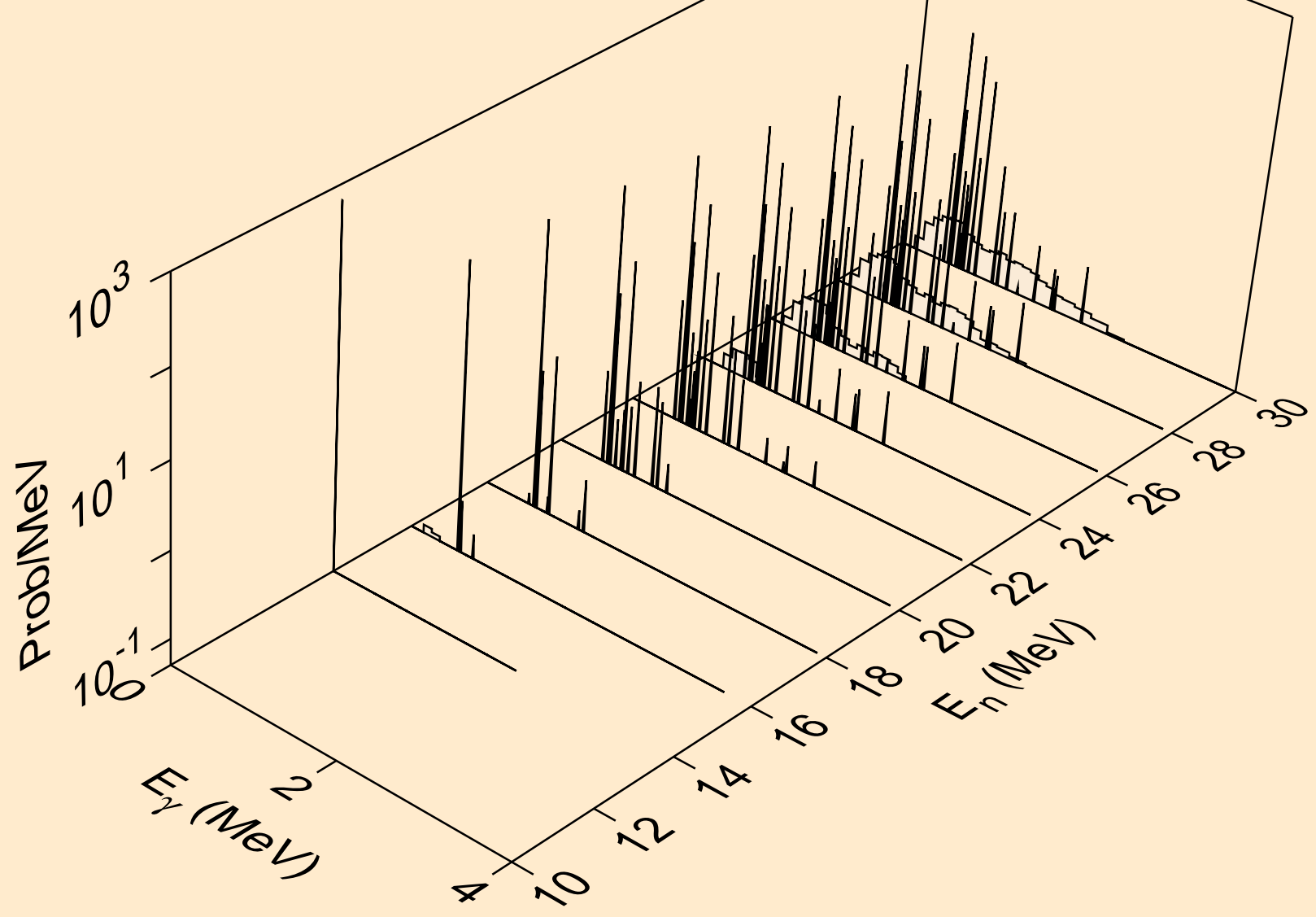

ZR085M NEUTRON ACER TENDL-2021 LIBRARY; T=293.6K
Photon emission for (n,da)

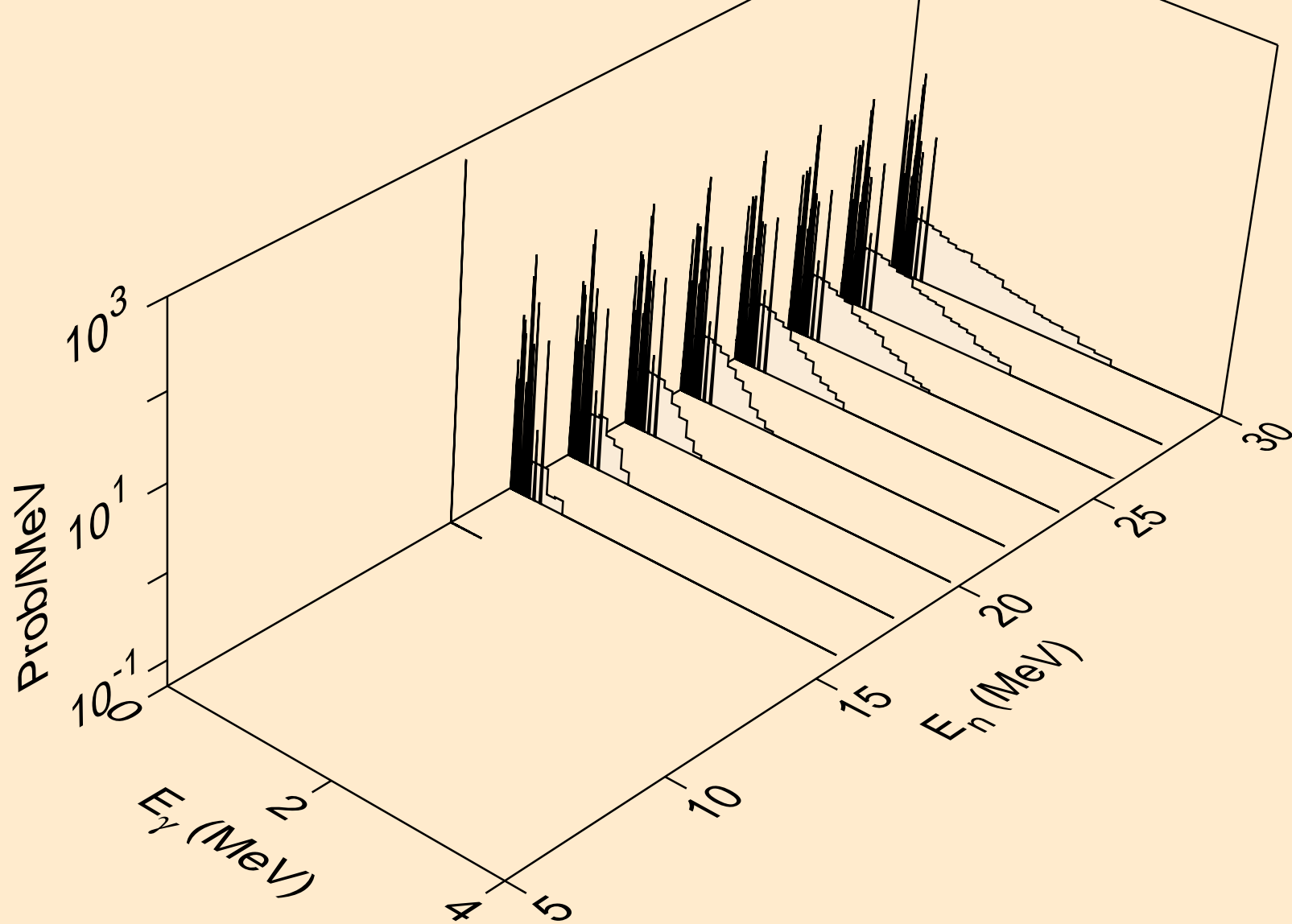

ZR085M NEUTRON ACER TENDL-2021 LIBRARY; T=293.6K
thermal capture photon spectrum

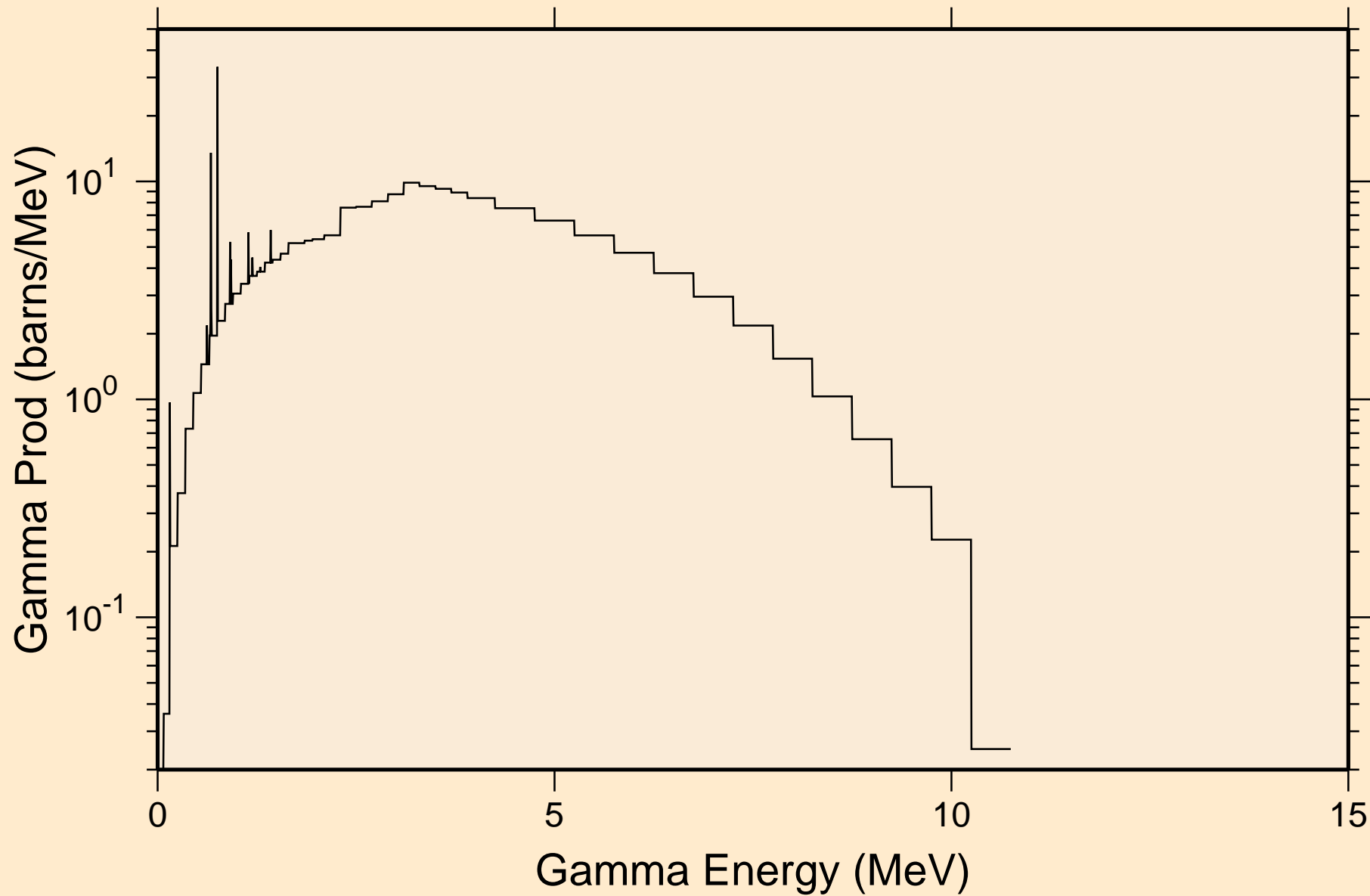

ZR085M NEUTRON ACER TENDL-2021 LIBRARY; T=293.6K
14 MeV photon spectrum

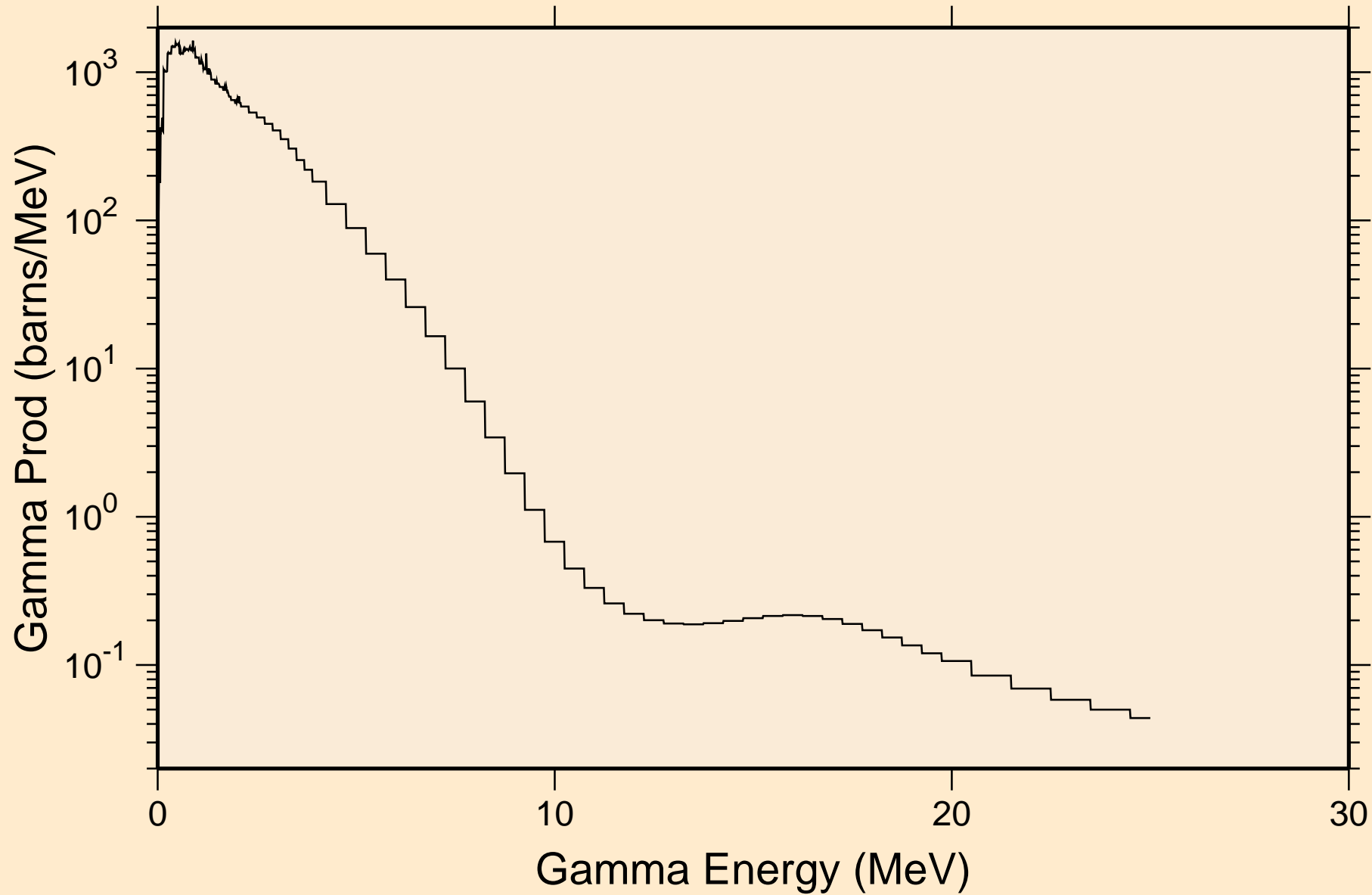

ZR085M NEUTRON ACER TENDL-2021 LIBRARY; T=293.6K
Particle heating contributions

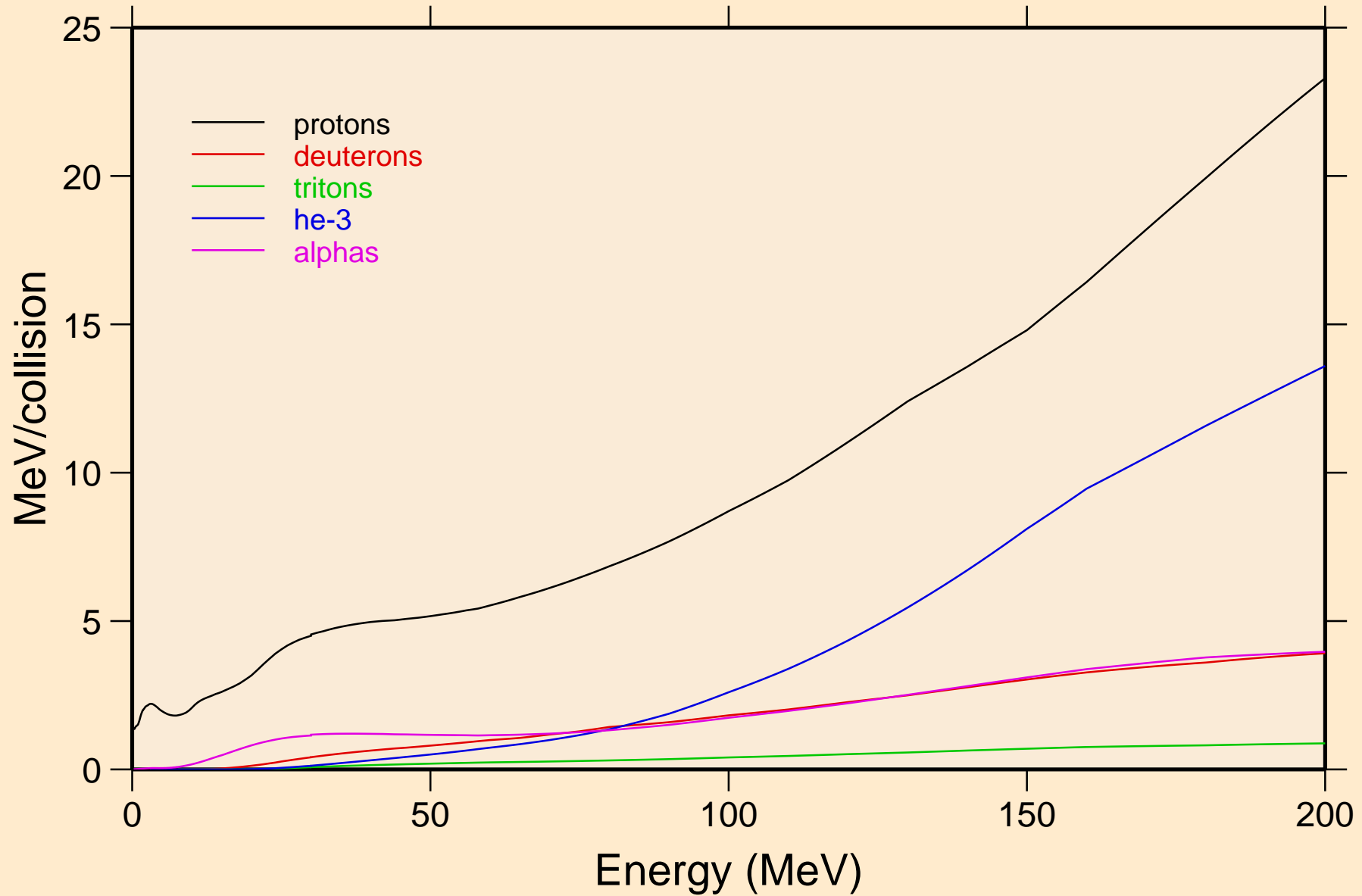

ZR085M NEUTRON ACER TENDL-2021 LIBRARY; T=293.6K
Recoil Heating

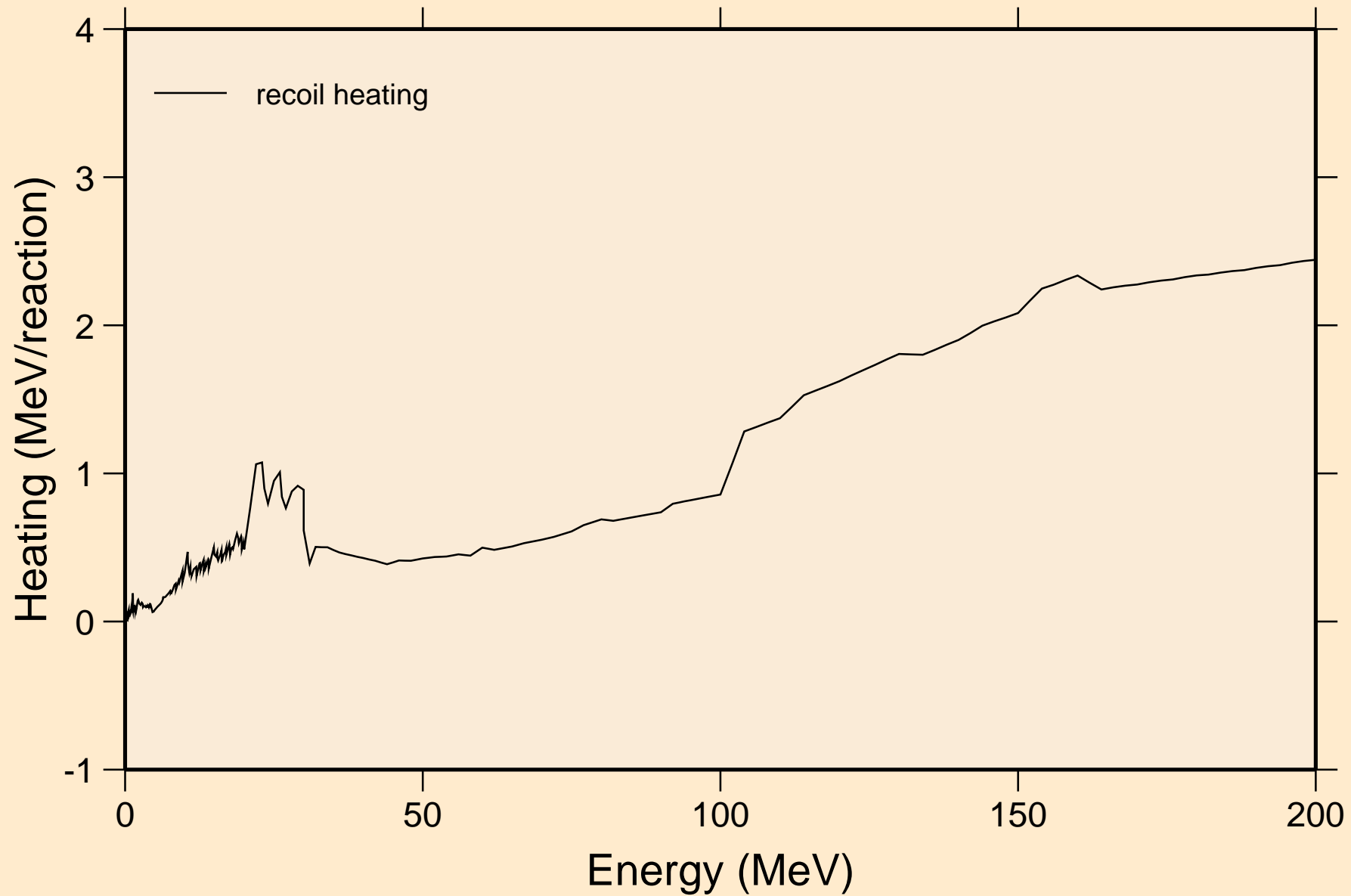

ZR085M NEUTRON ACER TENDL-2021 LIBRARY; T=293.6K
Particle production cross sections

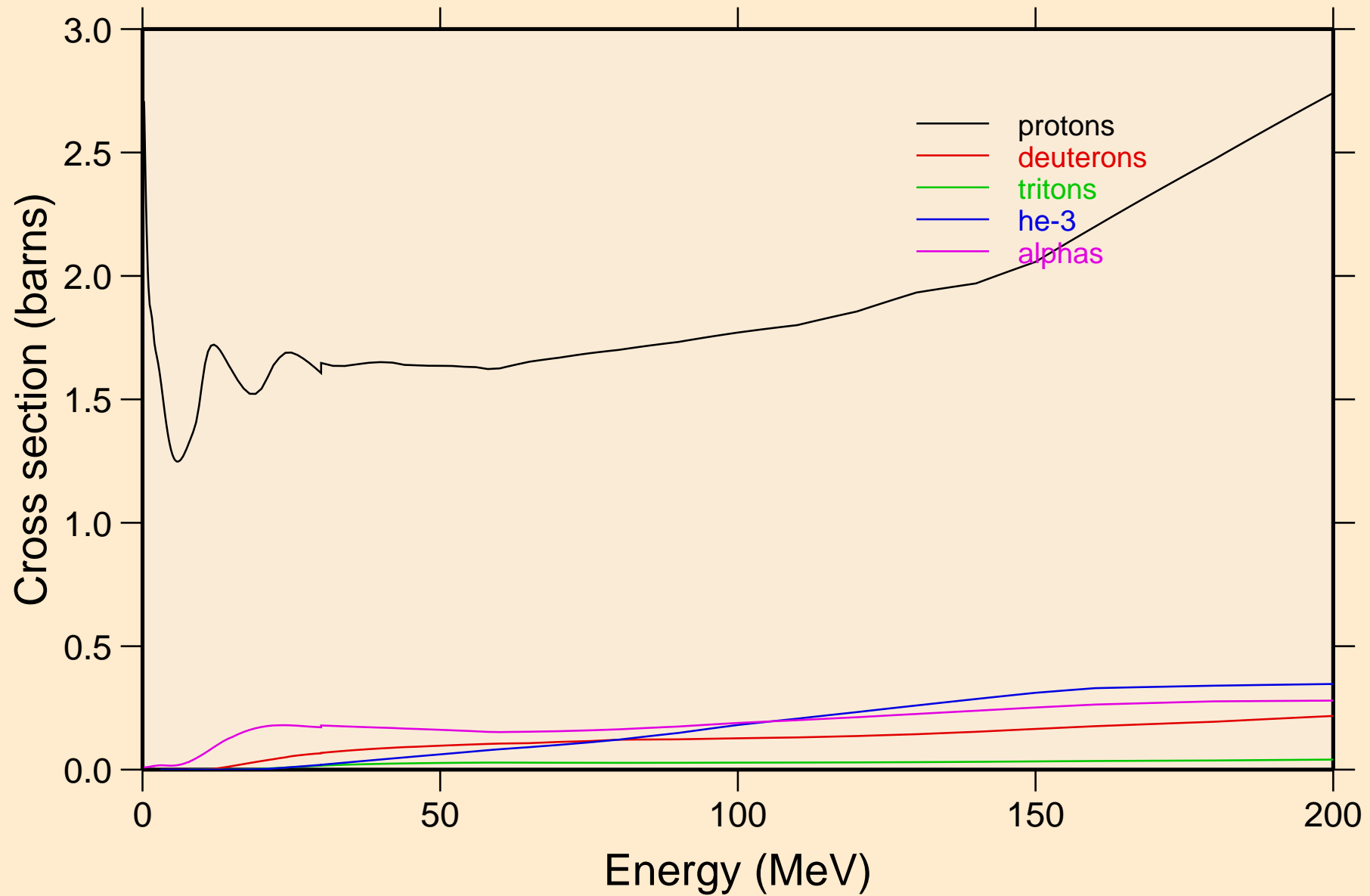

ZR085M NEUTRON ACER TENDL-2021 LIBRARY; T=293.6K
protons from (n,x)

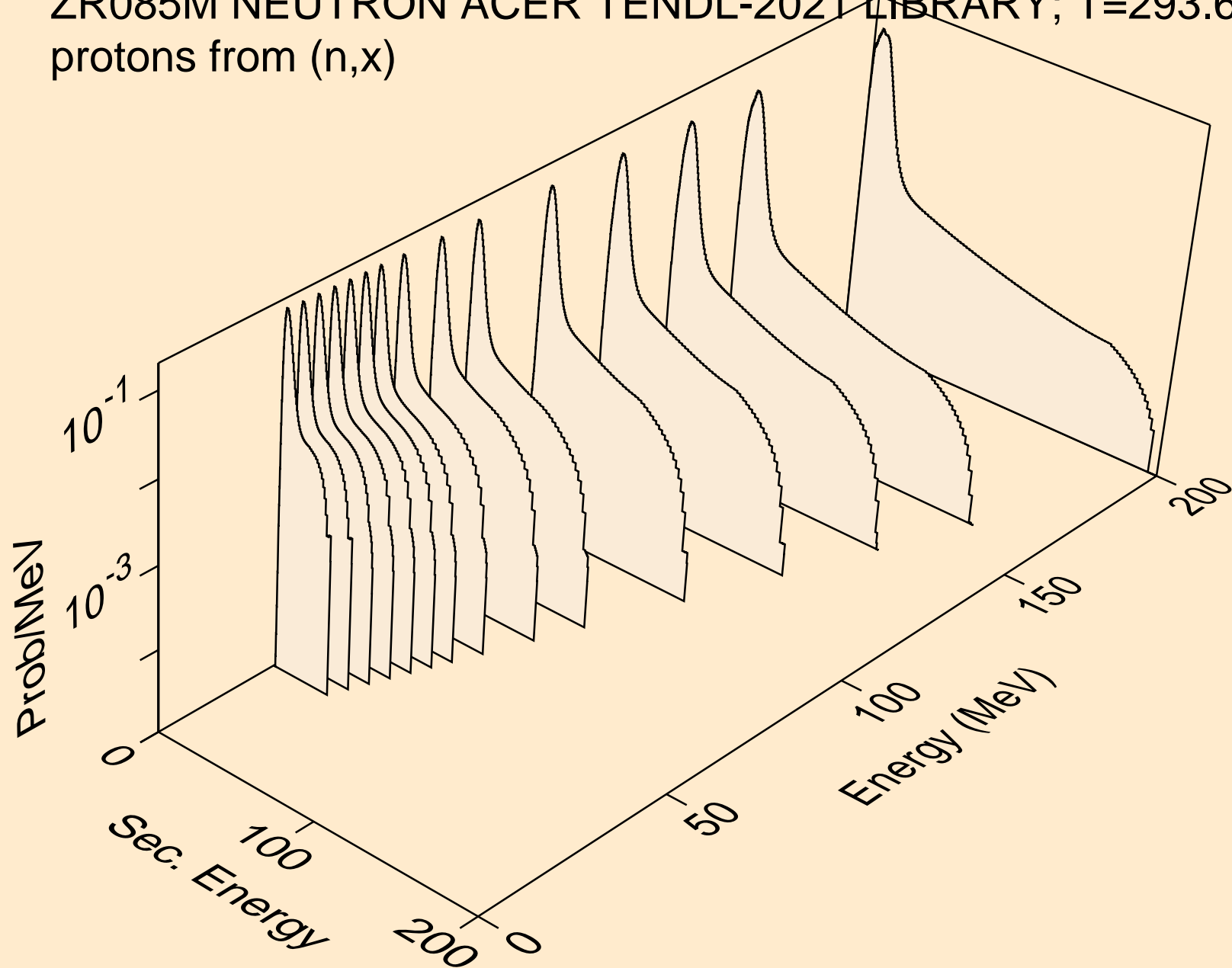

ZR085M NEUTRON ACER TENDL-2021 LIBRARY; T=293.6K
protons from (n,n*)p

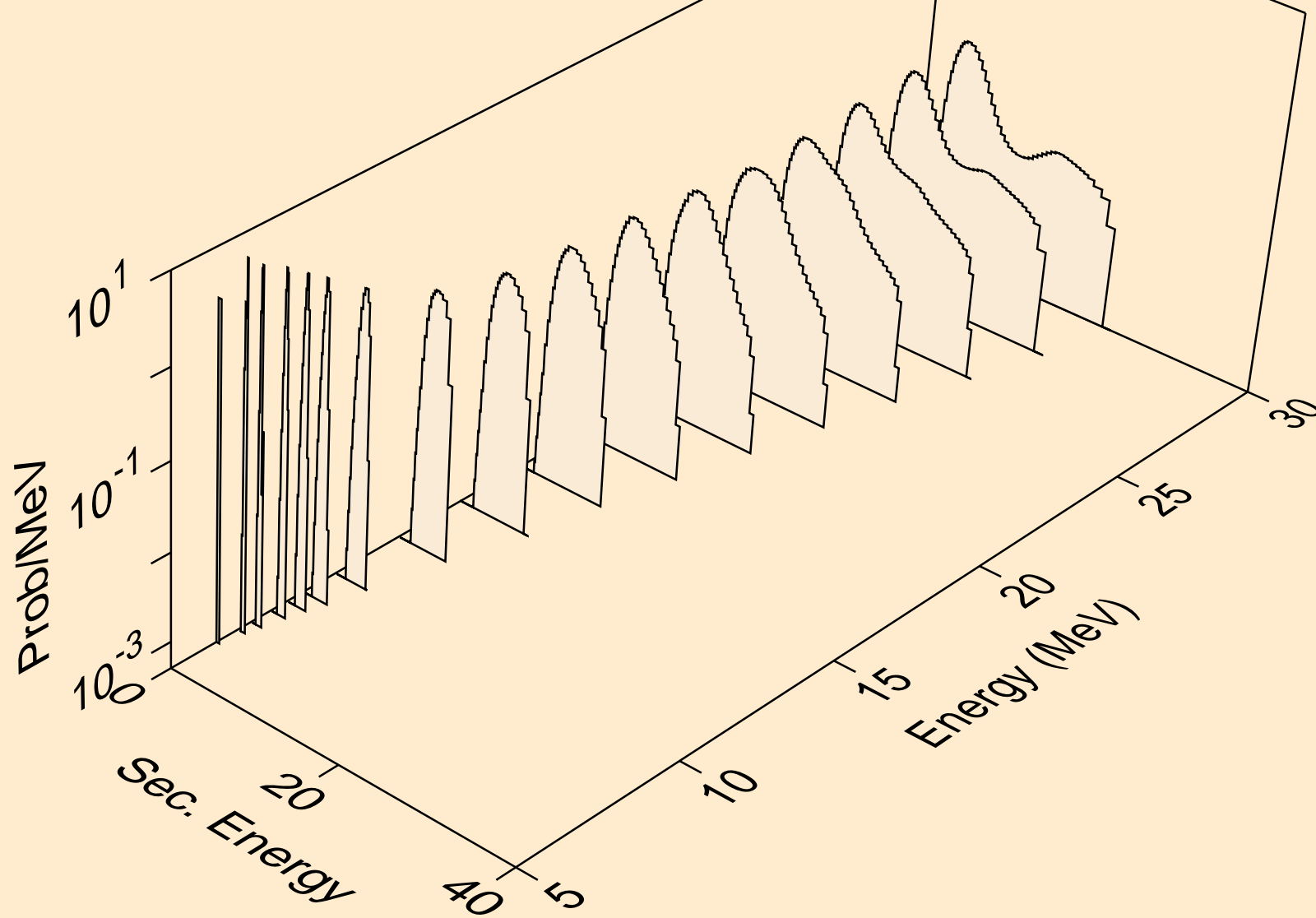

ZR085M NEUTRON ACER TENDL-2021 LIBRARY; T=293.6K
protons from (n,2np)

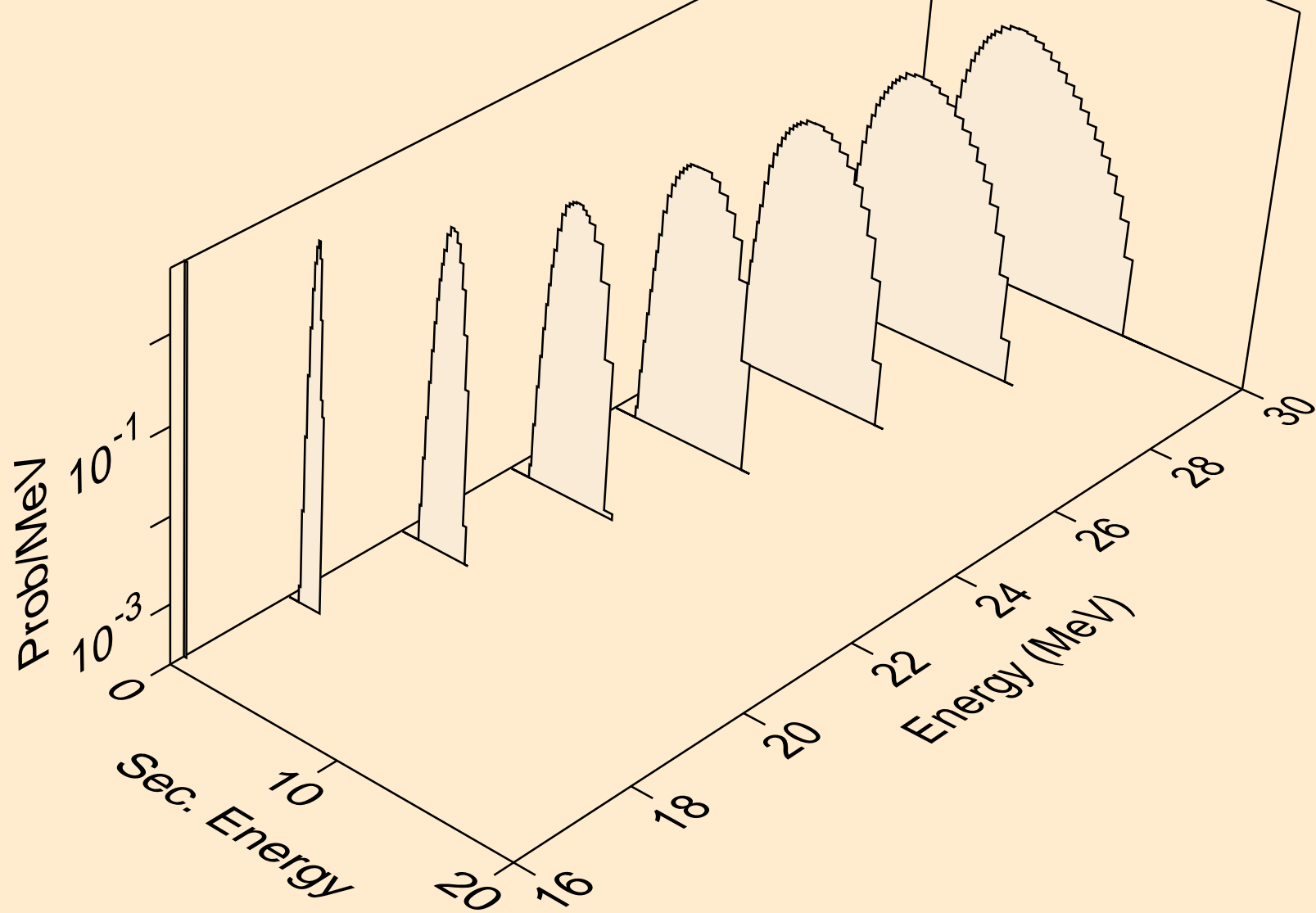

ZR085M NEUTRON ACER TENDL-2021 LIBRARY; T=293.6K
protons from (n,2np)

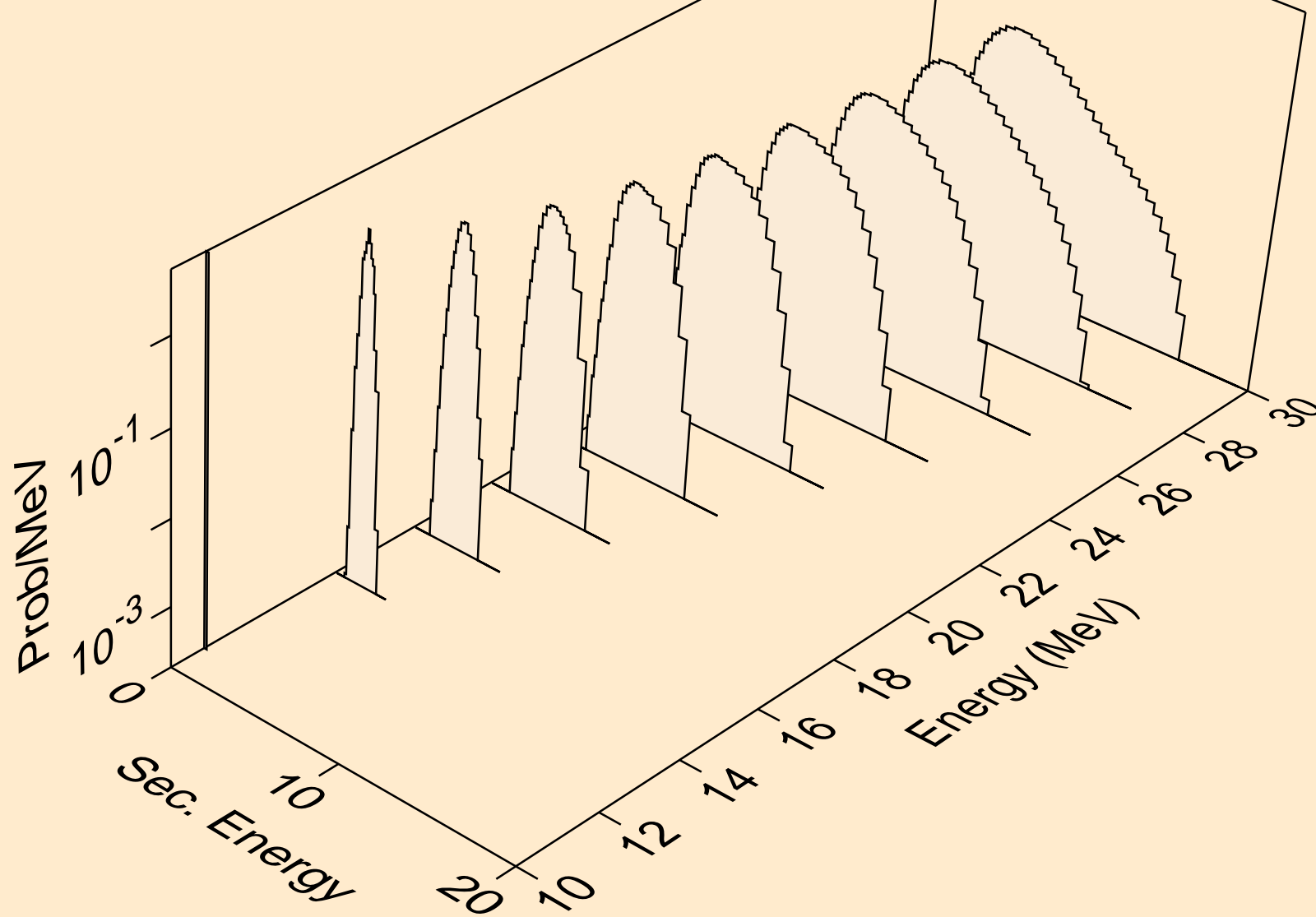

ZR085M NEUTRON ACER TENDL-2021 LIBRARY; T=293.6K
protons from (n,npa)

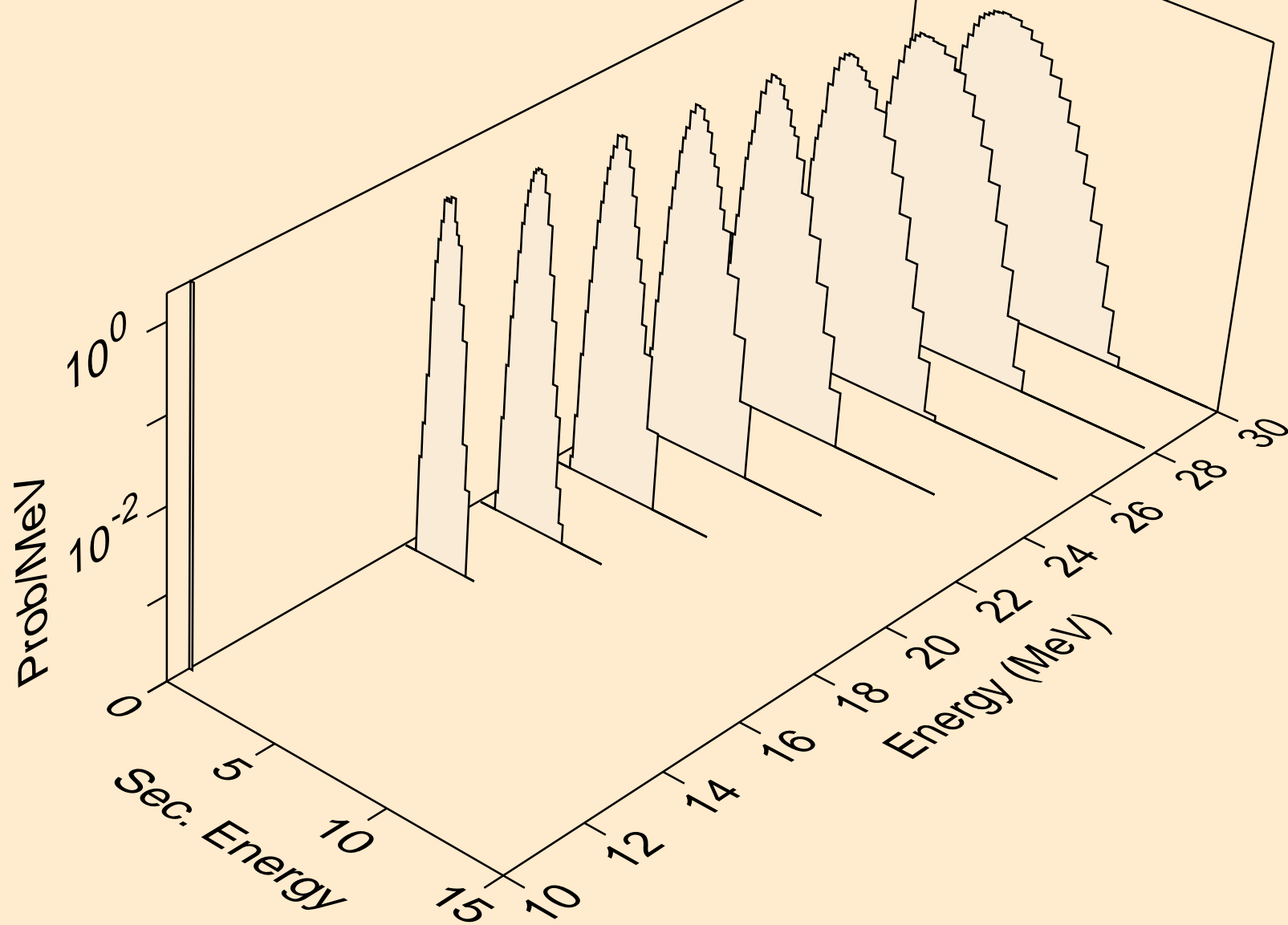

ZR085M NEUTRON ACER TENDL-2021 LIBRARY; T=293.6K
protons from (n,p)

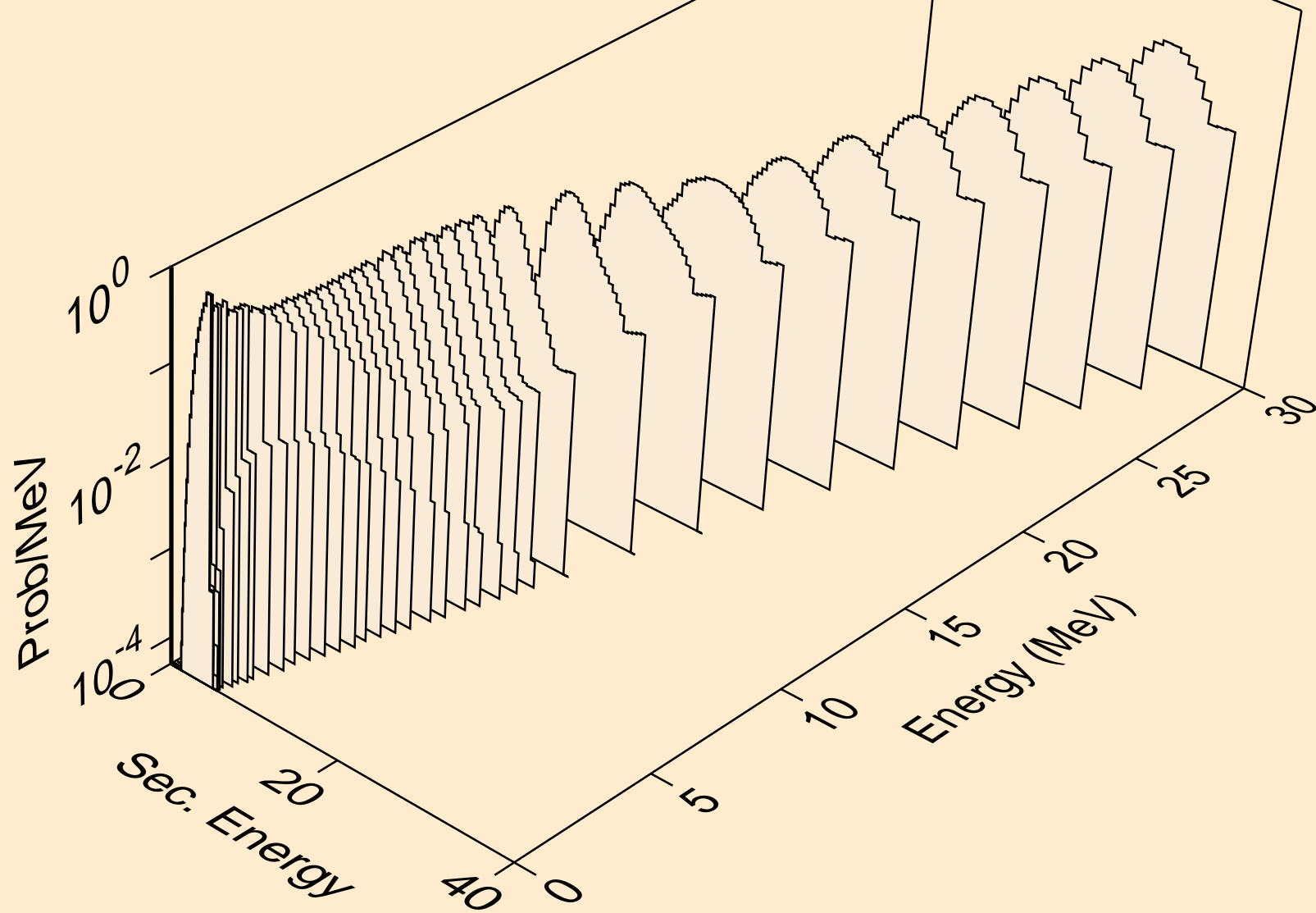

ZR085M NEUTRON ACER TENDL-2021 LIBRARY; T=293.6K
protons from (n,2p)

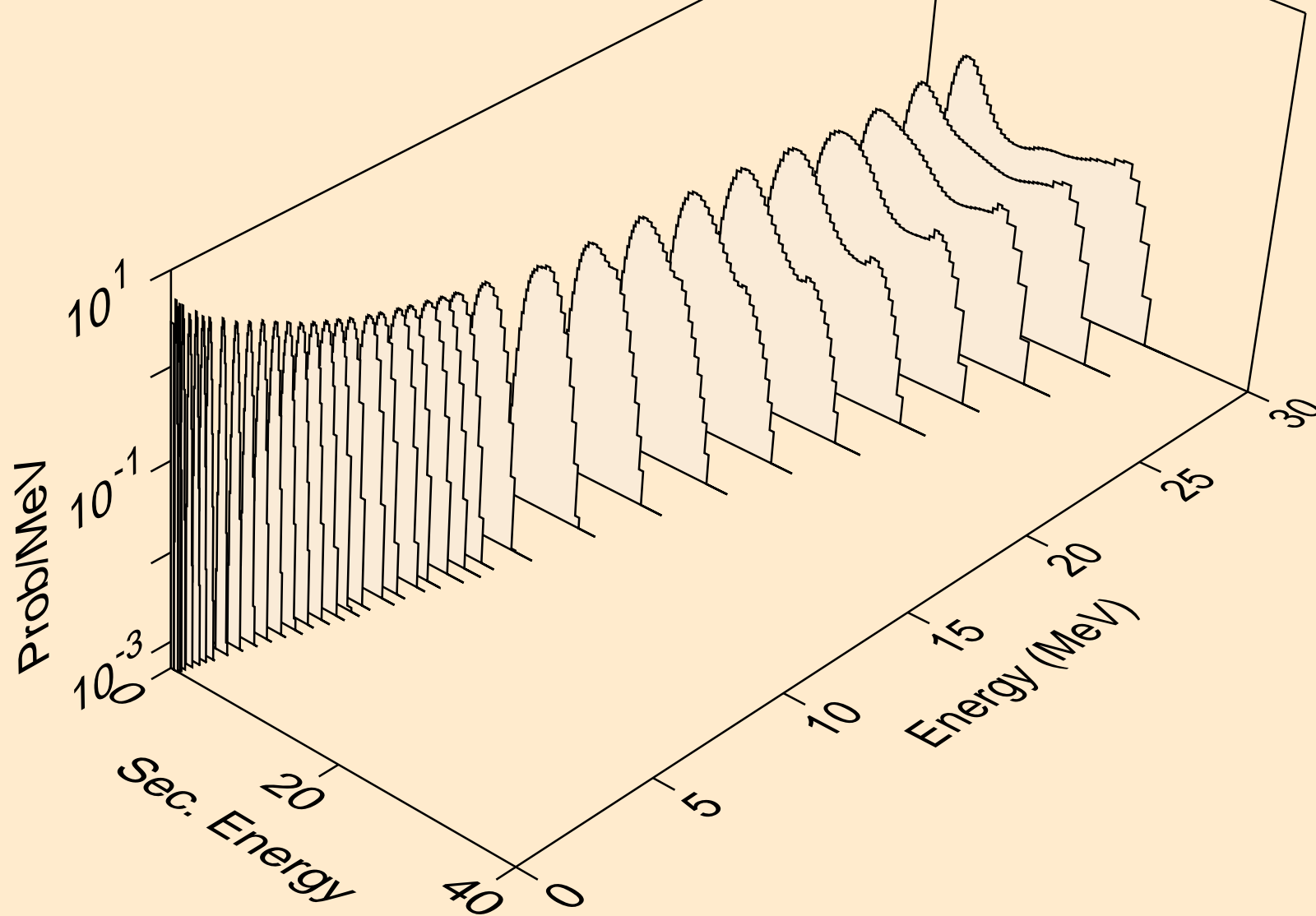

ZR085M NEUTRON ACER TENDL-2021 LIBRARY; T=293.6K
protons from (n,p)

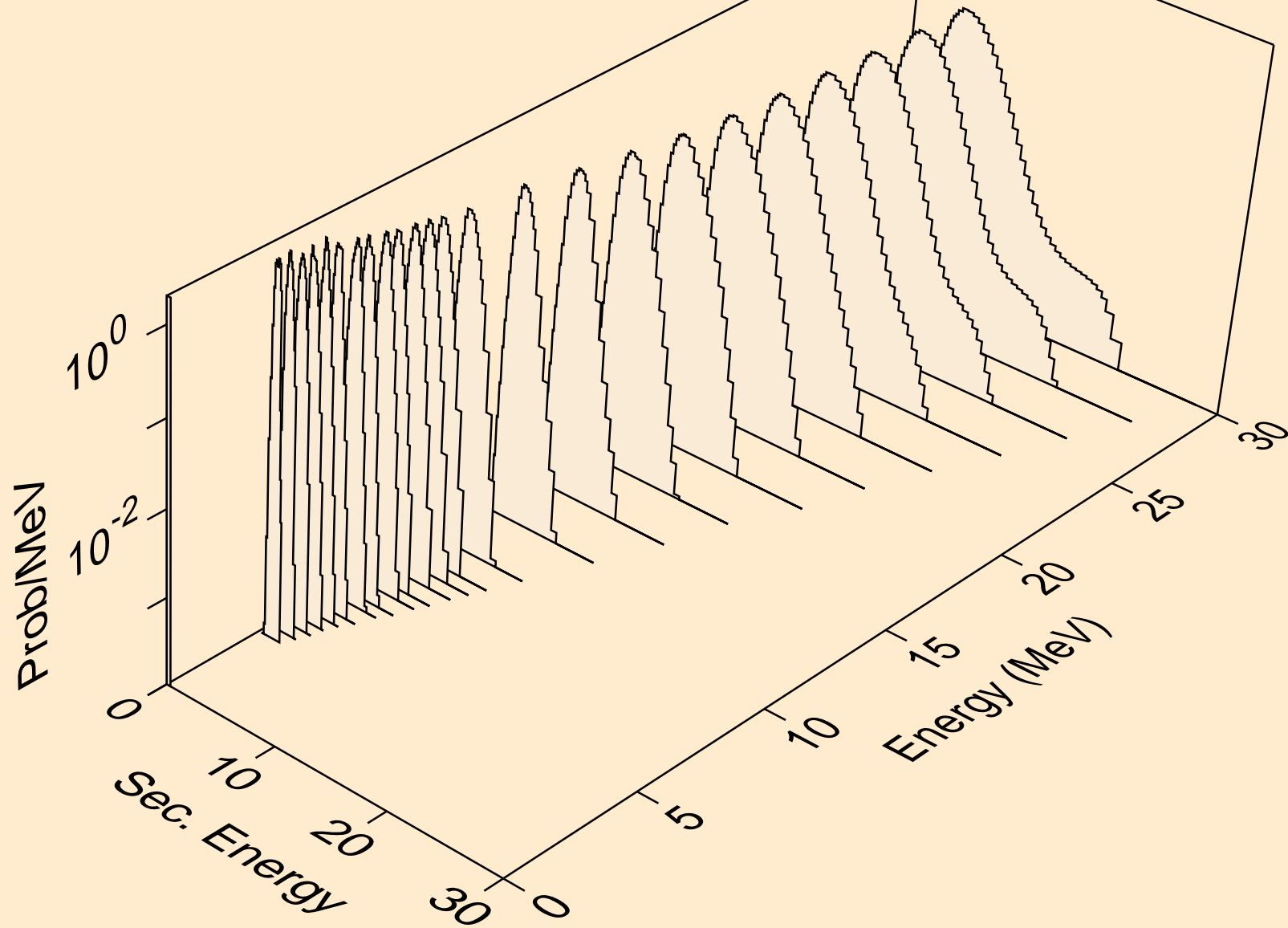

ZR085M NEUTRON ACER TENDL-2021 LIBRARY; T=293.6K
protons from (n,pd)

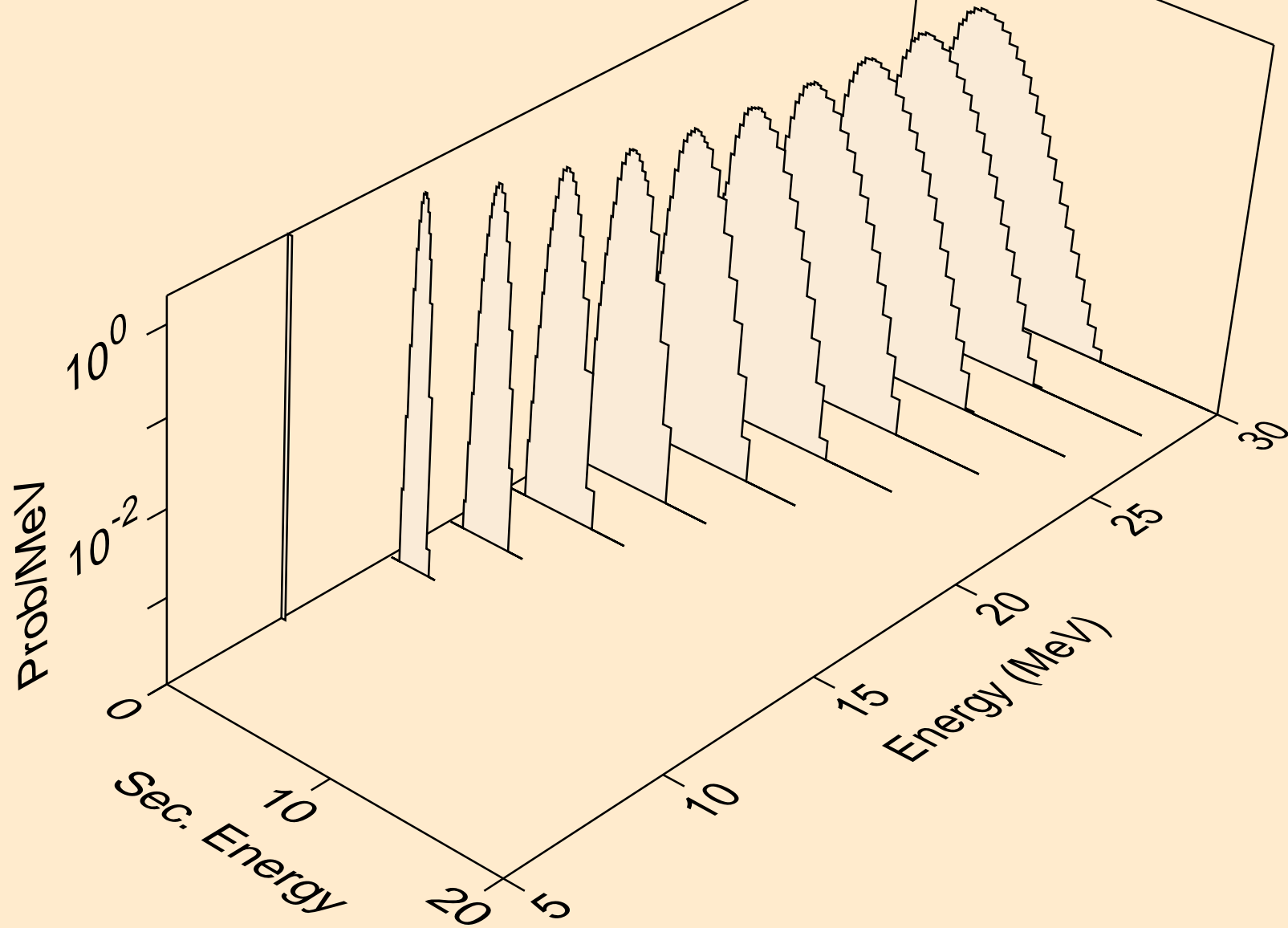

ZR085M NEUTRON ACER TENDL-2021 LIBRARY; T=293.6K
protons from (n,pt)

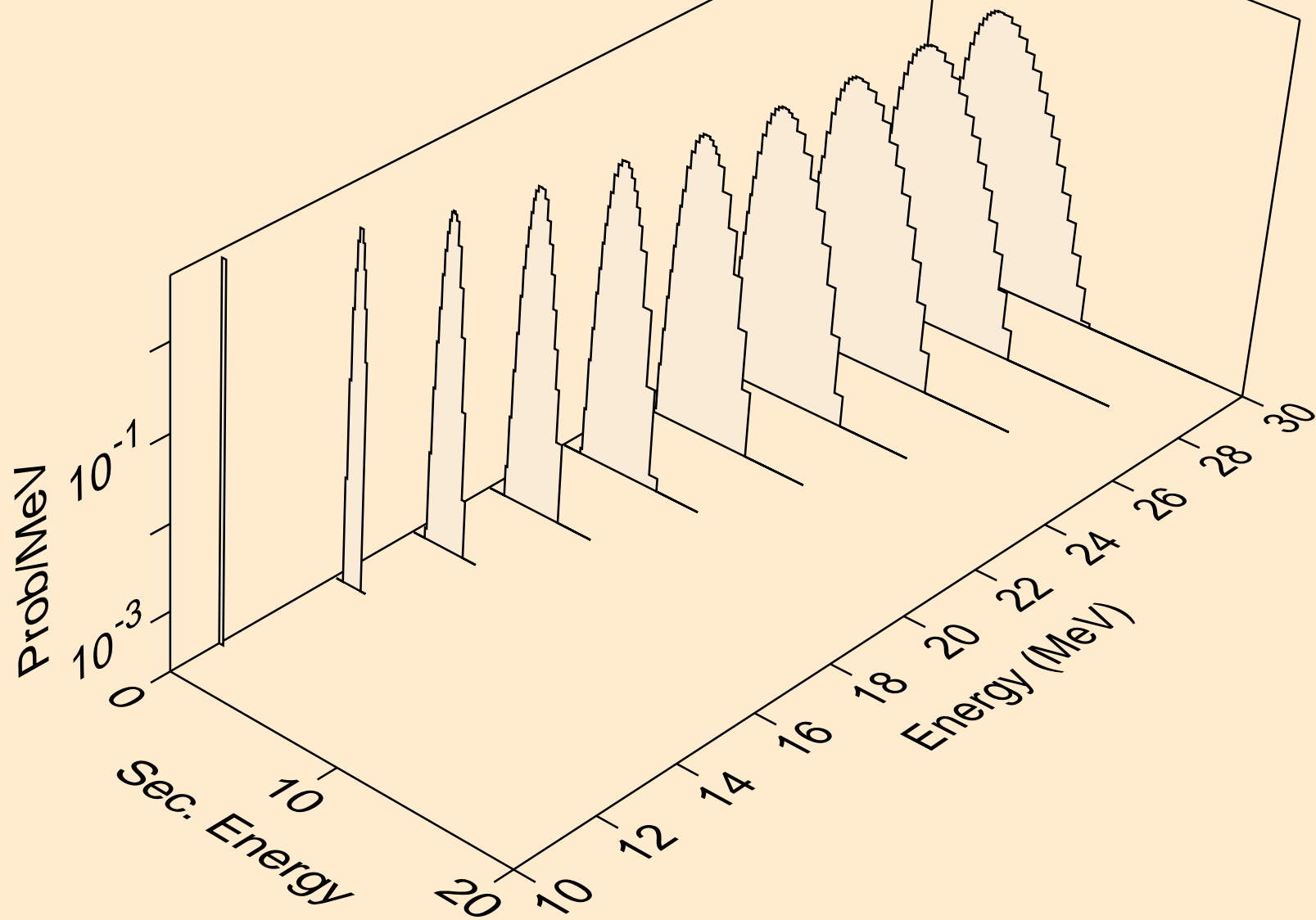

ZR085M NEUTRON ACER TENDL-2021 LIBRARY; T=293.6K
deuterons from (n,x)

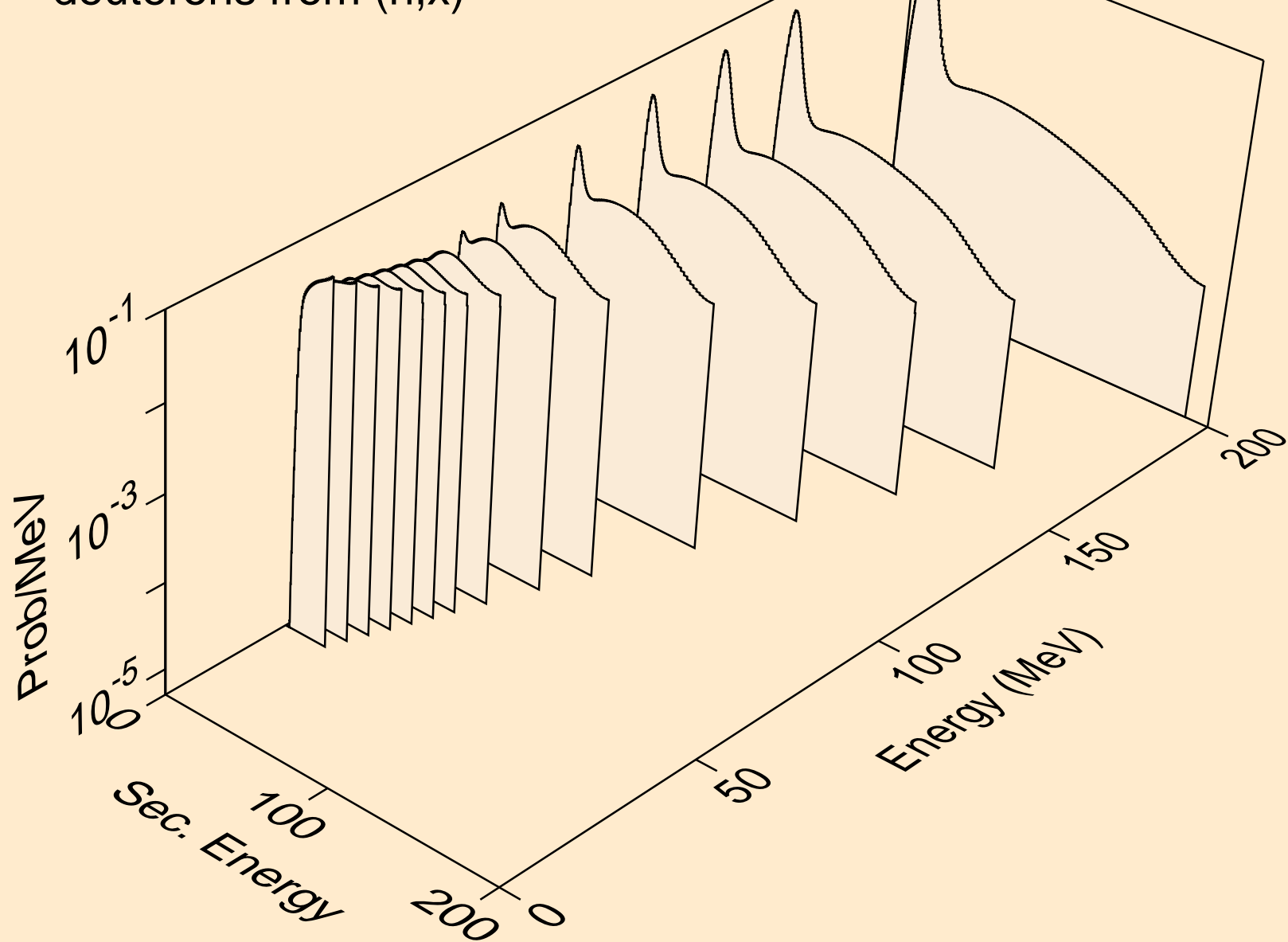

ZR085M NEUTRON ACER TENDL-2021 LIBRARY; T=293.6K
deuterons from (n,2nd)

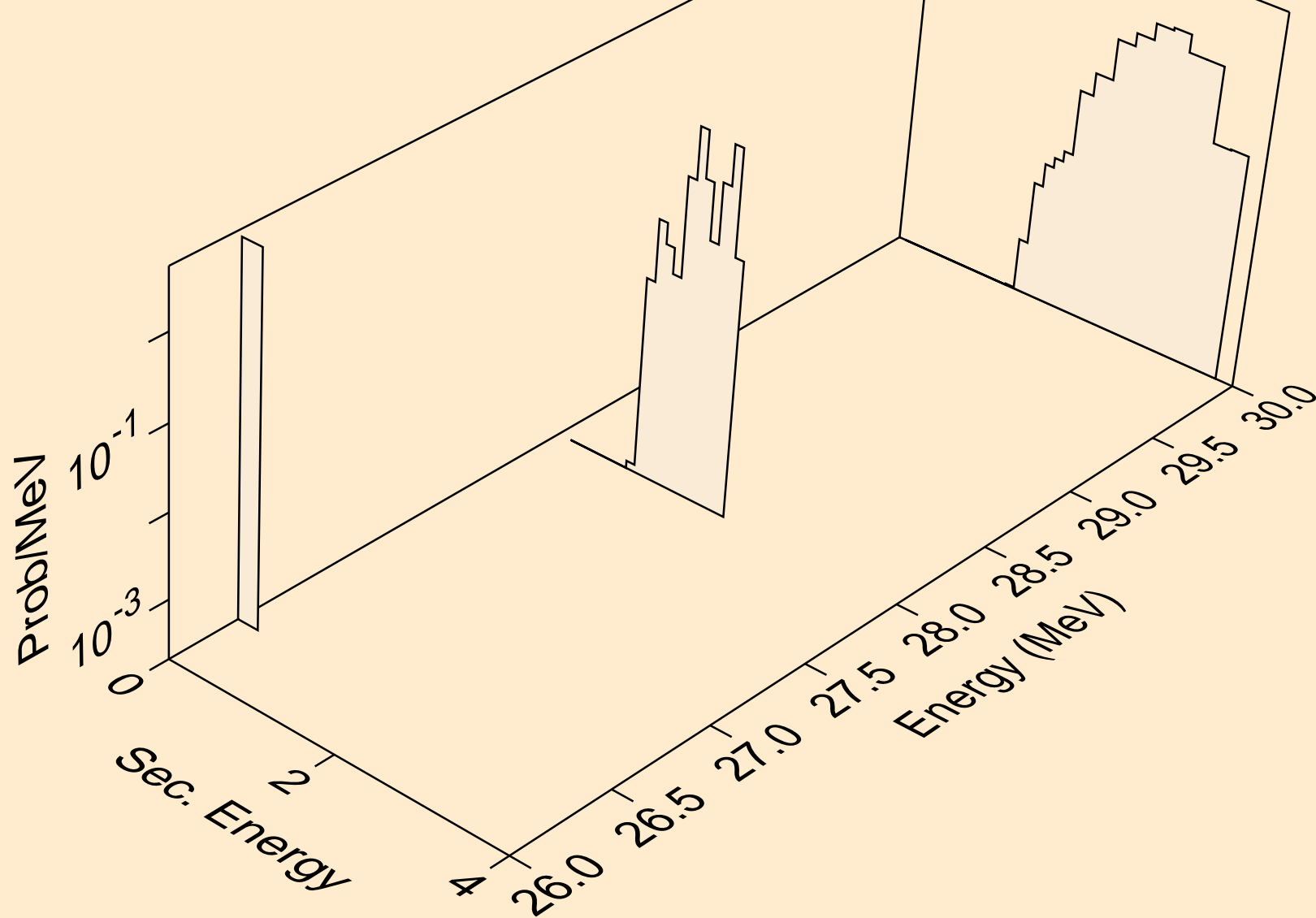

ZR085M NEUTRON ACER TENDL-2021 LIBRARY; T=293.6K
deuterons from (n,n*)d

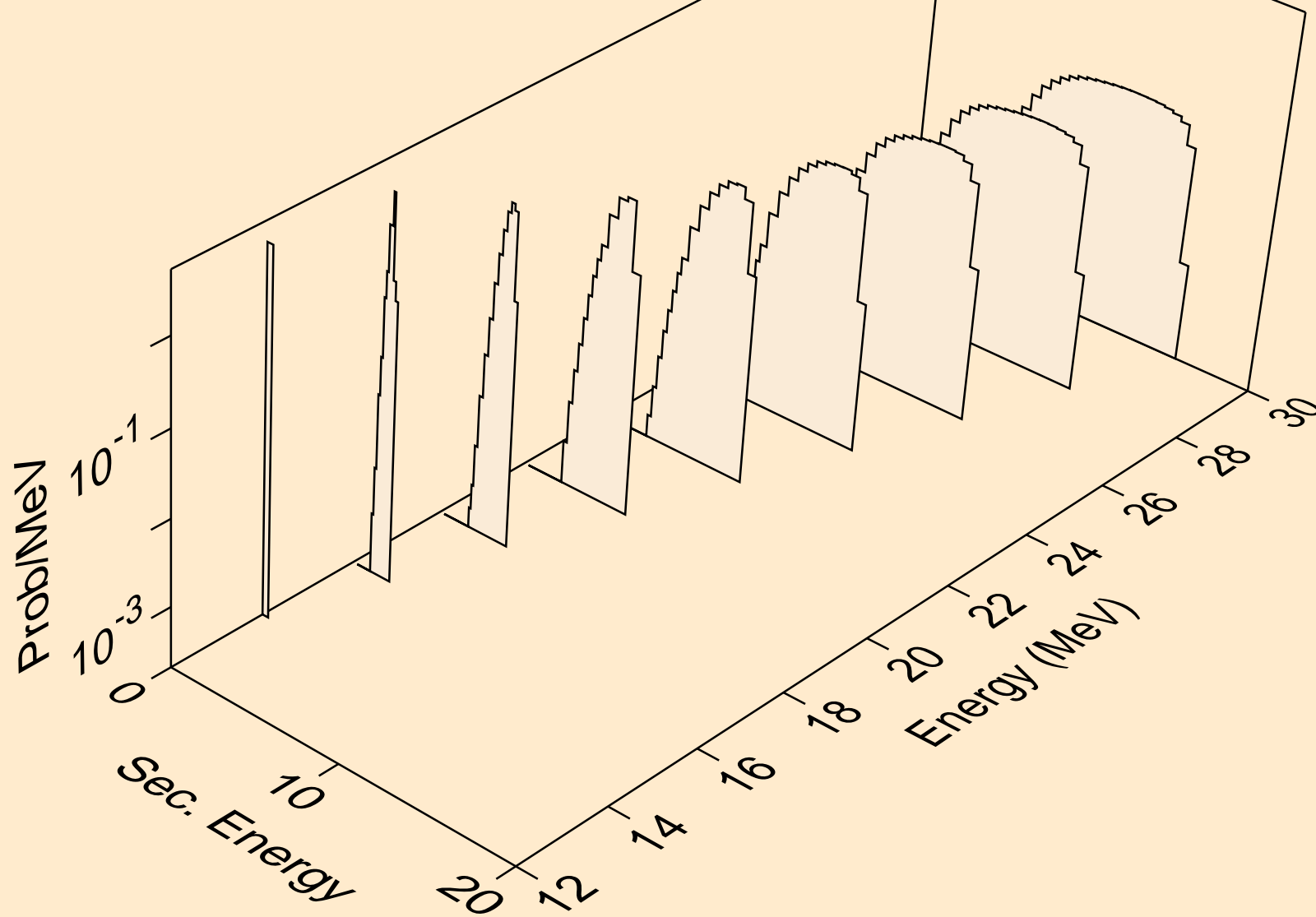

ZR085M NEUTRON ACER TENDL-2021 LIBRARY; T=293.6K
deuterons from (n,d)

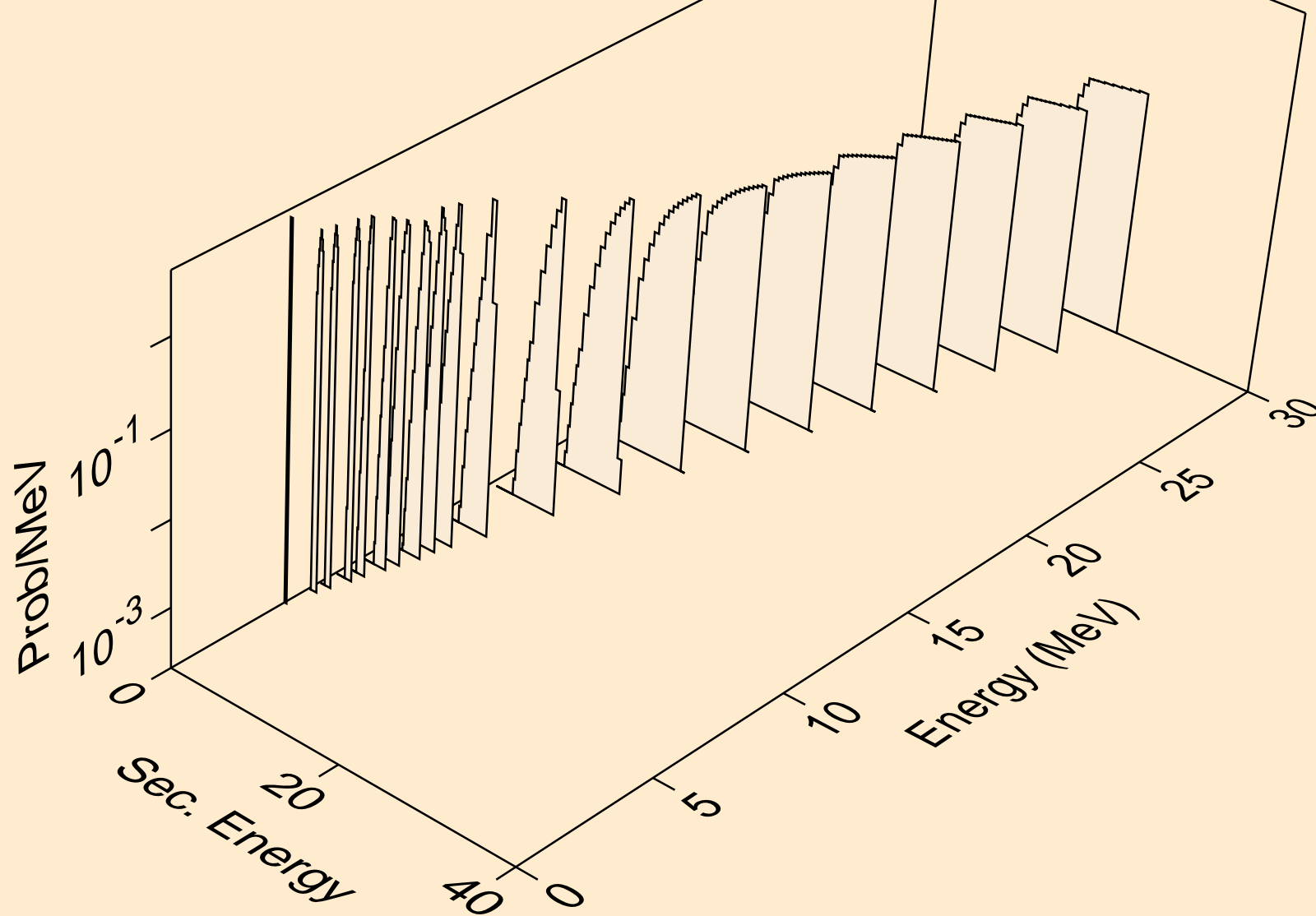

ZR085M NEUTRON ACER TENDL-2021 LIBRARY; T=293.6K
deuterons from (n,pd)

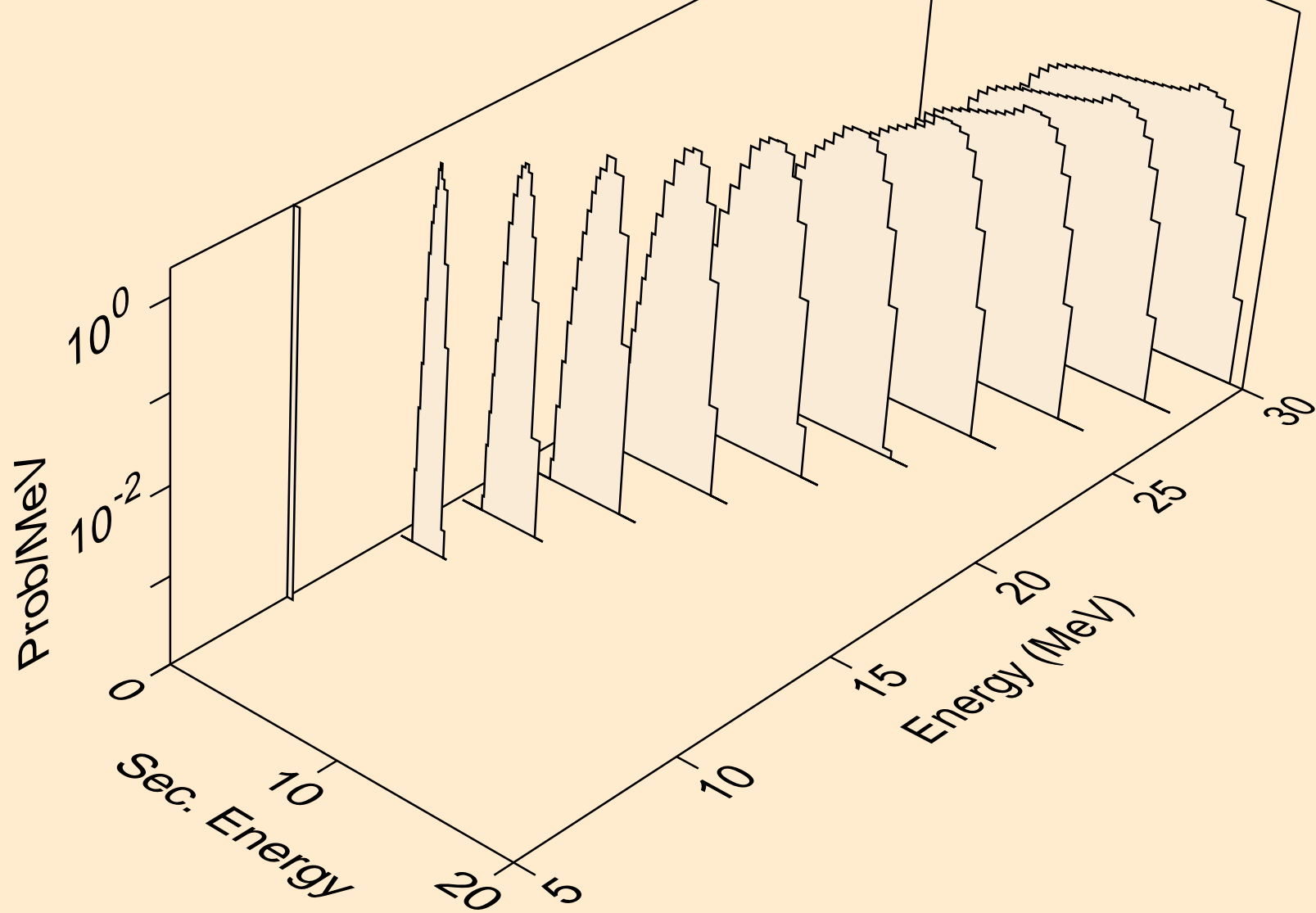

ZR085M NEUTRON ACER TENDL-2021 LIBRARY; T=293.6K
deuterons from (n,da)

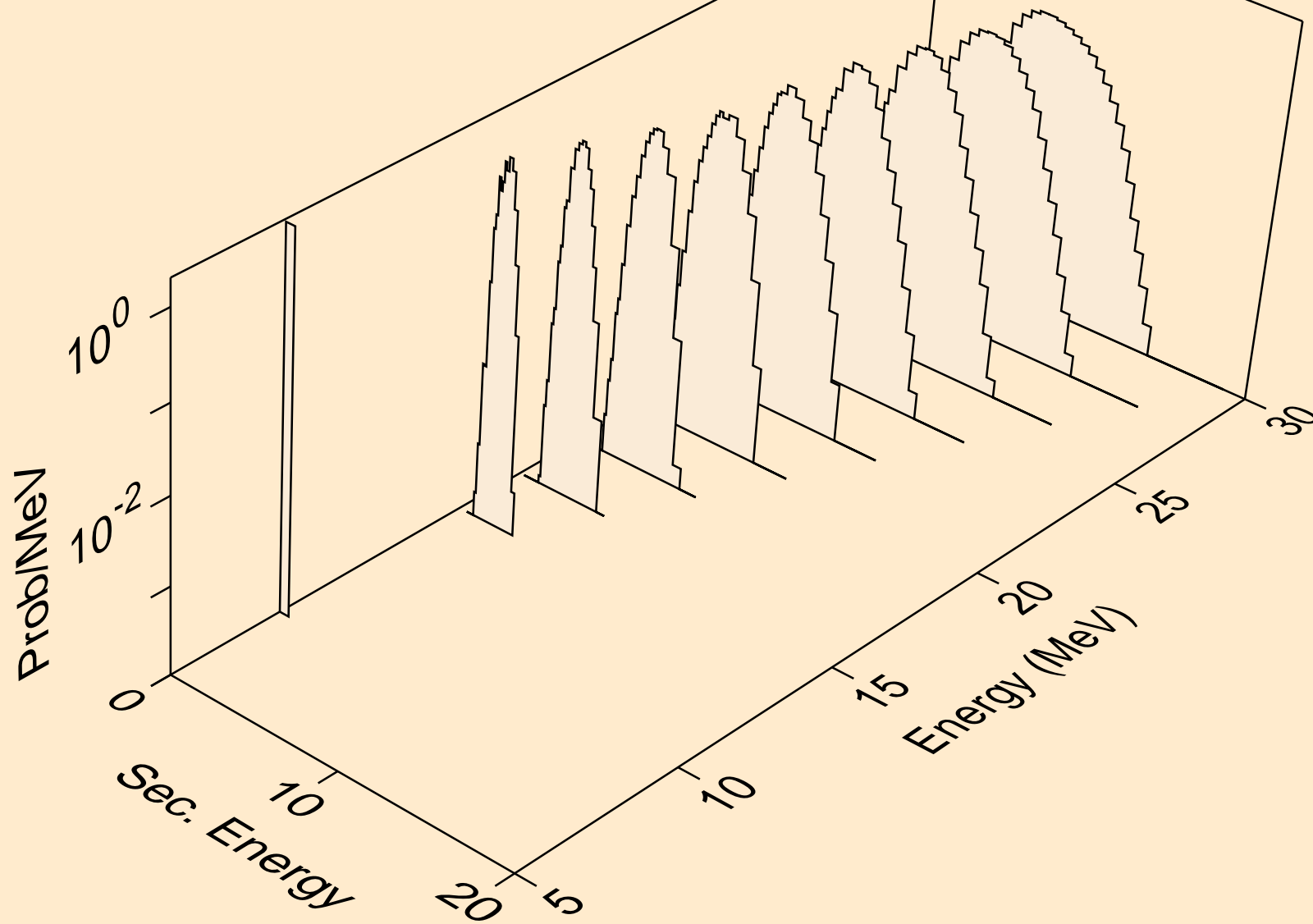

ZR085M NEUTRON ACER TENDL-2021 LIBRARY; T=293.6K
tritons from (n,x)

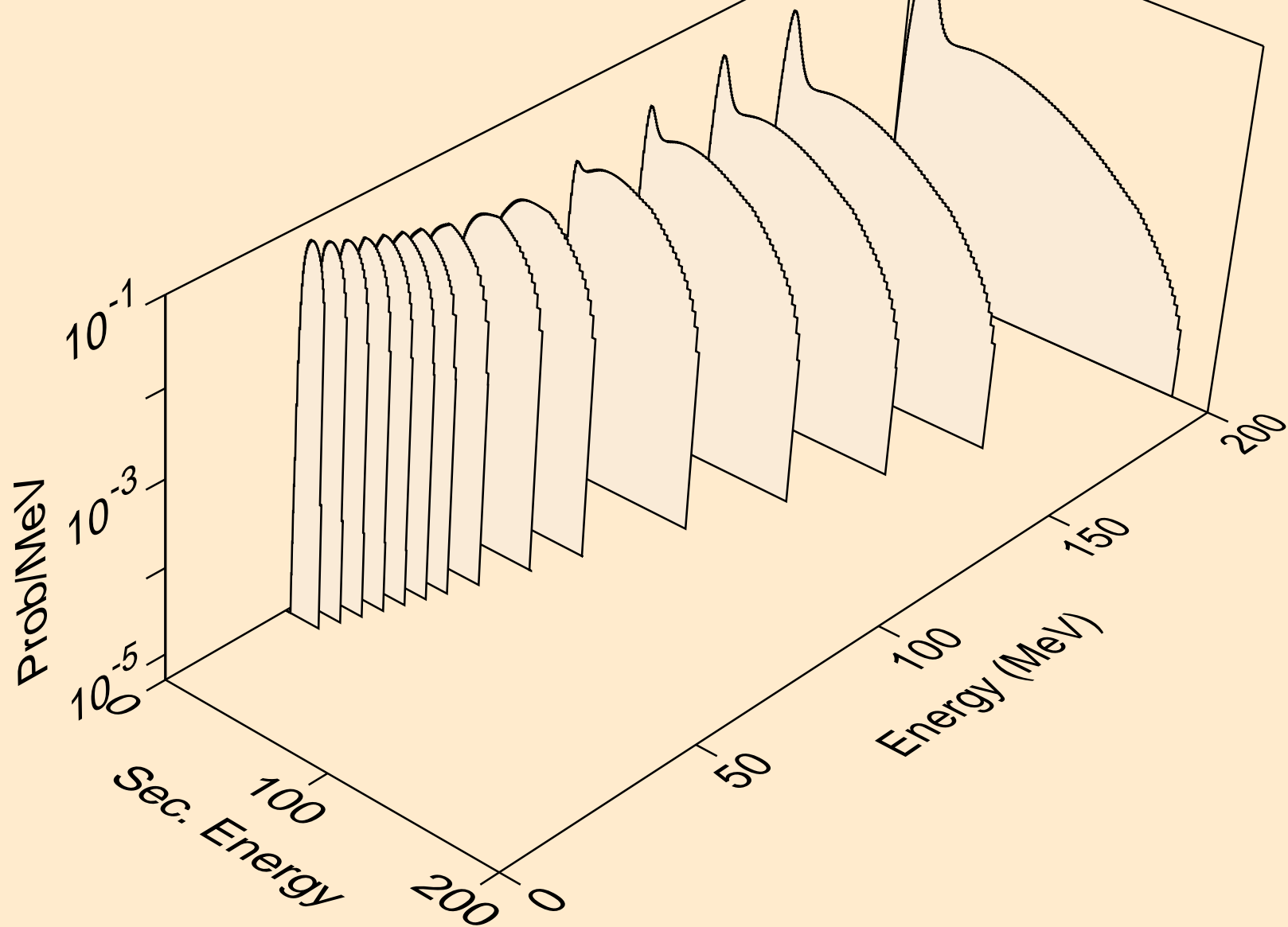

ZR085M NEUTRON ACER TENDL-2021 LIBRARY; T=293.6K
tritons from (n,n*)t

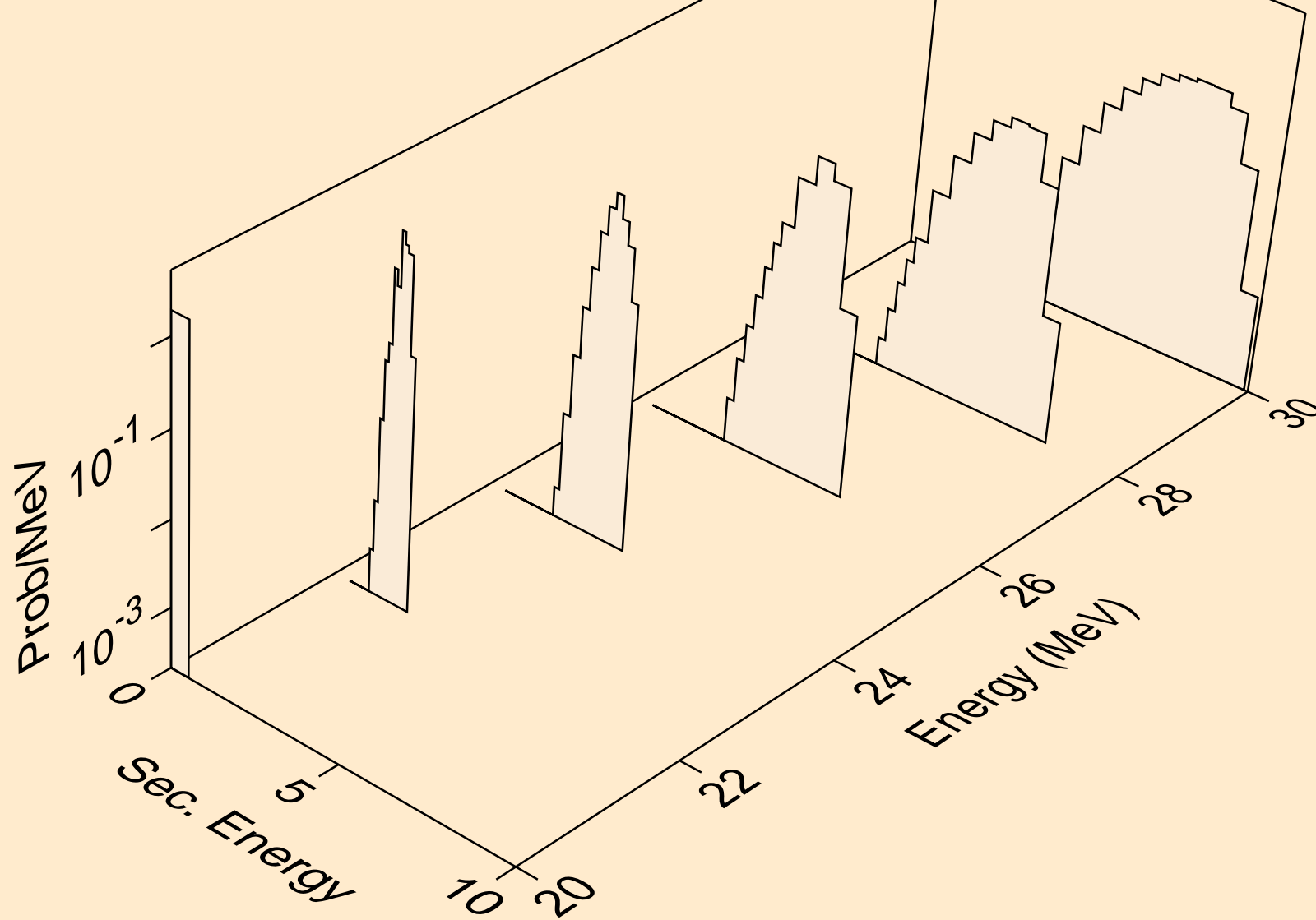

ZR085M NEUTRON ACER TENDL-2021 LIBRARY; T=293.6K
tritons from (n,t)

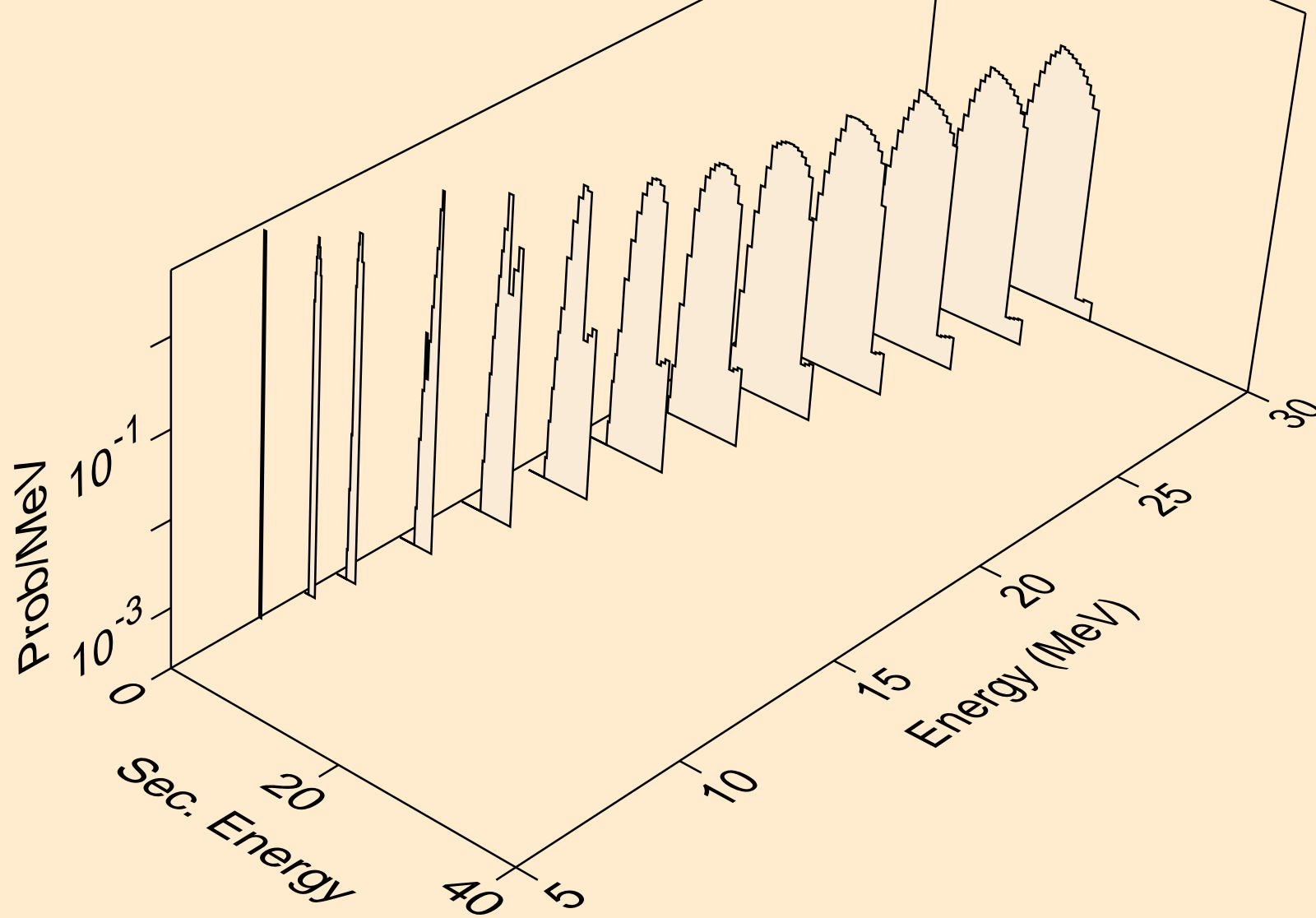

ZR085M NEUTRON ACER TENDL-2021 LIBRARY; T=293.6K
tritons from (n,pt)

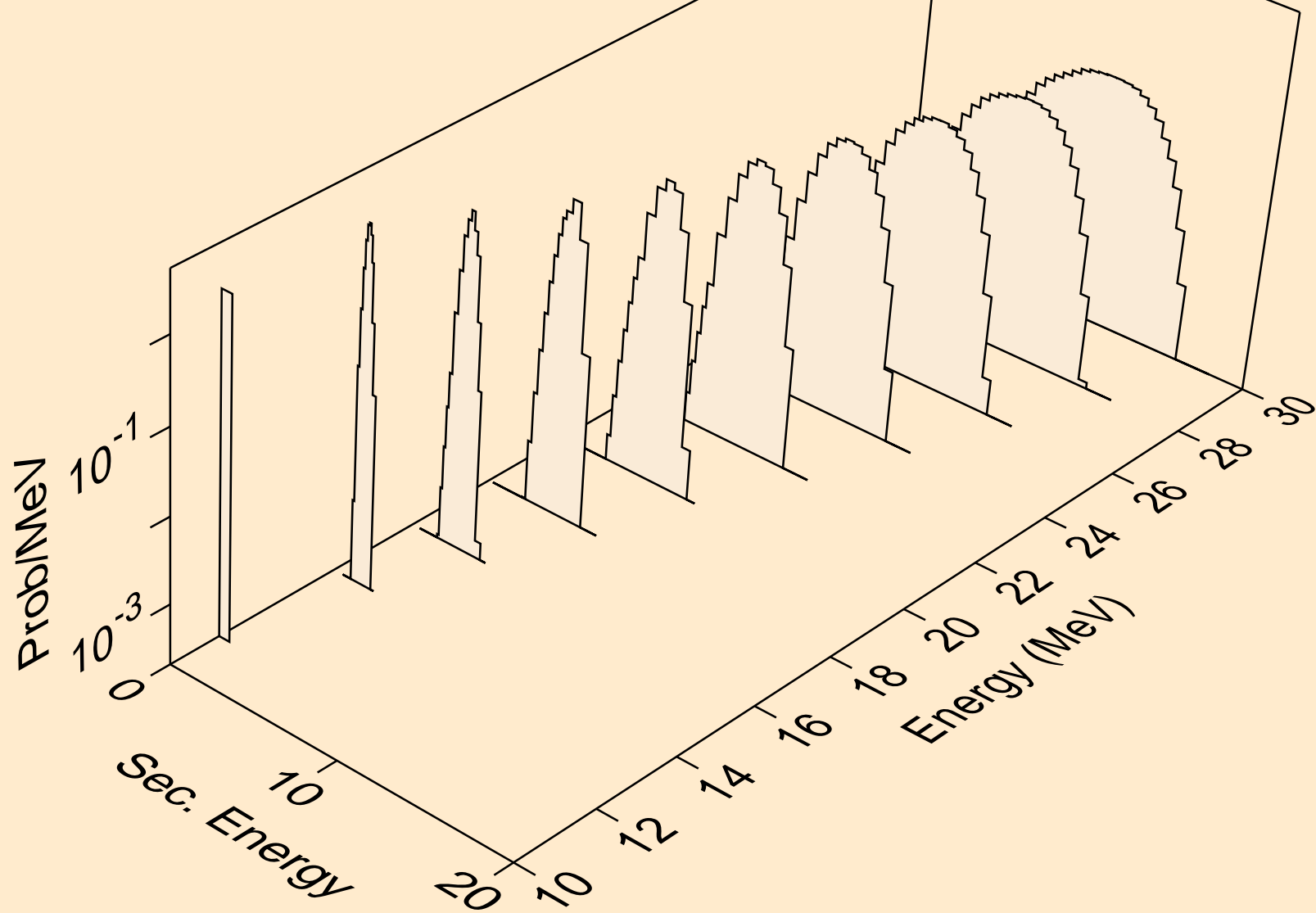

ZR085M NEUTRON ACER TENDL-2021 LIBRARY; T=293.6K
he3s from (n,x)

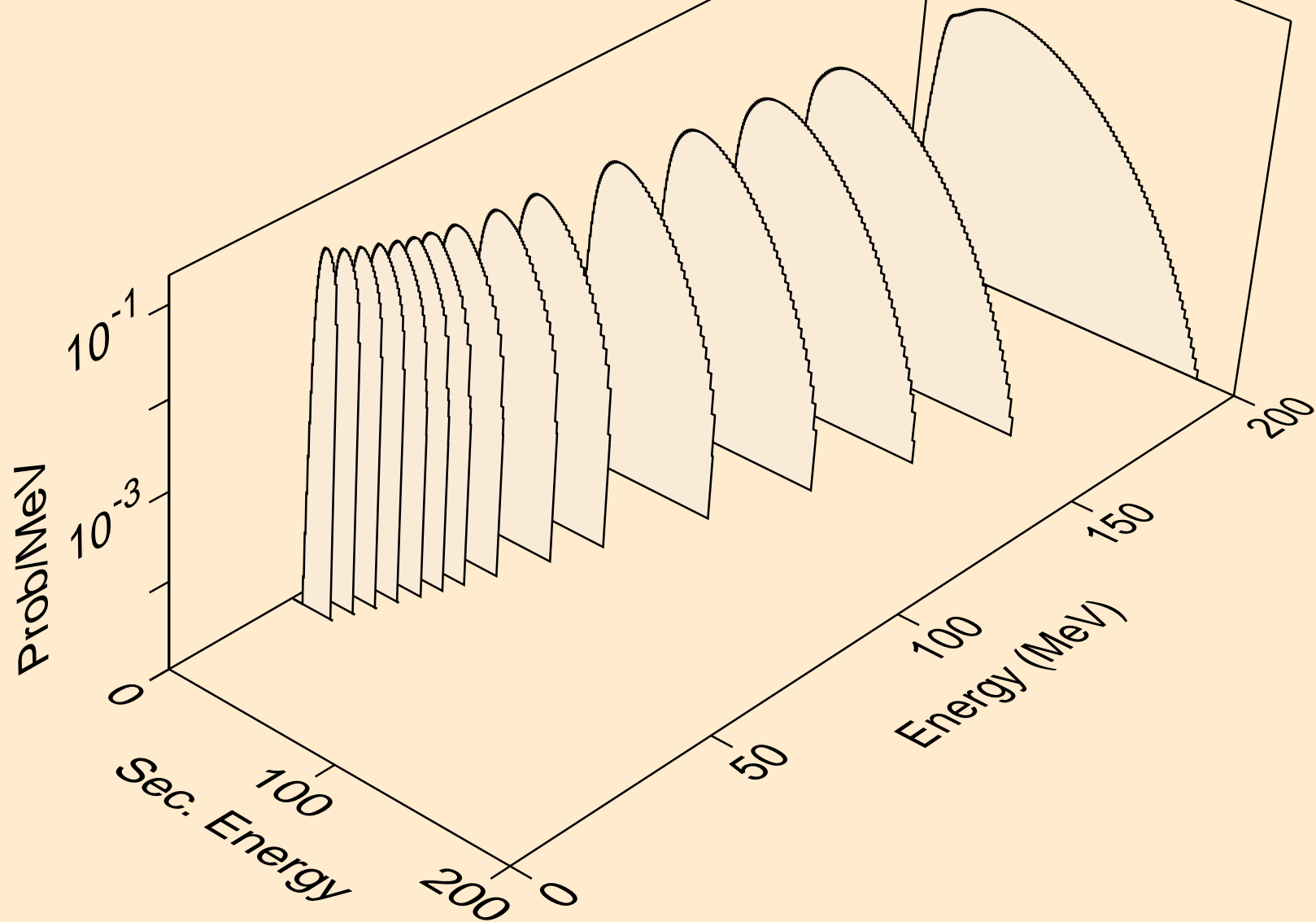

ZR085M NEUTRON ACER TENDL-2021 LIBRARY; T=293.6K
he3s from (n,n*)he3

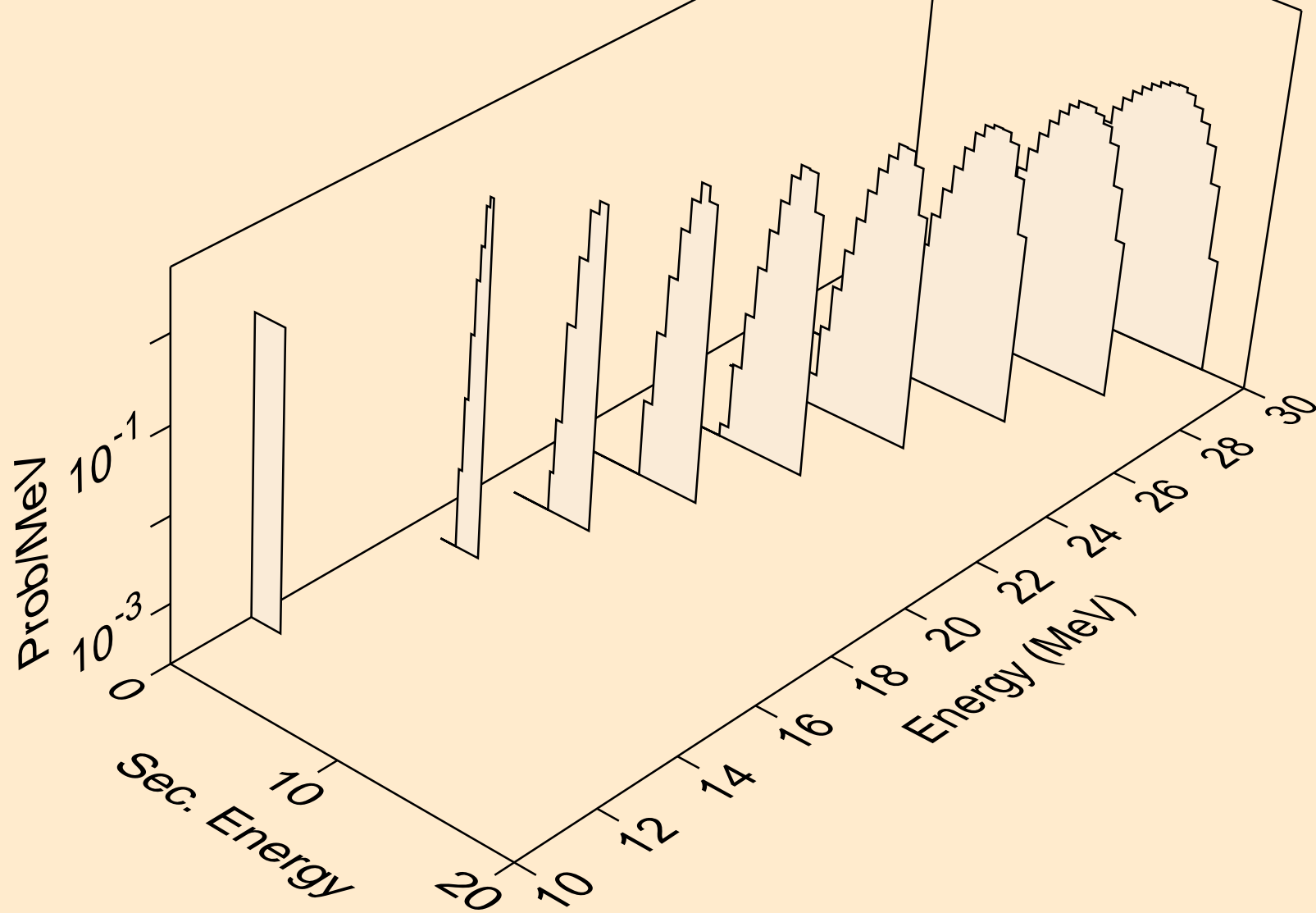

ZR085M NEUTRON ACER TENDL-2021 LIBRARY; T=293.6K
he3s from (n,he3)

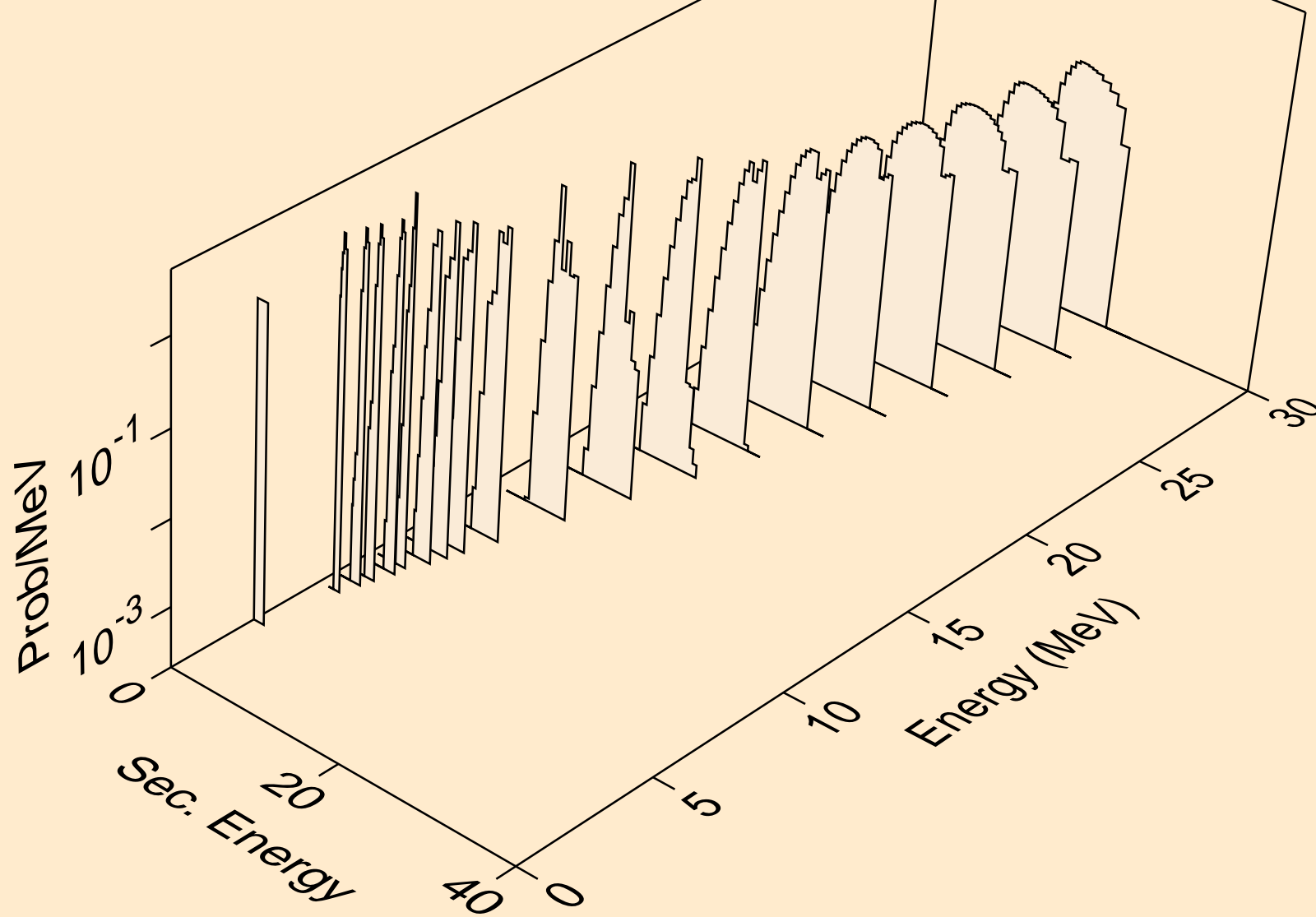

ZR085M NEUTRON ACER TENDL-2021 LIBRARY; T=293.6K
alphas from (n,x)

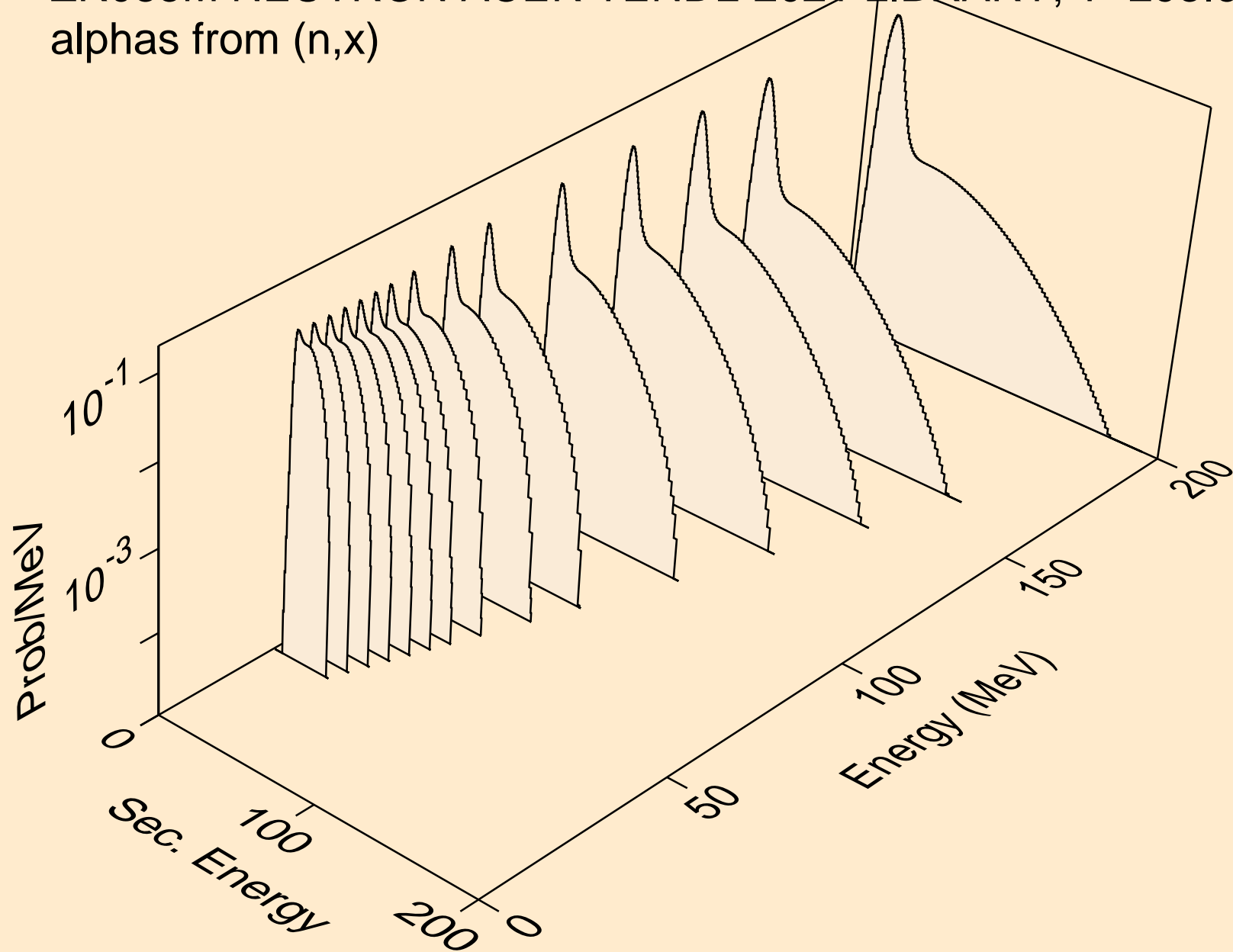

ZR085M NEUTRON ACER TENDL-2021 LIBRARY; T=293.6K
alphas from (n,n*)a

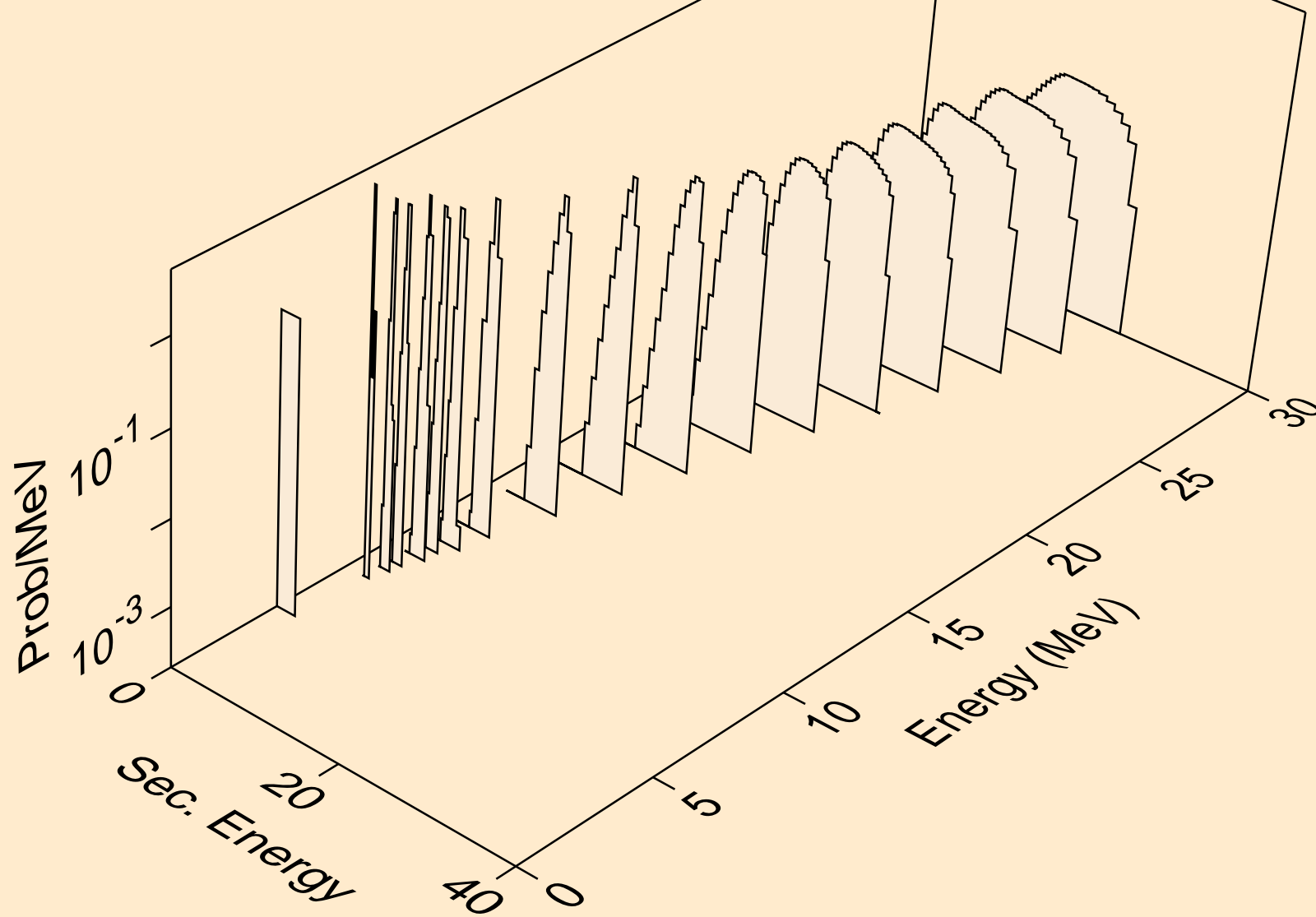

ZR085M NEUTRON ACER TENDL-2021 LIBRARY; T=293.6K
alphas from (n,2n)a

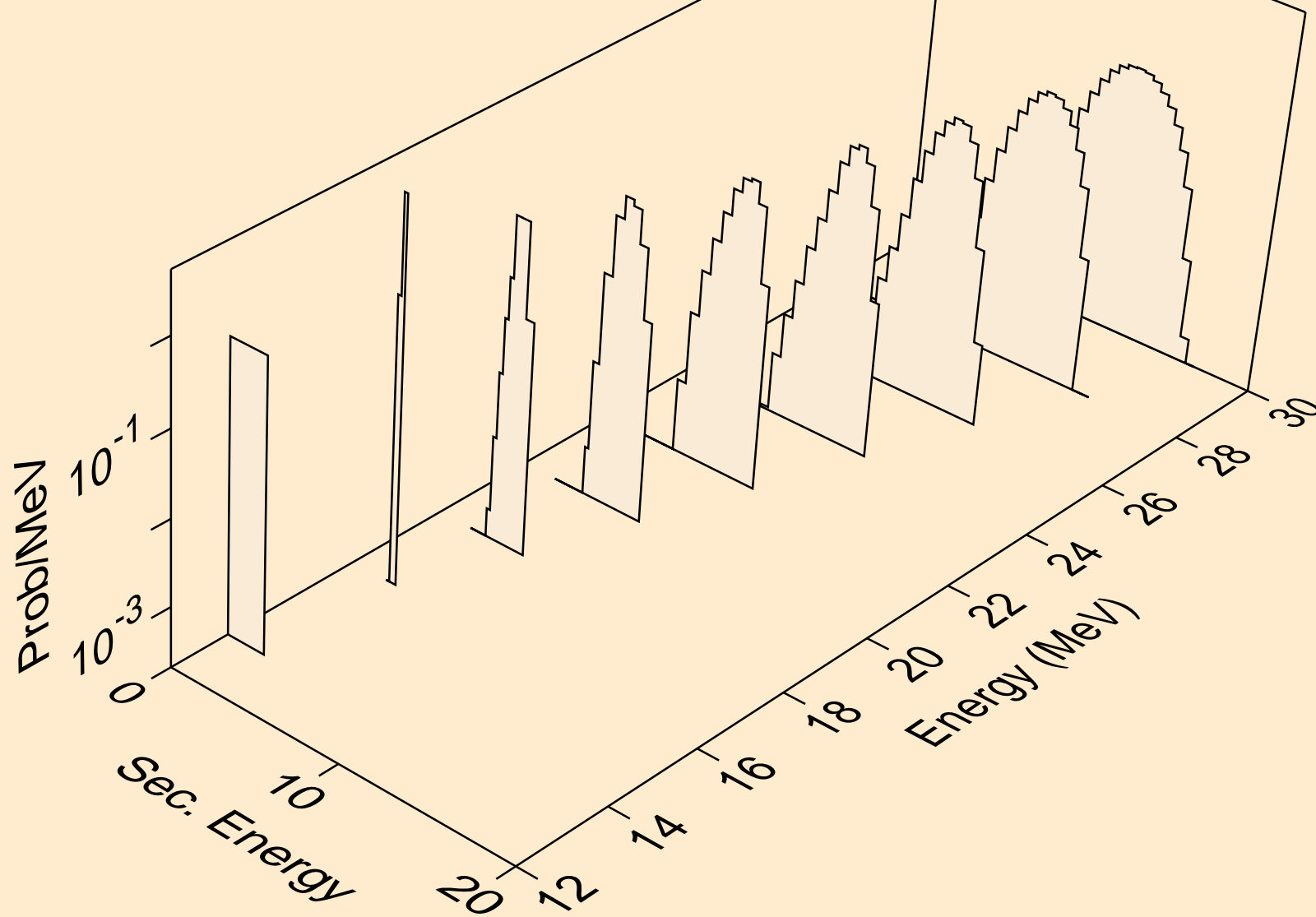

ZR085M NEUTRON ACER TENDL-2021 LIBRARY; T=293.6K
alphas from (n,n*)2a

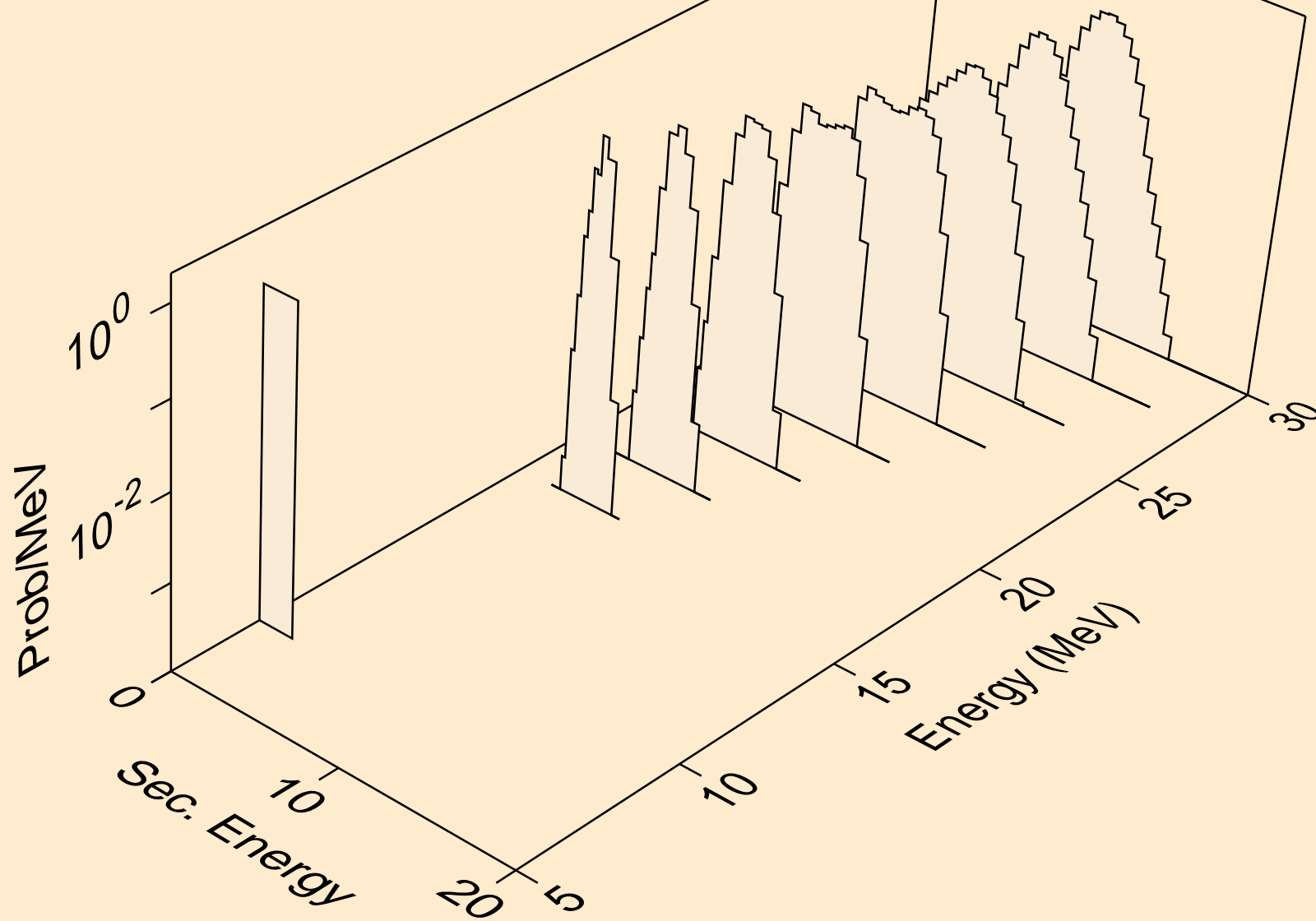

ZR085M NEUTRON ACER TENDL-2021 LIBRARY; T=293.6K
alphas from (n,npa)

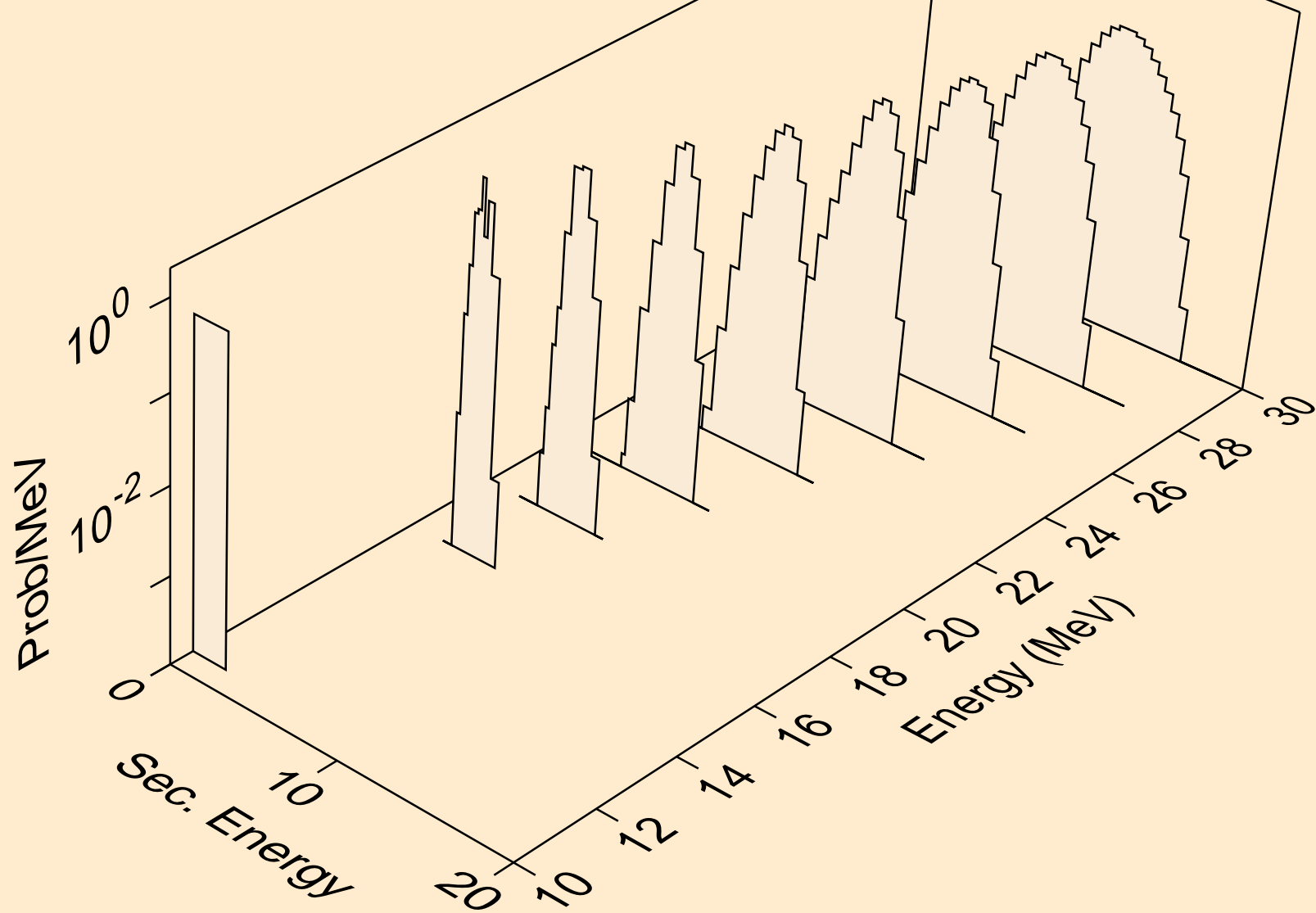

ZR085M NEUTRON ACER TENDL-2021 LIBRARY; T=293.6K
alphas from (n,a)

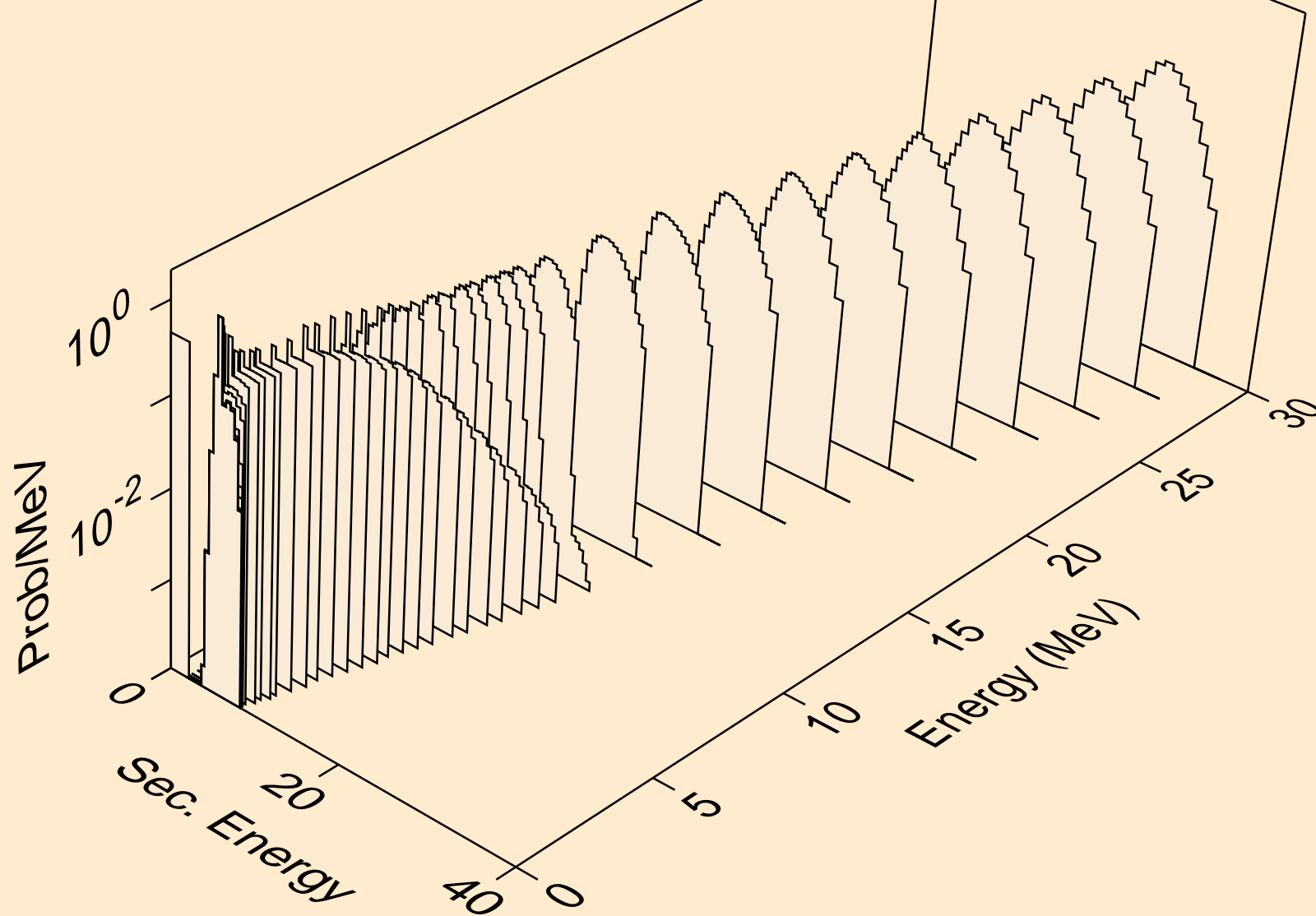

ZR085M NEUTRON ACER TENDL-2021 LIBRARY; T=293.6K
alphas from (n,2a)

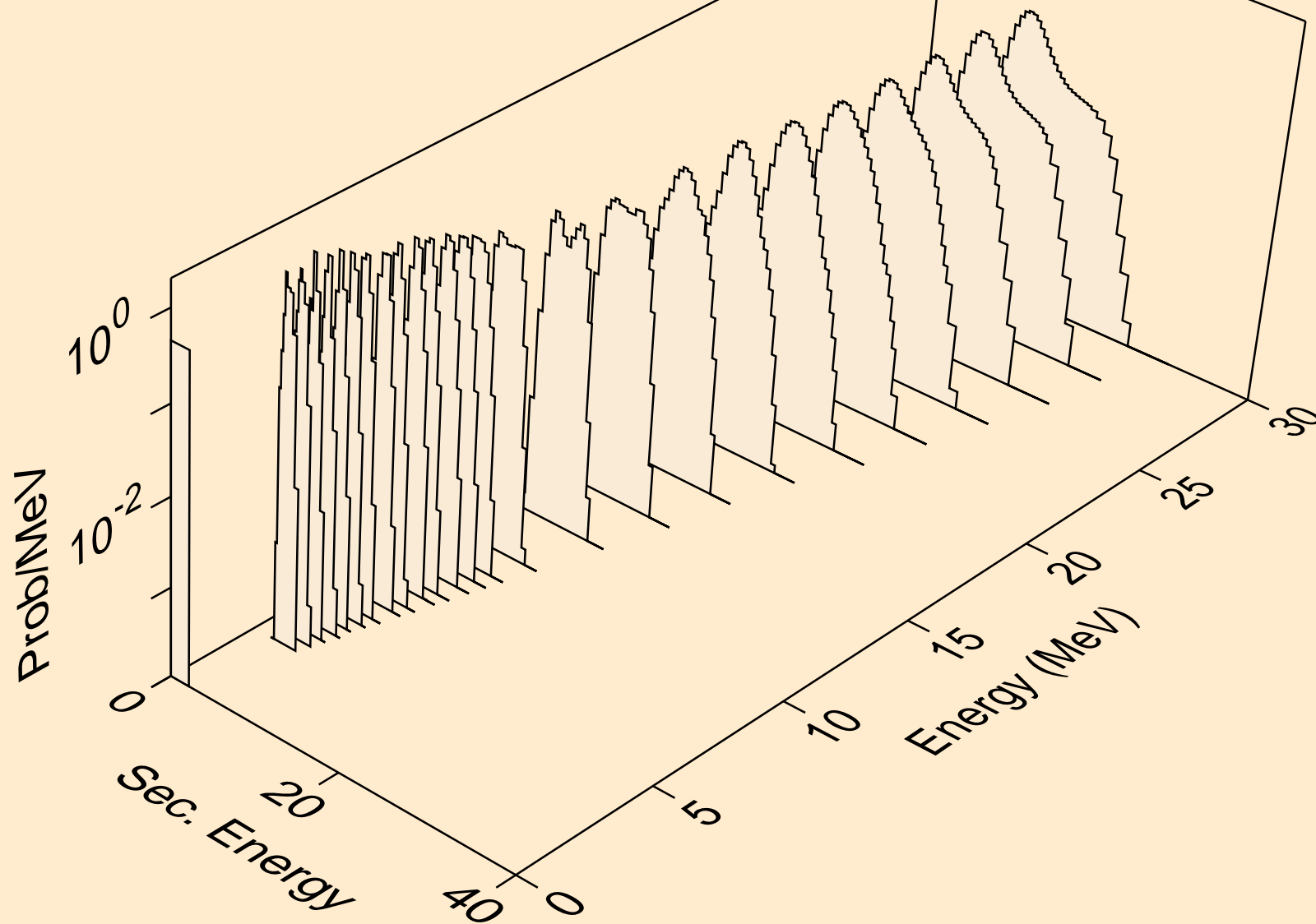

ZR085M NEUTRON ACER TENDL-2021 LIBRARY; T=293.6K
alphas from (n,3a)

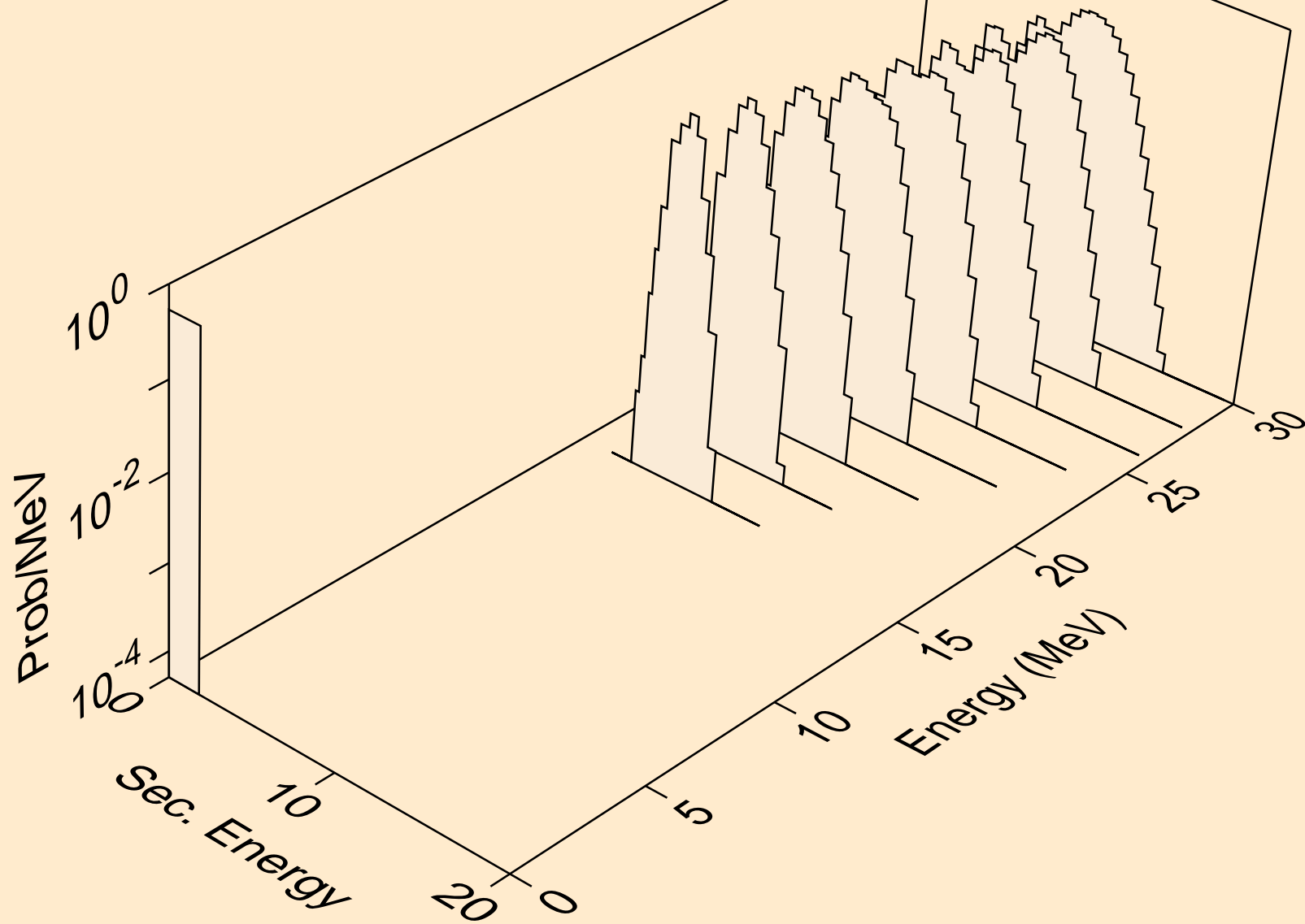

ZR085M NEUTRON ACER TENDL-2021 LIBRARY; T=293.6K
alphas from (n,pa)

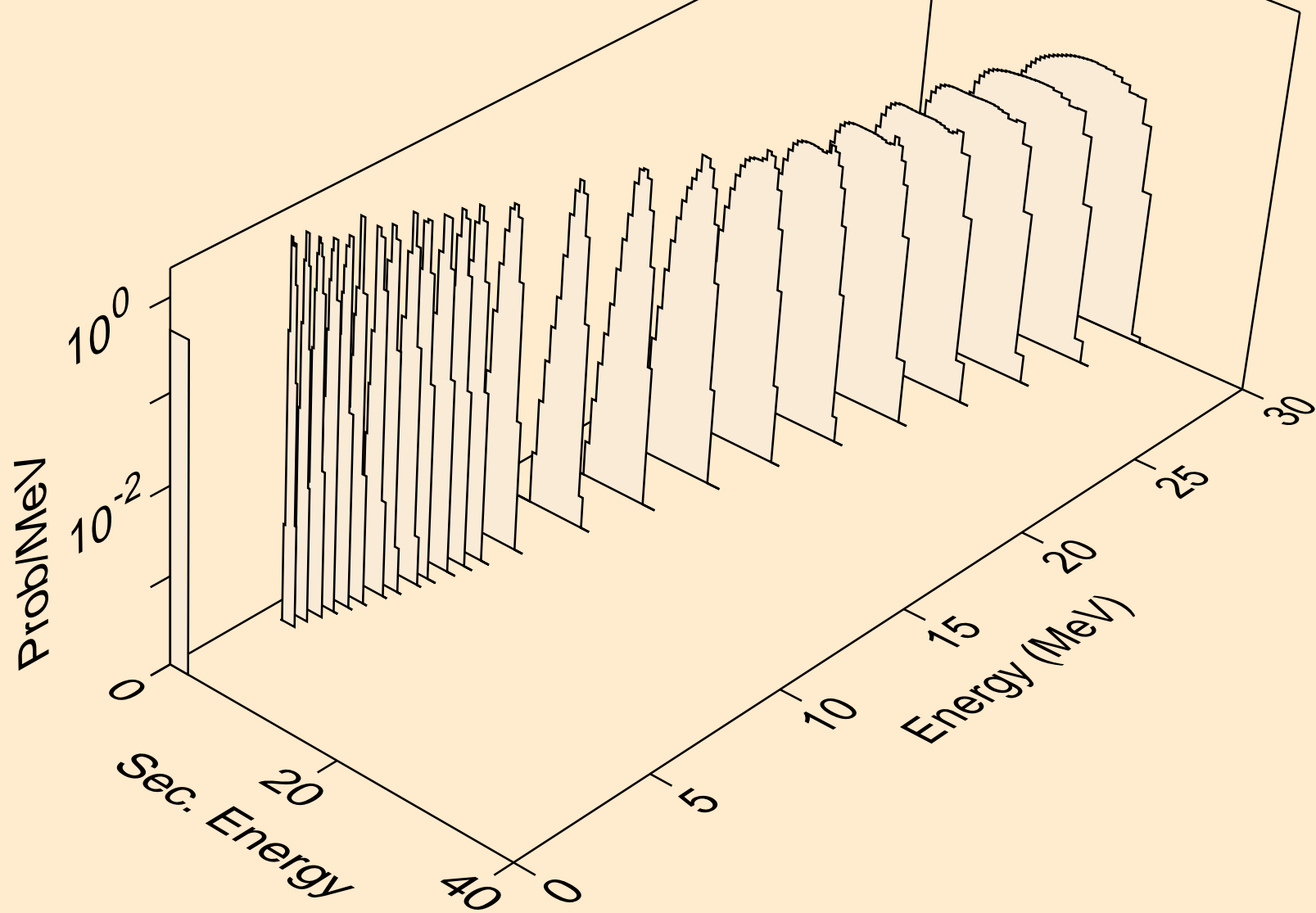

ZR085M NEUTRON ACER TENDL-2021 LIBRARY; T=293.6K
alphas from (n,da)

