

AM231 PROTON ACER TENDL-2021 LIBRARY; T=0.K  
Principal cross sections

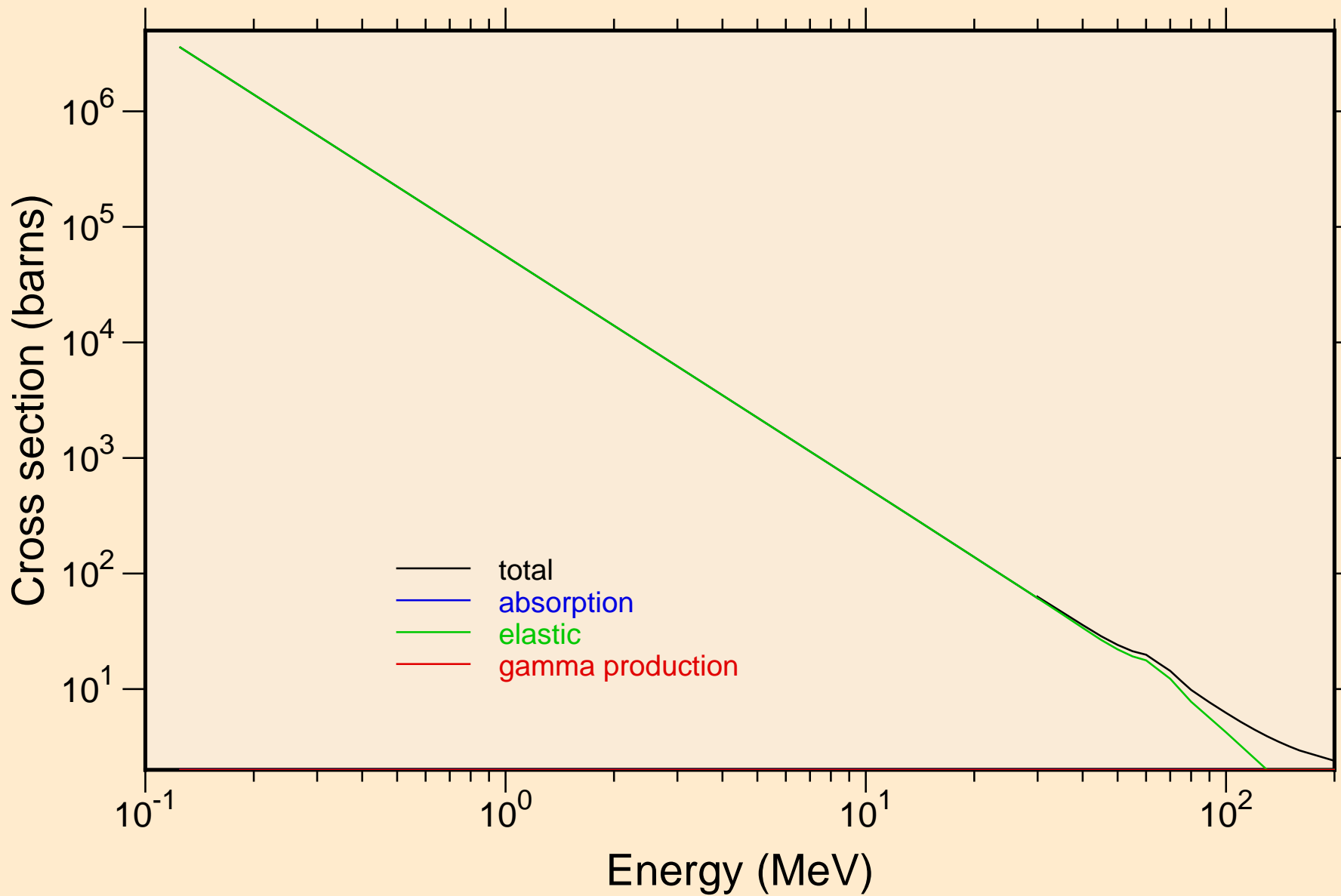

AM231 PROTON ACER TENDL-2021 LIBRARY; T=0.K  
Heating

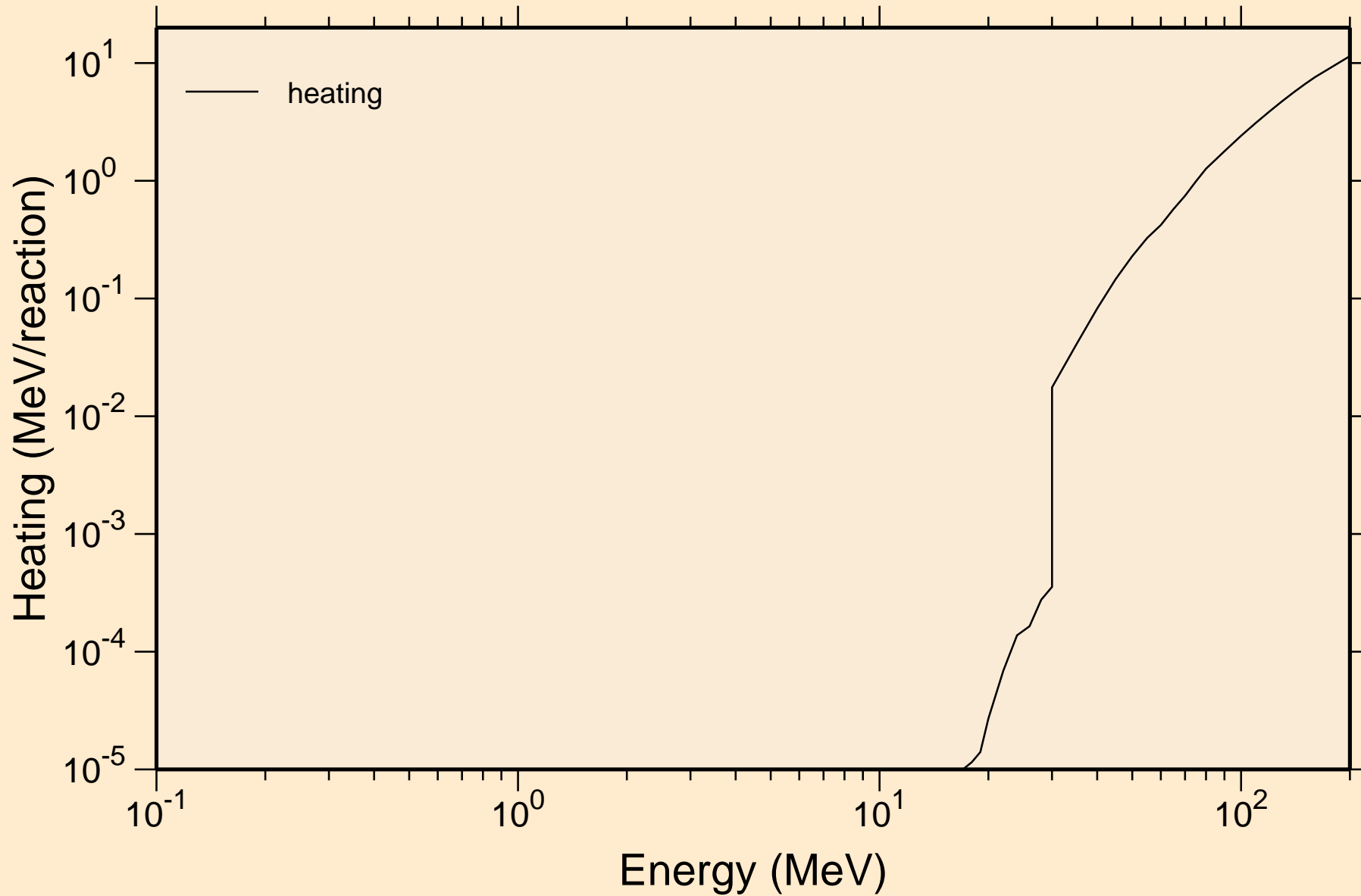

# AM231 PROTON ACER TENDL-2021 LIBRARY; T=0.K

## Principal cross sections

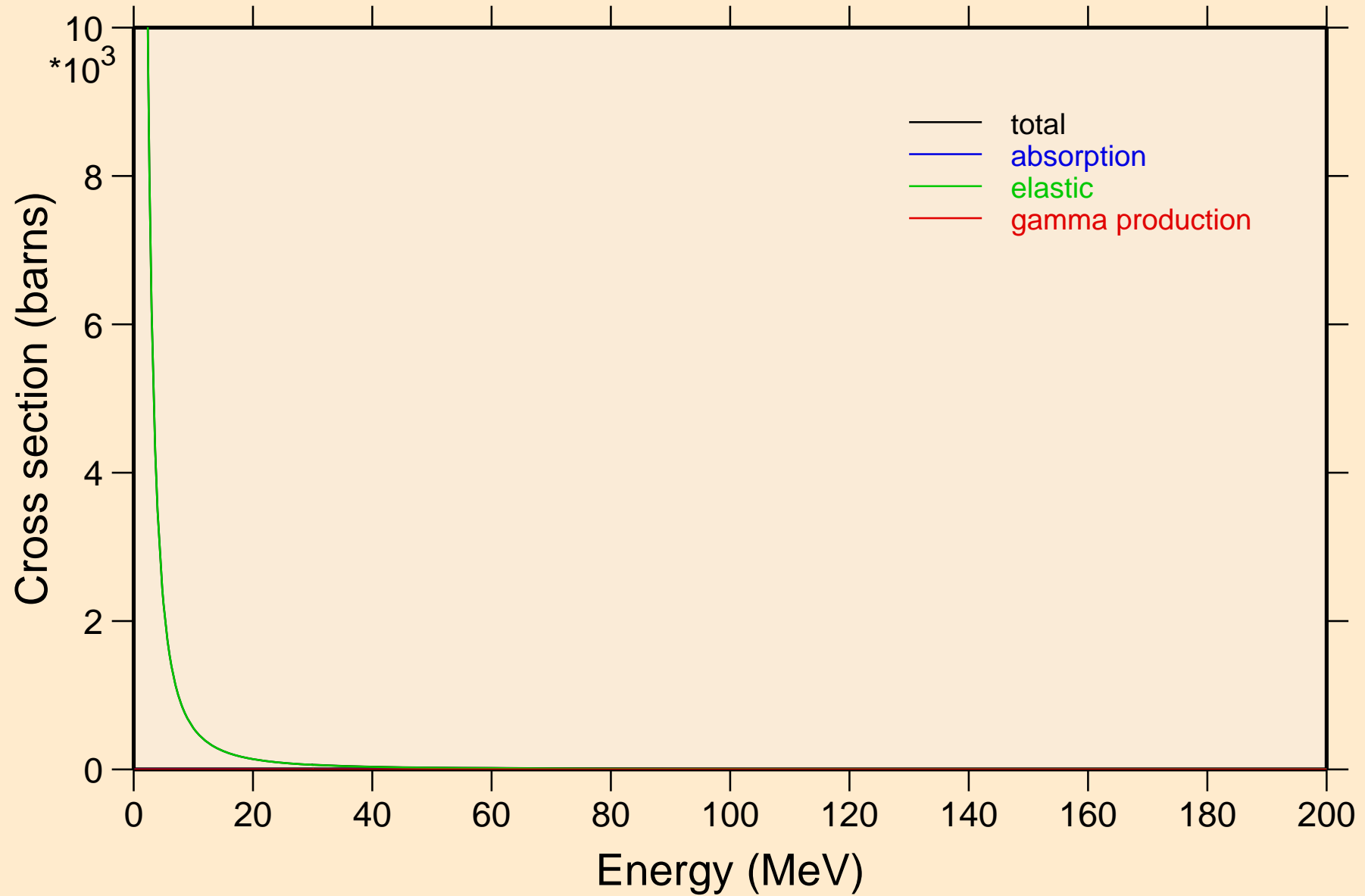

AM231 PROTON ACER TENDL-2021 LIBRARY; T=0.K

Heating

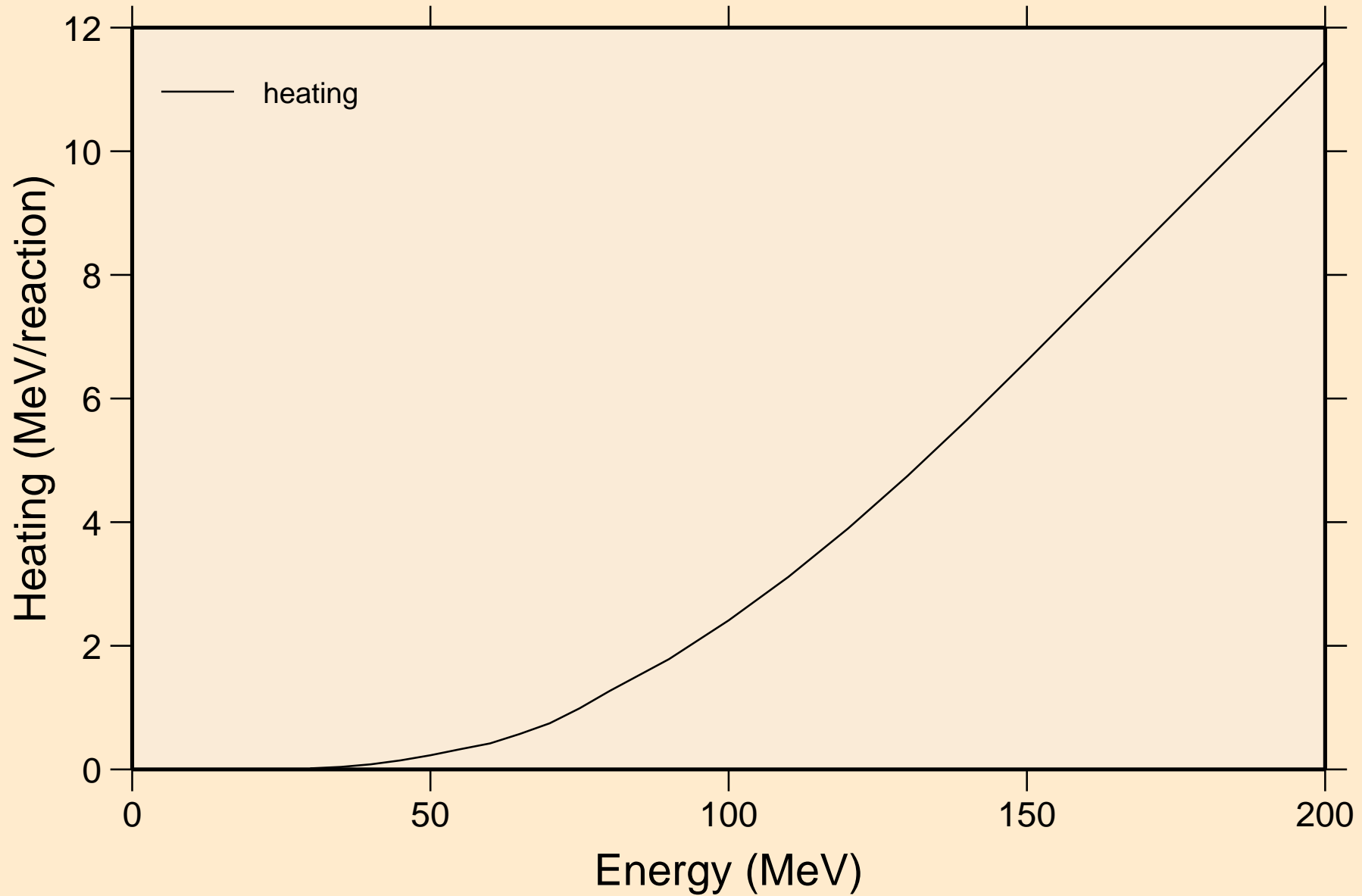

AM231 PROTON ACER TENDL-2021 LIBRARY; T=0.K  
Threshold reactions

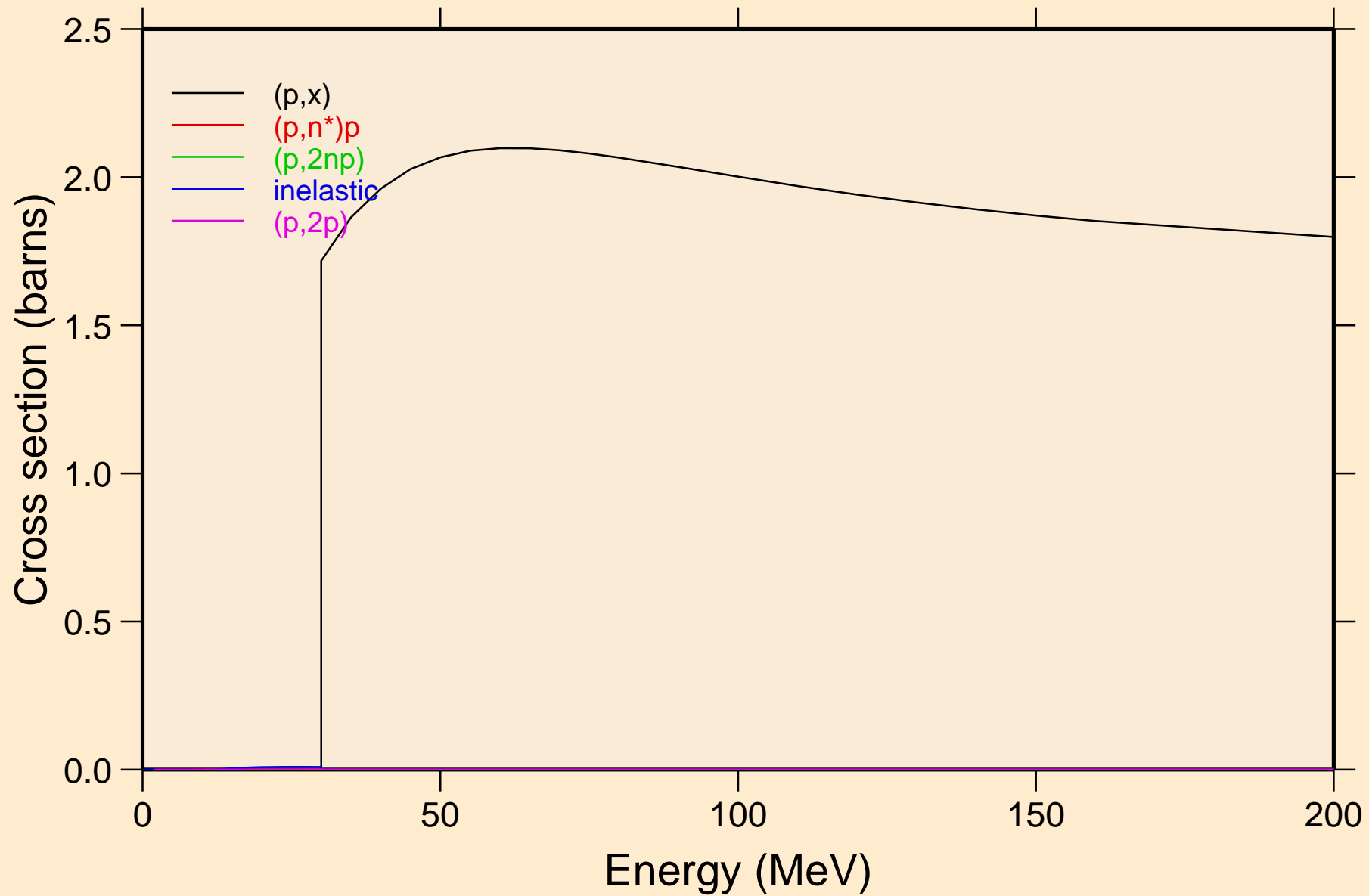

AM231 PROTON ACER TENDL-2021 LIBRARY; T=0.K  
Threshold reactions

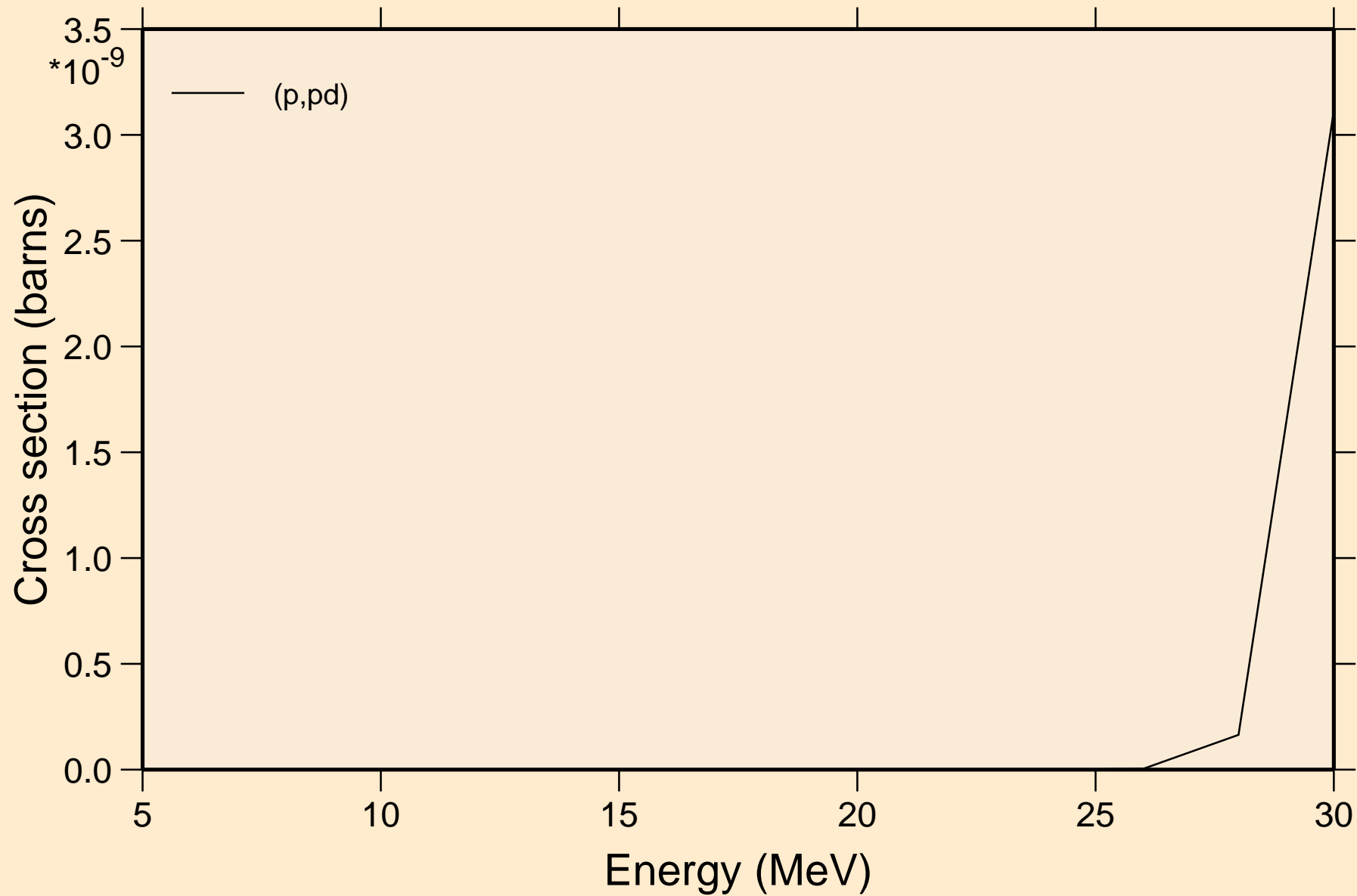

AM231 PROTON ACER TENDL-2021 LIBRARY; T=0.K  
angular distribution for elastic

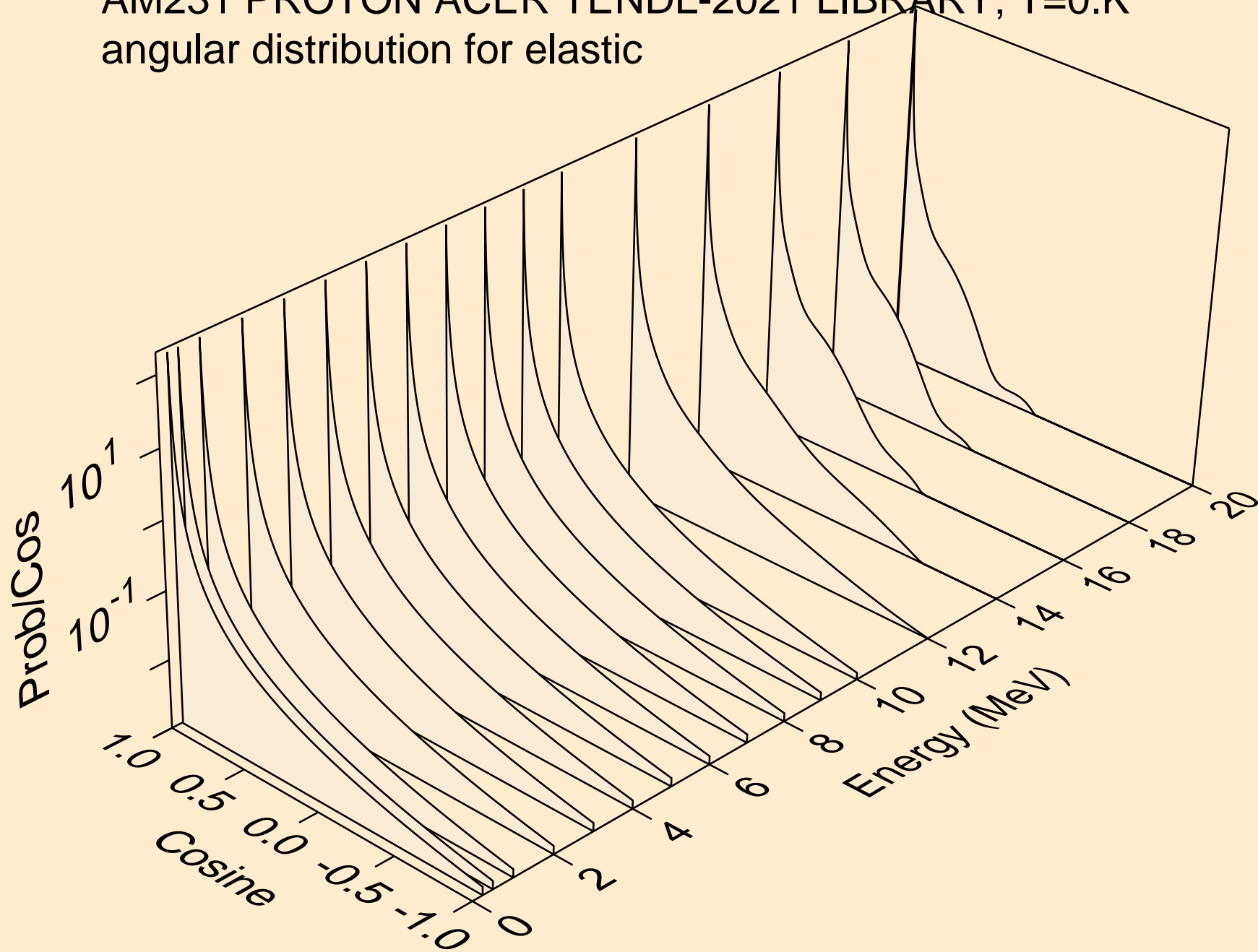

AM231 PROTON ACER TENDL-2021 LIBRARY; T=0.K  
angular distribution for elastic

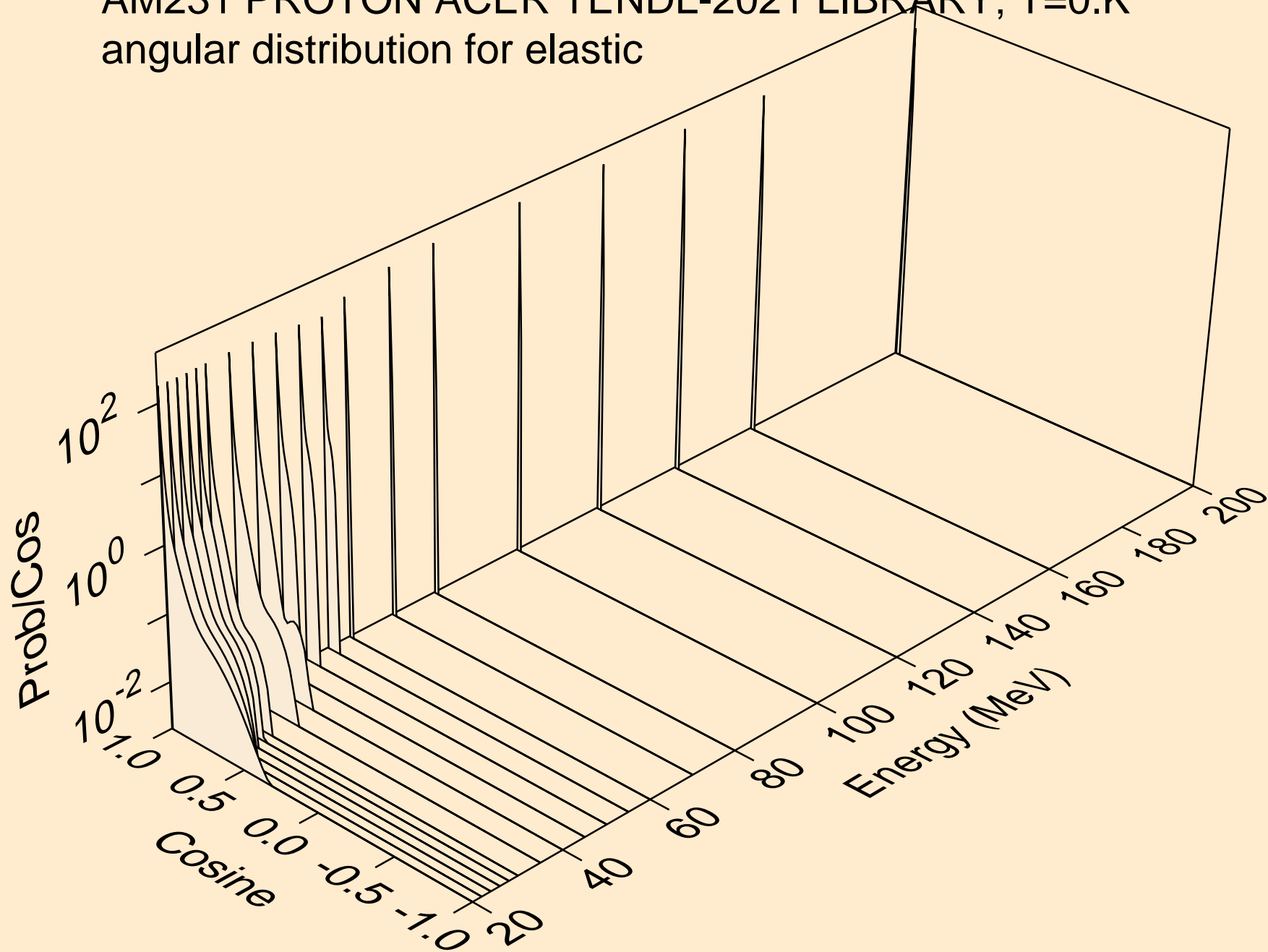



AM231 PROTON ACER TENDL-2021 LIBRARY; T=0.K  
Proton emission for (p,x)

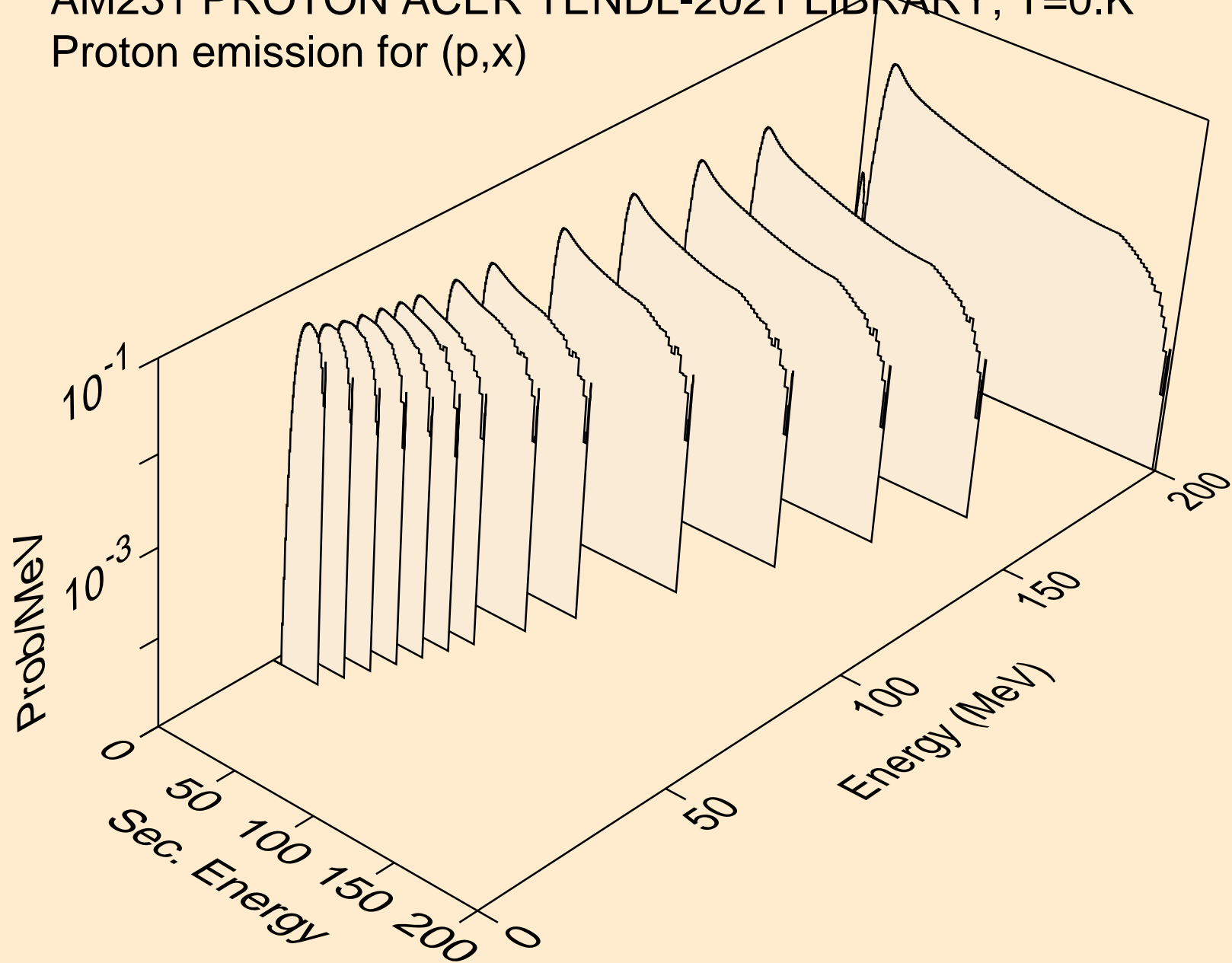

AM231 PROTON ACER TENDL-2021 LIBRARY; T=0.K  
Proton emission for (p,n\*)p

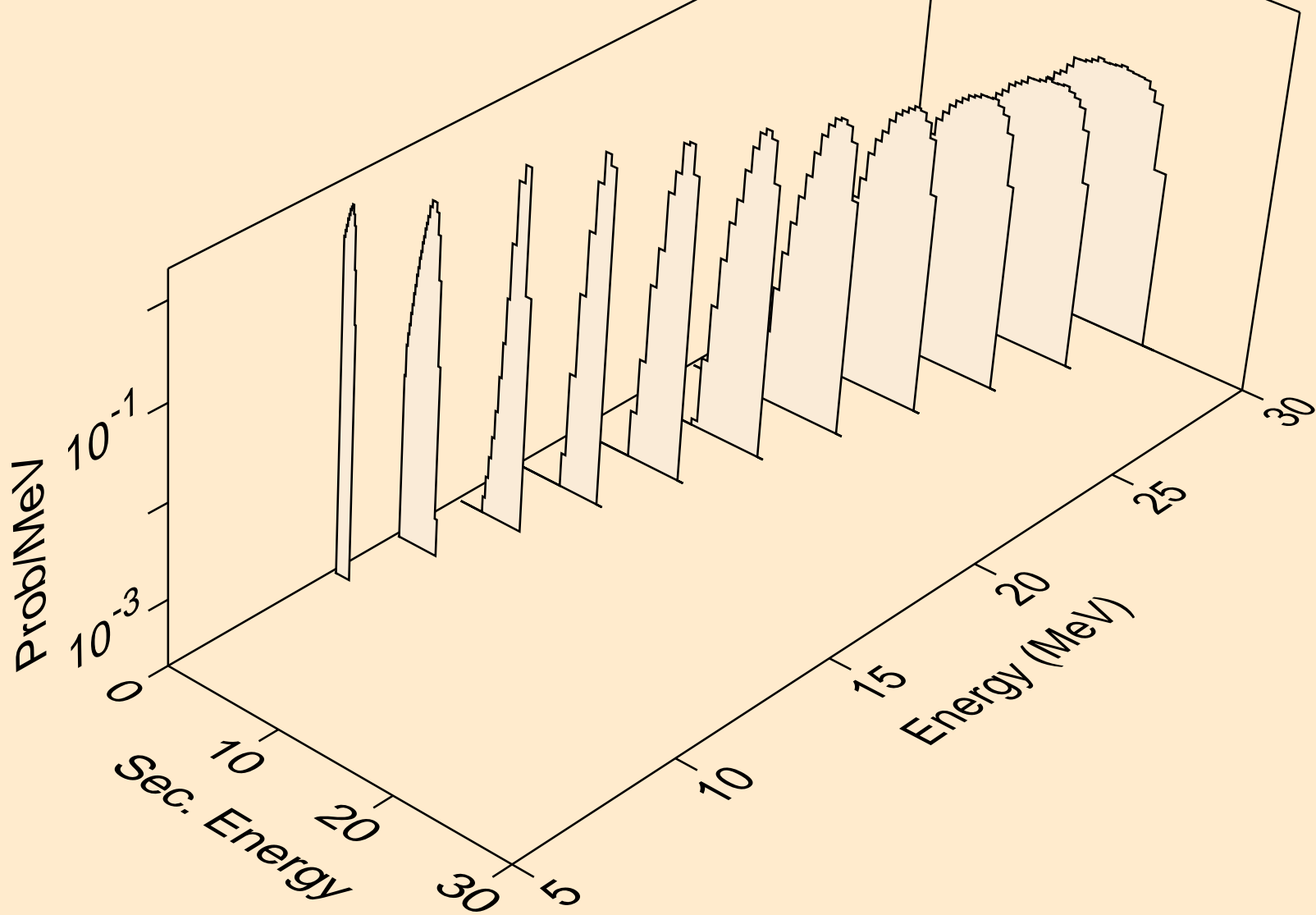

AM231 PROTON ACER TENDL-2021 LIBRARY; T=0.K  
Proton emission for (p,2np)

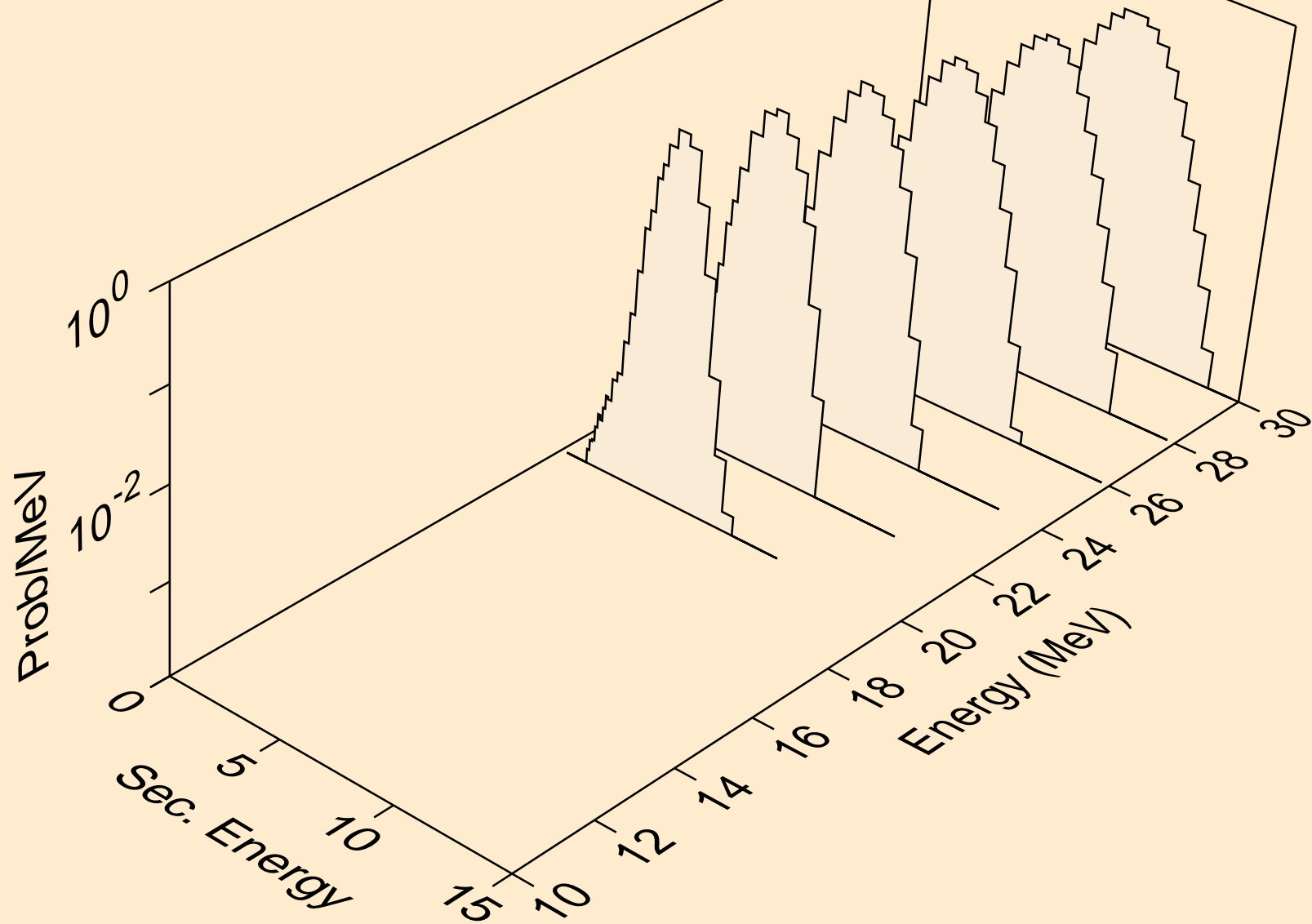

AM231 PROTON ACER TENDL-2021 LIBRARY; T=0.K  
Proton emission for inelastic

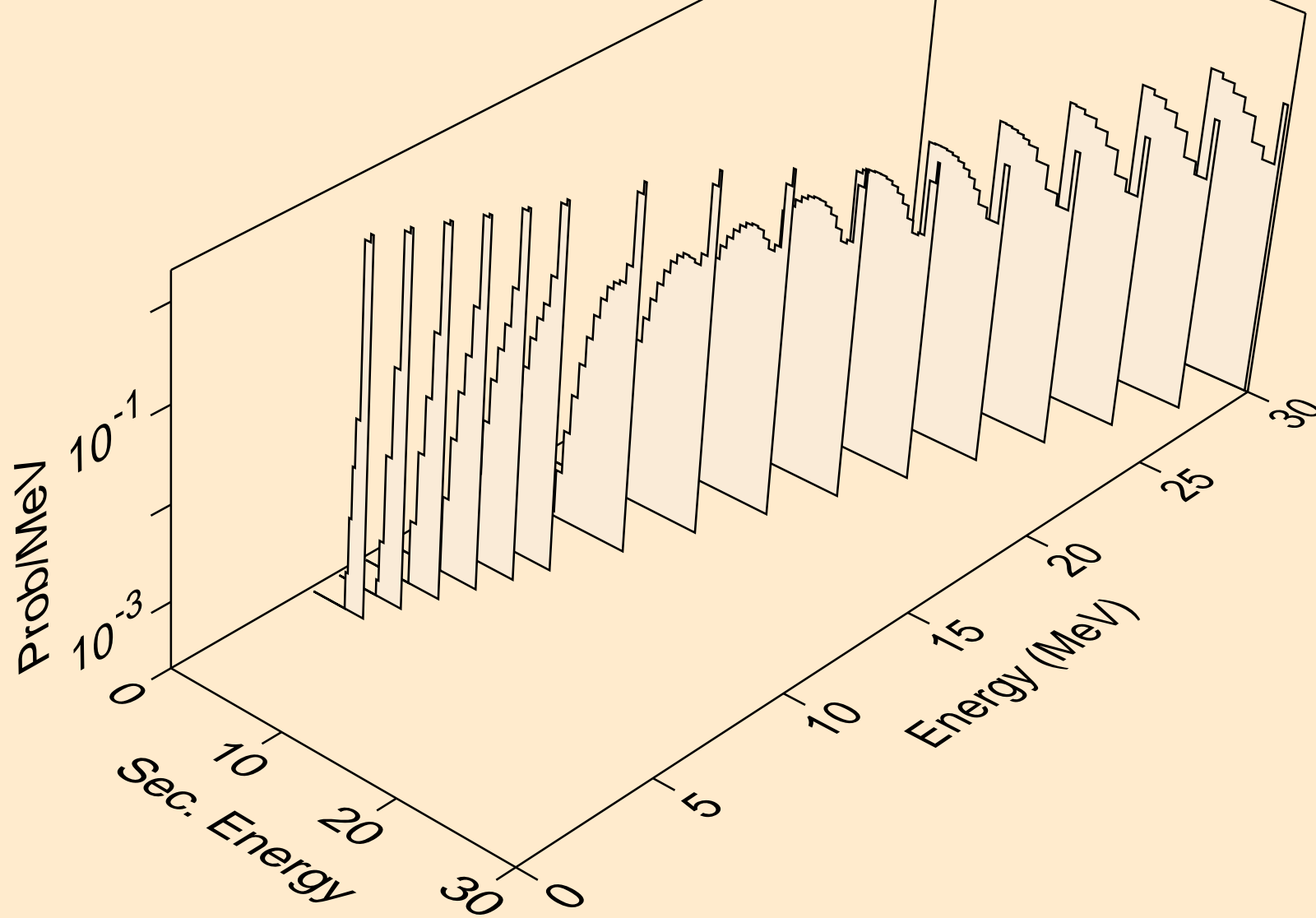

AM231 PROTON ACER TENDL-2021 LIBRARY; T=0.K  
Proton emission for (p,2p)

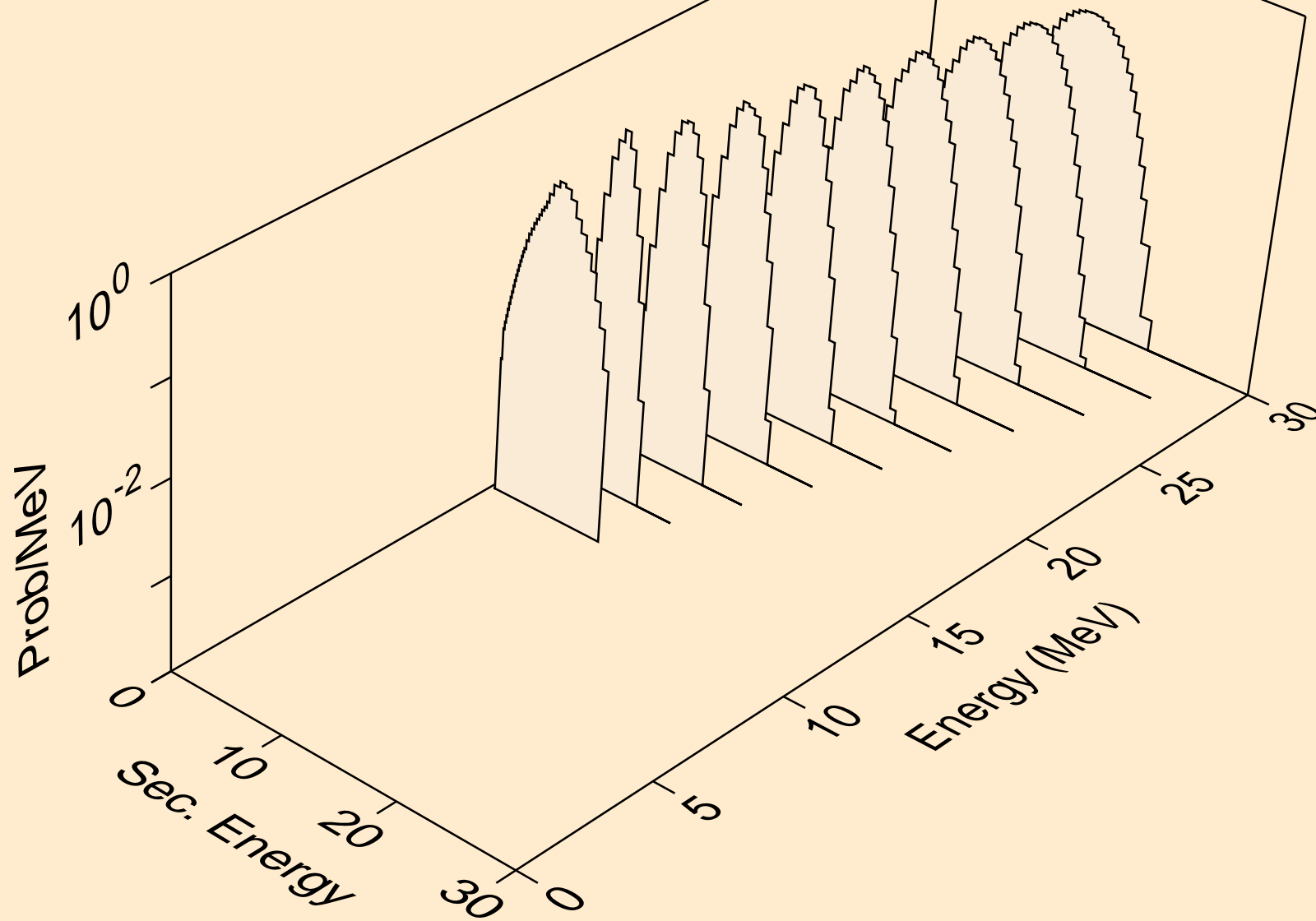

AM231 PROTON ACER TENDL-2021 LIBRARY; T=0.K  
Proton emission for (p,pd)

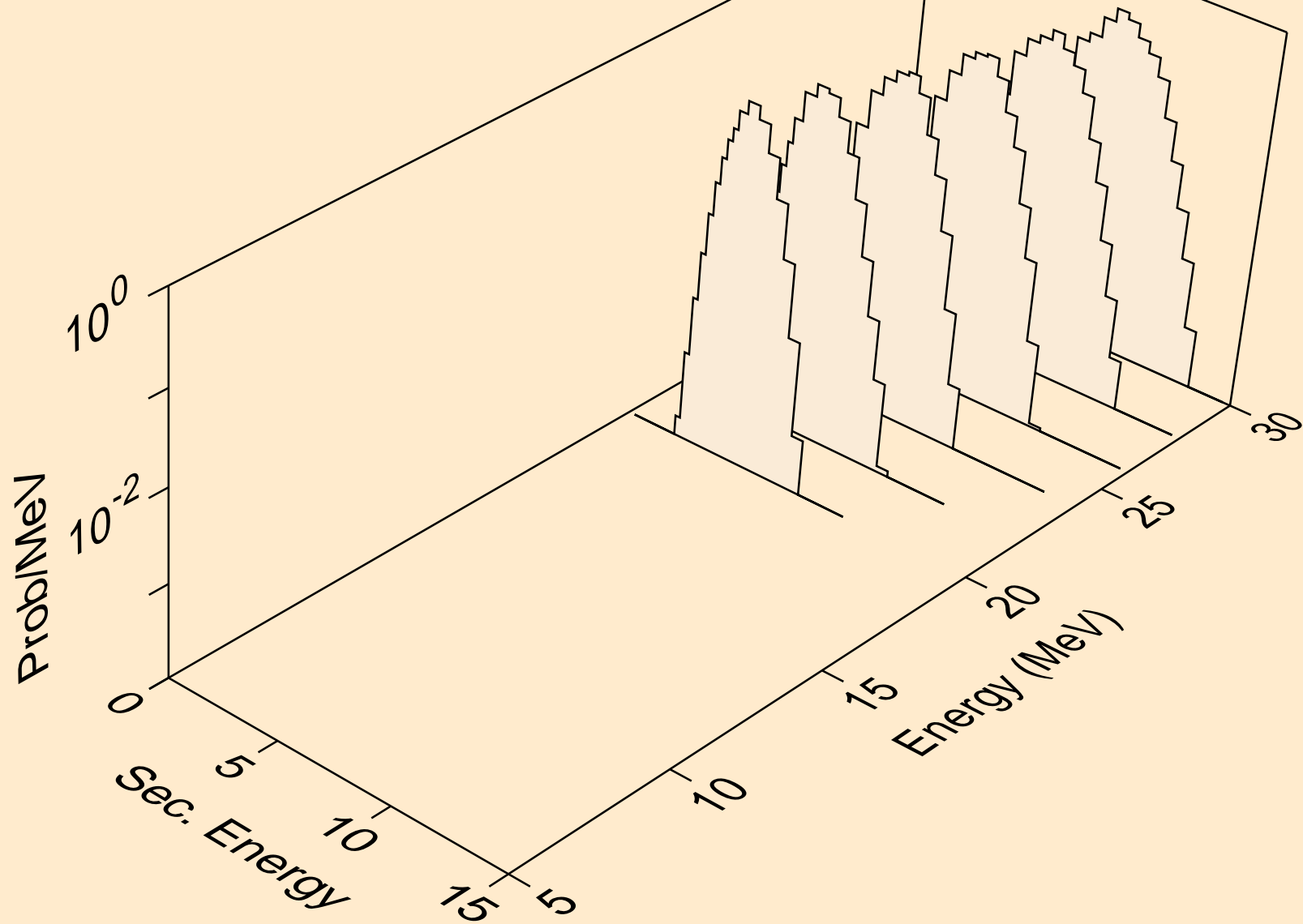

AM231 PROTON ACER TENDL-2021 LIBRARY; T=0.K  
Photon emission for (z,n)

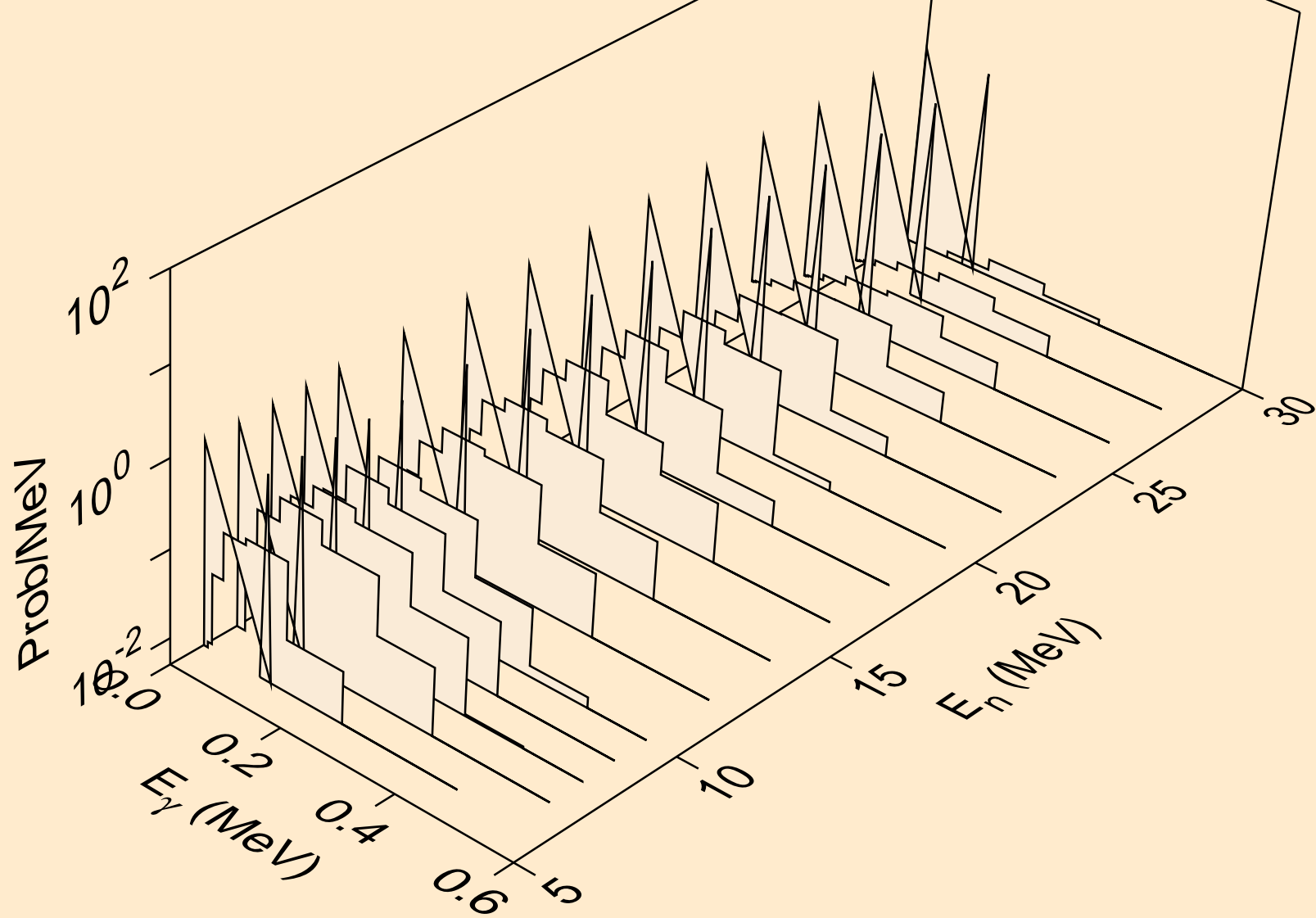

AM231 PROTON ACER TENDL-2021 LIBRARY; T=0.K  
Photon emission for (n,x)

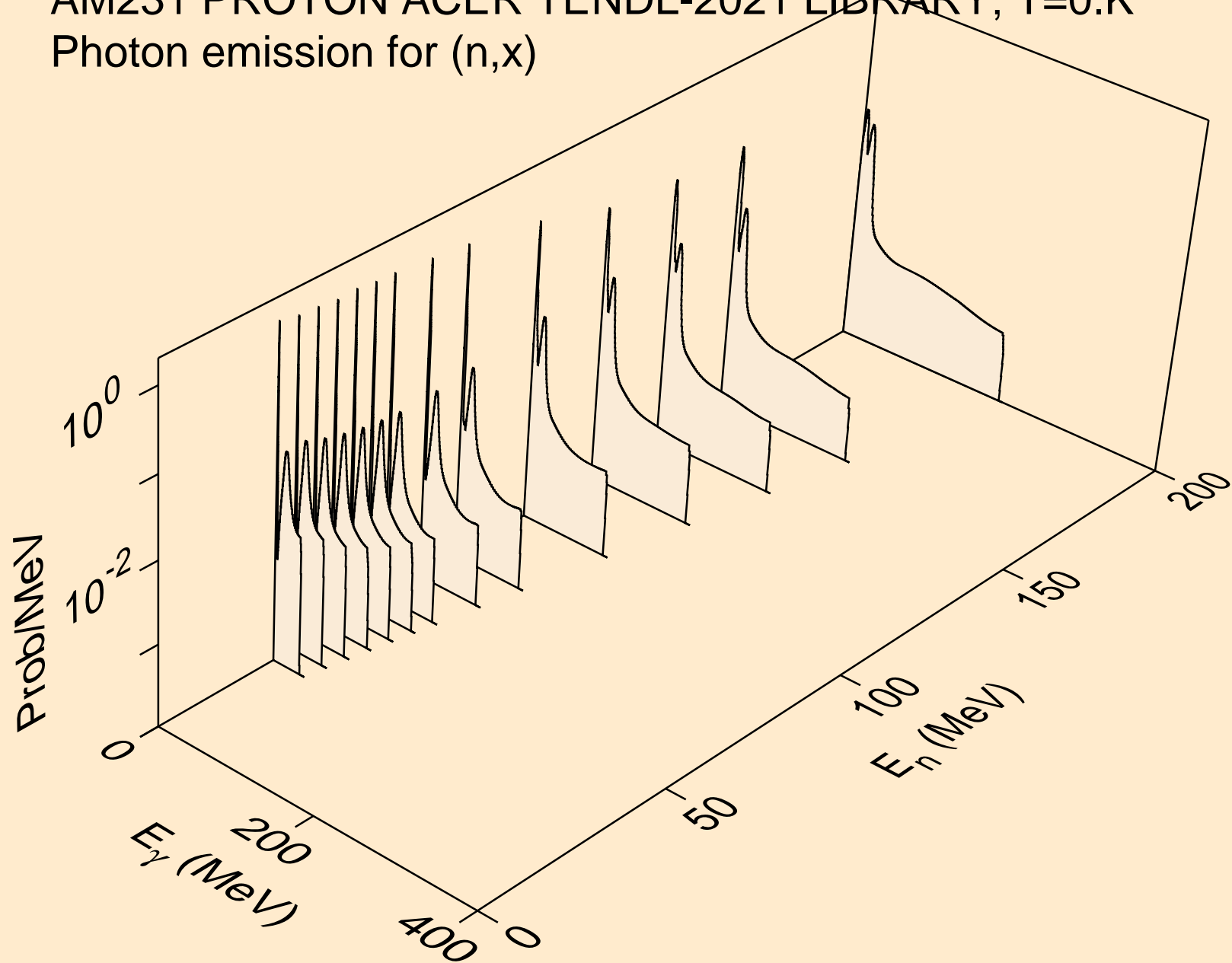



AM231 PROTON ACER TENDL-2021 LIBRARY; T=0.K  
Photon emission for (n,2n)

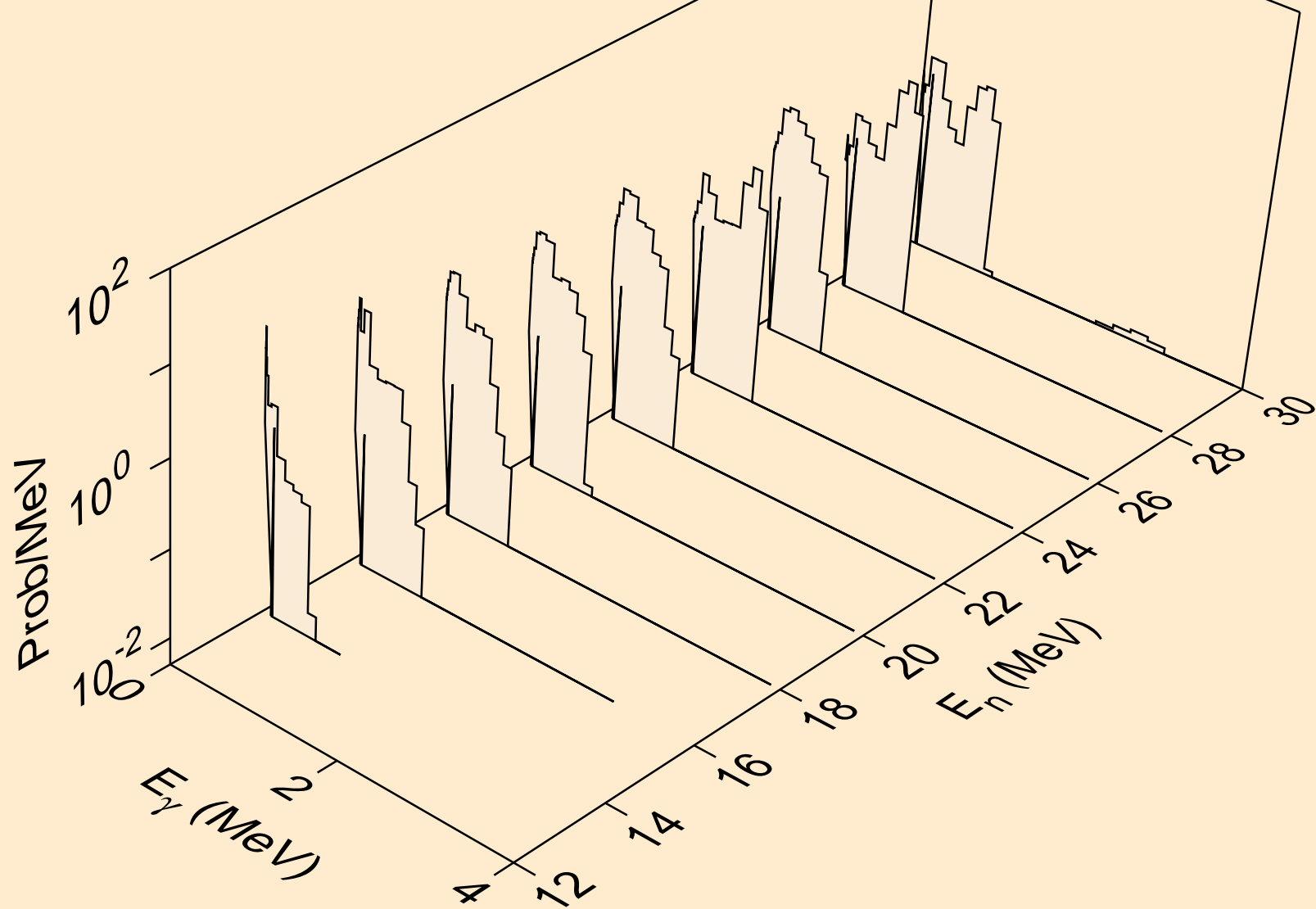

AM231 PROTON ACER TENDL-2021 LIBRARY; T=0.K  
Photon emission for (n,n\*)a

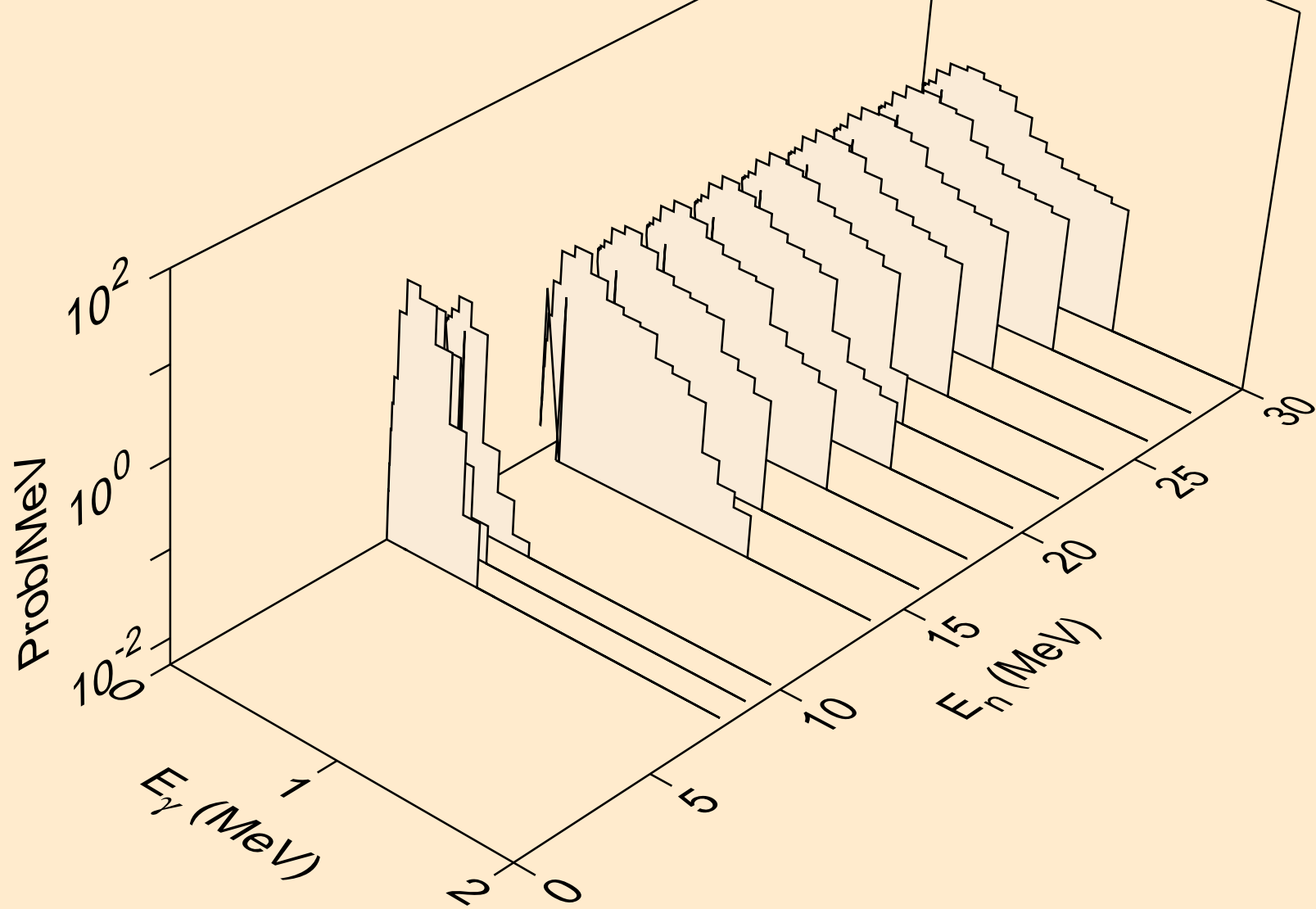

AM231 PROTON ACER TENDL-2021 LIBRARY; T=0.K  
Photon emission for (n,n\*)p

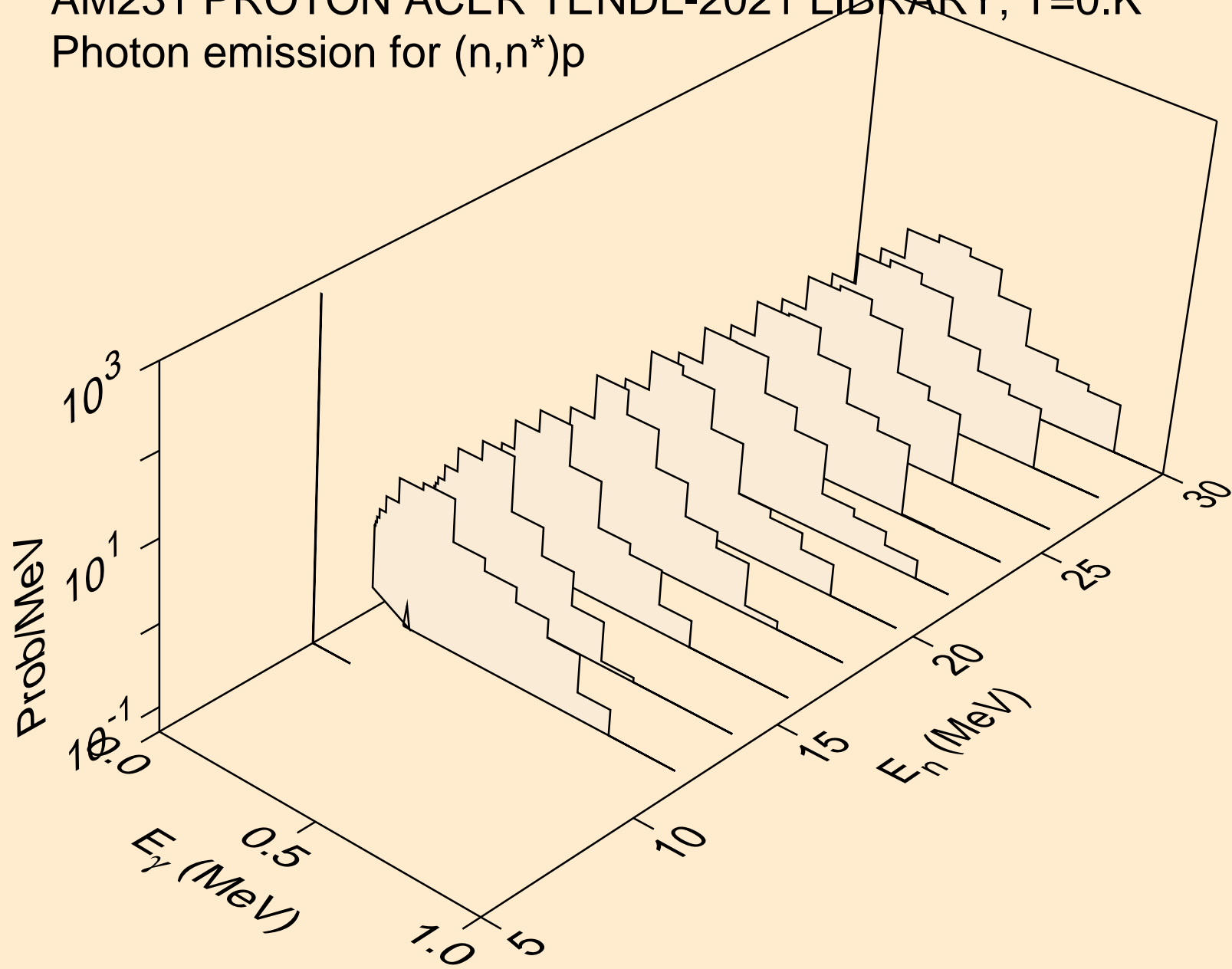

AM231 PROTON ACER TENDL-2021 LIBRARY; T=0.K  
Photon emission for (n,2np)

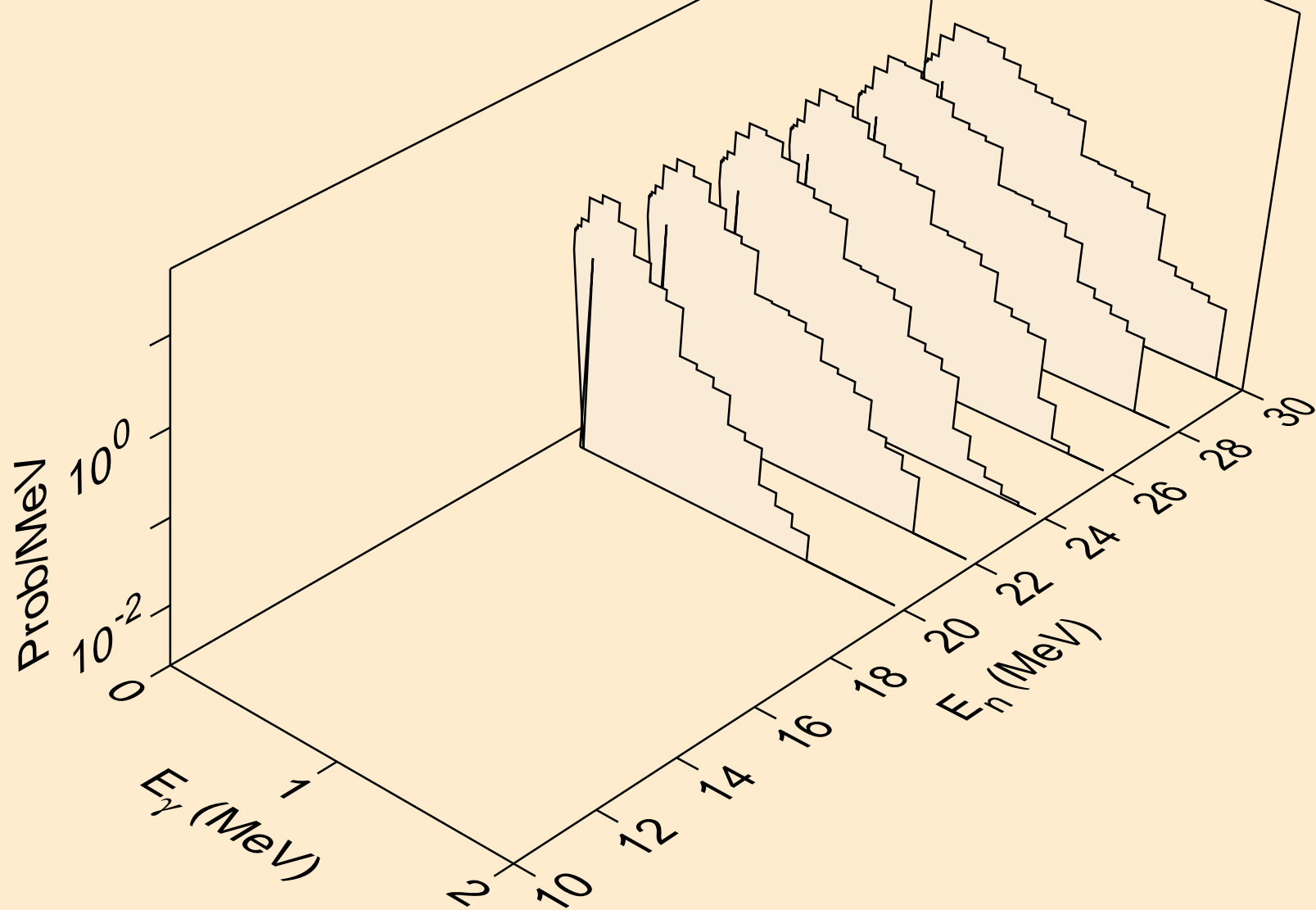

AM231 PROTON ACER TENDL-2021 LIBRARY; T=0.K  
Photon emission for (n,gma)

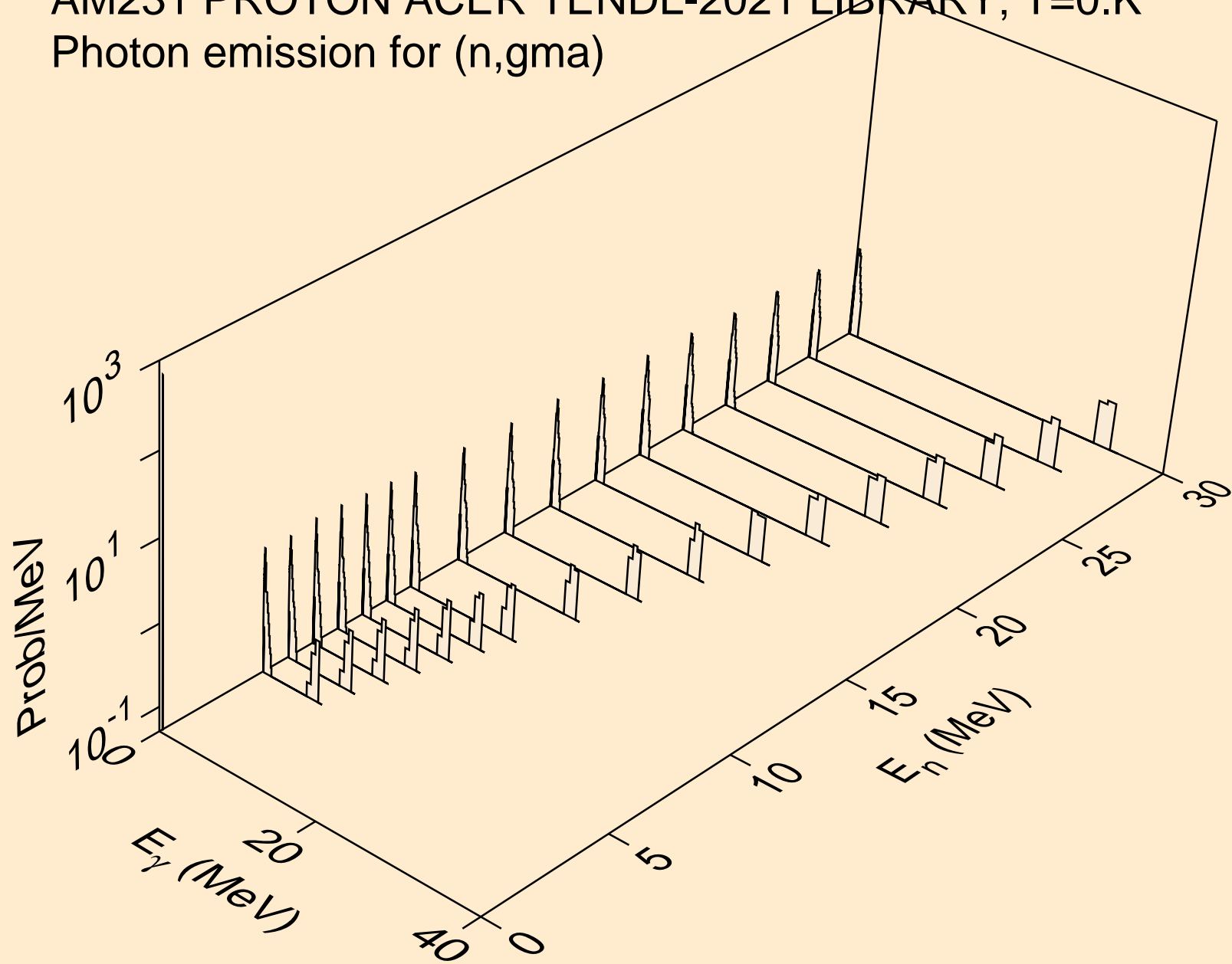

AM231 PROTON ACER TENDL-2021 LIBRARY; T=0.K  
Photon emission for inelastic

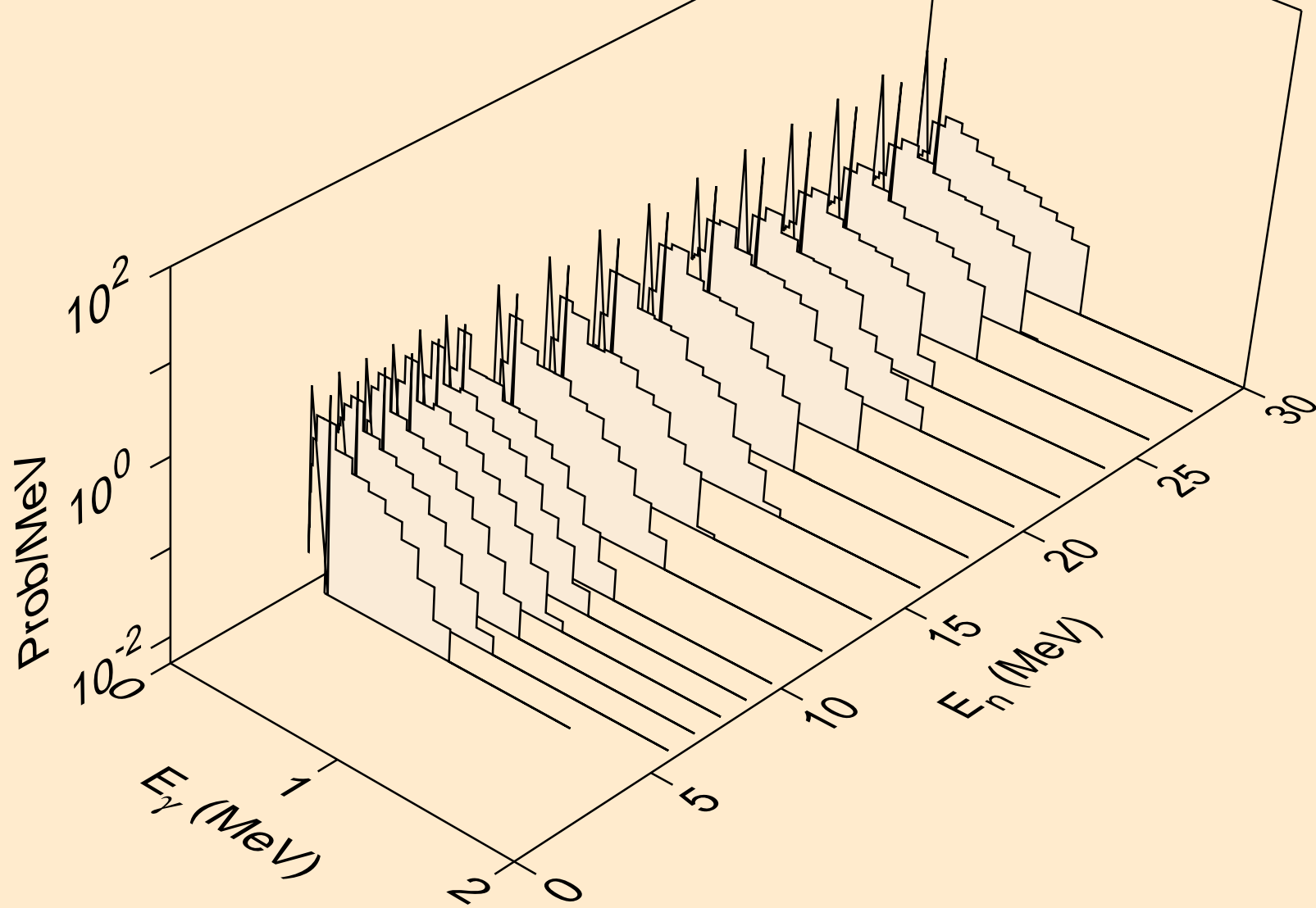

AM231 PROTON ACER TENDL-2021 LIBRARY; T=0.K  
Photon emission for (n,d)

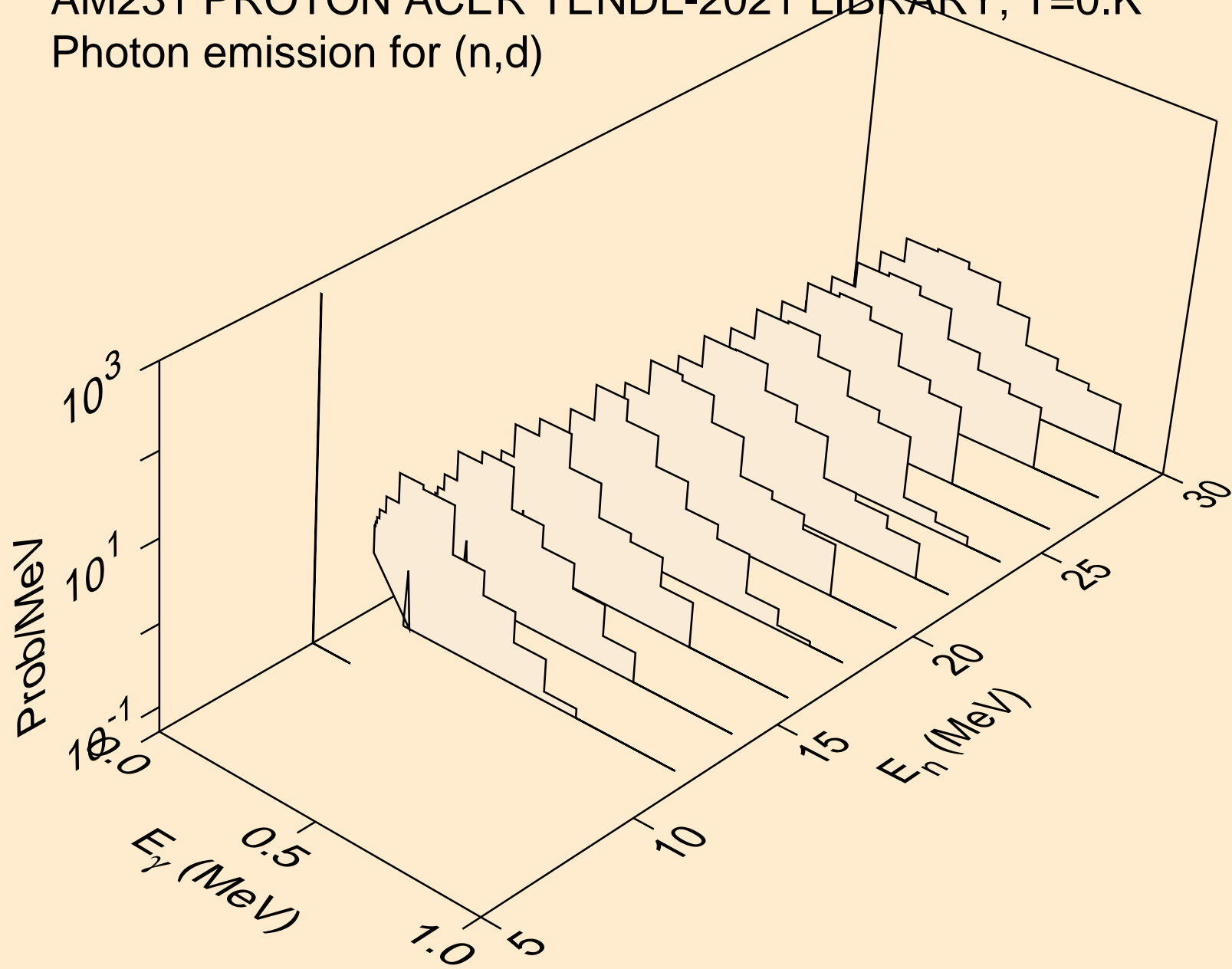

AM231 PROTON ACER TENDL-2021 LIBRARY; T=0.K  
Photon emission for (n,t)

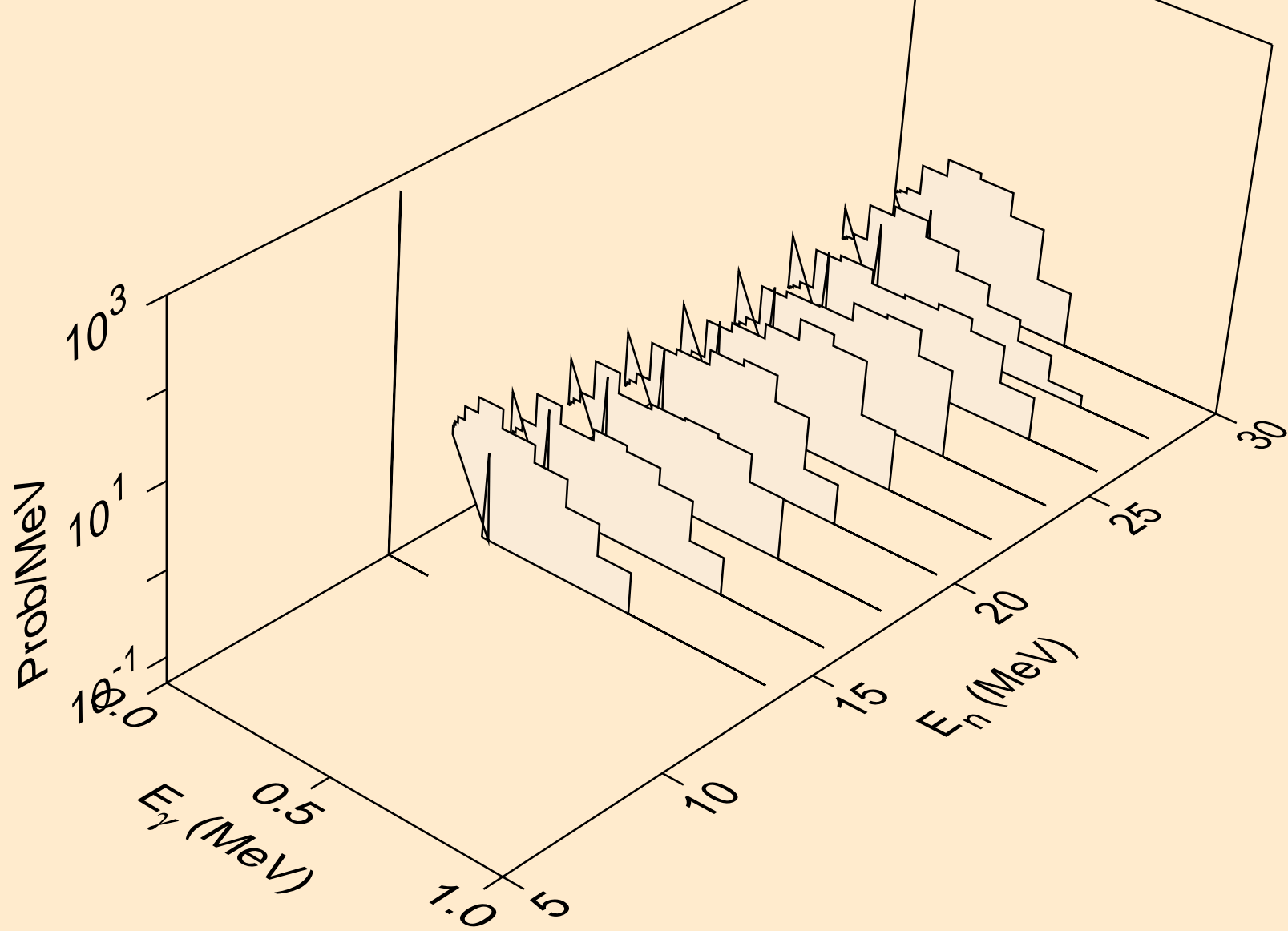



AM231 PROTON ACER TENDL-2021 LIBRARY; T=0.K  
Photon emission for (n,he3)

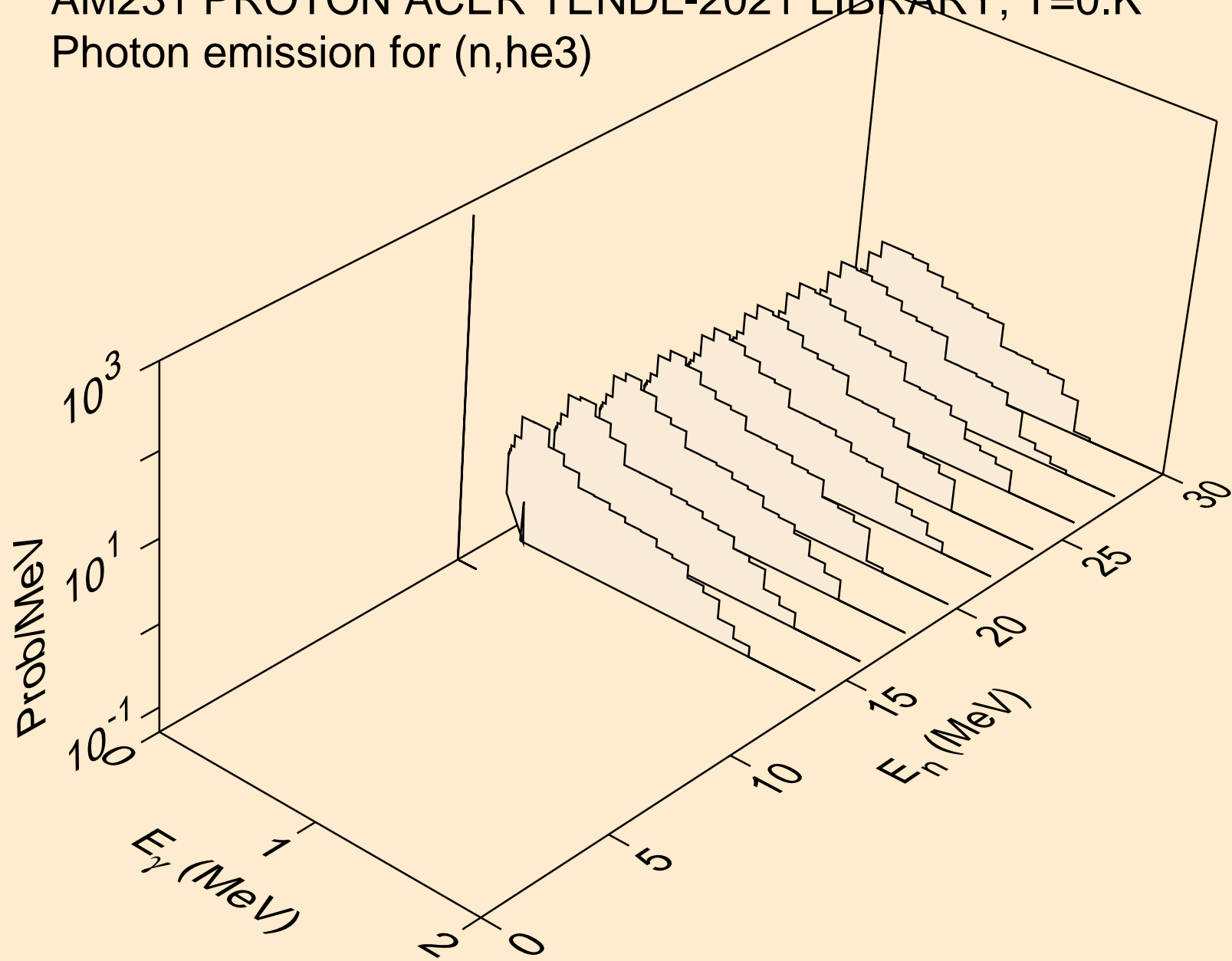

AM231 PROTON ACER TENDL-2021 LIBRARY; T=0.K  
Photon emission for (n,a)

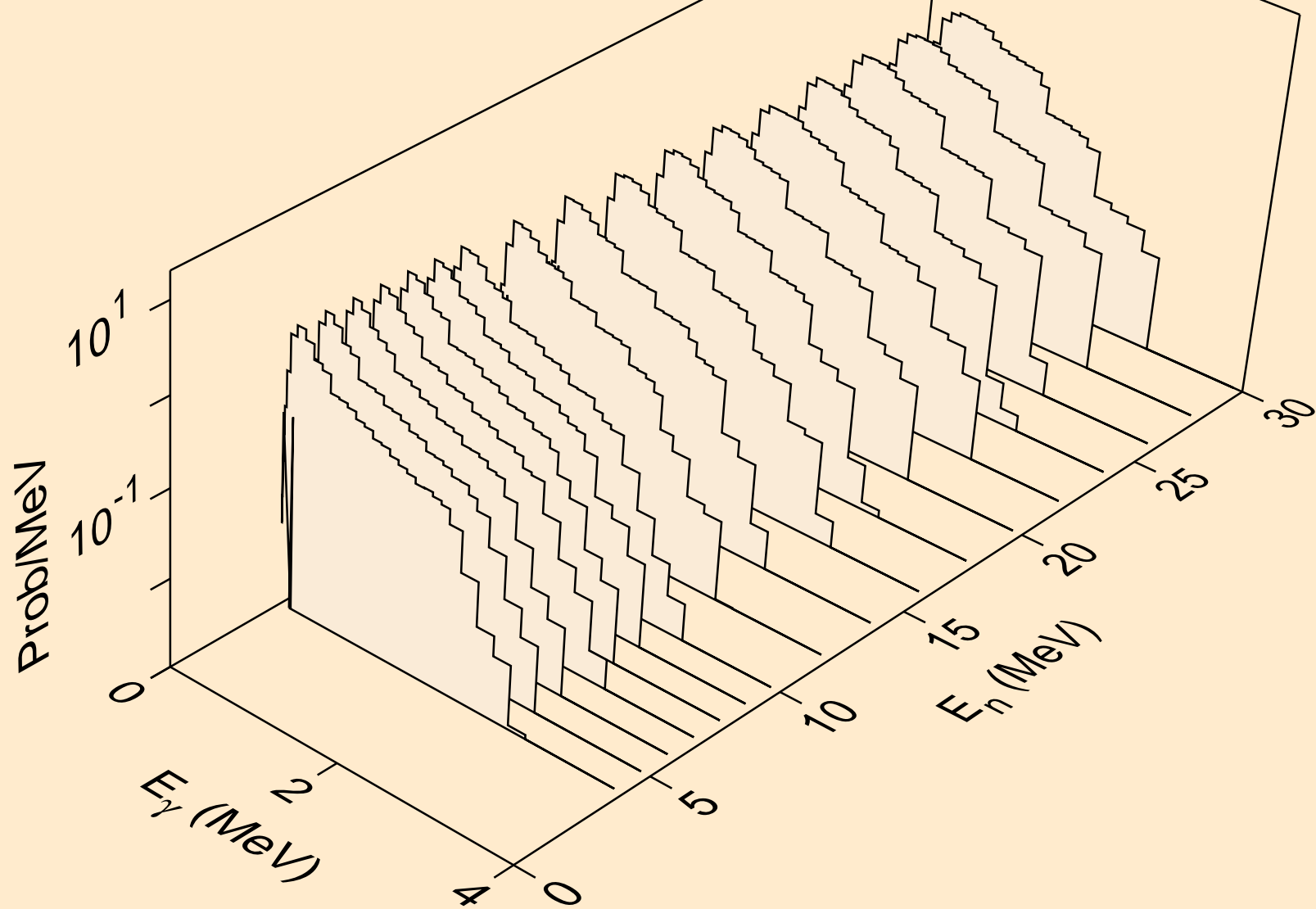

AM231 PROTON ACER TENDL-2021 LIBRARY; T=0.K  
Photon emission for (n,2p)

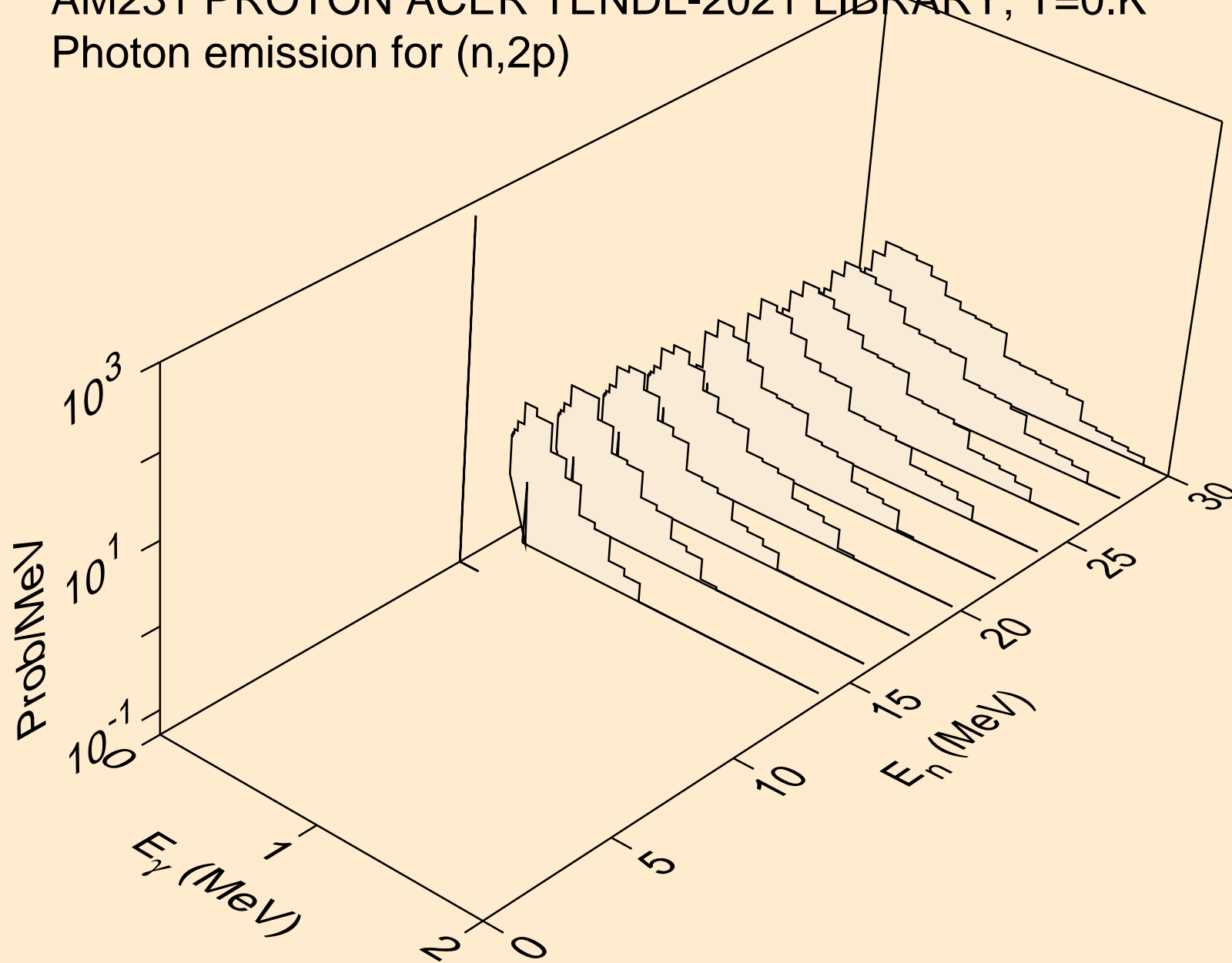

AM231 PROTON ACER TENDL-2021 LIBRARY; T=0.K  
Photon emission for (n,pd)

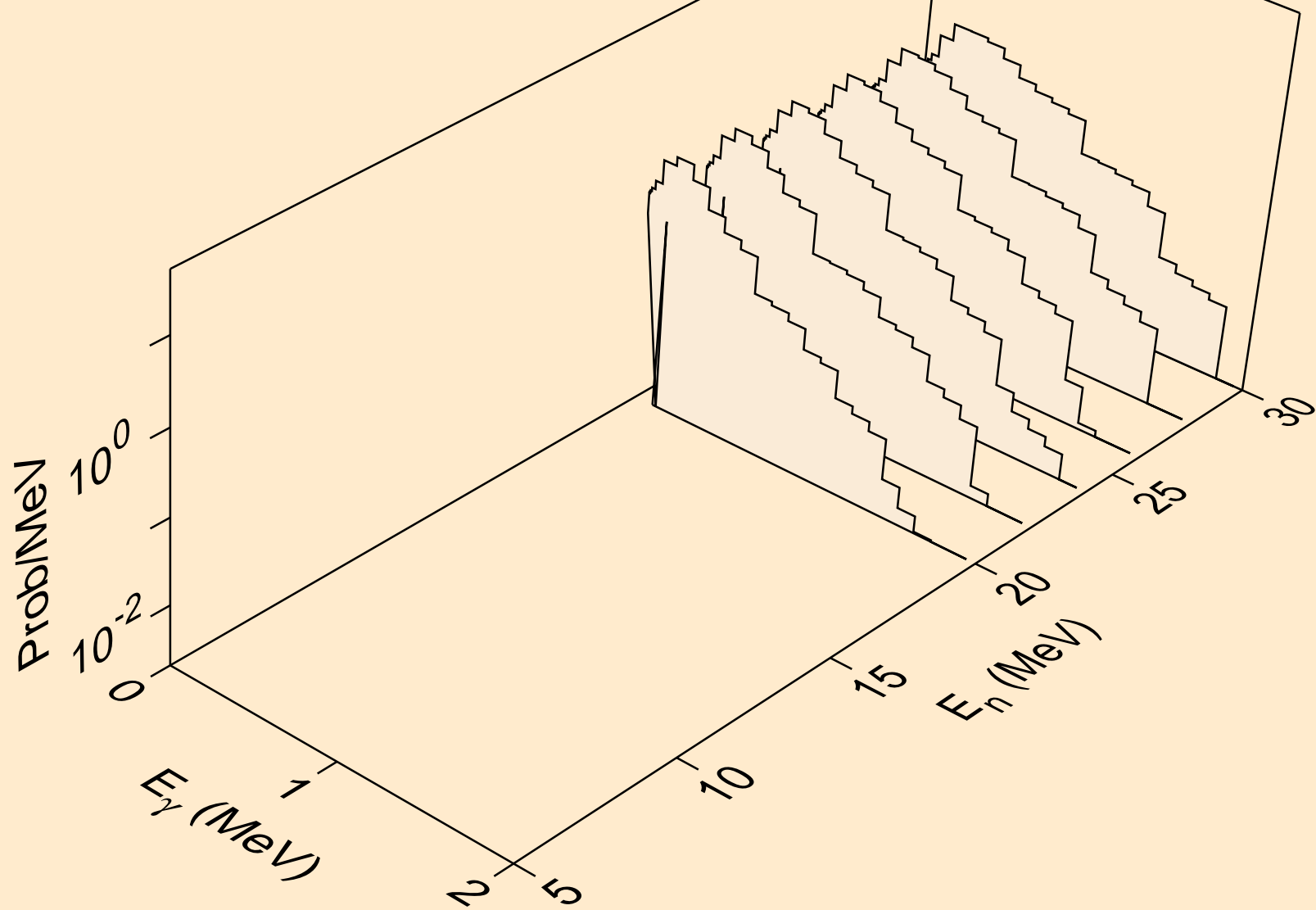

AM231 PROTON ACER TENDL-2021 LIBRARY; T=0.K  
Particle heating contributions

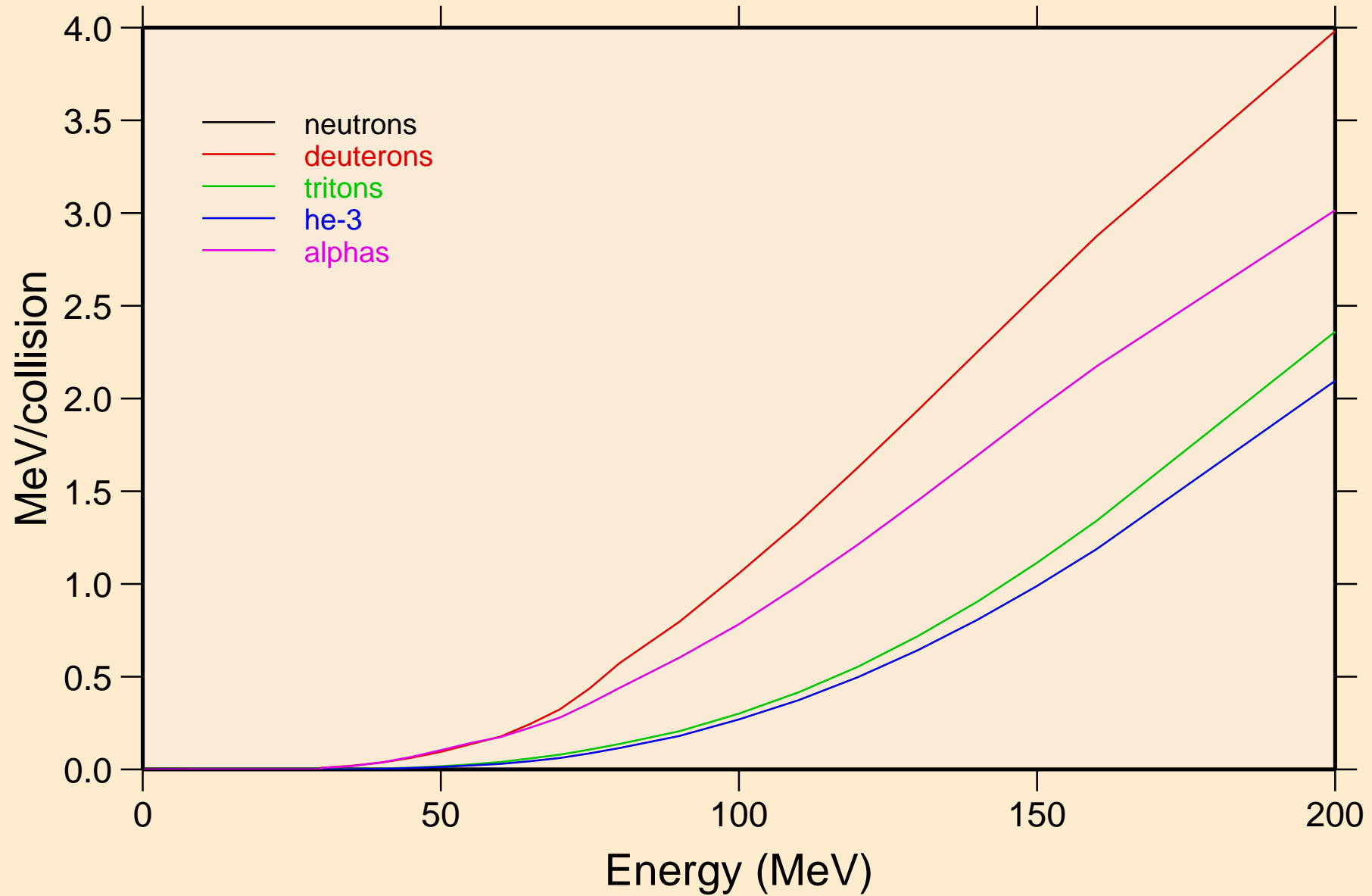

AM231 PROTON ACER TENDL-2021 LIBRARY; T=0.K  
Recoil Heating

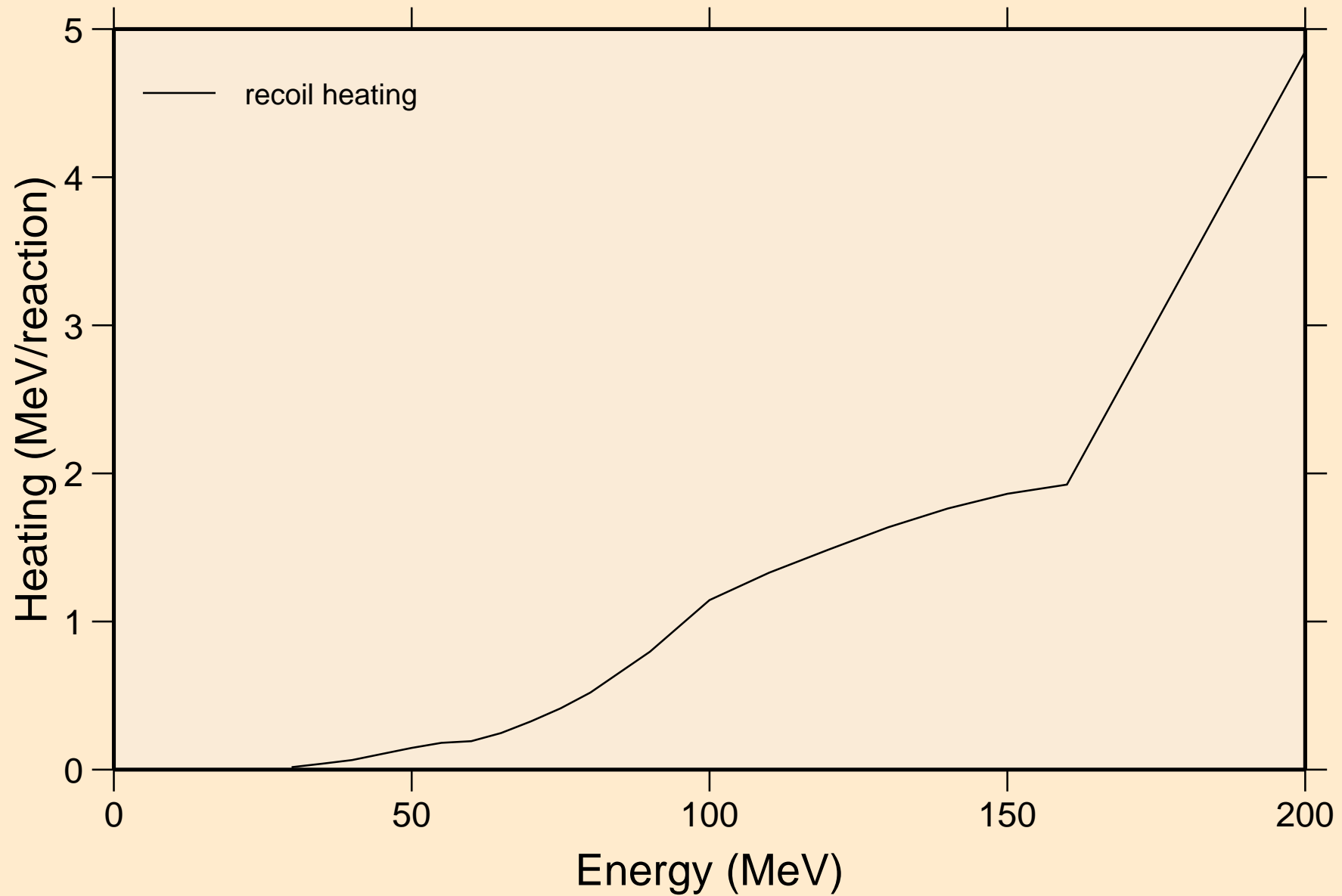

AM231 PROTON ACER TENDL-2021 LIBRARY; T=0.K  
Particle production cross sections

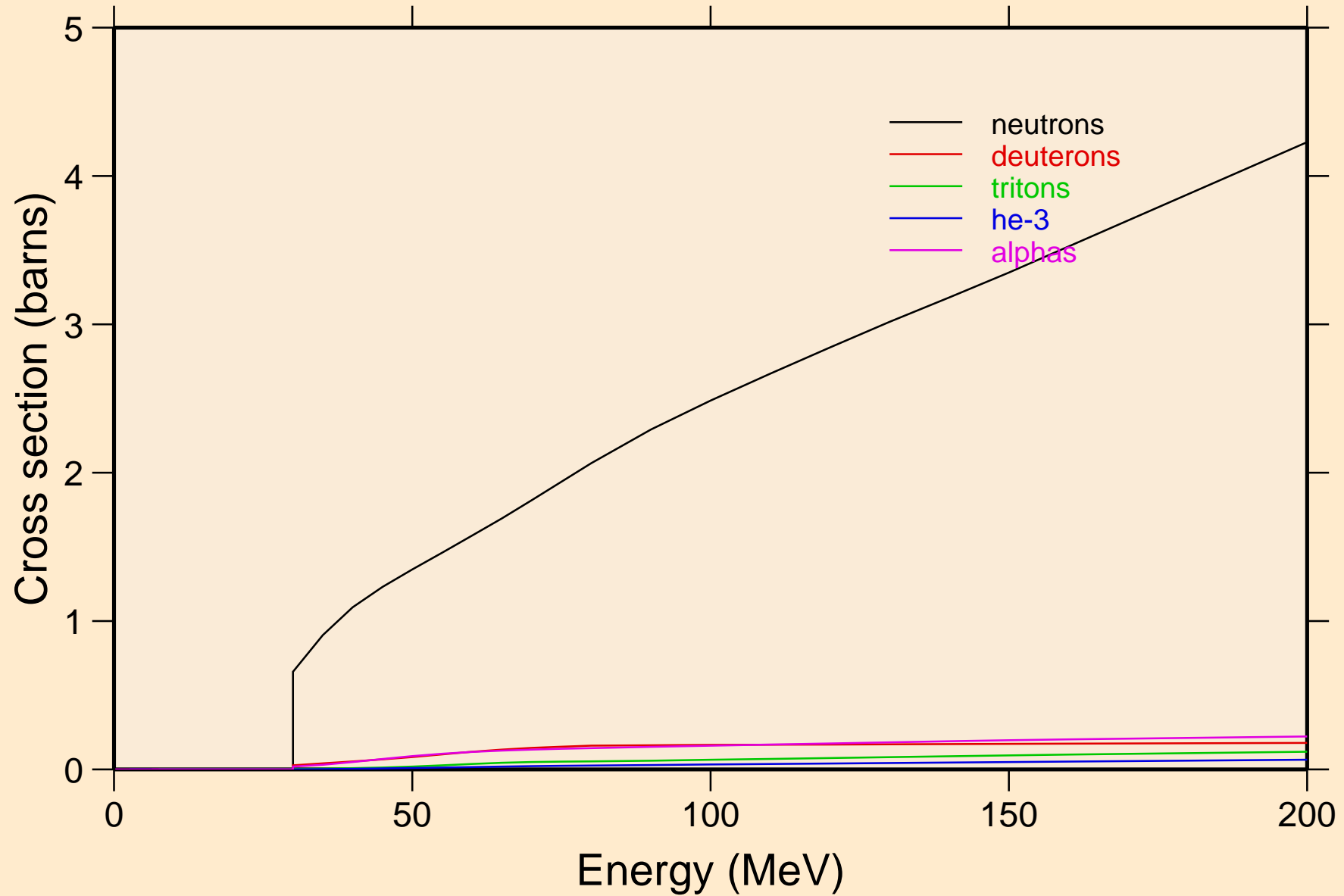

AM231 PROTON ACER TENDL-2021 LIBRARY; T=0.K  
neutrons from (p,n)

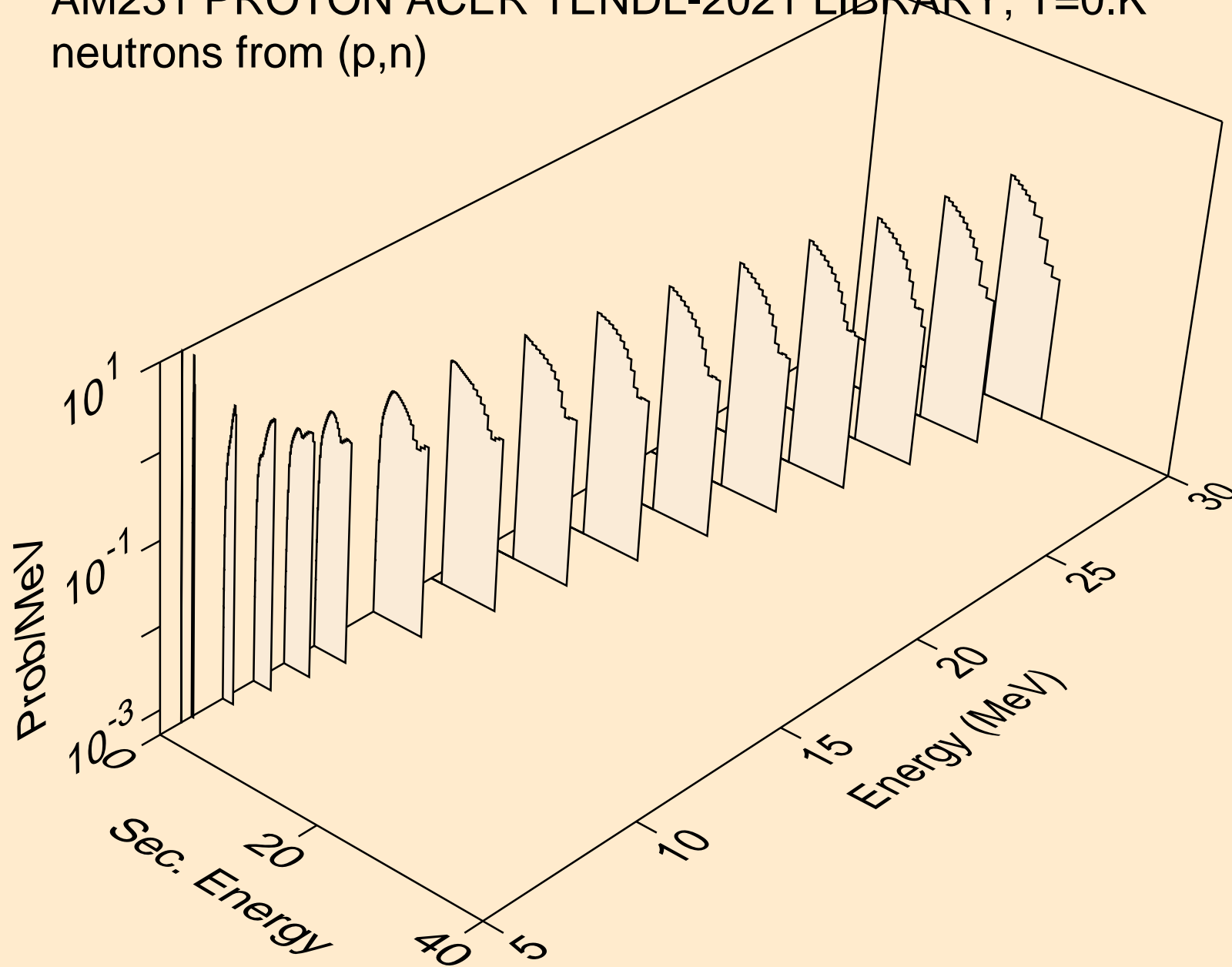



AM231 PROTON ACER TENDL-2021 LIBRARY; T=0.K  
neutrons from (p,x)

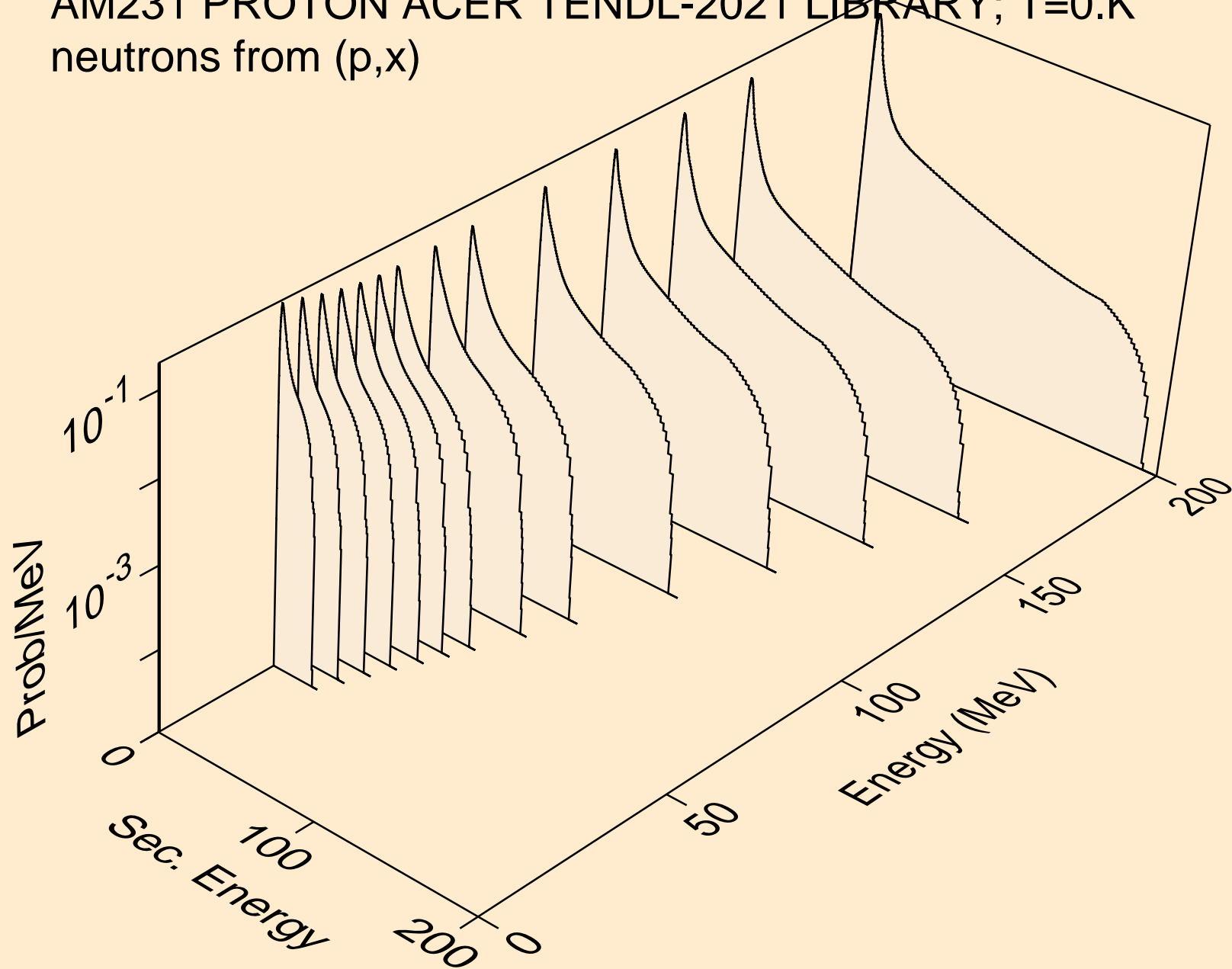

AM231 PROTON ACER TENDL-2021 LIBRARY; T=0.K  
neutrons from (p,2n)

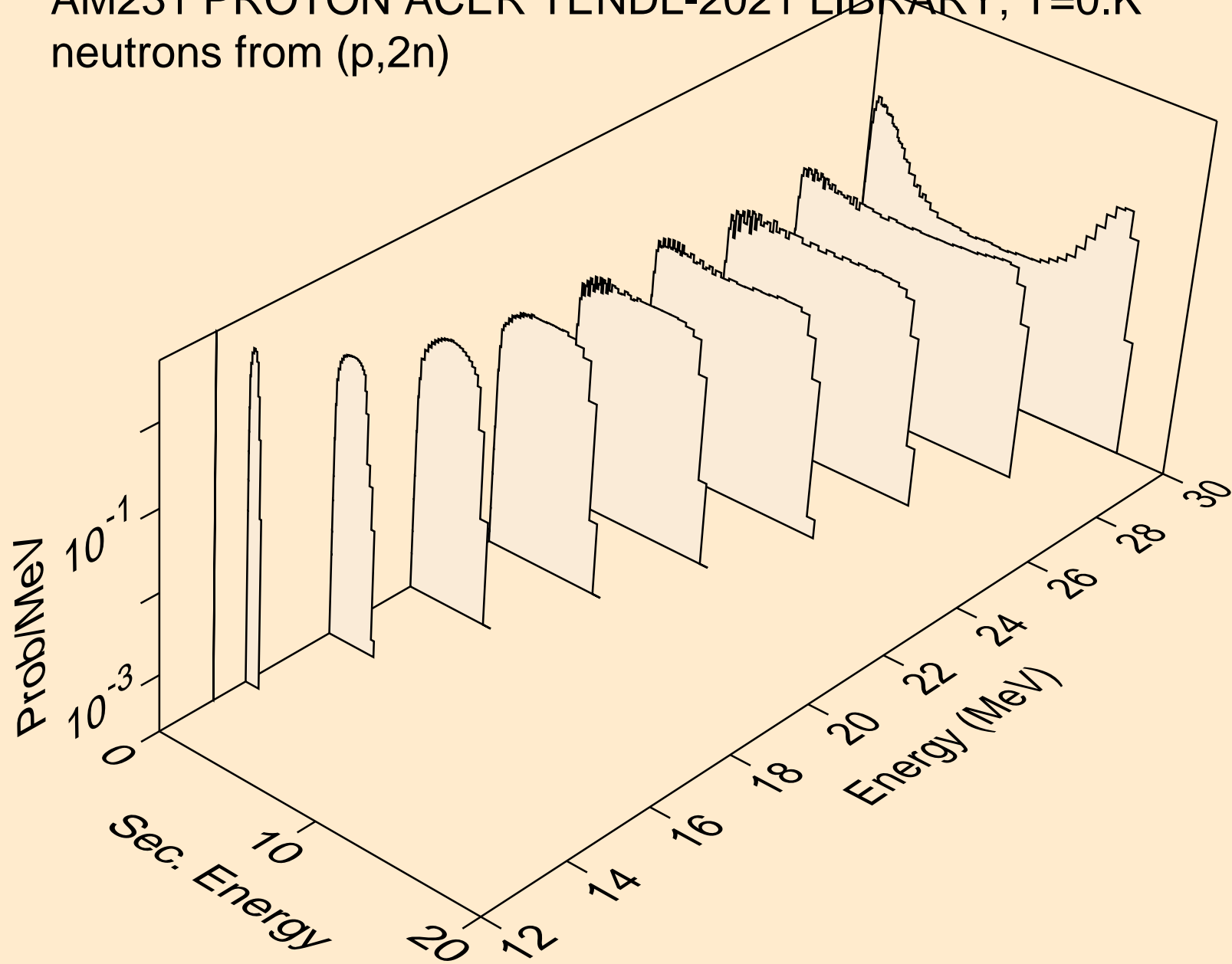

AM231 PROTON ACER TENDL-2021 LIBRARY; T=0.K  
neutrons from (p,n\*)a

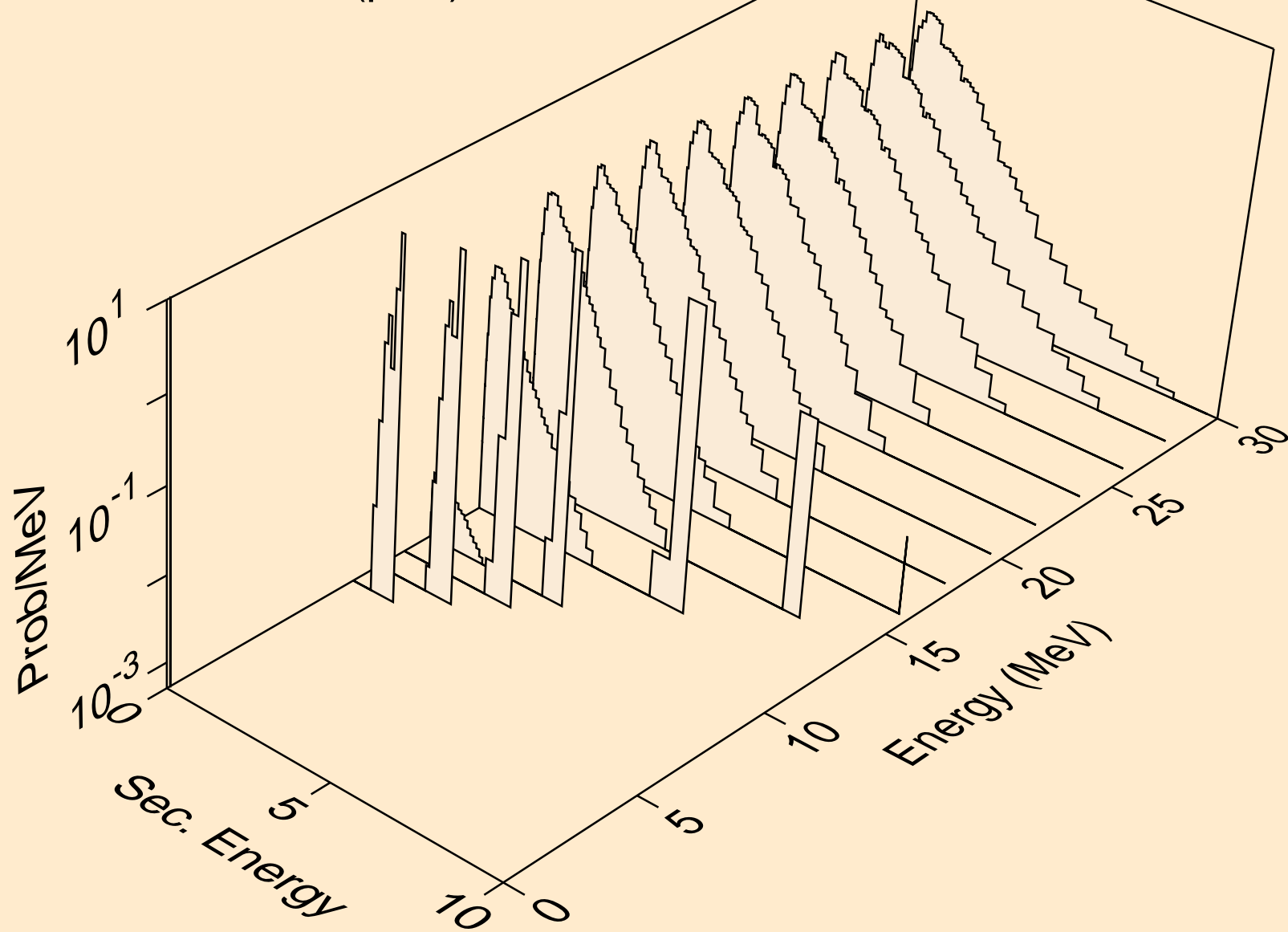

AM231 PROTON ACER TENDL-2021 LIBRARY; T=0.K  
neutrons from (p,n\*)p

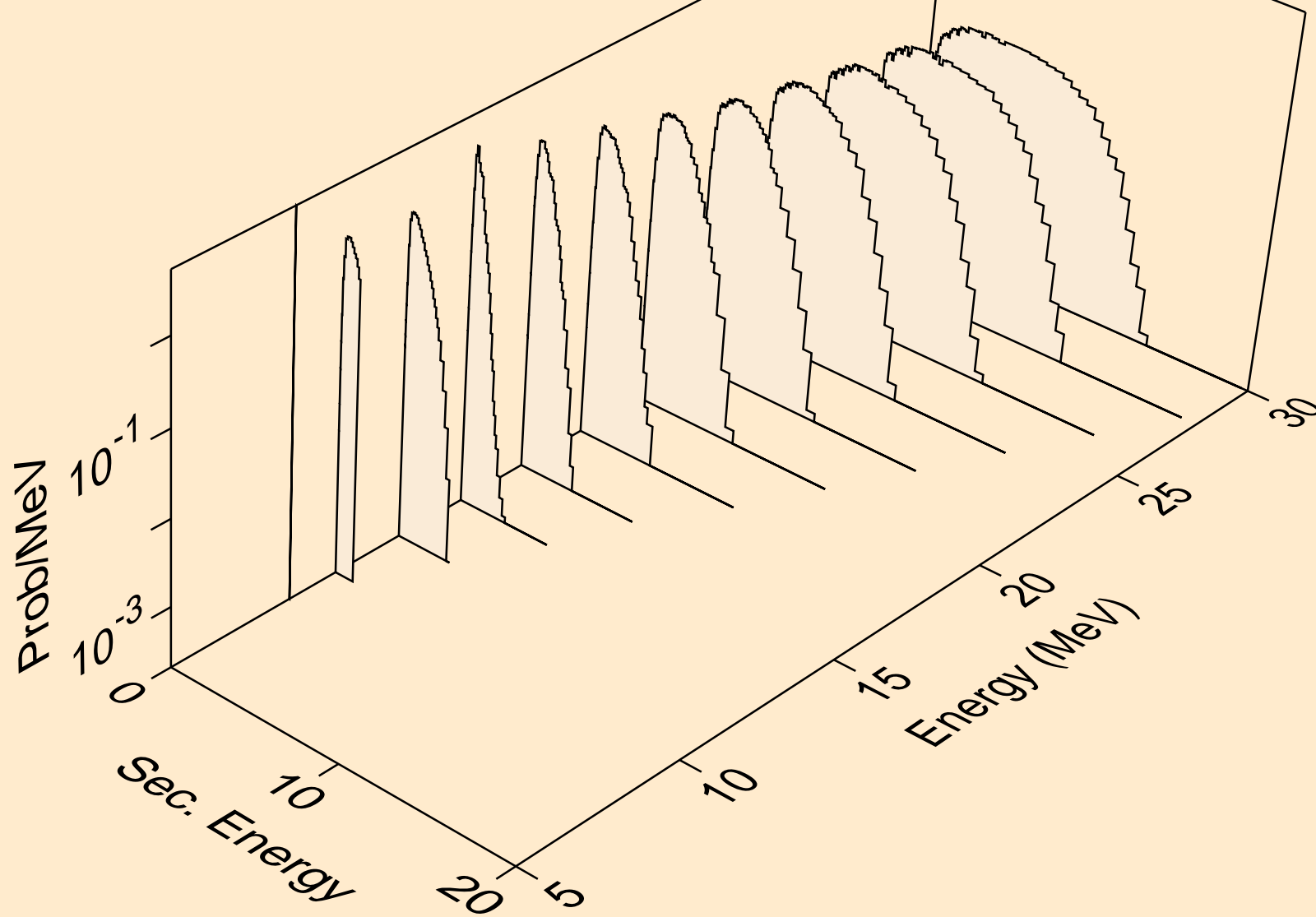

AM231 PROTON ACER TENDL-2021 LIBRARY; T=0.K  
neutrons from (p,2np)

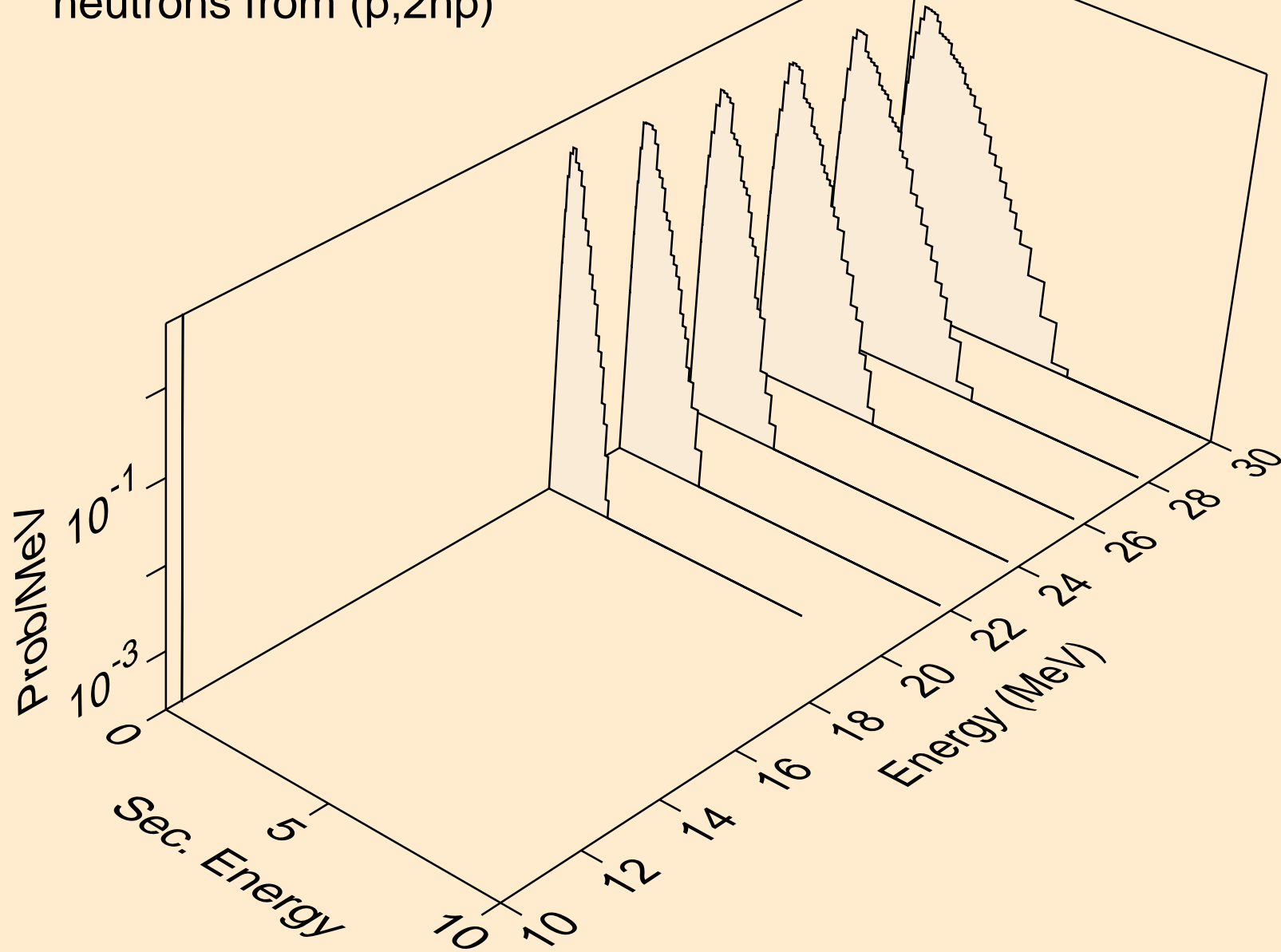

AM231 PROTON ACER TENDL-2021 LIBRARY; T=0.K  
deuterons from (p,x)

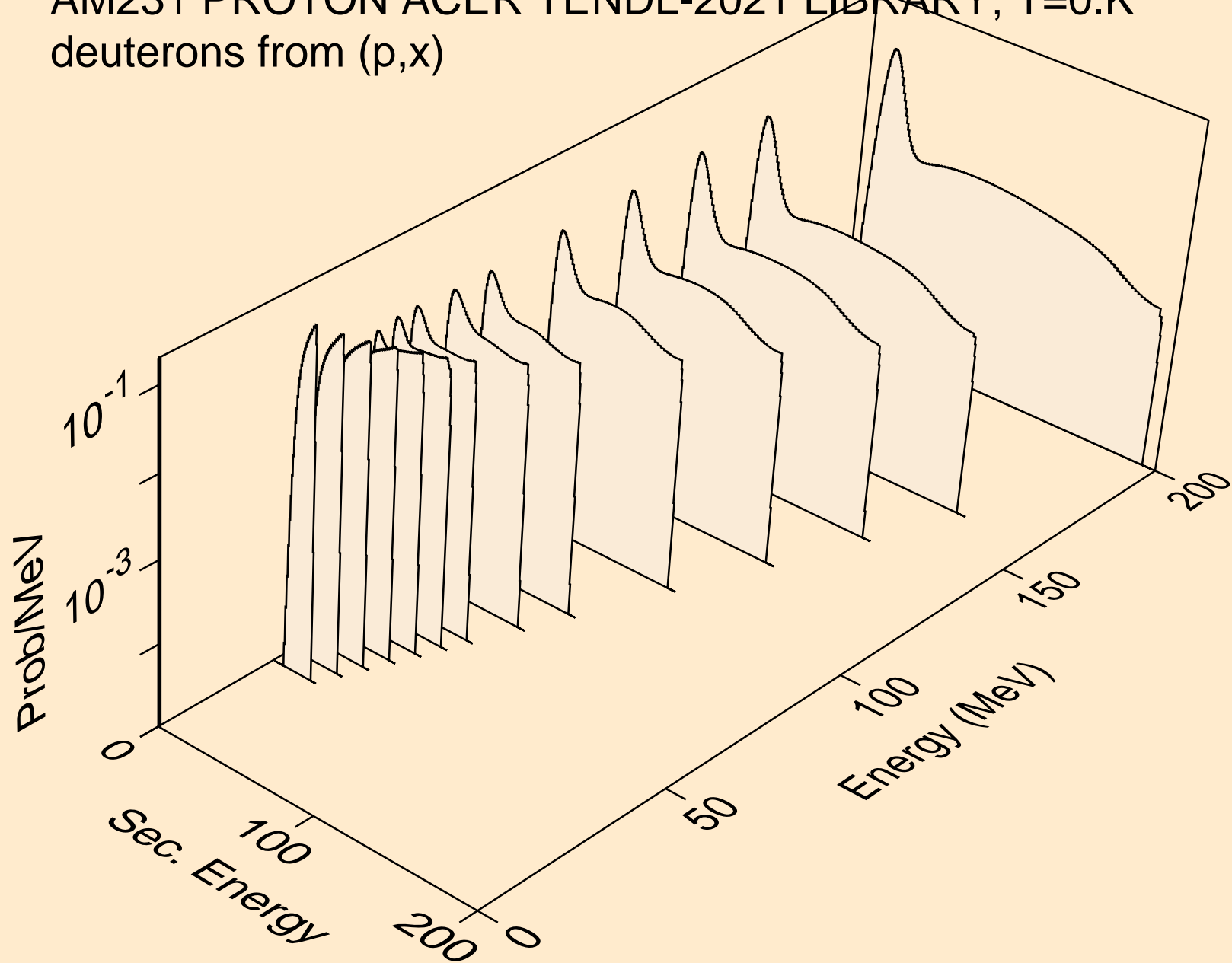

AM231 PROTON ACER TENDL-2021 LIBRARY; T=0.K  
deuterons from (p,d)

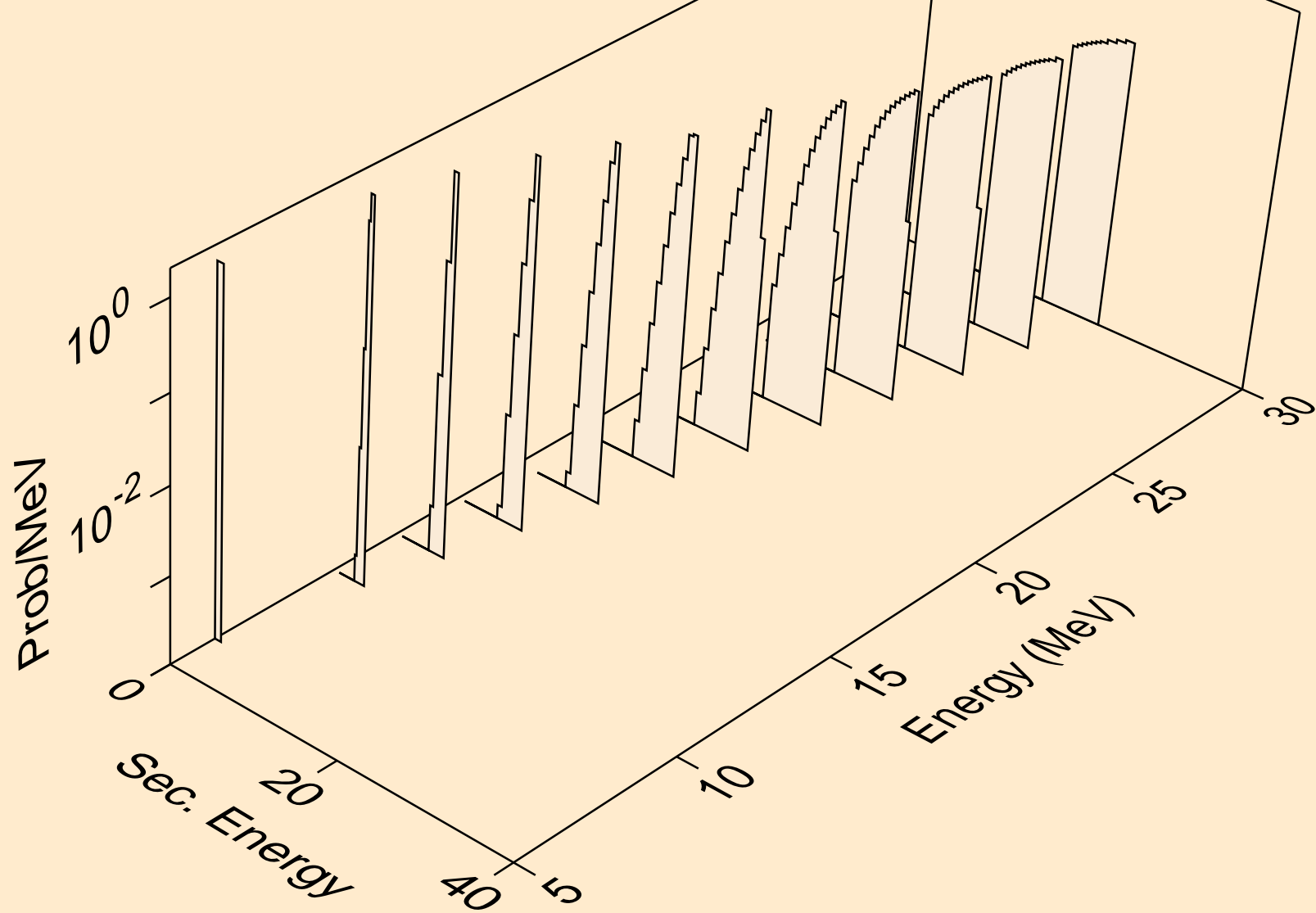

AM231 PROTON ACER TENDL-2021 LIBRARY; T=0.K  
deuterons from (p,pd)

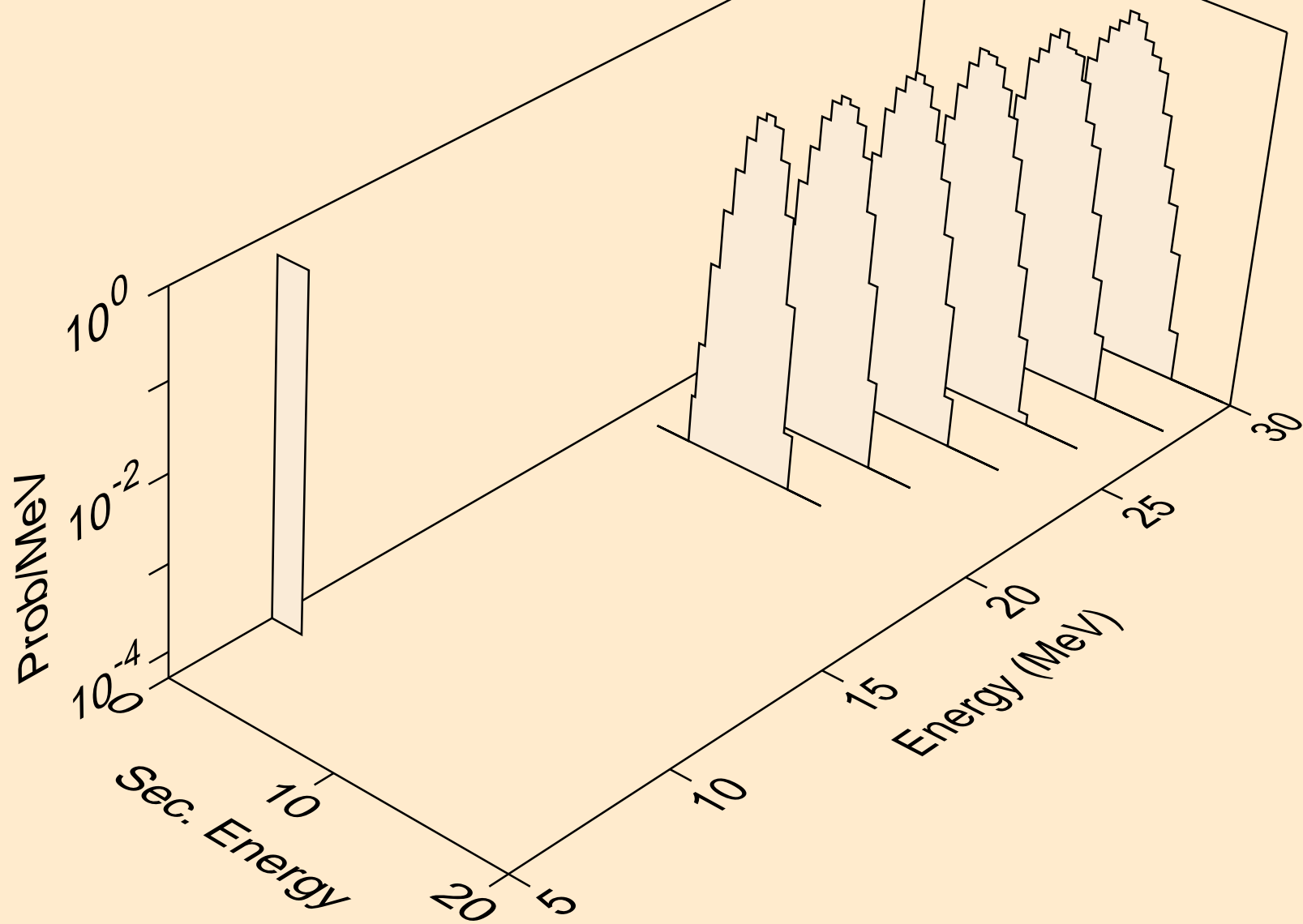



AM231 PROTON ACER TENDL-2021 LIBRARY; T=0.K  
tritons from (p,x)

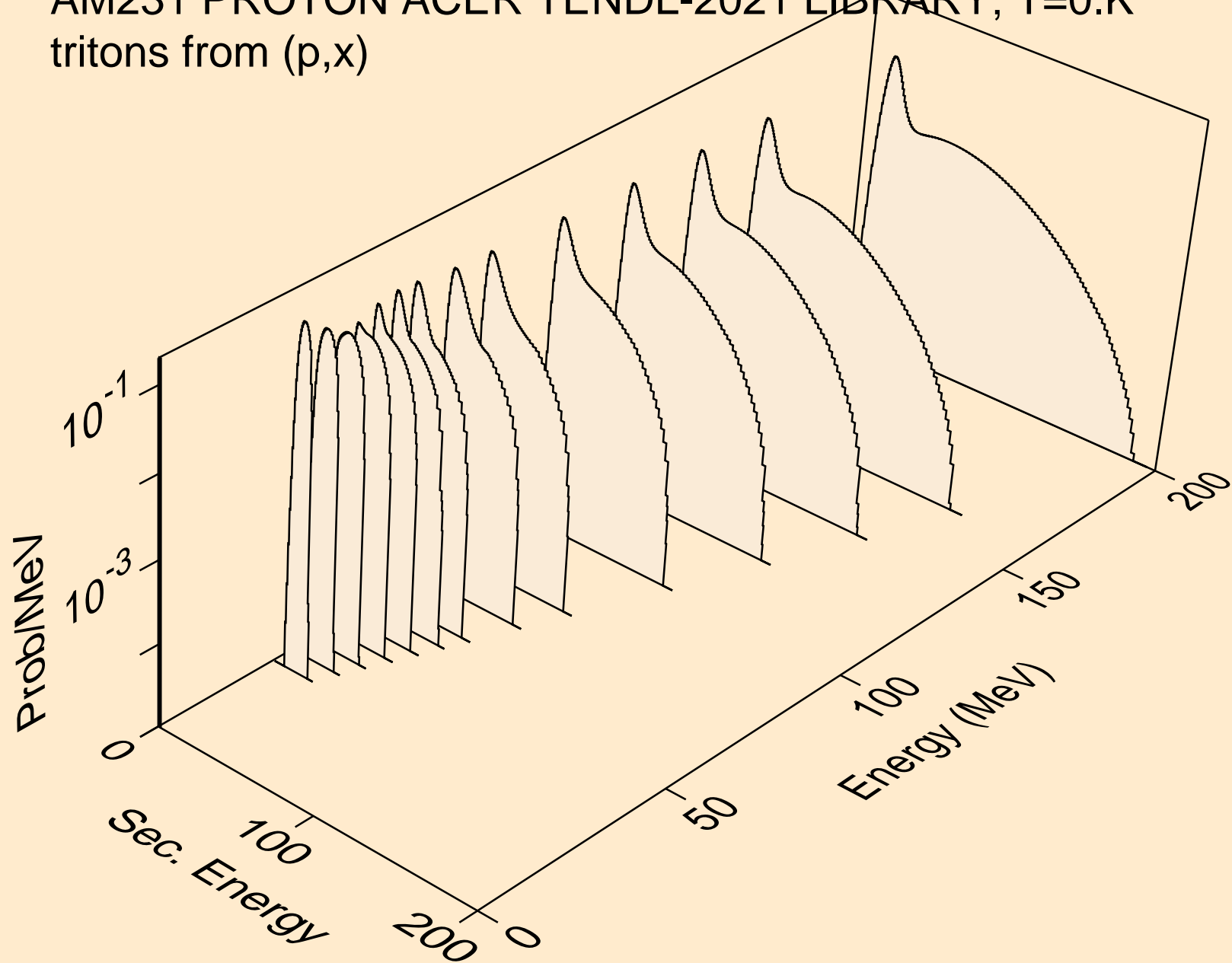

AM231 PROTON ACER TENDL-2021 LIBRARY; T=0.K  
tritons from (p,t)

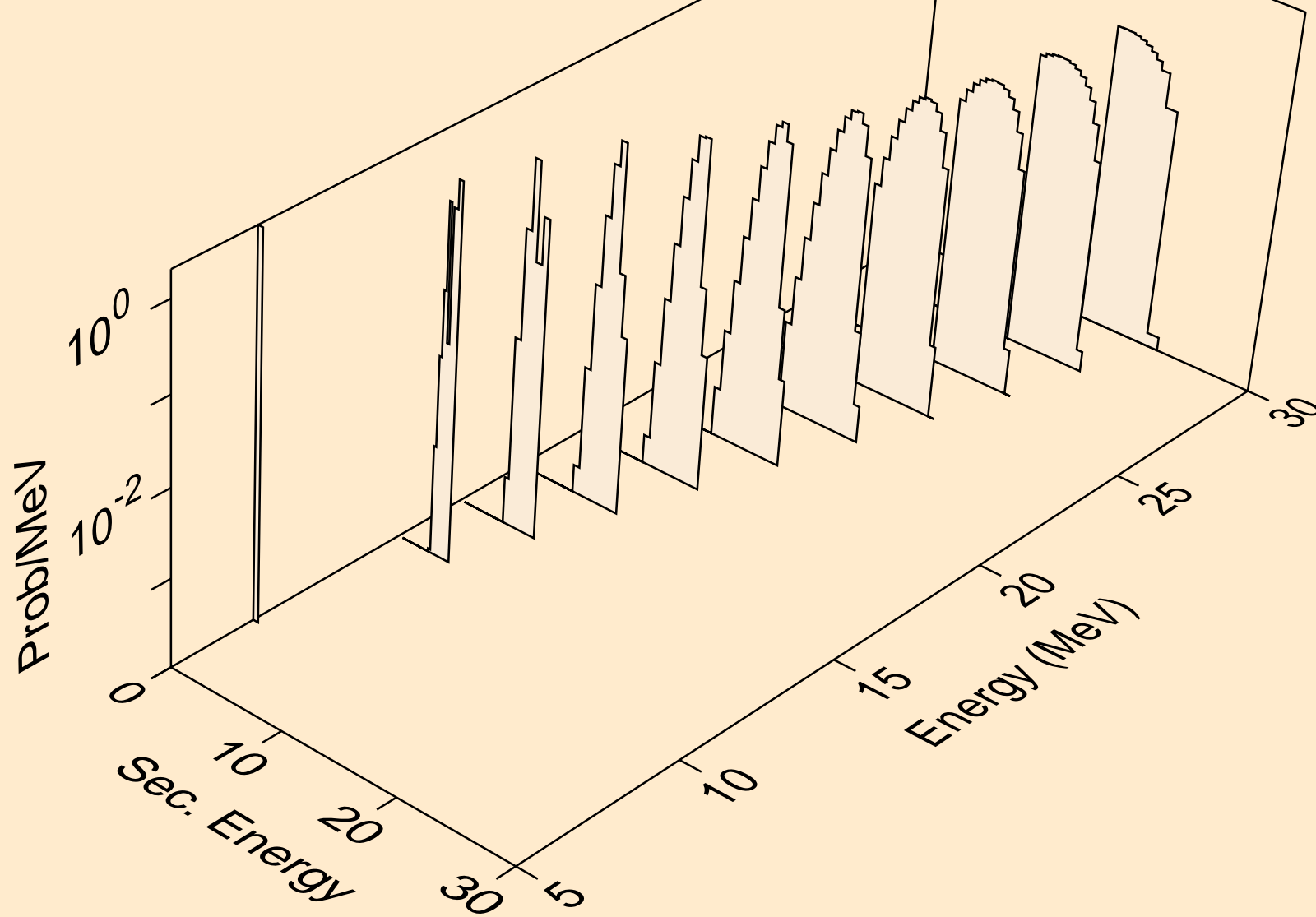

AM231 PROTON ACER TENDL-2021 LIBRARY; T=0.K  
he3s from (p,x)

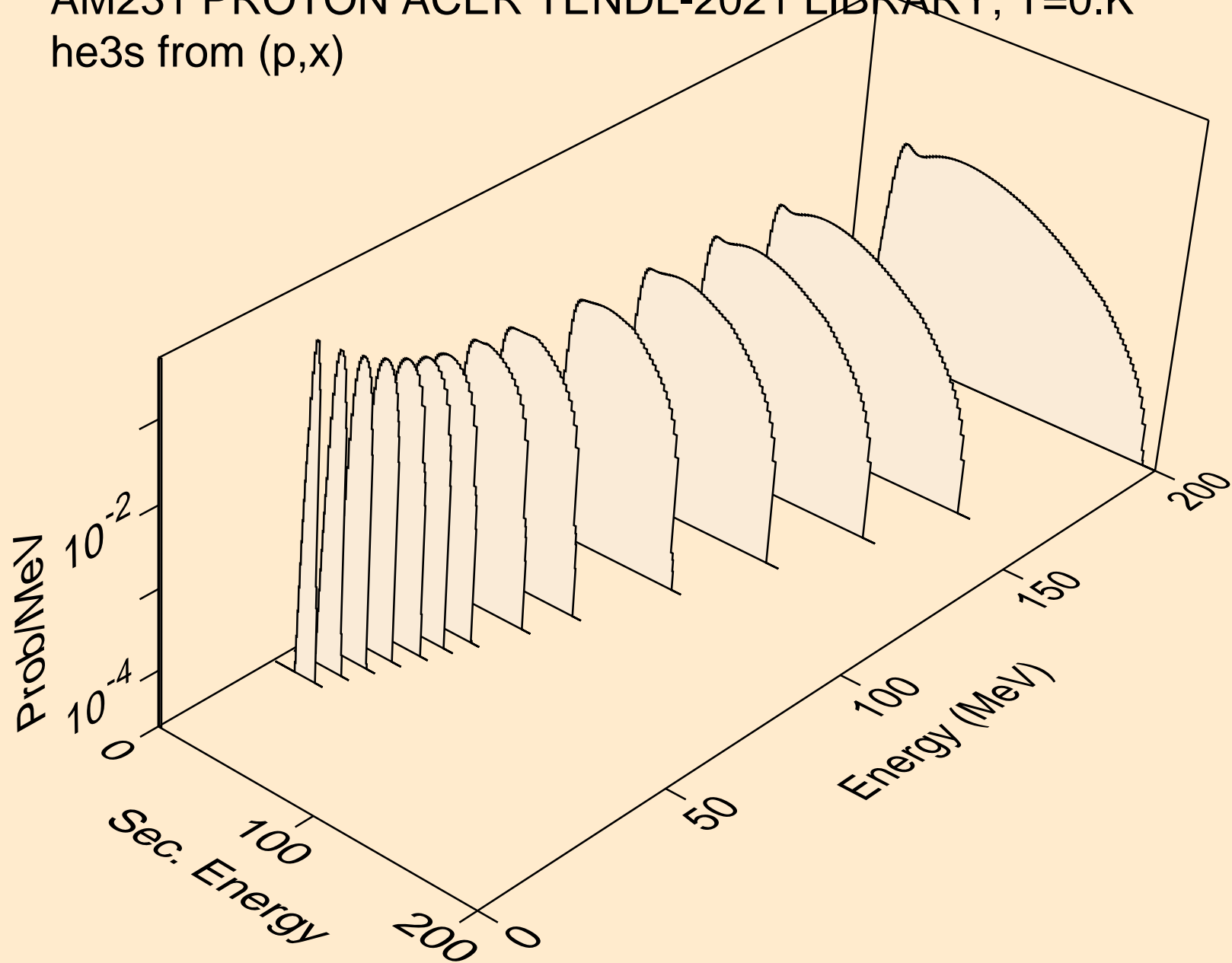

AM231 PROTON ACER TENDL-2021 LIBRARY; T=0.K  
he3s from (p,he3)

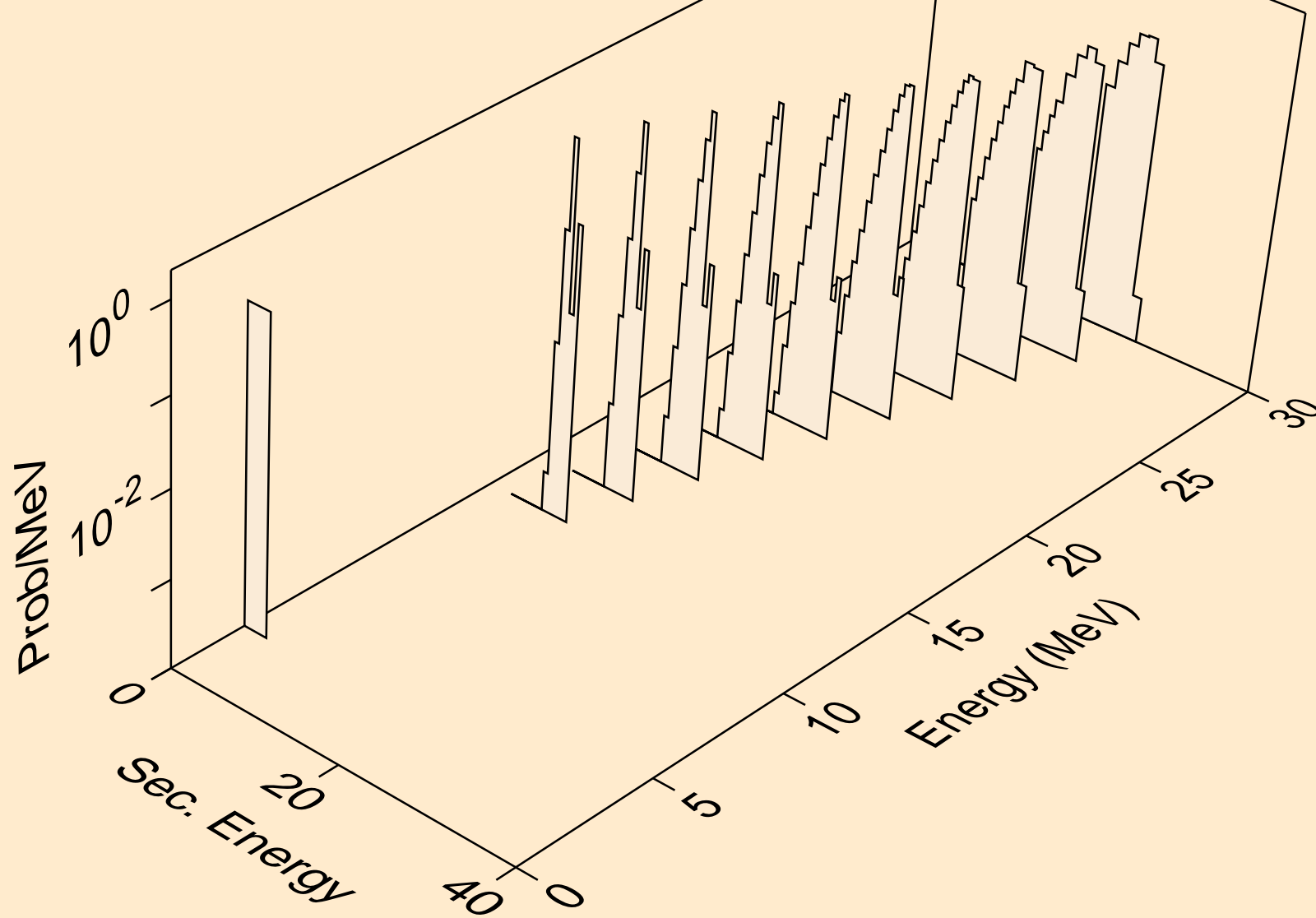

AM231 PROTON ACER TENDL-2021 LIBRARY; T=0.K  
alphas from (p,x)

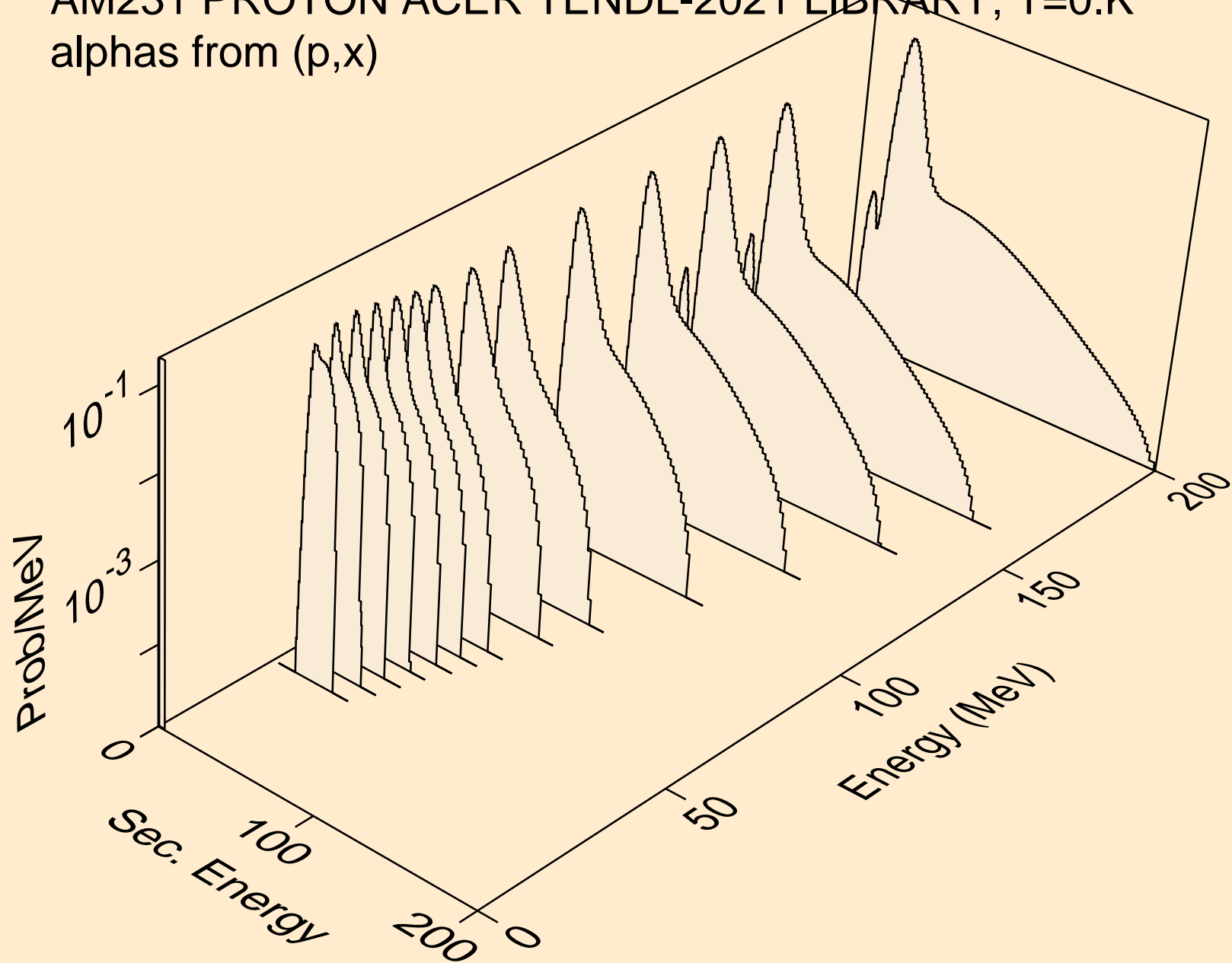

AM231 PROTON ACER TENDL-2021 LIBRARY; T=0.K  
alphas from (p,n\*)a

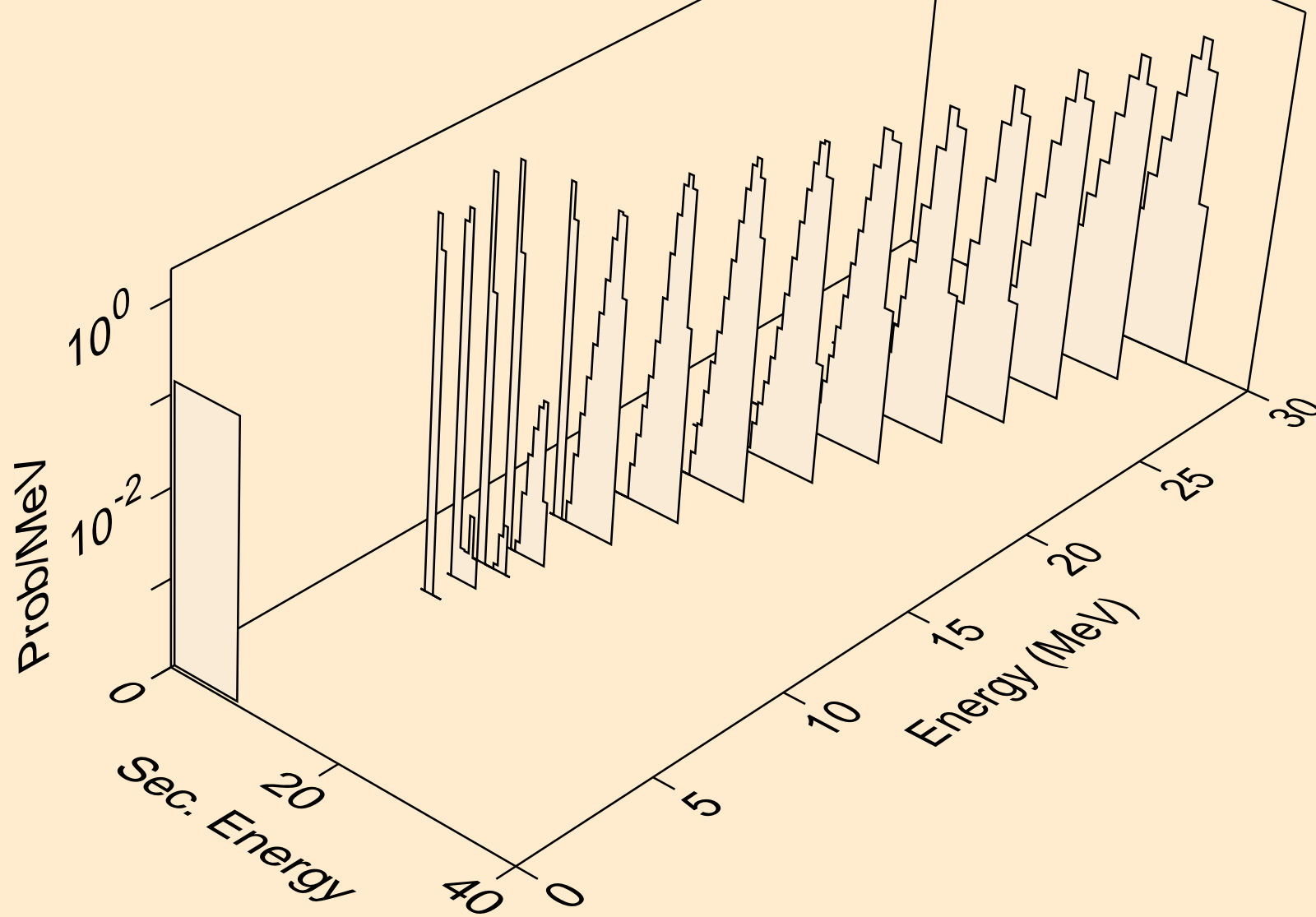

AM231 PROTON ACER TENDL-2021 LIBRARY; T=0.K  
alphas from (p,a)

