

AM235 PROTON ACER TENDL-2021 LIBRARY; T=0.K
Principal cross sections

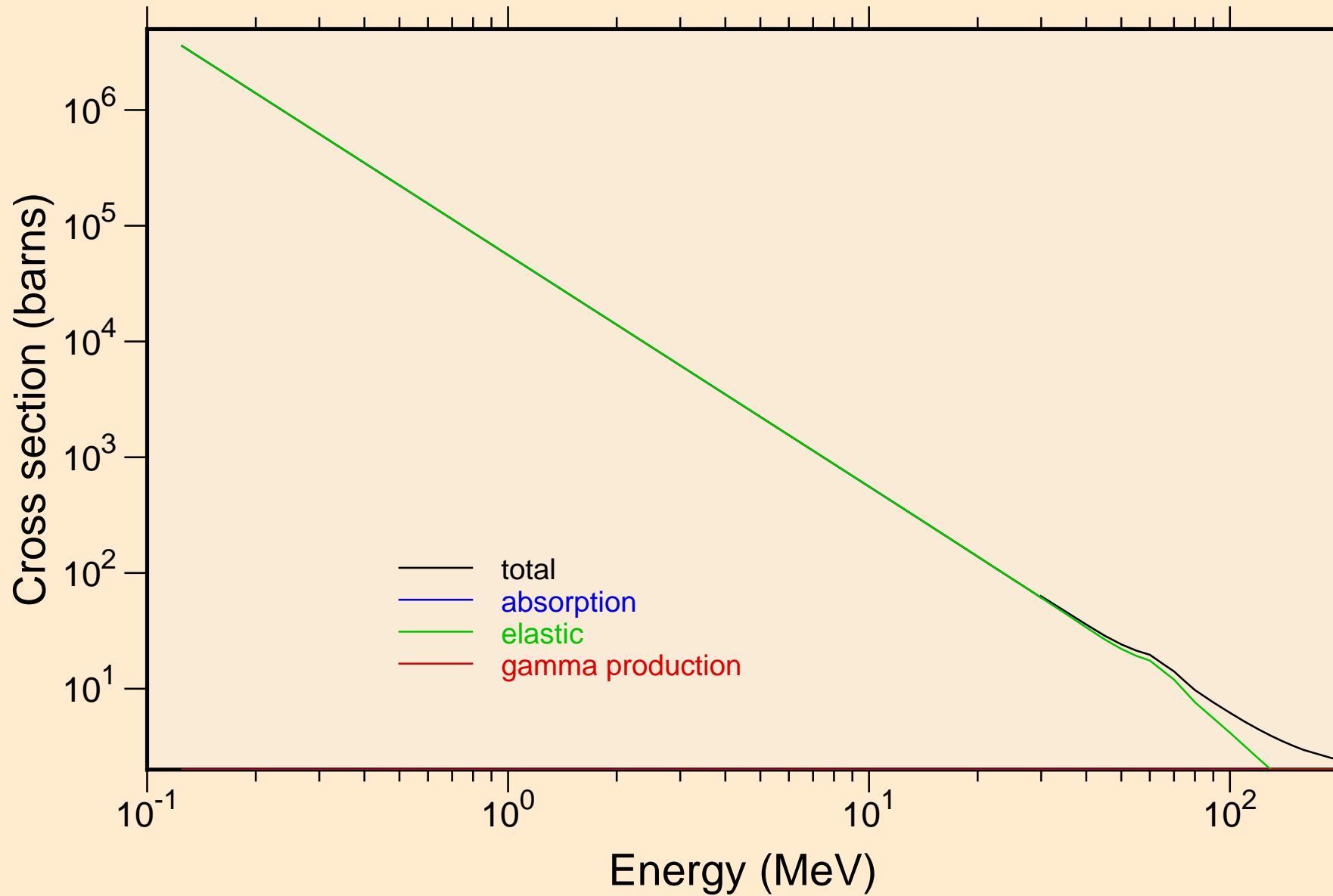

AM235 PROTON ACER TENDL-2021 LIBRARY; T=0.K
Heating

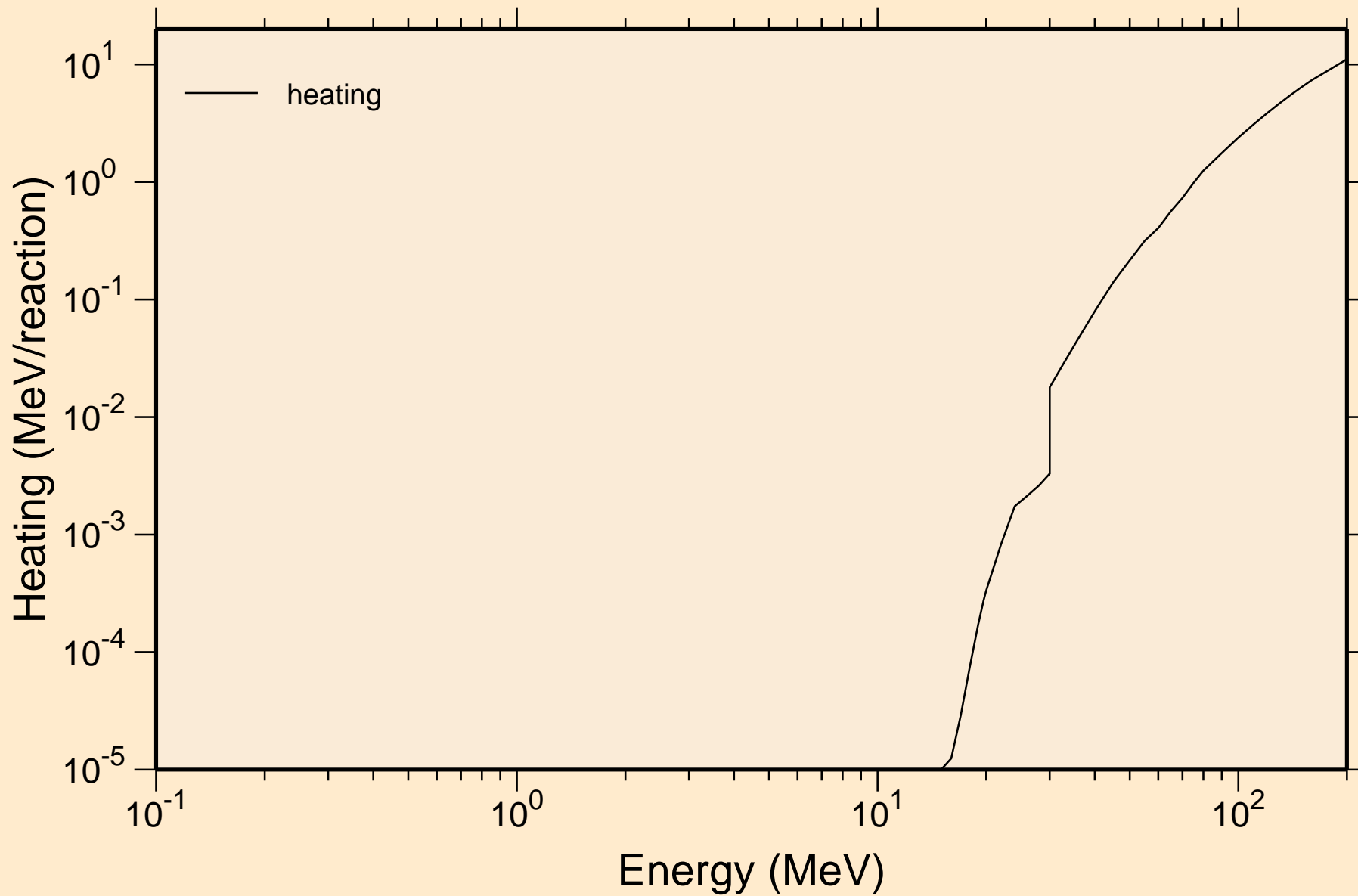

AM235 PROTON ACER TENDL-2021 LIBRARY; T=0.K

Principal cross sections

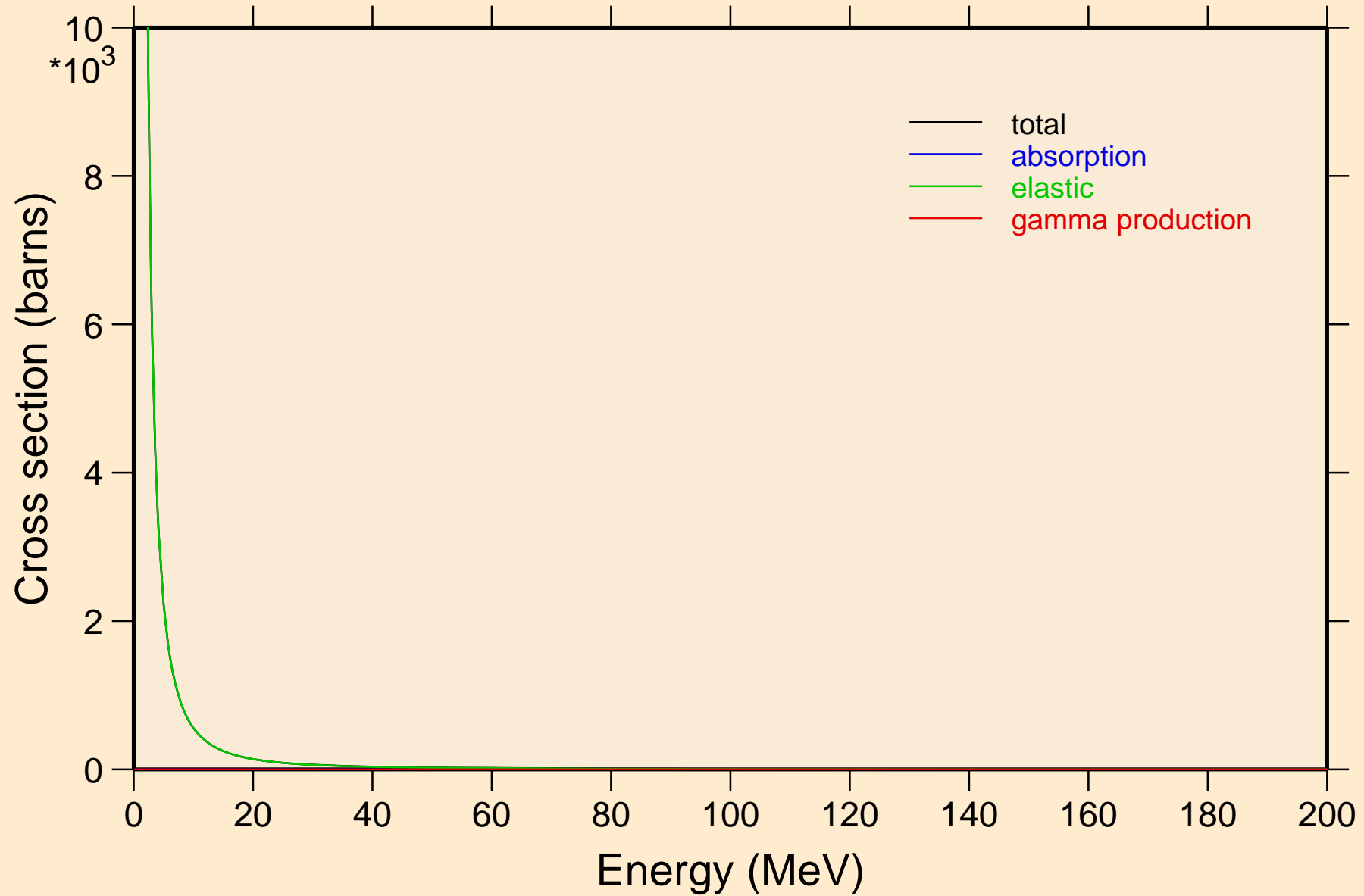

AM235 PROTON ACER TENDL-2021 LIBRARY; T=0.K

Heating

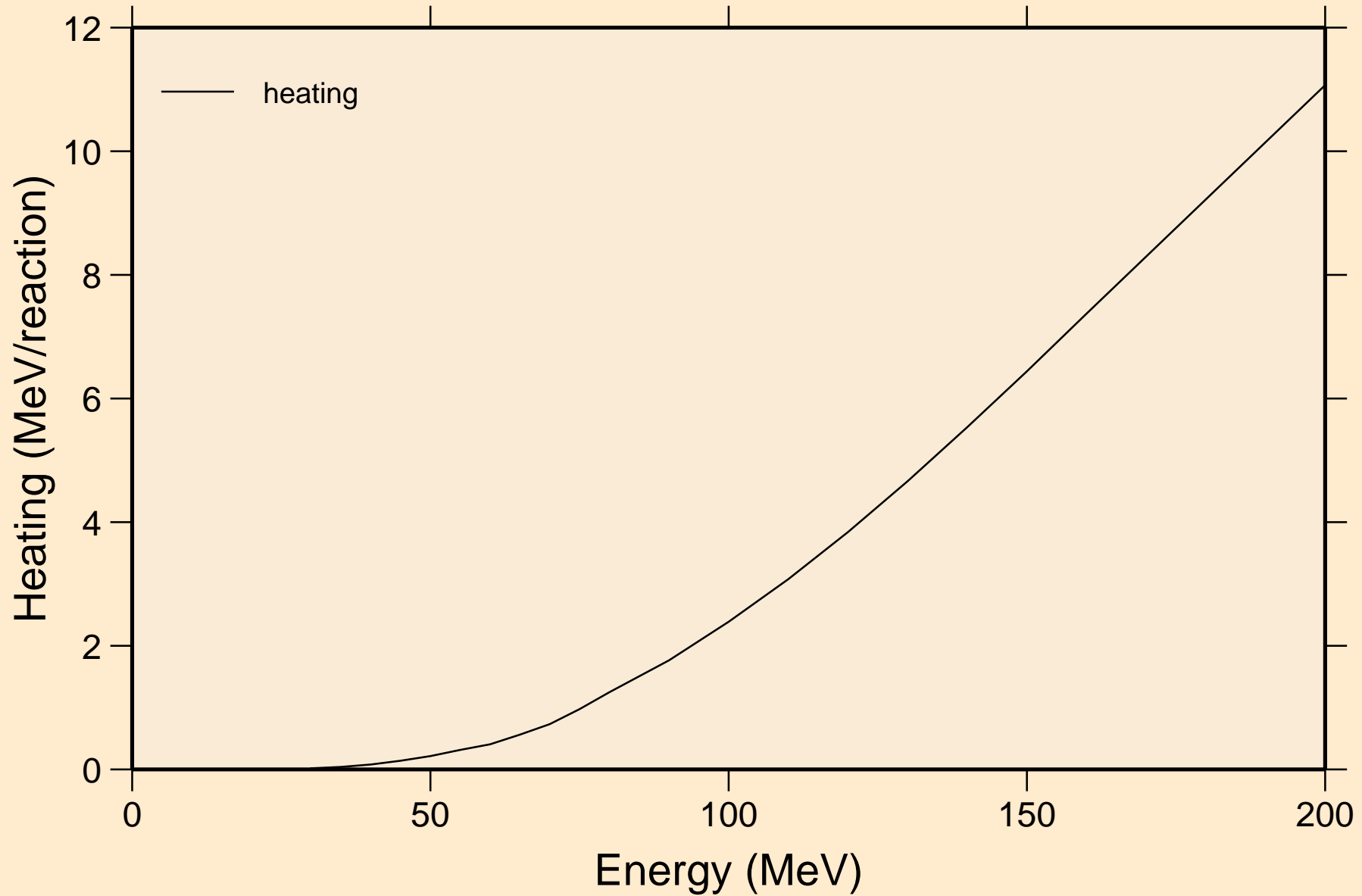

AM235 PROTON ACER TENDL-2021 LIBRARY; T=0.K

Threshold reactions

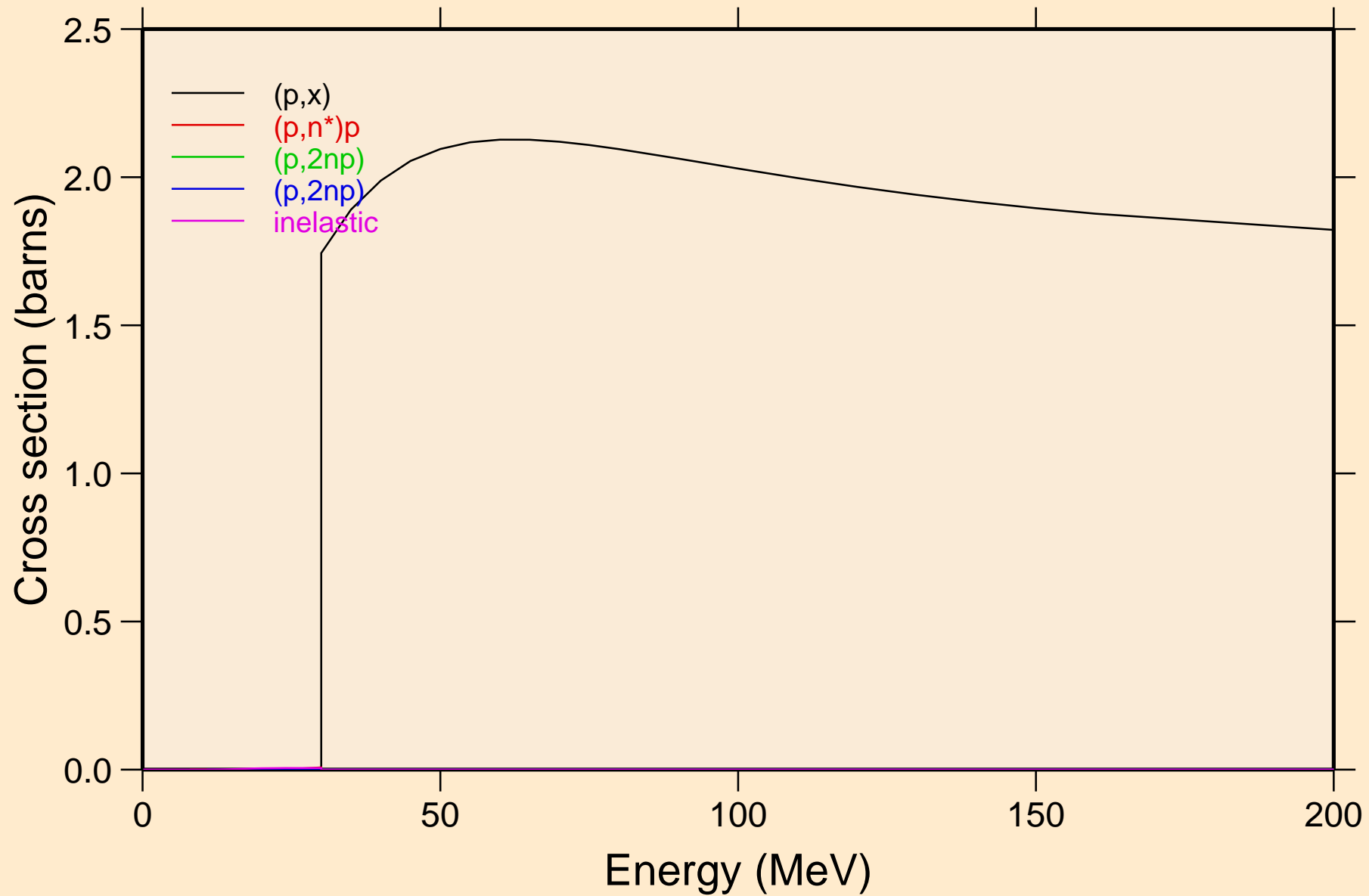

AM235 PROTON ACER TENDL-2021 LIBRARY; T=0.K
Threshold reactions

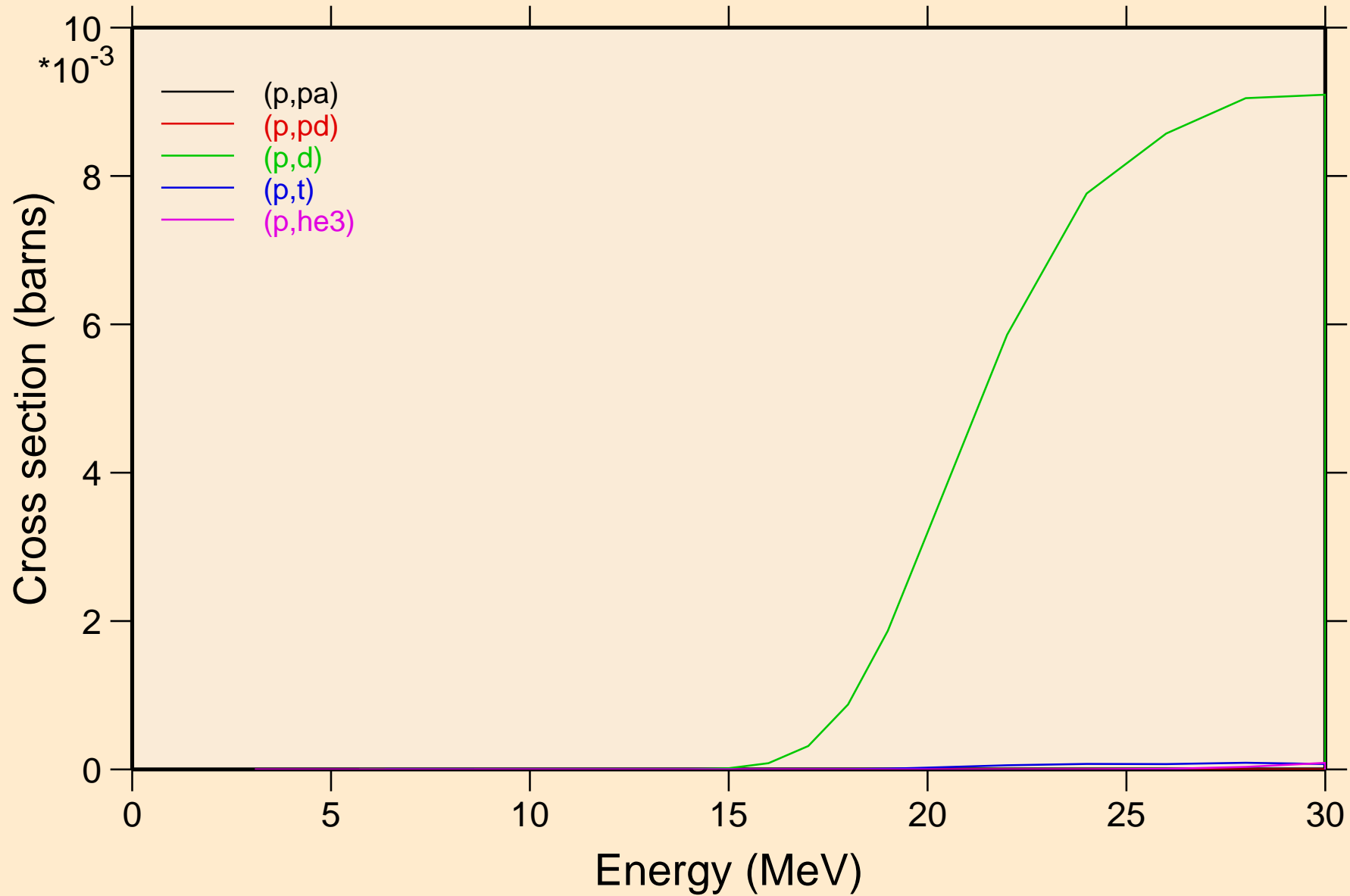

AM235 PROTON ACER TENDL-2021 LIBRARY; T=0.K
Threshold reactions

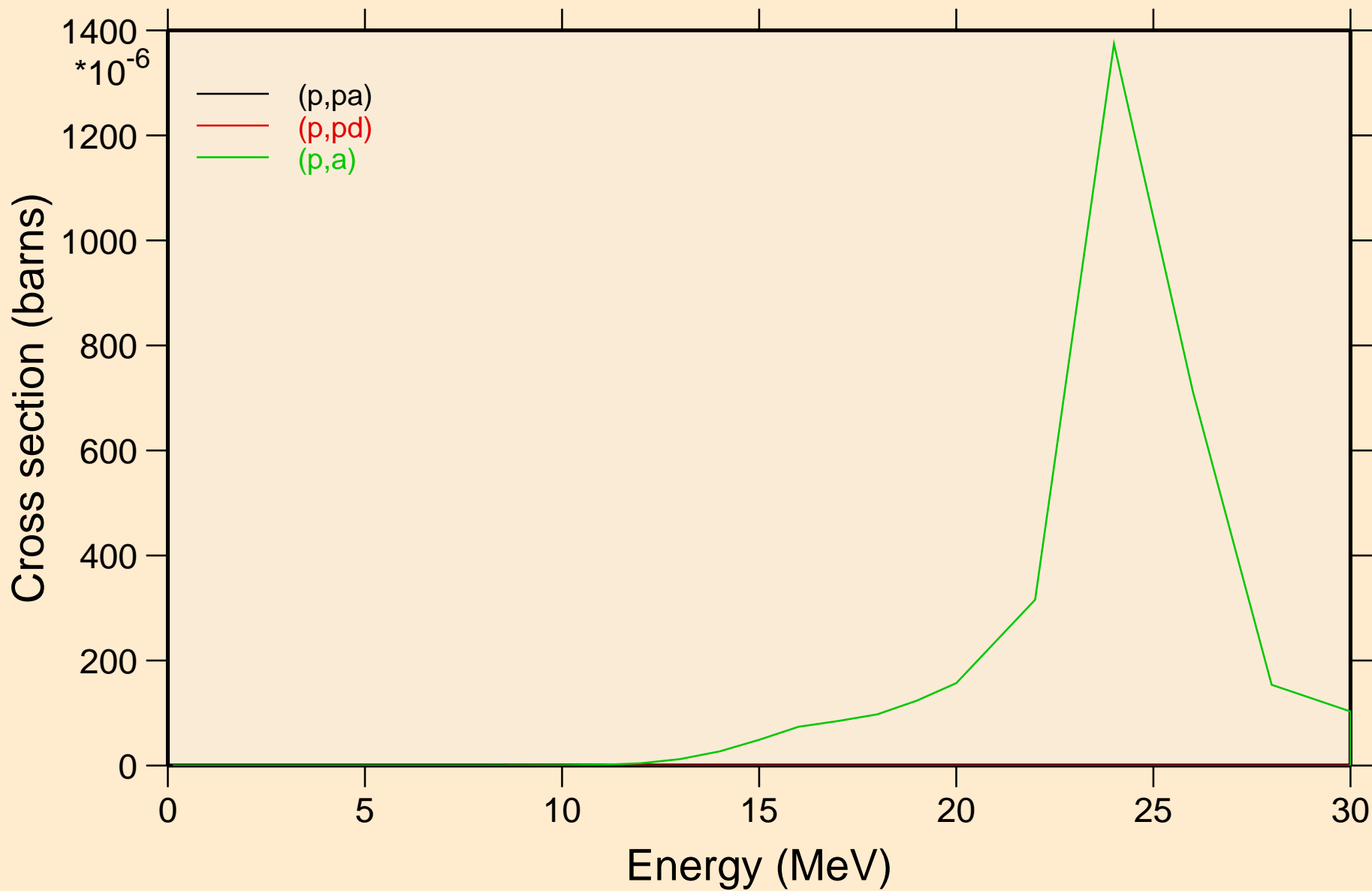

AM235 PROTON ACER TENDL-2021 LIBRARY; T=0.K
Threshold reactions

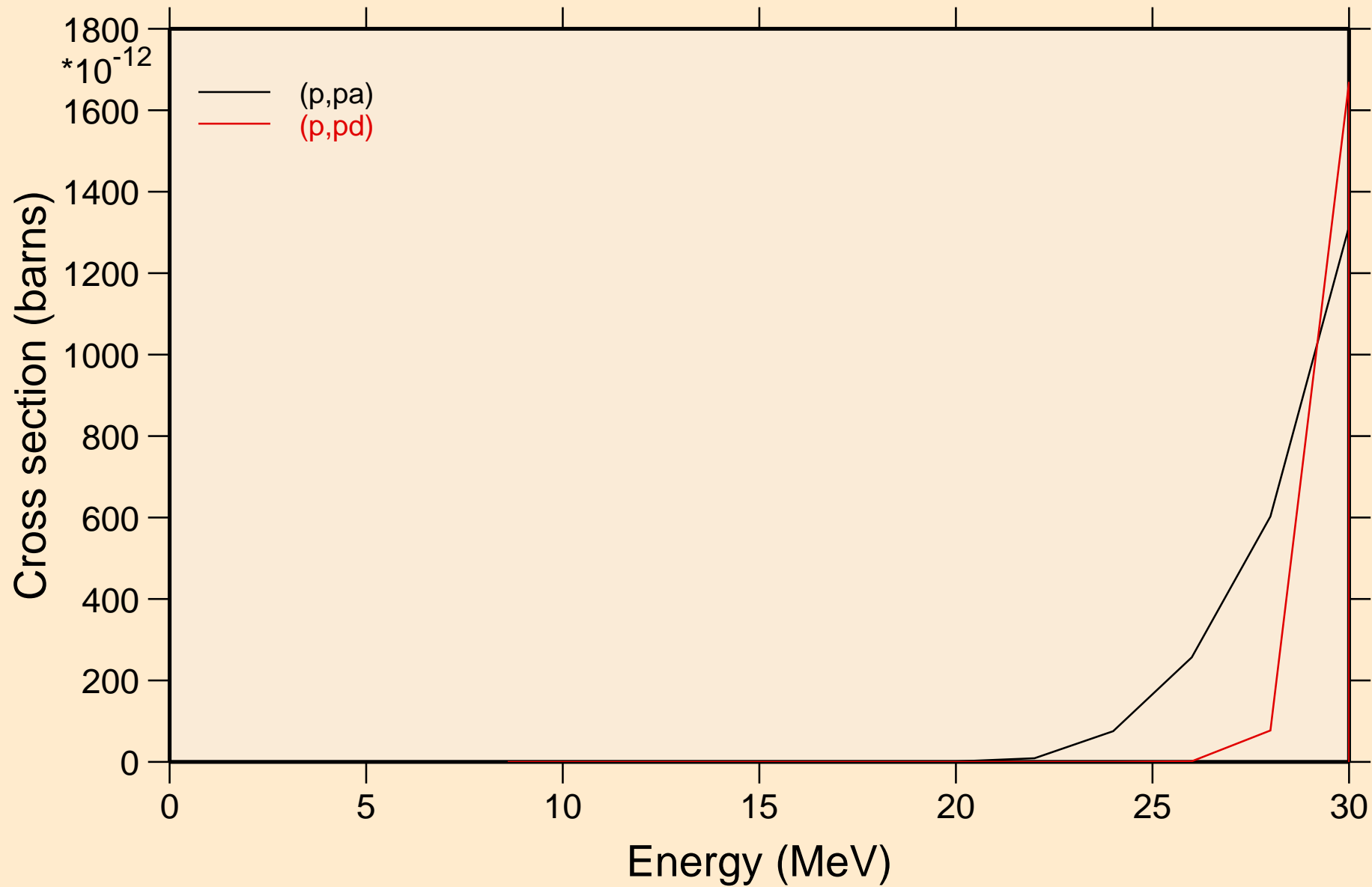

AM235 PROTON ACER TENDL-2021 LIBRARY; T=0.K
angular distribution for elastic

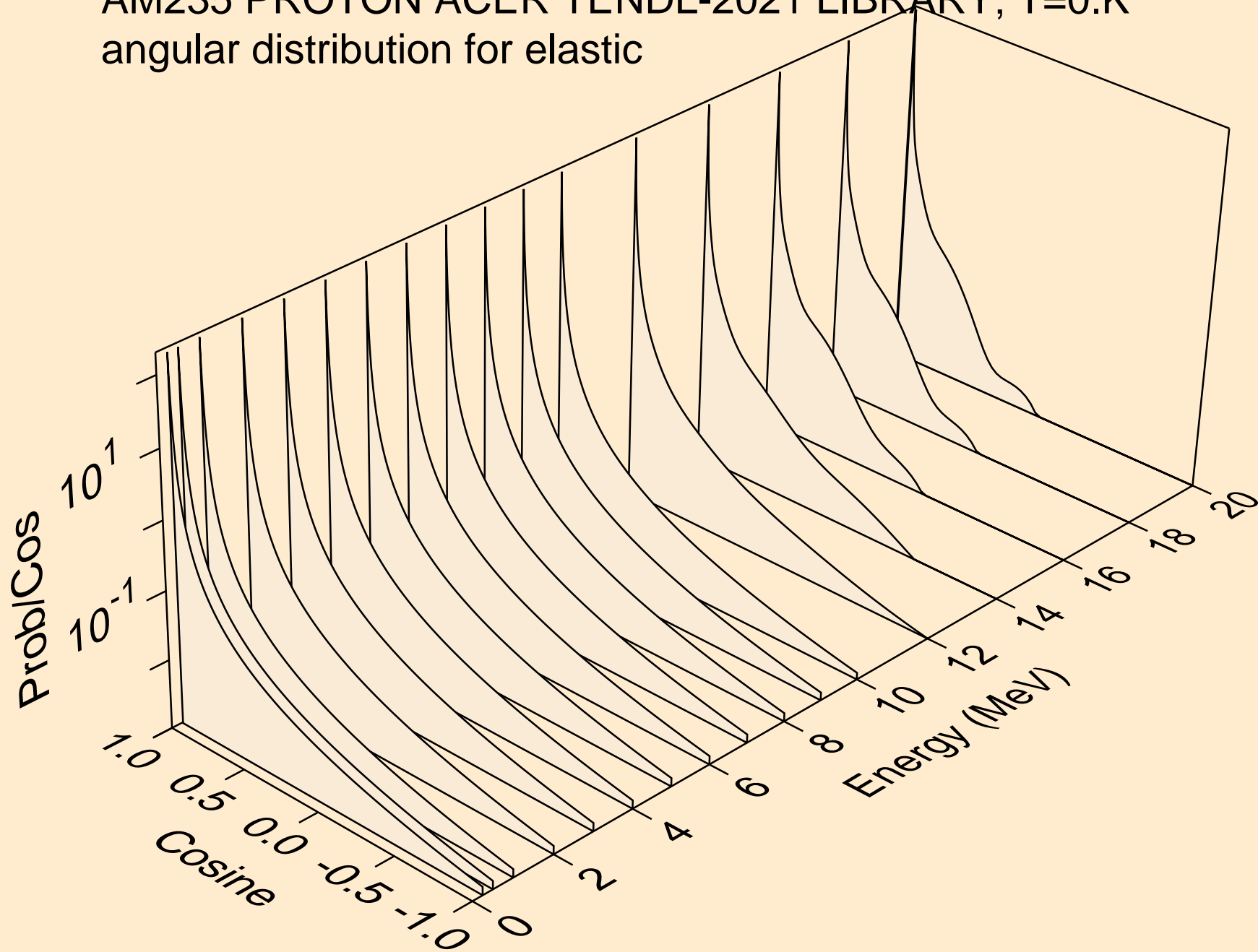

AM235 PROTON ACER TENDL-2021 LIBRARY; T=0.K
angular distribution for elastic

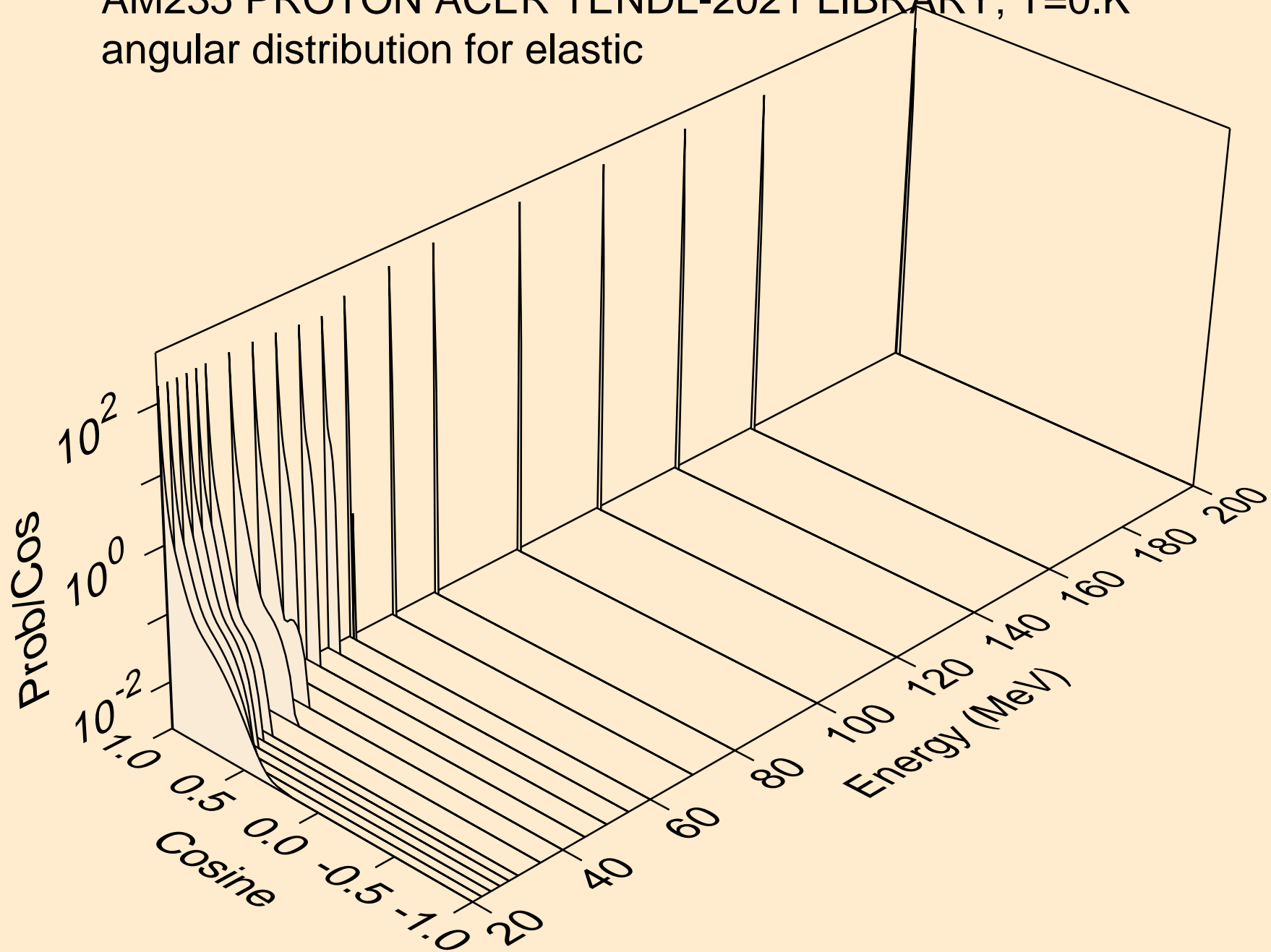

AM235 PROTON ACER TENDL-2021 LIBRARY; T=0.K
Proton emission for (p,x)

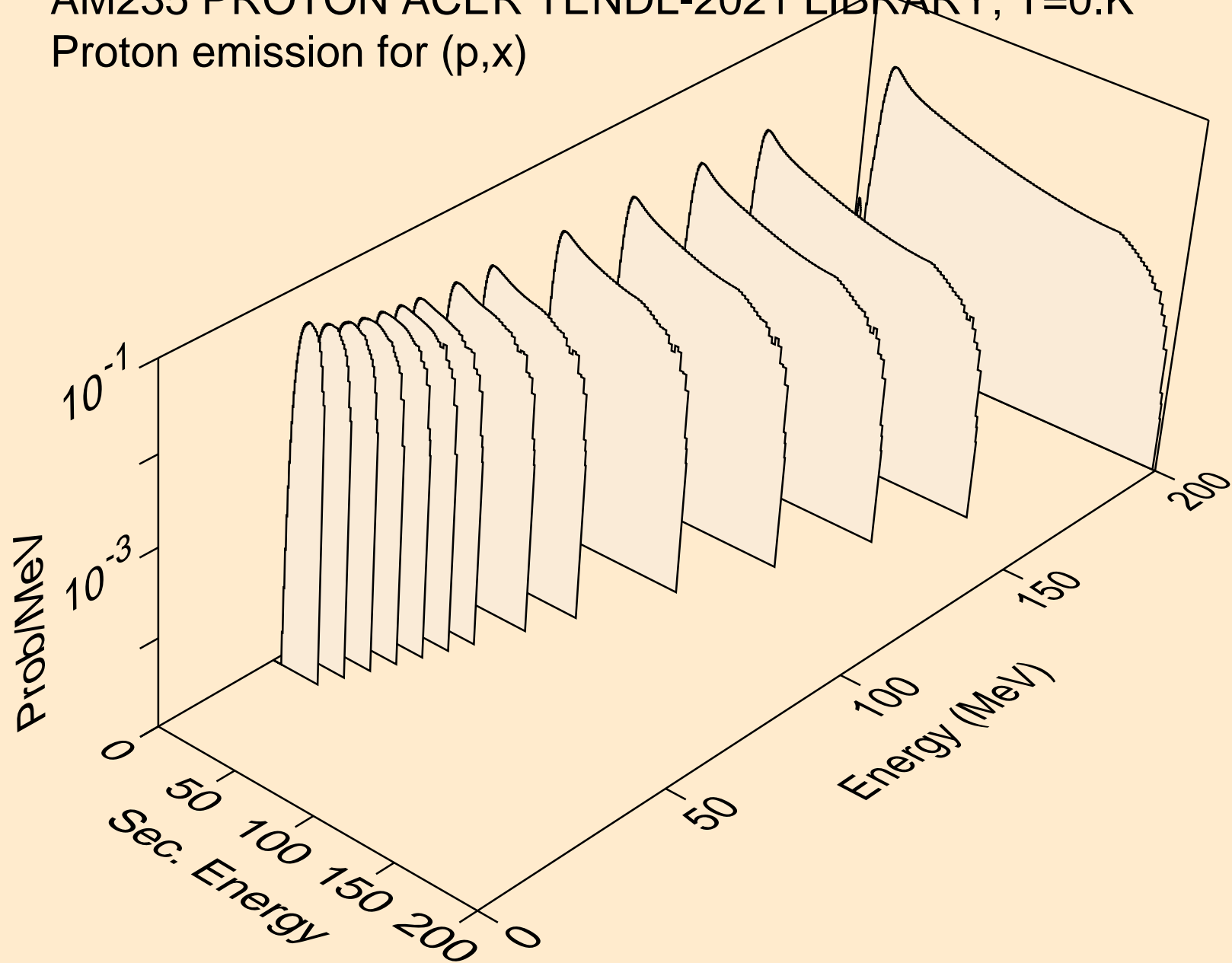

AM235 PROTON ACER TENDL-2021 LIBRARY; T=0.K
Proton emission for (p,n*)p

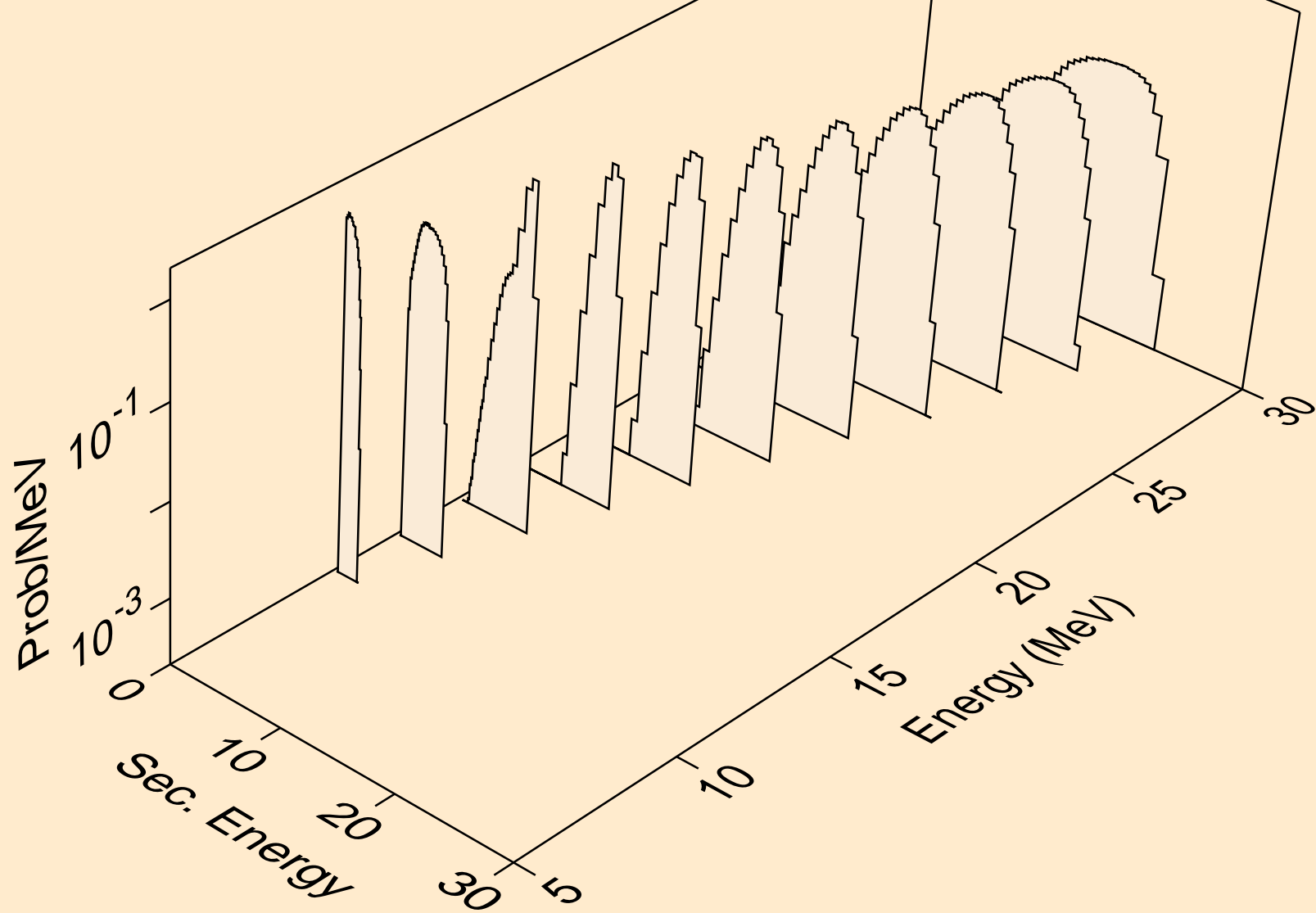

AM235 PROTON ACER TENDL-2021 LIBRARY; T=0.K
Proton emission for (p,2np)

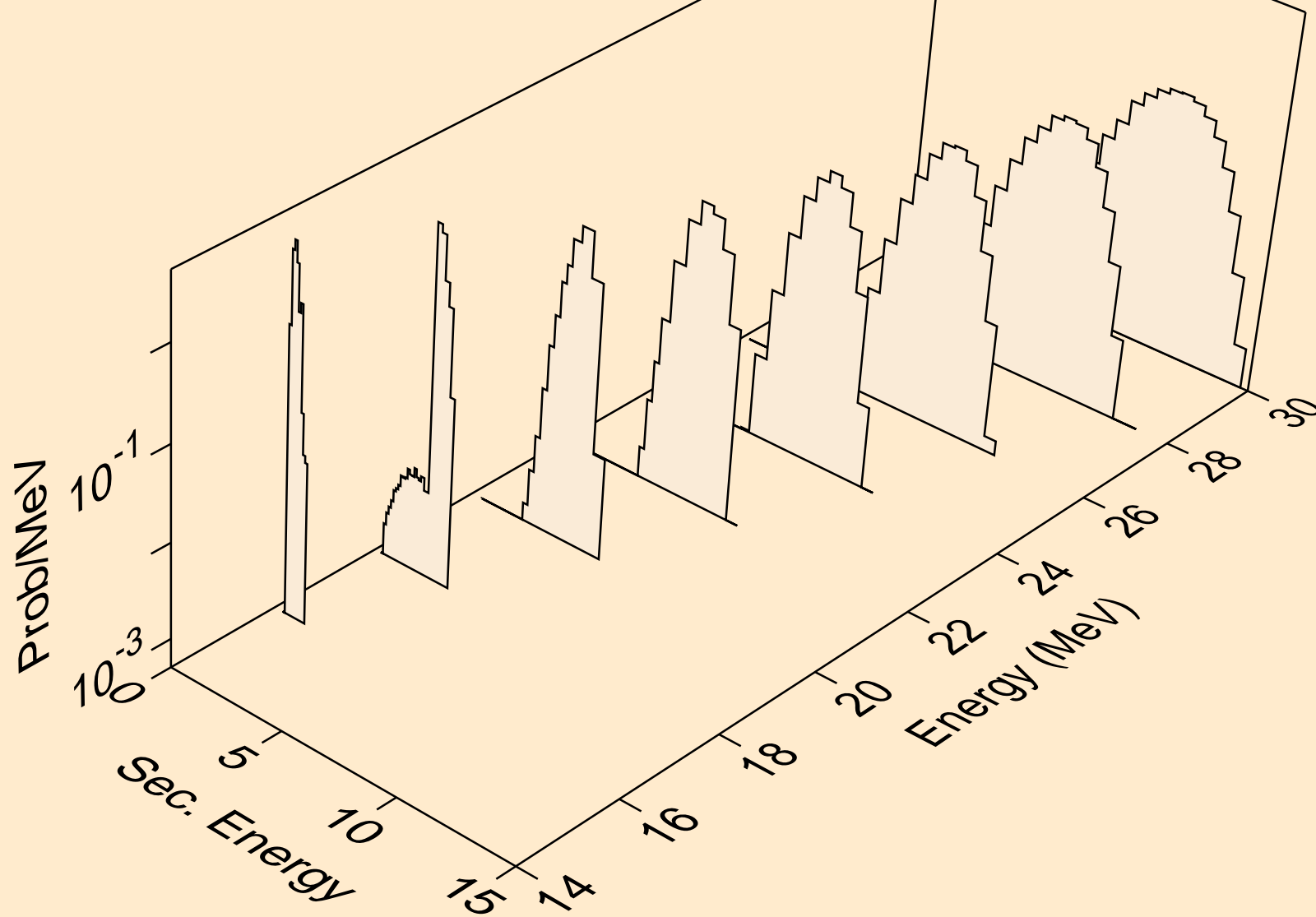

AM235 PROTON ACER TENDL-2021 LIBRARY; T=0.K
Proton emission for (p,2np)

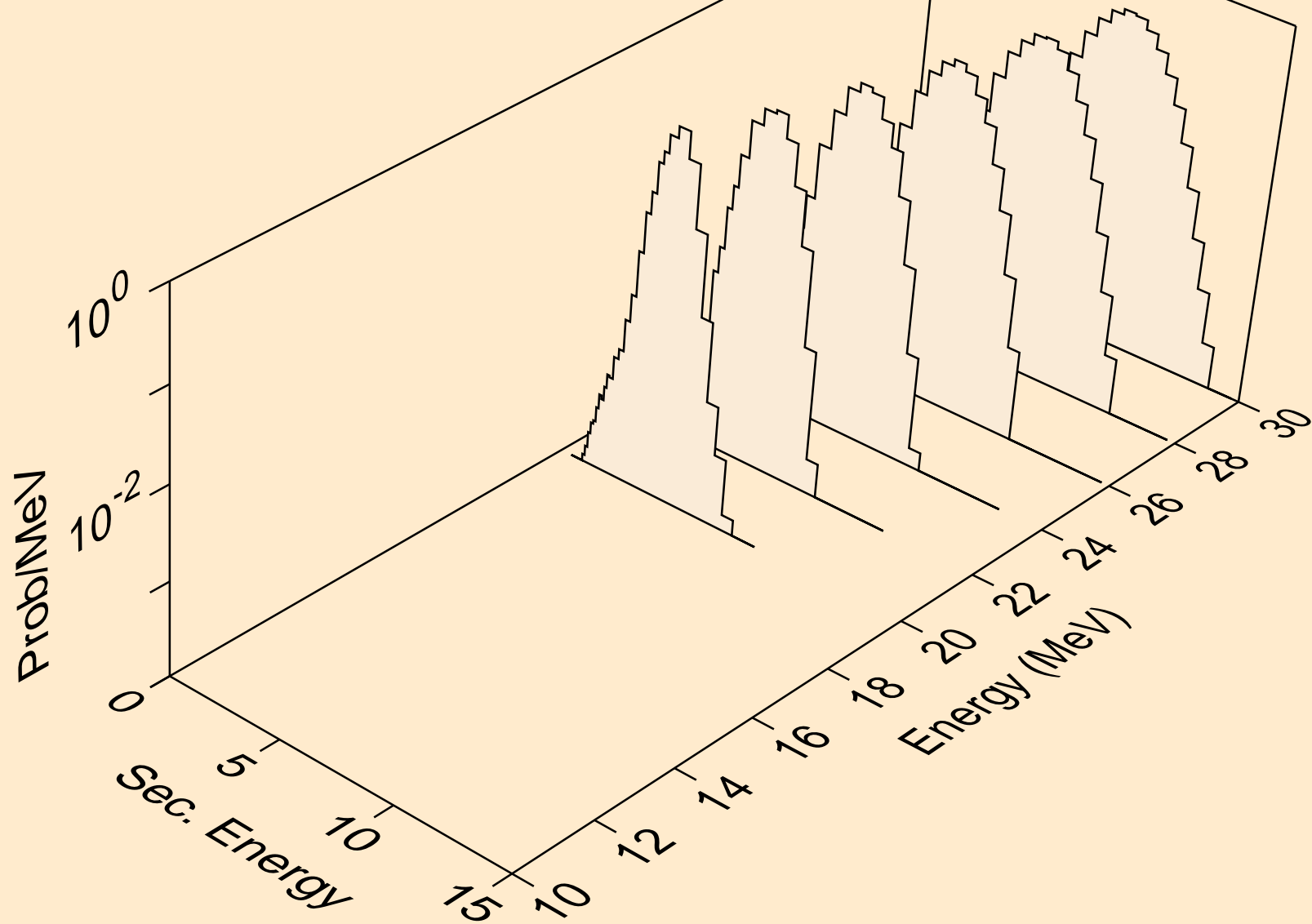

AM235 PROTON ACER TENDL-2021 LIBRARY; T=0.K
Proton emission for inelastic

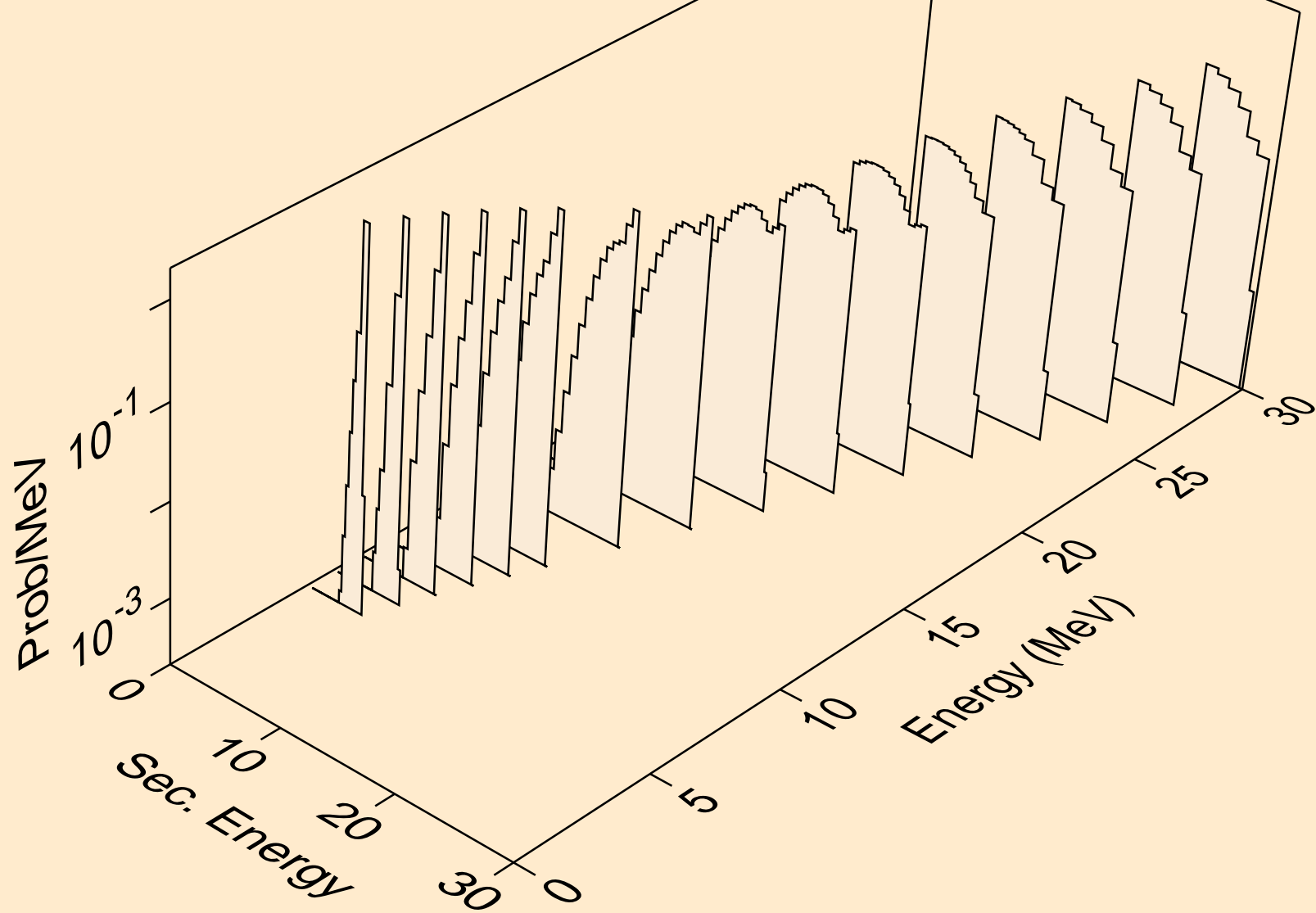

AM235 PROTON ACER TENDL-2021 LIBRARY; T=0.K
Proton emission for (p,pa)

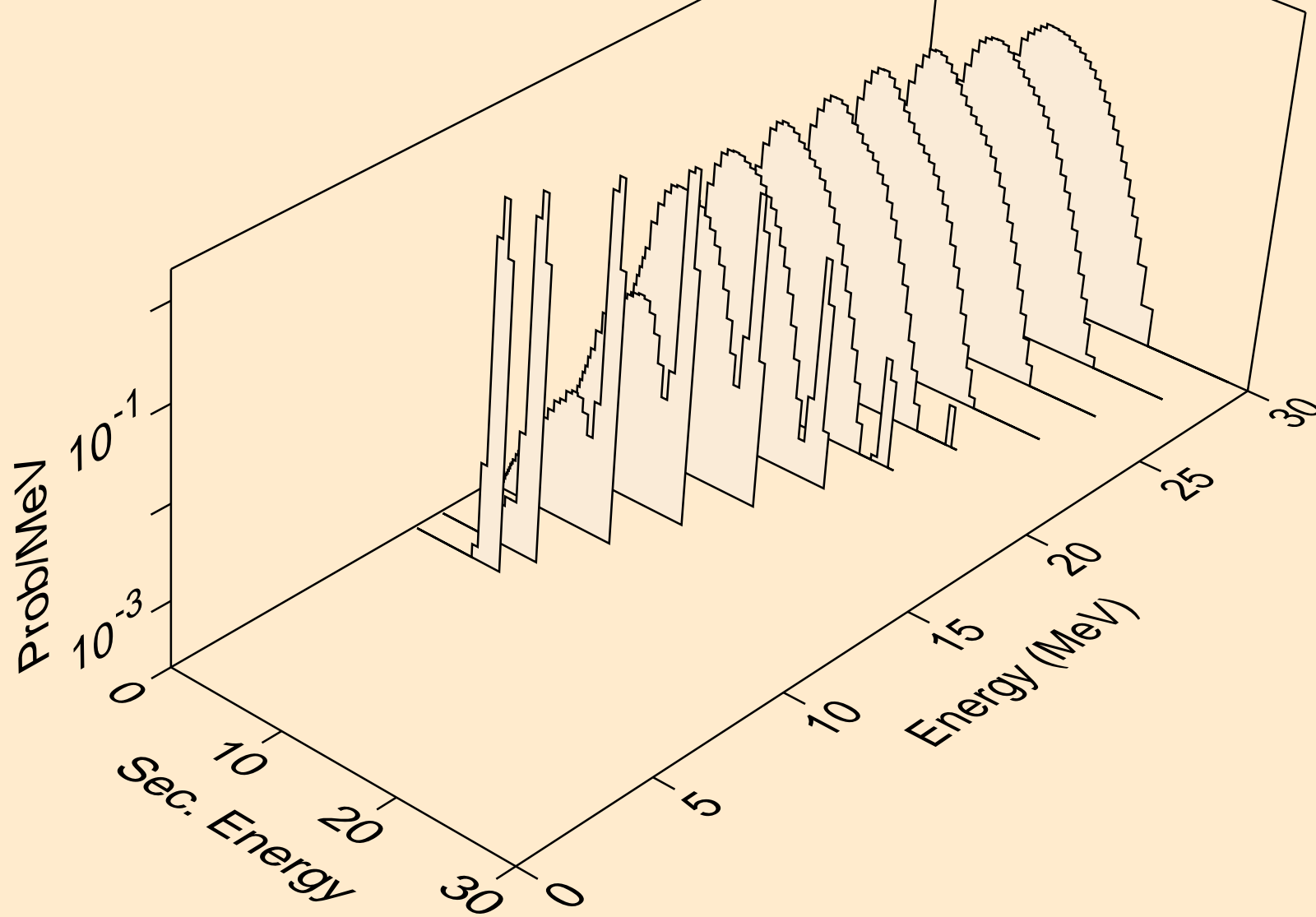

AM235 PROTON ACER TENDL-2021 LIBRARY; T=0.K
Proton emission for (p,pd)

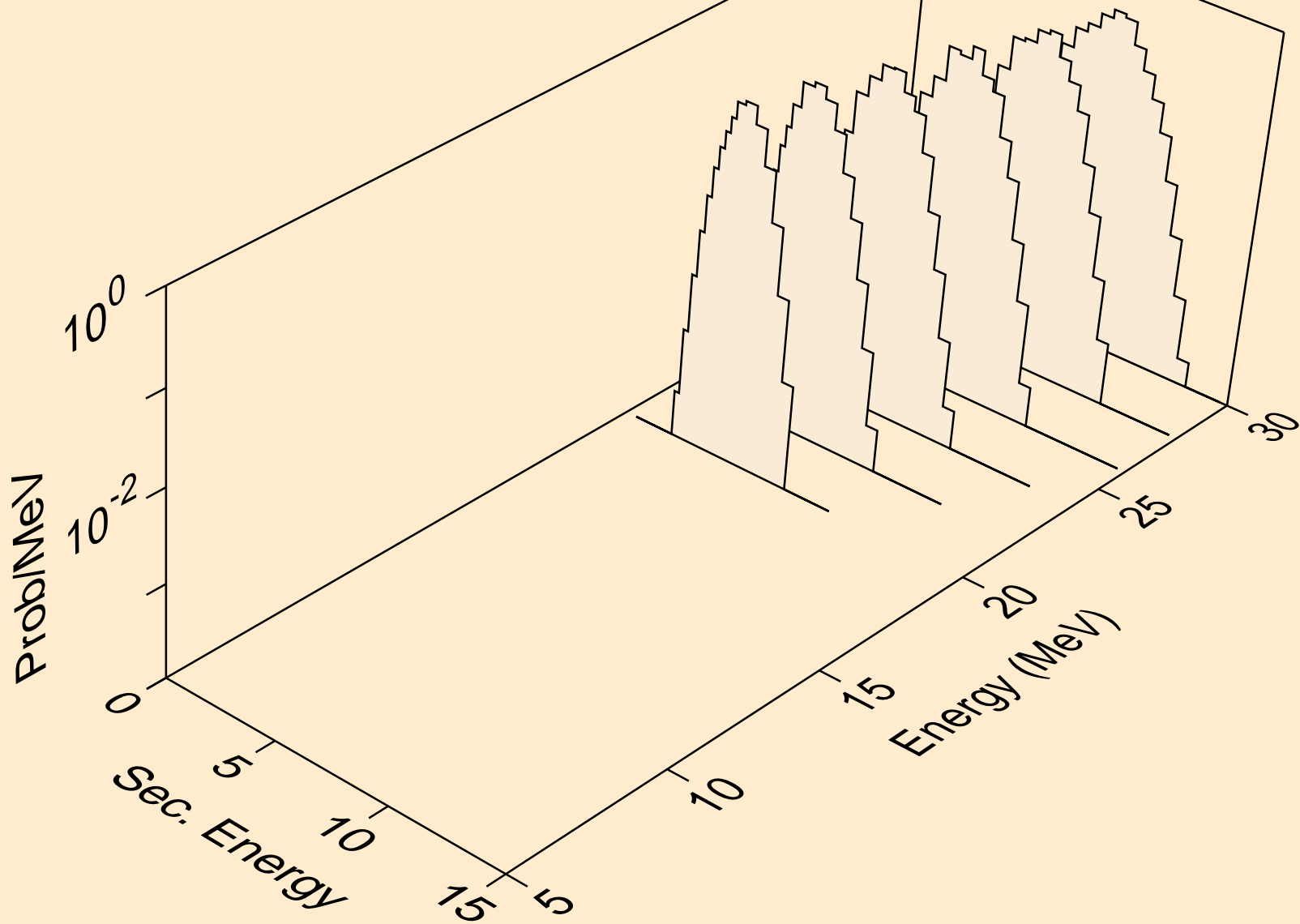

AM235 PROTON ACER TENDL-2021 LIBRARY; T=0.K
Photon emission for (z,n)

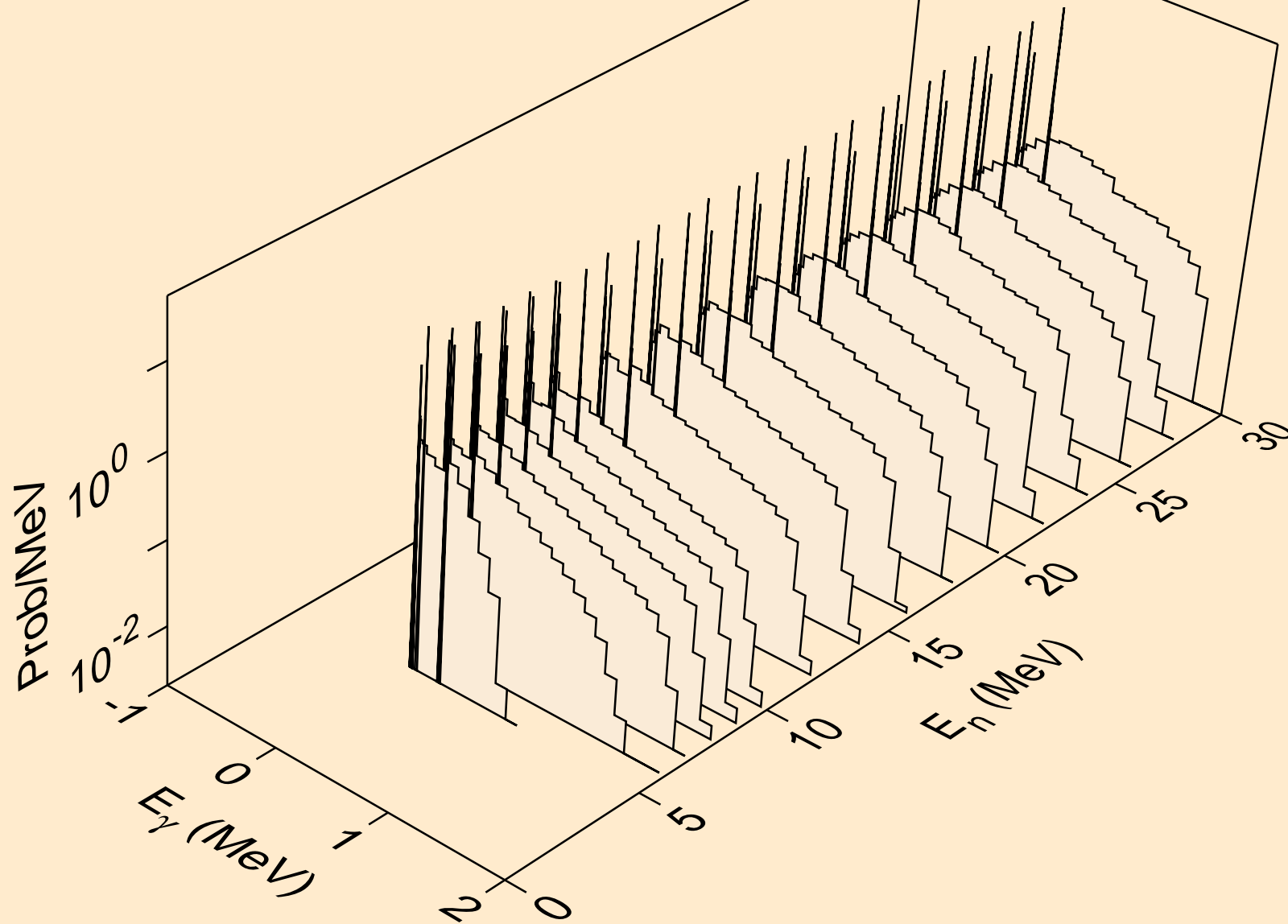

AM235 PROTON ACER TENDL-2021 LIBRARY; T=0.K
Photon emission for (n,x)

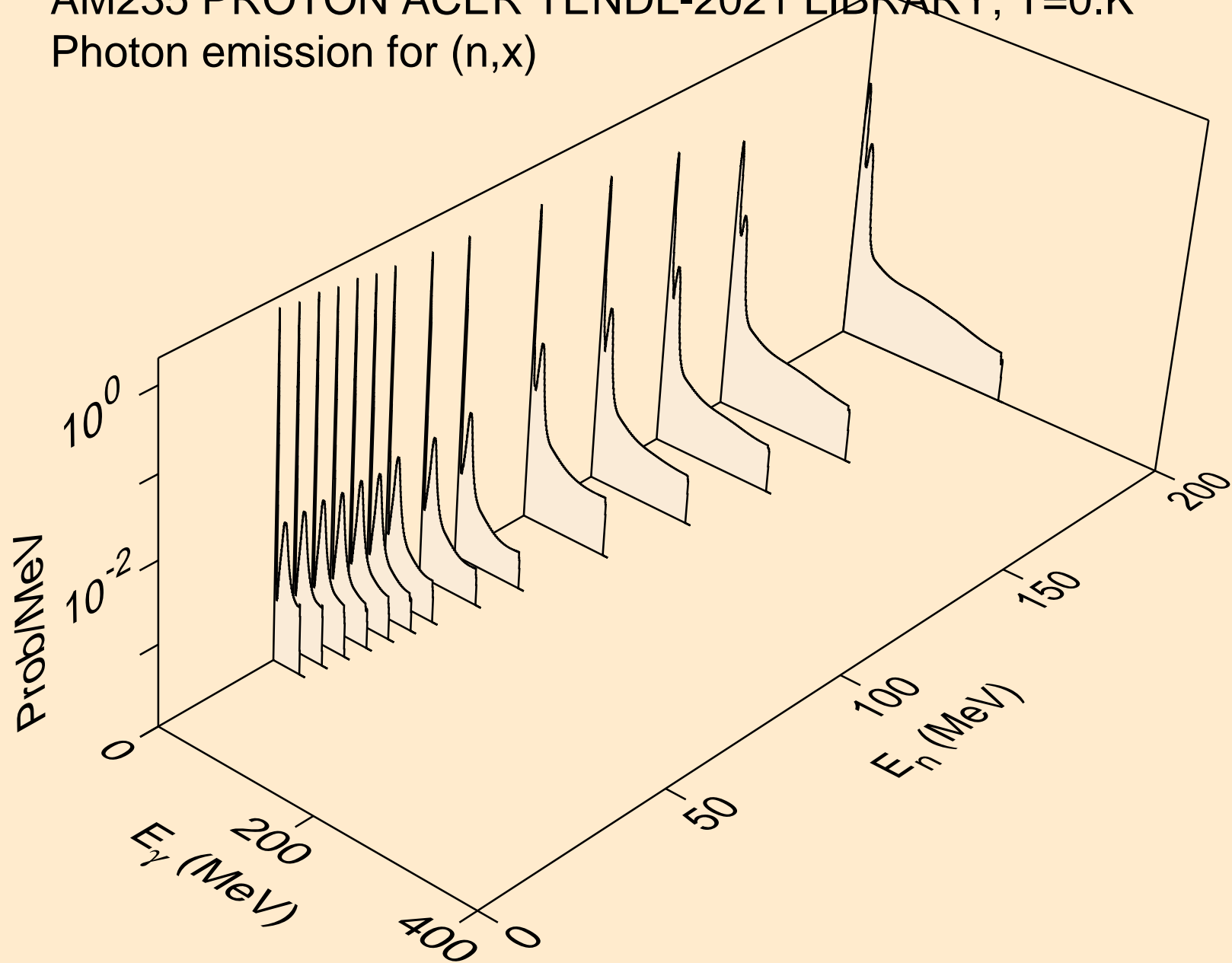

AM235 PROTON ACER TENDL-2021 LIBRARY; T=0.K
Photon emission for (n,2n)

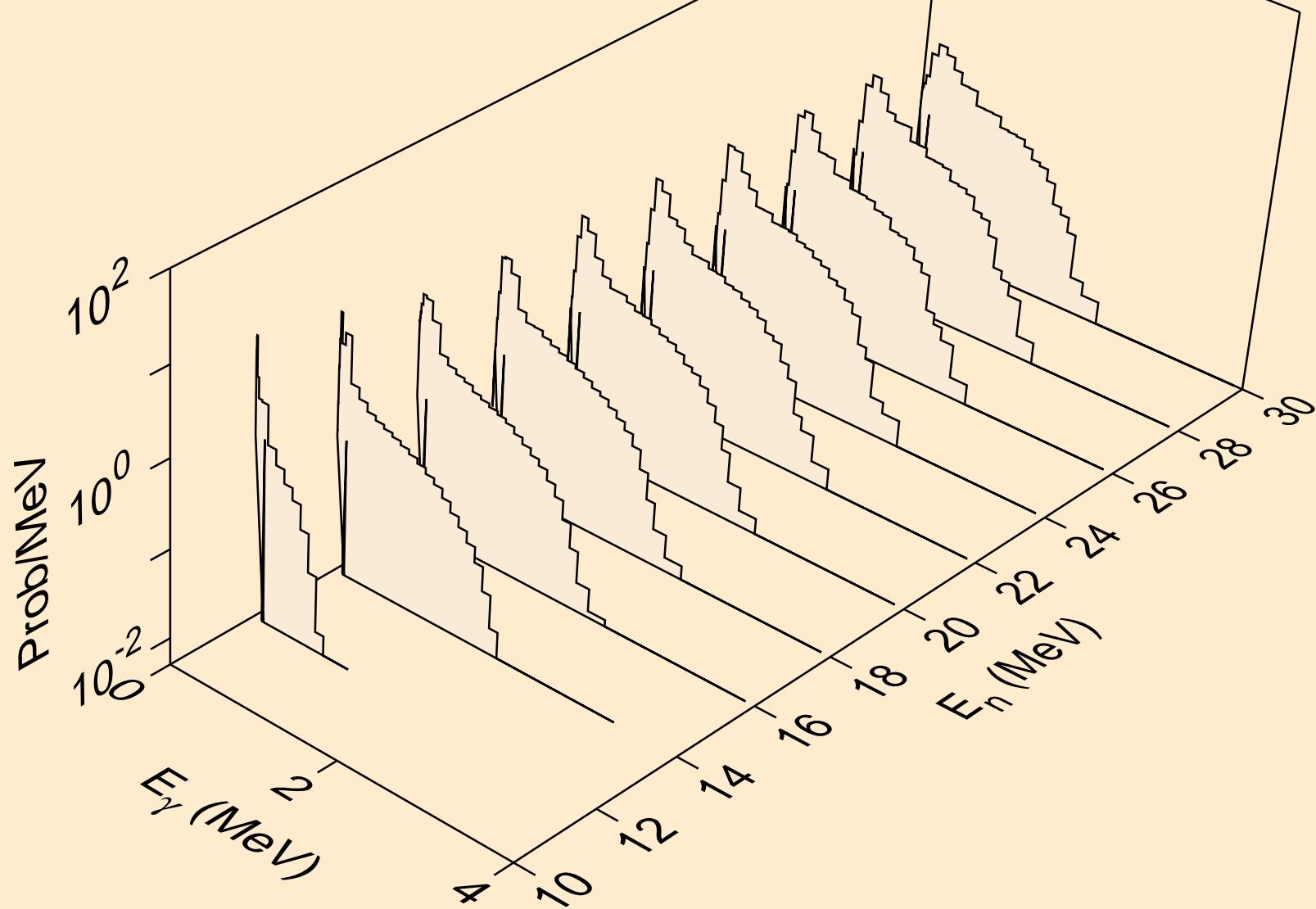

AM235 PROTON ACER TENDL-2021 LIBRARY; T=0.K
Photon emission for (n,3n)

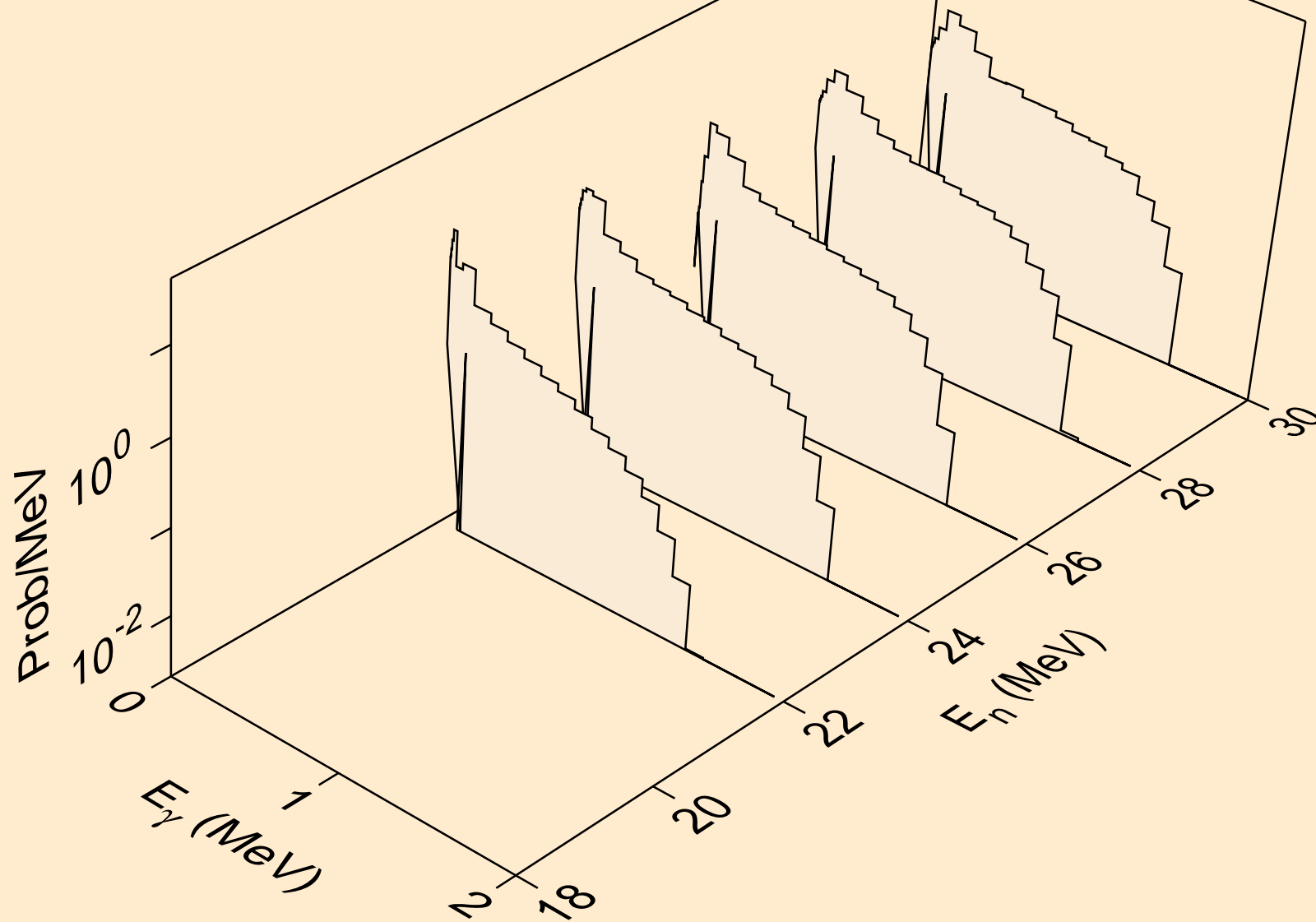

AM235 PROTON ACER TENDL-2021 LIBRARY; T=0.K
Photon emission for (n,n*)a

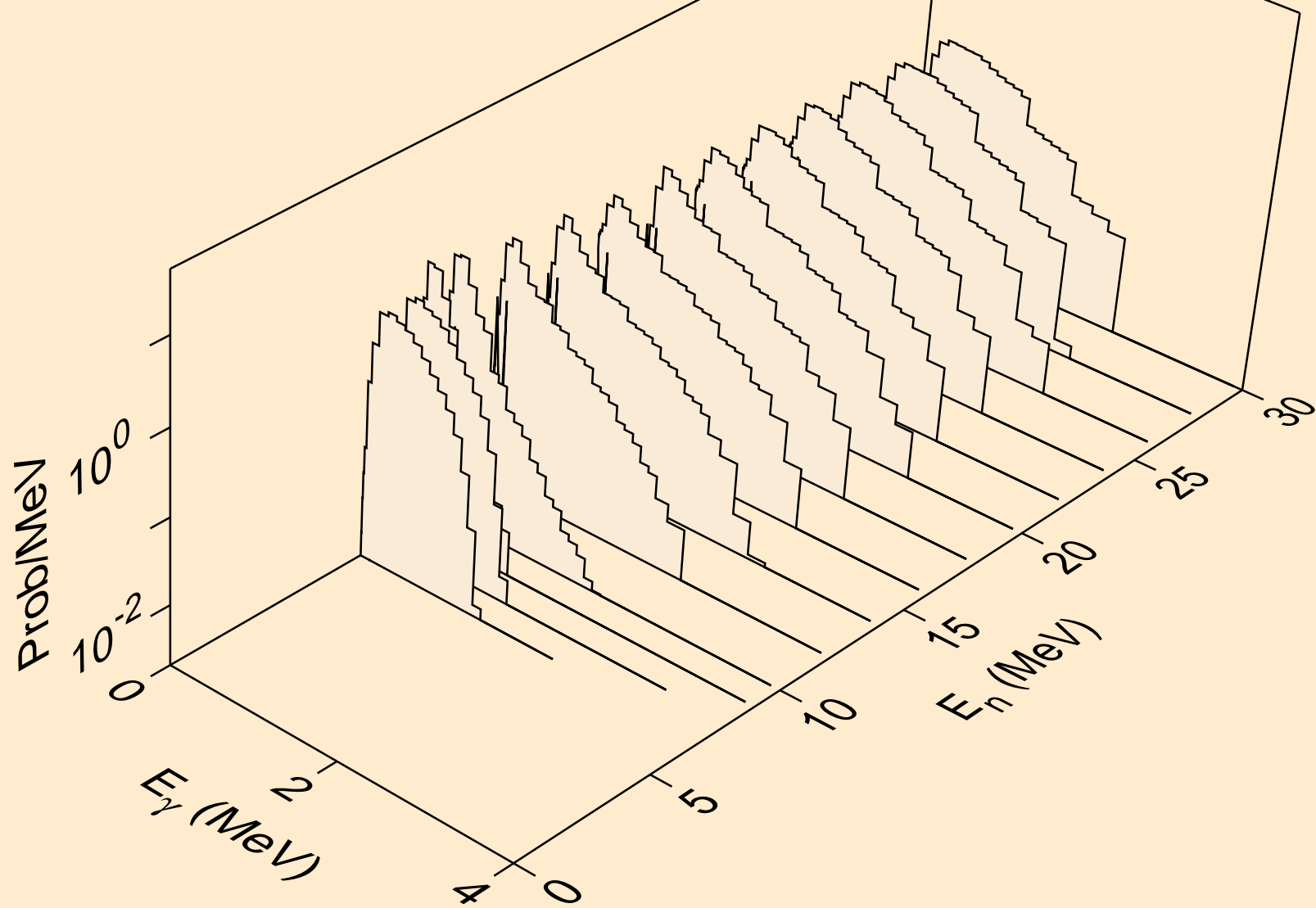

AM235 PROTON ACER TENDL-2021 LIBRARY; T=0.K
Photon emission for (n,2n)a

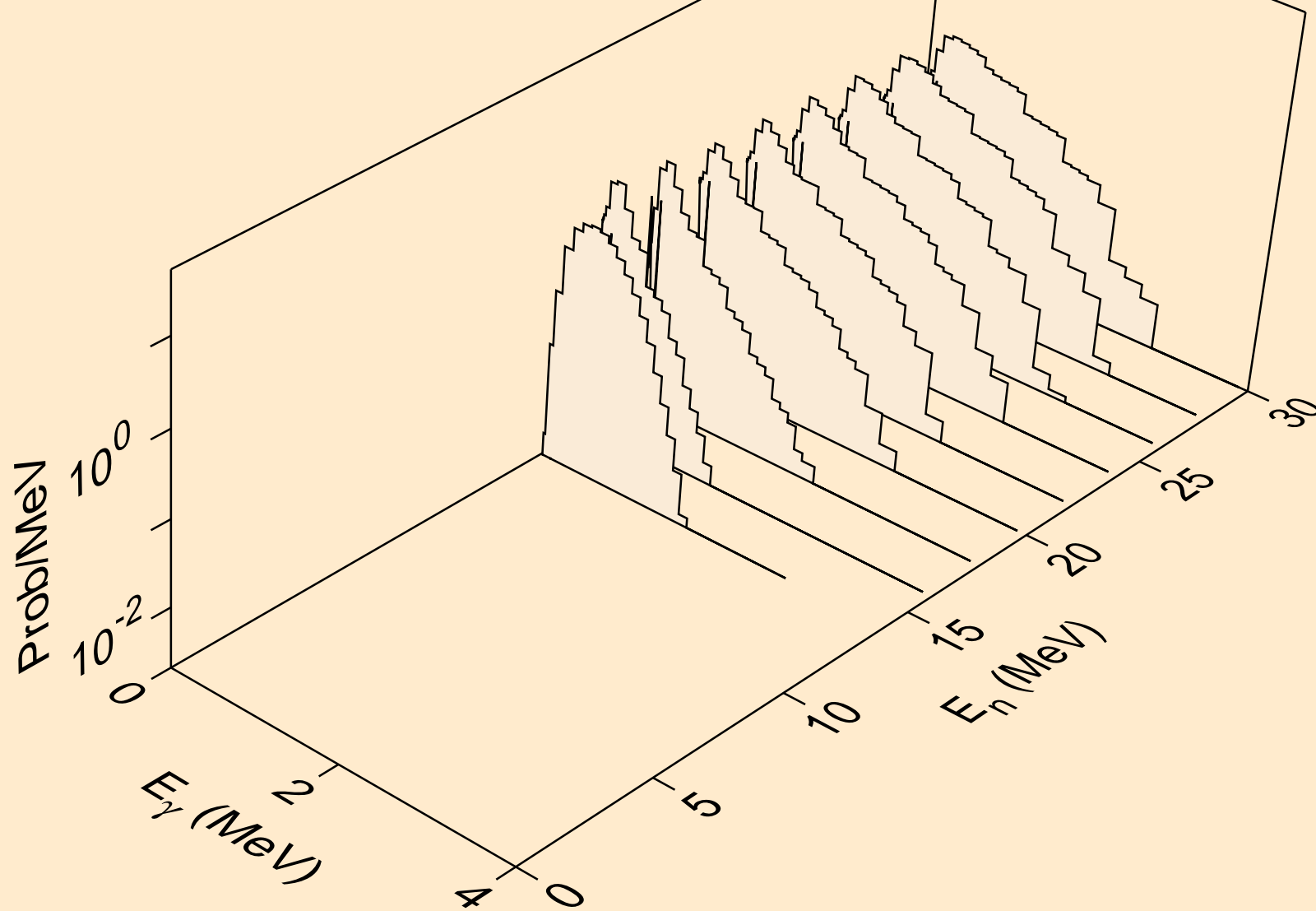

AM235 PROTON ACER TENDL-2021 LIBRARY; T=0.K
Photon emission for (n,n*)p

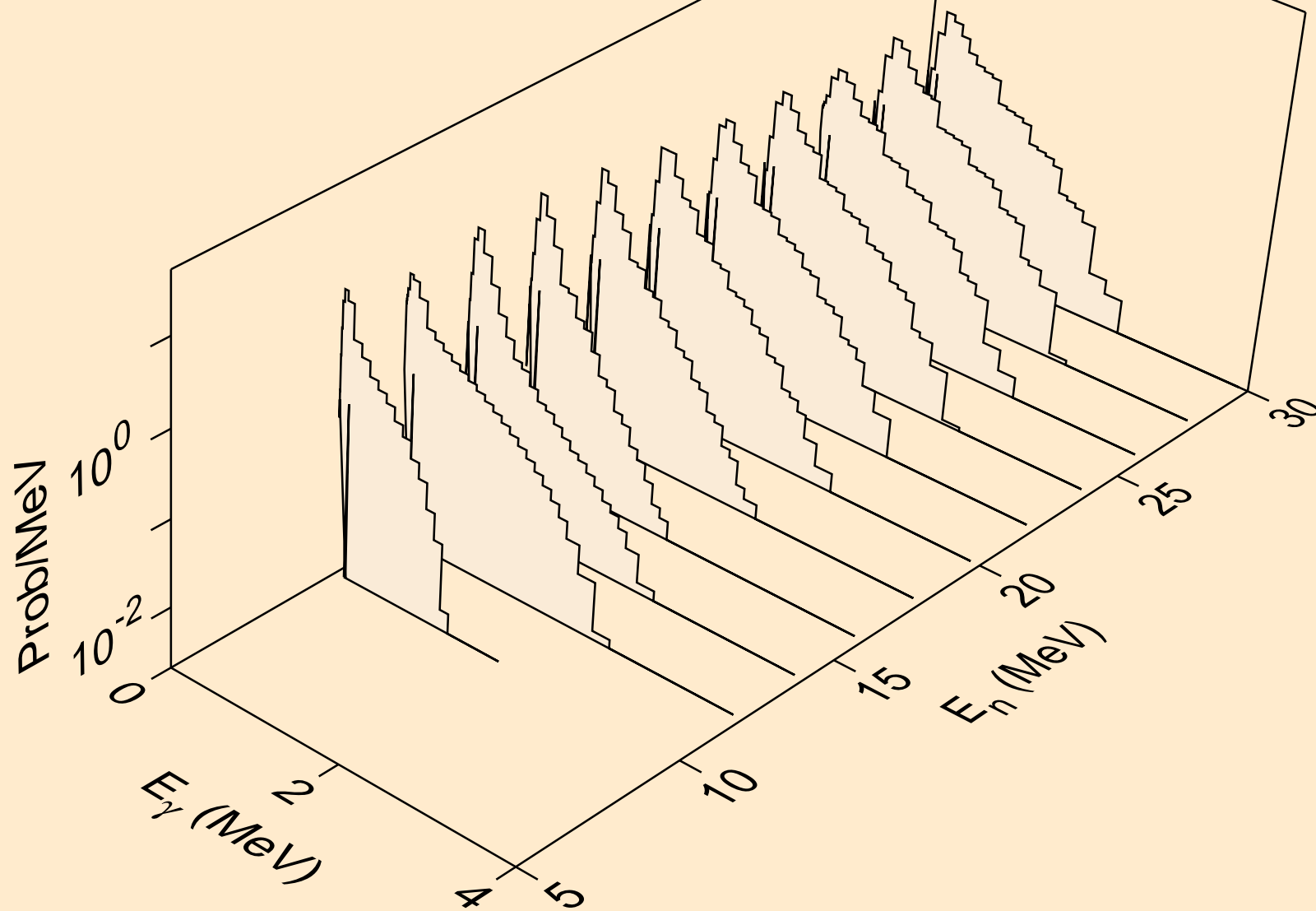

AM235 PROTON ACER TENDL-2021 LIBRARY; T=0.K
Photon emission for (n,n*)d

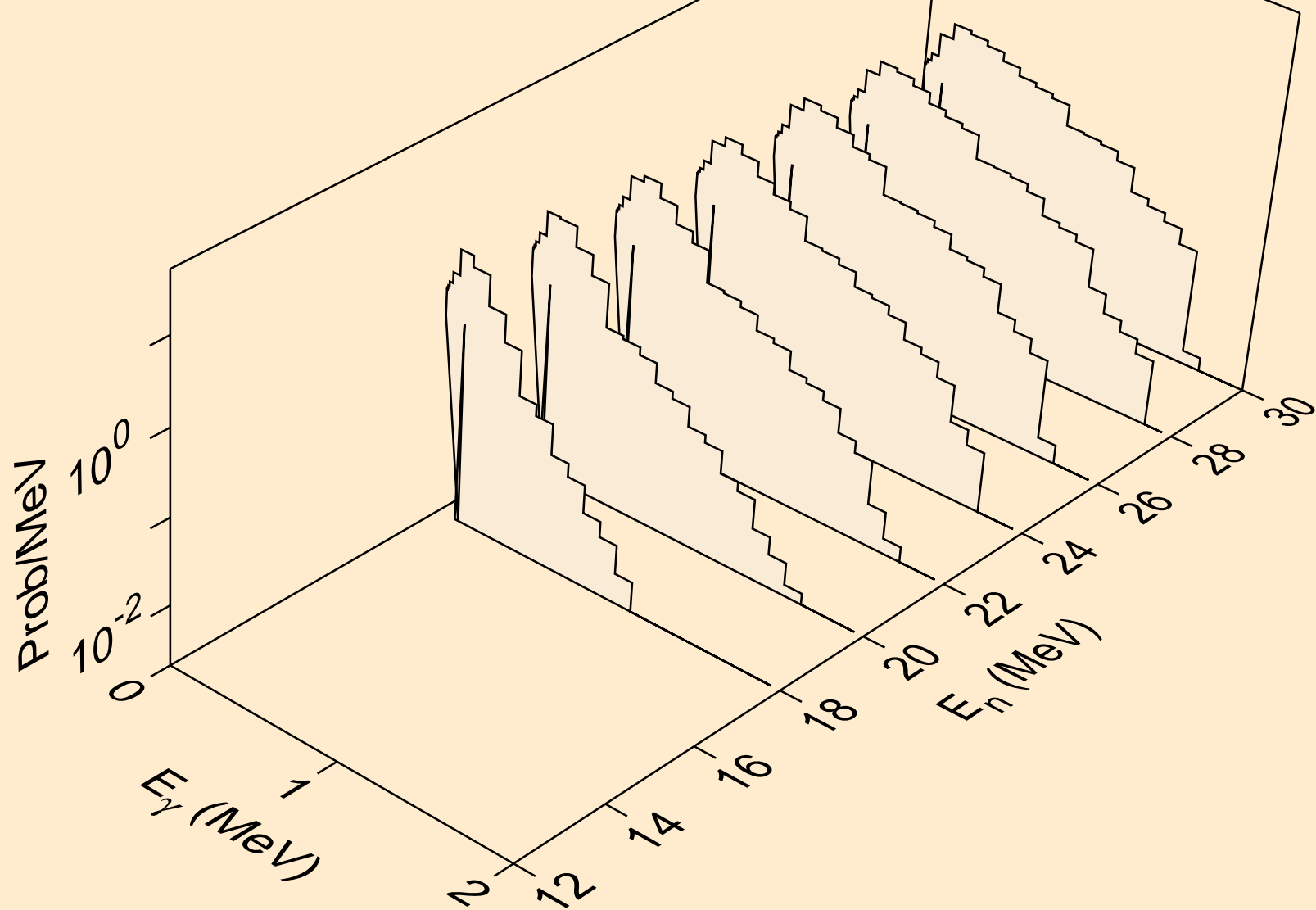

AM235 PROTON ACER TENDL-2021 LIBRARY; T=0.K
Photon emission for (n,n*)t

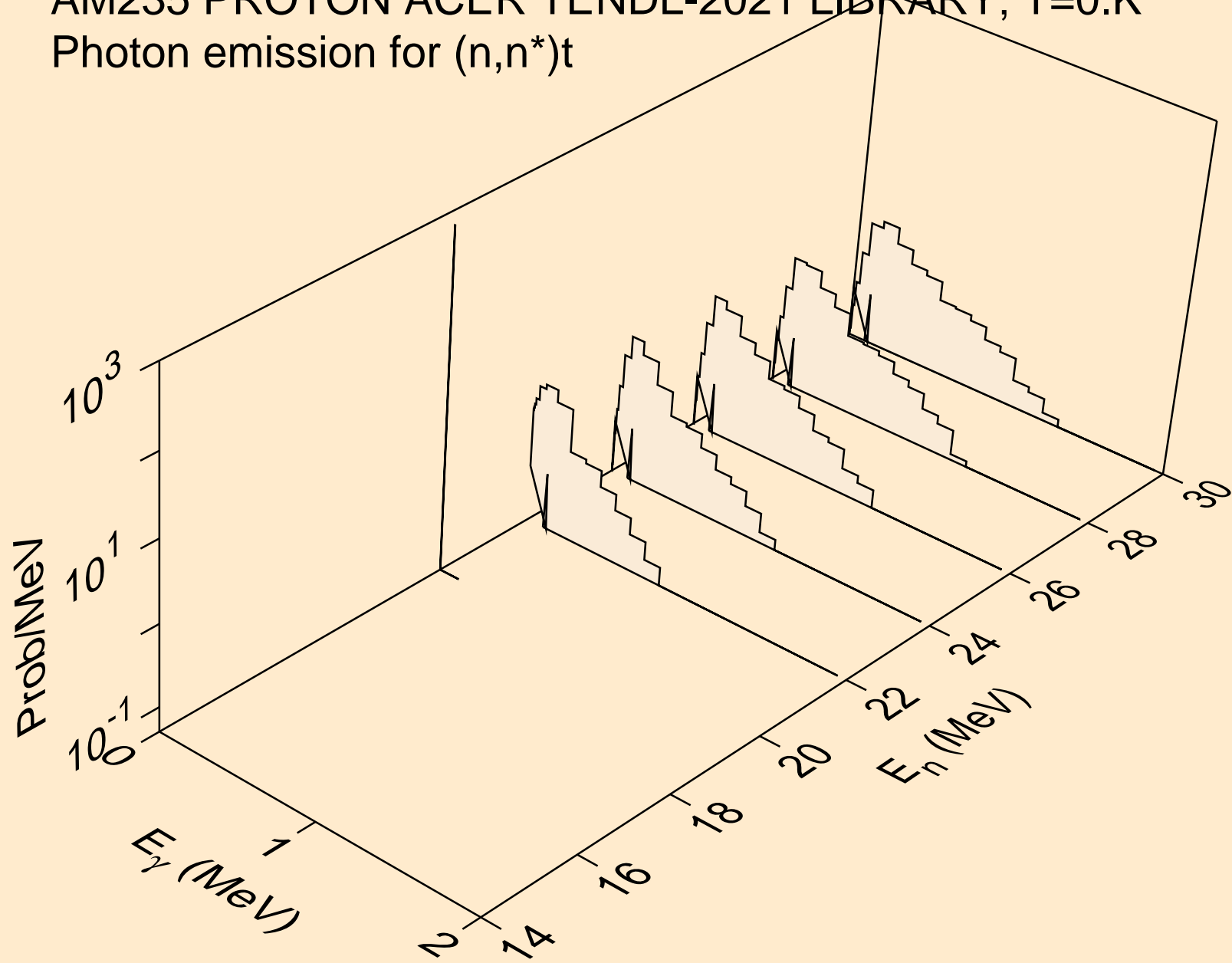

AM235 PROTON ACER TENDL-2021 LIBRARY; T=0.K
Photon emission for (n,n*)he3

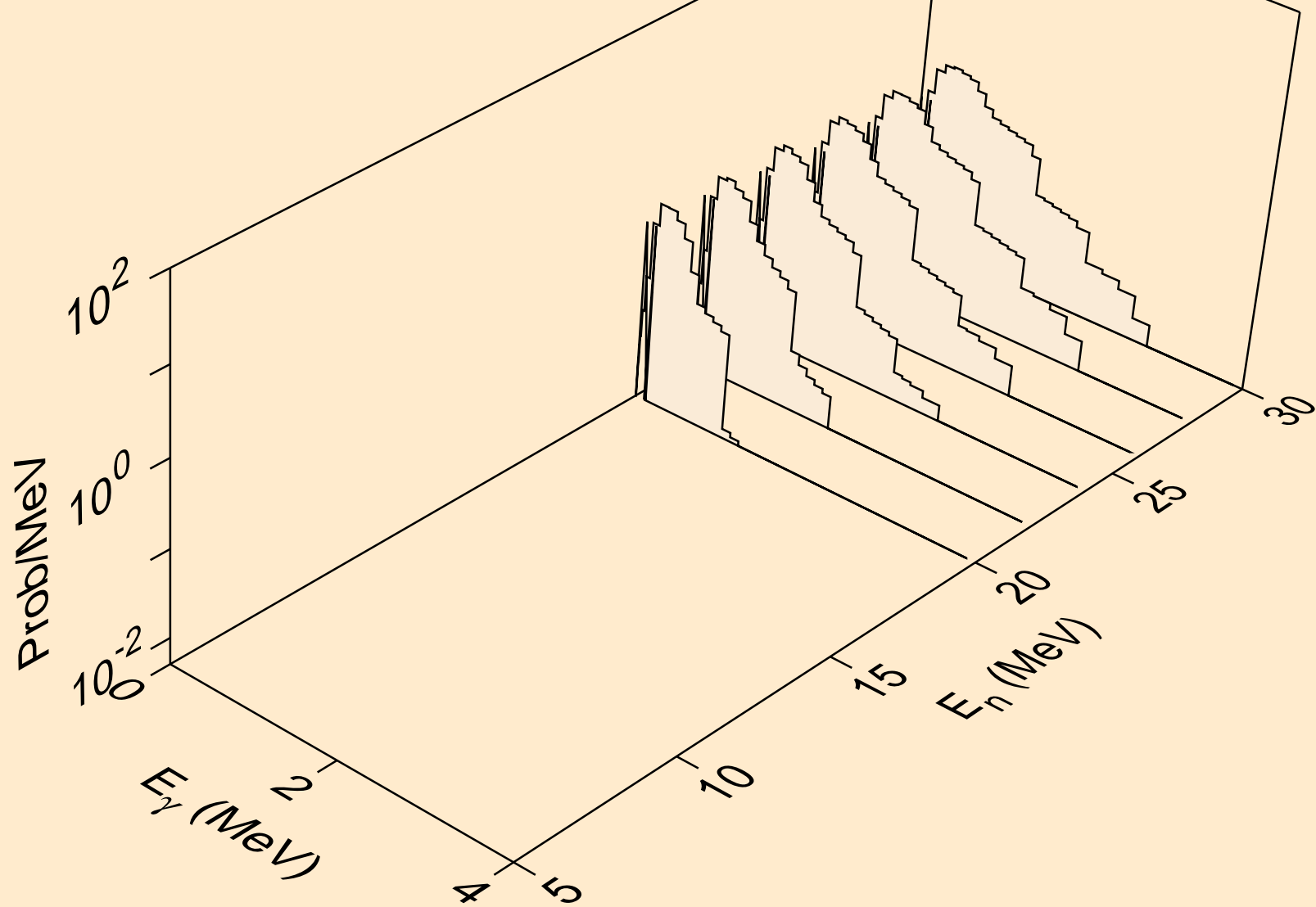

AM235 PROTON ACER TENDL-2021 LIBRARY; T=0.K
Photon emission for (n,2np)

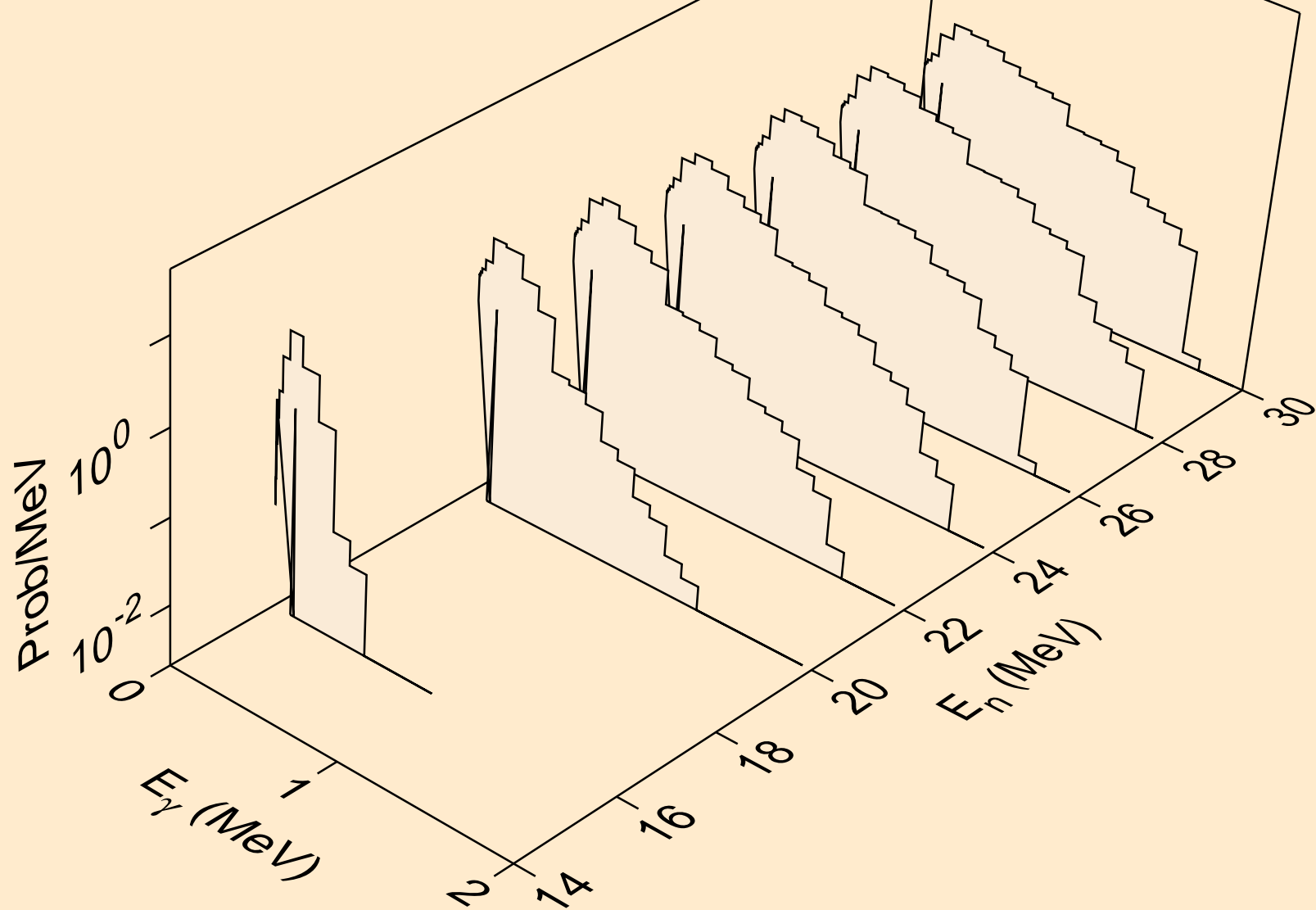

AM235 PROTON ACER TENDL-2021 LIBRARY; T=0.K
Photon emission for (n,2np)

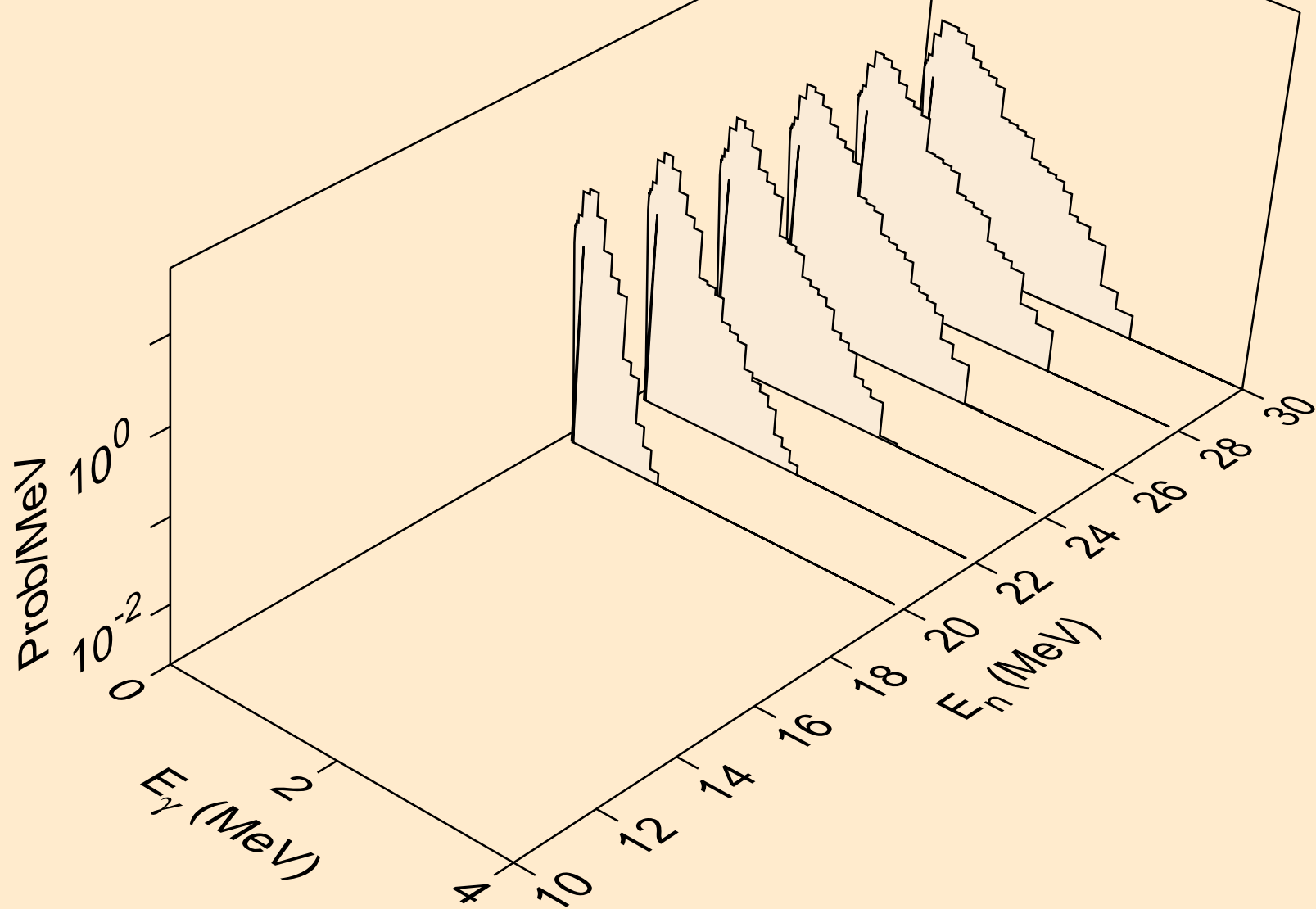

AM235 PROTON ACER TENDL-2021 LIBRARY; T=0.K
Photon emission for (n,gma)

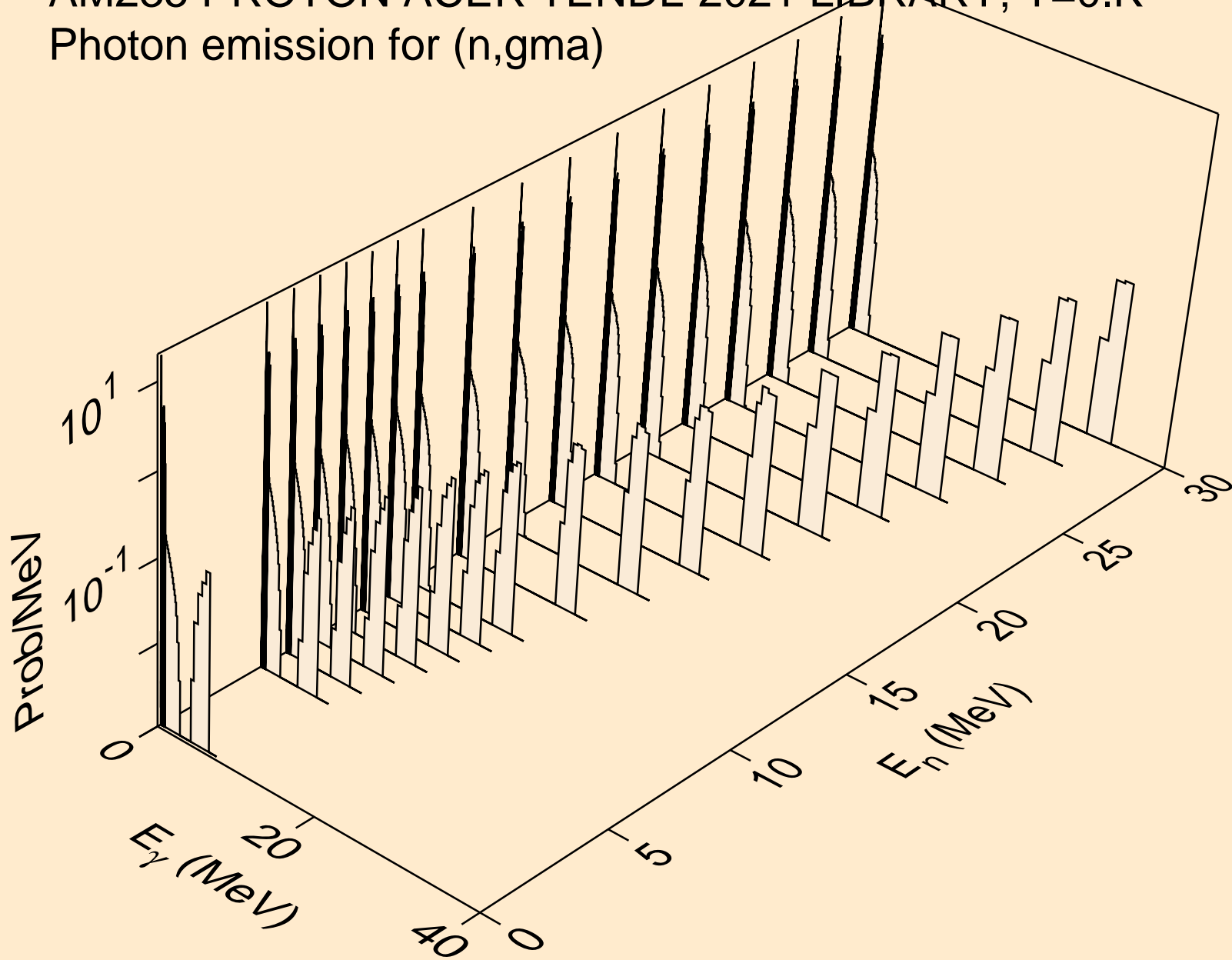

AM235 PROTON ACER TENDL-2021 LIBRARY; T=0.K
Photon emission for inelastic

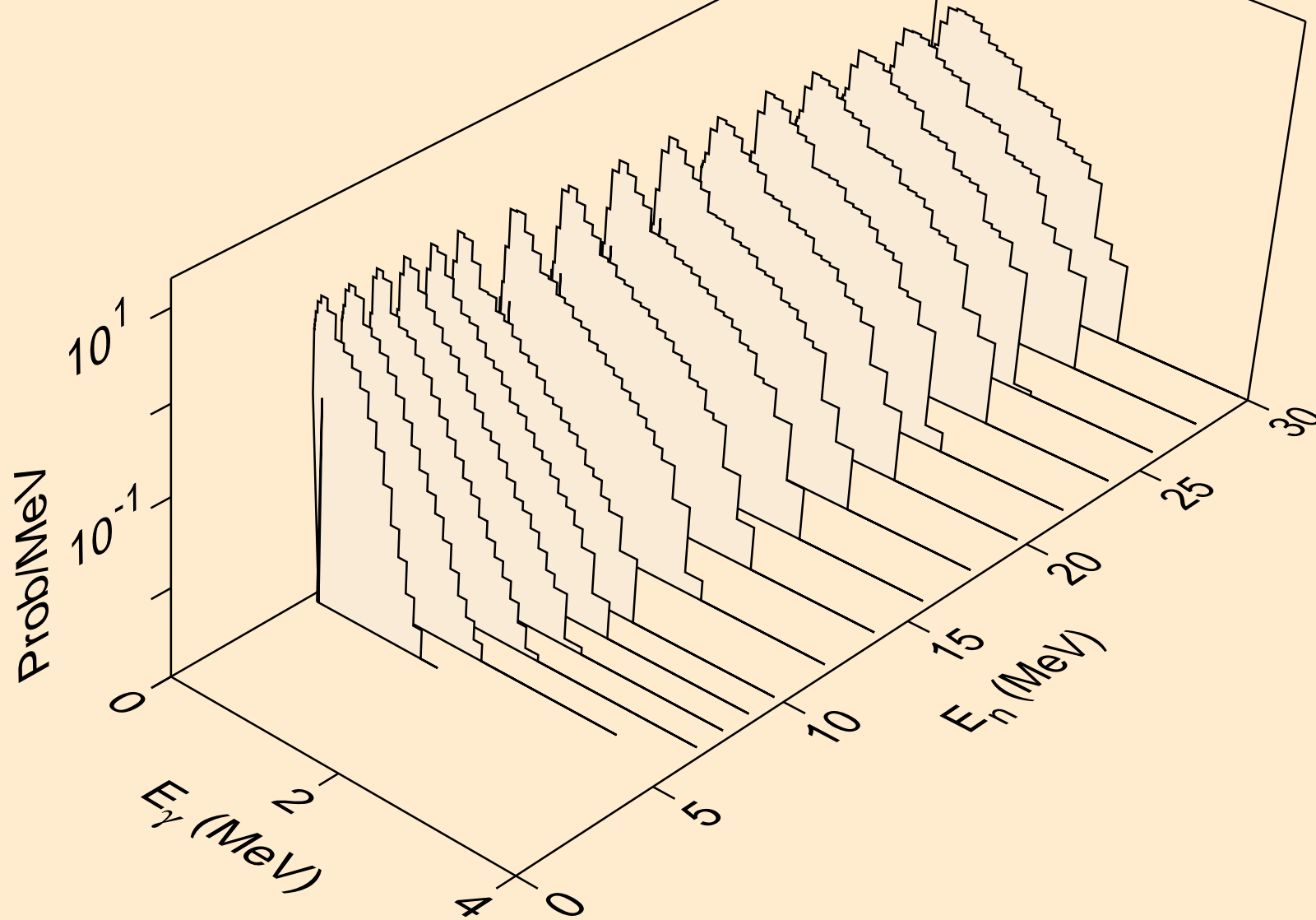

AM235 PROTON ACER TENDL-2021 LIBRARY; T=0.K
Photon emission for (n,d)

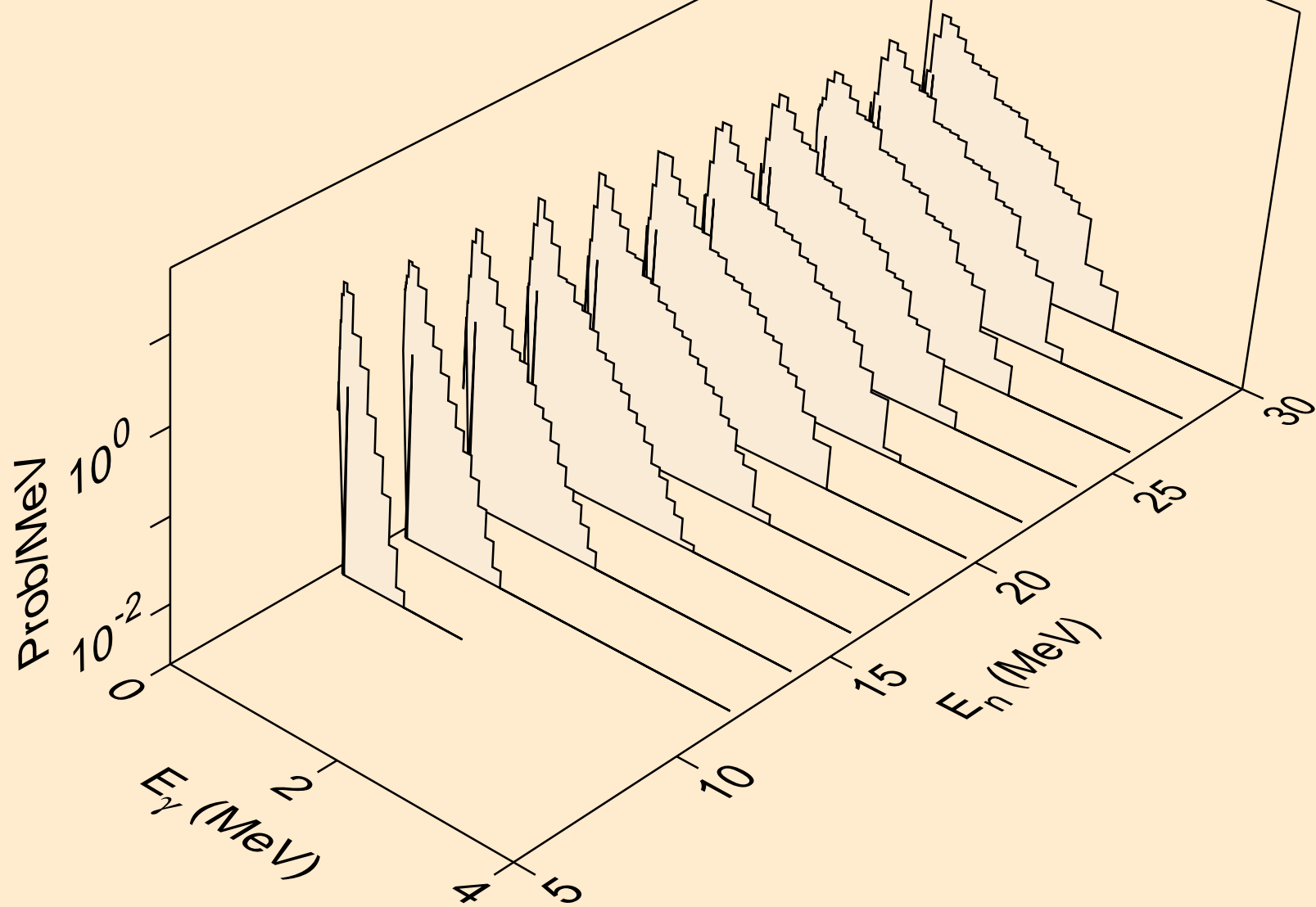

AM235 PROTON ACER TENDL-2021 LIBRARY; T=0.K
Photon emission for (n,t)

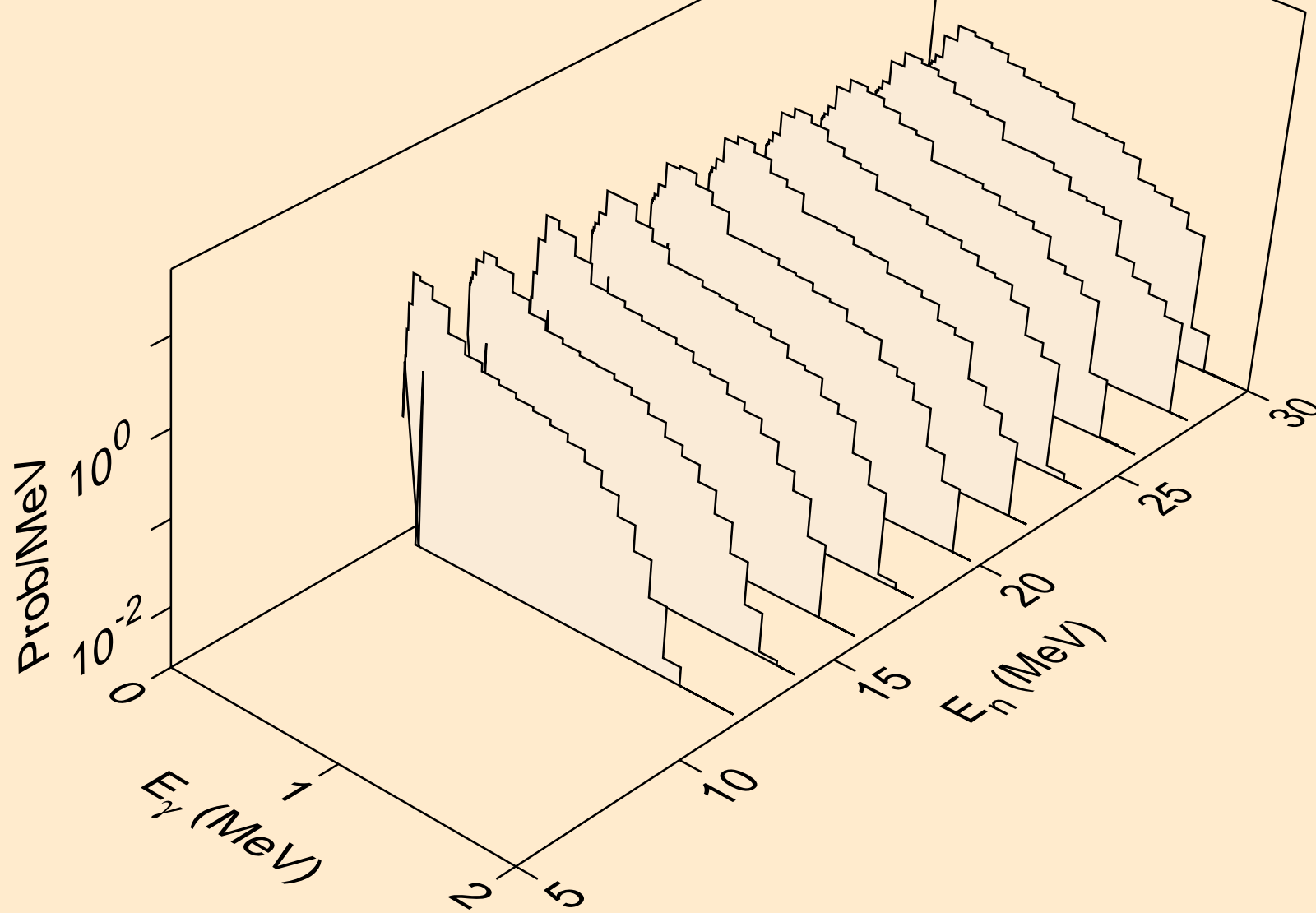

AM235 PROTON ACER TENDL-2021 LIBRARY; T=0.K
Photon emission for (n,he3)

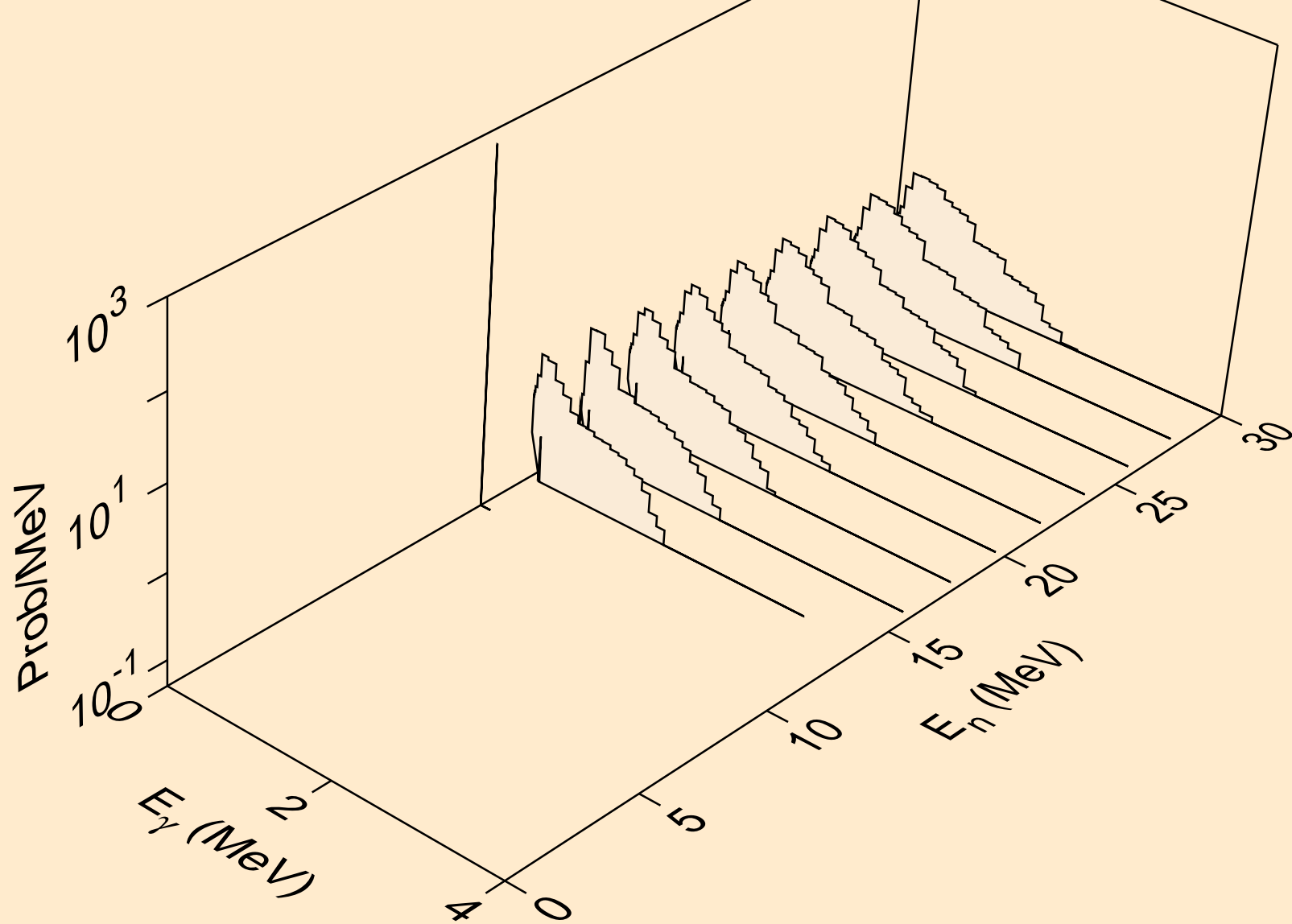

AM235 PROTON ACER TENDL-2021 LIBRARY; T=0.K
Photon emission for (n,a)

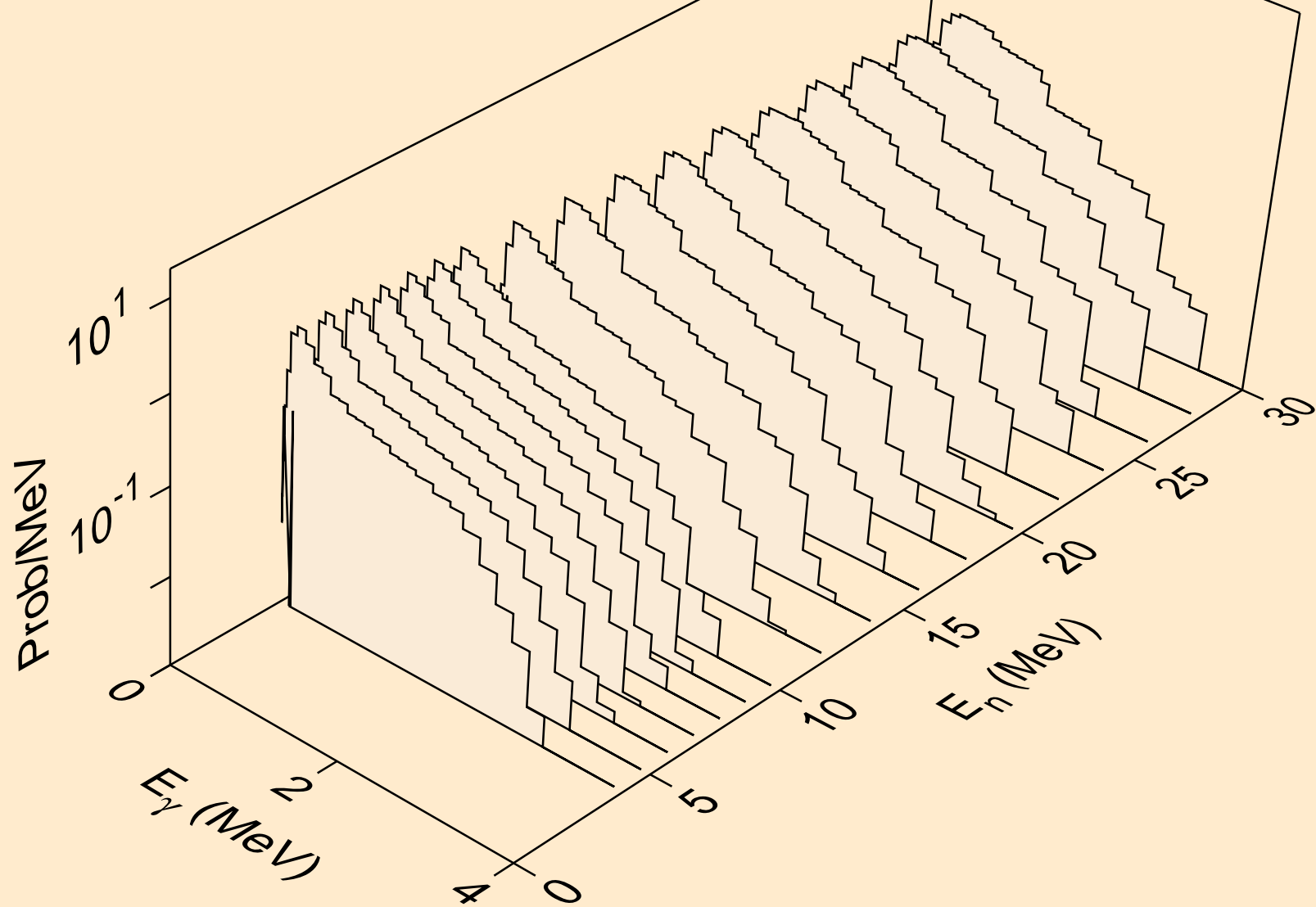

AM235 PROTON ACER TENDL-2021 LIBRARY; T=0.K
Photon emission for (n,pa)

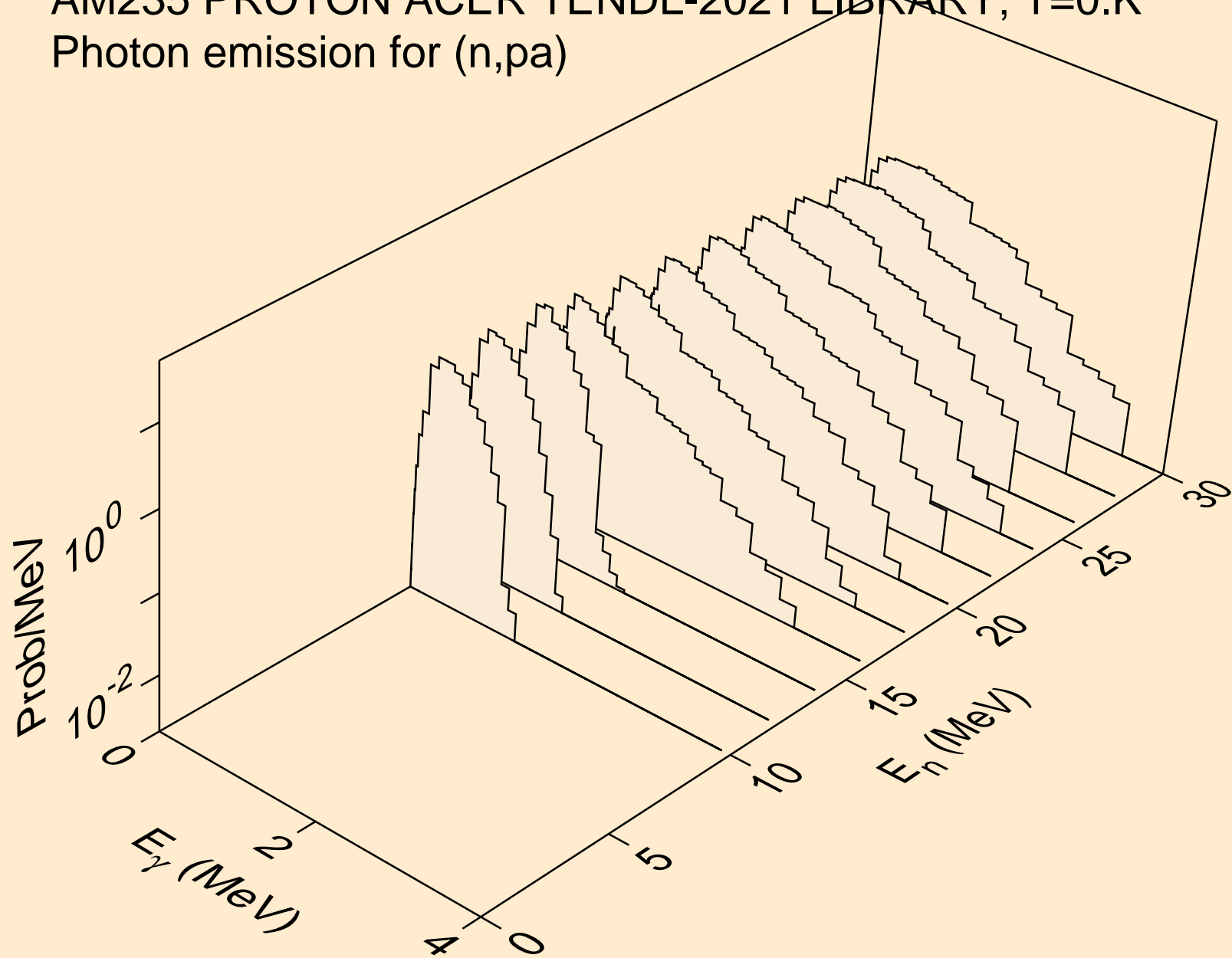

AM235 PROTON ACER TENDL-2021 LIBRARY; T=0.K
Photon emission for (n,pd)

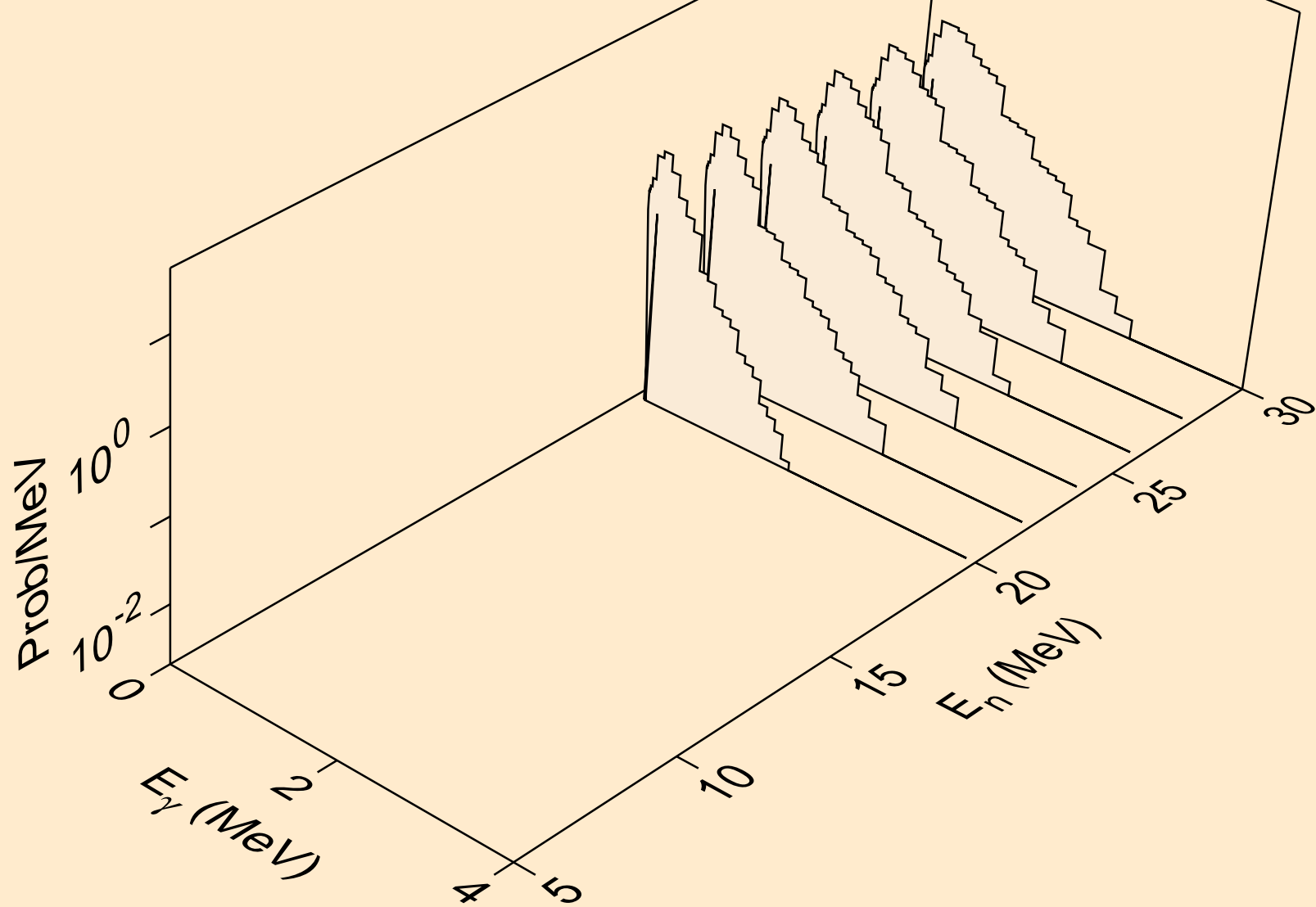

AM235 PROTON ACER TENDL-2021 LIBRARY; T=0.K
Particle heating contributions

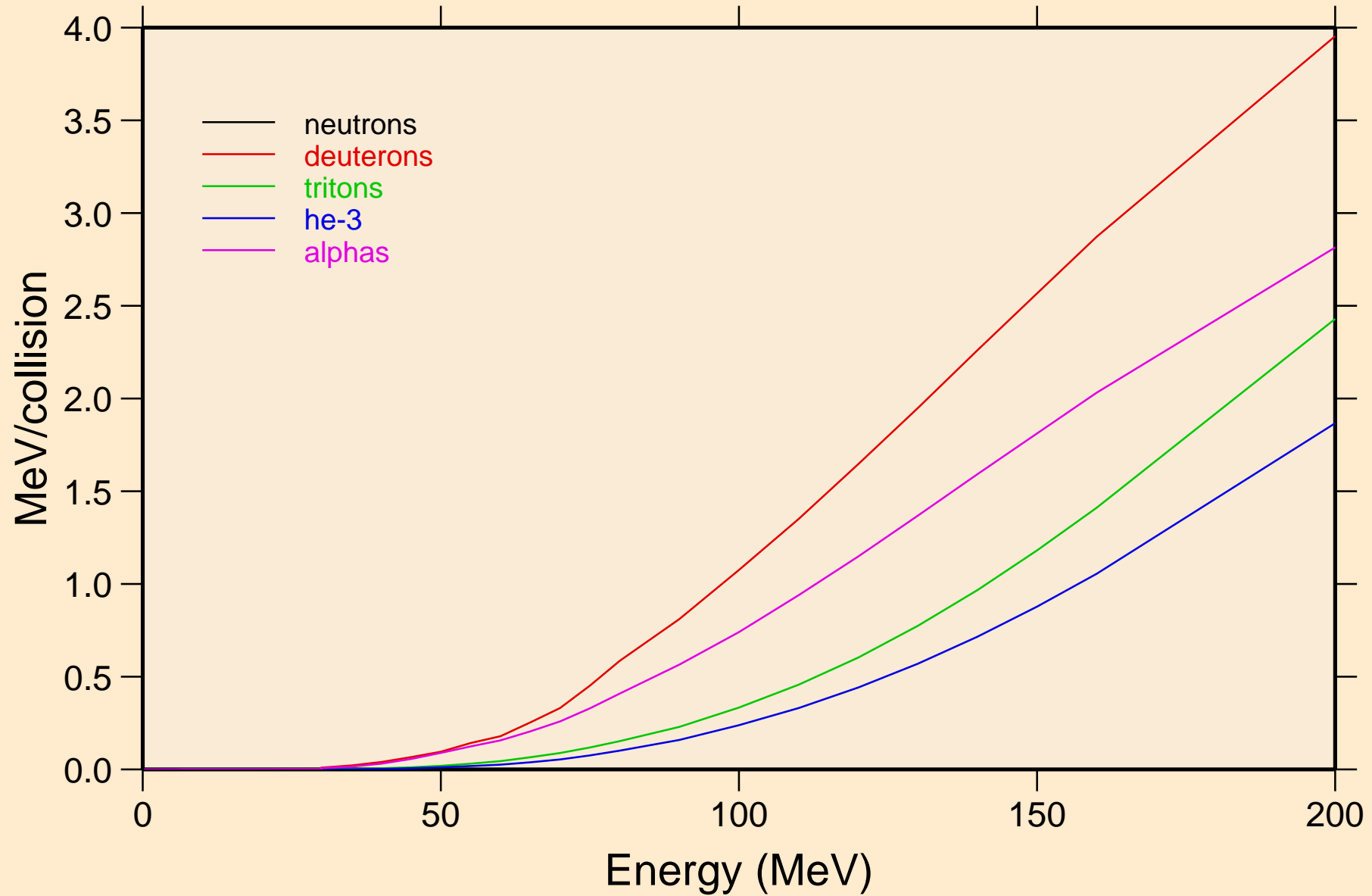

AM235 PROTON ACER TENDL-2021 LIBRARY; T=0.K

Recoil Heating

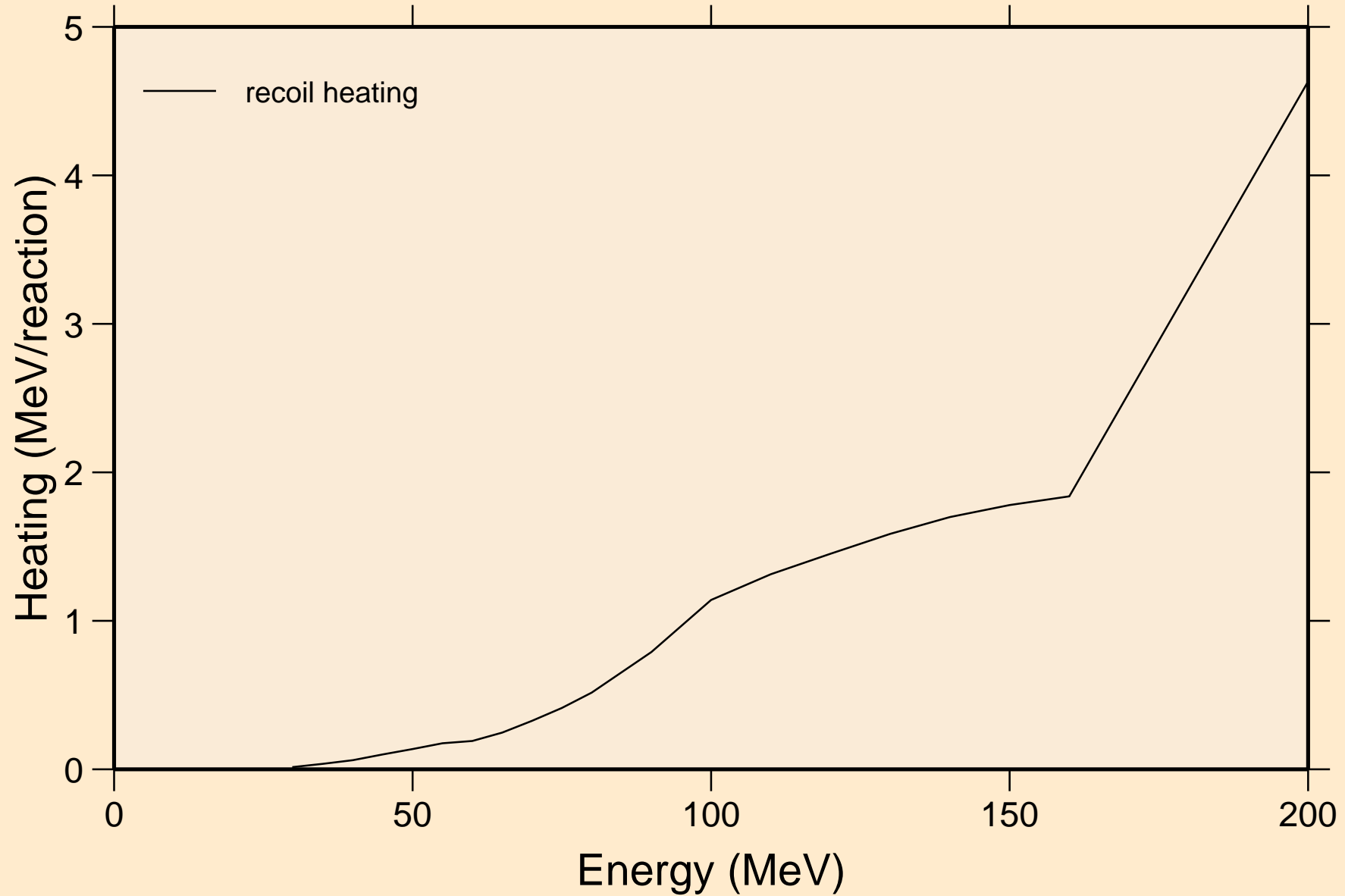

AM235 PROTON ACER TENDL-2021 LIBRARY; T=0.K

Particle production cross sections

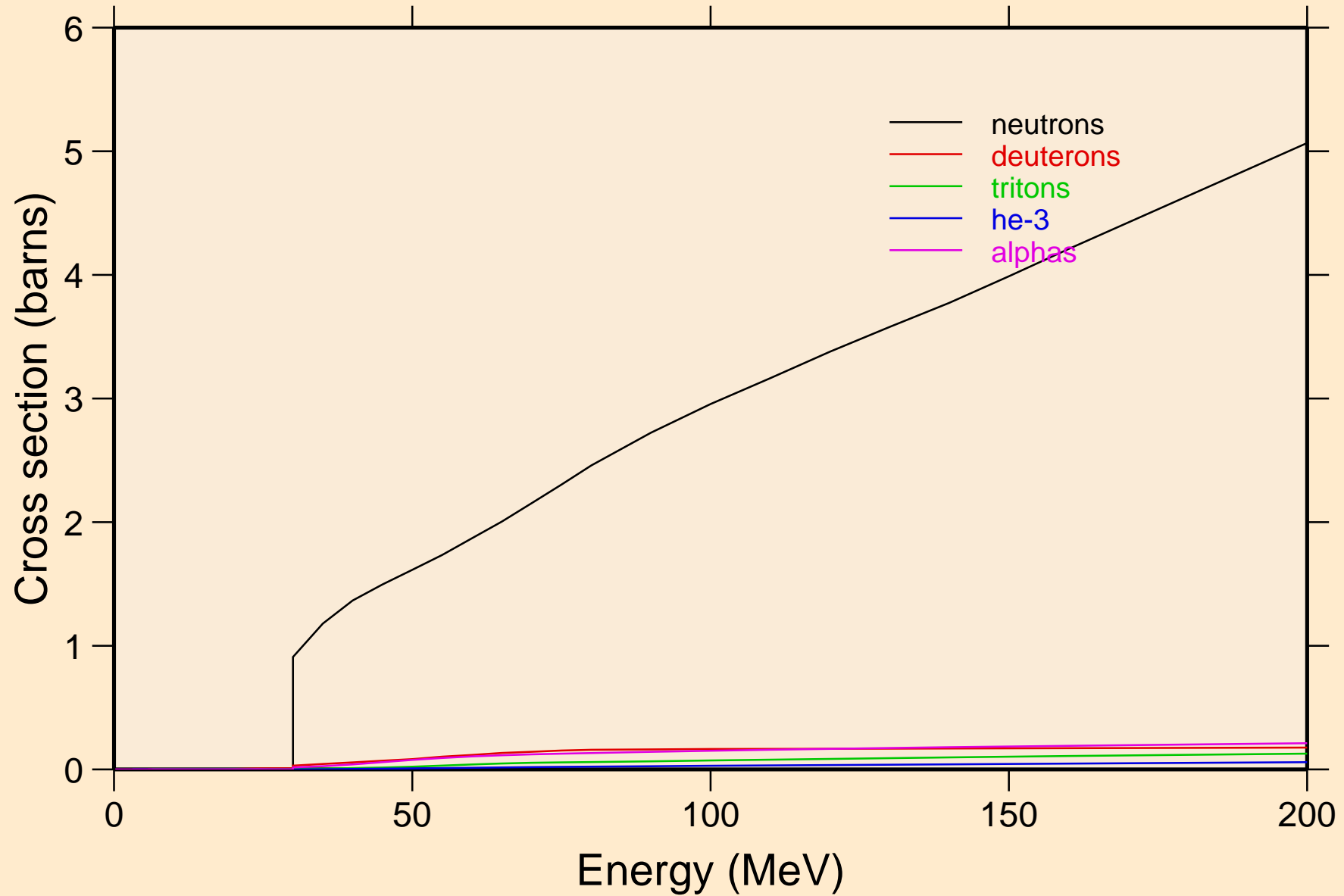

AM235 PROTON ACER TENDL-2021 LIBRARY; T=0.K
neutrons from (p,n)

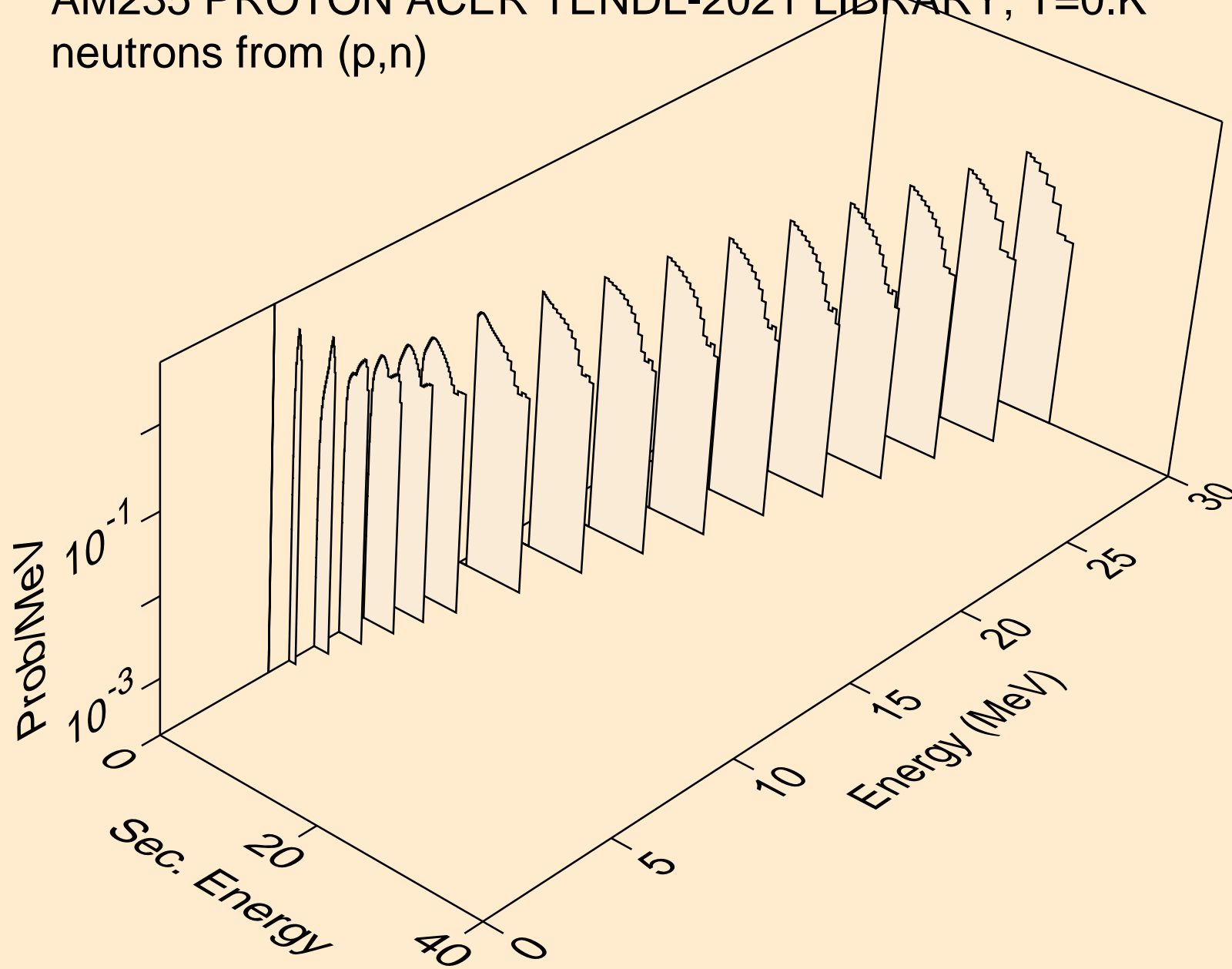

AM235 PROTON ACER TENDL-2021 LIBRARY; T=0.K
neutrons from (p,x)

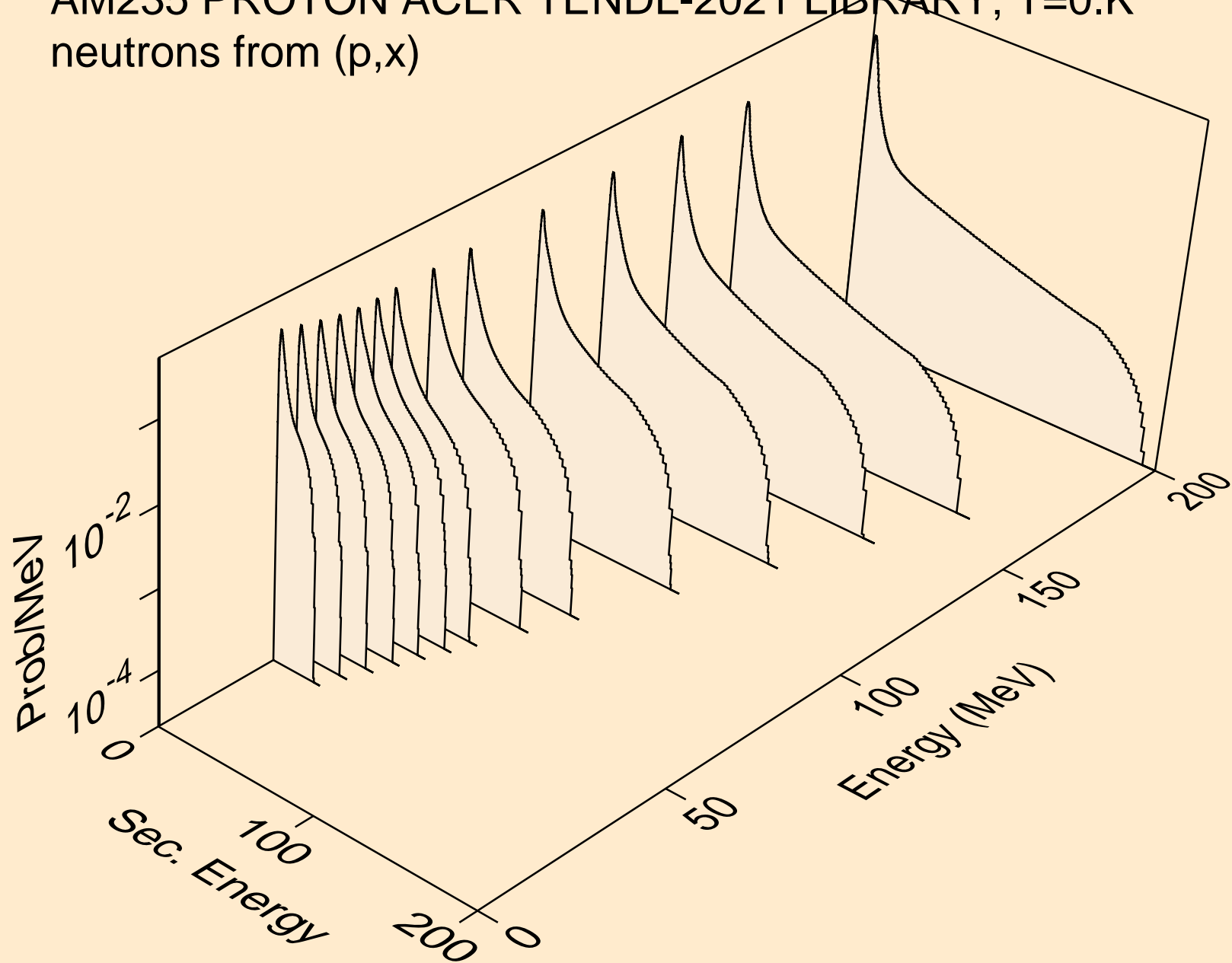

AM235 PROTON ACER TENDL-2021 LIBRARY; T=0.K
neutrons from (p,2n)

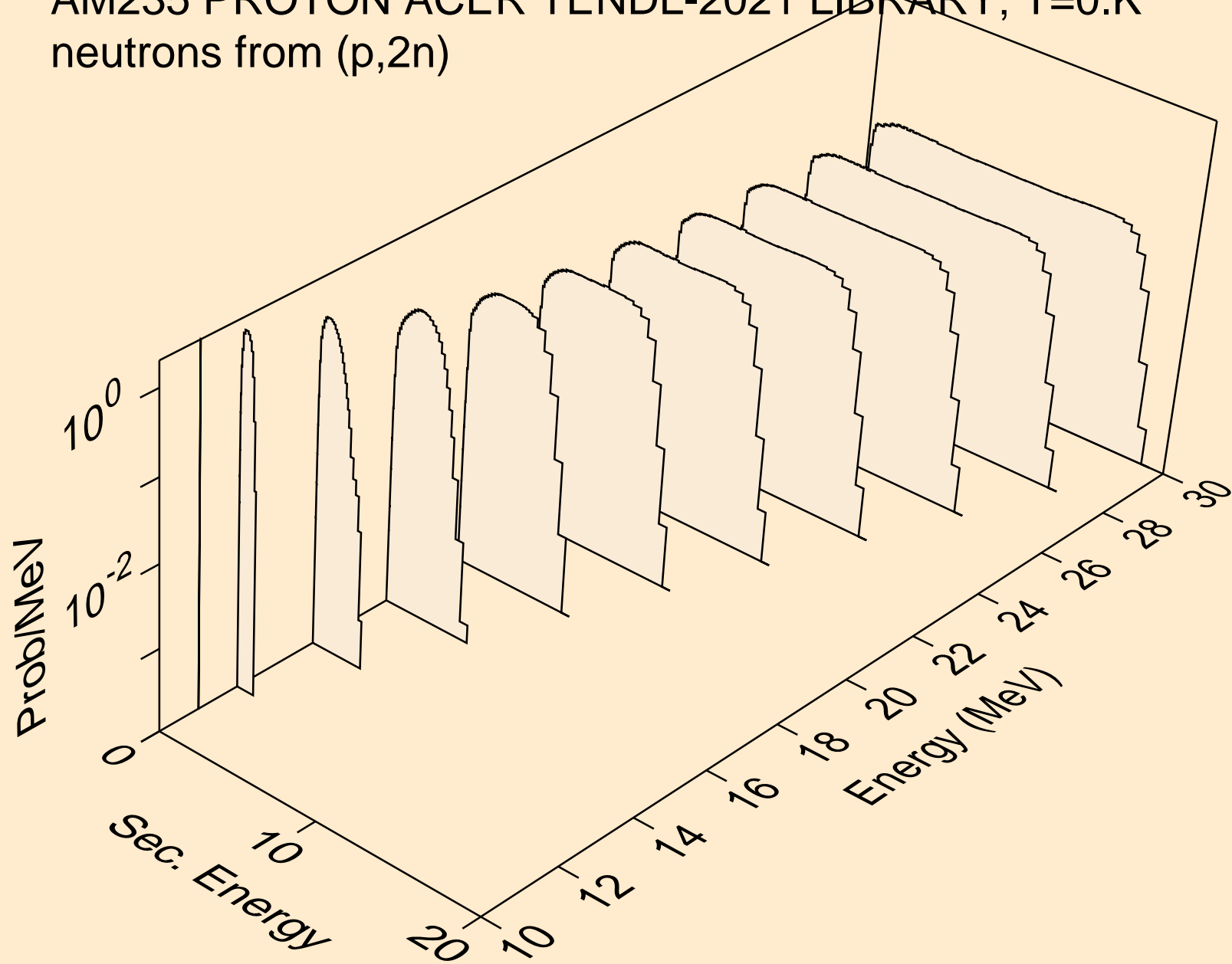

AM235 PROTON ACER TENDL-2021 LIBRARY; T=0.K
neutrons from (p,3n)

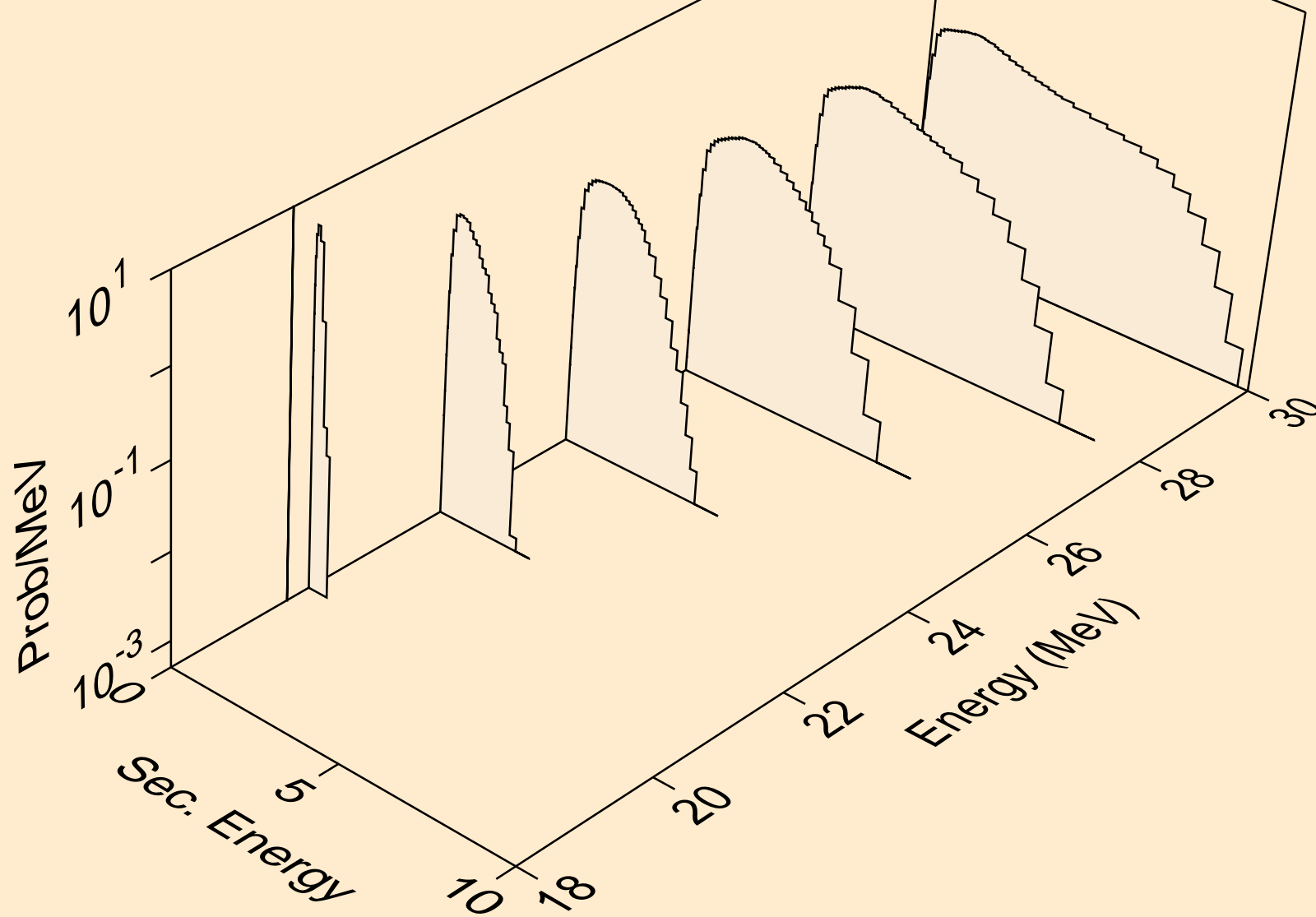

AM235 PROTON ACER TENDL-2021 LIBRARY; T=0.K
neutrons from (p,n*)a

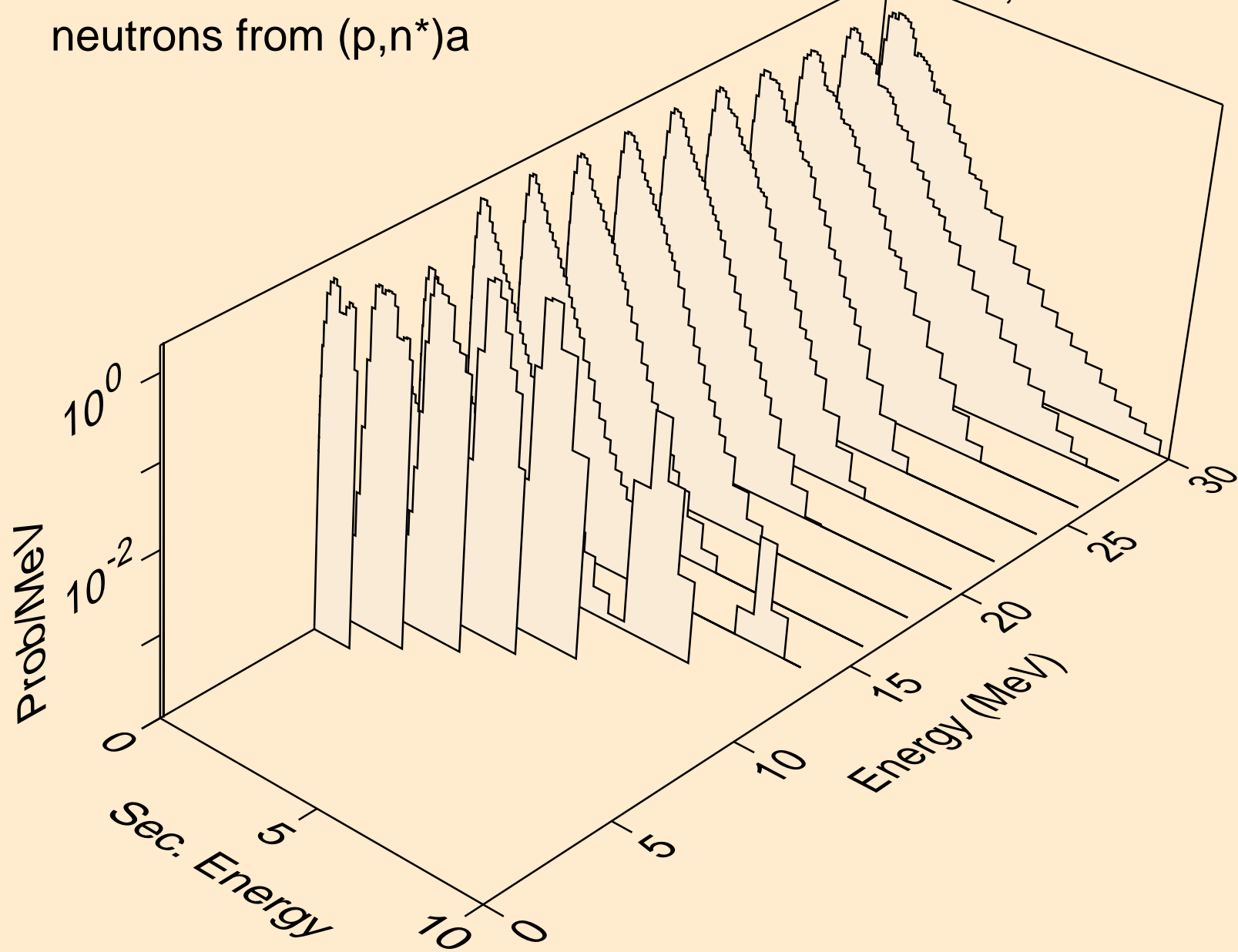

AM235 PROTON ACER TENDL-2021 LIBRARY; T=0.K
neutrons from (p,2n)a

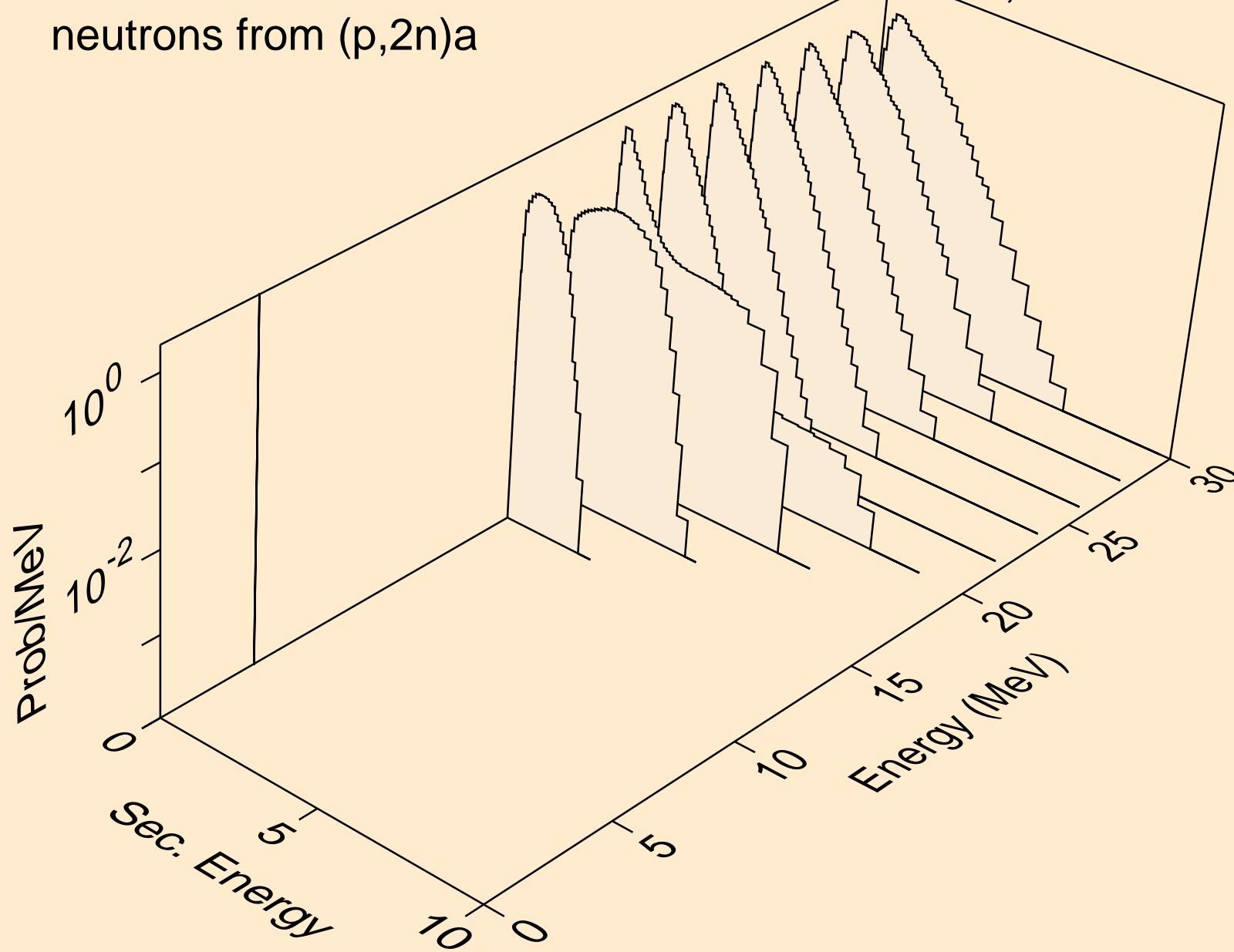

AM235 PROTON ACER TENDL-2021 LIBRARY; T=0.K
neutrons from (p,n*)p

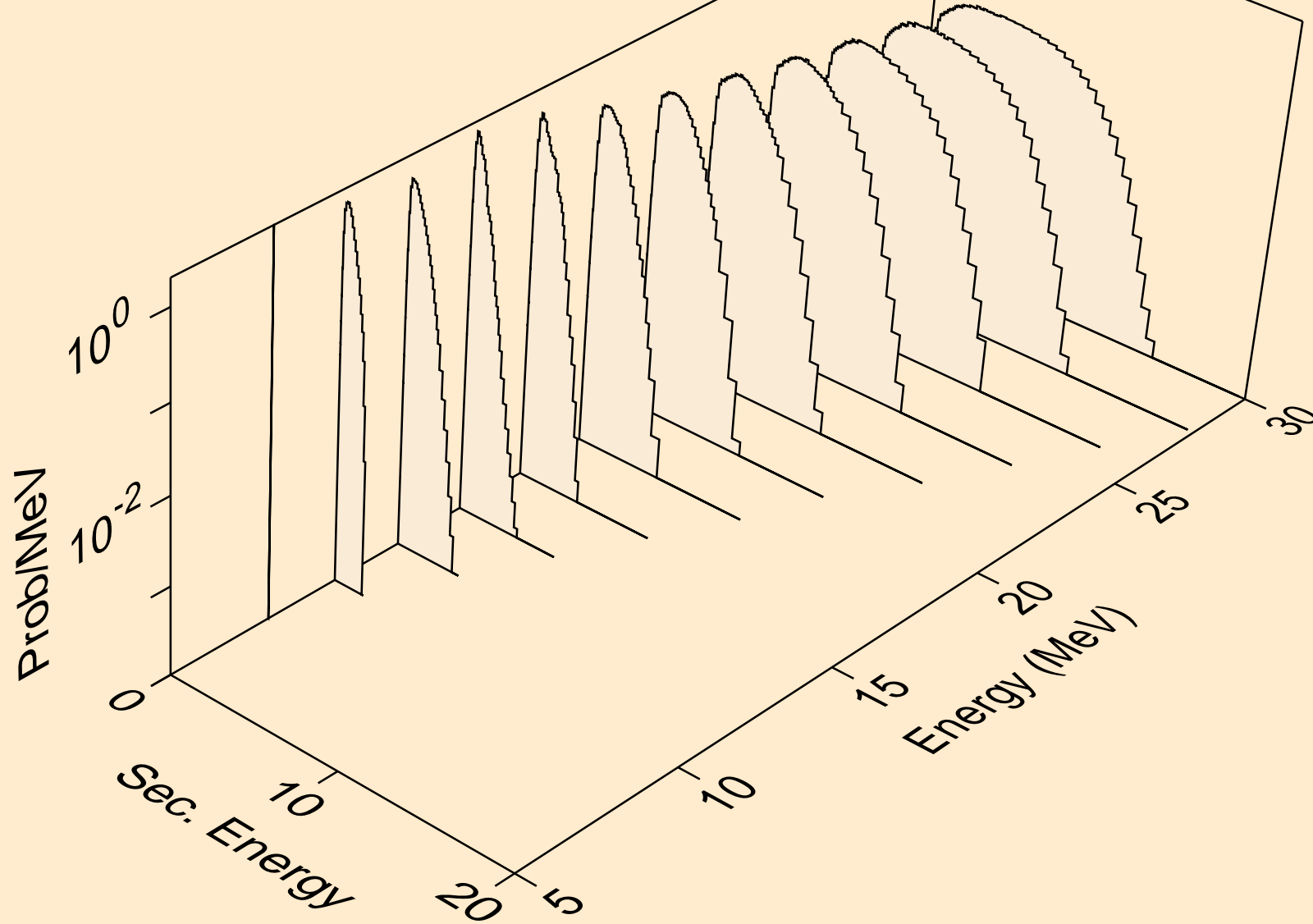

AM235 PROTON ACER TENDL-2021 LIBRARY; T=0.K
neutrons from (p,n*)d

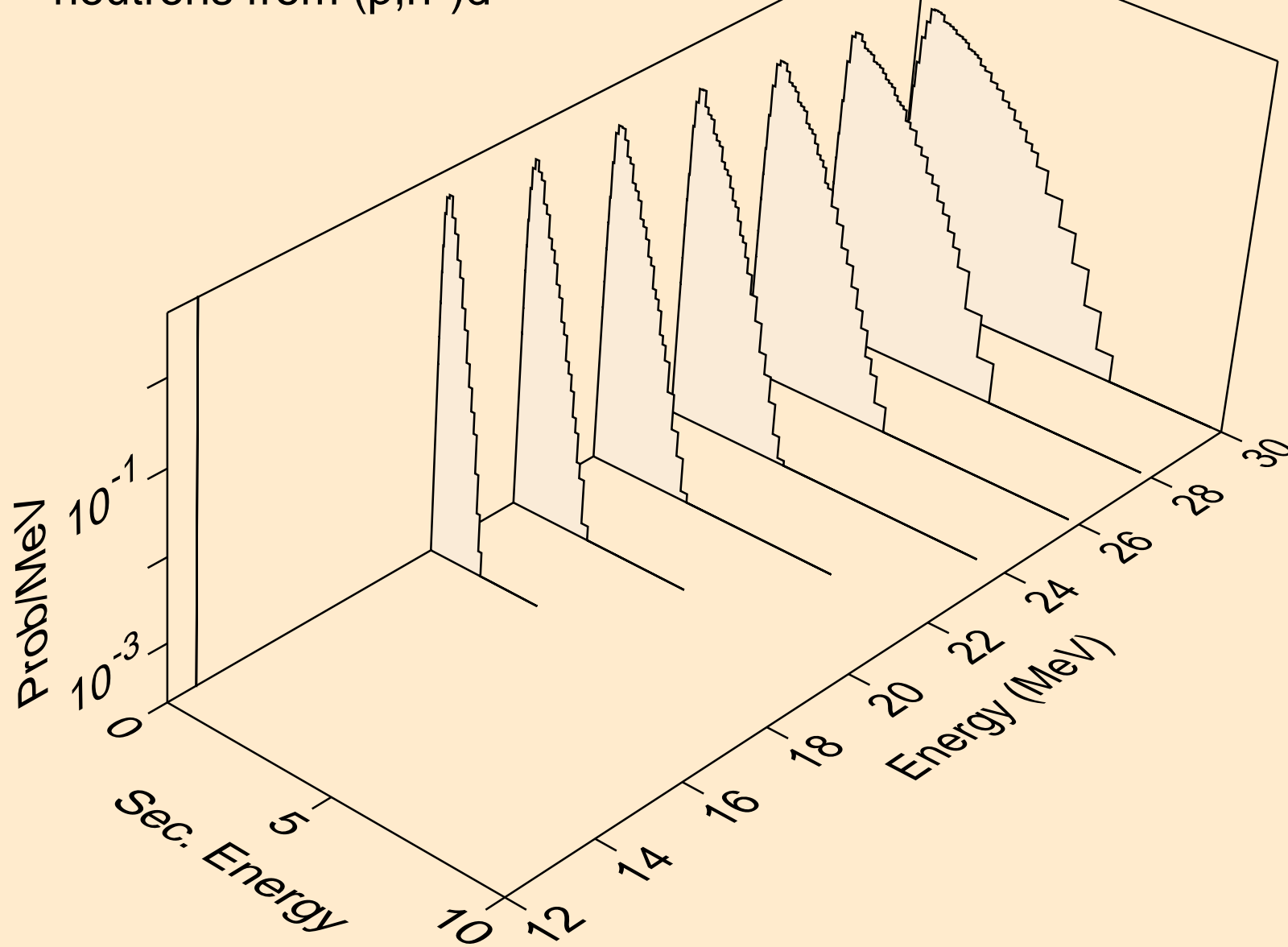

AM235 PROTON ACER TENDL-2021 LIBRARY; T=0.K
neutrons from (p,n*)t

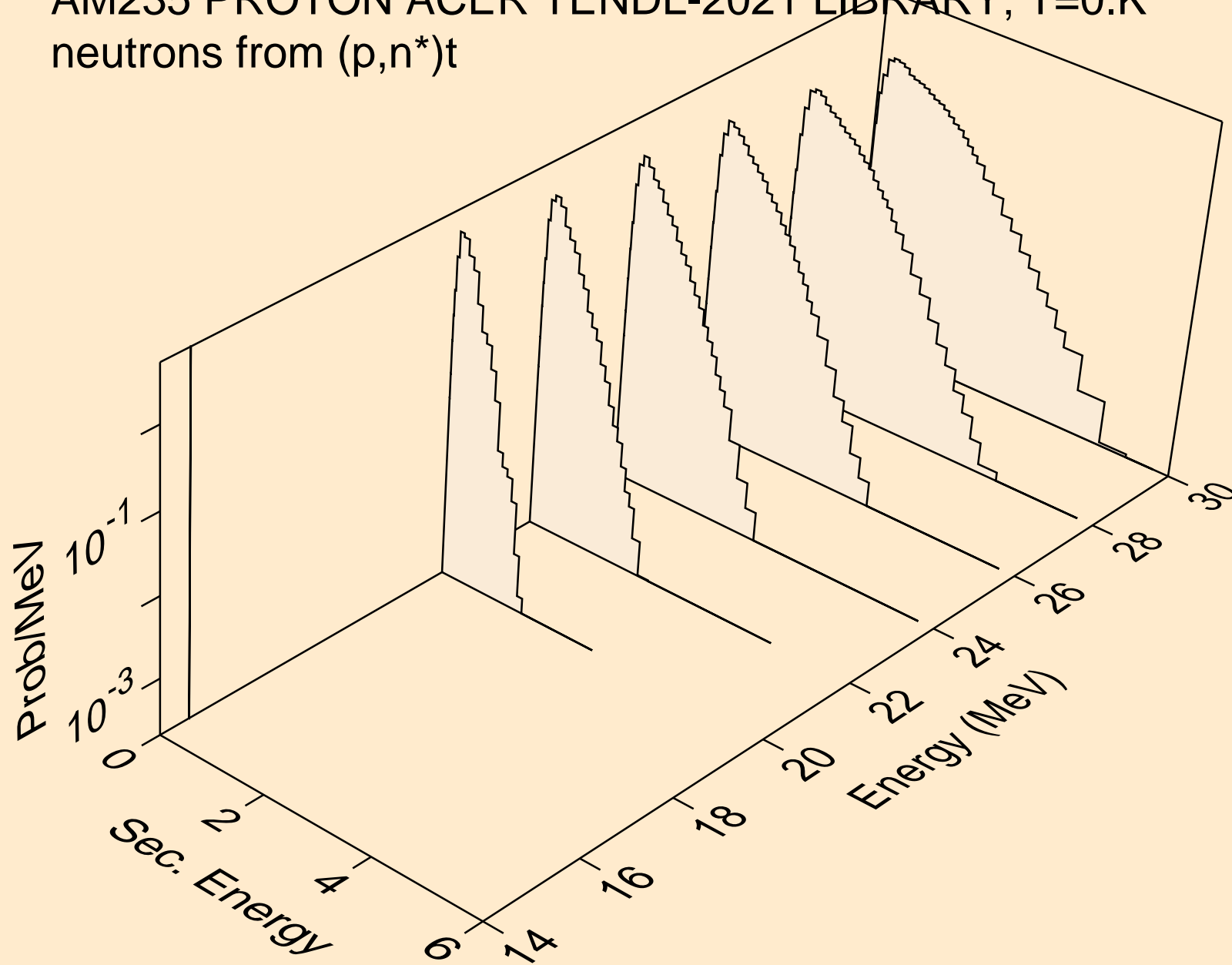

AM235 PROTON ACER TENDL-2021 LIBRARY; T=0.K
neutrons from (p,n*)he3

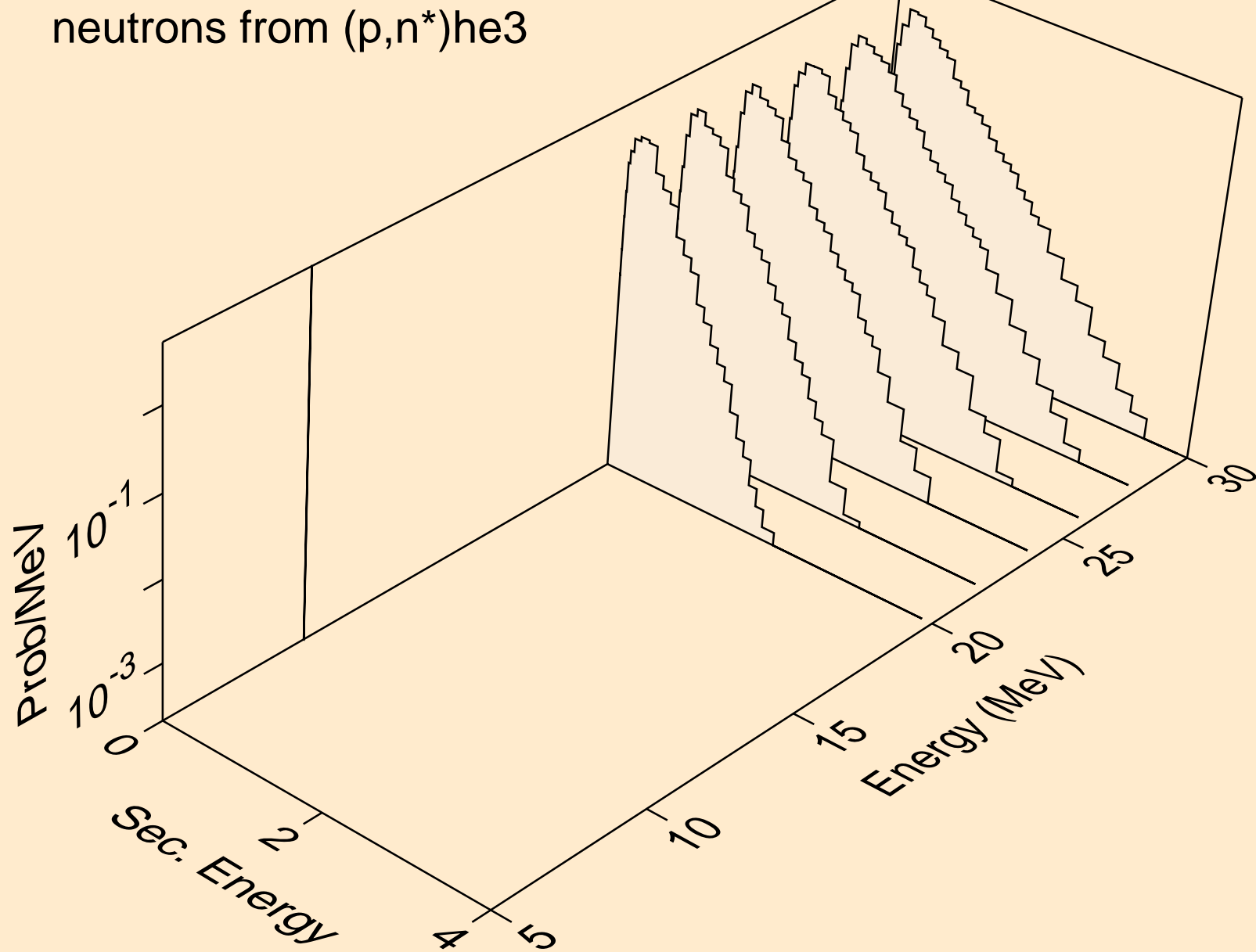

AM235 PROTON ACER TENDL-2021 LIBRARY; T=0.K
neutrons from (p,2np)

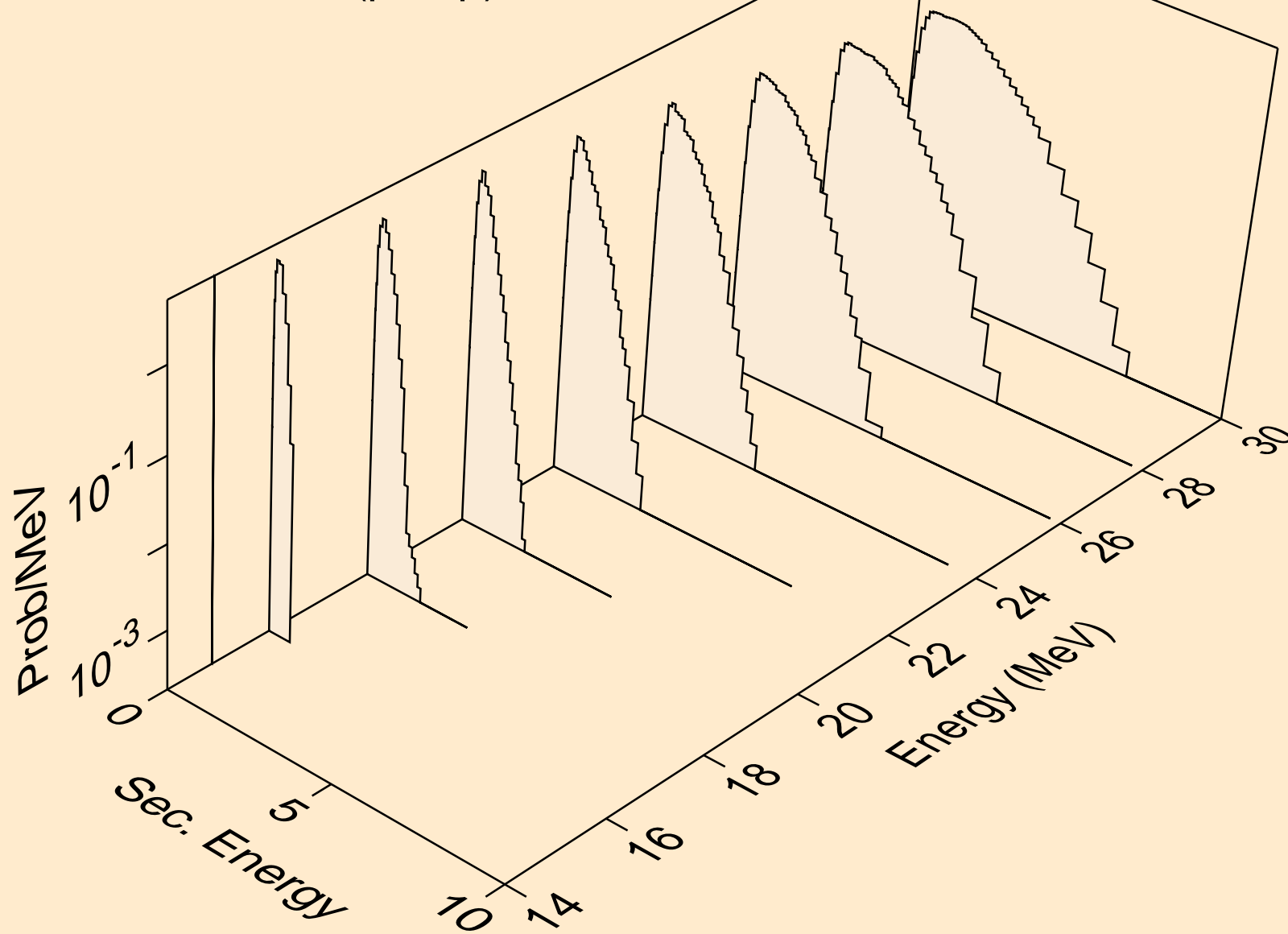

AM235 PROTON ACER TENDL-2021 LIBRARY; T=0.K
neutrons from (p,2np)

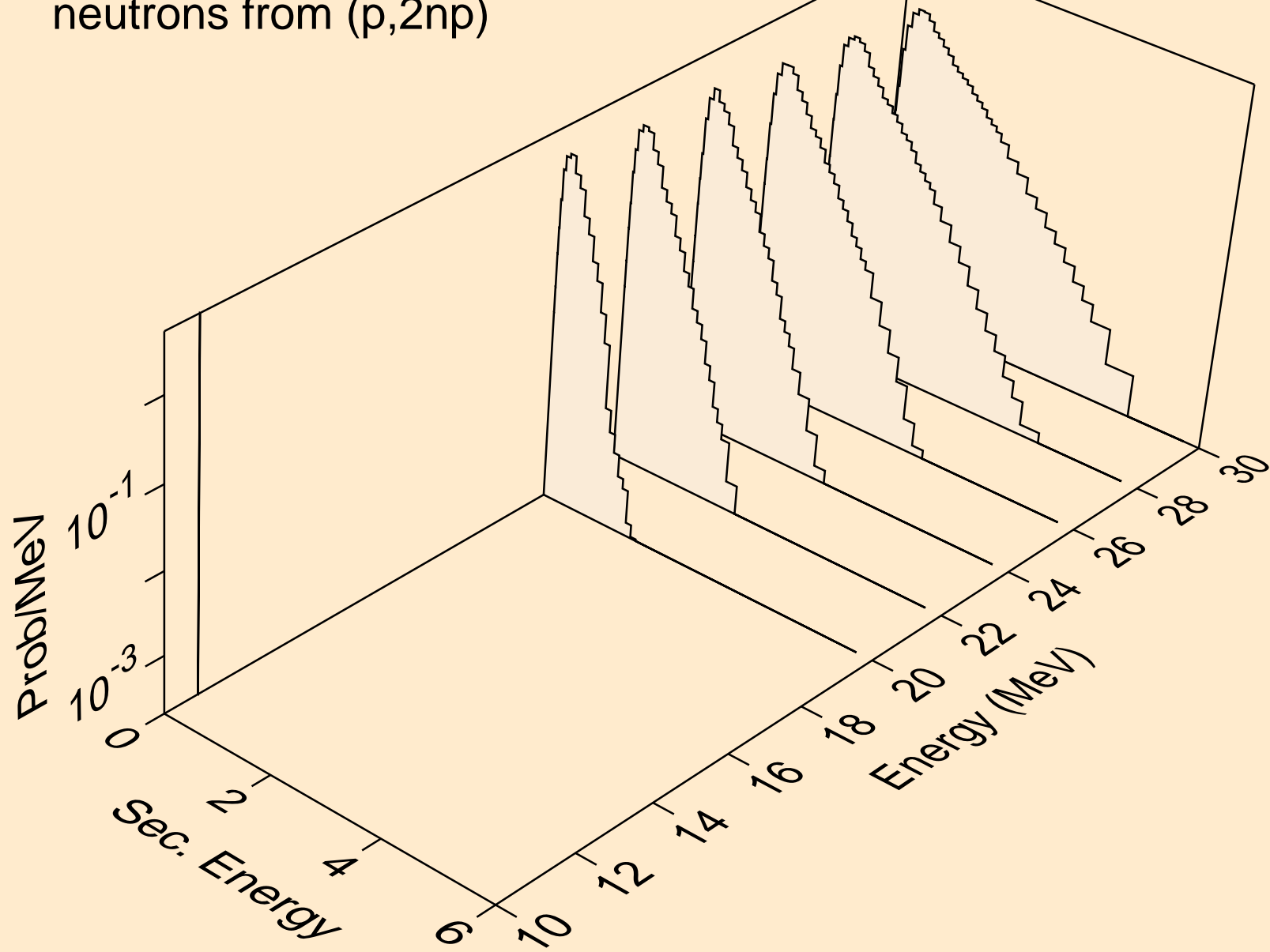

AM235 PROTON ACER TENDL-2021 LIBRARY; T=0.K
deuterons from (p,x)

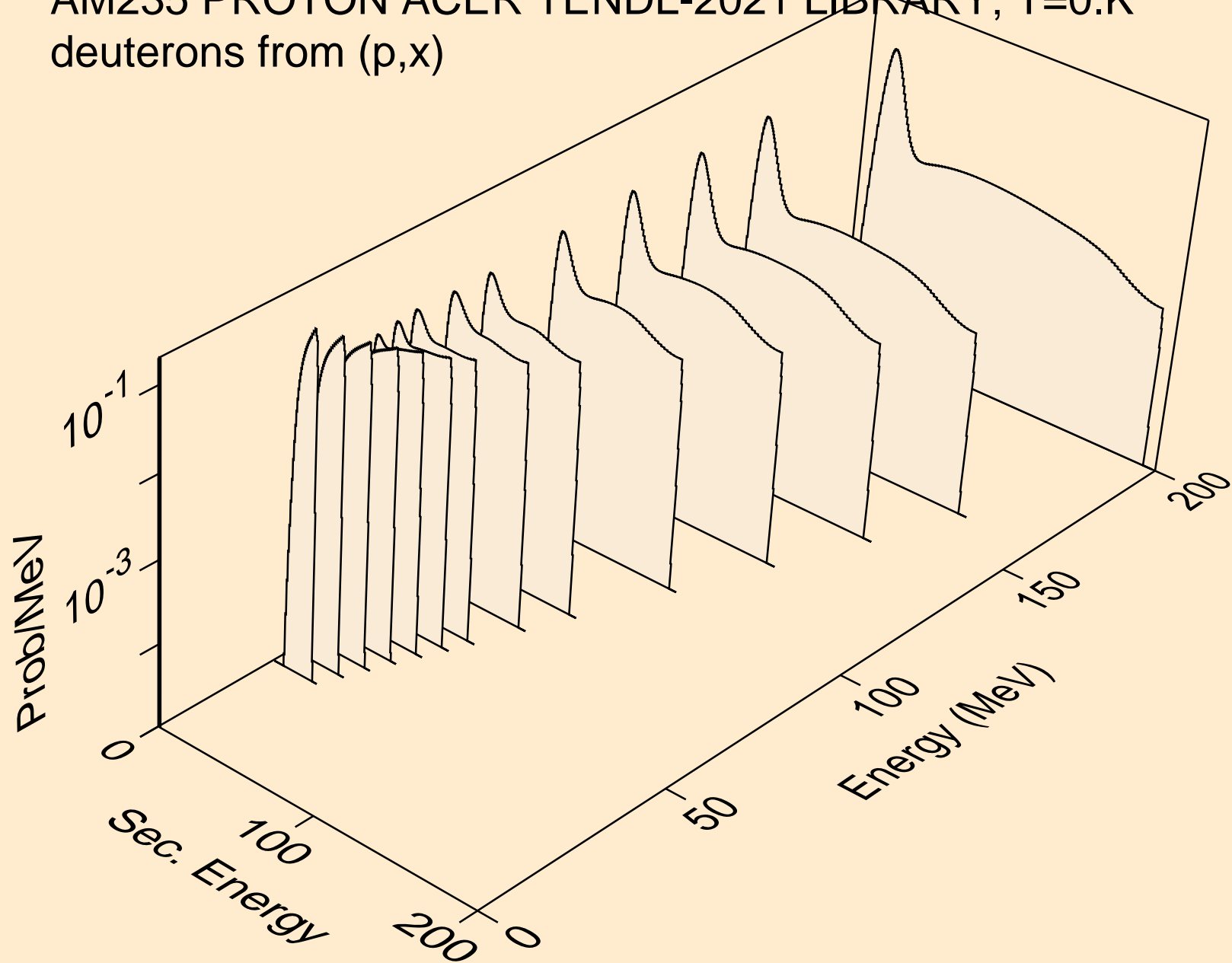

AM235 PROTON ACER TENDL-2021 LIBRARY; T=0.K
deuterons from (p,n*)d

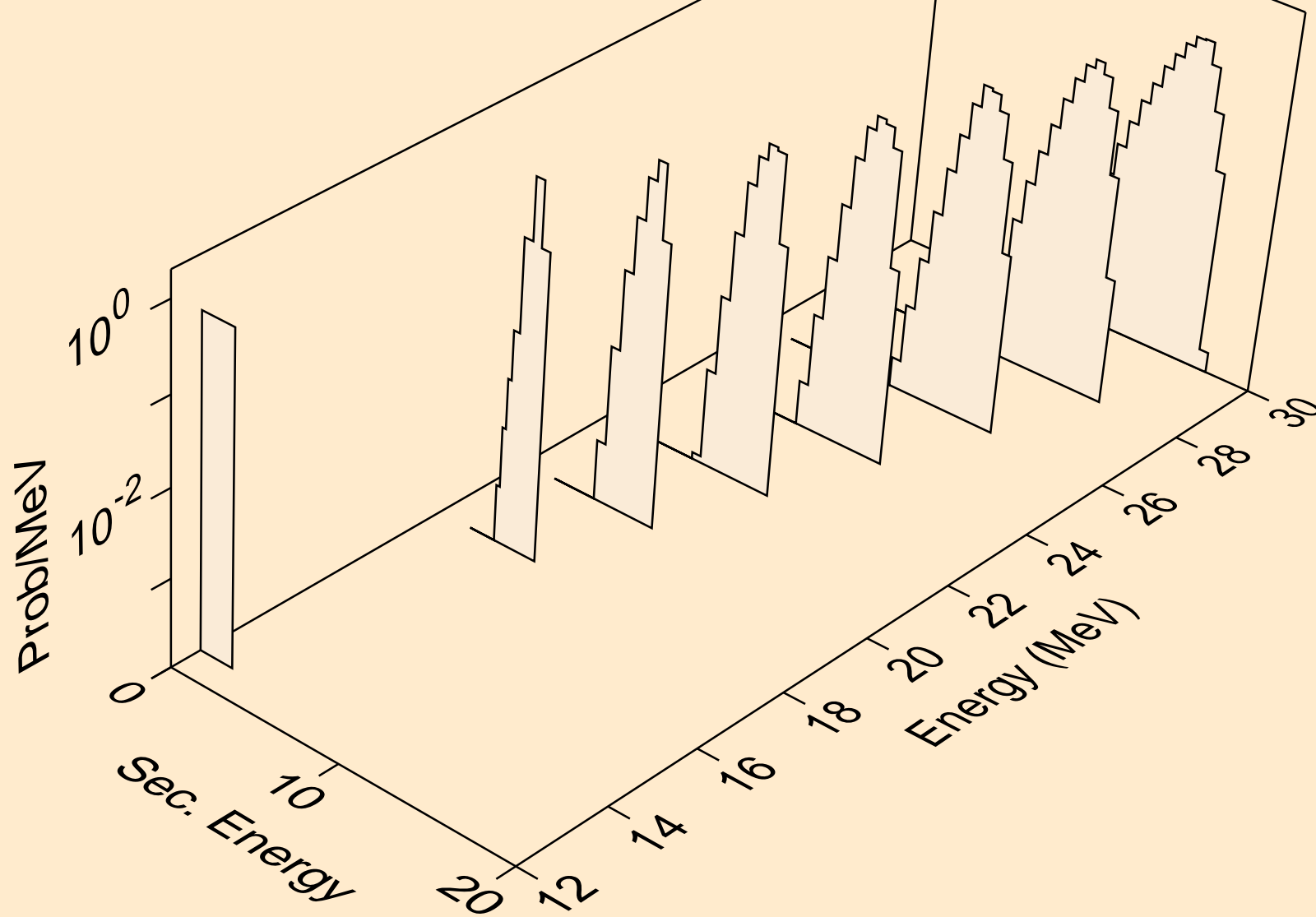

AM235 PROTON ACER TENDL-2021 LIBRARY; T=0.K
deuterons from (p,d)

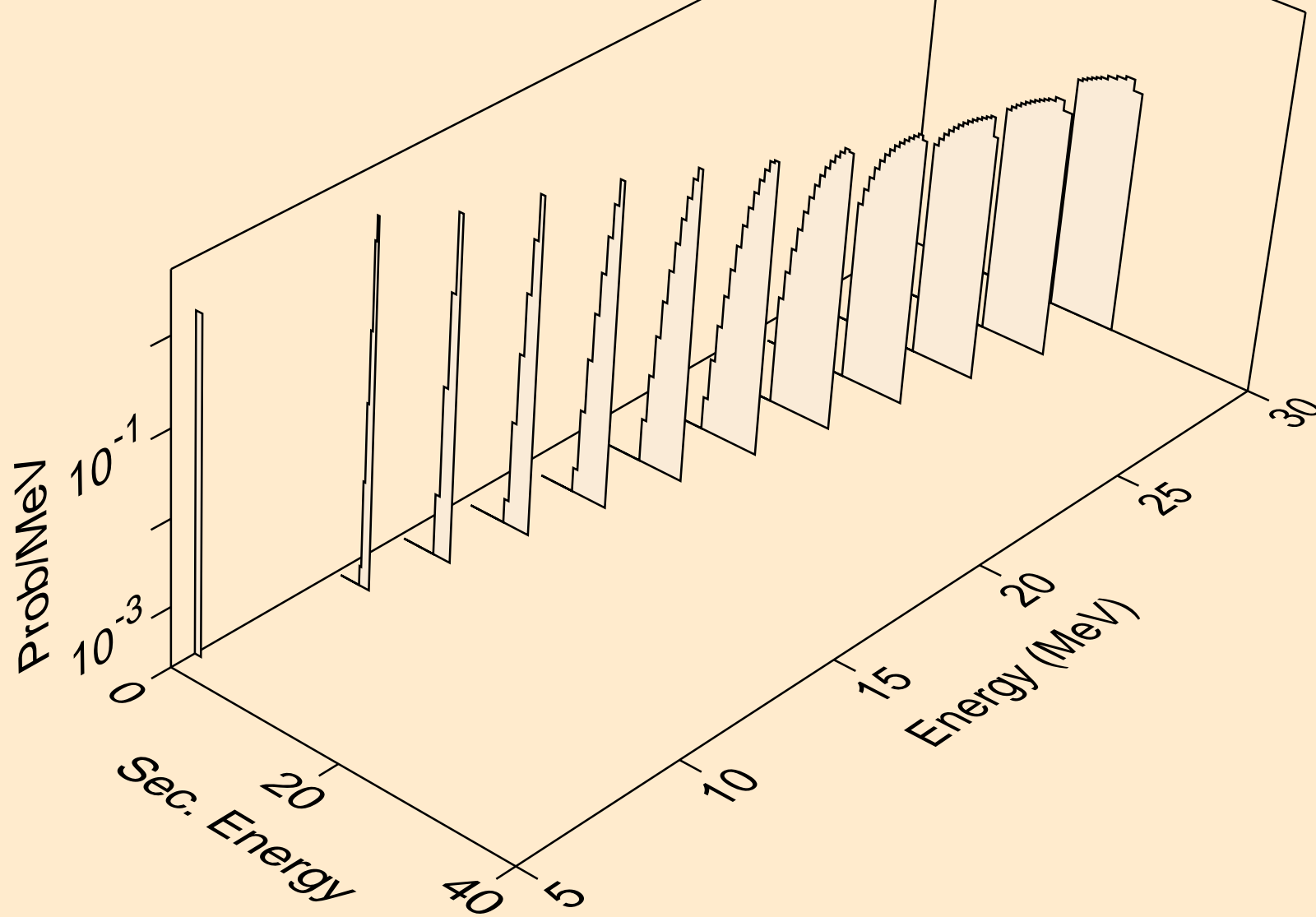

AM235 PROTON ACER TENDL-2021 LIBRARY; T=0.K
deuterons from (p,pd)

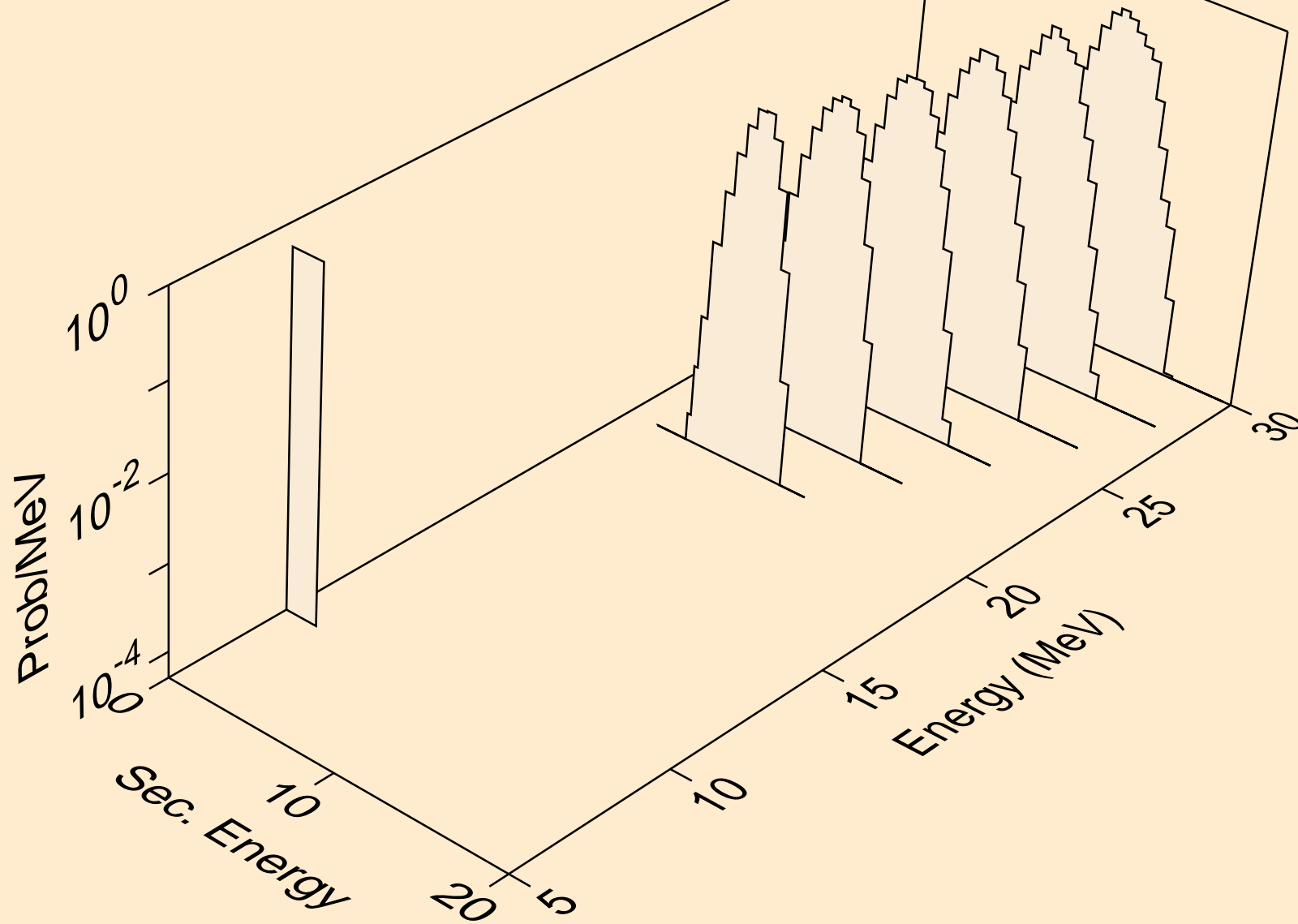

AM235 PROTON ACER TENDL-2021 LIBRARY; T=0.K
tritons from (p,x)

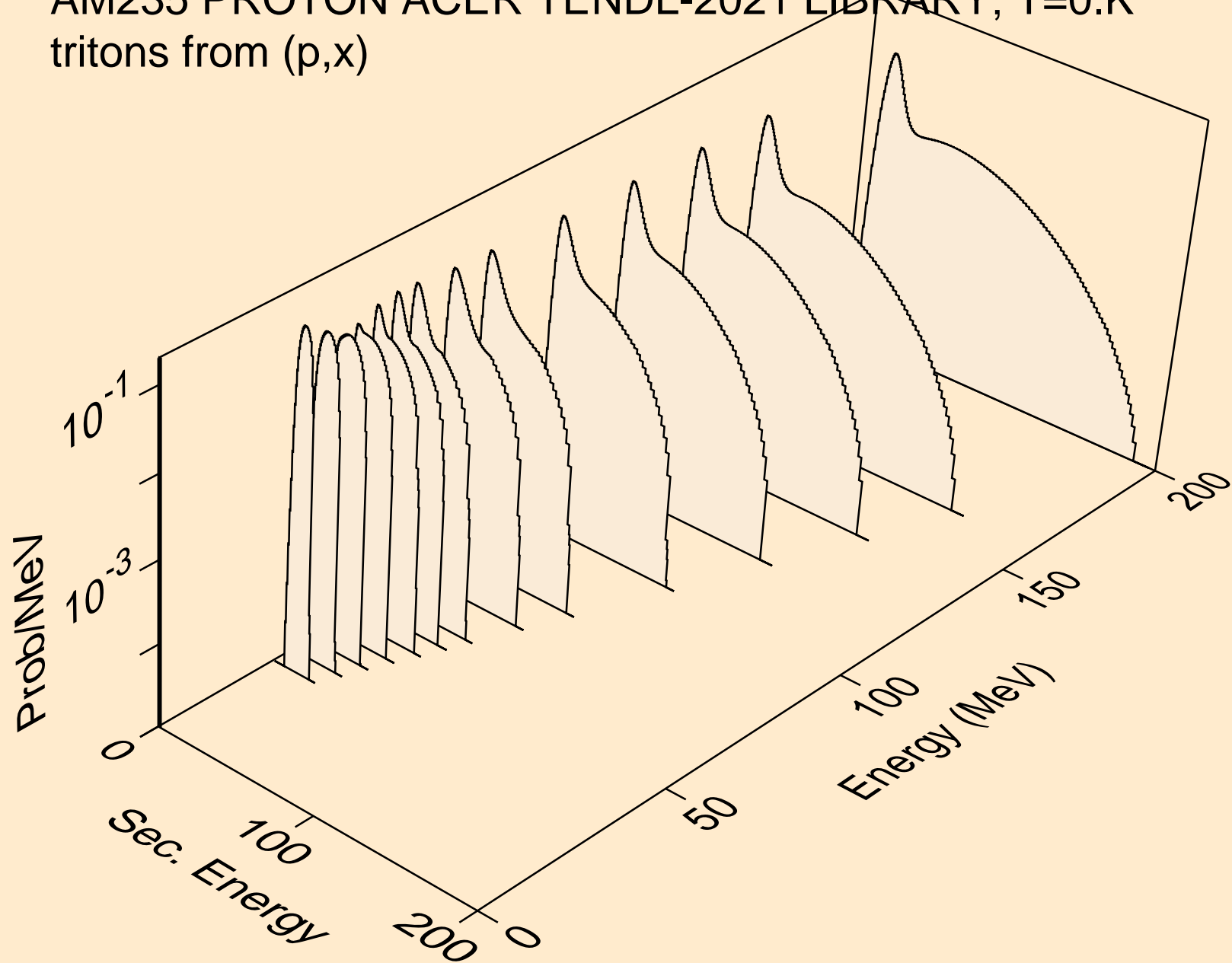

AM235 PROTON ACER TENDL-2021 LIBRARY; T=0.K
tritons from (p,n*)t

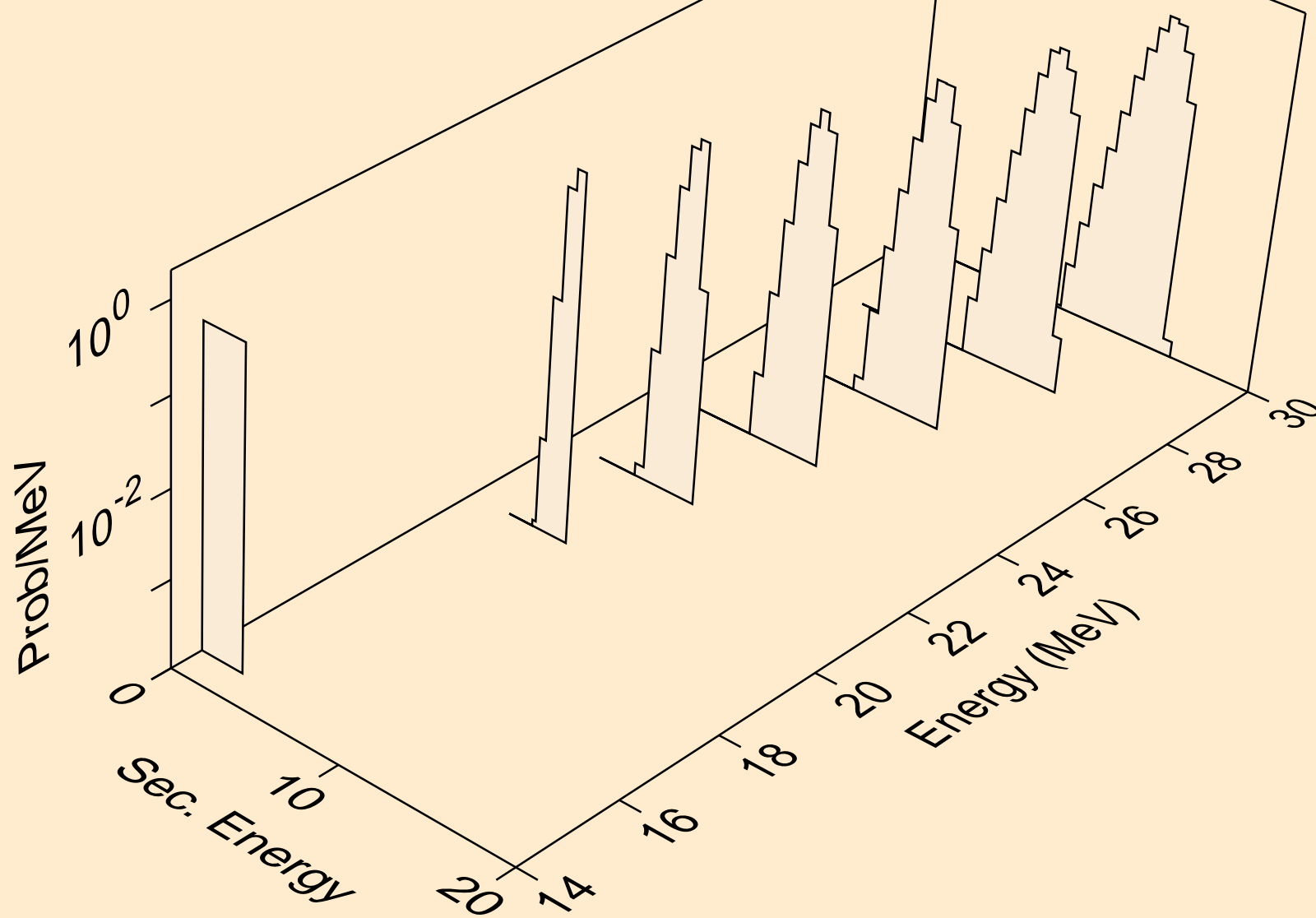

AM235 PROTON ACER TENDL-2021 LIBRARY; T=0.K
tritons from (p,t)

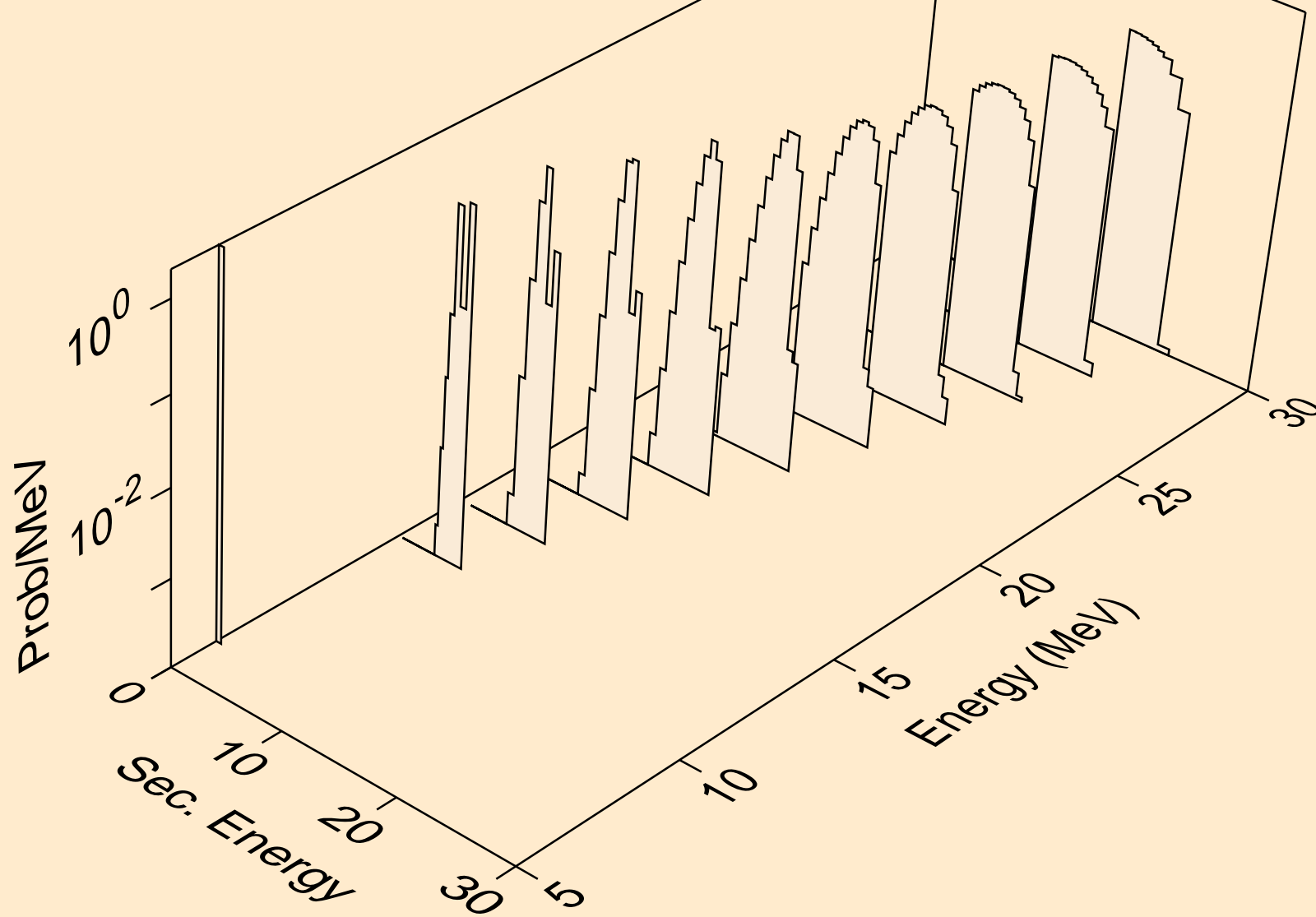

AM235 PROTON ACER TENDL-2021 LIBRARY; T=0.K
he3s from (p,x)

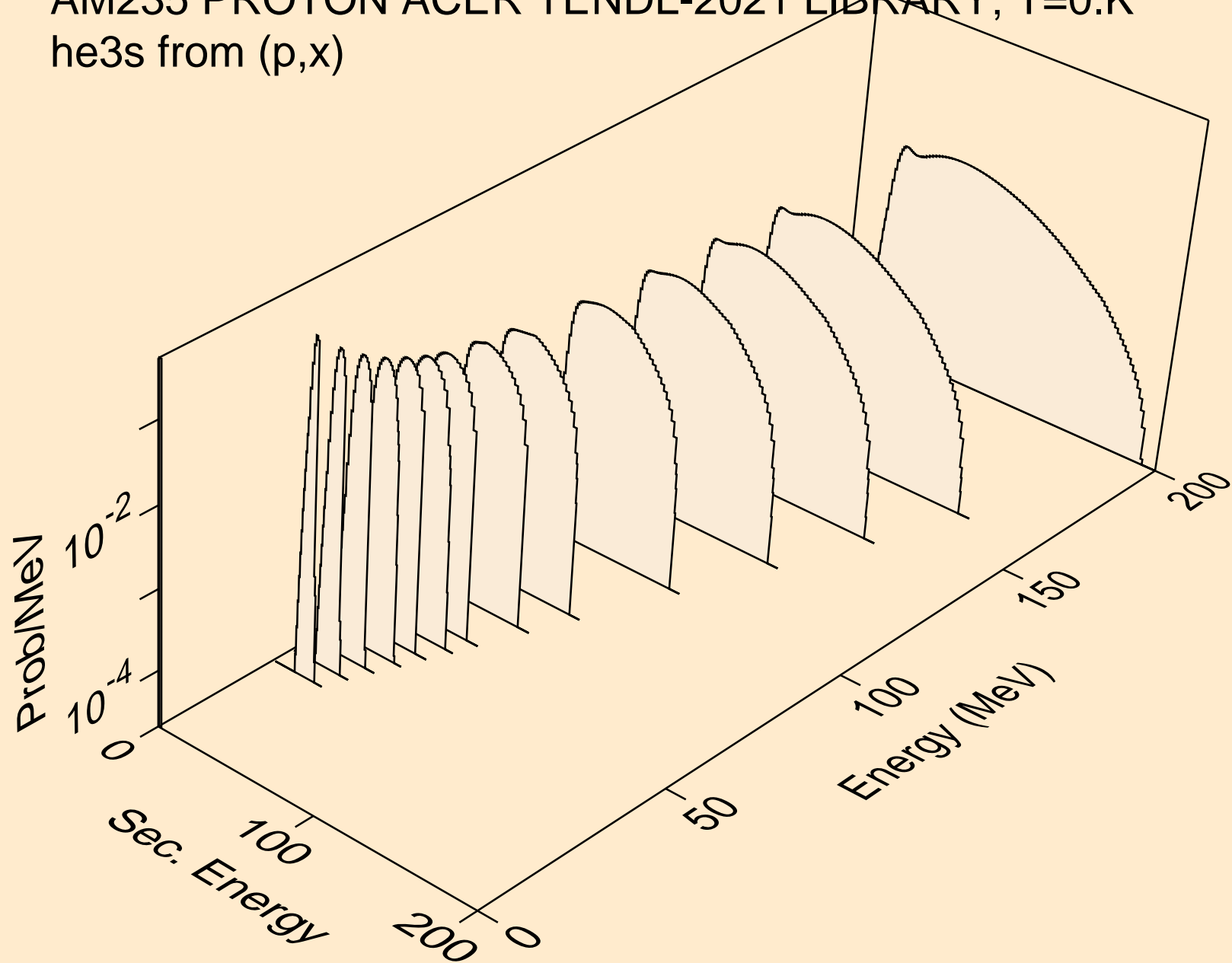

AM235 PROTON ACER TENDL-2021 LIBRARY; T=0.K
he3s from (p,n*)he3

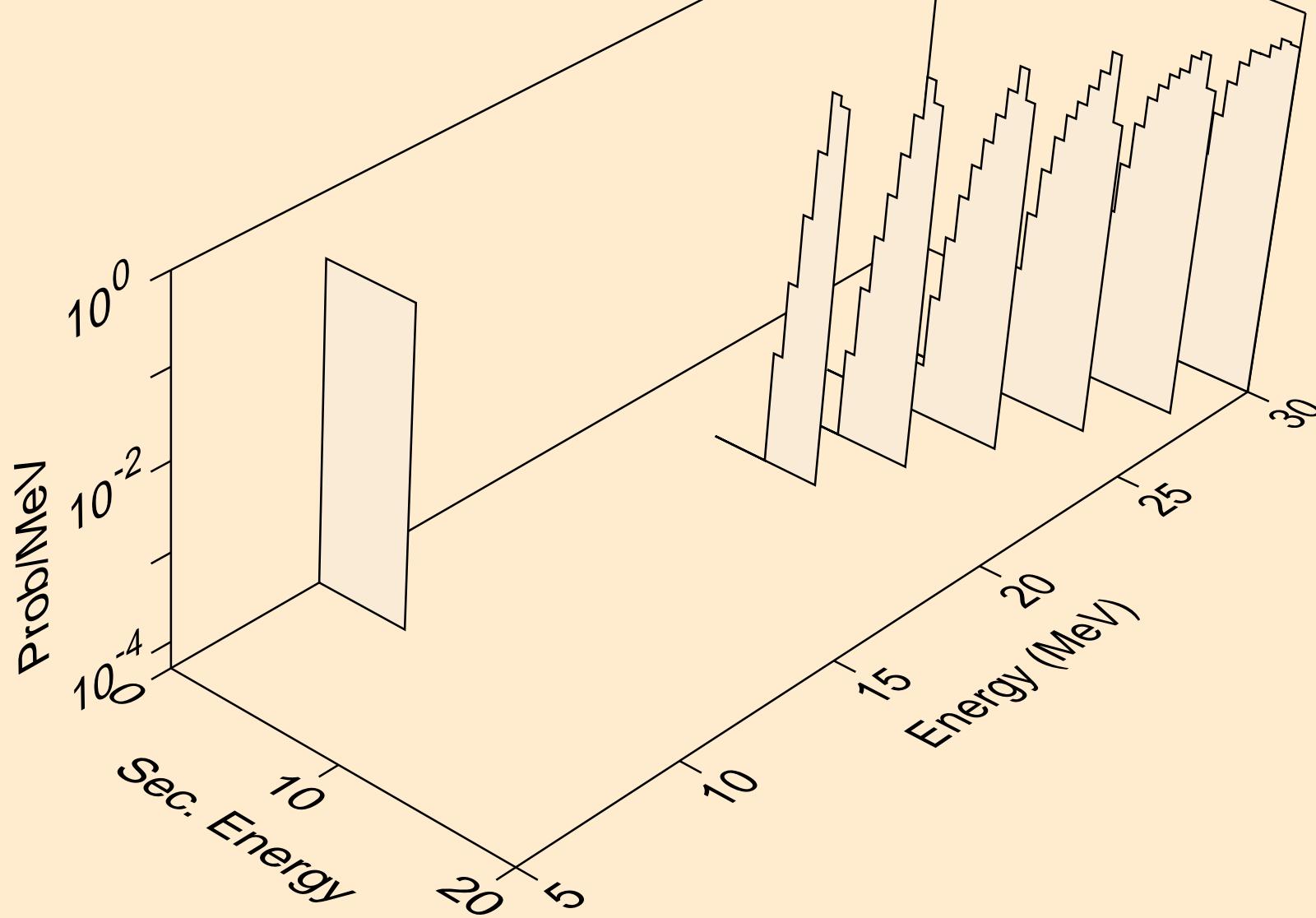

AM235 PROTON ACER TENDL-2021 LIBRARY; T=0.K
he3s from (p,he3)

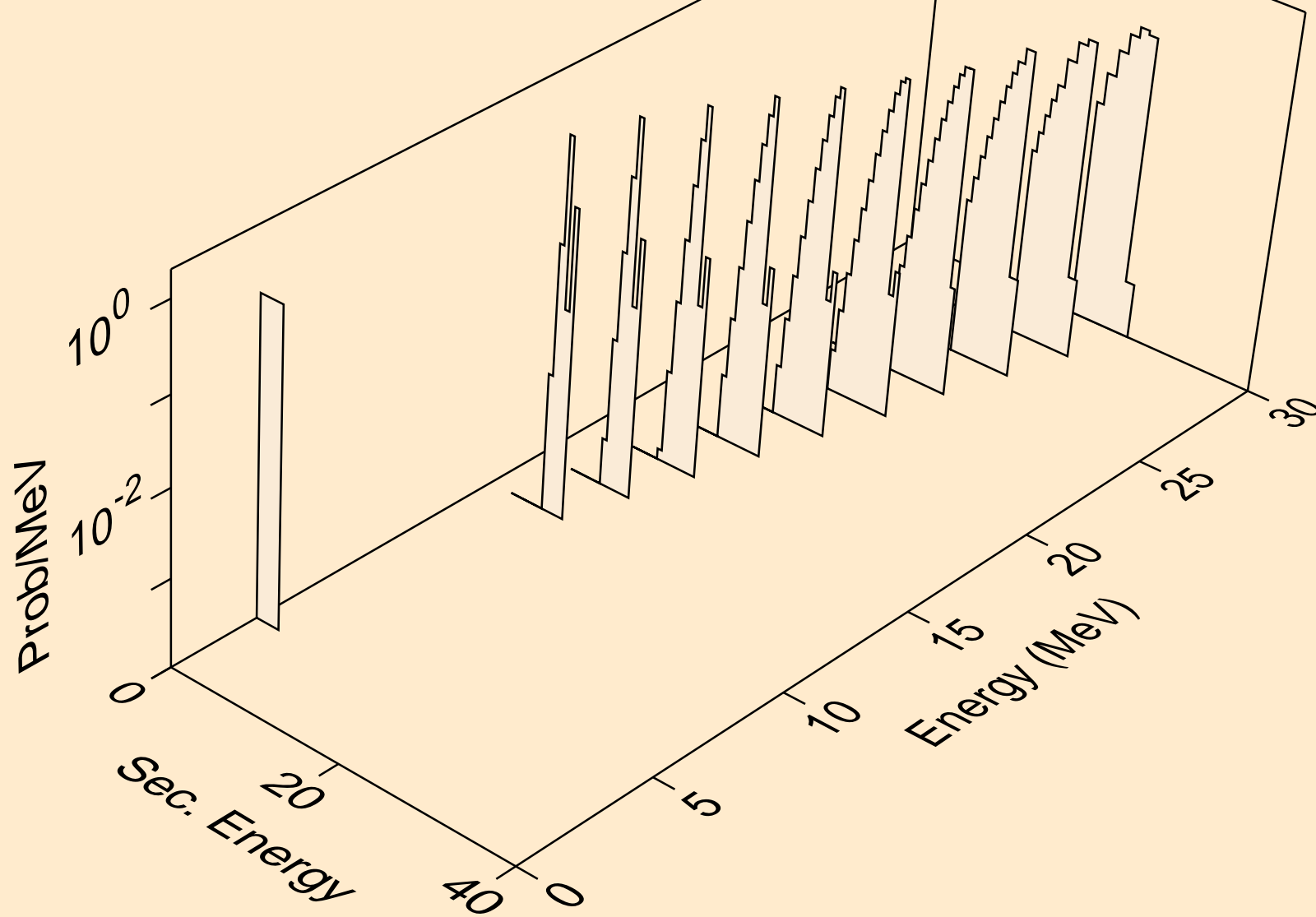

AM235 PROTON ACER TENDL-2021 LIBRARY; T=0.K
alphas from (p,x)

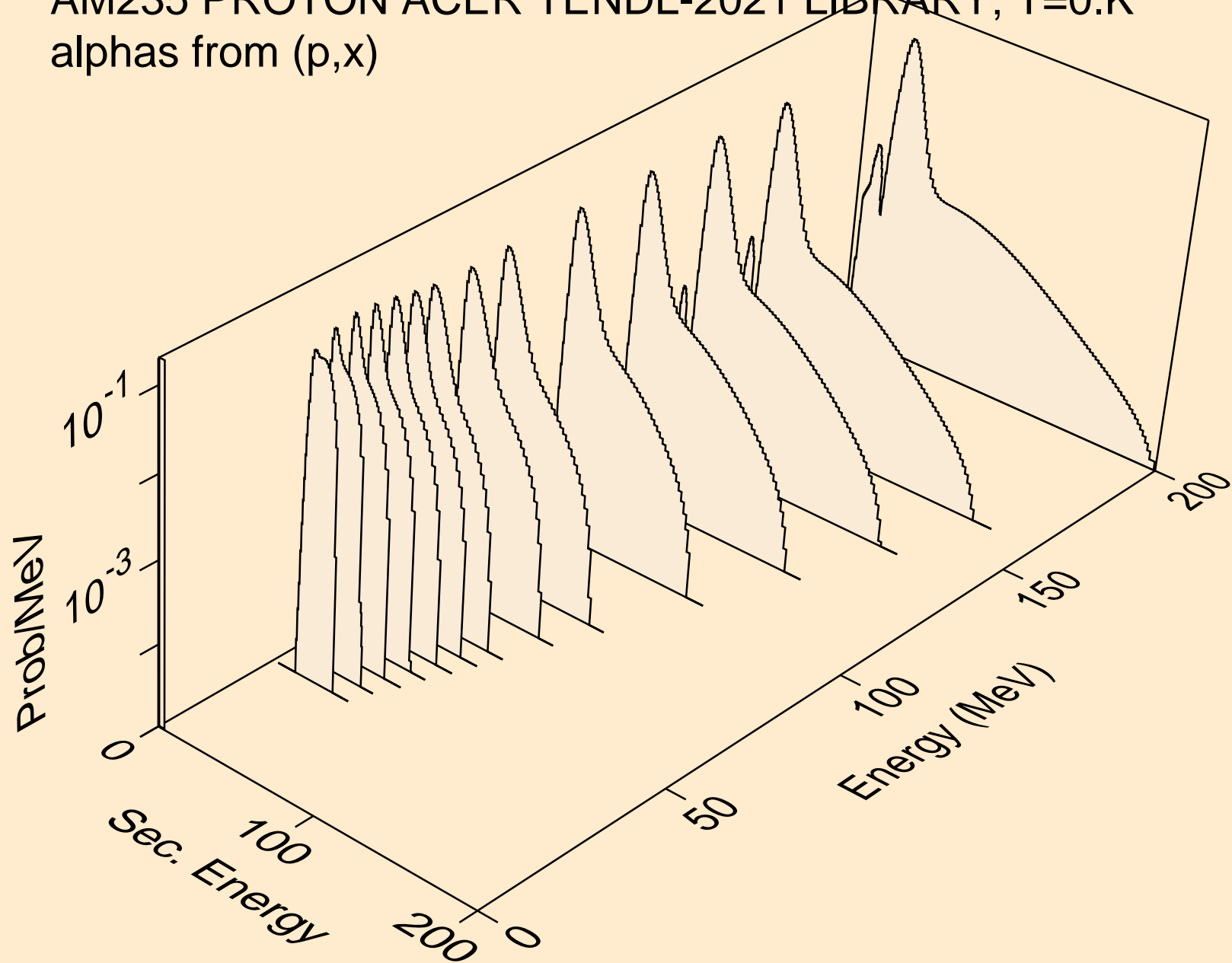

AM235 PROTON ACER TENDL-2021 LIBRARY; T=0.K
alphas from (p,n*)a

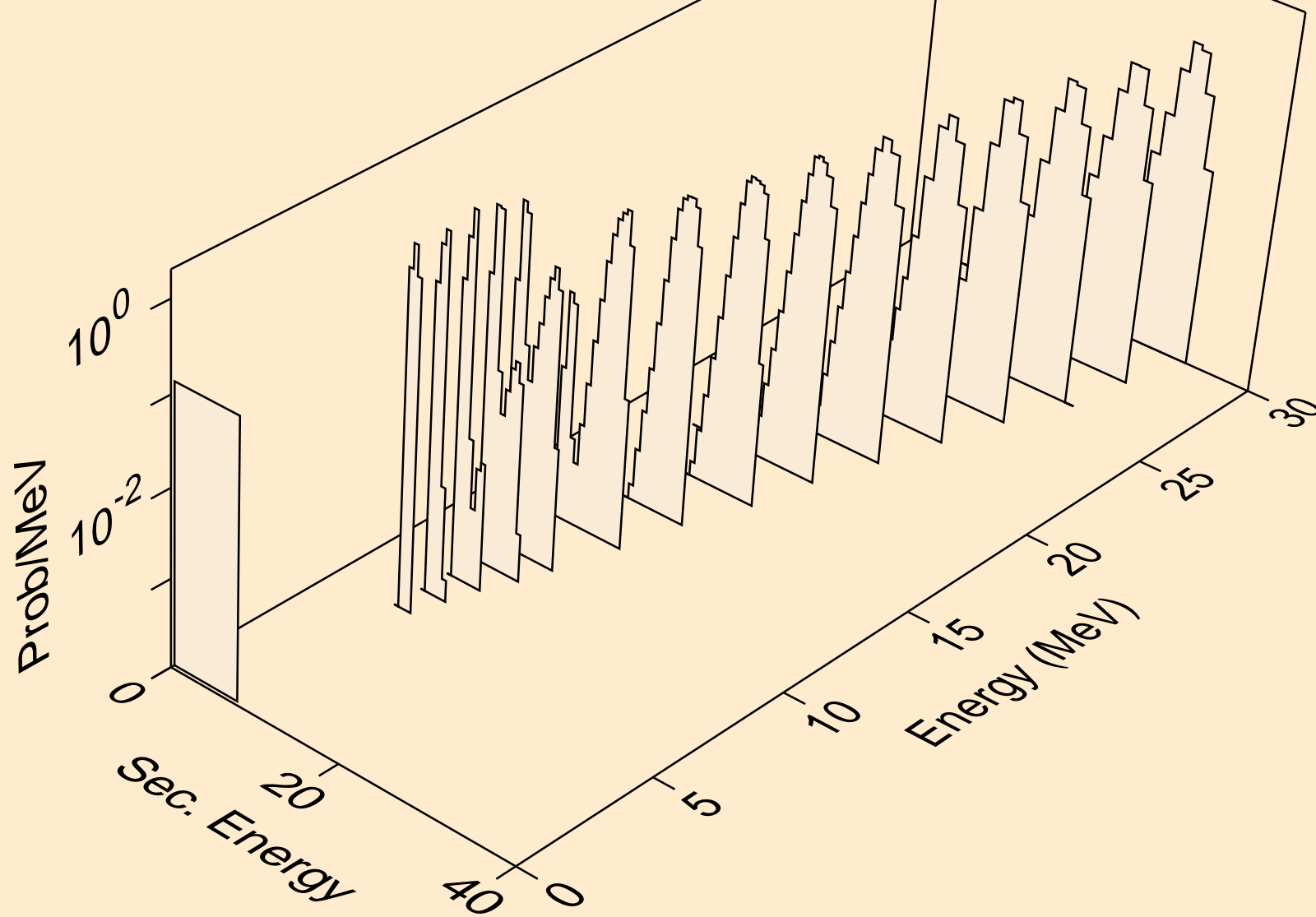

AM235 PROTON ACER TENDL-2021 LIBRARY; T=0.K
alphas from (p,2n)a

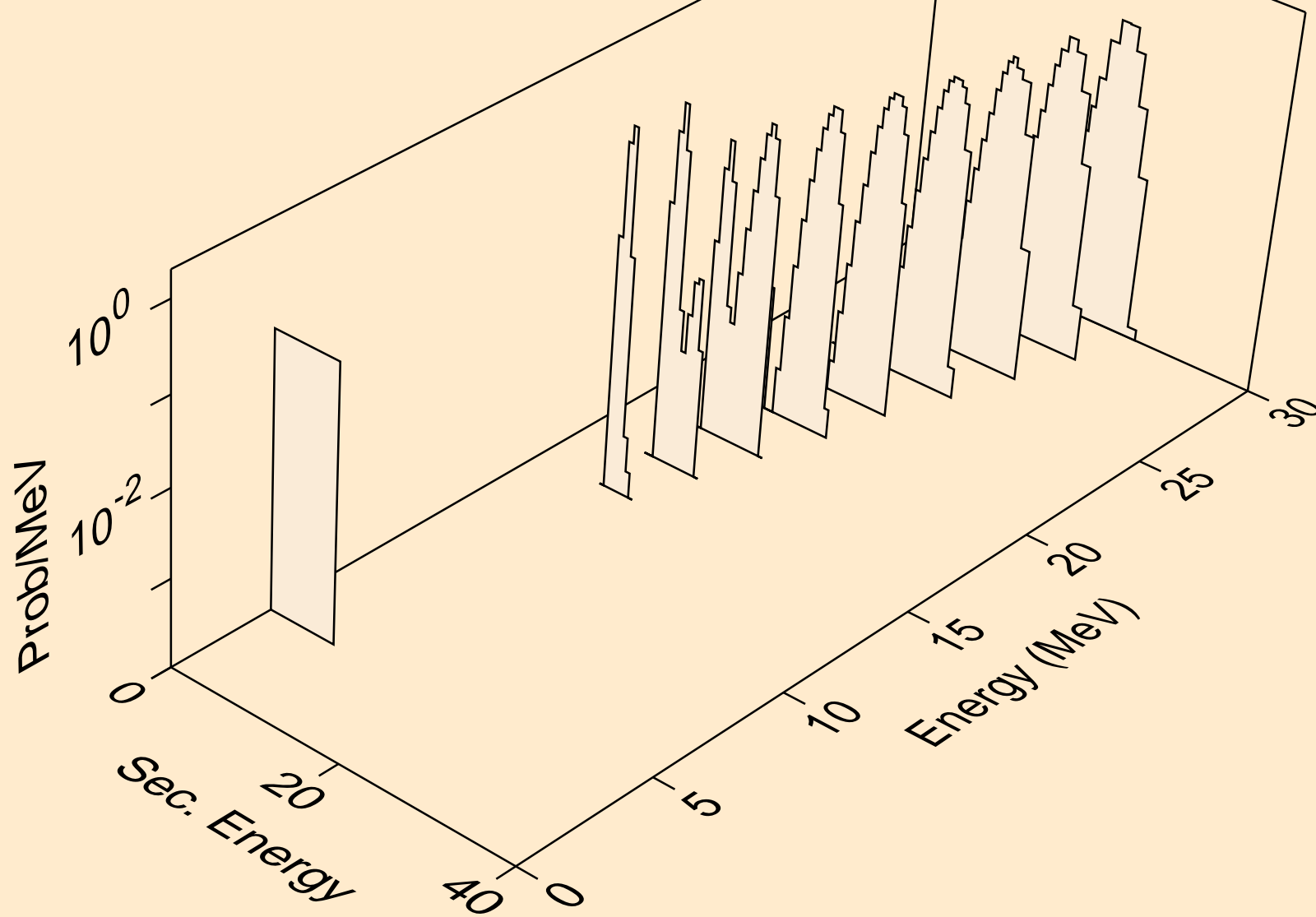

AM235 PROTON ACER TENDL-2021 LIBRARY; T=0.K
alphas from (p,a)

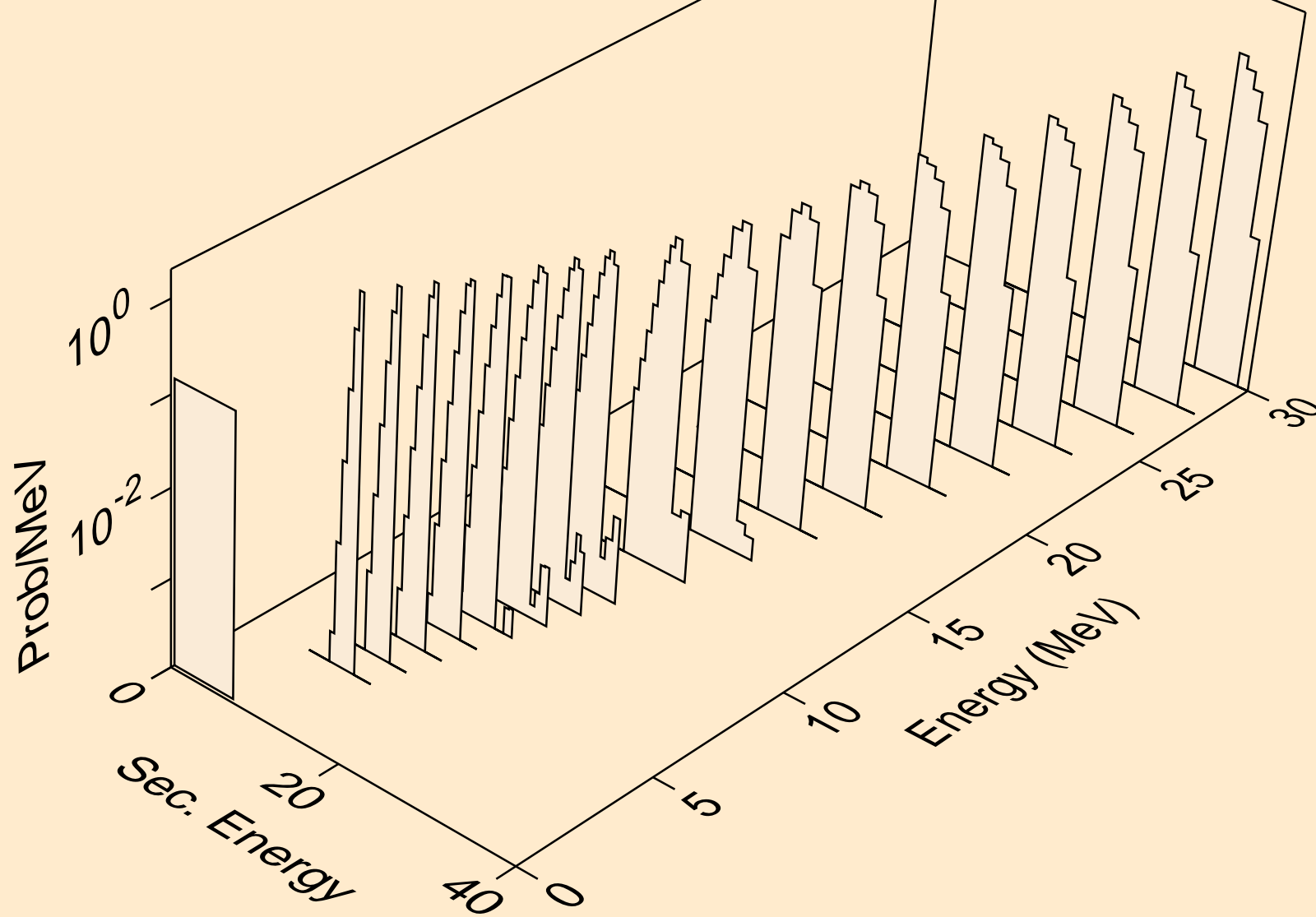

AM235 PROTON ACER TENDL-2021 LIBRARY; T=0.K
alphas from (p,pa)

