

# AT221 PROTON ACER TENDL-2021 LIBRARY; T=0.K

## Principal cross sections

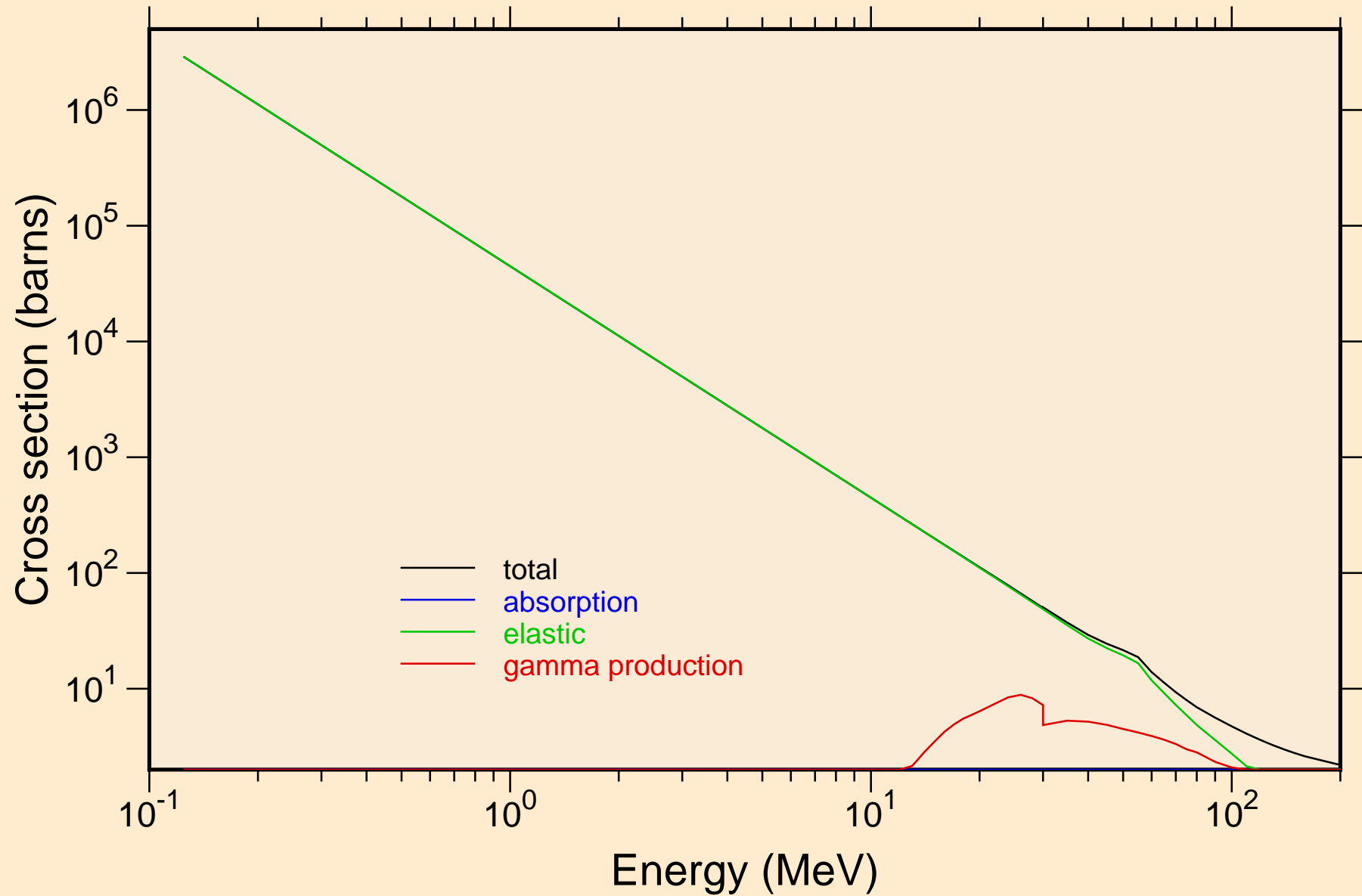

AT221 PROTON ACER TENDL-2021 LIBRARY; T=0.K  
Heating

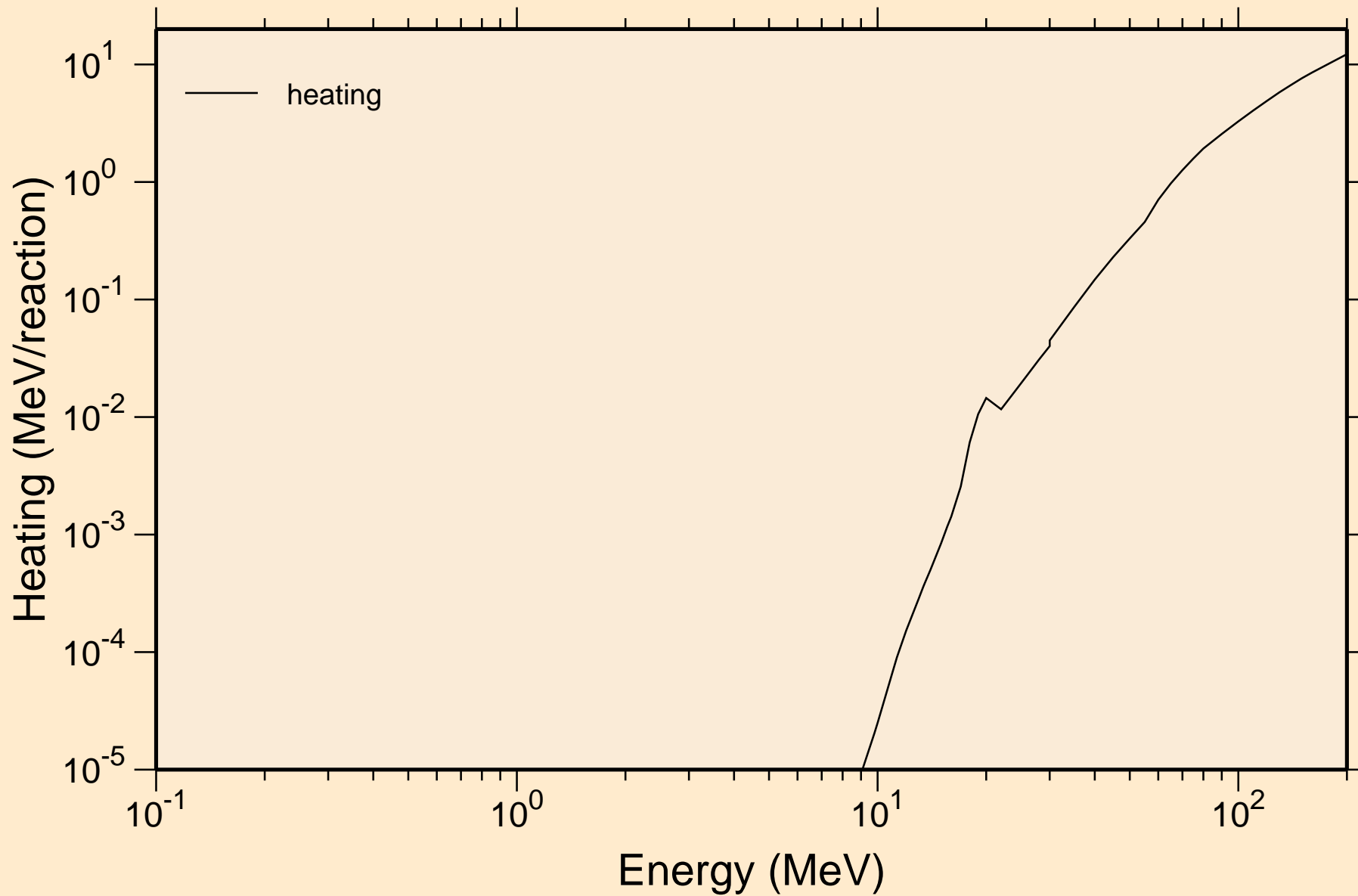

# AT221 PROTON ACER TENDL-2021 LIBRARY; T=0.K

## Principal cross sections

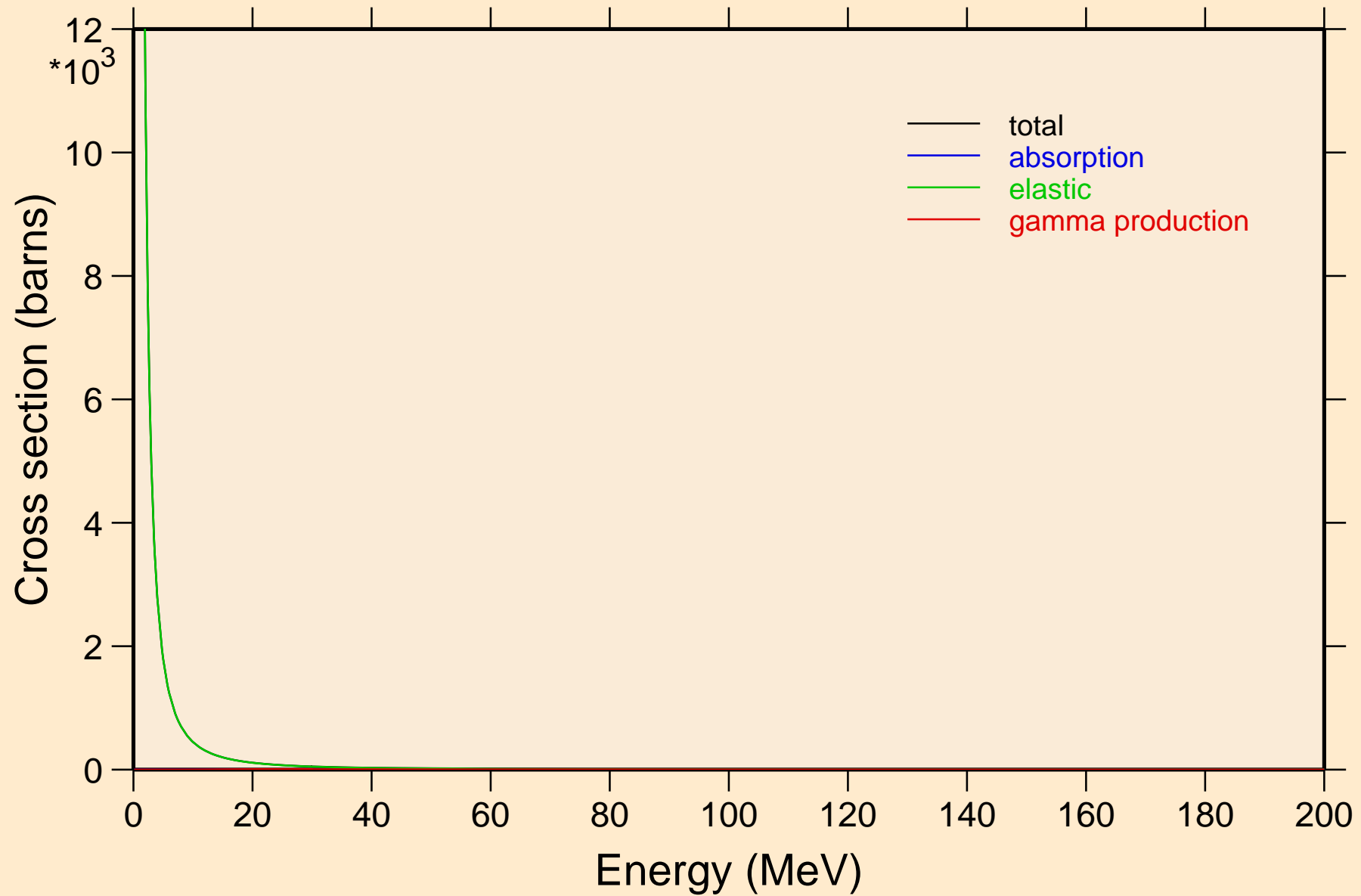

AT221 PROTON ACER TENDL-2021 LIBRARY; T=0.K

Heating

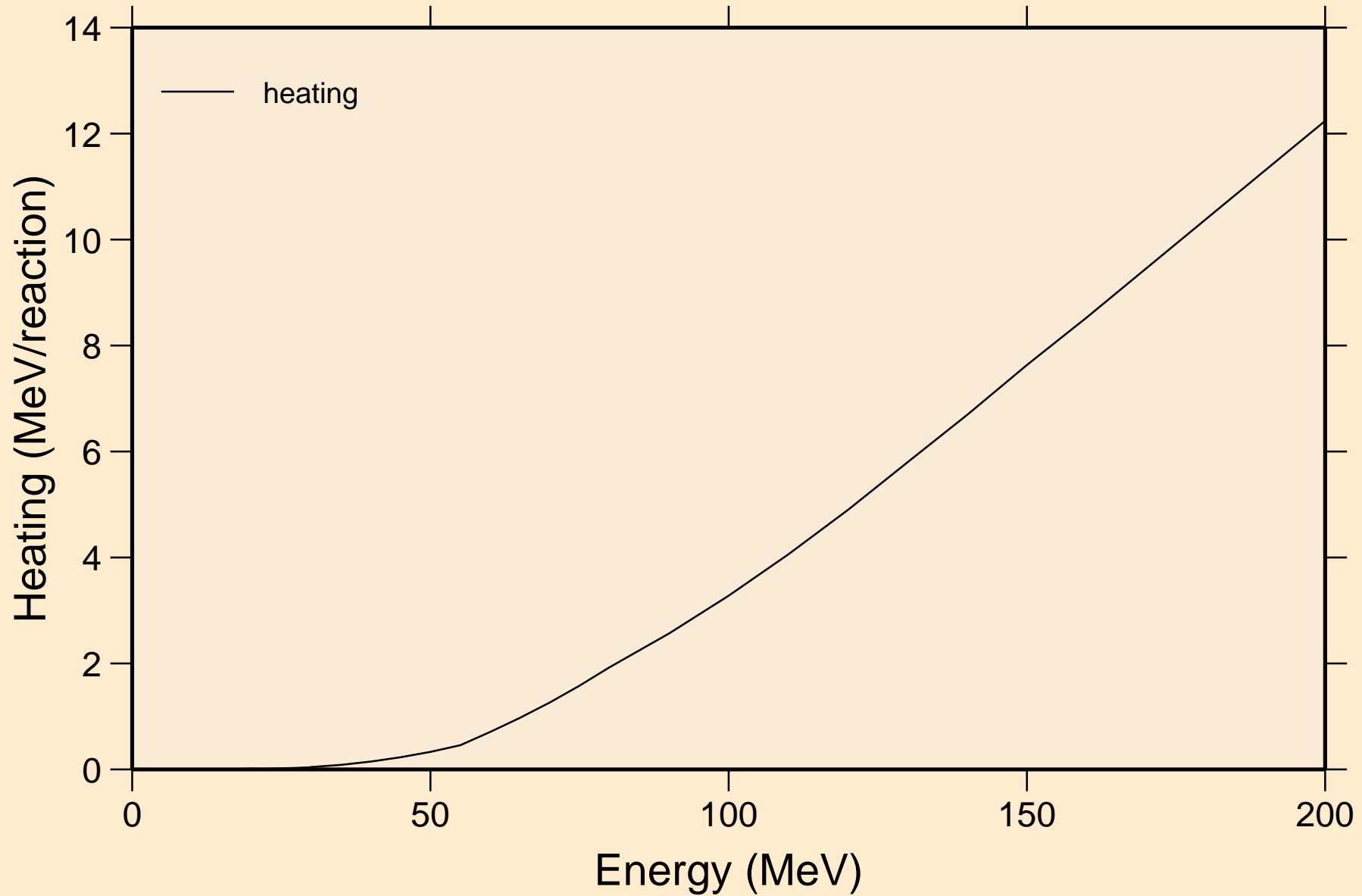

AT221 PROTON ACER TENDL-2021 LIBRARY; T=0.K  
Threshold reactions

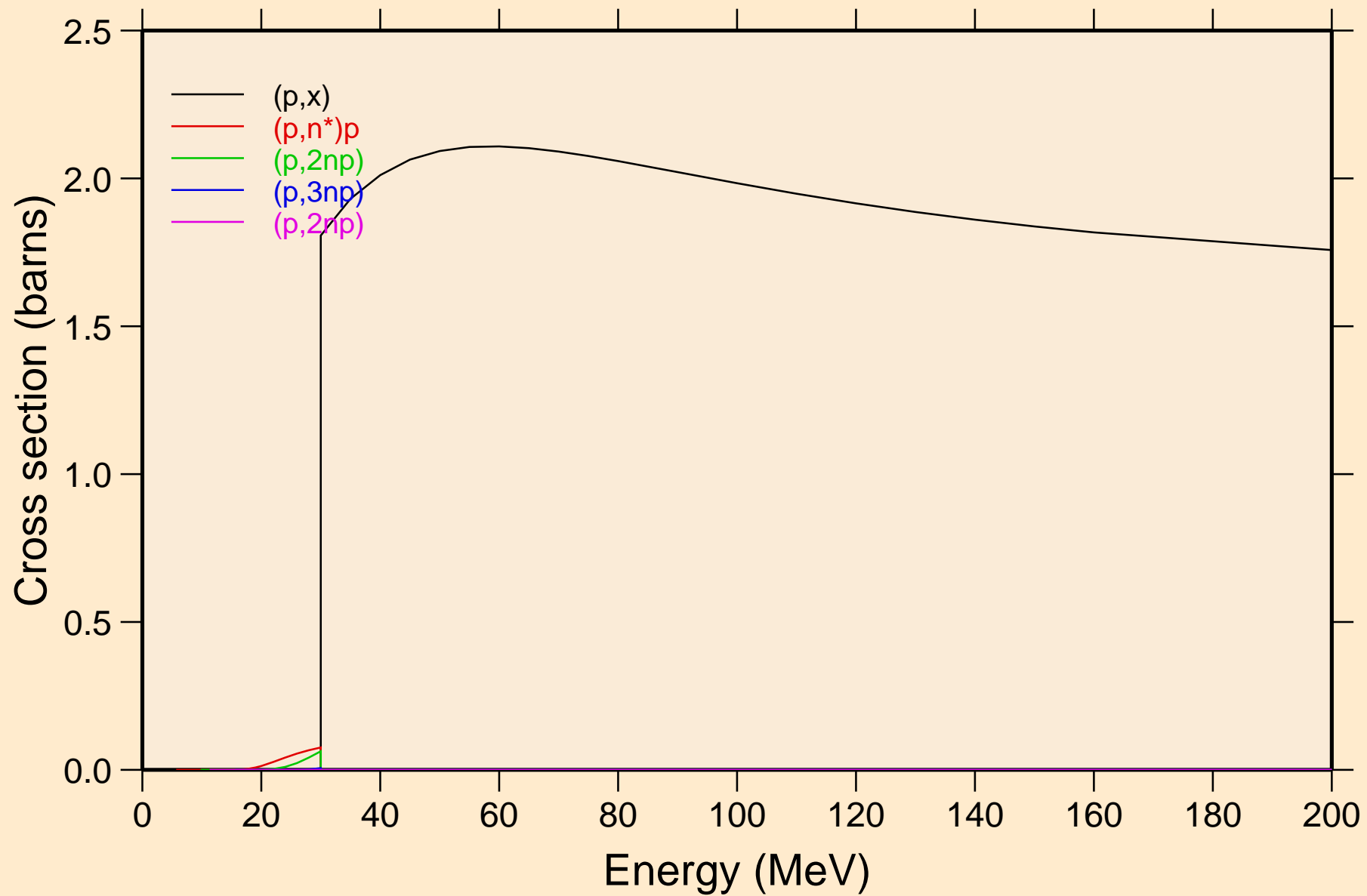

AT221 PROTON ACER TENDL-2021 LIBRARY; T=0.K  
Threshold reactions

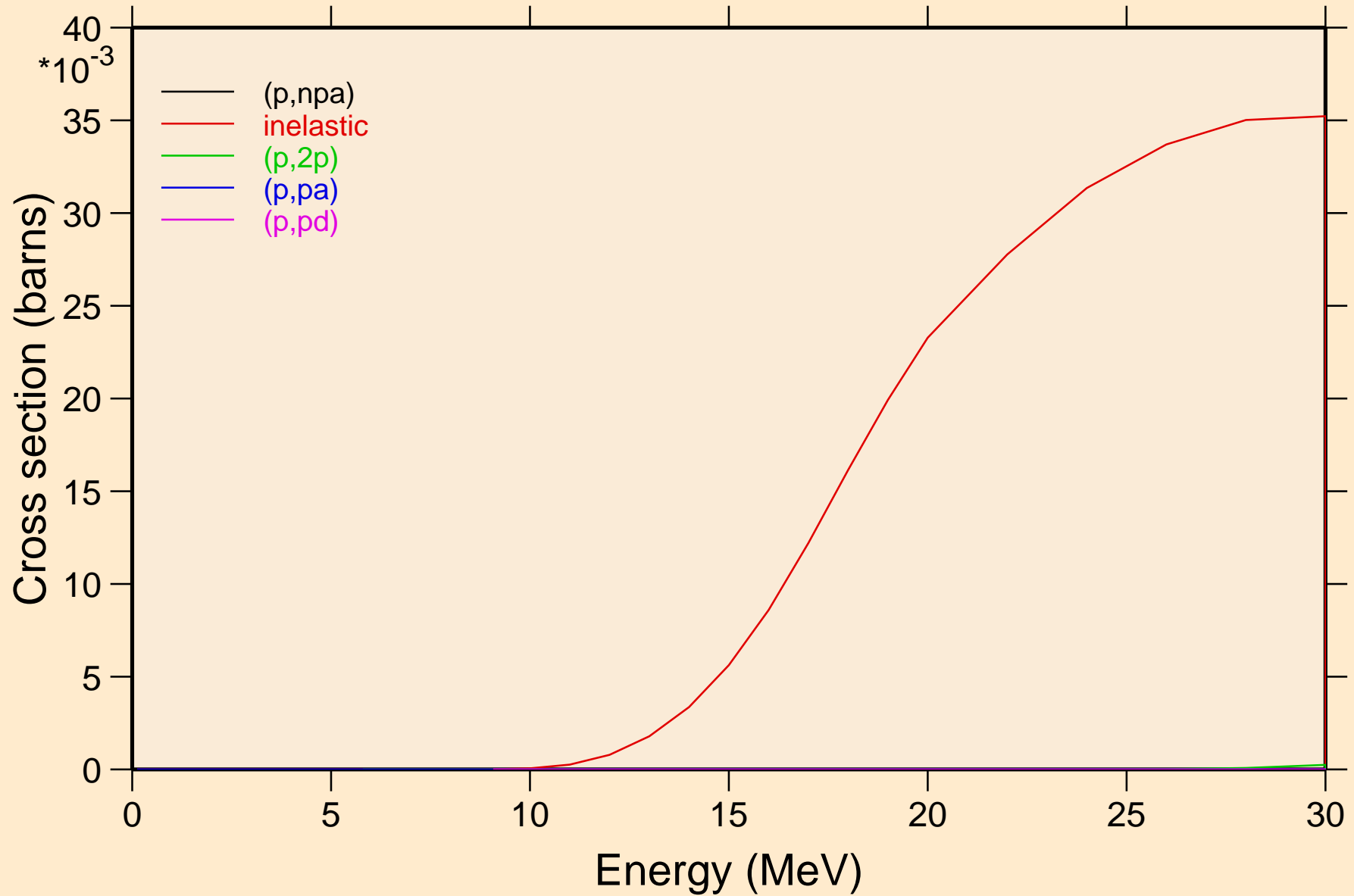

AT221 PROTON ACER TENDL-2021 LIBRARY; T=0.K  
Threshold reactions

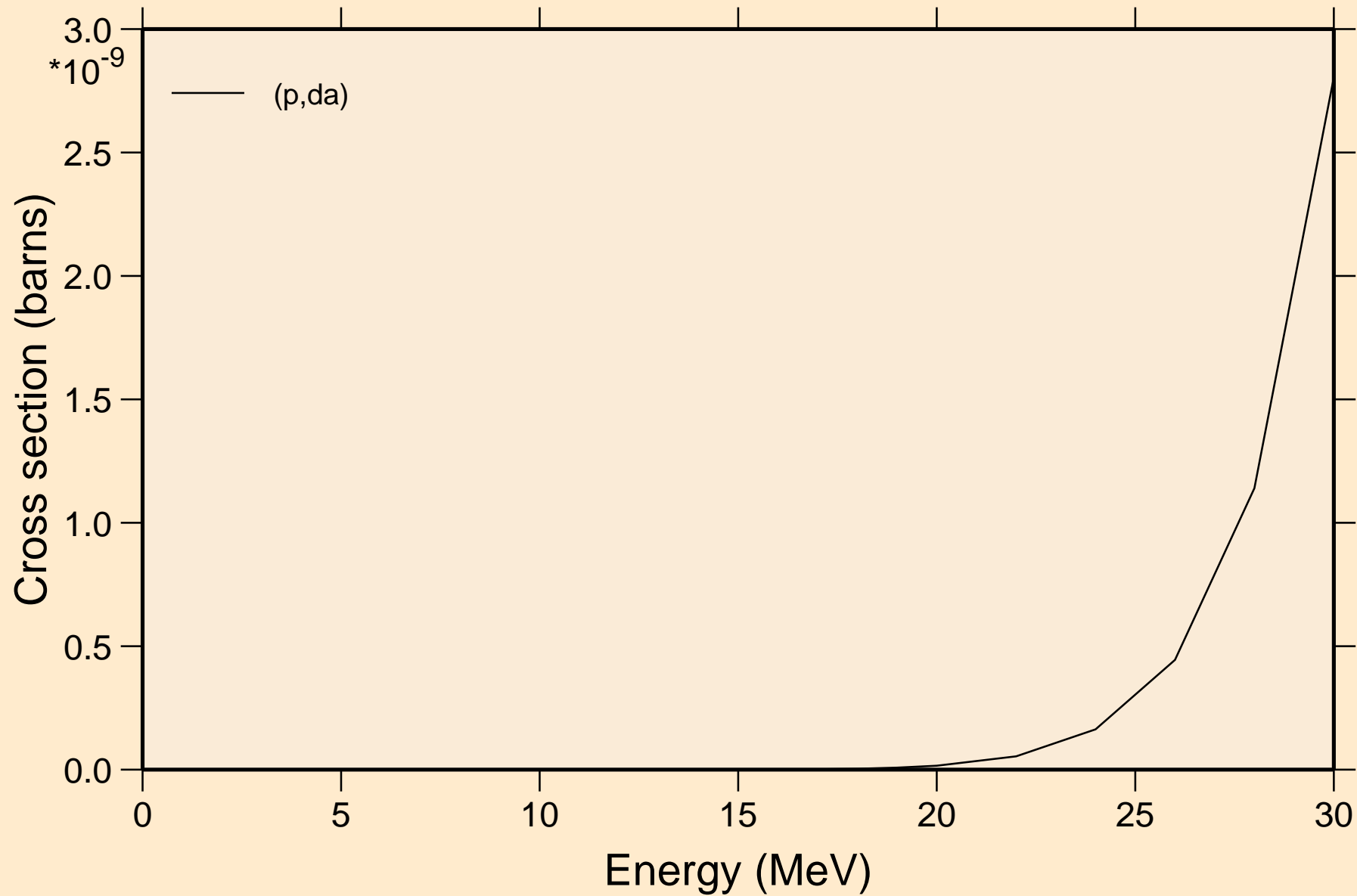

AT221 PROTON ACER TENDL-2021 LIBRARY; T=0.K  
angular distribution for elastic

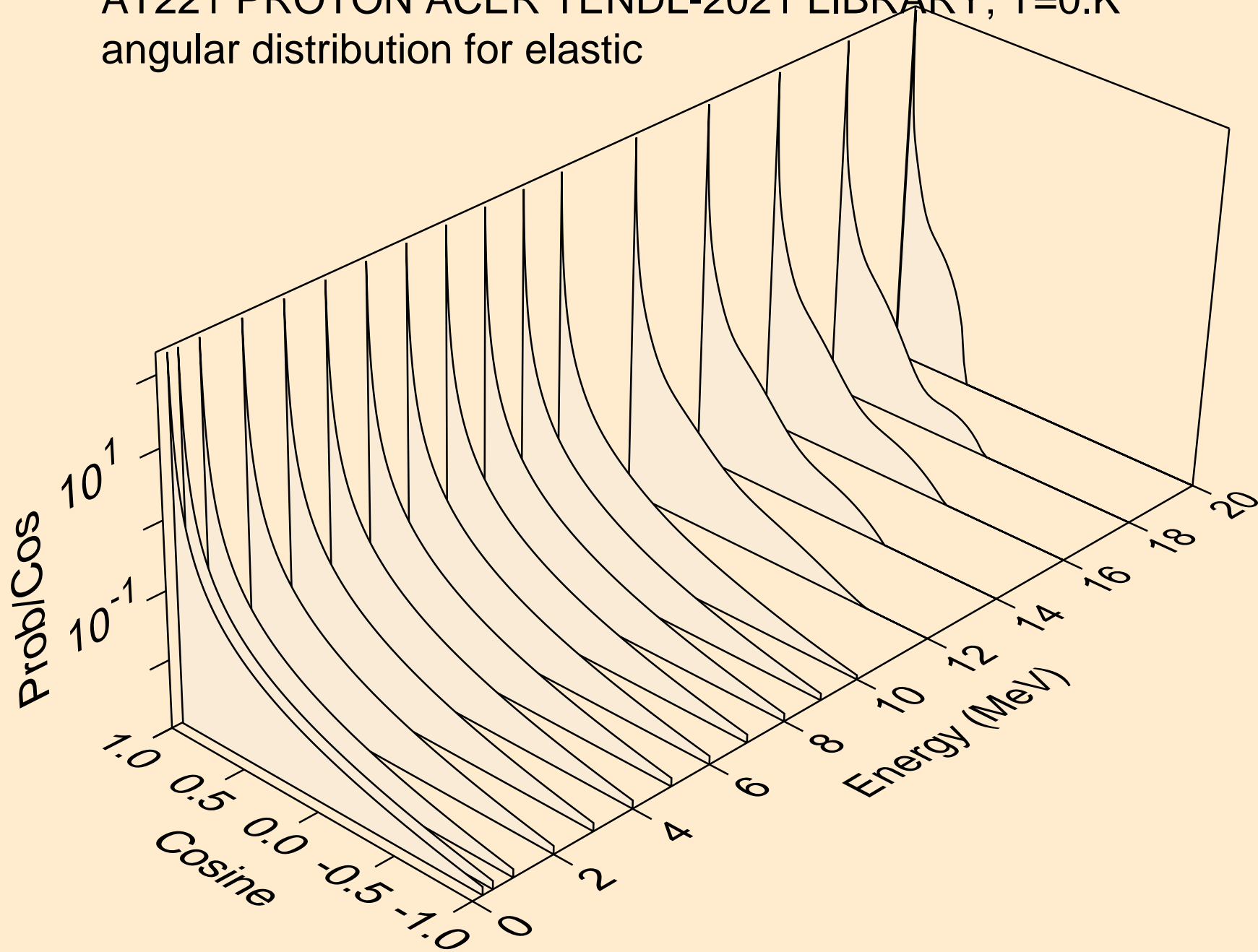



AT221 PROTON ACER TENDL-2021 LIBRARY; T=0.K  
angular distribution for elastic

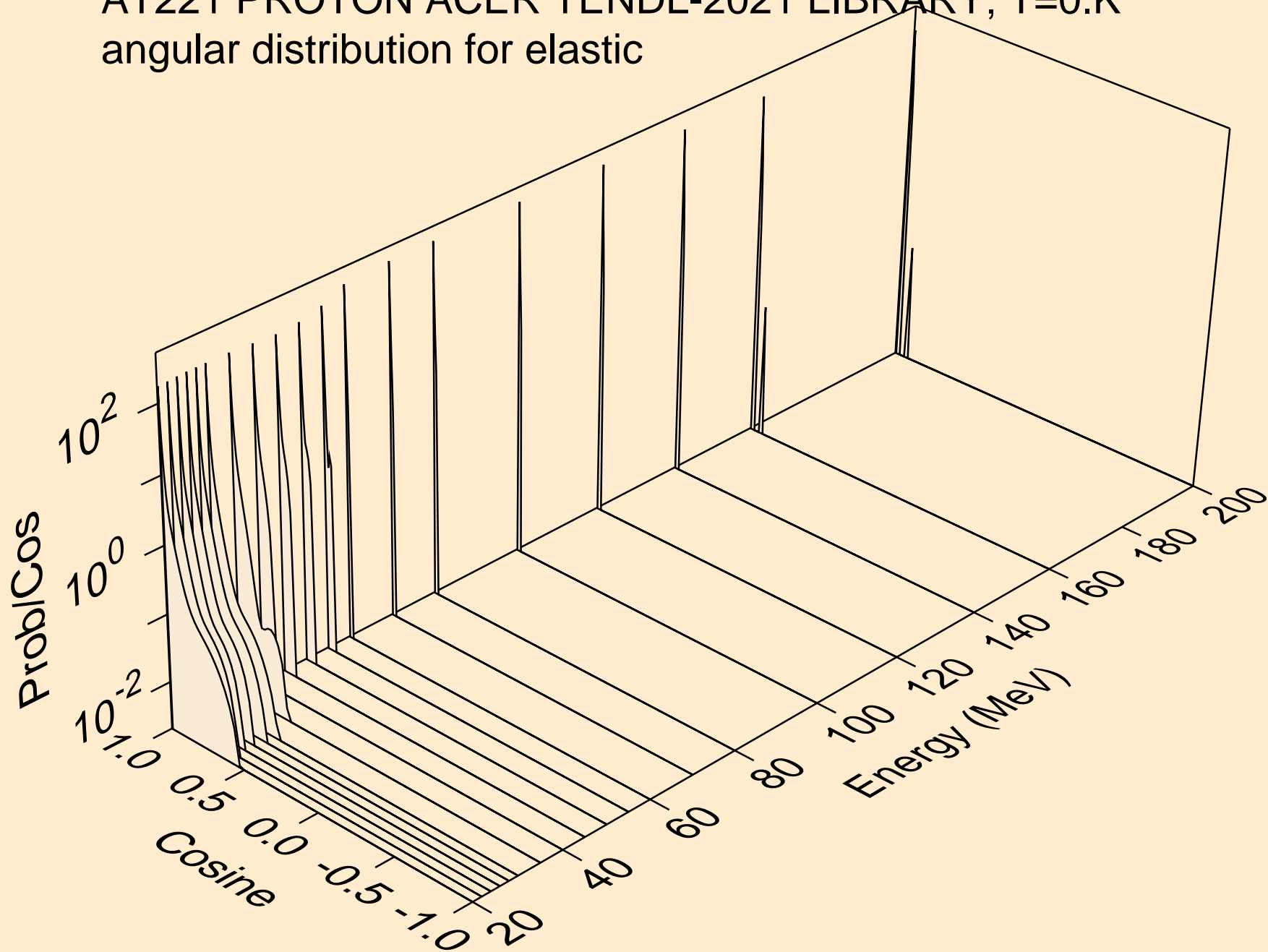

AT221 PROTON ACER TENDL-2021 LIBRARY; T=0.K  
Proton emission for (p,x)

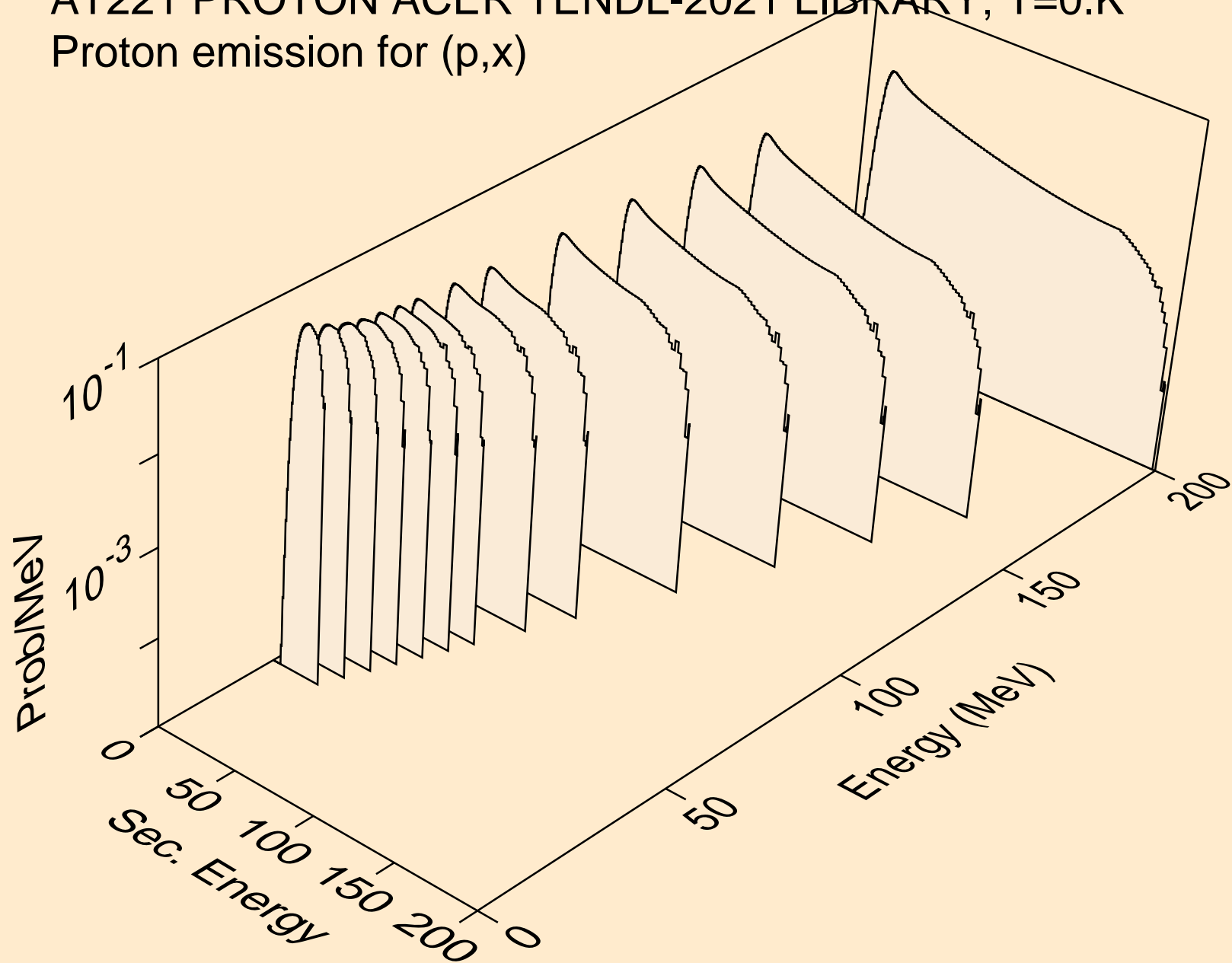

AT221 PROTON ACER TENDL-2021 LIBRARY; T=0.K  
Proton emission for (p,n\*)p

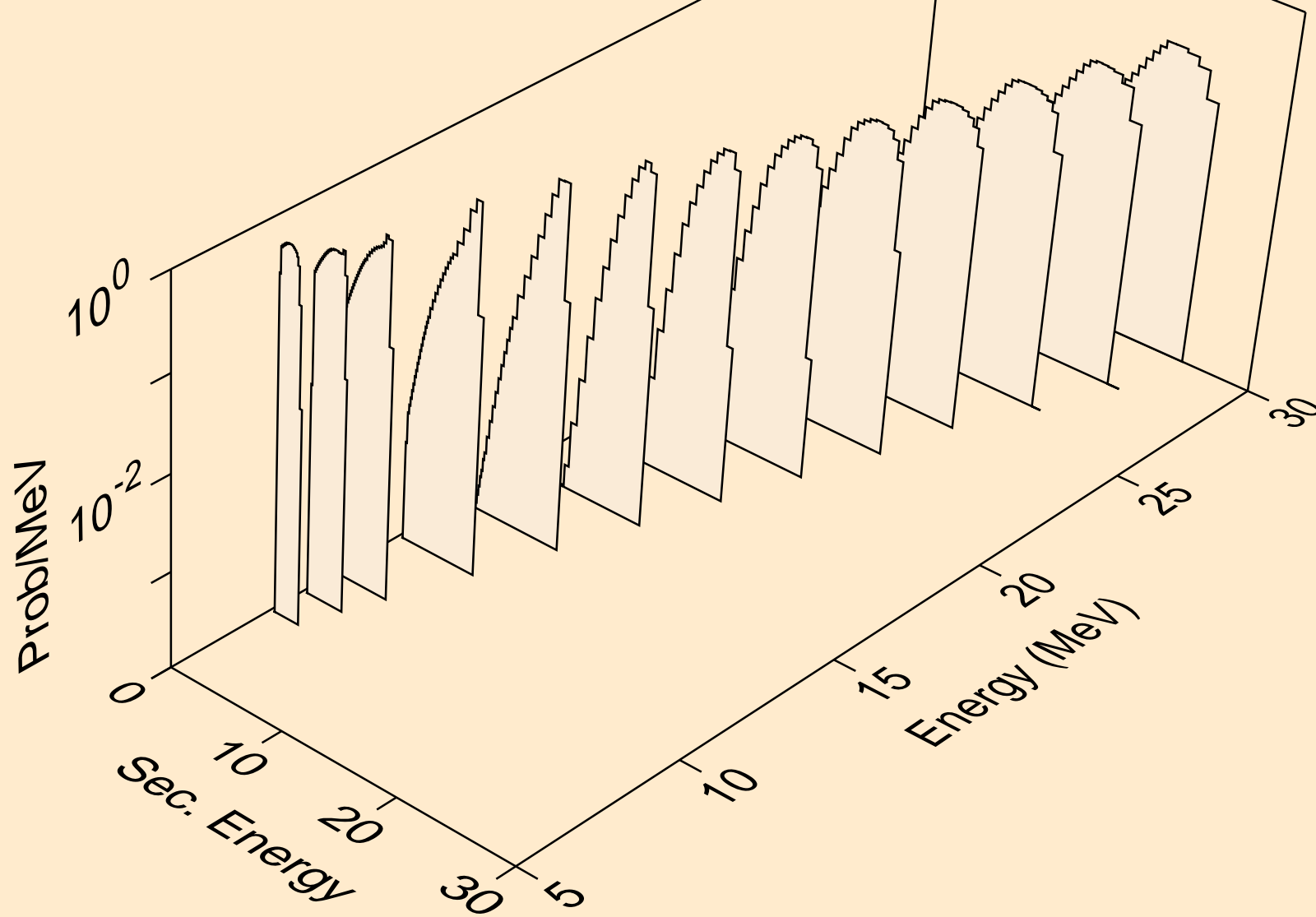

AT221 PROTON ACER TENDL-2021 LIBRARY; T=0.K  
Proton emission for (p,2np)

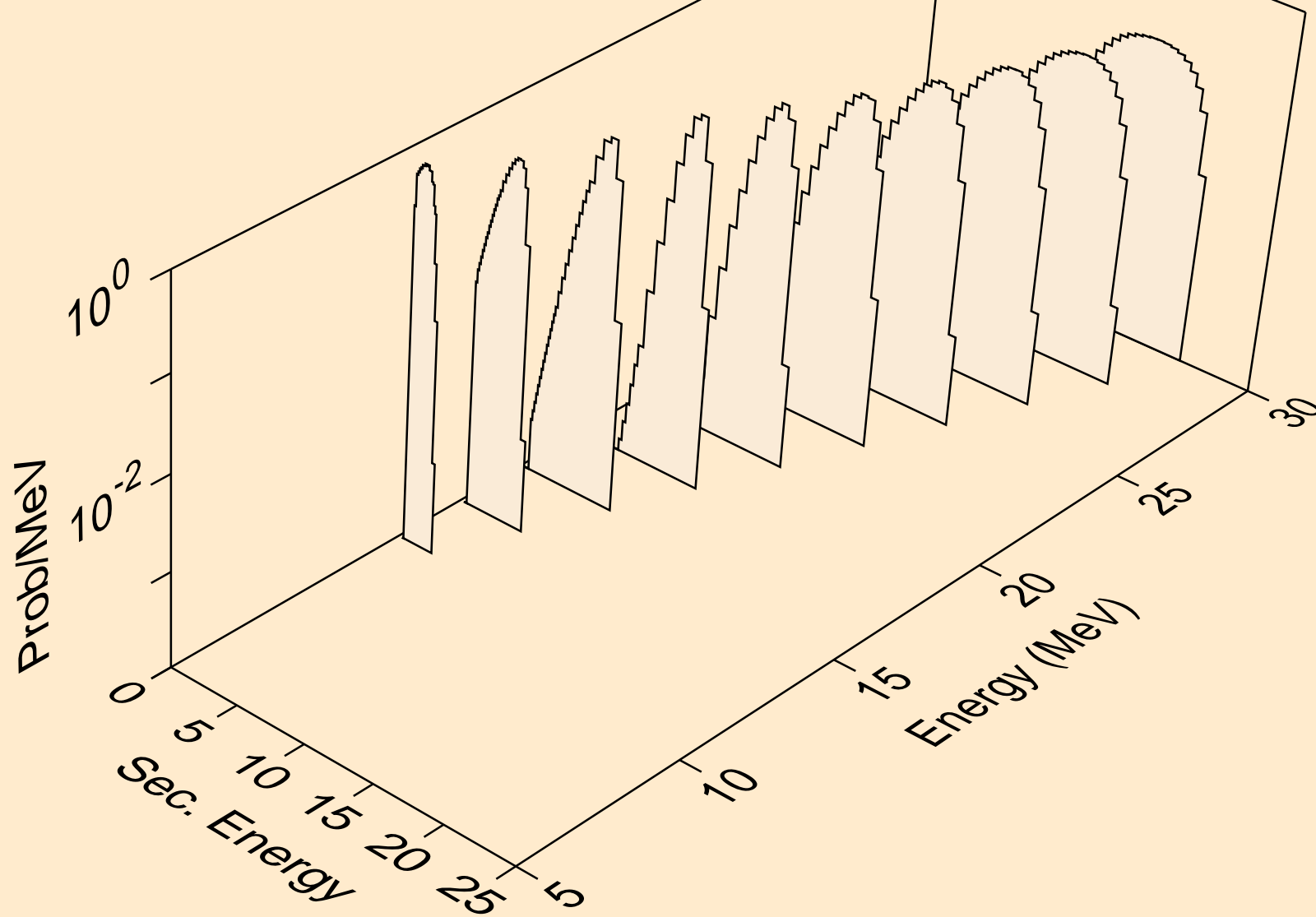

AT221 PROTON ACER TENDL-2021 LIBRARY; T=0.K  
Proton emission for (p,3np)

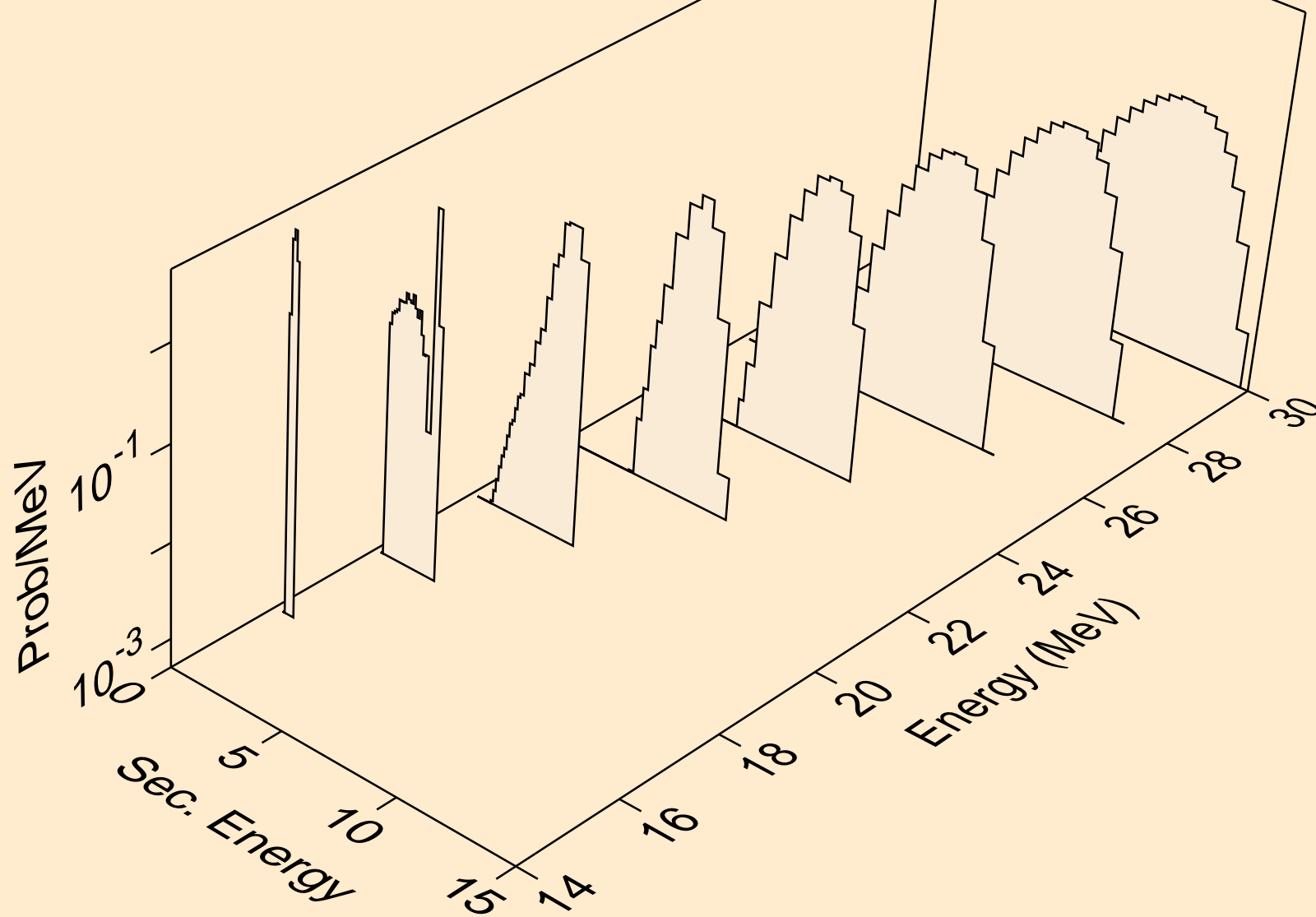

AT221 PROTON ACER TENDL-2021 LIBRARY; T=0.K  
Proton emission for (p,2np)

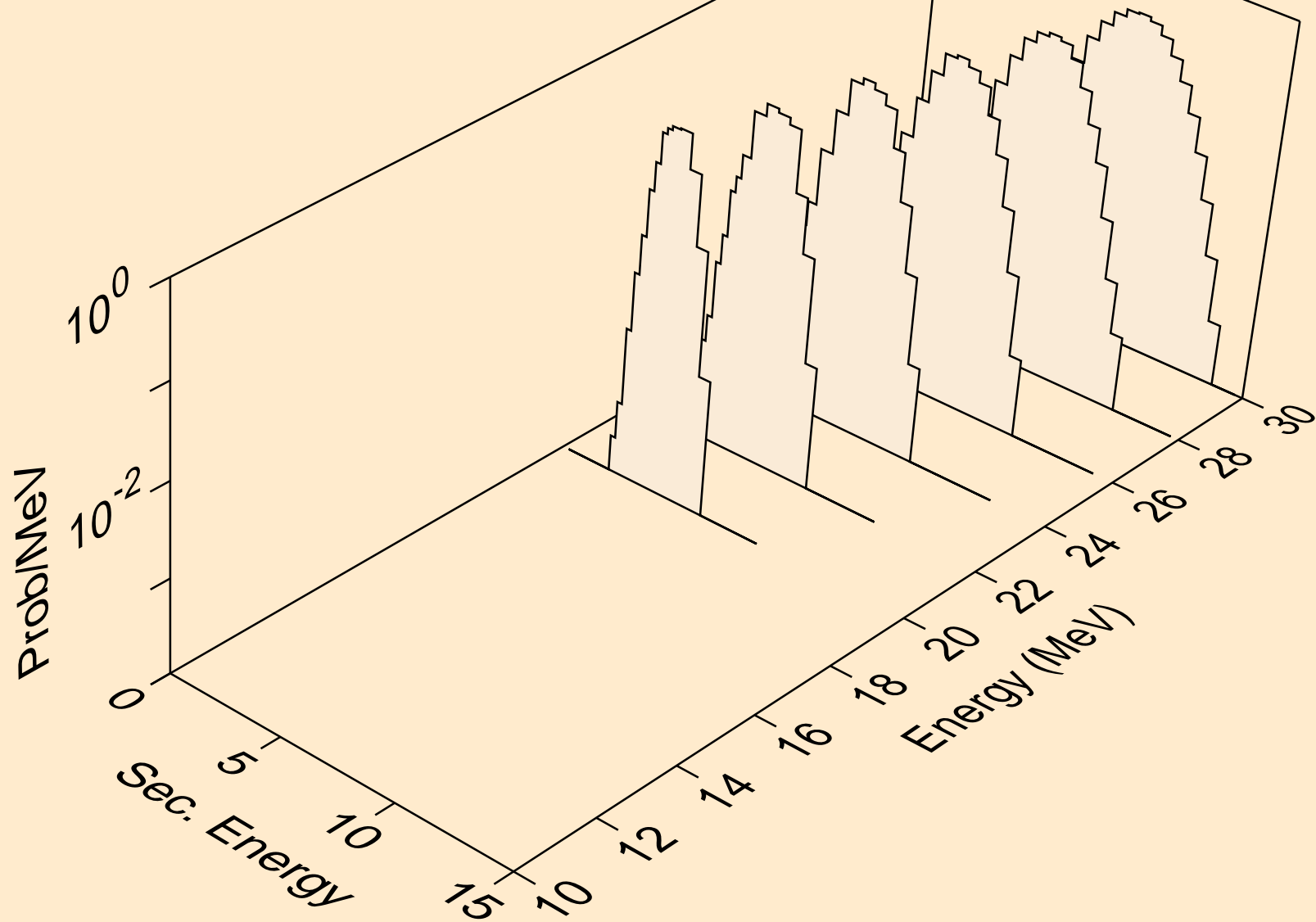

AT221 PROTON ACER TENDL-2021 LIBRARY; T=0.K  
Proton emission for (p,npa)

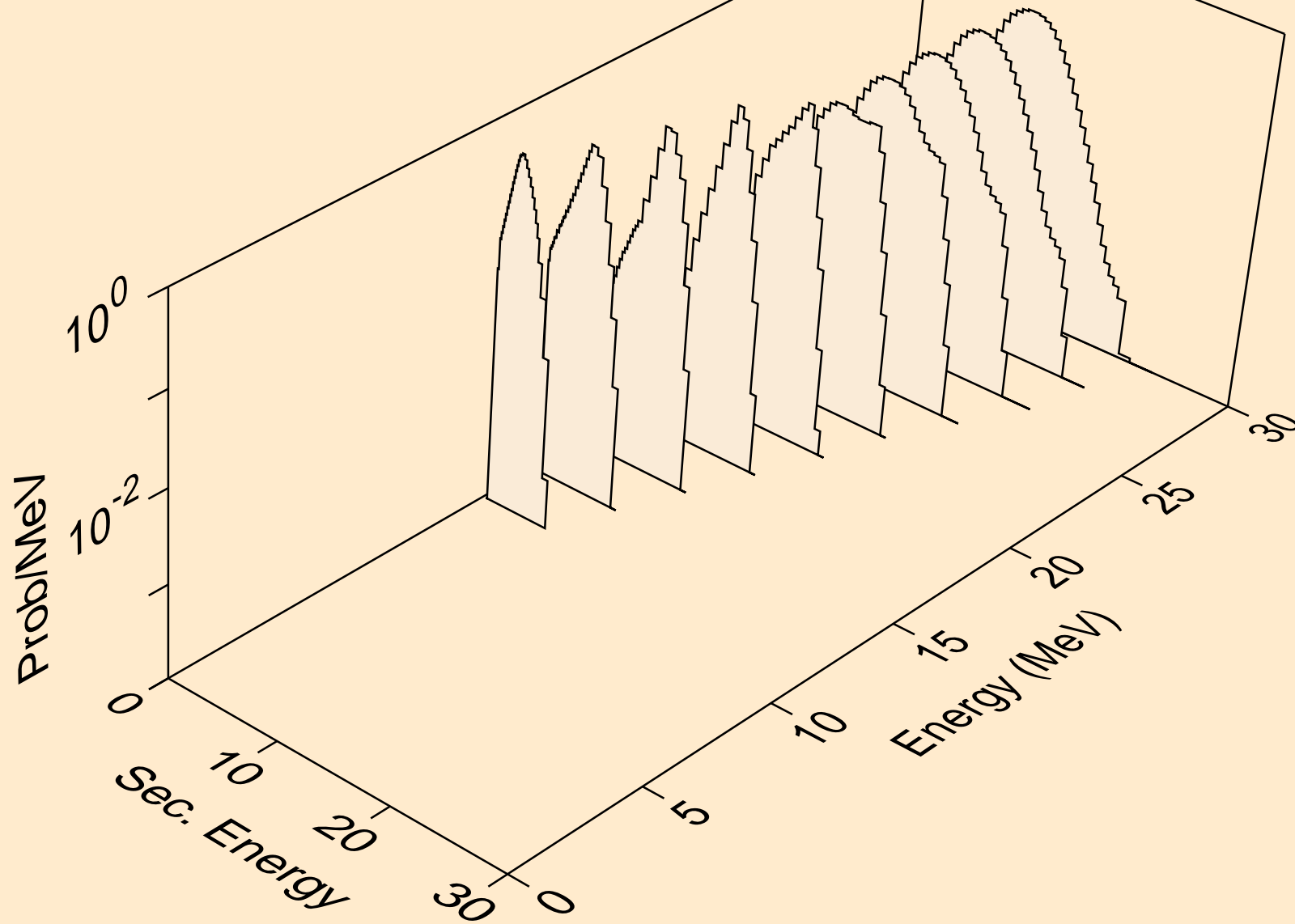

AT221 PROTON ACER TENDL-2021 LIBRARY; T=0.K  
Proton emission for inelastic

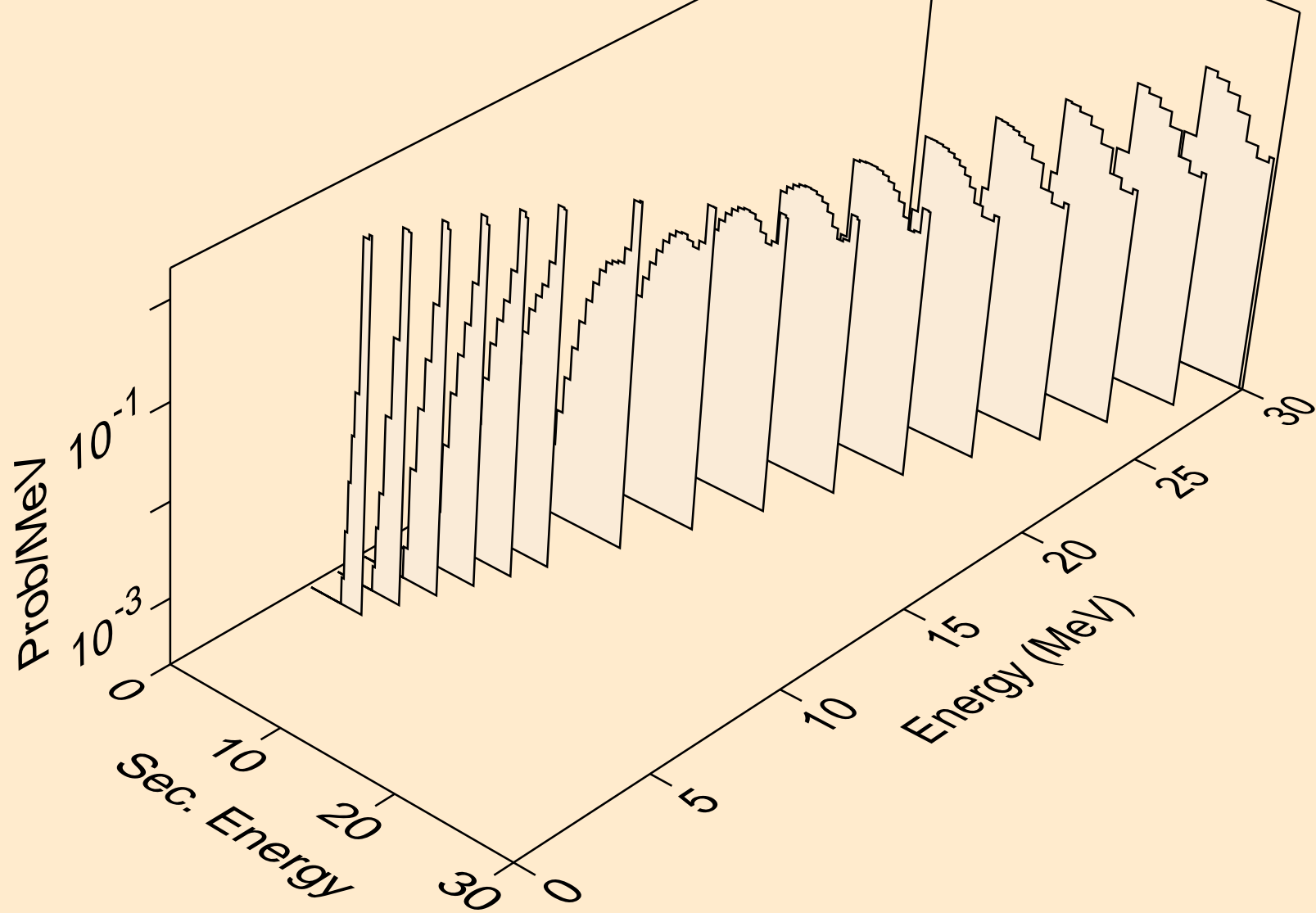



AT221 PROTON ACER TENDL-2021 LIBRARY; T=0.K  
Proton emission for (p,2p)

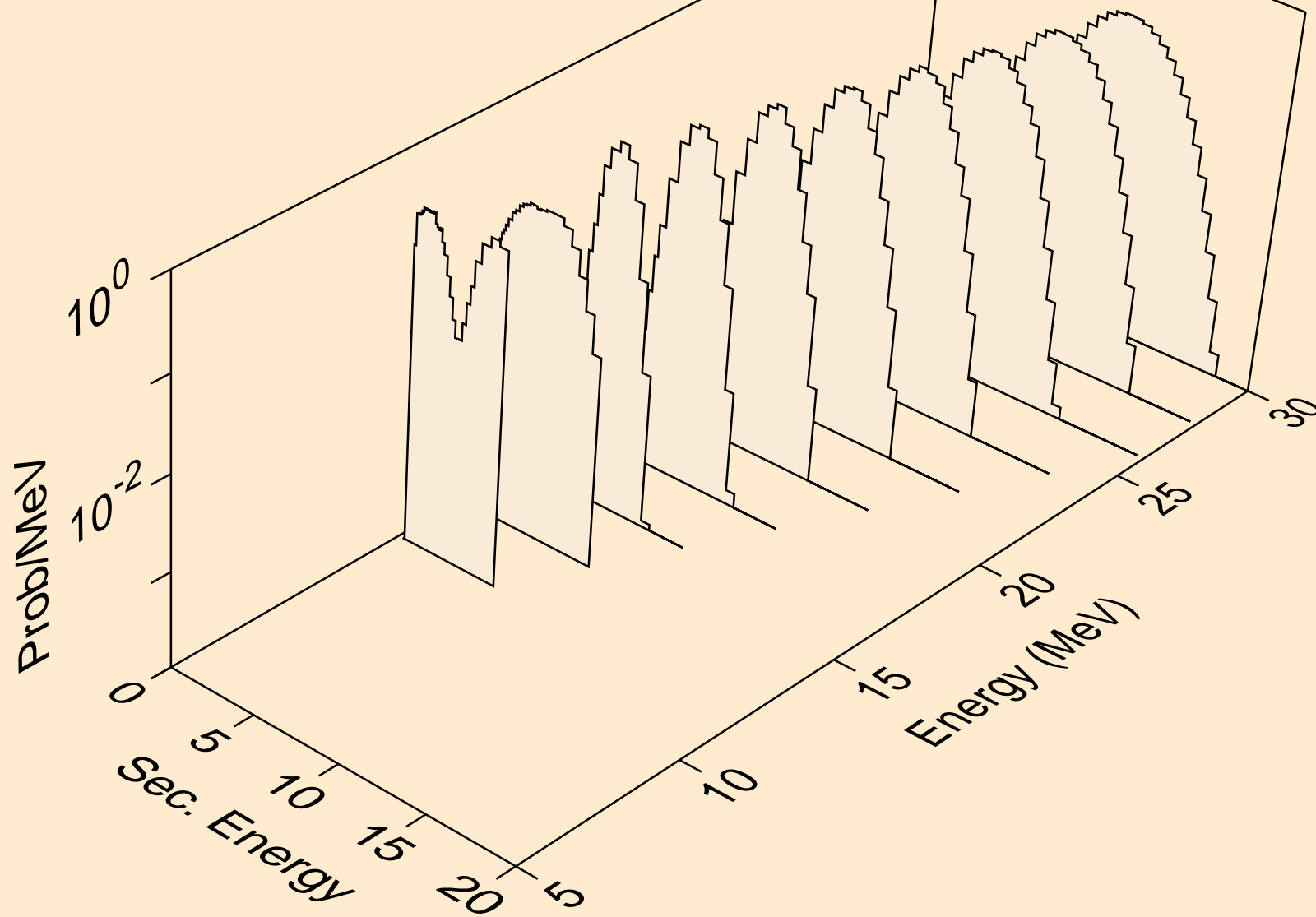

AT221 PROTON ACER TENDL-2021 LIBRARY; T=0.K  
Proton emission for (p,pa)

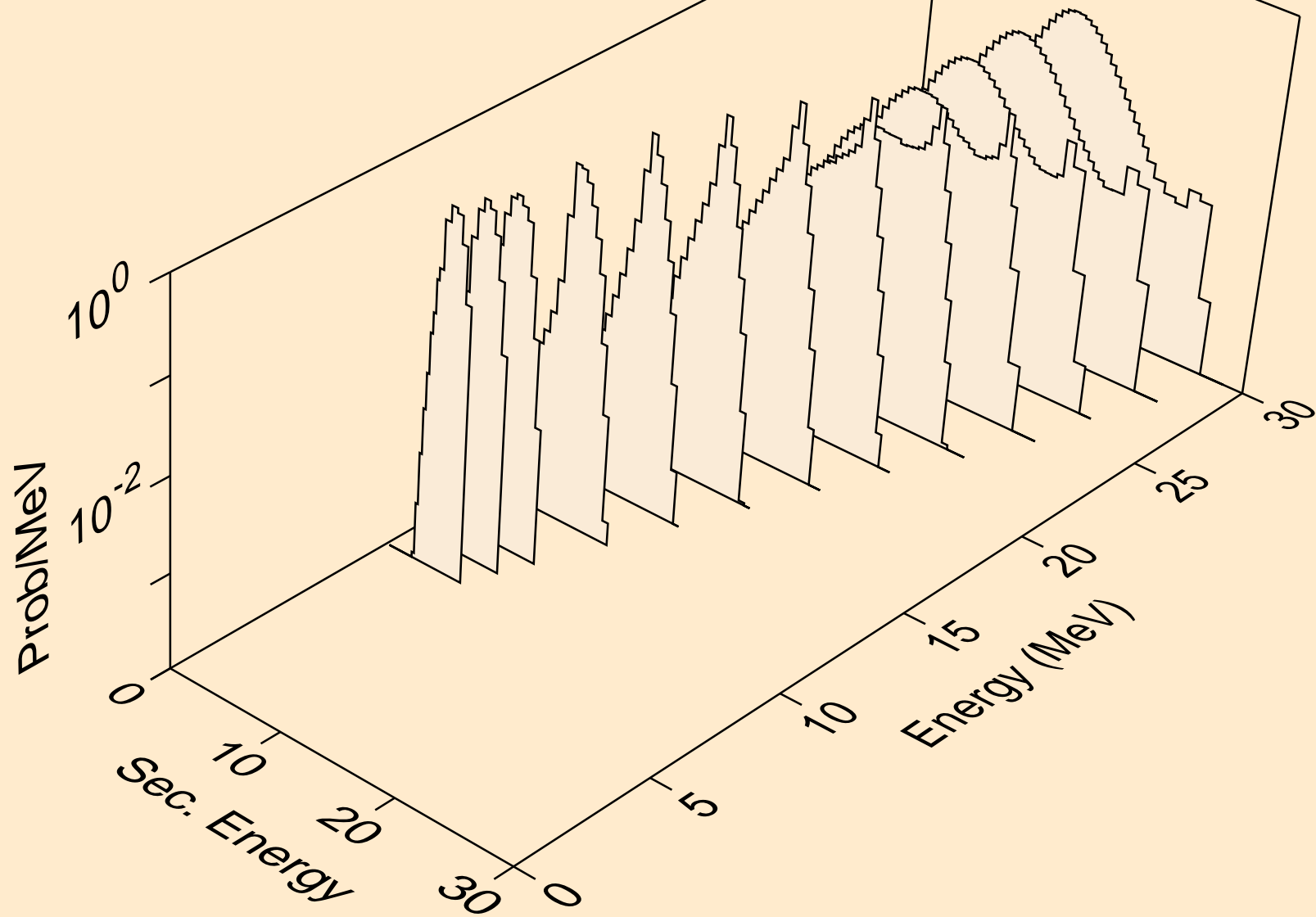

AT221 PROTON ACER TENDL-2021 LIBRARY; T=0.K  
Proton emission for (p,pd)

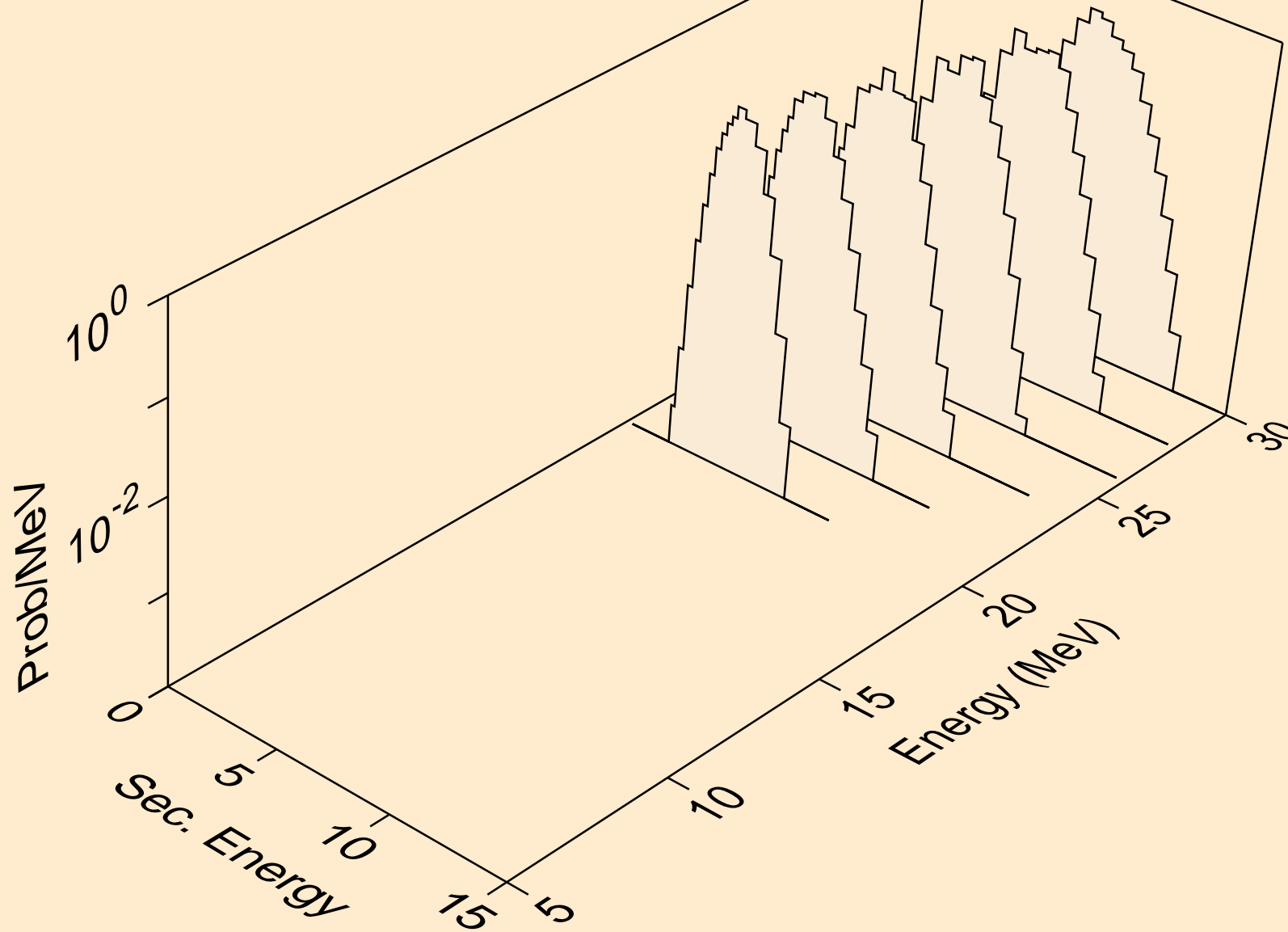

AT221 PROTON ACER TENDL-2021 LIBRARY; T=0.K  
Photon emission for (z,n)

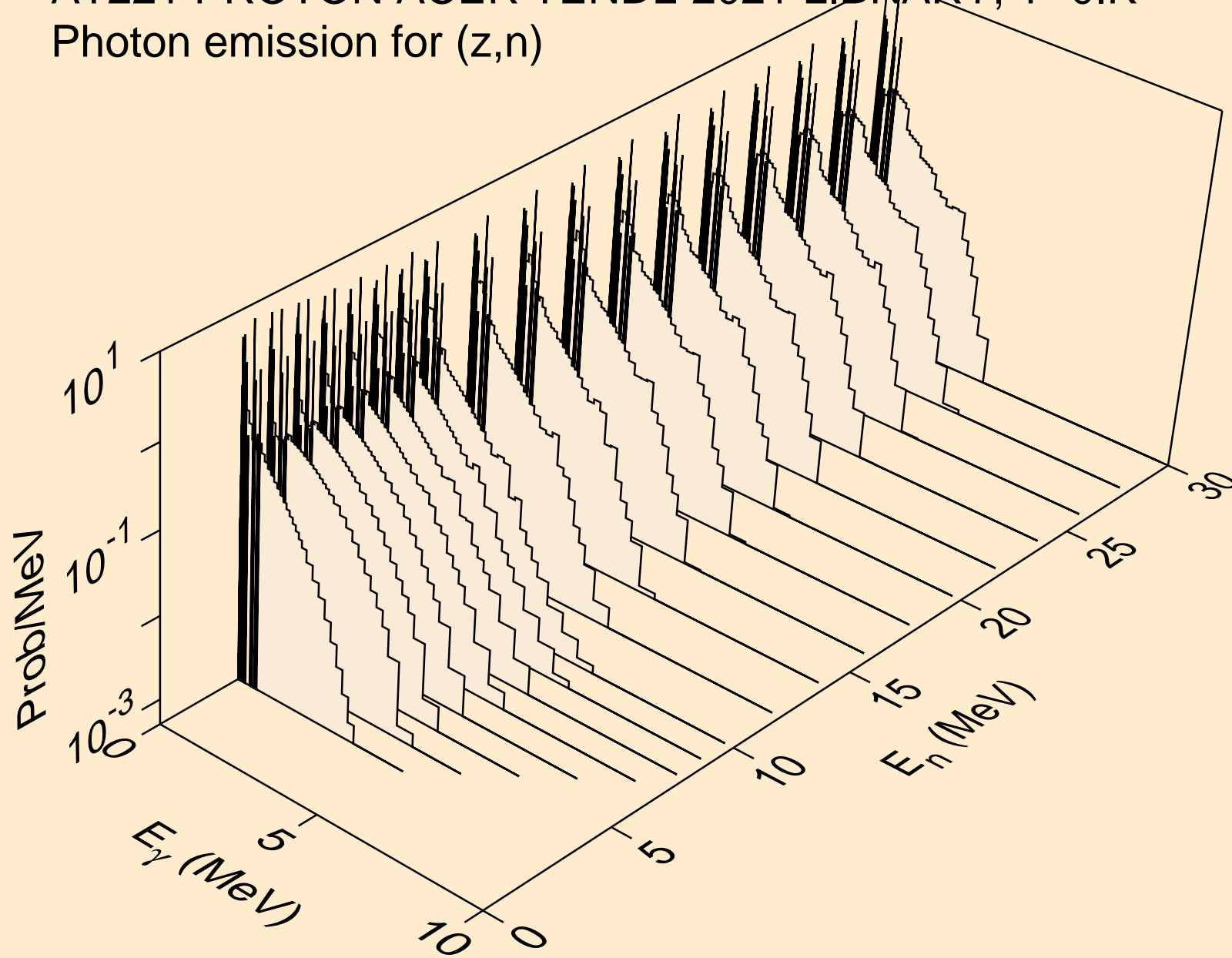

AT221 PROTON ACER TENDL-2021 LIBRARY; T=0.K  
Photon emission for (n,x)

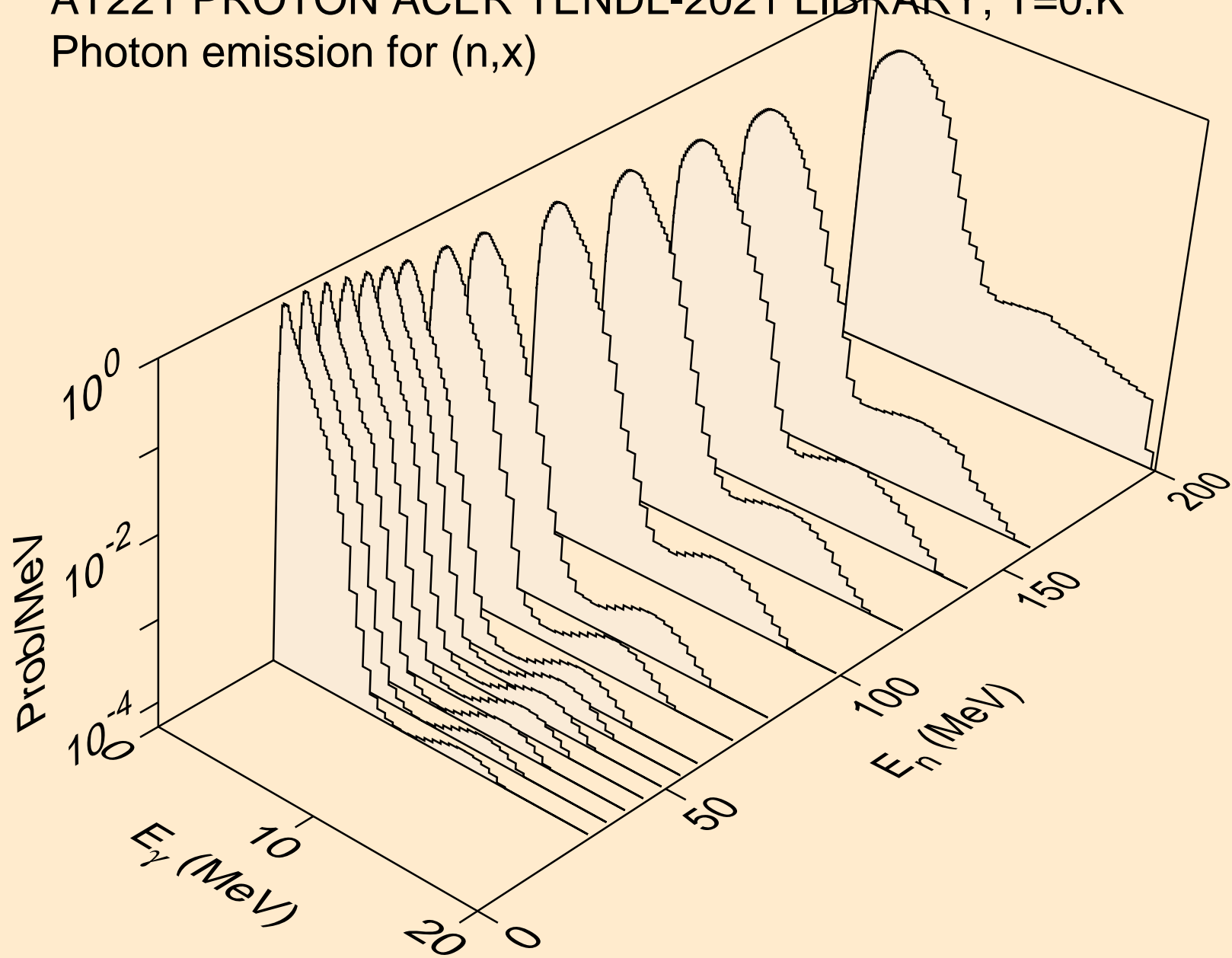

AT221 PROTON ACER TENDL-2021 LIBRARY; T=0.K  
Photon emission for (n,2nd)

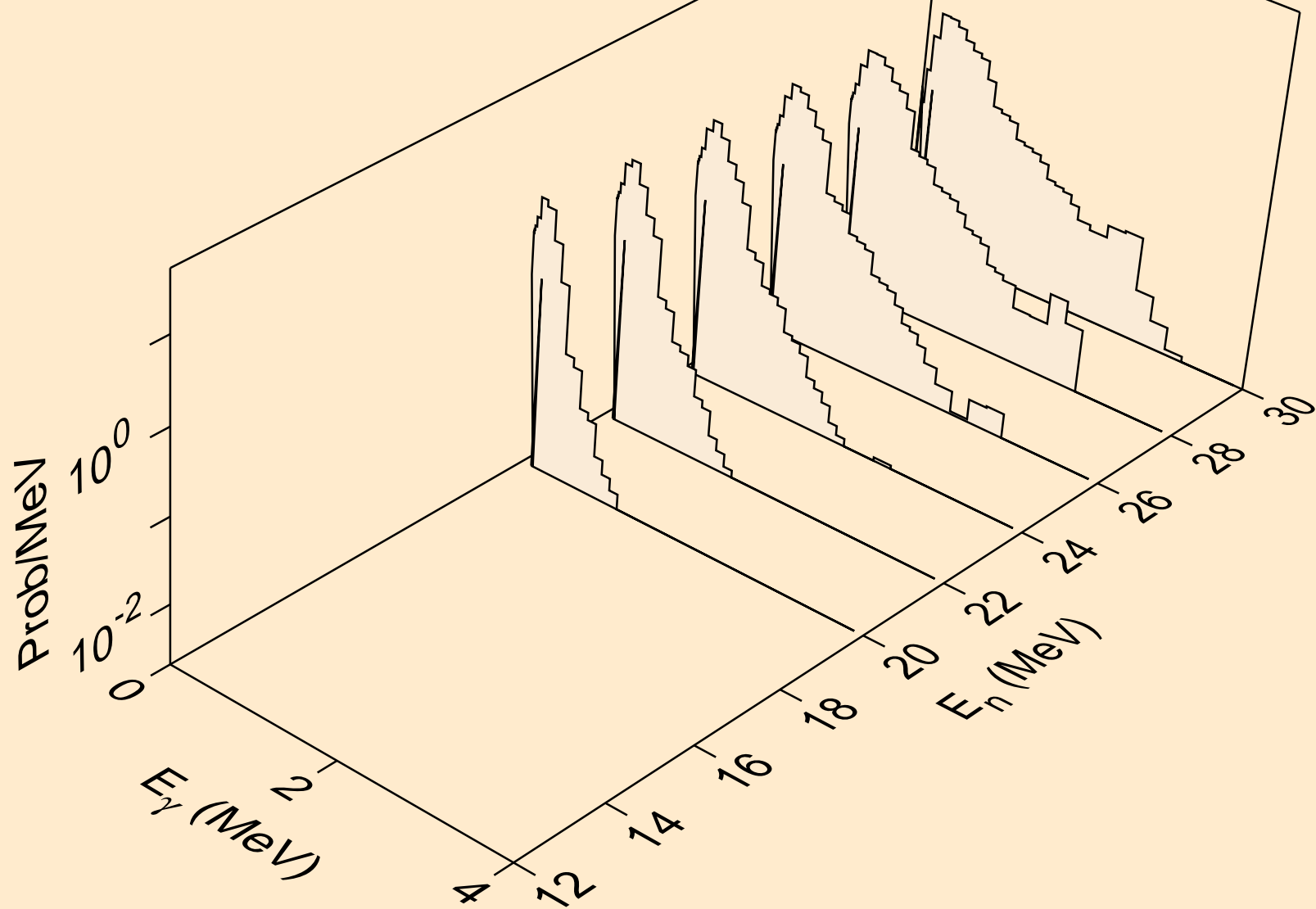

AT221 PROTON ACER TENDL-2021 LIBRARY; T=0.K  
Photon emission for (n,2n)

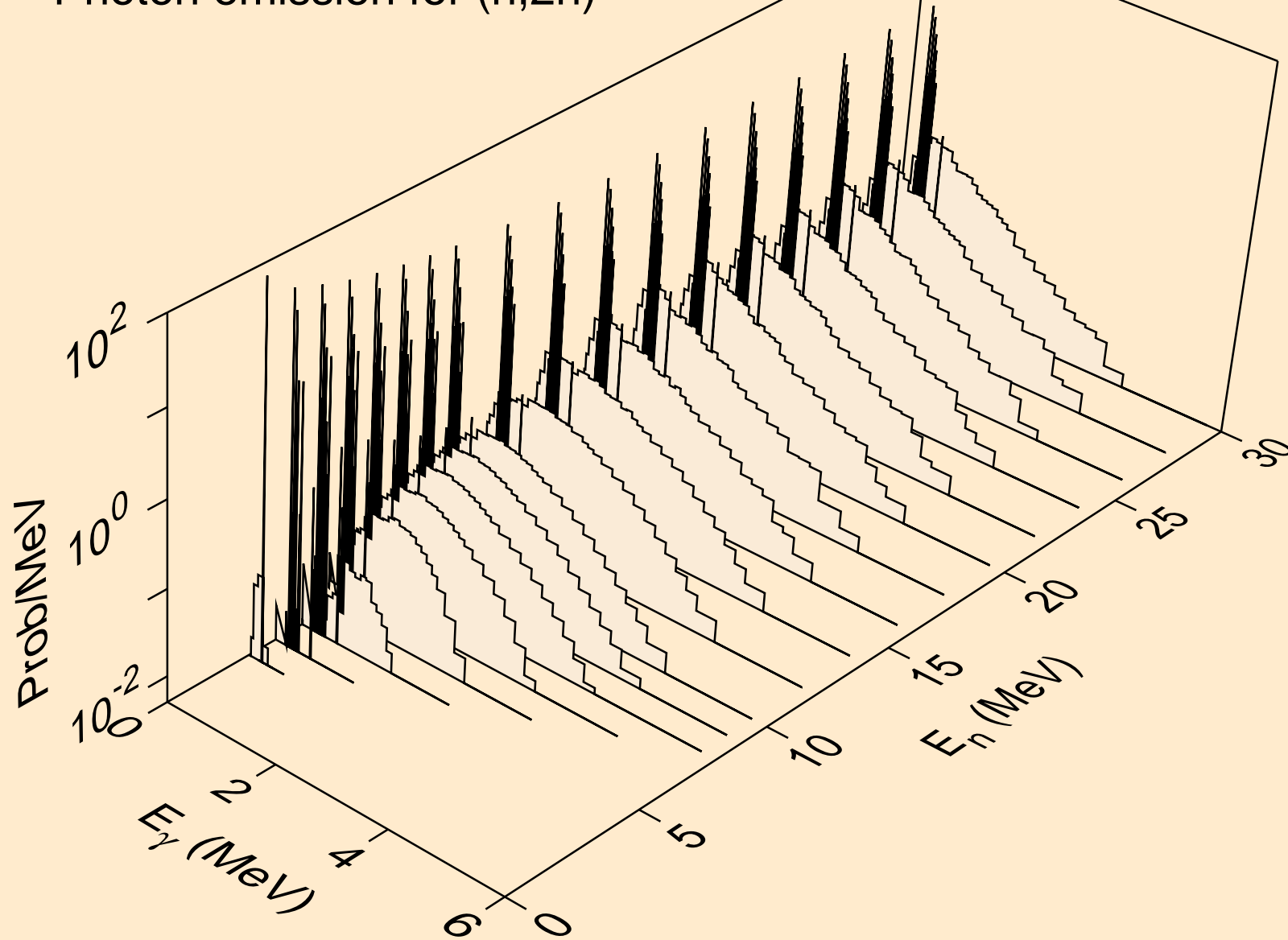

AT221 PROTON ACER TENDL-2021 LIBRARY; T=0.K  
Photon emission for (n,3n)

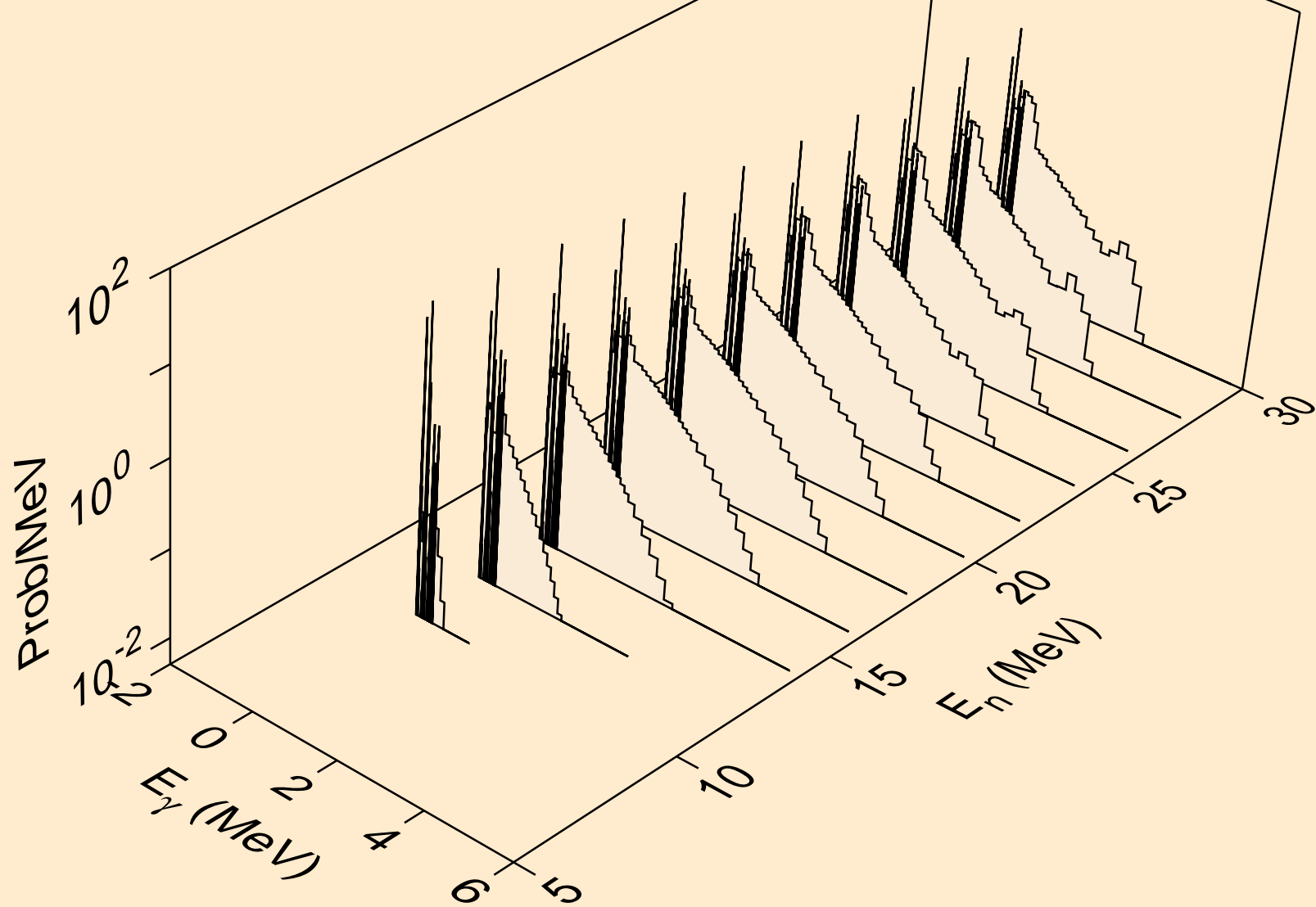



AT221 PROTON ACER TENDL-2021 LIBRARY; T=0.K  
Photon emission for (n,n\*)a

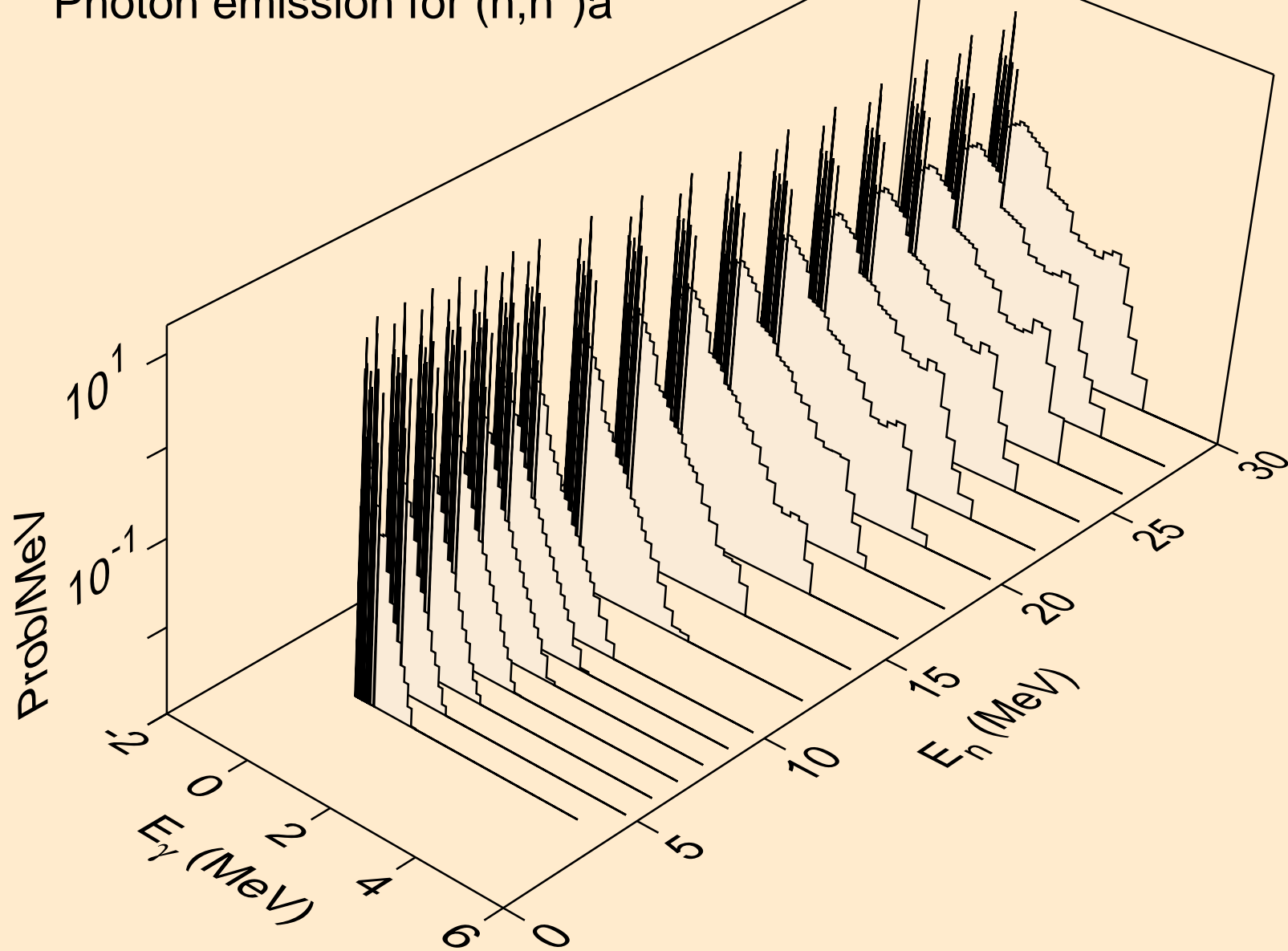

AT221 PROTON ACER TENDL-2021 LIBRARY; T=0.K  
Photon emission for (n,2n)a

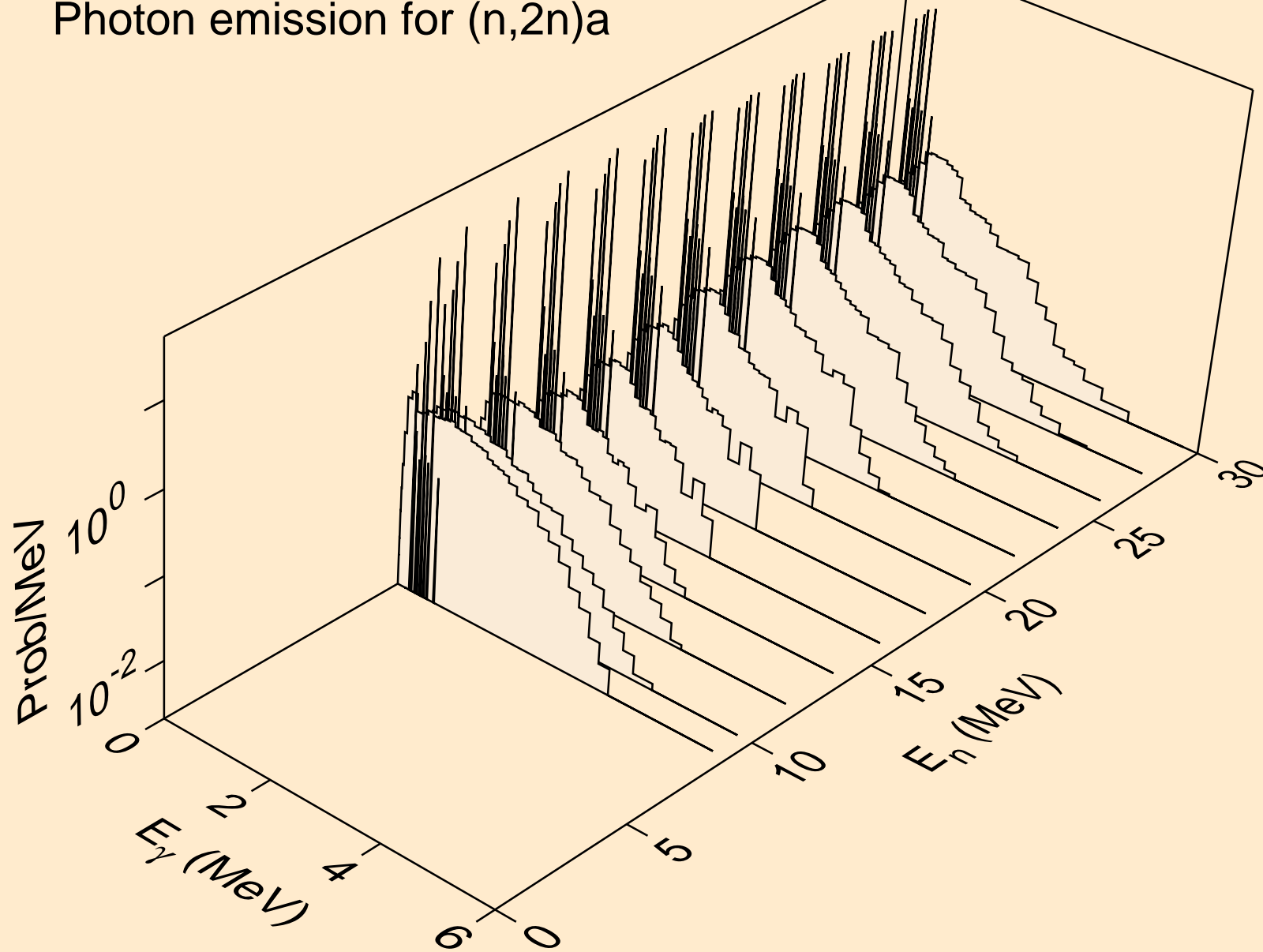

AT221 PROTON ACER TENDL-2021 LIBRARY; T=0.K  
Photon emission for (n,3n)a

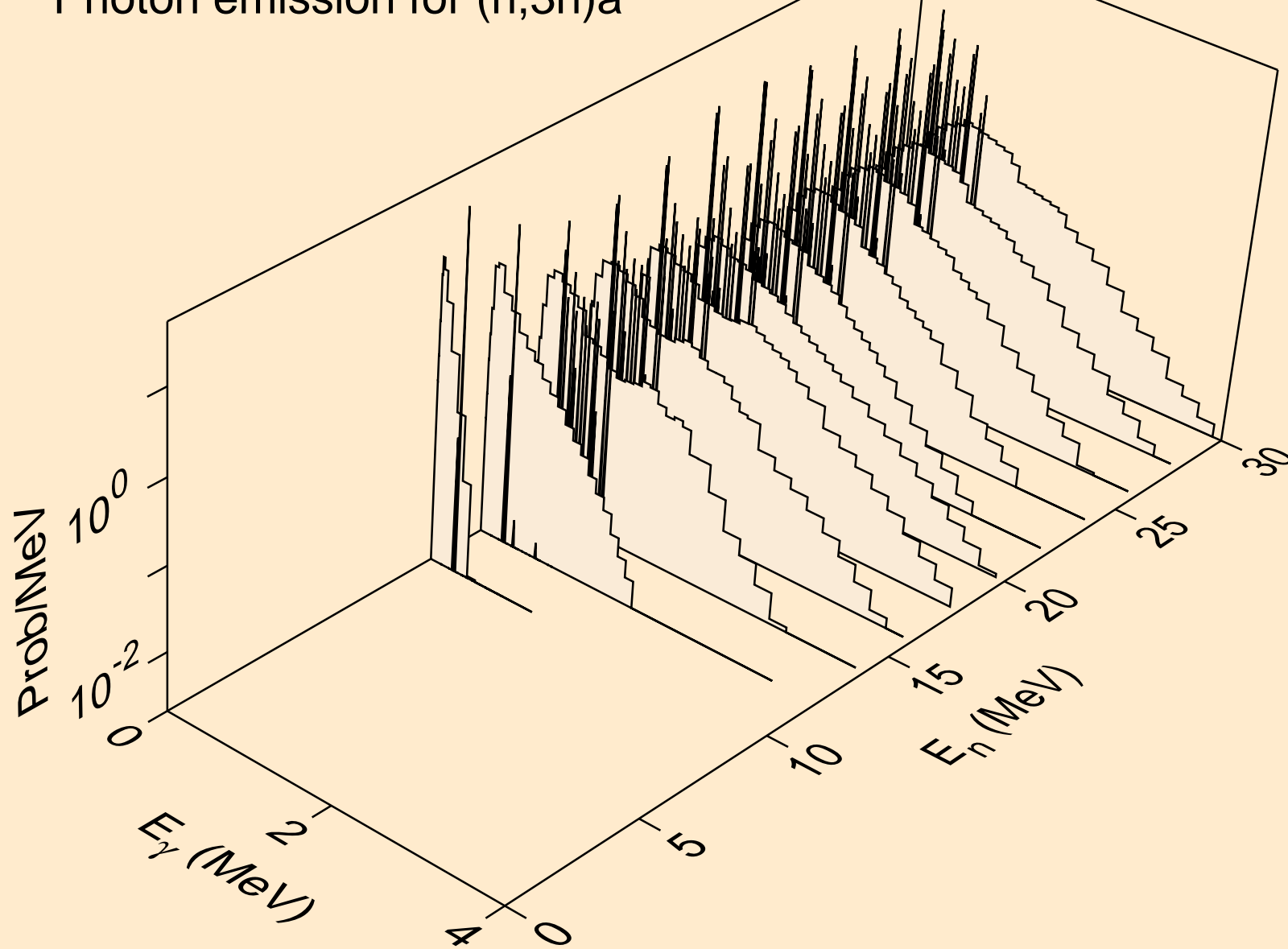

AT221 PROTON ACER TENDL-2021 LIBRARY; T=0.K  
Photon emission for (n,n\*)p

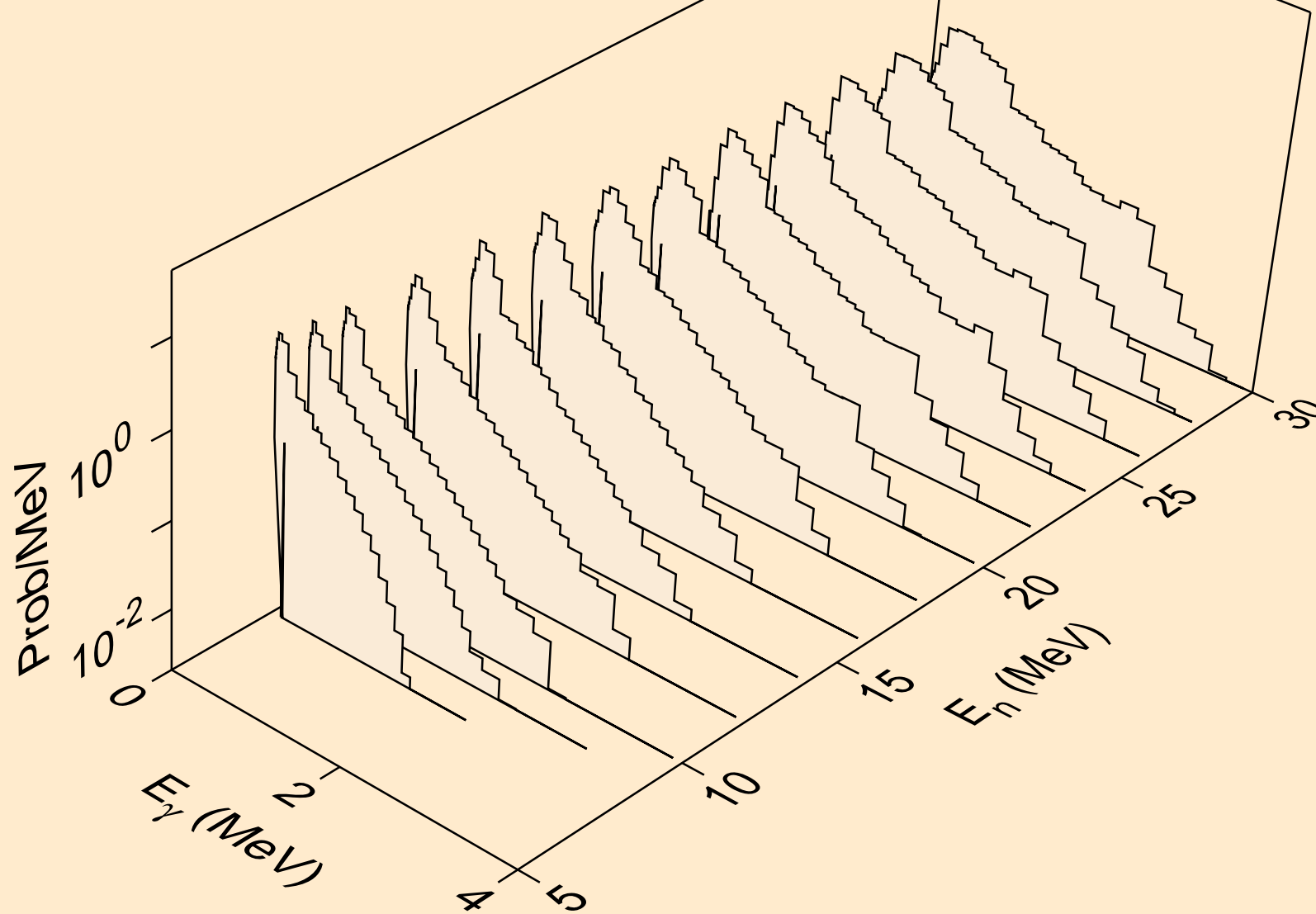

AT221 PROTON ACER TENDL-2021 LIBRARY; T=0.K  
Photon emission for (n,n\*)2a

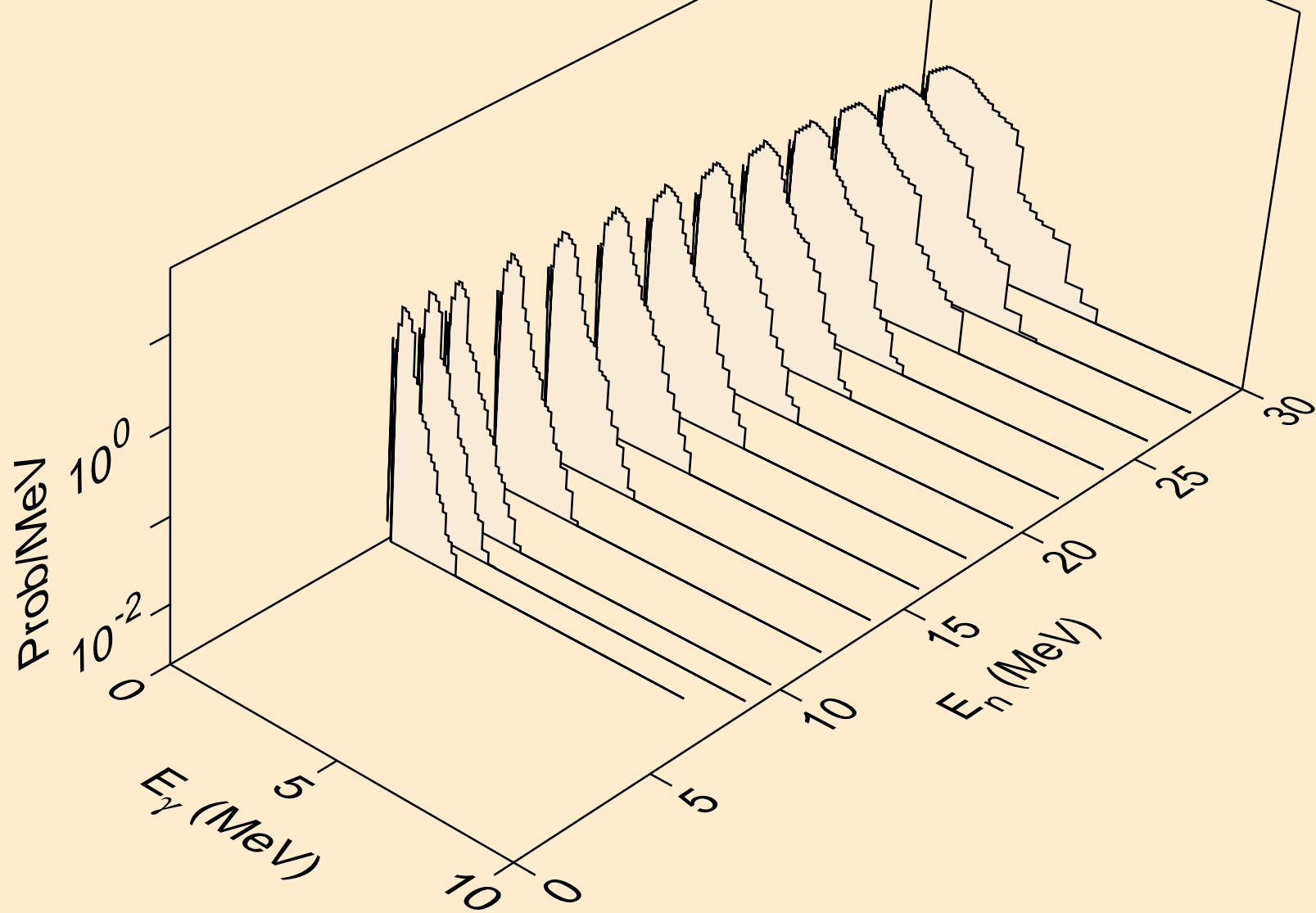

AT221 PROTON ACER TENDL-2021 LIBRARY; T=0.K  
Photon emission for (n,2n)2a

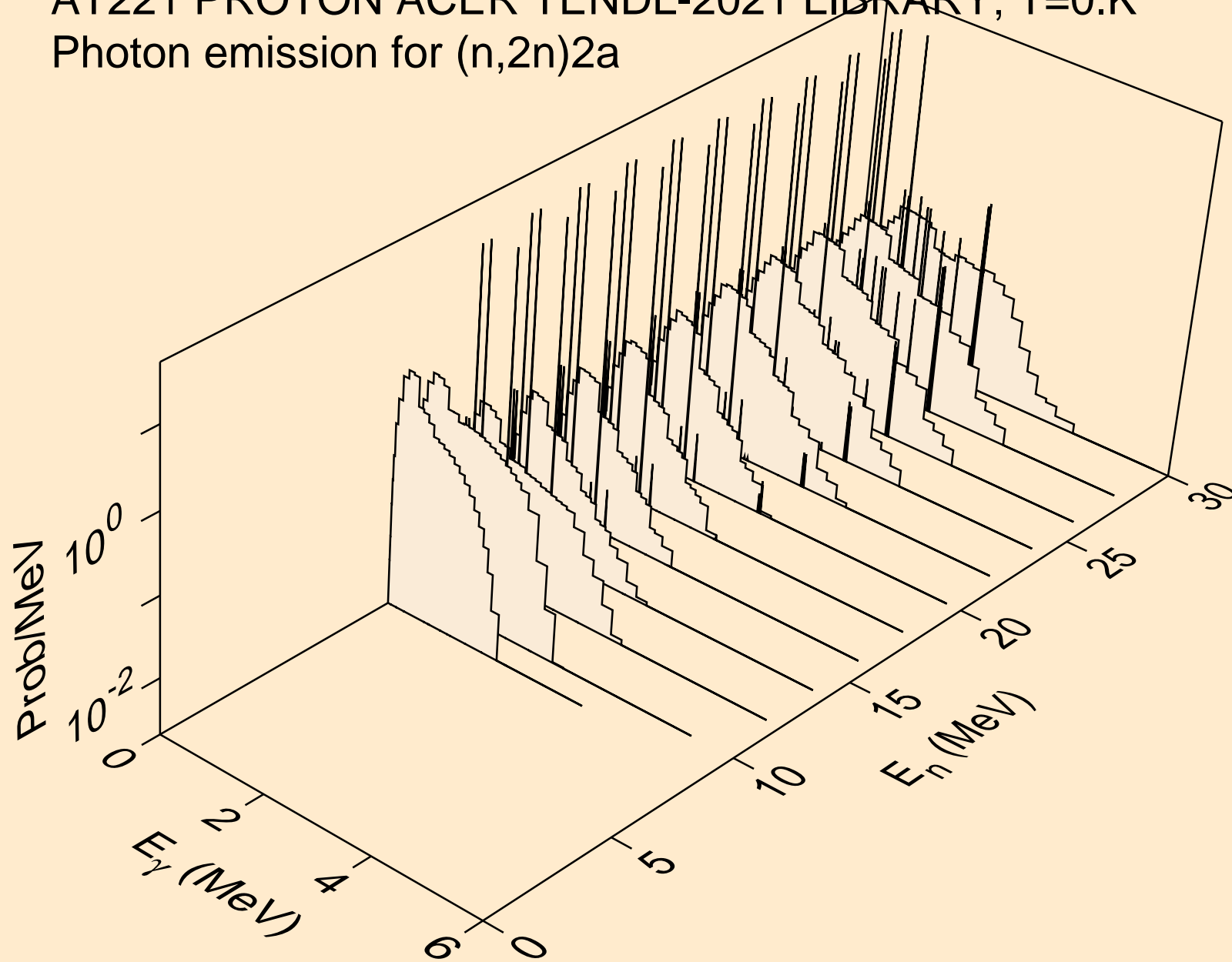

AT221 PROTON ACER TENDL-2021 LIBRARY; T=0.K  
Photon emission for (n,n\*)d

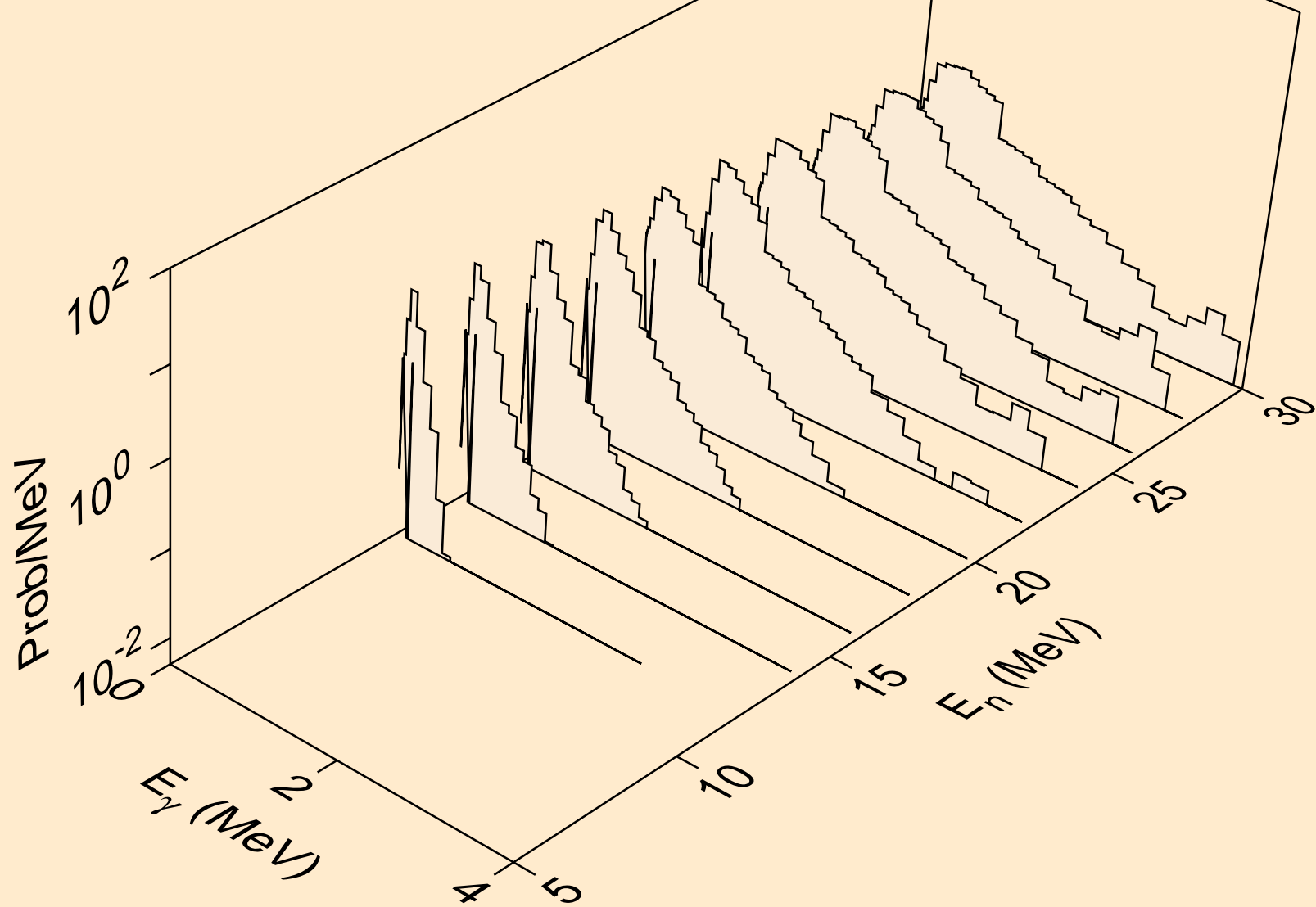

AT221 PROTON ACER TENDL-2021 LIBRARY; T=0.K  
Photon emission for (n,n\*)t

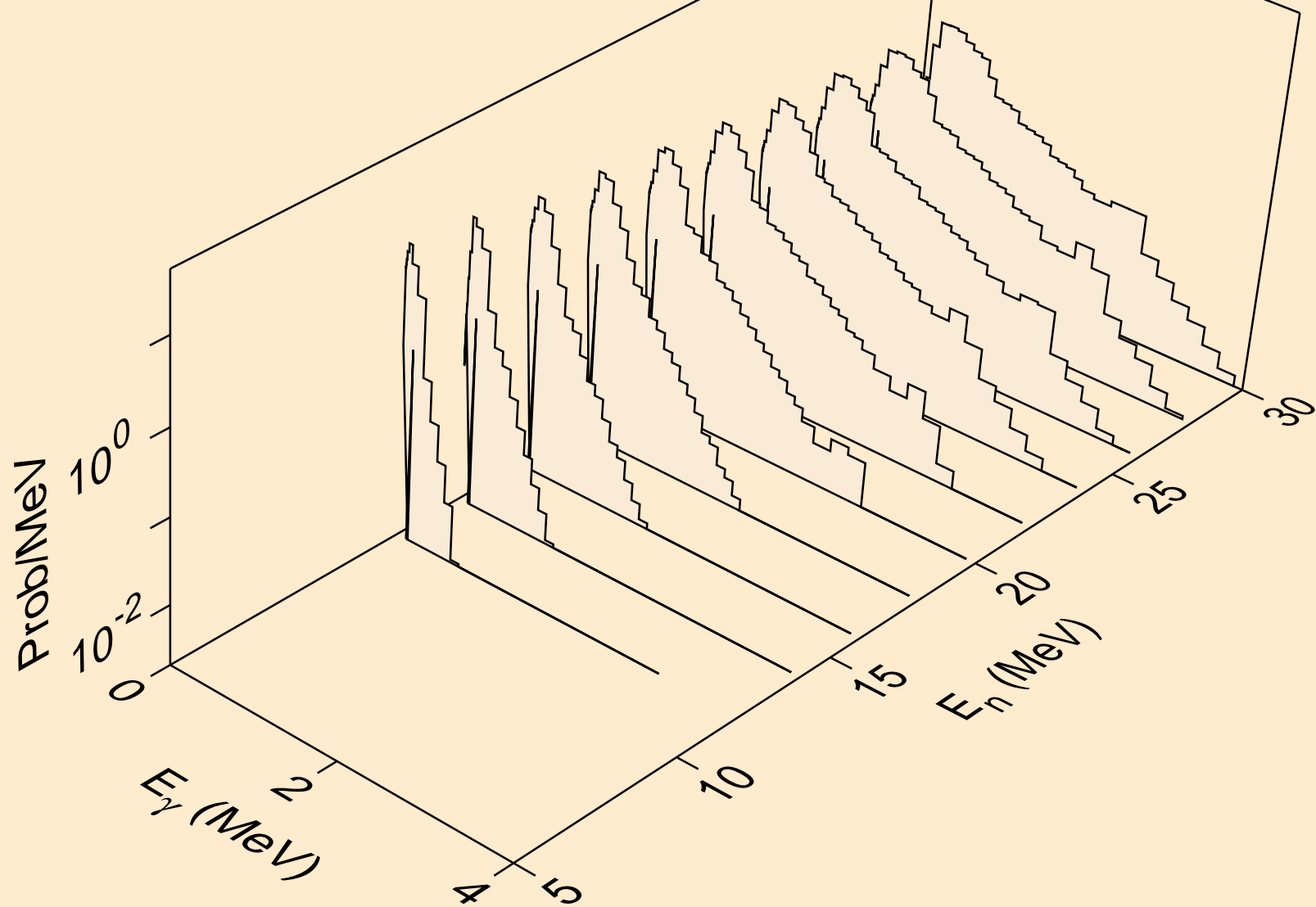



AT221 PROTON ACER TENDL-2021 LIBRARY; T=0.K  
Photon emission for (n,n\*)he3

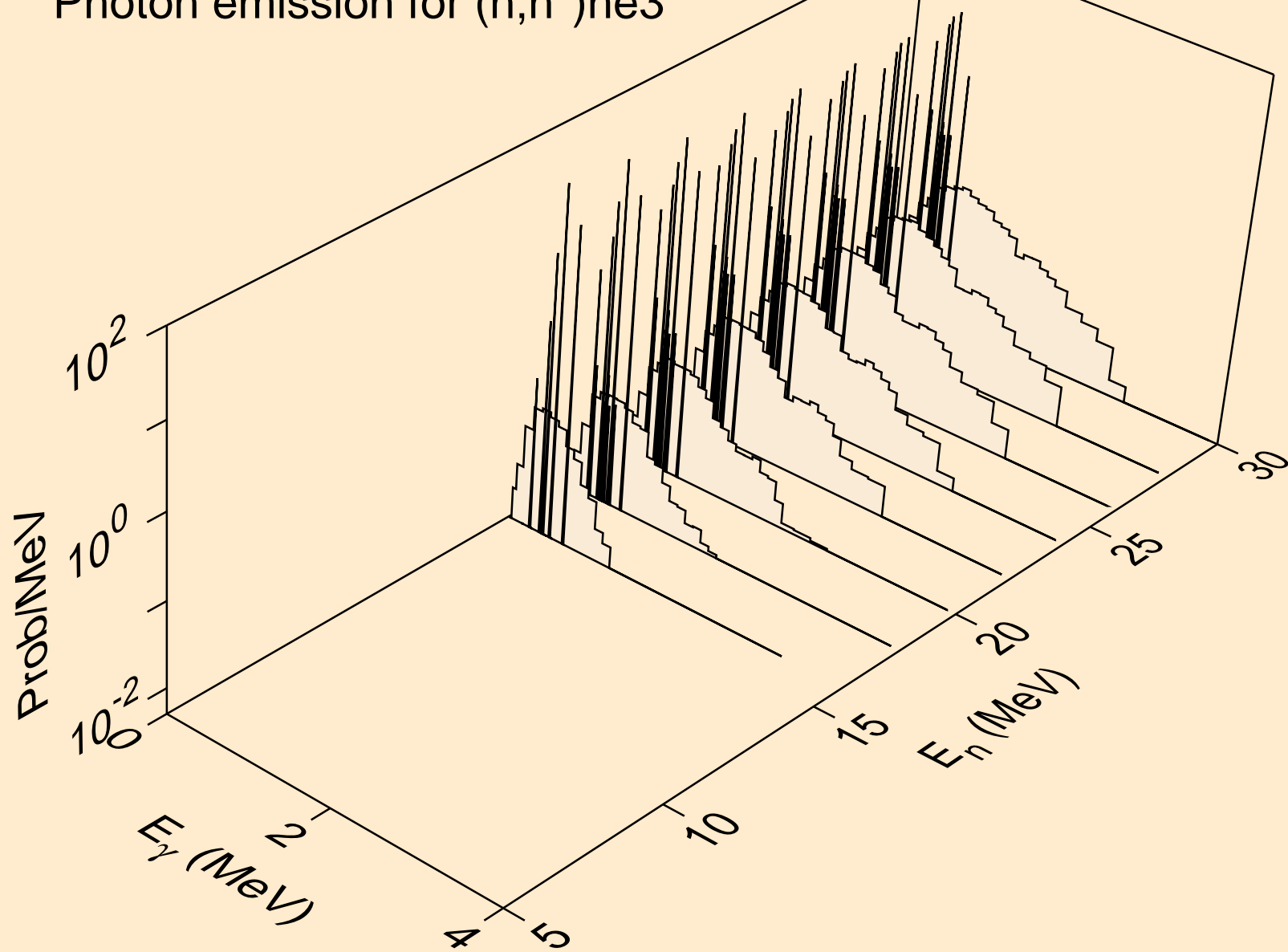

AT221 PROTON ACER TENDL-2021 LIBRARY; T=0.K  
Photon emission for (n,4n)

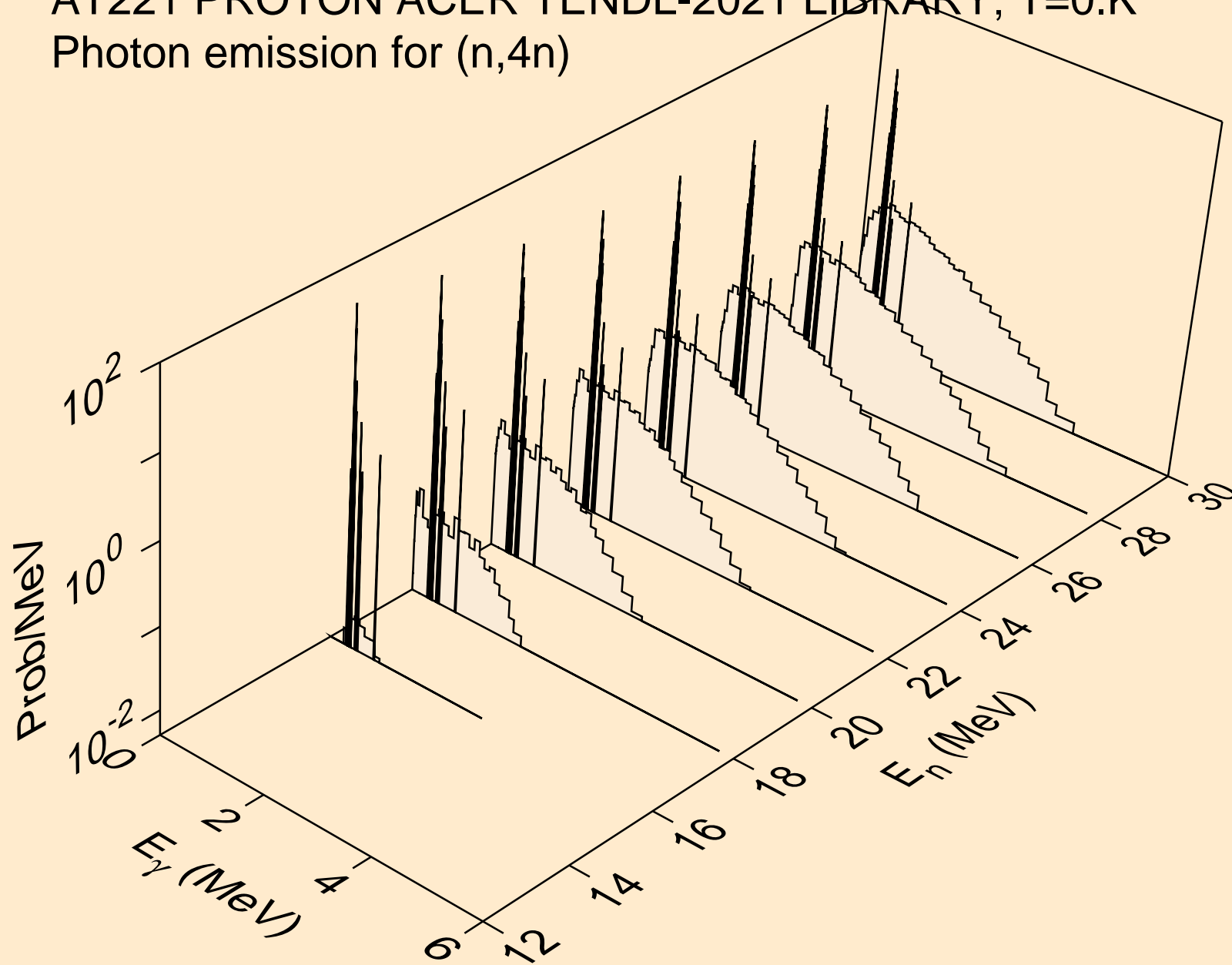

AT221 PROTON ACER TENDL-2021 LIBRARY; T=0.K  
Photon emission for (n,2np)

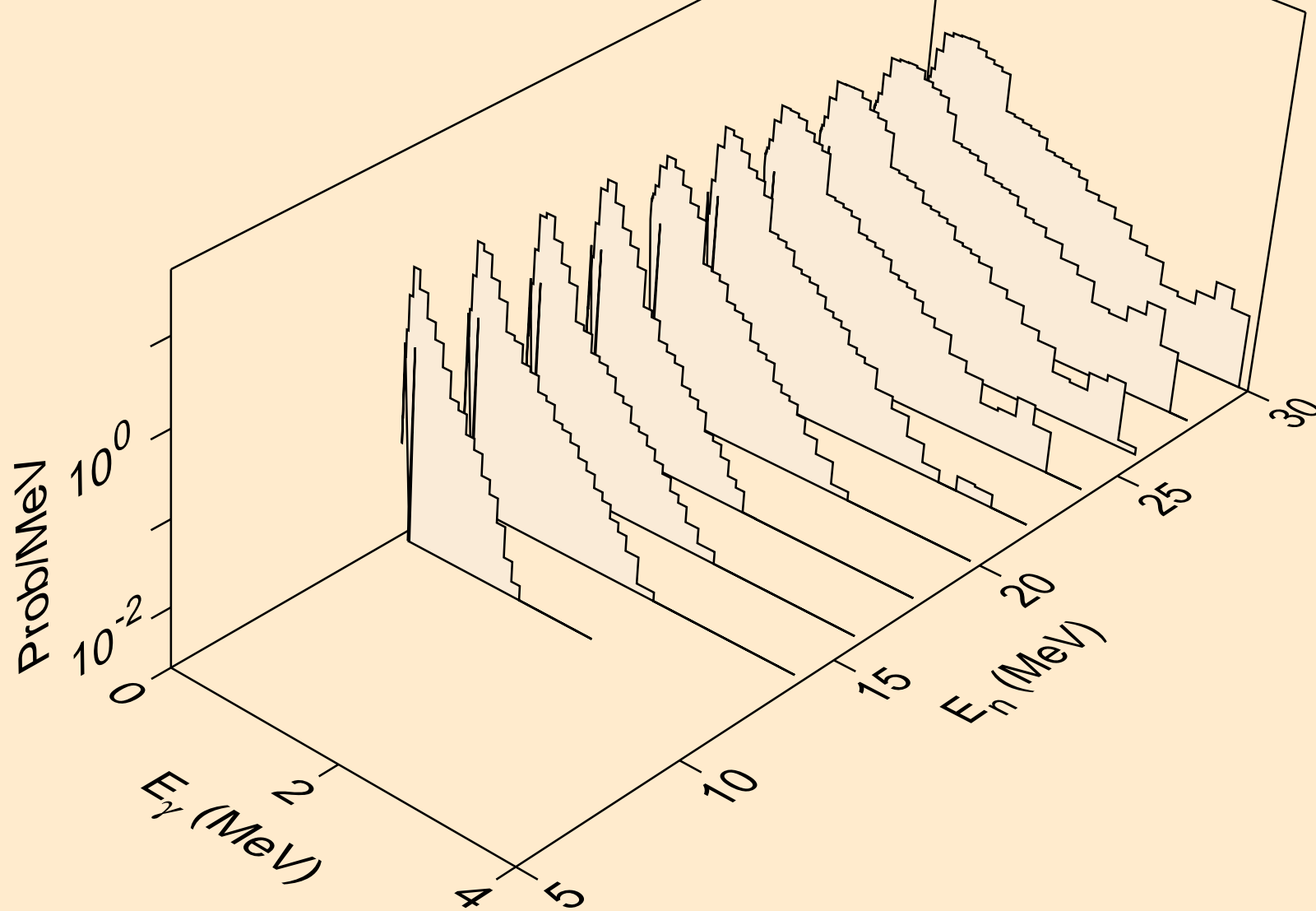

AT221 PROTON ACER TENDL-2021 LIBRARY; T=0.K  
Photon emission for (n,3np)

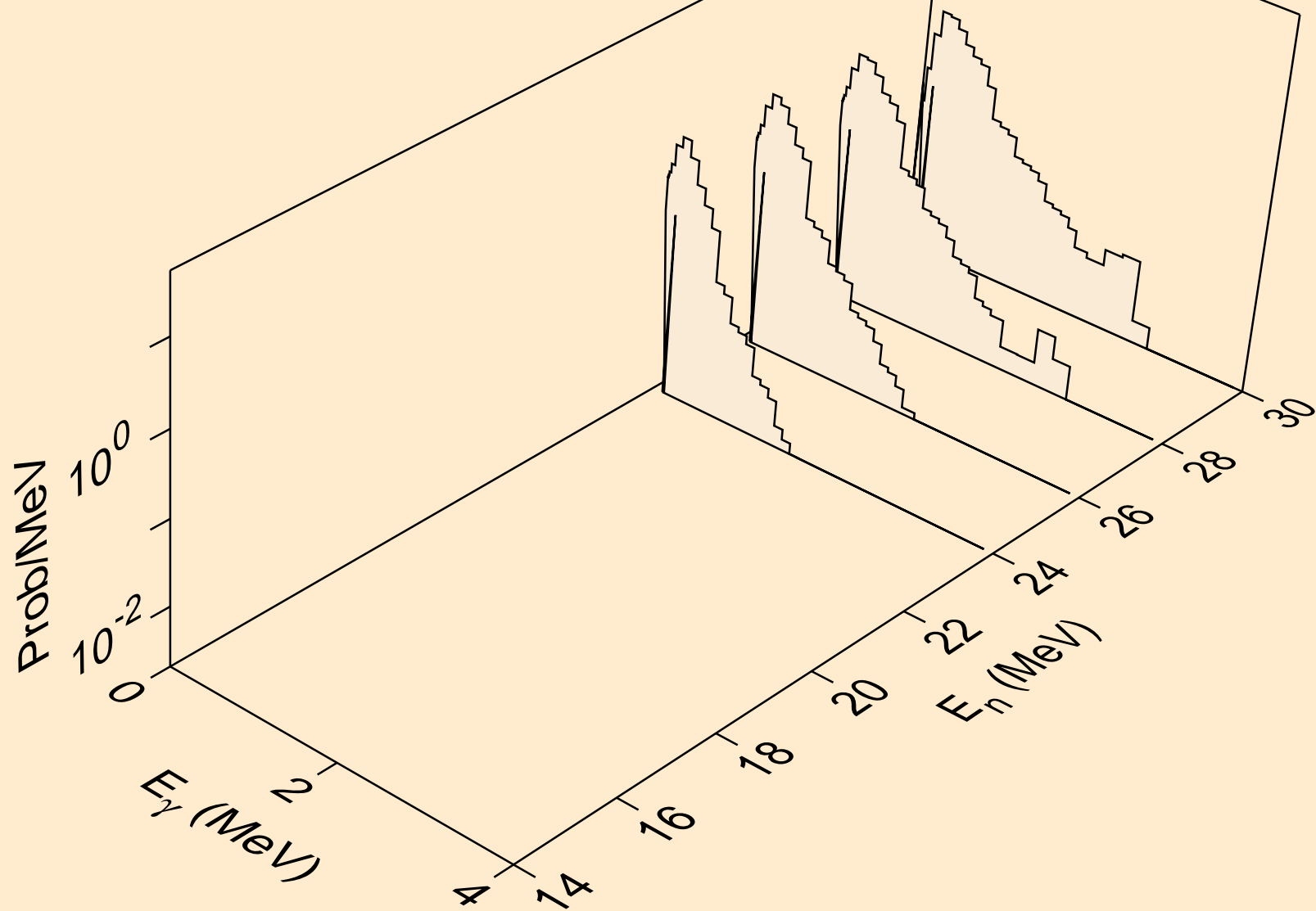

AT221 PROTON ACER TENDL-2021 LIBRARY; T=0.K  
Photon emission for (n,2np)

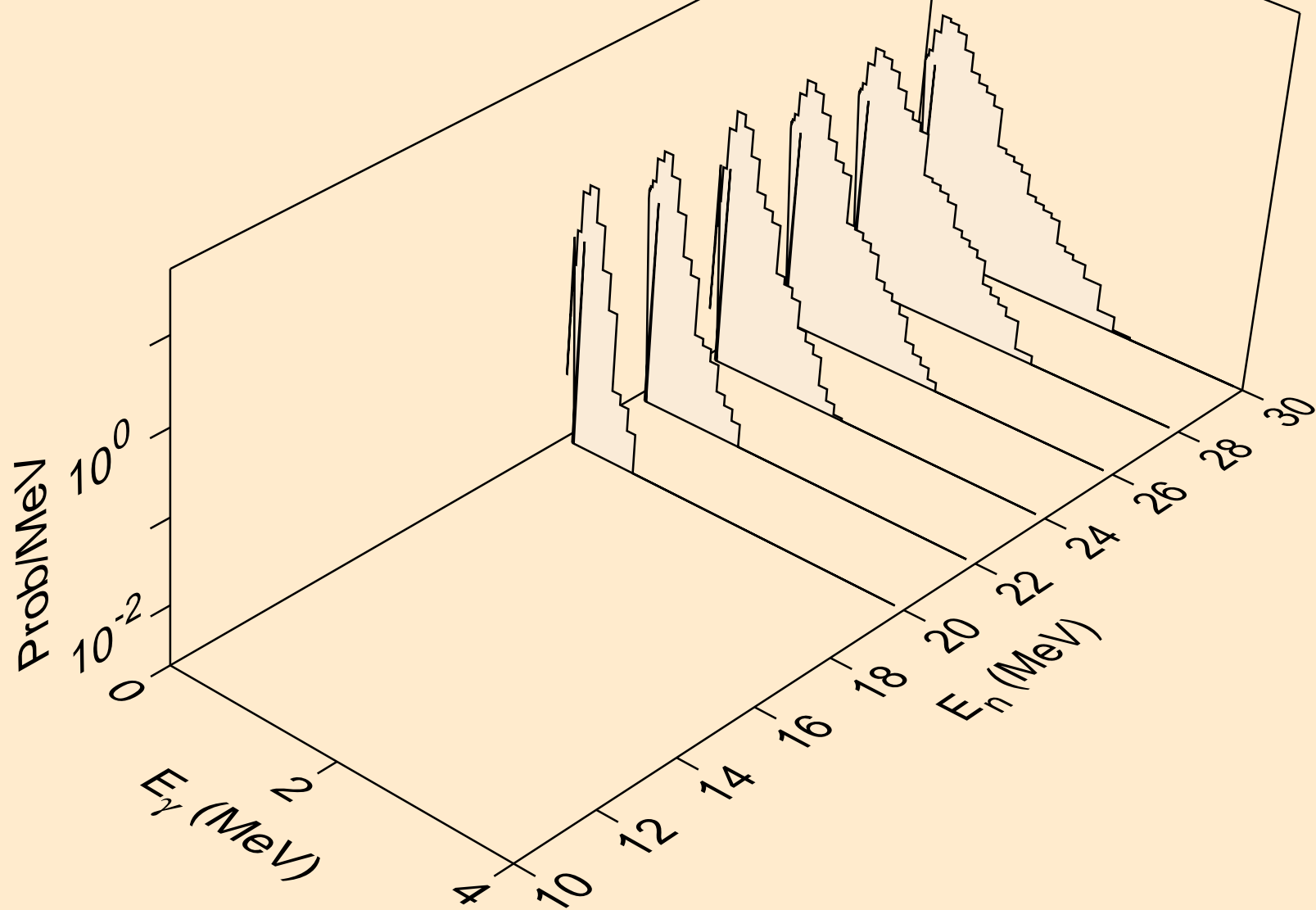

AT221 PROTON ACER TENDL-2021 LIBRARY; T=0.K  
Photon emission for (n,npa)

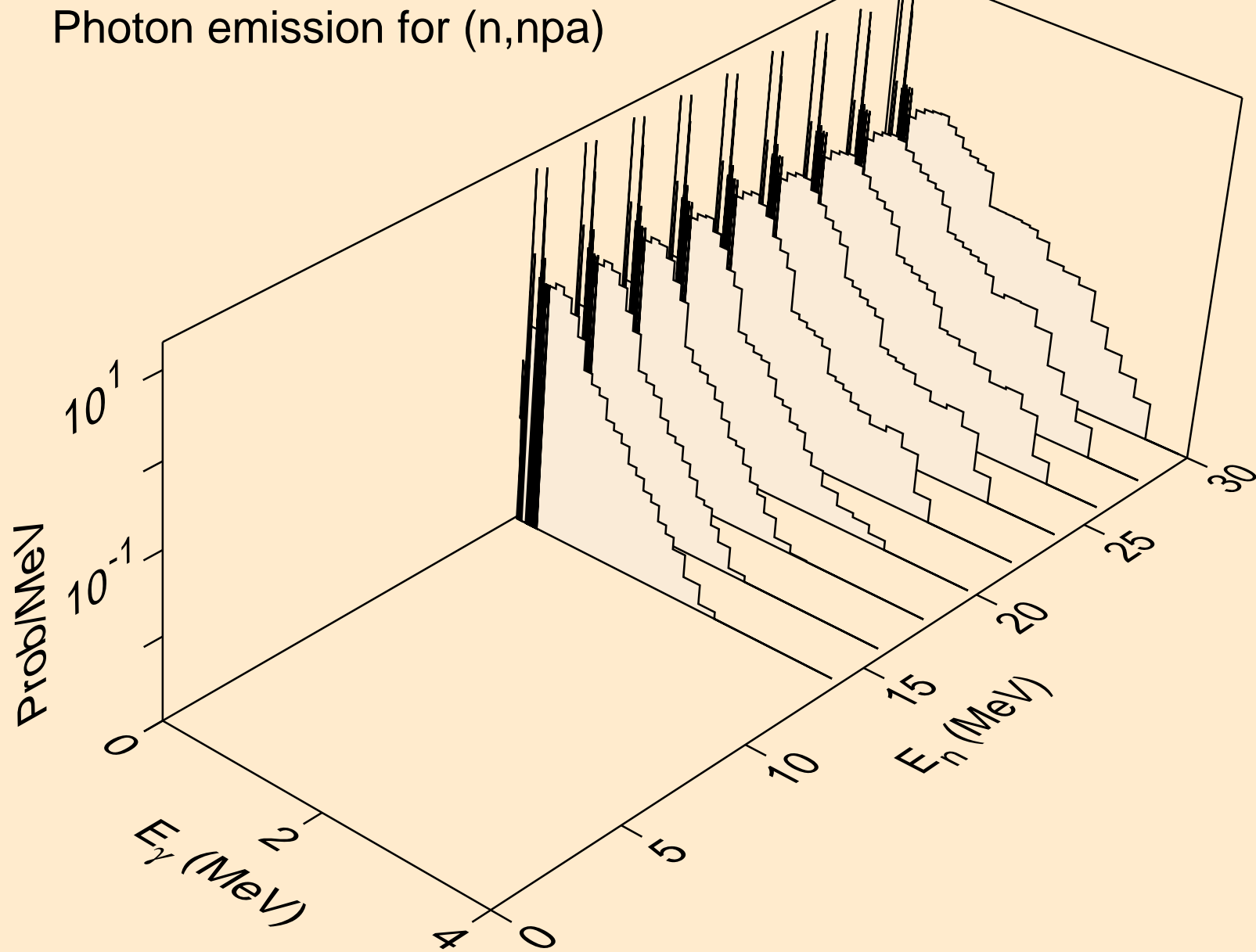

AT221 PROTON ACER TENDL-2021 LIBRARY; T=0.K  
Photon emission for (n,gma)

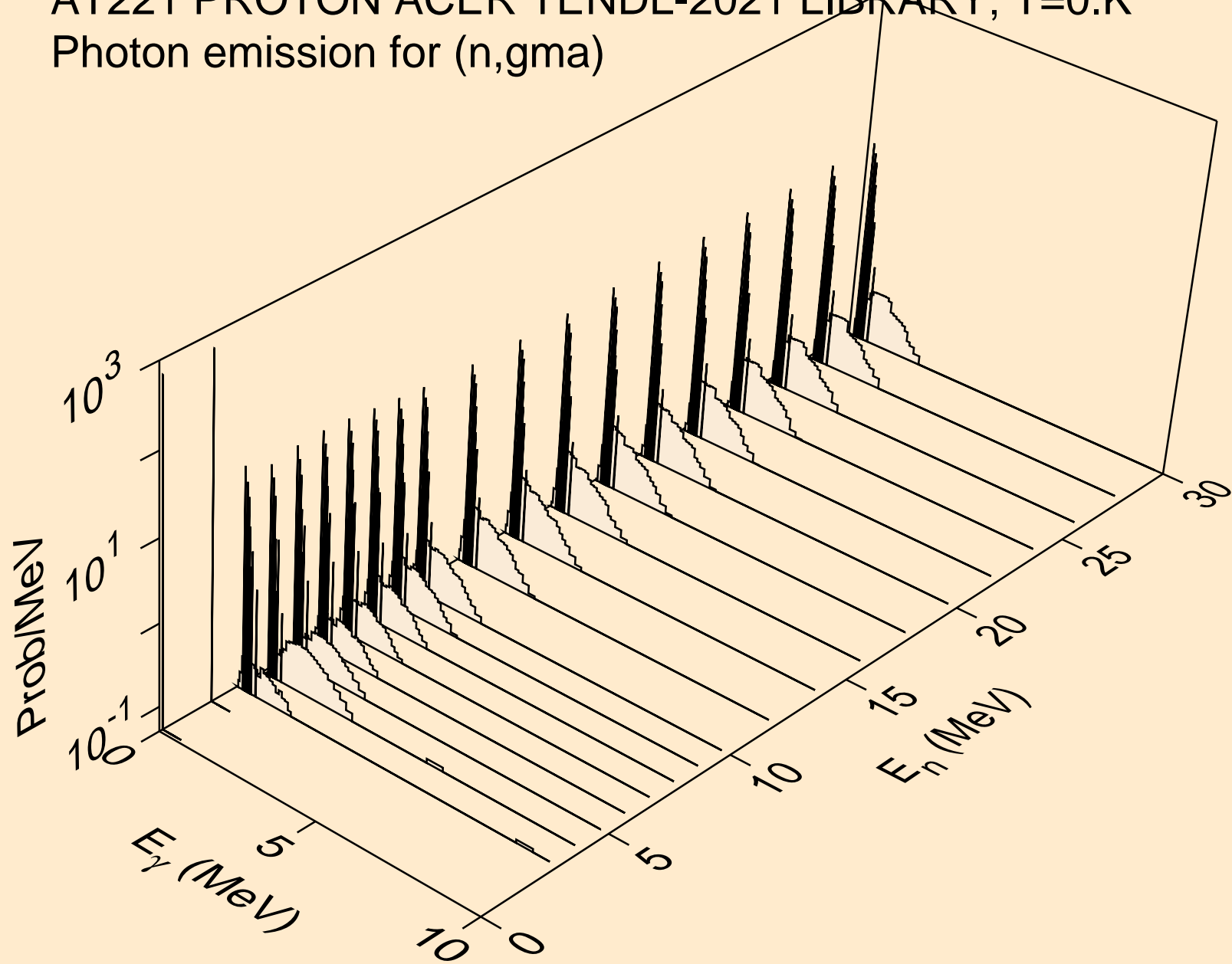

AT221 PROTON ACER TENDL-2021 LIBRARY; T=0.K  
Photon emission for inelastic

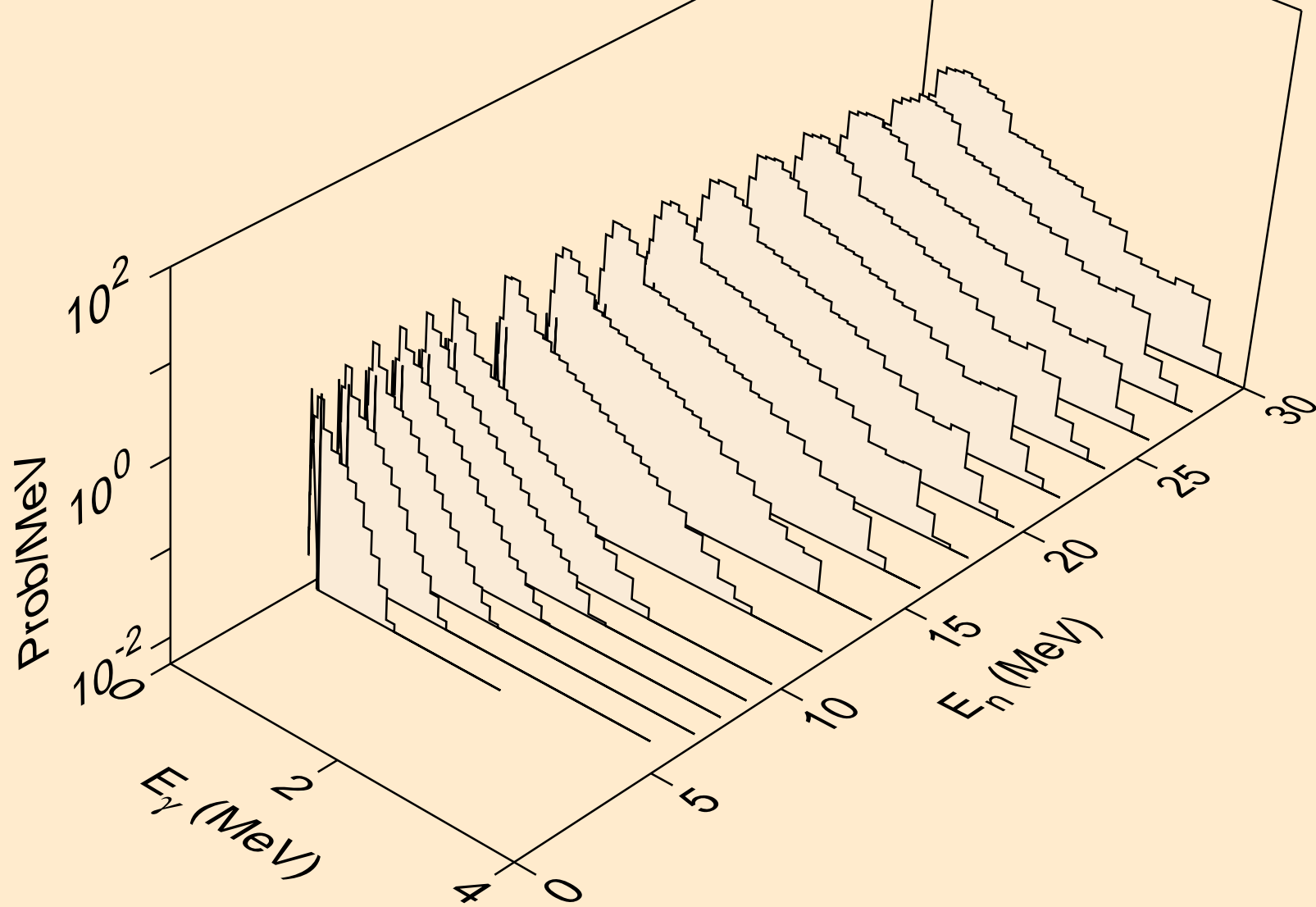



AT221 PROTON ACER TENDL-2021 LIBRARY; T=0.K  
Photon emission for (n,d)

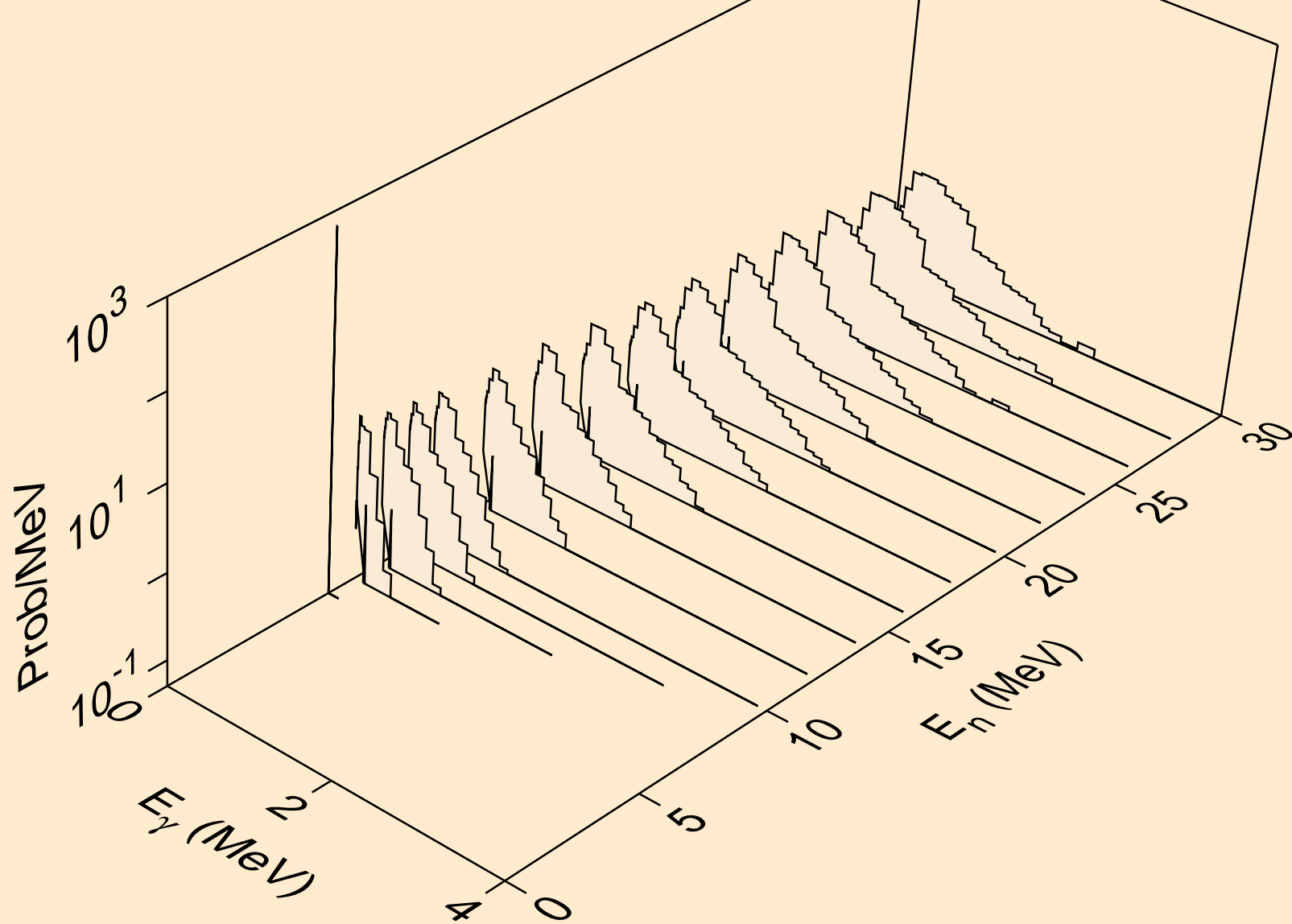

AT221 PROTON ACER TENDL-2021 LIBRARY; T=0.K  
Photon emission for (n,t)

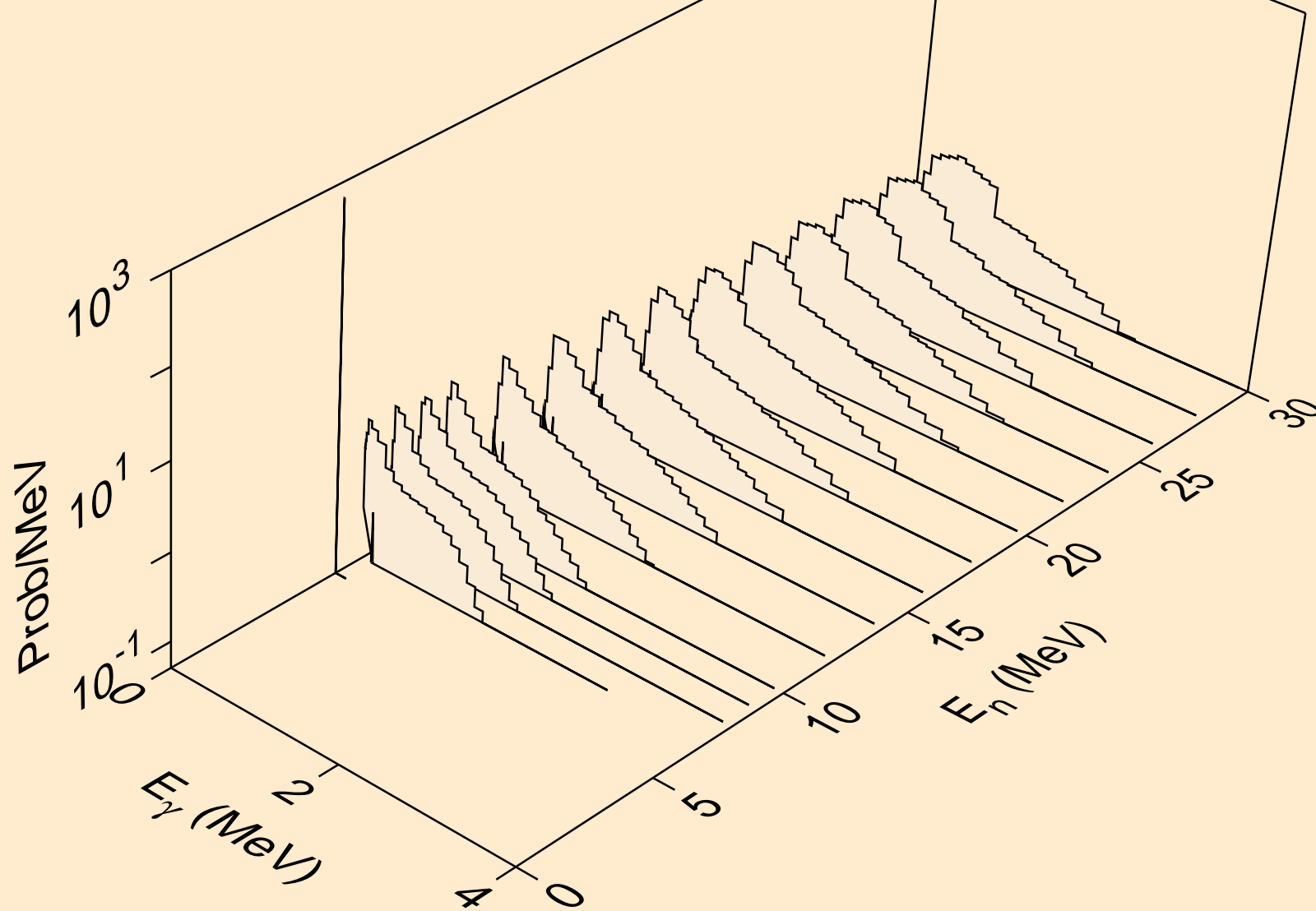

AT221 PROTON ACER TENDL-2021 LIBRARY; T=0.K  
Photon emission for (n,he3)

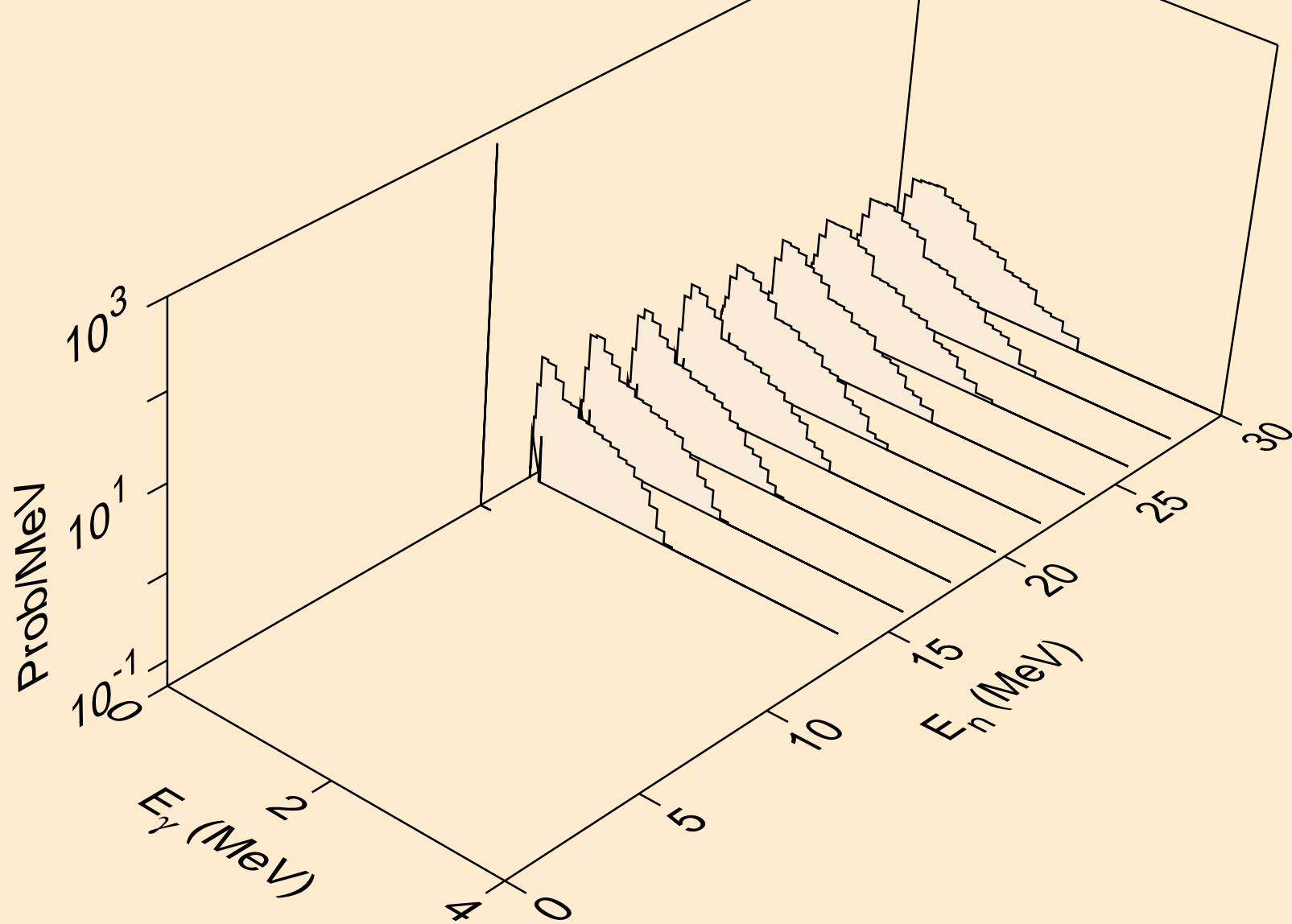

AT221 PROTON ACER TENDL-2021 LIBRARY; T=0.K  
Photon emission for (n,a)

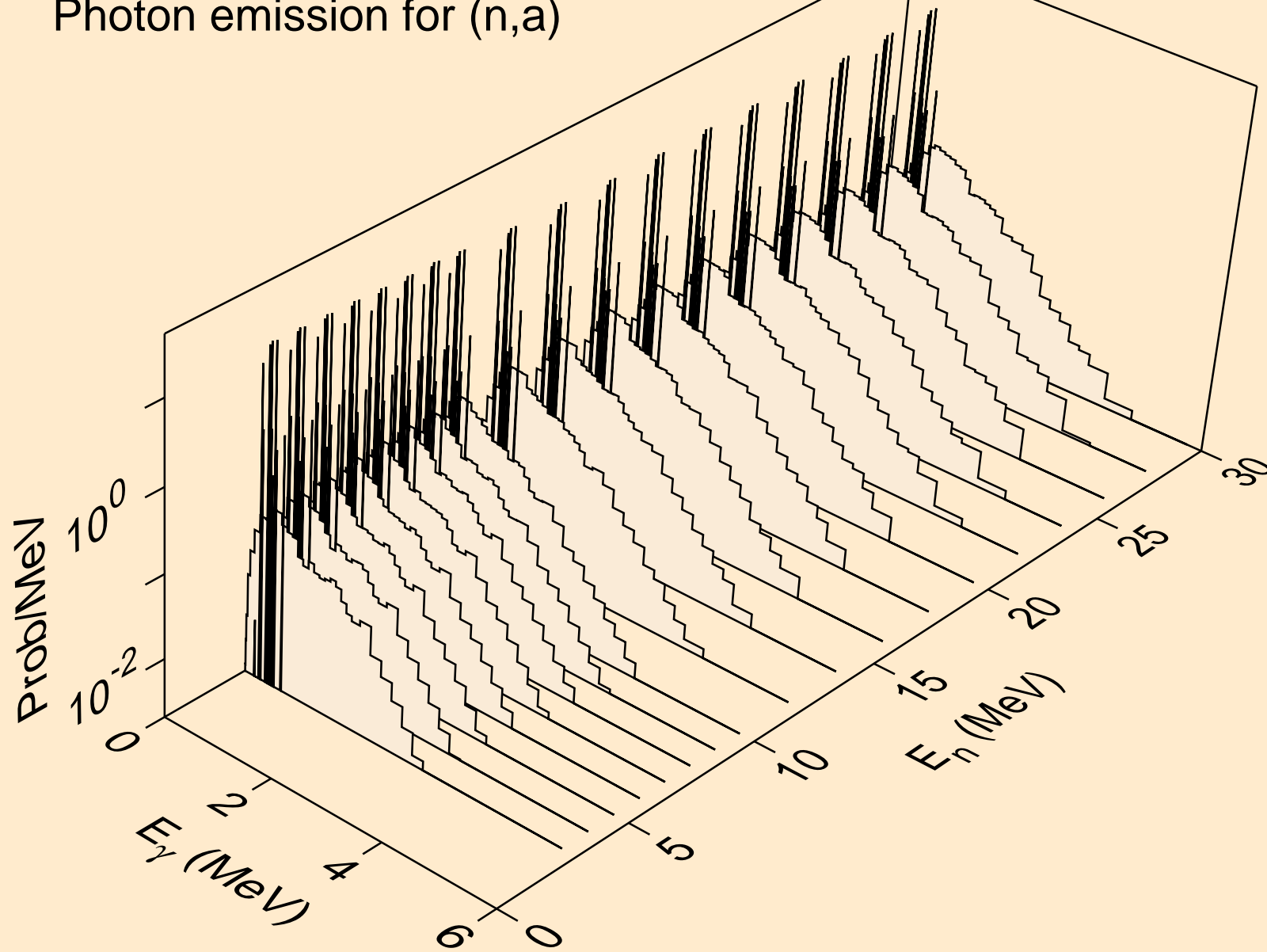

AT221 PROTON ACER TENDL-2021 LIBRARY; T=0.K  
Photon emission for (n,2a)

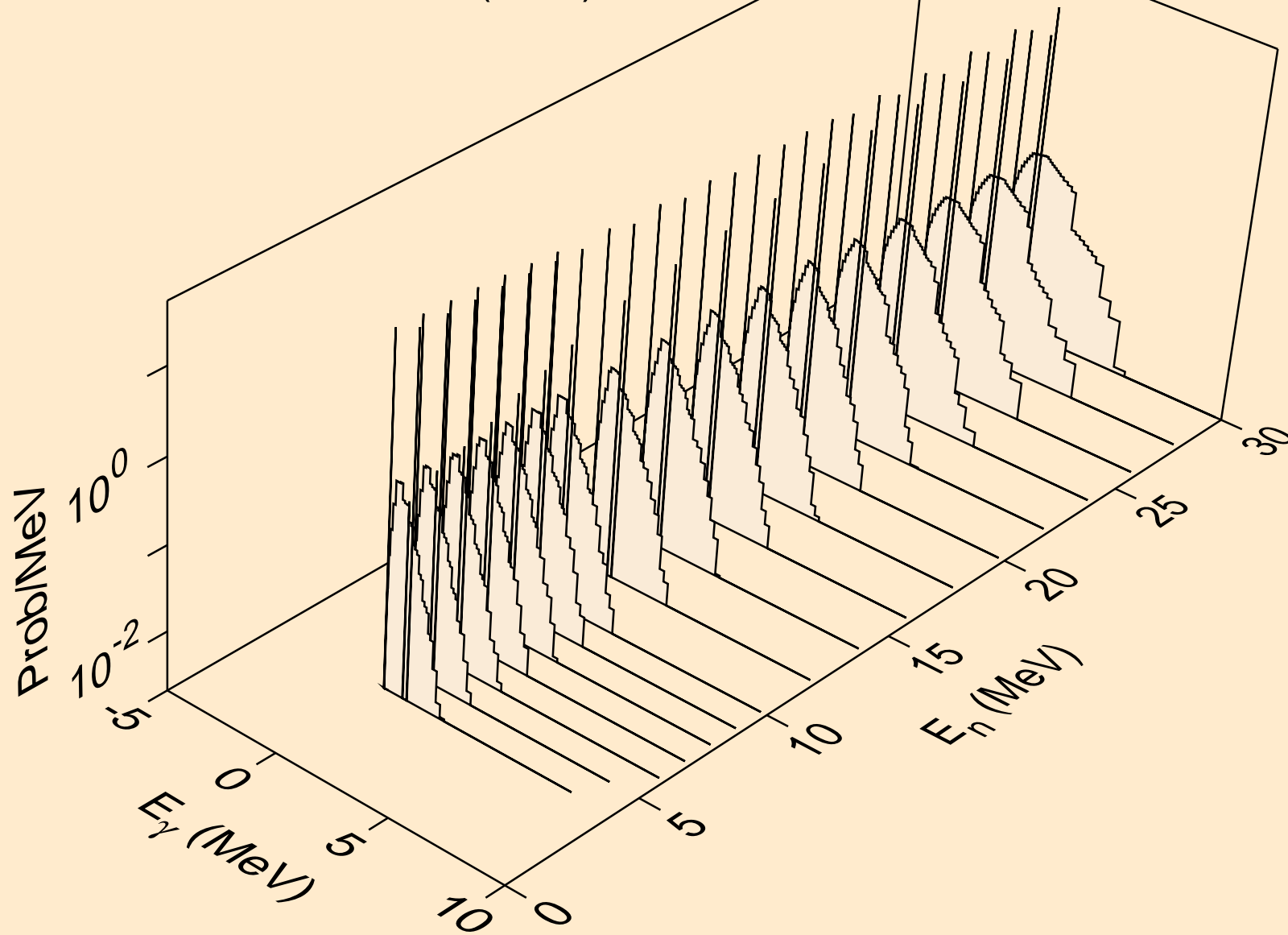

AT221 PROTON ACER TENDL-2021 LIBRARY; T=0.K  
Photon emission for (n,2p)

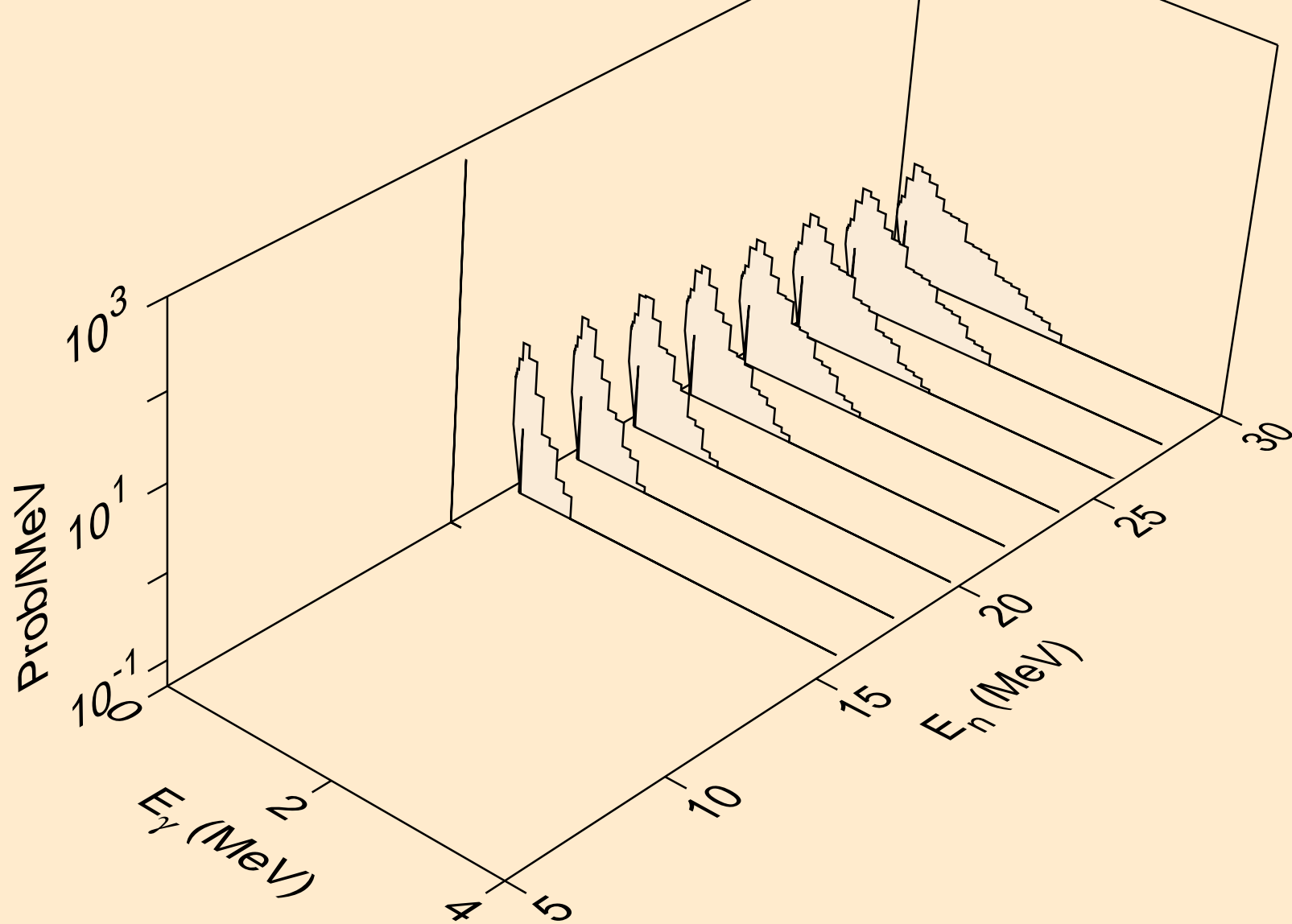

AT221 PROTON ACER TENDL-2021 LIBRARY; T=0.K  
Photon emission for (n,pa)

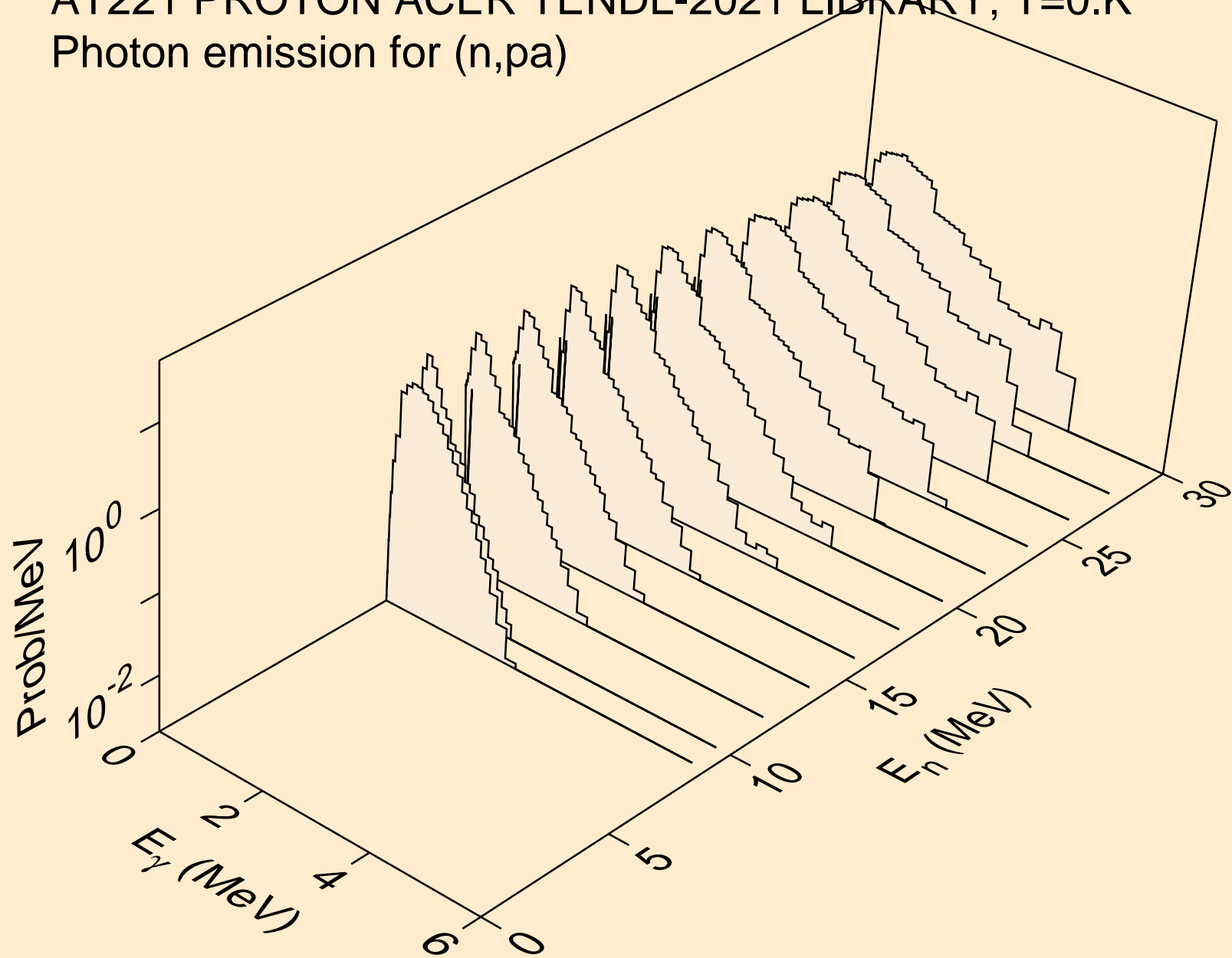

AT221 PROTON ACER TENDL-2021 LIBRARY; T=0.K  
Photon emission for (n,pd)

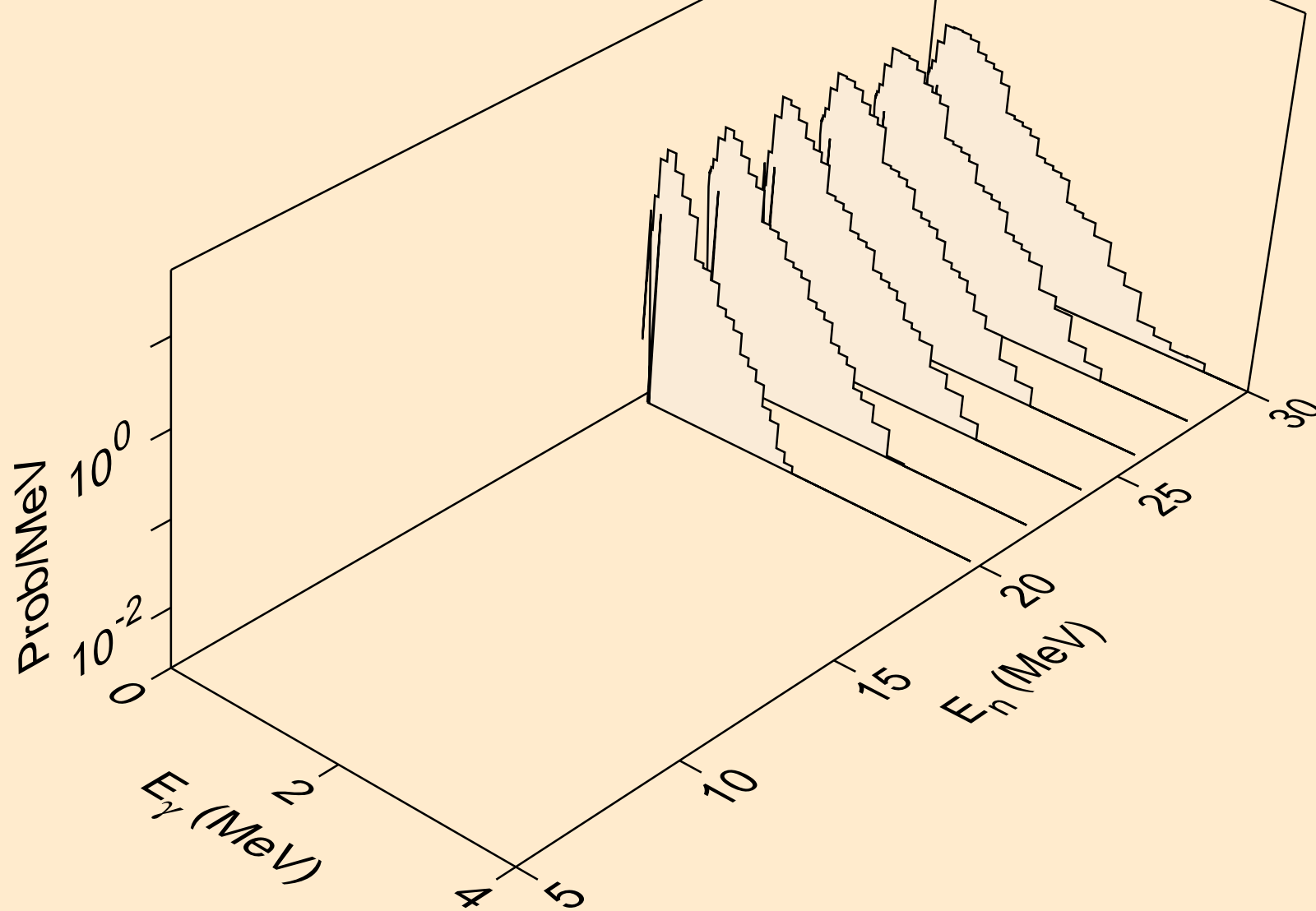



AT221 PROTON ACER TENDL-2021 LIBRARY; T=0.K  
Photon emission for (n,da)

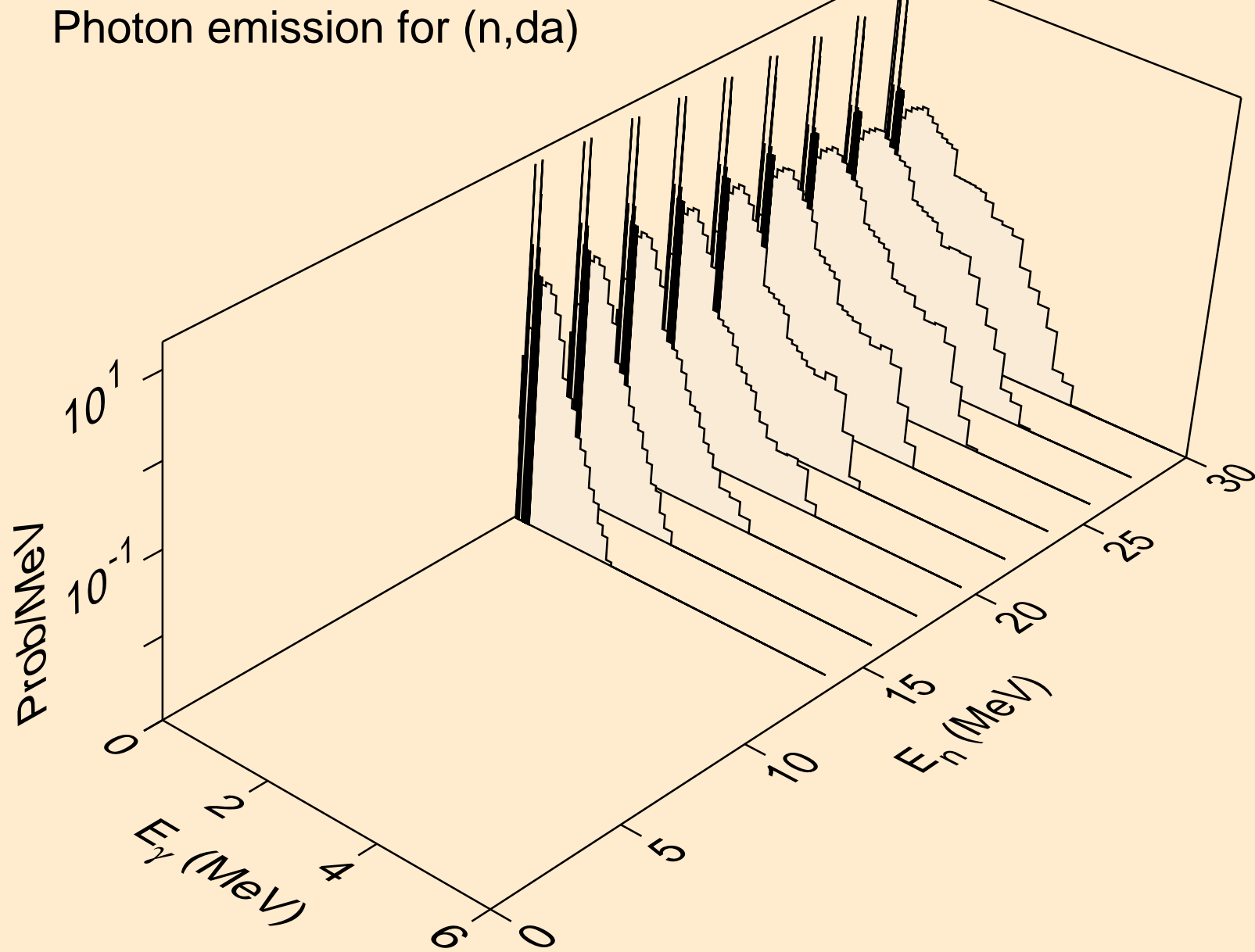

AT221 PROTON ACER TENDL-2021 LIBRARY; T=0.K  
Particle heating contributions

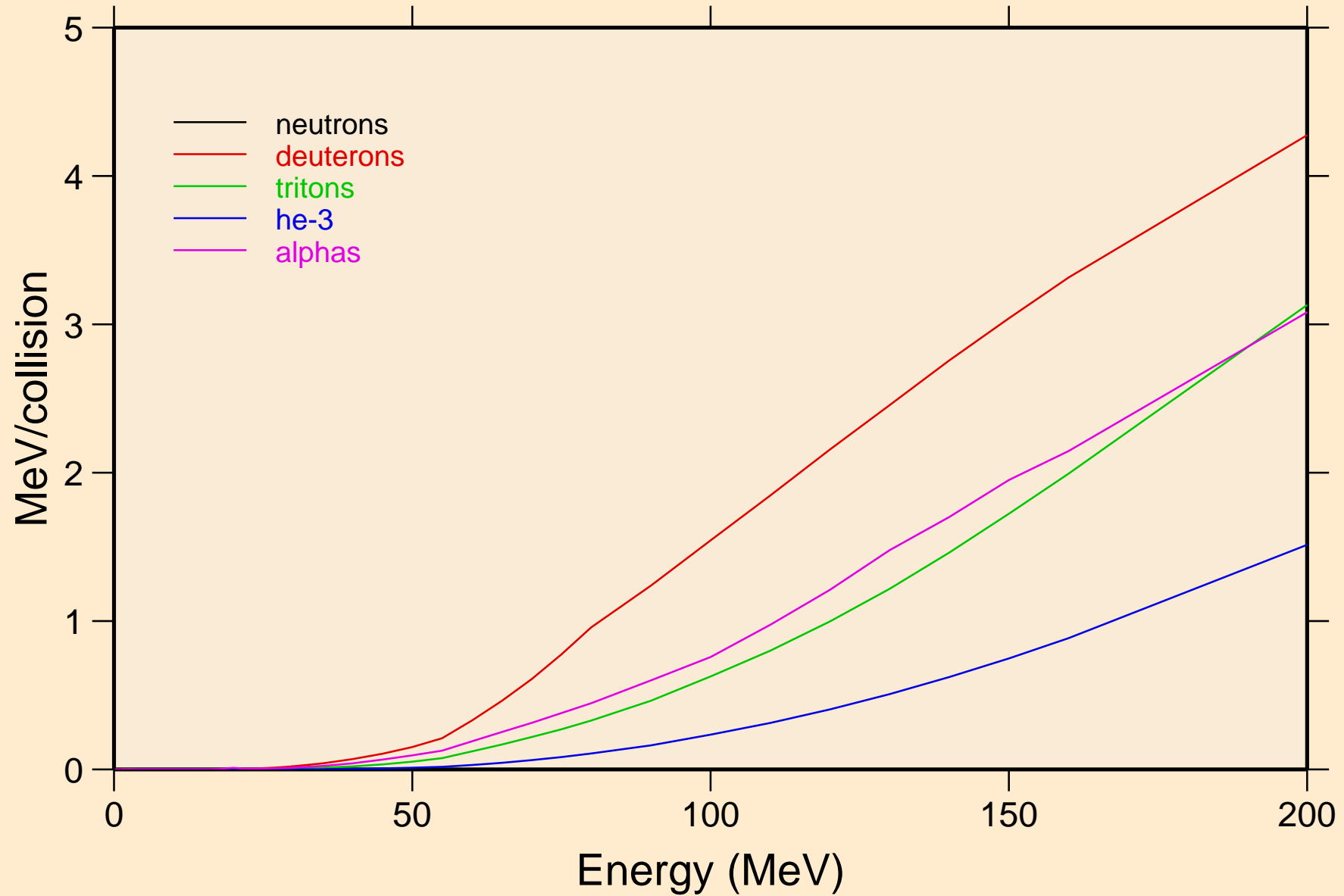

AT221 PROTON ACER TENDL-2021 LIBRARY; T=0.K  
Recoil Heating

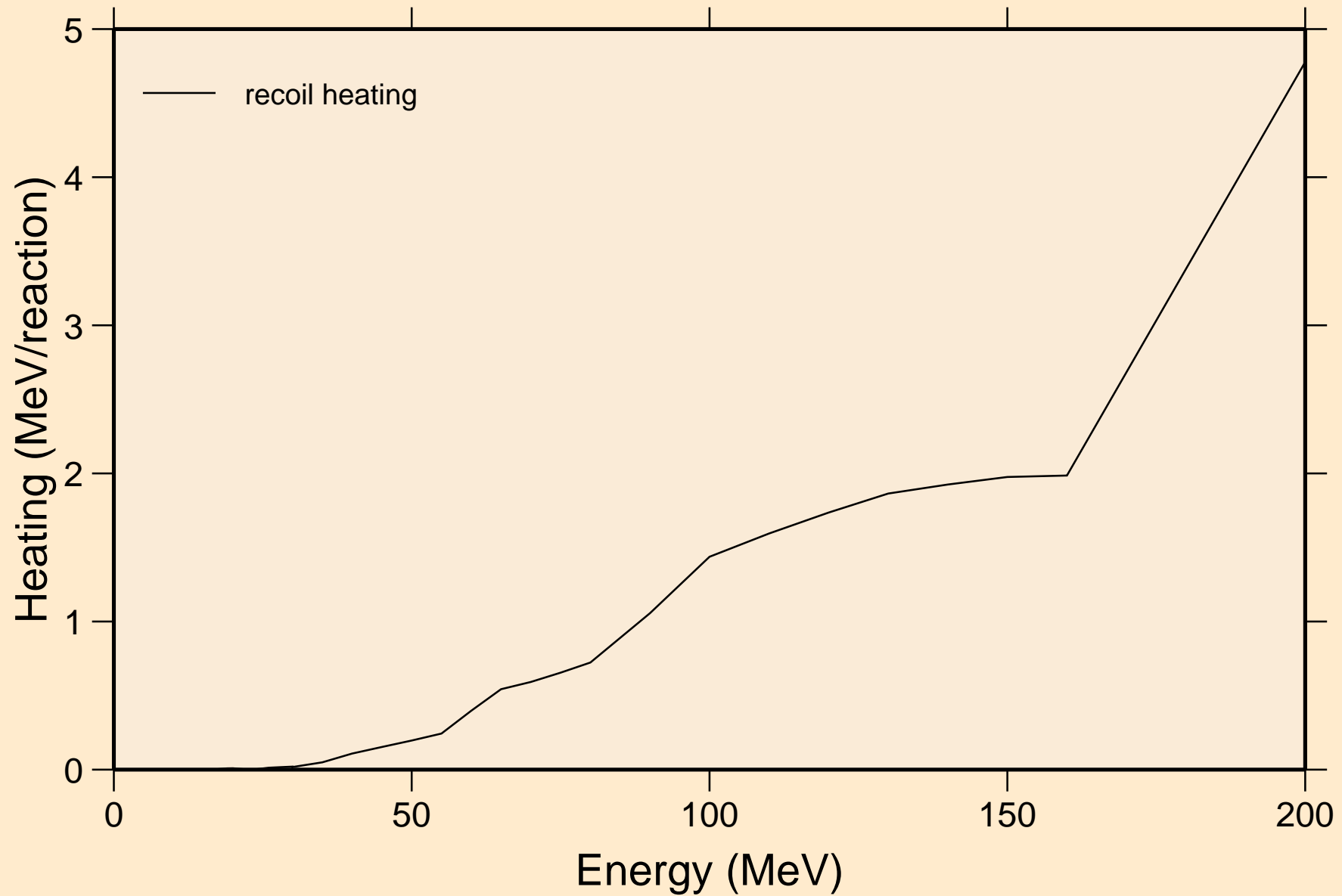

AT221 PROTON ACER TENDL-2021 LIBRARY; T=0.K  
Particle production cross sections

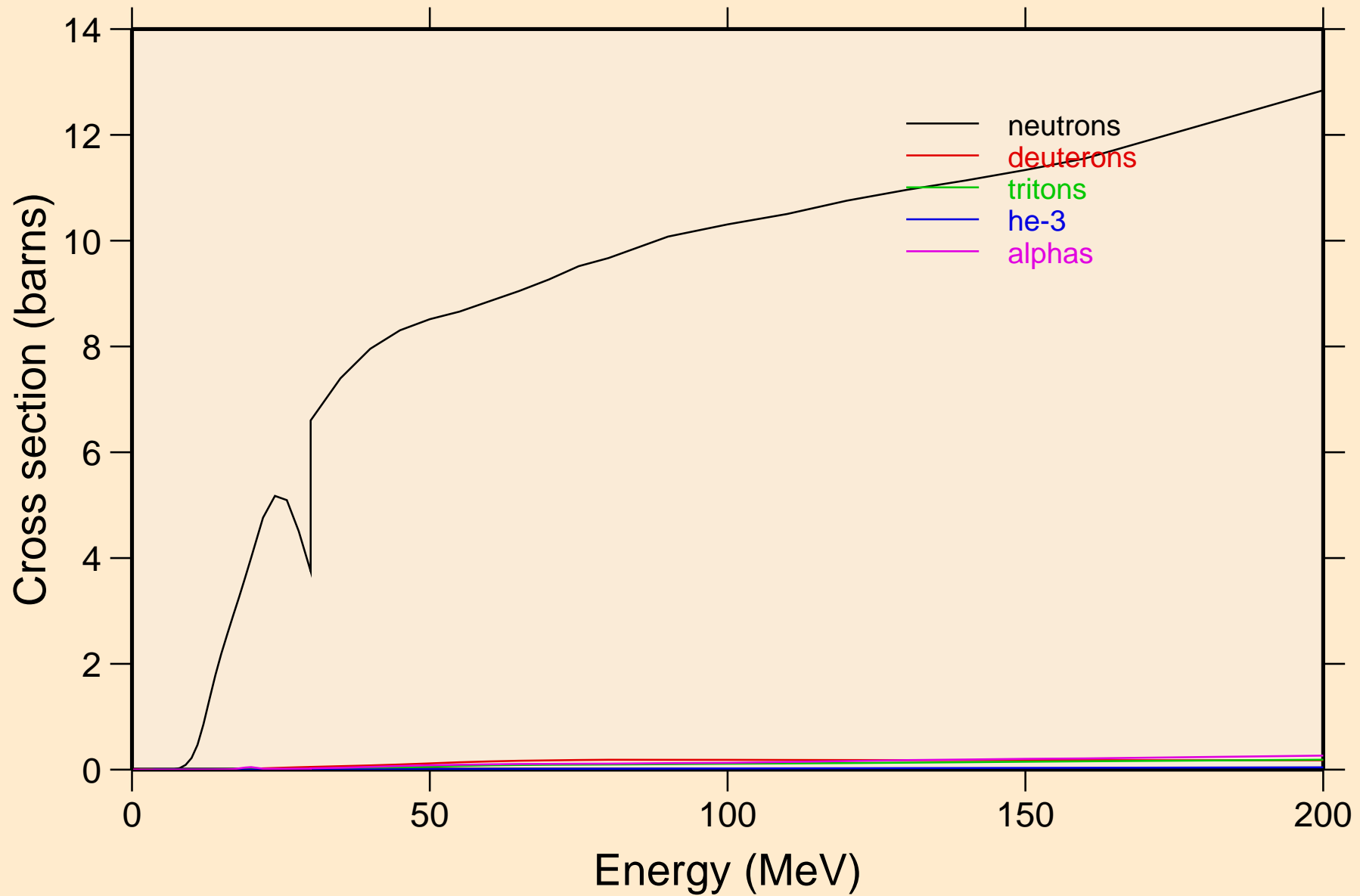

AT221 PROTON ACER TENDL-2021 LIBRARY; T=0.K  
neutrons from (p,n)

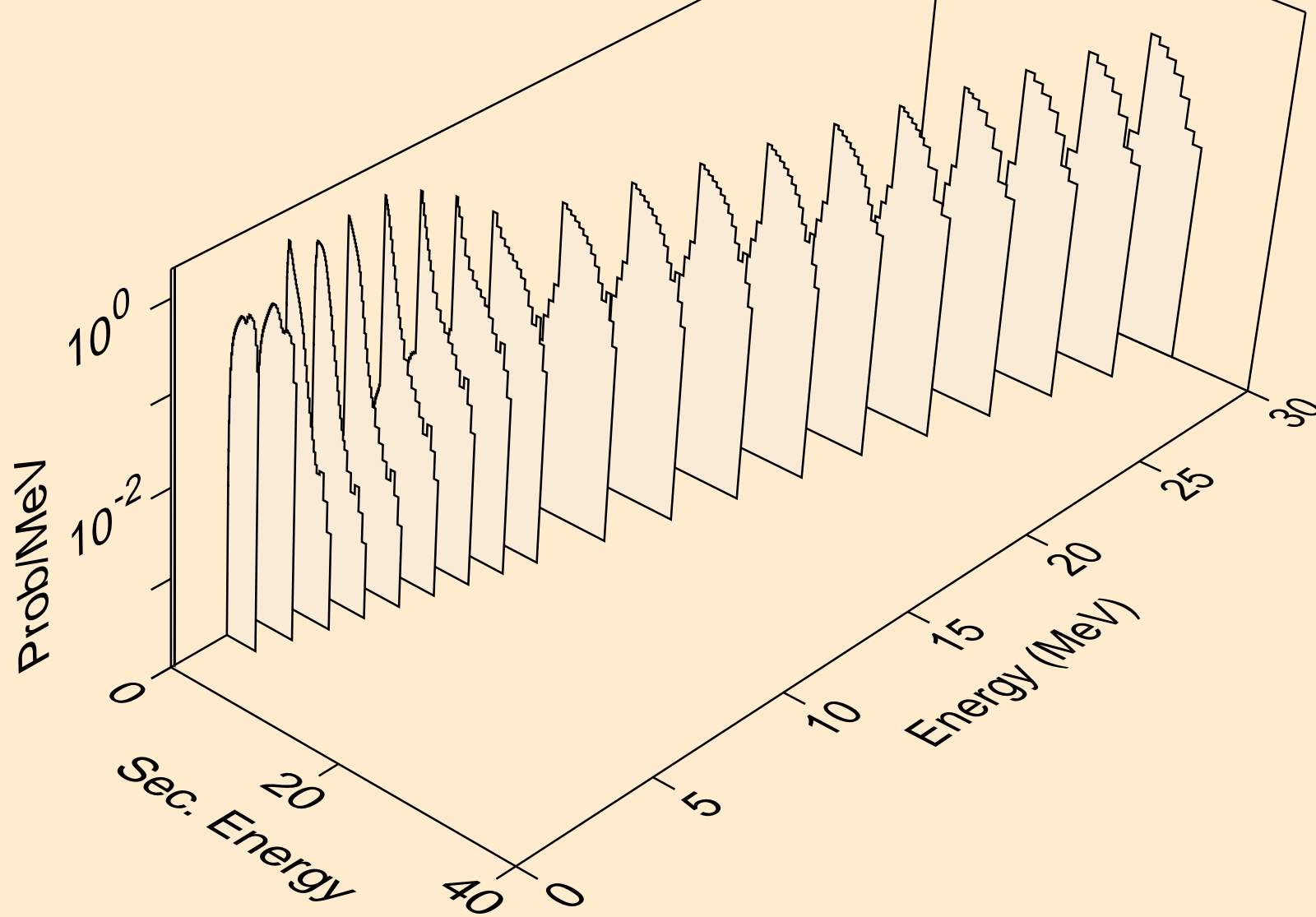

AT221 PROTON ACER TENDL-2021 LIBRARY; T=0.K  
neutrons from (p,x)

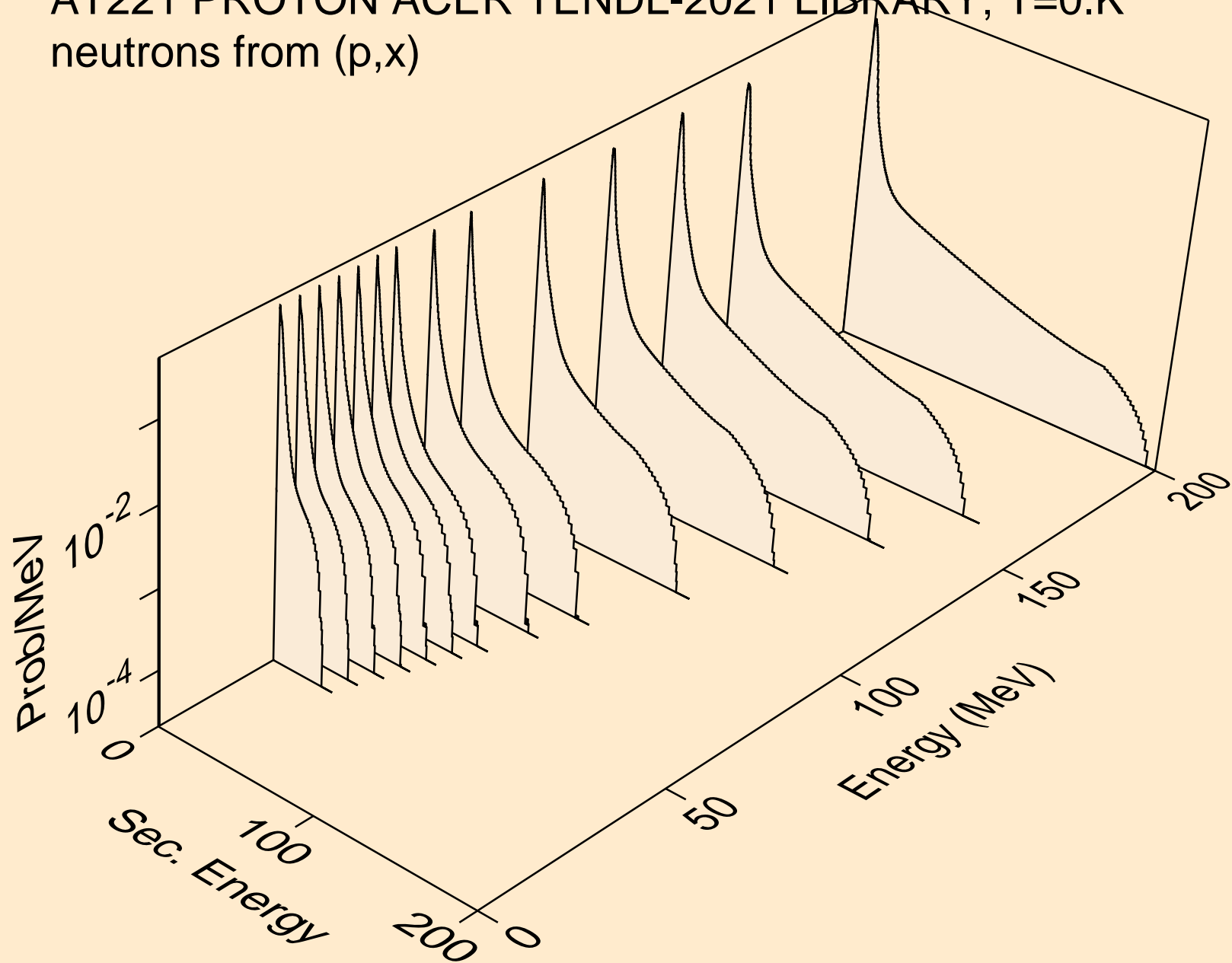

AT221 PROTON ACER TENDL-2021 LIBRARY; T=0.K  
neutrons from (p,2nd)

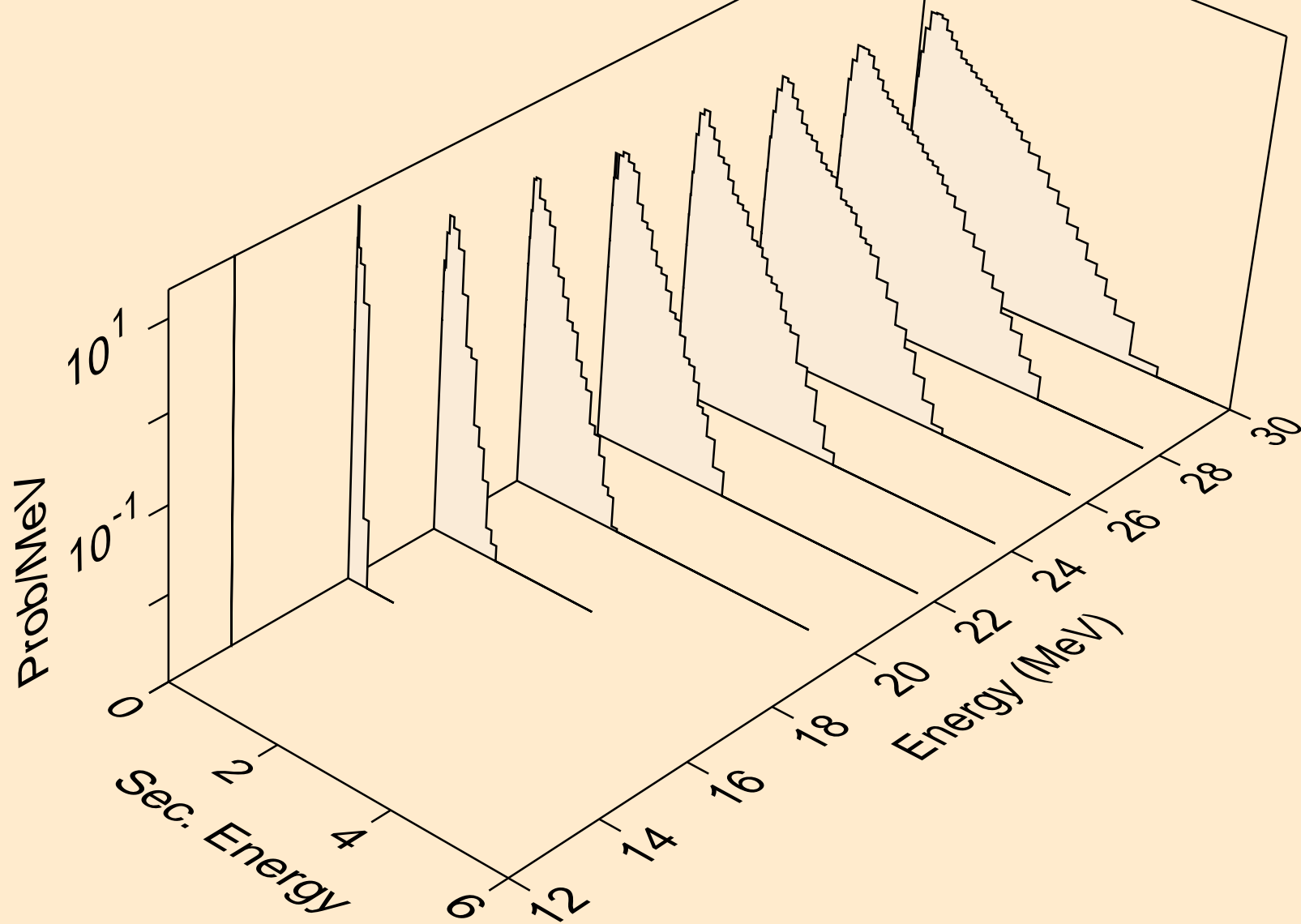

AT221 PROTON ACER TENDL-2021 LIBRARY; T=0.K  
neutrons from (p,2n)

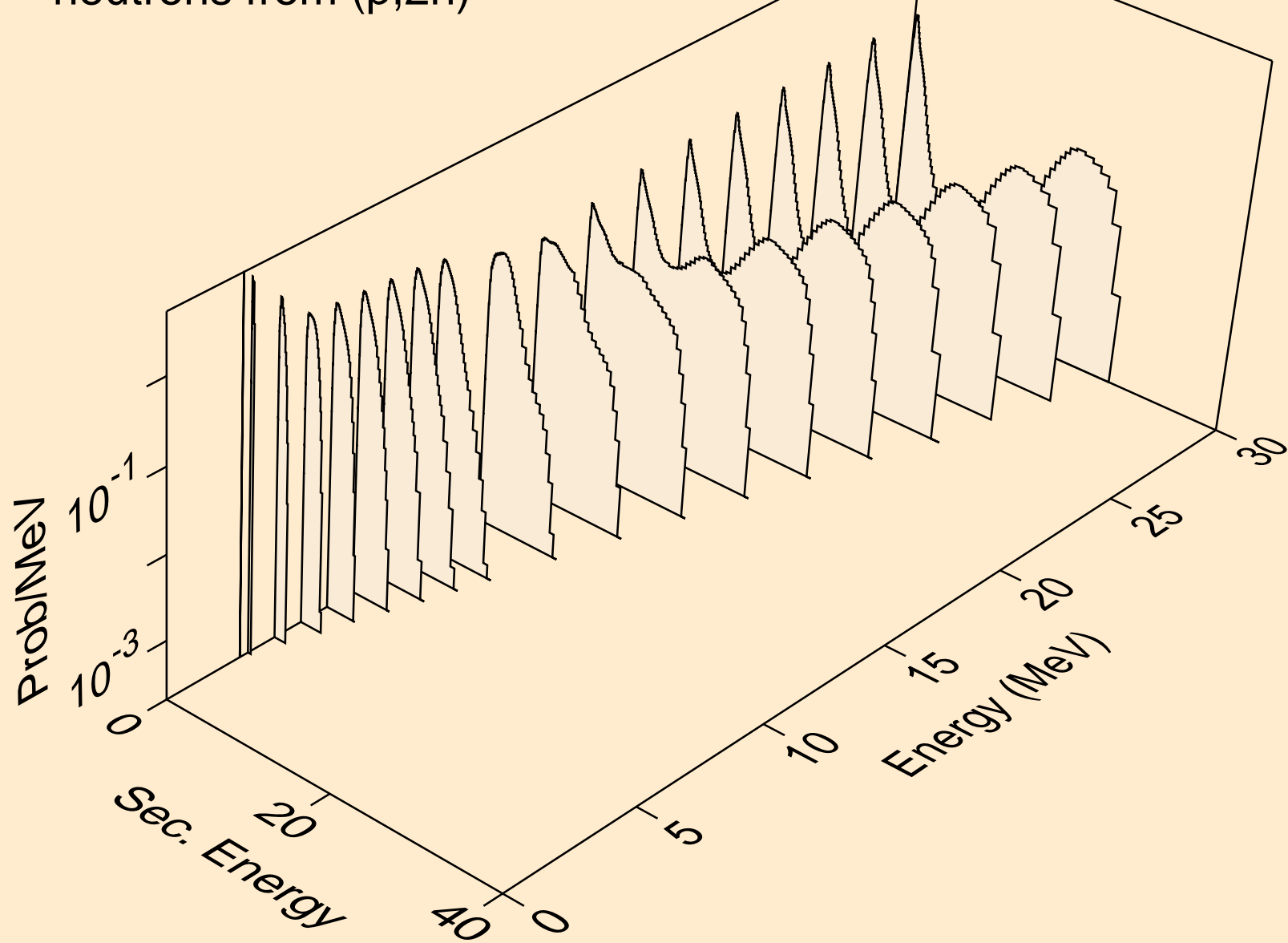



AT221 PROTON ACER TENDL-2021 LIBRARY; T=0.K  
neutrons from (p,3n)

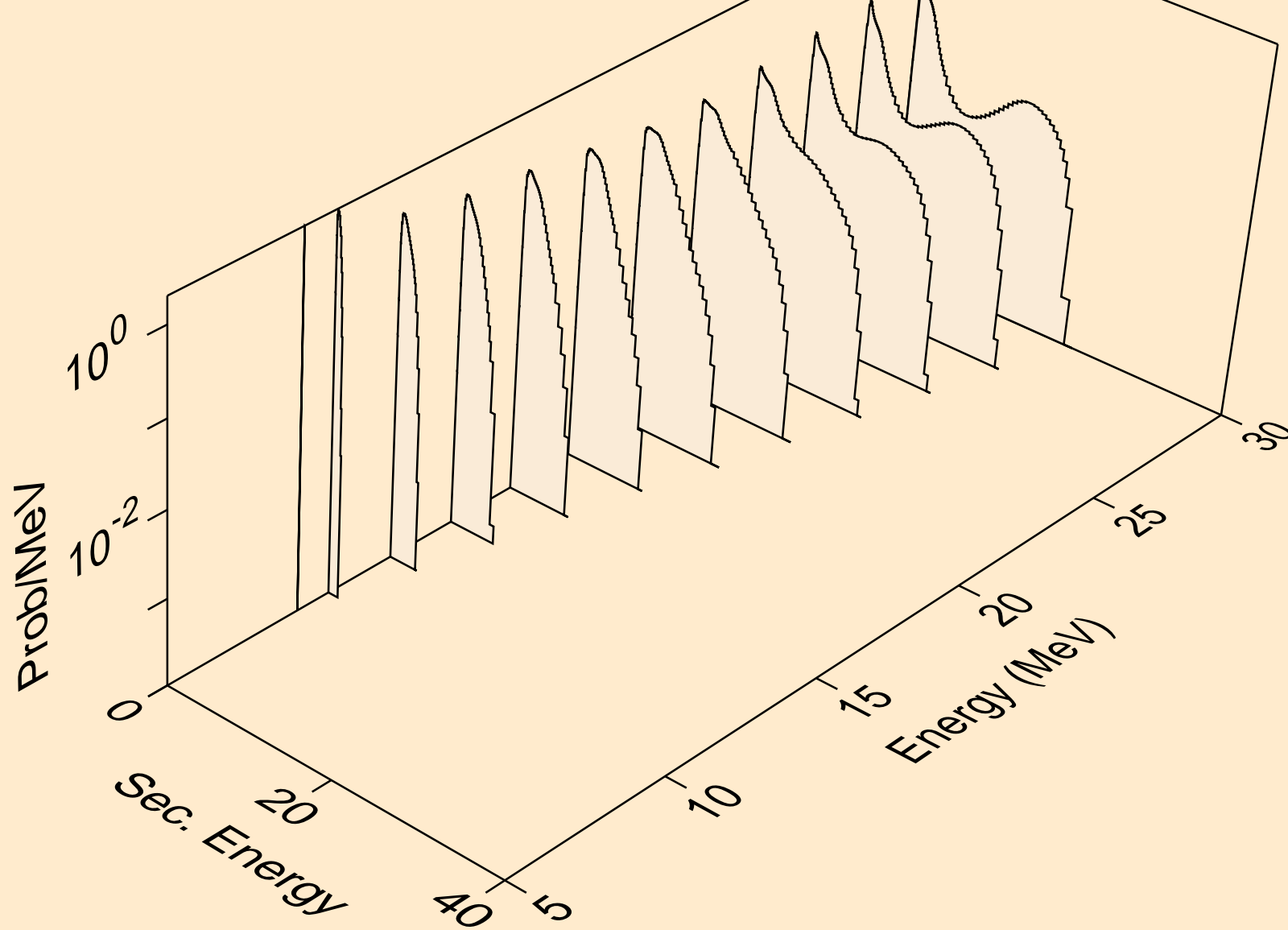

AT221 PROTON ACER TENDL-2021 LIBRARY; T=0.K  
neutrons from (p,n\*)a

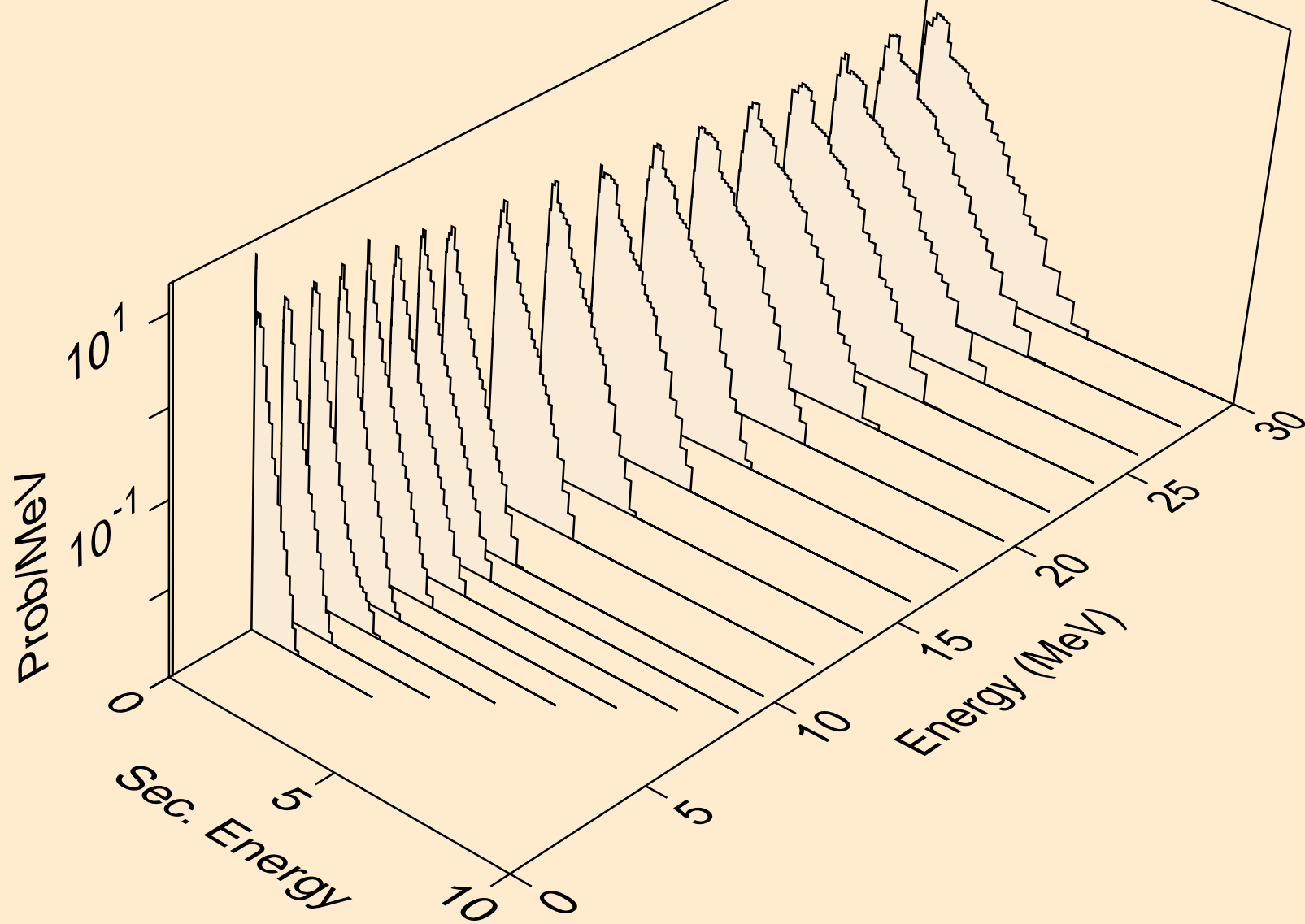

AT221 PROTON ACER TENDL-2021 LIBRARY; T=0.K  
neutrons from (p,2n)a

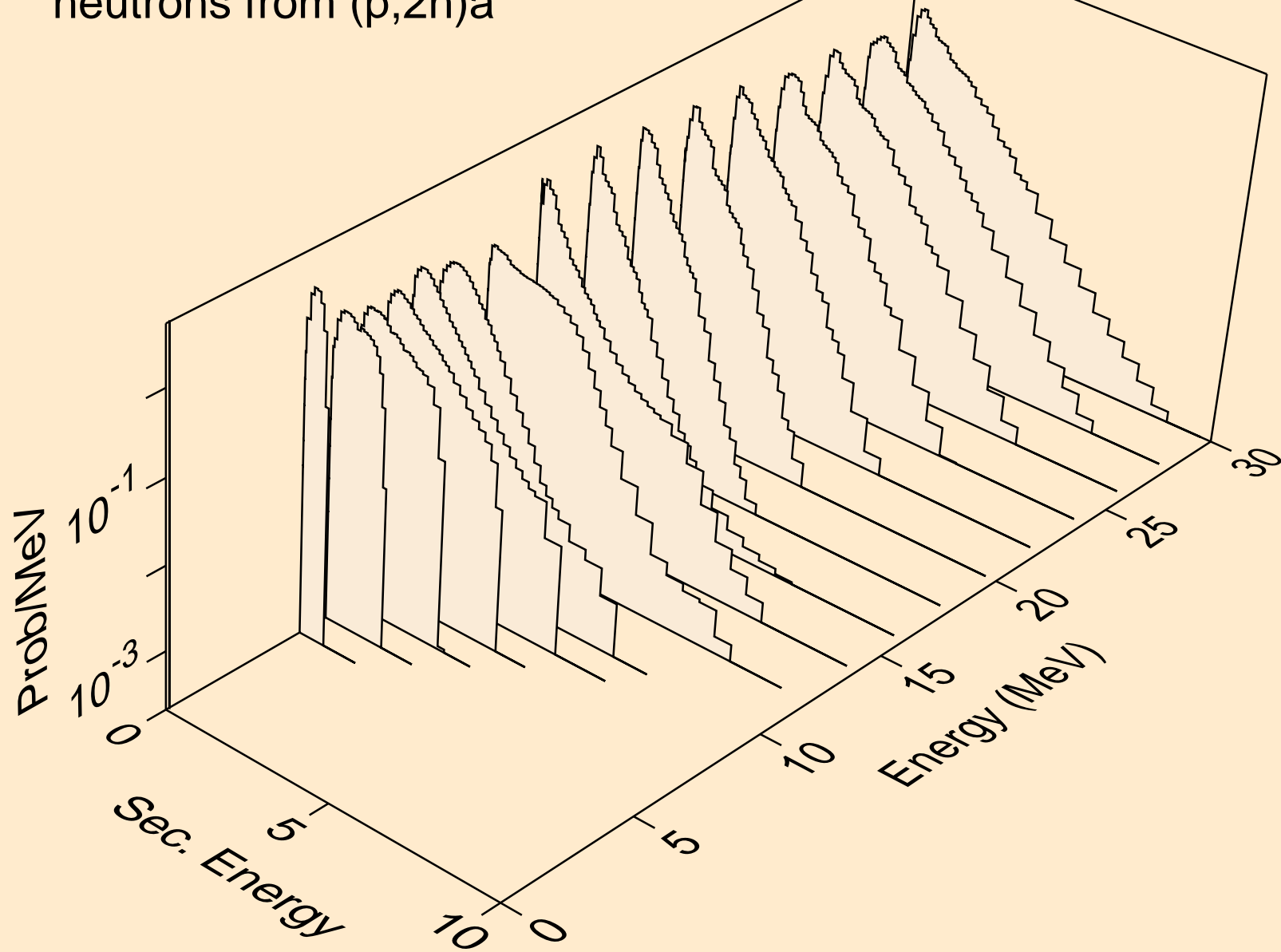

AT221 PROTON ACER TENDL-2021 LIBRARY; T=0.K  
neutrons from (p,3n)a

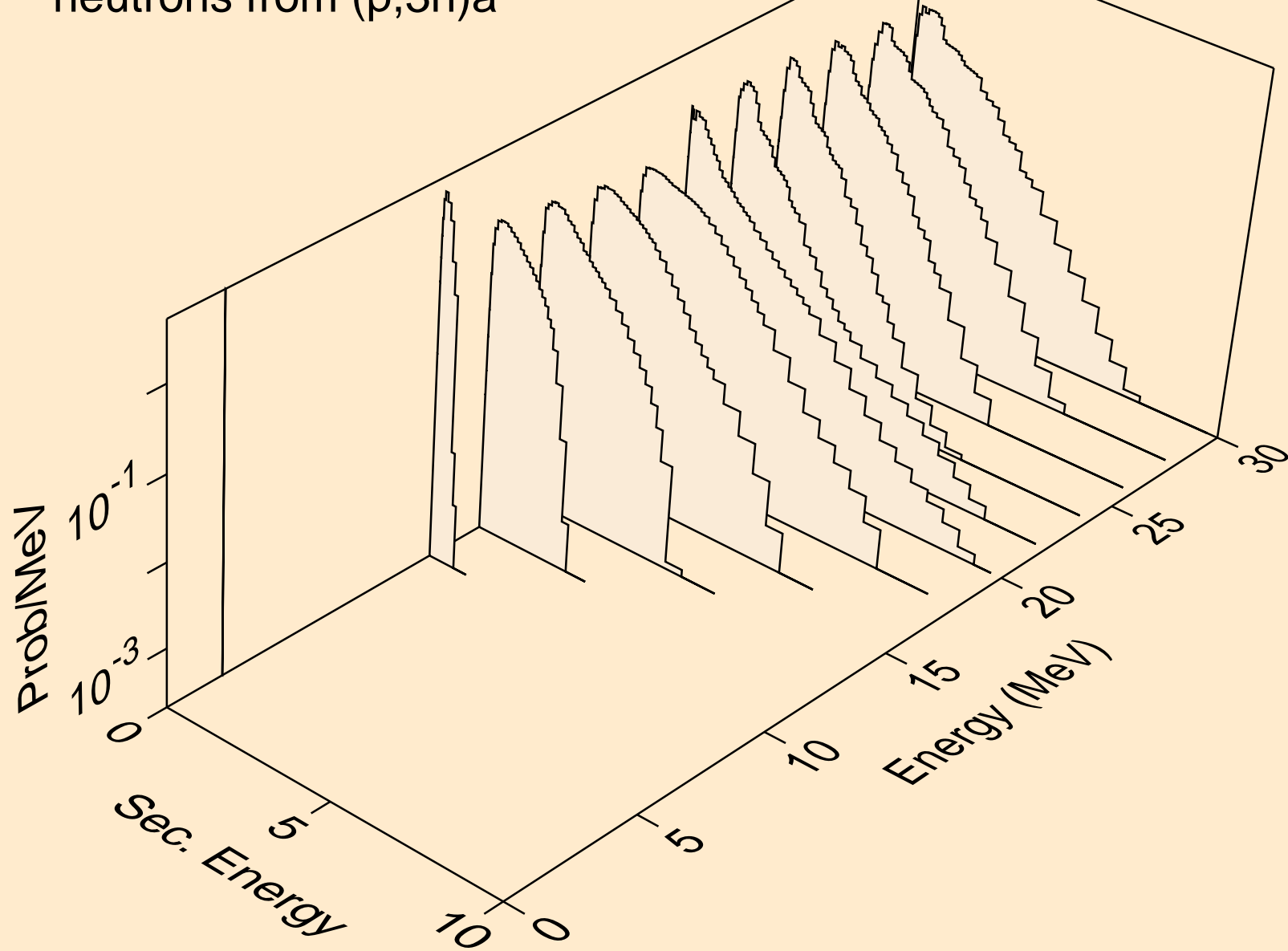

AT221 PROTON ACER TENDL-2021 LIBRARY; T=0.K  
neutrons from (p,n\*)p

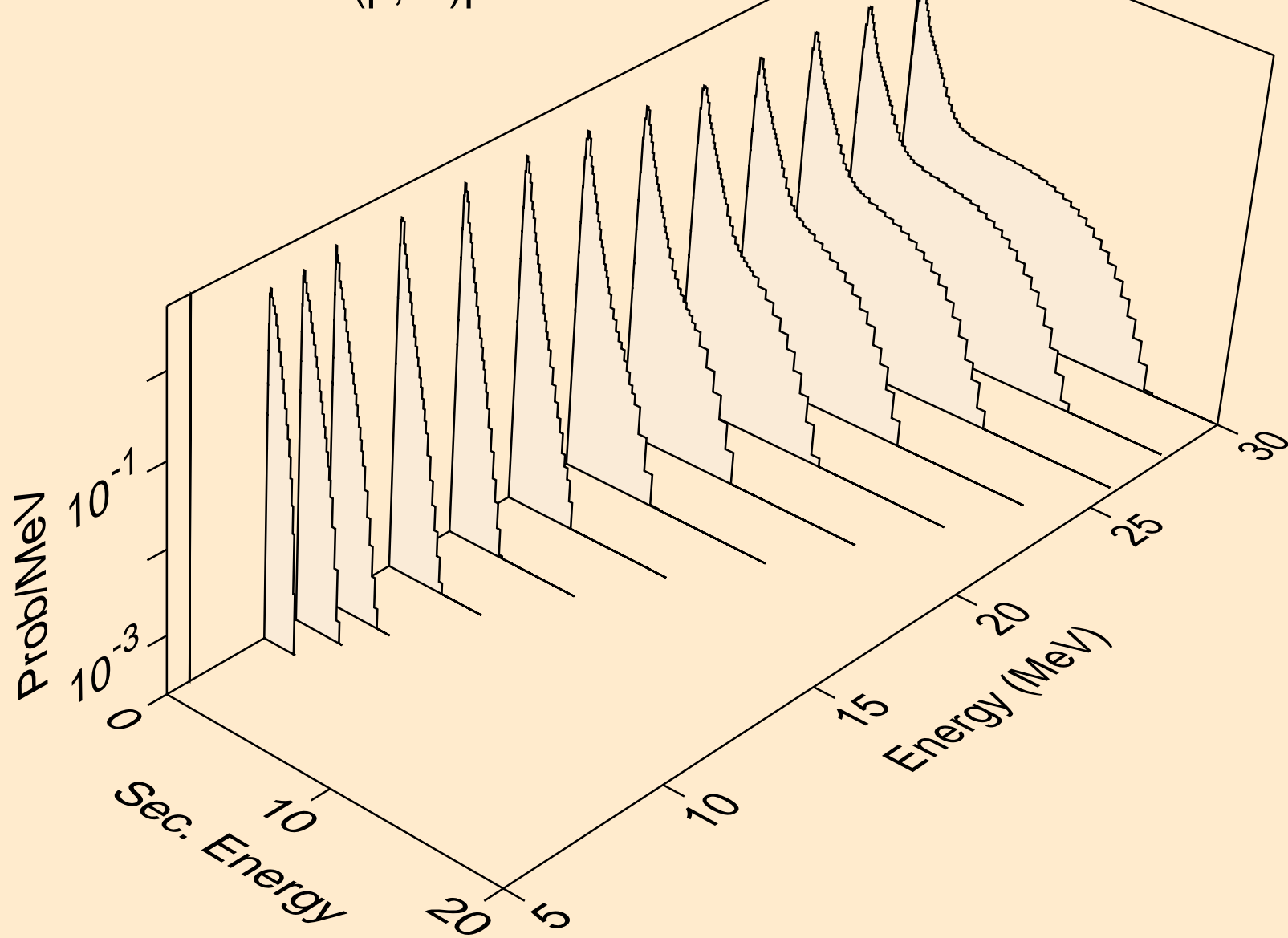

AT221 PROTON ACER TENDL-2021 LIBRARY; T=0.K  
neutrons from (p,n\*)2a

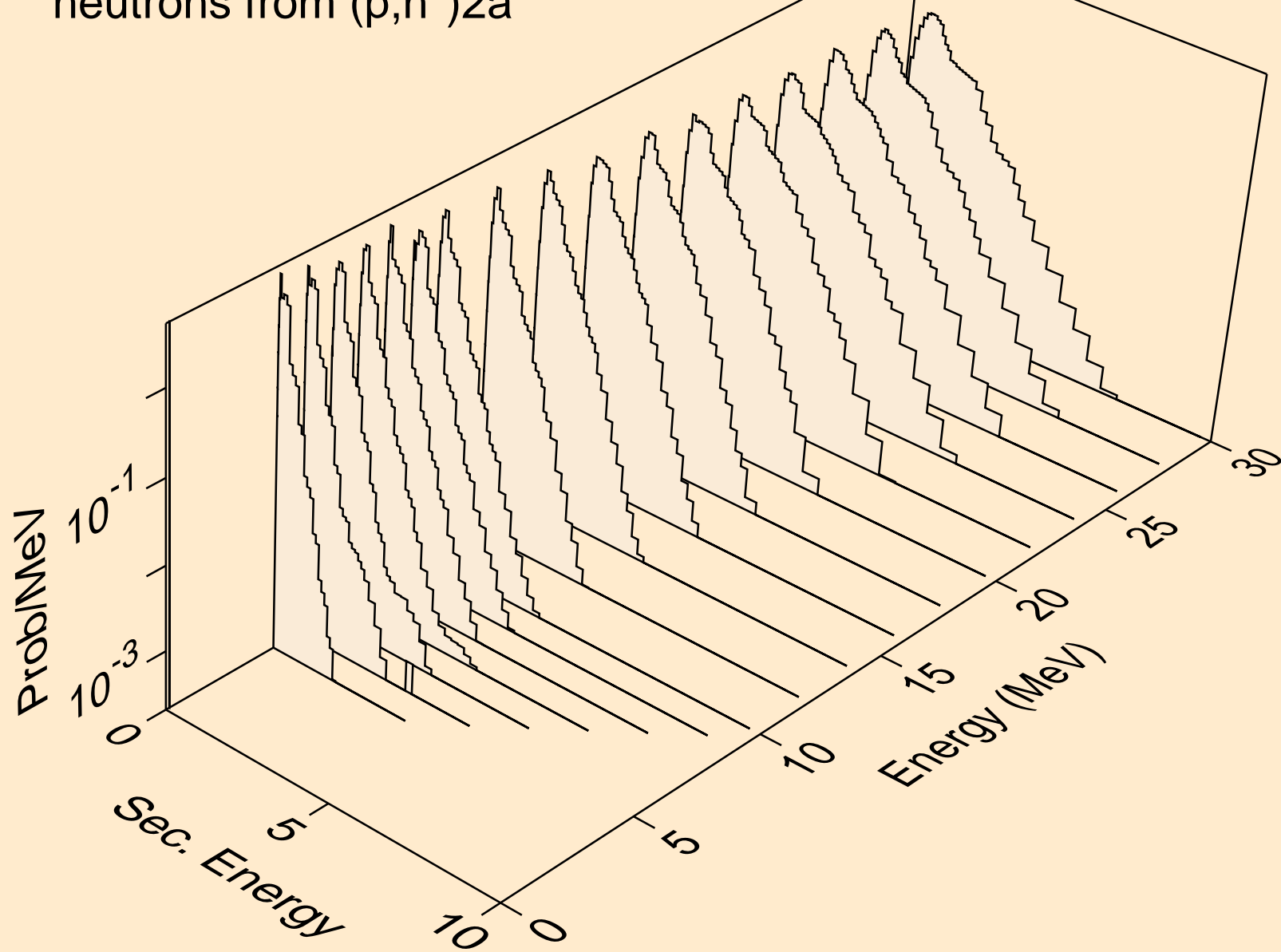

AT221 PROTON ACER TENDL-2021 LIBRARY; T=0.K  
neutrons from (p,2n)2a

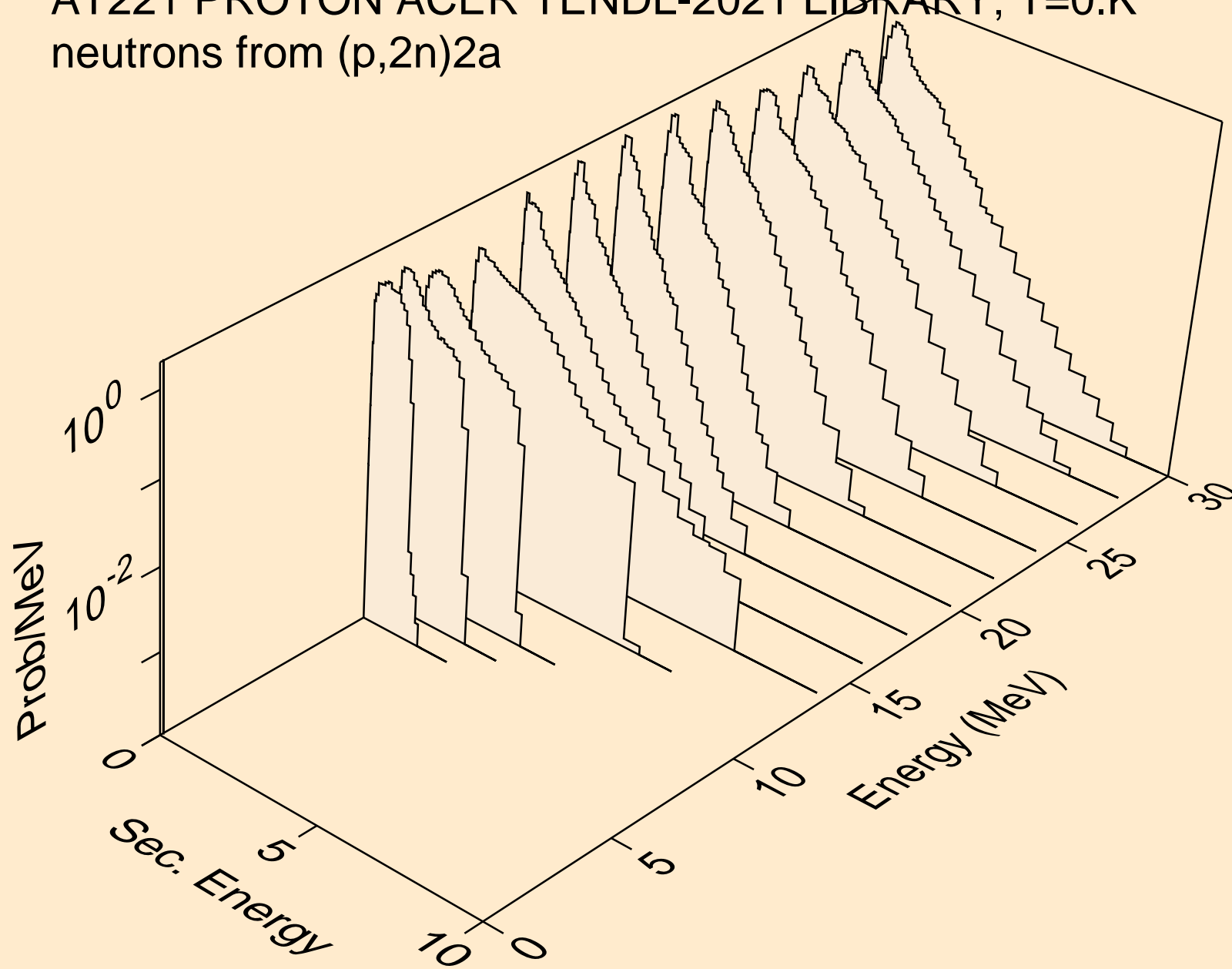

AT221 PROTON ACER TENDL-2021 LIBRARY; T=0.K  
neutrons from (p,n\*)d

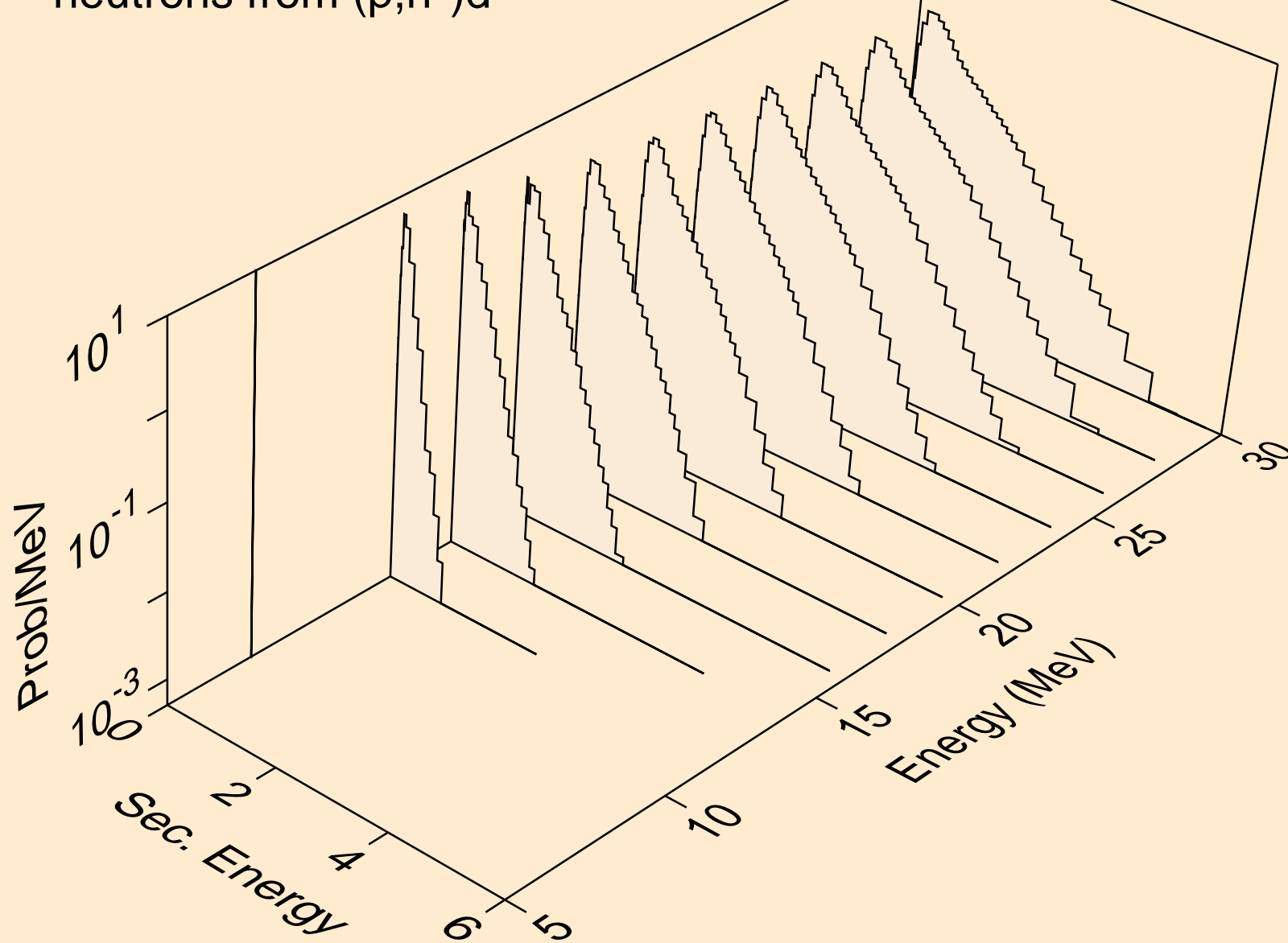



AT221 PROTON ACER TENDL-2021 LIBRARY; T=0.K  
neutrons from (p,n\*)t

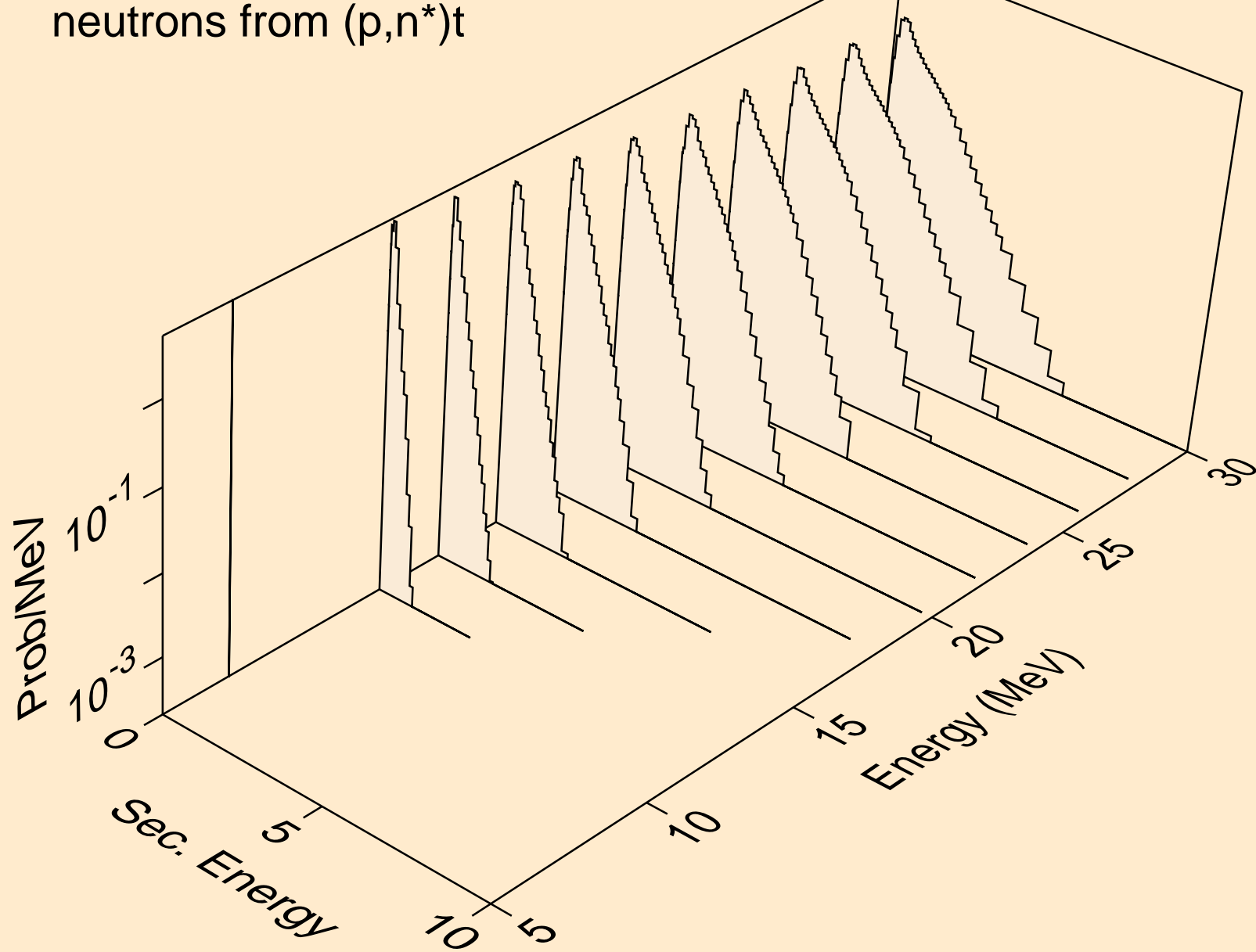

AT221 PROTON ACER TENDL-2021 LIBRARY; T=0.K  
neutrons from (p,n\*)he3

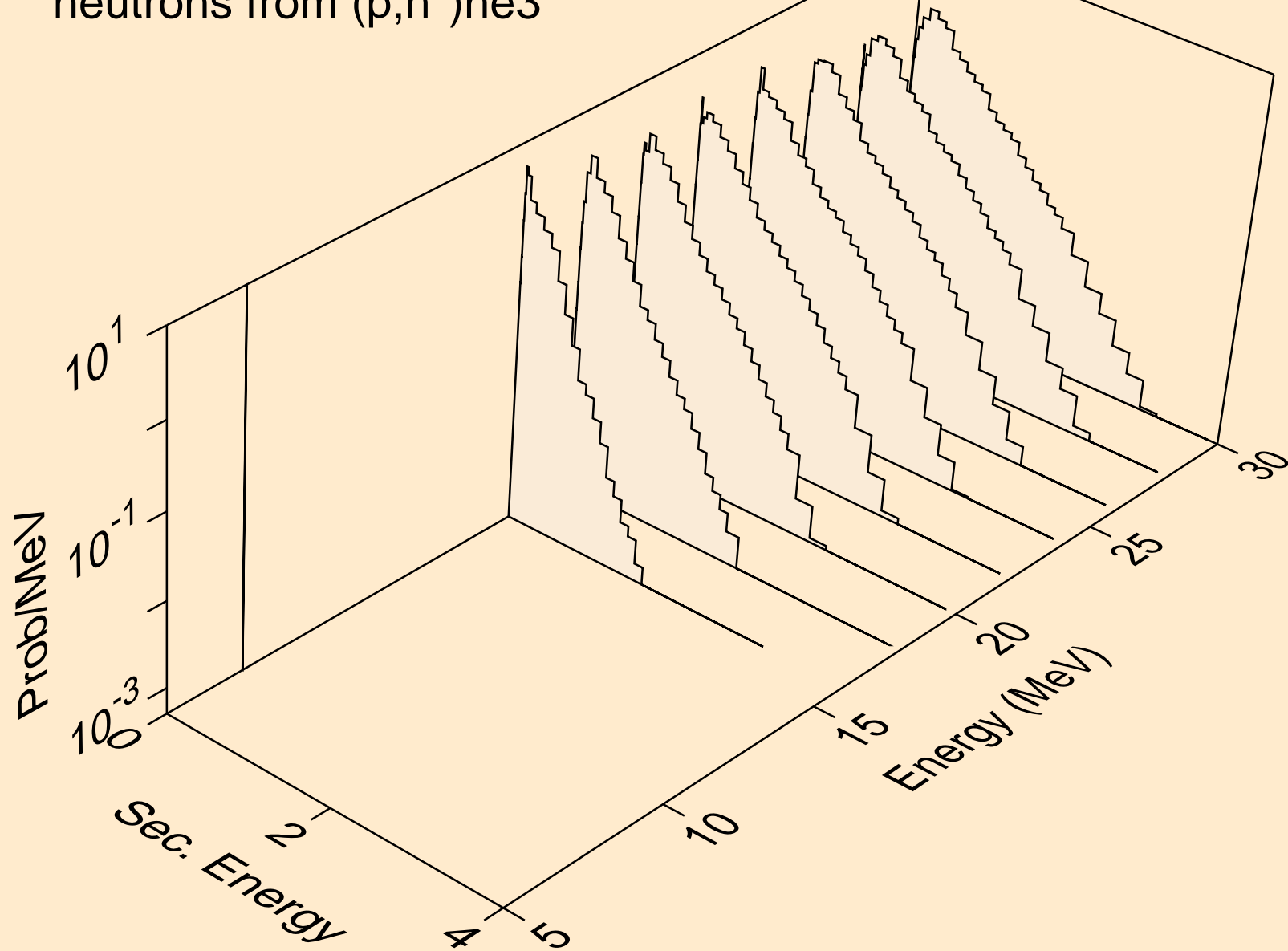

AT221 PROTON ACER TENDL-2021 LIBRARY; T=0.K  
neutrons from (p,4n)

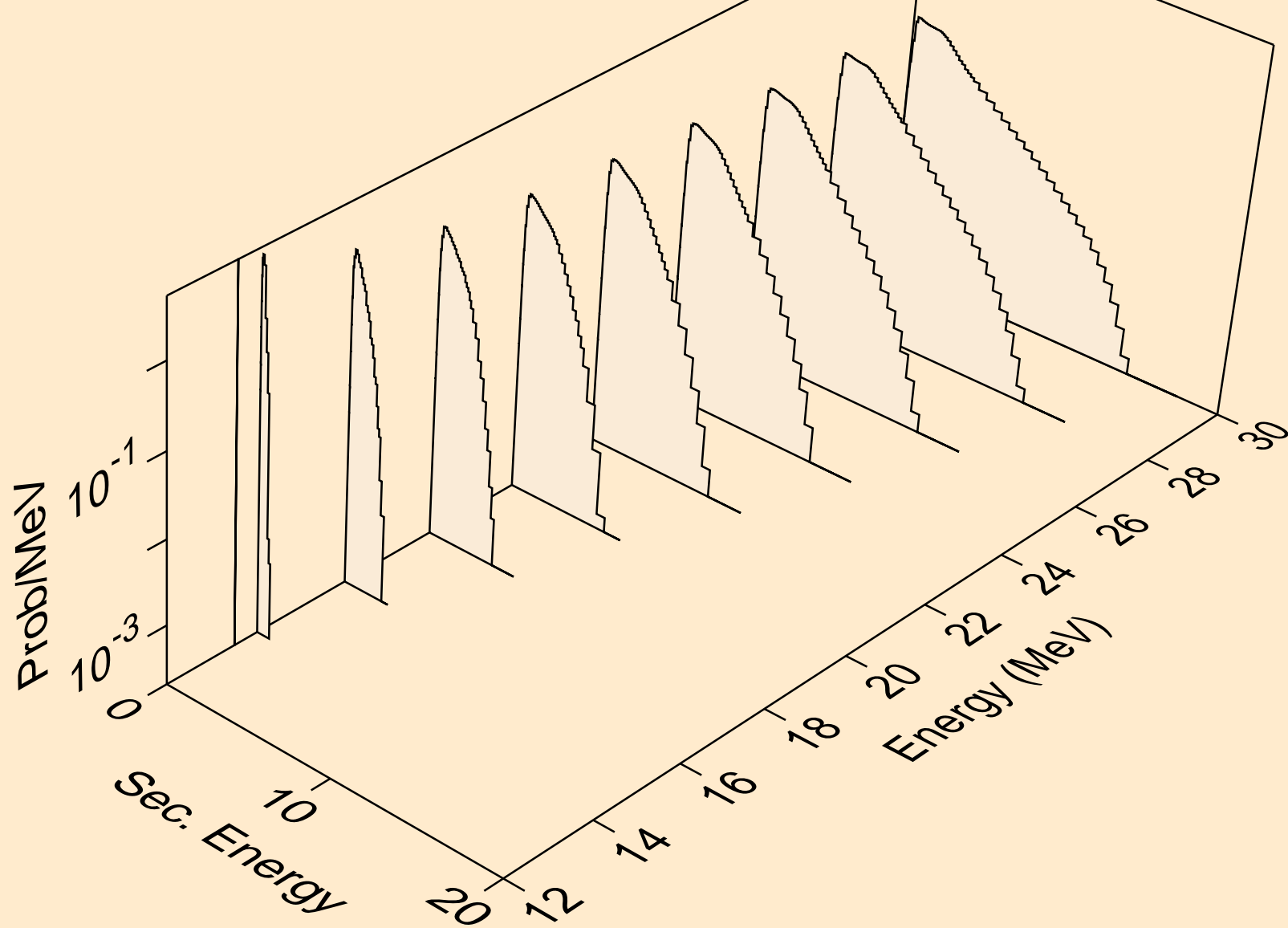

AT221 PROTON ACER TENDL-2021 LIBRARY; T=0.K  
neutrons from (p,2np)

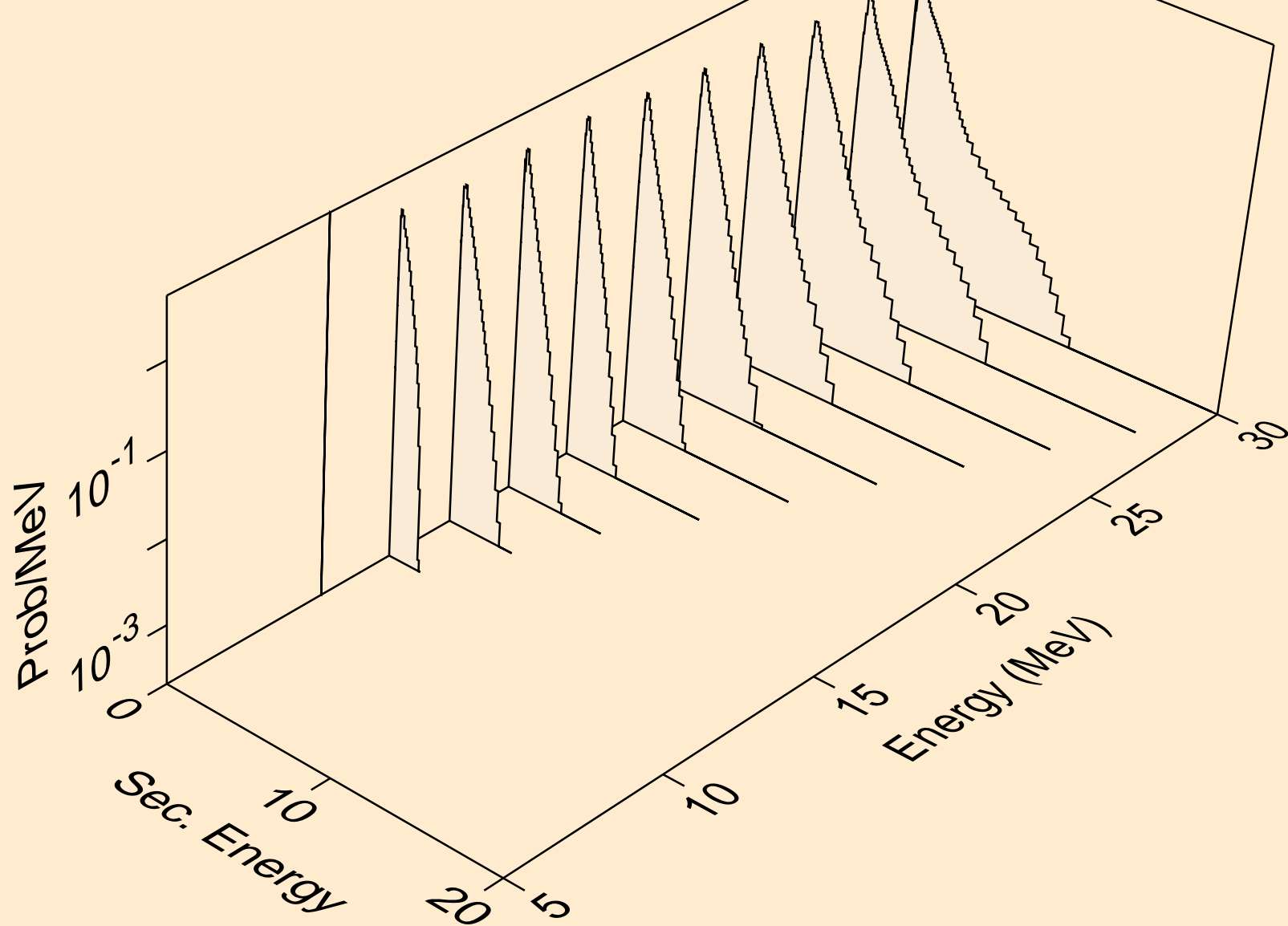

AT221 PROTON ACER TENDL-2021 LIBRARY; T=0.K  
neutrons from (p,3np)

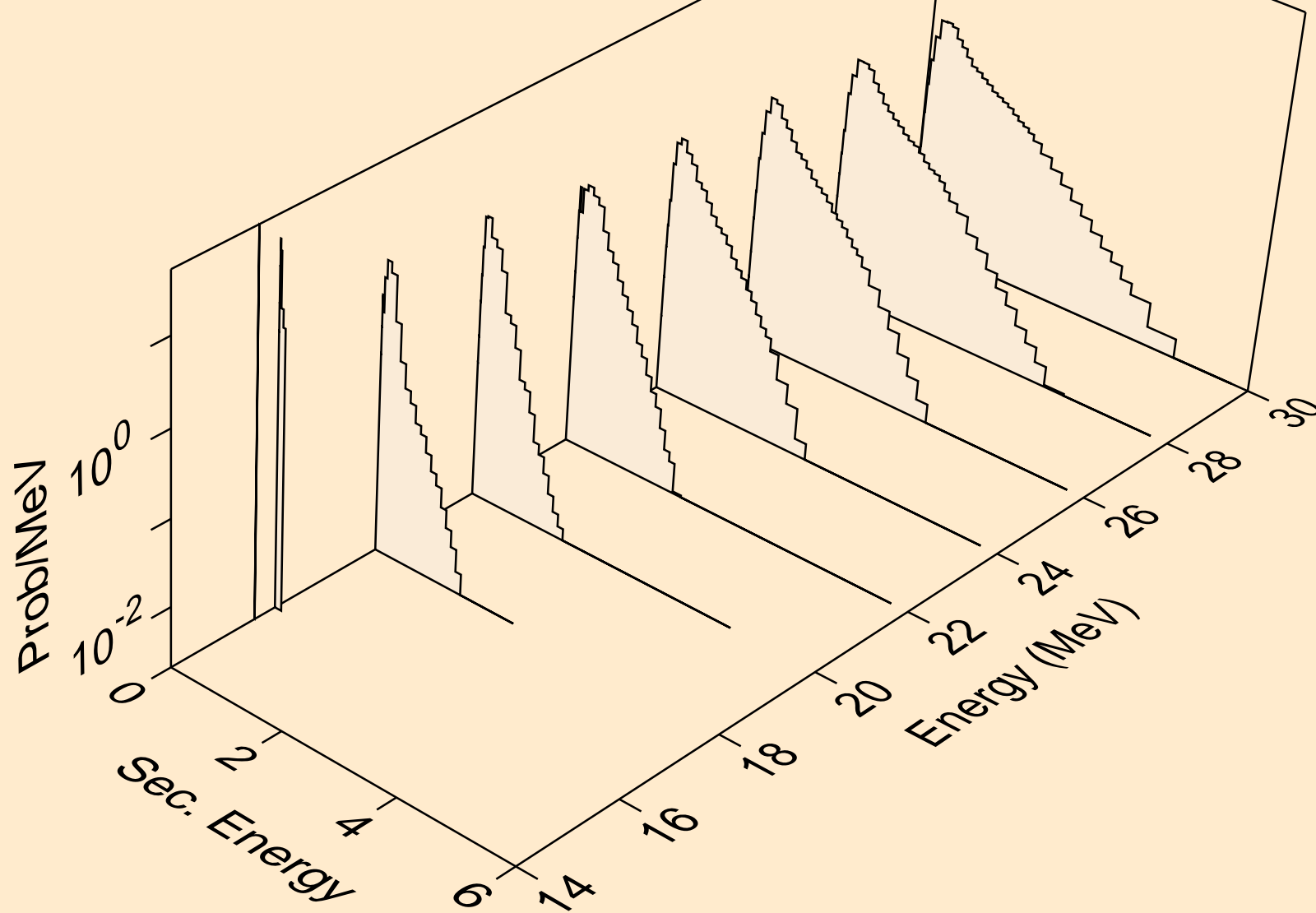

AT221 PROTON ACER TENDL-2021 LIBRARY; T=0.K  
neutrons from (p,2np)

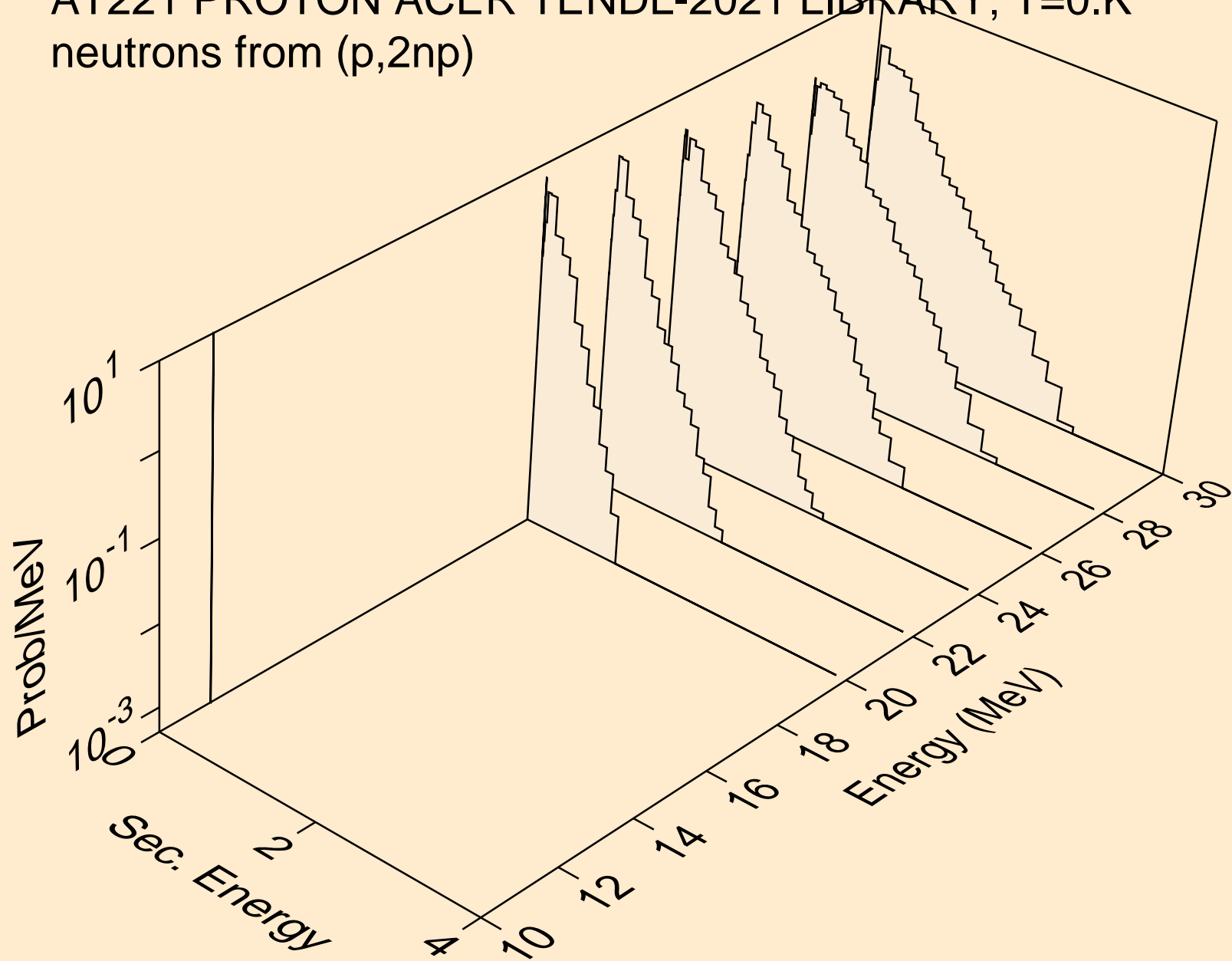

AT221 PROTON ACER TENDL-2021 LIBRARY; T=0.K  
neutrons from (p,npa)

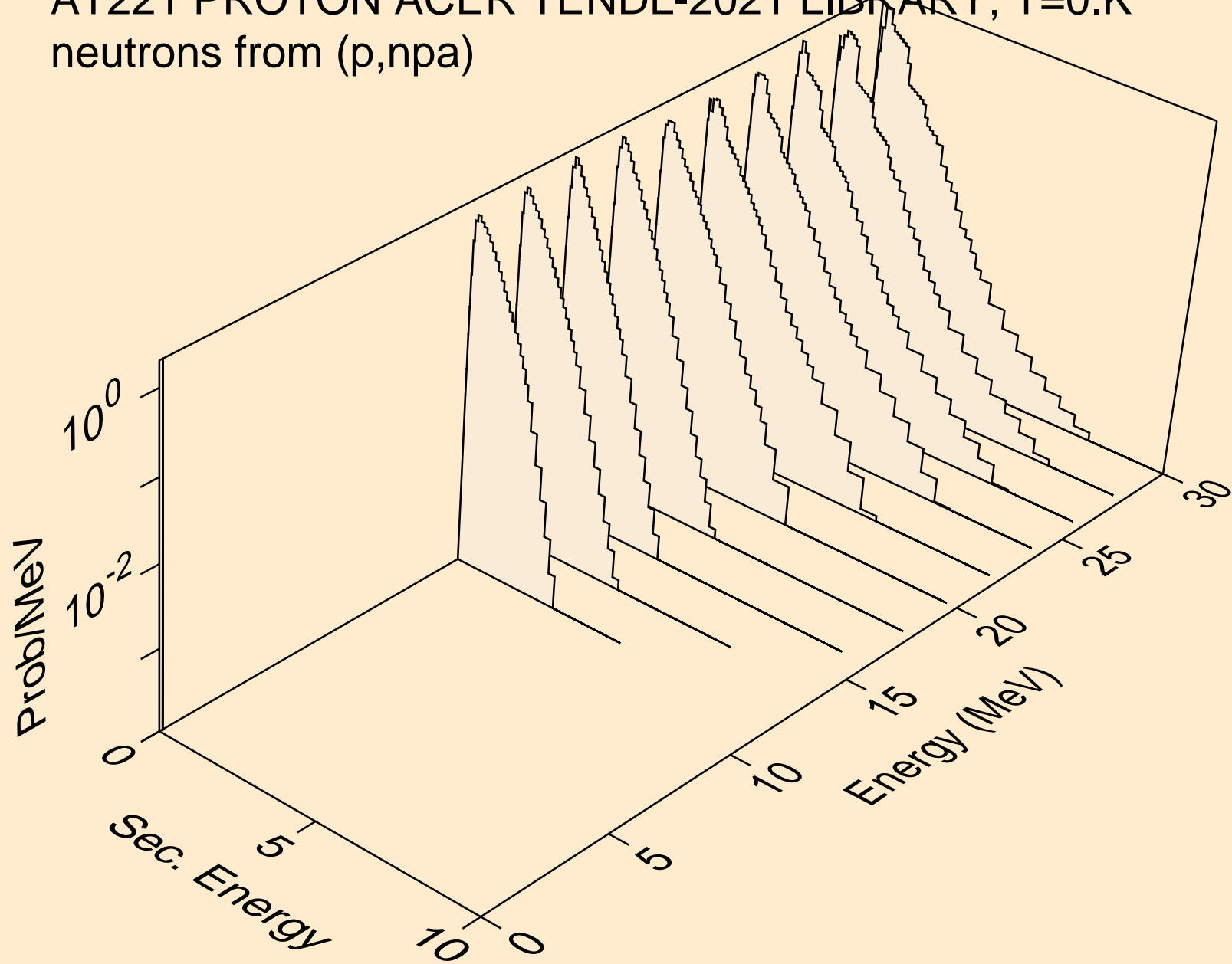

AT221 PROTON ACER TENDL-2021 LIBRARY; T=0.K  
deuterons from (p,x)

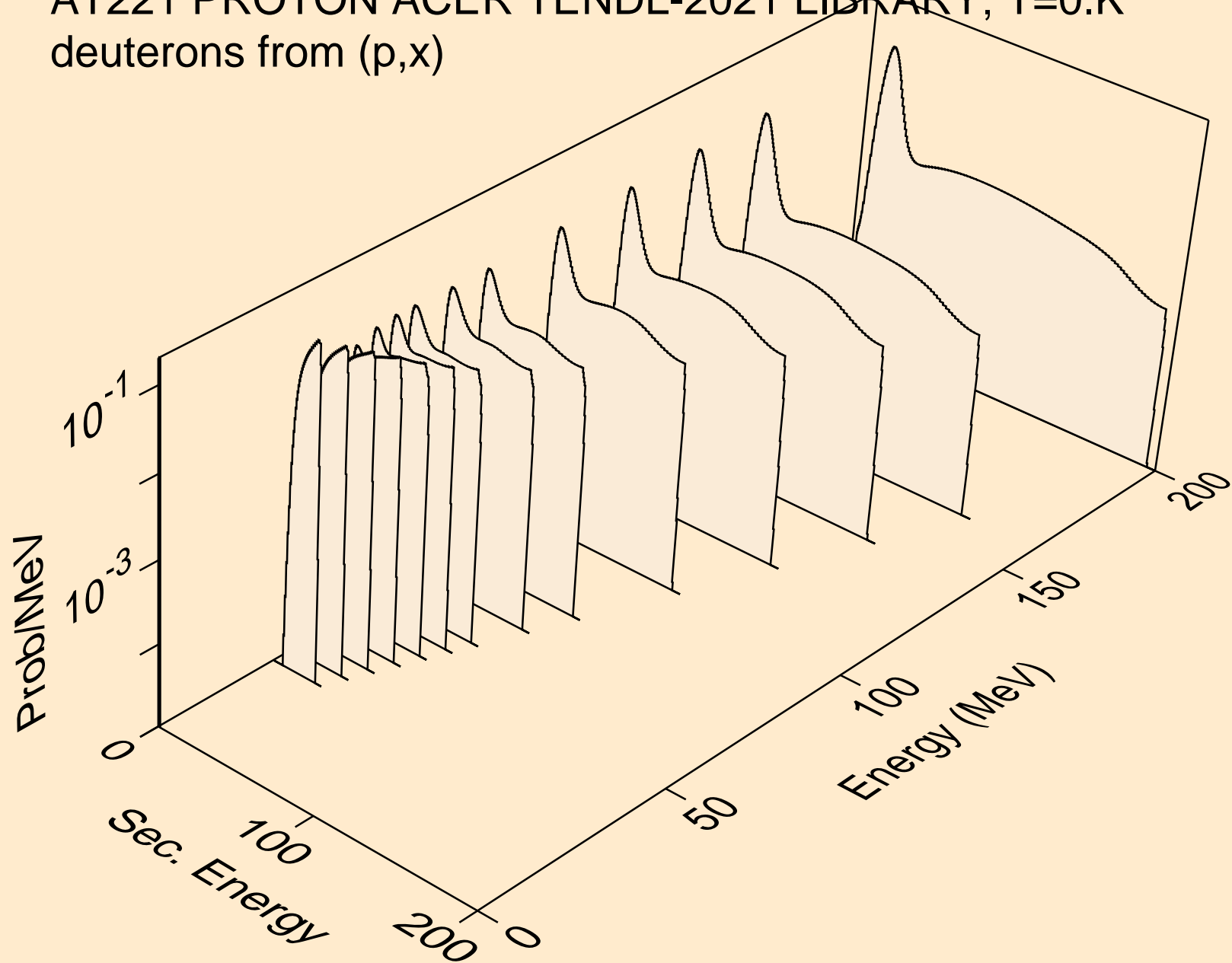



AT221 PROTON ACER TENDL-2021 LIBRARY; T=0.K  
deuterons from (p,2nd)

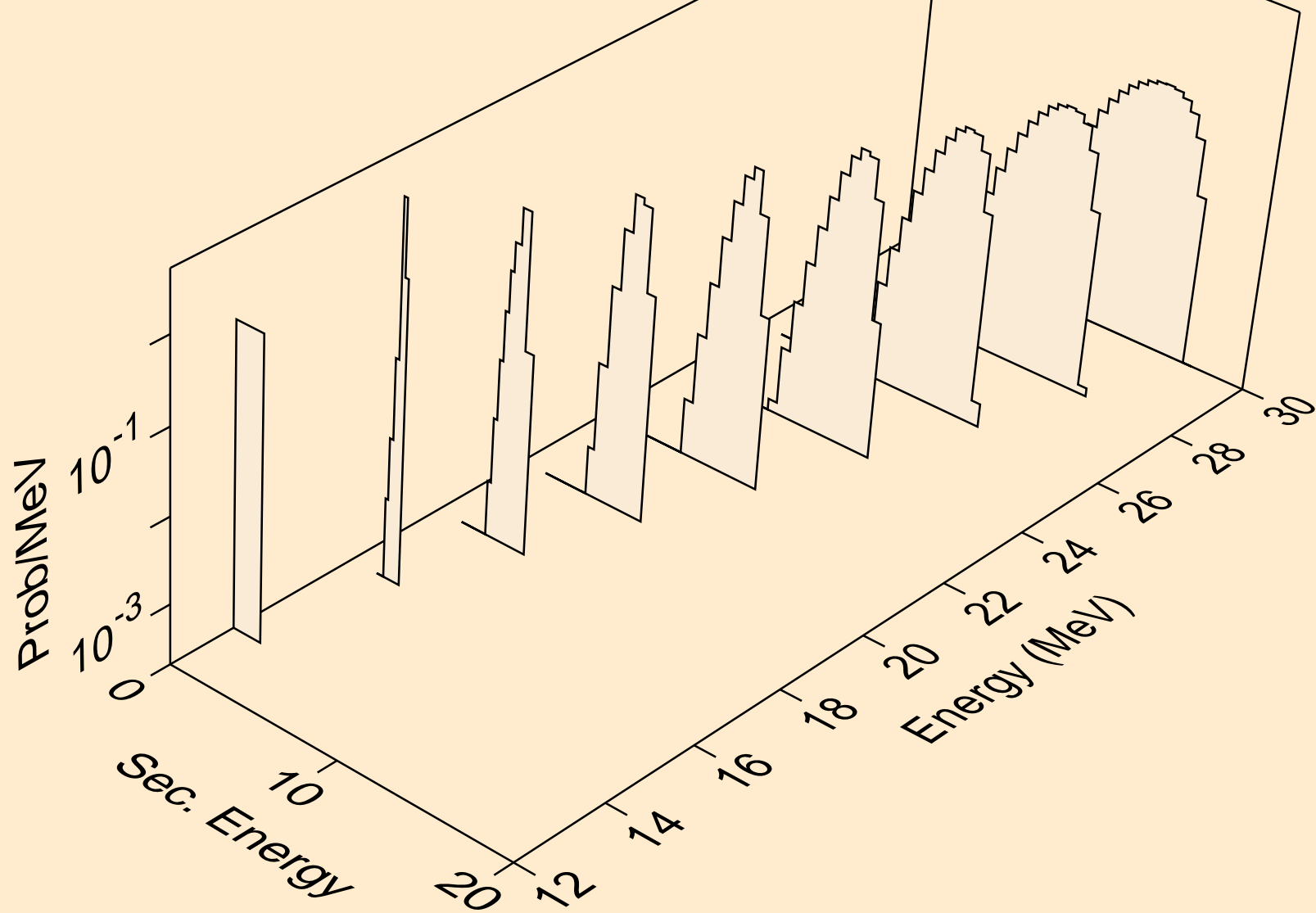

AT221 PROTON ACER TENDL-2021 LIBRARY; T=0.K  
deuterons from (p,n\*)d

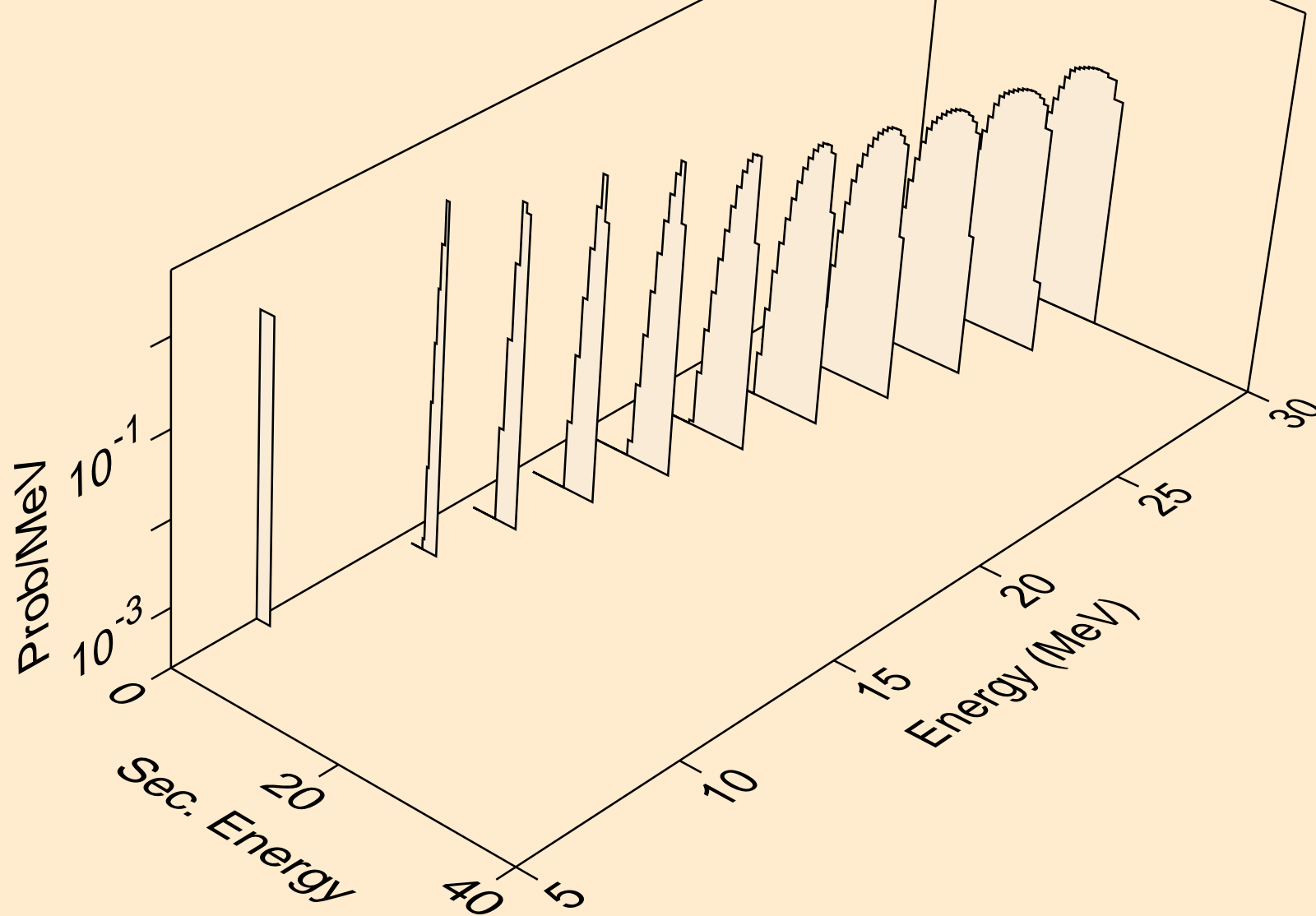

AT221 PROTON ACER TENDL-2021 LIBRARY; T=0.K  
deuterons from (p,d)

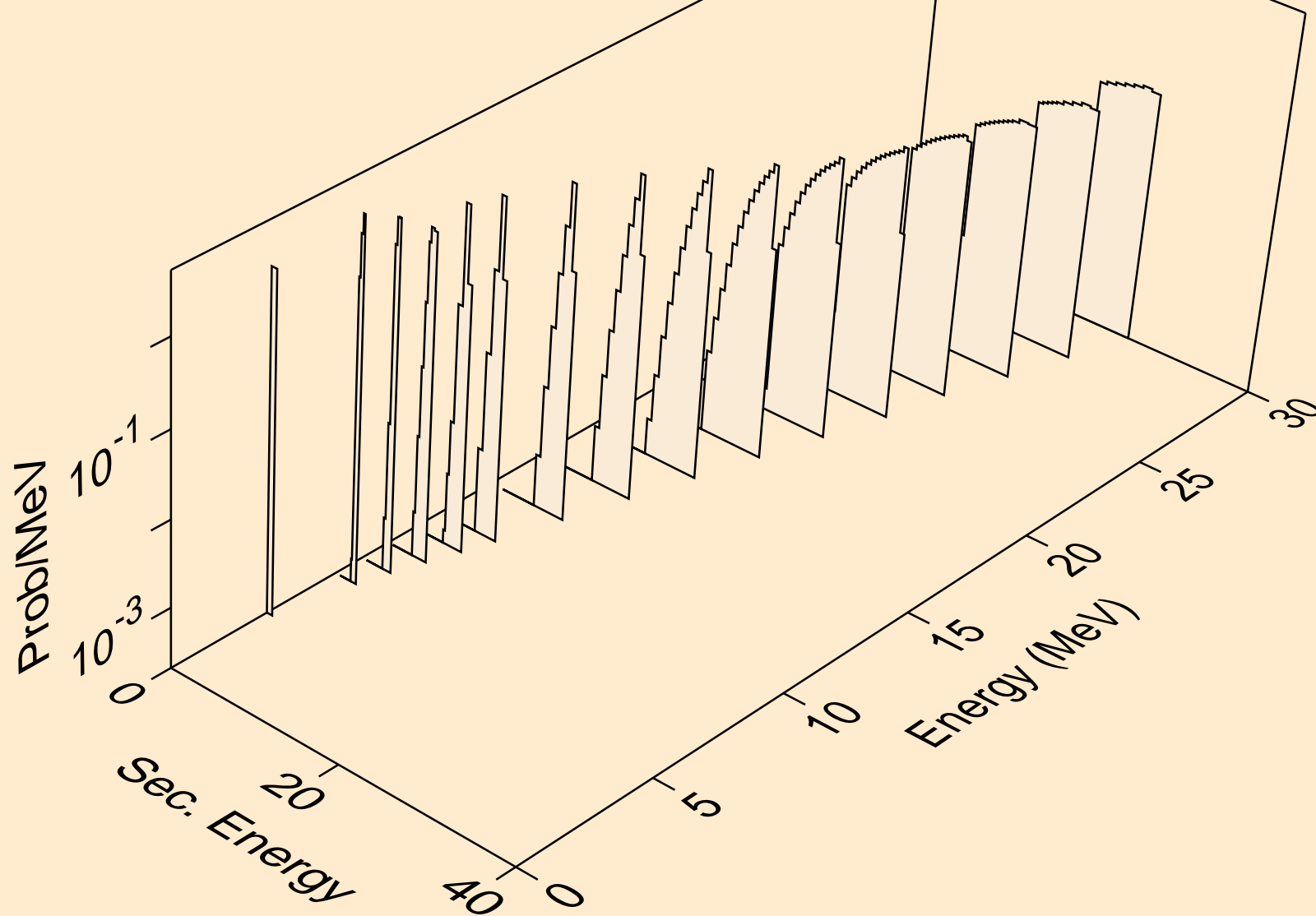

AT221 PROTON ACER TENDL-2021 LIBRARY; T=0.K  
deuterons from (p,pd)

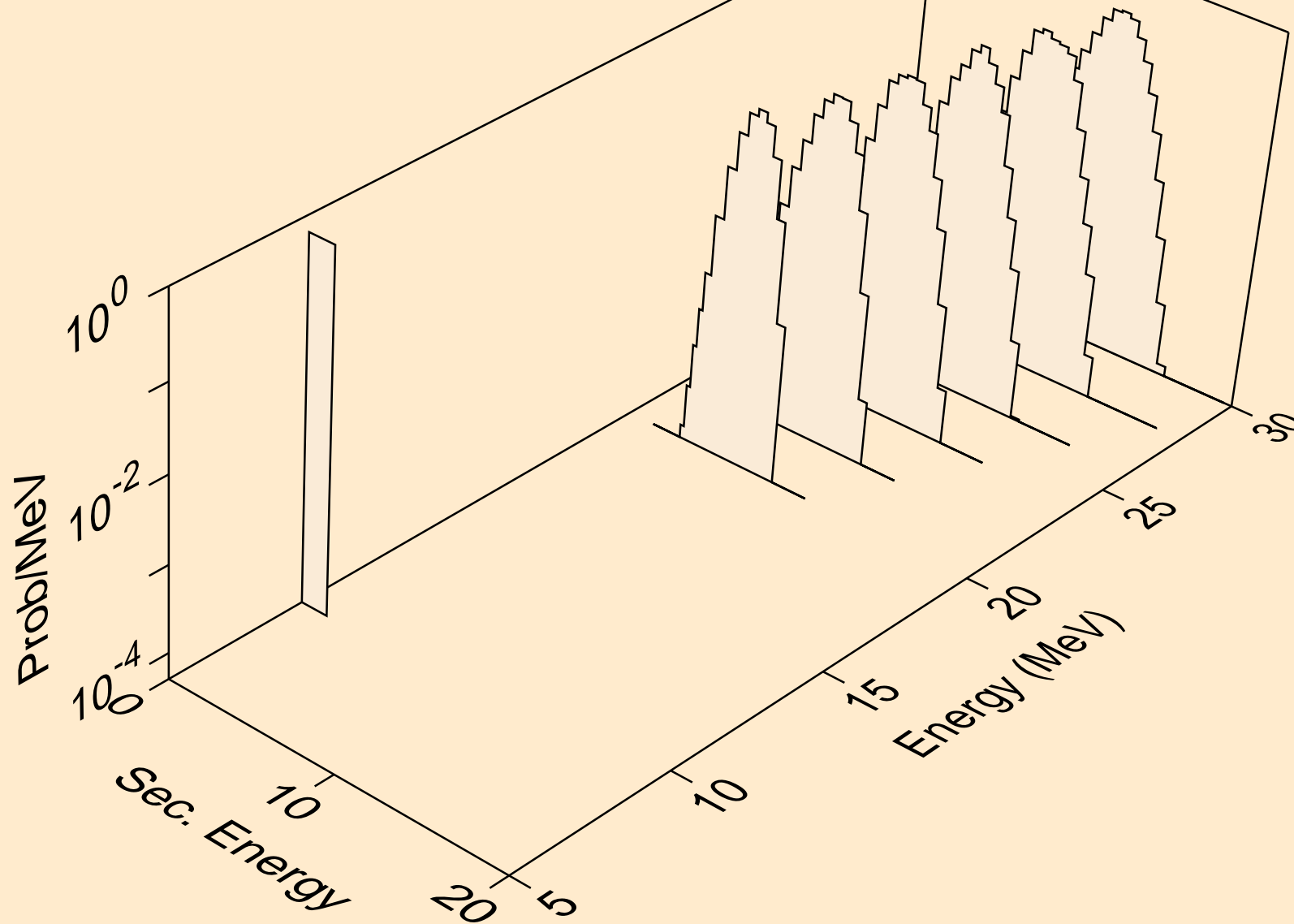

AT221 PROTON ACER TENDL-2021 LIBRARY; T=0.K  
deuterons from (p,da)

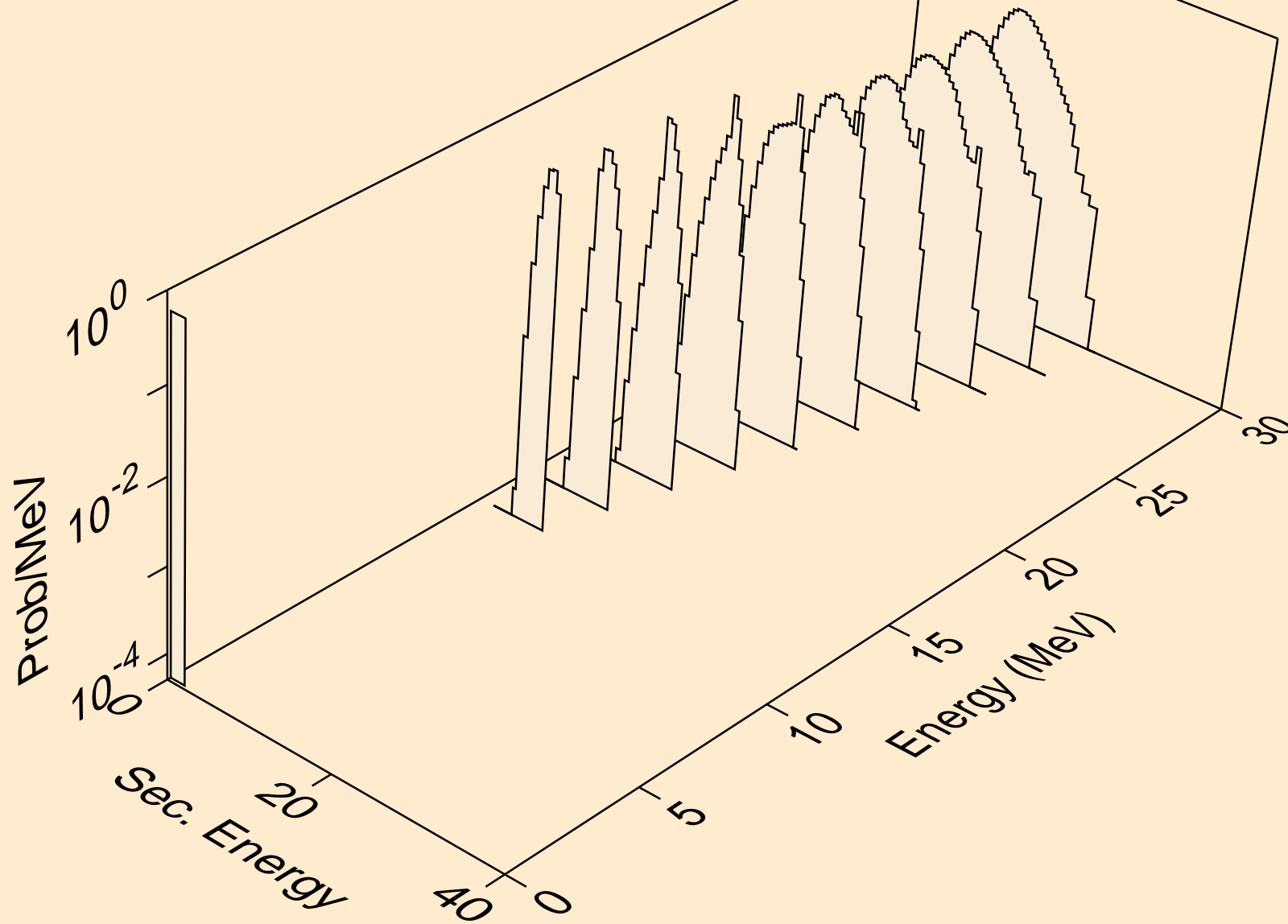

AT221 PROTON ACER TENDL-2021 LIBRARY; T=0.K  
tritons from (p,x)

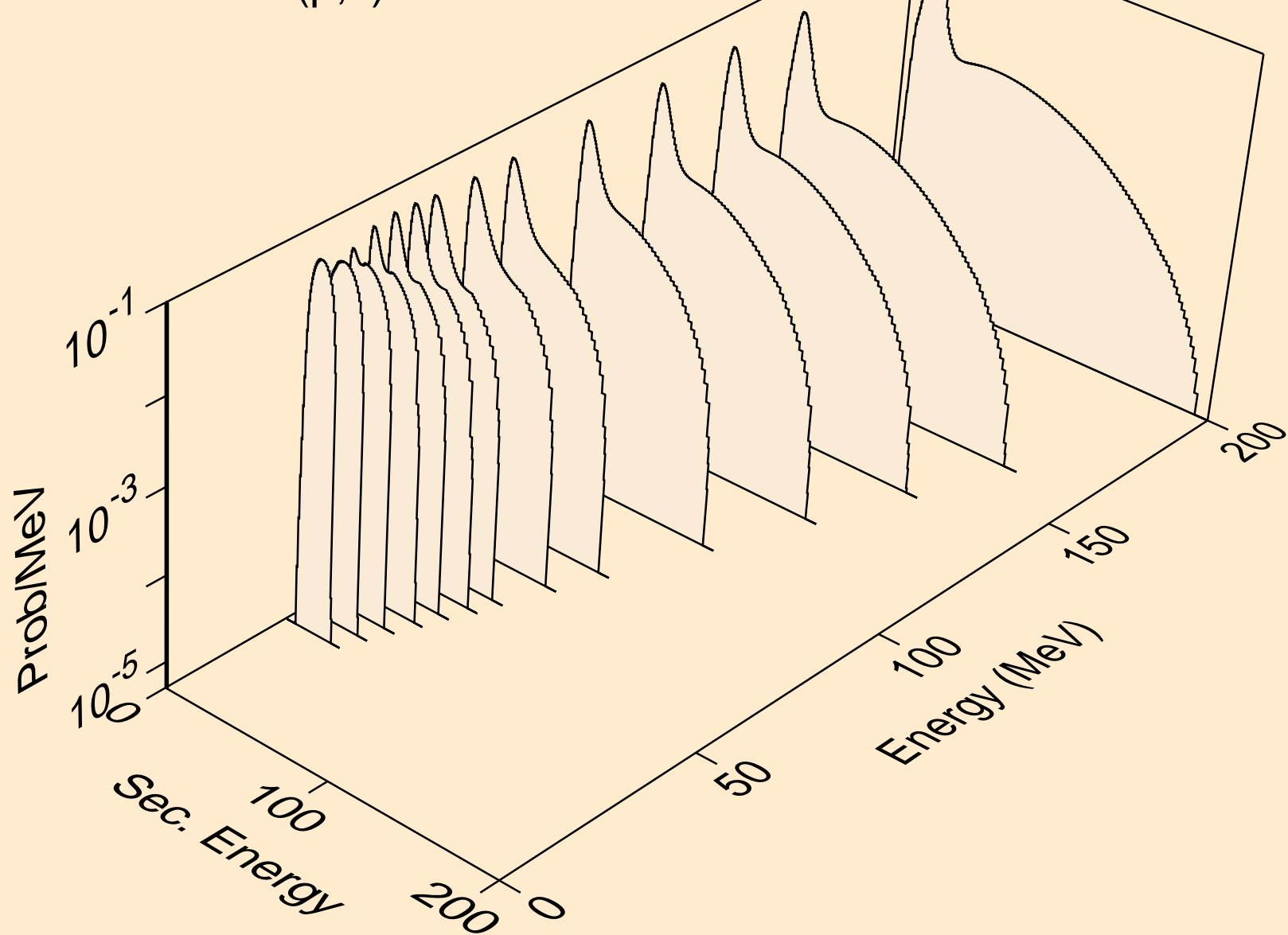

AT221 PROTON ACER TENDL-2021 LIBRARY; T=0.K  
tritons from (p,n\*)t

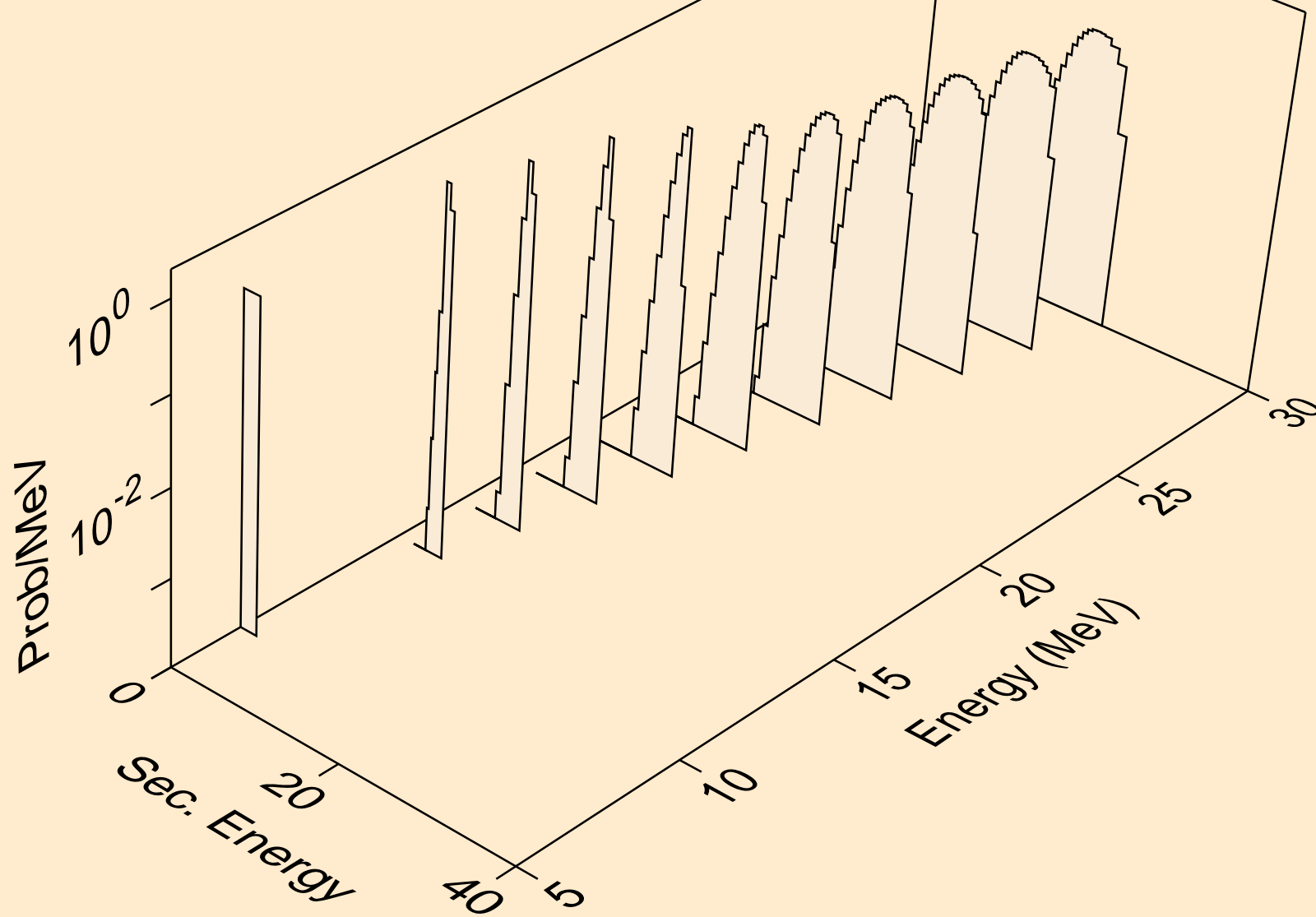

AT221 PROTON ACER TENDL-2021 LIBRARY; T=0.K  
tritons from (p,t)

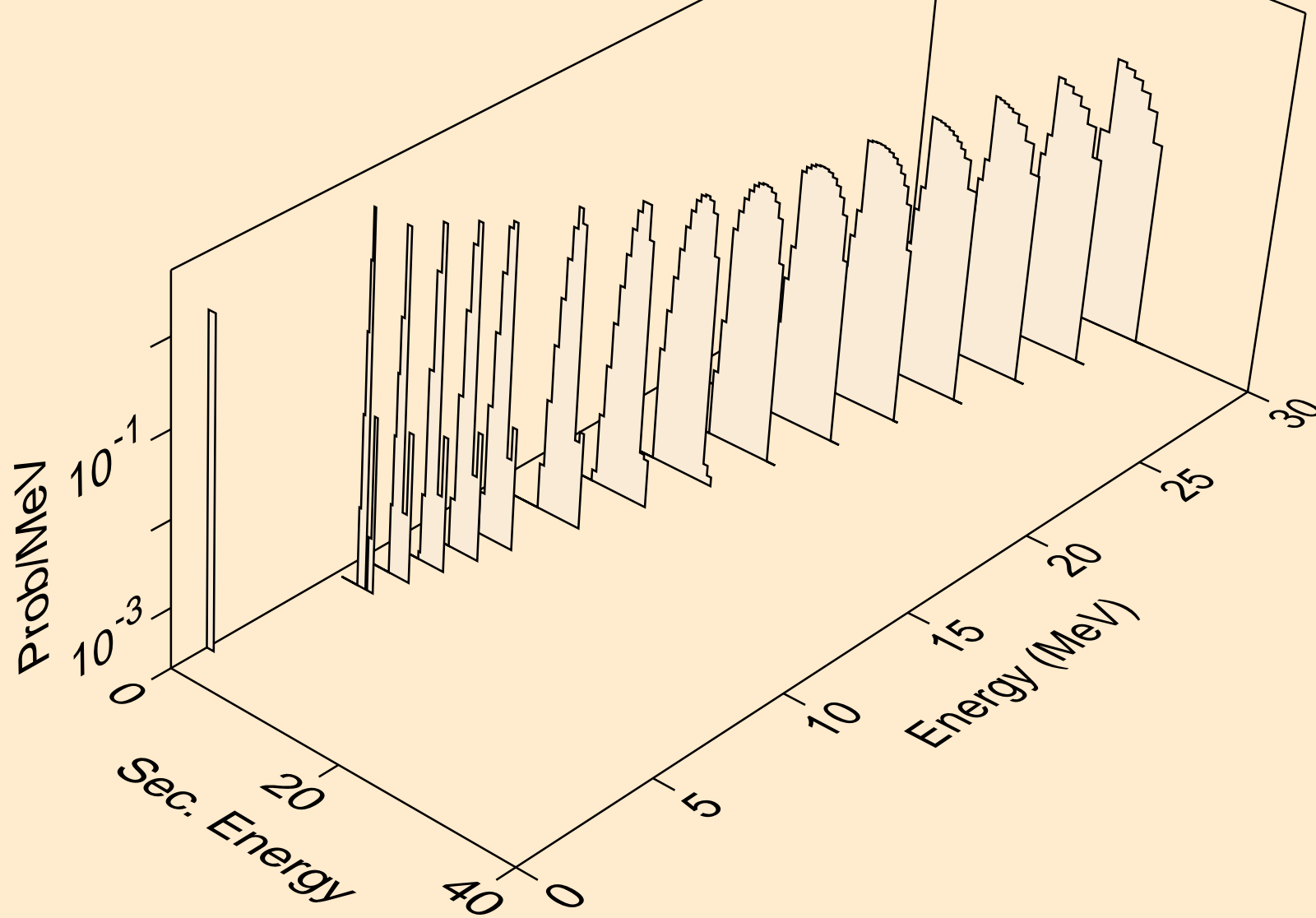



AT221 PROTON ACER TENDL-2021 LIBRARY; T=0.K  
he3s from (p,x)

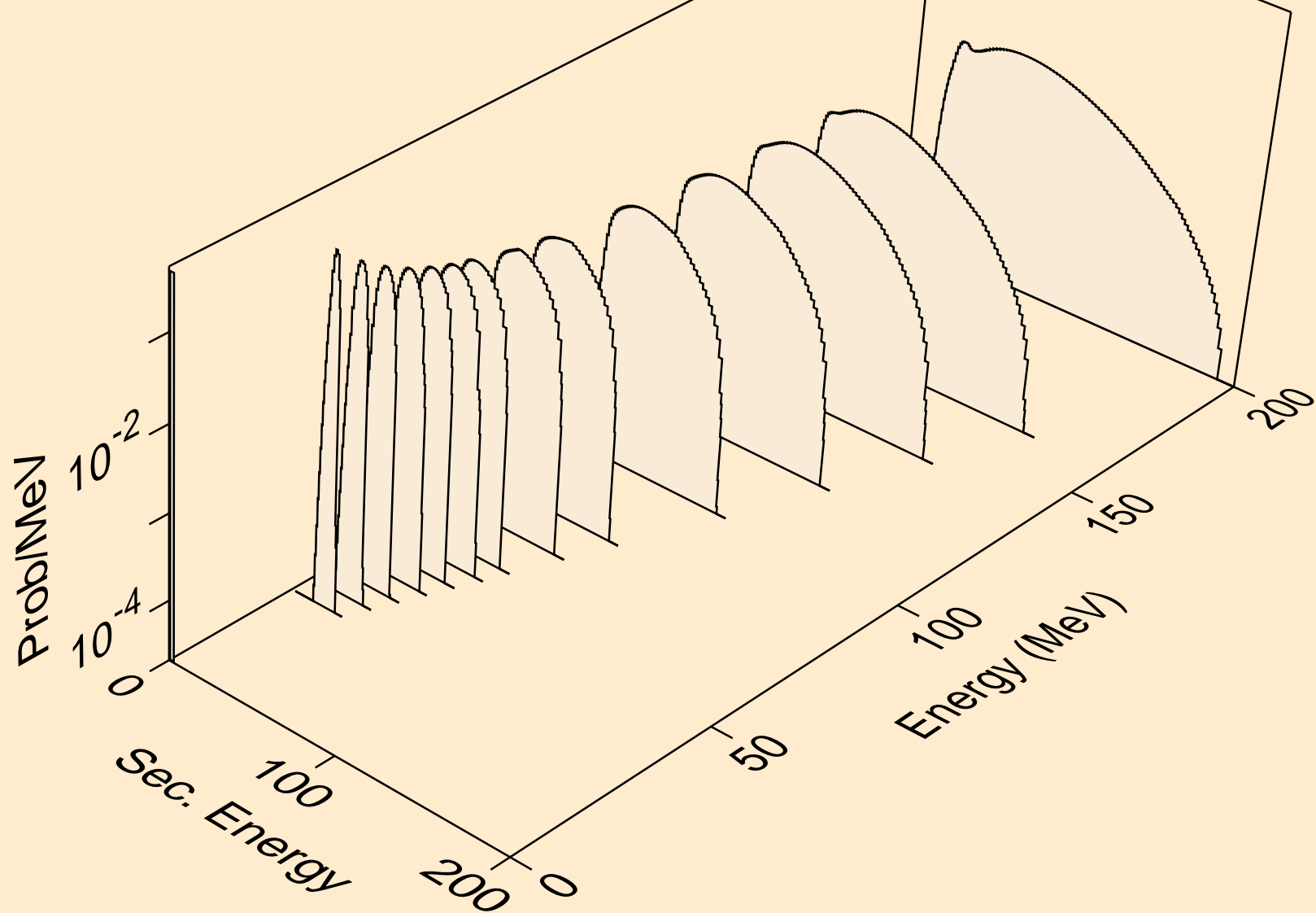

AT221 PROTON ACER TENDL-2021 LIBRARY; T=0.K  
he3s from (p,n\*)he3

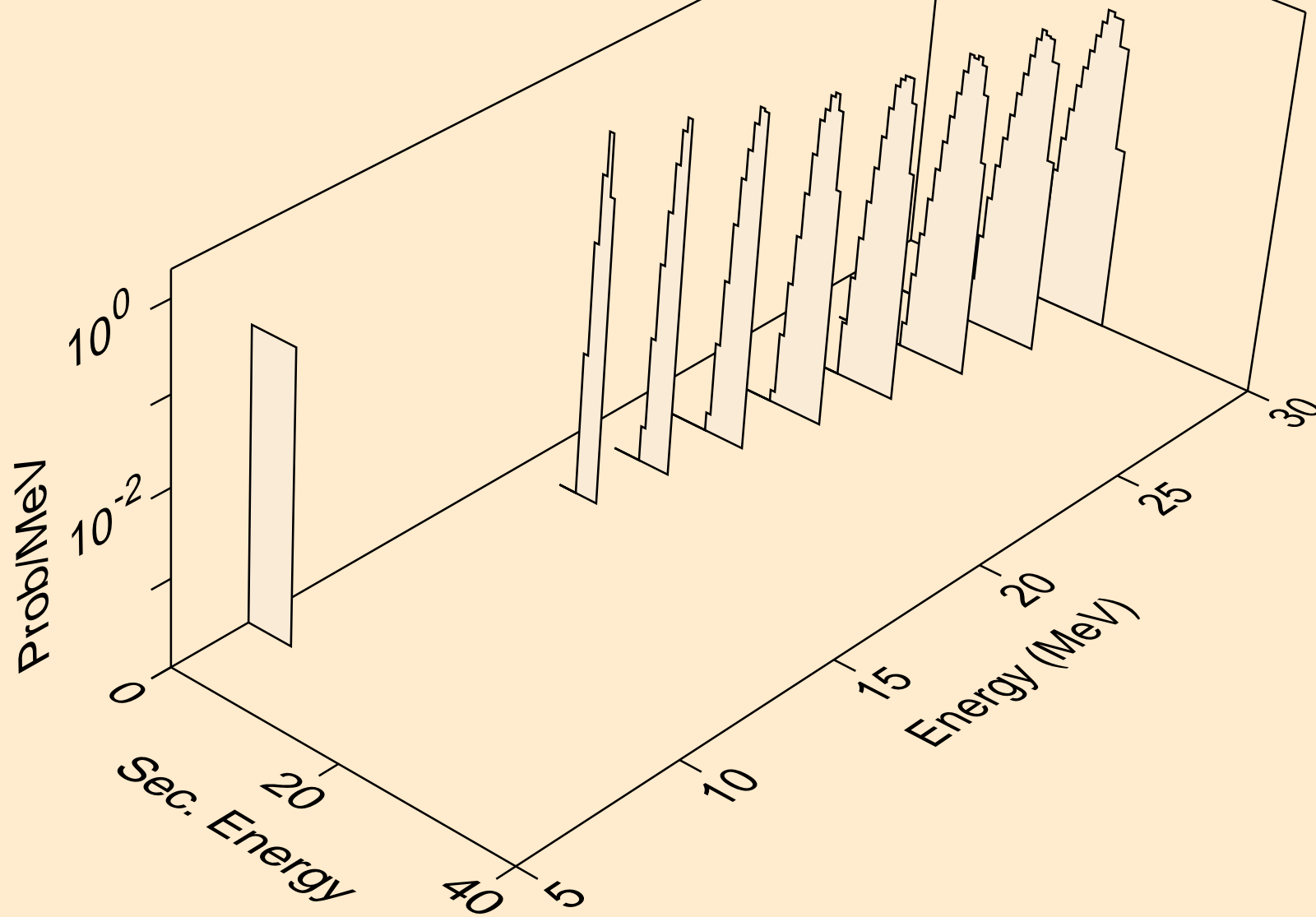

AT221 PROTON ACER TENDL-2021 LIBRARY; T=0.K  
he3s from (p,he3)

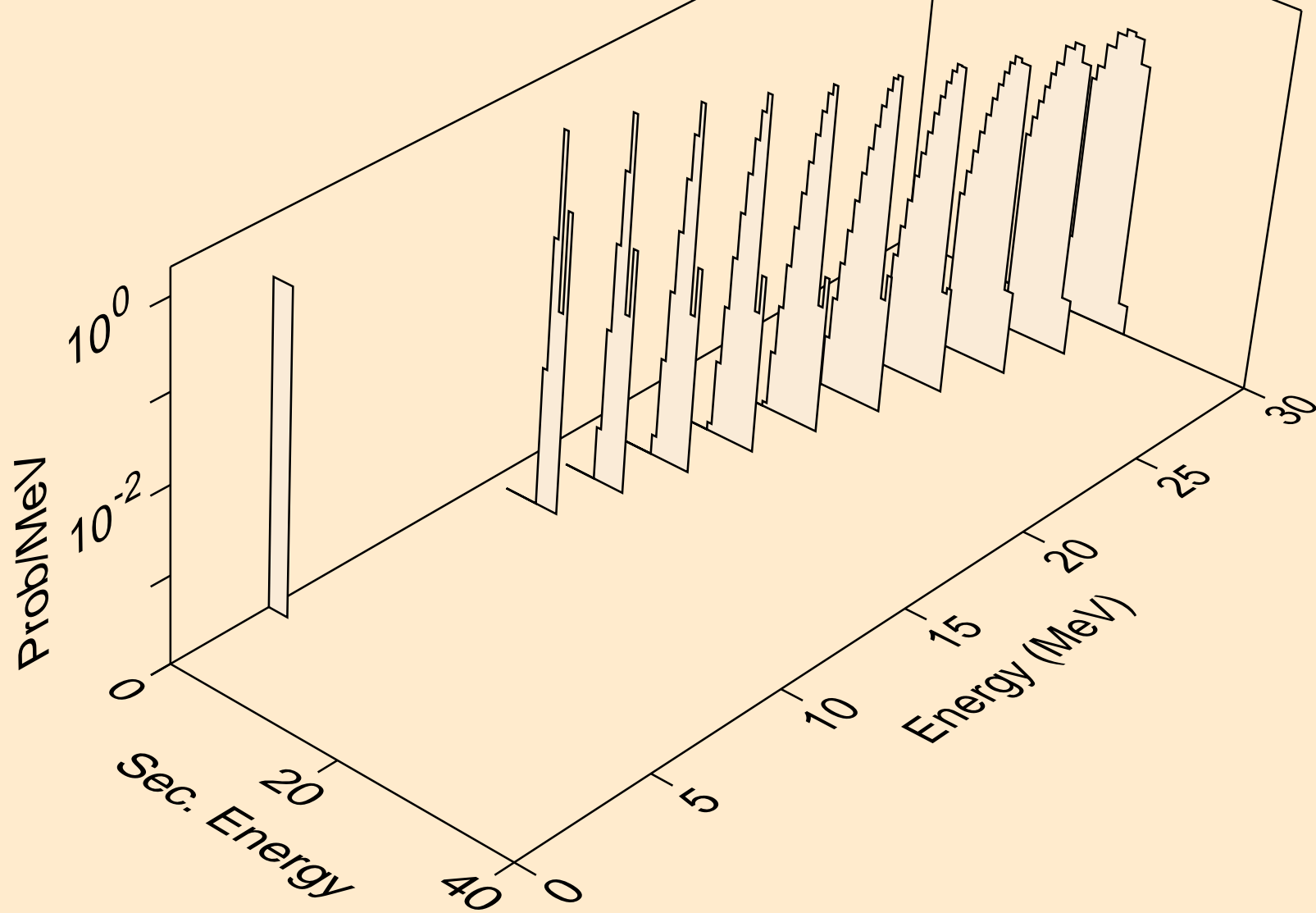

AT221 PROTON ACER TENDL-2021 LIBRARY; T=0.K  
alphas from (p,x)

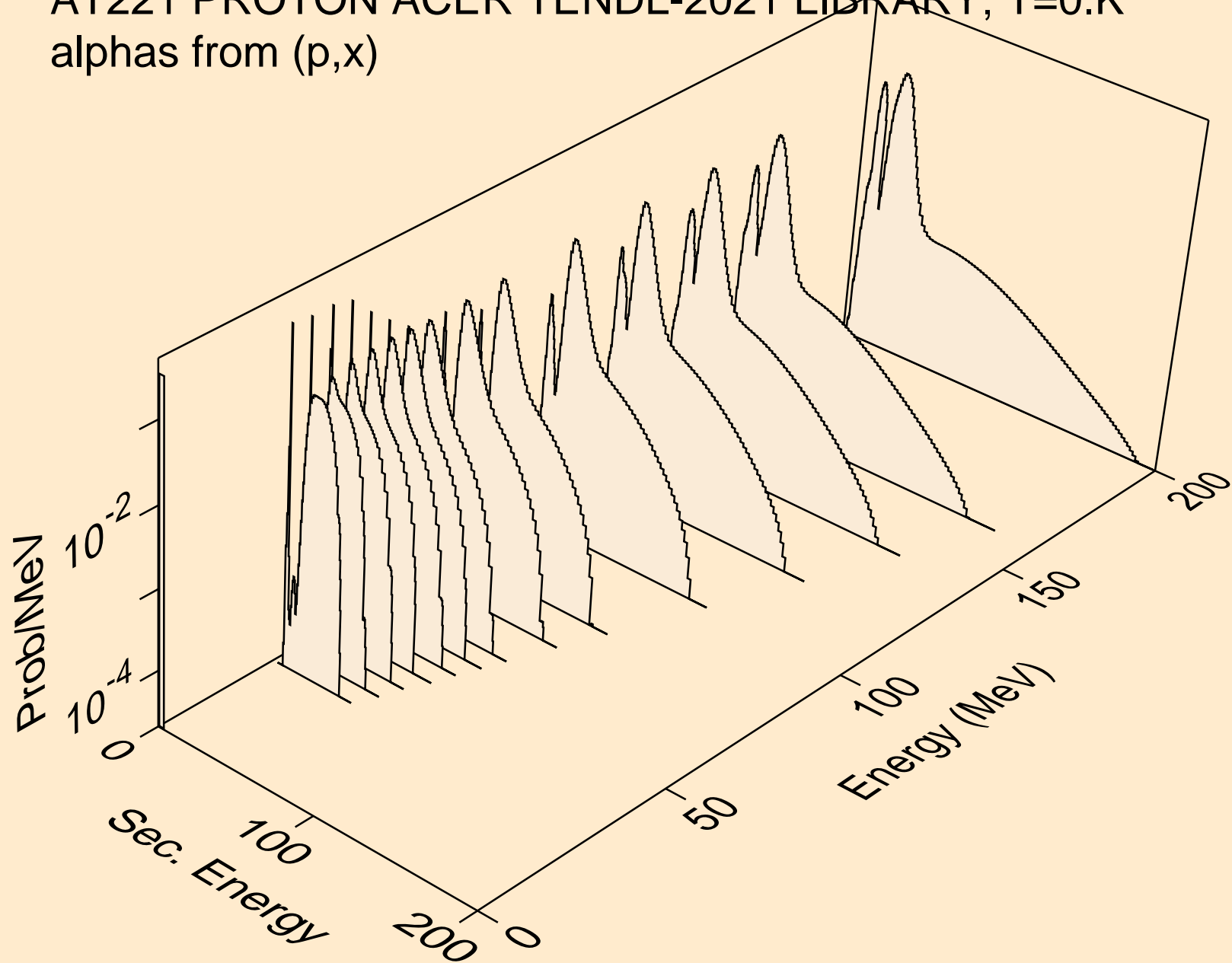

AT221 PROTON ACER TENDL-2021 LIBRARY; T=0.K  
alphas from (p,n\*)a

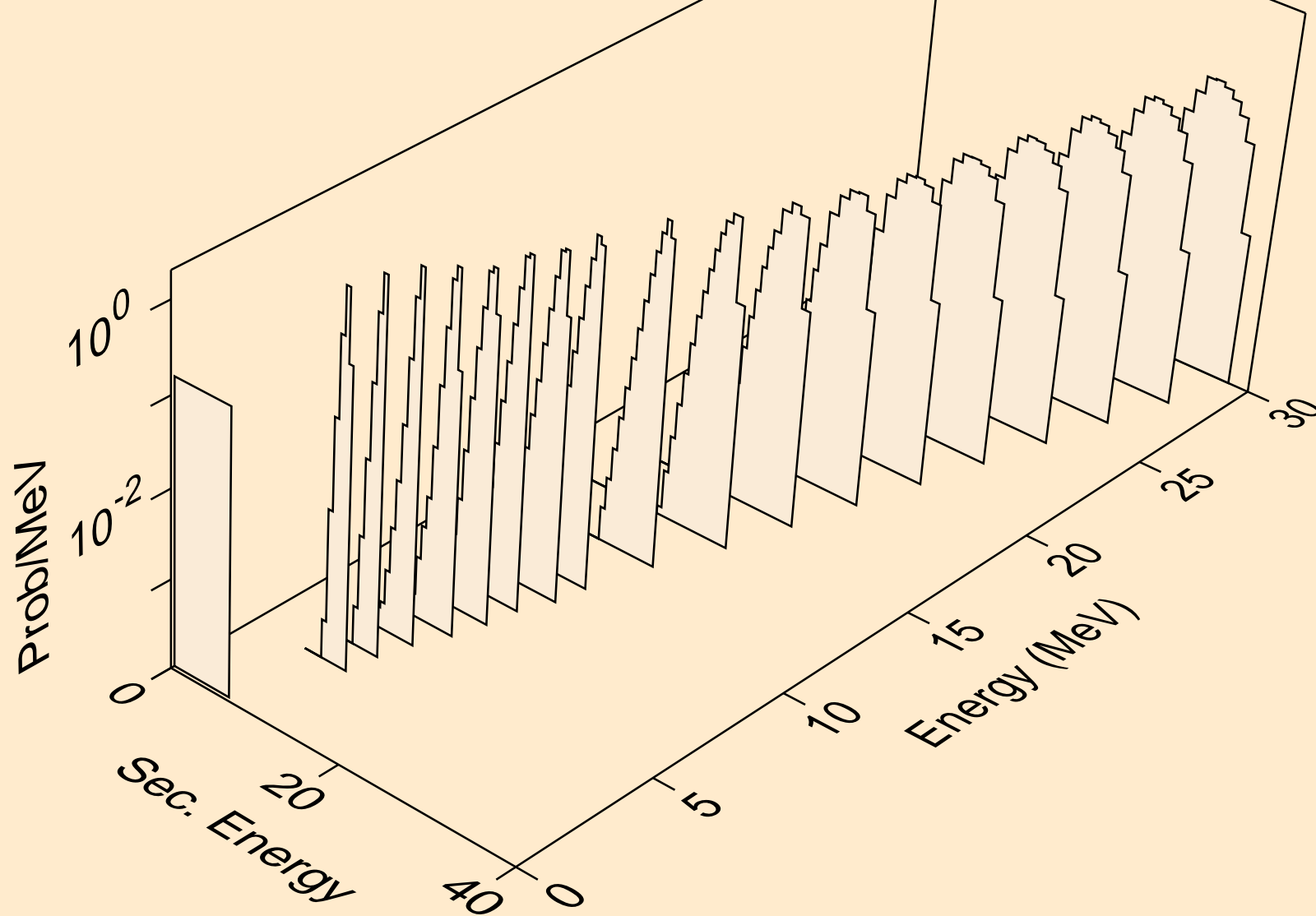

AT221 PROTON ACER TENDL-2021 LIBRARY; T=0.K  
alphas from (p,2n)a

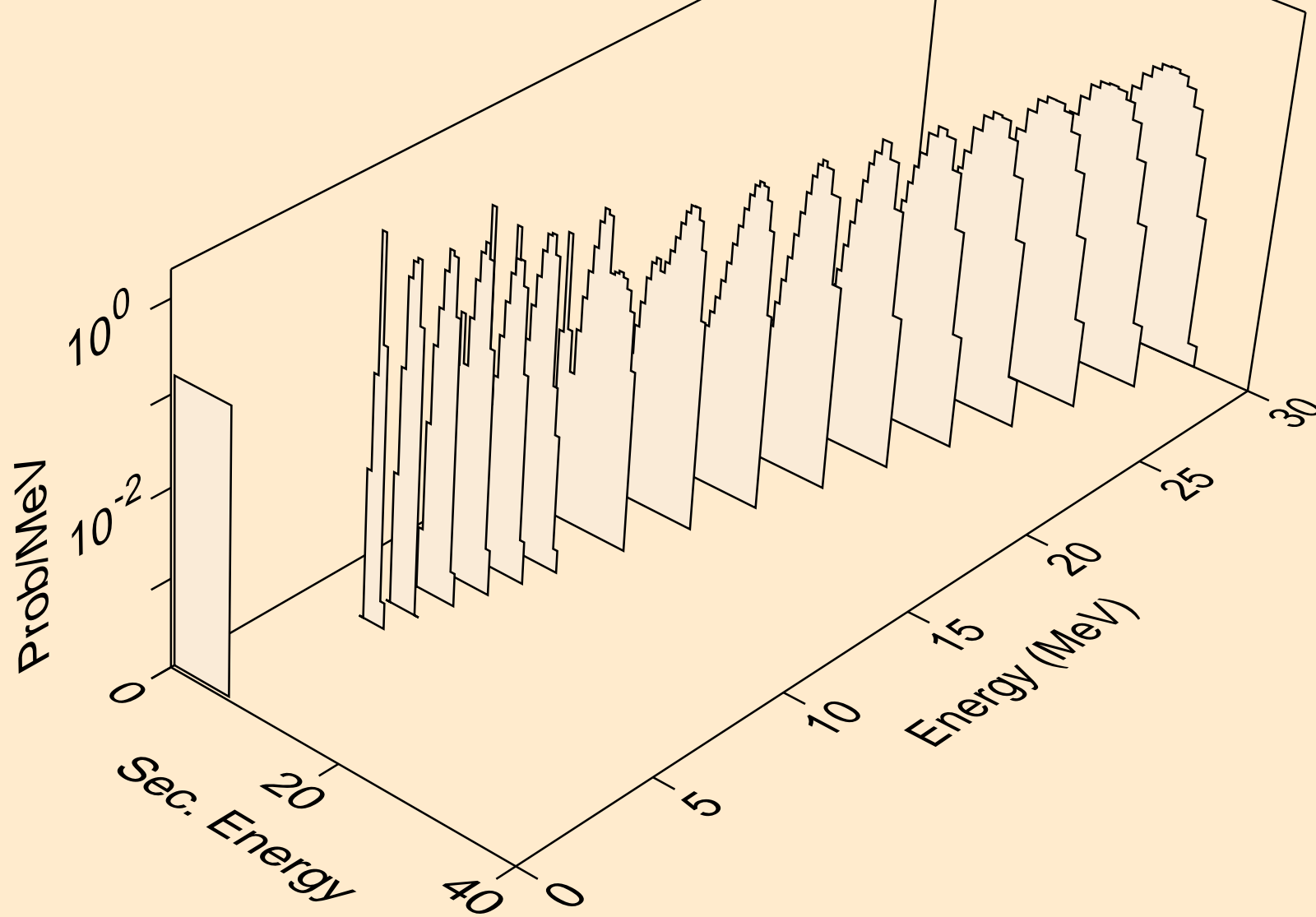

AT221 PROTON ACER TENDL-2021 LIBRARY; T=0.K  
alphas from (p,3n)a

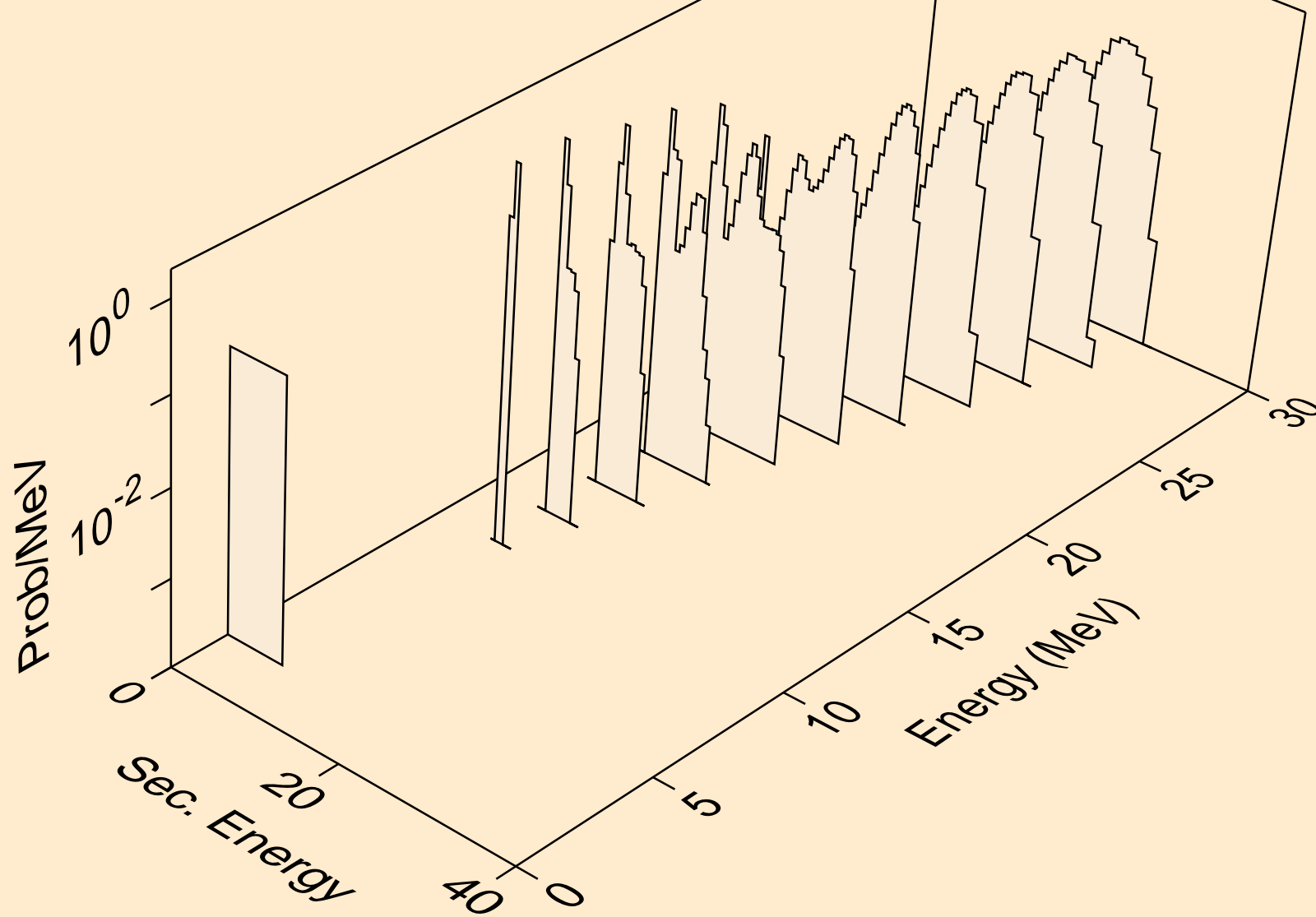

AT221 PROTON ACER TENDL-2021 LIBRARY; T=0.K  
alphas from (p,n\*)2a

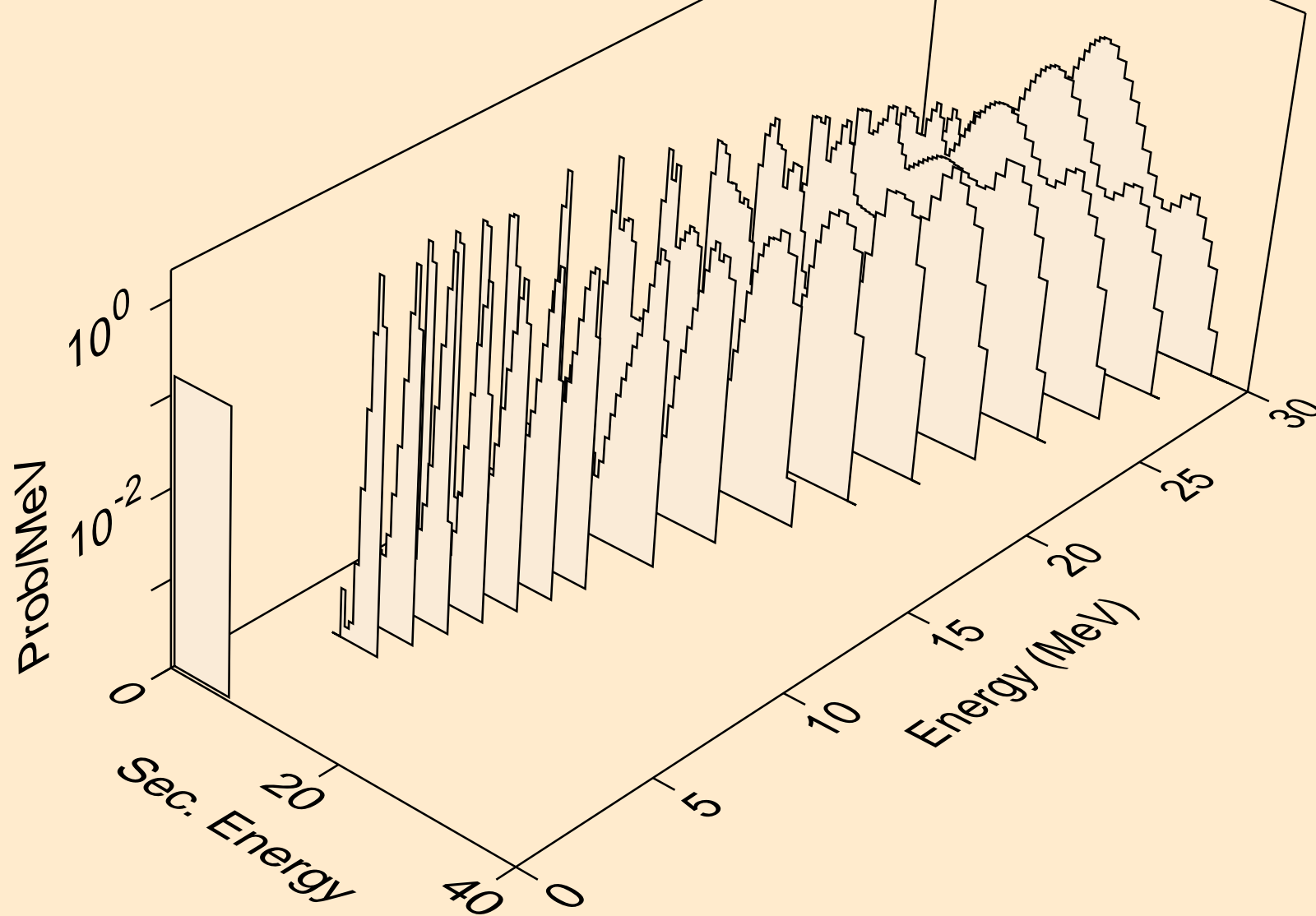



AT221 PROTON ACER TENDL-2021 LIBRARY; T=0.K  
alphas from (p,2n)2a

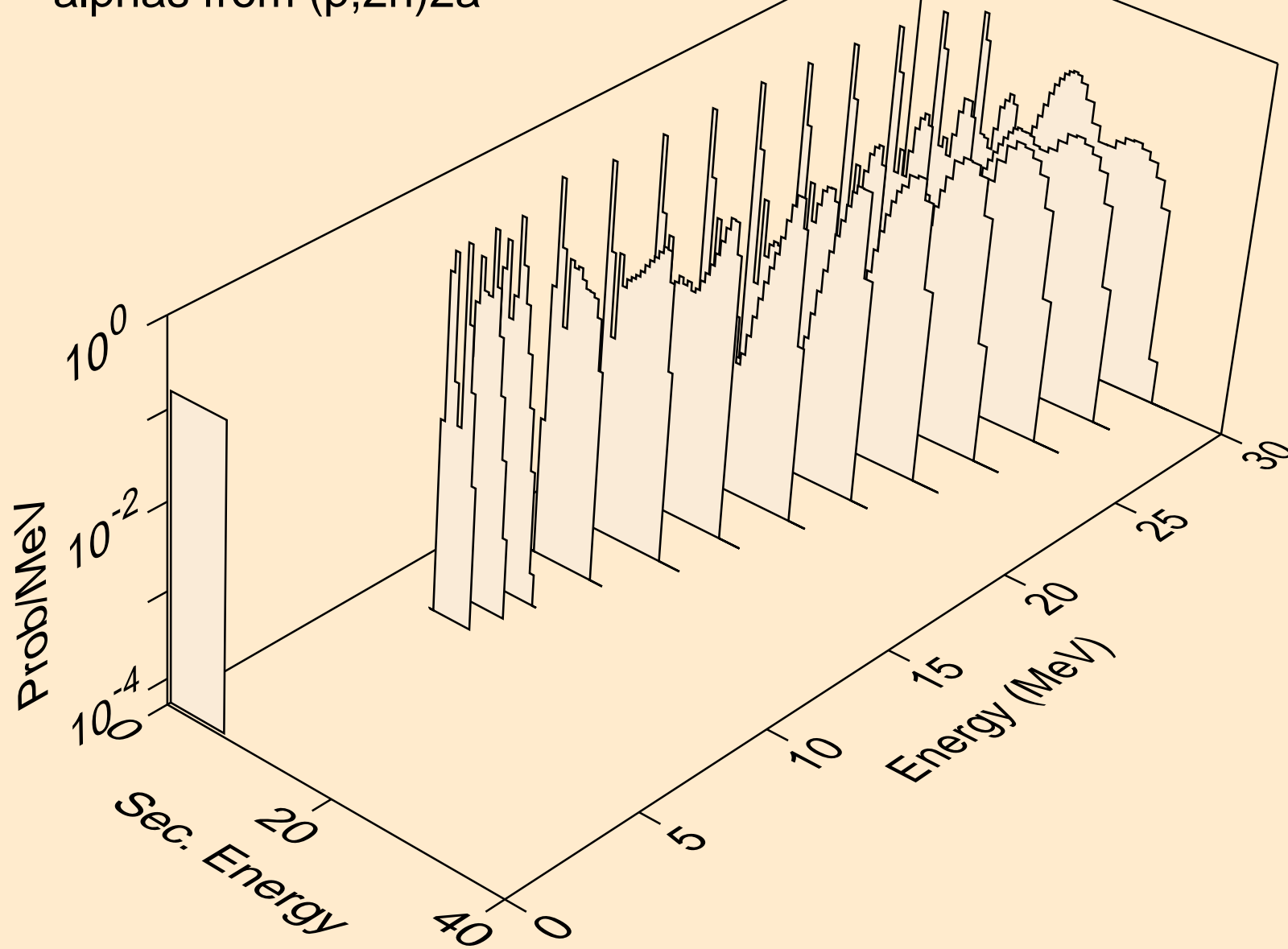

AT221 PROTON ACER TENDL-2021 LIBRARY; T=0.K  
alphas from (p,npa)

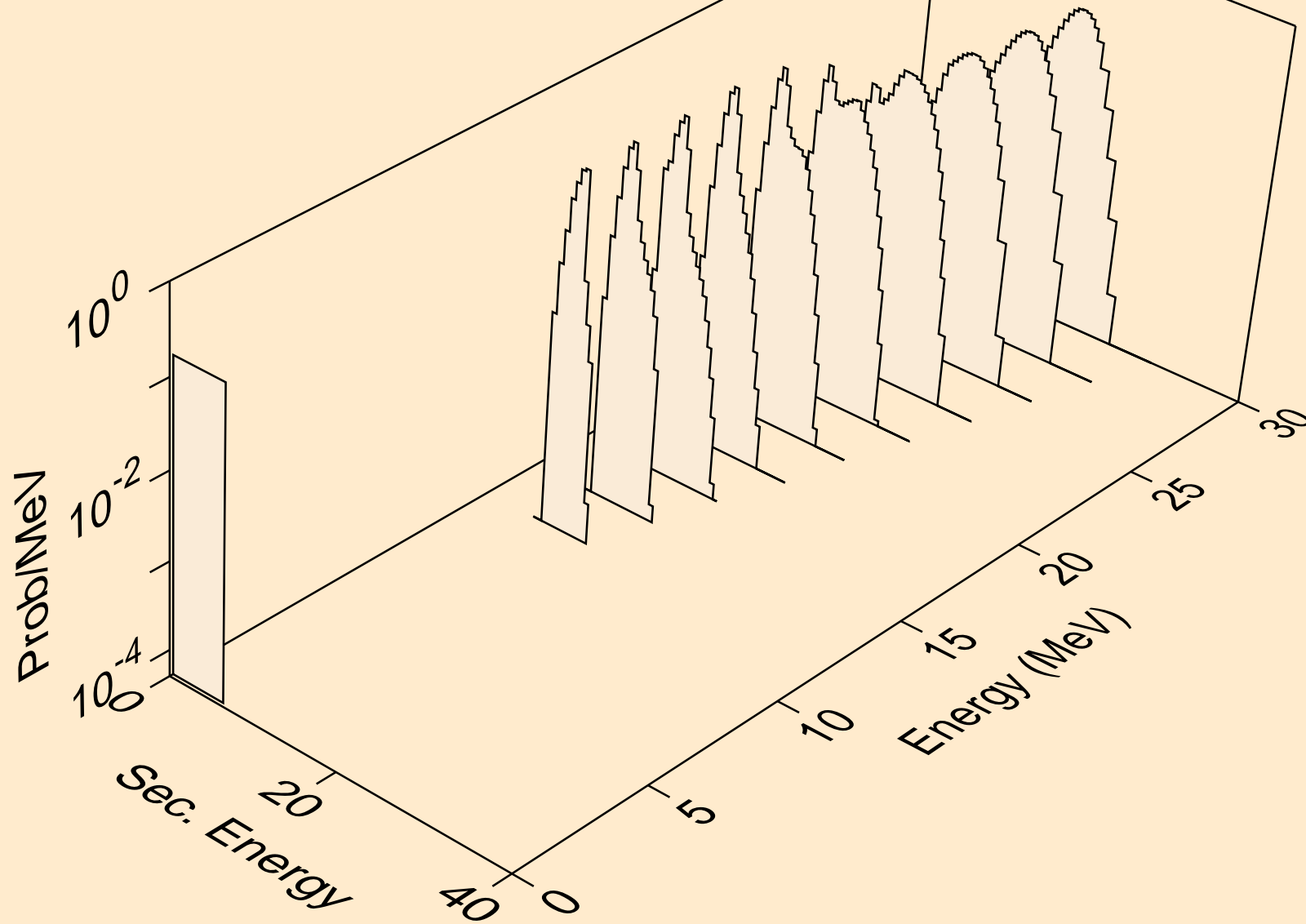

AT221 PROTON ACER TENDL-2021 LIBRARY; T=0.K  
alphas from (p,a)

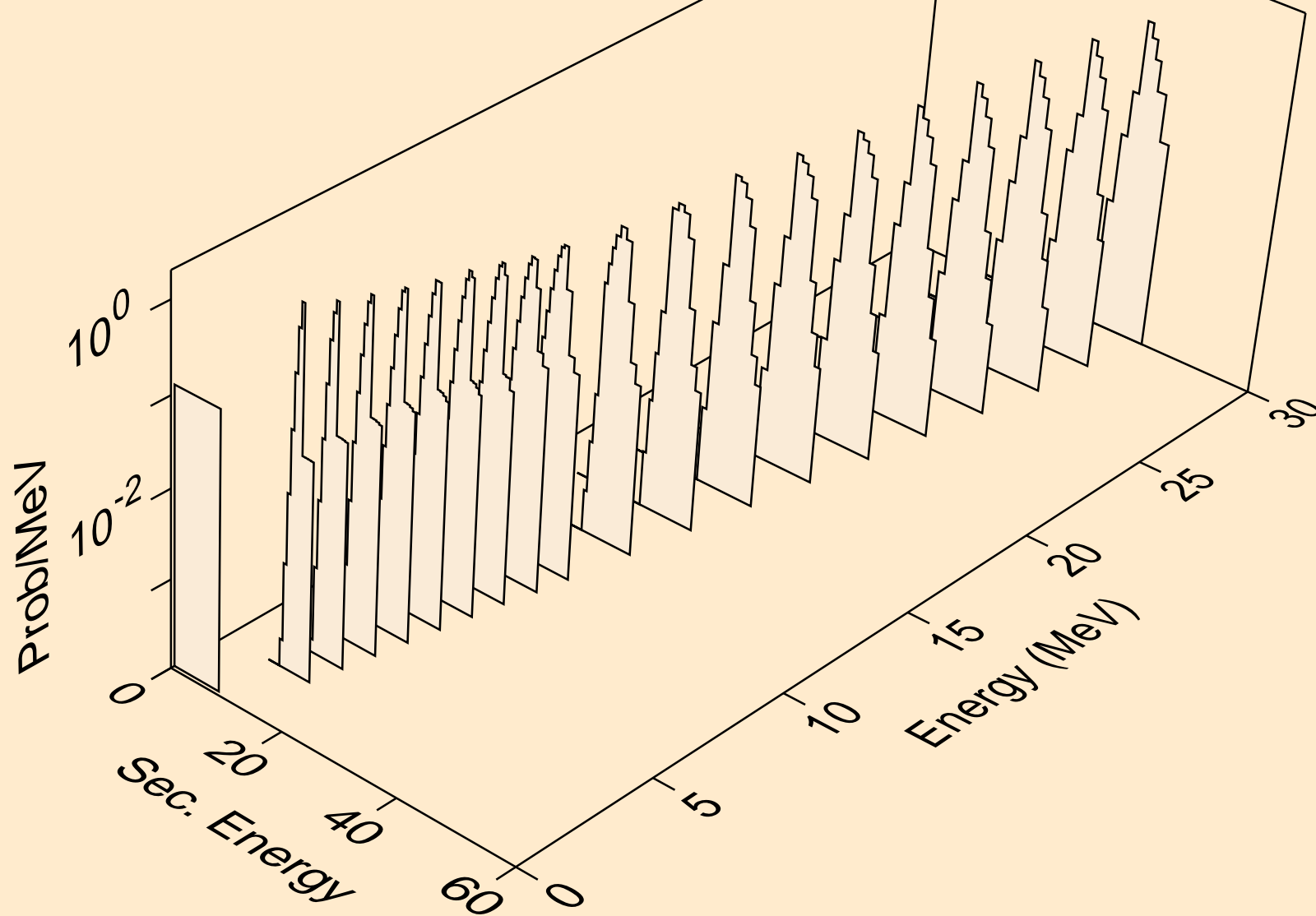

AT221 PROTON ACER TENDL-2021 LIBRARY; T=0.K  
alphas from (p,2a)

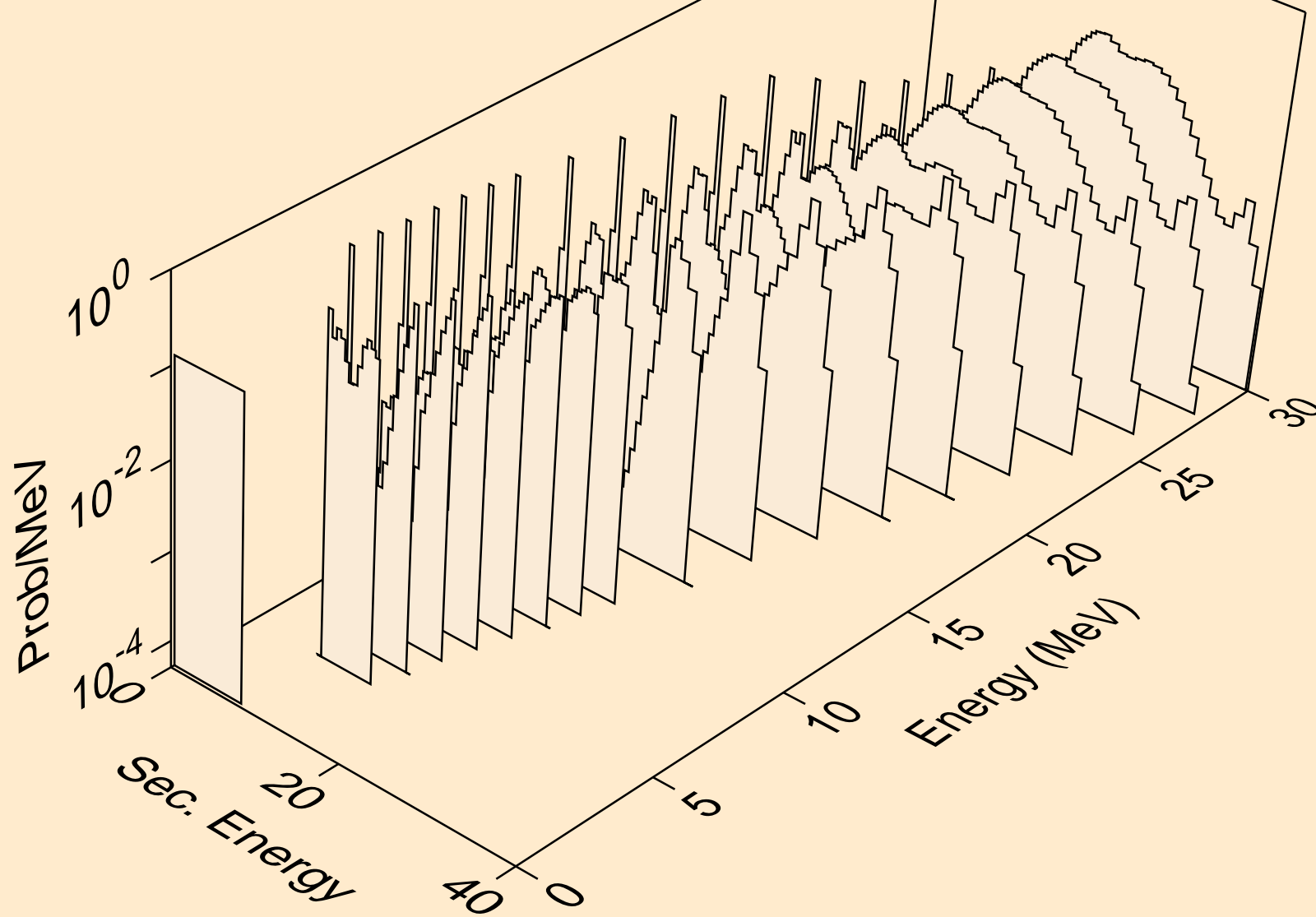

AT221 PROTON ACER TENDL-2021 LIBRARY; T=0.K  
alphas from (p,pa)

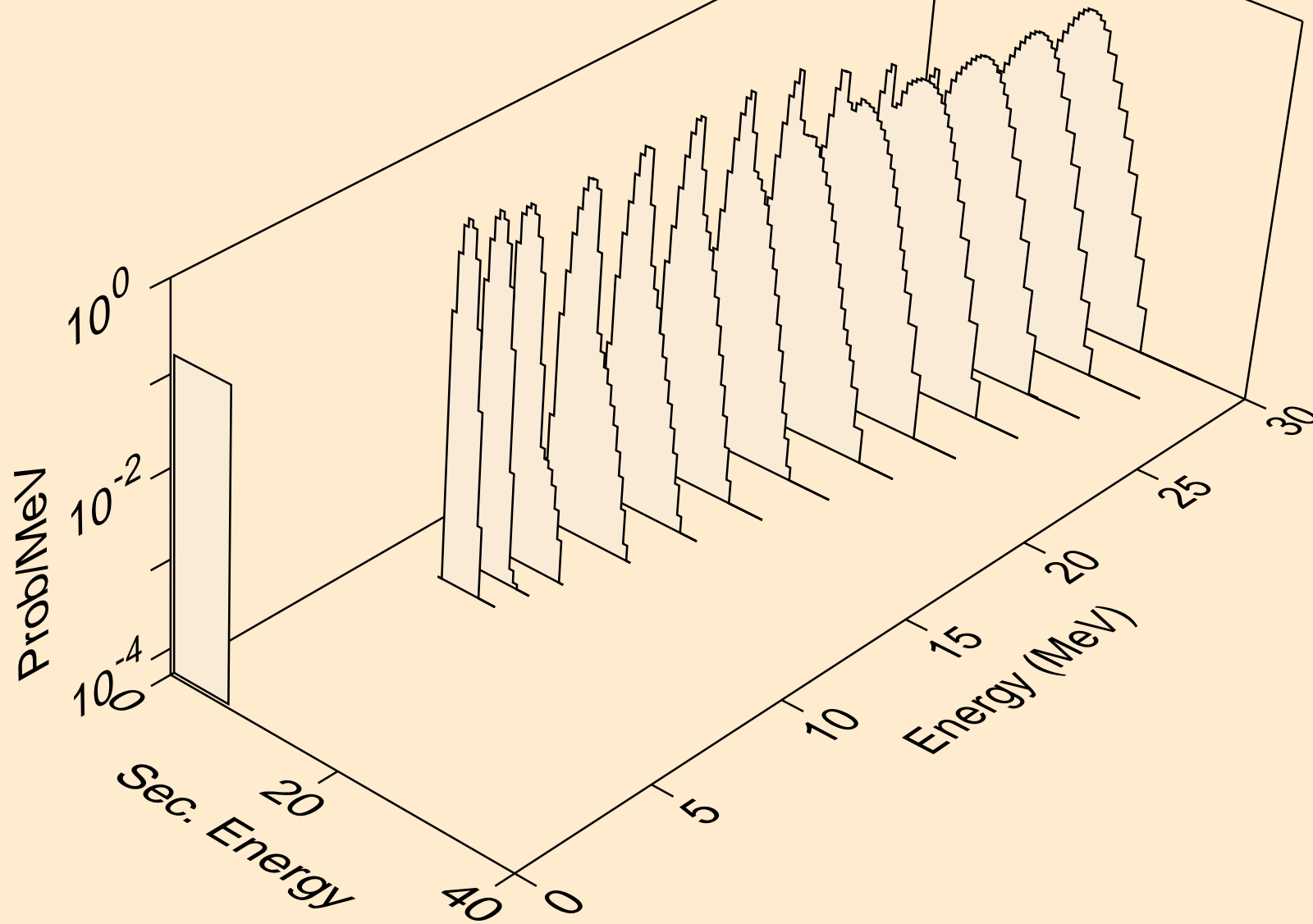

AT221 PROTON ACER TENDL-2021 LIBRARY; T=0.K  
alphas from (p,da)

