

AT224 PROTON ACER TENDL-2021 LIBRARY; T=0.K  
Principal cross sections

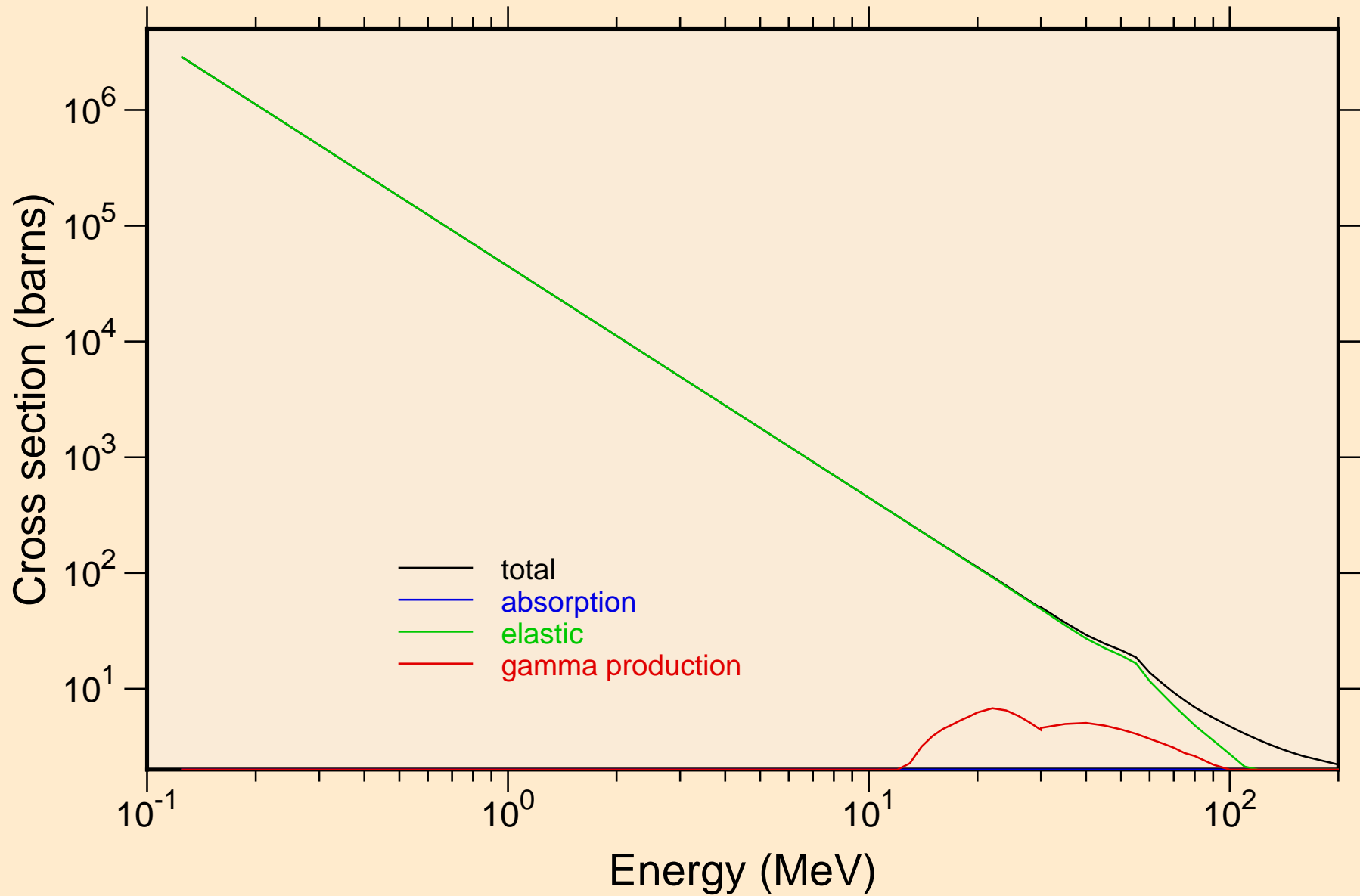

# AT224 PROTON ACER TENDL-2021 LIBRARY; T=0.K

## Heating

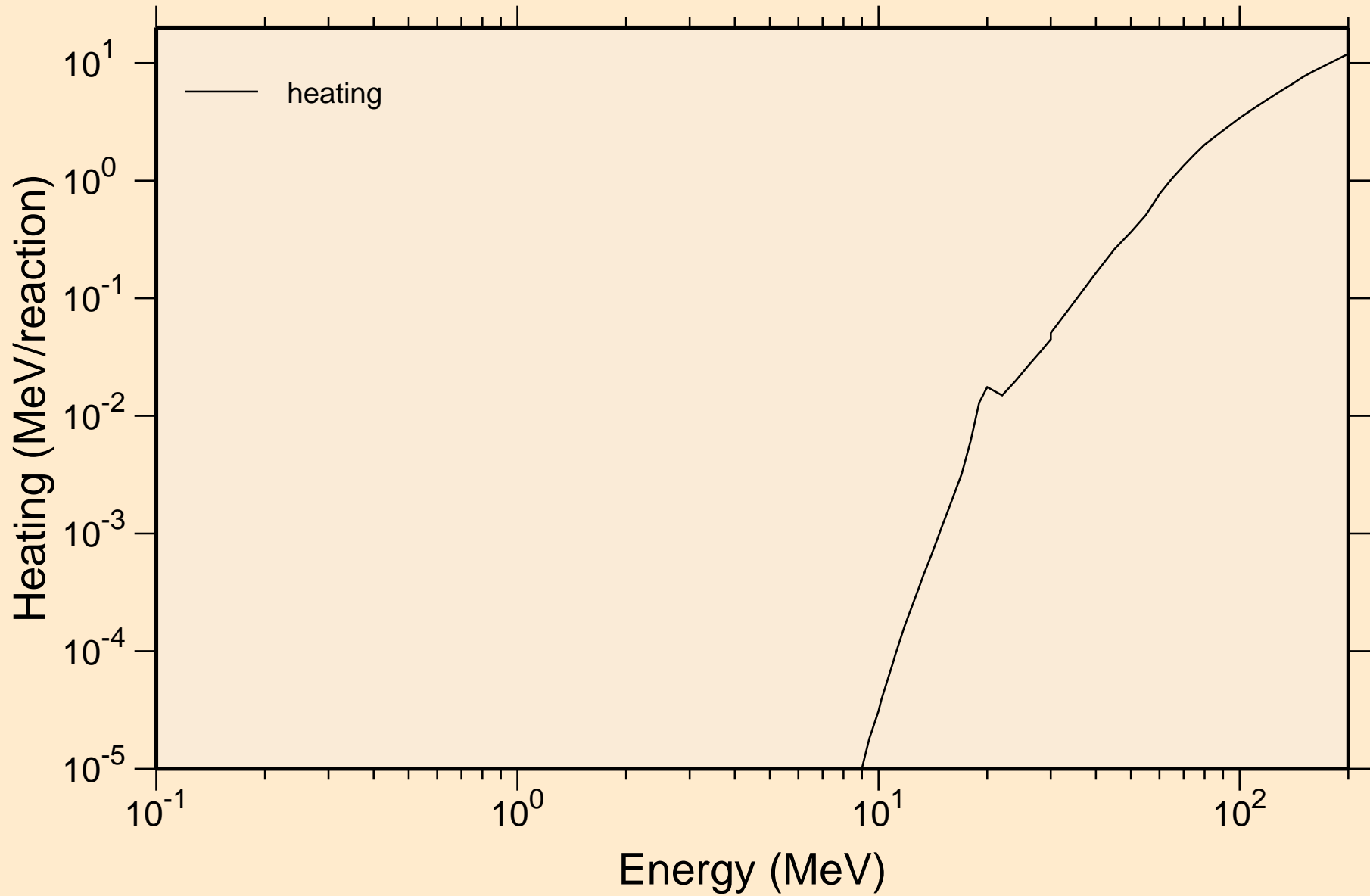

# AT224 PROTON ACER TENDL-2021 LIBRARY; T=0.K

## Principal cross sections

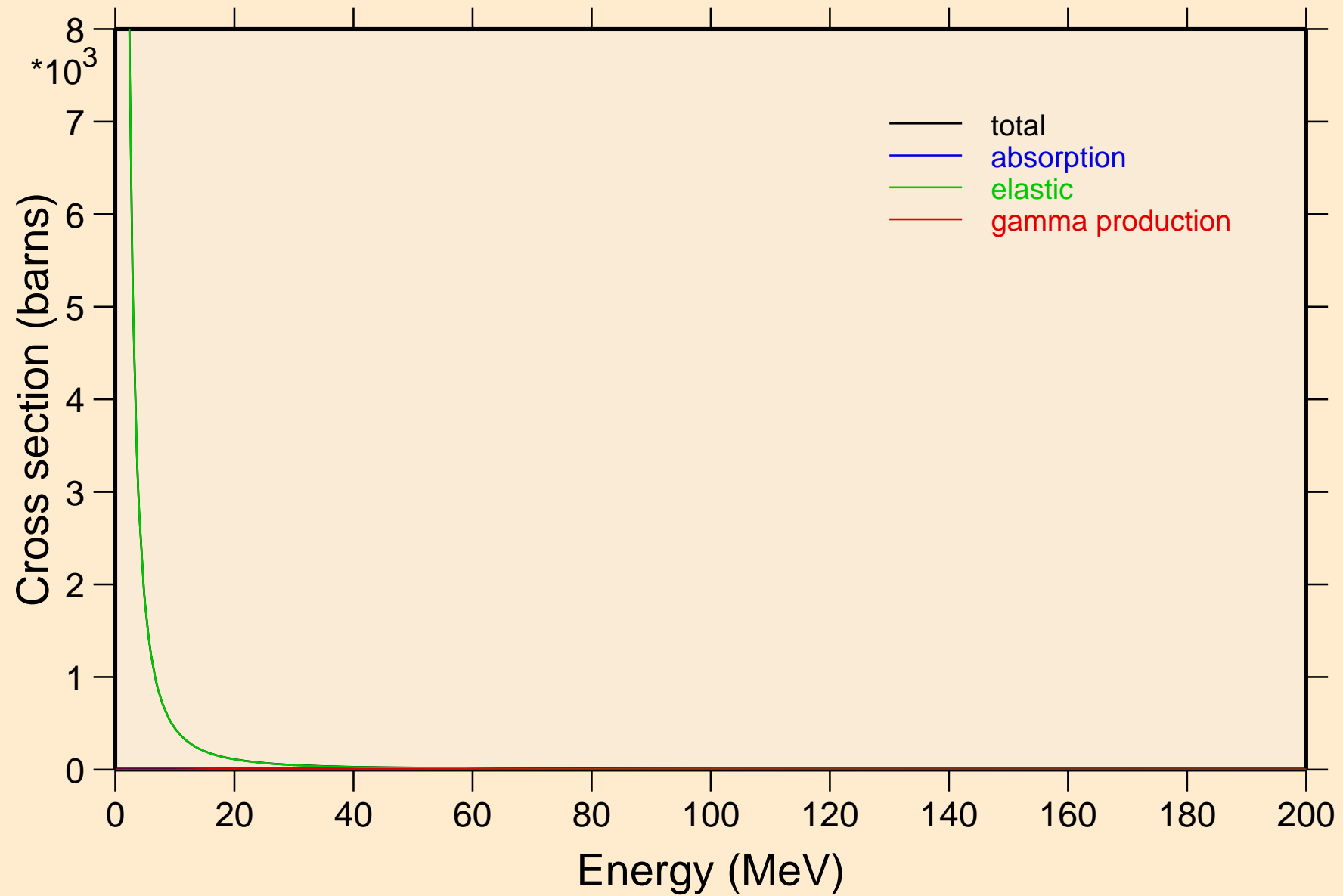

AT224 PROTON ACER TENDL-2021 LIBRARY; T=0.K

Heating

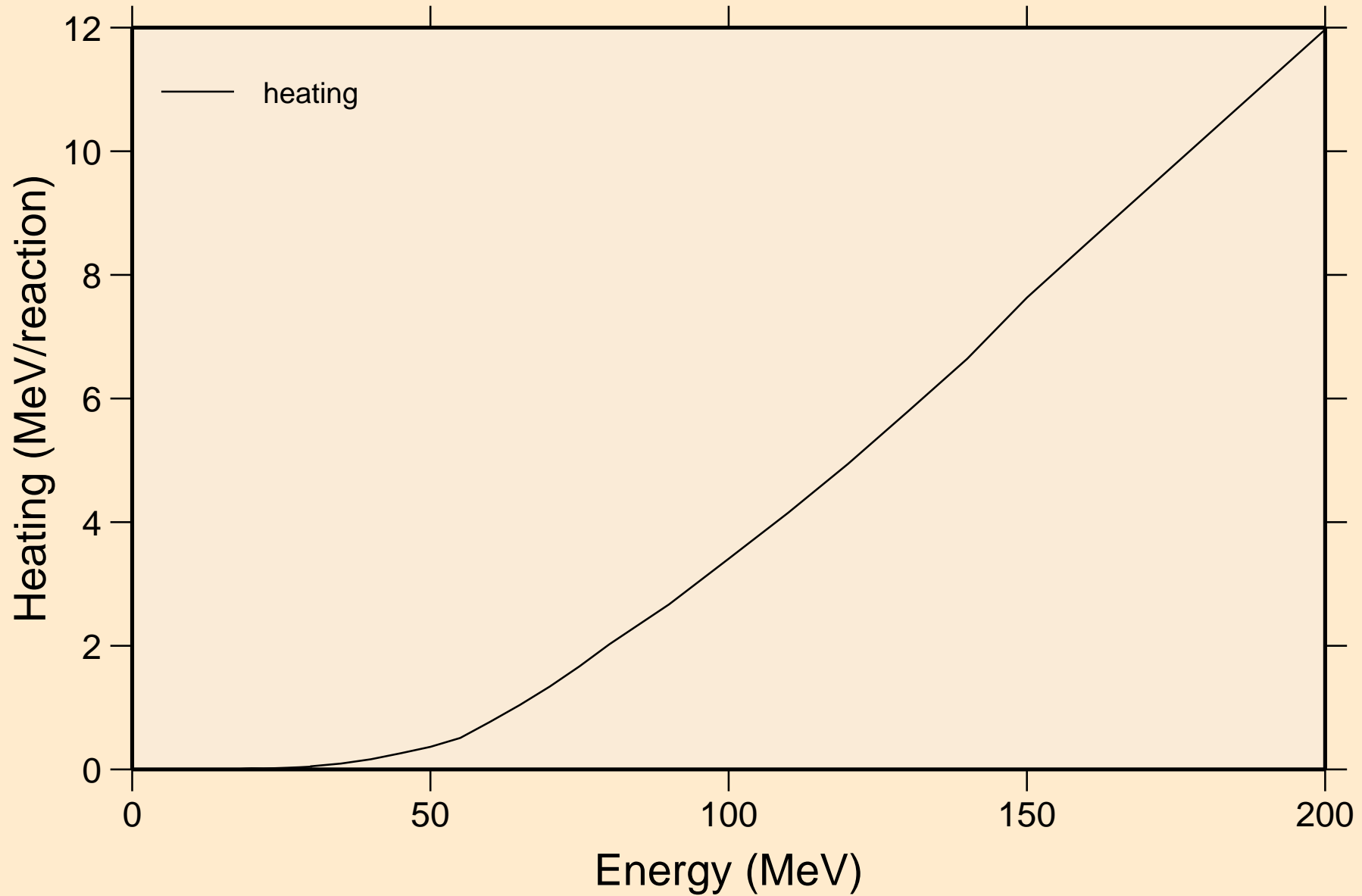

# AT224 PROTON ACER TENDL-2021 LIBRARY; T=0.K

## Threshold reactions

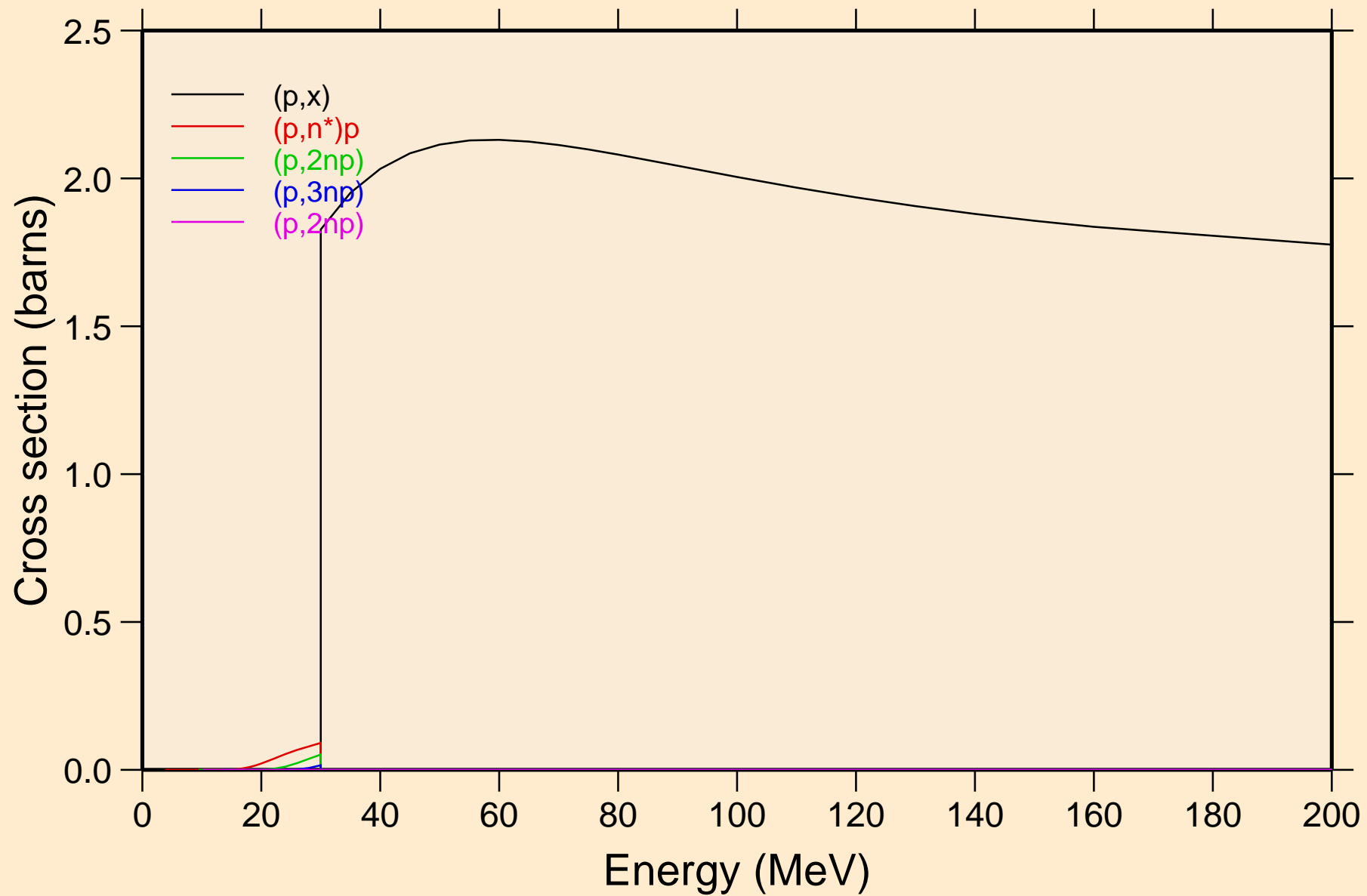

AT224 PROTON ACER TENDL-2021 LIBRARY; T=0.K  
Threshold reactions

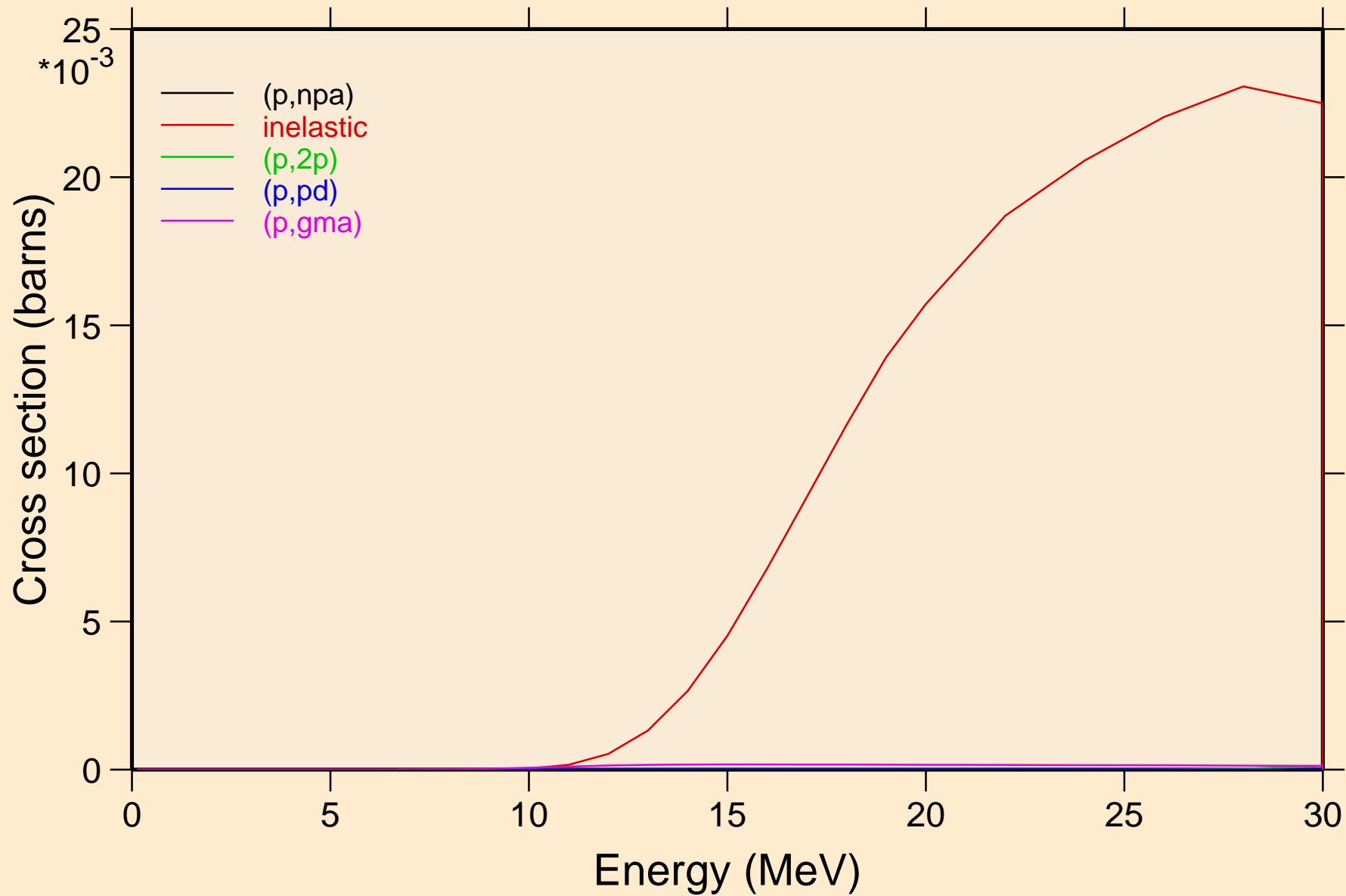

AT224 PROTON ACER TENDL-2021 LIBRARY; T=0.K  
Threshold reactions

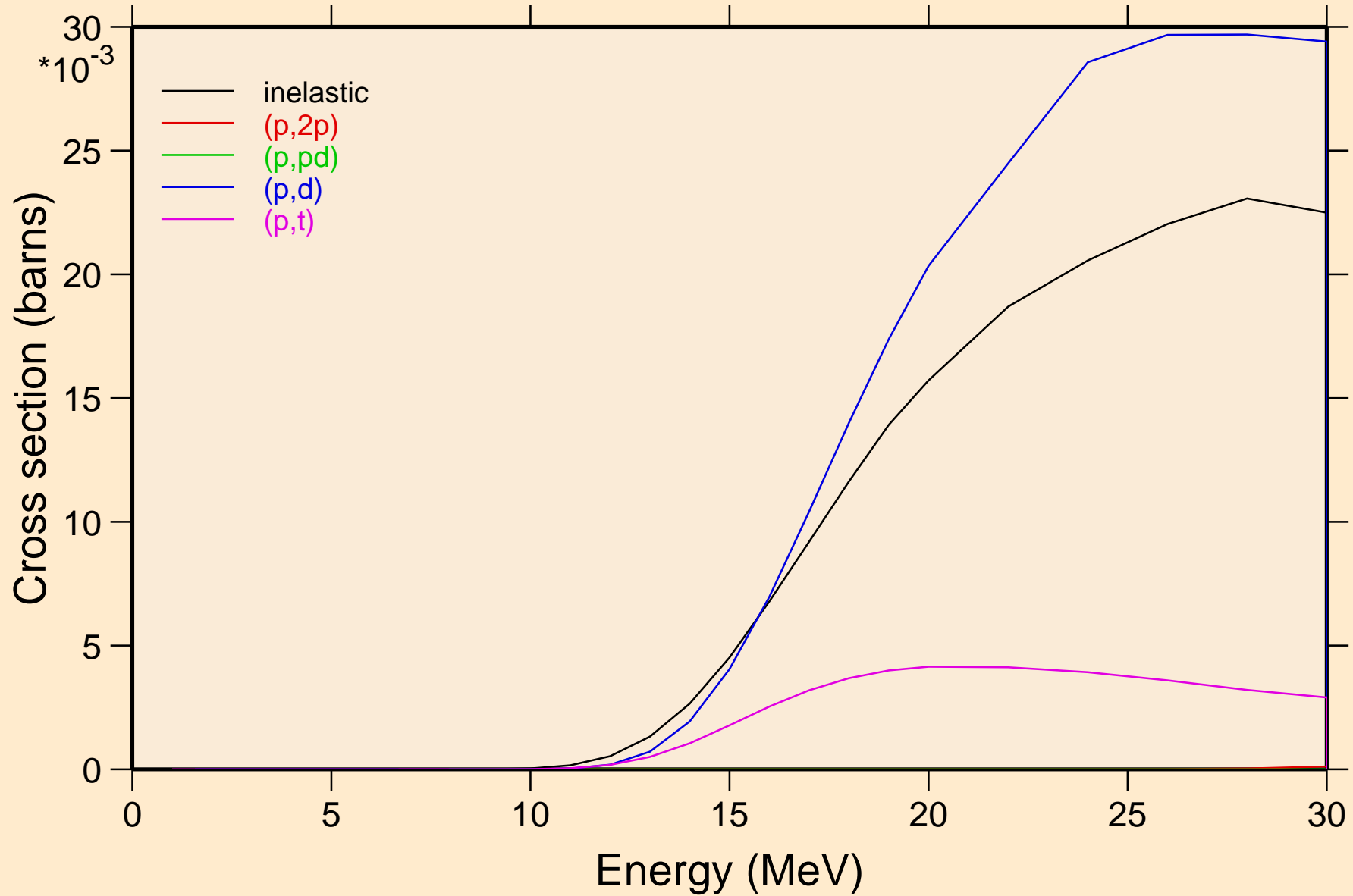

AT224 PROTON ACER TENDL-2021 LIBRARY; T=0.K  
Threshold reactions

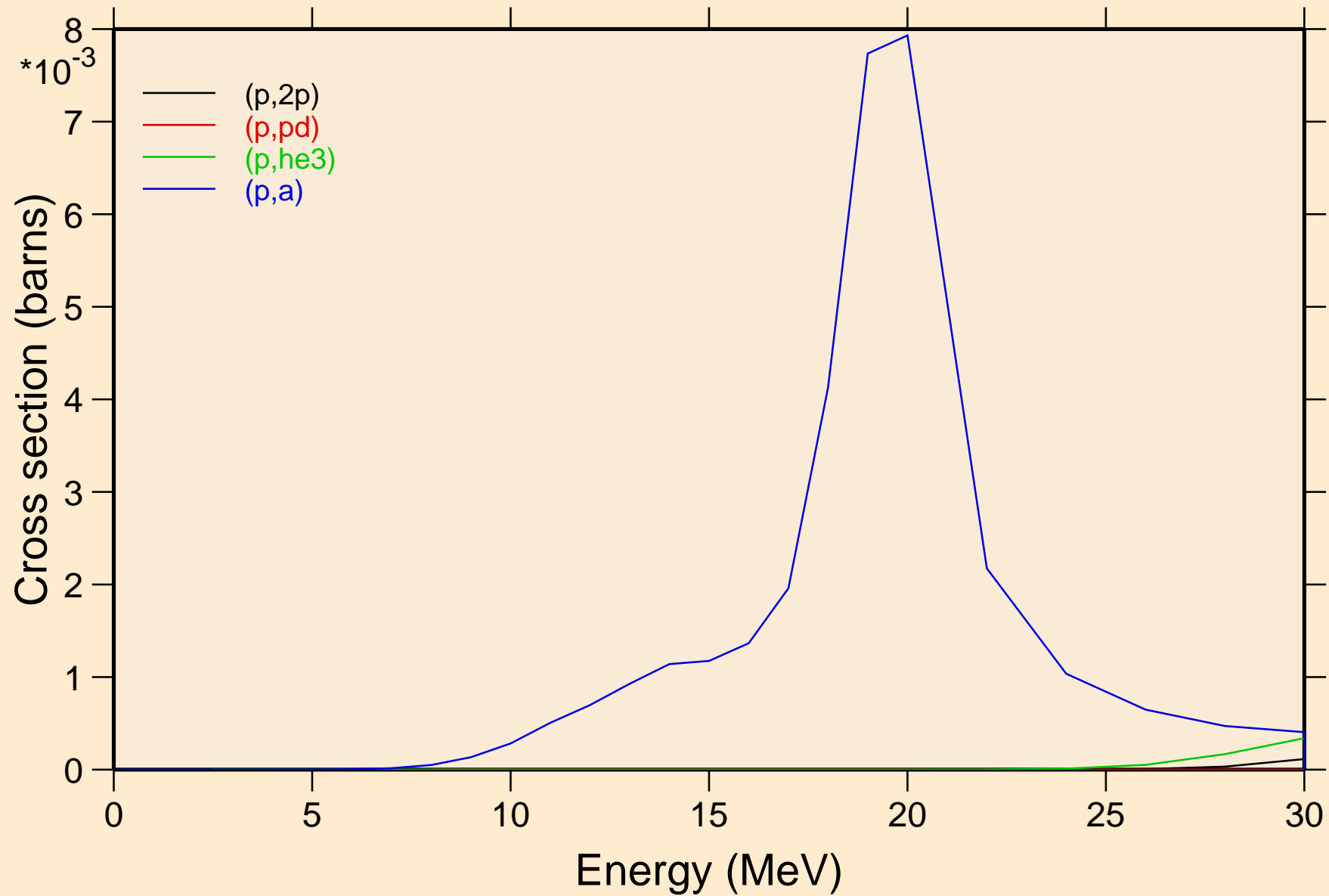



AT224 PROTON ACER TENDL-2021 LIBRARY; T=0.K  
Threshold reactions

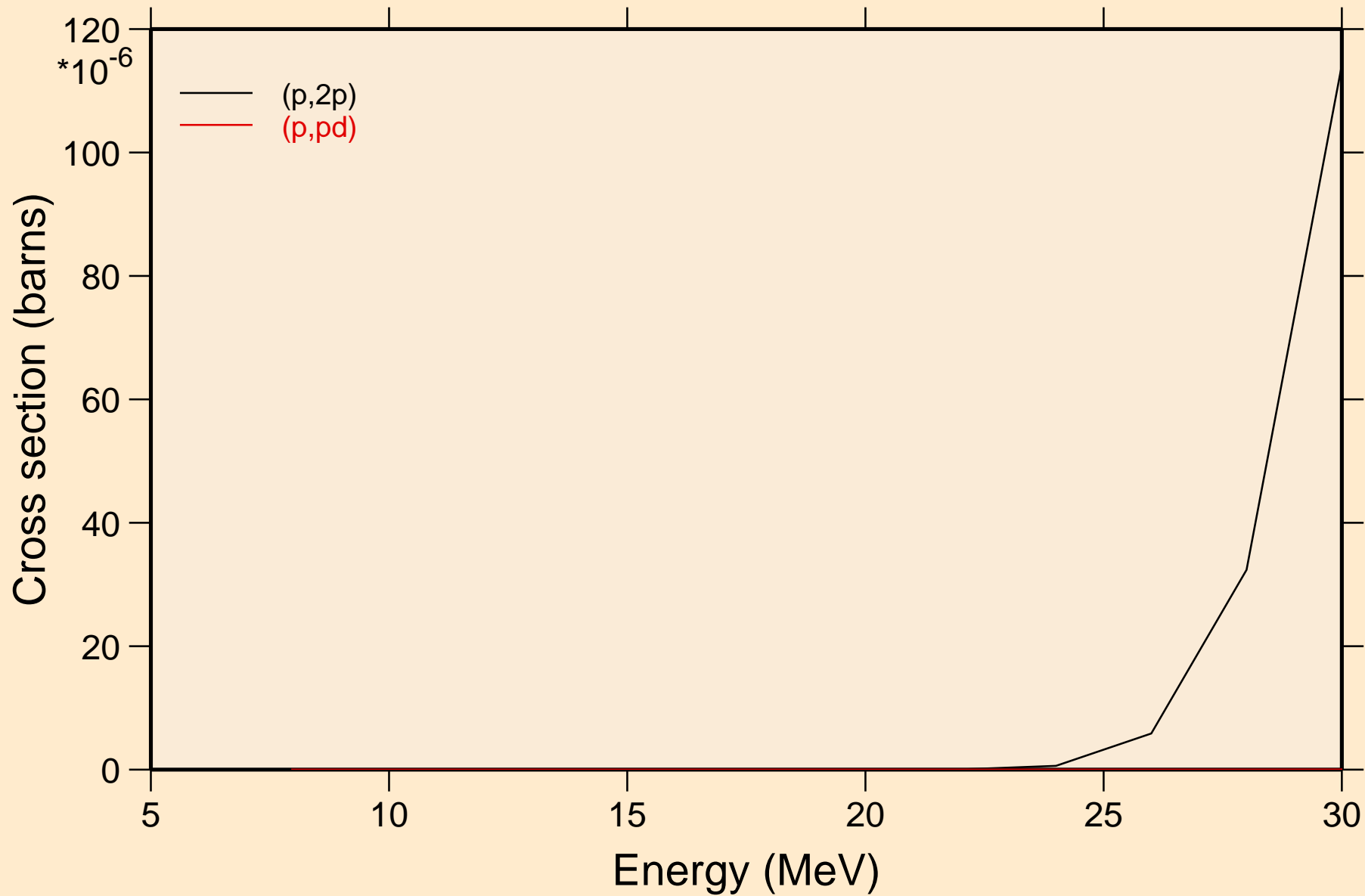

AT224 PROTON ACER TENDL-2021 LIBRARY; T=0.K  
angular distribution for elastic

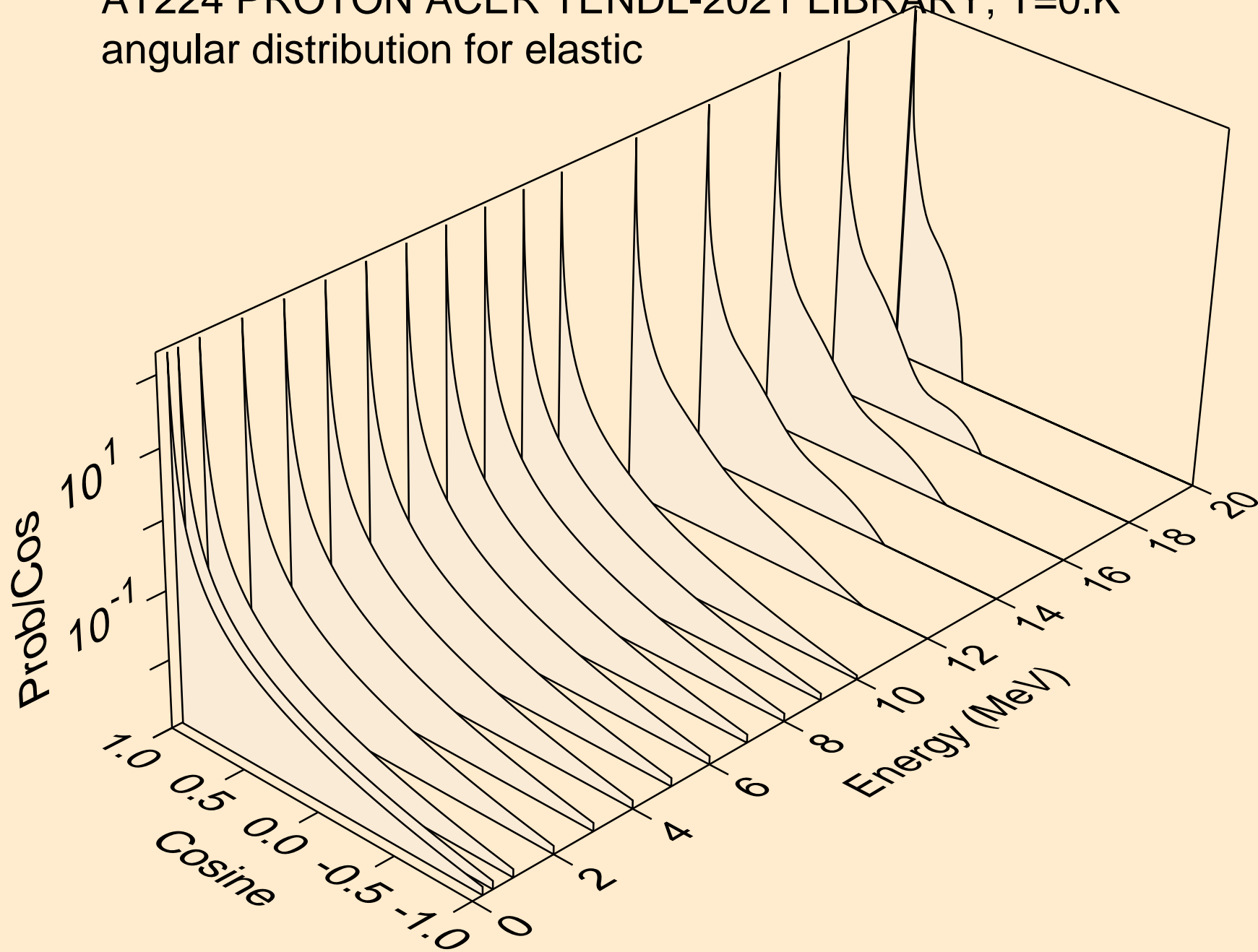

AT224 PROTON ACER TENDL-2021 LIBRARY; T=0.K  
angular distribution for elastic

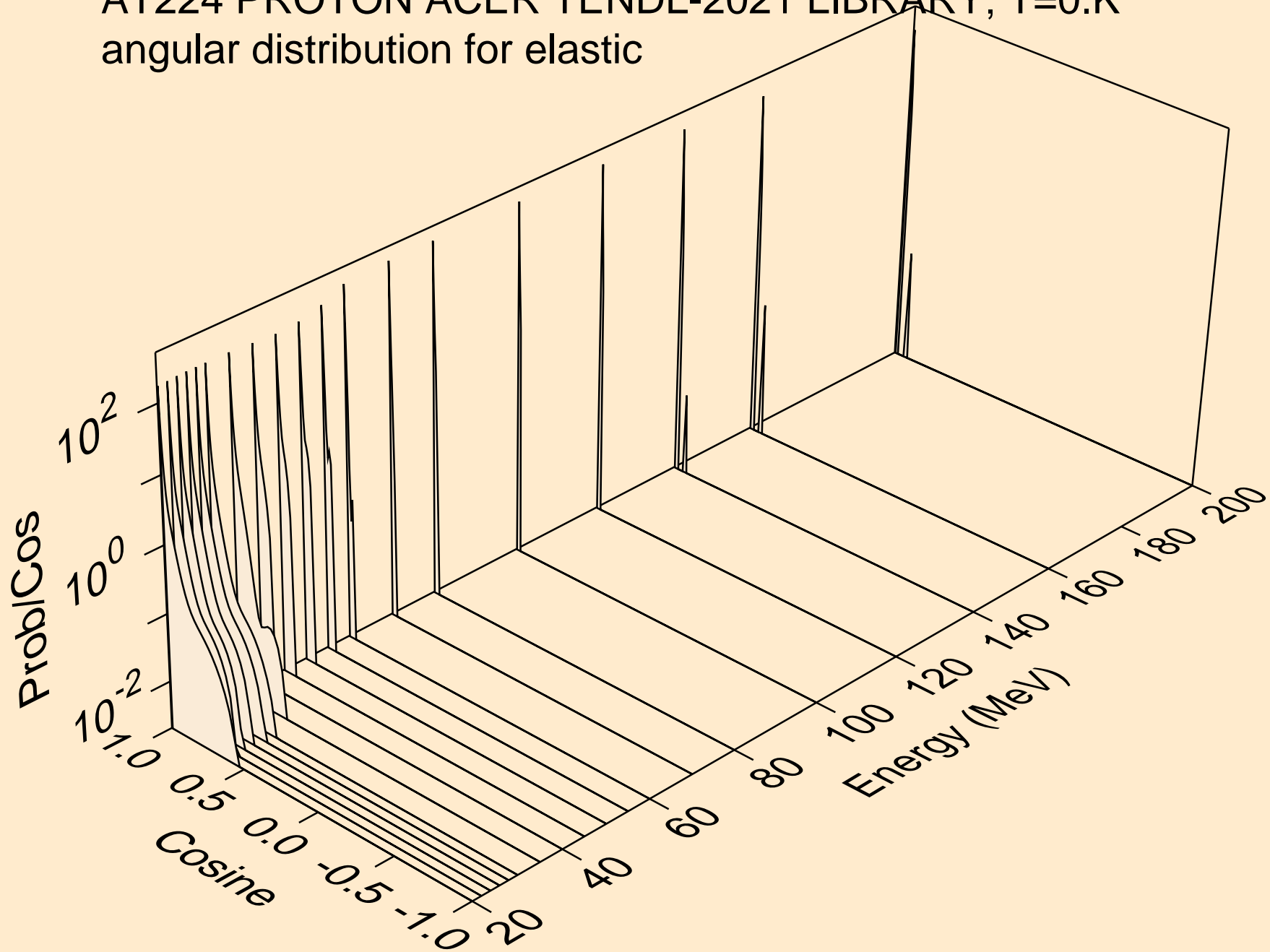

AT224 PROTON ACER TENDL-2021 LIBRARY; T=0.K  
Proton emission for (p,x)

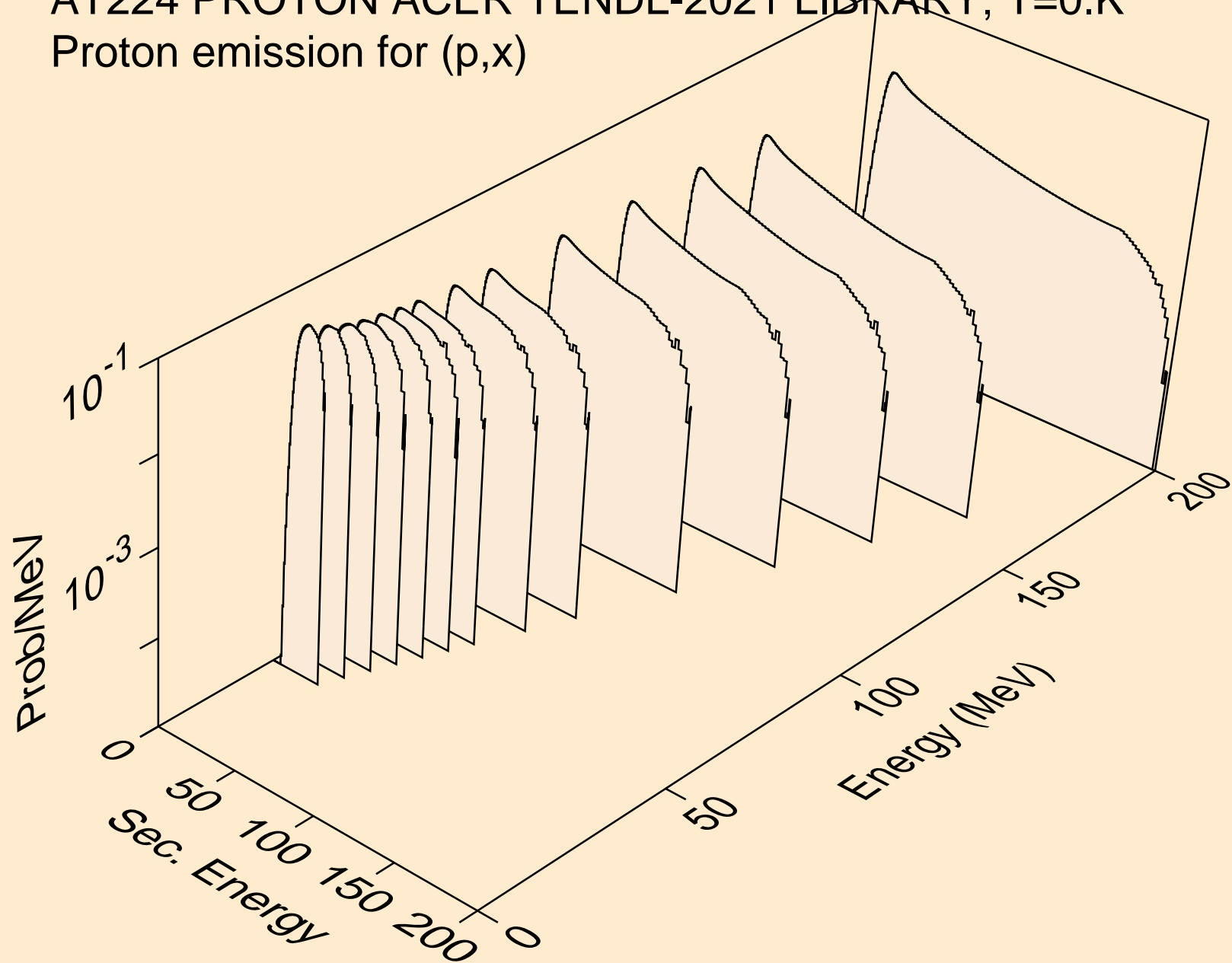

AT224 PROTON ACER TENDL-2021 LIBRARY; T=0.K  
Proton emission for (p,n\*)p

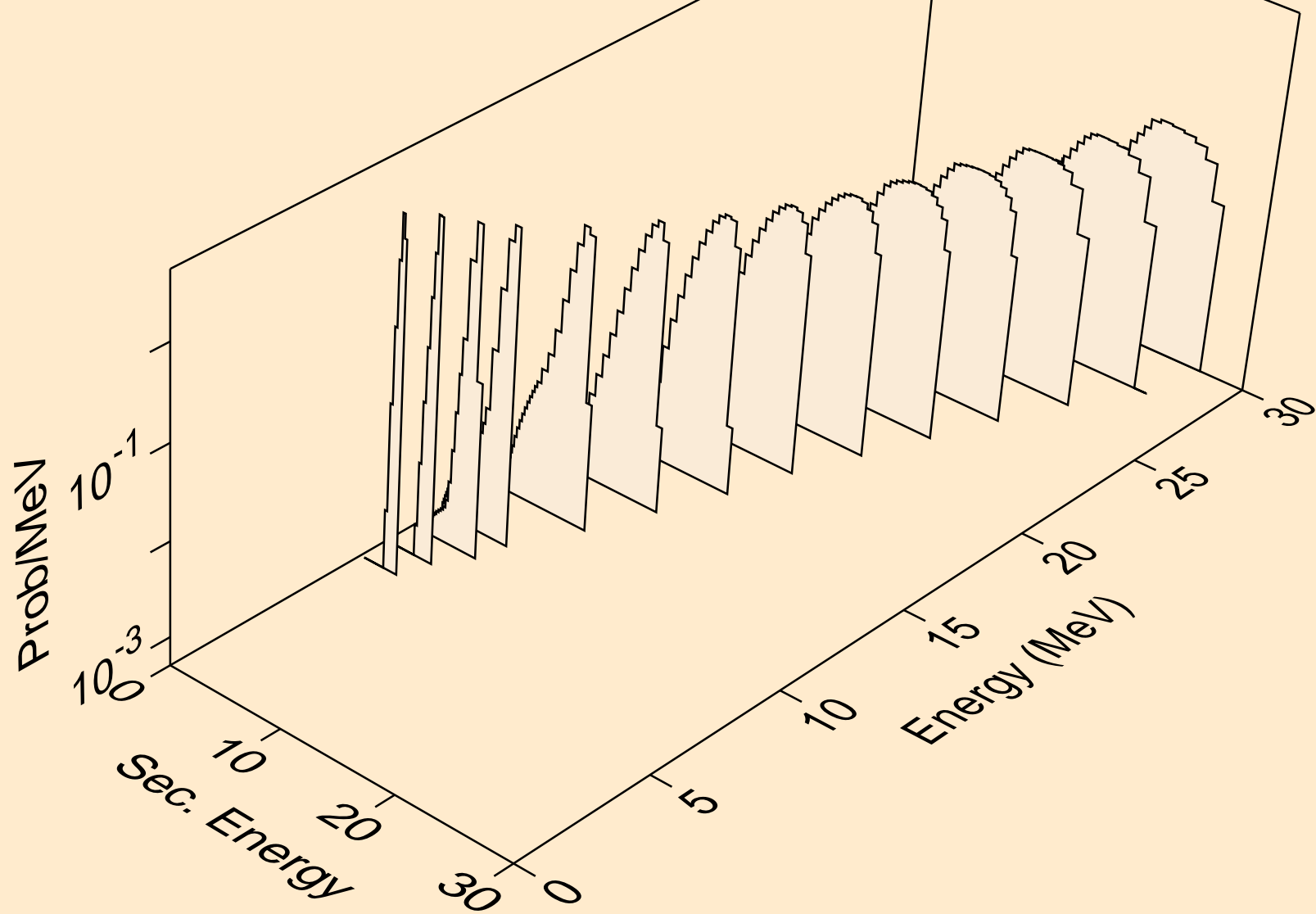

AT224 PROTON ACER TENDL-2021 LIBRARY; T=0.K  
Proton emission for (p,2np)

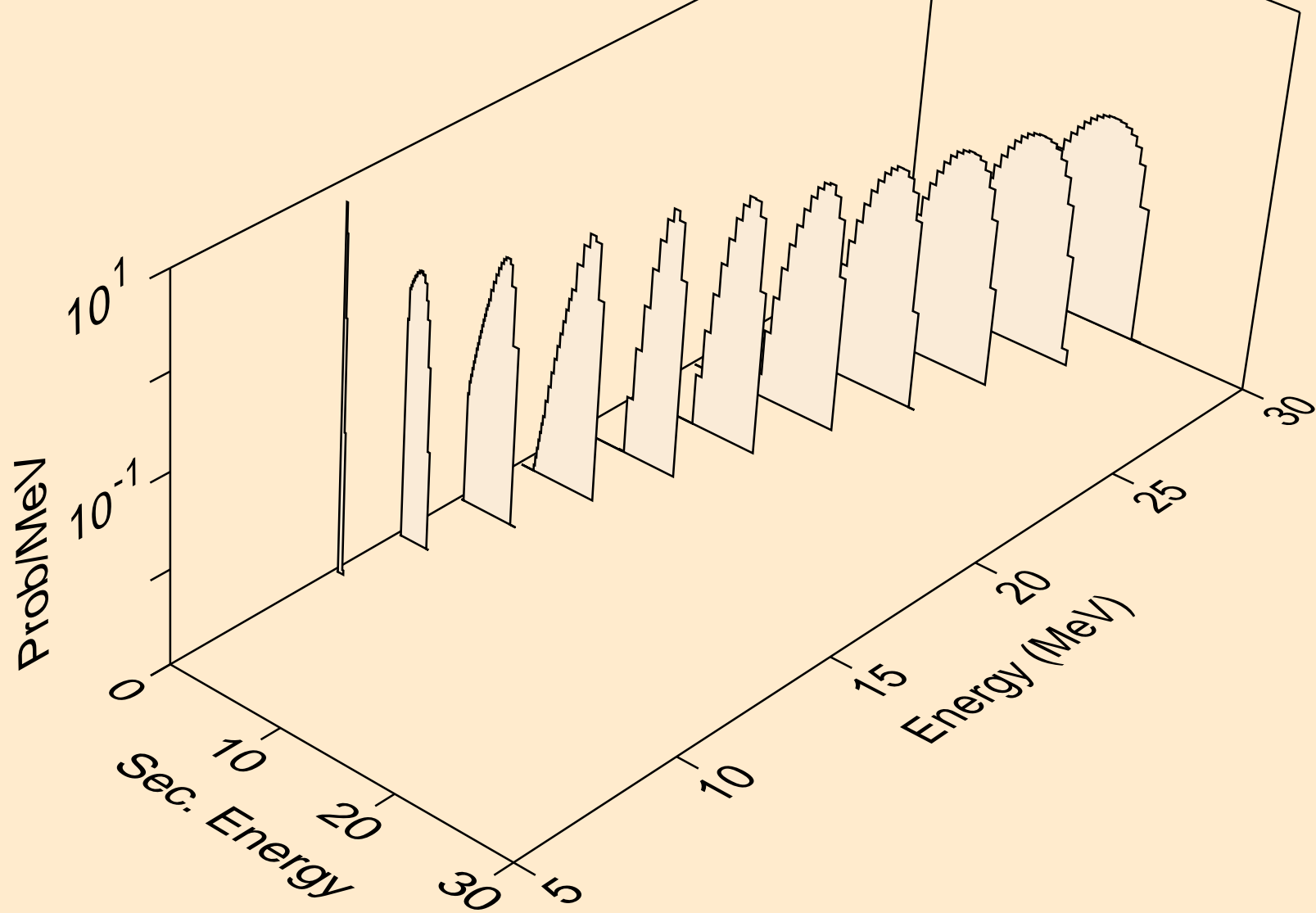

AT224 PROTON ACER TENDL-2021 LIBRARY; T=0.K  
Proton emission for (p,3np)

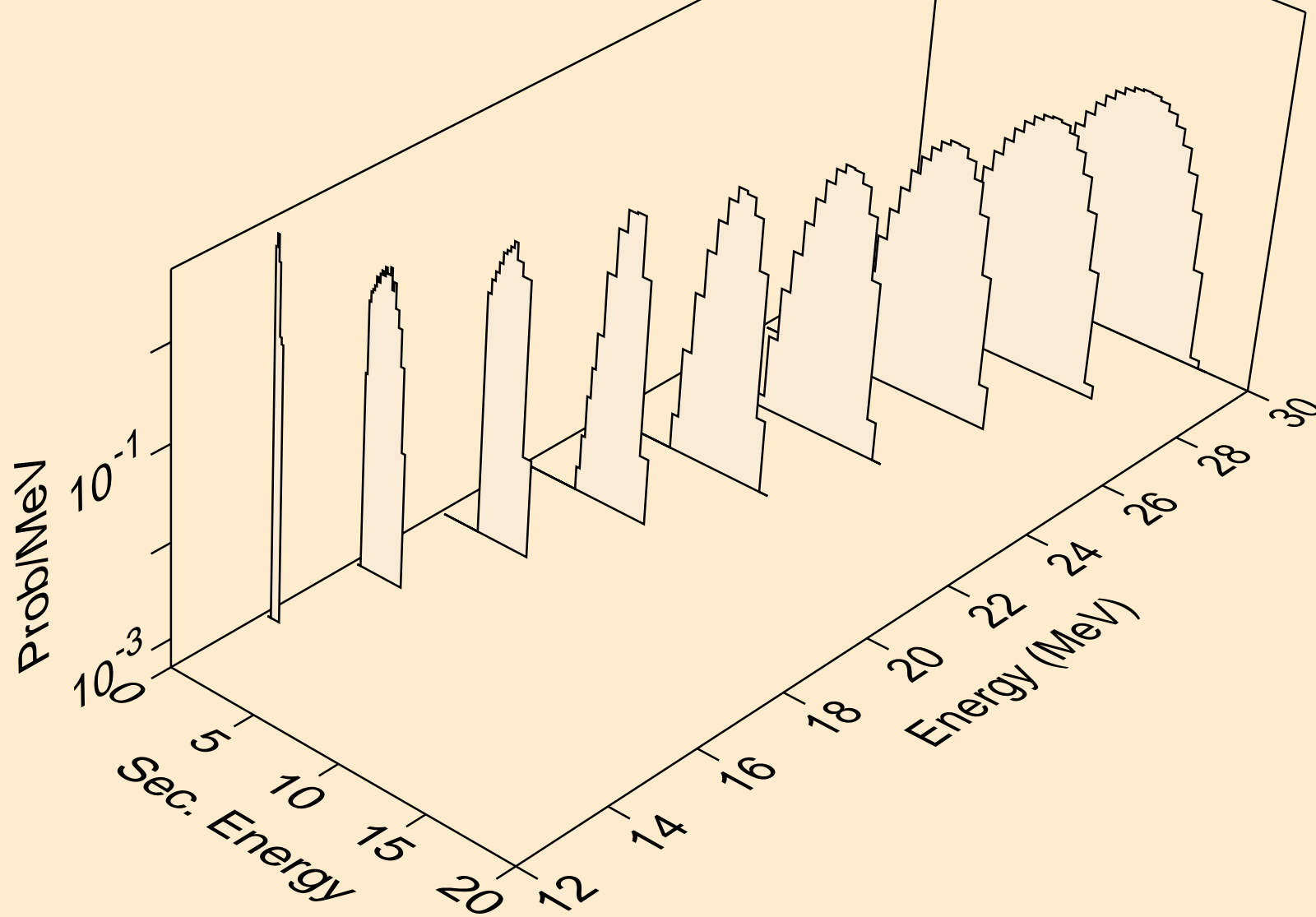

AT224 PROTON ACER TENDL-2021 LIBRARY; T=0.K  
Proton emission for (p,2np)

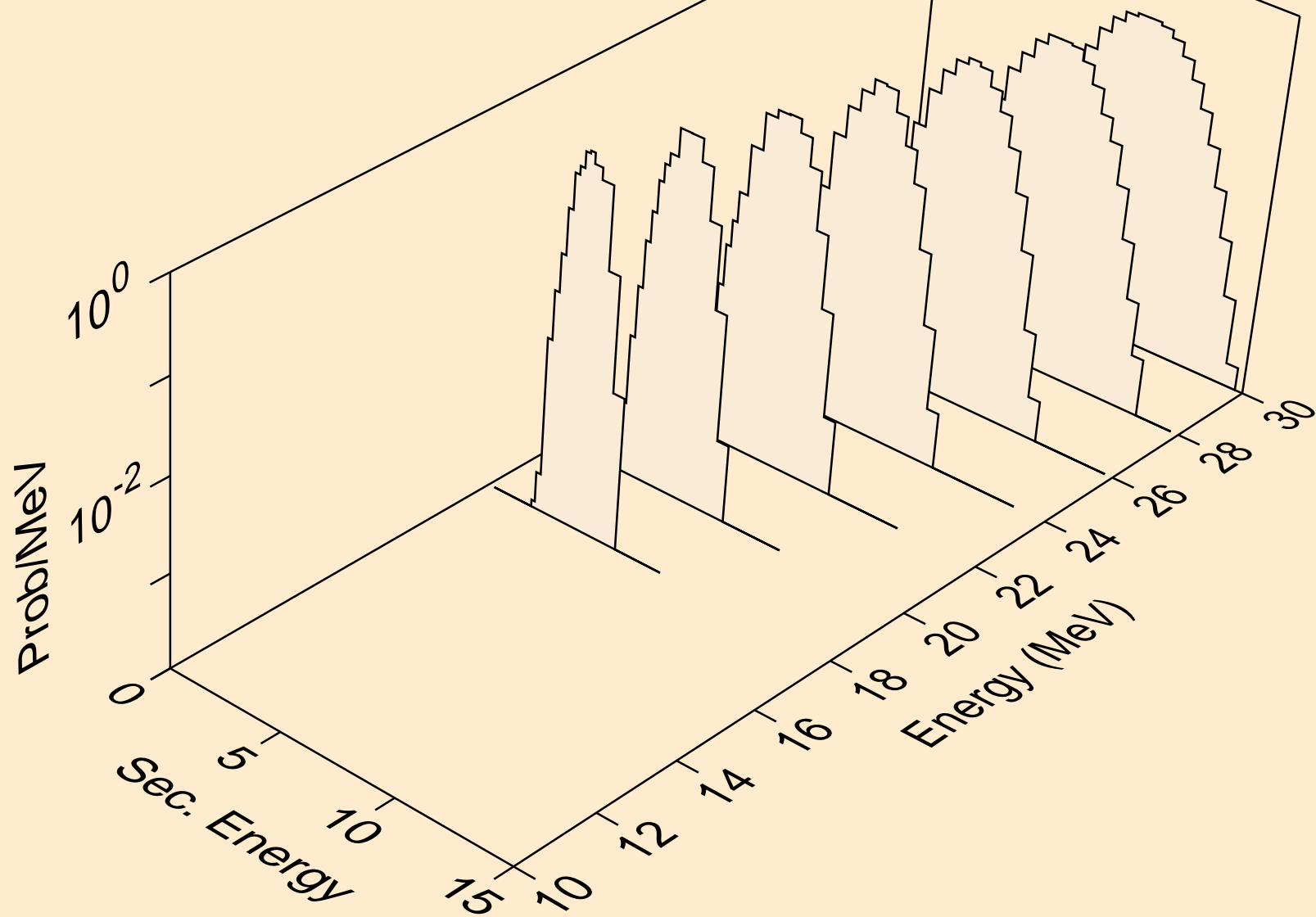



AT224 PROTON ACER TENDL-2021 LIBRARY; T=0.K  
Proton emission for (p,npa)

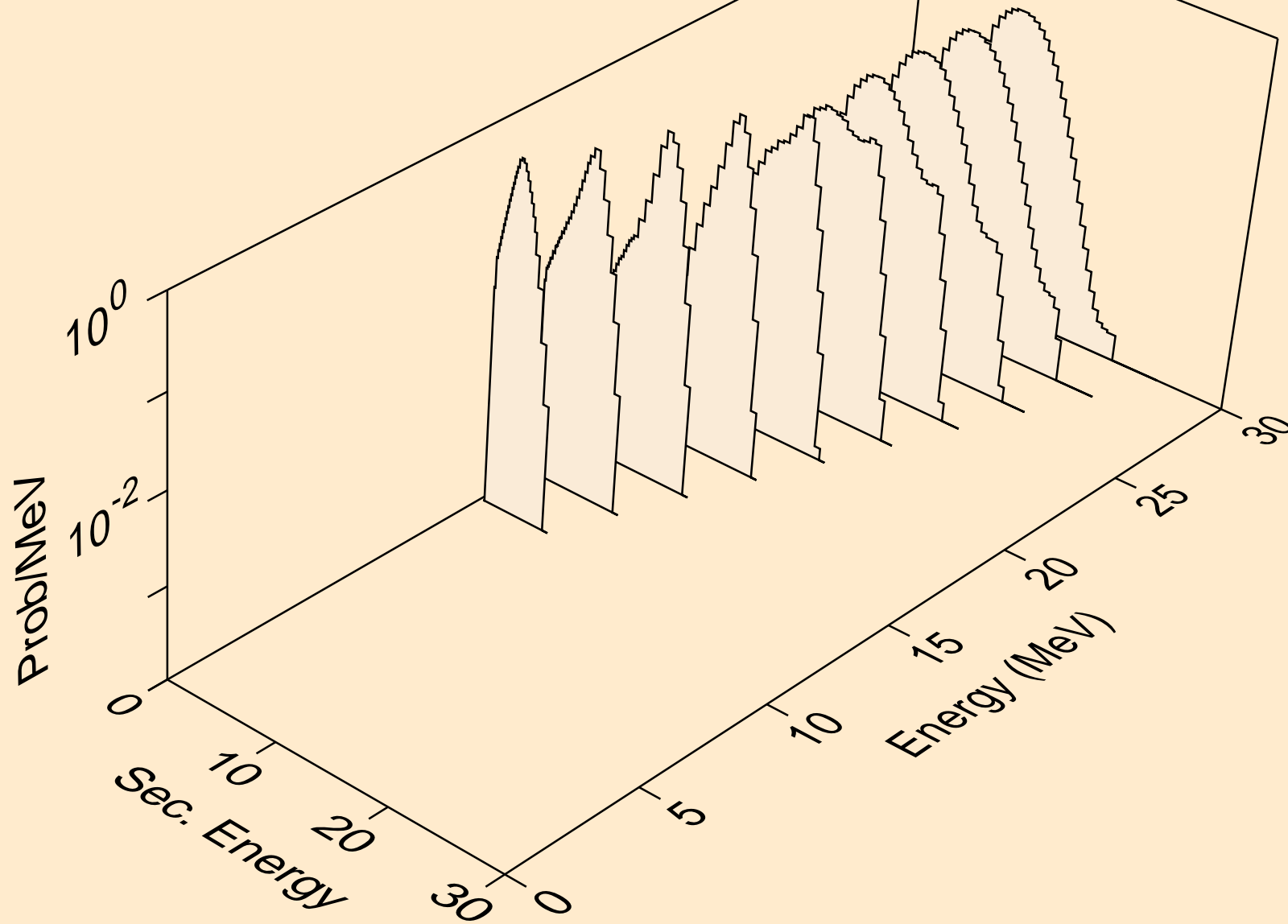

AT224 PROTON ACER TENDL-2021 LIBRARY; T=0.K  
Proton emission for inelastic

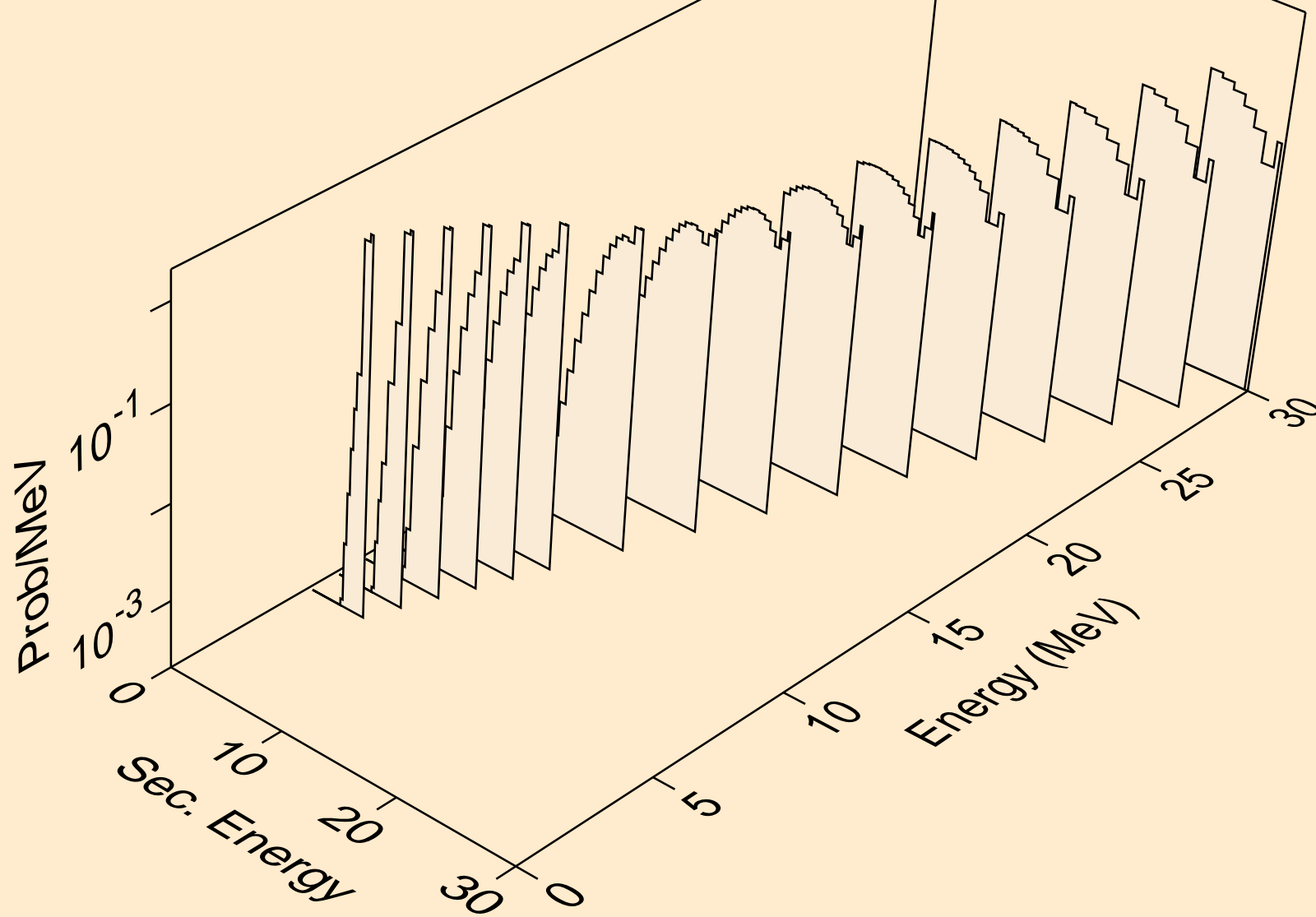

AT224 PROTON ACER TENDL-2021 LIBRARY; T=0.K  
Proton emission for (p,2p)

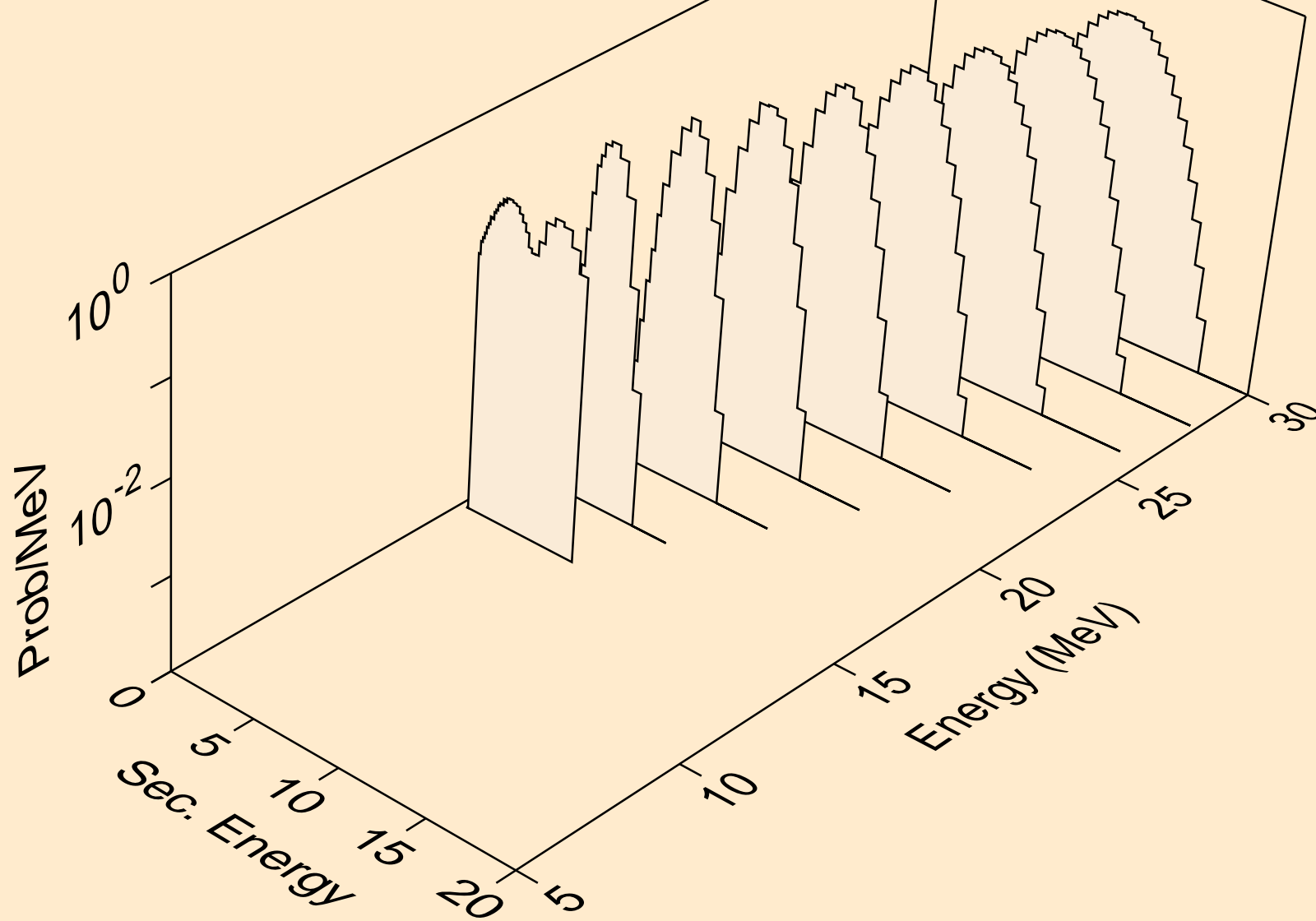

AT224 PROTON ACER TENDL-2021 LIBRARY; T=0.K  
Proton emission for (p,pd)

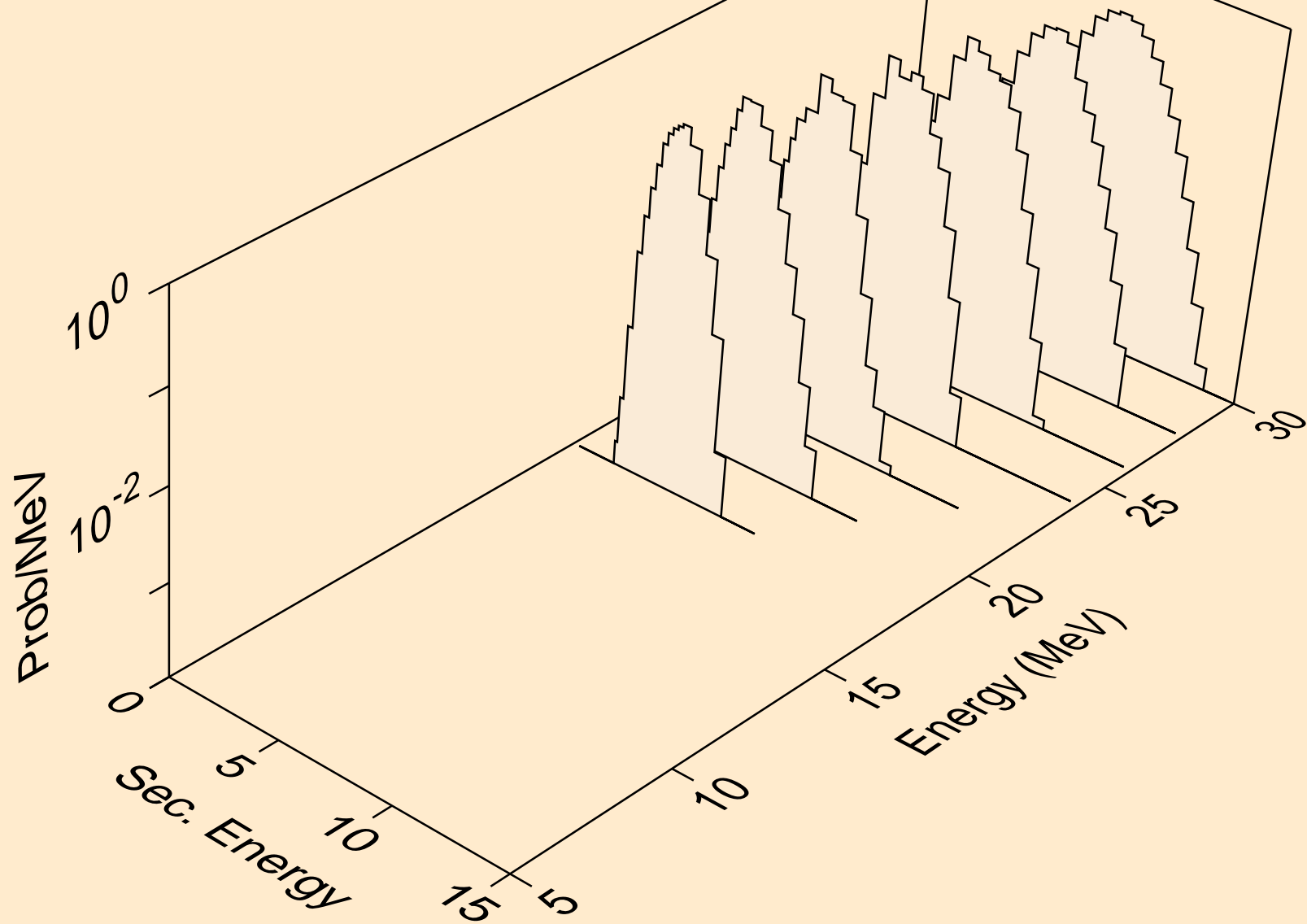

AT224 PROTON ACER TENDL-2021 LIBRARY; T=0.K  
Photon emission for (z,n)

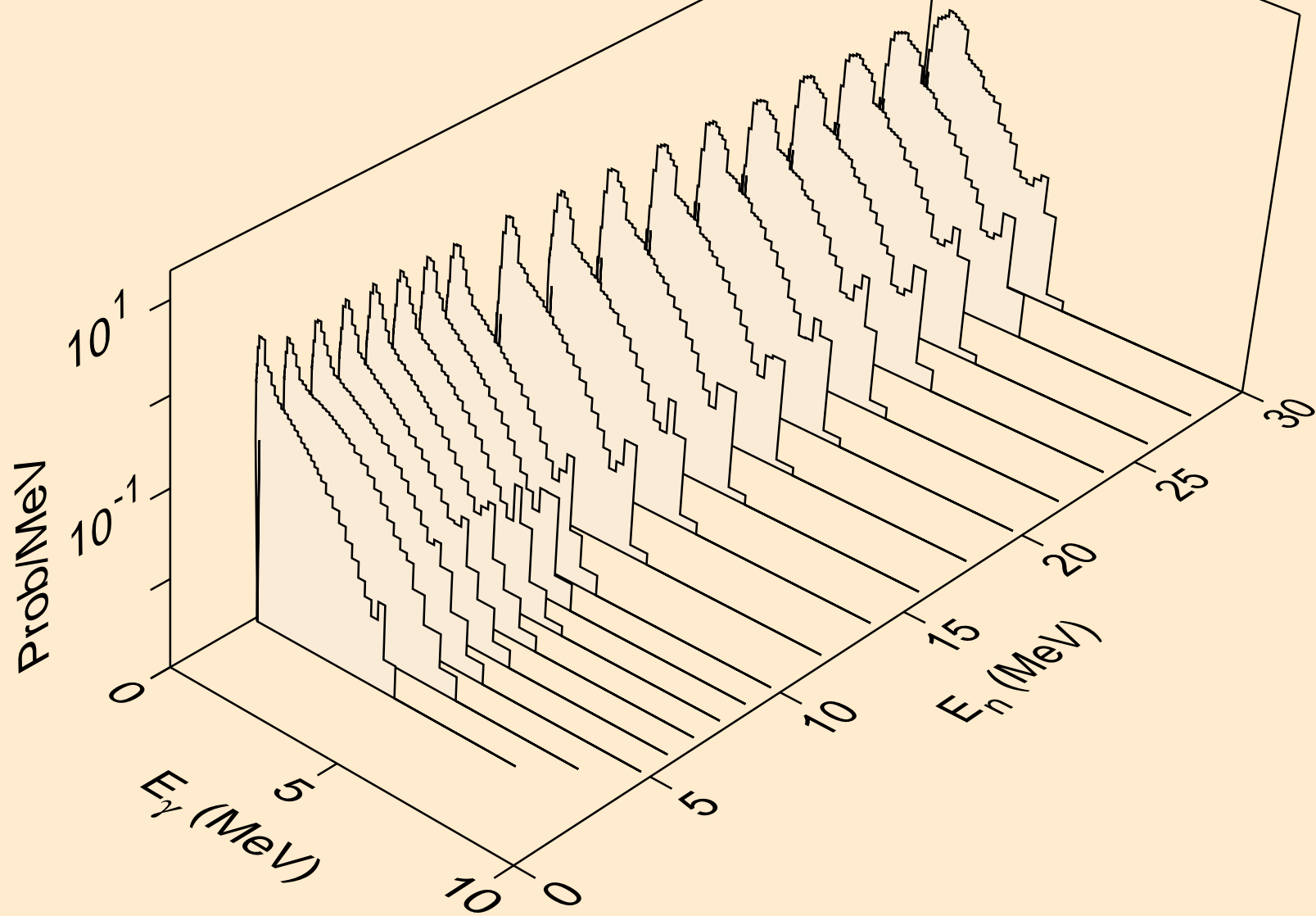

AT224 PROTON ACER TENDL-2021 LIBRARY; T=0.K  
Photon emission for (n,x)

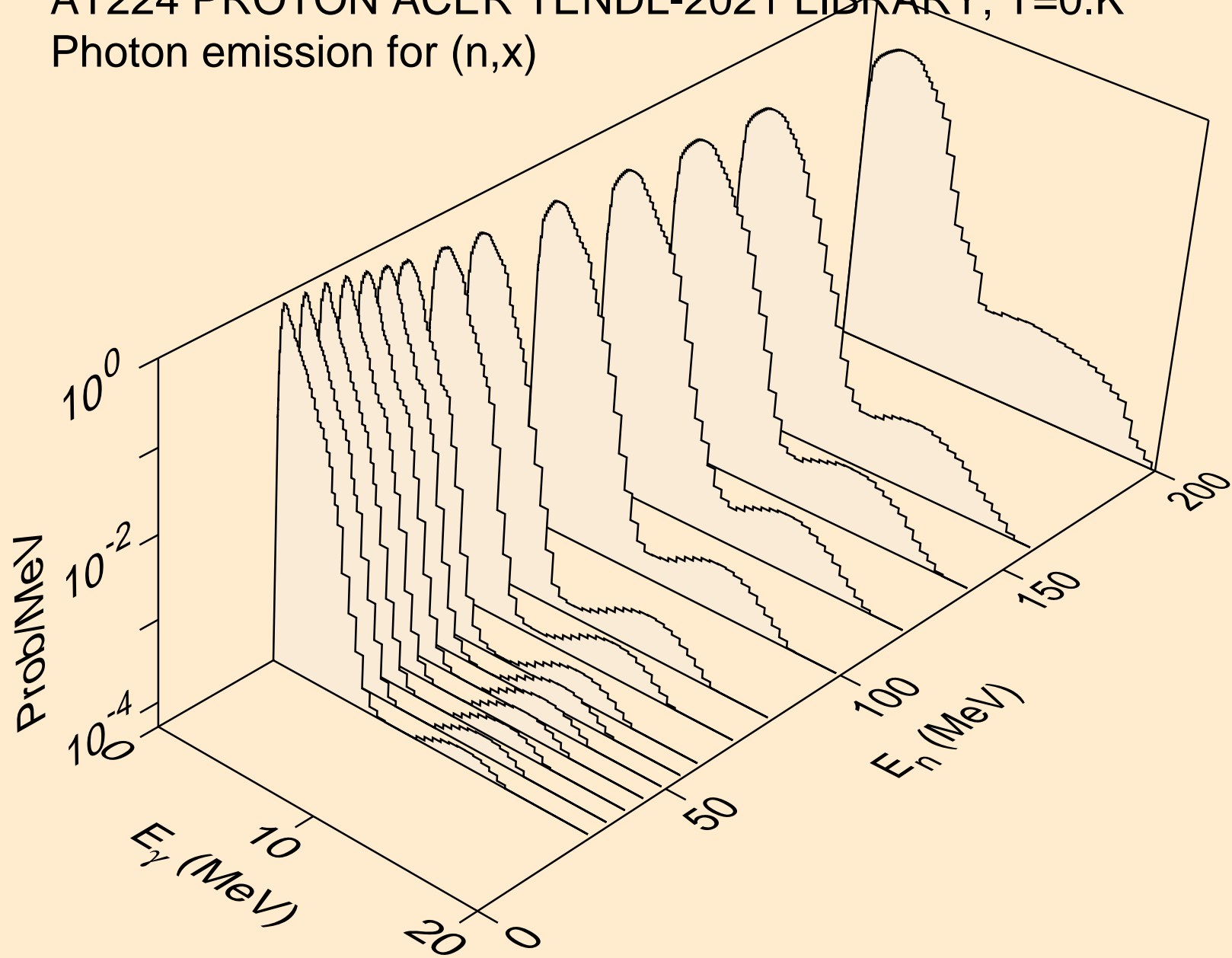

AT224 PROTON ACER TENDL-2021 LIBRARY; T=0.K  
Photon emission for (n,2nd)

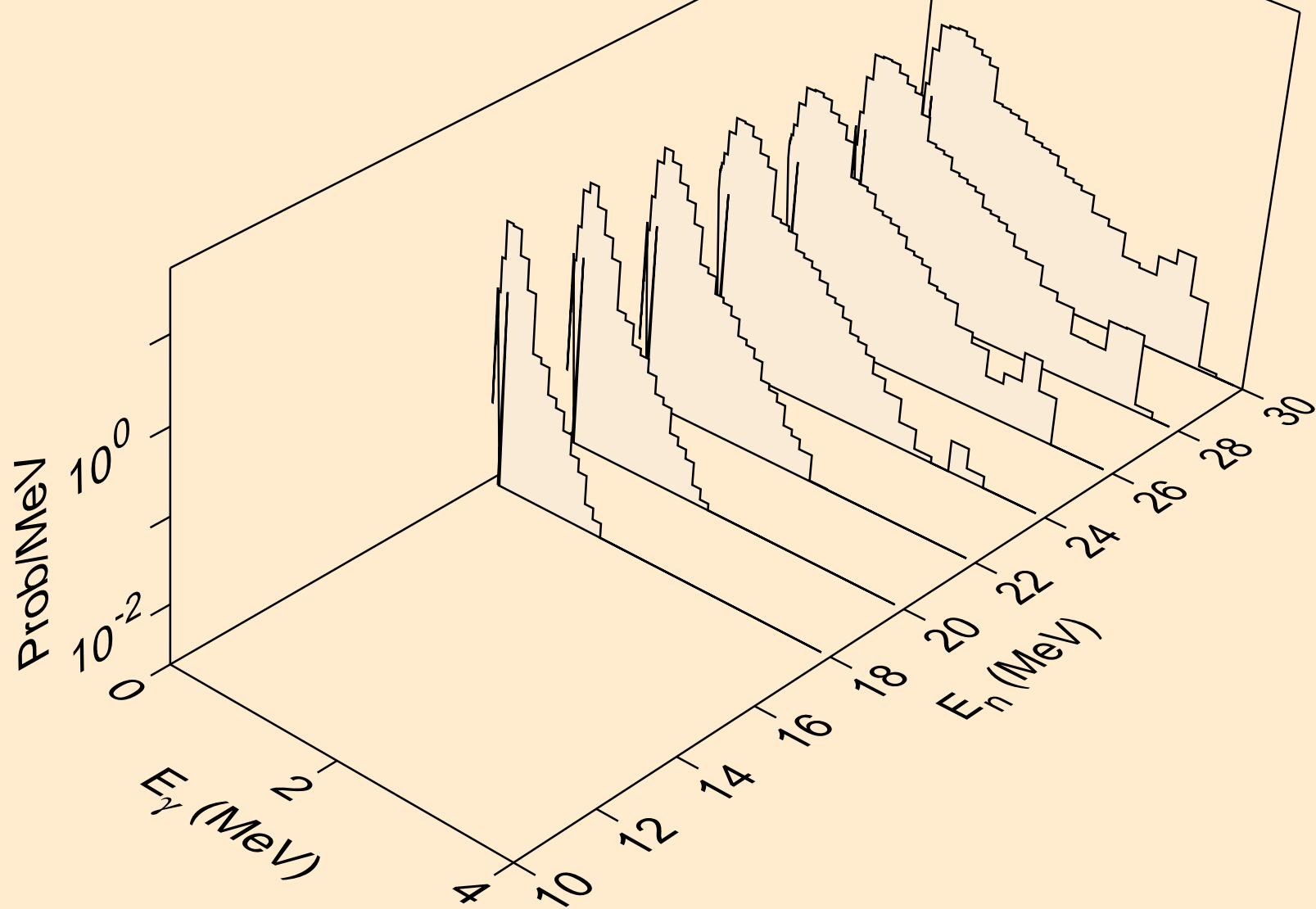

AT224 PROTON ACER TENDL-2021 LIBRARY; T=0.K  
Photon emission for (n,2n)

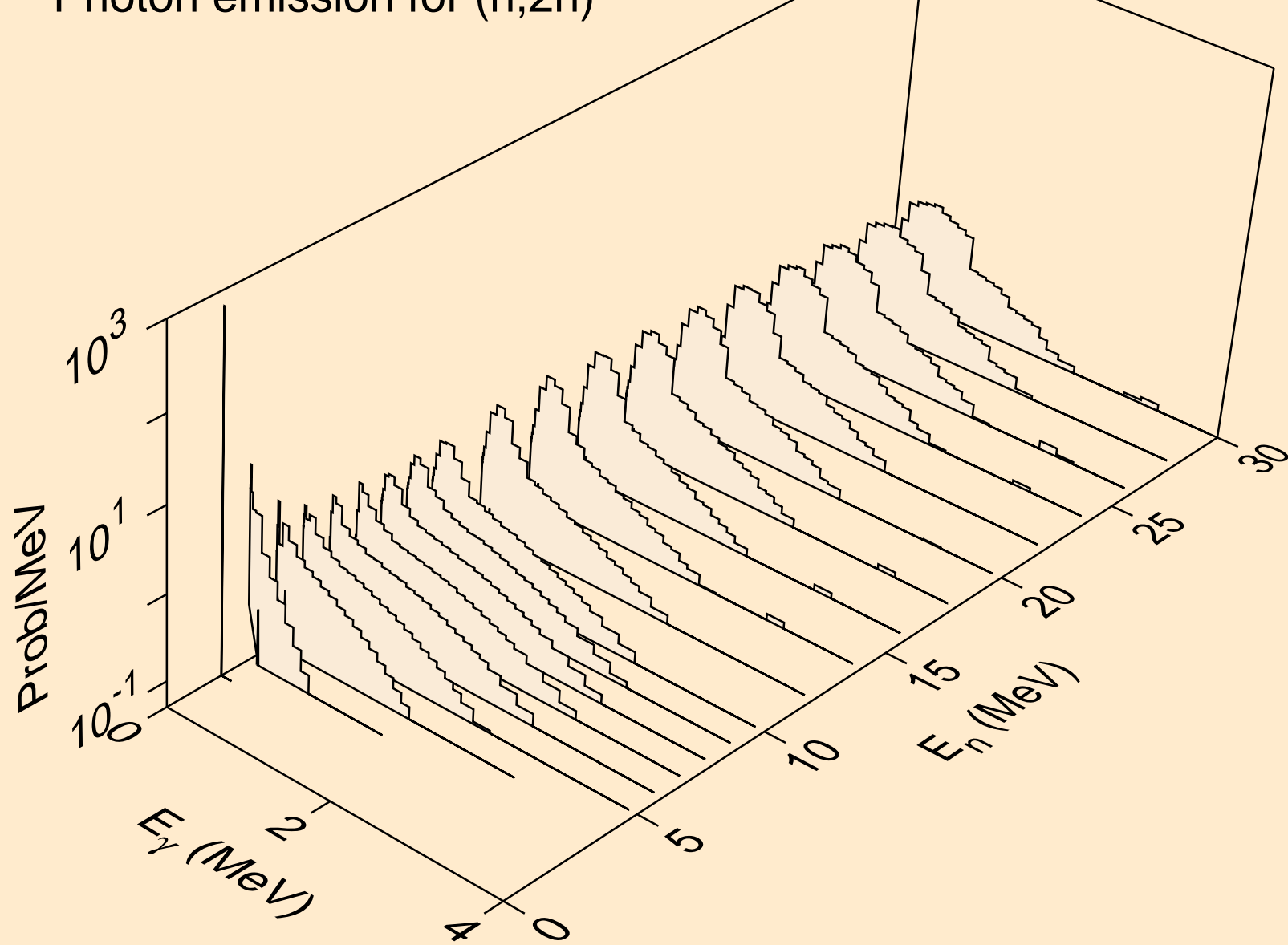



AT224 PROTON ACER TENDL-2021 LIBRARY; T=0.K  
Photon emission for (n,3n)

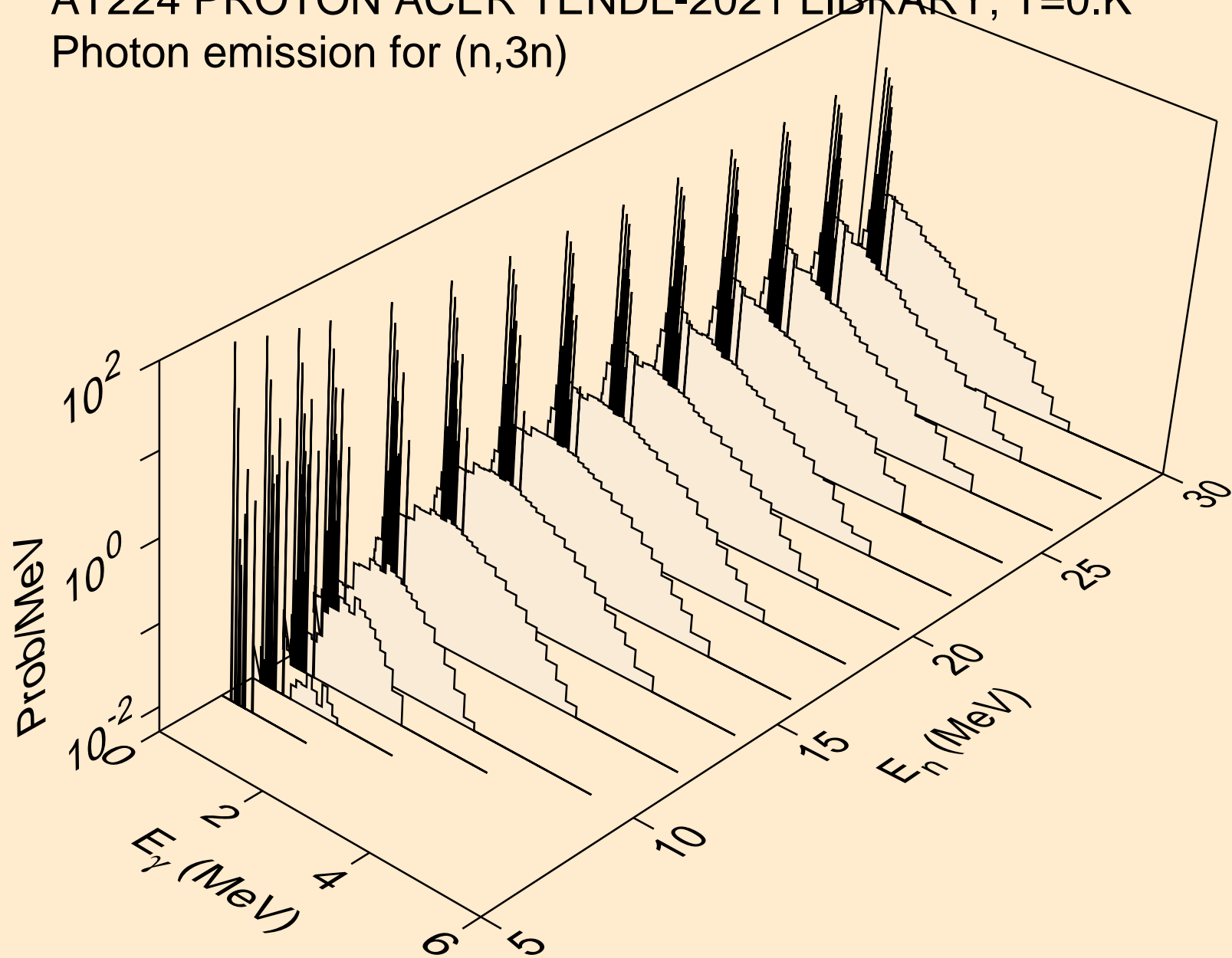

AT224 PROTON ACER TENDL-2021 LIBRARY; T=0.K  
Photon emission for (n,n\*)a

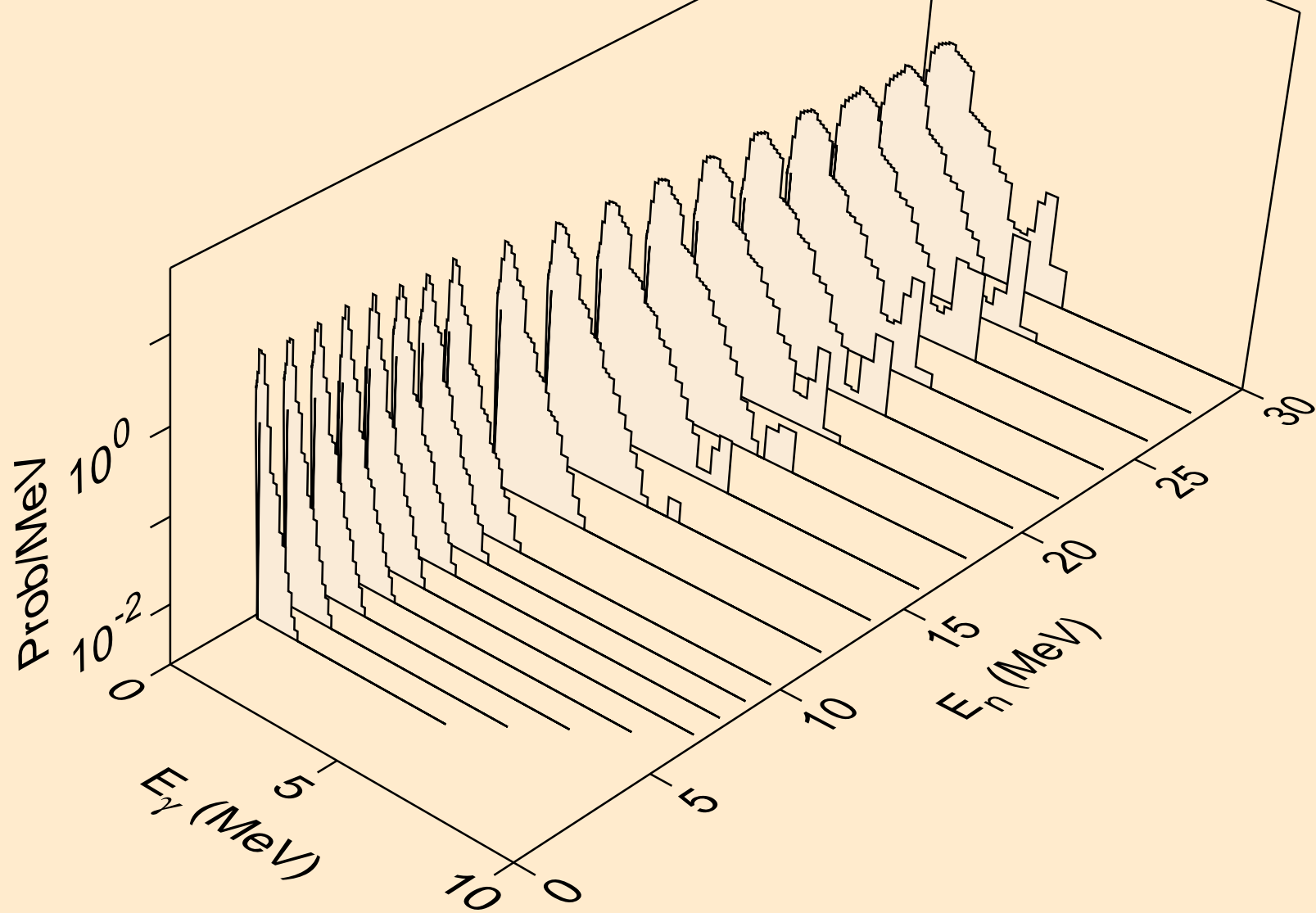

AT224 PROTON ACER TENDL-2021 LIBRARY; T=0.K  
Photon emission for (n,2n)a

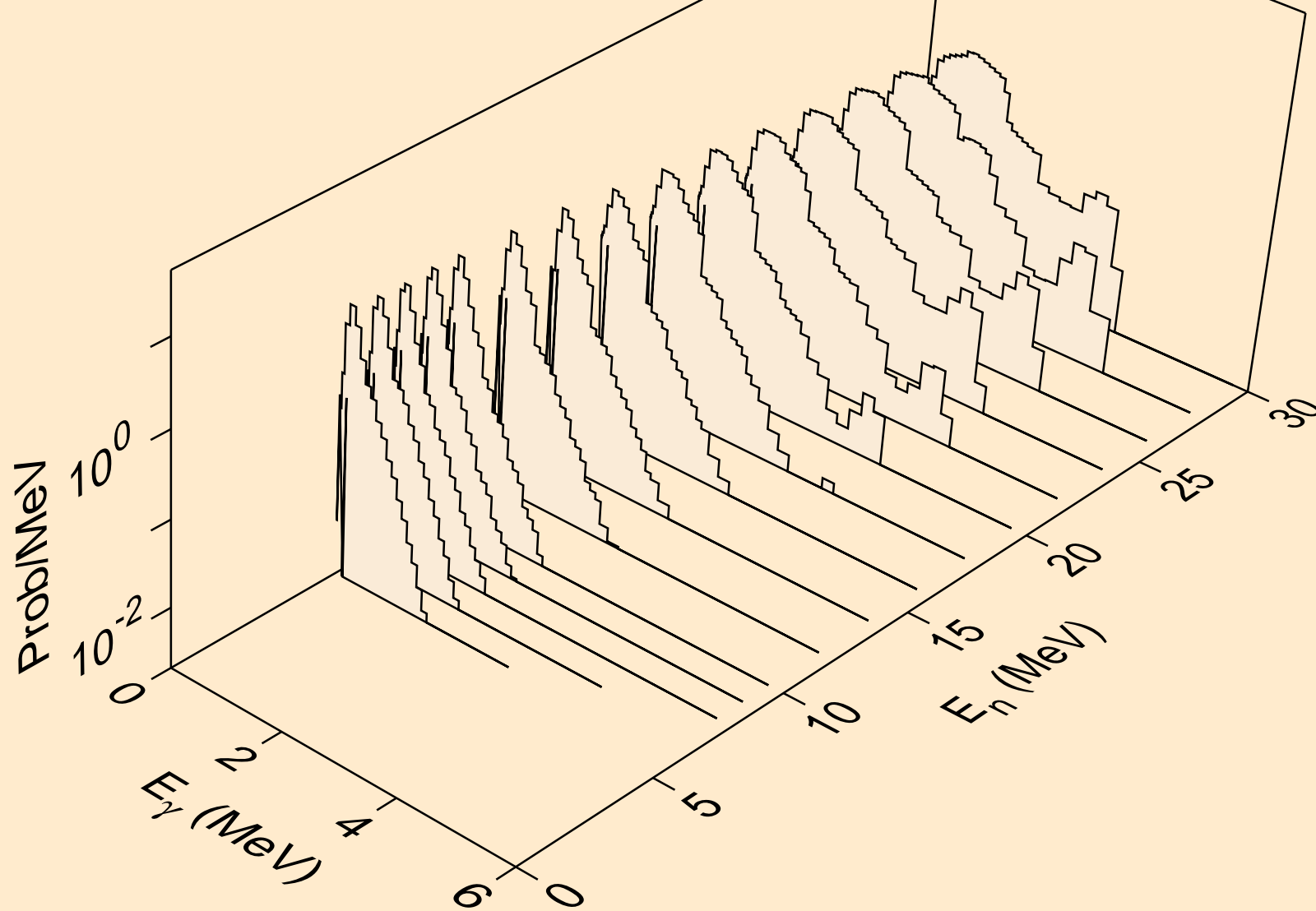

AT224 PROTON ACER TENDL-2021 LIBRARY; T=0.K  
Photon emission for (n,3n)a

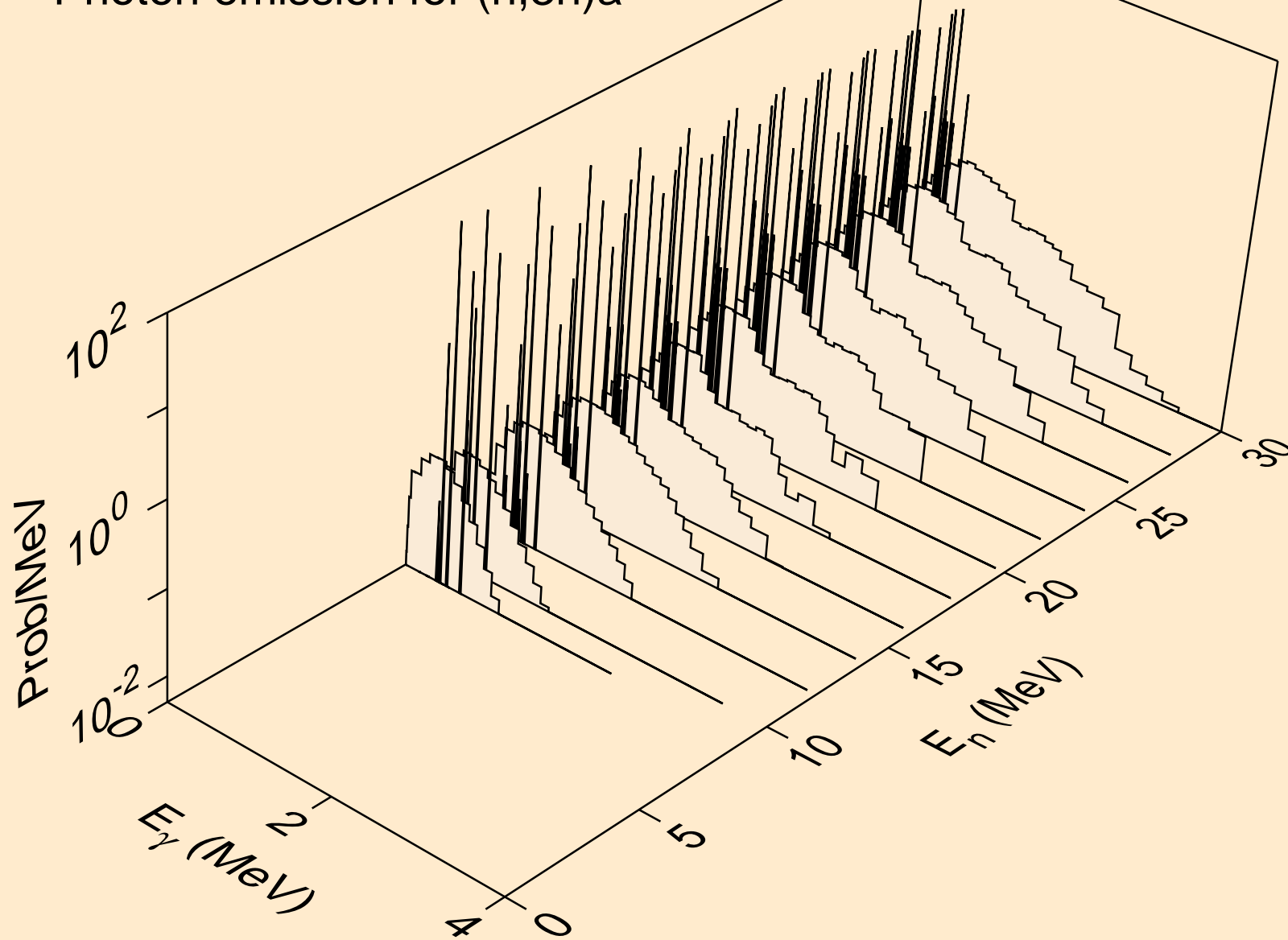

AT224 PROTON ACER TENDL-2021 LIBRARY; T=0.K  
Photon emission for (n,n\*)p

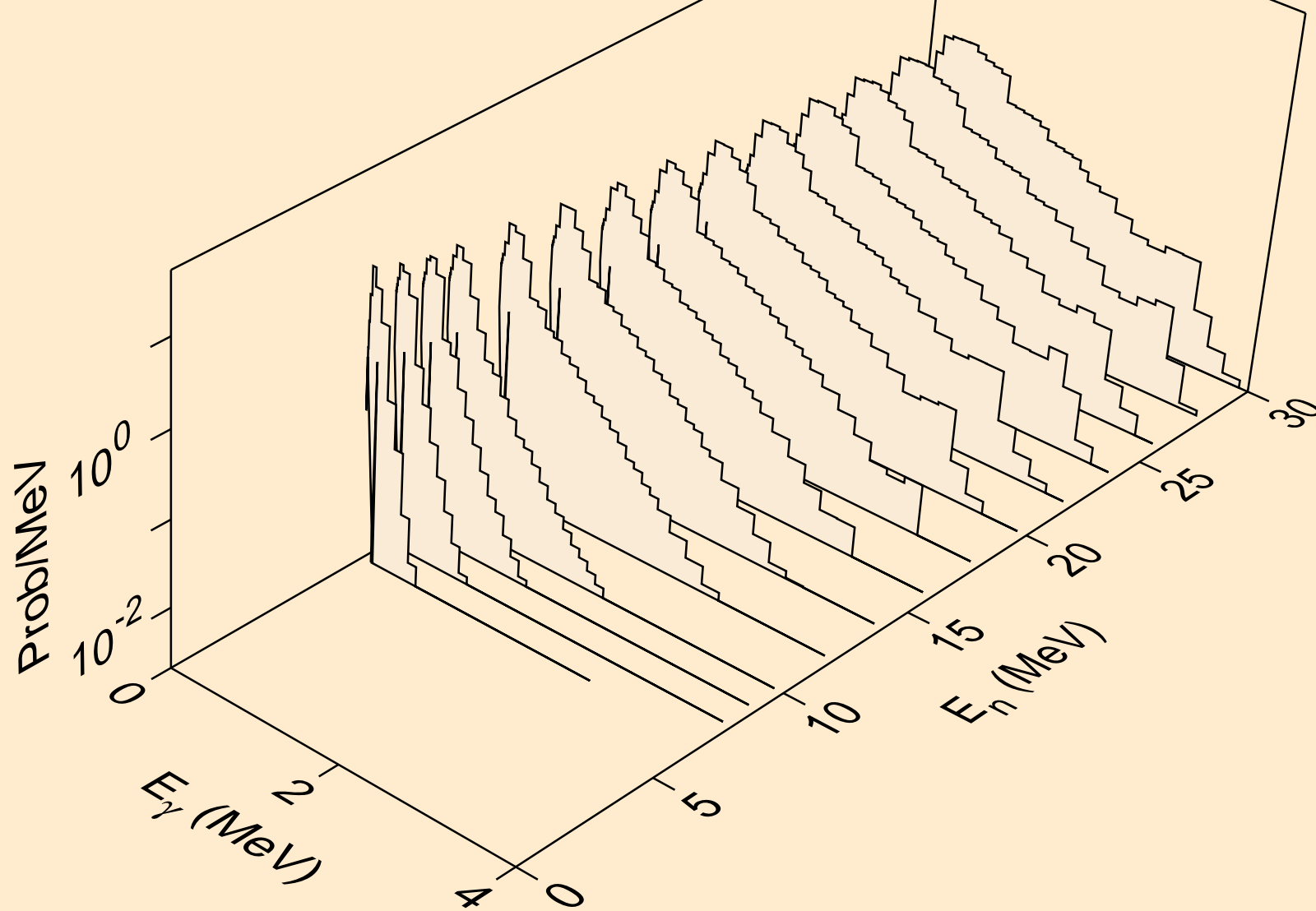

AT224 PROTON ACER TENDL-2021 LIBRARY; T=0.K  
Photon emission for (n,n\*)2a

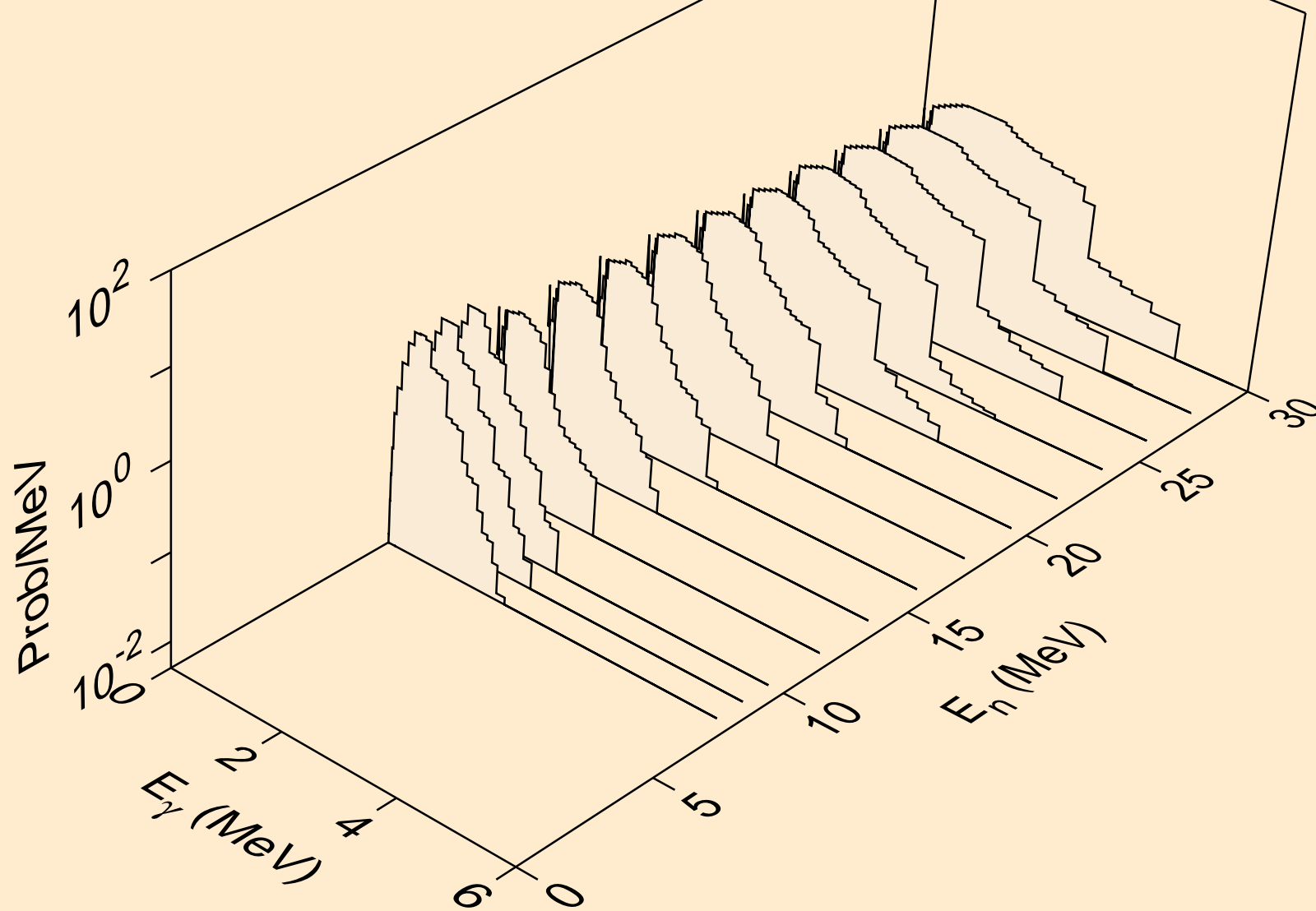

AT224 PROTON ACER TENDL-2021 LIBRARY; T=0.K  
Photon emission for (n,2n)2a

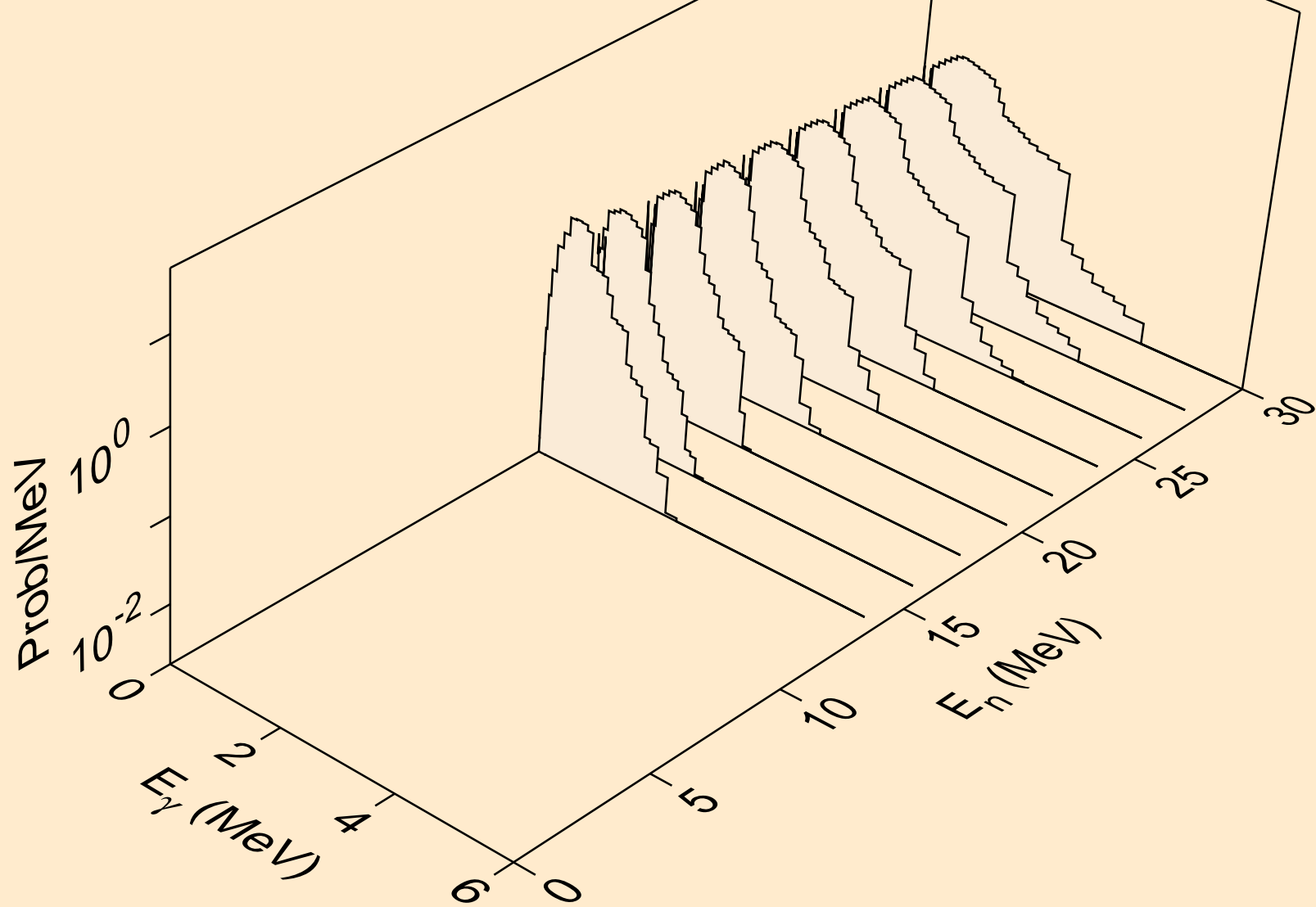

AT224 PROTON ACER TENDL-2021 LIBRARY; T=0.K  
Photon emission for (n,n\*)d

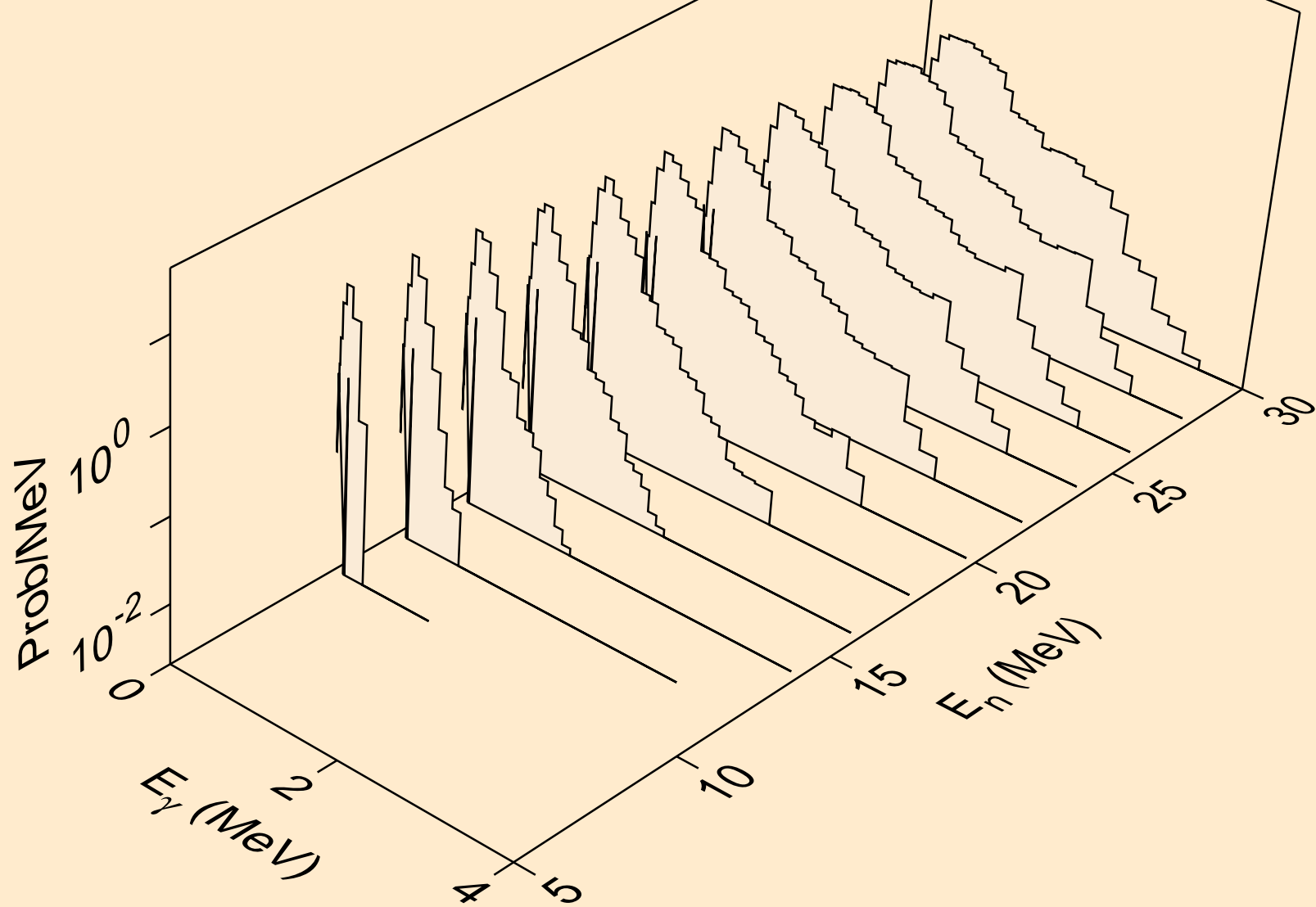



AT224 PROTON ACER TENDL-2021 LIBRARY; T=0.K  
Photon emission for (n,n\*)t

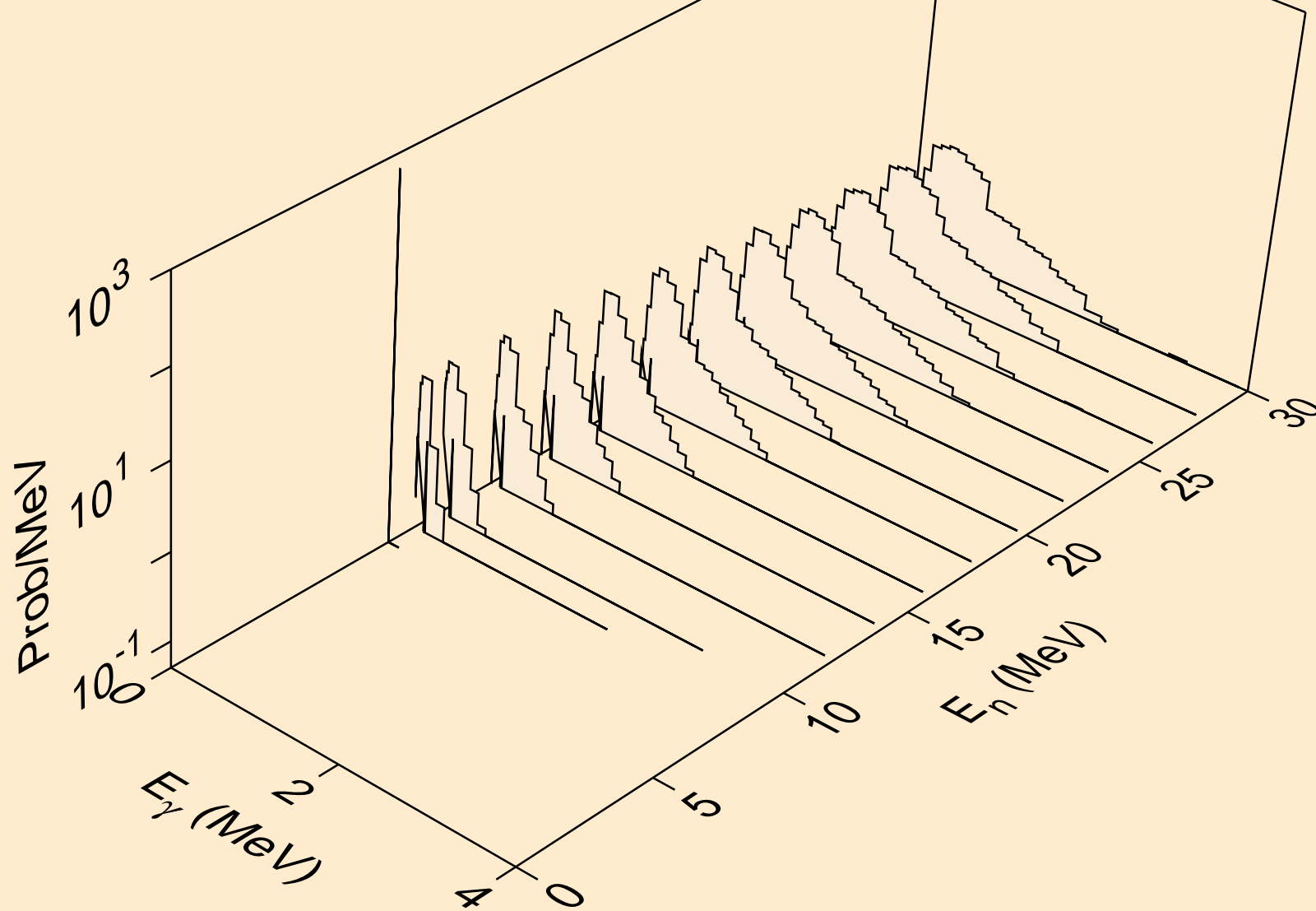

AT224 PROTON ACER TENDL-2021 LIBRARY; T=0.K  
Photon emission for (n,n\*)he3

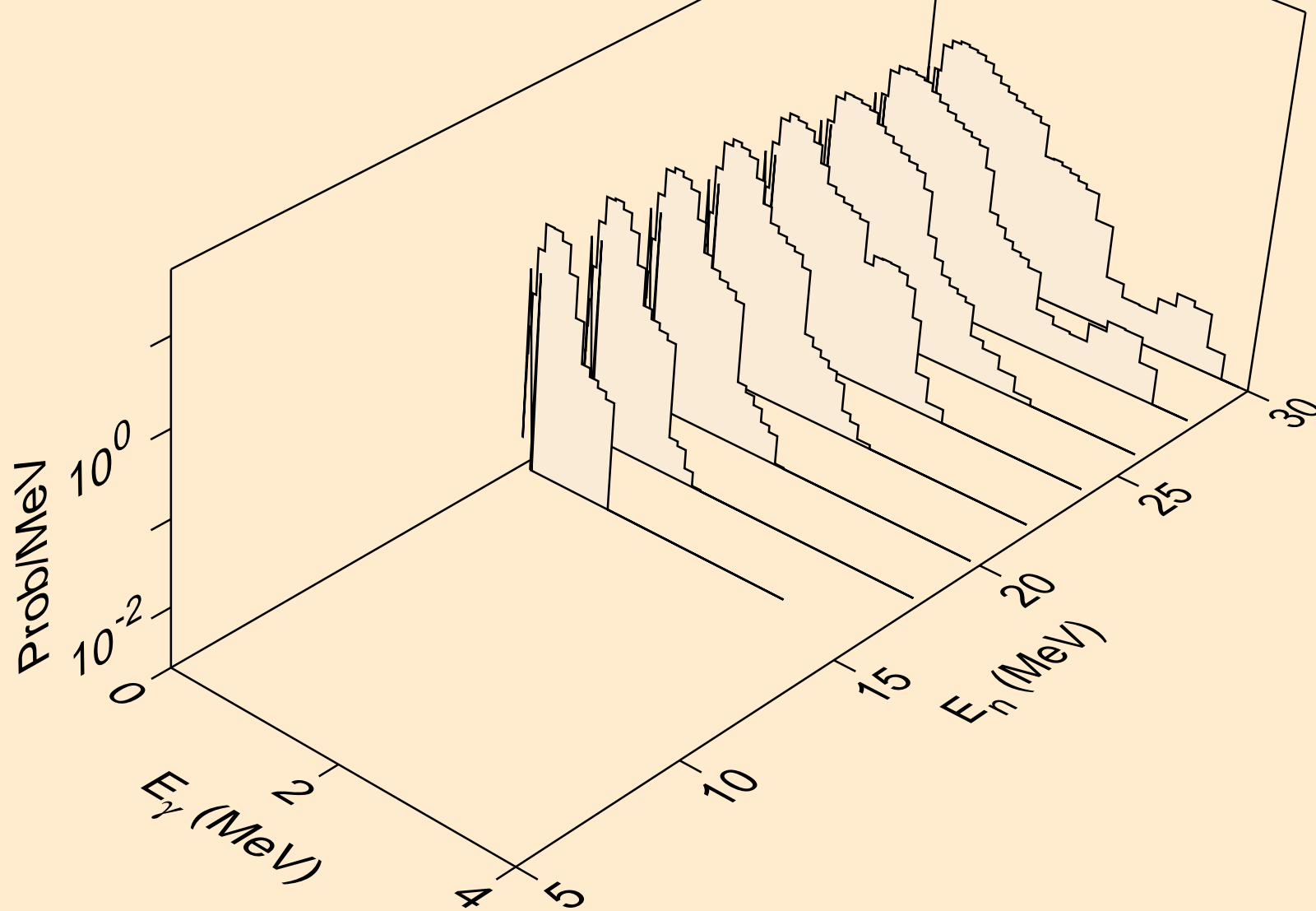

AT224 PROTON ACER TENDL-2021 LIBRARY; T=0.K  
Photon emission for (n,4n)

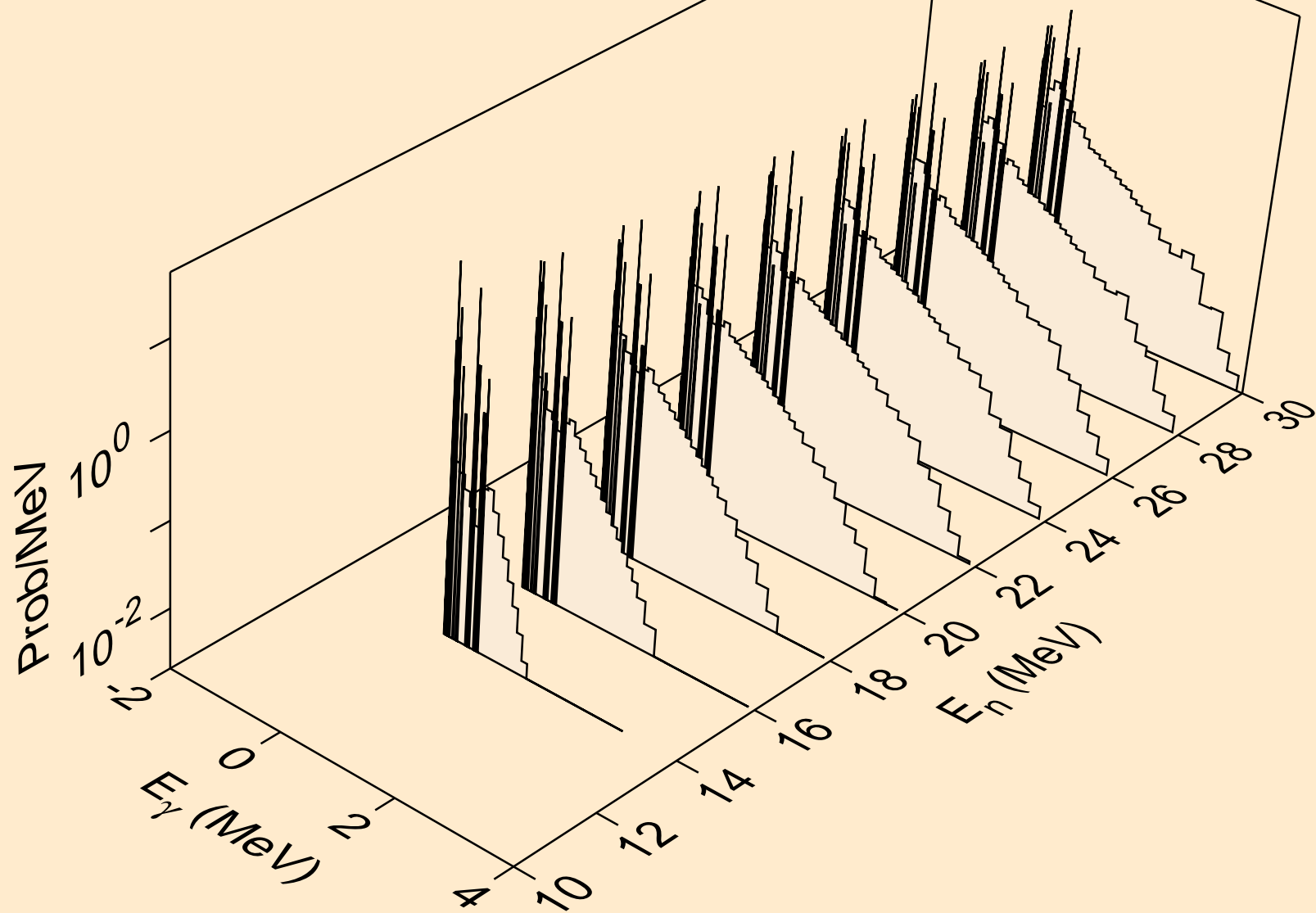

AT224 PROTON ACER TENDL-2021 LIBRARY; T=0.K  
Photon emission for (n,2np)

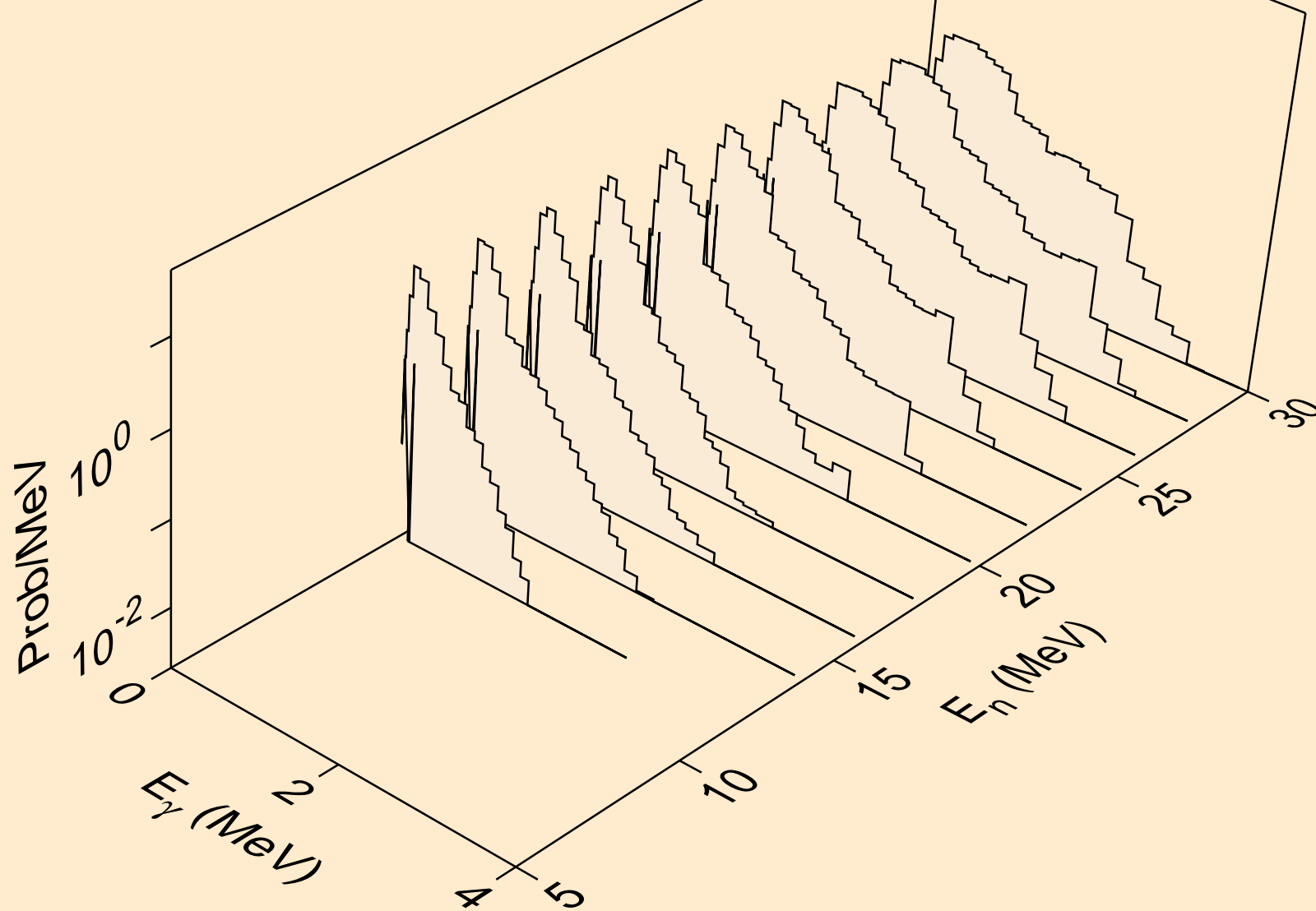

AT224 PROTON ACER TENDL-2021 LIBRARY; T=0.K  
Photon emission for (n,3np)

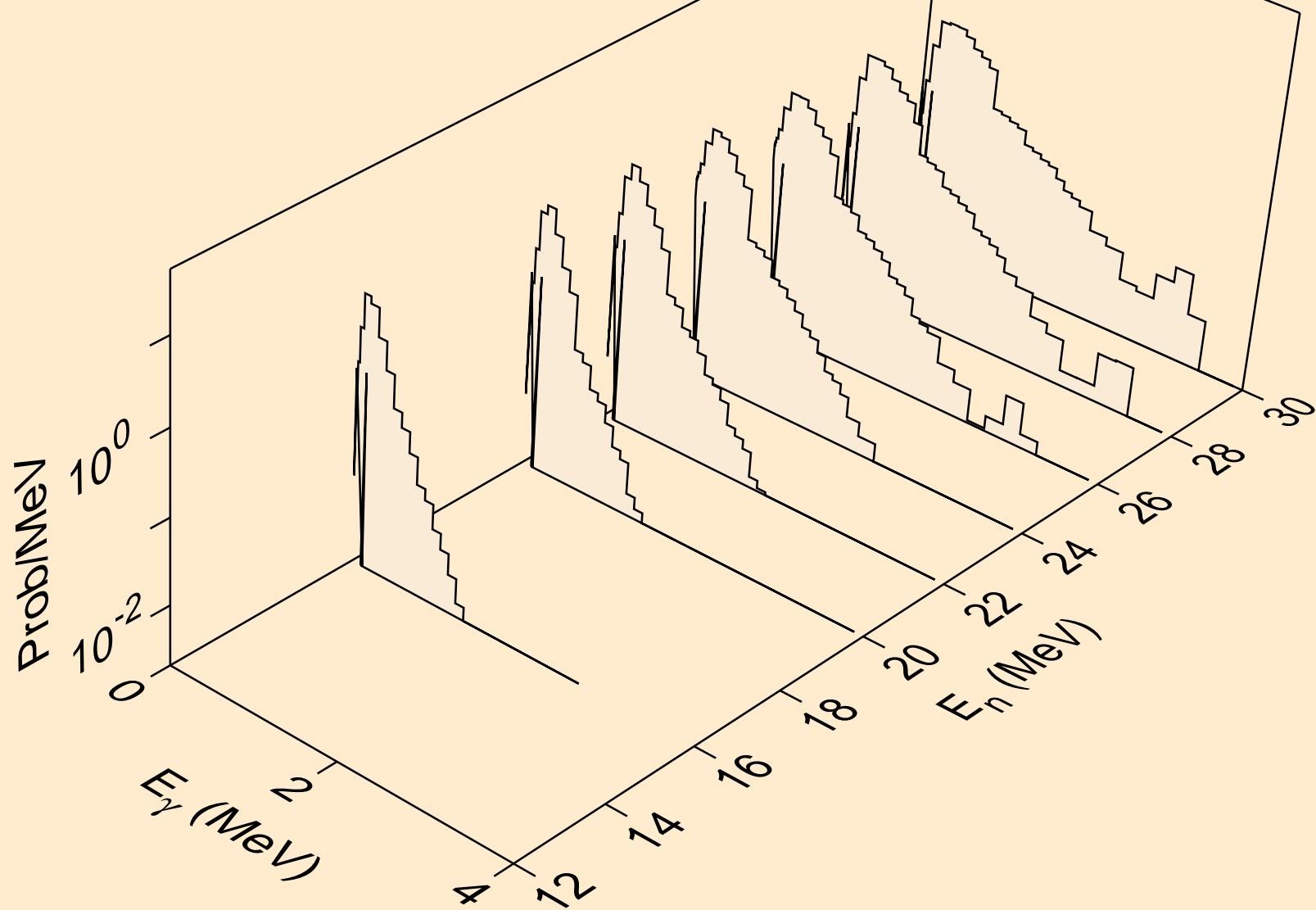

AT224 PROTON ACER TENDL-2021 LIBRARY; T=0.K  
Photon emission for (n,2np)

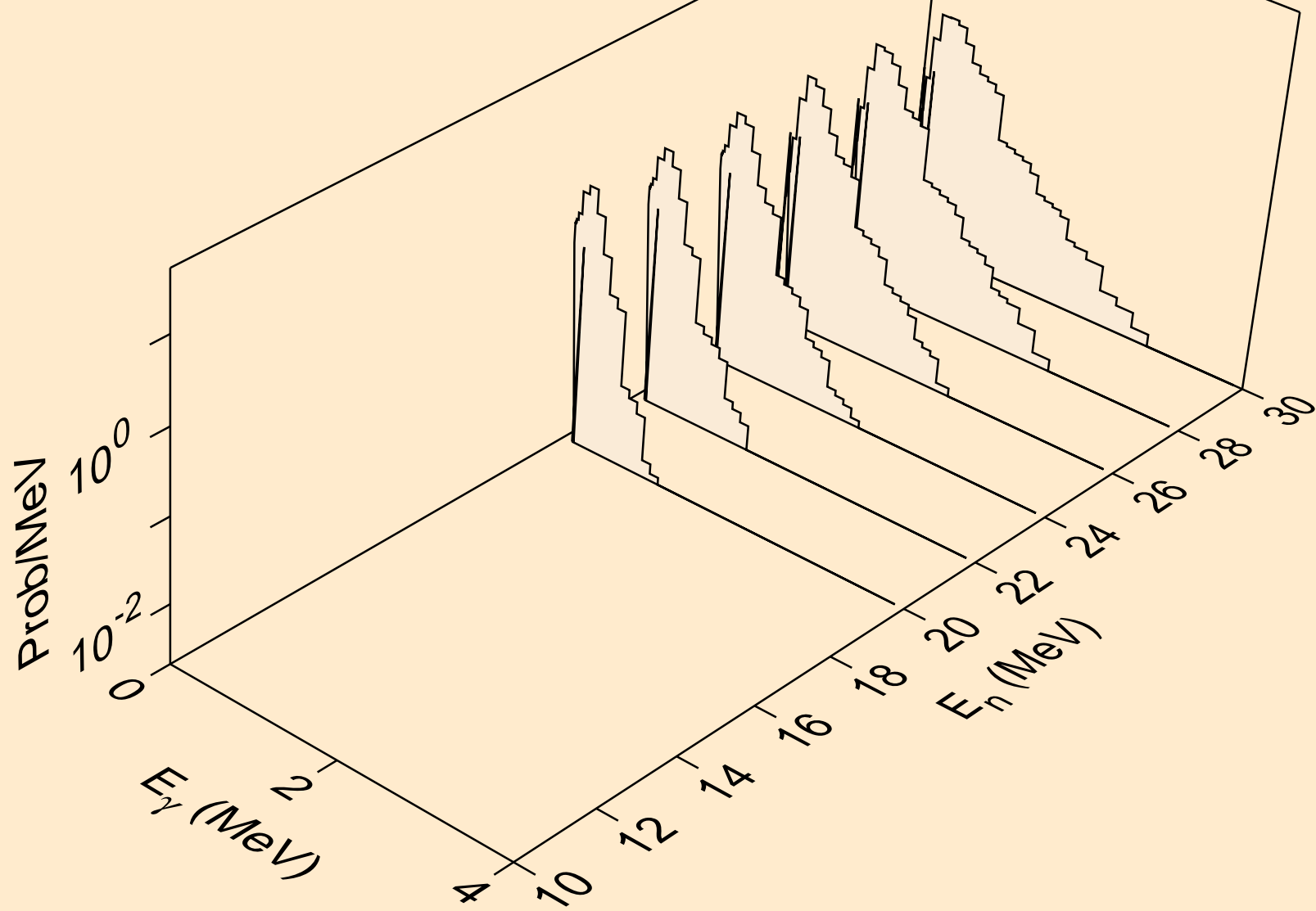

AT224 PROTON ACER TENDL-2021 LIBRARY; T=0.K  
Photon emission for (n,npa)

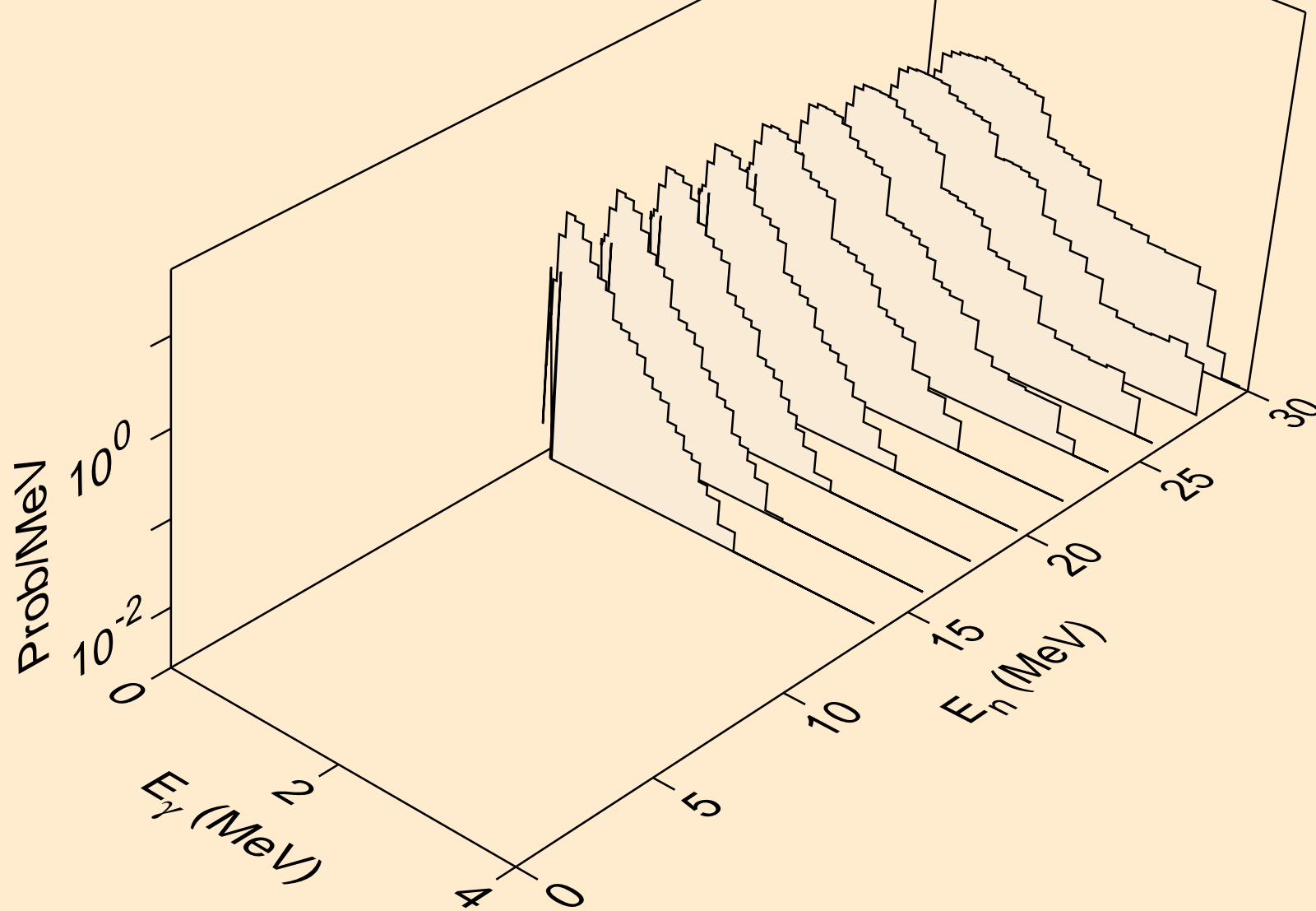

AT224 PROTON ACER TENDL-2021 LIBRARY; T=0.K  
Photon emission for (n,gma)

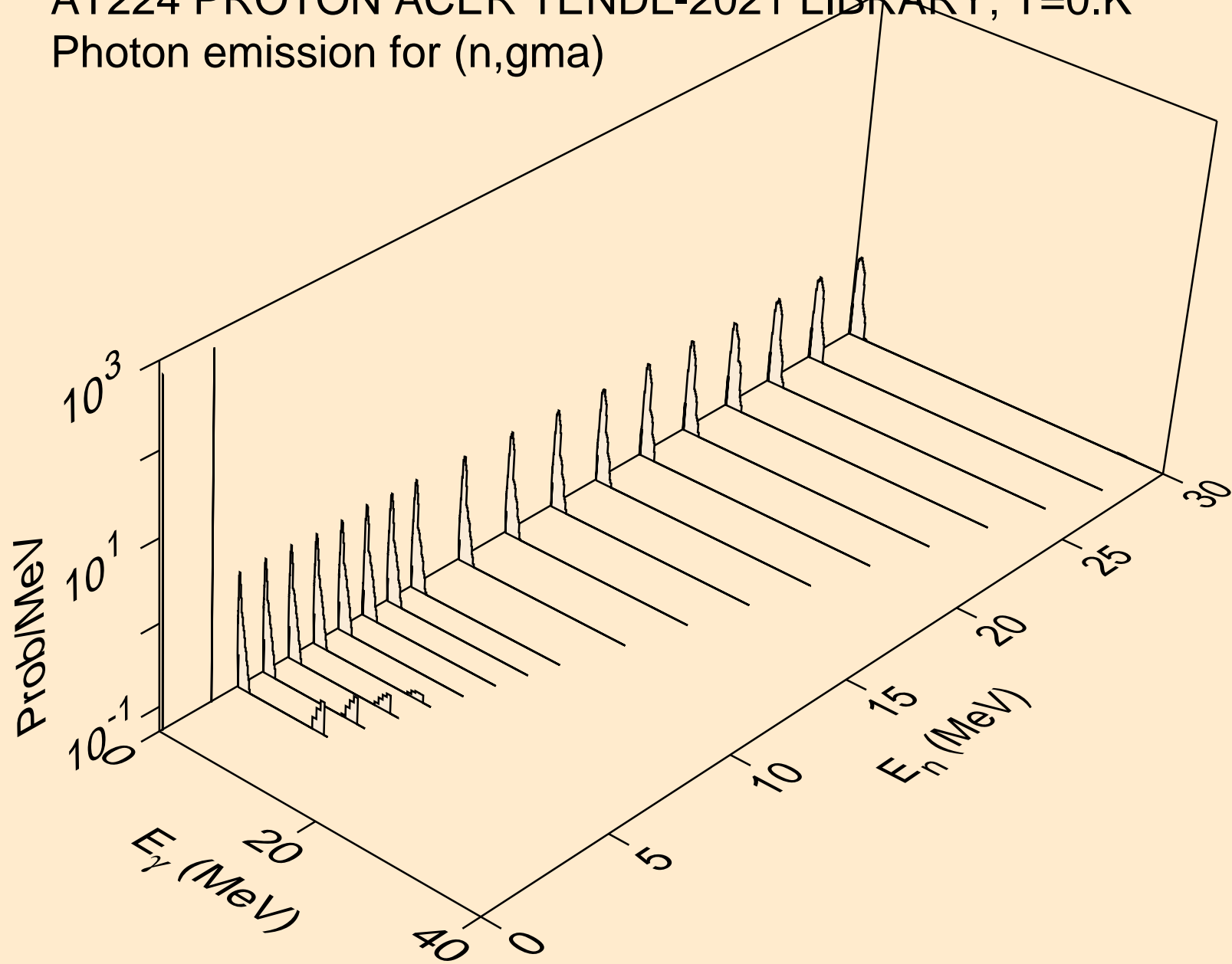



AT224 PROTON ACER TENDL-2021 LIBRARY; T=0.K  
Photon emission for inelastic

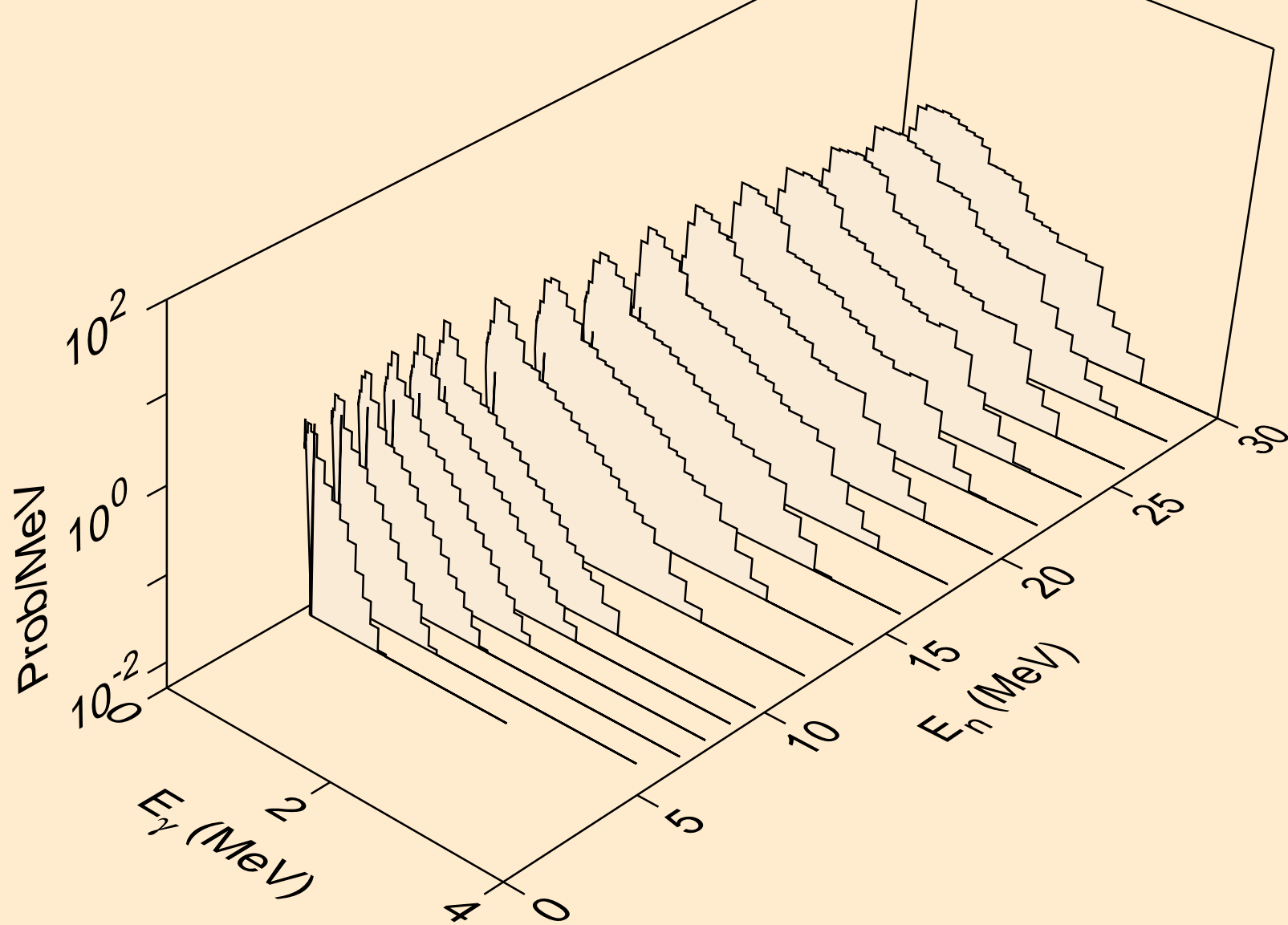

AT224 PROTON ACER TENDL-2021 LIBRARY; T=0.K  
Photon emission for (n,d)

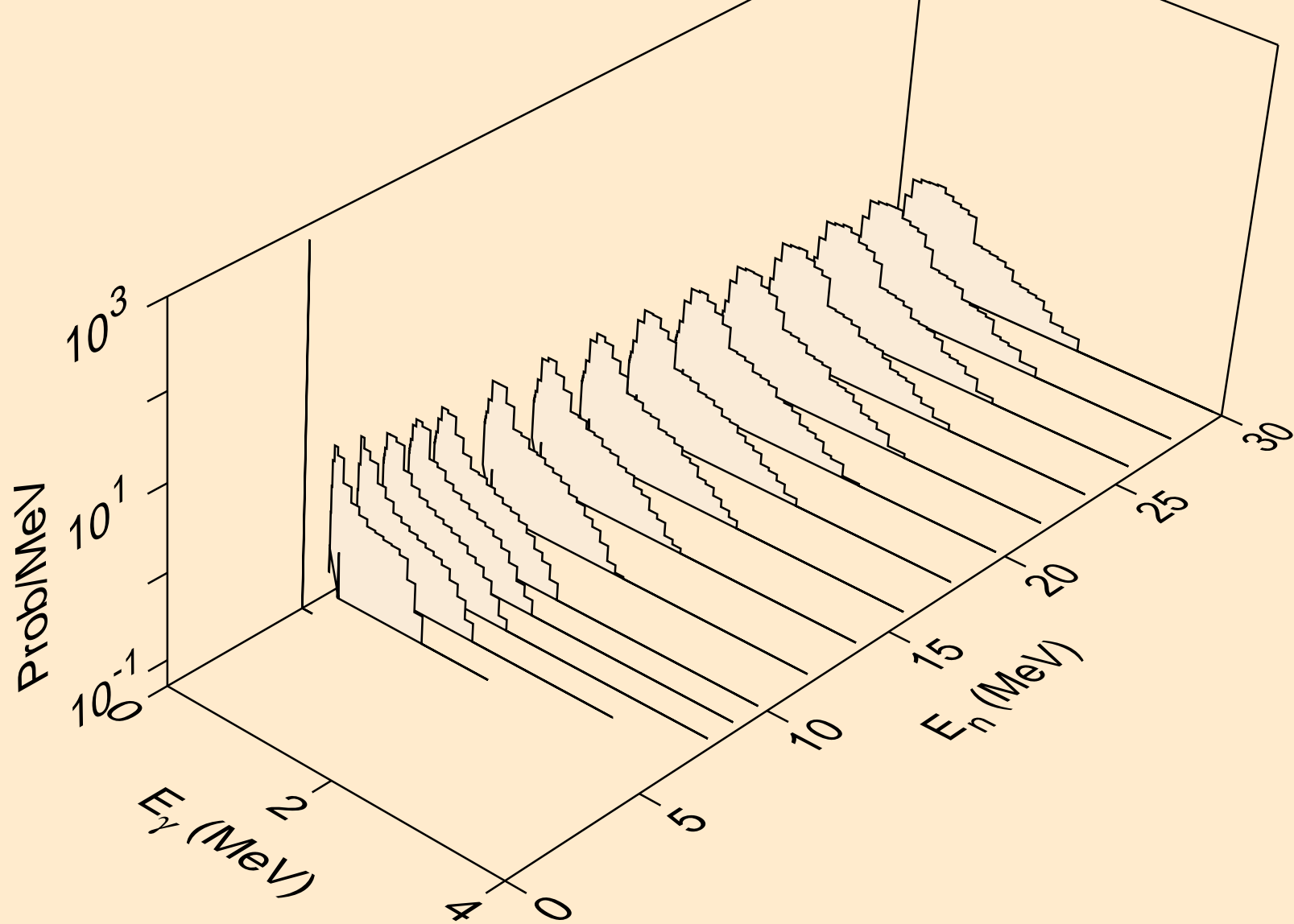

AT224 PROTON ACER TENDL-2021 LIBRARY; T=0.K  
Photon emission for (n,t)

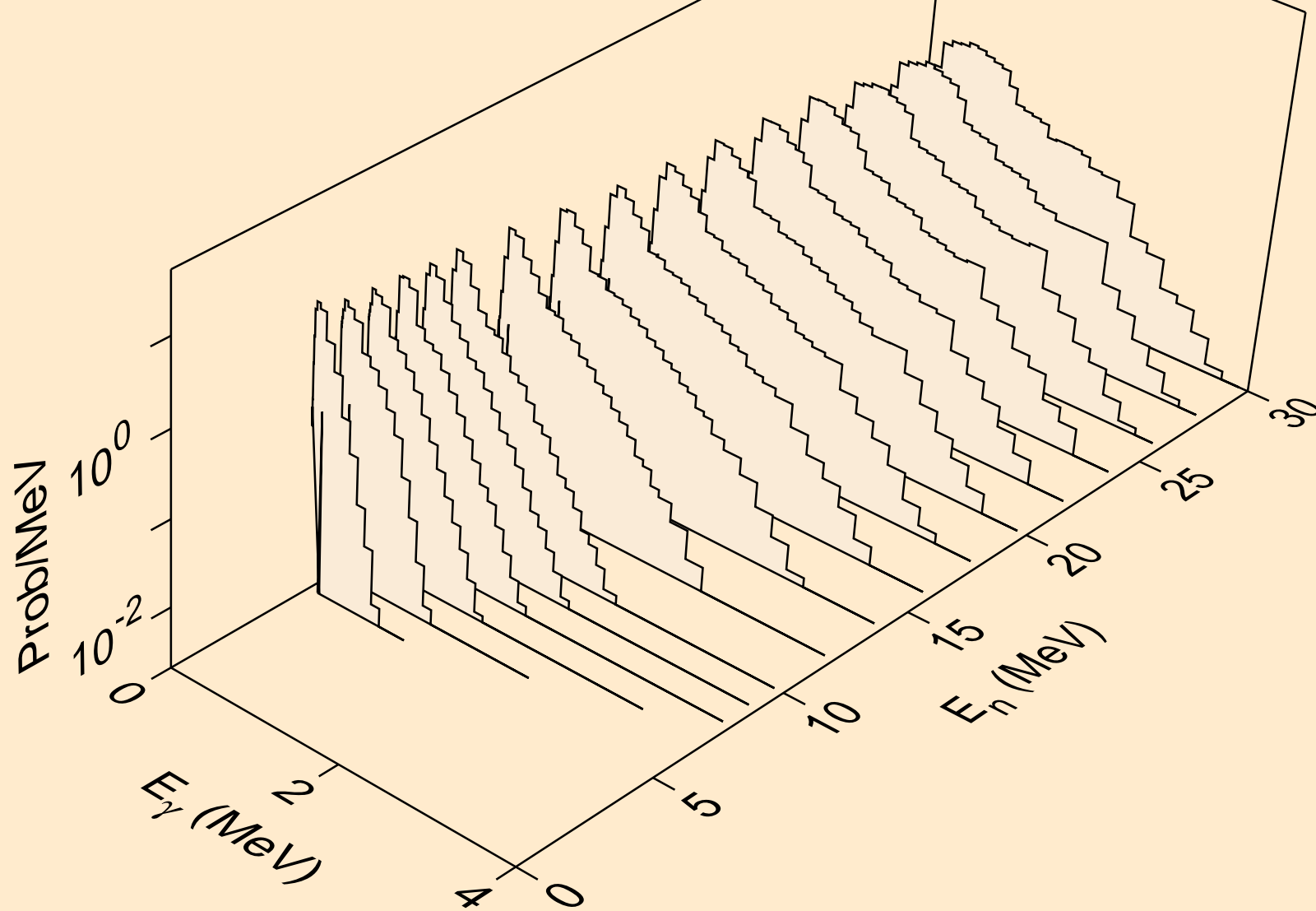

AT224 PROTON ACER TENDL-2021 LIBRARY; T=0.K  
Photon emission for (n,he3)

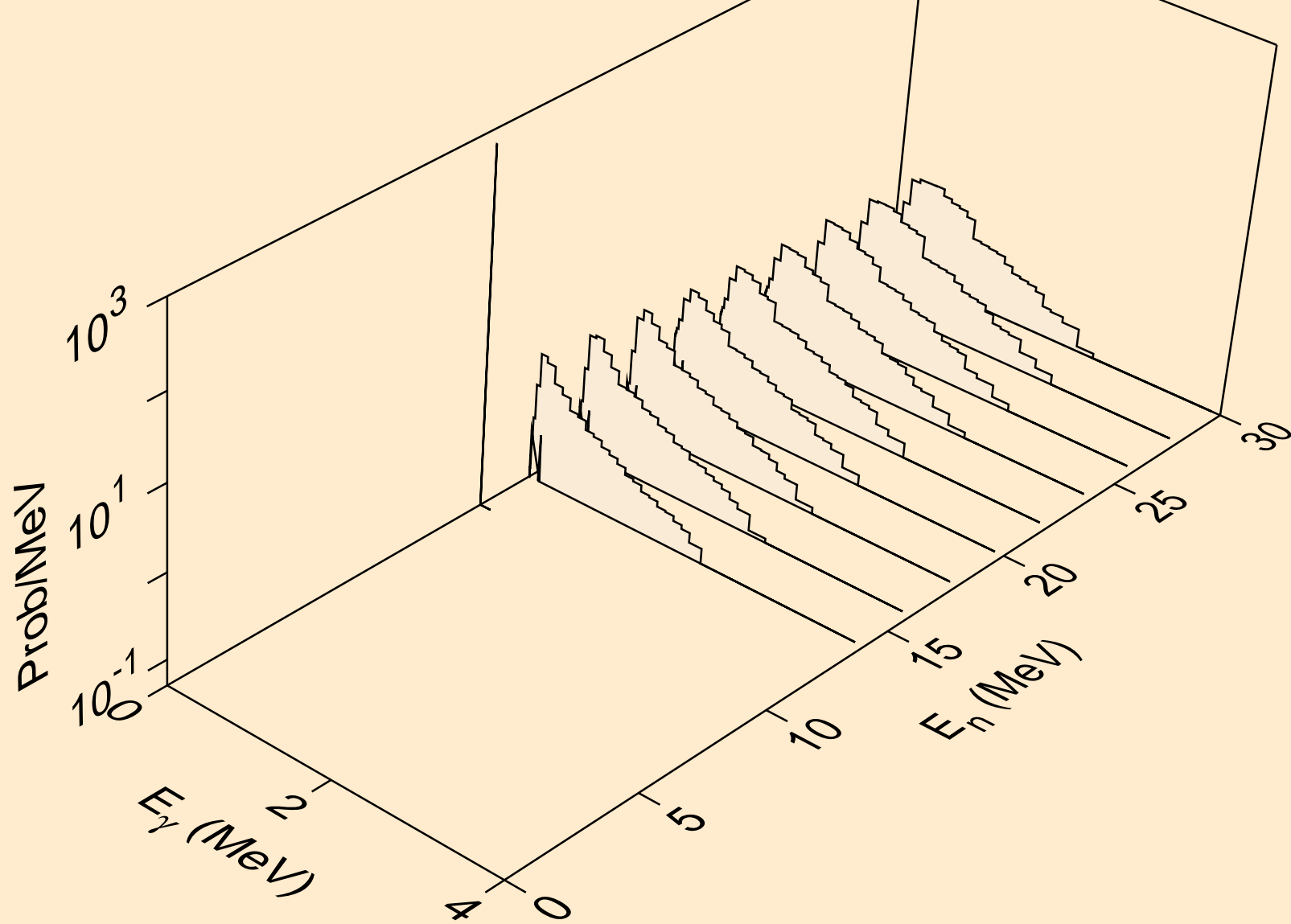

AT224 PROTON ACER TENDL-2021 LIBRARY; T=0.K  
Photon emission for (n,a)

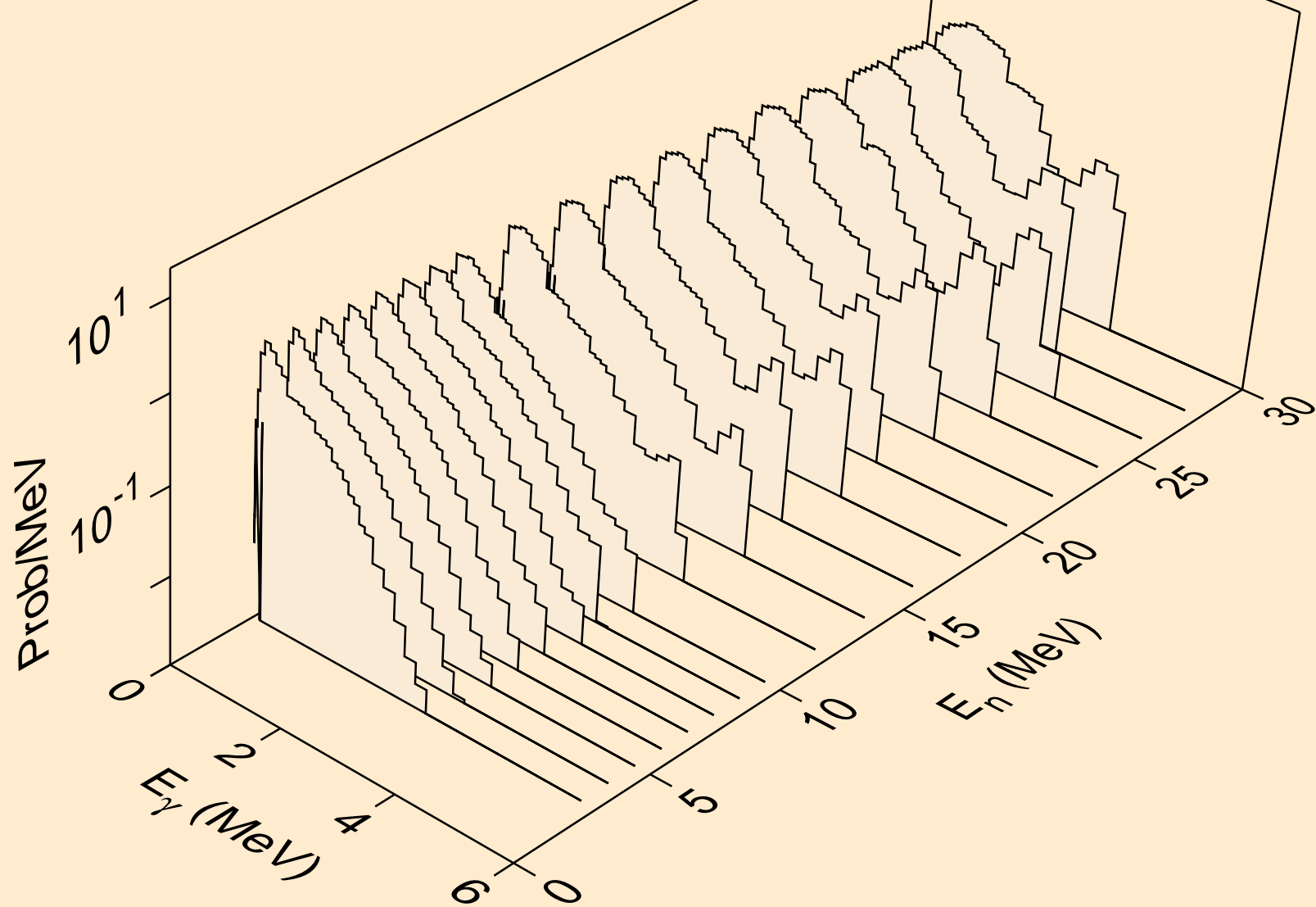

AT224 PROTON ACER TENDL-2021 LIBRARY; T=0.K  
Photon emission for (n,2p)

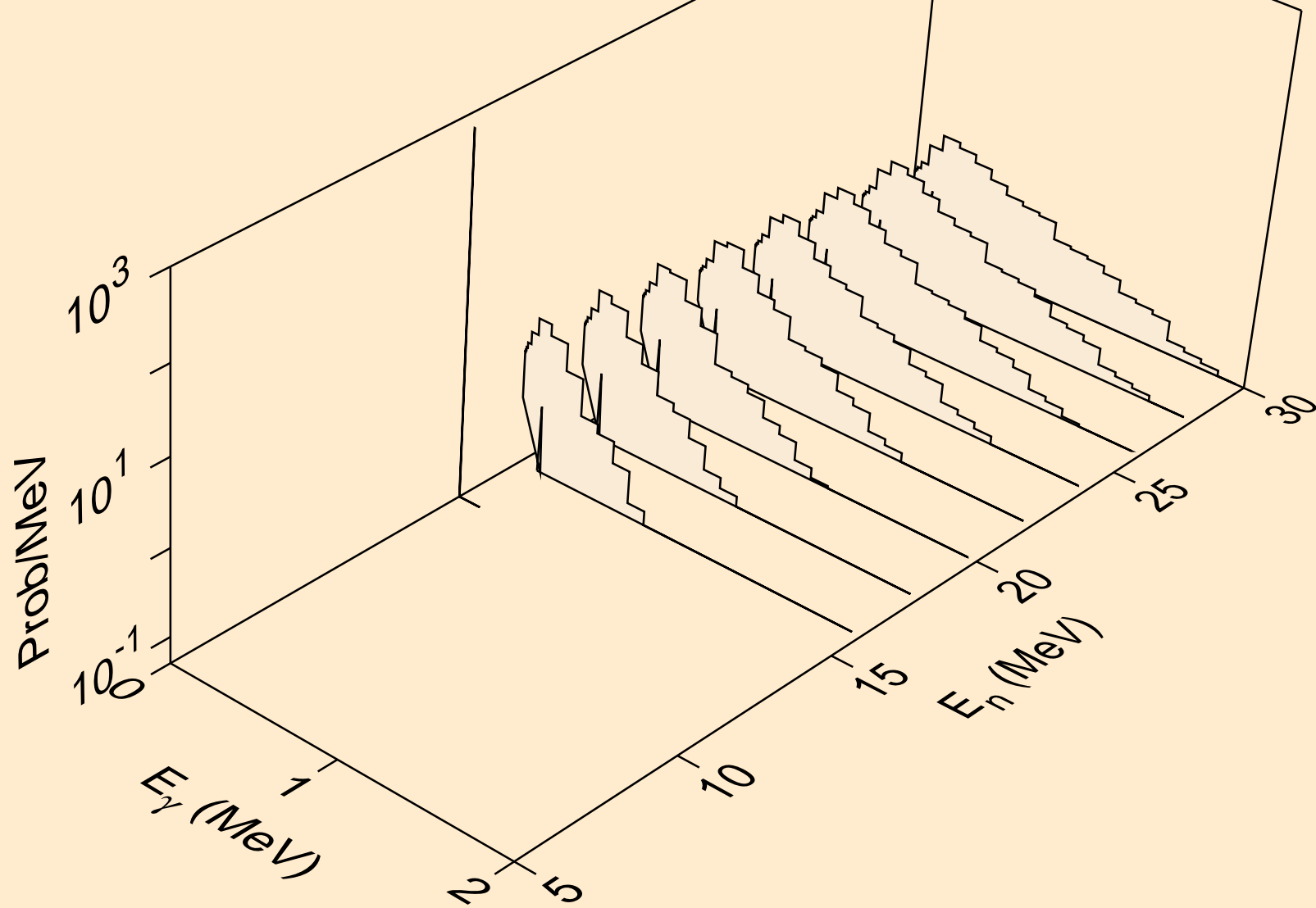

AT224 PROTON ACER TENDL-2021 LIBRARY; T=0.K  
Photon emission for (n,pd)

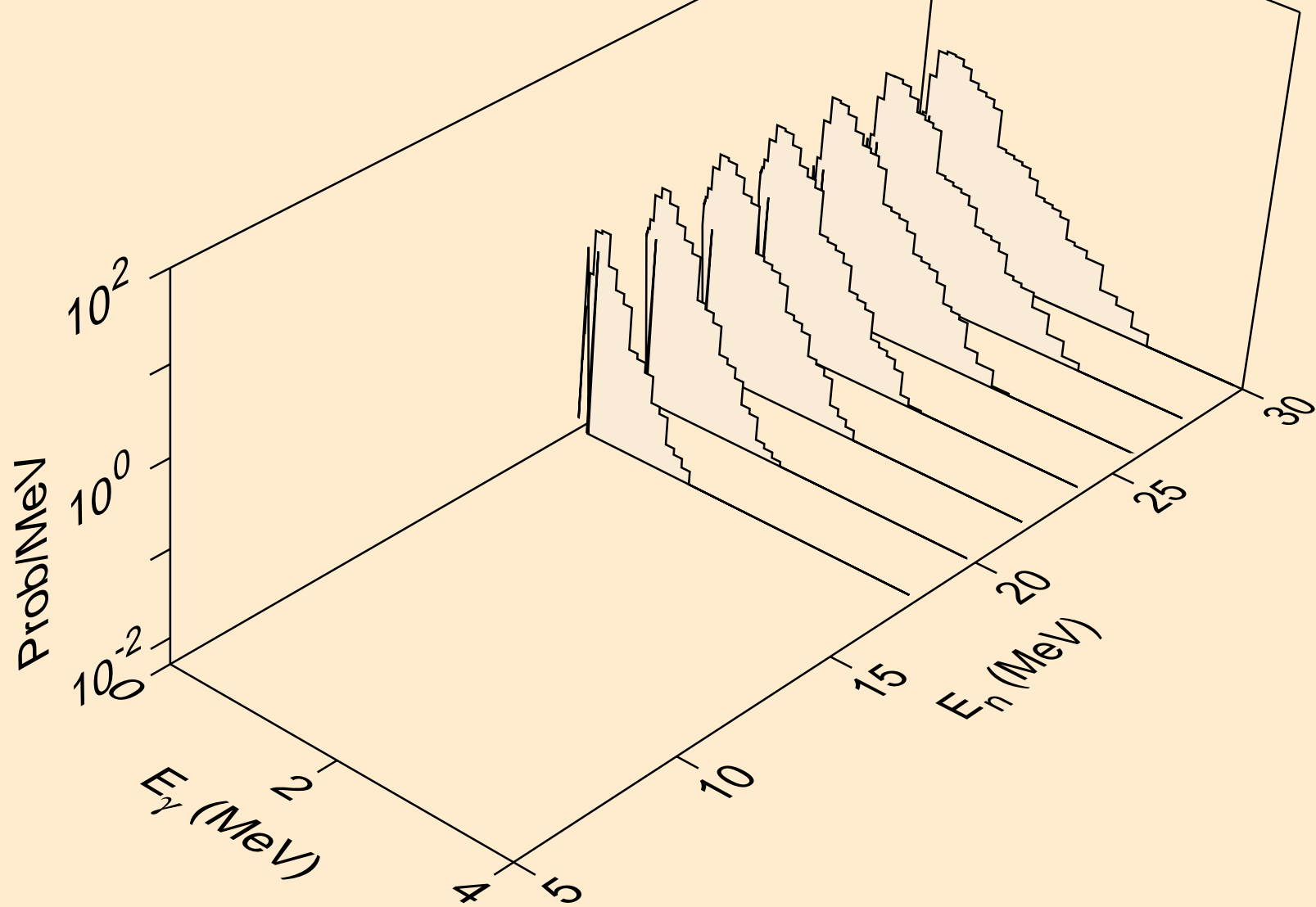

AT224 PROTON ACER TENDL-2021 LIBRARY; T=0.K  
Particle heating contributions

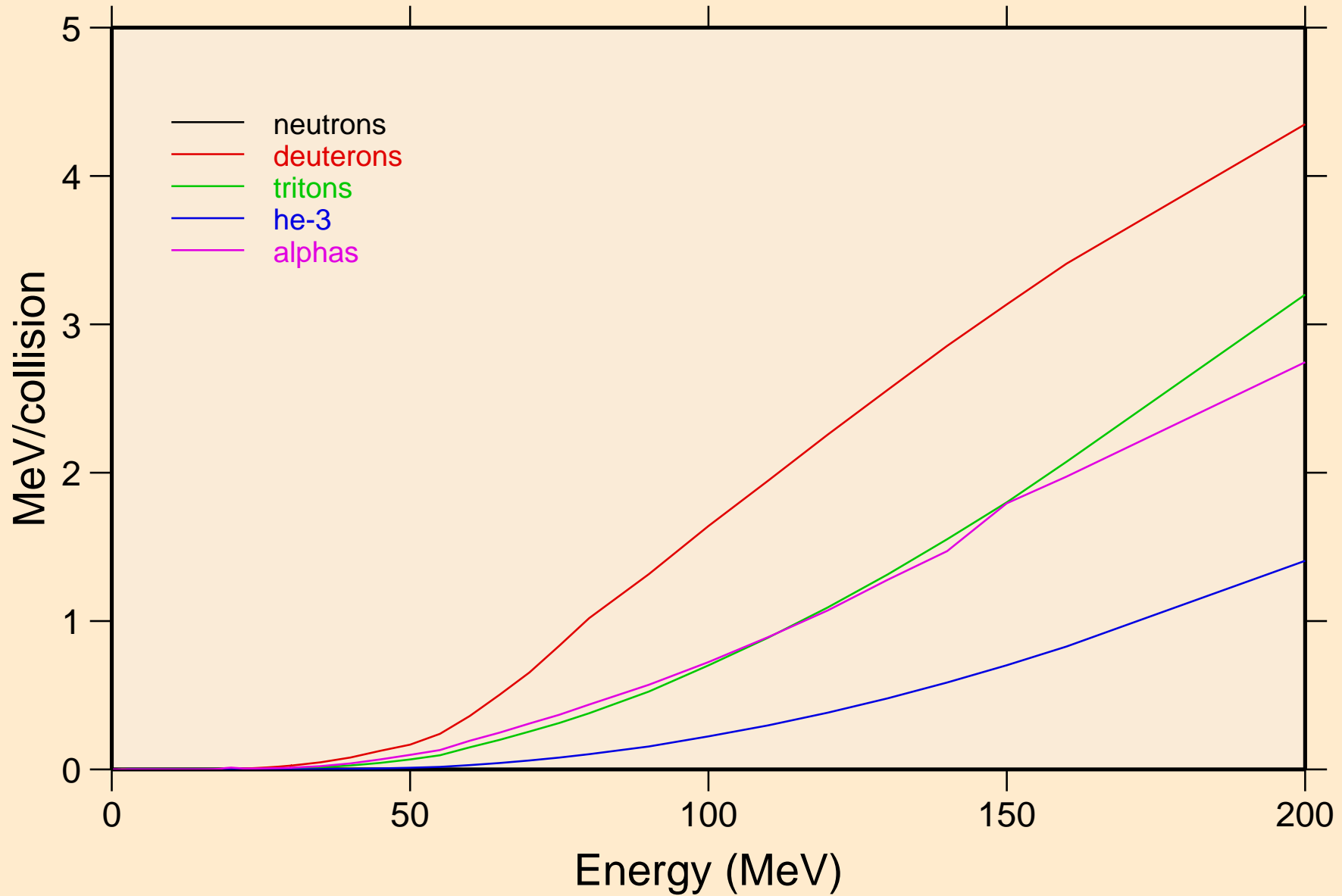



AT224 PROTON ACER TENDL-2021 LIBRARY; T=0.K  
Recoil Heating

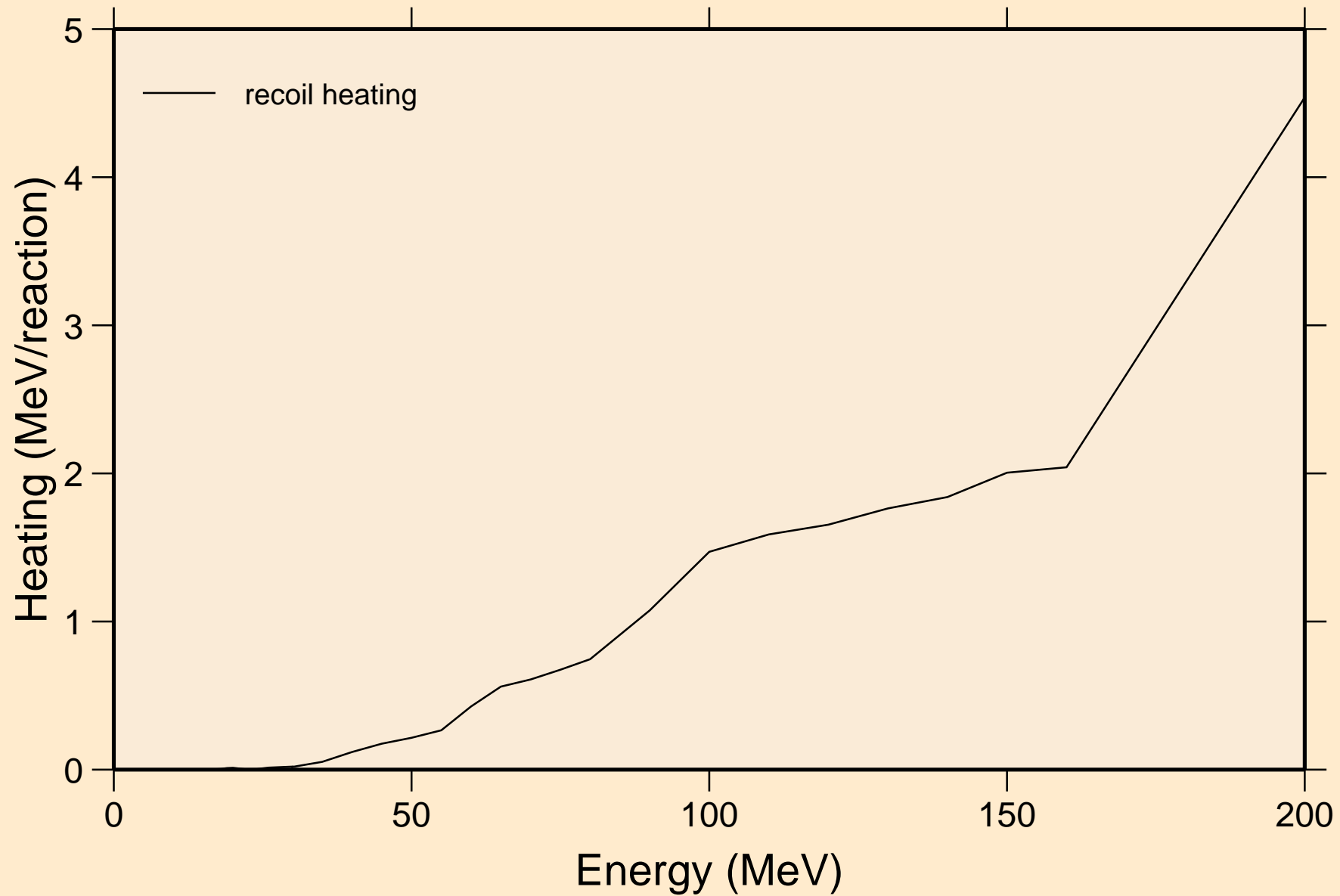

AT224 PROTON ACER TENDL-2021 LIBRARY; T=0.K  
Particle production cross sections

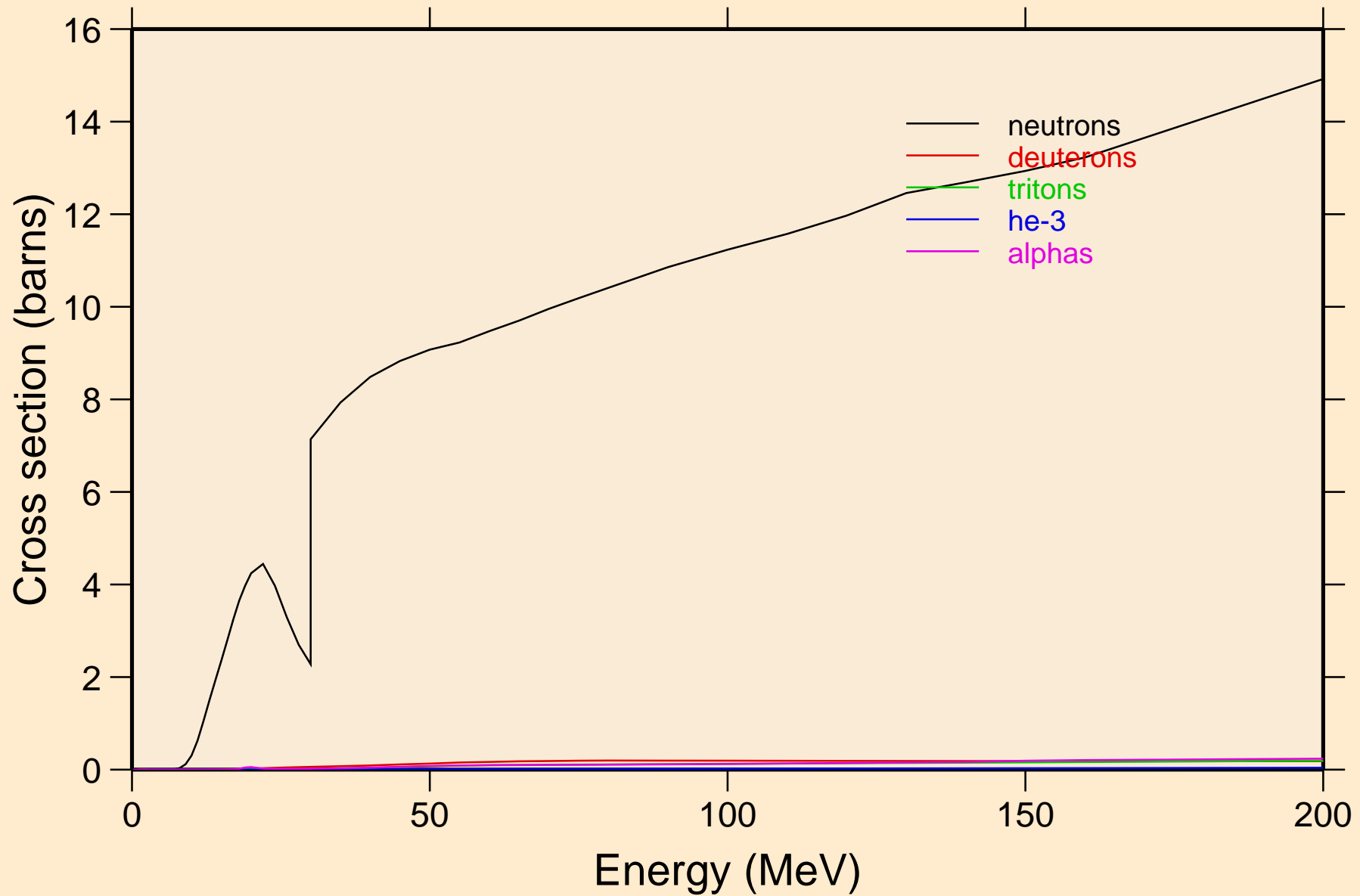

AT224 PROTON ACER TENDL-2021 LIBRARY; T=0.K  
neutrons from (p,n)

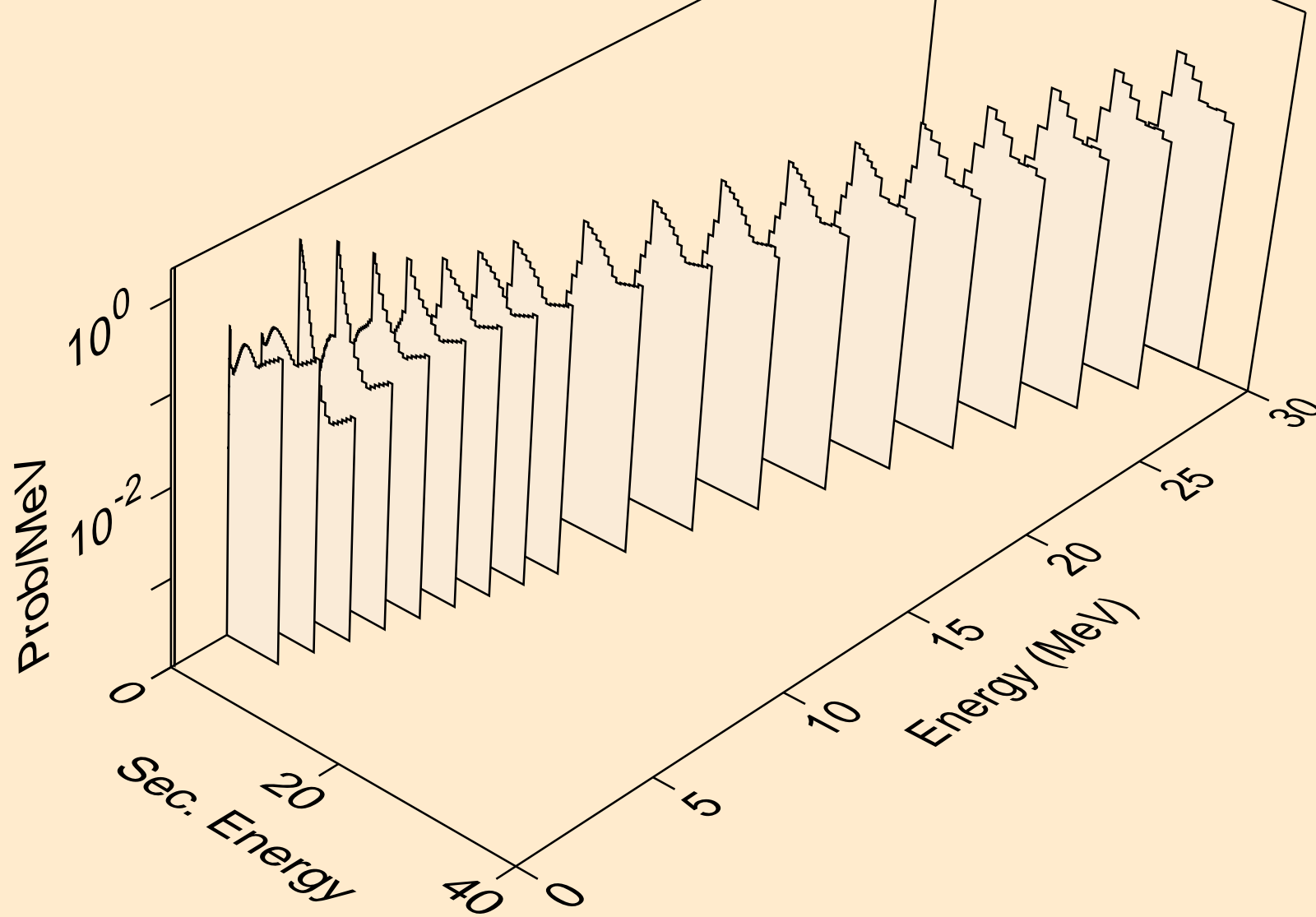

AT224 PROTON ACER TENDL-2021 LIBRARY; T=0.K  
neutrons from (p,x)

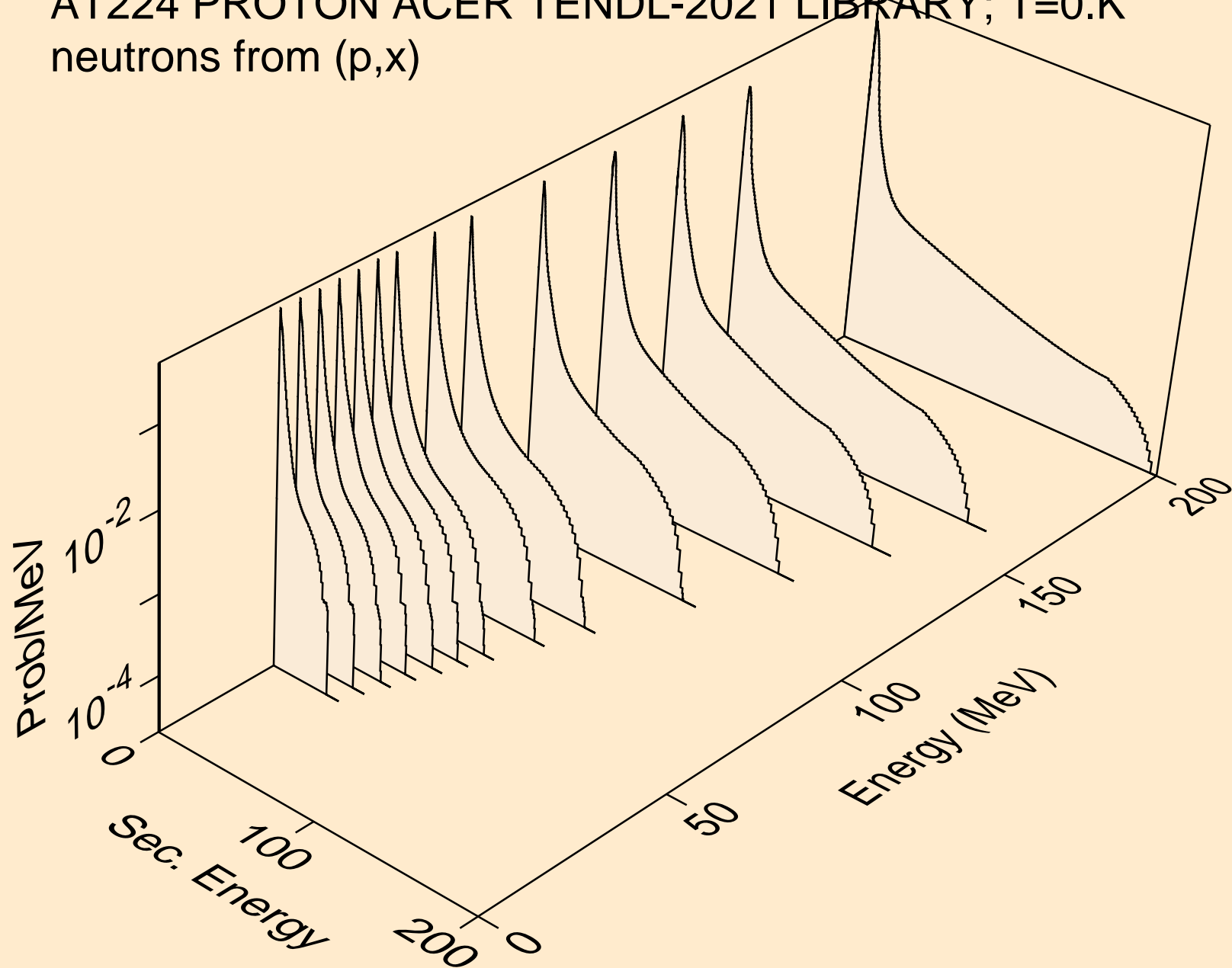

AT224 PROTON ACER TENDL-2021 LIBRARY; T=0.K  
neutrons from (p,2nd)

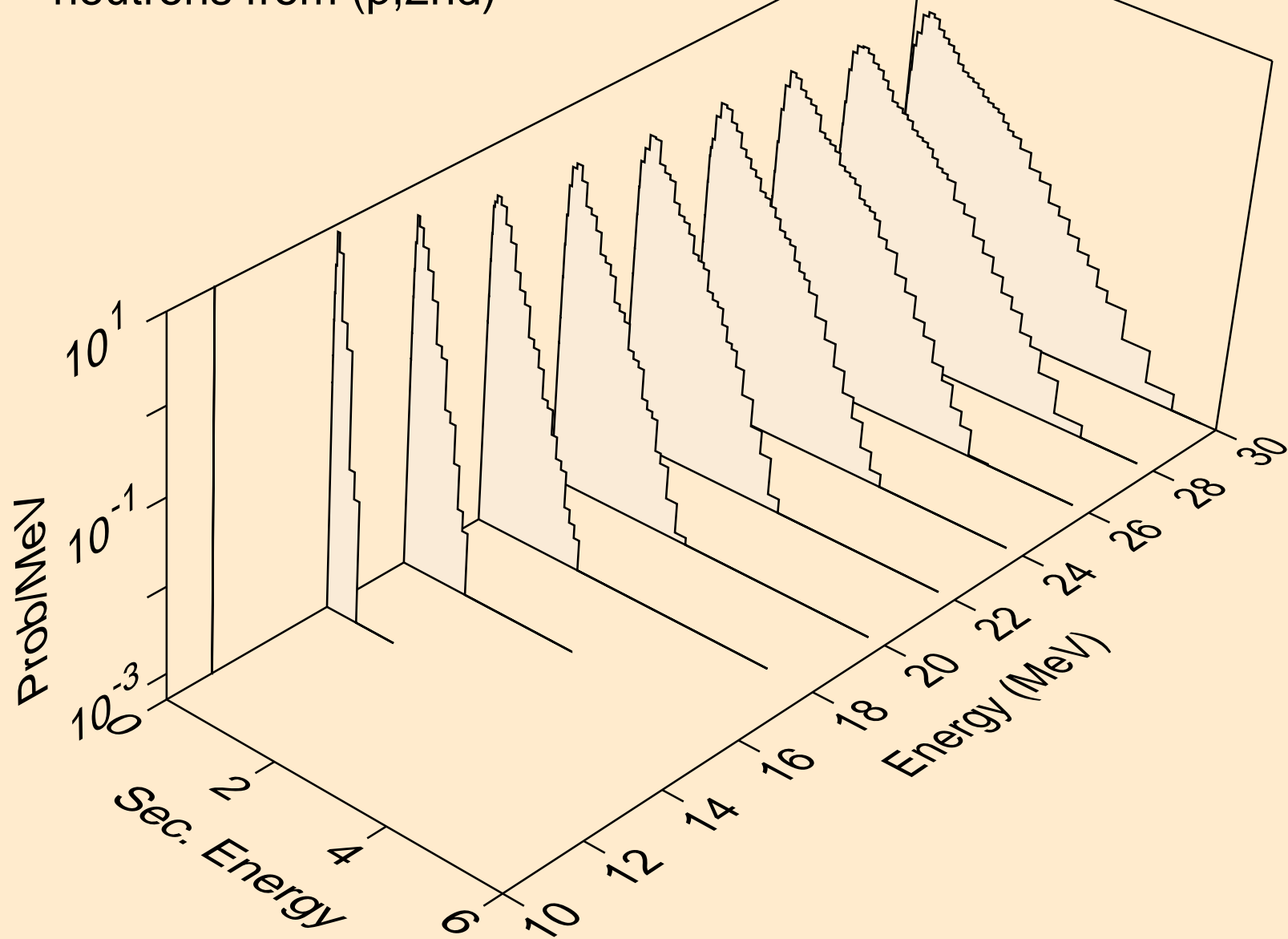

AT224 PROTON ACER TENDL-2021 LIBRARY; T=0.K  
neutrons from (p,2n)

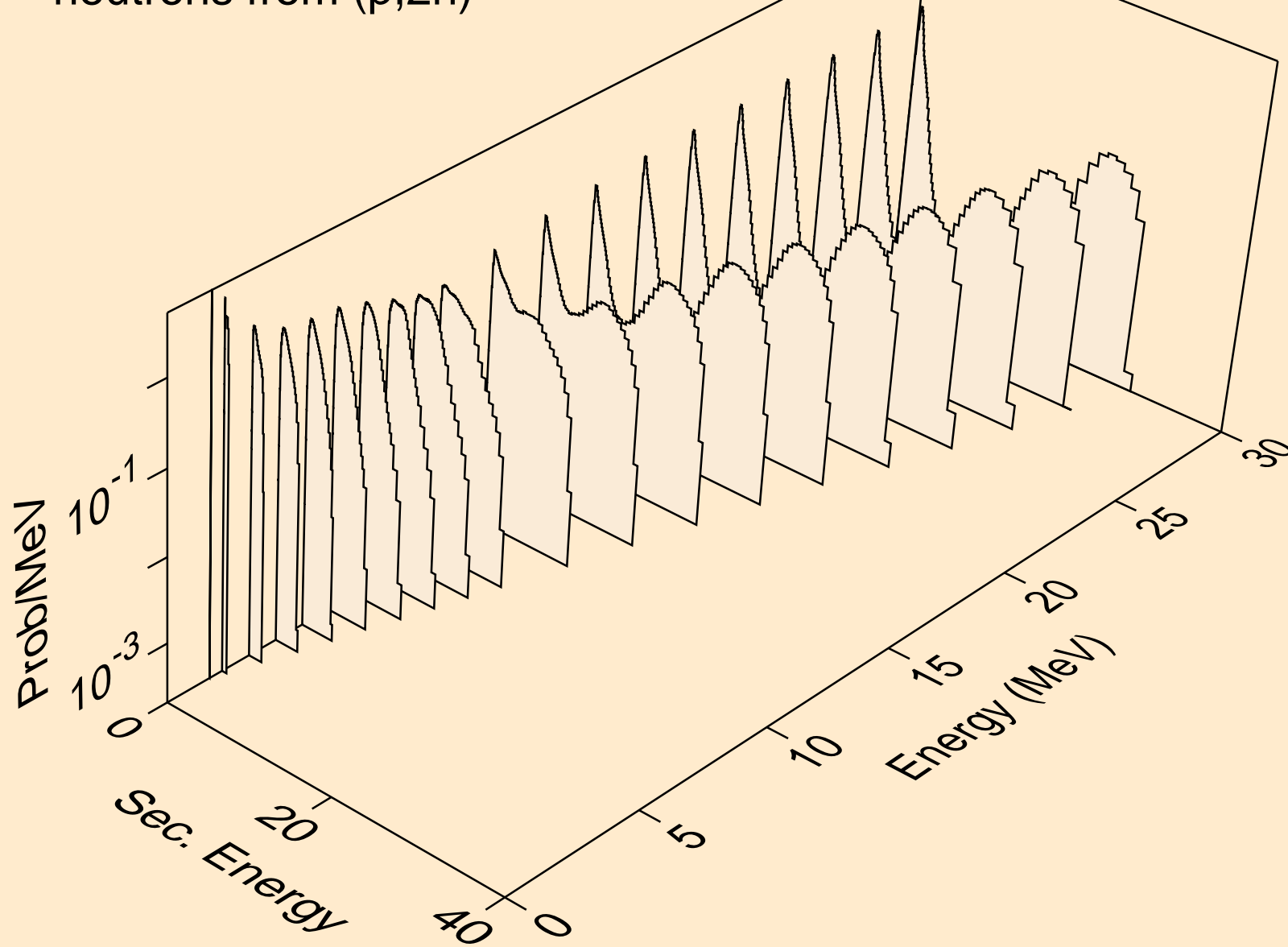

AT224 PROTON ACER TENDL-2021 LIBRARY; T=0.K  
neutrons from (p,3n)

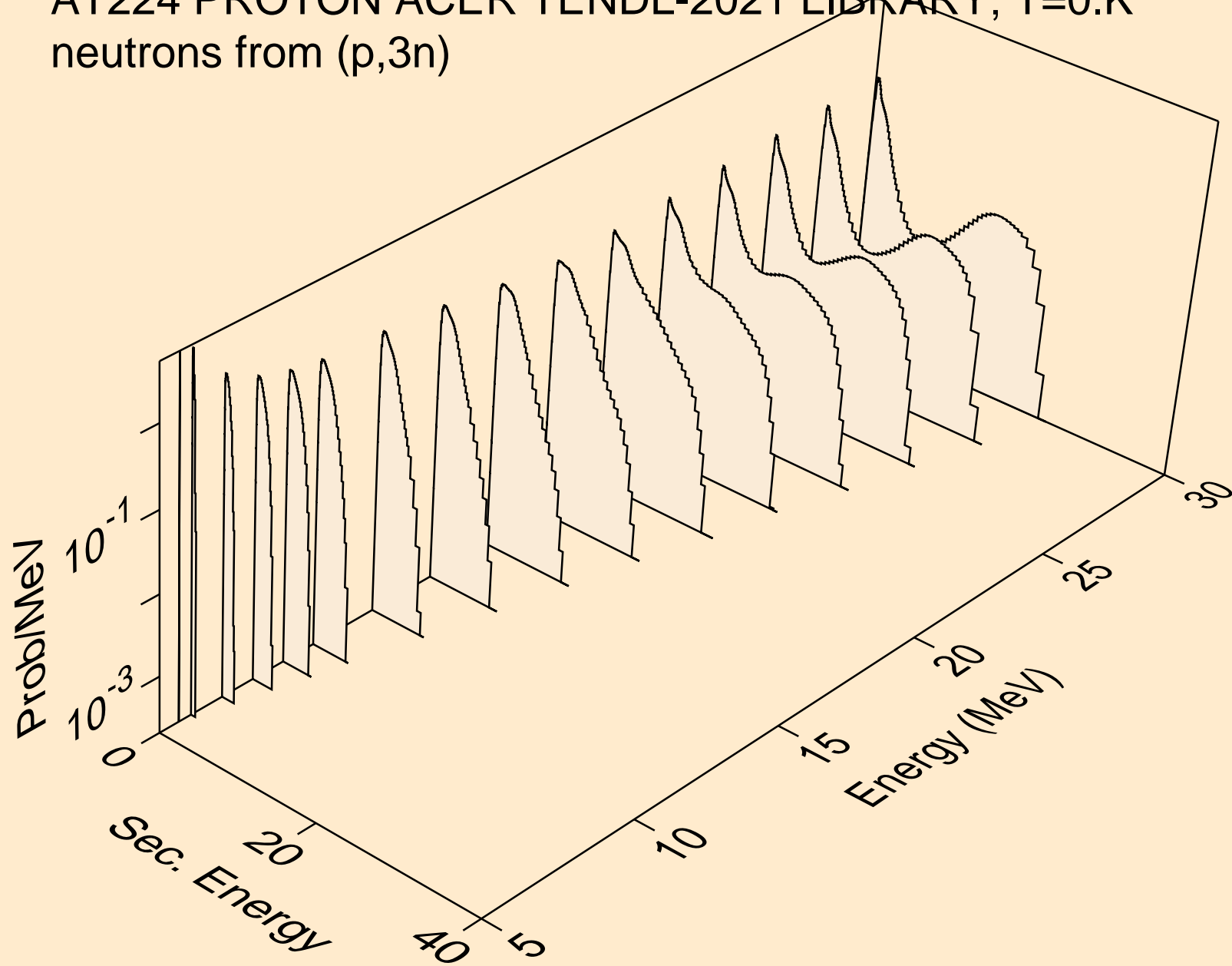

AT224 PROTON ACER TENDL-2021 LIBRARY; T=0.K  
neutrons from (p,n\*)a

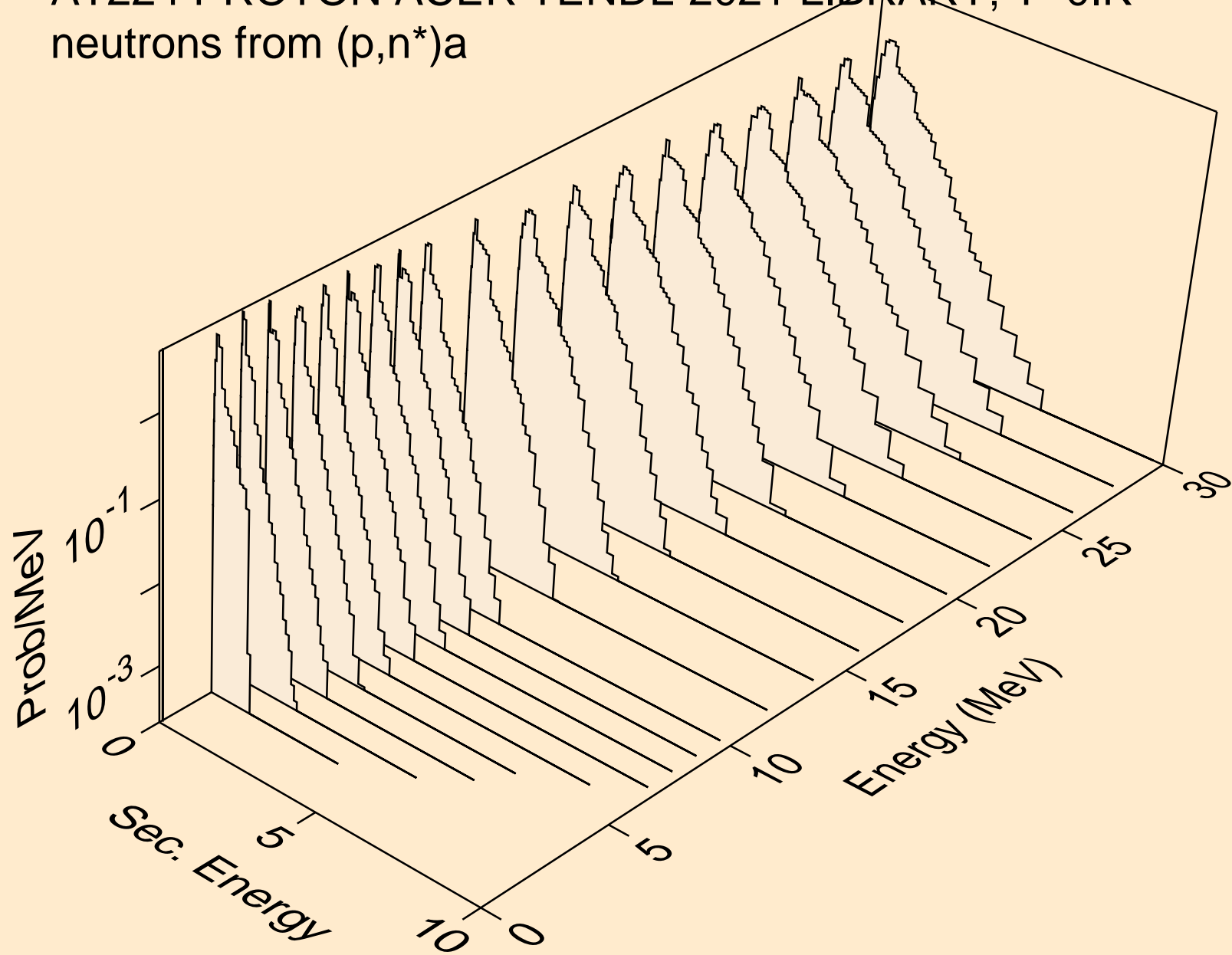



AT224 PROTON ACER TENDL-2021 LIBRARY; T=0.K  
neutrons from (p,2n)a

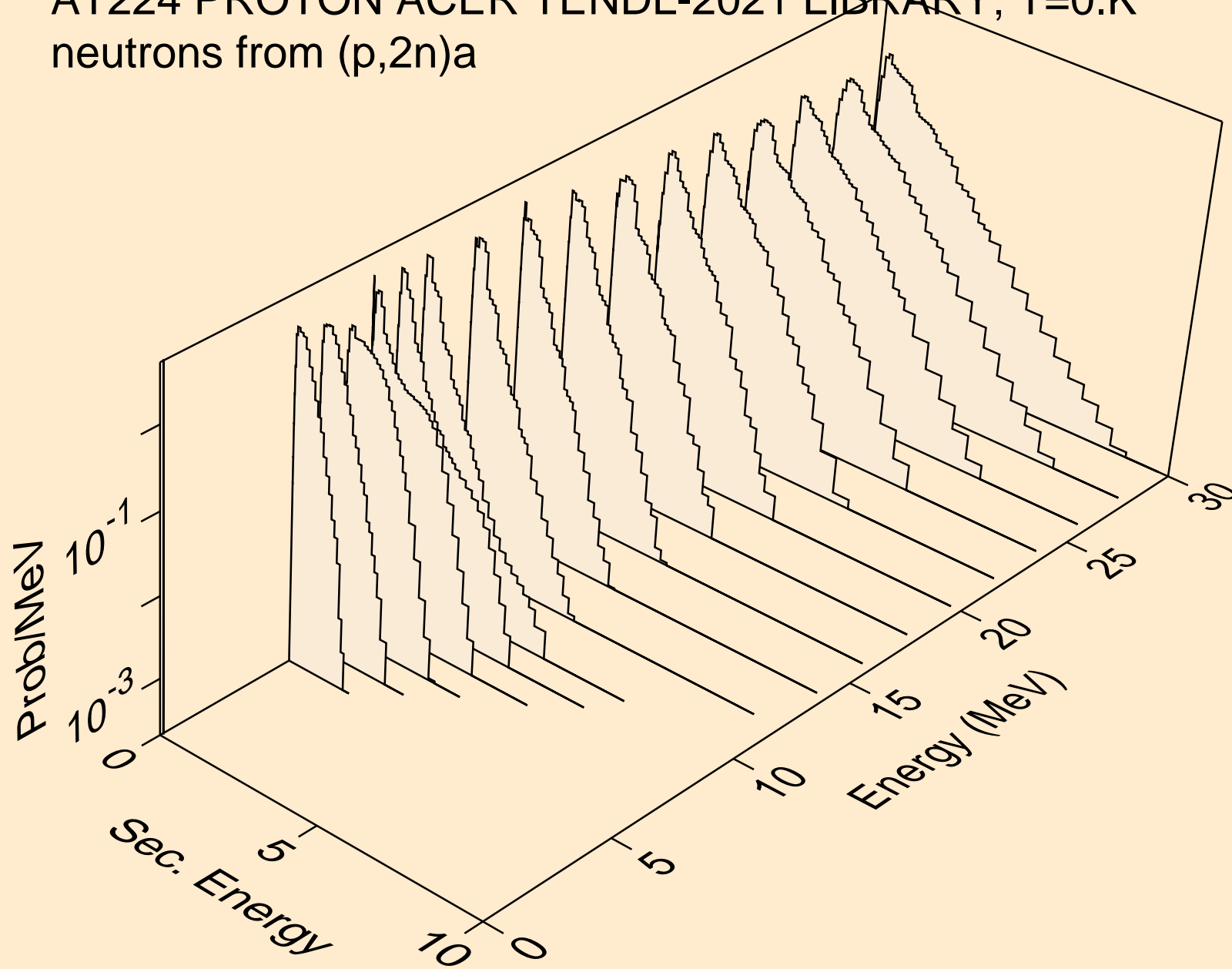

AT224 PROTON ACER TENDL-2021 LIBRARY; T=0.K  
neutrons from (p,3n)a

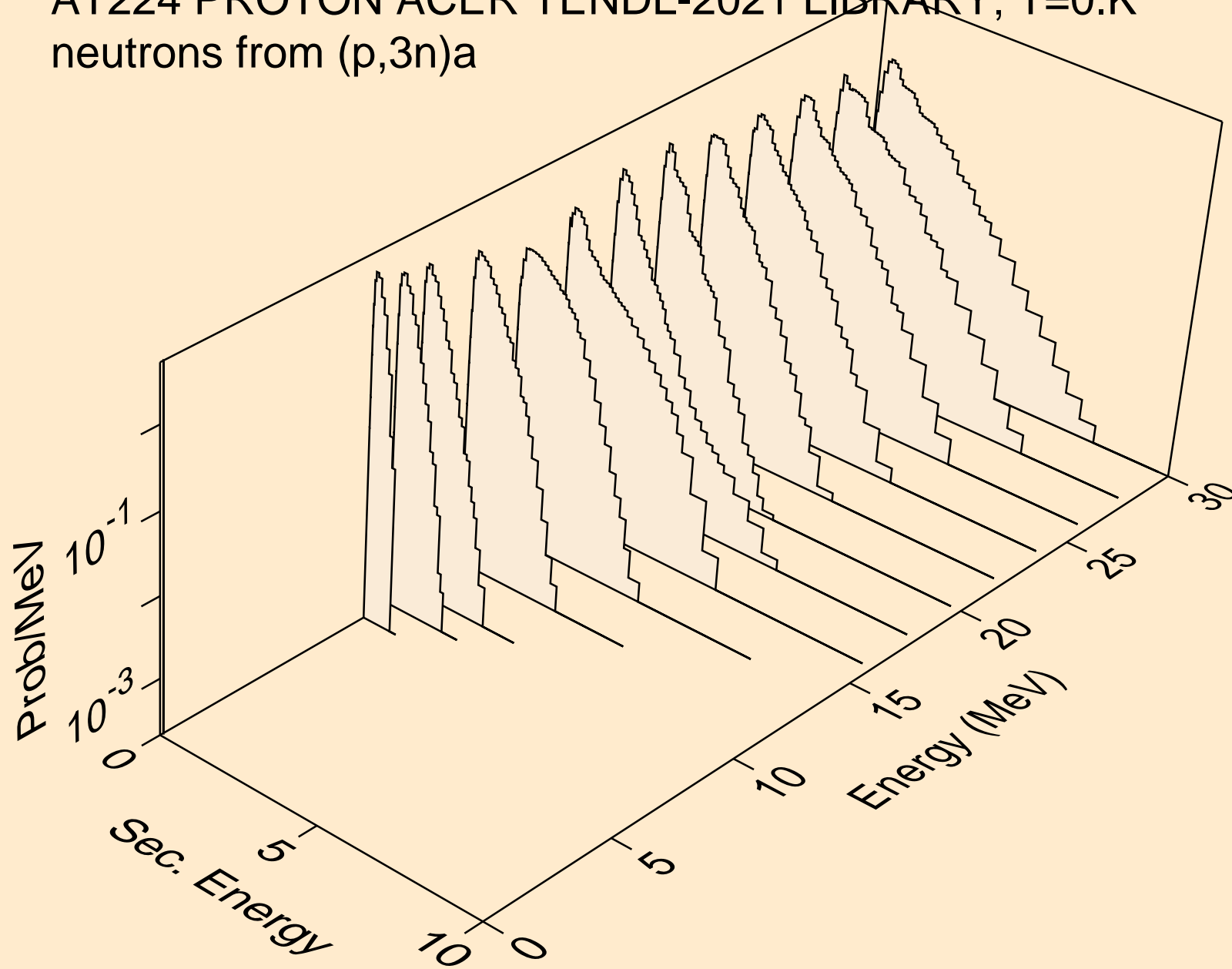

AT224 PROTON ACER TENDL-2021 LIBRARY; T=0.K  
neutrons from (p,n\*)p

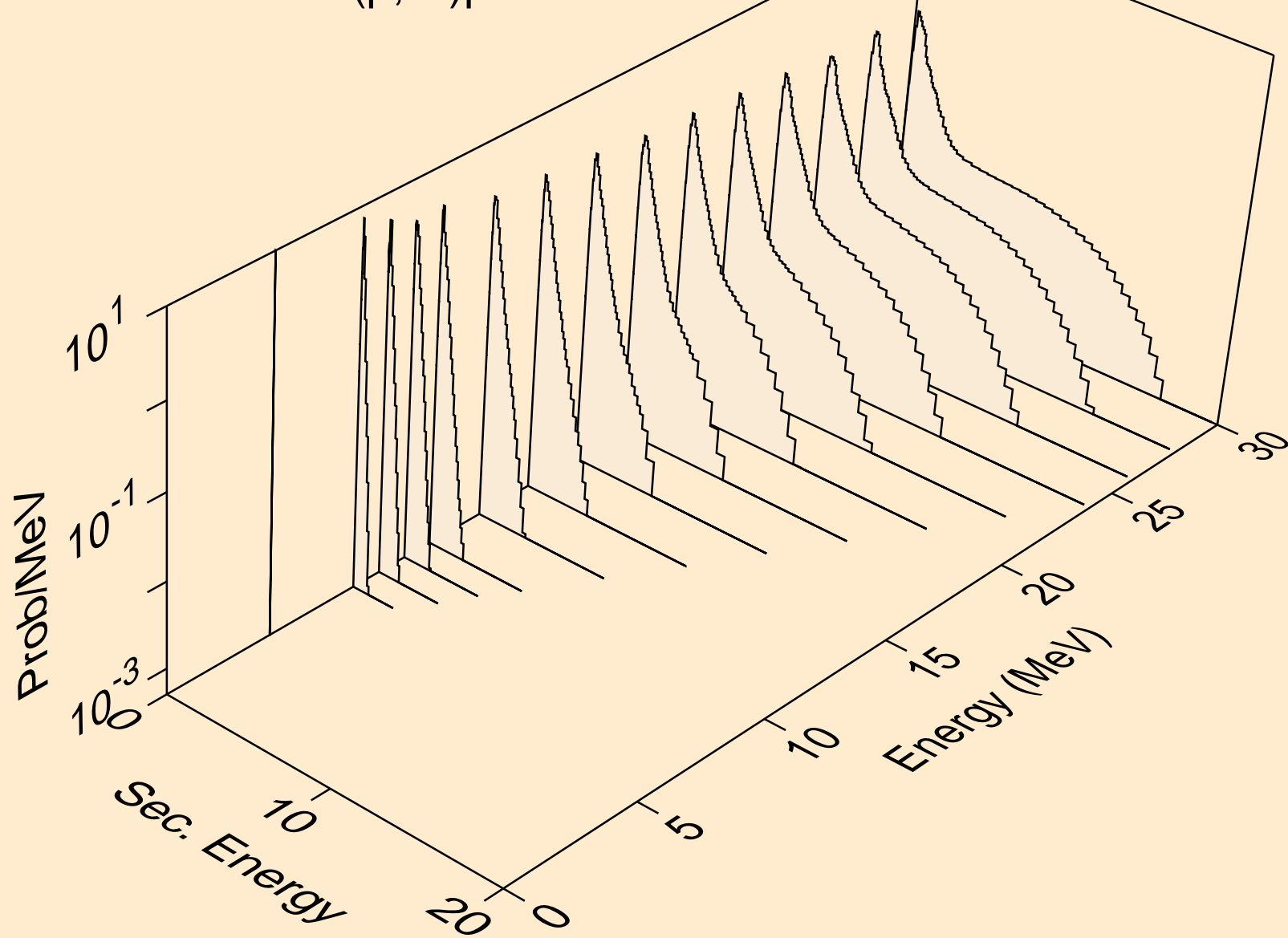

AT224 PROTON ACER TENDL-2021 LIBRARY; T=0.K  
neutrons from (p,n\*)2a

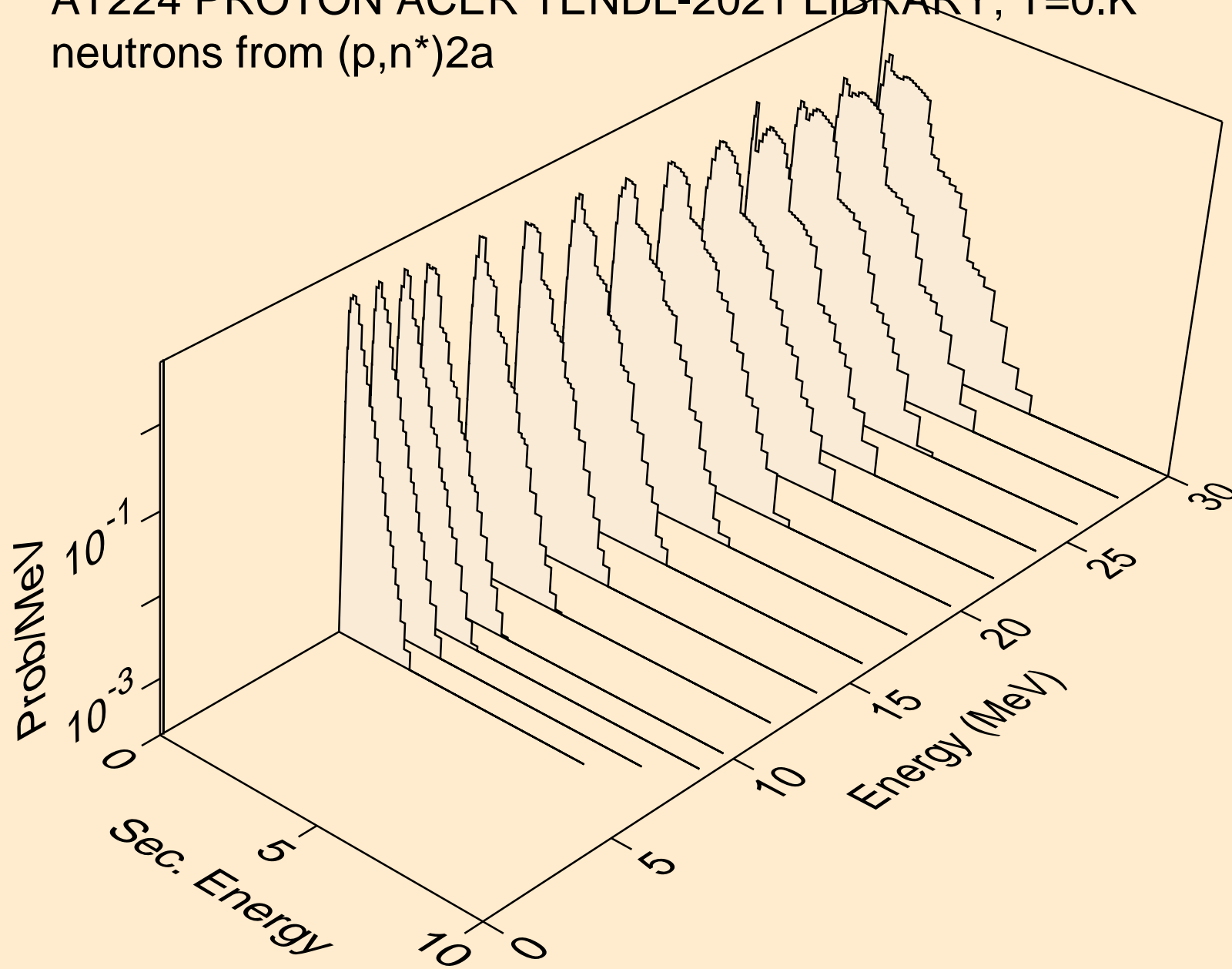

AT224 PROTON ACER TENDL-2021 LIBRARY; T=0.K  
neutrons from (p,2n)2a

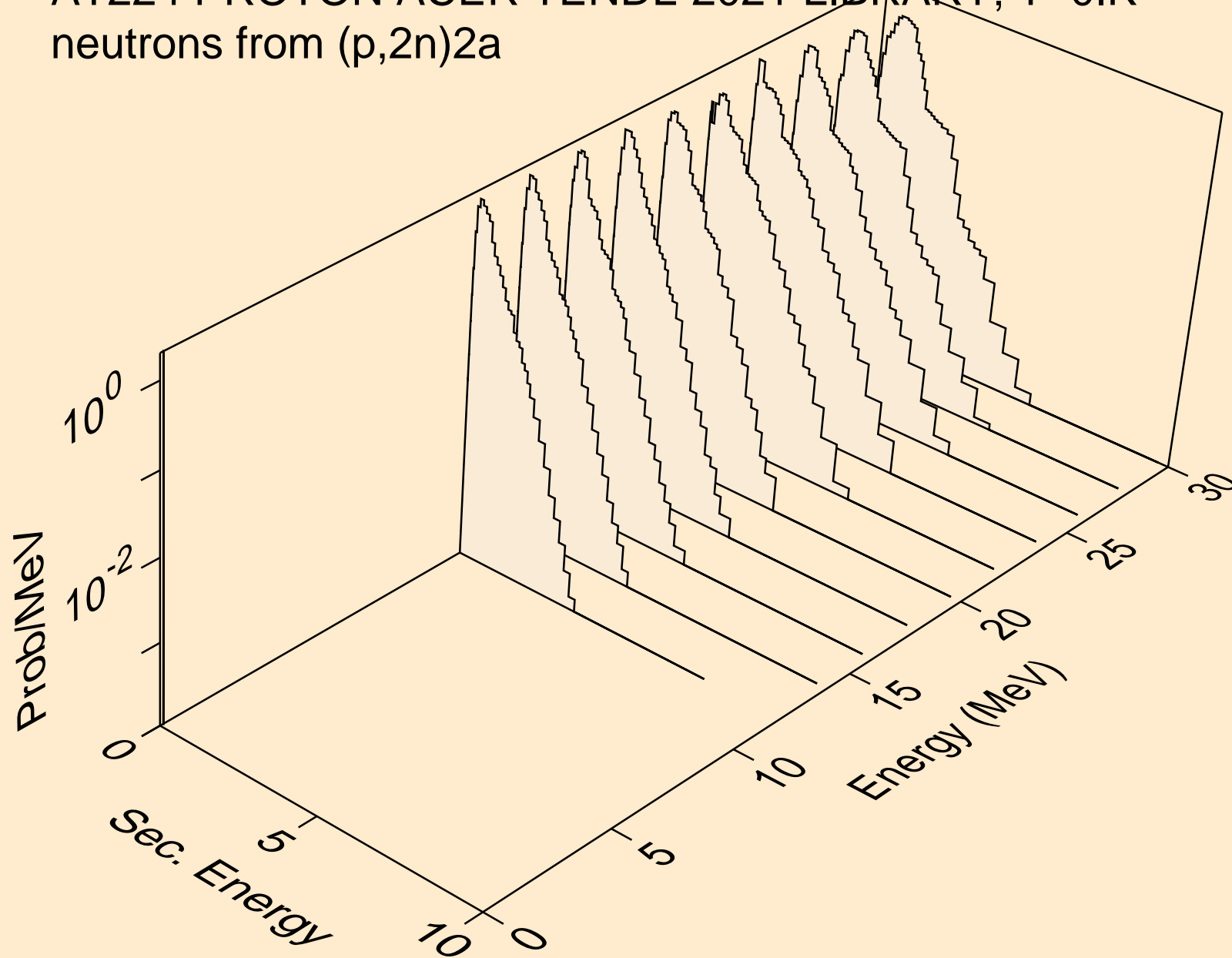

AT224 PROTON ACER TENDL-2021 LIBRARY; T=0.K  
neutrons from (p,n\*)d

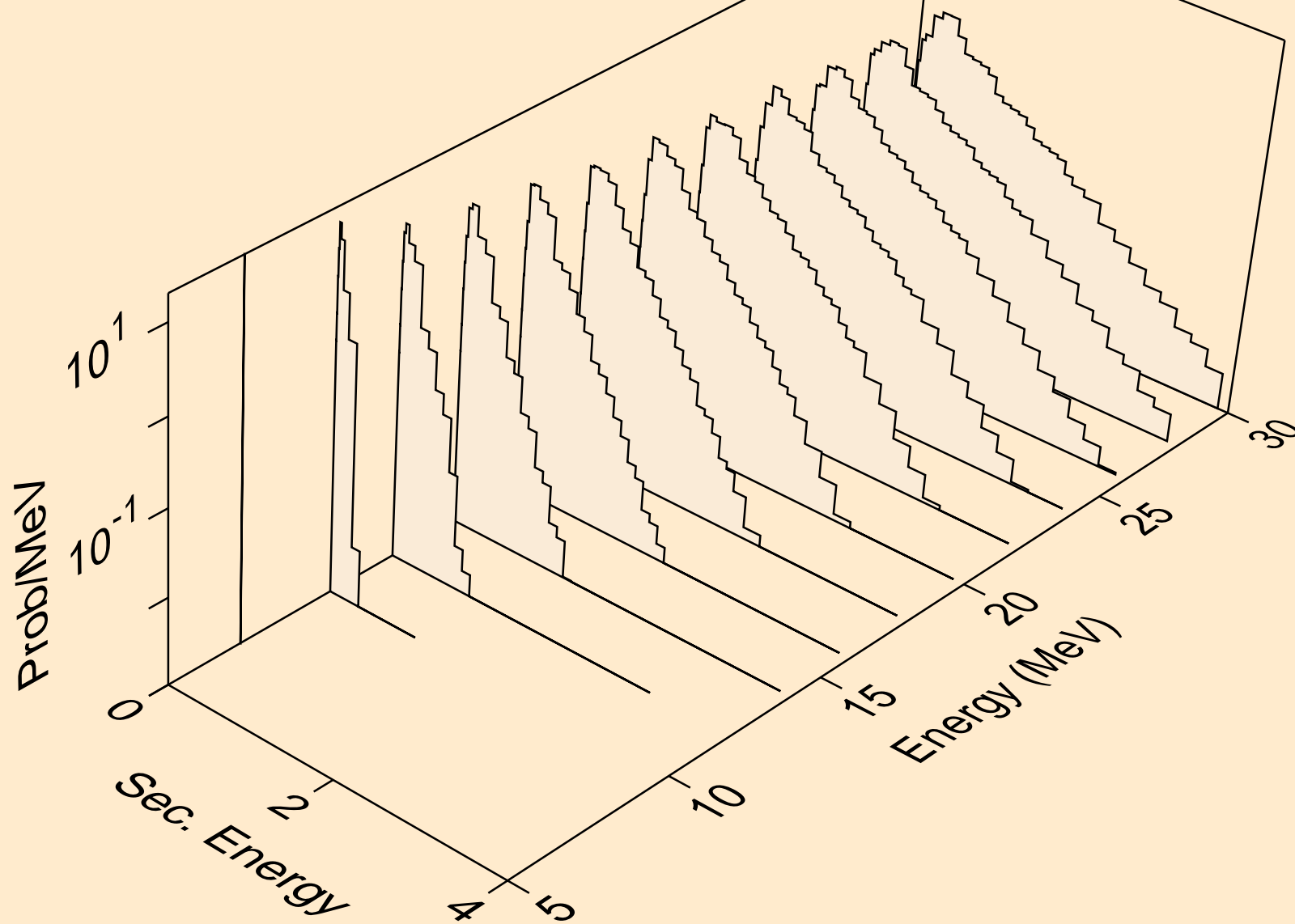

AT224 PROTON ACER TENDL-2021 LIBRARY; T=0.K  
neutrons from (p,n\*)t

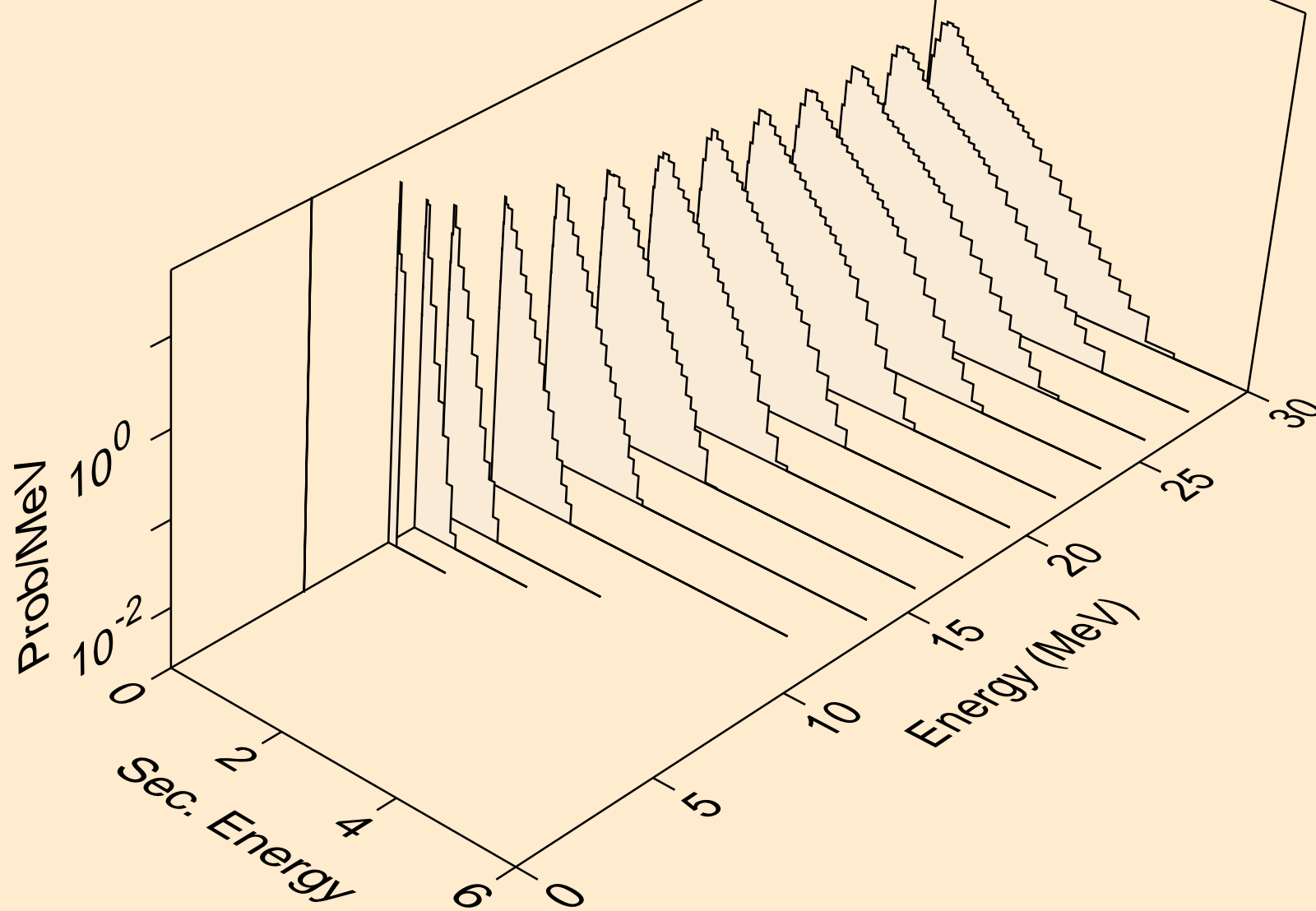

AT224 PROTON ACER TENDL-2021 LIBRARY; T=0.K  
neutrons from (p,n\*)he3

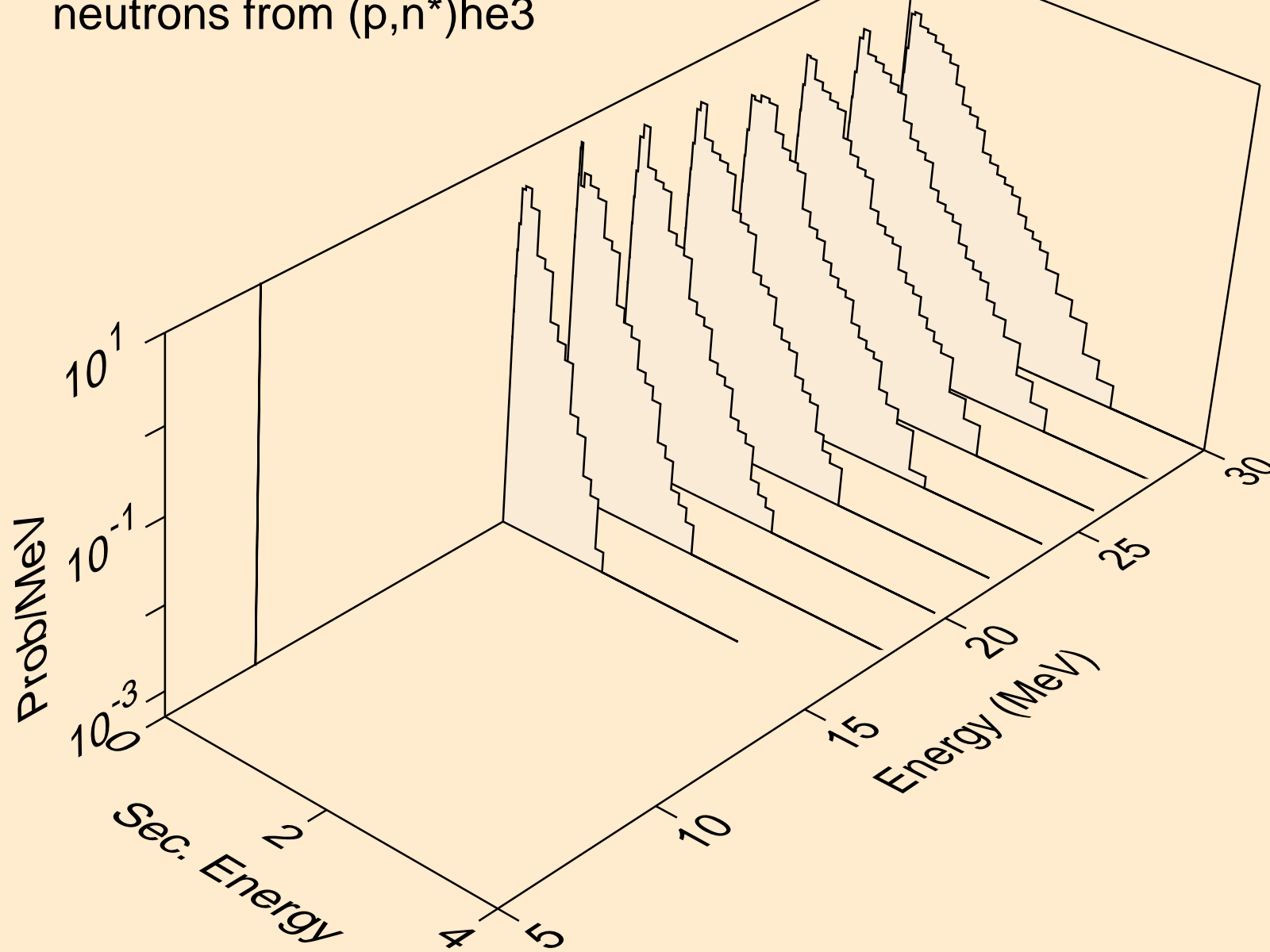



AT224 PROTON ACER TENDL-2021 LIBRARY; T=0.K  
neutrons from (p,4n)

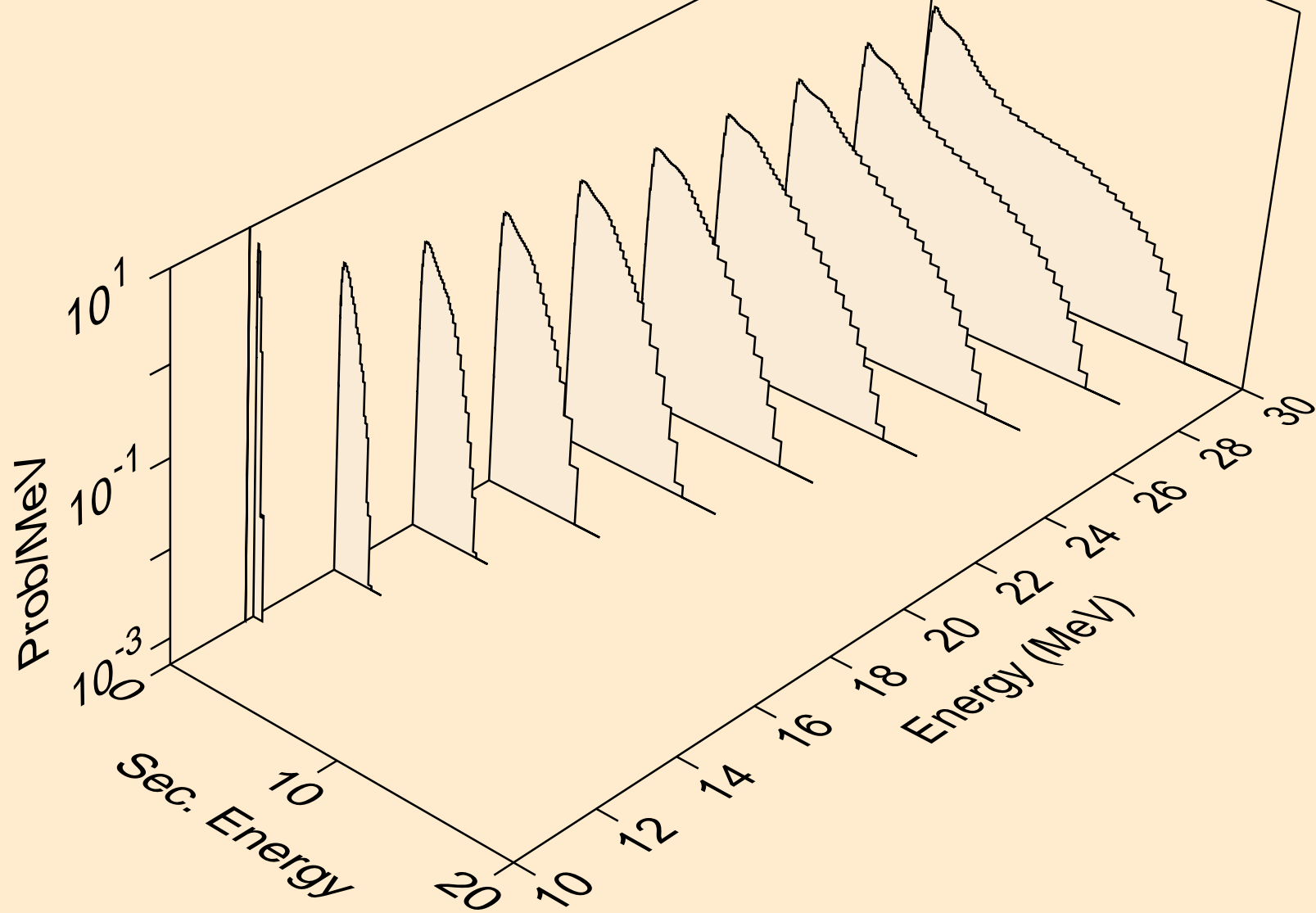

AT224 PROTON ACER TENDL-2021 LIBRARY; T=0.K  
neutrons from (p,2np)

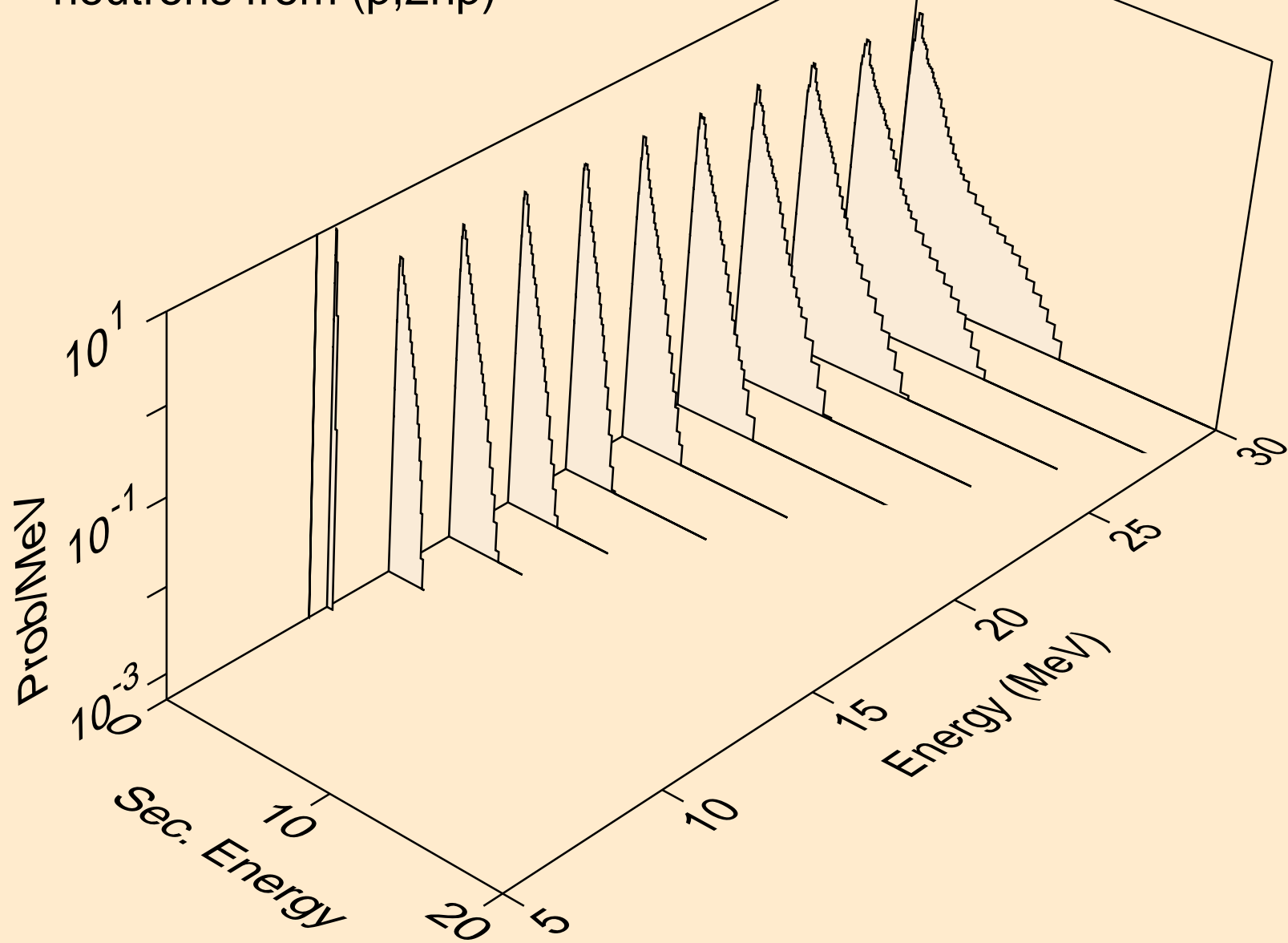

AT224 PROTON ACER TENDL-2021 LIBRARY; T=0.K  
neutrons from (p,3np)

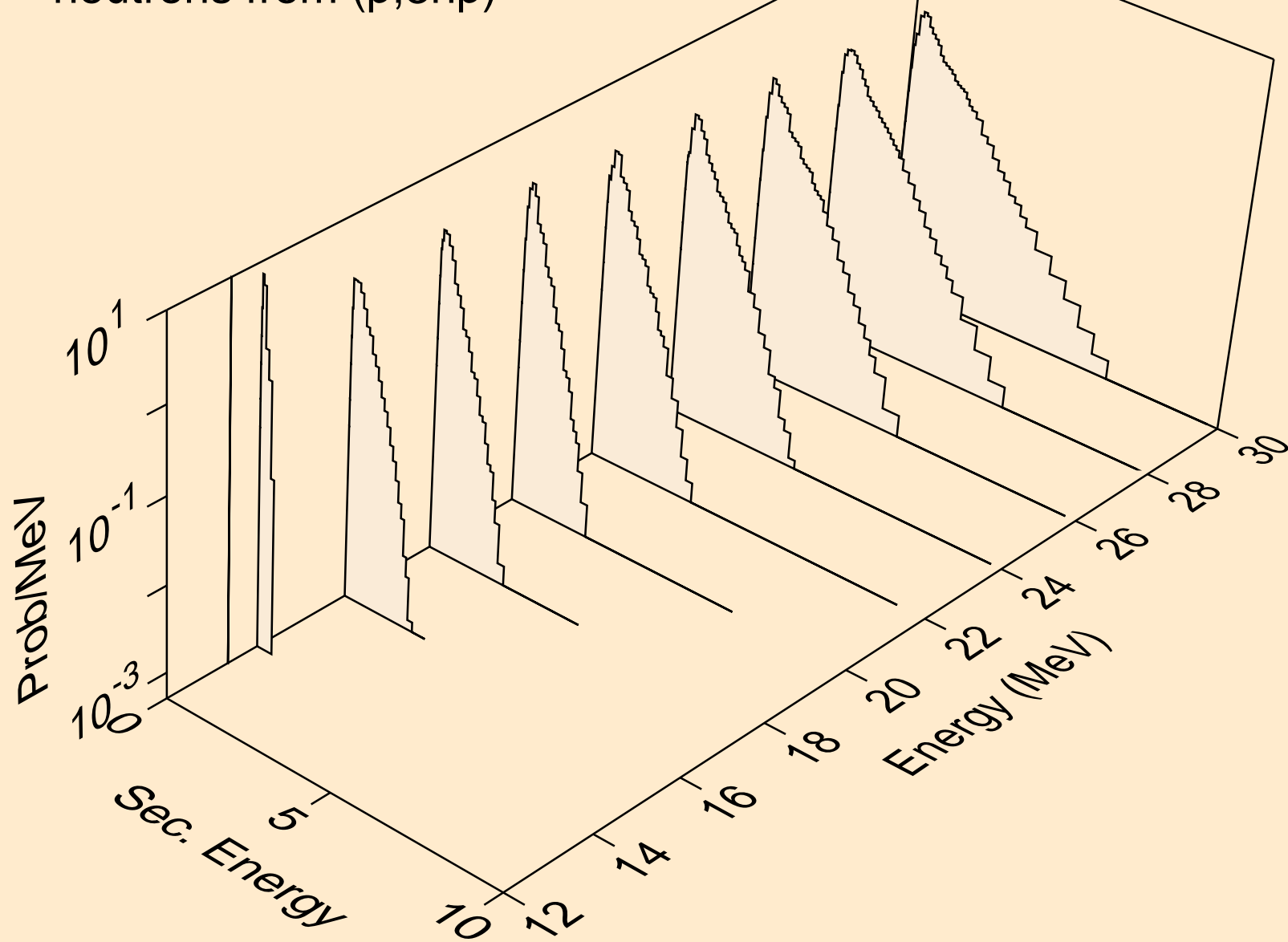

AT224 PROTON ACER TENDL-2021 LIBRARY; T=0.K  
neutrons from (p,2np)

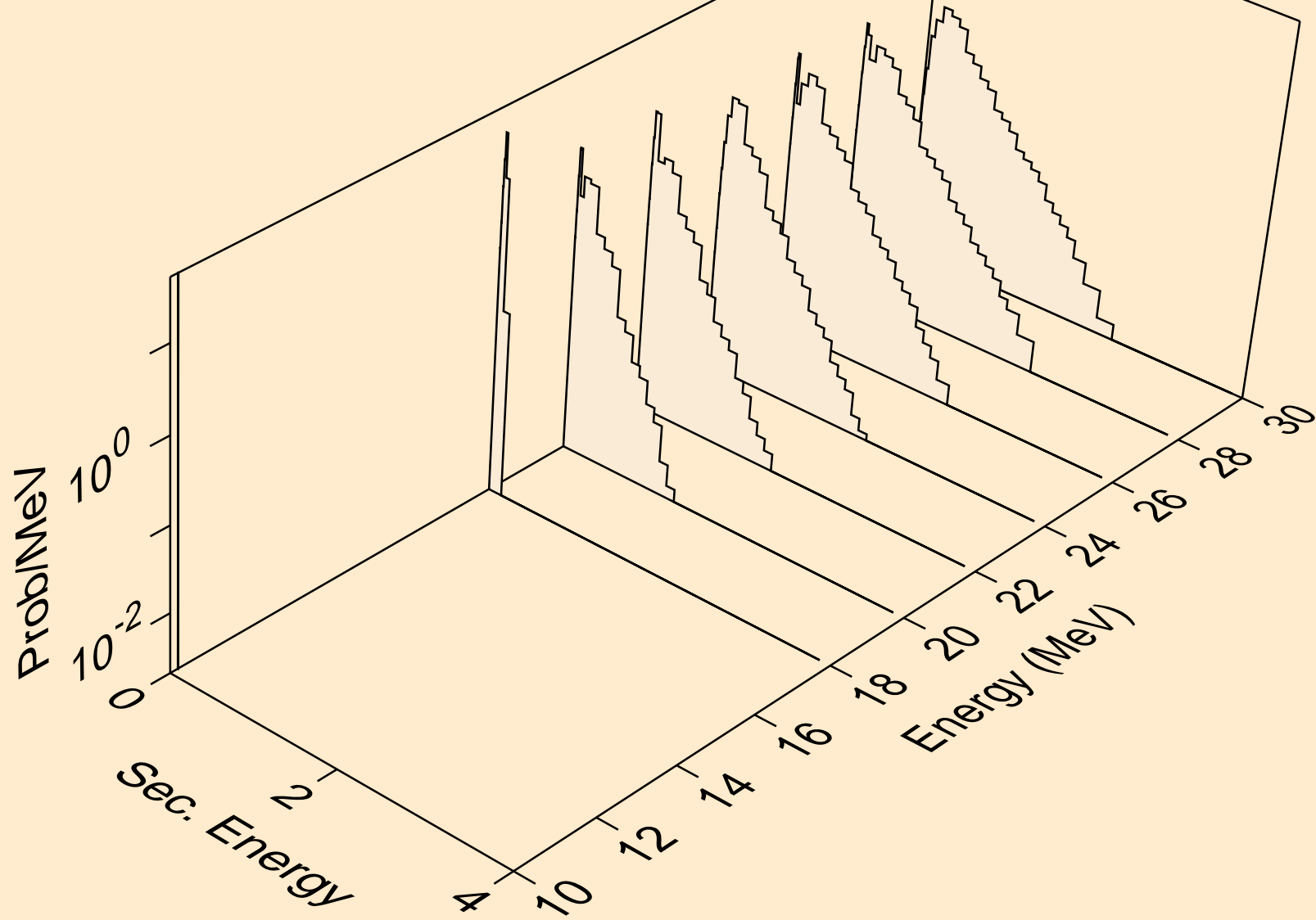

AT224 PROTON ACER TENDL-2021 LIBRARY; T=0.K  
neutrons from (p,npa)

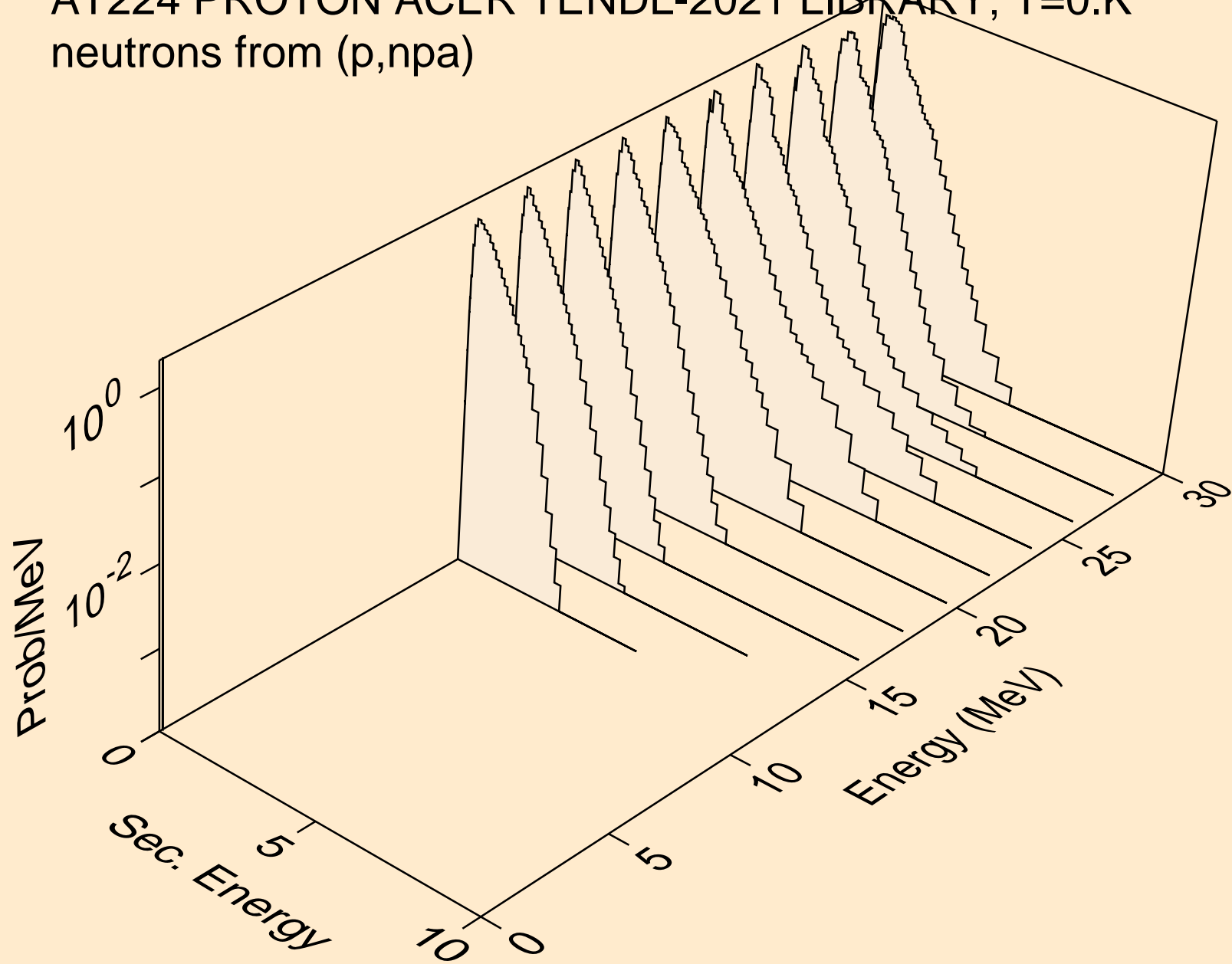

AT224 PROTON ACER TENDL-2021 LIBRARY; T=0.K  
deuterons from (p,x)

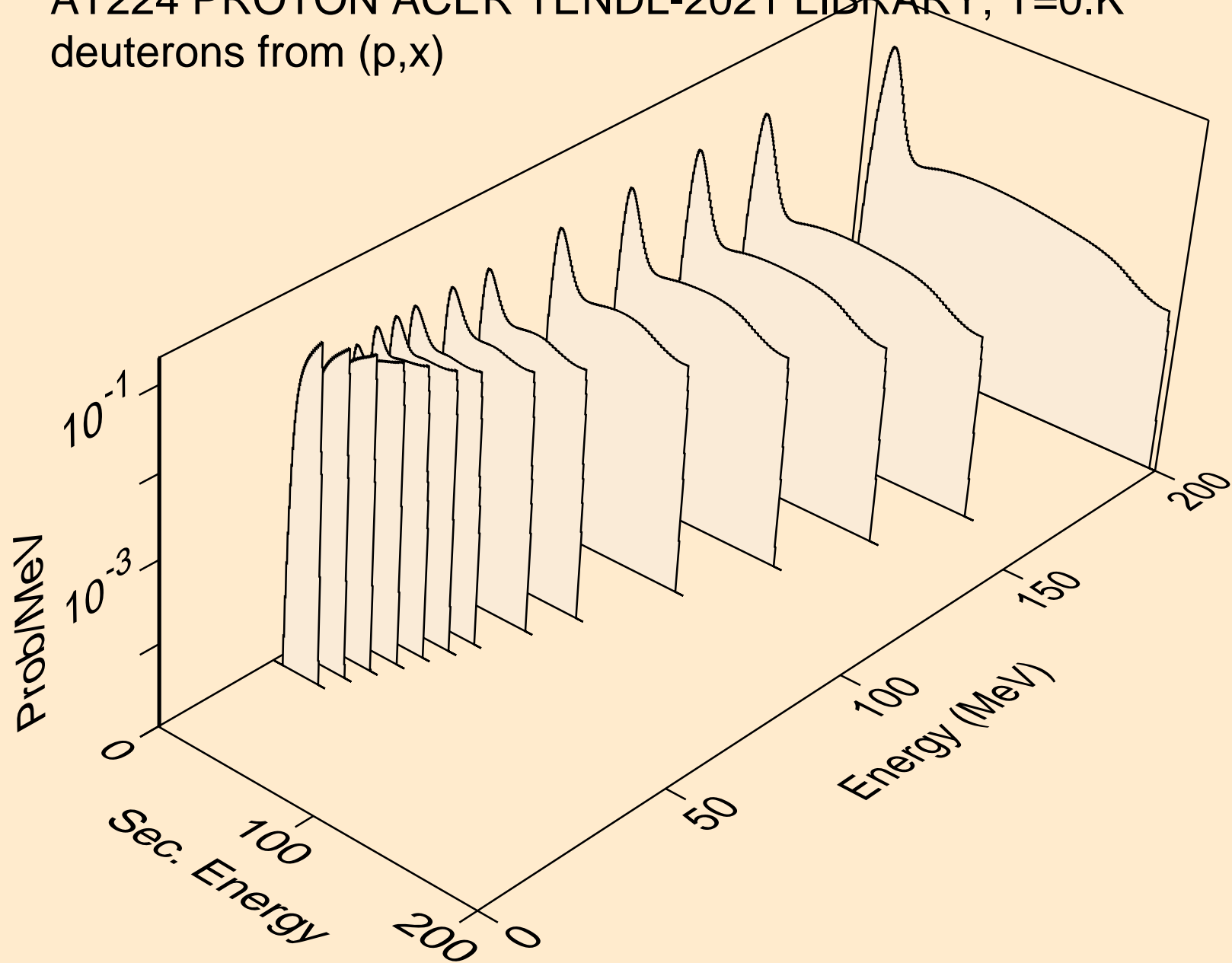

AT224 PROTON ACER TENDL-2021 LIBRARY; T=0.K  
deuterons from (p,2nd)

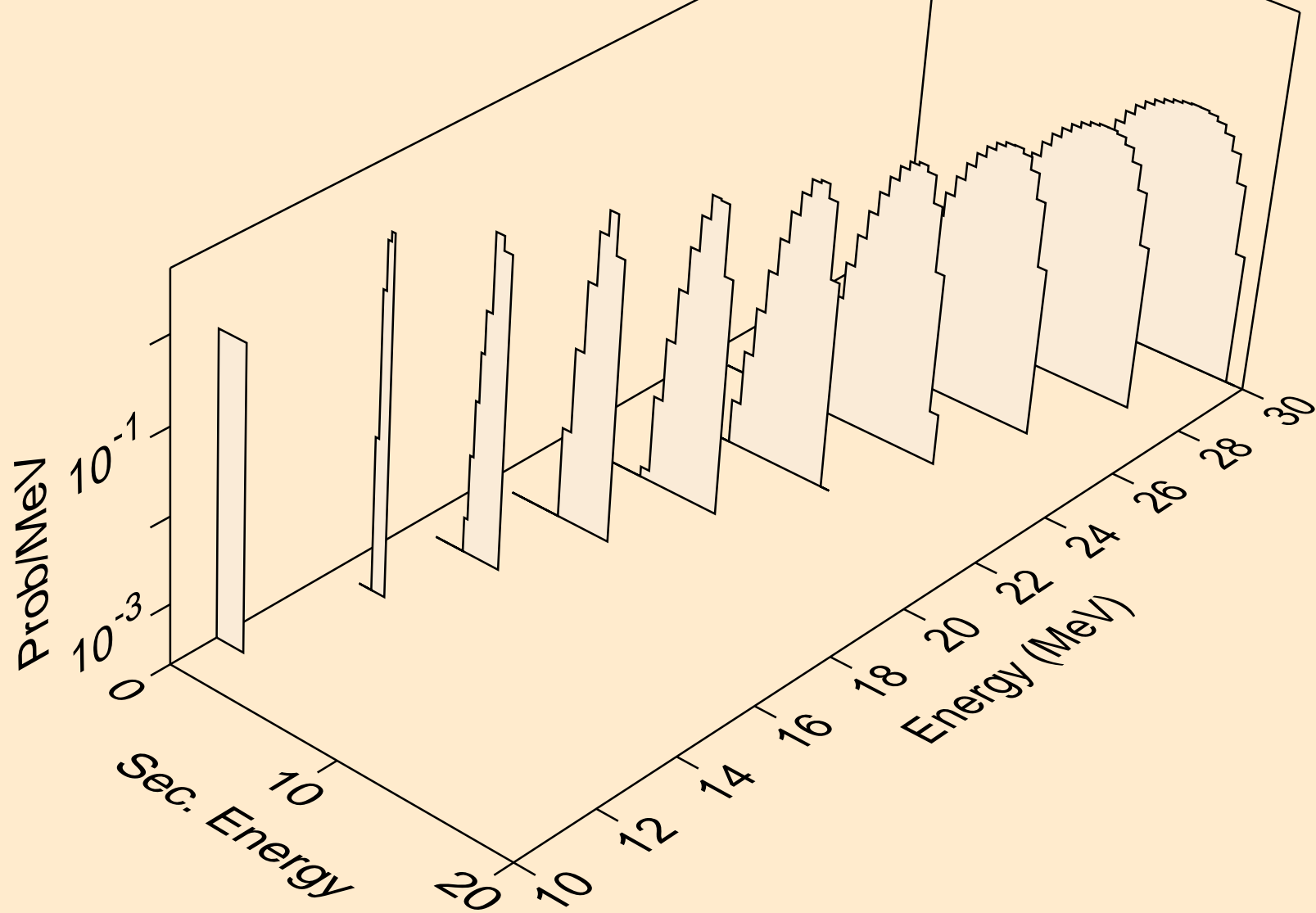

AT224 PROTON ACER TENDL-2021 LIBRARY; T=0.K  
deuterons from (p,n\*)d

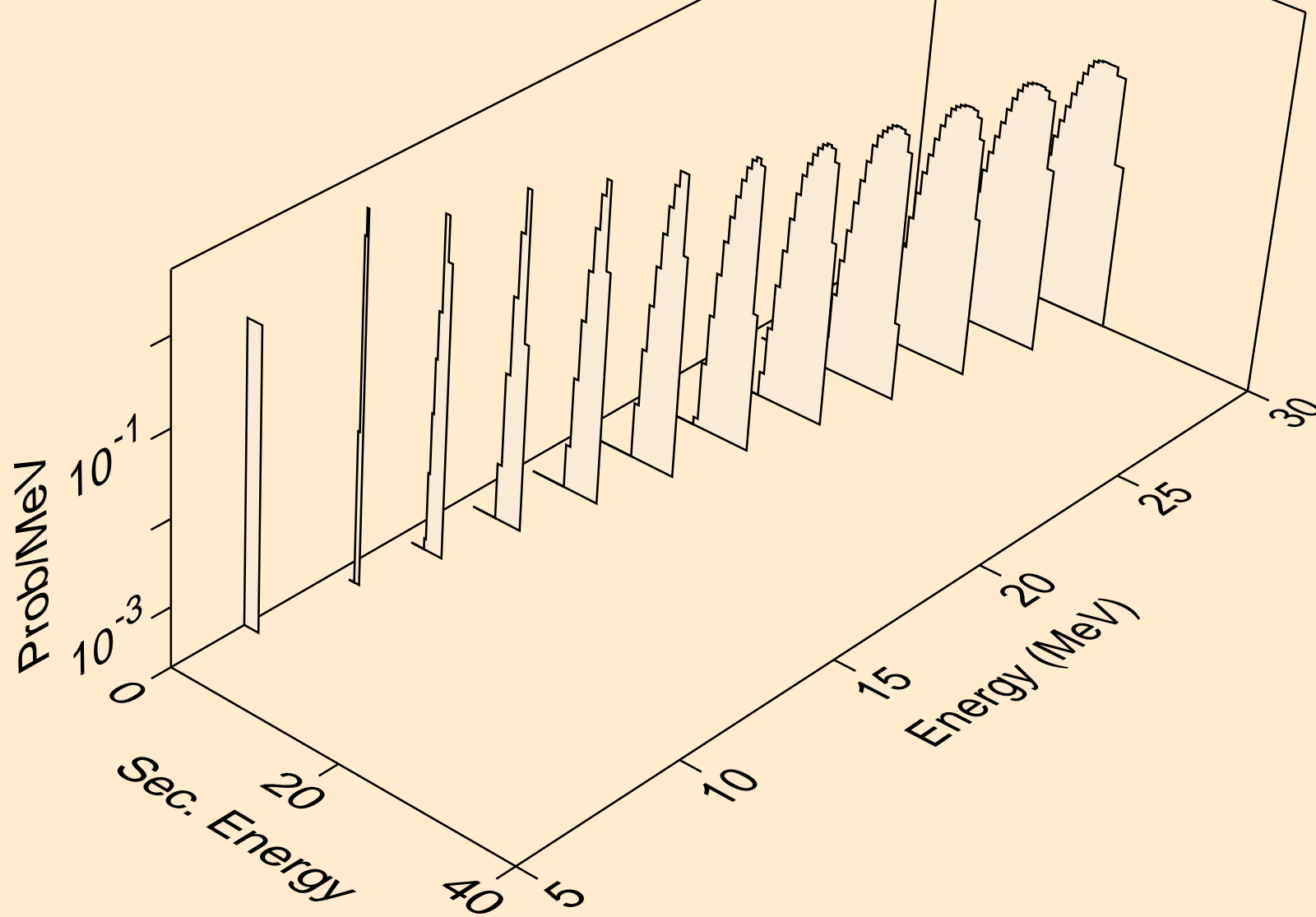



AT224 PROTON ACER TENDL-2021 LIBRARY; T=0.K  
deuterons from (p,d)

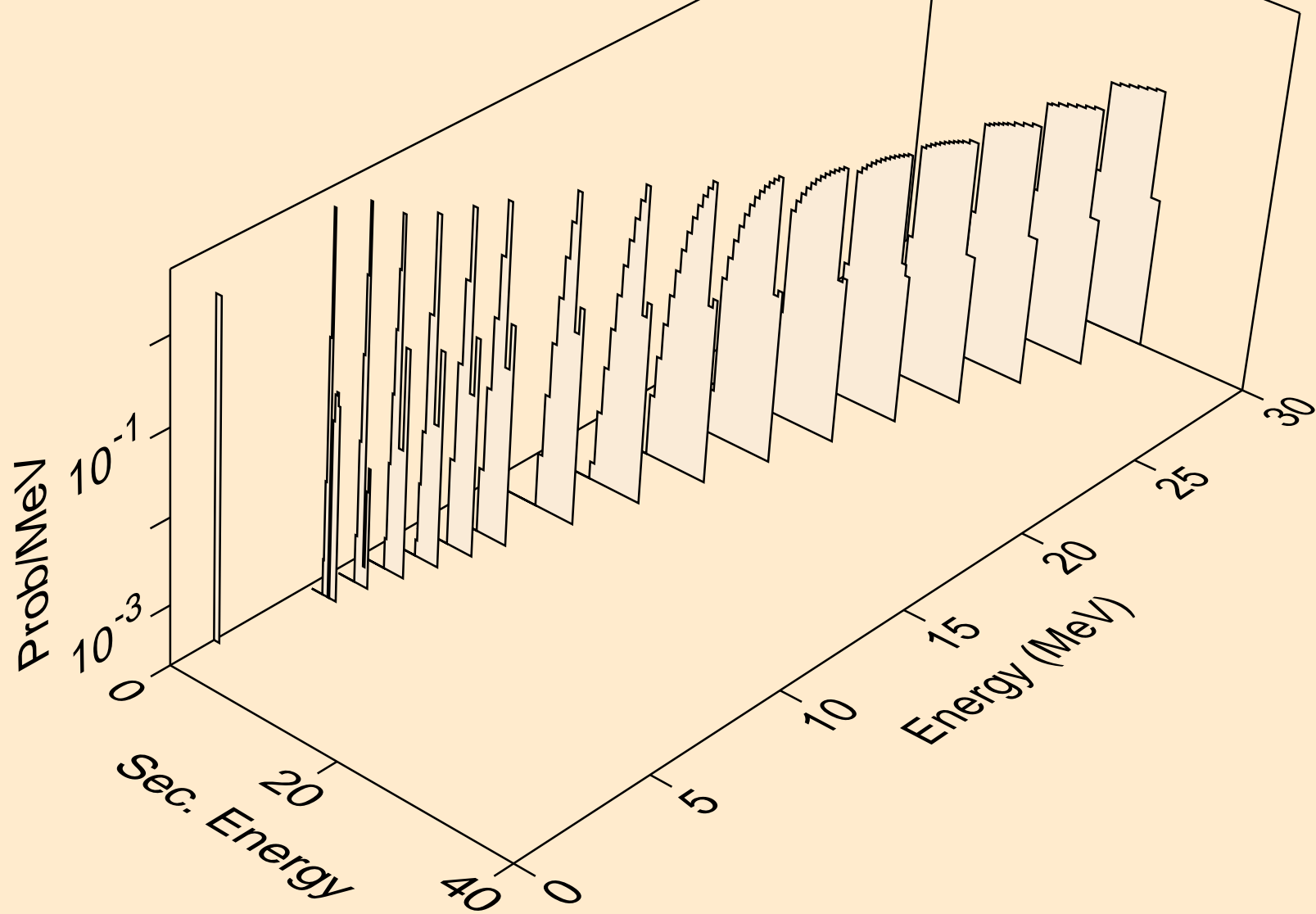

AT224 PROTON ACER TENDL-2021 LIBRARY; T=0.K  
deuterons from (p,pd)

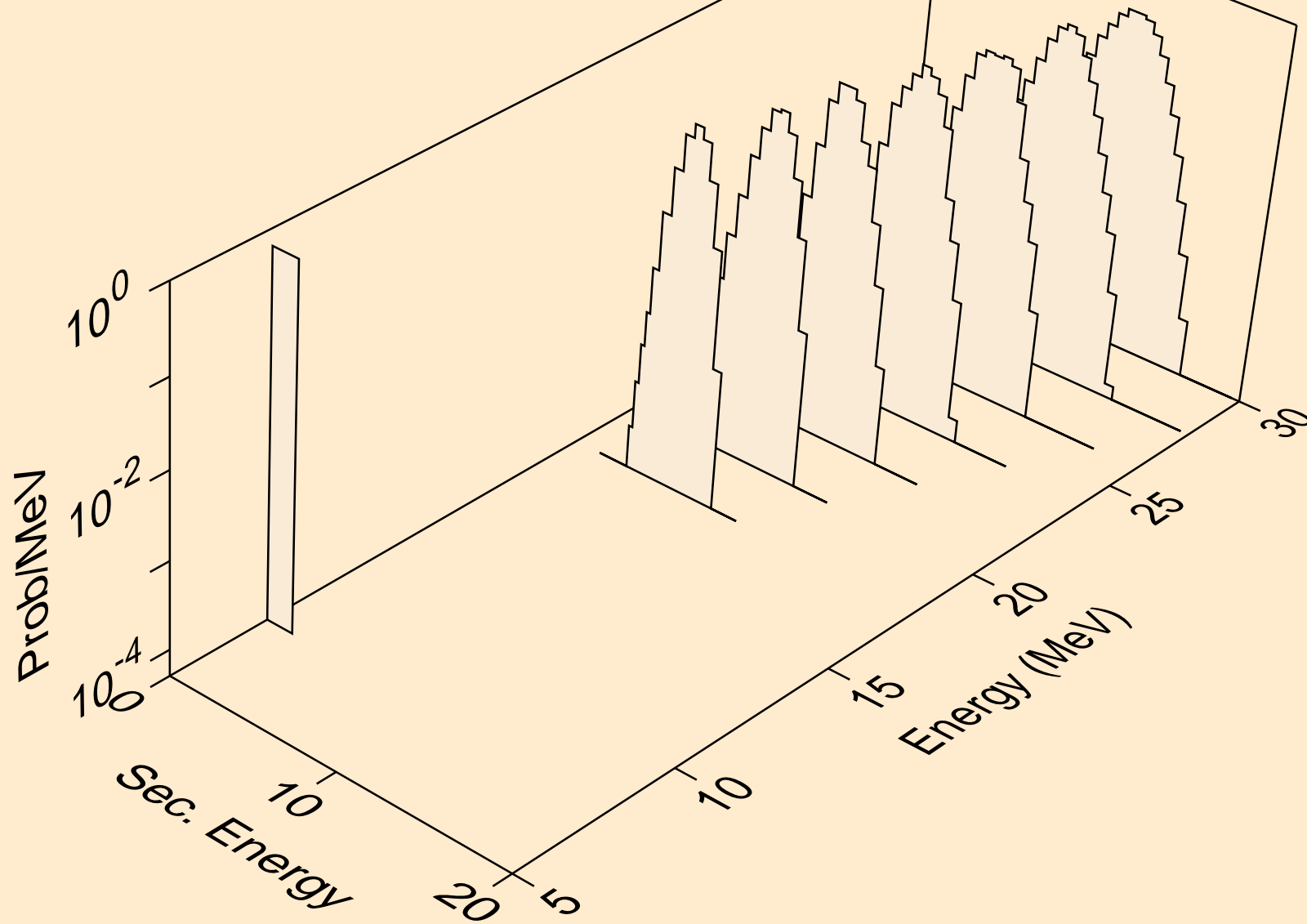

AT224 PROTON ACER TENDL-2021 LIBRARY; T=0.K  
tritons from (p,x)

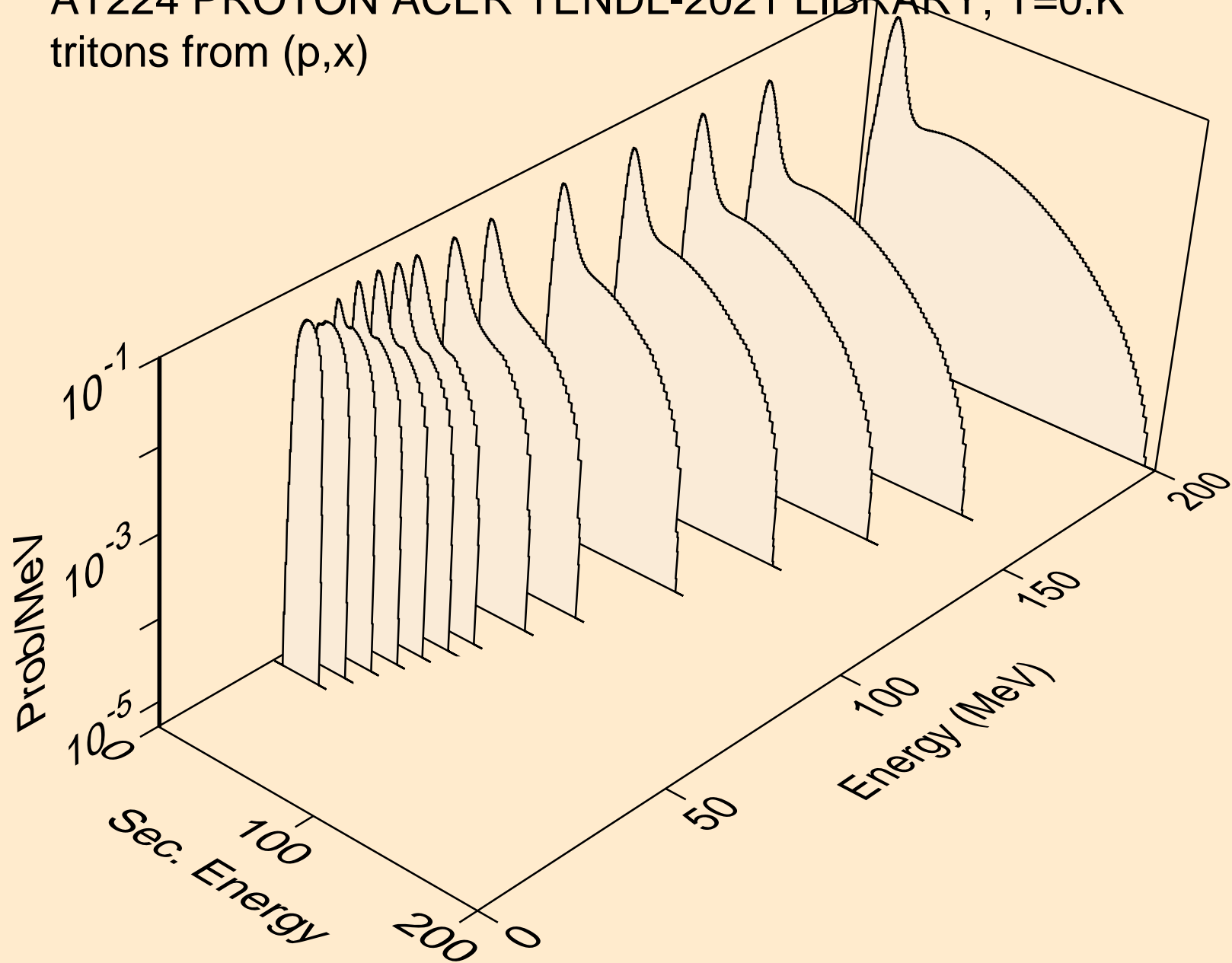

AT224 PROTON ACER TENDL-2021 LIBRARY; T=0.K  
tritons from (p,n\*)t

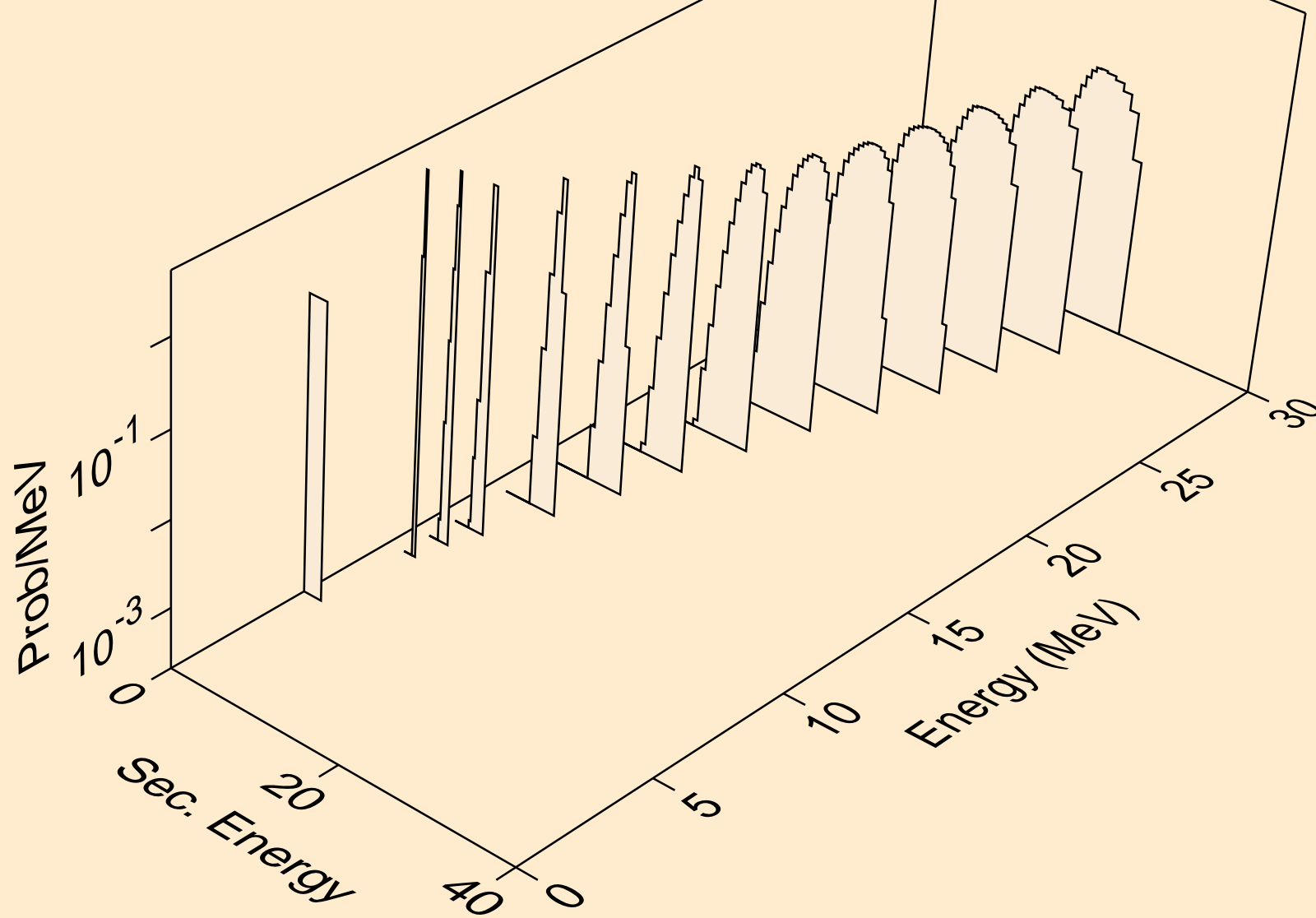

AT224 PROTON ACER TENDL-2021 LIBRARY; T=0.K  
tritons from (p,t)

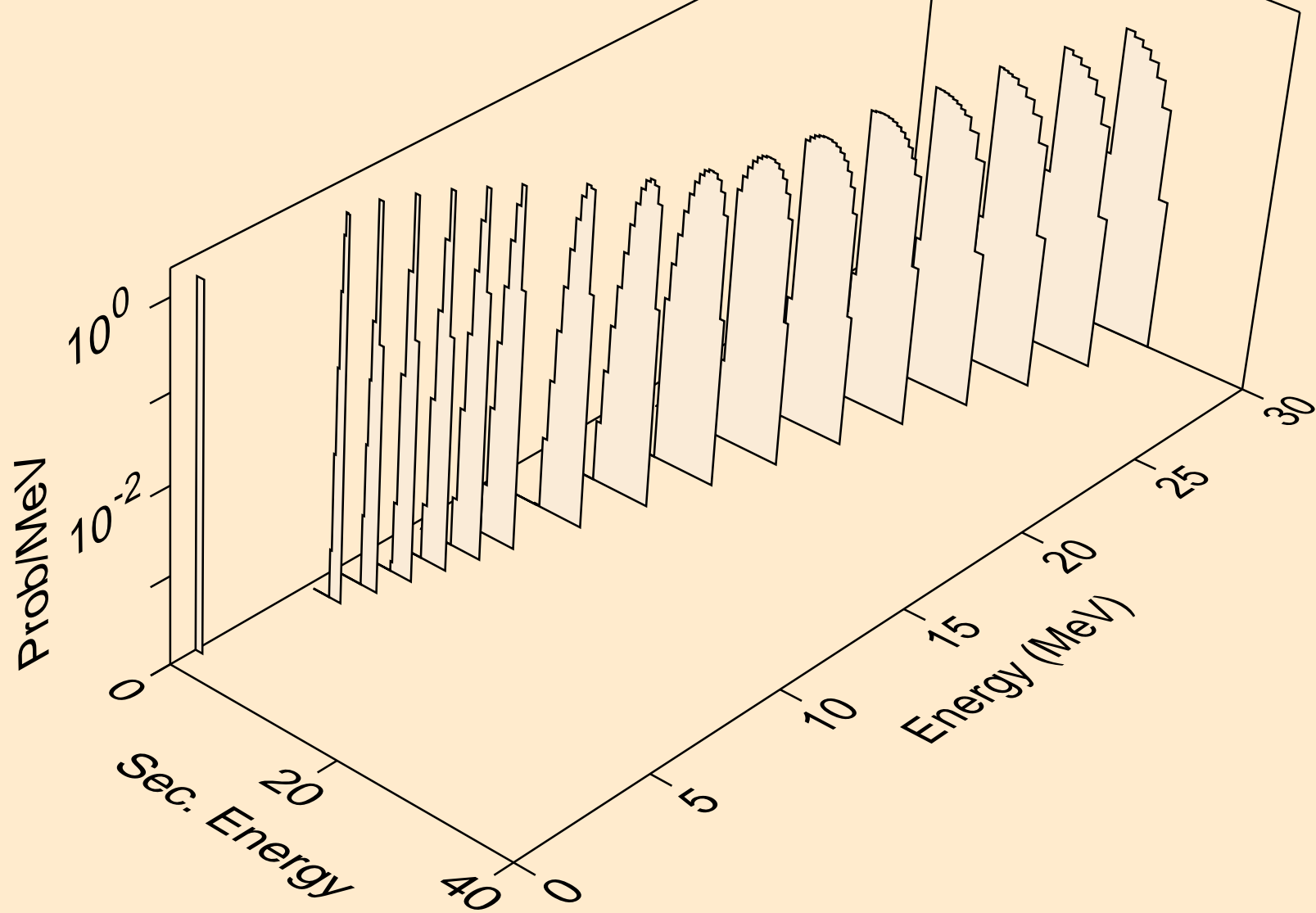

AT224 PROTON ACER TENDL-2021 LIBRARY; T=0.K  
he3s from (p,x)

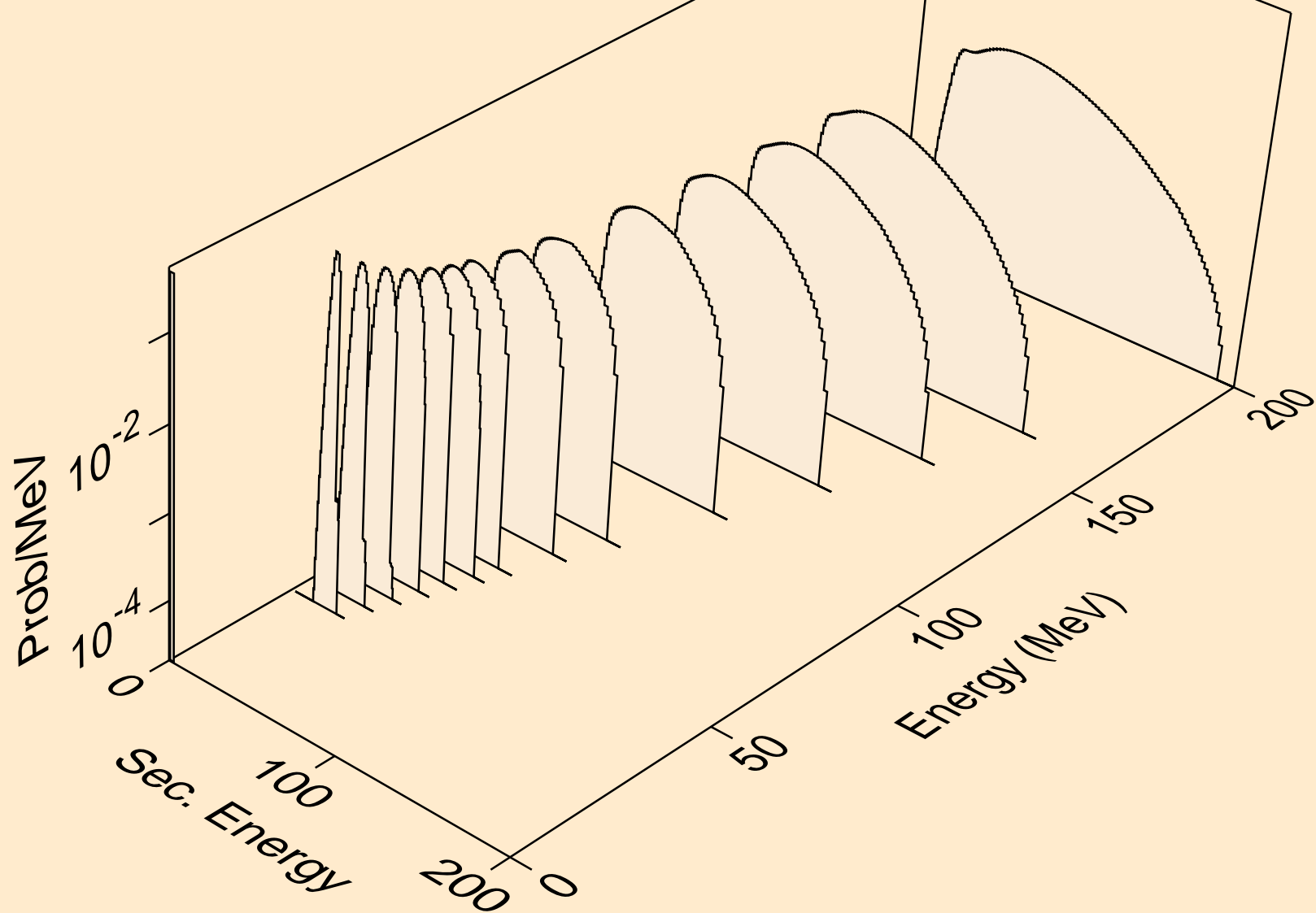

AT224 PROTON ACER TENDL-2021 LIBRARY; T=0.K  
he3s from (p,n\*)he3

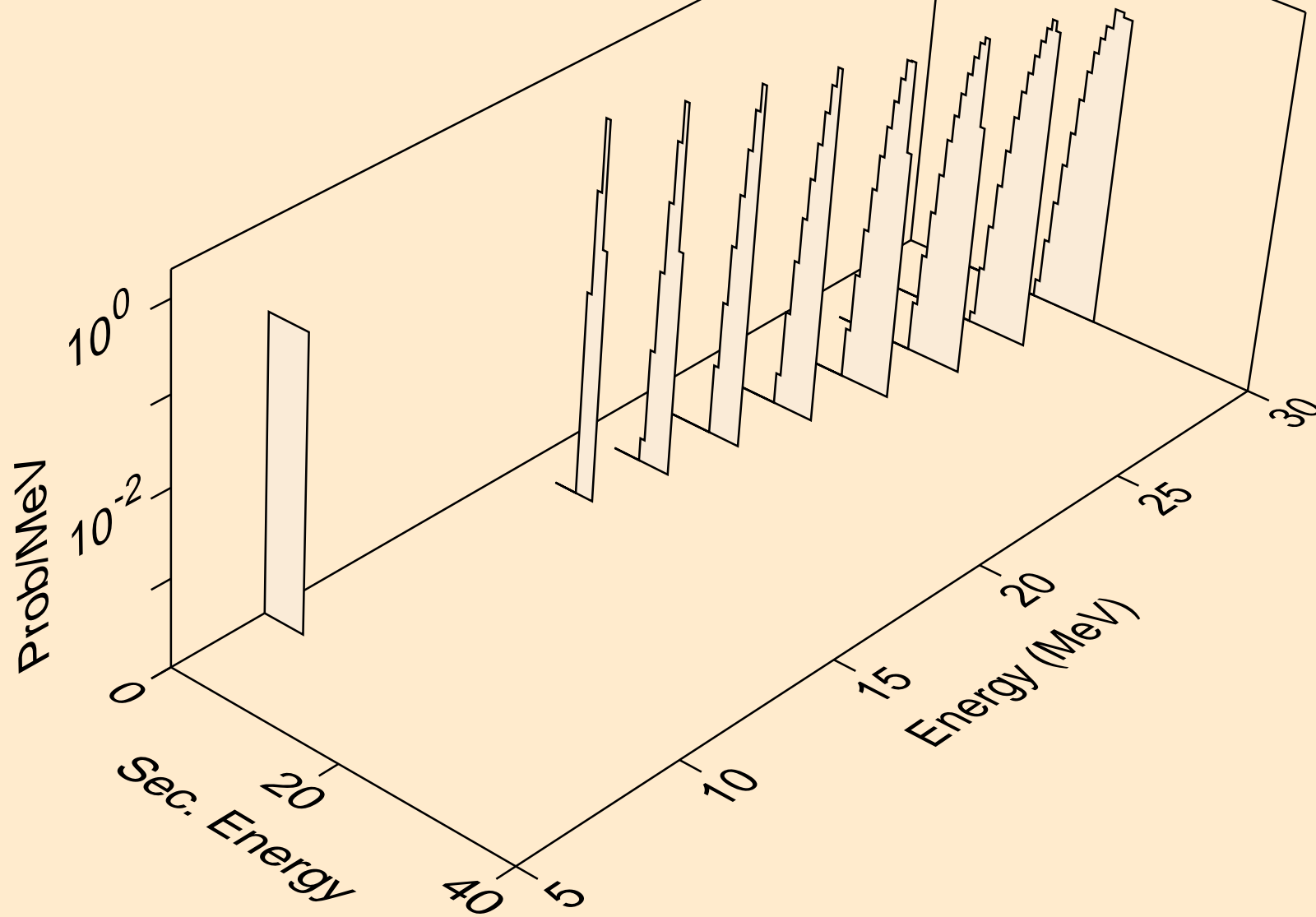

AT224 PROTON ACER TENDL-2021 LIBRARY; T=0.K  
he3s from (p,he3)

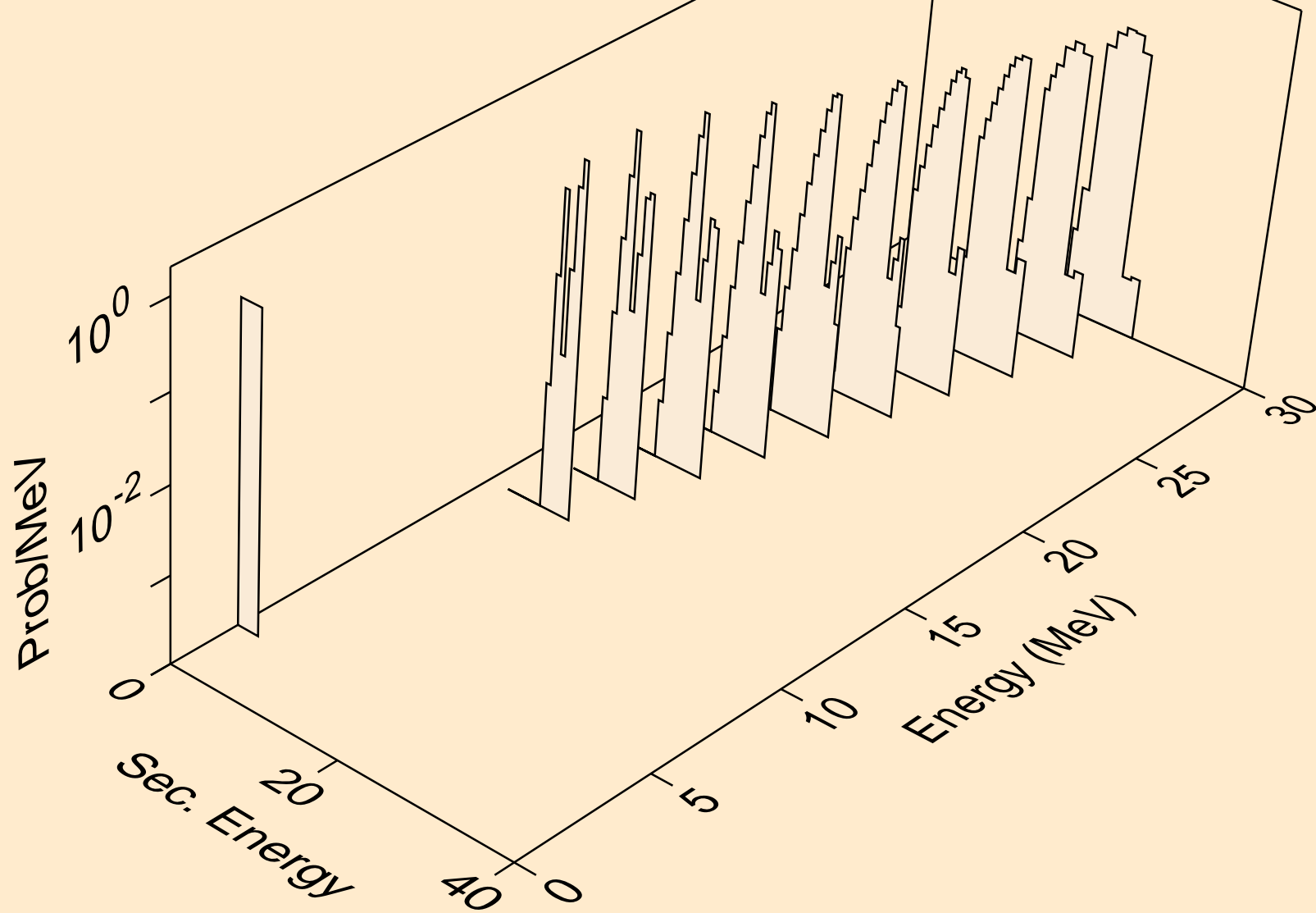



AT224 PROTON ACER TENDL-2021 LIBRARY; T=0.K  
alphas from (p,x)

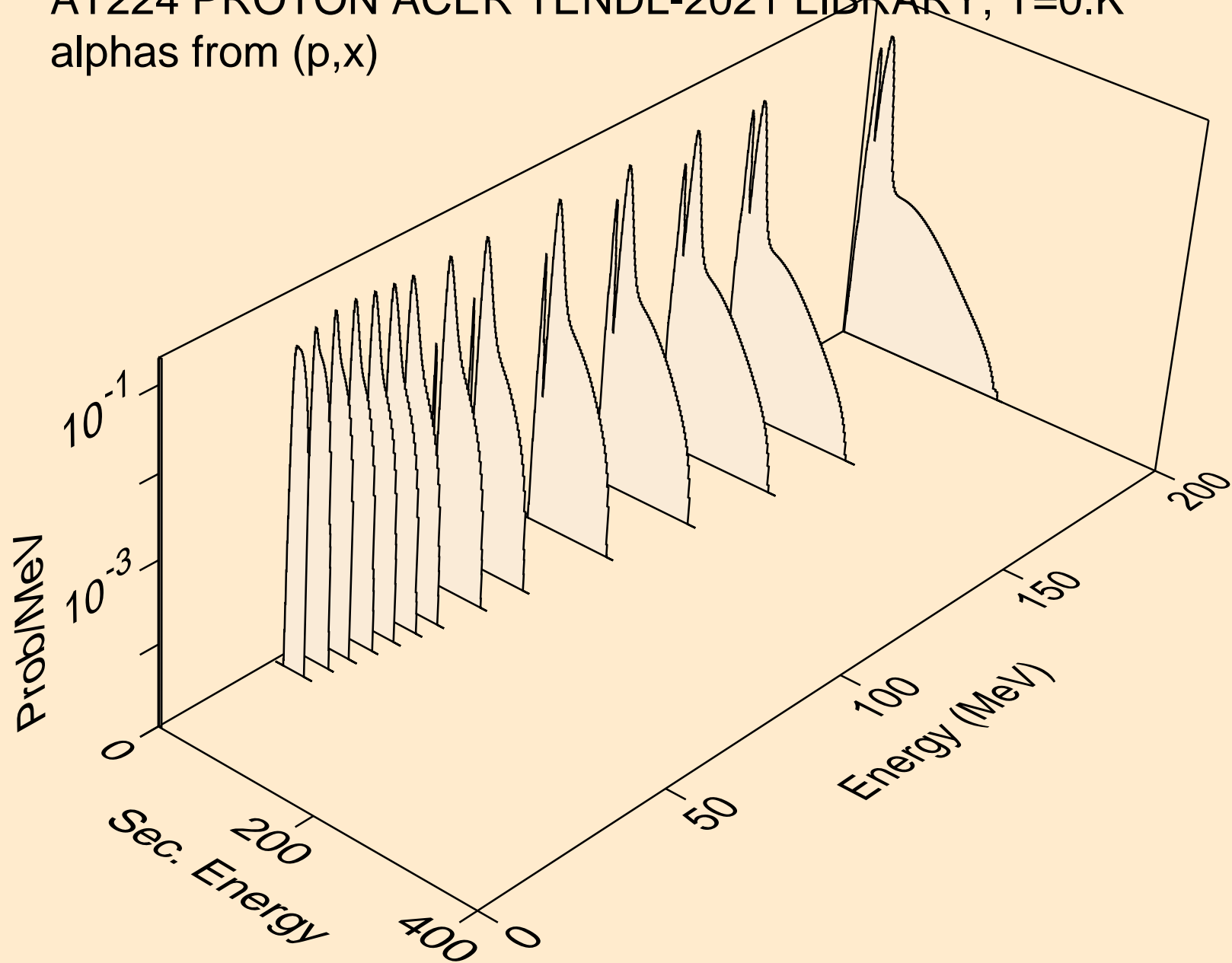

AT224 PROTON ACER TENDL-2021 LIBRARY; T=0.K  
alphas from (p,n\*)a

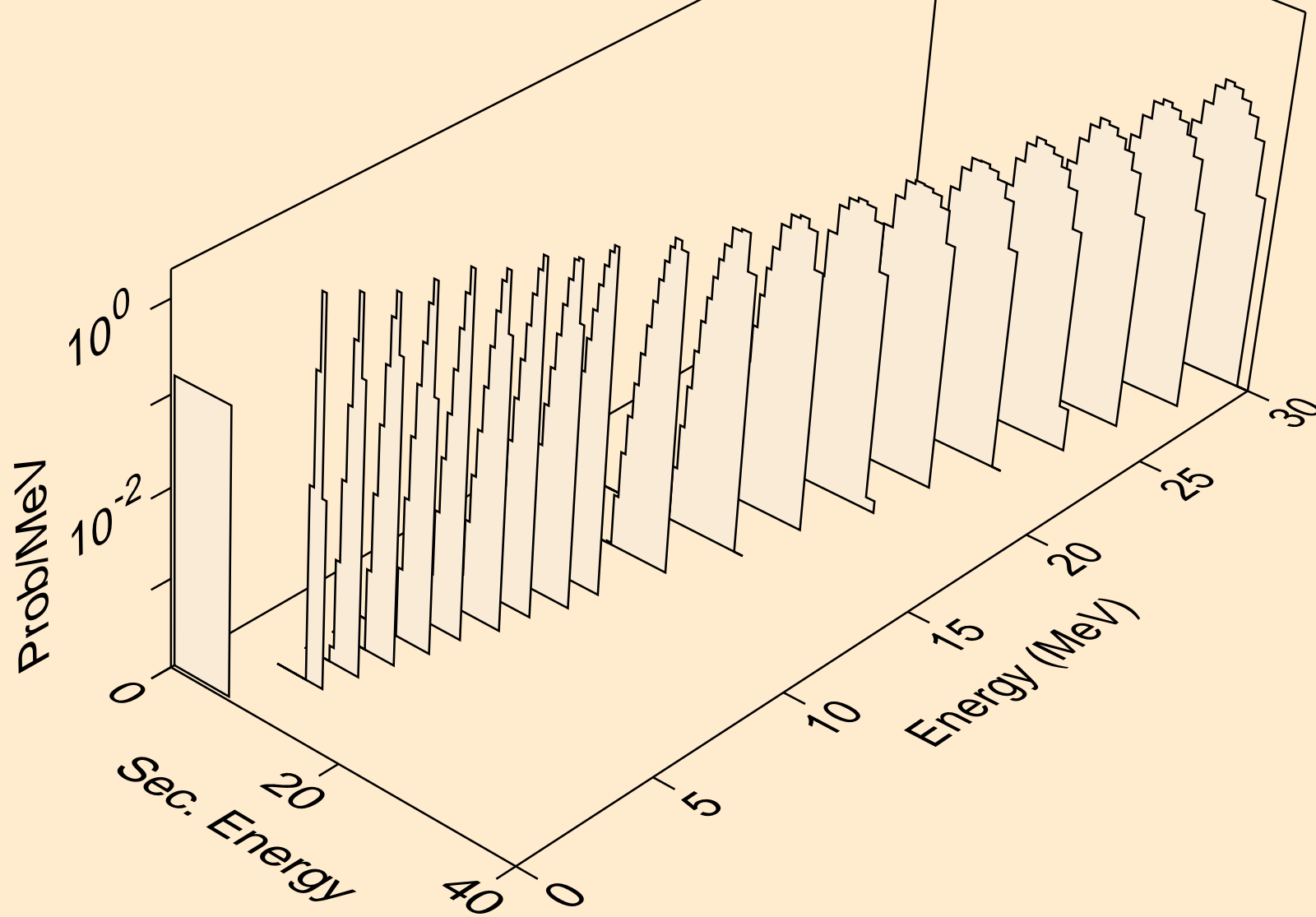

AT224 PROTON ACER TENDL-2021 LIBRARY; T=0.K  
alphas from (p,2n)a

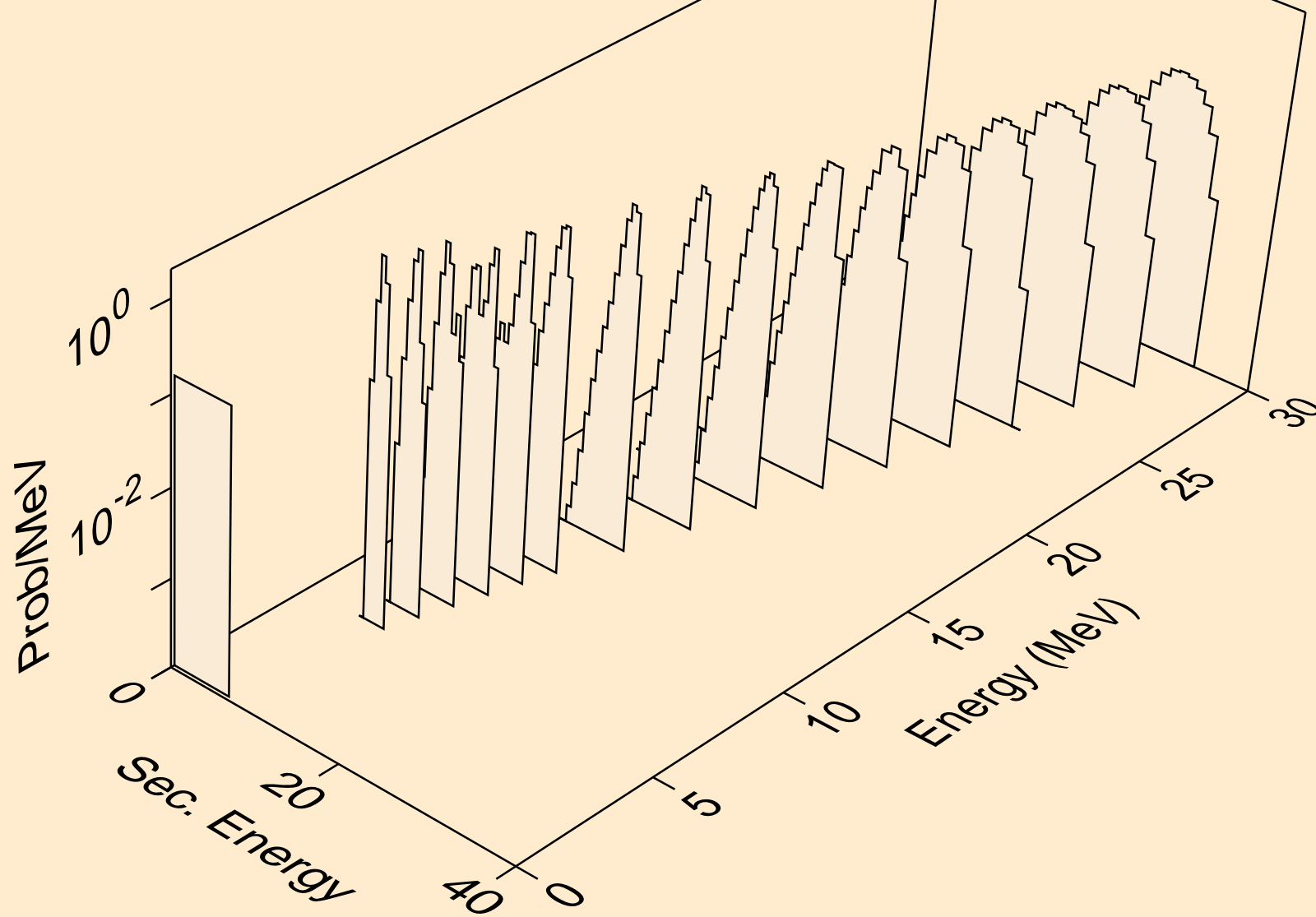

AT224 PROTON ACER TENDL-2021 LIBRARY; T=0.K  
alphas from (p,3n)a

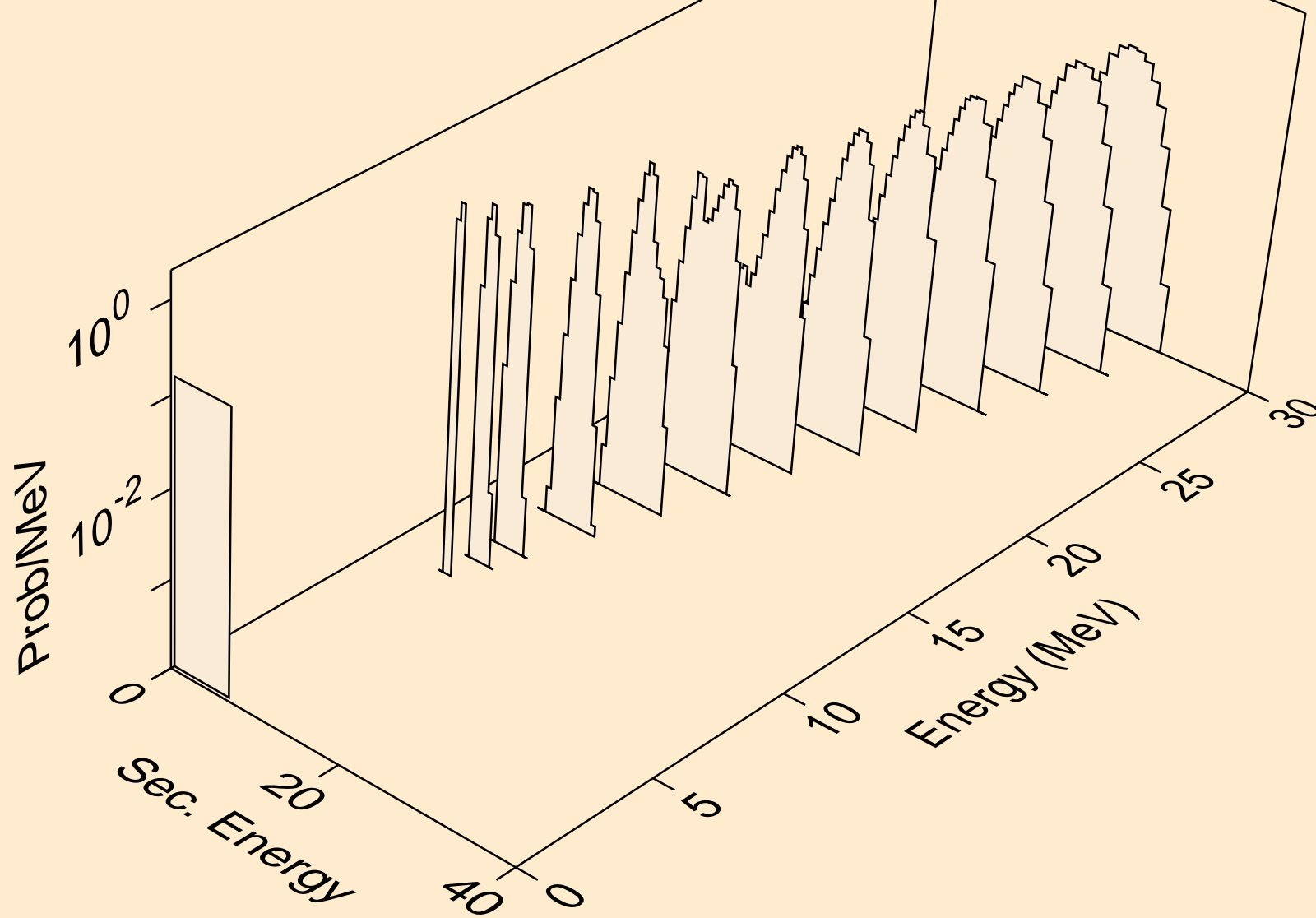

AT224 PROTON ACER TENDL-2021 LIBRARY; T=0.K  
alphas from (p,n\*)2a

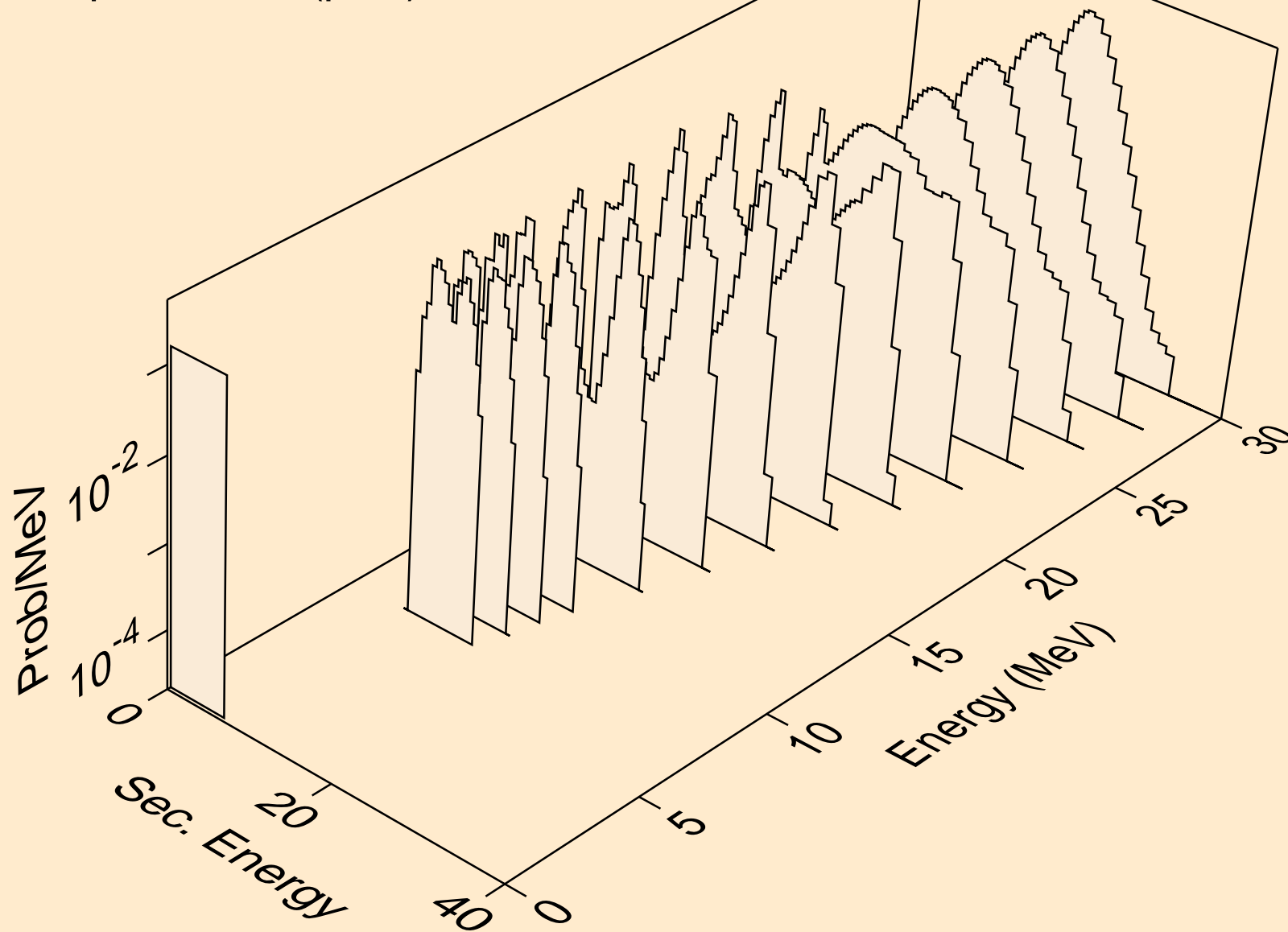

AT224 PROTON ACER TENDL-2021 LIBRARY; T=0.K  
alphas from (p,2n)2a

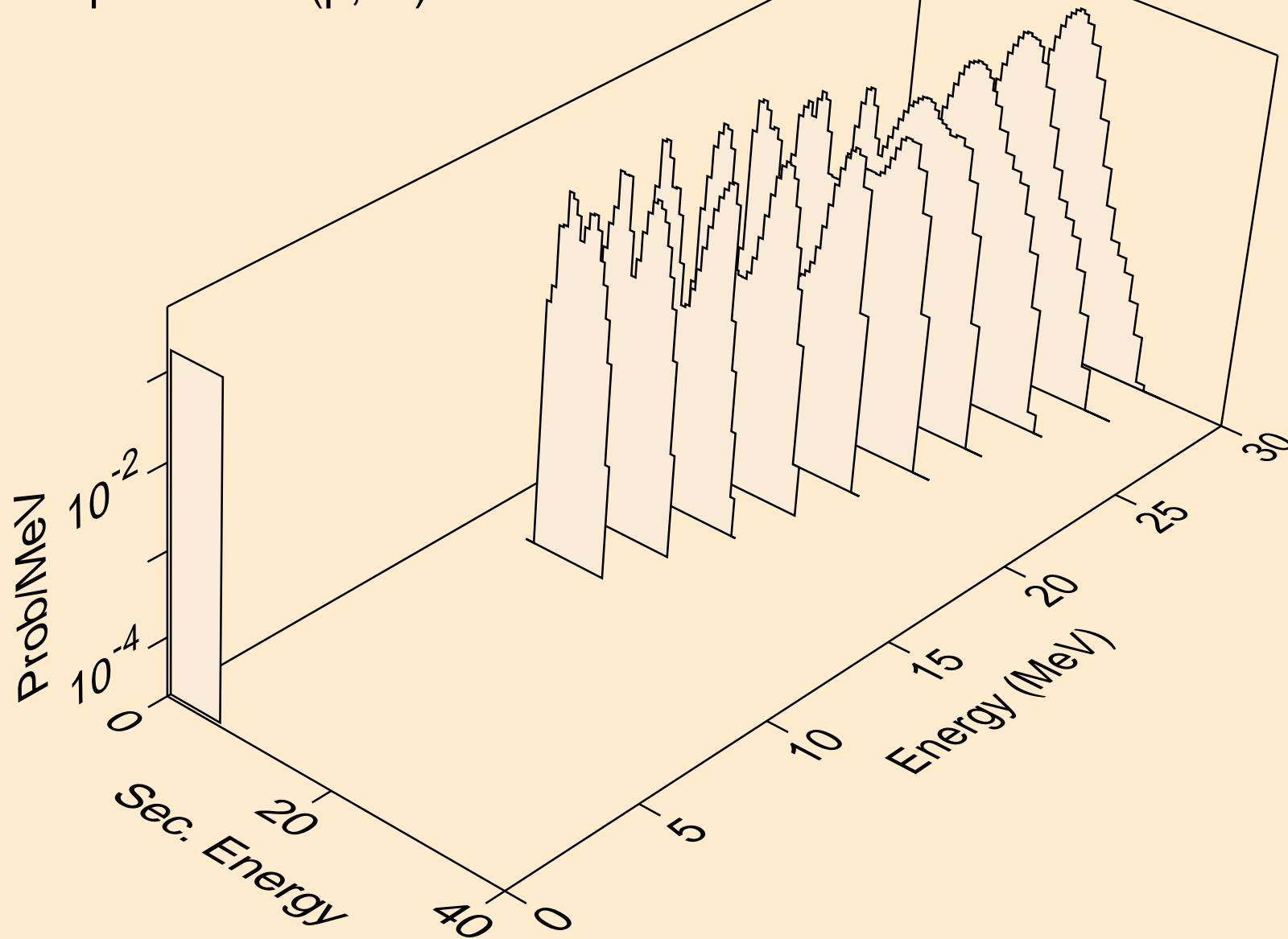

AT224 PROTON ACER TENDL-2021 LIBRARY; T=0.K  
alphas from (p,npa)

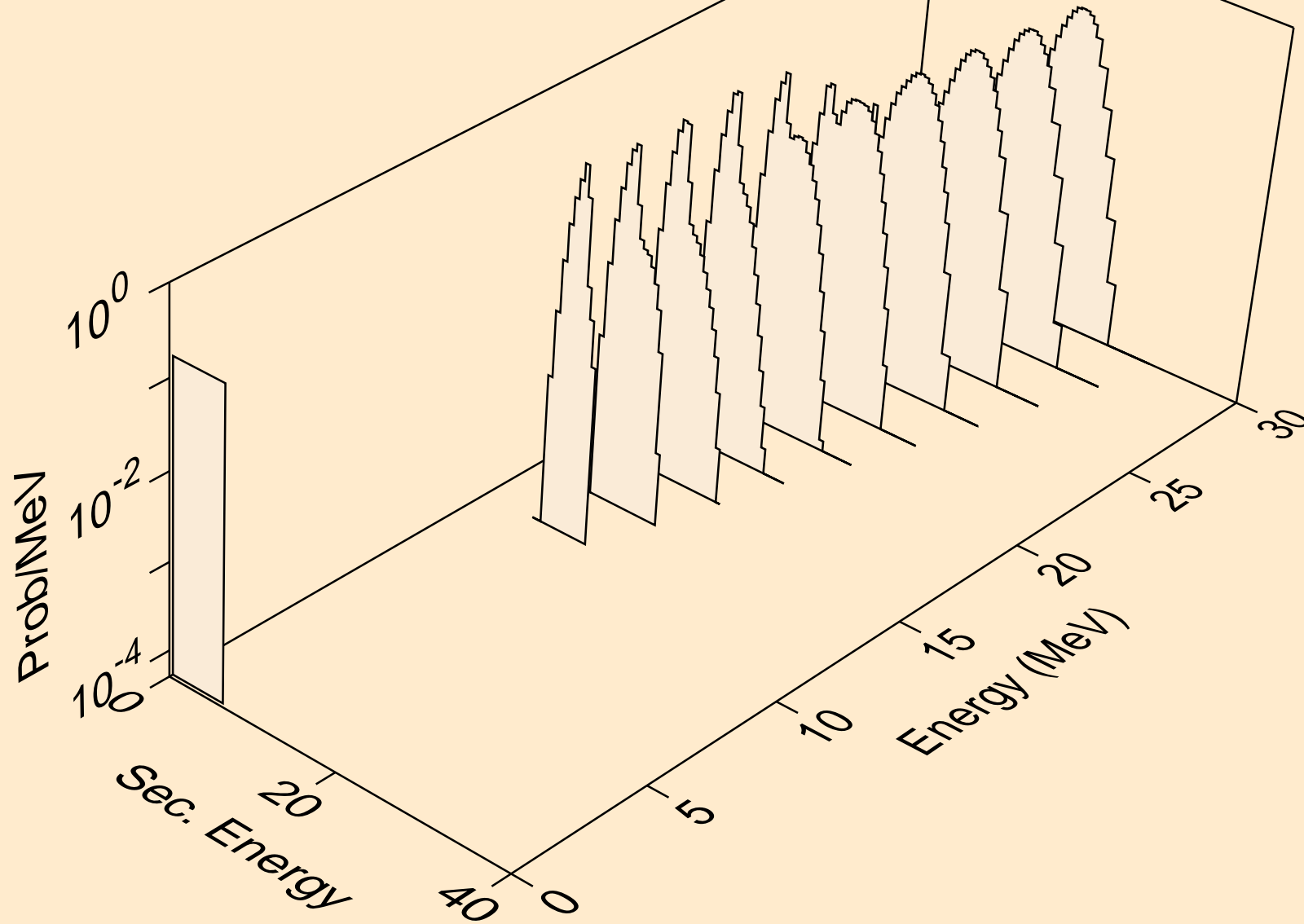

AT224 PROTON ACER TENDL-2021 LIBRARY; T=0.K  
alphas from (p,a)

