

AU187 PROTON ACER TENDL-2021 LIBRARY; T=0.K  
Principal cross sections

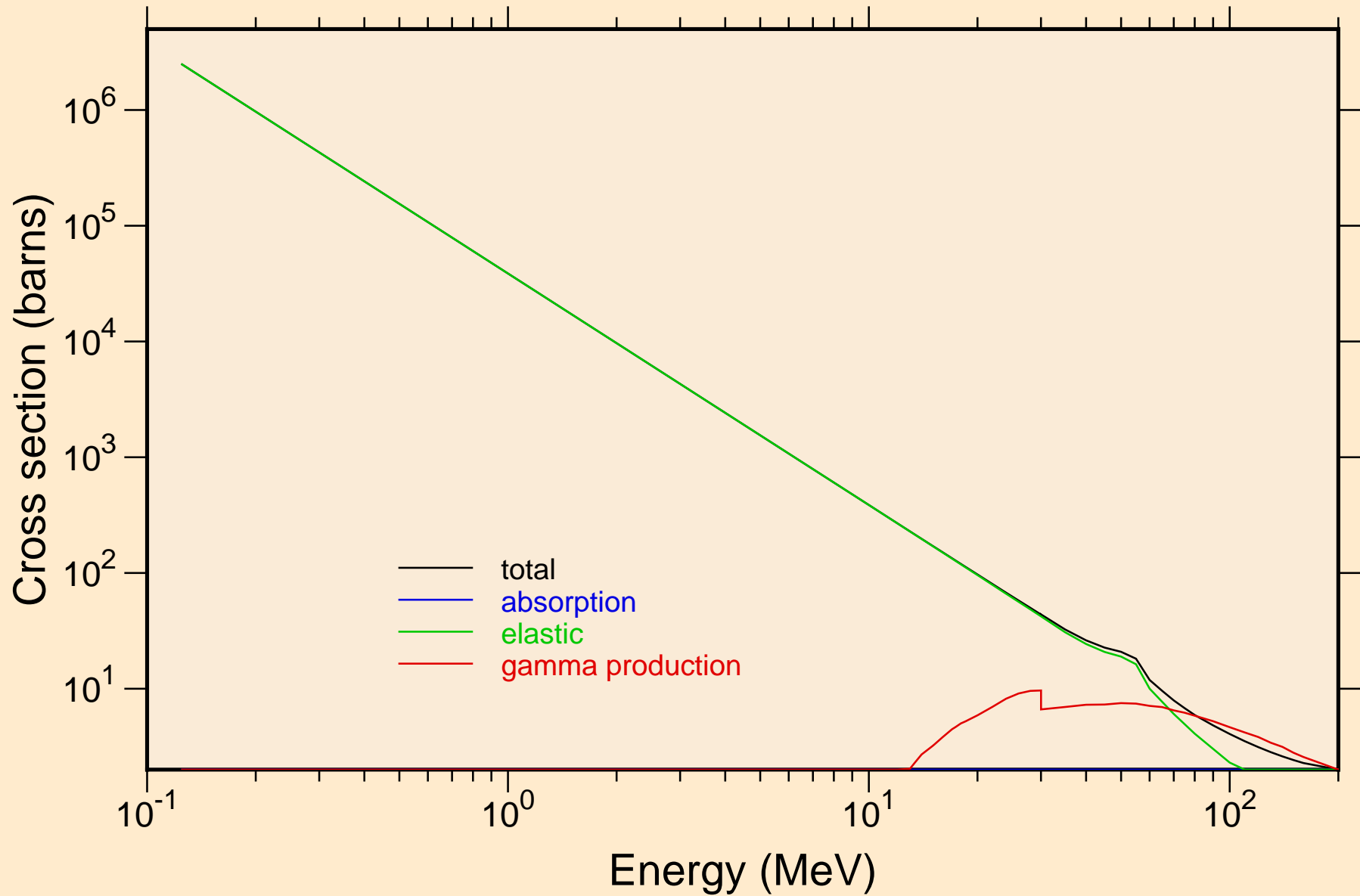

# AU187 PROTON ACER TENDL-2021 LIBRARY; T=0.K

## Heating

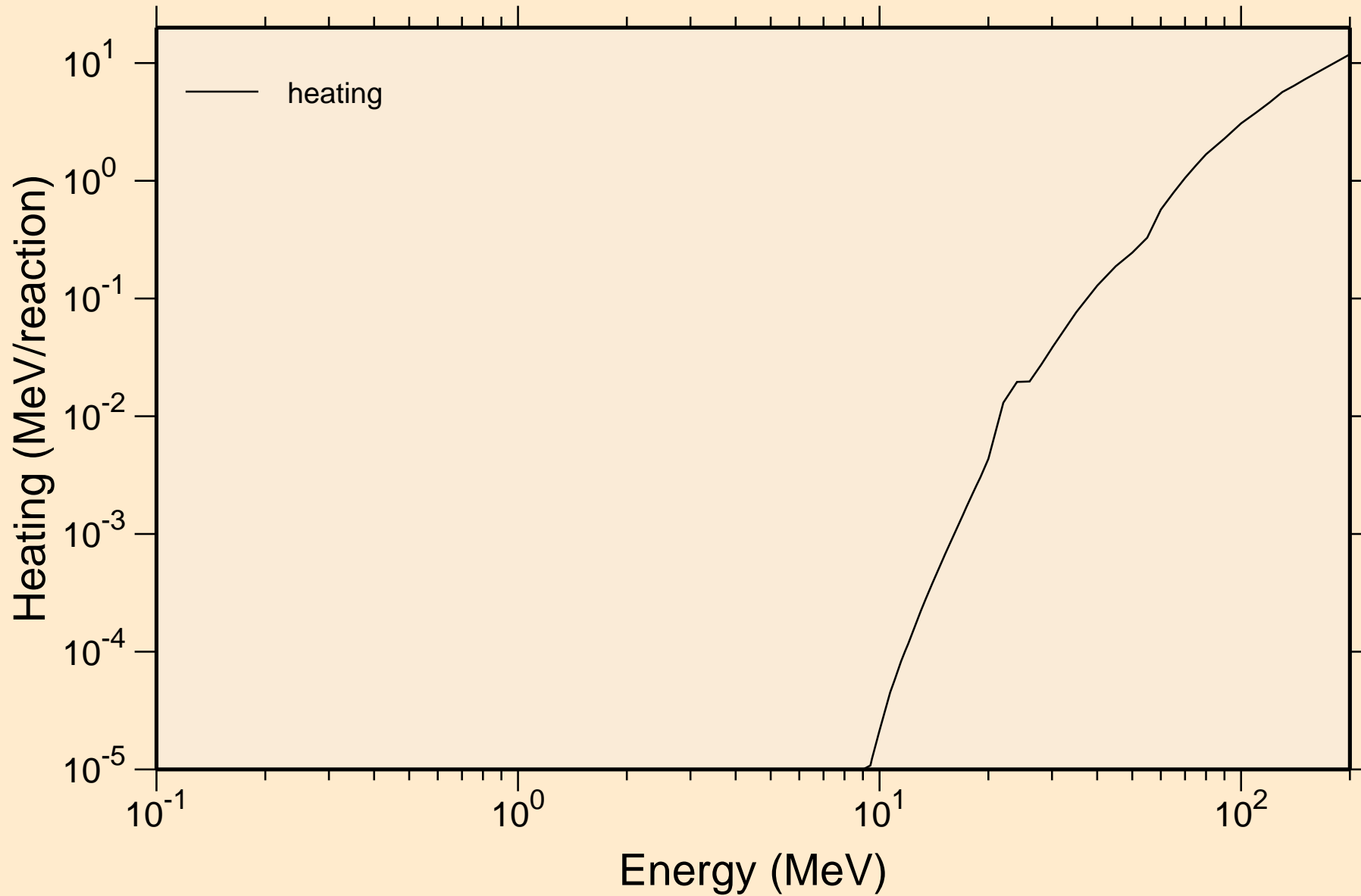

# AU187 PROTON ACER TENDL-2021 LIBRARY; T=0.K

## Principal cross sections

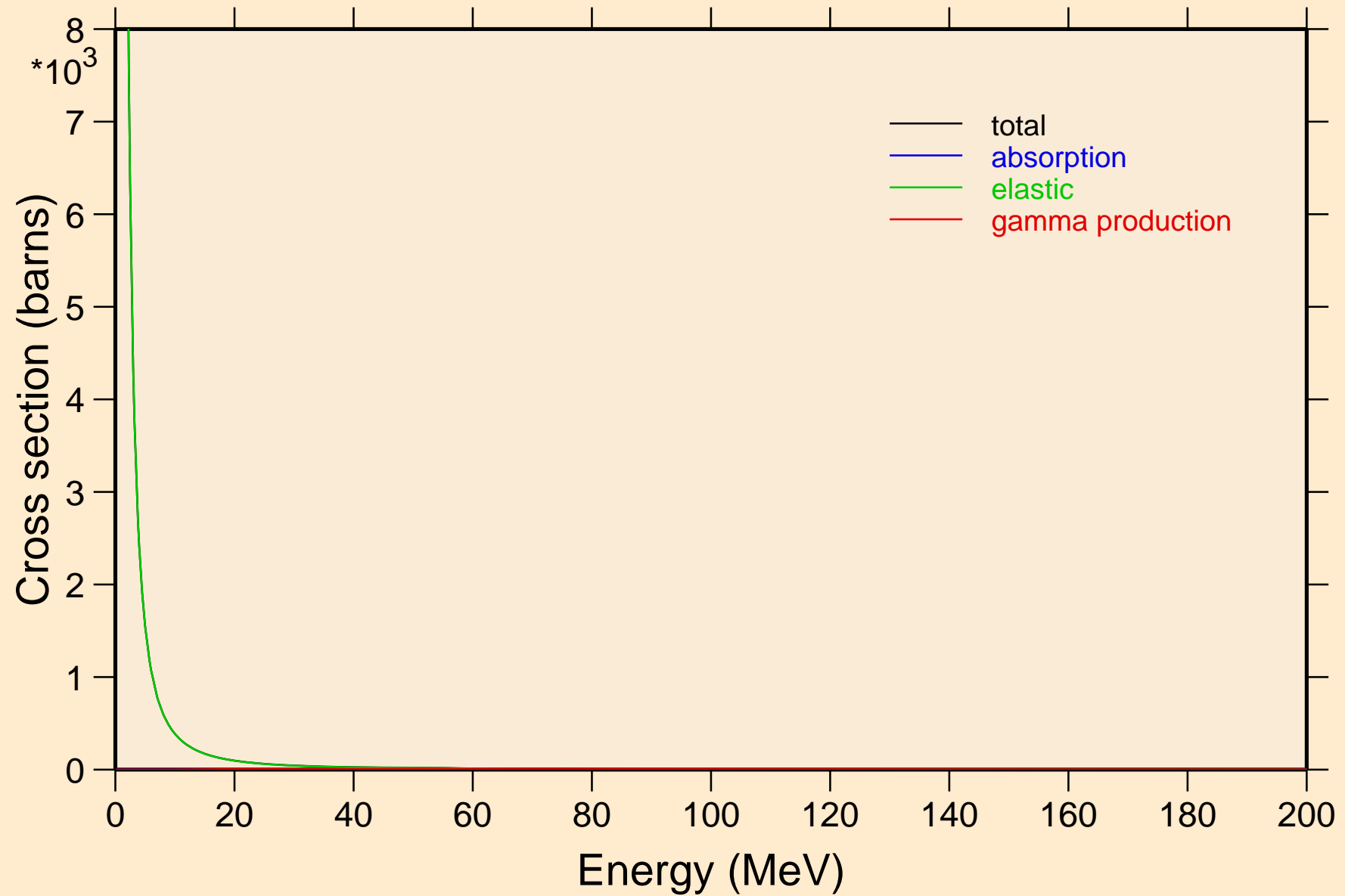

AU187 PROTON ACER TENDL-2021 LIBRARY; T=0.K

Heating

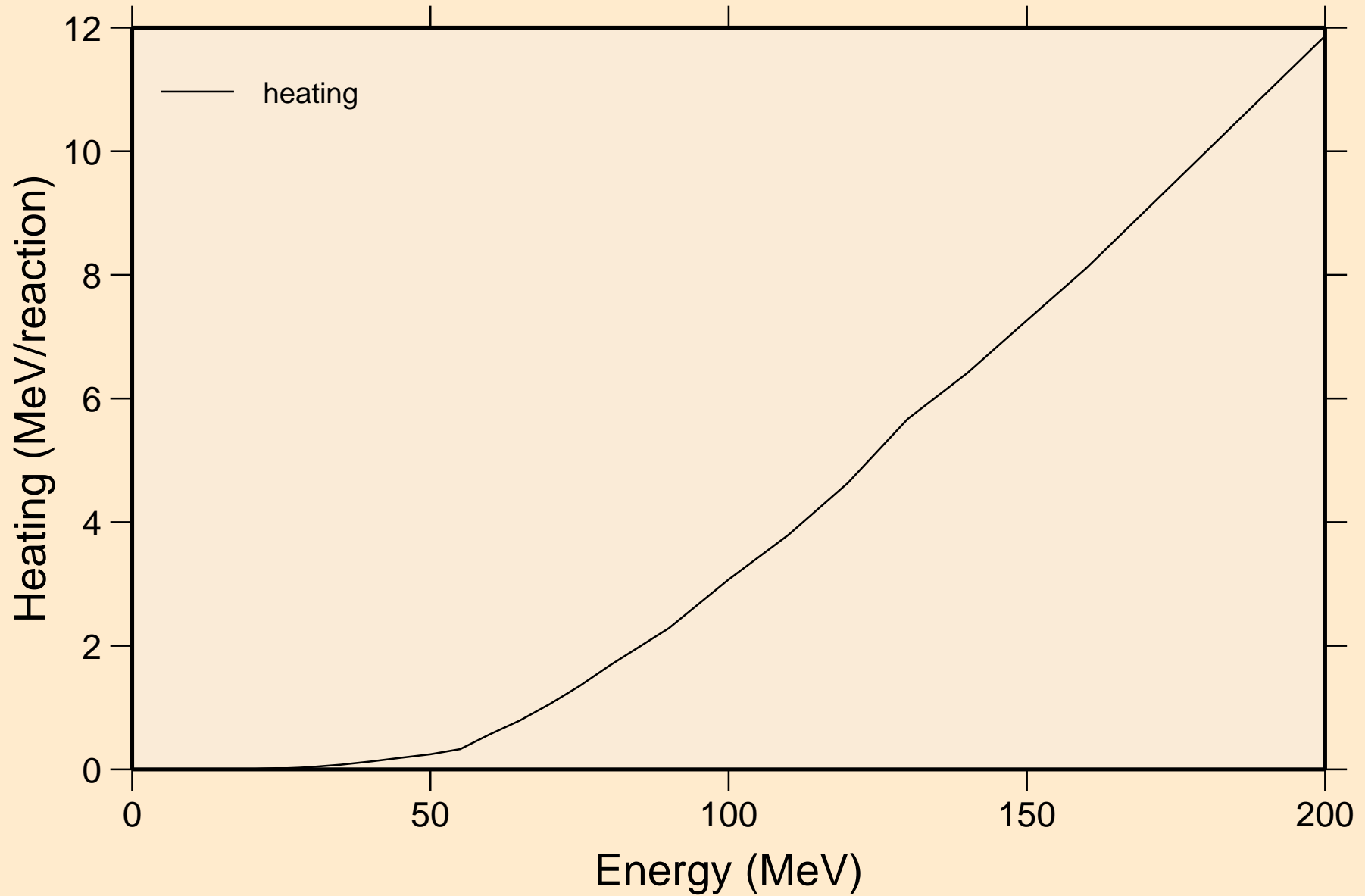

# AU187 PROTON ACER TENDL-2021 LIBRARY; T=0.K

## Threshold reactions

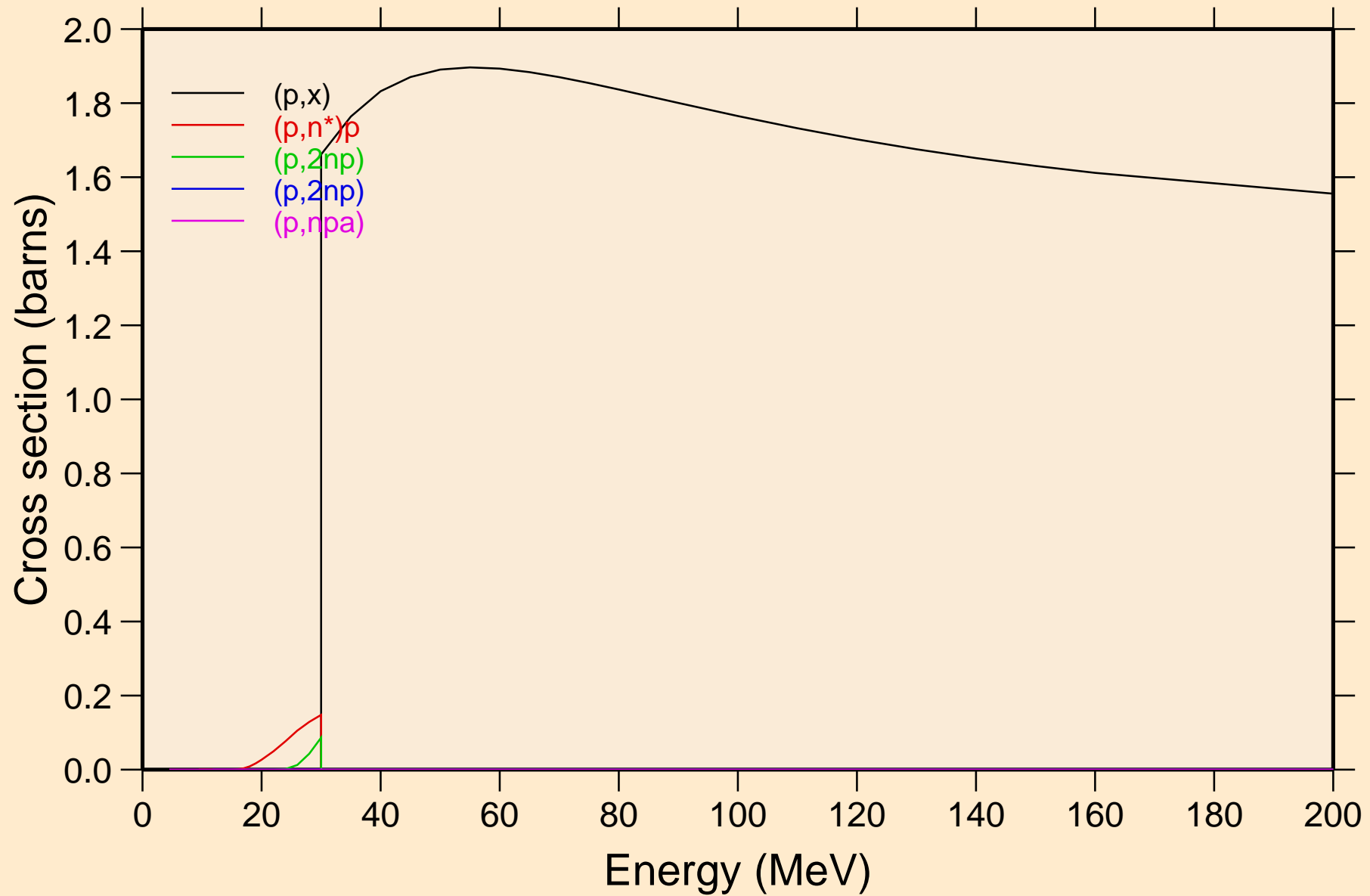

AU187 PROTON ACER TENDL-2021 LIBRARY; T=0.K  
Threshold reactions

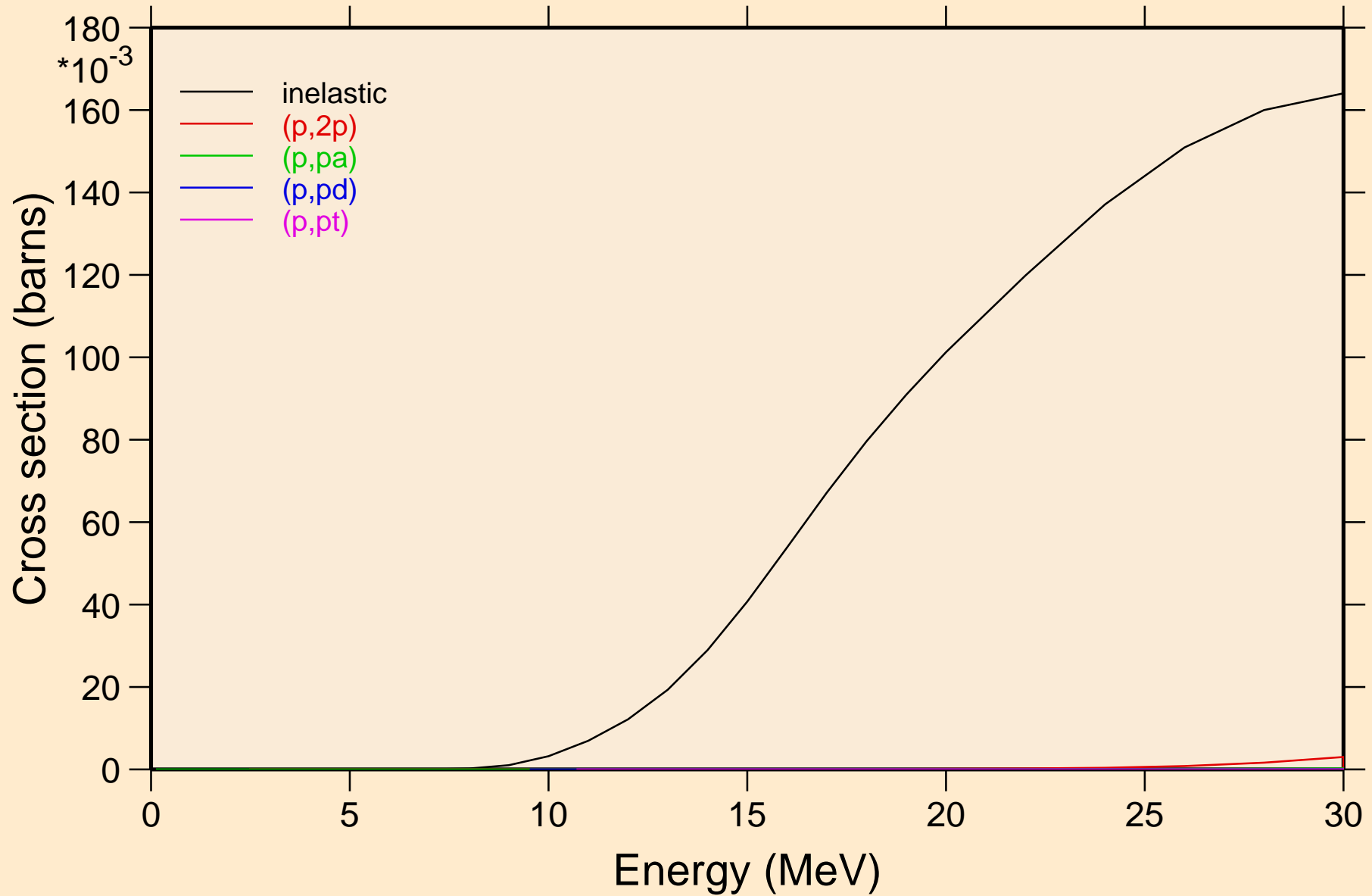

AU187 PROTON ACER TENDL-2021 LIBRARY; T=0.K  
Threshold reactions

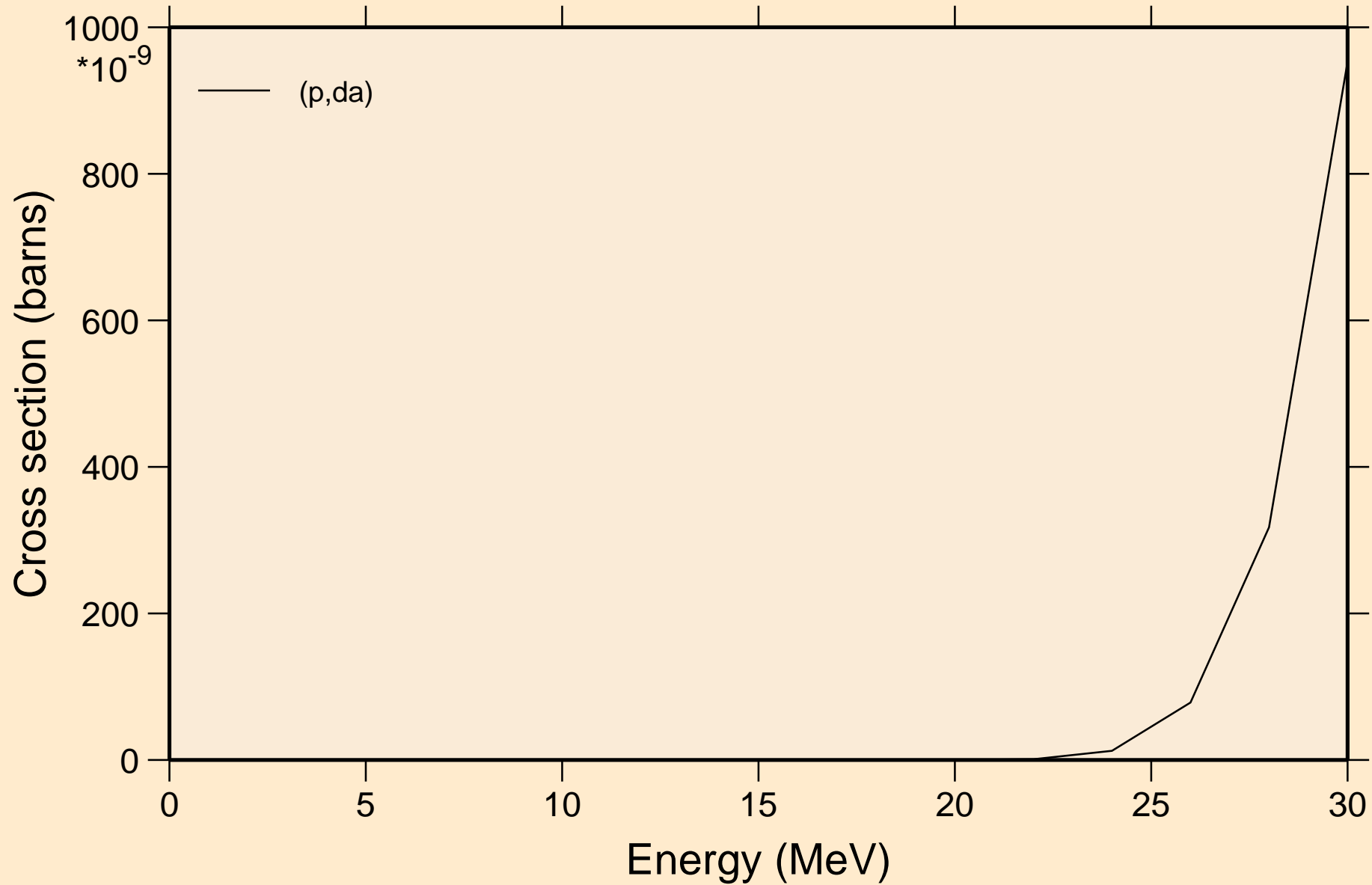

AU187 PROTON ACER TENDL-2021 LIBRARY; T=0.K  
angular distribution for elastic

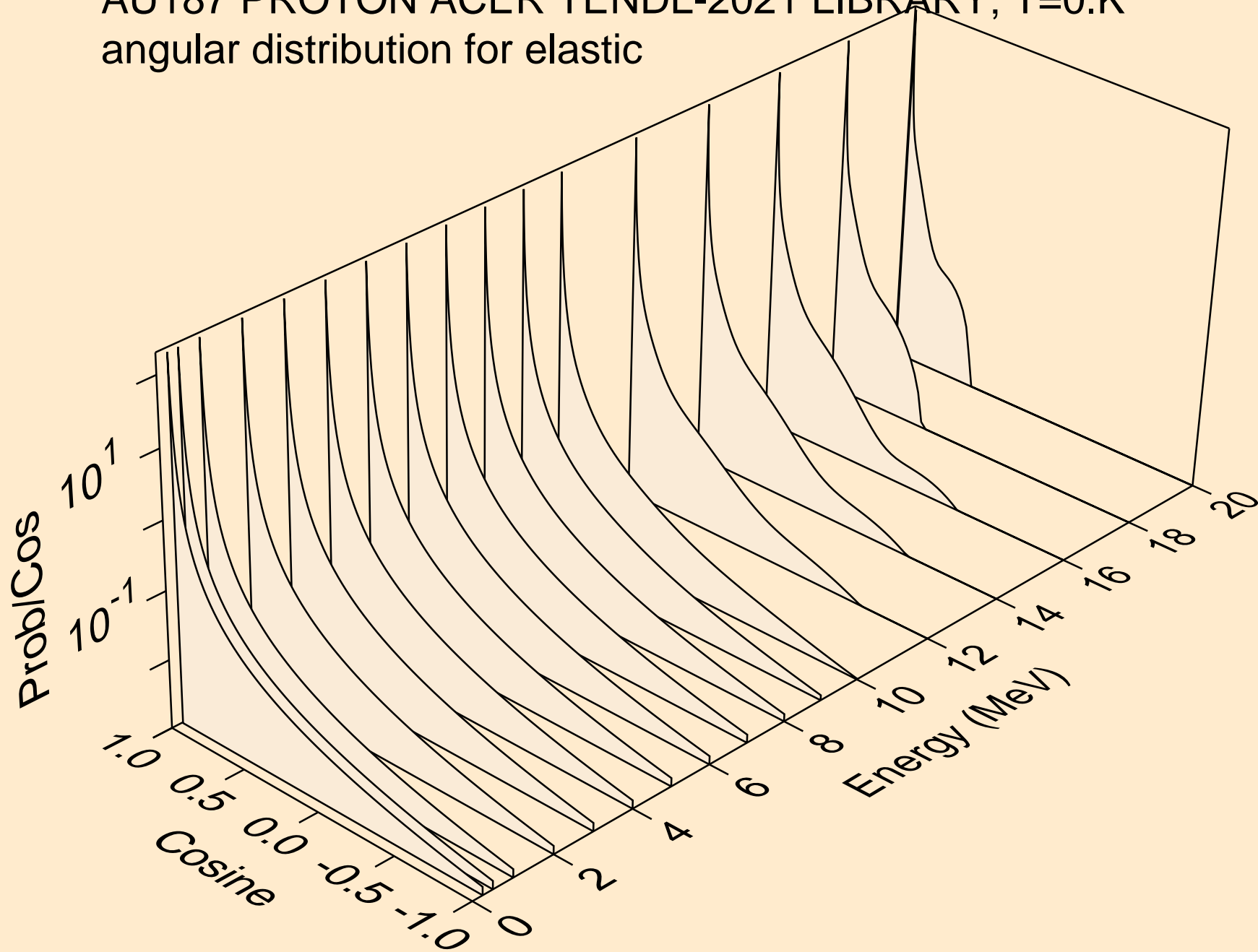



AU187 PROTON ACER TENDL-2021 LIBRARY; T=0.K  
angular distribution for elastic

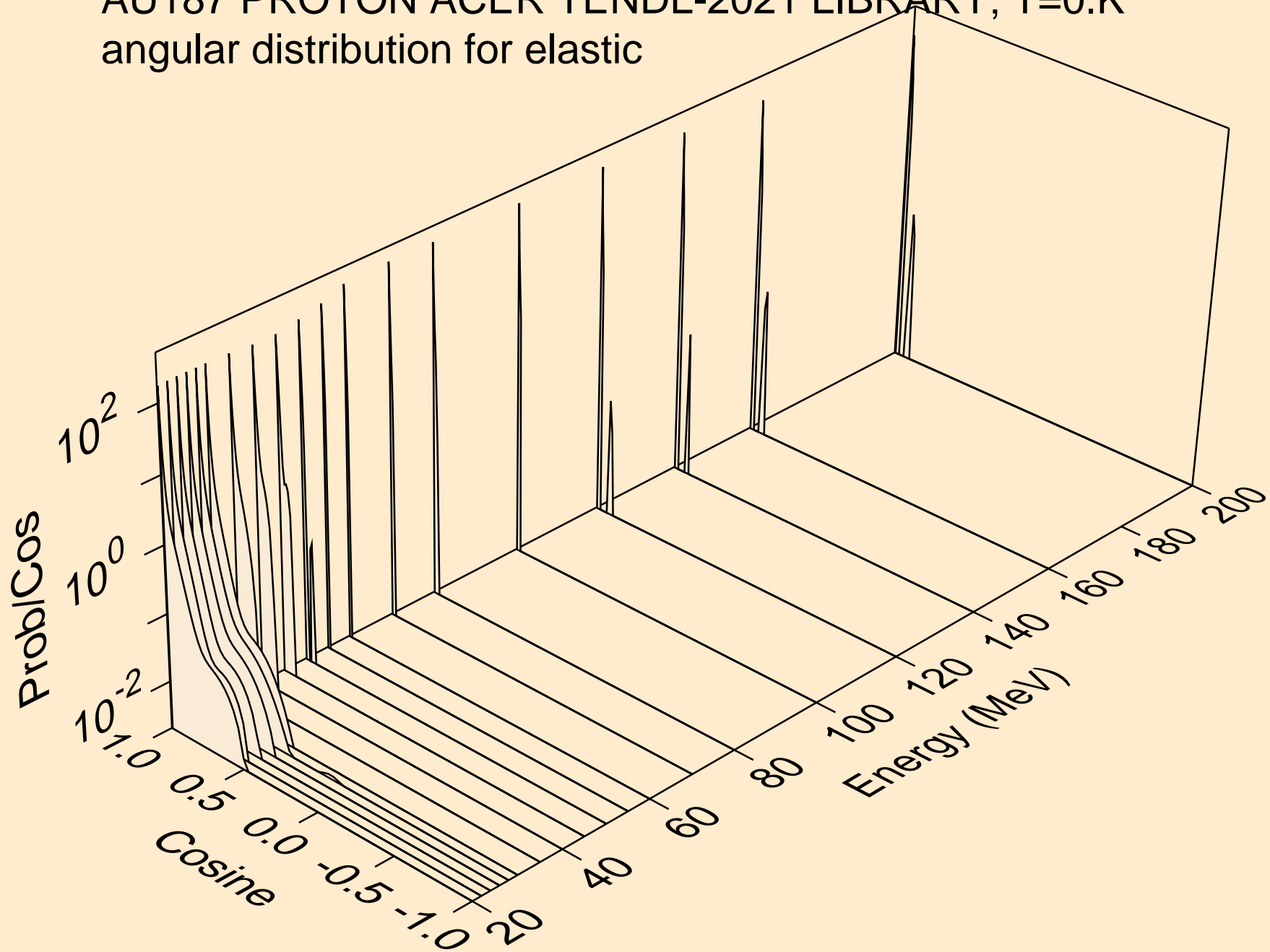

AU187 PROTON ACER TENDL-2021 LIBRARY; T=0.K  
Proton emission for (p,x)

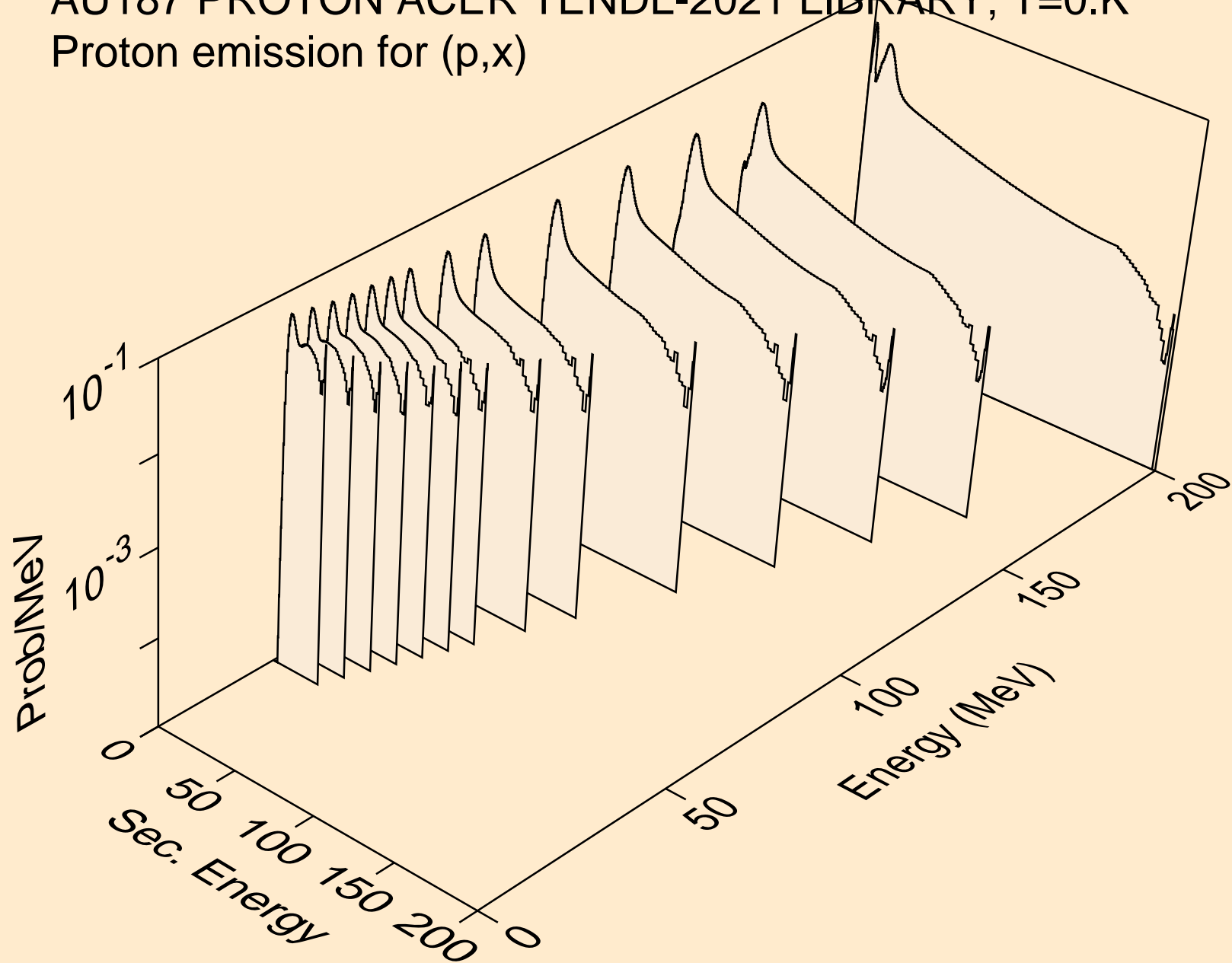

AU187 PROTON ACER TENDL-2021 LIBRARY; T=0.K  
Proton emission for (p,n\*)p

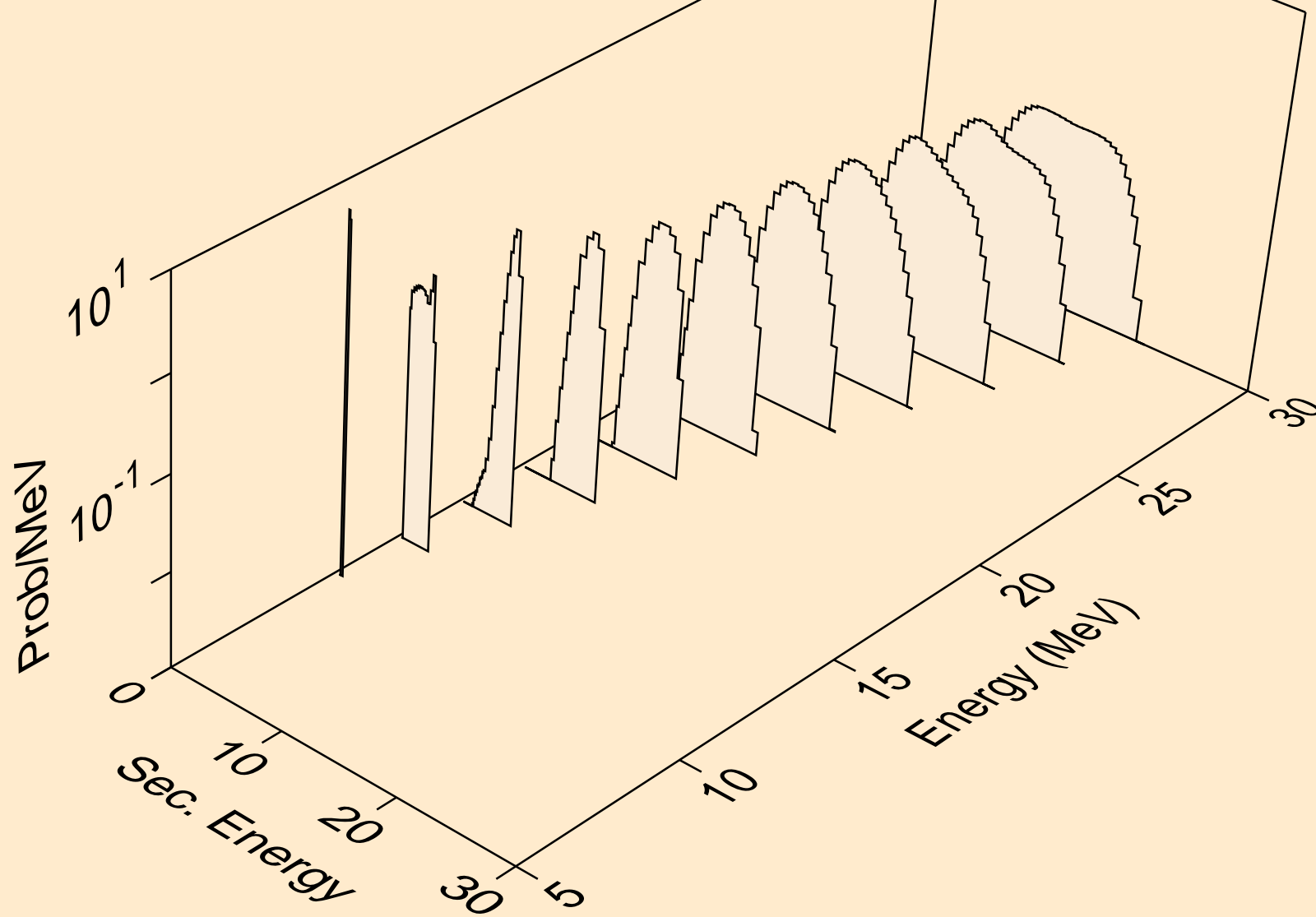

AU187 PROTON ACER TENDL-2021 LIBRARY; T=0.K  
Proton emission for (p,2np)

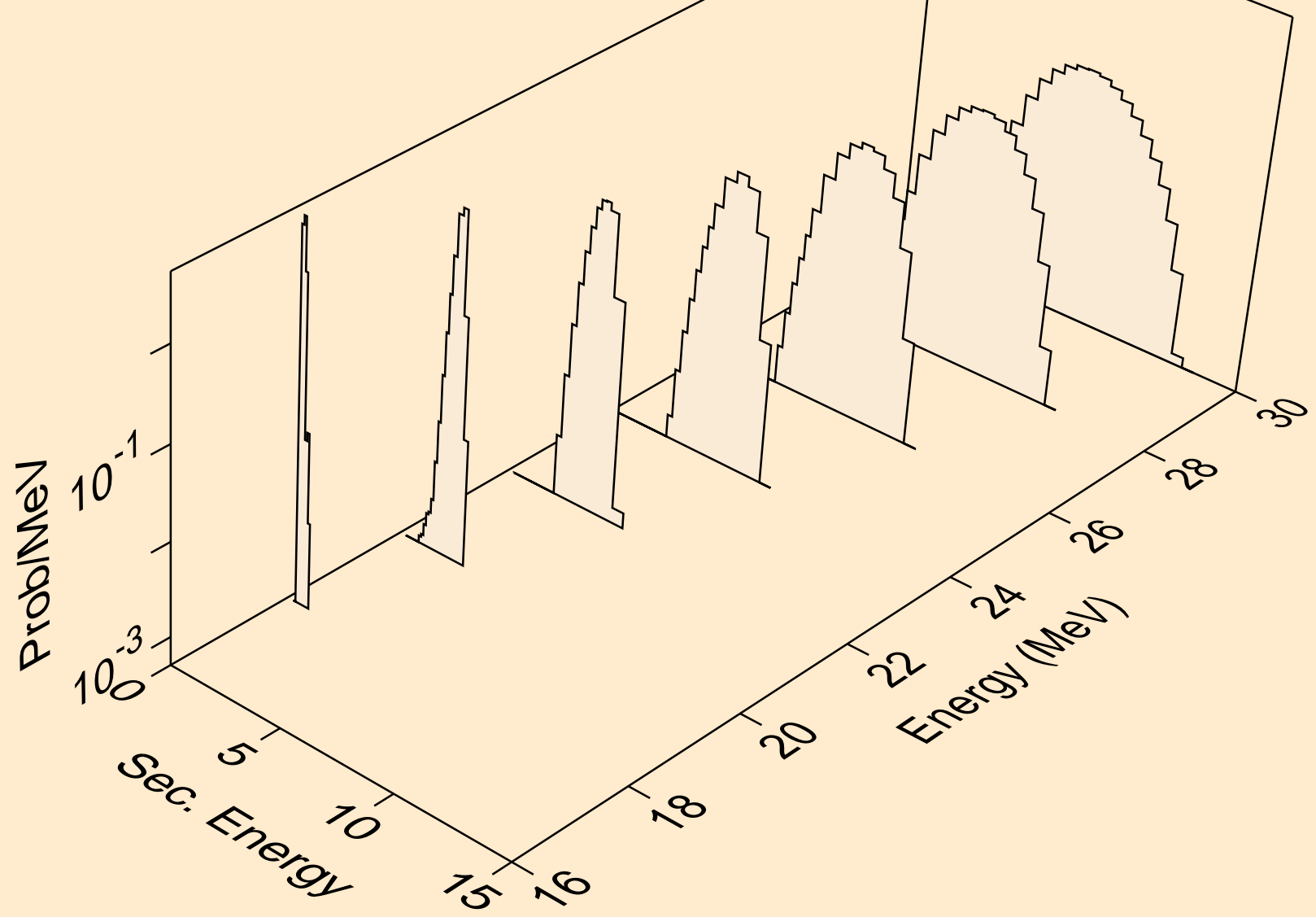

AU187 PROTON ACER TENDL-2021 LIBRARY; T=0.K  
Proton emission for (p,2np)

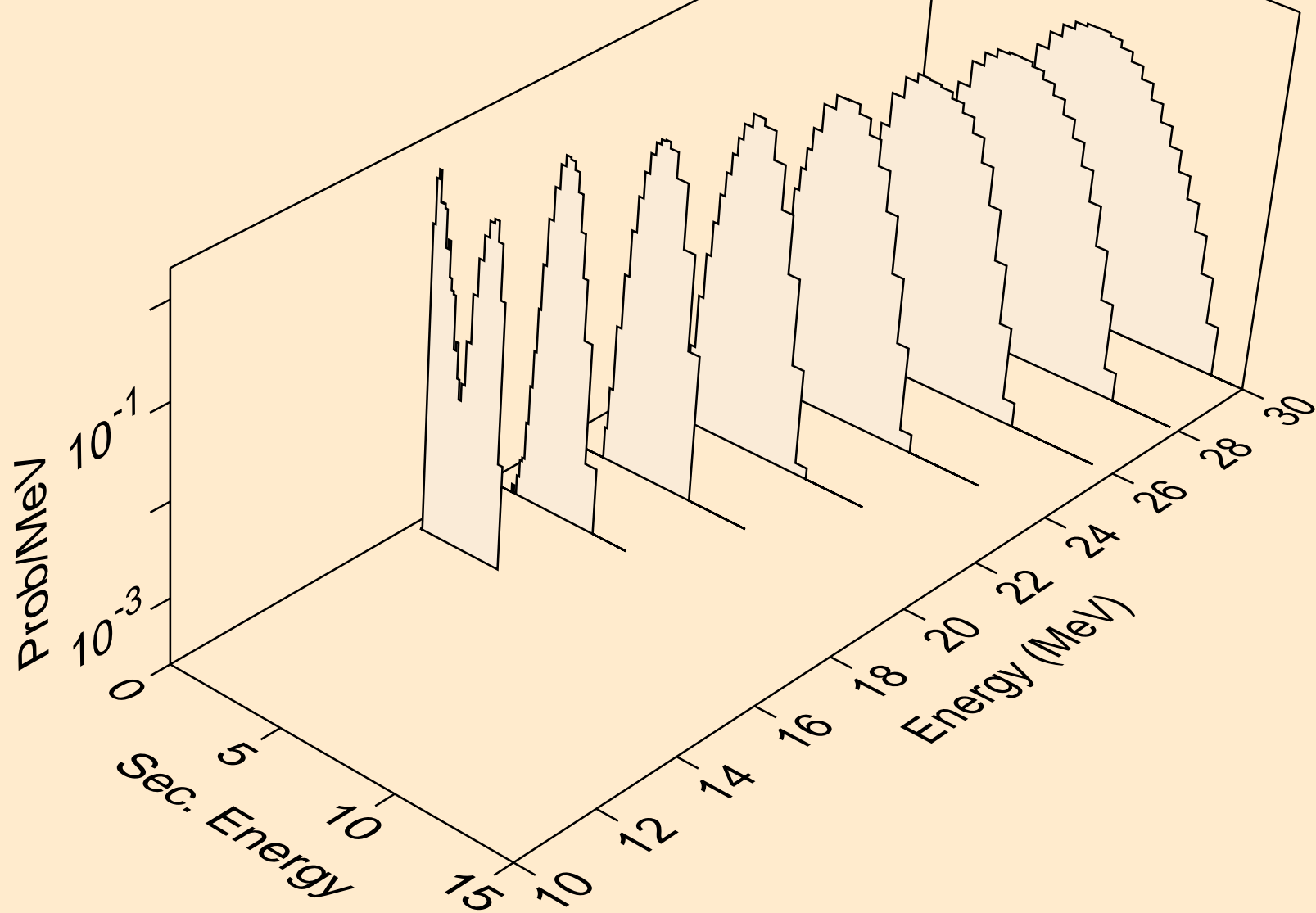

AU187 PROTON ACER TENDL-2021 LIBRARY; T=0.K  
Proton emission for (p,npa)

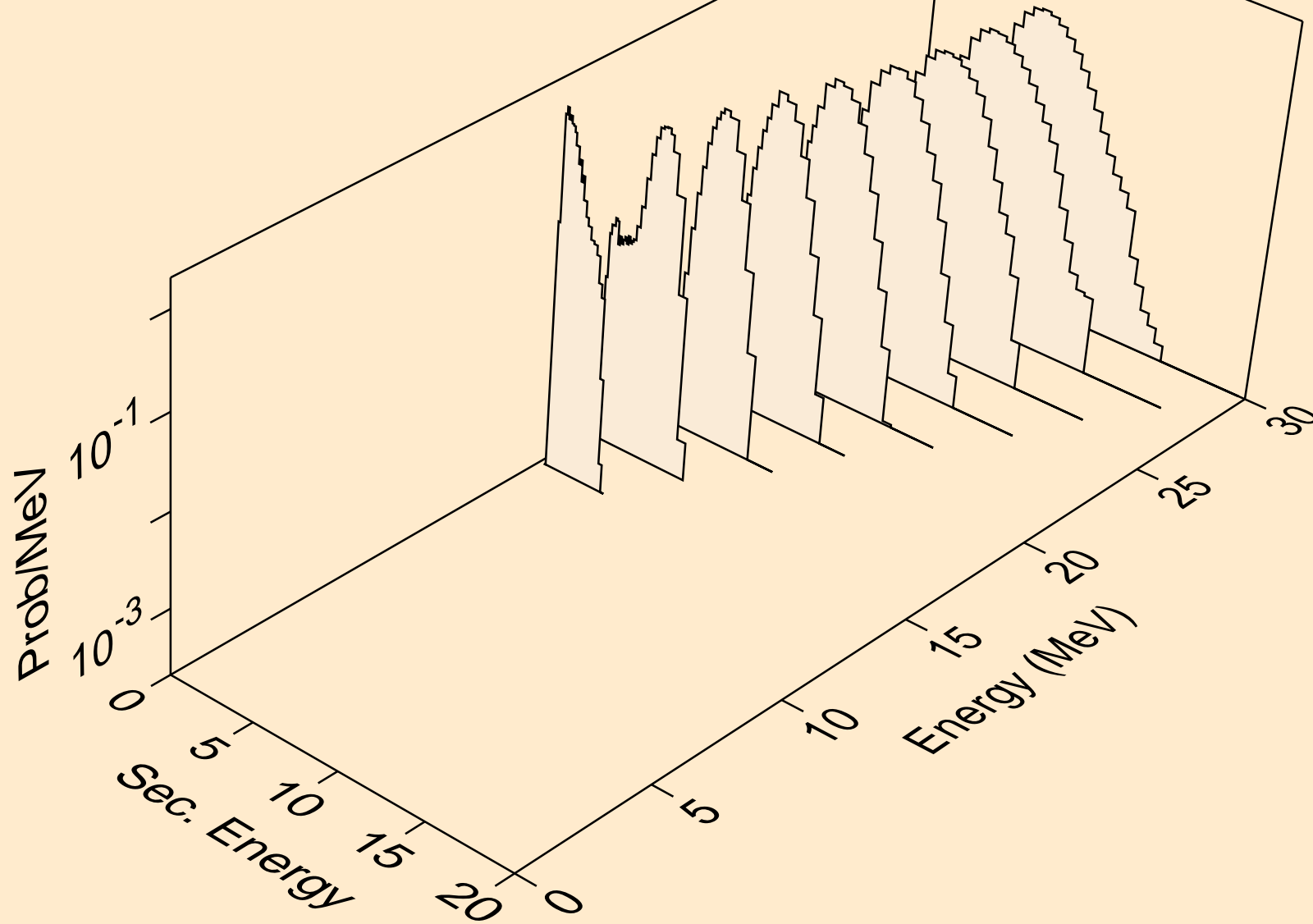

AU187 PROTON ACER TENDL-2021 LIBRARY; T=0.K  
Proton emission for inelastic

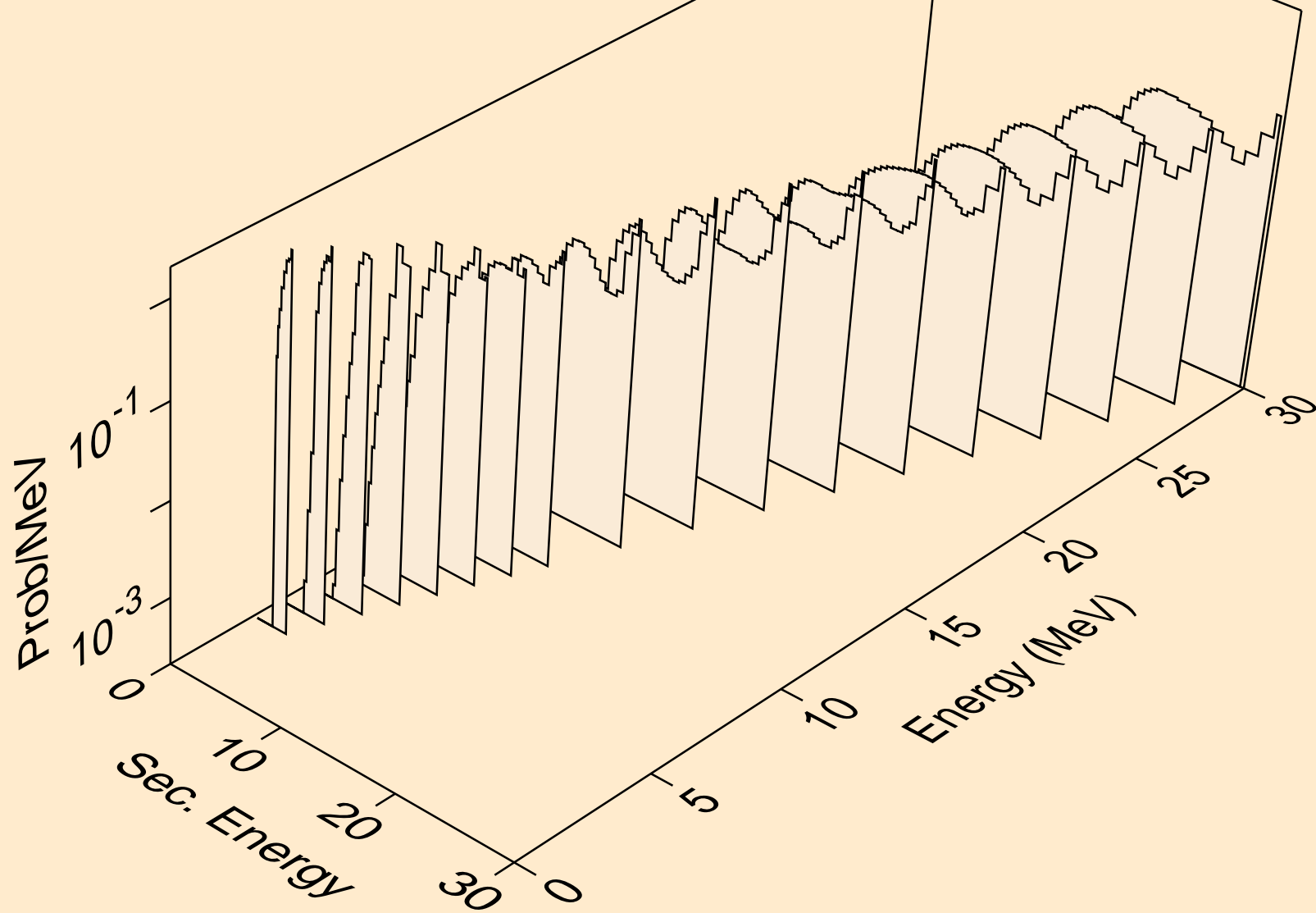

AU187 PROTON ACER TENDL-2021 LIBRARY; T=0.K  
Proton emission for (p,2p)

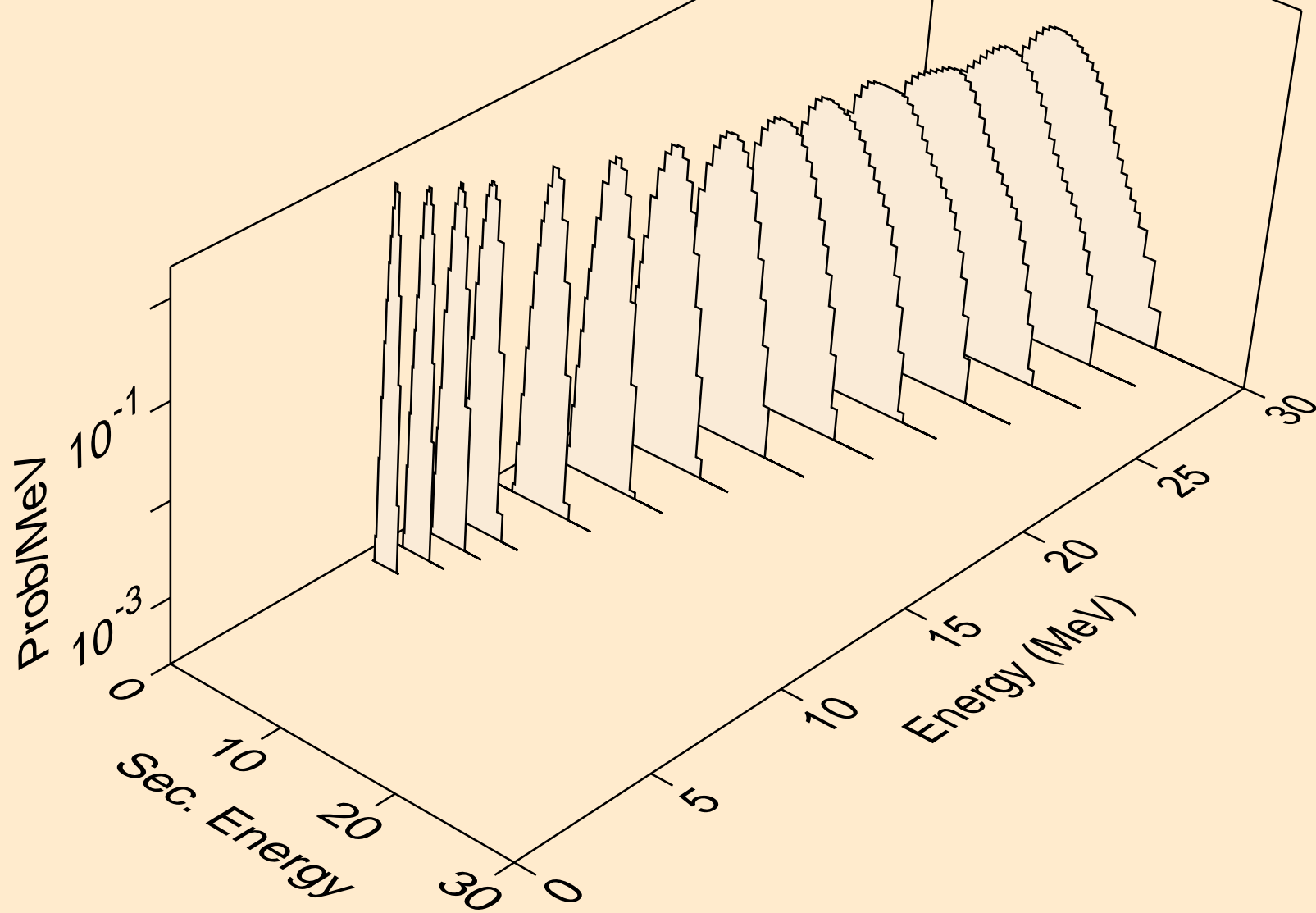



AU187 PROTON ACER TENDL-2021 LIBRARY; T=0.K  
Proton emission for (p,pa)

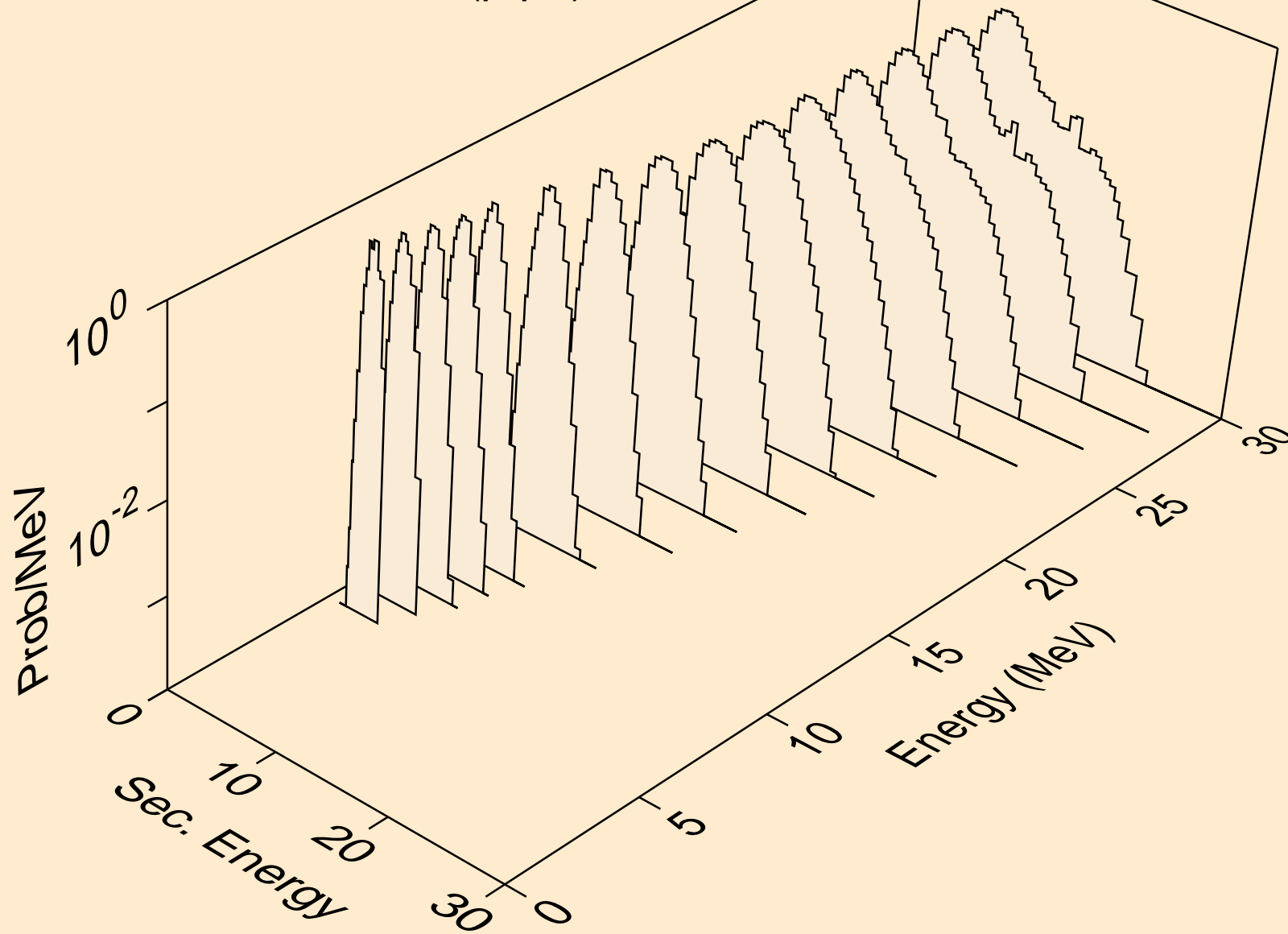

AU187 PROTON ACER TENDL-2021 LIBRARY; T=0.K  
Proton emission for (p,pd)

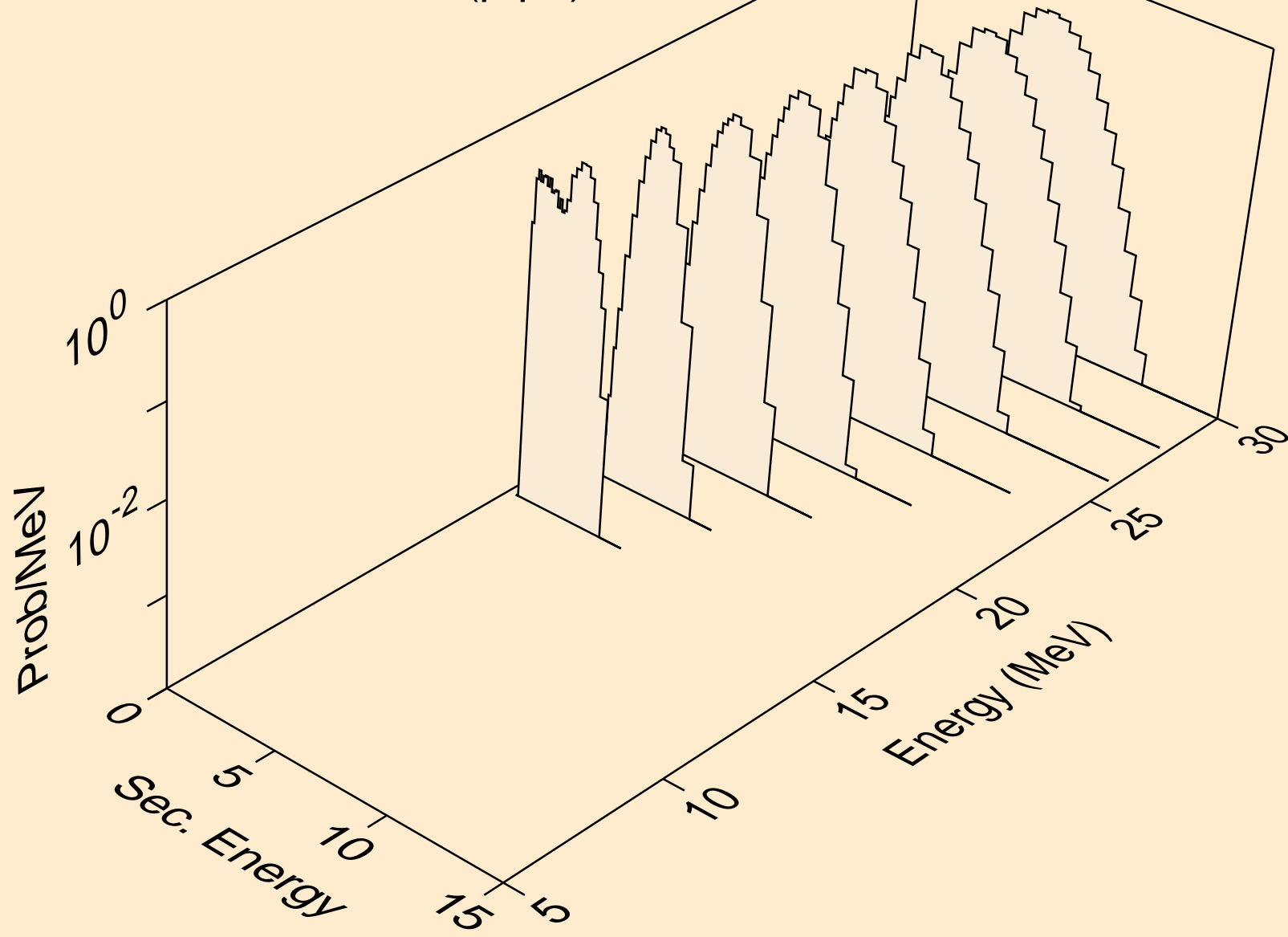

AU187 PROTON ACER TENDL-2021 LIBRARY; T=0.K  
Proton emission for (p,pt)

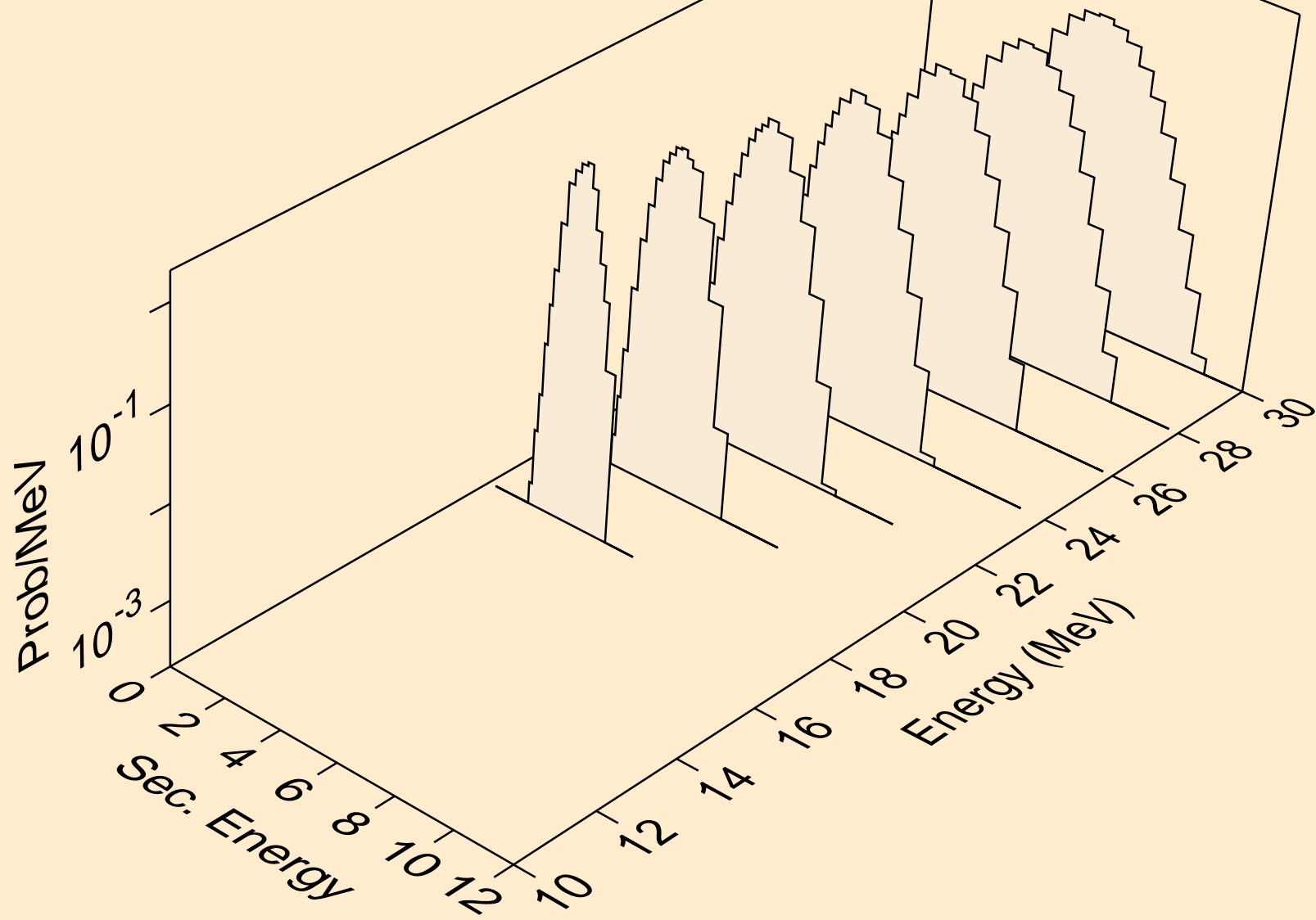

AU187 PROTON ACER TENDL-2021 LIBRARY; T=0.K  
Photon emission for (z,n)

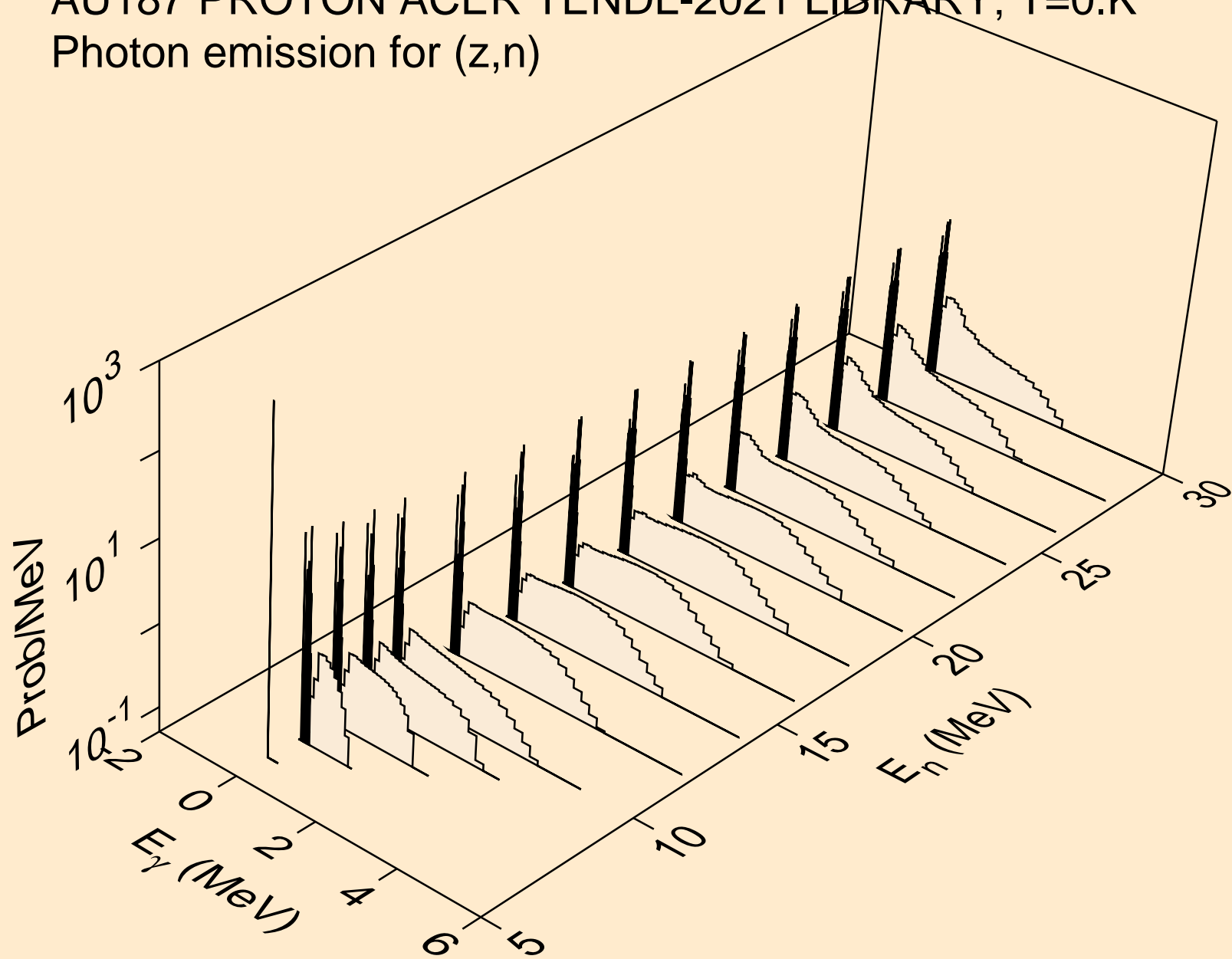

AU187 PROTON ACER TENDL-2021 LIBRARY; T=0.K  
Photon emission for (n,x)

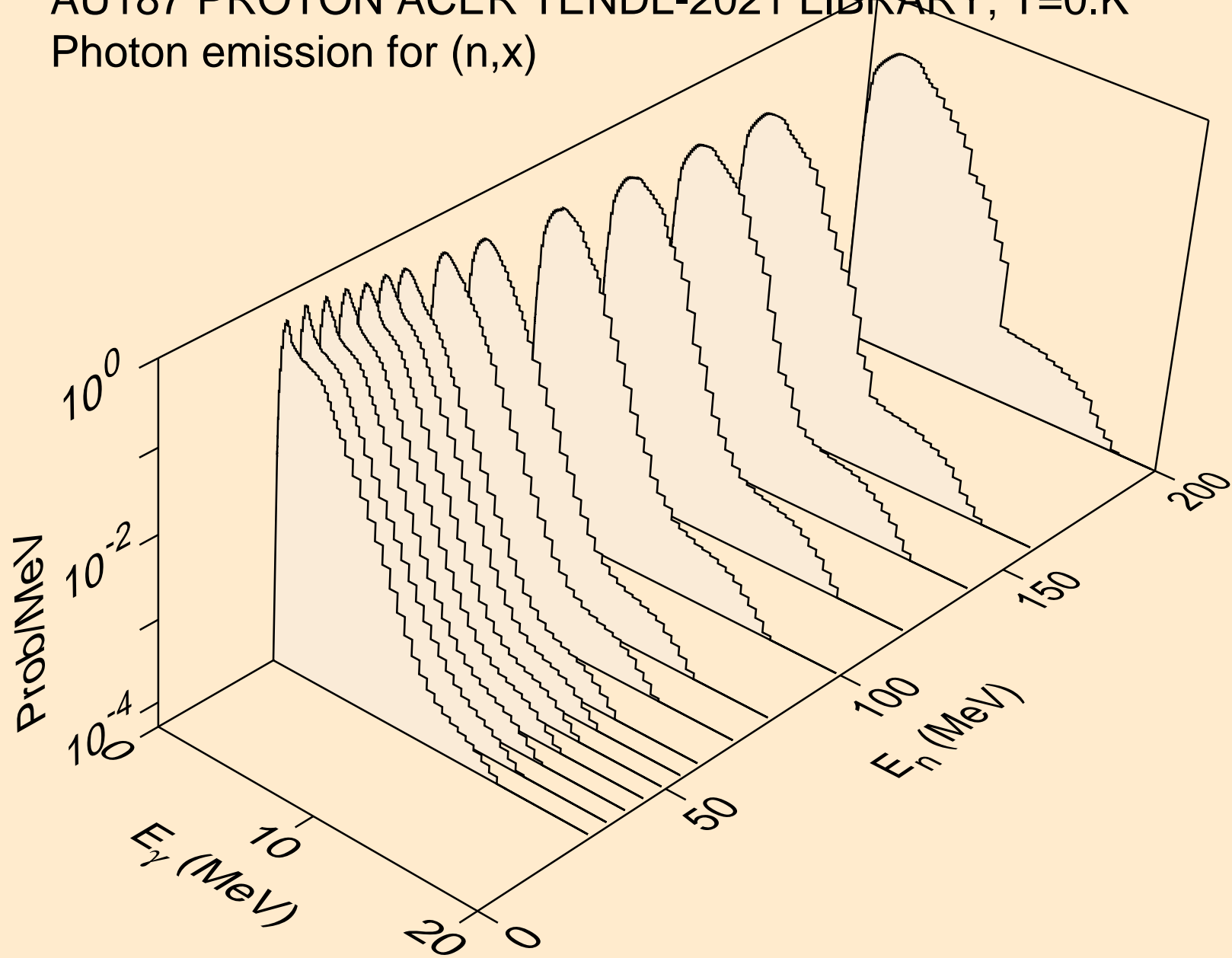

AU187 PROTON ACER TENDL-2021 LIBRARY; T=0.K  
Photon emission for (n,2n)

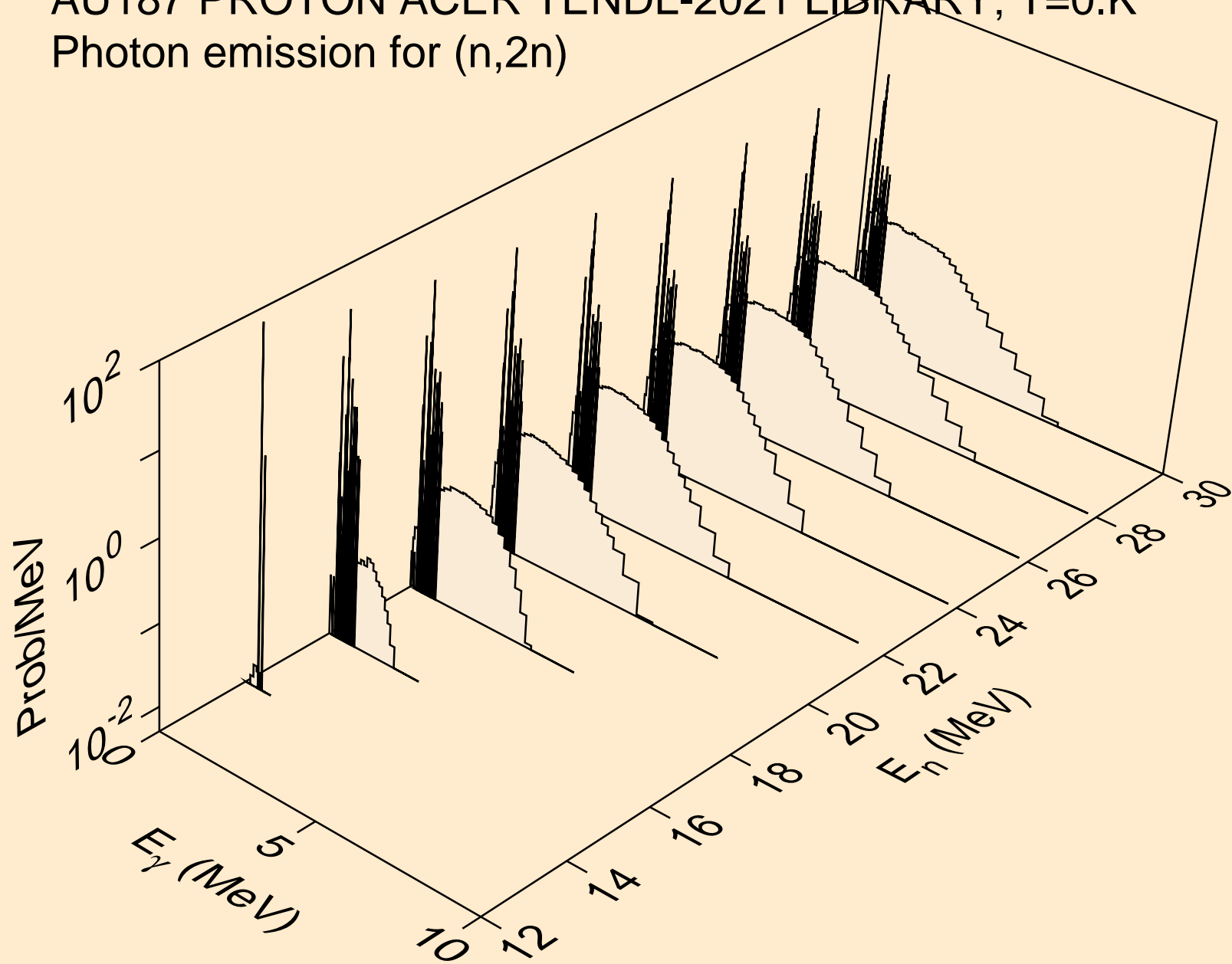

AU187 PROTON ACER TENDL-2021 LIBRARY; T=0.K  
Photon emission for (n,3n)

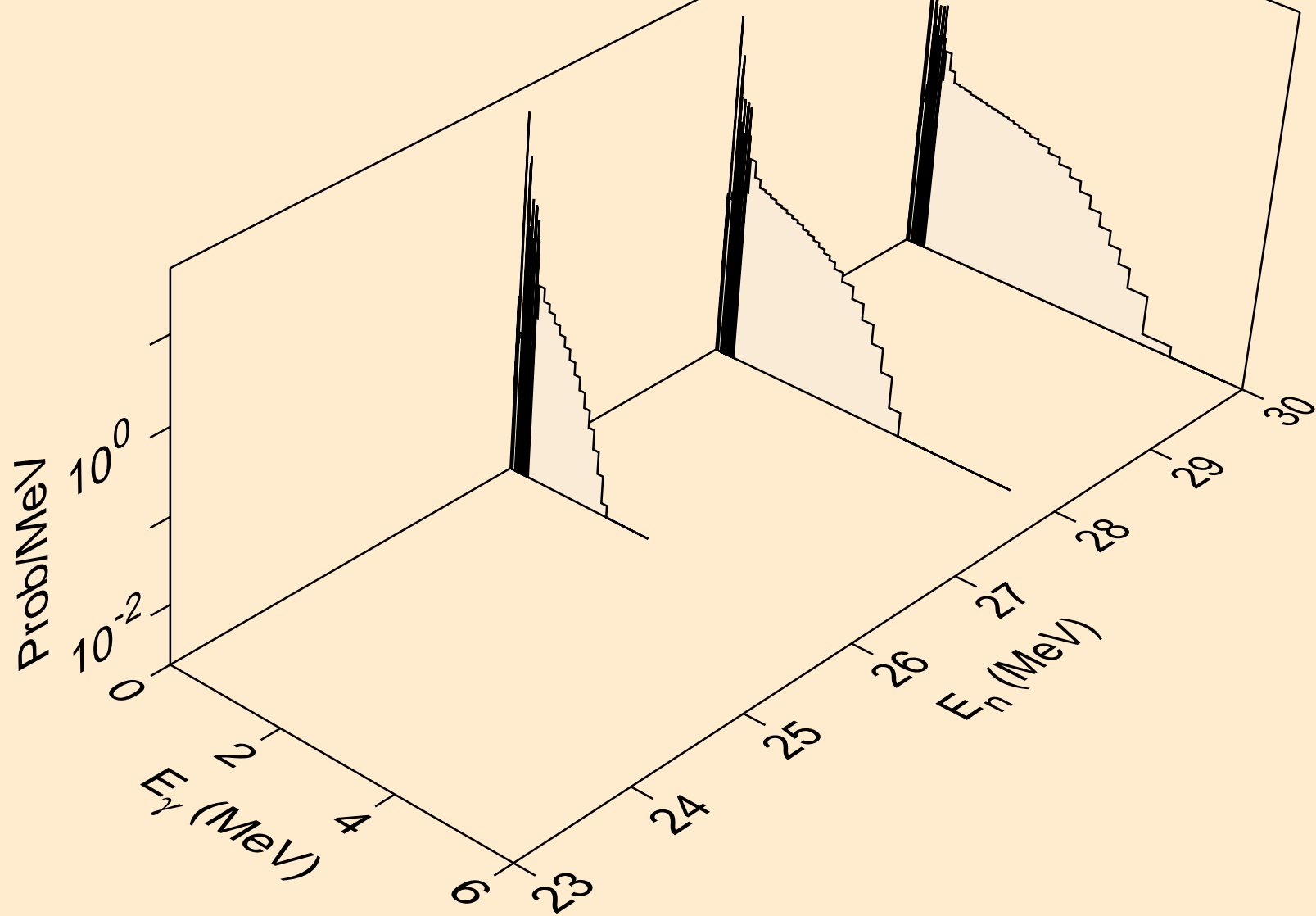

AU187 PROTON ACER TENDL-2021 LIBRARY; T=0.K  
Photon emission for (n,n\*)a

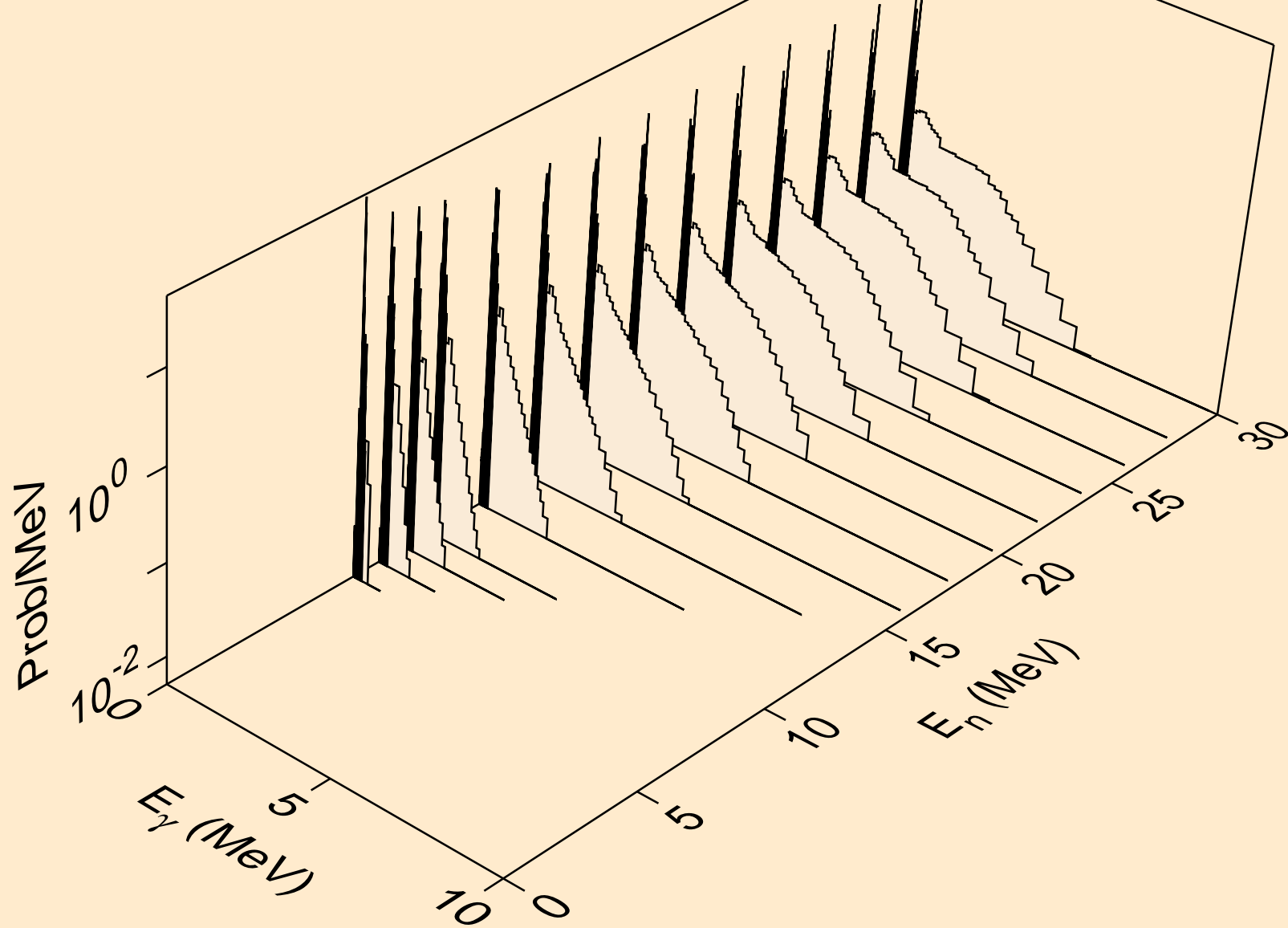



AU187 PROTON ACER TENDL-2021 LIBRARY; T=0.K  
Photon emission for (n,2n)a

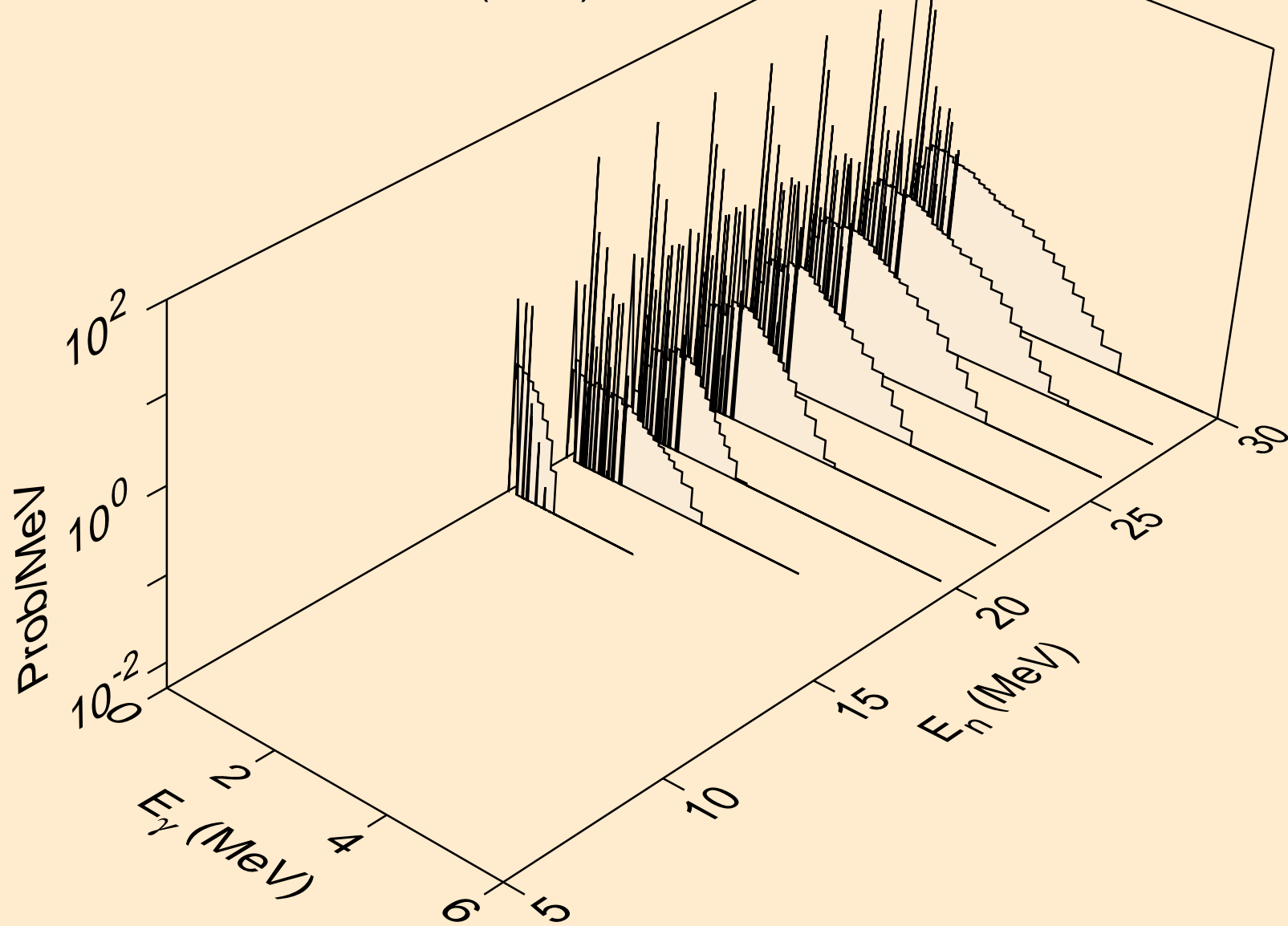

AU187 PROTON ACER TENDL-2021 LIBRARY; T=0.K  
Photon emission for (n,3n)a

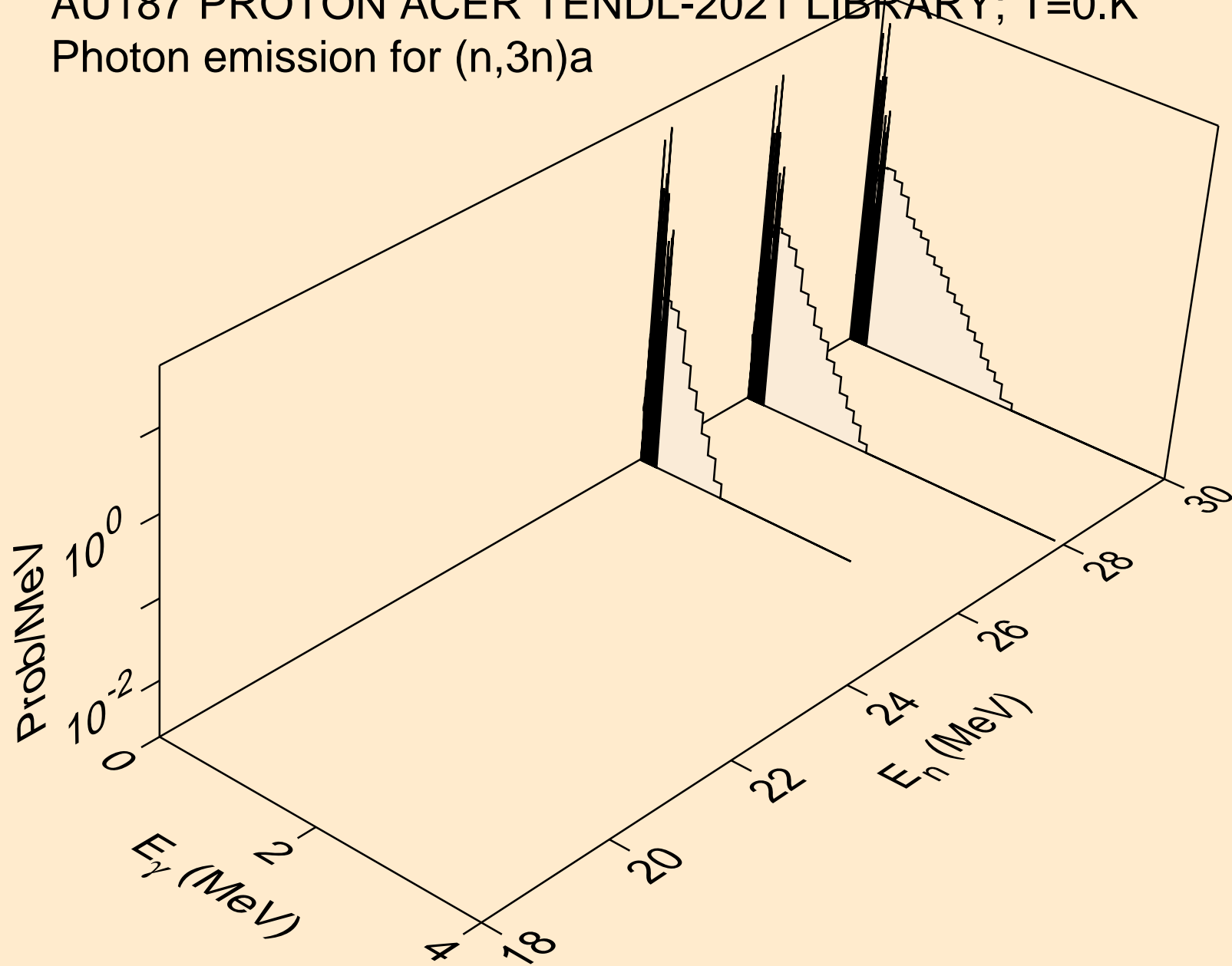

AU187 PROTON ACER TENDL-2021 LIBRARY; T=0.K  
Photon emission for (n,n\*)p

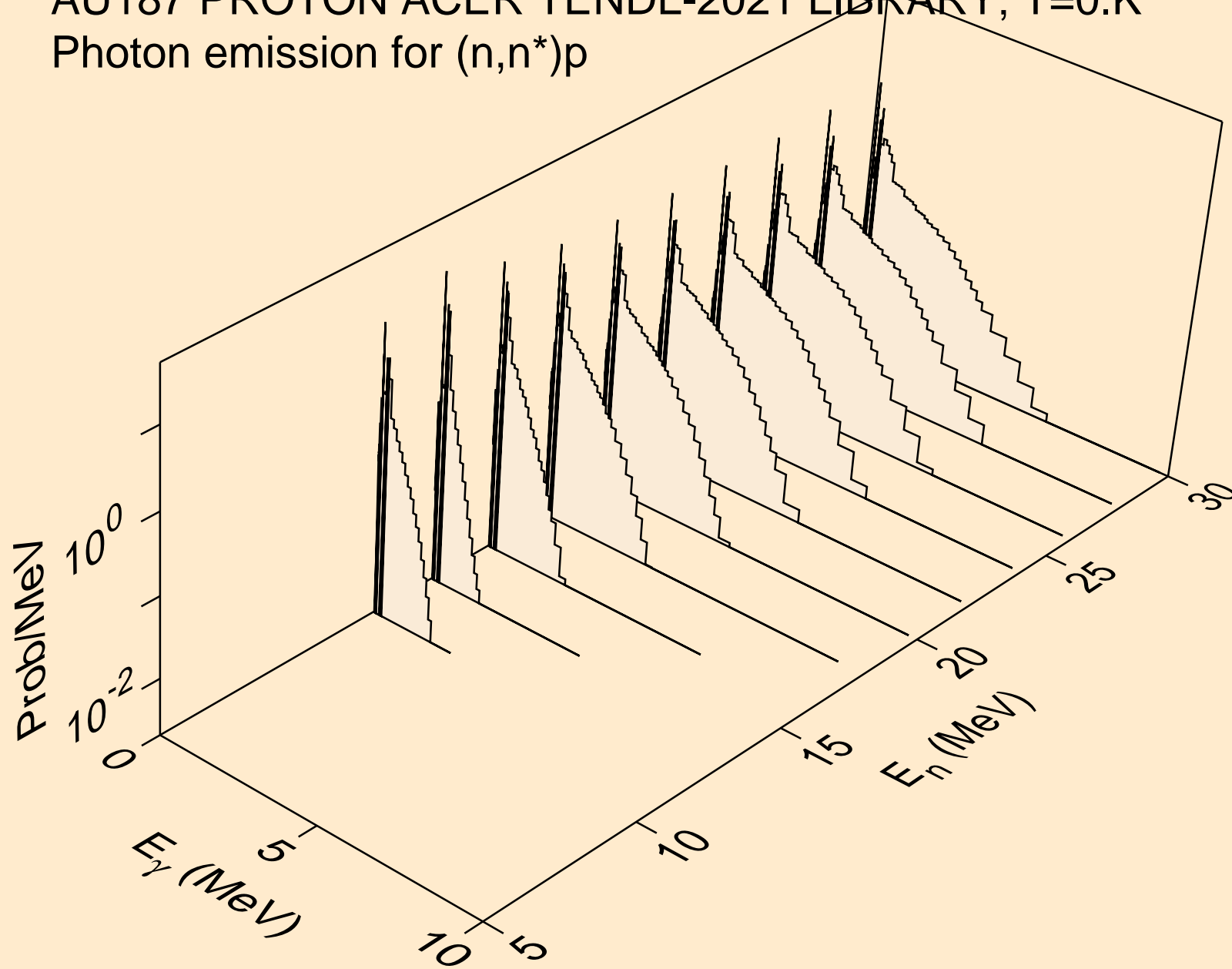

AU187 PROTON ACER TENDL-2021 LIBRARY; T=0.K  
Photon emission for (n,n\*)2a

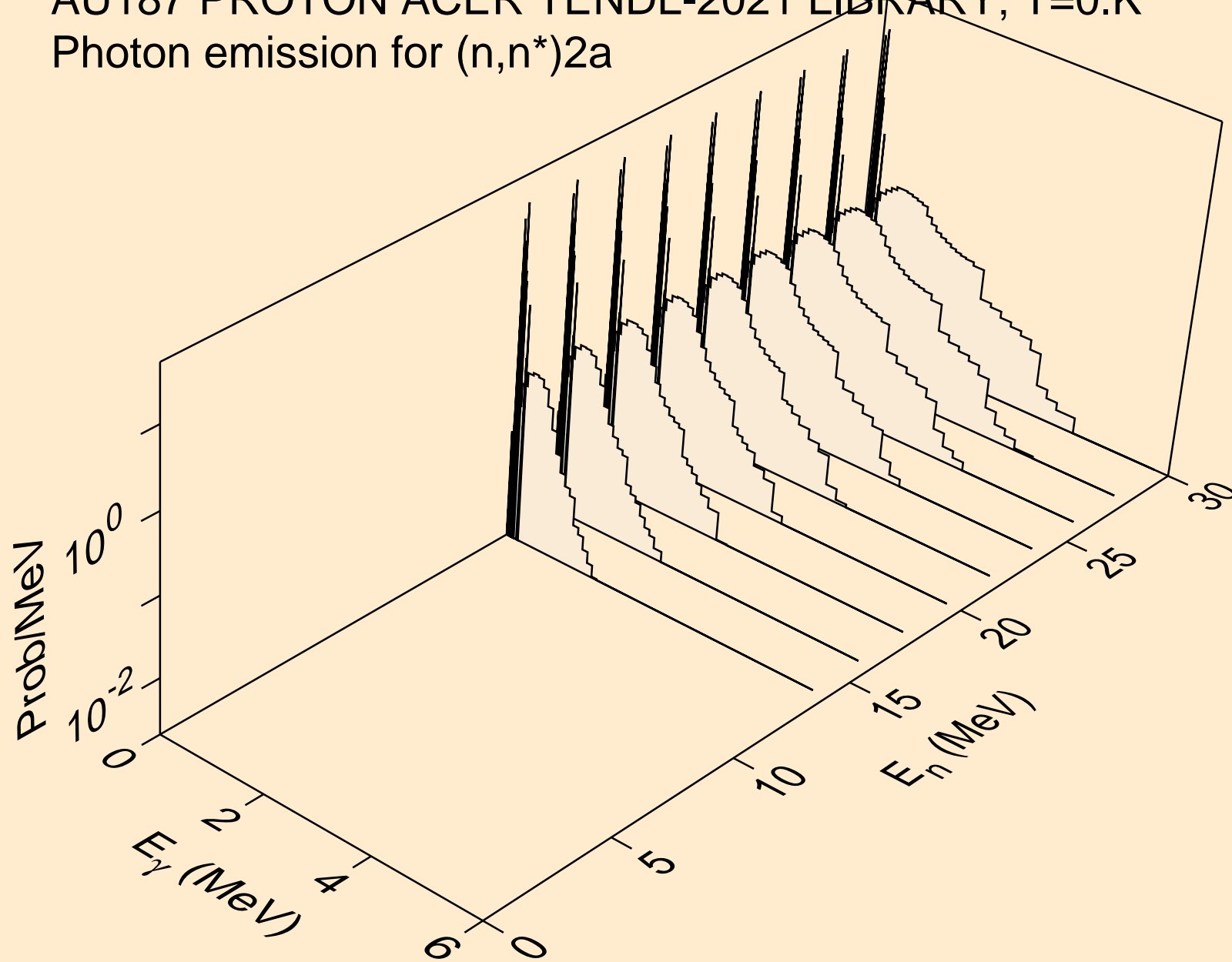

AU187 PROTON ACER TENDL-2021 LIBRARY; T=0.K  
Photon emission for (n,2n)2a

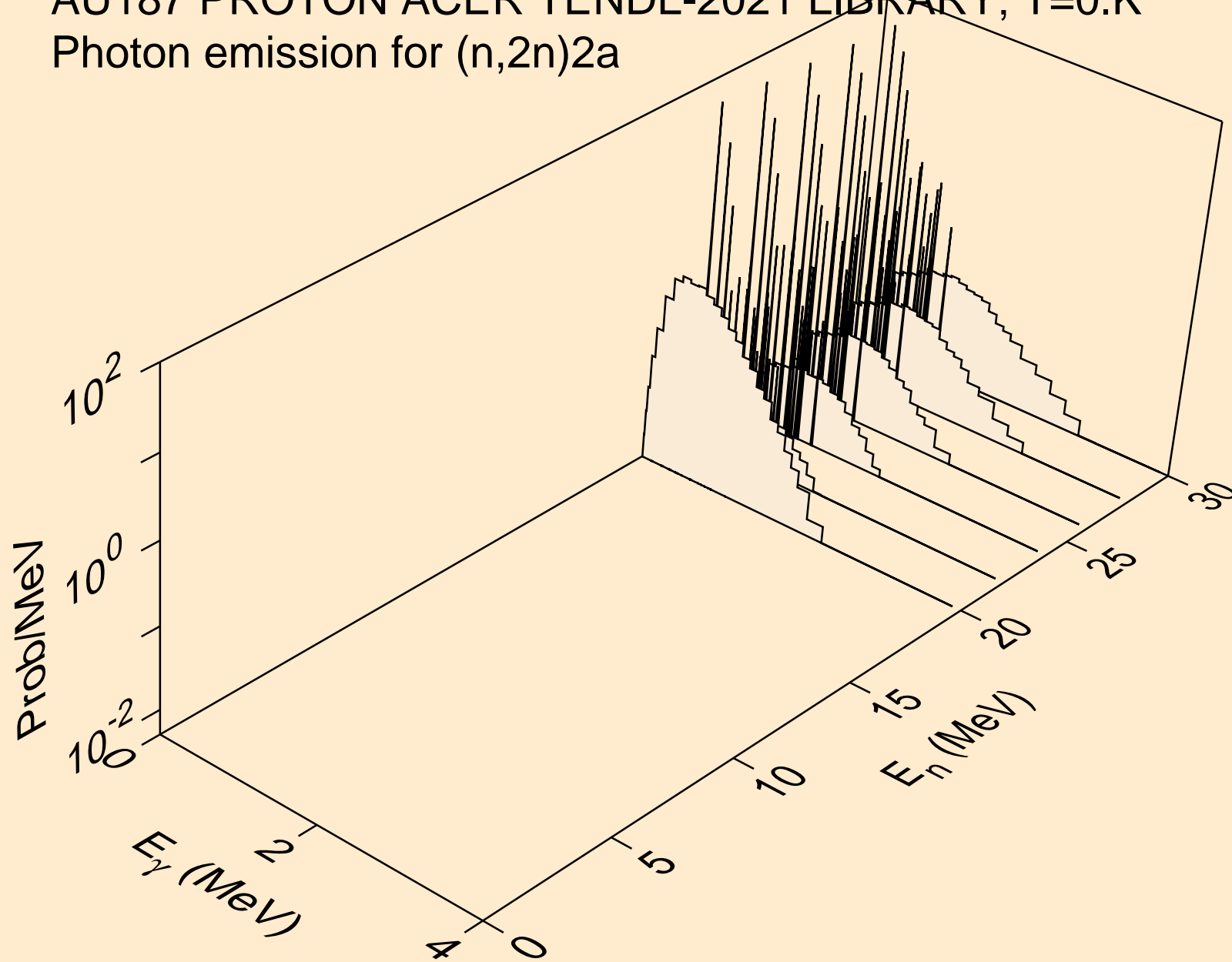

AU187 PROTON ACER TENDL-2021 LIBRARY; T=0.K  
Photon emission for (n,n\*)d

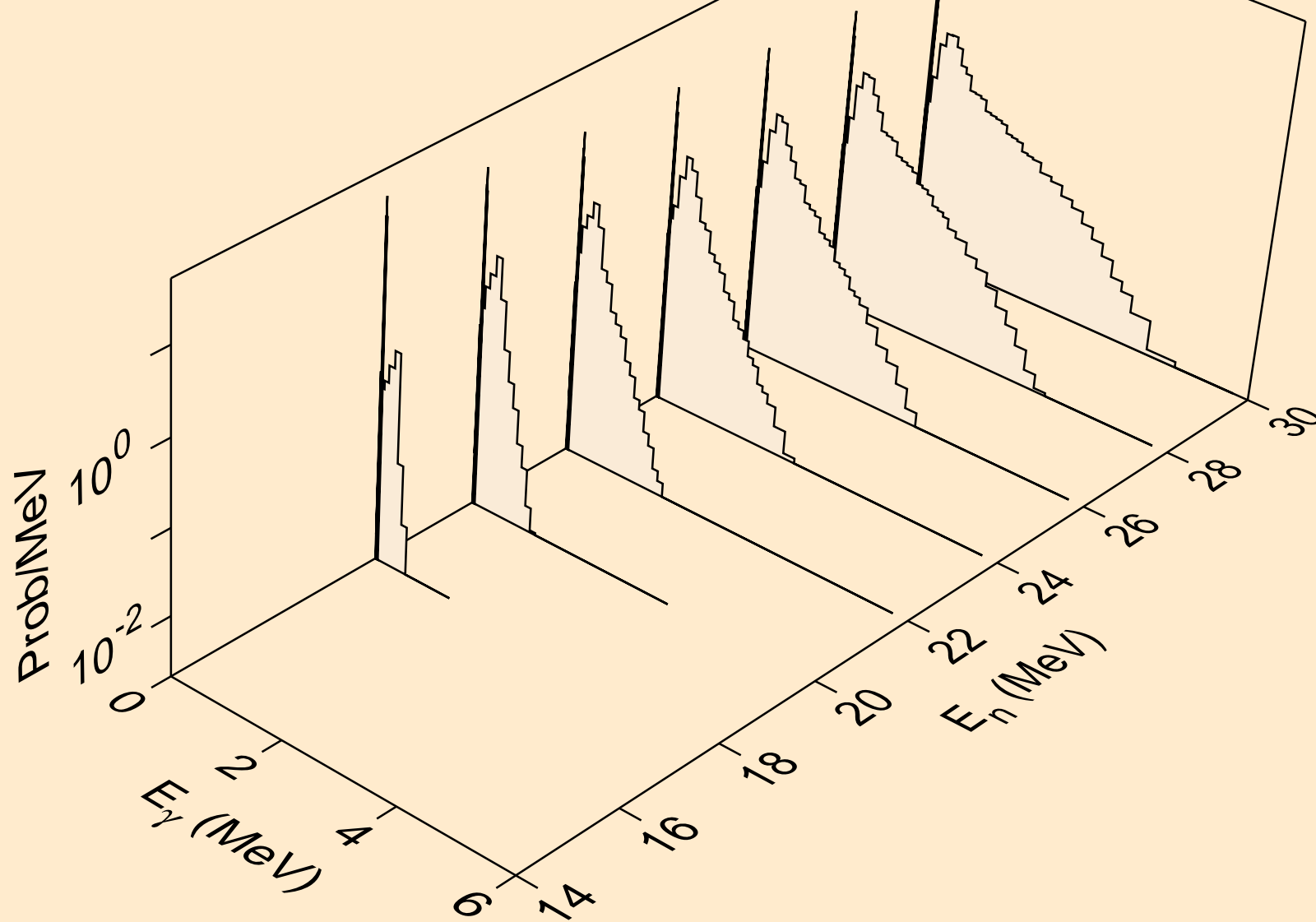

AU187 PROTON ACER TENDL-2021 LIBRARY; T=0.K  
Photon emission for (n,n\*)t

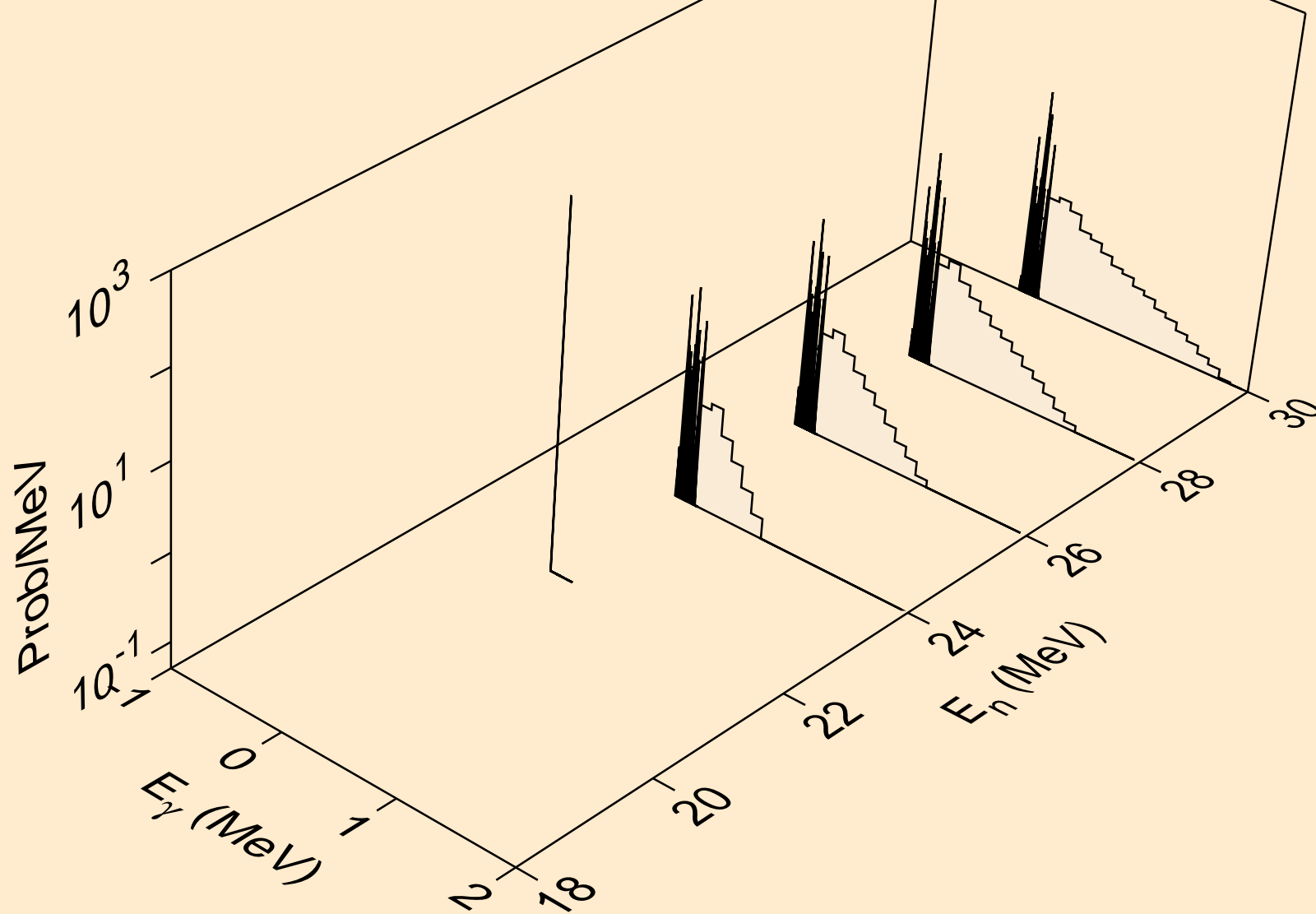

AU187 PROTON ACER TENDL-2021 LIBRARY; T=0.K  
Photon emission for (n,n\*)he3

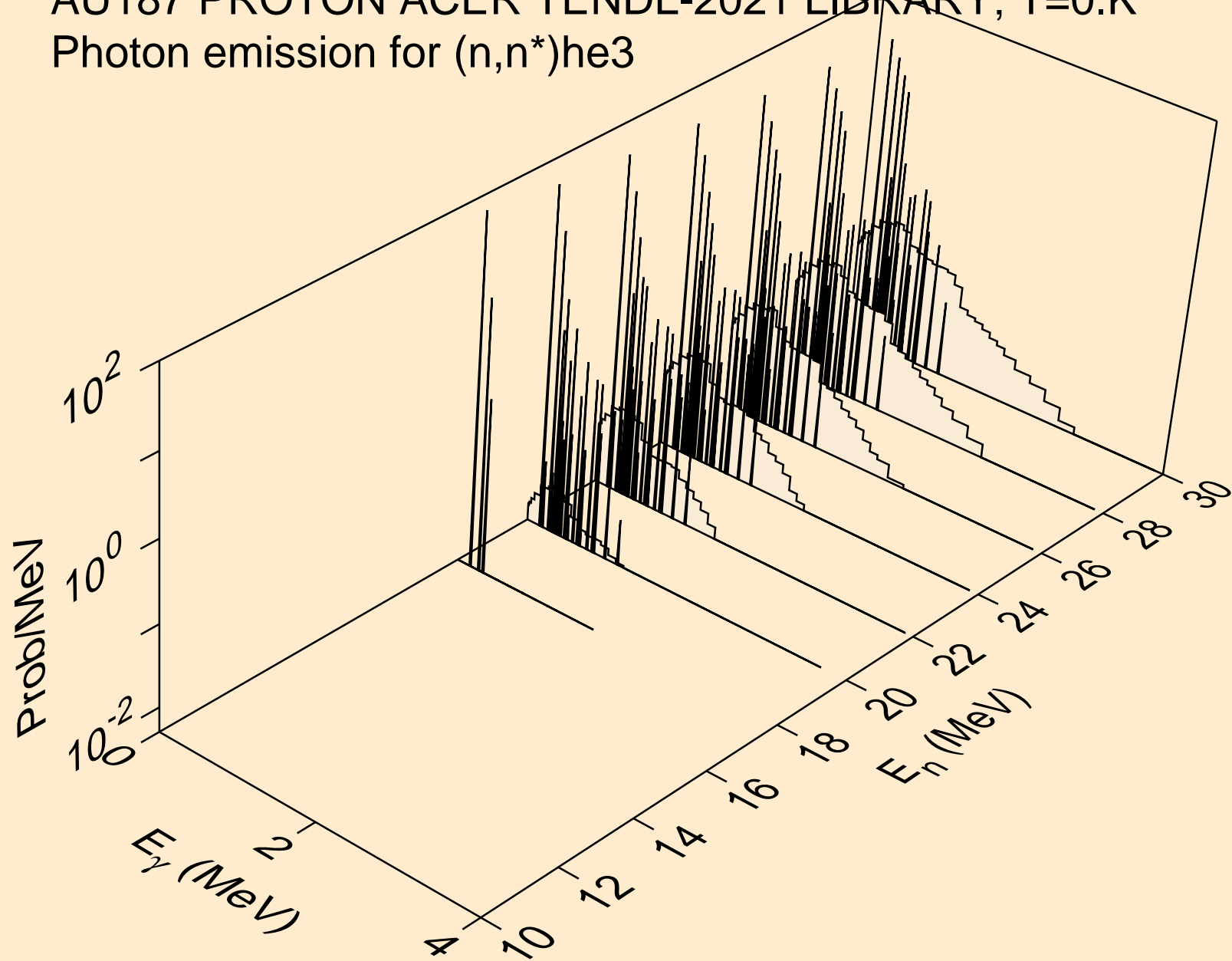



AU187 PROTON ACER TENDL-2021 LIBRARY; T=0.K  
Photon emission for (n,2np)

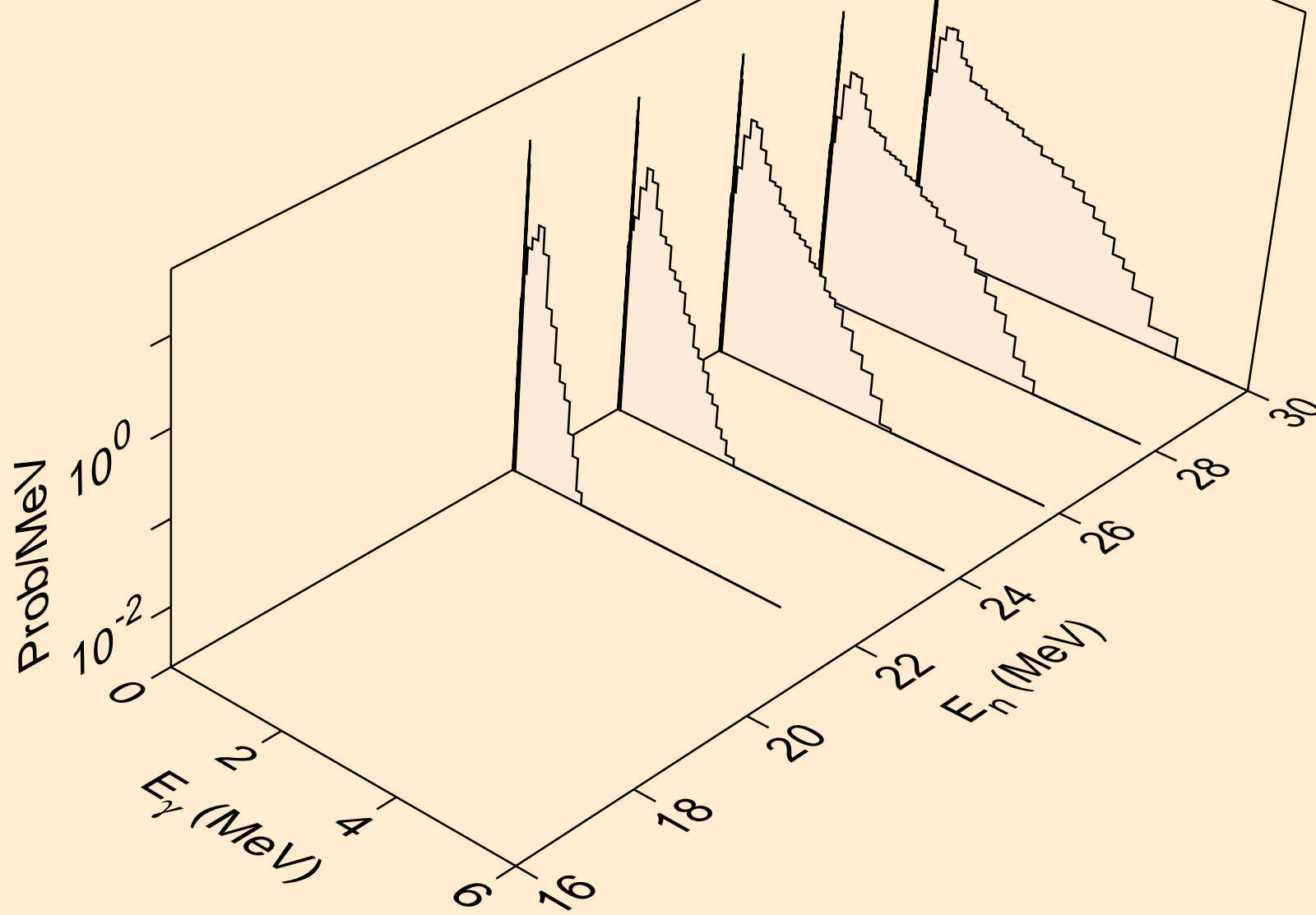

AU187 PROTON ACER TENDL-2021 LIBRARY; T=0.K  
Photon emission for (n,2np)

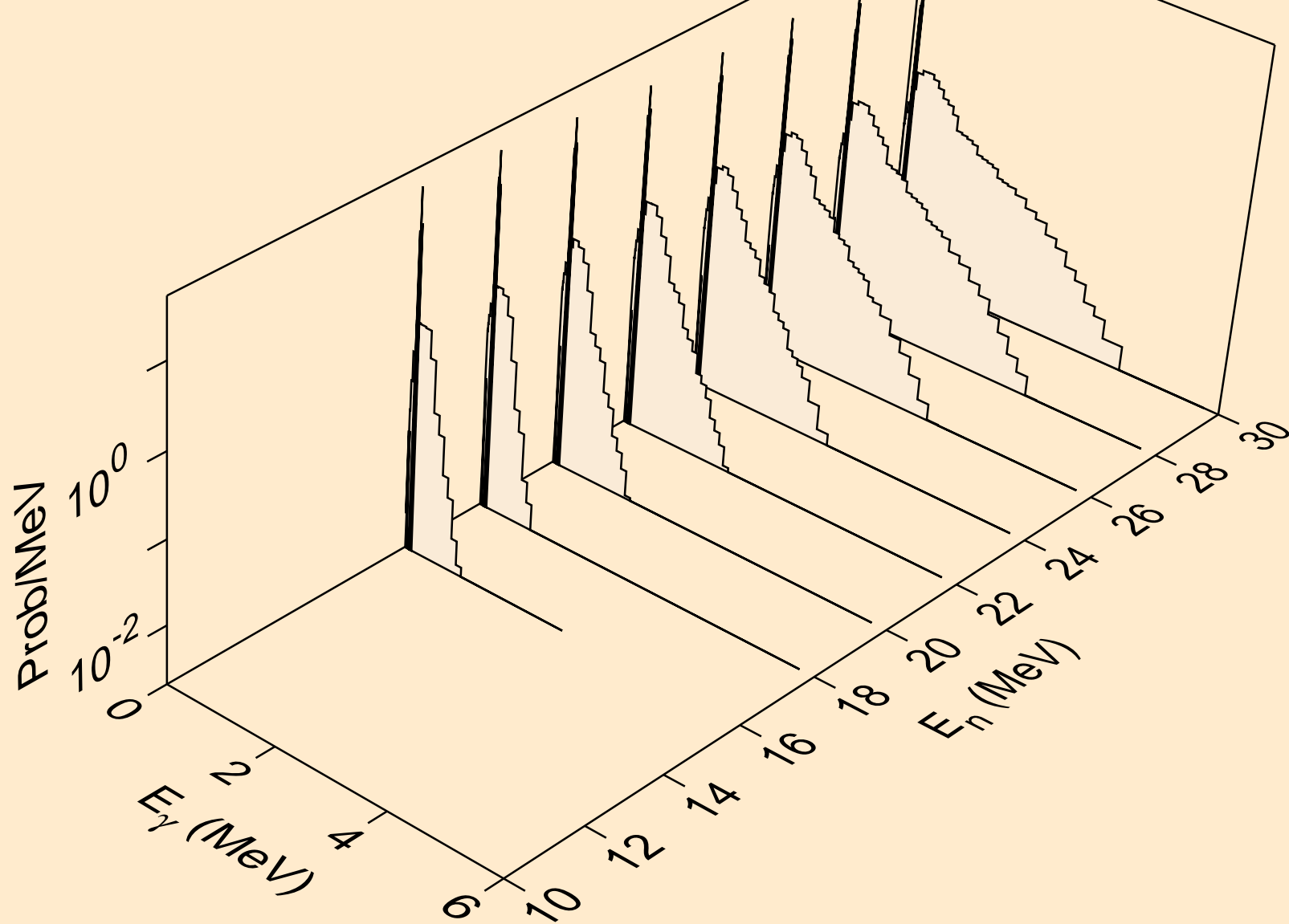

AU187 PROTON ACER TENDL-2021 LIBRARY; T=0.K  
Photon emission for (n,npa)

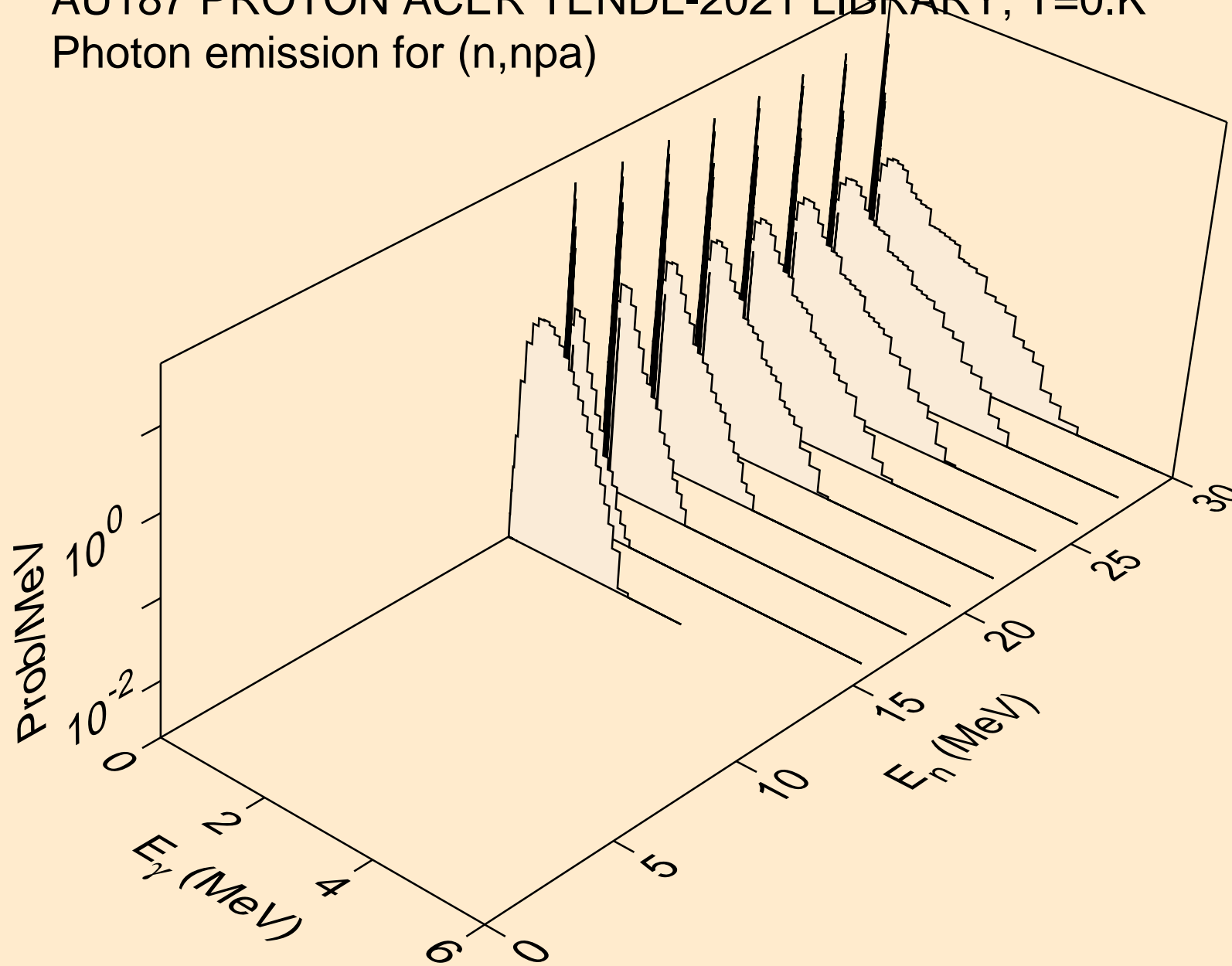

AU187 PROTON ACER TENDL-2021 LIBRARY; T=0.K  
Photon emission for (n,gma)

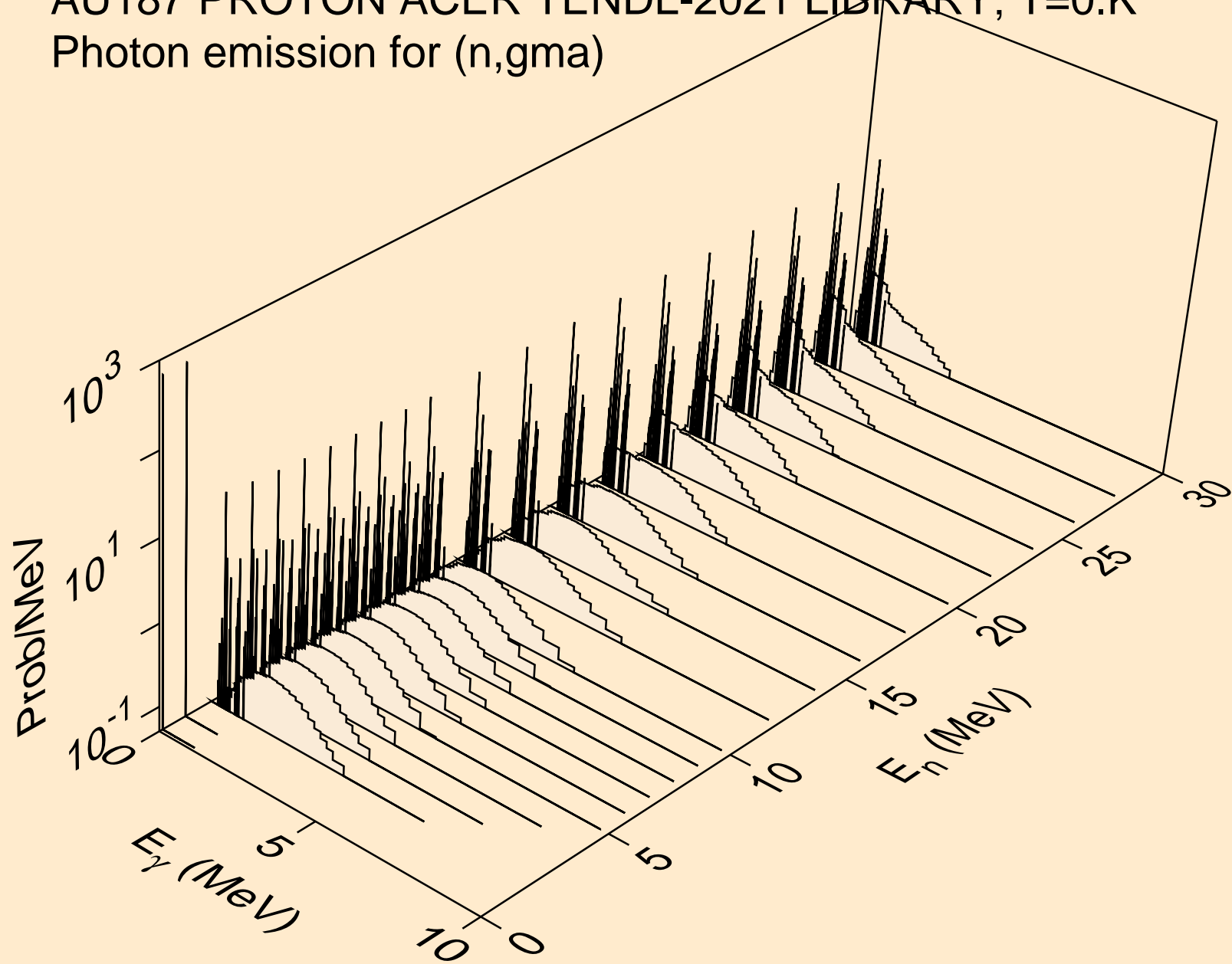

AU187 PROTON ACER TENDL-2021 LIBRARY; T=0.K  
Photon emission for inelastic

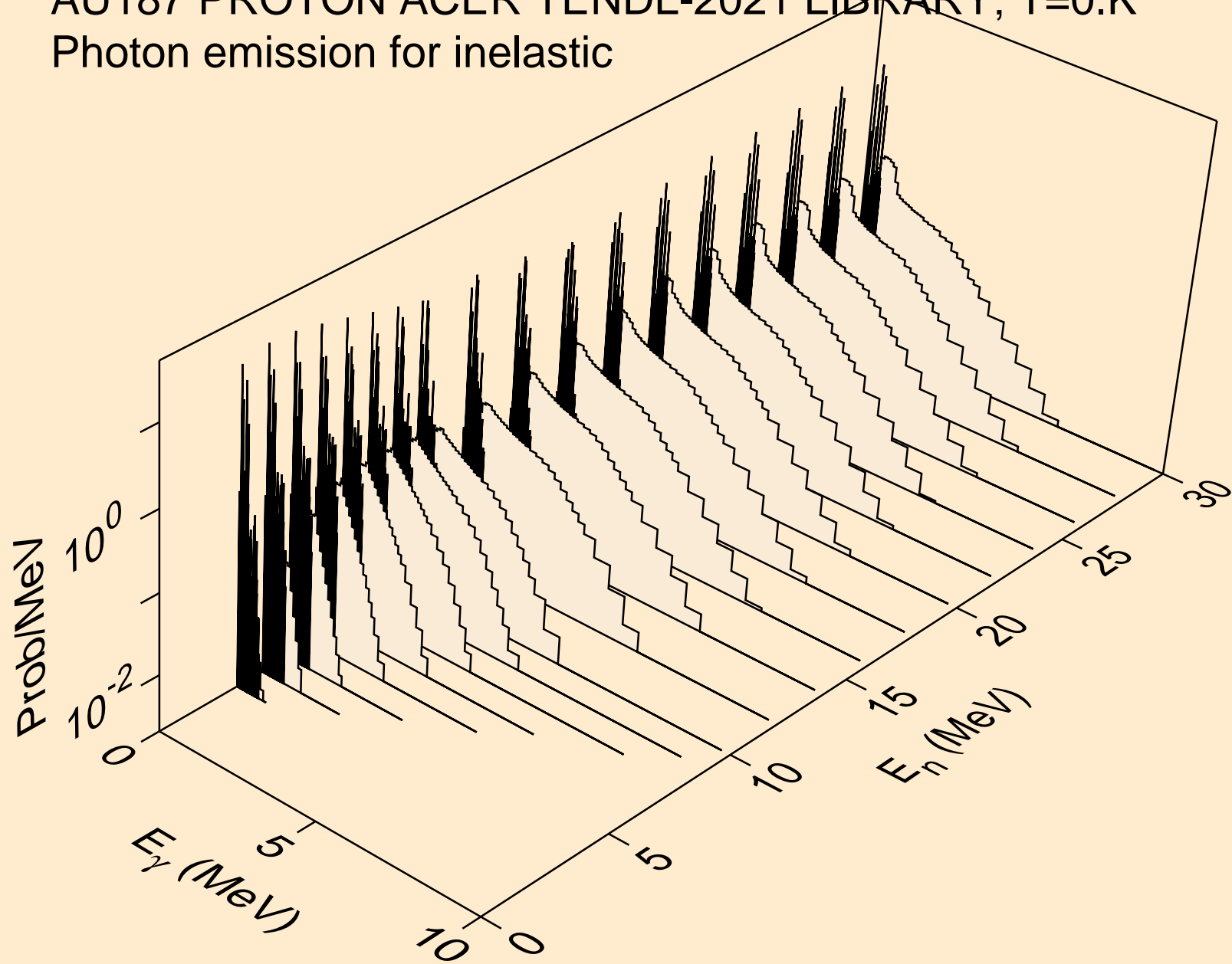

AU187 PROTON ACER TENDL-2021 LIBRARY; T=0.K  
Photon emission for (n,d)

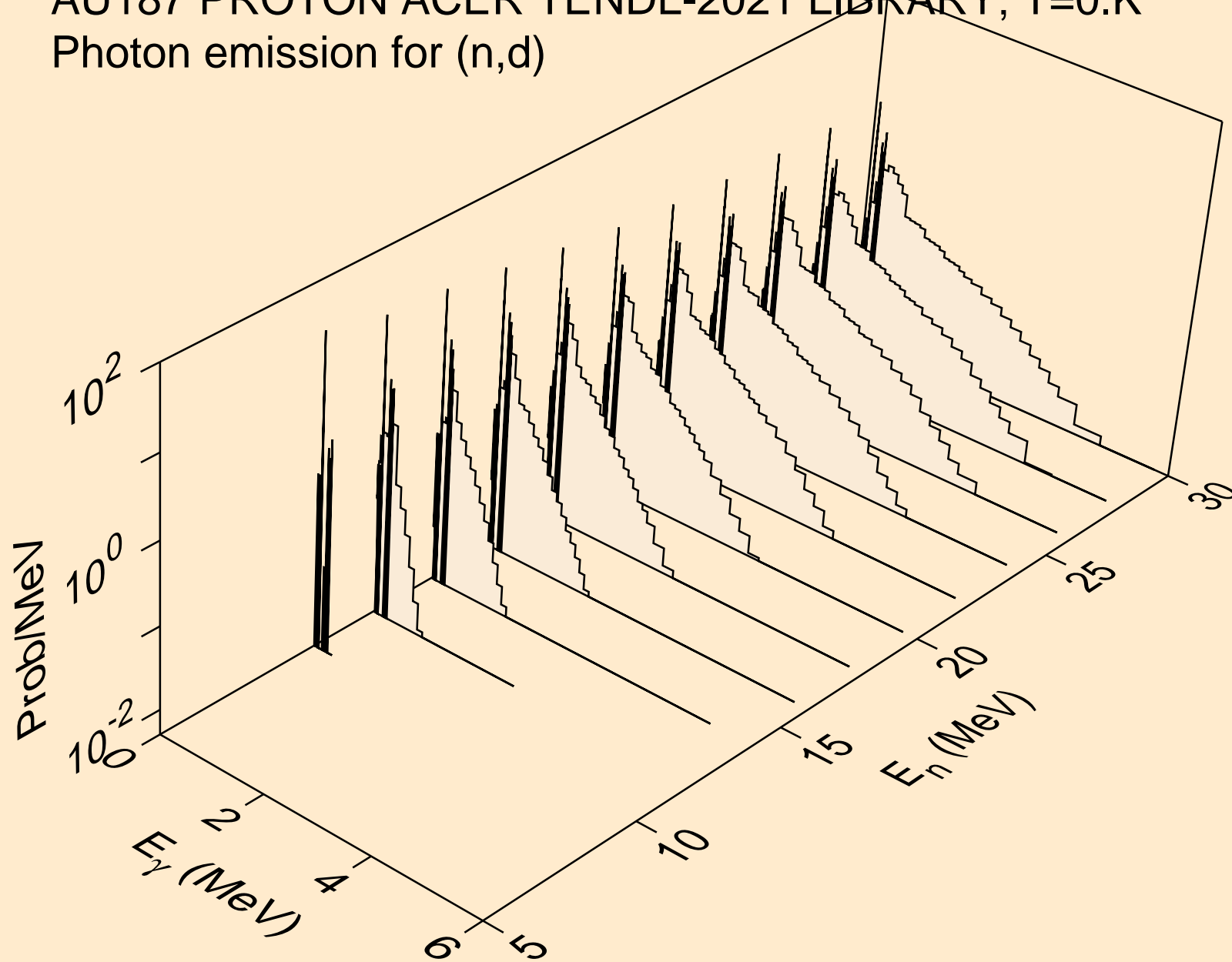

AU187 PROTON ACER TENDL-2021 LIBRARY; T=0.K  
Photon emission for (n,t)

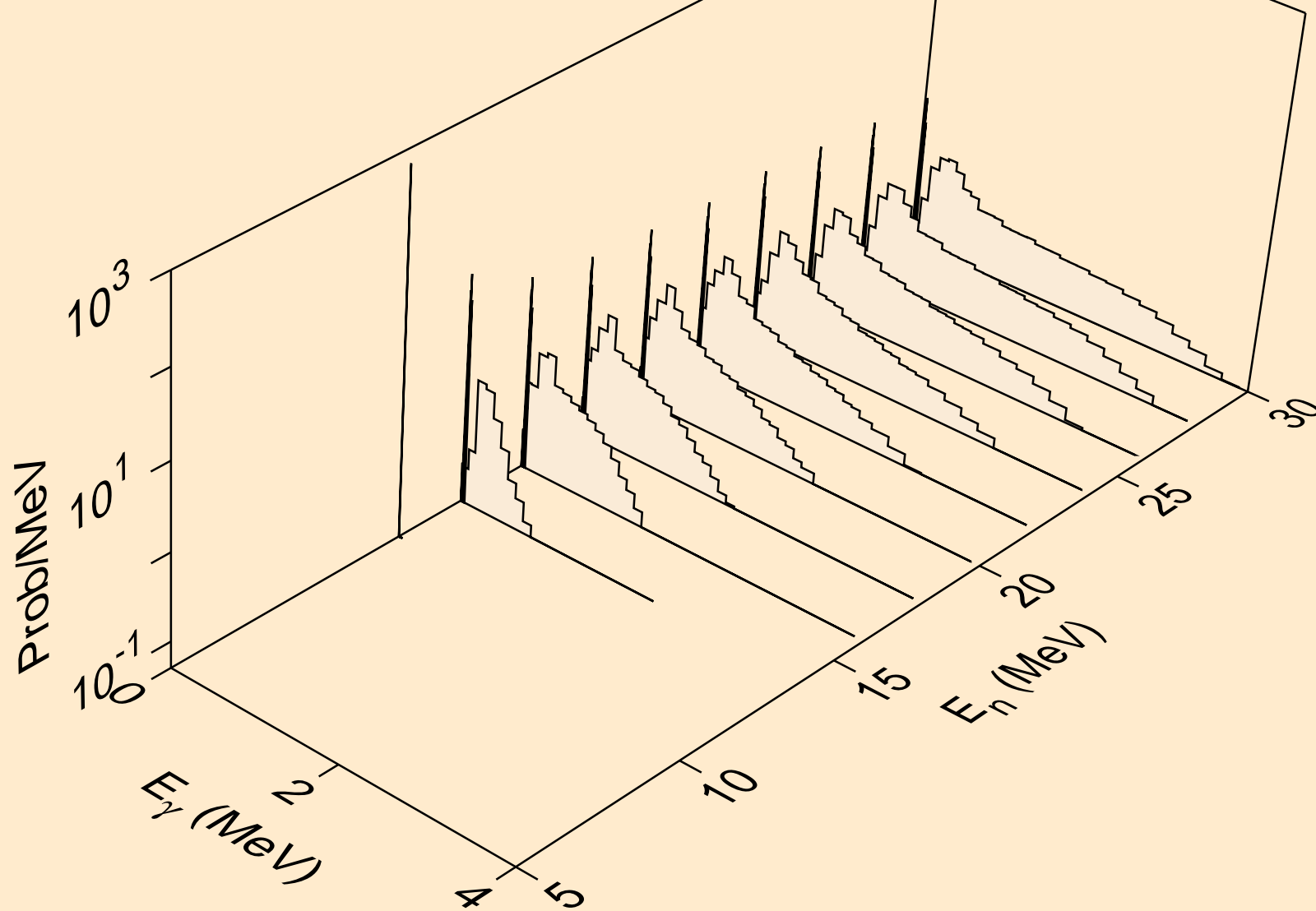

AU187 PROTON ACER TENDL-2021 LIBRARY; T=0.K  
Photon emission for (n,he3)

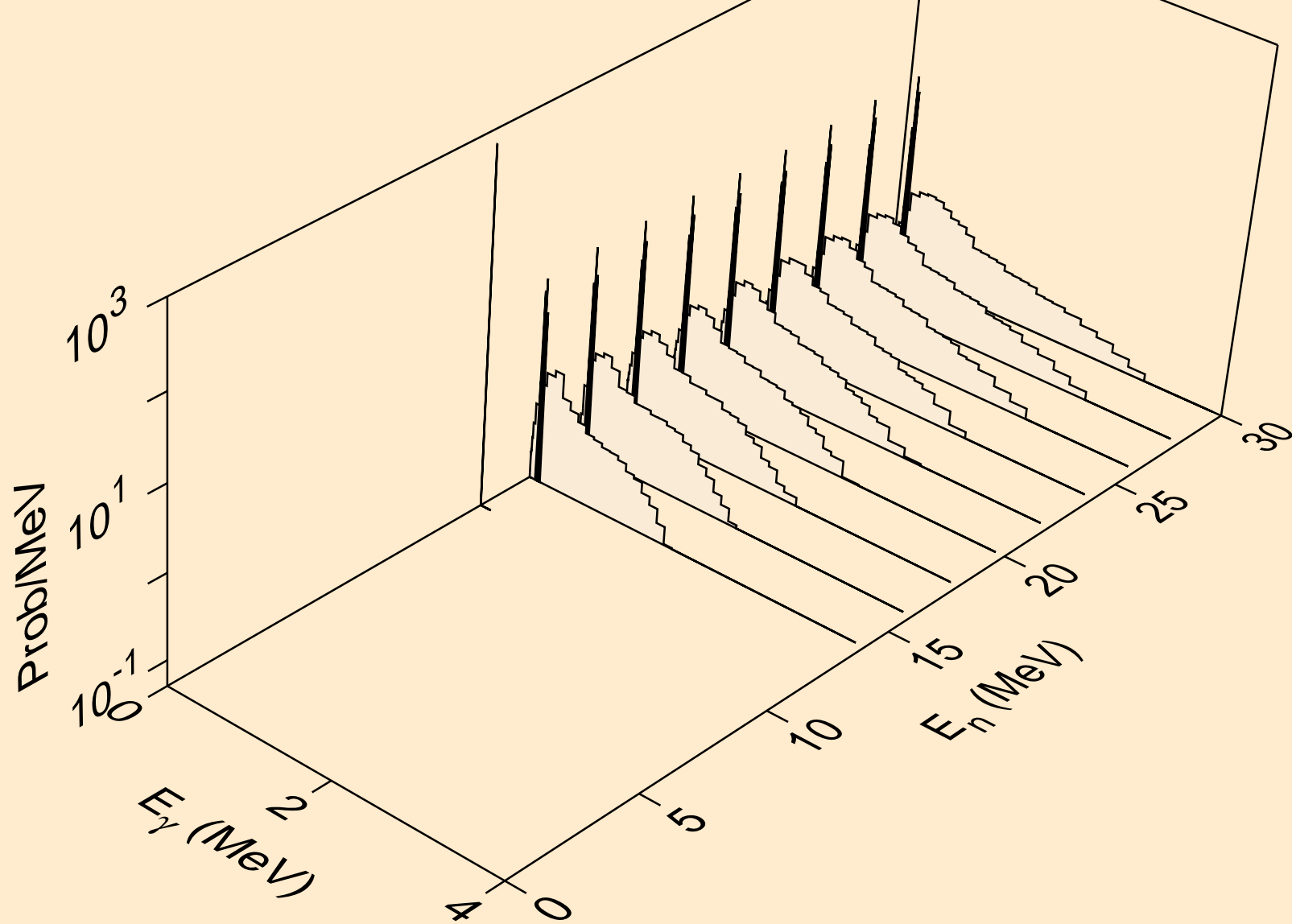



AU187 PROTON ACER TENDL-2021 LIBRARY; T=0.K  
Photon emission for (n,a)

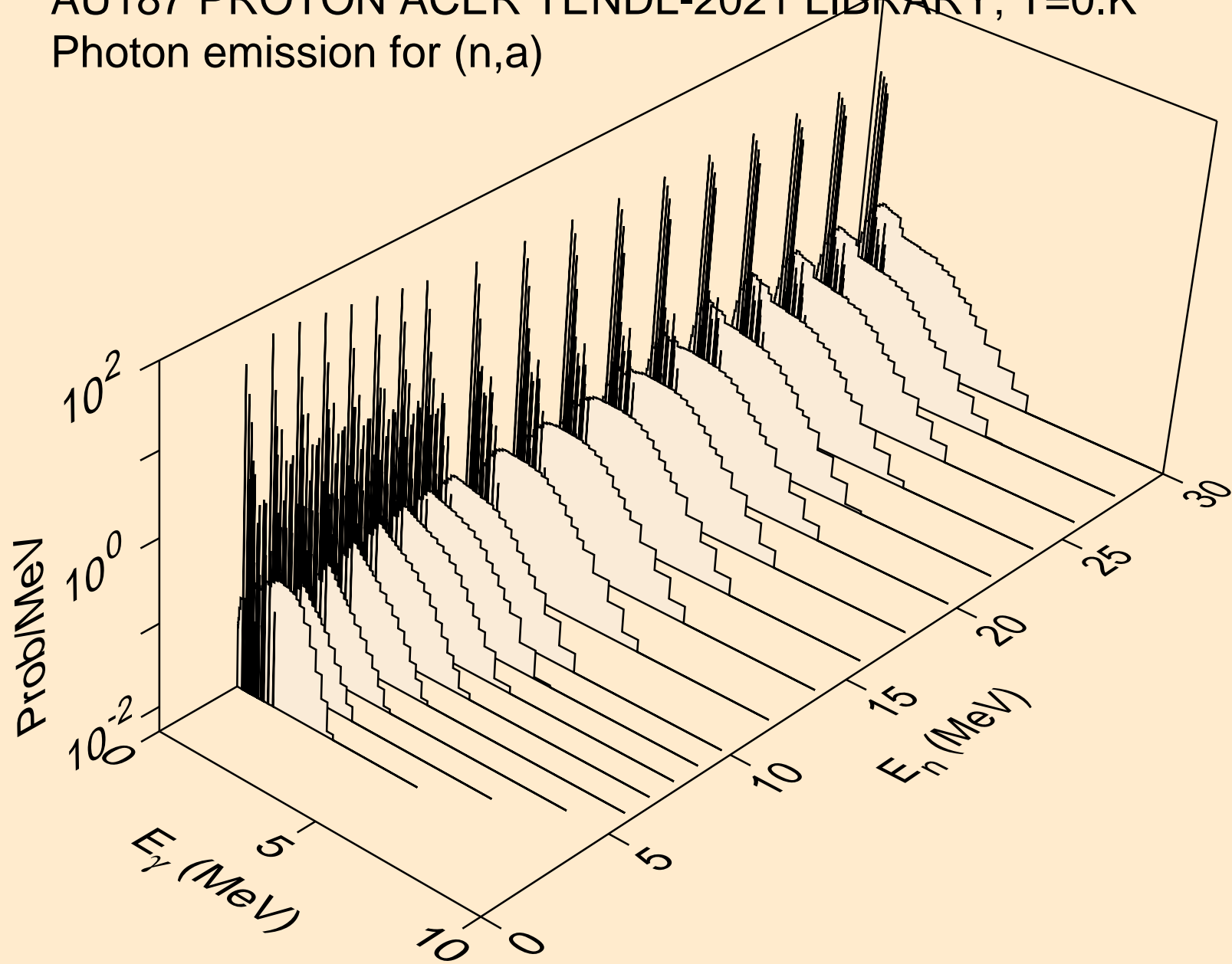

AU187 PROTON ACER TENDL-2021 LIBRARY; T=0.K  
Photon emission for (n,2a)

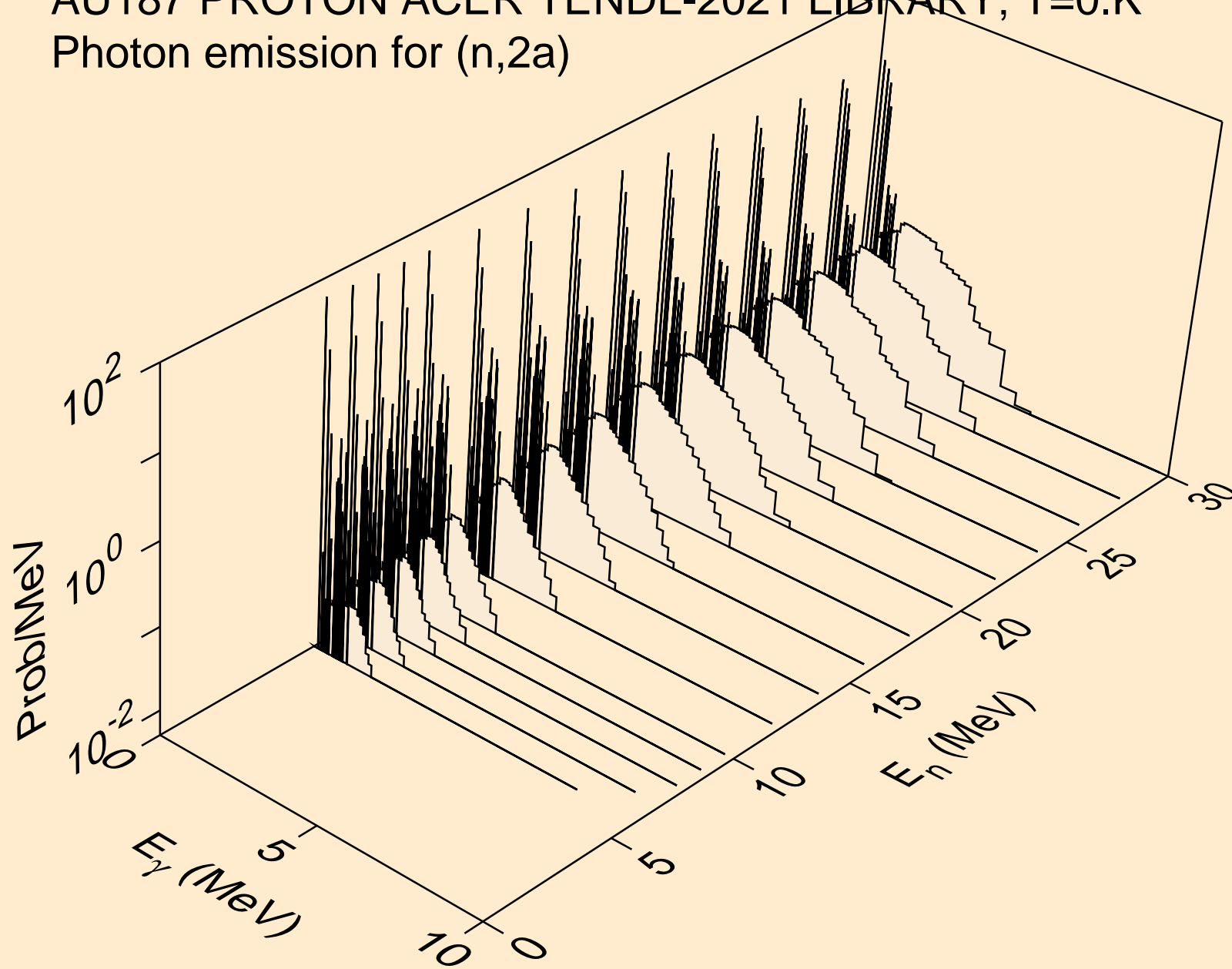

AU187 PROTON ACER TENDL-2021 LIBRARY; T=0.K  
Photon emission for (n,2p)

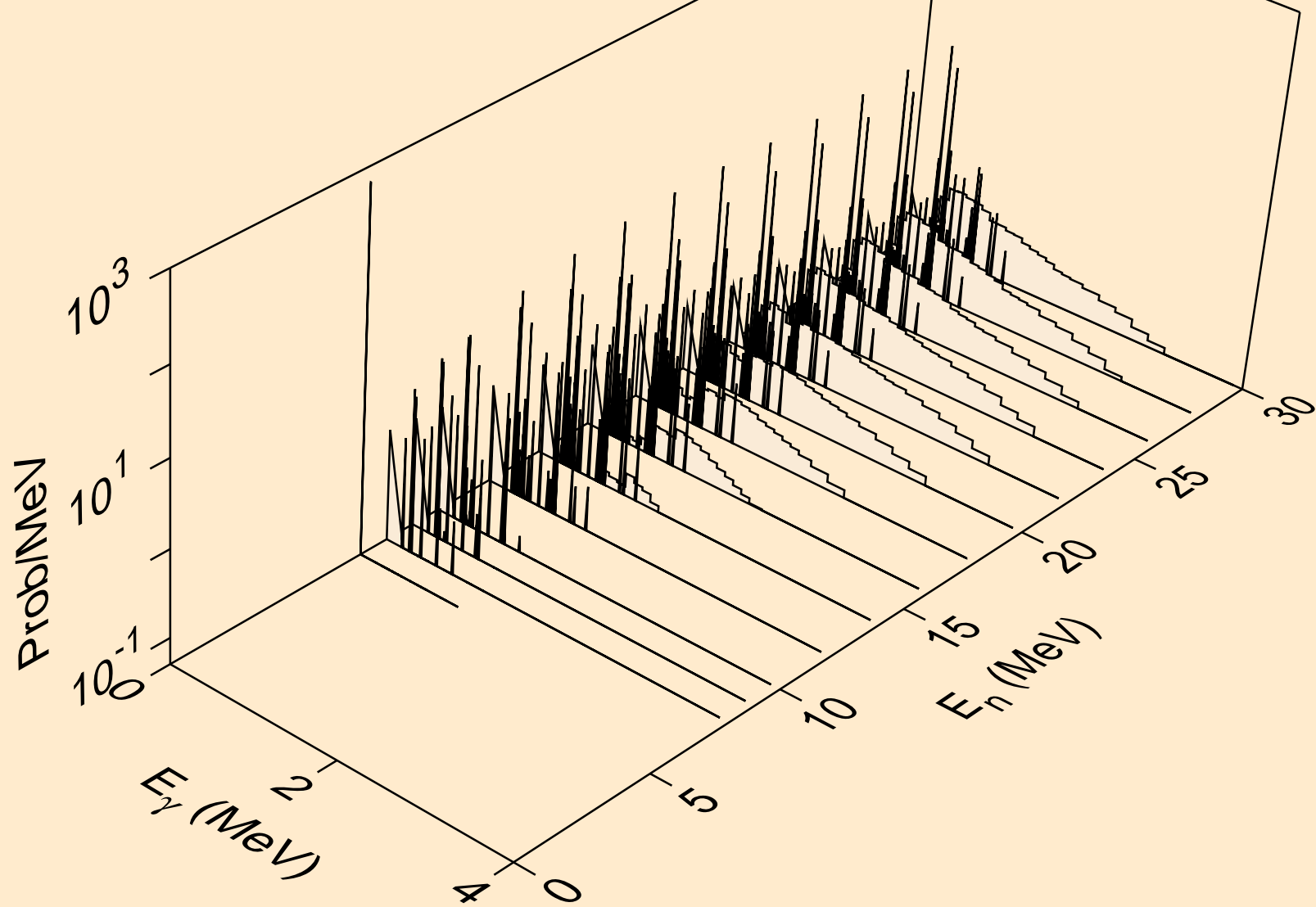

AU187 PROTON ACER TENDL-2021 LIBRARY; T=0.K  
Photon emission for (n,pa)

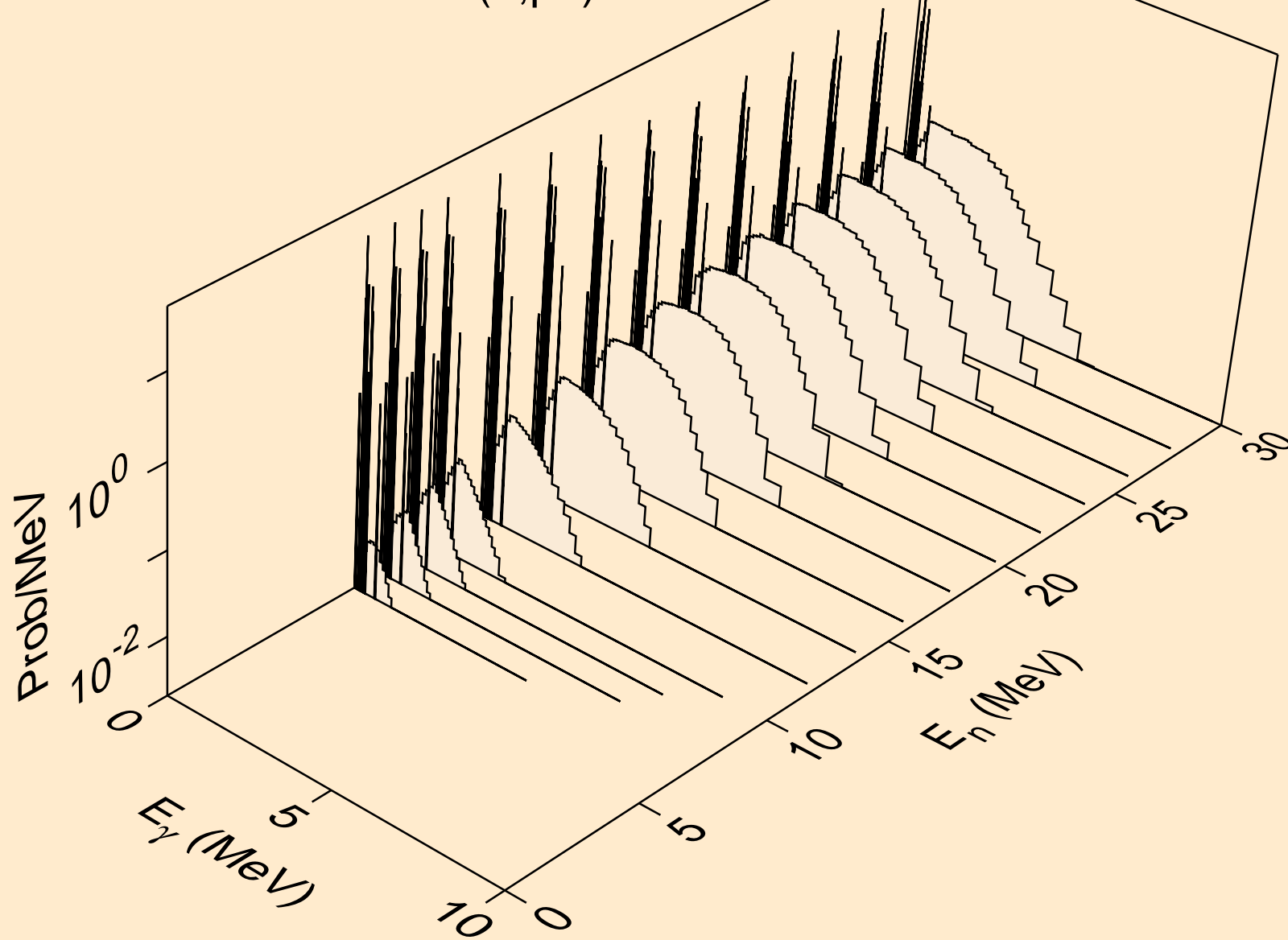

AU187 PROTON ACER TENDL-2021 LIBRARY; T=0.K  
Photon emission for (n,pd)

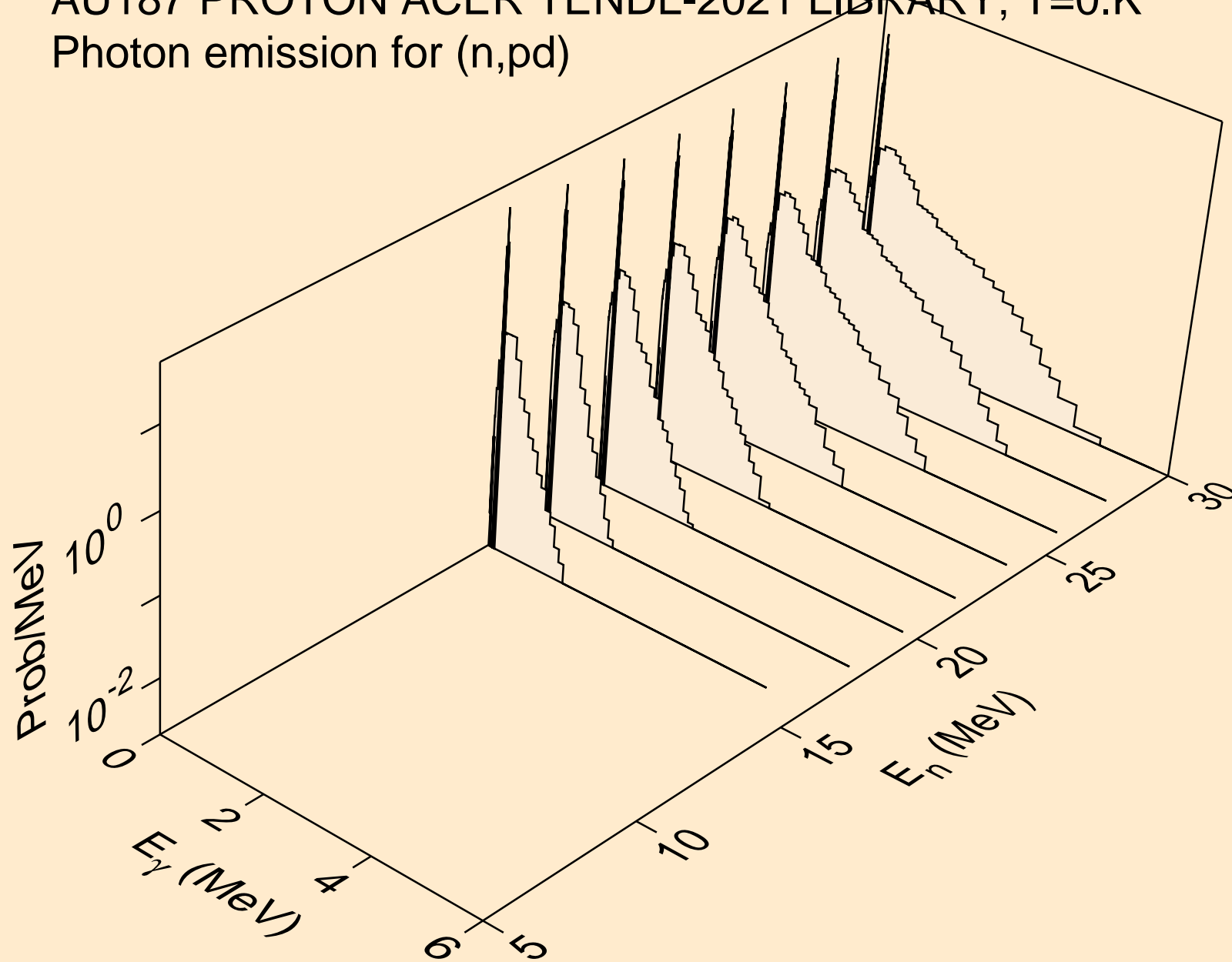

AU187 PROTON ACER TENDL-2021 LIBRARY; T=0.K  
Photon emission for (n,pt)

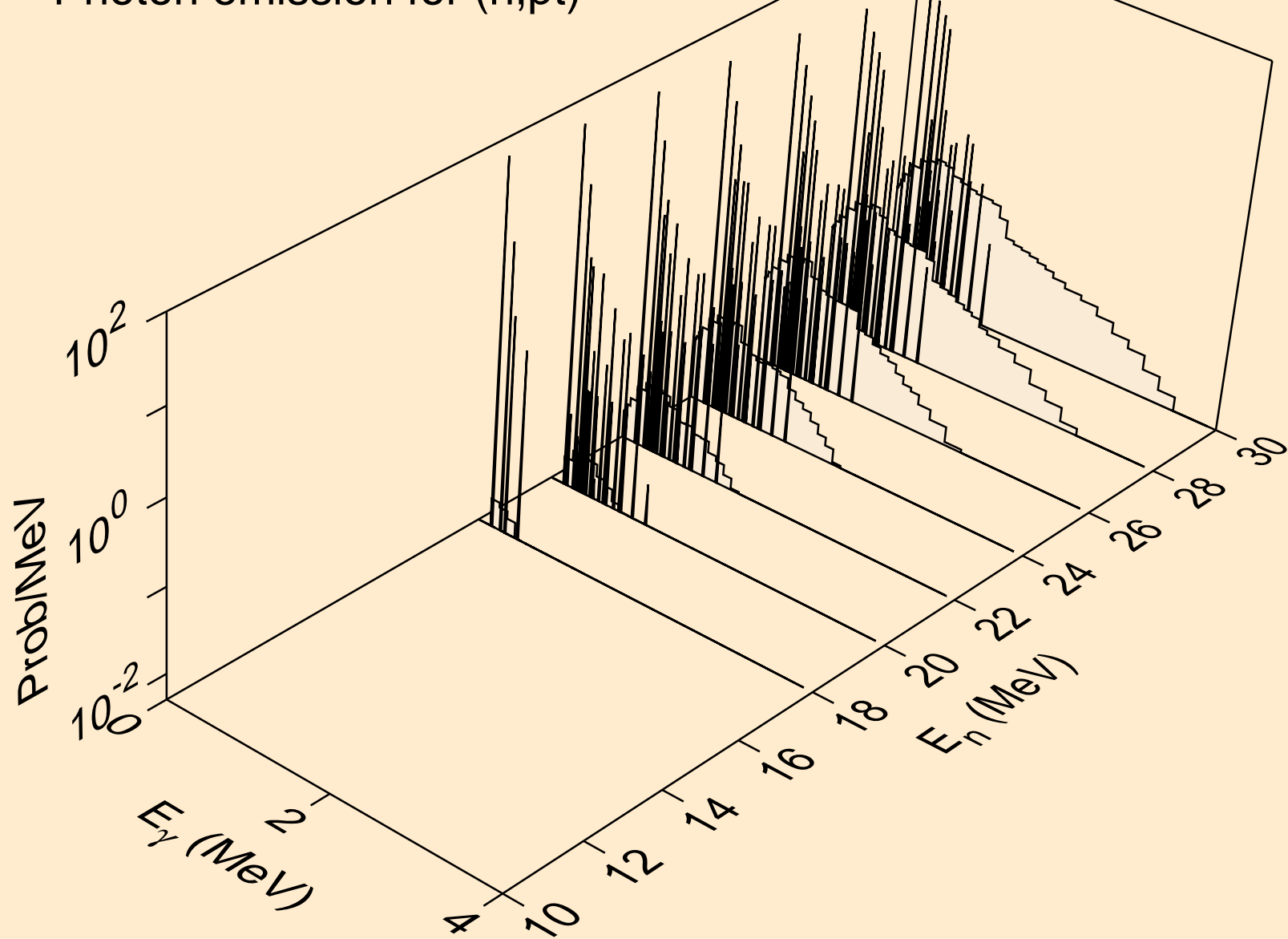

AU187 PROTON ACER TENDL-2021 LIBRARY; T=0.K  
Photon emission for (n,da)

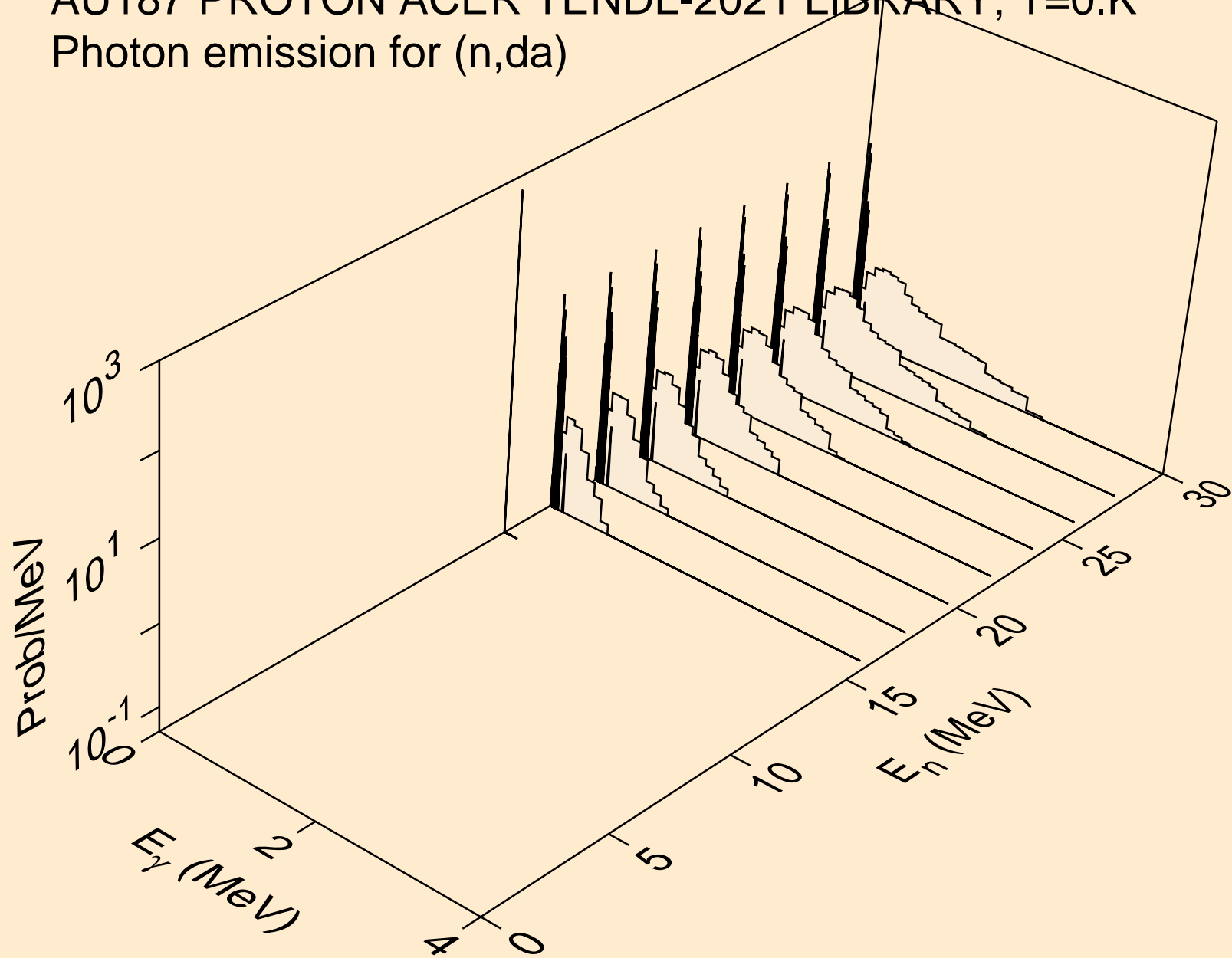

# AU187 PROTON ACER TENDL-2021 LIBRARY; T=0.K

## Particle heating contributions

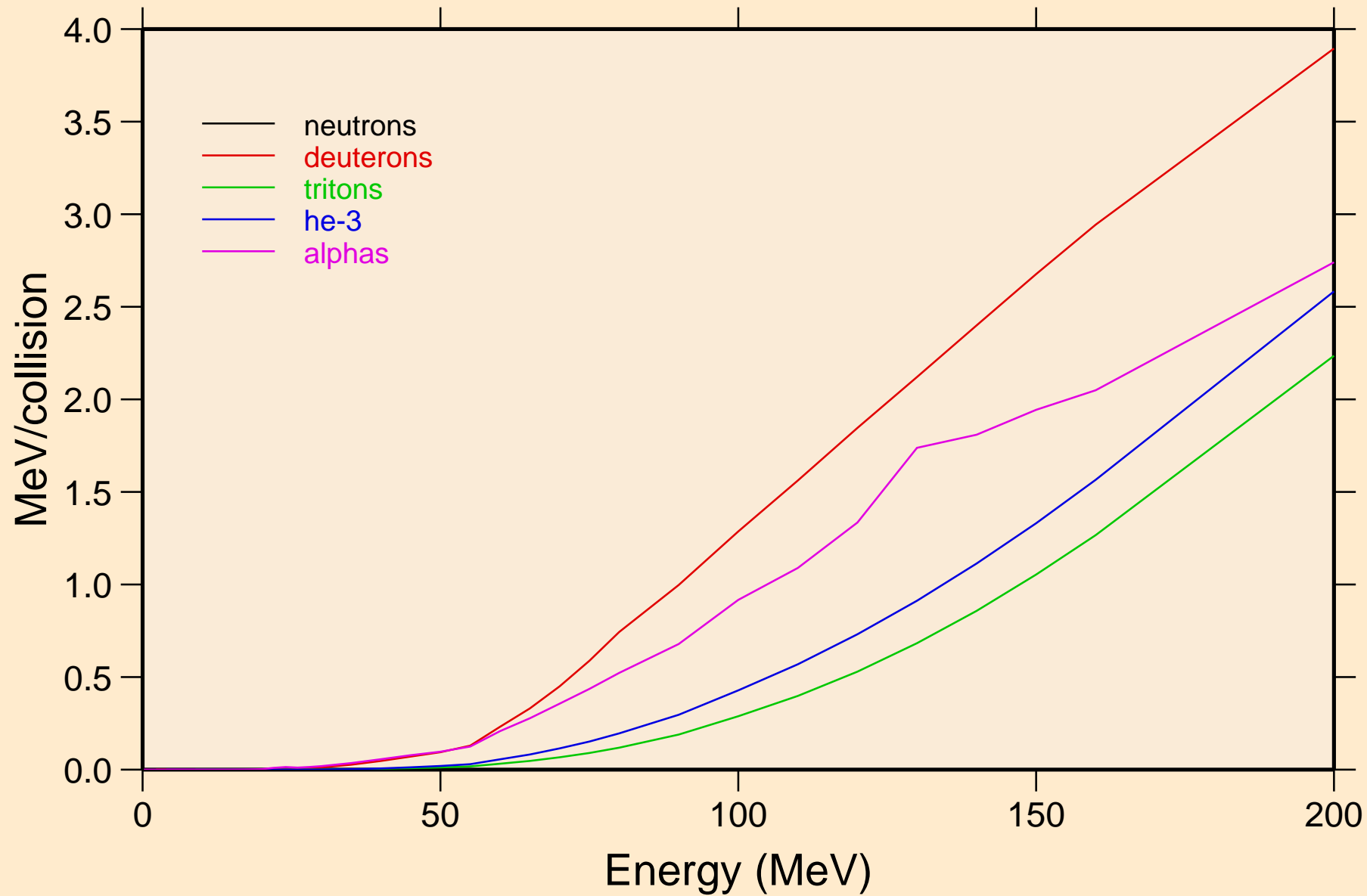



AU187 PROTON ACER TENDL-2021 LIBRARY; T=0.K  
Recoil Heating

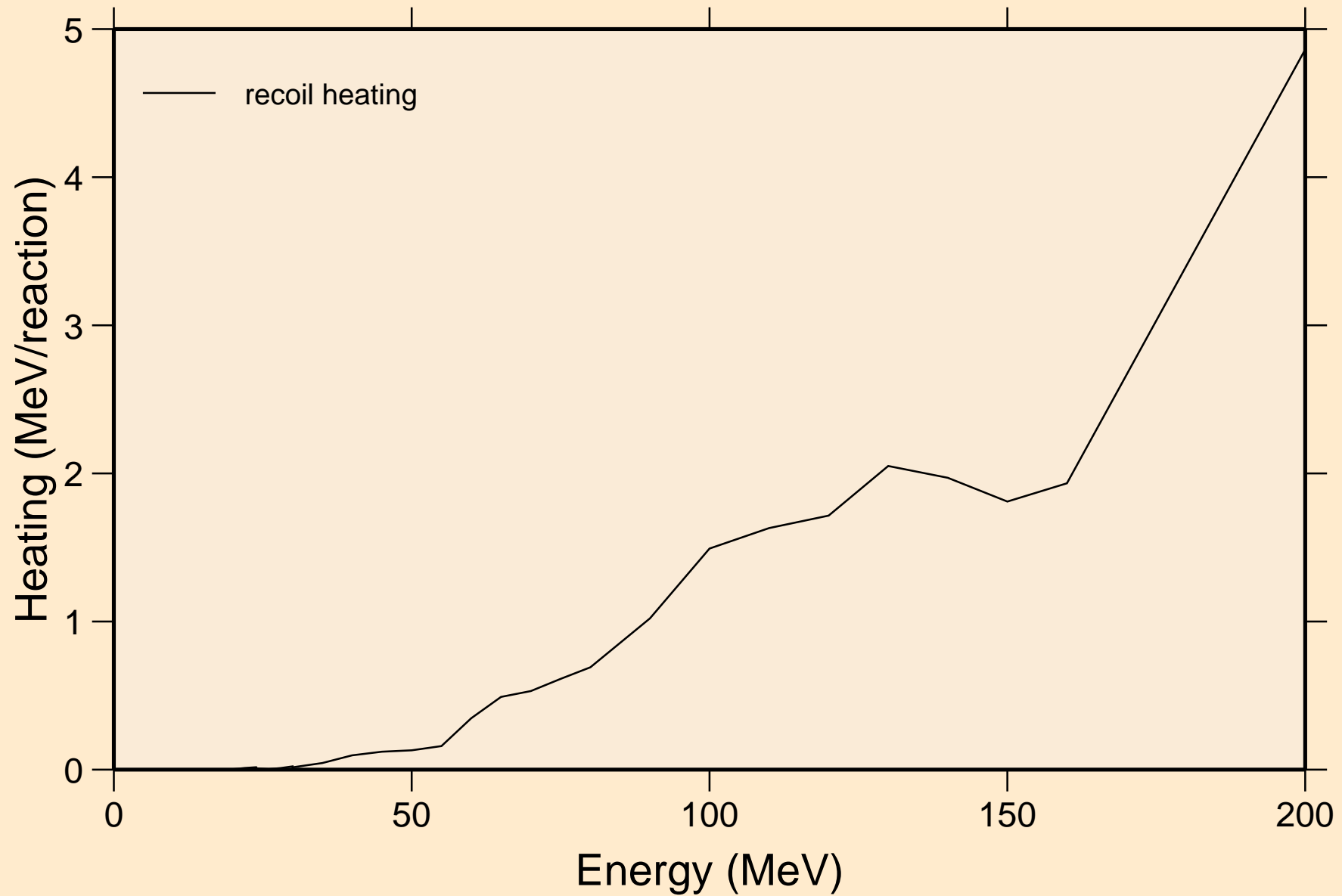

AU187 PROTON ACER TENDL-2021 LIBRARY; T=0.K  
Particle production cross sections

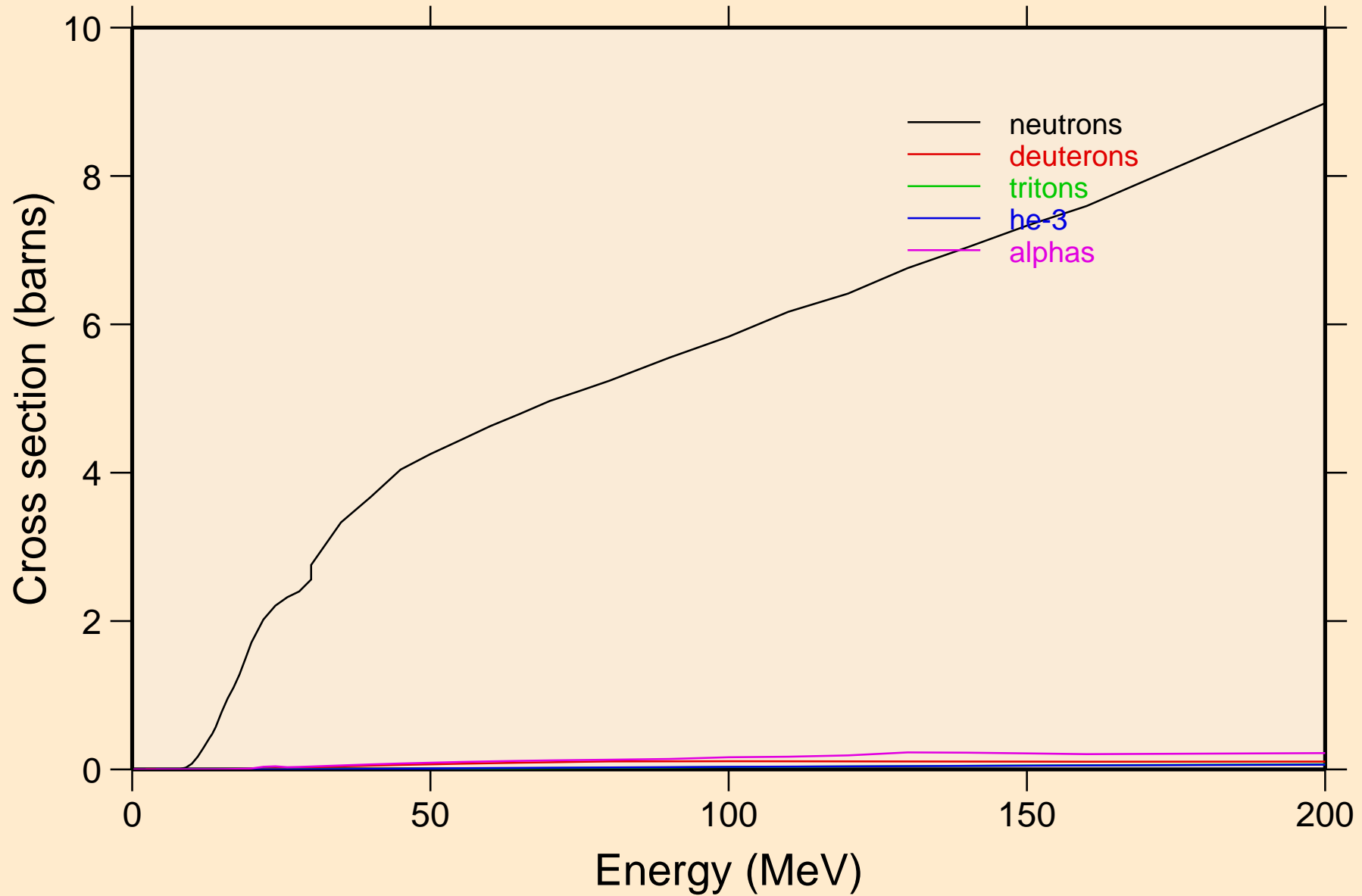

AU187 PROTON ACER TENDL-2021 LIBRARY; T=0.K  
neutrons from (p,n)

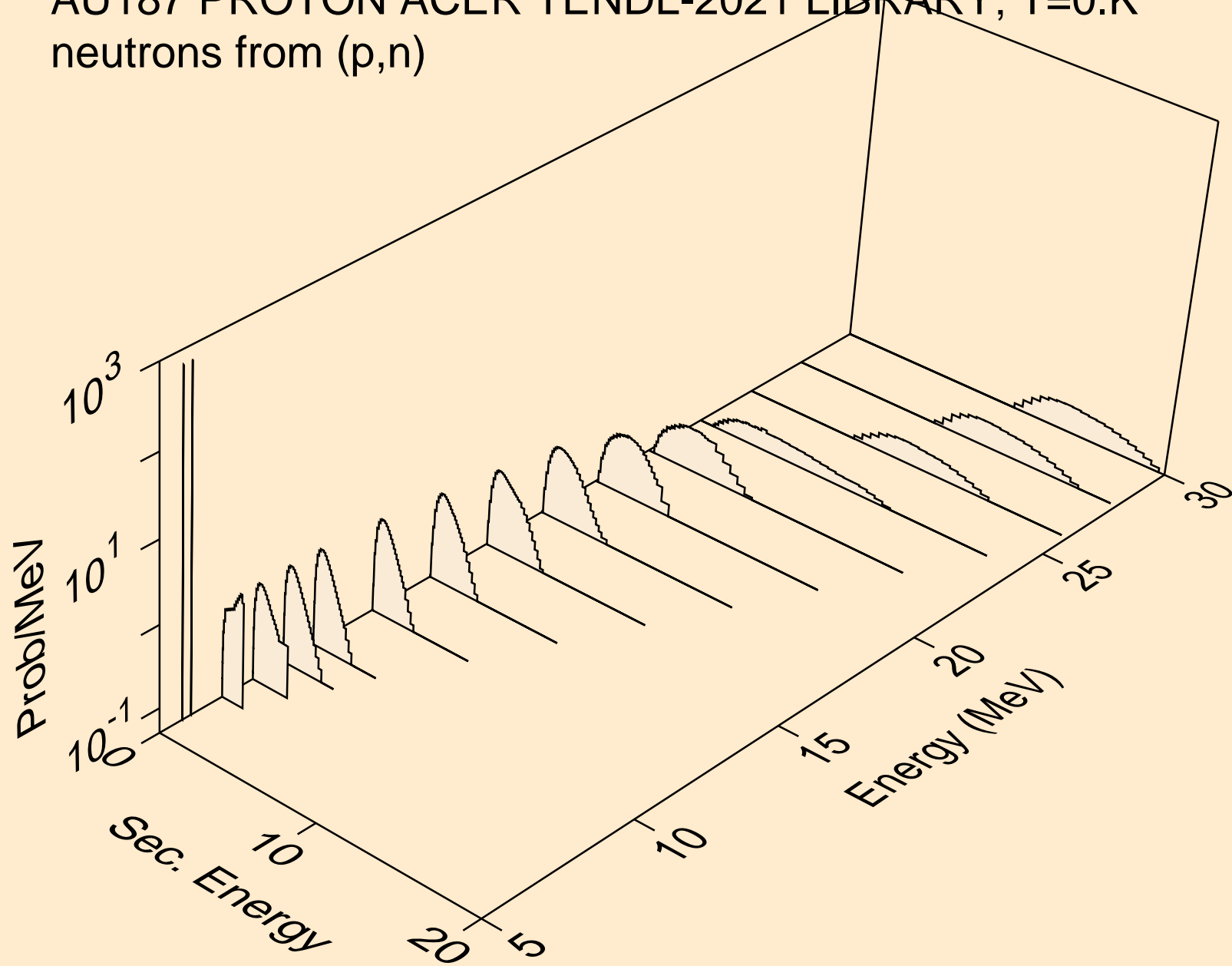

AU187 PROTON ACER TENDL-2021 LIBRARY; T=0.K  
neutrons from (p,x)

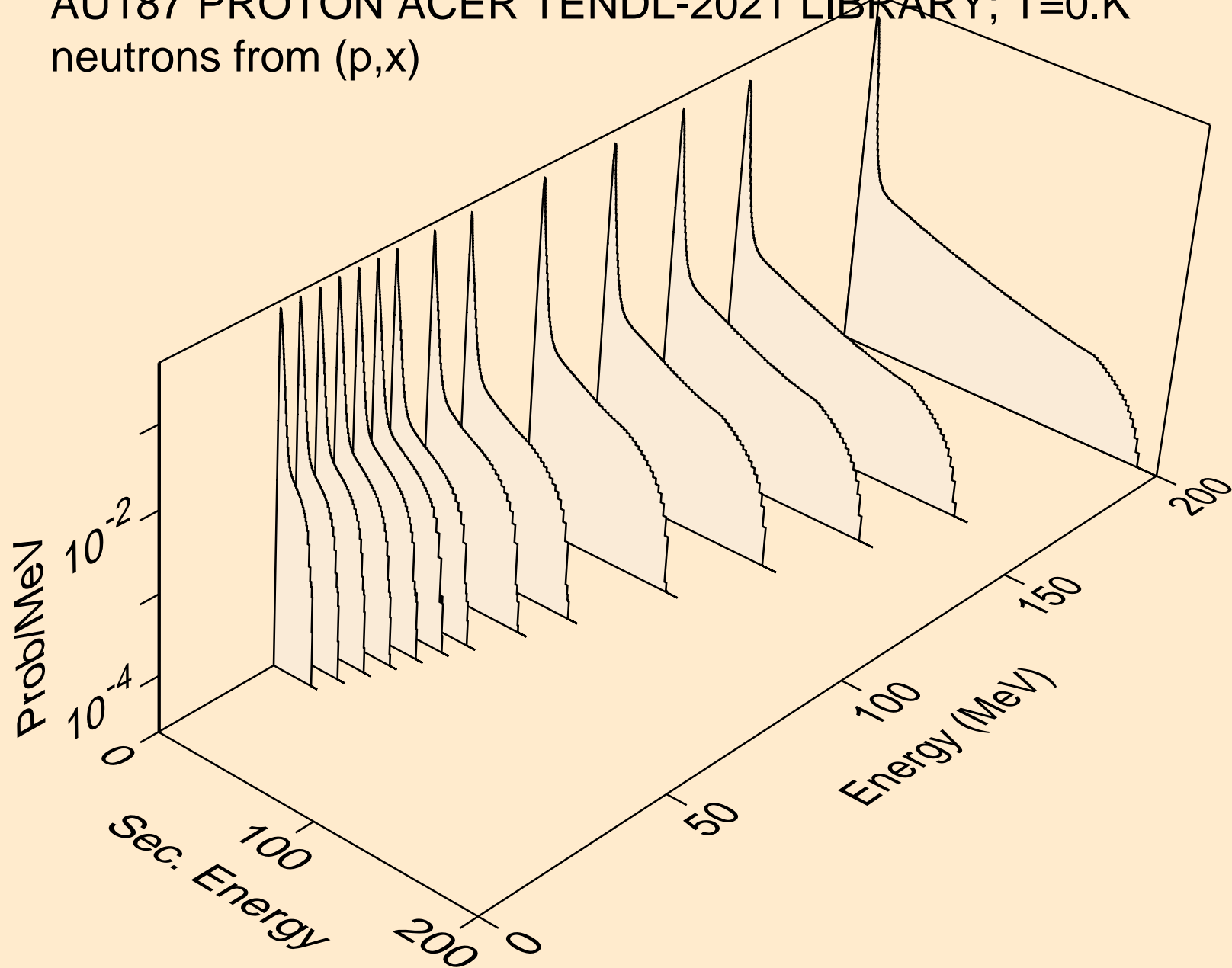

AU187 PROTON ACER TENDL-2021 LIBRARY; T=0.K  
neutrons from (p,2n)

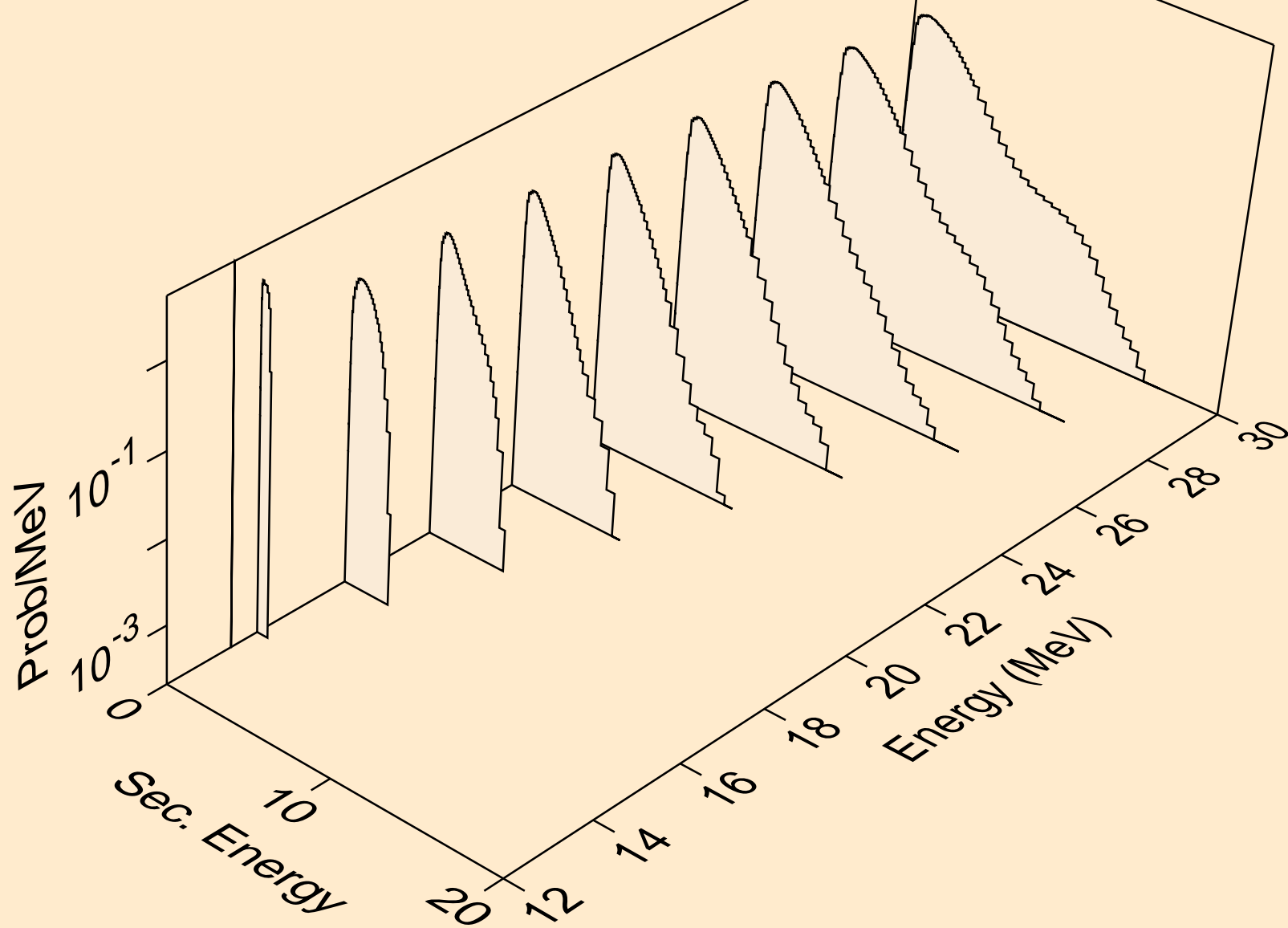

AU187 PROTON ACER TENDL-2021 LIBRARY; T=0.K  
neutrons from (p,3n)

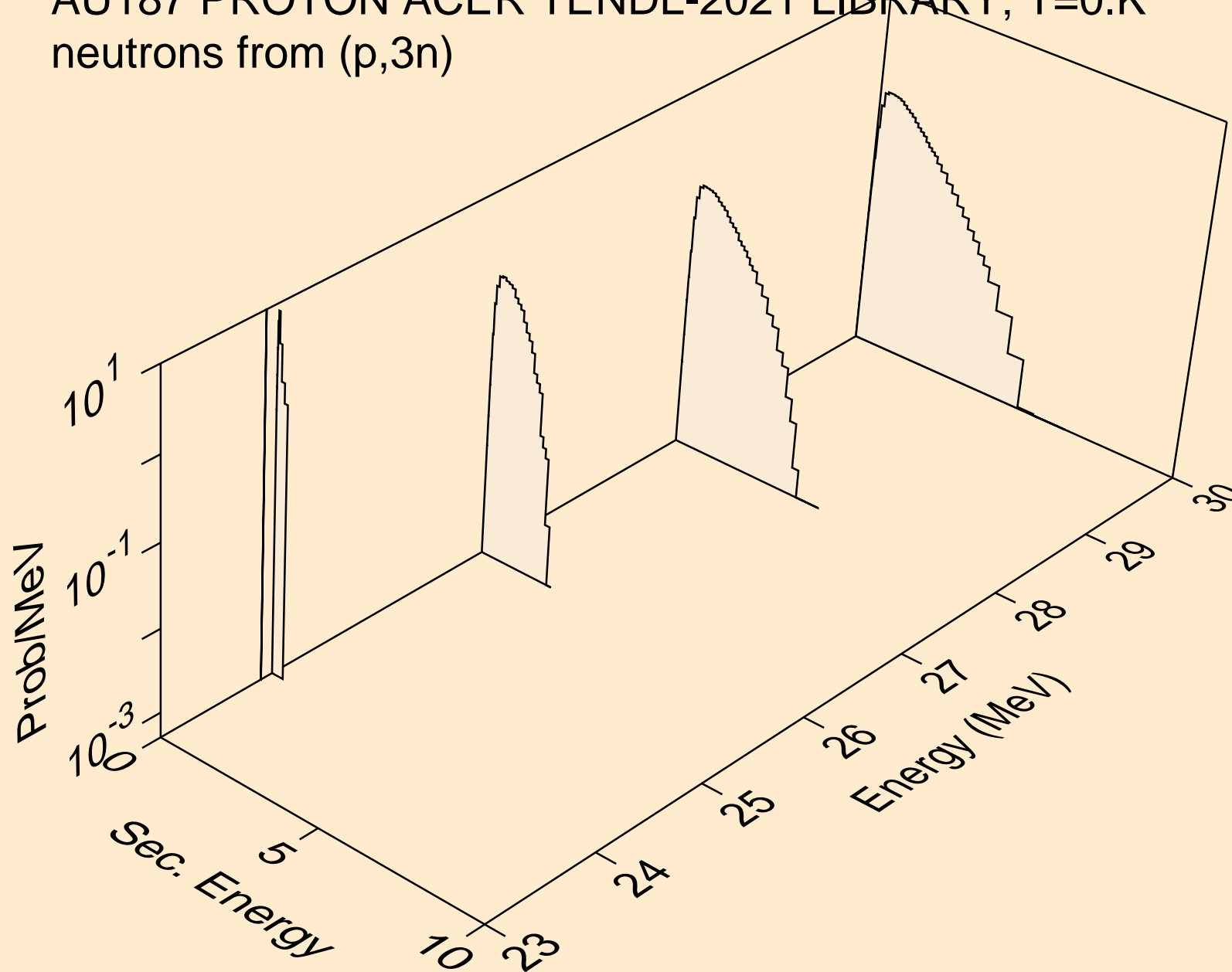

AU187 PROTON ACER TENDL-2021 LIBRARY; T=0.K  
neutrons from (p,n\*)a

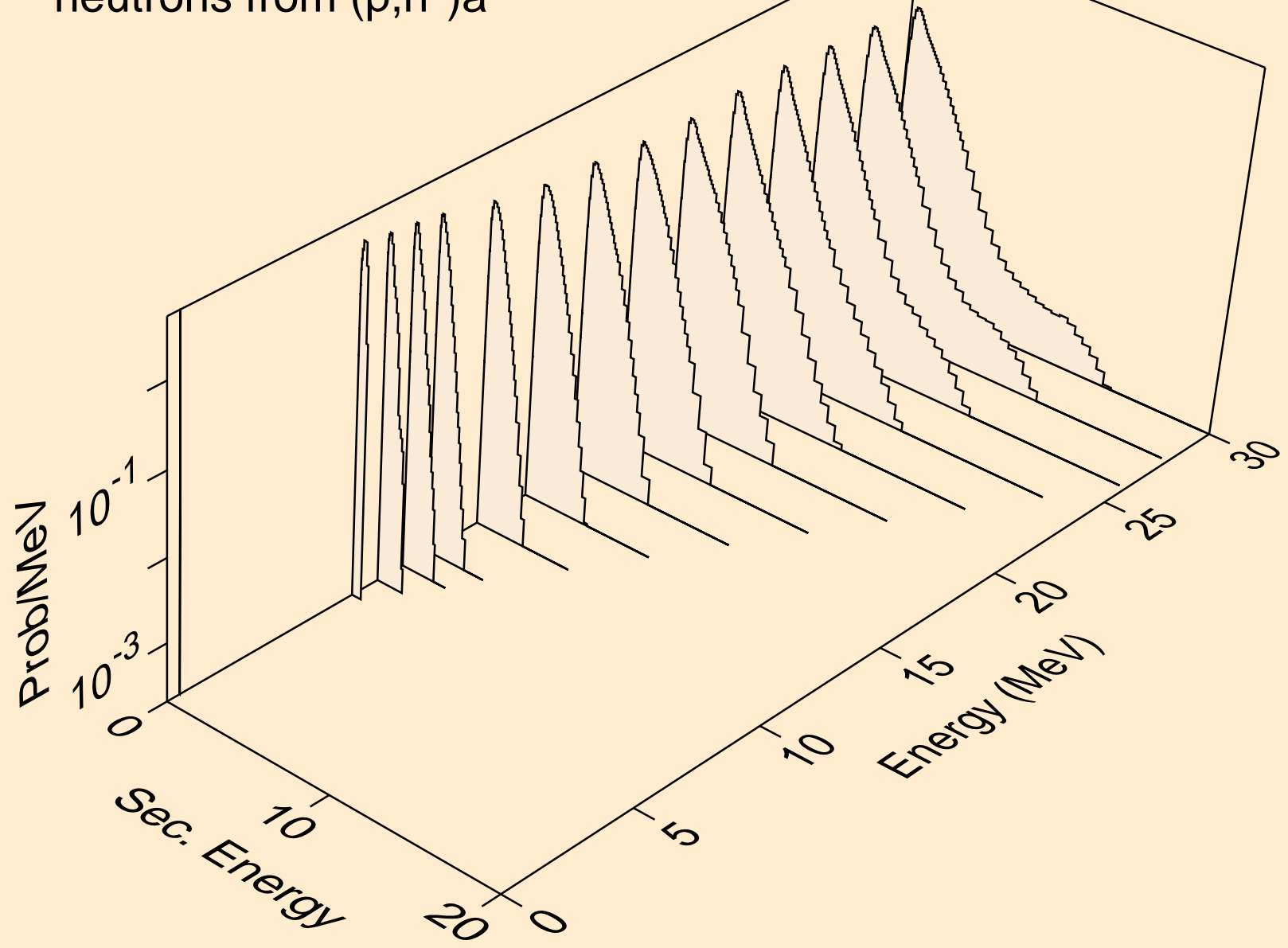

AU187 PROTON ACER TENDL-2021 LIBRARY; T=0.K  
neutrons from (p,2n)a

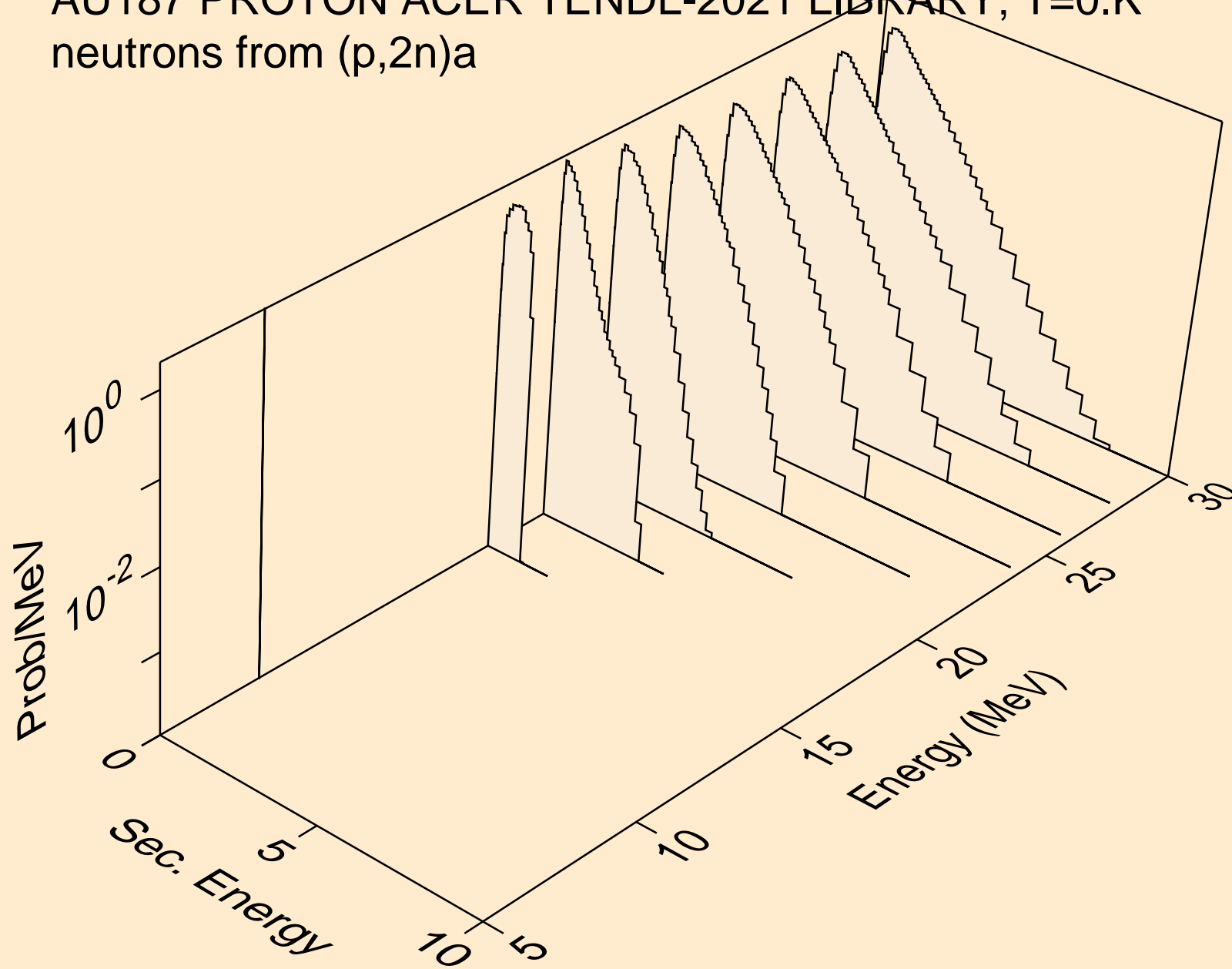



AU187 PROTON ACER TENDL-2021 LIBRARY; T=0.K  
neutrons from (p,3n)a

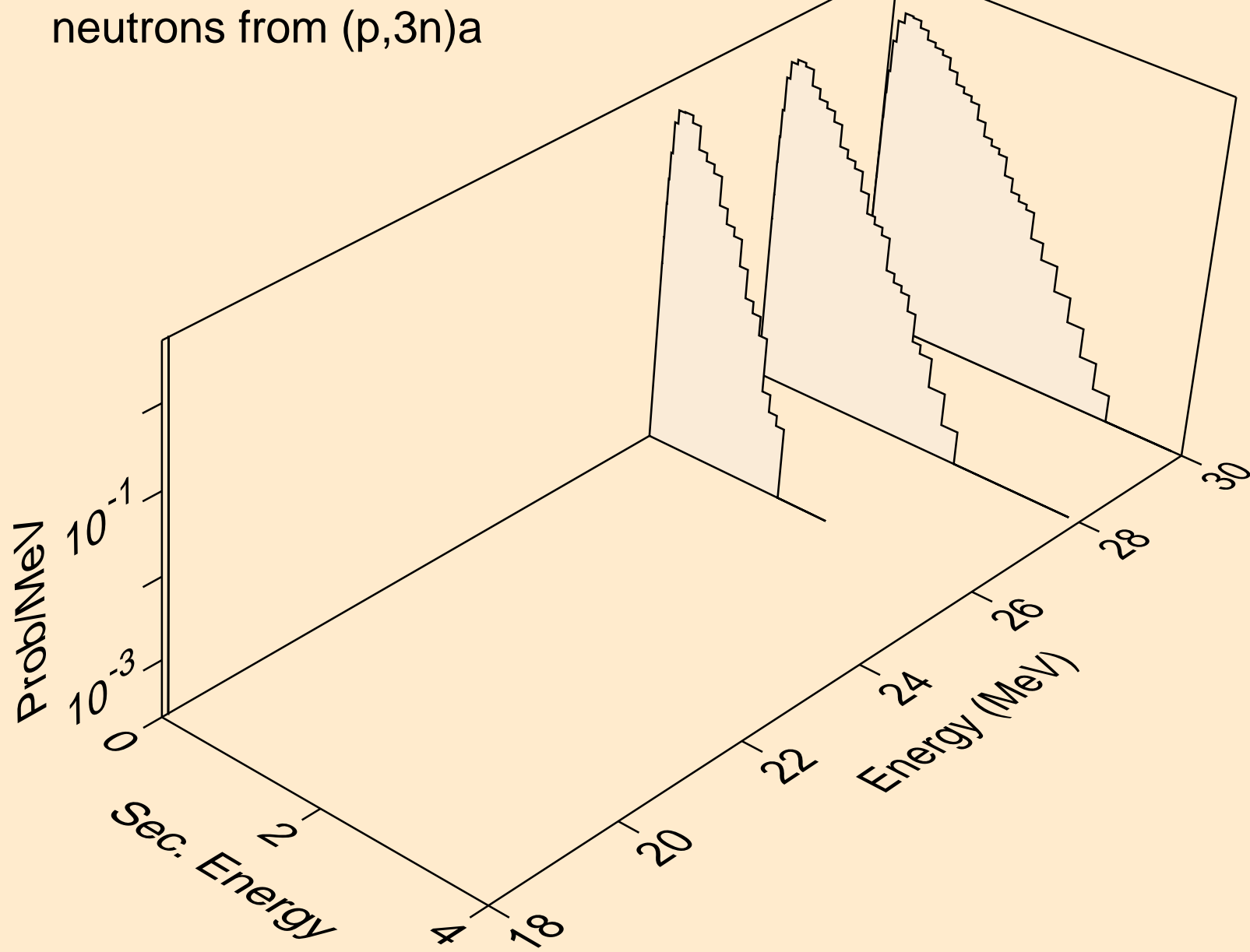

AU187 PROTON ACER TENDL-2021 LIBRARY; T=0.K  
neutrons from (p,n\*)p

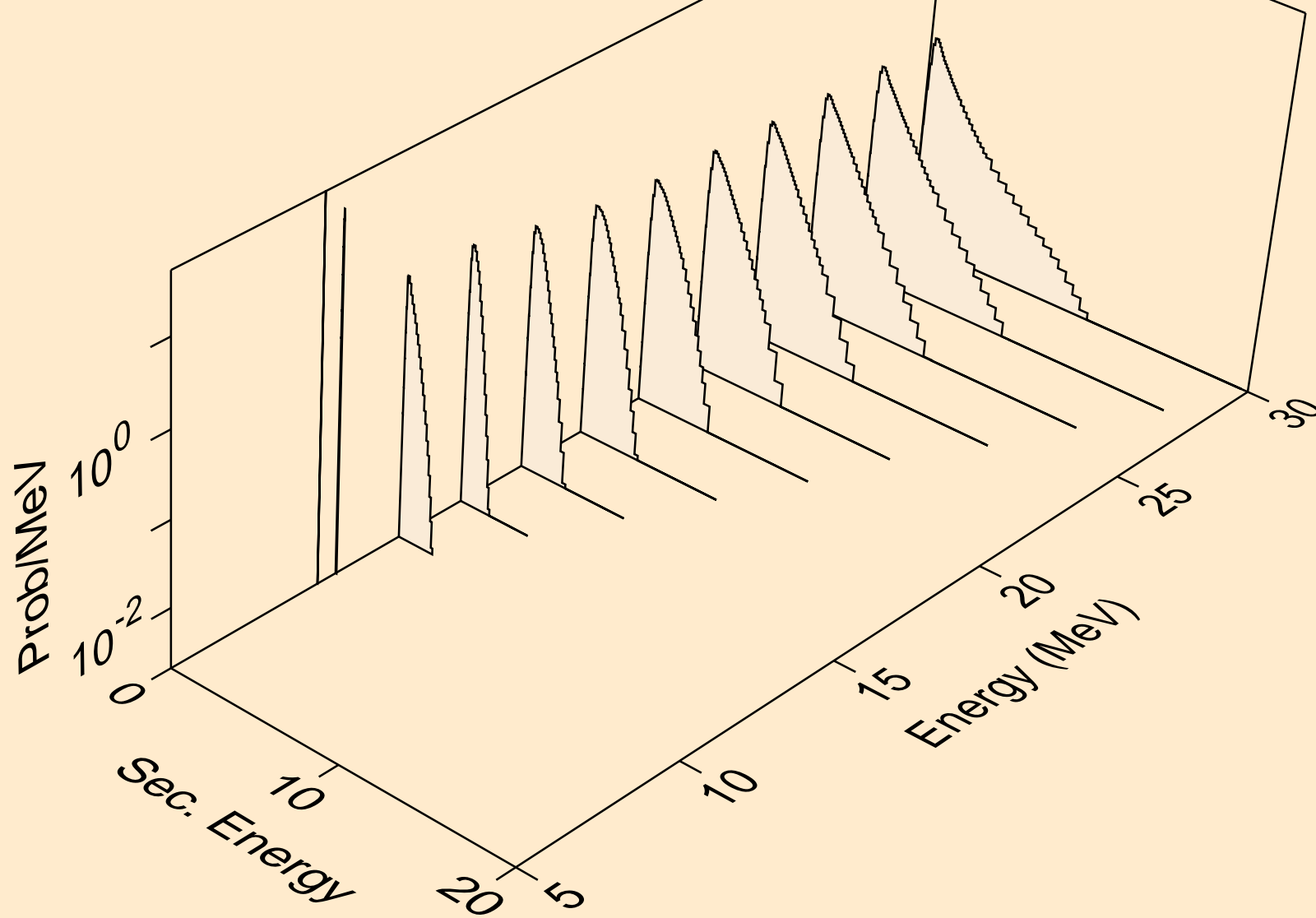

AU187 PROTON ACER TENDL-2021 LIBRARY; T=0.K  
neutrons from (p,n\*)2a

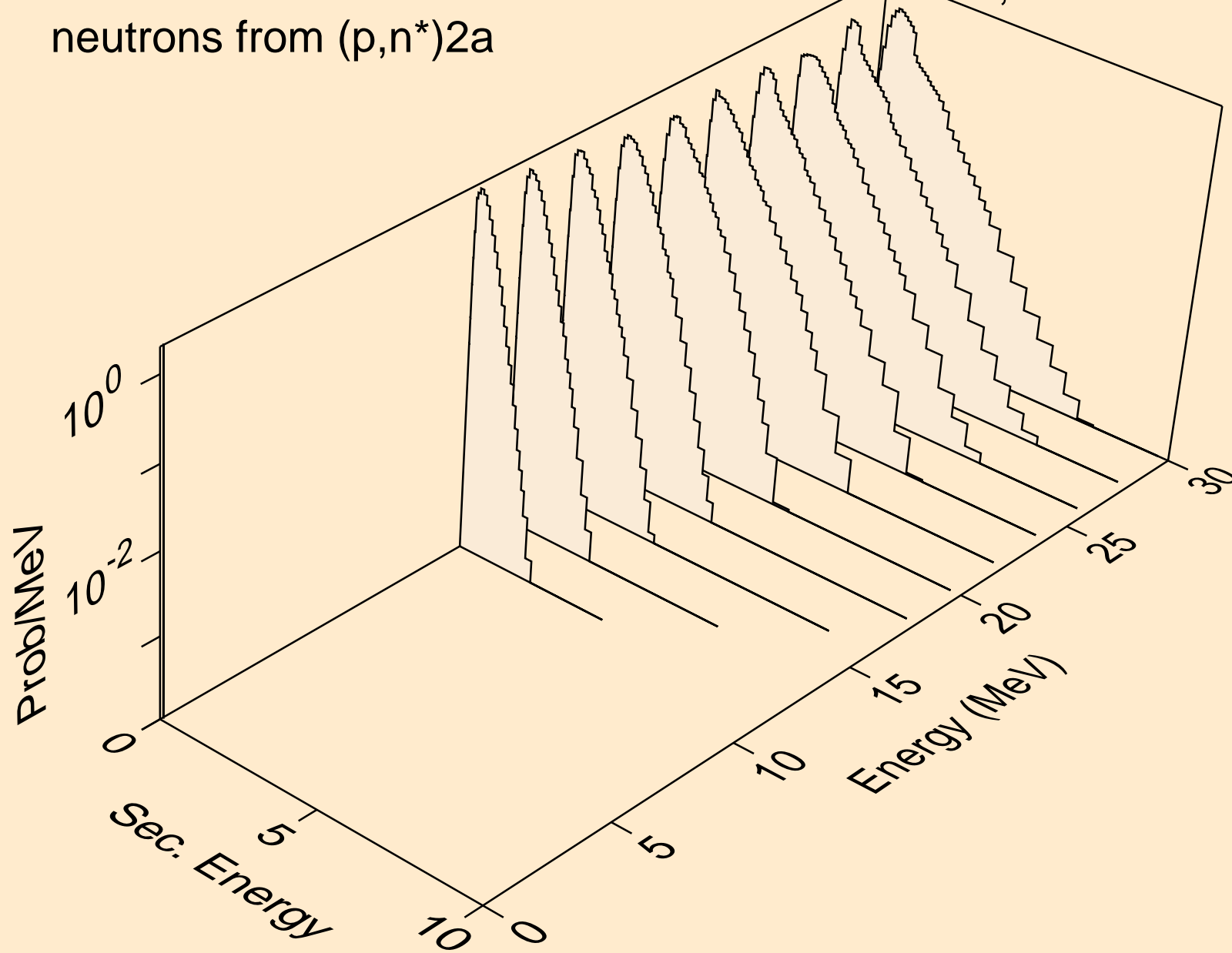

AU187 PROTON ACER TENDL-2021 LIBRARY; T=0.K  
neutrons from (p,2n)2a

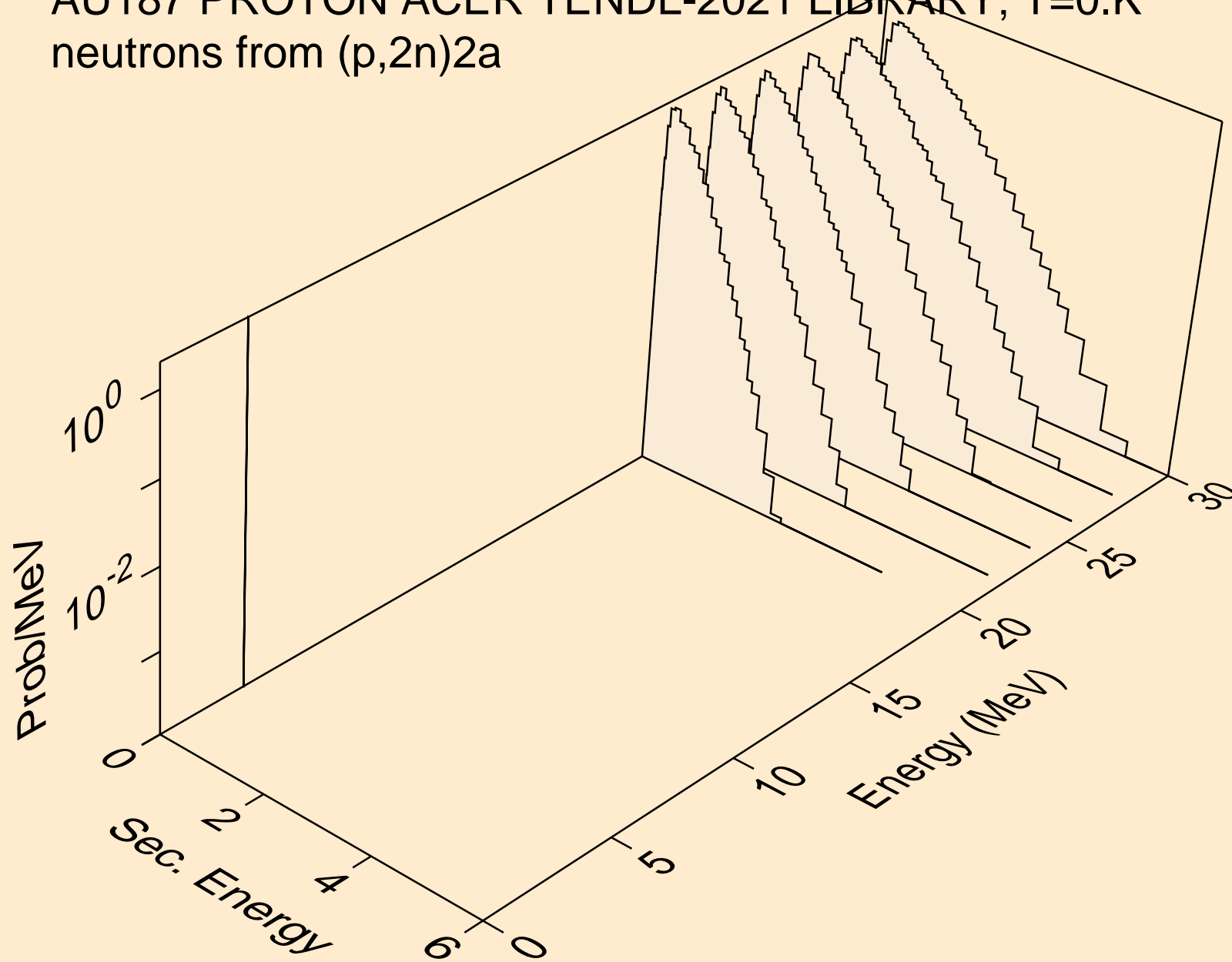

AU187 PROTON ACER TENDL-2021 LIBRARY; T=0.K  
neutrons from (p,n\*)d

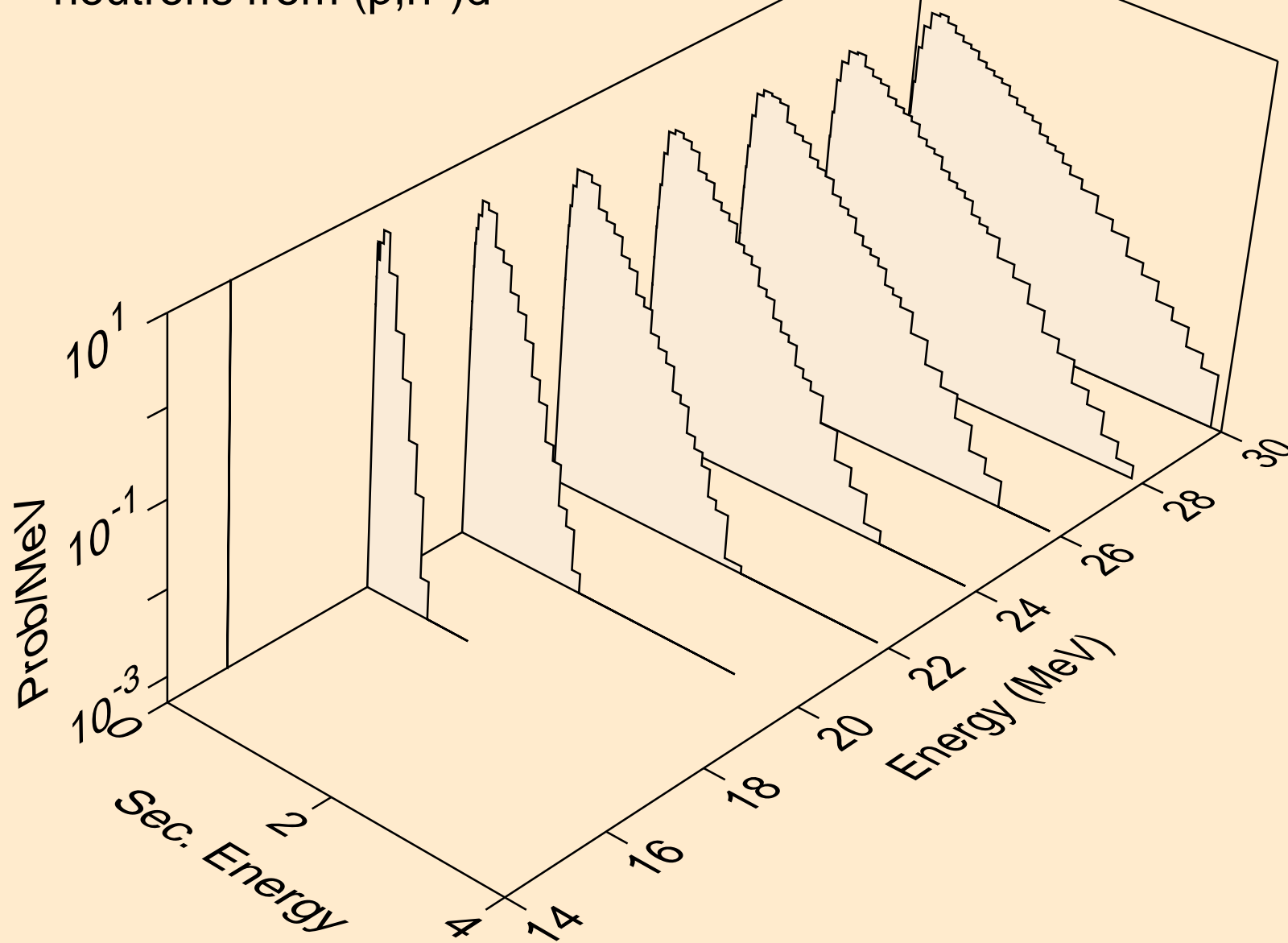

AU187 PROTON ACER TENDL-2021 LIBRARY; T=0.K  
neutrons from (p,n\*)t

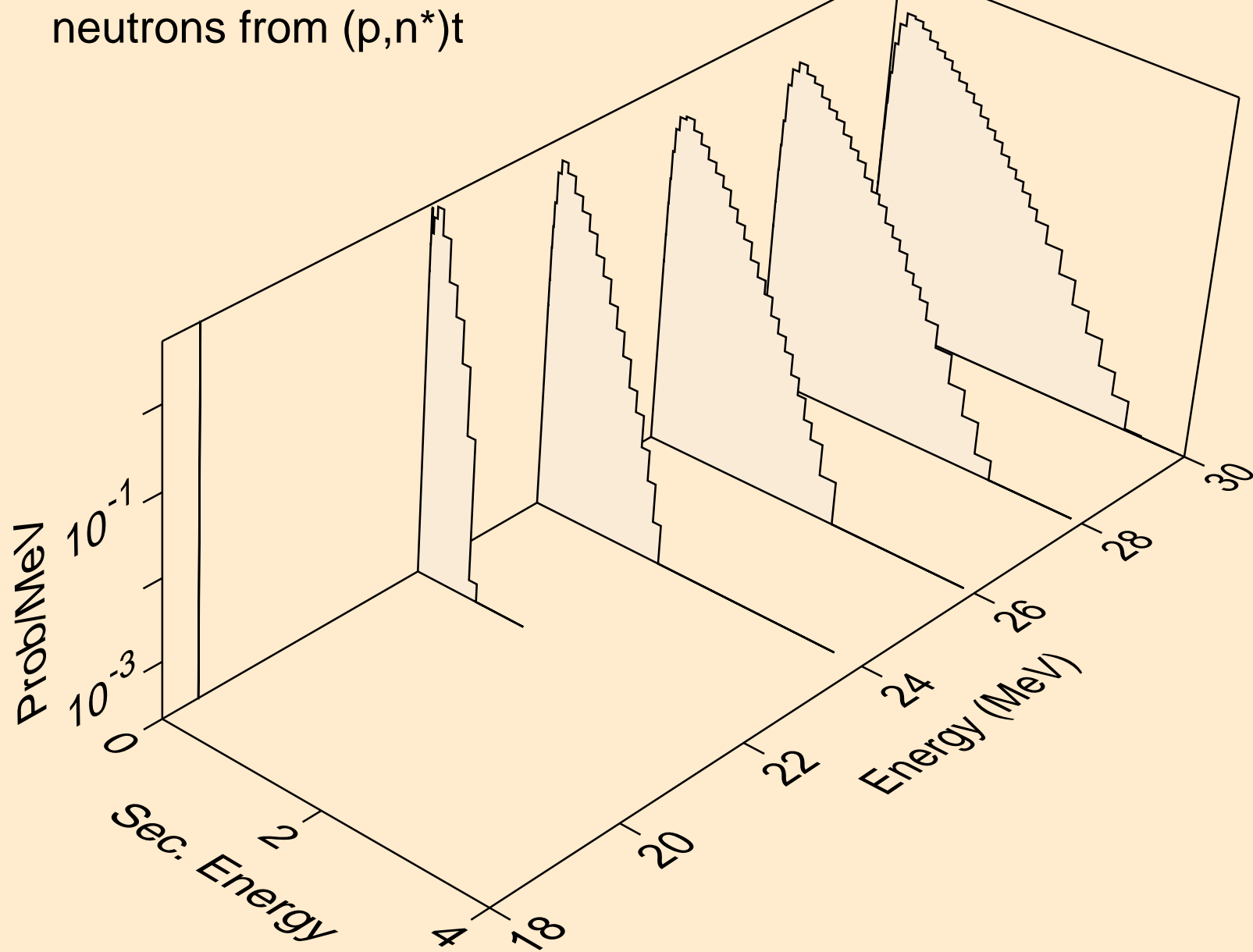

AU187 PROTON ACER TENDL-2021 LIBRARY; T=0.K  
neutrons from (p,n\*)he3

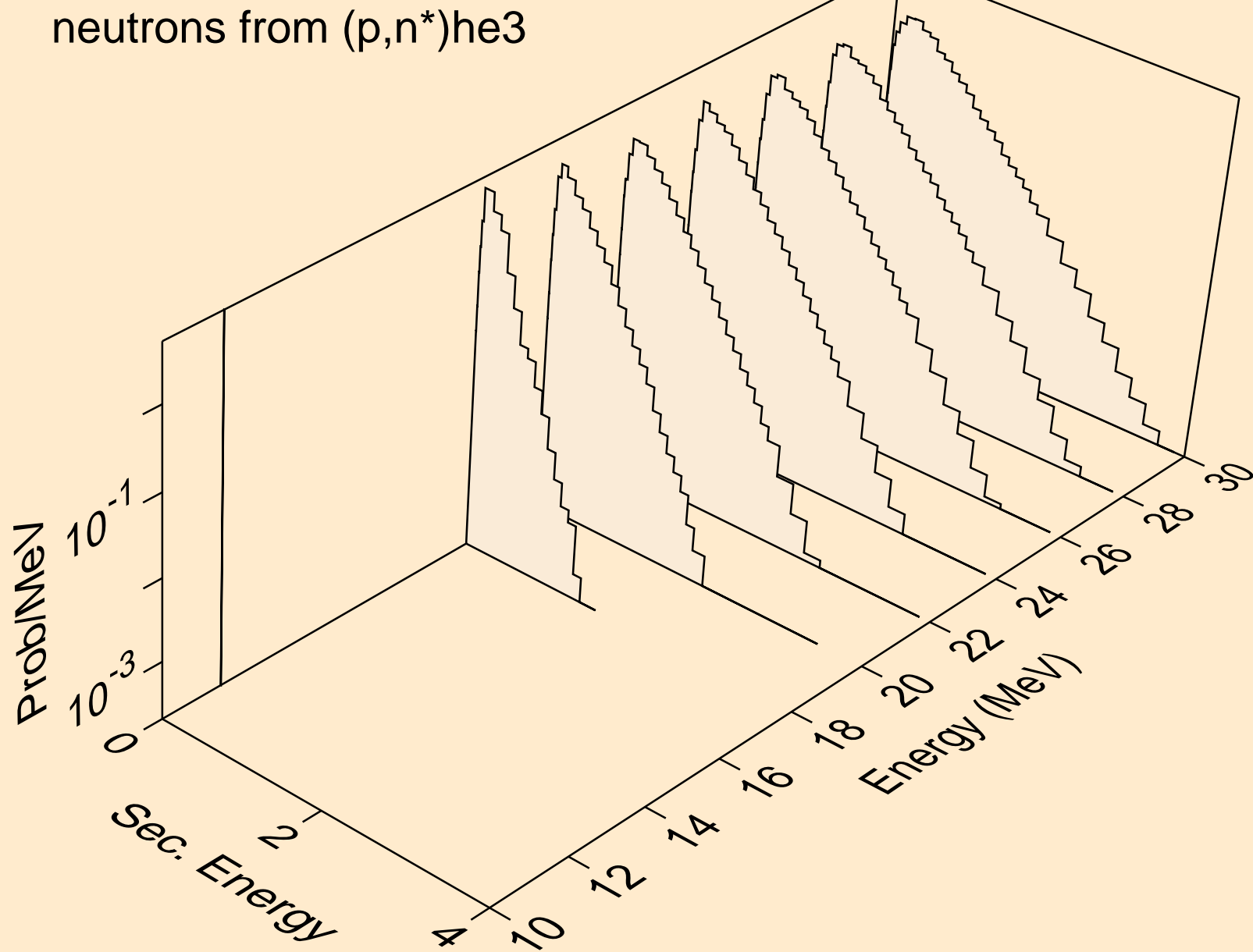

AU187 PROTON ACER TENDL-2021 LIBRARY; T=0.K  
neutrons from (p,2np)

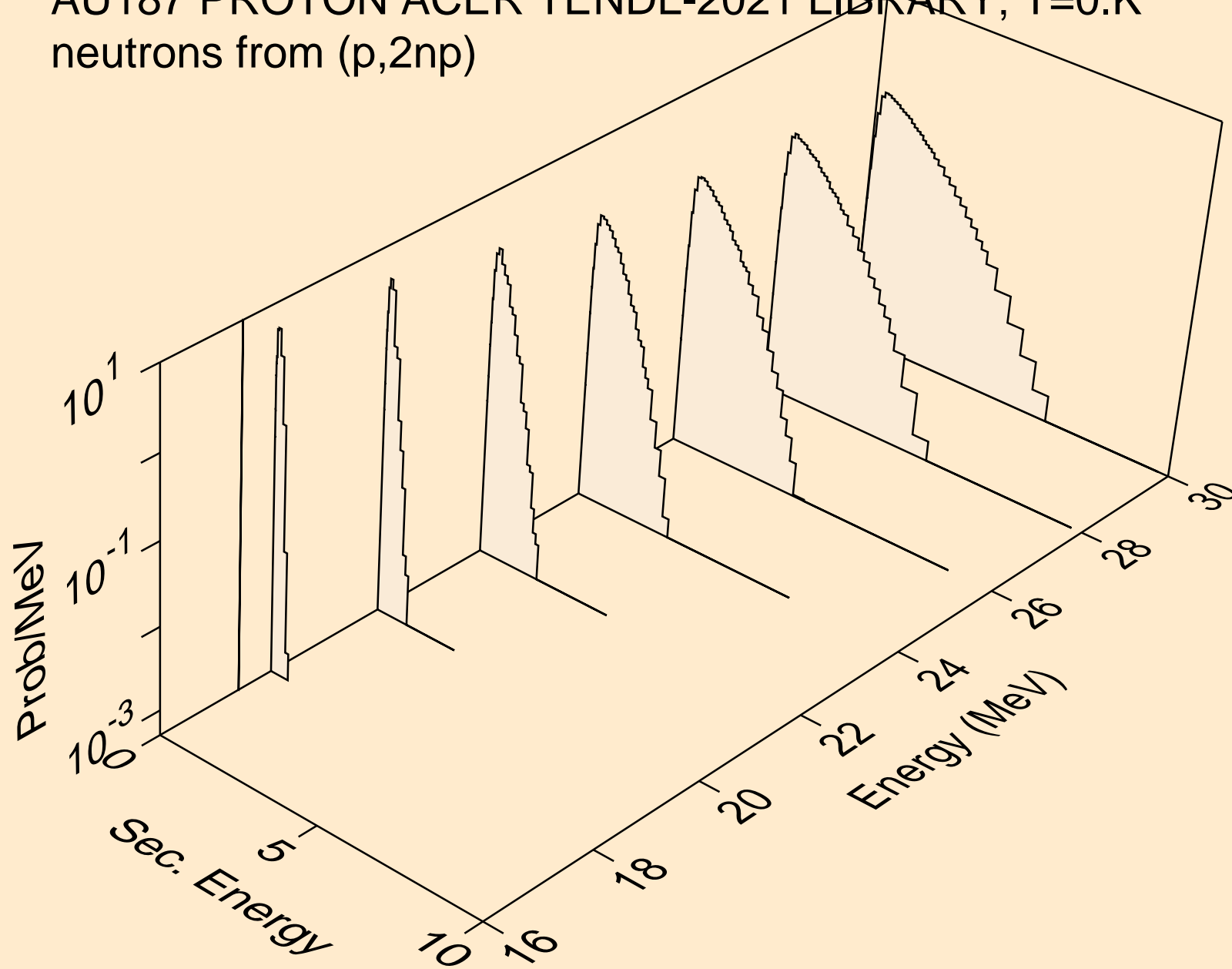



AU187 PROTON ACER TENDL-2021 LIBRARY; T=0.K  
neutrons from (p,2np)

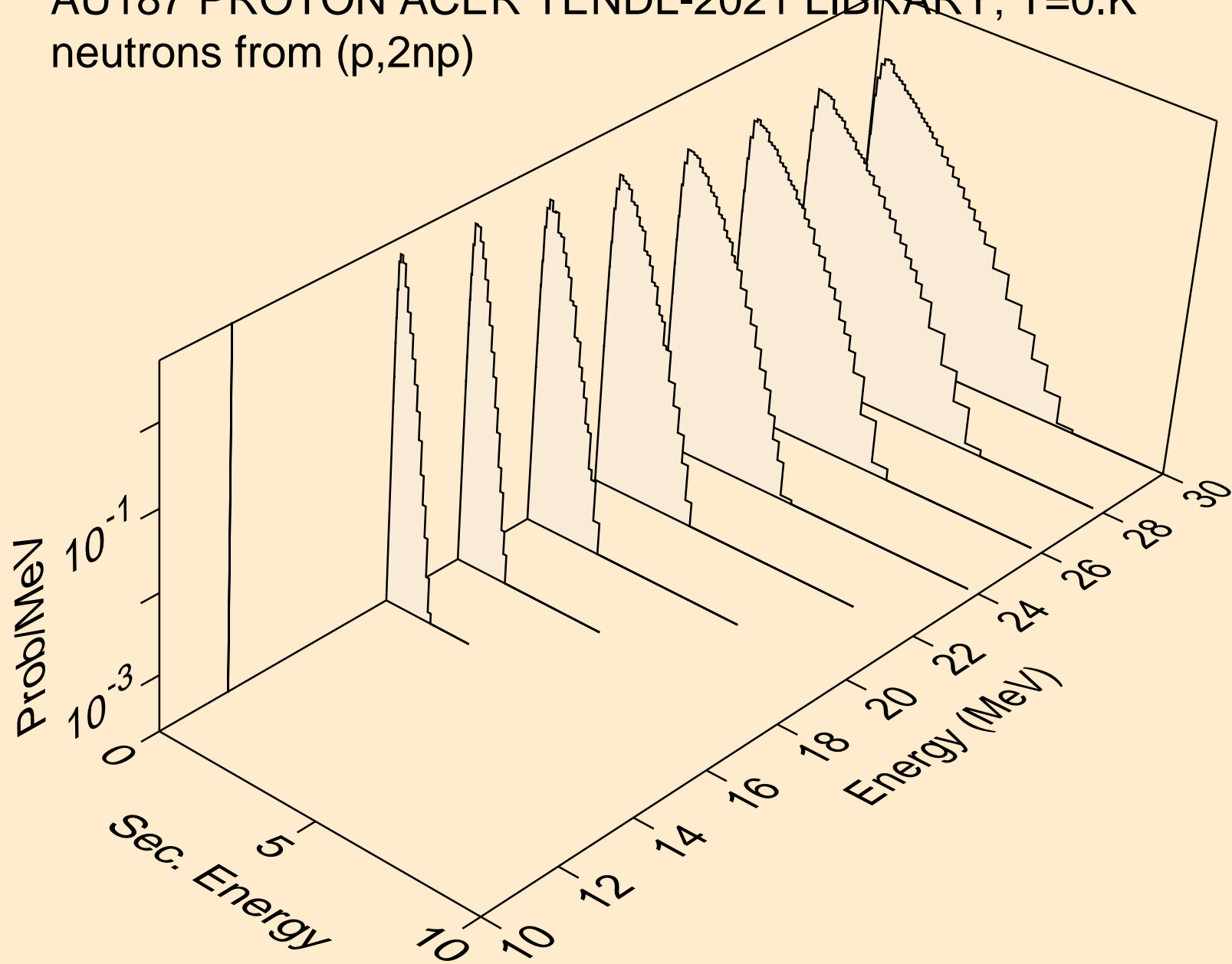

AU187 PROTON ACER TENDL-2021 LIBRARY; T=0.K  
neutrons from (p,npa)

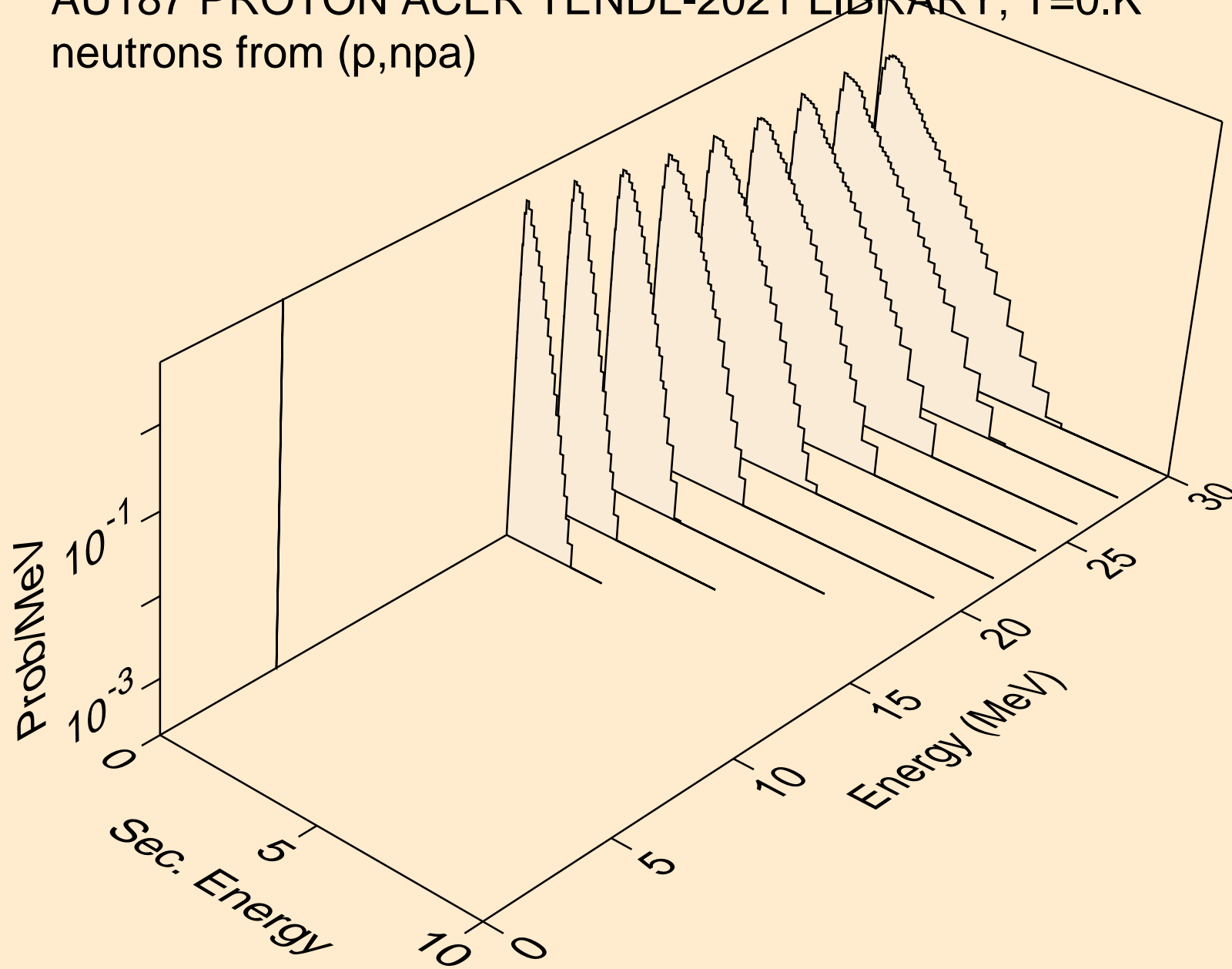

AU187 PROTON ACER TENDL-2021 LIBRARY; T=0.K  
deuterons from (p,x)

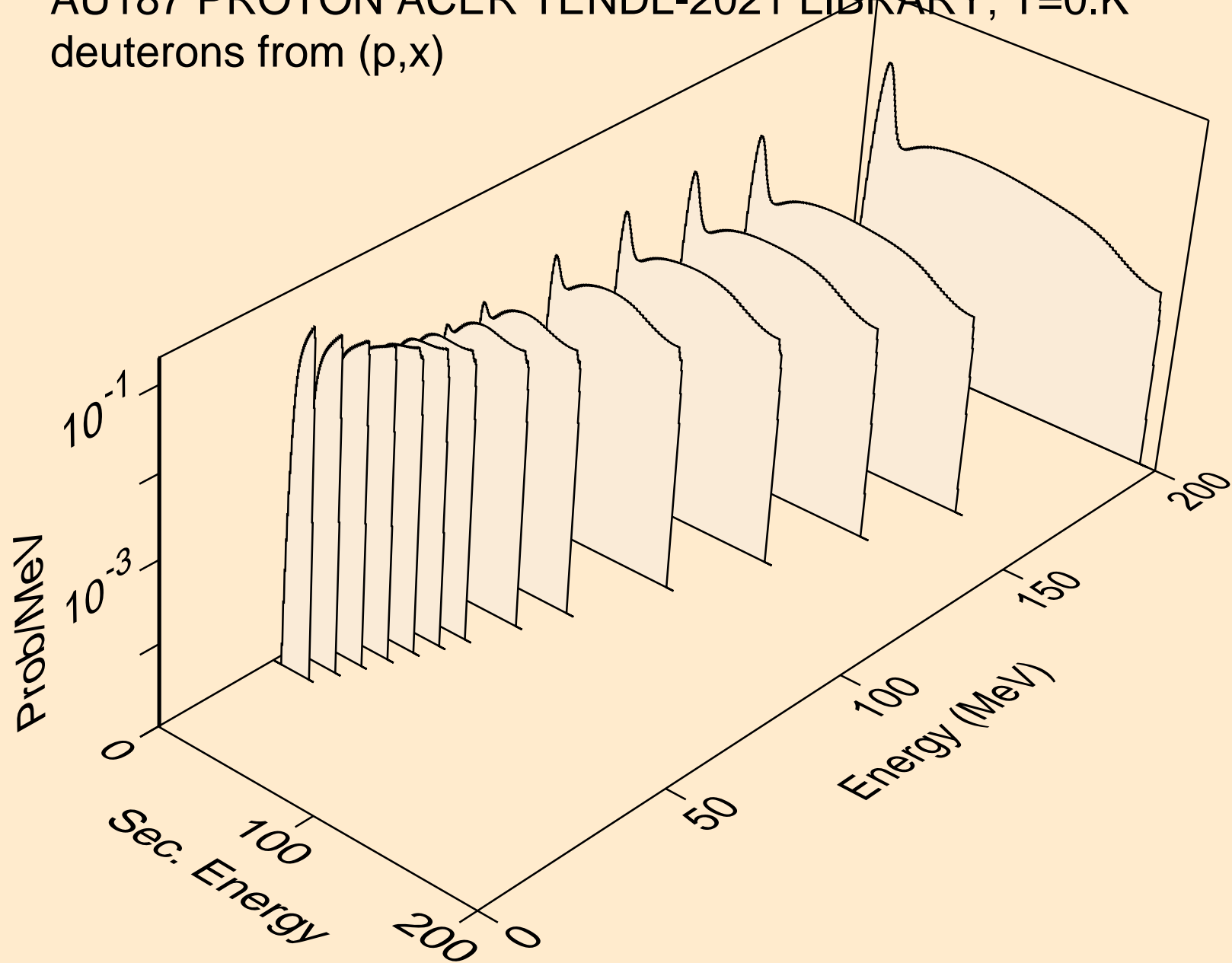

AU187 PROTON ACER TENDL-2021 LIBRARY; T=0.K  
deuterons from (p,n\*)d

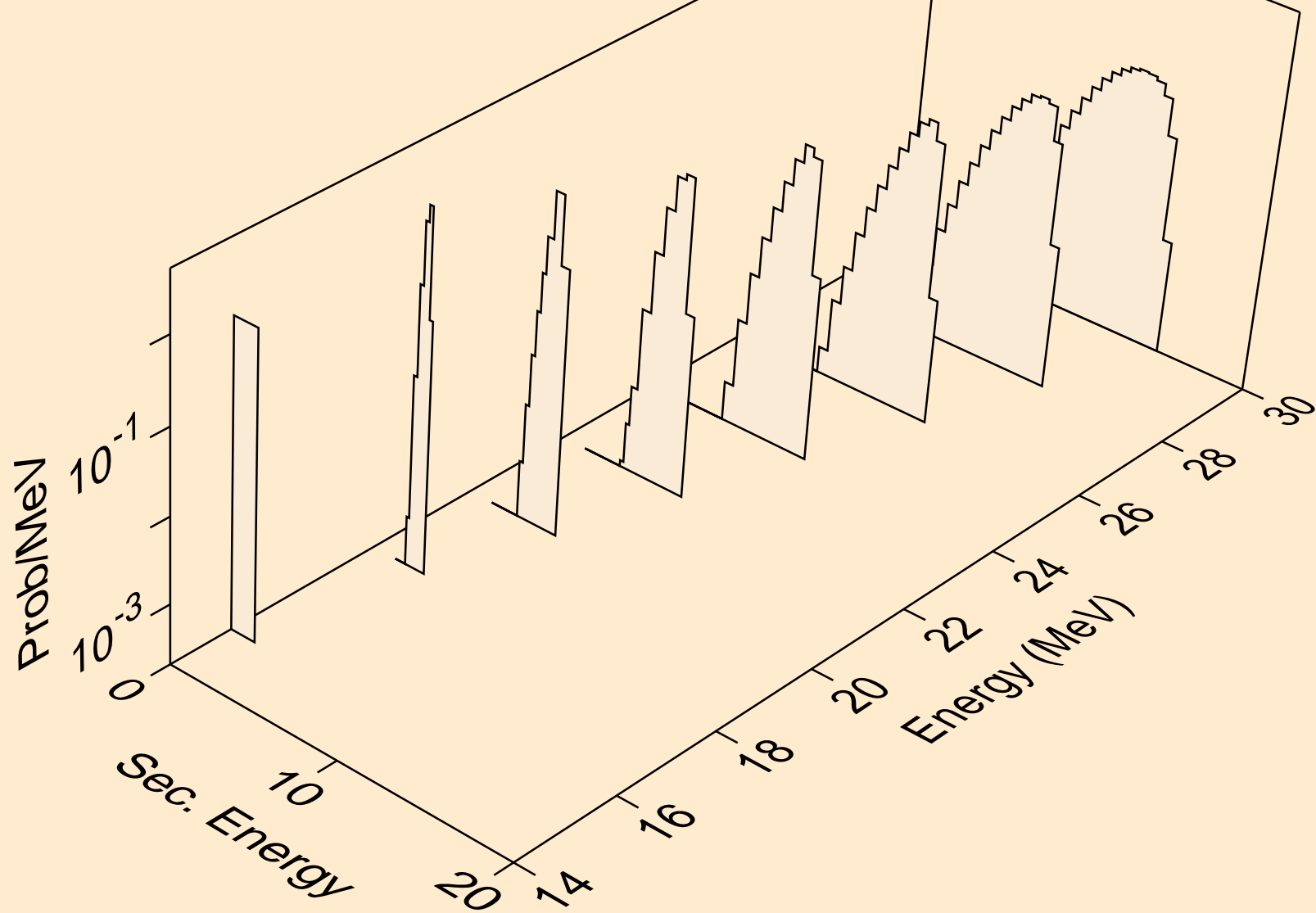

AU187 PROTON ACER TENDL-2021 LIBRARY; T=0.K  
deuterons from (p,d)

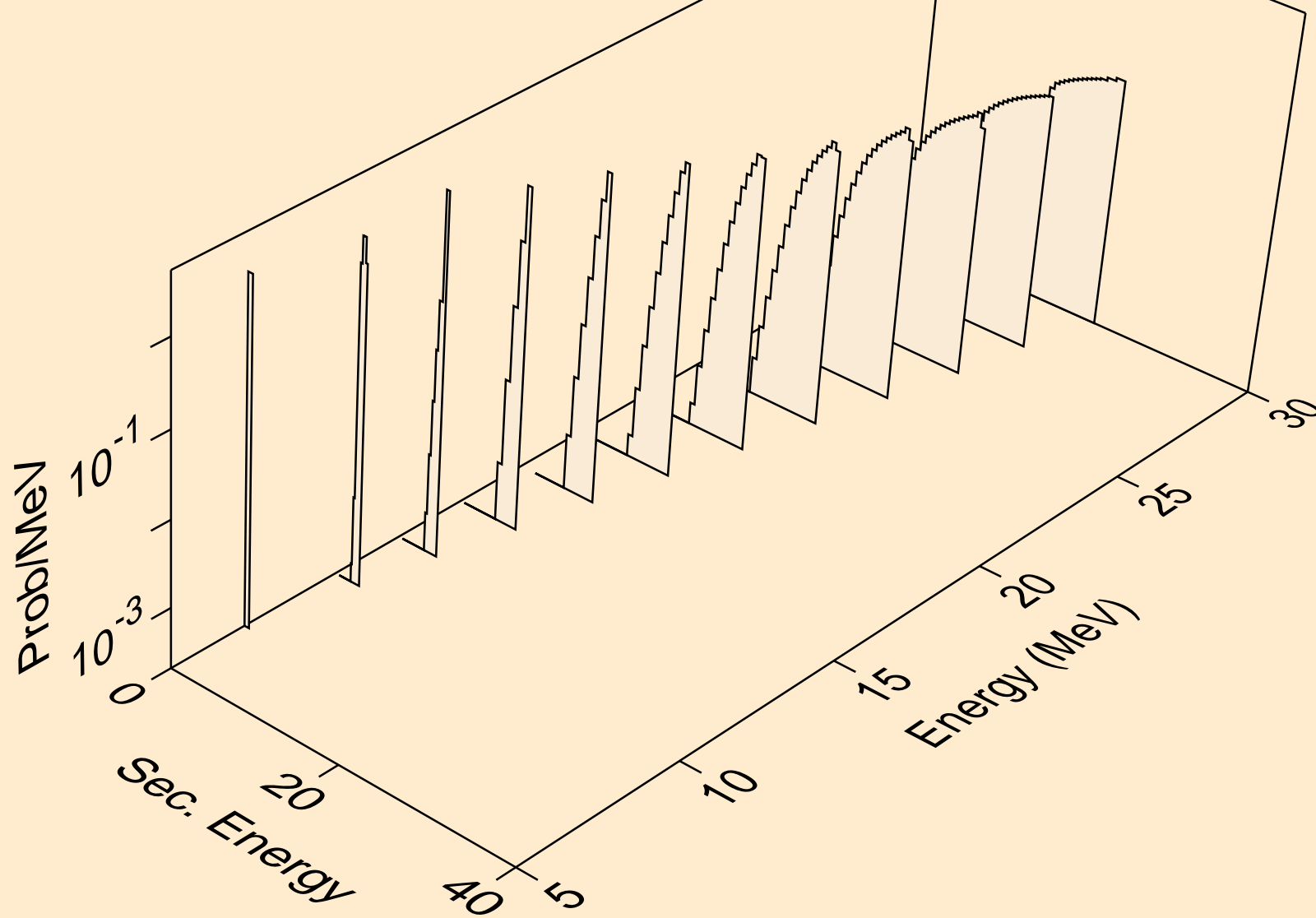

AU187 PROTON ACER TENDL-2021 LIBRARY; T=0.K  
deuterons from (p,pd)

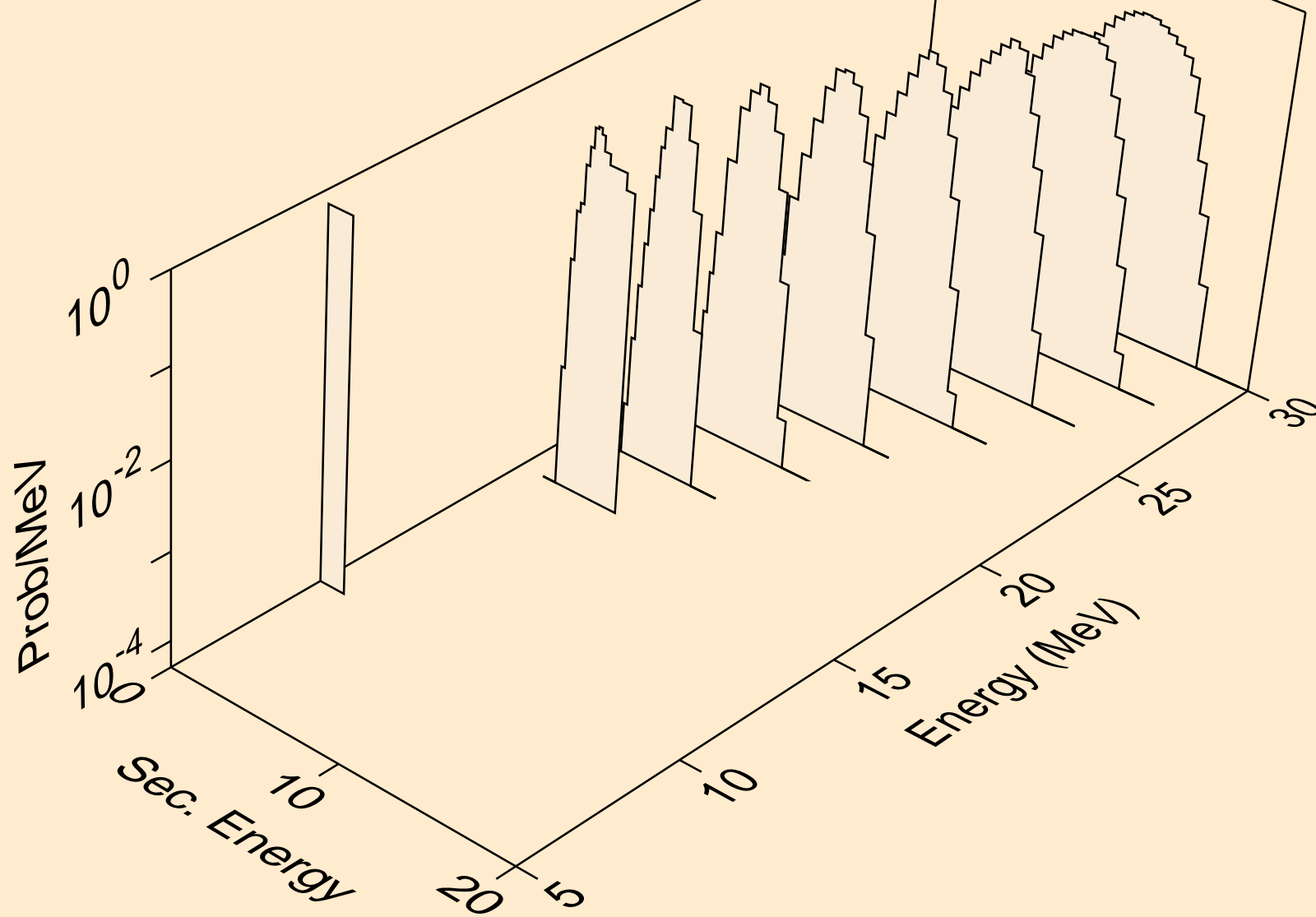

AU187 PROTON ACER TENDL-2021 LIBRARY; T=0.K  
deuterons from (p,da)

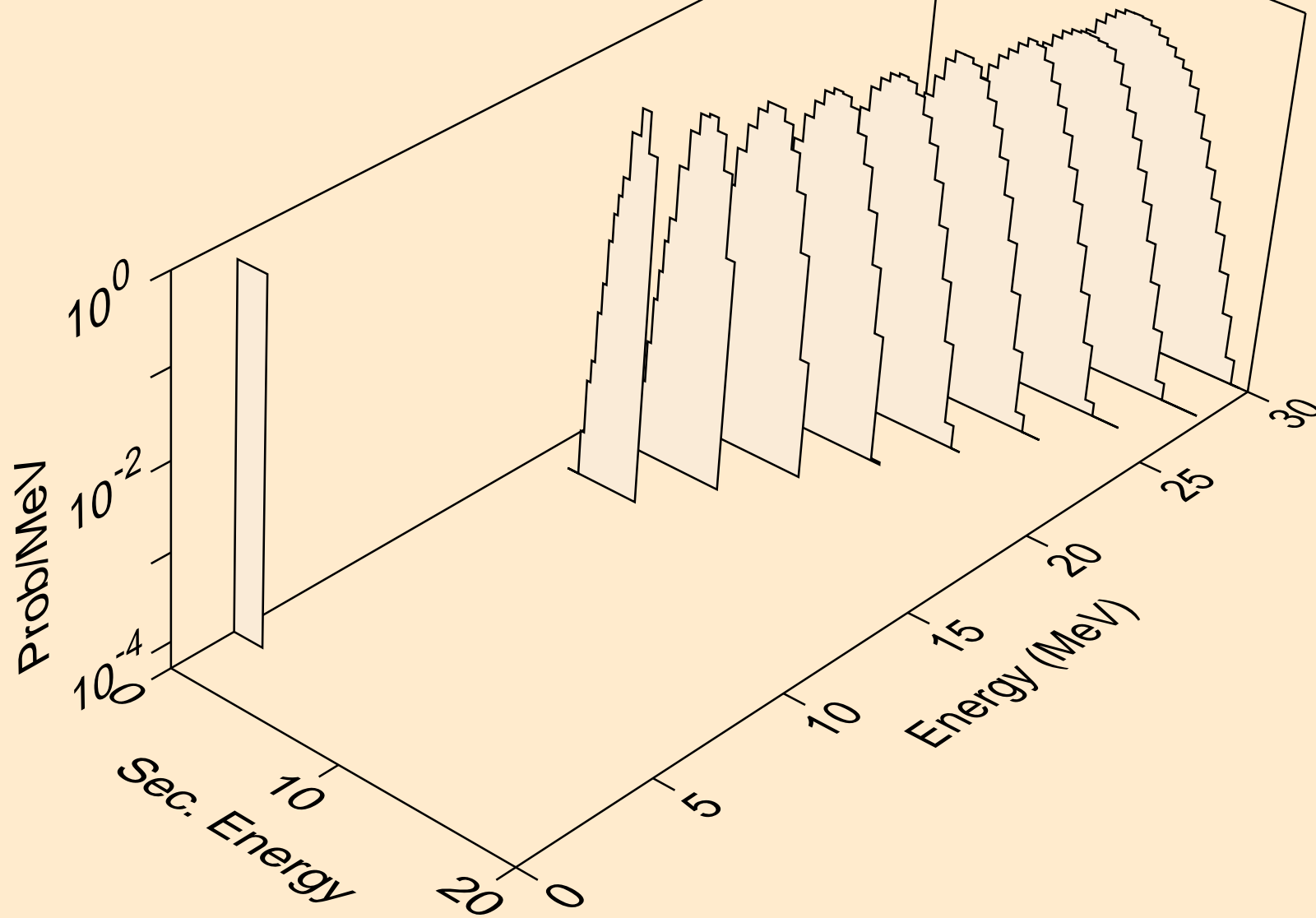

AU187 PROTON ACER TENDL-2021 LIBRARY; T=0.K  
tritons from (p,x)

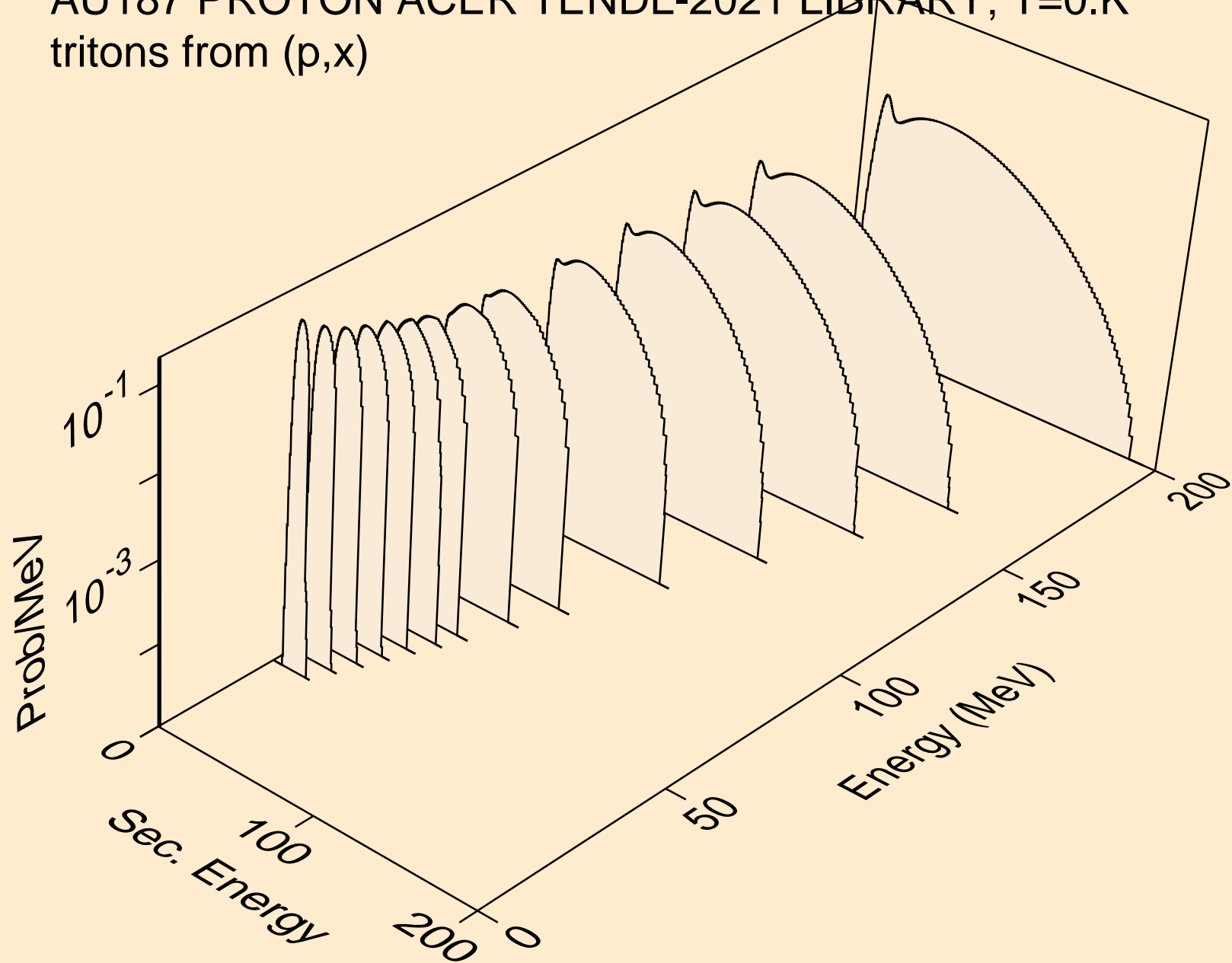



AU187 PROTON ACER TENDL-2021 LIBRARY; T=0.K  
tritons from (p,n\*)t

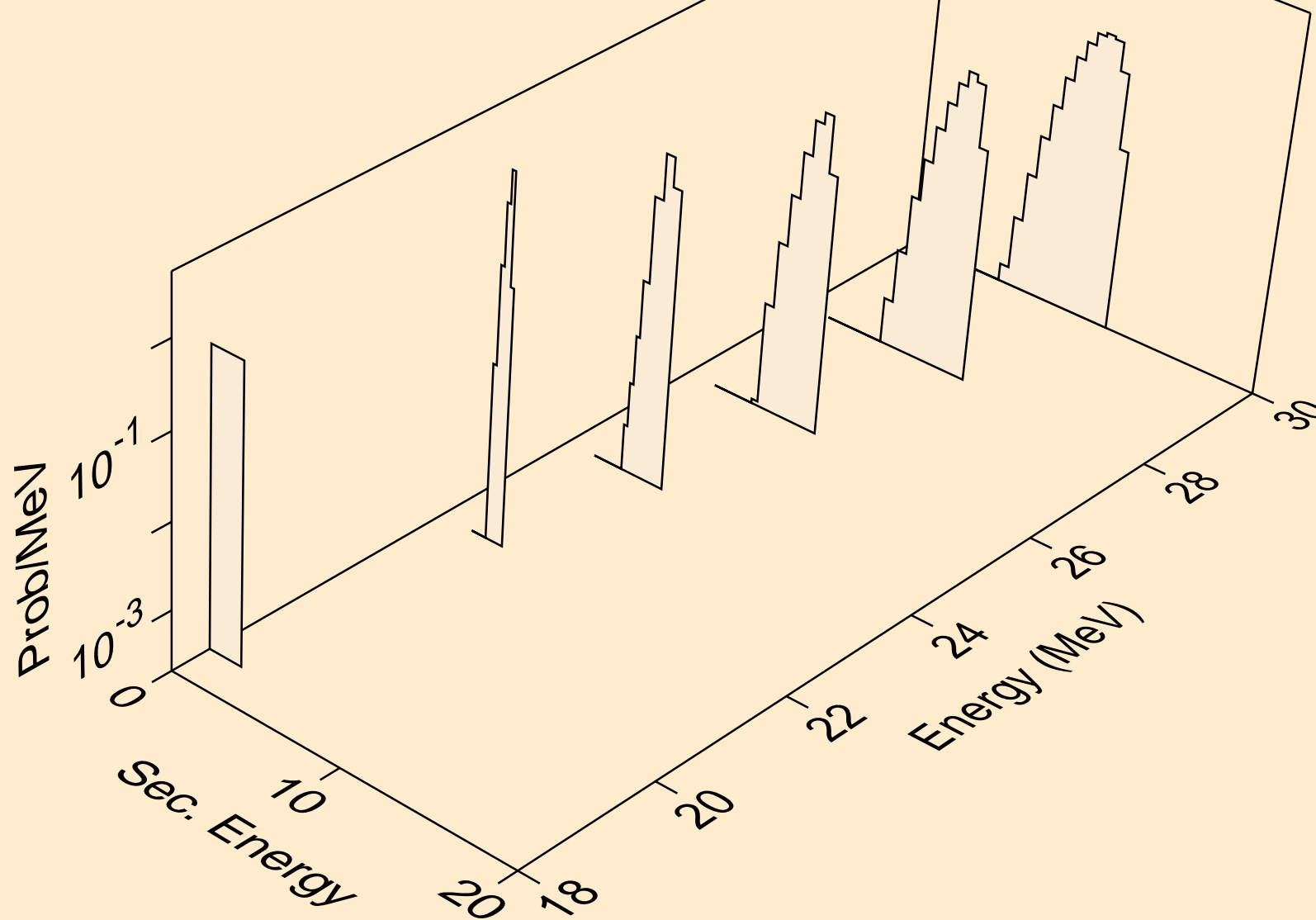

AU187 PROTON ACER TENDL-2021 LIBRARY; T=0.K  
tritons from (p,t)

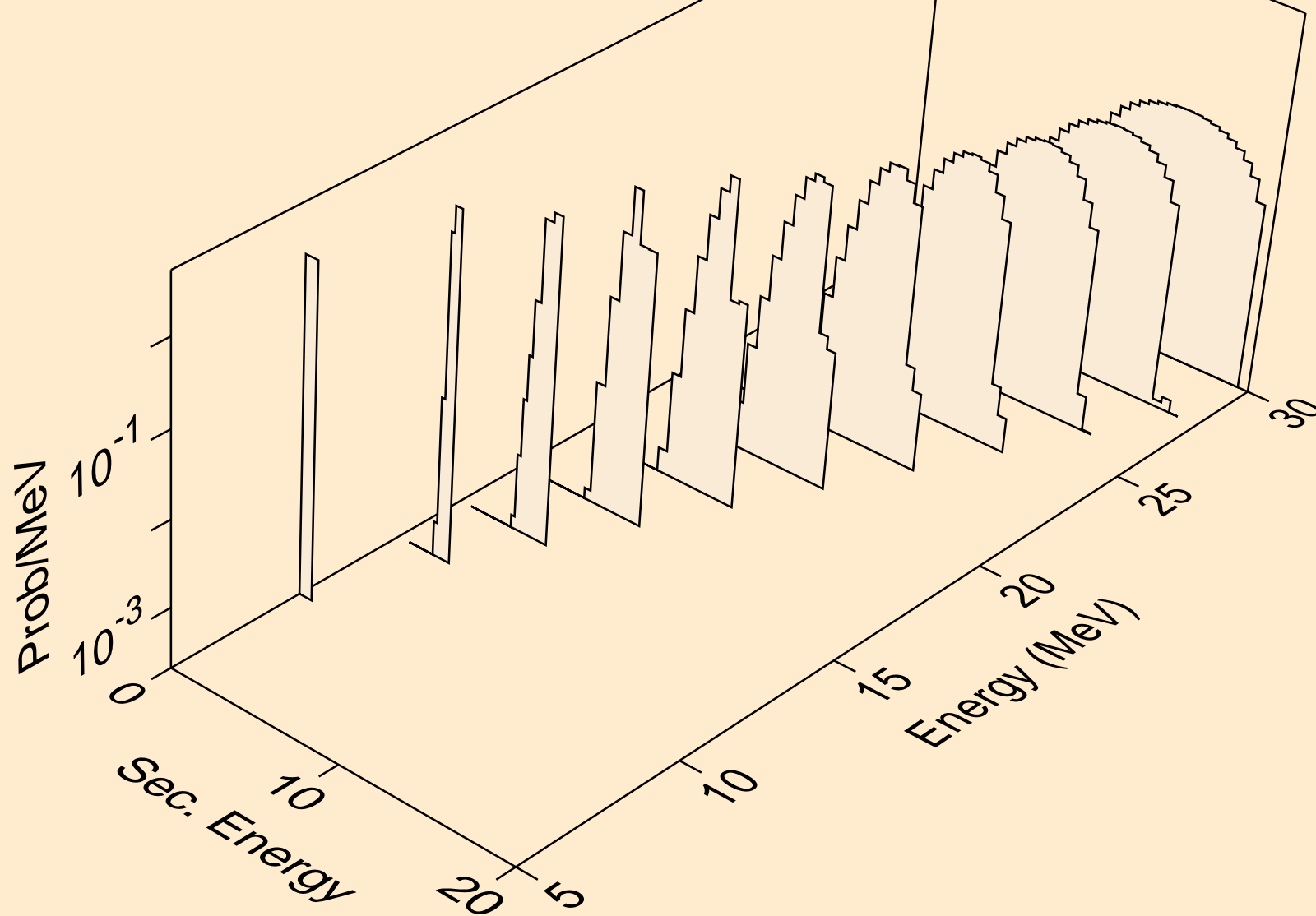

AU187 PROTON ACER TENDL-2021 LIBRARY; T=0.K  
tritons from (p,pt)

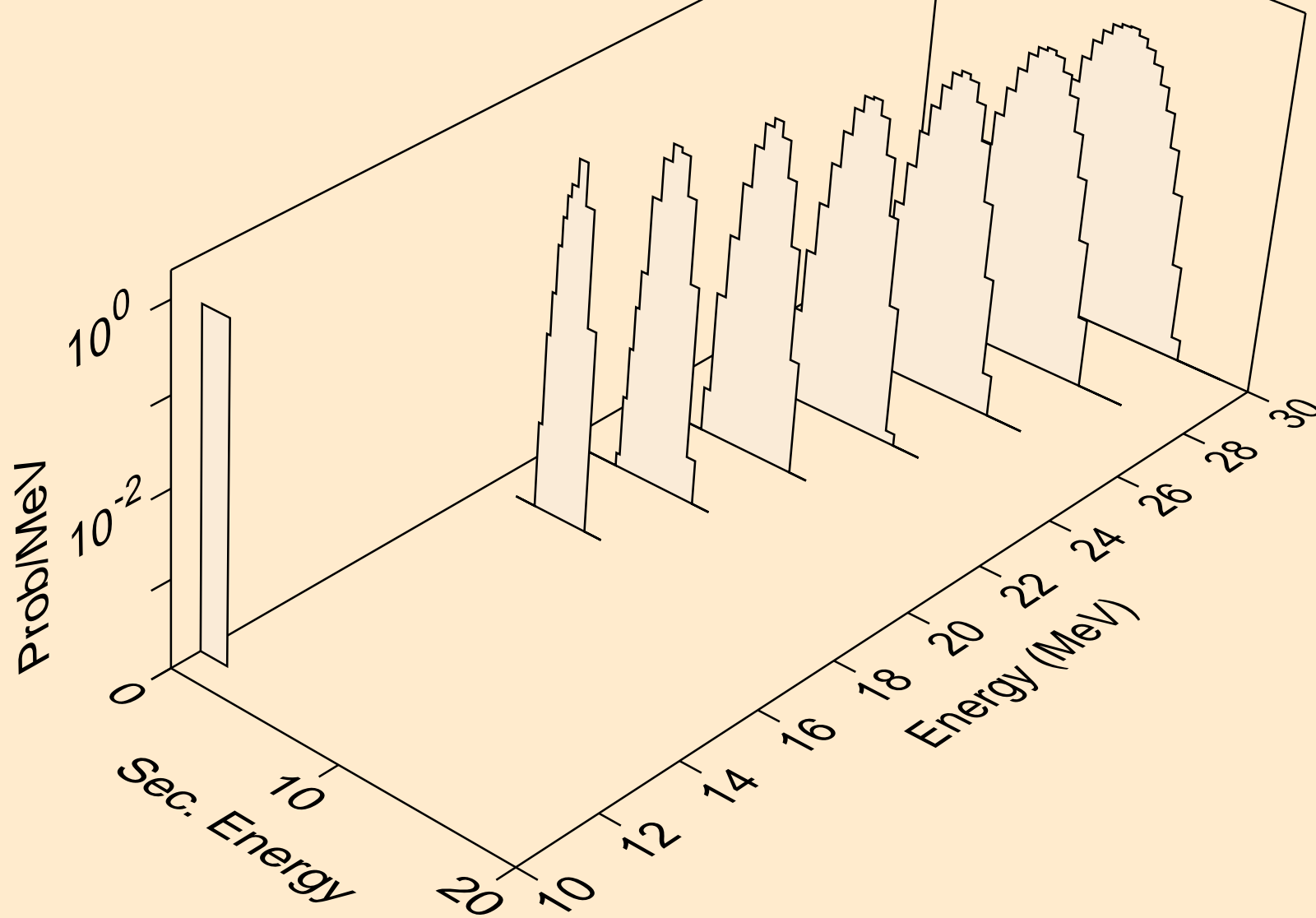

AU187 PROTON ACER TENDL-2021 LIBRARY; T=0.K  
he3s from (p,x)

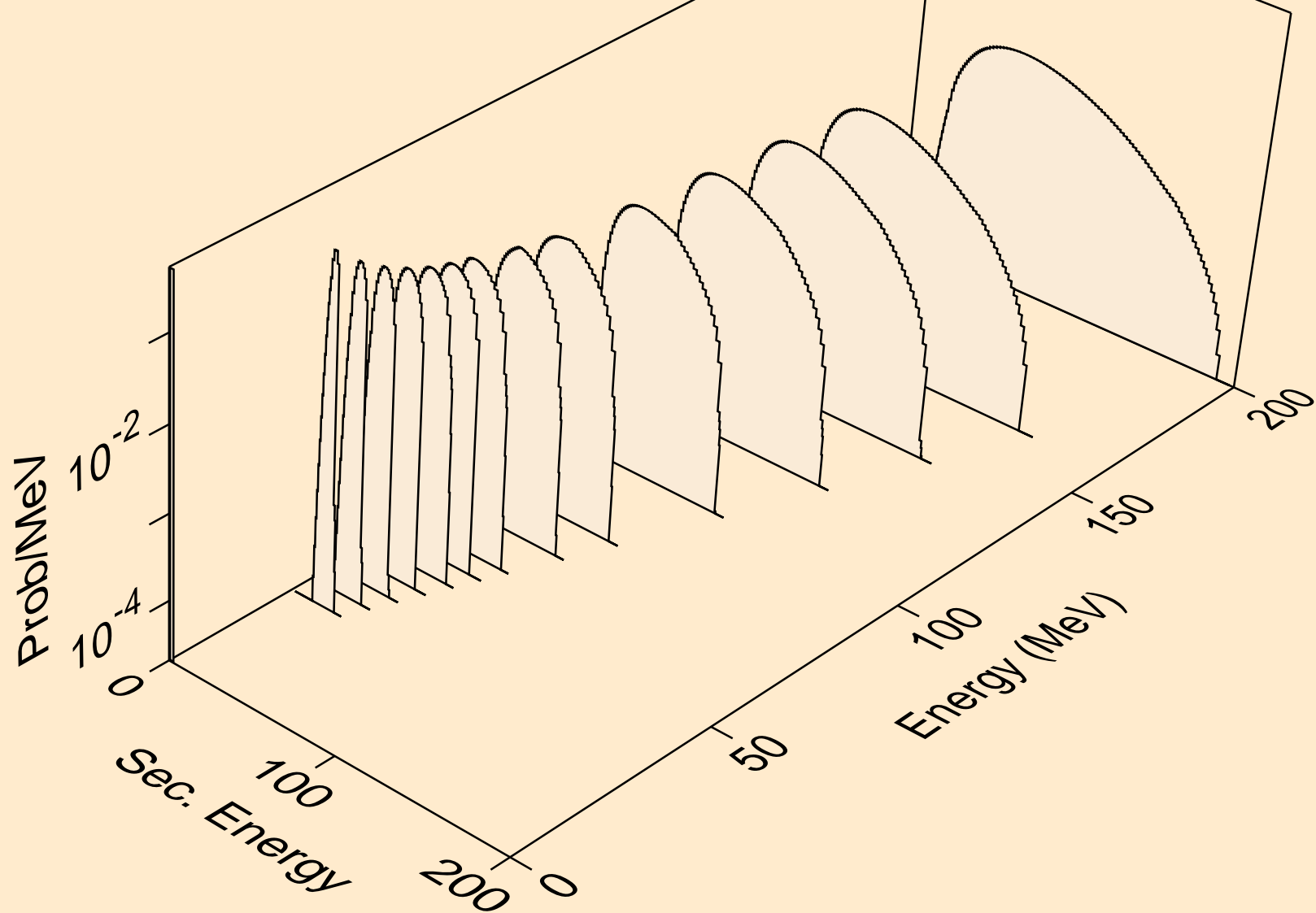

AU187 PROTON ACER TENDL-2021 LIBRARY; T=0.K  
he3s from (p,n\*)he3

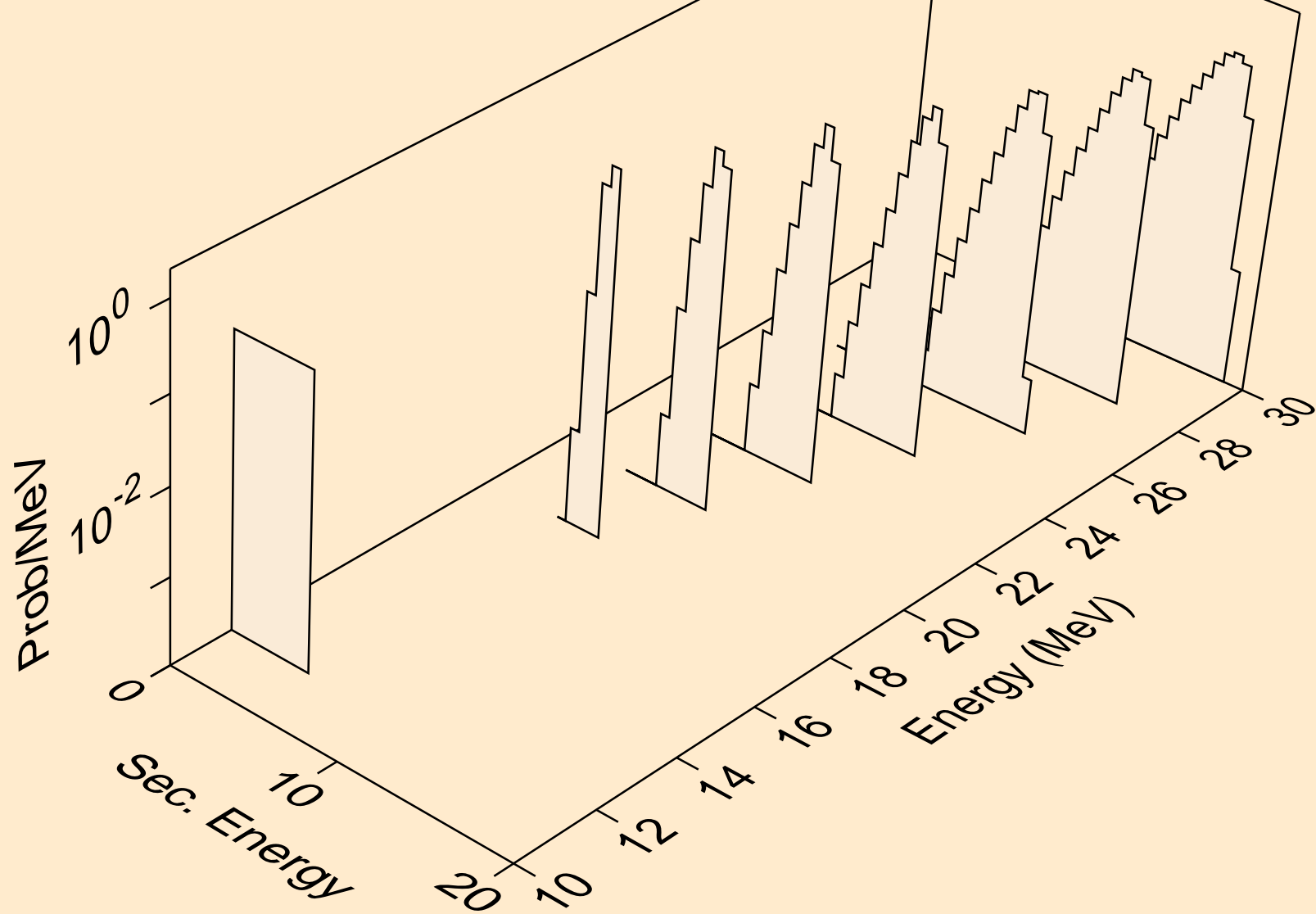

AU187 PROTON ACER TENDL-2021 LIBRARY; T=0.K  
he3s from (p,he3)

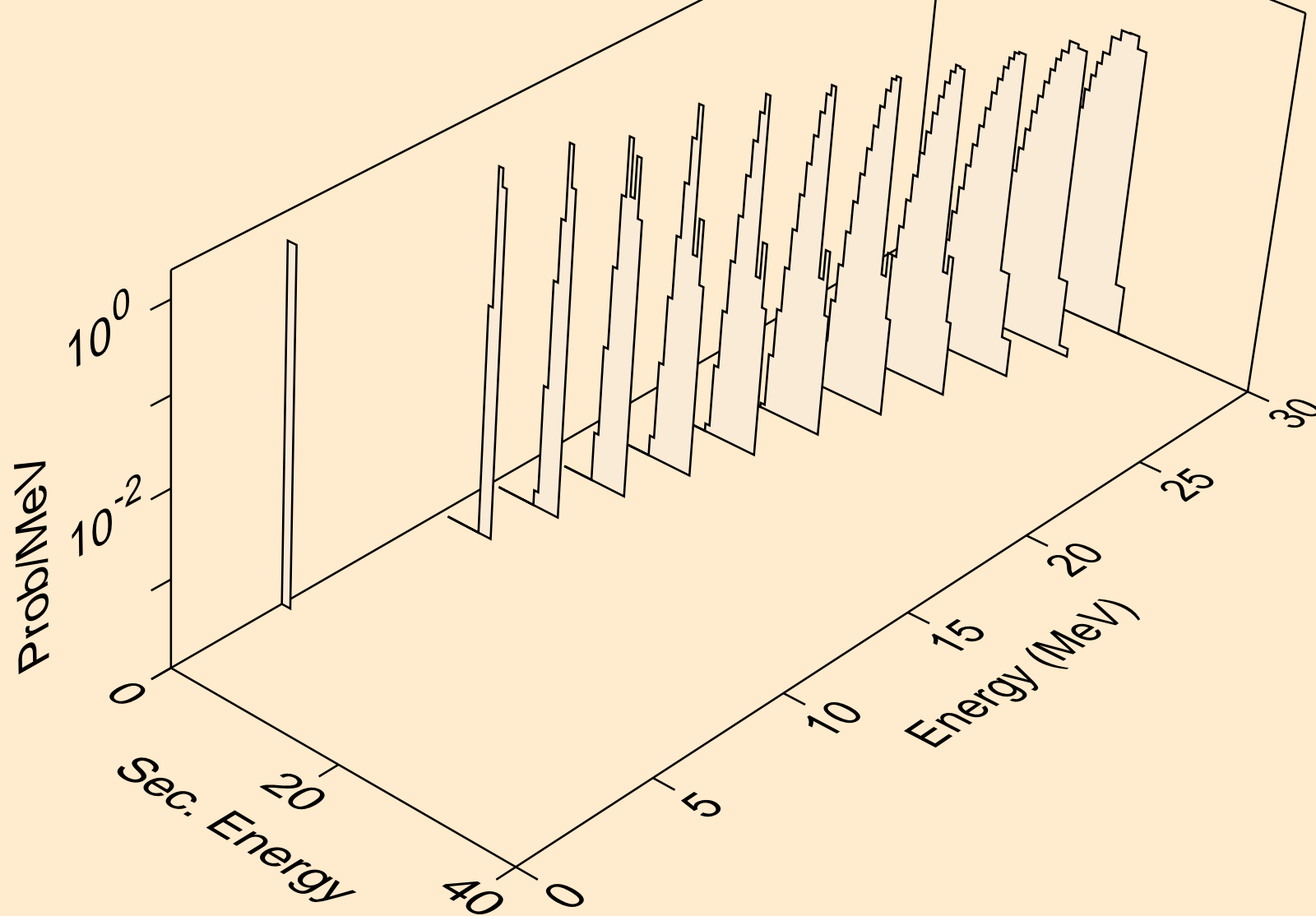

AU187 PROTON ACER TENDL-2021 LIBRARY; T=0.K  
alphas from (p,x)

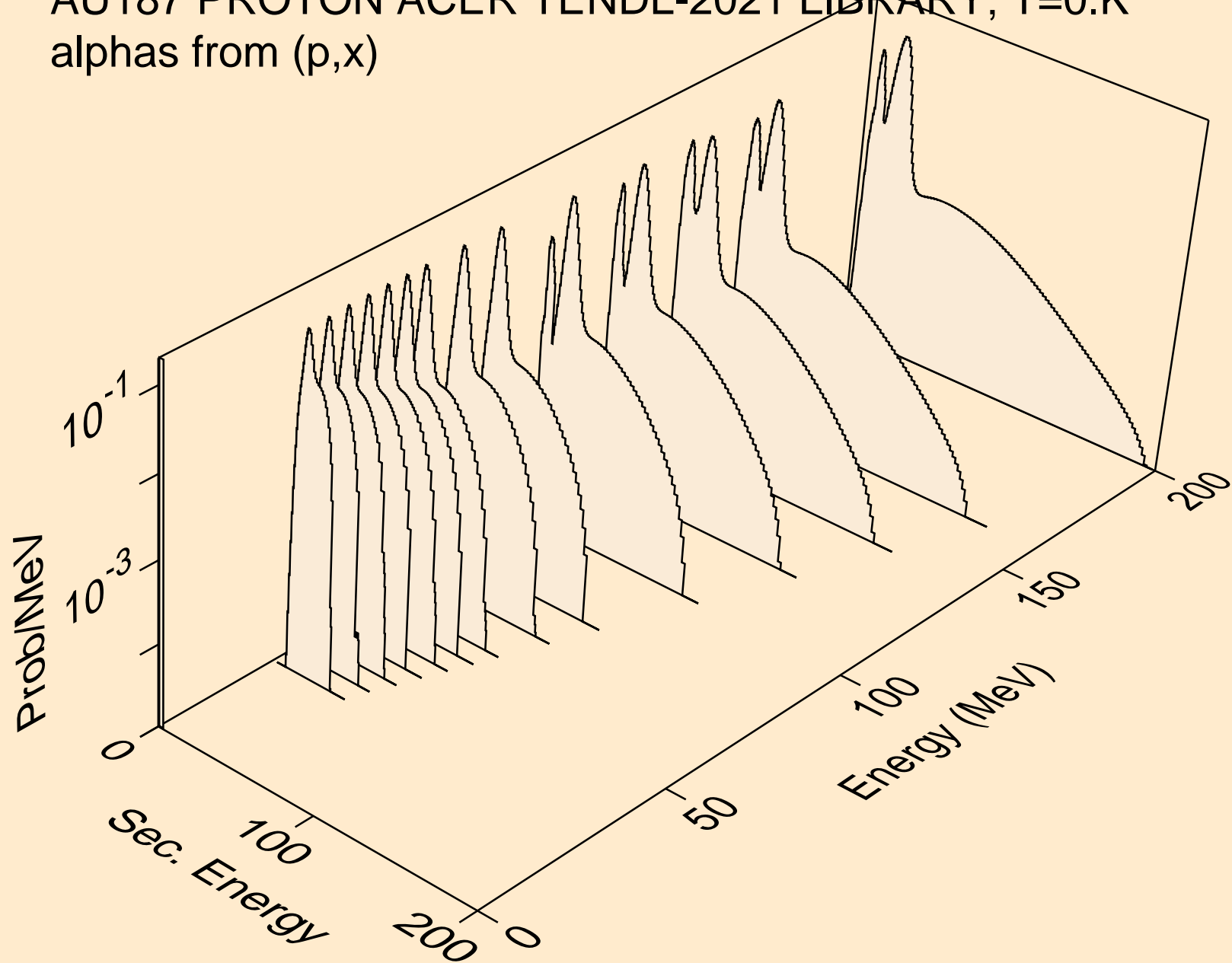

AU187 PROTON ACER TENDL-2021 LIBRARY; T=0.K  
alphas from (p,n\*)a

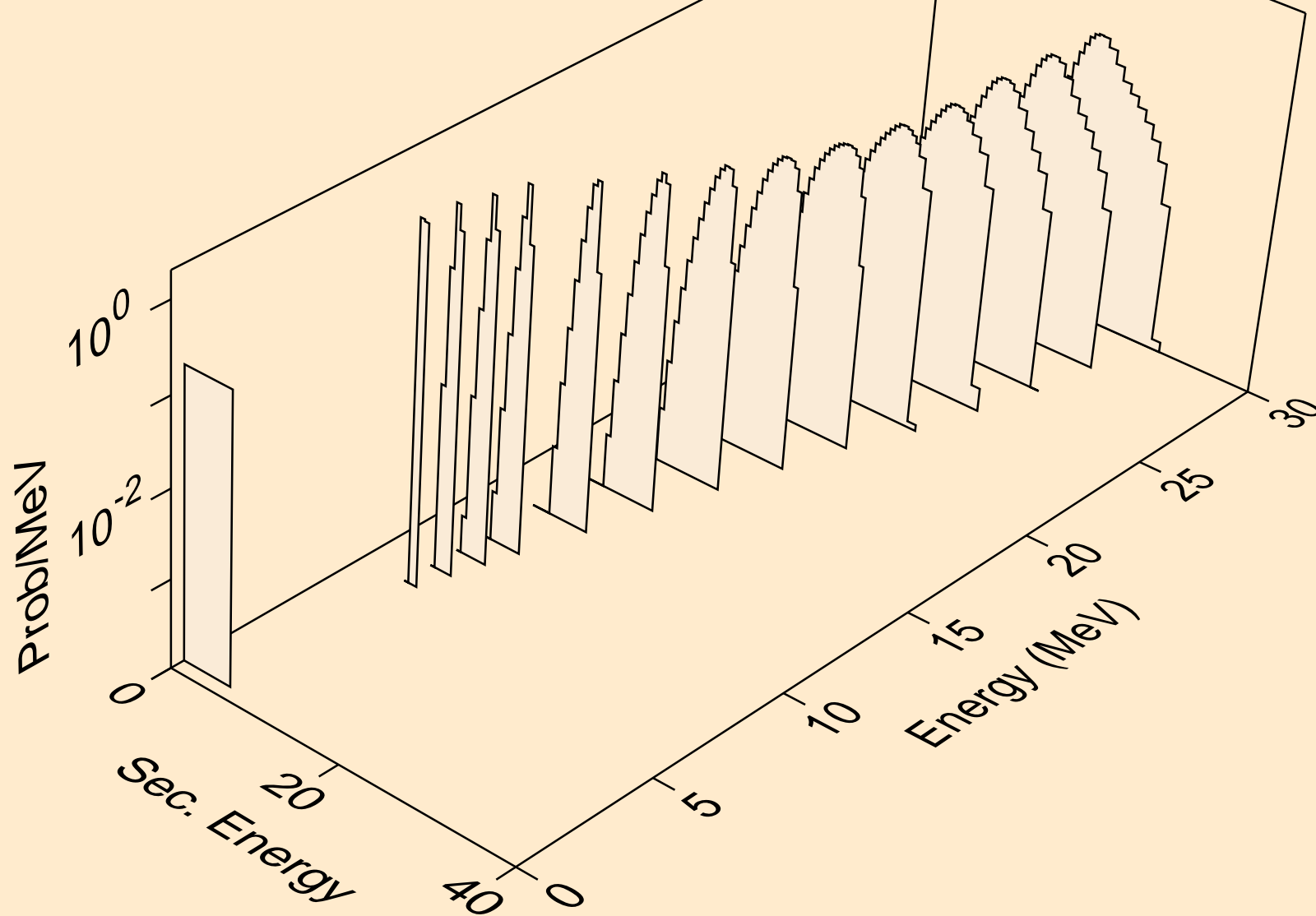



AU187 PROTON ACER TENDL-2021 LIBRARY; T=0.K  
alphas from (p,2n)a

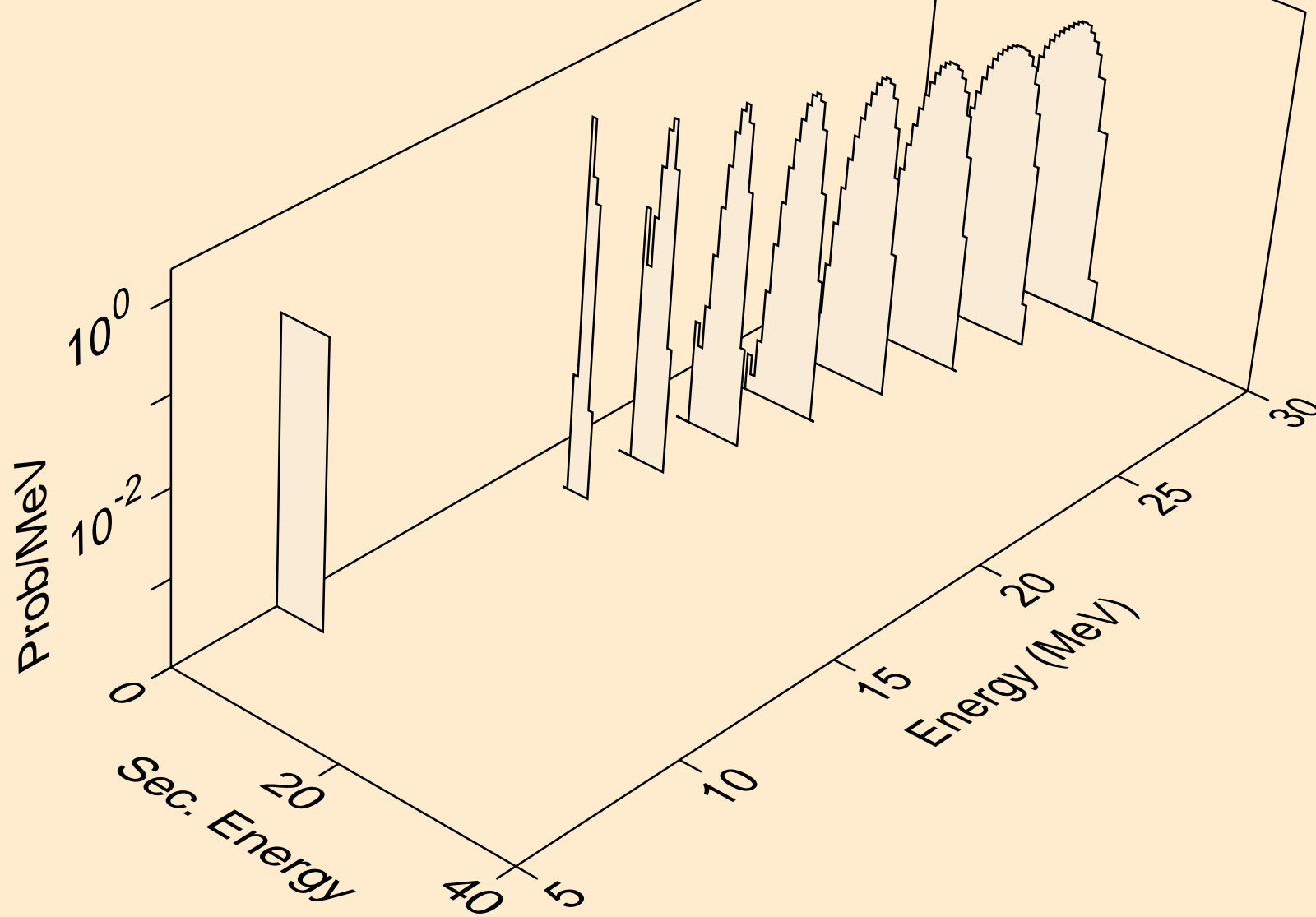

AU187 PROTON ACER TENDL-2021 LIBRARY; T=0.K  
alphas from (p,3n)a

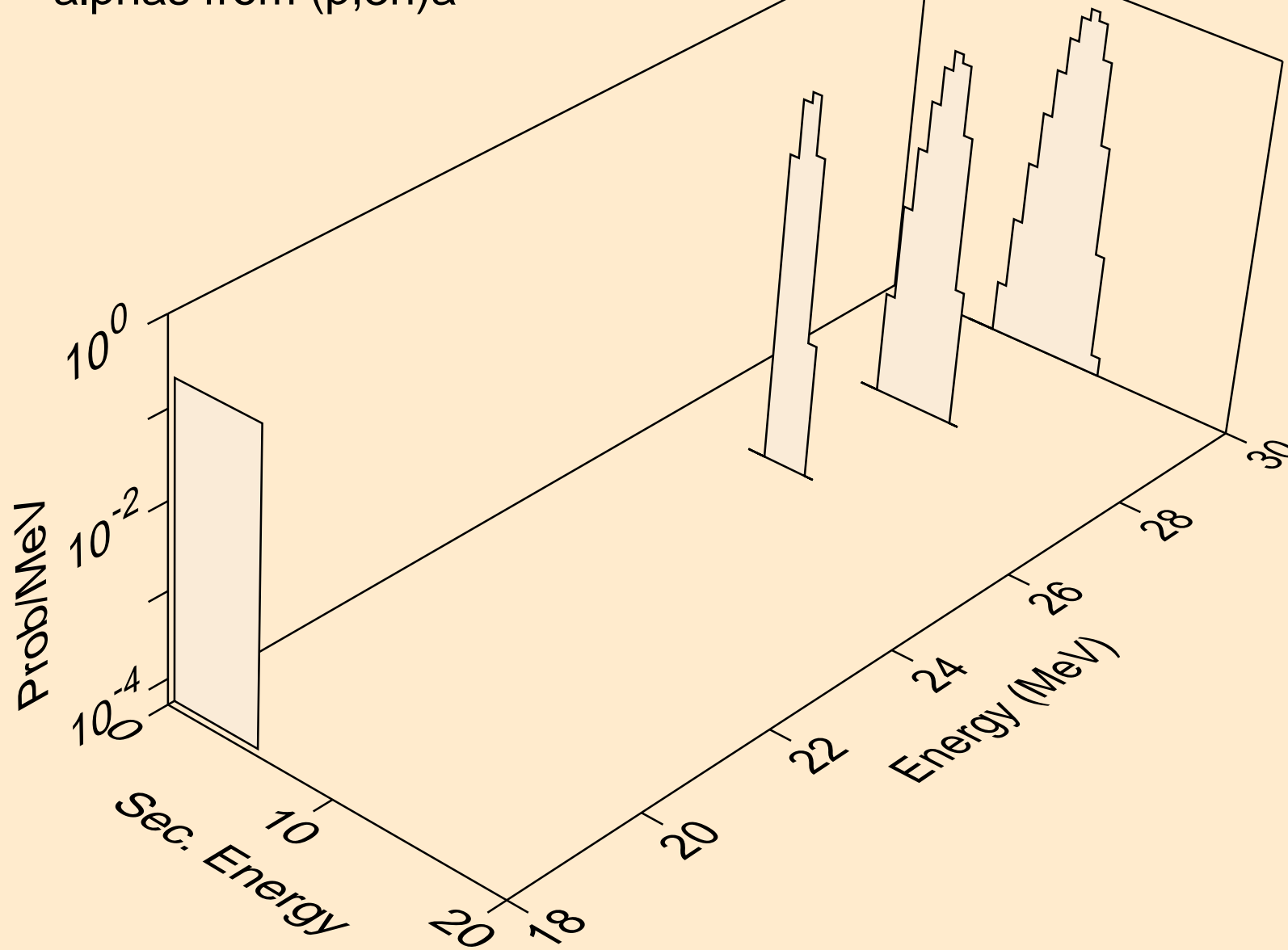

AU187 PROTON ACER TENDL-2021 LIBRARY; T=0.K  
alphas from (p,n\*)2a

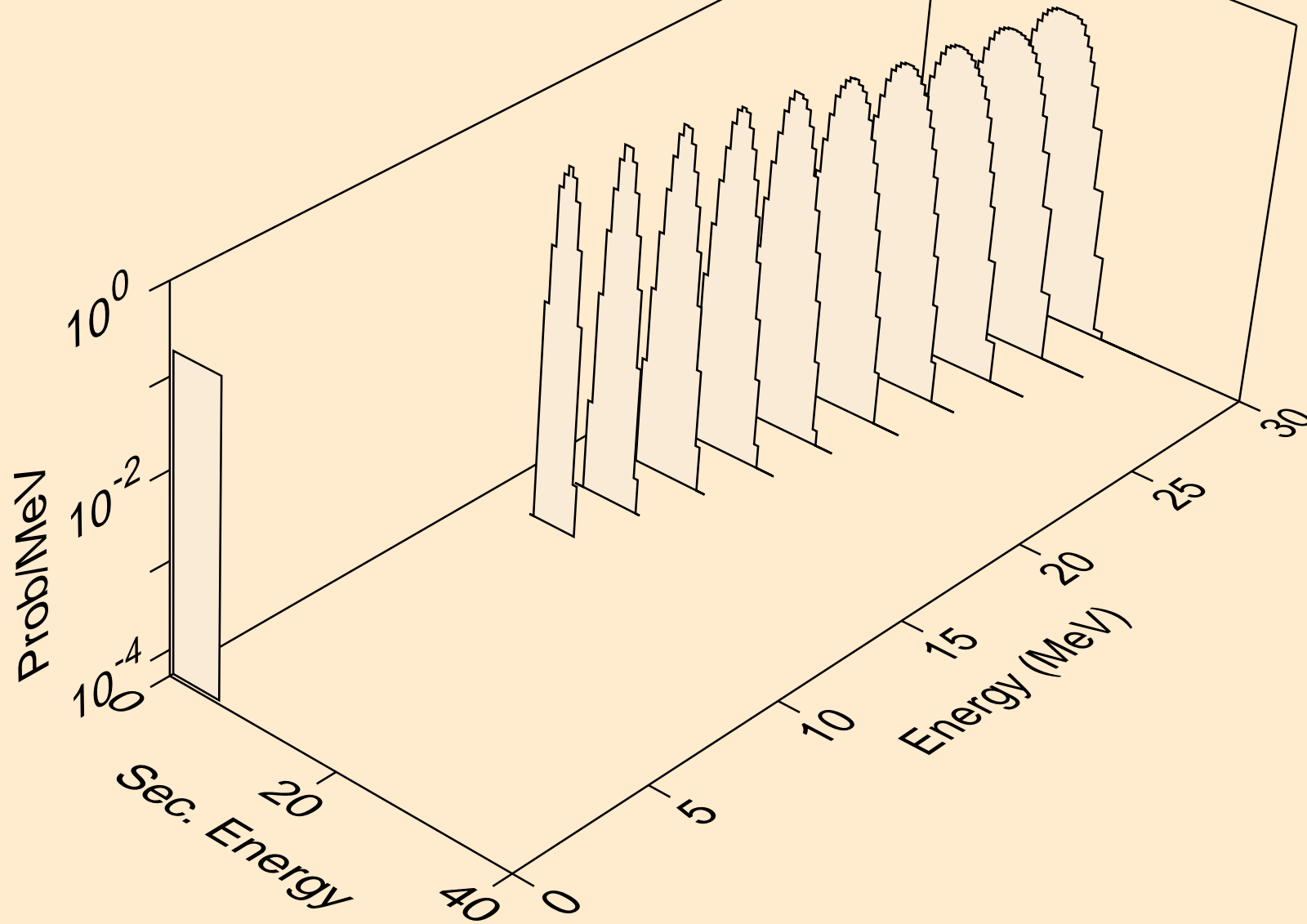

AU187 PROTON ACER TENDL-2021 LIBRARY; T=0.K  
alphas from (p,2n)2a

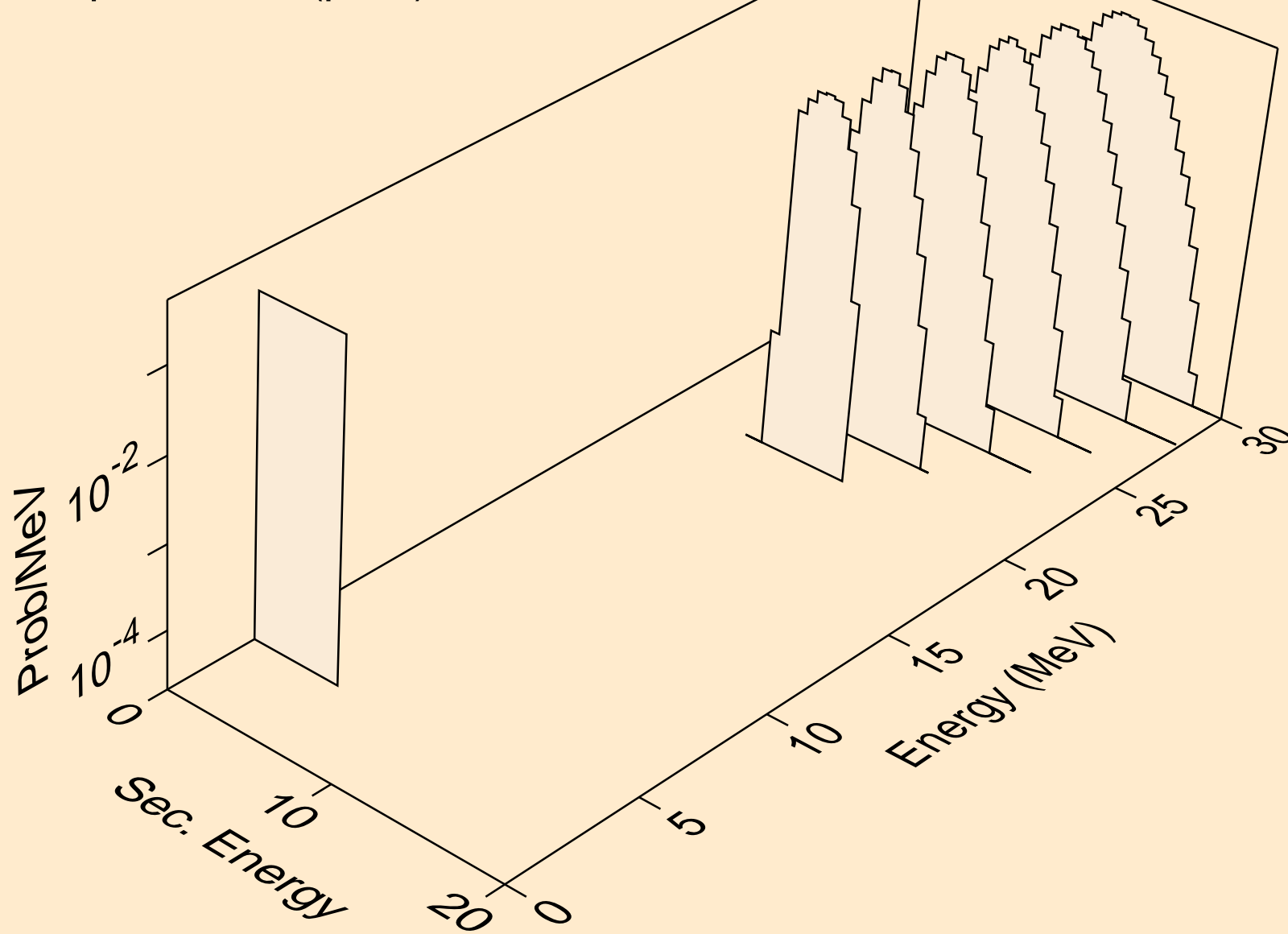

AU187 PROTON ACER TENDL-2021 LIBRARY; T=0.K  
alphas from (p,npa)

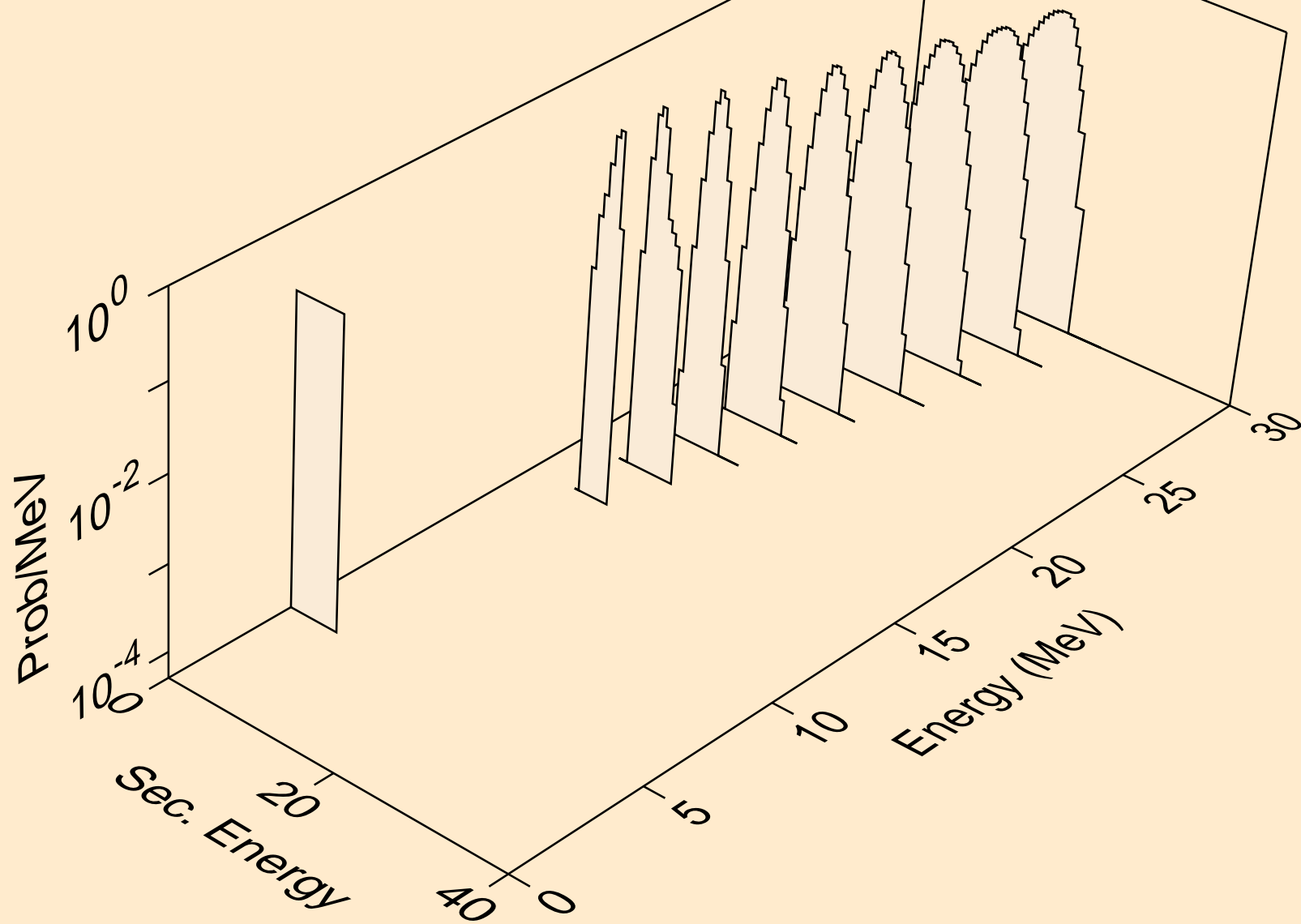

AU187 PROTON ACER TENDL-2021 LIBRARY; T=0.K  
alphas from (p,a)

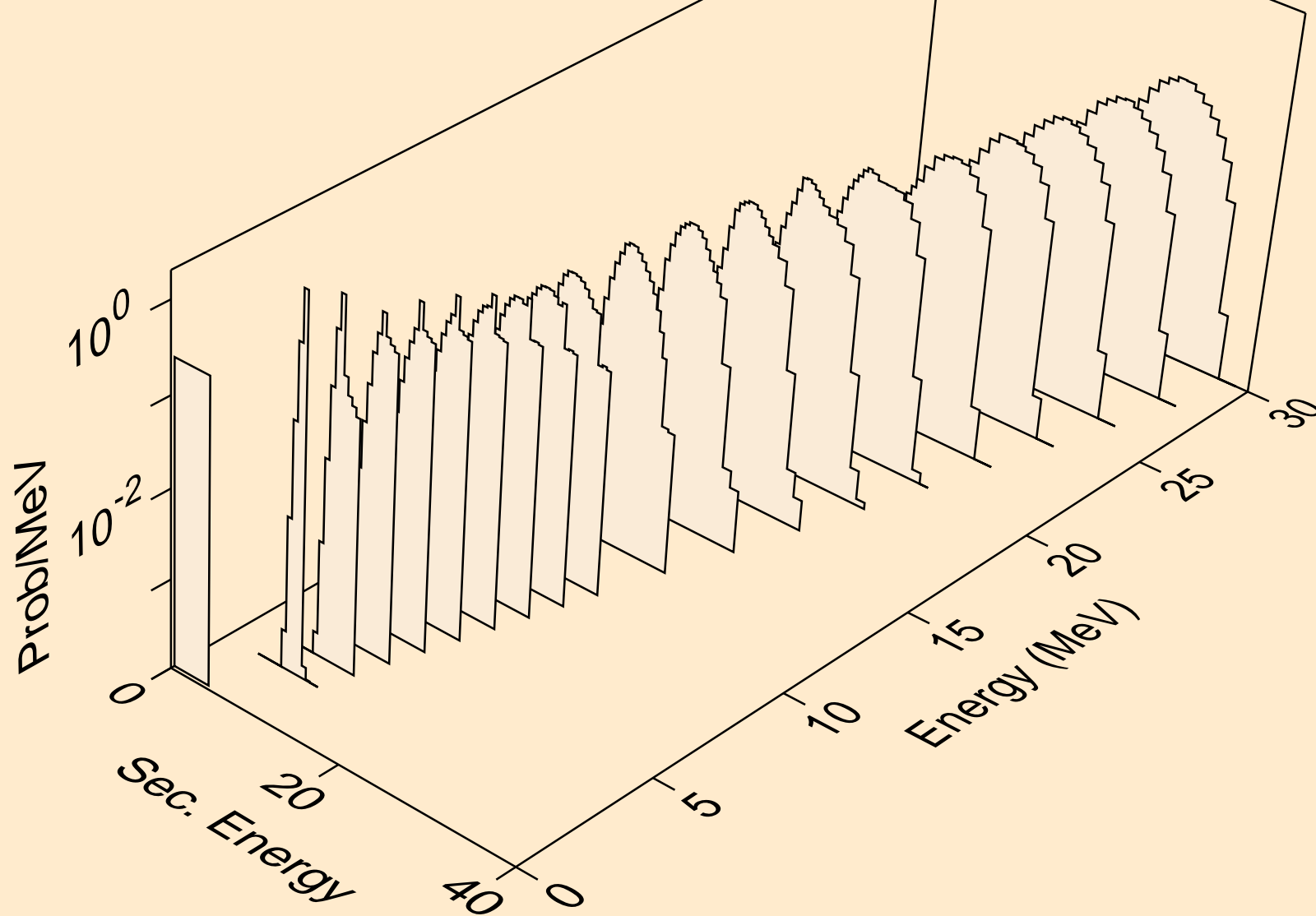

AU187 PROTON ACER TENDL-2021 LIBRARY; T=0.K  
alphas from (p,2a)

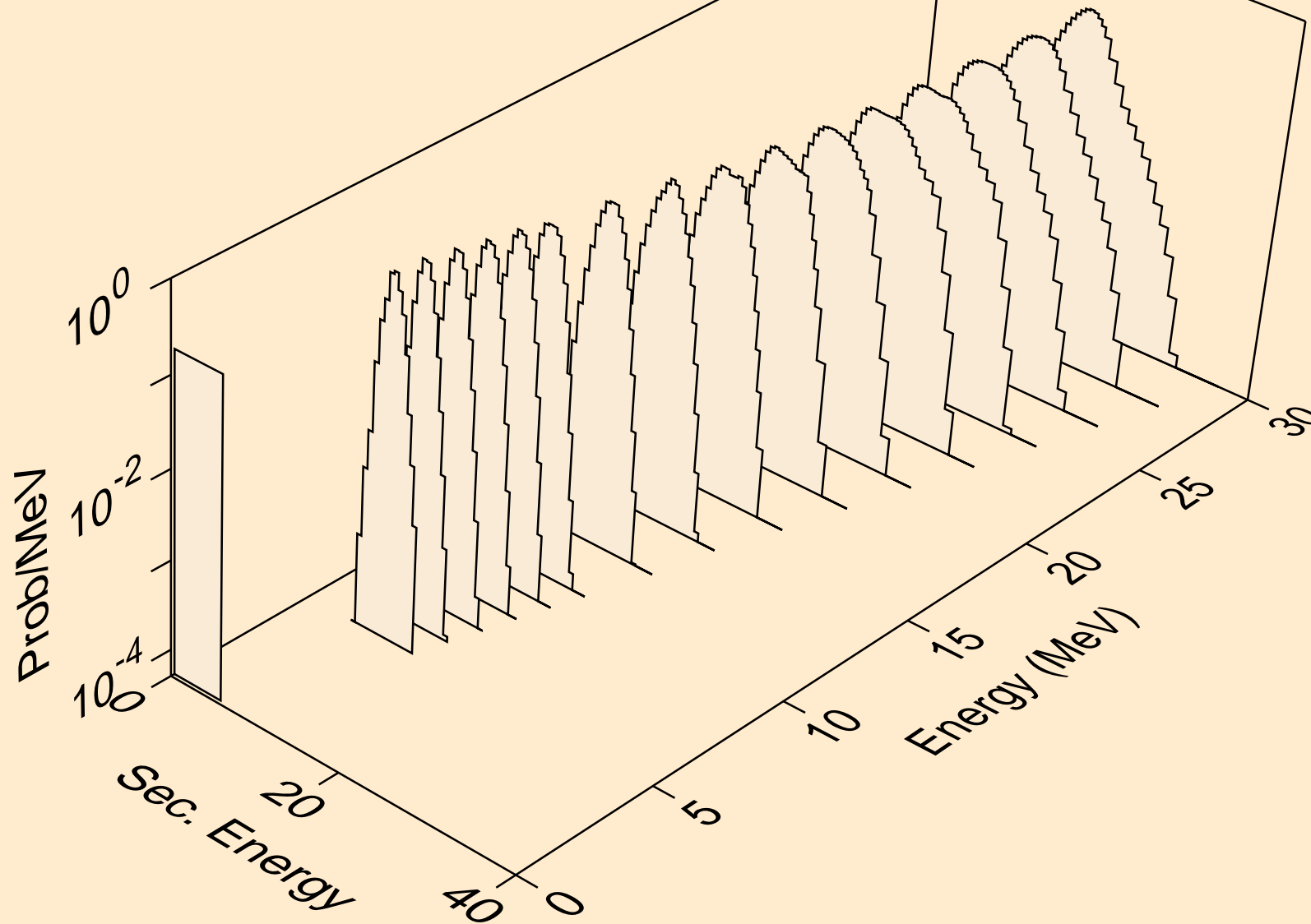

AU187 PROTON ACER TENDL-2021 LIBRARY; T=0.K  
alphas from (p,pa)

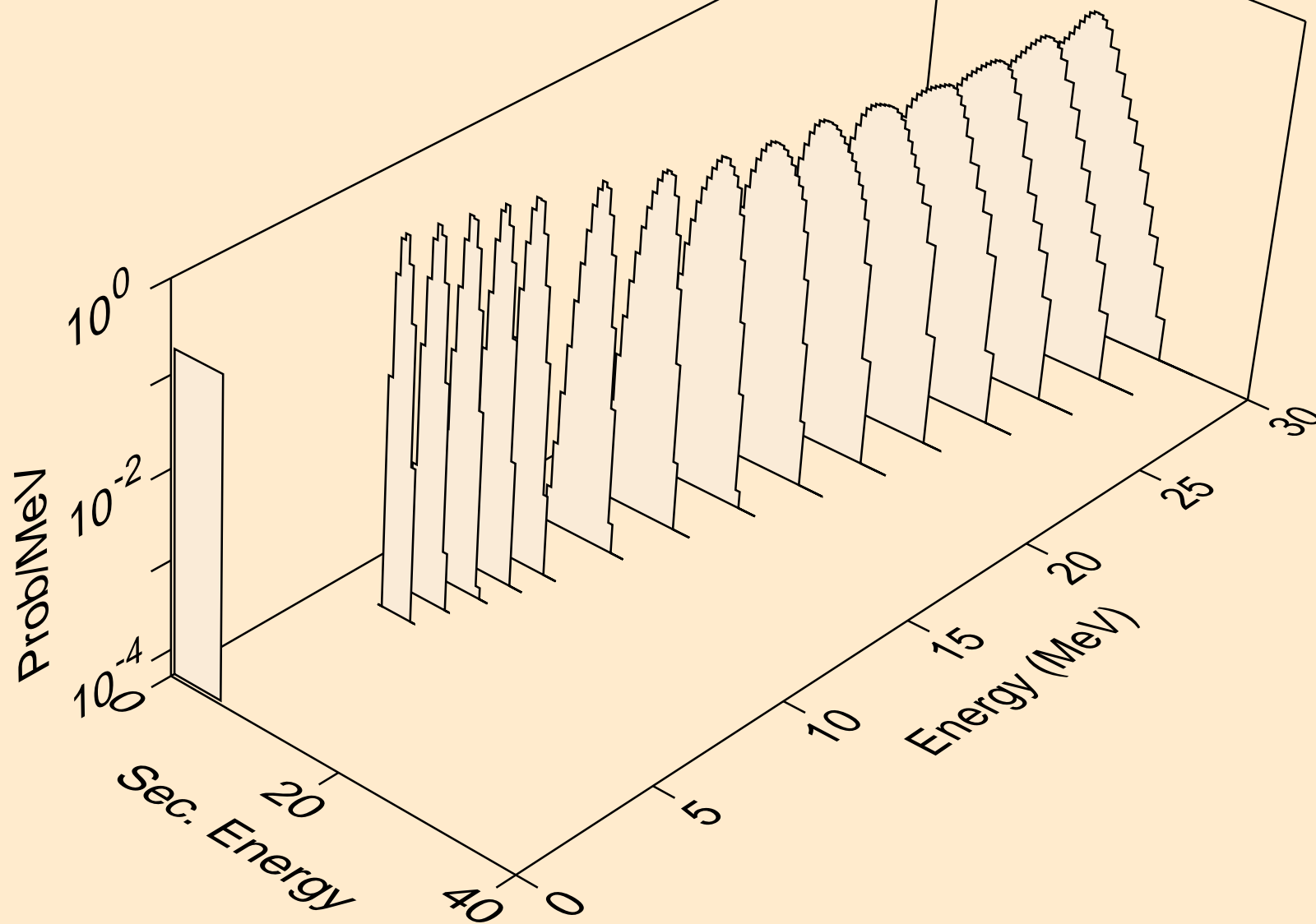



AU187 PROTON ACER TENDL-2021 LIBRARY; T=0.K  
alphas from (p,da)

