

AU206 PROTON ACER TENDL-2021 LIBRARY; T=0.K  
Principal cross sections

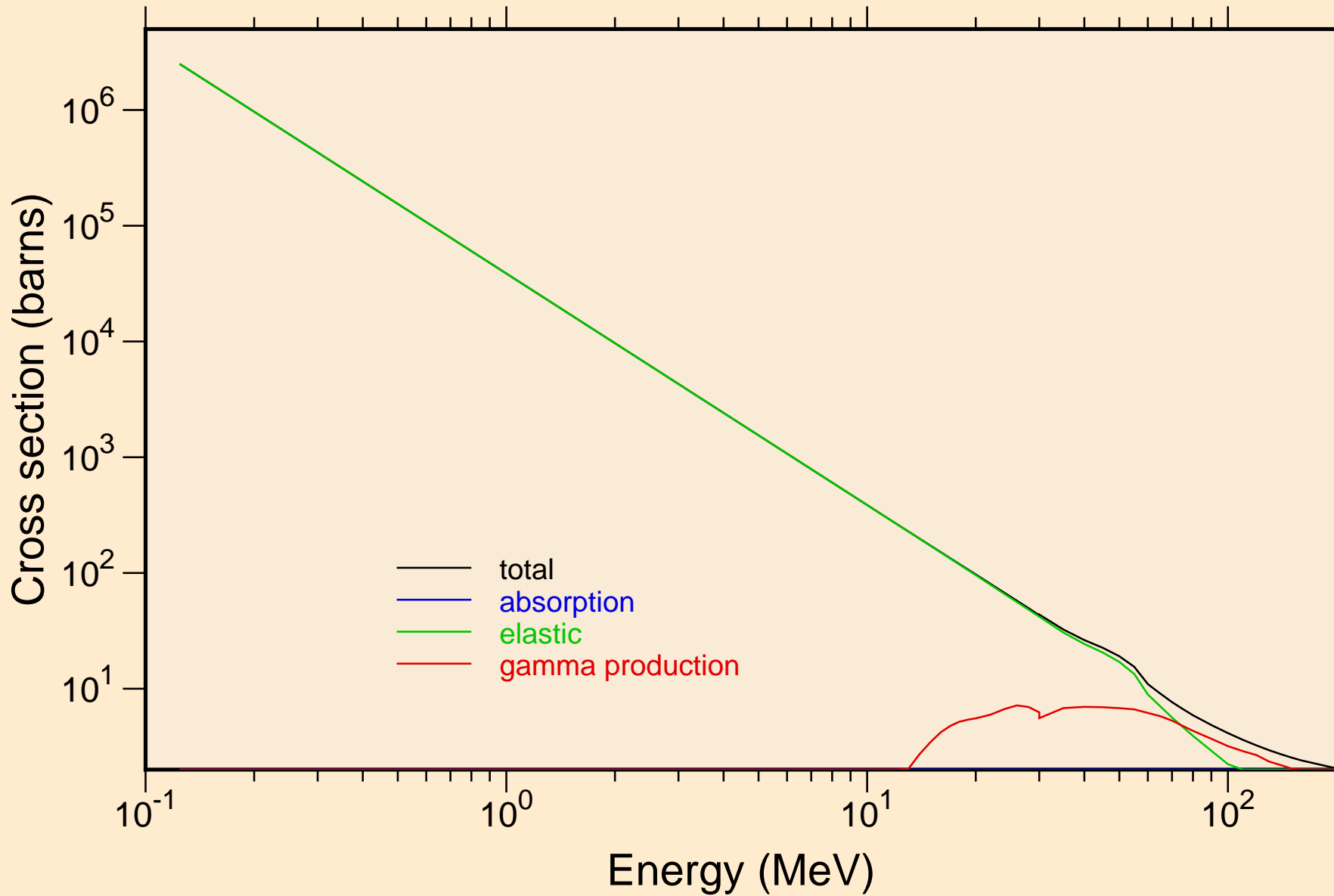

# AU206 PROTON ACER TENDL-2021 LIBRARY; T=0.K

## Heating

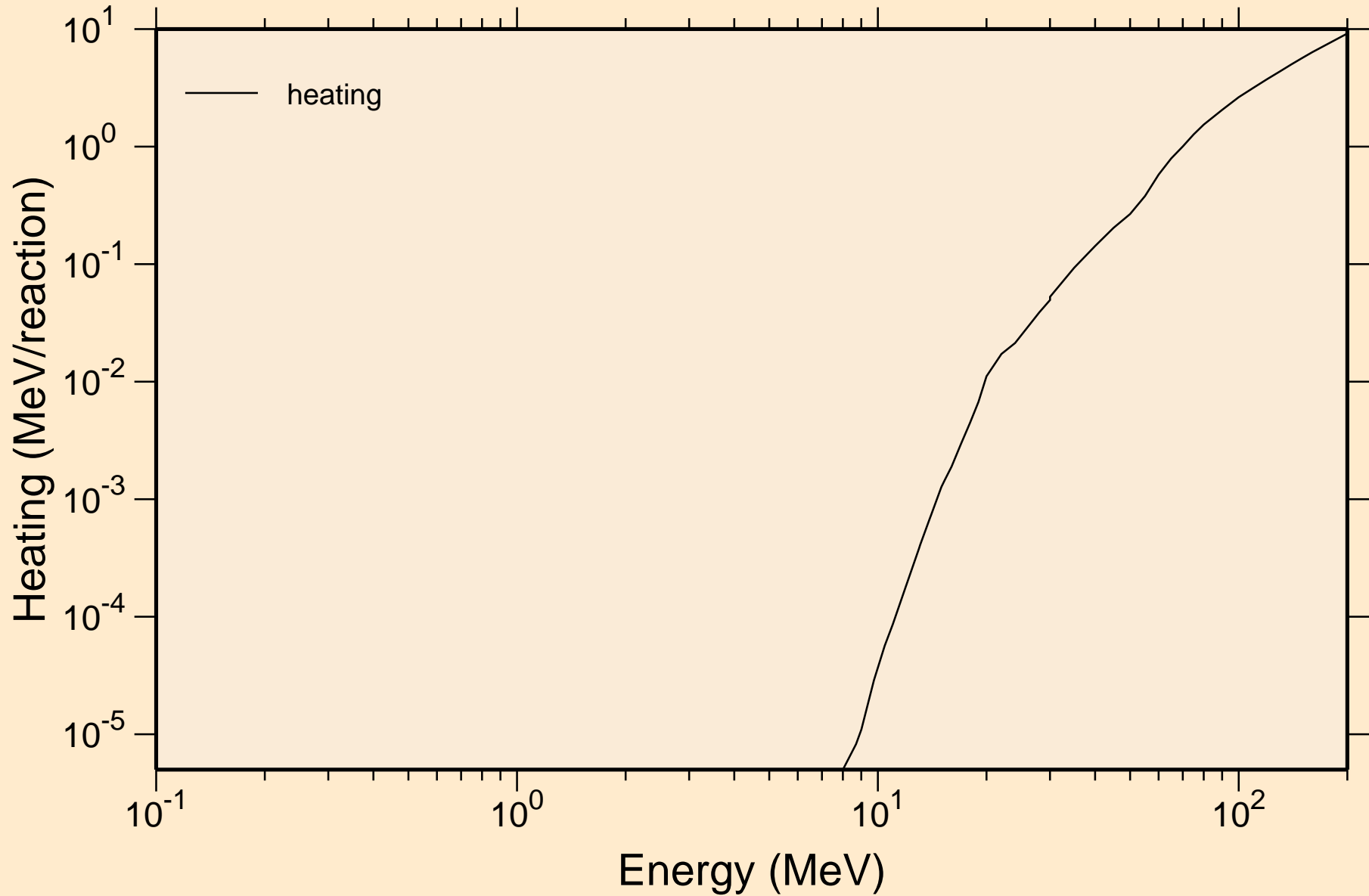

# AU206 PROTON ACER TENDL-2021 LIBRARY; T=0.K

## Principal cross sections

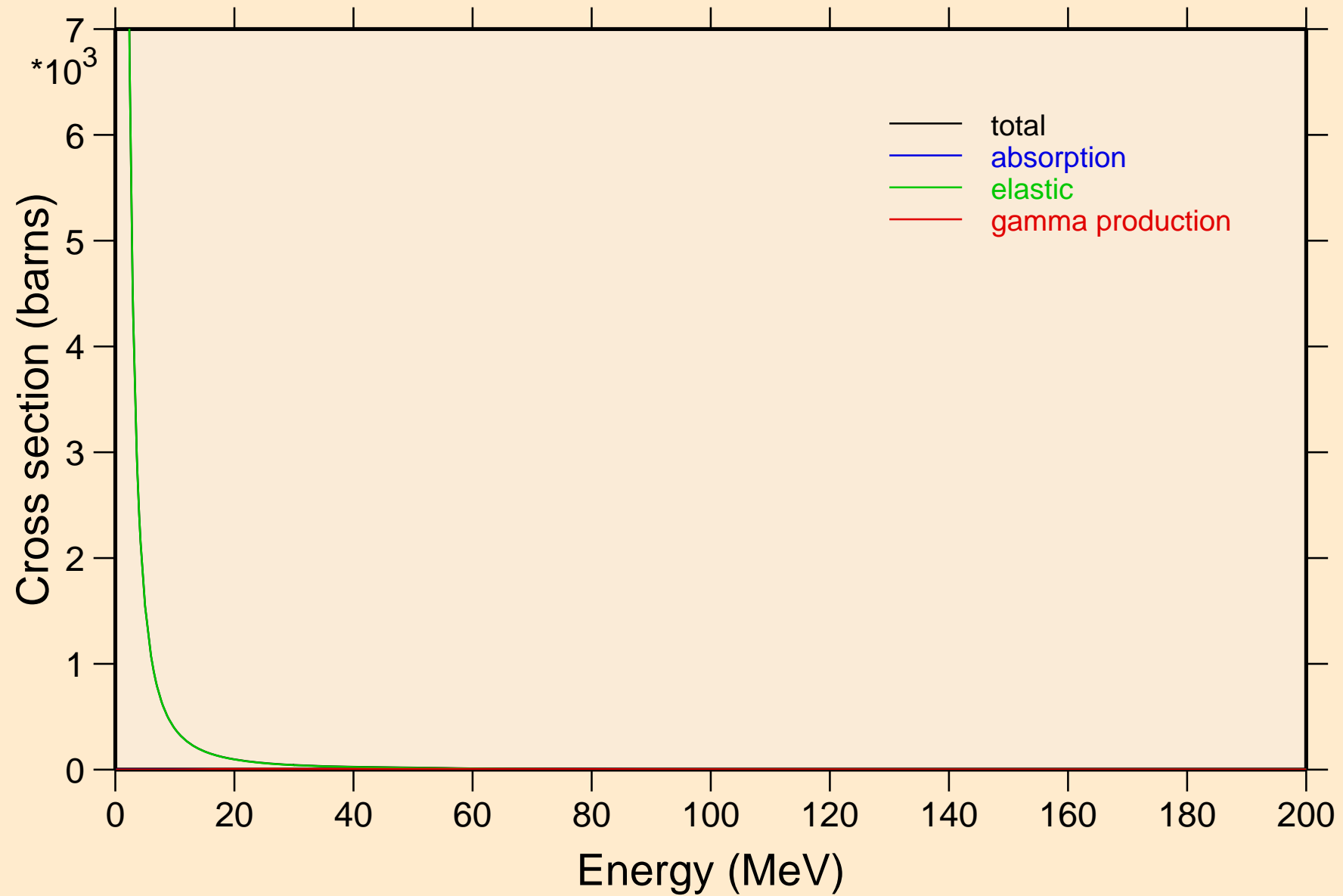

AU206 PROTON ACER TENDL-2021 LIBRARY; T=0.K

Heating

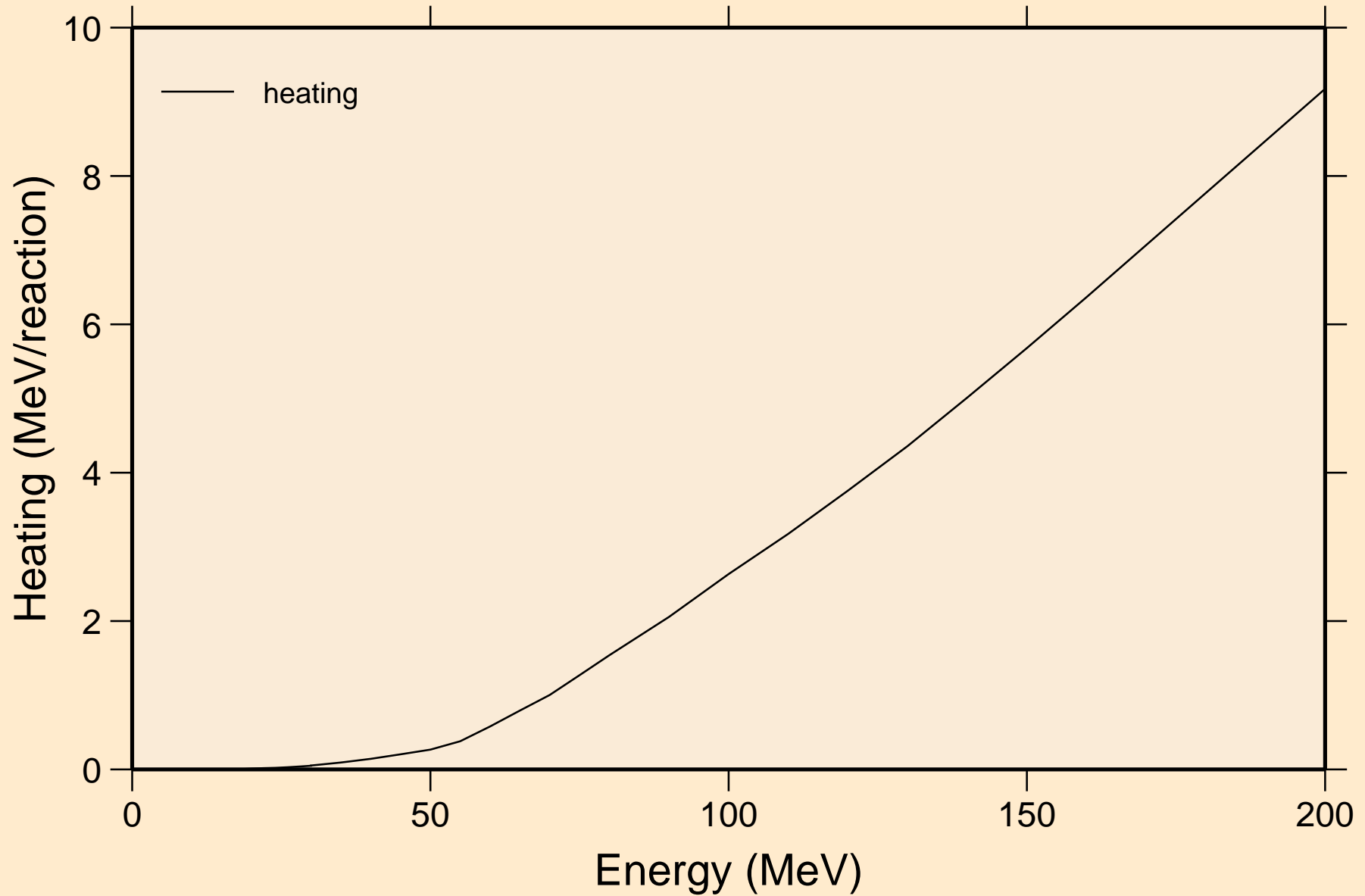

# AU206 PROTON ACER TENDL-2021 LIBRARY; T=0.K

## Threshold reactions

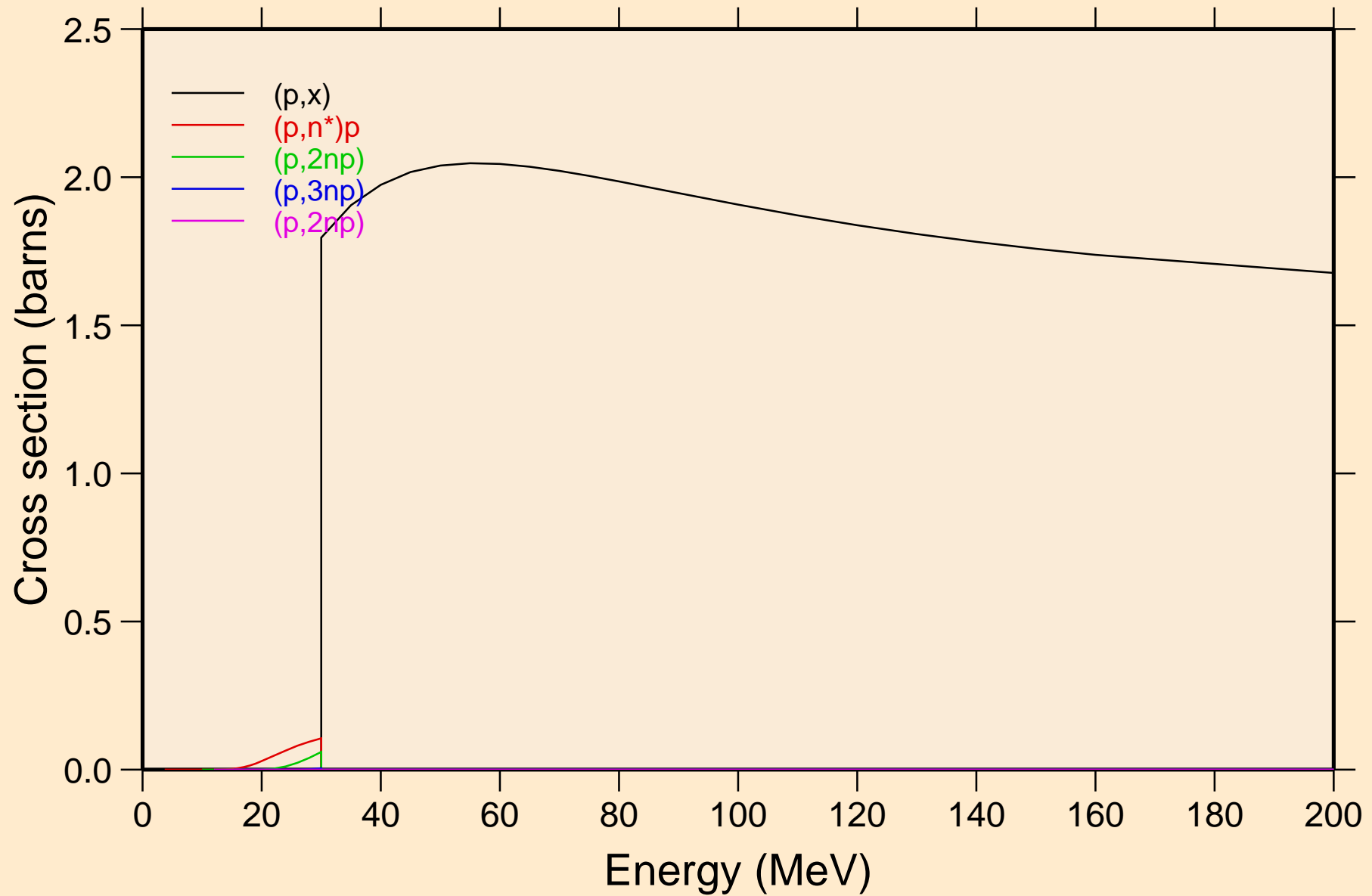

# AU206 PROTON ACER TENDL-2021 LIBRARY; T=0.K

## Threshold reactions

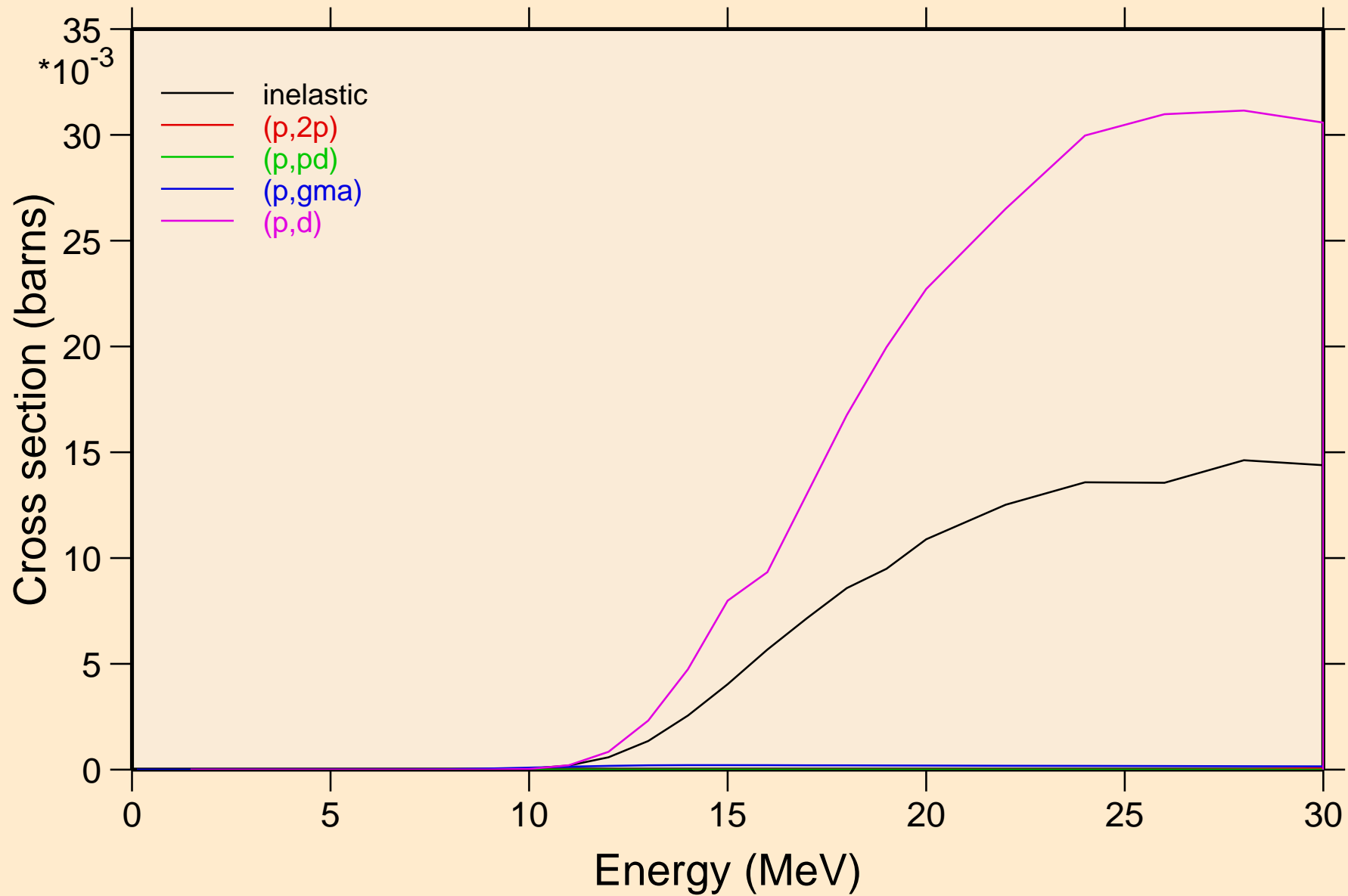

AU206 PROTON ACER TENDL-2021 LIBRARY; T=0.K  
Threshold reactions

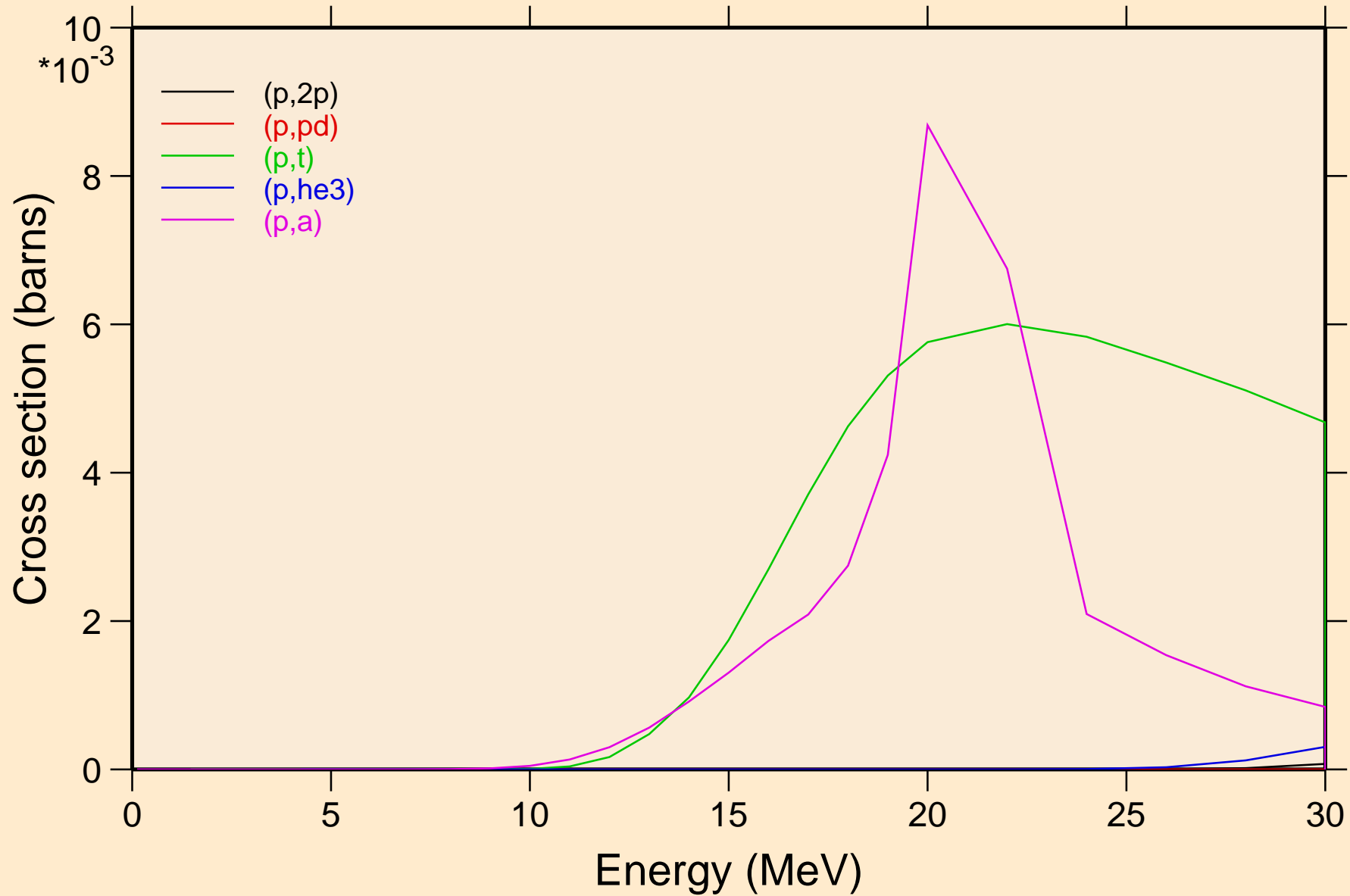

AU206 PROTON ACER TENDL-2021 LIBRARY; T=0.K  
Threshold reactions

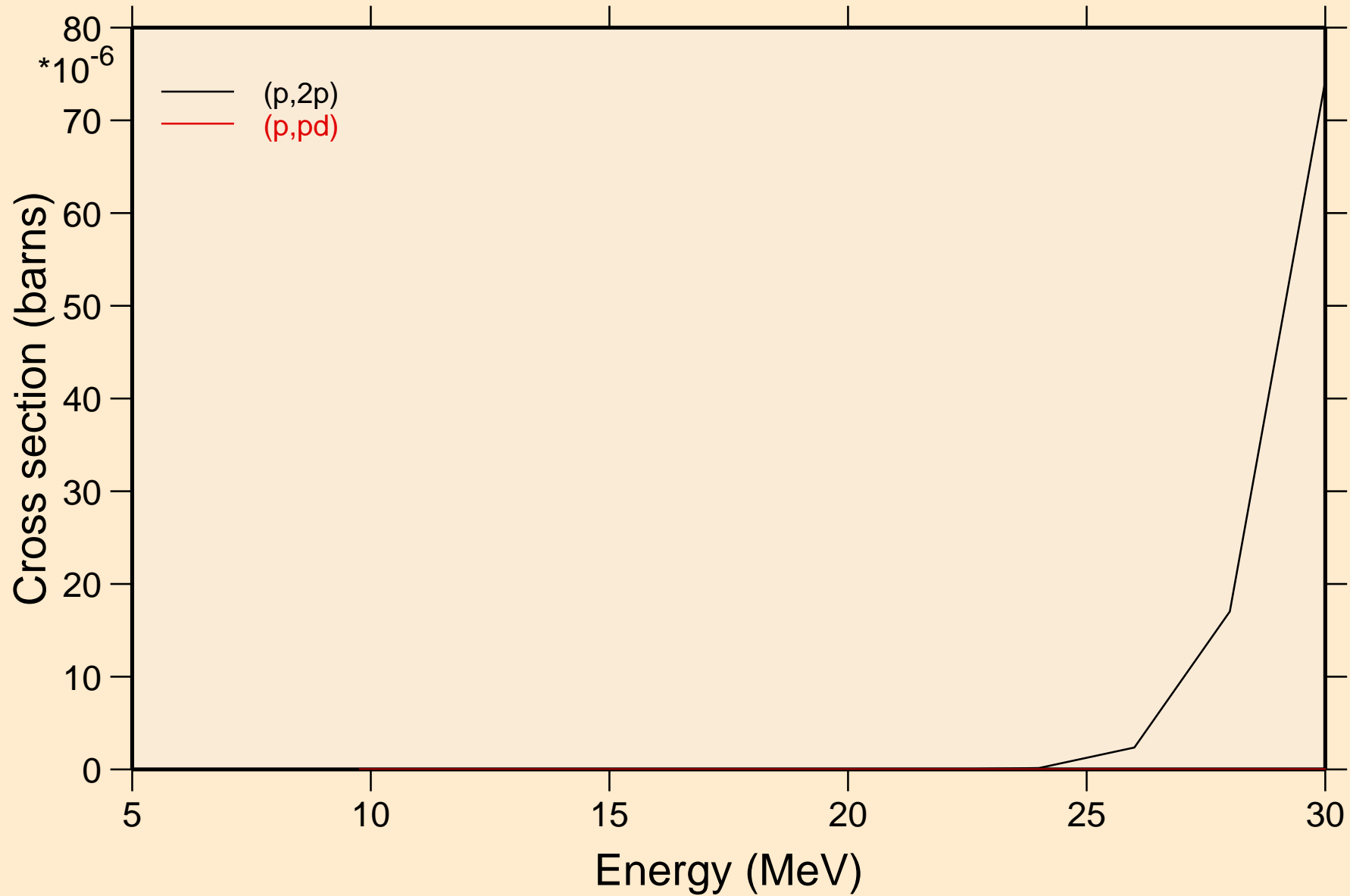



AU206 PROTON ACER TENDL-2021 LIBRARY; T=0.K  
angular distribution for elastic

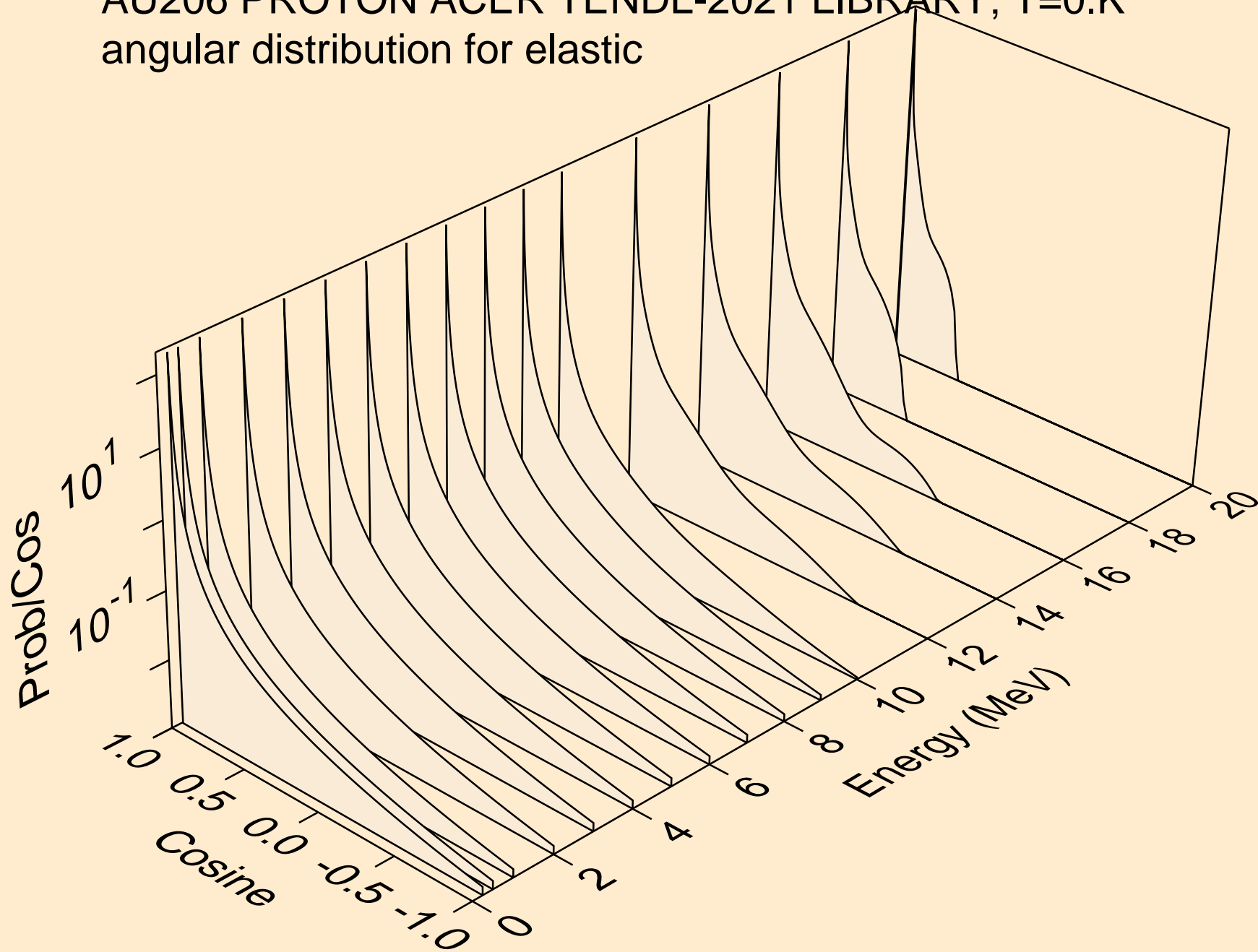

AU206 PROTON ACER TENDL-2021 LIBRARY; T=0.K  
angular distribution for elastic

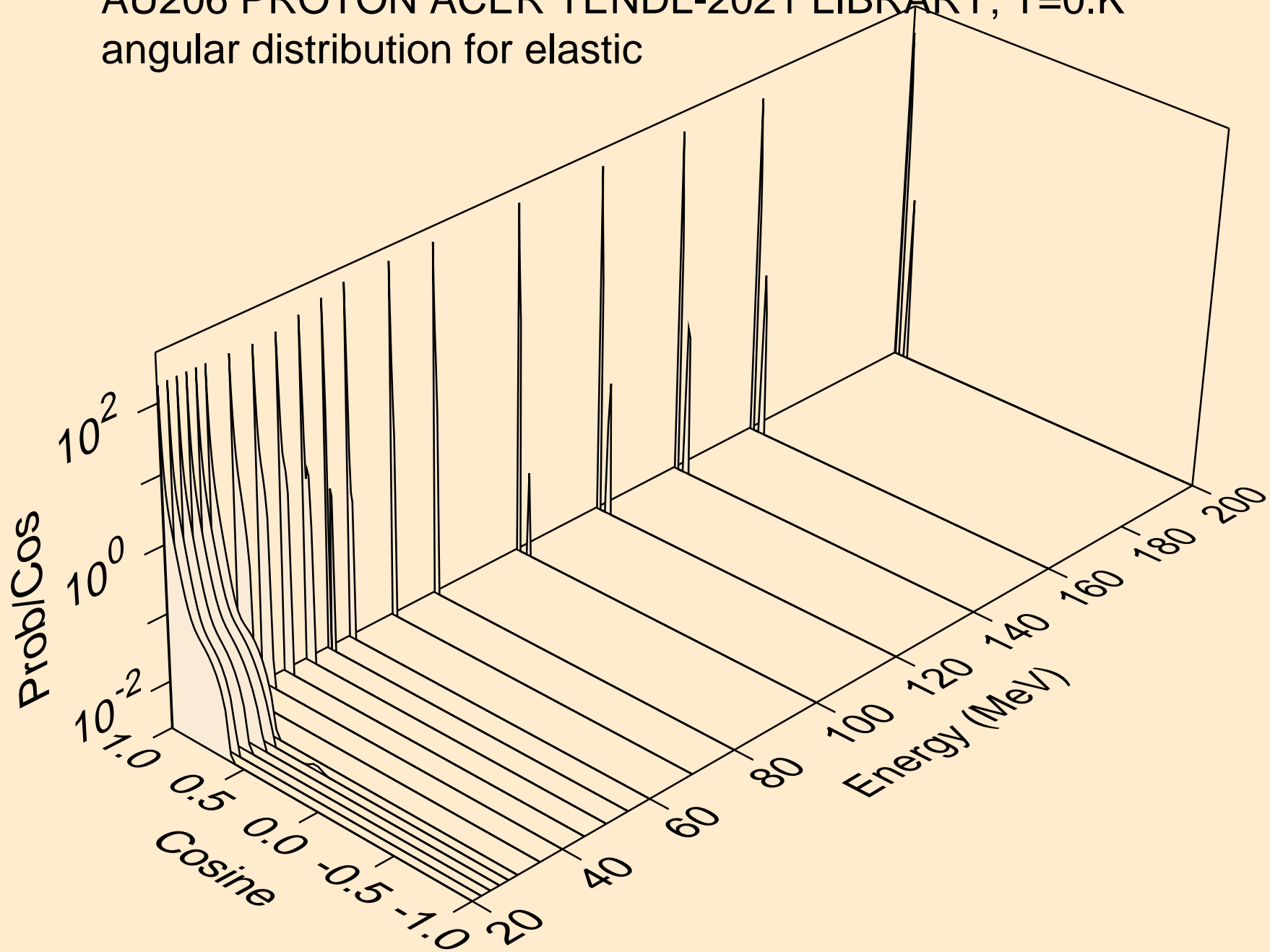

AU206 PROTON ACER TENDL-2021 LIBRARY; T=0.K  
Proton emission for (p,x)

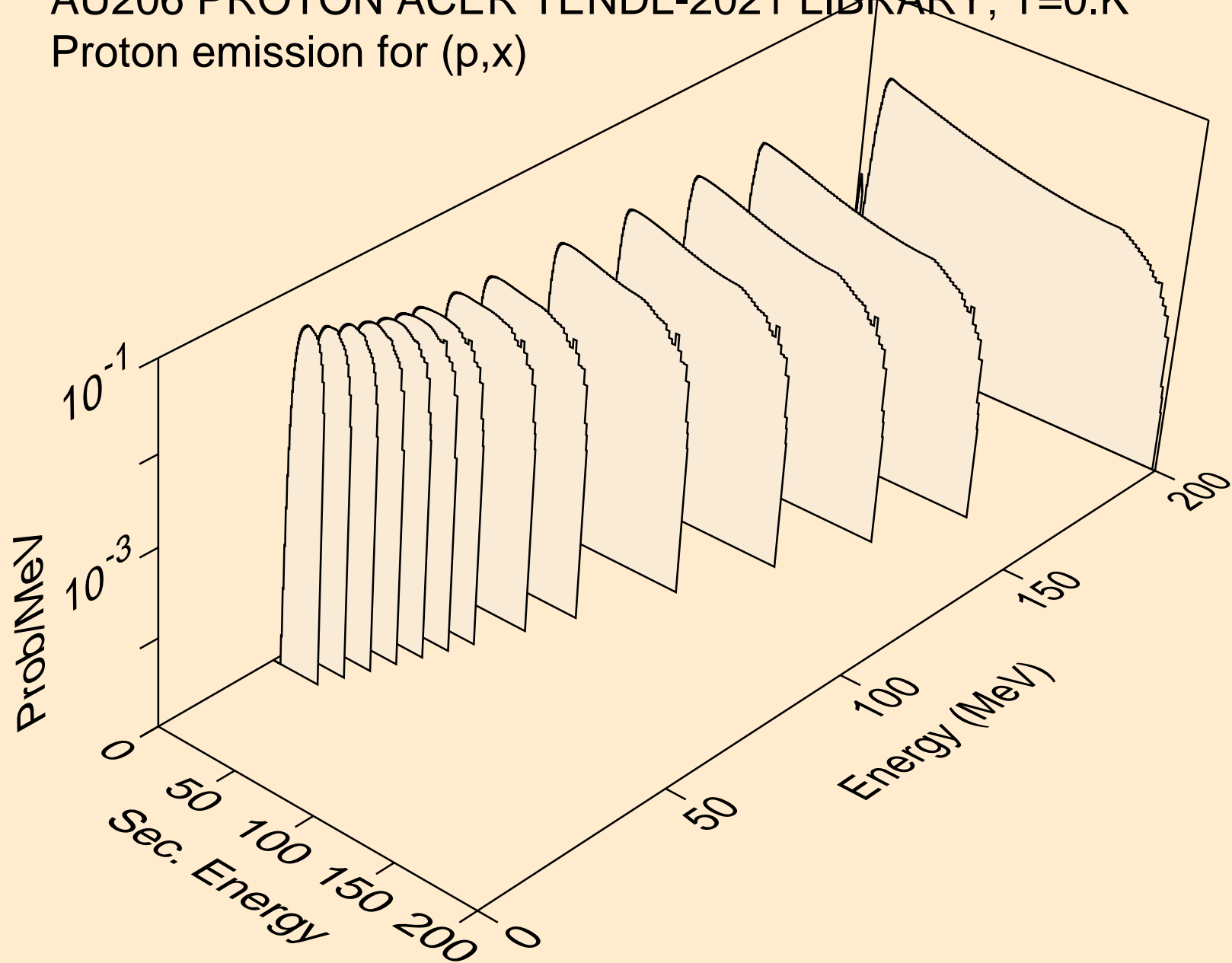

AU206 PROTON ACER TENDL-2021 LIBRARY; T=0.K  
Proton emission for (p,n\*)p

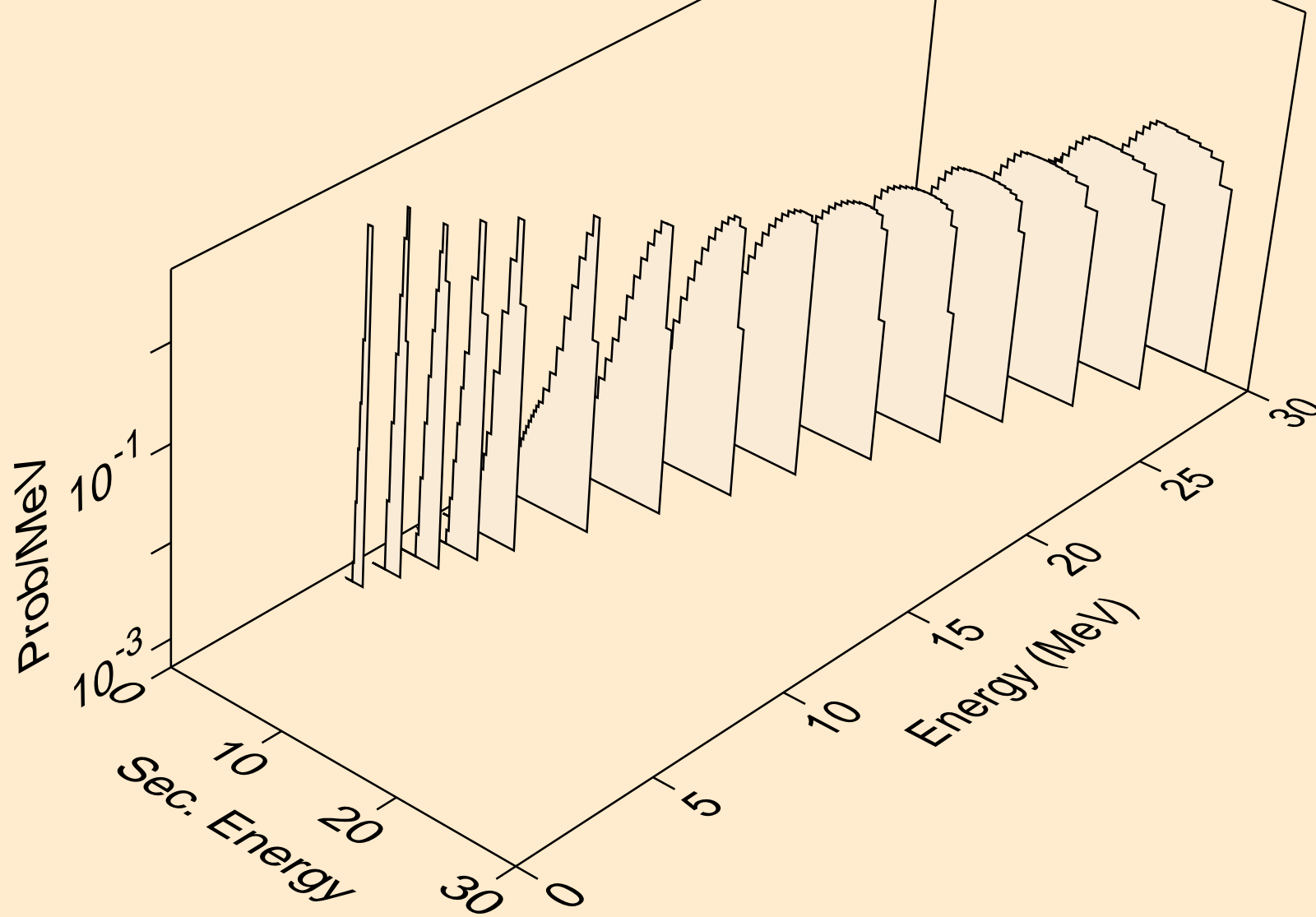

AU206 PROTON ACER TENDL-2021 LIBRARY; T=0.K  
Proton emission for (p,2np)

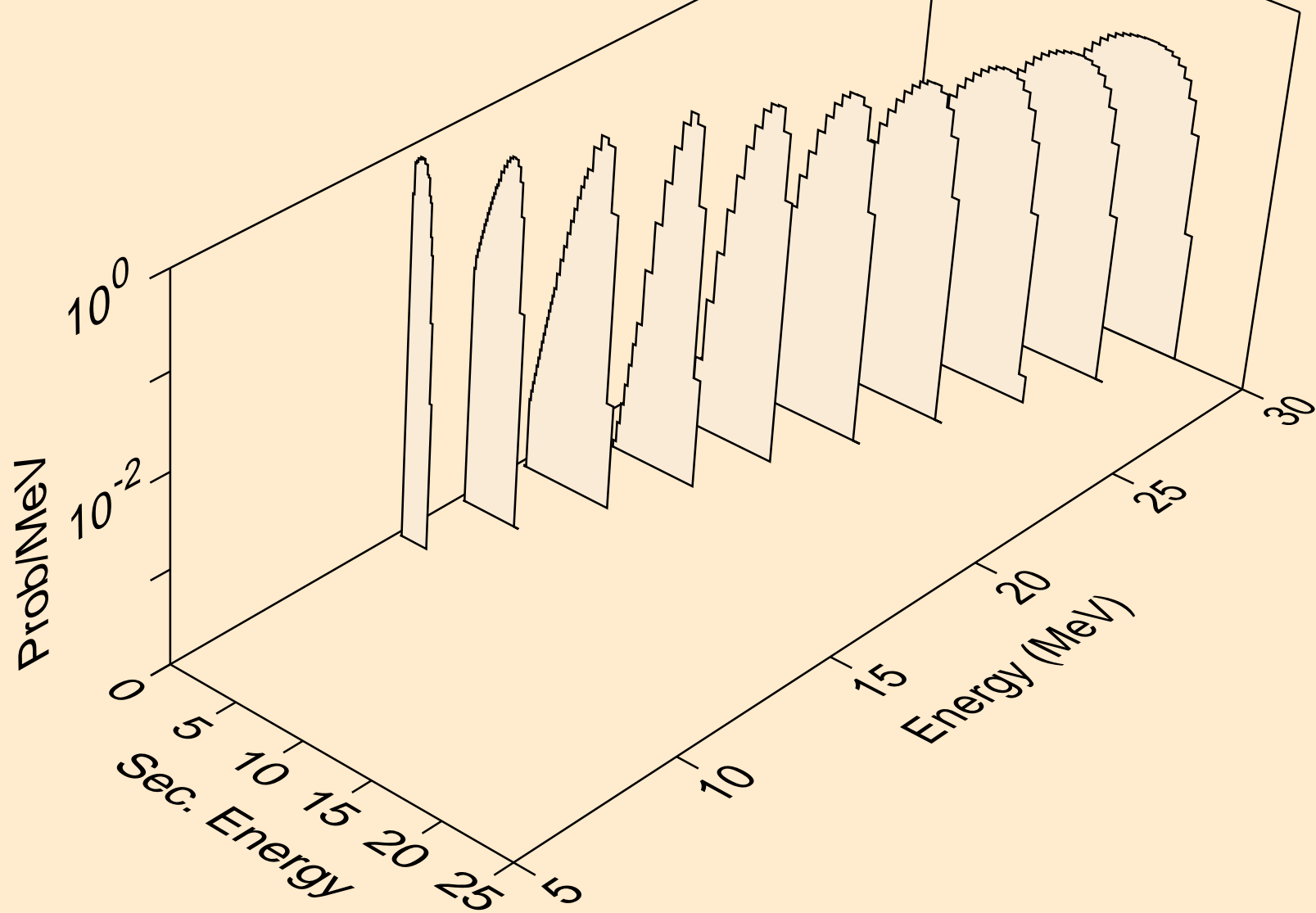

AU206 PROTON ACER TENDL-2021 LIBRARY; T=0.K  
Proton emission for (p,3np)

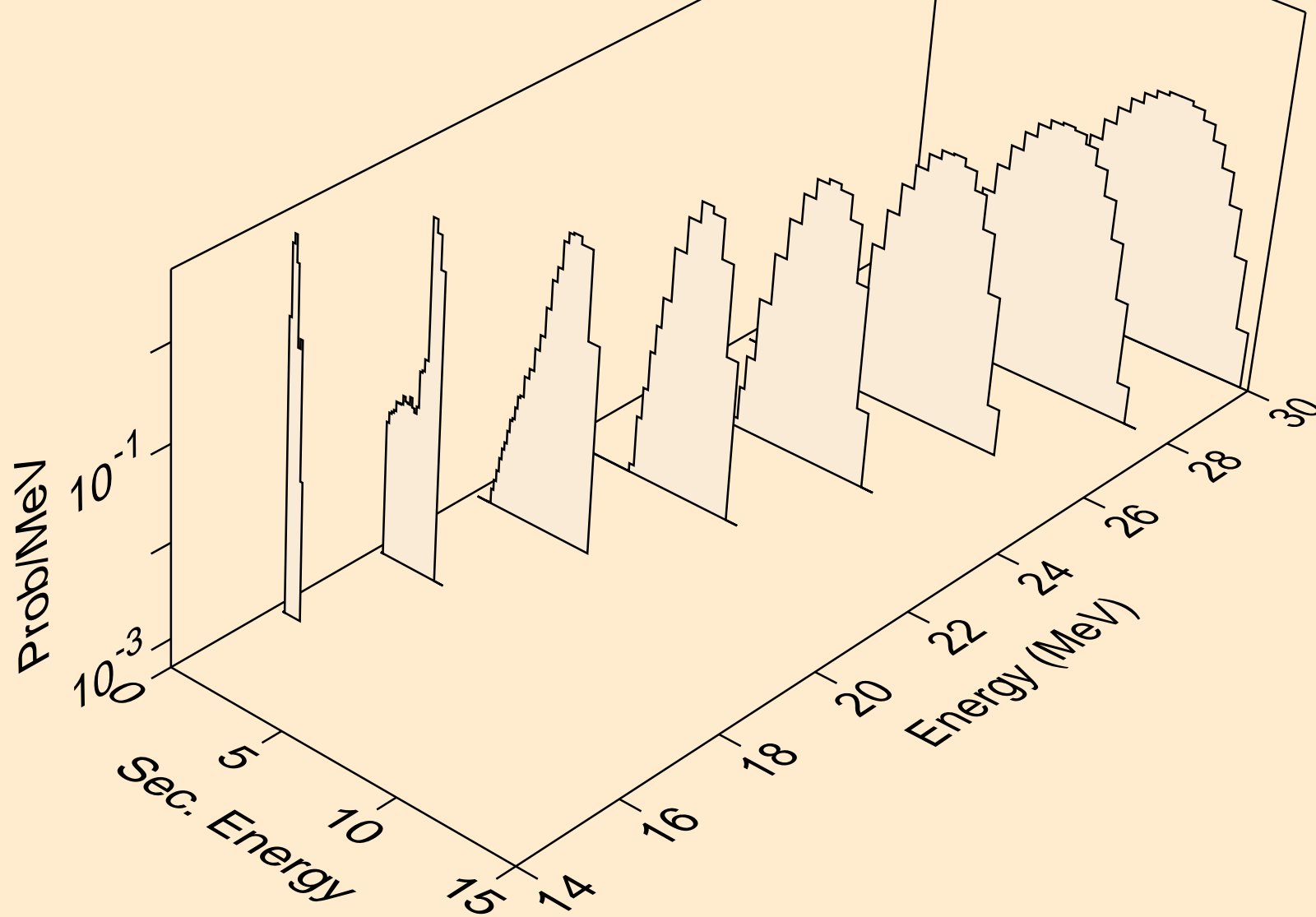

AU206 PROTON ACER TENDL-2021 LIBRARY; T=0.K  
Proton emission for (p,2np)

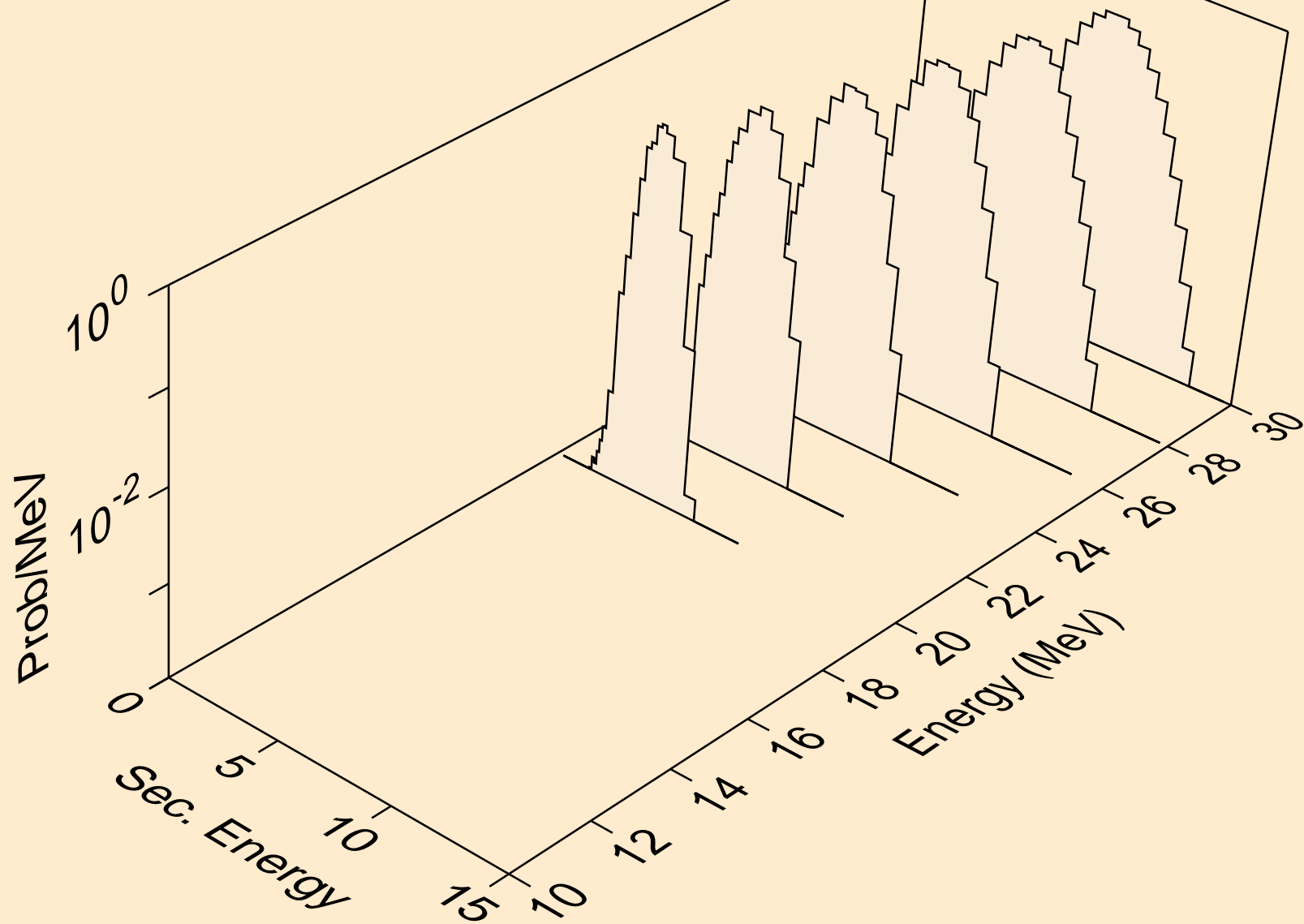

AU206 PROTON ACER TENDL-2021 LIBRARY; T=0.K  
Proton emission for inelastic

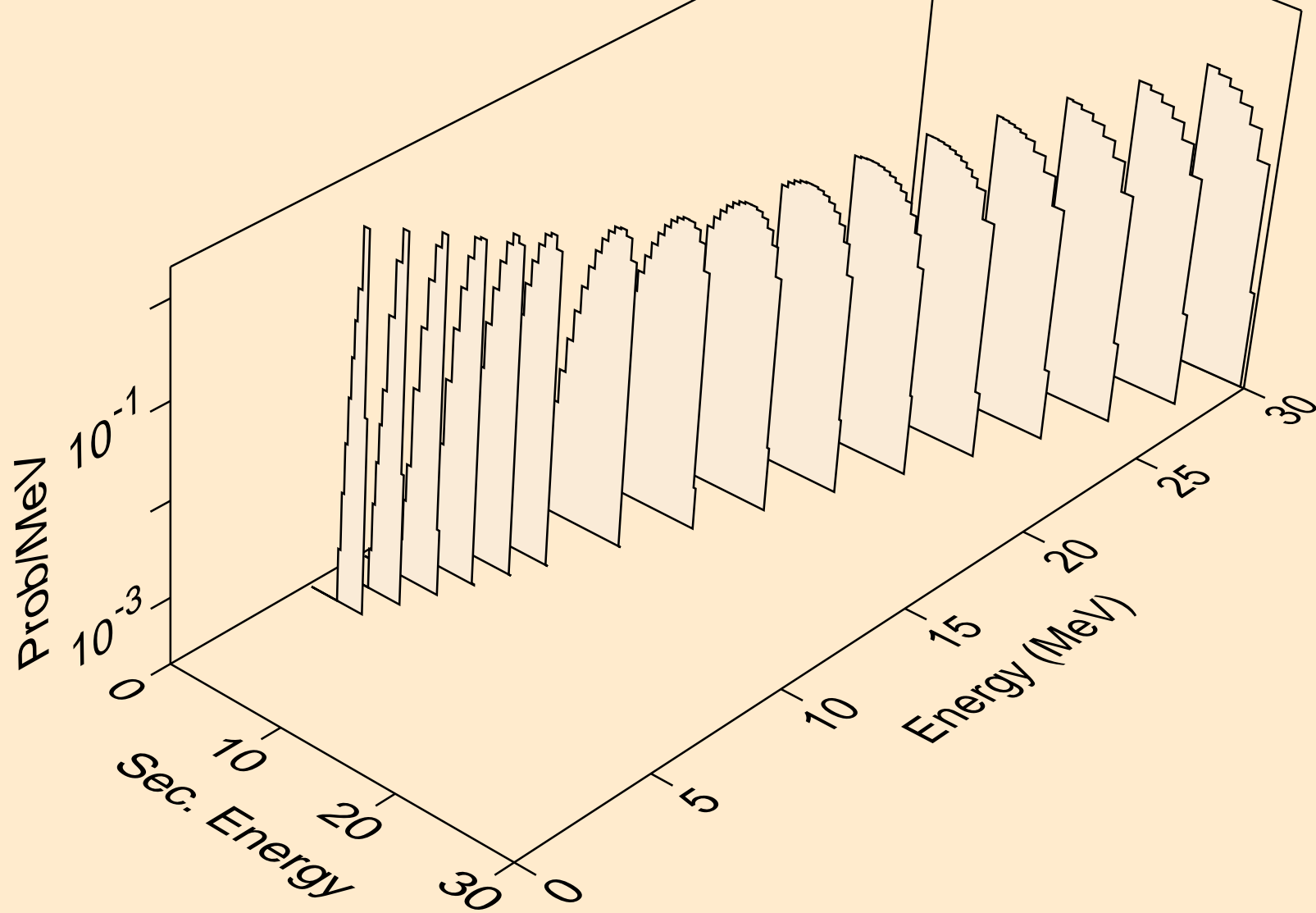



AU206 PROTON ACER TENDL-2021 LIBRARY; T=0.K  
Proton emission for (p,2p)

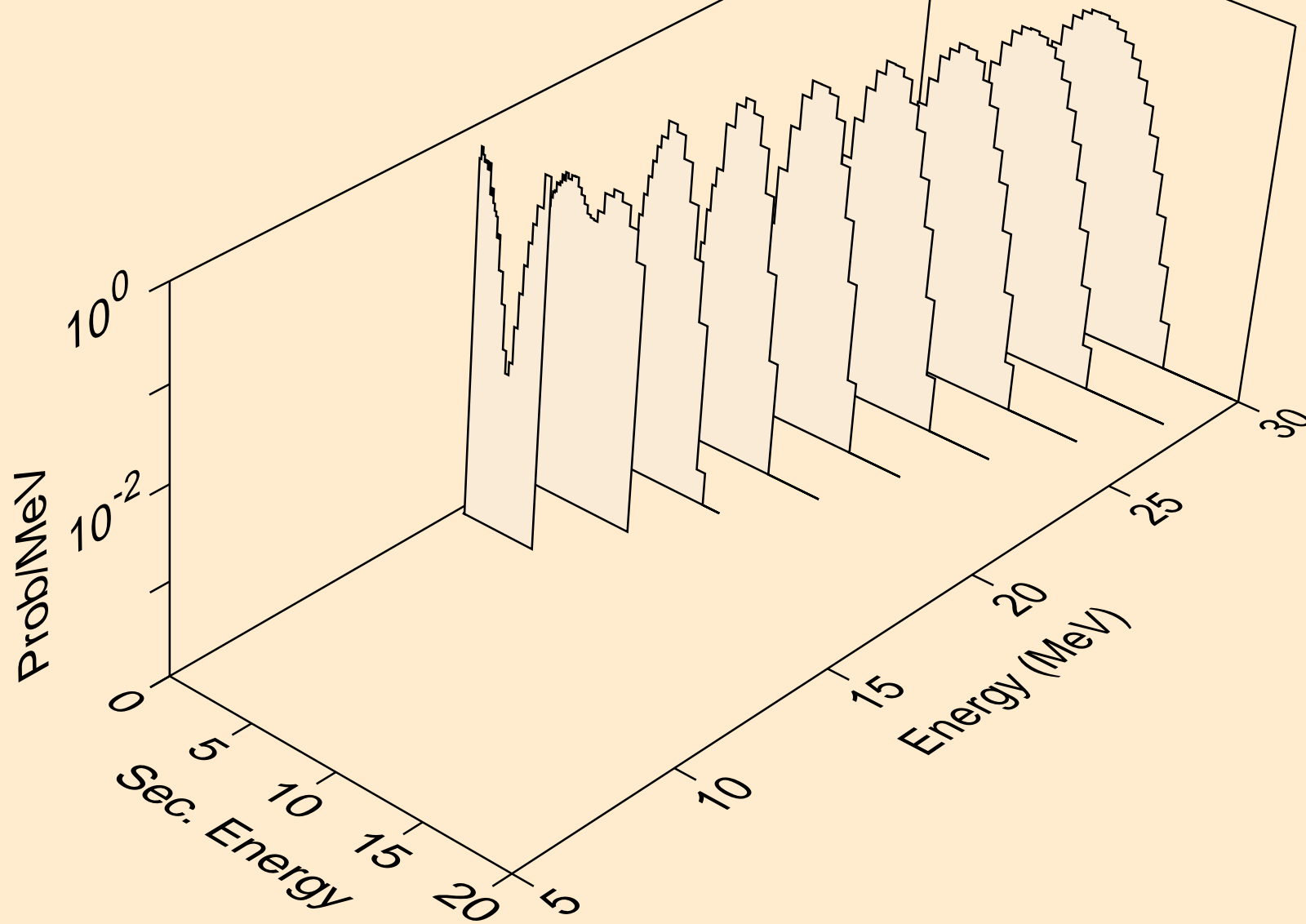

AU206 PROTON ACER TENDL-2021 LIBRARY; T=0.K  
Proton emission for (p,pd)

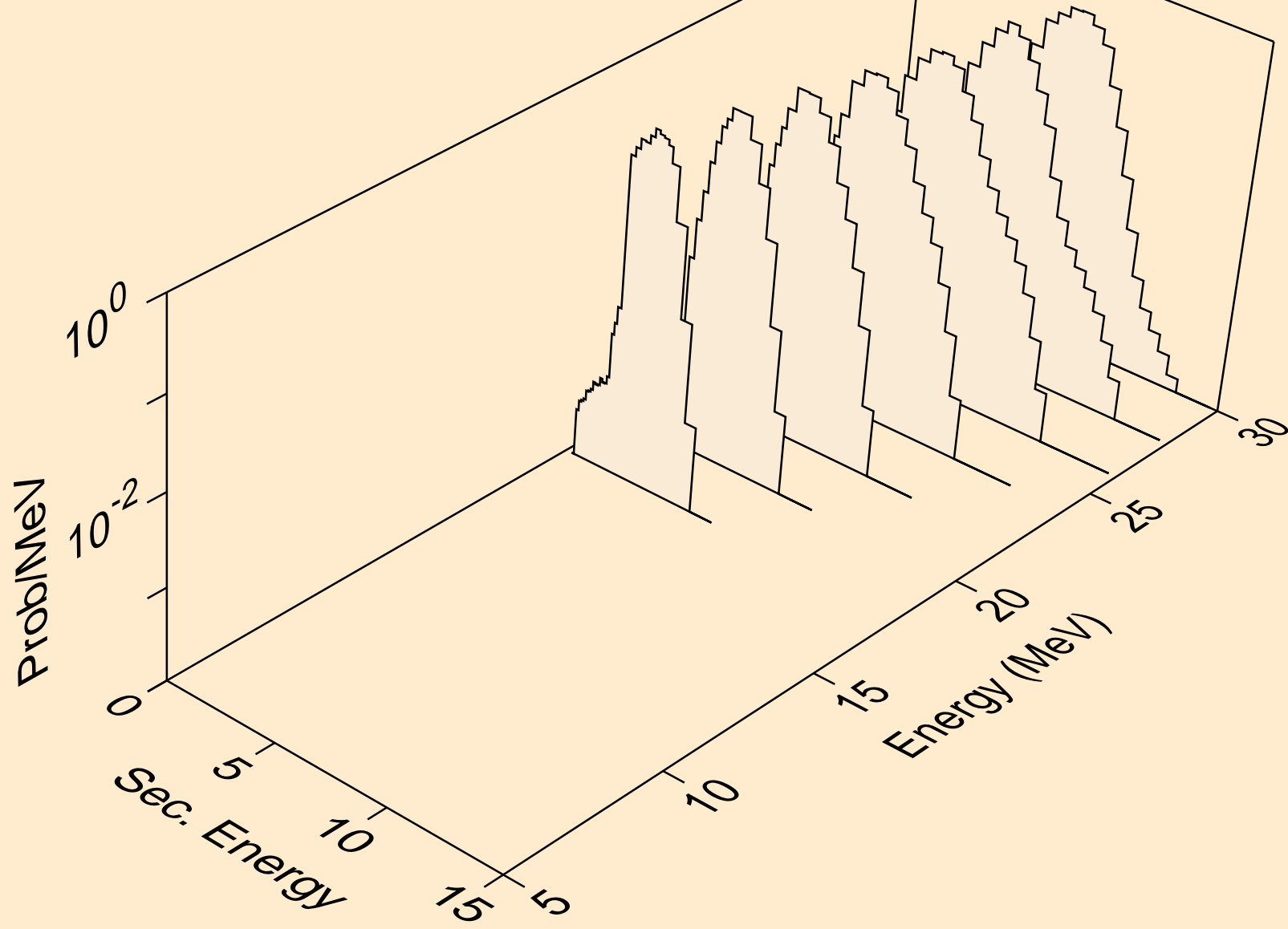

AU206 PROTON ACER TENDL-2021 LIBRARY; T=0.K  
Photon emission for (z,n)

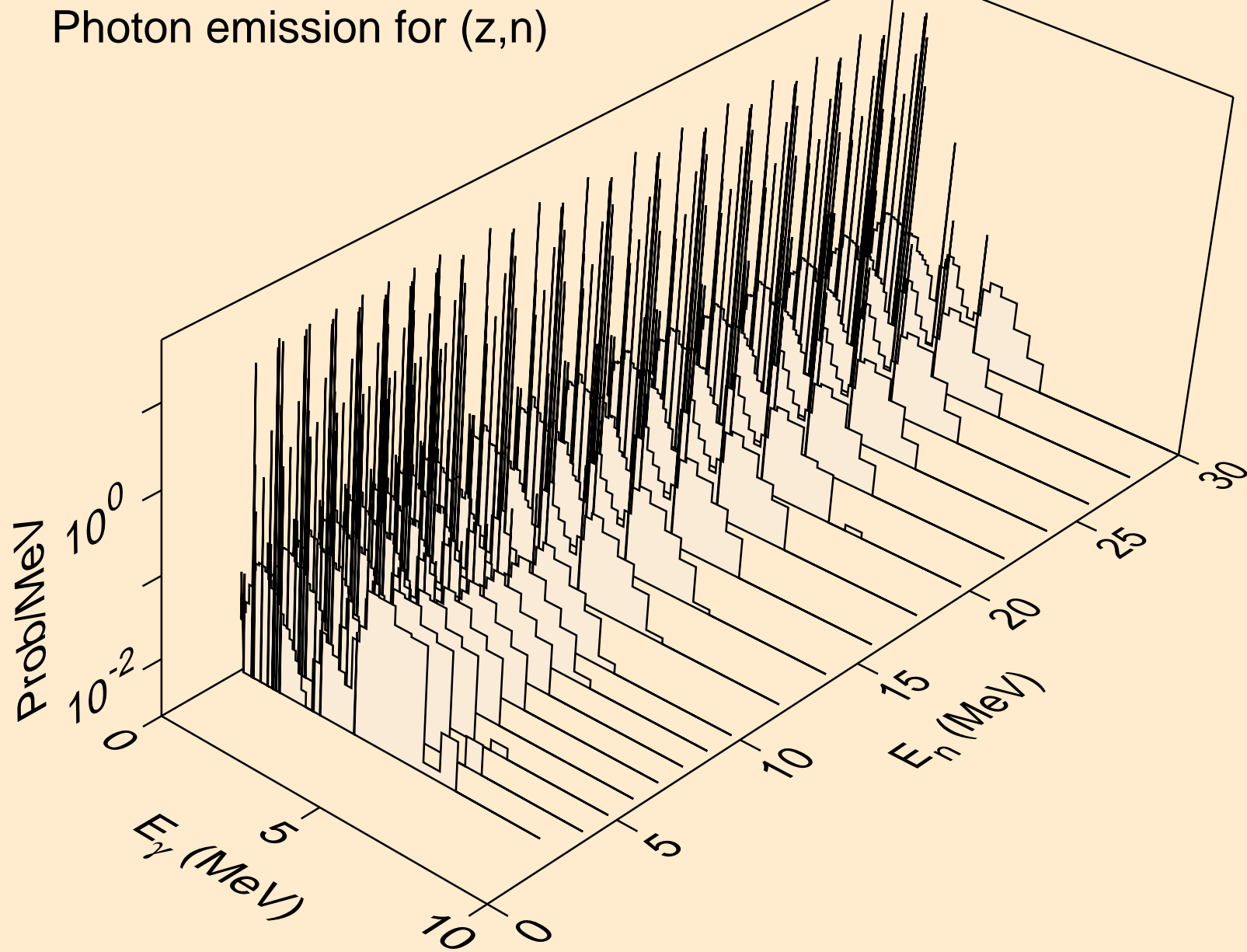

AU206 PROTON ACER TENDL-2021 LIBRARY; T=0.K  
Photon emission for (n,x)

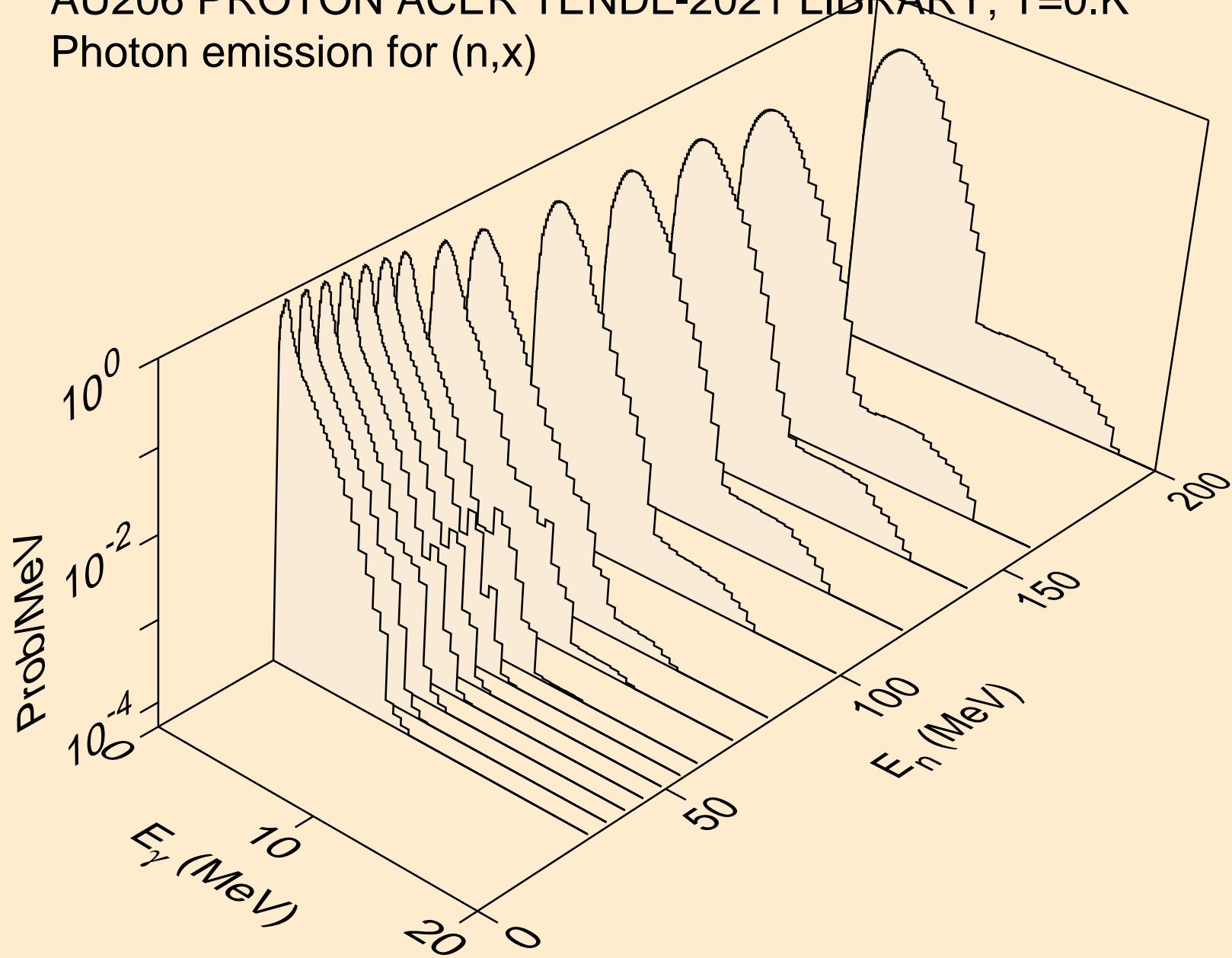

AU206 PROTON ACER TENDL-2021 LIBRARY; T=0.K  
Photon emission for (n,2nd)

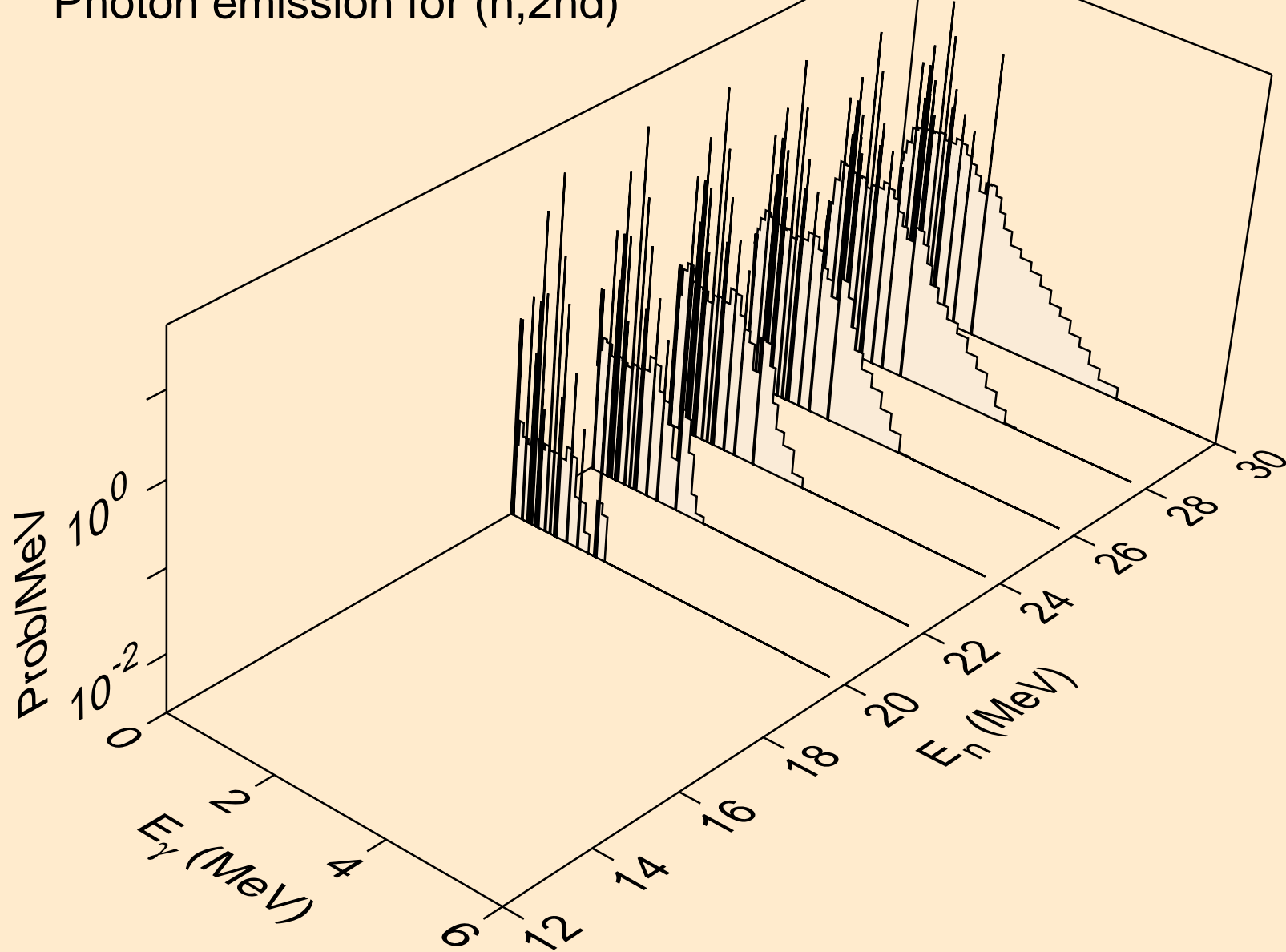

AU206 PROTON ACER TENDL-2021 LIBRARY; T=0.K  
Photon emission for (n,2n)

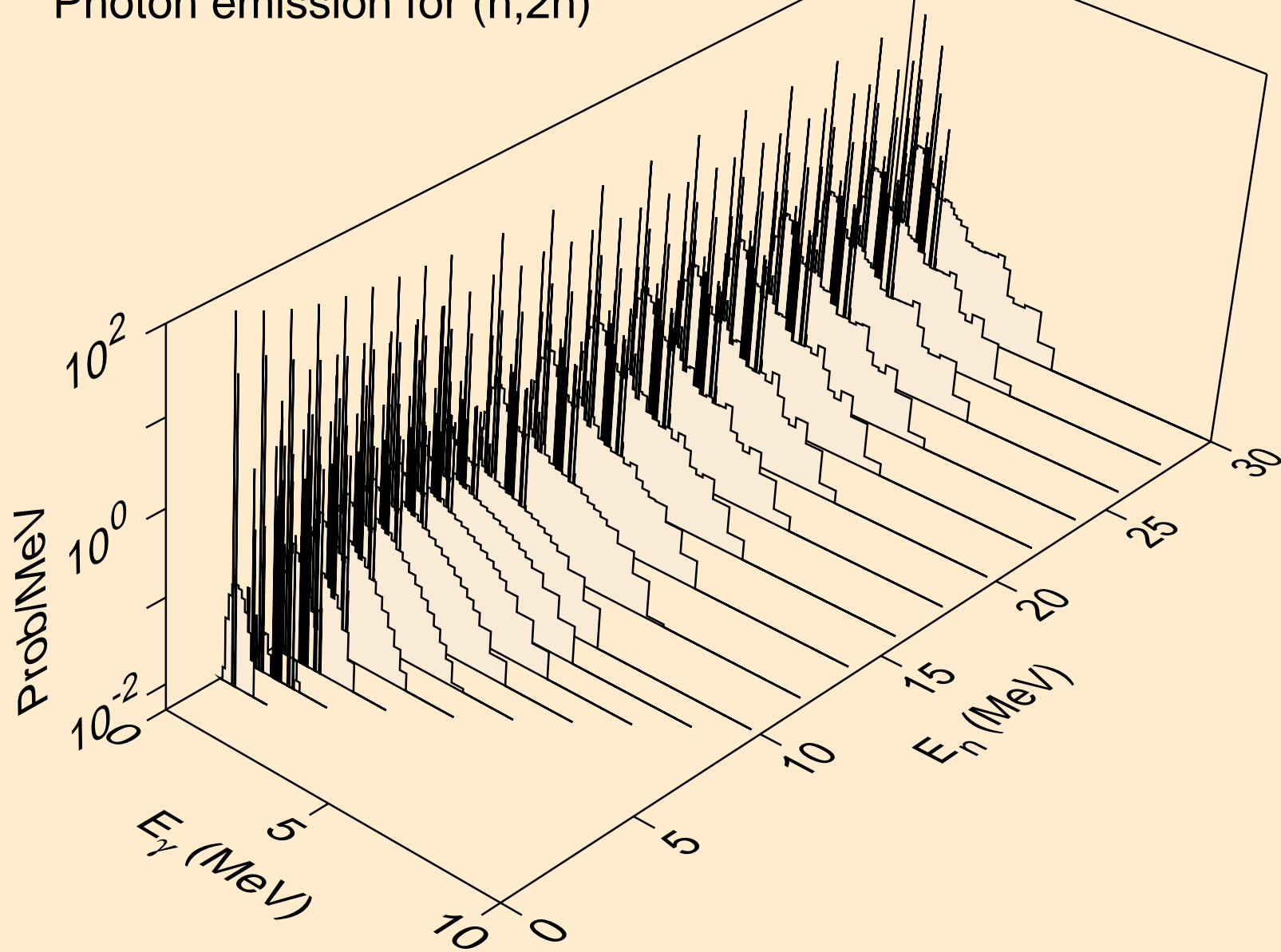

AU206 PROTON ACER TENDL-2021 LIBRARY; T=0.K  
Photon emission for (n,3n)

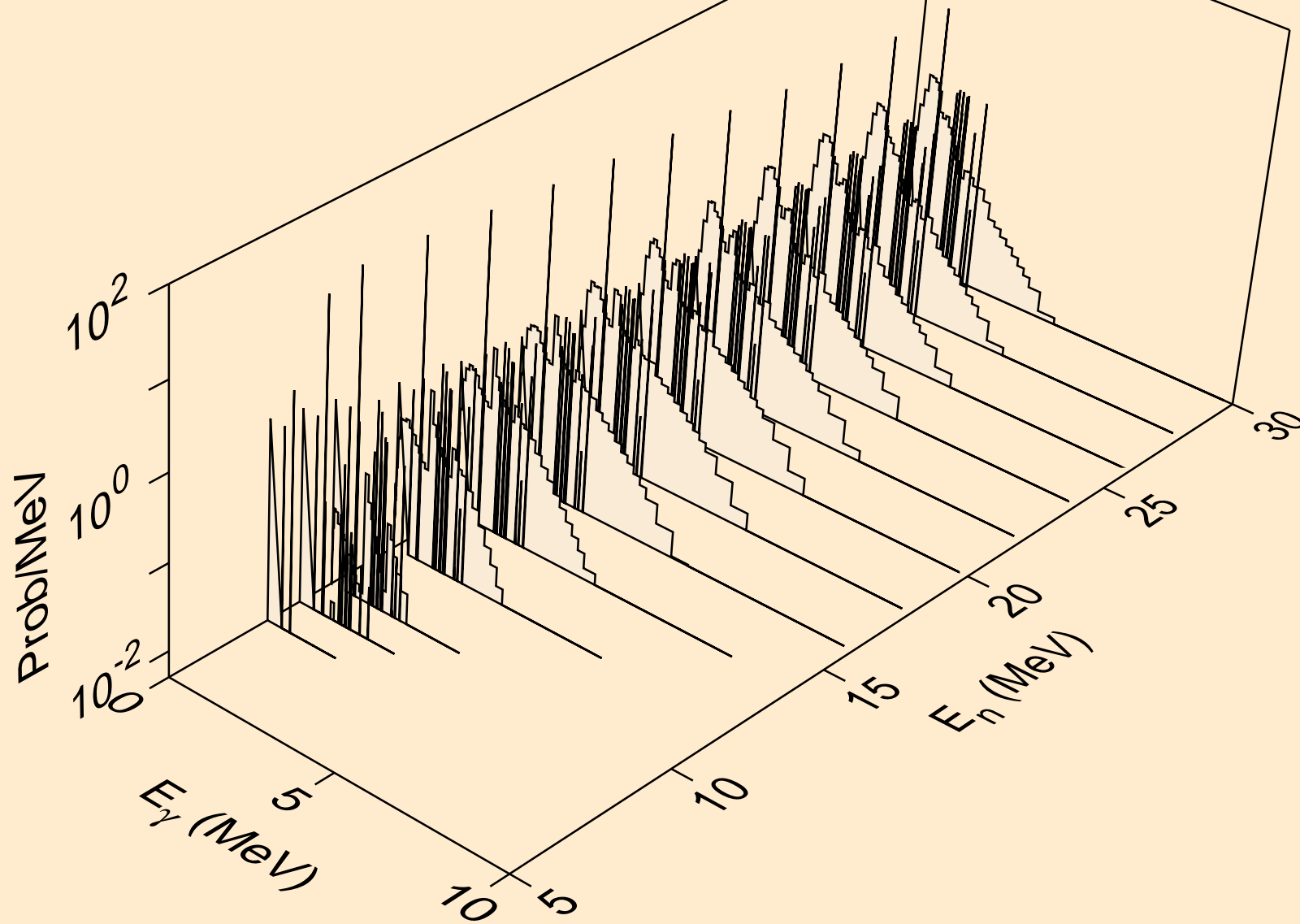

AU206 PROTON ACER TENDL-2021 LIBRARY; T=0.K  
Photon emission for (n,n\*)a

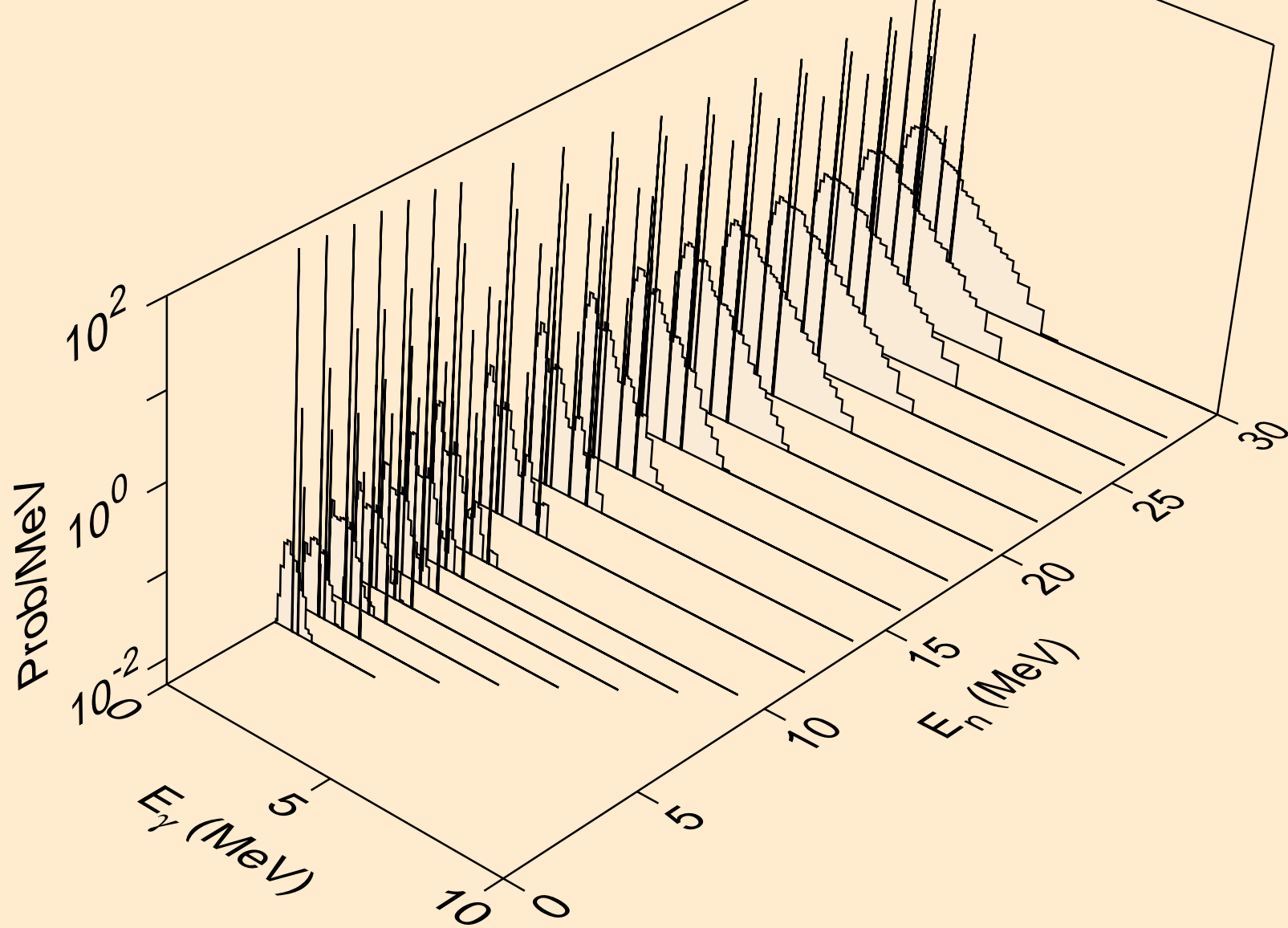



AU206 PROTON ACER TENDL-2021 LIBRARY; T=0.K  
Photon emission for (n,2n)a

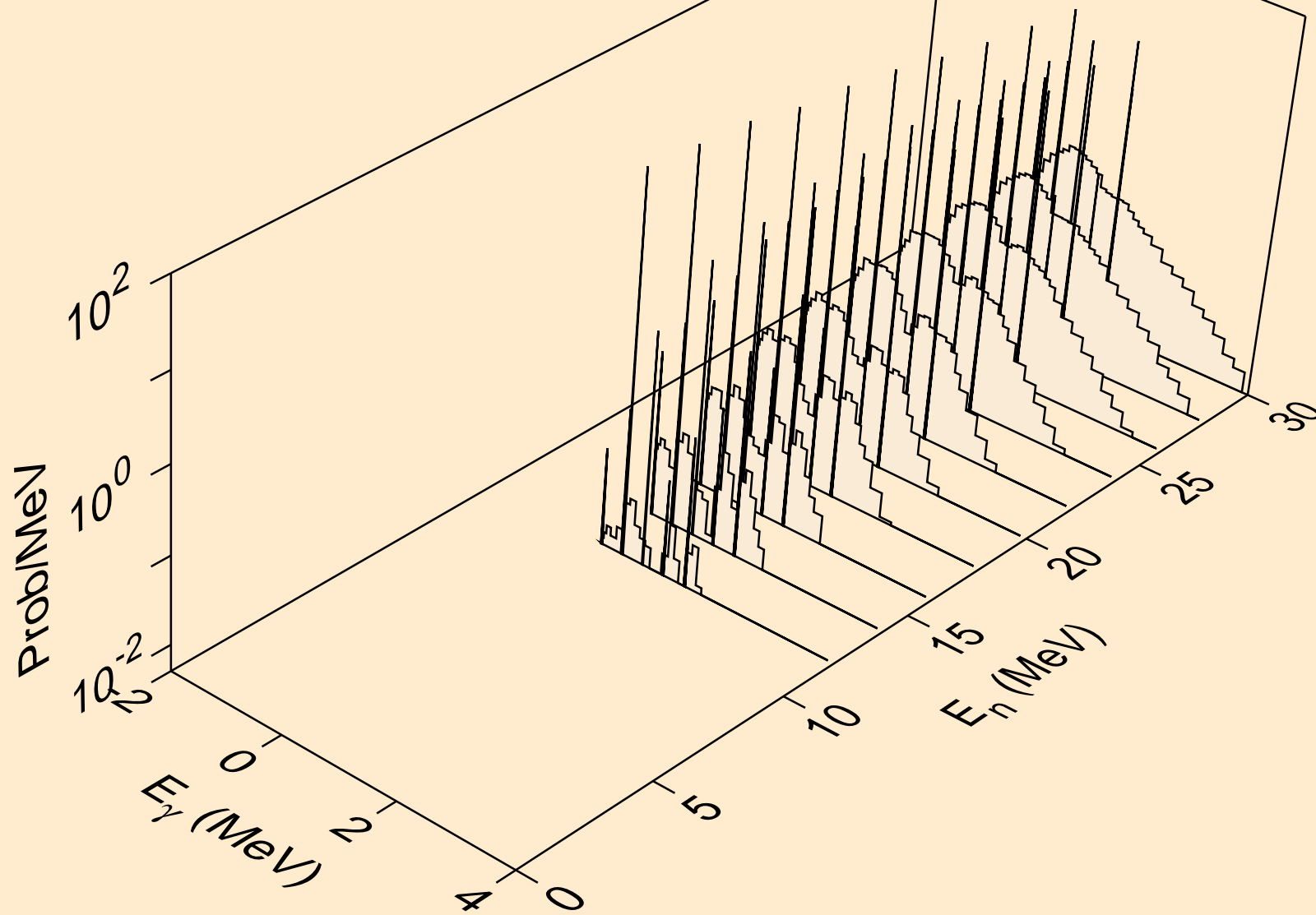

AU206 PROTON ACER TENDL-2021 LIBRARY; T=0.K  
Photon emission for (n,3n)a

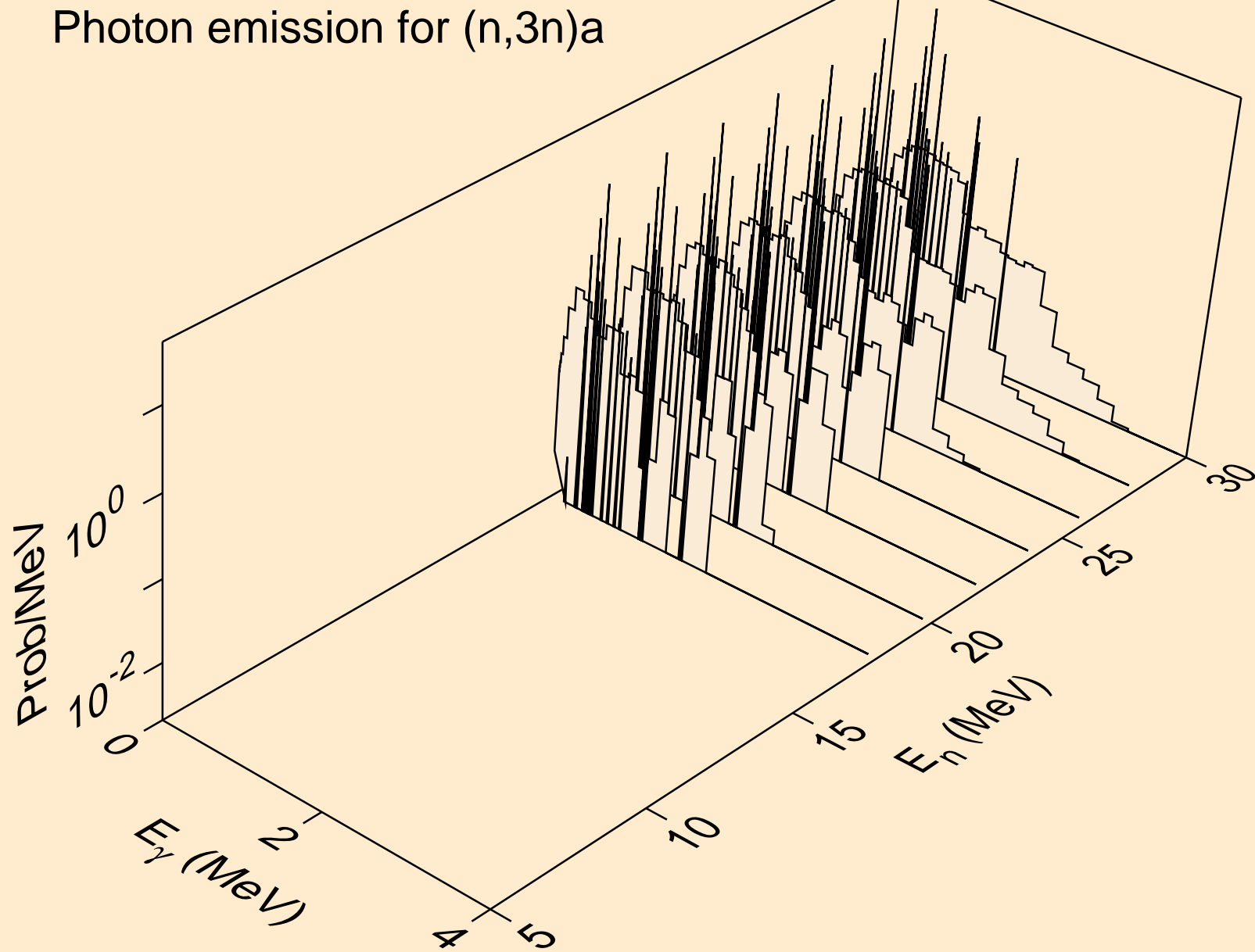

AU206 PROTON ACER TENDL-2021 LIBRARY; T=0.K  
Photon emission for (n,n\*)p

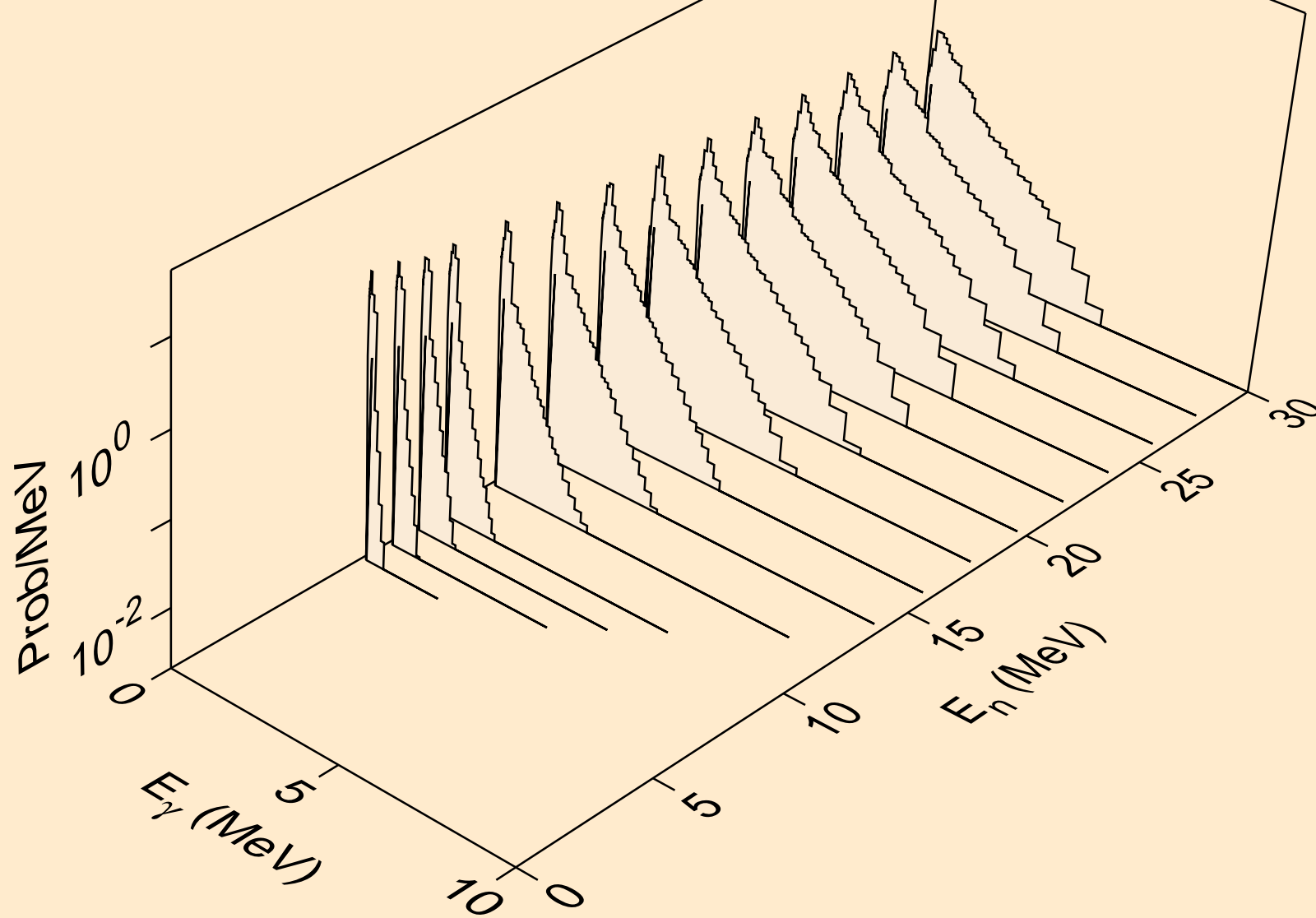

AU206 PROTON ACER TENDL-2021 LIBRARY; T=0.K  
Photon emission for (n,n\*)d

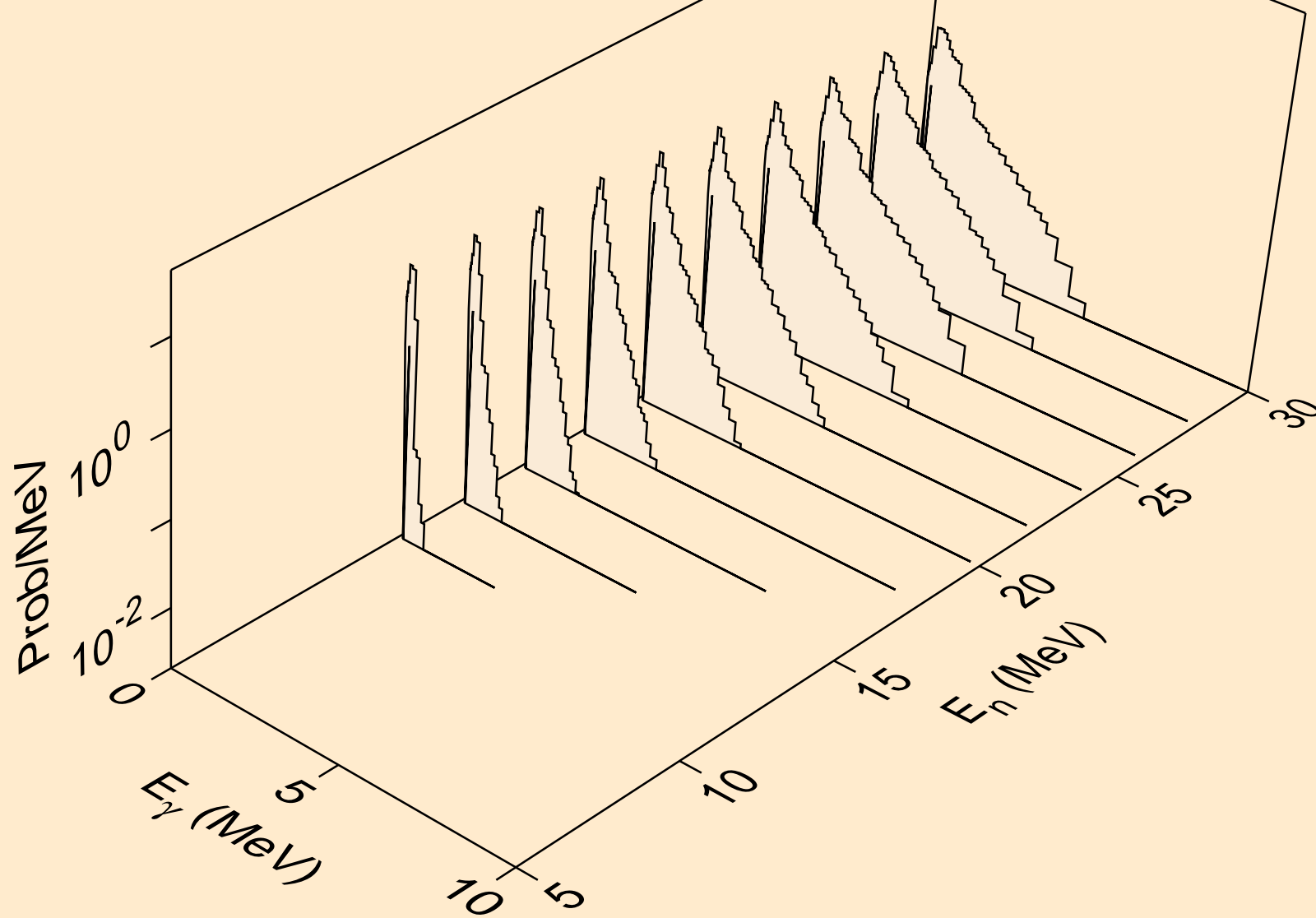

AU206 PROTON ACER TENDL-2021 LIBRARY; T=0.K  
Photon emission for (n,n\*)t

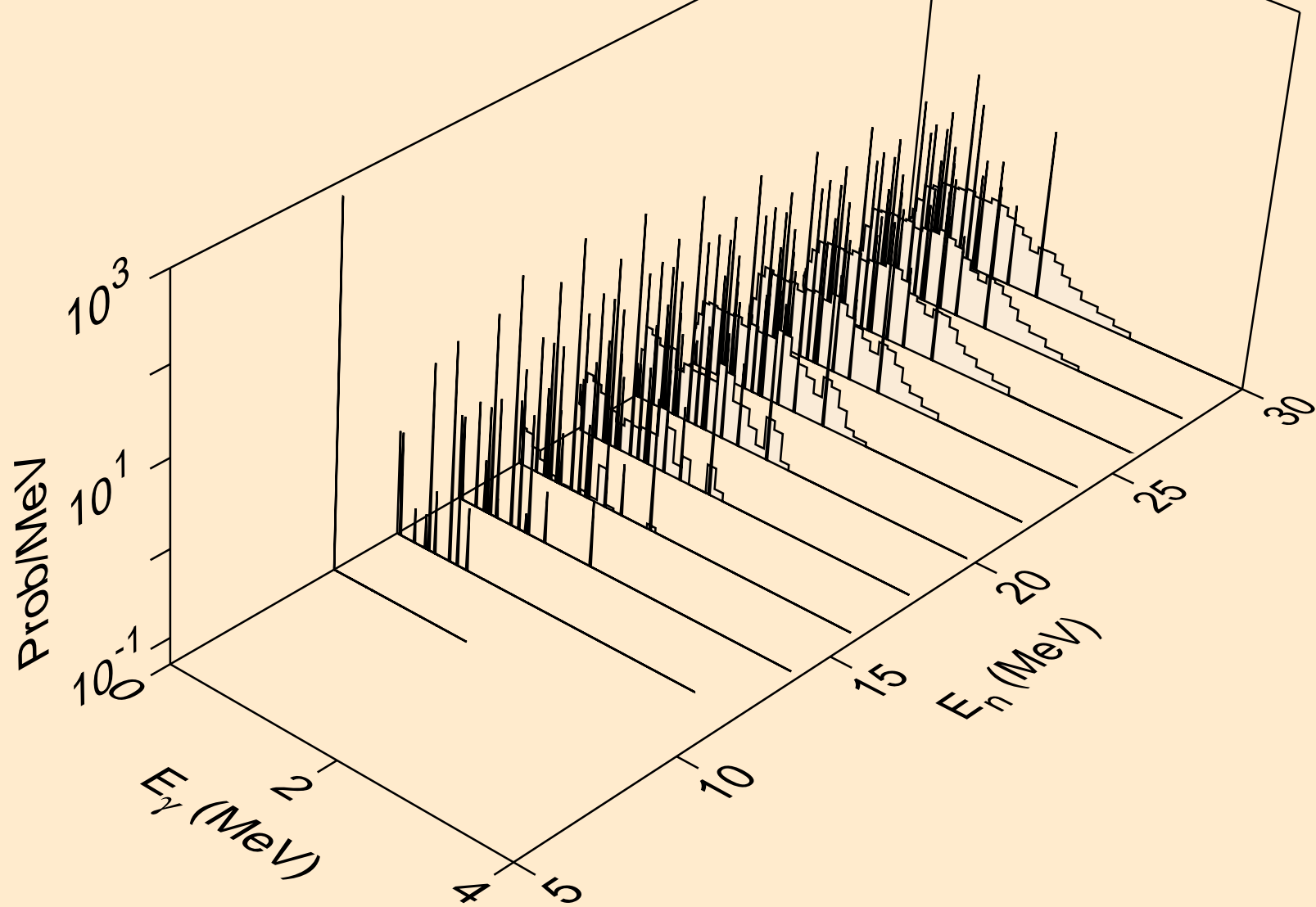

AU206 PROTON ACER TENDL-2021 LIBRARY; T=0.K  
Photon emission for (n,n\*)he3

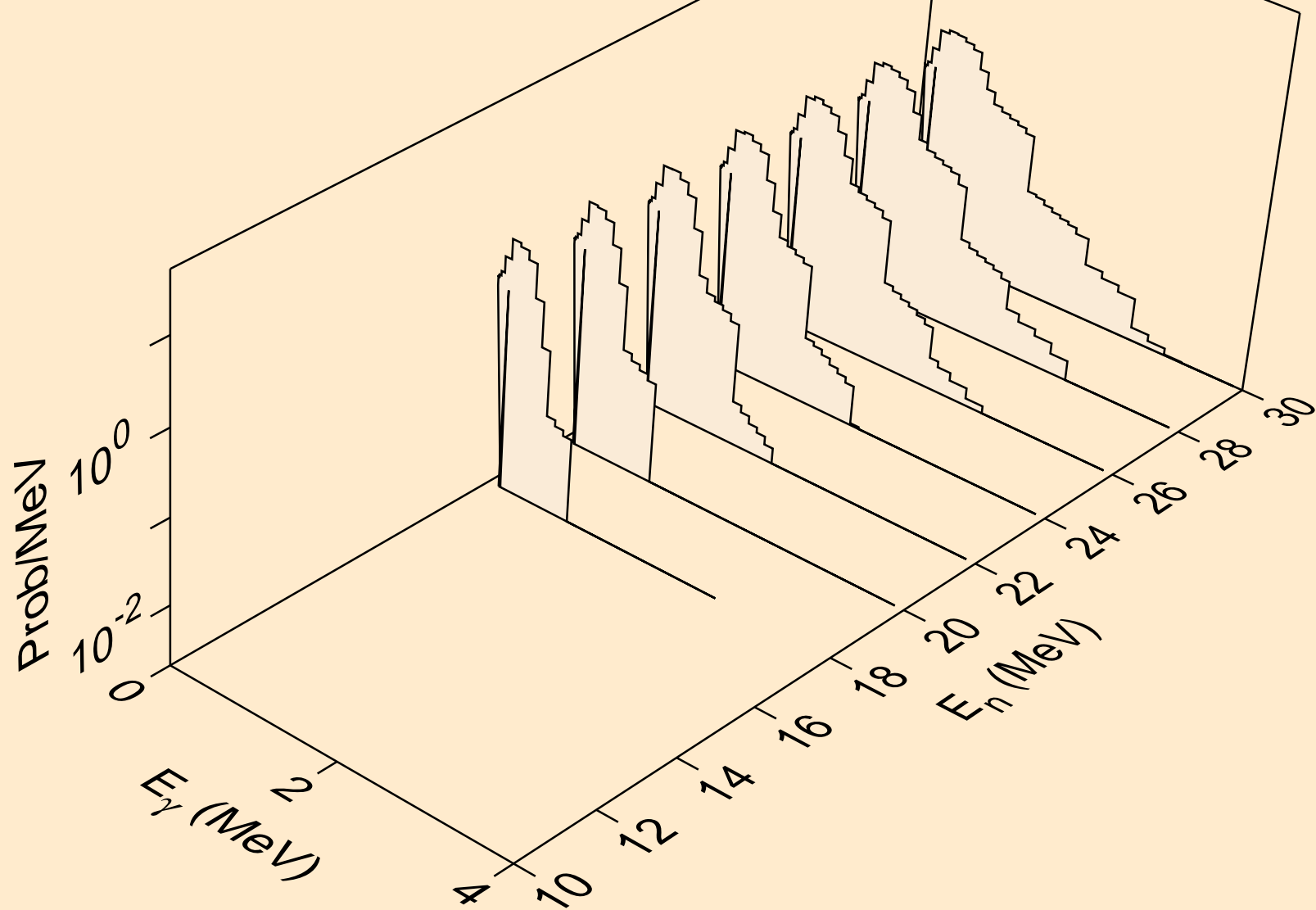

AU206 PROTON ACER TENDL-2021 LIBRARY; T=0.K  
Photon emission for (n,4n)

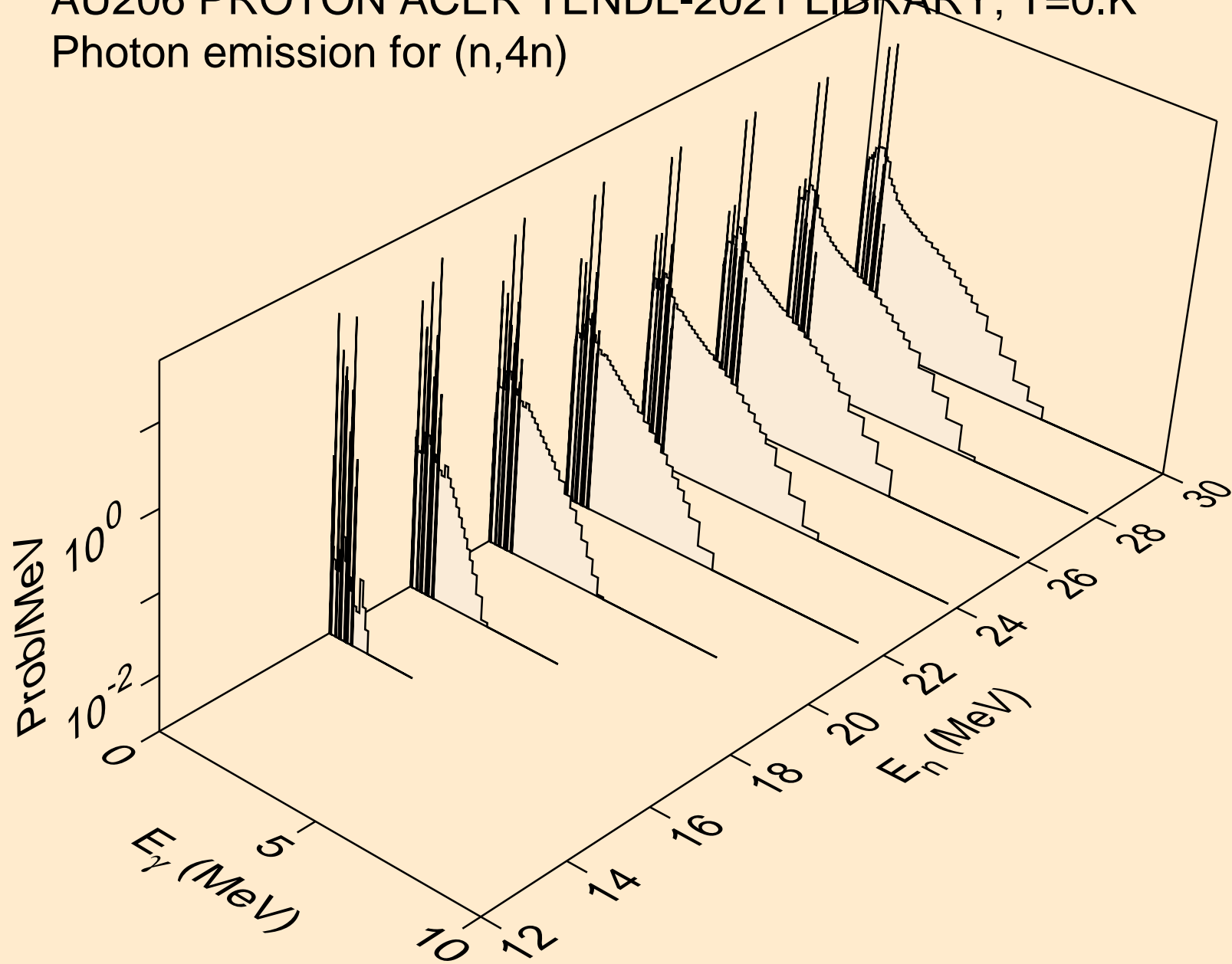

AU206 PROTON ACER TENDL-2021 LIBRARY; T=0.K  
Photon emission for (n,2np)

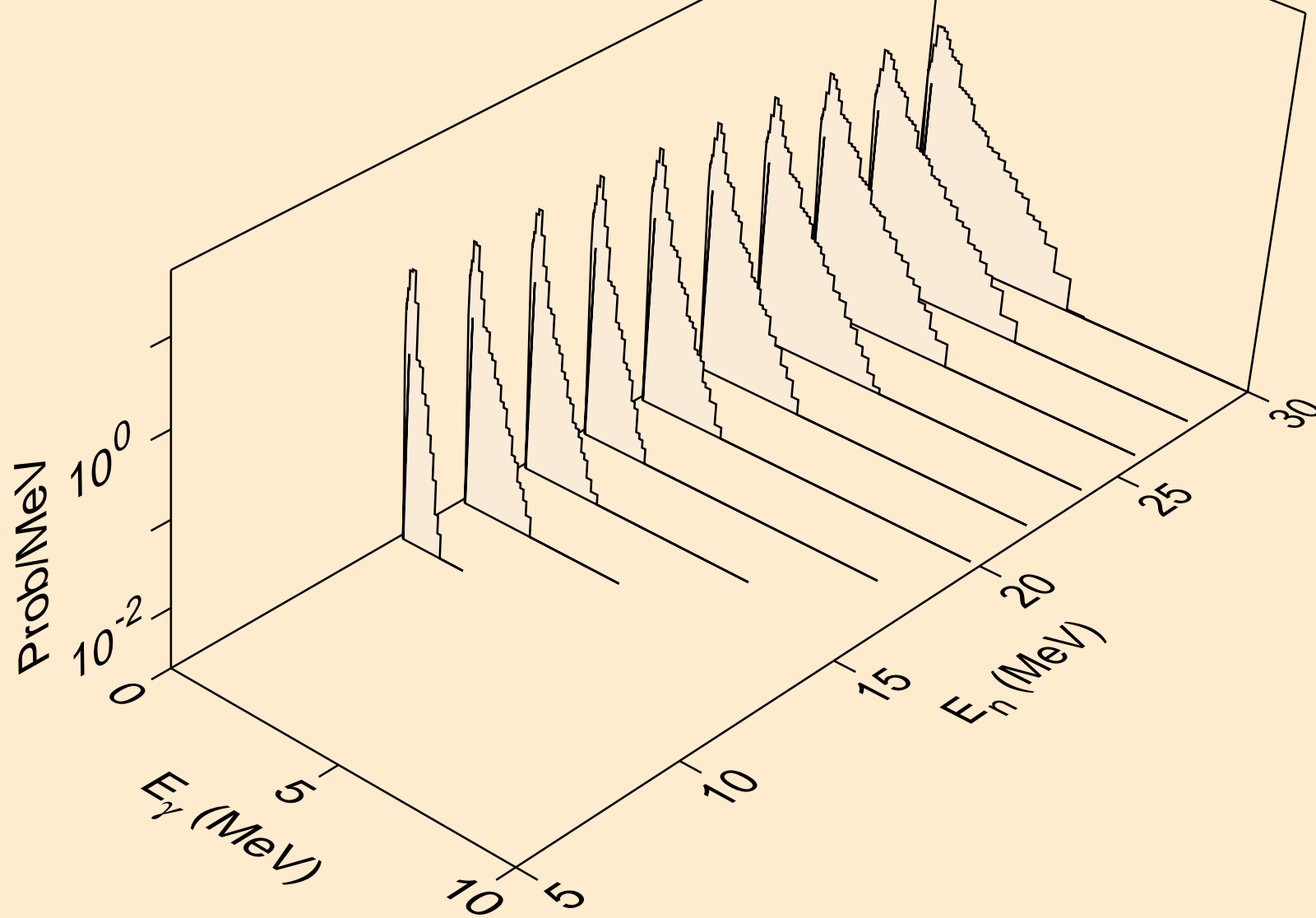



AU206 PROTON ACER TENDL-2021 LIBRARY; T=0.K  
Photon emission for (n,3np)

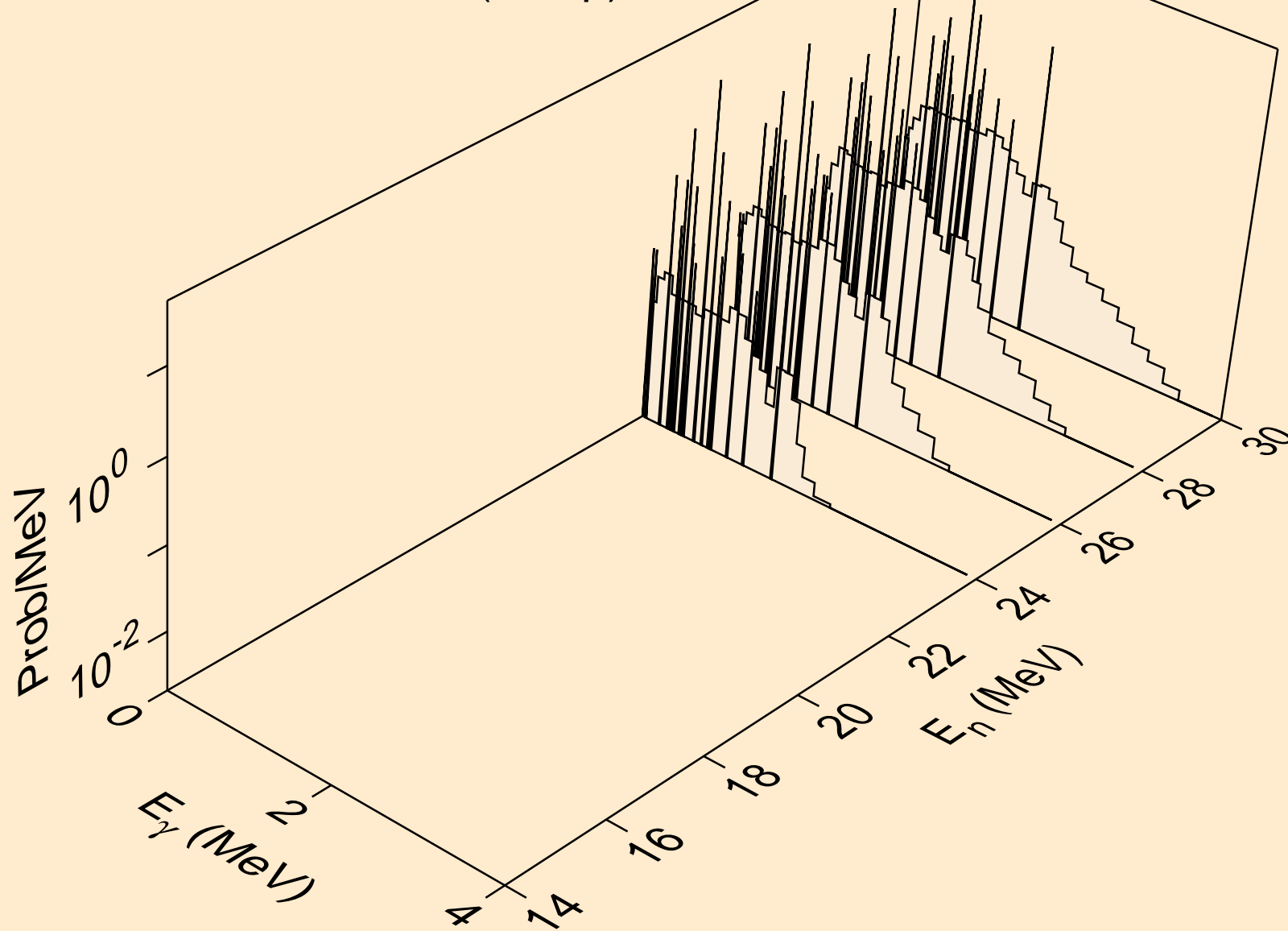

AU206 PROTON ACER TENDL-2021 LIBRARY; T=0.K  
Photon emission for (n,2np)

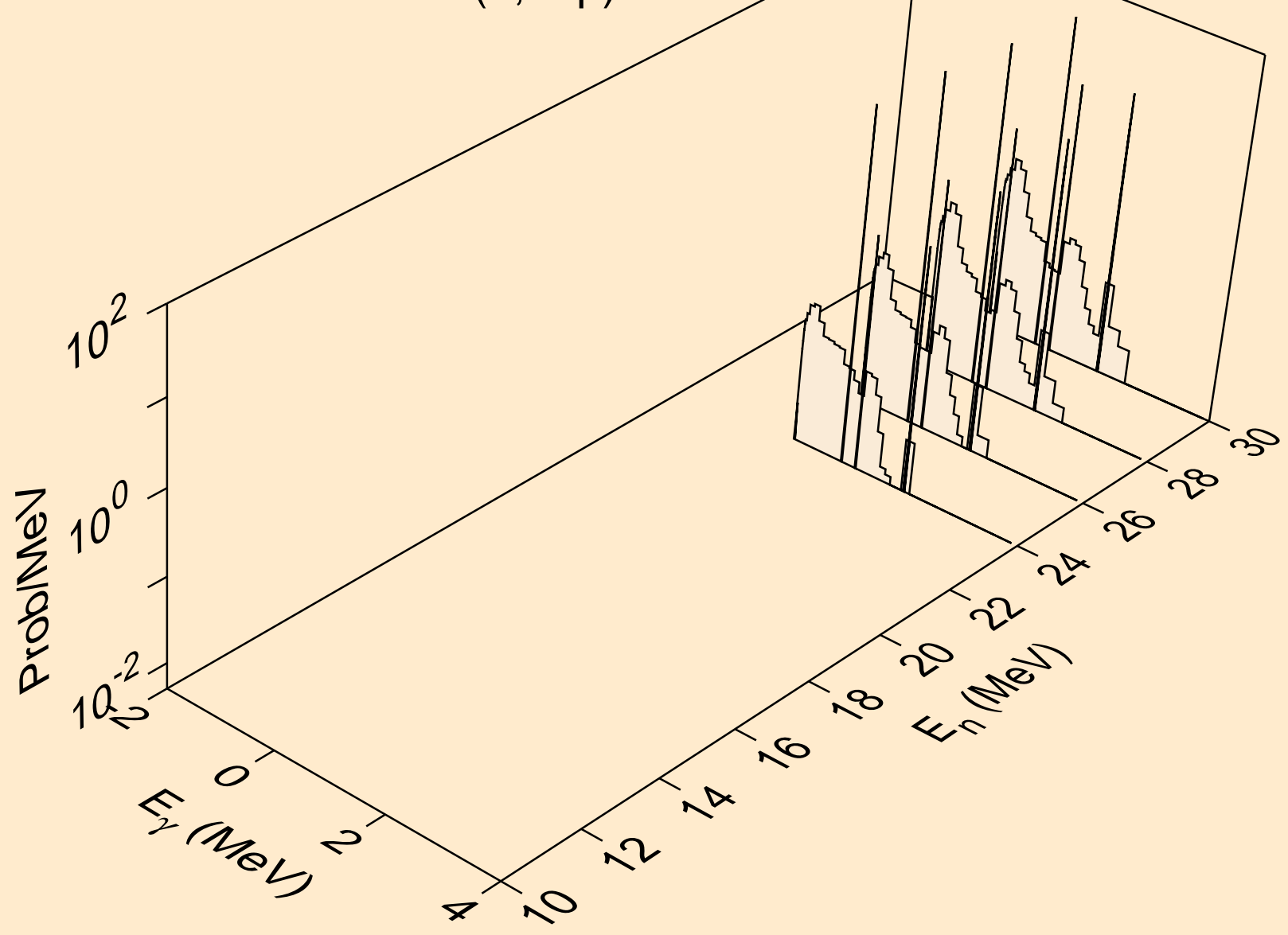

AU206 PROTON ACER TENDL-2021 LIBRARY; T=0.K  
Photon emission for (n,gma)

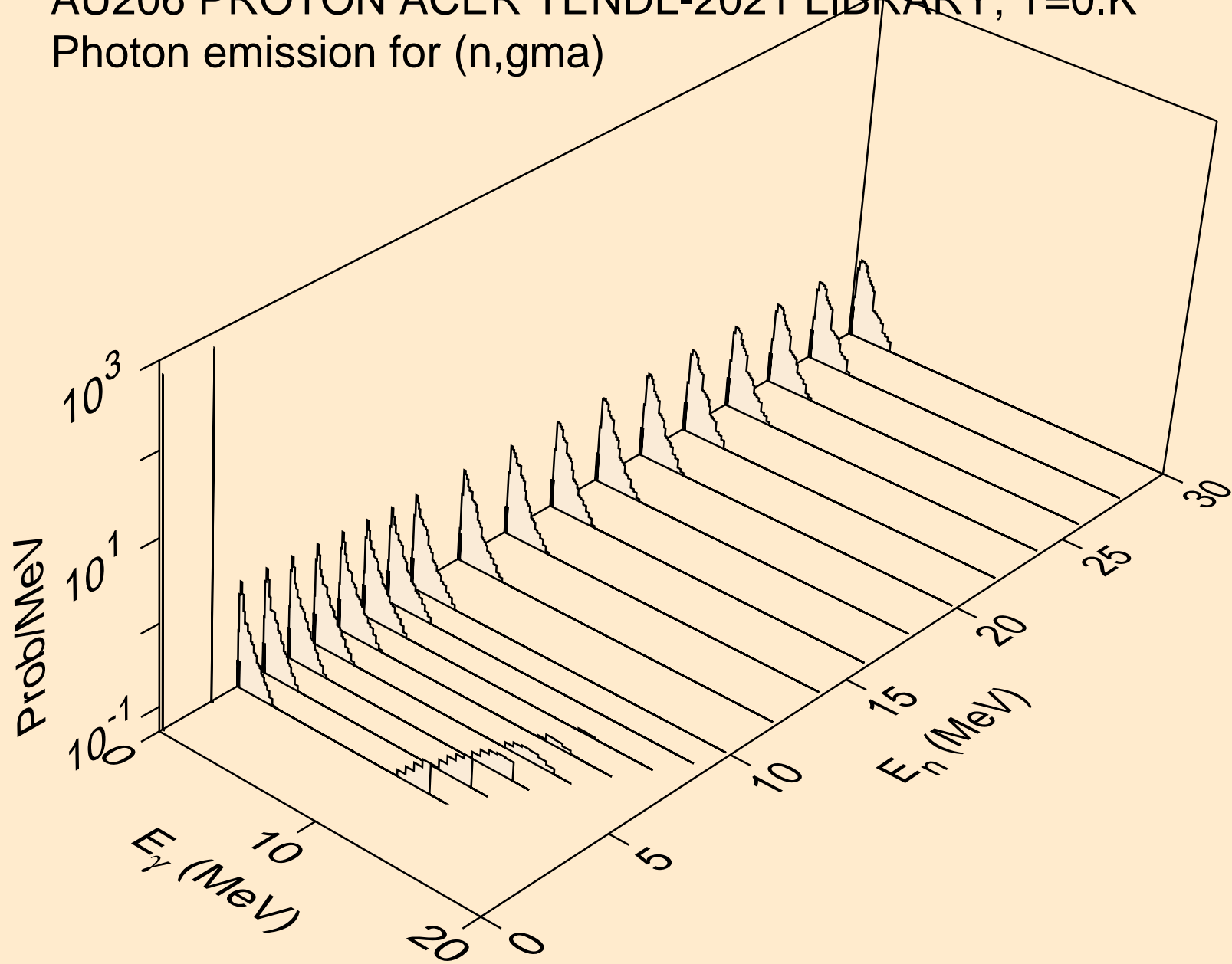

AU206 PROTON ACER TENDL-2021 LIBRARY; T=0.K  
Photon emission for inelastic

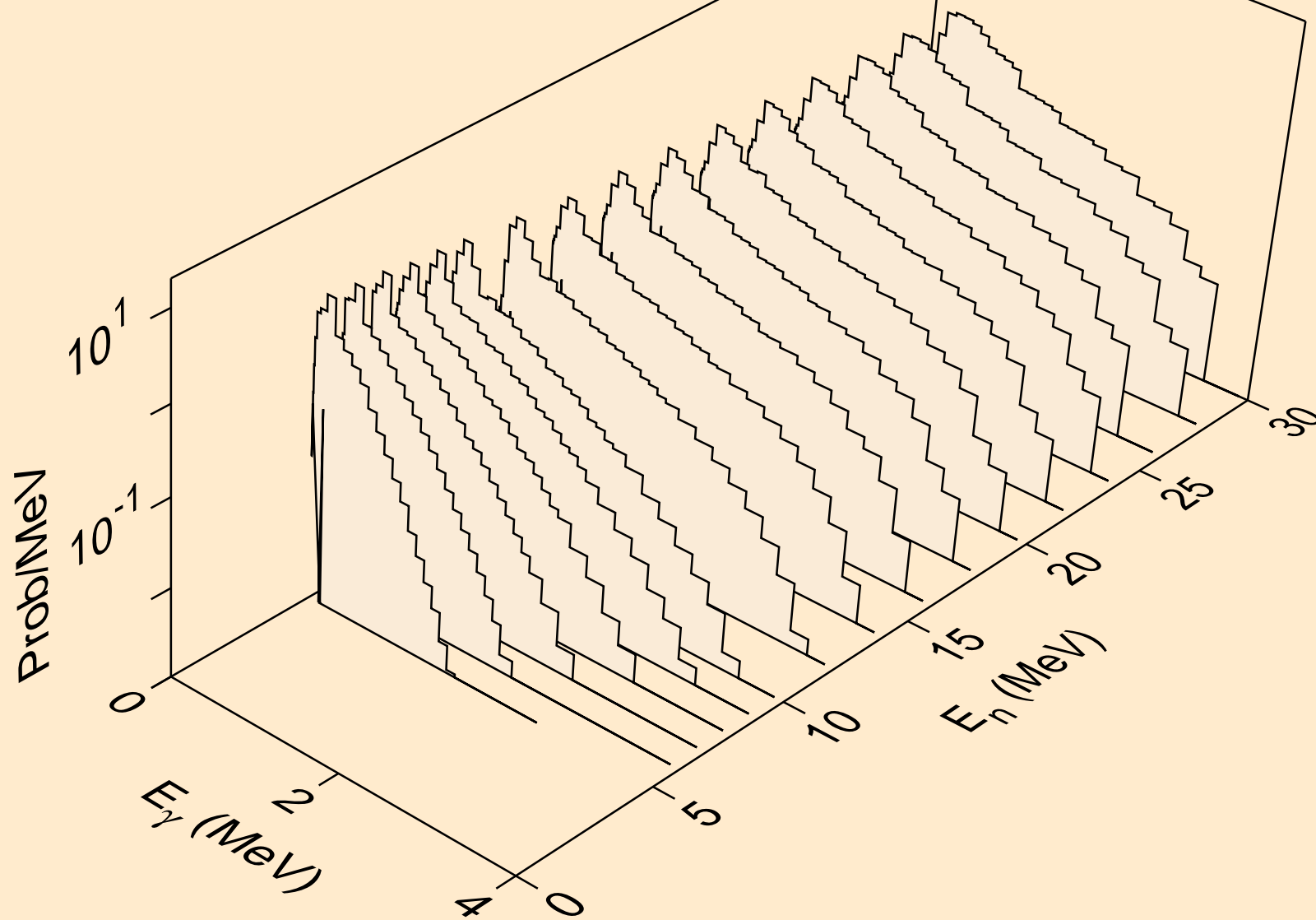

AU206 PROTON ACER TENDL-2021 LIBRARY; T=0.K  
Photon emission for (n,d)

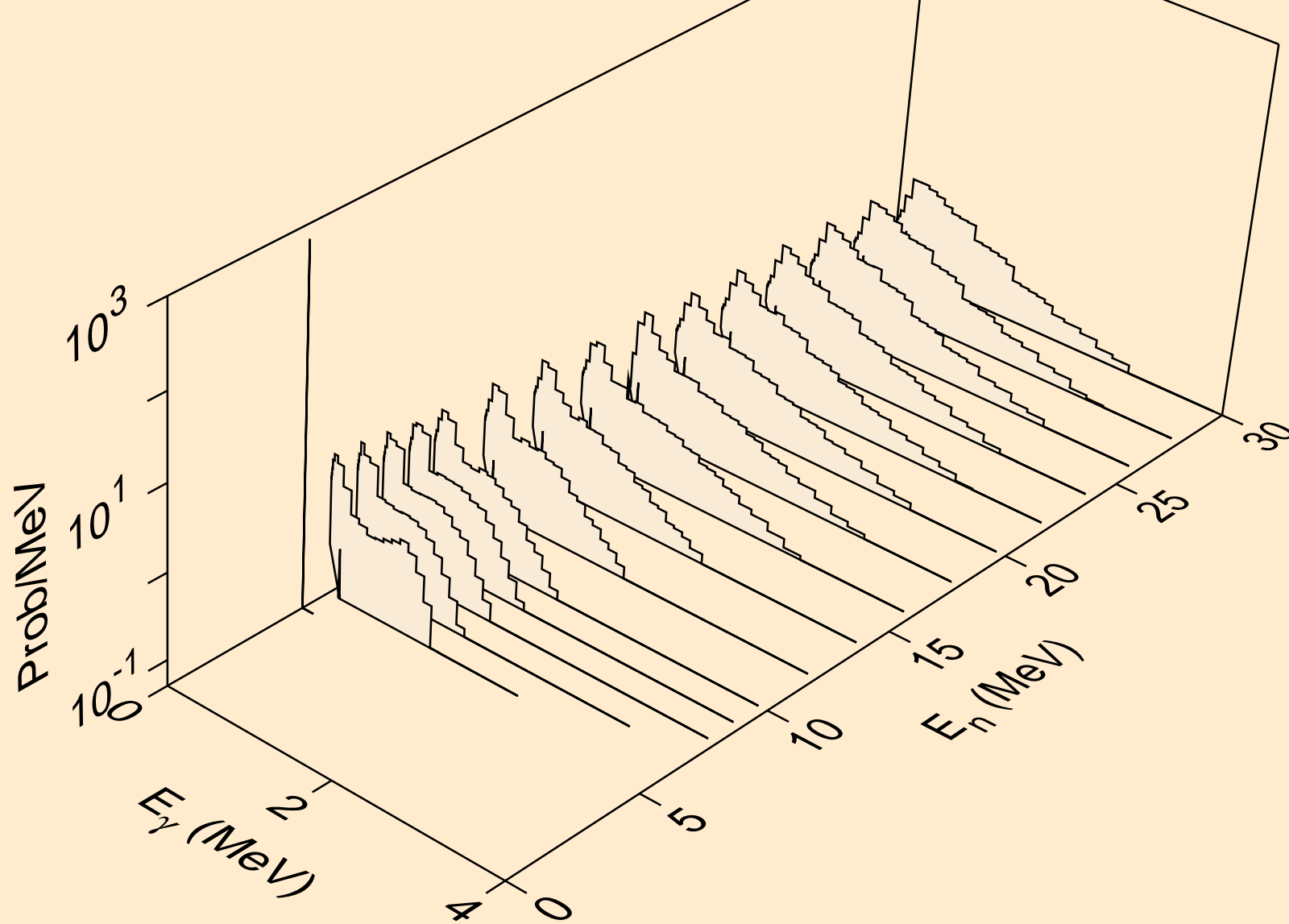

AU206 PROTON ACER TENDL-2021 LIBRARY; T=0.K  
Photon emission for (n,t)

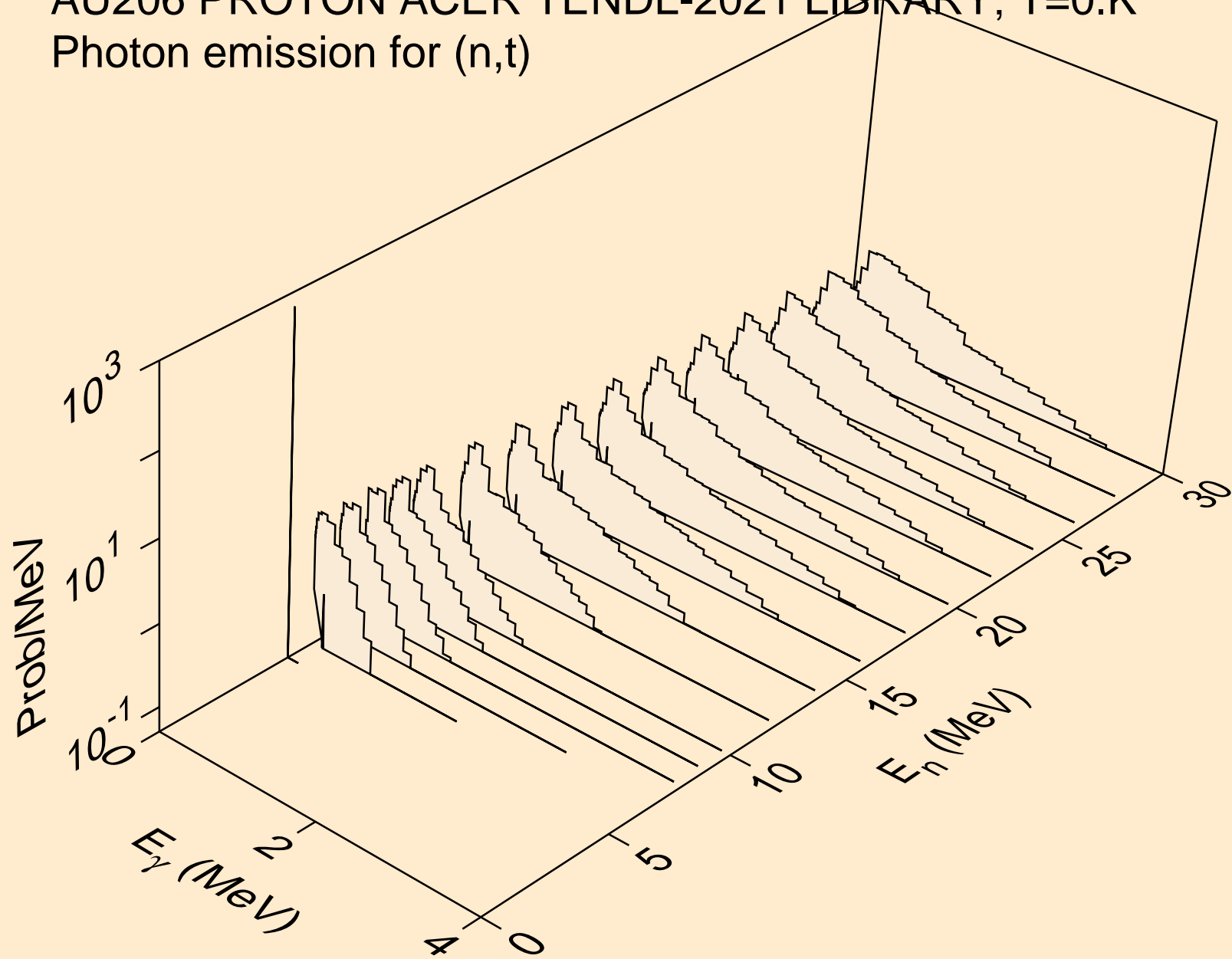

AU206 PROTON ACER TENDL-2021 LIBRARY; T=0.K  
Photon emission for (n,he3)

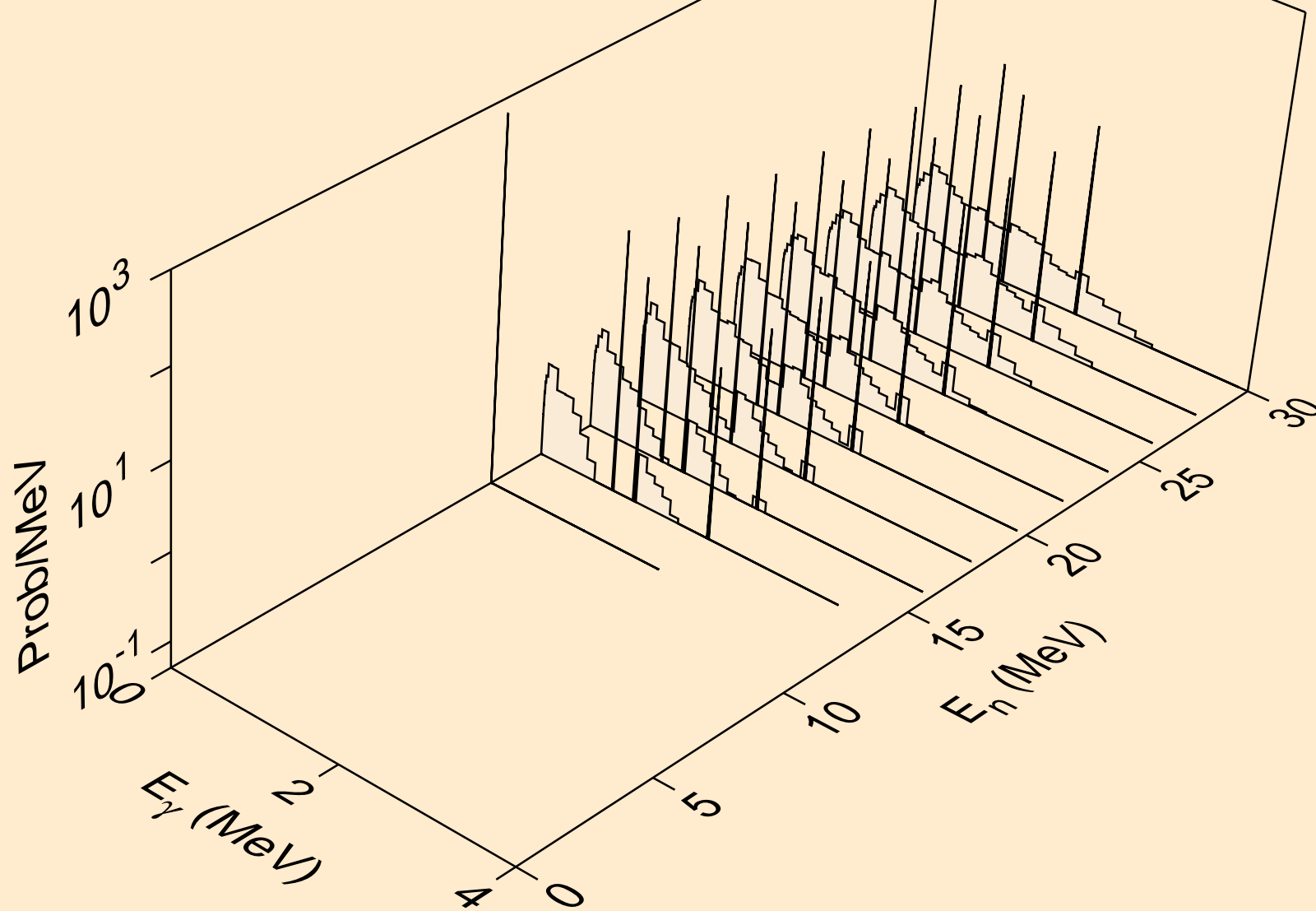

AU206 PROTON ACER TENDL-2021 LIBRARY; T=0.K  
Photon emission for (n,a)

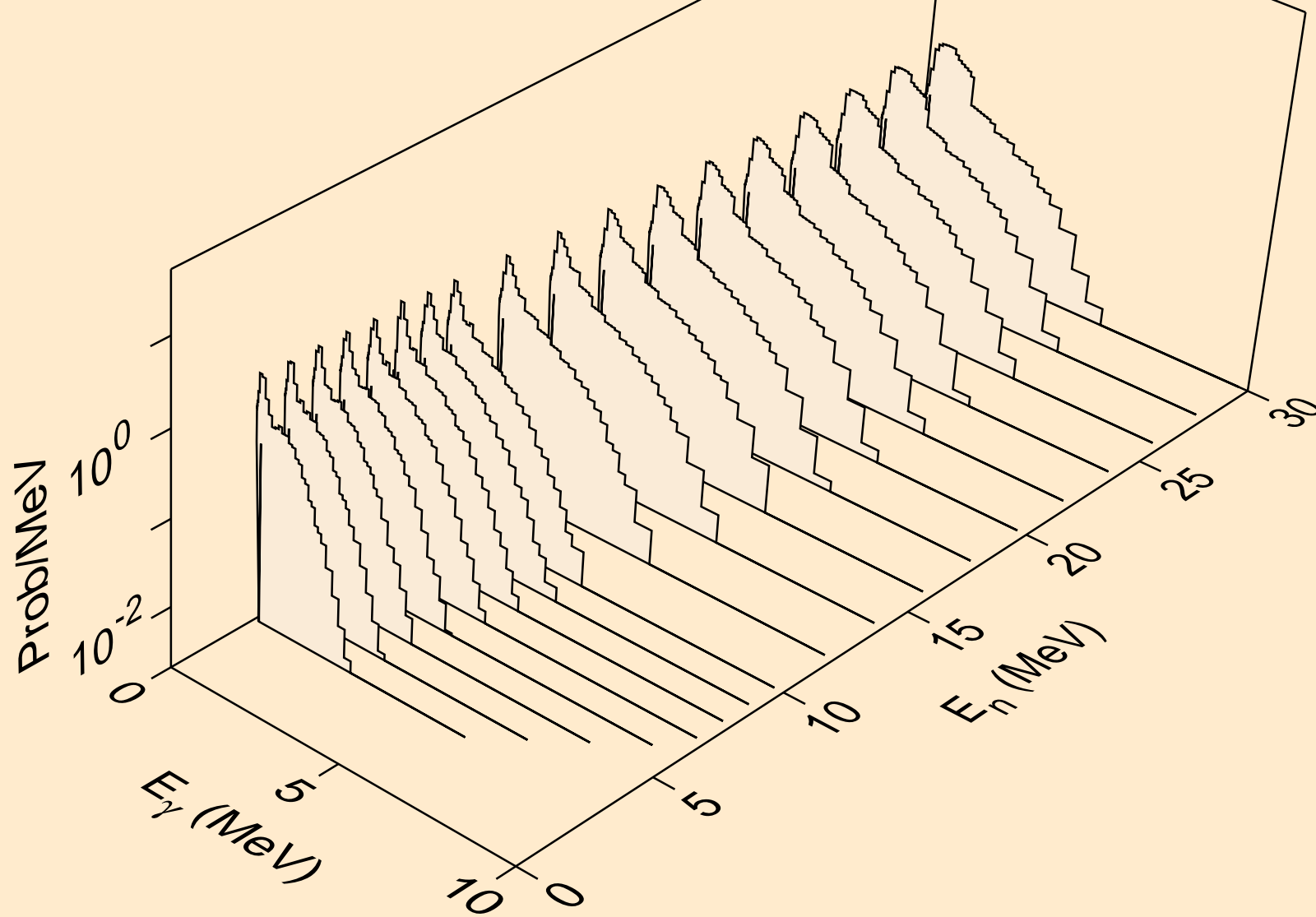



AU206 PROTON ACER TENDL-2021 LIBRARY; T=0.K  
Photon emission for (n,2p)

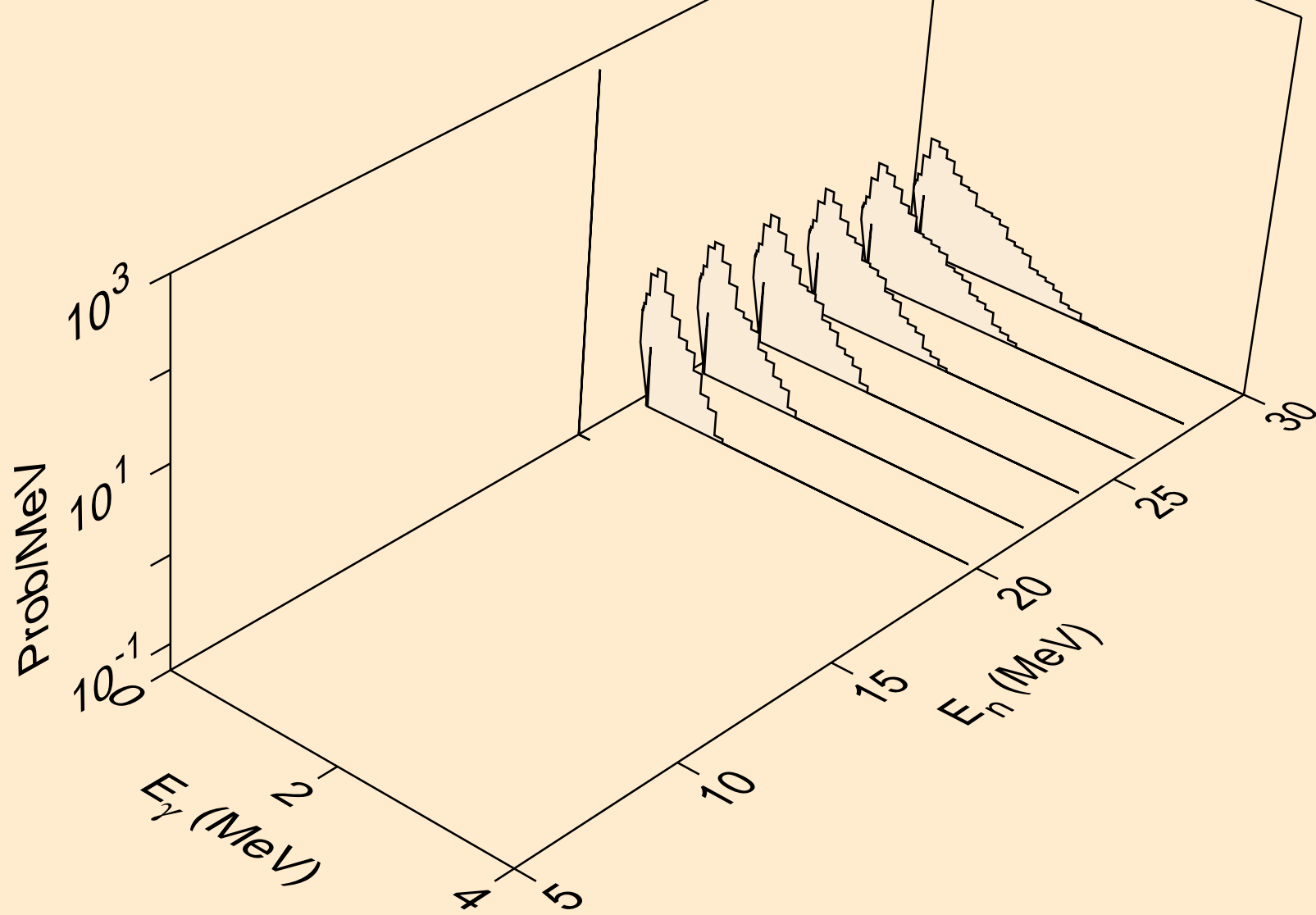

AU206 PROTON ACER TENDL-2021 LIBRARY; T=0.K  
Photon emission for (n,pd)

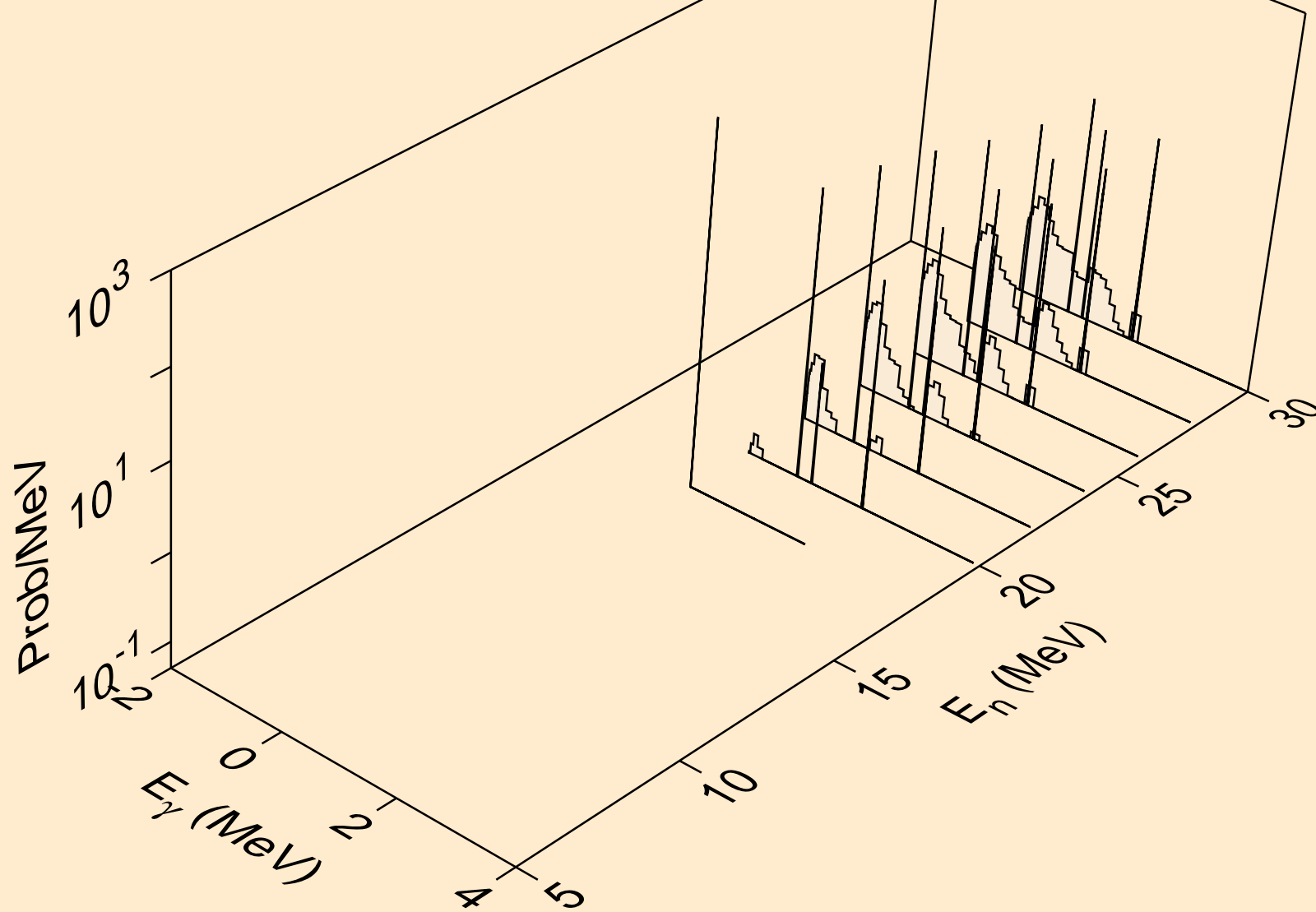

AU206 PROTON ACER TENDL-2021 LIBRARY; T=0.K  
Particle heating contributions

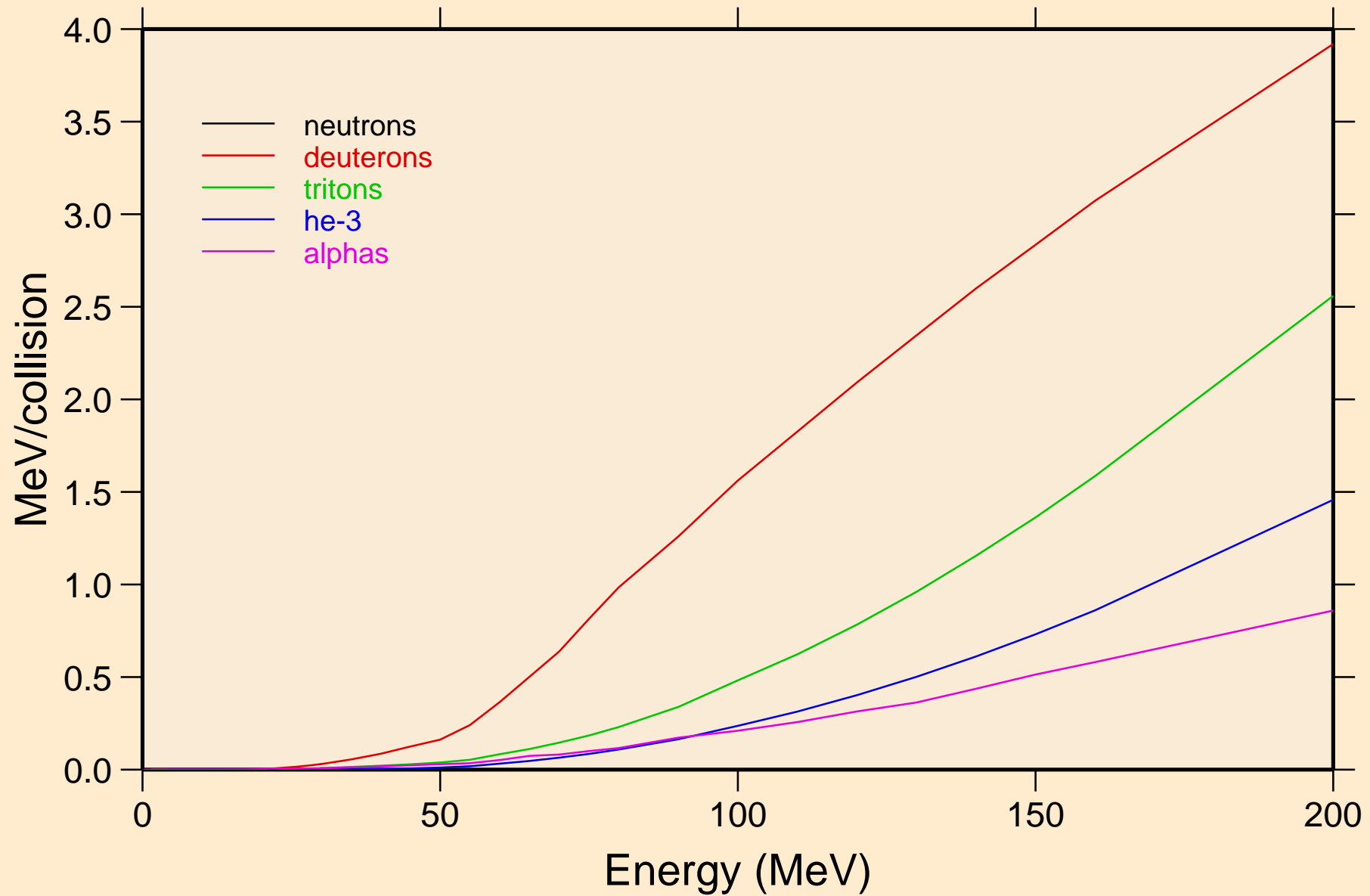

AU206 PROTON ACER TENDL-2021 LIBRARY; T=0.K  
Recoil Heating

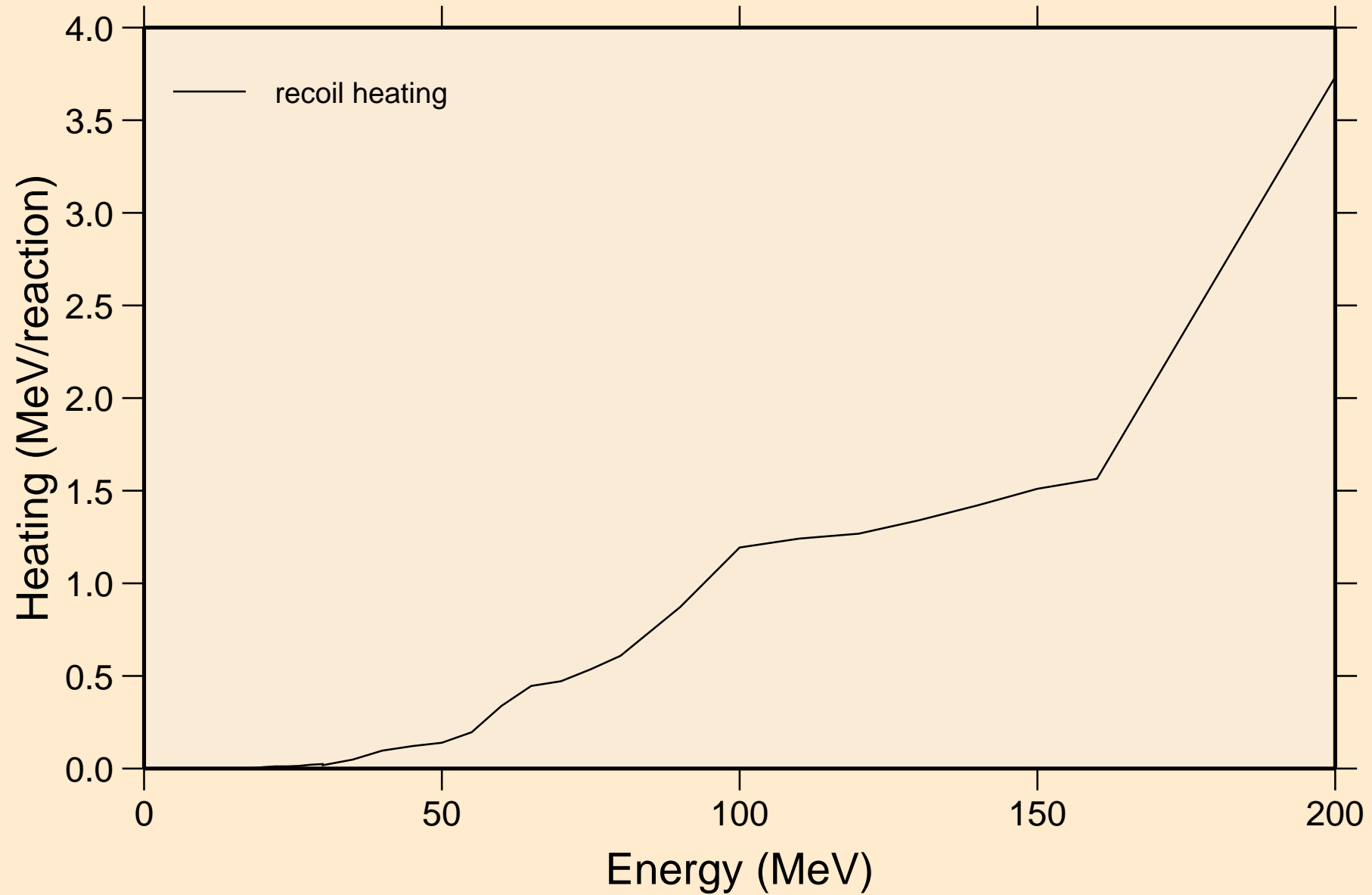

AU206 PROTON ACER TENDL-2021 LIBRARY; T=0.K  
Particle production cross sections

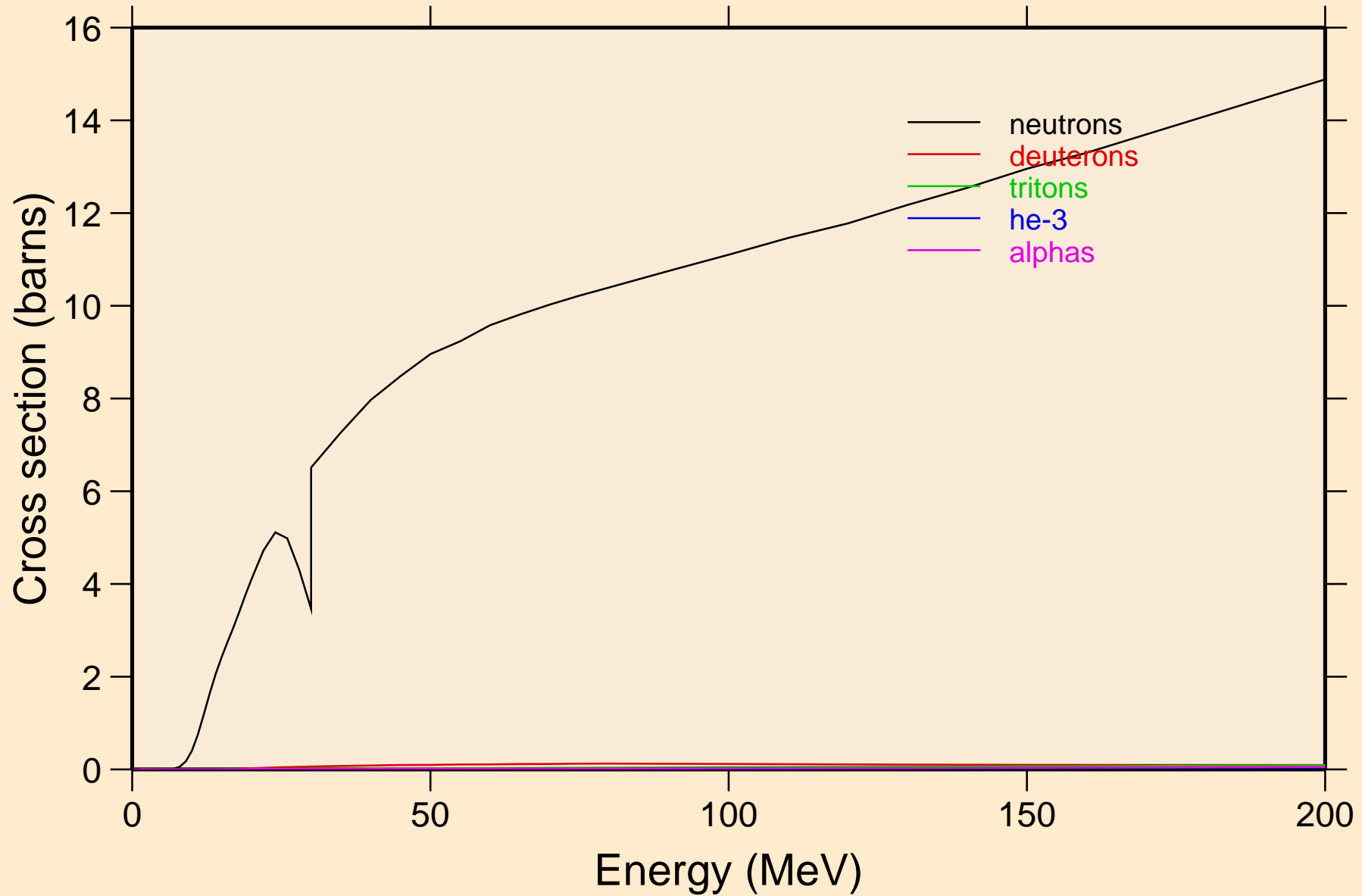

AU206 PROTON ACER TENDL-2021 LIBRARY; T=0.K  
neutrons from (p,n)

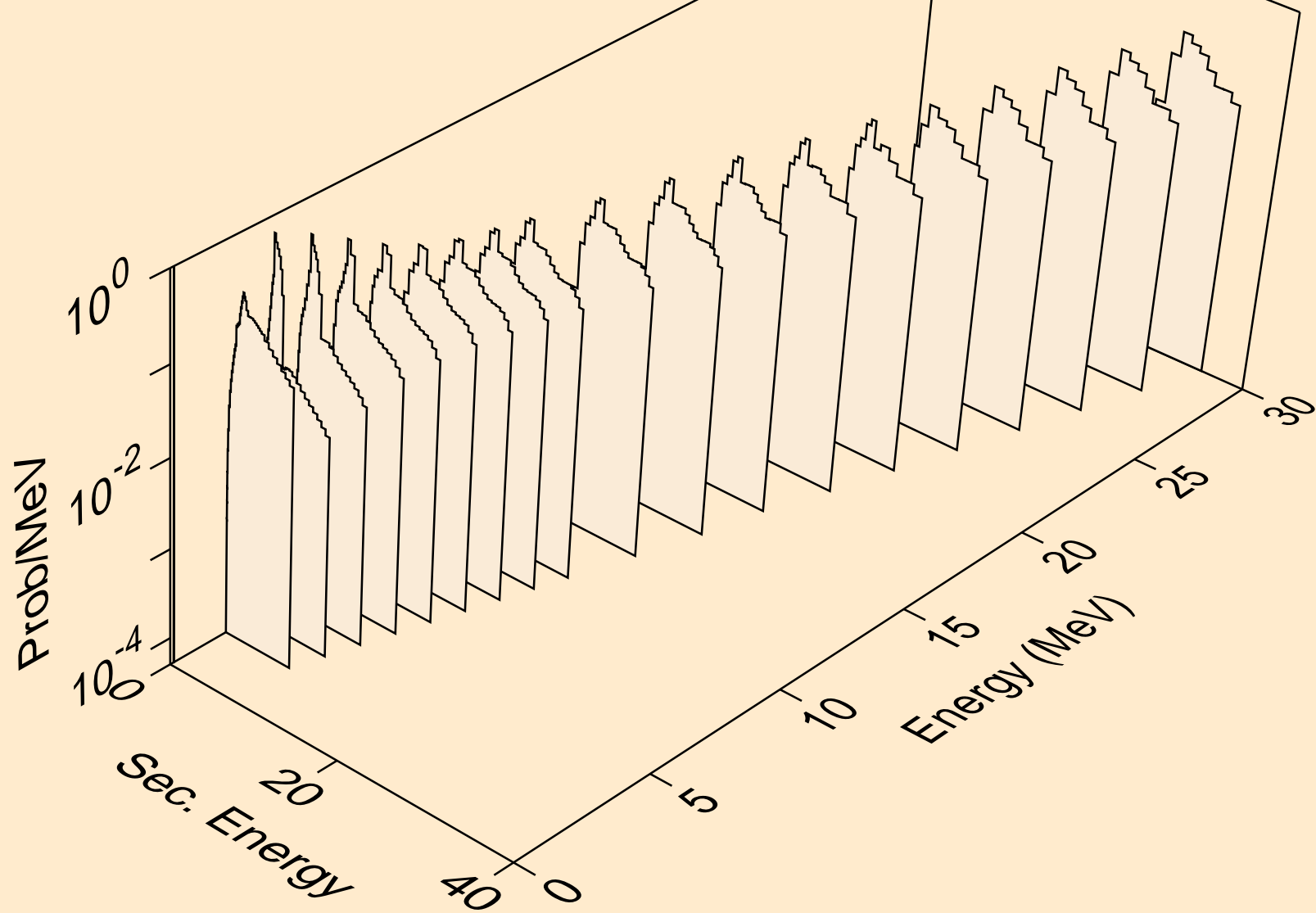

AU206 PROTON ACER TENDL-2021 LIBRARY; T=0.K  
neutrons from (p,x)

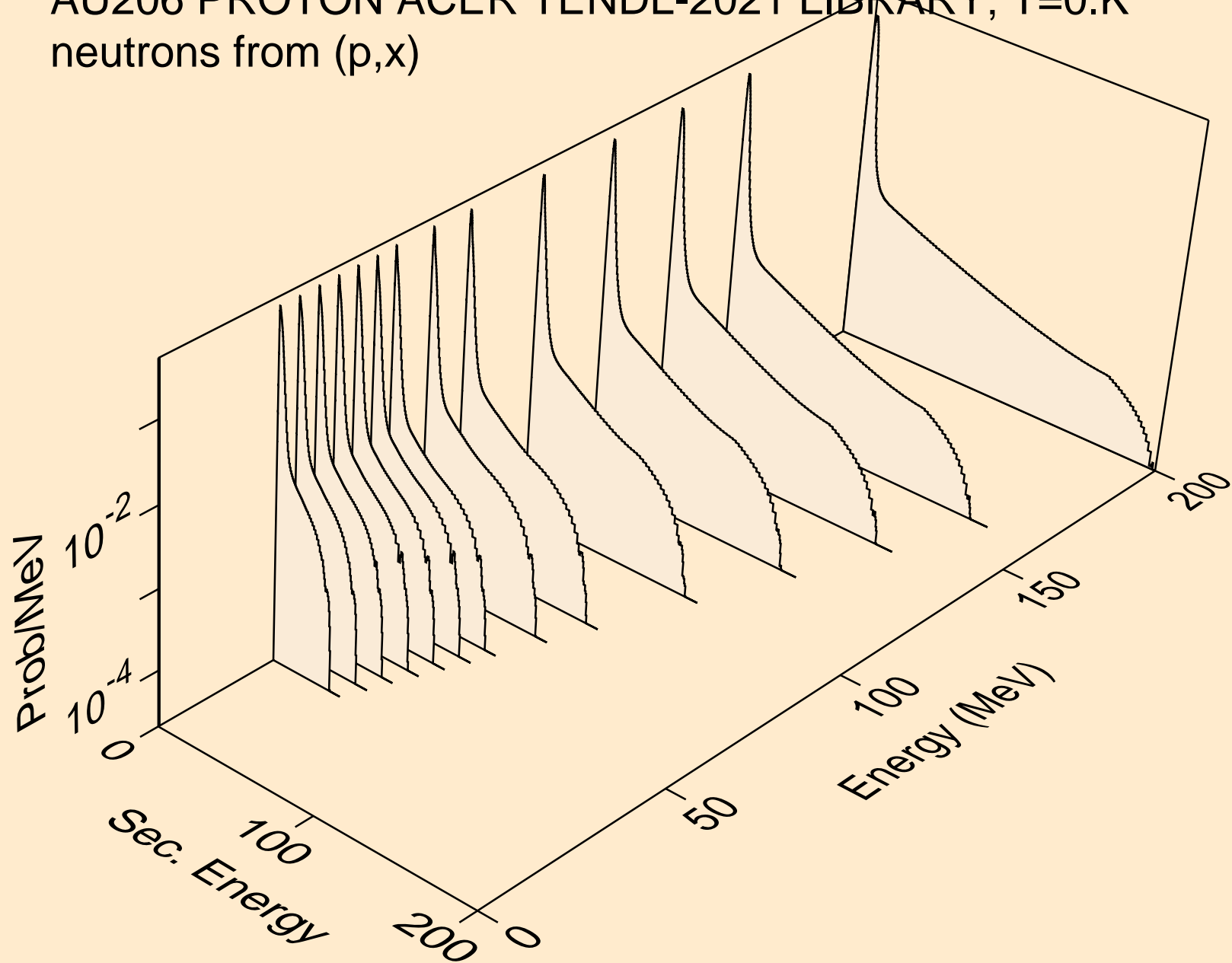

AU206 PROTON ACER TENDL-2021 LIBRARY; T=0.K  
neutrons from (p,2nd)

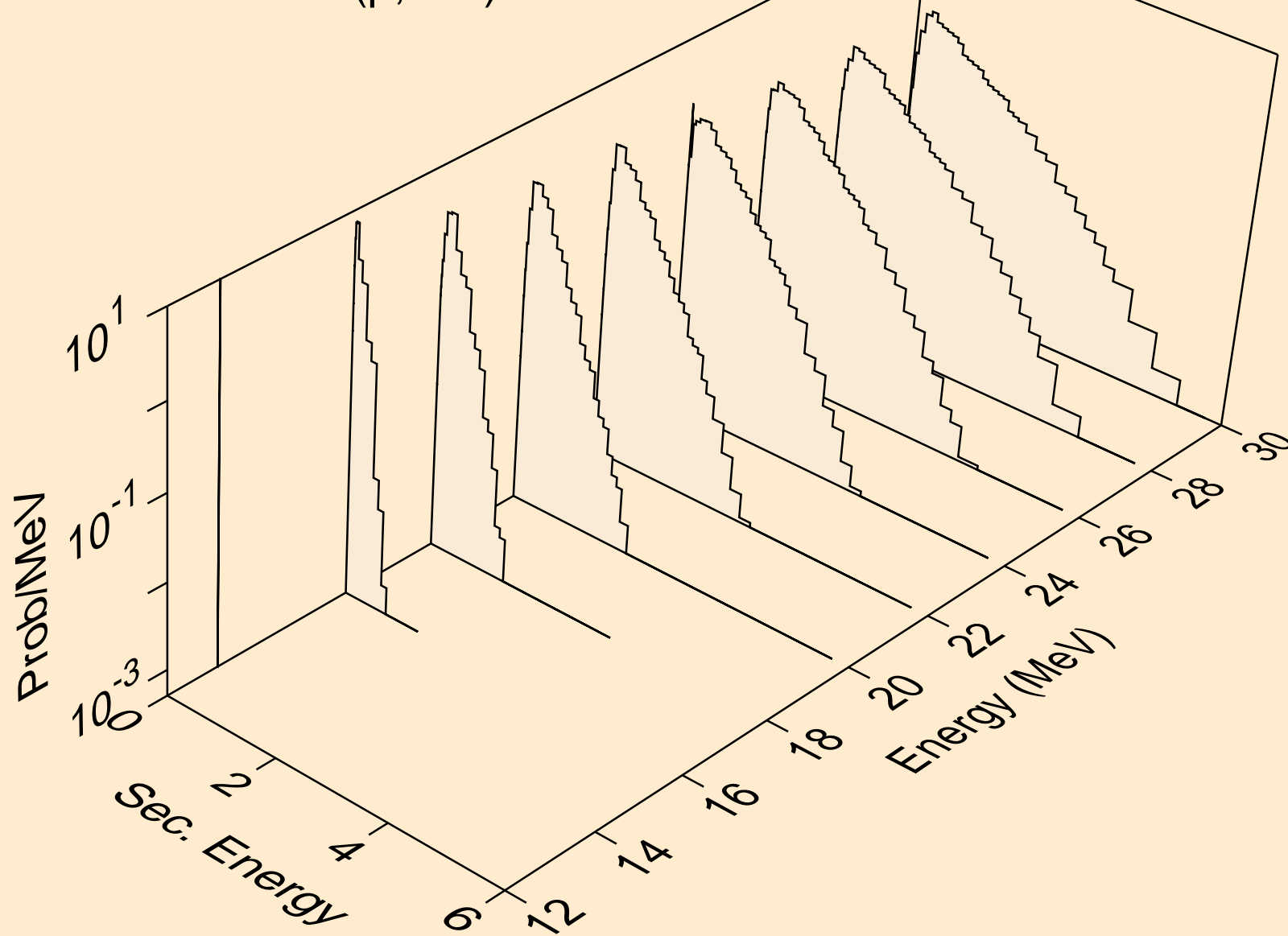



AU206 PROTON ACER TENDL-2021 LIBRARY; T=0.K  
neutrons from (p,2n)

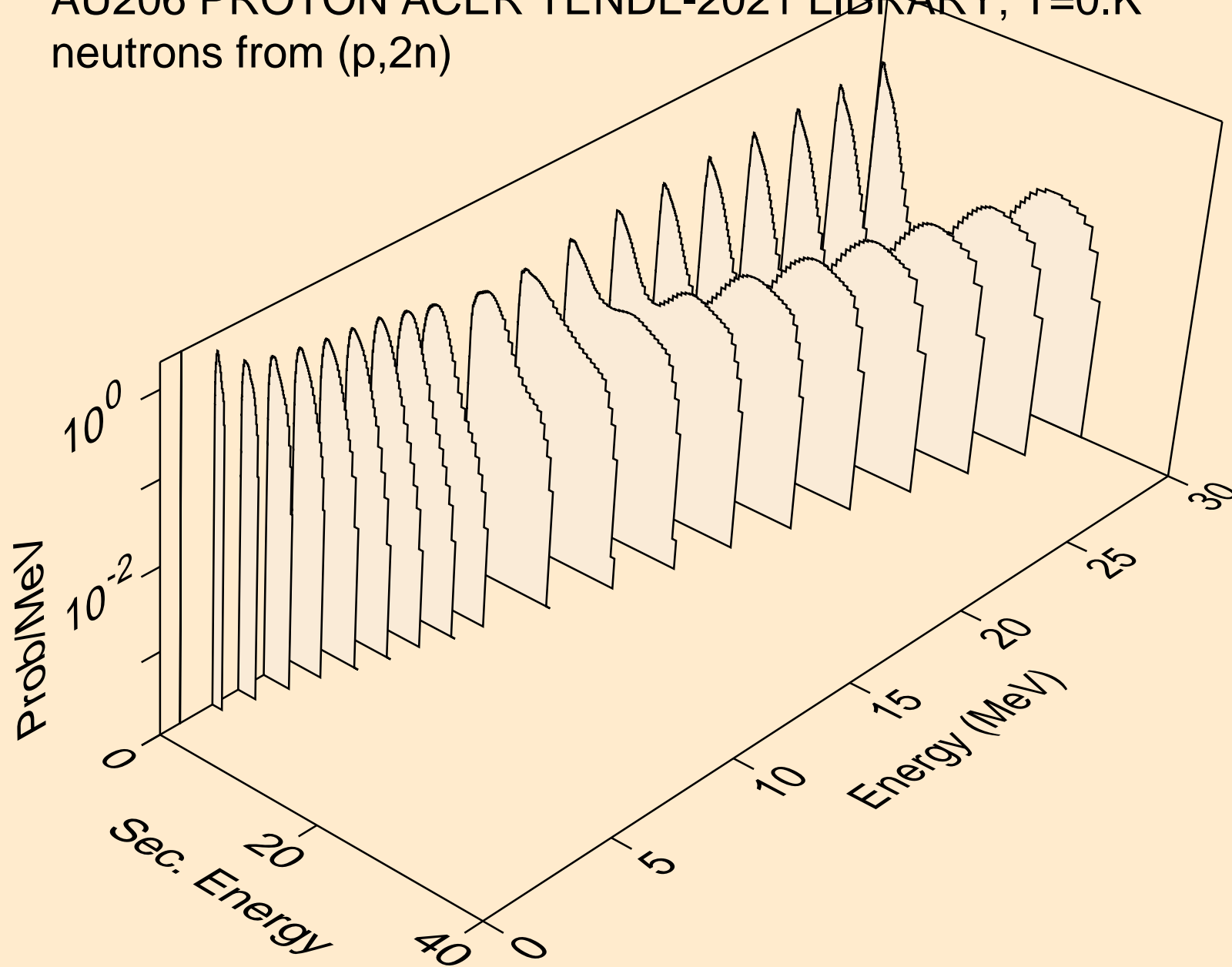

AU206 PROTON ACER TENDL-2021 LIBRARY; T=0.K  
neutrons from (p,3n)

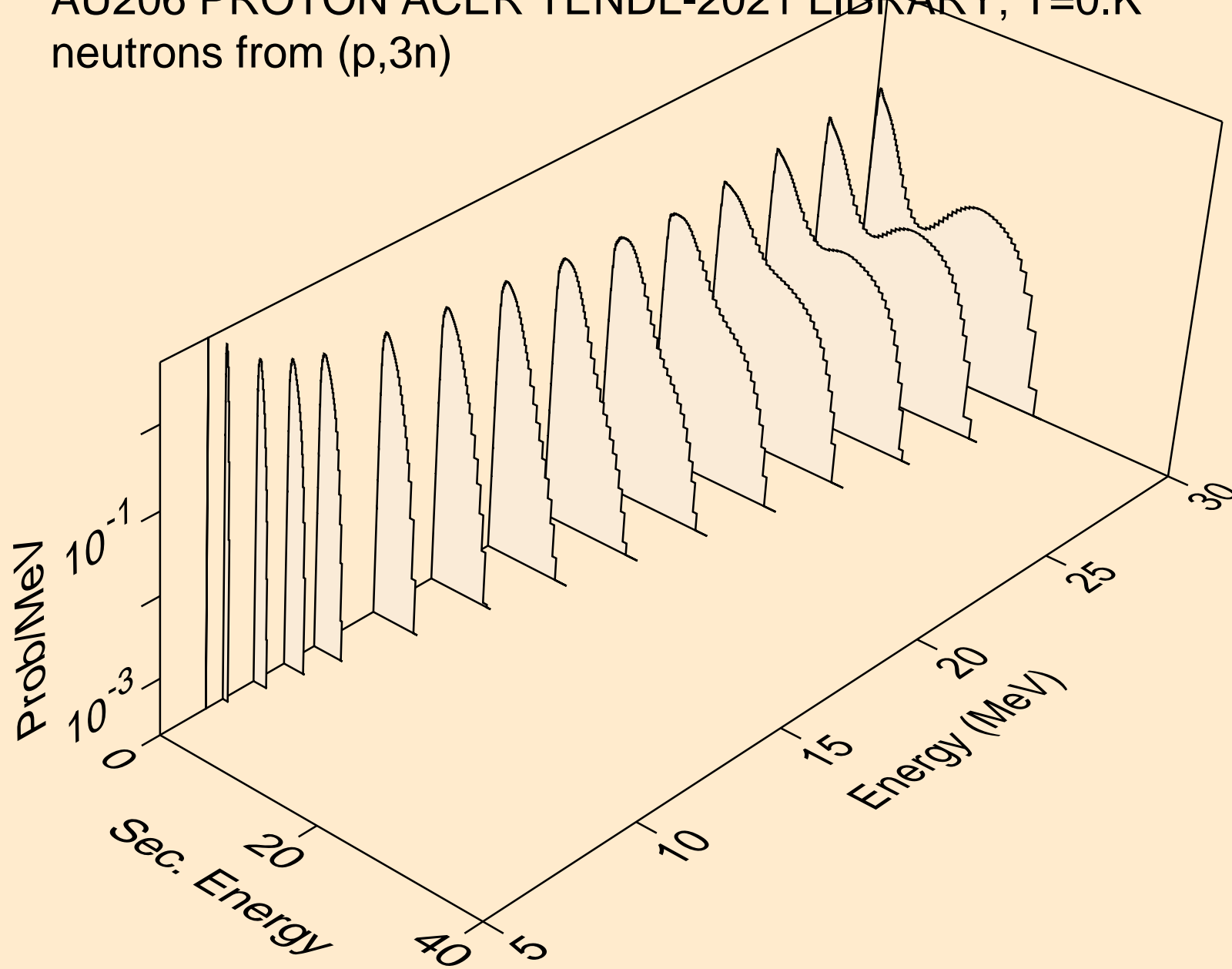

AU206 PROTON ACER TENDL-2021 LIBRARY; T=0.K  
neutrons from (p,n\*)a

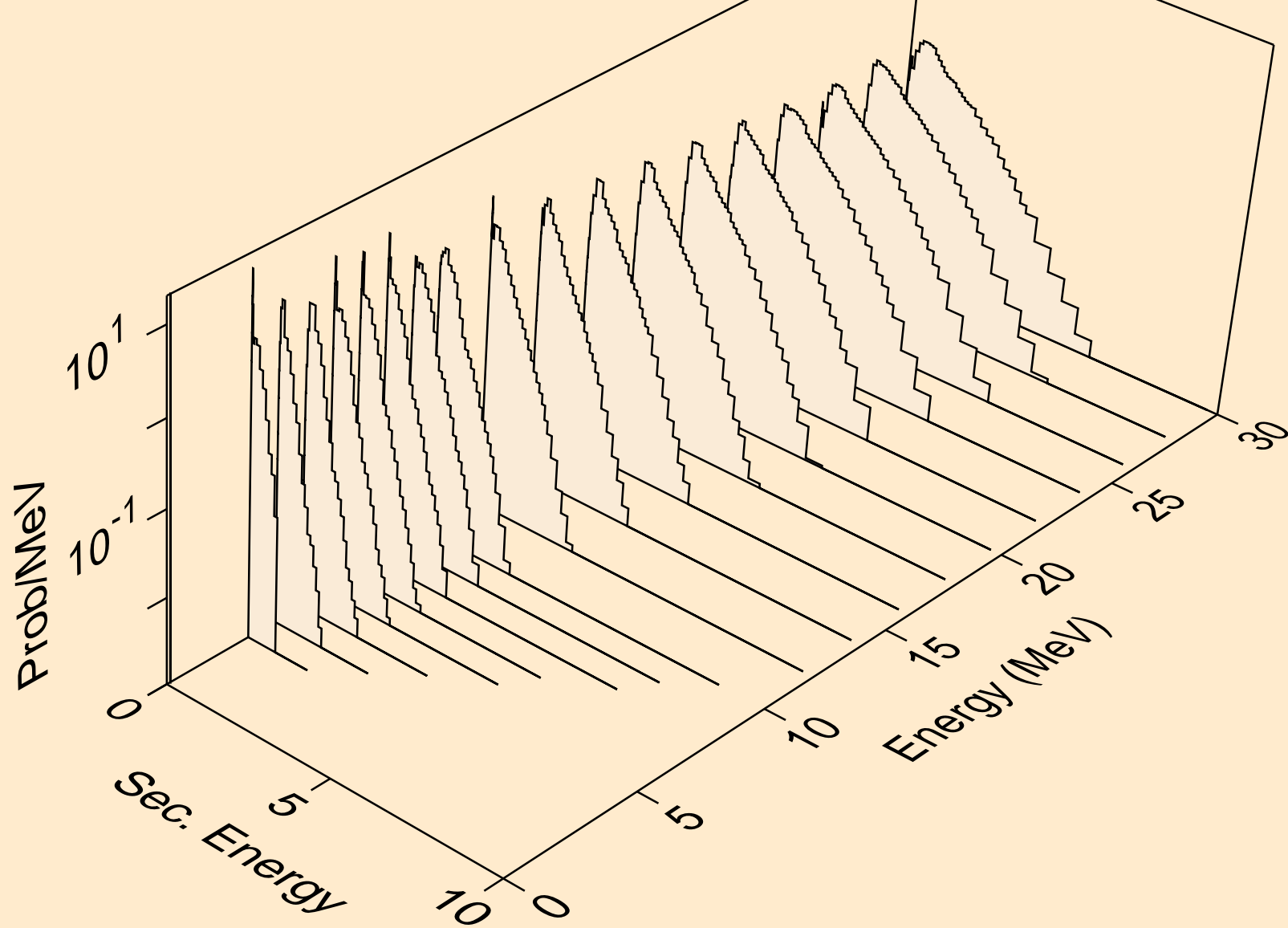

AU206 PROTON ACER TENDL-2021 LIBRARY; T=0.K  
neutrons from (p,2n)a

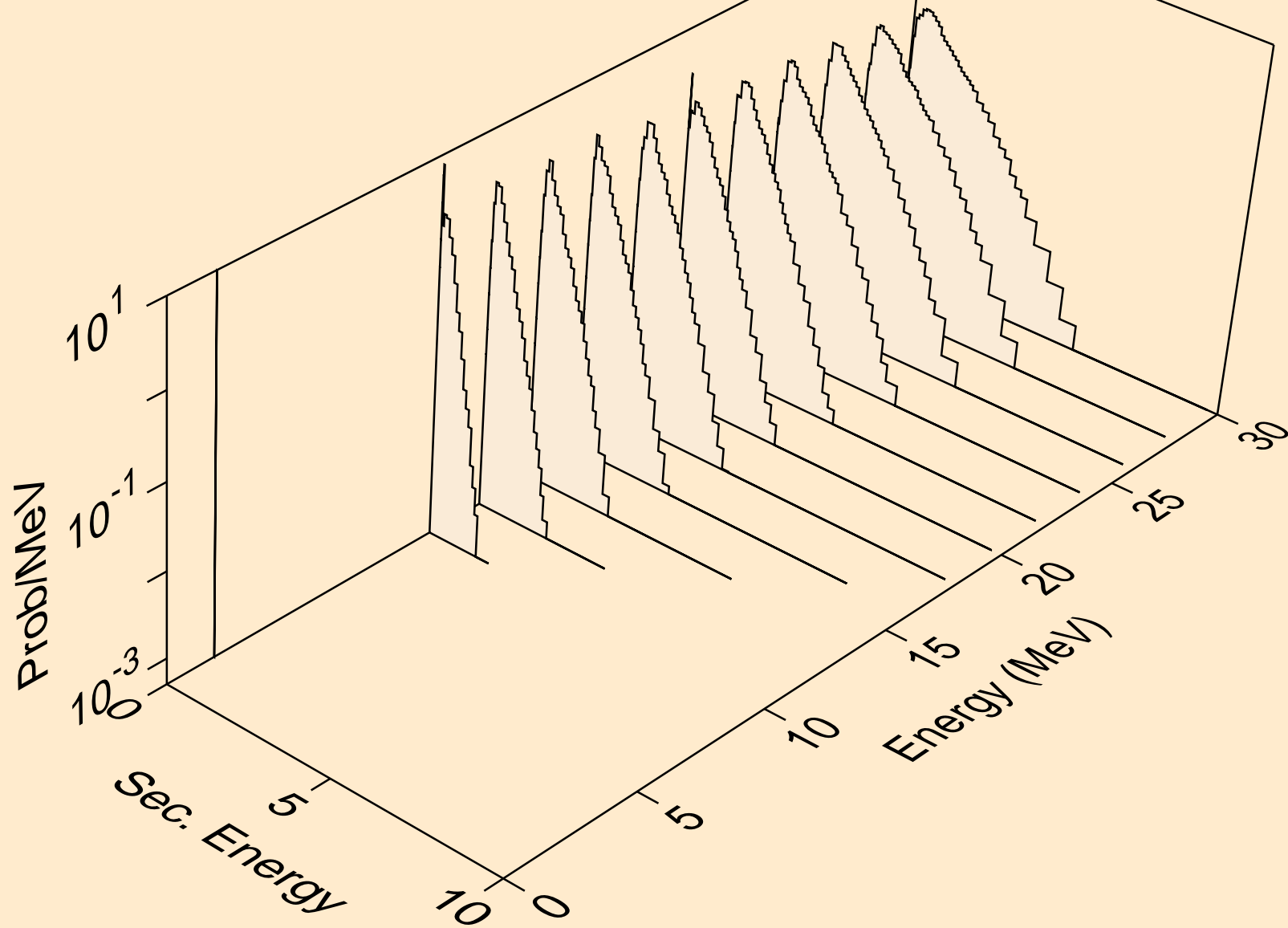

AU206 PROTON ACER TENDL-2021 LIBRARY; T=0.K  
neutrons from (p,3n)a

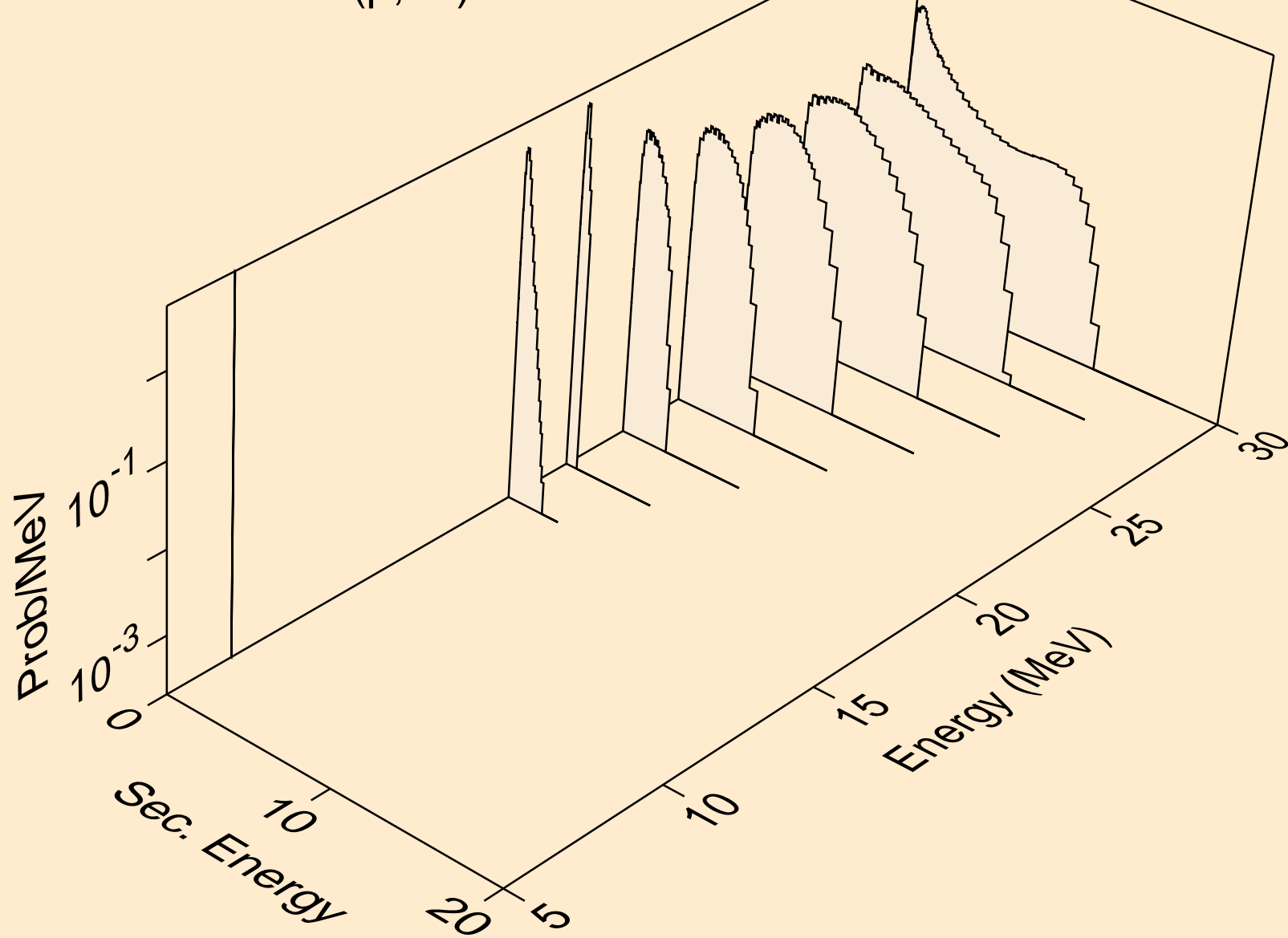

AU206 PROTON ACER TENDL-2021 LIBRARY; T=0.K  
neutrons from (p,n\*)p

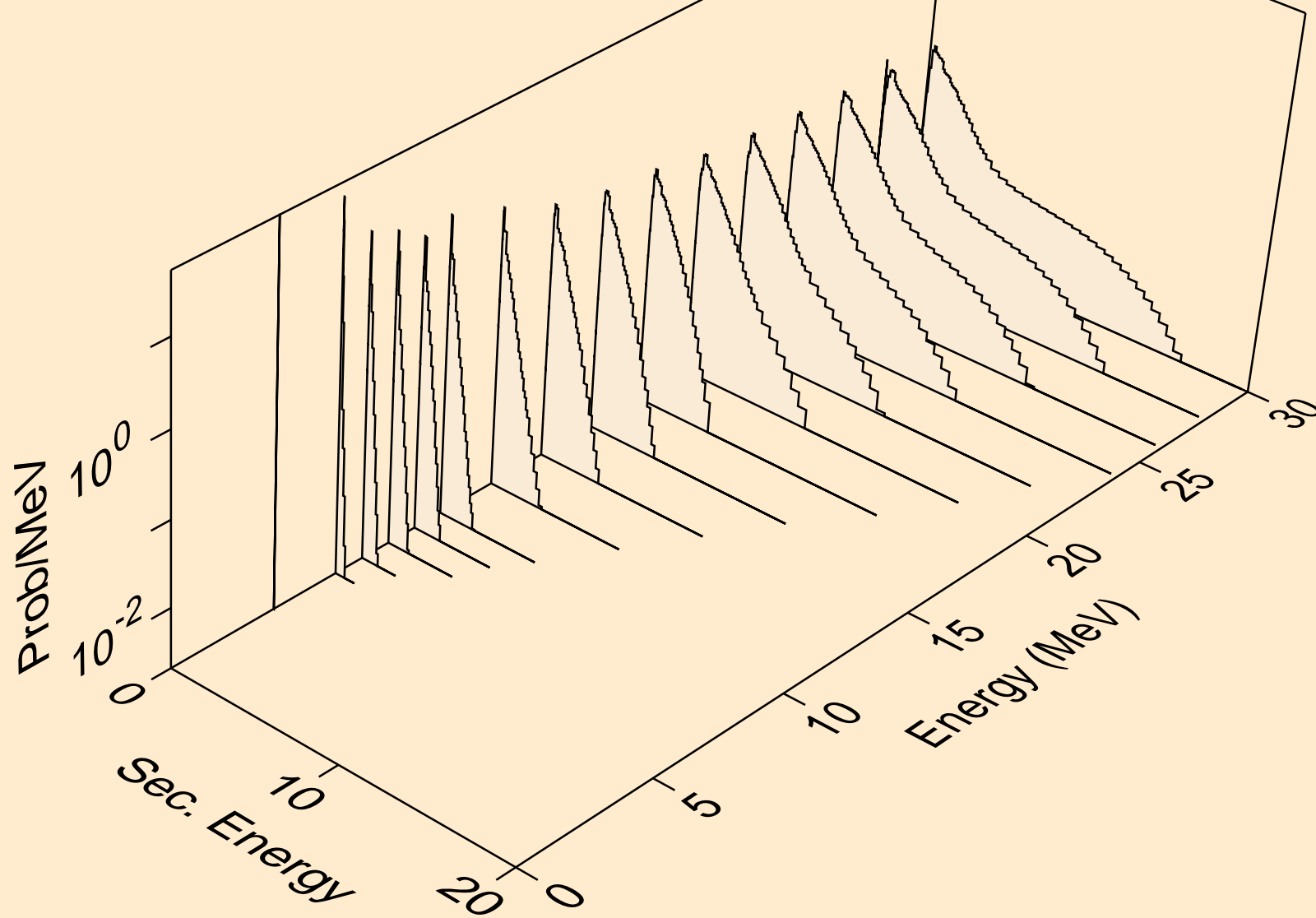

AU206 PROTON ACER TENDL-2021 LIBRARY; T=0.K  
neutrons from (p,n\*)d

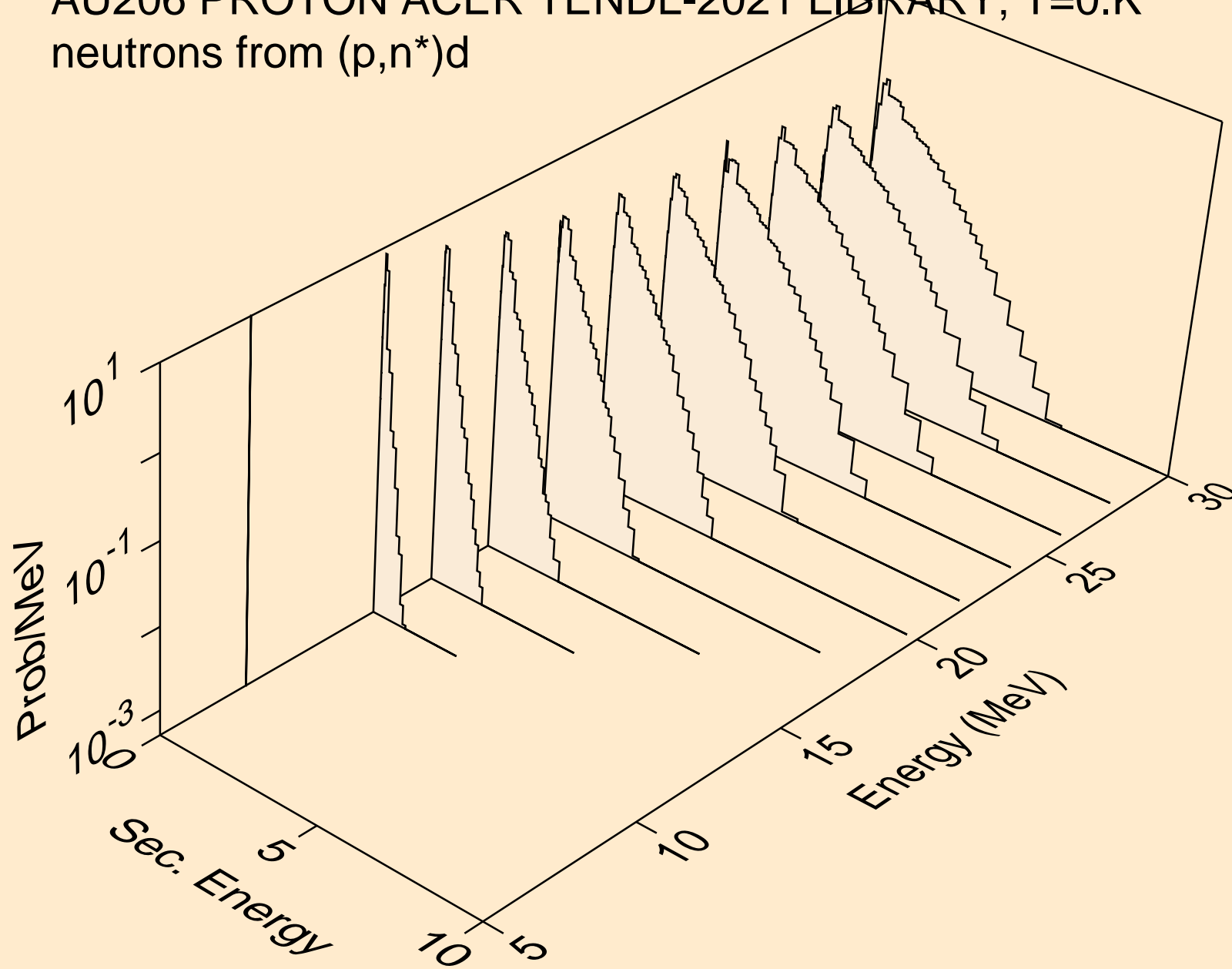

AU206 PROTON ACER TENDL-2021 LIBRARY; T=0.K  
neutrons from (p,n\*)t

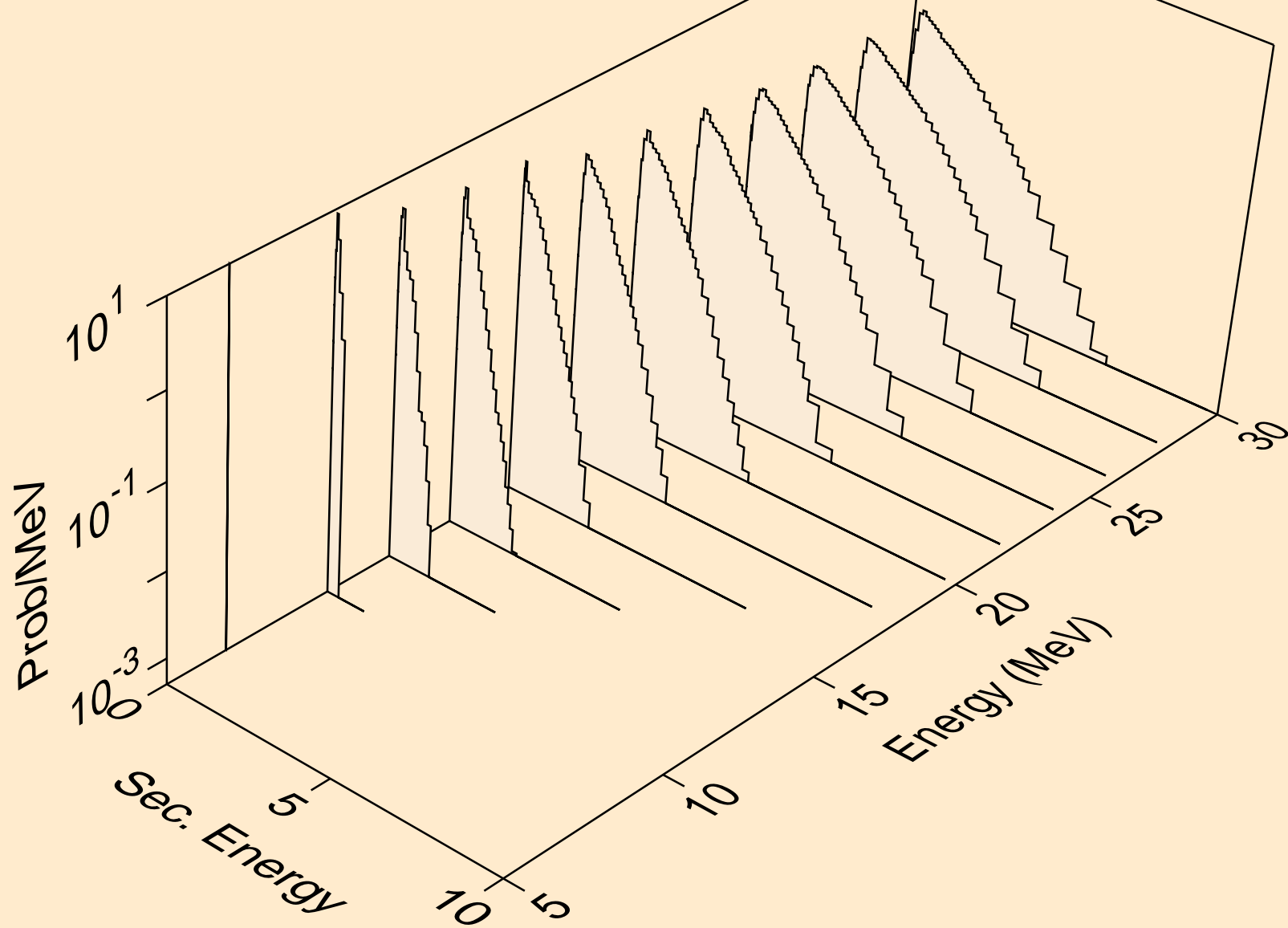



AU206 PROTON ACER TENDL-2021 LIBRARY; T=0.K  
neutrons from (p,n\*)he3

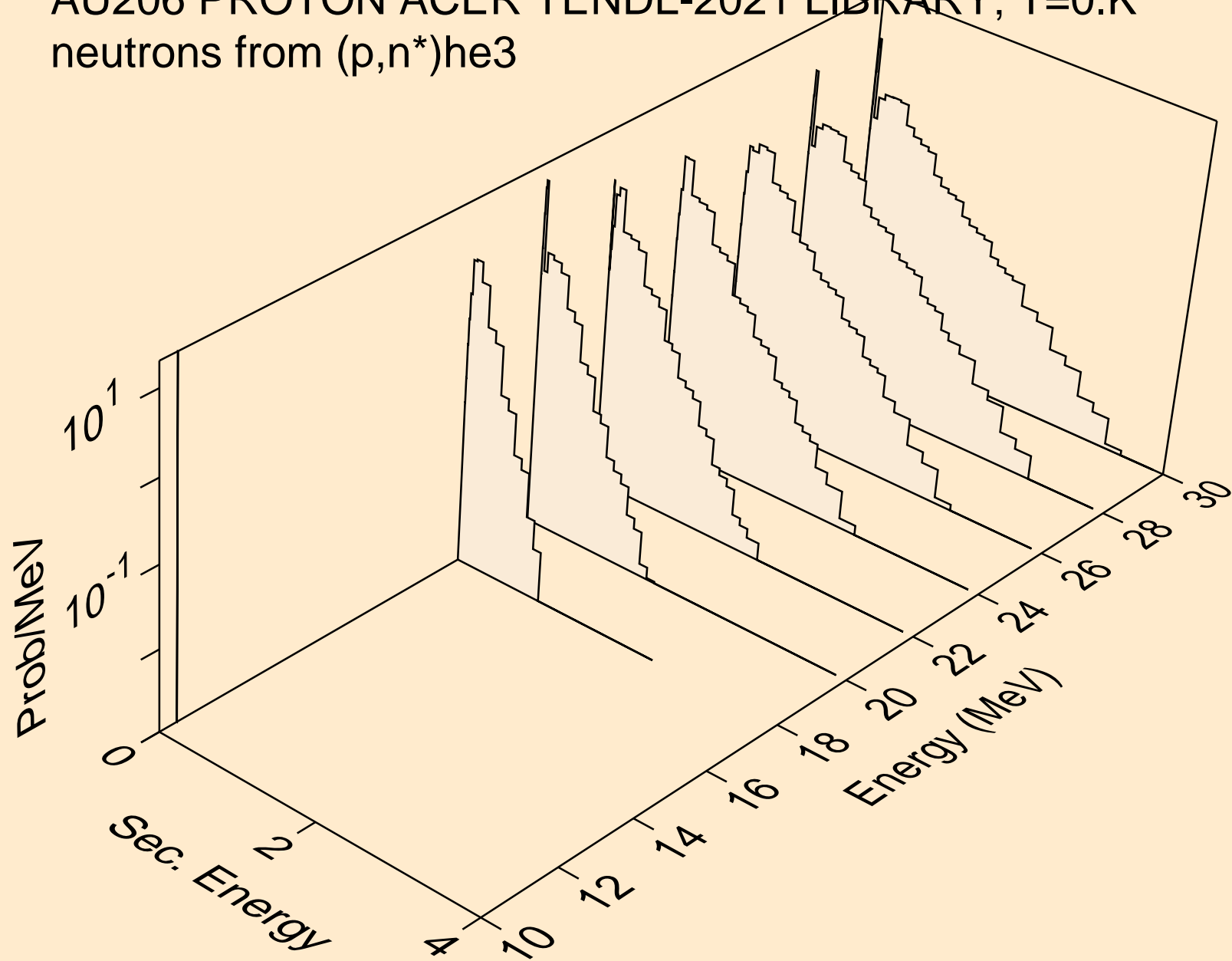

AU206 PROTON ACER TENDL-2021 LIBRARY; T=0.K  
neutrons from (p,4n)

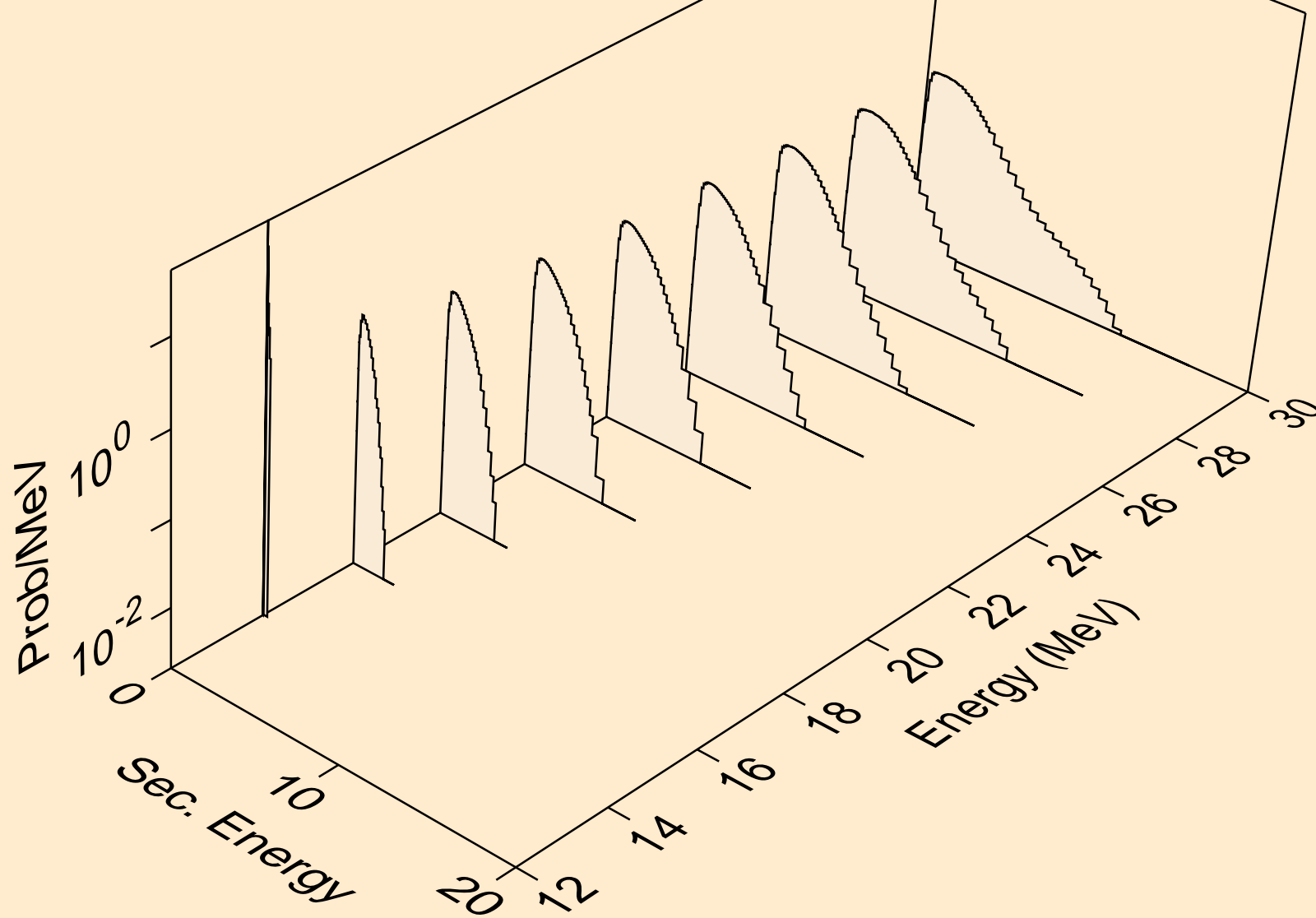

AU206 PROTON ACER TENDL-2021 LIBRARY; T=0.K  
neutrons from (p,2np)

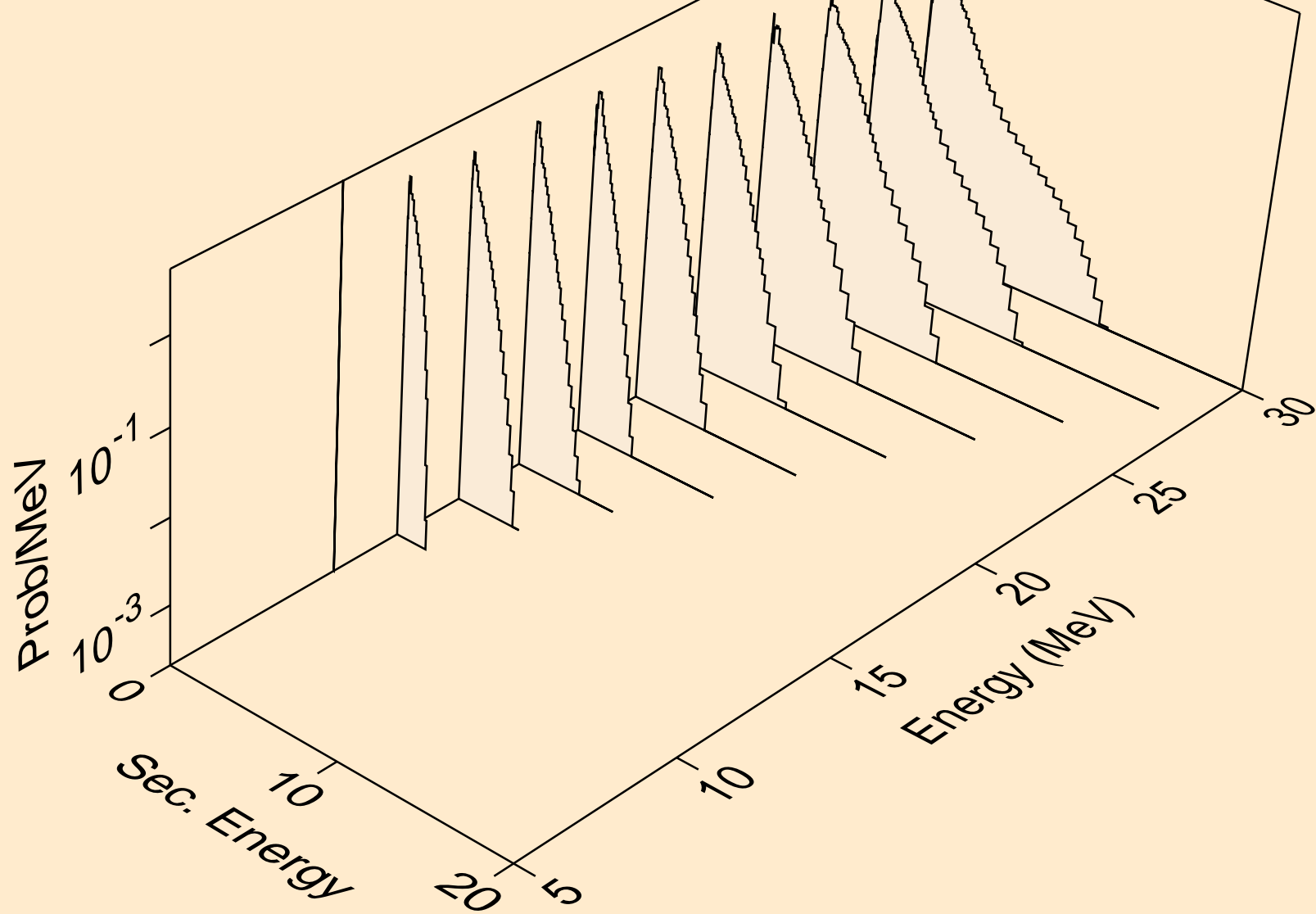

AU206 PROTON ACER TENDL-2021 LIBRARY; T=0.K  
neutrons from (p,3np)

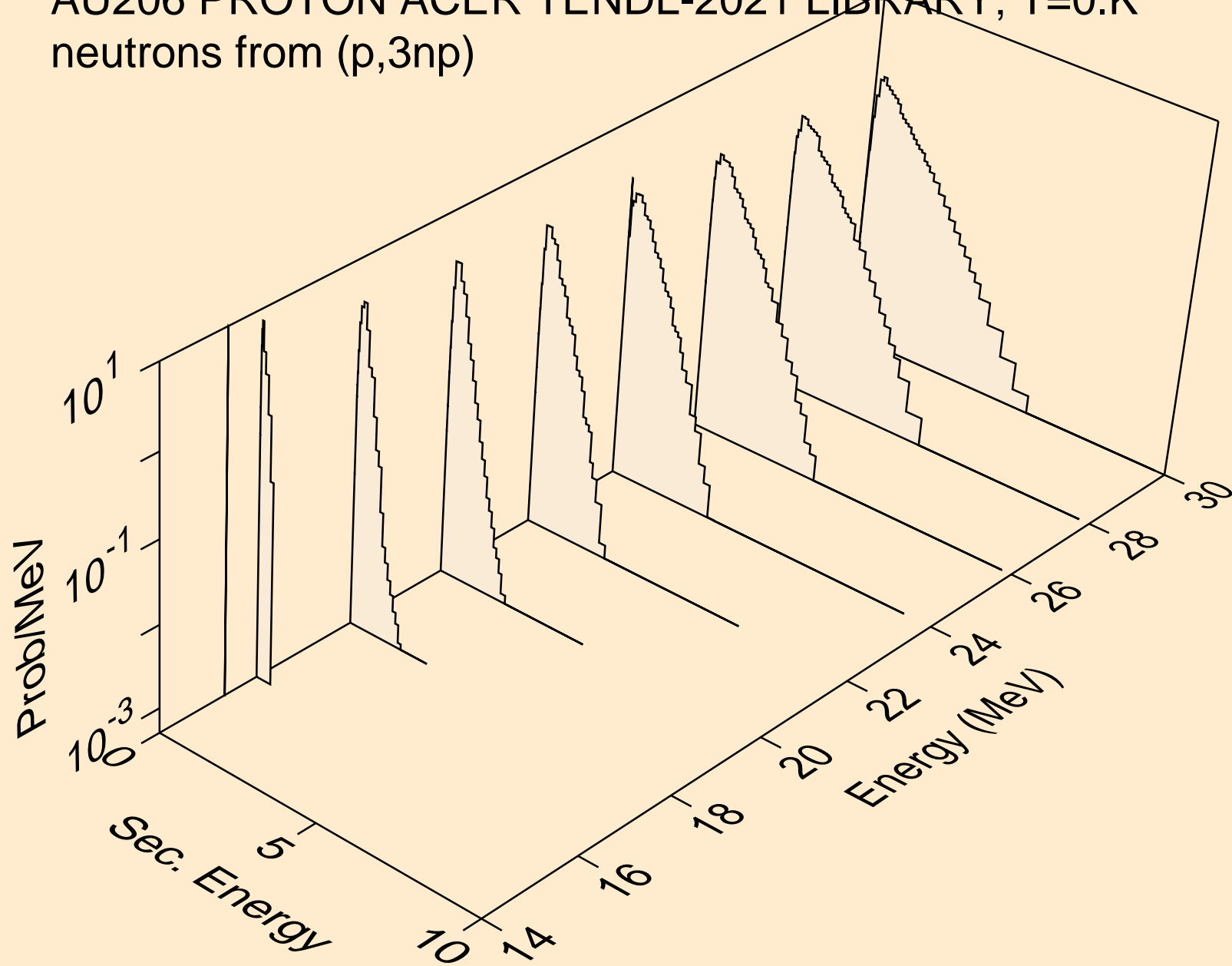

AU206 PROTON ACER TENDL-2021 LIBRARY; T=0.K  
neutrons from (p,2np)

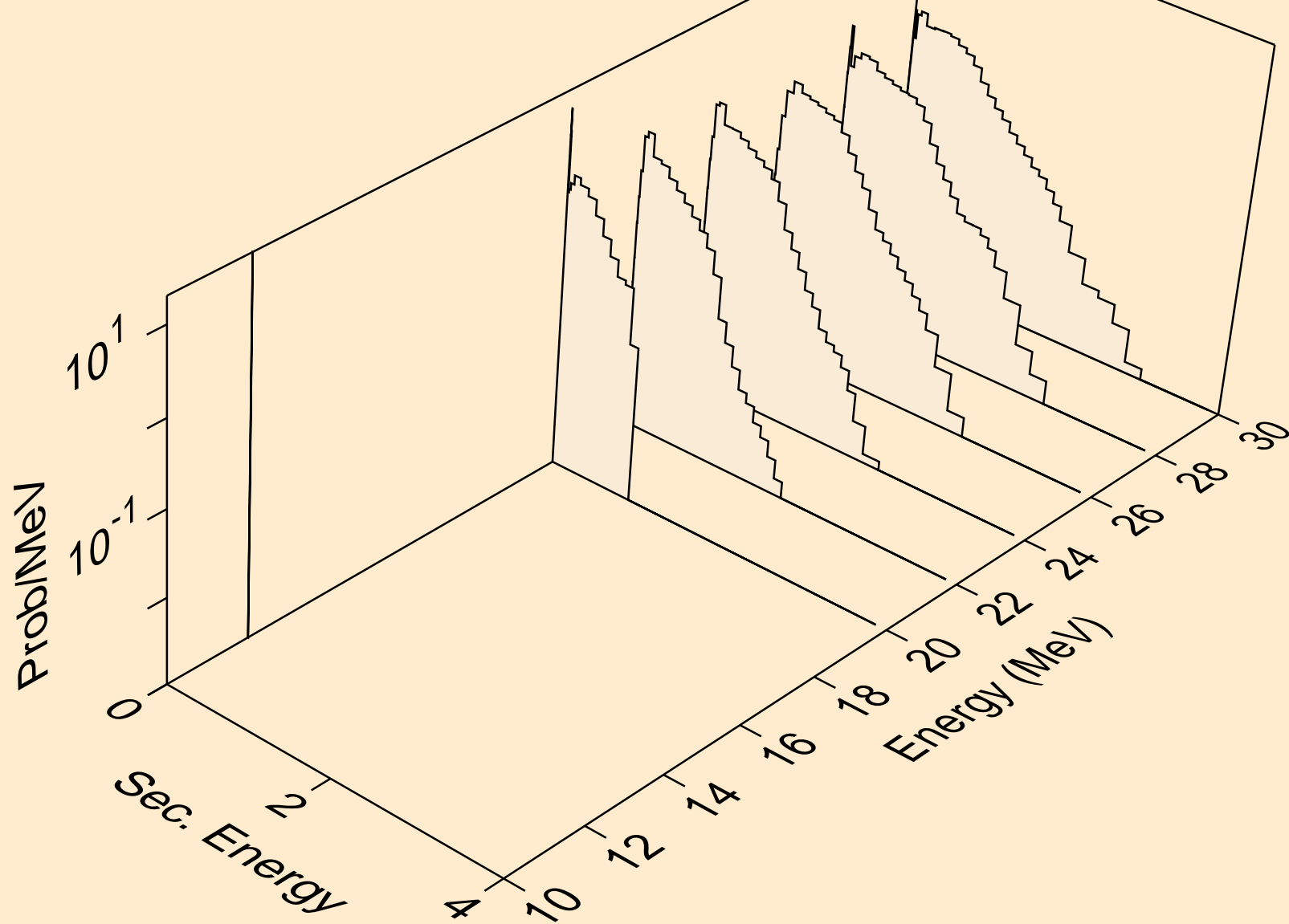

AU206 PROTON ACER TENDL-2021 LIBRARY; T=0.K  
deuterons from (p,x)

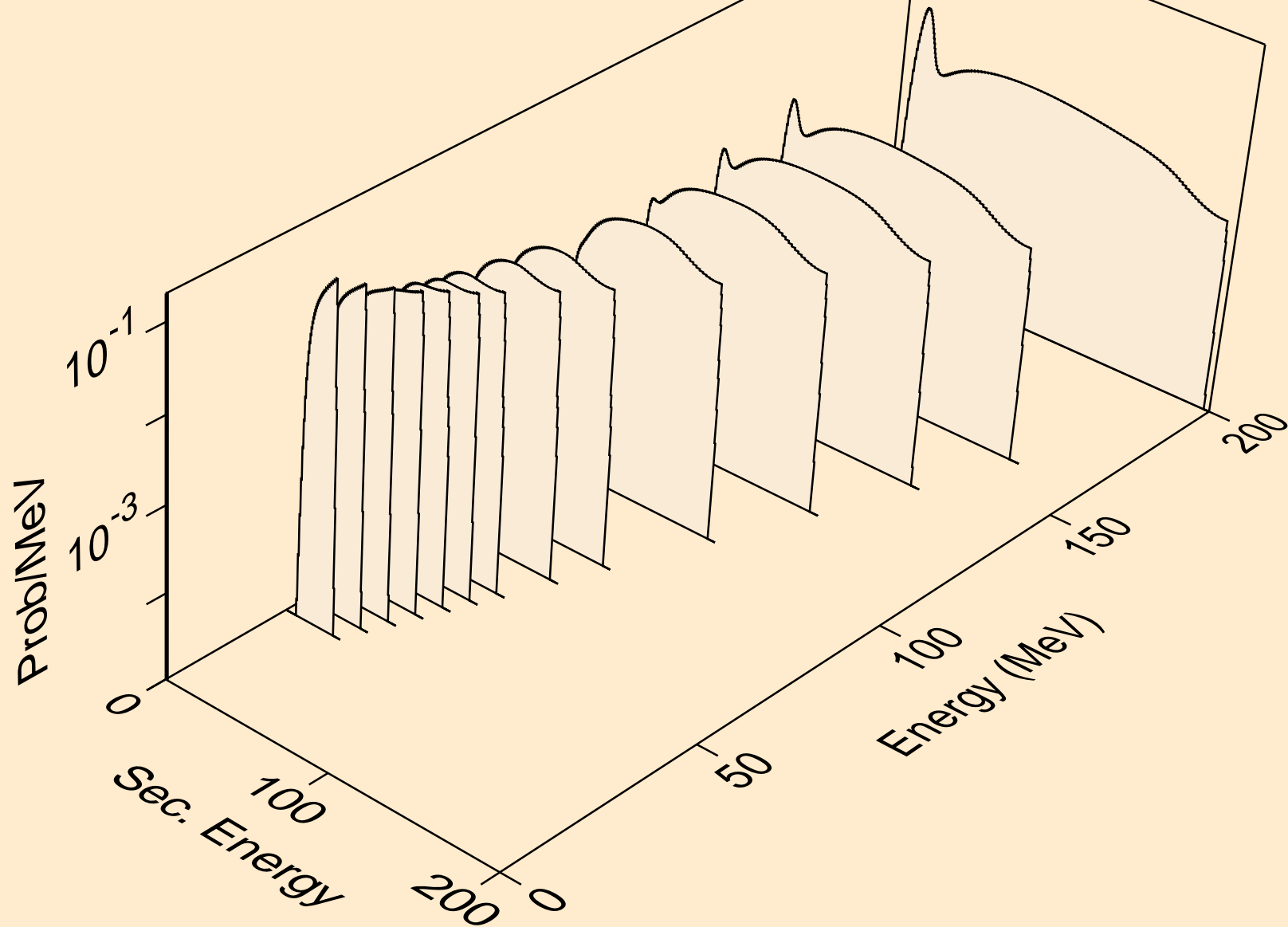

AU206 PROTON ACER TENDL-2021 LIBRARY; T=0.K  
deuterons from (p,2nd)

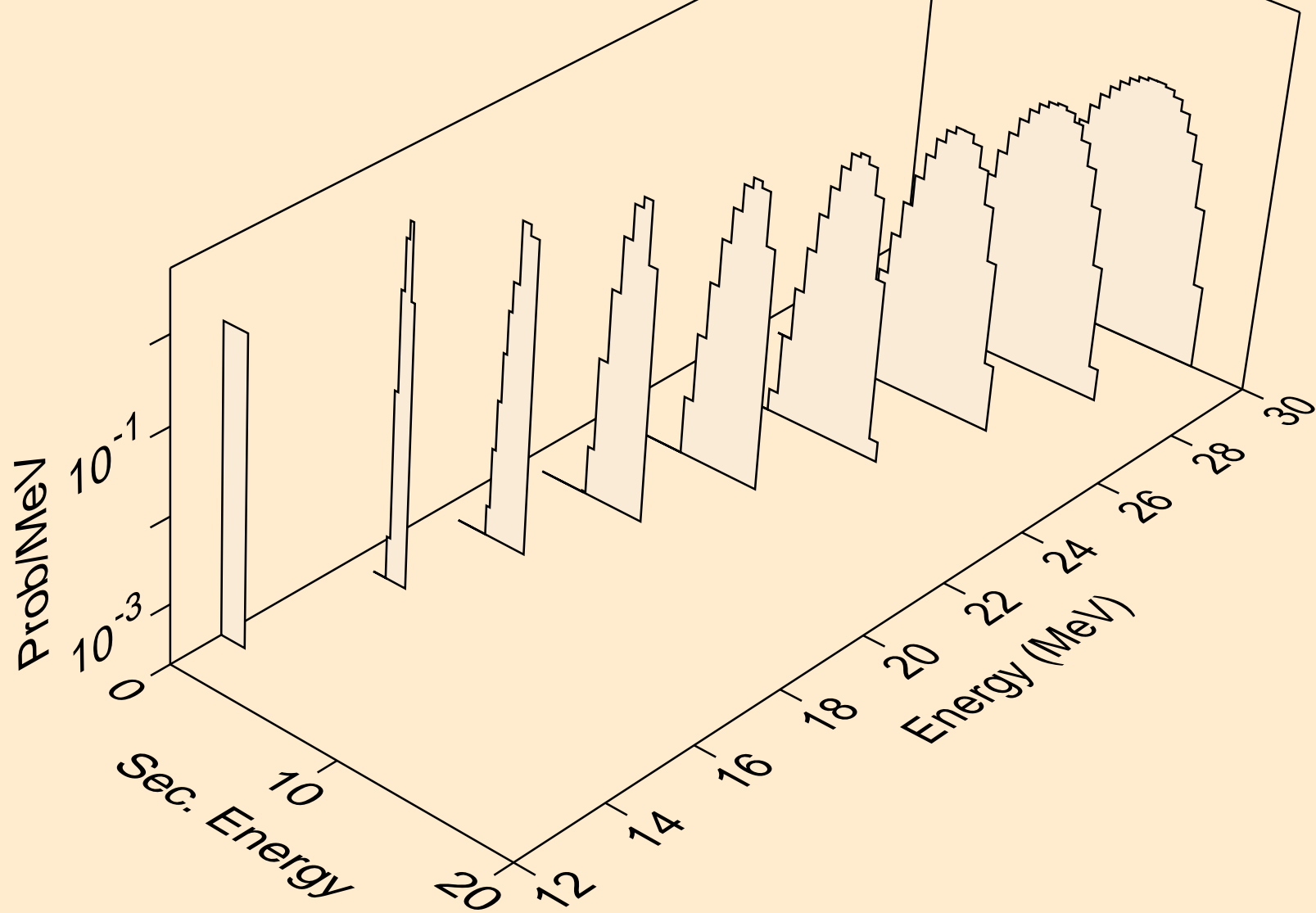

AU206 PROTON ACER TENDL-2021 LIBRARY; T=0.K  
deuterons from (p,n\*)d

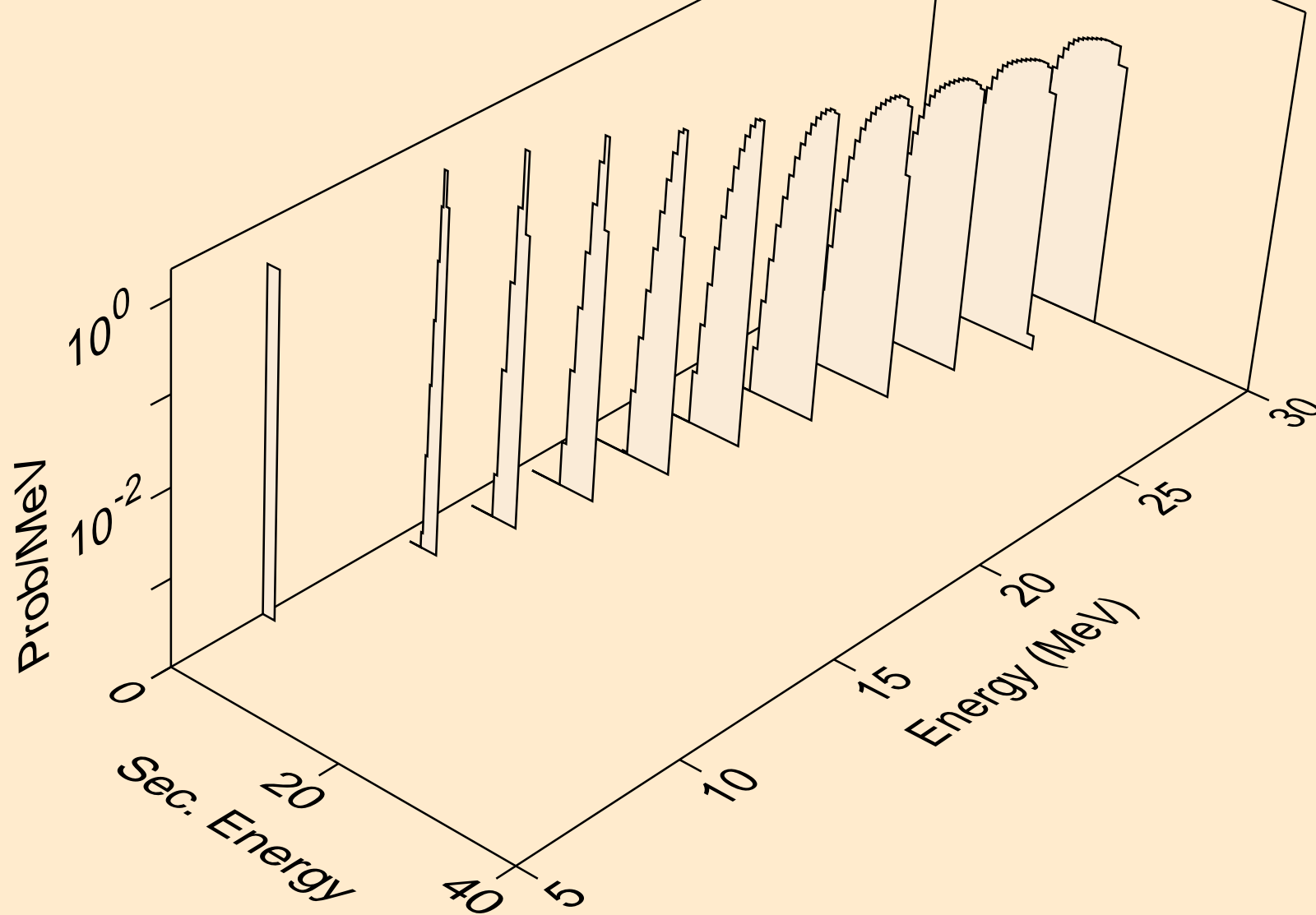



AU206 PROTON ACER TENDL-2021 LIBRARY; T=0.K  
deuterons from (p,d)

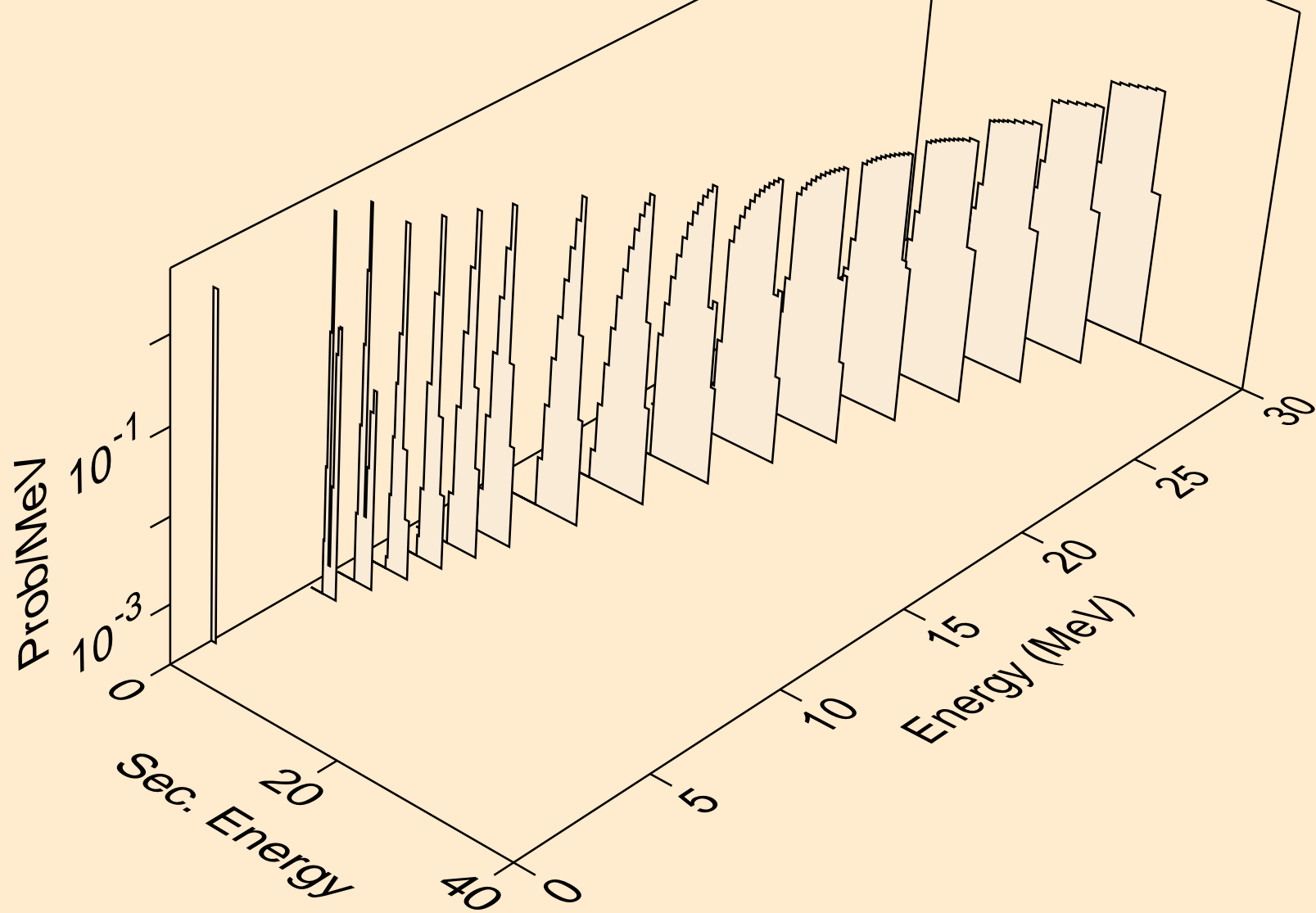

AU206 PROTON ACER TENDL-2021 LIBRARY; T=0.K  
deuterons from (p,pd)

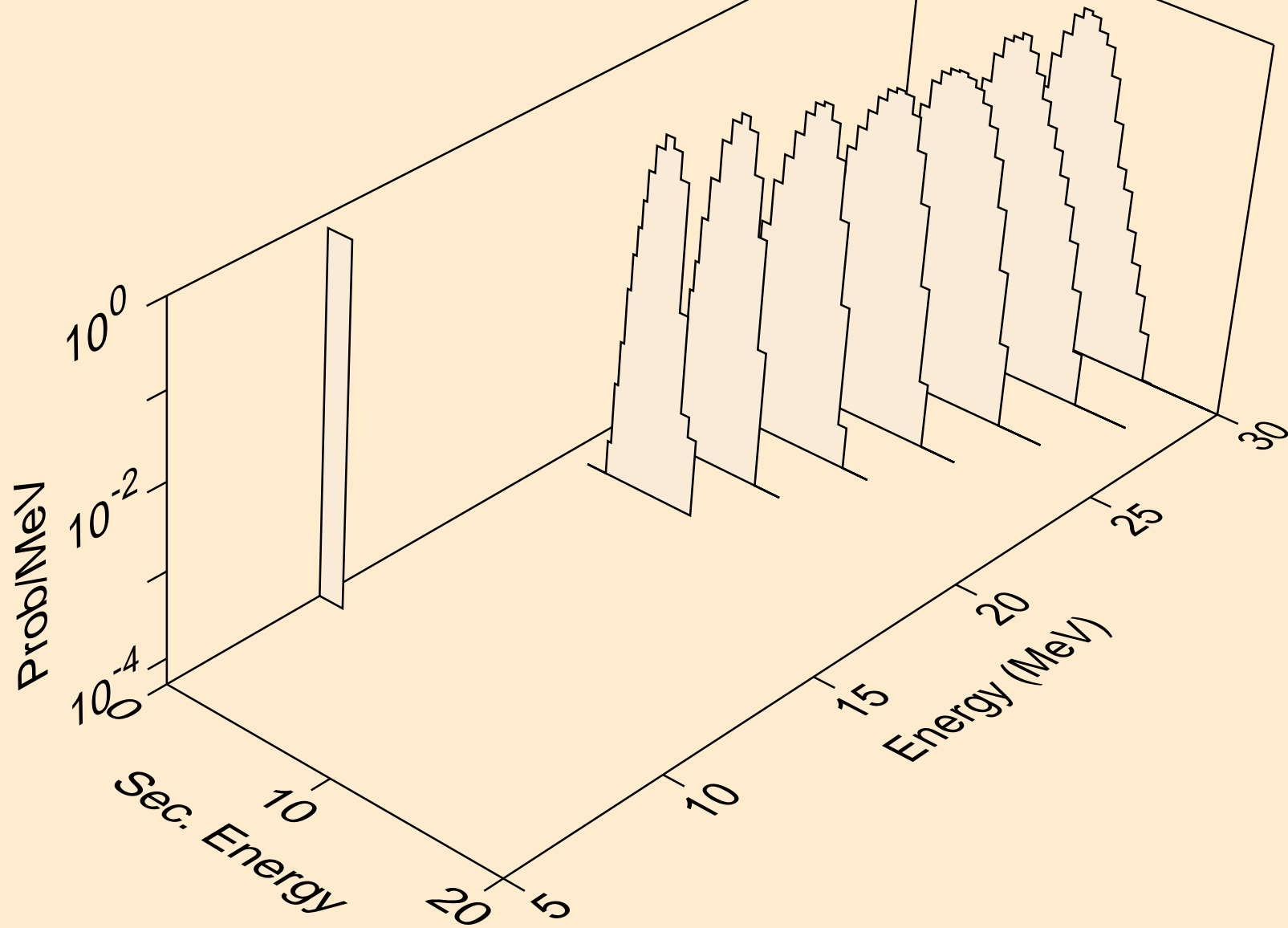

AU206 PROTON ACER TENDL-2021 LIBRARY; T=0.K  
tritons from (p,x)

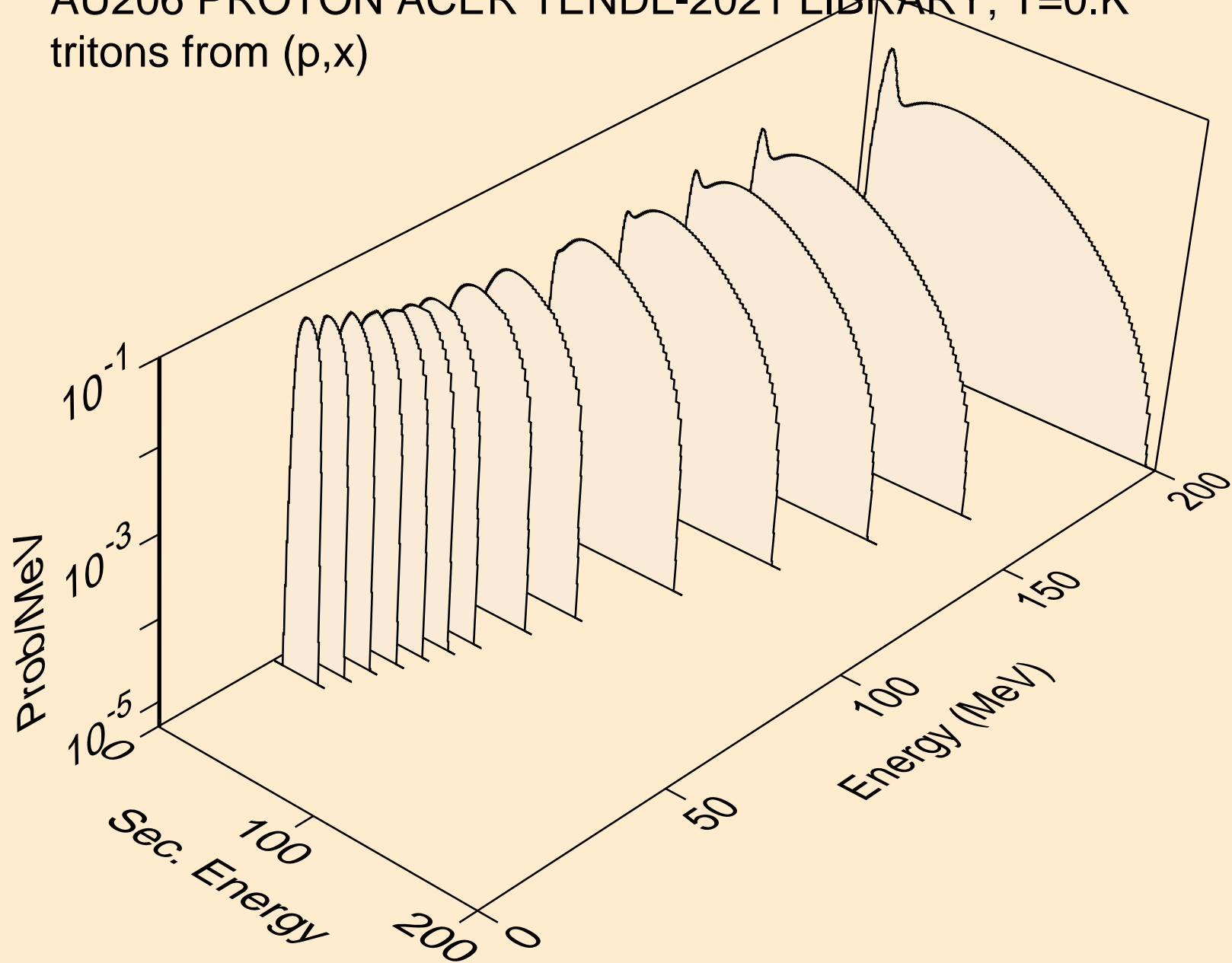

AU206 PROTON ACER TENDL-2021 LIBRARY; T=0.K  
tritons from (p,n\*)t

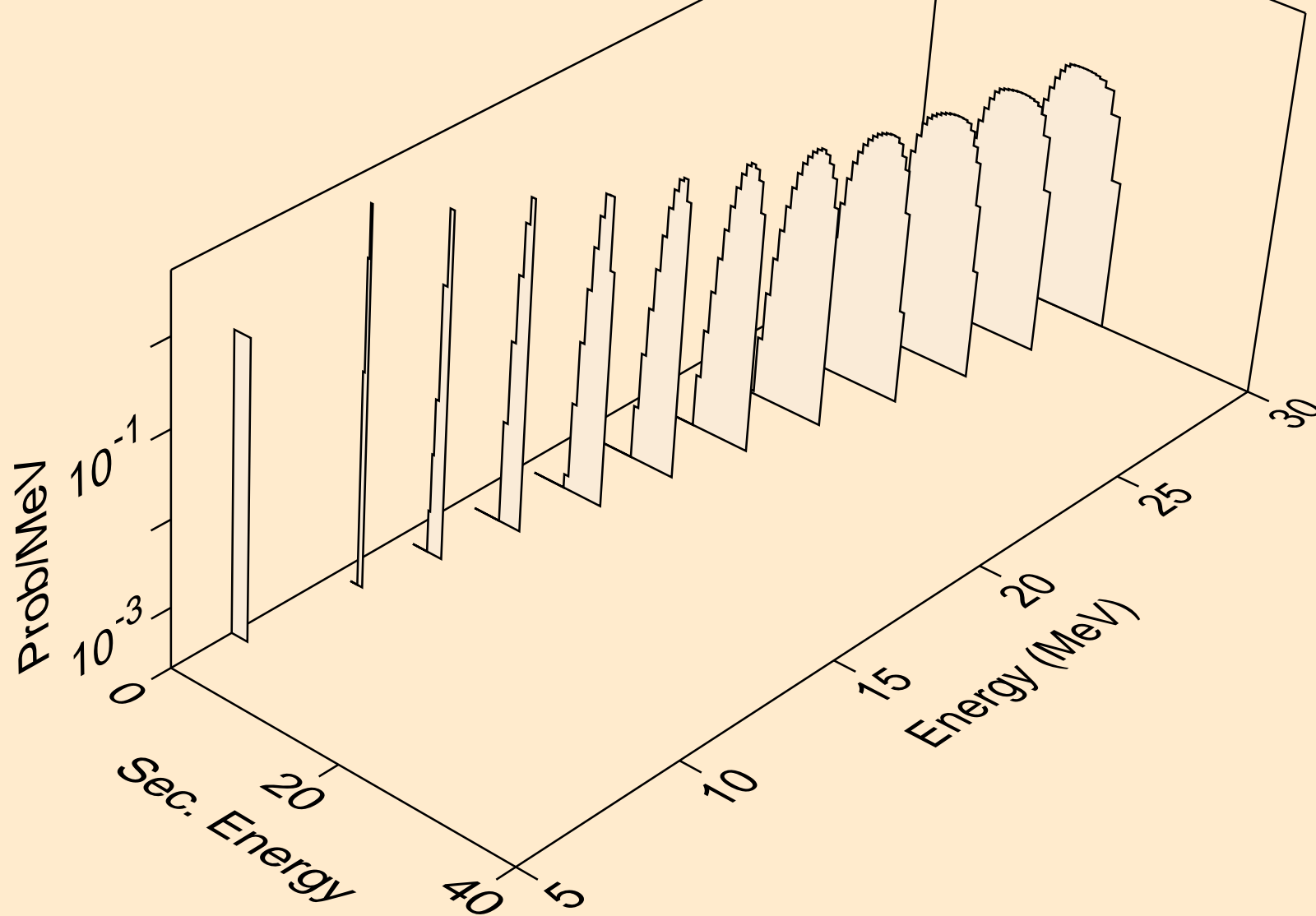

AU206 PROTON ACER TENDL-2021 LIBRARY; T=0.K  
tritons from (p,t)

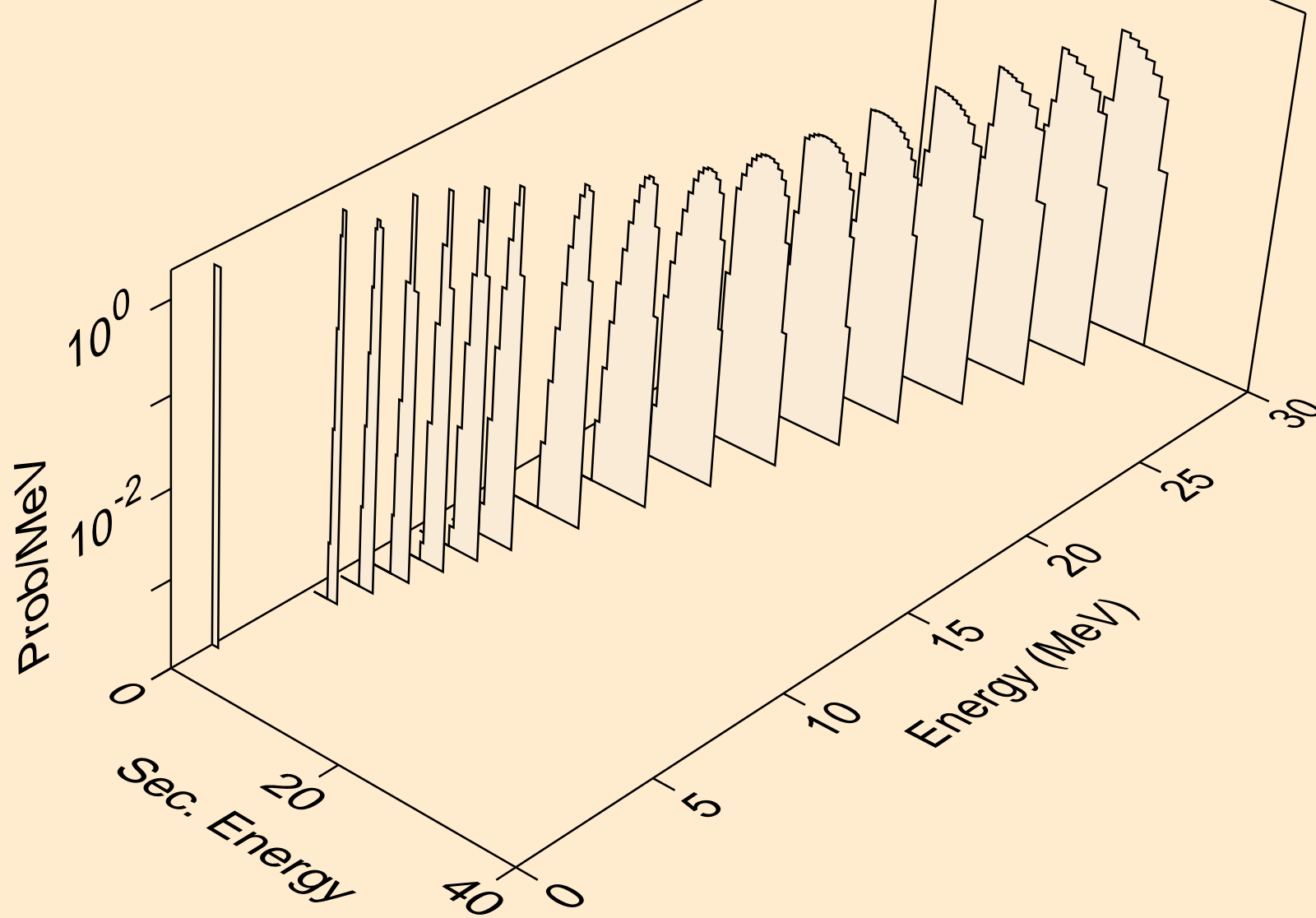

AU206 PROTON ACER TENDL-2021 LIBRARY; T=0.K  
he3s from (p,x)

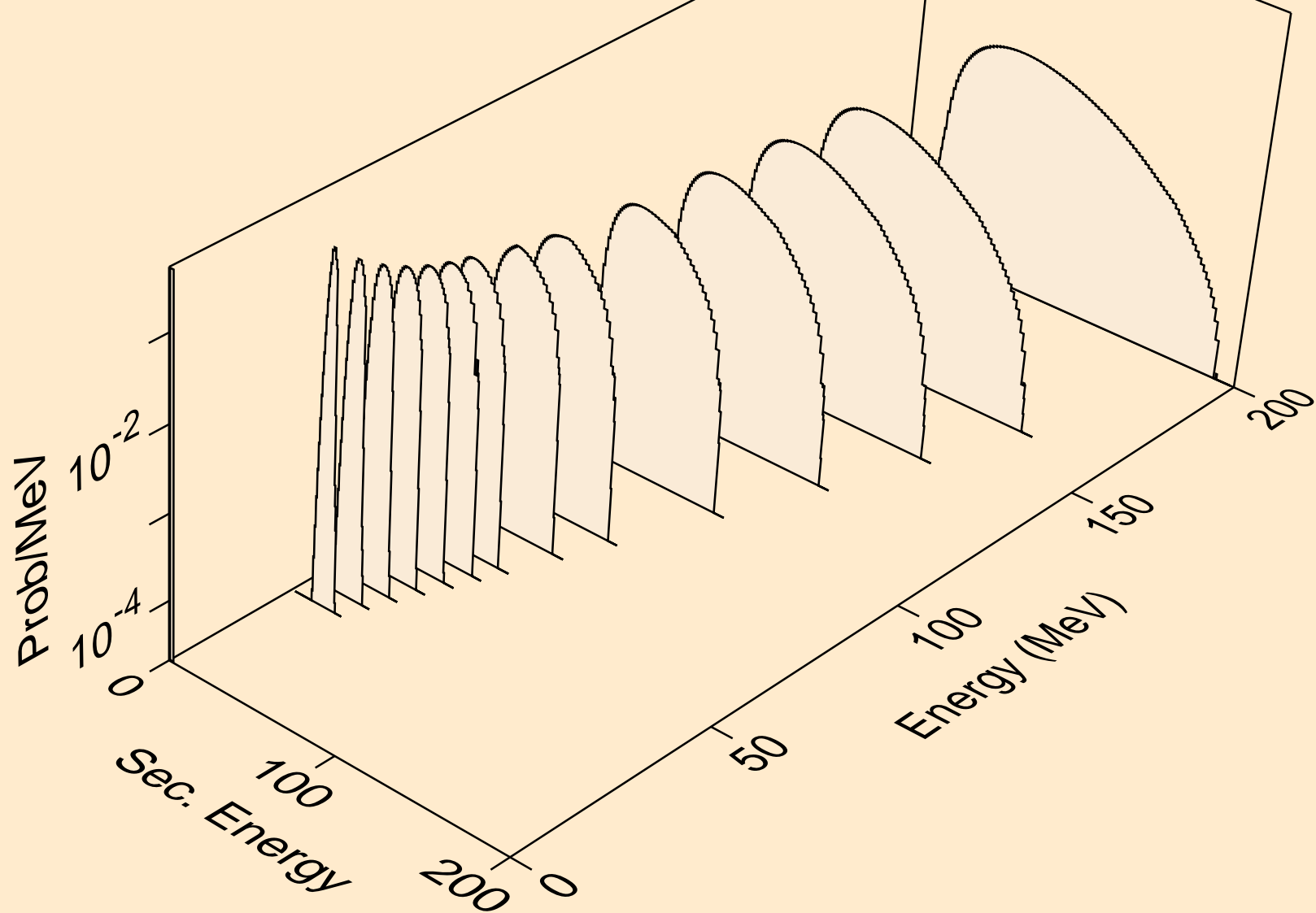

AU206 PROTON ACER TENDL-2021 LIBRARY; T=0.K  
he3s from (p,n\*)he3

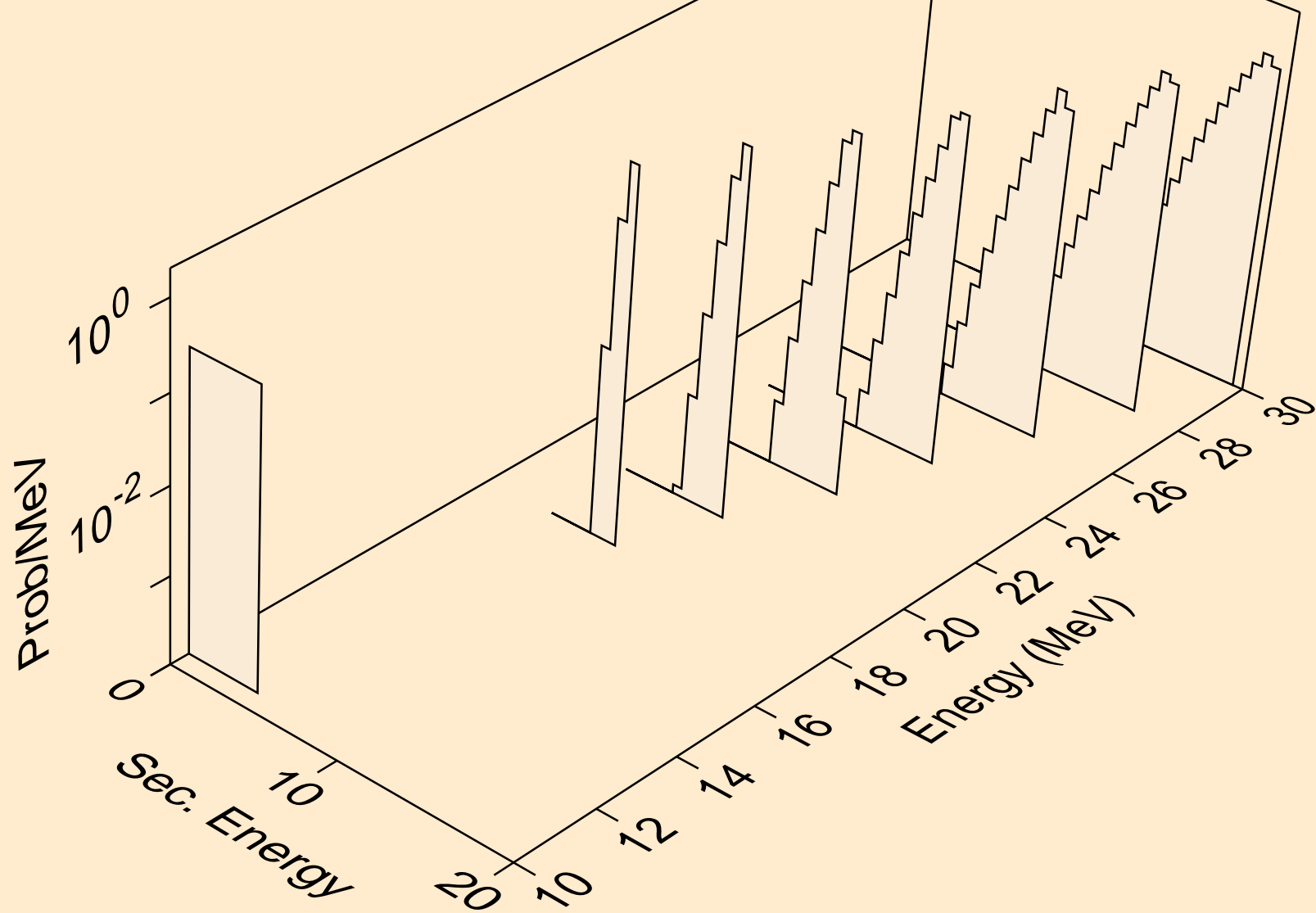

AU206 PROTON ACER TENDL-2021 LIBRARY; T=0.K  
he3s from (p,he3)

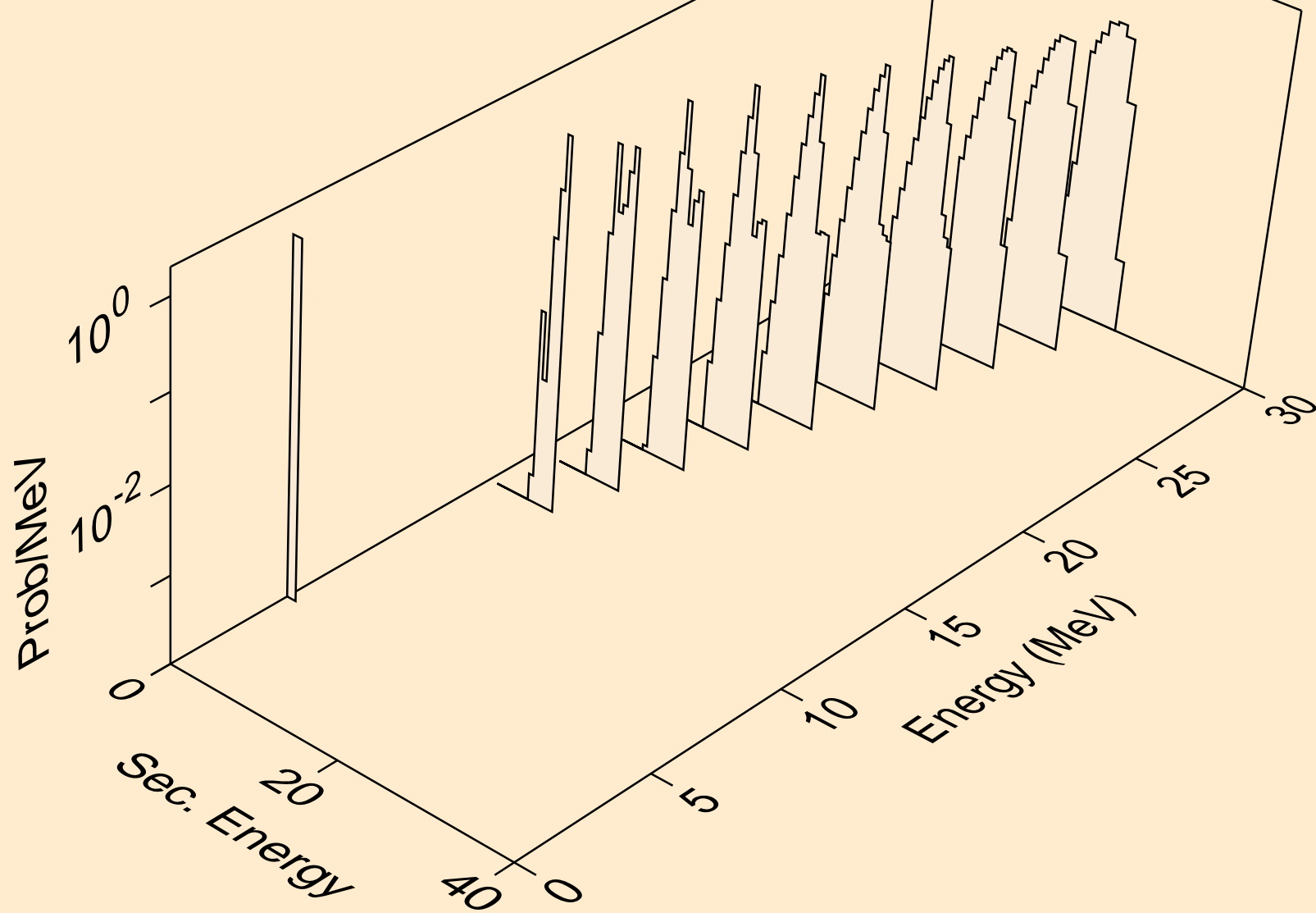



AU206 PROTON ACER TENDL-2021 LIBRARY; T=0.K  
alphas from (p,x)

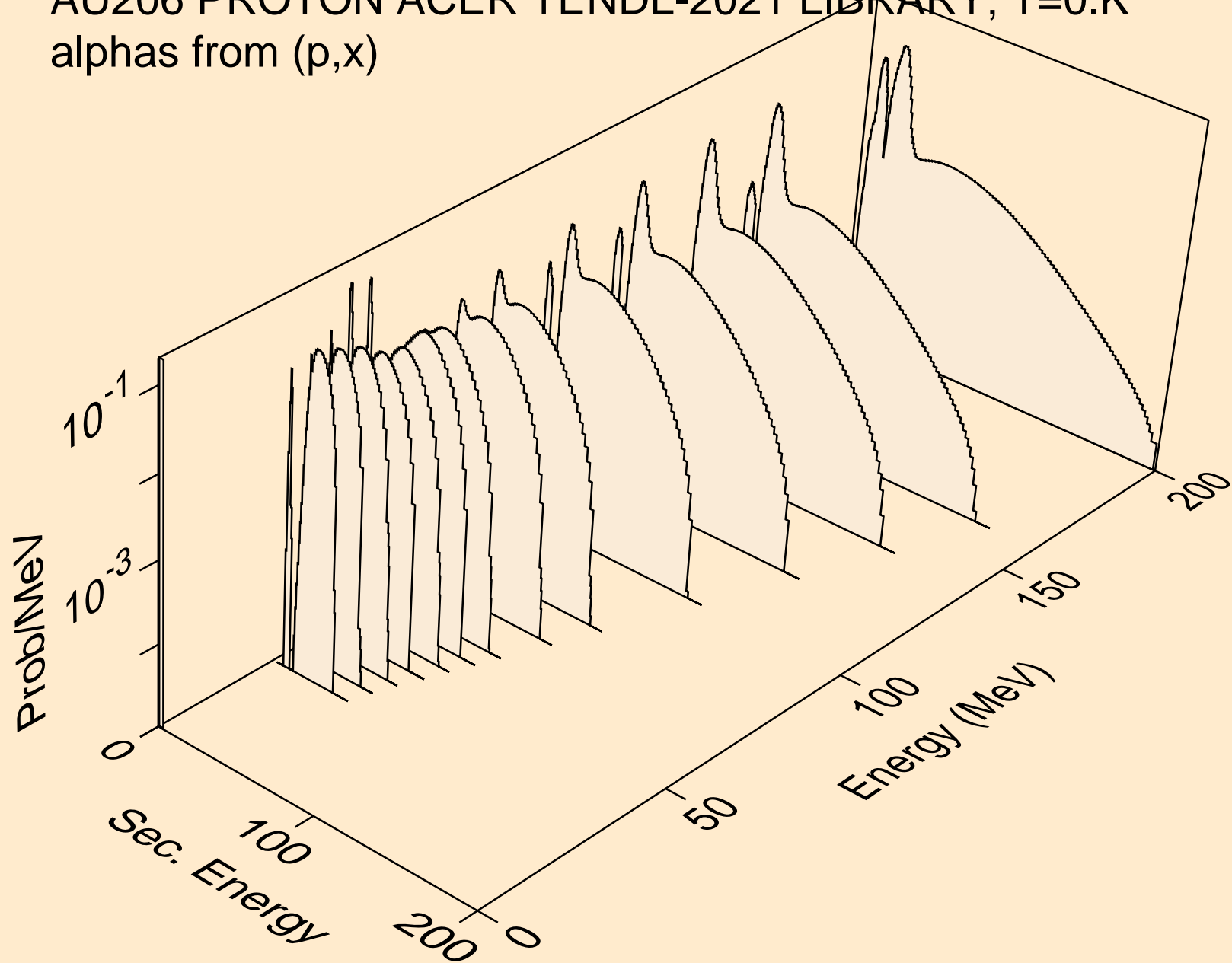

AU206 PROTON ACER TENDL-2021 LIBRARY; T=0.K  
alphas from (p,n\*)a

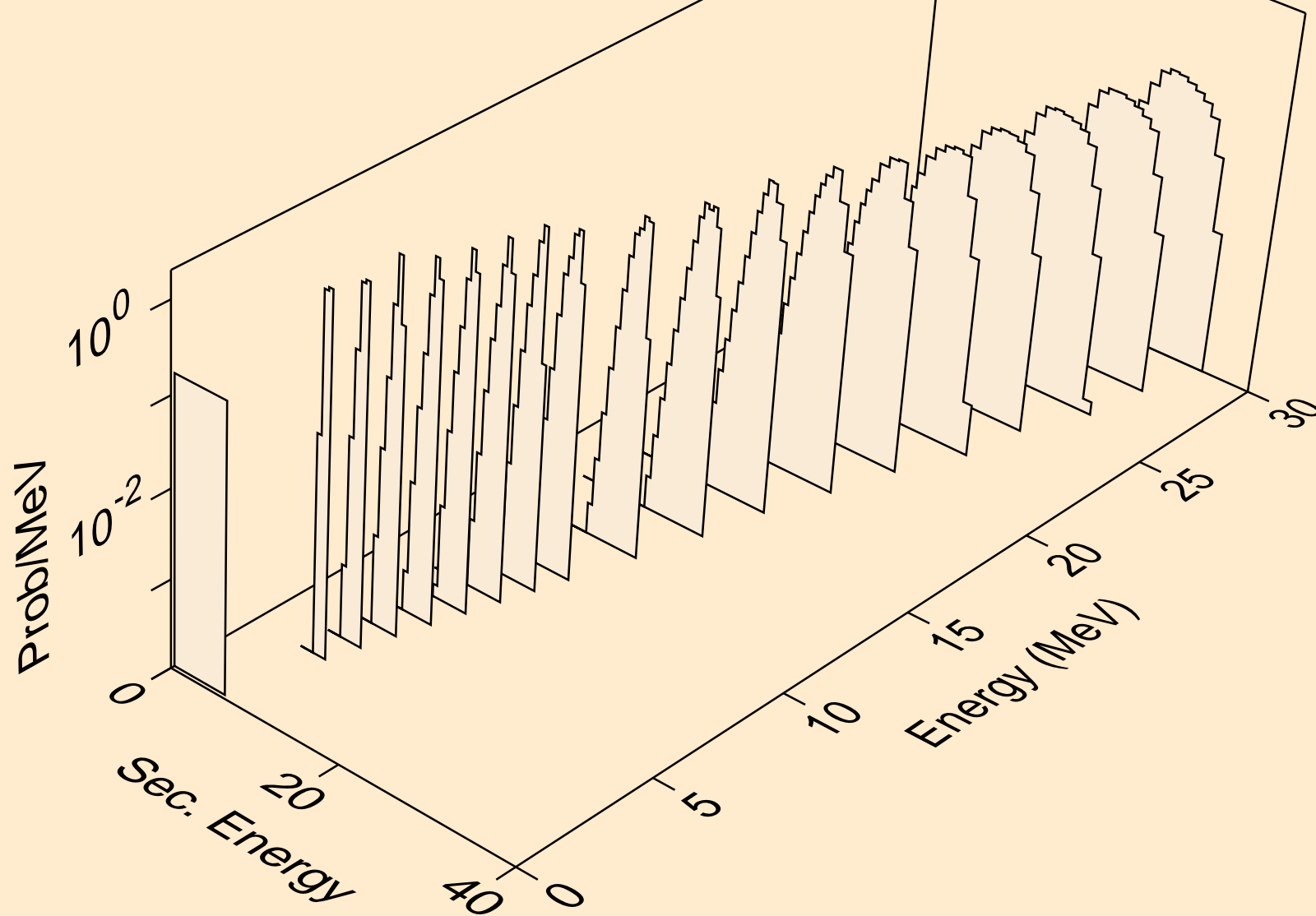

AU206 PROTON ACER TENDL-2021 LIBRARY; T=0.K  
alphas from (p,2n)a

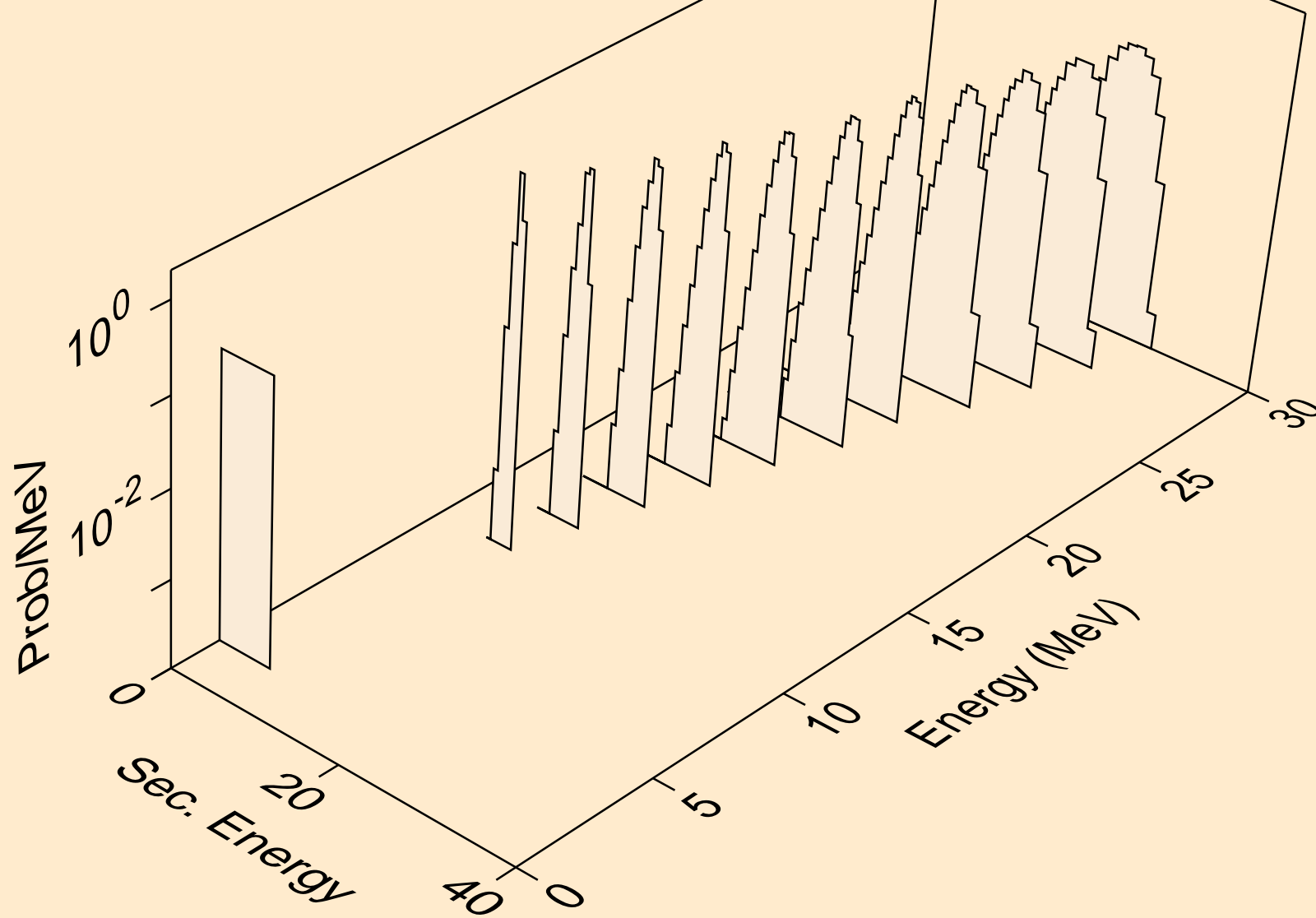

AU206 PROTON ACER TENDL-2021 LIBRARY; T=0.K  
alphas from (p,3n)a

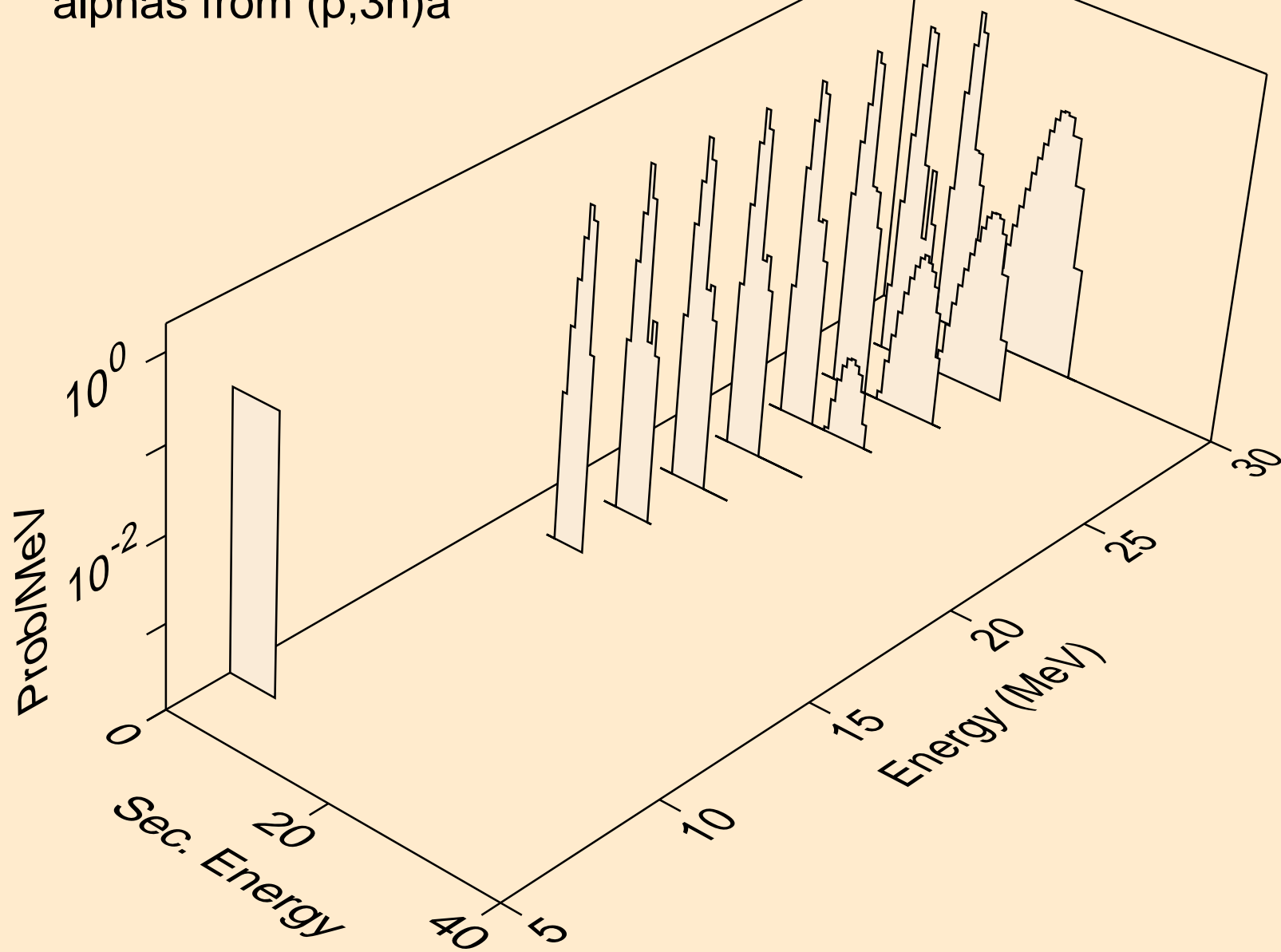

AU206 PROTON ACER TENDL-2021 LIBRARY; T=0.K  
alphas from (p,a)

