

BK236 PROTON ACER TENDL-2021 LIBRARY; T=0.K  
Principal cross sections

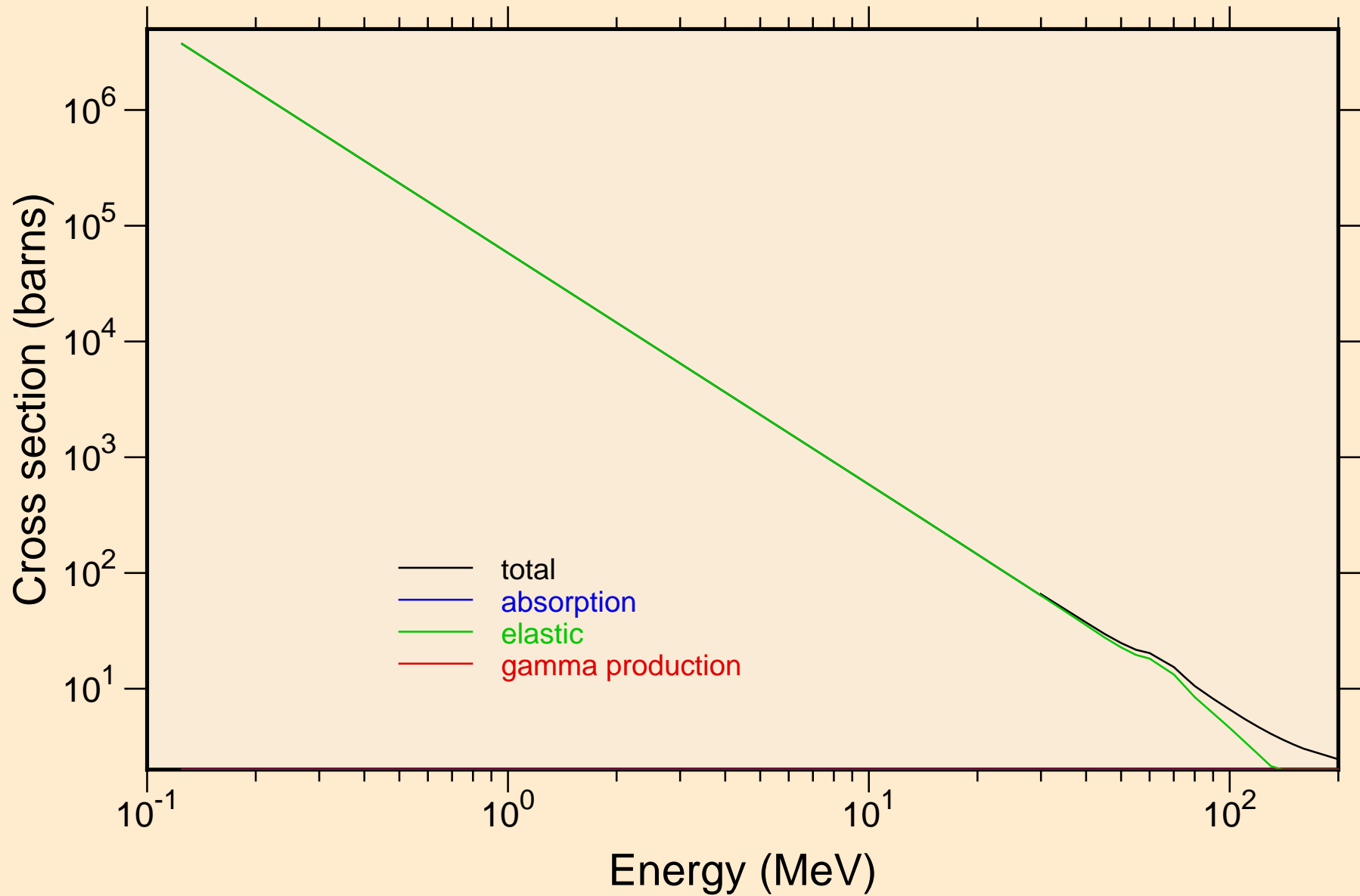

# BK236 PROTON ACER TENDL-2021 LIBRARY; T=0.K

## Heating

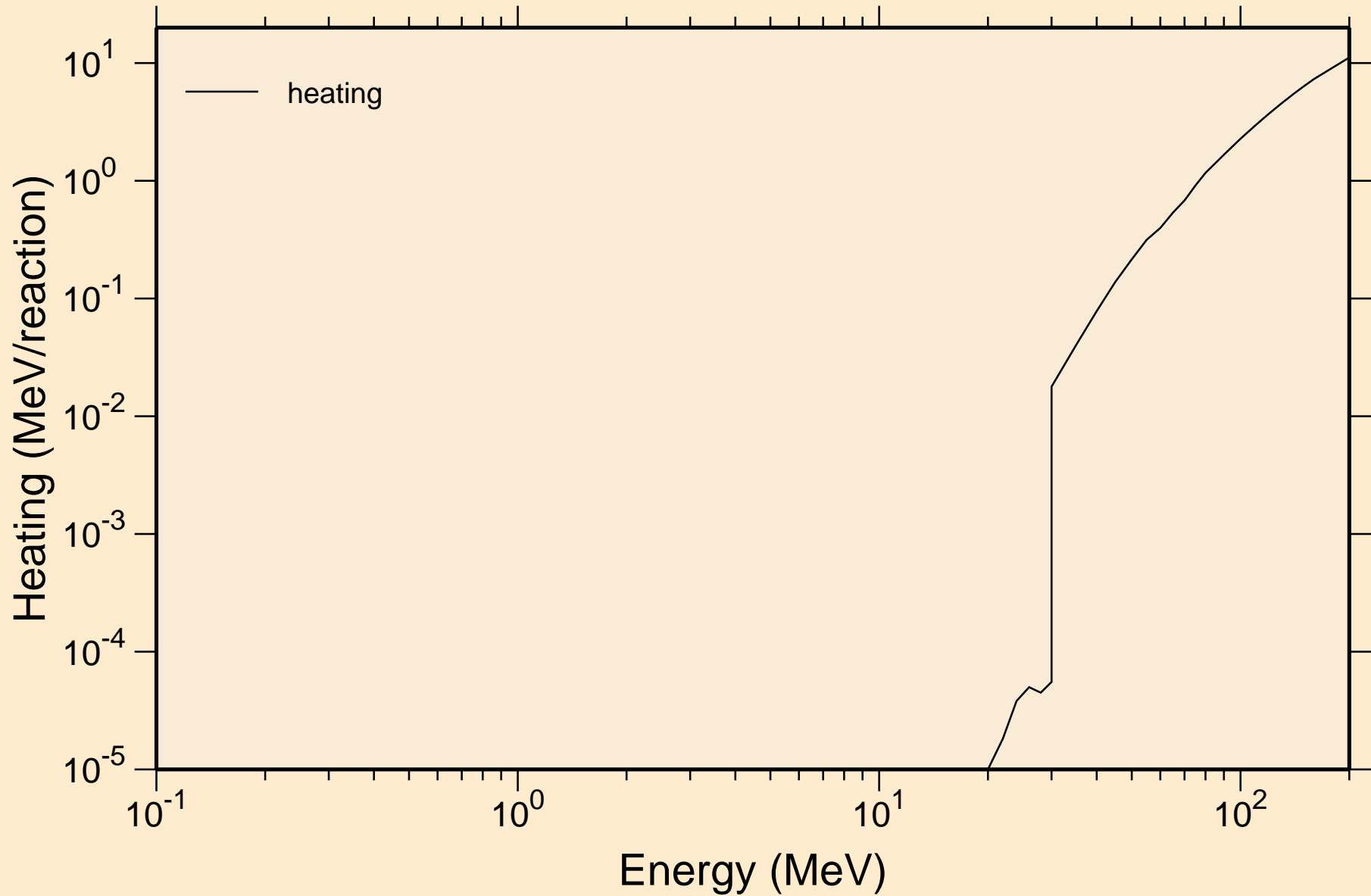

# BK236 PROTON ACER TENDL-2021 LIBRARY; T=0.K

## Principal cross sections

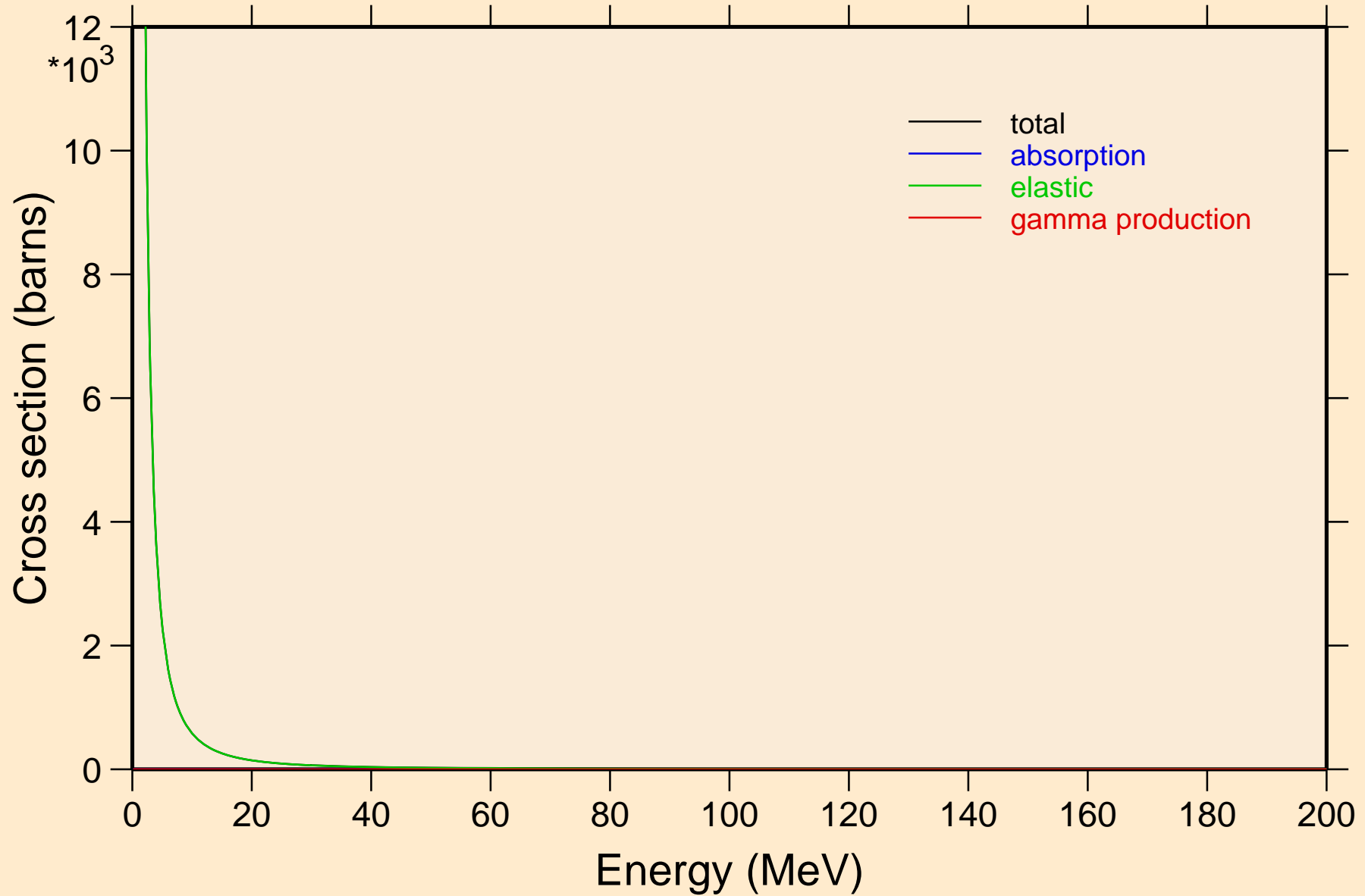

BK236 PROTON ACER TENDL-2021 LIBRARY; T=0.K

Heating

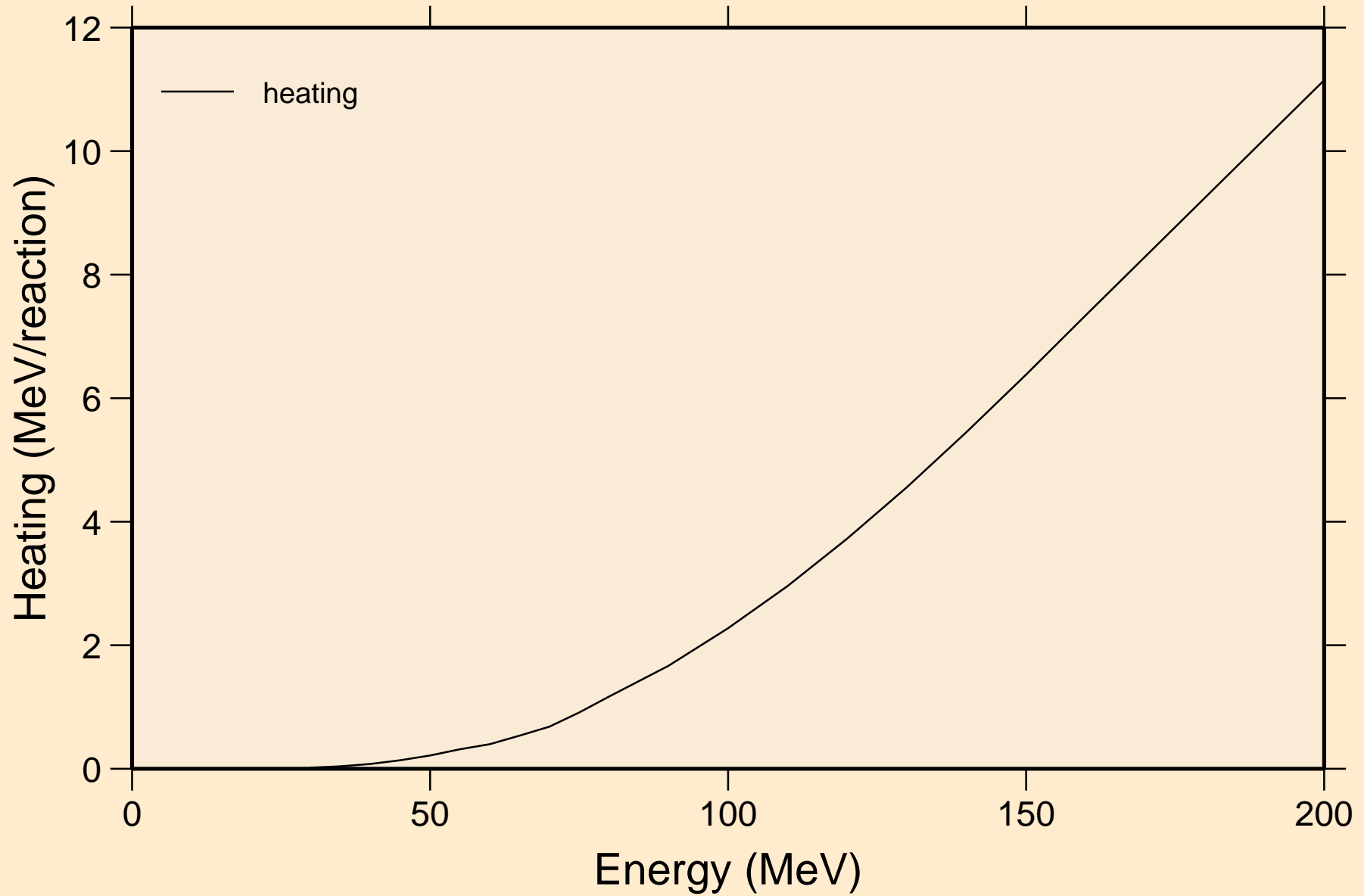

BK236 PROTON ACER TENDL-2021 LIBRARY; T=0.K  
Threshold reactions

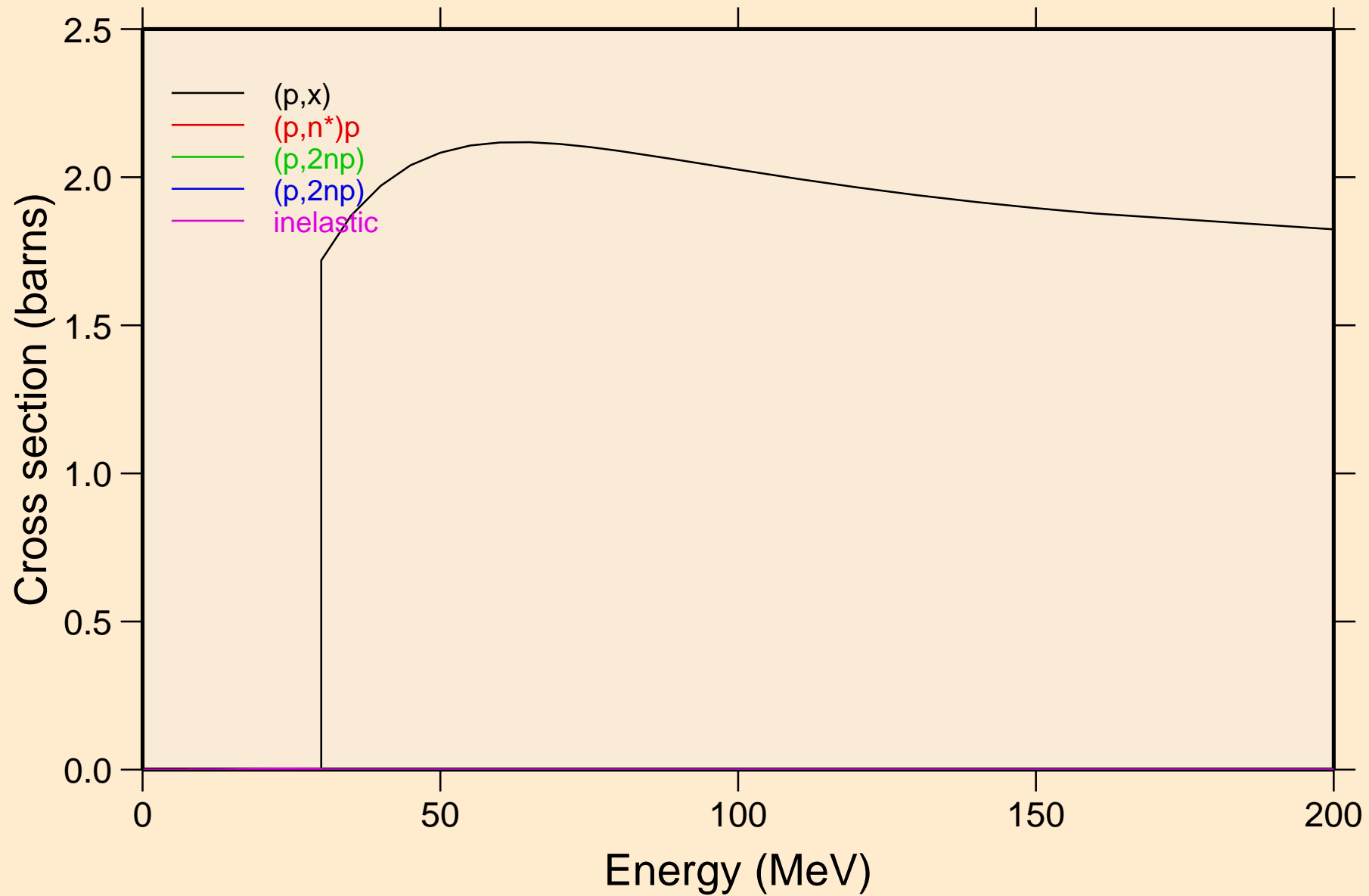

BK236 PROTON ACER TENDL-2021 LIBRARY; T=0.K  
Threshold reactions

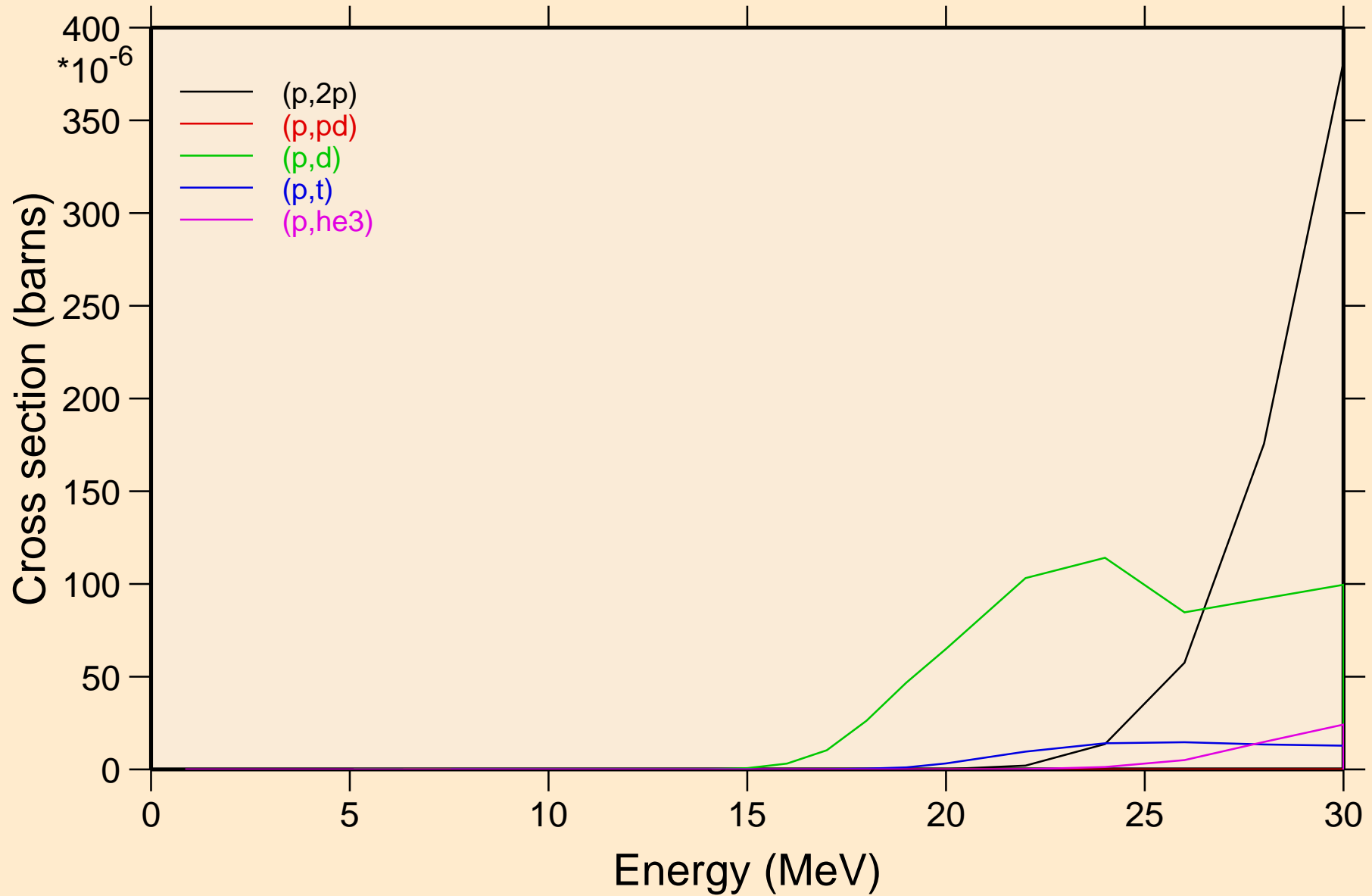

BK236 PROTON ACER TENDL-2021 LIBRARY; T=0.K  
Threshold reactions

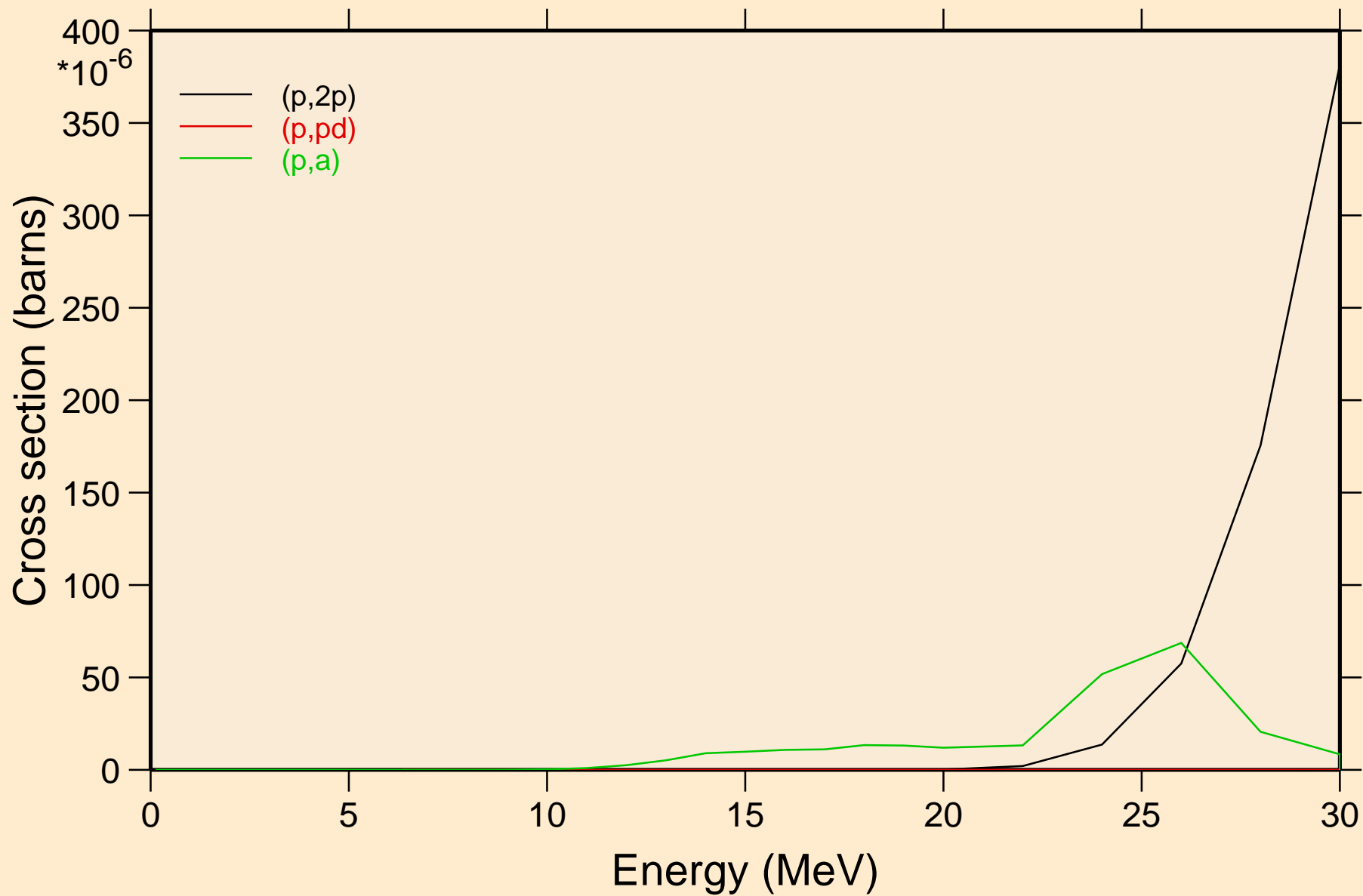

BK236 PROTON ACER TENDL-2021 LIBRARY; T=0.K  
Threshold reactions

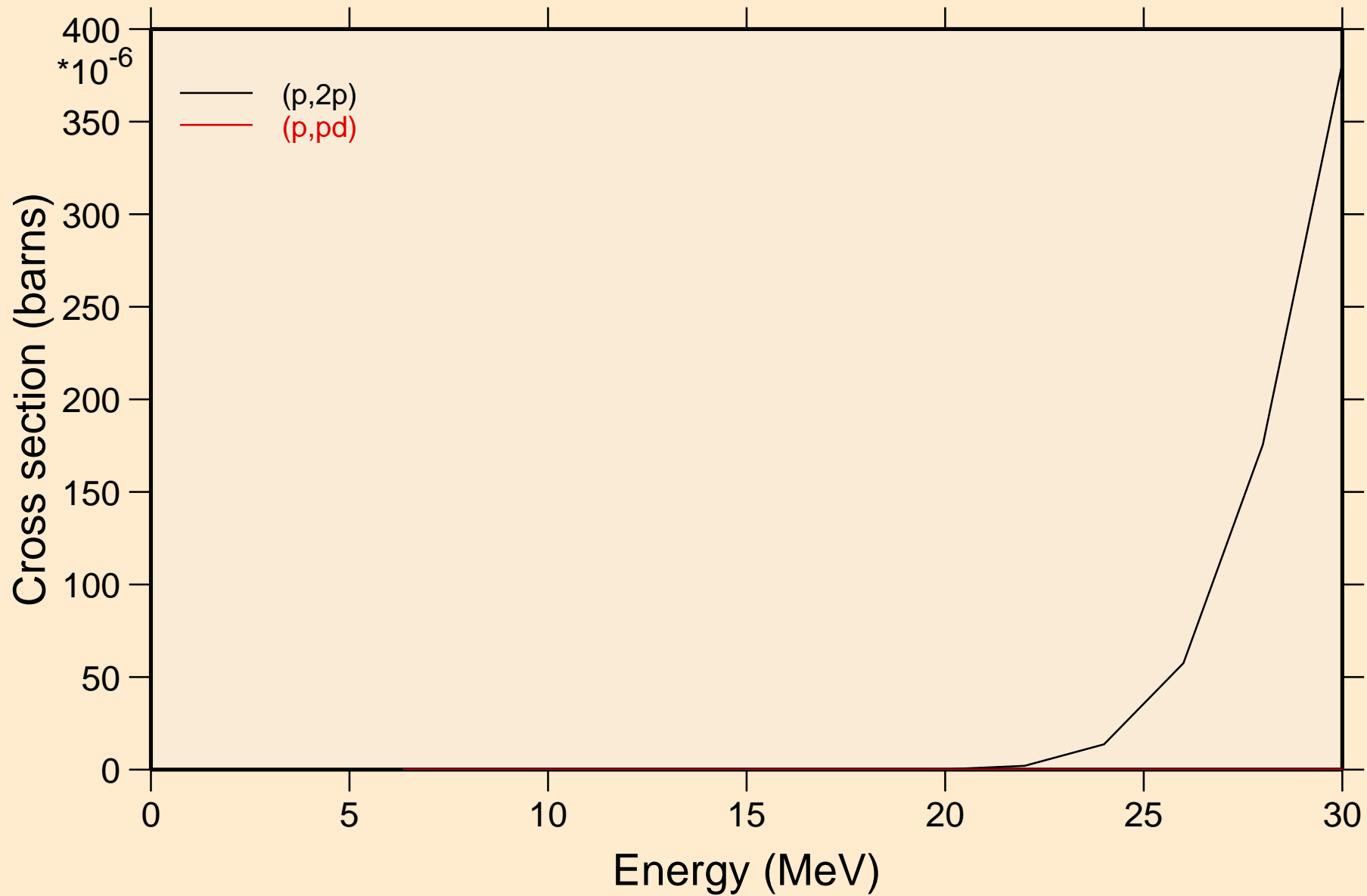



BK236 PROTON ACER TENDL-2021 LIBRARY; T=0.K  
angular distribution for elastic

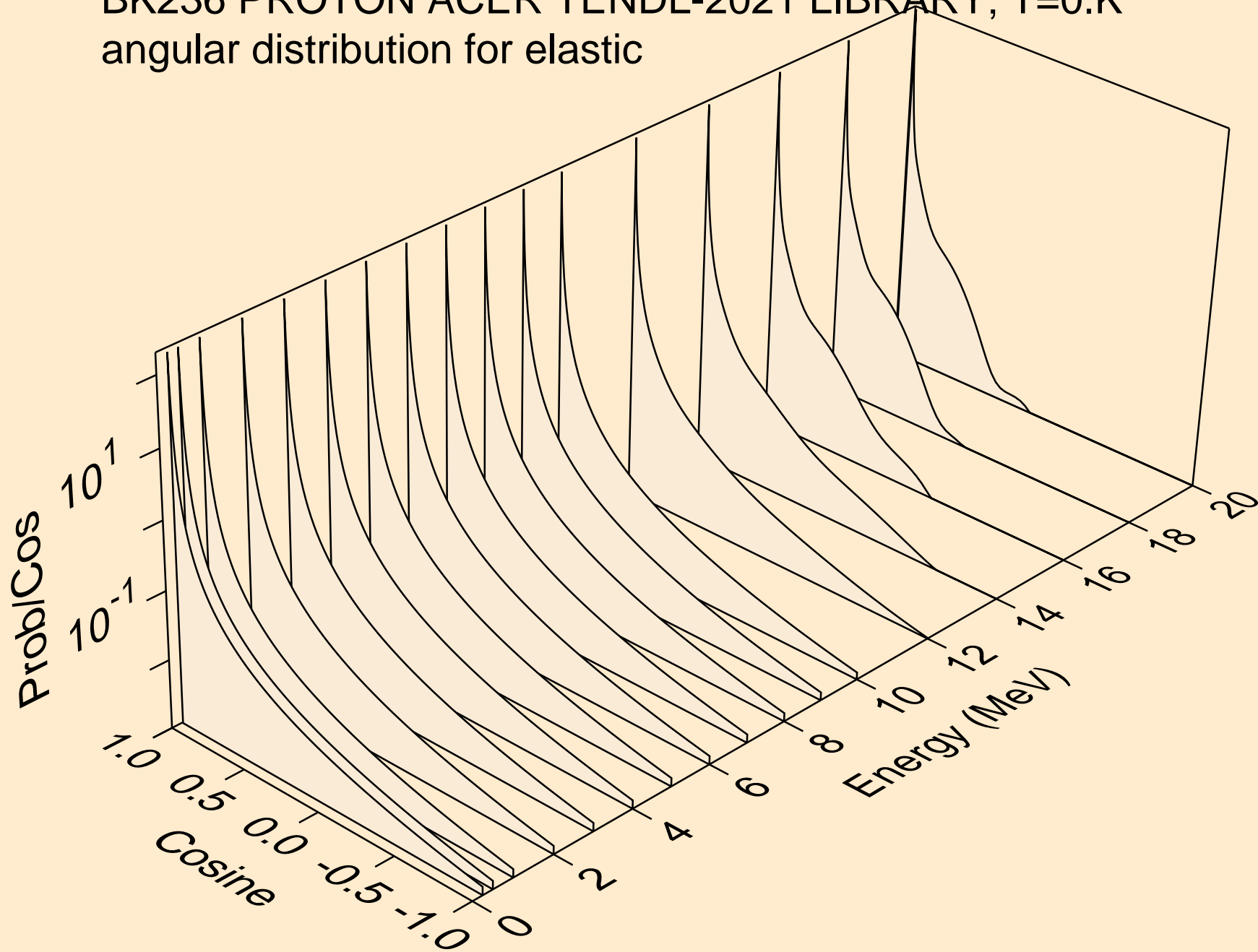

BK236 PROTON ACER TENDL-2021 LIBRARY; T=0.K  
angular distribution for elastic

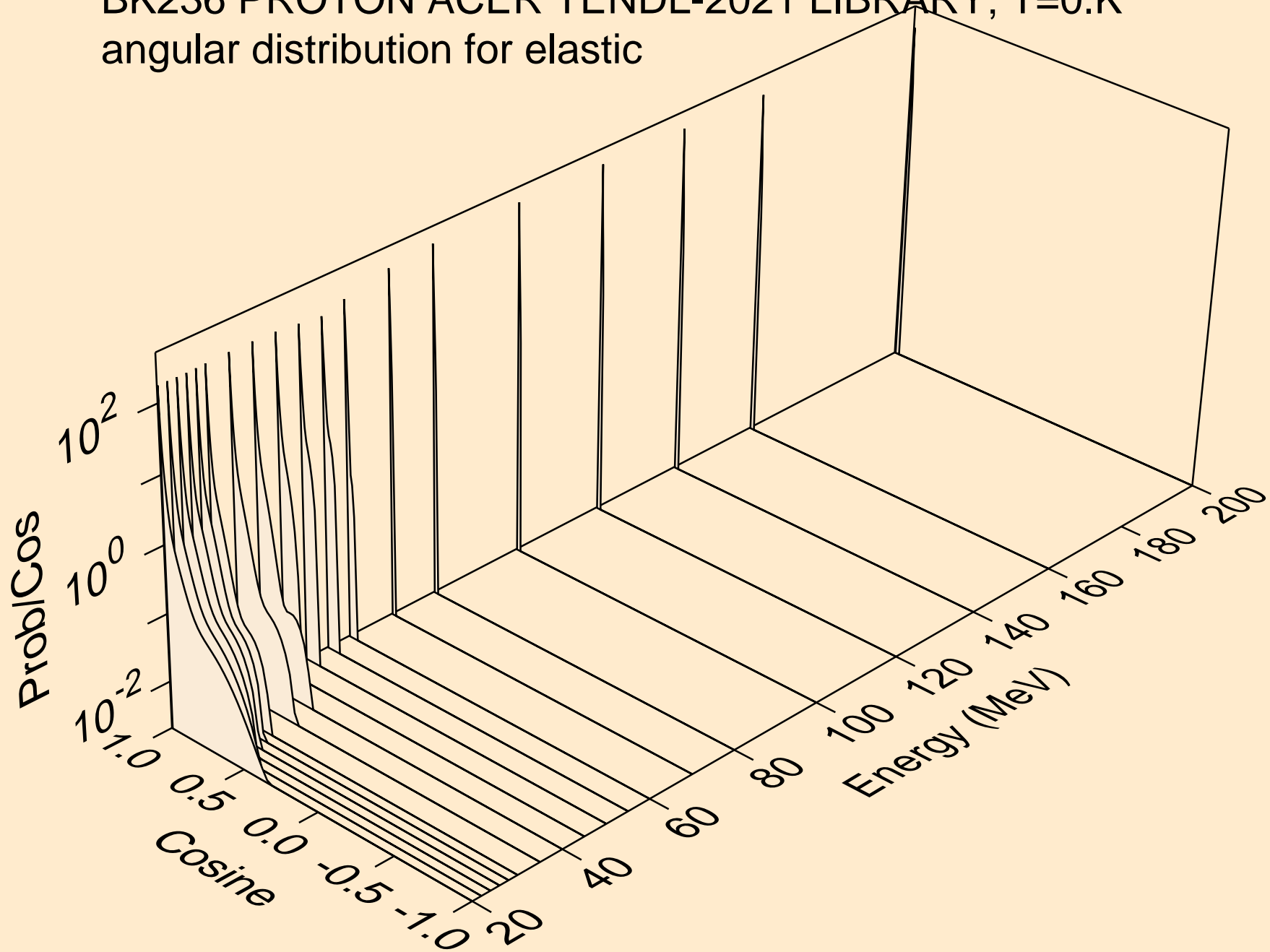

BK236 PROTON ACER TENDL-2021 LIBRARY; T=0.K  
Proton emission for (p,x)

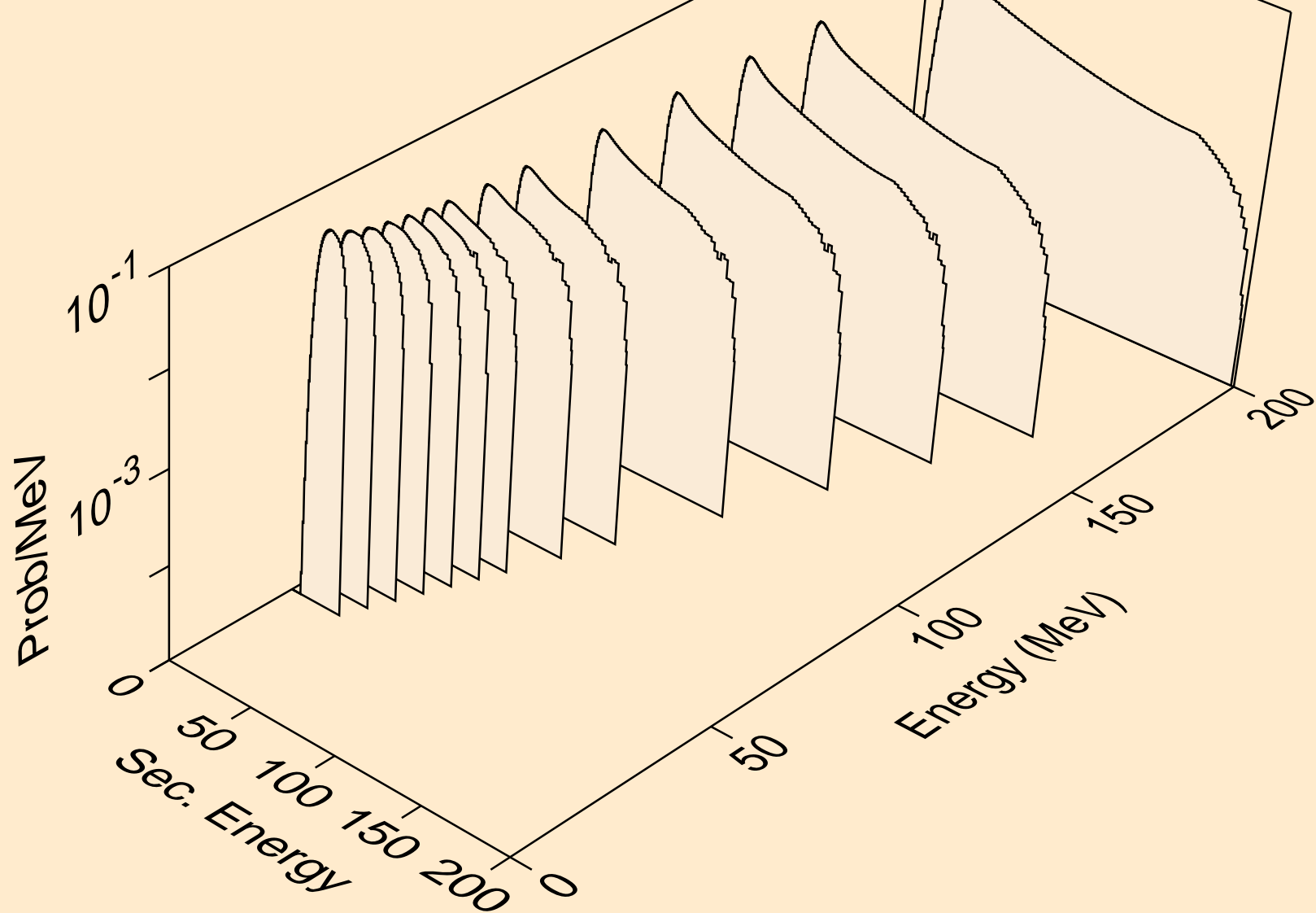

BK236 PROTON ACER TENDL-2021 LIBRARY; T=0.K  
Proton emission for (p,n\*)p

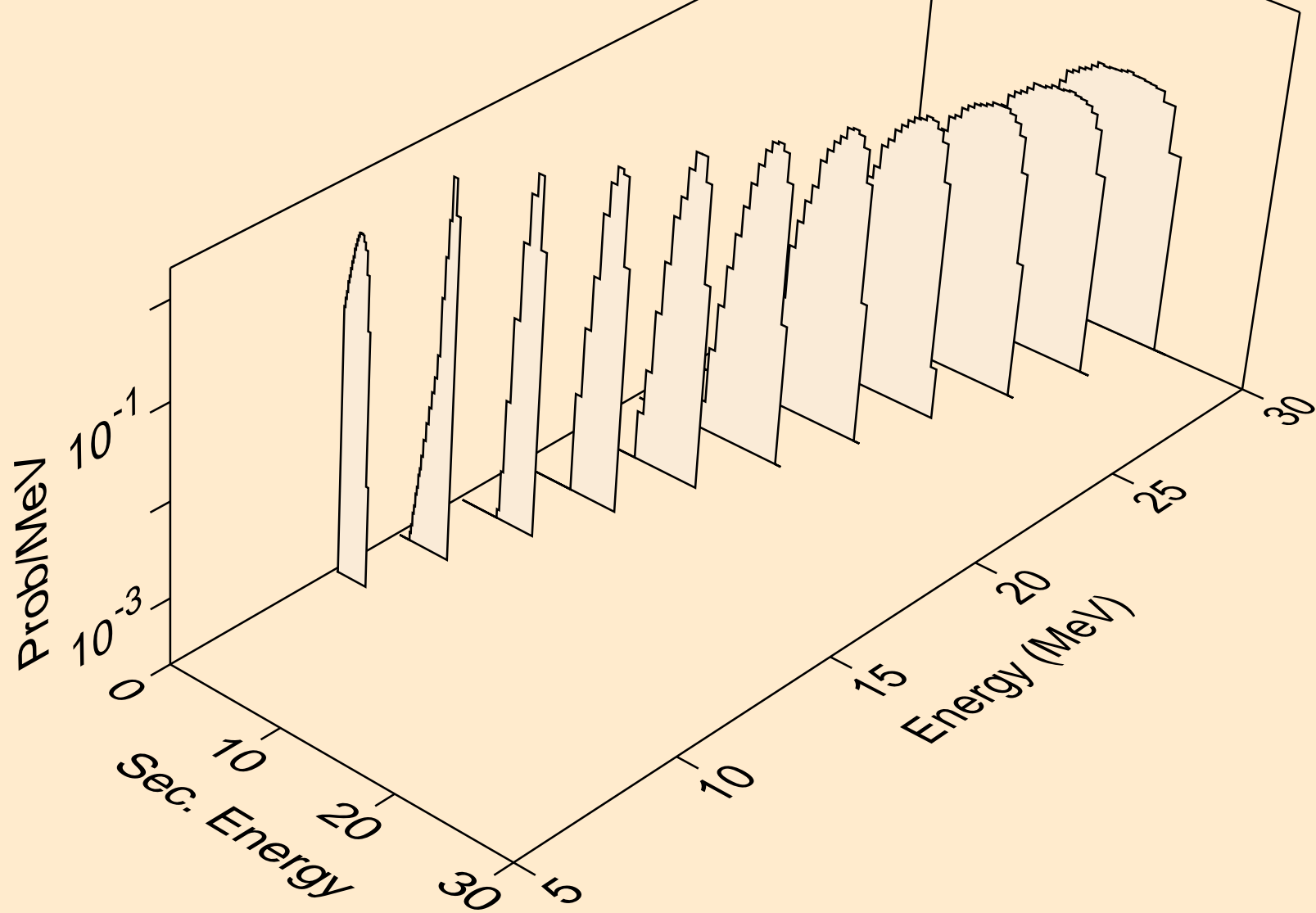

BK236 PROTON ACER TENDL-2021 LIBRARY; T=0.K  
Proton emission for (p,2np)

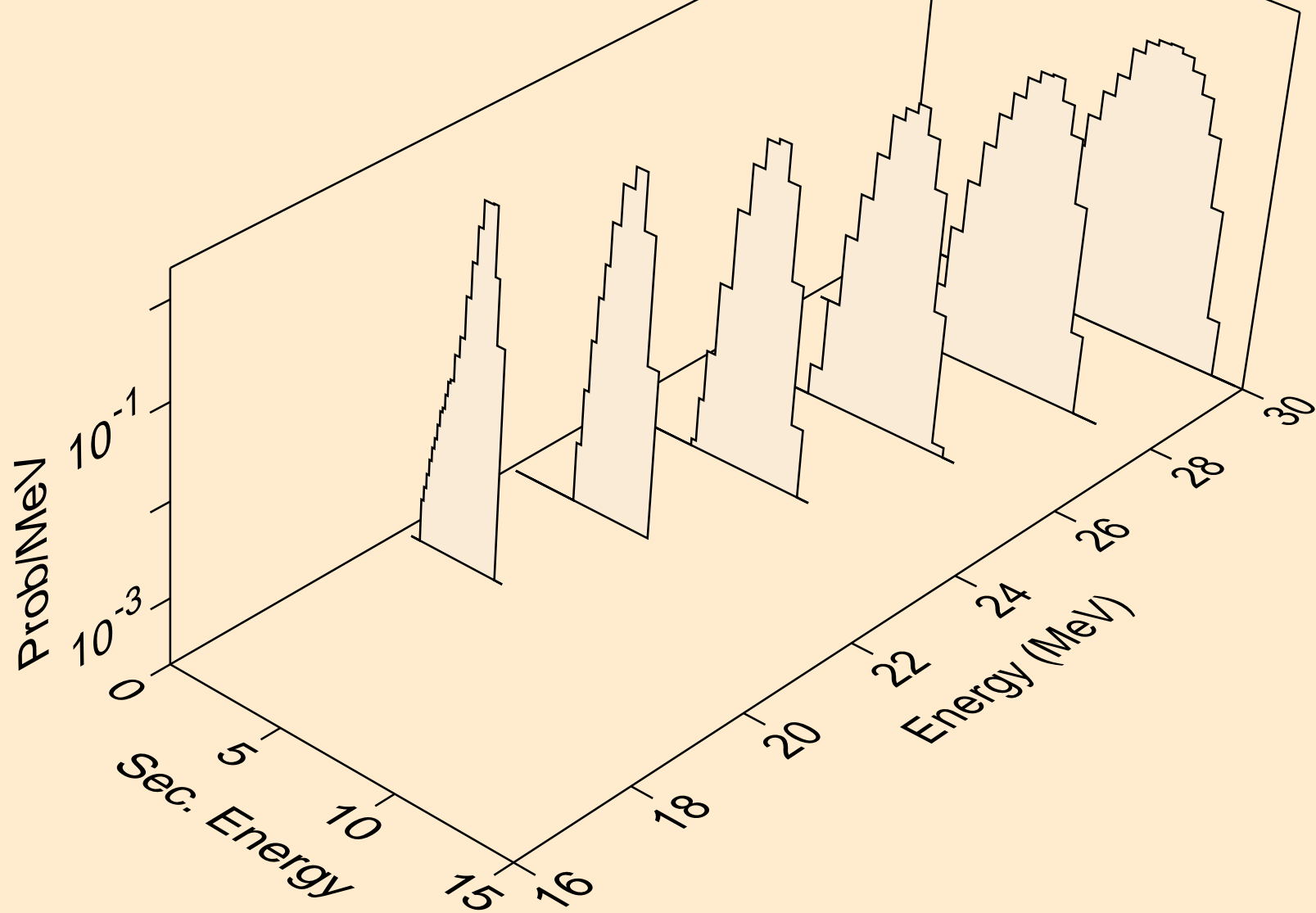

BK236 PROTON ACER TENDL-2021 LIBRARY; T=0.K  
Proton emission for (p,2np)

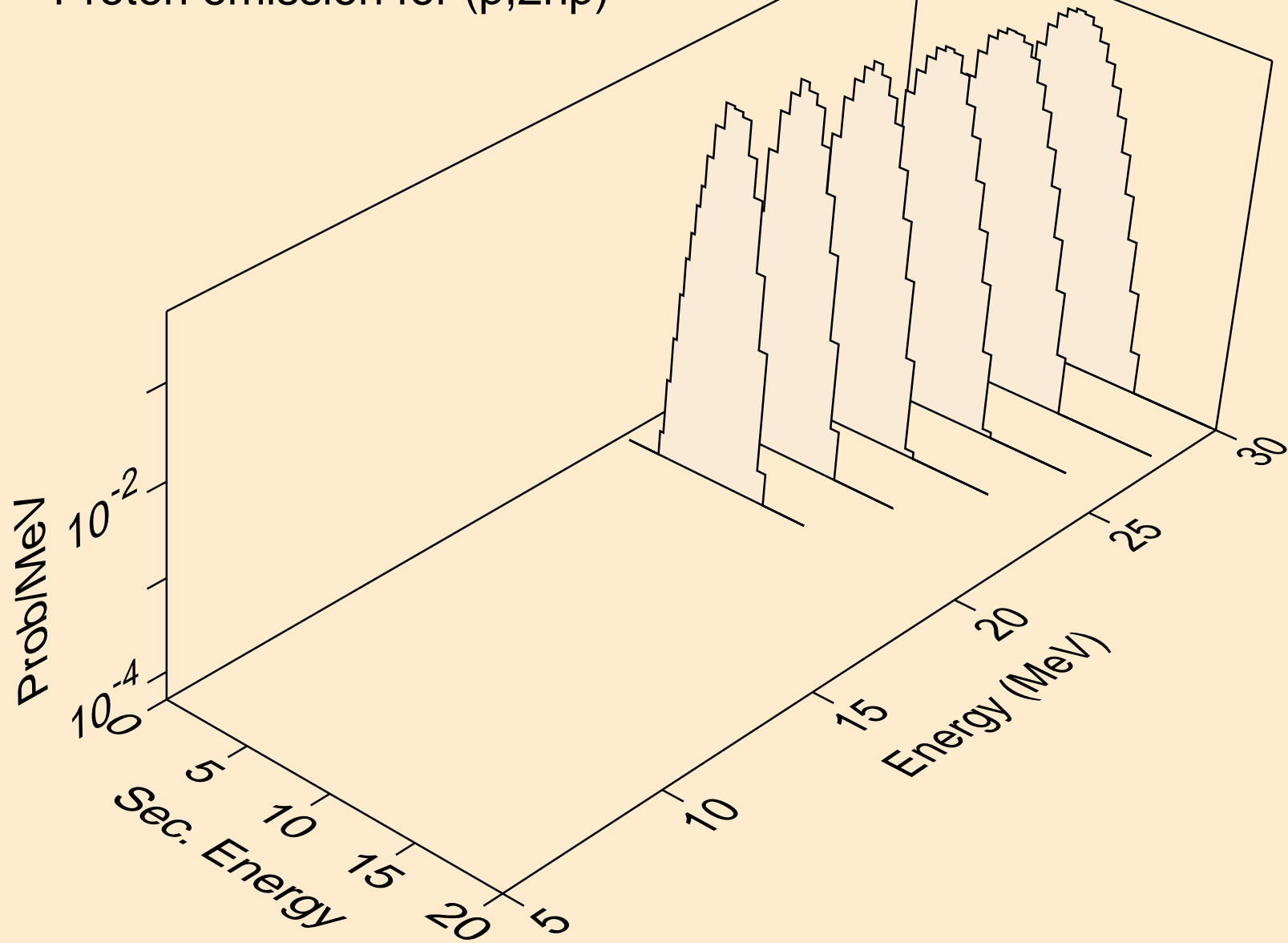

BK236 PROTON ACER TENDL-2021 LIBRARY; T=0.K  
Proton emission for inelastic

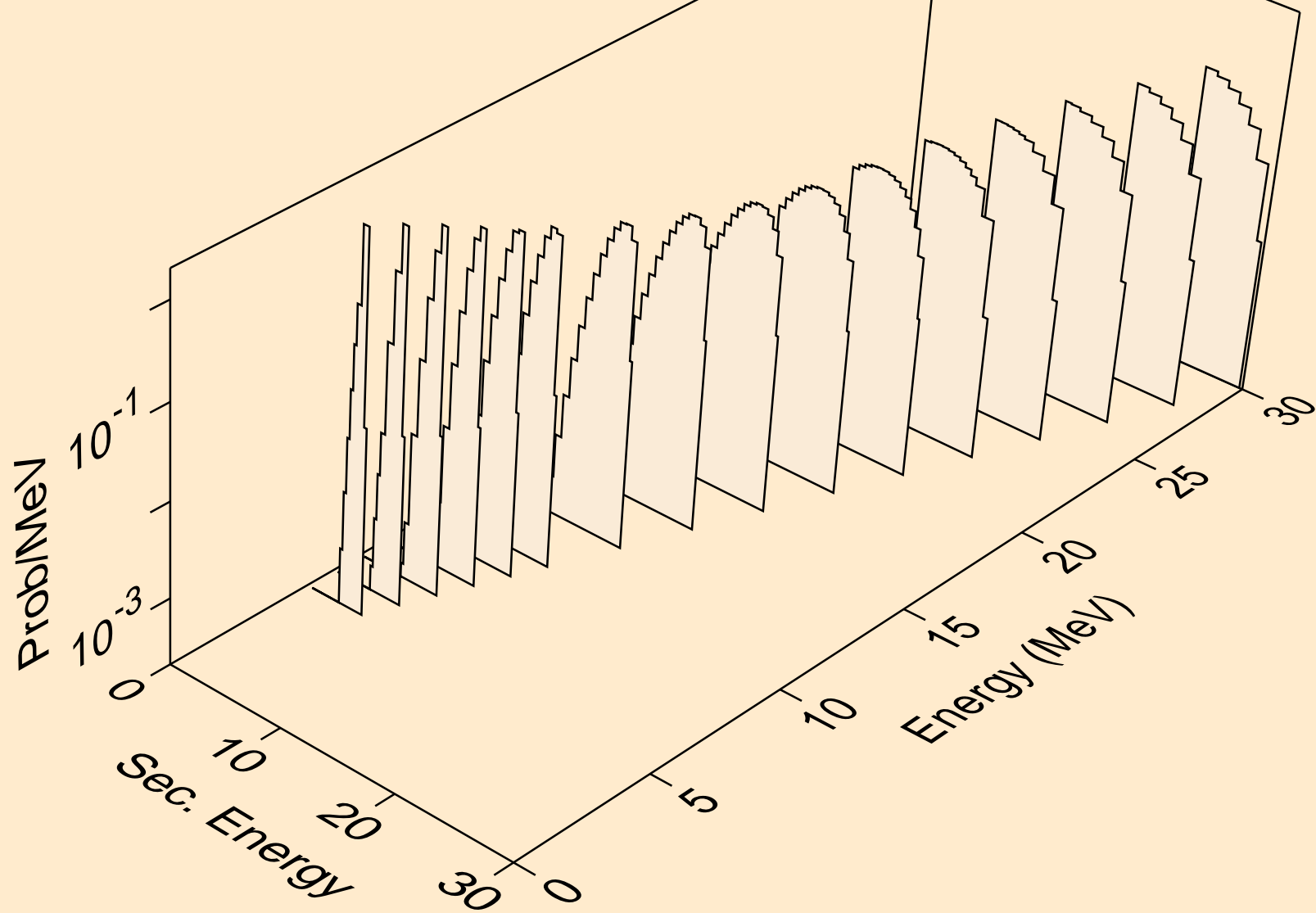

BK236 PROTON ACER TENDL-2021 LIBRARY; T=0.K  
Proton emission for (p,2p)

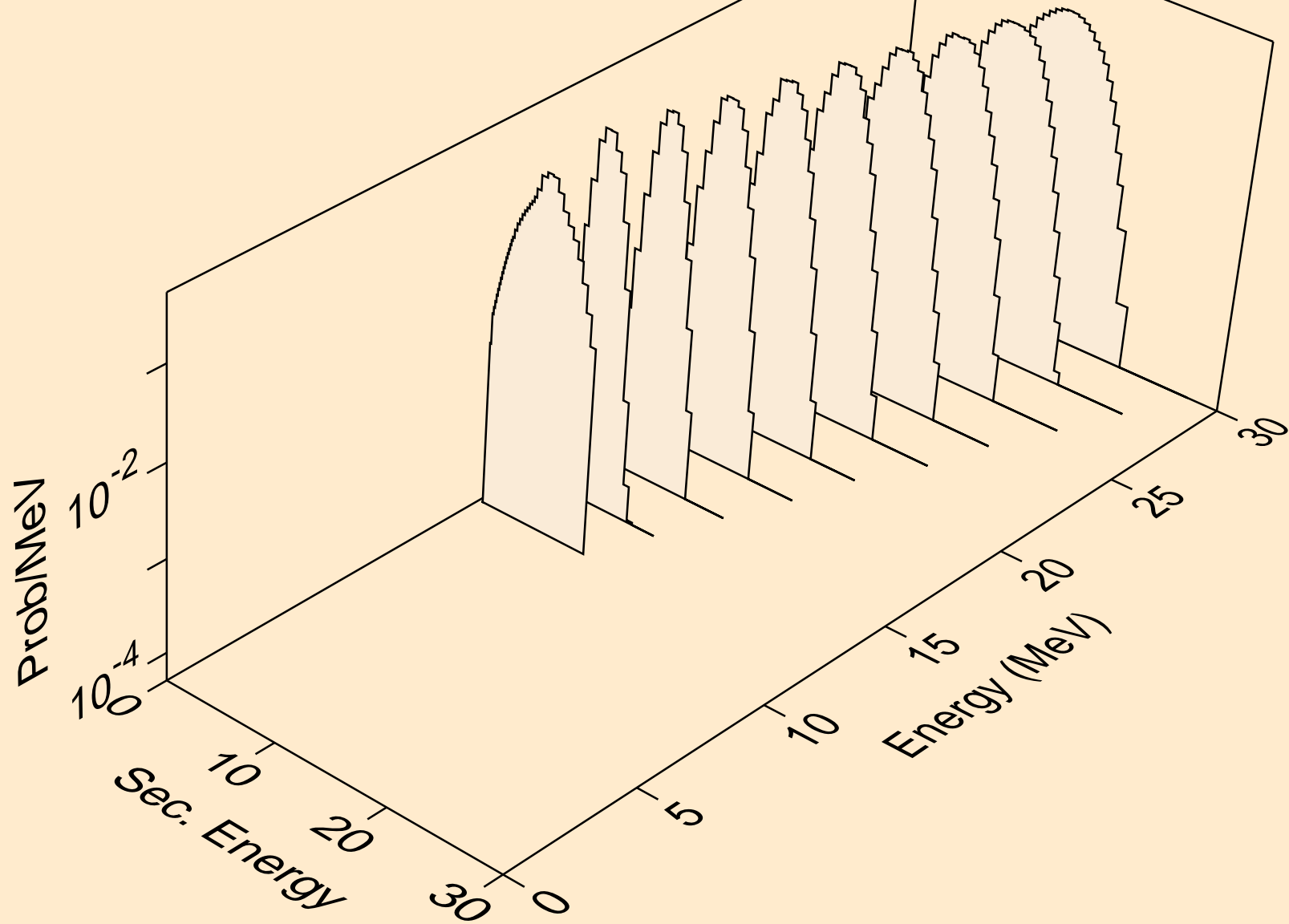



BK236 PROTON ACER TENDL-2021 LIBRARY; T=0.K  
Proton emission for (p,pd)

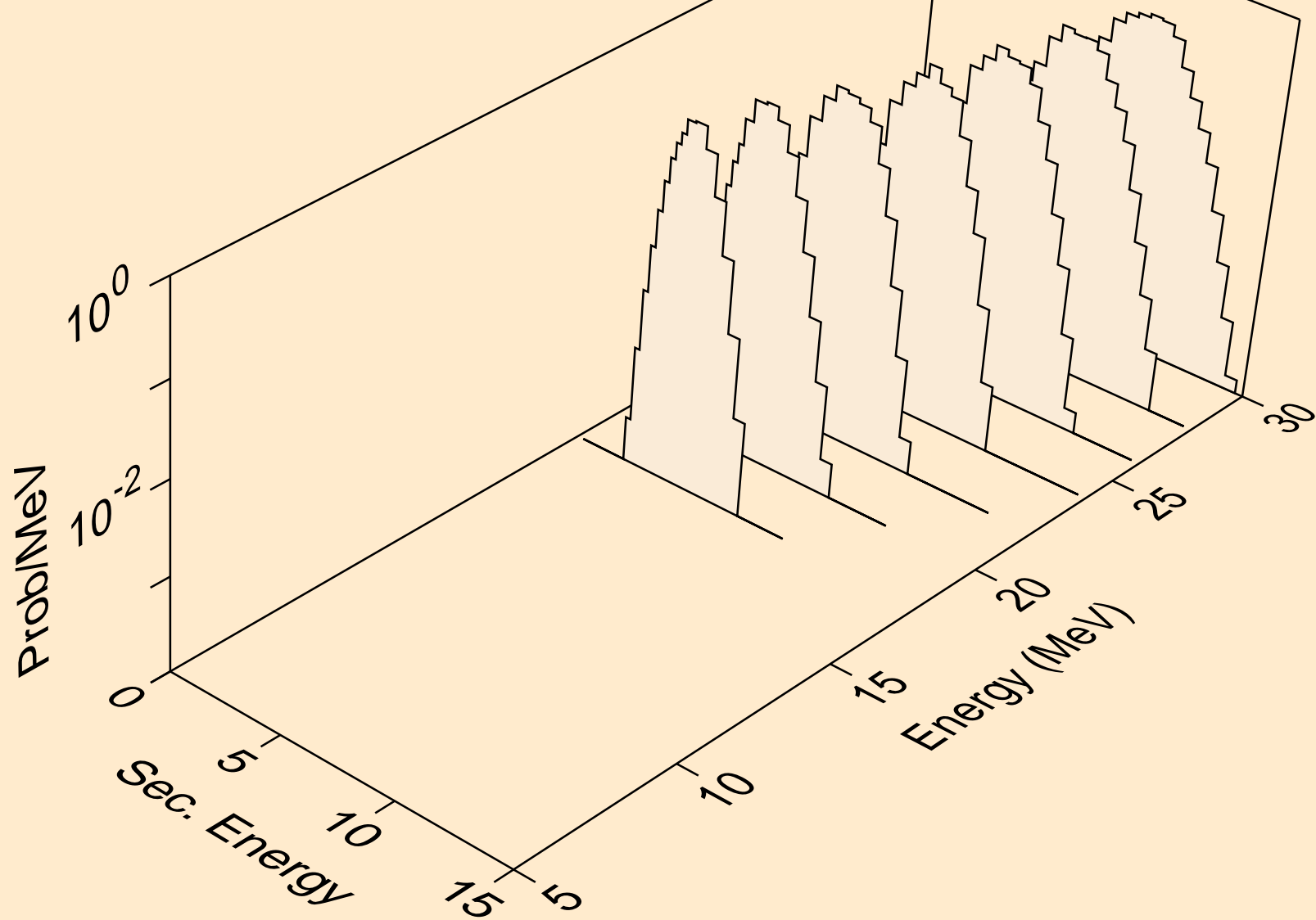

BK236 PROTON ACER TENDL-2021 LIBRARY; T=0.K  
Photon emission for (z,n)

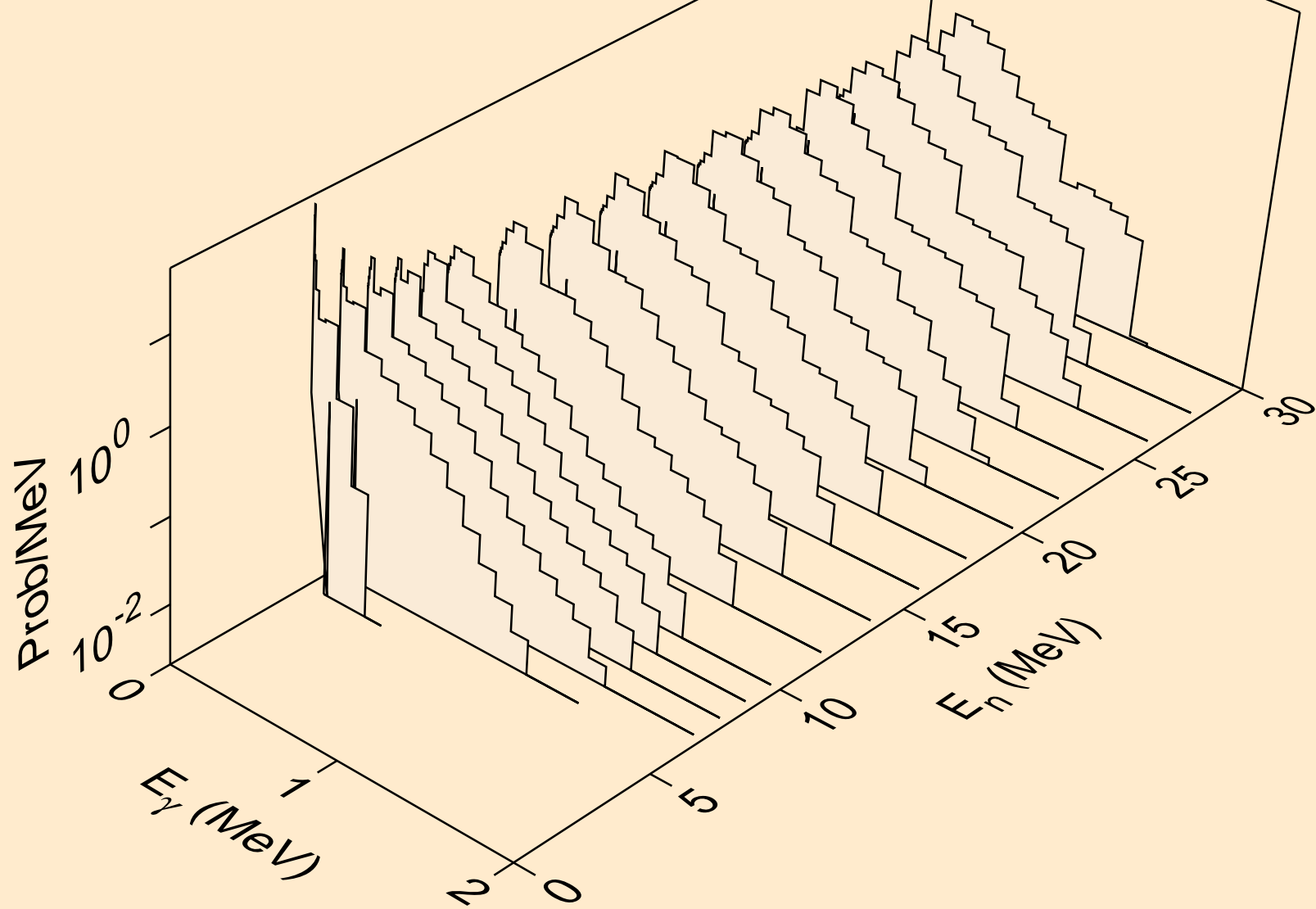

BK236 PROTON ACER TENDL-2021 LIBRARY; T=0.K  
Photon emission for (n,x)

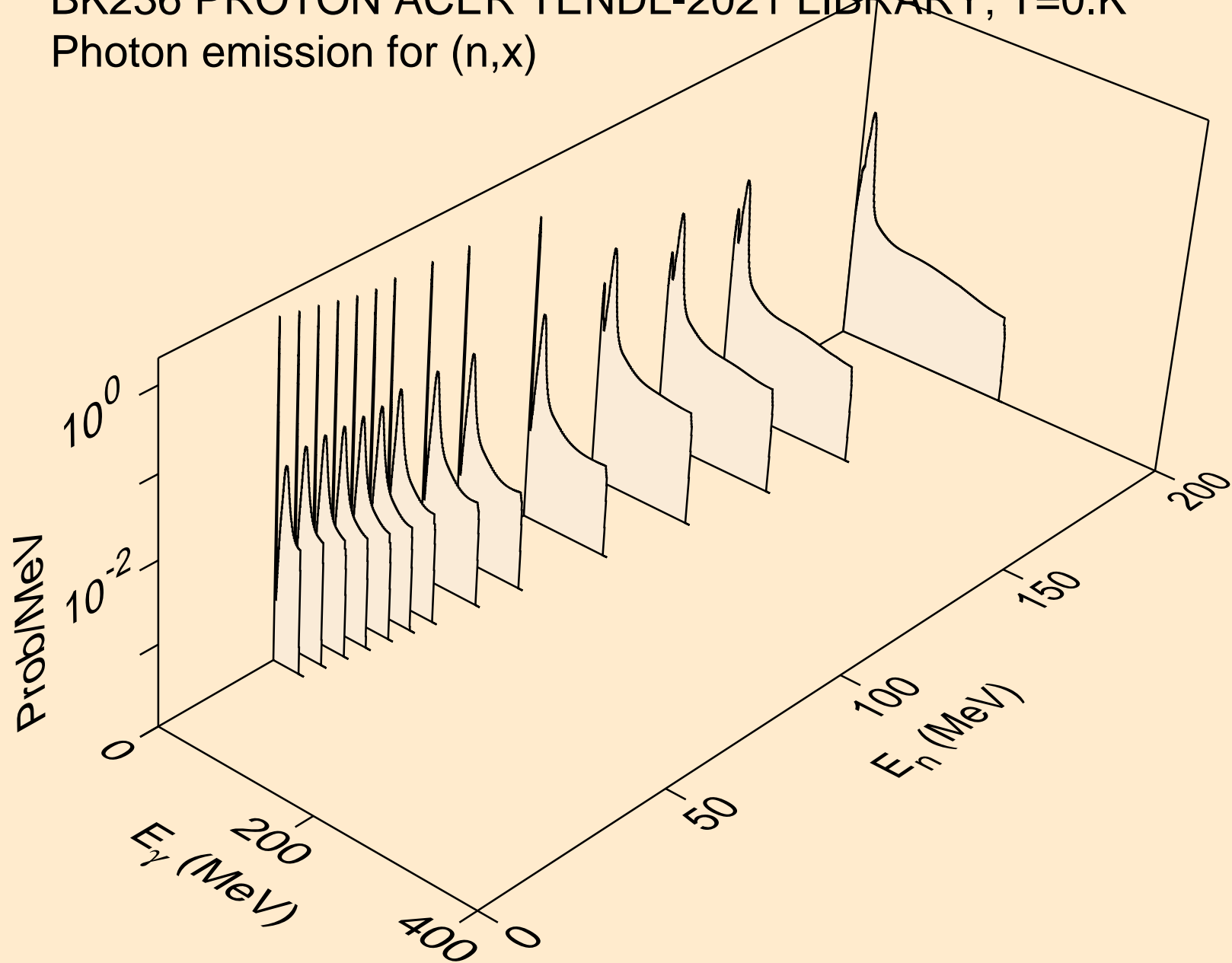

BK236 PROTON ACER TENDL-2021 LIBRARY; T=0.K  
Photon emission for (n,2n)

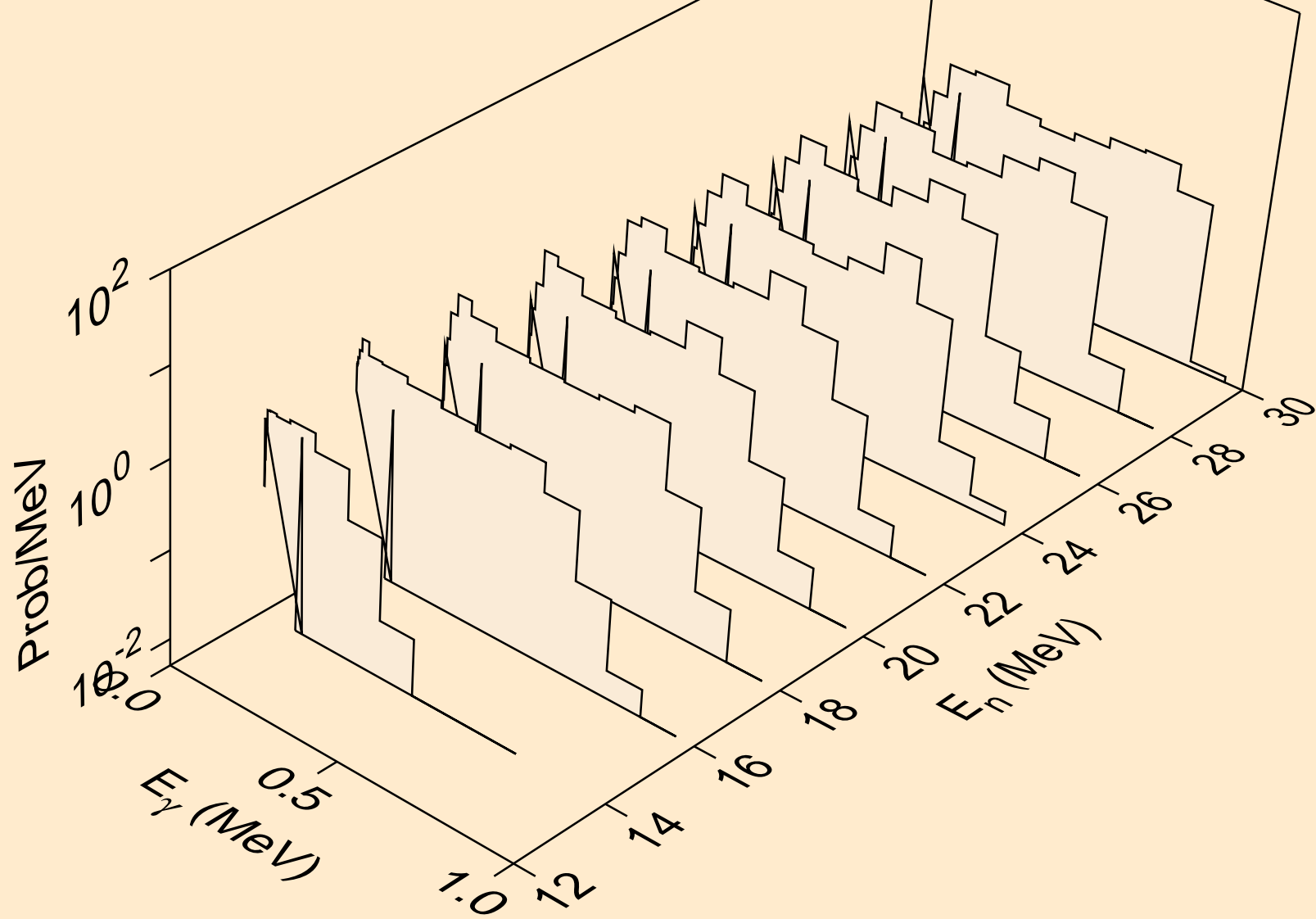

BK236 PROTON ACER TENDL-2021 LIBRARY; T=0.K  
Photon emission for (n,n\*)a

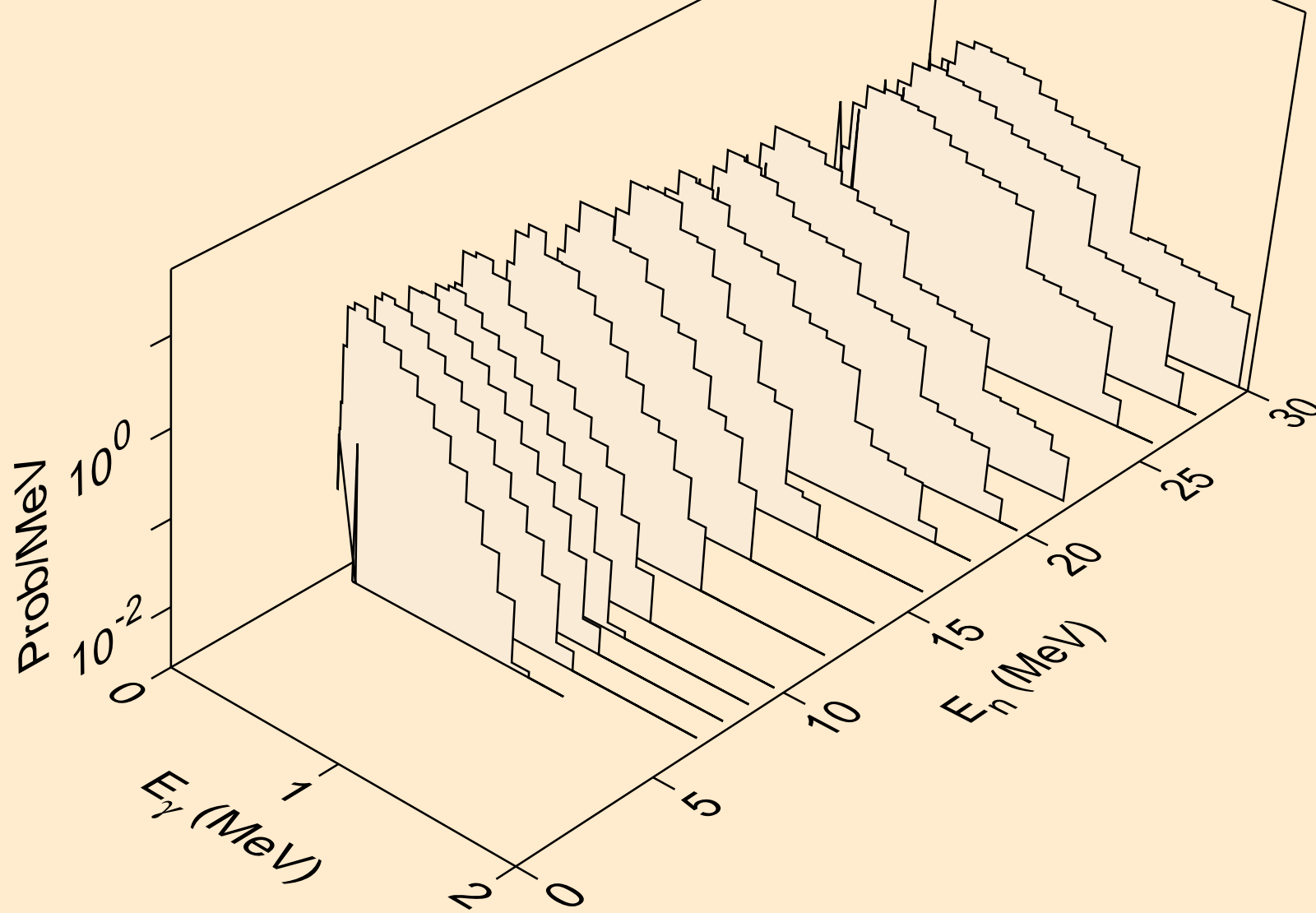

BK236 PROTON ACER TENDL-2021 LIBRARY; T=0.K  
Photon emission for (n,n\*)p

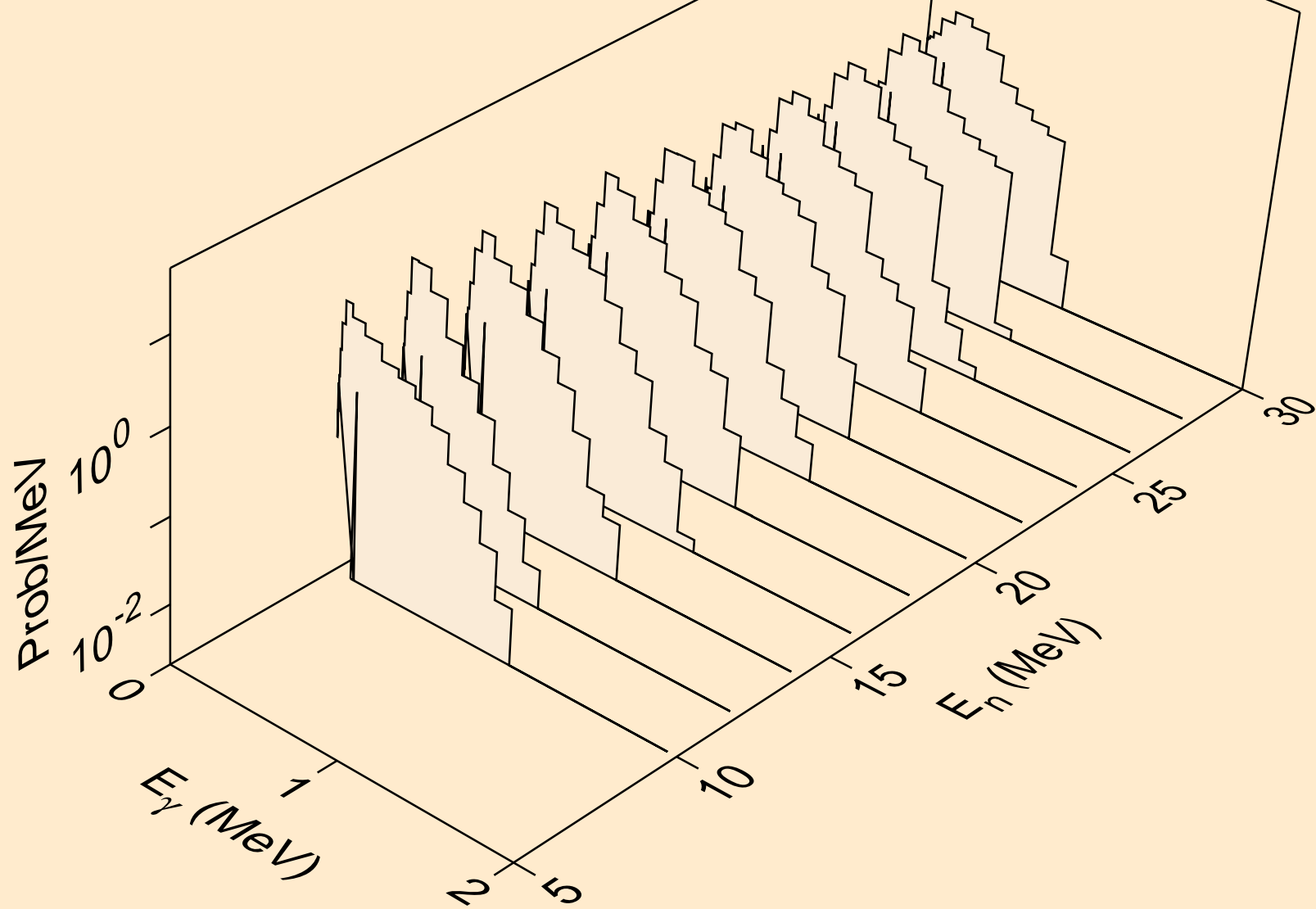

BK236 PROTON ACER TENDL-2021 LIBRARY; T=0.K  
Photon emission for (n,n\*)d

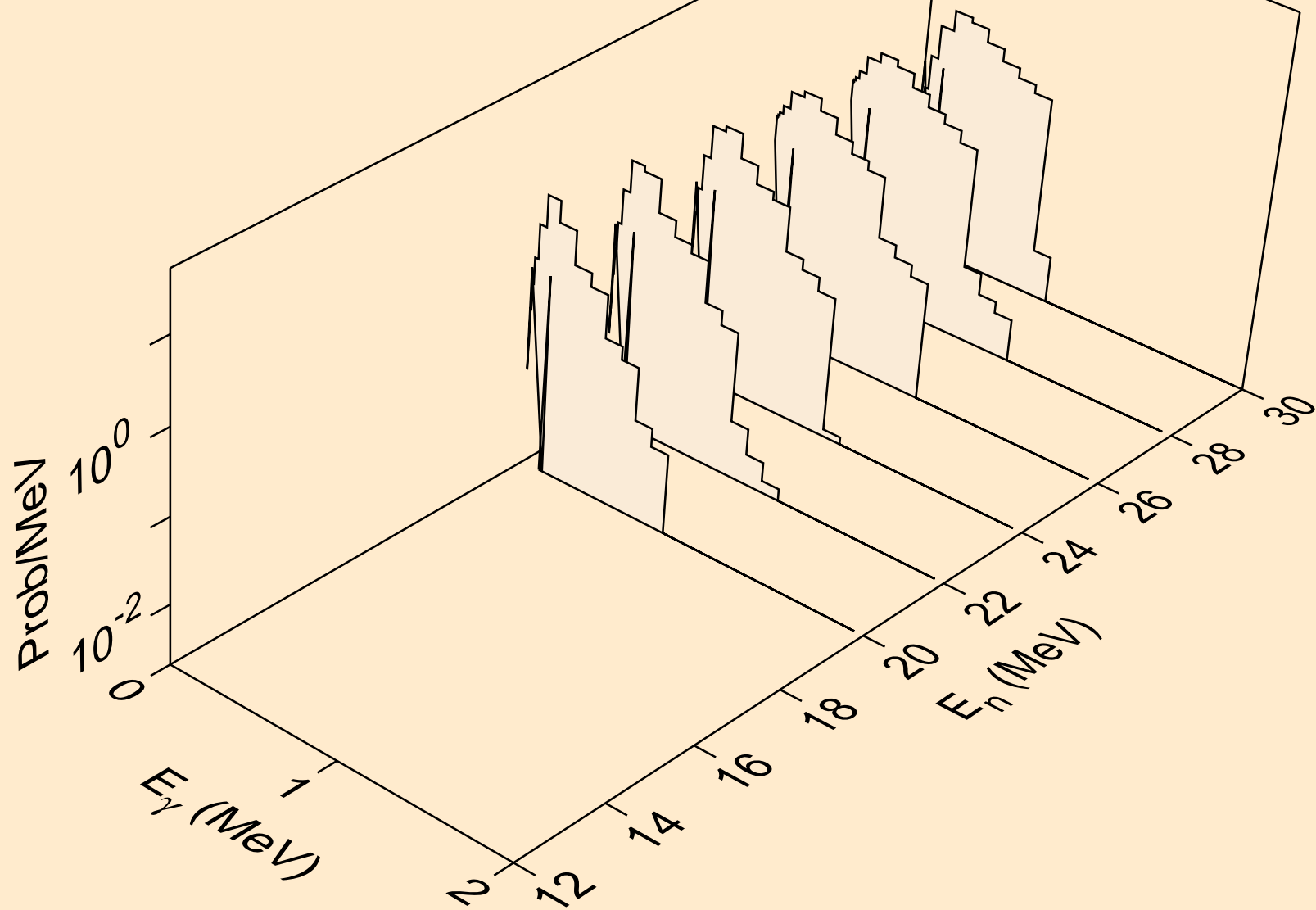

BK236 PROTON ACER TENDL-2021 LIBRARY; T=0.K  
Photon emission for (n,2np)

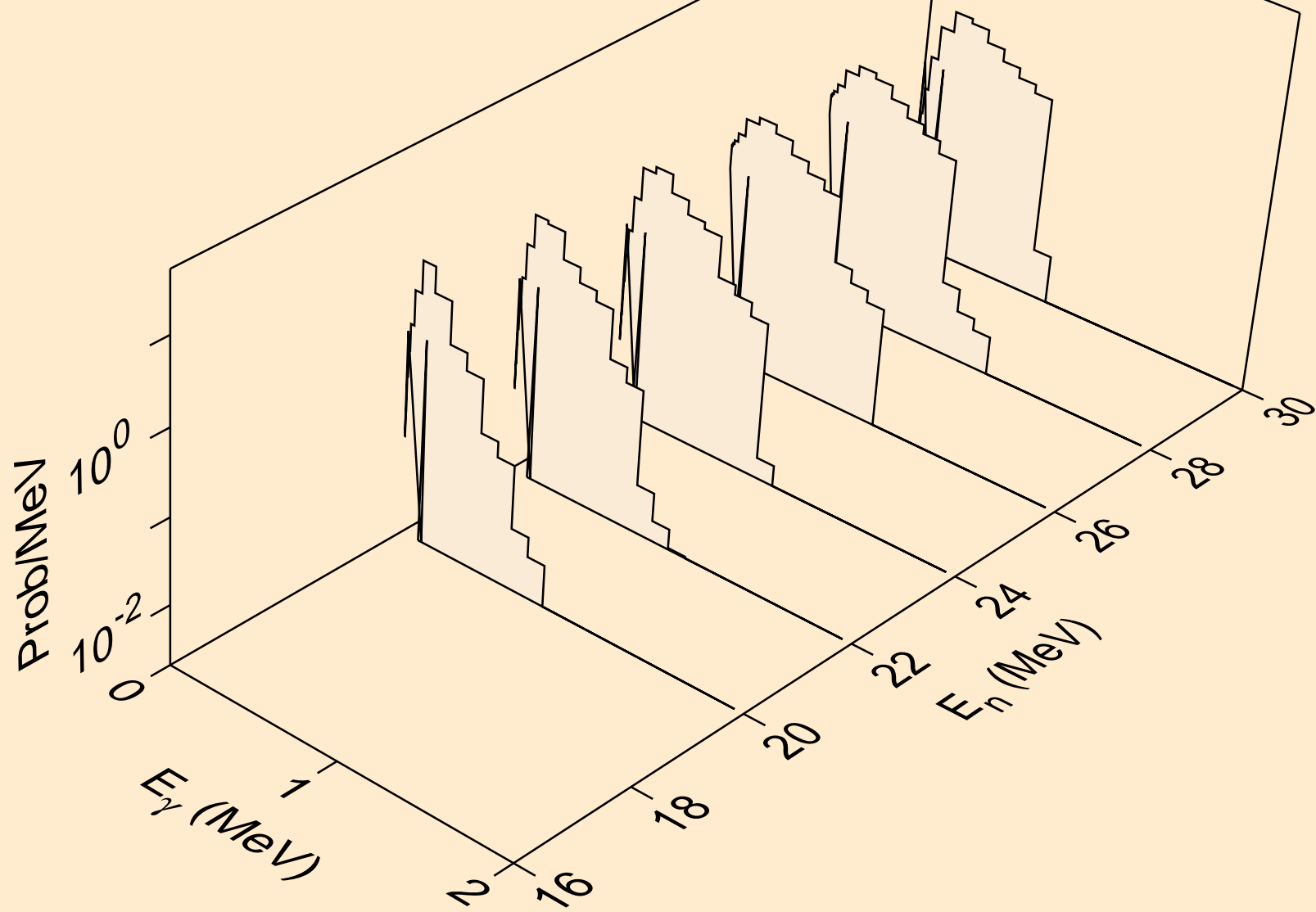



BK236 PROTON ACER TENDL-2021 LIBRARY; T=0.K  
Photon emission for (n,2np)

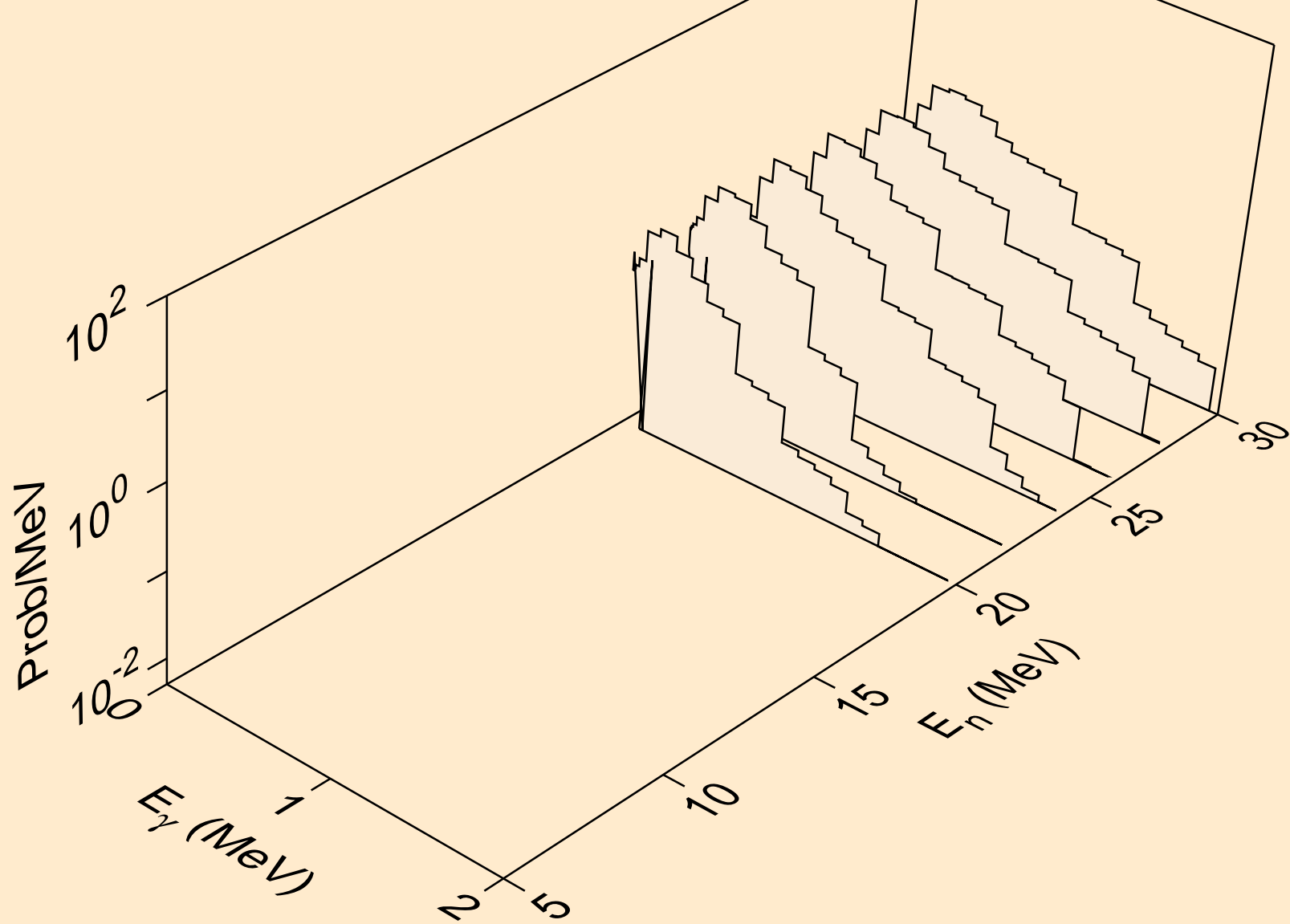

BK236 PROTON ACER TENDL-2021 LIBRARY; T=0.K  
Photon emission for (n,gma)

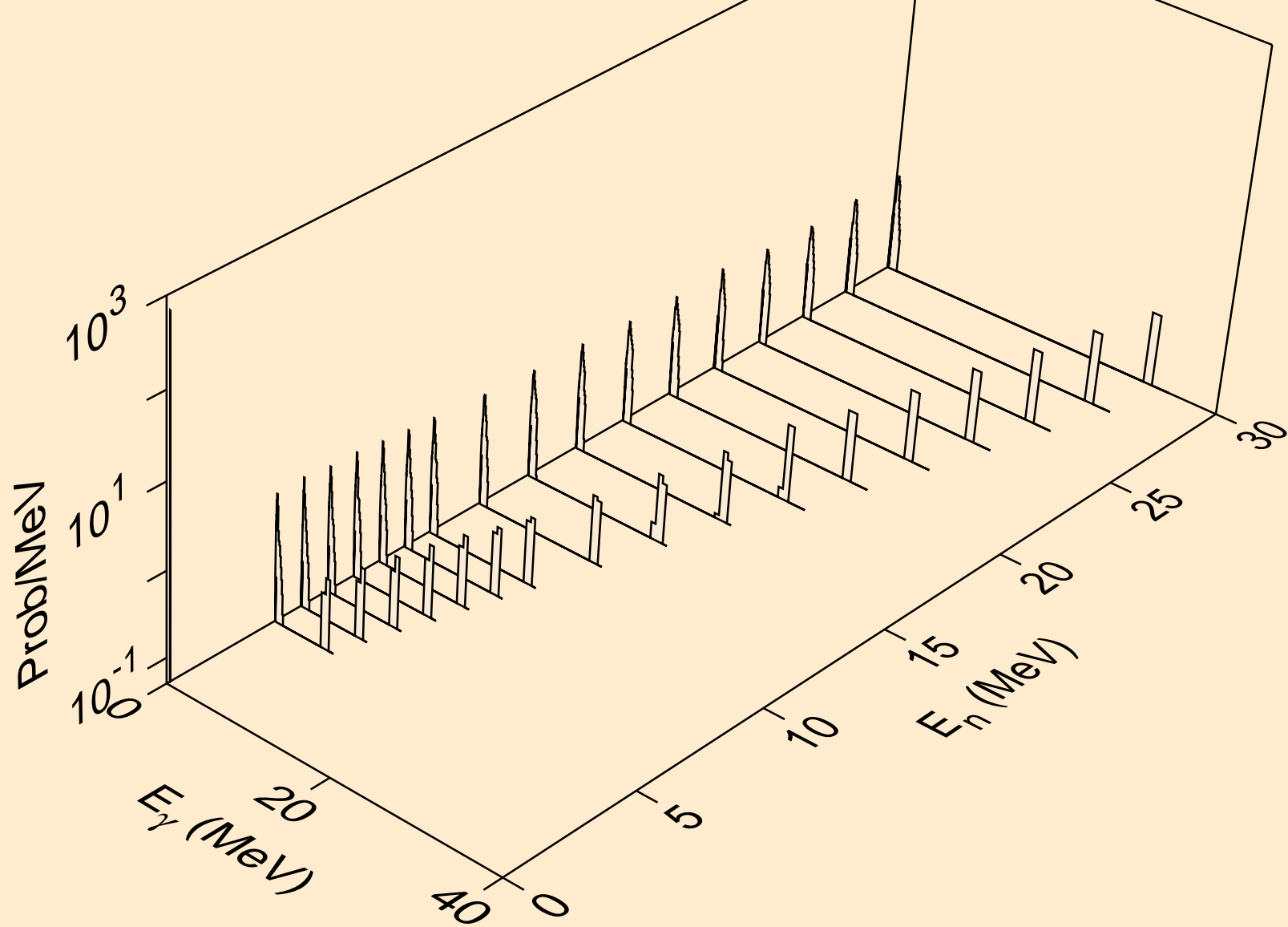

BK236 PROTON ACER TENDL-2021 LIBRARY; T=0.K  
Photon emission for inelastic

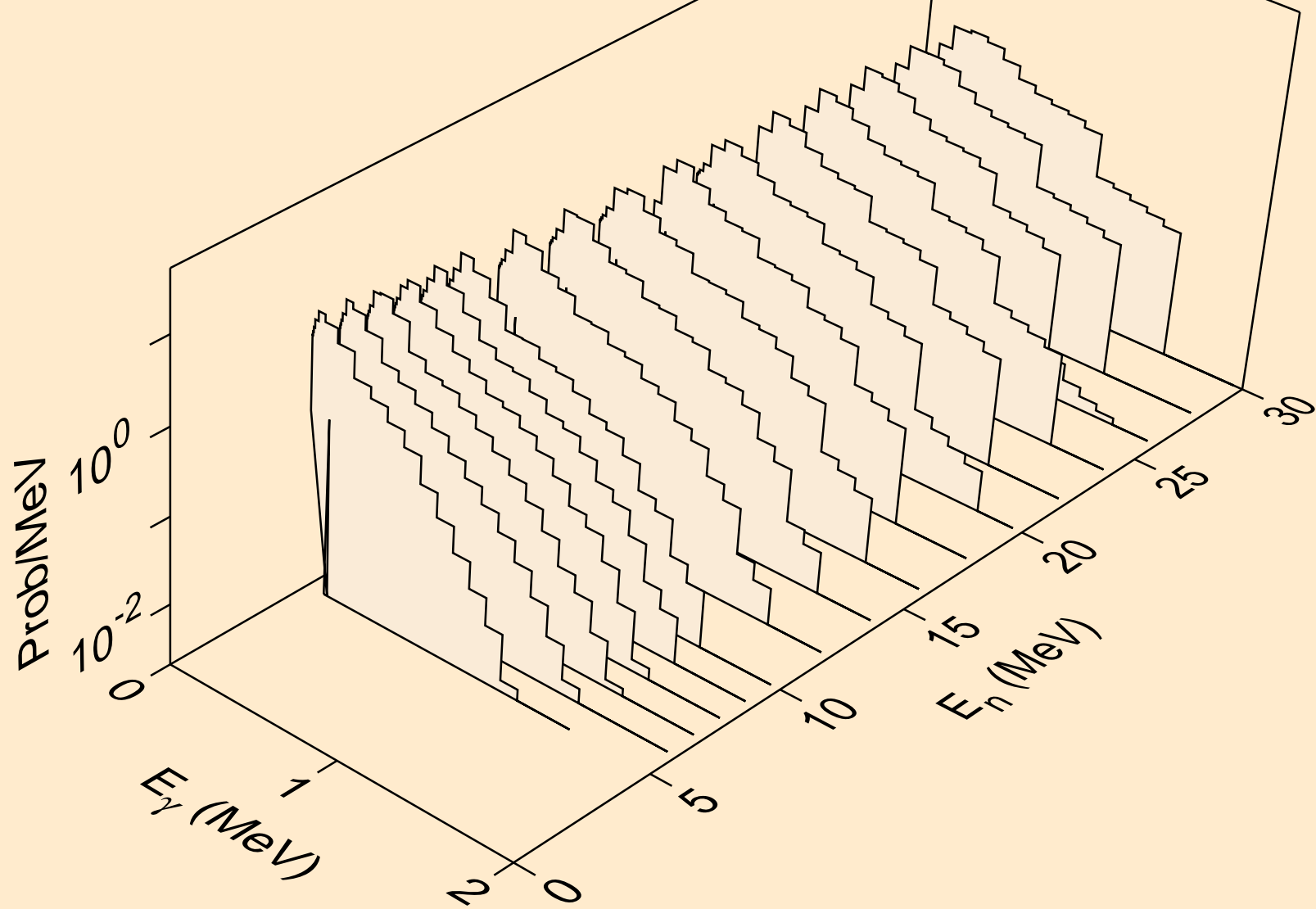

BK236 PROTON ACER TENDL-2021 LIBRARY; T=0.K  
Photon emission for (n,d)

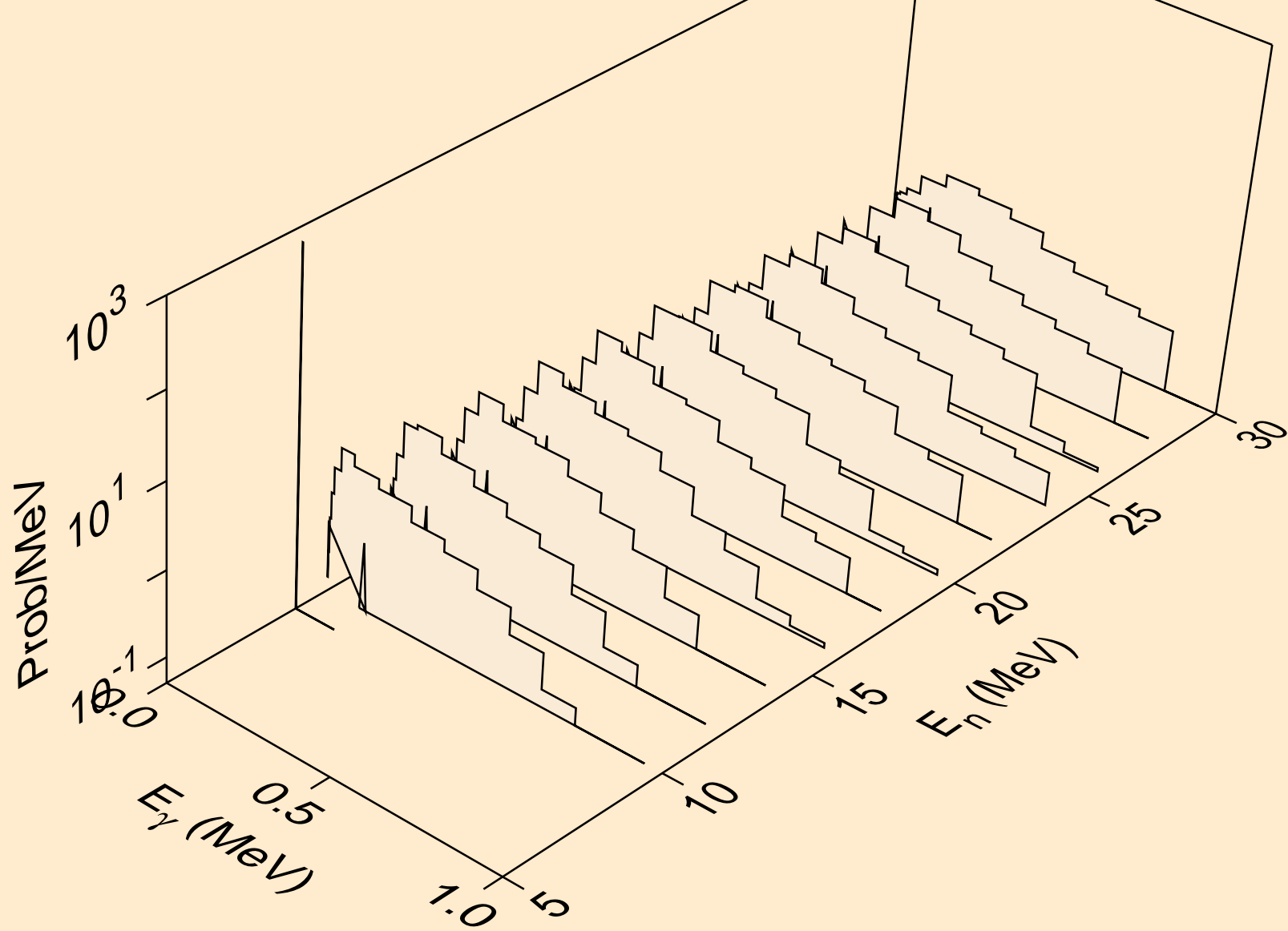

BK236 PROTON ACER TENDL-2021 LIBRARY; T=0.K  
Photon emission for (n,t)

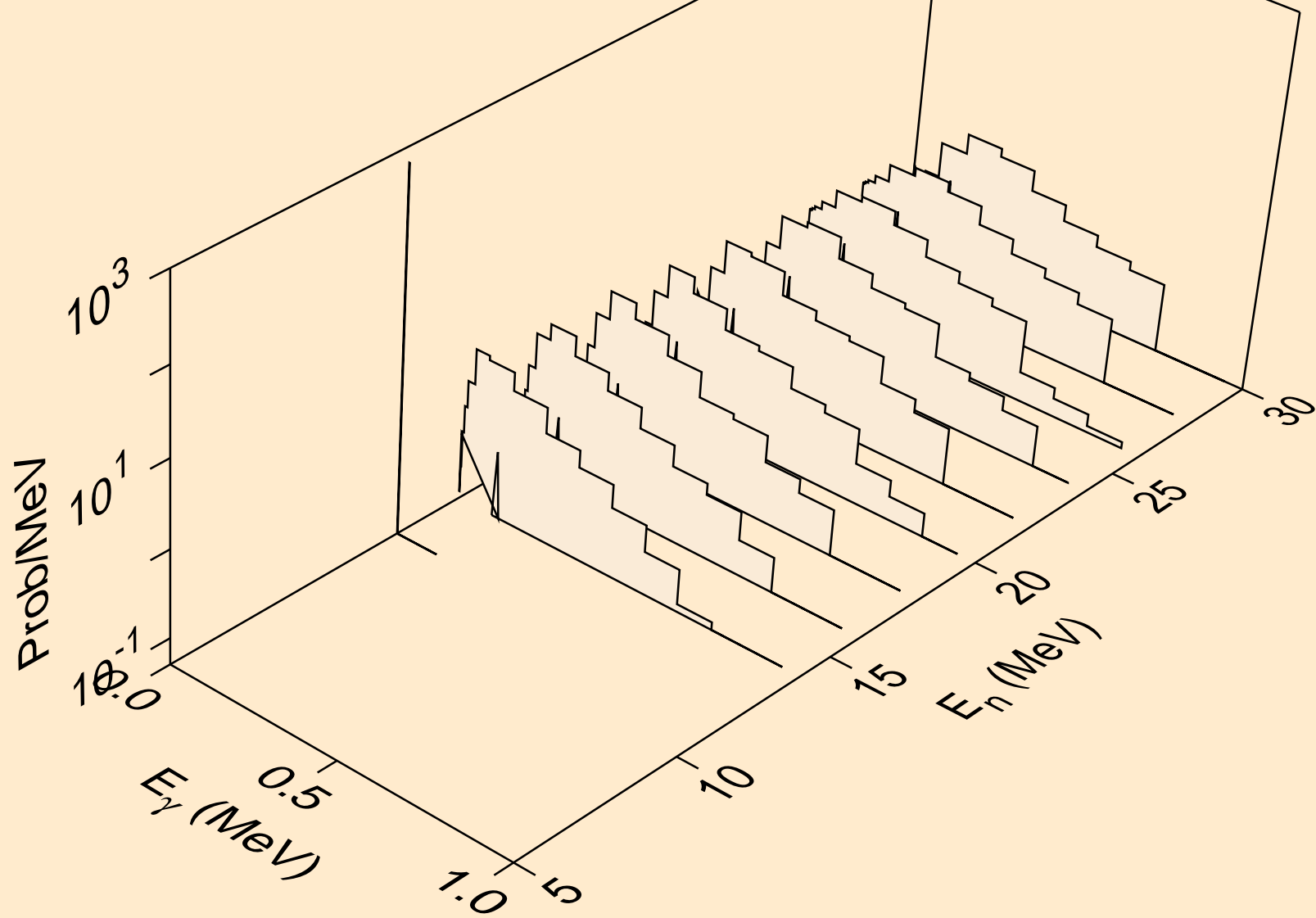

BK236 PROTON ACER TENDL-2021 LIBRARY; T=0.K  
Photon emission for (n,he3)

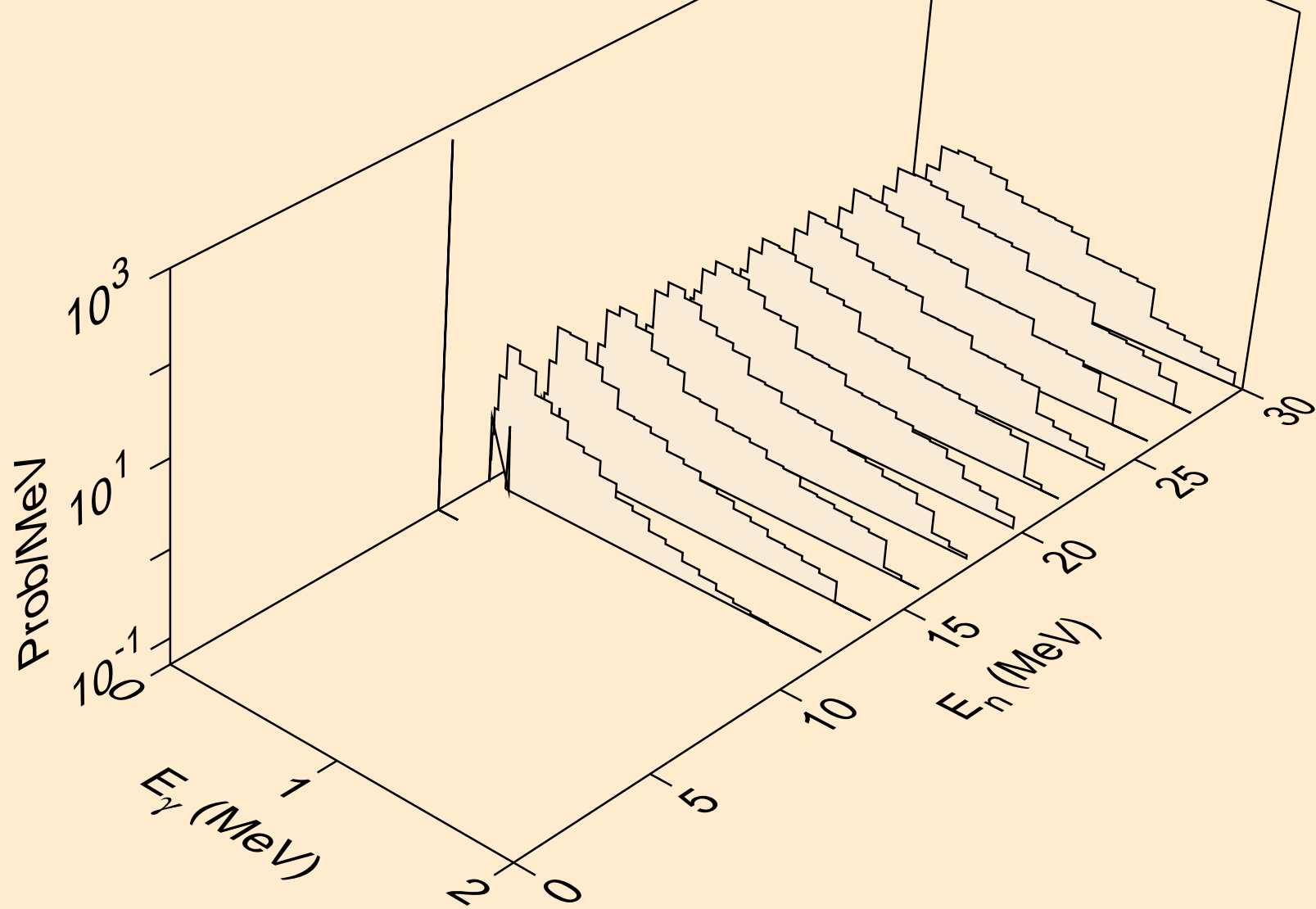

BK236 PROTON ACER TENDL-2021 LIBRARY; T=0.K  
Photon emission for (n,a)

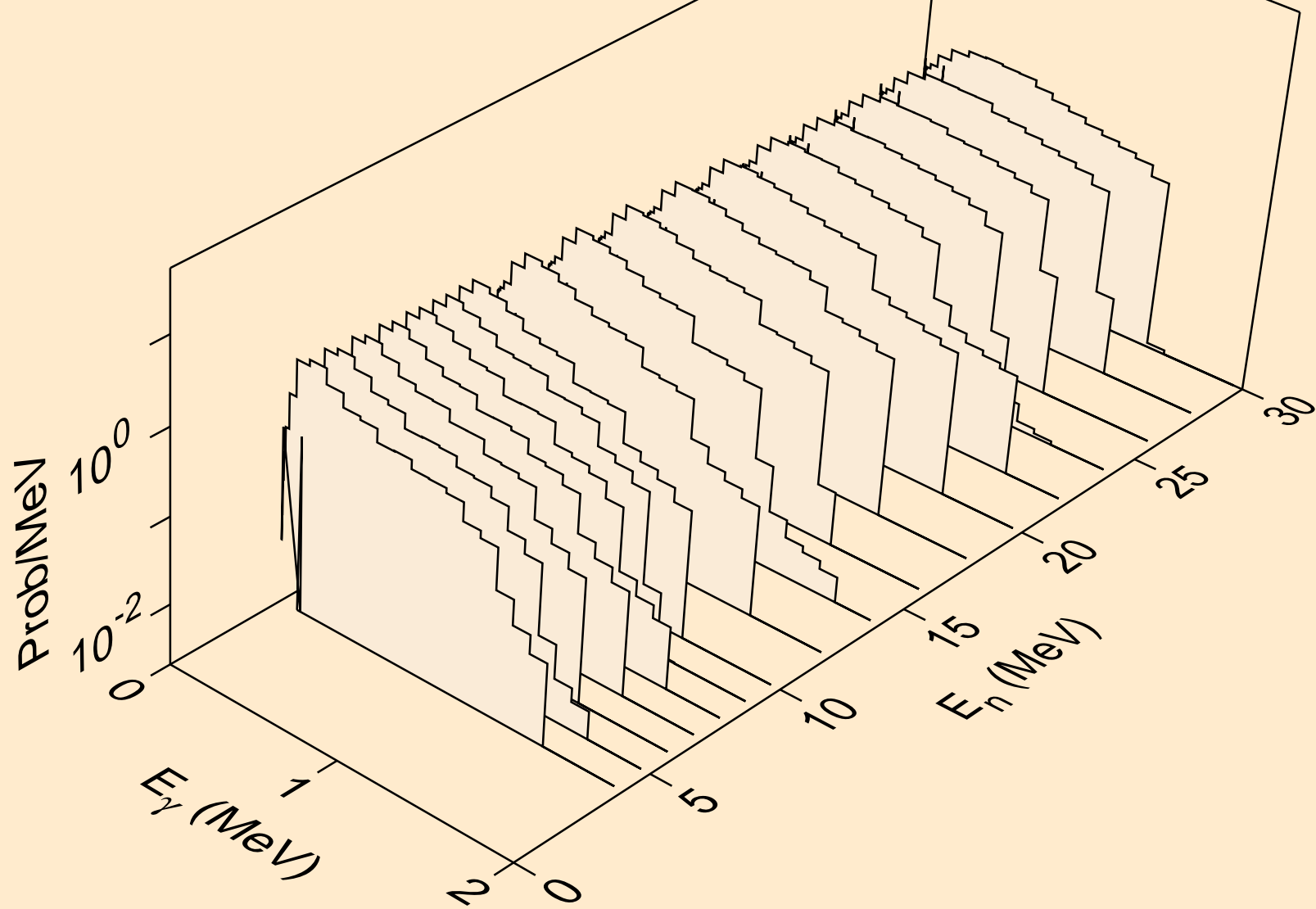

BK236 PROTON ACER TENDL-2021 LIBRARY; T=0.K  
Photon emission for (n,2p)

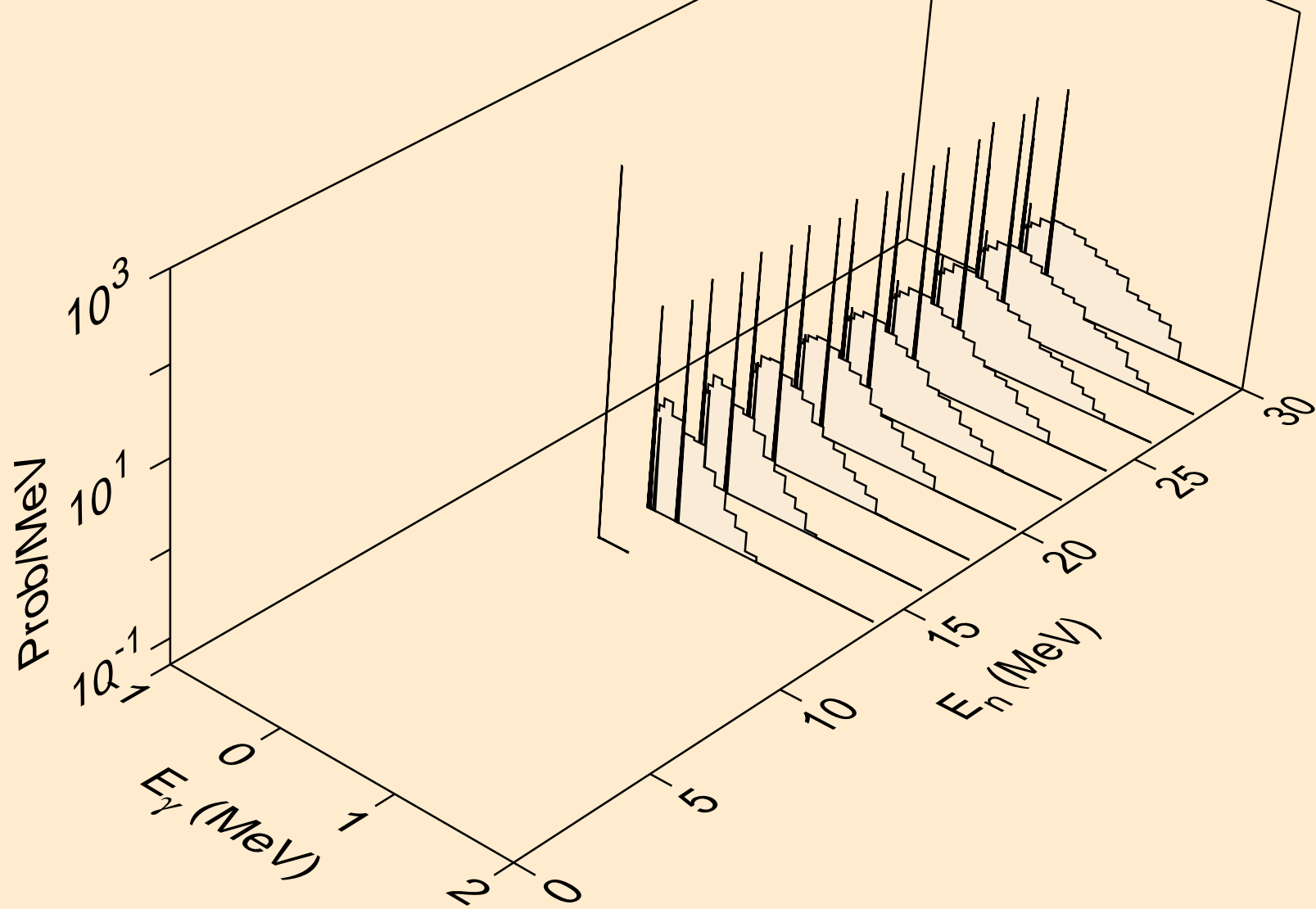



BK236 PROTON ACER TENDL-2021 LIBRARY; T=0.K  
Photon emission for (n,pd)

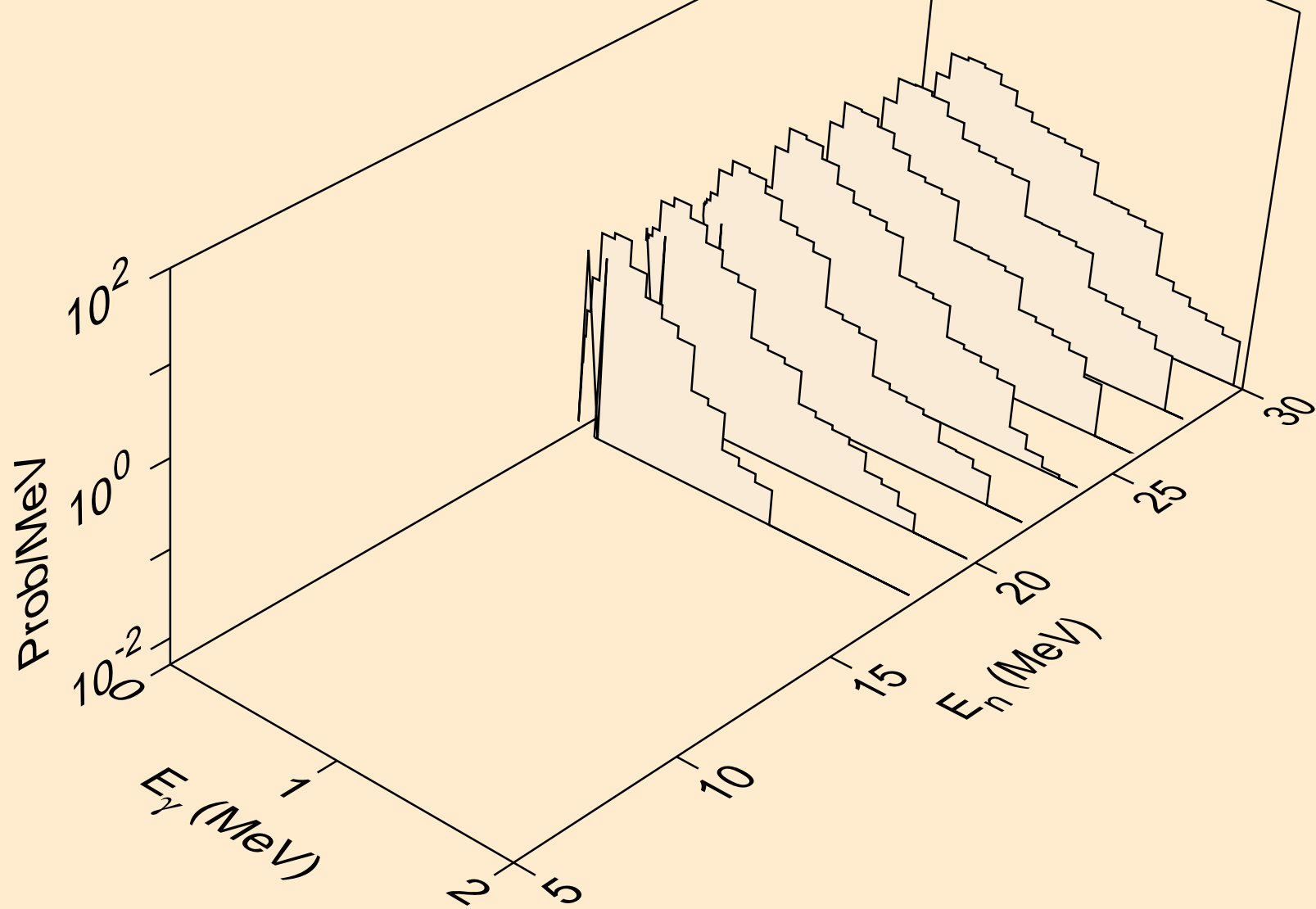

BK236 PROTON ACER TENDL-2021 LIBRARY; T=0.K  
Particle heating contributions

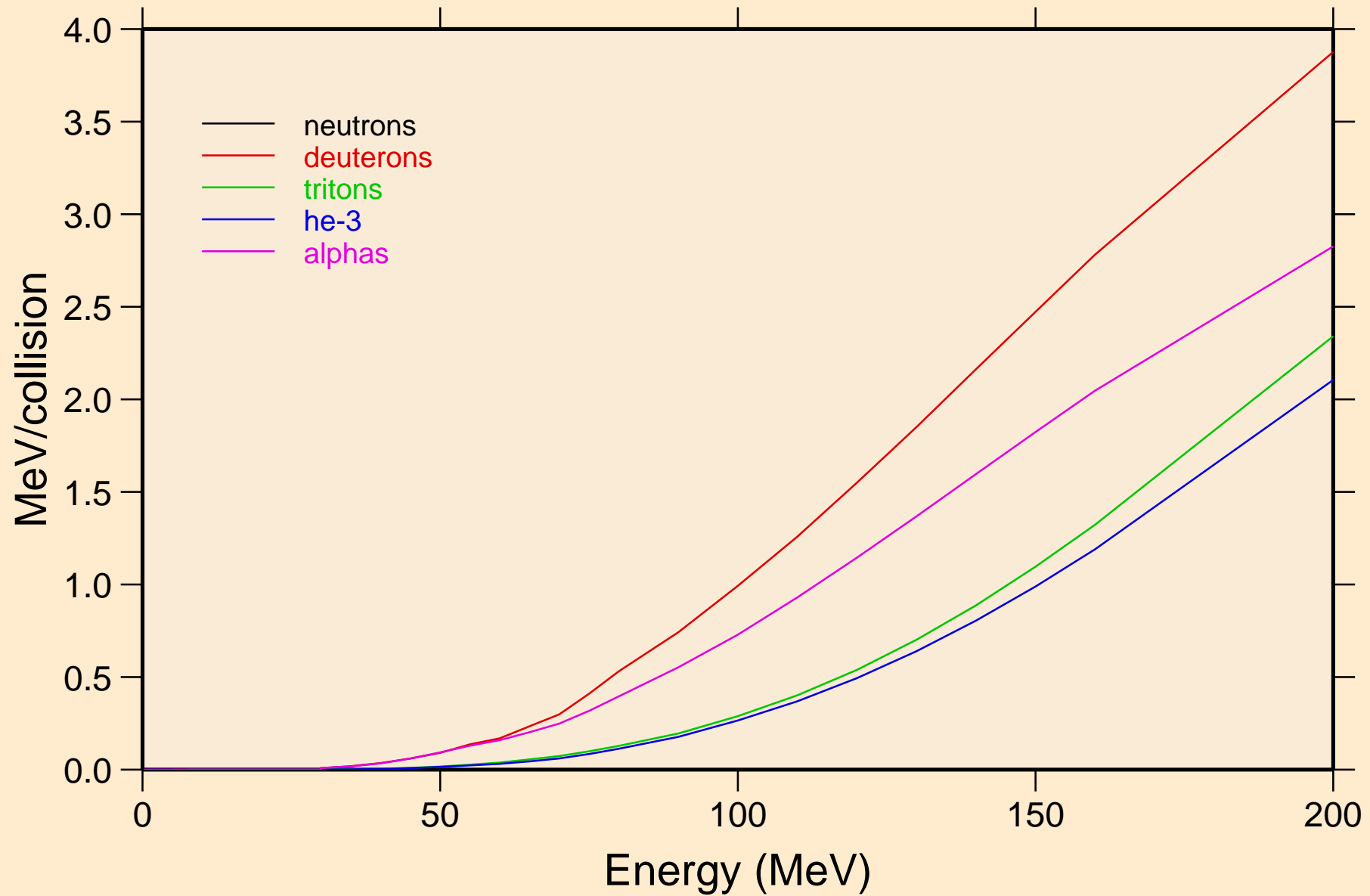

BK236 PROTON ACER TENDL-2021 LIBRARY; T=0.K  
Recoil Heating

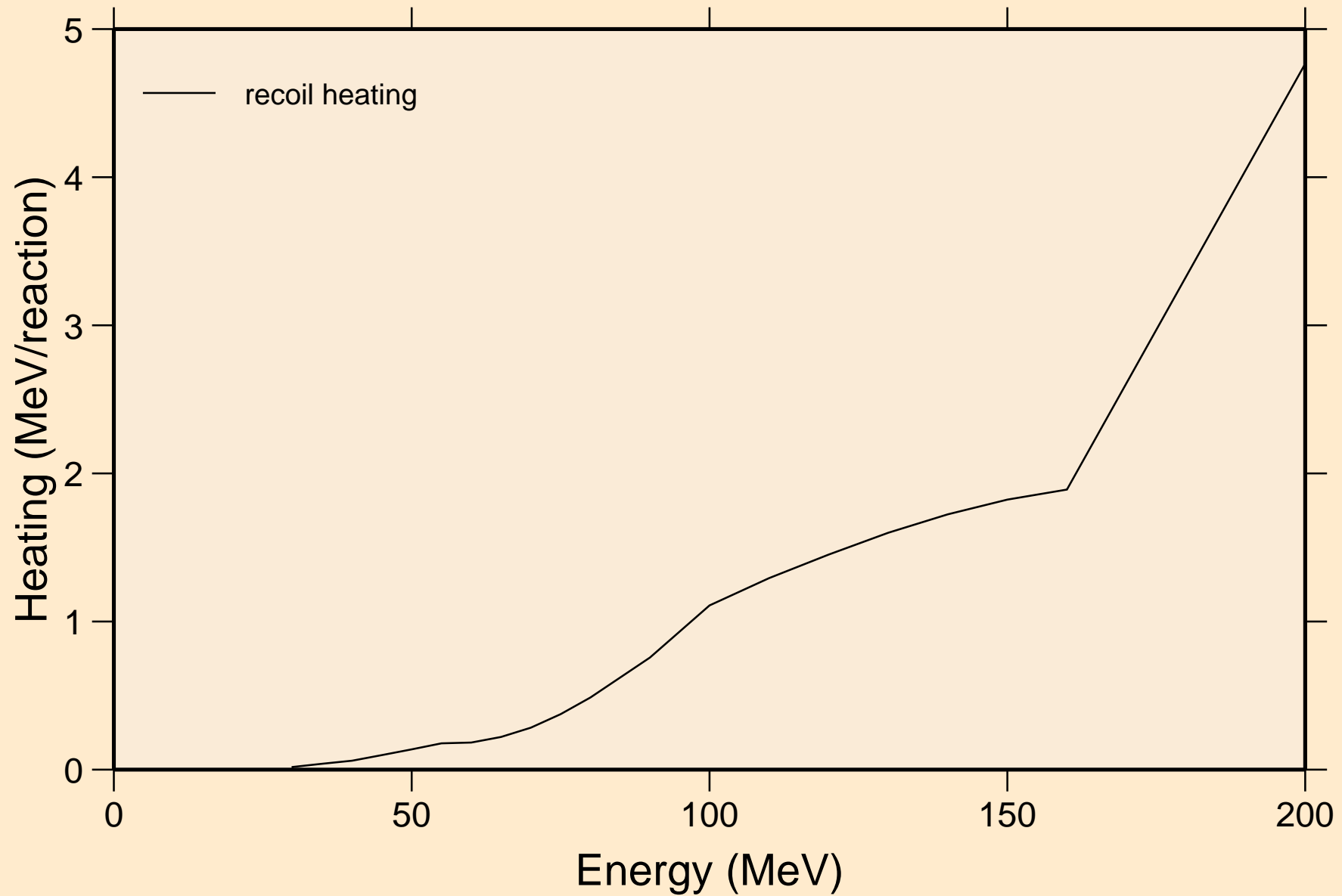

BK236 PROTON ACER TENDL-2021 LIBRARY; T=0.K  
Particle production cross sections

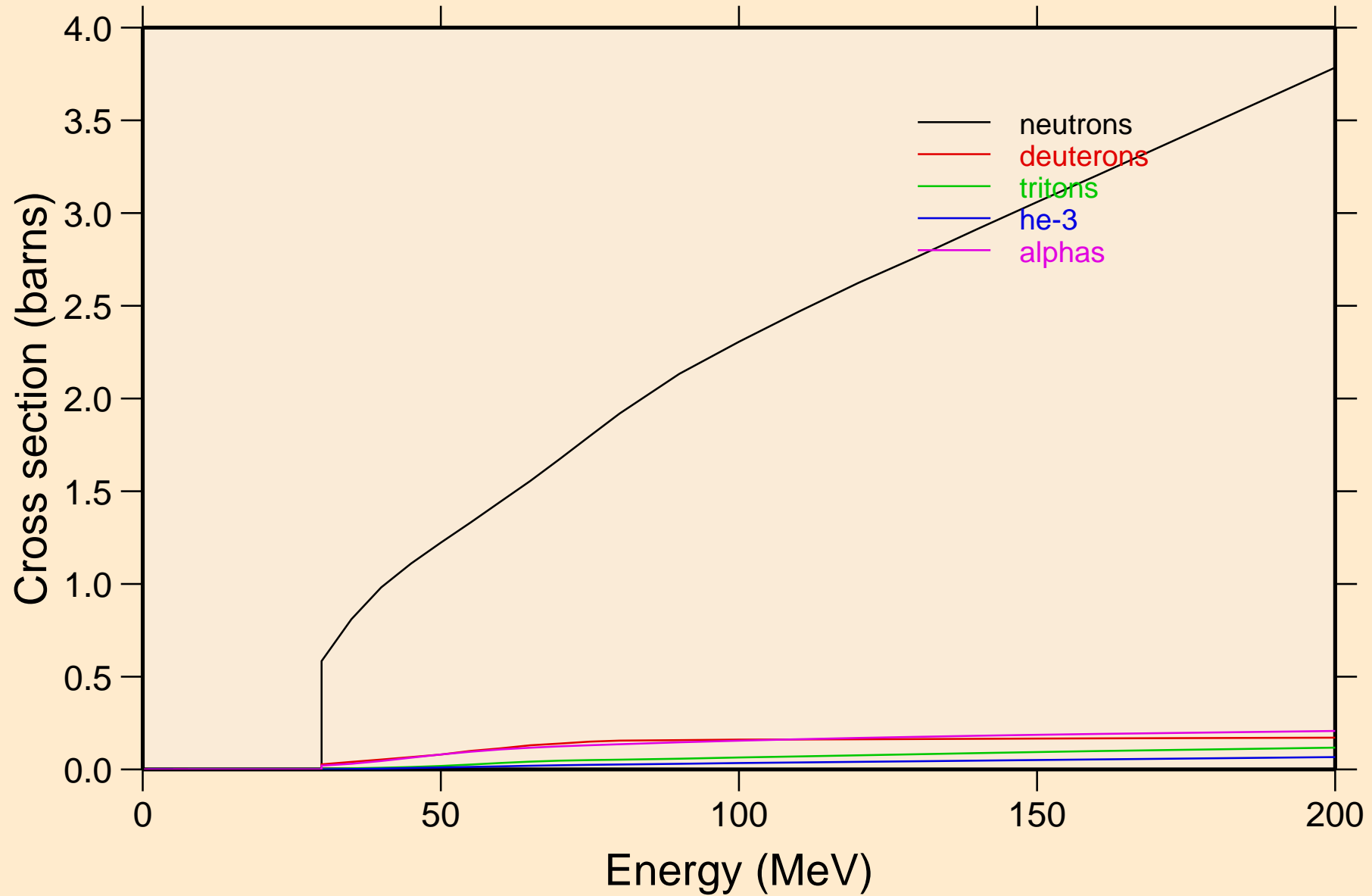

BK236 PROTON ACER TENDL-2021 LIBRARY; T=0.K  
neutrons from (p,n)

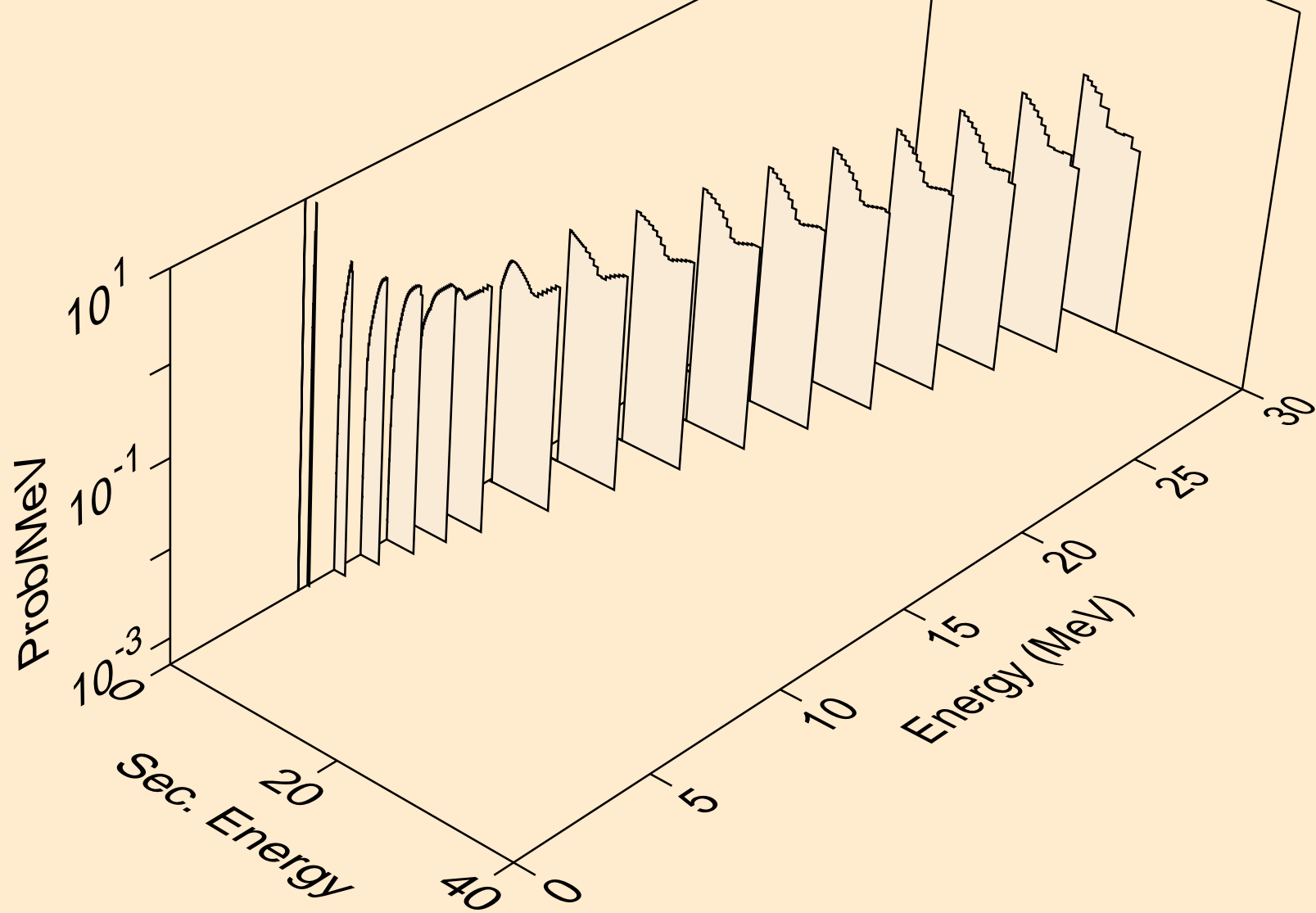

BK236 PROTON ACER TENDL-2021 LIBRARY; T=0.K  
neutrons from (p,x)

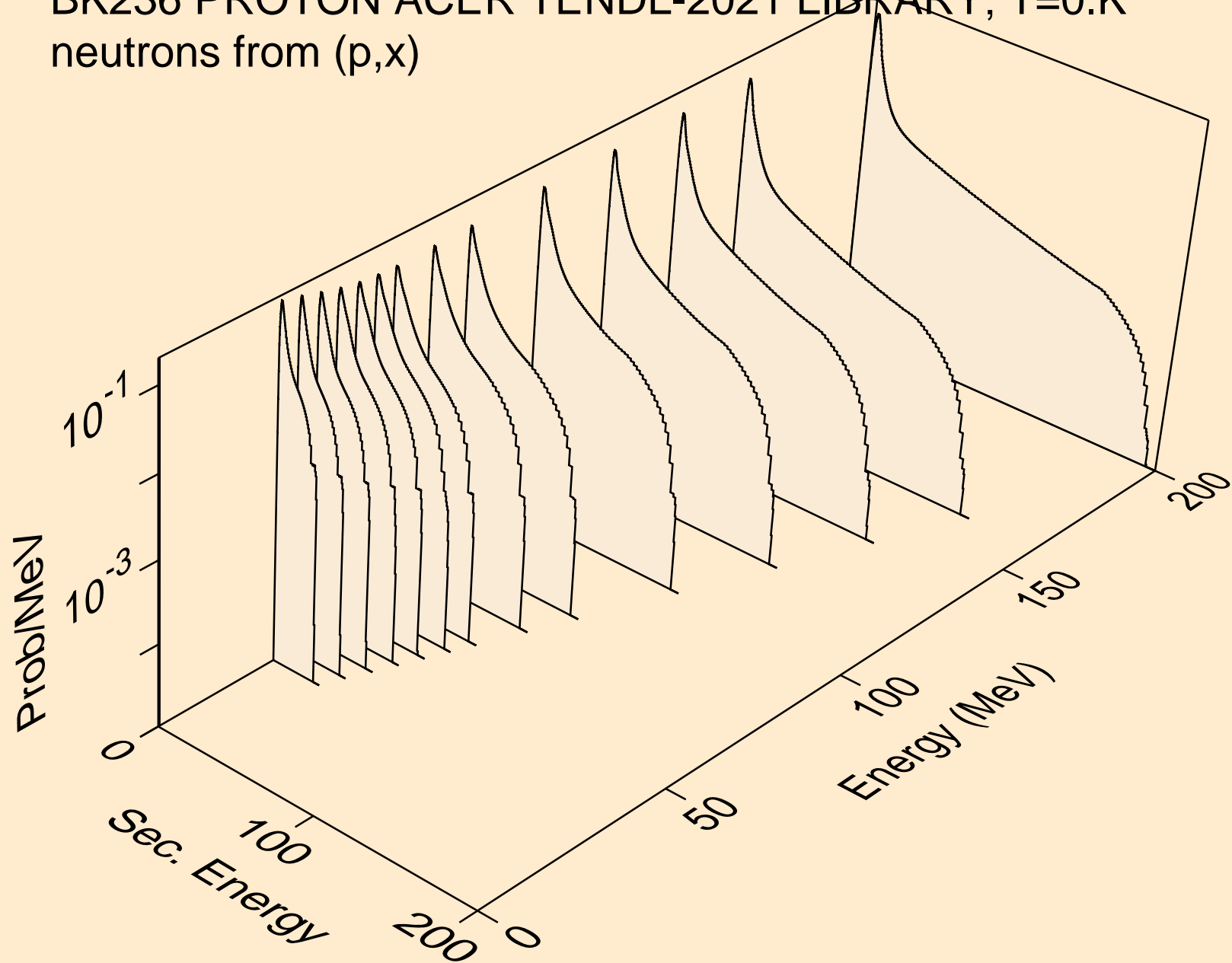

BK236 PROTON ACER TENDL-2021 LIBRARY; T=0.K  
neutrons from (p,2n)

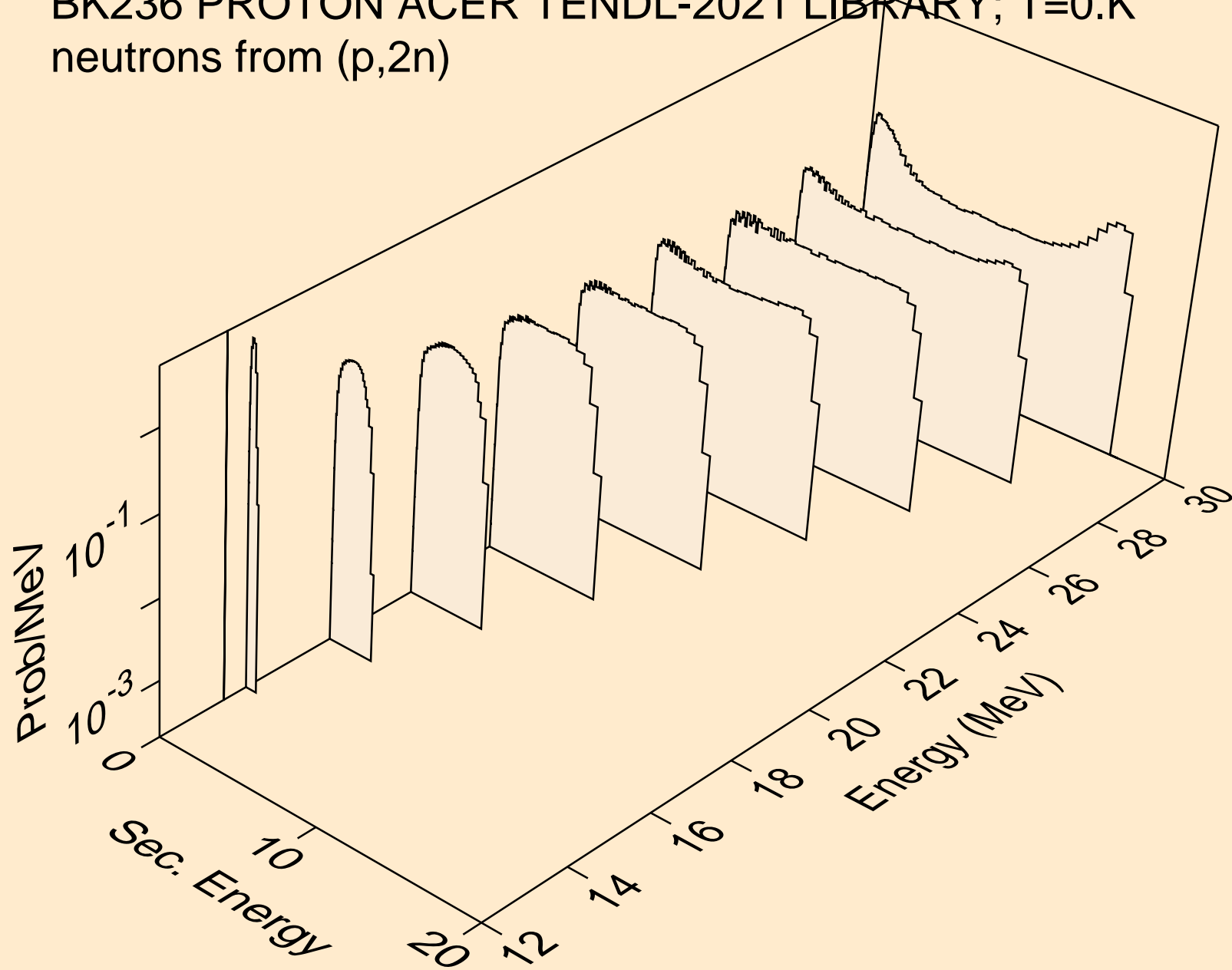

BK236 PROTON ACER TENDL-2021 LIBRARY; T=0.K  
neutrons from (p,n\*)a

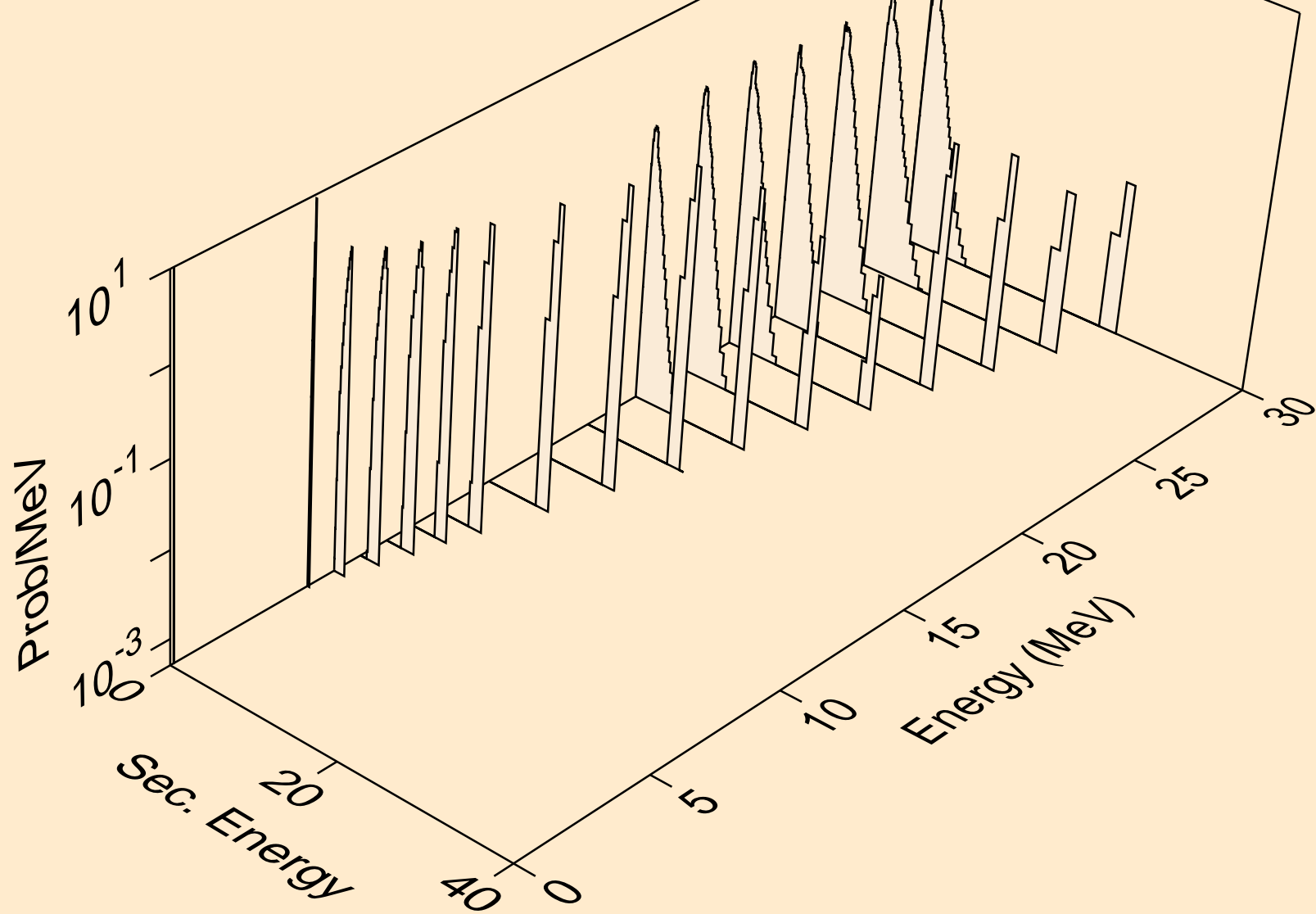



BK236 PROTON ACER TENDL-2021 LIBRARY; T=0.K  
neutrons from (p,n\*)p

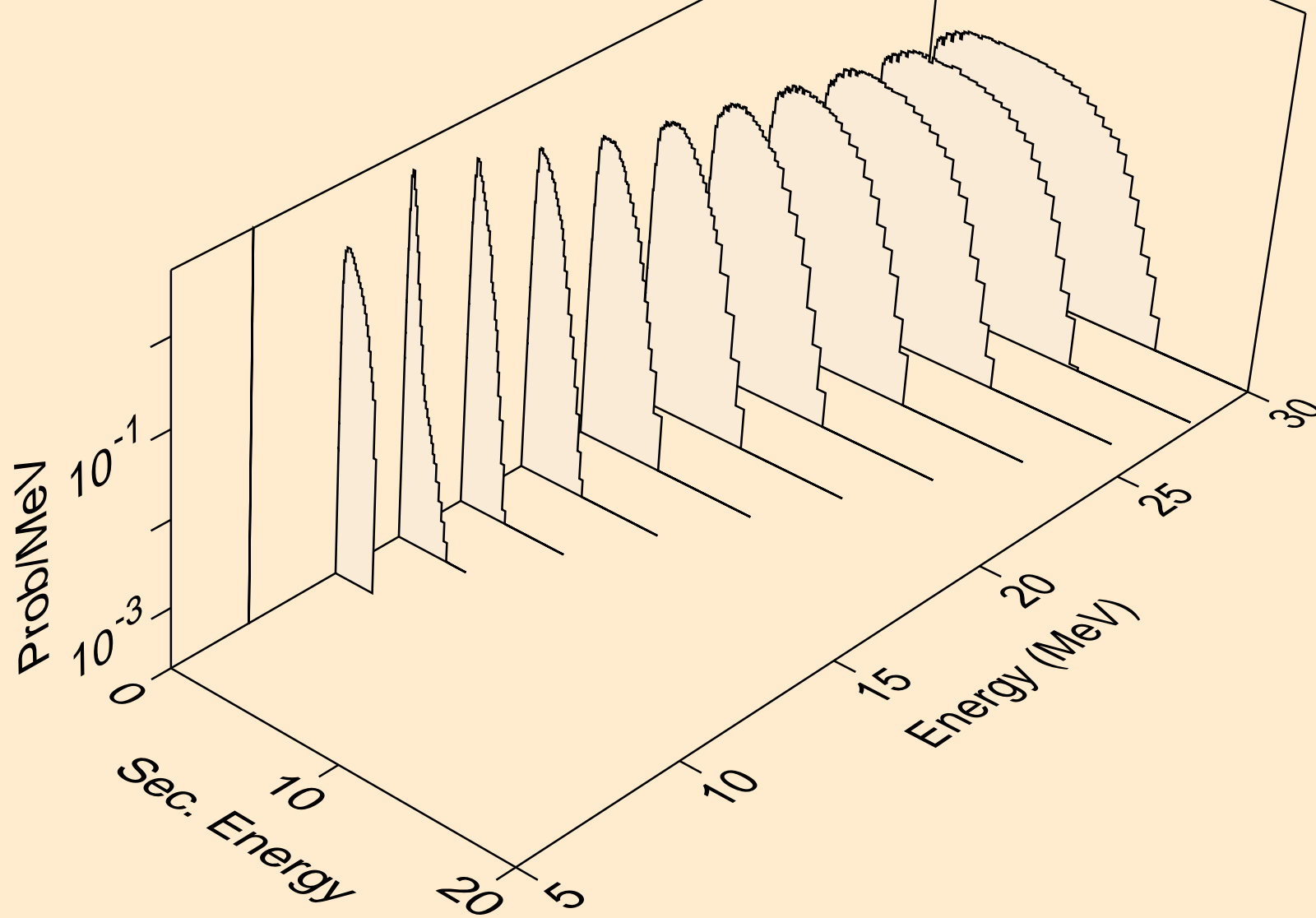

BK236 PROTON ACER TENDL-2021 LIBRARY; T=0.K  
neutrons from (p,n\*)d

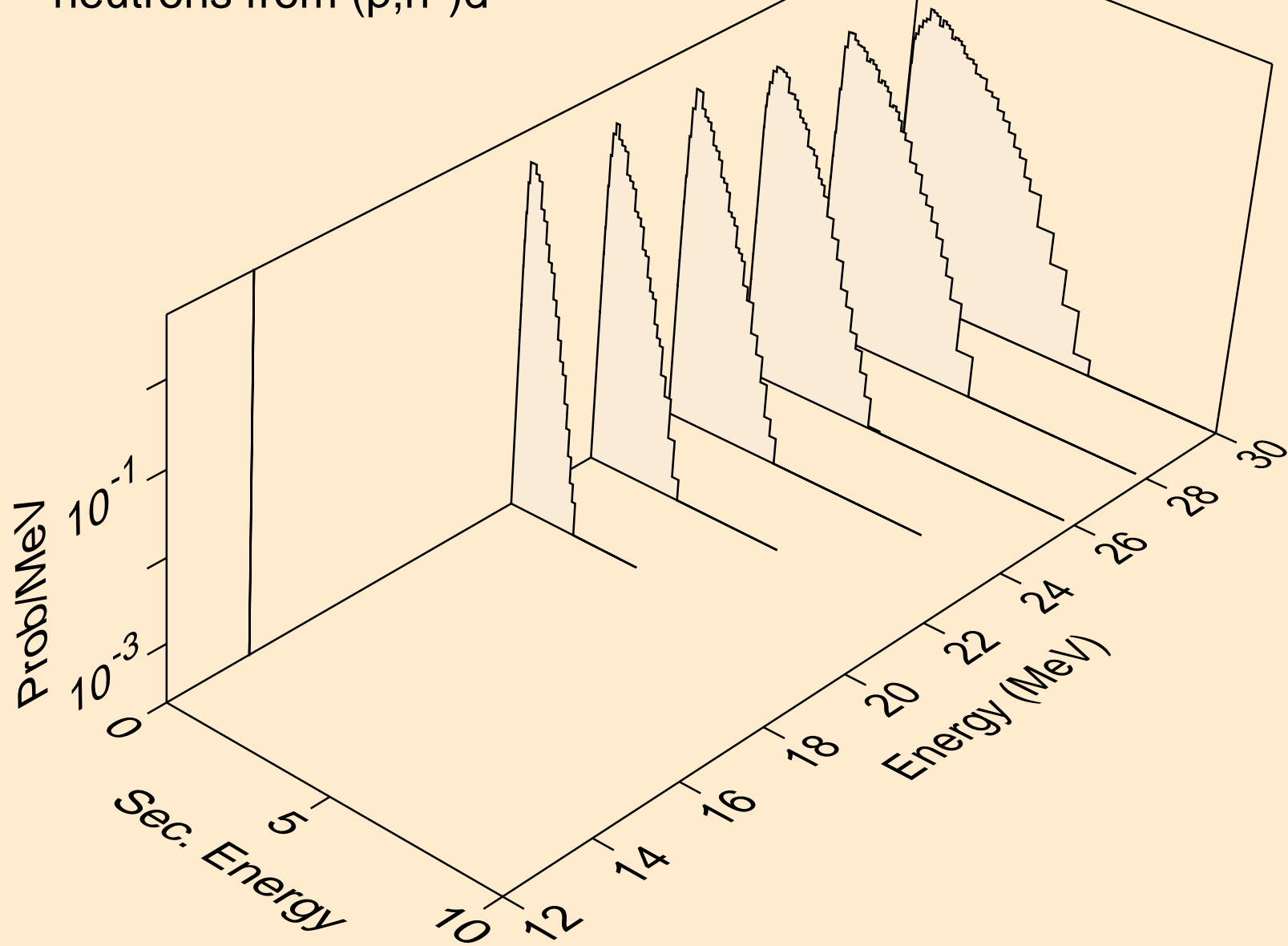

BK236 PROTON ACER TENDL-2021 LIBRARY; T=0.K  
neutrons from (p,2np)

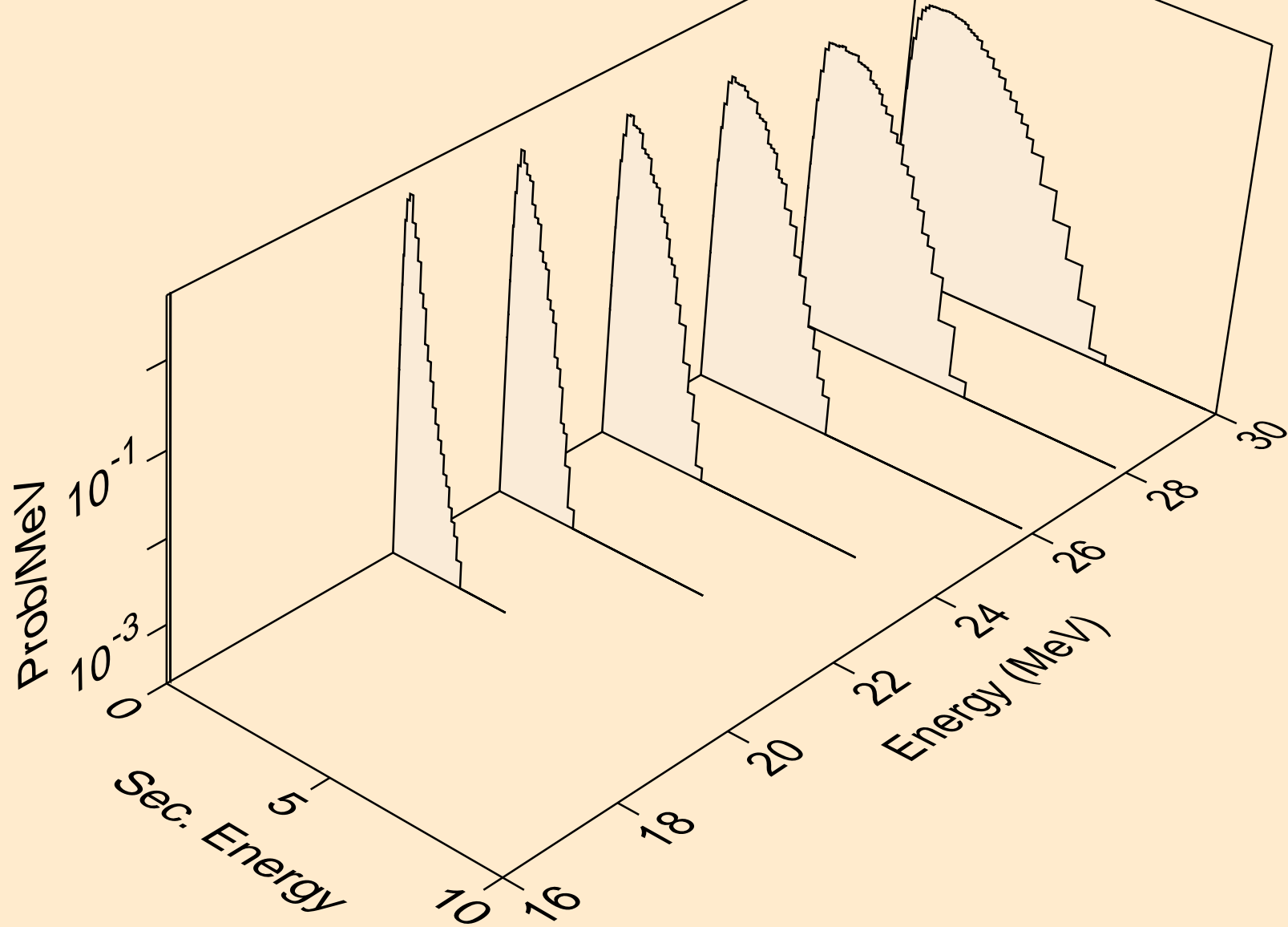

BK236 PROTON ACER TENDL-2021 LIBRARY; T=0.K  
neutrons from (p,2np)

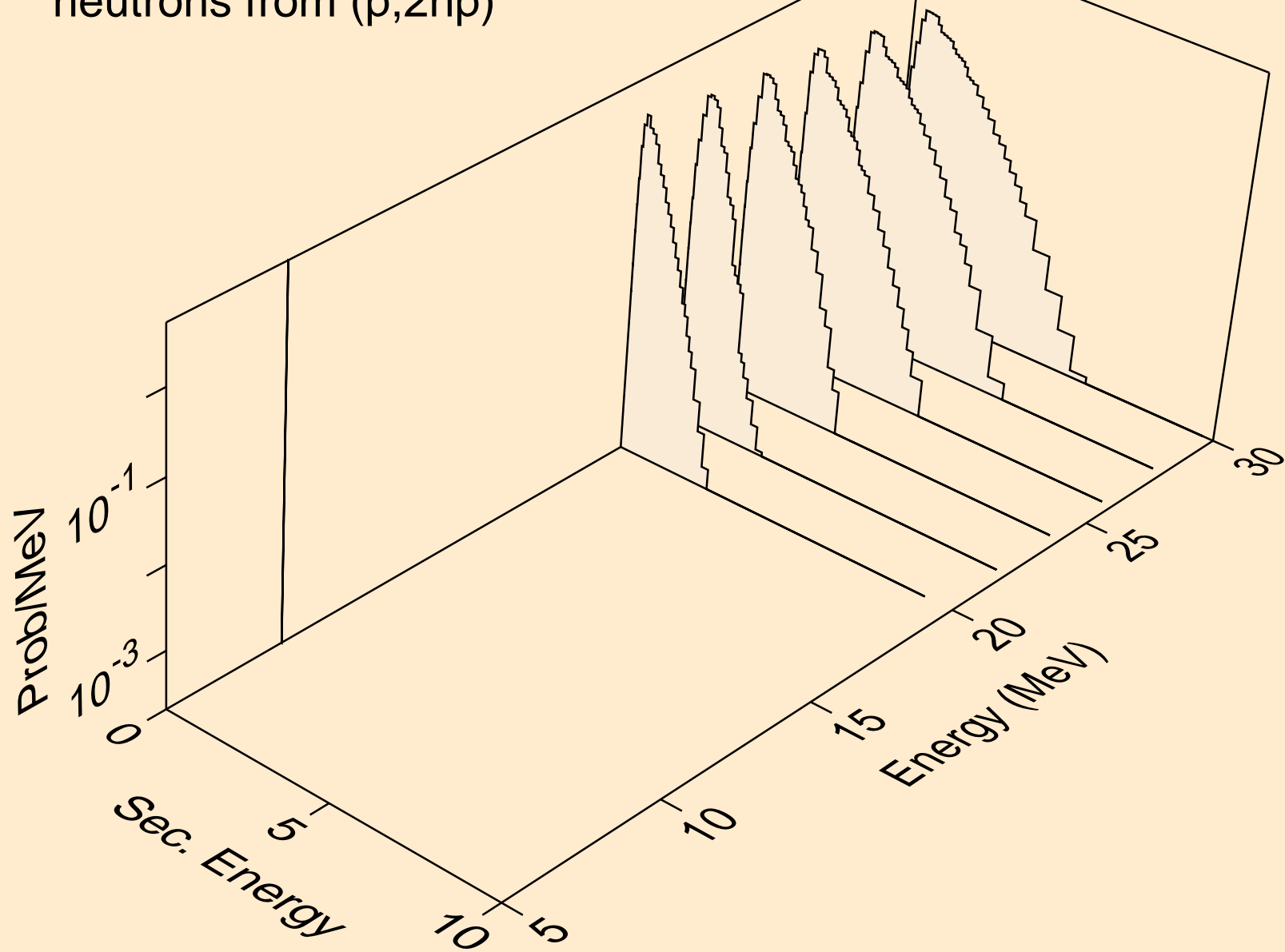

BK236 PROTON ACER TENDL-2021 LIBRARY; T=0.K  
deuterons from (p,x)

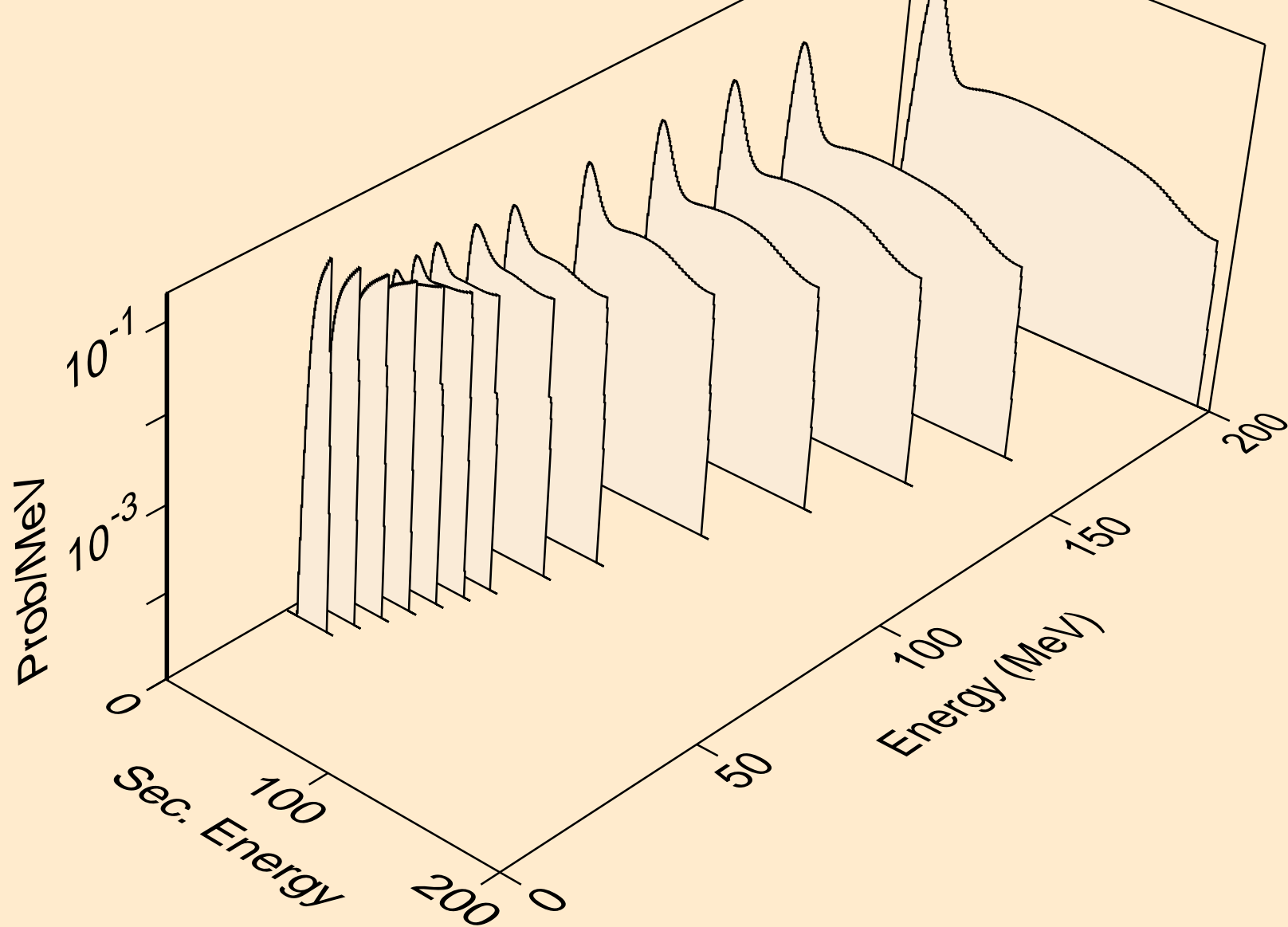

BK236 PROTON ACER TENDL-2021 LIBRARY; T=0.K  
deuterons from (p,n\*)d

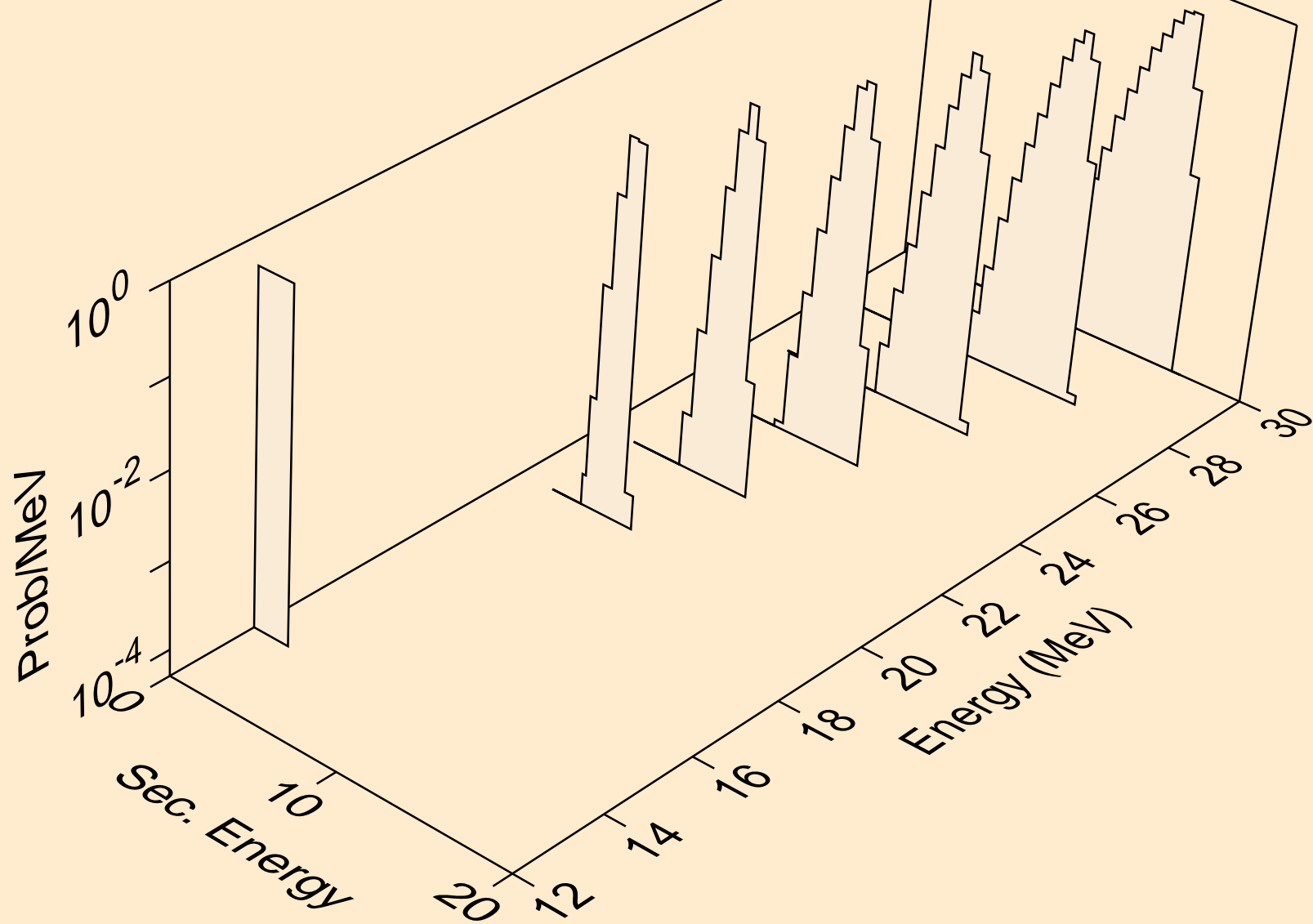

BK236 PROTON ACER TENDL-2021 LIBRARY; T=0.K  
deuterons from (p,d)

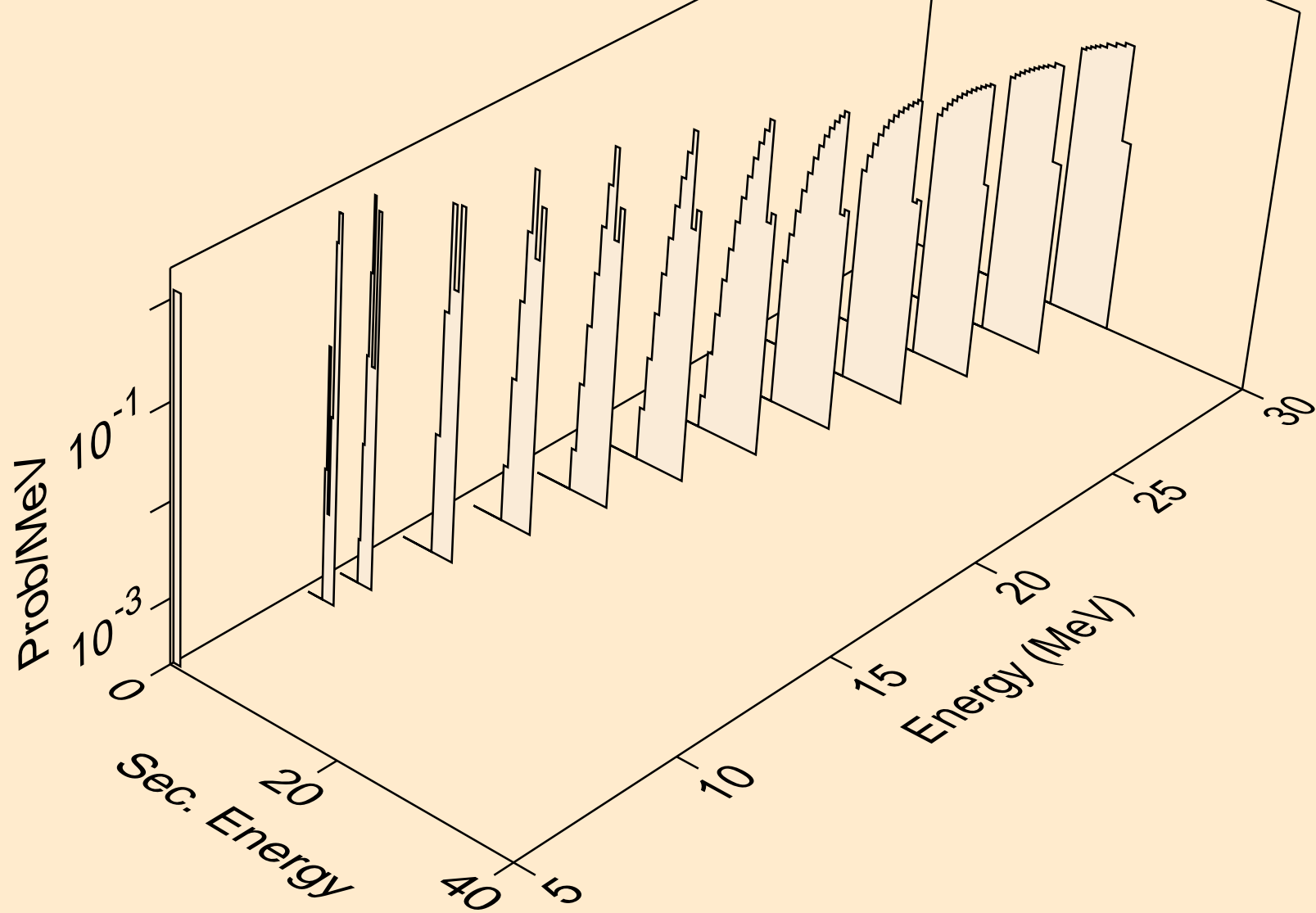

BK236 PROTON ACER TENDL-2021 LIBRARY; T=0.K  
deuterons from (p,pd)

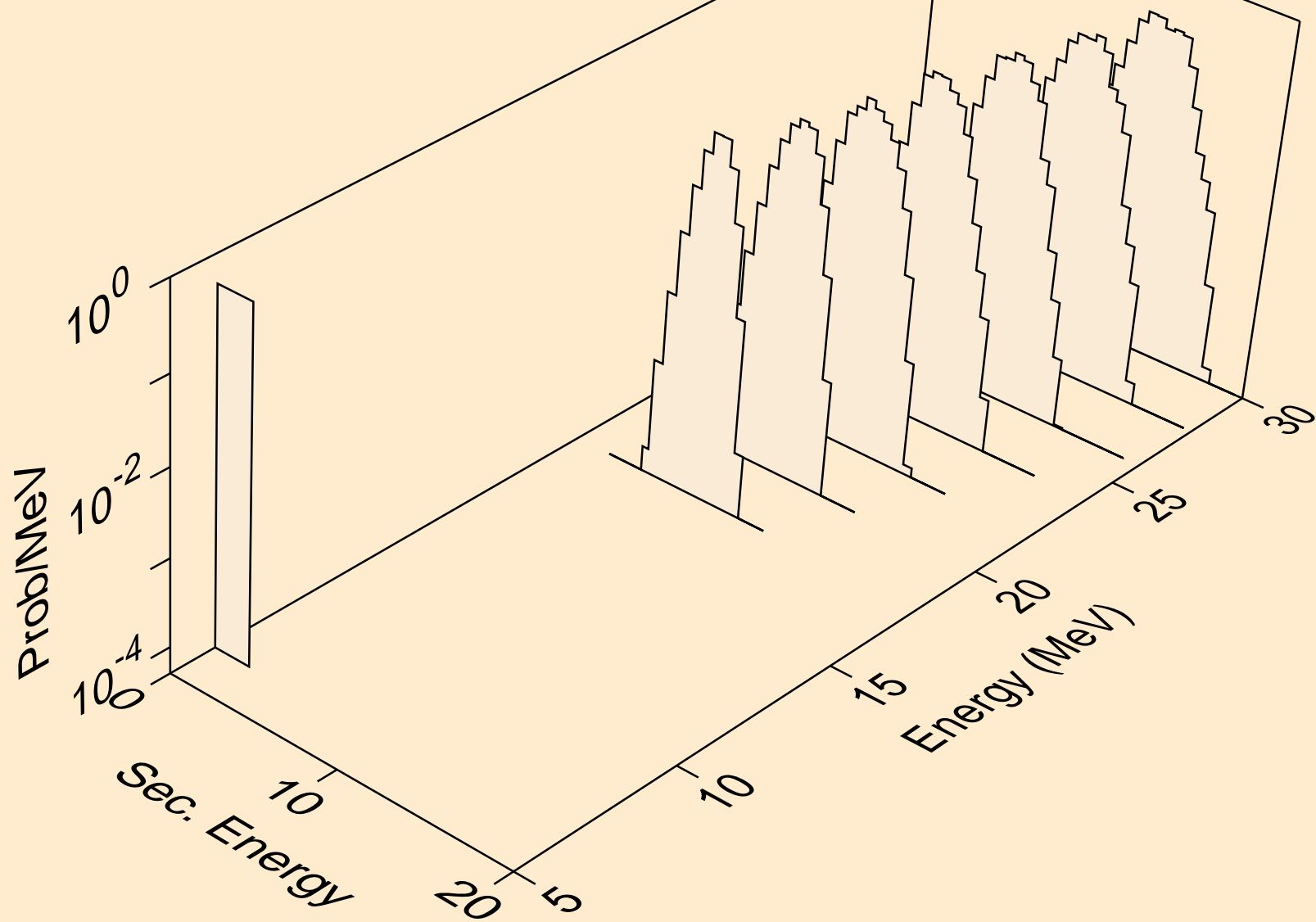



BK236 PROTON ACER TENDL-2021 LIBRARY; T=0.K  
tritons from (p,x)

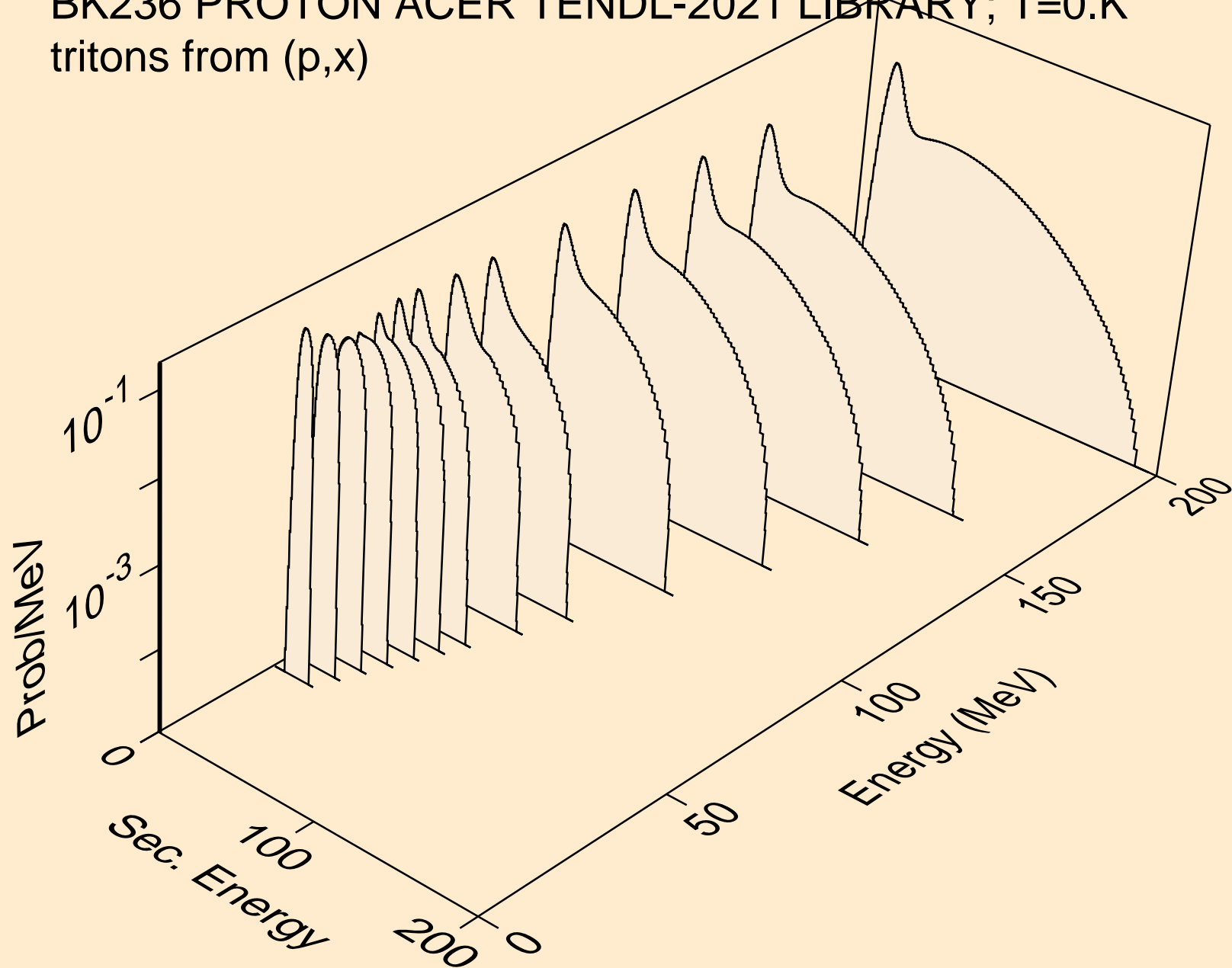

BK236 PROTON ACER TENDL-2021 LIBRARY; T=0.K  
tritons from (p,t)

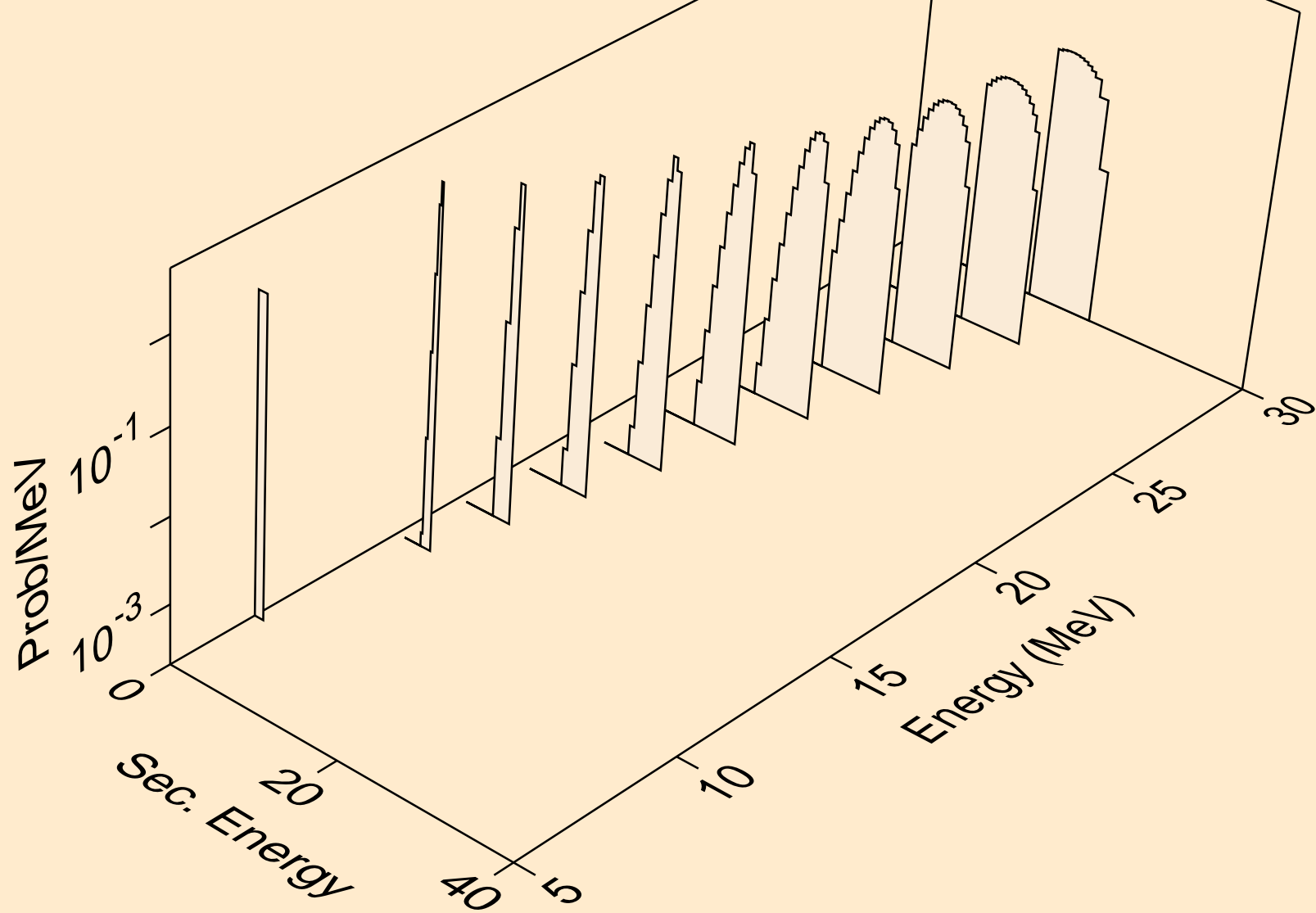

BK236 PROTON ACER TENDL-2021 LIBRARY; T=0.K  
he3s from (p,x)

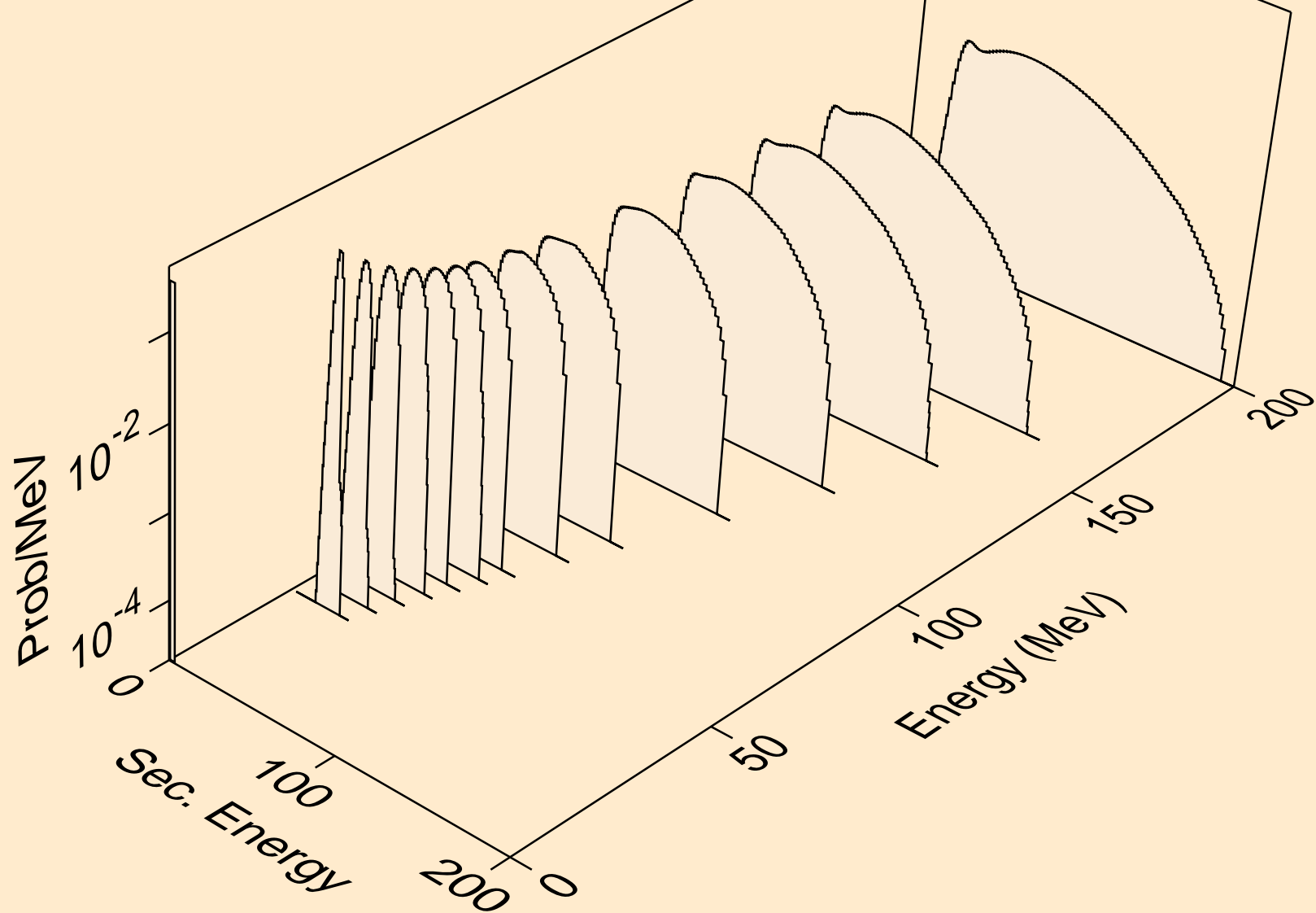

BK236 PROTON ACER TENDL-2021 LIBRARY; T=0.K  
he3s from (p,he3)

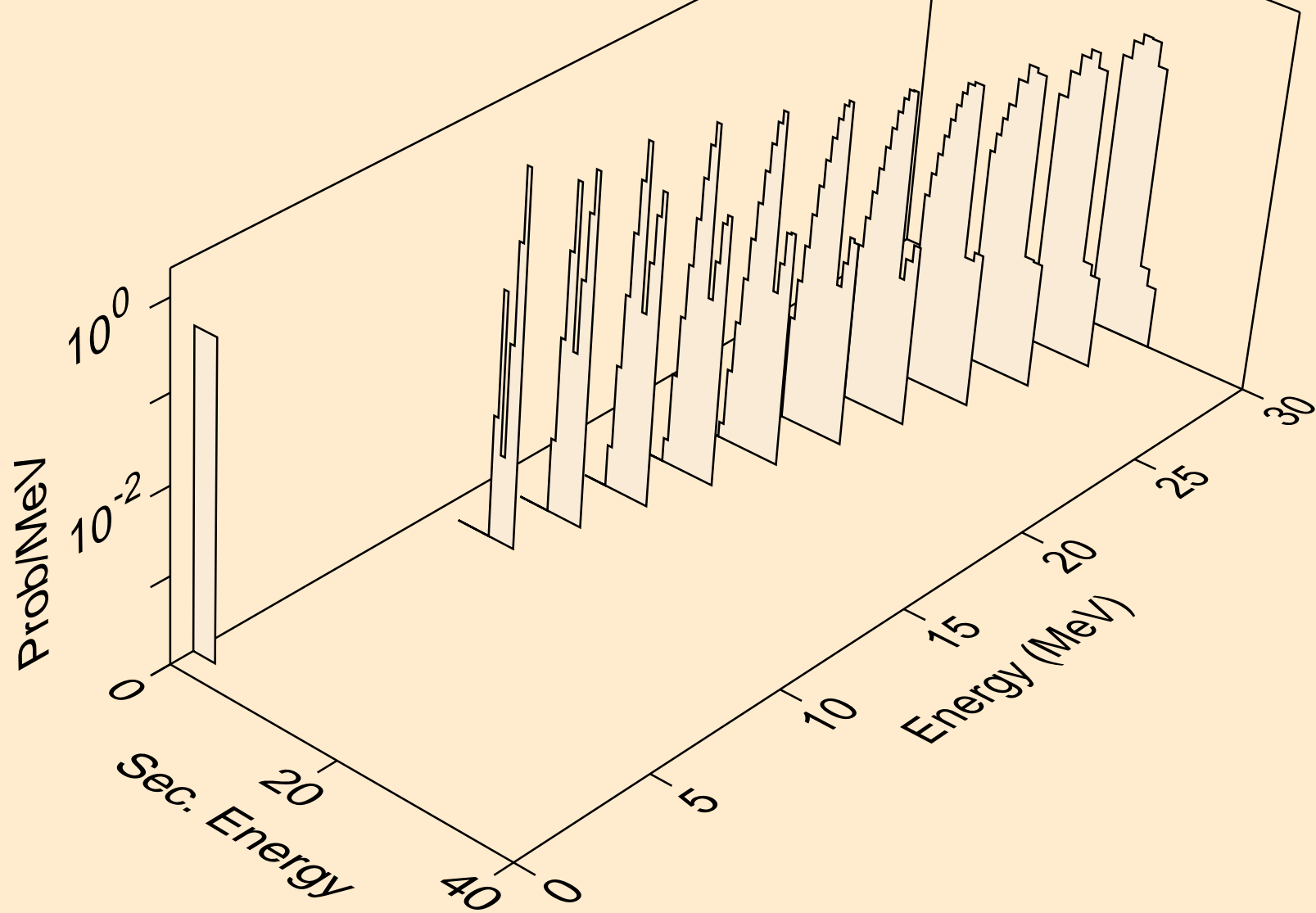

BK236 PROTON ACER TENDL-2021 LIBRARY; T=0.K  
alphas from (p,x)

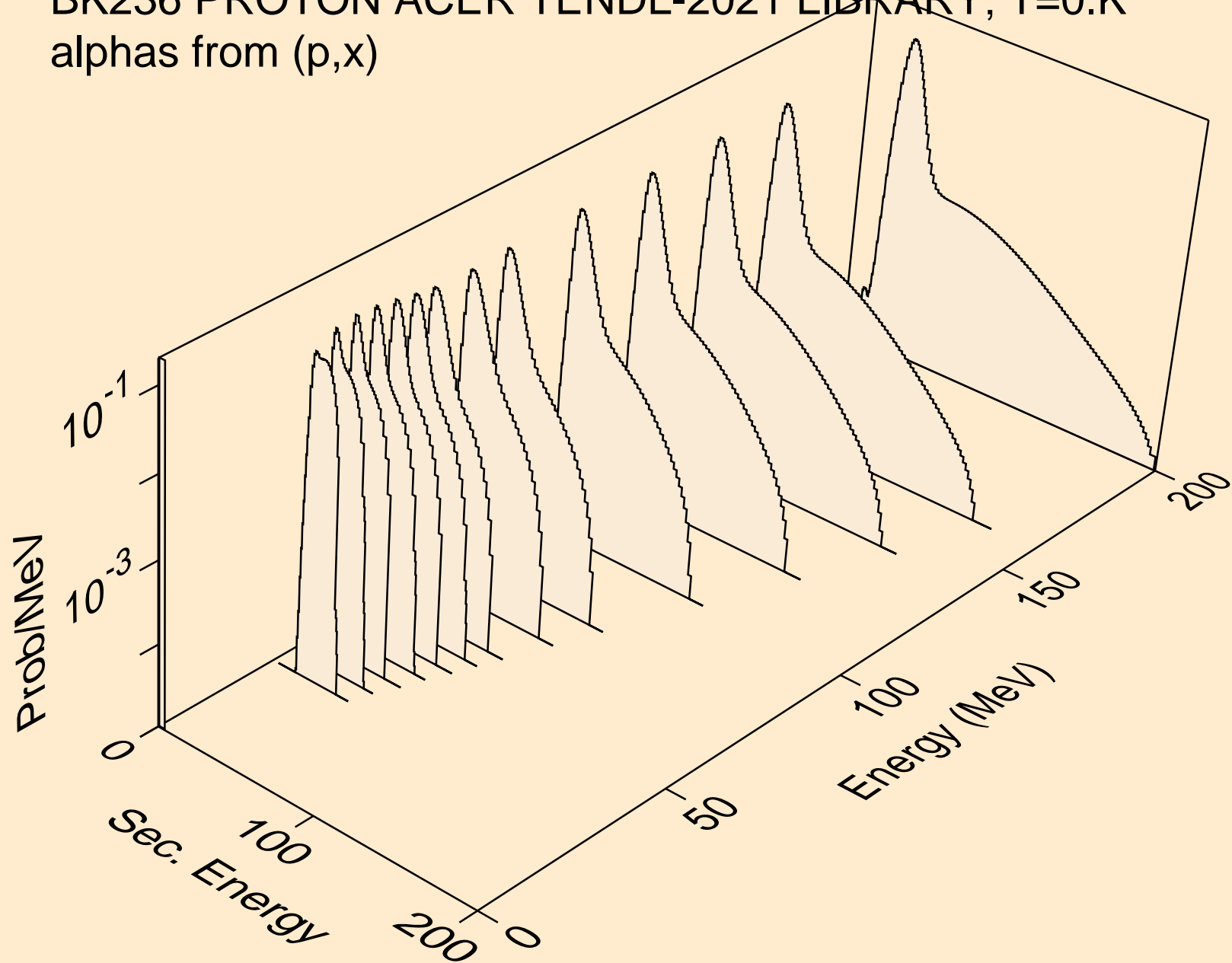

BK236 PROTON ACER TENDL-2021 LIBRARY; T=0.K  
alphas from (p,n\*)a

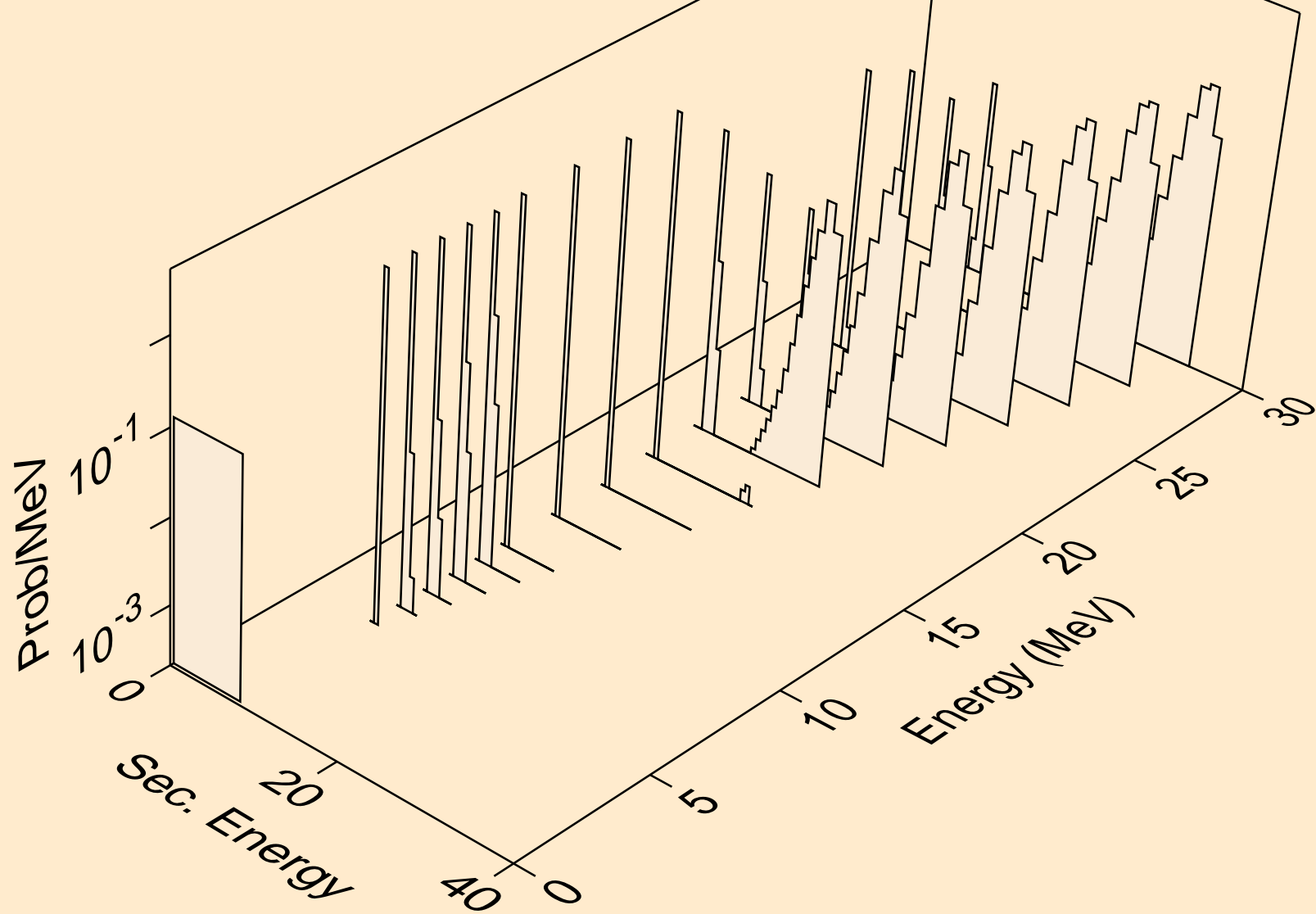

BK236 PROTON ACER TENDL-2021 LIBRARY; T=0.K  
alphas from (p,a)

