

CF242 PROTON ACER TENDL-2021 LIBRARY; T=0.K
Principal cross sections

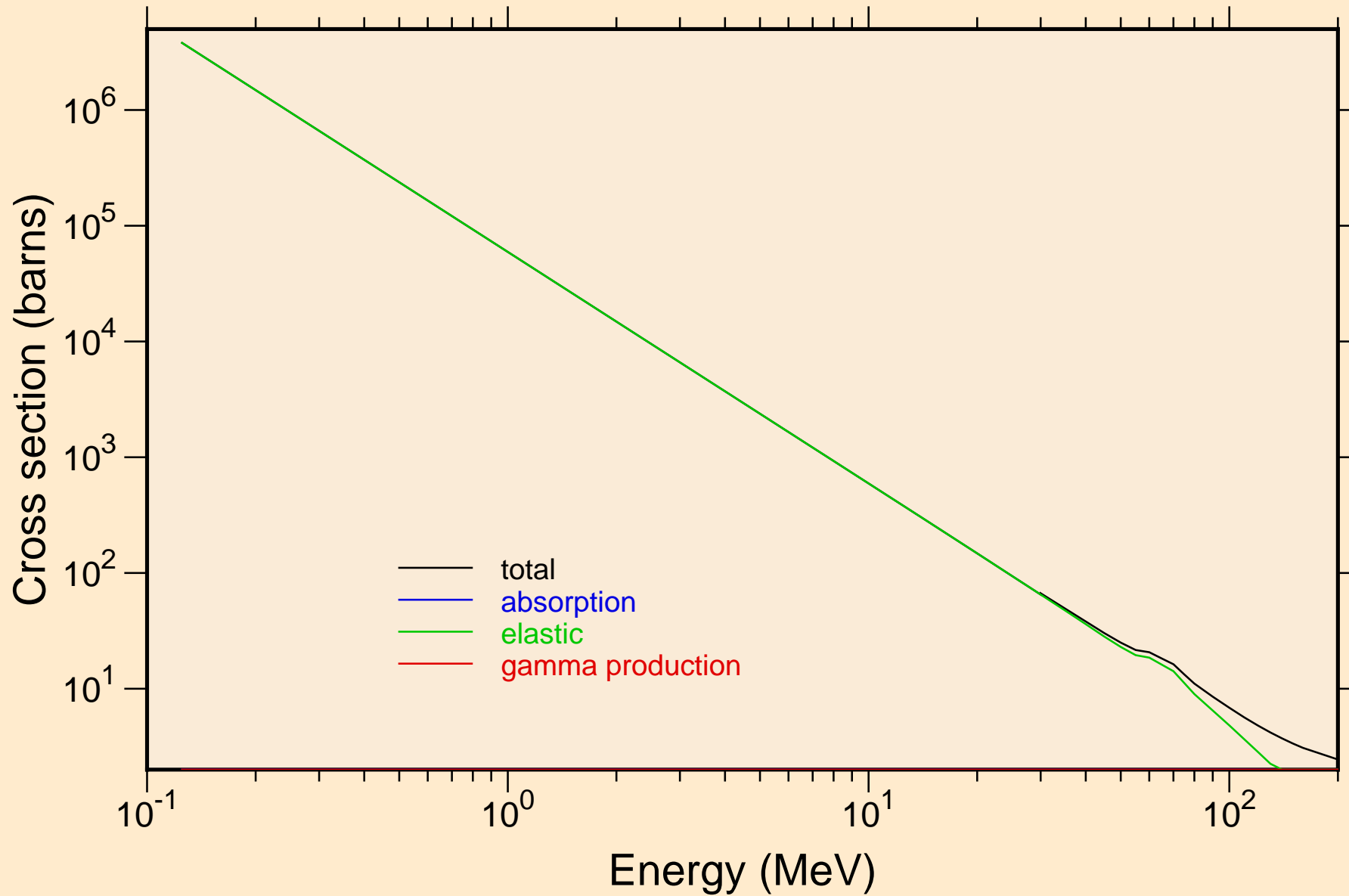

CF242 PROTON ACER TENDL-2021 LIBRARY; T=0.K

Heating

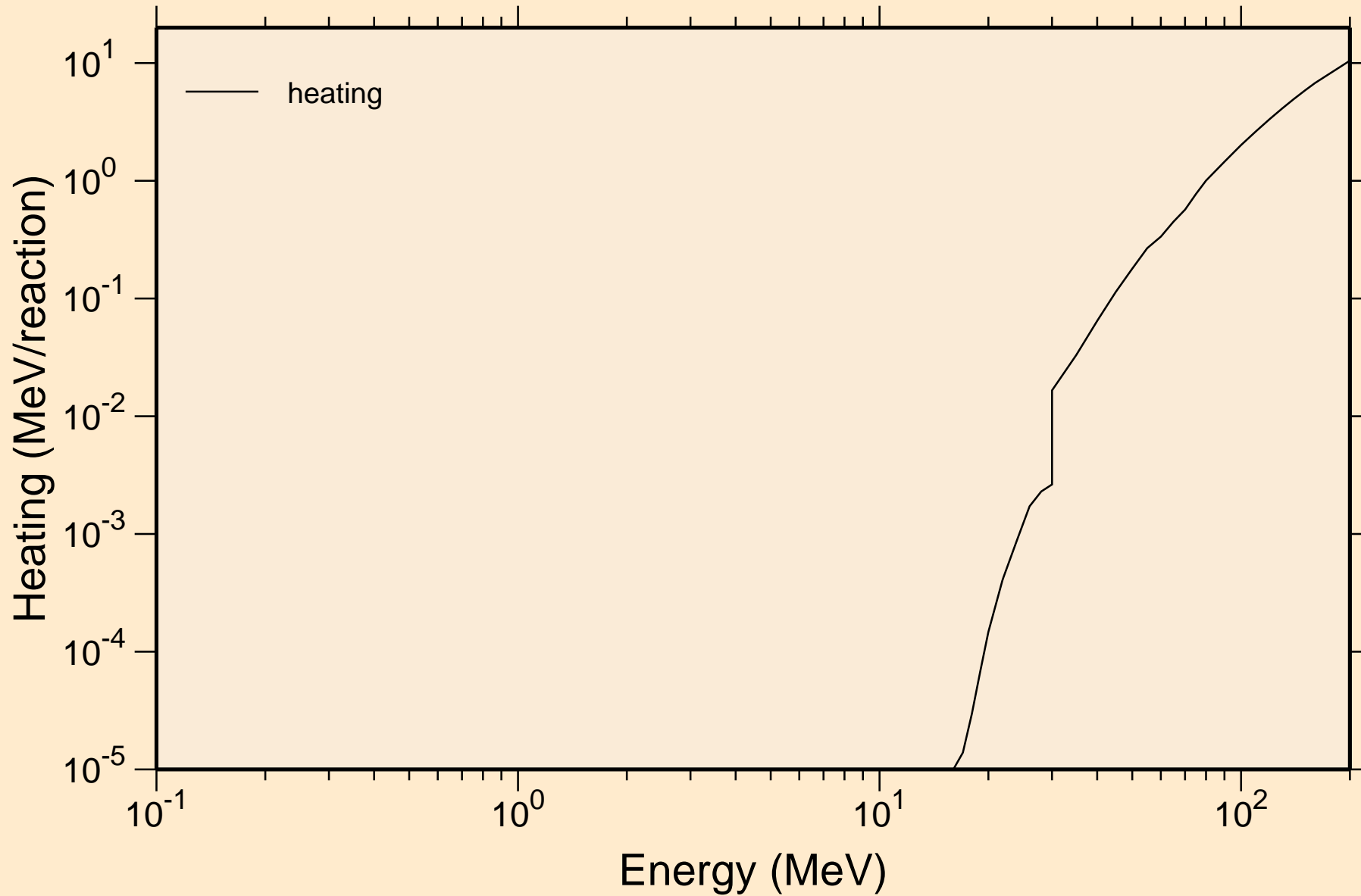

CF242 PROTON ACER TENDL-2021 LIBRARY; T=0.K

Principal cross sections

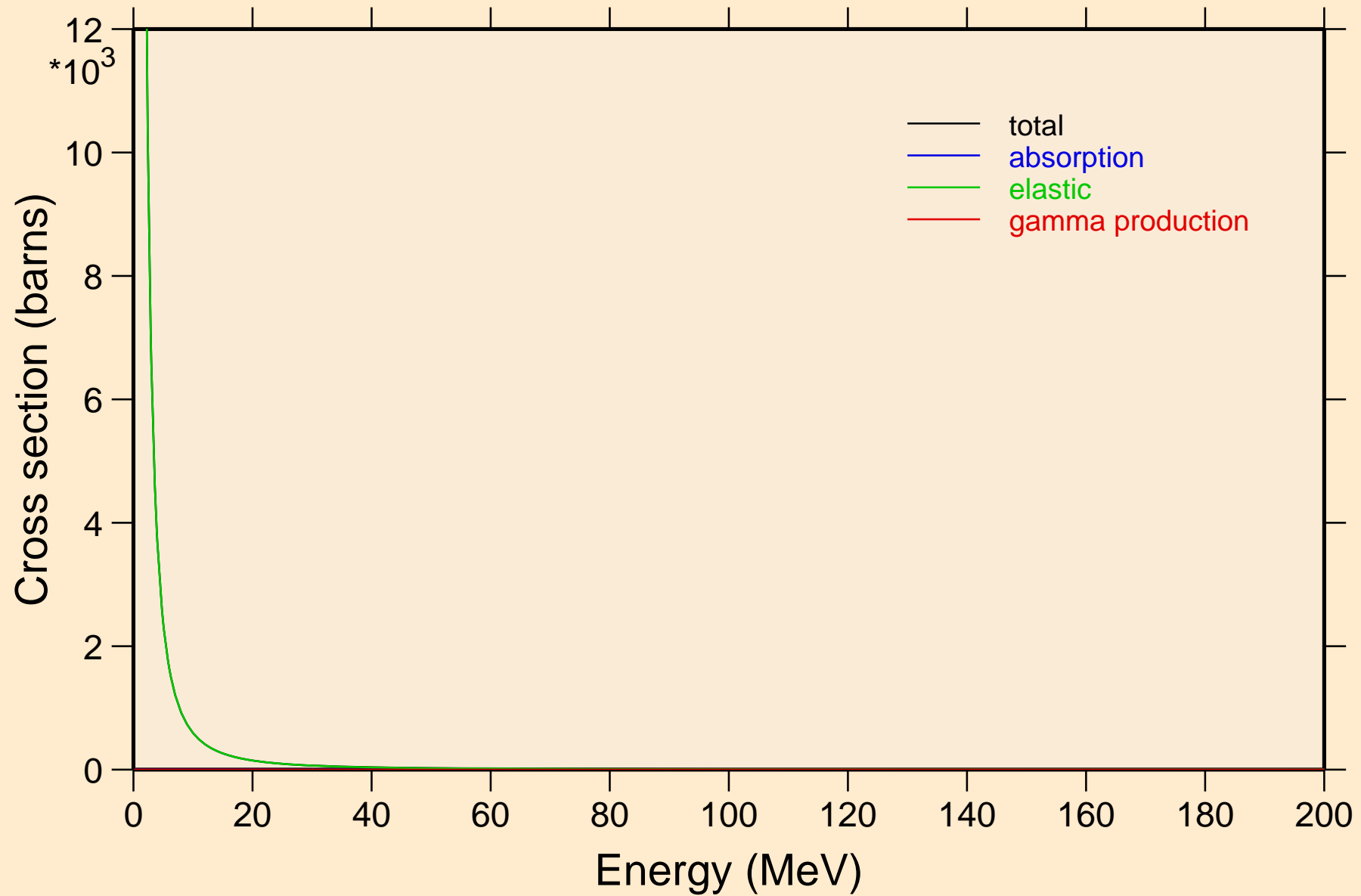

CF242 PROTON ACER TENDL-2021 LIBRARY; T=0.K

Heating

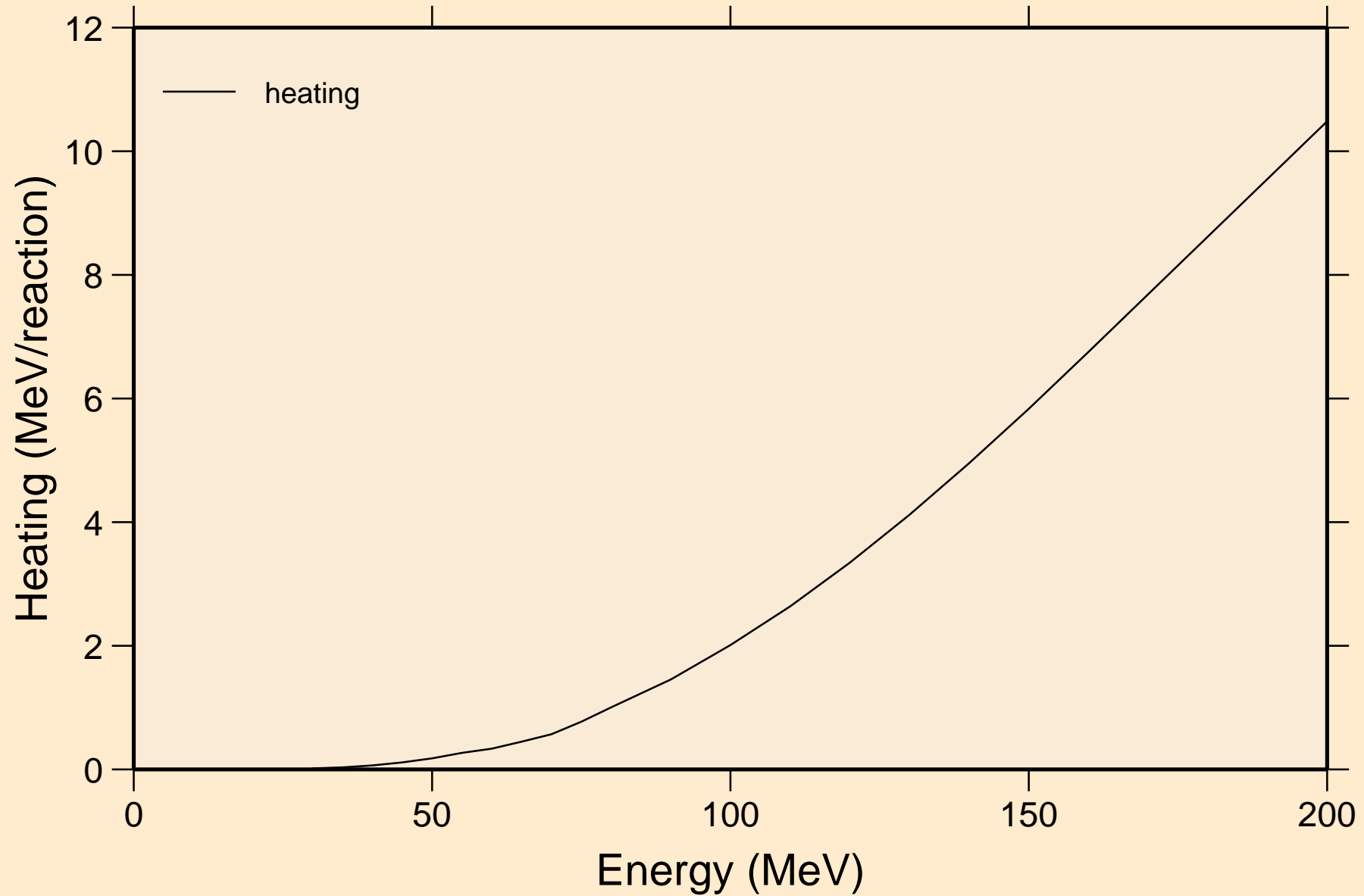

CF242 PROTON ACER TENDL-2021 LIBRARY; T=0.K

Threshold reactions

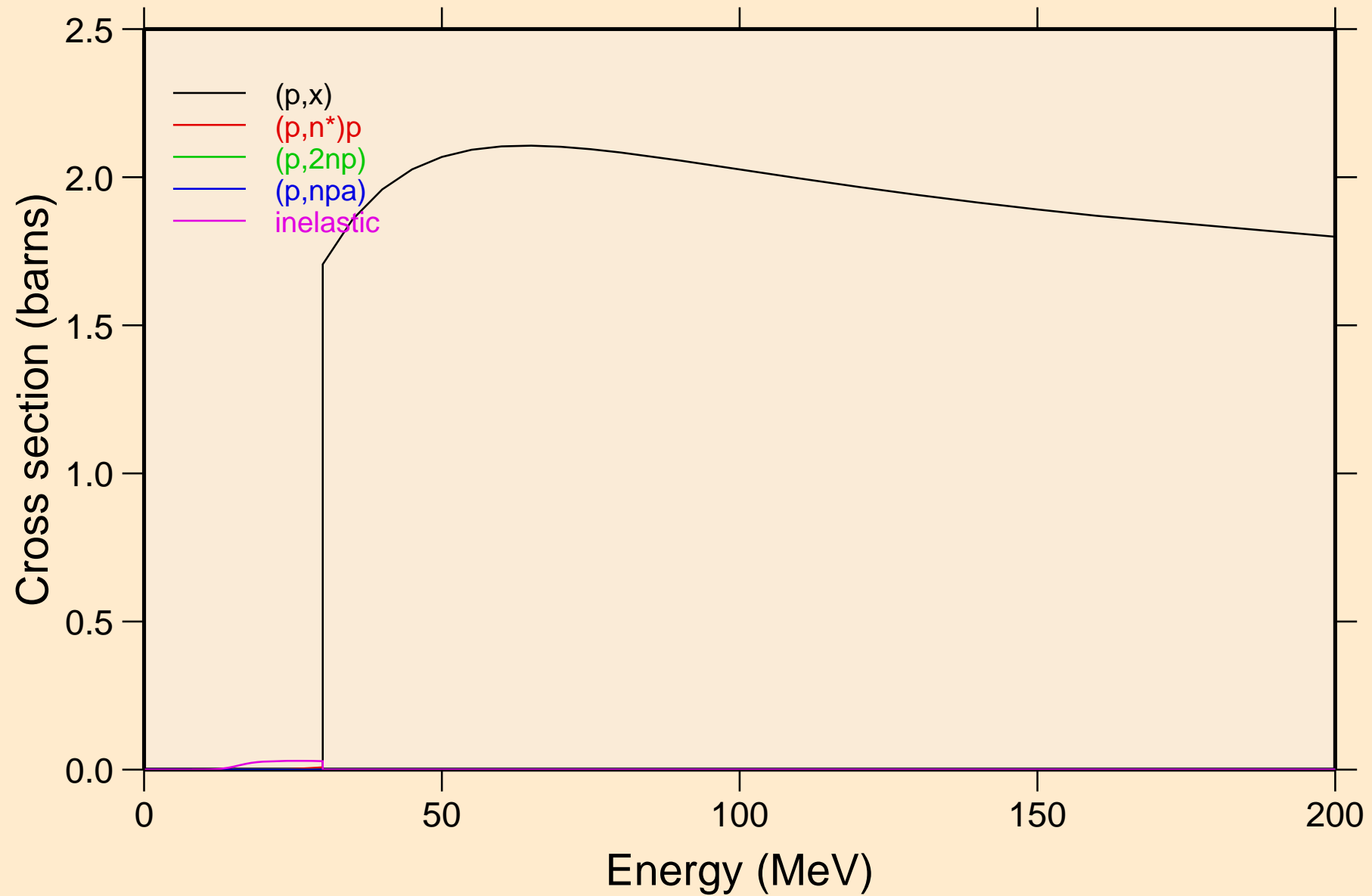

CF242 PROTON ACER TENDL-2021 LIBRARY; T=0.K

Threshold reactions

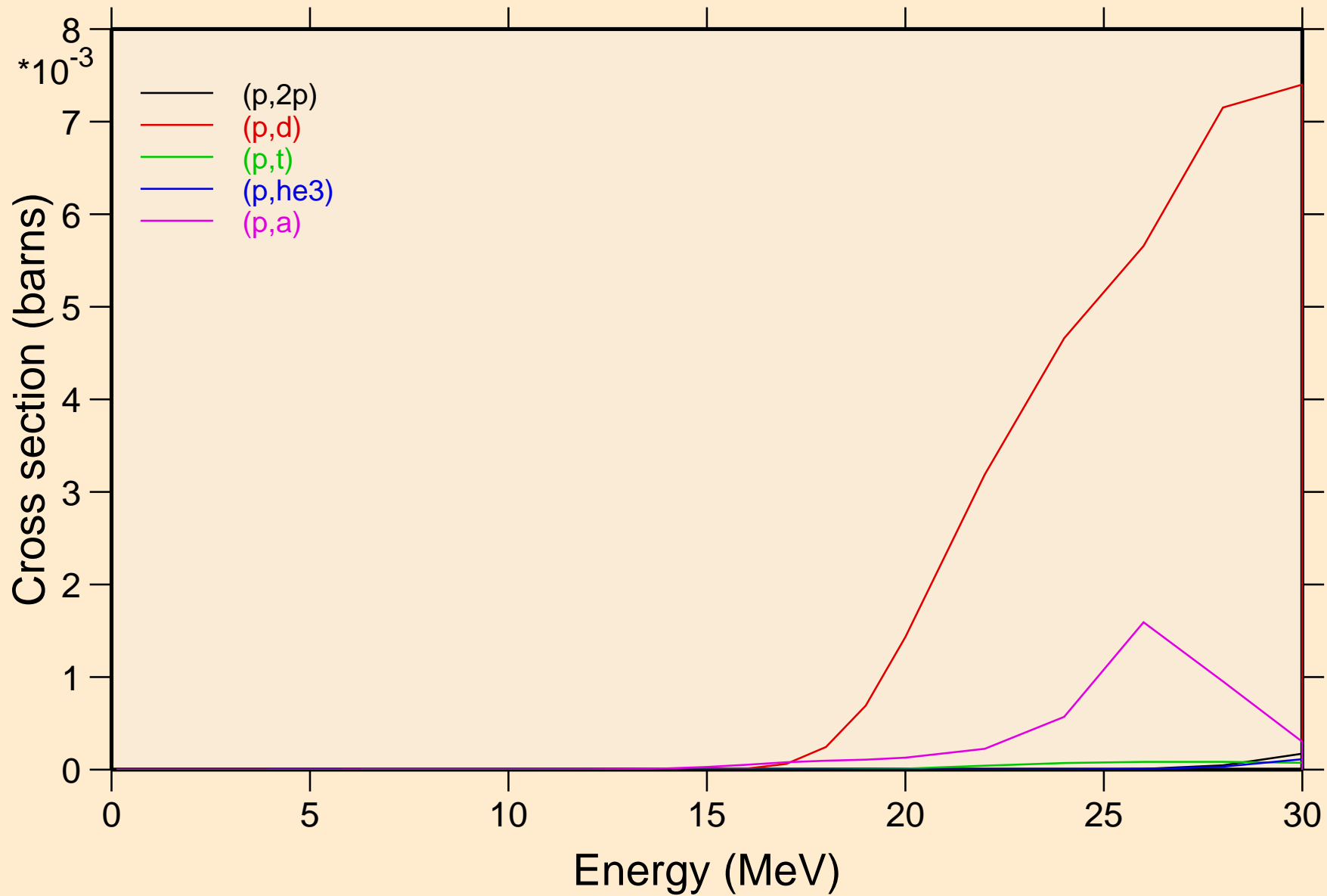

CF242 PROTON ACER TENDL-2021 LIBRARY; T=0.K
Threshold reactions

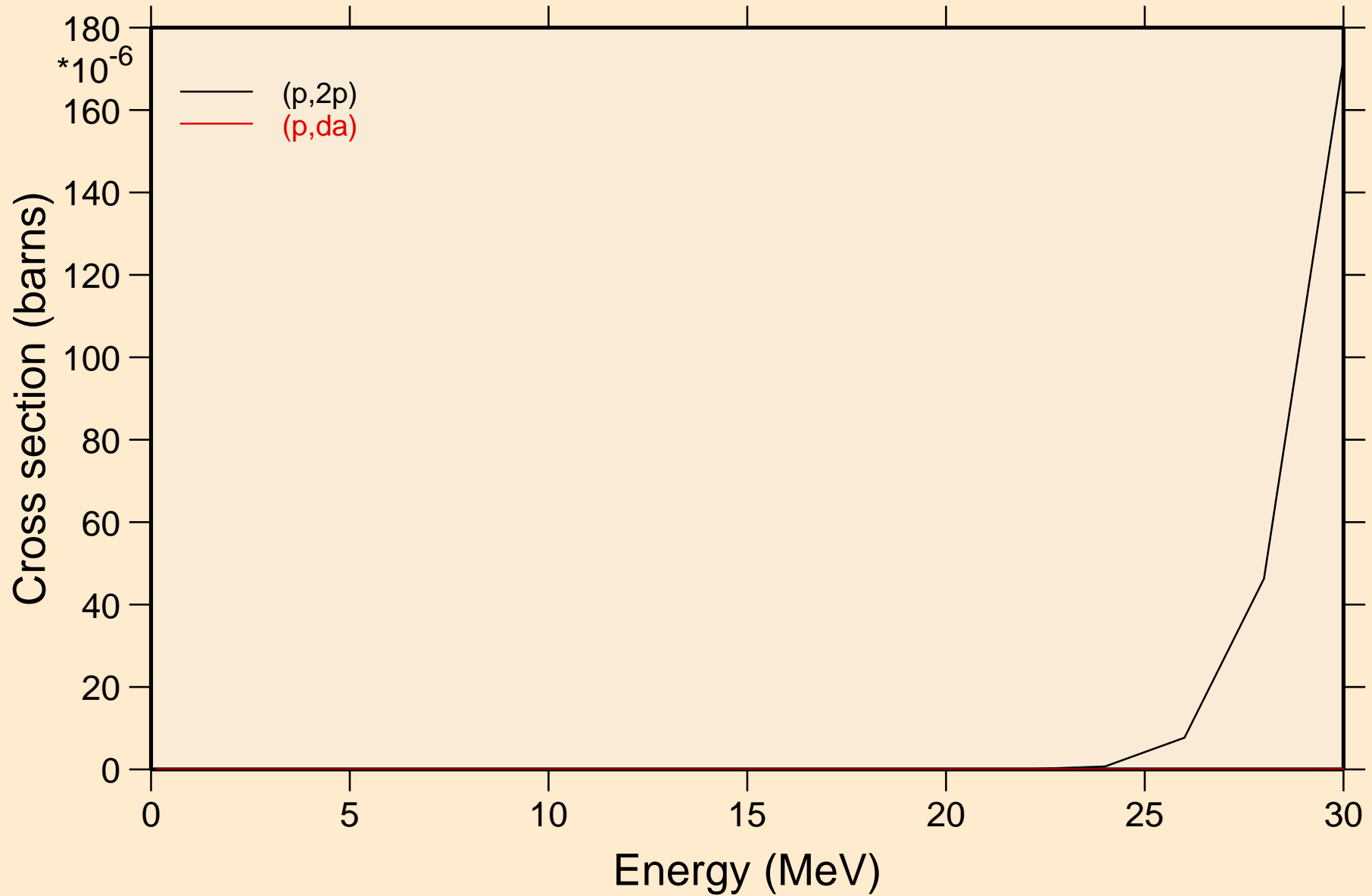

CF242 PROTON ACER TENDL-2021 LIBRARY; T=0.K
angular distribution for elastic

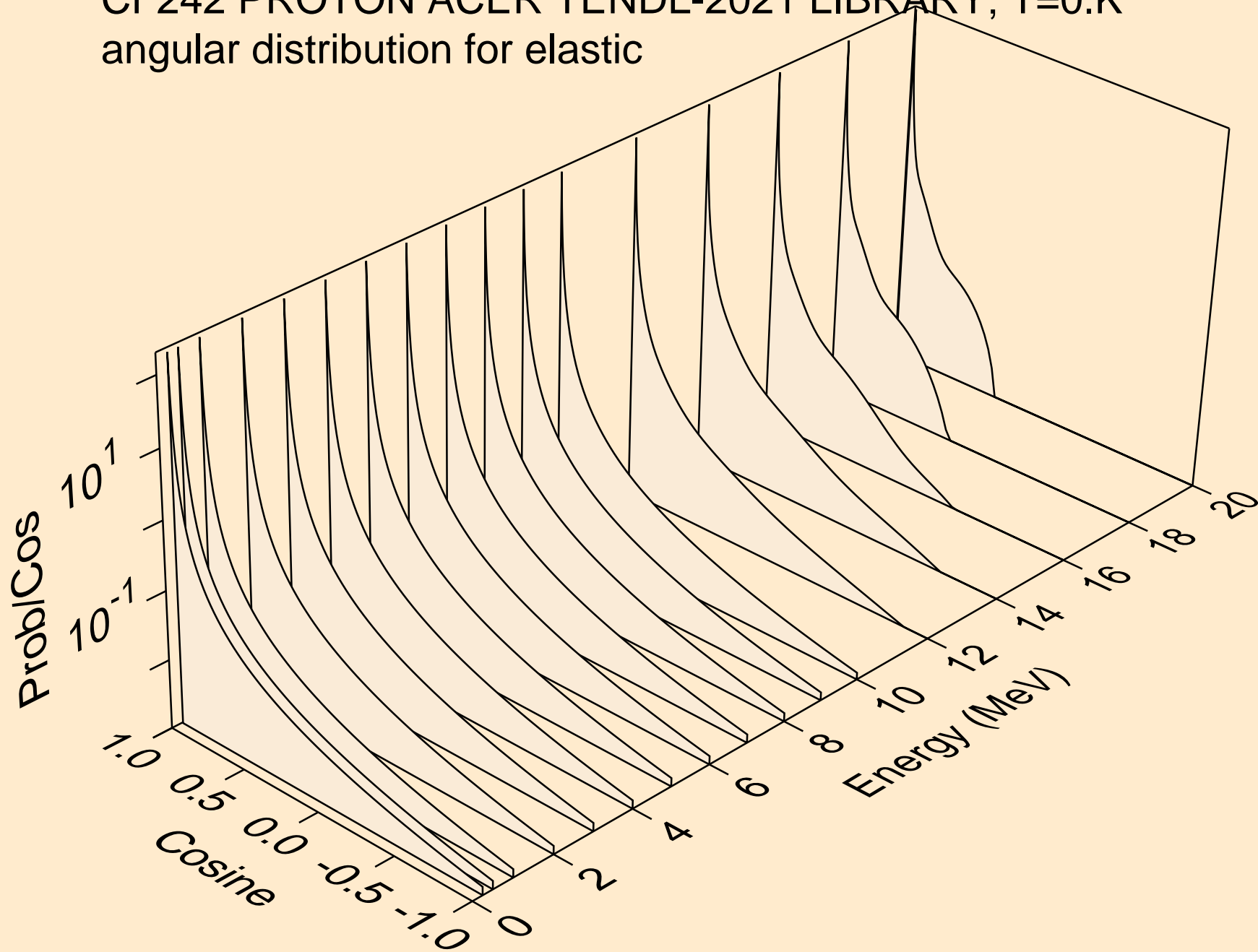

CF242 PROTON ACER TENDL-2021 LIBRARY; T=0.K
angular distribution for elastic

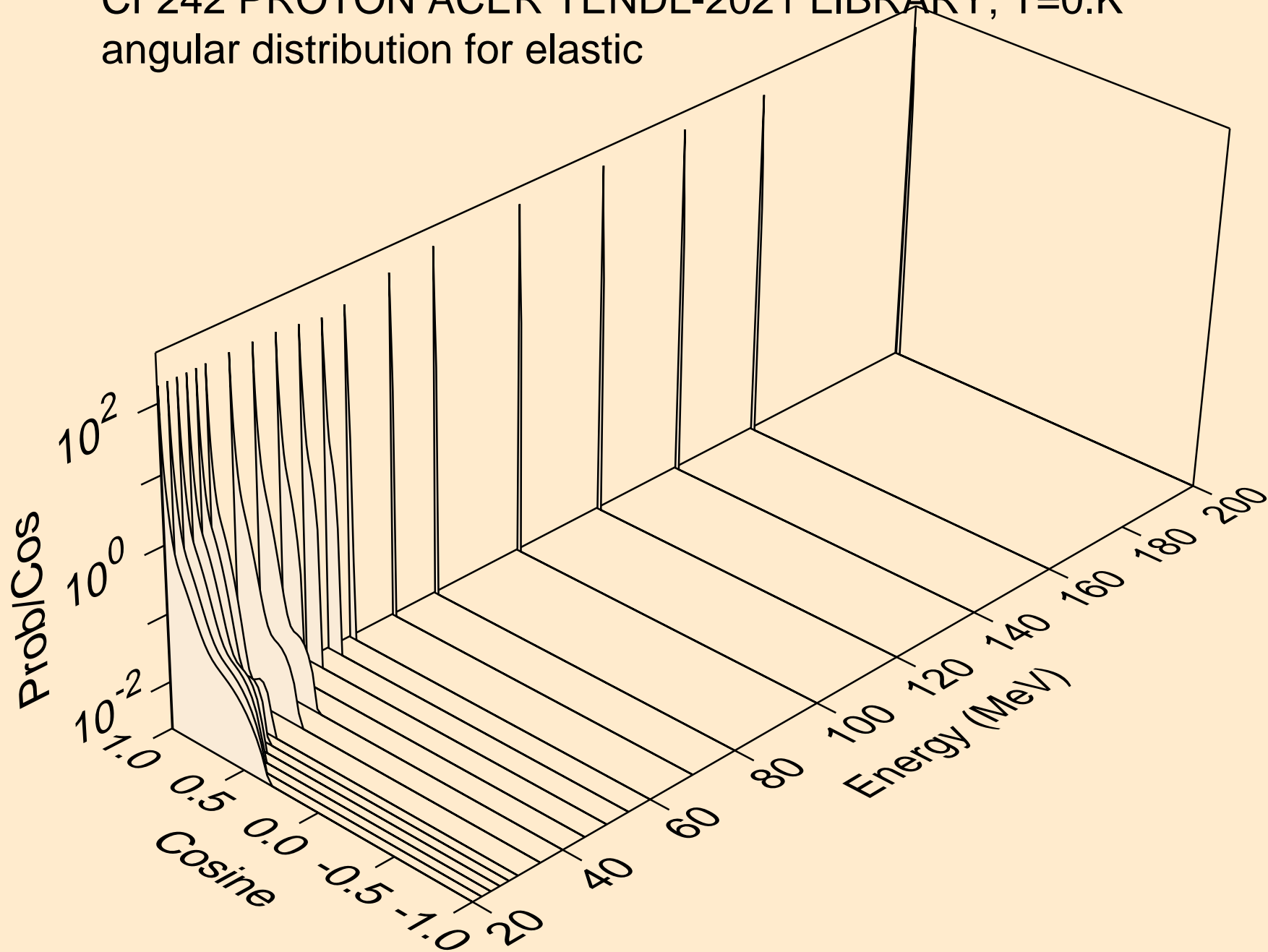

CF242 PROTON ACER TENDL-2021 LIBRARY; T=0.K
Proton emission for (p,x)

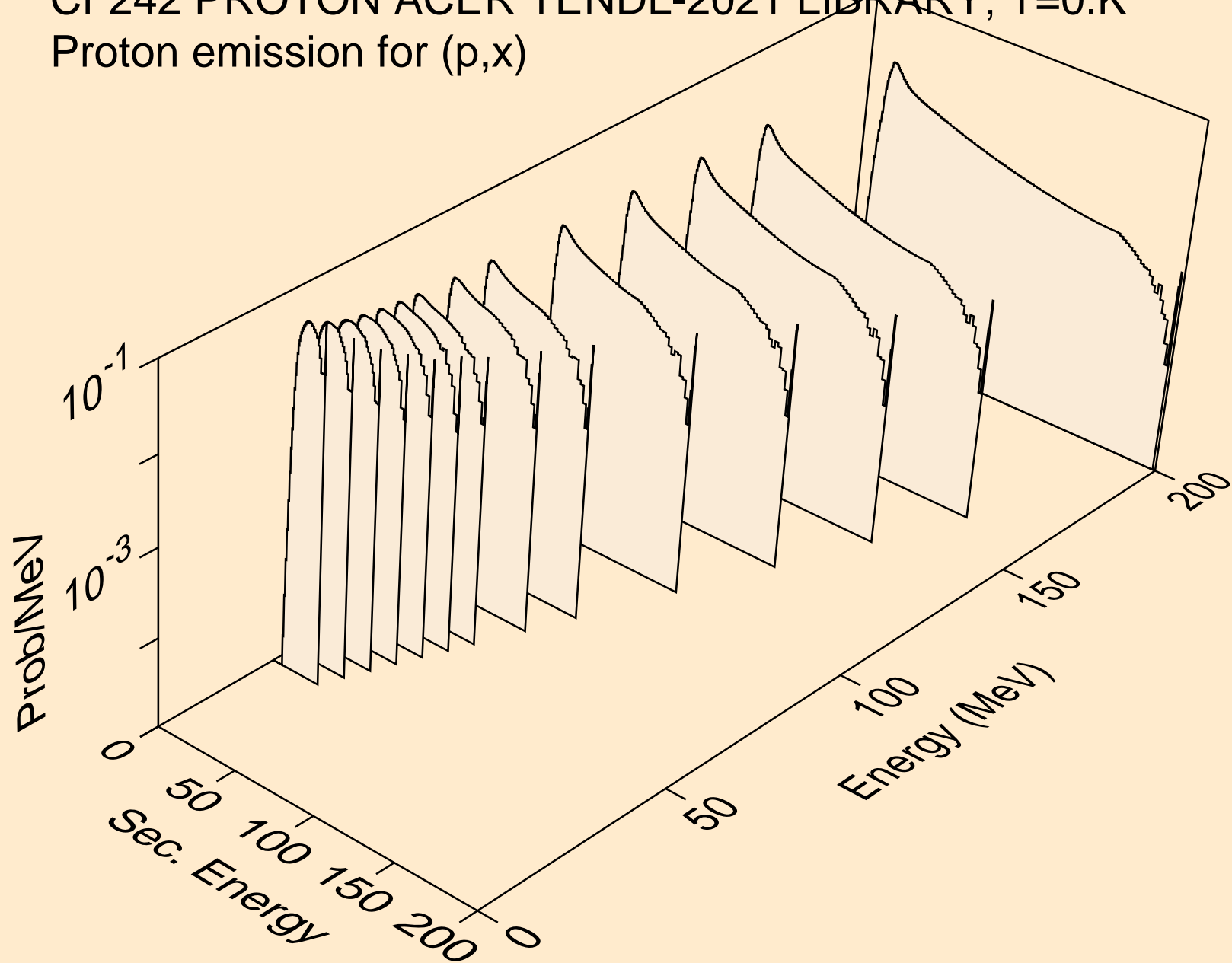

CF242 PROTON ACER TENDL-2021 LIBRARY; T=0.K
Proton emission for (p,n*)p

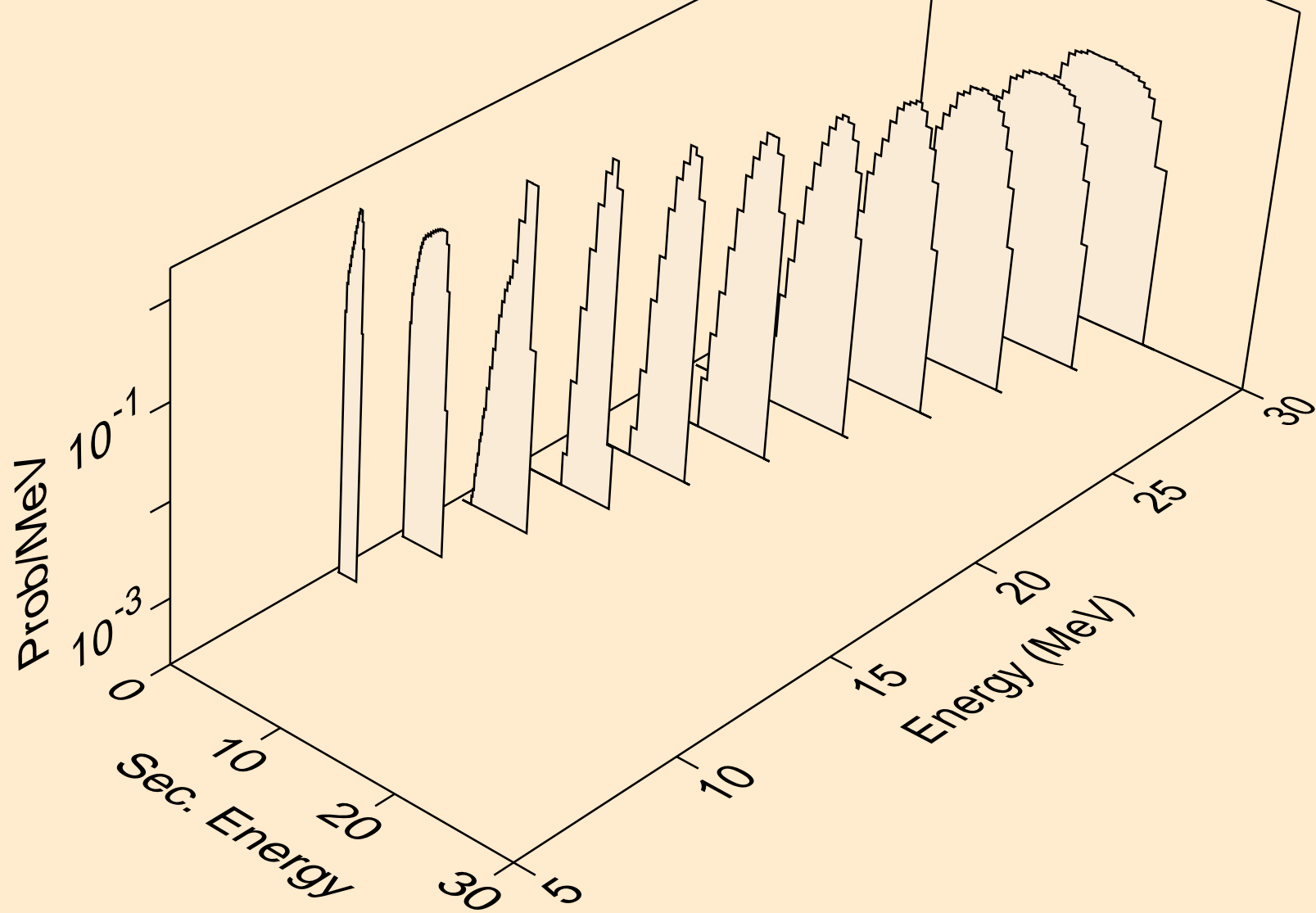

CF242 PROTON ACER TENDL-2021 LIBRARY; T=0.K
Proton emission for (p,2np)

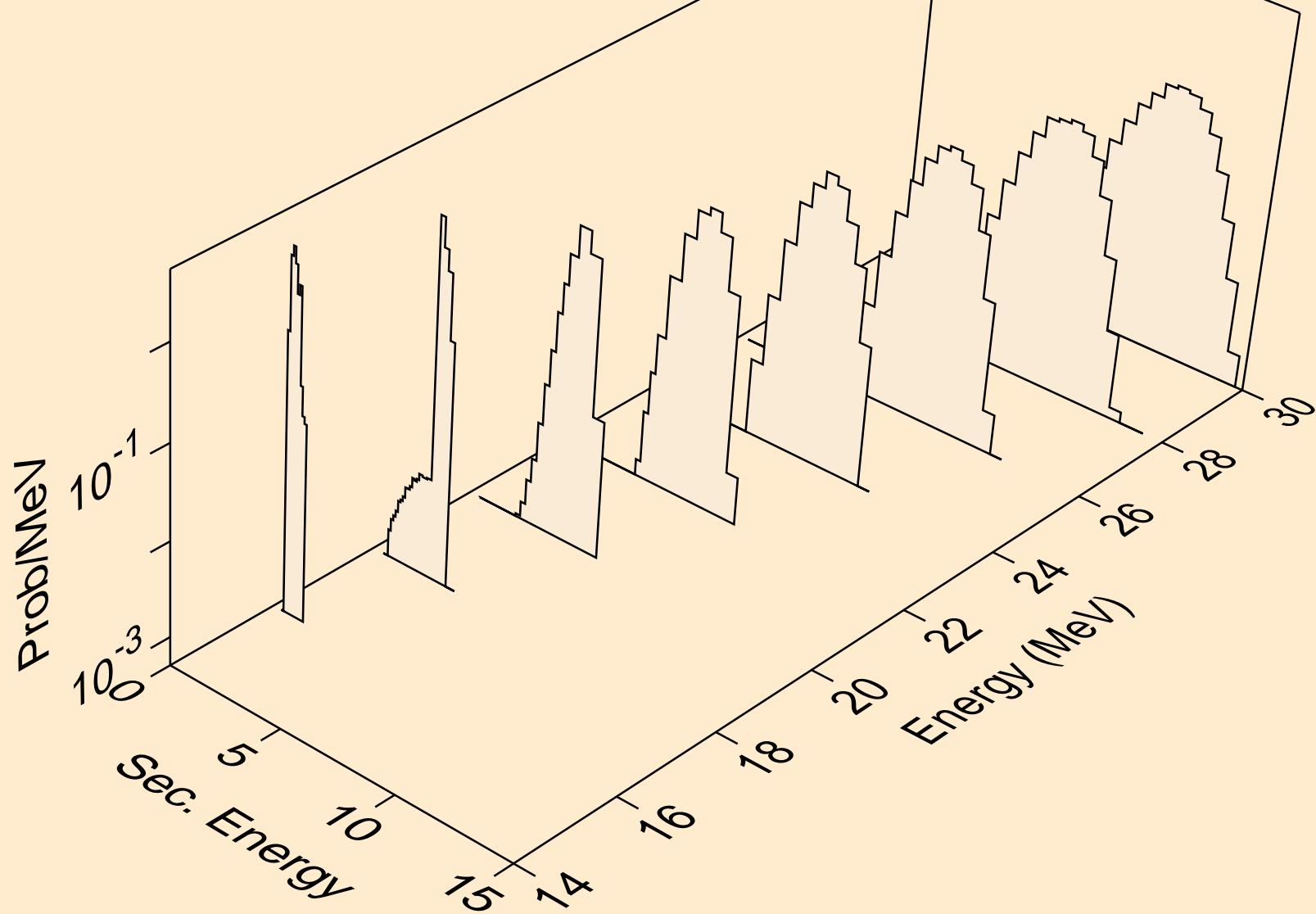

CF242 PROTON ACER TENDL-2021 LIBRARY; T=0.K
Proton emission for (p,npa)

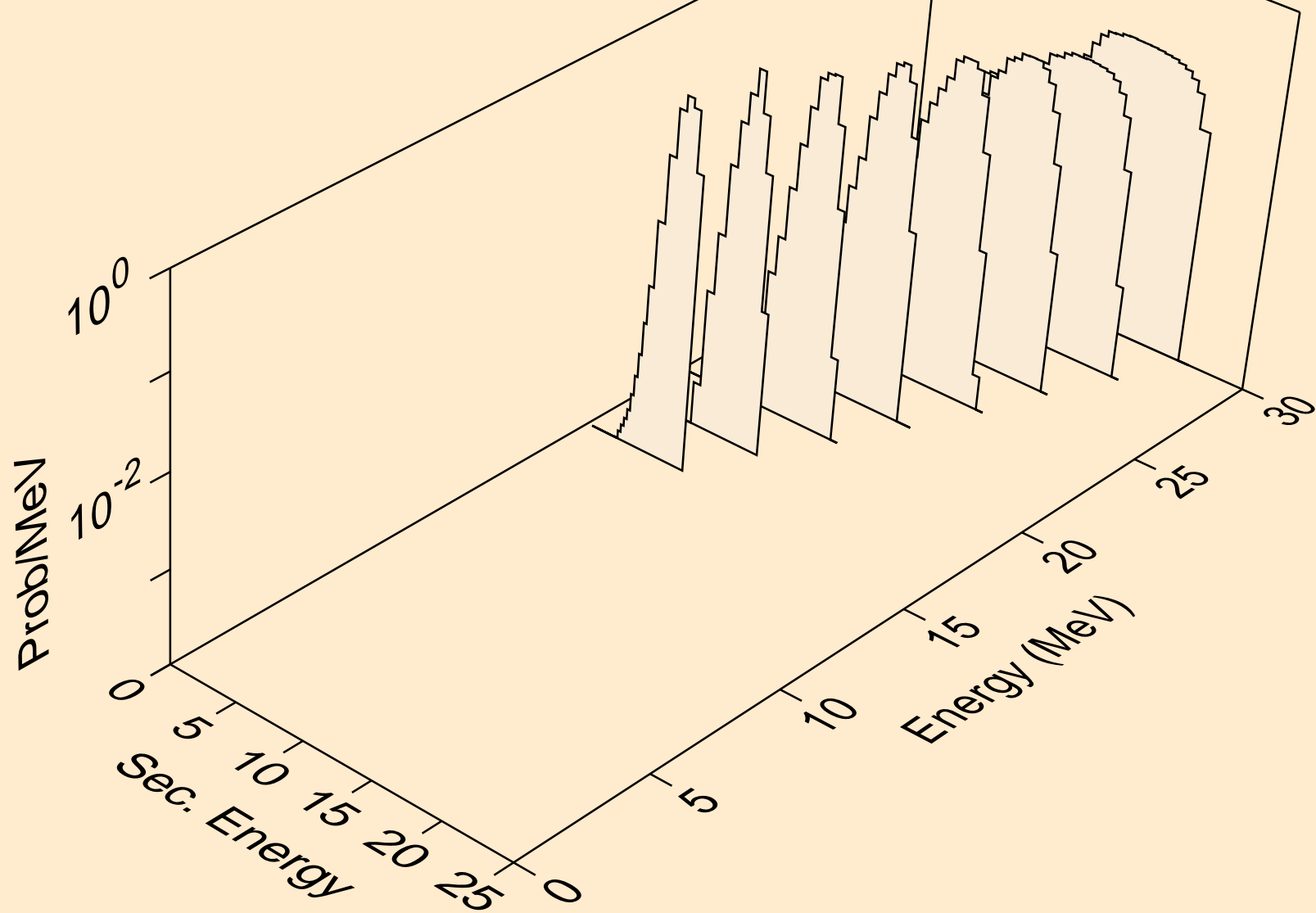

CF242 PROTON ACER TENDL-2021 LIBRARY; T=0.K
Proton emission for inelastic

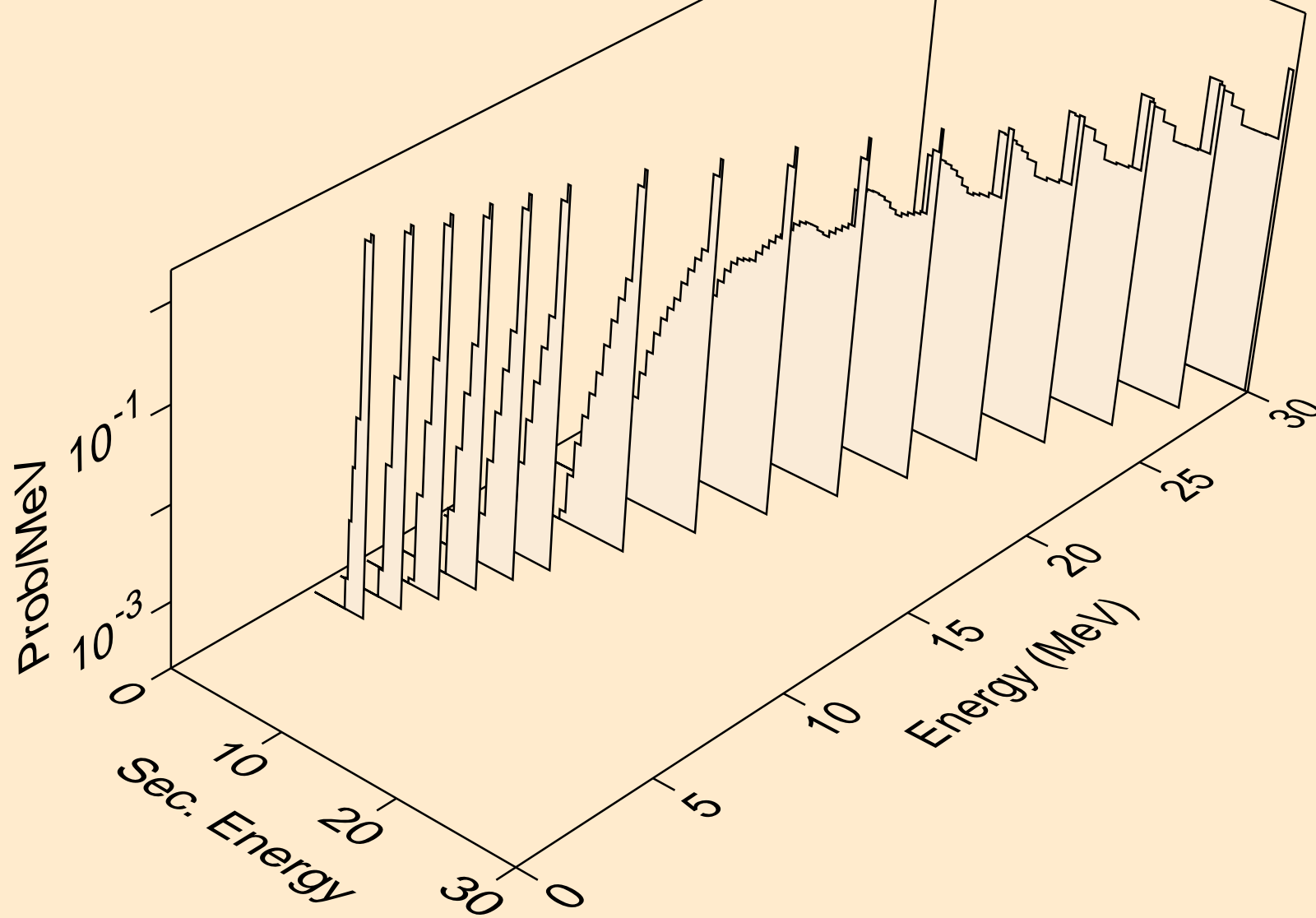

CF242 PROTON ACER TENDL-2021 LIBRARY; T=0.K
Proton emission for (p,2p)

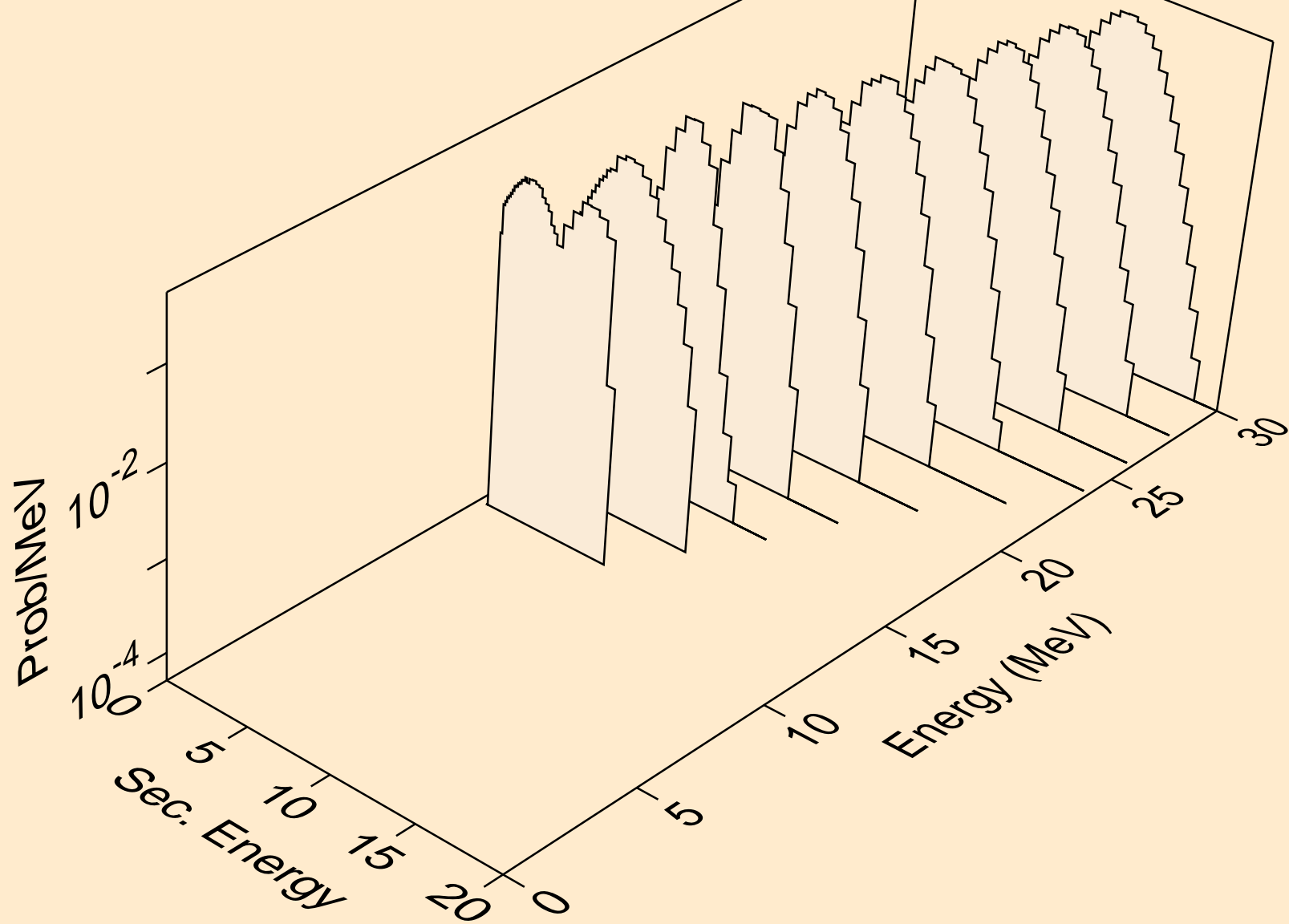

CF242 PROTON ACER TENDL-2021 LIBRARY; T=0.K
Photon emission for (z,n)

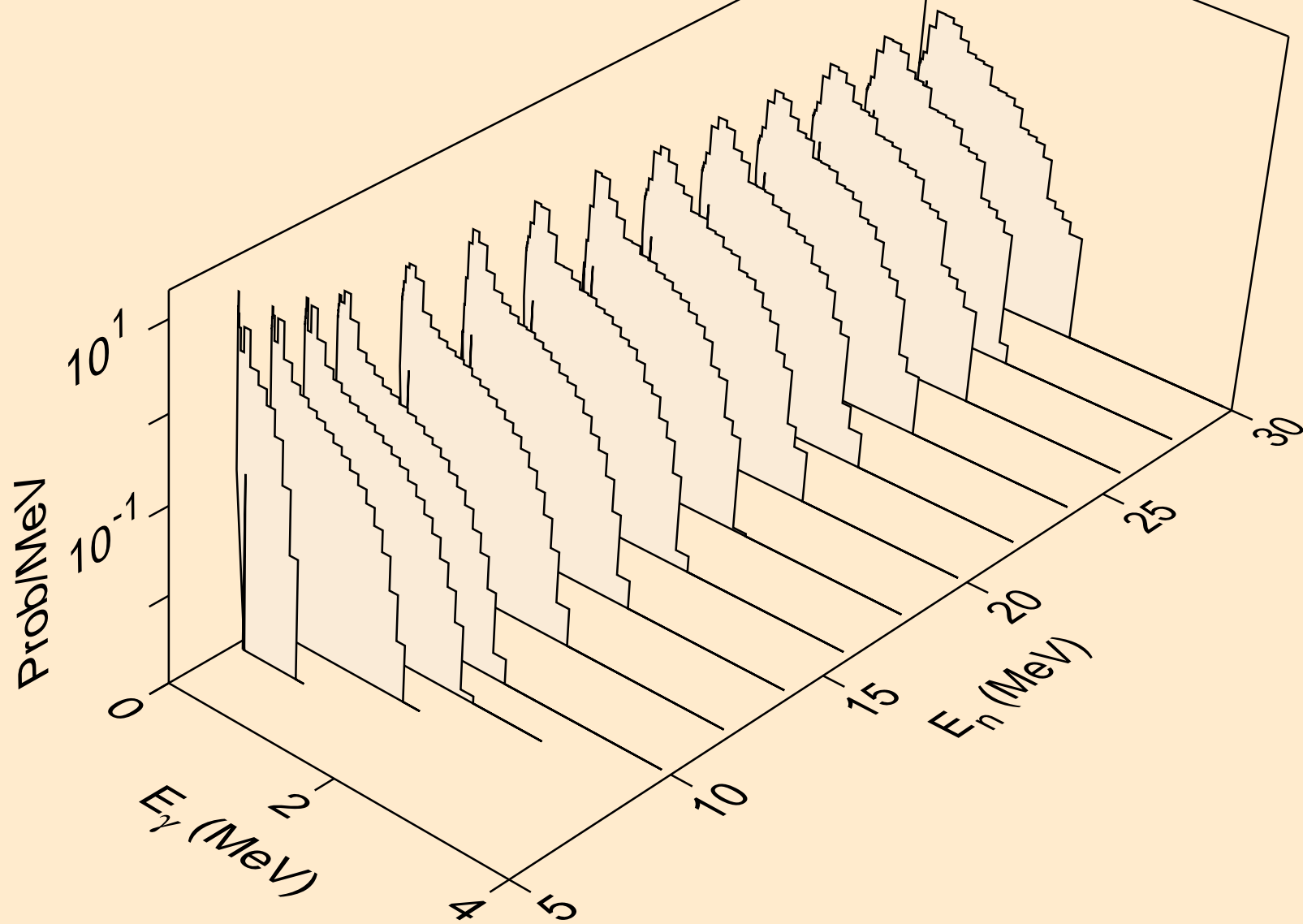

CF242 PROTON ACER TENDL-2021 LIBRARY; T=0.K
Photon emission for (n,x)

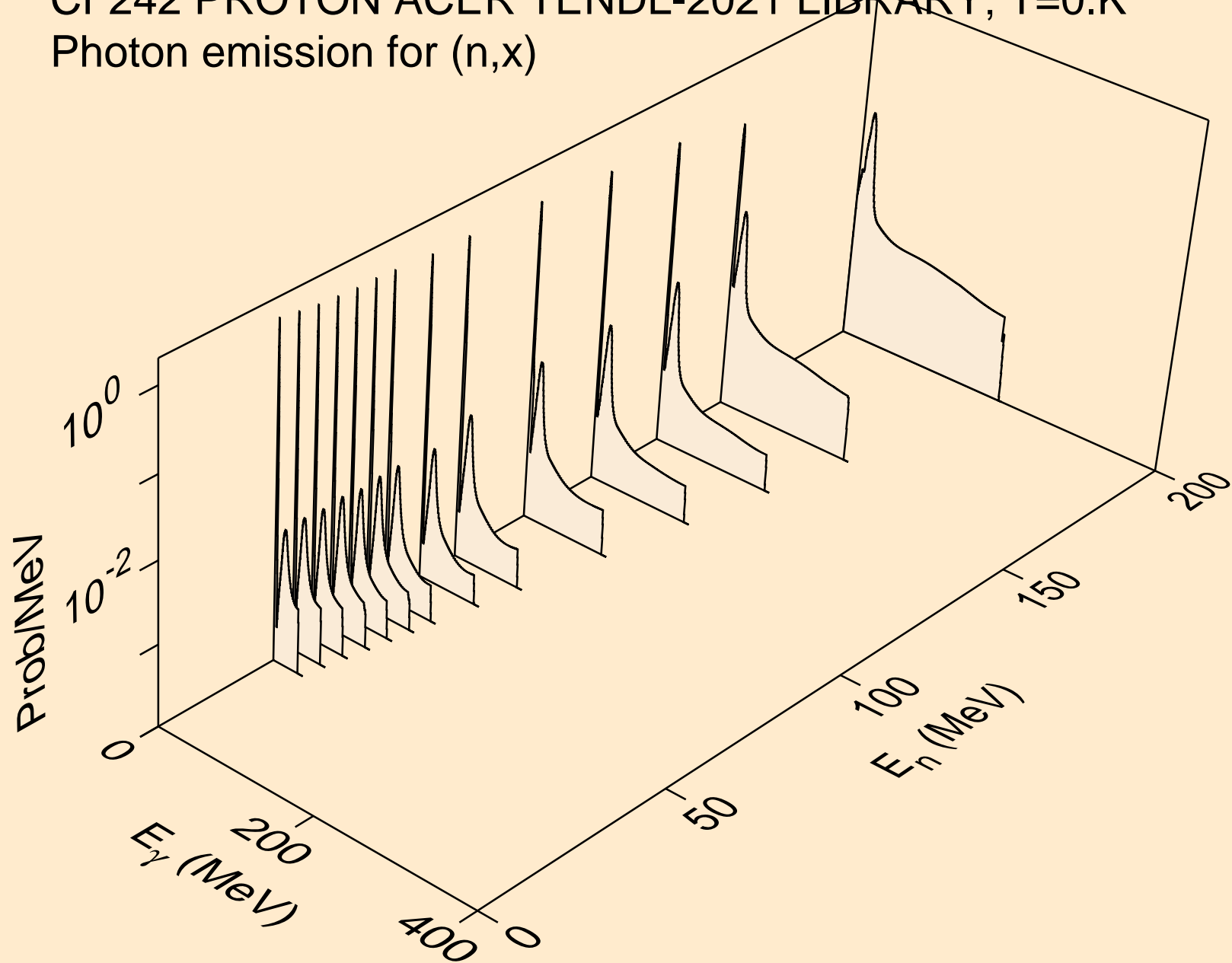

CF242 PROTON ACER TENDL-2021 LIBRARY; T=0.K
Photon emission for (n,2n)

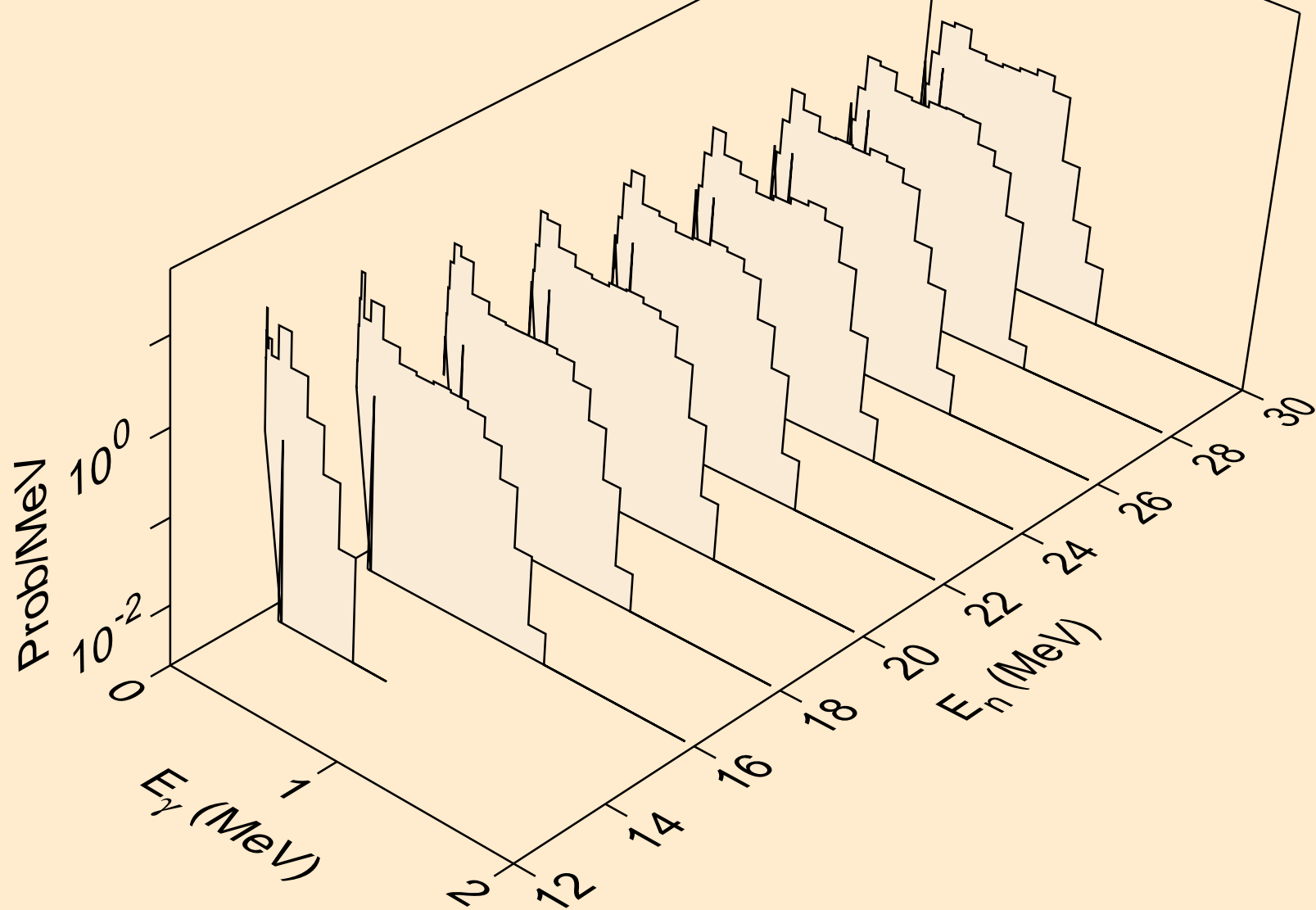

CF242 PROTON ACER TENDL-2021 LIBRARY; T=0.K
Photon emission for (n,3n)

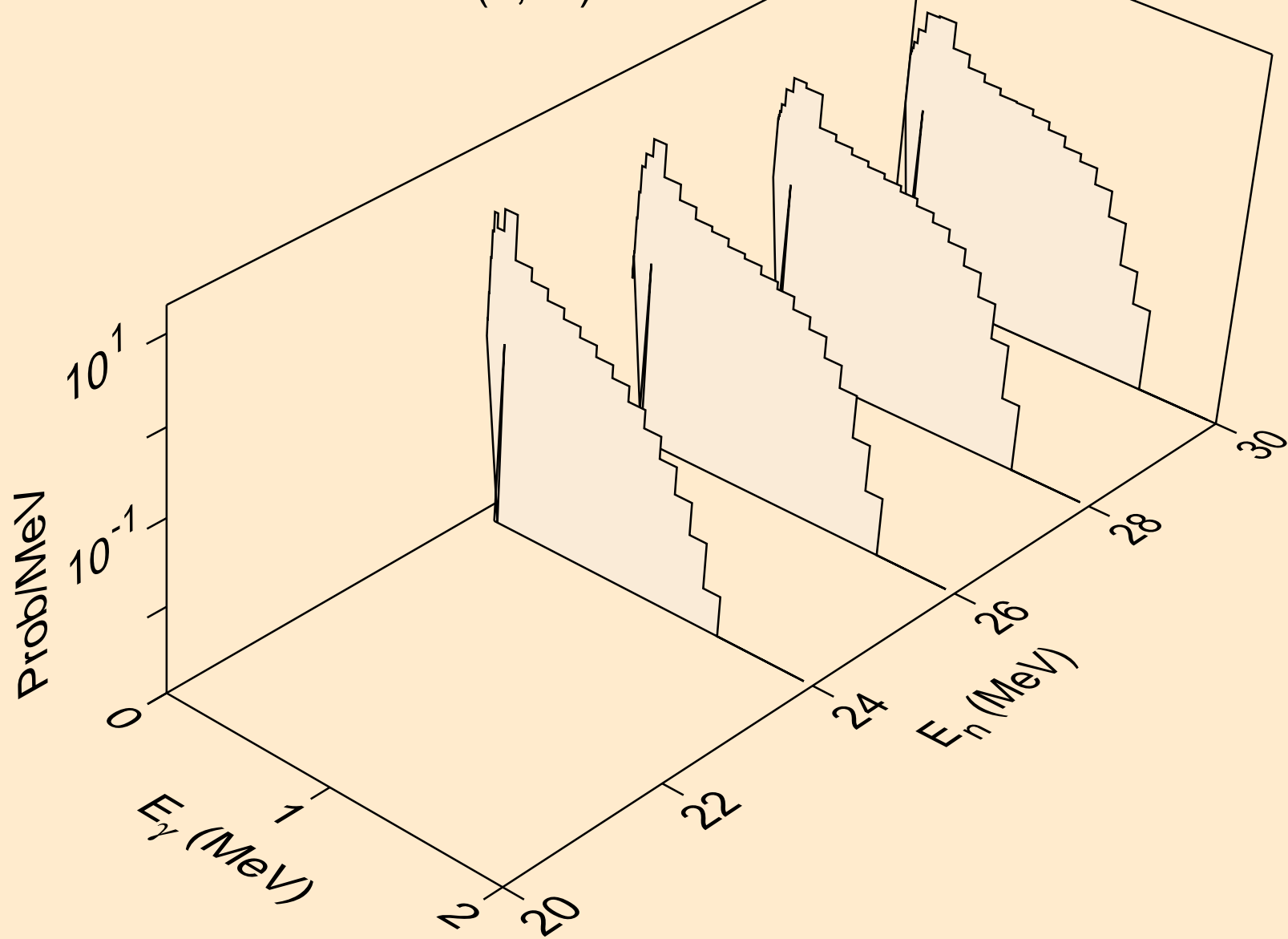

CF242 PROTON ACER TENDL-2021 LIBRARY; T=0.K
Photon emission for (n,n*)a

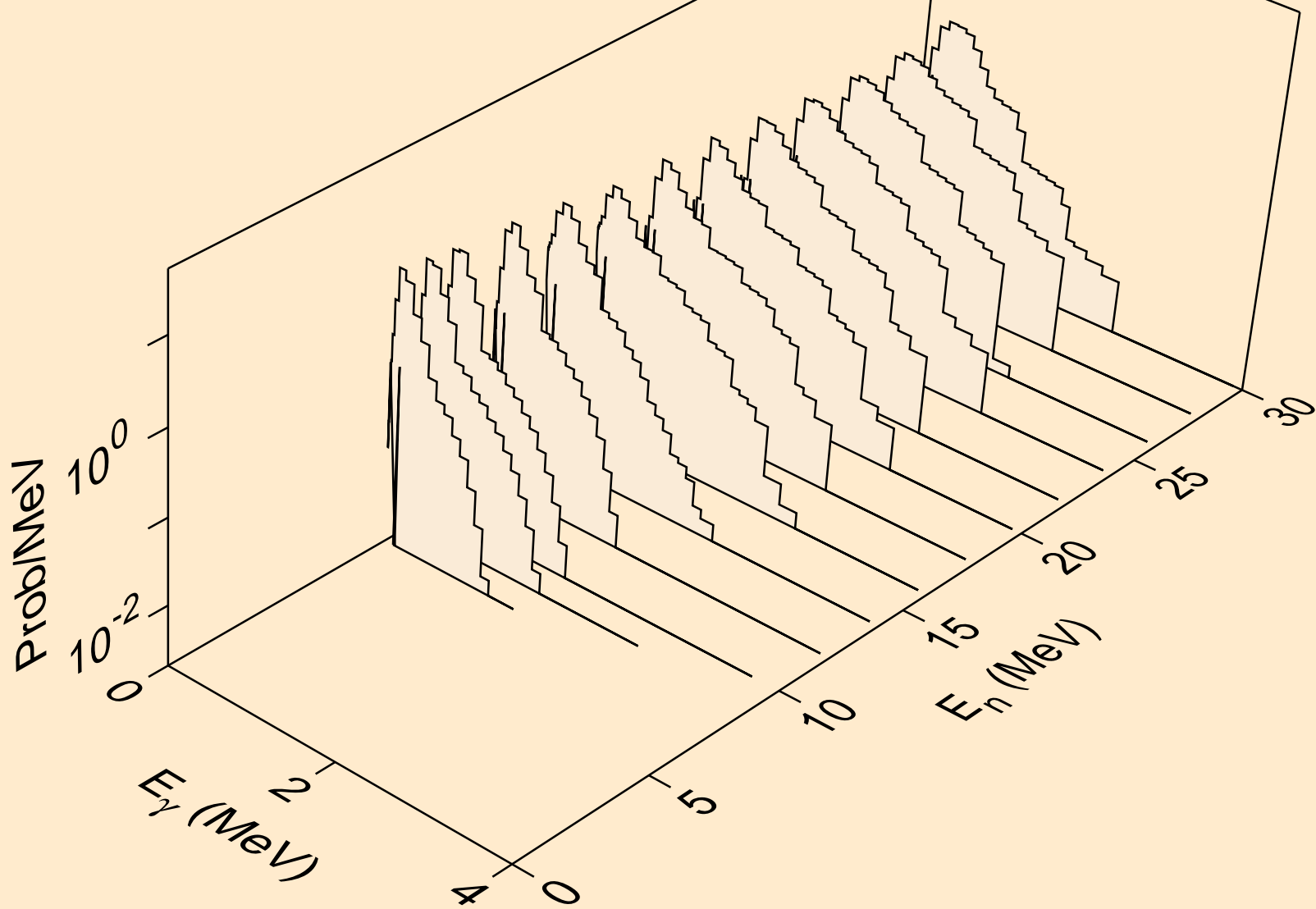

CF242 PROTON ACER TENDL-2021 LIBRARY; T=0.K
Photon emission for (n,2n)a

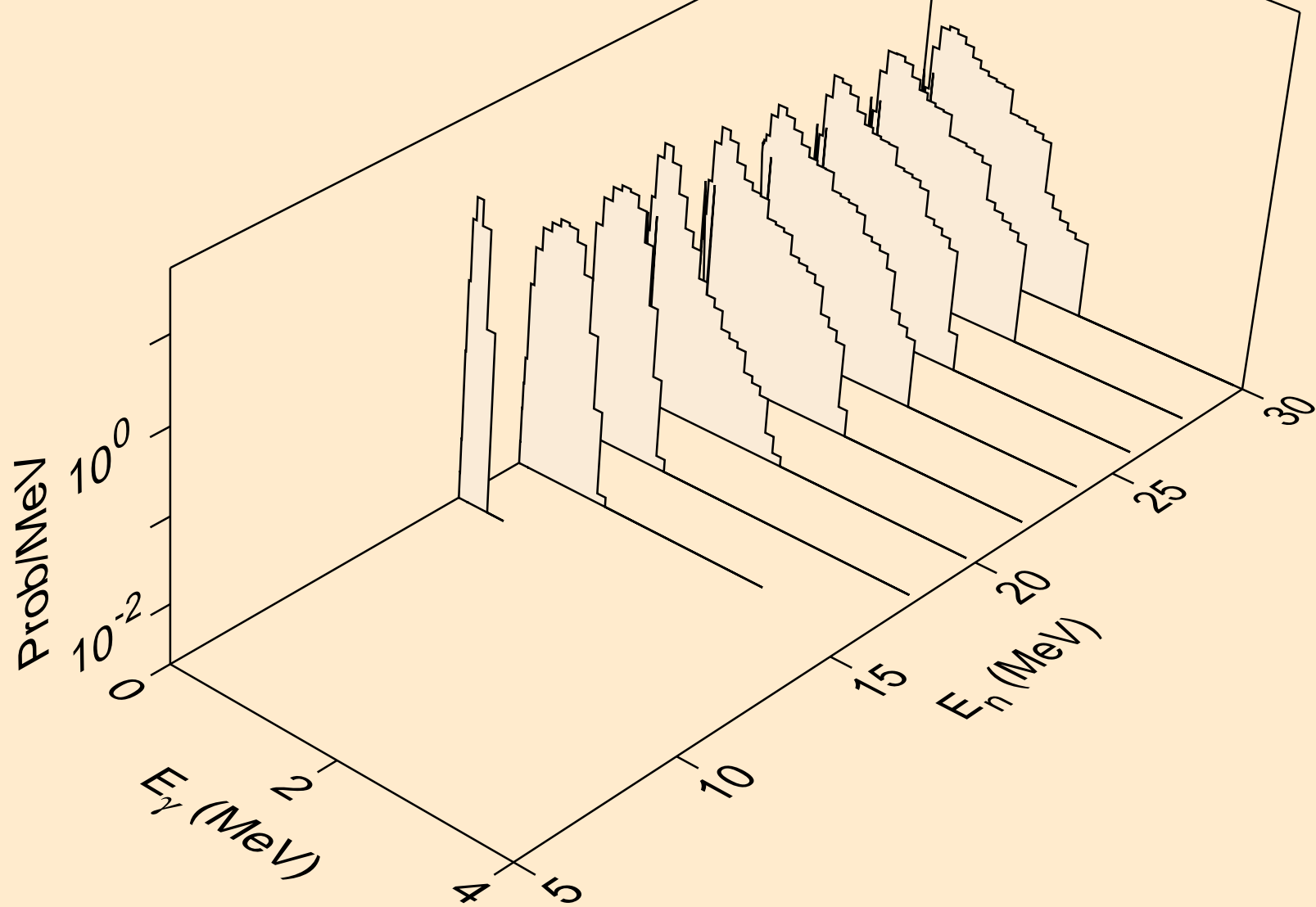

CF242 PROTON ACER TENDL-2021 LIBRARY; T=0.K
Photon emission for (n,n*)p

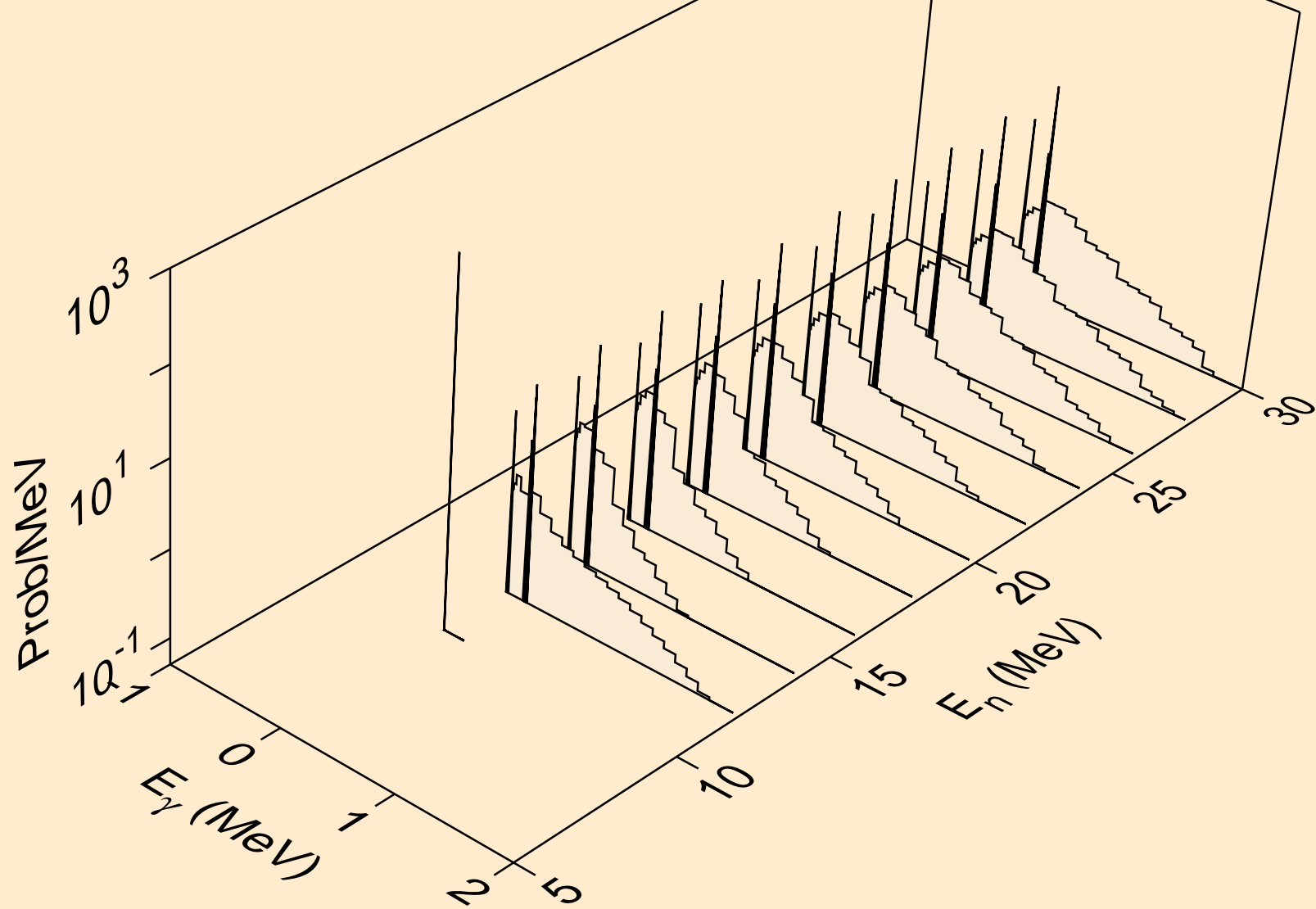

CF242 PROTON ACER TENDL-2021 LIBRARY; T=0.K
Photon emission for (n,n*)d

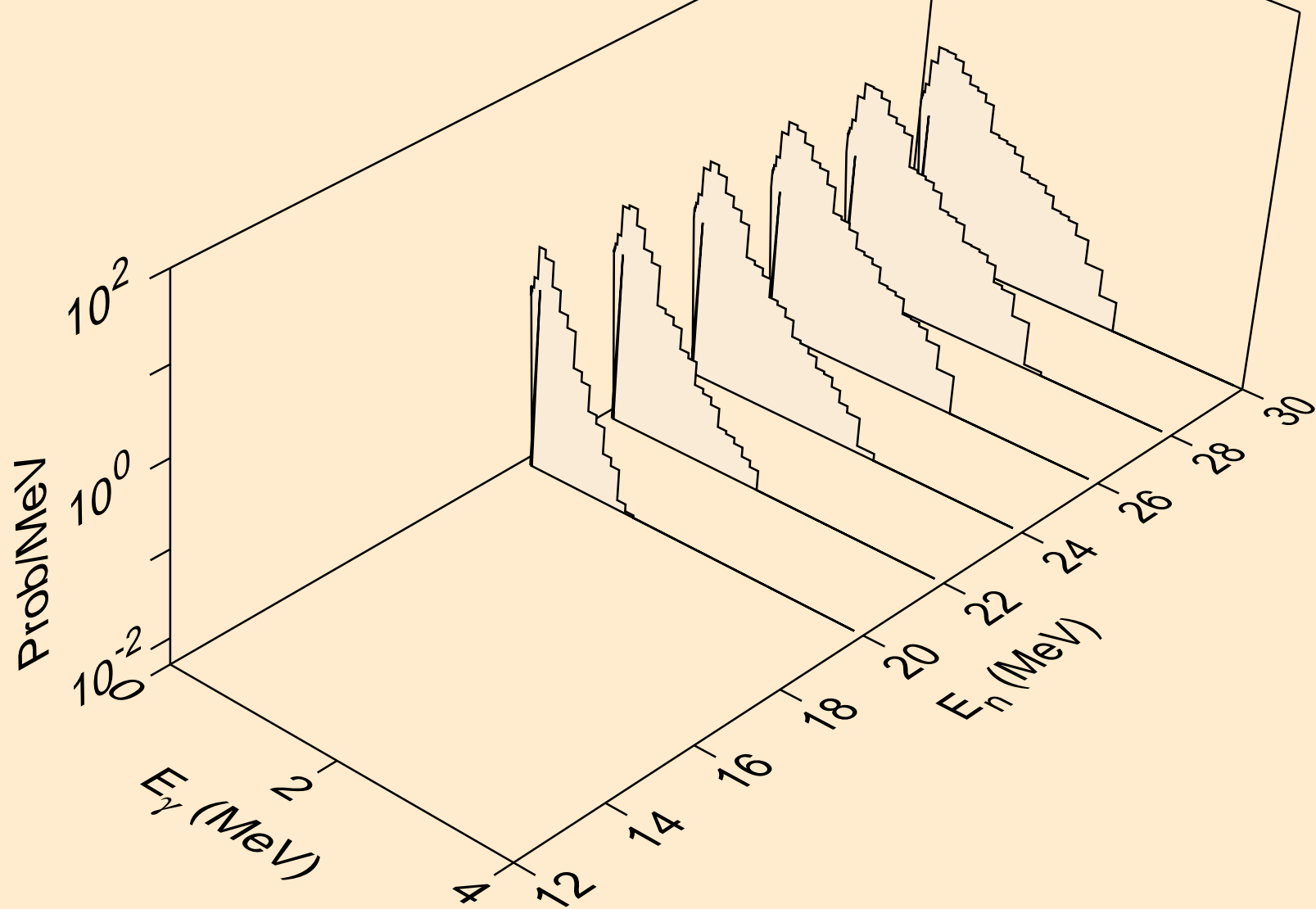

CF242 PROTON ACER TENDL-2021 LIBRARY; T=0.K
Photon emission for (n,n*)t

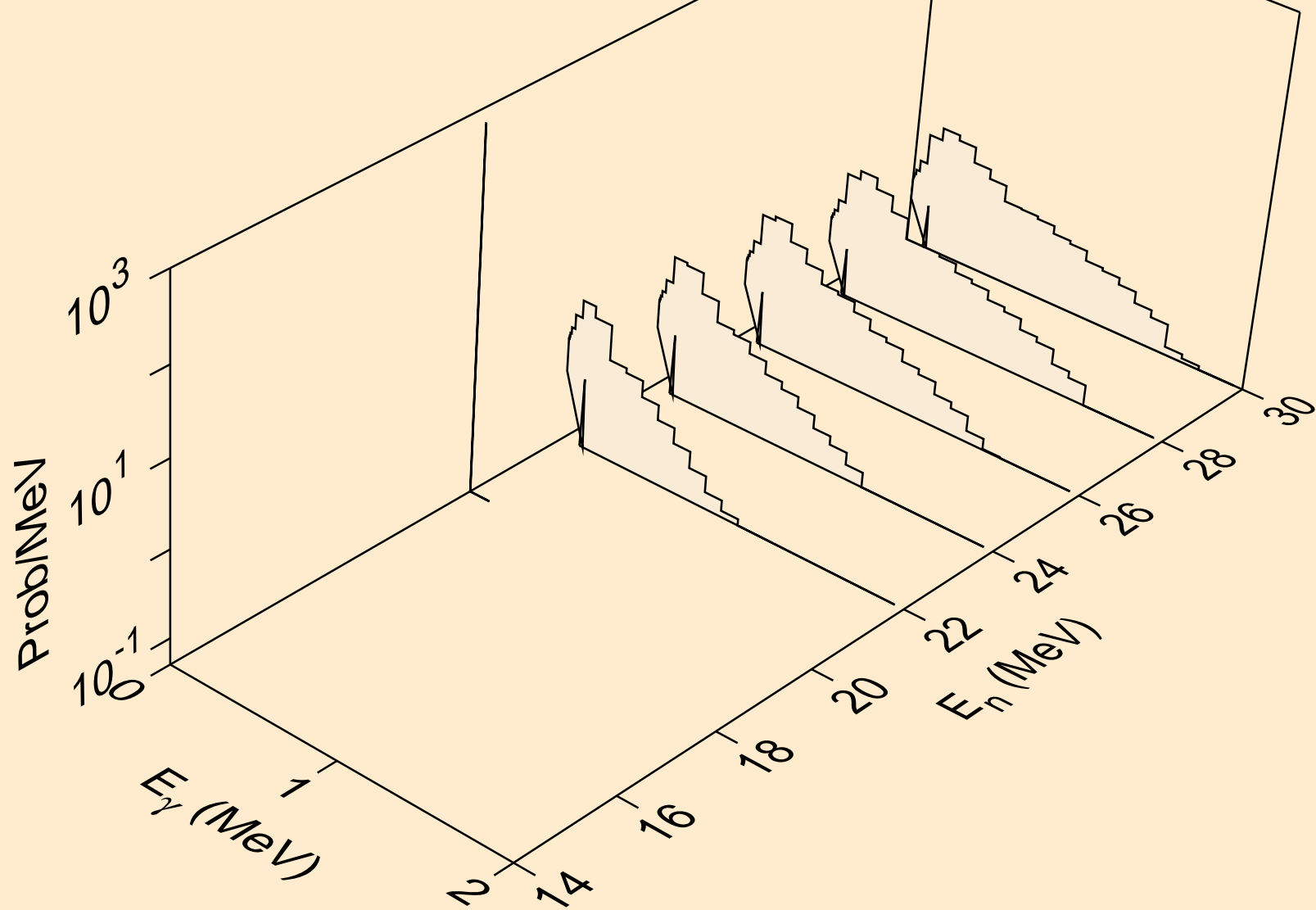

CF242 PROTON ACER TENDL-2021 LIBRARY; T=0.K
Photon emission for (n,2np)

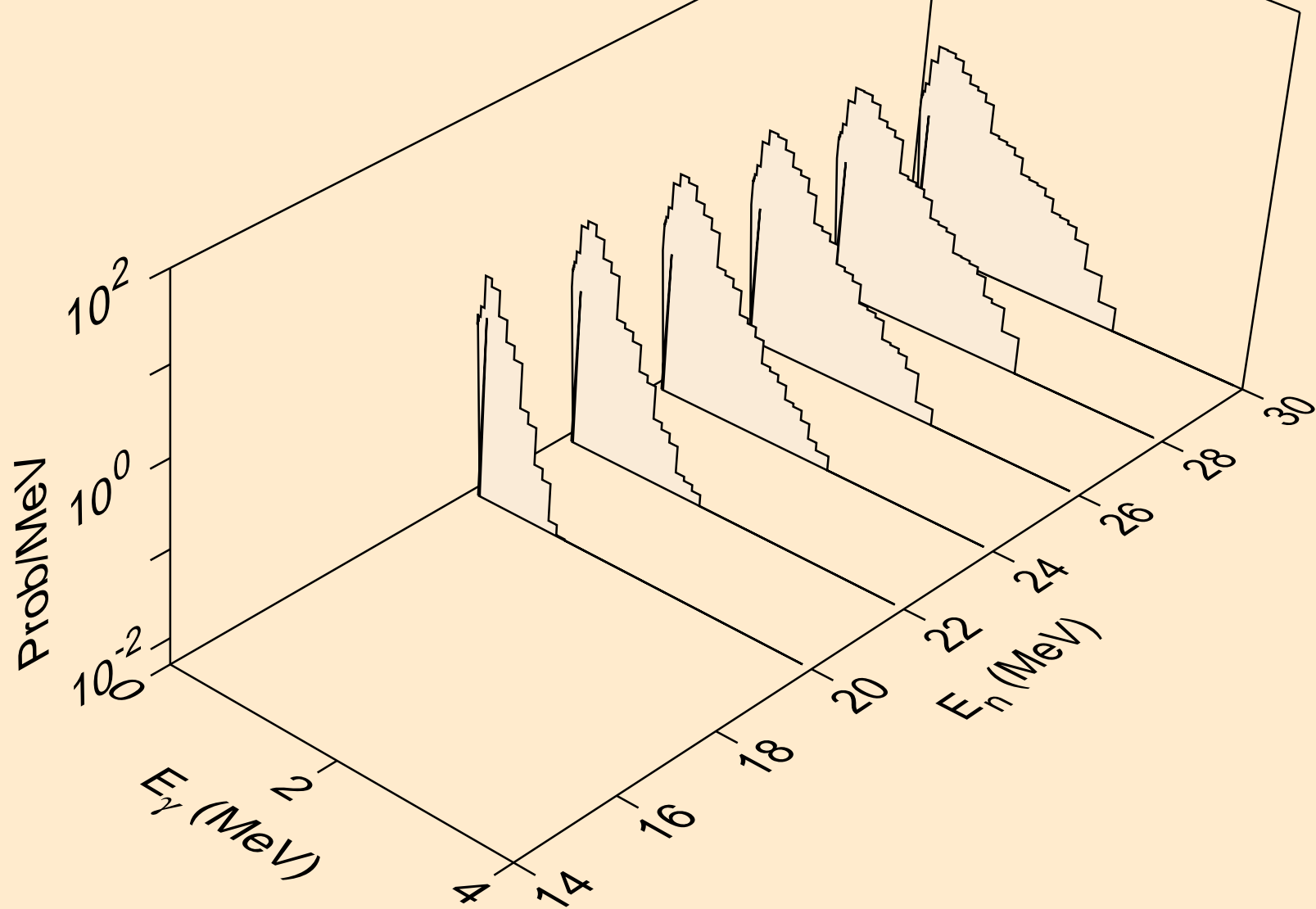

CF242 PROTON ACER TENDL-2021 LIBRARY; T=0.K
Photon emission for (n,npa)

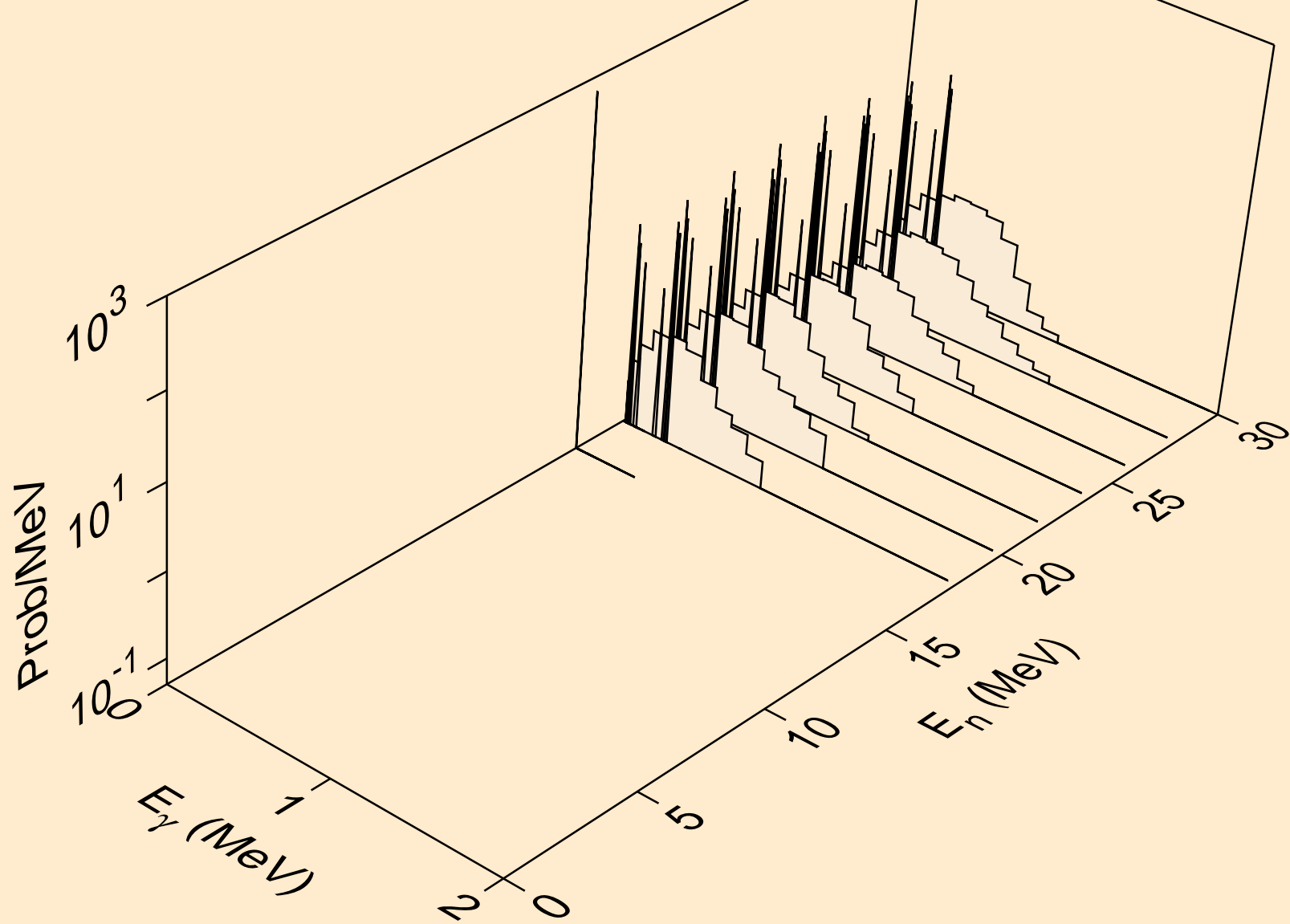

CF242 PROTON ACER TENDL-2021 LIBRARY; T=0.K
Photon emission for (n,gma)

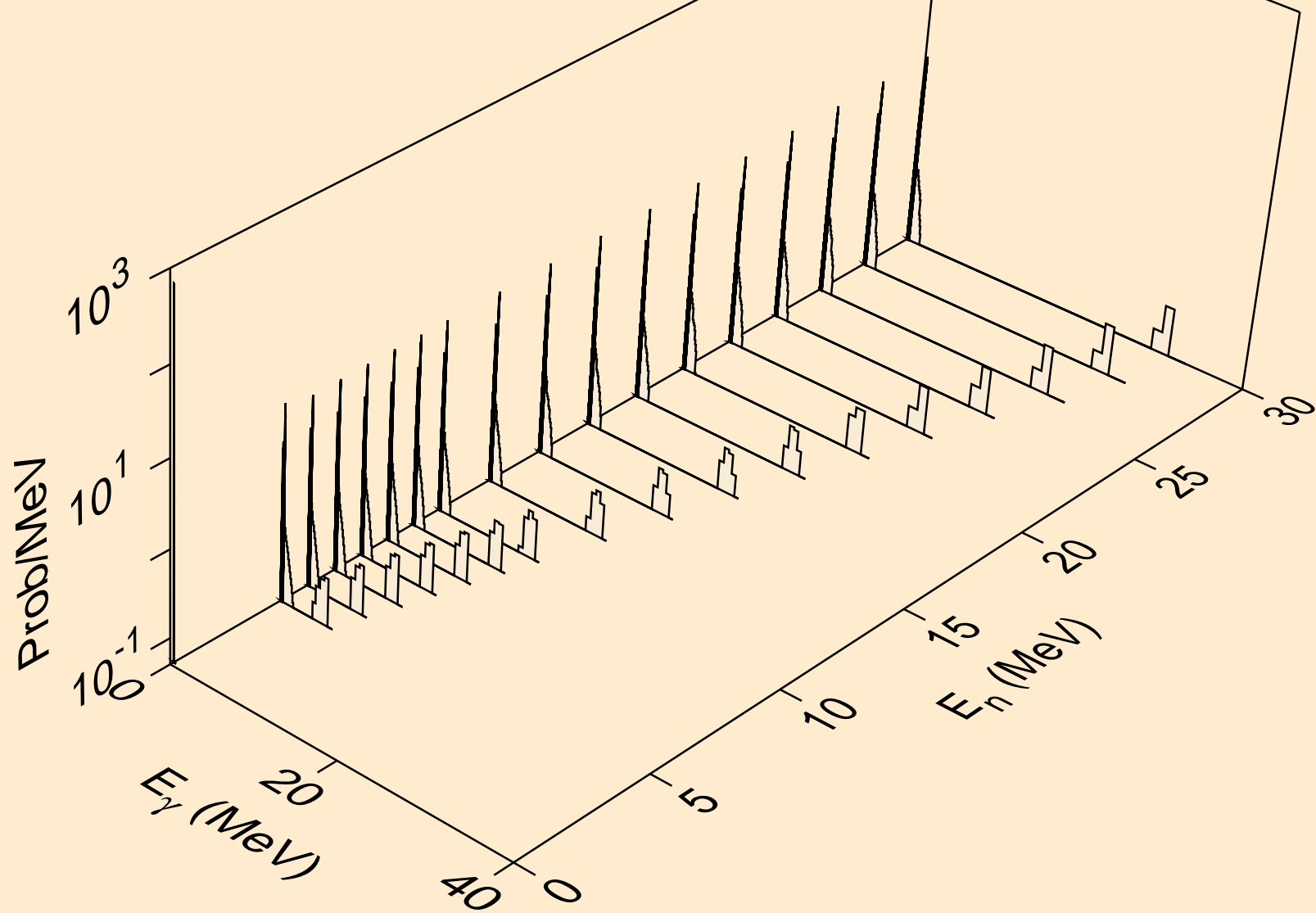

CF242 PROTON ACER TENDL-2021 LIBRARY; T=0.K
Photon emission for inelastic

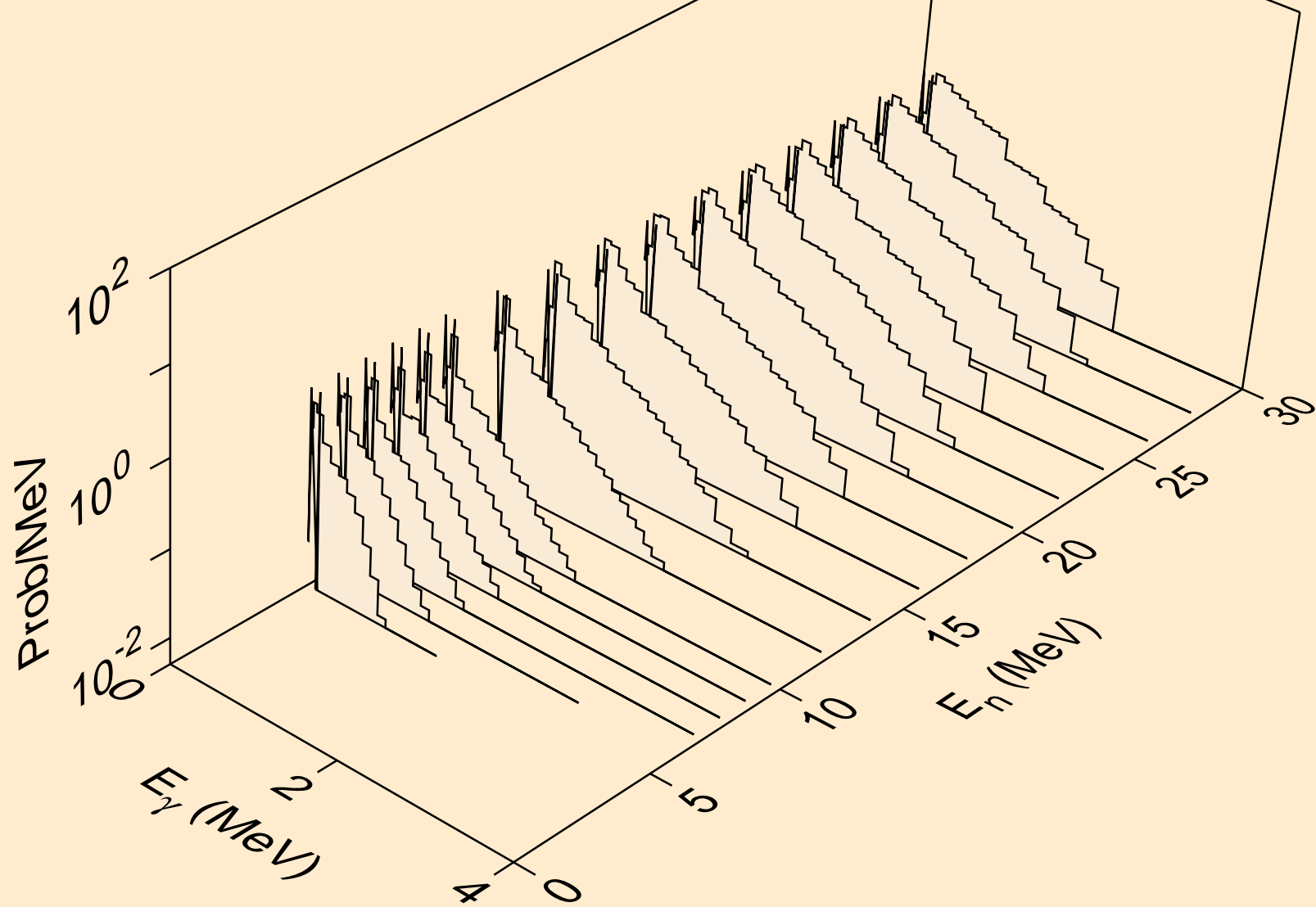

CF242 PROTON ACER TENDL-2021 LIBRARY; T=0.K
Photon emission for (n,d)

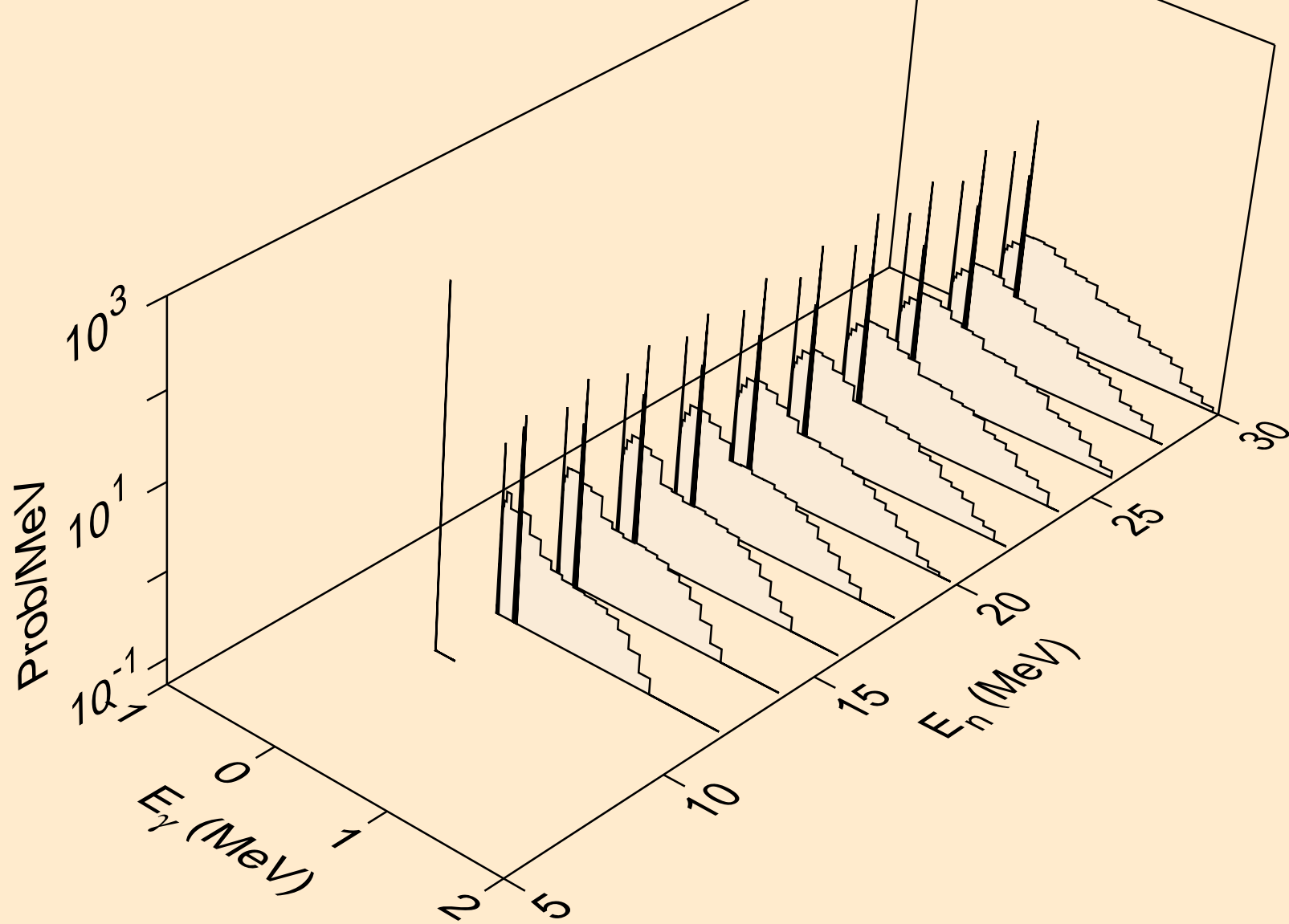

CF242 PROTON ACER TENDL-2021 LIBRARY; T=0.K
Photon emission for (n,t)

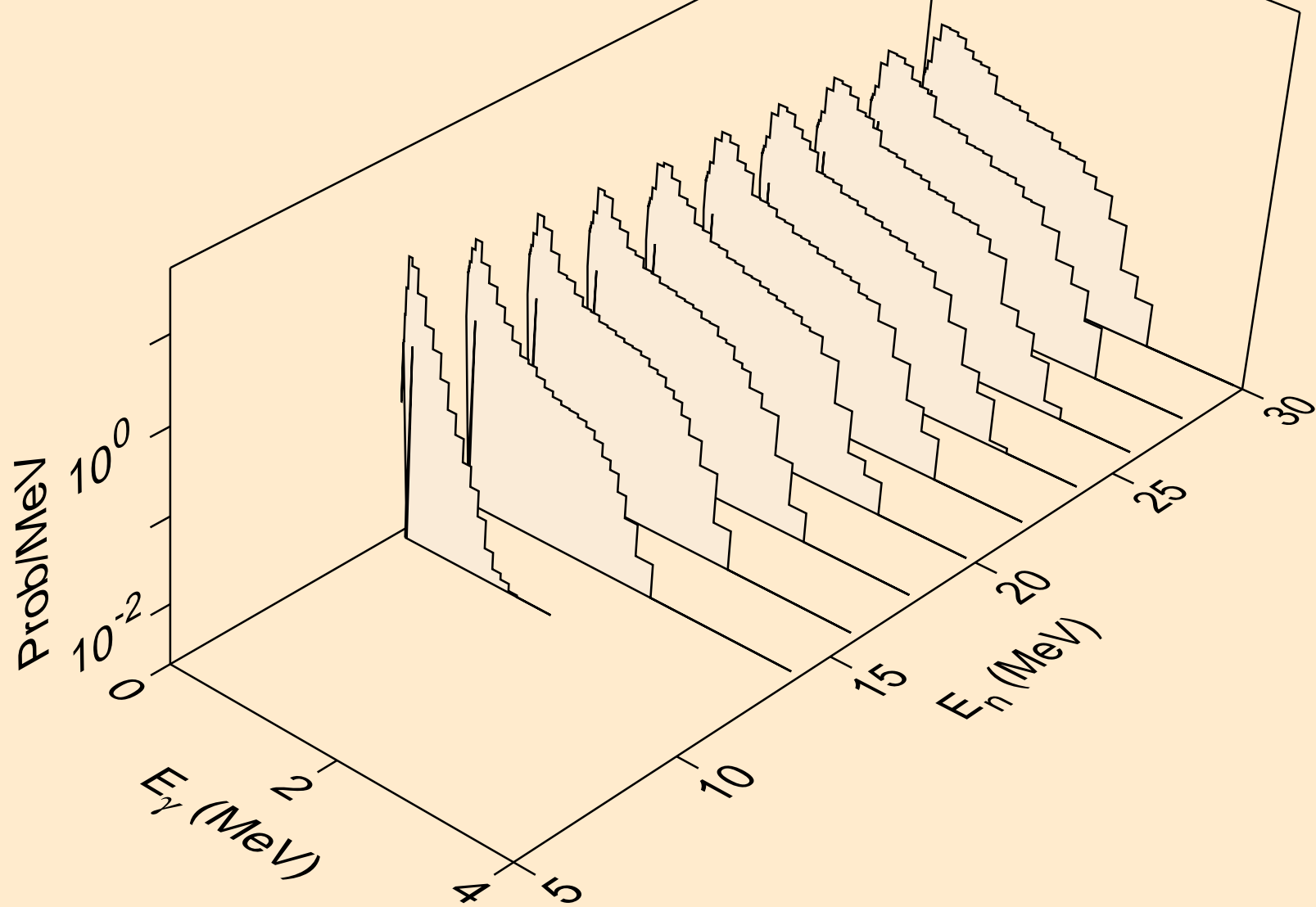

CF242 PROTON ACER TENDL-2021 LIBRARY; T=0.K
Photon emission for (n,he3)

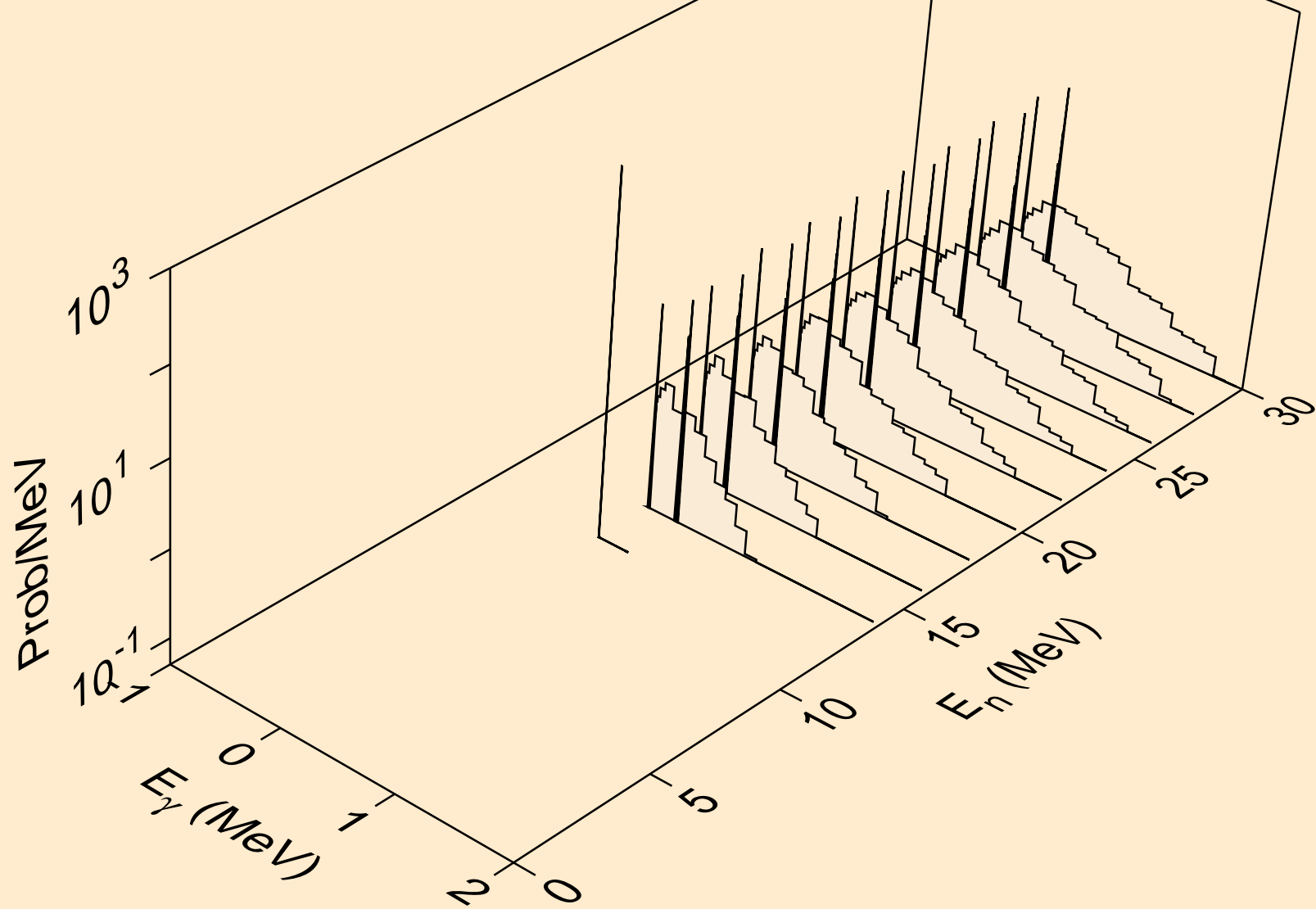

CF242 PROTON ACER TENDL-2021 LIBRARY; T=0.K
Photon emission for (n,a)

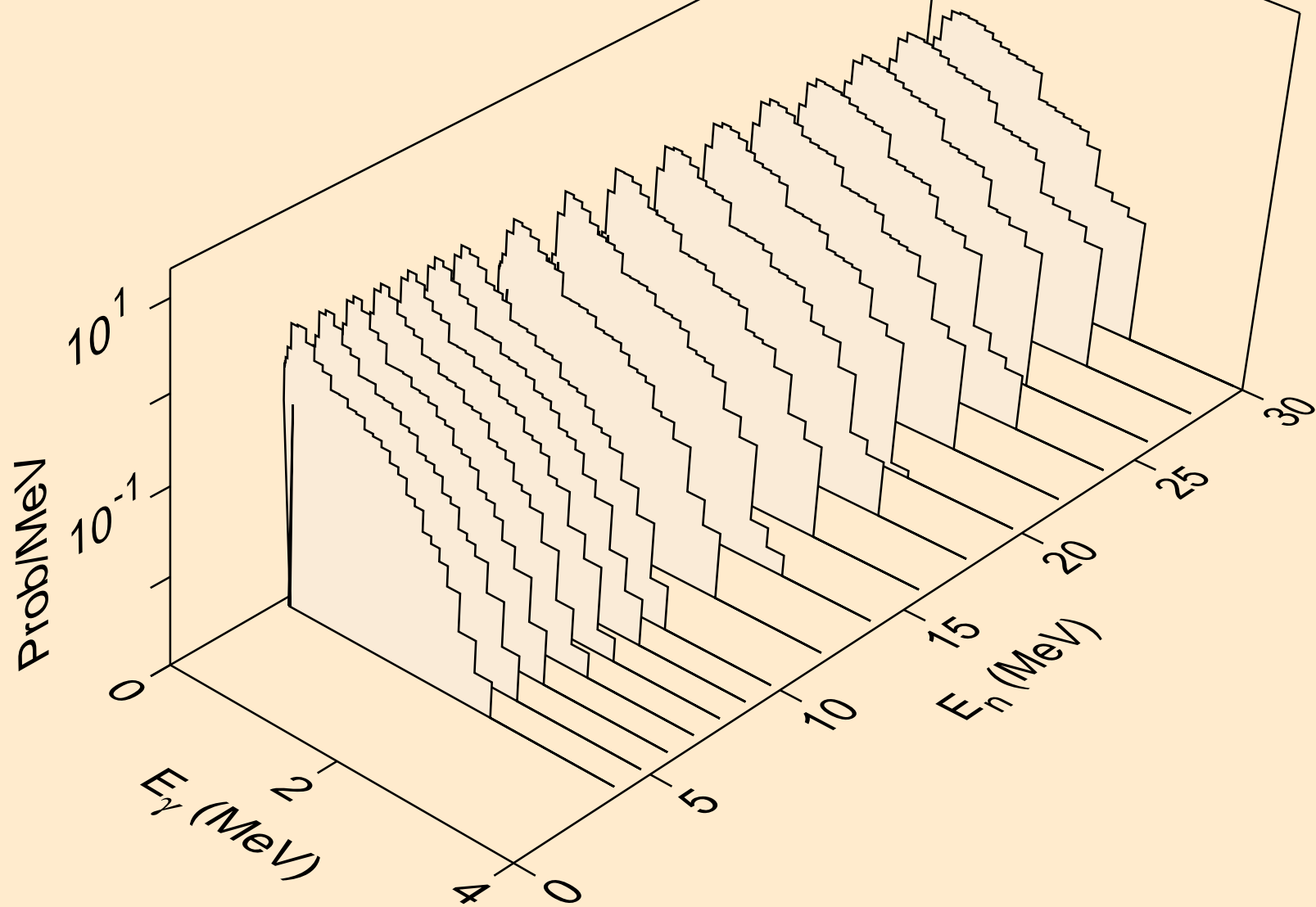

CF242 PROTON ACER TENDL-2021 LIBRARY; T=0.K
Photon emission for (n,2p)

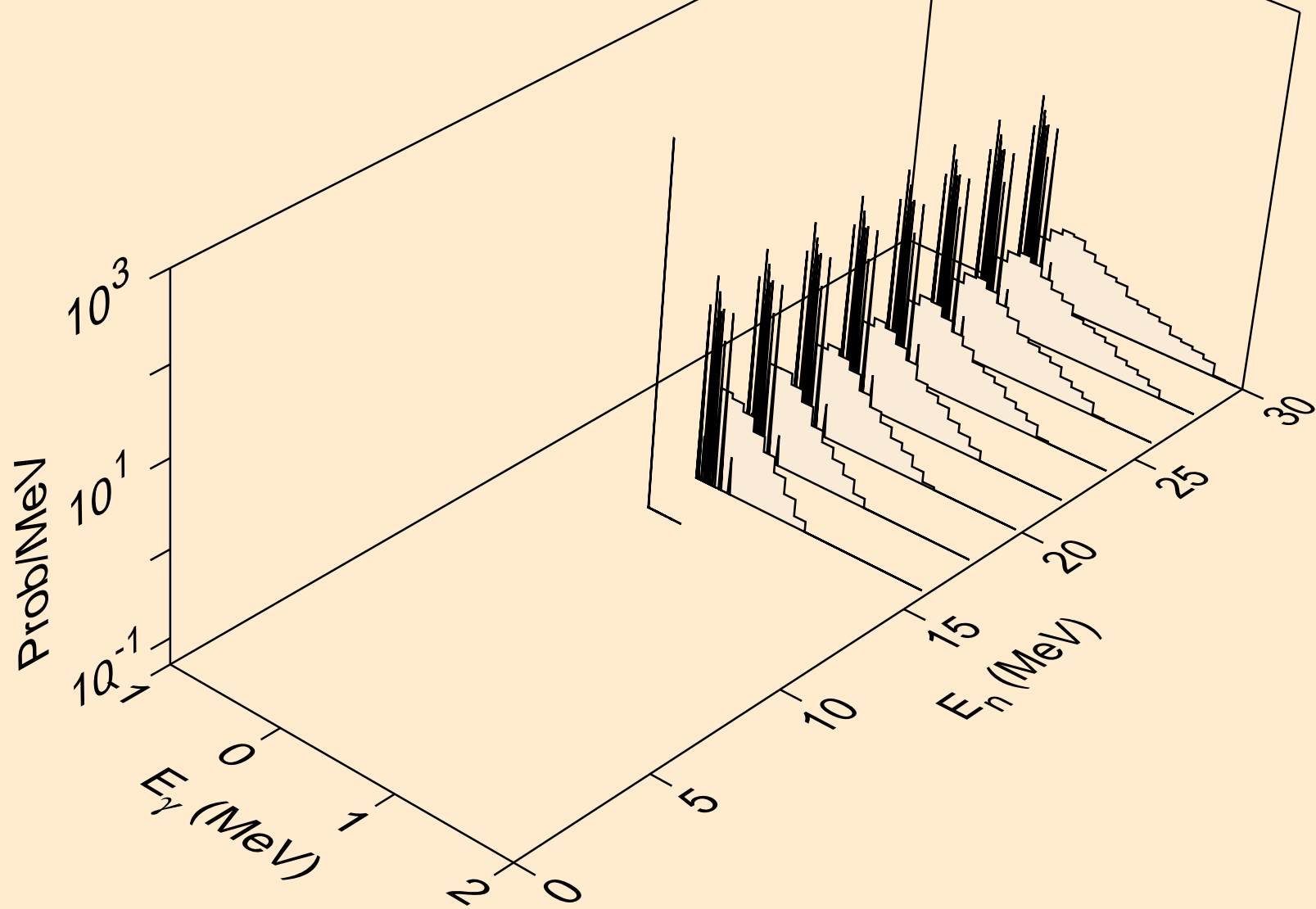

CF242 PROTON ACER TENDL-2021 LIBRARY; T=0.K
Photon emission for (n,da)

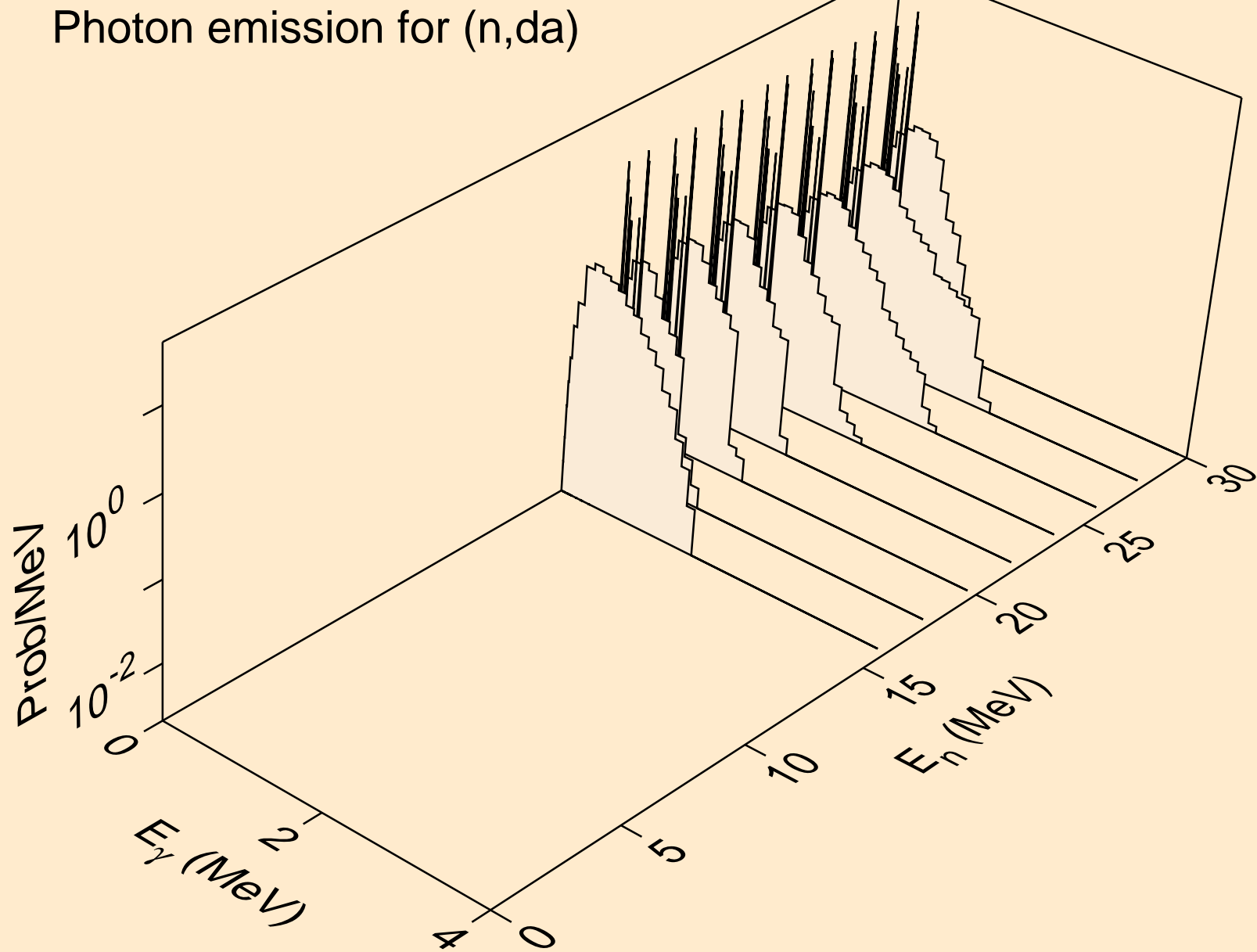

CF242 PROTON ACER TENDL-2021 LIBRARY; T=0.K
Particle heating contributions

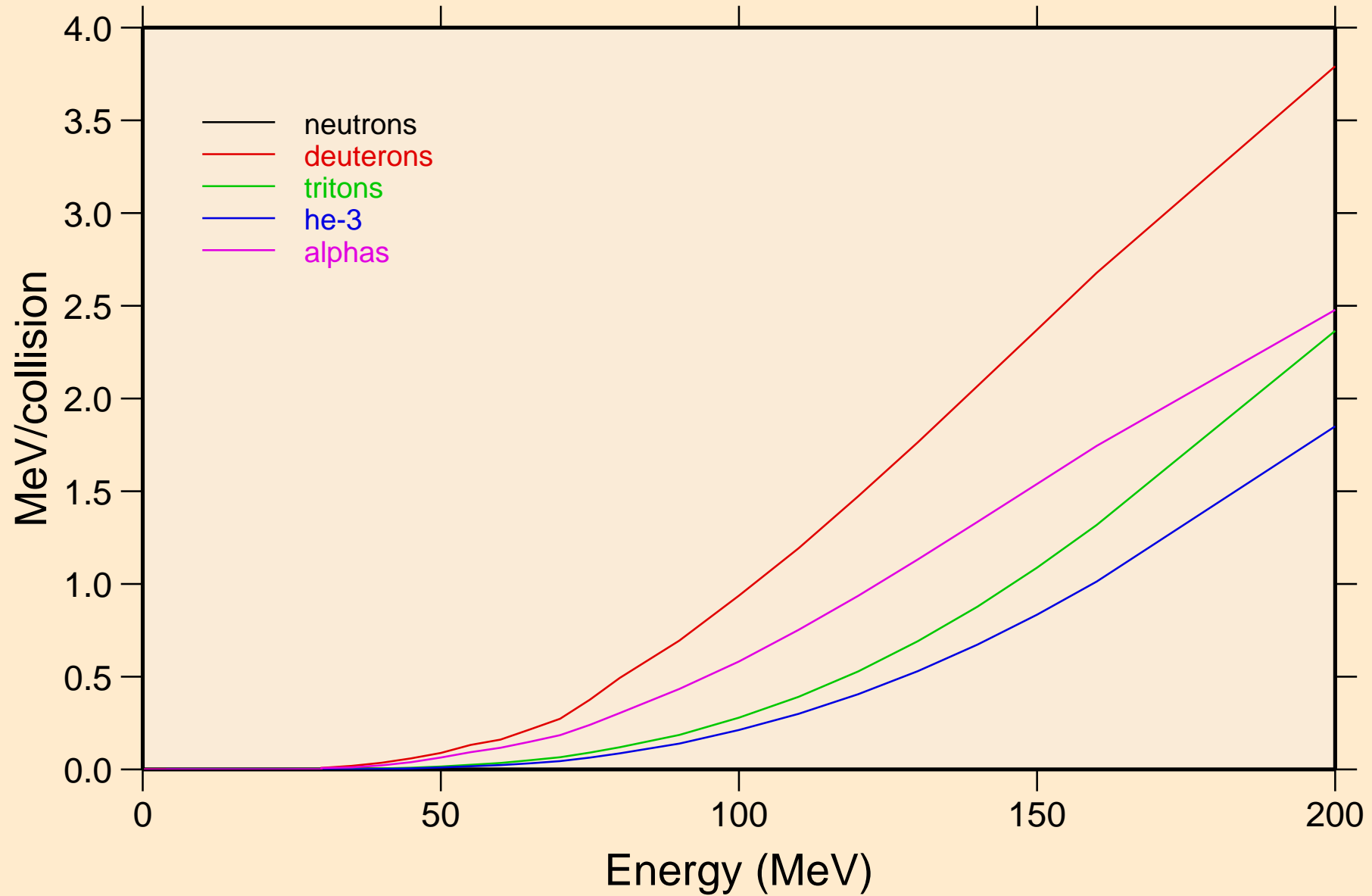

CF242 PROTON ACER TENDL-2021 LIBRARY; T=0.K

Recoil Heating

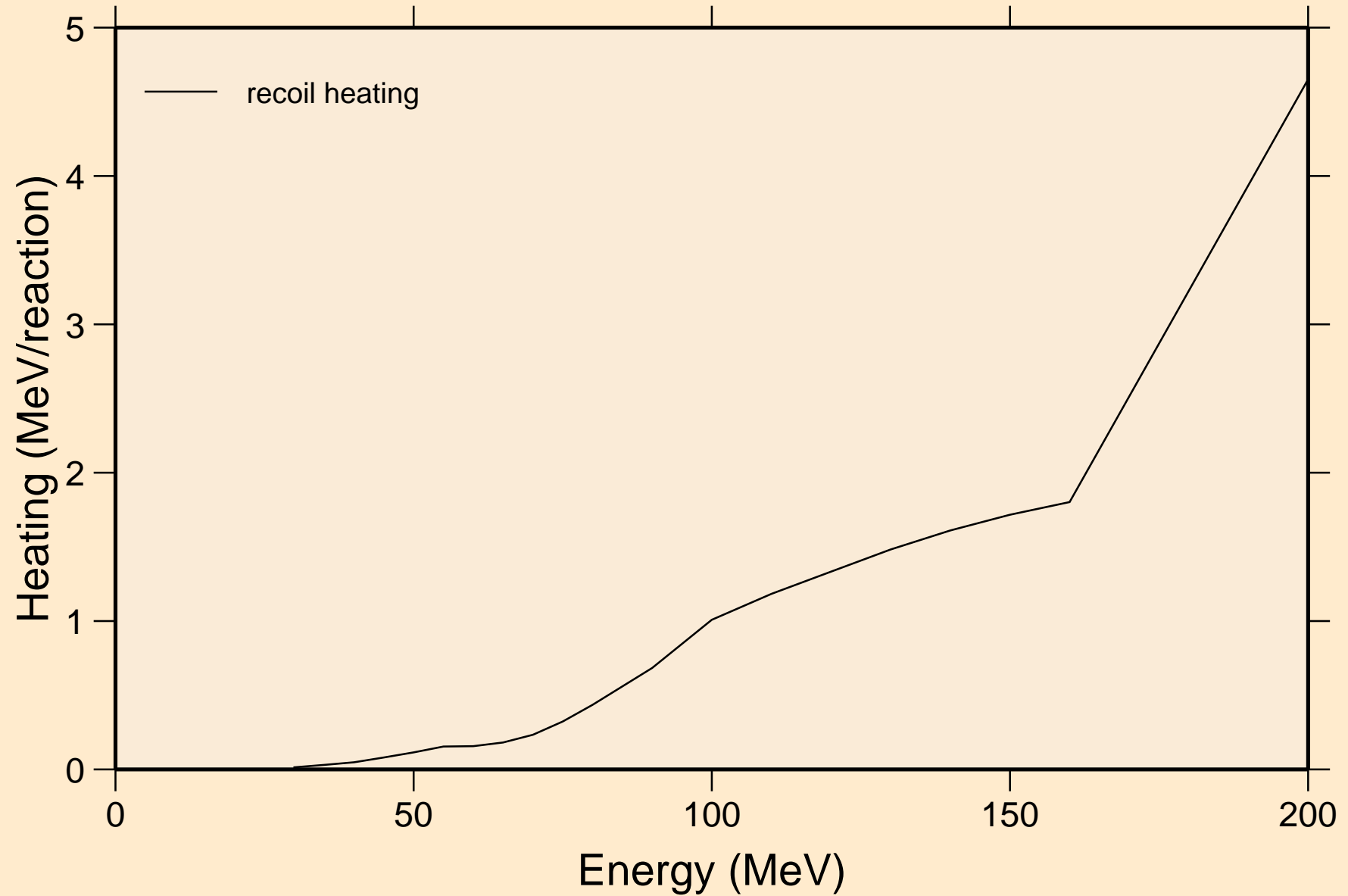

CF242 PROTON ACER TENDL-2021 LIBRARY; T=0.K
Particle production cross sections

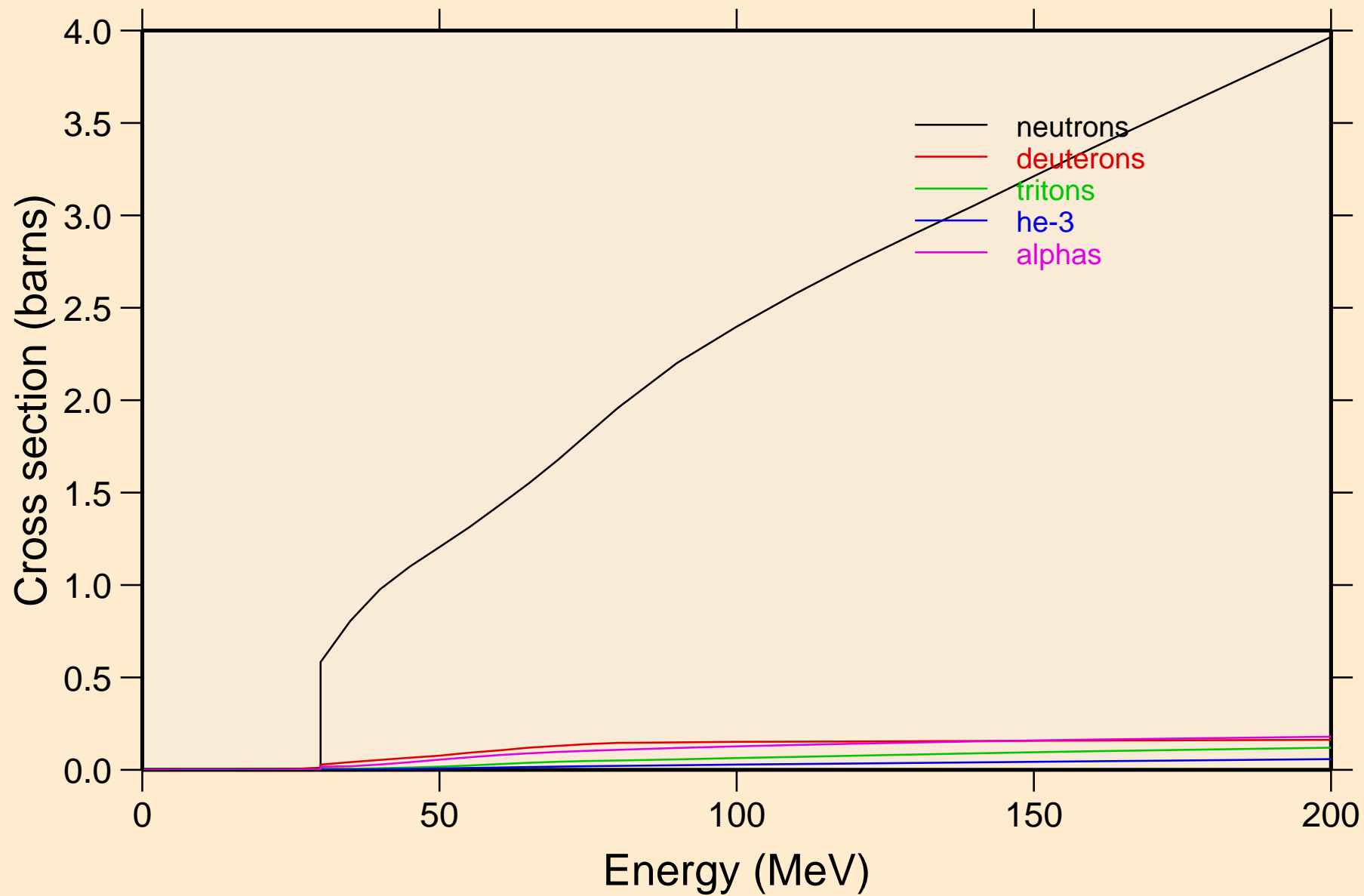

CF242 PROTON ACER TENDL-2021 LIBRARY; T=0.K
neutrons from (p,n)

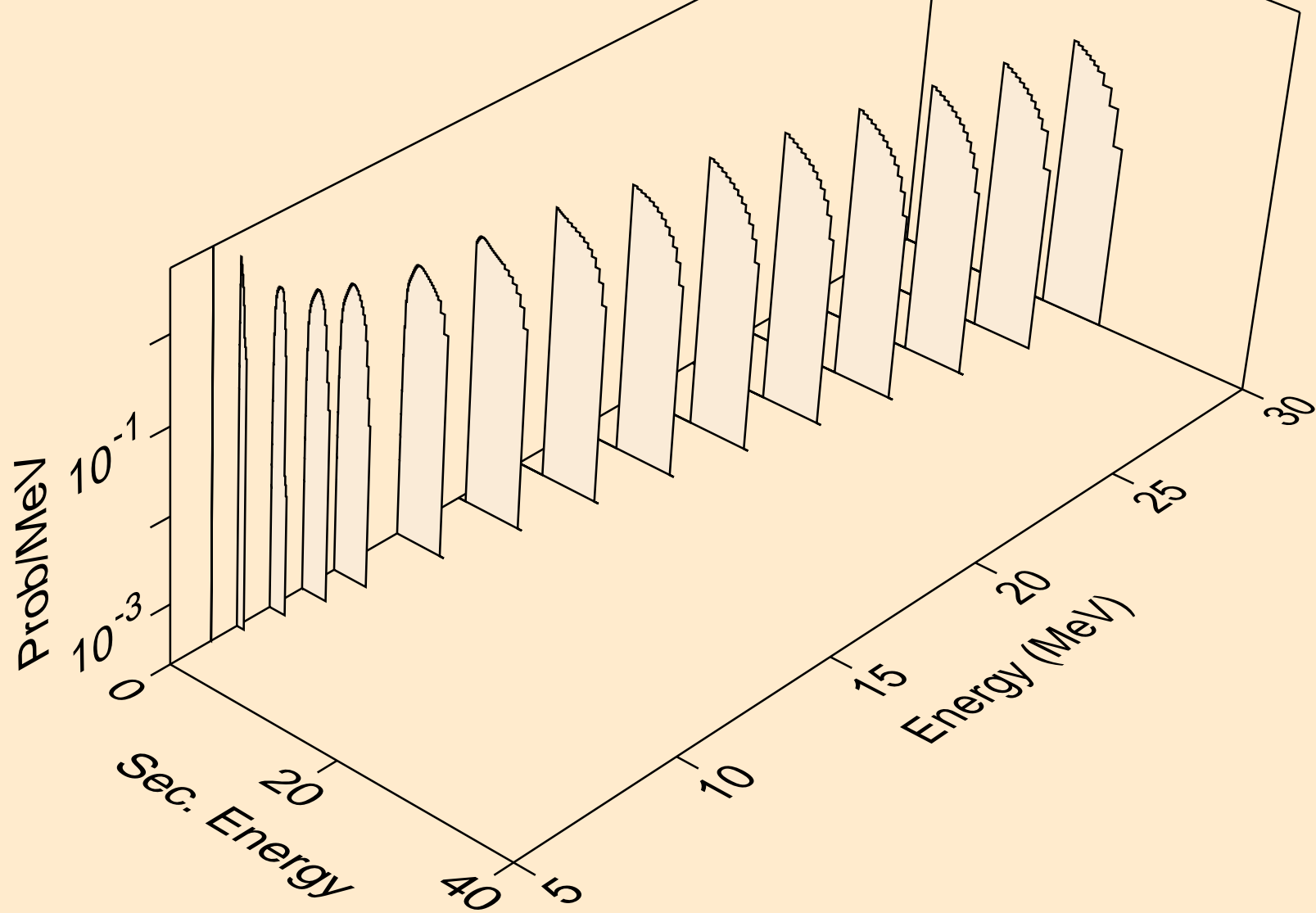

CF242 PROTON ACER TENDL-2021 LIBRARY; T=0.K
neutrons from (p,x)

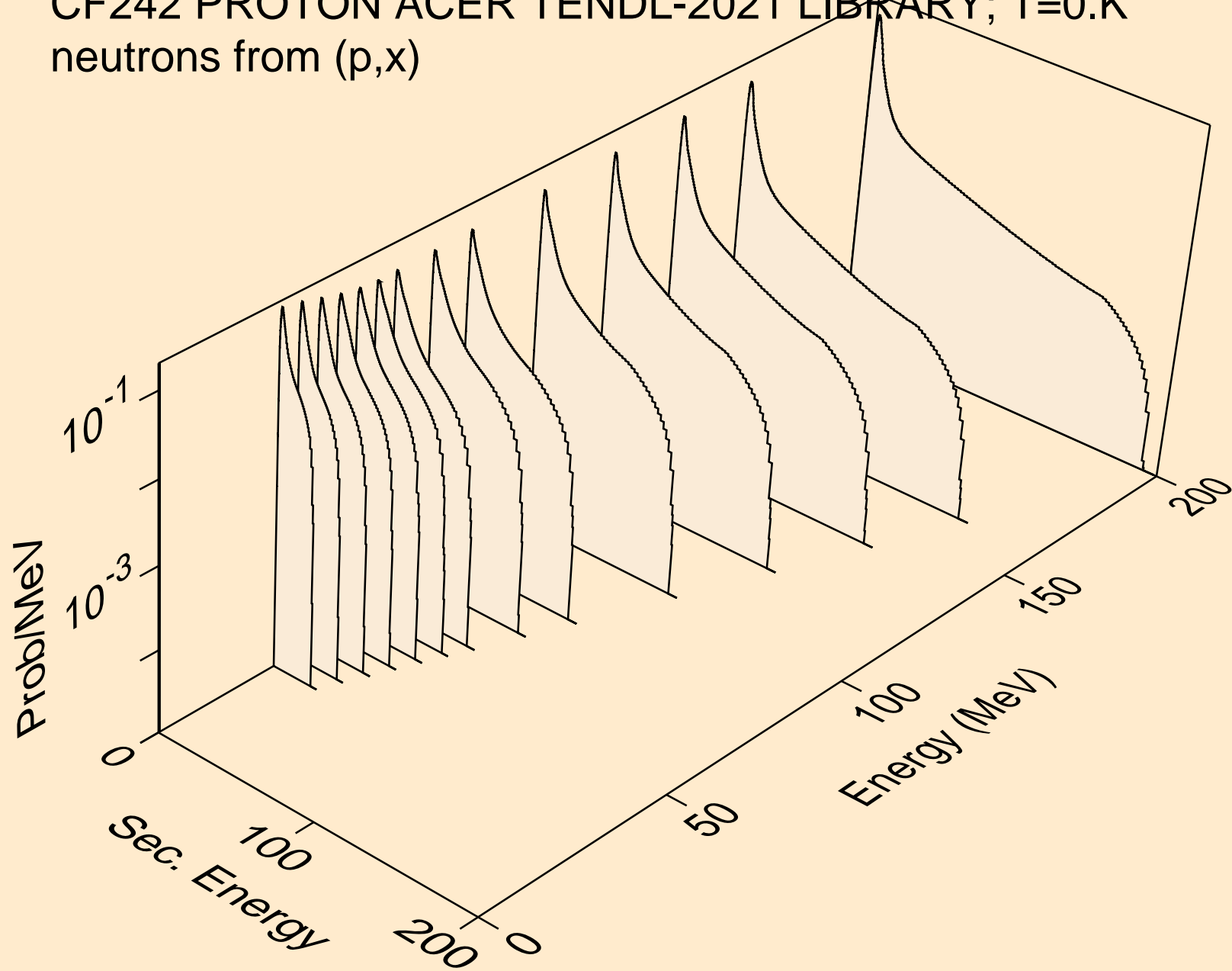

CF242 PROTON ACER TENDL-2021 LIBRARY; T=0.K
neutrons from (p,2n)

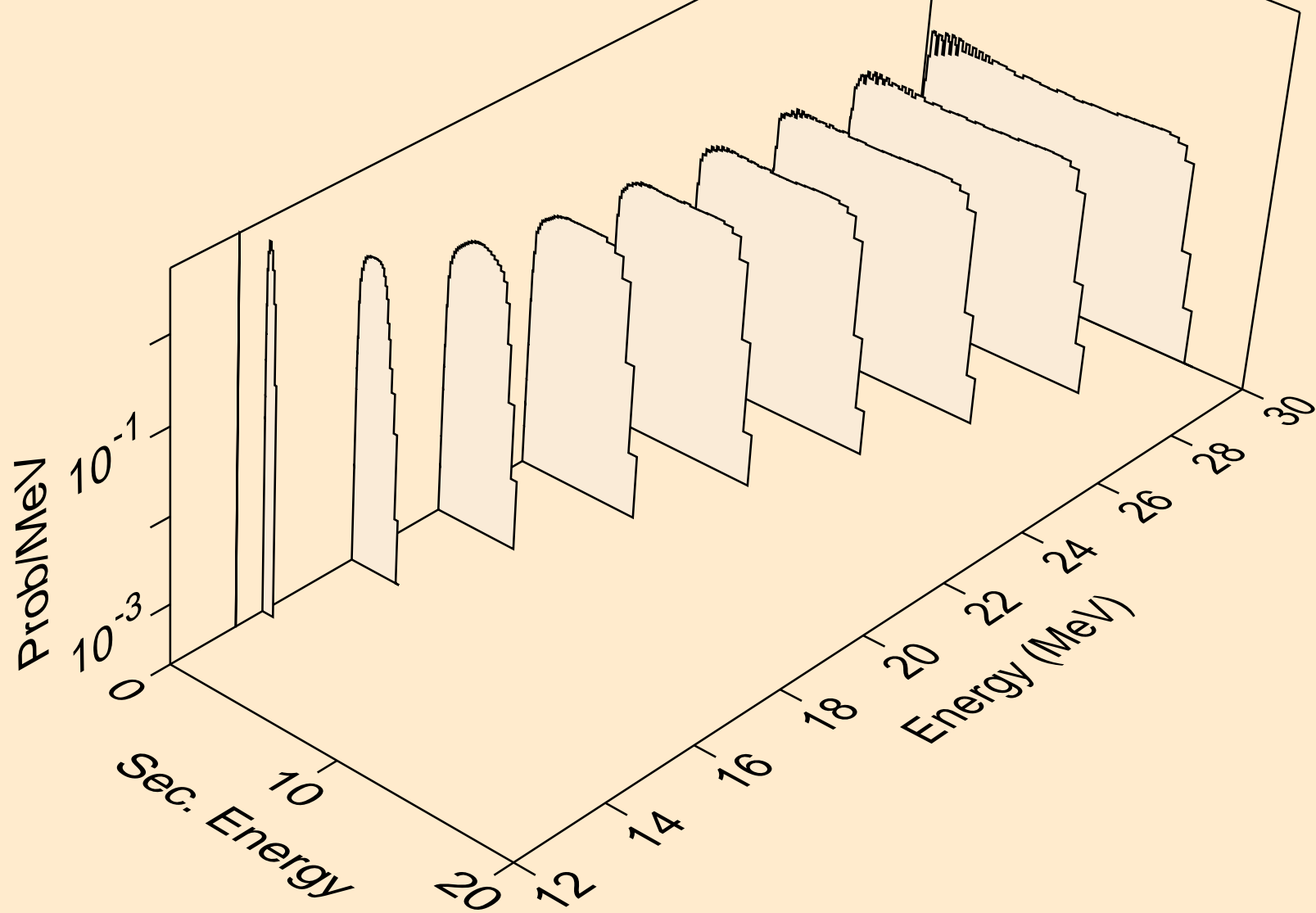

CF242 PROTON ACER TENDL-2021 LIBRARY; T=0.K
neutrons from (p,3n)

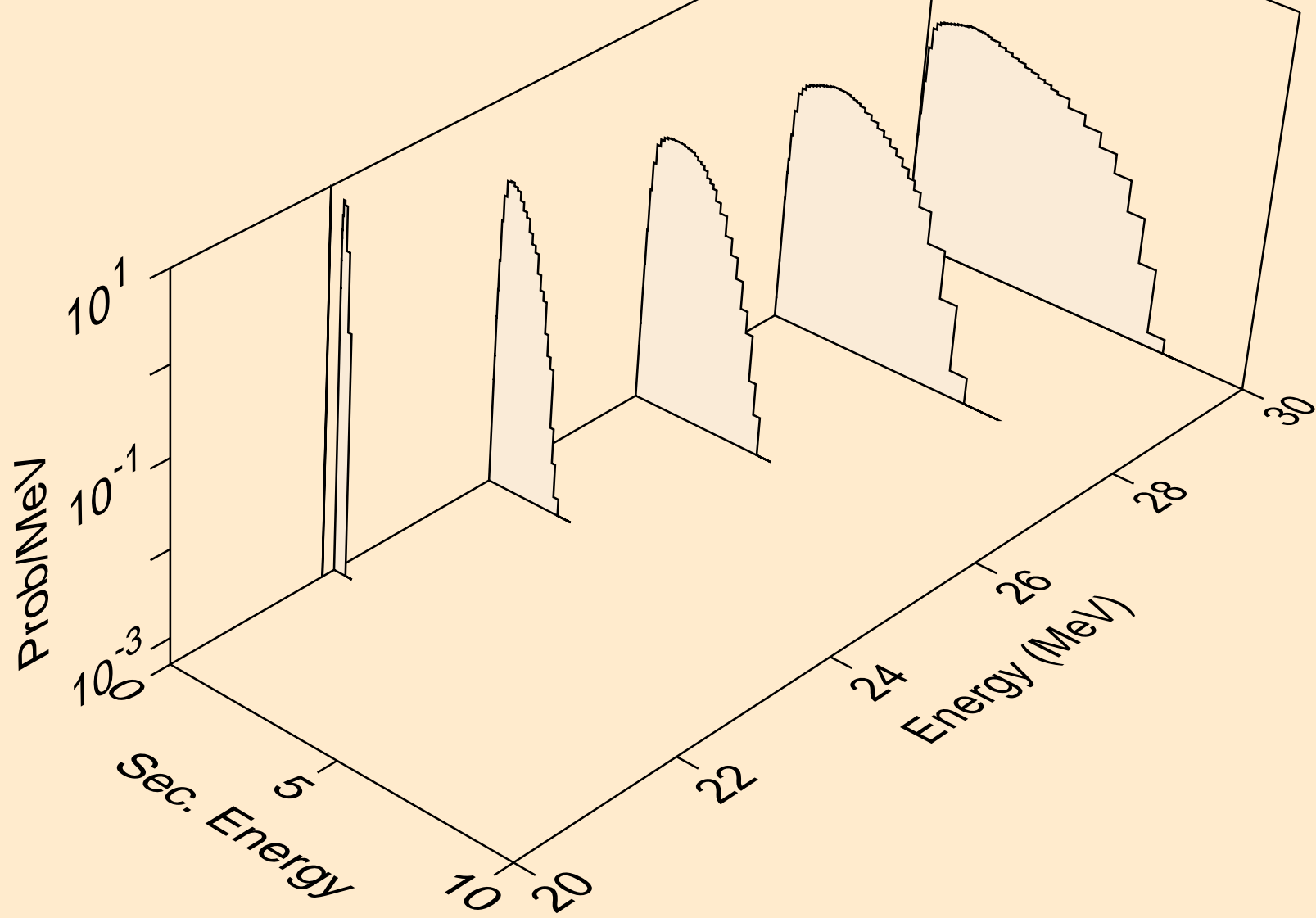

CF242 PROTON ACER TENDL-2021 LIBRARY; T=0.K
neutrons from (p,n*)a

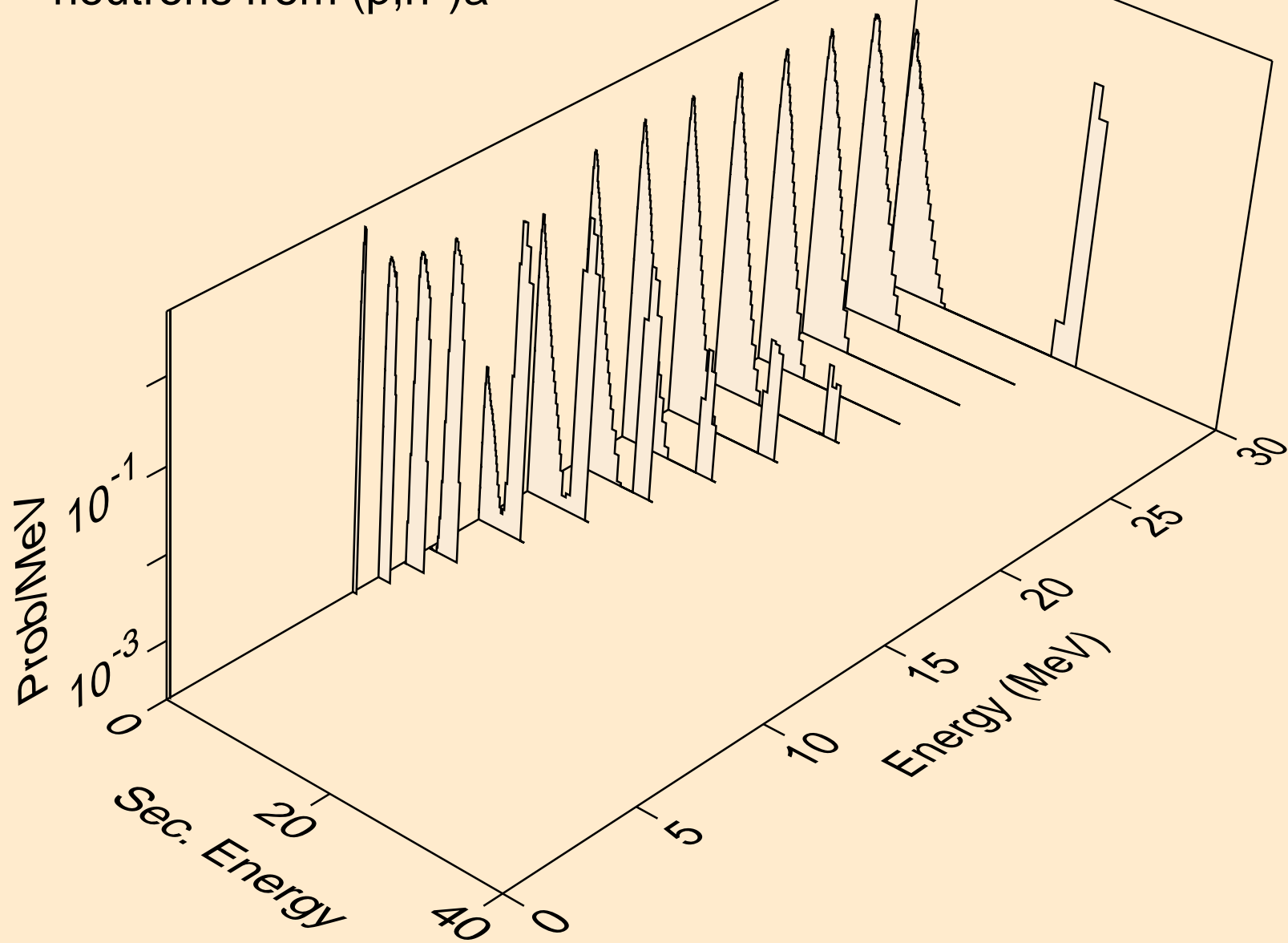

CF242 PROTON ACER TENDL-2021 LIBRARY; T=0.K
neutrons from (p,2n)a

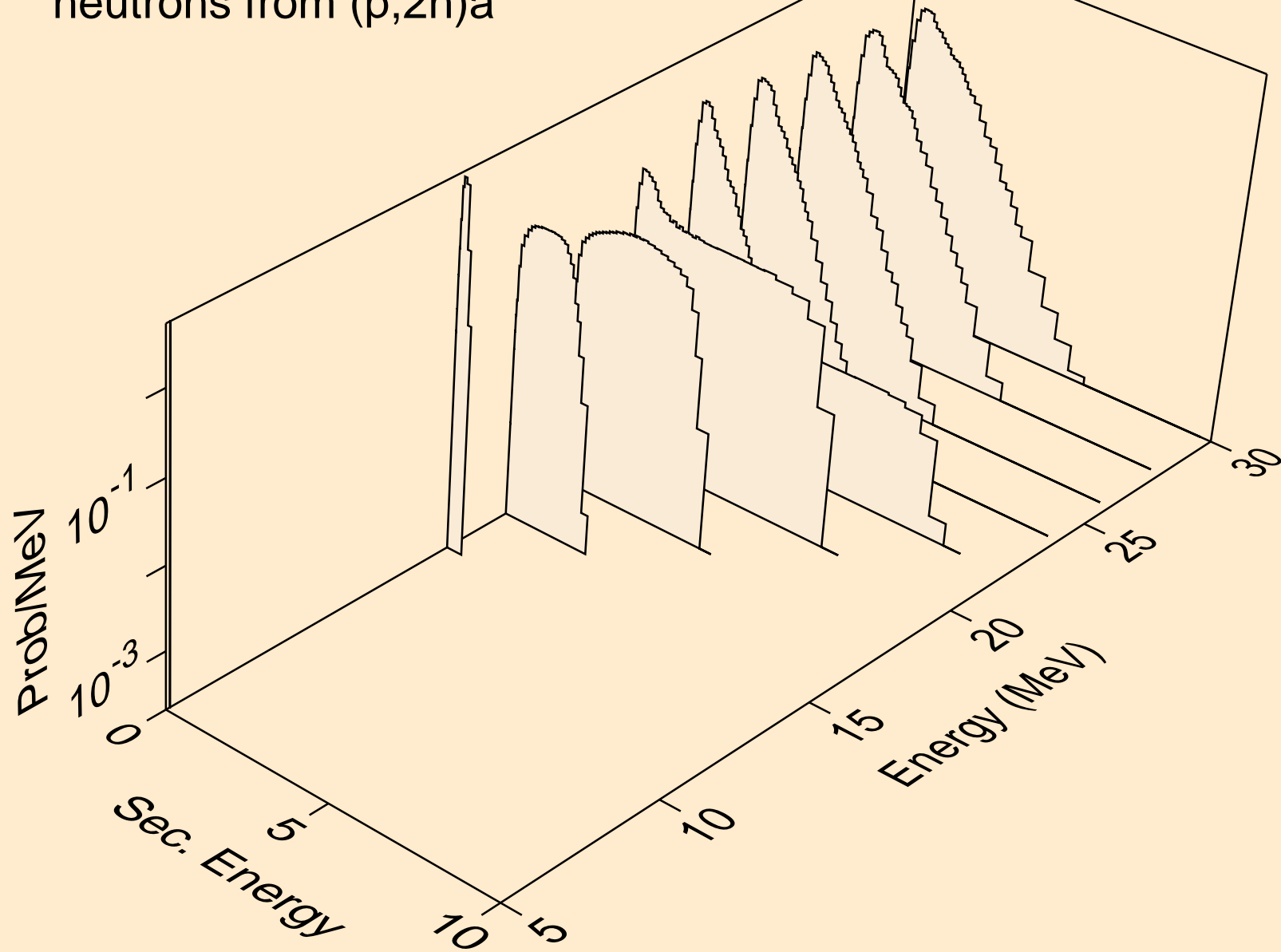

CF242 PROTON ACER TENDL-2021 LIBRARY; T=0.K
neutrons from (p,n*)p

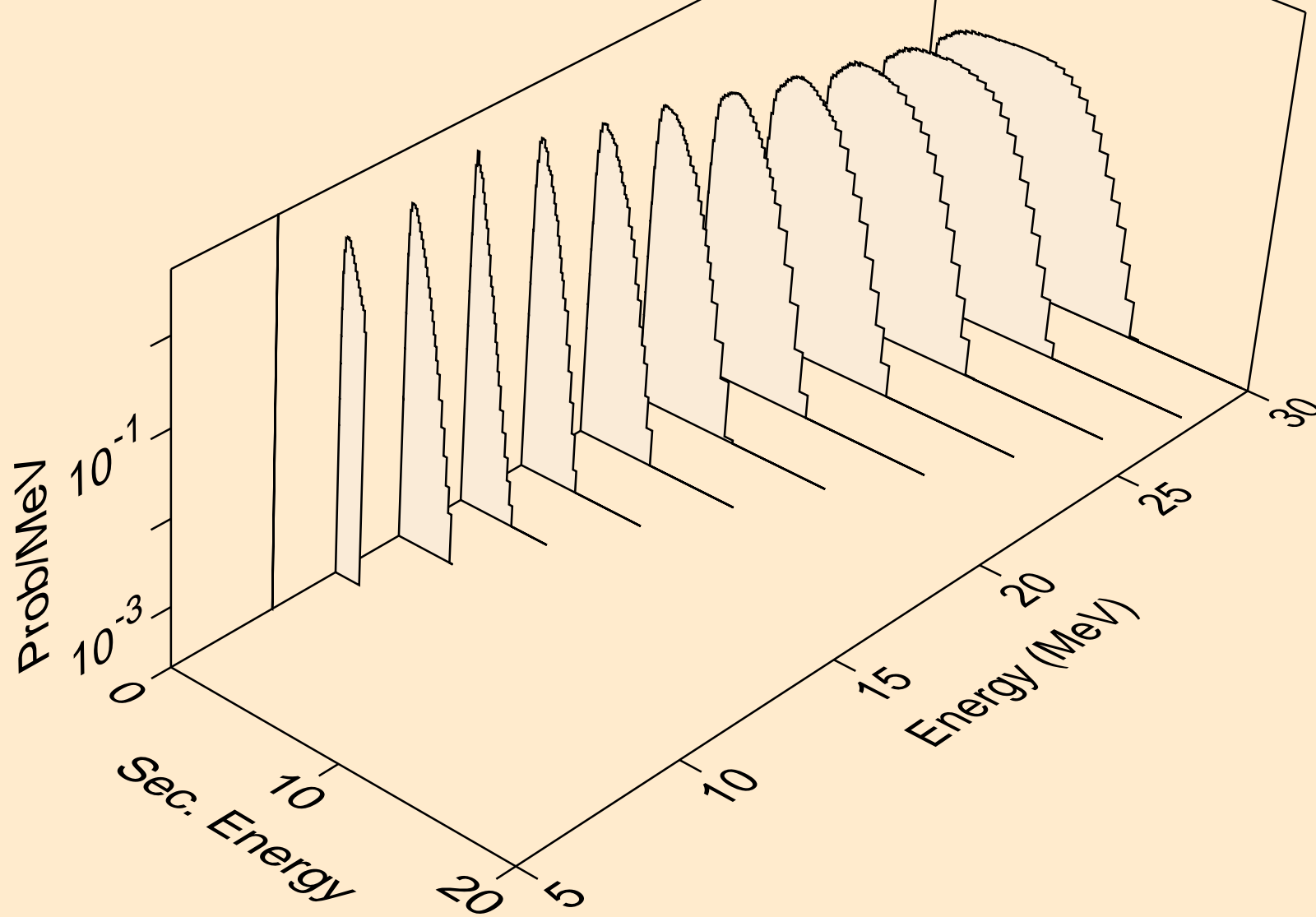

CF242 PROTON ACER TENDL-2021 LIBRARY; T=0.K
neutrons from (p,n*)d

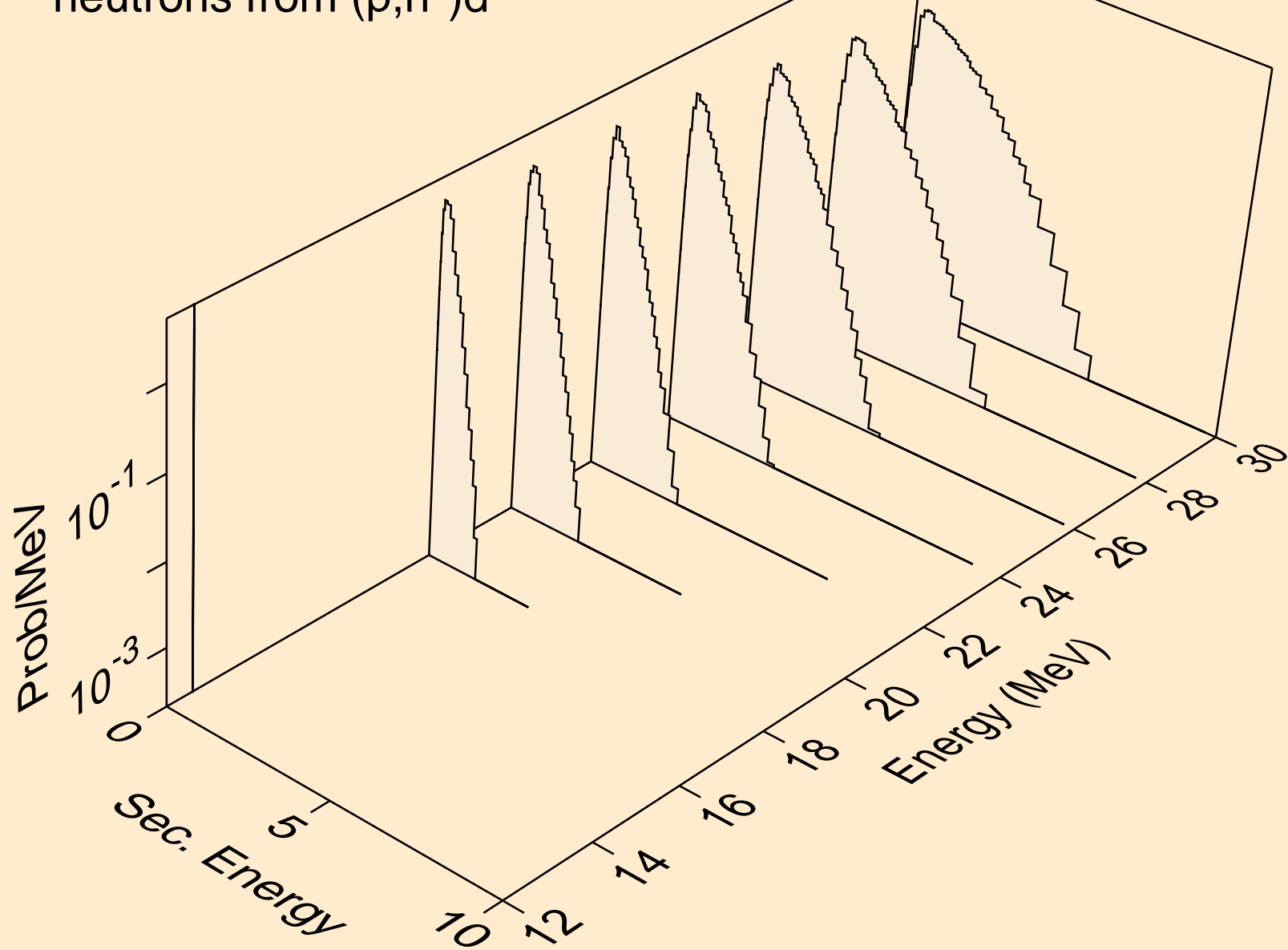

CF242 PROTON ACER TENDL-2021 LIBRARY; T=0.K
neutrons from (p,n*)t

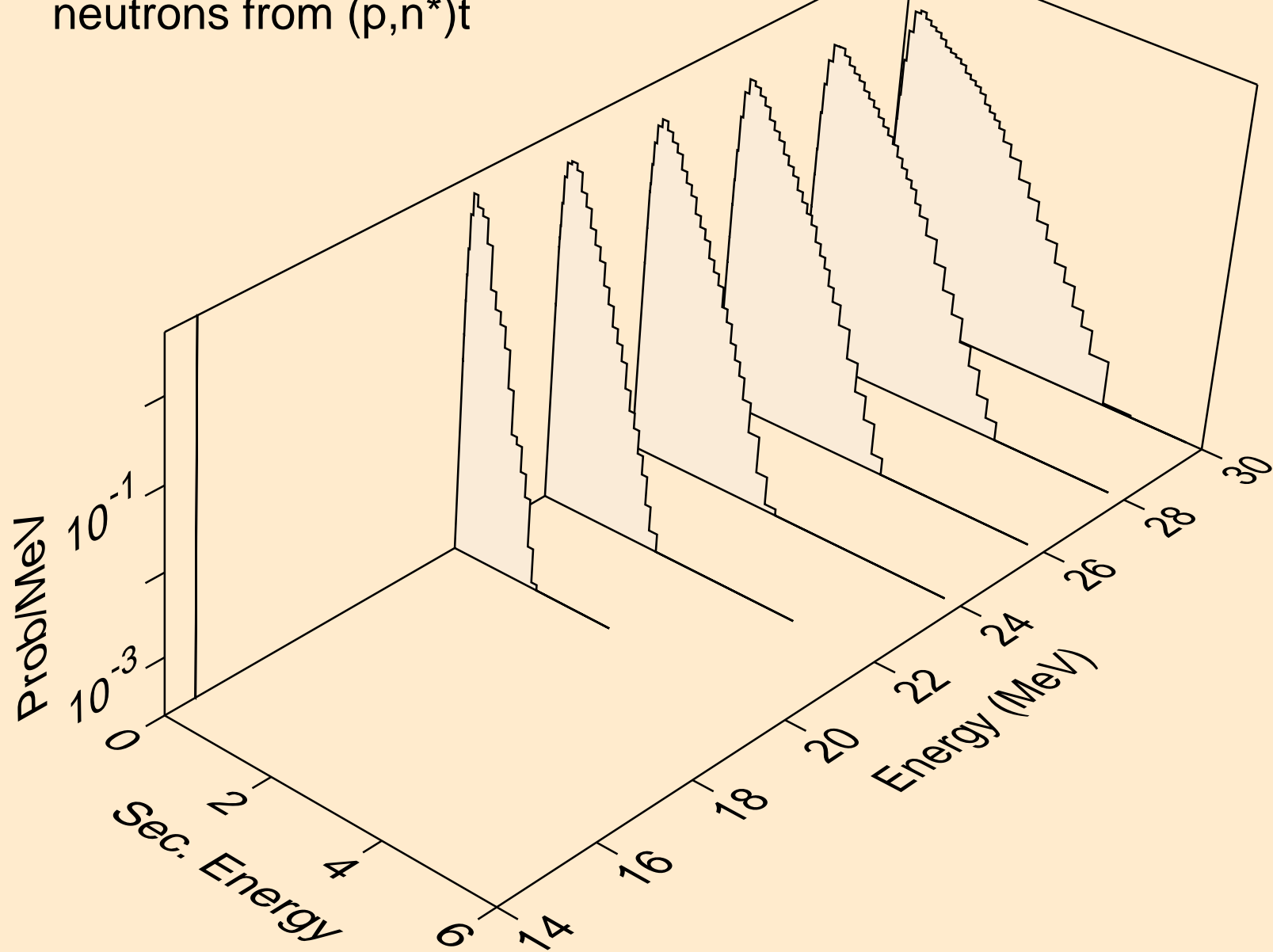

CF242 PROTON ACER TENDL-2021 LIBRARY; T=0.K
neutrons from (p,2np)

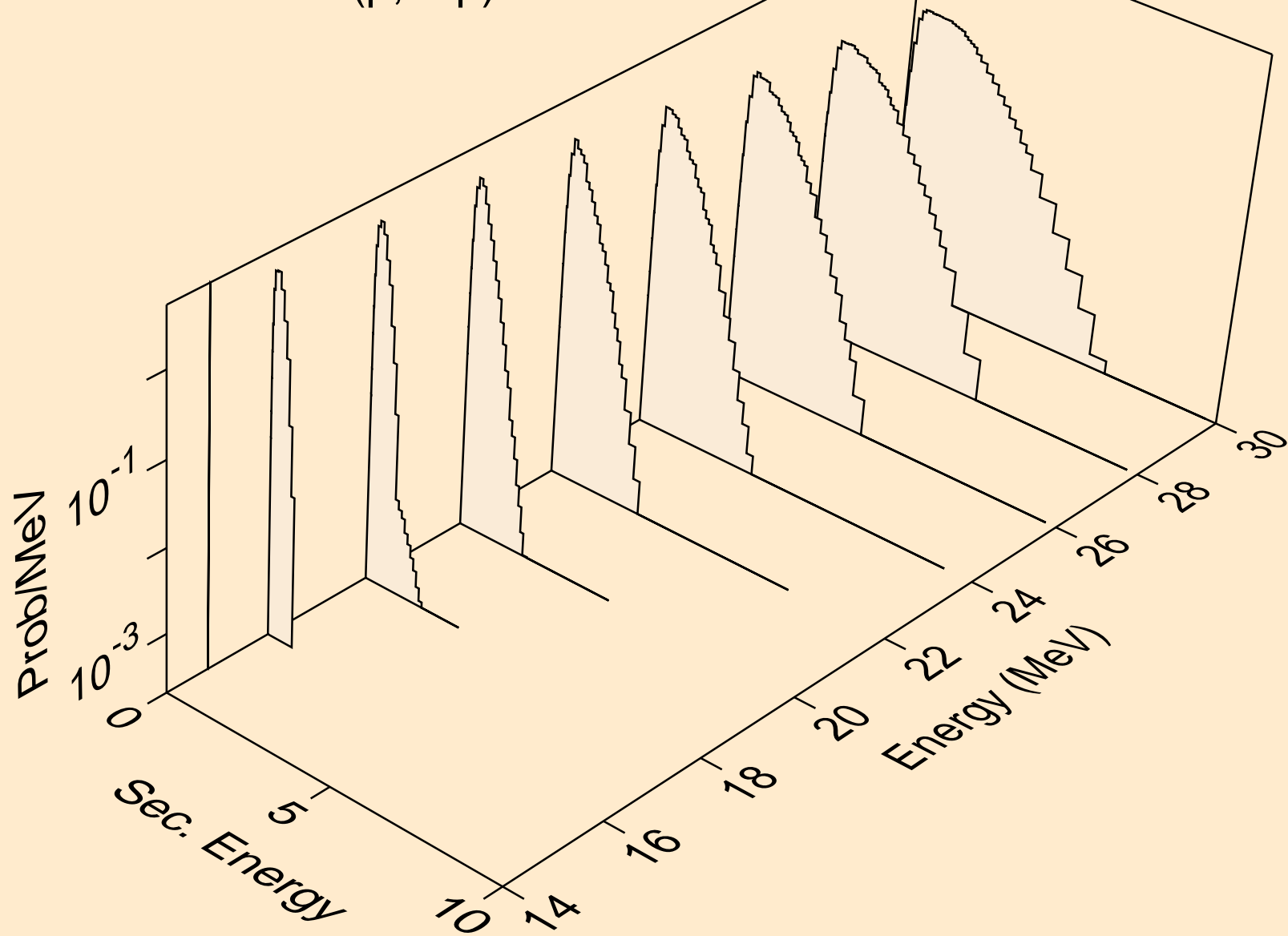

CF242 PROTON ACER TENDL-2021 LIBRARY; T=0.K
neutrons from (p,npa)

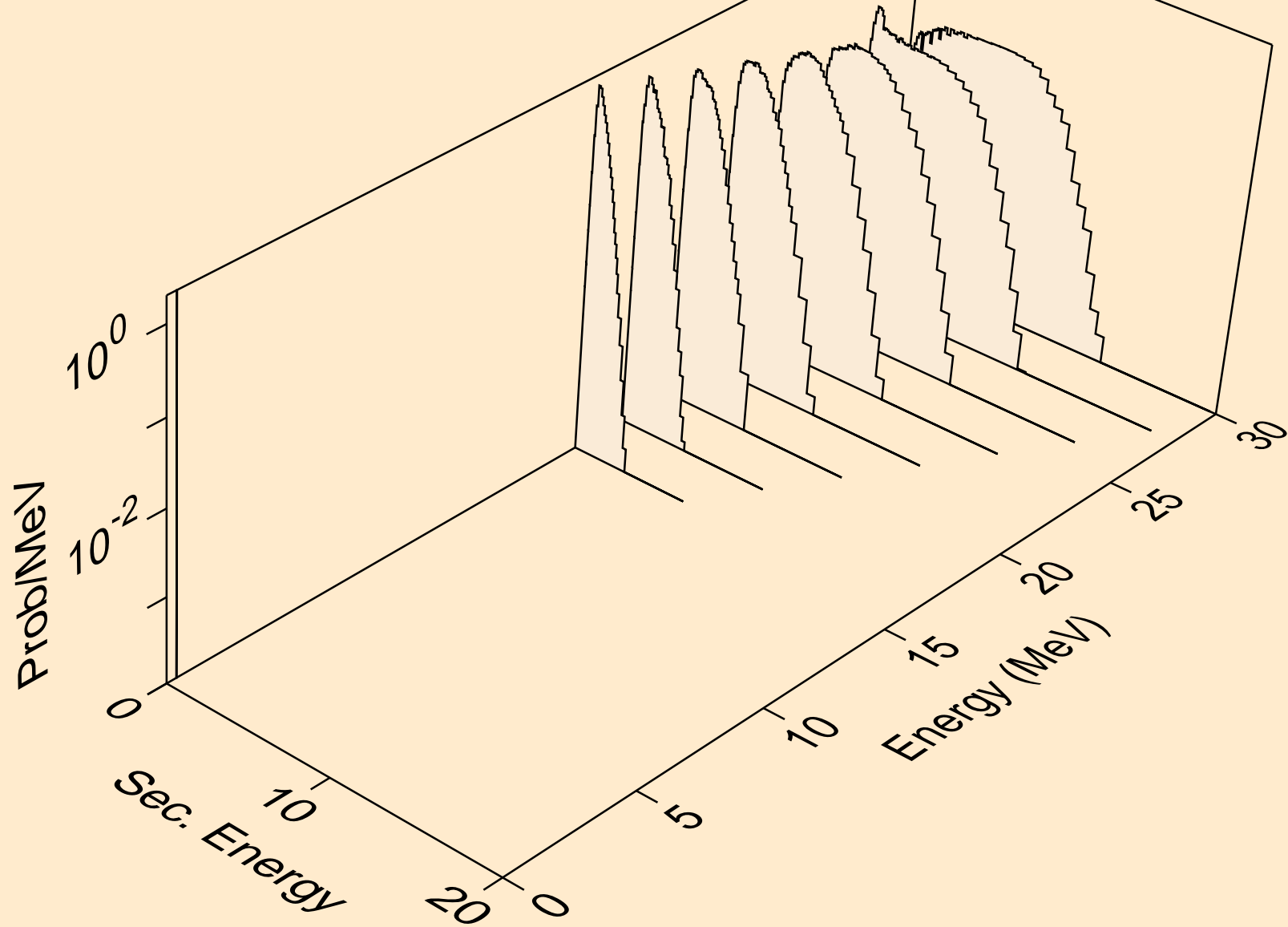

CF242 PROTON ACER TENDL-2021 LIBRARY; T=0.K
deuterons from (p,x)

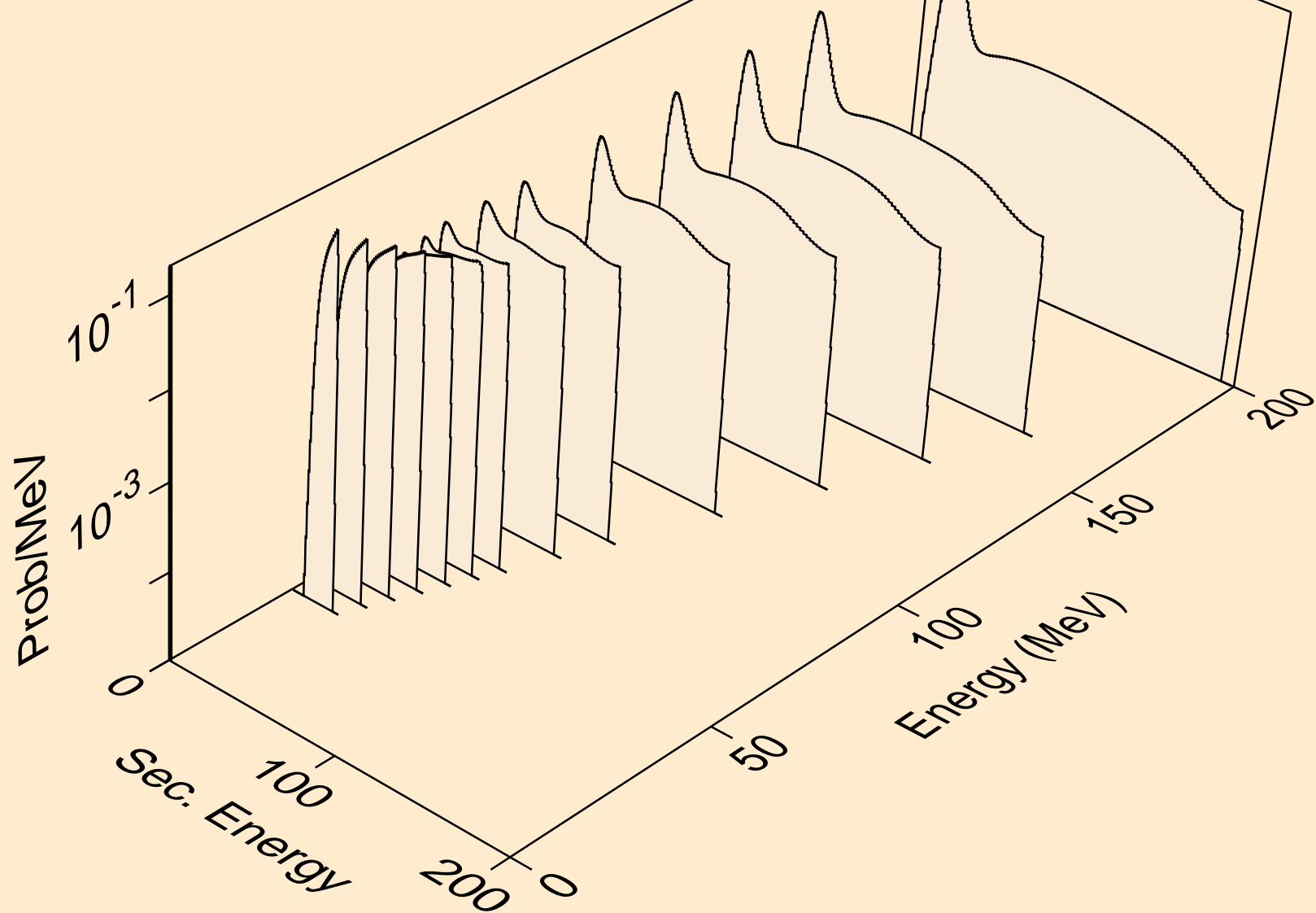

CF242 PROTON ACER TENDL-2021 LIBRARY; T=0.K
deuterons from (p,n*)d

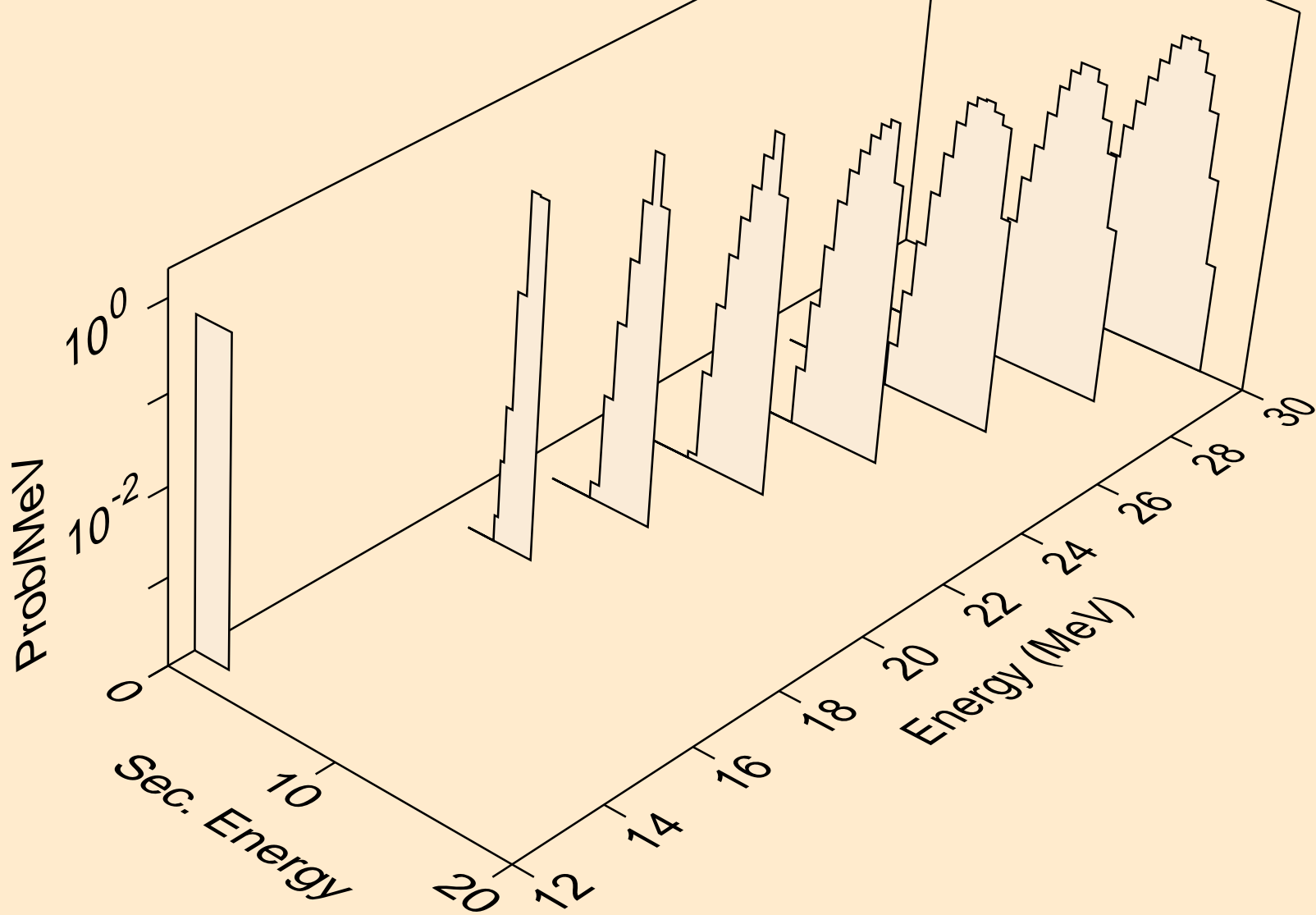

CF242 PROTON ACER TENDL-2021 LIBRARY; T=0.K
deuterons from (p,d)

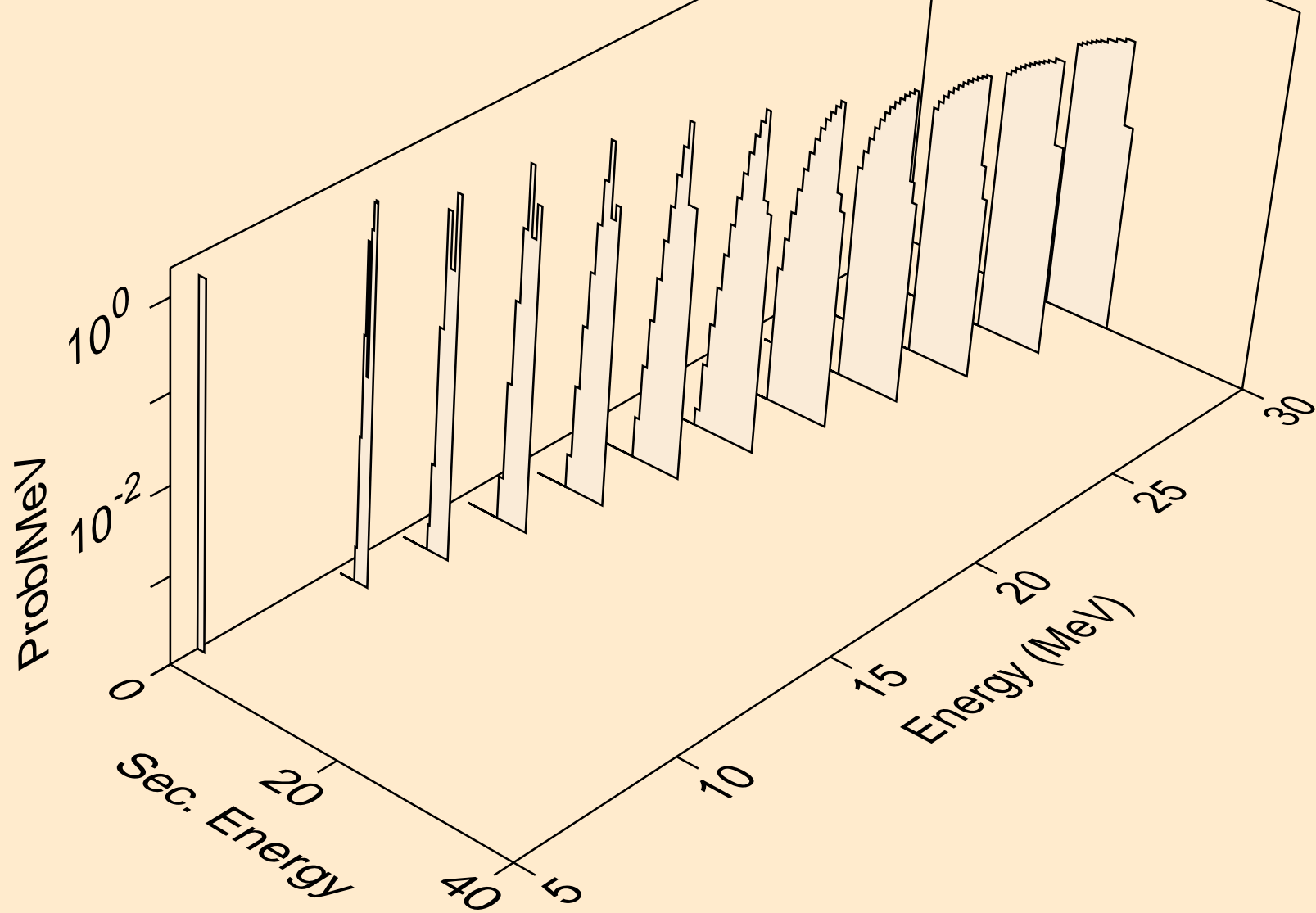

CF242 PROTON ACER TENDL-2021 LIBRARY; T=0.K
deuterons from (p,da)

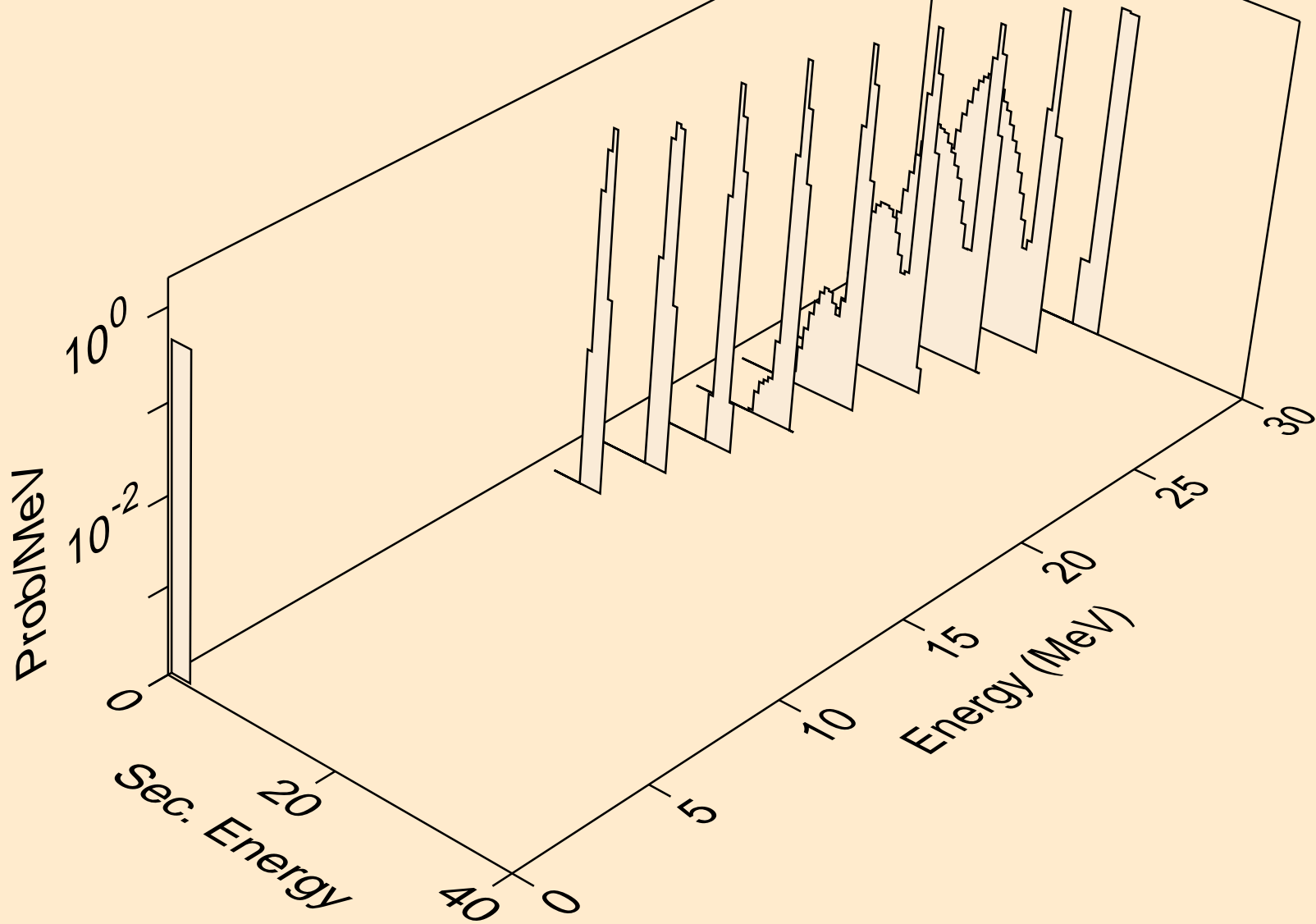

CF242 PROTON ACER TENDL-2021 LIBRARY; T=0.K
tritons from (p,x)

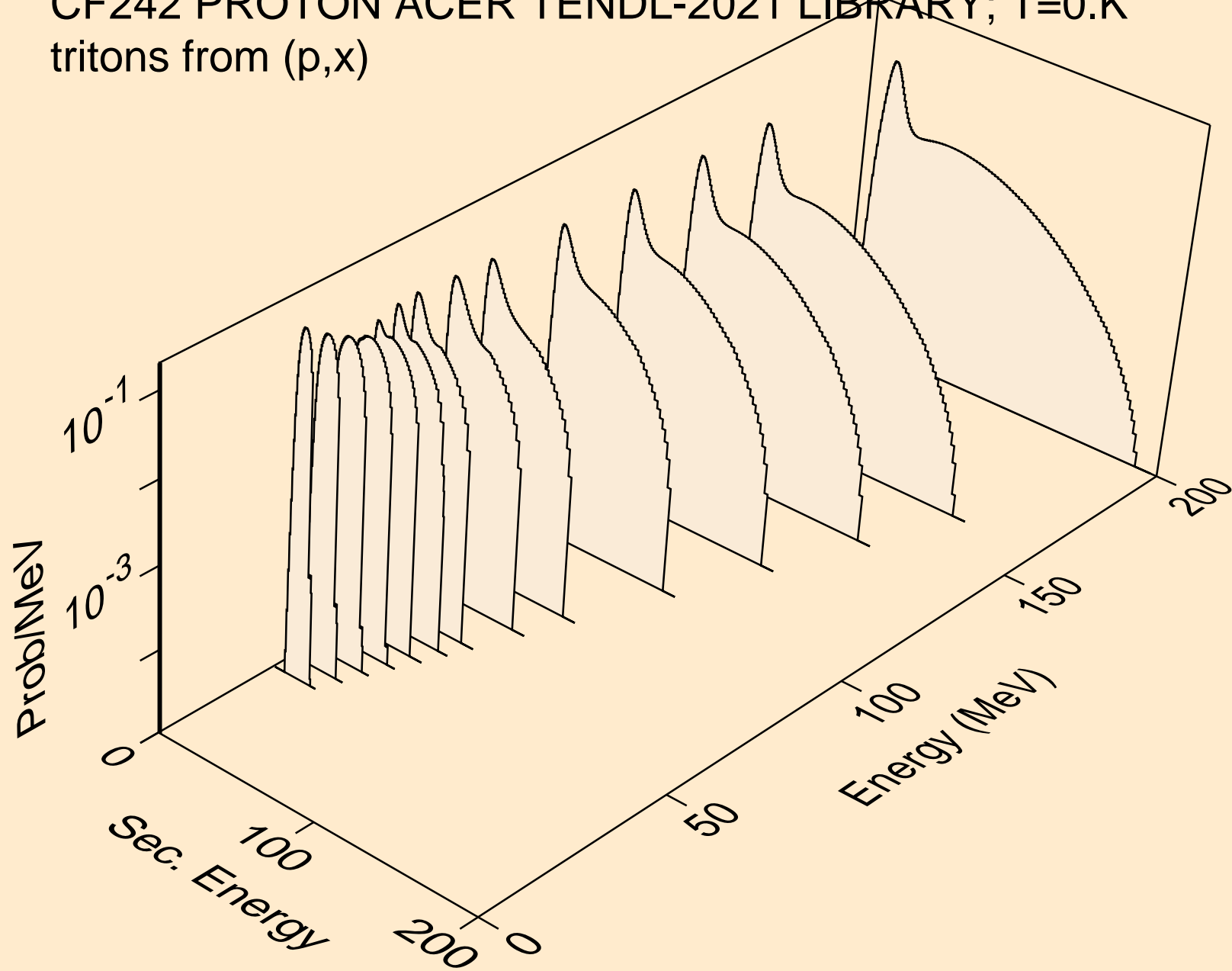

CF242 PROTON ACER TENDL-2021 LIBRARY; T=0.K

tritons from (p,n*)t

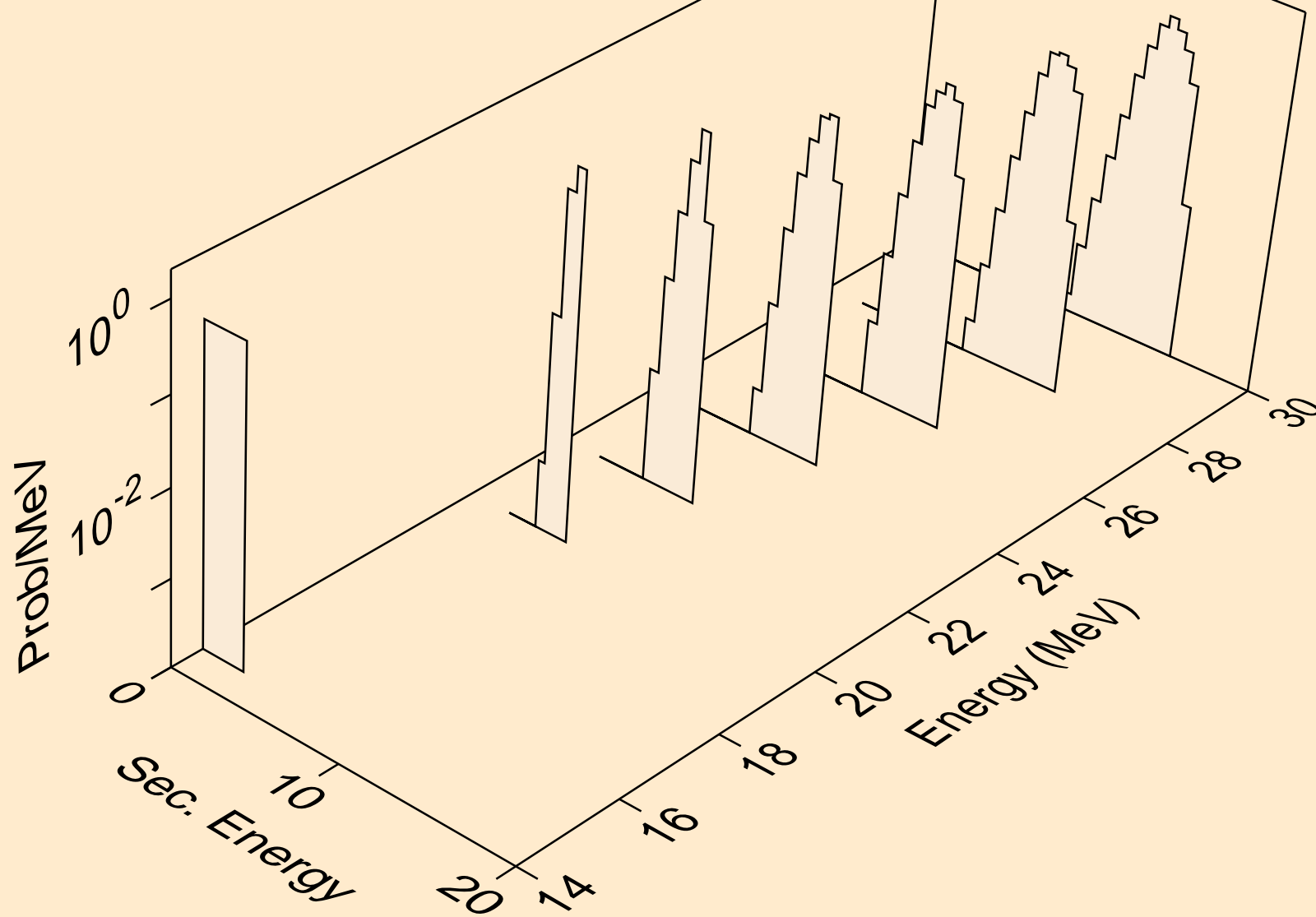

CF242 PROTON ACER TENDL-2021 LIBRARY; T=0.K
tritons from (p,t)

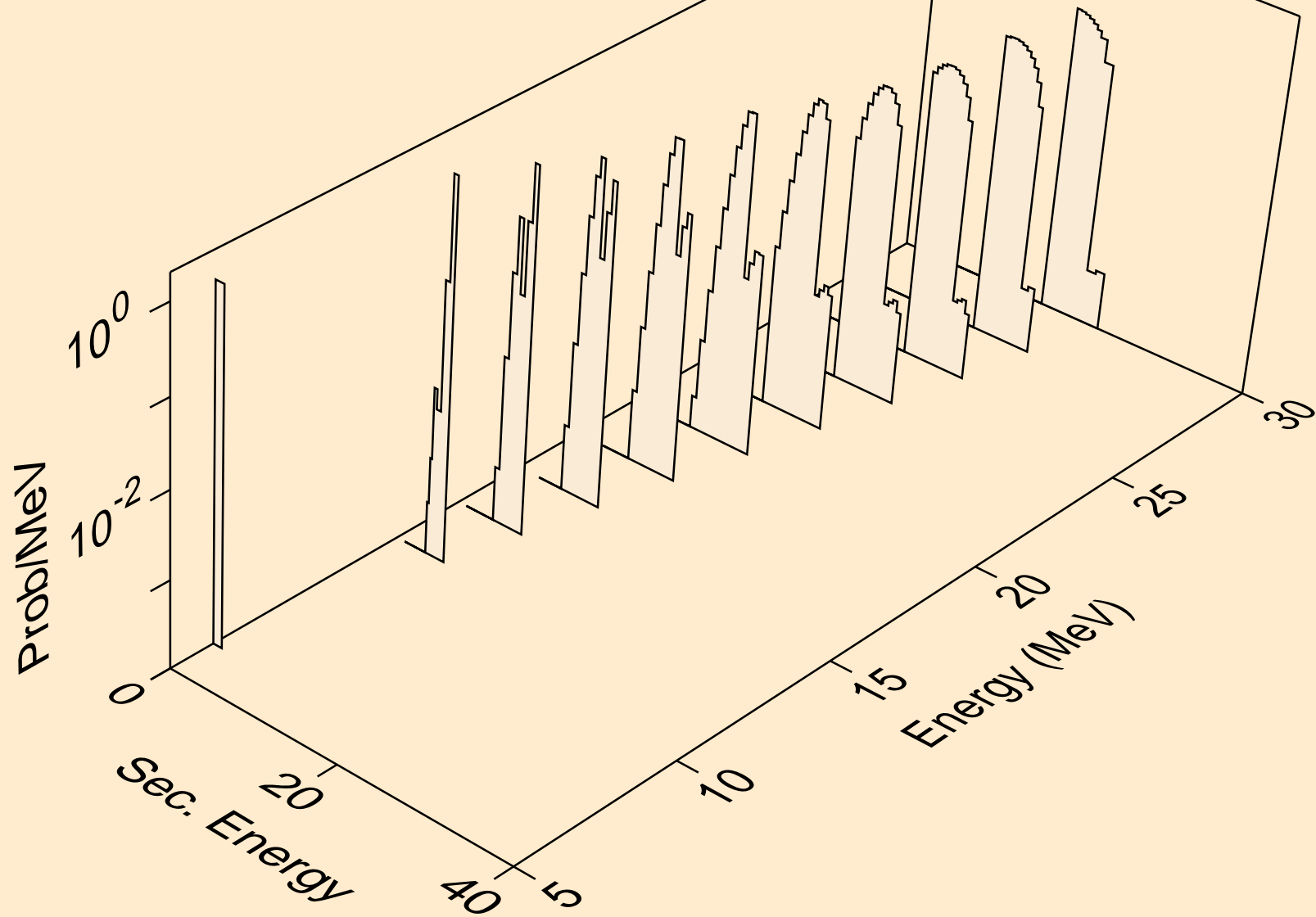

CF242 PROTON ACER TENDL-2021 LIBRARY; T=0.K
he3s from (p,x)

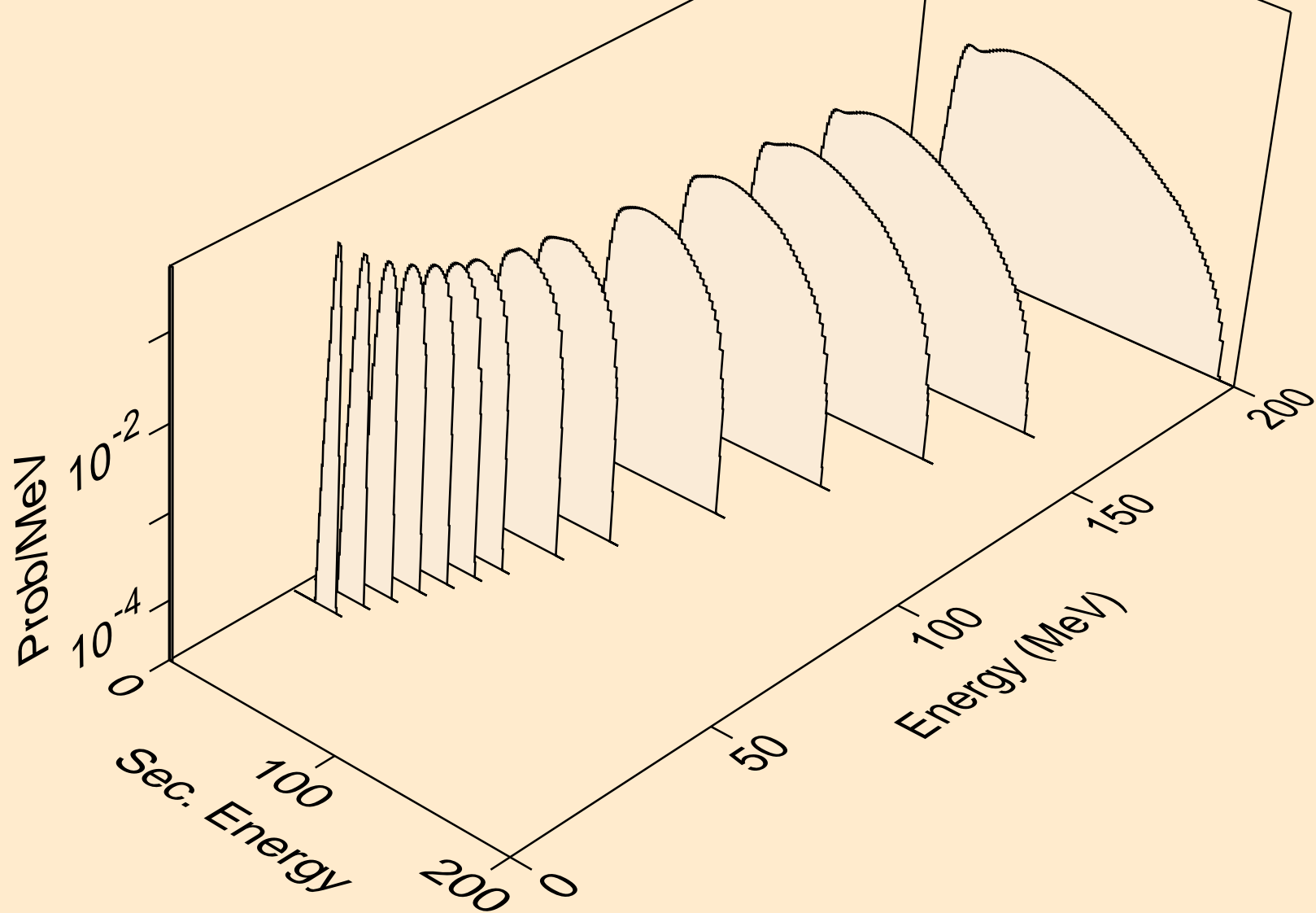

CF242 PROTON ACER TENDL-2021 LIBRARY; T=0.K
he3s from (p,he3)

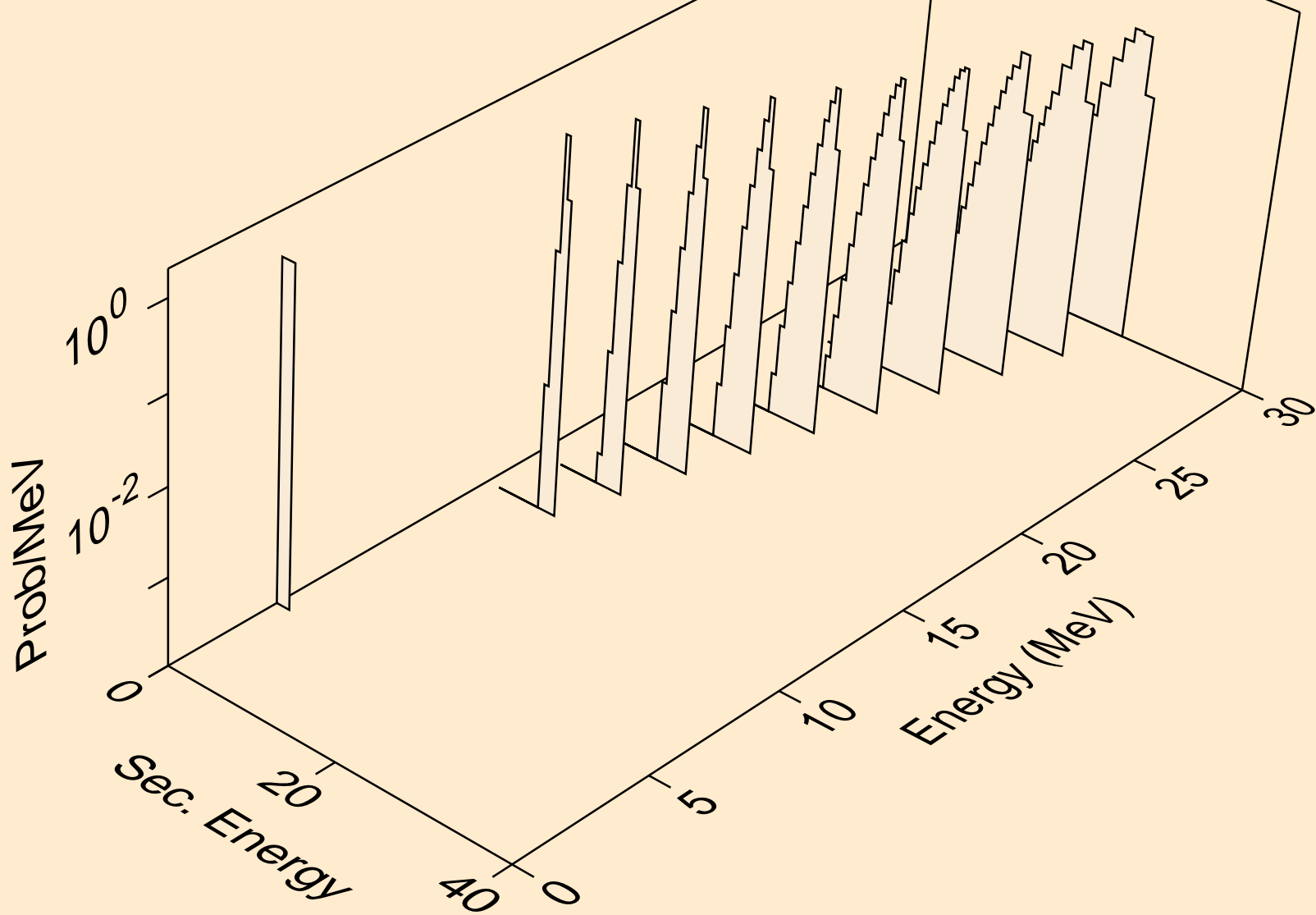

CF242 PROTON ACER TENDL-2021 LIBRARY; T=0.K
alphas from (p,x)

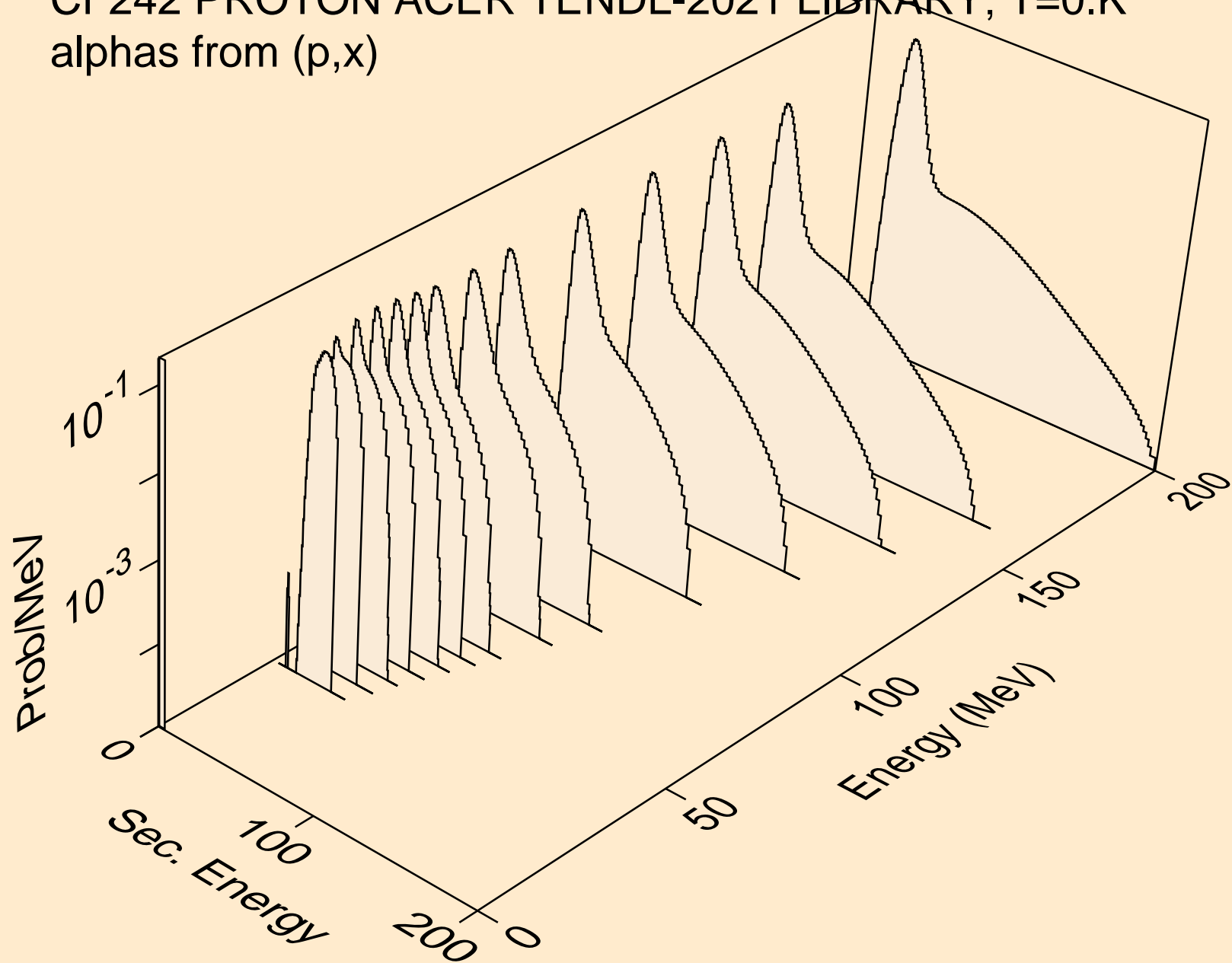

CF242 PROTON ACER TENDL-2021 LIBRARY; T=0.K
alphas from (p,n*)a

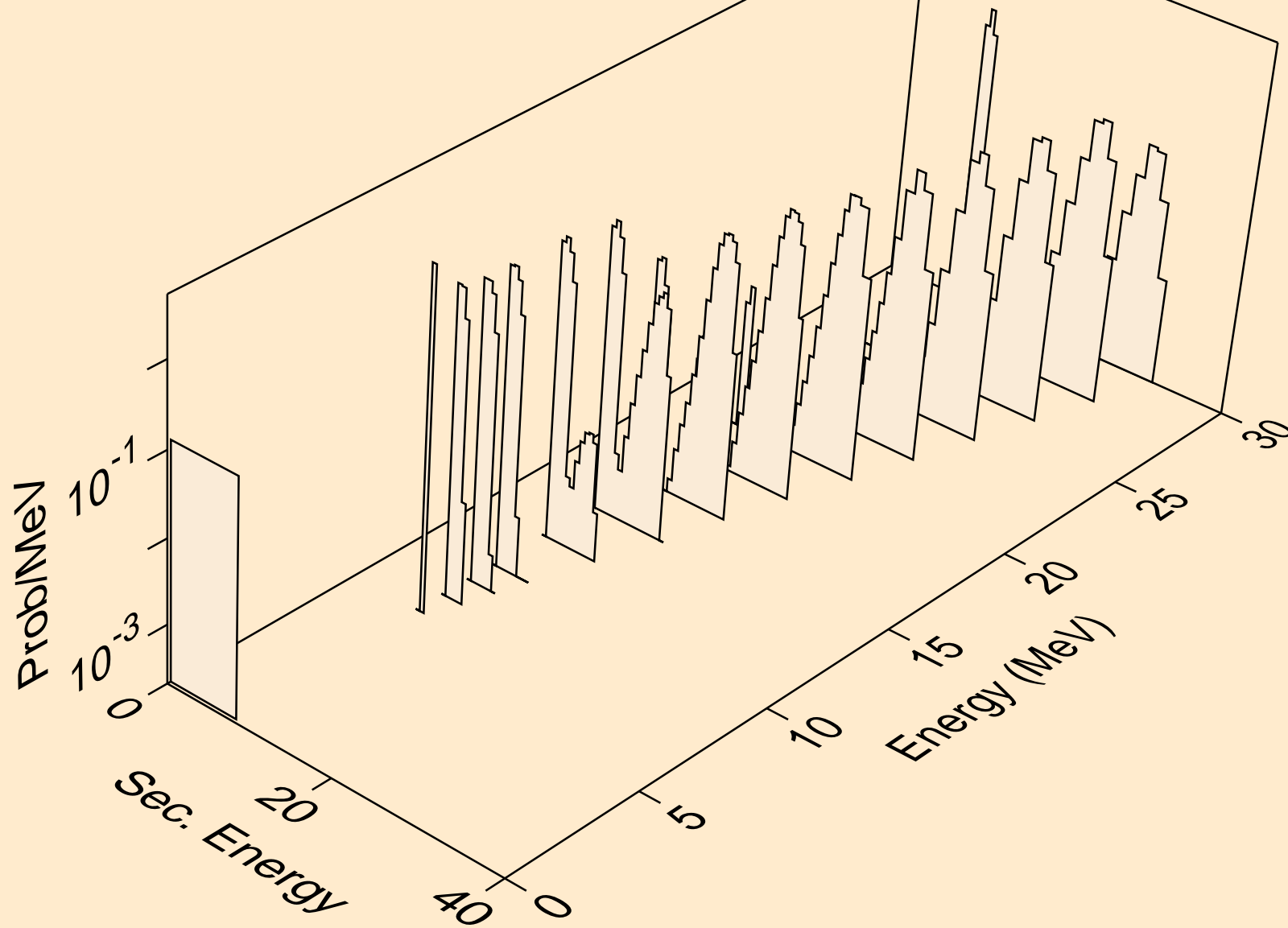

CF242 PROTON ACER TENDL-2021 LIBRARY; T=0.K
alphas from (p,2n)a

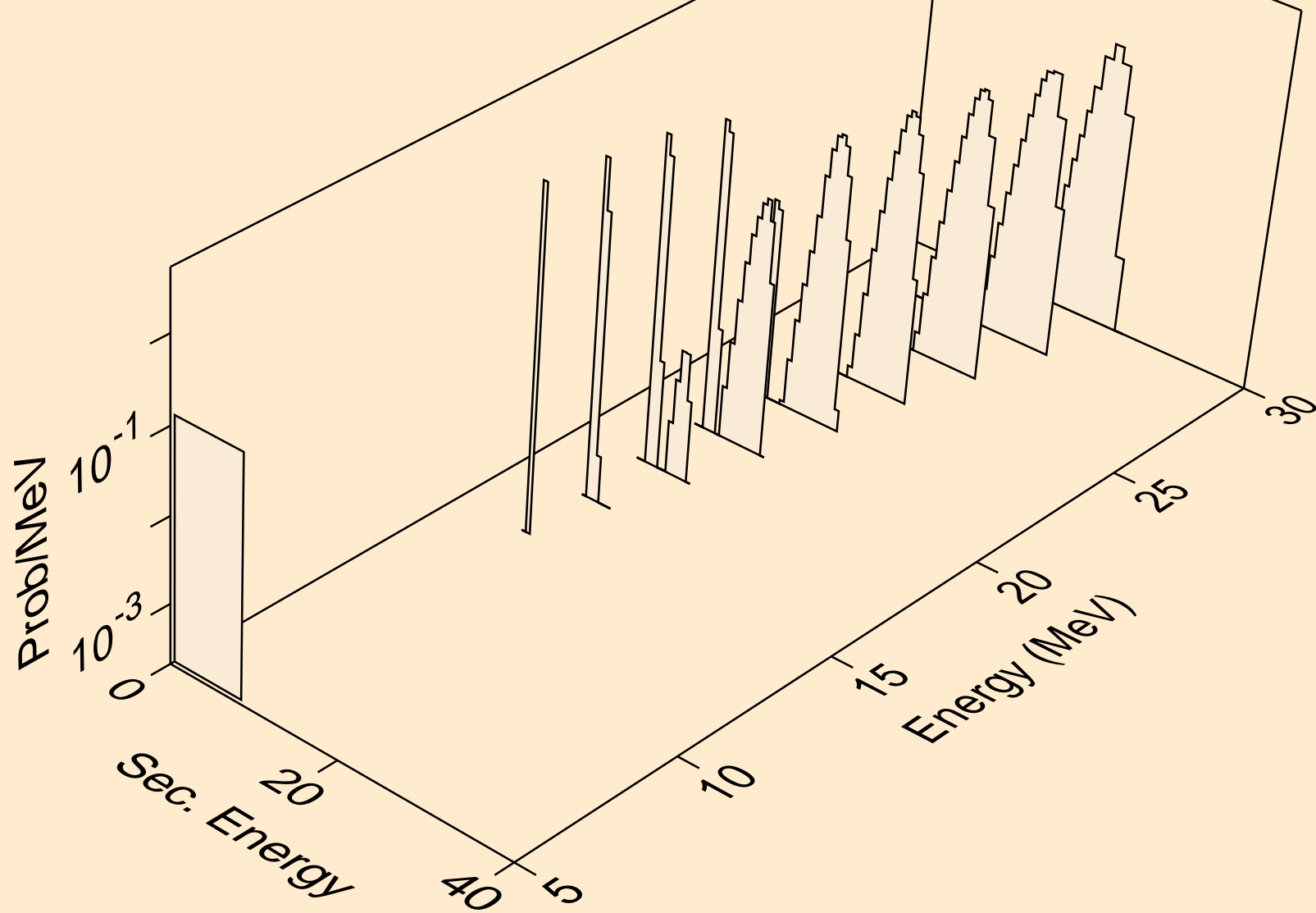

CF242 PROTON ACER TENDL-2021 LIBRARY; T=0.K
alphas from (p,npa)

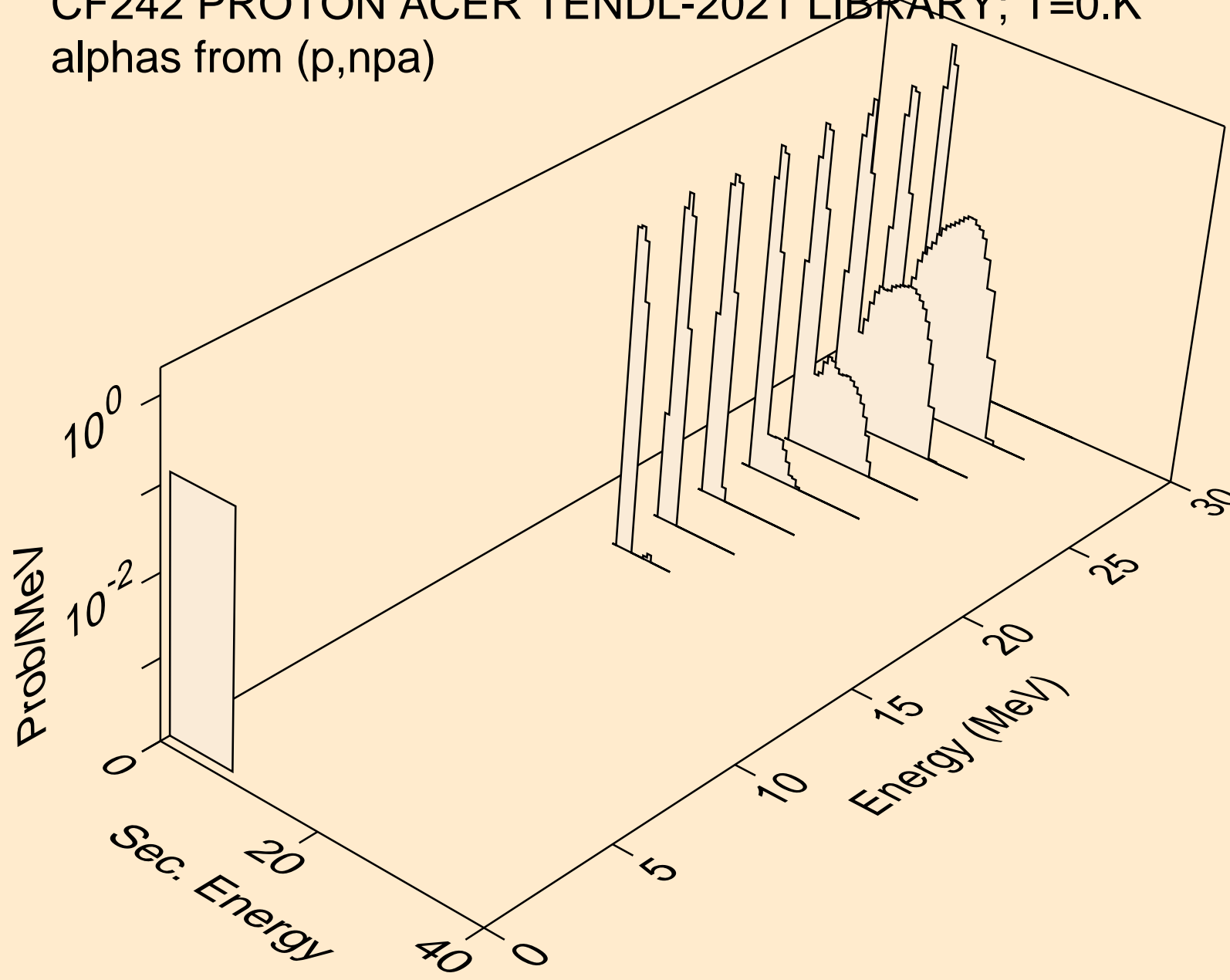

CF242 PROTON ACER TENDL-2021 LIBRARY; T=0.K
alphas from (p,a)

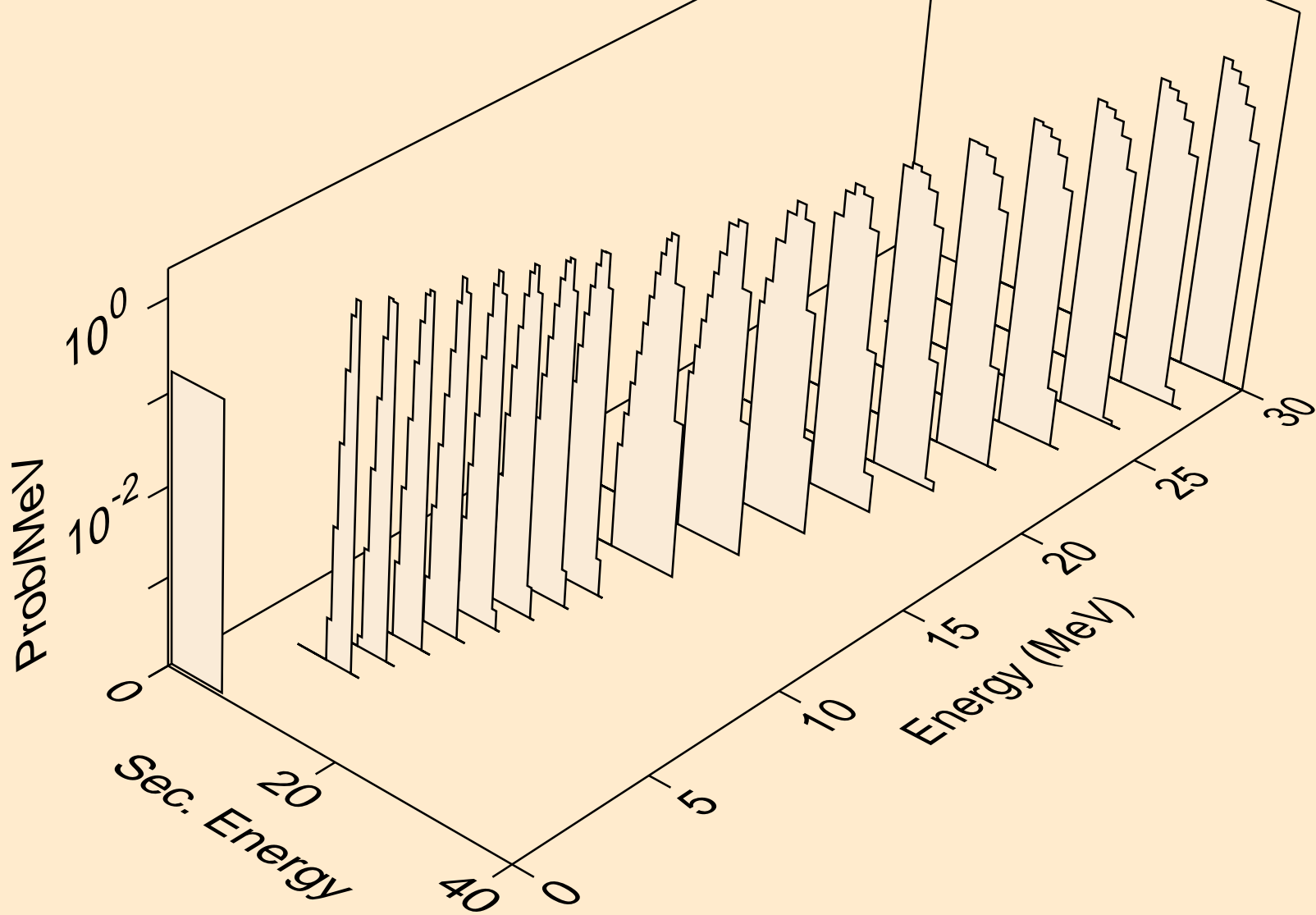

CF242 PROTON ACER TENDL-2021 LIBRARY; T=0.K
alphas from (p,da)

