

CF255 PROTON ACER TENDL-2021 LIBRARY; T=0.K  
Principal cross sections

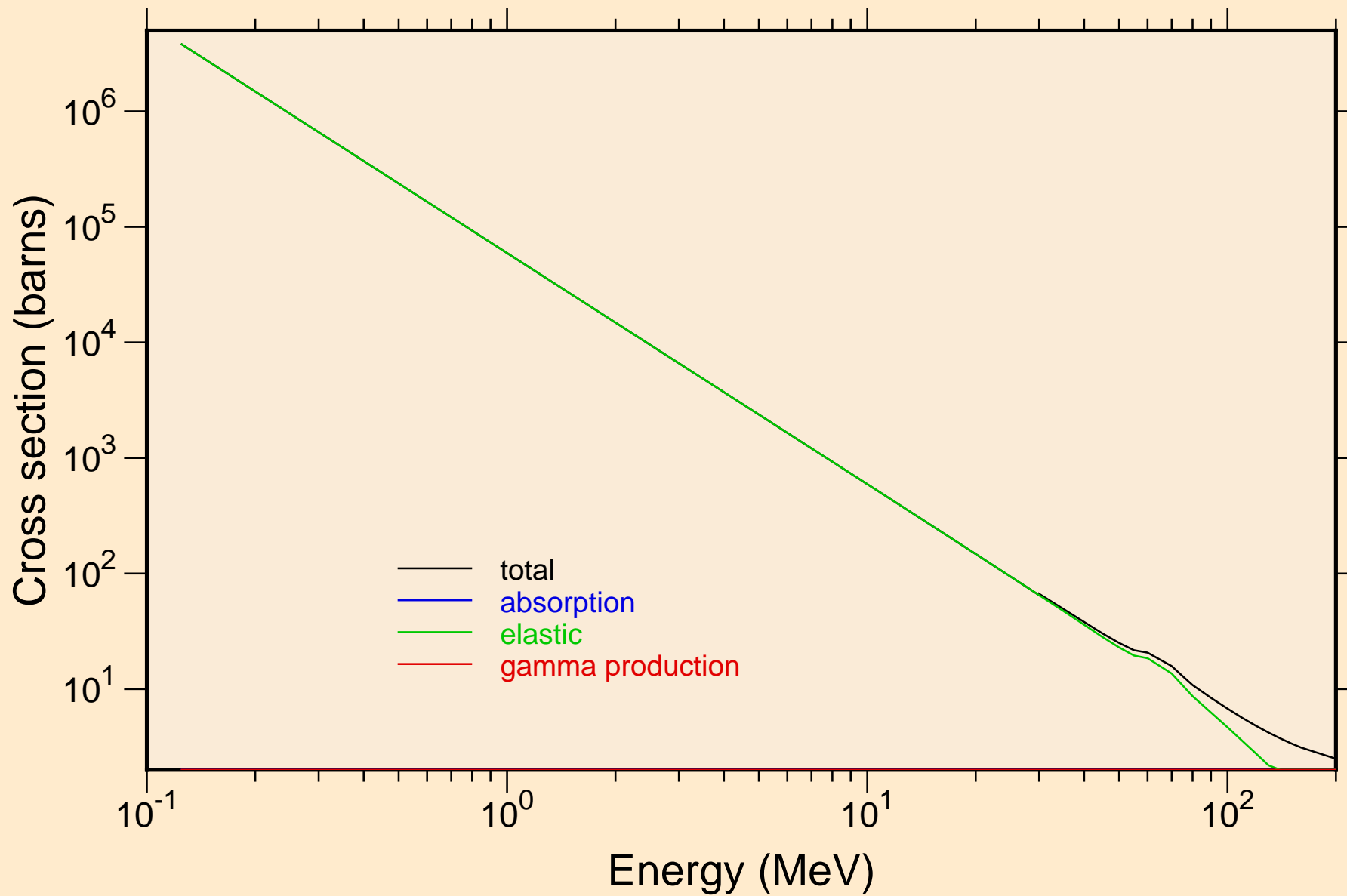

# CF255 PROTON ACER TENDL-2021 LIBRARY; T=0.K

## Heating

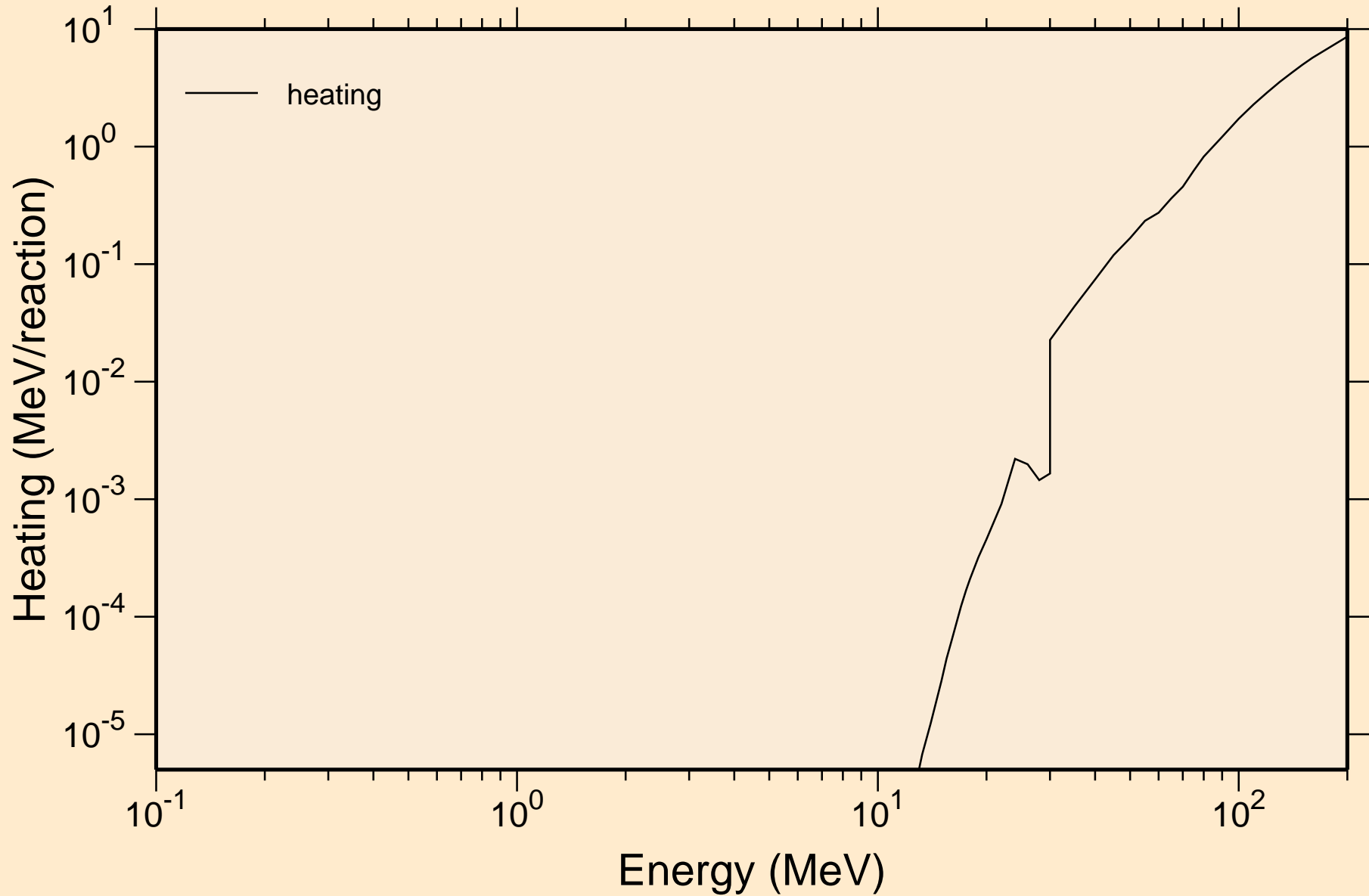

# CF255 PROTON ACER TENDL-2021 LIBRARY; T=0.K

## Principal cross sections

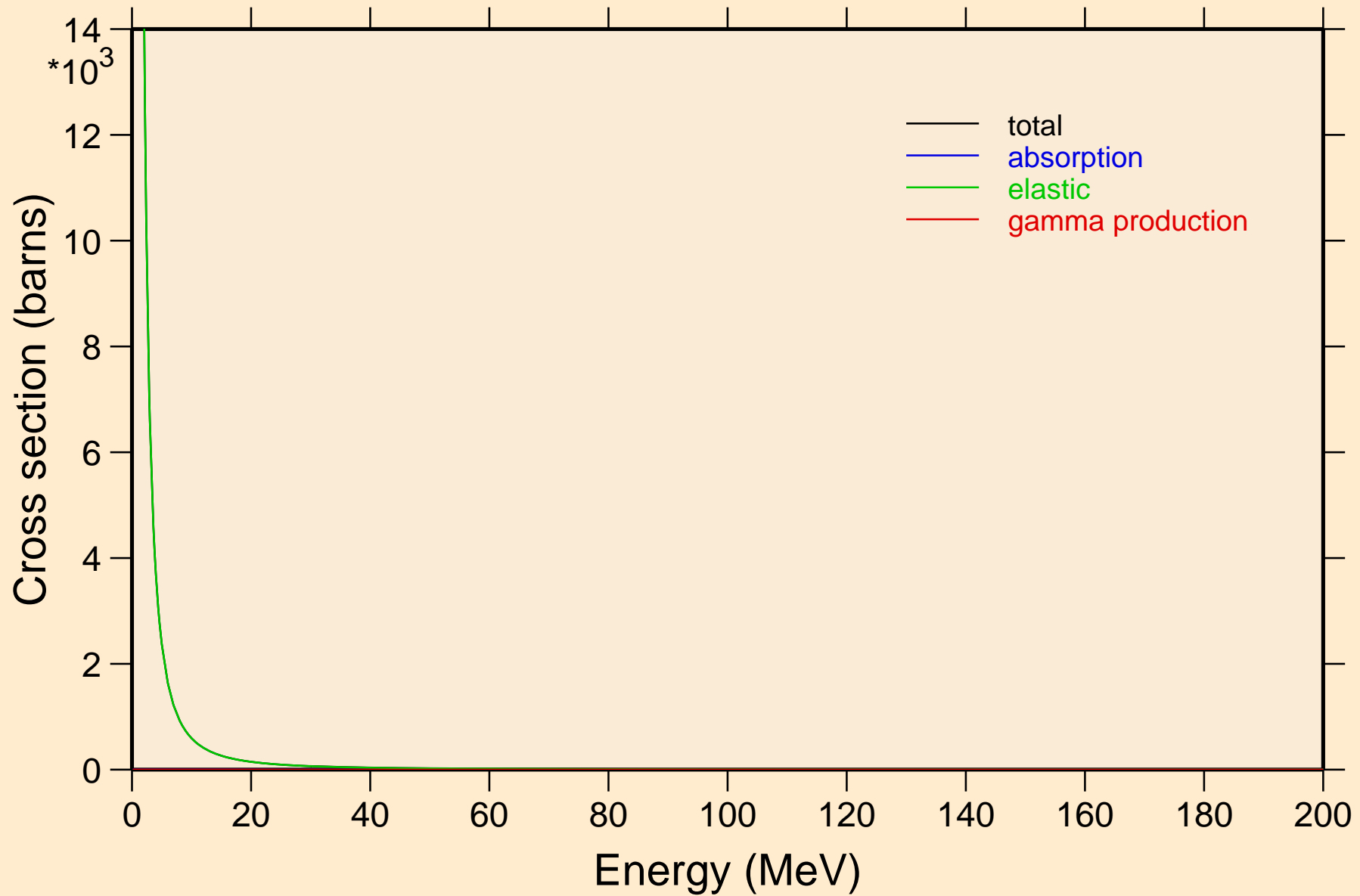

# CF255 PROTON ACER TENDL-2021 LIBRARY; T=0.K

## Heating

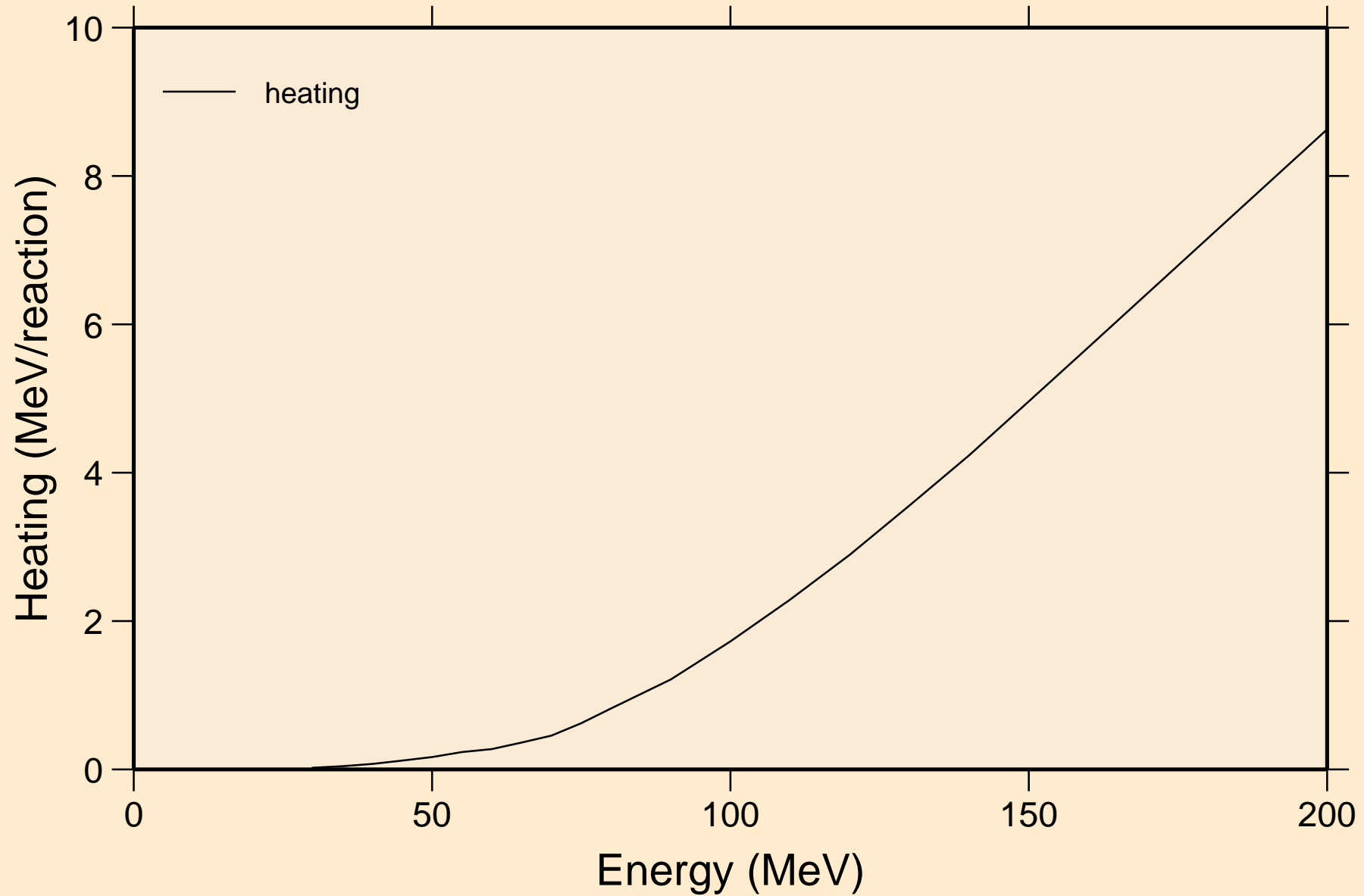

# CF255 PROTON ACER TENDL-2021 LIBRARY; T=0.K

## Threshold reactions

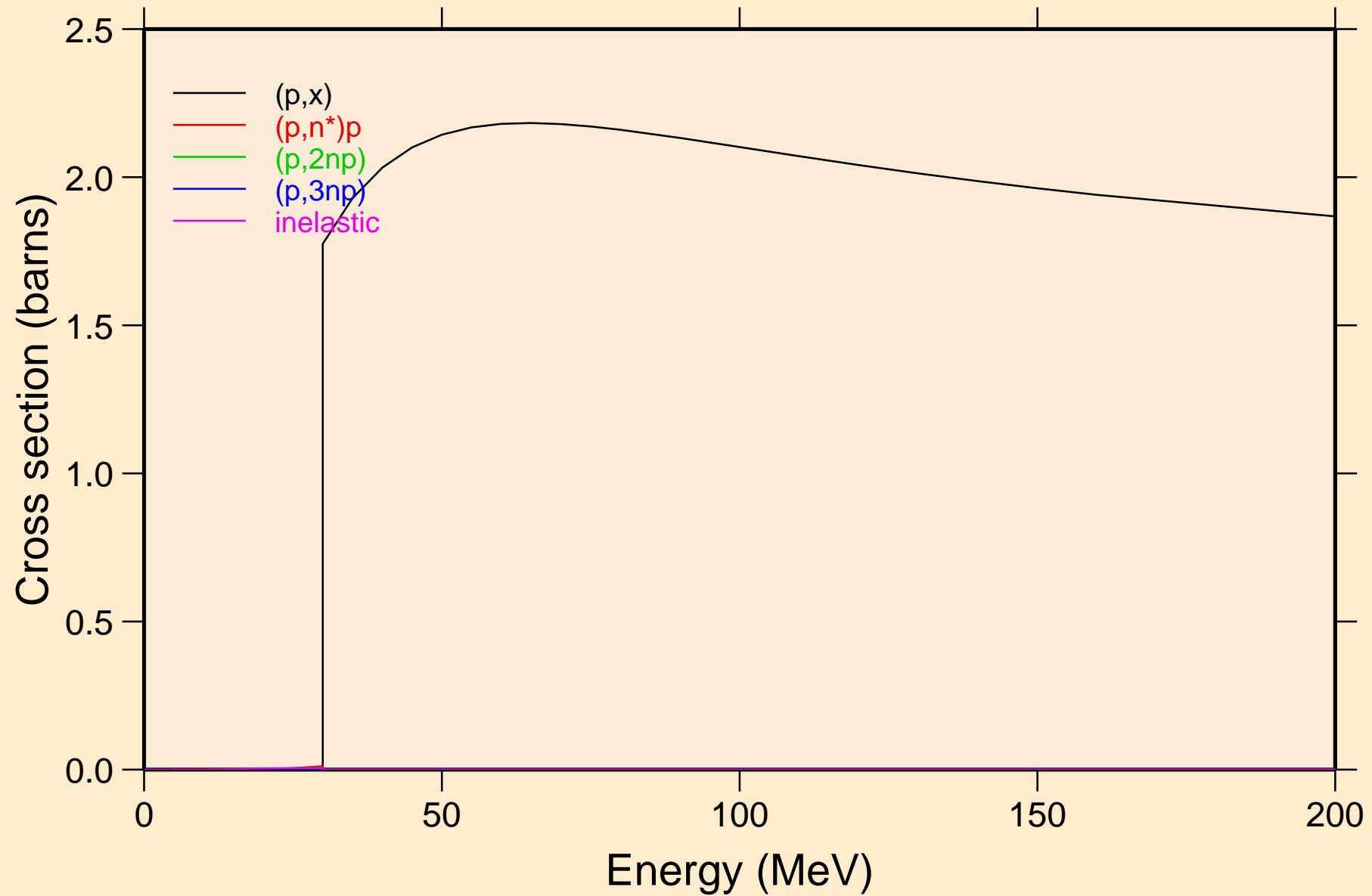

CF255 PROTON ACER TENDL-2021 LIBRARY; T=0.K  
Threshold reactions

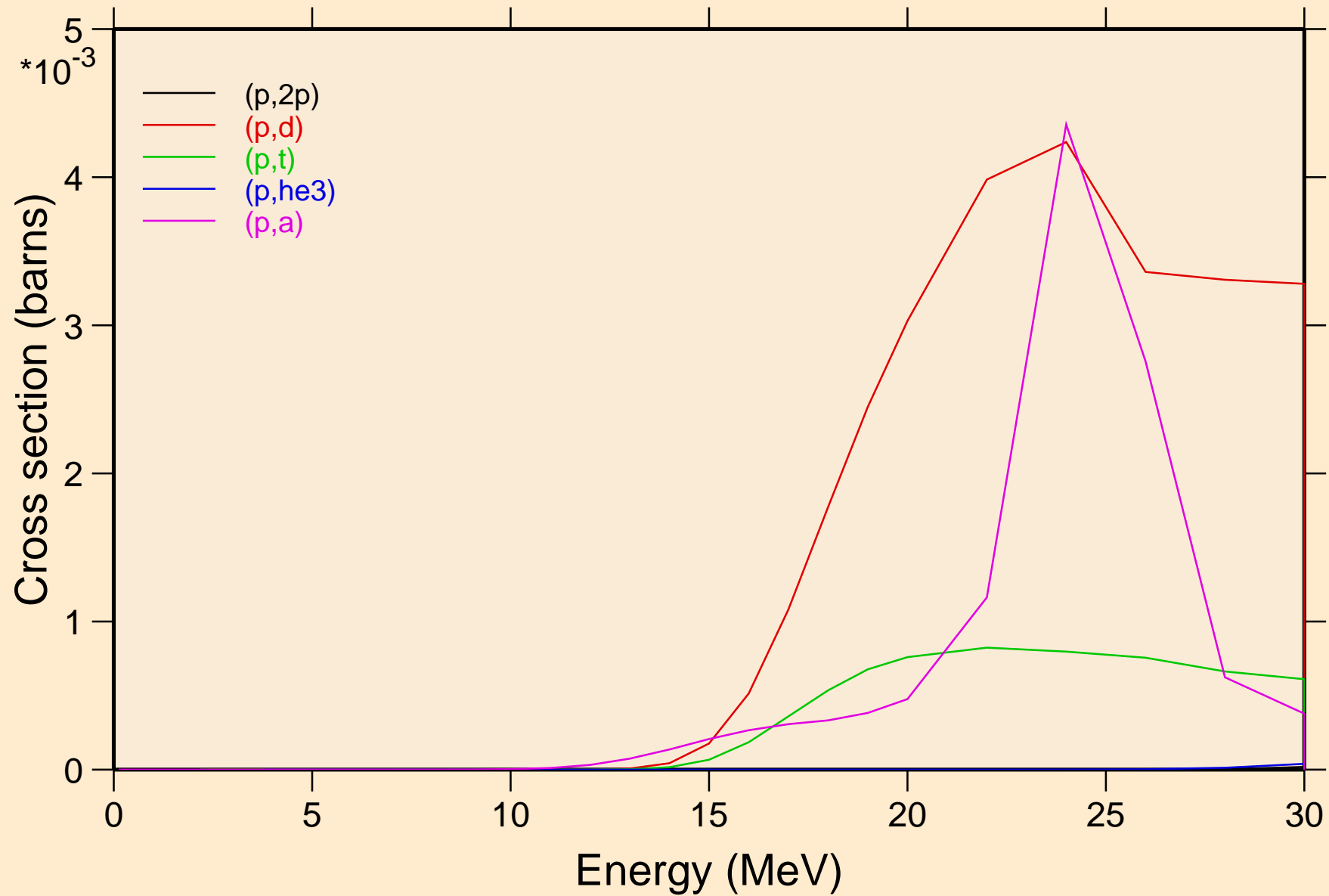

CF255 PROTON ACER TENDL-2021 LIBRARY; T=0.K  
Threshold reactions

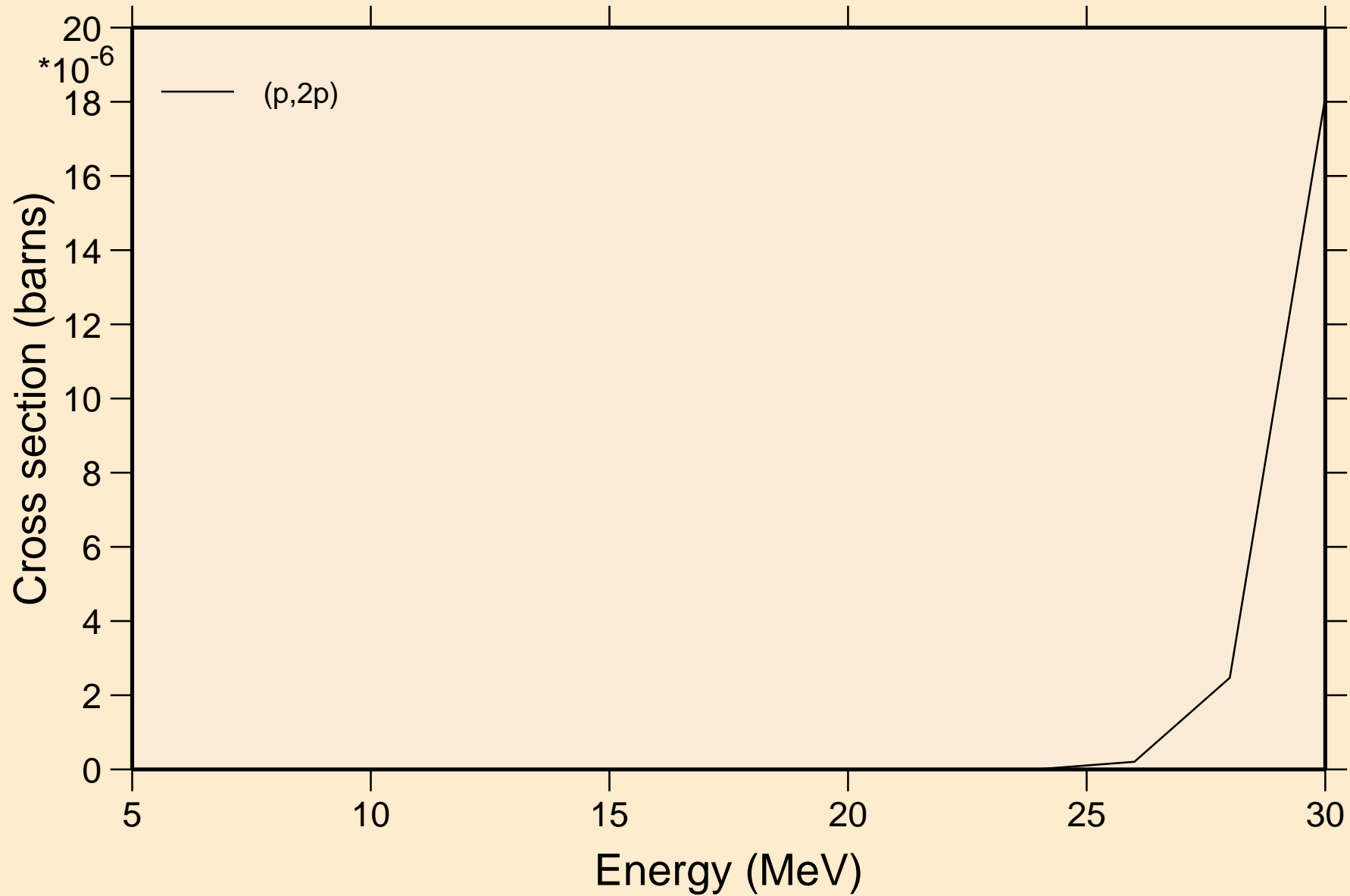

CF255 PROTON ACER TENDL-2021 LIBRARY; T=0.K  
angular distribution for elastic

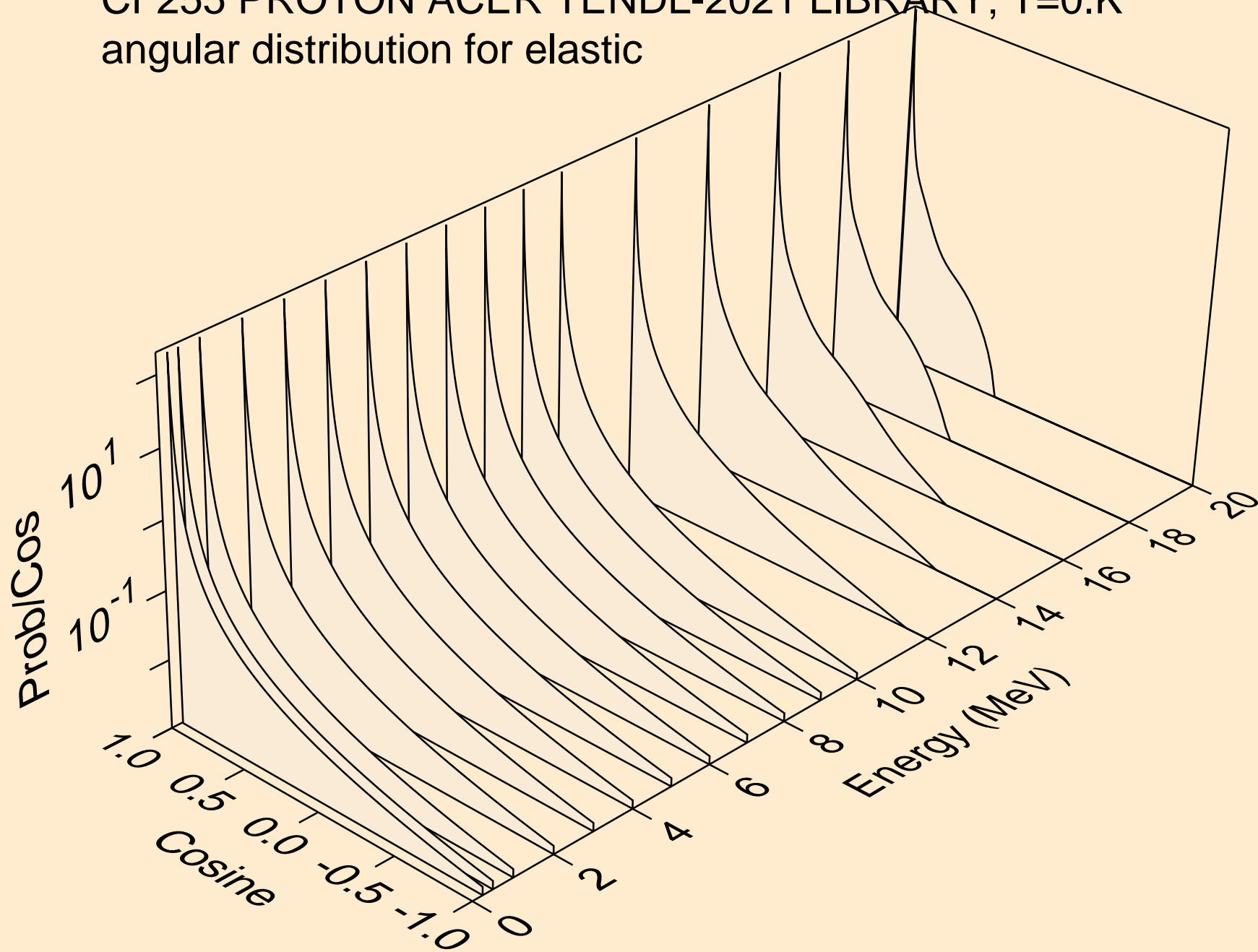



CF255 PROTON ACER TENDL-2021 LIBRARY; T=0.K  
angular distribution for elastic

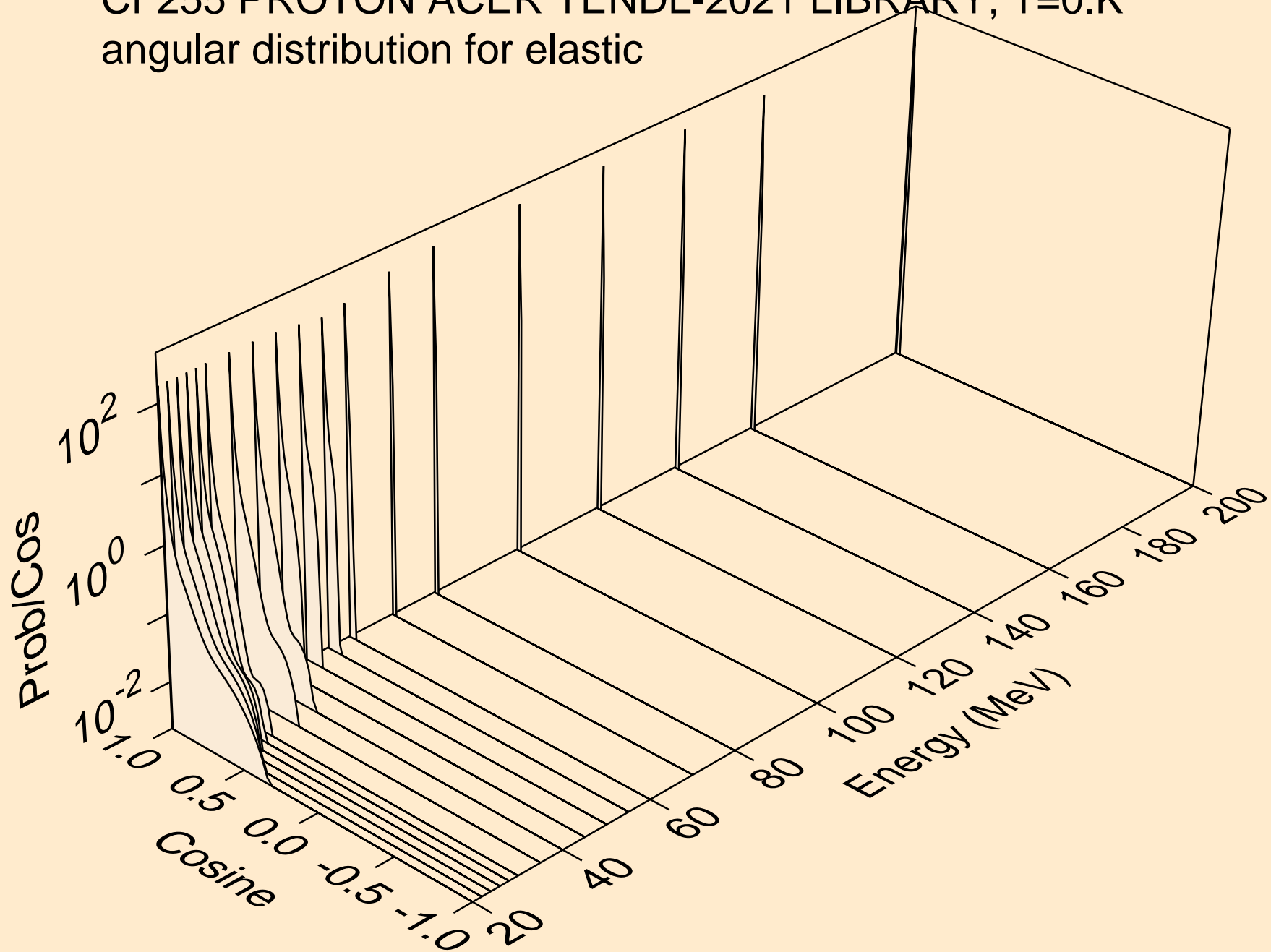

CF255 PROTON ACER TENDL-2021 LIBRARY; T=0.K  
Proton emission for (p,x)

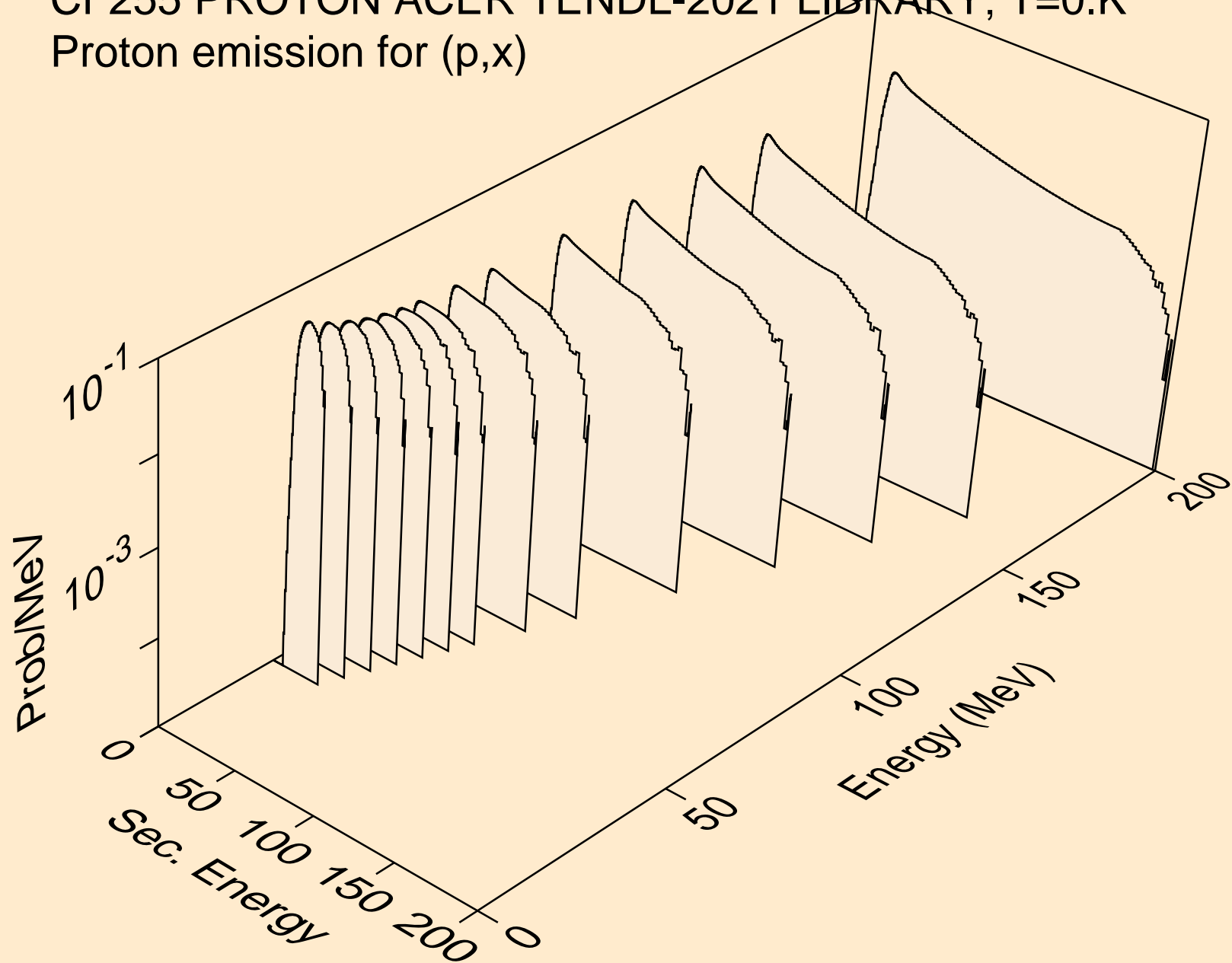

CF255 PROTON ACER TENDL-2021 LIBRARY; T=0.K  
Proton emission for (p,n\*)p

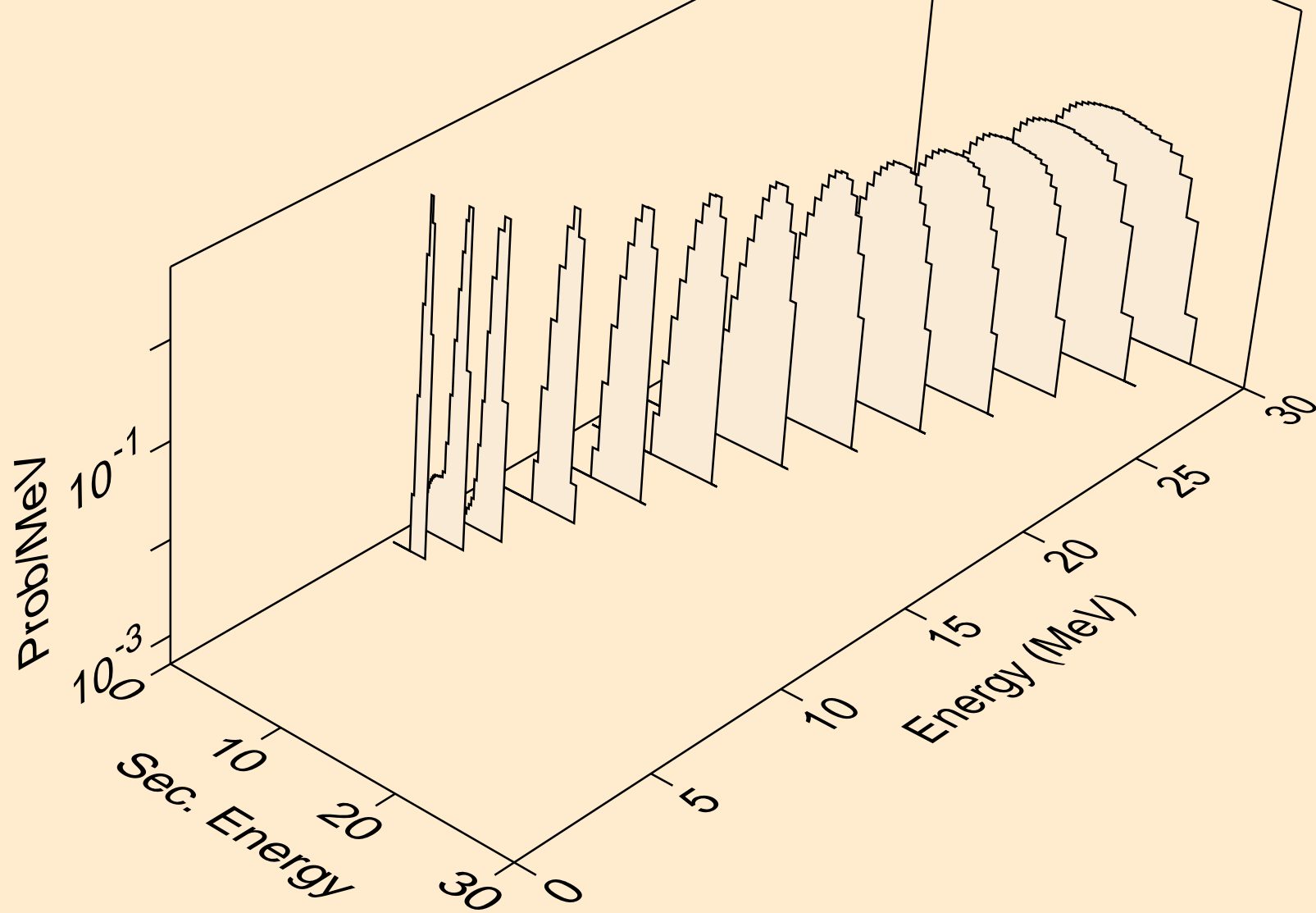

CF255 PROTON ACER TENDL-2021 LIBRARY; T=0.K  
Proton emission for (p,2np)

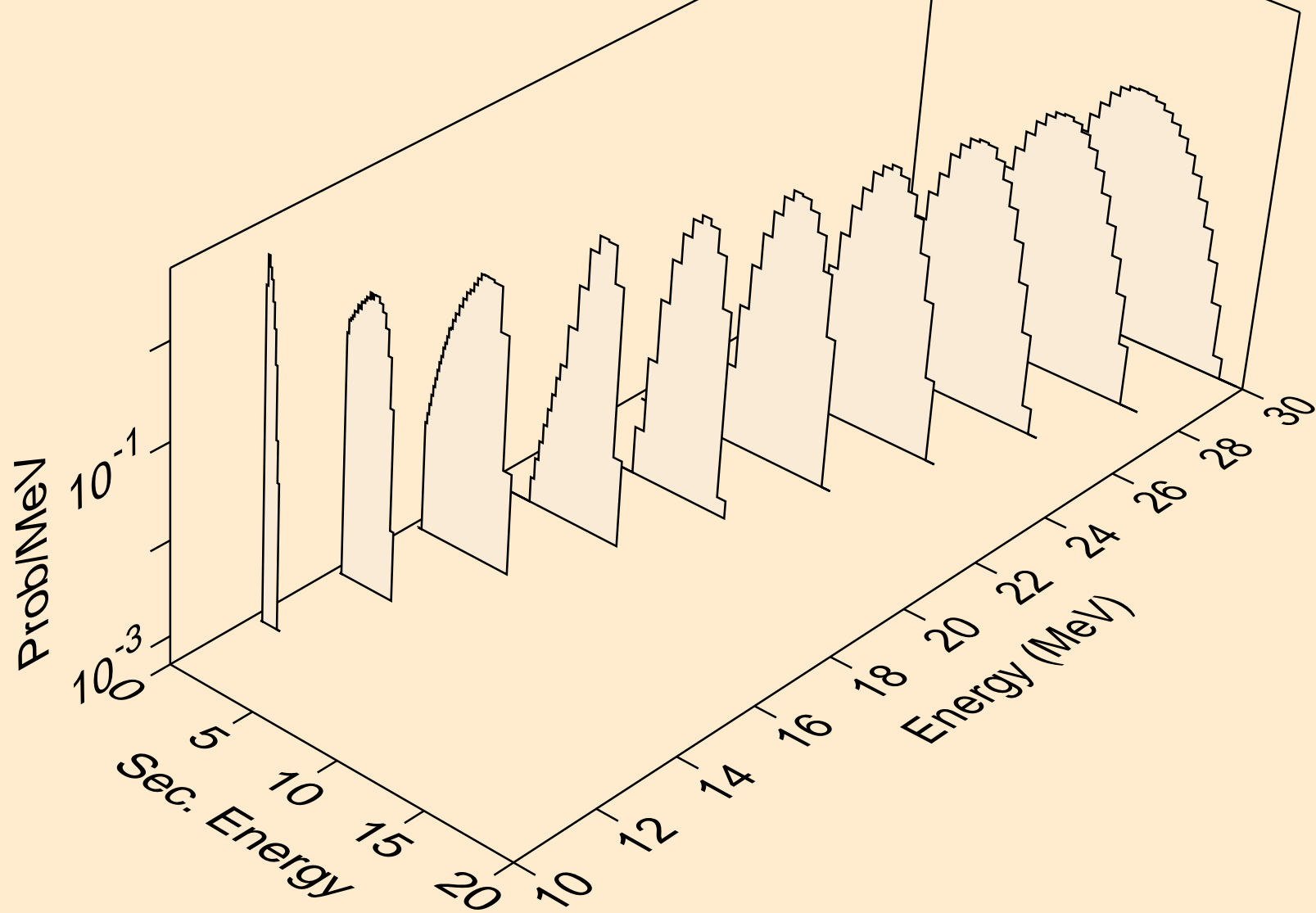

CF255 PROTON ACER TENDL-2021 LIBRARY; T=0.K  
Proton emission for (p,3np)

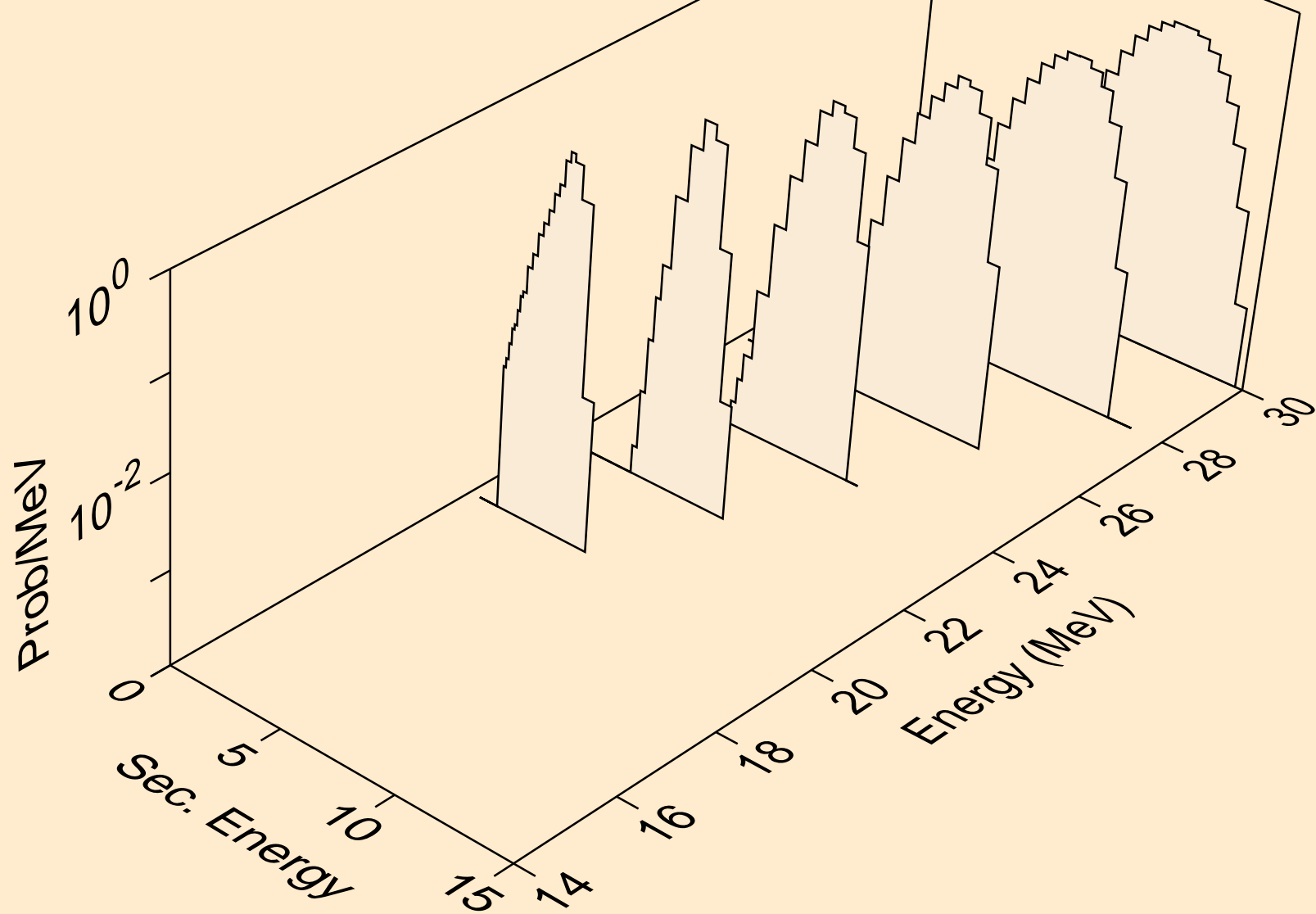

CF255 PROTON ACER TENDL-2021 LIBRARY; T=0.K  
Proton emission for inelastic

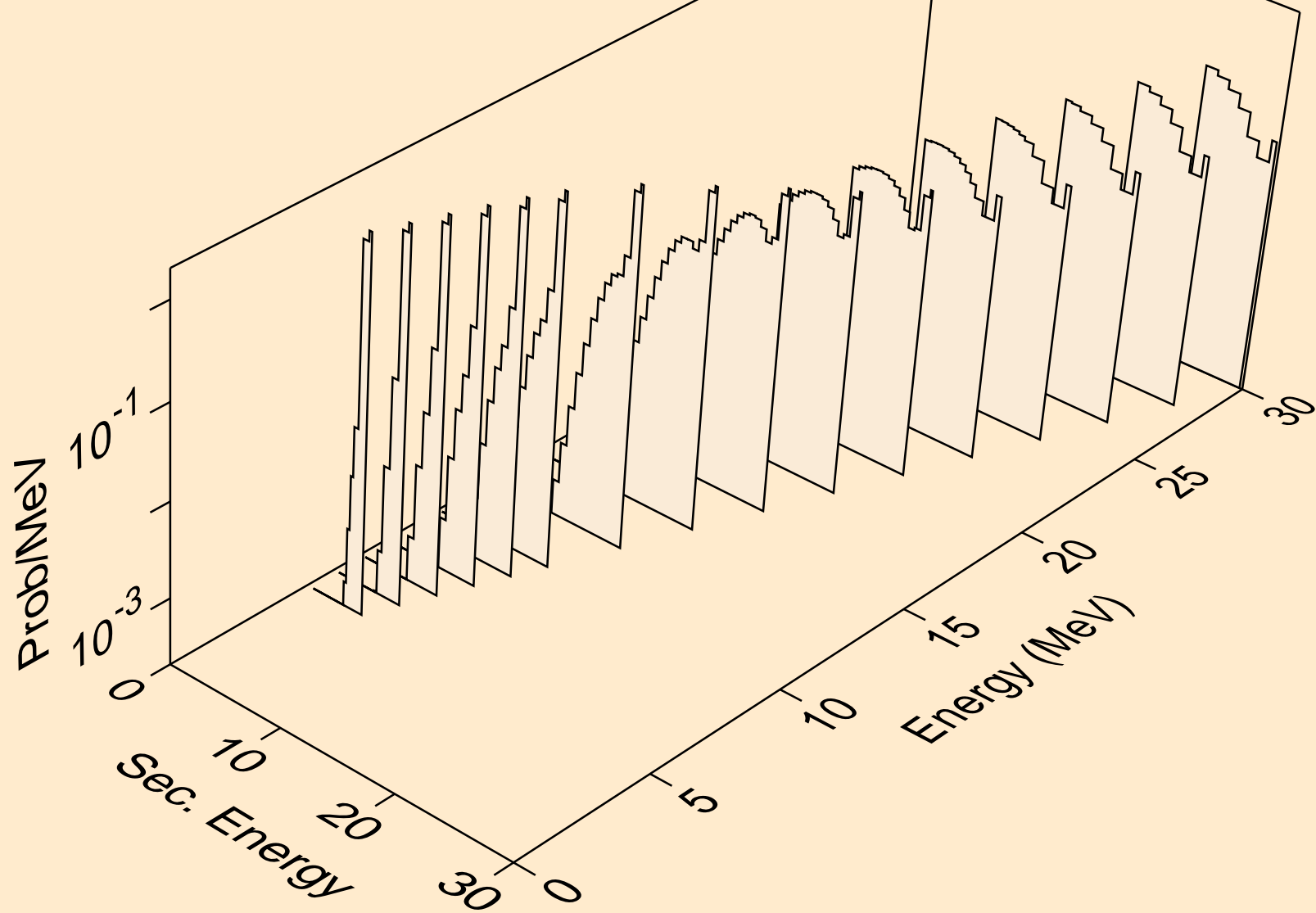

CF255 PROTON ACER TENDL-2021 LIBRARY; T=0.K  
Proton emission for (p,2p)

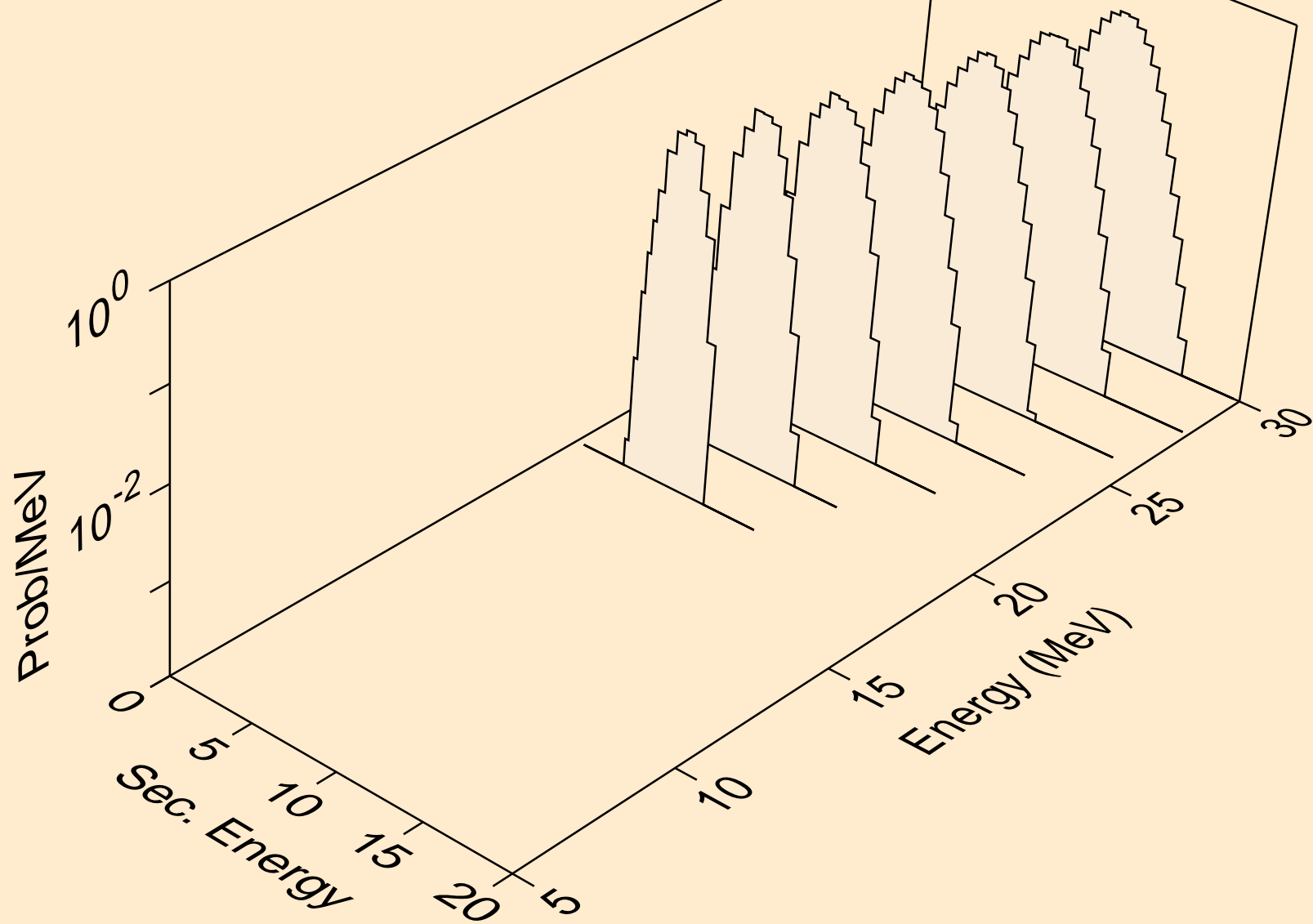

CF255 PROTON ACER TENDL-2021 LIBRARY; T=0.K  
Photon emission for (z,n)

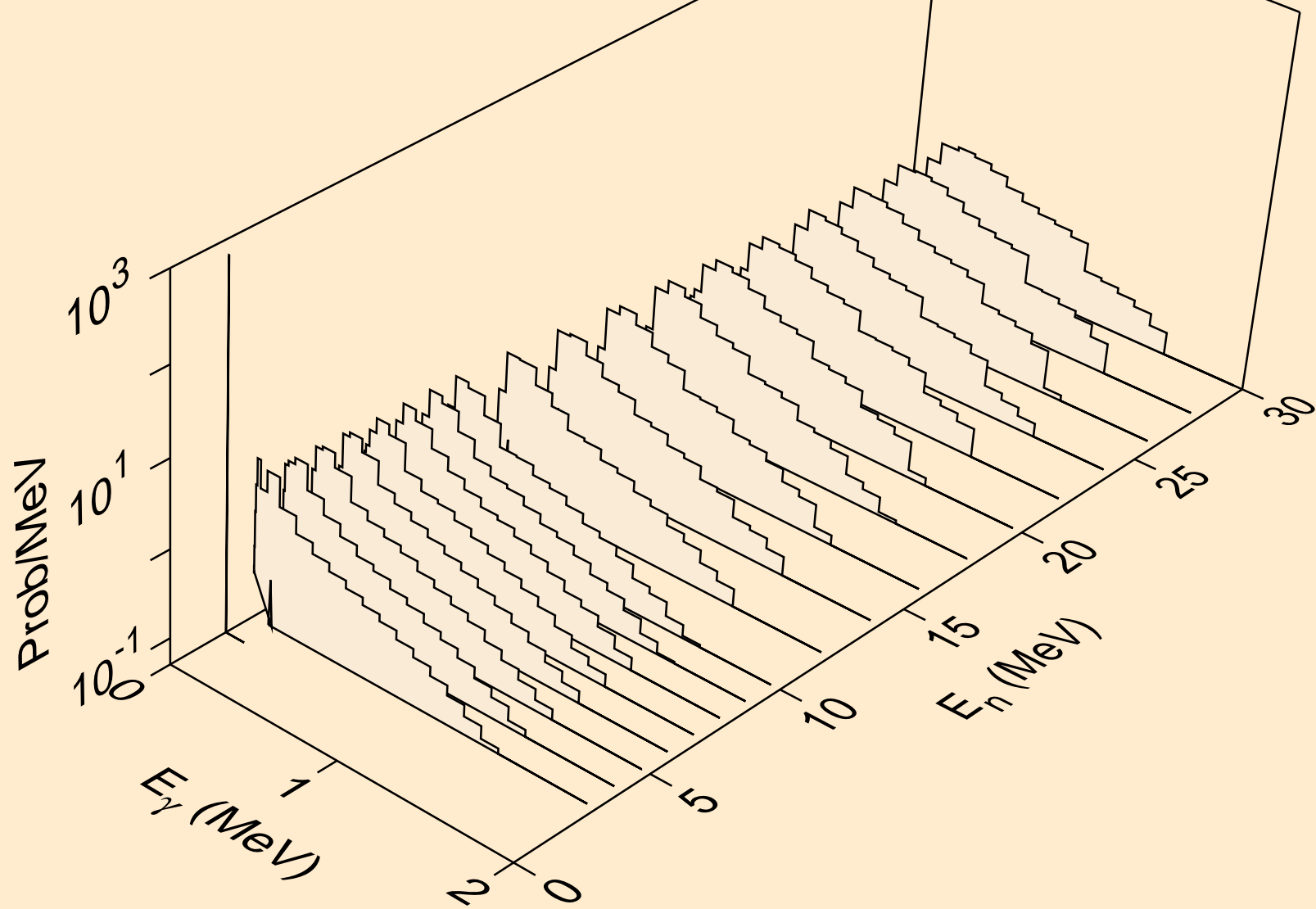



CF255 PROTON ACER TENDL-2021 LIBRARY; T=0.K  
Photon emission for (n,x)

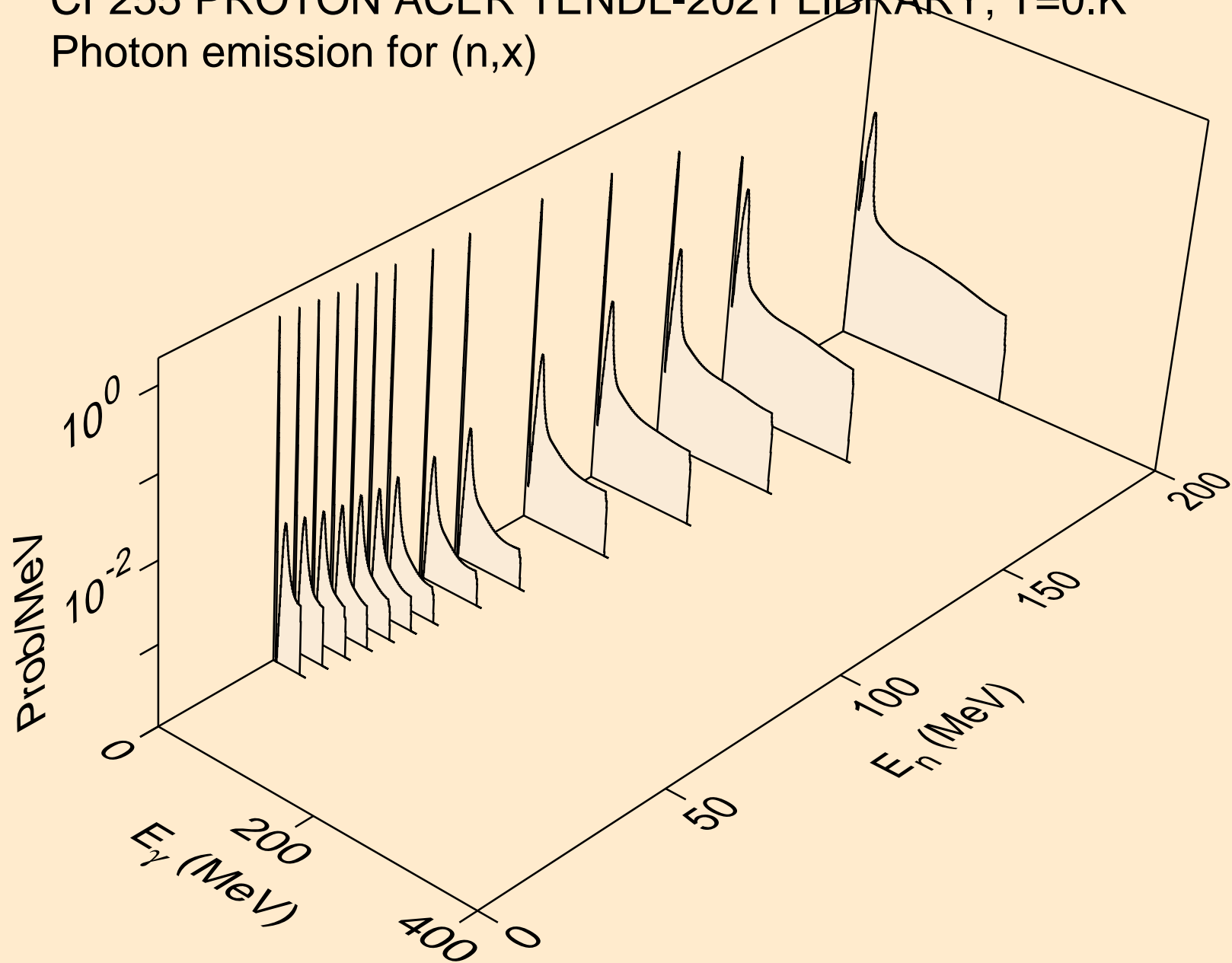

CF255 PROTON ACER TENDL-2021 LIBRARY; T=0.K  
Photon emission for (n,2nd)

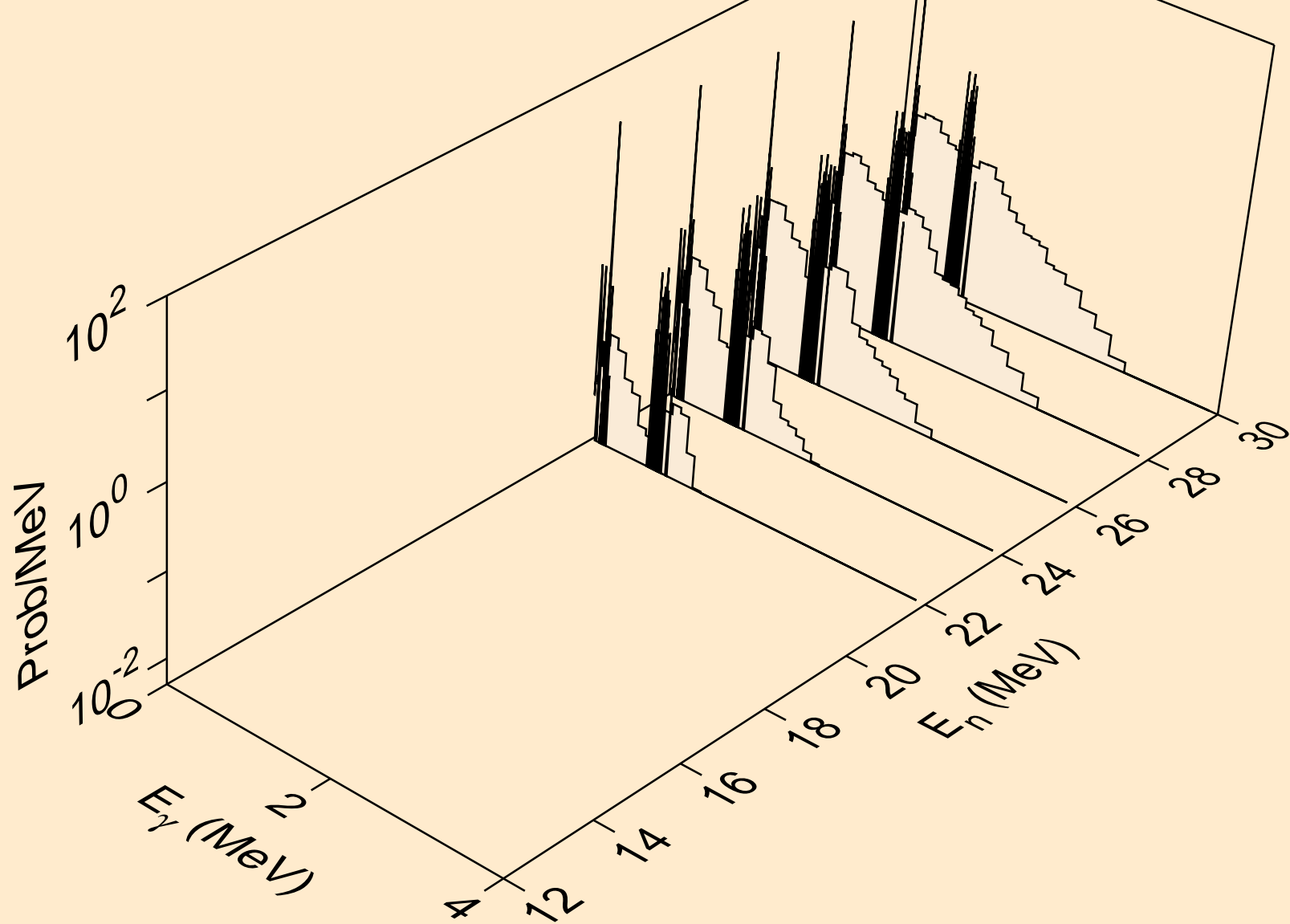

CF255 PROTON ACER TENDL-2021 LIBRARY; T=0.K  
Photon emission for (n,2n)

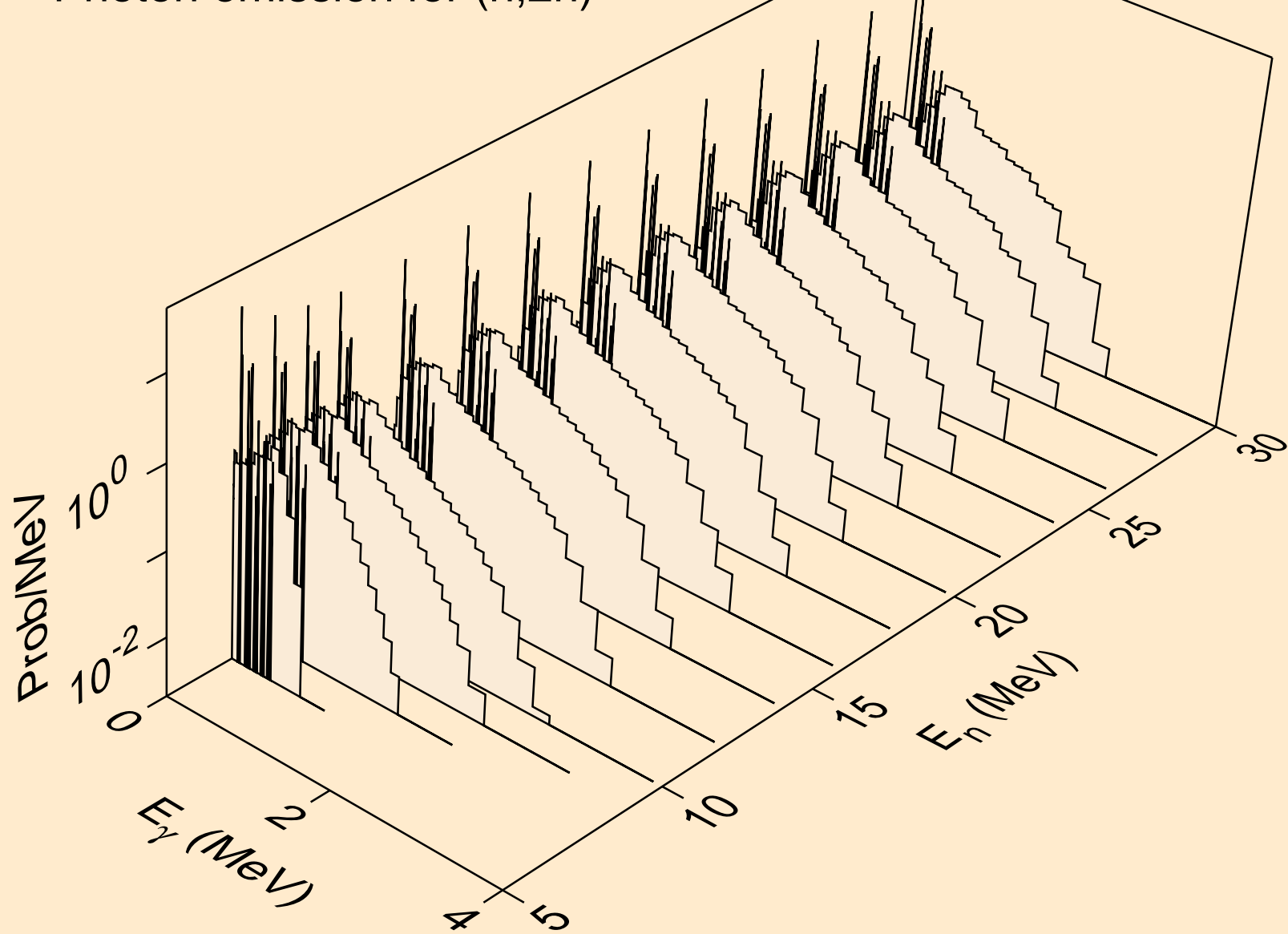

CF255 PROTON ACER TENDL-2021 LIBRARY; T=0.K  
Photon emission for (n,3n)

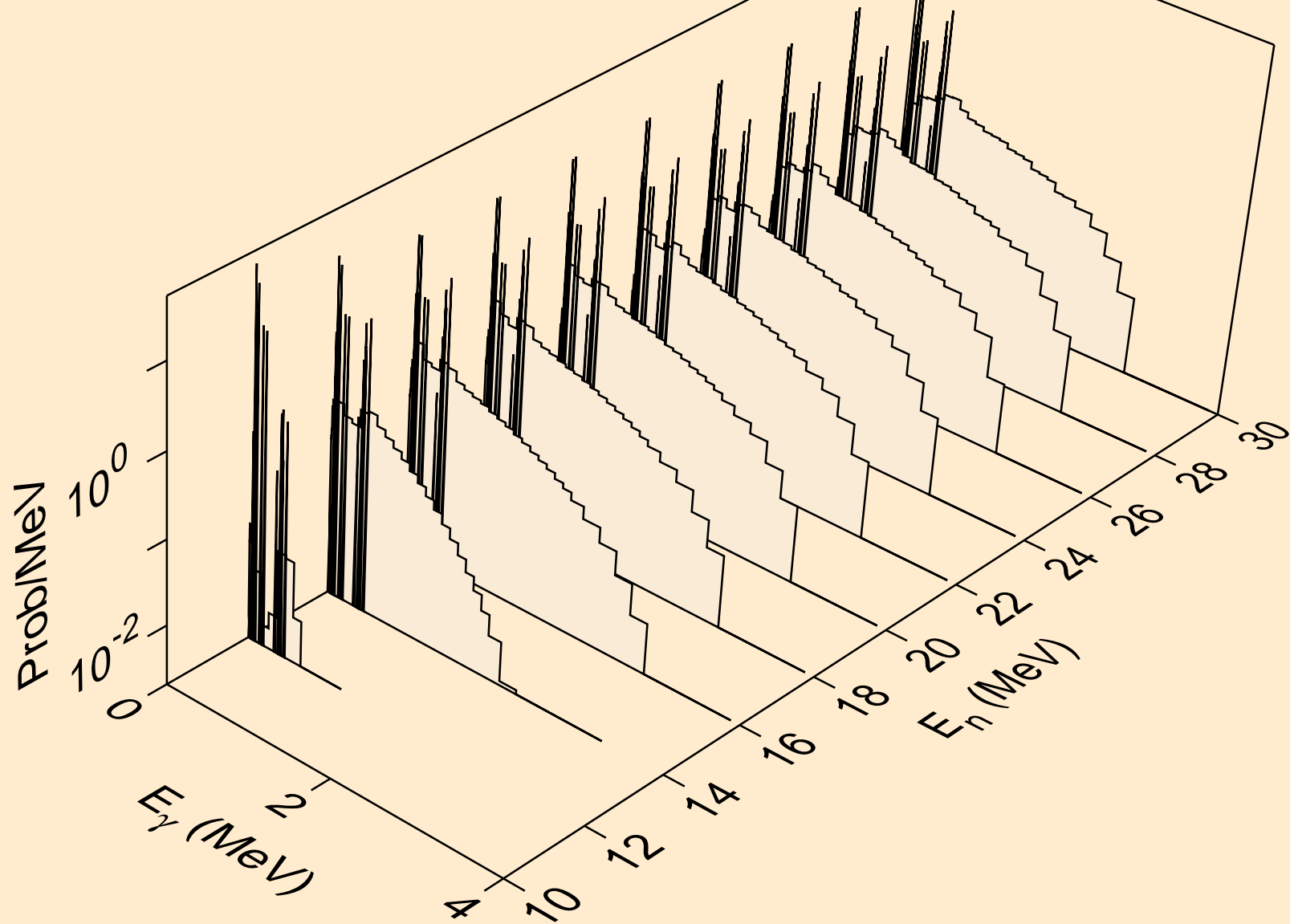

CF255 PROTON ACER TENDL-2021 LIBRARY; T=0.K  
Photon emission for (n,n\*)a

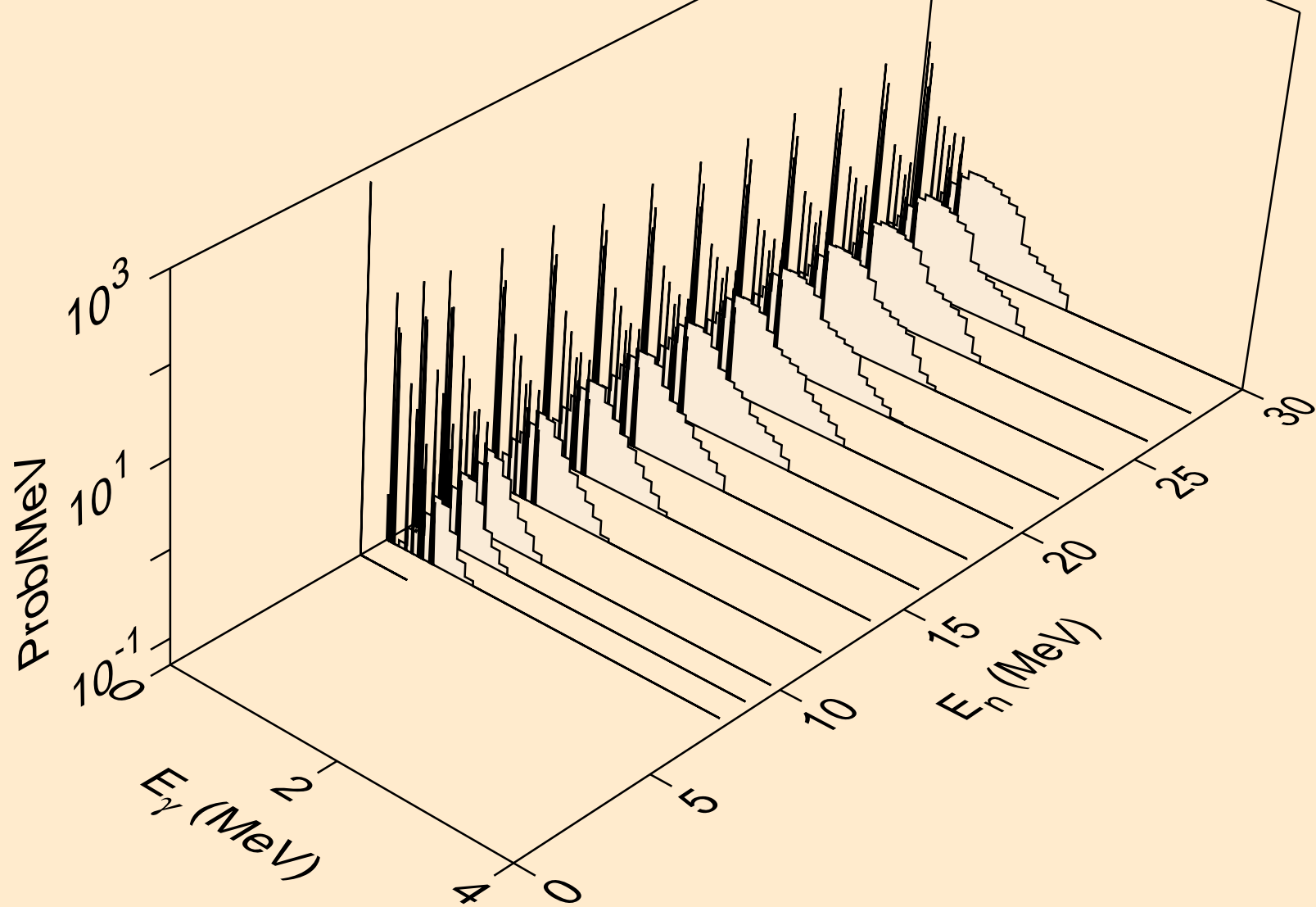

CF255 PROTON ACER TENDL-2021 LIBRARY; T=0.K  
Photon emission for (n,2n)a

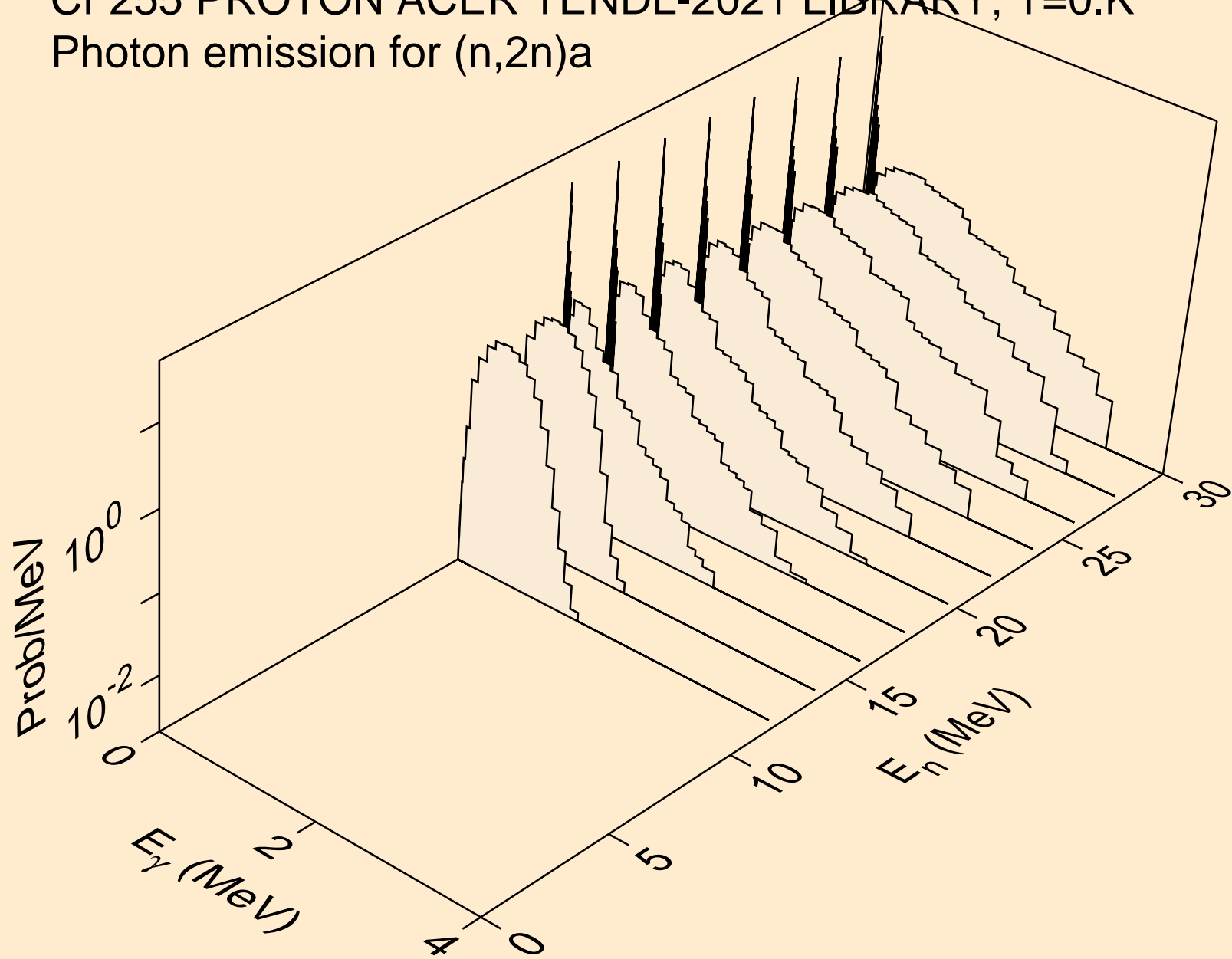

CF255 PROTON ACER TENDL-2021 LIBRARY; T=0.K  
Photon emission for (n,3n)a

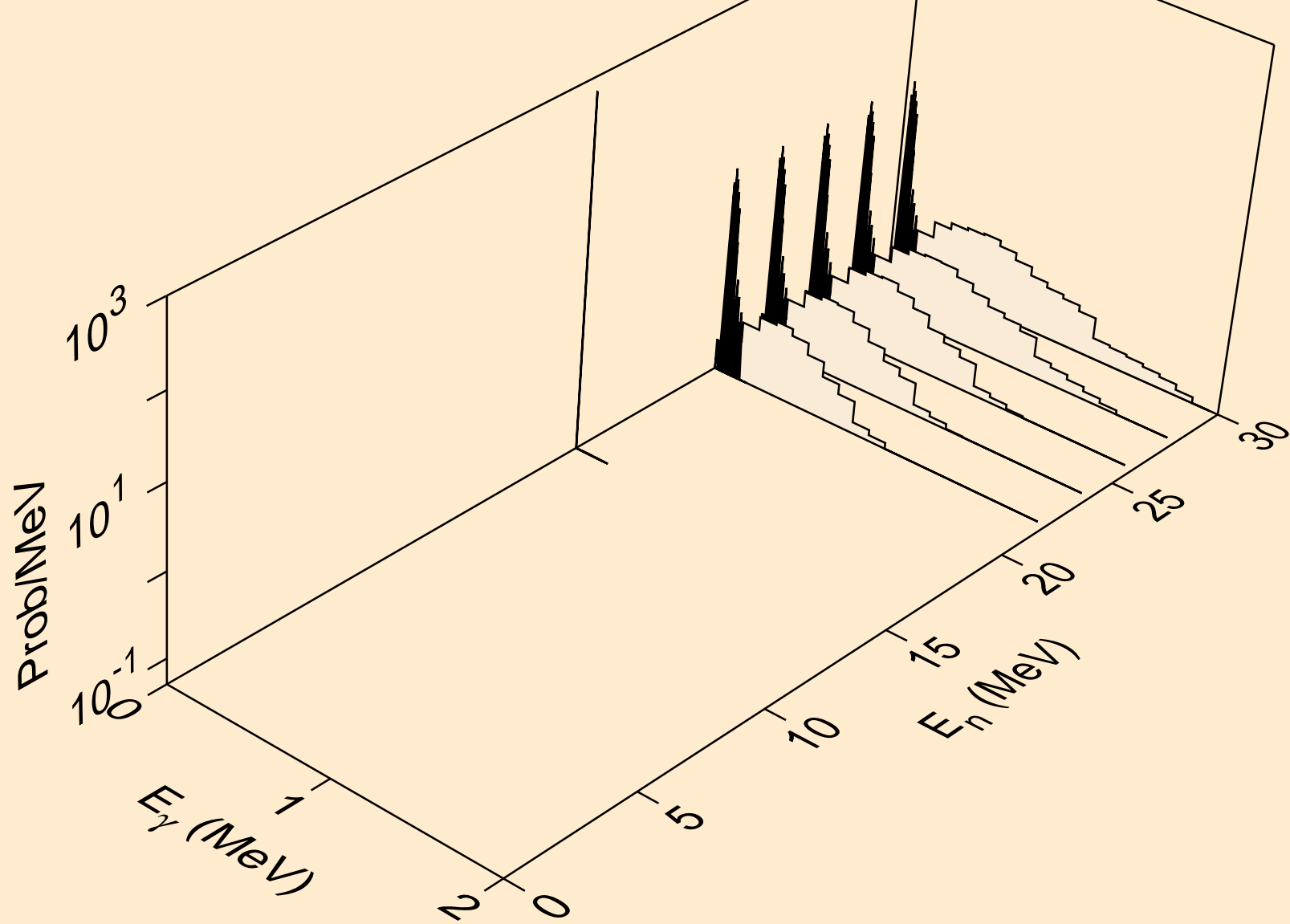

CF255 PROTON ACER TENDL-2021 LIBRARY; T=0.K  
Photon emission for (n,n\*)p

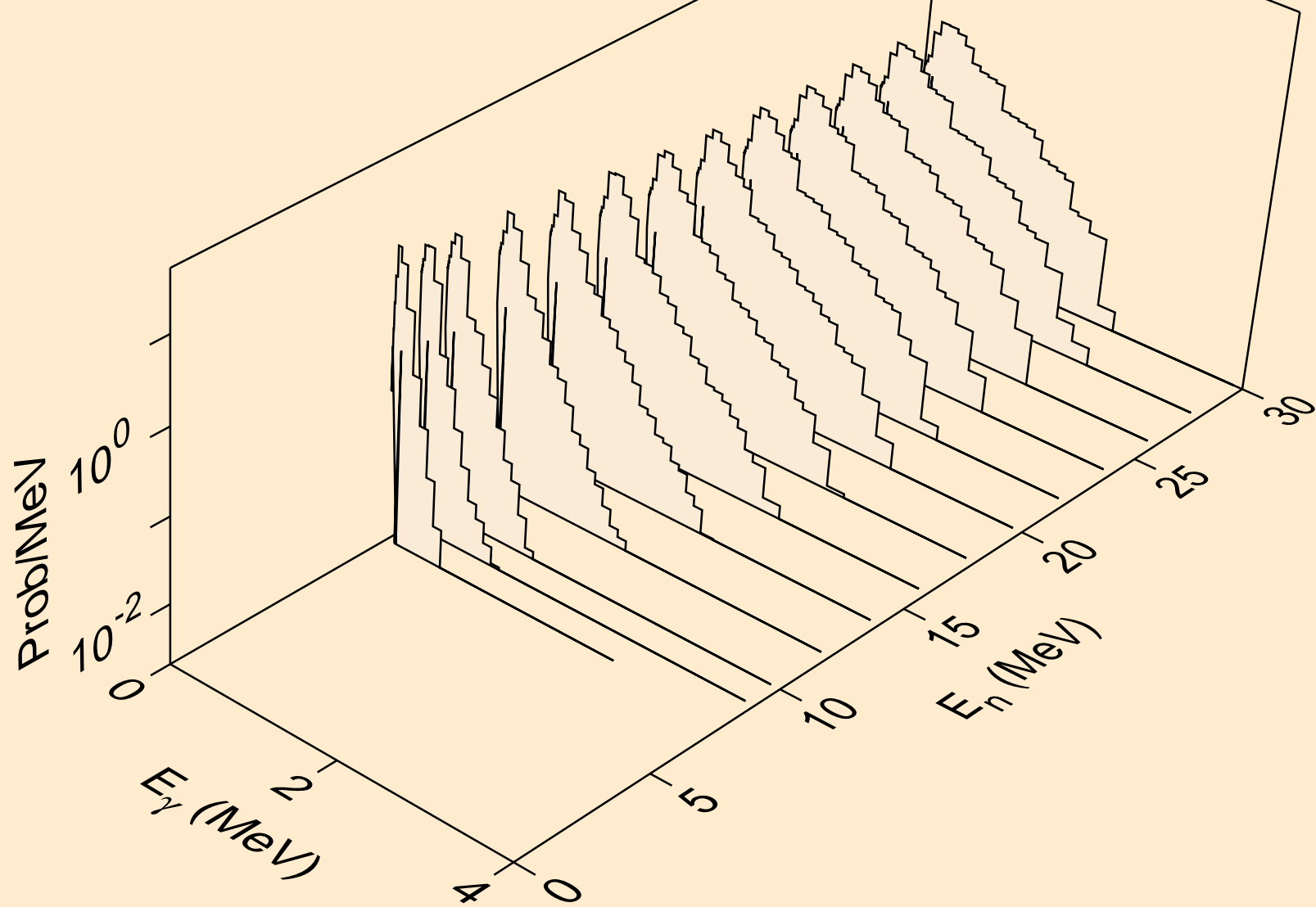



CF255 PROTON ACER TENDL-2021 LIBRARY; T=0.K  
Photon emission for (n,n\*)d

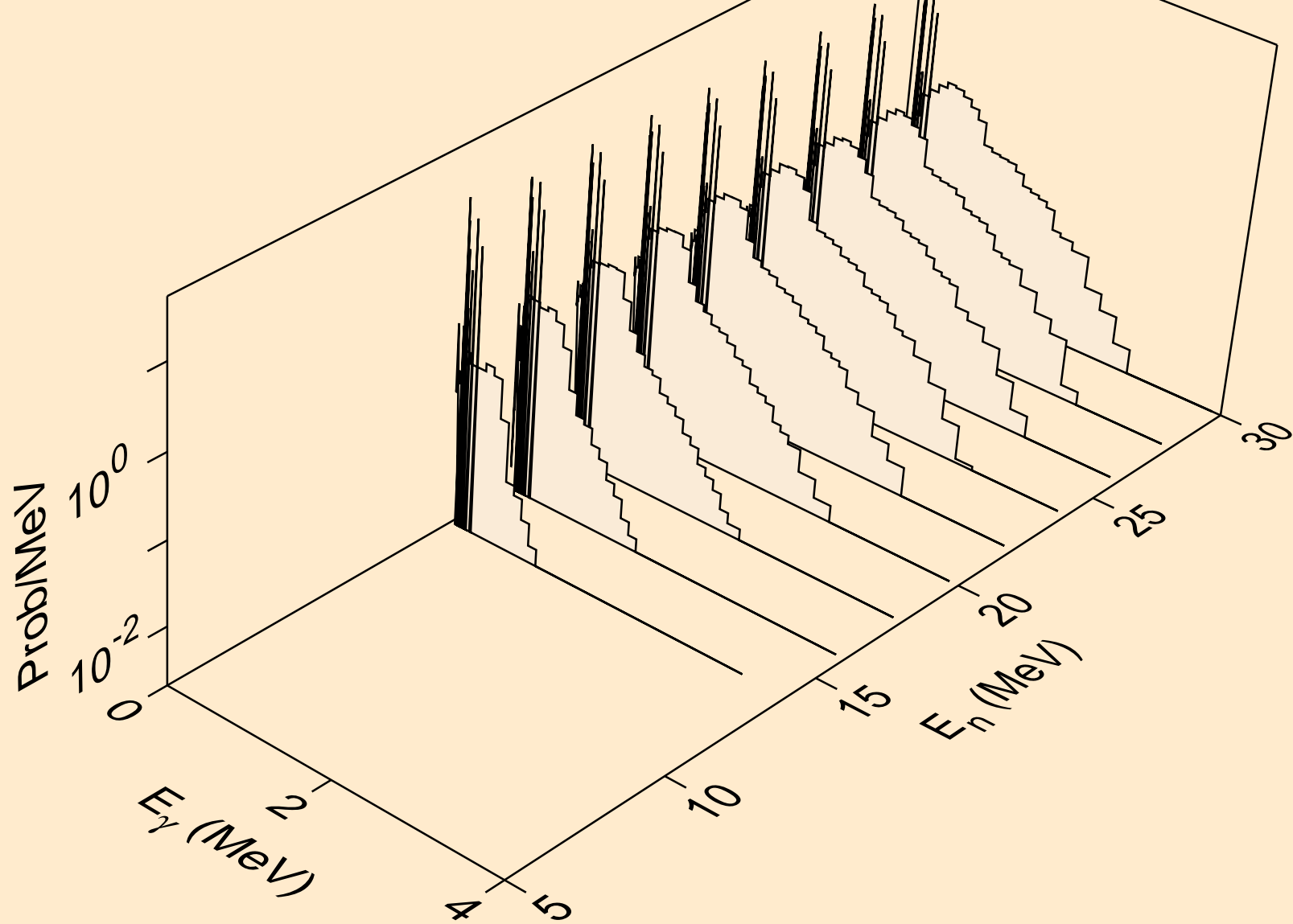

CF255 PROTON ACER TENDL-2021 LIBRARY; T=0.K  
Photon emission for (n,n\*)t

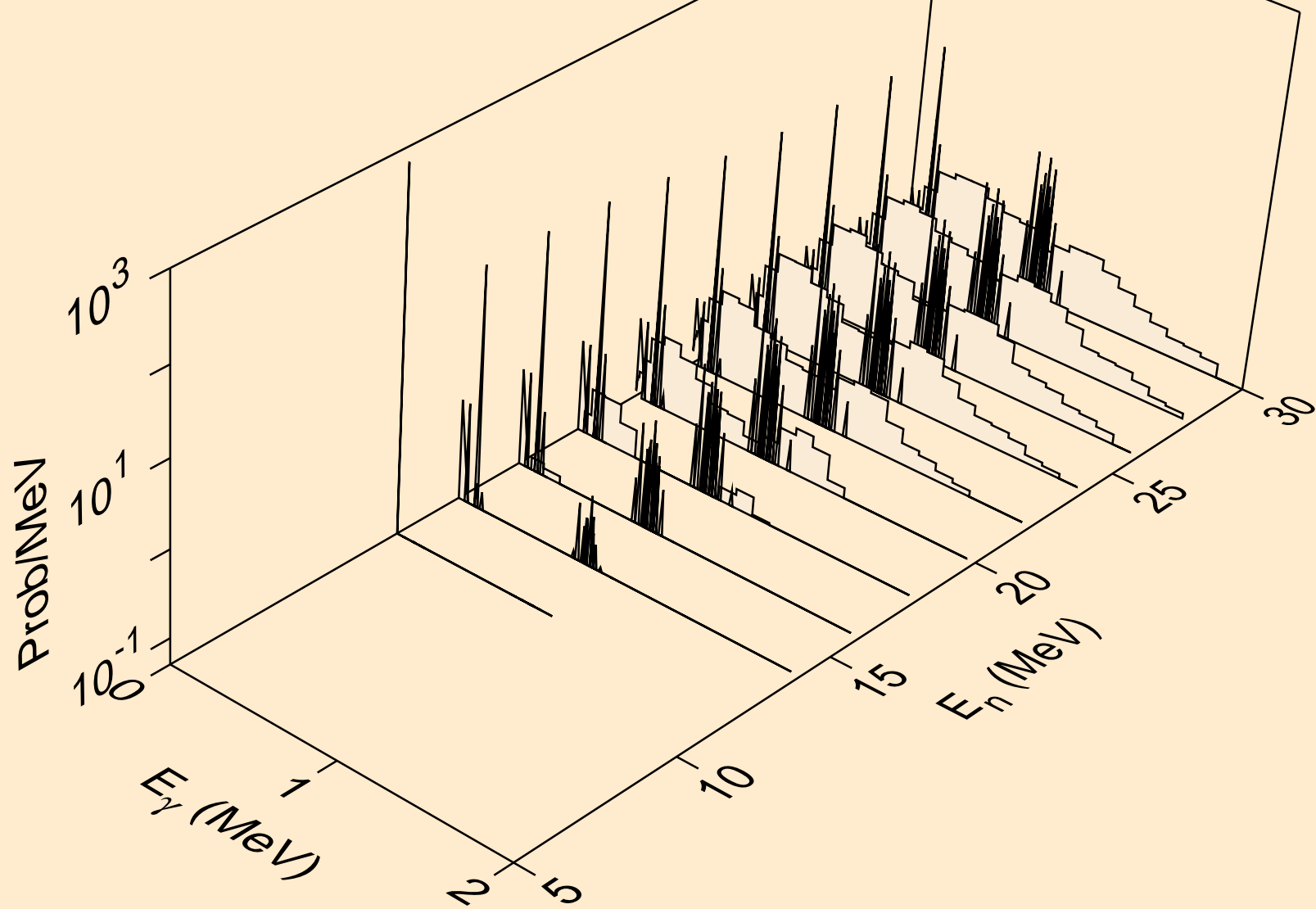

CF255 PROTON ACER TENDL-2021 LIBRARY; T=0.K  
Photon emission for (n,n\*)he3

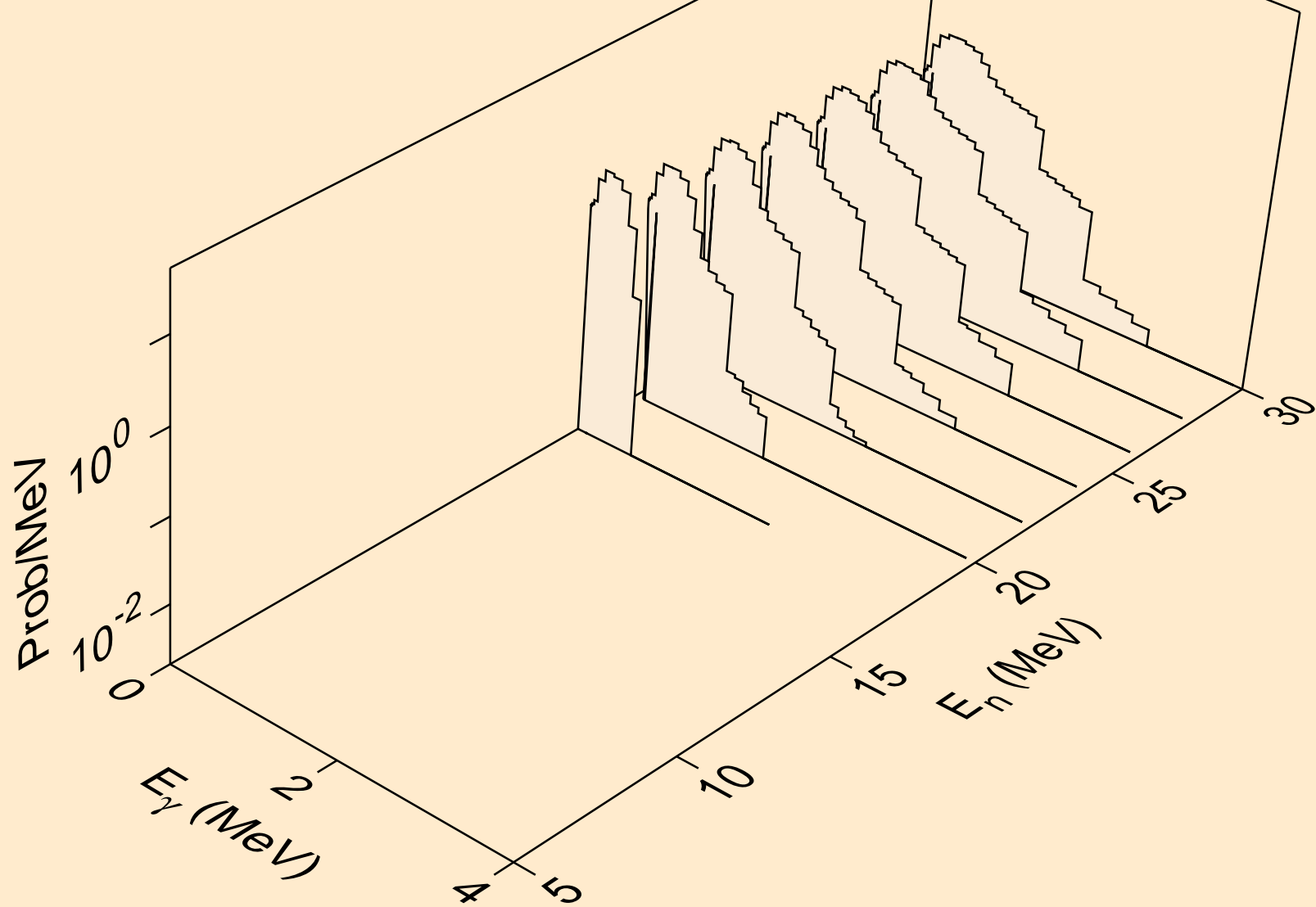

CF255 PROTON ACER TENDL-2021 LIBRARY; T=0.K  
Photon emission for (n,4n)

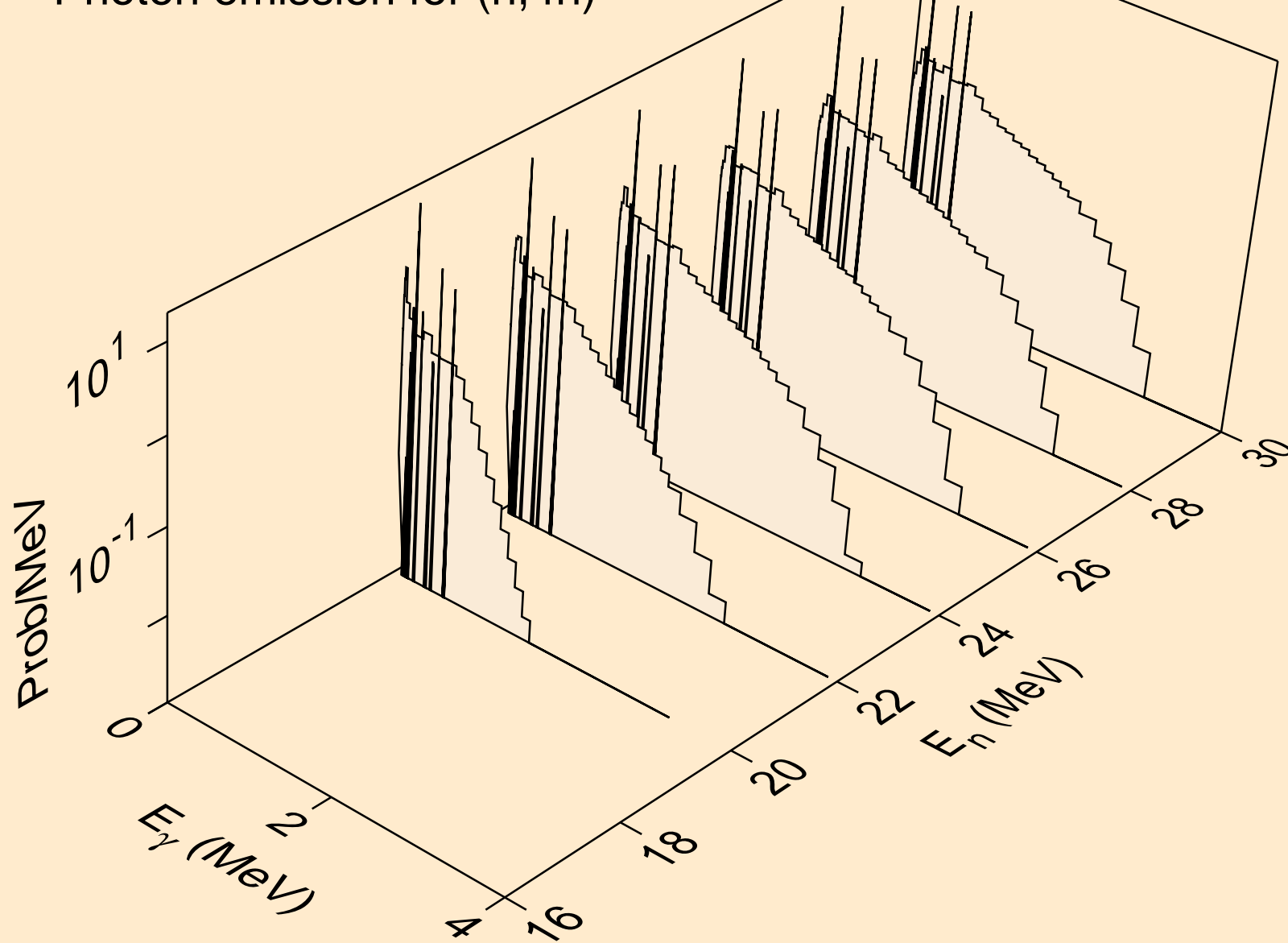

CF255 PROTON ACER TENDL-2021 LIBRARY; T=0.K  
Photon emission for (n,2np)

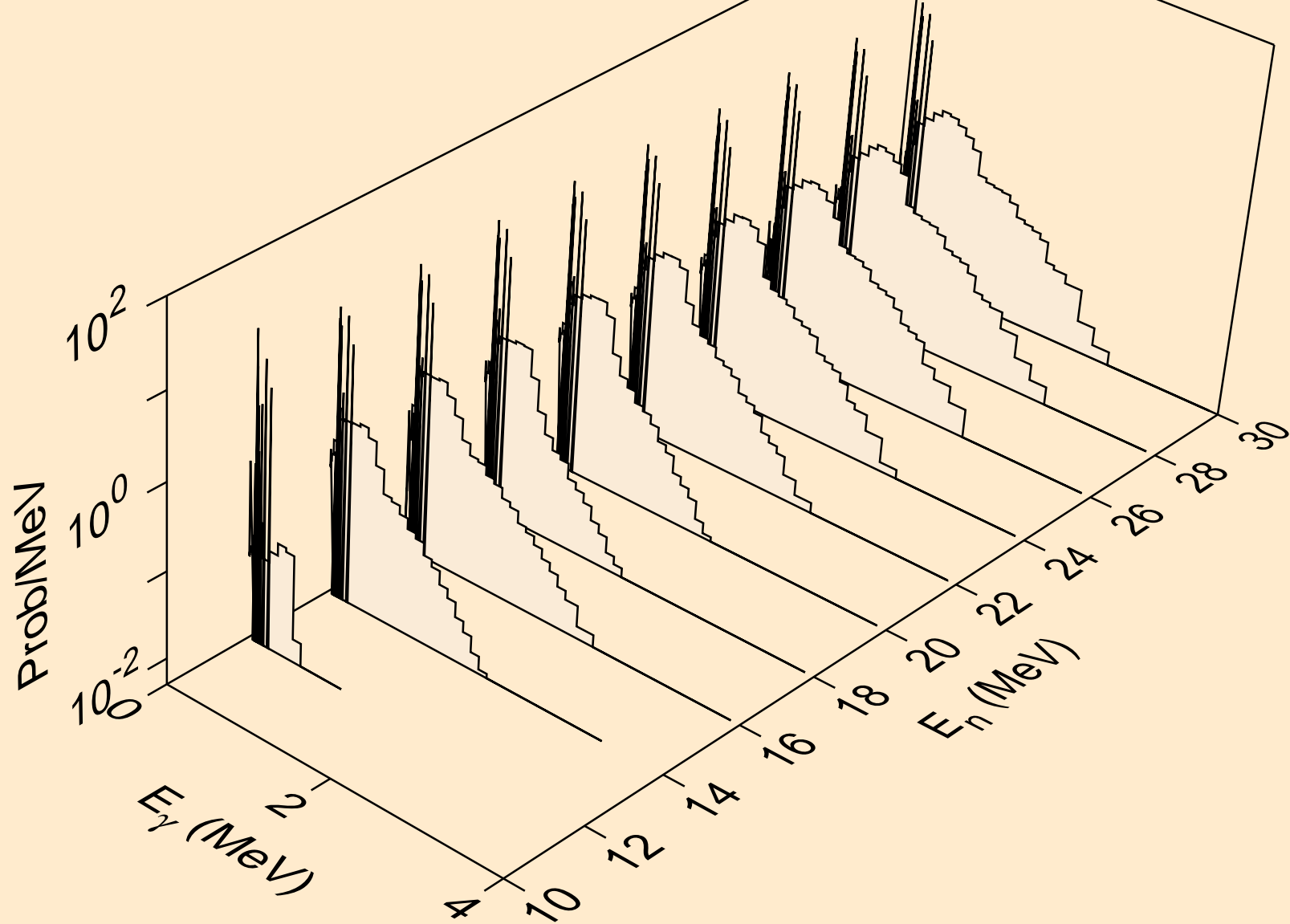

CF255 PROTON ACER TENDL-2021 LIBRARY; T=0.K  
Photon emission for (n,3np)

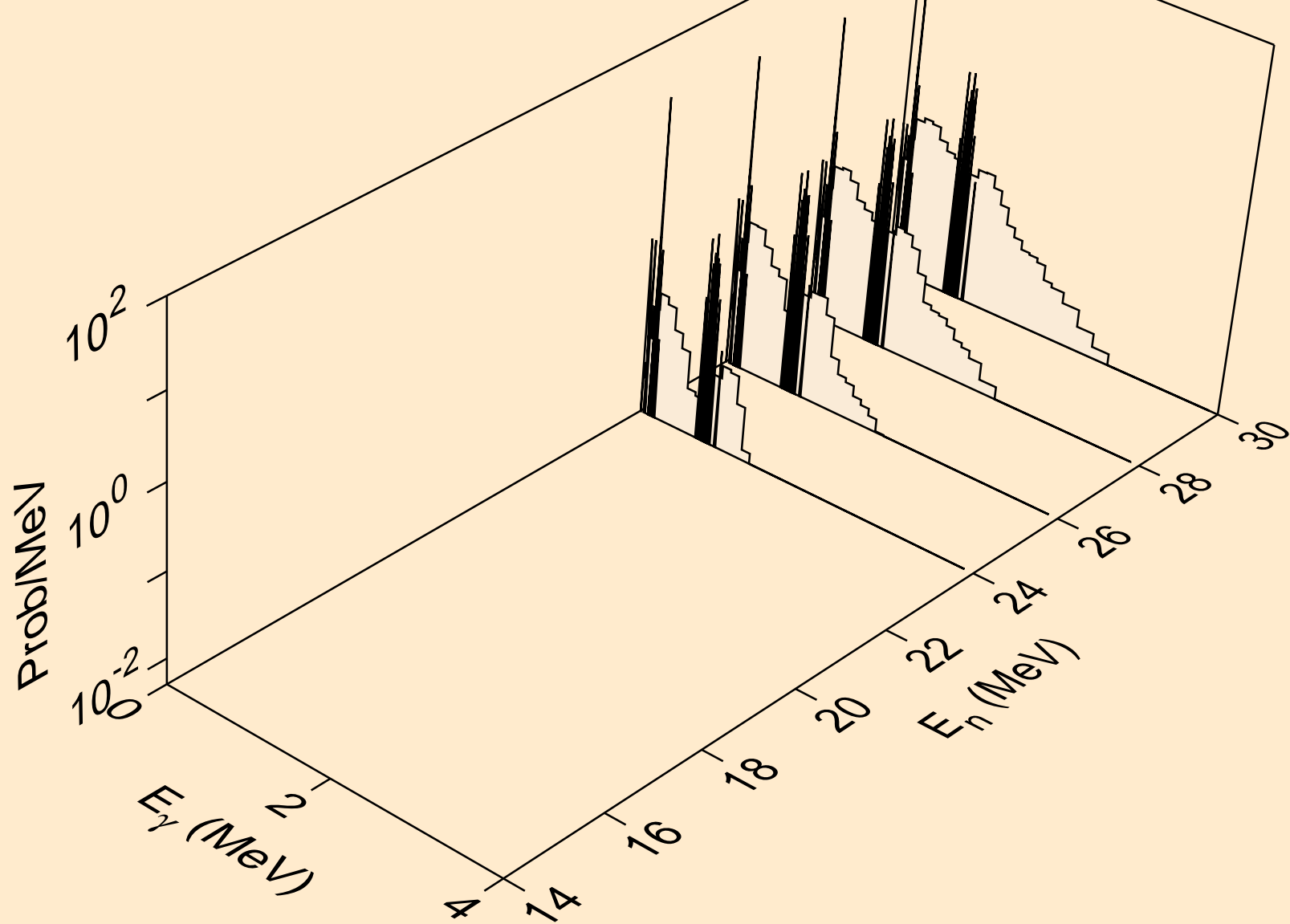

CF255 PROTON ACER TENDL-2021 LIBRARY; T=0.K  
Photon emission for (n,gma)

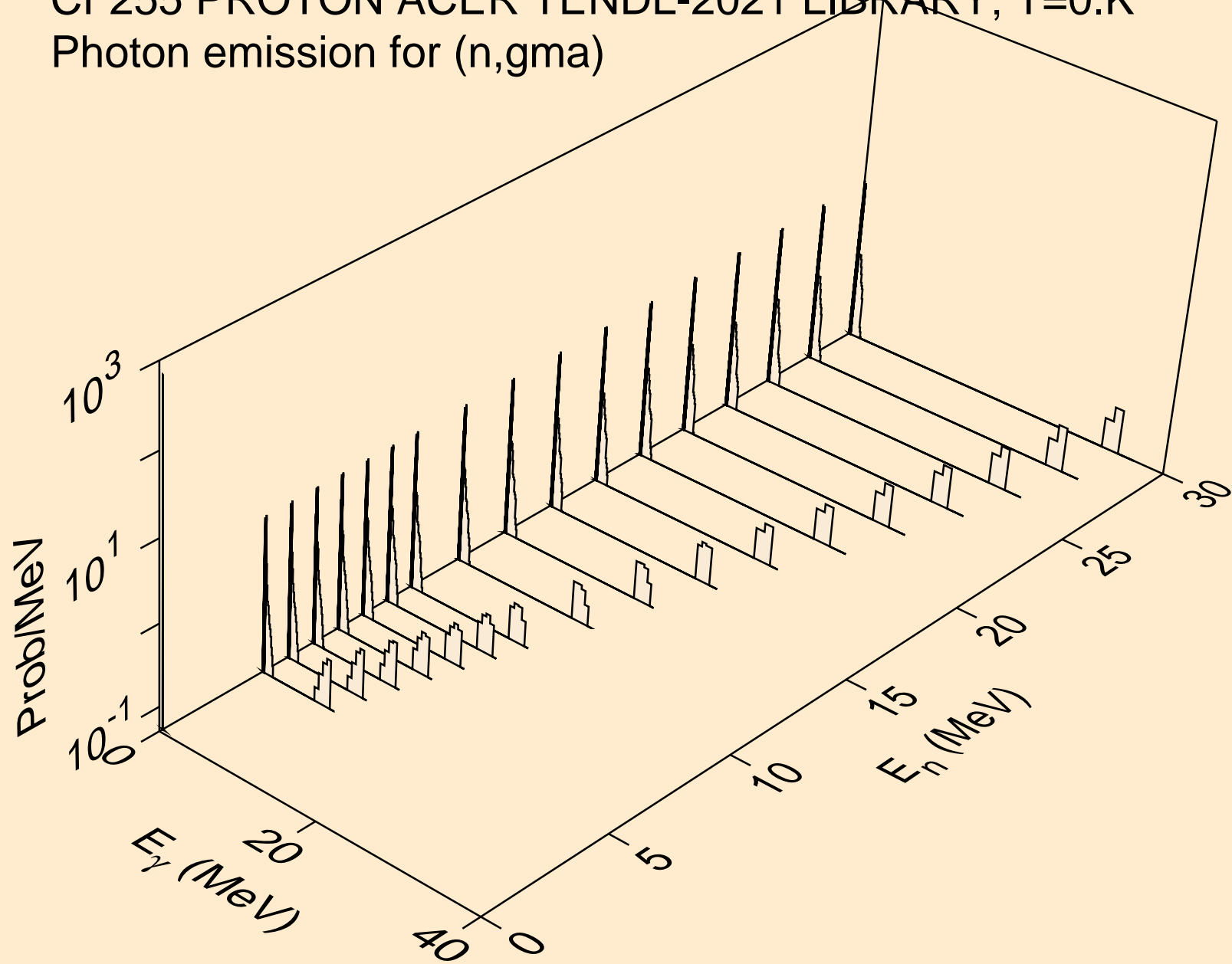

CF255 PROTON ACER TENDL-2021 LIBRARY; T=0.K  
Photon emission for inelastic

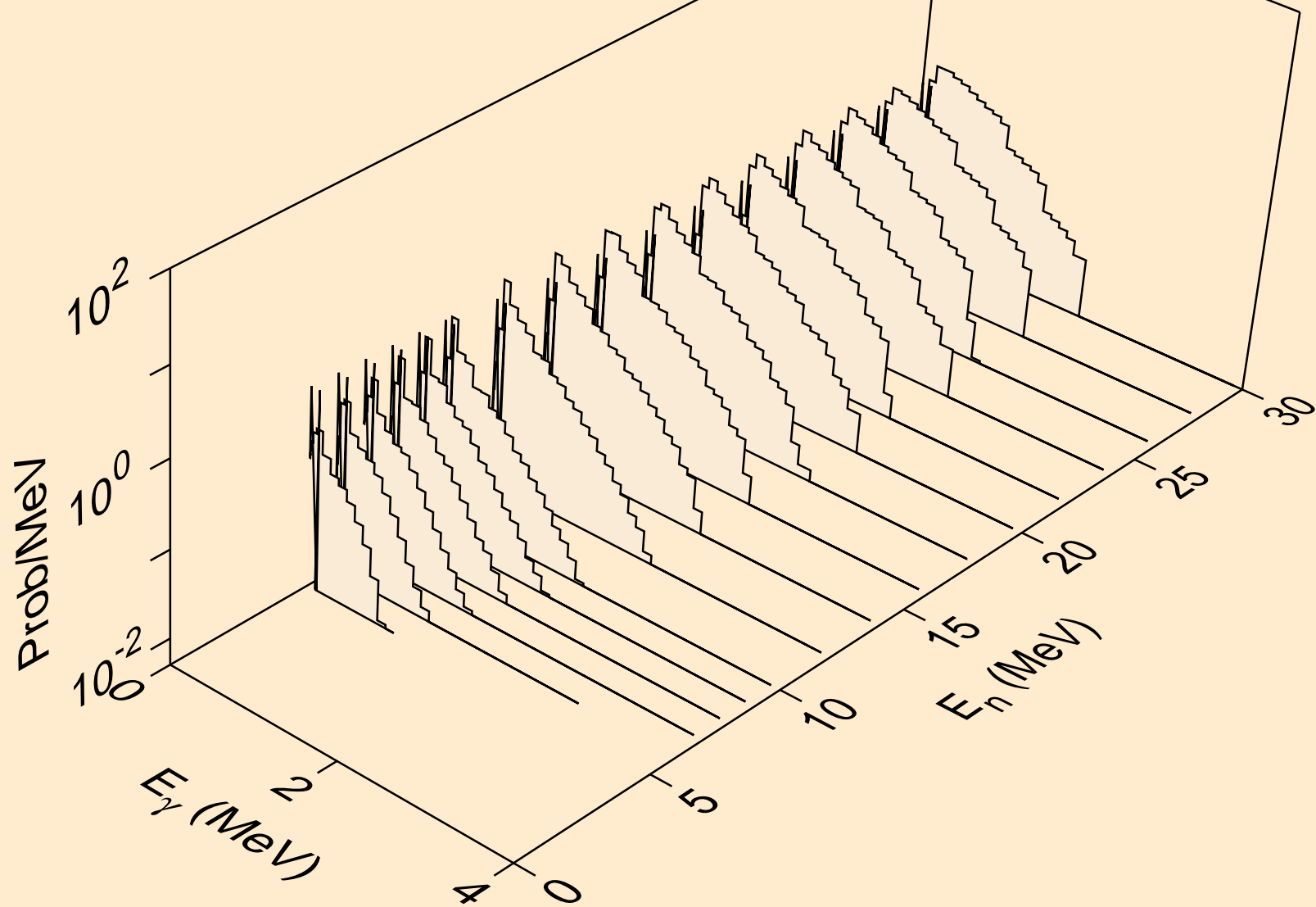



CF255 PROTON ACER TENDL-2021 LIBRARY; T=0.K  
Photon emission for (n,d)

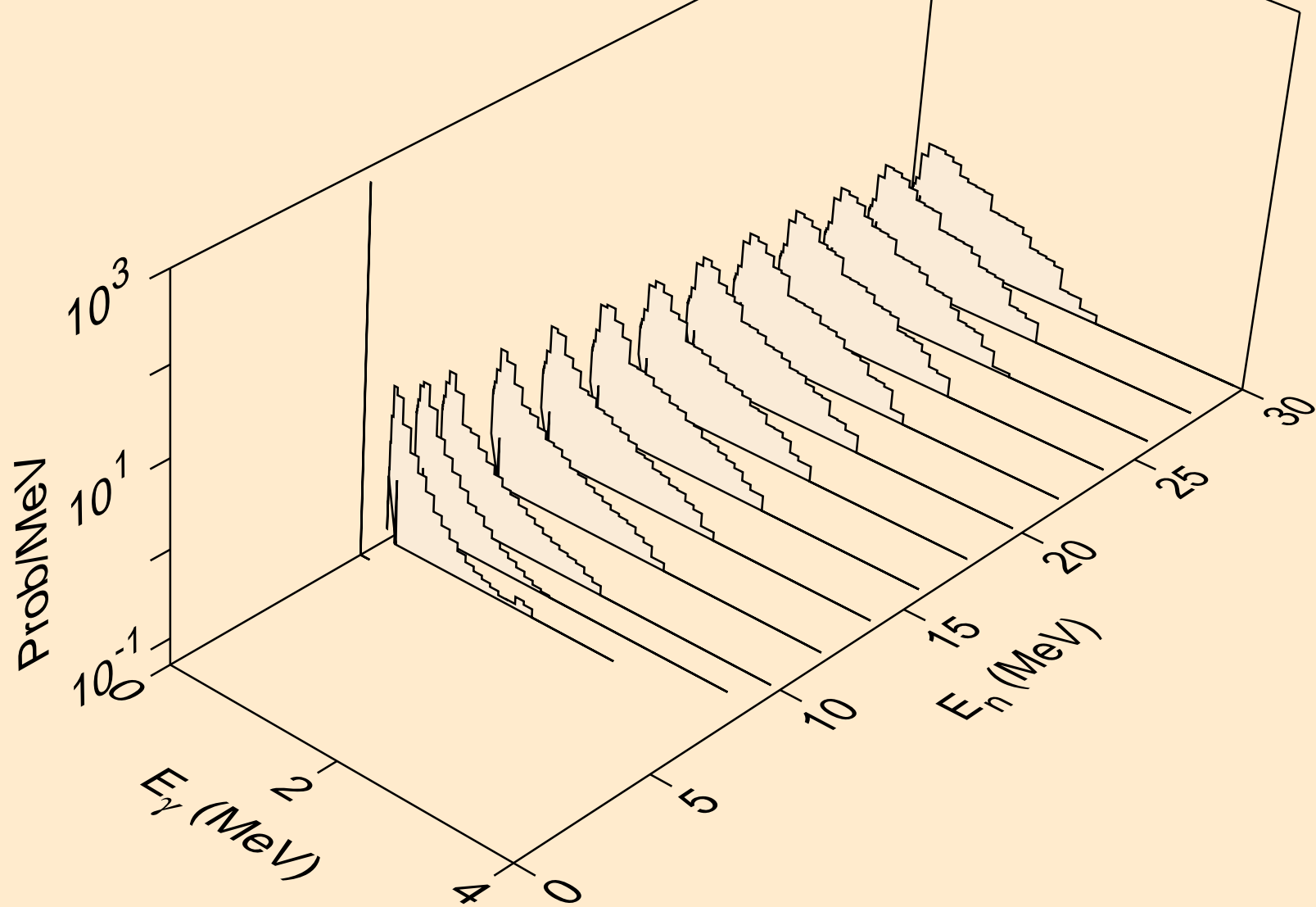

CF255 PROTON ACER TENDL-2021 LIBRARY; T=0.K  
Photon emission for (n,t)

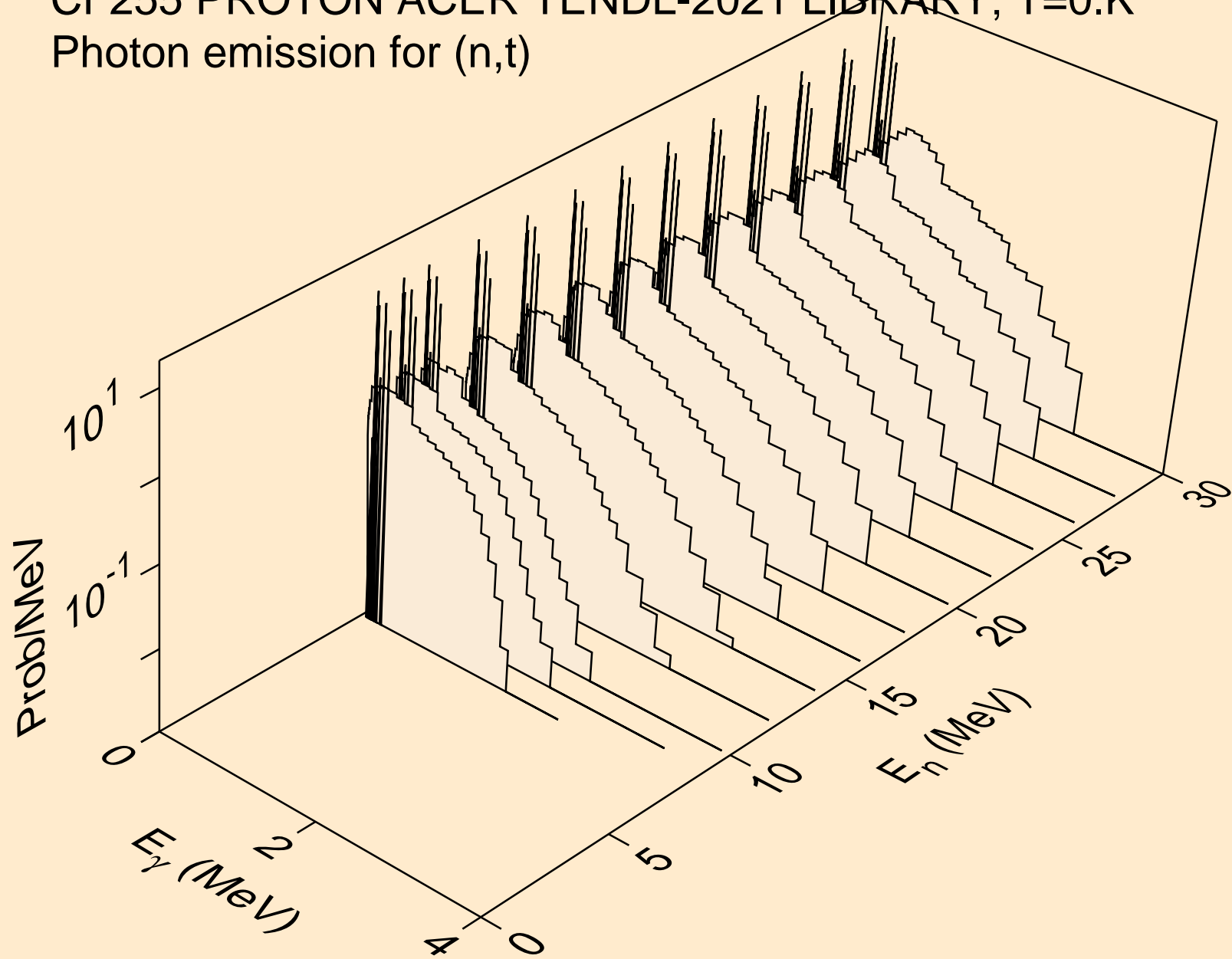

CF255 PROTON ACER TENDL-2021 LIBRARY; T=0.K  
Photon emission for (n,he3)

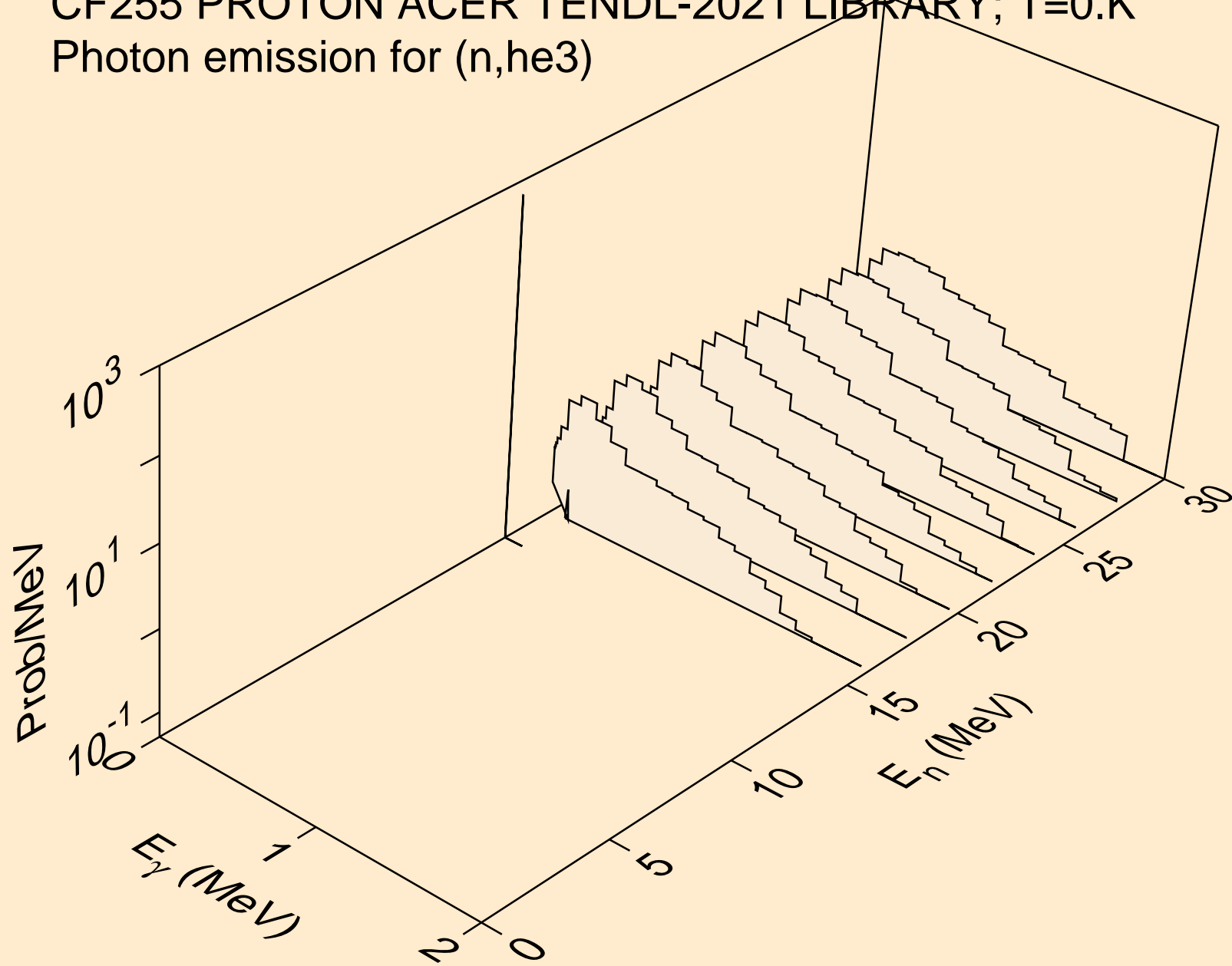

CF255 PROTON ACER TENDL-2021 LIBRARY; T=0.K  
Photon emission for (n,a)

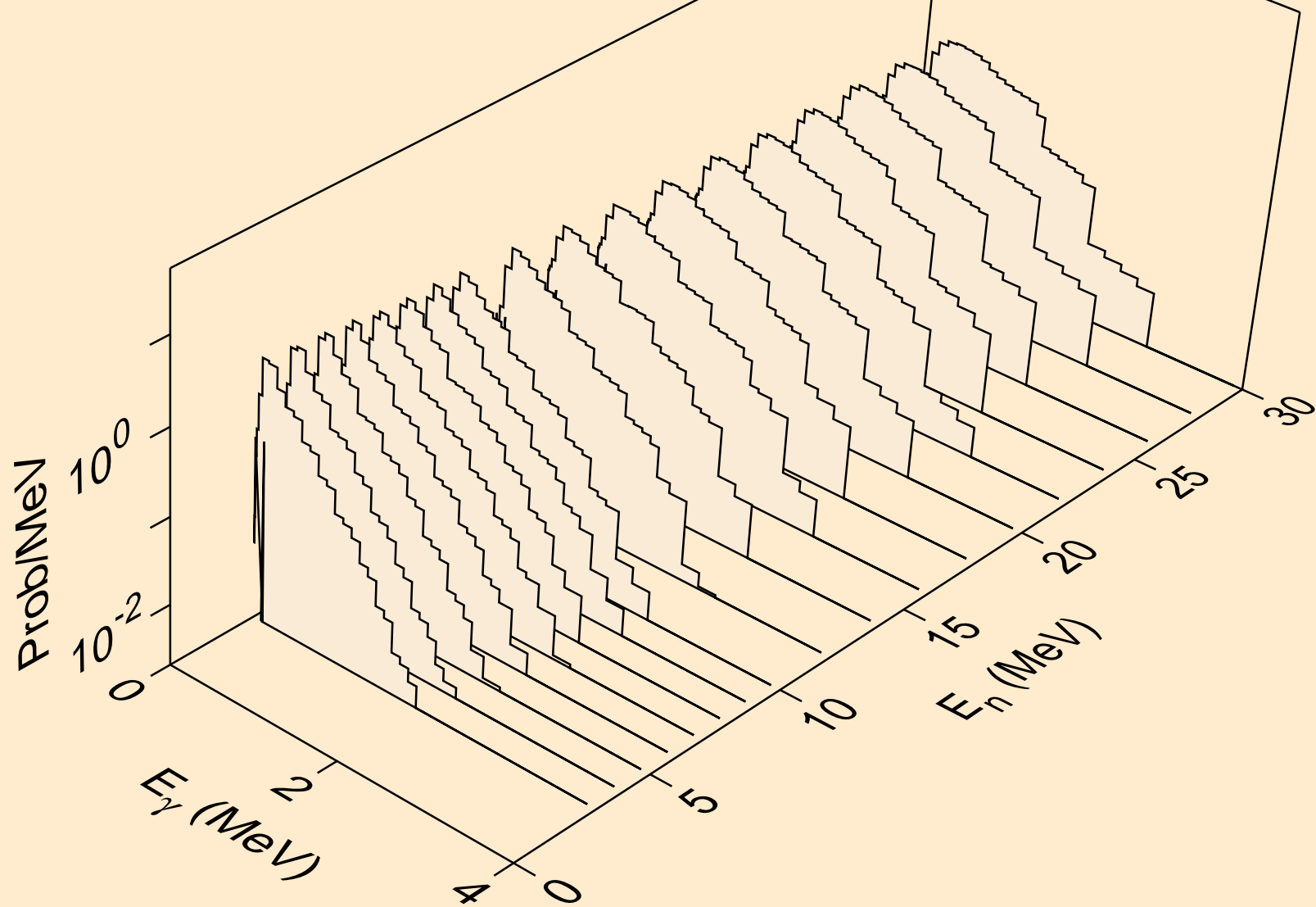

CF255 PROTON ACER TENDL-2021 LIBRARY; T=0.K  
Photon emission for (n,2p)

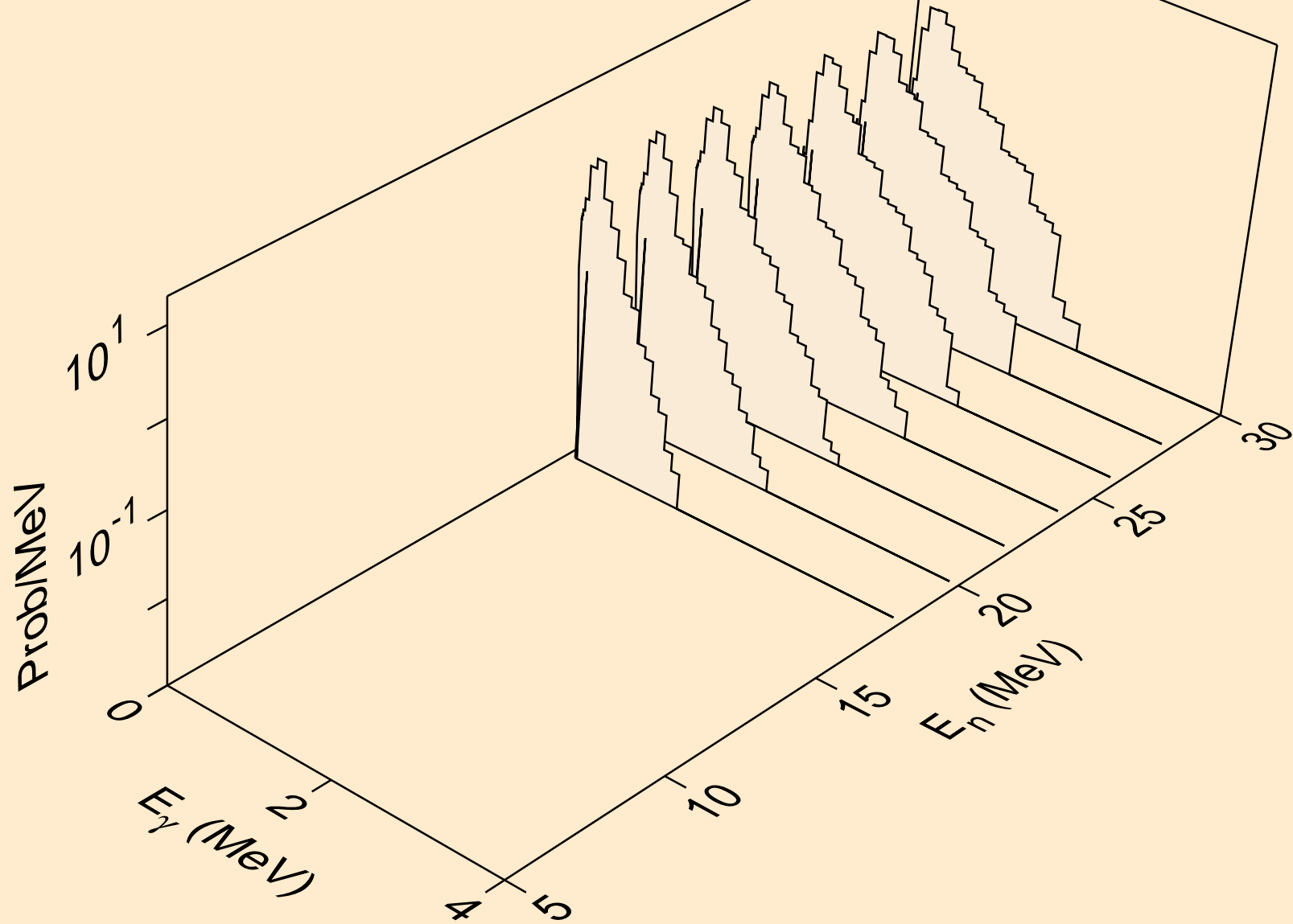

CF255 PROTON ACER TENDL-2021 LIBRARY; T=0.K  
Particle heating contributions

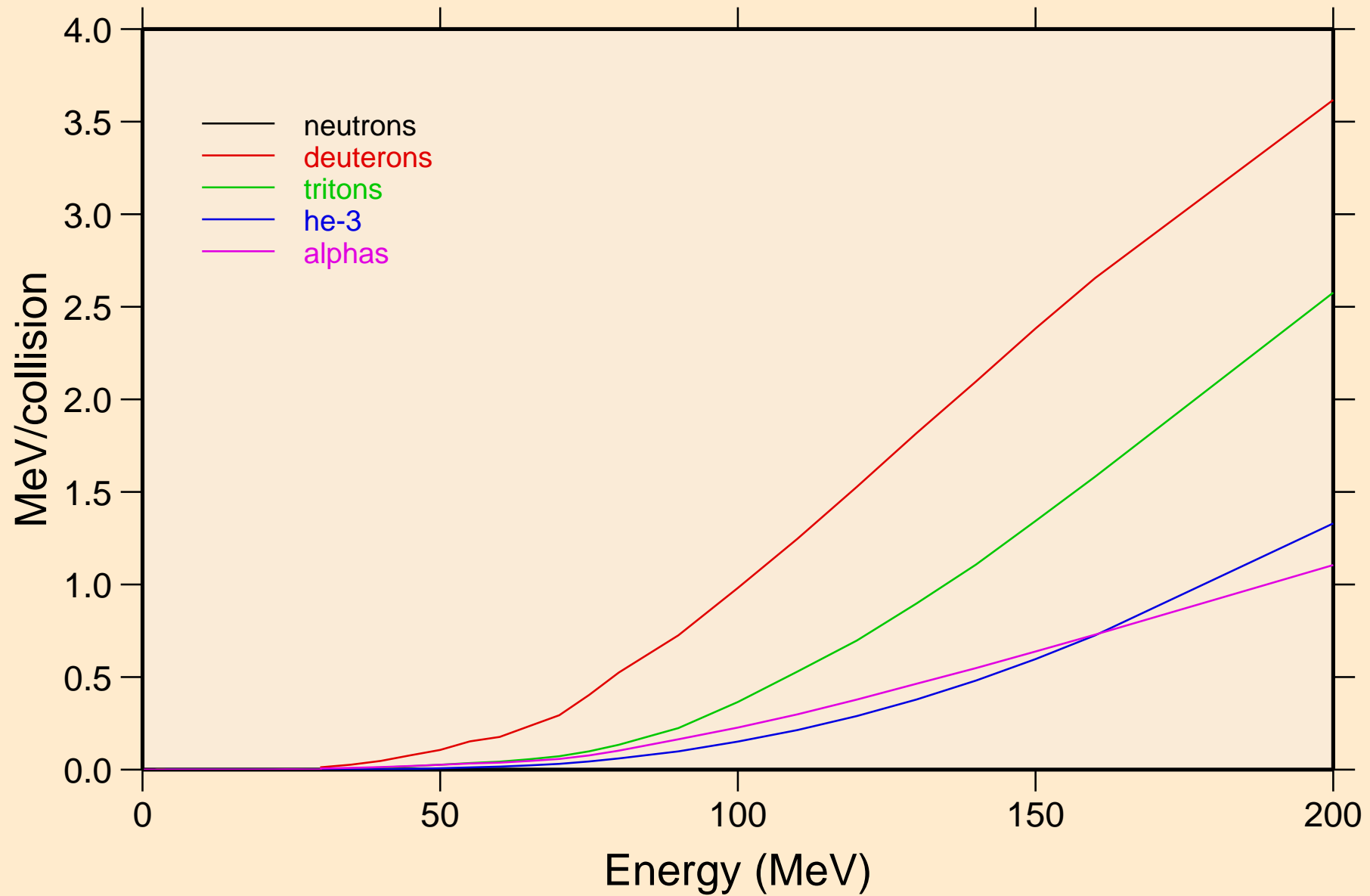

CF255 PROTON ACER TENDL-2021 LIBRARY; T=0.K  
Recoil Heating

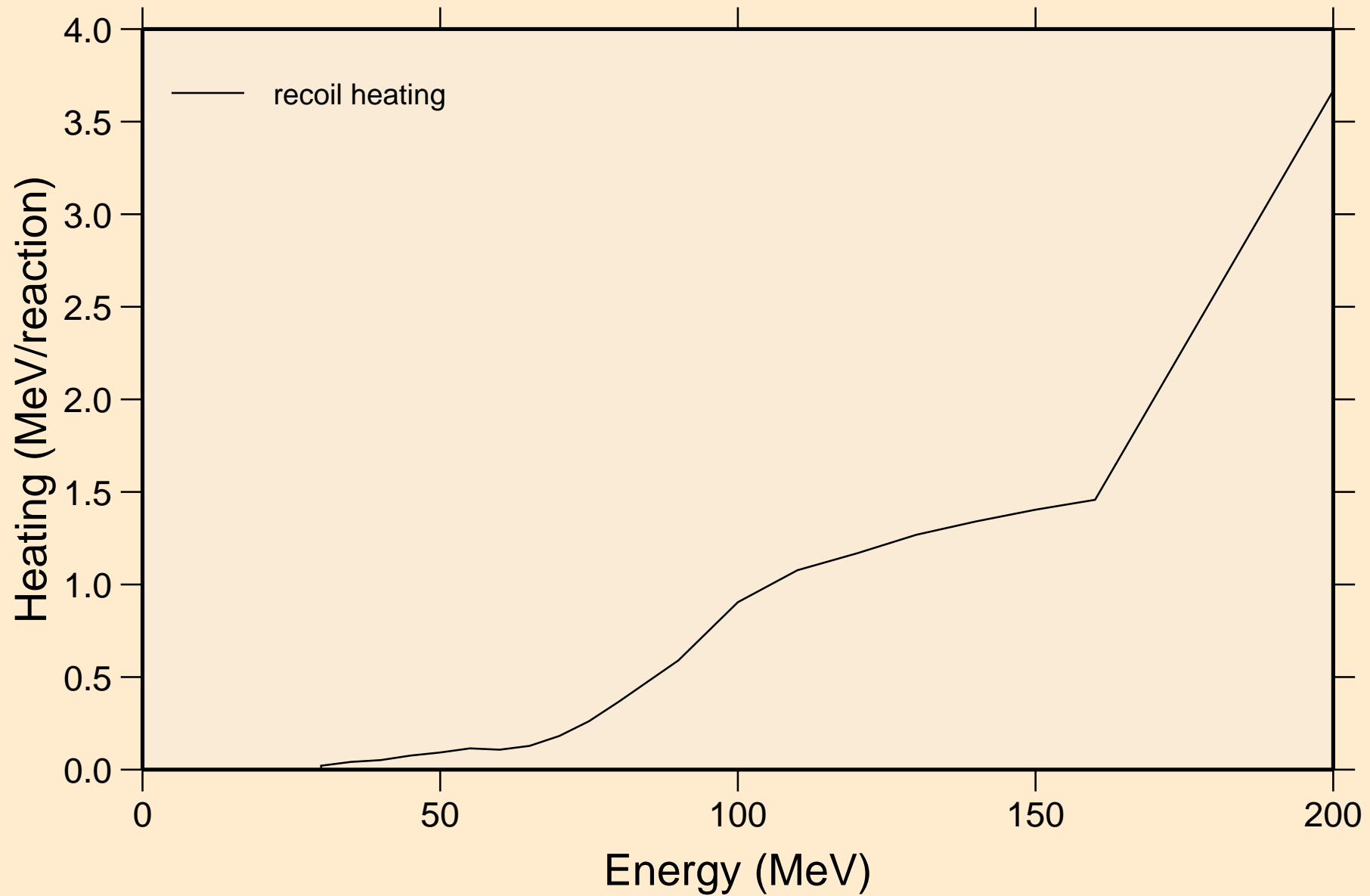

CF255 PROTON ACER TENDL-2021 LIBRARY; T=0.K  
Particle production cross sections

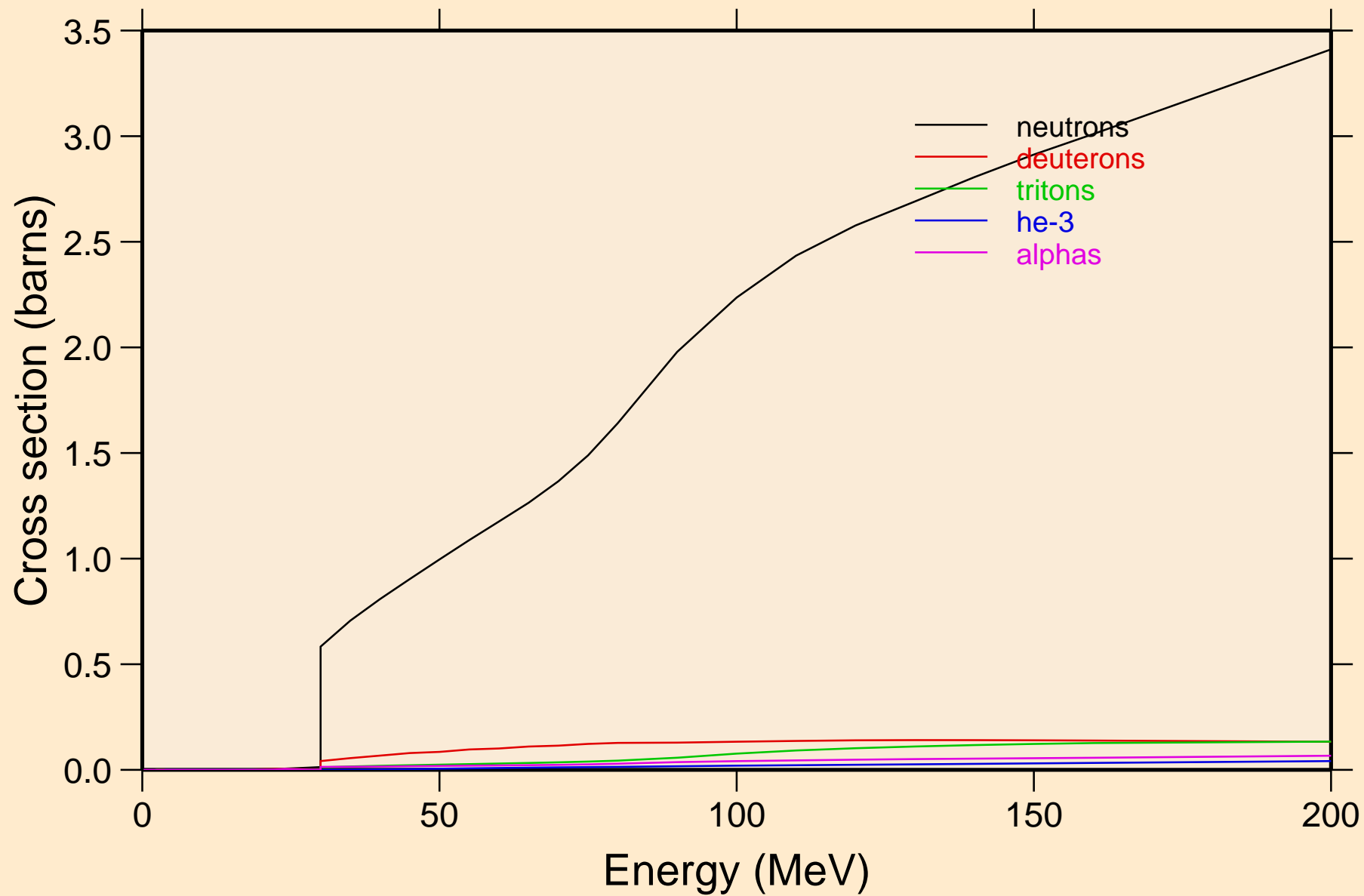



CF255 PROTON ACER TENDL-2021 LIBRARY; T=0.K  
neutrons from (p,n)

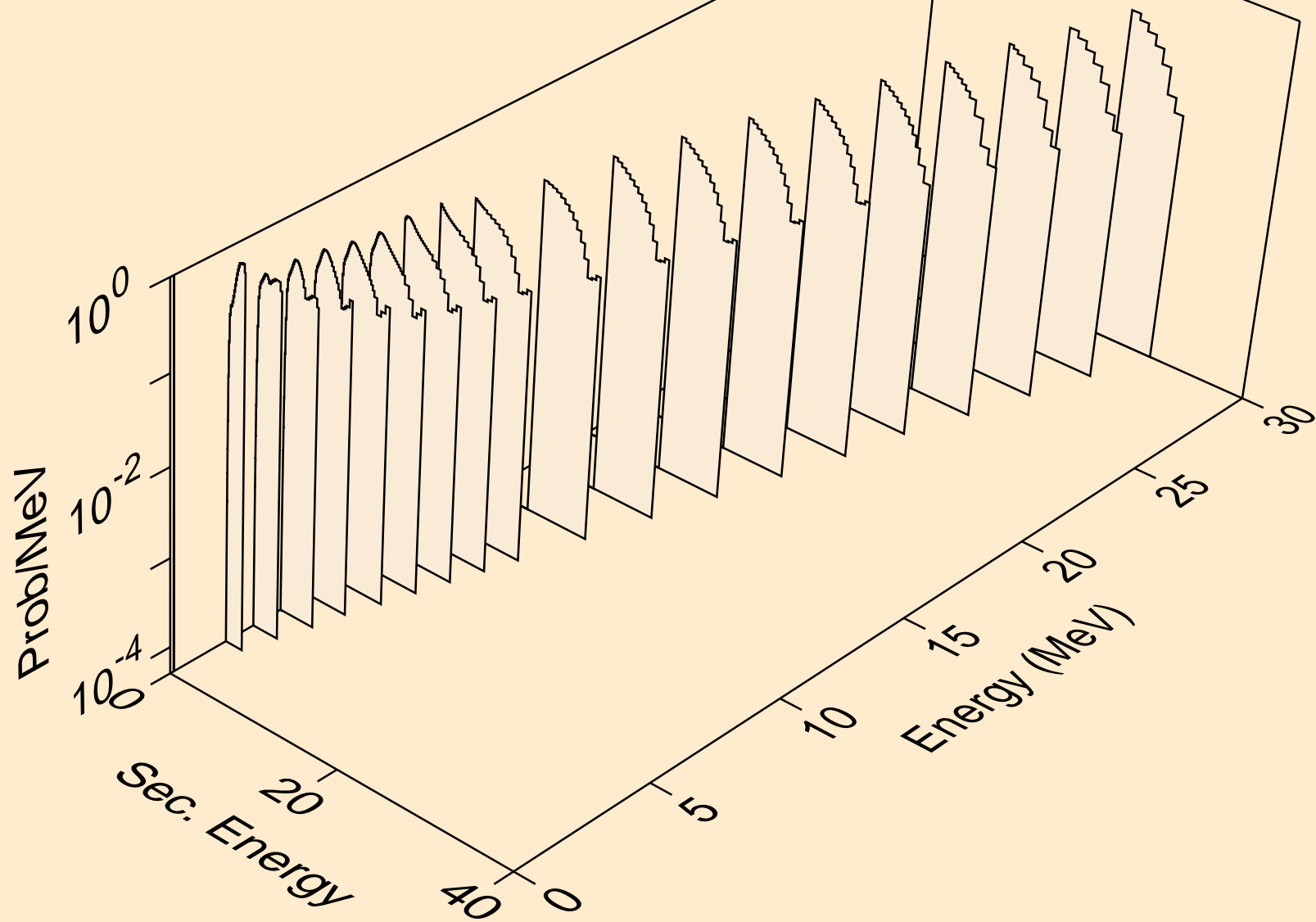

CF255 PROTON ACER TENDL-2021 LIBRARY; T=0.K  
neutrons from (p,x)

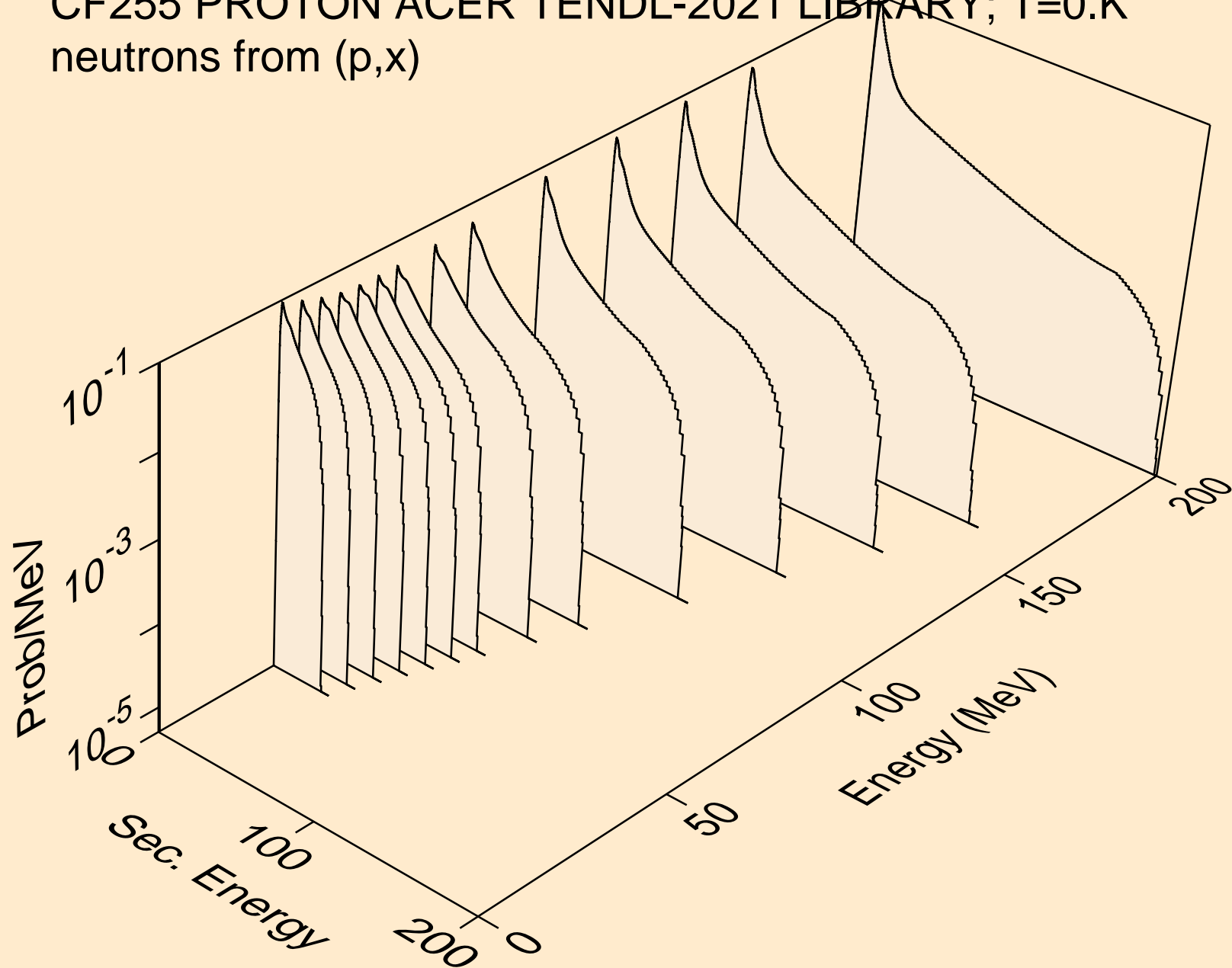

CF255 PROTON ACER TENDL-2021 LIBRARY; T=0.K  
neutrons from (p,2nd)

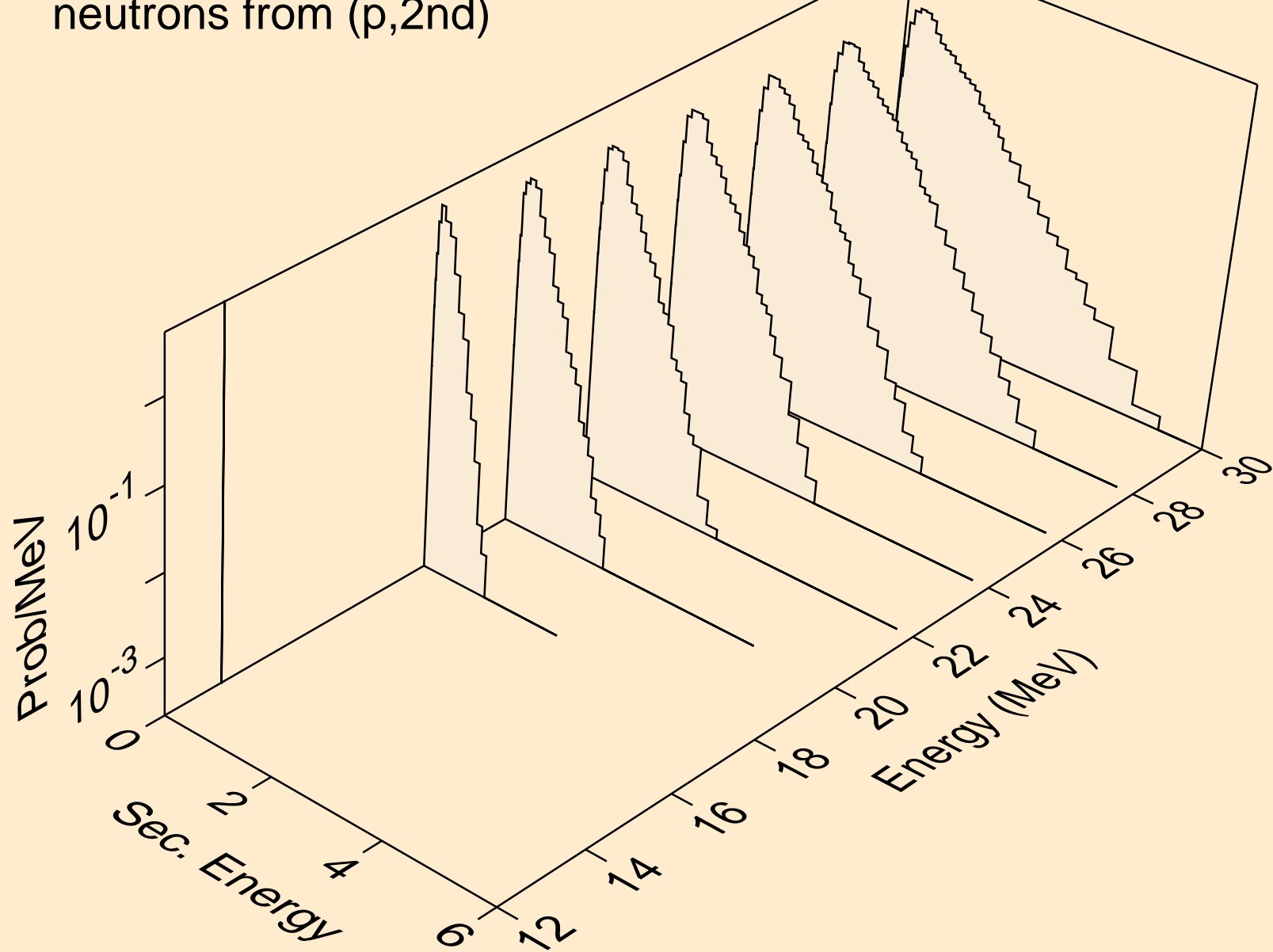

CF255 PROTON ACER TENDL-2021 LIBRARY; T=0.K  
neutrons from (p,2n)

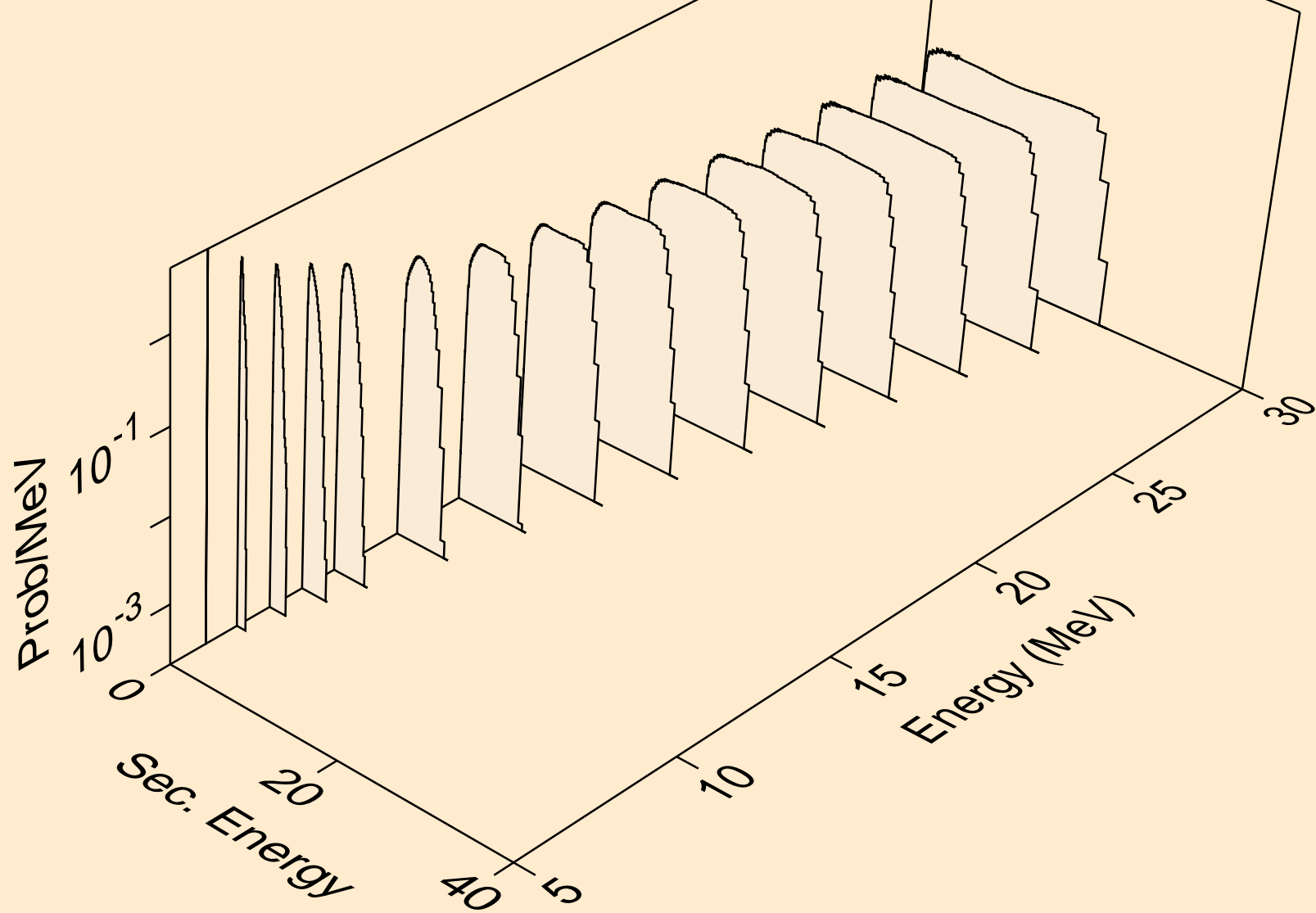

CF255 PROTON ACER TENDL-2021 LIBRARY; T=0.K  
neutrons from (p,3n)

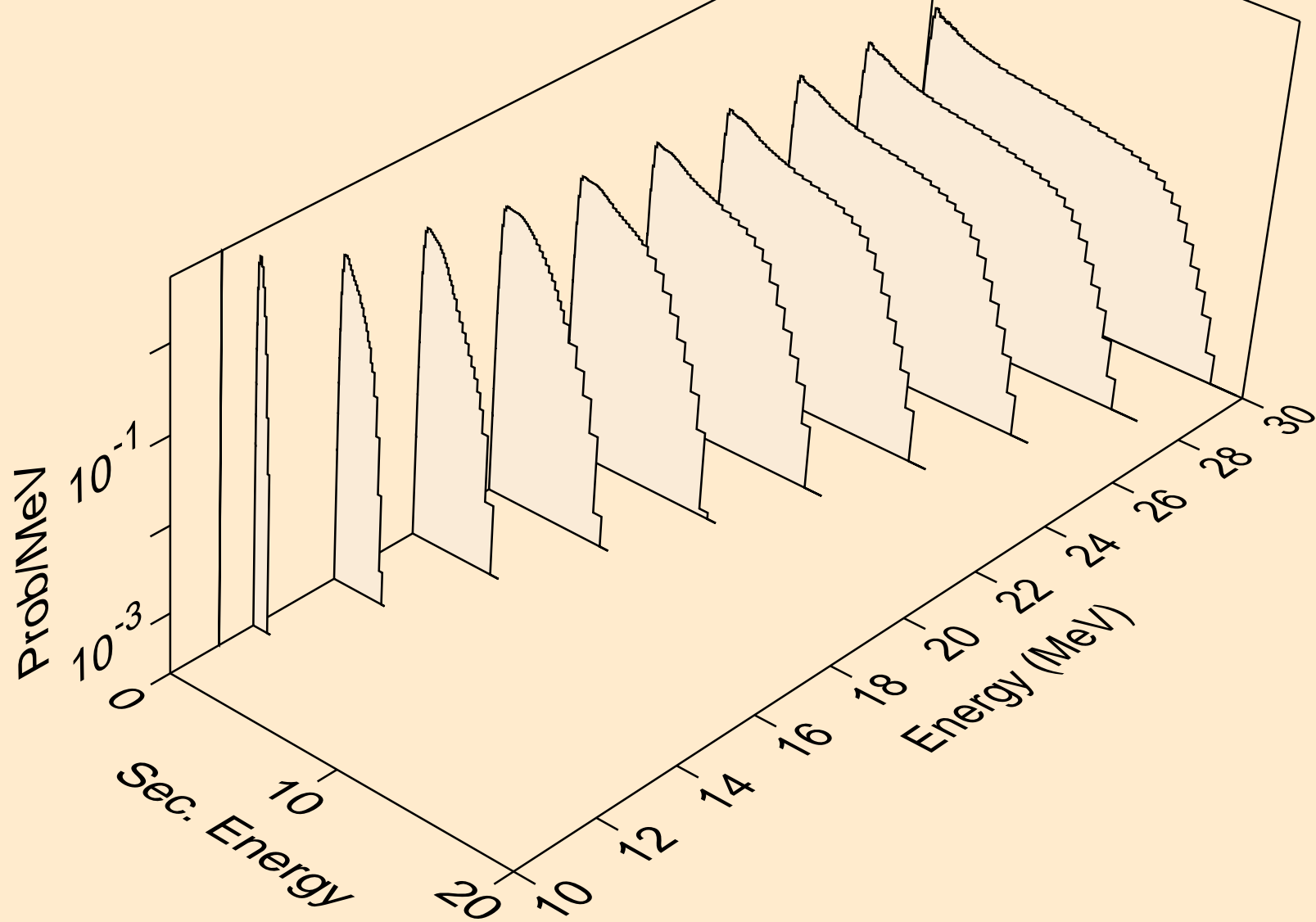

CF255 PROTON ACER TENDL-2021 LIBRARY; T=0.K  
neutrons from (p,n\*)a

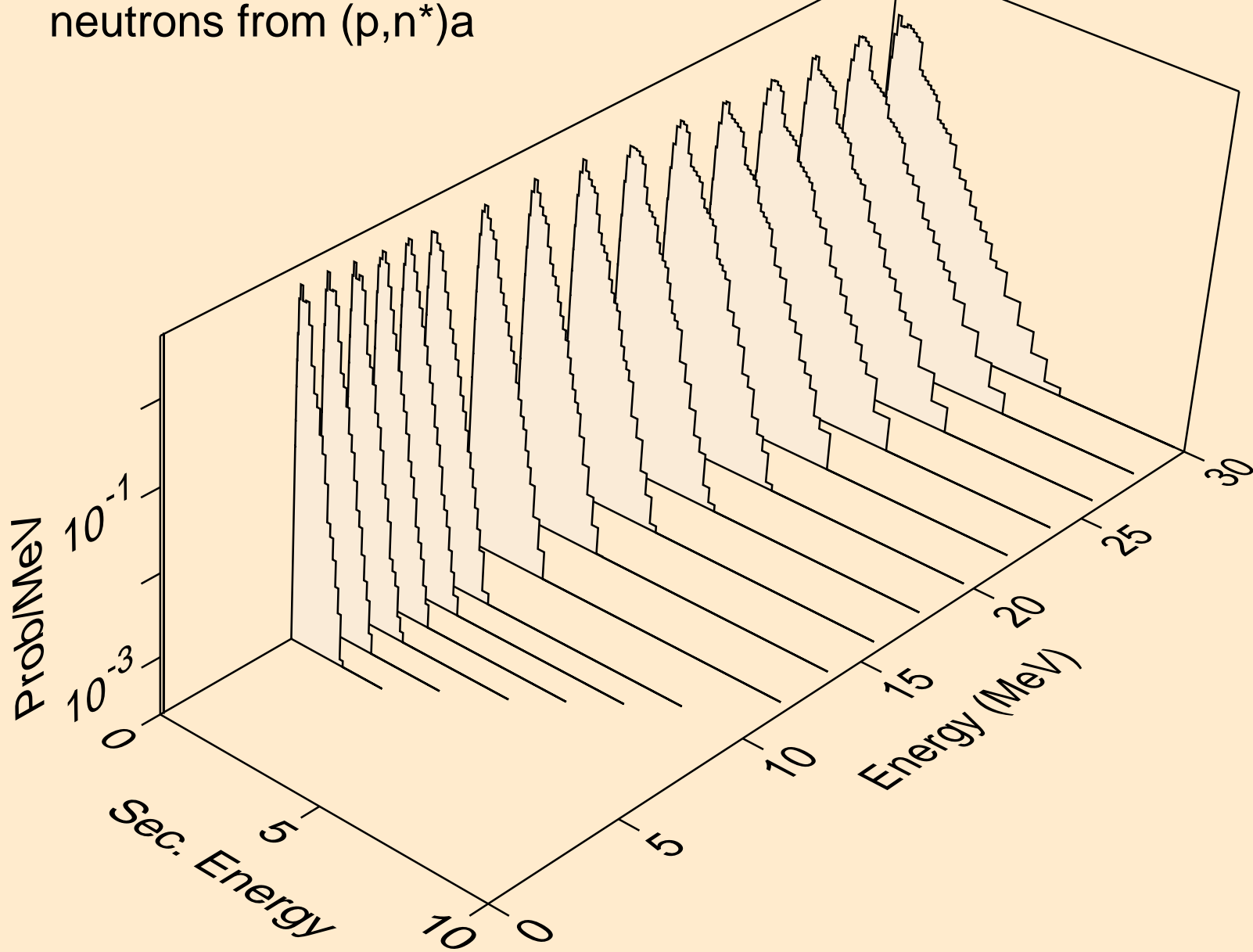

CF255 PROTON ACER TENDL-2021 LIBRARY; T=0.K  
neutrons from (p,2n)a

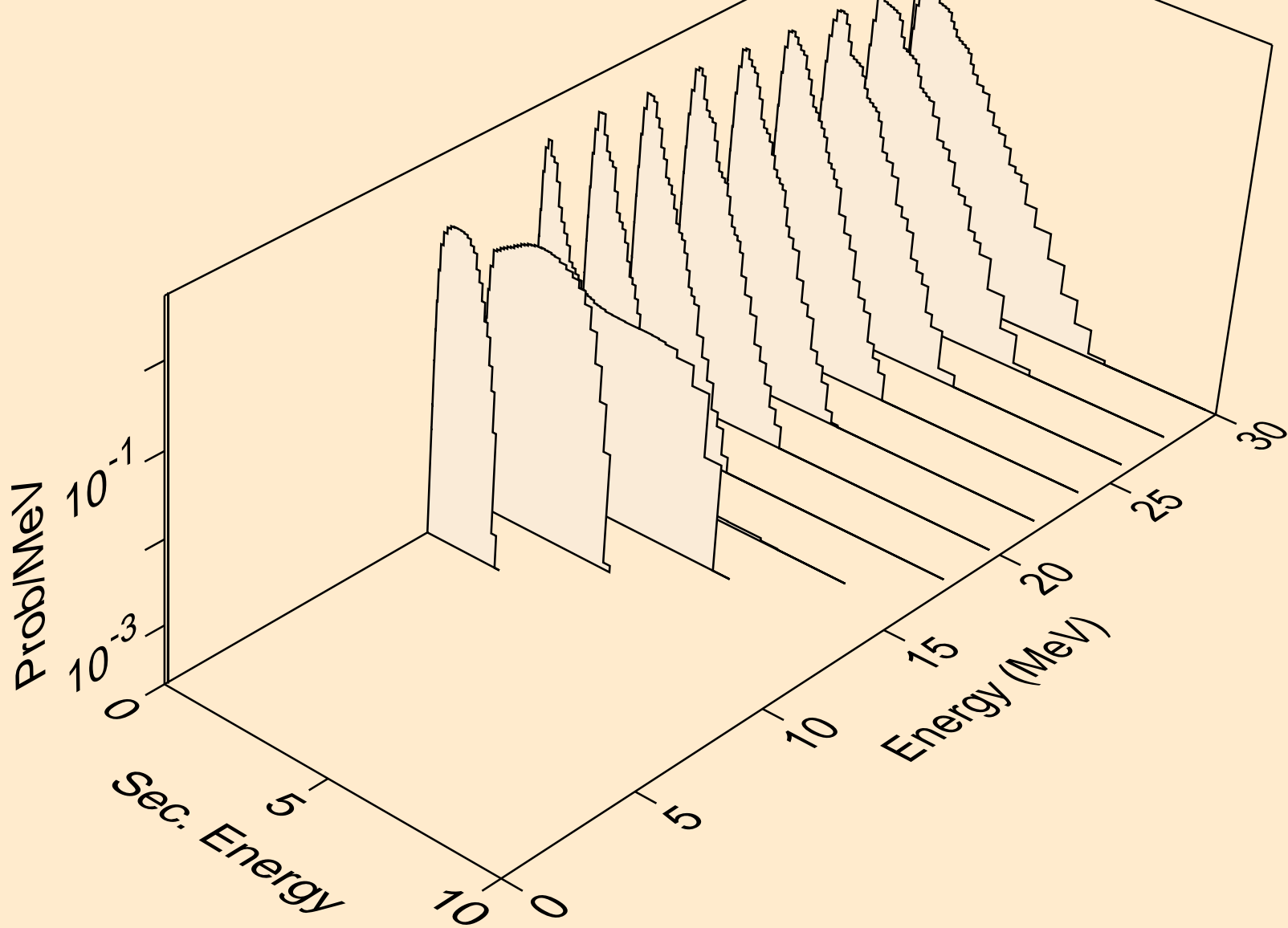

CF255 PROTON ACER TENDL-2021 LIBRARY; T=0.K  
neutrons from (p,3n)a

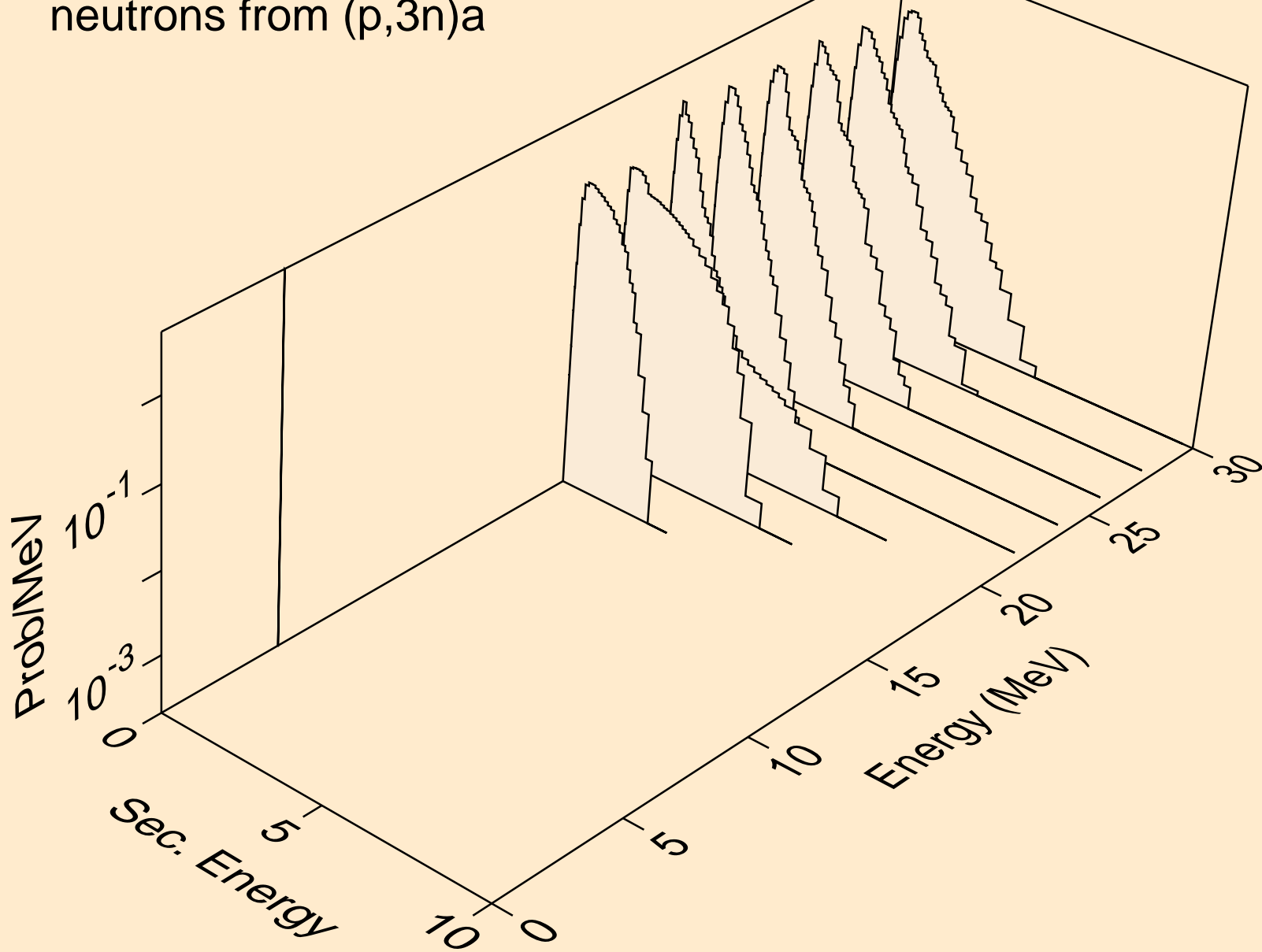



CF255 PROTON ACER TENDL-2021 LIBRARY; T=0.K  
neutrons from (p,n\*)p

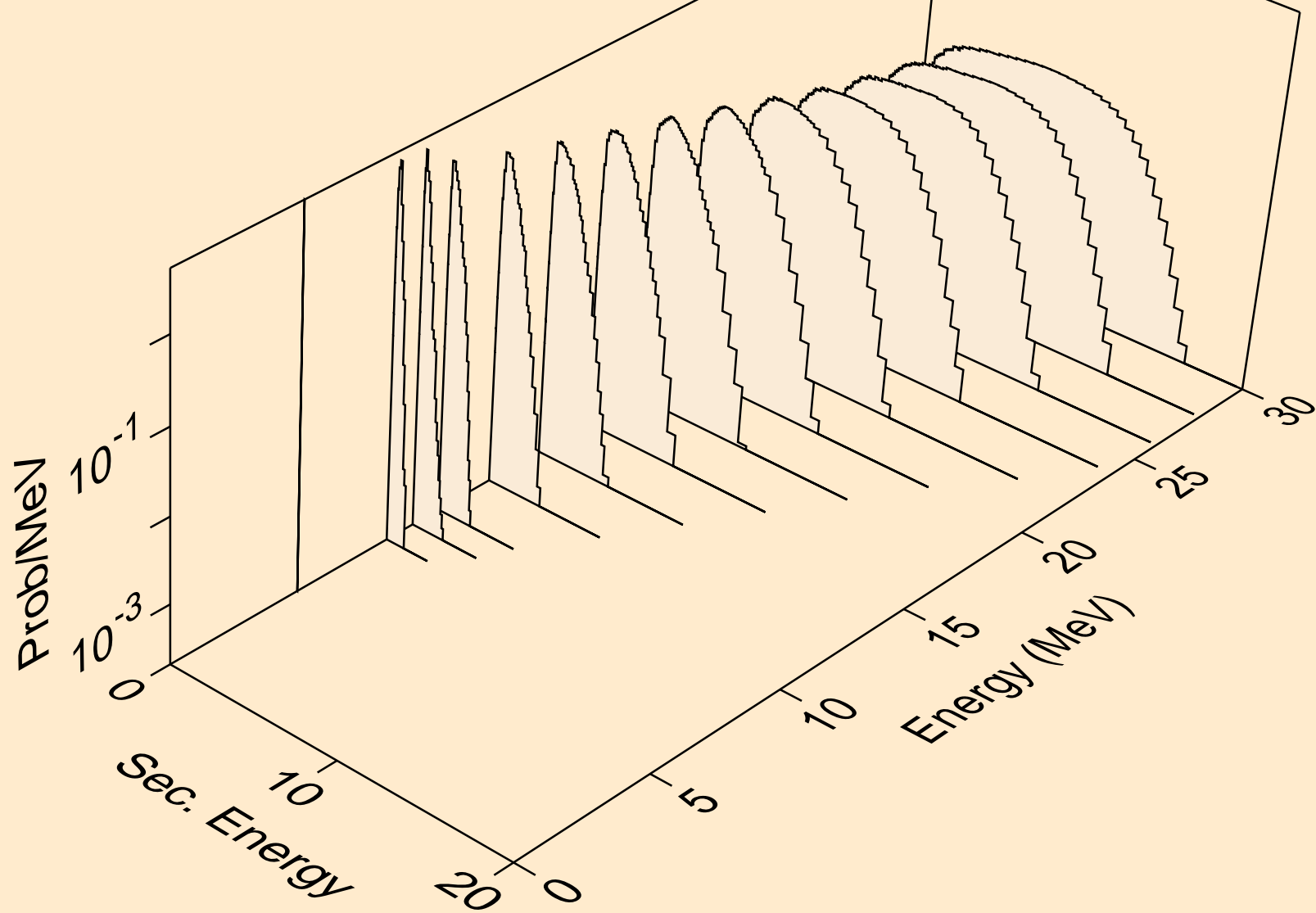

CF255 PROTON ACER TENDL-2021 LIBRARY; T=0.K  
neutrons from (p,n\*)d

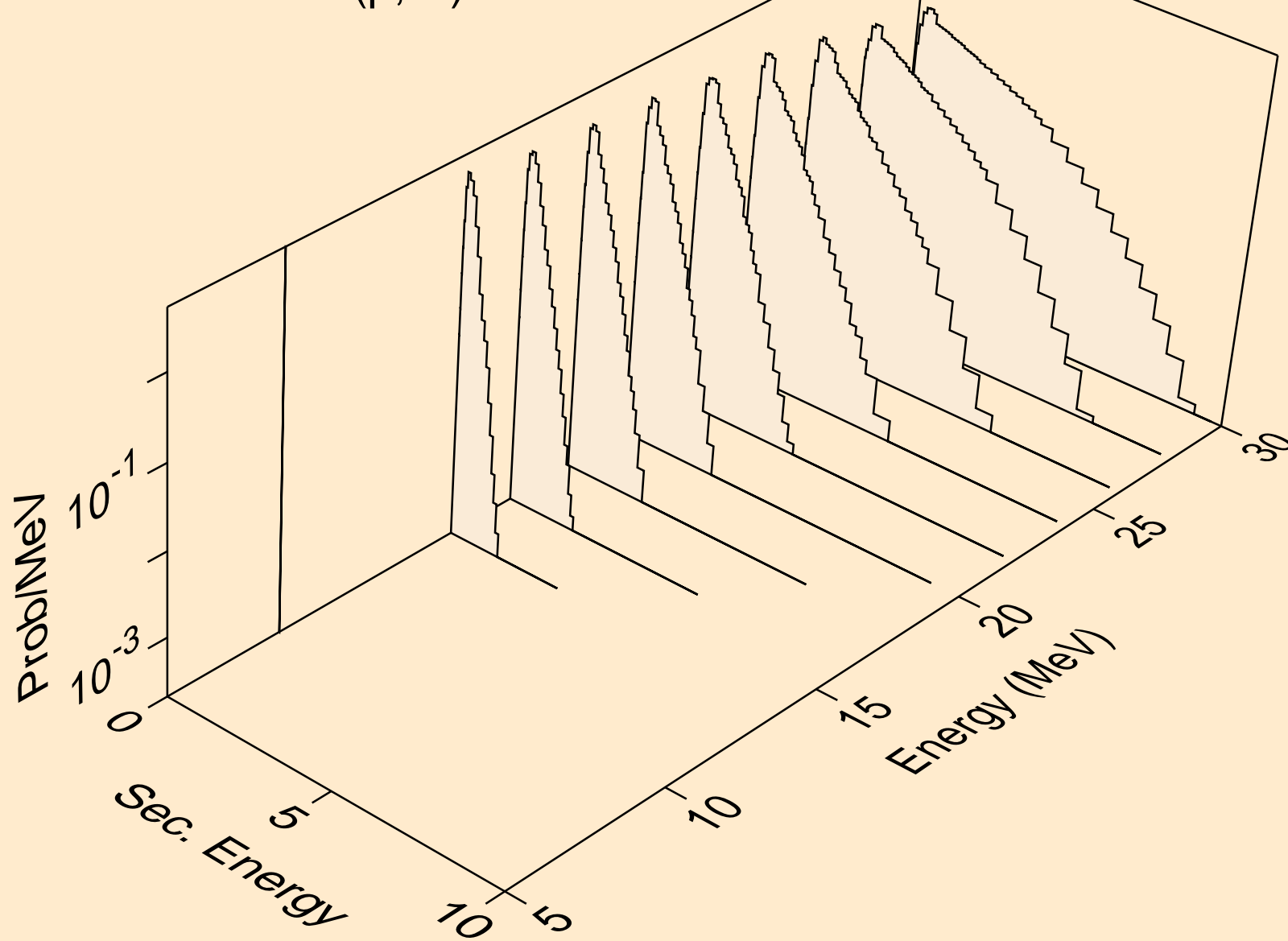

CF255 PROTON ACER TENDL-2021 LIBRARY; T=0.K  
neutrons from (p,n\*)t

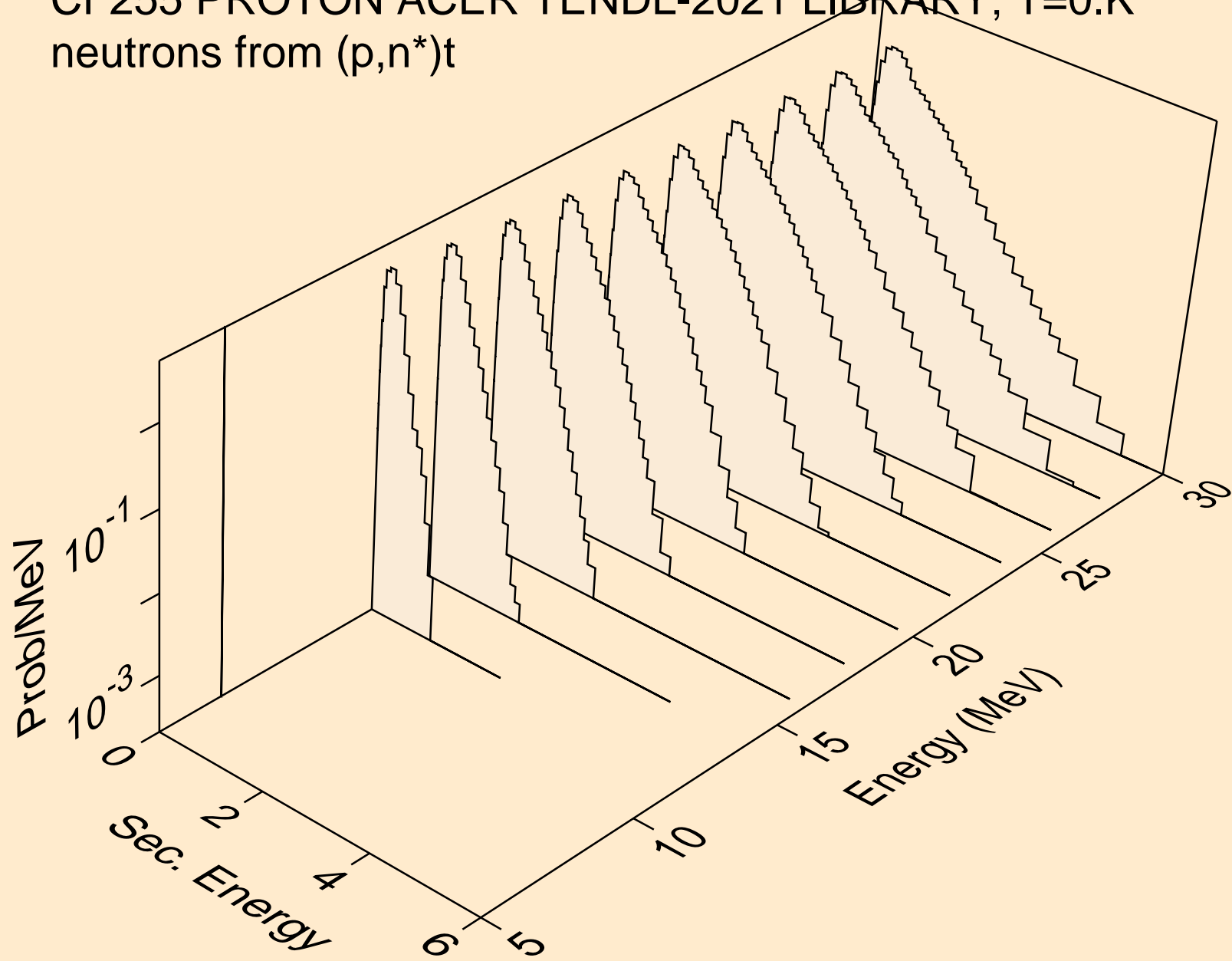

CF255 PROTON ACER TENDL-2021 LIBRARY; T=0.K  
neutrons from (p,n\*)he3

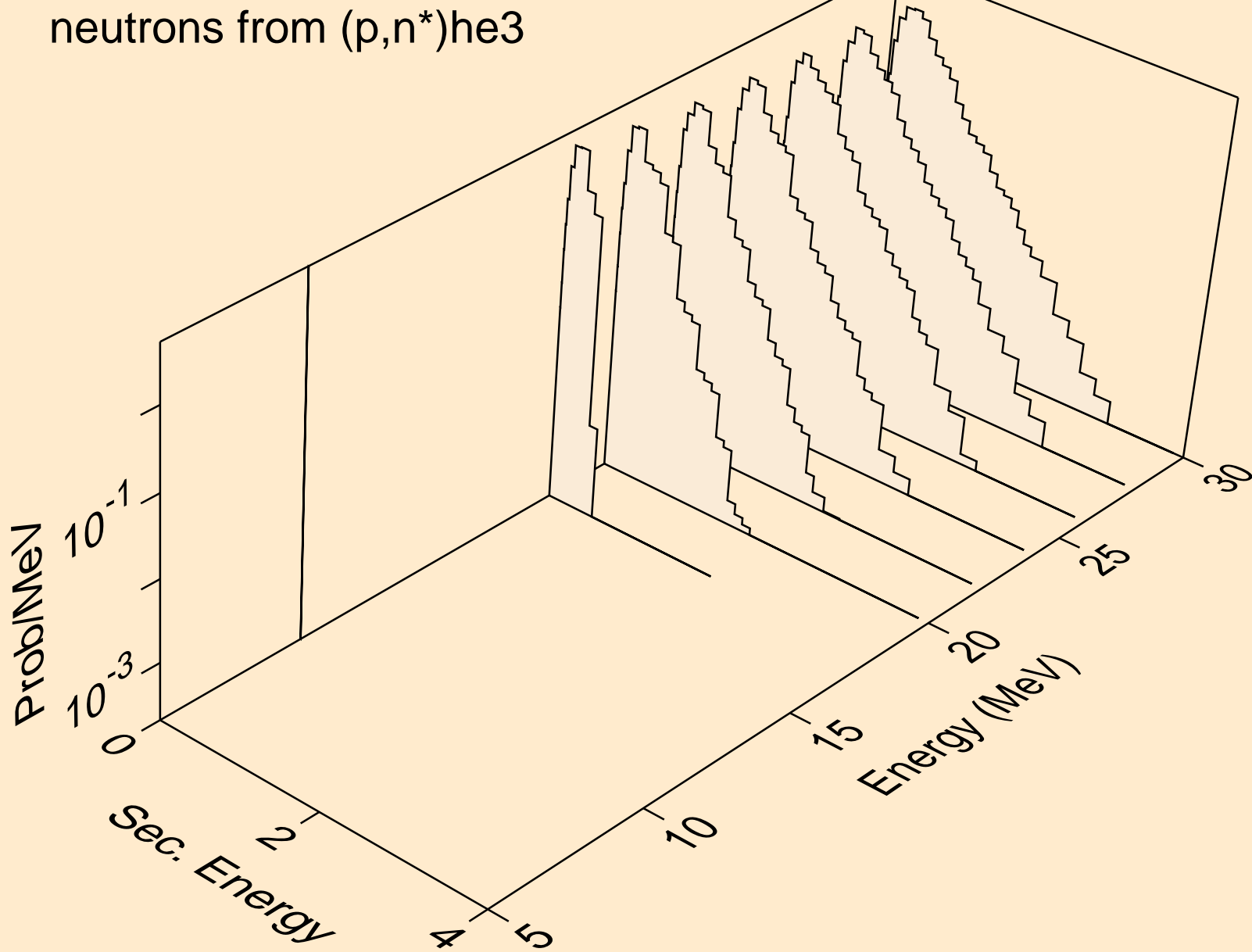

CF255 PROTON ACER TENDL-2021 LIBRARY; T=0.K  
neutrons from (p,4n)

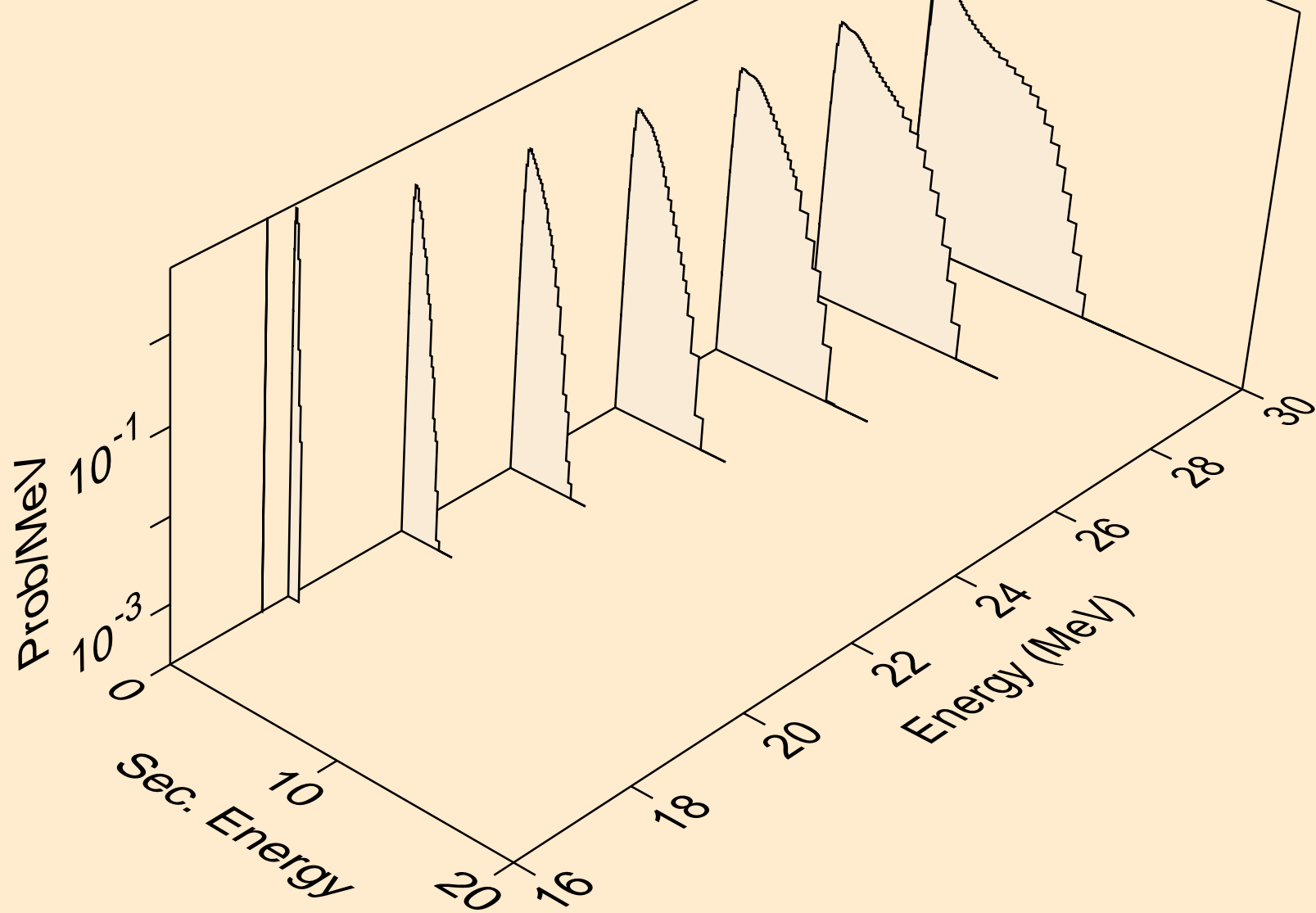

CF255 PROTON ACER TENDL-2021 LIBRARY; T=0.K  
neutrons from (p,2np)

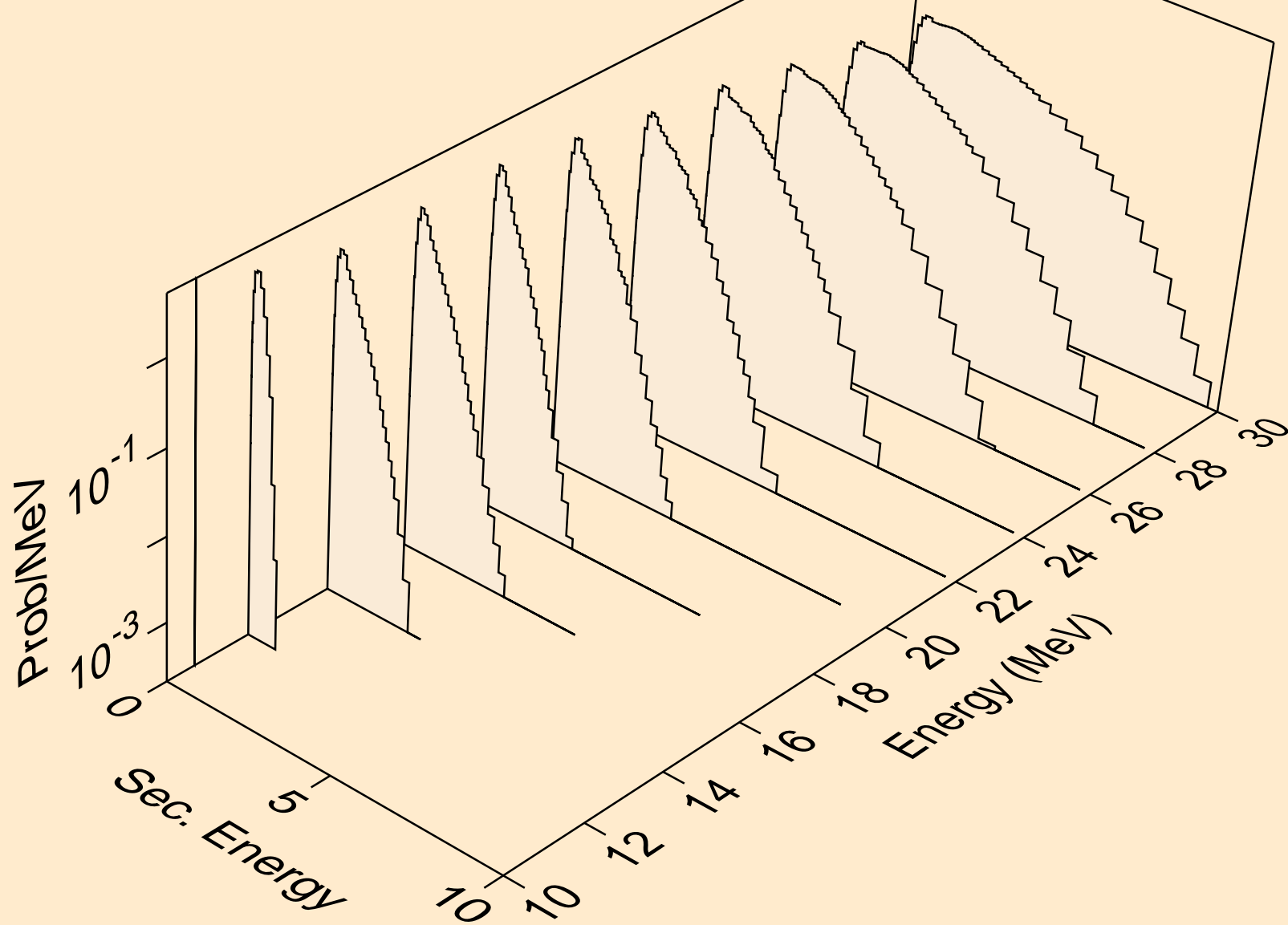

CF255 PROTON ACER TENDL-2021 LIBRARY; T=0.K  
neutrons from (p,3np)

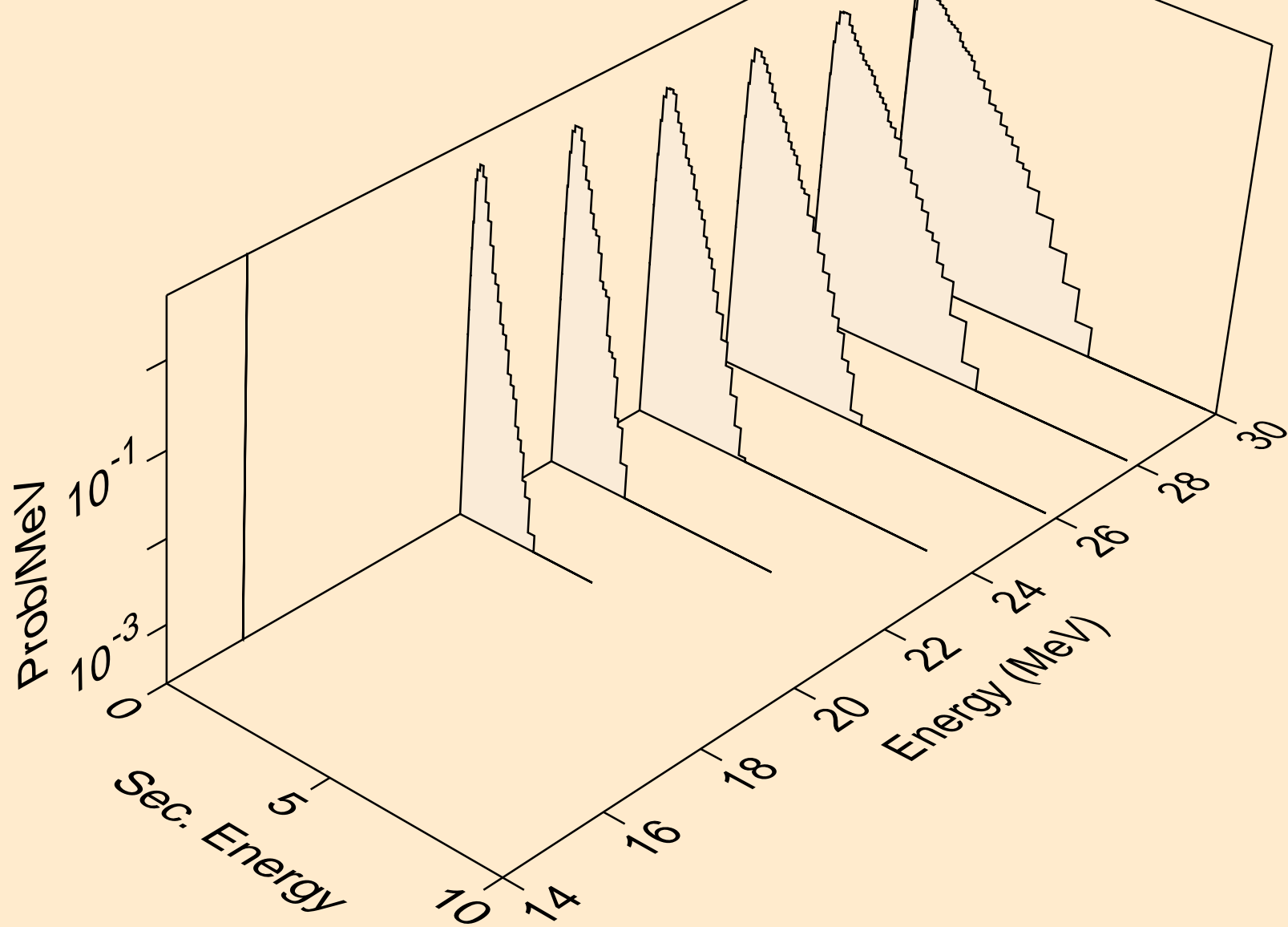

CF255 PROTON ACER TENDL-2021 LIBRARY; T=0.K  
deuterons from (p,x)

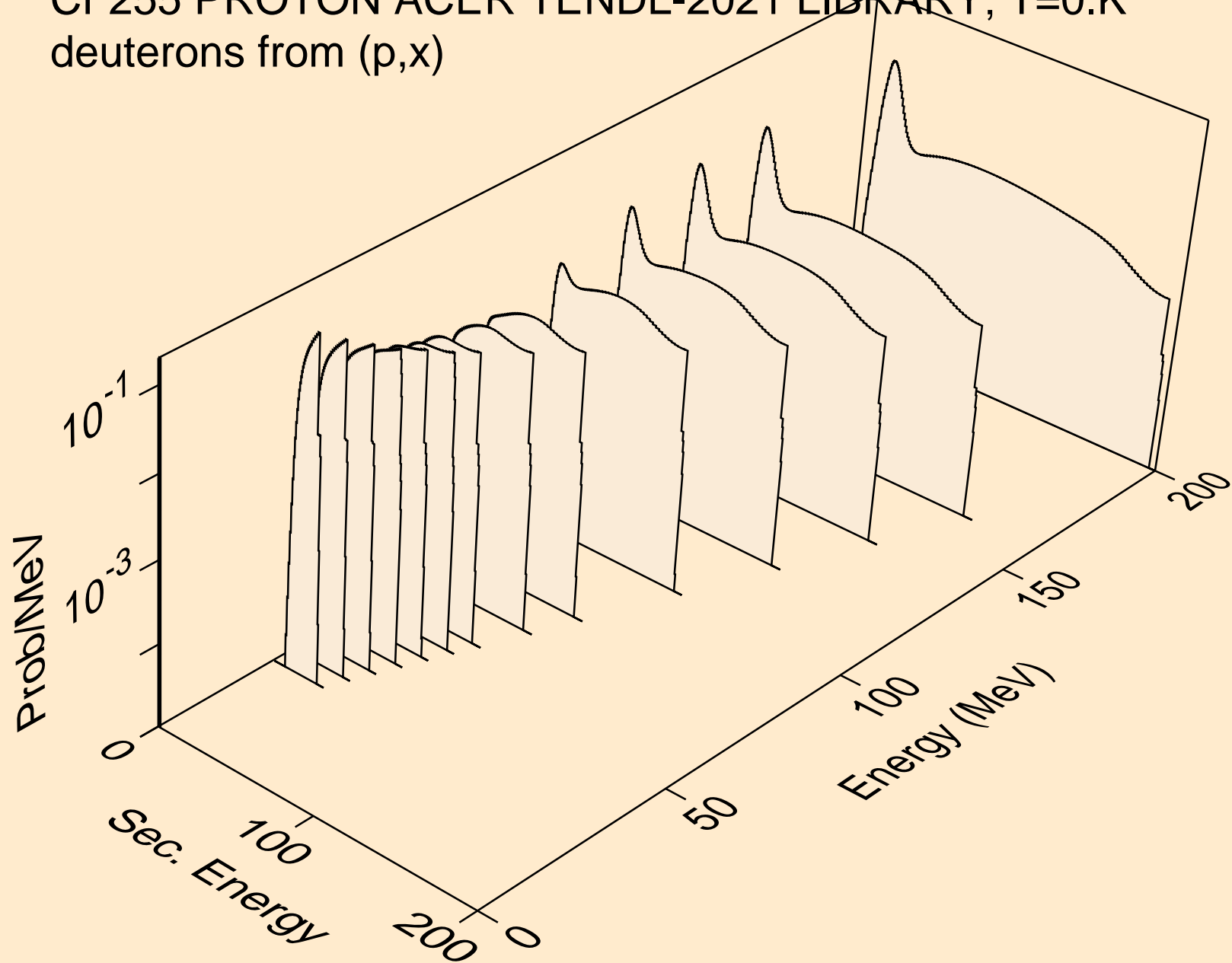



CF255 PROTON ACER TENDL-2021 LIBRARY; T=0.K  
deuterons from (p,2nd)

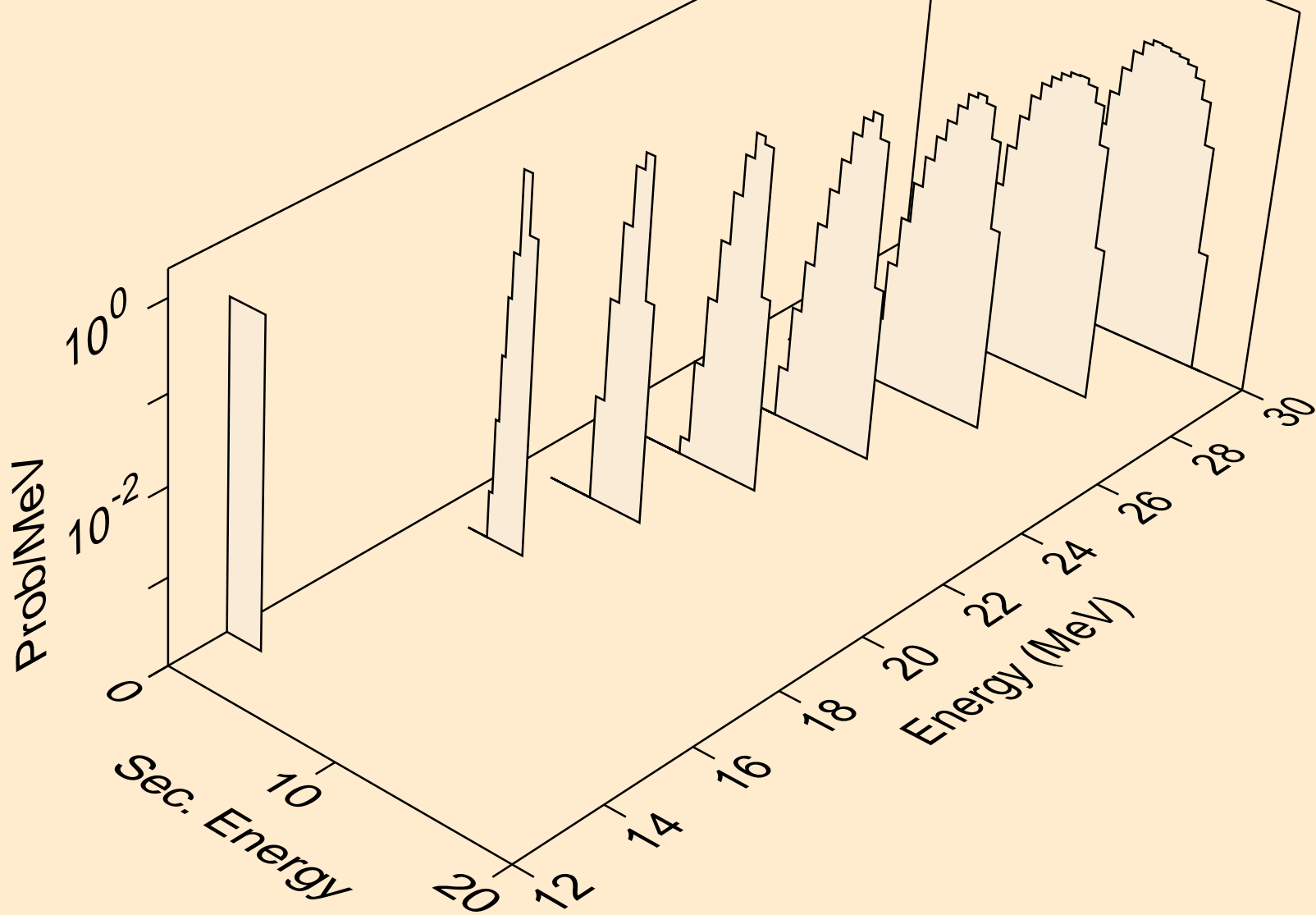

CF255 PROTON ACER TENDL-2021 LIBRARY; T=0.K  
deuterons from (p,n\*)d

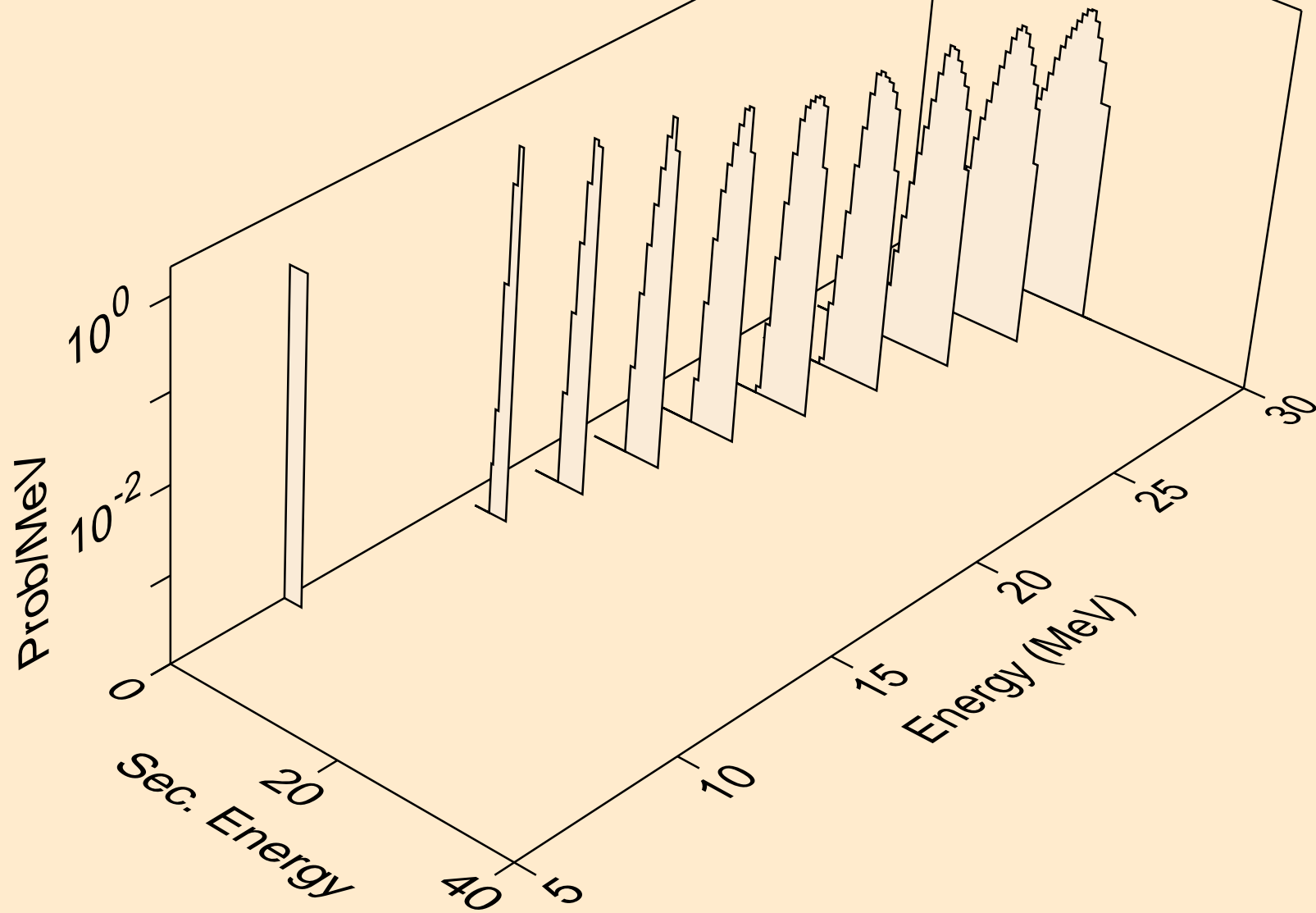

CF255 PROTON ACER TENDL-2021 LIBRARY; T=0.K  
deuterons from (p,d)

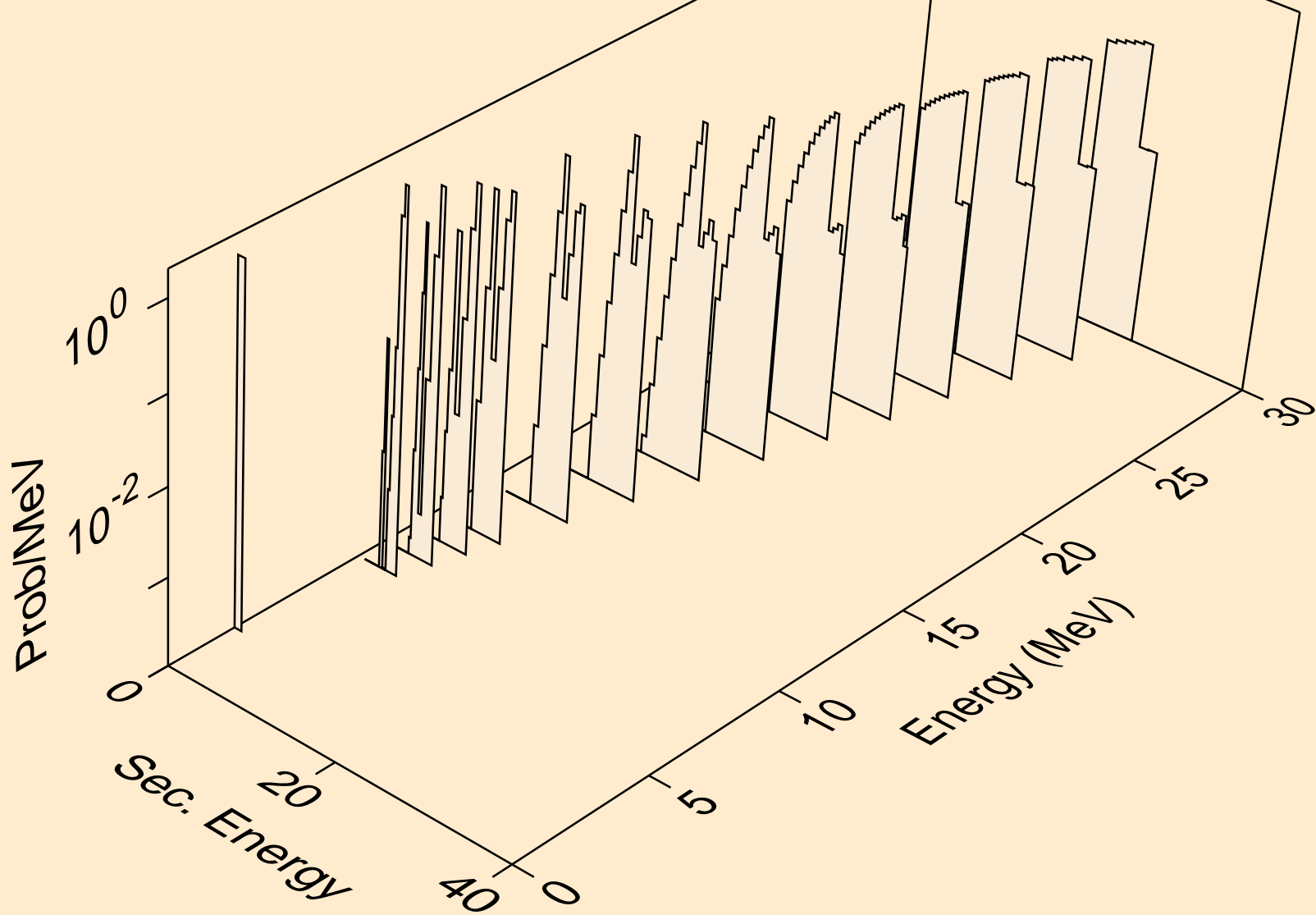

CF255 PROTON ACER TENDL-2021 LIBRARY; T=0.K  
tritons from (p,x)

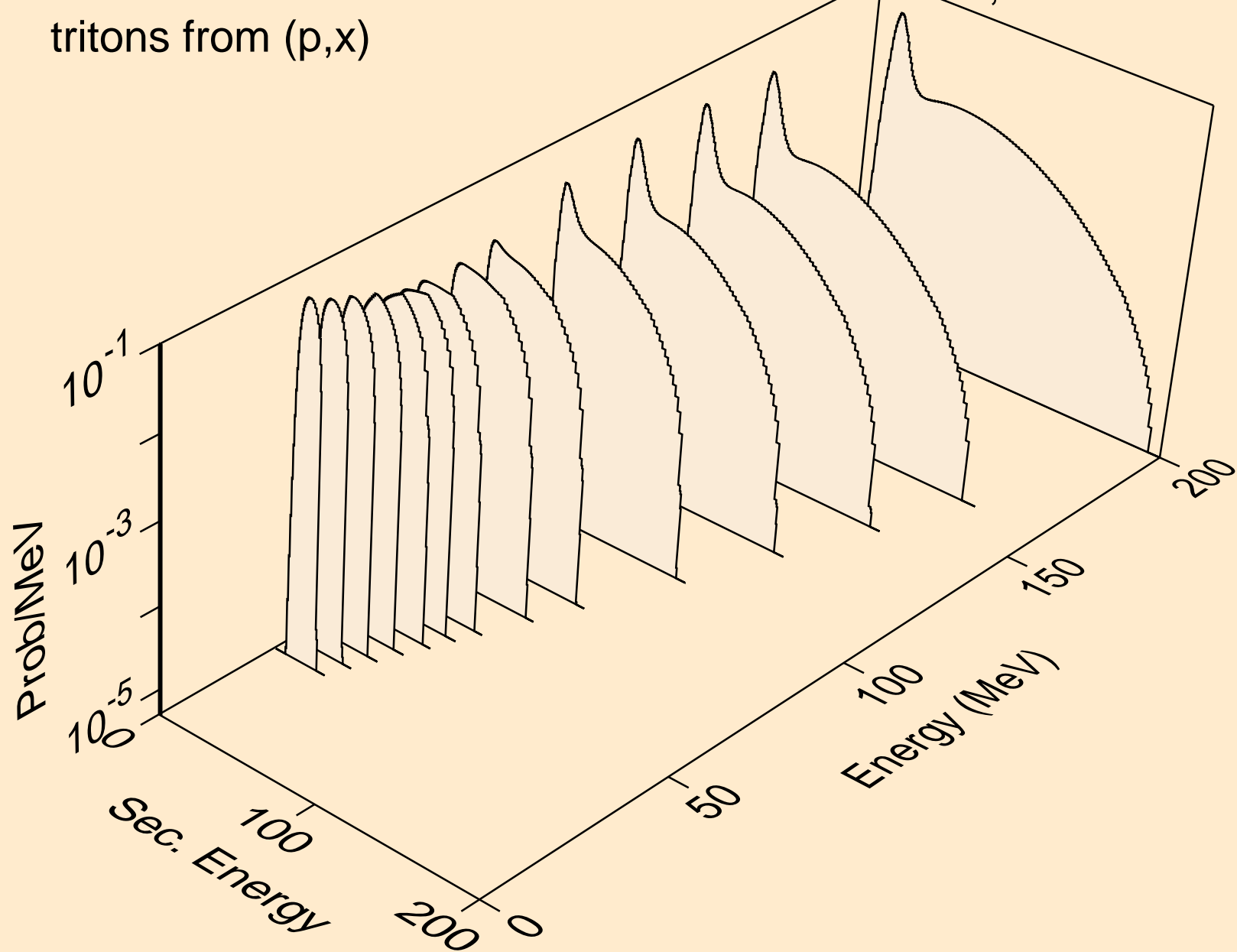

CF255 PROTON ACER TENDL-2021 LIBRARY; T=0.K  
tritons from (p,n\*)t

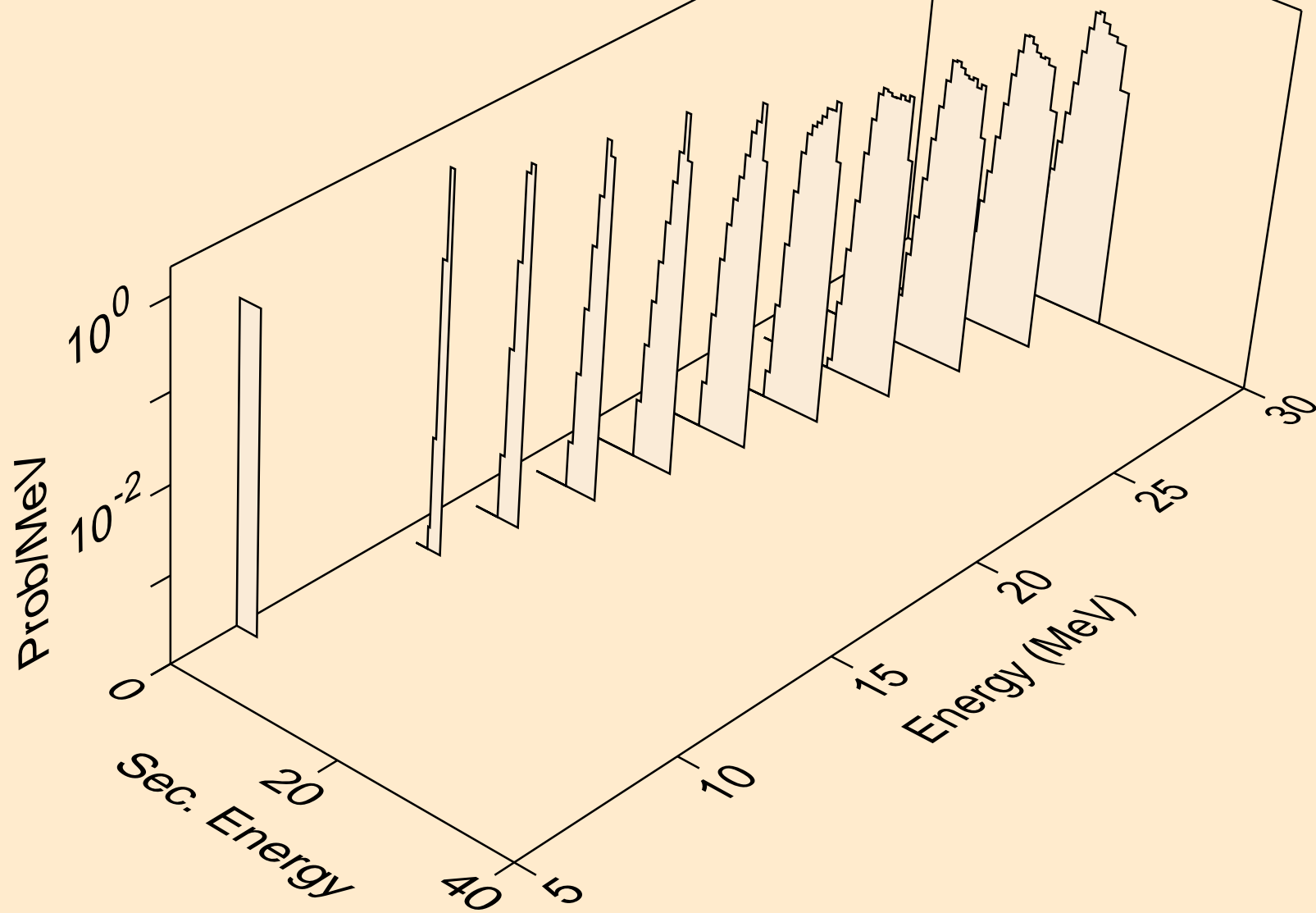

CF255 PROTON ACER TENDL-2021 LIBRARY; T=0.K  
tritons from (p,t)

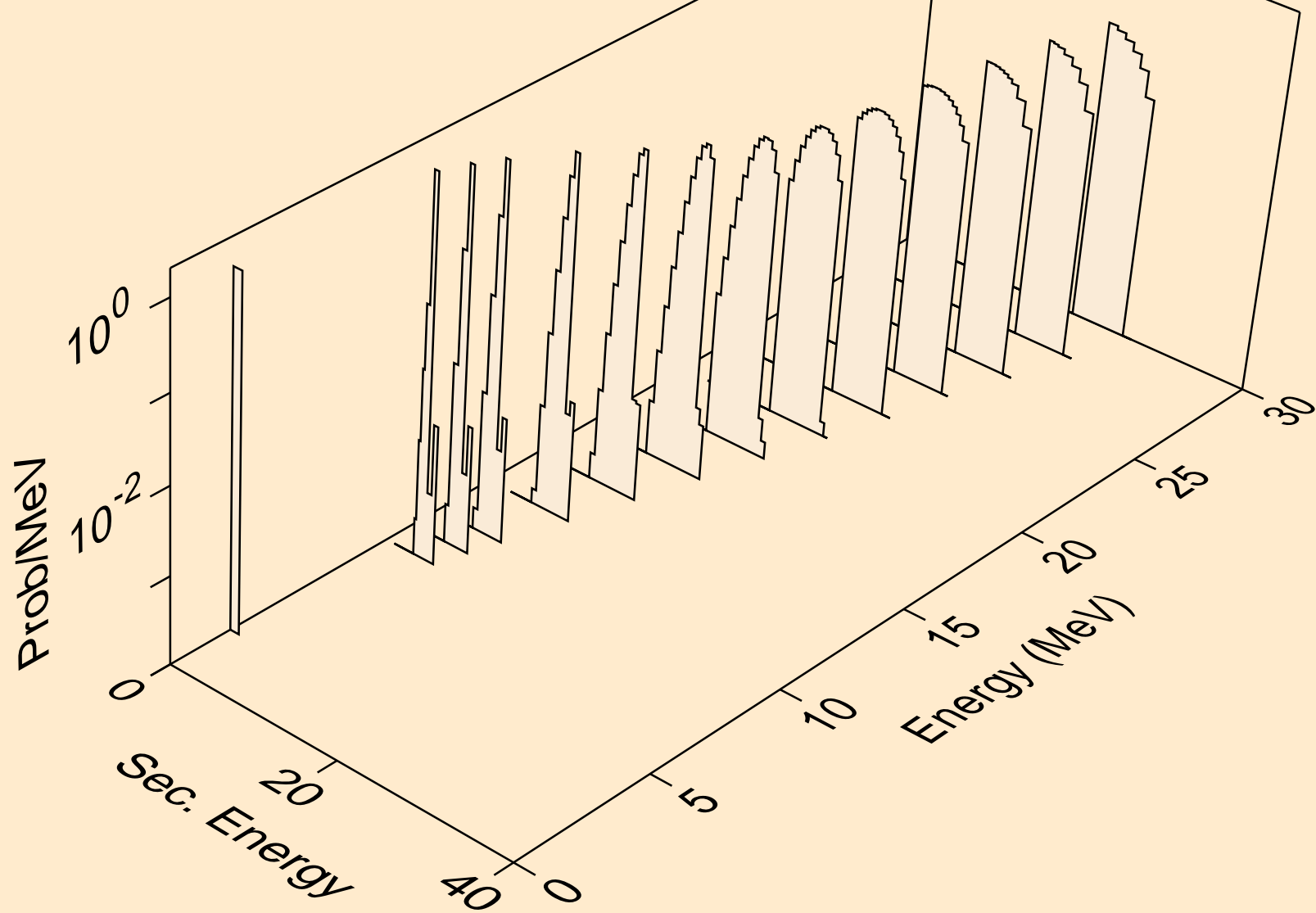

CF255 PROTON ACER TENDL-2021 LIBRARY; T=0.K  
he3s from (p,x)

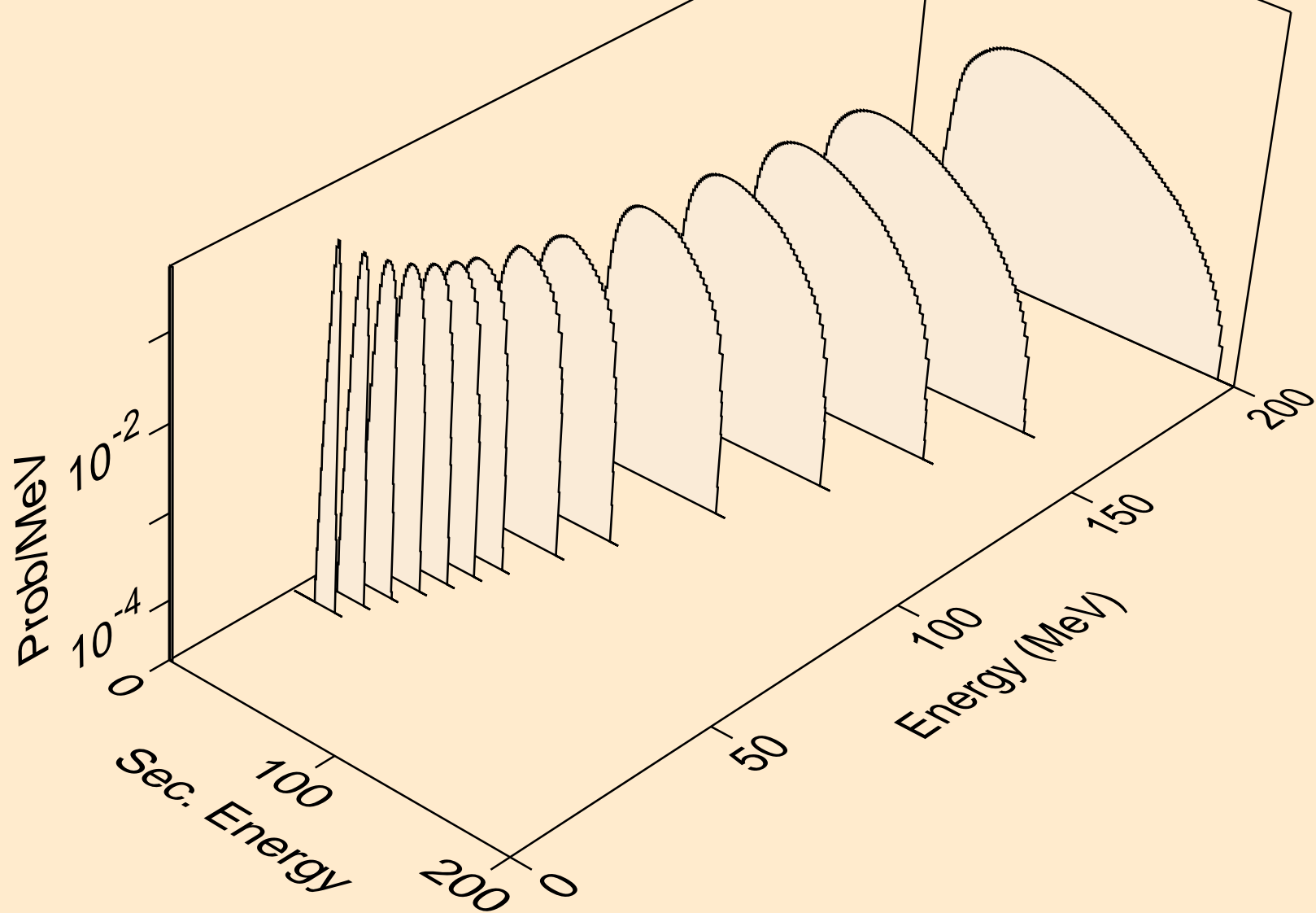

CF255 PROTON ACER TENDL-2021 LIBRARY; T=0.K  
he3s from (p,n\*)he3

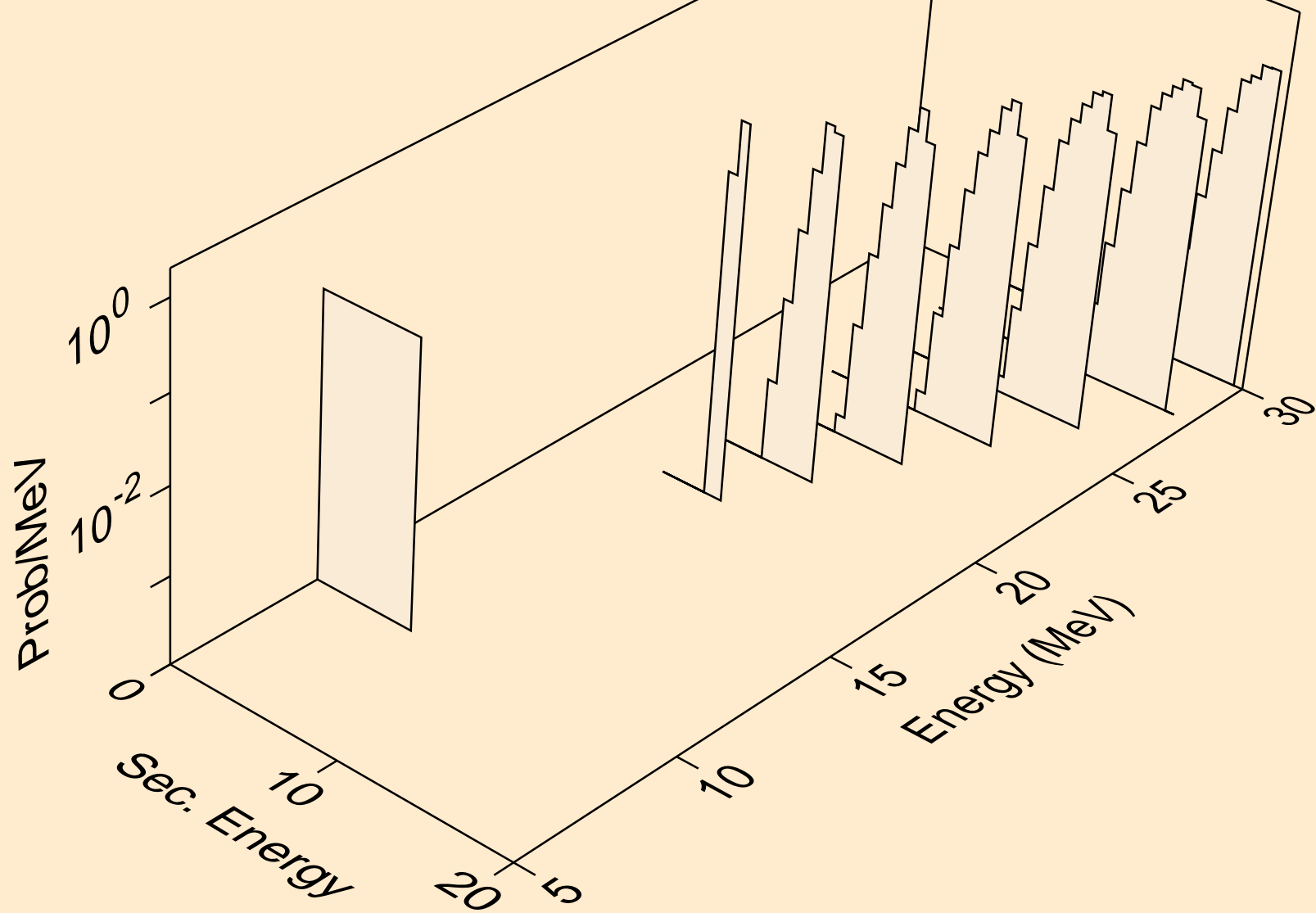



CF255 PROTON ACER TENDL-2021 LIBRARY; T=0.K  
he3s from (p,he3)

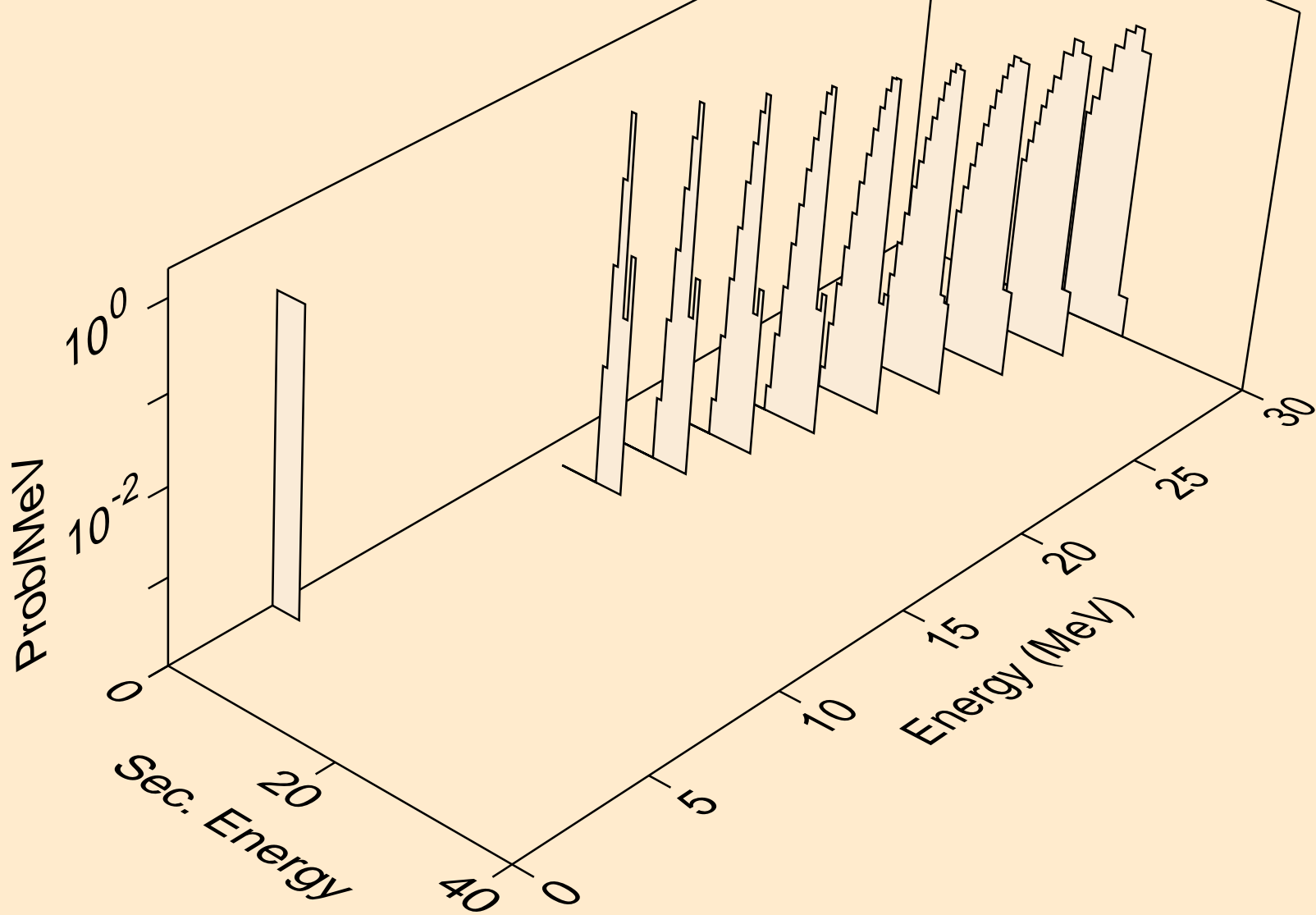

CF255 PROTON ACER TENDL-2021 LIBRARY; T=0.K  
alphas from (p,x)

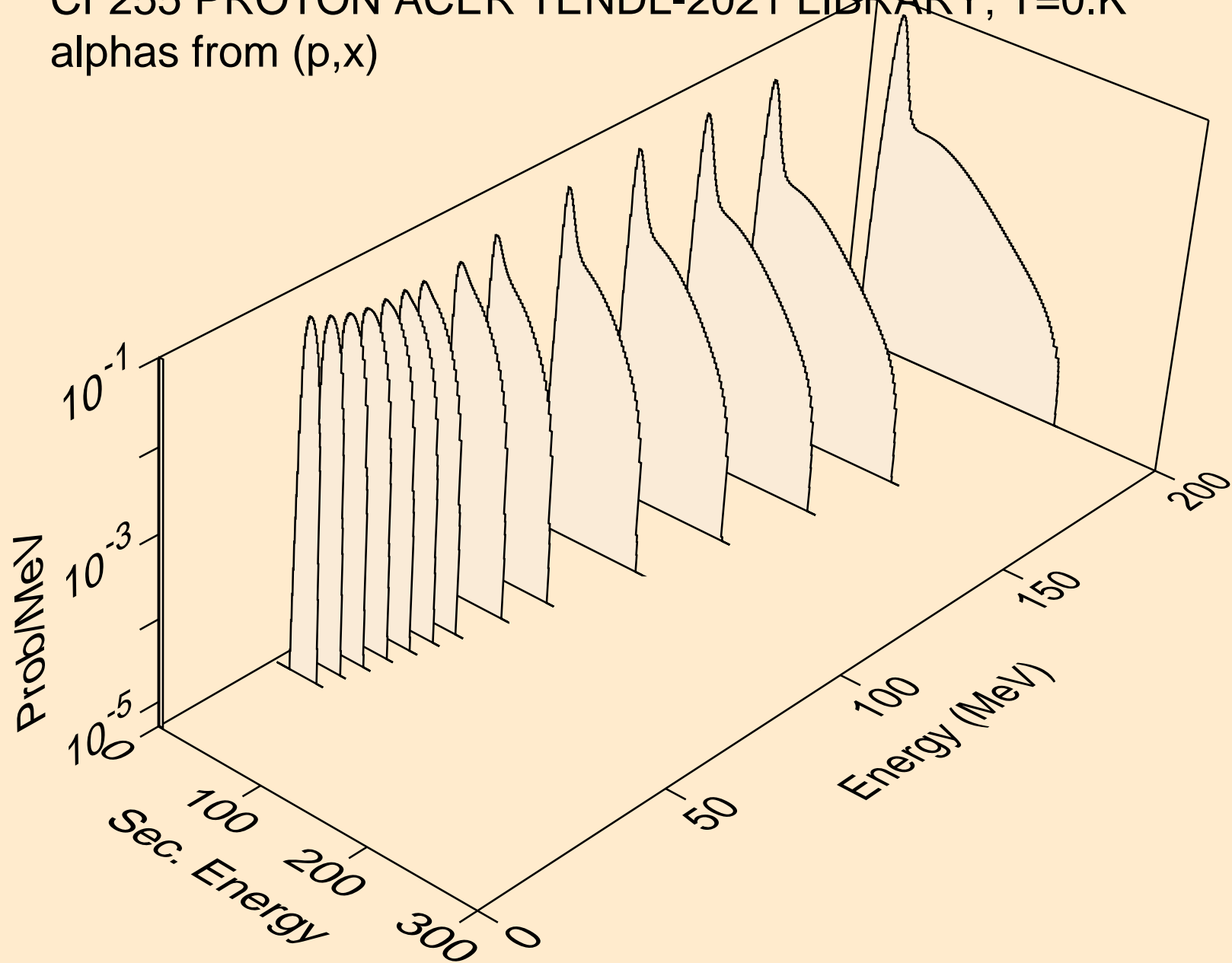

CF255 PROTON ACER TENDL-2021 LIBRARY; T=0.K  
alphas from (p,n\*)a

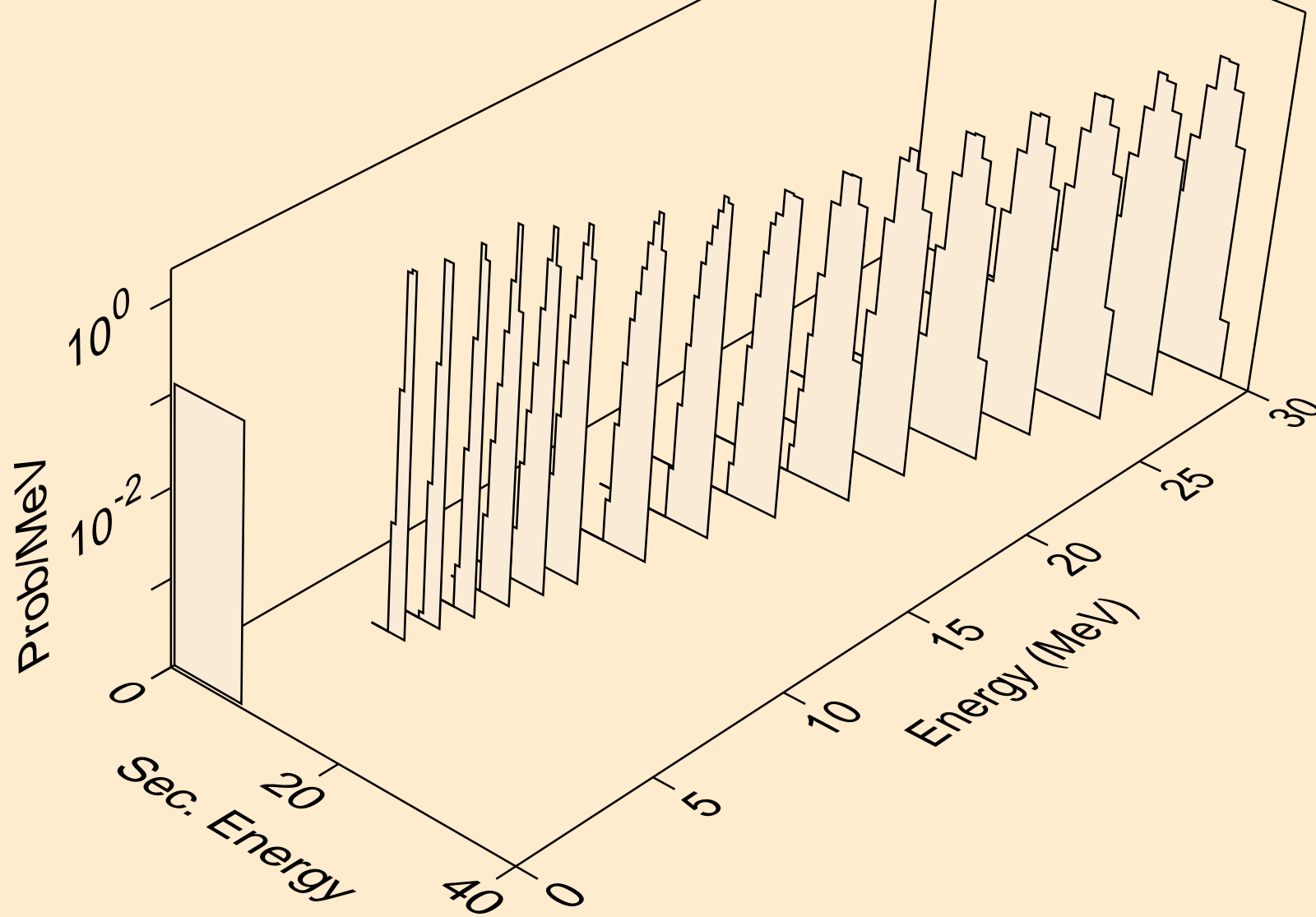

CF255 PROTON ACER TENDL-2021 LIBRARY; T=0.K  
alphas from (p,2n)a

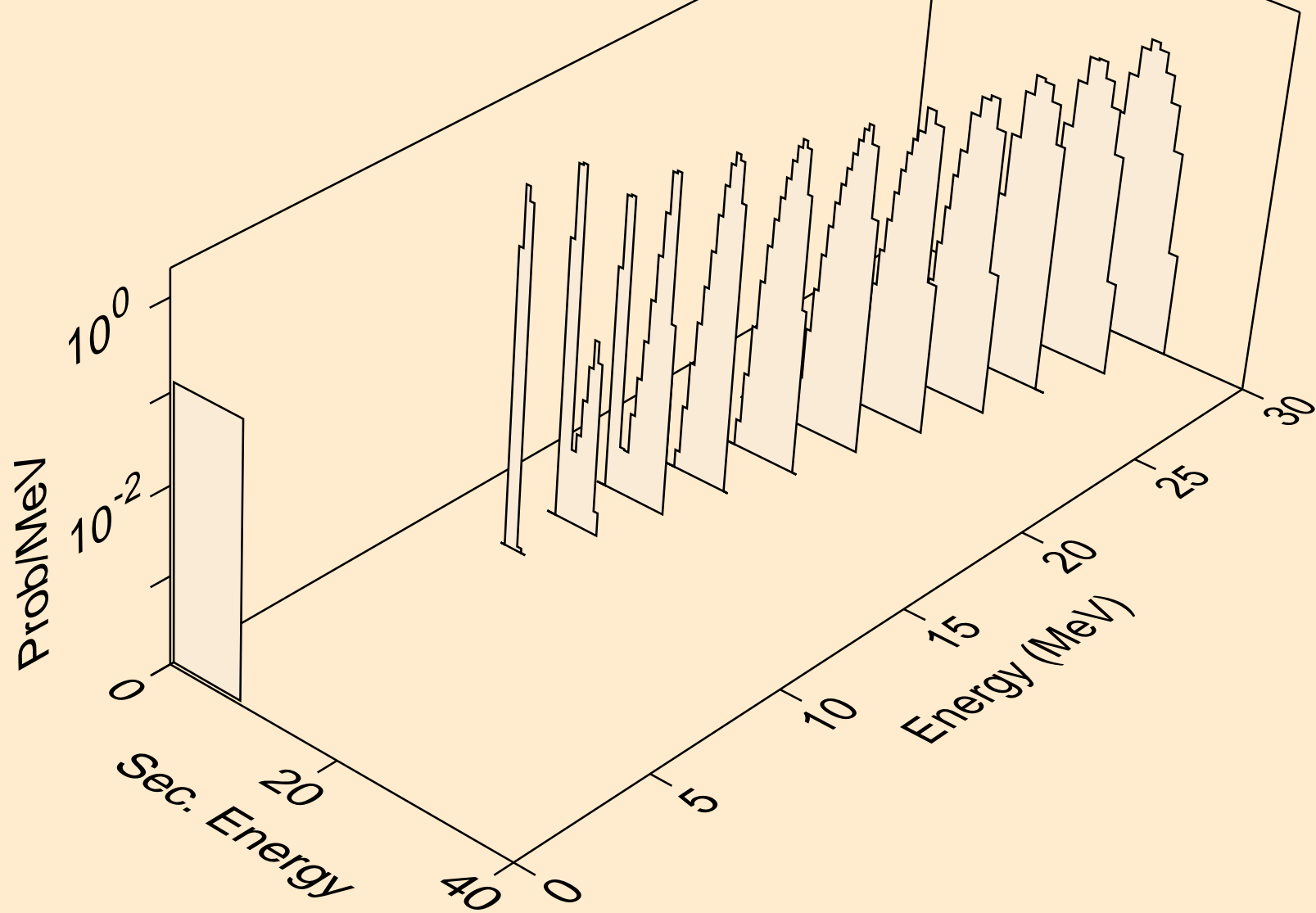

CF255 PROTON ACER TENDL-2021 LIBRARY; T=0.K  
alphas from (p,3n)a

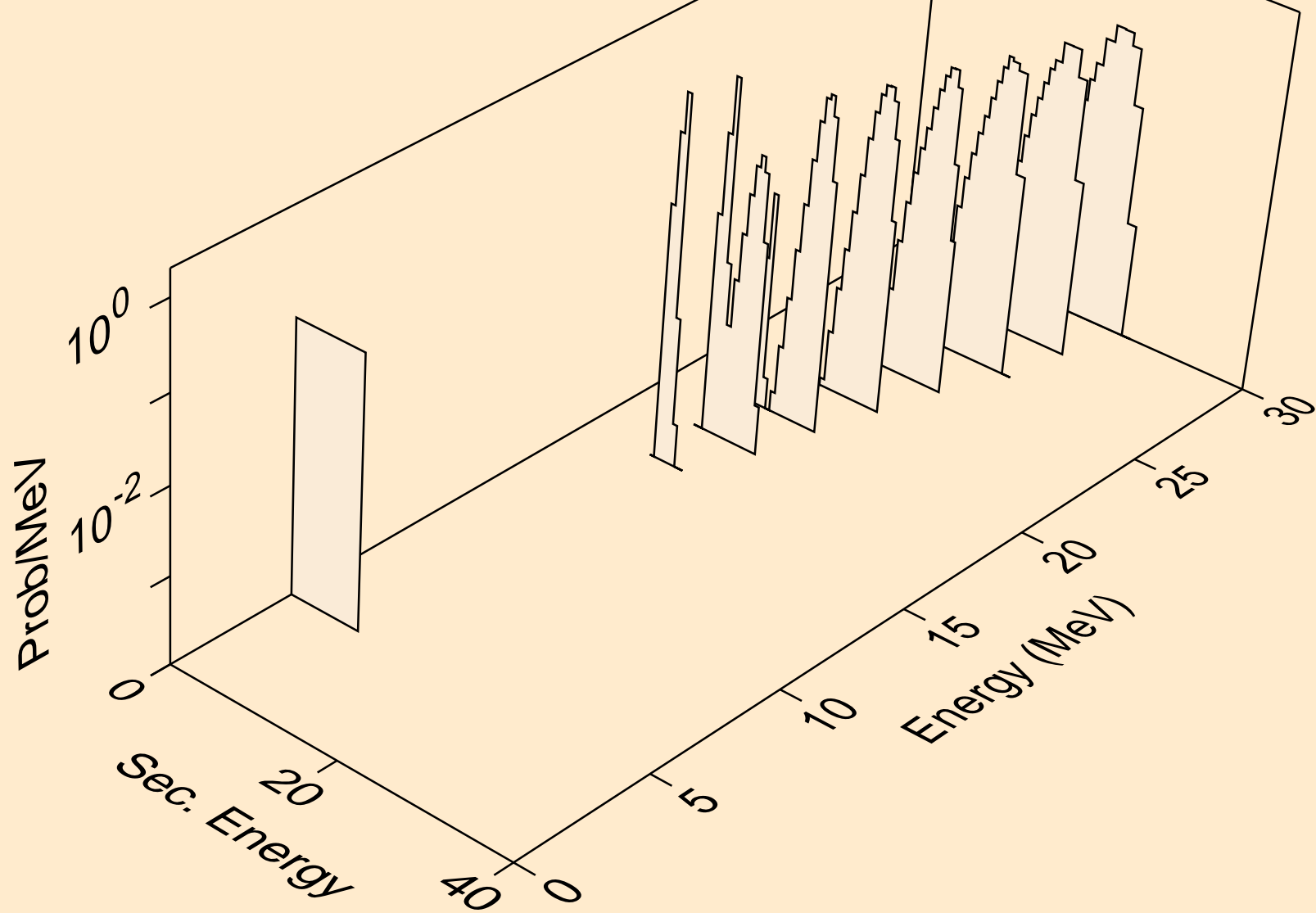

CF255 PROTON ACER TENDL-2021 LIBRARY; T=0.K  
alphas from (p,a)

