

CM236 PROTON ACER TENDL-2021 LIBRARY; T=0.K

Principal cross sections

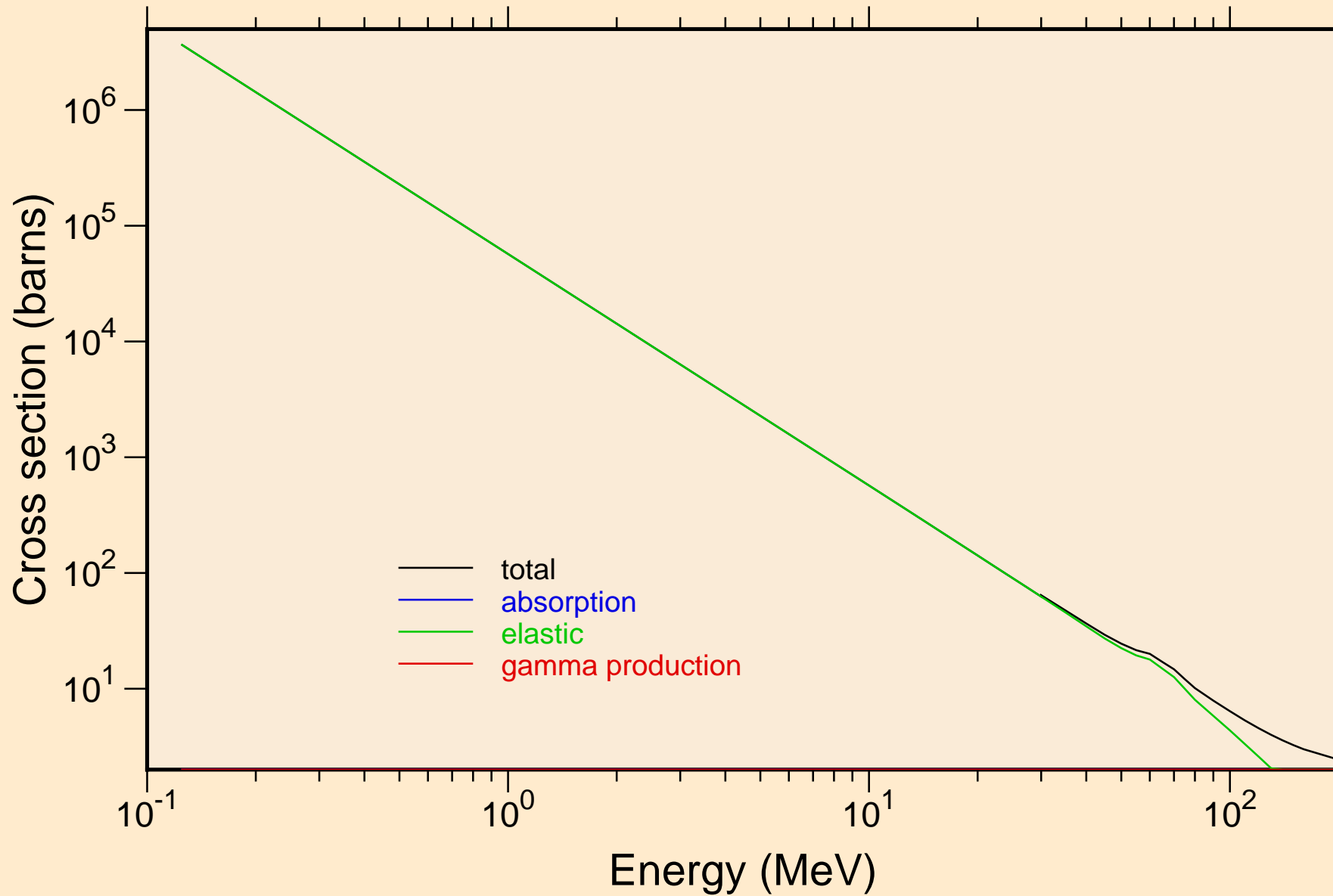

CM236 PROTON ACER TENDL-2021 LIBRARY; T=0.K
Heating

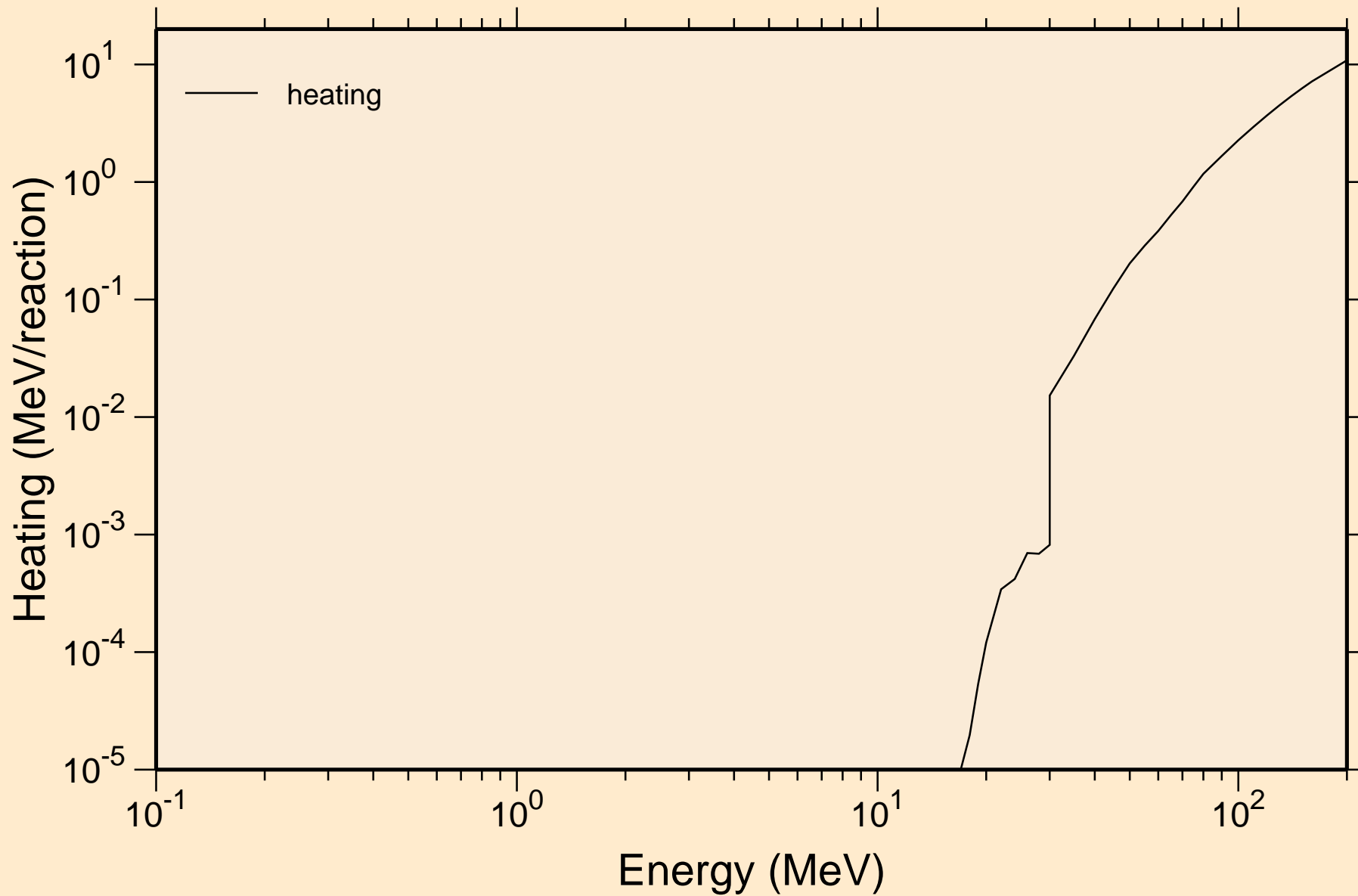

CM236 PROTON ACER TENDL-2021 LIBRARY; T=0.K
Principal cross sections

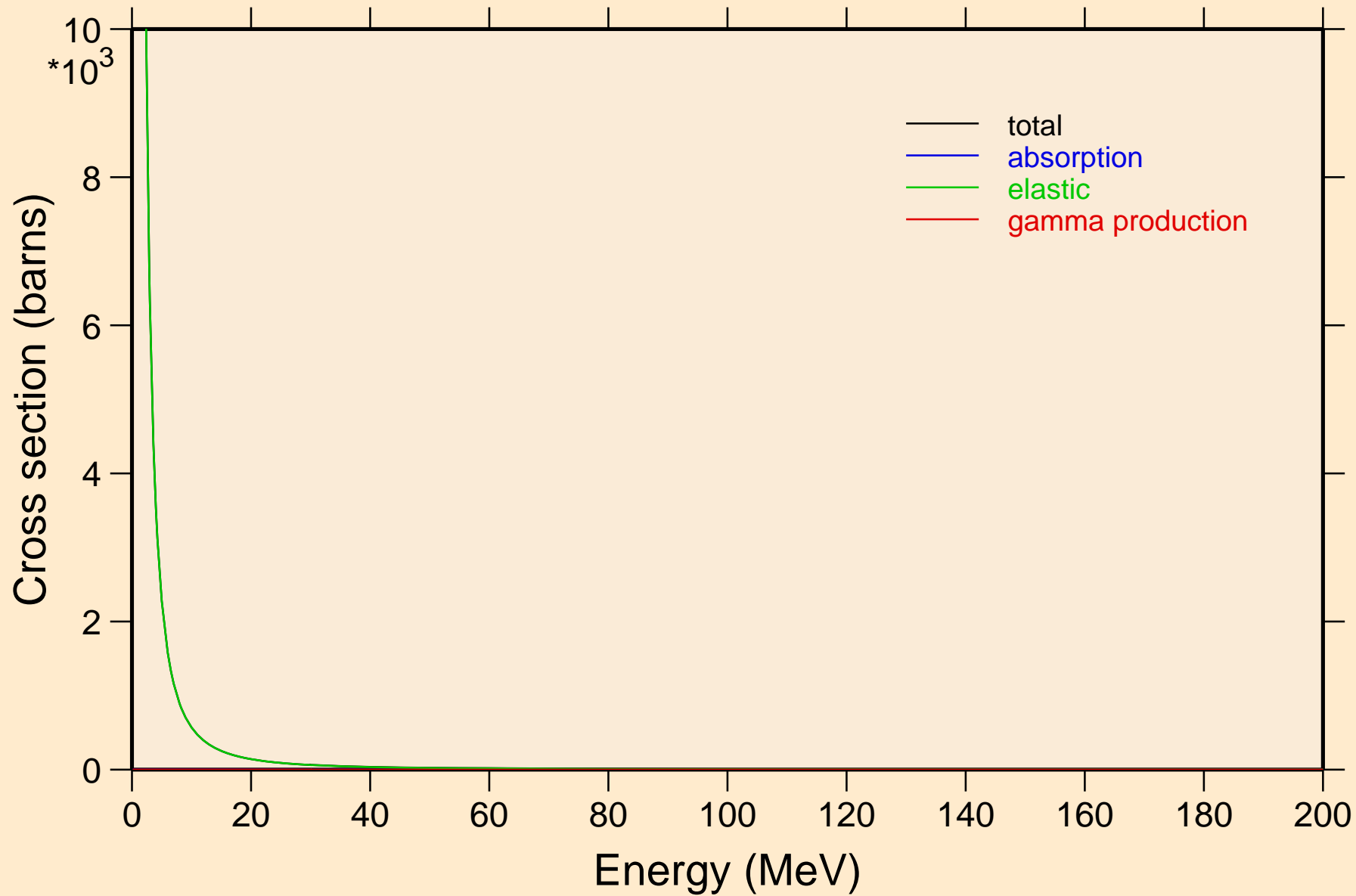

CM236 PROTON ACER TENDL-2021 LIBRARY; T=0.K

Heating

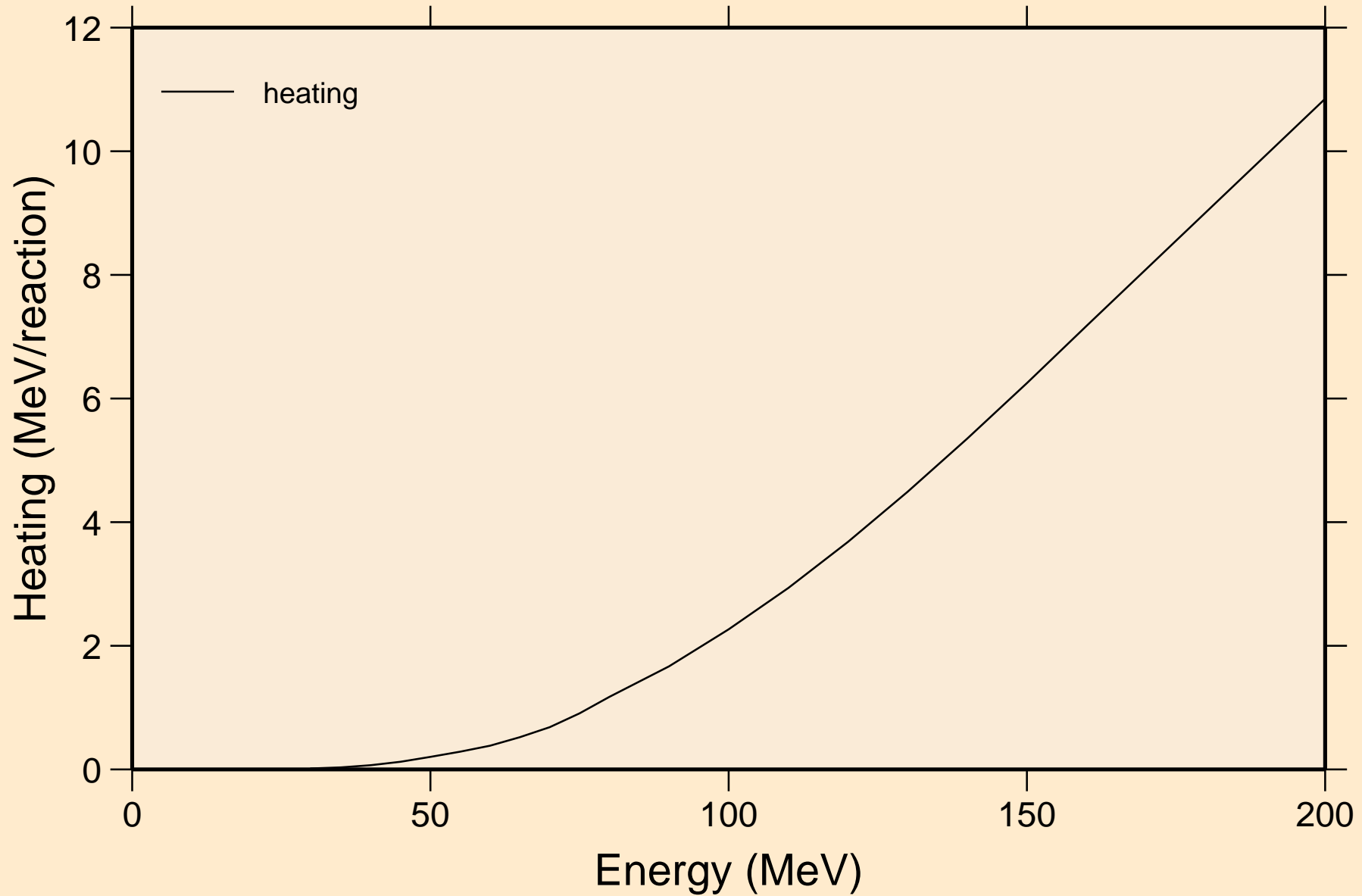

CM236 PROTON ACER TENDL-2021 LIBRARY; T=0.K

Threshold reactions

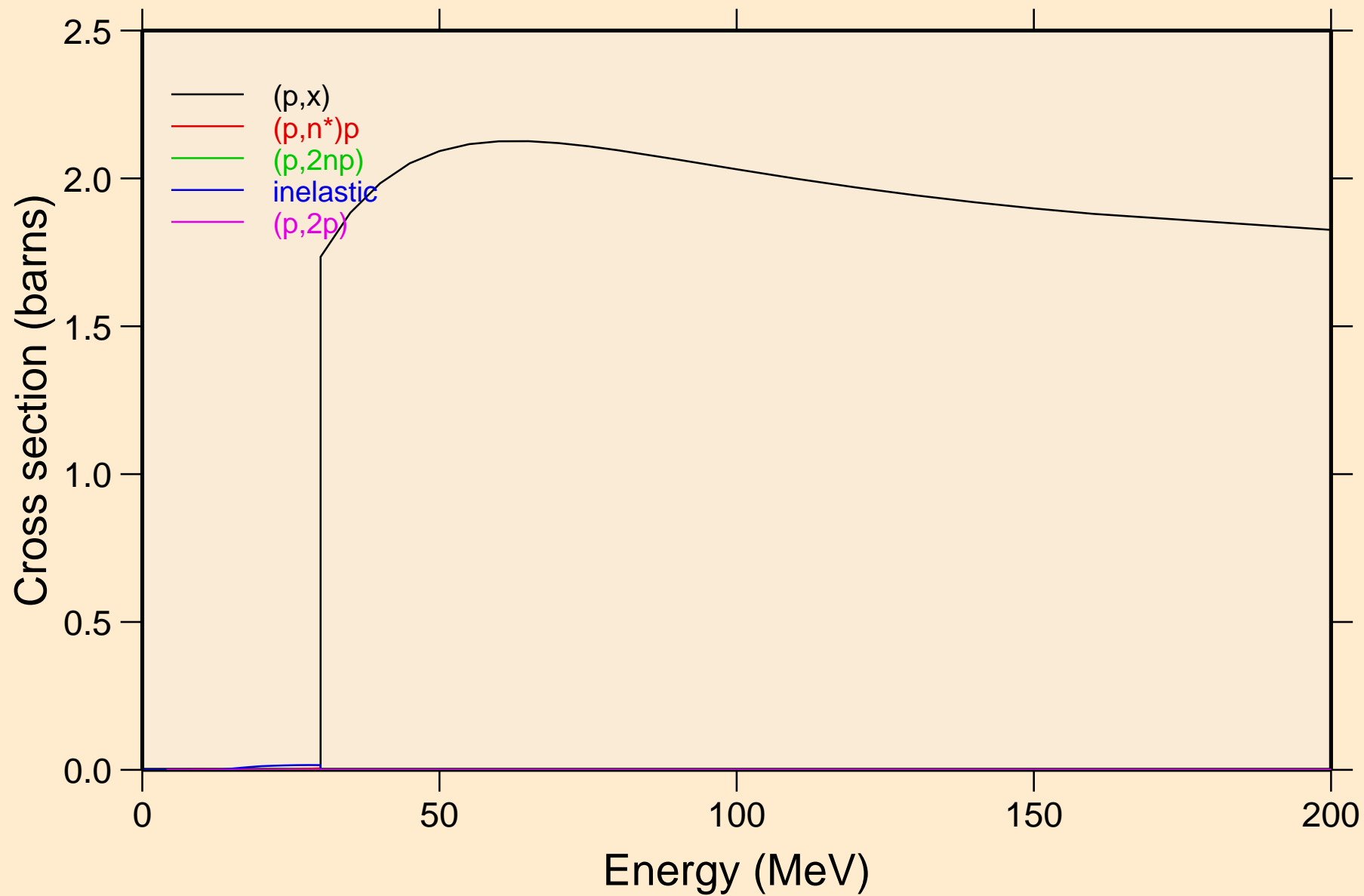

CM236 PROTON ACER TENDL-2021 LIBRARY; T=0.K
angular distribution for elastic

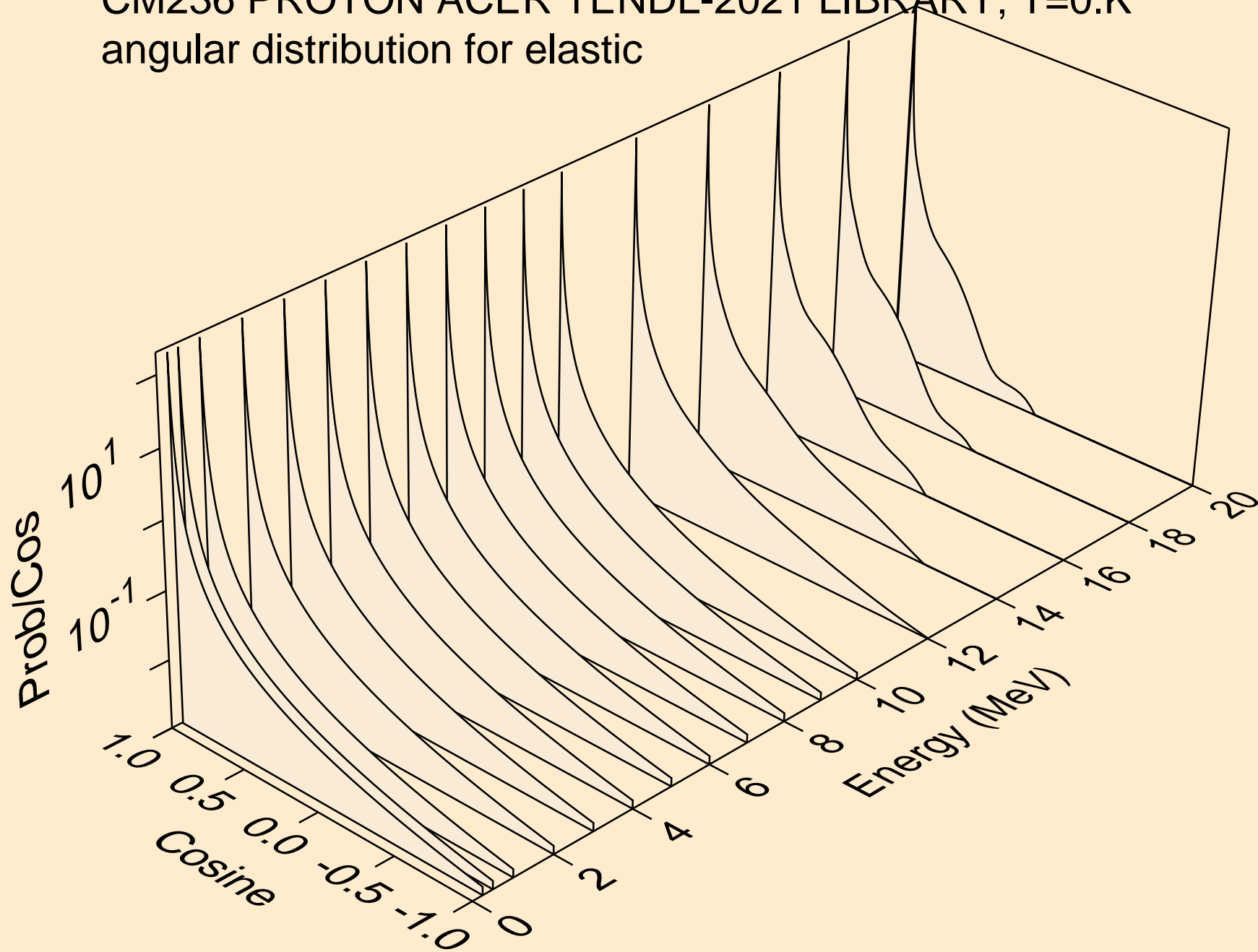

CM236 PROTON ACER TENDL-2021 LIBRARY; T=0.K
angular distribution for elastic

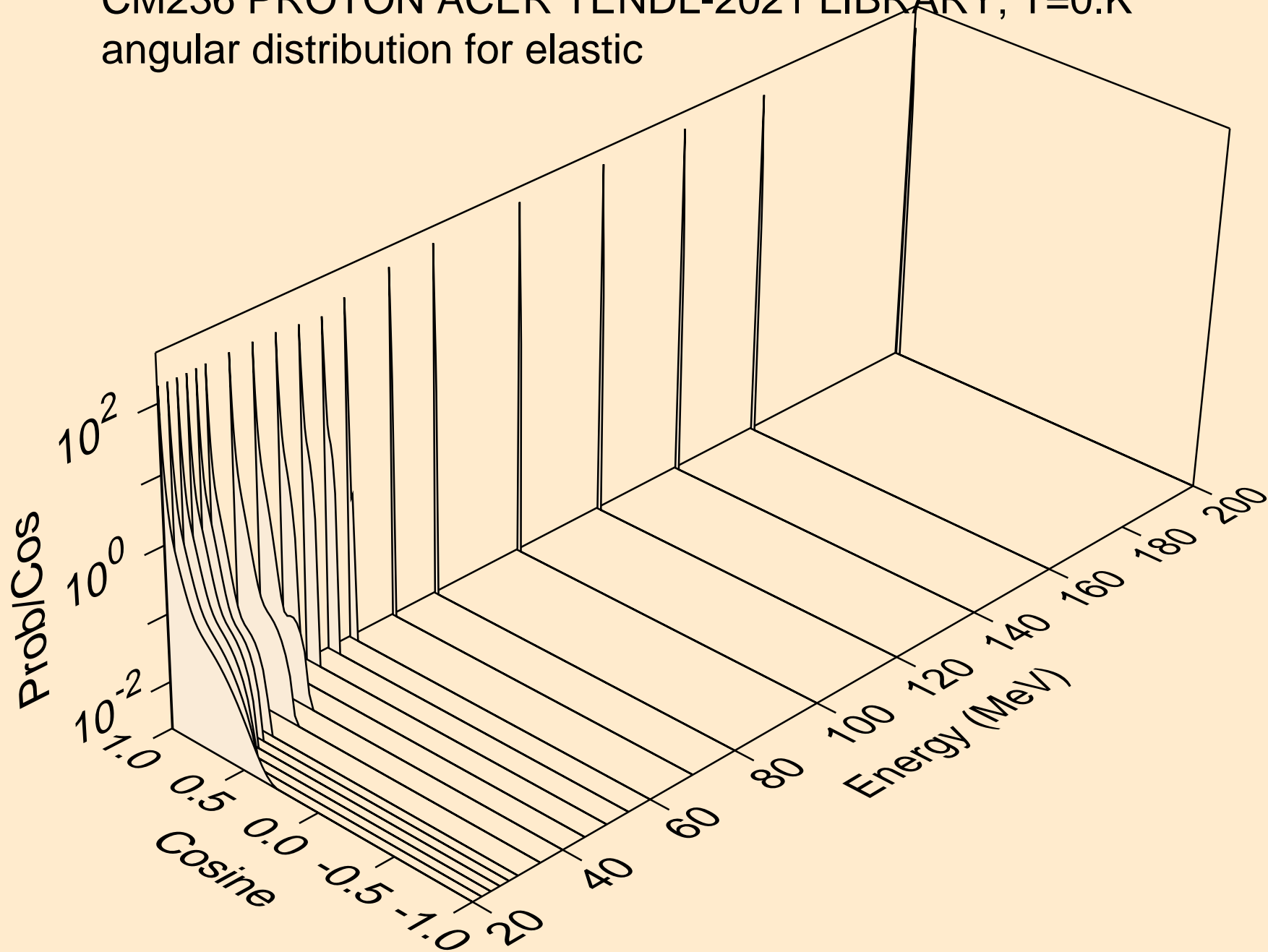

CM236 PROTON ACER TENDL-2021 LIBRARY; T=0.K
Proton emission for (p,x)

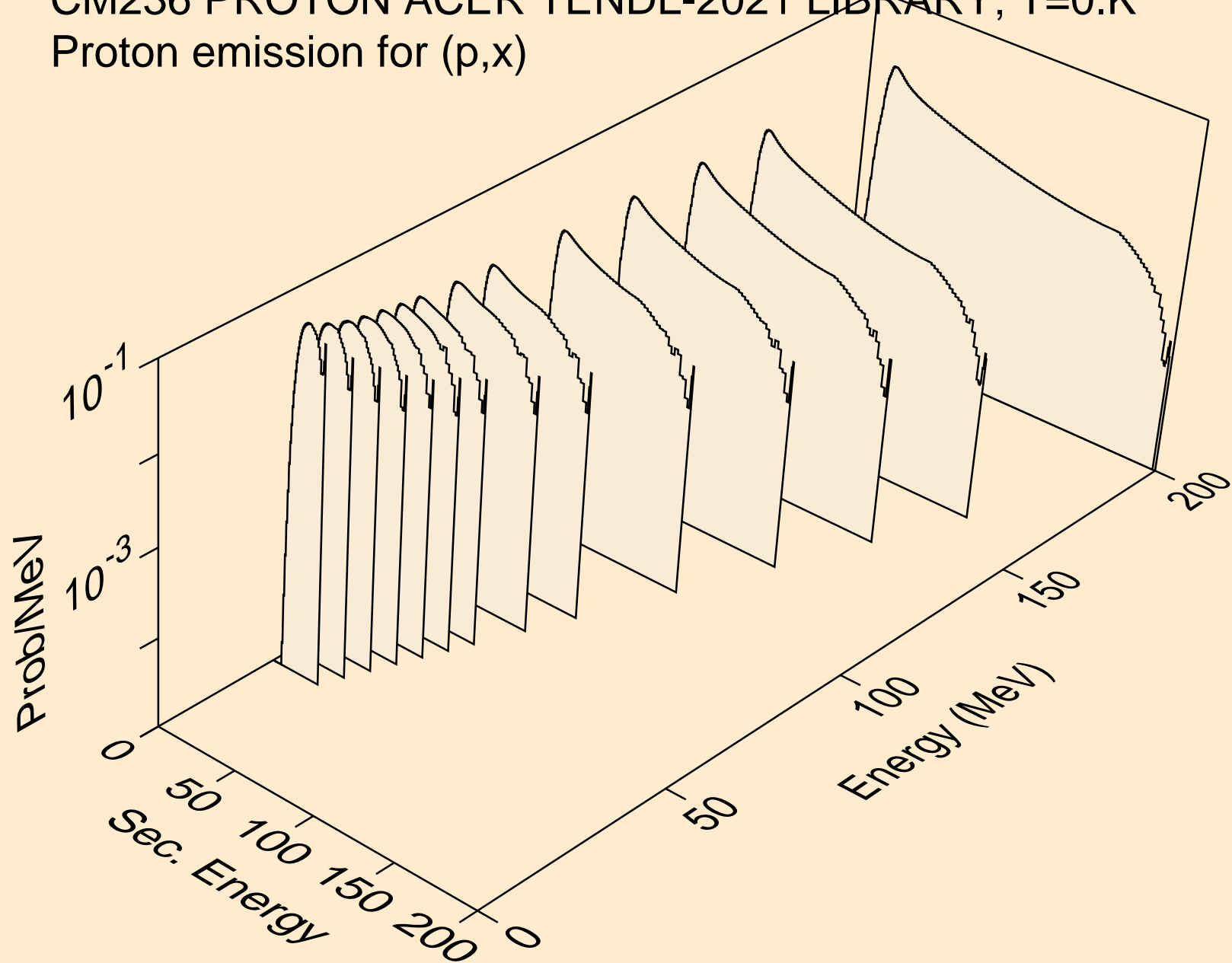

CM236 PROTON ACER TENDL-2021 LIBRARY; T=0.K
Proton emission for (p,n*)p

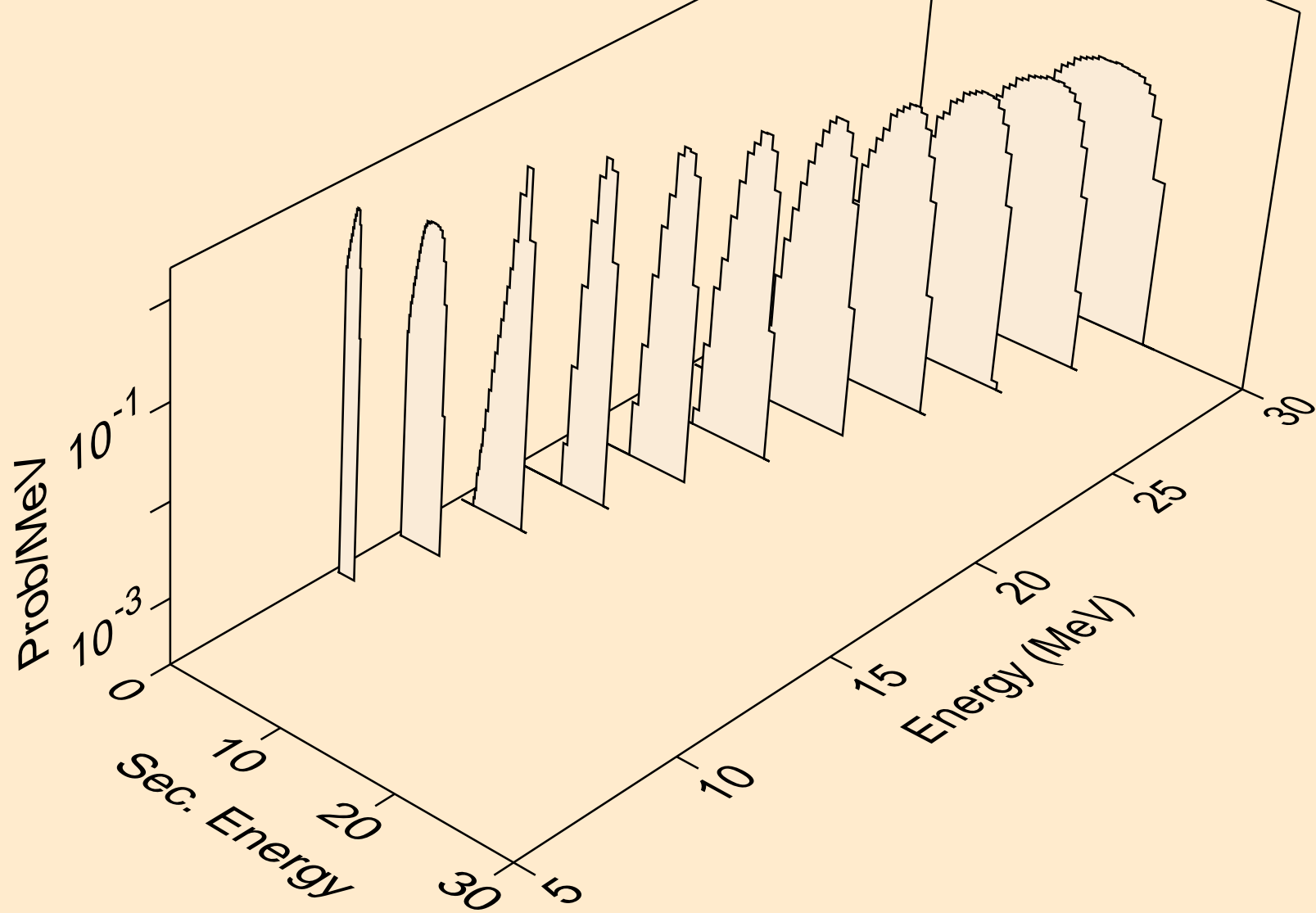

CM236 PROTON ACER TENDL-2021 LIBRARY; T=0.K
Proton emission for (p,2np)

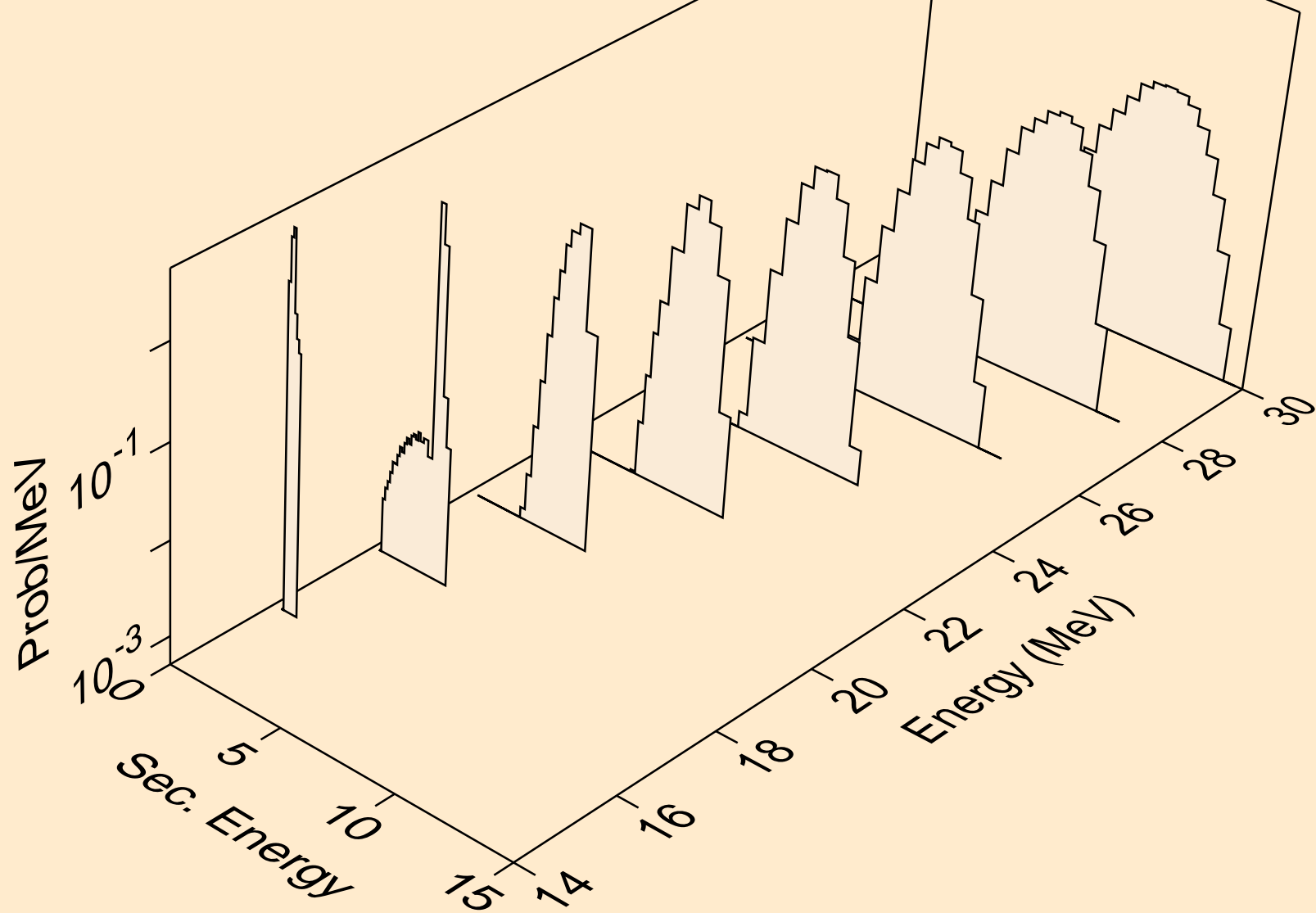

CM236 PROTON ACER TENDL-2021 LIBRARY; T=0.K
Proton emission for inelastic

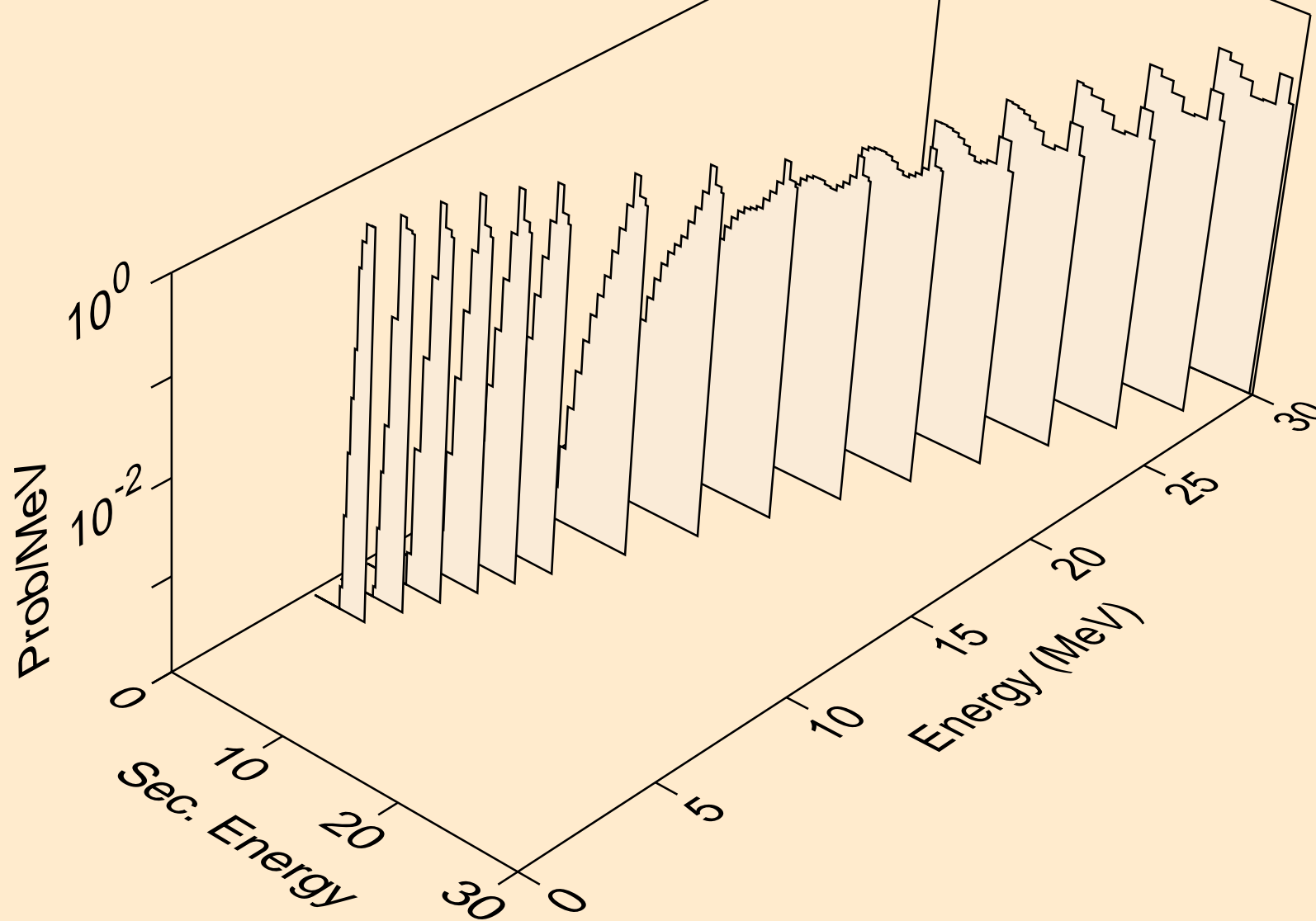

CM236 PROTON ACER TENDL-2021 LIBRARY; T=0.K
Proton emission for (p,2p)

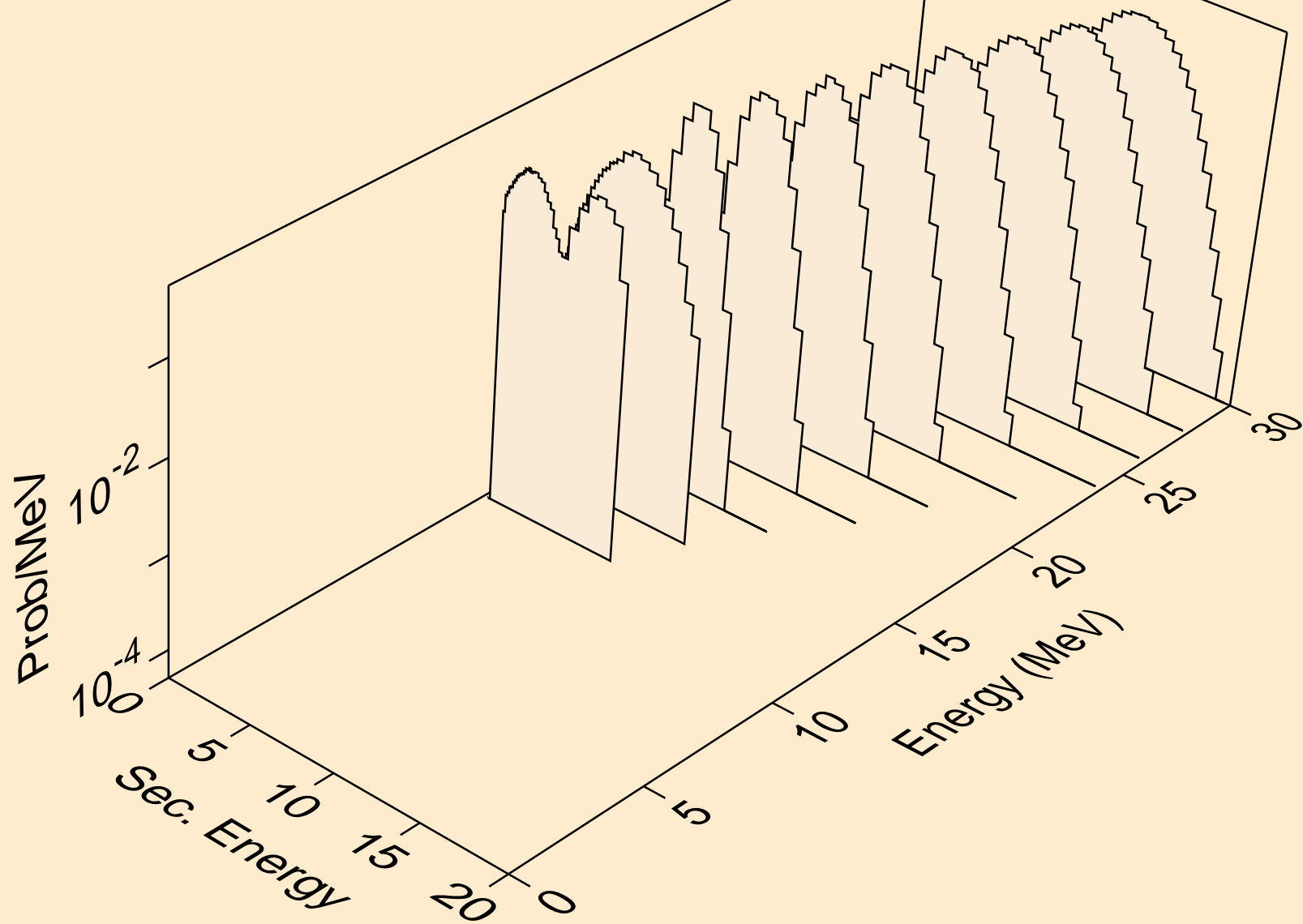

CM236 PROTON ACER TENDL-2021 LIBRARY; T=0.K
Photon emission for (z,n)

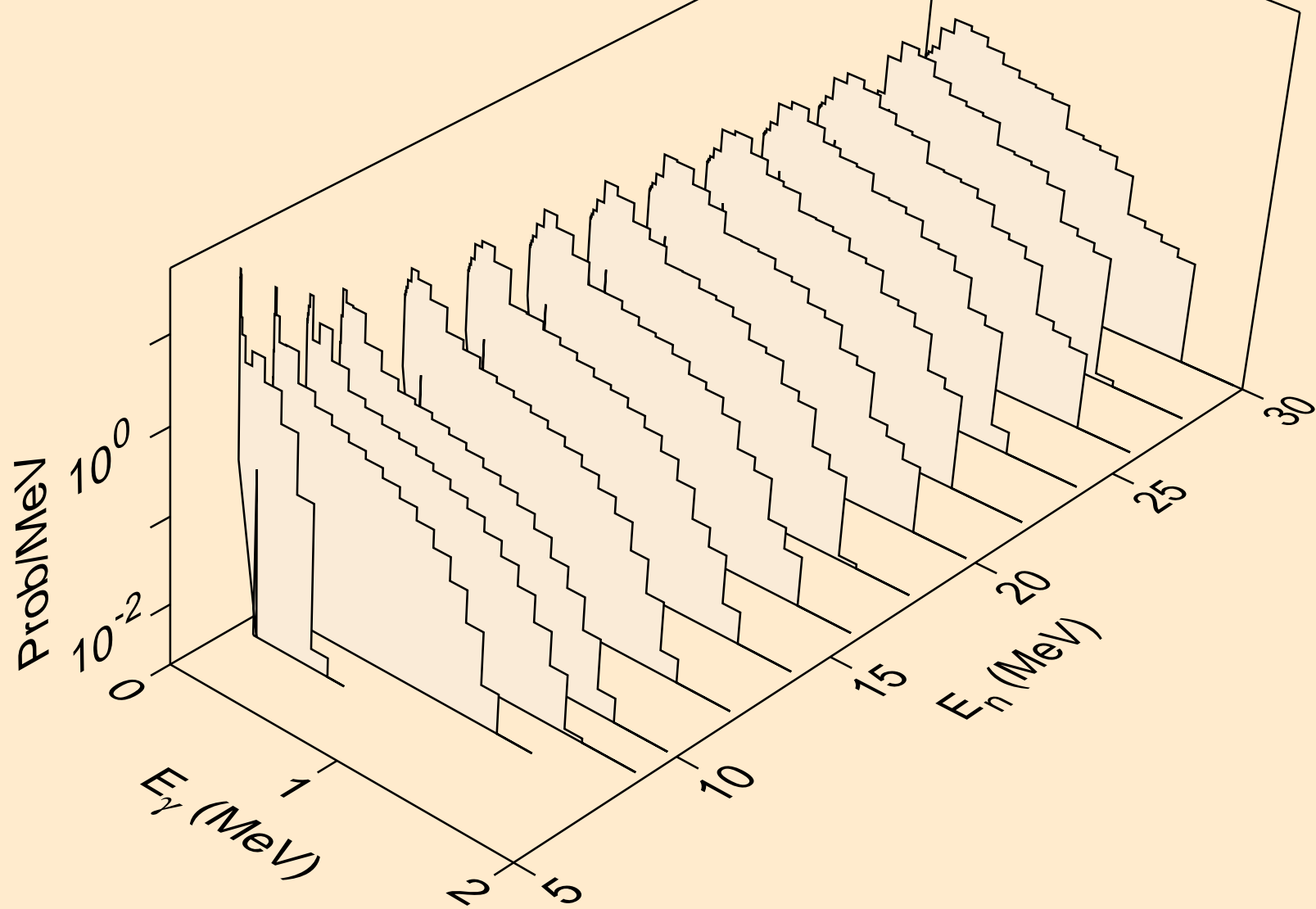

CM236 PROTON ACER TENDL-2021 LIBRARY; T=0.K
Photon emission for (n,x)

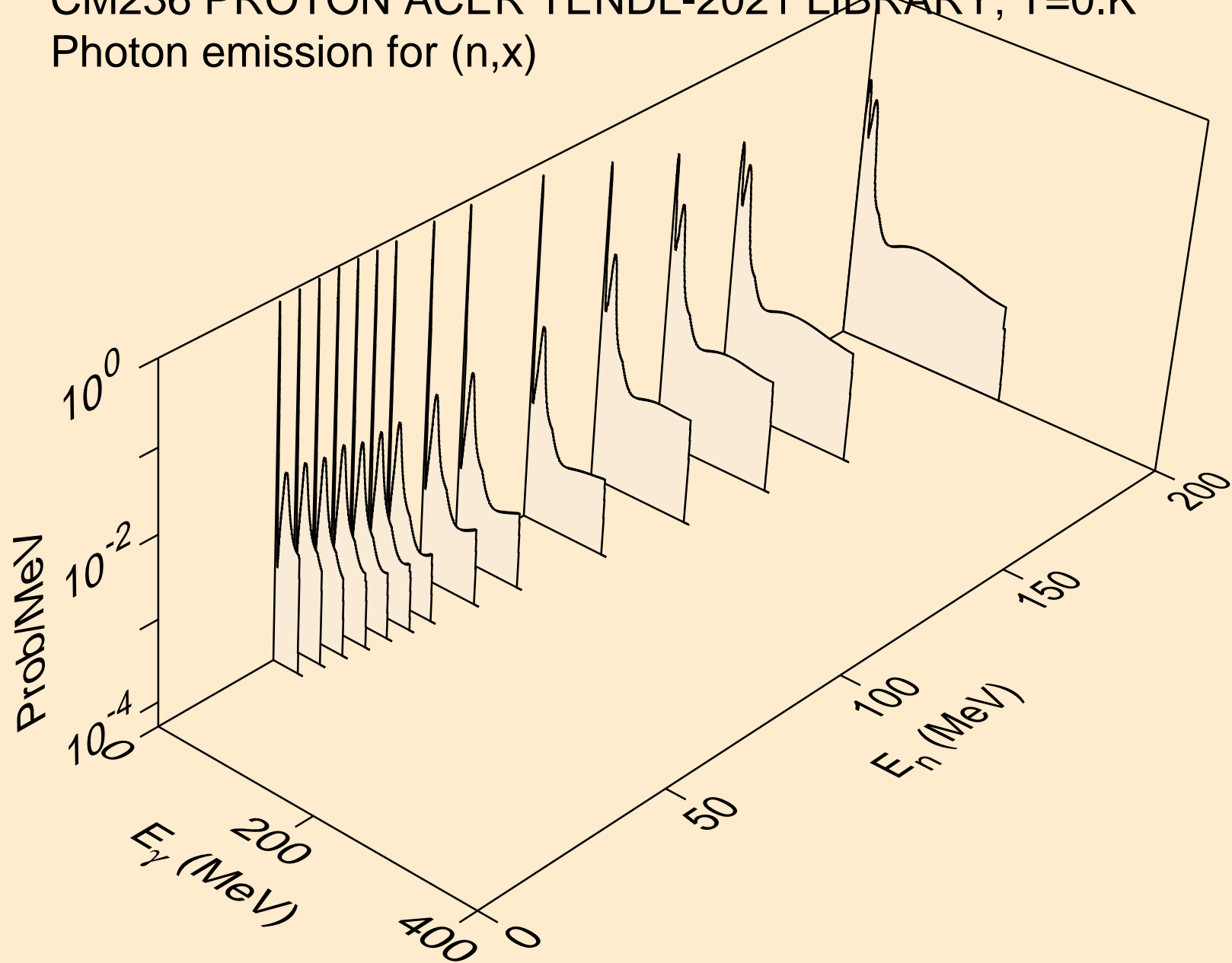

CM236 PROTON ACER TENDL-2021 LIBRARY; T=0.K
Photon emission for (n,2n)

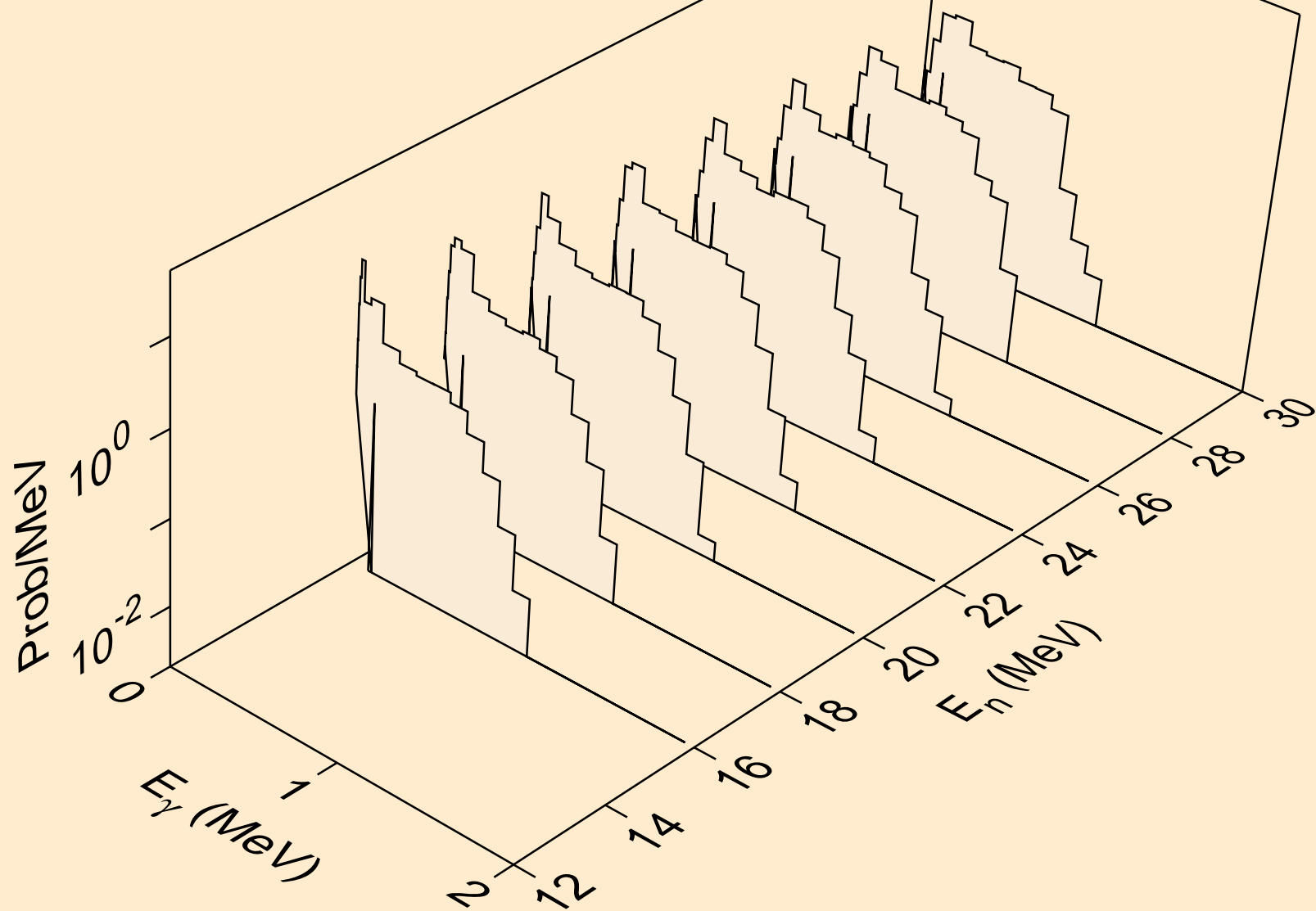

CM236 PROTON ACER TENDL-2021 LIBRARY; T=0.K
Photon emission for (n,3n)

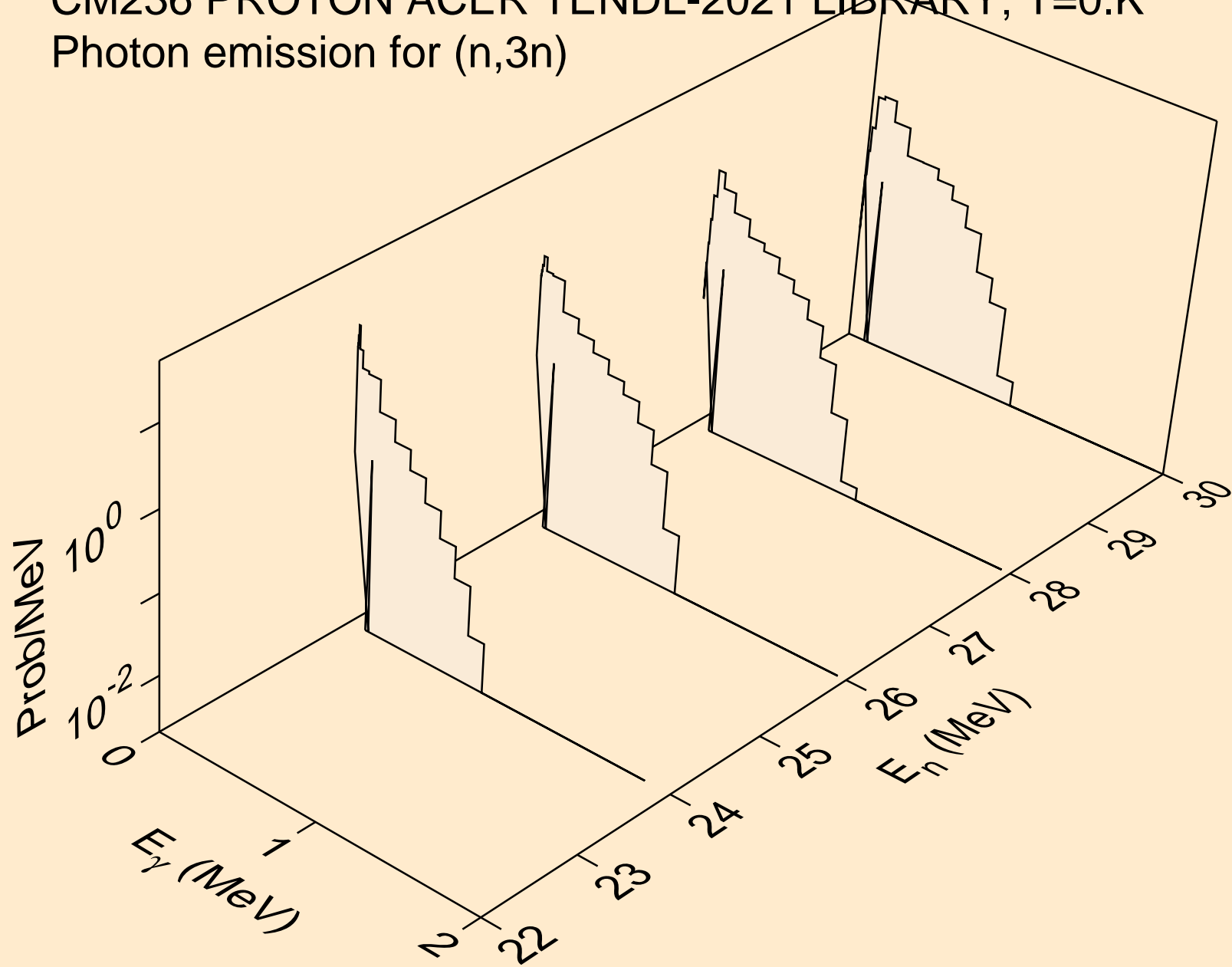

CM236 PROTON ACER TENDL-2021 LIBRARY; T=0.K
Photon emission for (n,n*)a

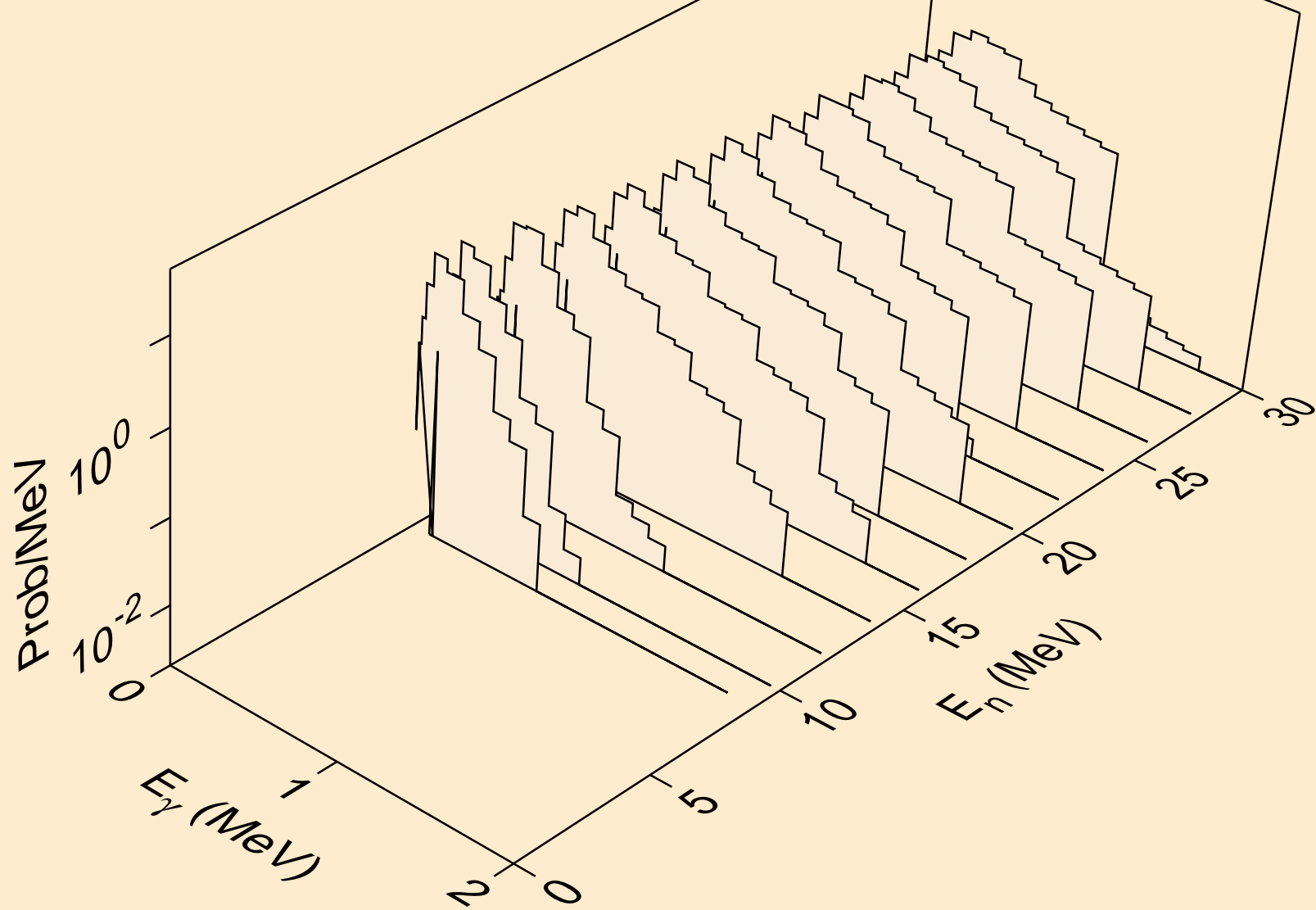

CM236 PROTON ACER TENDL-2021 LIBRARY; T=0.K
Photon emission for (n,n*)p

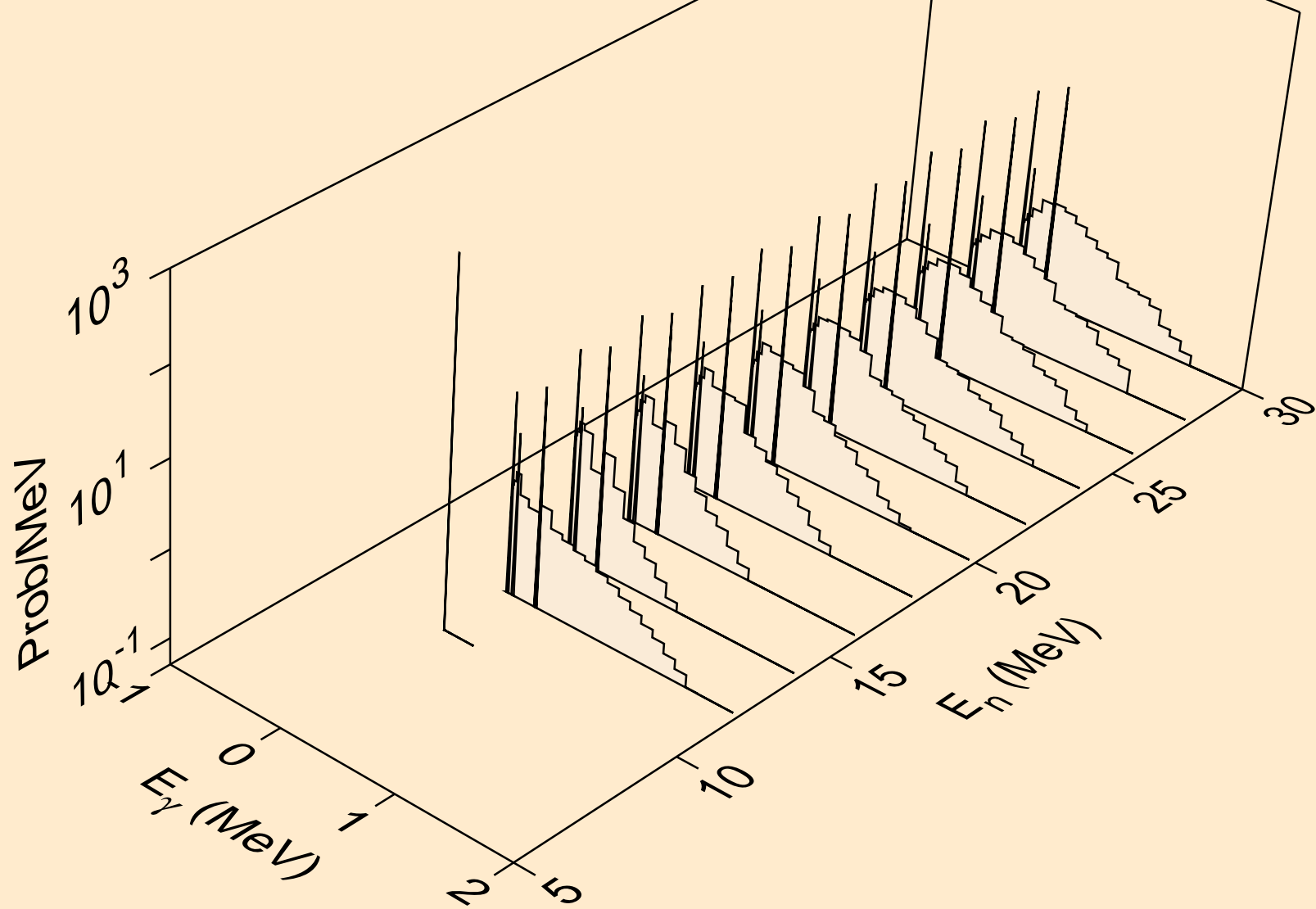

CM236 PROTON ACER TENDL-2021 LIBRARY; T=0.K
Photon emission for (n,n*)d

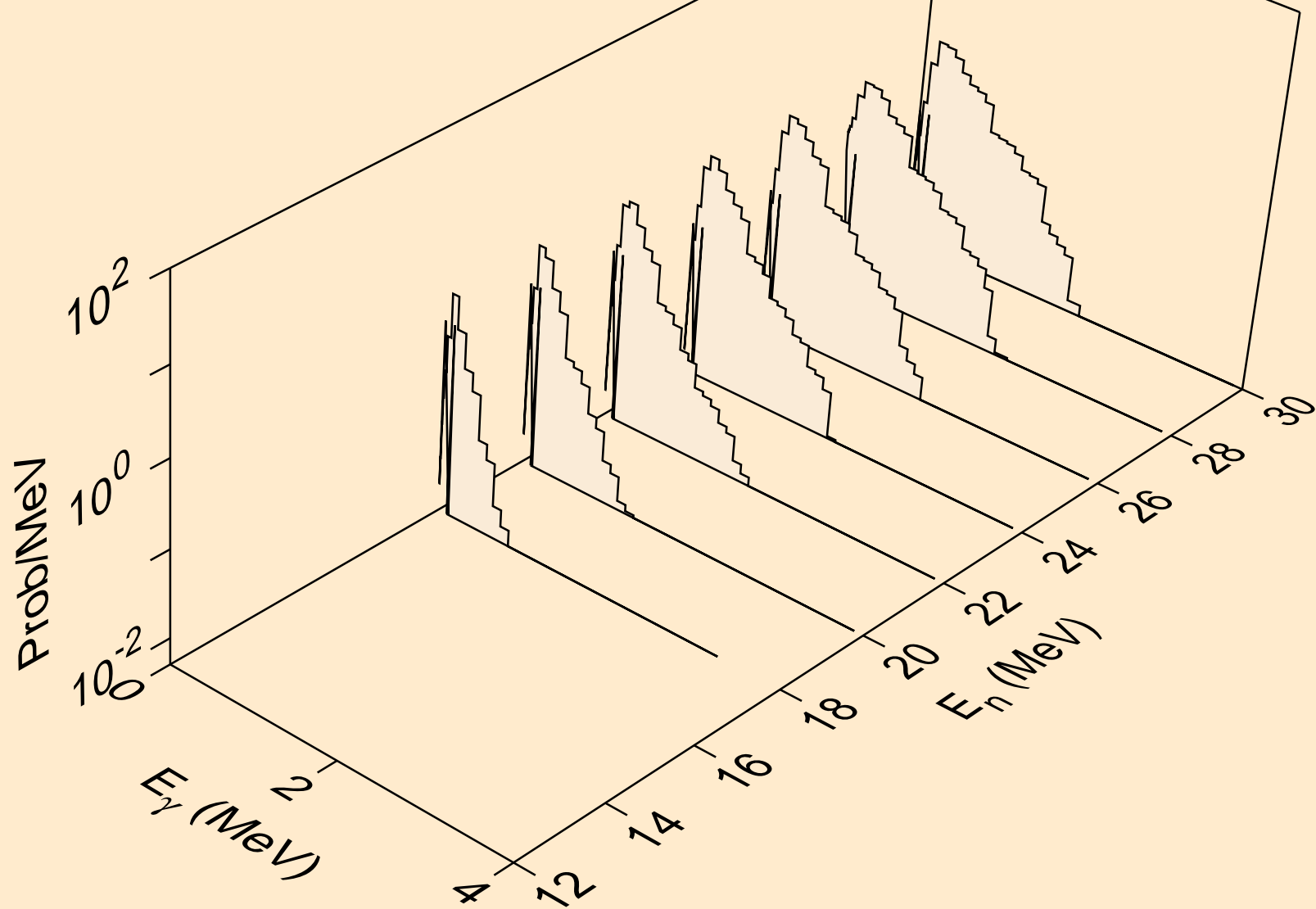

CM236 PROTON ACER TENDL-2021 LIBRARY; T=0.K
Photon emission for (n,n*)t

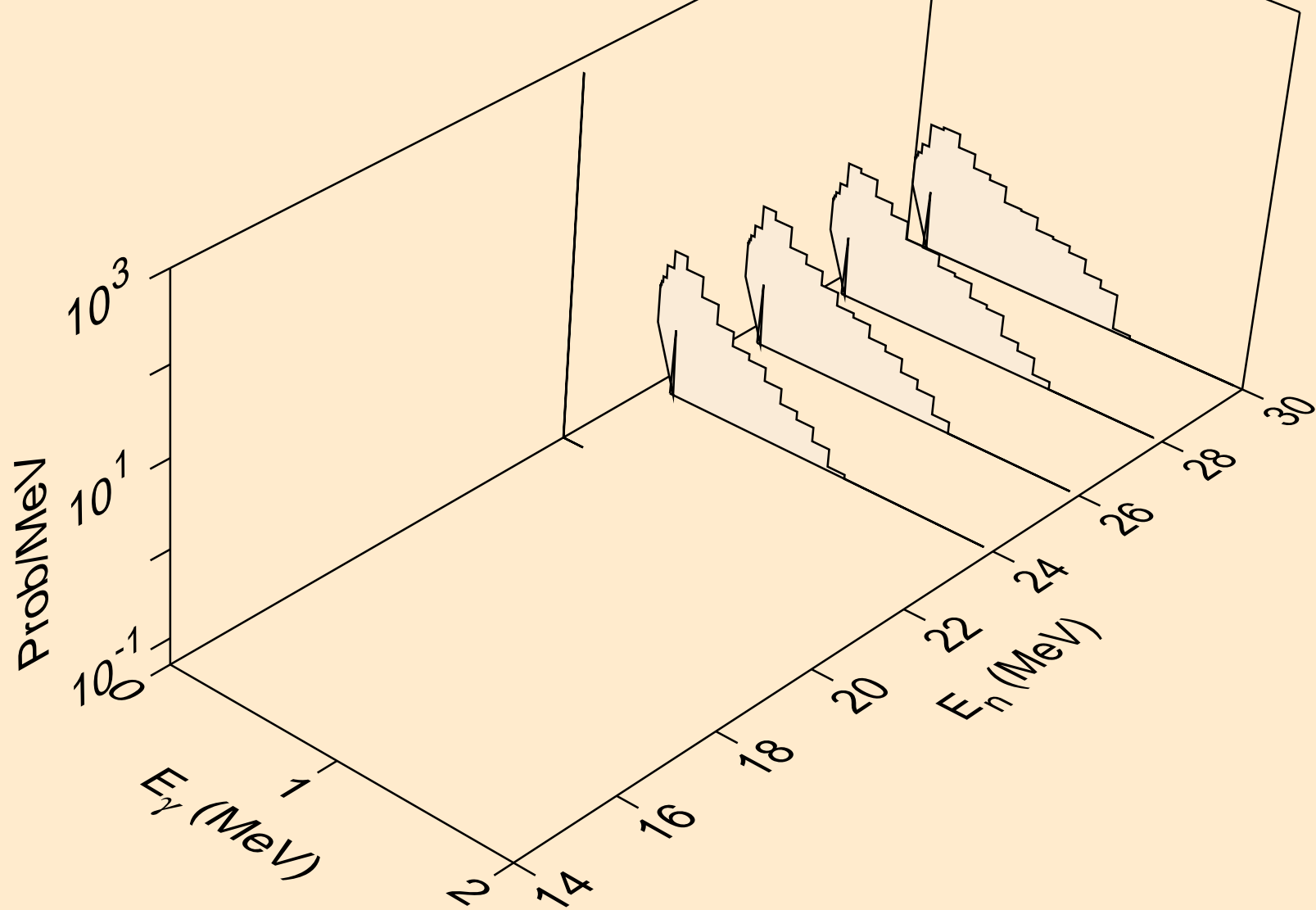

CM236 PROTON ACER TENDL-2021 LIBRARY; T=0.K
Photon emission for (n,2np)

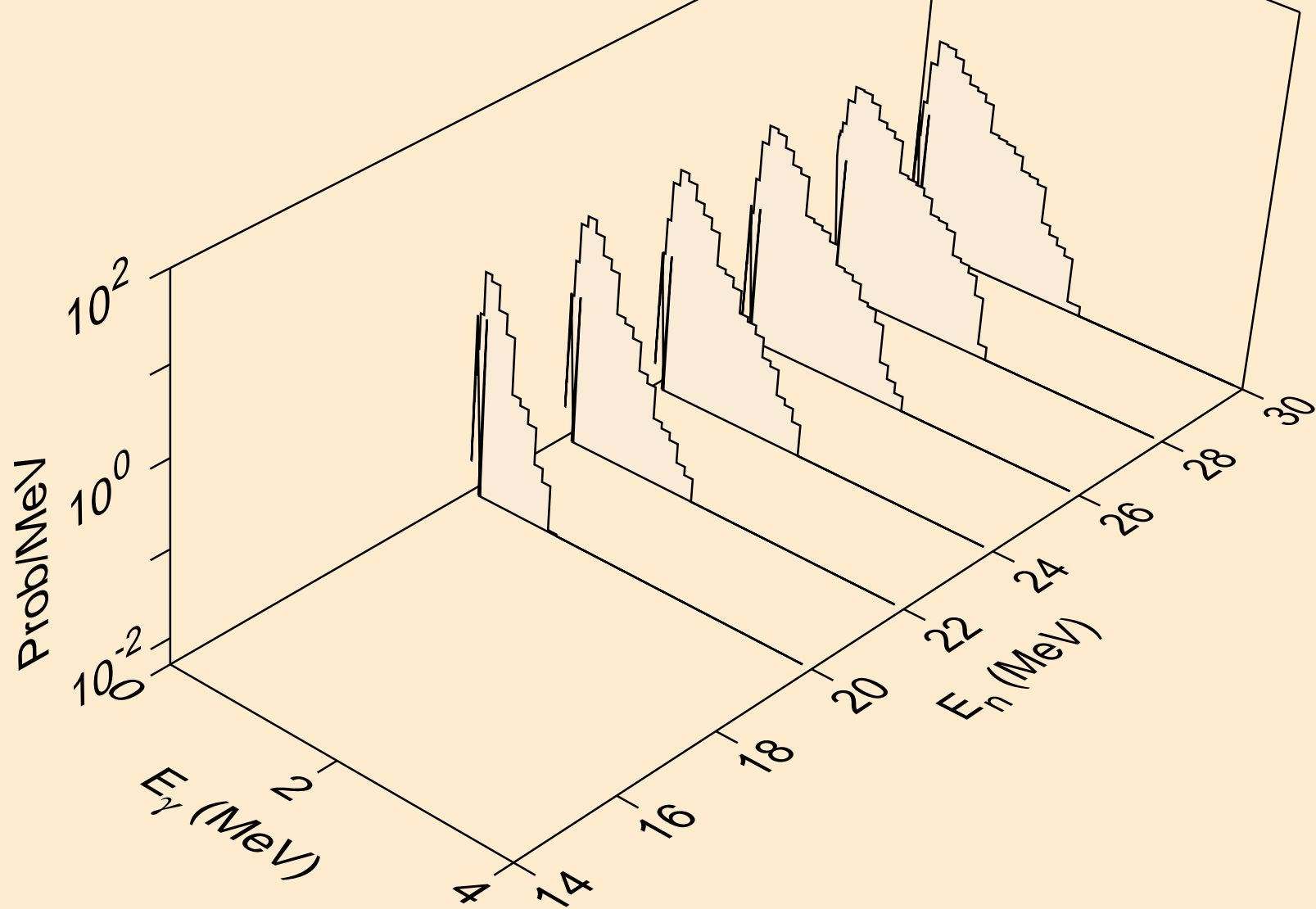

CM236 PROTON ACER TENDL-2021 LIBRARY; T=0.K
Photon emission for (n,gma)

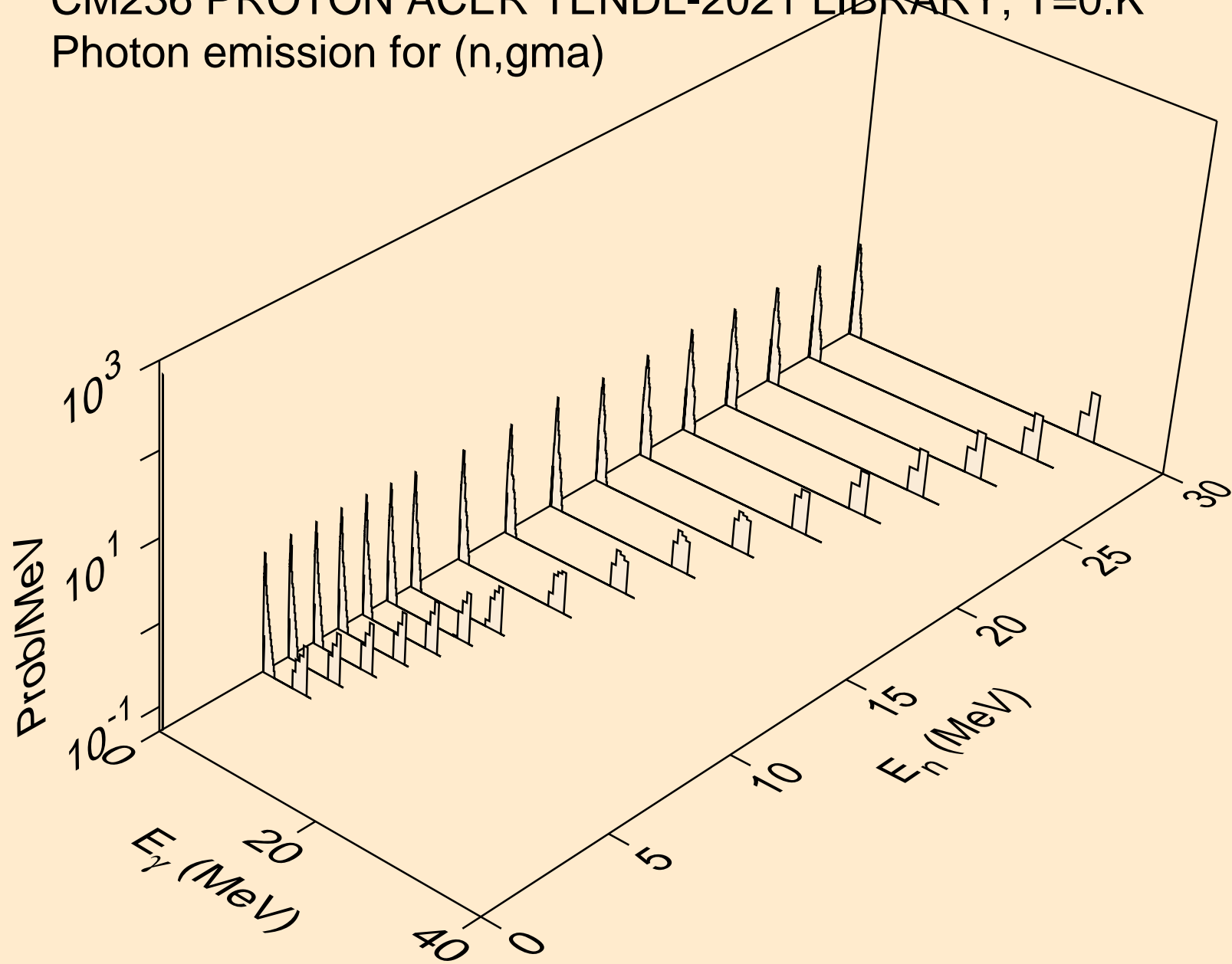

CM236 PROTON ACER TENDL-2021 LIBRARY; T=0.K
Photon emission for inelastic

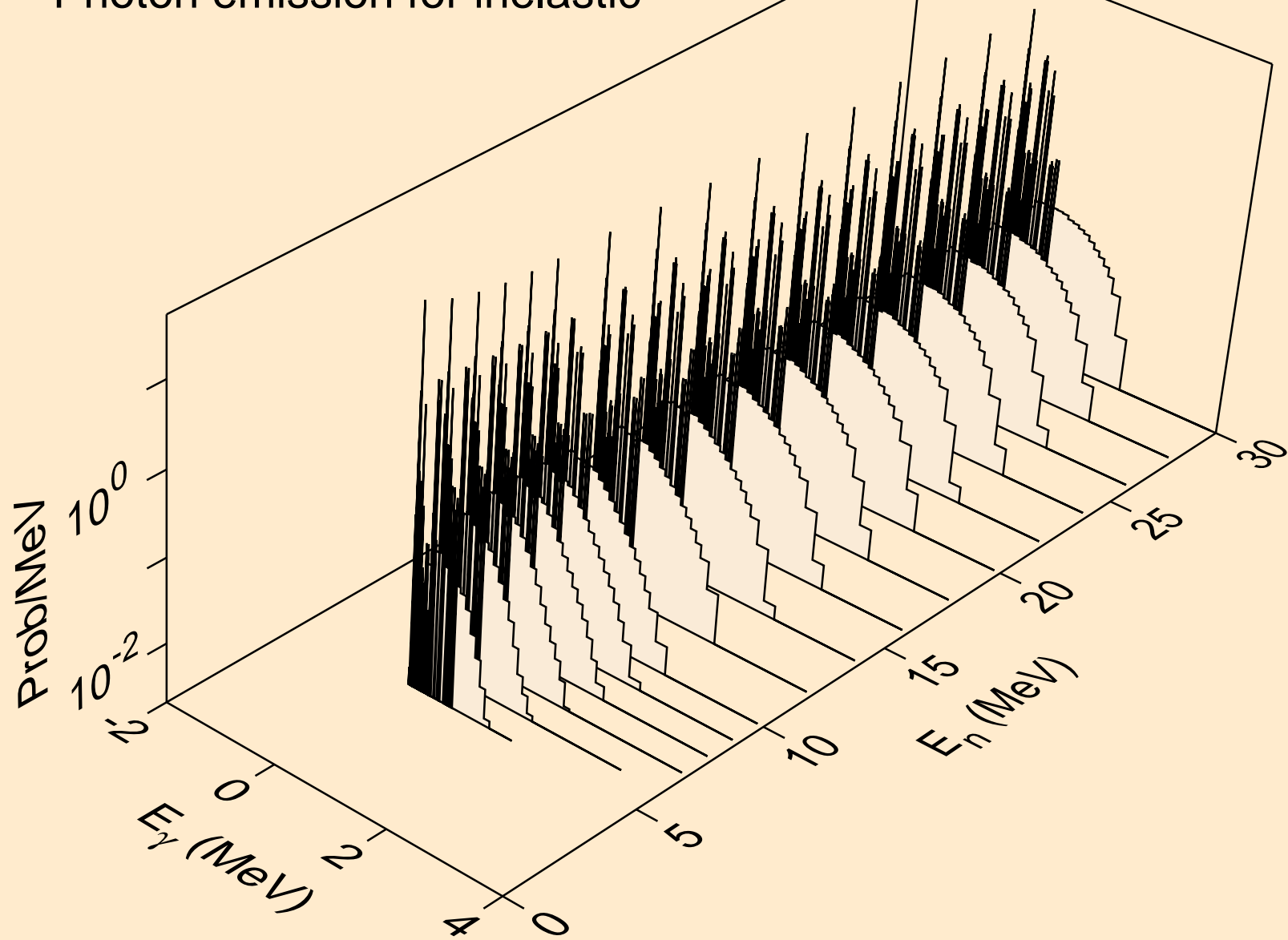

CM236 PROTON ACER TENDL-2021 LIBRARY; T=0.K
Photon emission for (n,d)

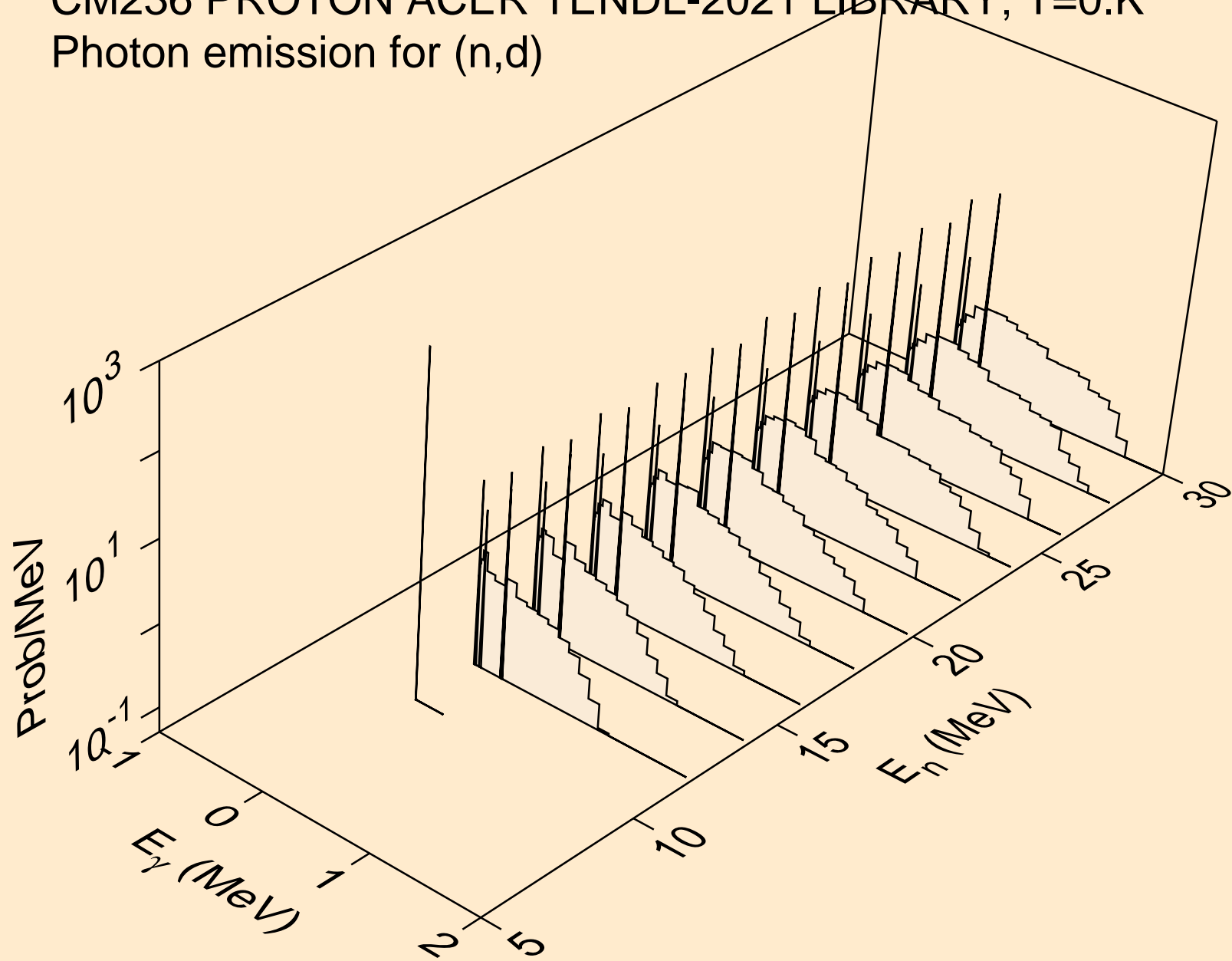

CM236 PROTON ACER TENDL-2021 LIBRARY; T=0.K
Photon emission for (n,t)

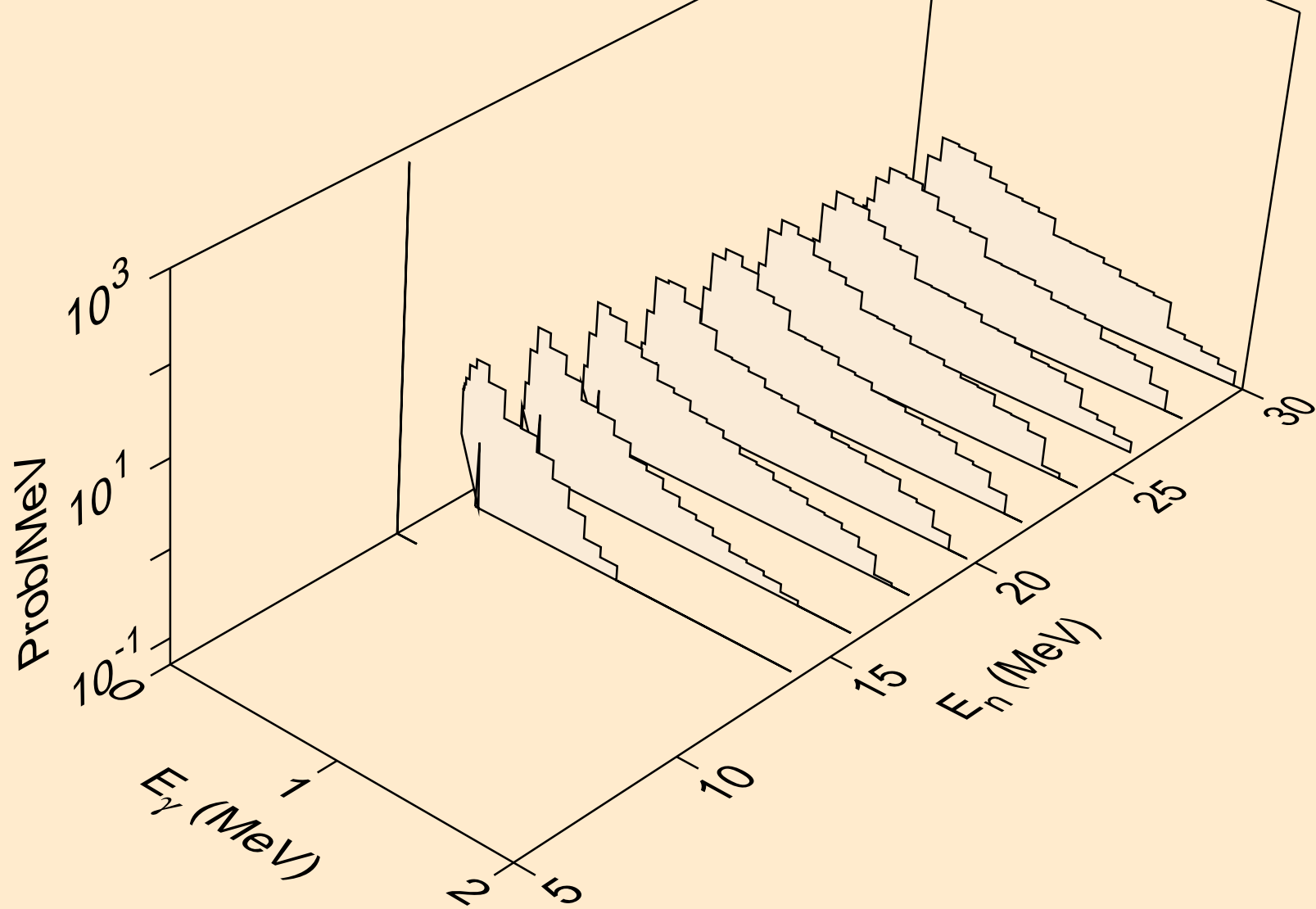

CM236 PROTON ACER TENDL-2021 LIBRARY; T=0.K
Photon emission for (n,he3)

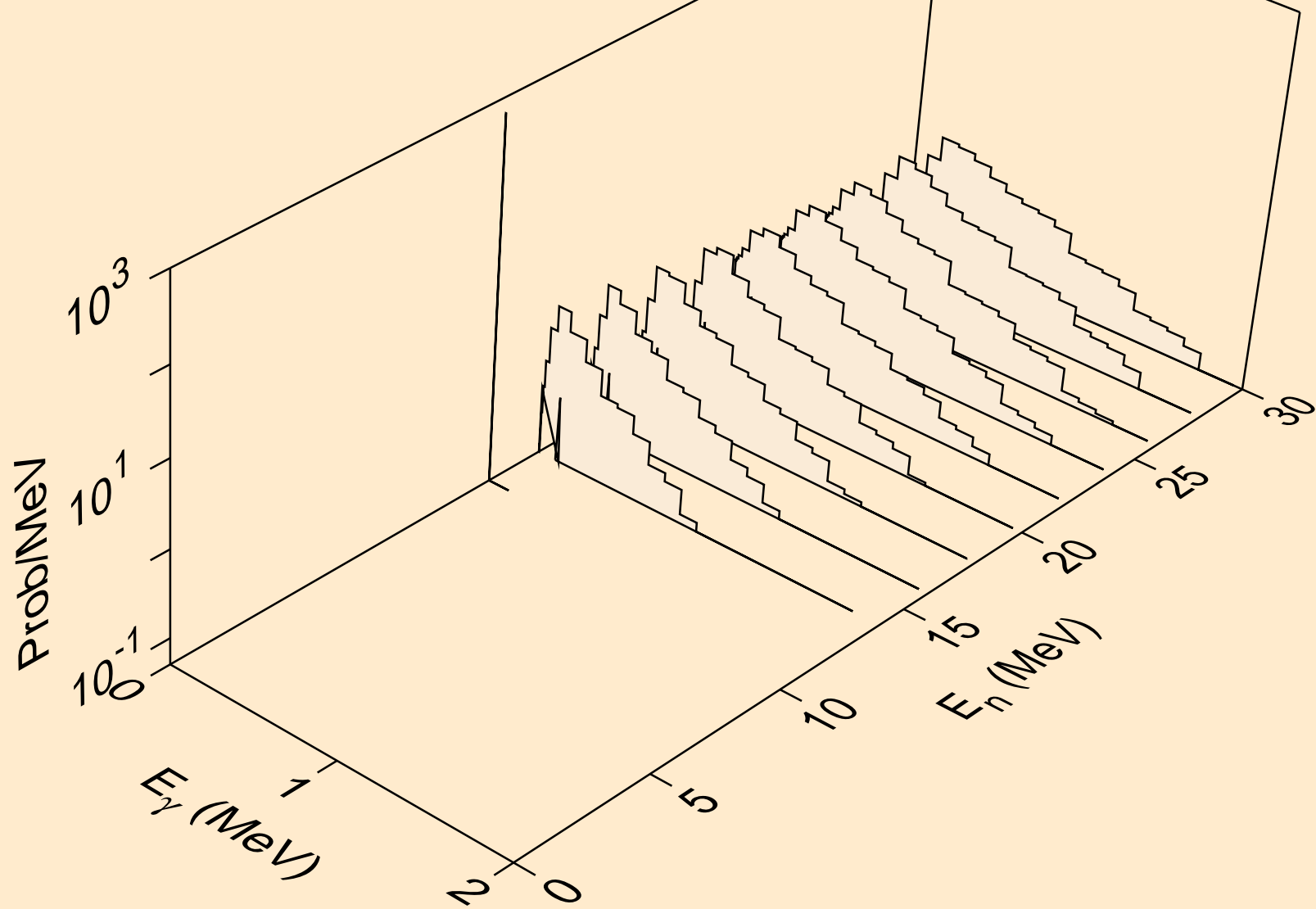

CM236 PROTON ACER TENDL-2021 LIBRARY; T=0.K
Photon emission for (n,a)

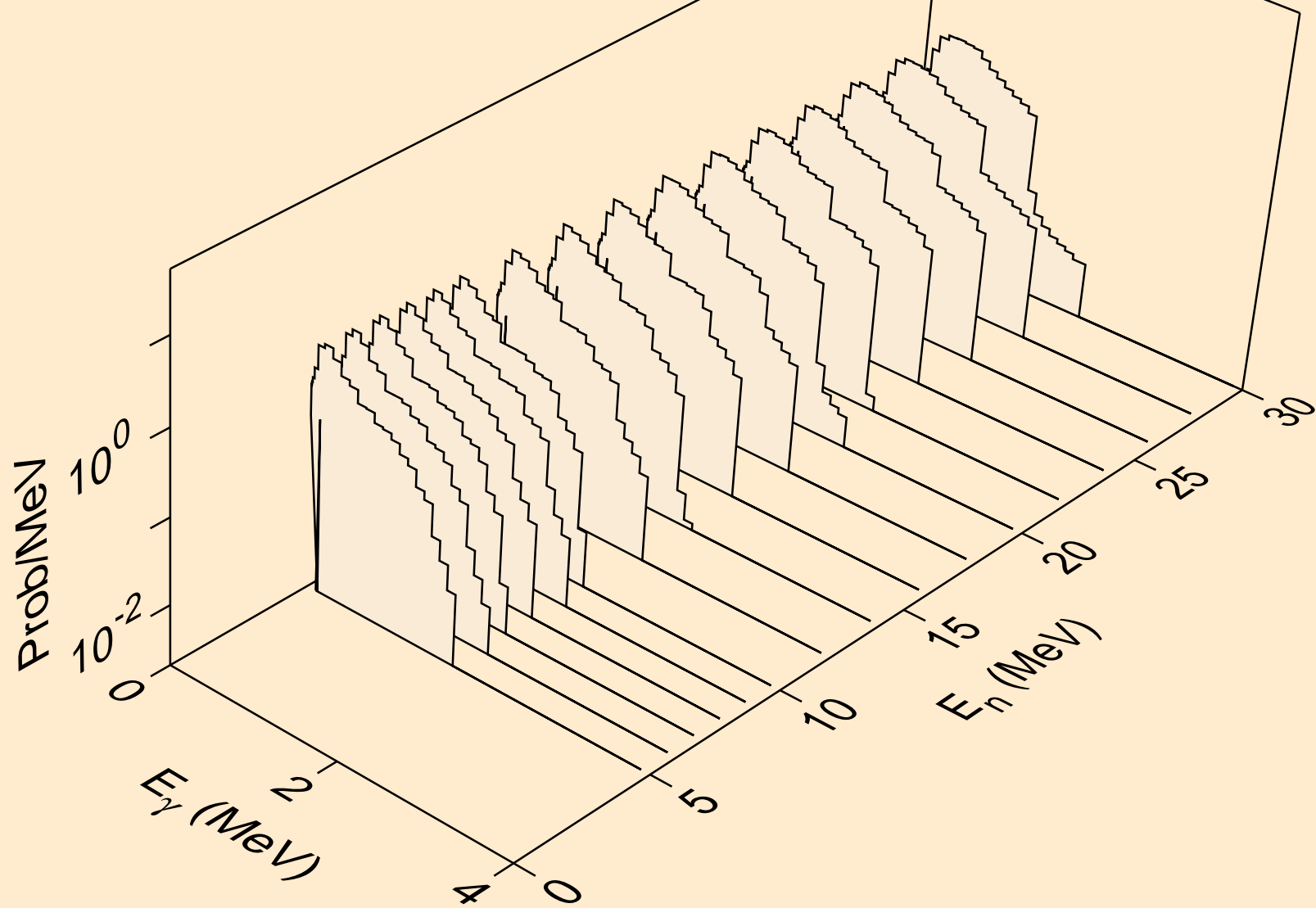

CM236 PROTON ACER TENDL-2021 LIBRARY; T=0.K
Photon emission for (n,2p)

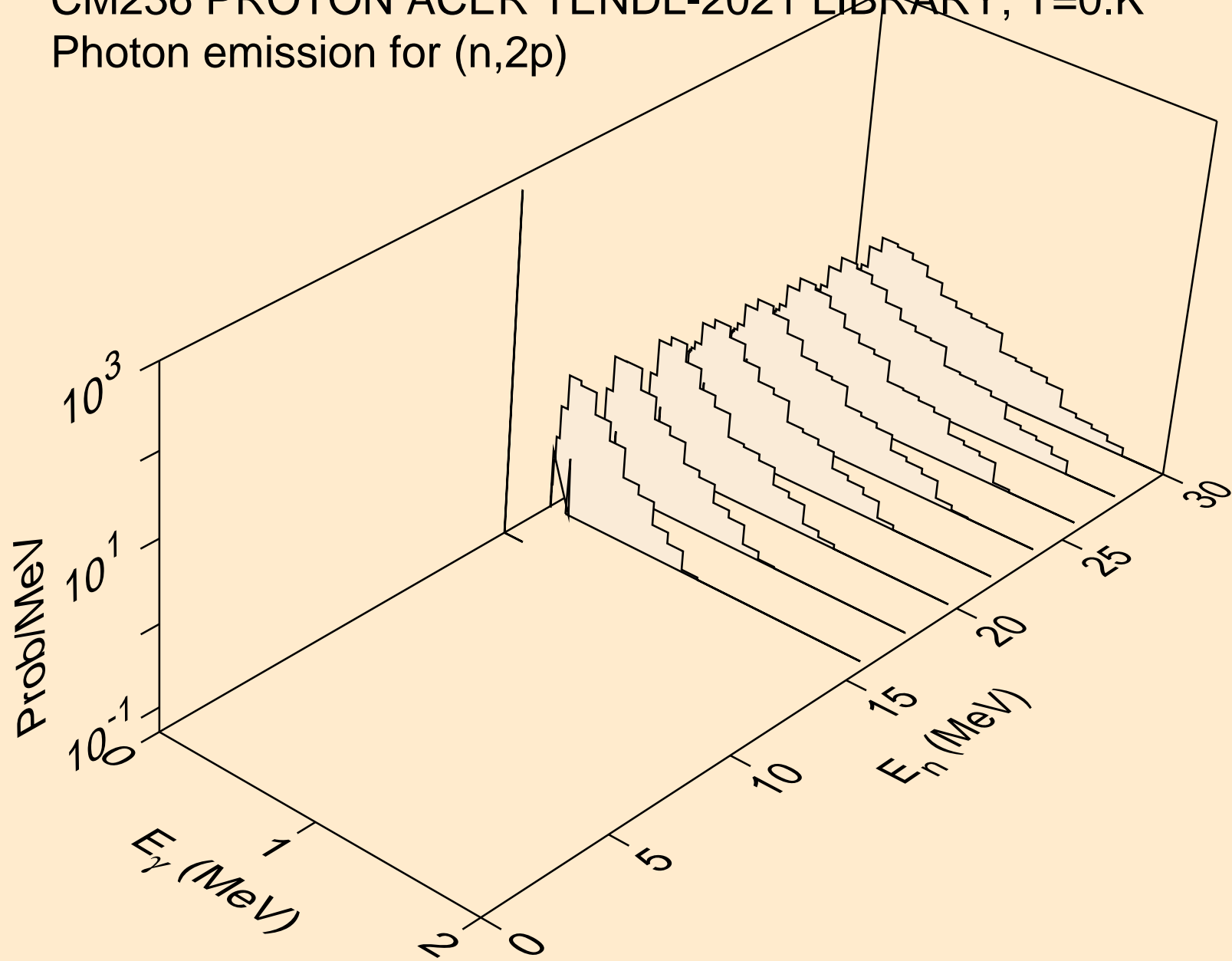

CM236 PROTON ACER TENDL-2021 LIBRARY; T=0.K

Particle heating contributions

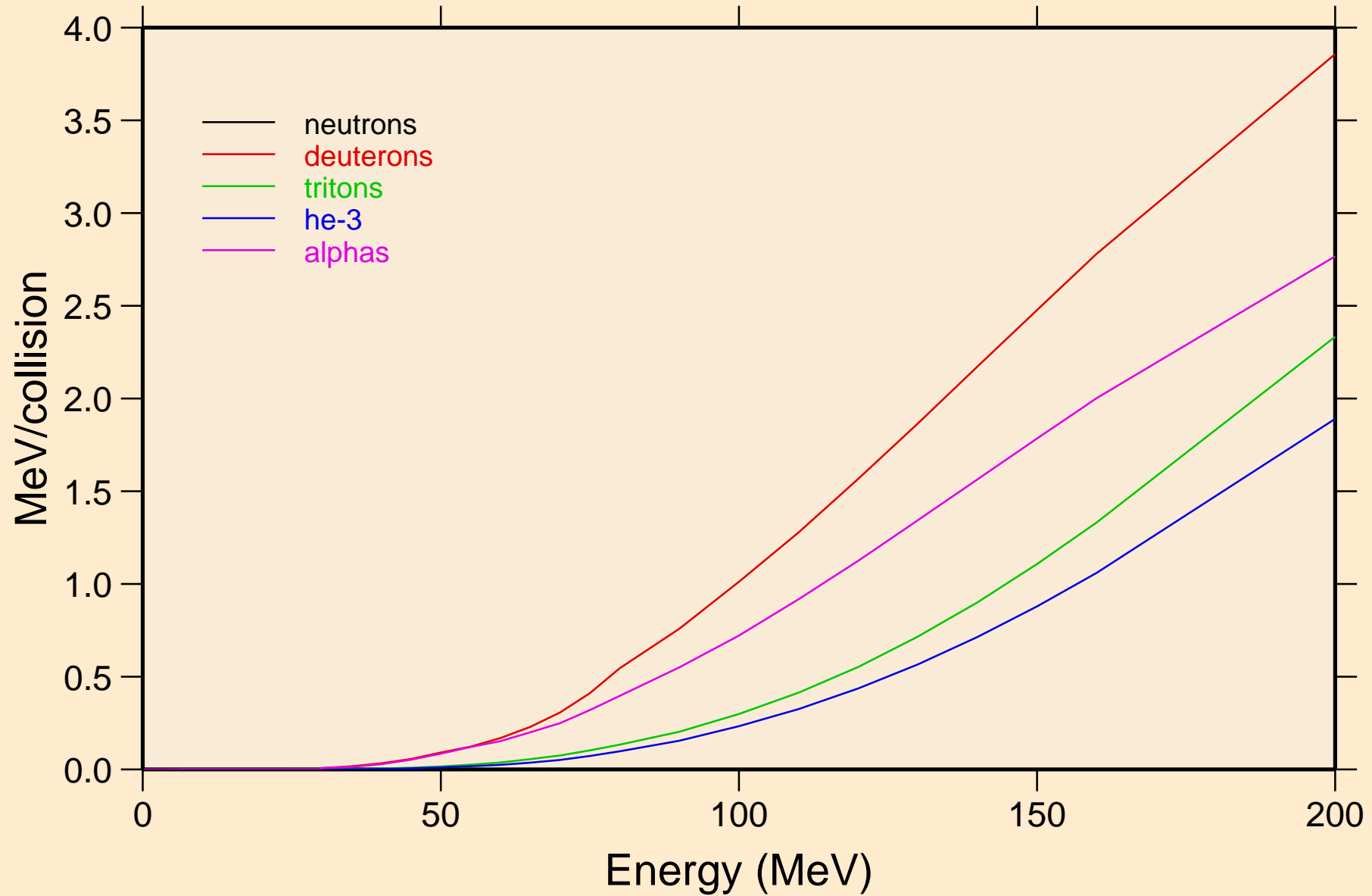

CM236 PROTON ACER TENDL-2021 LIBRARY; T=0.K
Recoil Heating

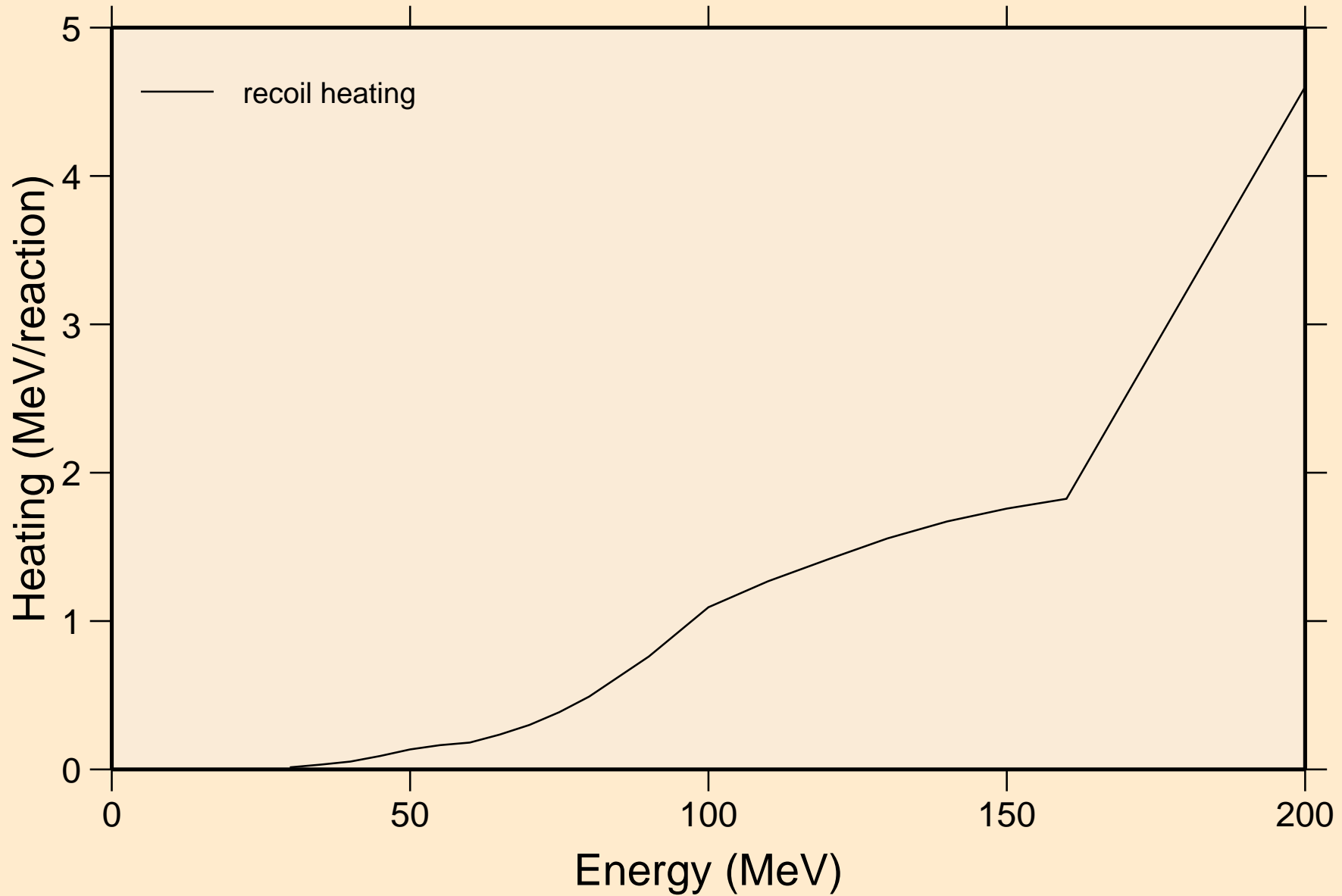

CM236 PROTON ACER TENDL-2021 LIBRARY; T=0.K
Particle production cross sections

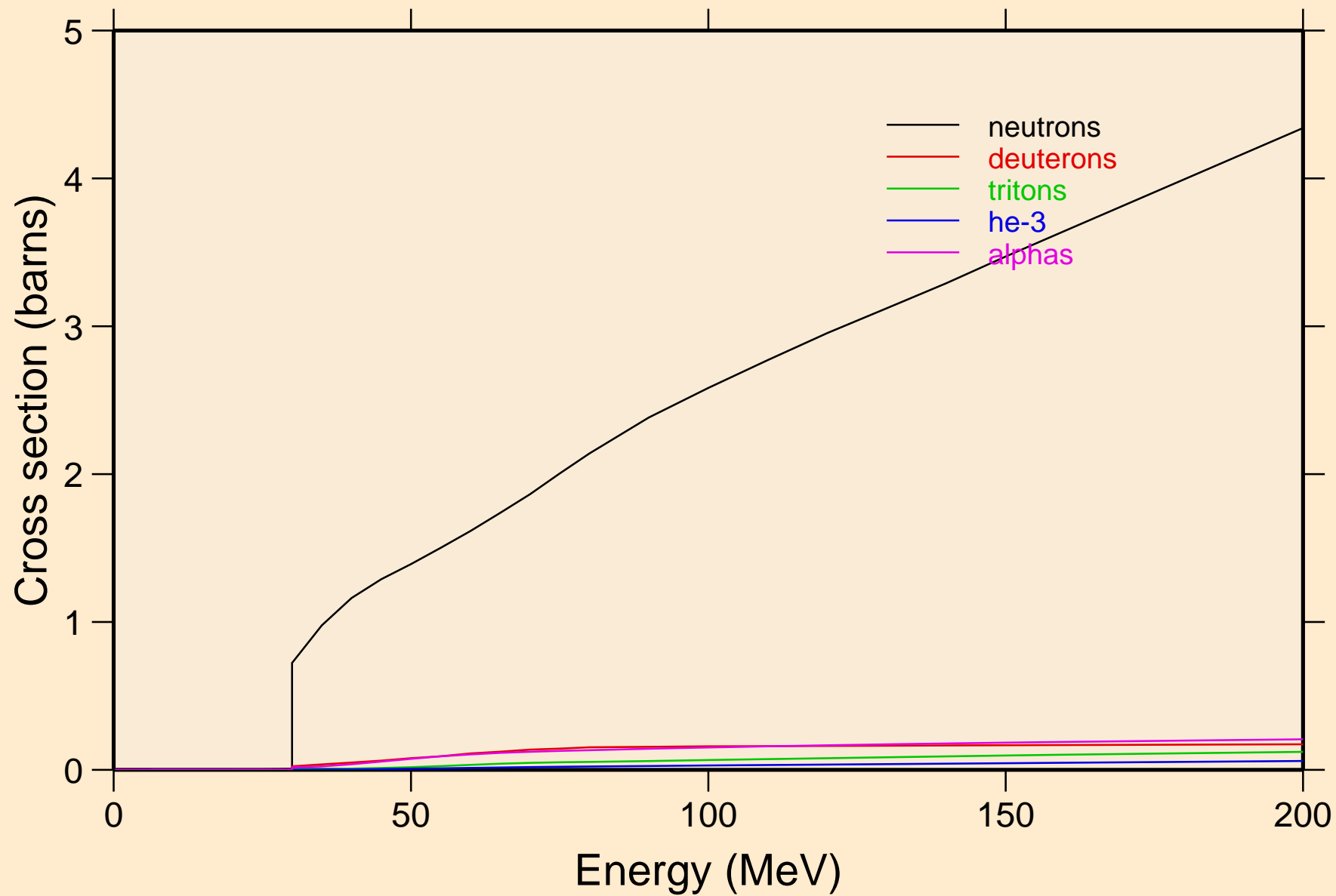

CM236 PROTON ACER TENDL-2021 LIBRARY; T=0.K
neutrons from (p,n)

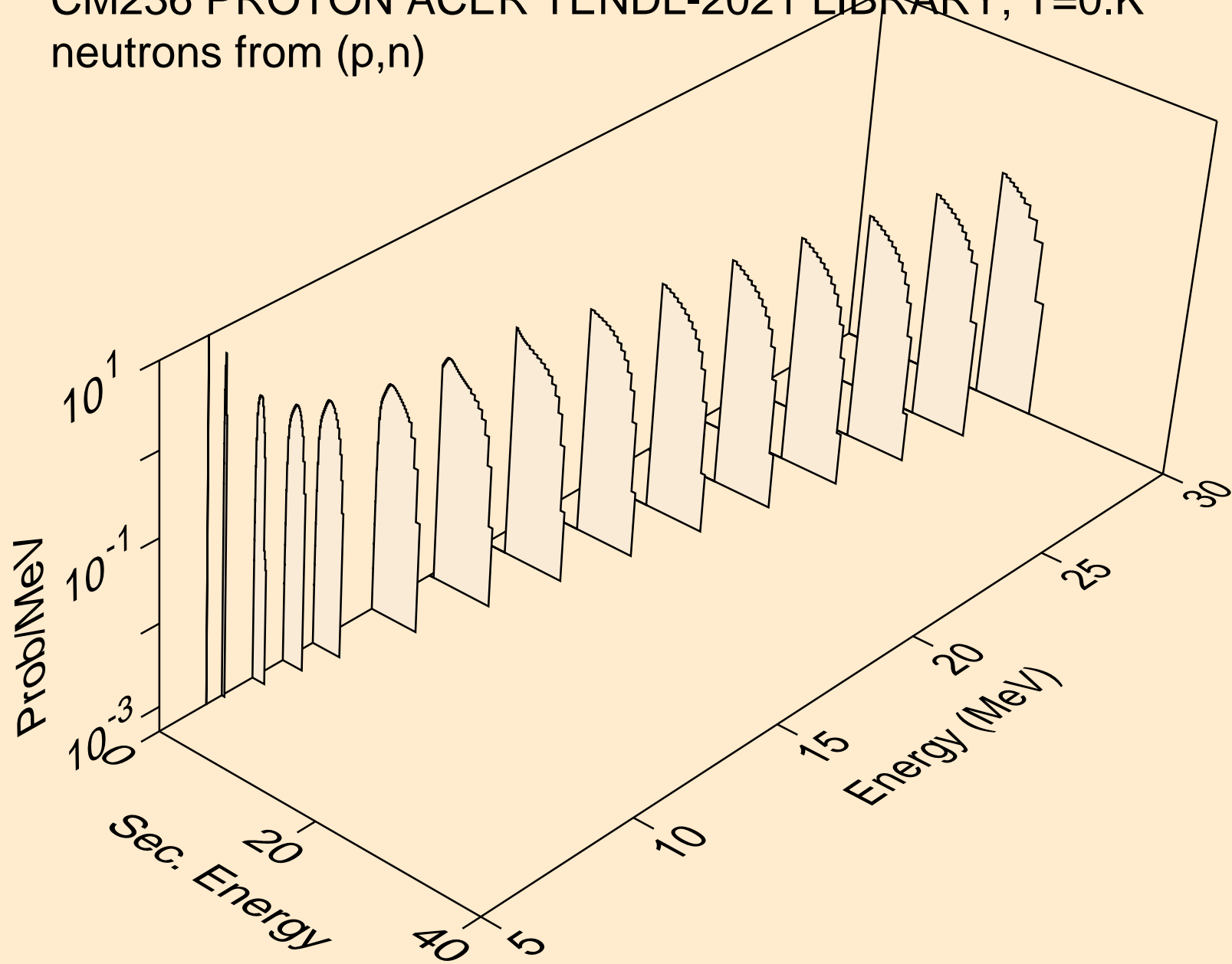

CM236 PROTON ACER TENDL-2021 LIBRARY; T=0.K
neutrons from (p,x)

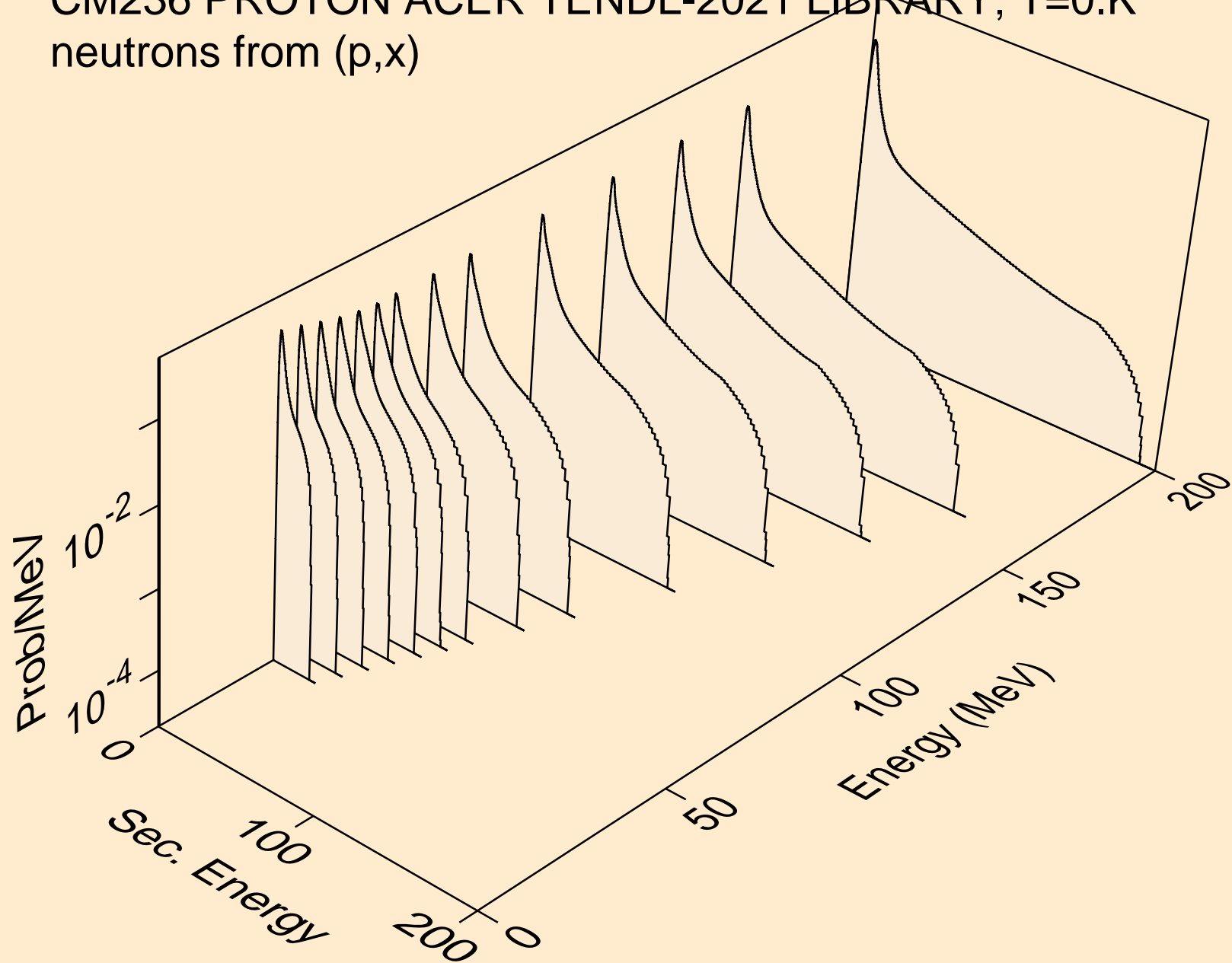

CM236 PROTON ACER TENDL-2021 LIBRARY; T=0.K
neutrons from (p,2n)

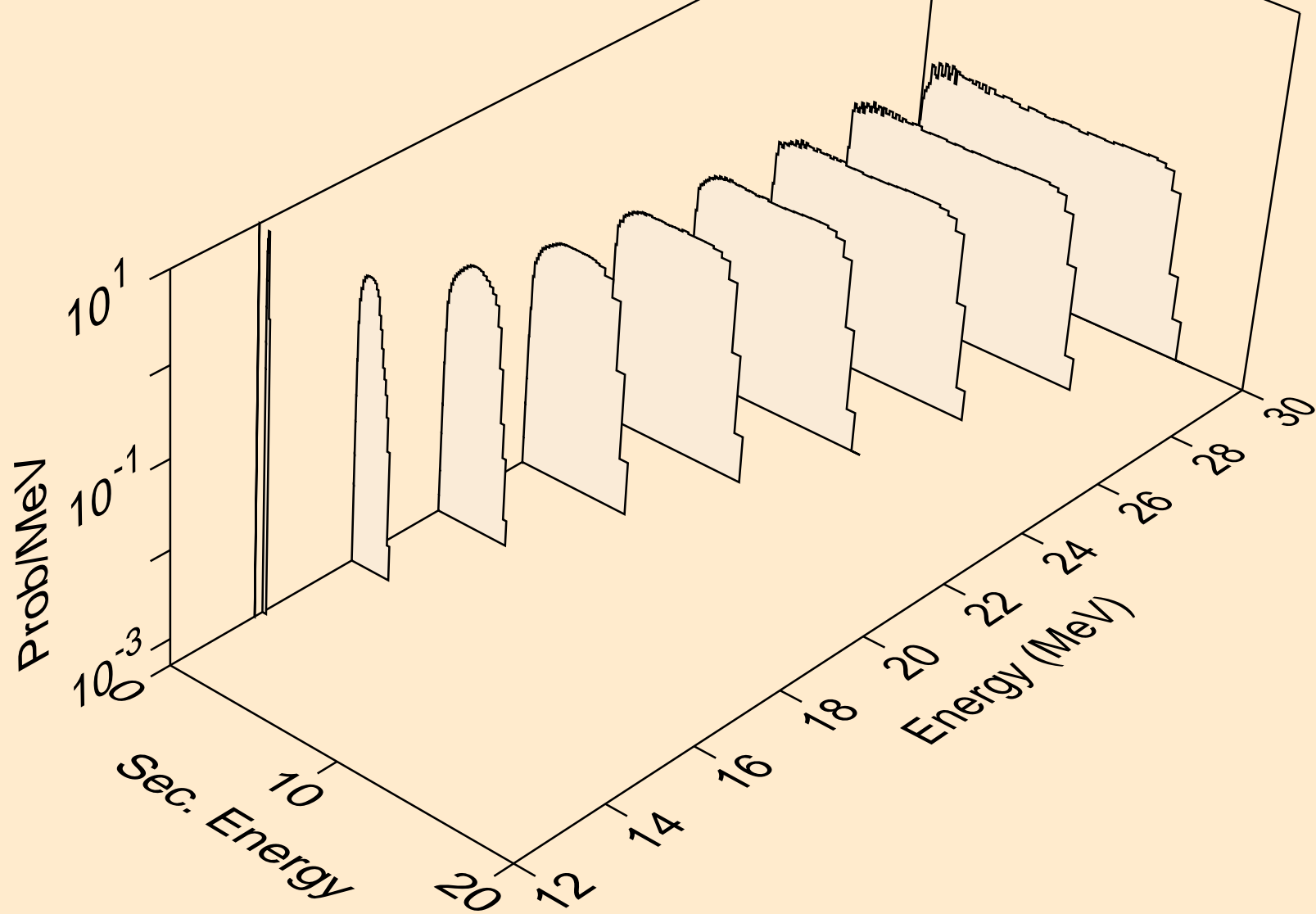

CM236 PROTON ACER TENDL-2021 LIBRARY; T=0.K
neutrons from (p,3n)

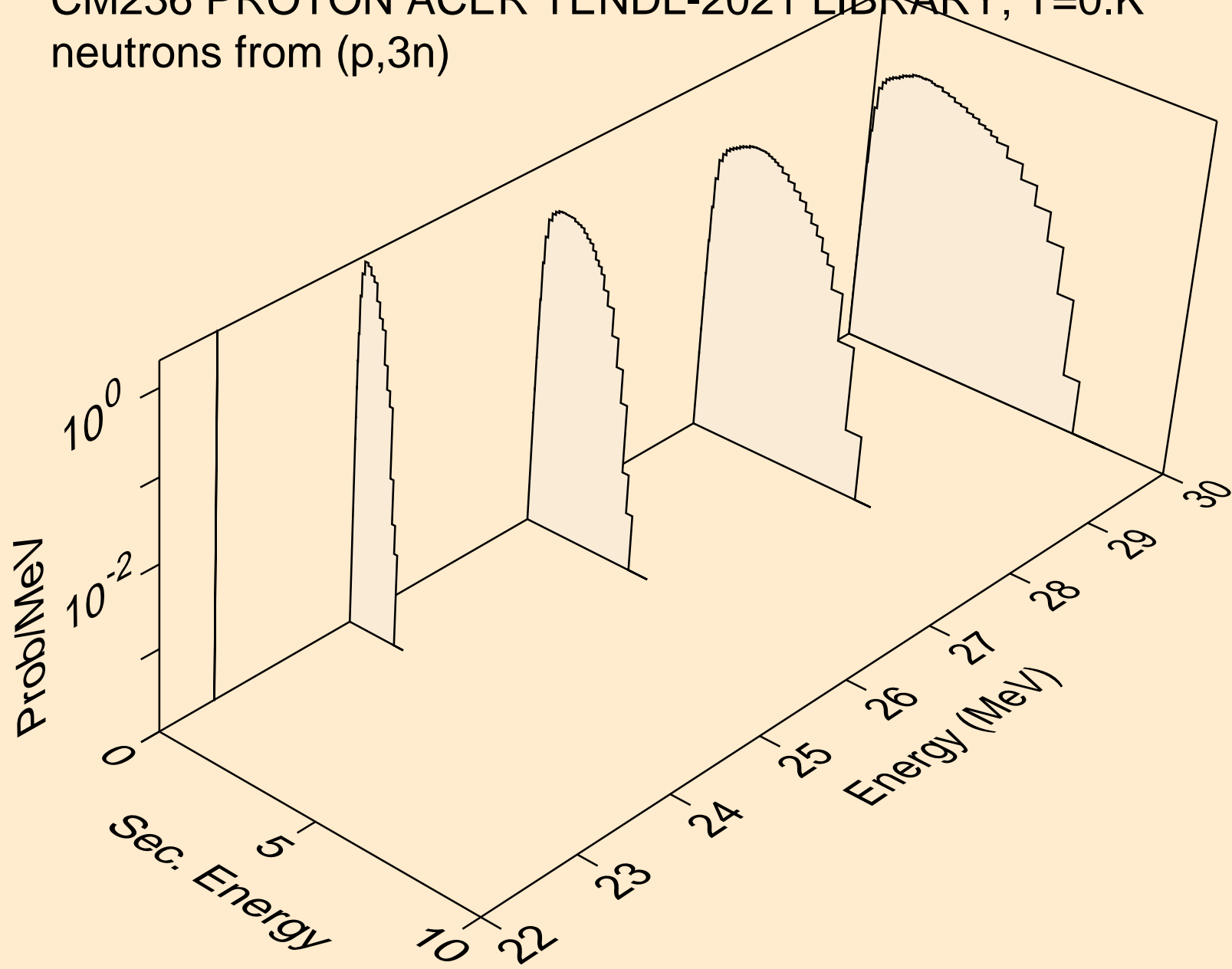

CM236 PROTON ACER TENDL-2021 LIBRARY; T=0.K
neutrons from (p,n*)a

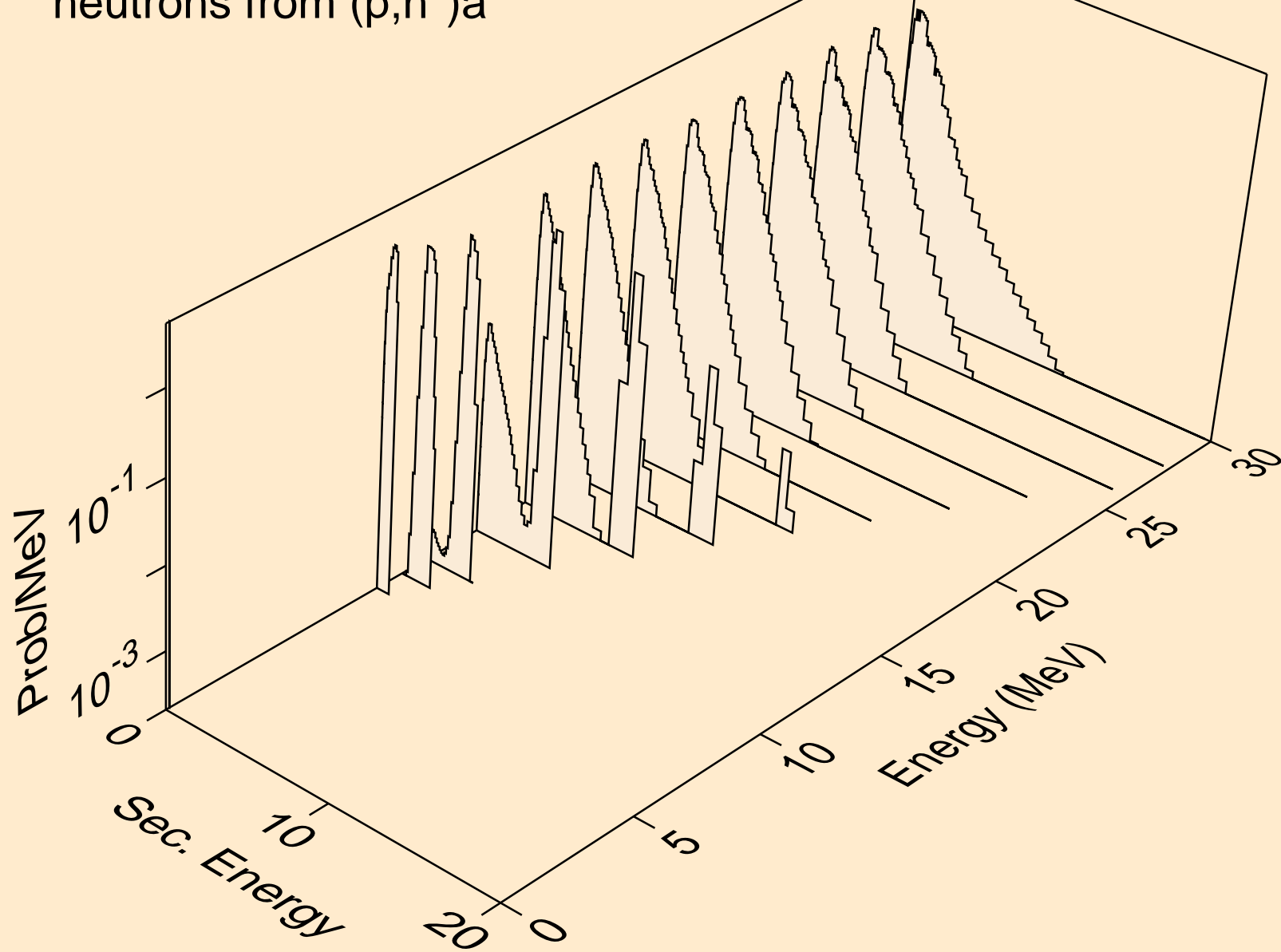

CM236 PROTON ACER TENDL-2021 LIBRARY; T=0.K
neutrons from (p,n*)p

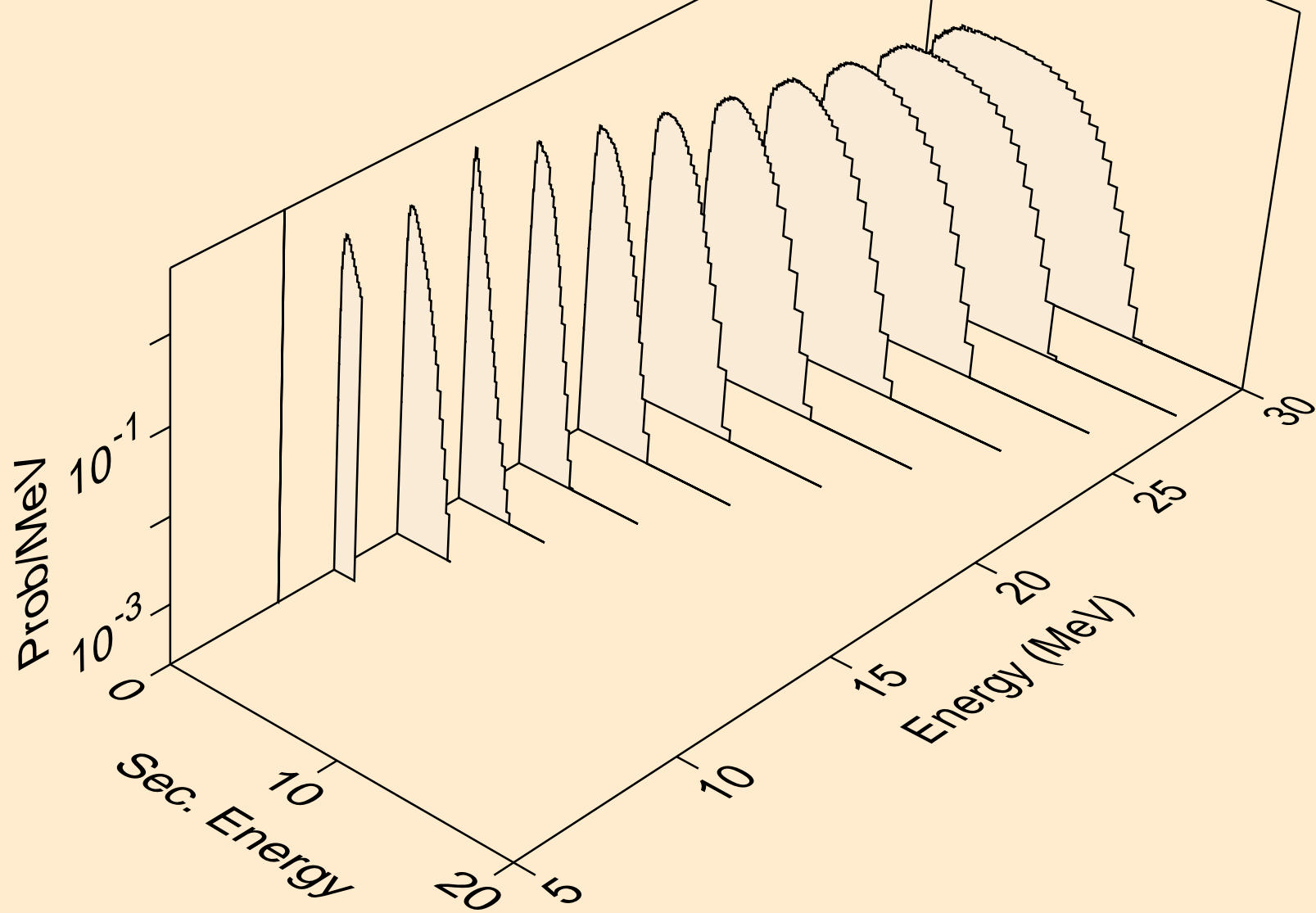

CM236 PROTON ACER TENDL-2021 LIBRARY; T=0.K
neutrons from (p,n*)d

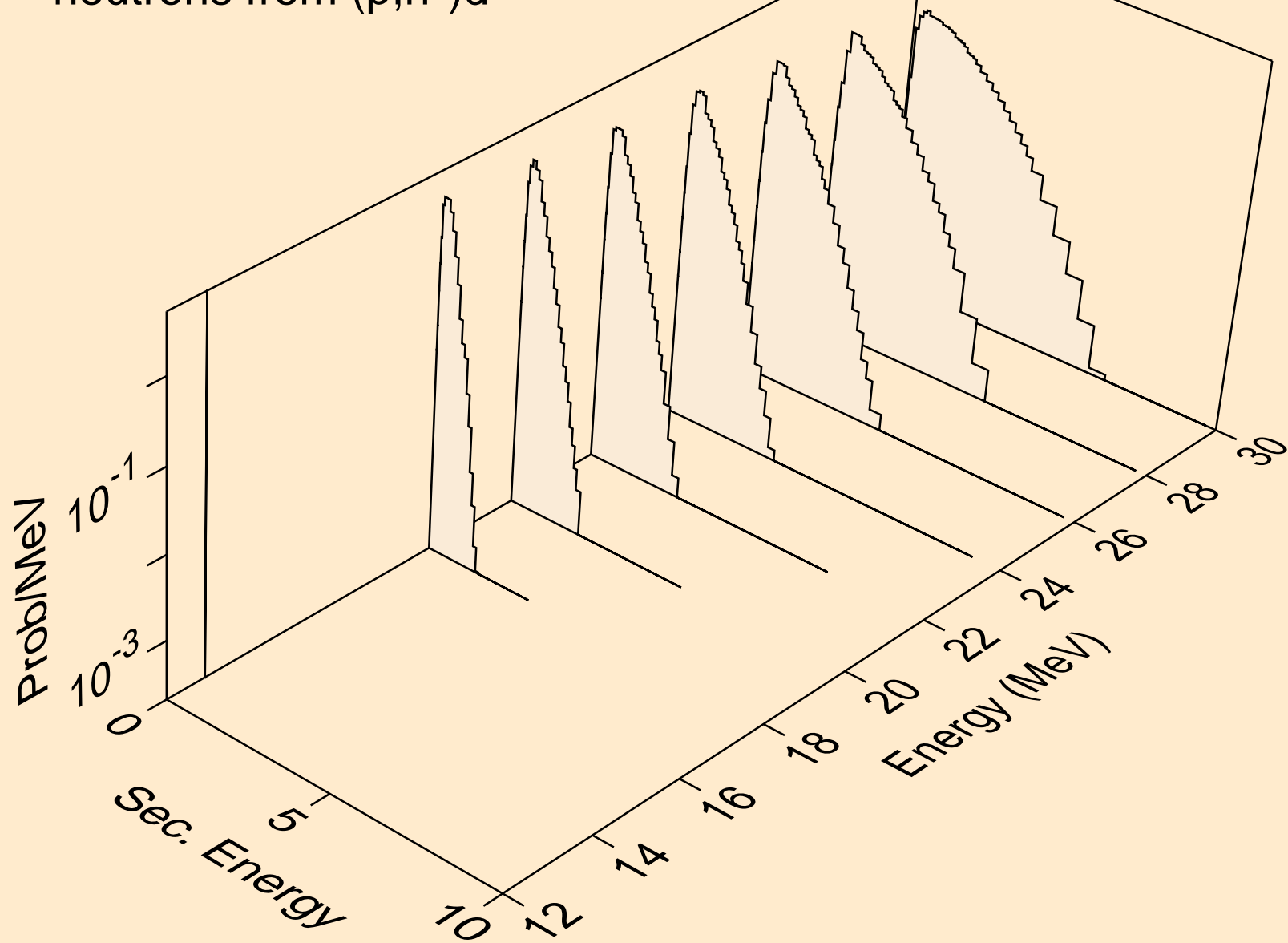

CM236 PROTON ACER TENDL-2021 LIBRARY; T=0.K
neutrons from (p,n*)t

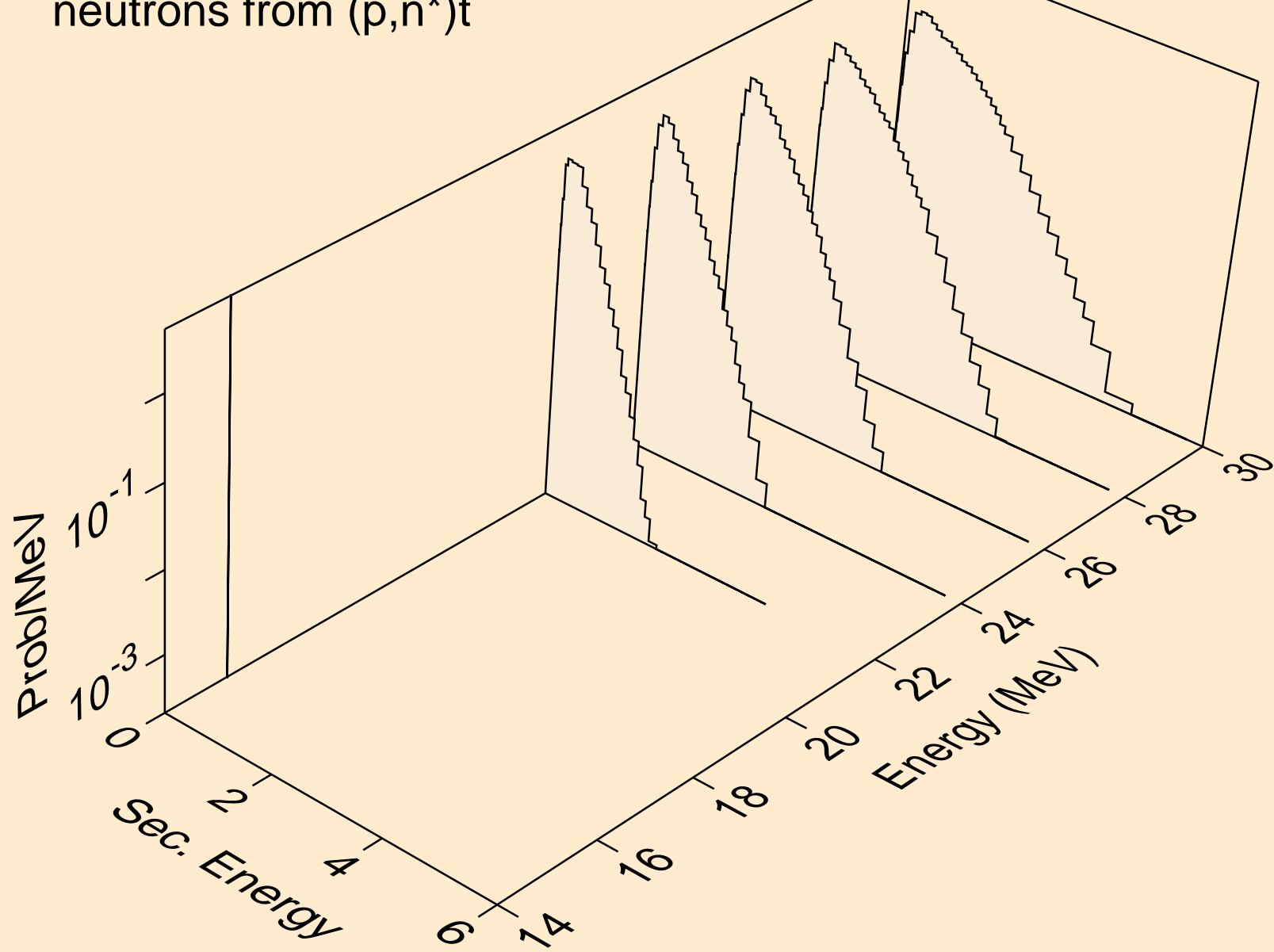

CM236 PROTON ACER TENDL-2021 LIBRARY; T=0.K
neutrons from (p,2np)

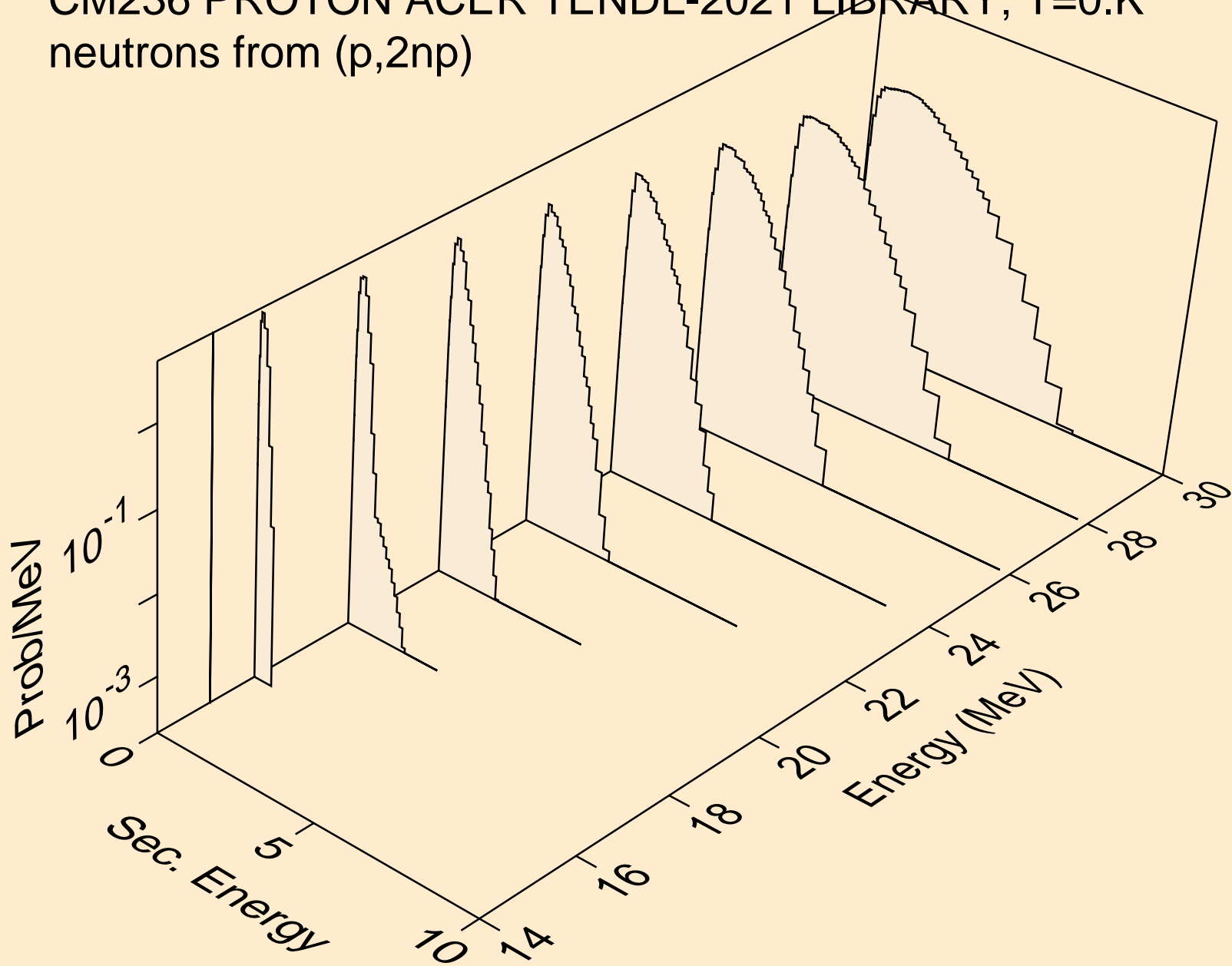

CM236 PROTON ACER TENDL-2021 LIBRARY; T=0.K
deuterons from (p,x)

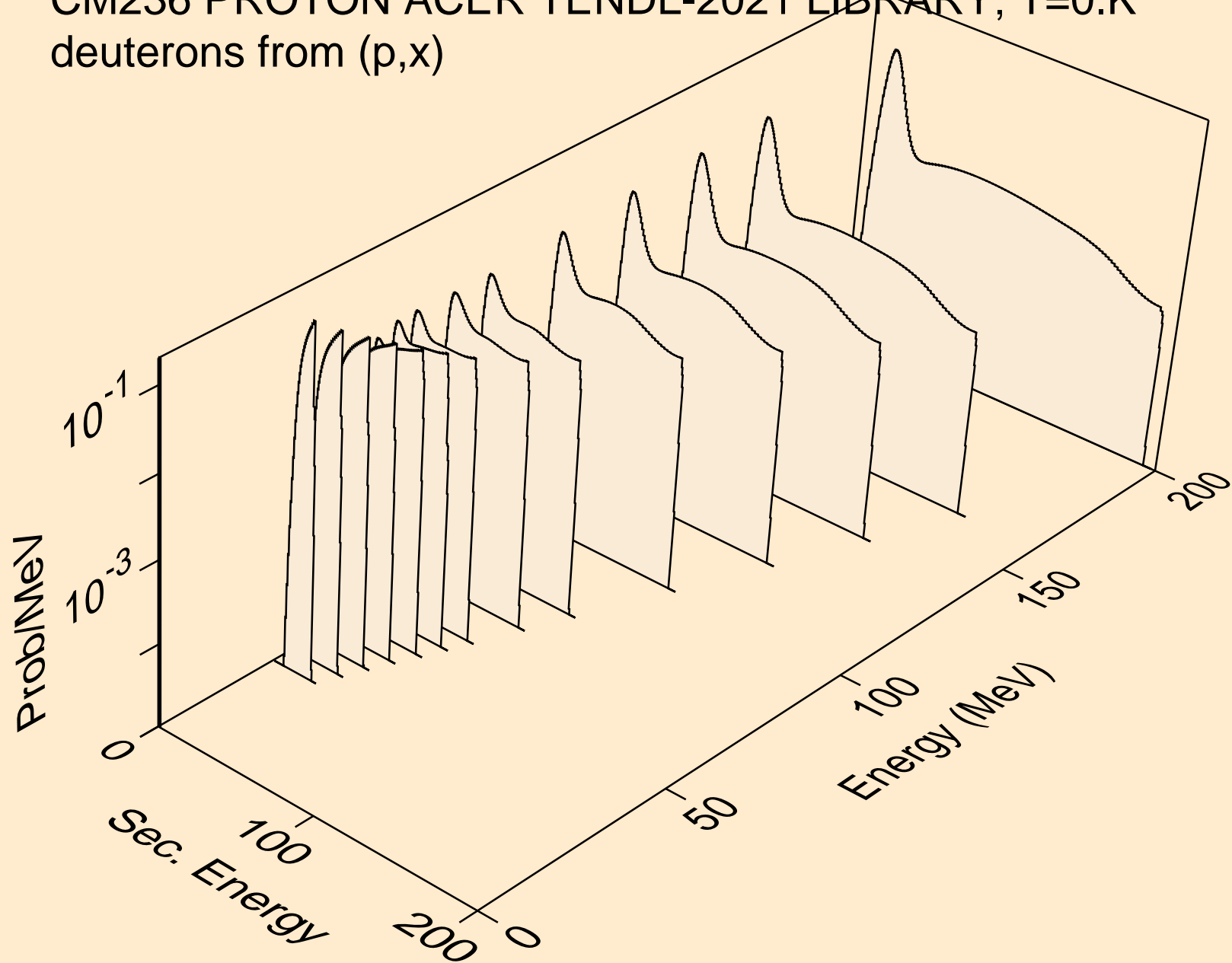

CM236 PROTON ACER TENDL-2021 LIBRARY; T=0.K
deuterons from (p,n*)d

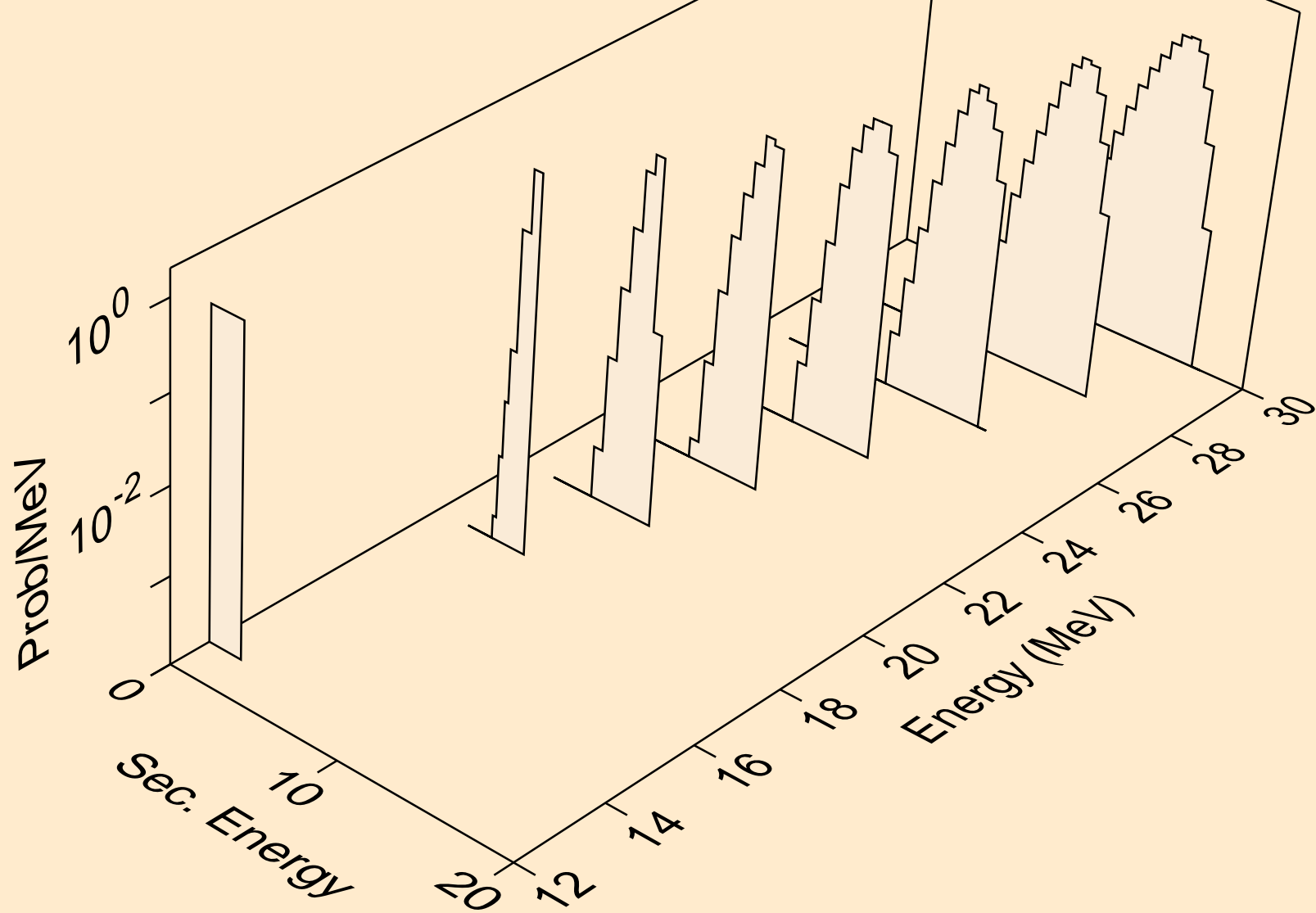

CM236 PROTON ACER TENDL-2021 LIBRARY; T=0.K
deuterons from (p,d)

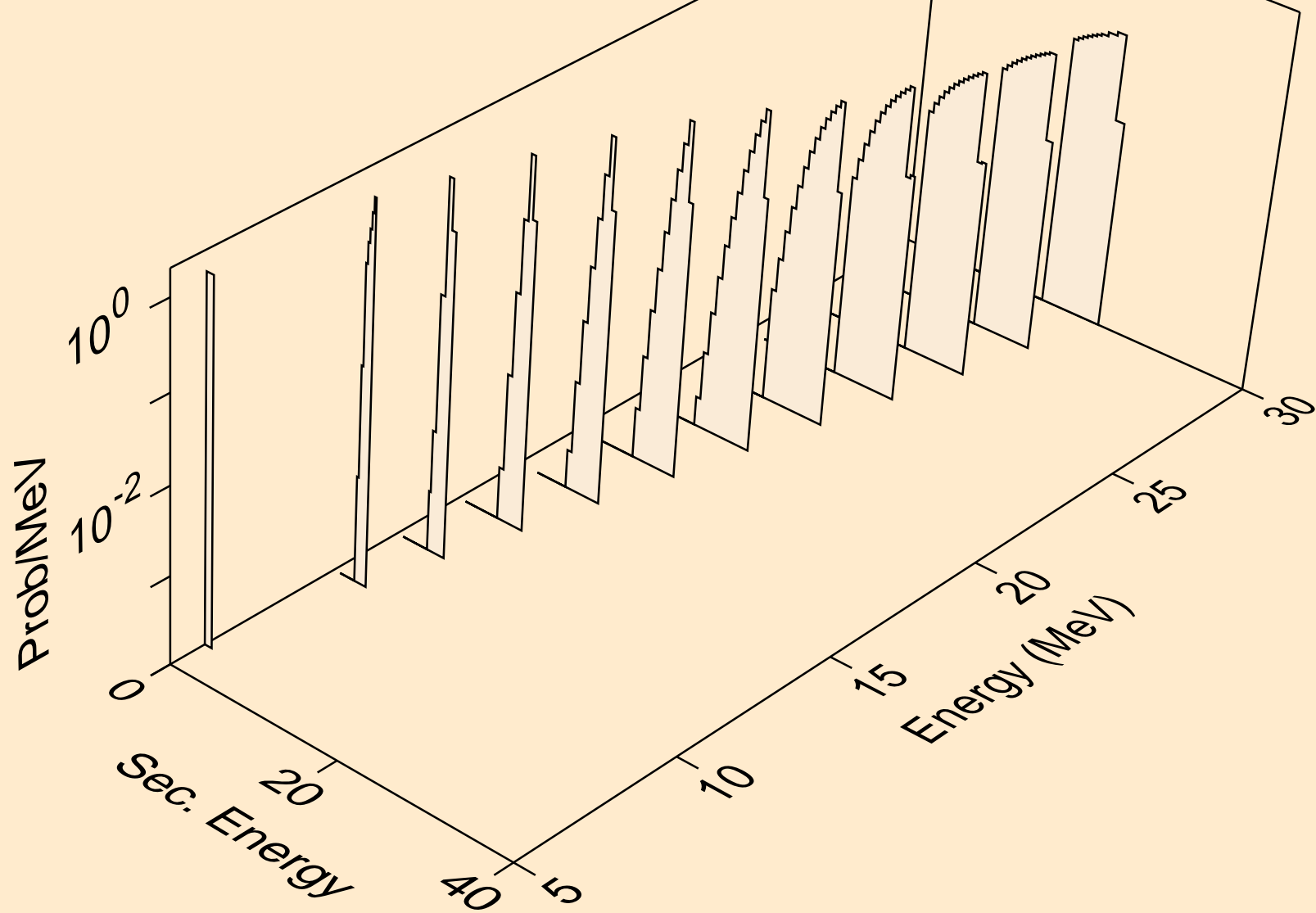

CM236 PROTON ACER TENDL-2021 LIBRARY; T=0.K
tritons from (p,x)

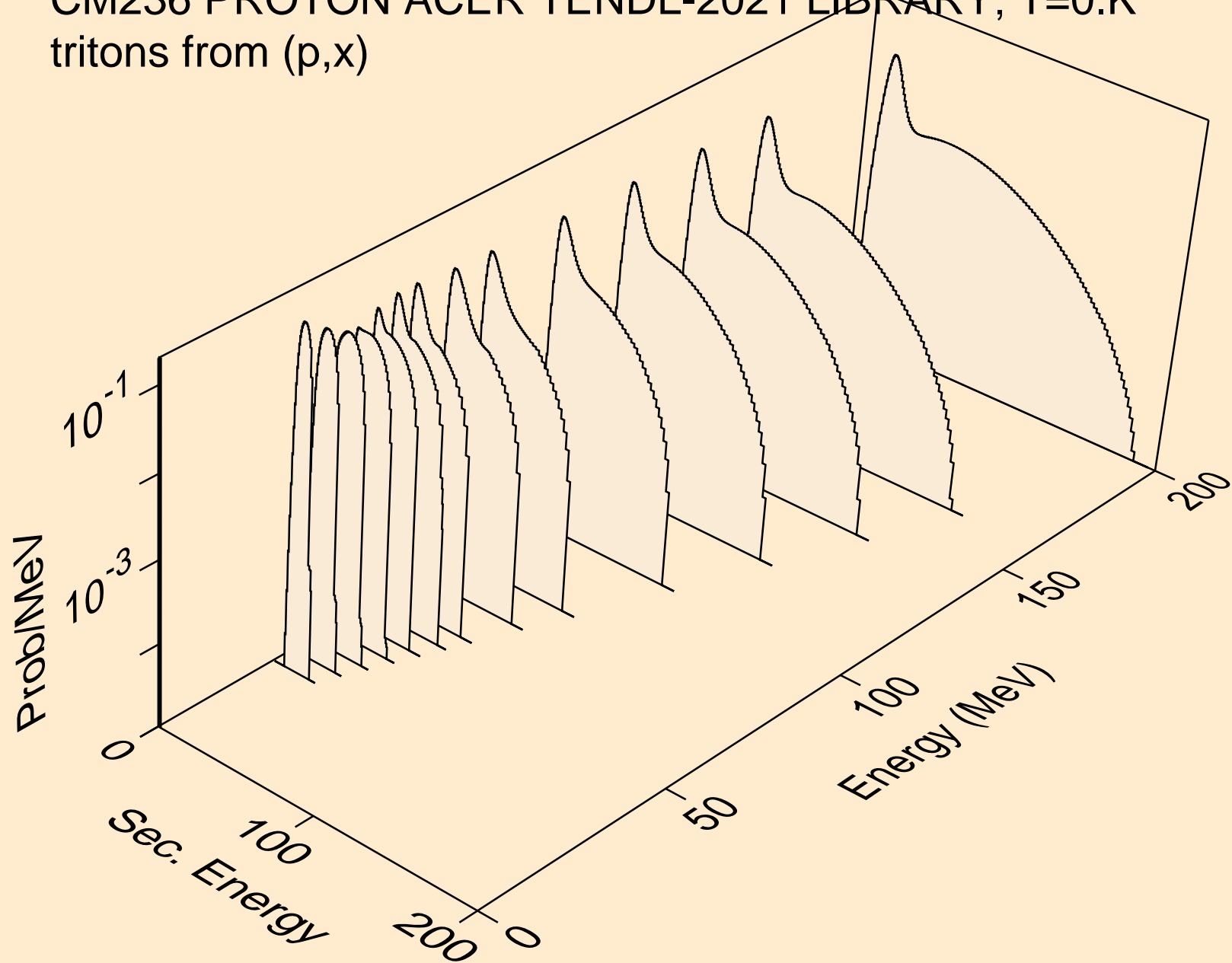

CM236 PROTON ACER TENDL-2021 LIBRARY; T=0.K
tritons from (p,n*)t

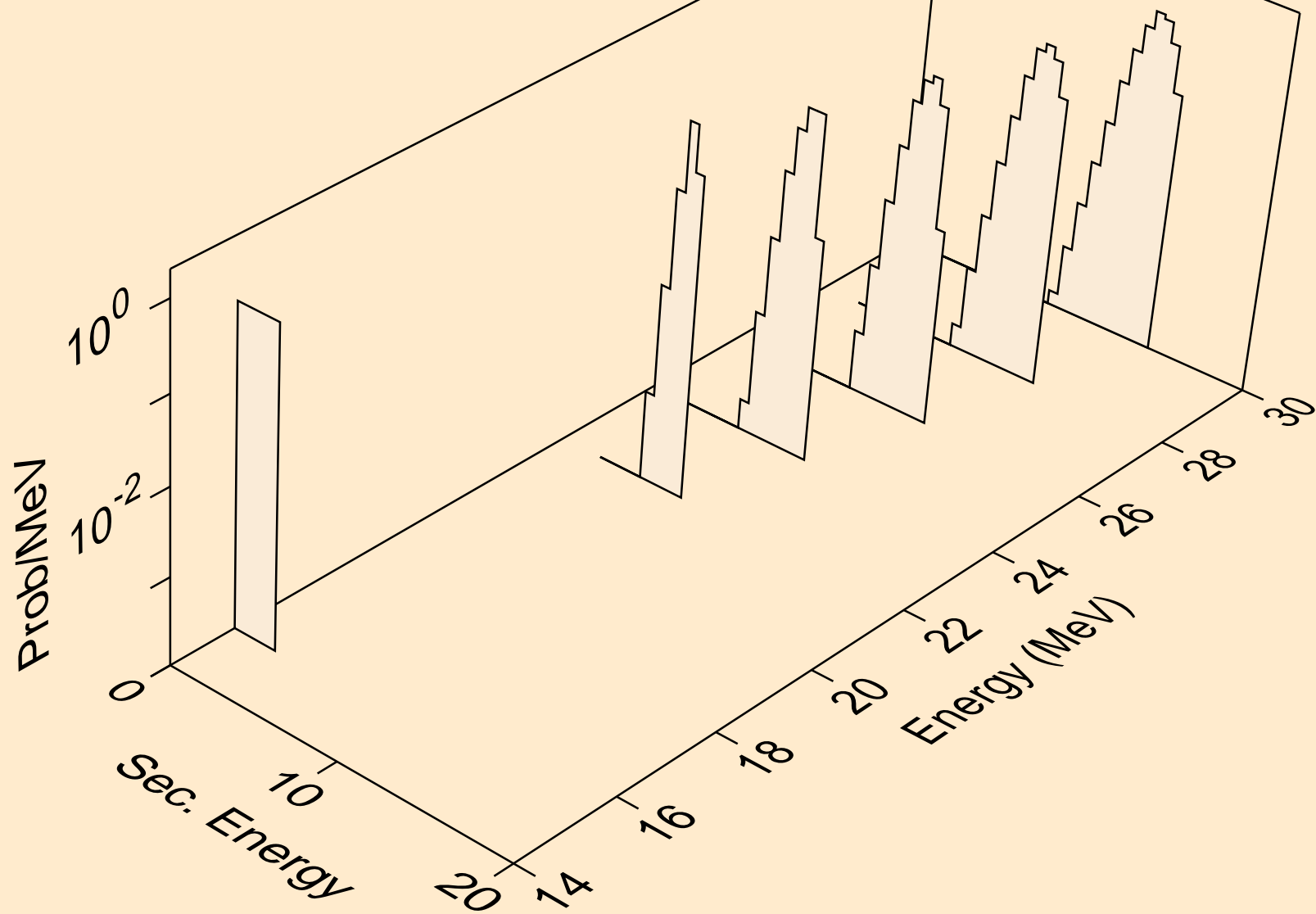

CM236 PROTON ACER TENDL-2021 LIBRARY; T=0.K
tritons from (p,t)

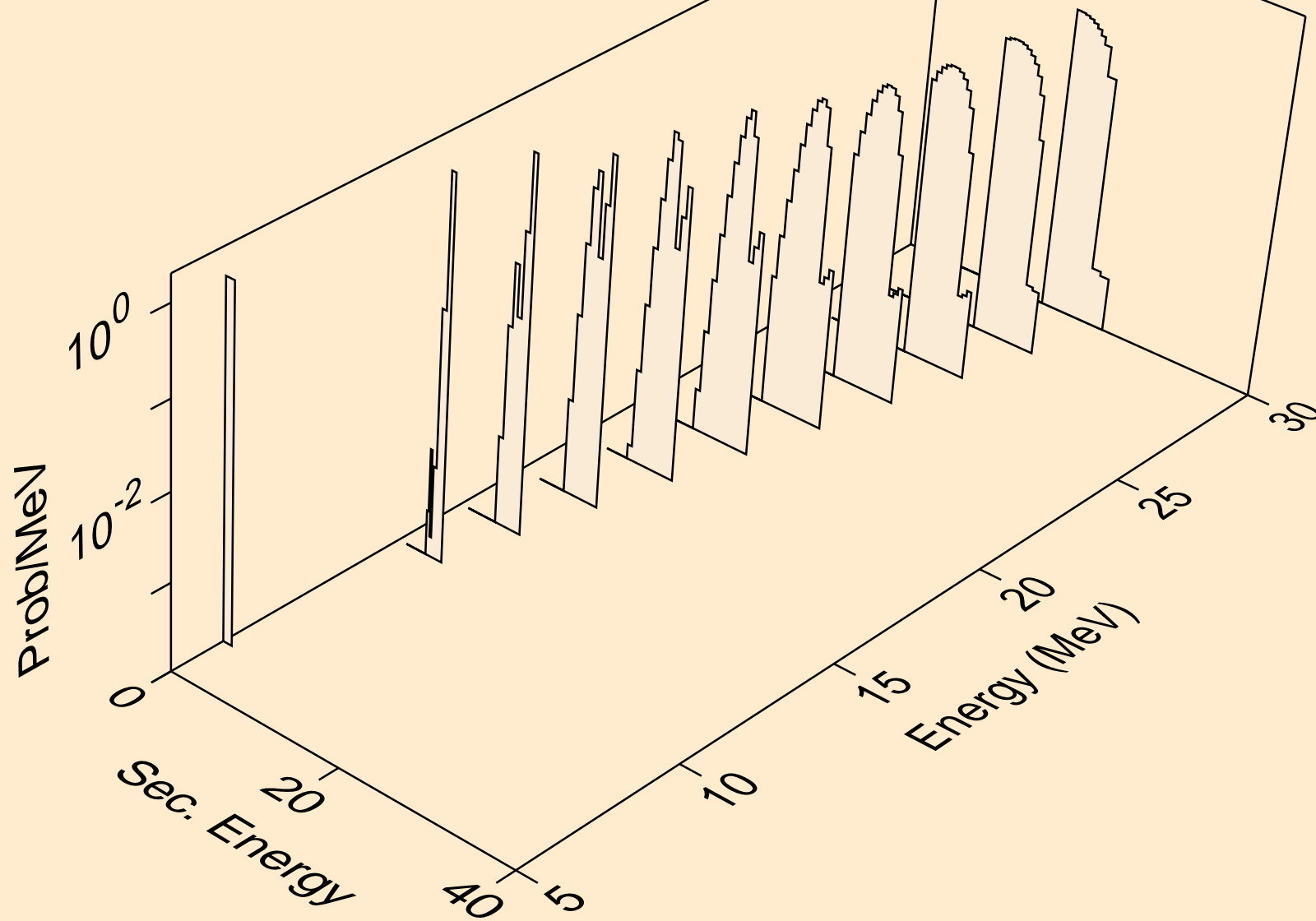

CM236 PROTON ACER TENDL-2021 LIBRARY; T=0.K
he3s from (p,x)

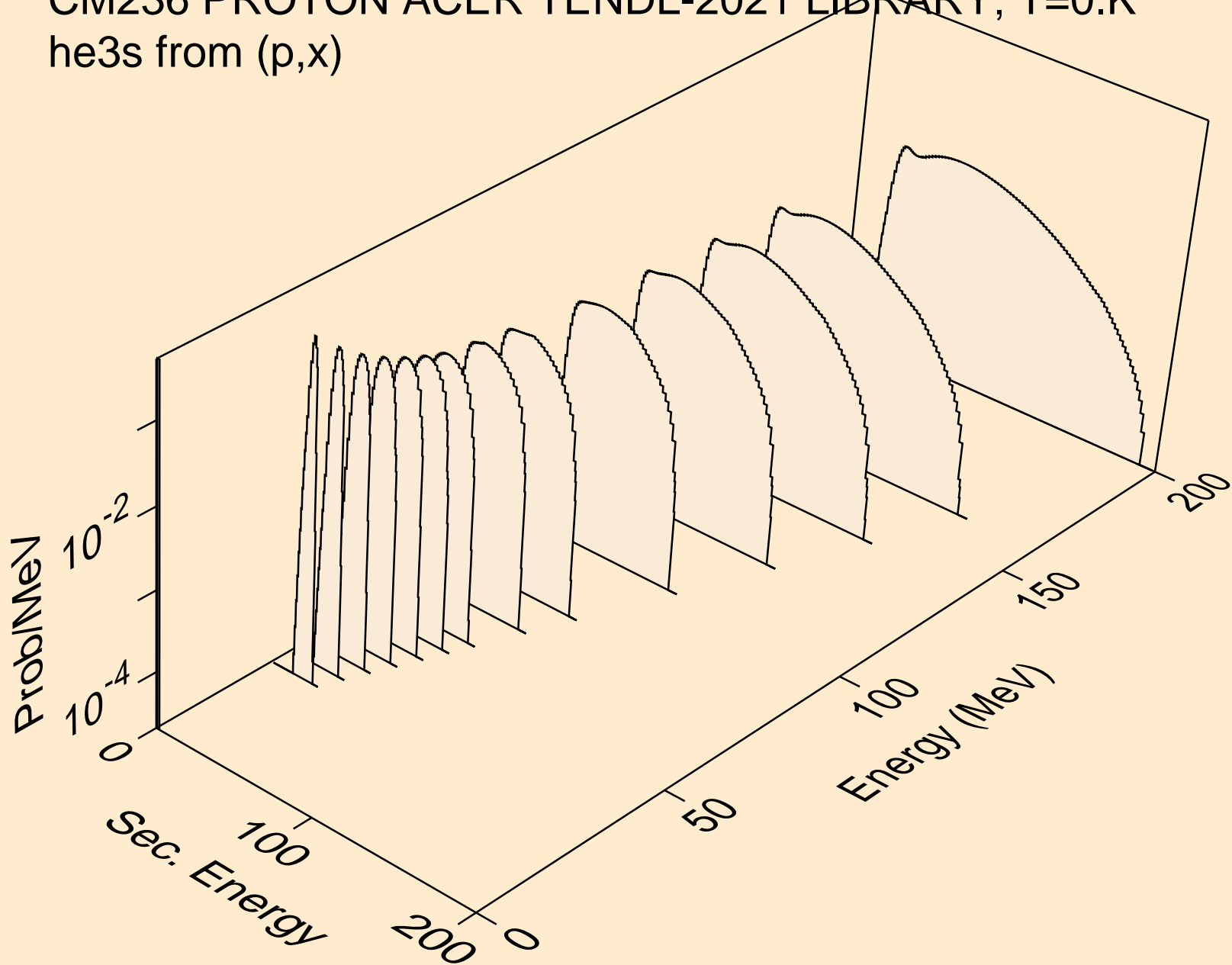

CM236 PROTON ACER TENDL-2021 LIBRARY; T=0.K
he3s from (p,he3)

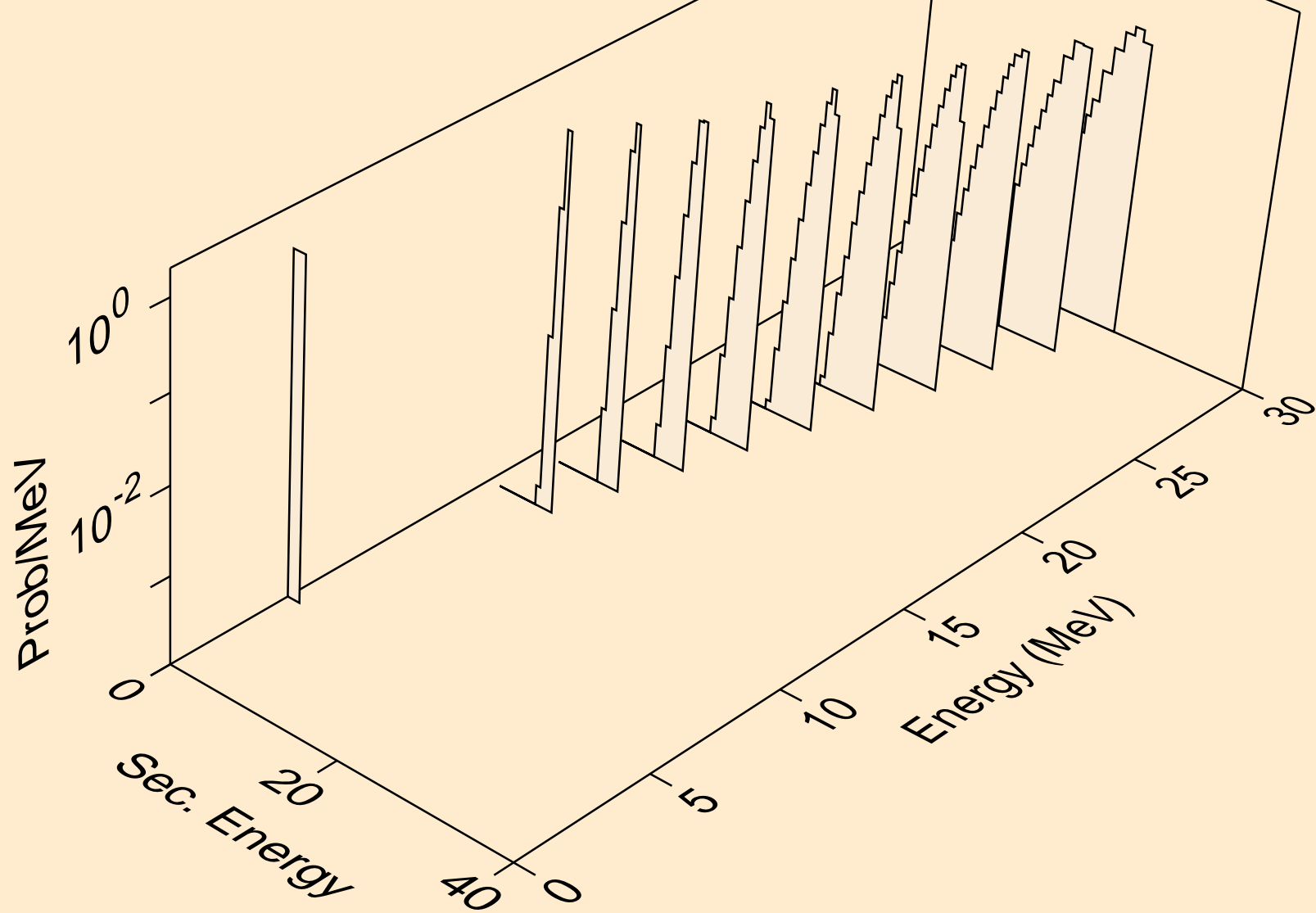

CM236 PROTON ACER TENDL-2021 LIBRARY; T=0.K
alphas from (p,x)

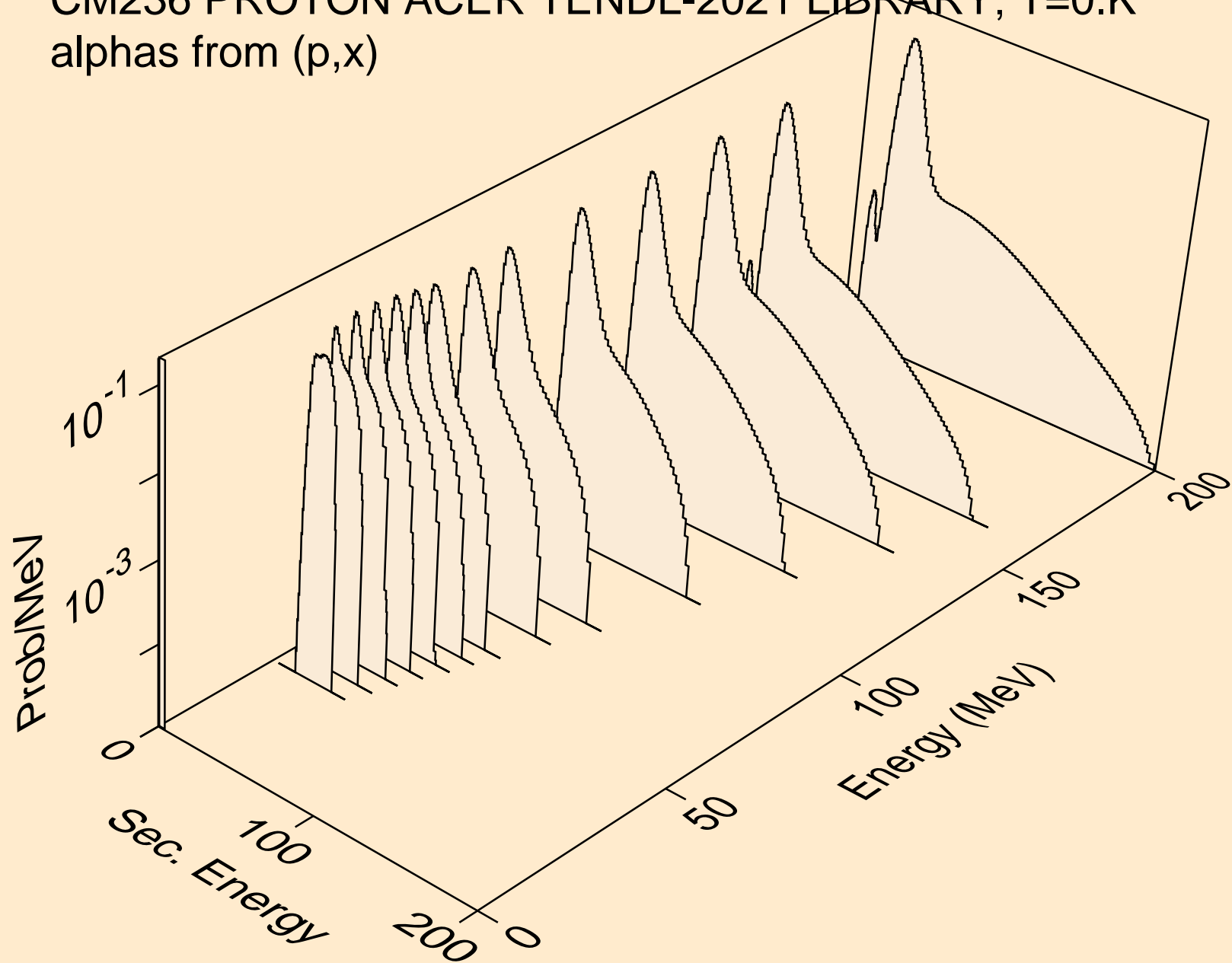

CM236 PROTON ACER TENDL-2021 LIBRARY; T=0.K
alphas from (p,n*)a

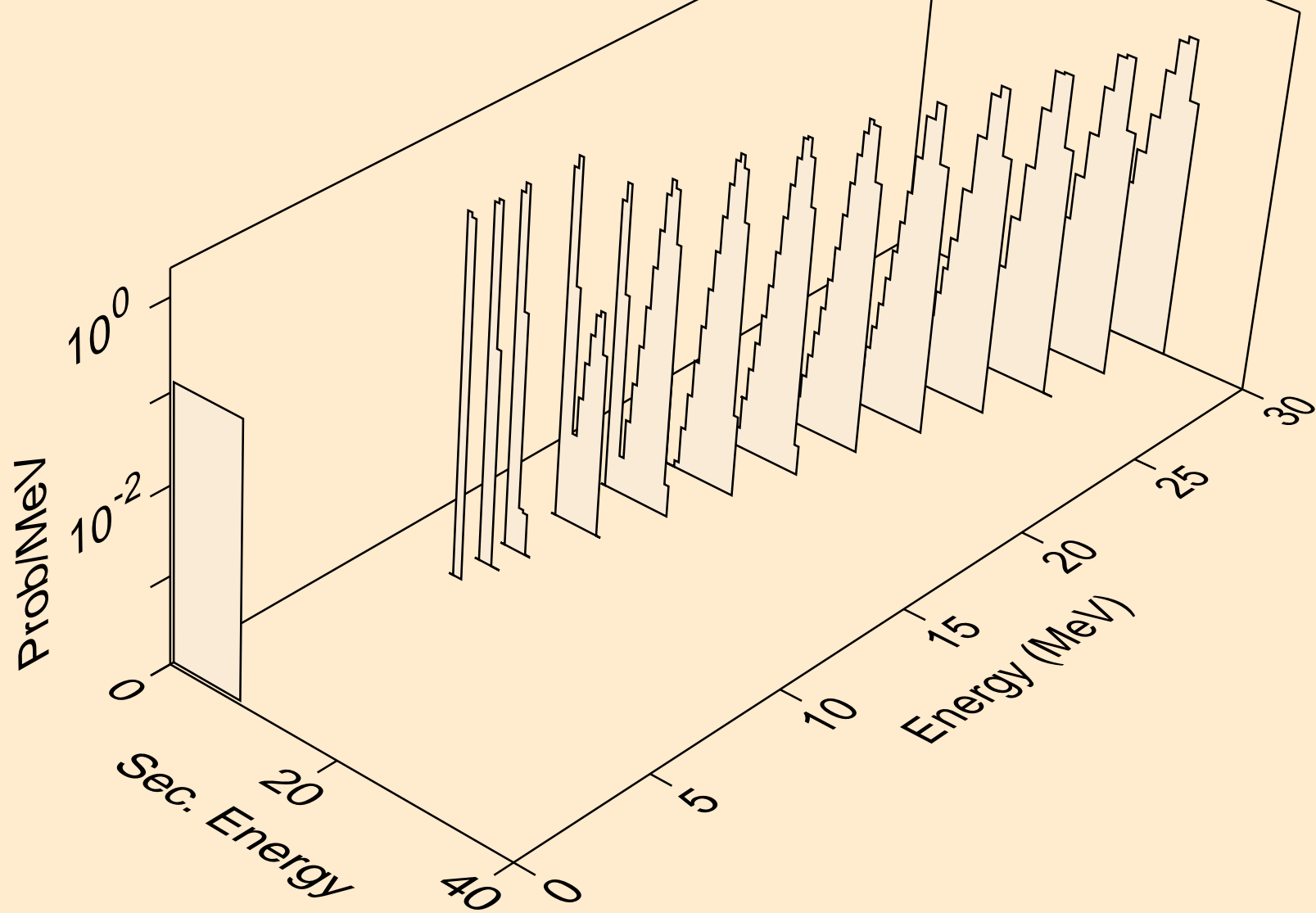

CM236 PROTON ACER TENDL-2021 LIBRARY; T=0.K
alphas from (p,a)

