

# CS118M PROTON ACER TENDL-2021 LIBRARY; T=0.K

## Principal cross sections

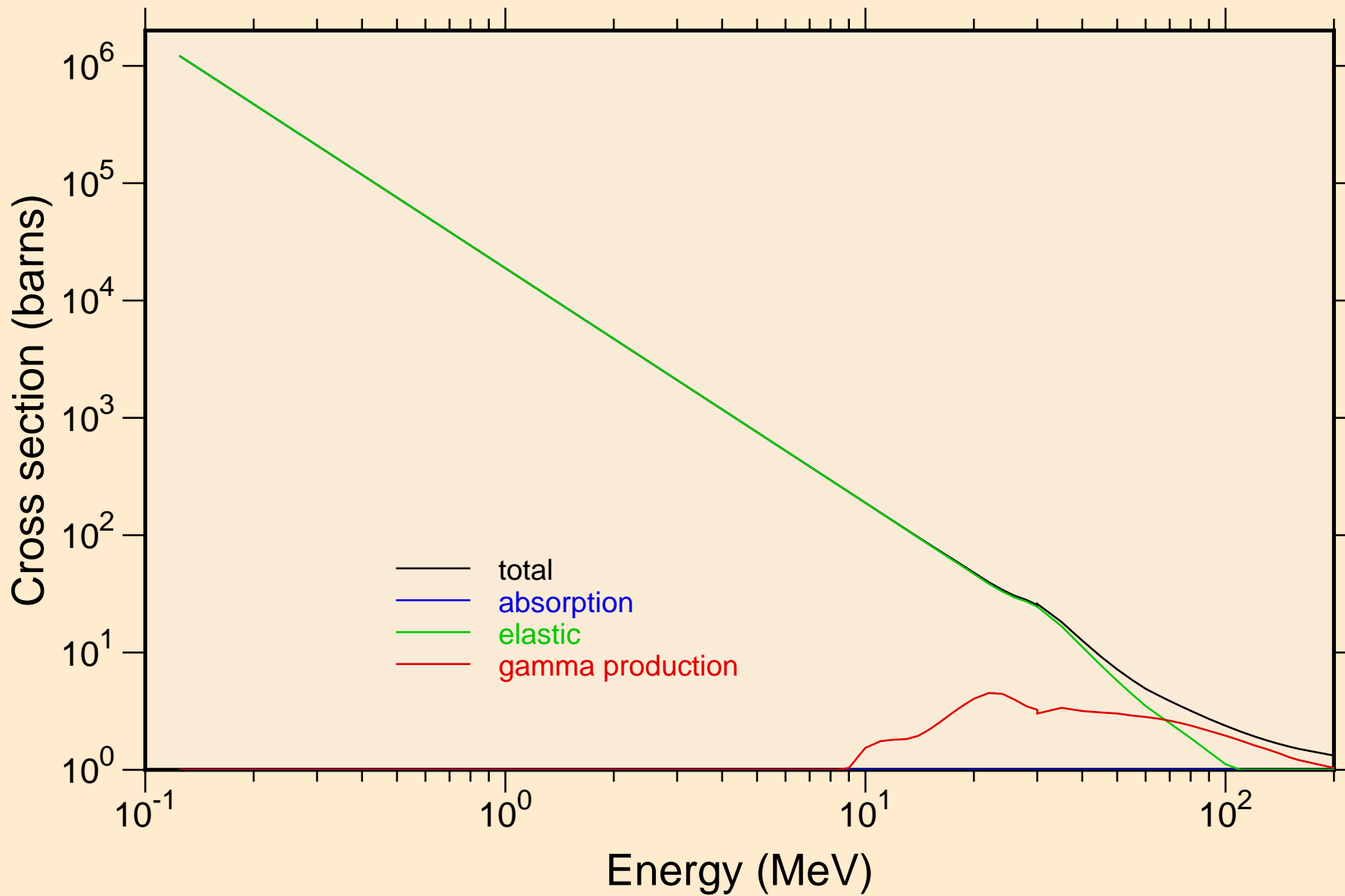

CS118M PROTON ACER TENDL-2021 LIBRARY; T=0.K  
Heating

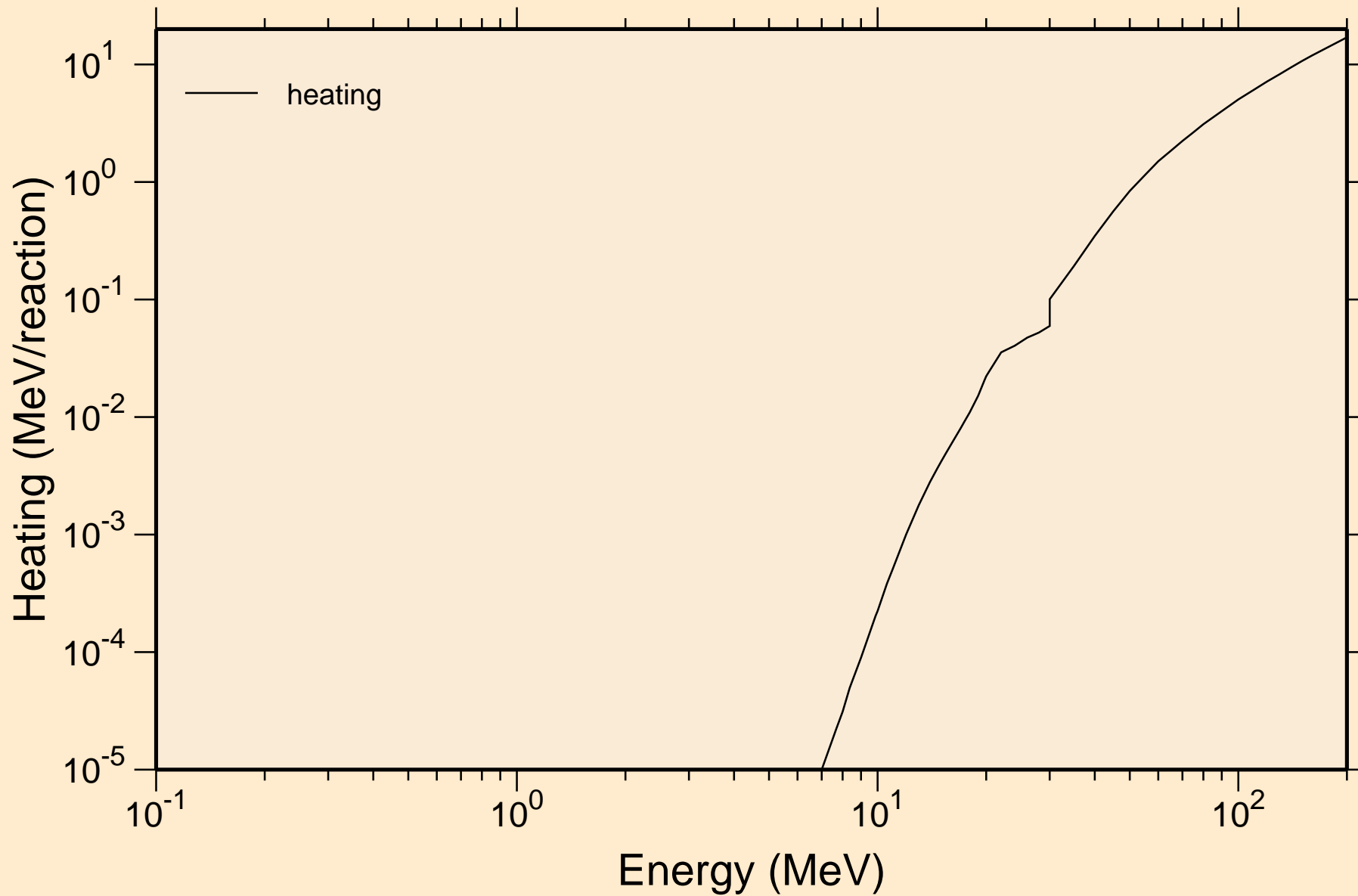

CS118M PROTON ACER TENDL-2021 LIBRARY; T=0.K  
Principal cross sections

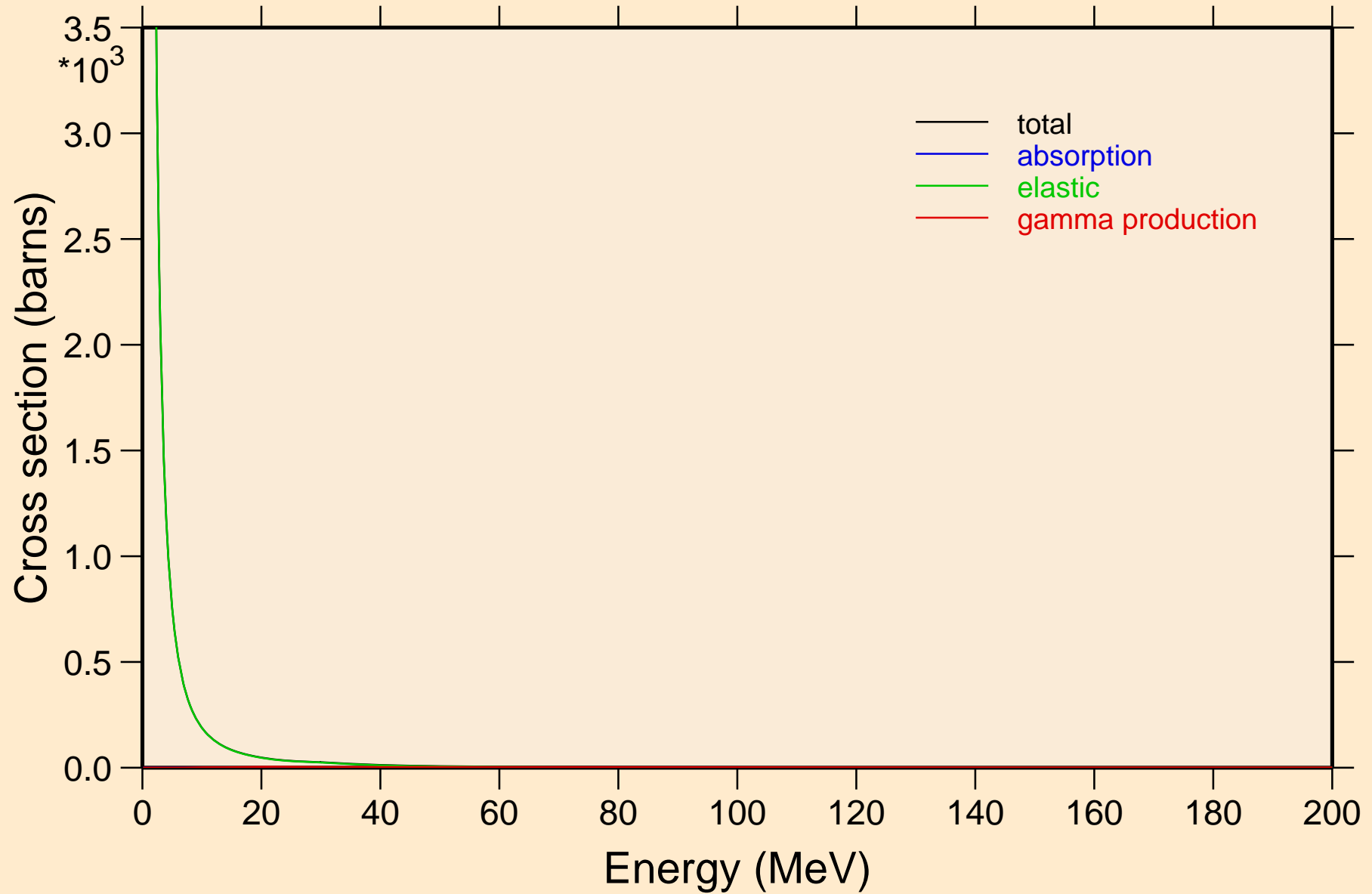

# CS118M PROTON ACER TENDL-2021 LIBRARY; T=0.K

## Heating

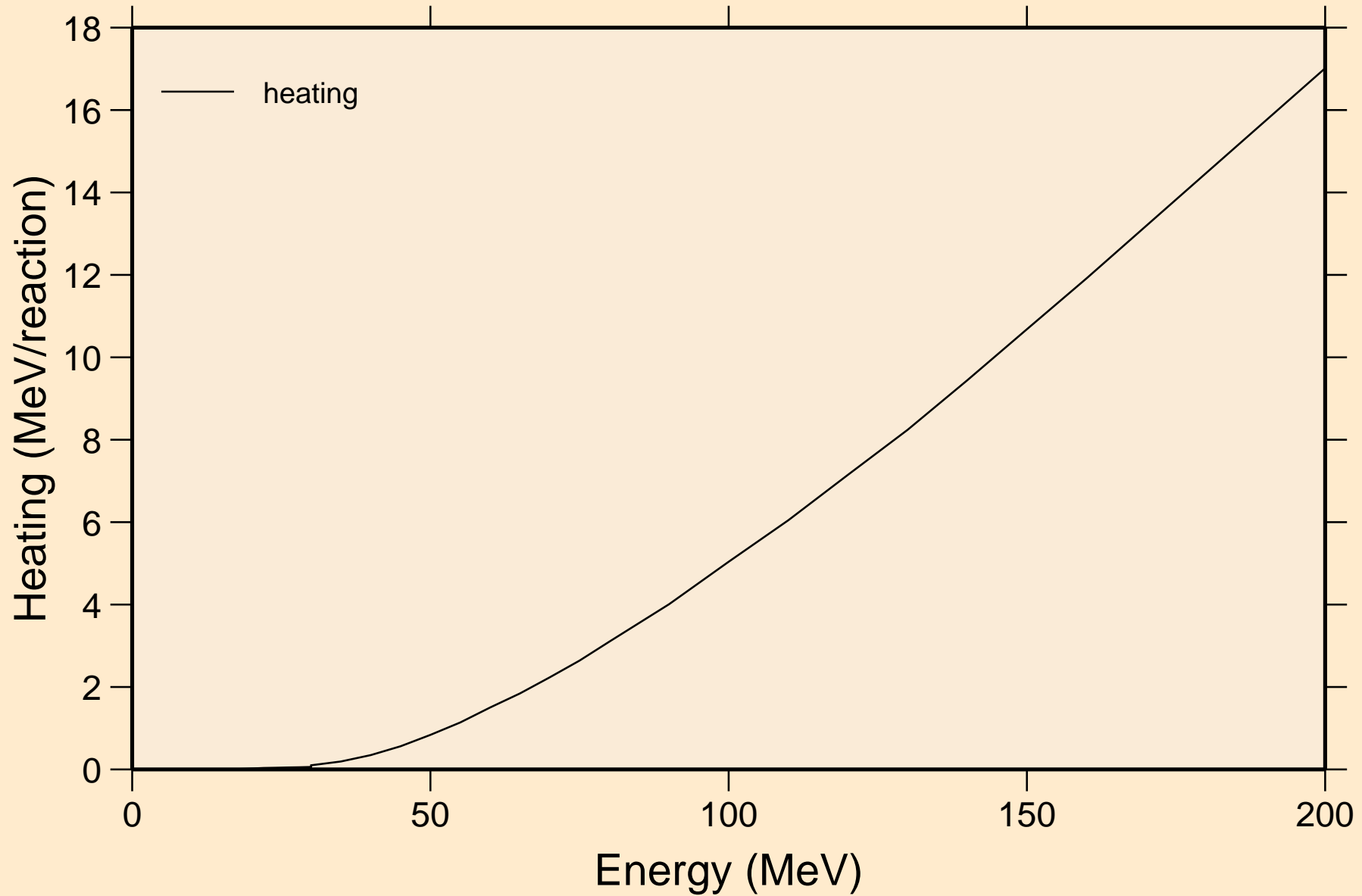

# CS118M PROTON ACER TENDL-2021 LIBRARY; T=0.K

## Threshold reactions

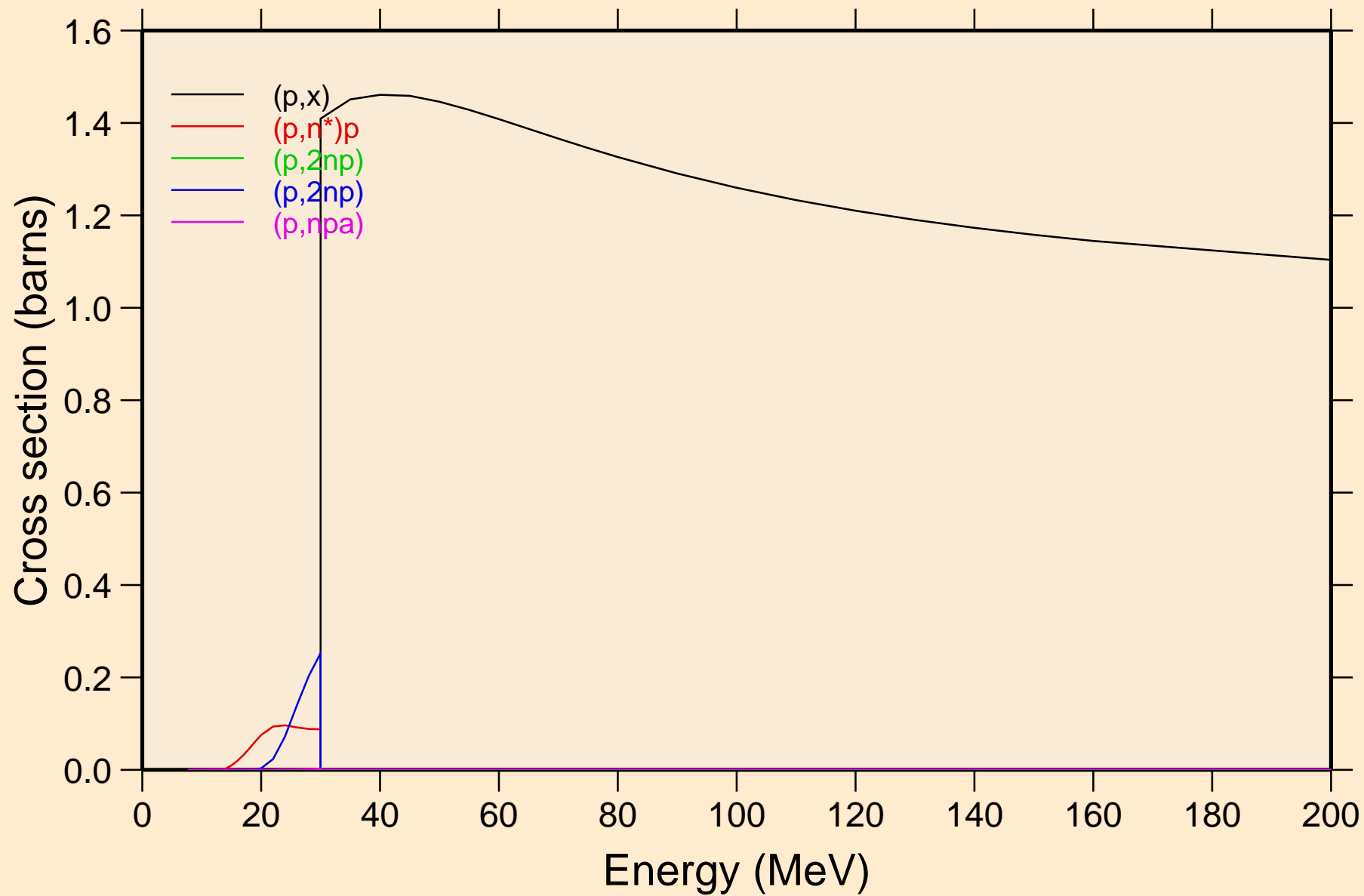

# CS118M PROTON ACER TENDL-2021 LIBRARY; T=0.K

## Threshold reactions

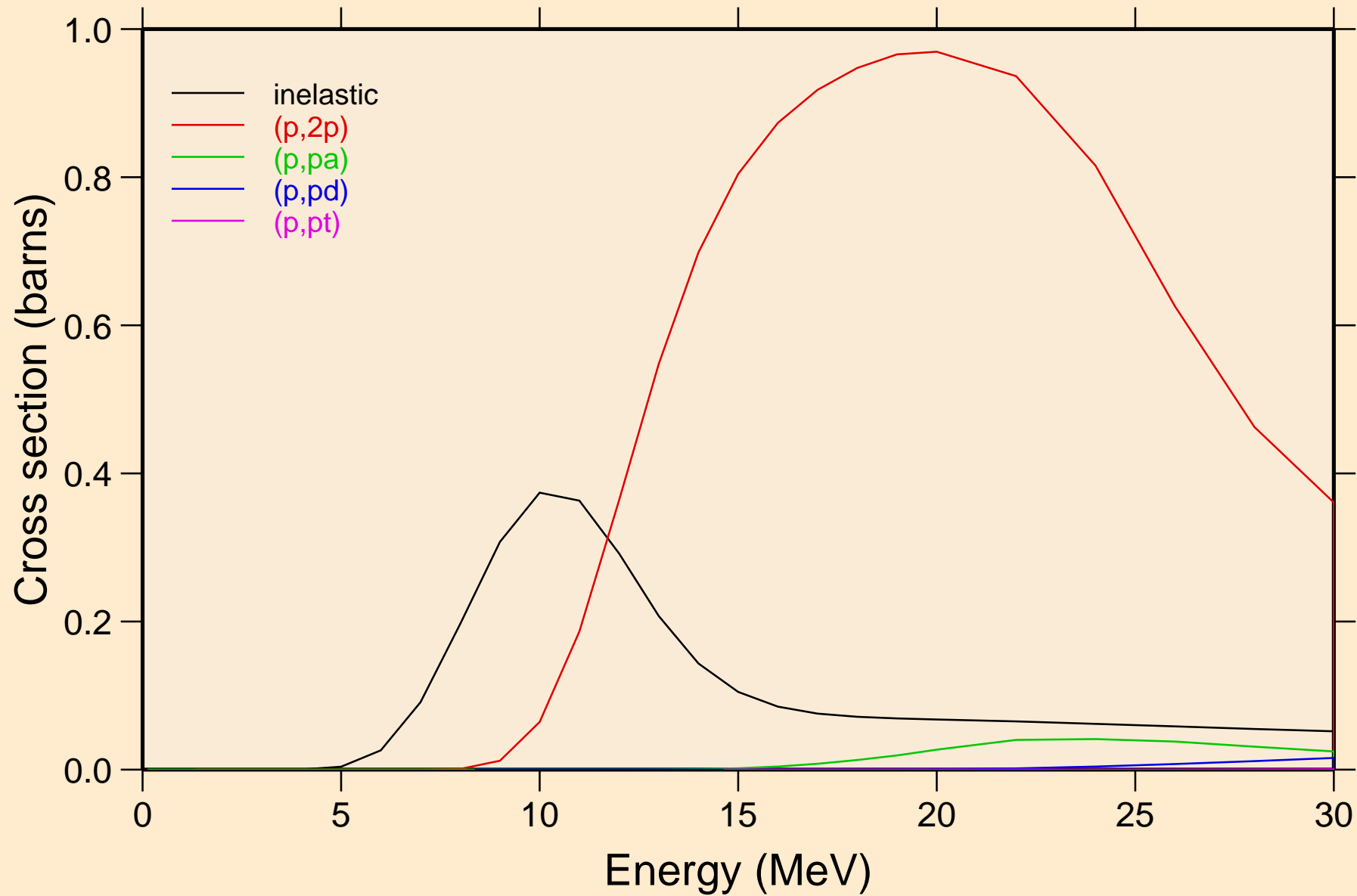

CS118M PROTON ACER TENDL-2021 LIBRARY; T=0.K  
Threshold reactions

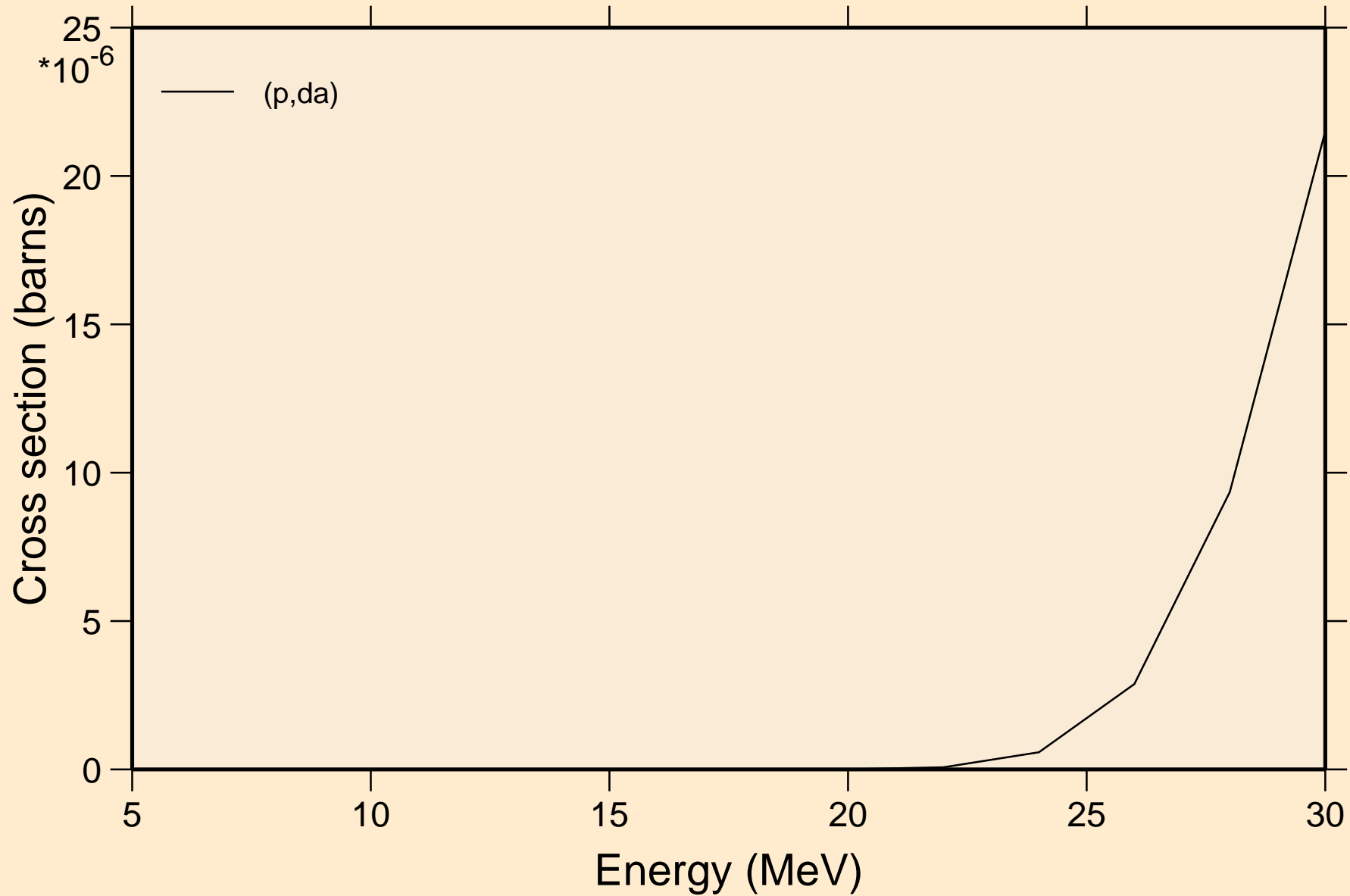

CS118M PROTON ACER TENDL-2021 LIBRARY; T=0.K  
angular distribution for elastic

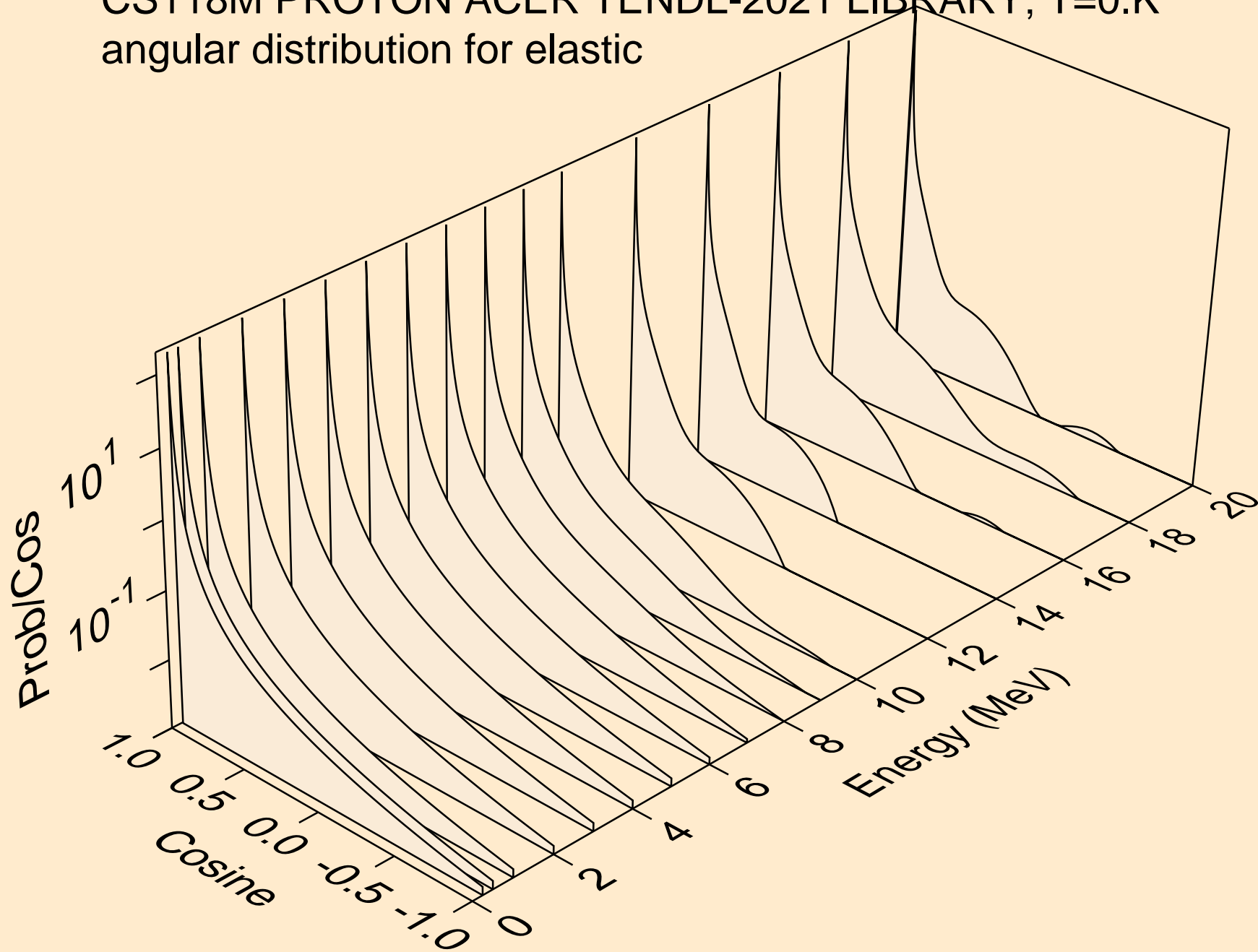



CS118M PROTON ACER TENDL-2021 LIBRARY; T=0.K  
angular distribution for elastic

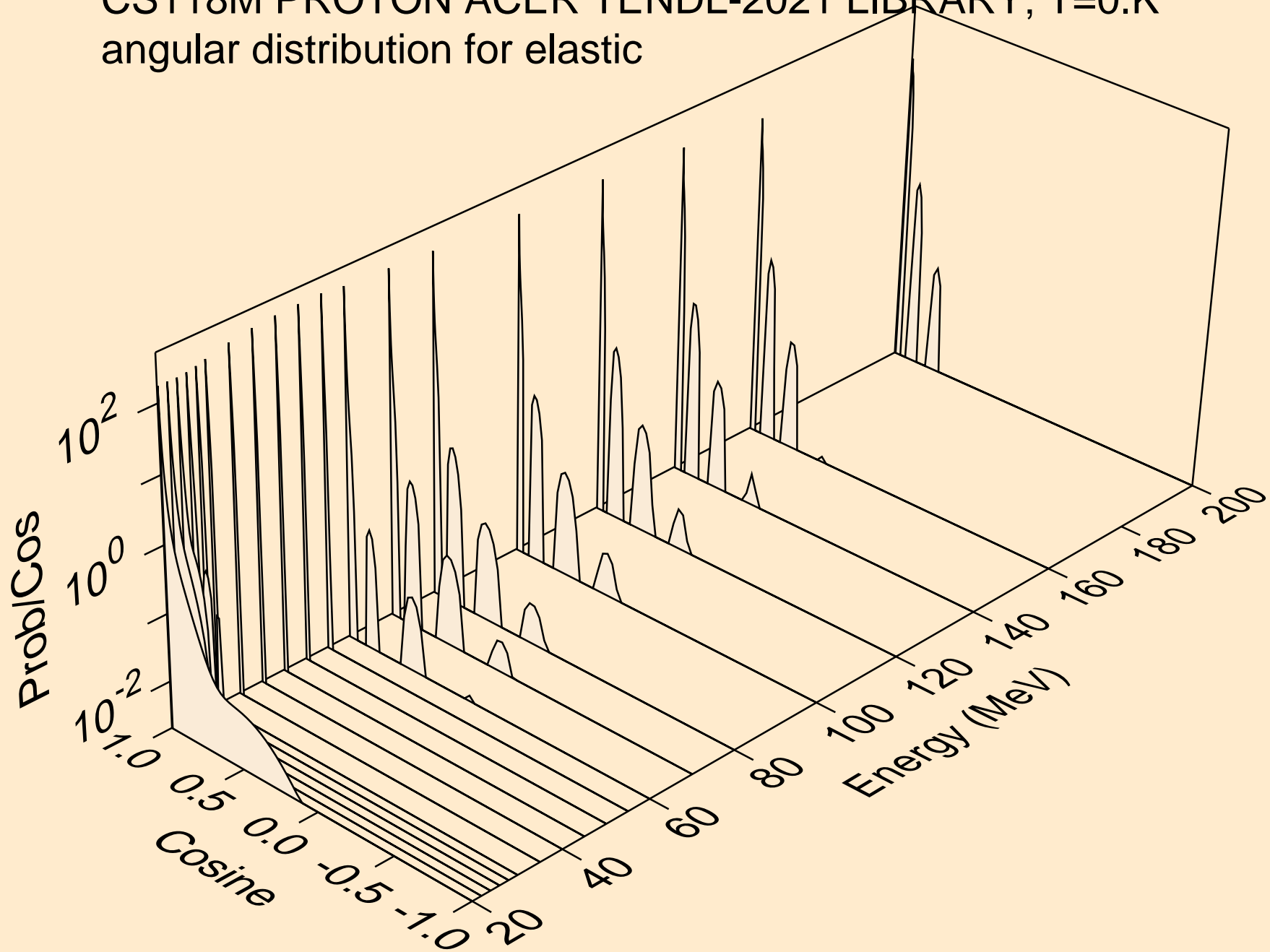

CS118M PROTON ACER TENDL-2021 LIBRARY; T=0.K  
Proton emission for (p,x)

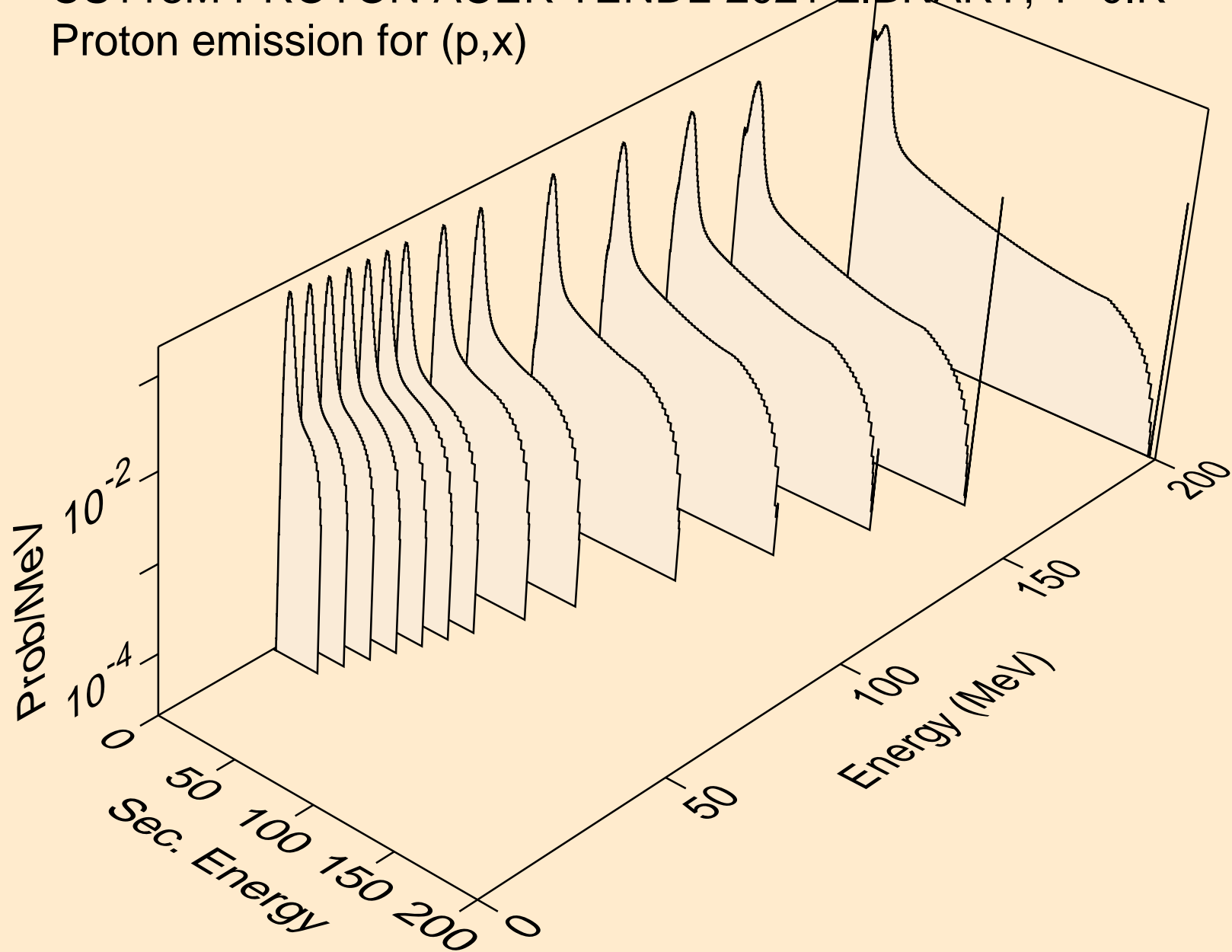

CS118M PROTON ACER TENDL-2021 LIBRARY; T=0.K  
Proton emission for (p,n\*)p

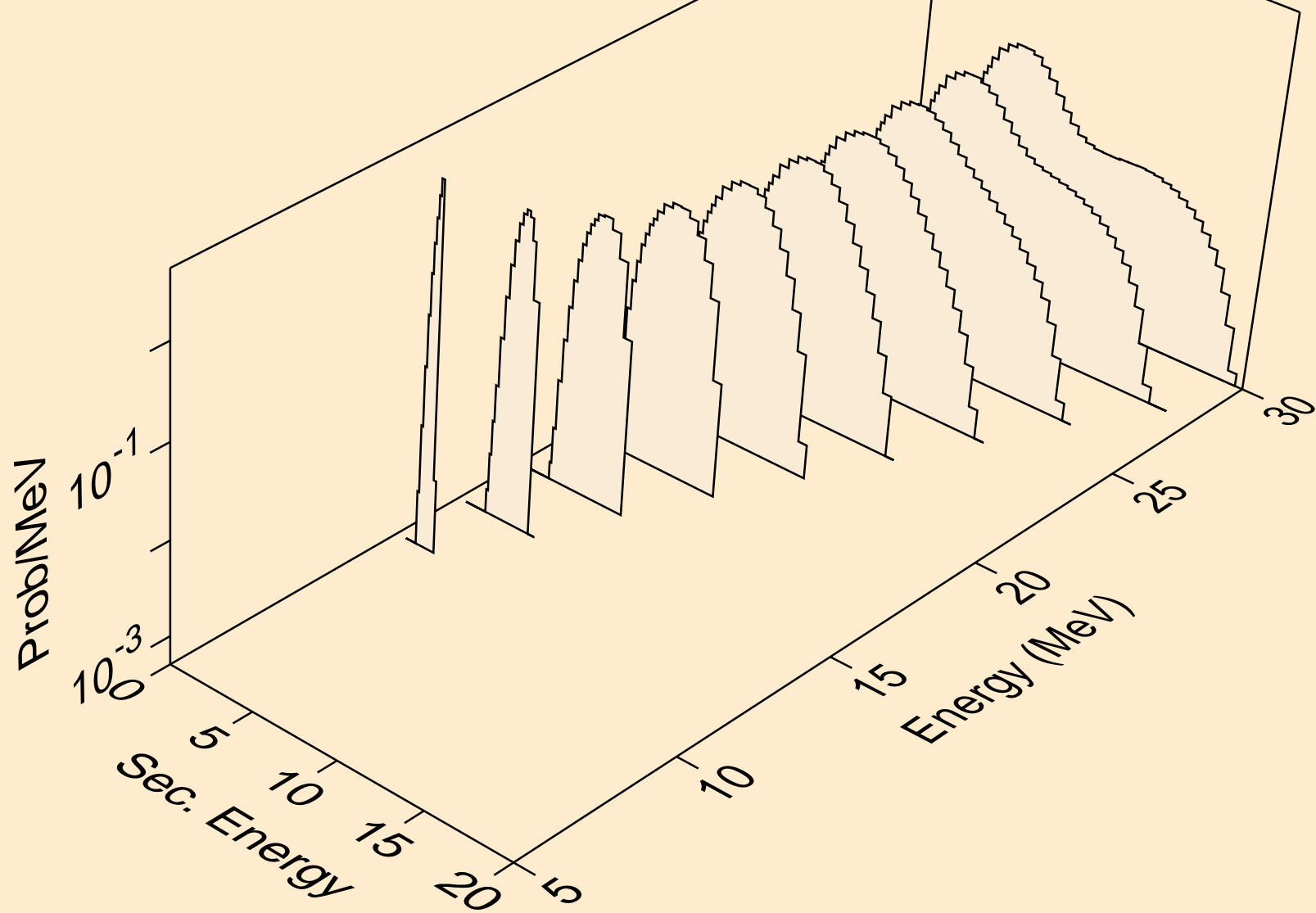

CS118M PROTON ACER TENDL-2021 LIBRARY; T=0.K  
Proton emission for (p,2np)

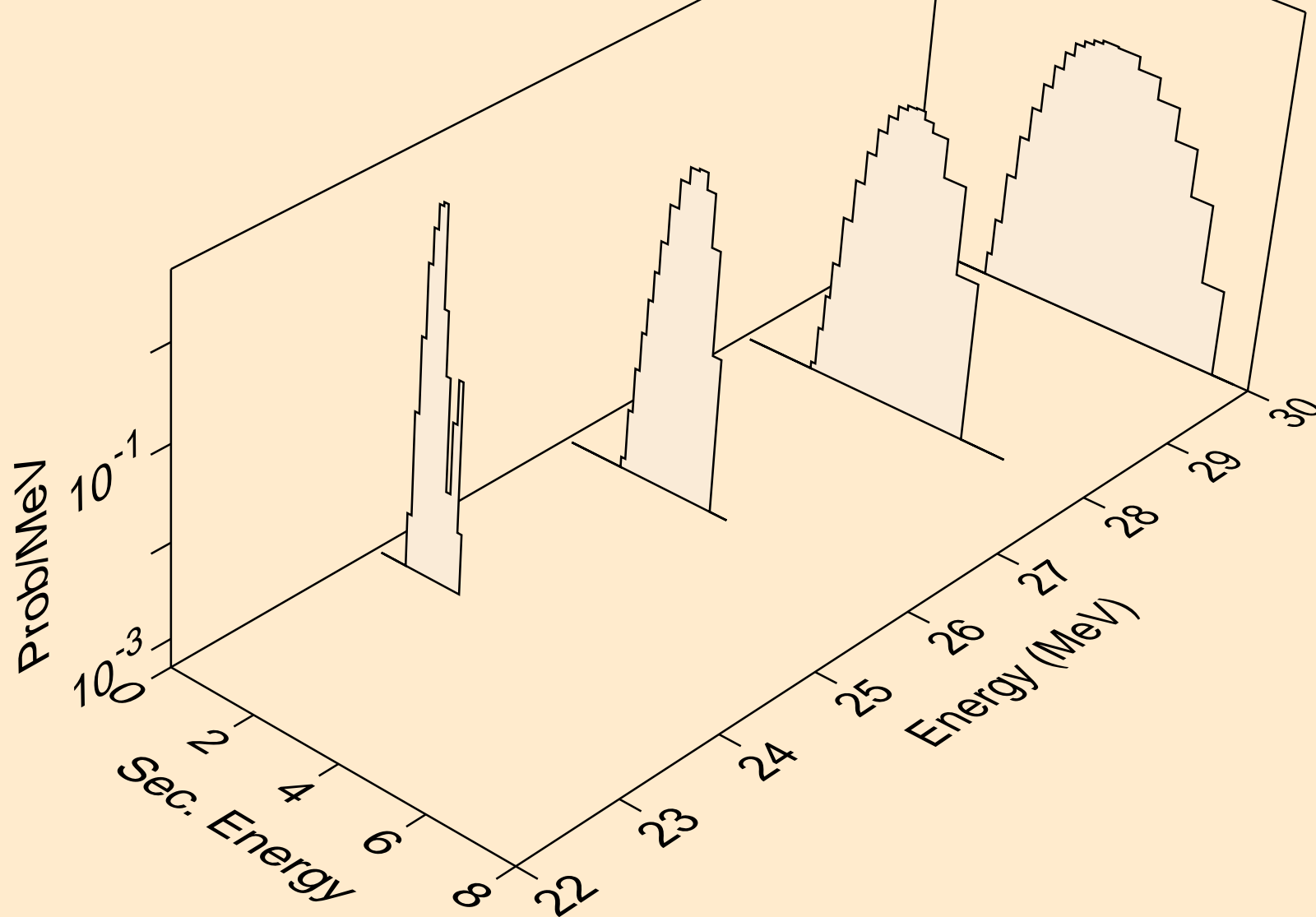

CS118M PROTON ACER TENDL-2021 LIBRARY; T=0.K  
Proton emission for (p,2np)

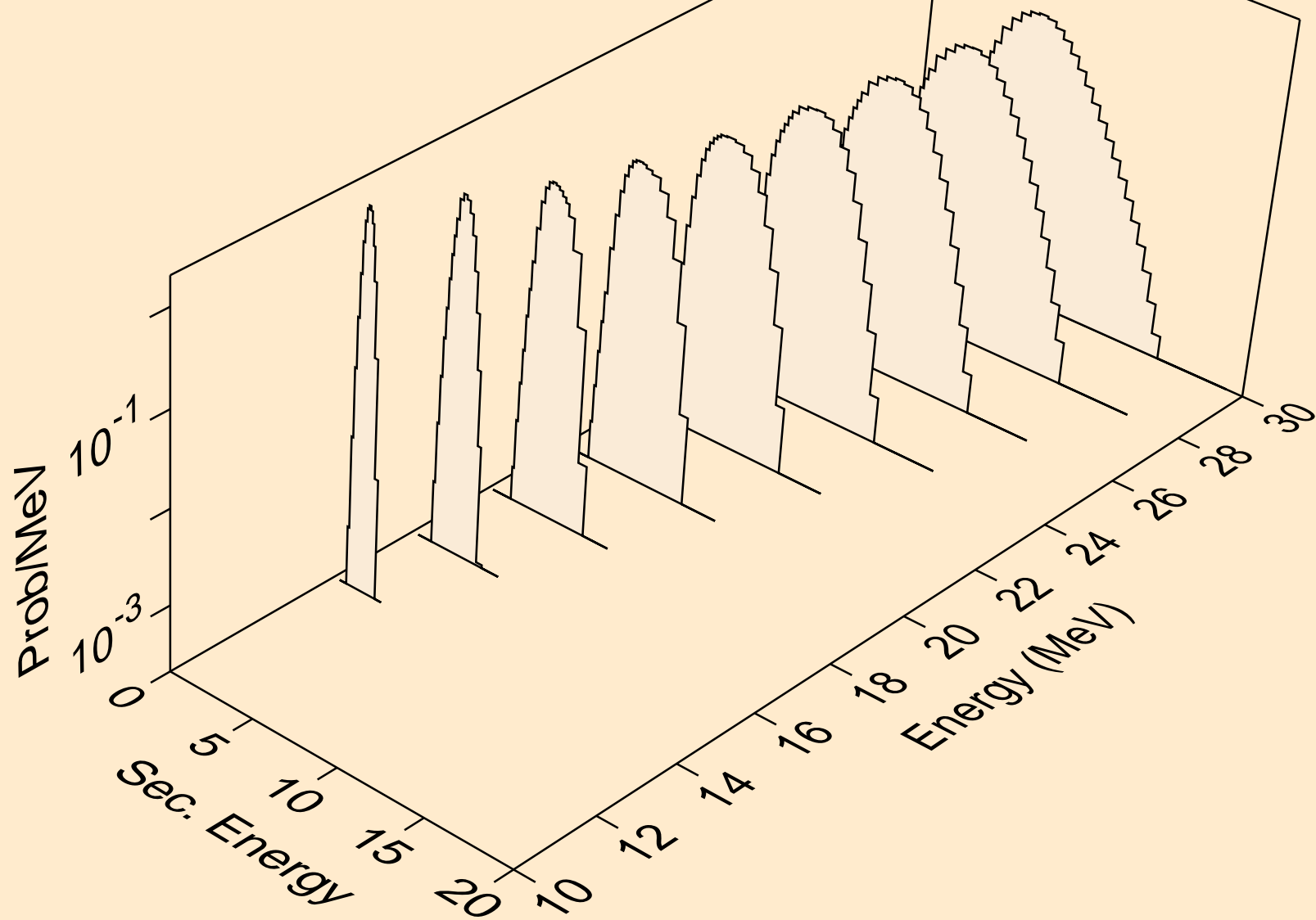

CS118M PROTON ACER TENDL-2021 LIBRARY; T=0.K  
Proton emission for (p,npa)

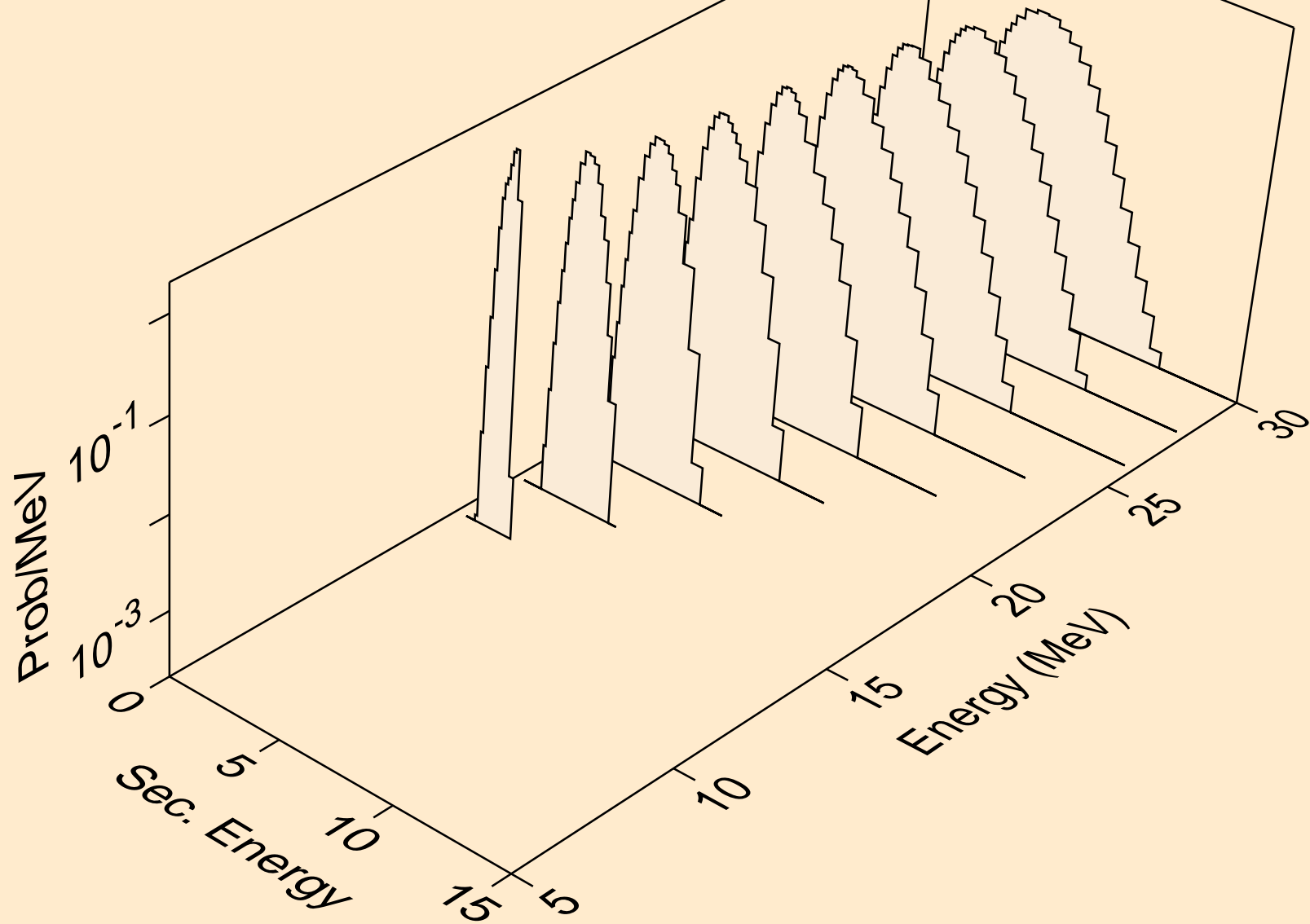

CS118M PROTON ACER TENDL-2021 LIBRARY; T=0.K  
Proton emission for inelastic

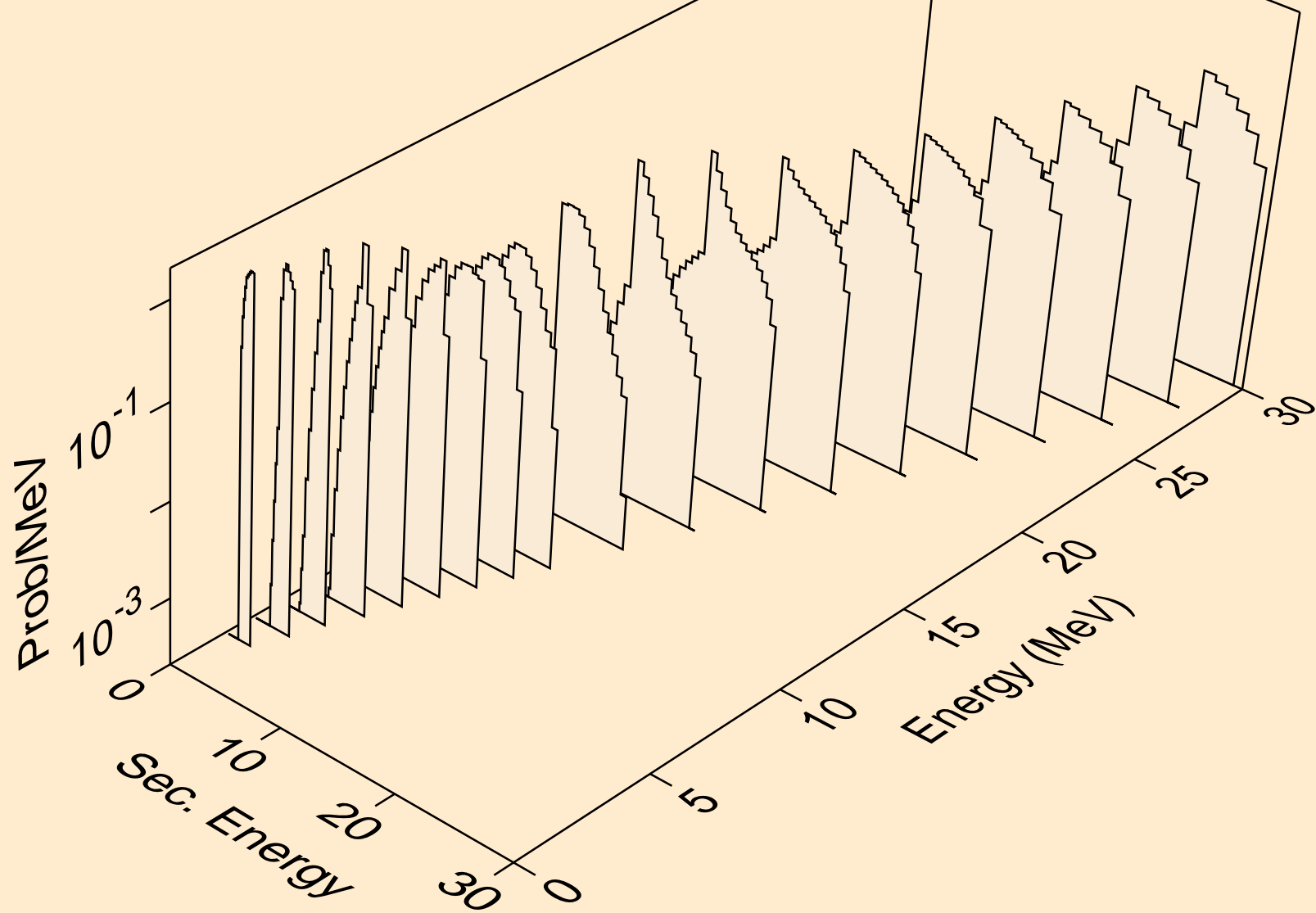

CS118M PROTON ACER TENDL-2021 LIBRARY; T=0.K  
Proton emission for (p,2p)

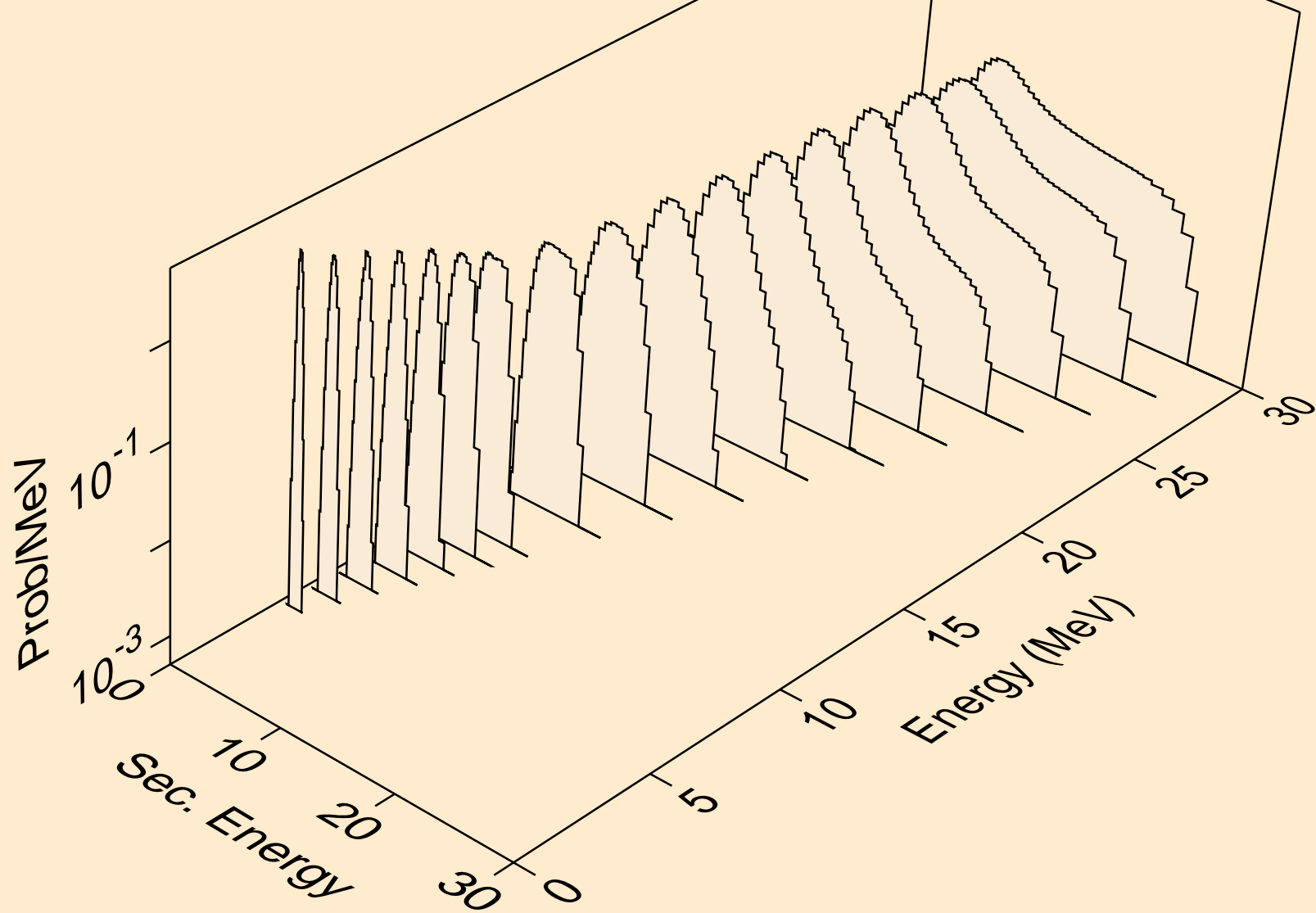



CS118M PROTON ACER TENDL-2021 LIBRARY; T=0.K  
Proton emission for (p,pa)

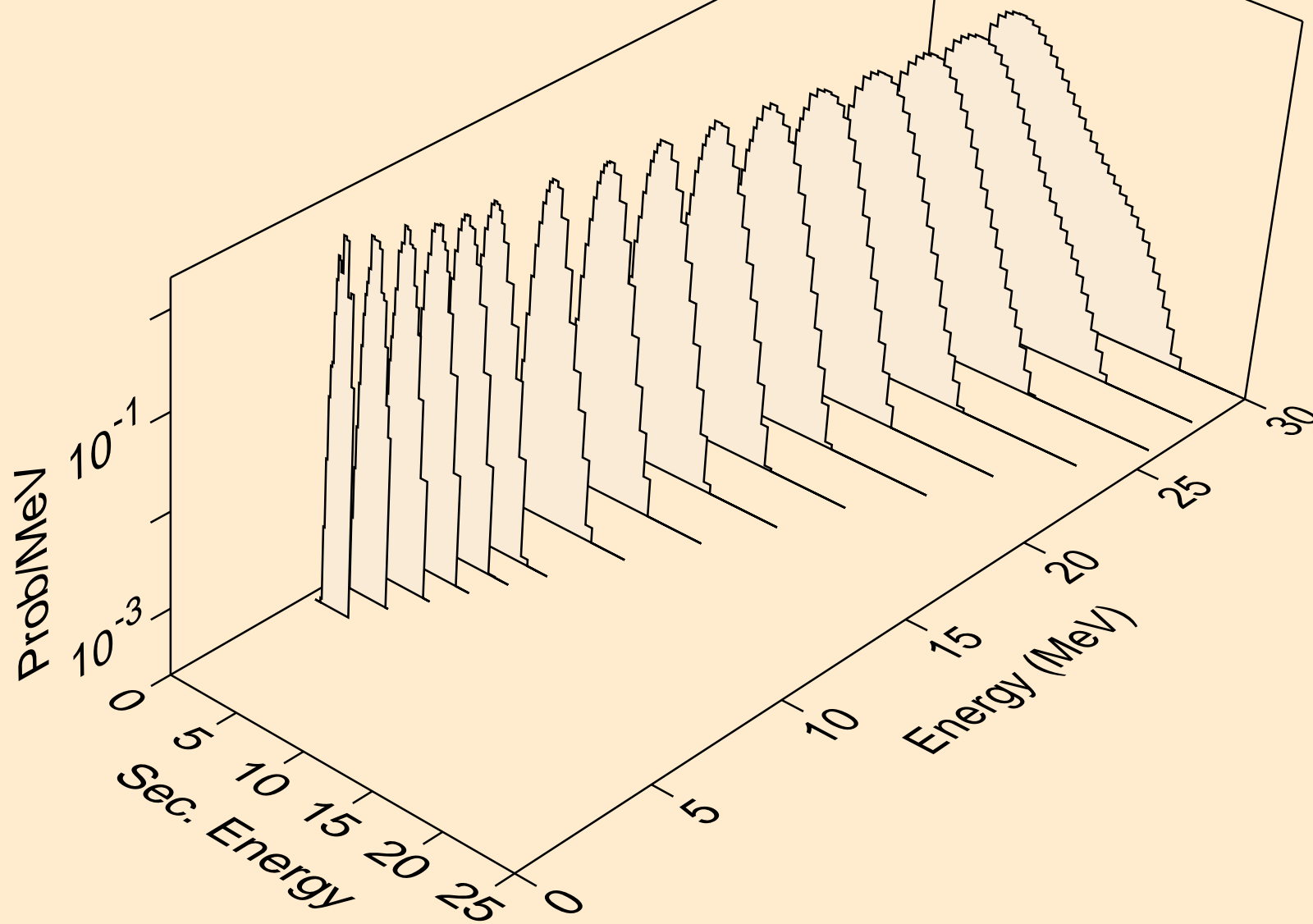

CS118M PROTON ACER TENDL-2021 LIBRARY; T=0.K  
Proton emission for (p,pd)

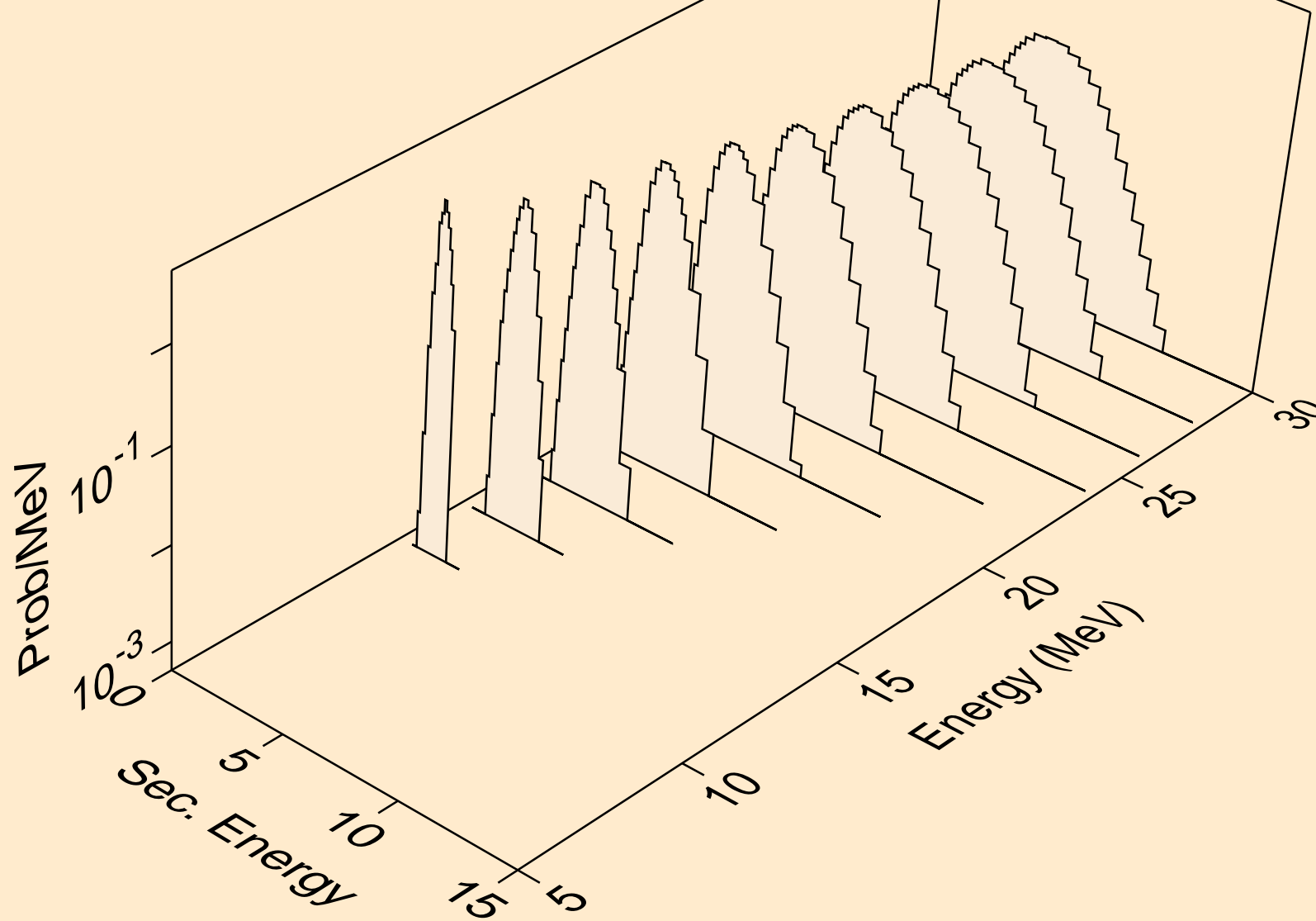

CS118M PROTON ACER TENDL-2021 LIBRARY; T=0.K  
Proton emission for (p,pt)

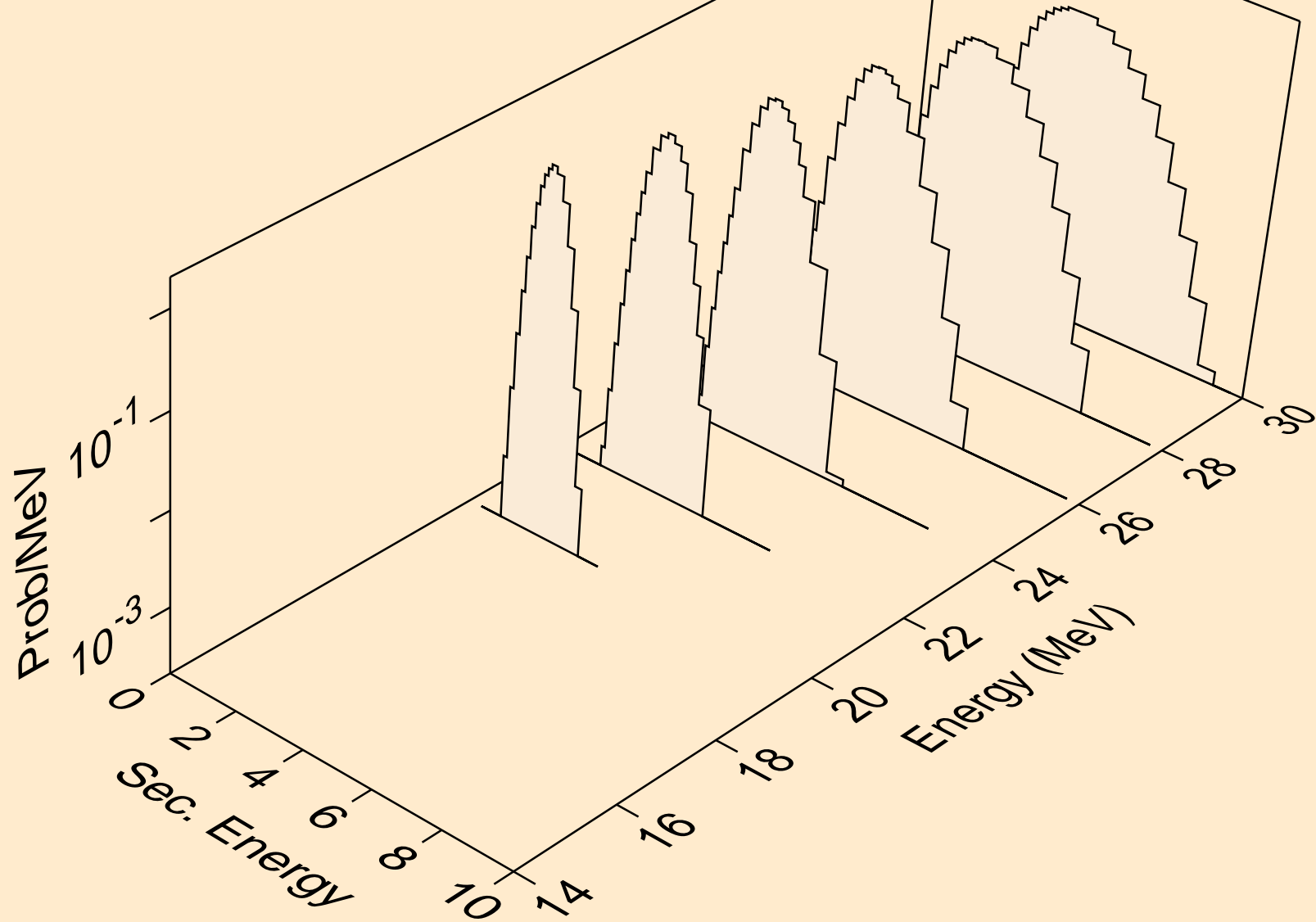

CS118M PROTON ACER TENDL-2021 LIBRARY; T=0.K  
Photon emission for (z,n)

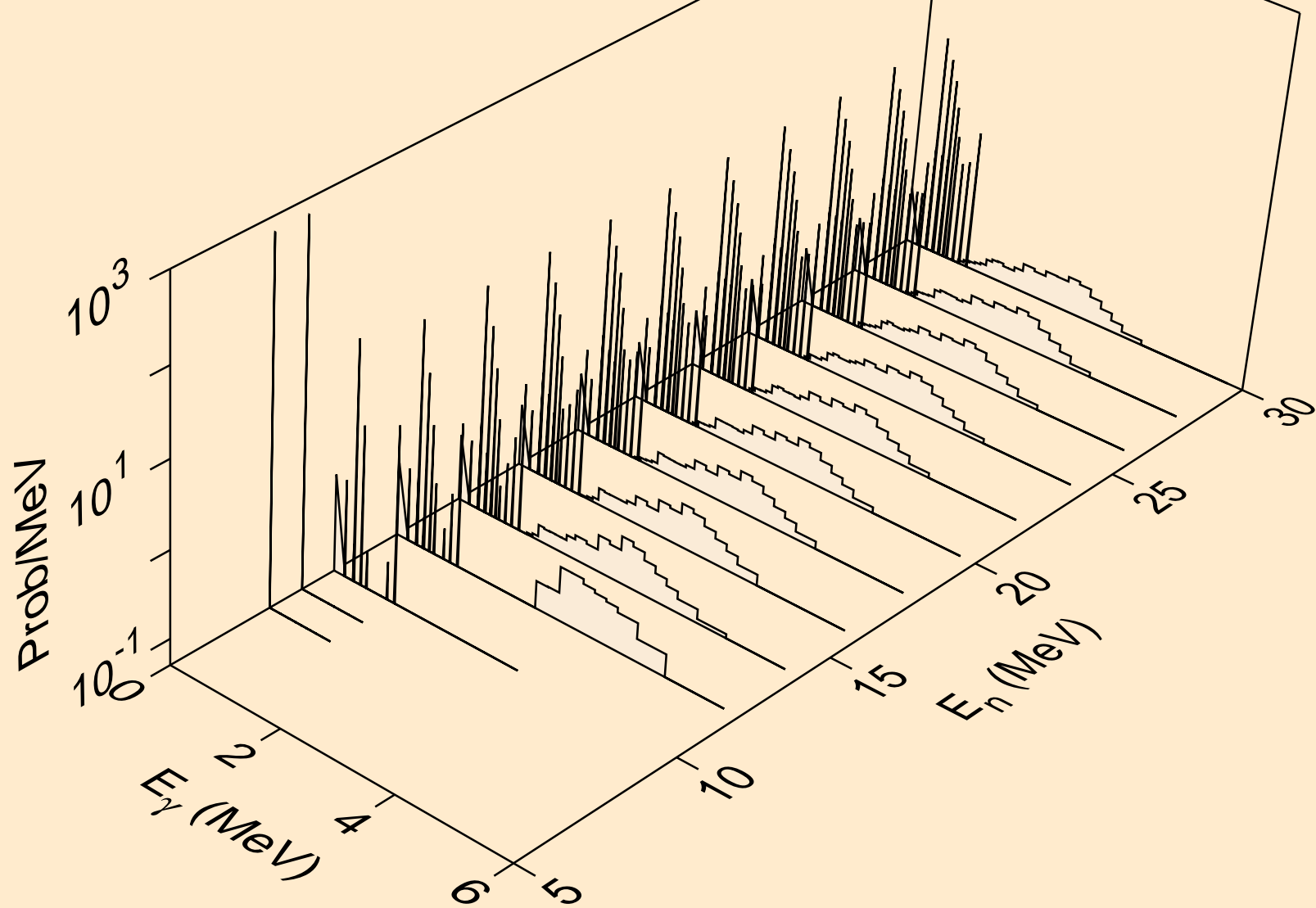

CS118M PROTON ACER TENDL-2021 LIBRARY; T=0.K  
Photon emission for (n,x)

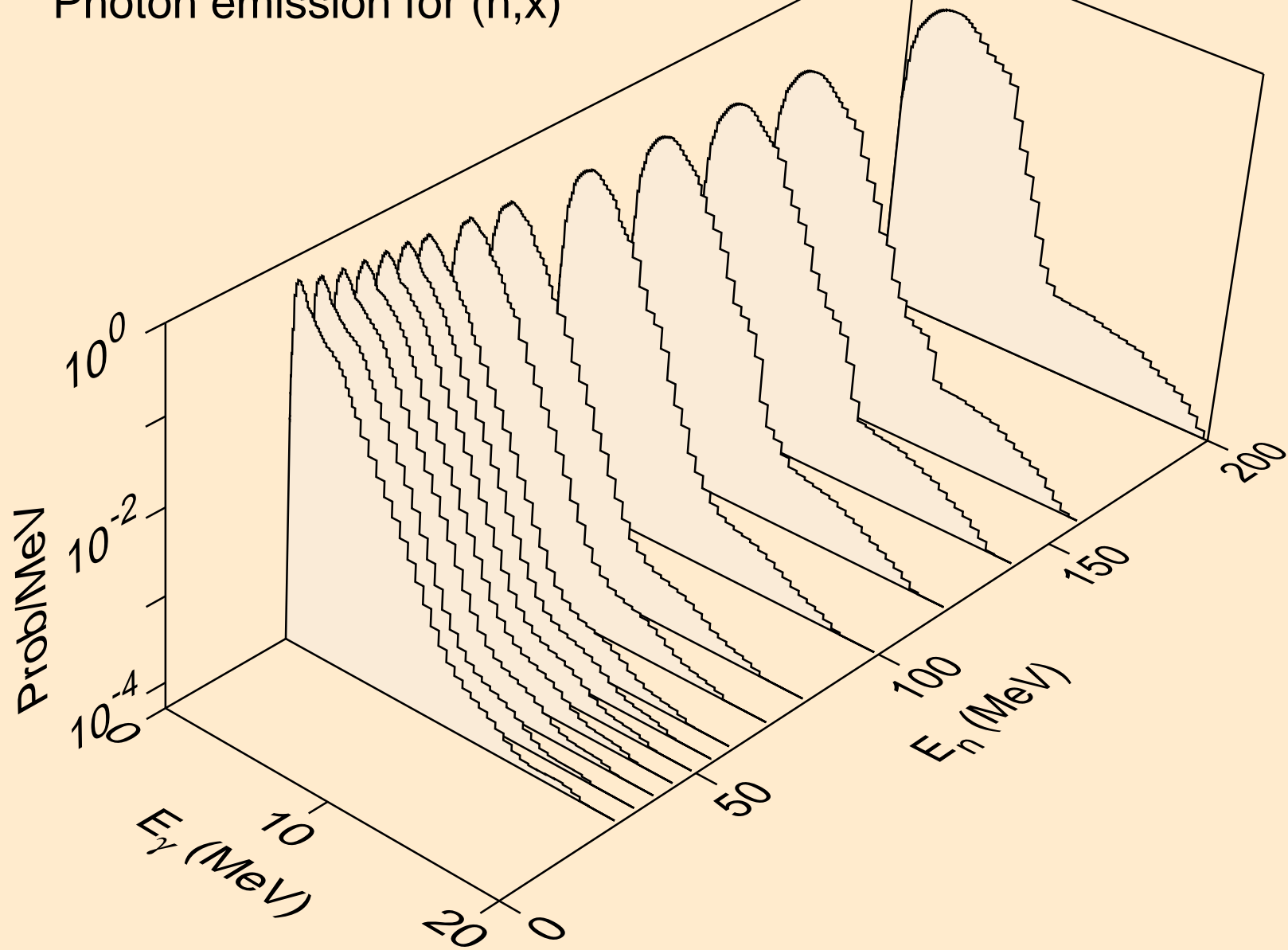

CS118M PROTON ACER TENDL-2021 LIBRARY; T=0.K  
Photon emission for (n,2n)

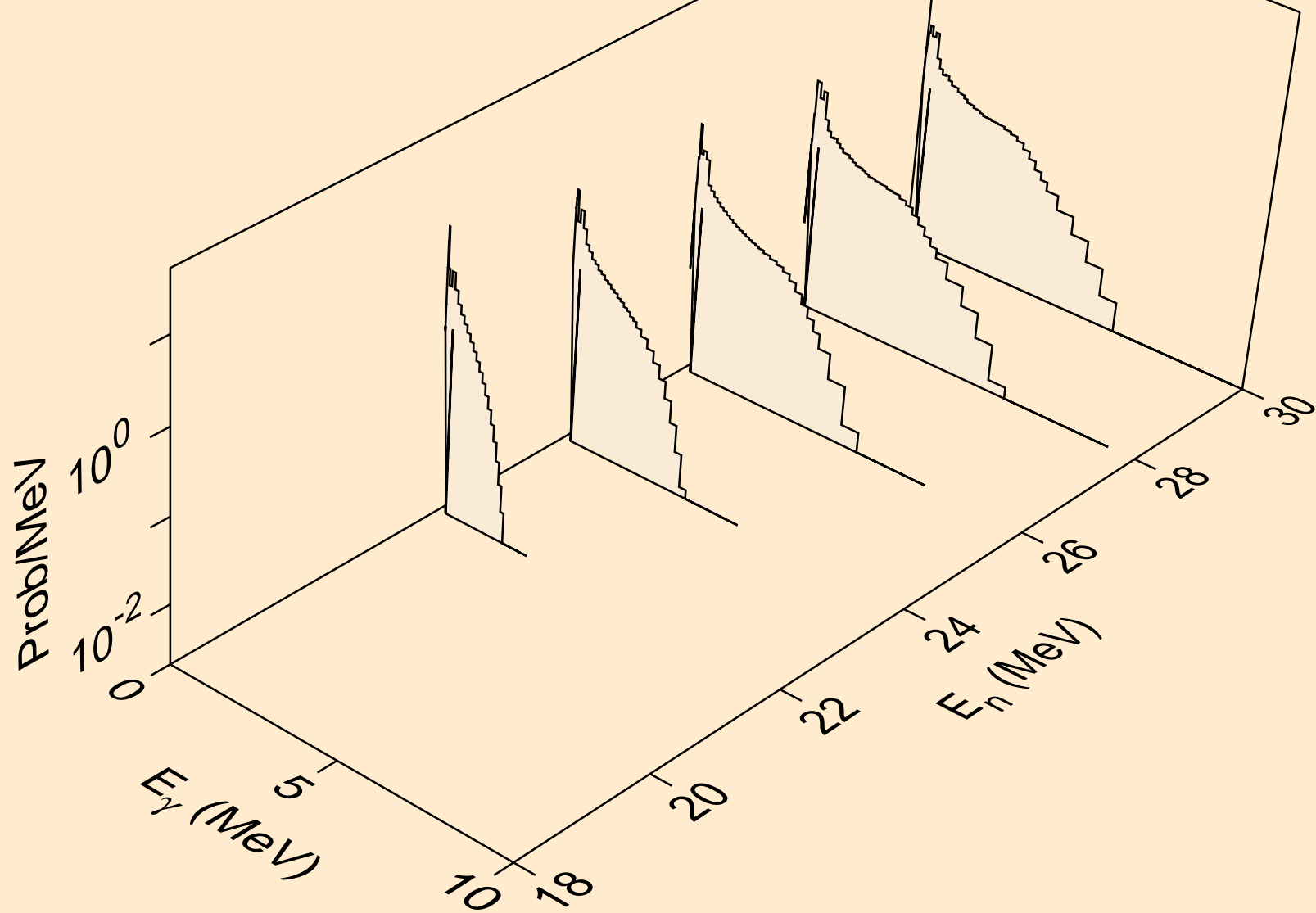

CS118M PROTON ACER TENDL-2021 LIBRARY; T=0.K  
Photon emission for (n,n\*)a

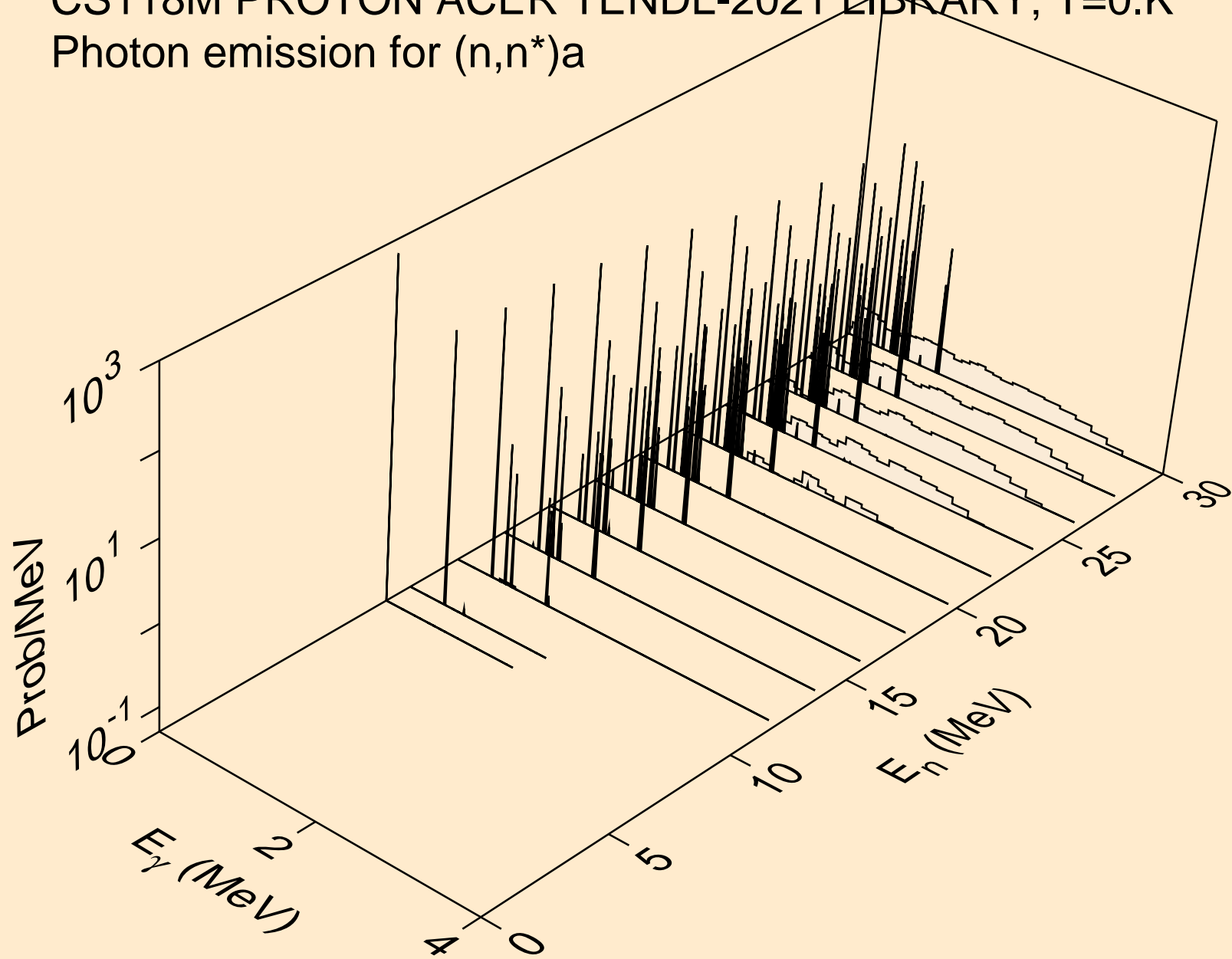

CS118M PROTON ACER TENDL-2021 LIBRARY; T=0.K  
Photon emission for (n,2n)a

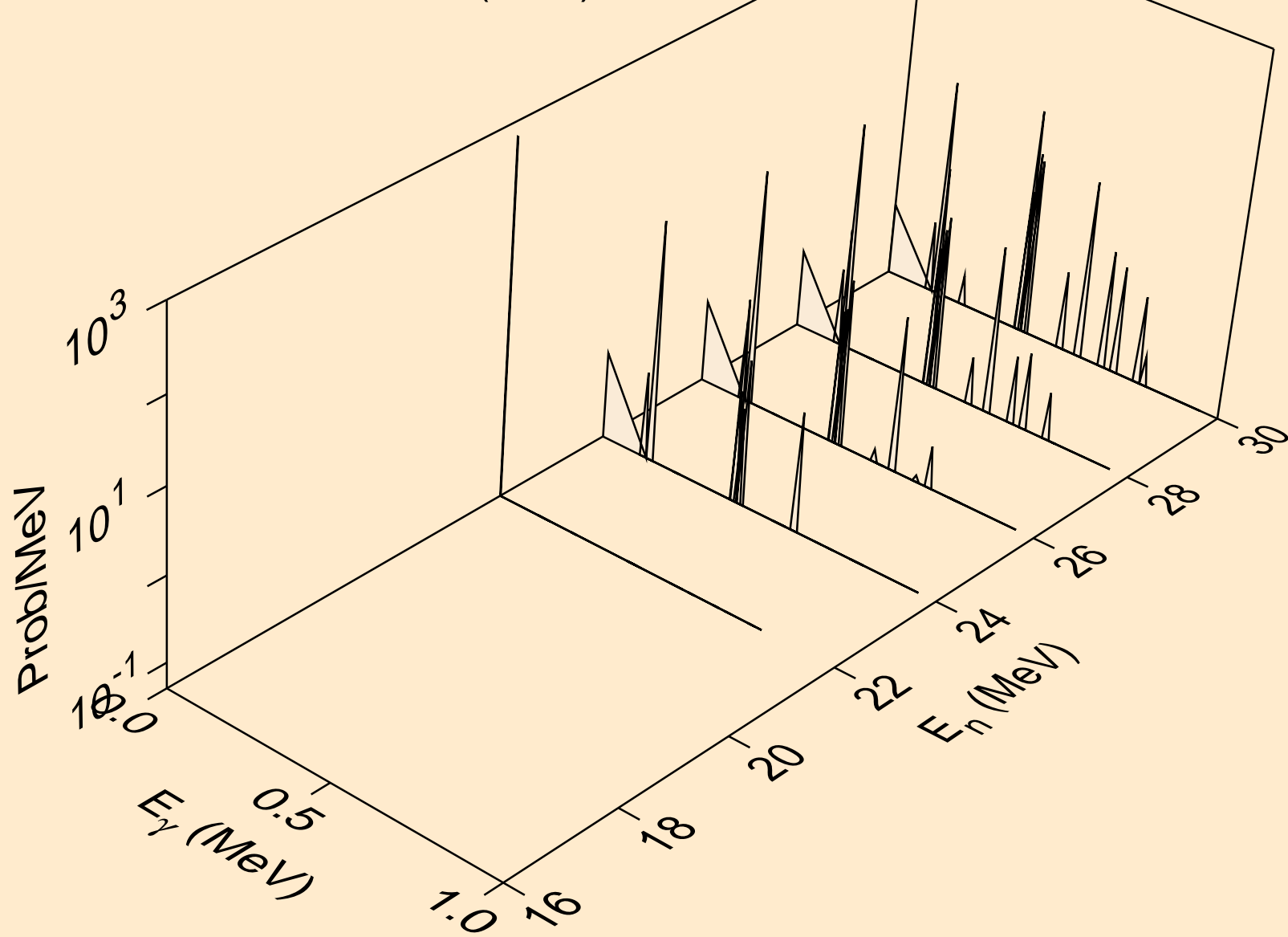



CS118M PROTON ACER TENDL-2021 LIBRARY; T=0.K  
Photon emission for (n,n\*)p

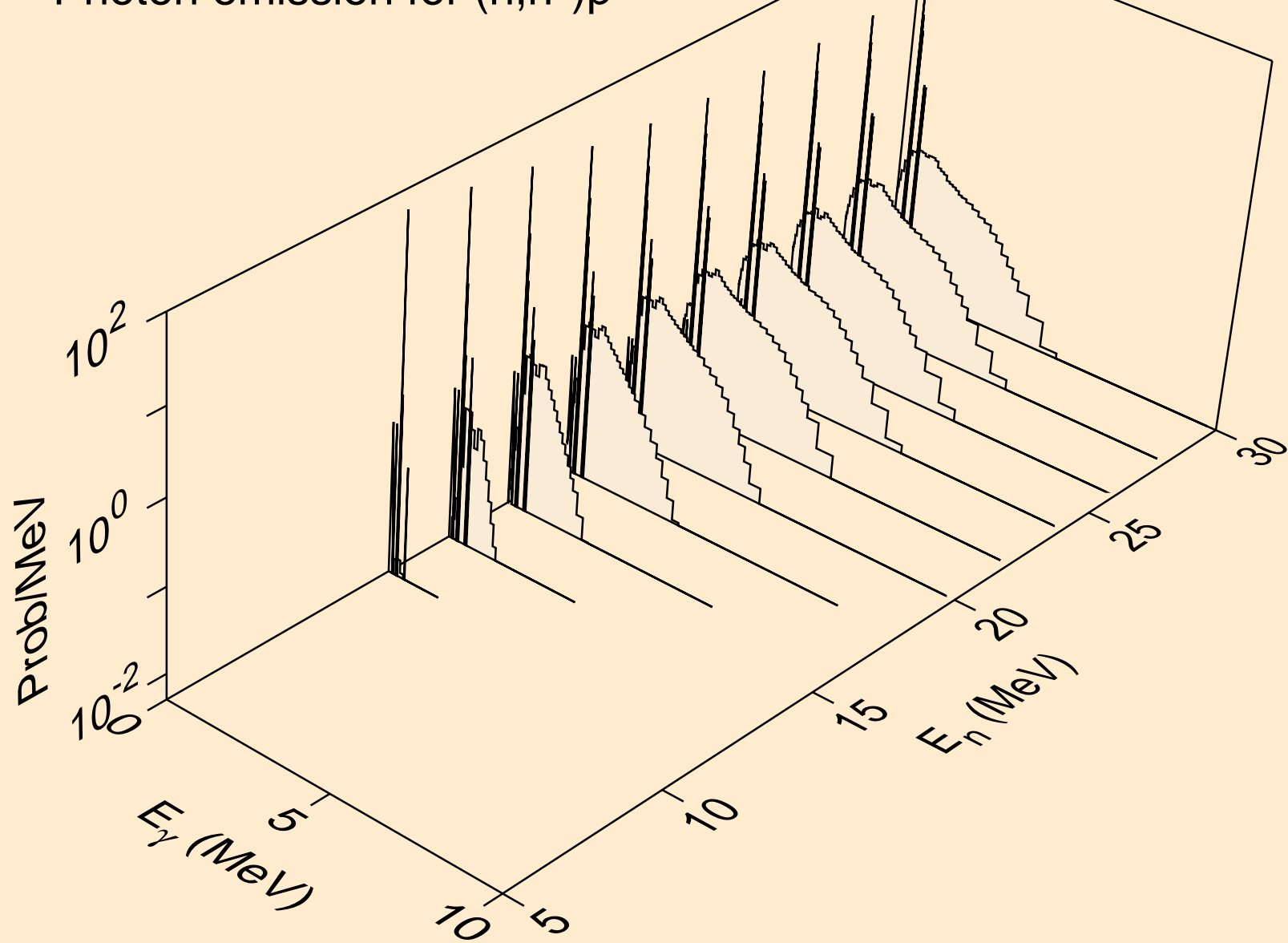

CS118M PROTON ACER TENDL-2021 LIBRARY; T=0.K  
Photon emission for (n,n\*)2a

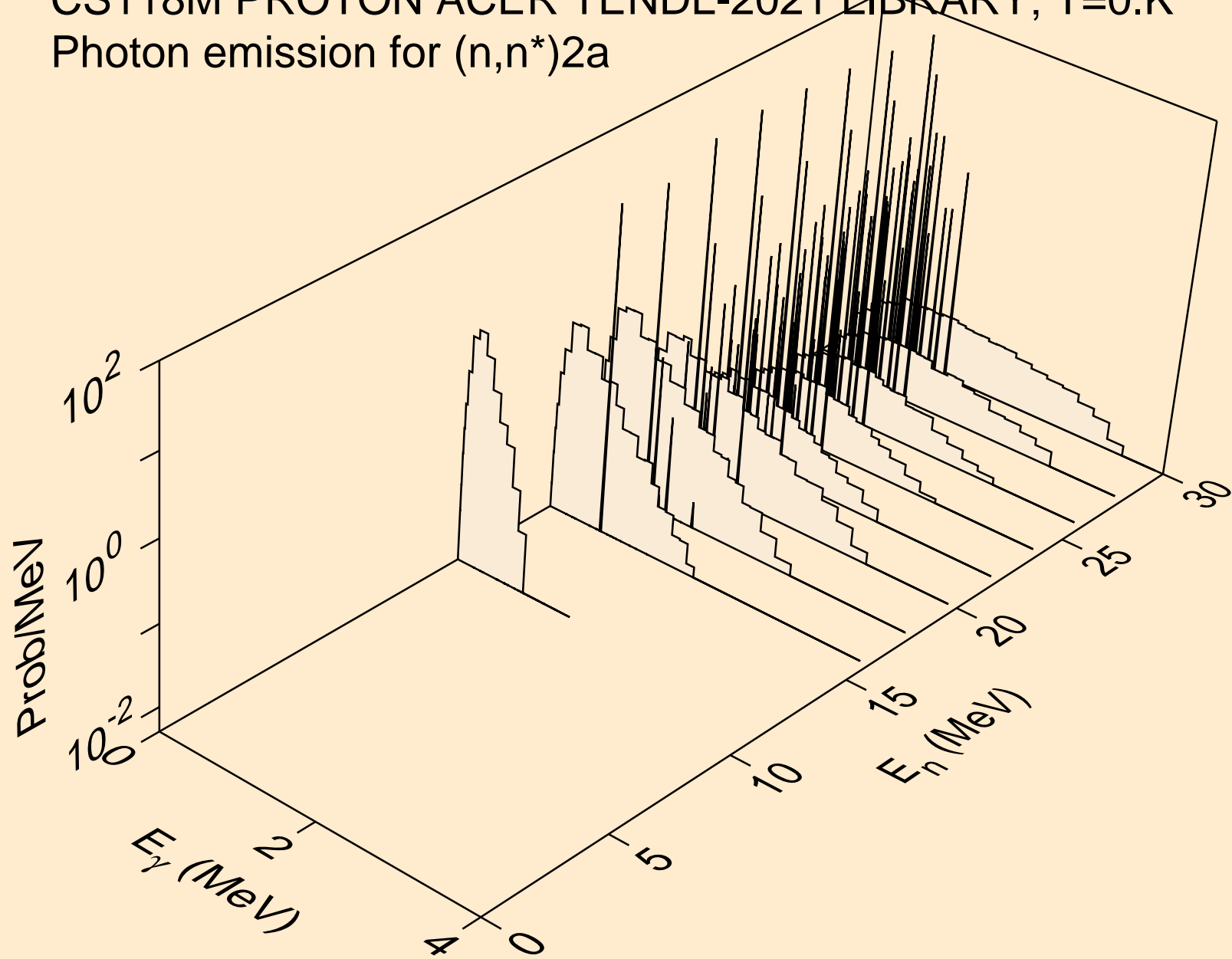

CS118M PROTON ACER TENDL-2021 LIBRARY; T=0.K  
Photon emission for (n,n\*)d

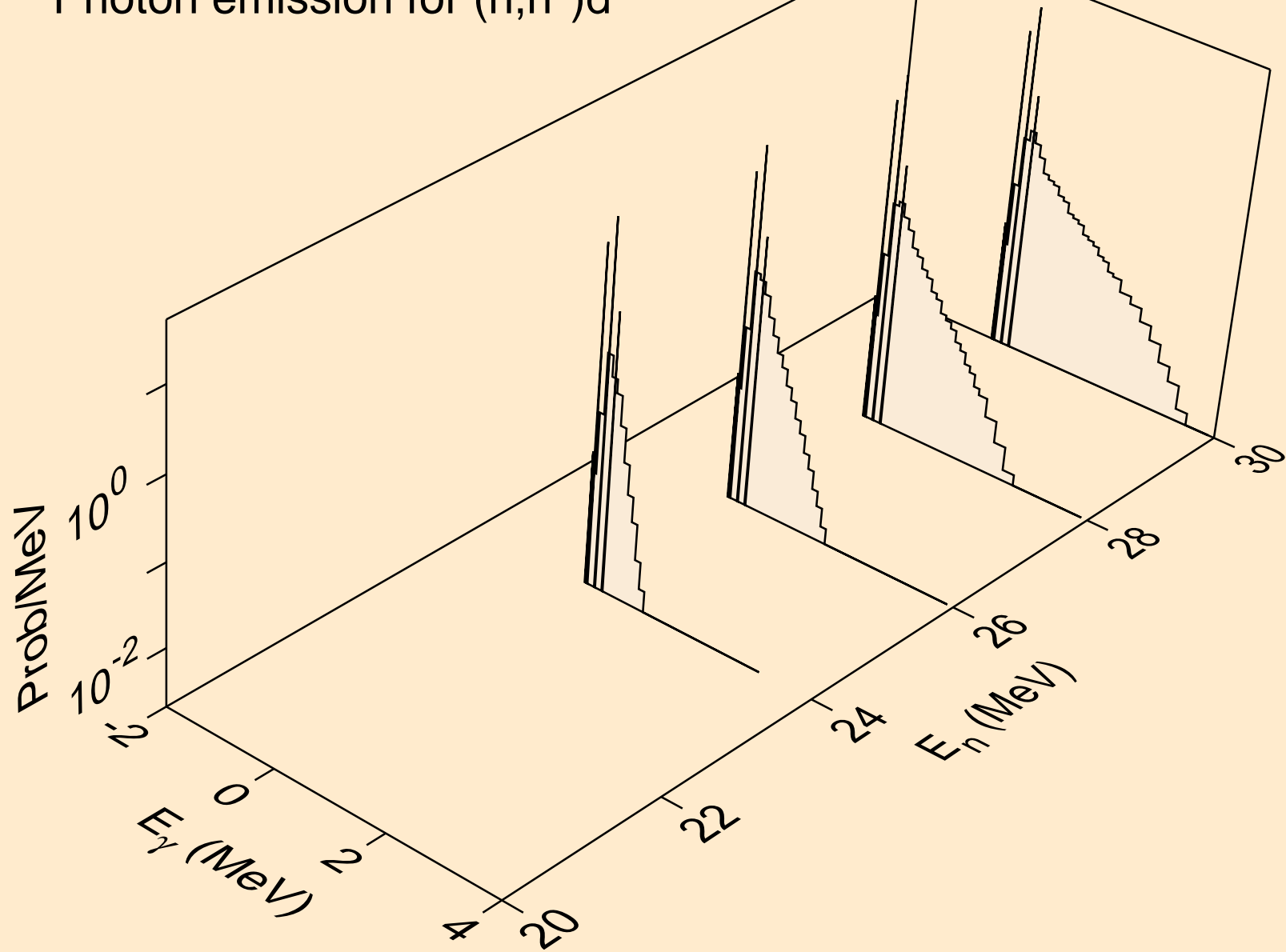

CS118M PROTON ACER TENDL-2021 LIBRARY; T=0.K  
Photon emission for (n,n\*)he3

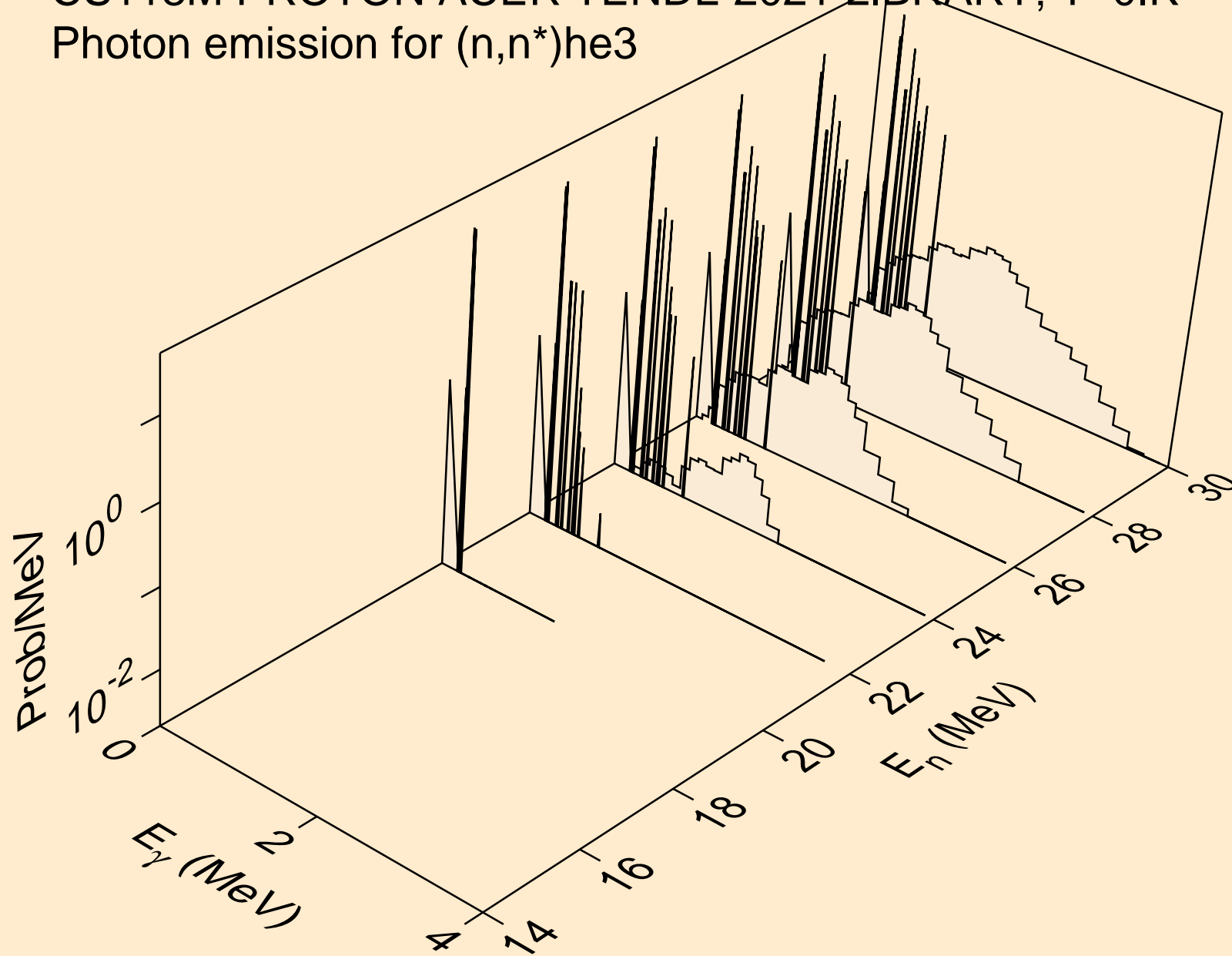

CS118M PROTON ACER TENDL-2021 LIBRARY; T=0.K  
Photon emission for (n,2np)

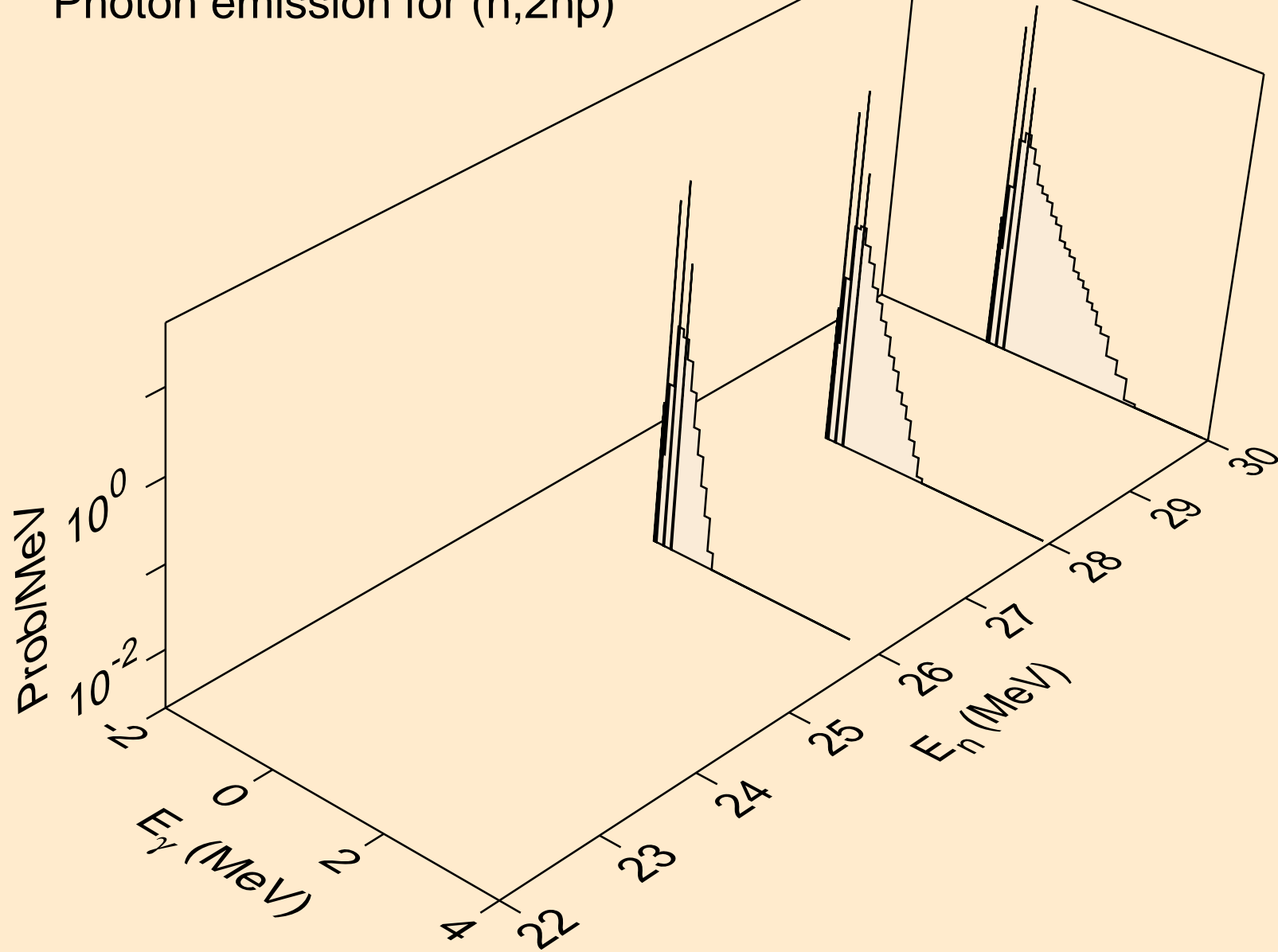

CS118M PROTON ACER TENDL-2021 LIBRARY; T=0.K  
Photon emission for (n,2np)

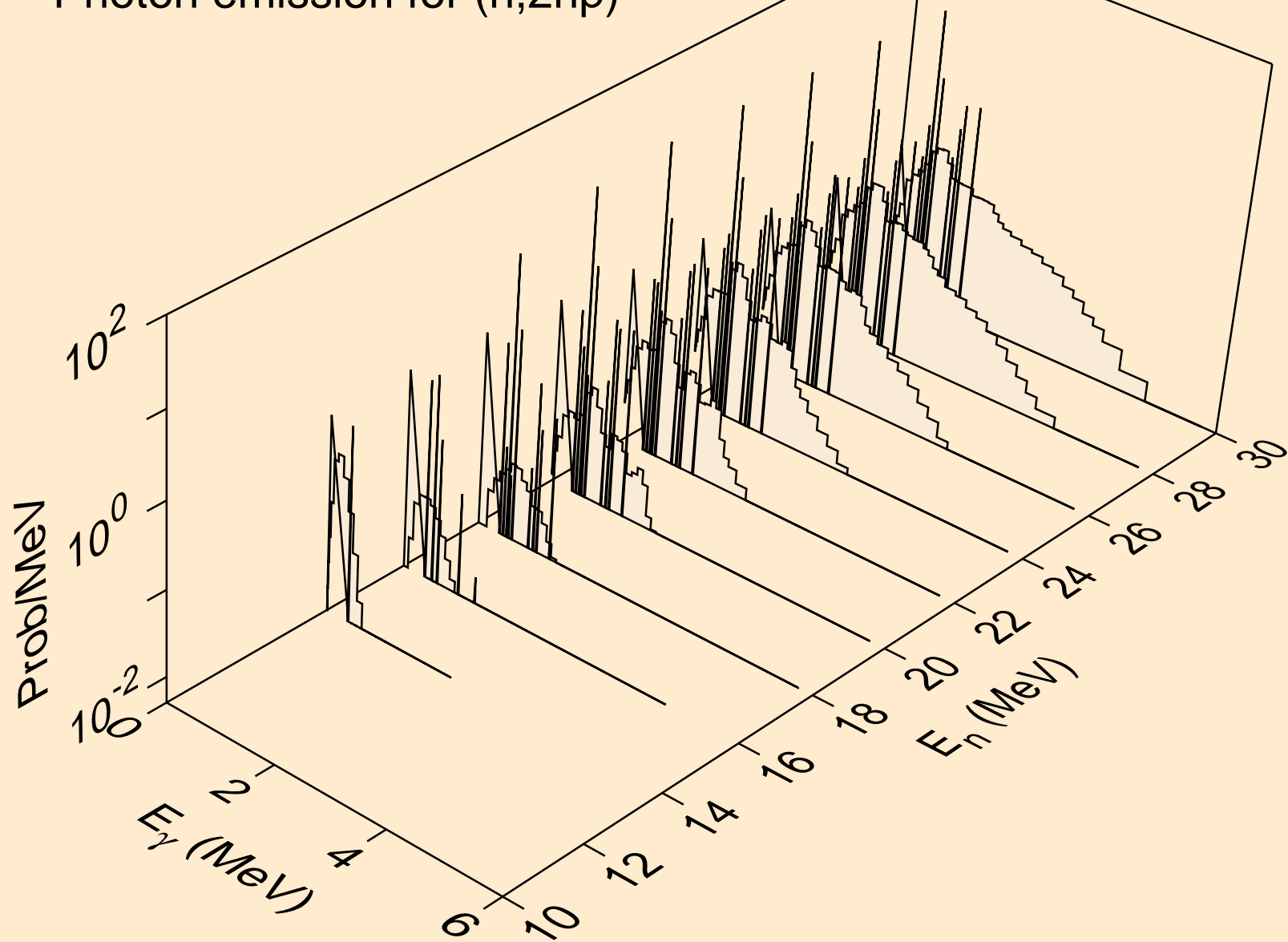

CS118M PROTON ACER TENDL-2021 LIBRARY; T=0.K  
Photon emission for (n,npa)

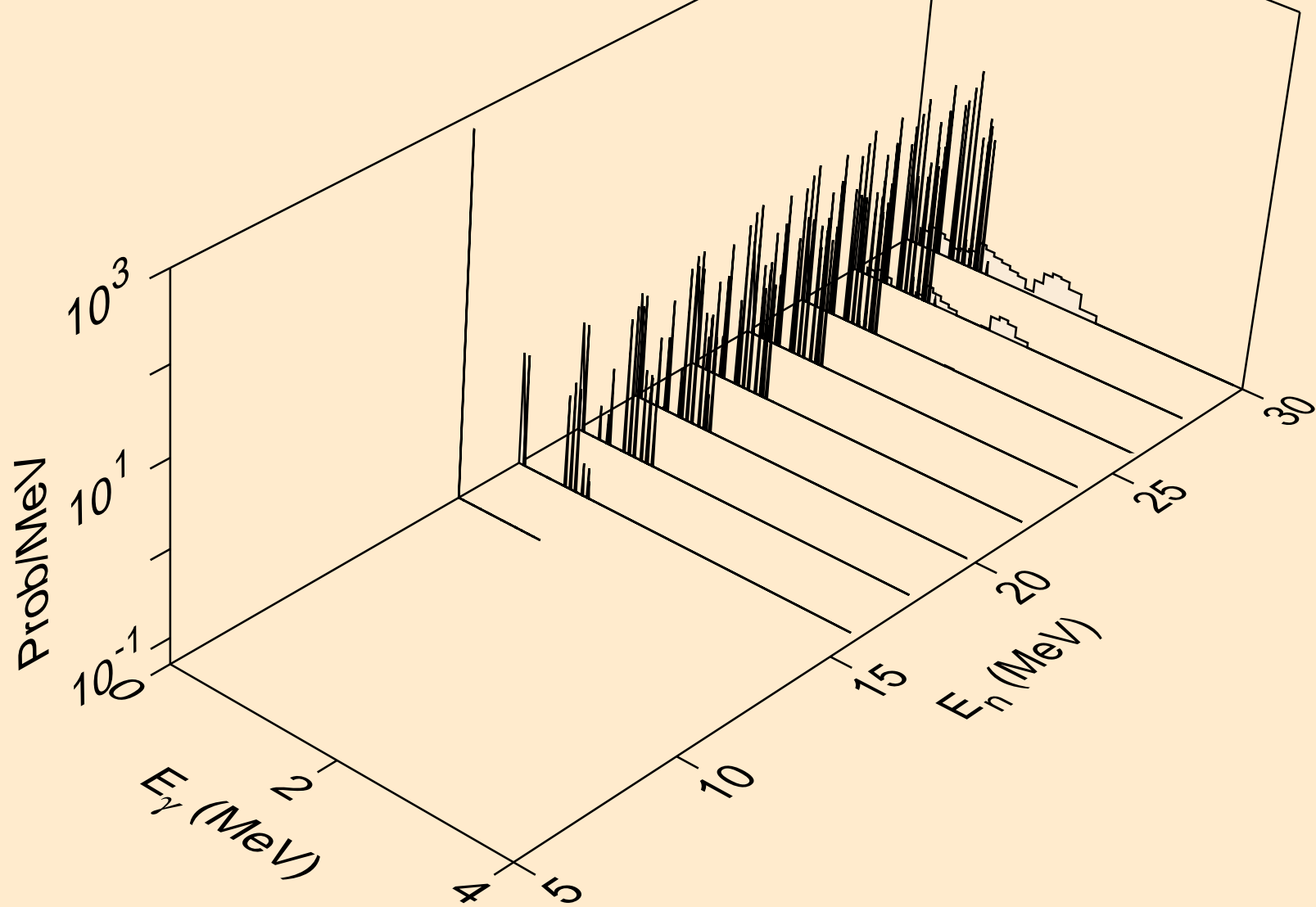

CS118M PROTON ACER TENDL-2021 LIBRARY; T=0.K  
Photon emission for (n,gma)

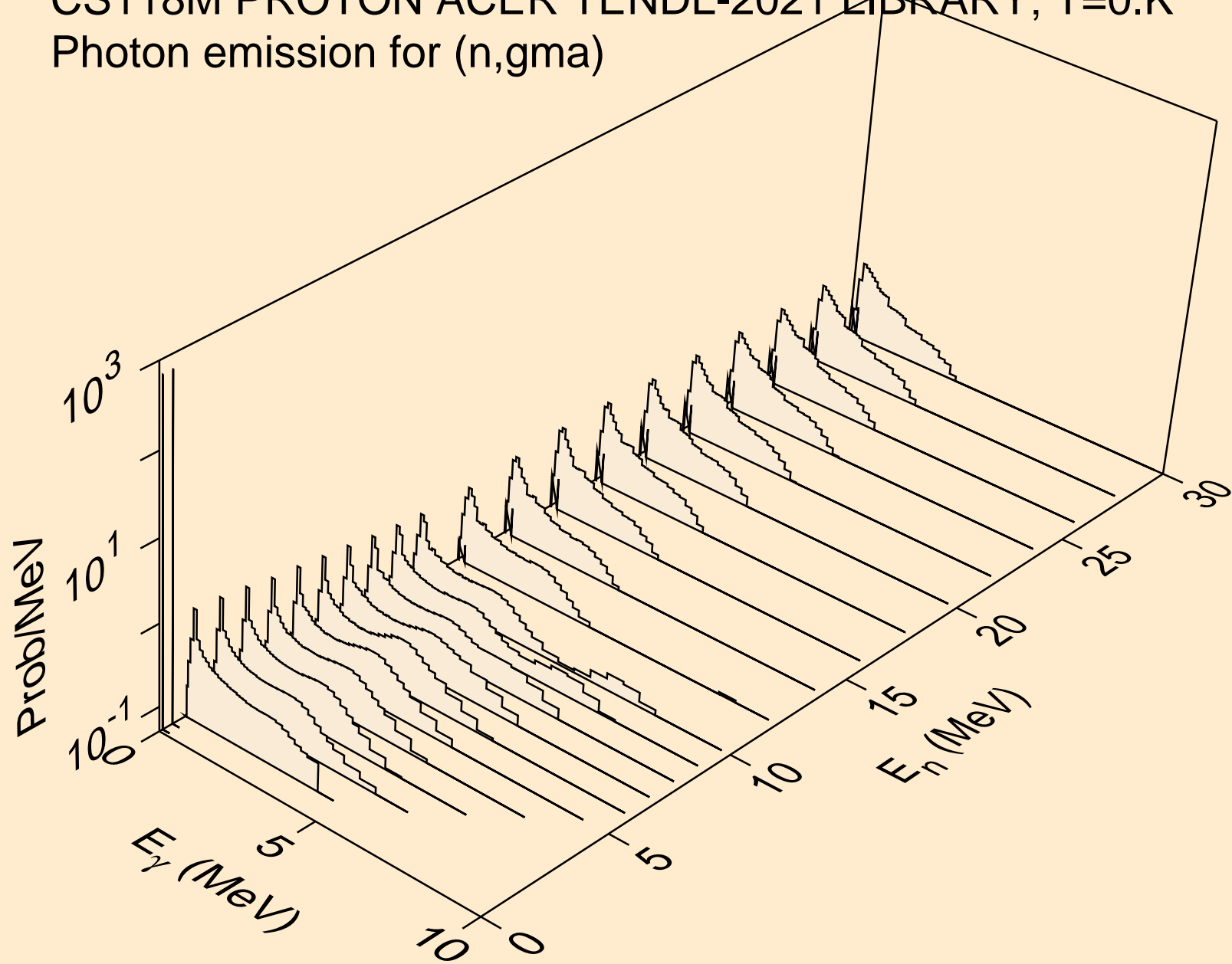



CS118M PROTON ACER TENDL-2021 LIBRARY; T=0.K  
Photon emission for inelastic

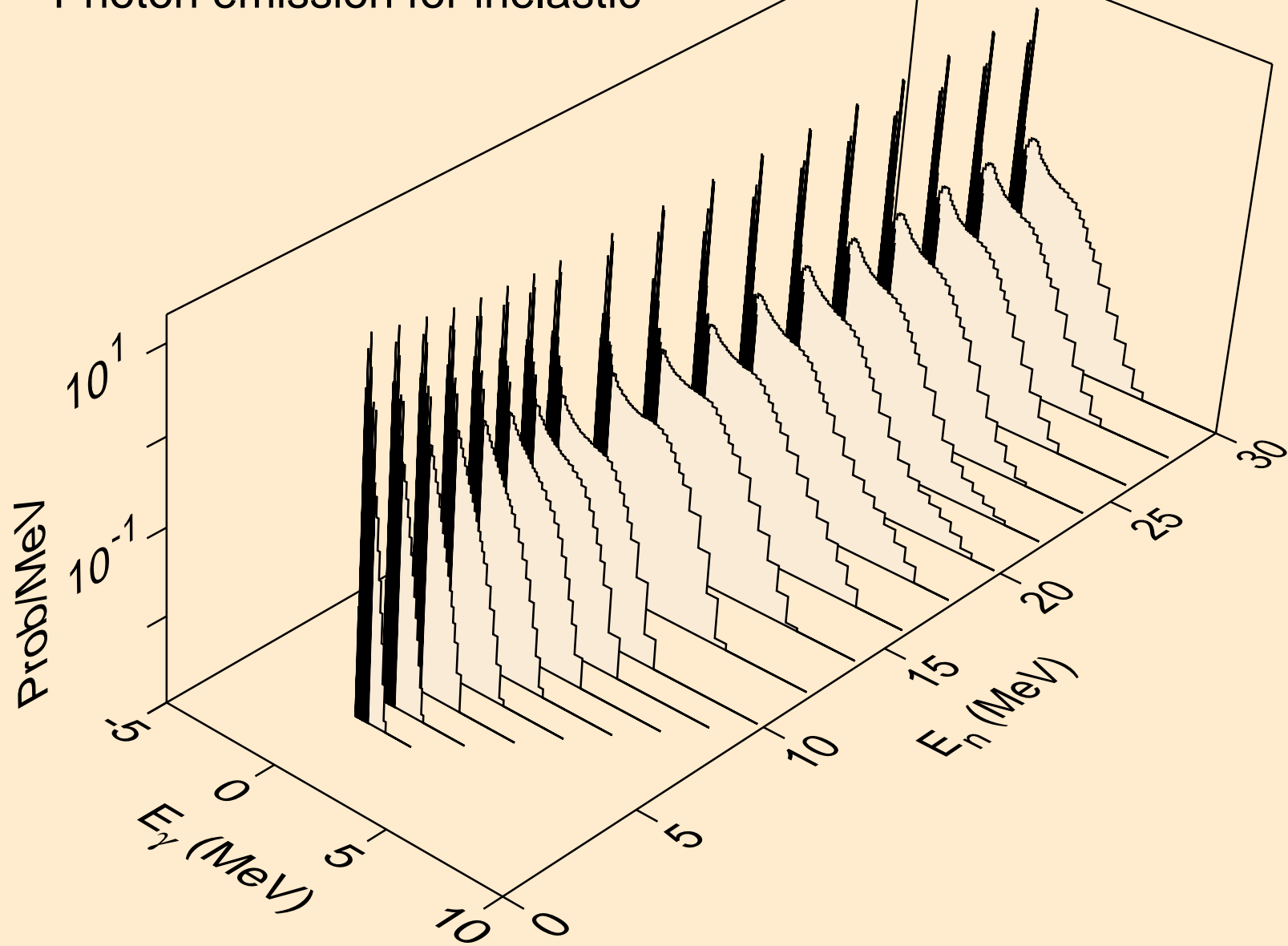

CS118M PROTON ACER TENDL-2021 LIBRARY; T=0.K  
Photon emission for (n,d)

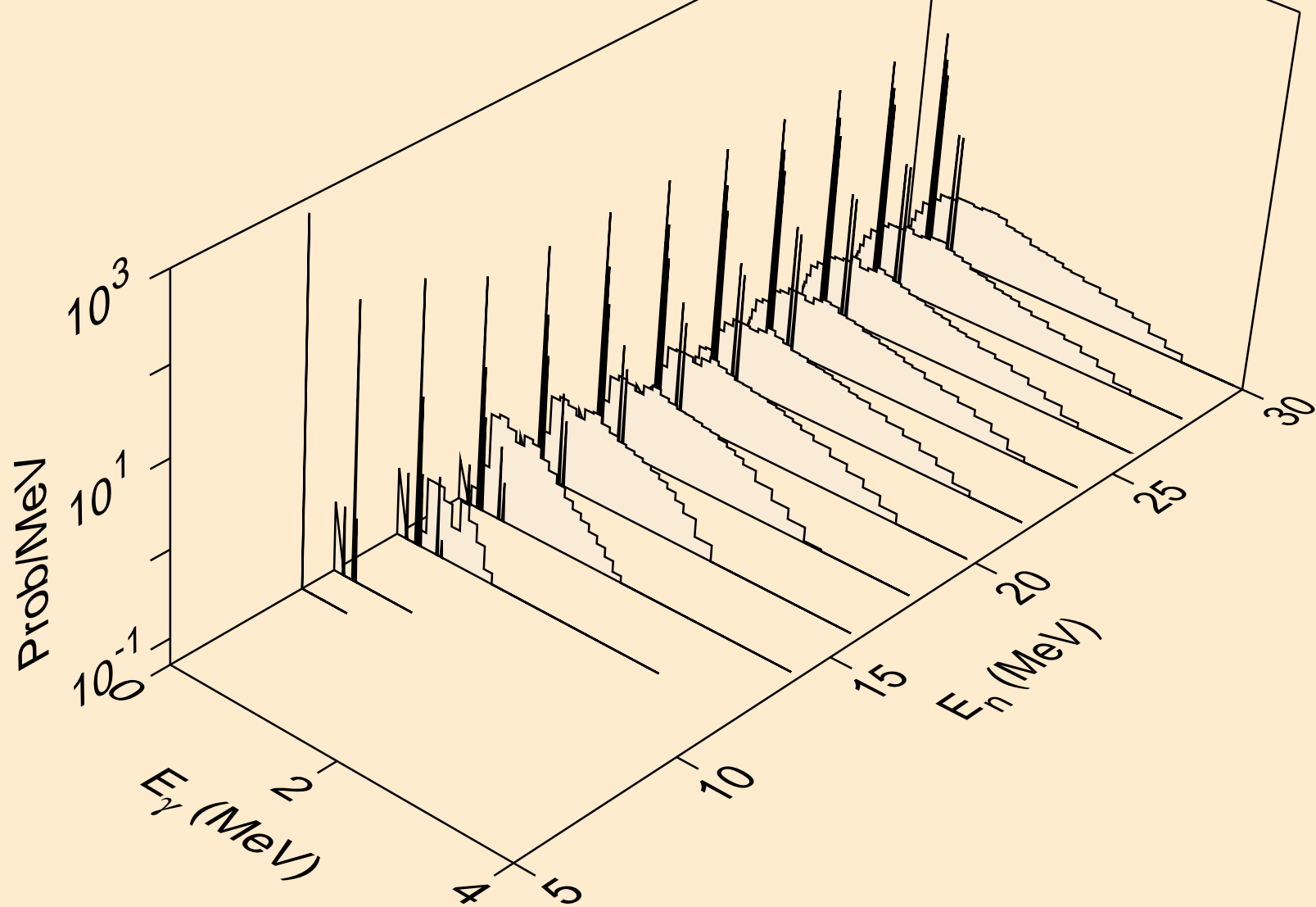

CS118M PROTON ACER TENDL-2021 LIBRARY; T=0.K  
Photon emission for (n,t)

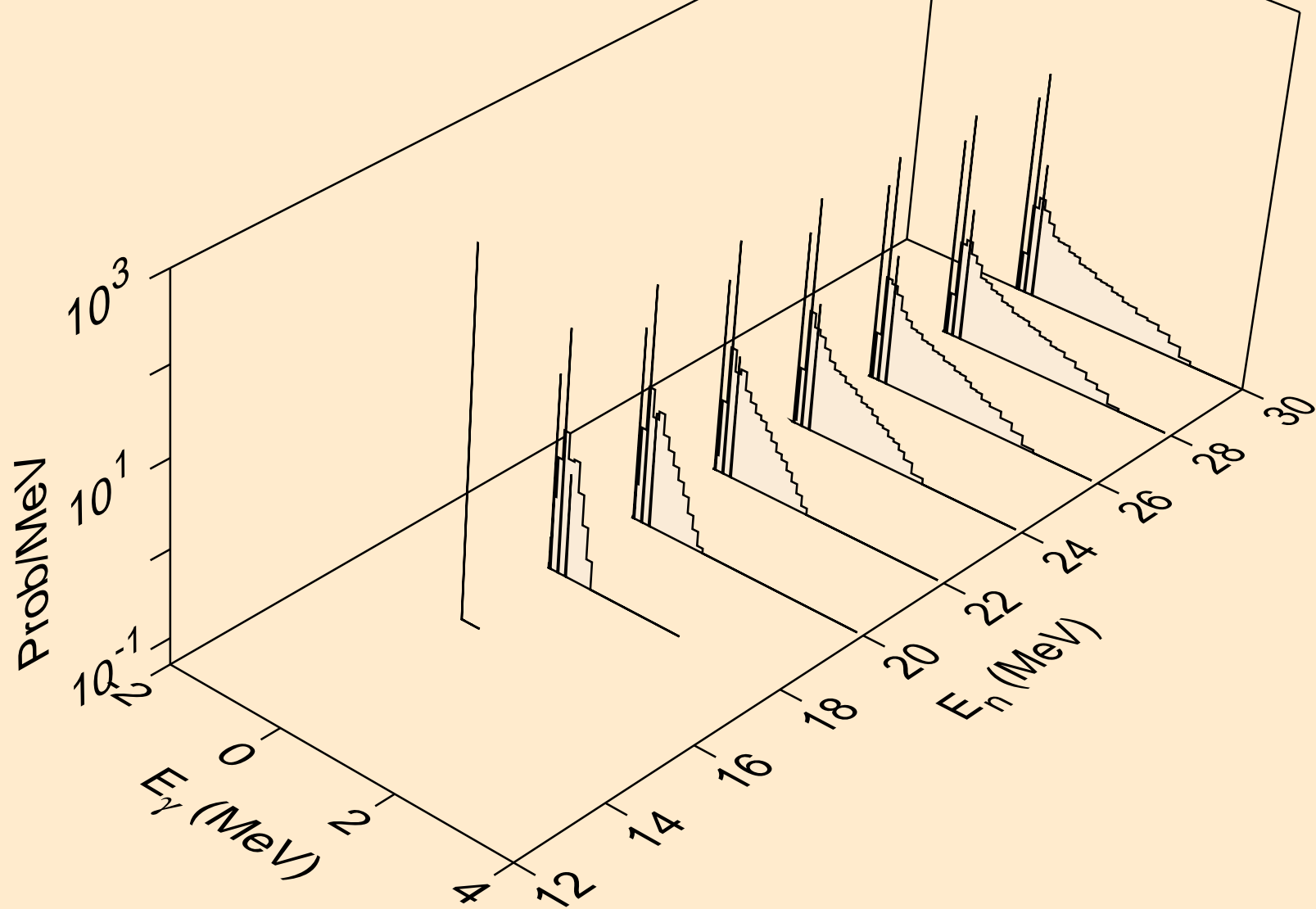

CS118M PROTON ACER TENDL-2021 LIBRARY; T=0.K  
Photon emission for (n,he3)

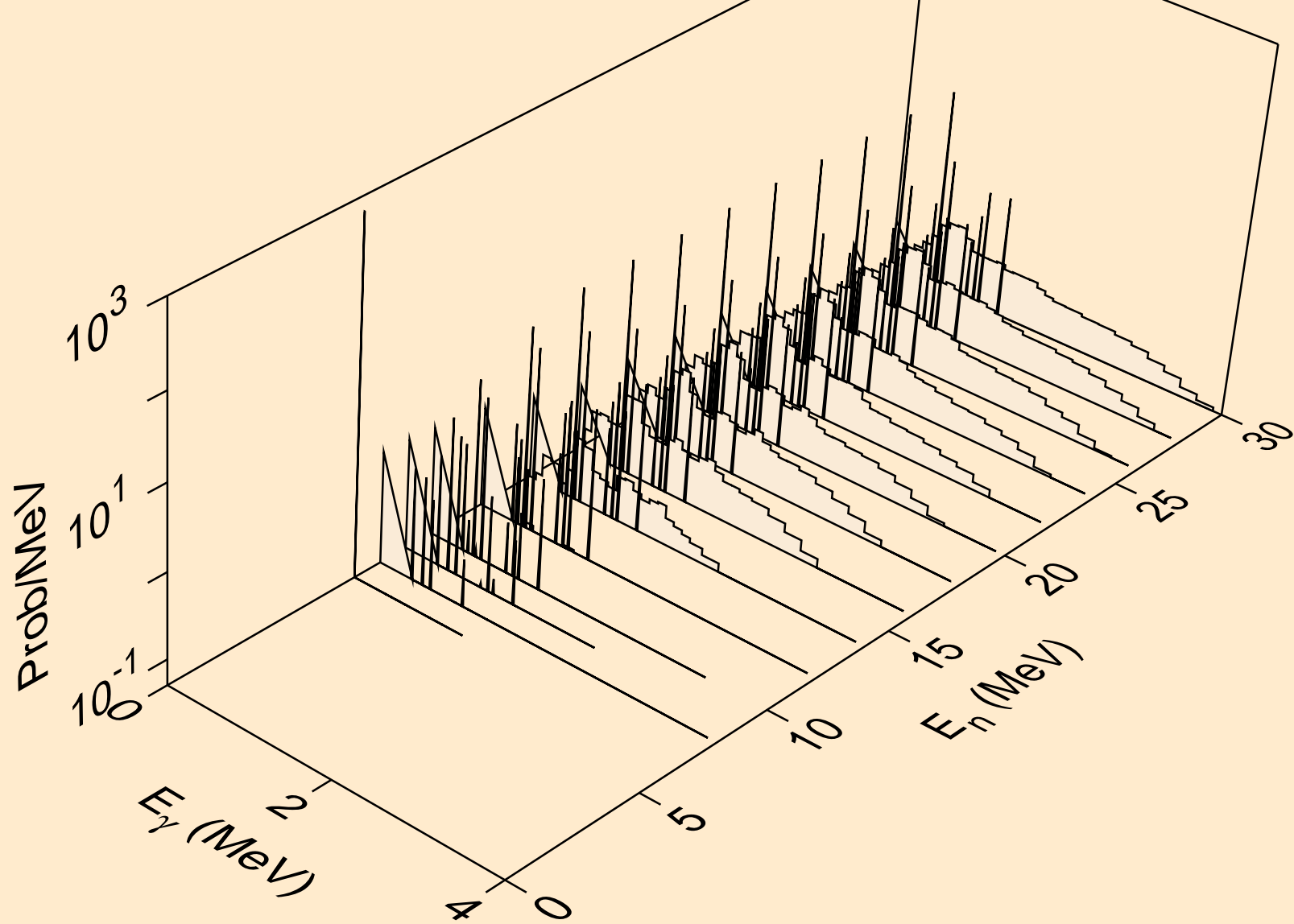

CS118M PROTON ACER TENDL-2021 LIBRARY; T=0.K  
Photon emission for (n,a)

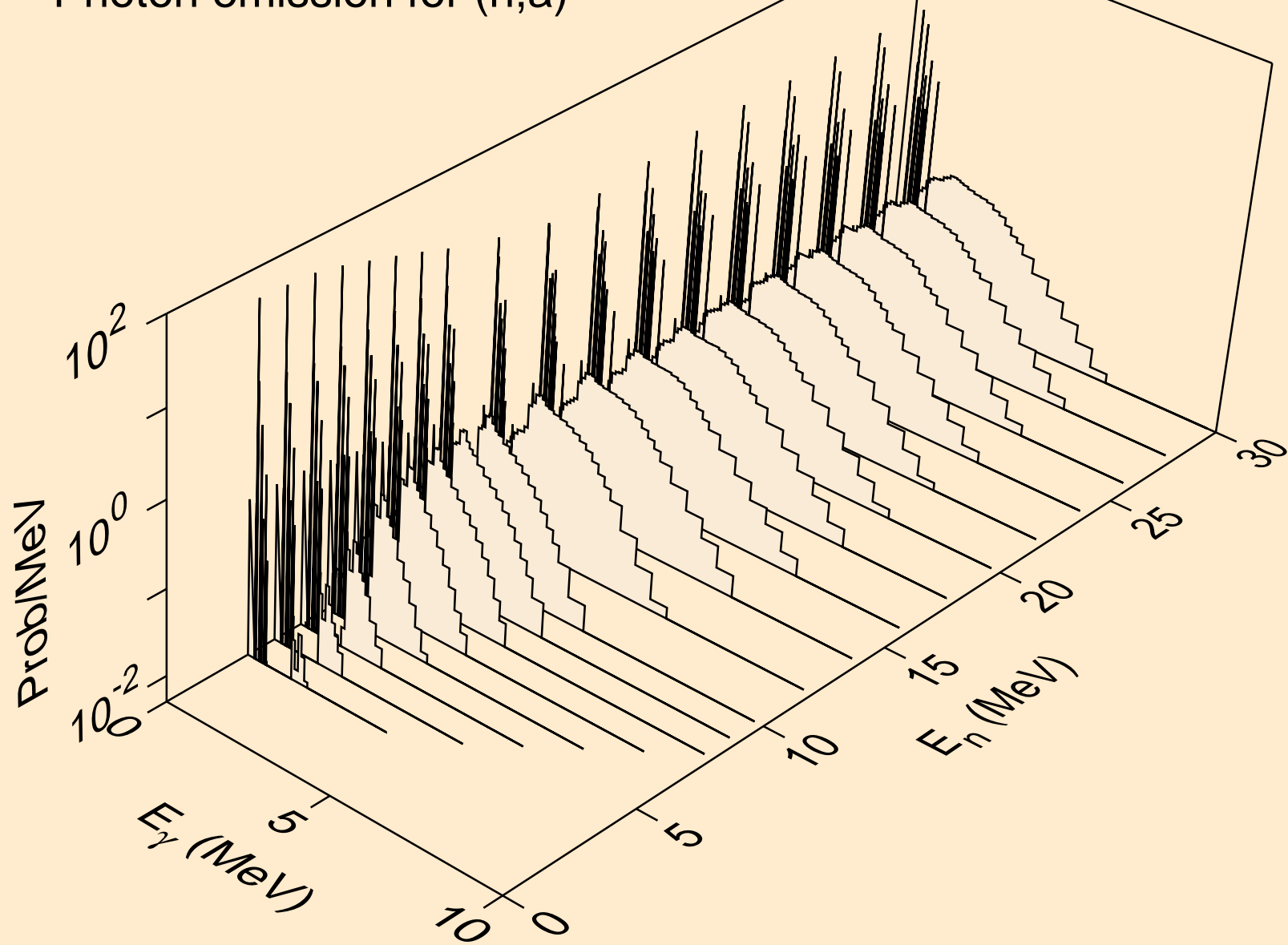

CS118M PROTON ACER TENDL-2021 LIBRARY; T=0.K  
Photon emission for (n,2a)

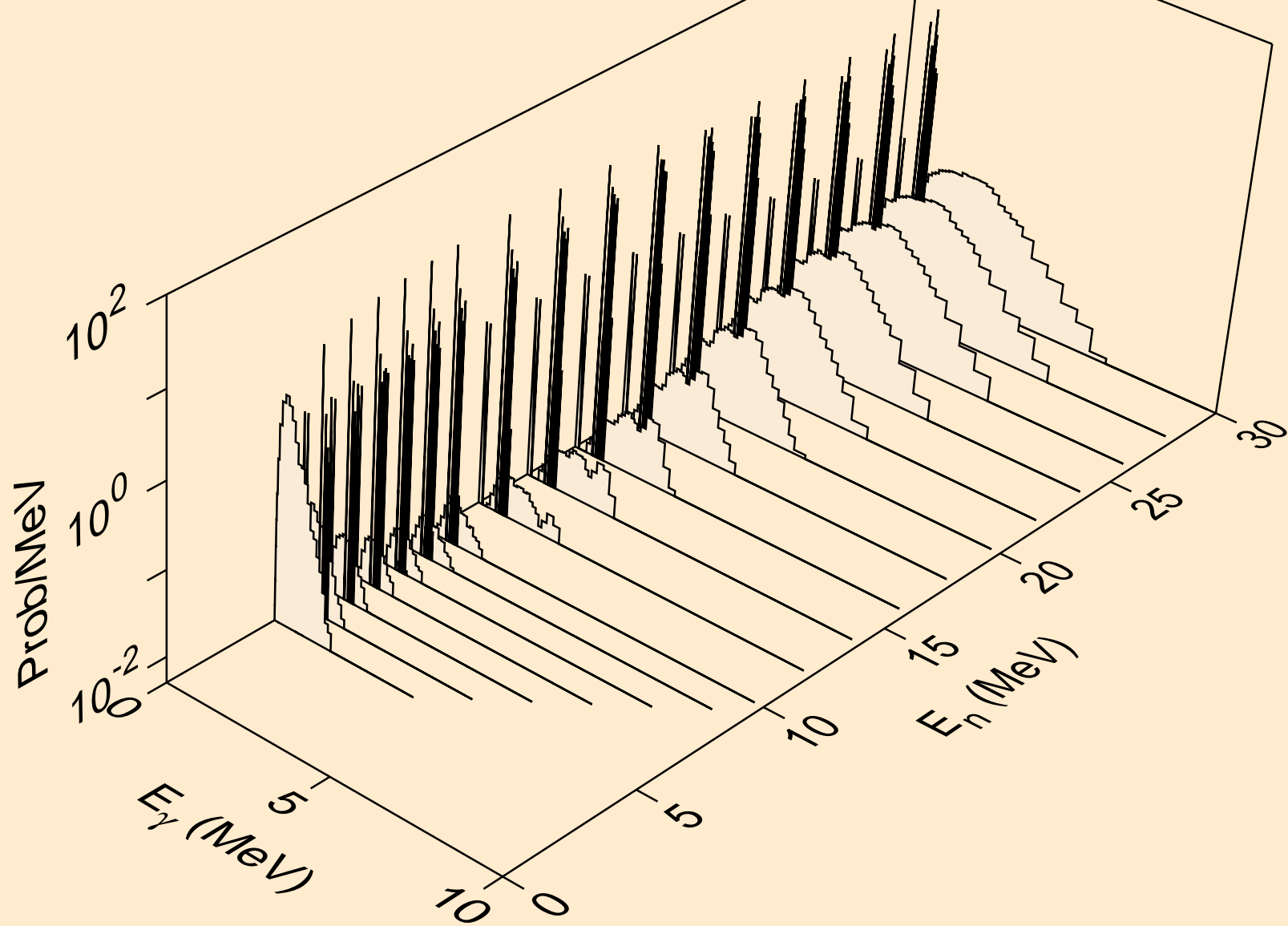

CS118M PROTON ACER TENDL-2021 LIBRARY; T=0.K  
Photon emission for (n,3a)

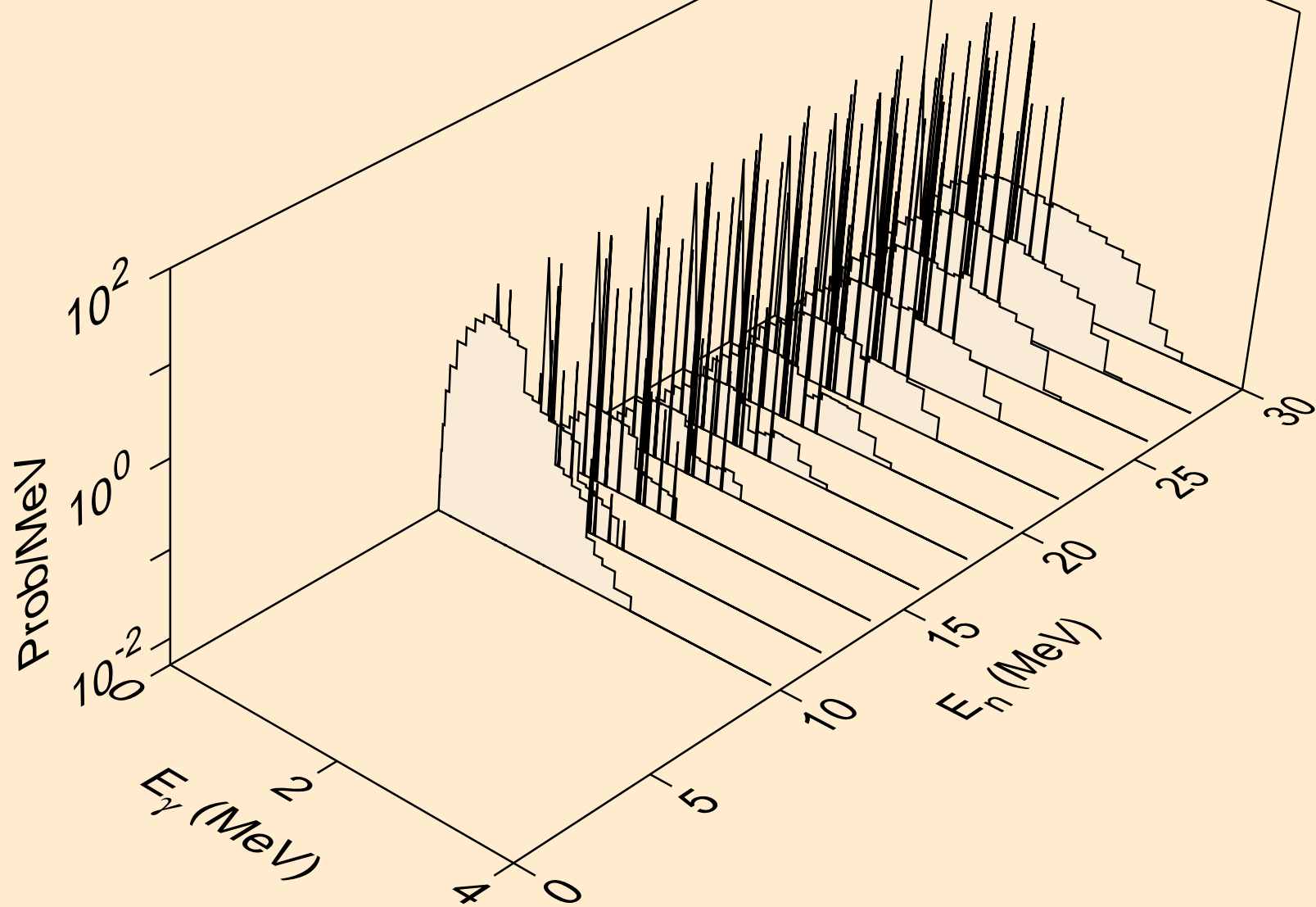

CS118M PROTON ACER TENDL-2021 LIBRARY; T=0.K  
Photon emission for (n,2p)

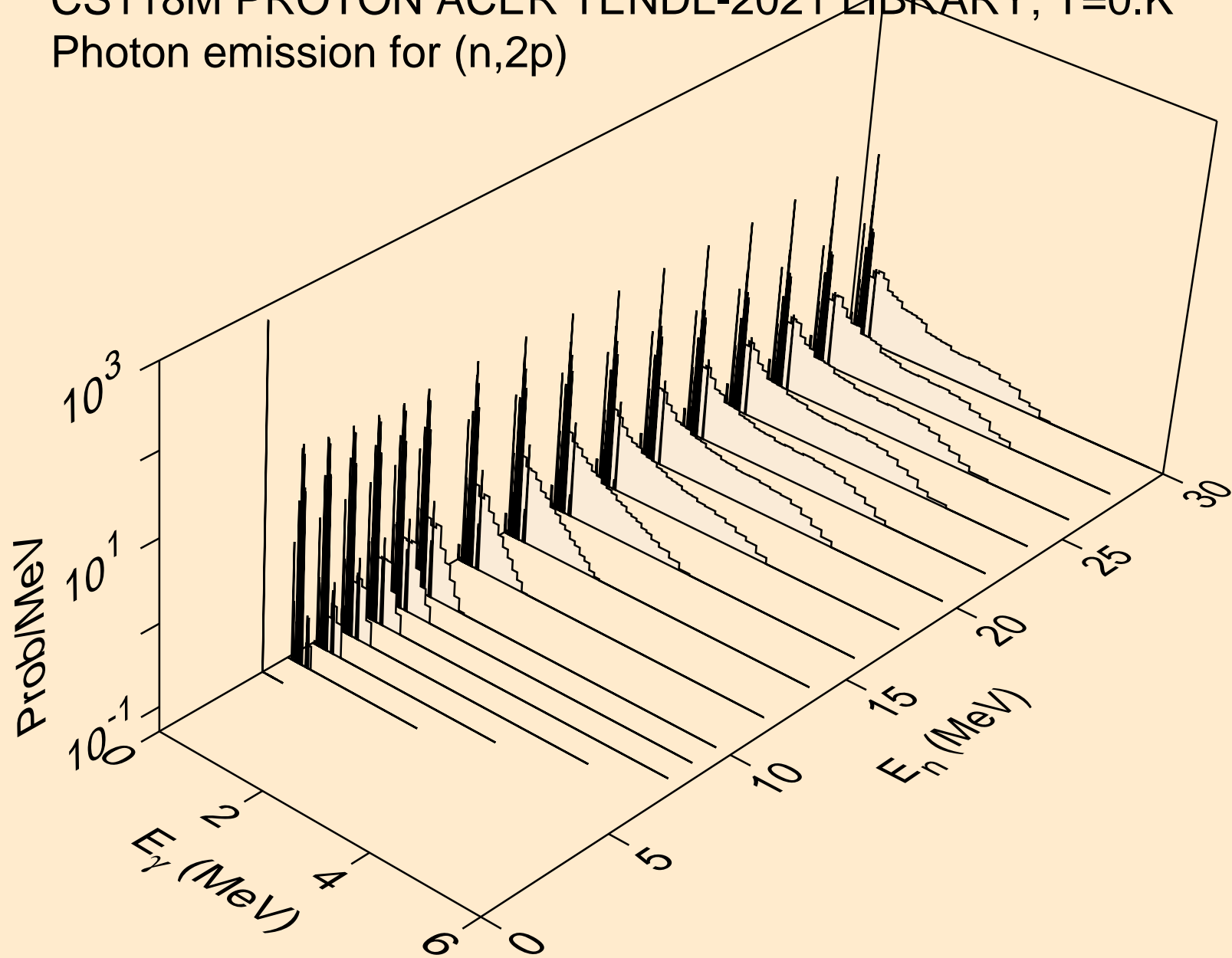



CS118M PROTON ACER TENDL-2021 LIBRARY; T=0.K  
Photon emission for (n,pa)

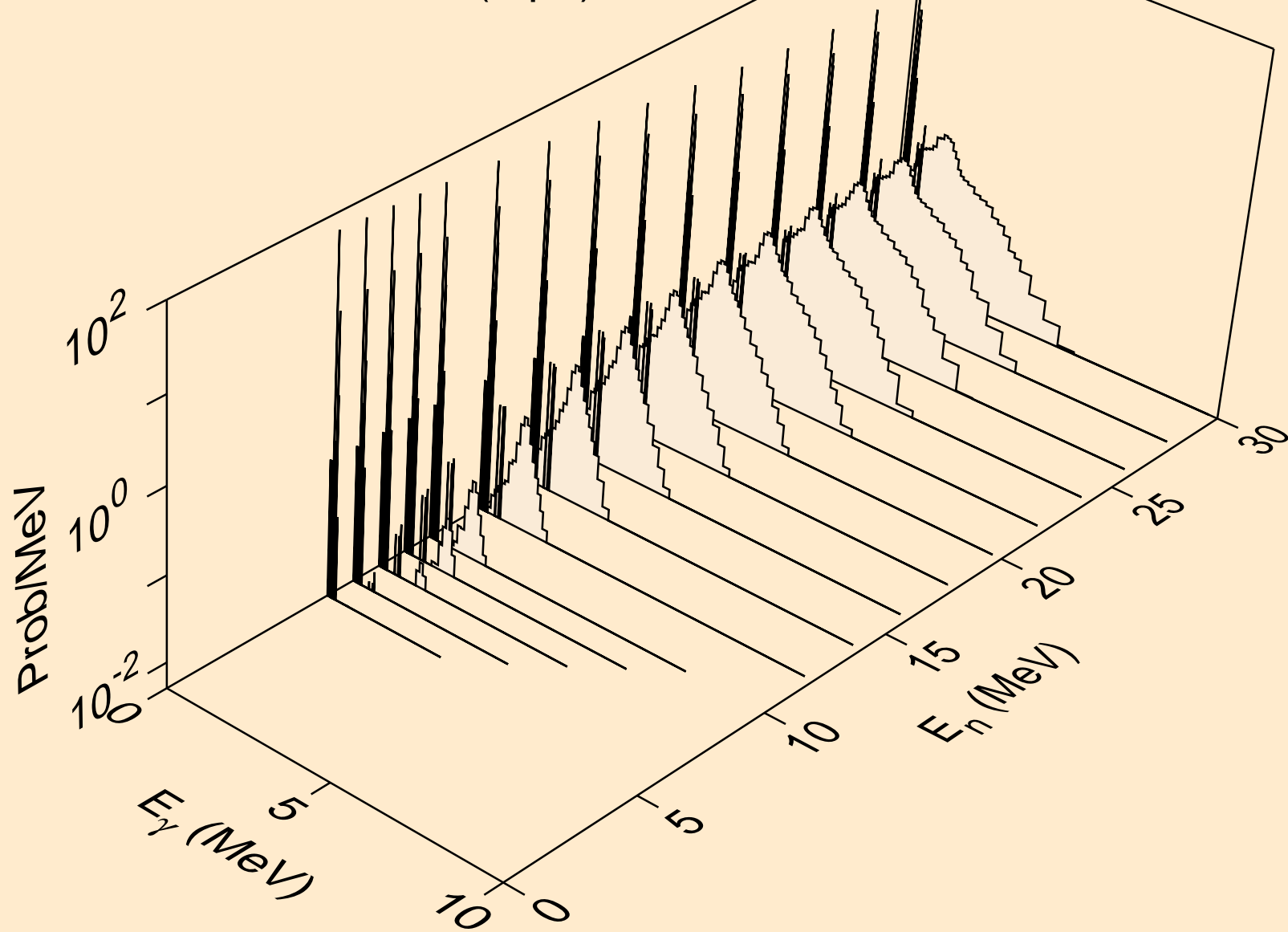

CS118M PROTON ACER TENDL-2021 LIBRARY; T=0.K  
Photon emission for (n,pd)

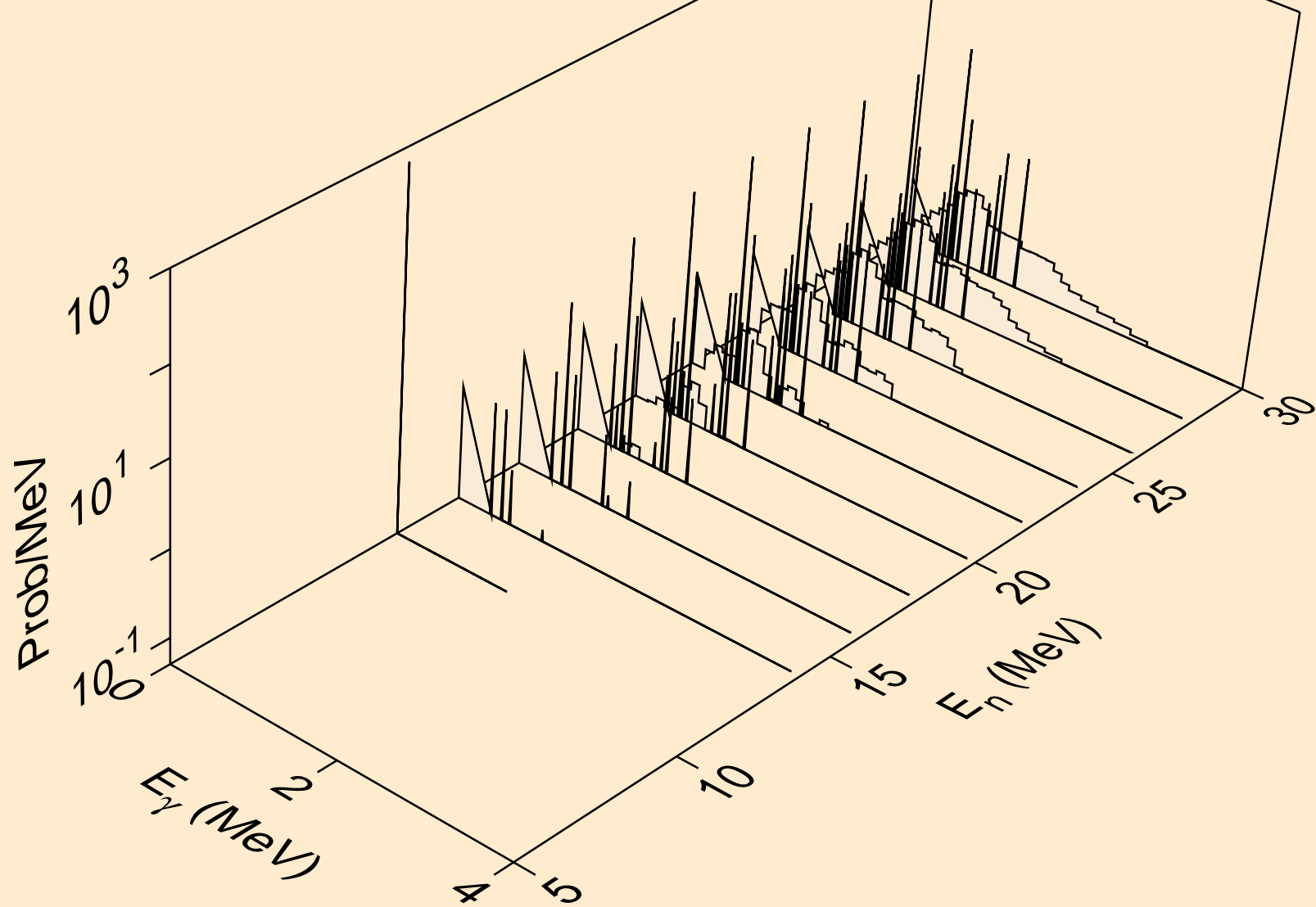

CS118M PROTON ACER TENDL-2021 LIBRARY; T=0.K  
Photon emission for (n,pt)

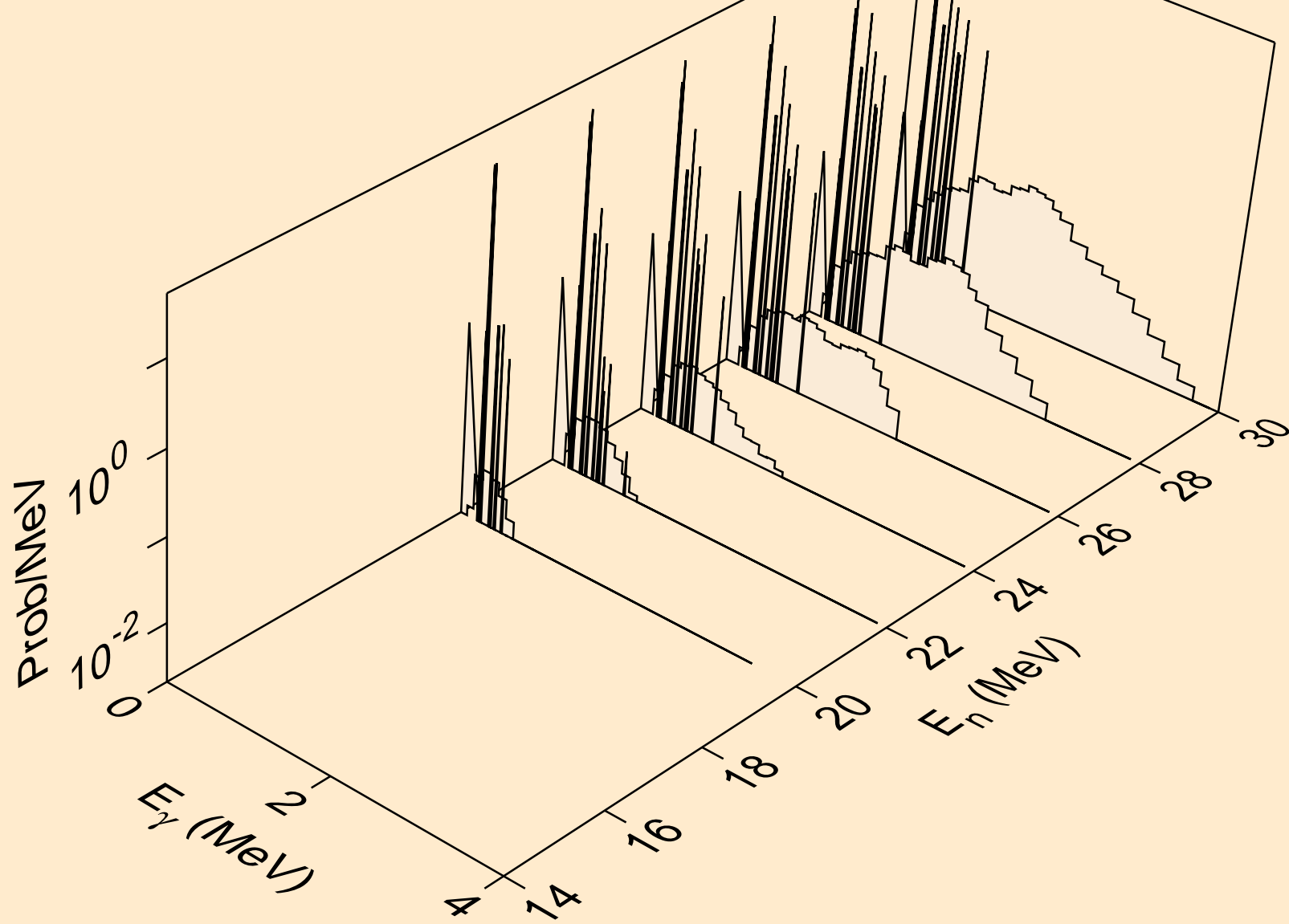

CS118M PROTON ACER TENDL-2021 LIBRARY; T=0.K  
Photon emission for (n,da)

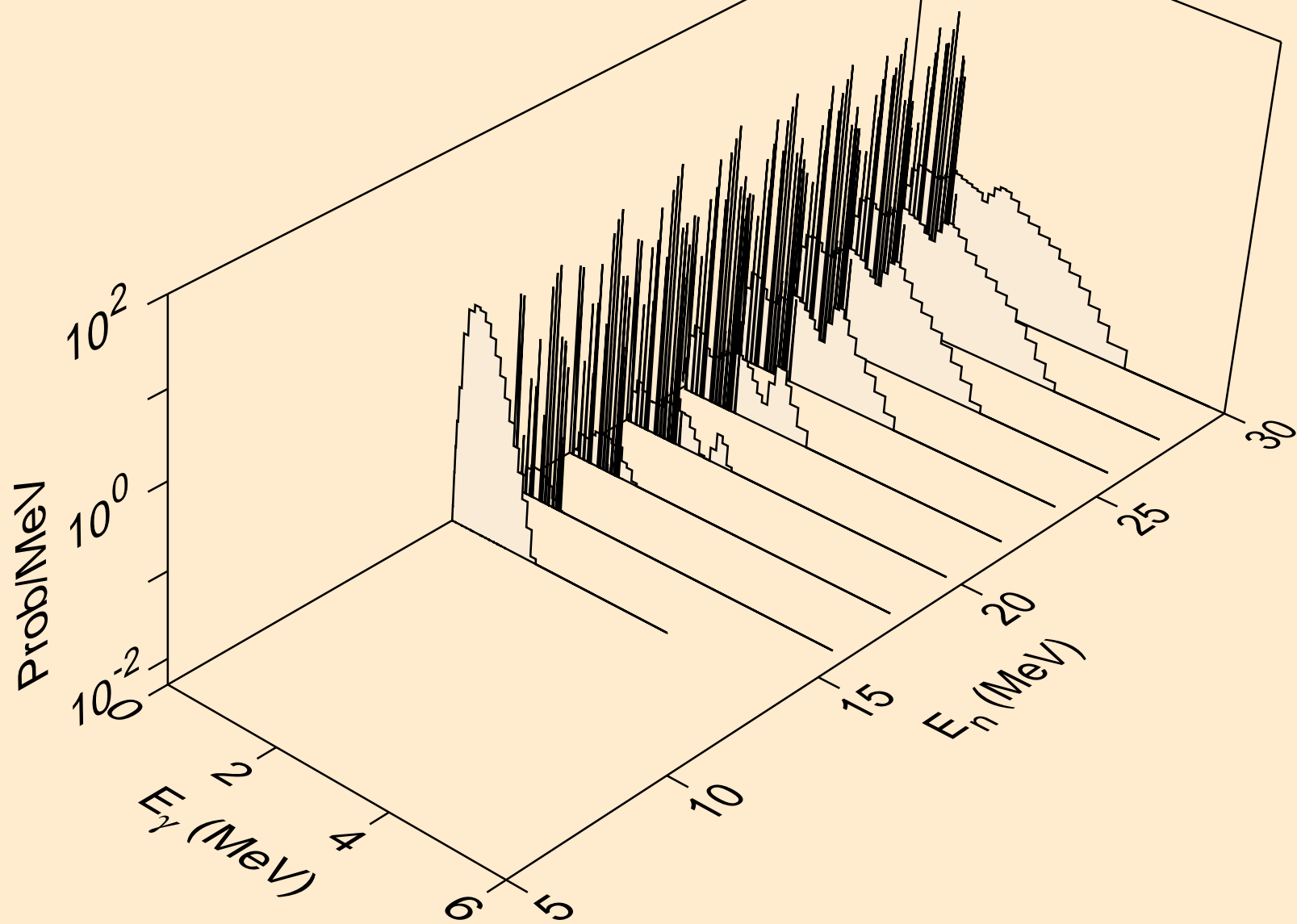

CS118M PROTON ACER TENDL-2021 LIBRARY; T=0.K  
Particle heating contributions

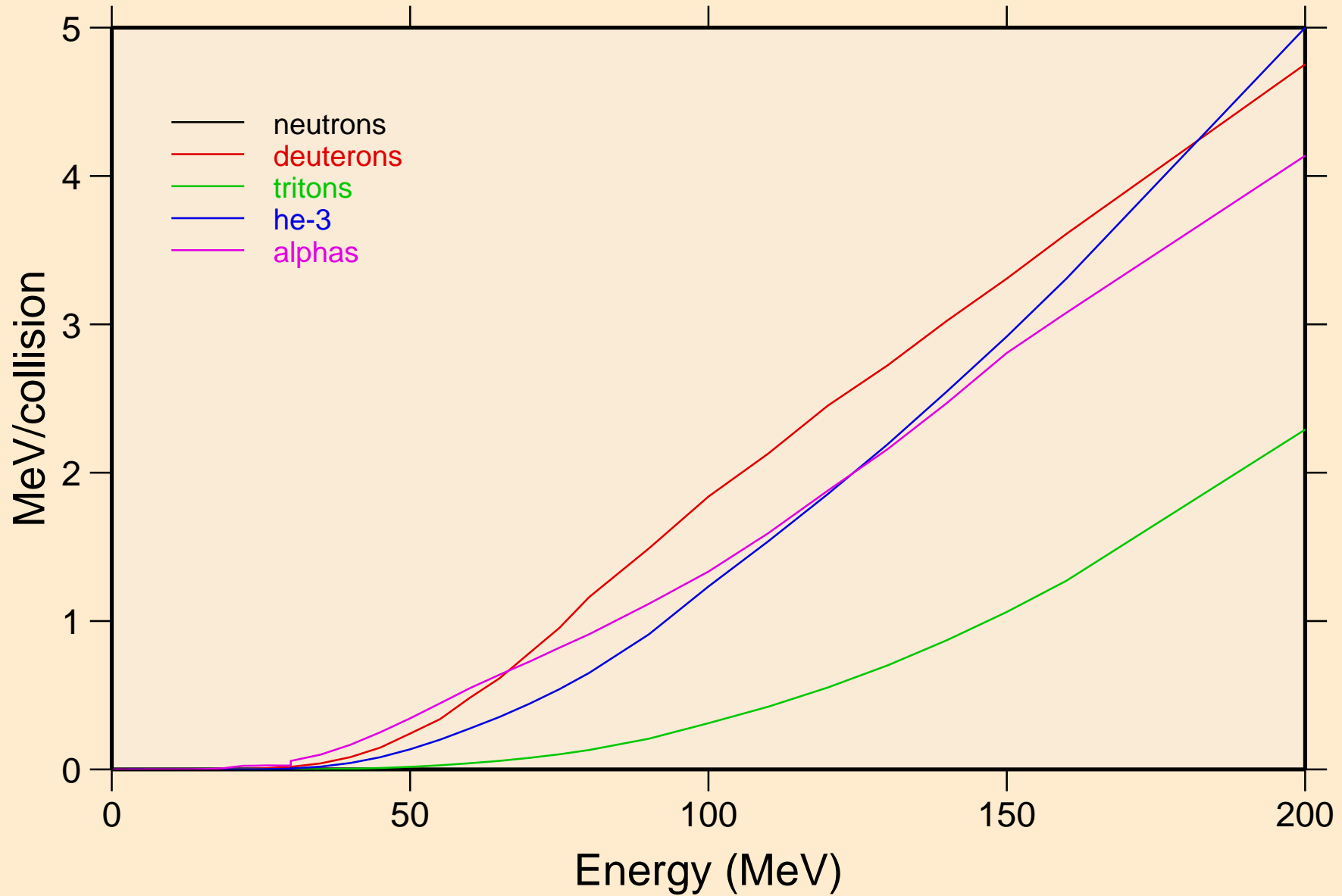

CS118M PROTON ACER TENDL-2021 LIBRARY; T=0.K  
Recoil Heating

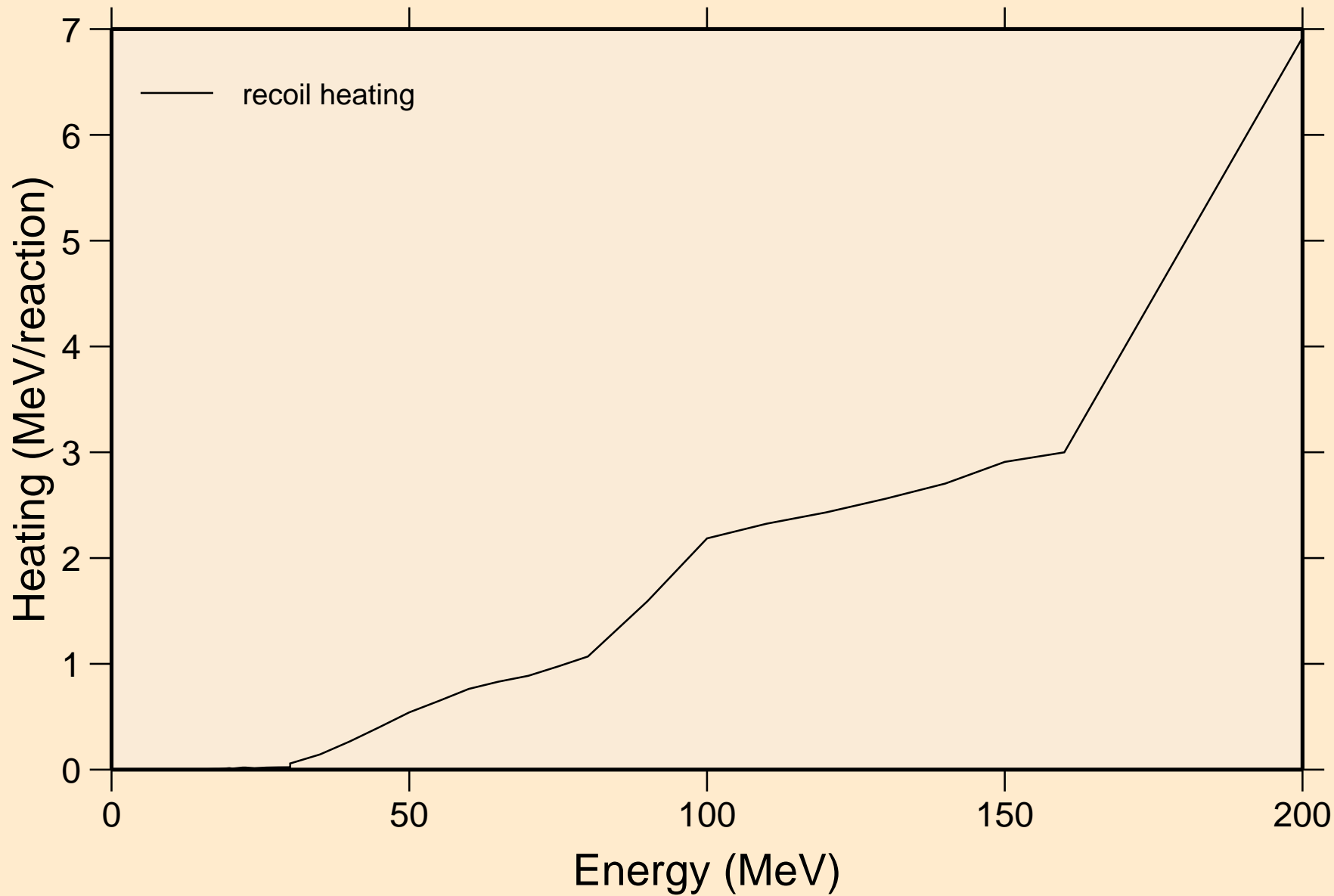

# CS118M PROTON ACER TENDL-2021 LIBRARY; T=0.K

## Particle production cross sections

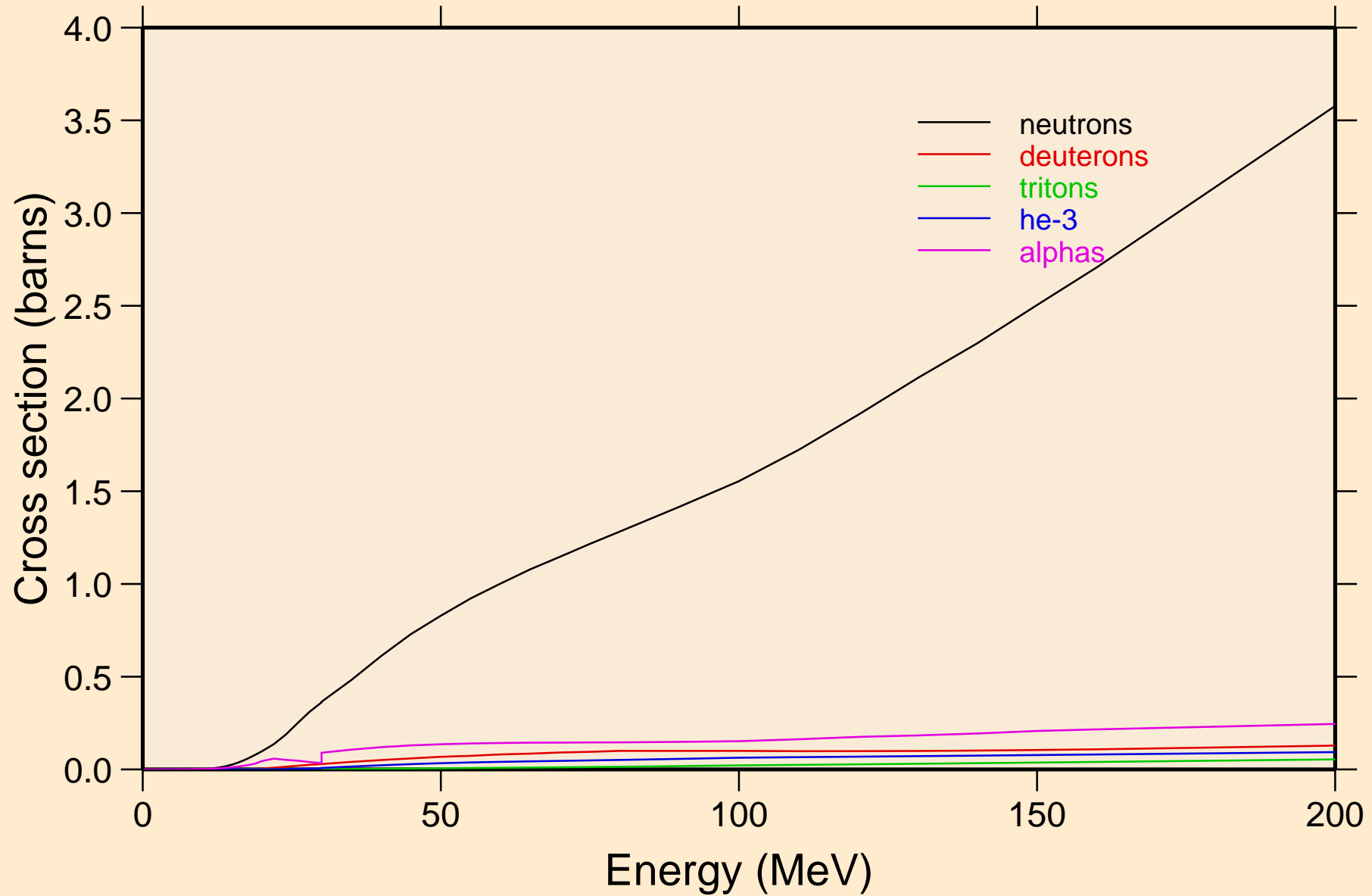

CS118M PROTON ACER TENDL-2021 LIBRARY; T=0.K  
neutrons from (p,n)

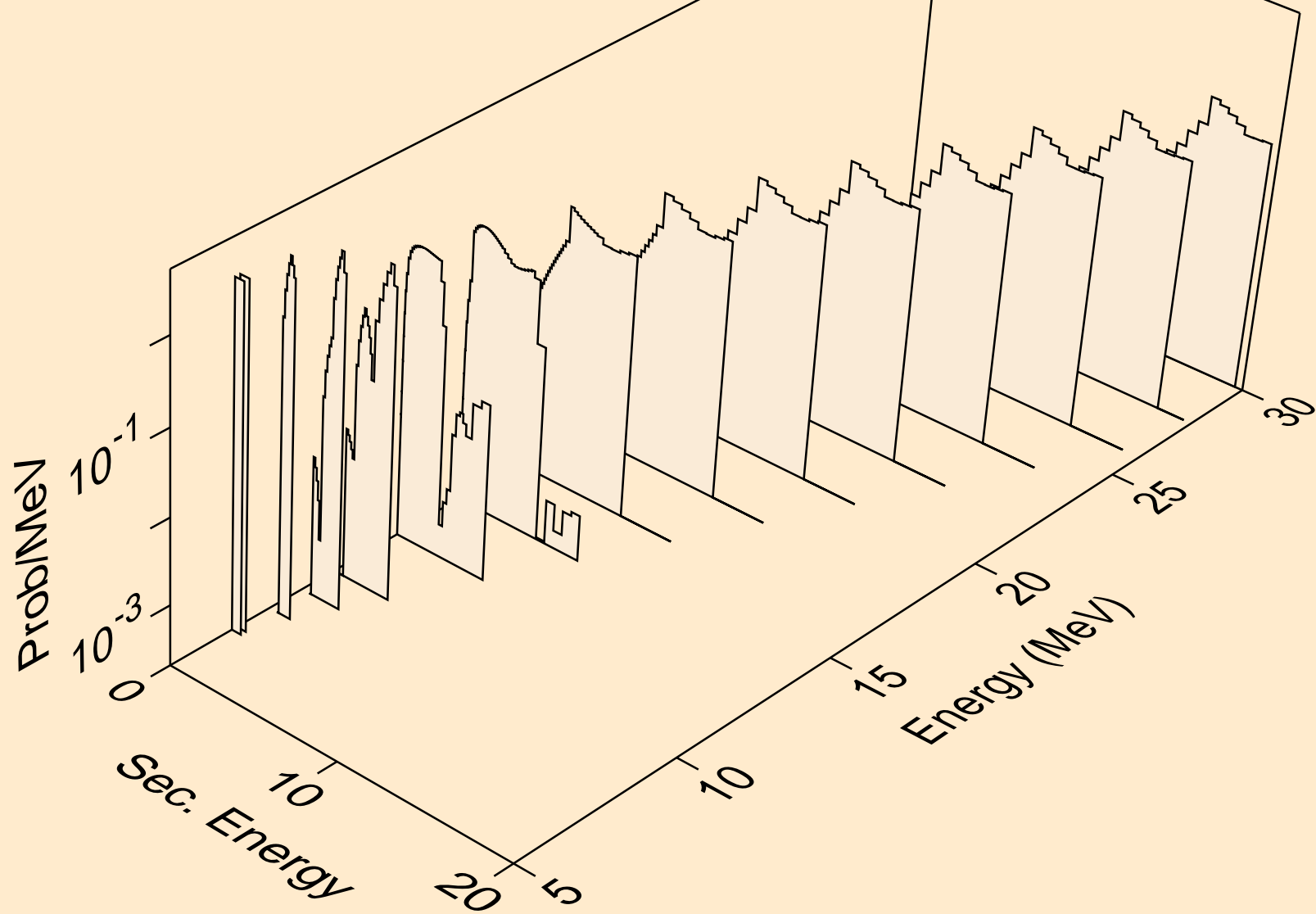



CS118M PROTON ACER TENDL-2021 LIBRARY; T=0.K  
neutrons from (p,x)

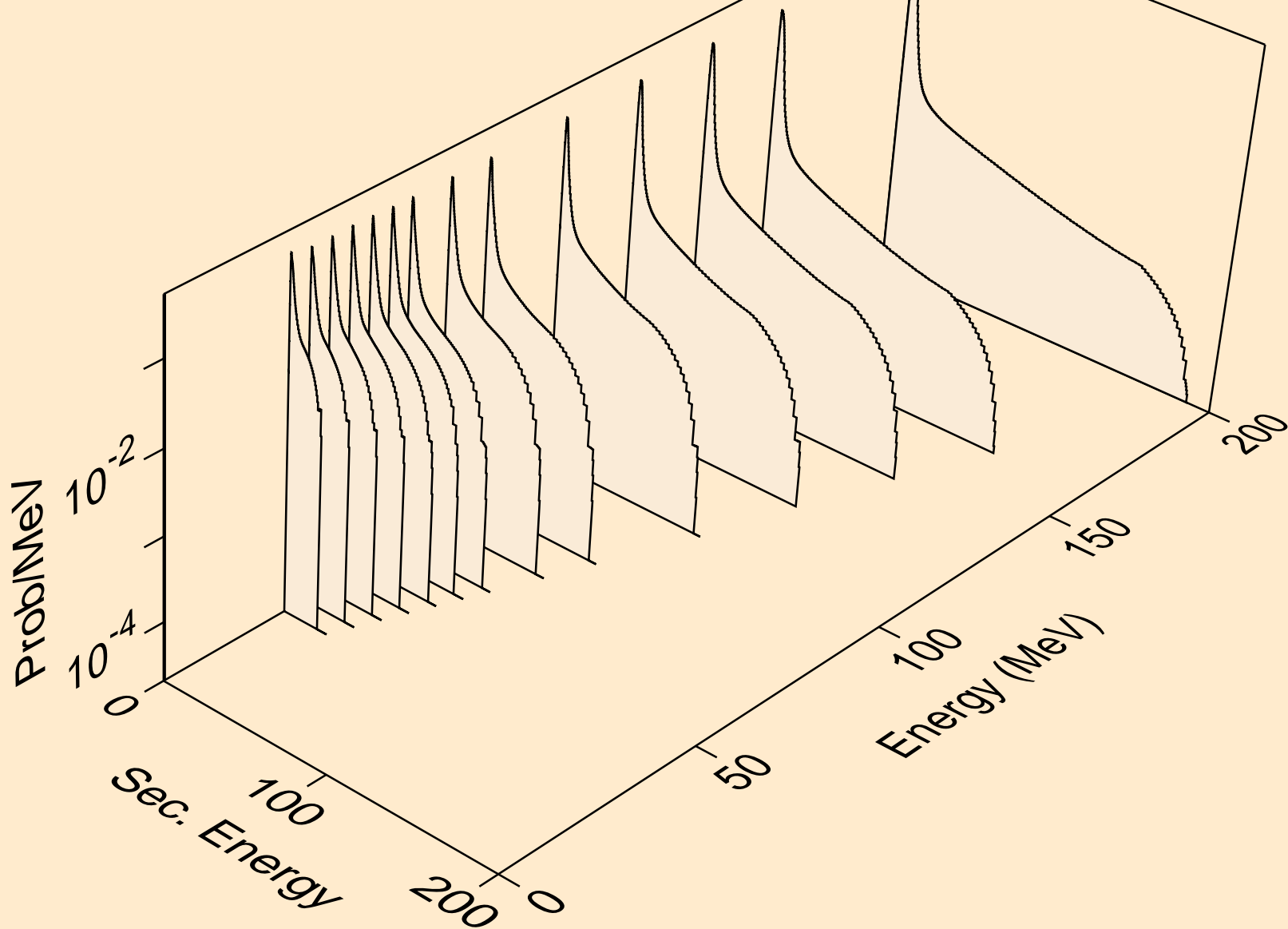

CS118M PROTON ACER TENDL-2021 LIBRARY; T=0.K  
neutrons from (p,2n)

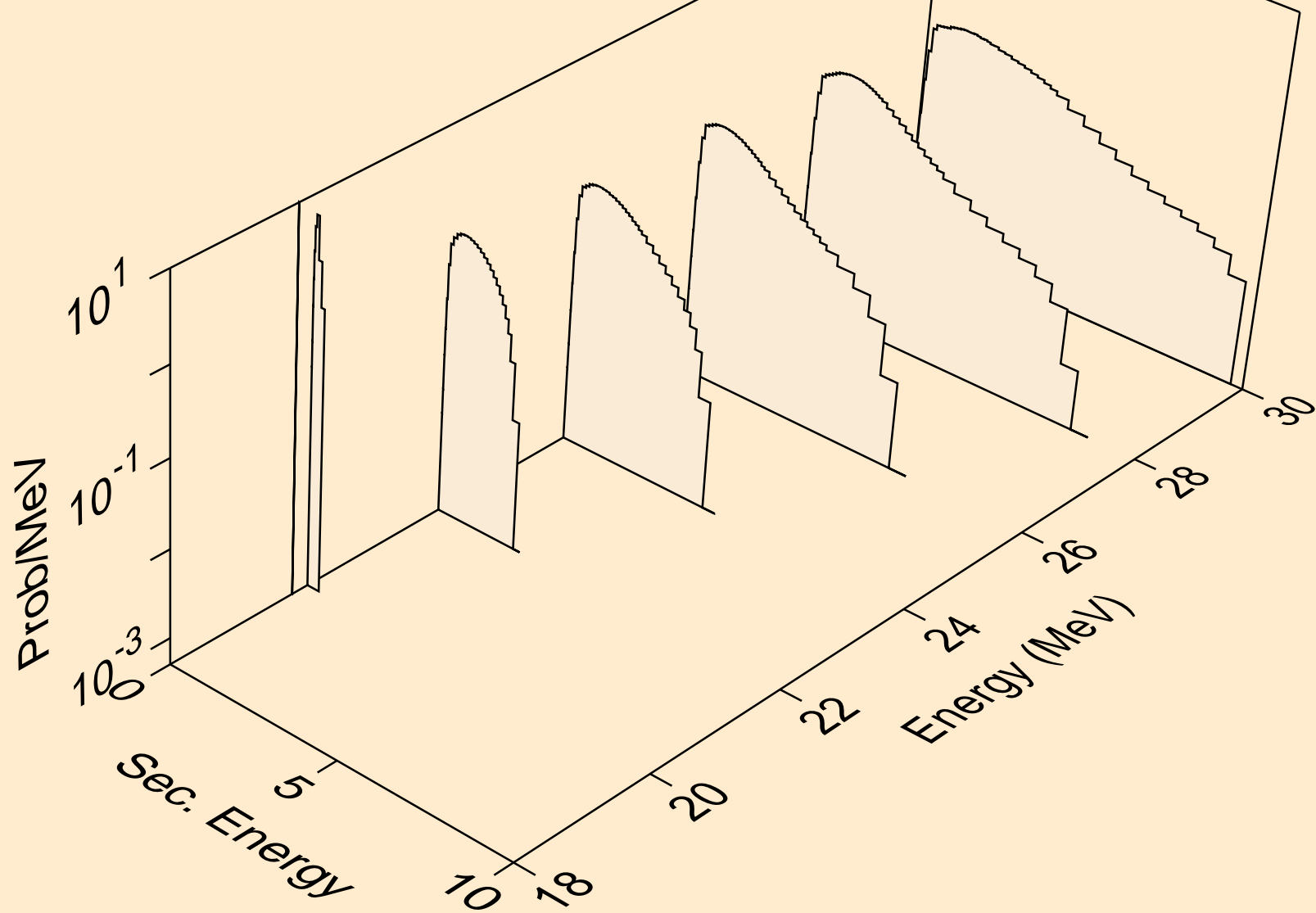

CS118M PROTON ACER TENDL-2021 LIBRARY; T=0.K  
neutrons from (p,n\*)a

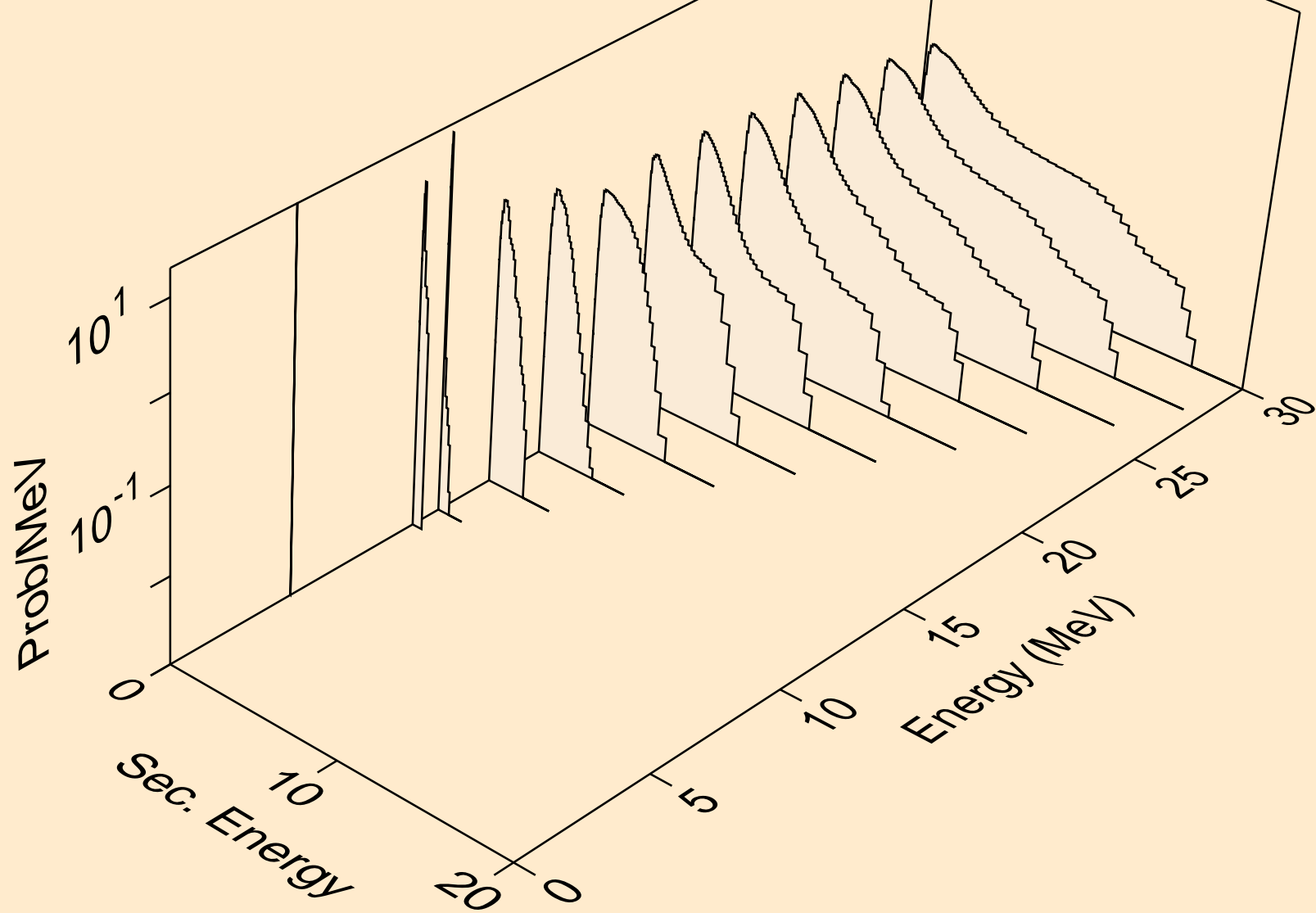

CS118M PROTON ACER TENDL-2021 LIBRARY; T=0.K  
neutrons from (p,2n)a

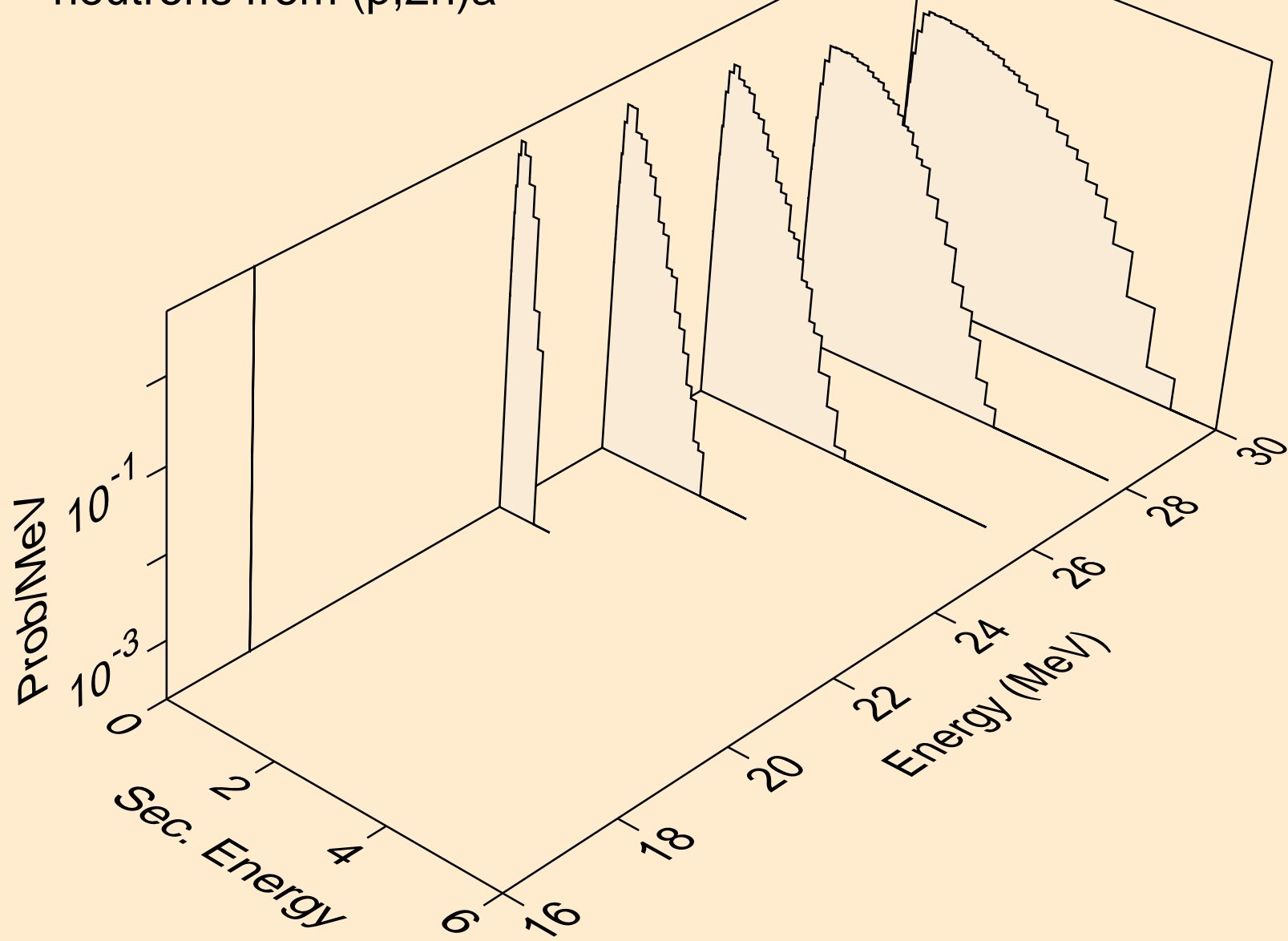

CS118M PROTON ACER TENDL-2021 LIBRARY; T=0.K  
neutrons from (p,n\*)p

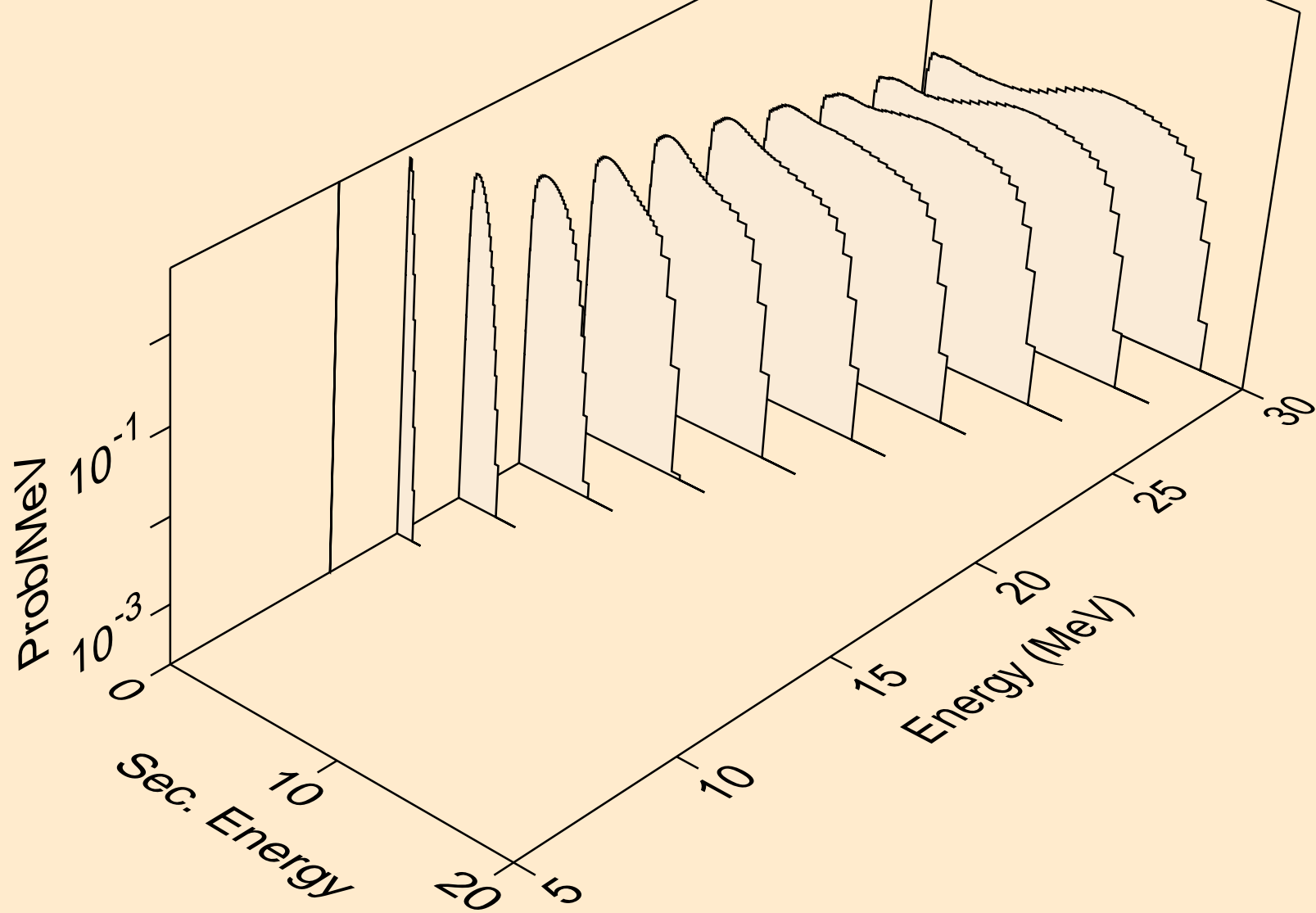

CS118M PROTON ACER TENDL-2021 LIBRARY; T=0.K  
neutrons from (p,n\*)2a

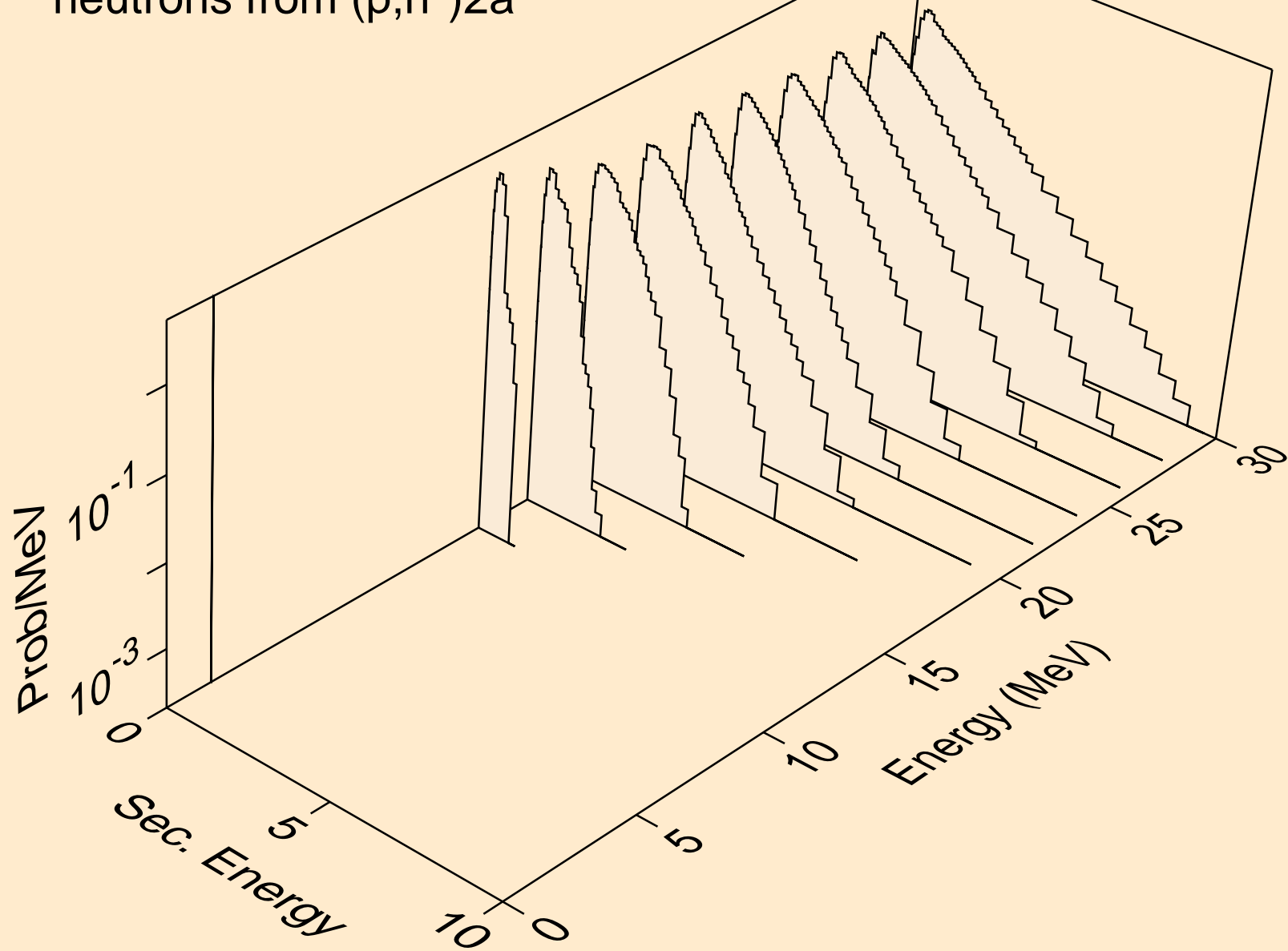

CS118M PROTON ACER TENDL-2021 LIBRARY; T=0.K  
neutrons from (p,n\*)d

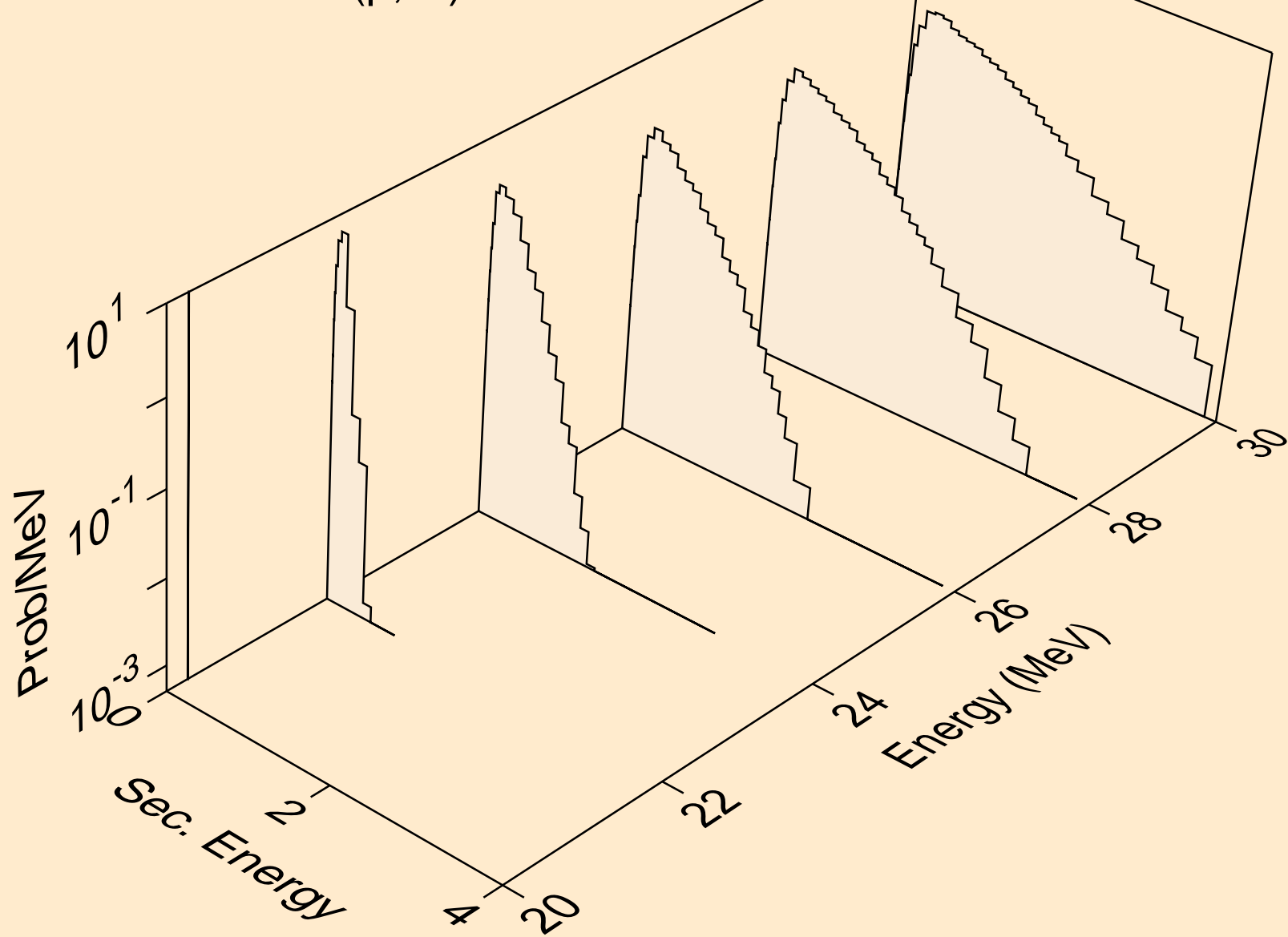

CS118M PROTON ACER TENDL-2021 LIBRARY; T=0.K  
neutrons from (p,n\*)he3

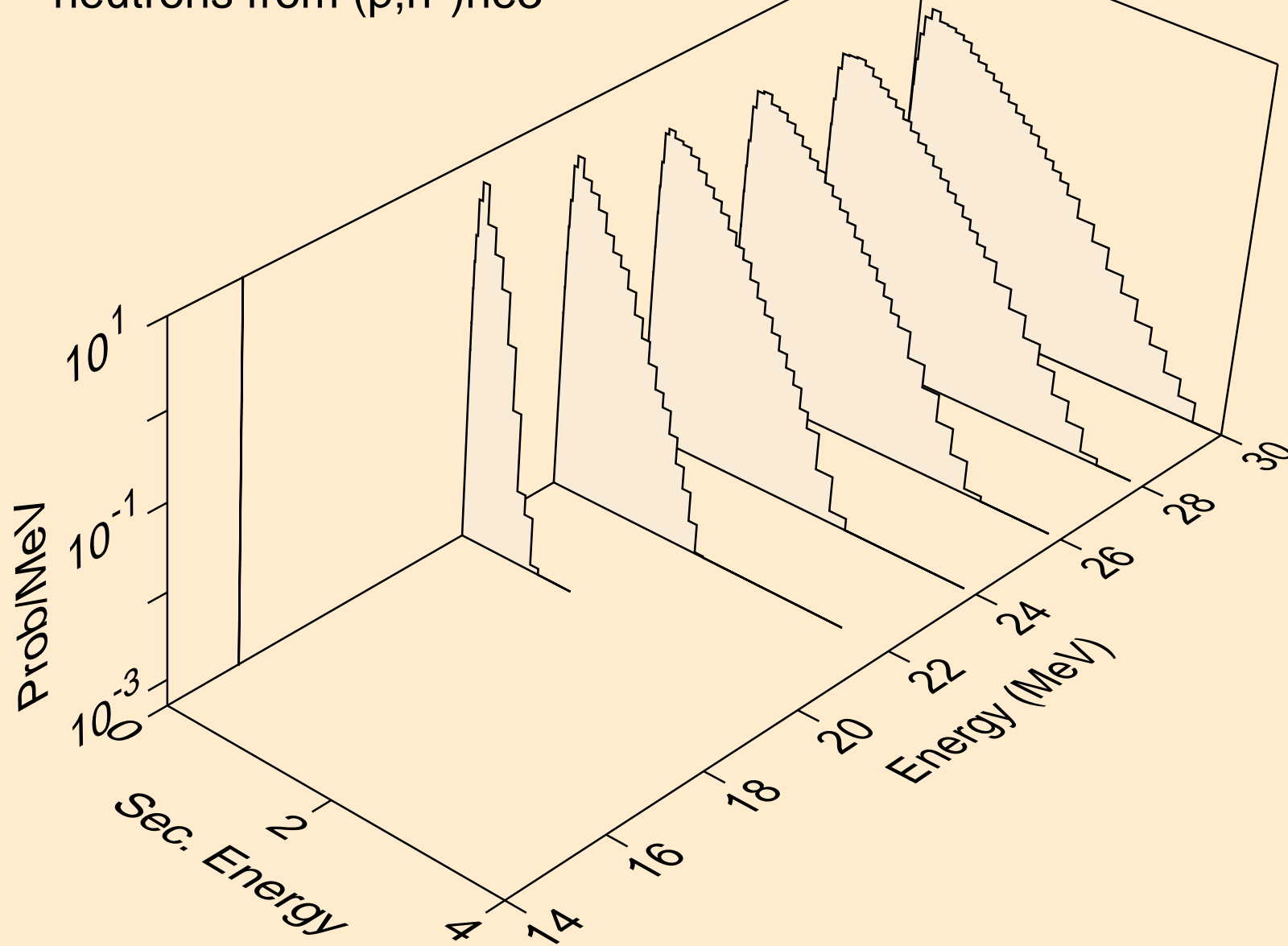



CS118M PROTON ACER TENDL-2021 LIBRARY; T=0.K  
neutrons from (p,2np)

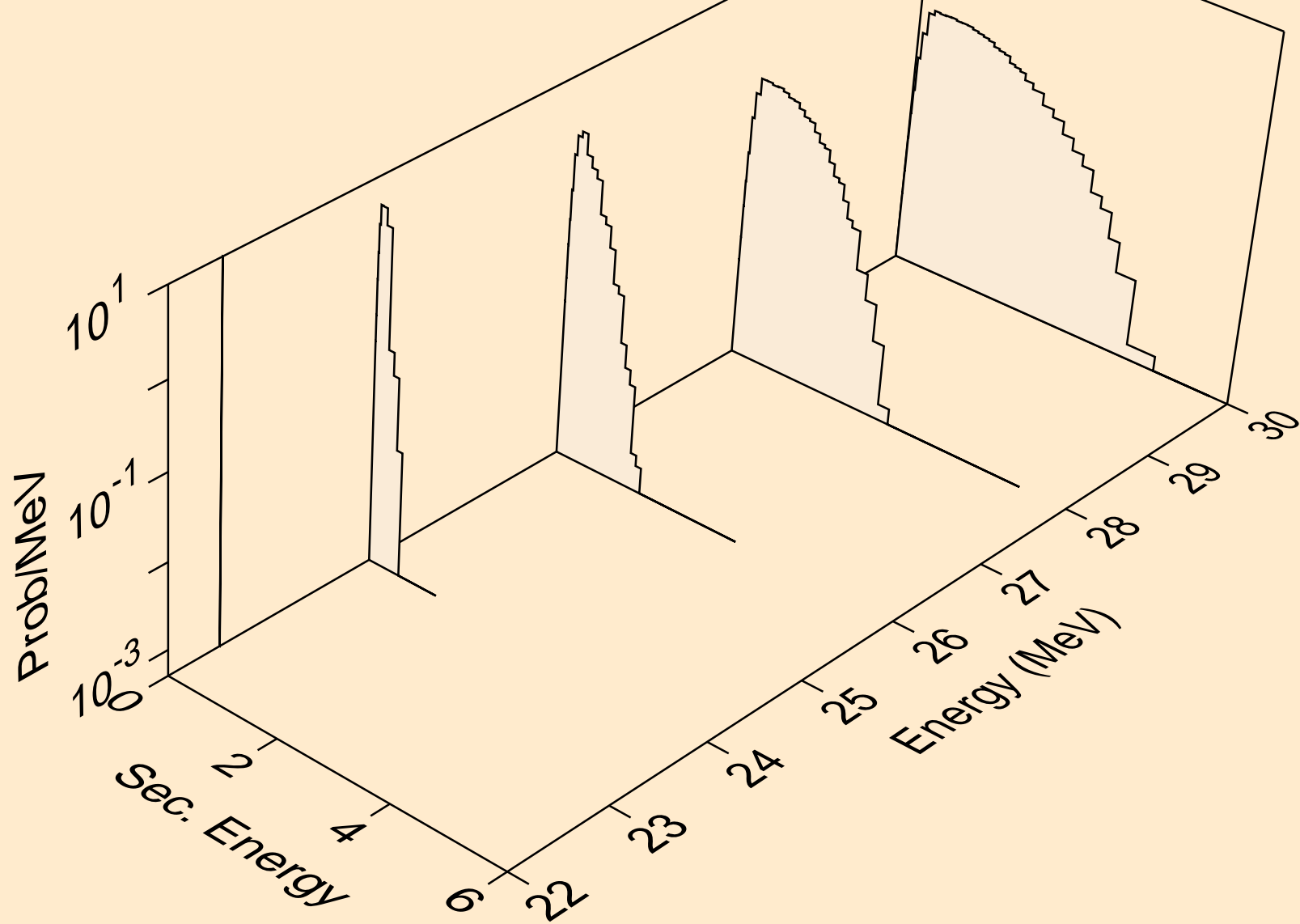

CS118M PROTON ACER TENDL-2021 LIBRARY; T=0.K  
neutrons from (p,2np)

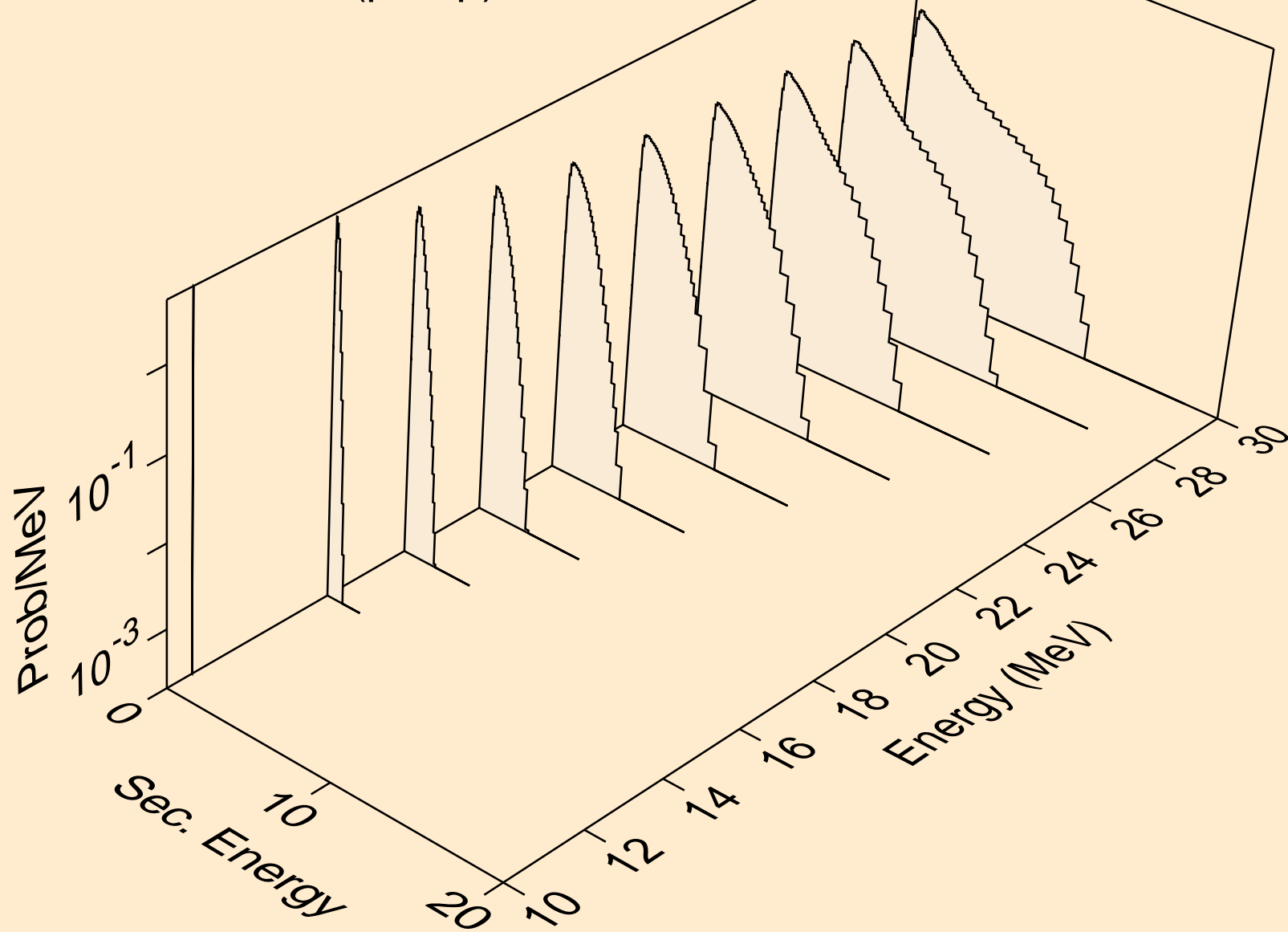

CS118M PROTON ACER TENDL-2021 LIBRARY; T=0.K  
neutrons from (p,npa)

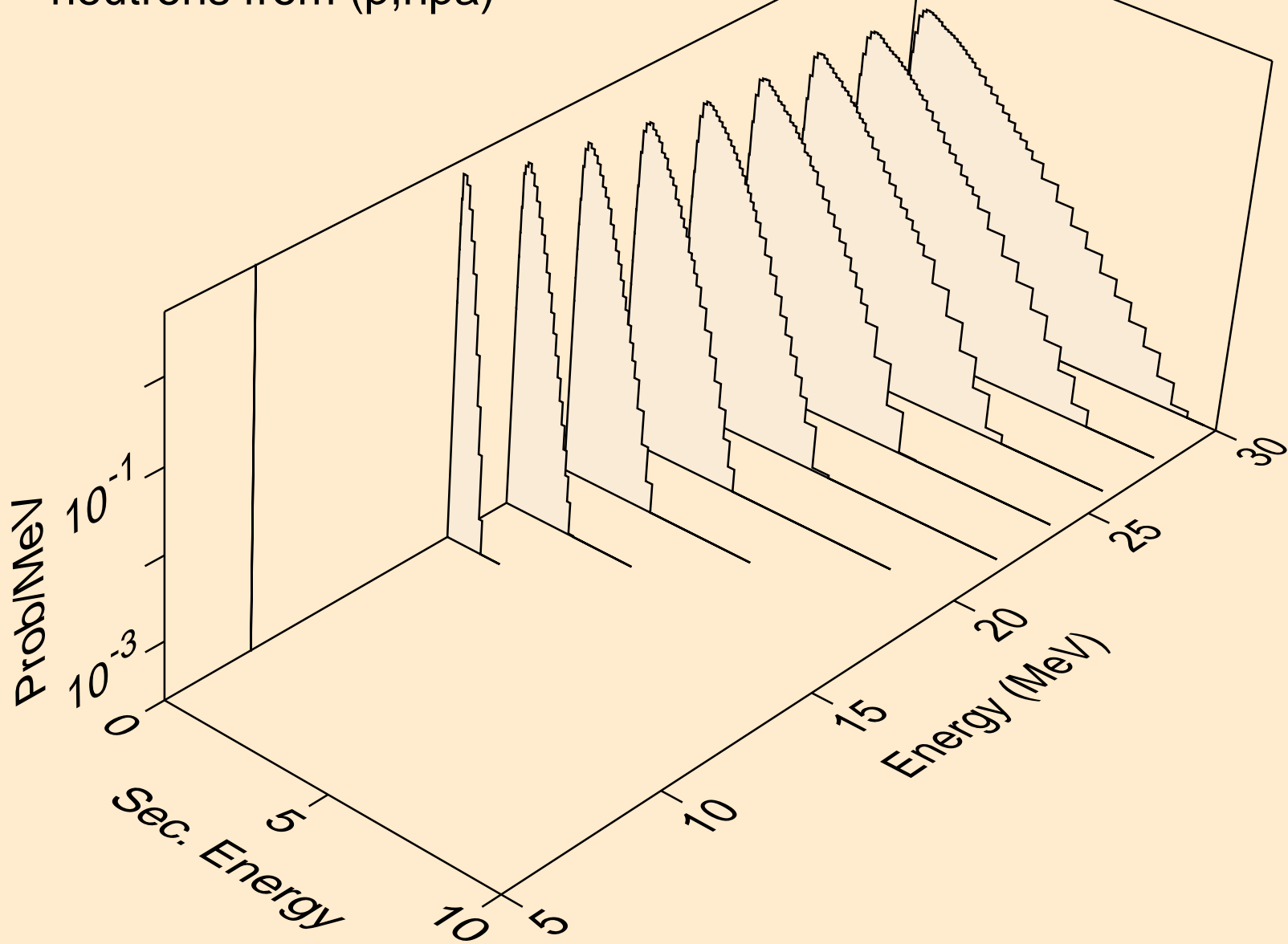

CS118M PROTON ACER TENDL-2021 LIBRARY; T=0.K  
deuterons from (p,x)

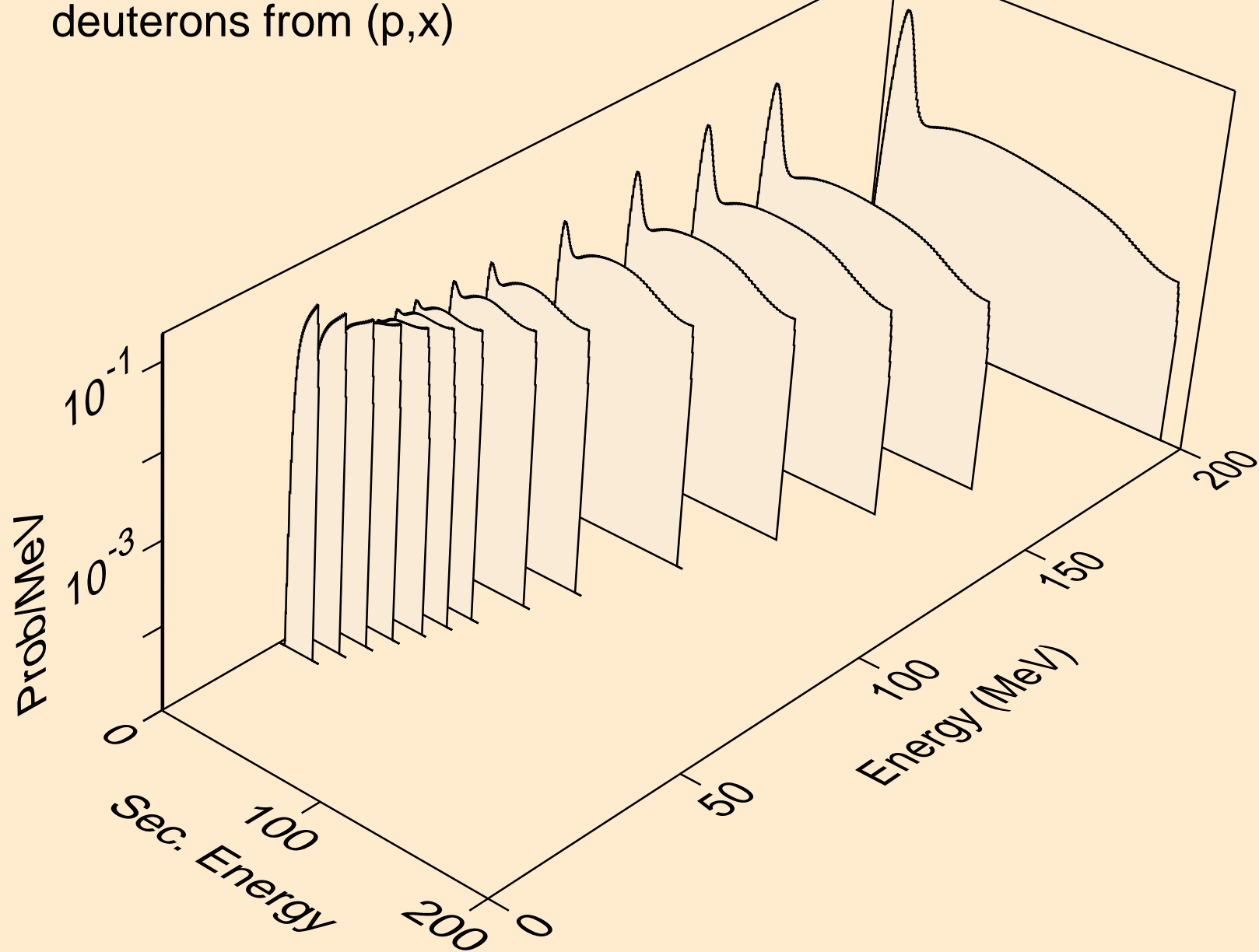

CS118M PROTON ACER TENDL-2021 LIBRARY; T=0.K  
deuterons from (p,n\*)d

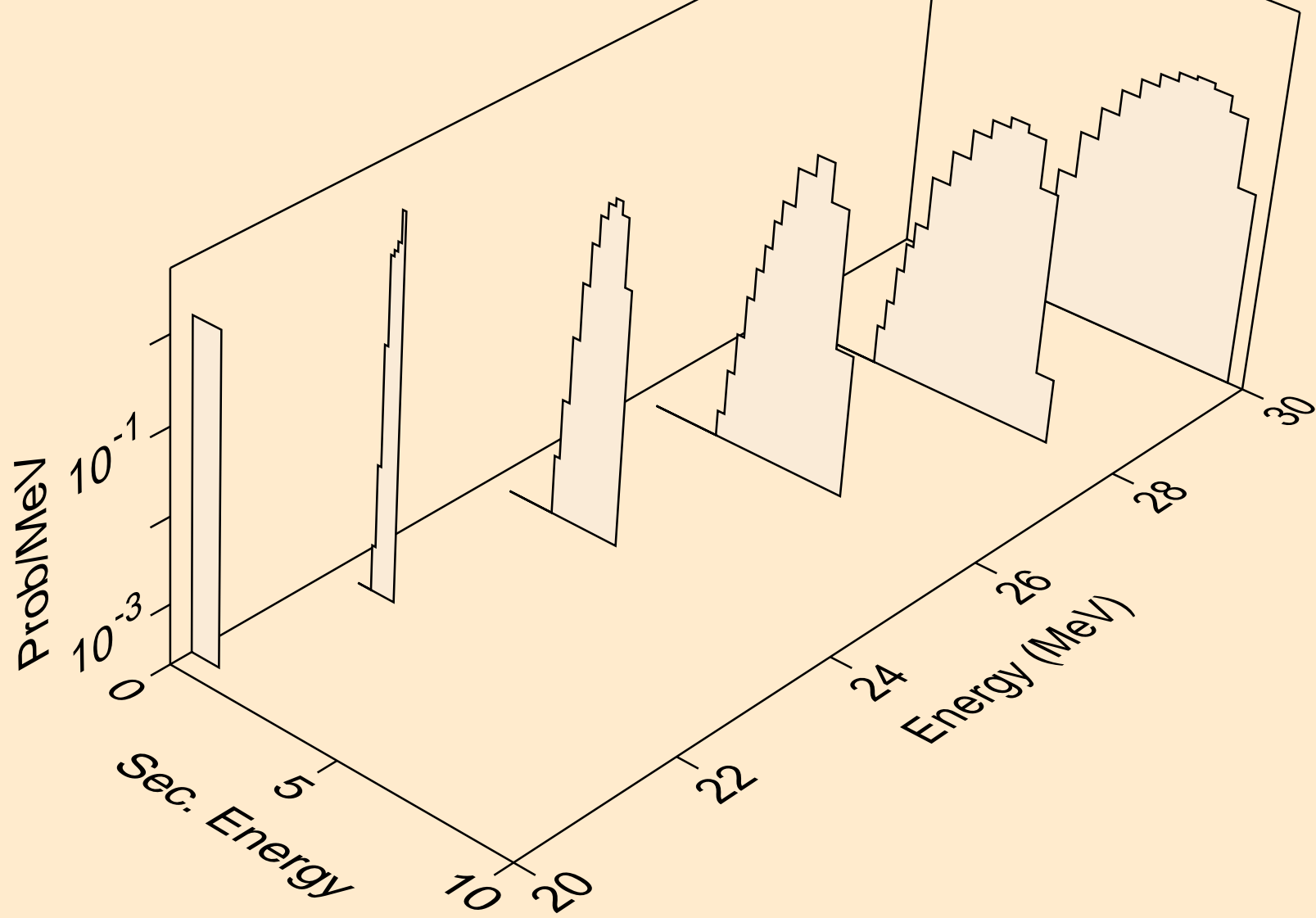

CS118M PROTON ACER TENDL-2021 LIBRARY; T=0.K  
deuterons from (p,d)

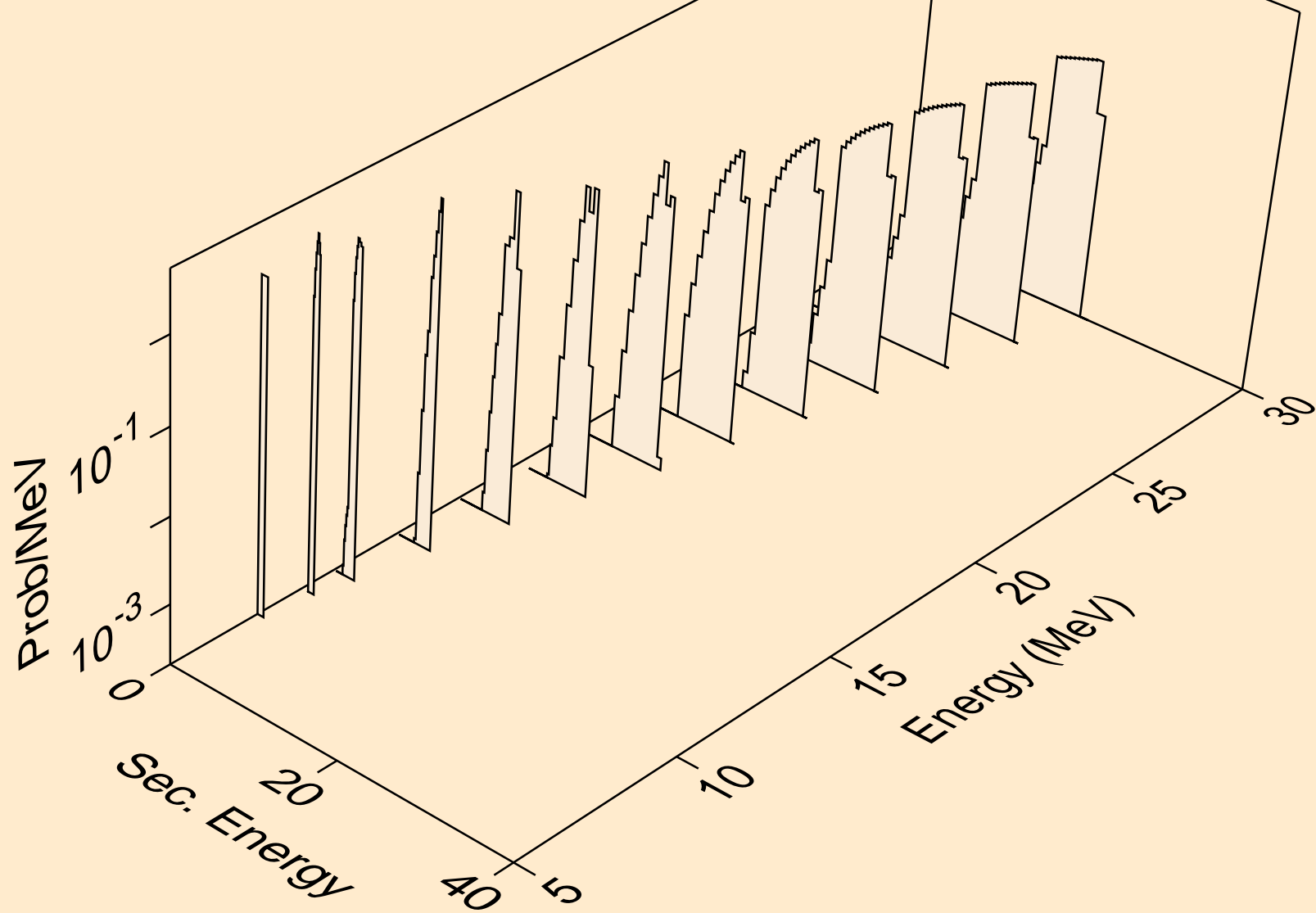

CS118M PROTON ACER TENDL-2021 LIBRARY; T=0.K  
deuterons from (p,pd)

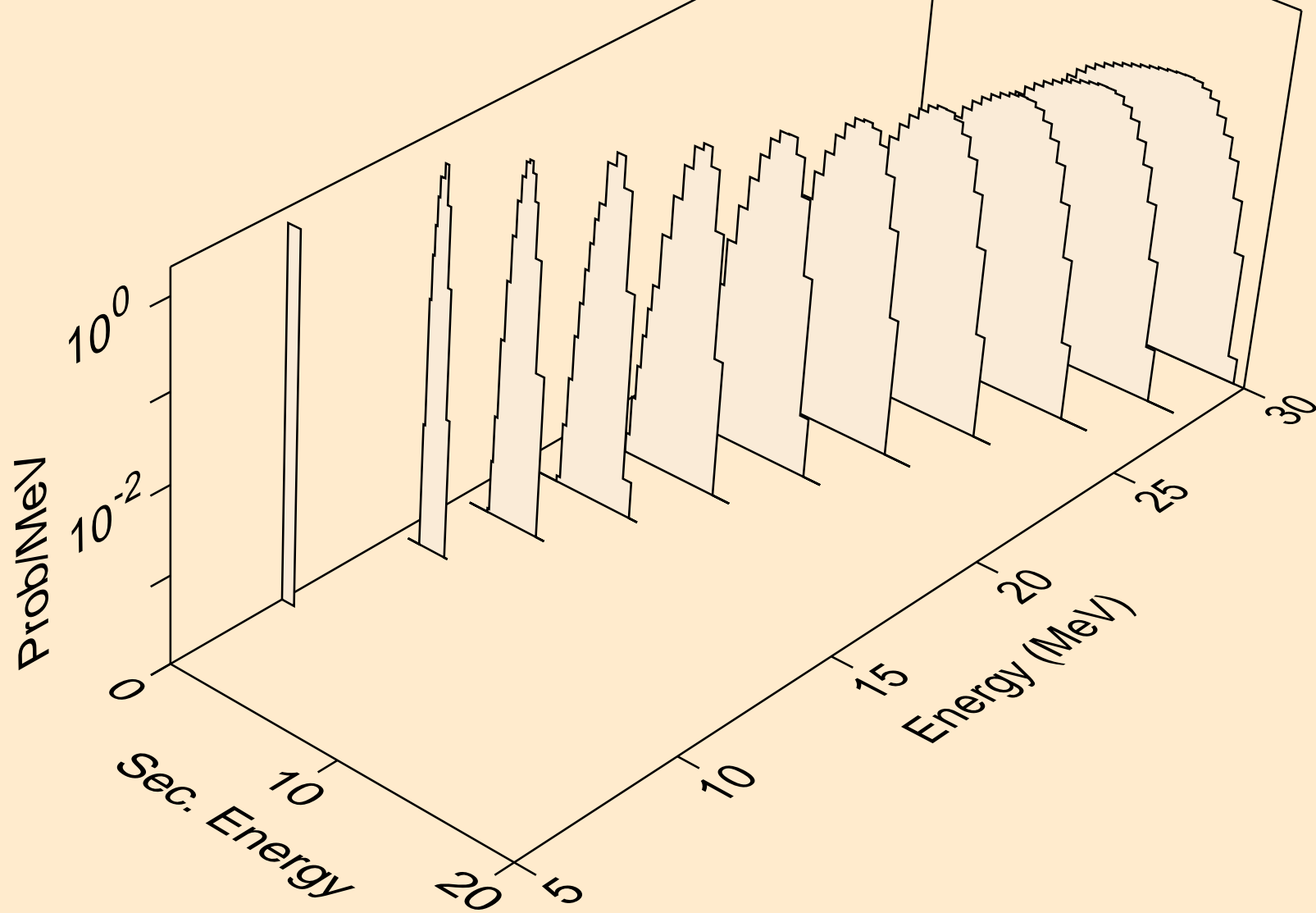

CS118M PROTON ACER TENDL-2021 LIBRARY; T=0.K  
deuterons from (p,da)

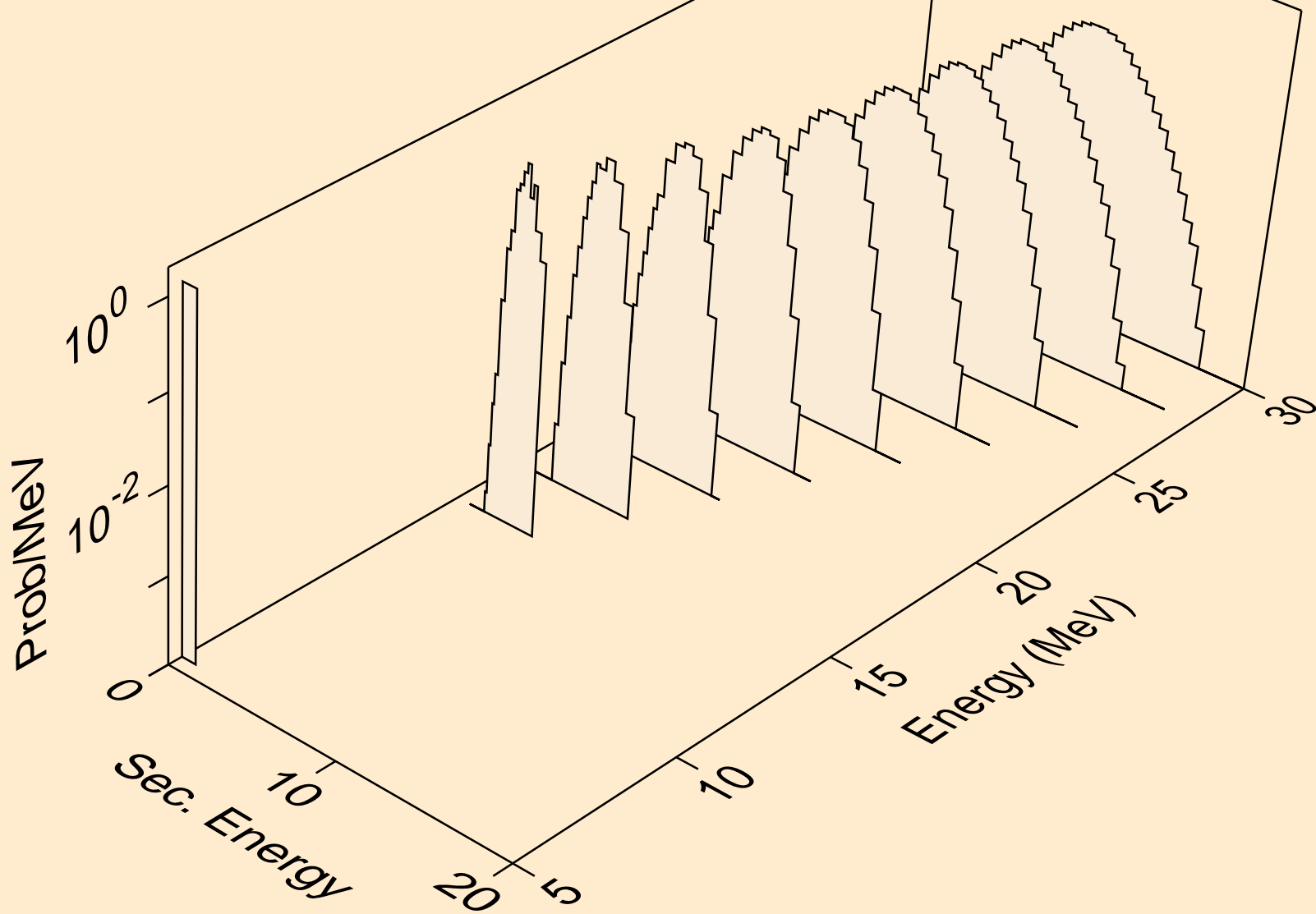



CS118M PROTON ACER TENDL-2021 LIBRARY; T=0.K  
tritons from (p,x)

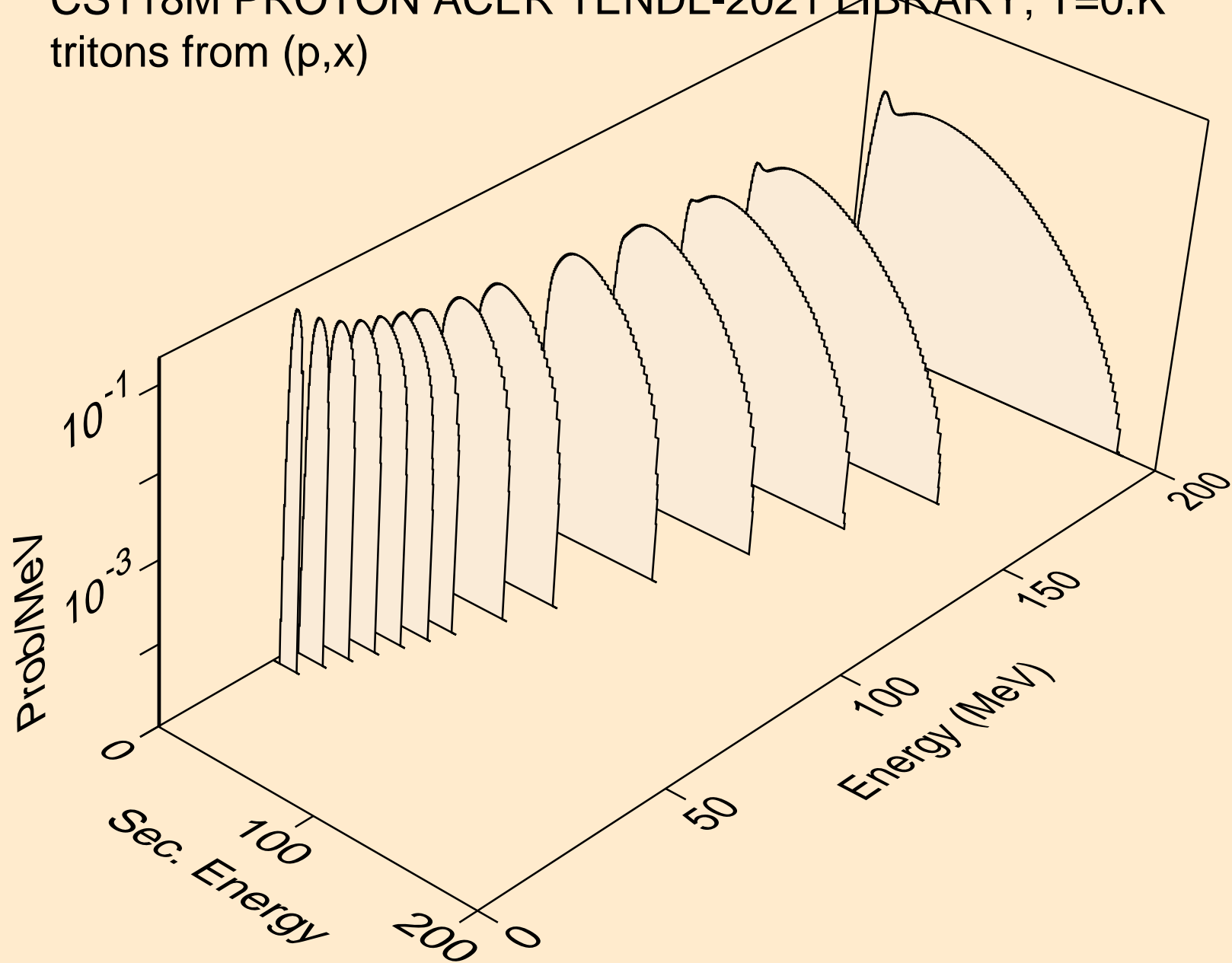

CS118M PROTON ACER TENDL-2021 LIBRARY; T=0.K  
tritons from (p,t)

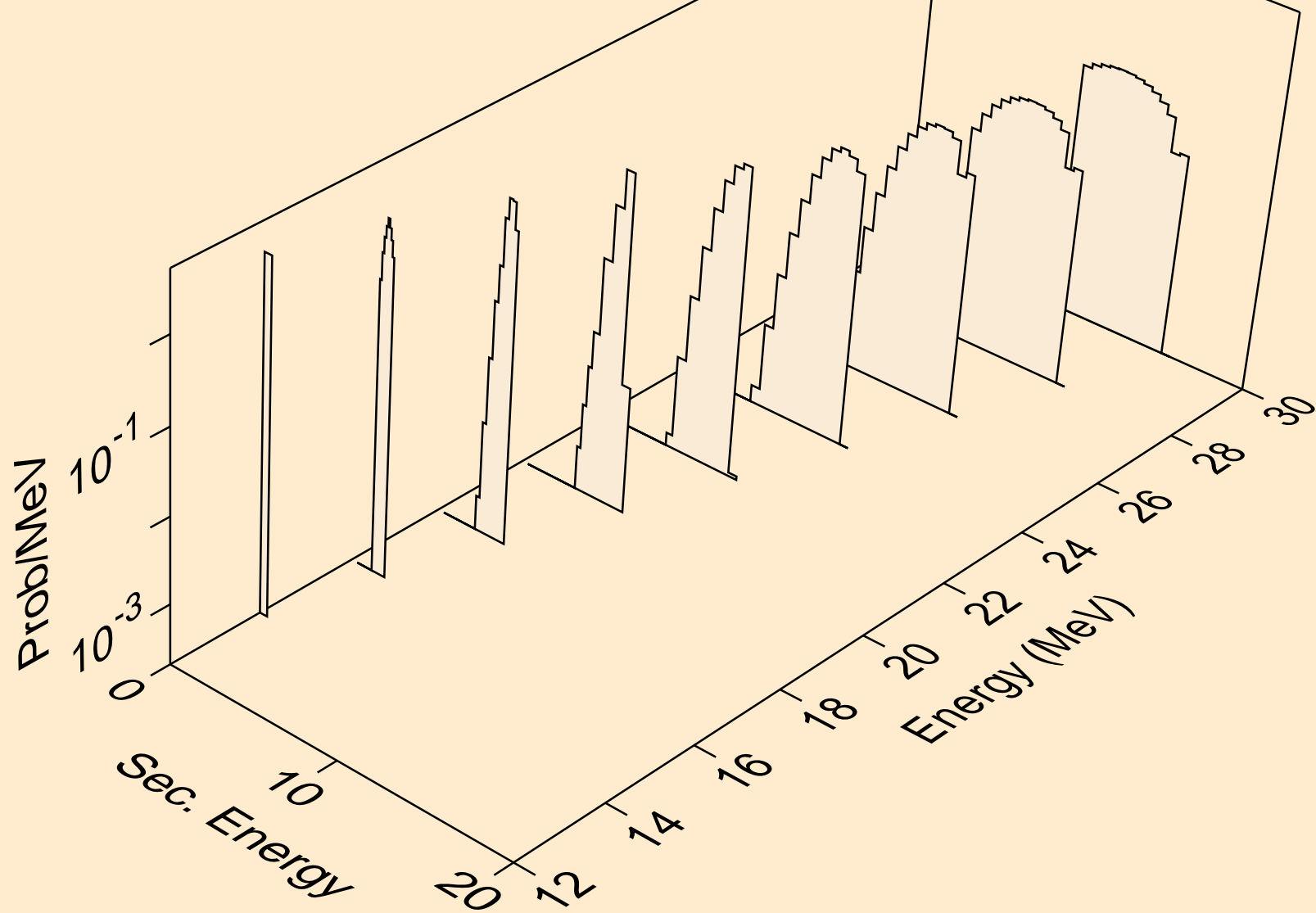

CS118M PROTON ACER TENDL-2021 LIBRARY; T=0.K  
tritons from (p,pt)

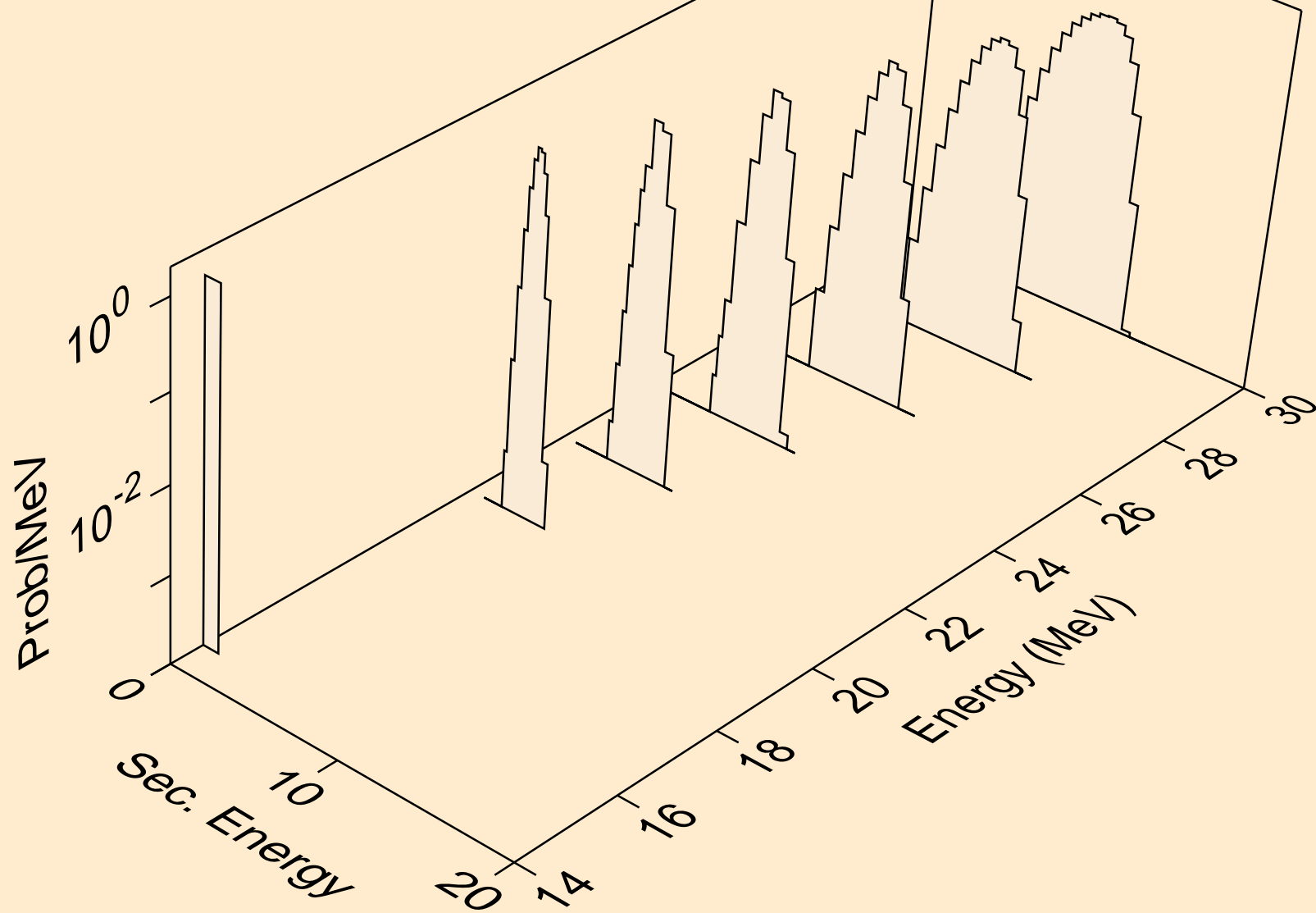

CS118M PROTON ACER TENDL-2021 LIBRARY; T=0.K  
he3s from (p,x)

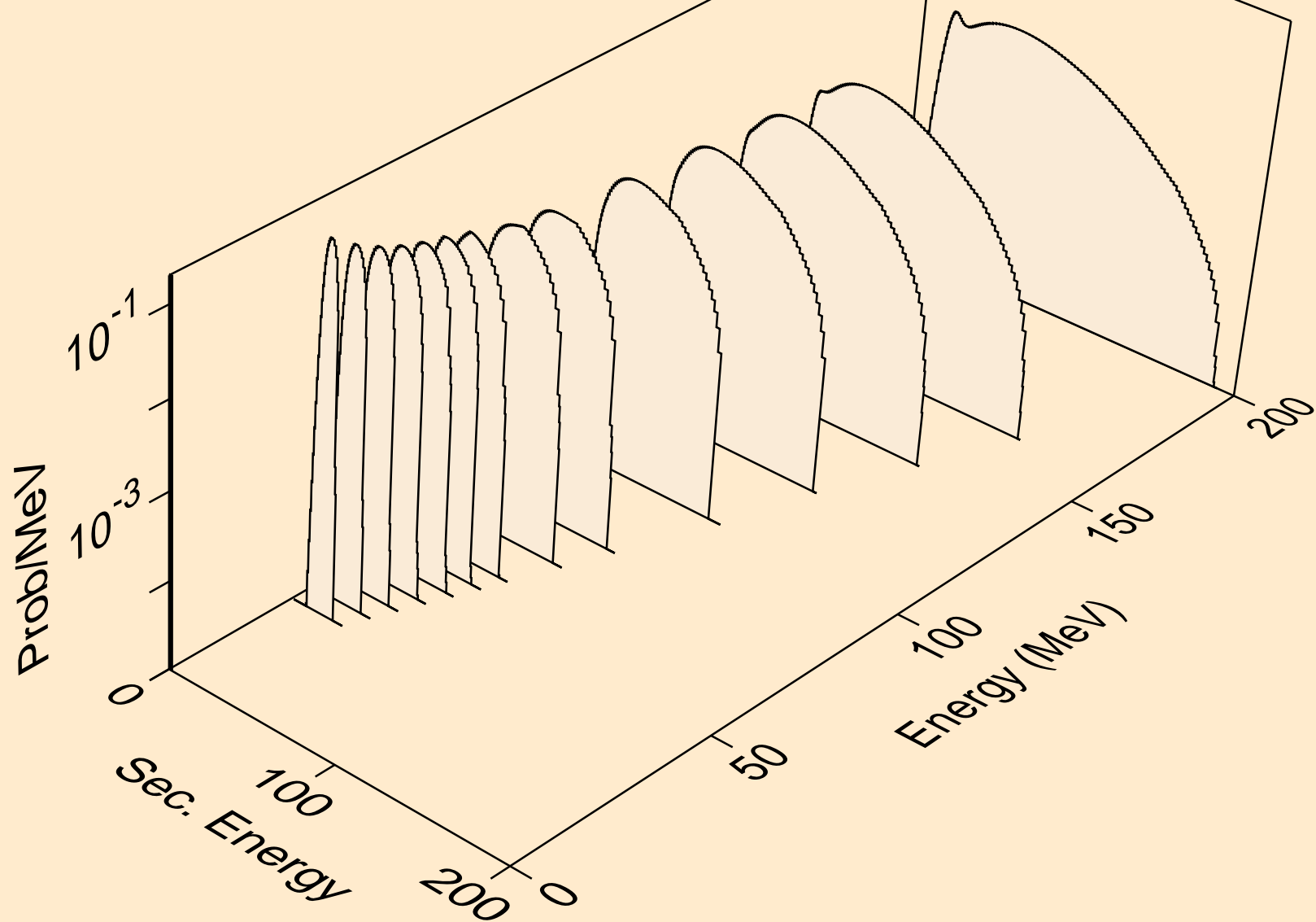

CS118M PROTON ACER TENDL-2021 LIBRARY; T=0.K  
he3s from (p,n\*)he3

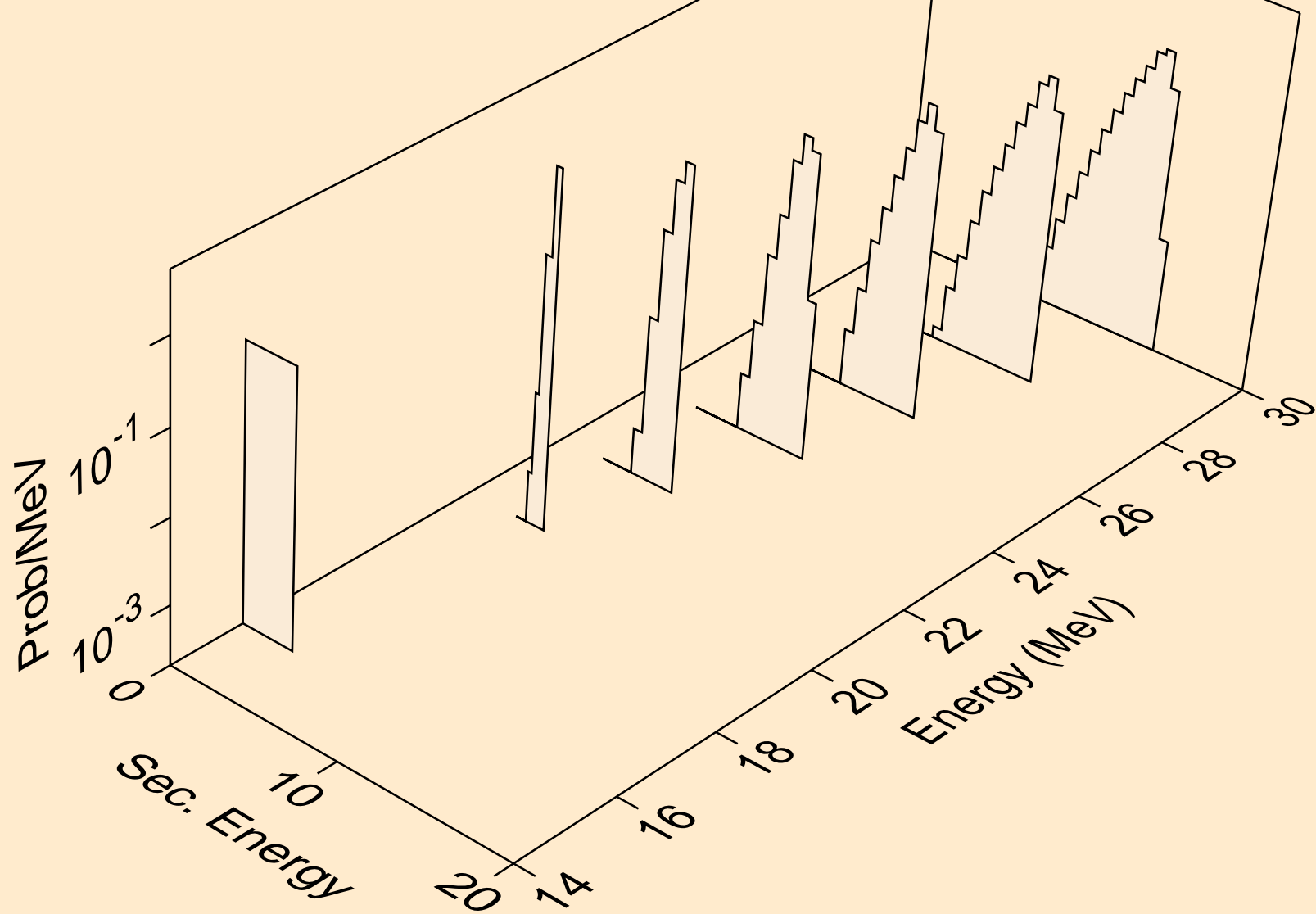

CS118M PROTON ACER TENDL-2021 LIBRARY; T=0.K  
he3s from (p,he3)

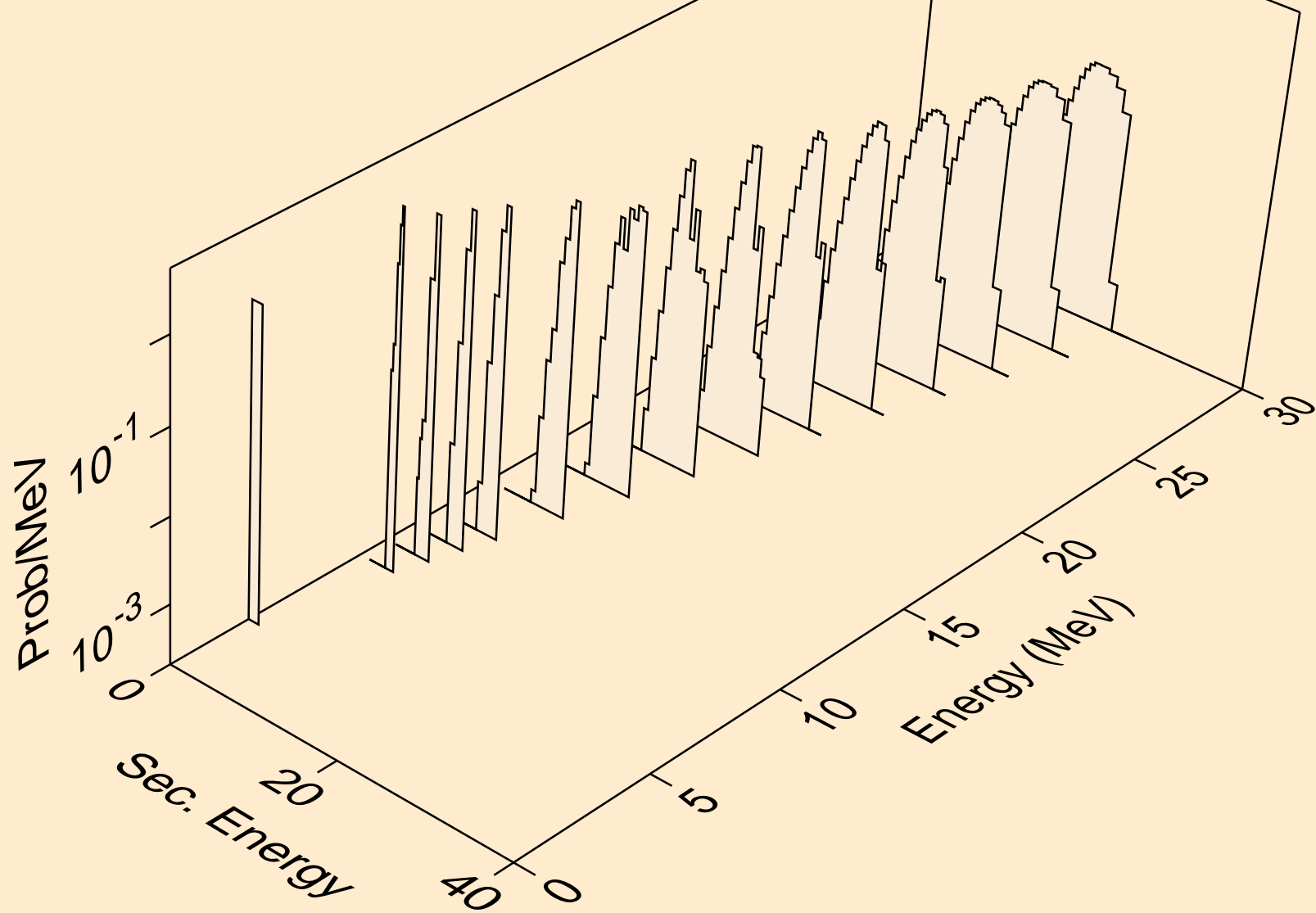

CS118M PROTON ACER TENDL-2021 LIBRARY; T=0.K  
alphas from (p,x)

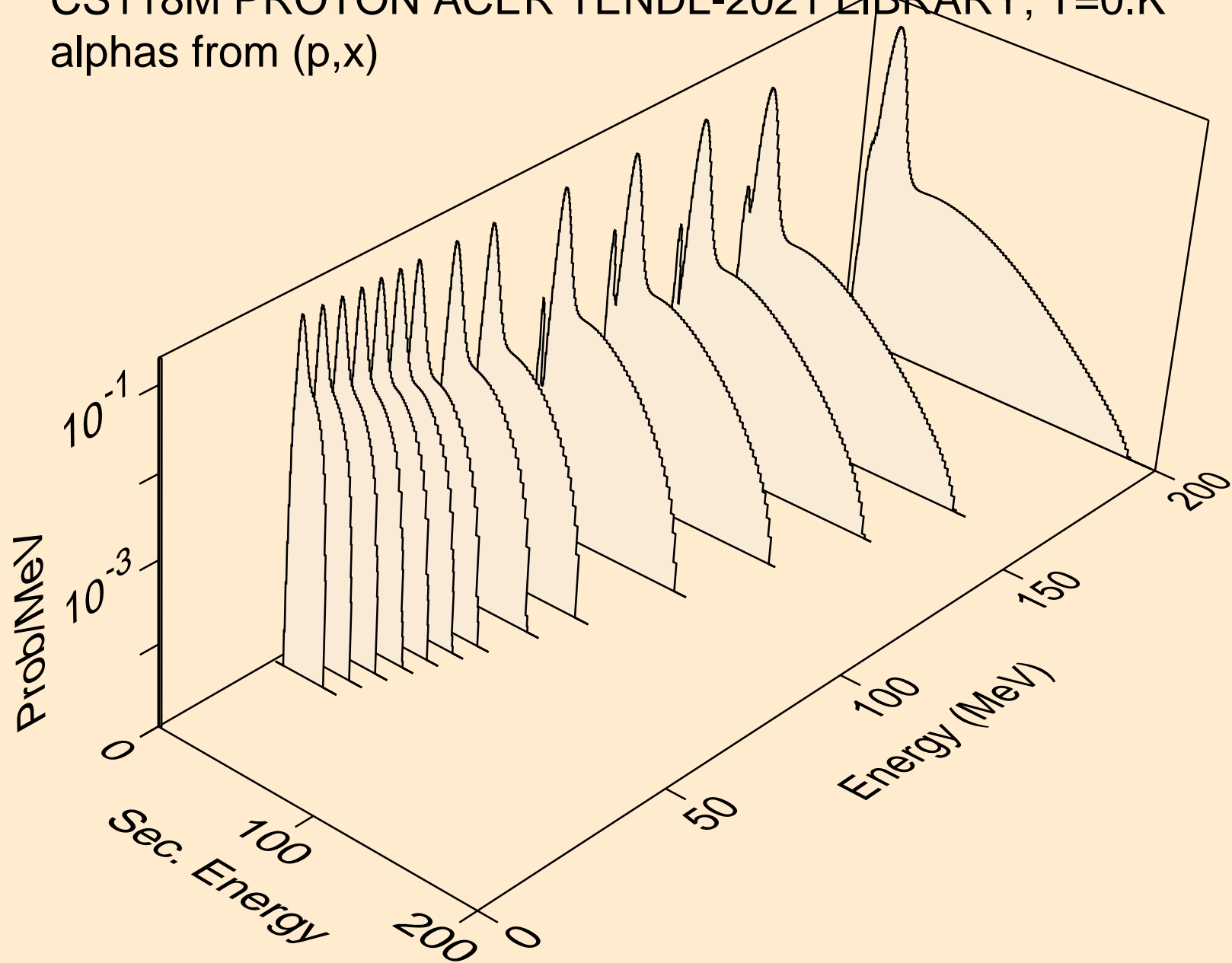

CS118M PROTON ACER TENDL-2021 LIBRARY; T=0.K  
alphas from (p,n\*)a

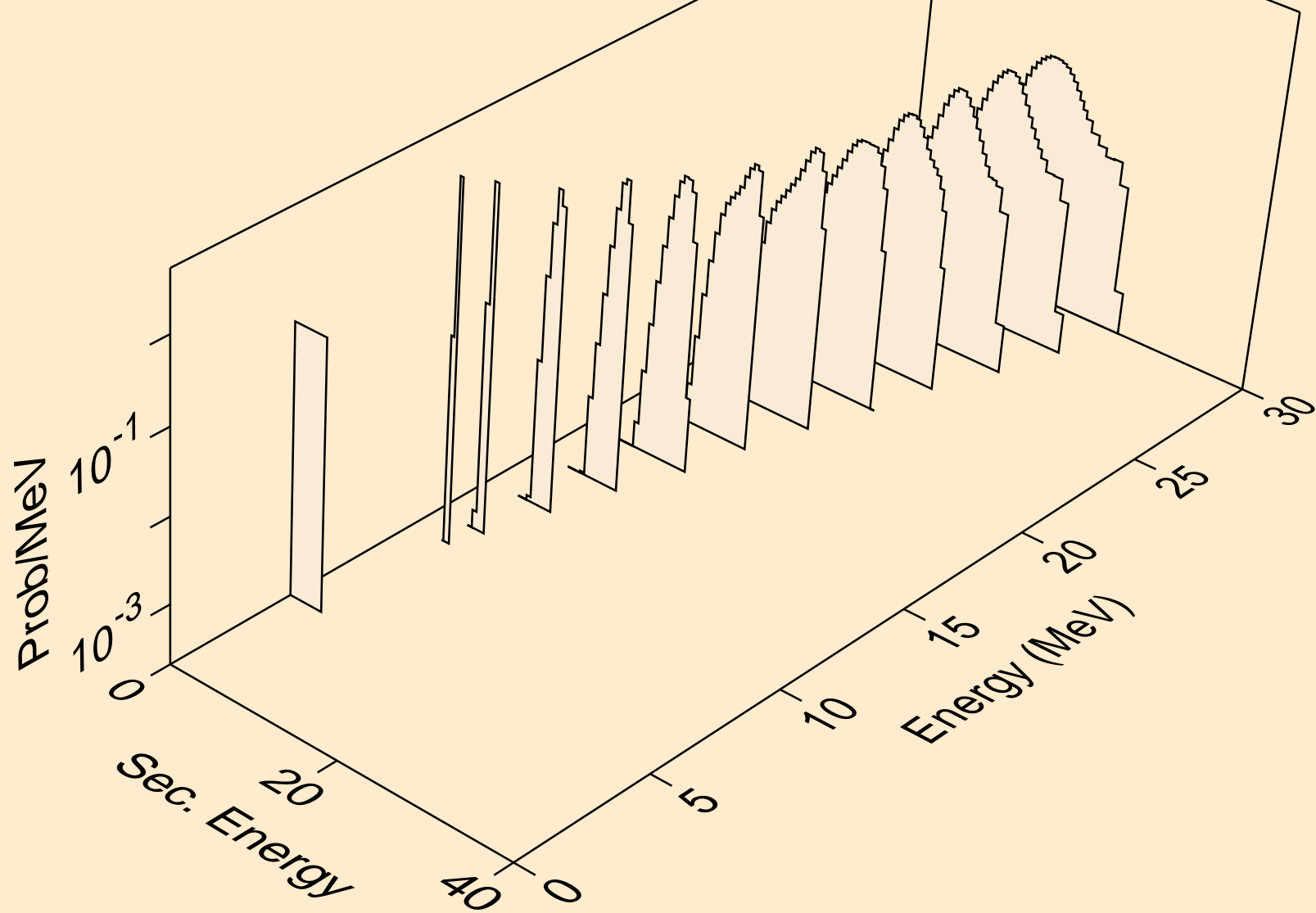



CS118M PROTON ACER TENDL-2021 LIBRARY; T=0.K  
alphas from (p,2n)a

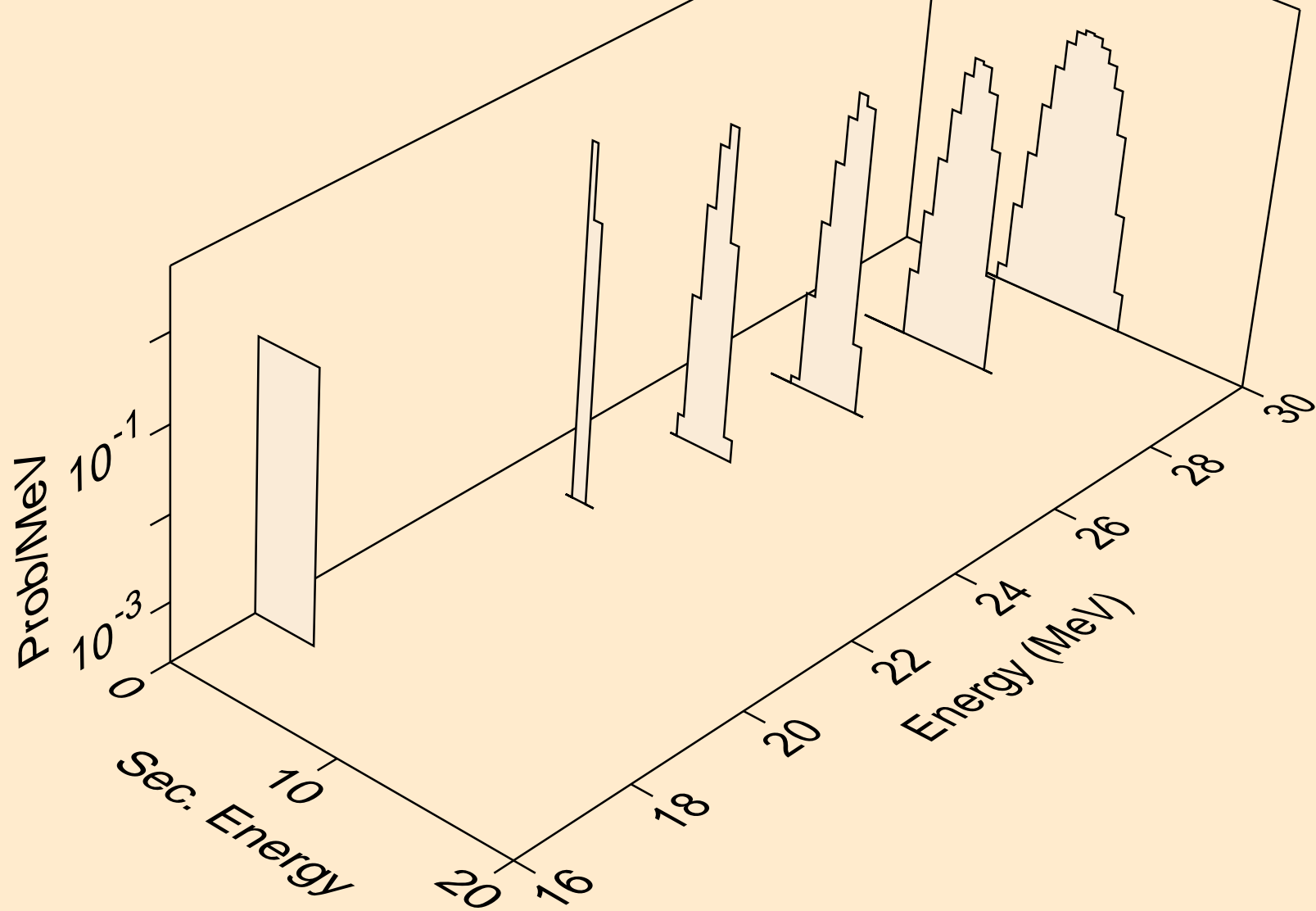

CS118M PROTON ACER TENDL-2021 LIBRARY; T=0.K  
alphas from (p,n\*)2a

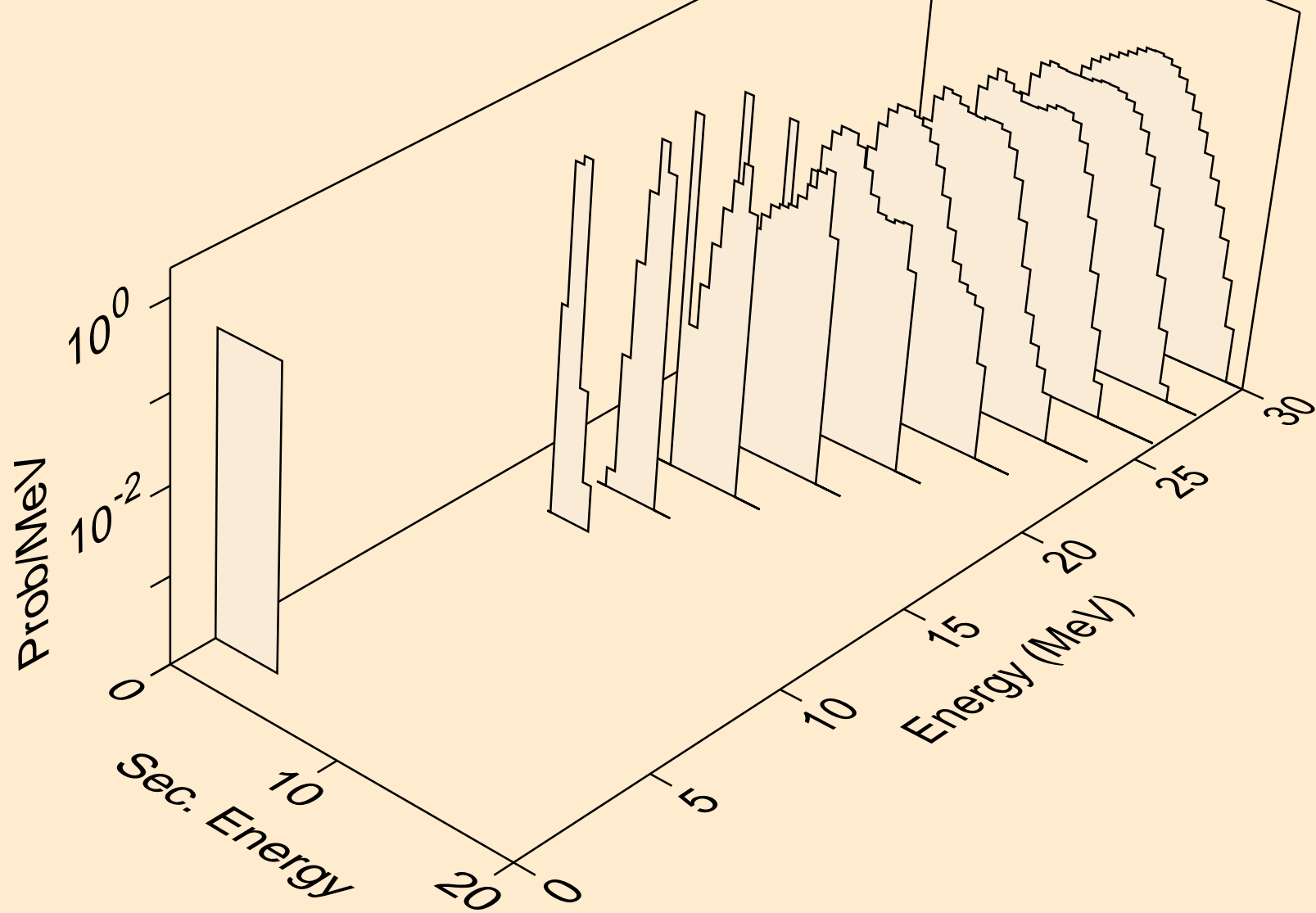

CS118M PROTON ACER TENDL-2021 LIBRARY; T=0.K  
alphas from (p,npa)

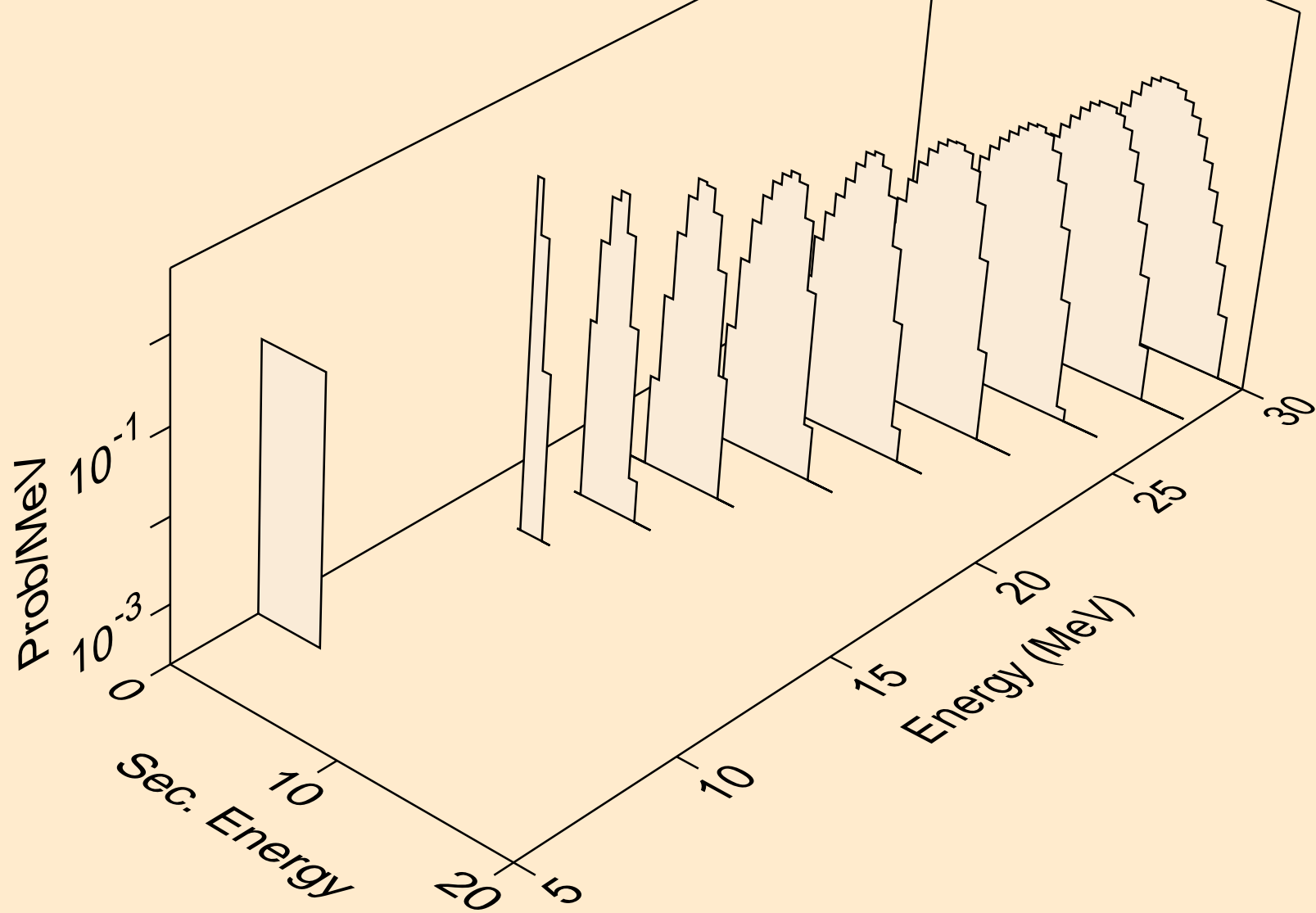

CS118M PROTON ACER TENDL-2021 LIBRARY; T=0.K  
alphas from (p,a)

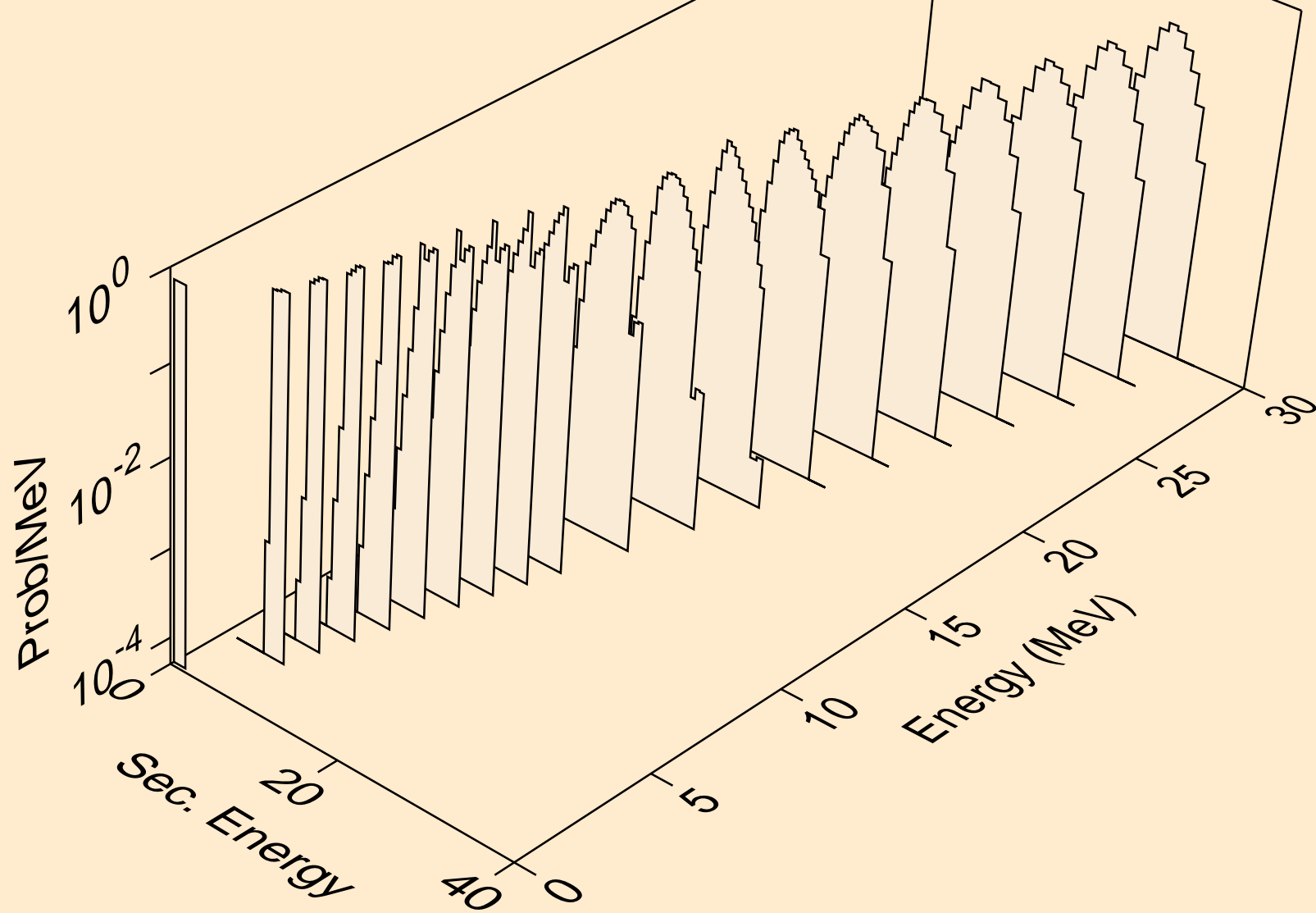

CS118M PROTON ACER TENDL-2021 LIBRARY; T=0.K  
alphas from (p,2a)

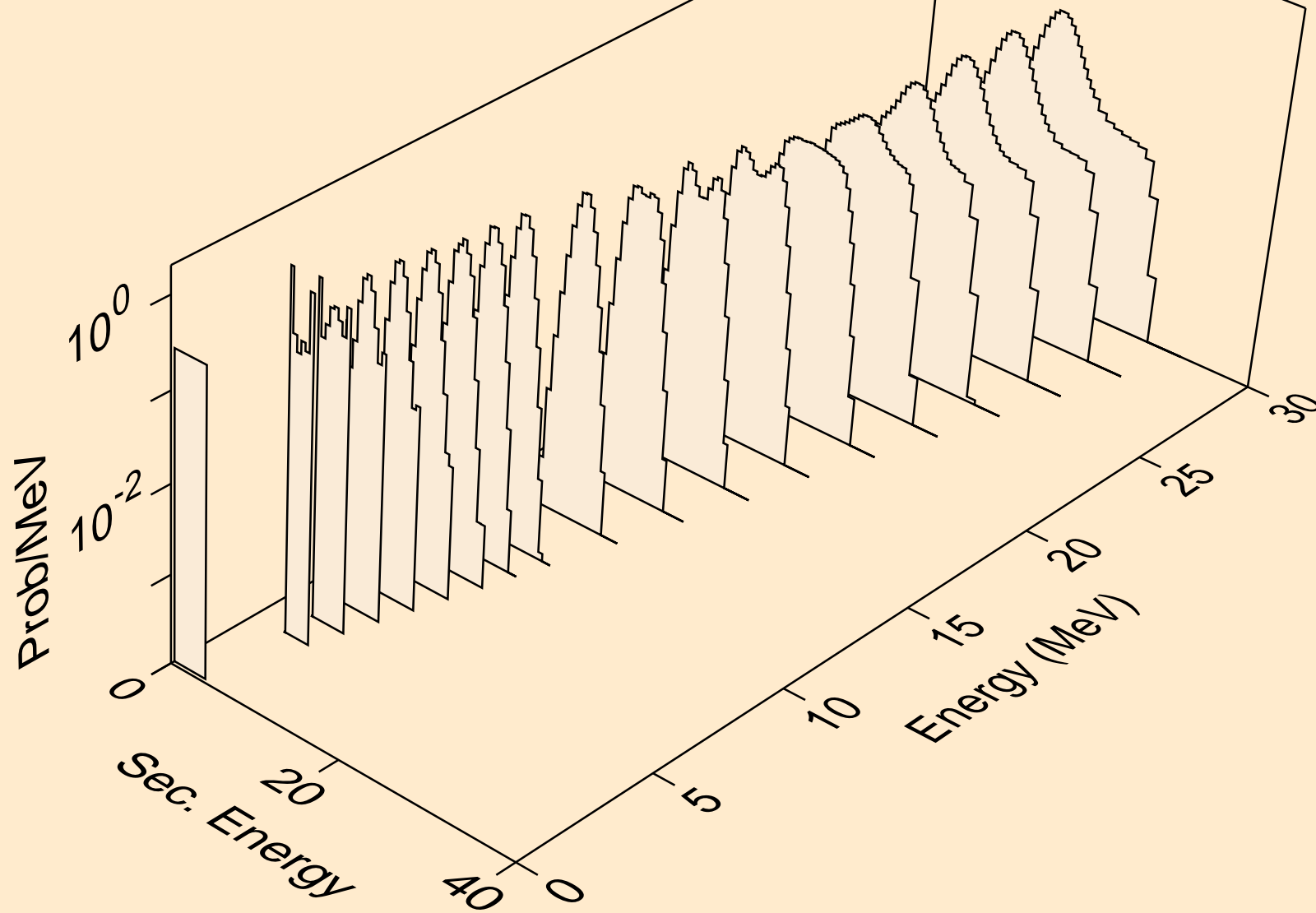

CS118M PROTON ACER TENDL-2021 LIBRARY; T=0.K  
alphas from (p,3a)

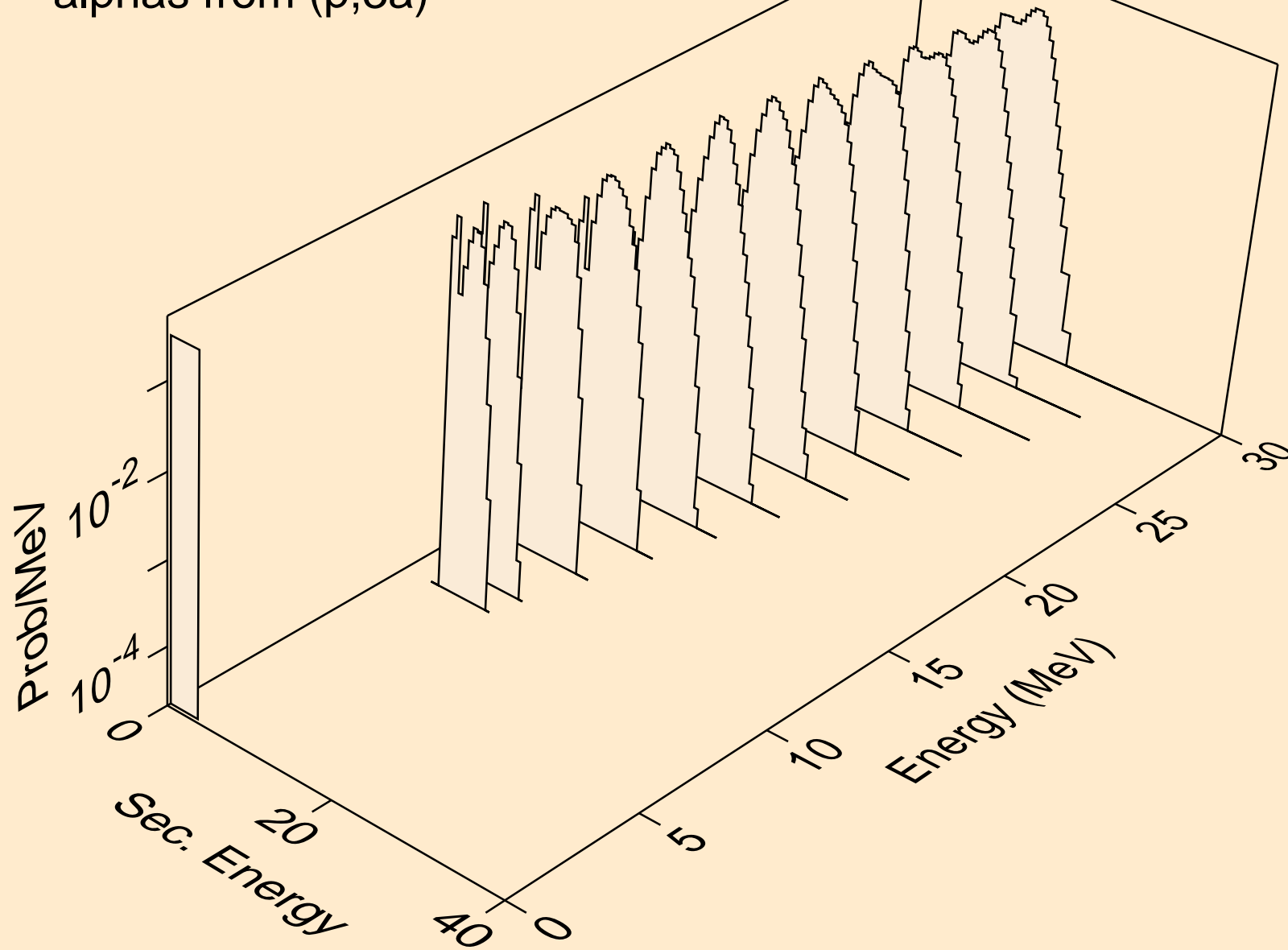

CS118M PROTON ACER TENDL-2021 LIBRARY; T=0.K  
alphas from (p,pa)

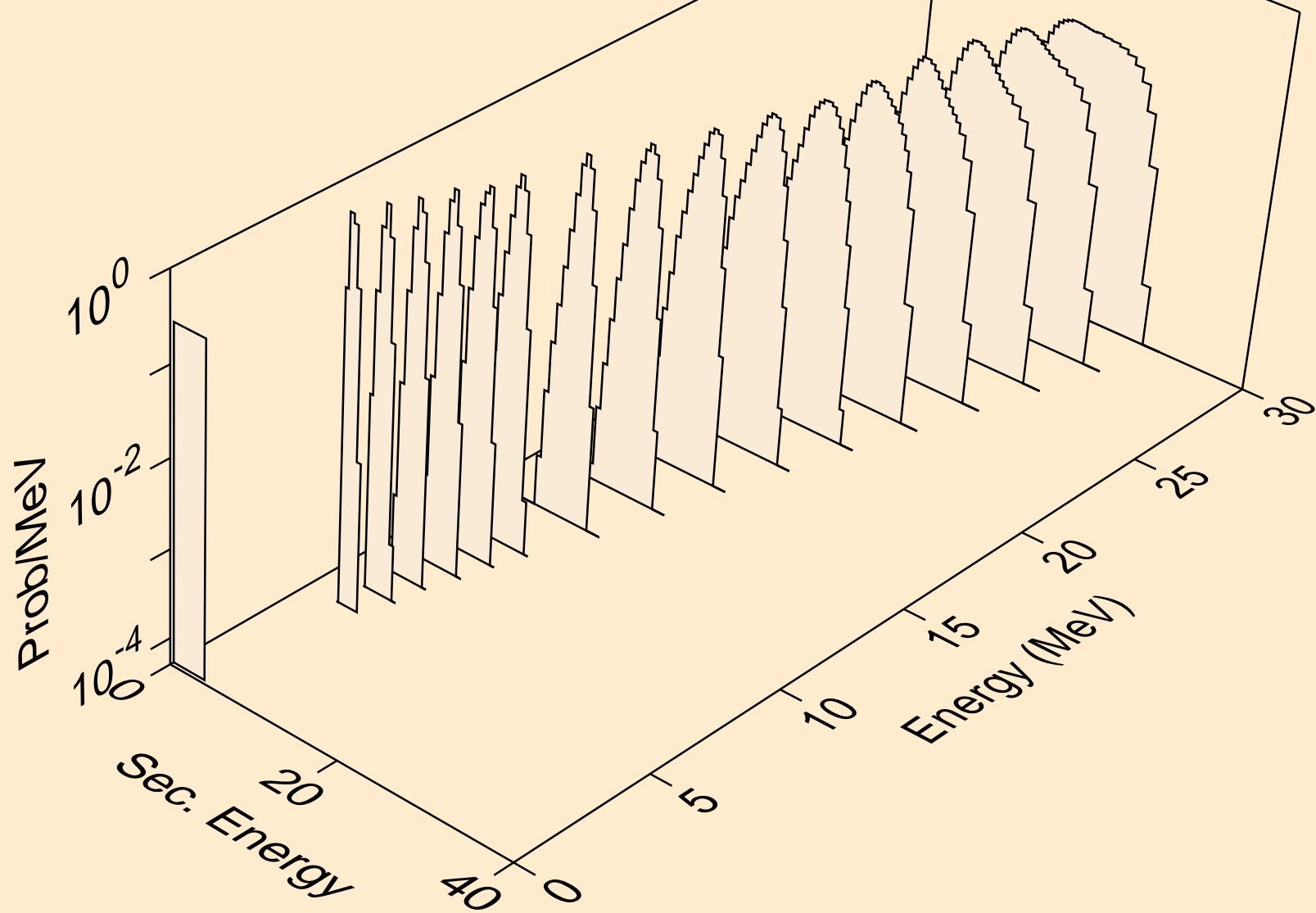

CS118M PROTON ACER TENDL-2021 LIBRARY; T=0.K  
alphas from (p,da)

