

# CS132 PROTON ACER TENDL-2021 LIBRARY; T=0.K

## Principal cross sections

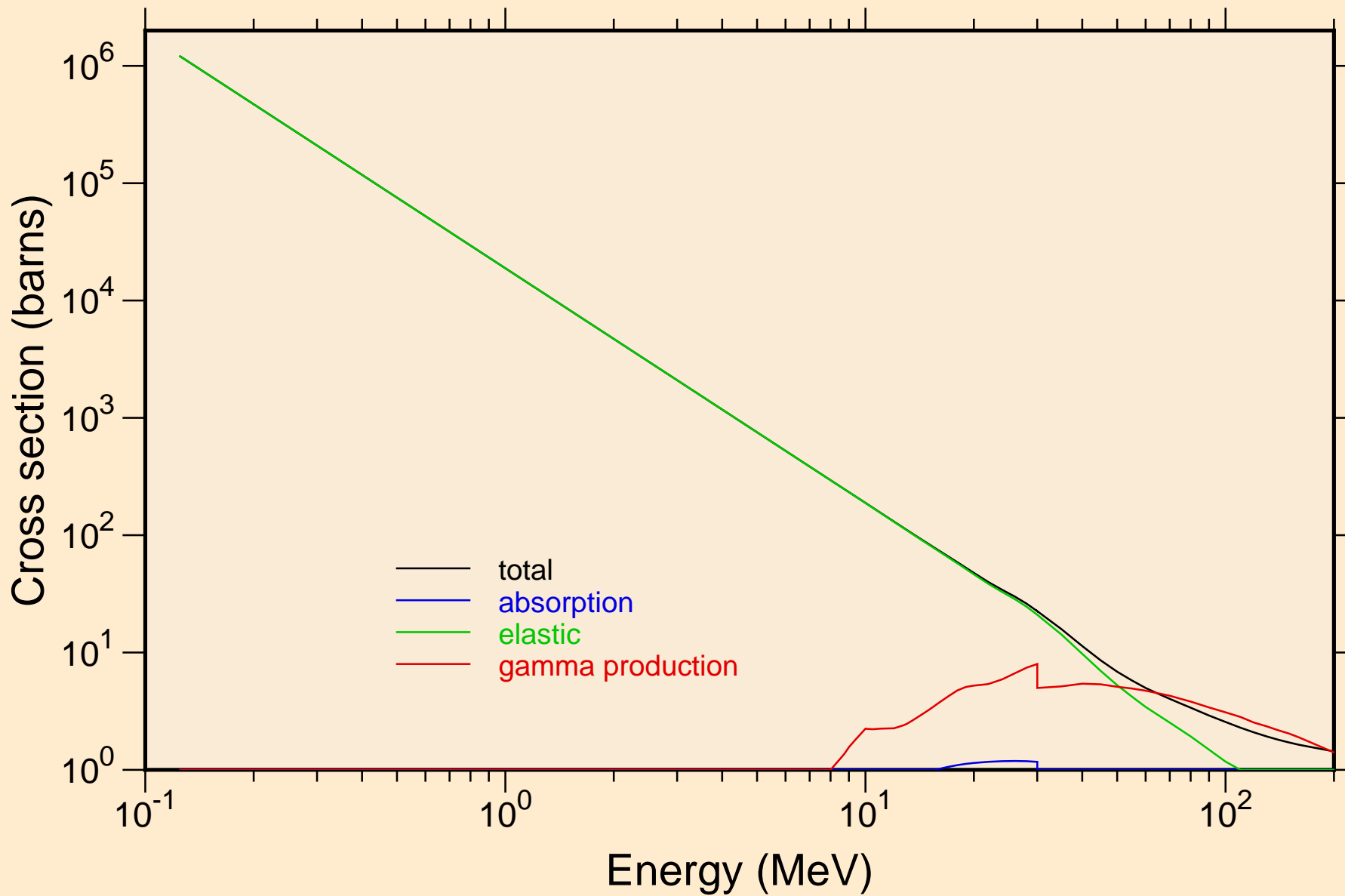

# CS132 PROTON ACER TENDL-2021 LIBRARY; T=0.K

## Heating

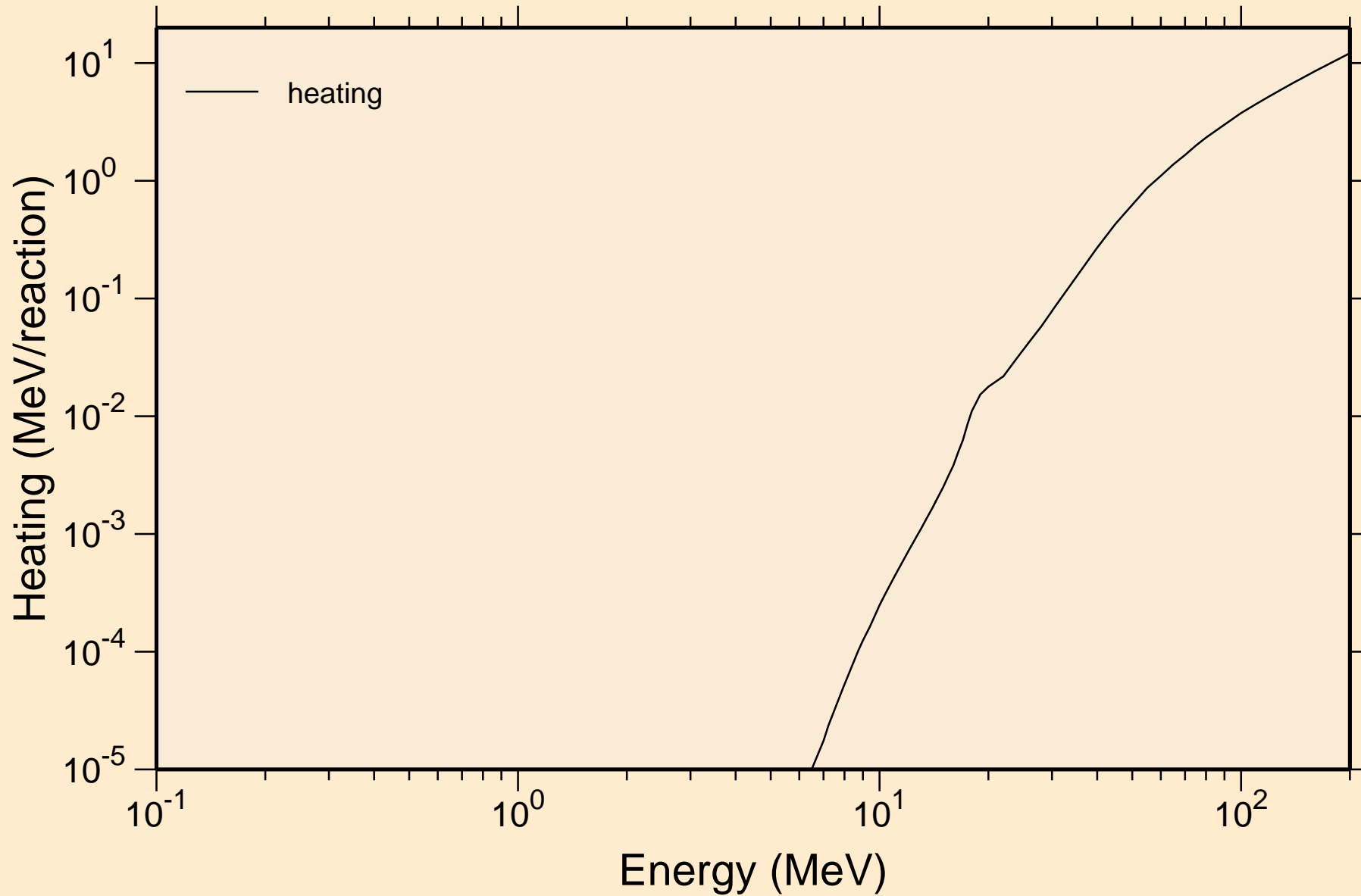

# CS132 PROTON ACER TENDL-2021 LIBRARY; T=0.K

## Principal cross sections

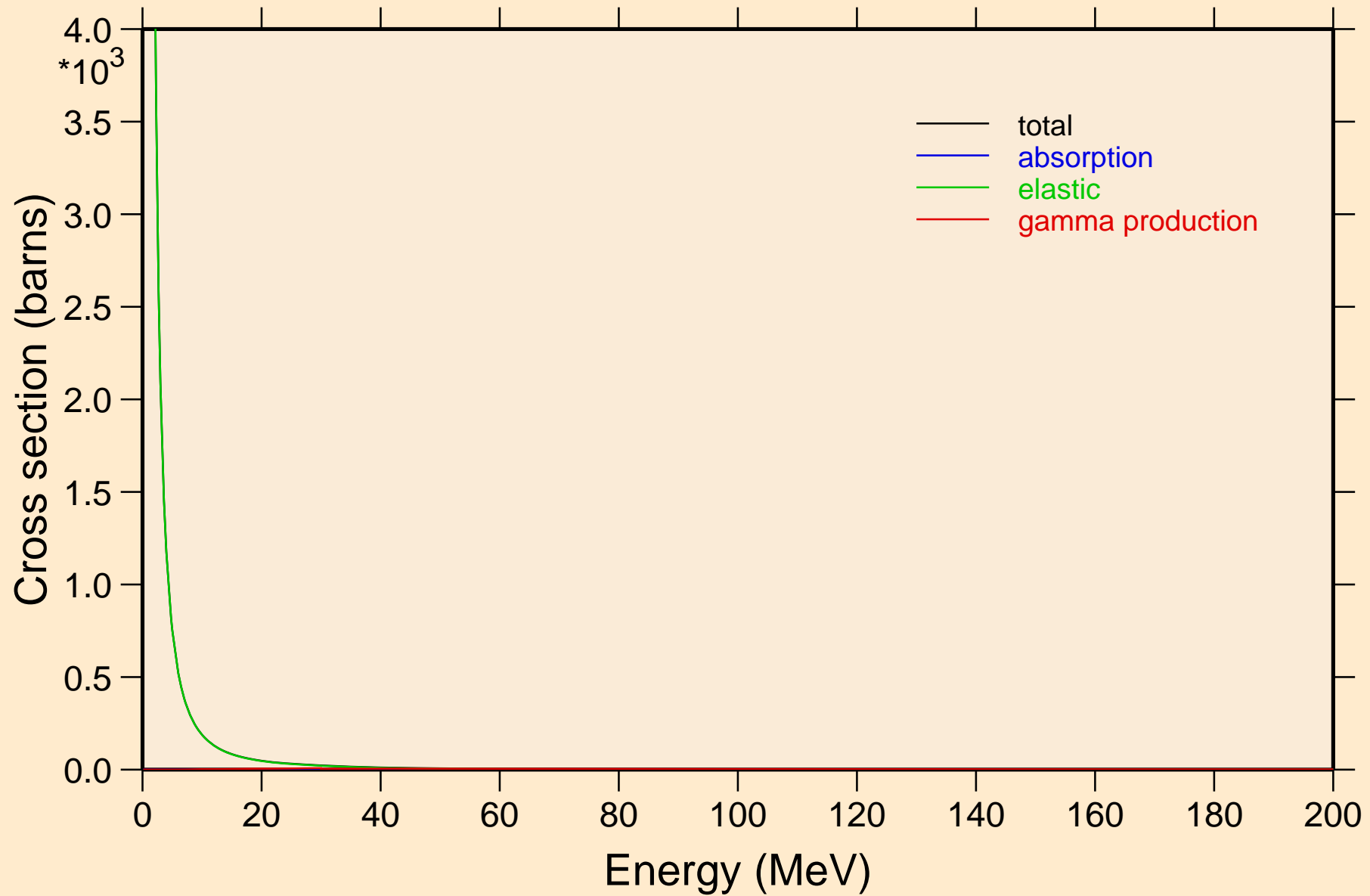

CS132 PROTON ACER TENDL-2021 LIBRARY; T=0.K

Heating

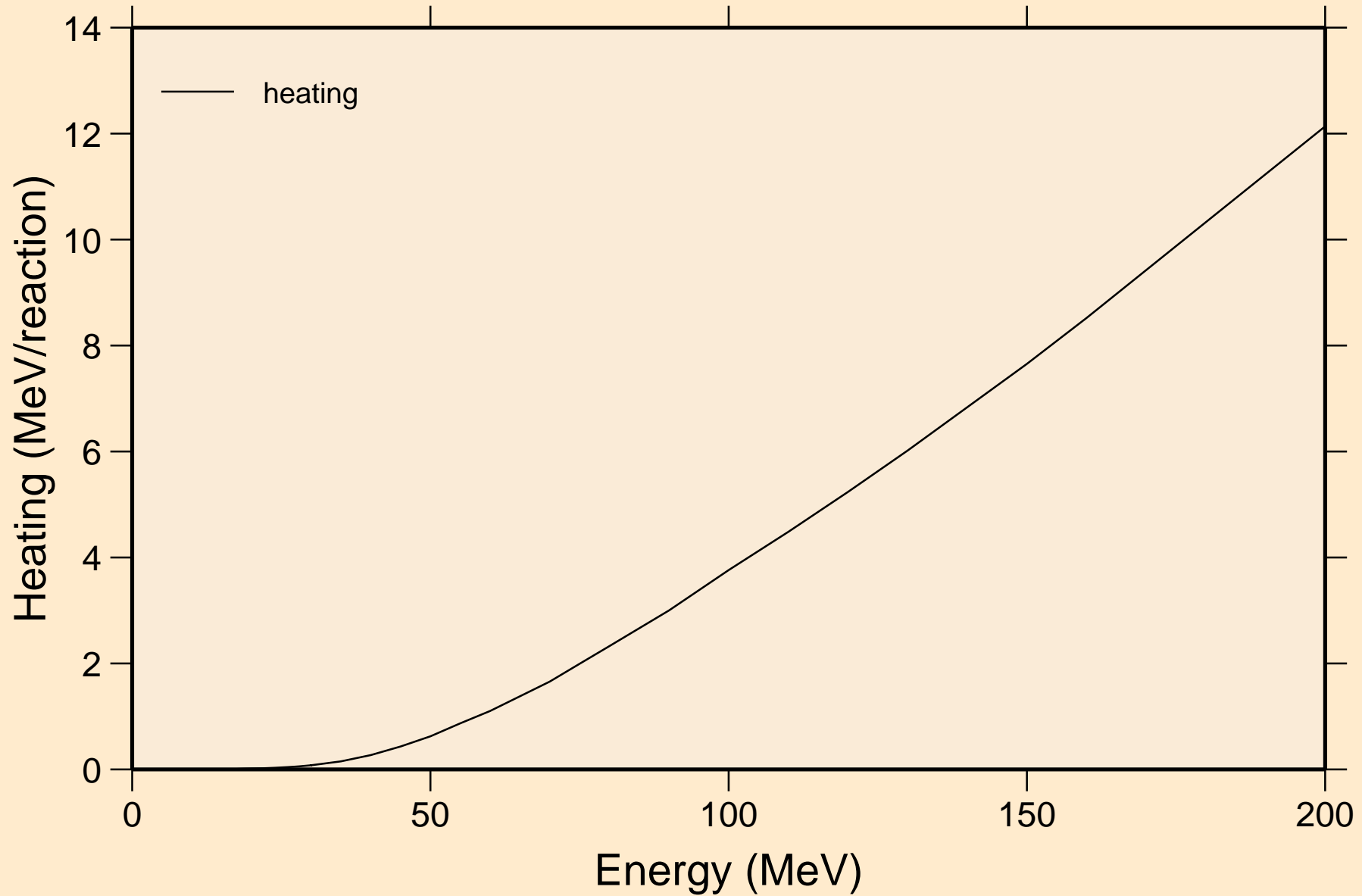

# CS132 PROTON ACER TENDL-2021 LIBRARY; T=0.K

## Threshold reactions

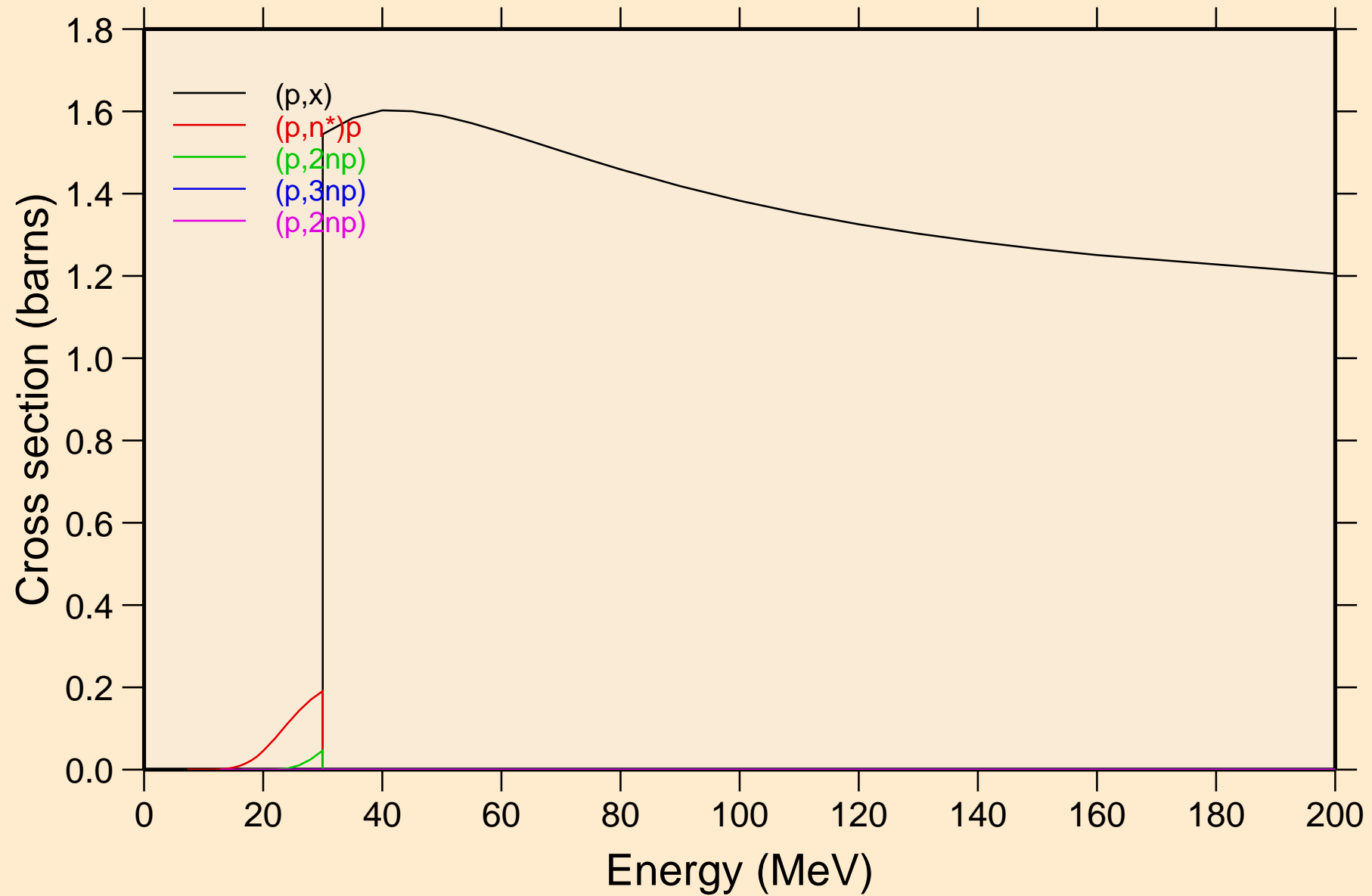

# CS132 PROTON ACER TENDL-2021 LIBRARY; T=0.K

## Threshold reactions

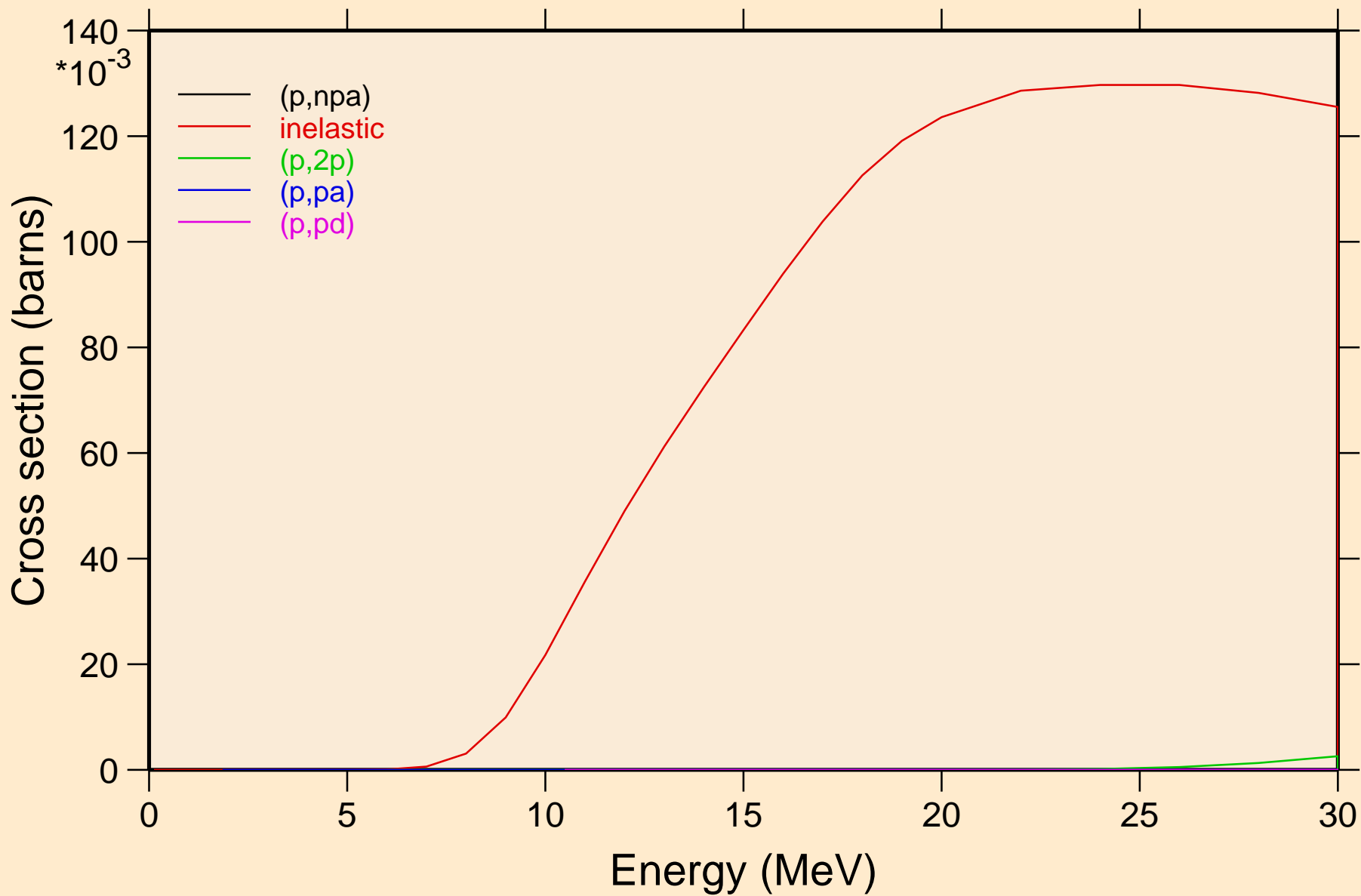

CS132 PROTON ACER TENDL-2021 LIBRARY; T=0.K  
Threshold reactions

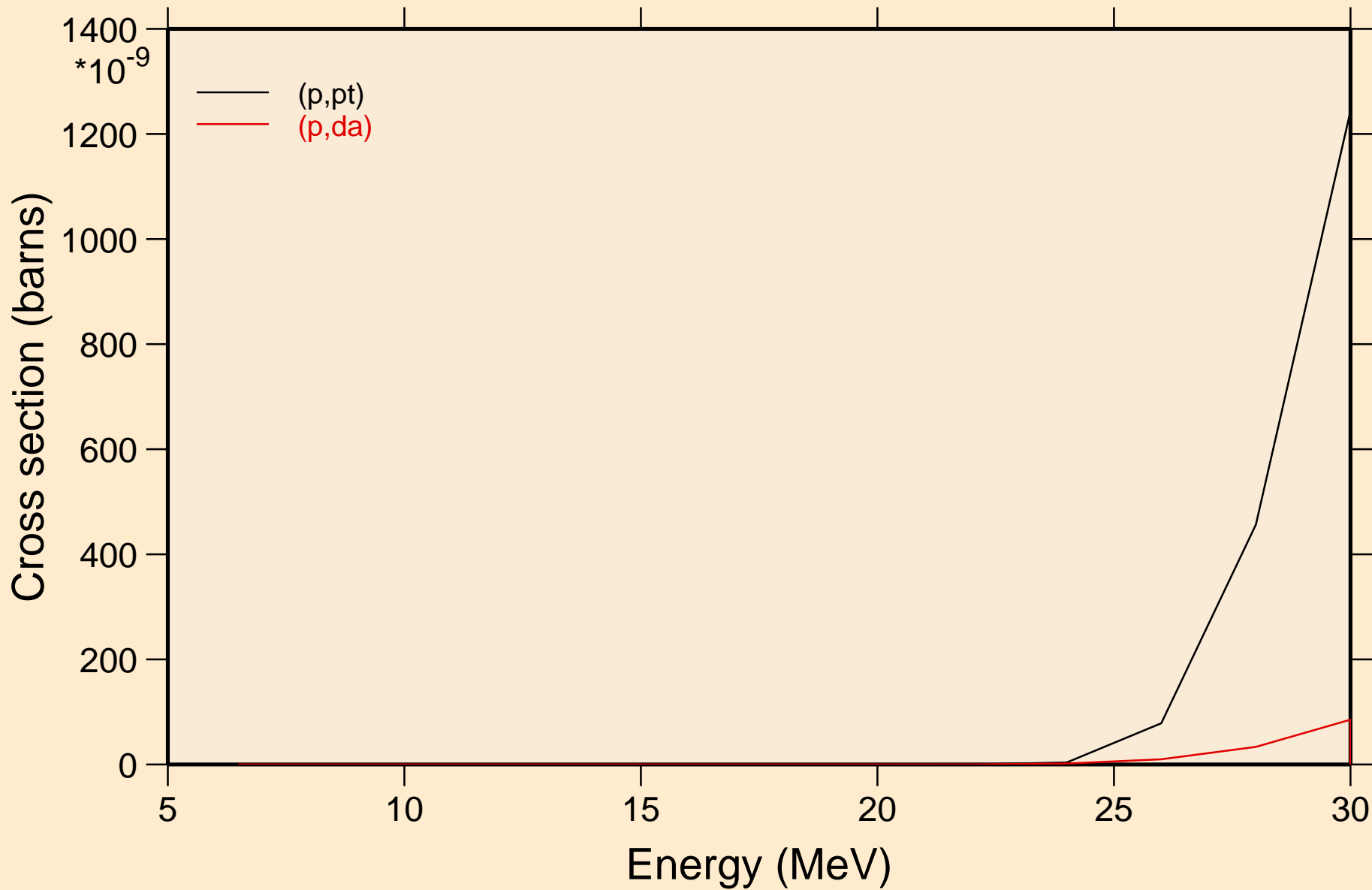

CS132 PROTON ACER TENDL-2021 LIBRARY; T=0.K  
angular distribution for elastic

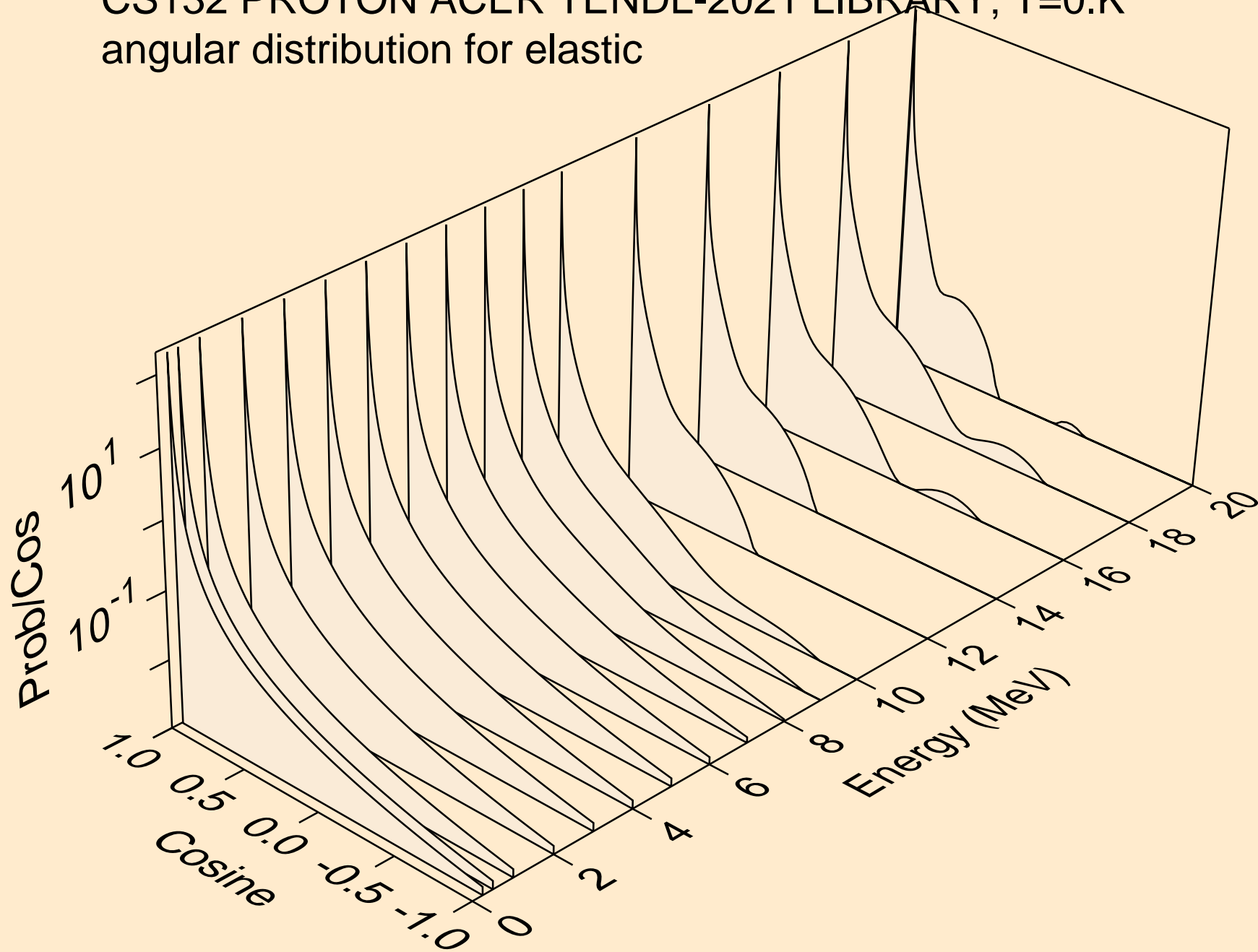



CS132 PROTON ACER TENDL-2021 LIBRARY; T=0.K  
angular distribution for elastic

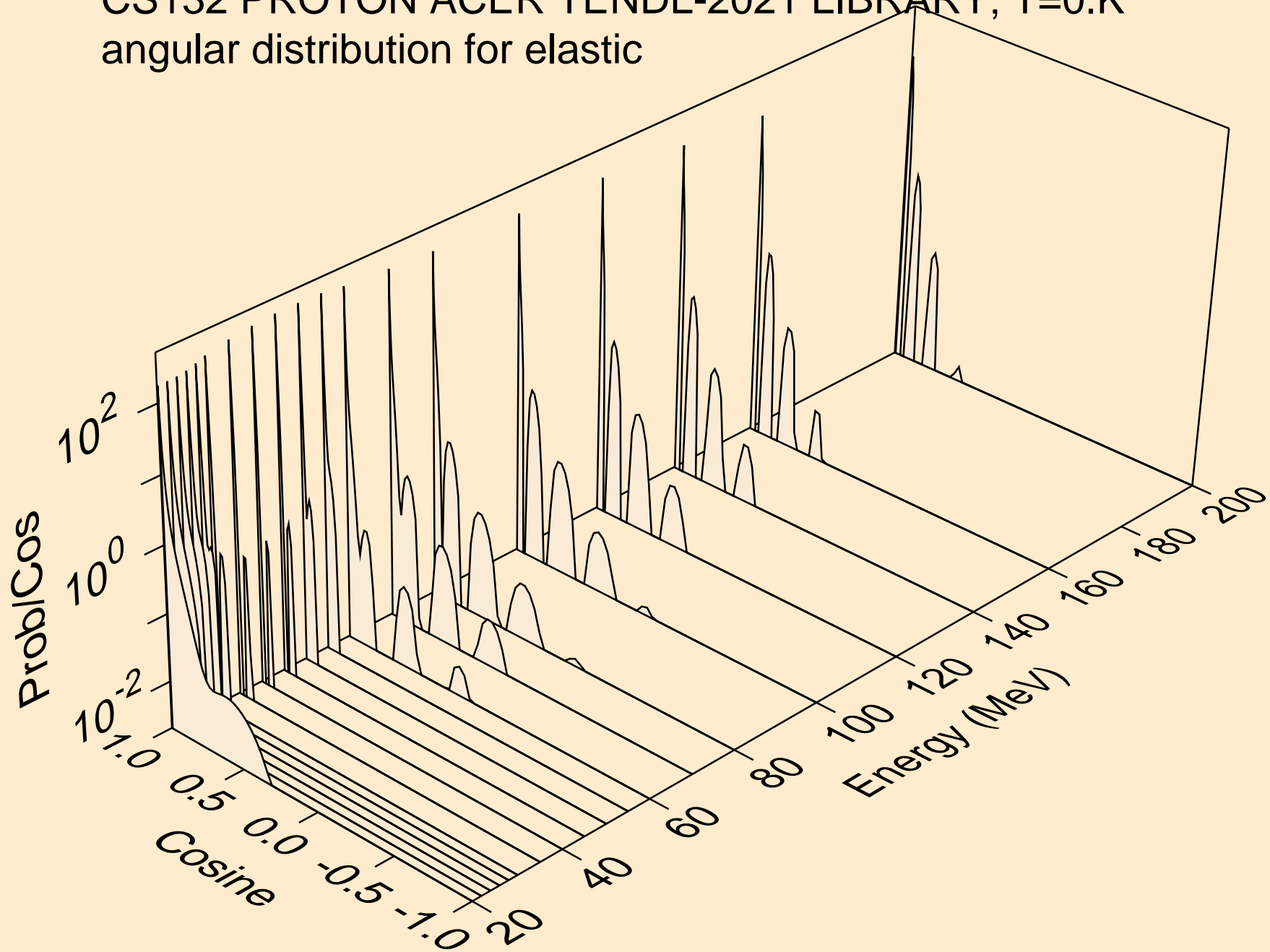

CS132 PROTON ACER TENDL-2021 LIBRARY; T=0.K  
Proton emission for (p,x)

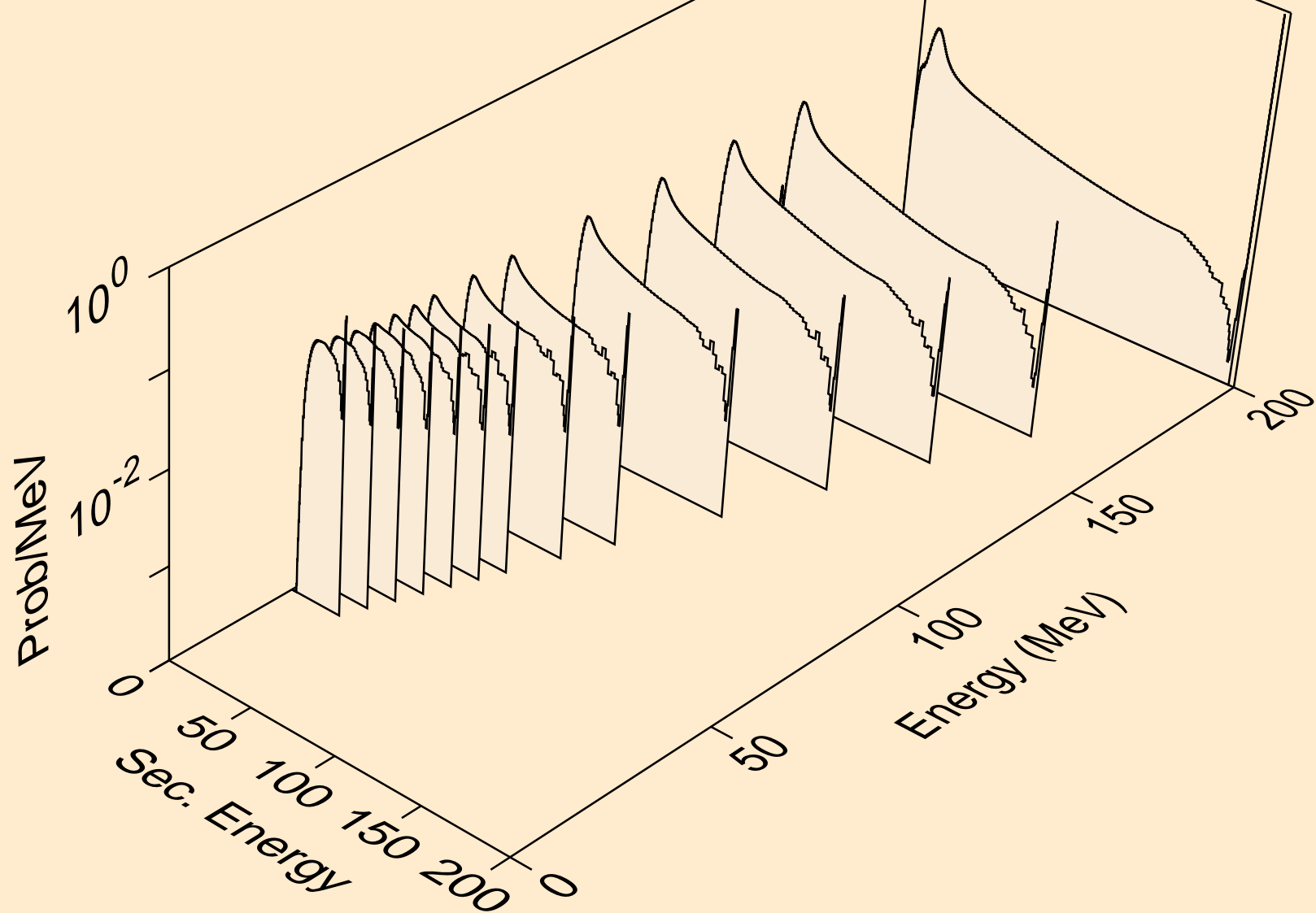

CS132 PROTON ACER TENDL-2021 LIBRARY; T=0.K  
Proton emission for (p,n\*)p

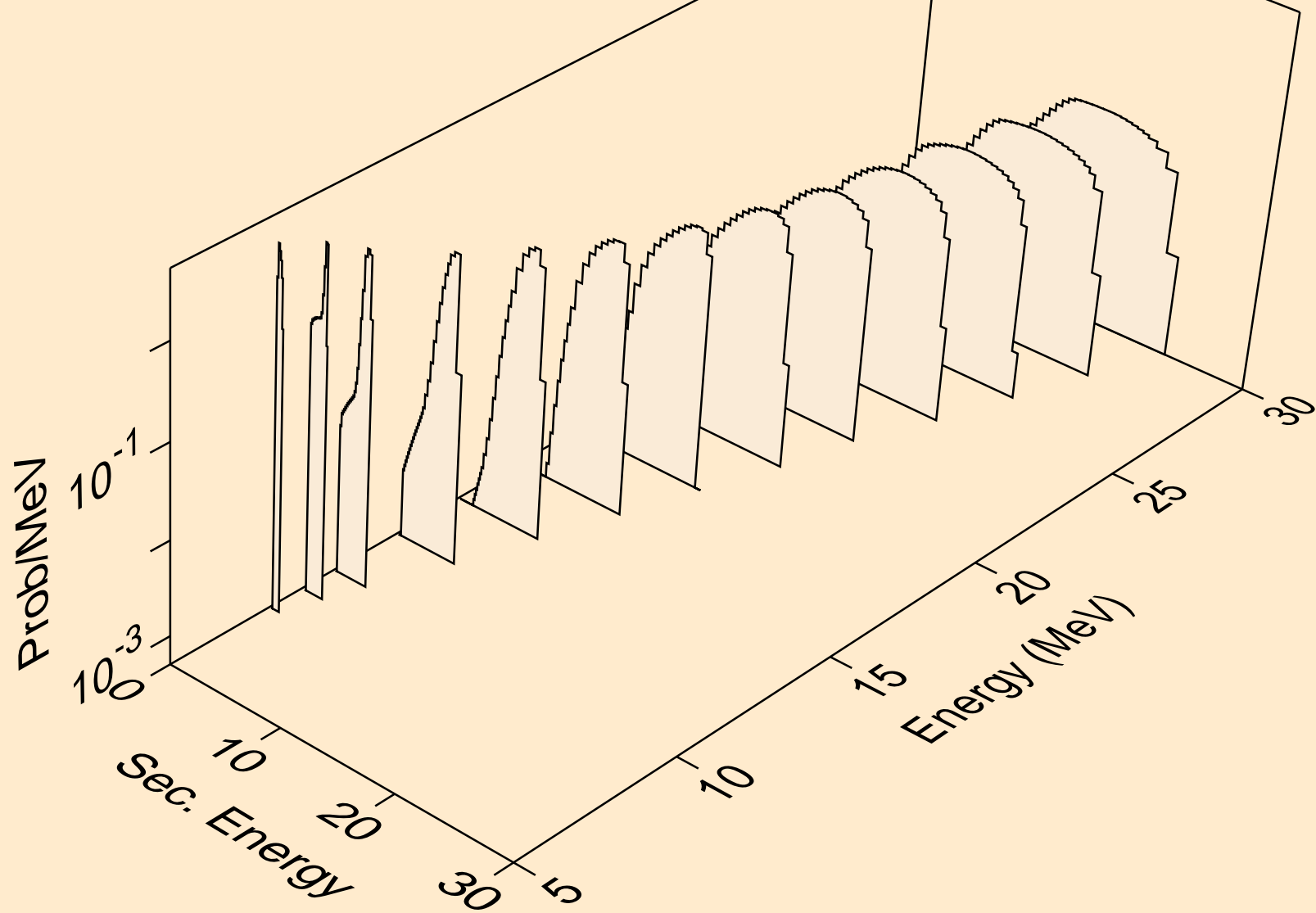

CS132 PROTON ACER TENDL-2021 LIBRARY; T=0.K  
Proton emission for (p,2np)

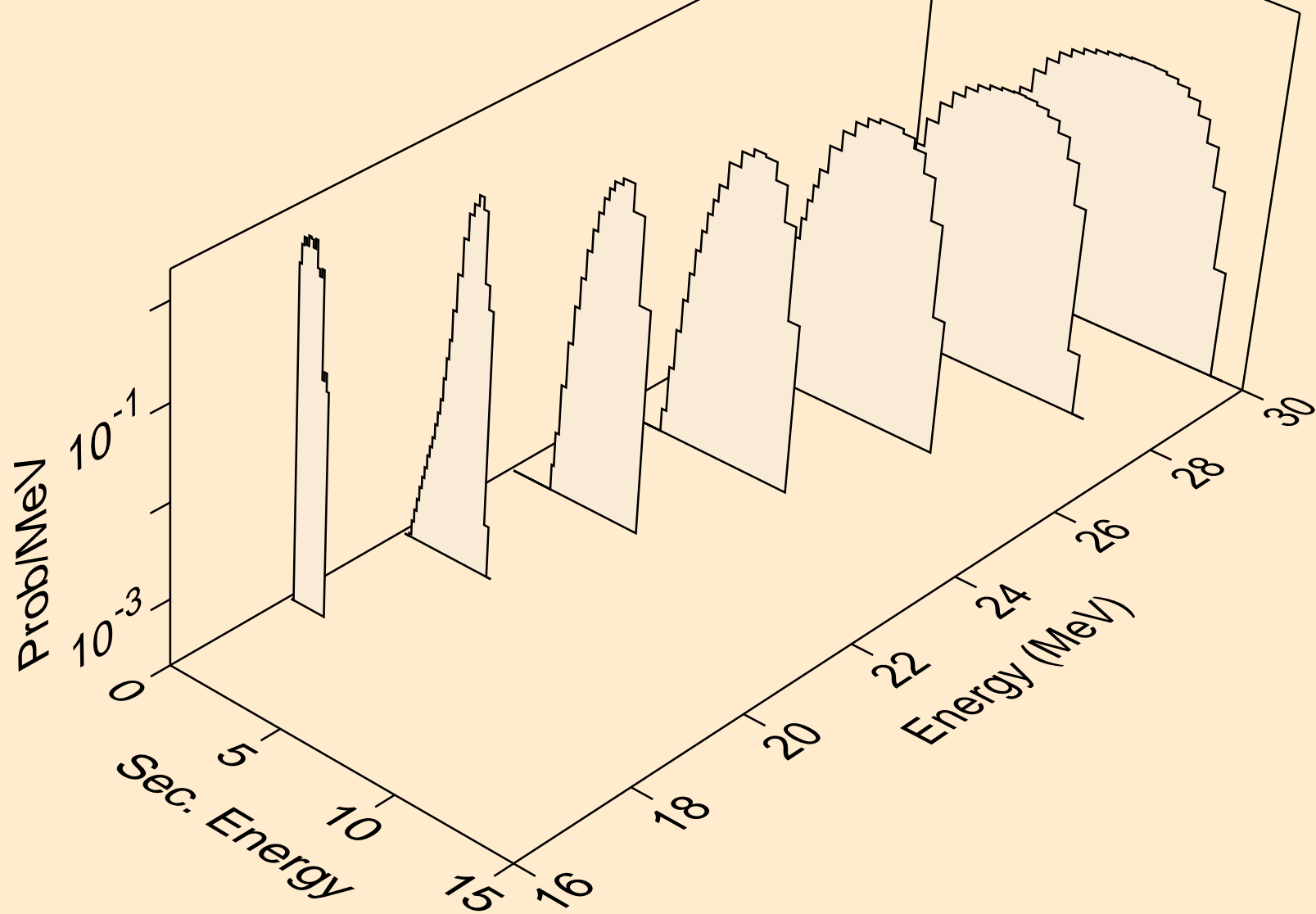

CS132 PROTON ACER TENDL-2021 LIBRARY; T=0.K  
Proton emission for (p,3np)

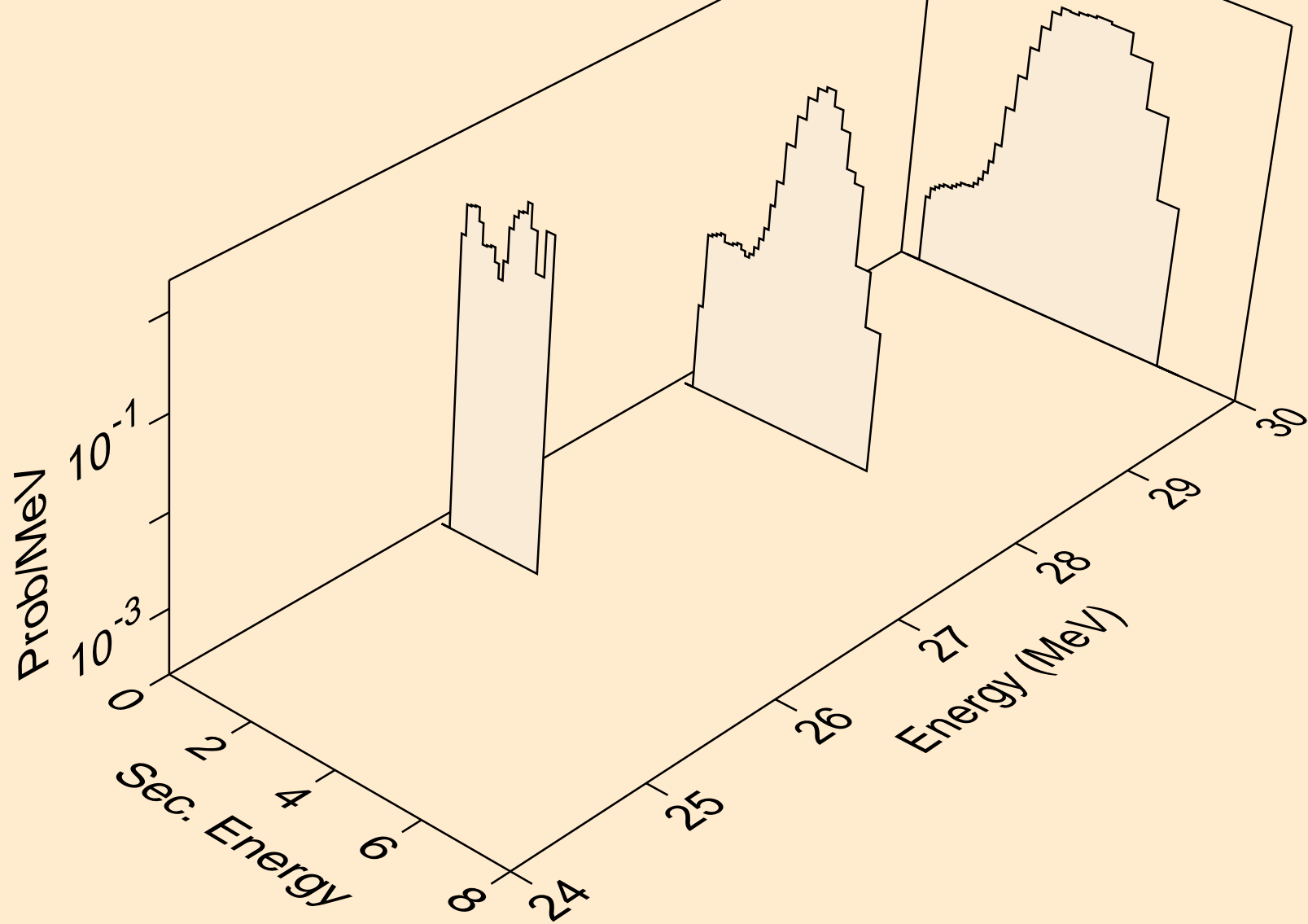

CS132 PROTON ACER TENDL-2021 LIBRARY; T=0.K  
Proton emission for (p,2np)

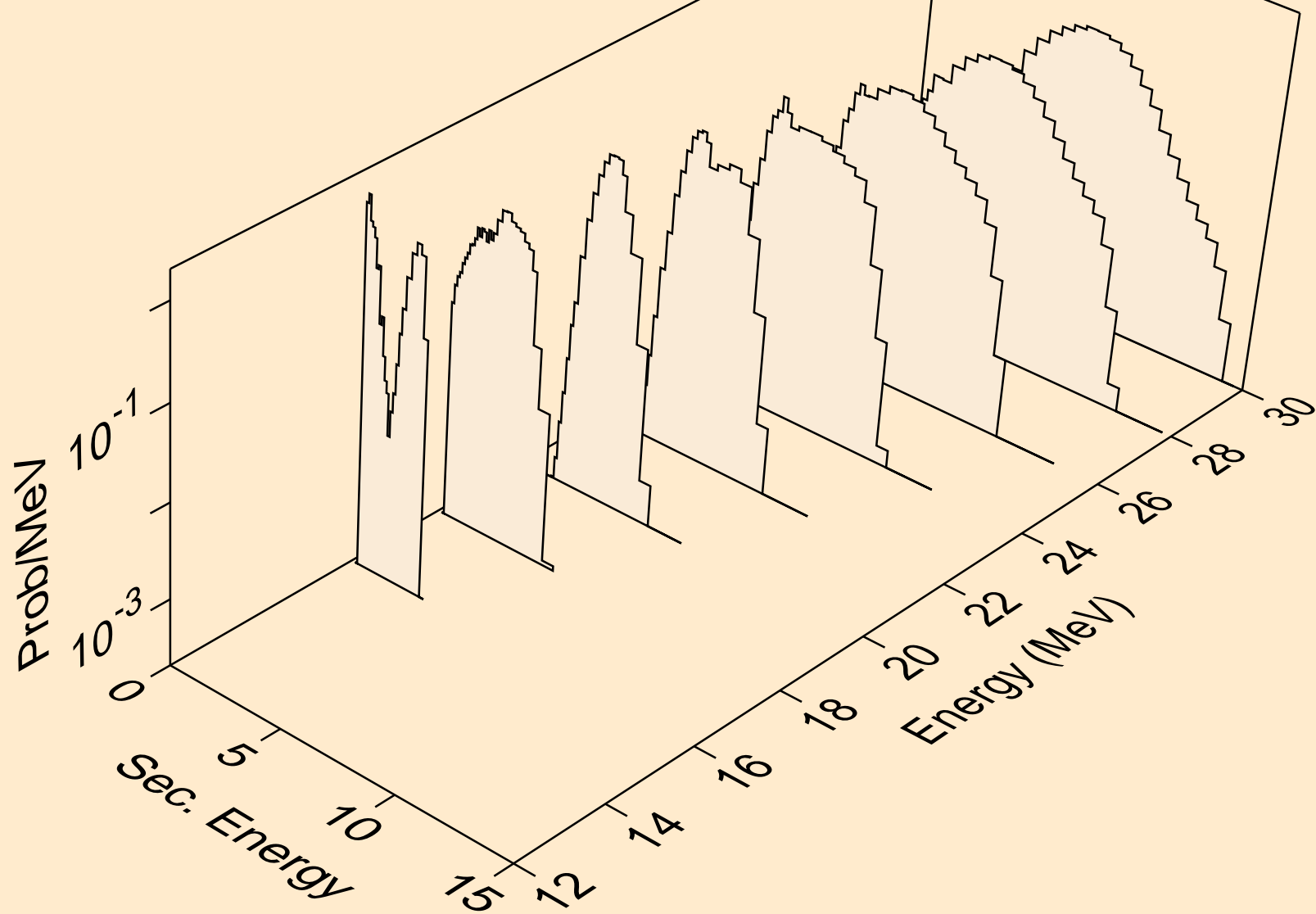

CS132 PROTON ACER TENDL-2021 LIBRARY; T=0.K  
Proton emission for (p,npa)

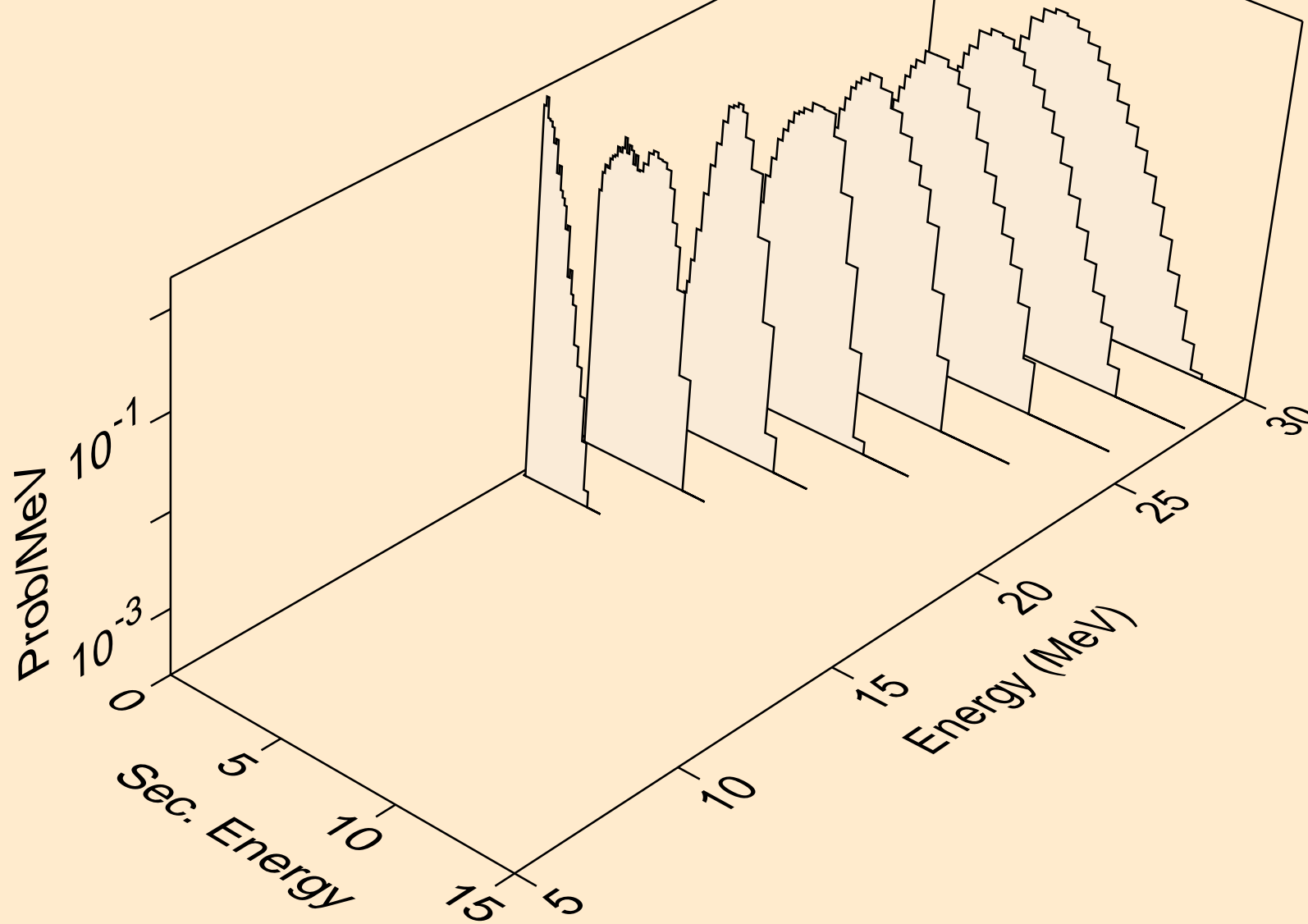

CS132 PROTON ACER TENDL-2021 LIBRARY; T=0.K  
Proton emission for inelastic

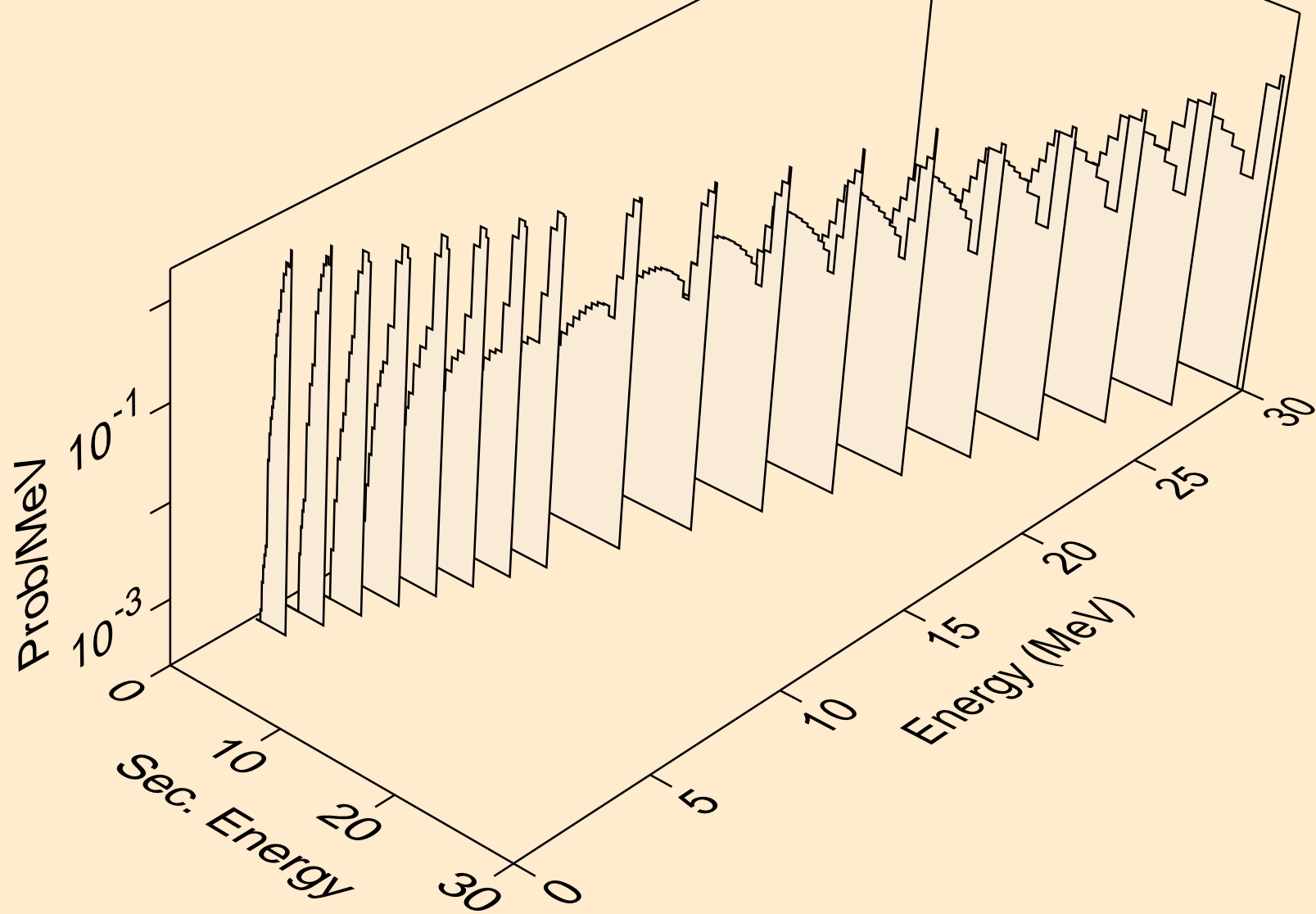



CS132 PROTON ACER TENDL-2021 LIBRARY; T=0.K  
Proton emission for (p,2p)

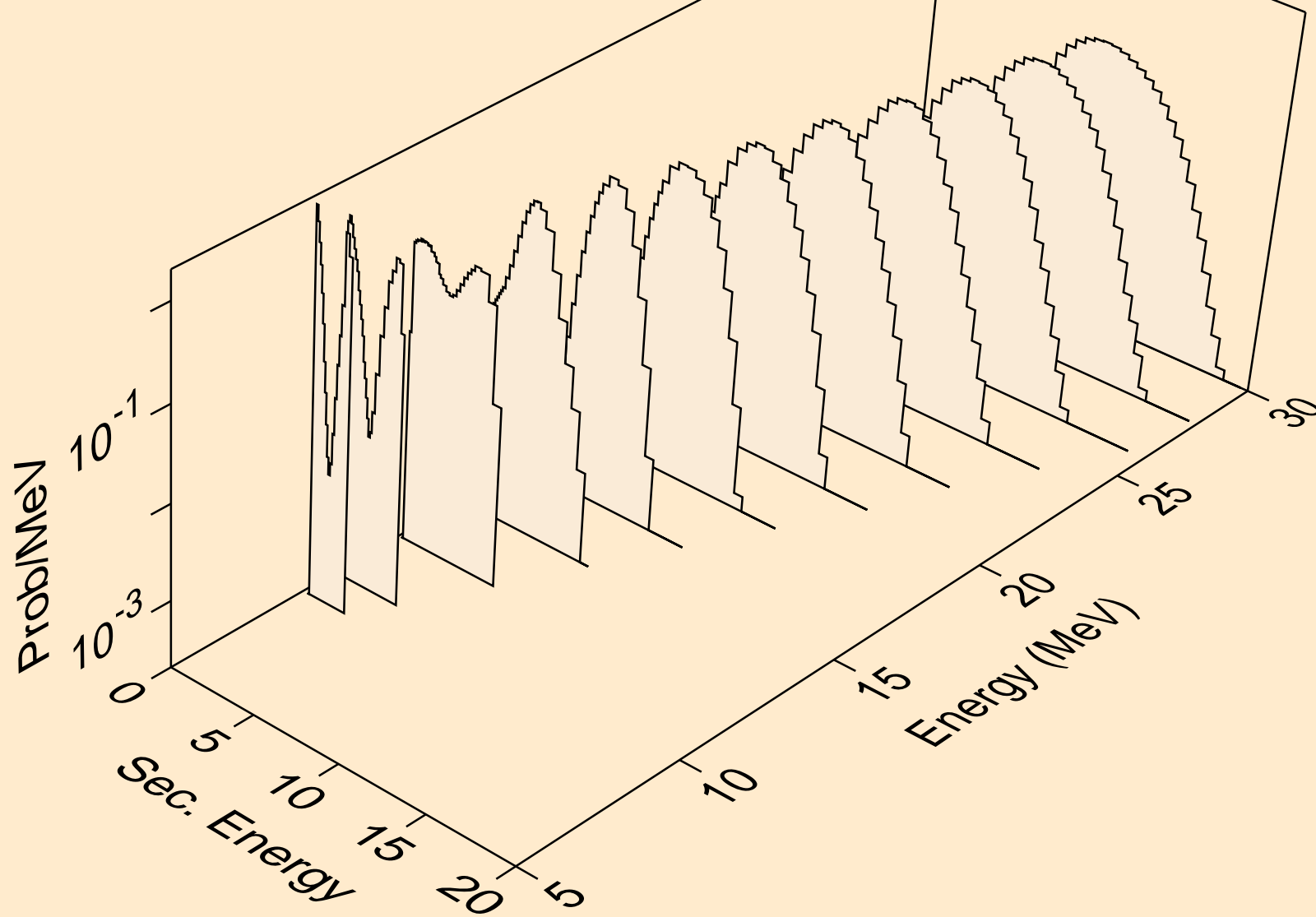

CS132 PROTON ACER TENDL-2021 LIBRARY; T=0.K  
Proton emission for (p,pa)

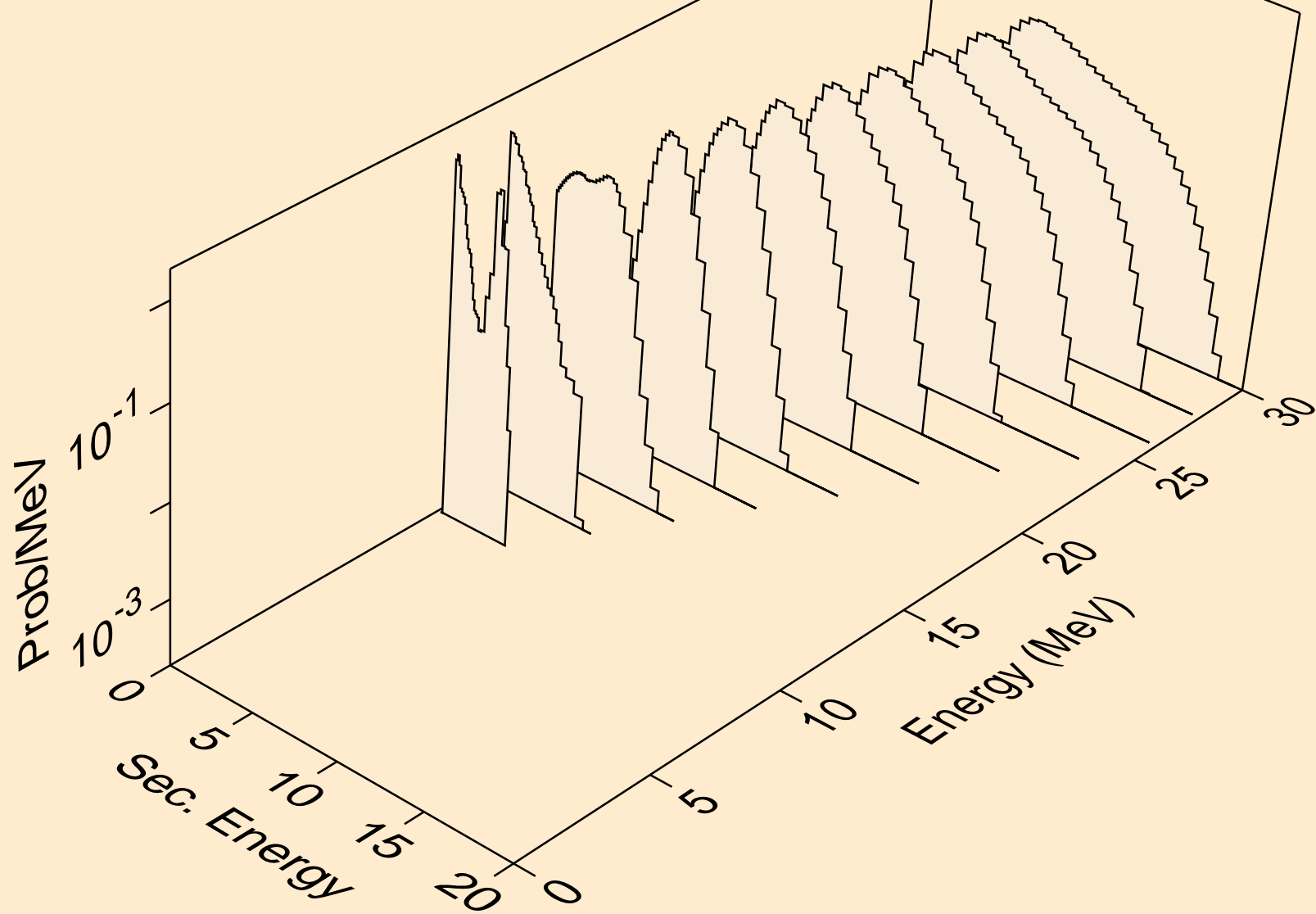

CS132 PROTON ACER TENDL-2021 LIBRARY; T=0.K  
Proton emission for (p,pd)

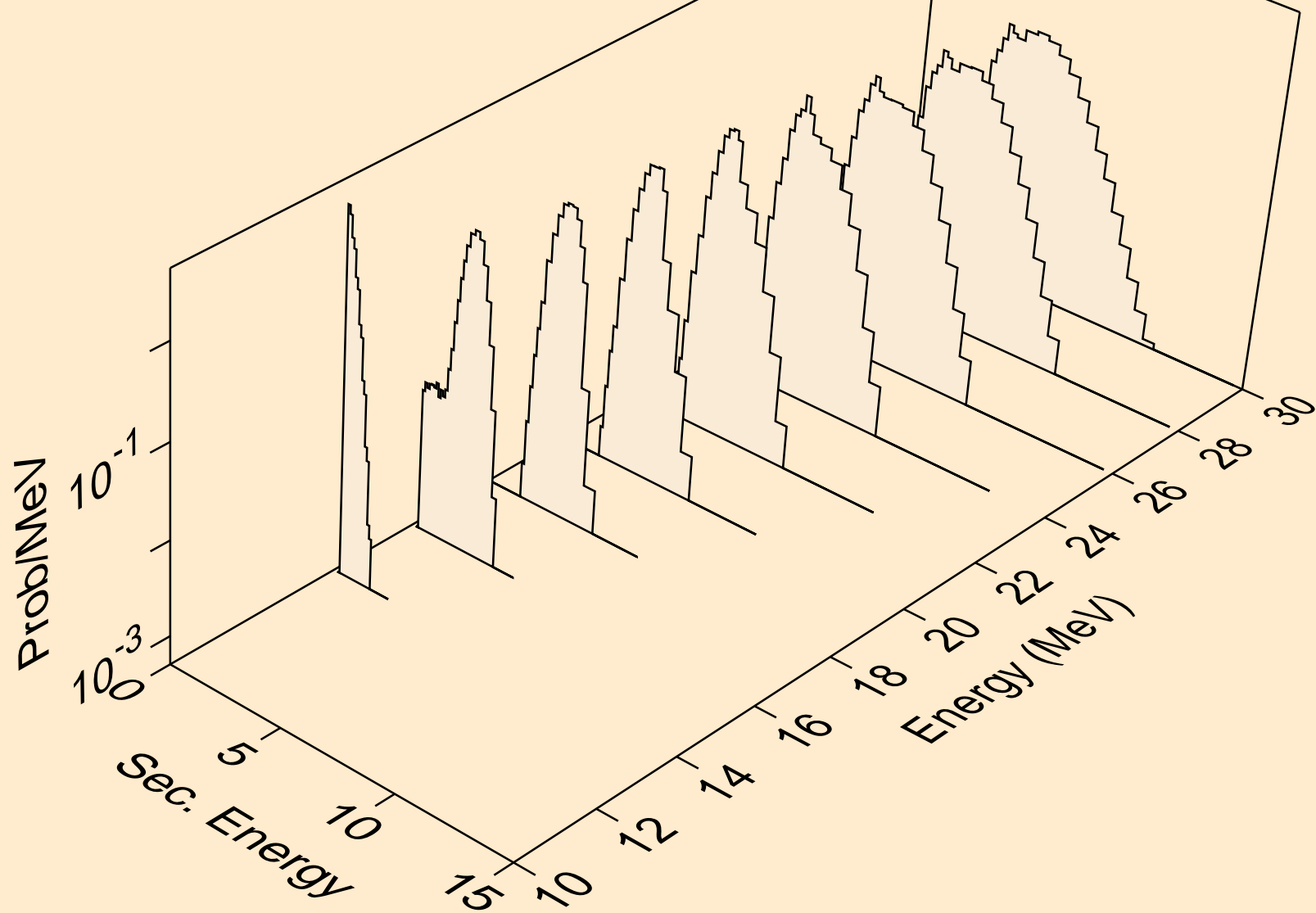

CS132 PROTON ACER TENDL-2021 LIBRARY; T=0.K  
Proton emission for (p,pt)

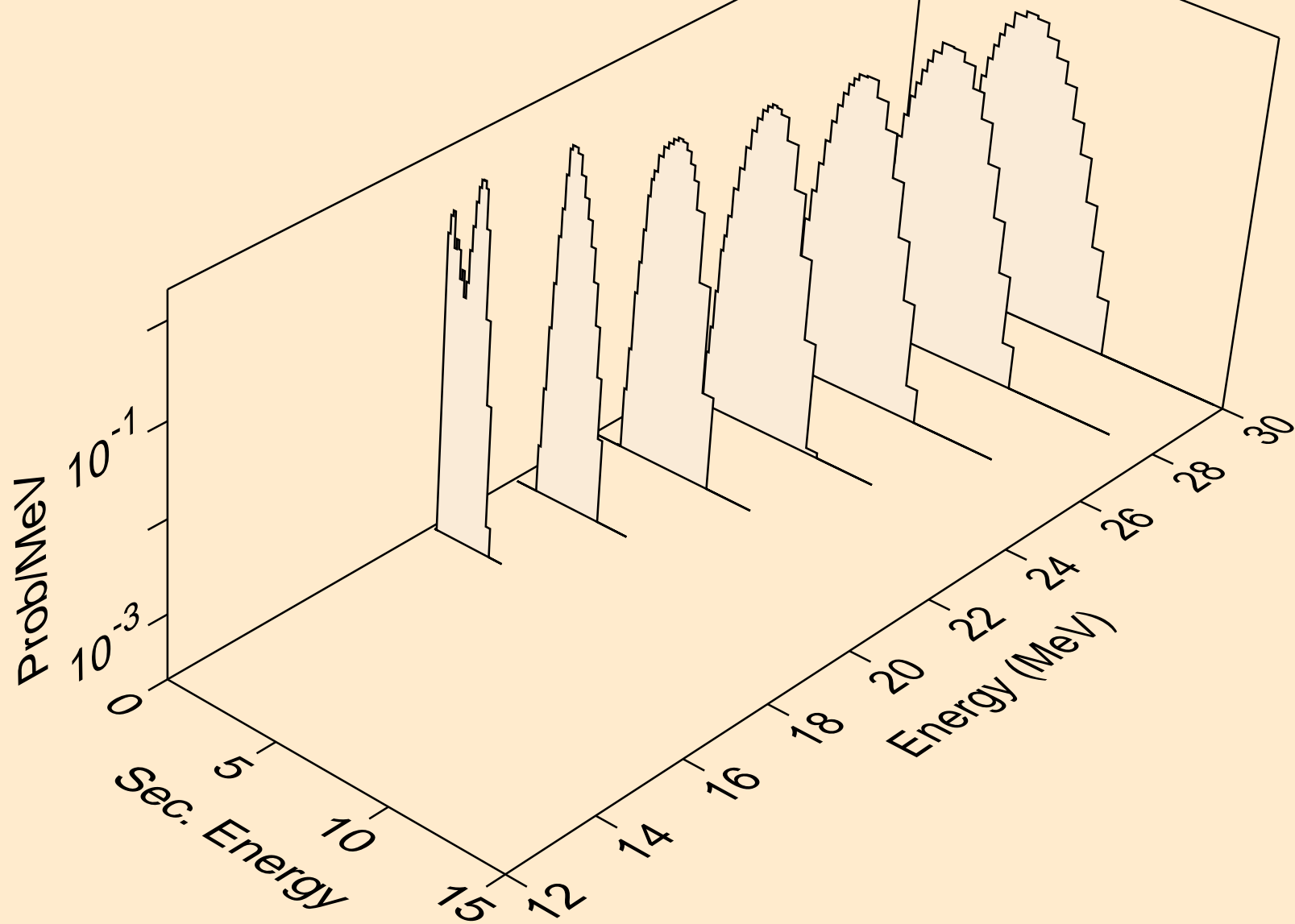

CS132 PROTON ACER TENDL-2021 LIBRARY; T=0.K  
Photon emission for (z,n)

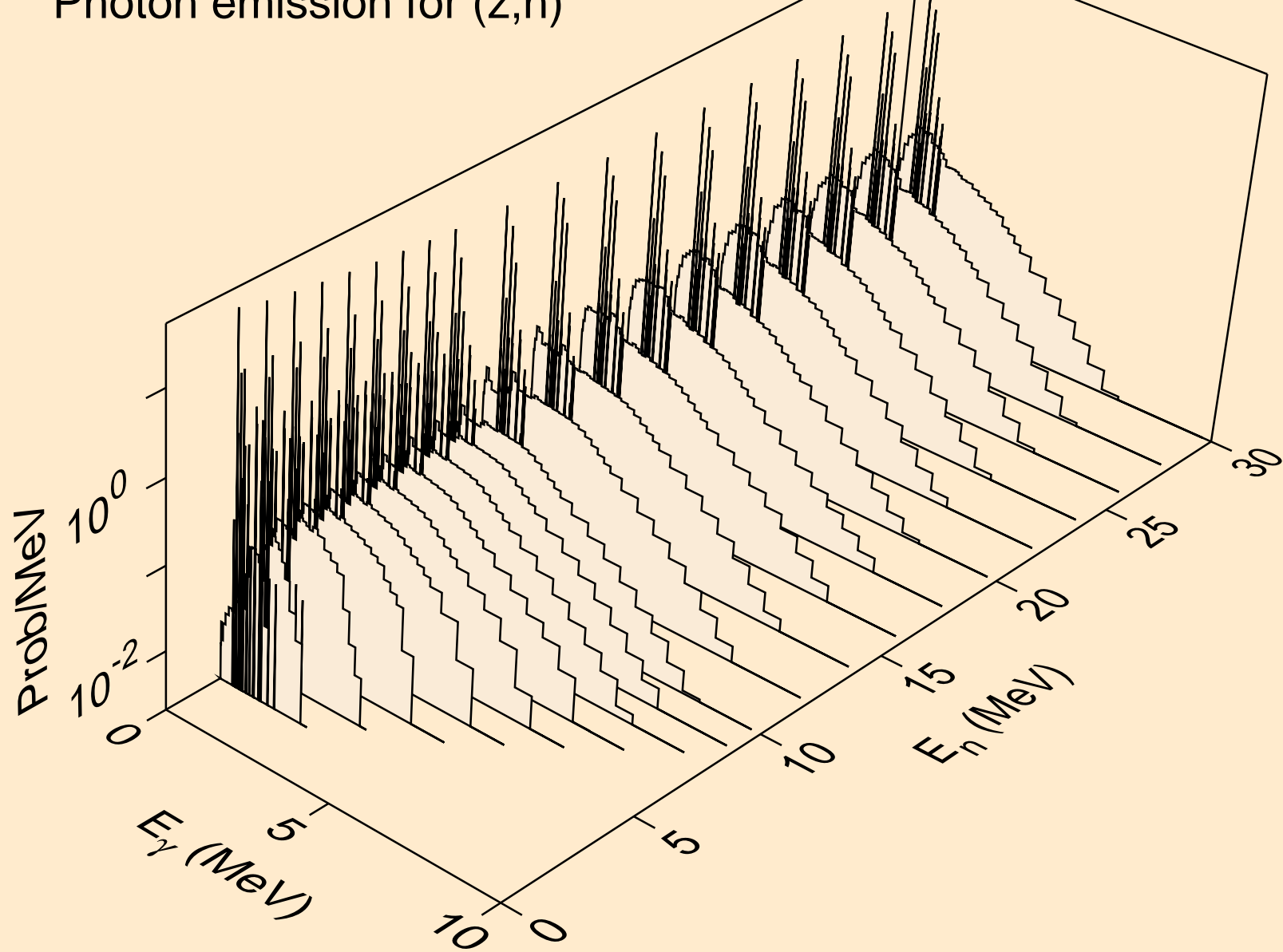

CS132 PROTON ACER TENDL-2021 LIBRARY; T=0.K  
Photon emission for (n,x)

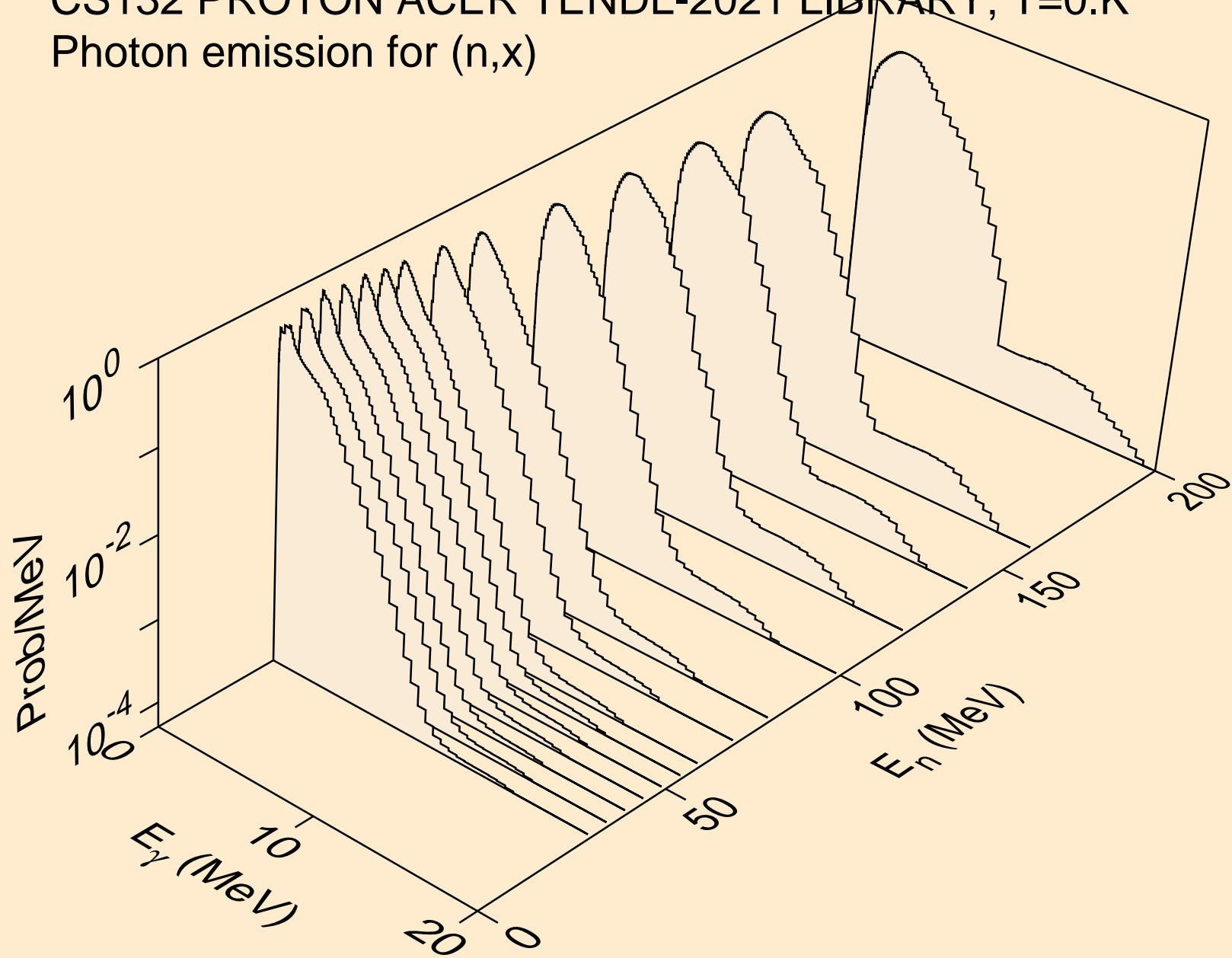

CS132 PROTON ACER TENDL-2021 LIBRARY; T=0.K  
Photon emission for (n,2nd)

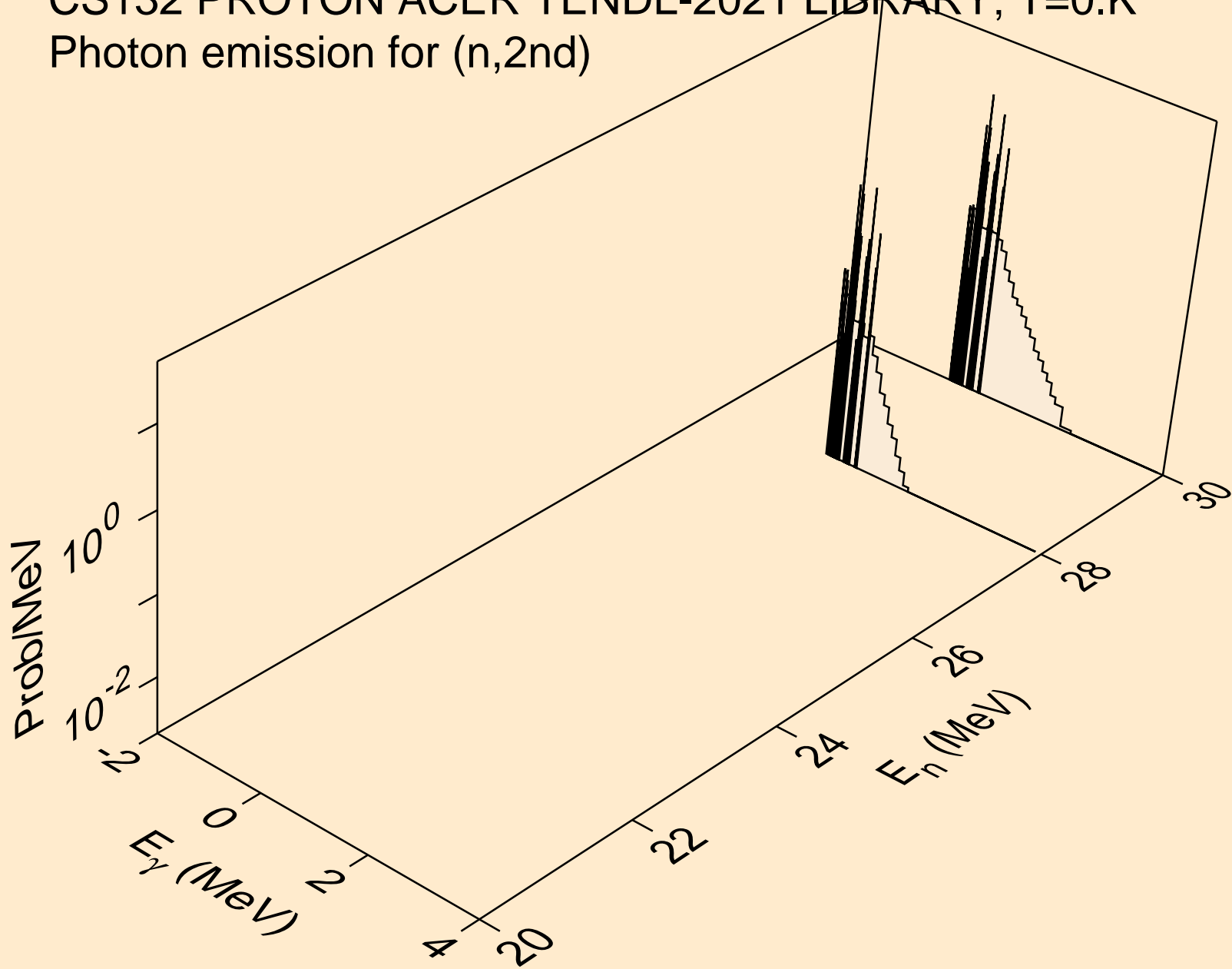

CS132 PROTON ACER TENDL-2021 LIBRARY; T=0.K  
Photon emission for (n,2n)

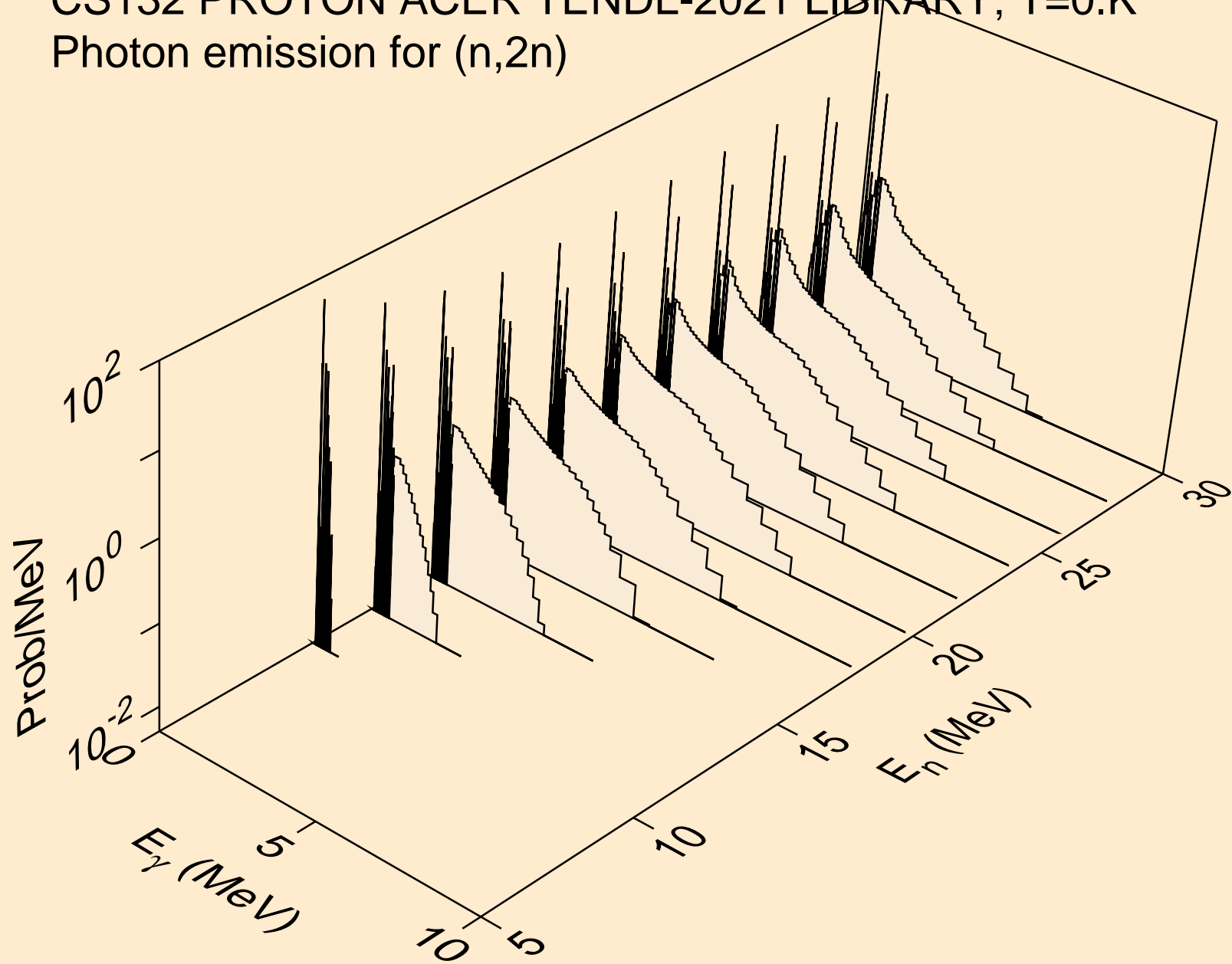



CS132 PROTON ACER TENDL-2021 LIBRARY; T=0.K  
Photon emission for (n,3n)

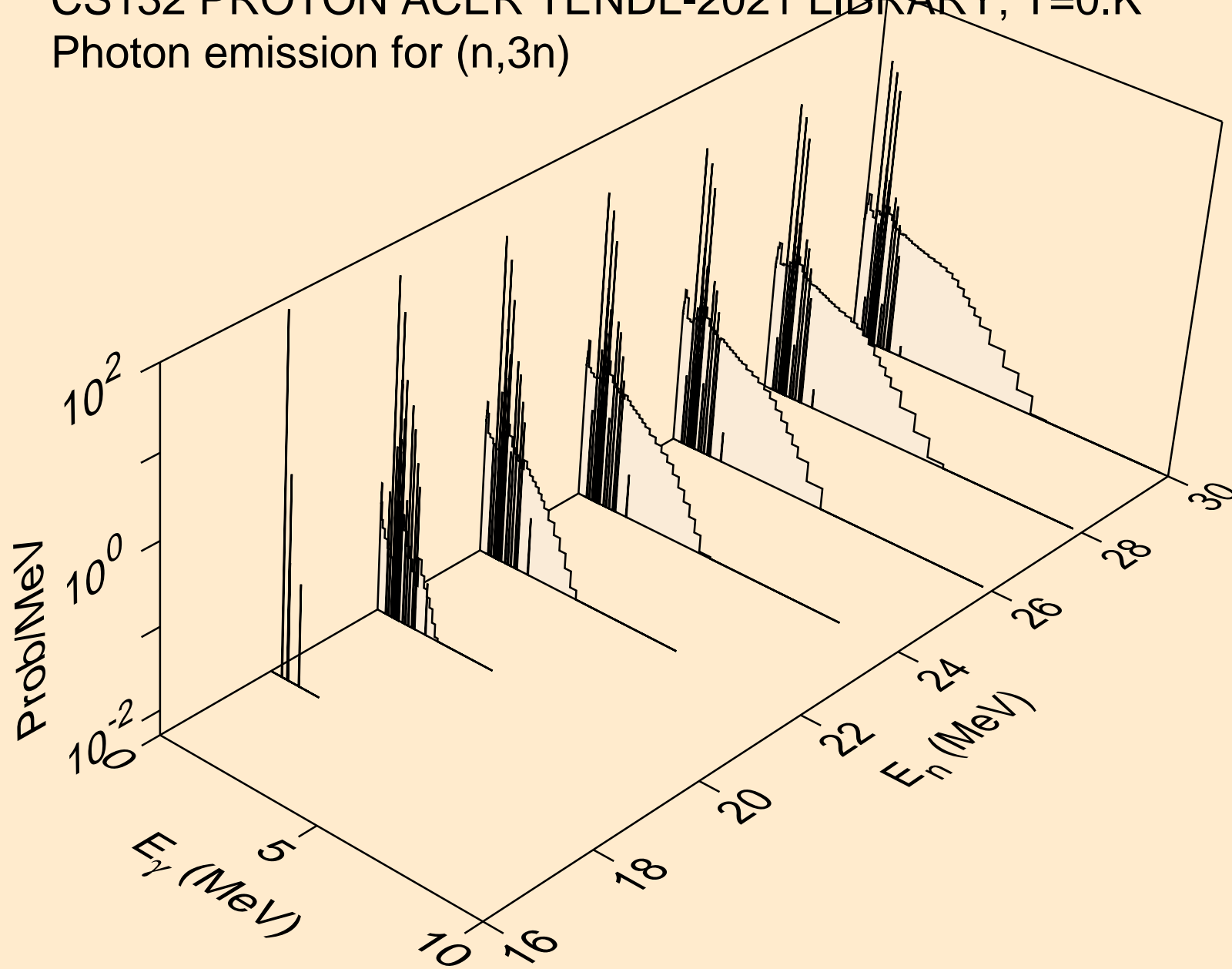

CS132 PROTON ACER TENDL-2021 LIBRARY; T=0.K  
Photon emission for (n,n\*)a

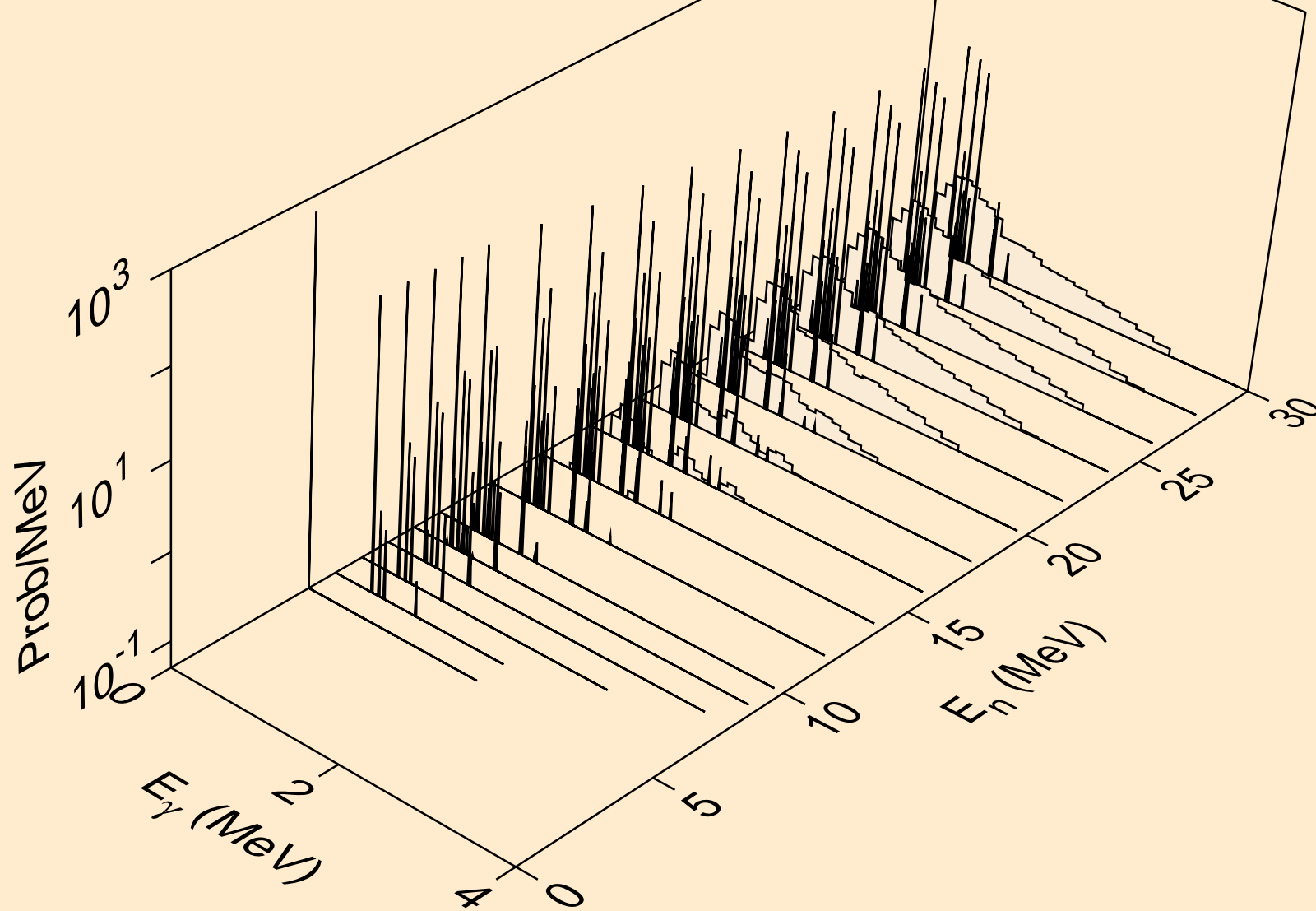

CS132 PROTON ACER TENDL-2021 LIBRARY; T=0.K  
Photon emission for (n,2n)a

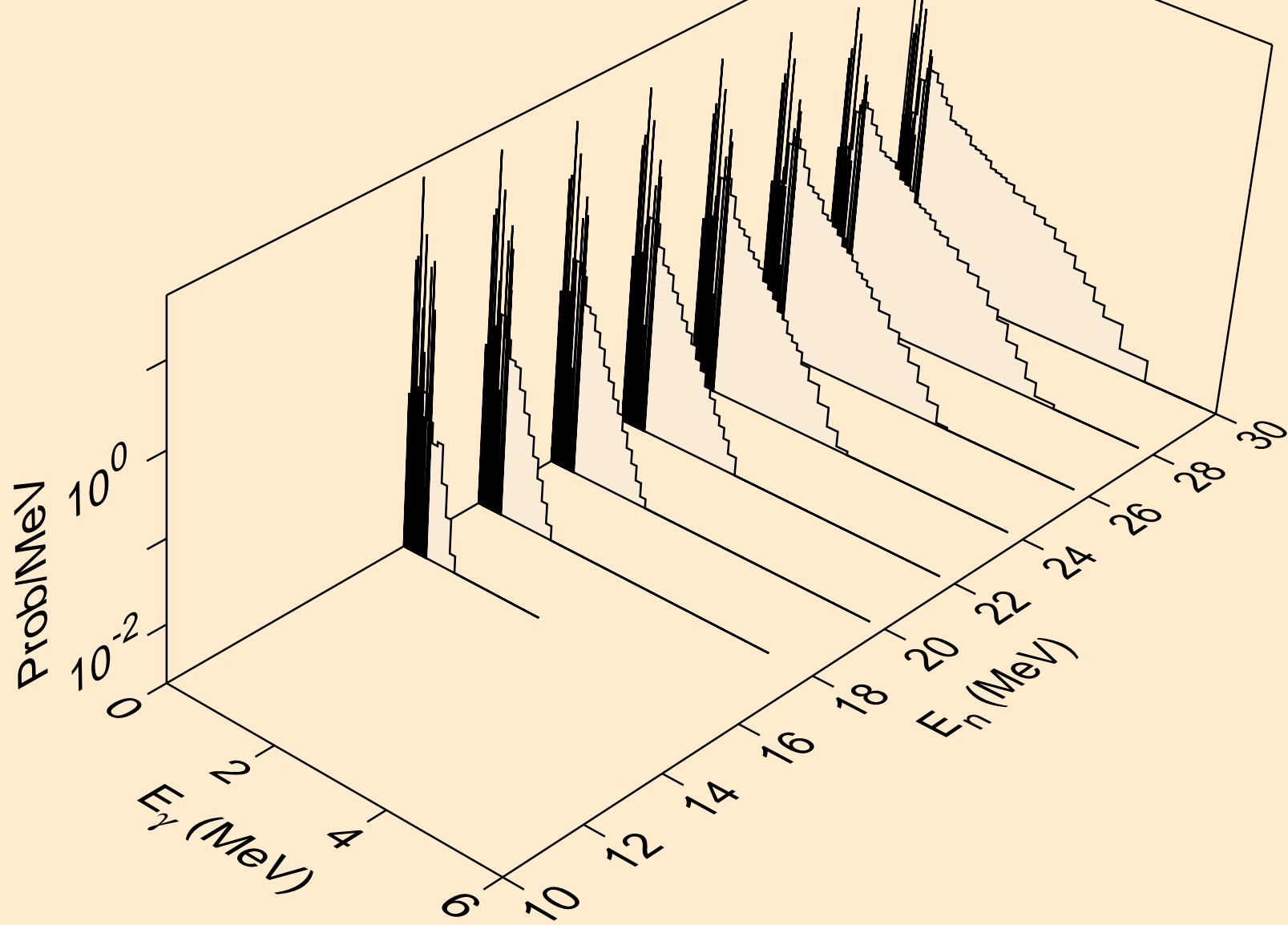

CS132 PROTON ACER TENDL-2021 LIBRARY; T=0.K  
Photon emission for (n,3n)a

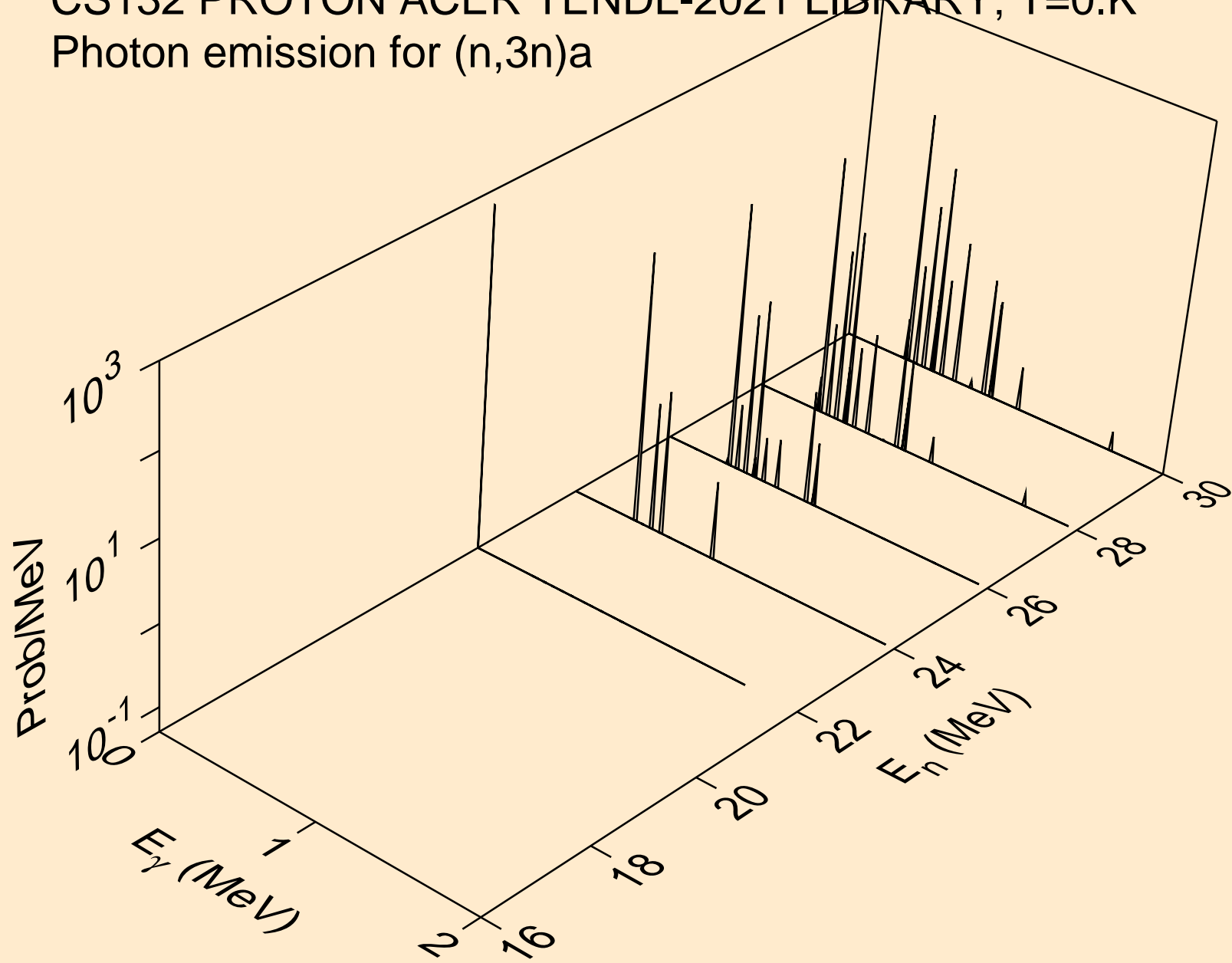

CS132 PROTON ACER TENDL-2021 LIBRARY; T=0.K  
Photon emission for (n,n\*)p

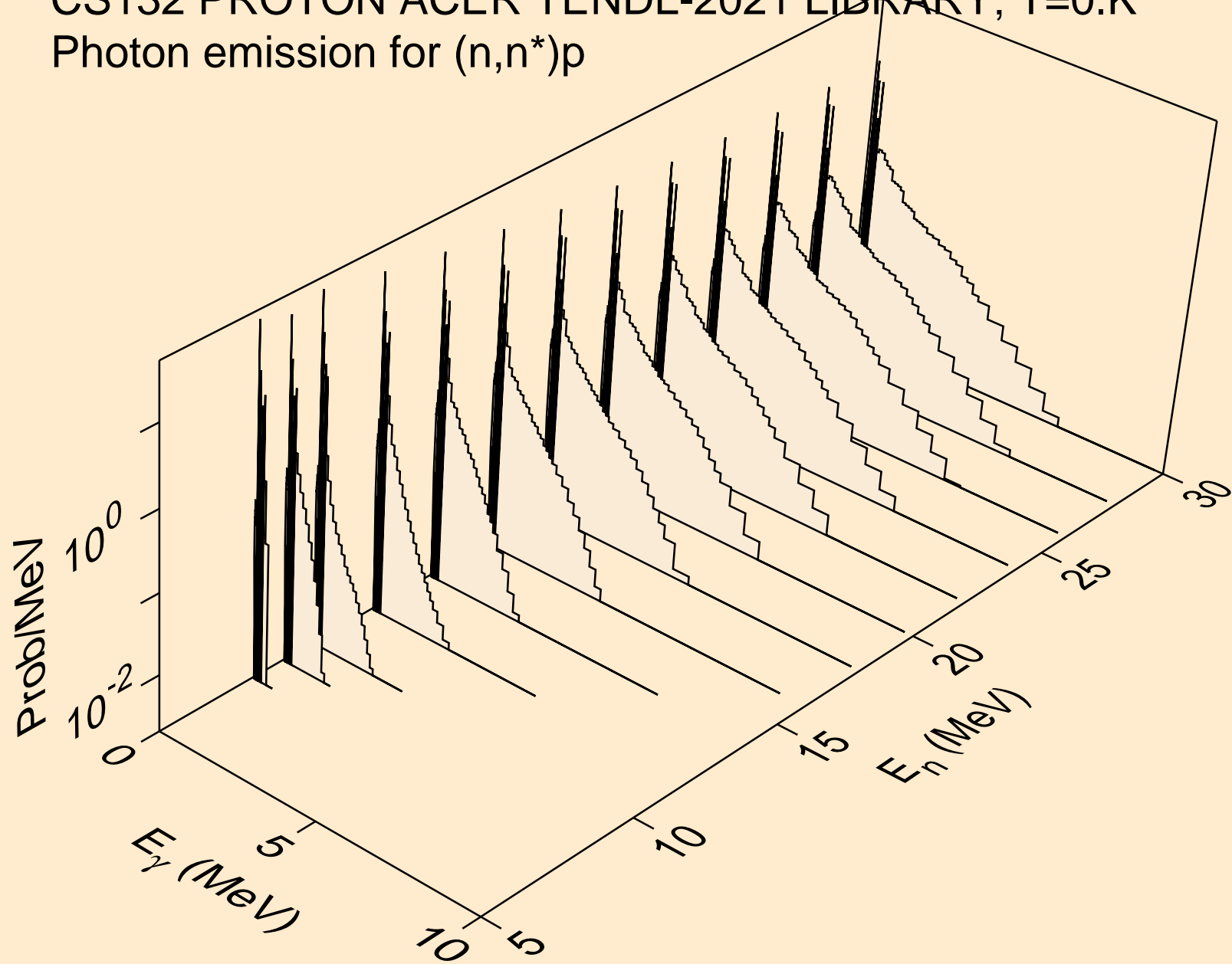

CS132 PROTON ACER TENDL-2021 LIBRARY; T=0.K  
Photon emission for (n,n\*)2a

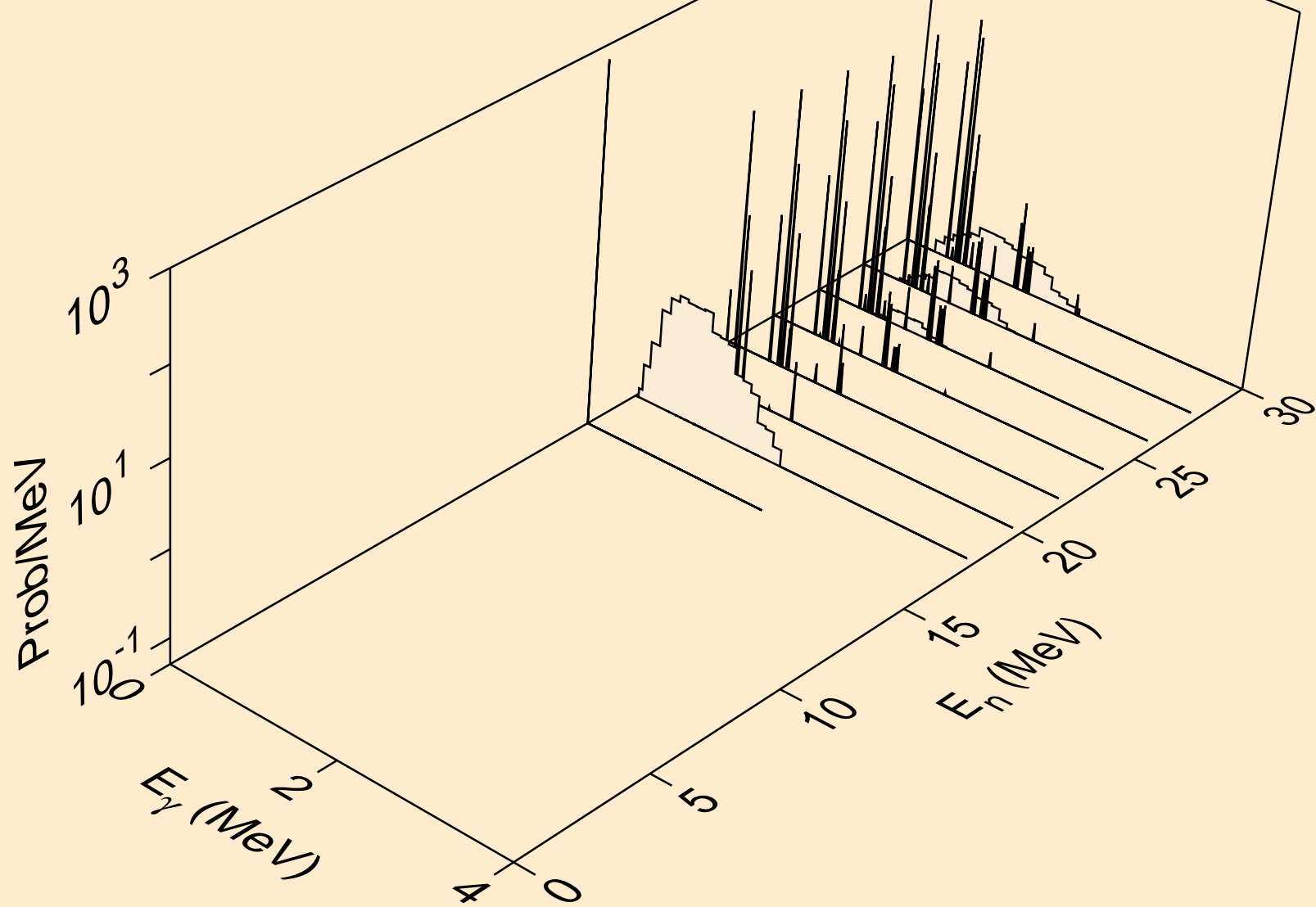

CS132 PROTON ACER TENDL-2021 LIBRARY; T=0.K  
Photon emission for (n,n\*)d

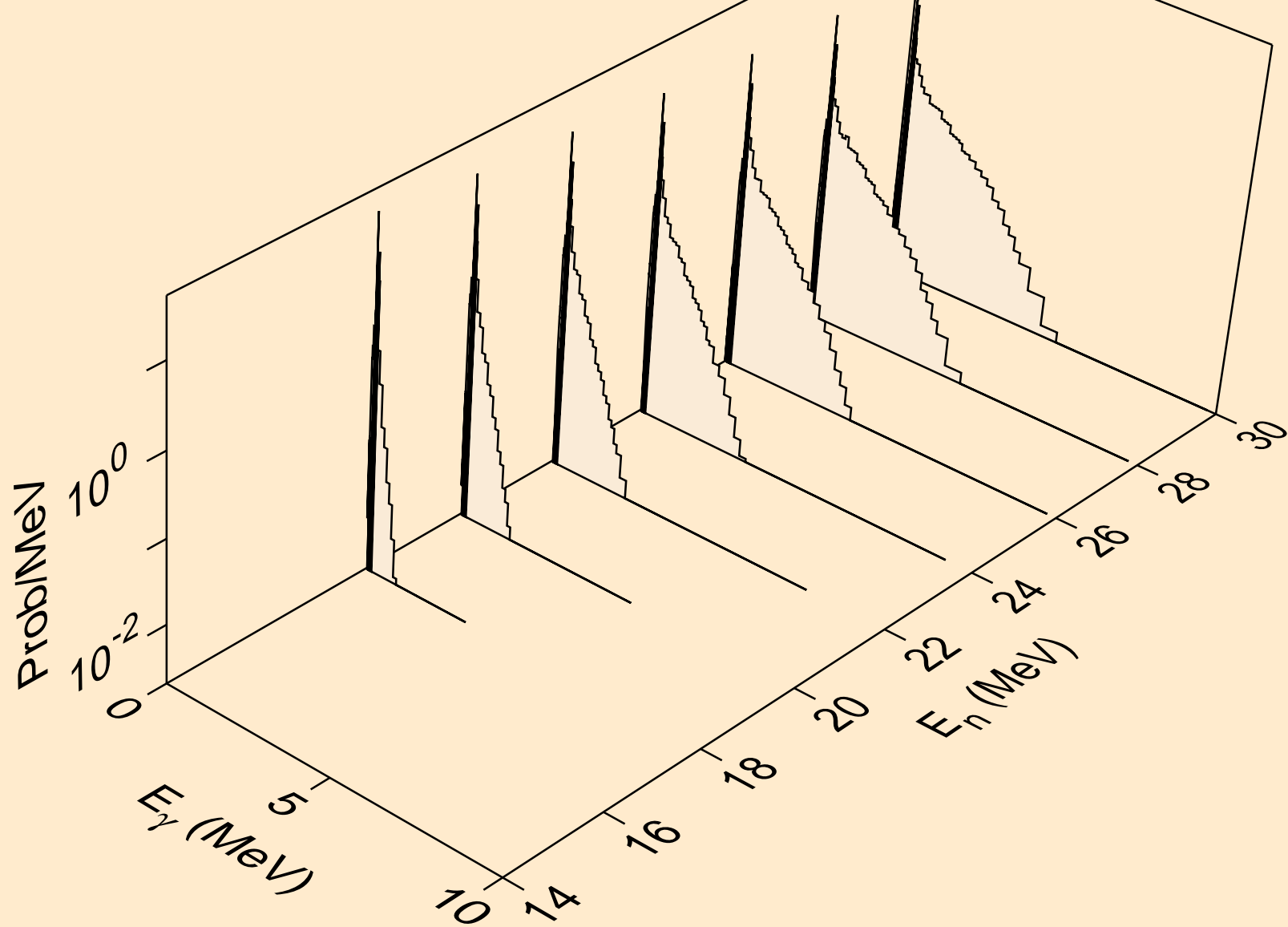

CS132 PROTON ACER TENDL-2021 LIBRARY; T=0.K  
Photon emission for (n,n\*)t

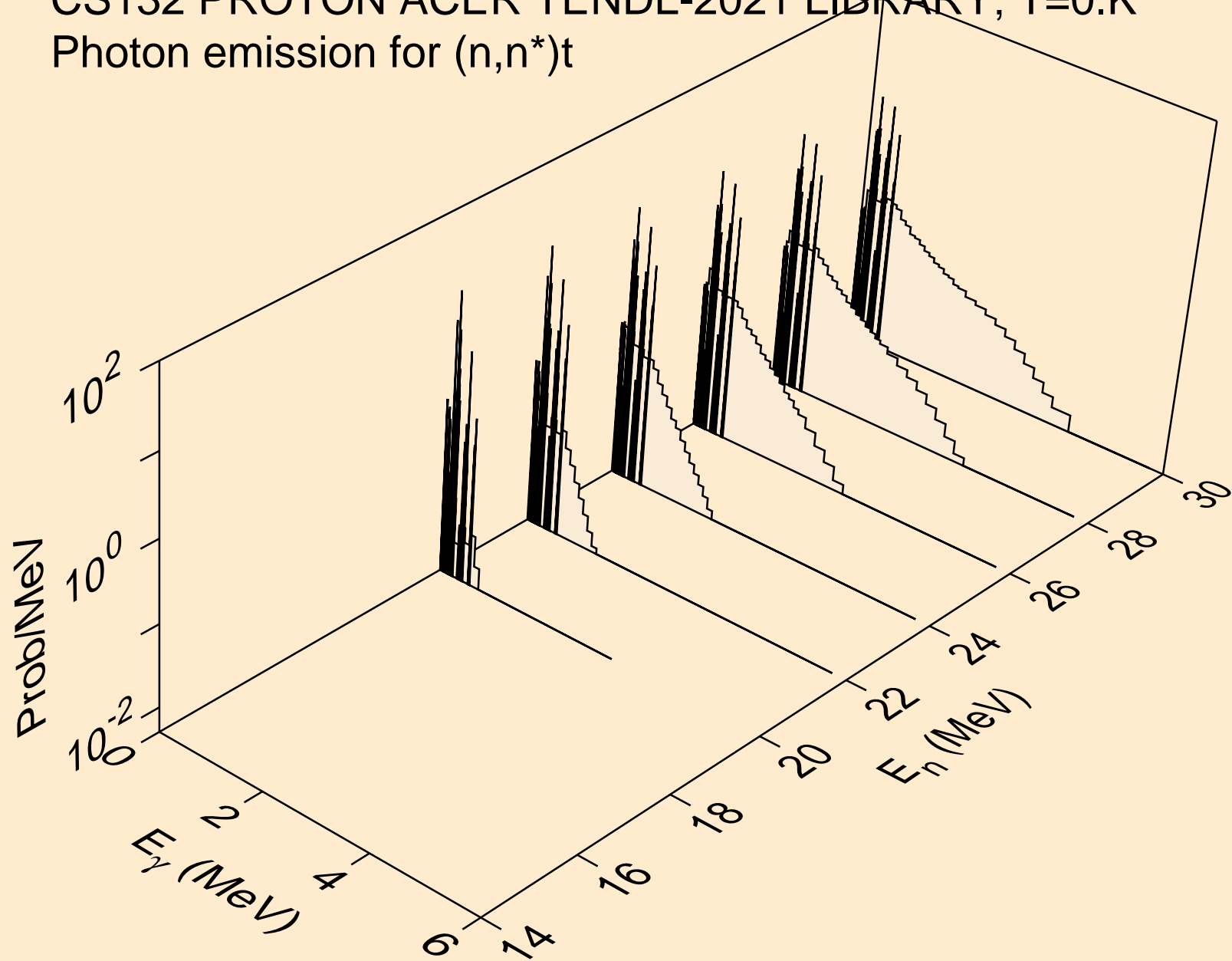



CS132 PROTON ACER TENDL-2021 LIBRARY; T=0.K  
Photon emission for (n,n\*)he3

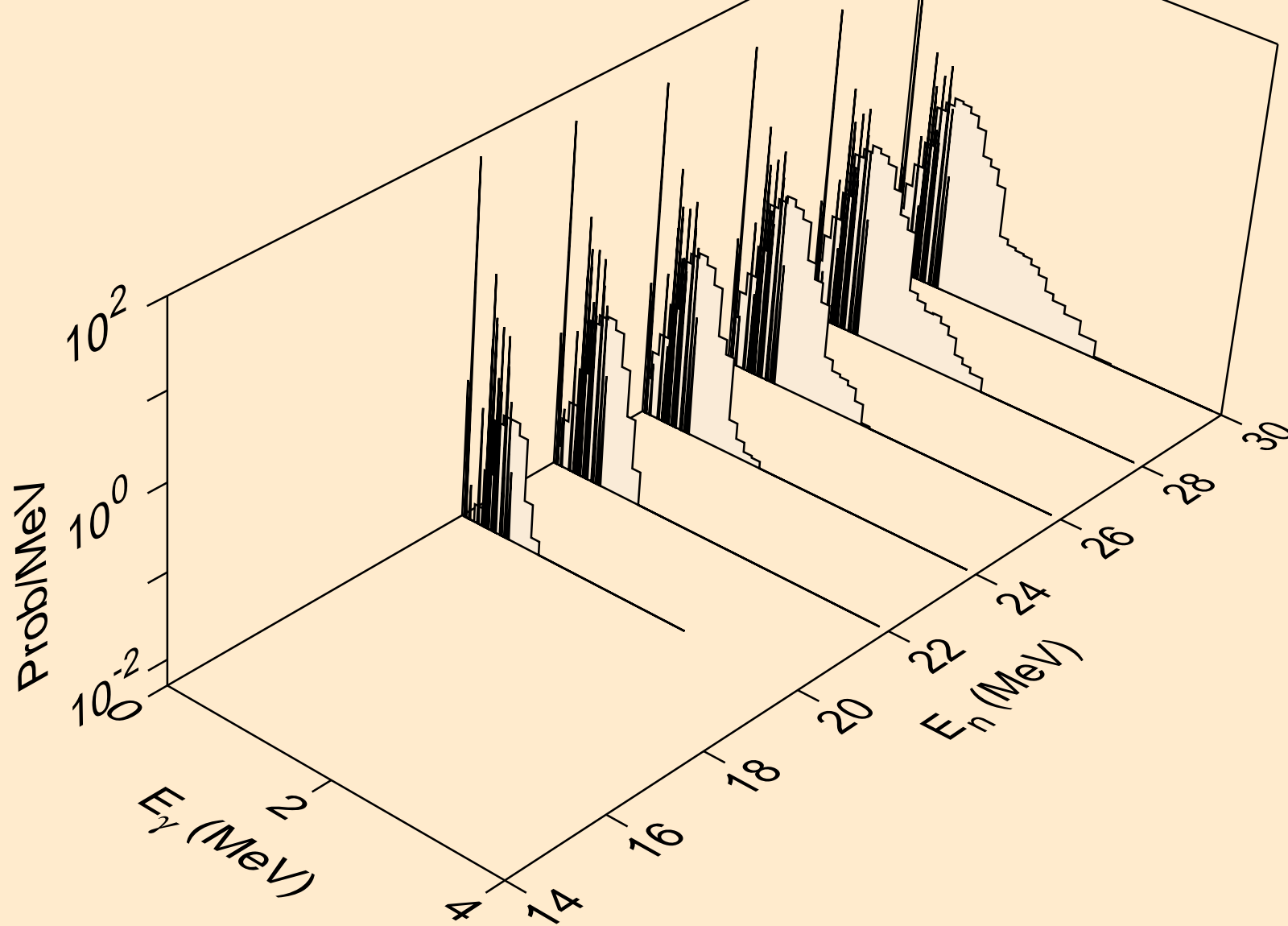

CS132 PROTON ACER TENDL-2021 LIBRARY; T=0.K  
Photon emission for (n,4n)

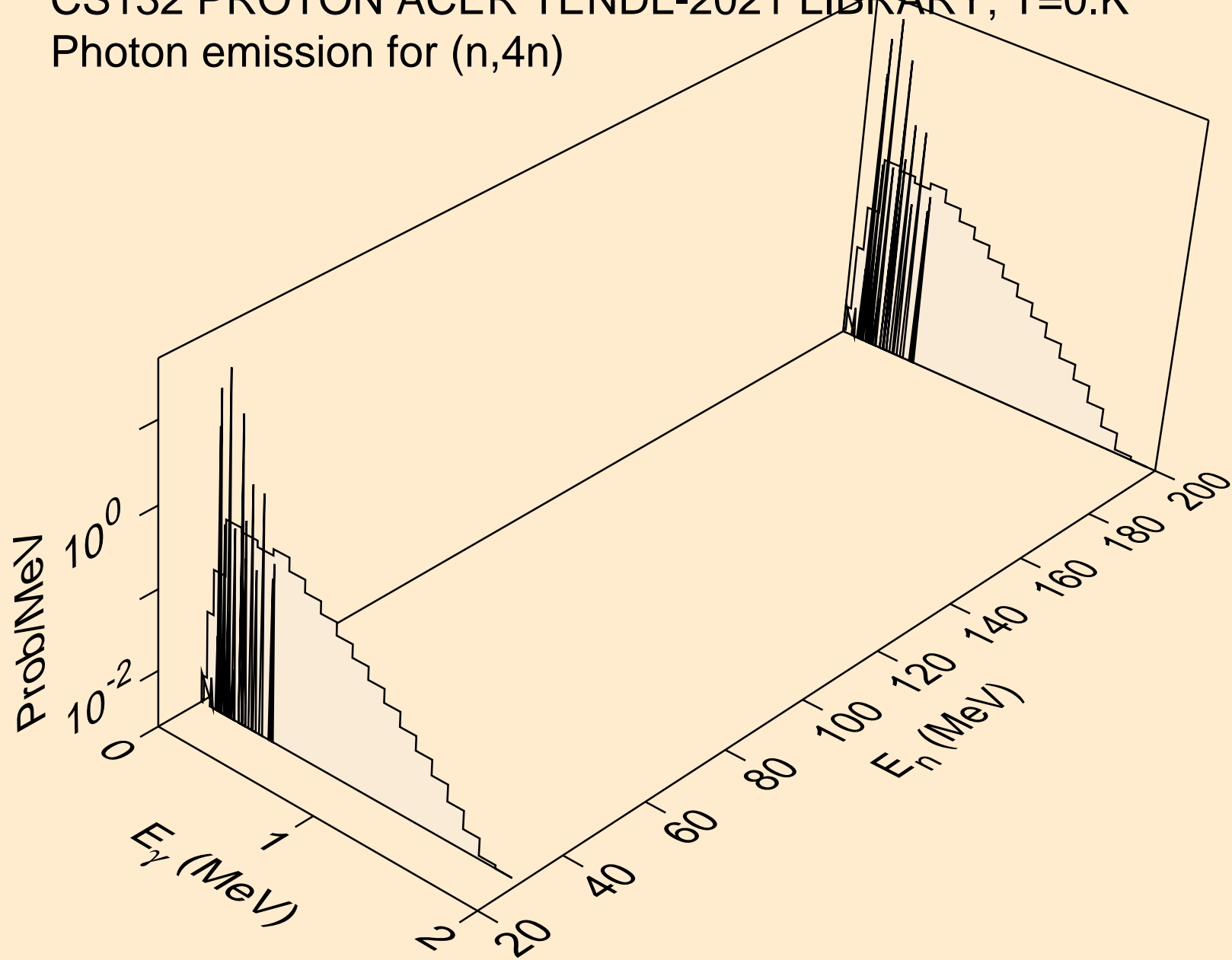

CS132 PROTON ACER TENDL-2021 LIBRARY; T=0.K  
Photon emission for (n,2np)

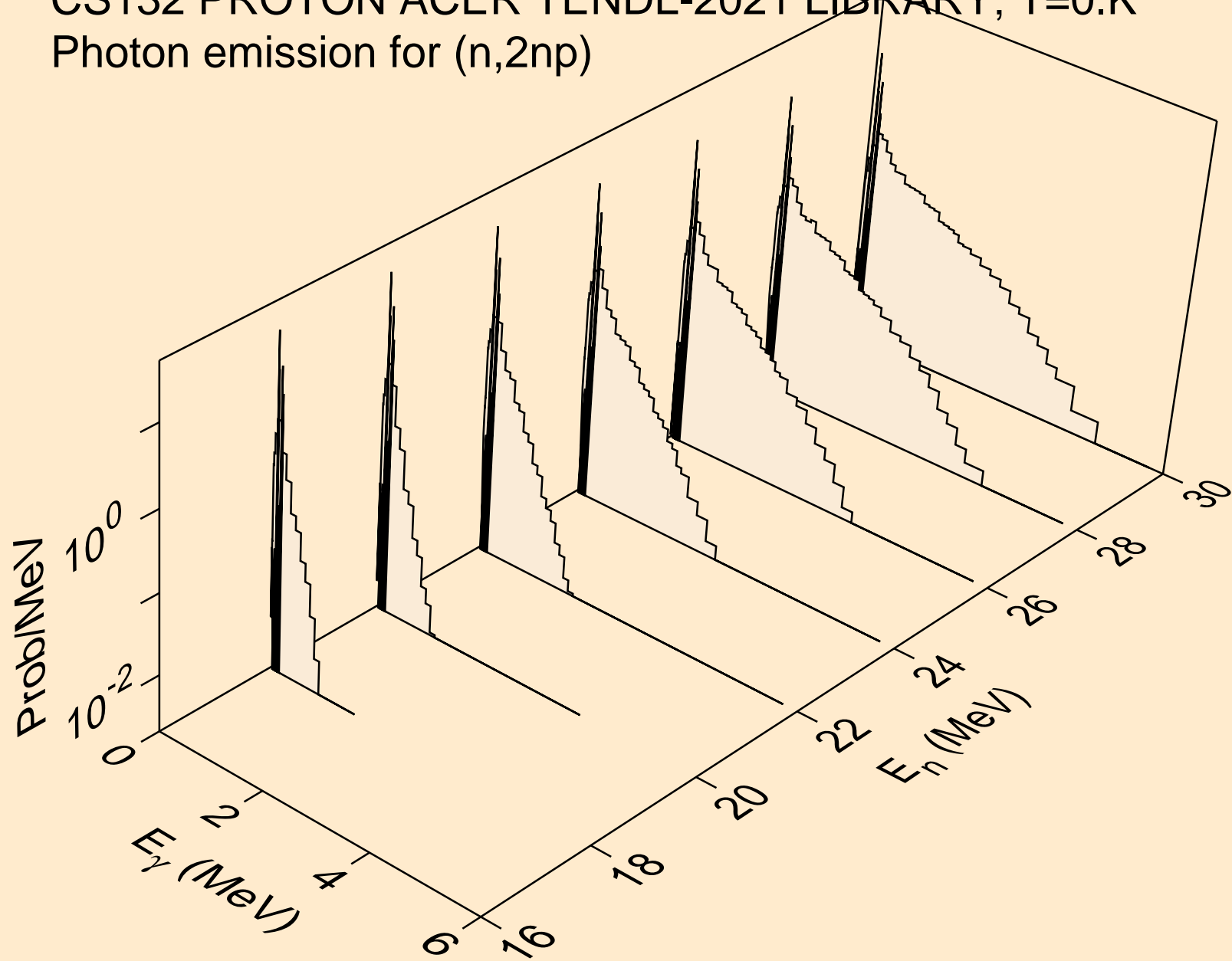

CS132 PROTON ACER TENDL-2021 LIBRARY; T=0.K  
Photon emission for (n,3np)

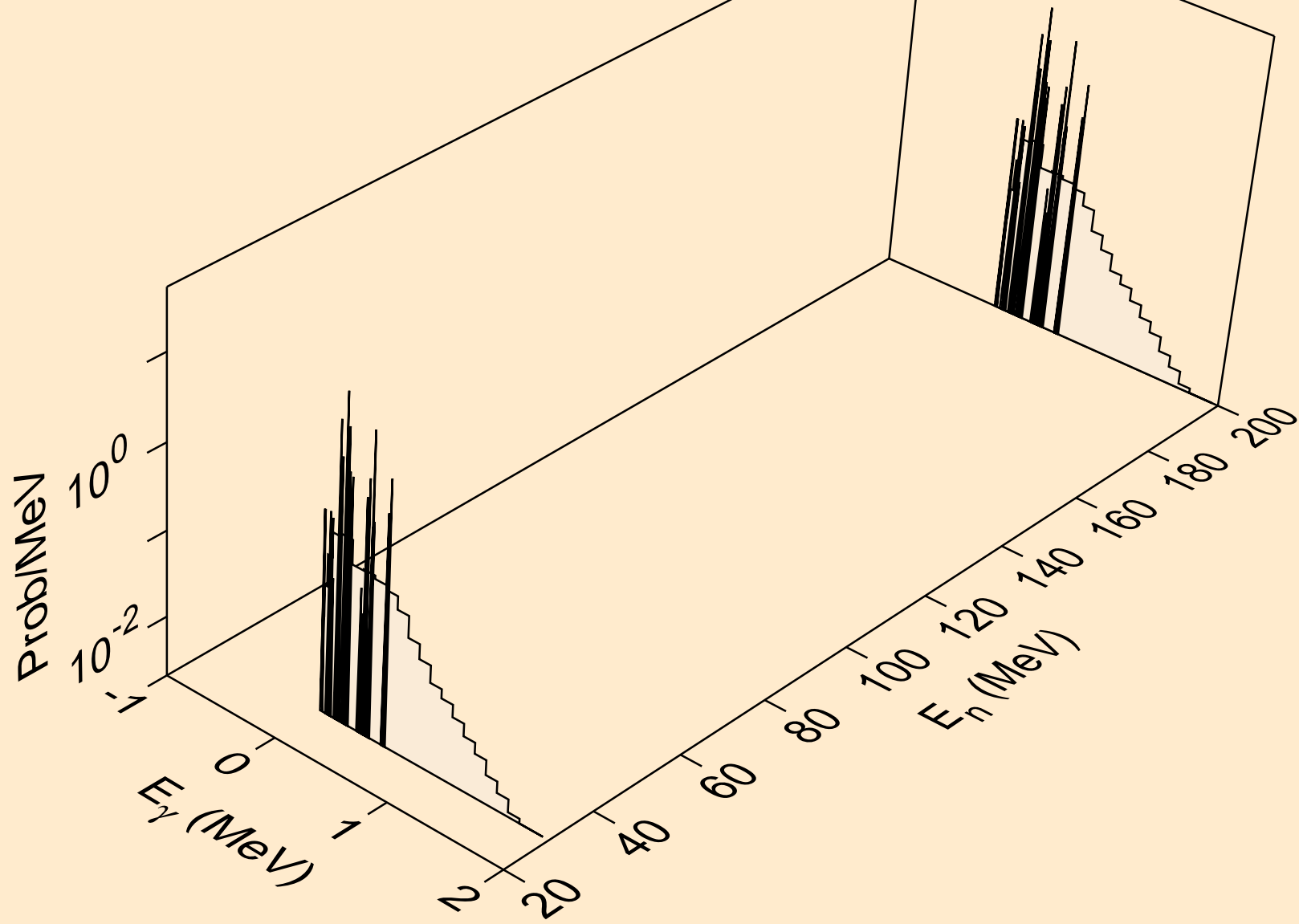

CS132 PROTON ACER TENDL-2021 LIBRARY; T=0.K  
Photon emission for (n,2np)

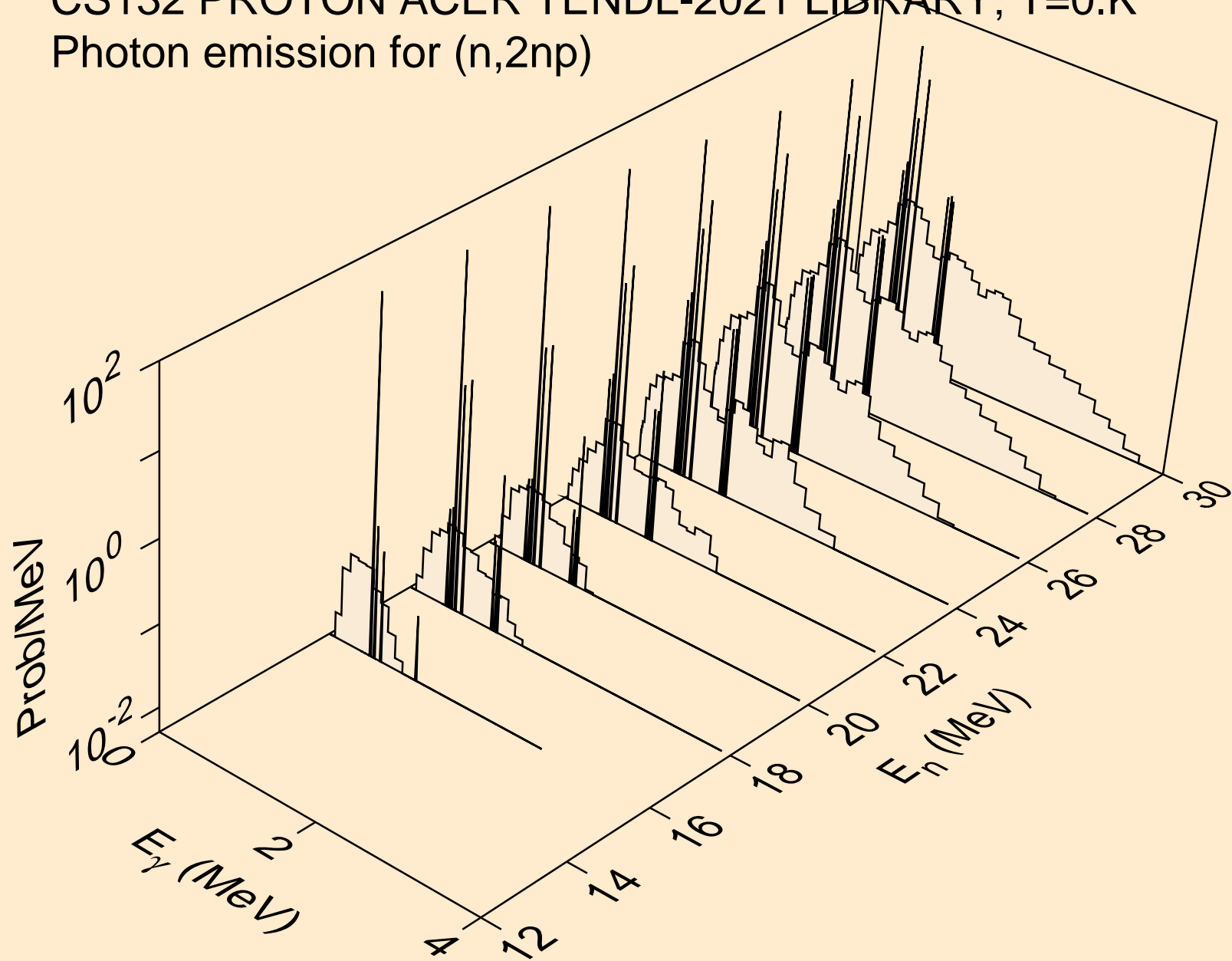

CS132 PROTON ACER TENDL-2021 LIBRARY; T=0.K  
Photon emission for (n,npa)

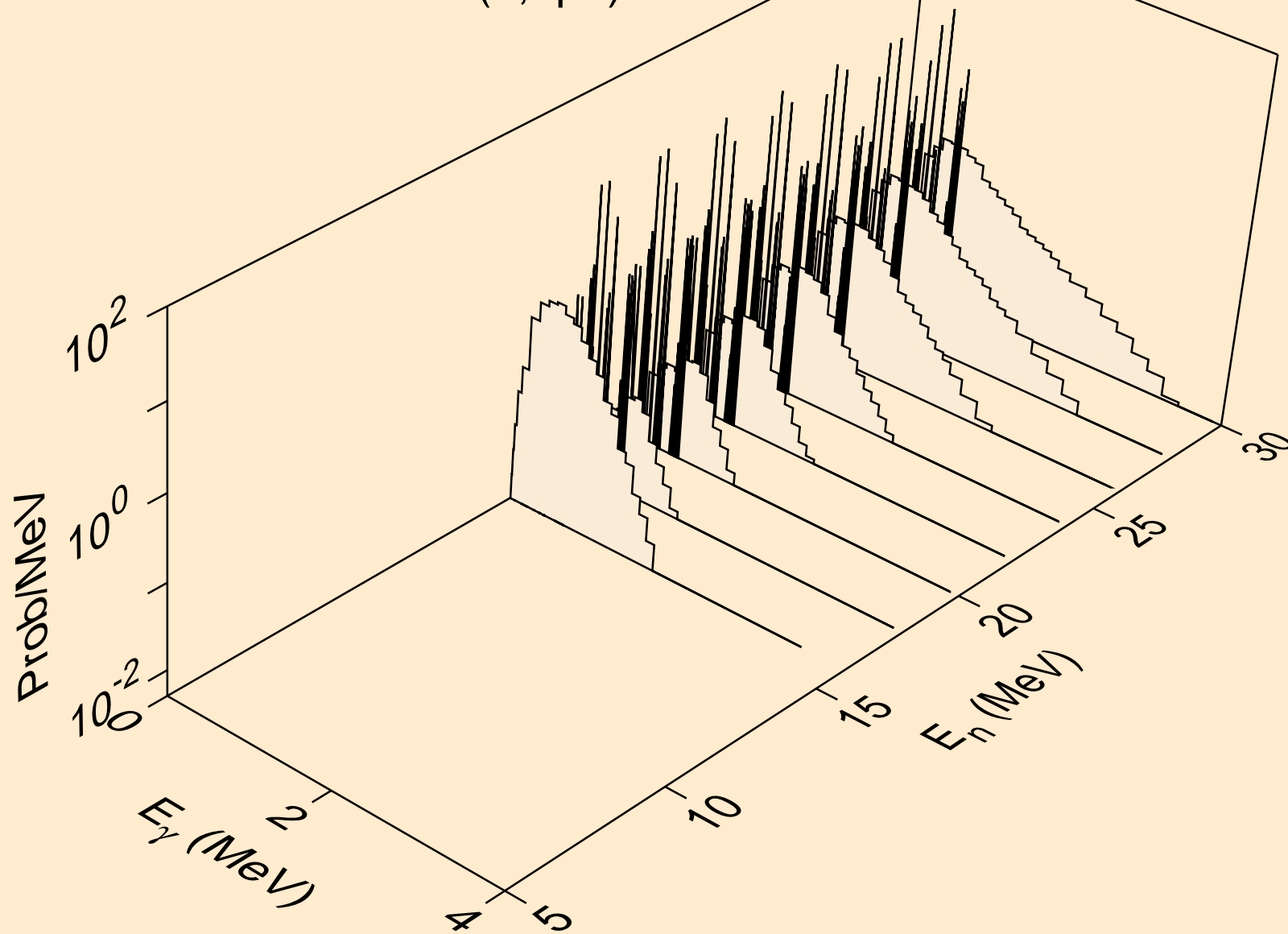

CS132 PROTON ACER TENDL-2021 LIBRARY; T=0.K  
Photon emission for (n,gma)

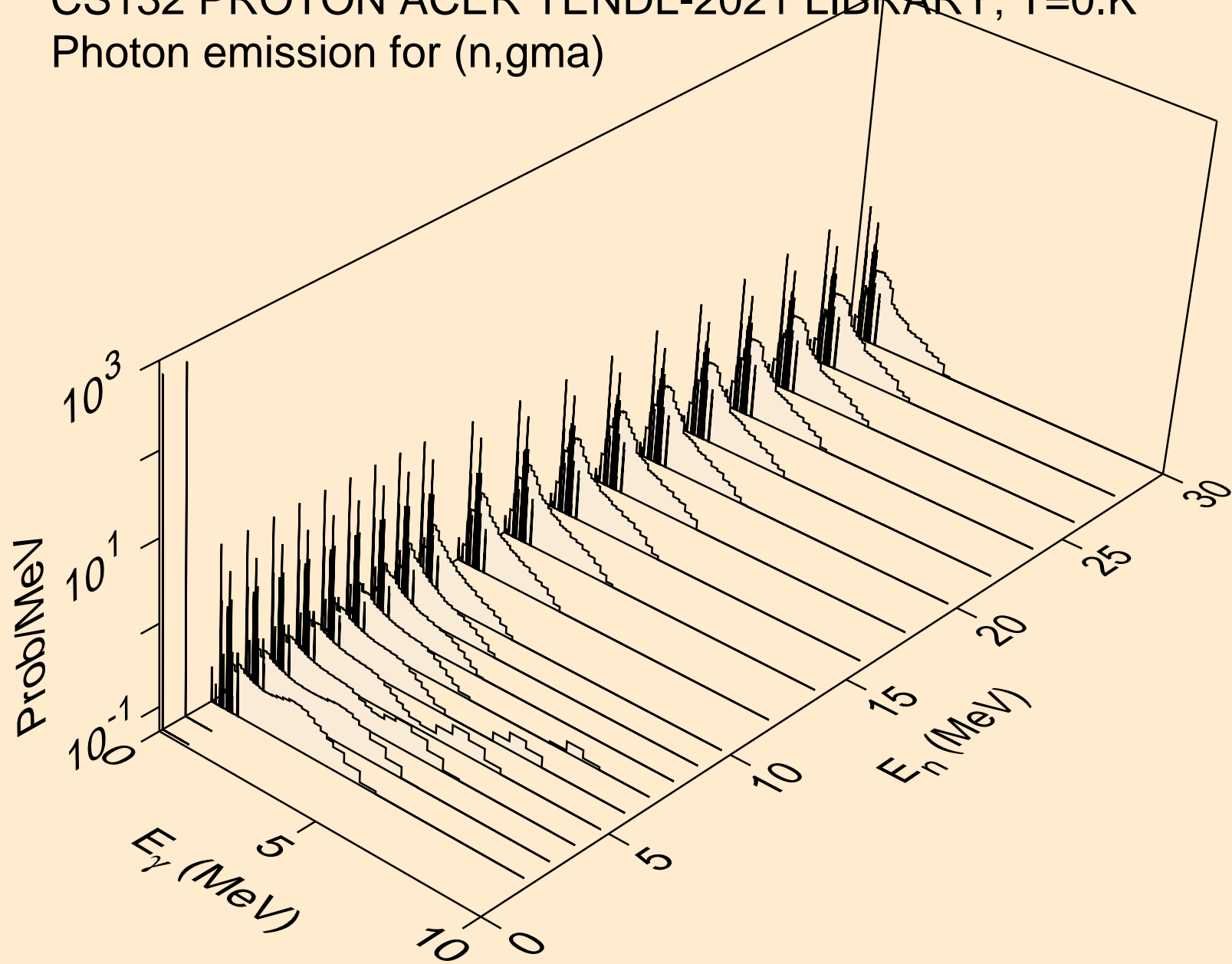

CS132 PROTON ACER TENDL-2021 LIBRARY; T=0.K  
Photon emission for inelastic

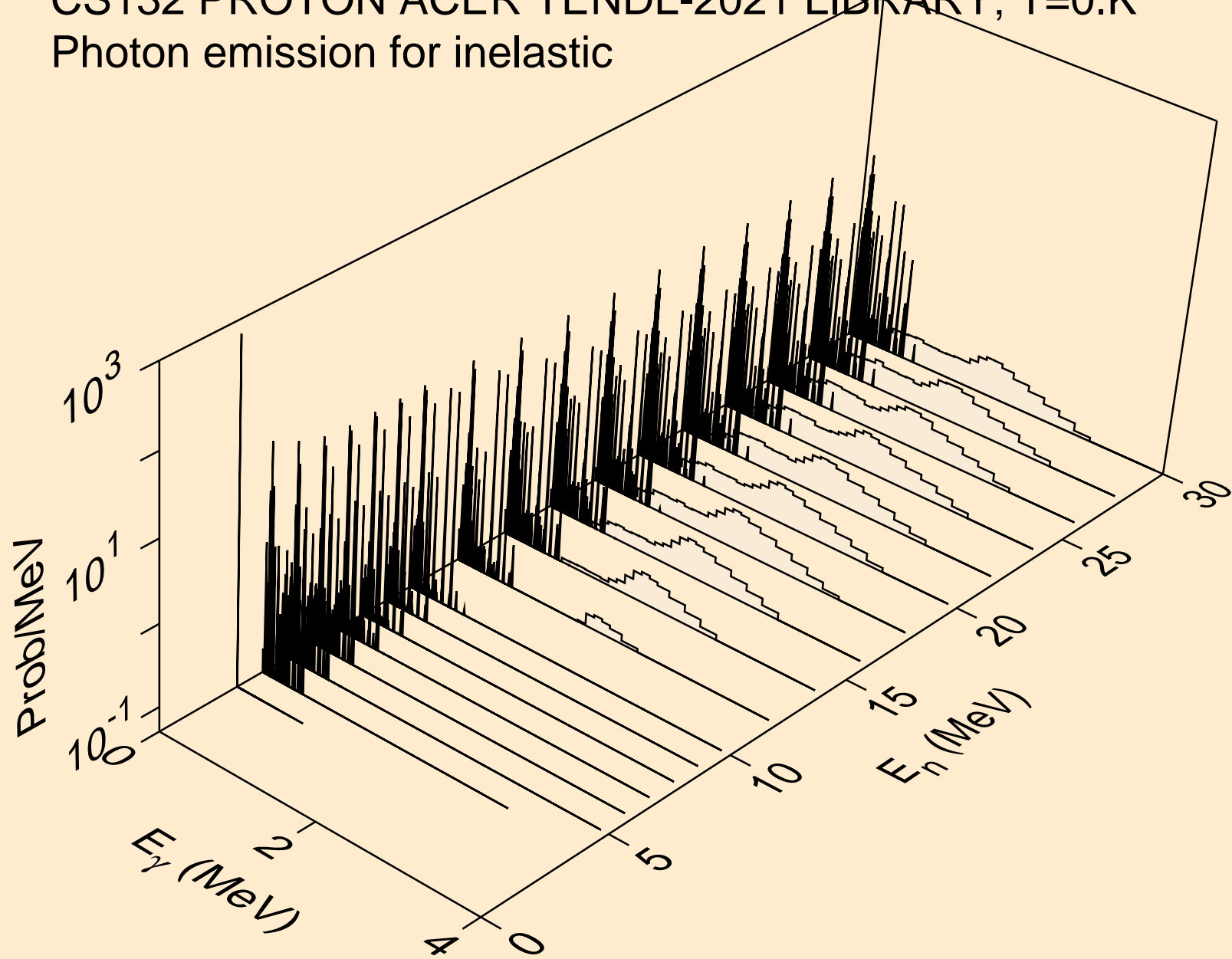



CS132 PROTON ACER TENDL-2021 LIBRARY; T=0.K  
Photon emission for (n,d)

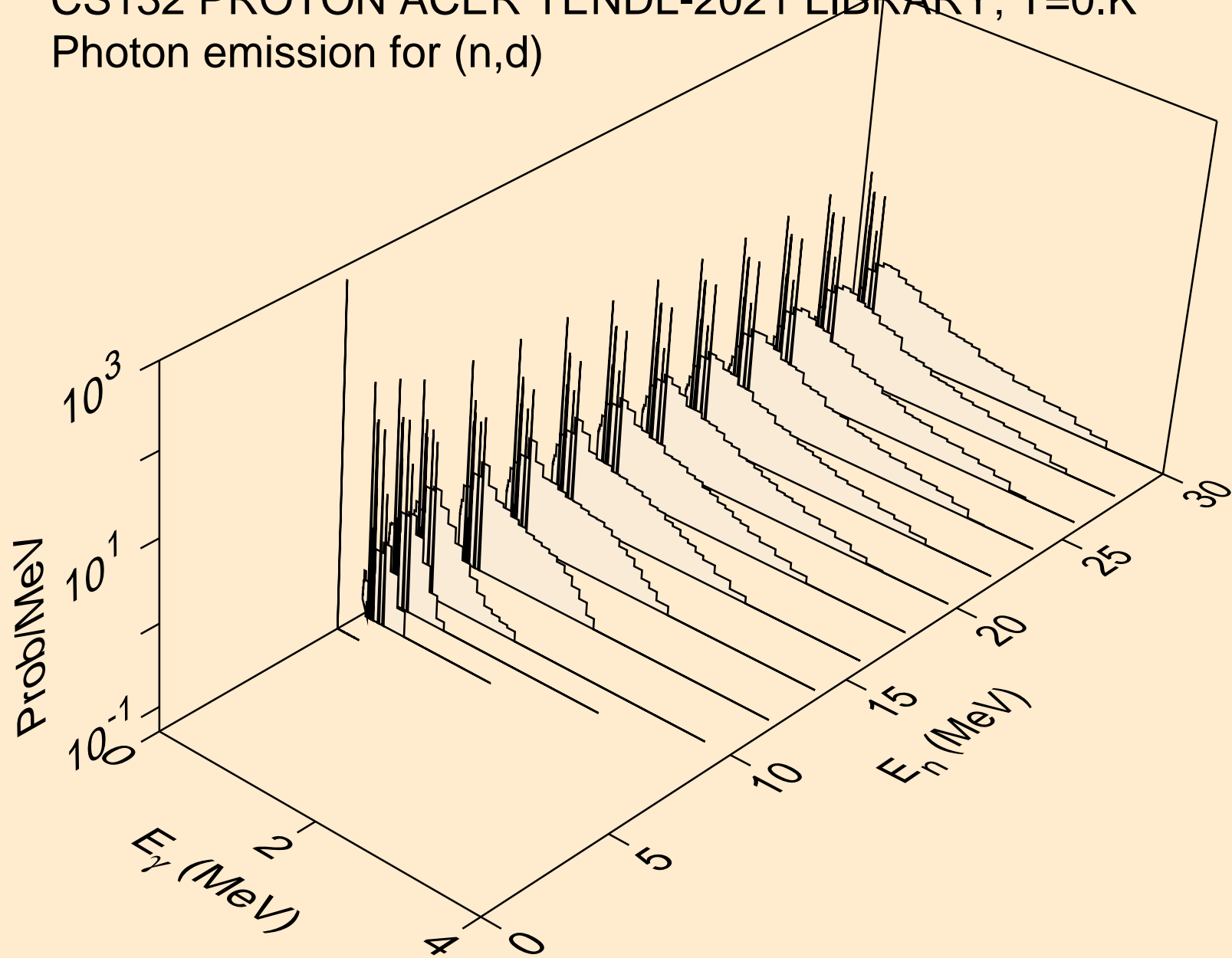

CS132 PROTON ACER TENDL-2021 LIBRARY; T=0.K  
Photon emission for (n,t)

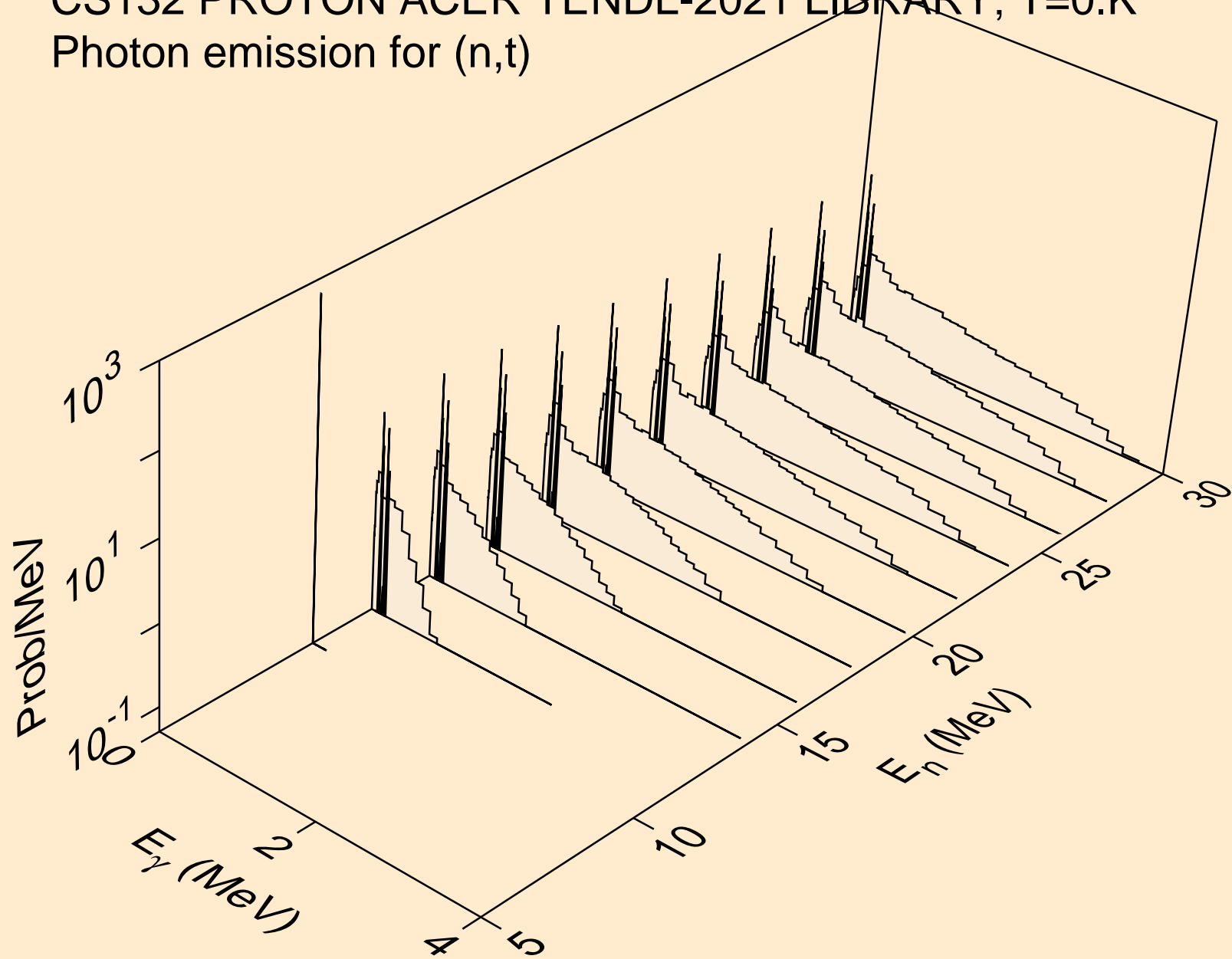

CS132 PROTON ACER TENDL-2021 LIBRARY; T=0.K  
Photon emission for (n,he3)

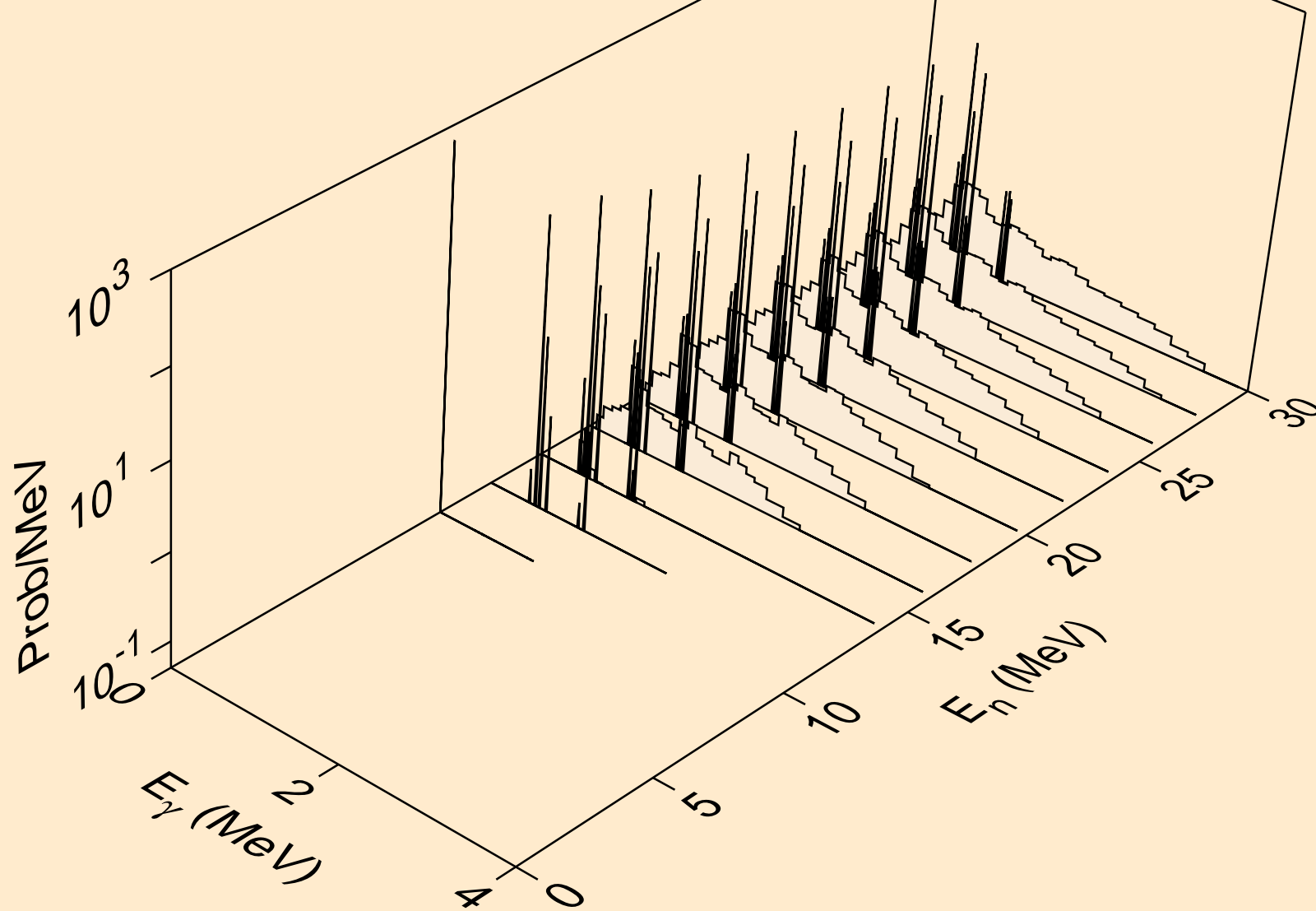

CS132 PROTON ACER TENDL-2021 LIBRARY; T=0.K  
Photon emission for (n,a)

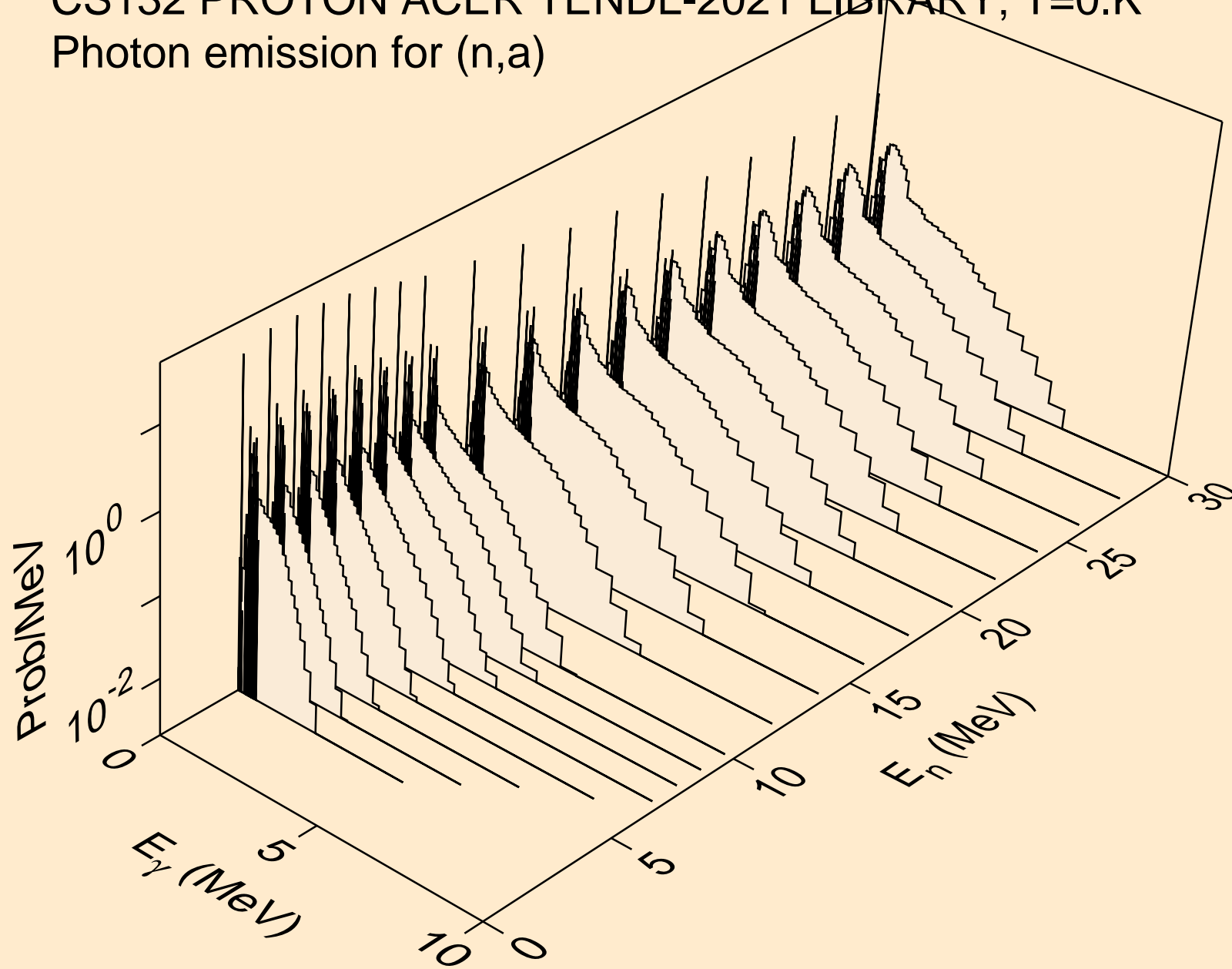

CS132 PROTON ACER TENDL-2021 LIBRARY; T=0.K  
Photon emission for (n,2a)

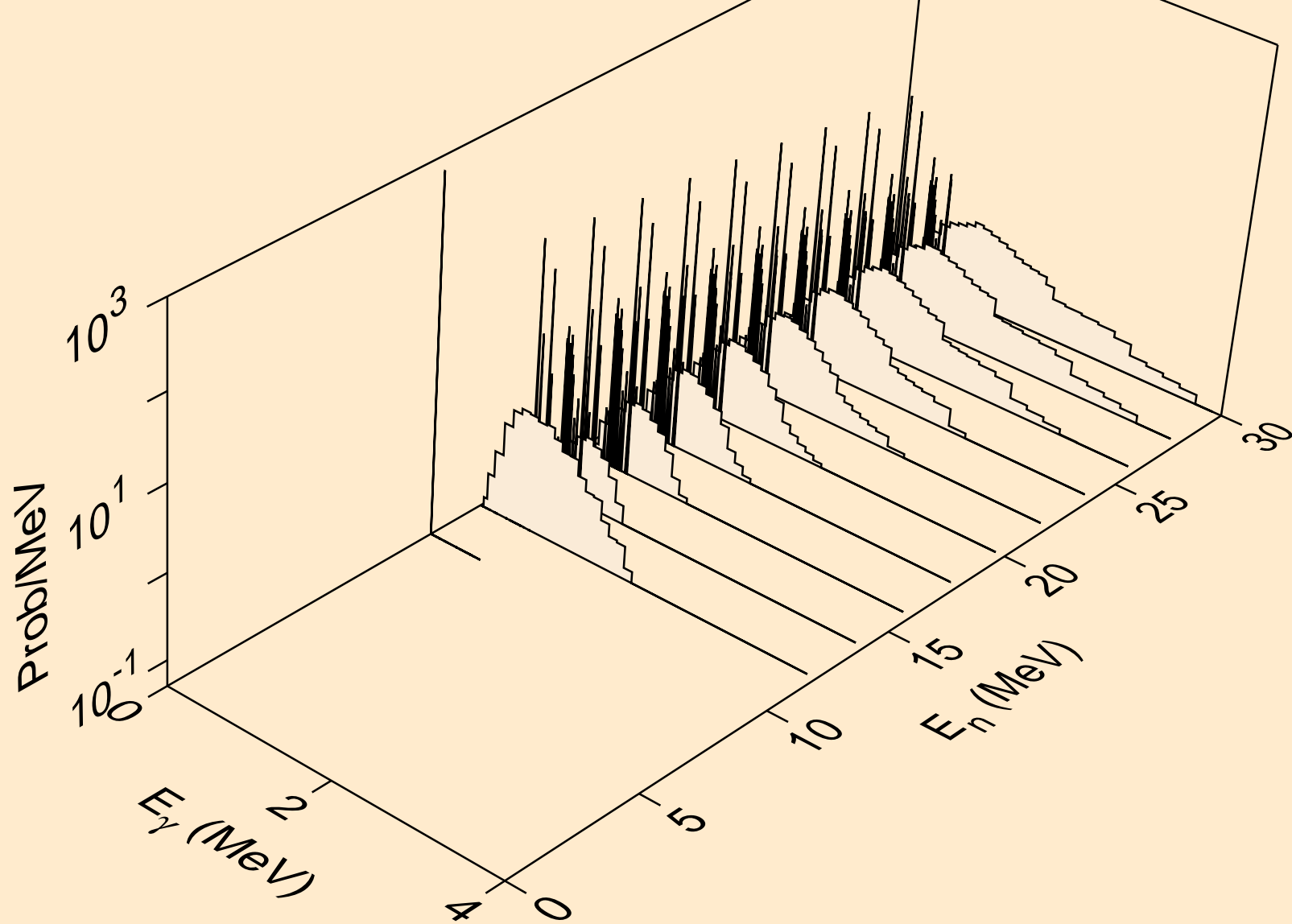

CS132 PROTON ACER TENDL-2021 LIBRARY; T=0.K  
Photon emission for (n,2p)

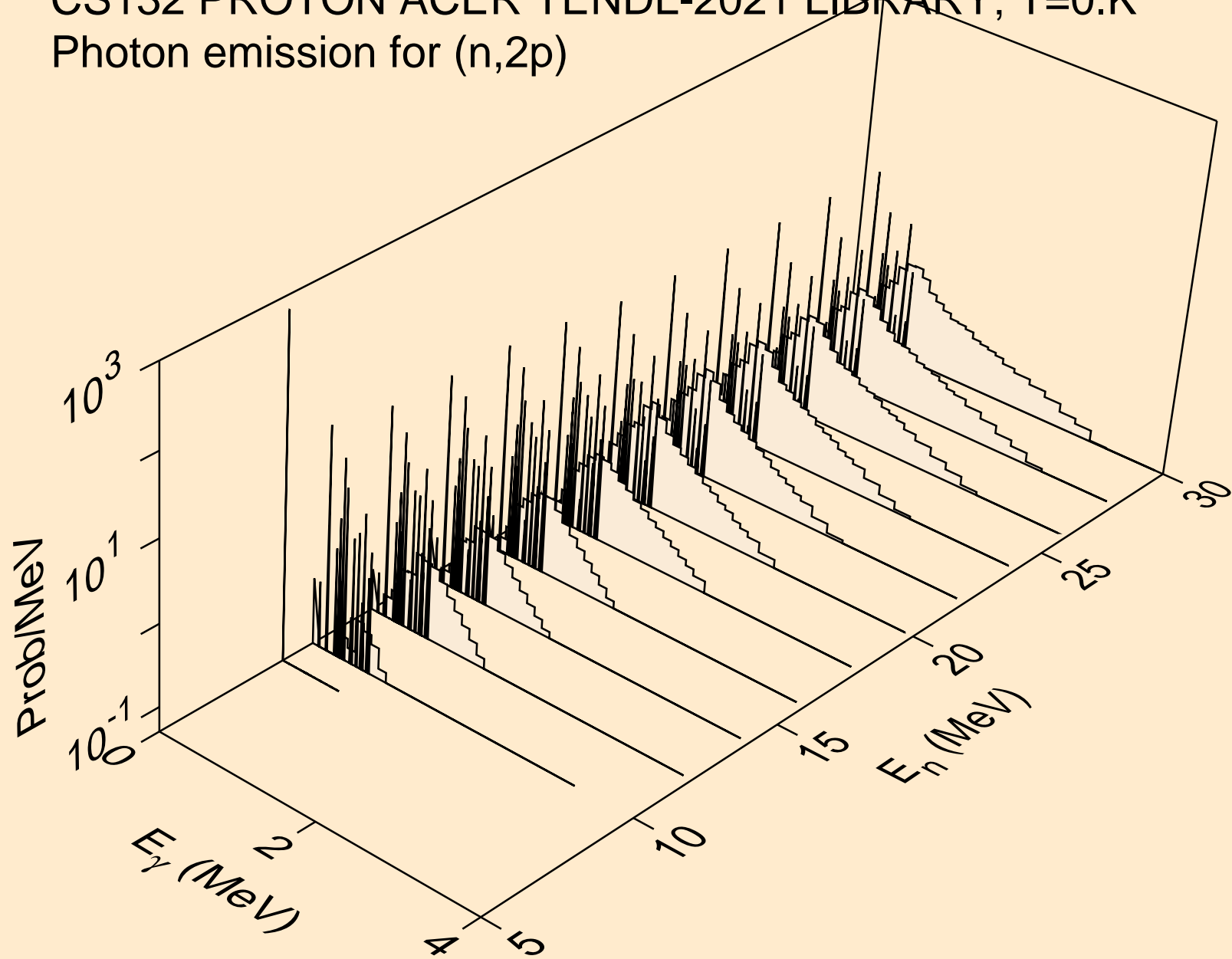

CS132 PROTON ACER TENDL-2021 LIBRARY; T=0.K  
Photon emission for (n,pa)

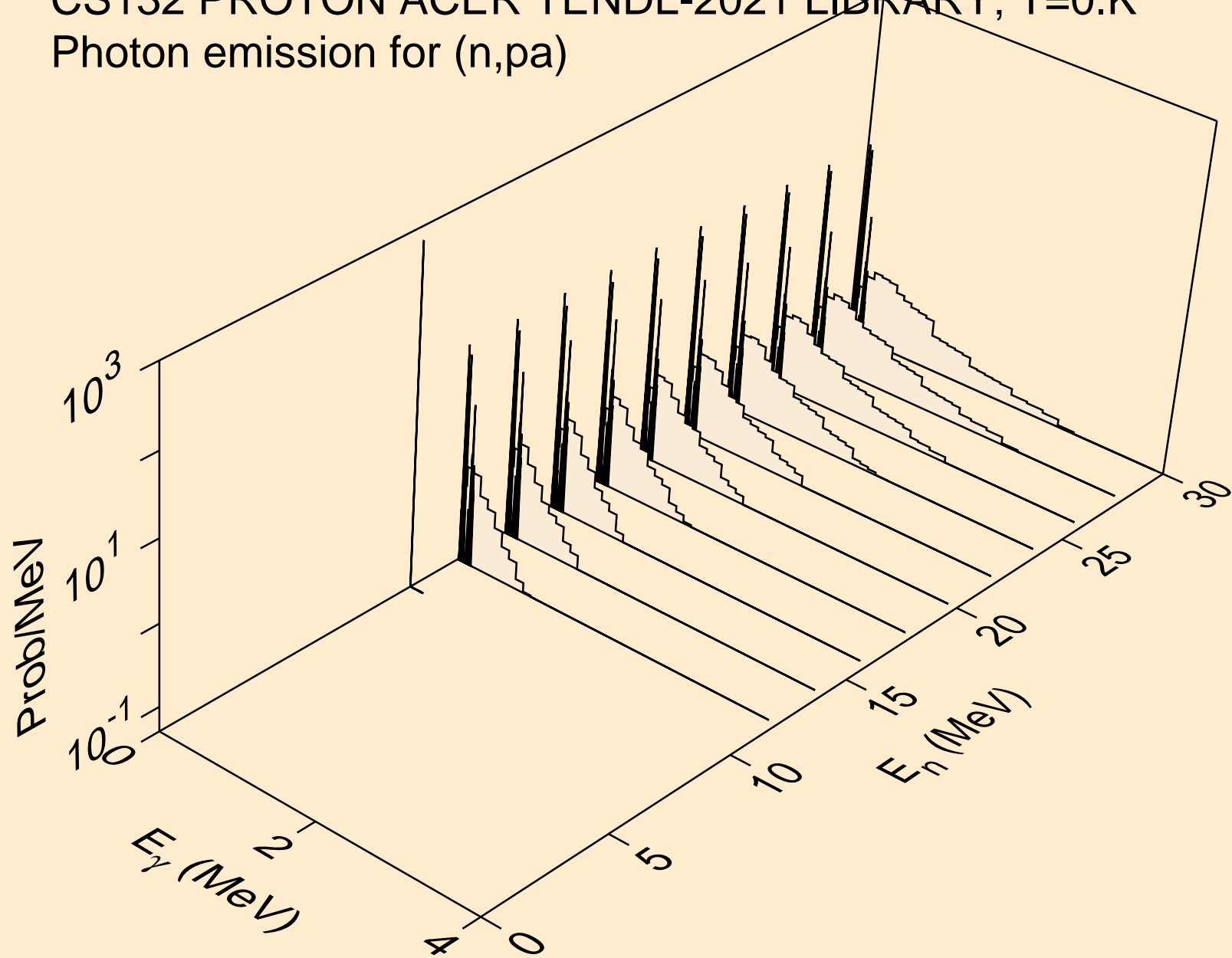

CS132 PROTON ACER TENDL-2021 LIBRARY; T=0.K  
Photon emission for (n,pd)

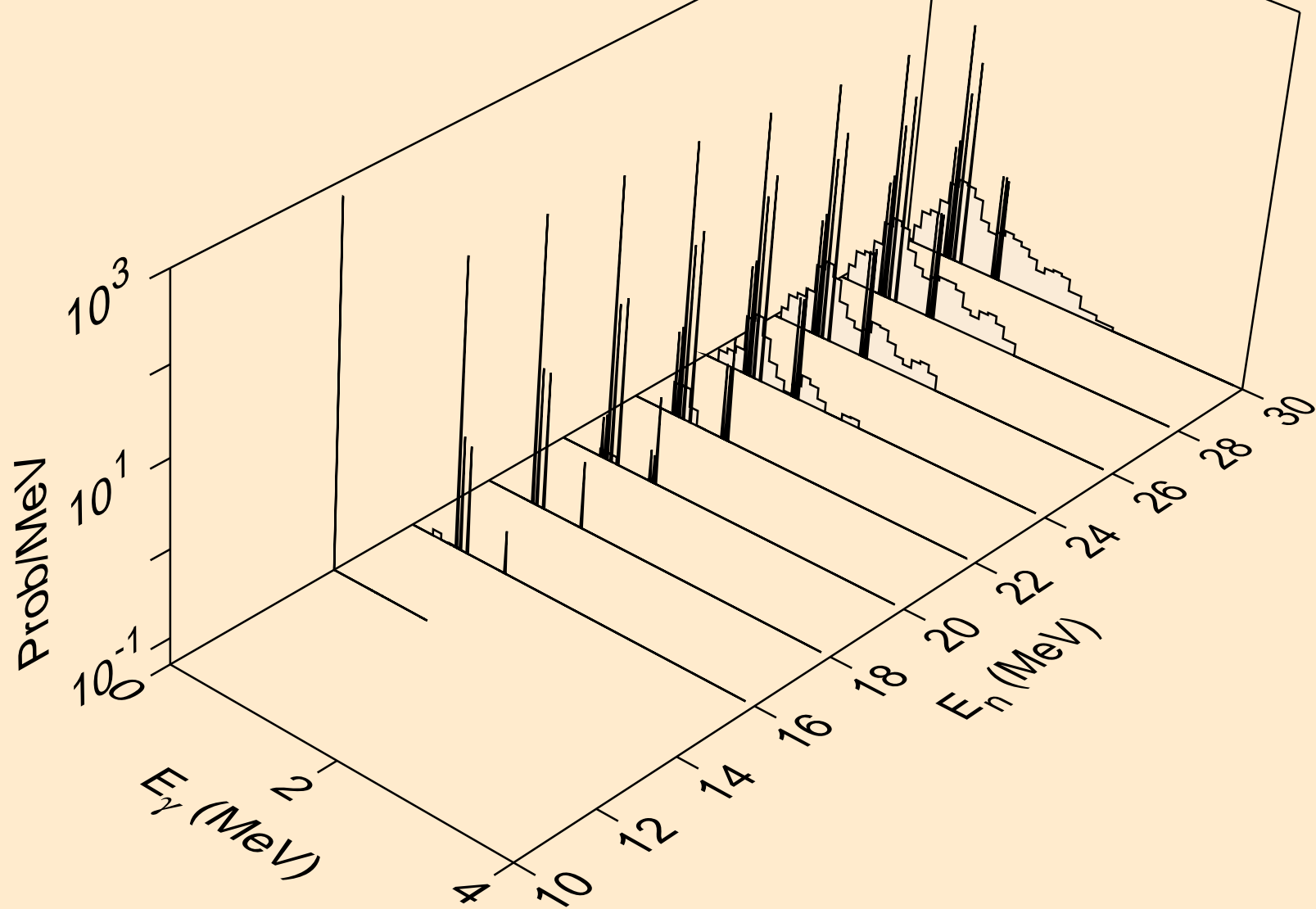



CS132 PROTON ACER TENDL-2021 LIBRARY; T=0.K  
Photon emission for (n,pt)

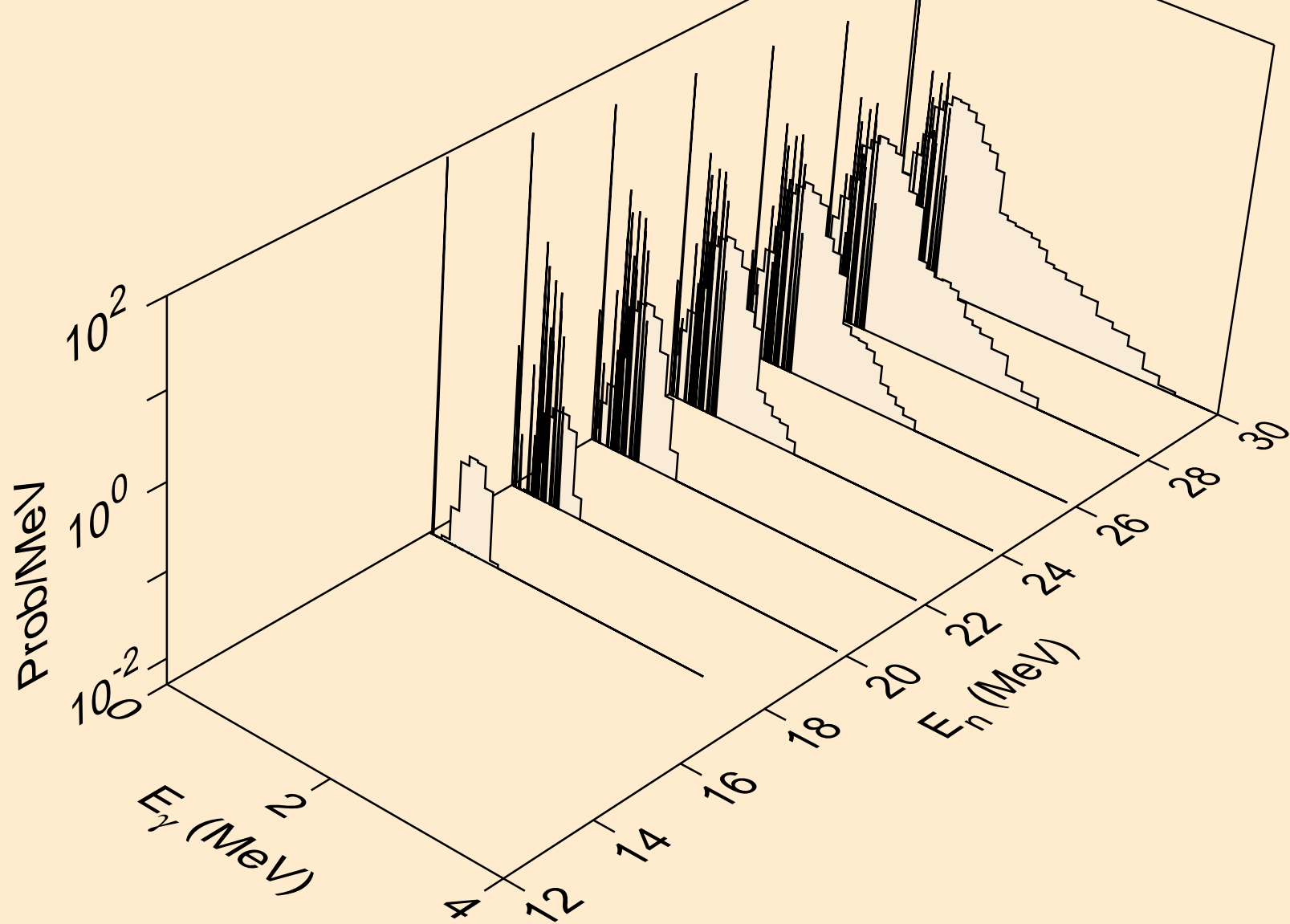

CS132 PROTON ACER TENDL-2021 LIBRARY; T=0.K  
Photon emission for (n,da)

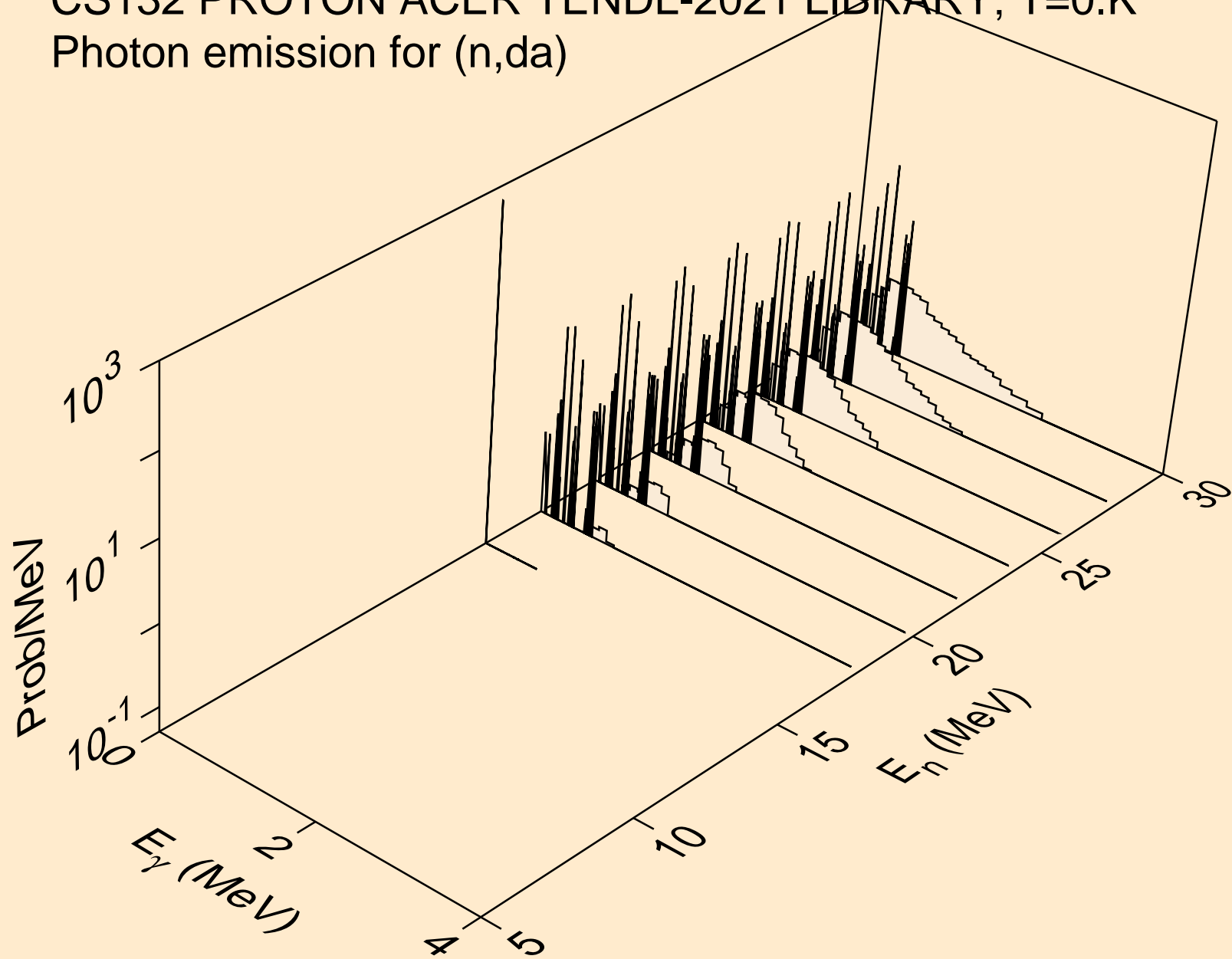

CS132 PROTON ACER TENDL-2021 LIBRARY; T=0.K  
Particle heating contributions

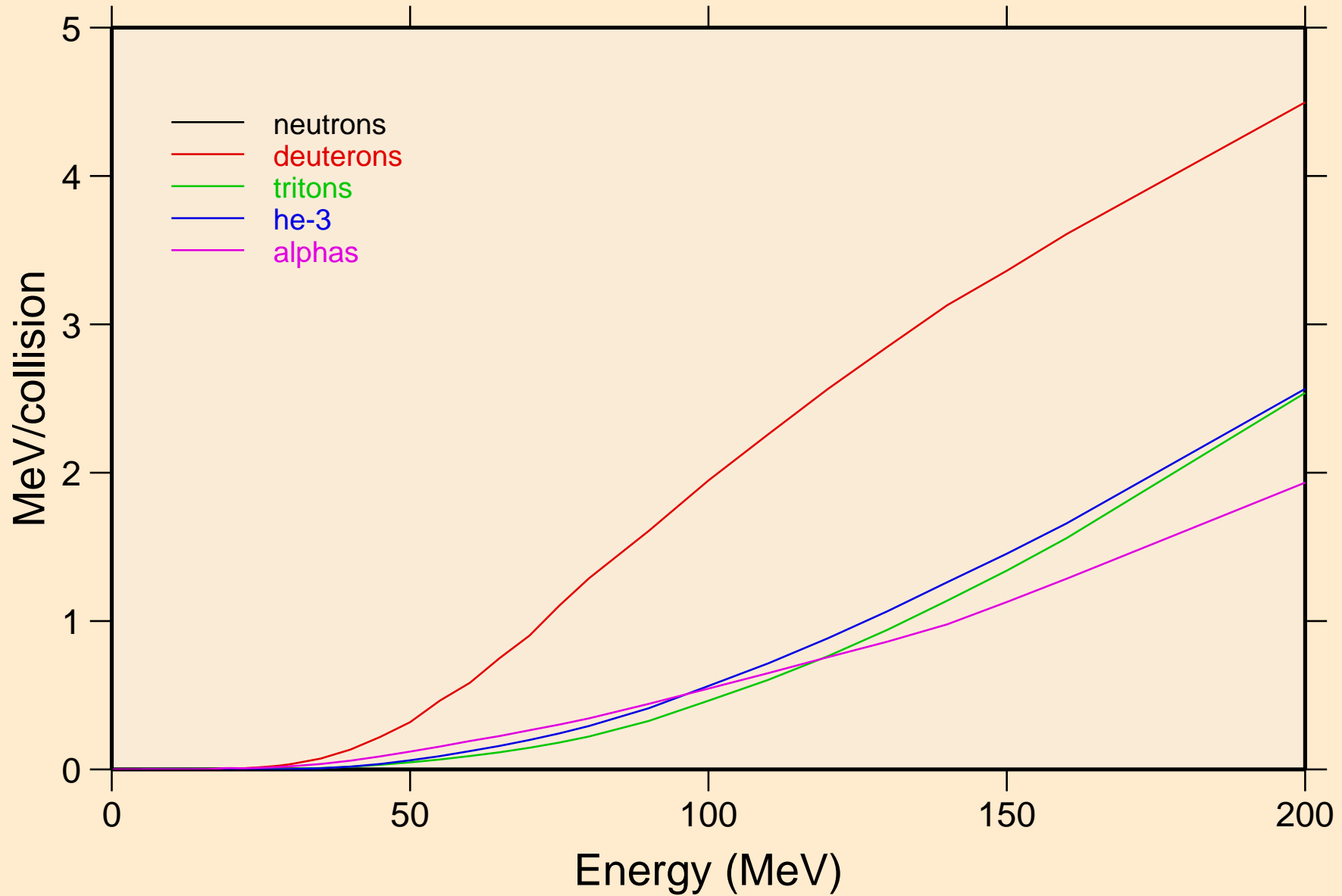

# CS132 PROTON ACER TENDL-2021 LIBRARY; T=0.K

## Recoil Heating

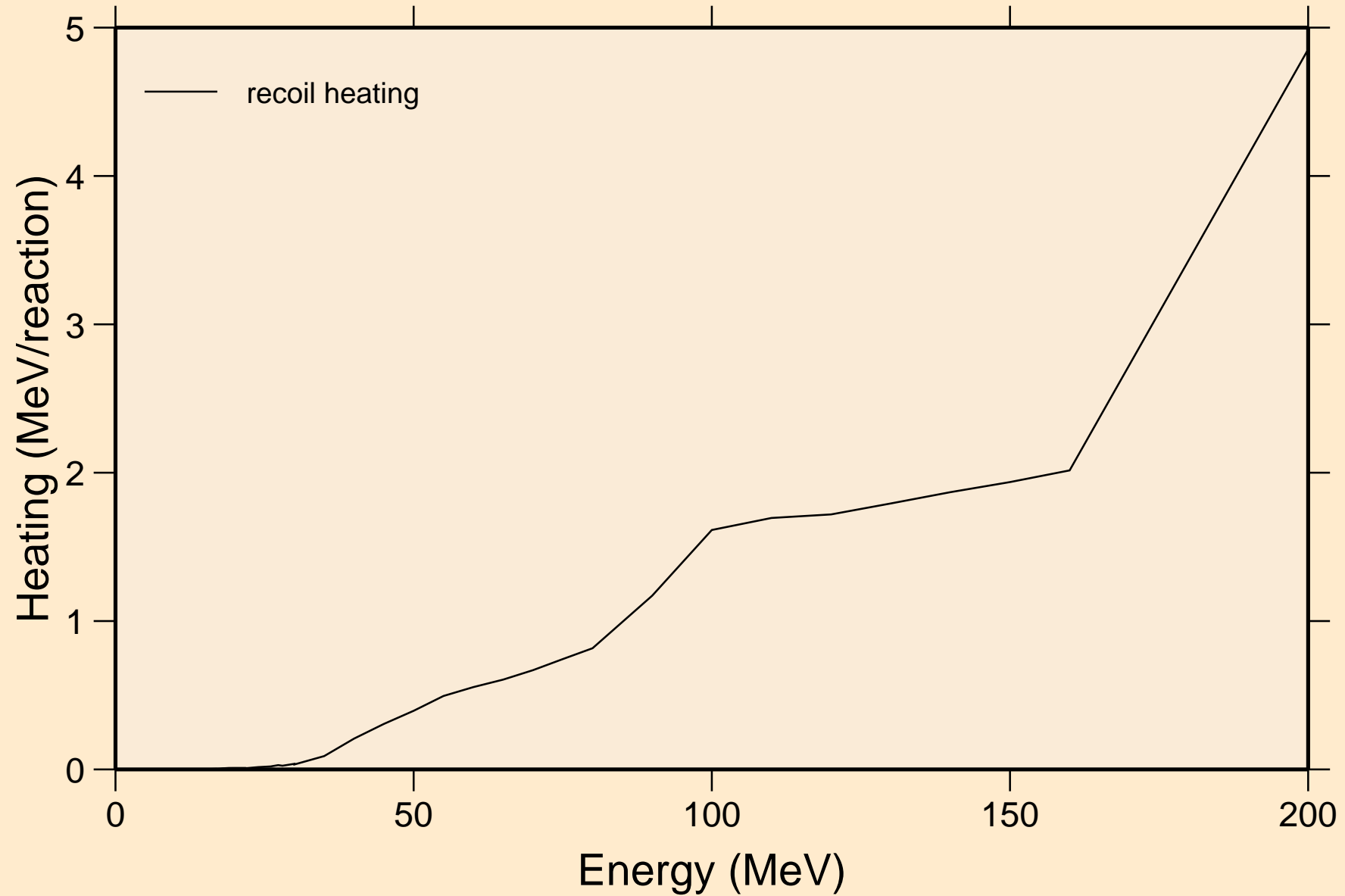

CS132 PROTON ACER TENDL-2021 LIBRARY; T=0.K  
Particle production cross sections

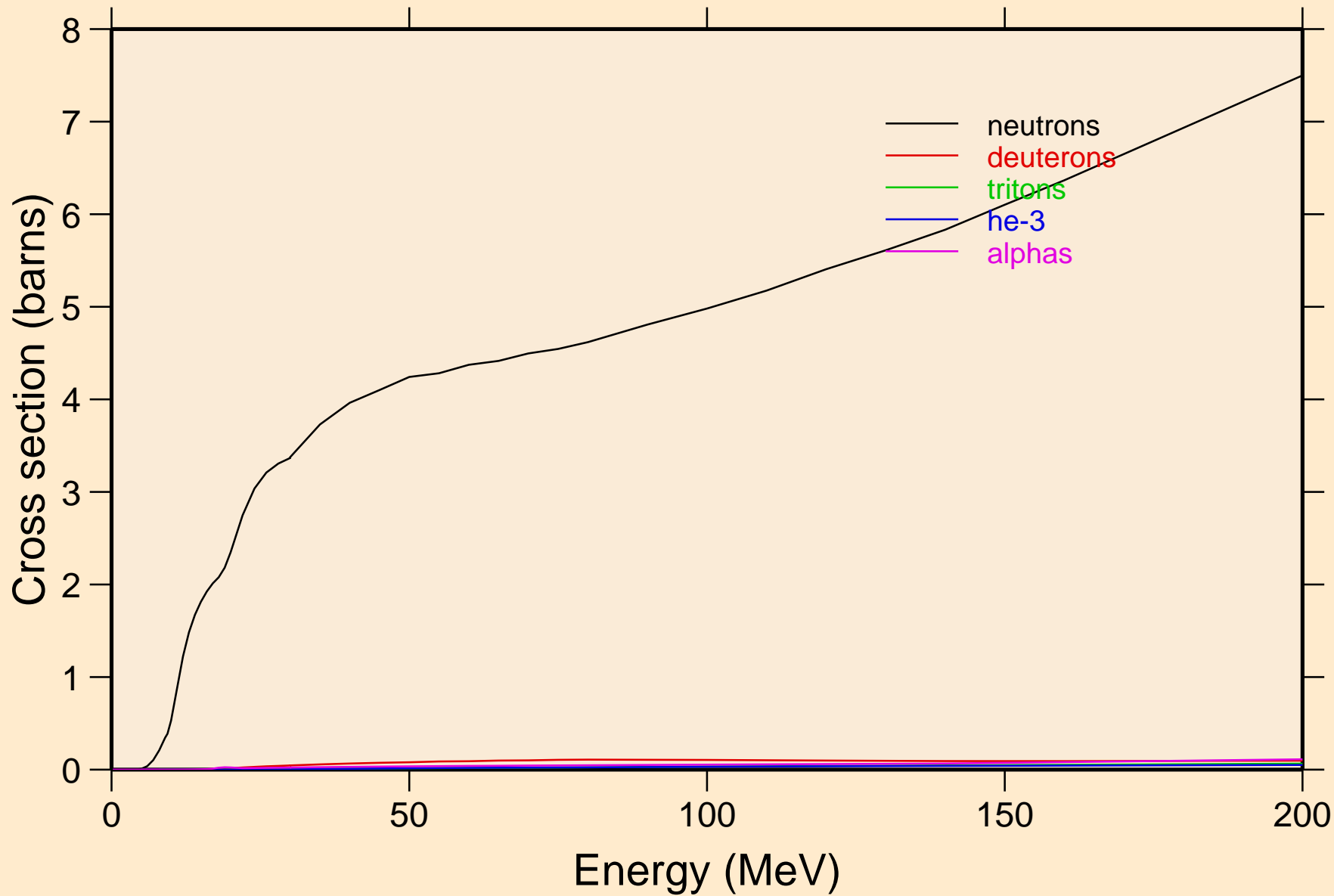

CS132 PROTON ACER TENDL-2021 LIBRARY; T=0.K  
neutrons from (p,n)

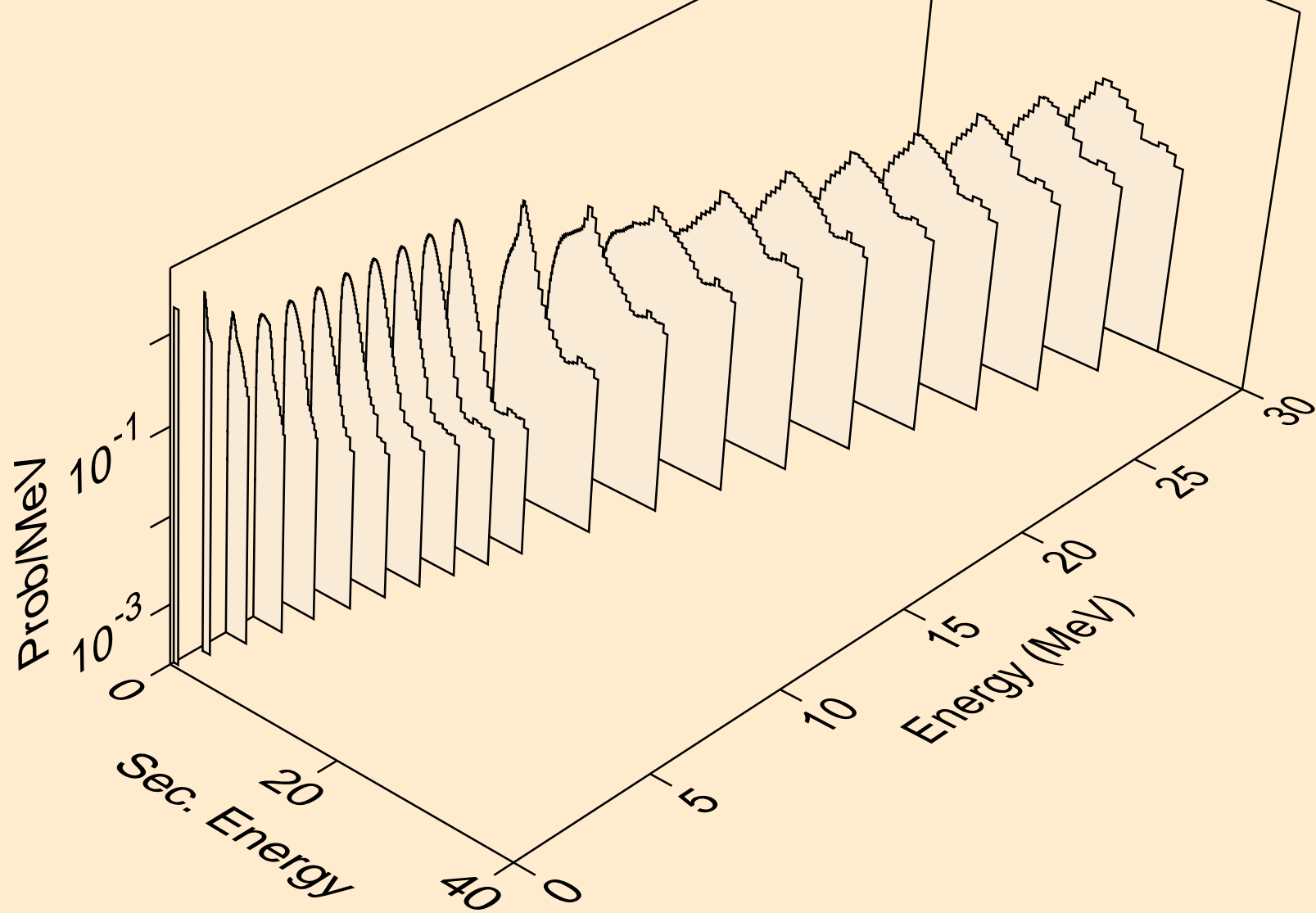

CS132 PROTON ACER TENDL-2021 LIBRARY; T=0.K  
neutrons from (p,x)

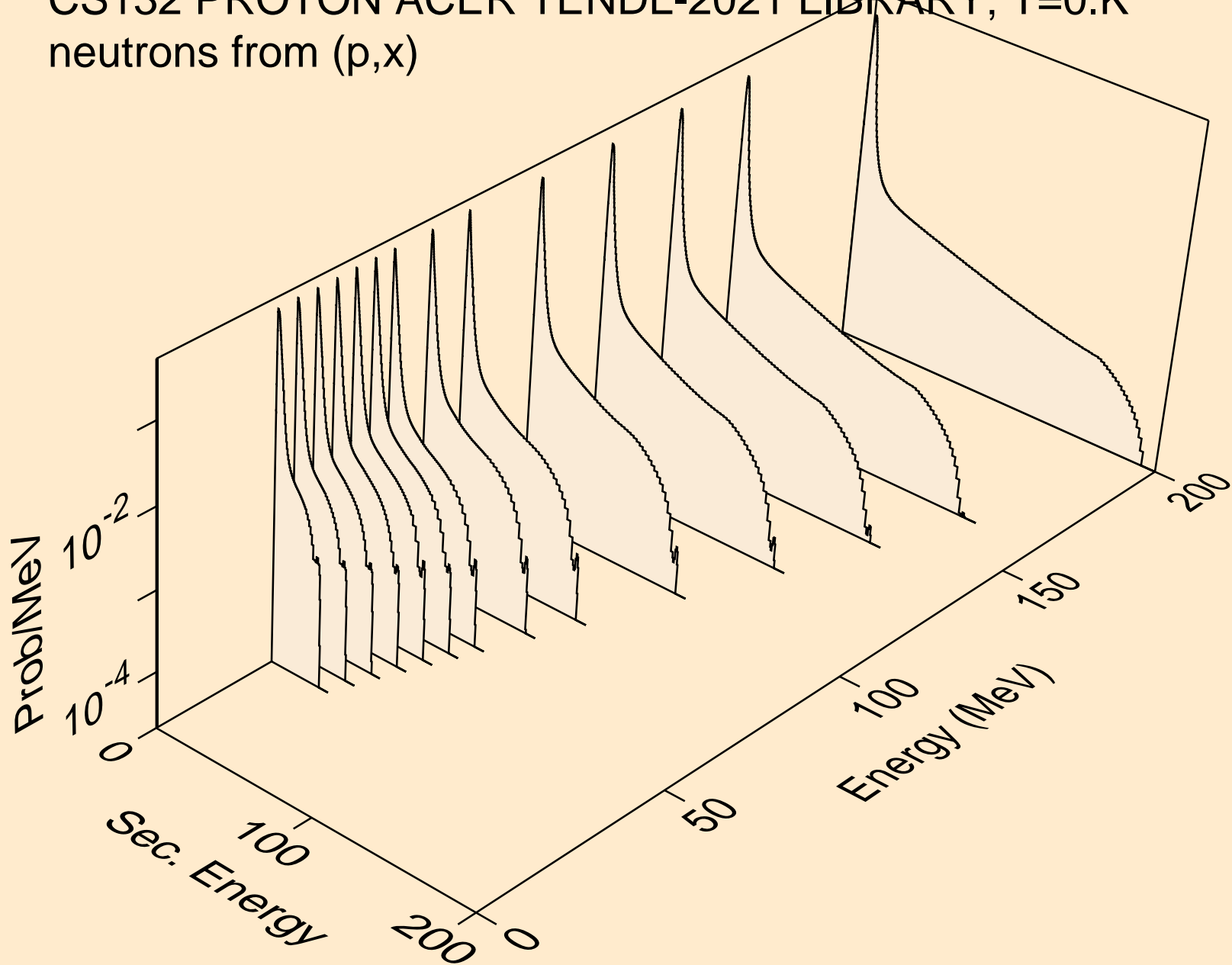

CS132 PROTON ACER TENDL-2021 LIBRARY; T=0.K  
neutrons from (p,2nd)

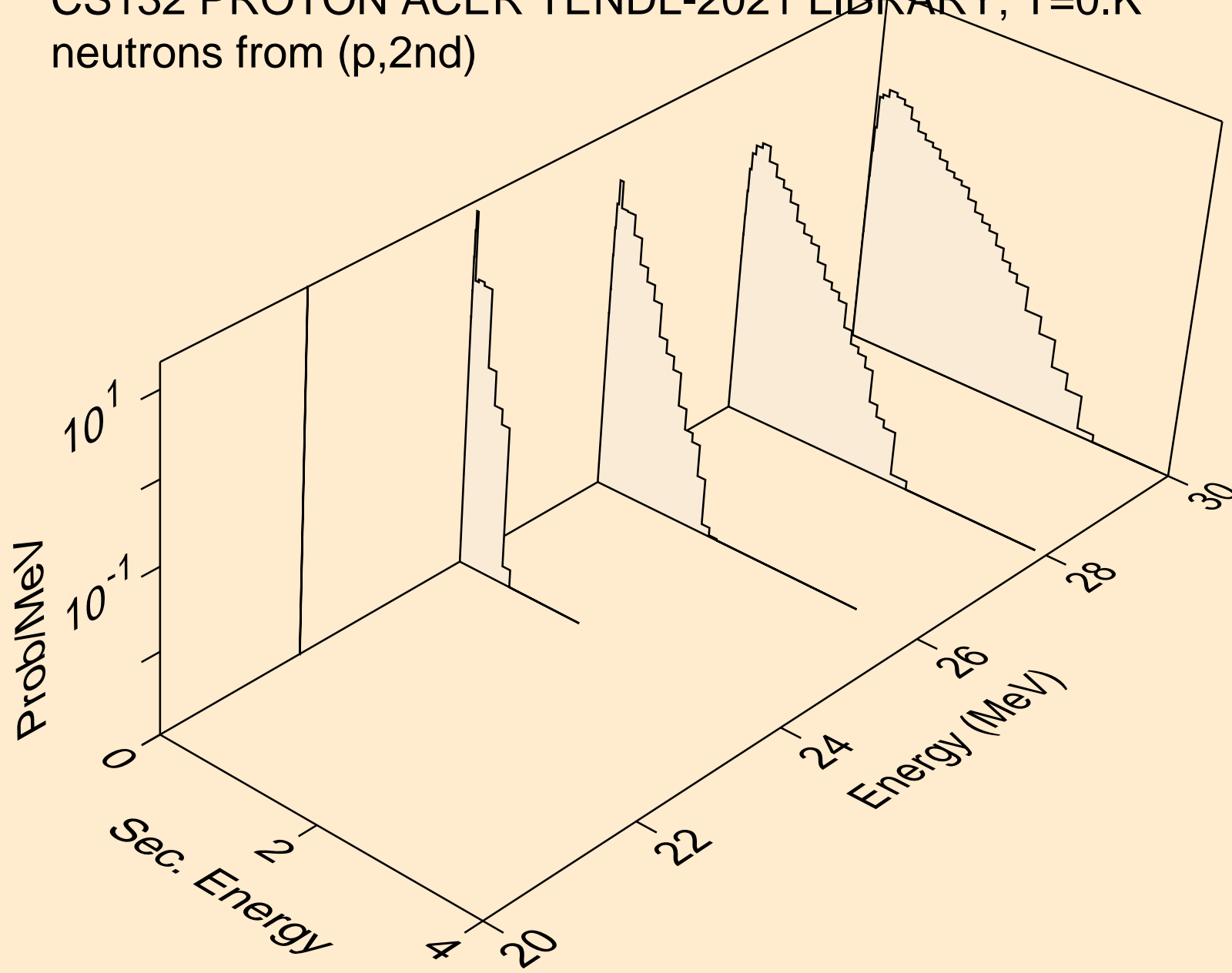



CS132 PROTON ACER TENDL-2021 LIBRARY; T=0.K  
neutrons from (p,2n)

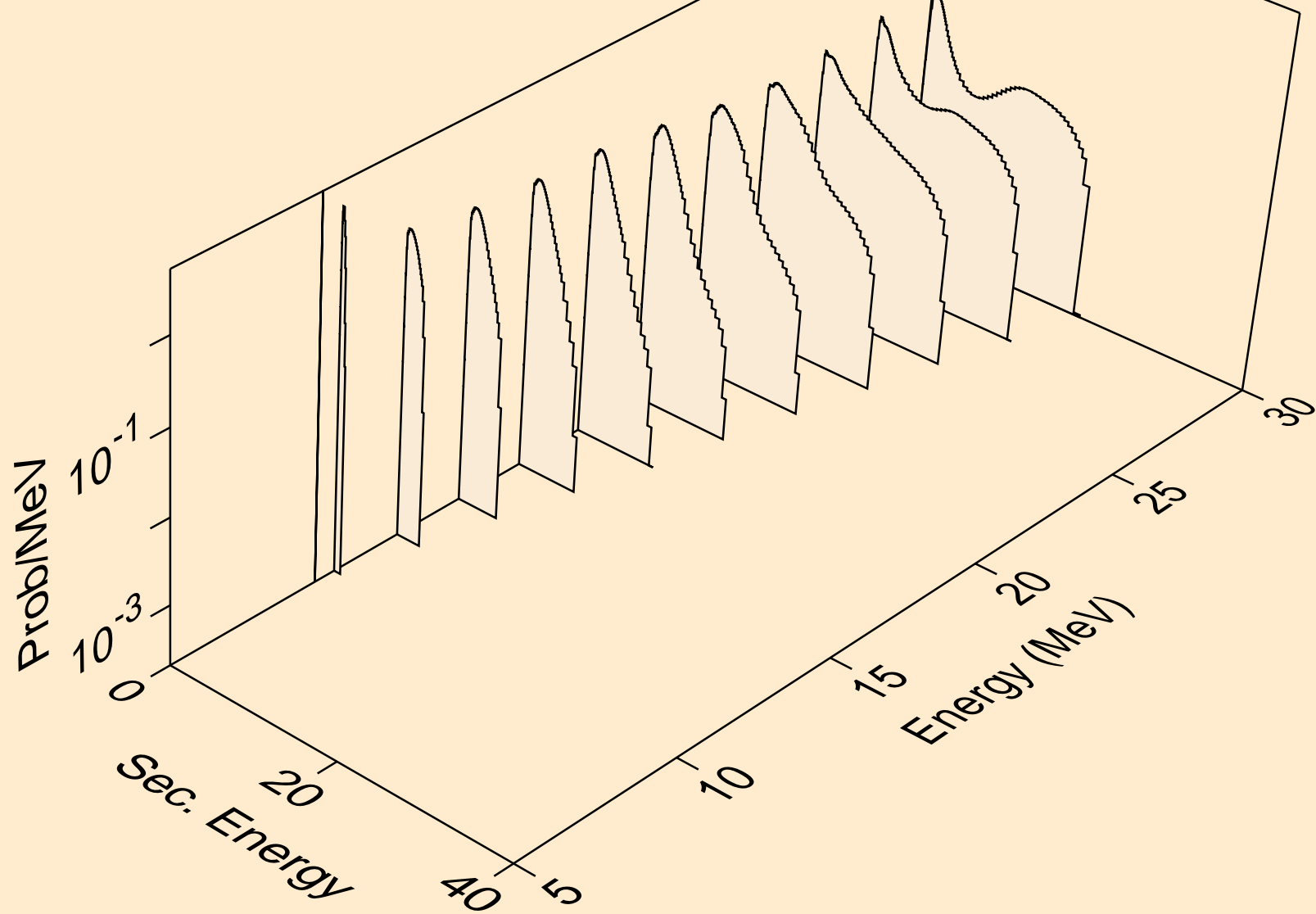

CS132 PROTON ACER TENDL-2021 LIBRARY; T=0.K  
neutrons from (p,3n)

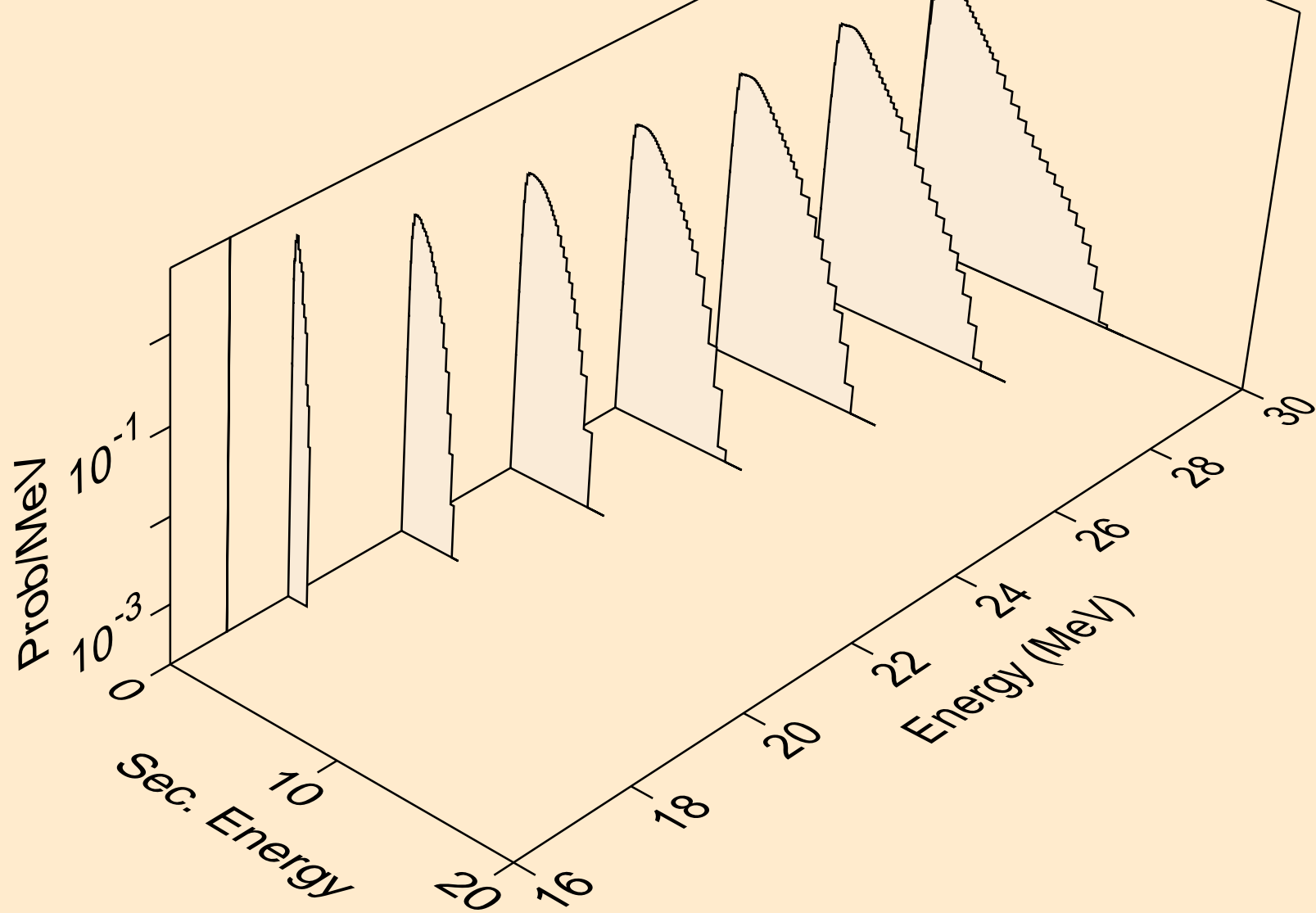

CS132 PROTON ACER TENDL-2021 LIBRARY; T=0.K  
neutrons from (p,n\*)a

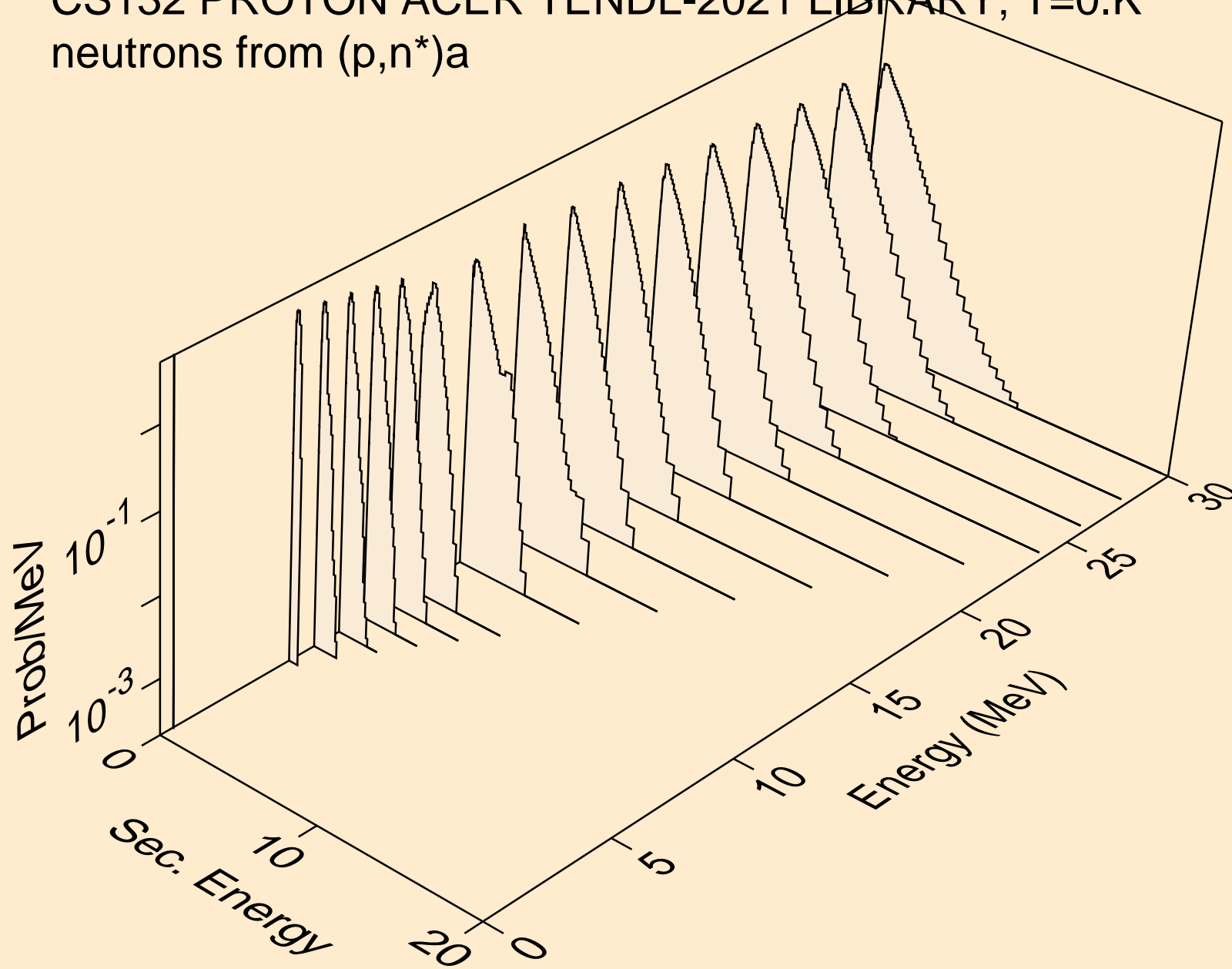

CS132 PROTON ACER TENDL-2021 LIBRARY; T=0.K  
neutrons from (p,2n)a

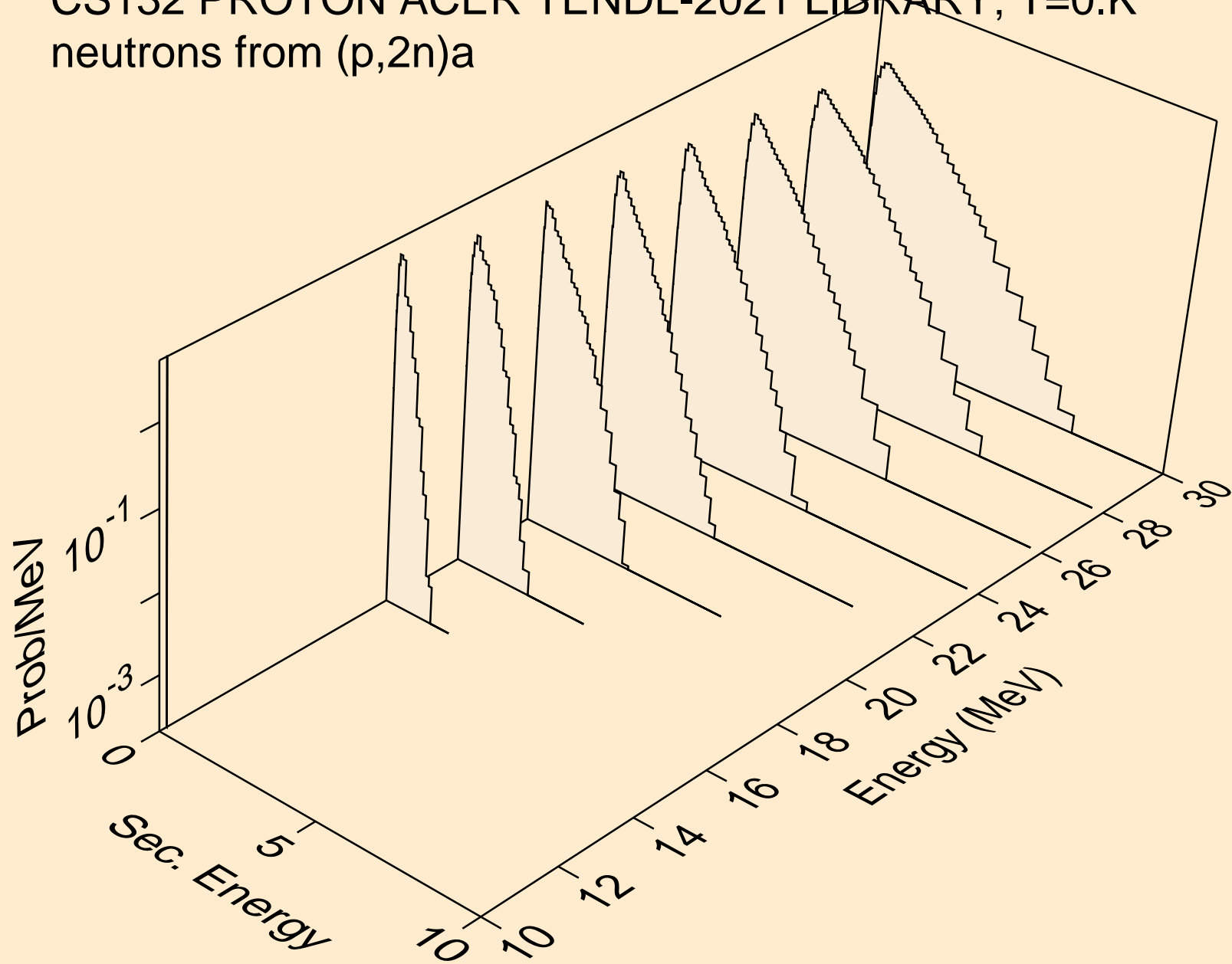

CS132 PROTON ACER TENDL-2021 LIBRARY; T=0.K  
neutrons from (p,3n)a

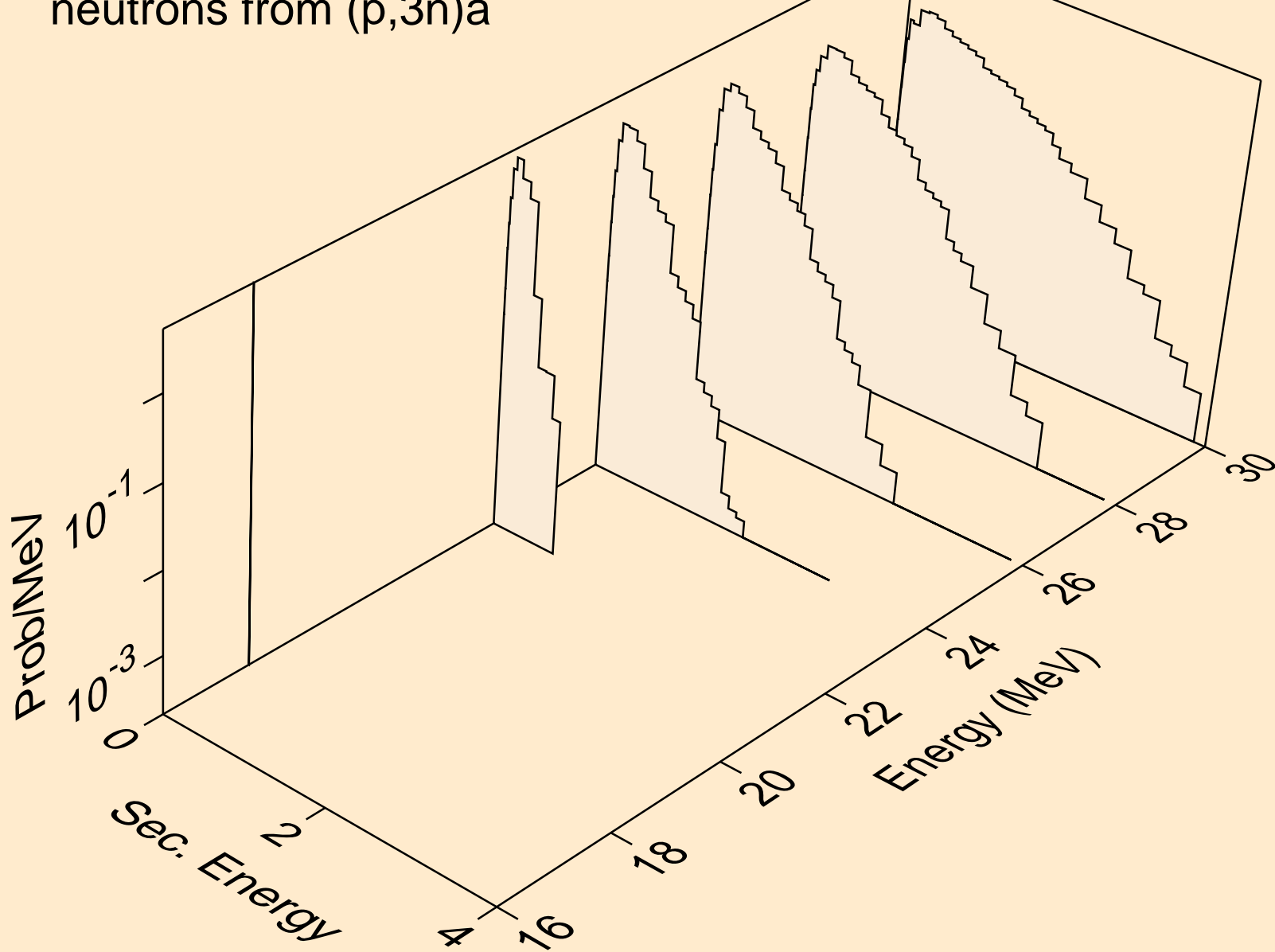

CS132 PROTON ACER TENDL-2021 LIBRARY; T=0.K  
neutrons from (p,n\*)p

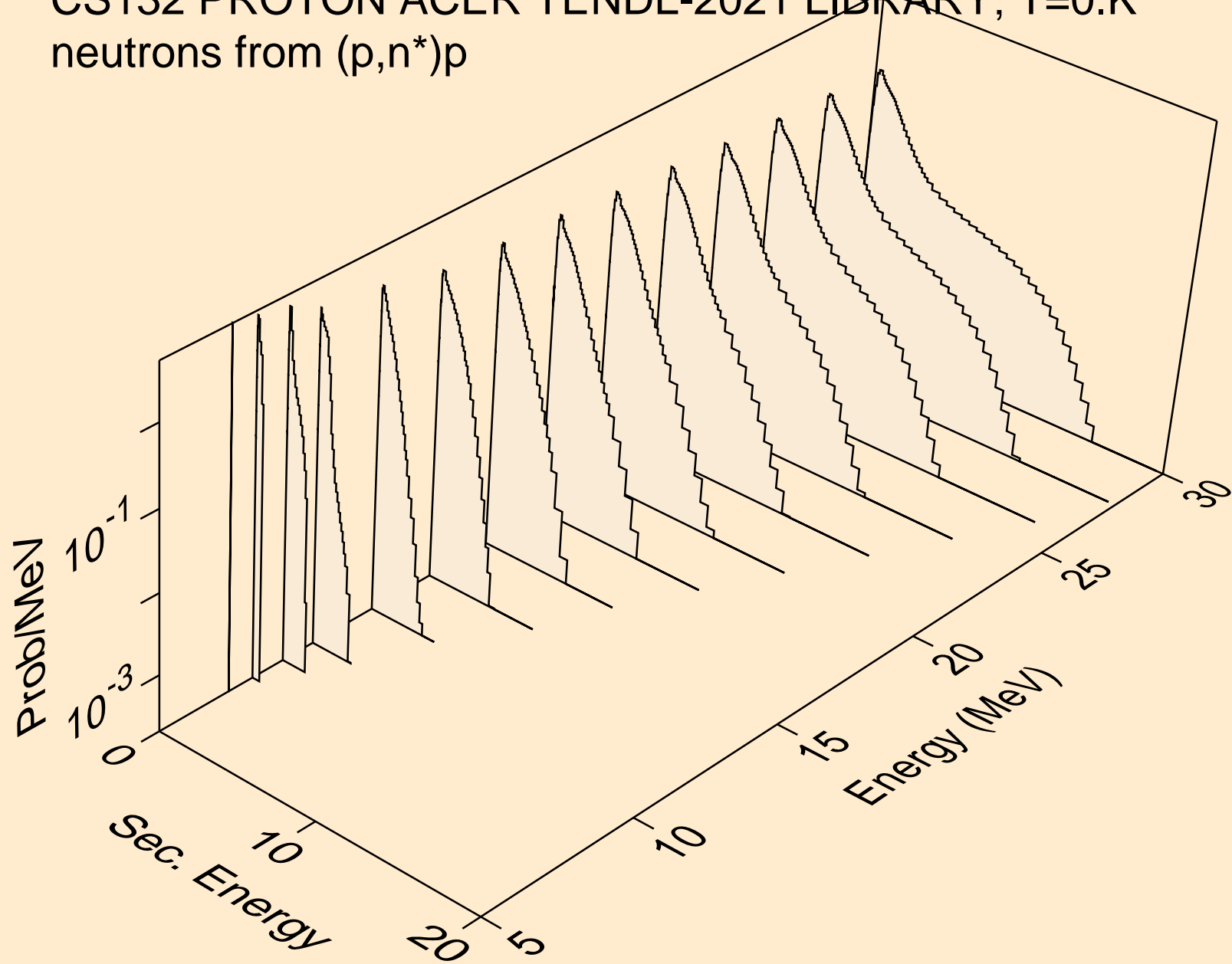

CS132 PROTON ACER TENDL-2021 LIBRARY; T=0.K  
neutrons from (p,n\*)2a

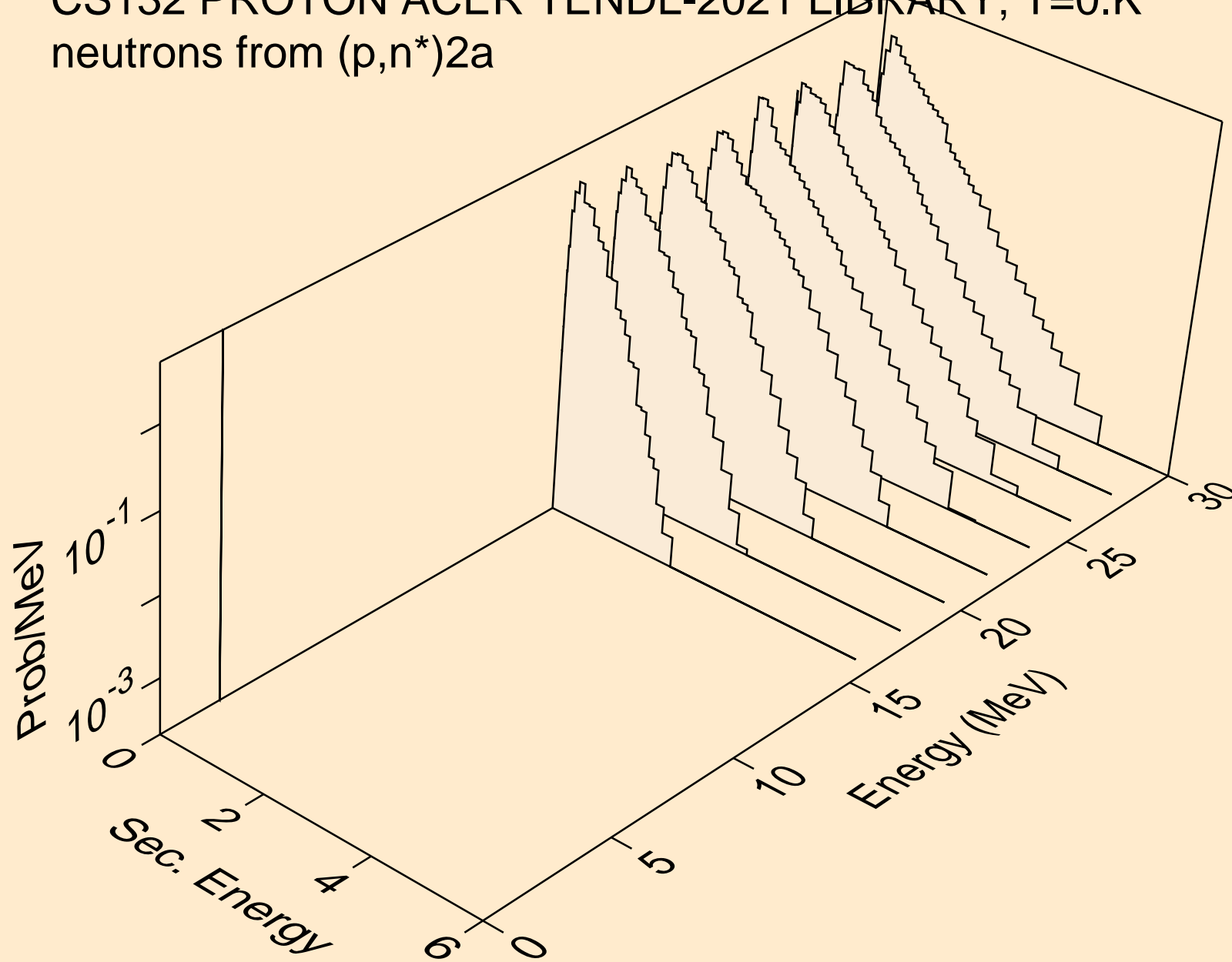

CS132 PROTON ACER TENDL-2021 LIBRARY; T=0.K  
neutrons from (p,n\*)d

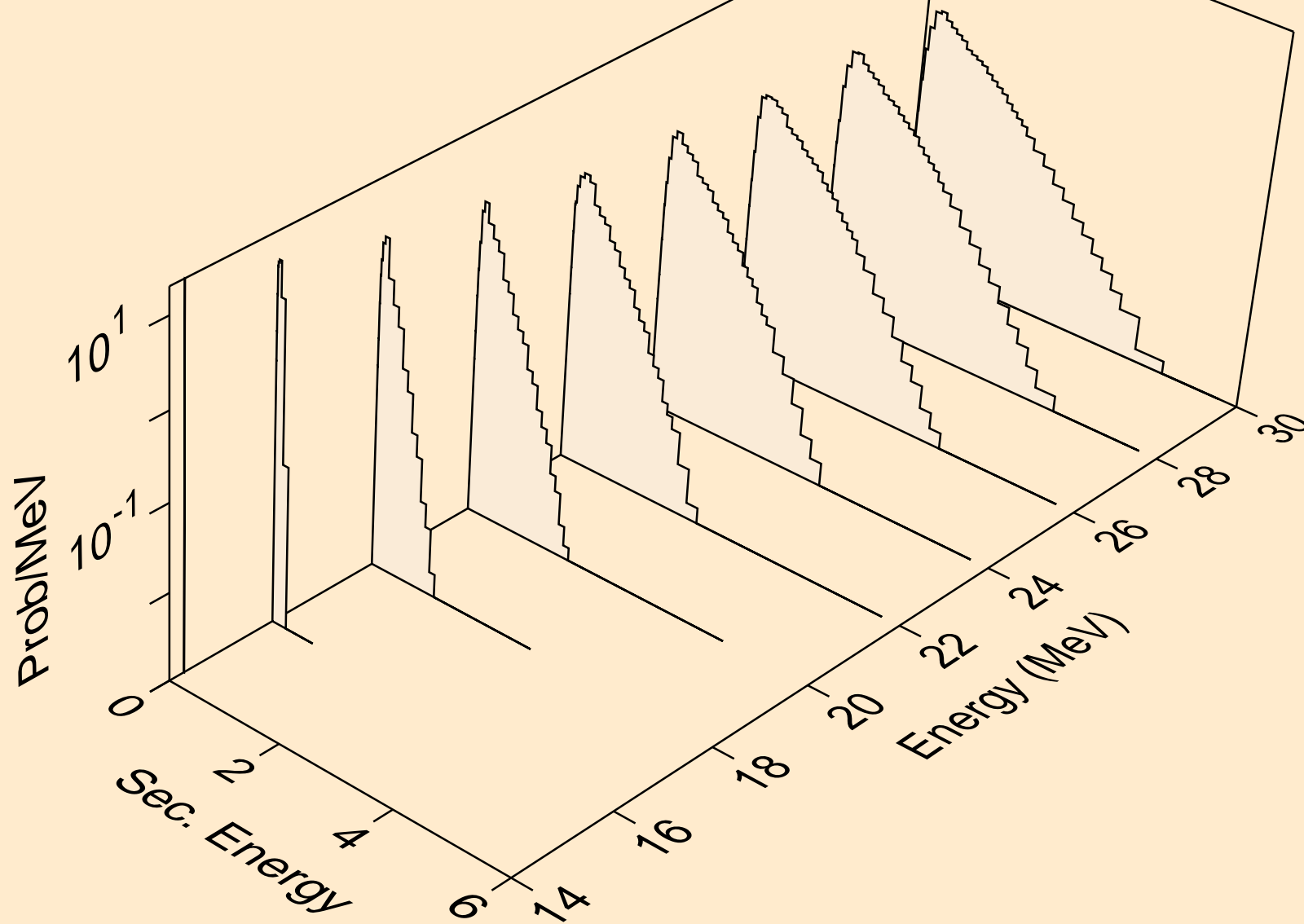



CS132 PROTON ACER TENDL-2021 LIBRARY; T=0.K  
neutrons from (p,n\*)t

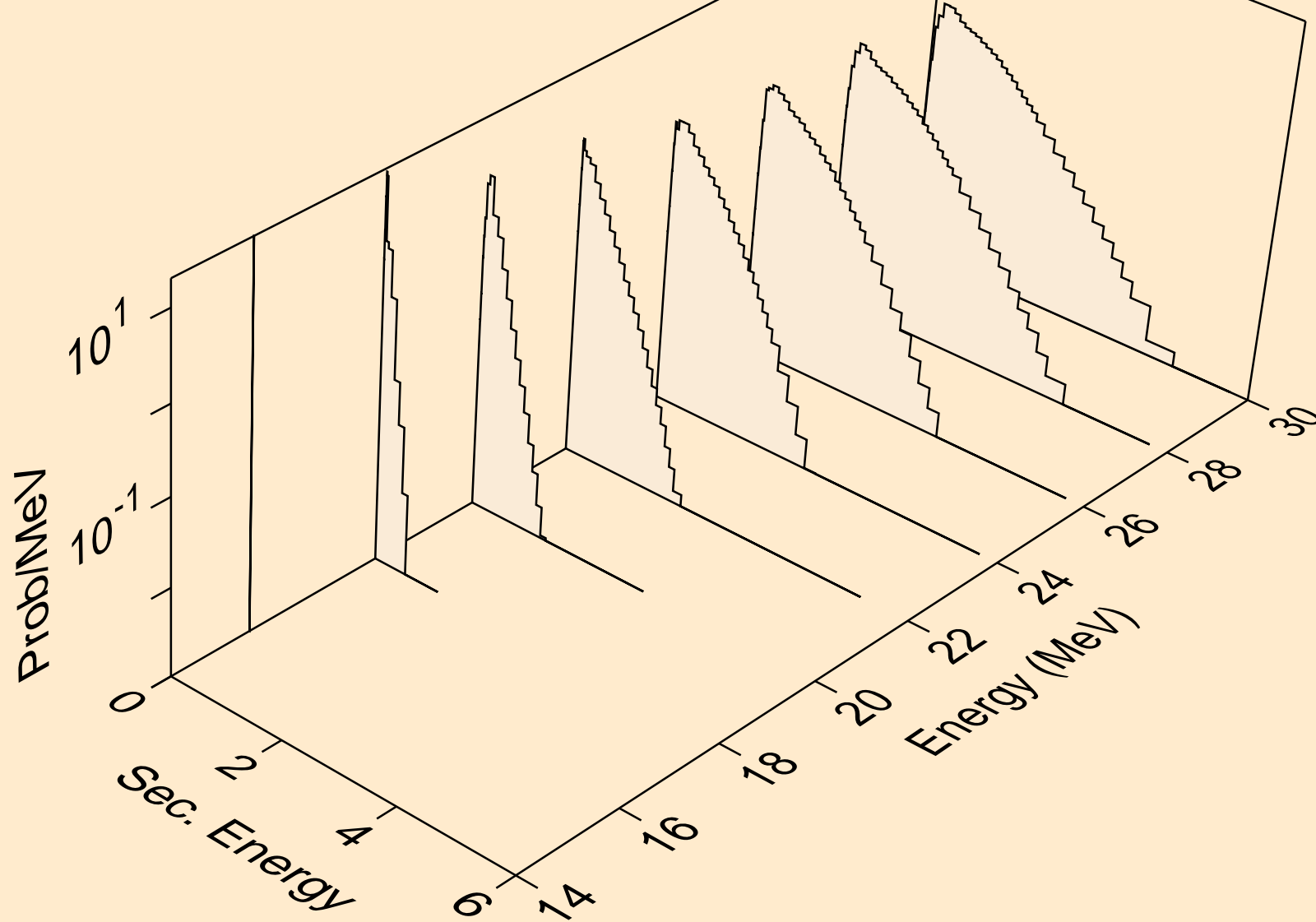

CS132 PROTON ACER TENDL-2021 LIBRARY; T=0.K  
neutrons from (p,n\*)he3

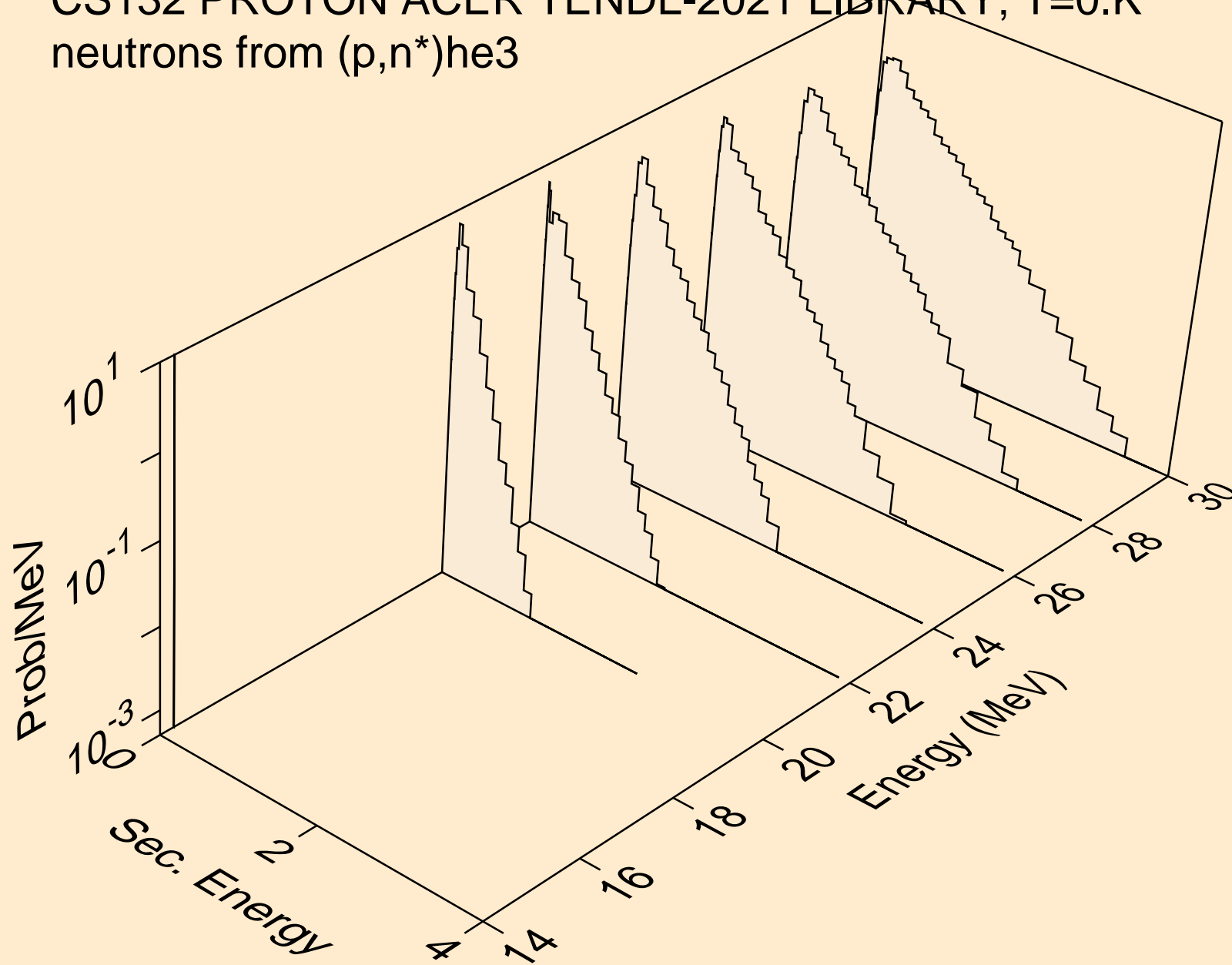

CS132 PROTON ACER TENDL-2021 LIBRARY; T=0.K  
neutrons from (p,4n)

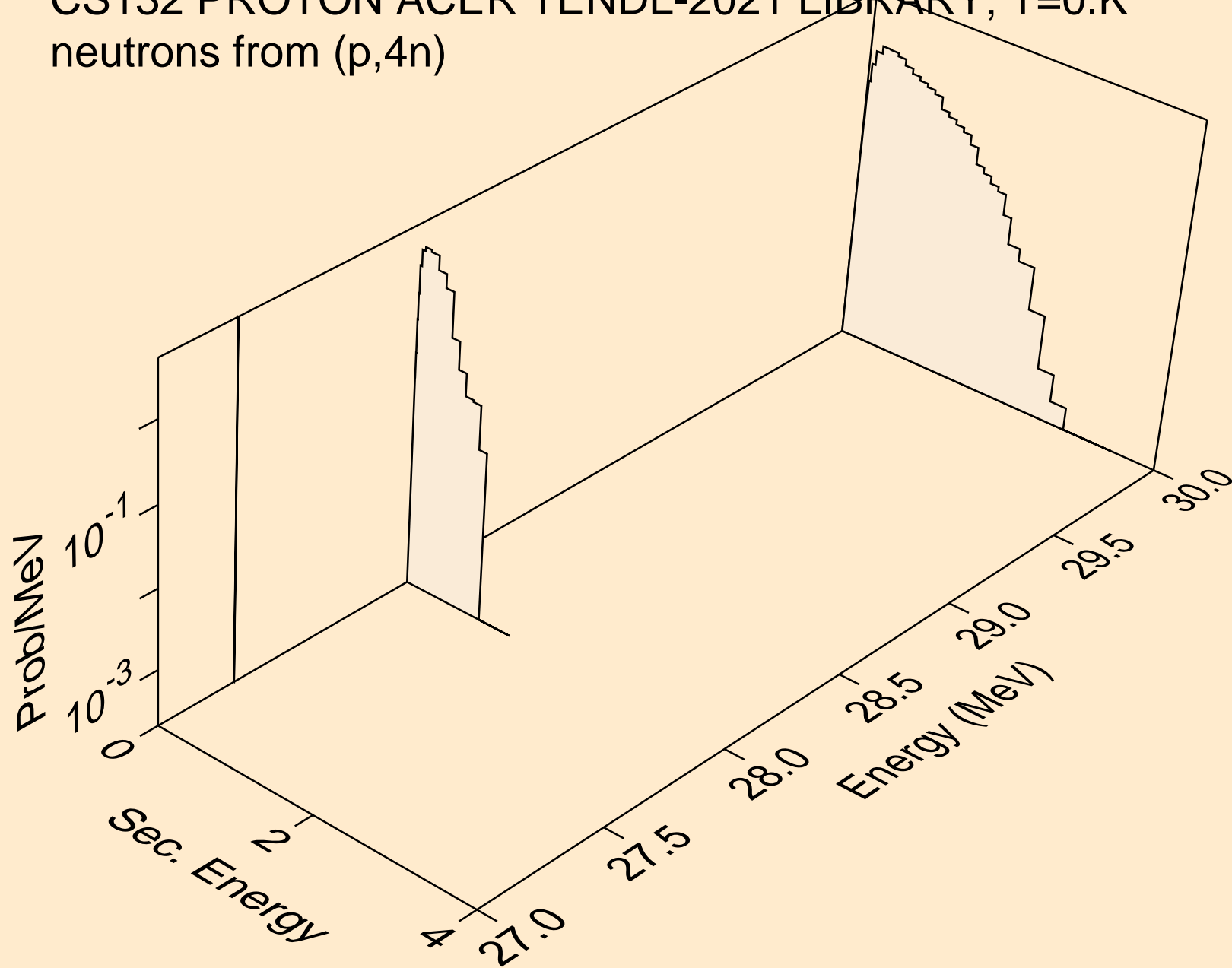

CS132 PROTON ACER TENDL-2021 LIBRARY; T=0.K  
neutrons from (p,2np)

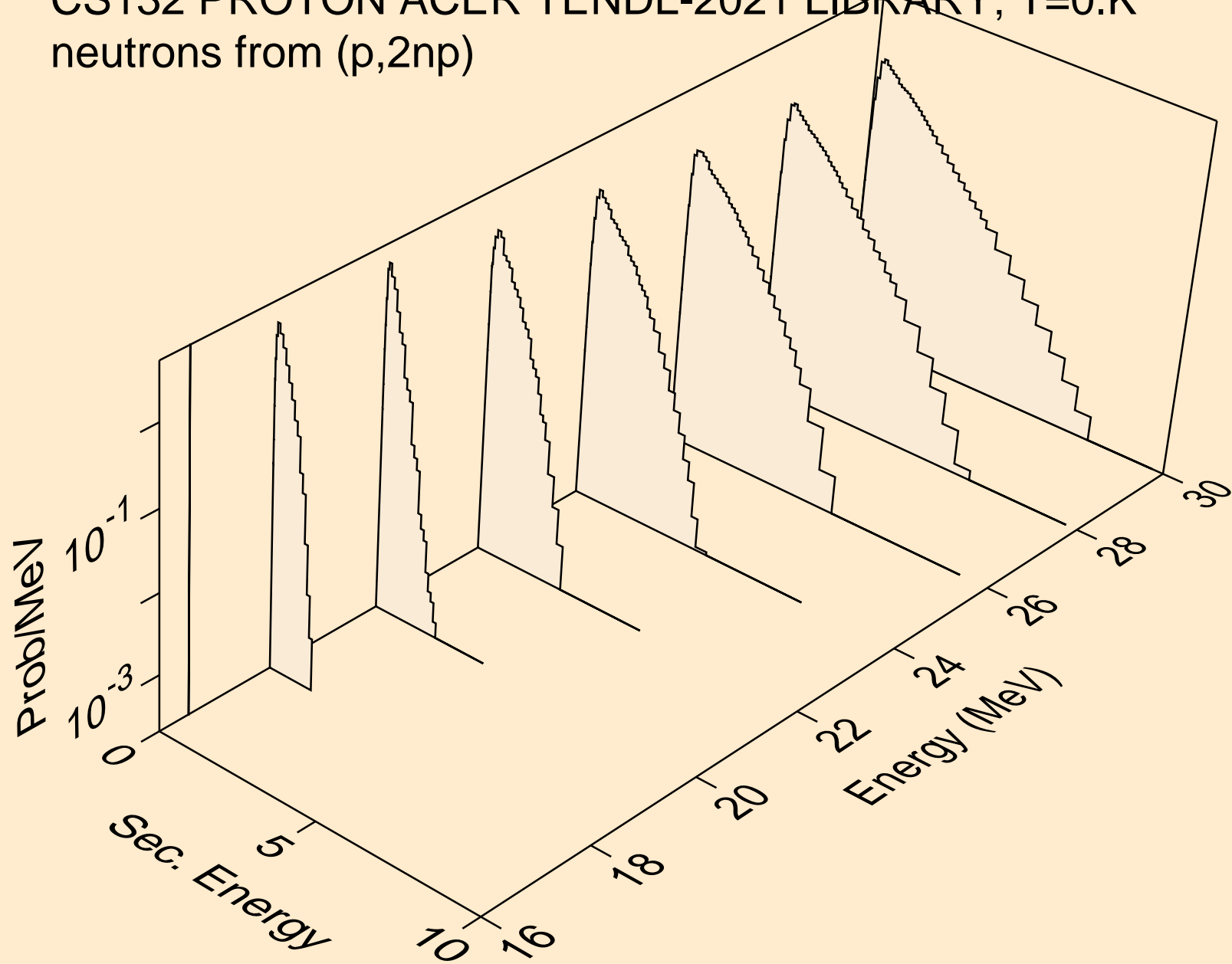

CS132 PROTON ACER TENDL-2021 LIBRARY; T=0.K  
neutrons from (p,3np)

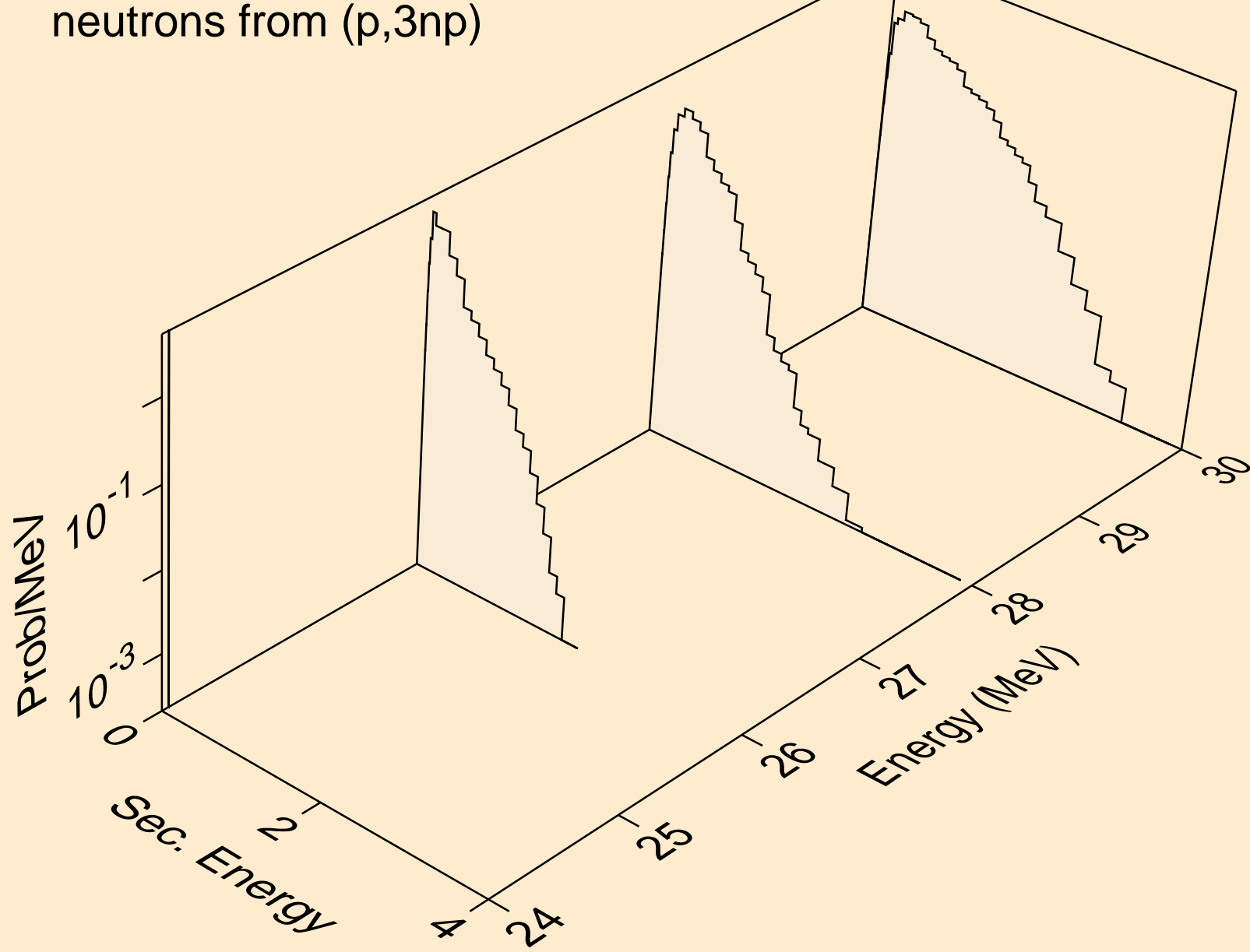

CS132 PROTON ACER TENDL-2021 LIBRARY; T=0.K  
neutrons from (p,2np)

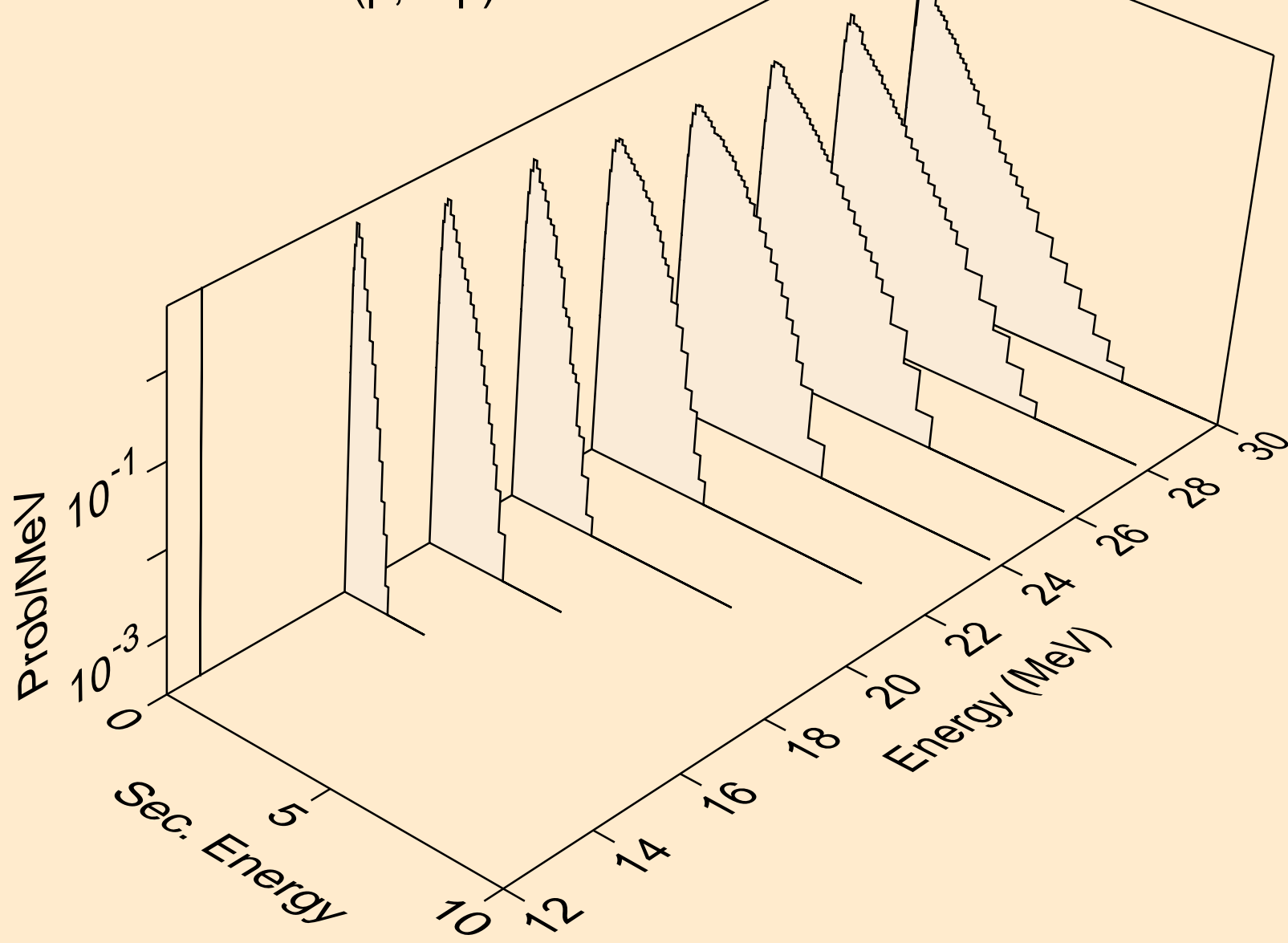

CS132 PROTON ACER TENDL-2021 LIBRARY; T=0.K  
neutrons from (p,npa)

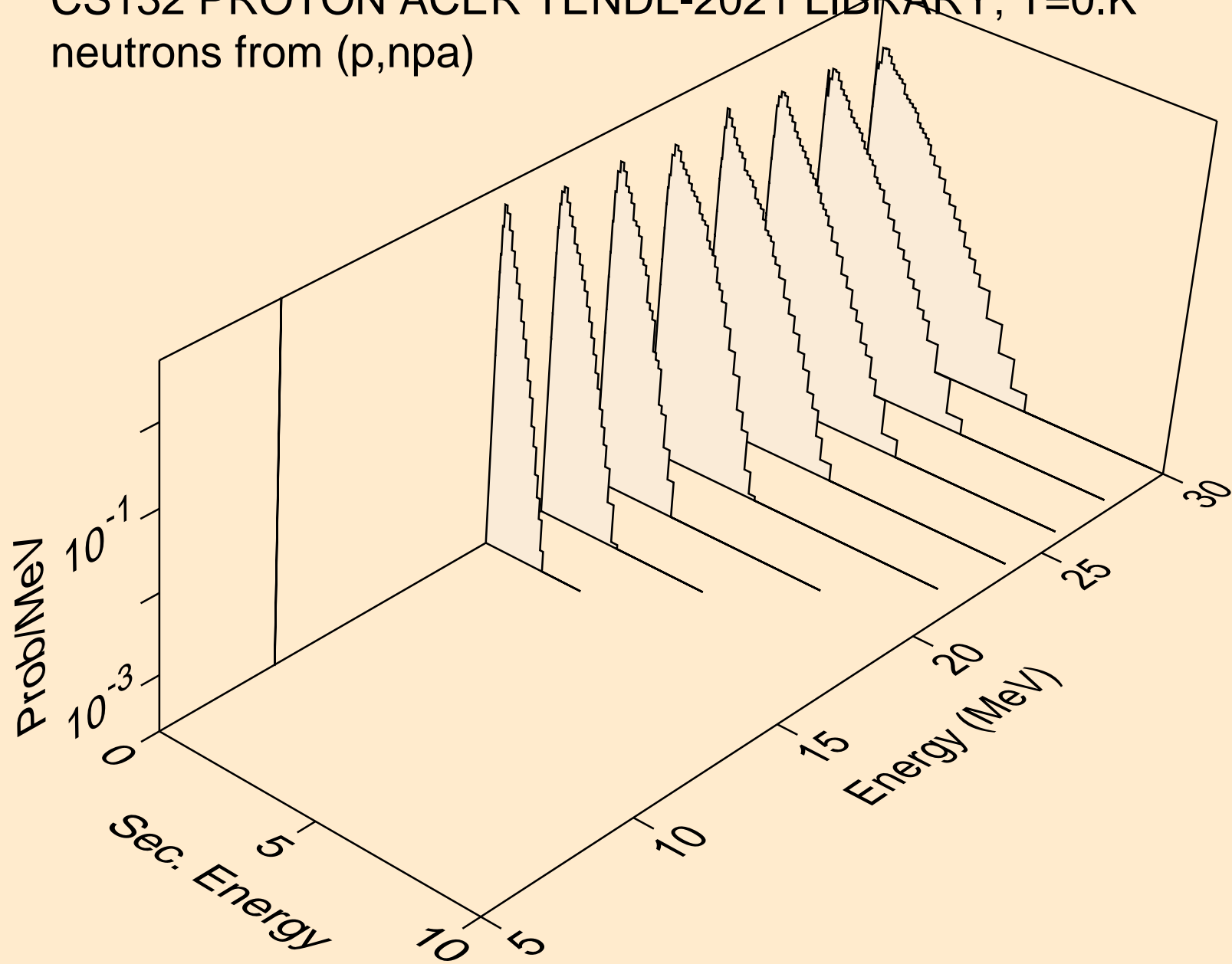

CS132 PROTON ACER TENDL-2021 LIBRARY; T=0.K  
deuterons from (p,x)

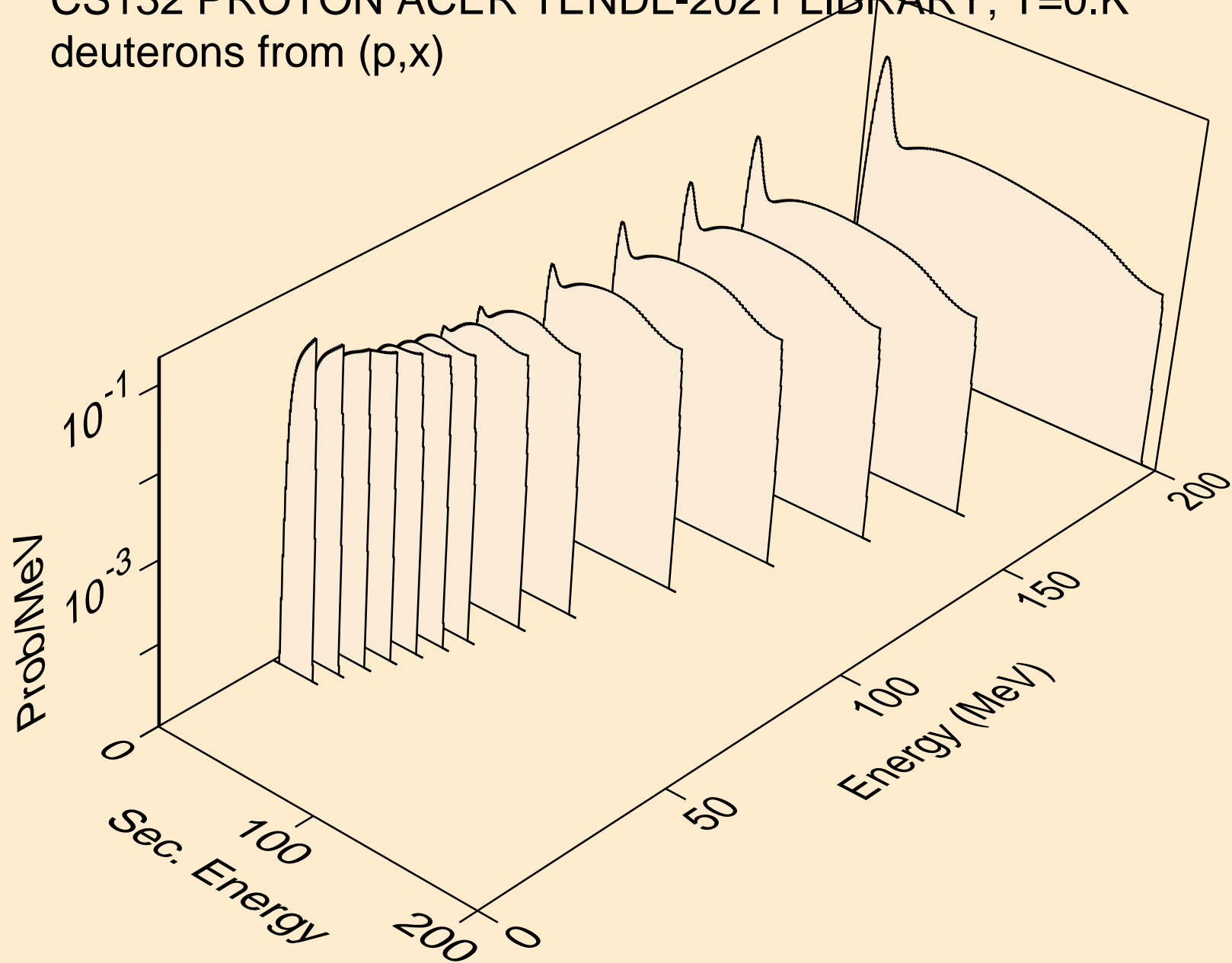



CS132 PROTON ACER TENDL-2021 LIBRARY; T=0.K  
deuterons from (p,2nd)

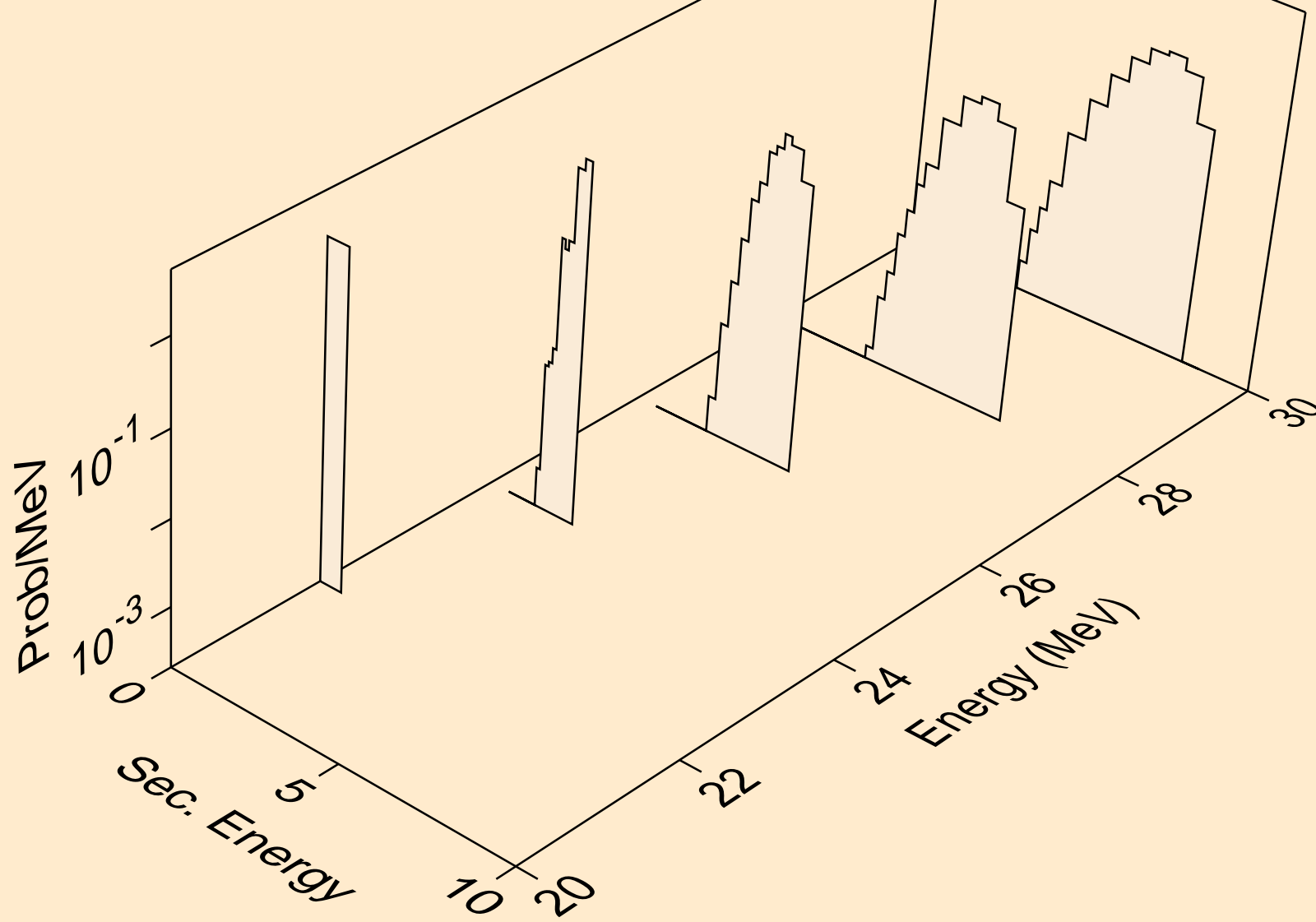

CS132 PROTON ACER TENDL-2021 LIBRARY; T=0.K  
deuterons from (p,n\*)d

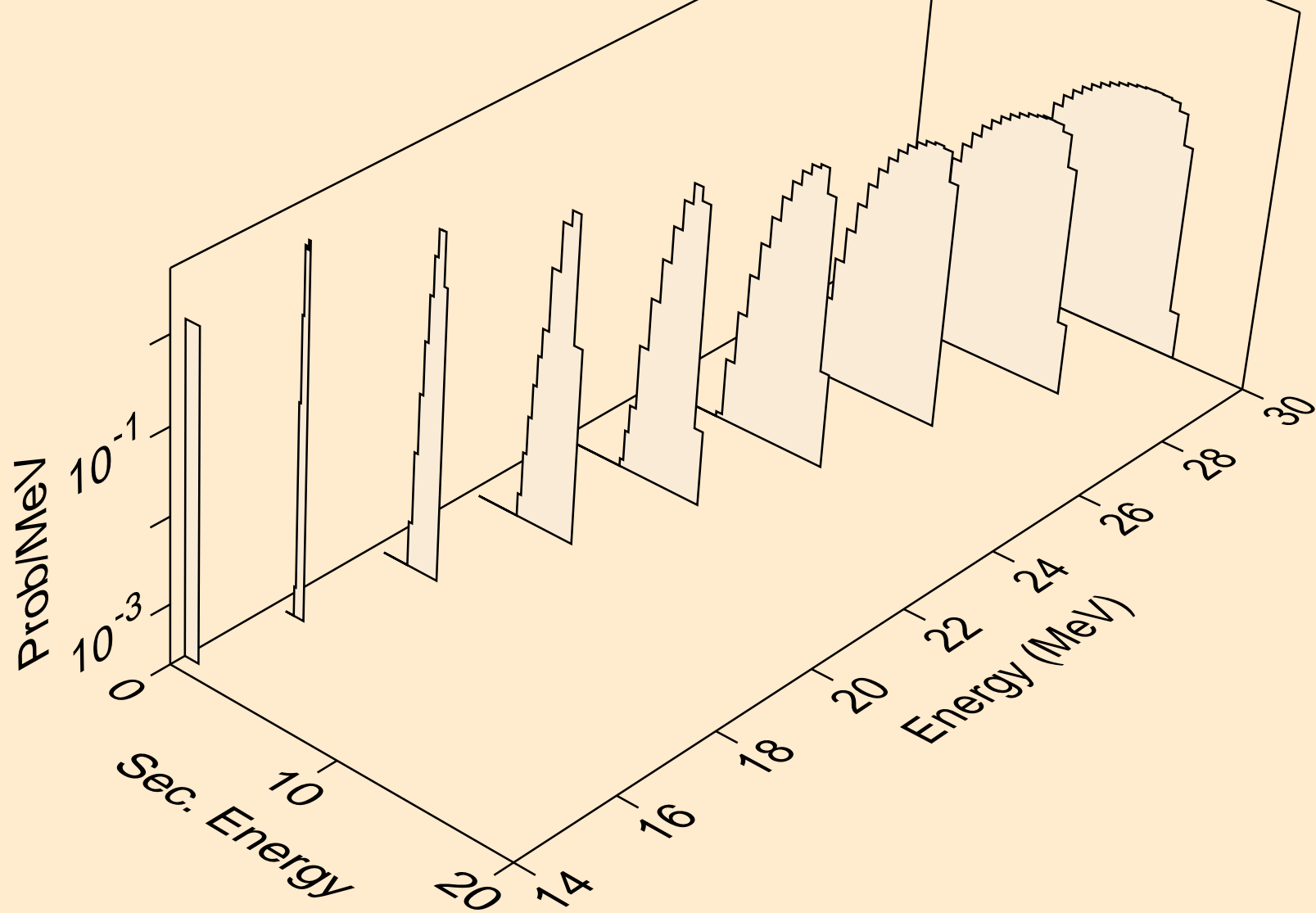

CS132 PROTON ACER TENDL-2021 LIBRARY; T=0.K  
deuterons from (p,d)

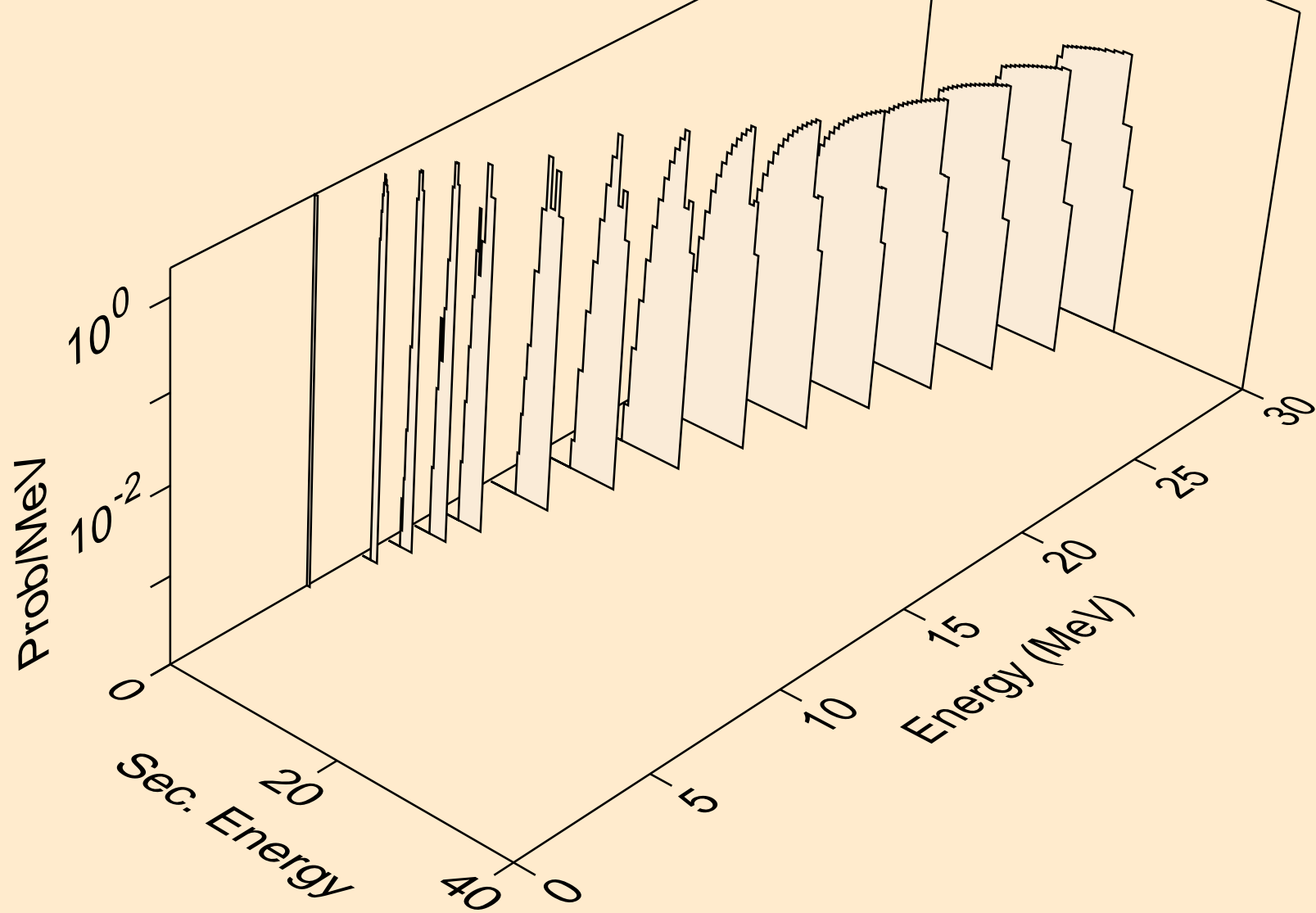

CS132 PROTON ACER TENDL-2021 LIBRARY; T=0.K  
deuterons from (p,pd)

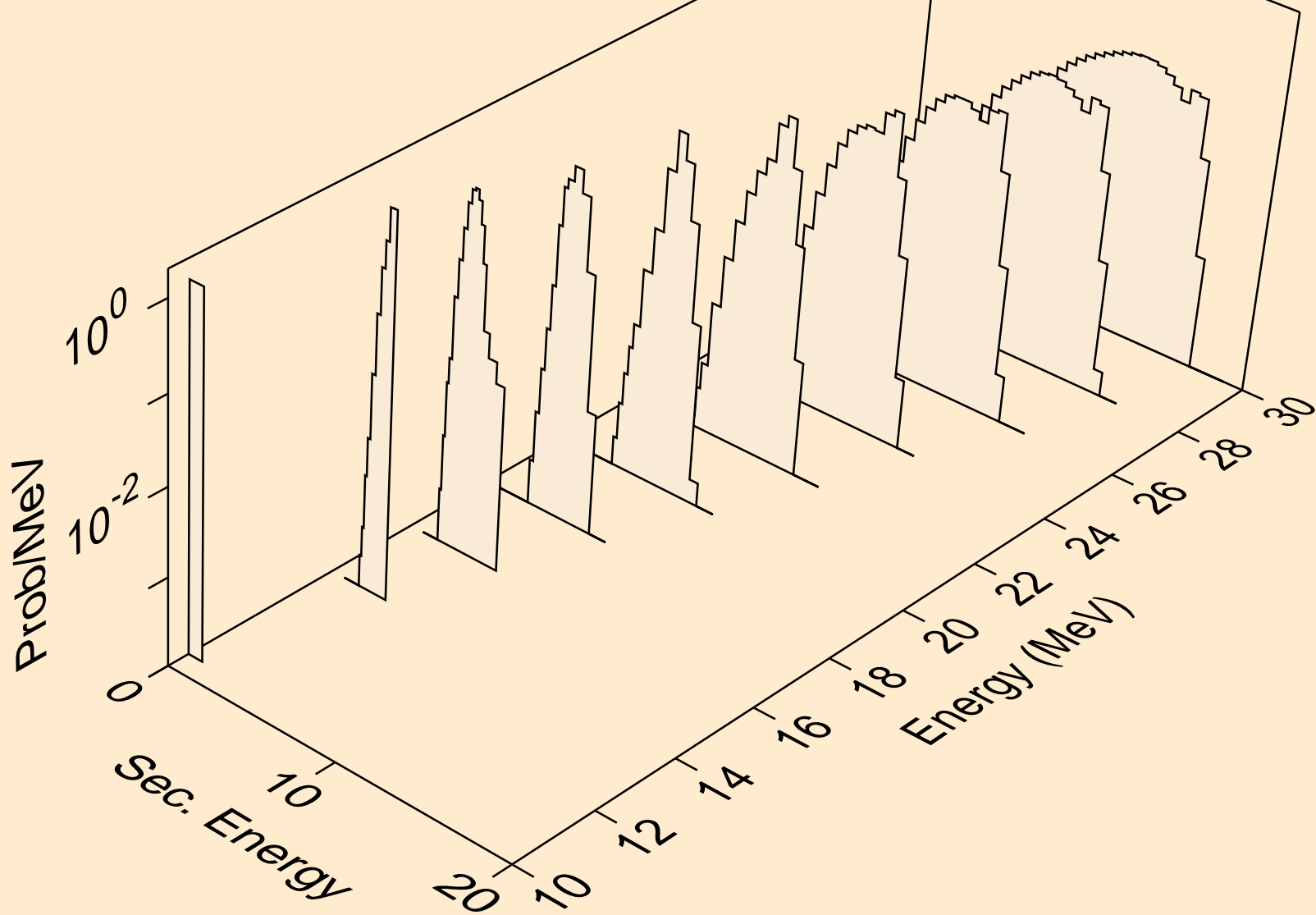

CS132 PROTON ACER TENDL-2021 LIBRARY; T=0.K  
deuterons from (p,da)

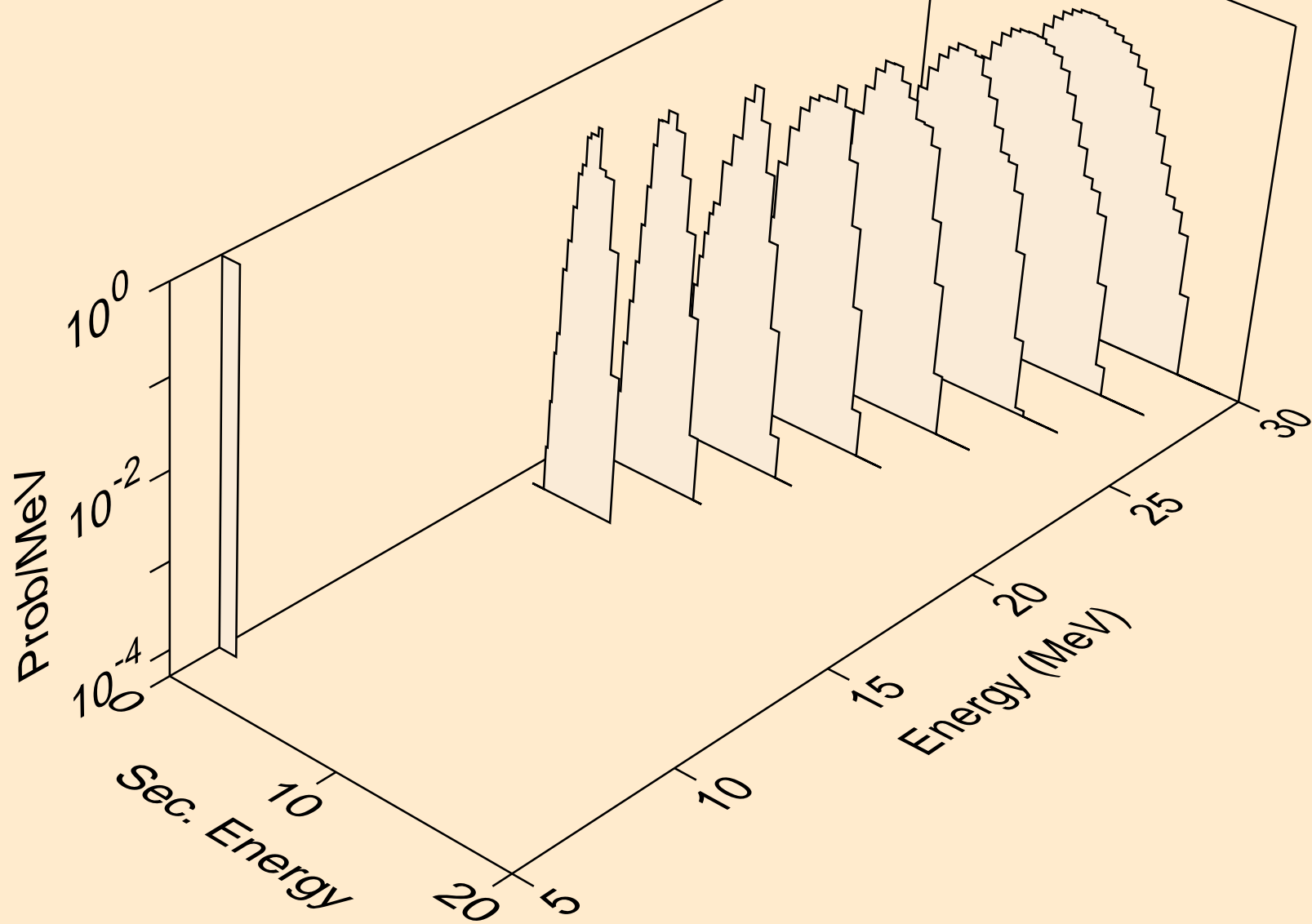

CS132 PROTON ACER TENDL-2021 LIBRARY; T=0.K  
tritons from (p,x)

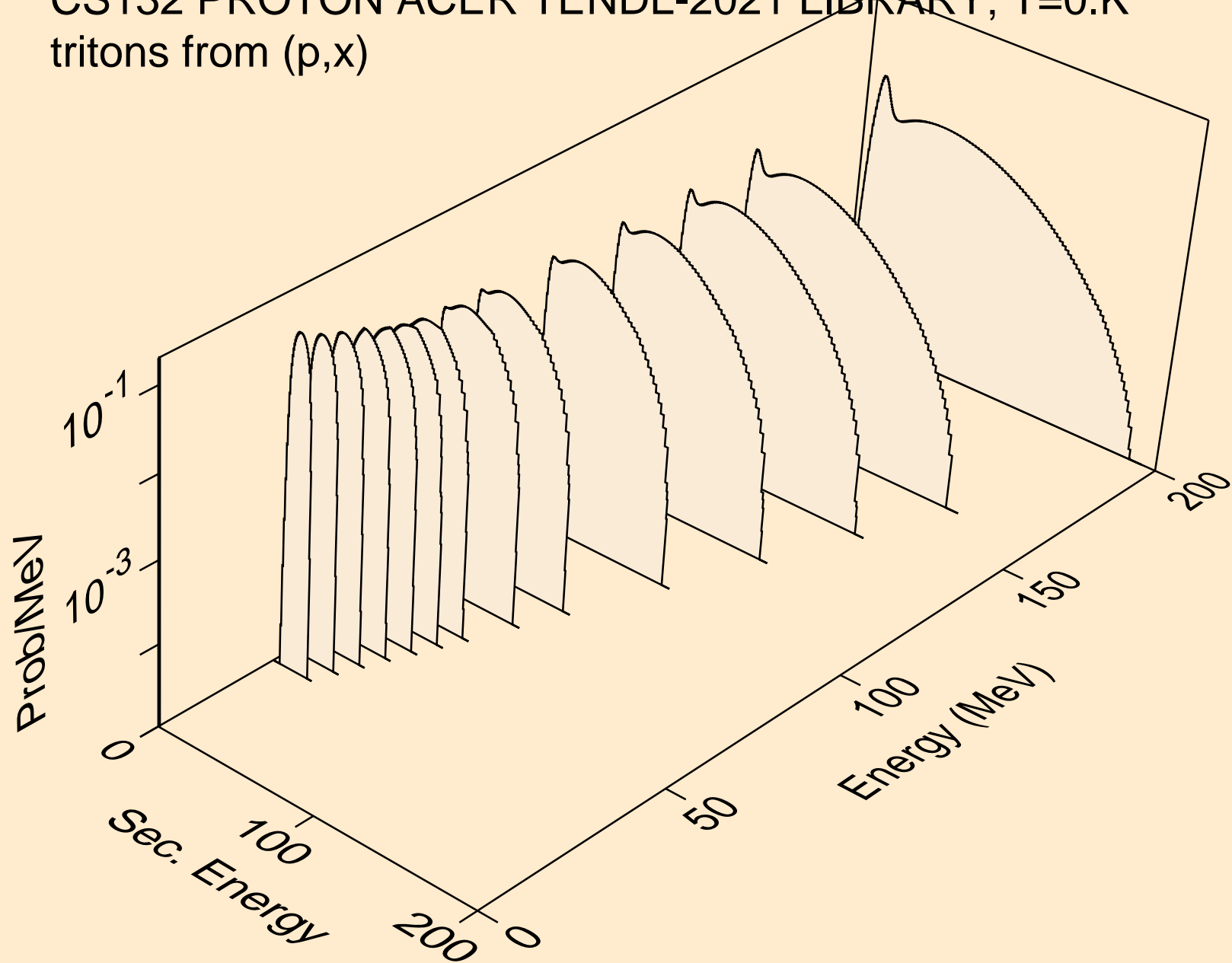

CS132 PROTON ACER TENDL-2021 LIBRARY; T=0.K  
tritons from (p,n\*)t

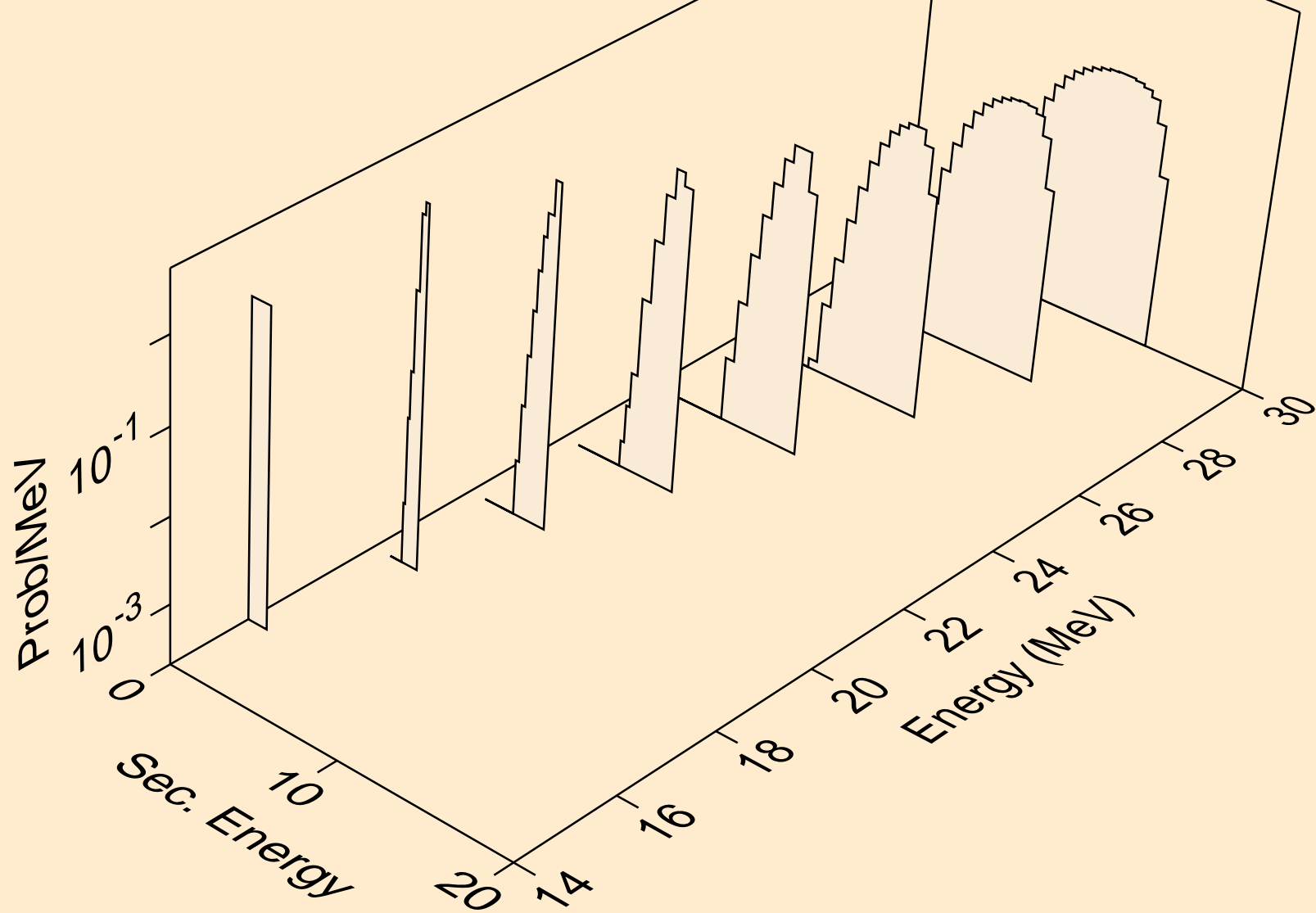

CS132 PROTON ACER TENDL-2021 LIBRARY; T=0.K  
tritons from (p,t)

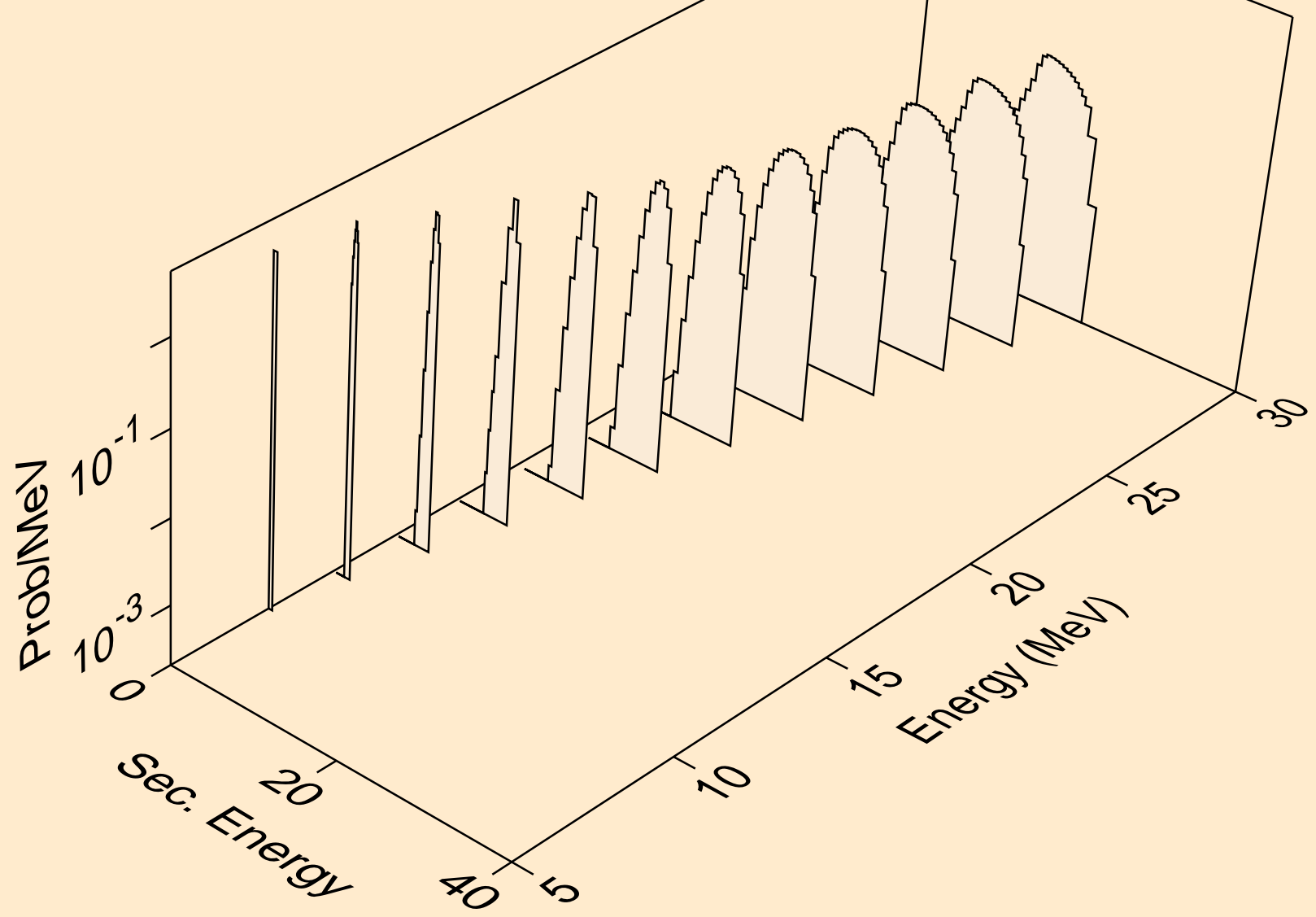



CS132 PROTON ACER TENDL-2021 LIBRARY; T=0.K  
tritons from (p,pt)

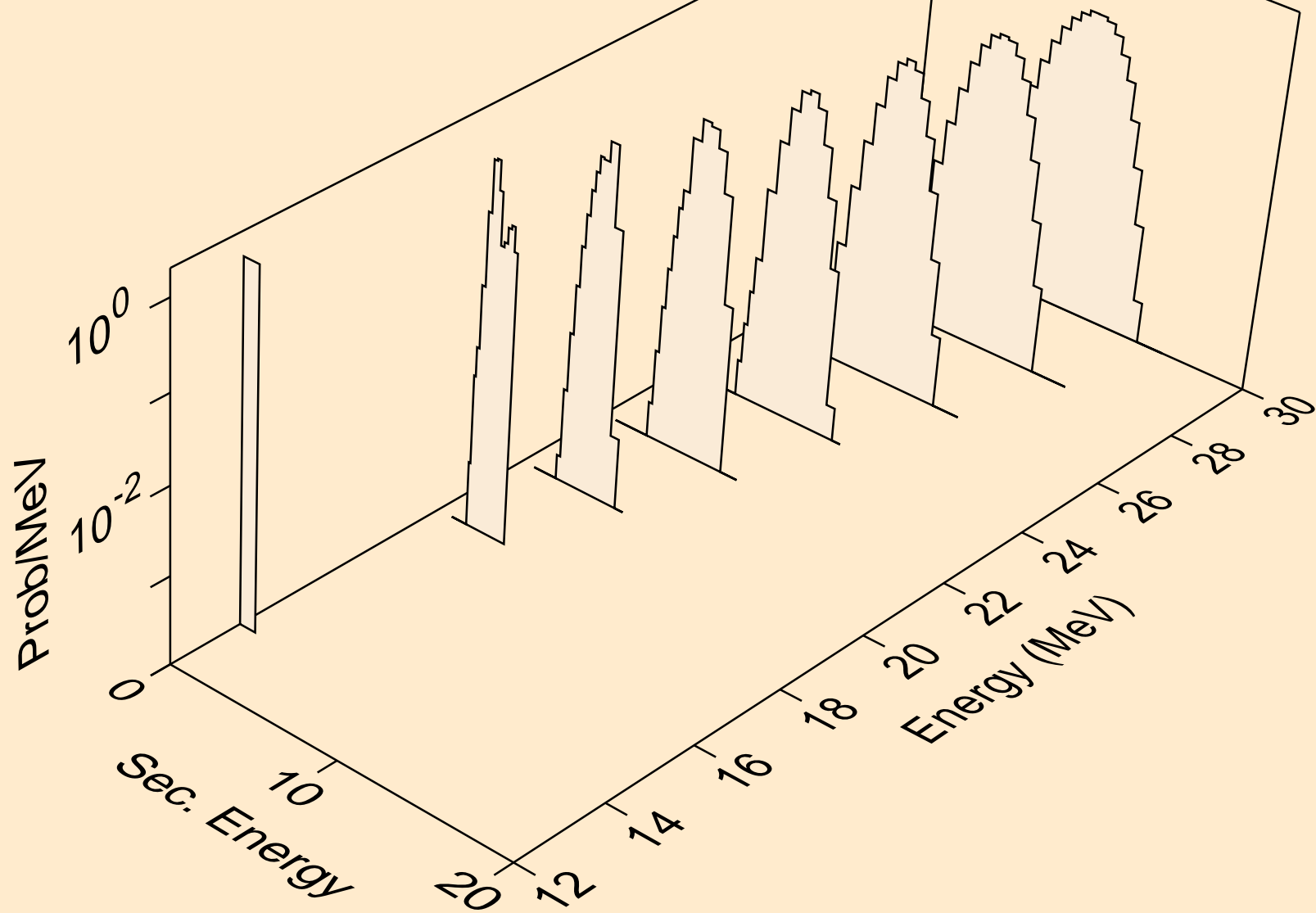

CS132 PROTON ACER TENDL-2021 LIBRARY; T=0.K  
he3s from (p,x)

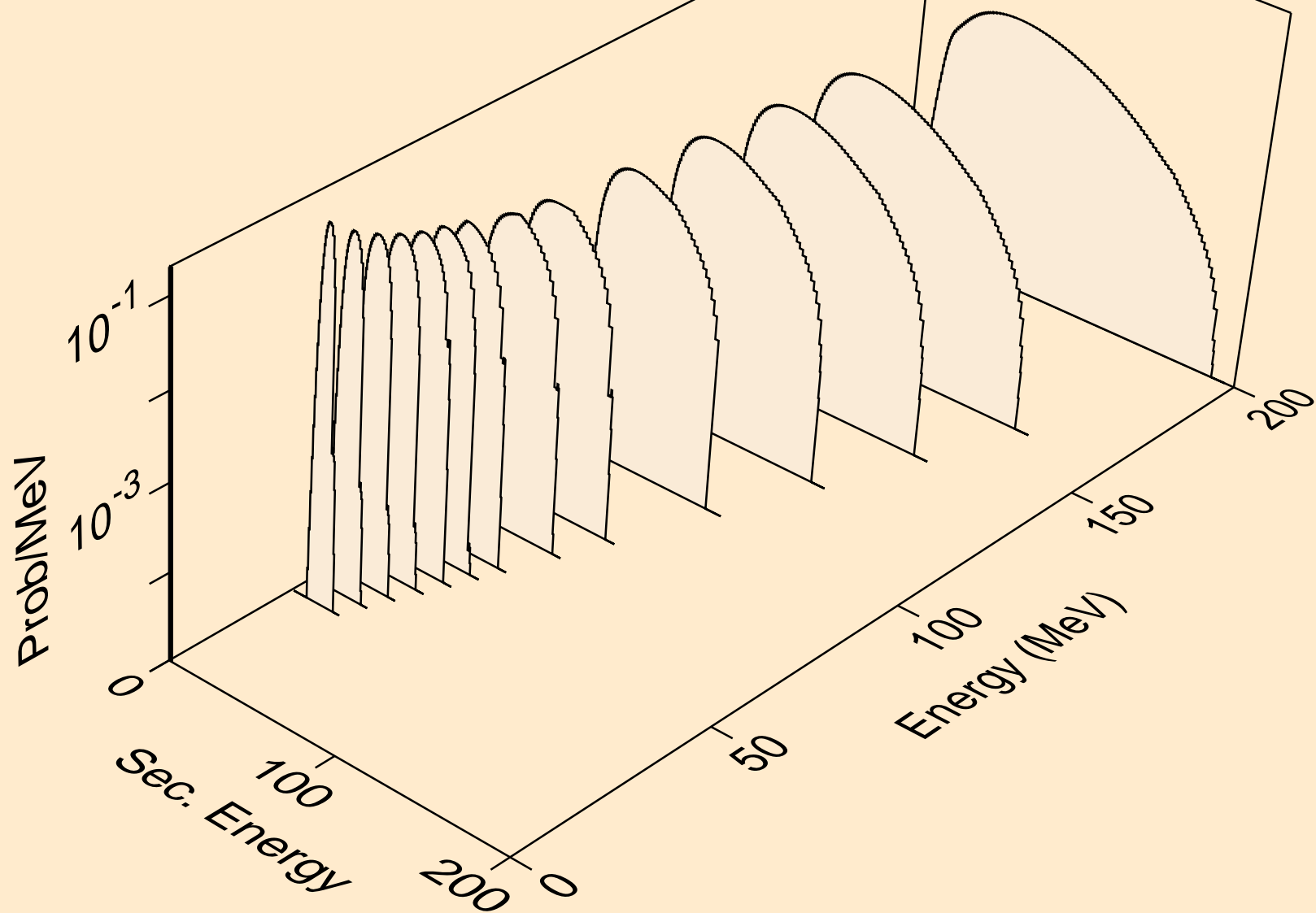

CS132 PROTON ACER TENDL-2021 LIBRARY; T=0.K  
he3s from (p,n\*)he3

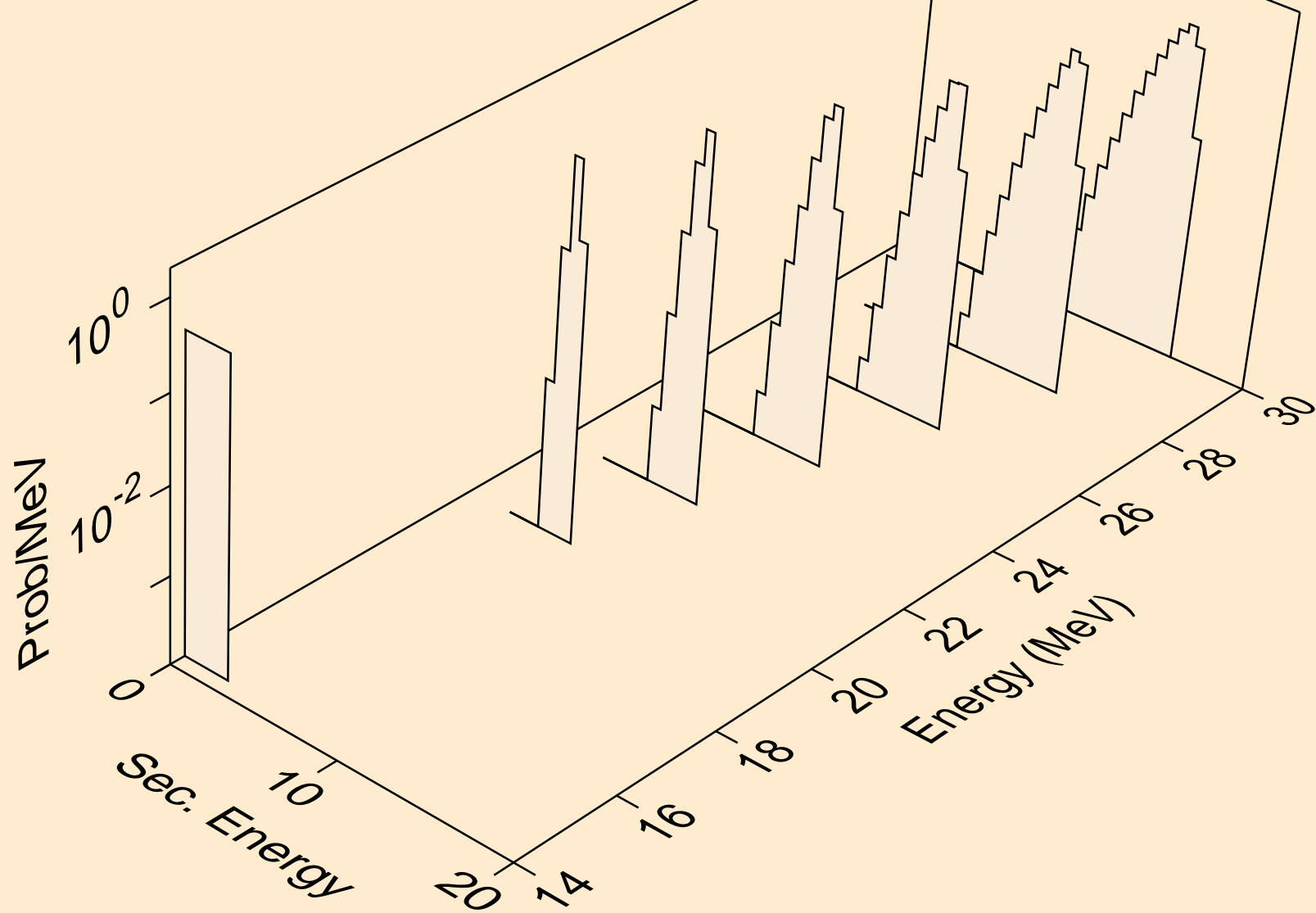

CS132 PROTON ACER TENDL-2021 LIBRARY; T=0.K  
he3s from (p,he3)

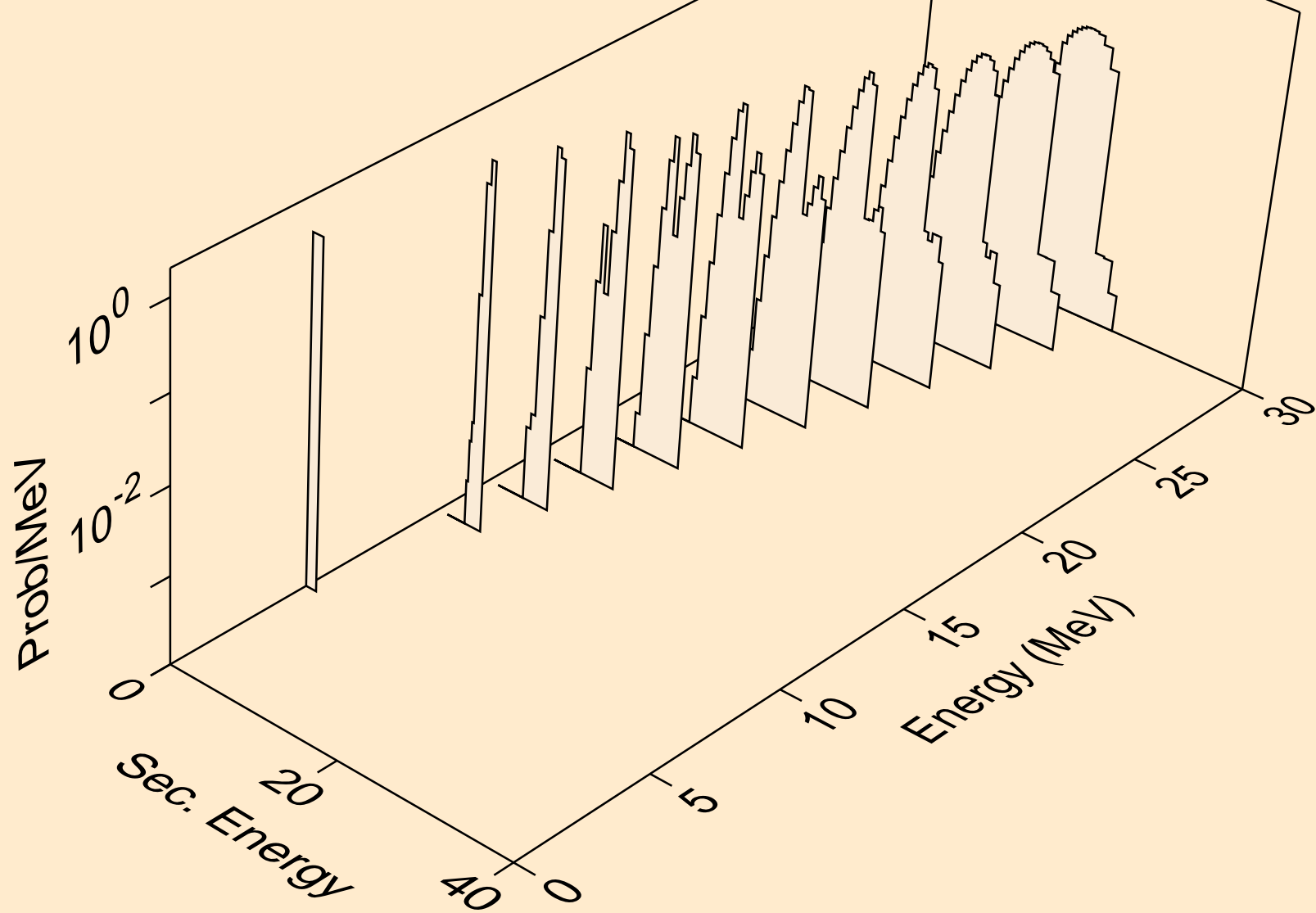

CS132 PROTON ACER TENDL-2021 LIBRARY; T=0.K  
alphas from (p,x)

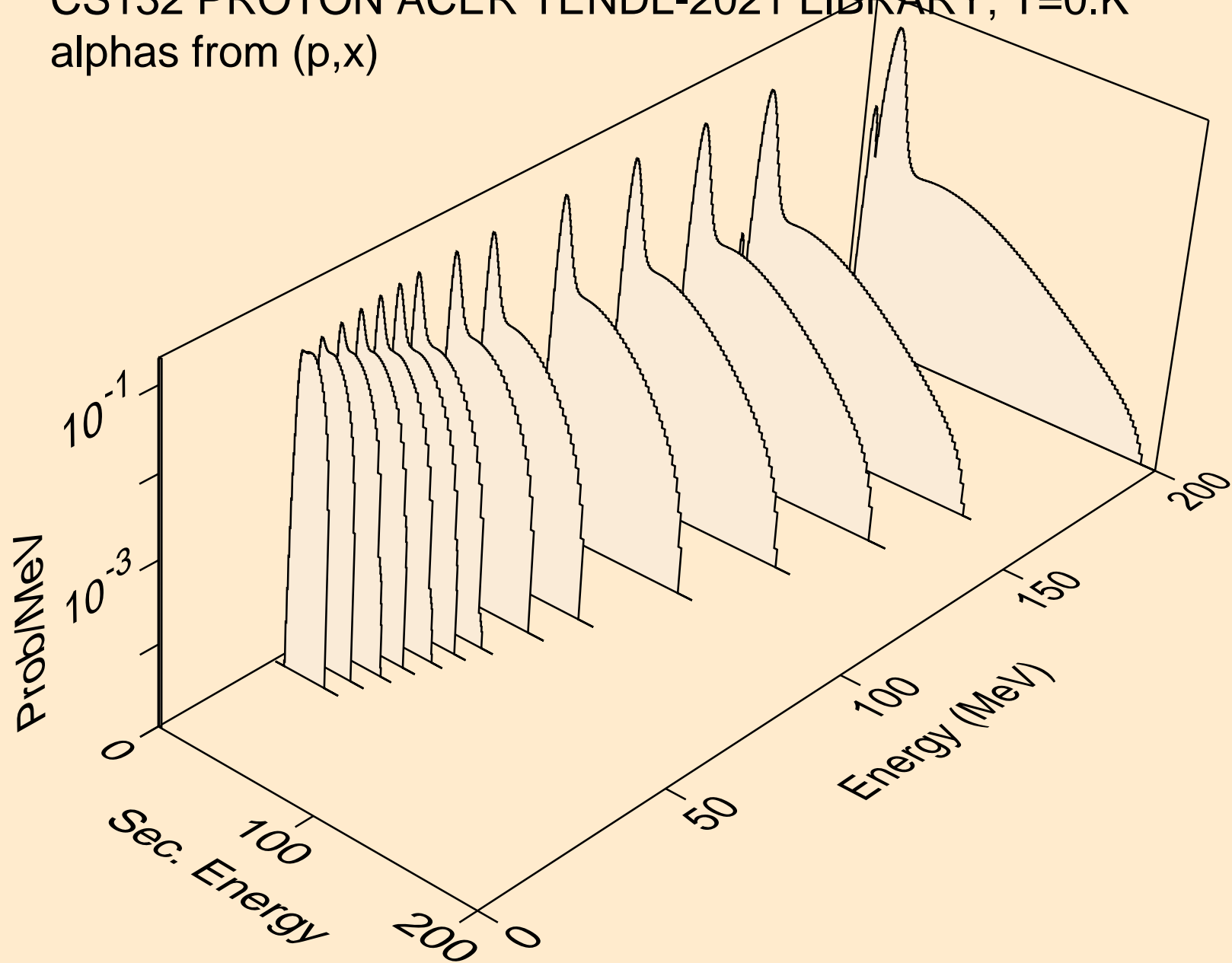

CS132 PROTON ACER TENDL-2021 LIBRARY; T=0.K  
alphas from (p,n\*)a

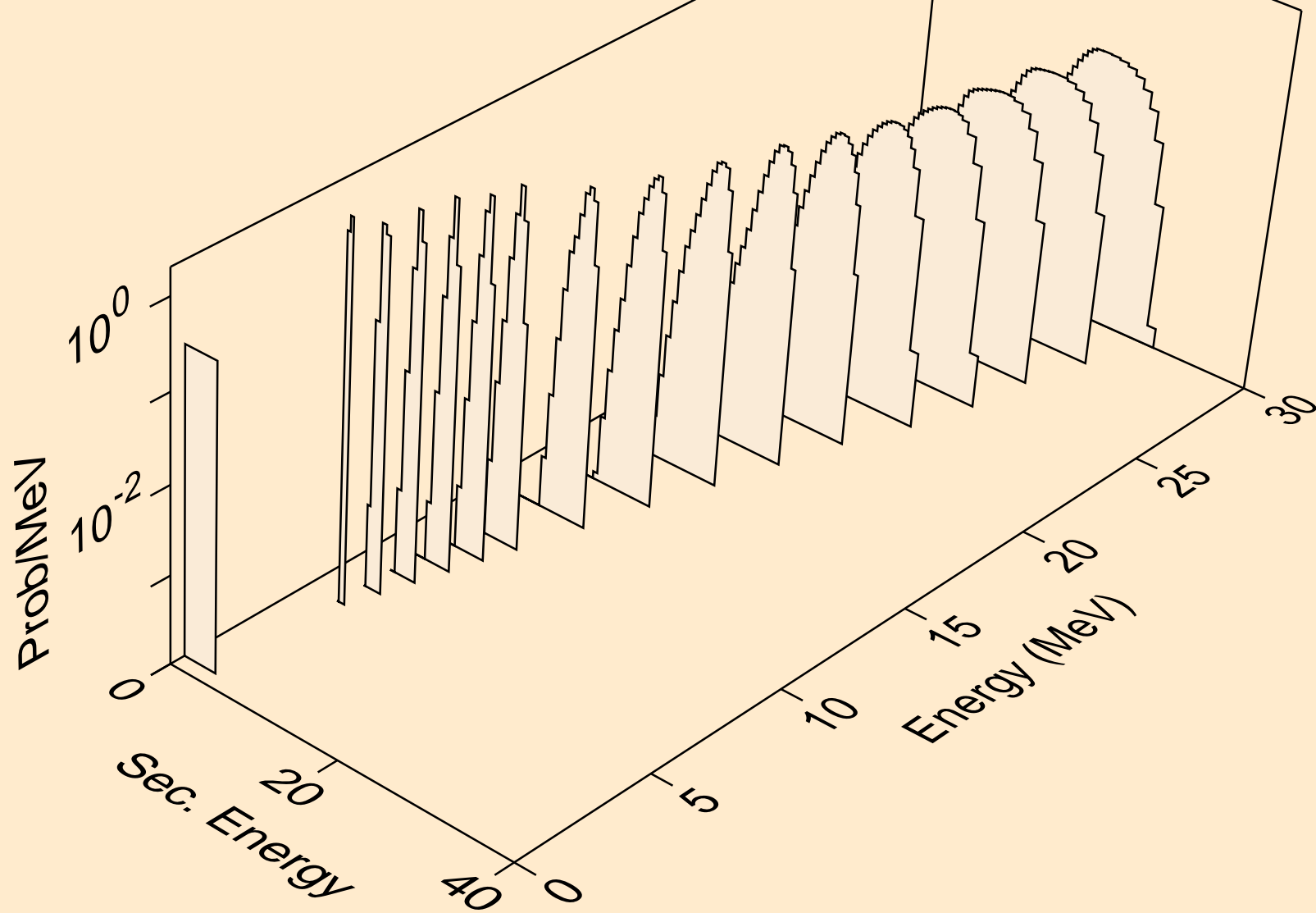

CS132 PROTON ACER TENDL-2021 LIBRARY; T=0.K  
alphas from (p,2n)a

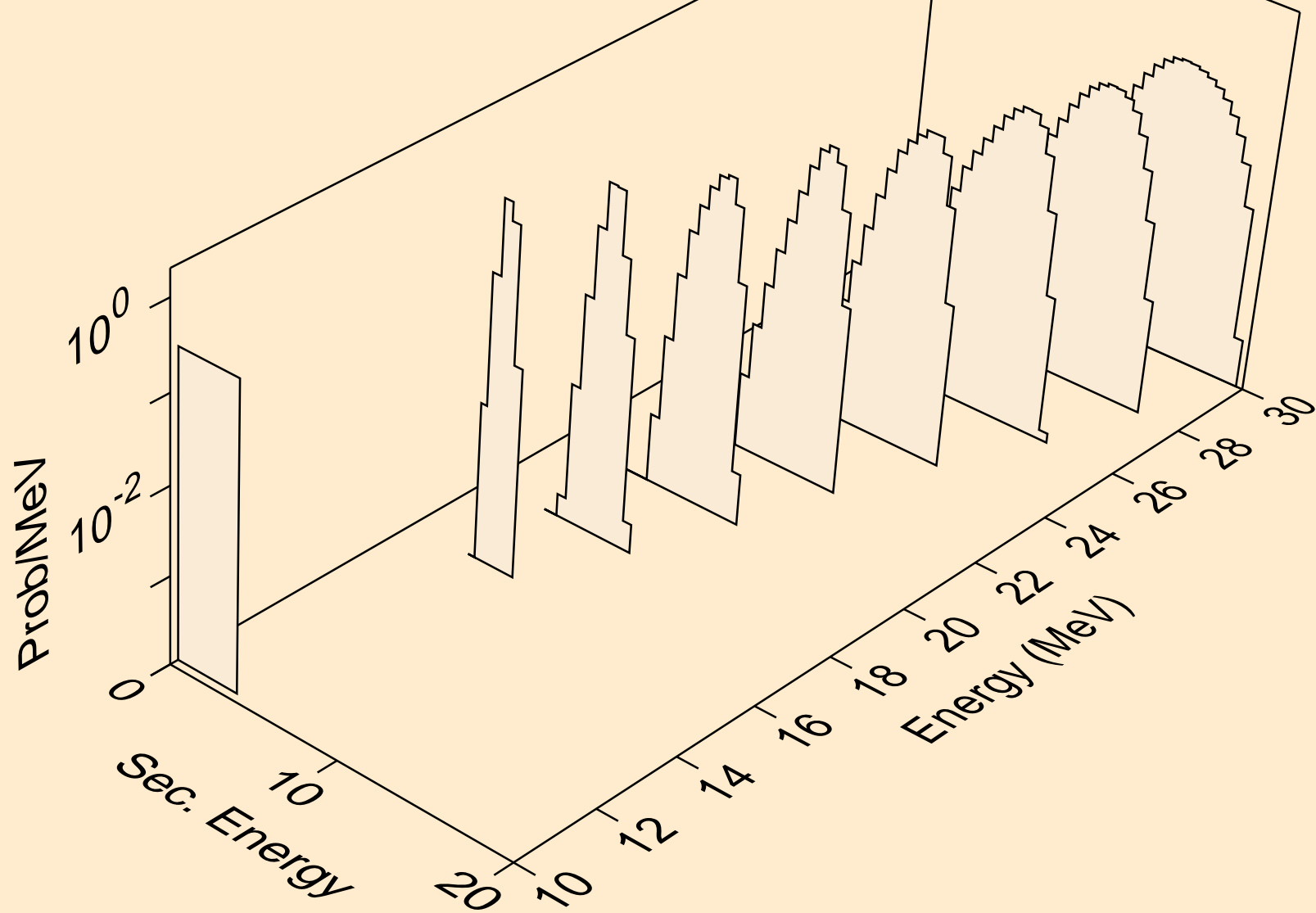

CS132 PROTON ACER TENDL-2021 LIBRARY; T=0.K  
alphas from (p,3n)a

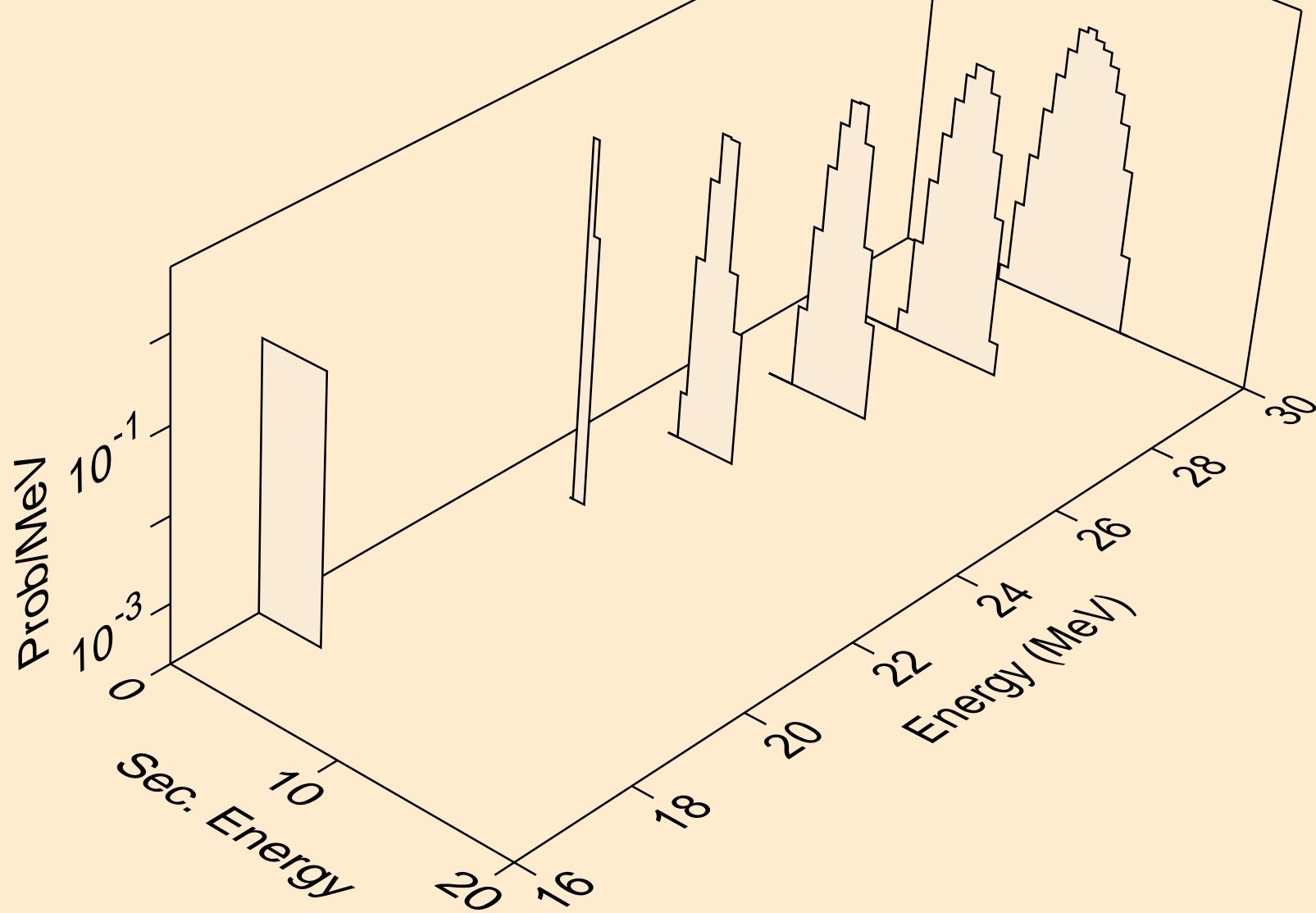



CS132 PROTON ACER TENDL-2021 LIBRARY; T=0.K  
alphas from (p,n\*)2a

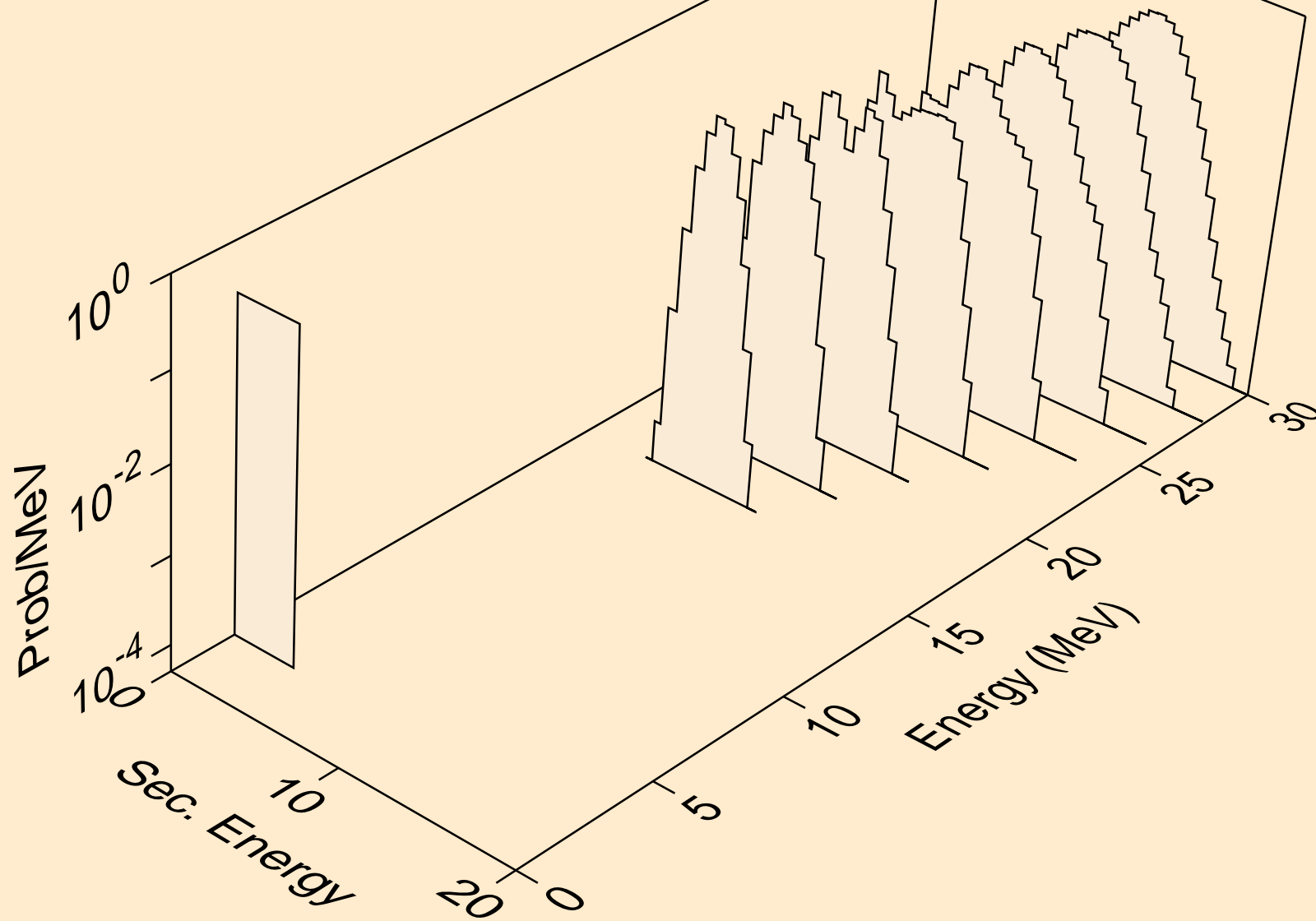

CS132 PROTON ACER TENDL-2021 LIBRARY; T=0.K  
alphas from (p,npa)

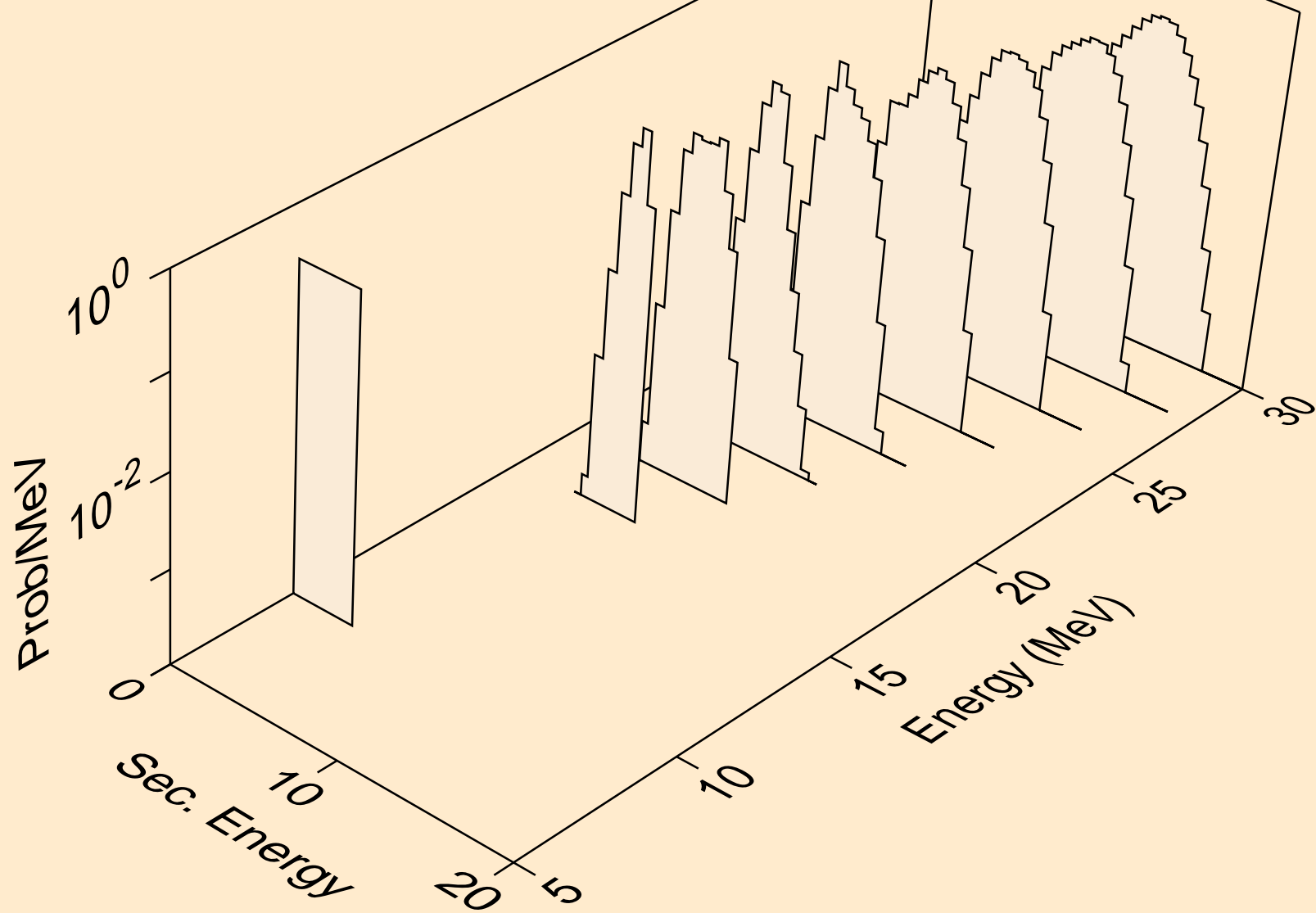

CS132 PROTON ACER TENDL-2021 LIBRARY; T=0.K  
alphas from (p,a)

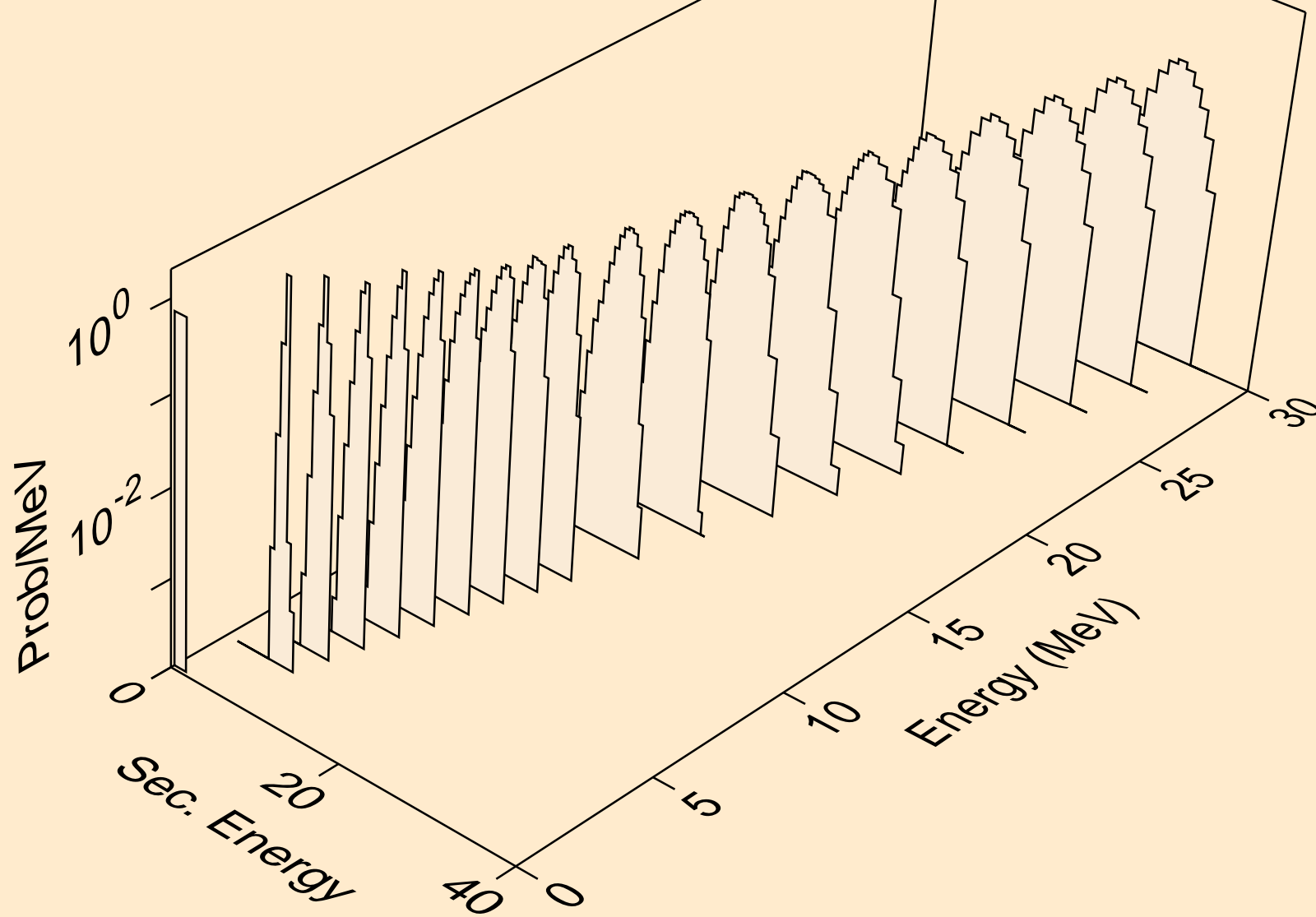

CS132 PROTON ACER TENDL-2021 LIBRARY; T=0.K  
alphas from (p,2a)

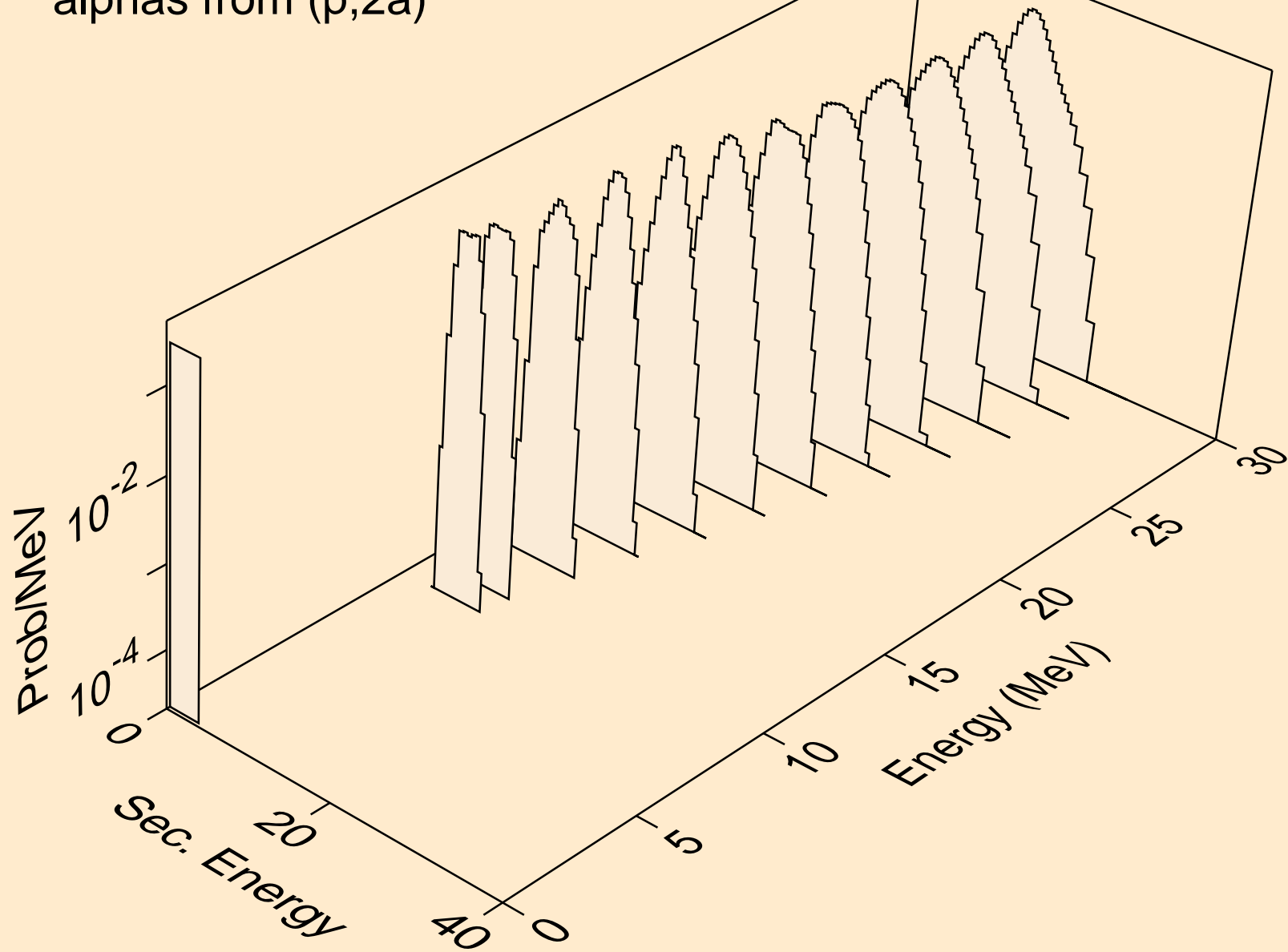

CS132 PROTON ACER TENDL-2021 LIBRARY; T=0.K  
alphas from (p,pa)

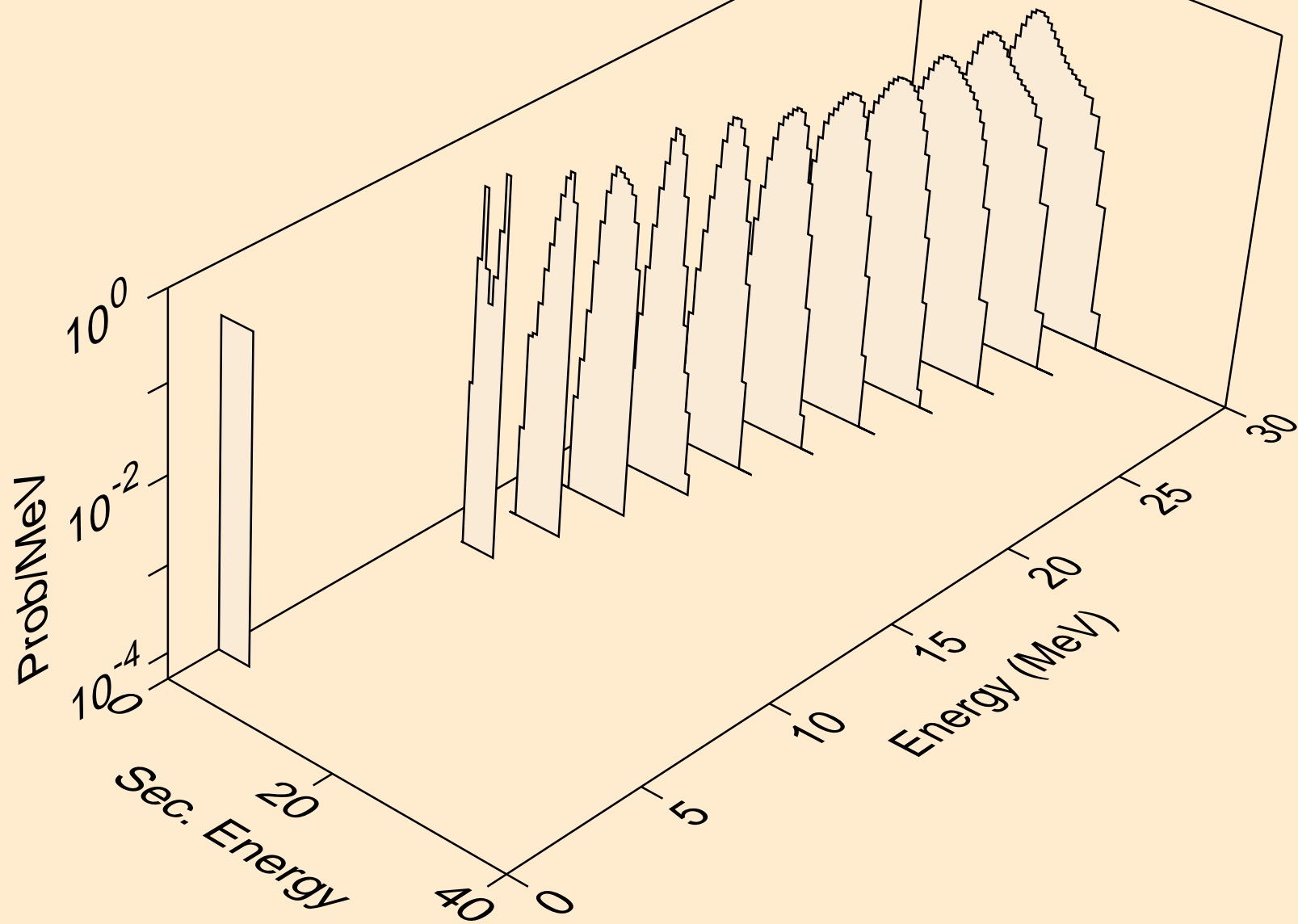

CS132 PROTON ACER TENDL-2021 LIBRARY; T=0.K  
alphas from (p,da)

